

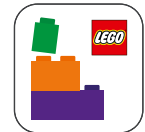

21352



Booklet available in English
Livret disponible en français
Folleto disponible en español



LEGO® Builder

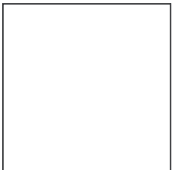



WE'RE MAKING OUR PACKAGING MORE SUSTAINABLE

We're transitioning from single-use plastic to paper-based packaging. As we progress, you may find a mix of paper and plastic in our boxes.

NOUS RENDONS NOS EMBALLAGES PLUS DURABLES

Nous passons des emballages en plastique à usage unique aux emballages à base de papier. Durant la transition, vous pourriez trouver un mélange de papier et de plastique dans nos boîtes.

QUEREMOS HACER MÁS SUSTENTABLES NUESTROS MATERIALES DE EMBALAJE

Estamos cambiando las bolsas de plástico desechables por bolsas con base de papel. Conforme avanzamos en este propósito, puedes encontrar una mezcla de papel y de plástico en nuestras cajas.

LEGO.com/sustainable-packaging



BUILDER



Apple and the Apple logo are trademarks of Apple Inc., registered in the U.S. and other countries and regions. App Store is a service mark of Apple Inc. Google Play and the Google Play logo are trademarks of Google LLC. Tencent and the Tencent logo are trademarks of Tencent Inc.

LEGO.com/devicecheck



LEGO® Builder

MEET THE FAN DESIGNER

As if in a fairytale of her own, fan designer Anna Chen (LEGO® Ideas name 2A2A), won the hearts and votes of thousands of LEGO and Disney fans in the 2023 LEGO Ideas *100 Years of Fairytales!* challenge. The service engineer from Hong Kong cast a passionate and creative spell on her favorite Disney characters and movie moments in her challenge entry, and in addition to providing services to hospitals and healthcare professionals, she can now add LEGO Fan Designer to her résumé.

"I have loved playing with LEGO bricks since early childhood, and I love the Disney animated movies, so I was thrilled to seize the opportunity to enter in the challenge and let my Disney and LEGO fueled imagination run wild! It took maybe two or three weeks to design the model. I knew I wanted to include a big brick-built Mickey Mouse, and around Mickey I added mini-models representing some of my favorite Disney movies. Of course, I used the contest as an excuse to rewatch some of the movies I remember so fondly from my childhood! This also helped me select some of the most iconic symbols, accessories and characters to include in the model. When the voting began, I was so happy that the model resonated with other LEGO and Disney fans, and I am really thankful for all the fans who voted for this design. I hope they will be just as excited about the official, final design as I am. I am also thankful to the LEGO Ideas team for creating this special challenge – It allowed so many fans to express our love for classic Disney films and their beloved themes and characters."

*Anna and her original challenge submission
Anna avec sa contribution originale au concours
Anna con su proposta original para el desafío*



RENCONTRE AVEC LA CONCEPTRICE AMATRICE

Comme dans un conte de fées, la conceptrice amatrice Anna Chen (pseudonyme LEGO® Ideas : 2A2A) a gagné le cœur et le vote de milliers d'amateurs de LEGO et de Disney lors du défi LEGO Ideas *100 ans de contes de fées !* de 2023. Cette ingénieure de service de Hong Kong a jeté un sort passionné et créatif sur ses personnages et films de Disney préférés dans son modèle, et en plus de l'aide qu'elle apporte aux hôpitaux et aux professionnels de la santé, elle peut maintenant ajouter « Conceptrice amatrice LEGO » à son curriculum vitae.

« J'aime jouer avec des briques LEGO depuis ma plus tendre enfance et j'adore les films d'animation de Disney. J'ai donc sauté sur l'occasion de participer au défi et de laisser libre cours à mon imagination nourrie de Disney et de LEGO ! Il m'a fallu deux ou trois semaines pour concevoir le modèle. Je savais que je voulais inclure un grand Mickey Mouse en briques. Autour de lui, j'ai ensuite ajouté des modèles miniatures représentant certains de mes films de Disney préférés. Bien sûr, j'ai aussi profité du concours pour revoir certains des films qui ont marqué mon enfance ! Cela m'a également permis de choisir certains des symboles, accessoires et personnages les plus emblématiques à inclure dans le modèle. Pendant la période de vote, j'ai été très heureuse de constater que le modèle avait trouvé un écho auprès d'autres amateurs de LEGO et de Disney, et je suis très reconnaissante à tous les amateurs qui ont voté pour ce modèle. J'espère qu'ils apprécieront autant que moi le modèle final officiel. Je remercie également l'équipe LEGO Ideas d'avoir créé ce défi spécial, qui a permis à de nombreux amateurs d'exprimer leur amour pour les films classiques de Disney, leurs thèmes et leurs personnages bien-aimés. »



CONOCE A LA FAN DISEÑADORA

Como si estuviera viviendo su propio cuento de hadas, la fan diseñadora Anna Chen (conocida en LEGO® Ideas como 2A2A) se ganó el corazón y los votos de miles de fans de LEGO y Disney en el desafío LEGO Ideas *100 Years of Fairytales!* que tuvo lugar en 2023. Para participar, la ingeniera de servicios residente en Hong Kong lanzó un apasionado y creativo hechizo sobre sus personajes y escenas Disney favoritos. Y ahora, junto con su trayectoria como prestadora de servicios para hospitales y profesionales de la salud, puede señalar en su curriculum que es oficialmente una fan diseñadora de LEGO.

“Jugar con bricks LEGO ha sido una de mis actividades favoritas desde mi más tierna infancia, y también me encantan las películas animadas Disney. Por eso, no podría haber estado más emocionada de tener la oportunidad de participar en el desafío y dar rienda suelta a mi imaginación con el impulso de Disney y LEGO. Me tomó unas dos o tres semanas diseñar el modelo. Sabía que quería incluir un gran Mickey Mouse construido con bricks y añadí varios minimodelos alrededor de él que representan algunas de mis películas Disney favoritas. Naturalmente, la competencia fue la excusa perfecta para volver a ver las películas que, con gran cariño, recuerdo haber disfrutado cuando era una niña. Hacerlo también me ayudó a seleccionar algunos de los símbolos, accesorios y personajes más icónicos para incluirlos en el modelo. Cuando empezaron las votaciones, me alegré mucho de que el modelo encontrara resonancia entre otros fans de LEGO y Disney, y estoy muy agradecida con todos los que votaron por este diseño. Espero que la versión final oficial los emocione tanto como a mí. También agradezco al equipo de LEGO Ideas por haber creado un desafío tan especial y por darnos la oportunidad a tantos fans de expresar nuestro amor por las películas clásicas Disney y sus entrañables temas y personajes.”

AN IRRESISTIBLE MAGIC FORMULA

Through generations, our favorite Disney movies have made us laugh, cry, dance and hum along to their captivating soundtracks – or bellow them at the top of our lungs. For some, they evoke fun memories of cozy movie nights, snuggled up with our family and friends, watching, rewinding and re-watching our cherished VHS cassettes until they literally frayed! From the big screen to streaming, from *Fantasia* to *Encanto* and beyond, an enchanted red thread has carried Disney's magic storytelling formula through ever-expanding realms. The engaging stories about endearing, relatable characters rooted in rich, diverse cultures from around the world – even the mythical Atlantica – inspire us to embrace the magical connections we share and follow our hearts, dreams and imaginations.



UNE FORMULE MAGIQUE IRRÉSISTIBLE

Au fil des générations, nos films de Disney préférés nous ont fait rire, pleurer, danser, fredonner et hurler à pleins poumons leurs bandes originales envoûtantes. Pour certains, ils évoquent des souvenirs de soirées cinéma douillettes en famille et entre amis, à regarder, rembobiner et revoir ces chères cassettes VHS jusqu'à ce que la bande vidéo s'effiloche littéralement ! Du grand écran à la diffusion en continu, de *Fantasia* à *Encanto* et au-delà, un fil rouge enchanté a porté la formule magique de Disney à travers des domaines toujours plus vastes. Les histoires captivantes de personnages attachants et sympathiques, enracinés dans des cultures riches et diverses du monde entier (et même dans le mythique royaume d'Atlantica) nous inspirent à célébrer les liens magiques que nous entretenons et à suivre nos cœurs, nos rêves et nos imaginations.



UNA FÓRMULA TAN MÁGICA COMO IRRESISTIBLE

Por generaciones, nuestras películas Disney favoritas nos han hecho reír, llorar, bailar, tararear y cantar a todo pulmón sus cautivadoras bandas sonoras. A muchos de nosotros, estas nos evocan gratos recuerdos de las relajadas noches que solíamos pasar acurrucados frente al televisor en compañía de familiares y amigos, viendo, rebobinando y volviendo a ver nuestras preciadas cintas VHS hasta desgastarlas por completo. De la gran pantalla a la transmisión por Internet, de *Fantasia* a *Encanto* y más allá, un hilo rojo encantado ha llevado la mágica fórmula narrativa de Disney a recorrer incontables reinos que nunca dejan de crecer. Las cautivadoras historias sobre personajes tan entrañables como cercanos, arraigadas en ricas y diversas culturas de todo el mundo (incluida la mítica Atlántica), nos animan a celebrar las mágicas conexiones que compartimos y a dejarnos llevar por nuestros corazones, sueños e ilusiones.





100 YEARS OF FAIRYTALES!

In celebration of Disney's 100th anniversary in 2023, we had the unique opportunity to invite fans from all over the world to join our virtual LEGO® | Disney designers' ball. We launched the exclusive LEGO Ideas *100 Years of Fairytales!* challenge on the LEGO Ideas website, hoping it would inspire fans to show their love of classic and new Disney animated movies with LEGO bricks. With hundreds of enchanting, moving and funny interpretations of memorable movie scenes, heroes and villains, the LEGO Ideas fan community and a panel of judges cast their votes. Now, for the first time since we released the first LEGO | Disney set in 1999, we can share a set created not only for fans but also by a fan, and usher in the next century of creative magic.

100 ANS DE CONTES DE FÉES !

Pour célébrer le 100^e anniversaire de Disney en 2023, nous avons eu l'occasion unique d'inviter des amateurs du monde entier à participer à notre bal virtuel des concepteurs LEGO® Disney. Nous avons lancé le défi LEGO Ideas *100 ans de contes de fées !* sur le site Web de LEGO Ideas en espérant qu'il inciterait les amateurs à montrer leur amour des films d'animation de Disney, classiques comme modernes, à l'aide de briques LEGO. La communauté des amateurs de LEGO Ideas et un jury ont fait leurs choix parmi des centaines d'interprétations enchantées, émouvantes et amusantes de scènes de films, de héros et de méchants mémorables. Aujourd'hui, pour la première fois depuis la sortie du premier ensemble LEGO | Disney en 1999, nous pouvons partager un ensemble créé non seulement pour les amateurs, mais aussi par une amatrice, et marquer le début d'un nouveau siècle de magie créative.

¡100 AÑOS DE CUENTOS DE HADAS!

La celebración del centenario de Disney en 2023 nos dio la irrepitible oportunidad de invitar a fans de todo el mundo a unirse a una gala virtual con diseñadores de LEGO® | Disney. Lanzamos el exclusivo desafío LEGO Ideas *100 Years of Fairytales!* en el sitio web de LEGO Ideas con la premisa de invitar a los fans a mostrar su amor por las películas animadas Disney clásicas y más recientes usando bricks LEGO. Recibimos cientos de interpretaciones llenas de encanto, conmovedoras y chistosas de las escenas, los héroes y los villanos más memorables, que fueron sometidas a una votación por parte de la comunidad de fans de LEGO Ideas y un jurado. Ahora, por primera vez desde que lanzamos el primer set LEGO | Disney en 1999, podemos compartir un set no solo creado para los fans, sino también diseñado por un miembro de la comunidad, dando paso así a un nuevo siglo de magia creativa.



FROM THE LEGO® IDEAS DESIGN TEAM

"Anna did such a wonderful job in showcasing the history of Disney animation in an exciting model! Mickey Mouse, as the Sorcerer's Apprentice from *Fantasia*, commands the waves, surrounded by a series of tributes to iconic Disney movies. In collaboration with Disney Studios, we modified some of Anna's scenes to represent different decades and eras. From Belle's enchanted rose to Bruno's emerald tablet, the set weaves together a series of memorable, magical Disney moments, beloved characters and iconic elements. Mickey's iconic brooms from *Fantasia* even seem to come alive on top of the flooded stairs! On the inside of Mickey's body and head, we hid an Easter egg for the fan designer, using the colors of characters from her favorite movie. (Can you guess which movie it is?)"

UN MOT DE L'ÉQUIPE DE CONCEPTION LEGO® IDEAS

« Anna a fait un travail formidable en présentant l'histoire de l'animation Disney dans un modèle passionnant ! Mickey Mouse, dans le rôle de l'apprenti sorcier de *Fantasia*, domine les vagues, entouré d'une série d'hommages à des films emblématiques de Disney. En collaboration avec les studios Disney, nous avons modifié certaines scènes d'Anna pour représenter différentes décennies et époques. De la rose enchantée de Belle à la tablette d'émeraude de Bruno, l'ensemble réunit une série de moments magiques et mémorables, de personnages bien-aimés et d'éléments emblématiques de Disney. Les balais de Mickey, emblème de *Fantasia*, semblent même prendre vie en haut des escaliers inondés ! À l'intérieur du corps et de la tête de Mickey, nous avons caché un œuf de Pâques pour la conceptrice amatrice en utilisant les couleurs des personnages de son film préféré. (Pouvez-vous deviner de quel film il s'agit ?) »

IMPRESIONES DEL EQUIPO DE DISEÑO DE LEGO® IDEAS

"¡Anna hizo un maravilloso trabajo representando la historia de la animación Disney en un emocionante modelo! Vistiendo el inconfundible ropaje del aprendiz de brujo de *Fantasia*, Mickey Mouse comanda las olas rodeado de una serie de homenajes a películas Disney que hicieron historia. En colaboración con Disney Studios, modificamos algunas de las escenas de Anna para representar distintas décadas y épocas. Desde la rosa encantada de Bella hasta la tabla esmeralda de Bruno, el set entrelaza una serie de momentos Disney mágicos y memorables, admirados personajes e icónicos elementos. ¡Las inolvidables escobas que Mickey embruja en *Fantasia* incluso parecen cobrar vida en lo alto de las escaleras inundadas! En el interior del cuerpo y la cabeza de Mickey, escondimos un homenaje secreto a la fan diseñadora, creado a partir de los colores de los personajes de su película favorita. ¿Podrás adivinar de qué película se trata?"

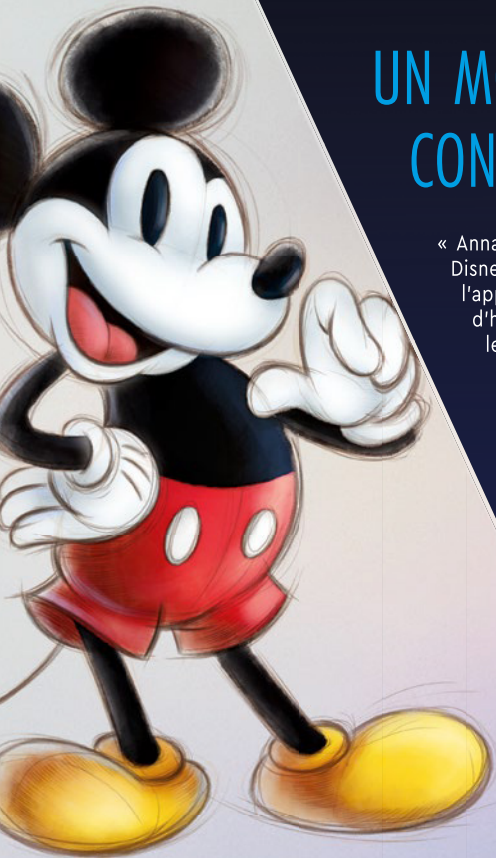



BRINGING A LEGO® IDEAS MODEL TO LIFE

Much like the brooms in *Fantasia*, ideas just seem to multiply when you start building with LEGO® bricks! Collaborating with the fan designer and Disney Studios, the LEGO Ideas design team waved their brick wands to bring the model to life.

DONNER VIE À UN MODÈLE LEGO® IDEAS

Tout comme les balais dans *Fantasia*, les idées semblent se multiplier lorsque vous commencez à construire avec des briques LEGO® ! En collaboration avec la conceptrice amatrice et les studios Disney, l'équipe de conception de LEGO Ideas a agité ses baguettes en briques pour donner vie au modèle.

CÓMO COBRA VIDA UN MODELO LEGO® IDEAS

Igual que las escobas de *Fantasia*, ¡las ideas parecen multiplicarse cuando empiezas a construir con bricks LEGO®! En colaboración con la fan diseñadora y Disney Studios, los miembros del equipo de diseño de LEGO Ideas agitaron sus varitas de bricks para dar vida al modelo.

PINOCCHIO (1940)

Geppetto is fighting the waves on his posable raft, inside the whale Monstro.

PINOCCHIO (1940)

Geppetto lutte contre les vagues sur son radeau mobile, à l'intérieur de la baleine Monstro.

PINOCHO (1940)

Geppetto lucha contra las olas sobre su balsa articulada, adentro de la ballena Monstruo.

LILO & STITCH (2002)

A posable Lilo is having fun surfing the waves.

LILLO ET STITCH (2002)

Une Lilo articulée s'amuse à surfer sur les vagues.

LILLO Y STITCH (2002)

Una Lilo articulada se divierte surfeando sobre las olas.

THE LION KING (1994)

Simba is admiring his kingdom from the top of Pride Rock, surrounded by savannah flora.

LE ROI LION (1994)

Simba admire son royaume du haut du Rocher des lions, entouré de la flore de la savane.

EL REY LEÓN (1994)

Simba admira su reino desde lo alto de la Roca del Rey, rodeado de la flora de la sabana.





FANTASIA (1940)

Mickey Mouse, as the Sorcerer's Apprentice, takes center stage, representing one of the most iconic animation movies of all time, *Fantasia*. With just a few flicks of his hands, the magic brooms may wake up, rush down the stairs and pour more water from their buckets!

FANTASIA (1940)

Mickey Mouse, en tant qu'apprenti sorcier, occupe le devant de la scène, représentant l'un des films d'animation les plus emblématiques de tous les temps, *Fantasia*. En quelques tours de main, les balais magiques peuvent se réveiller, se précipiter dans les escaliers et verser de l'eau dans leurs seaux !

FANTASÍA (1940)

Vestido como el aprendiz de brujo, Mickey Mouse ocupa el centro de la escena representando una de las películas de animación más icónicas de todos los tiempos: *Fantasia*. Con solo unos movimientos de sus manos, ¡las escobas mágicas pueden despertar, apresurarse a bajar las escaleras y transportar más agua con sus cubetas!

THE LITTLE MERMAID (1989)

Sebastian and Flounder playfully pop out of the waves.

LA PETITE SIRÈNE (1989)

Sébastien et Barboteur émergent joyeusement des vagues.

LA SIRENITA (1989)

Sebastián y Flounder se divierten saltando por encima de las olas.

ENCANTO (2021)

Bruno is standing outside the Casita, the Madrigal family's magic house, troubled by his visions.

ENCANTO (2021)

Bruno se tient devant la Casita, la maison magique de la famille Madrigal, troublé par ses visions.

ENCANTO (2021)

Bruno está afuera de la Casita, el hogar mágico de la familia Madrigal, preocupado por sus visiones.

BEAUTY AND THE BEAST (1991)

Belle is in the luxurious ballroom in Beast's castle, gazing at the enchanted rose.

LA BELLE ET LA BÊTE (1991)

Belle contemple la rose enchantée dans la luxueuse salle de bal du château de la Bête.

LA BELLA Y LA BESTIA (1991)

Bella está en el lujoso salón de baile del castillo de Bestia, contemplando la rosa encantada.

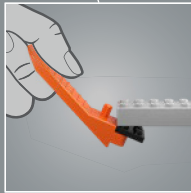
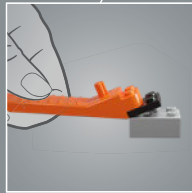
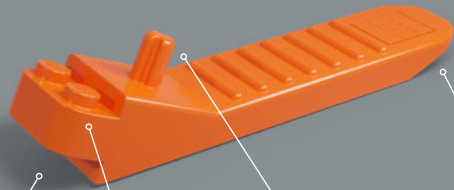

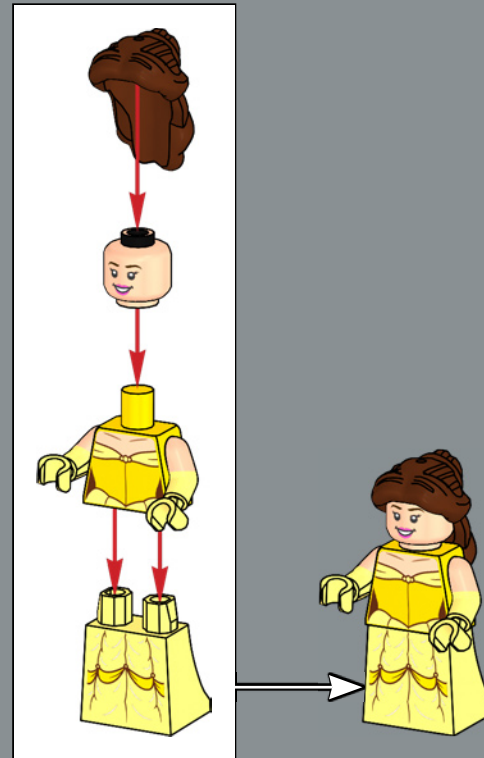

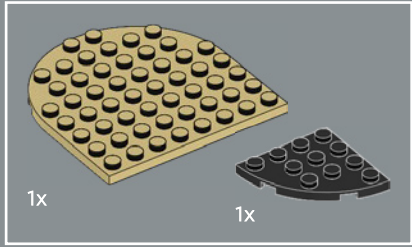

1

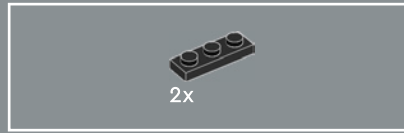
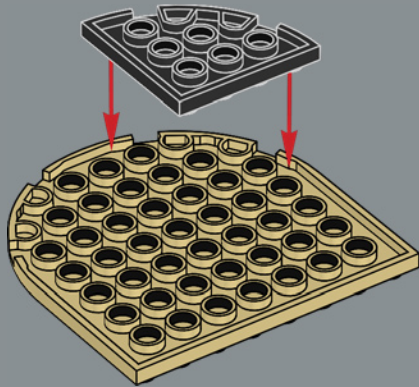

2

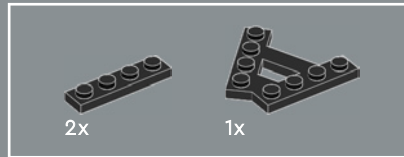
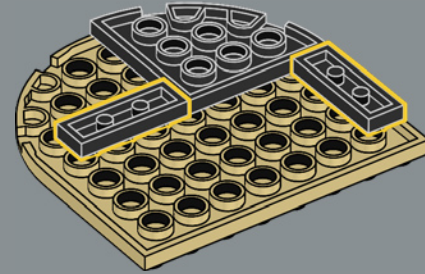

3

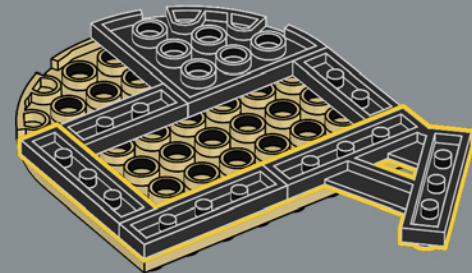

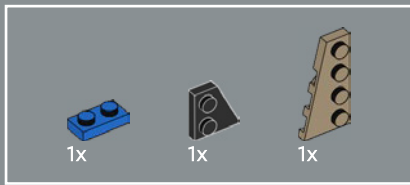

4

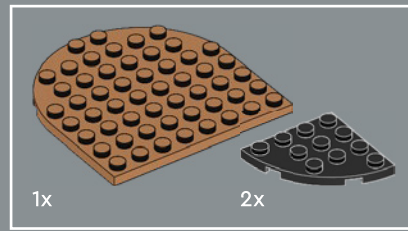
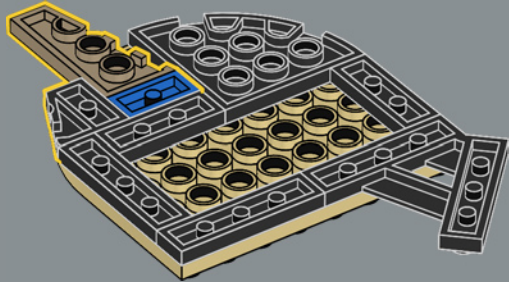

5

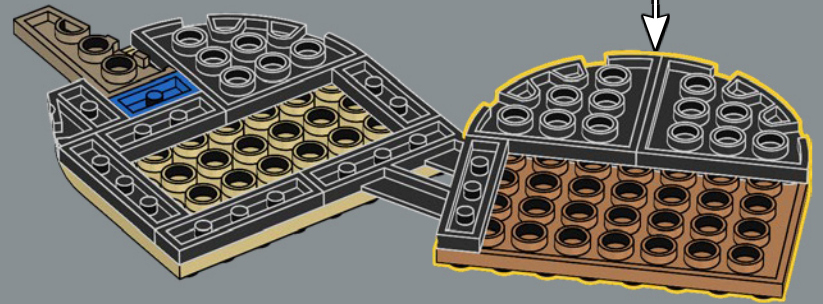
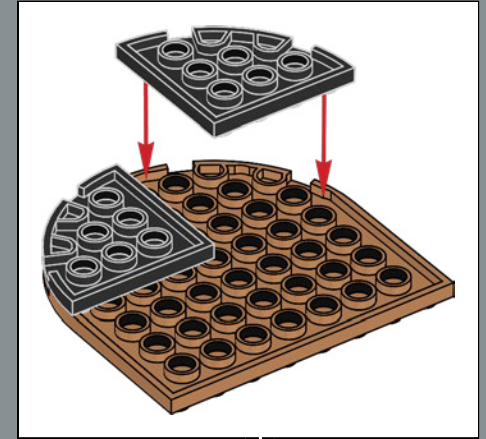

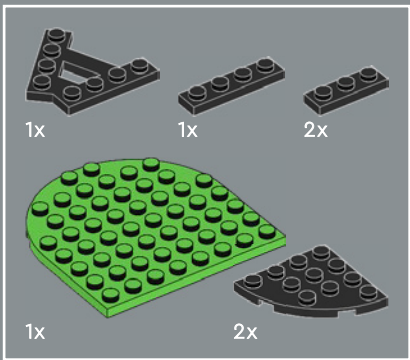

6

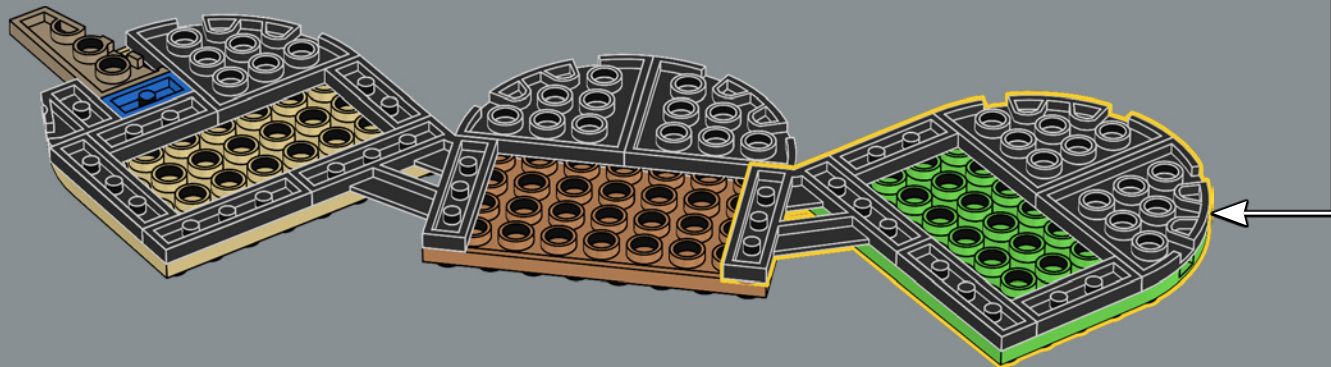
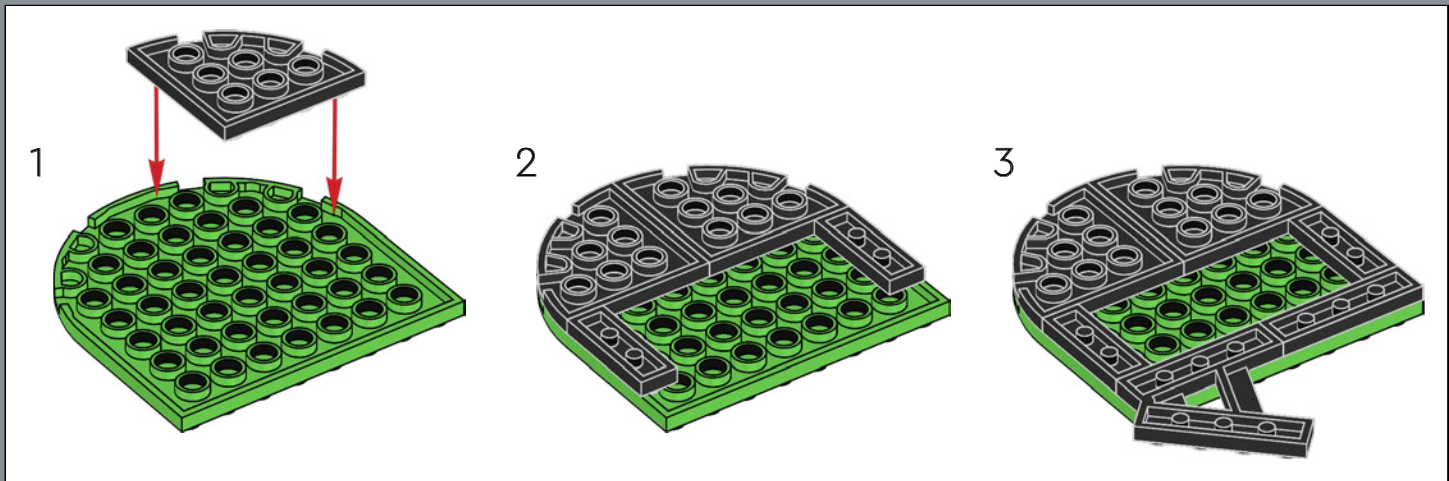

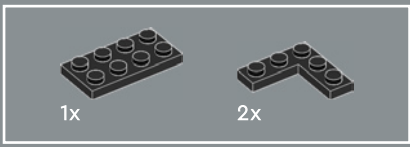

7

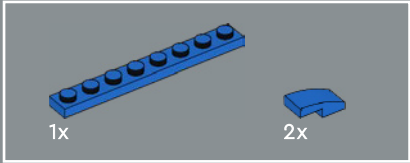
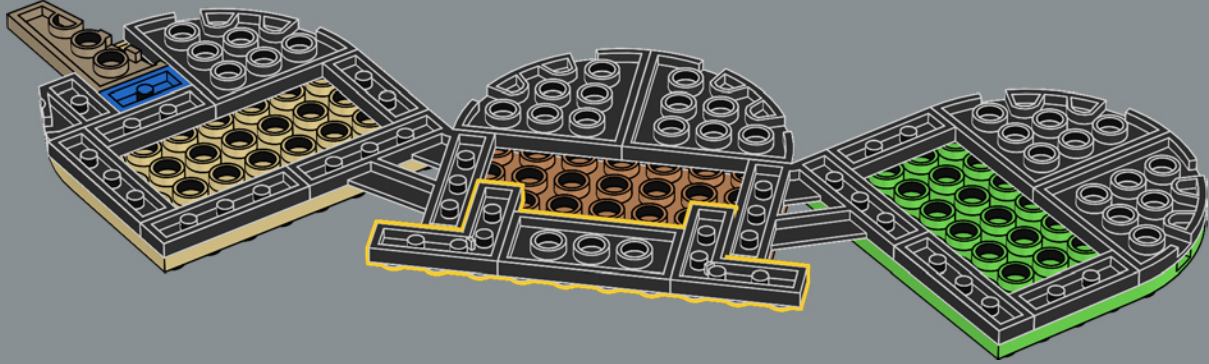

8

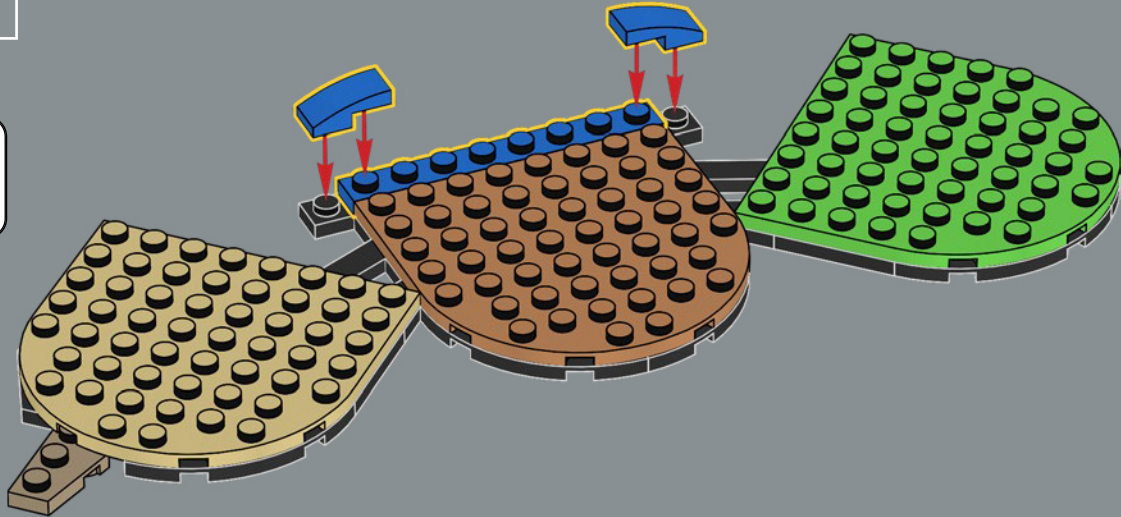

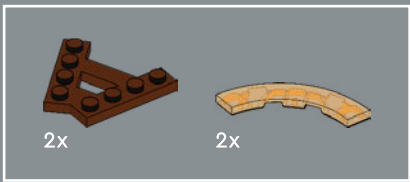

9

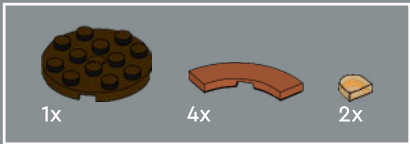

10

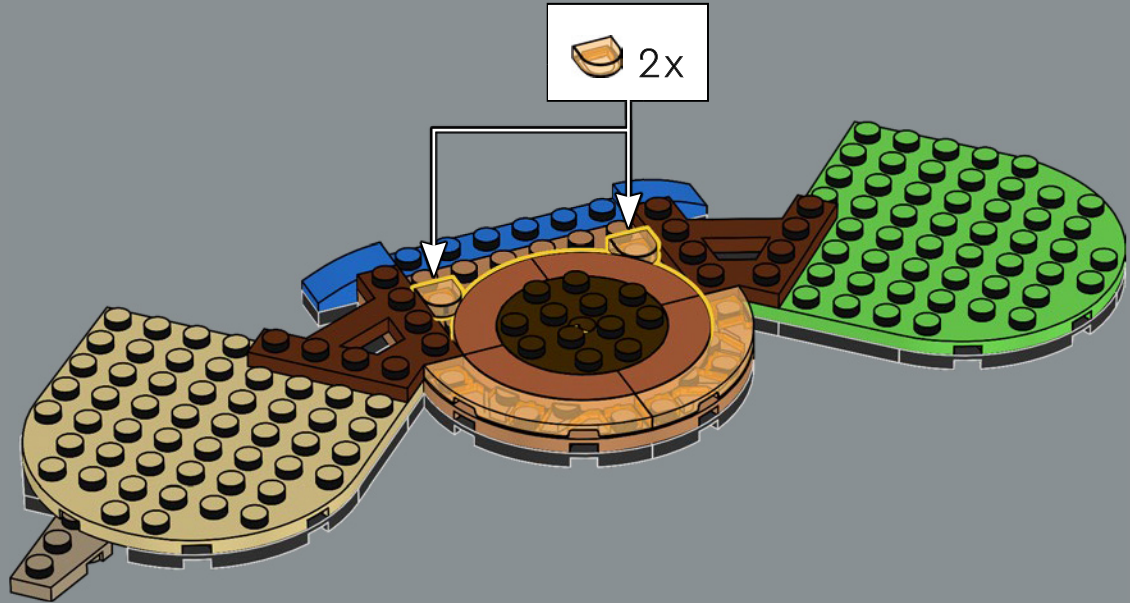

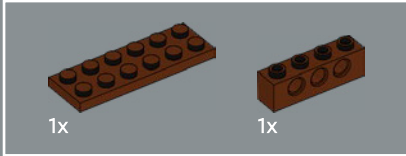

11

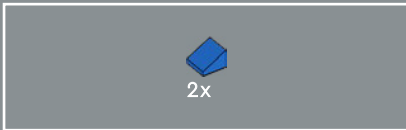
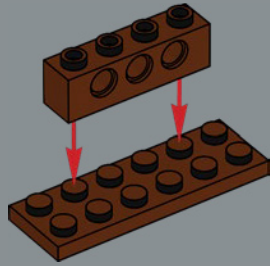

12

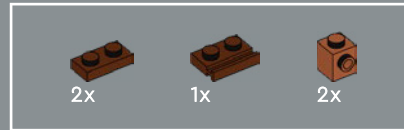
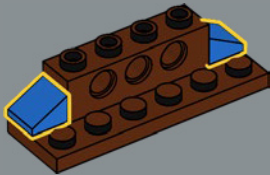

13

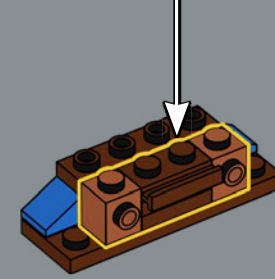
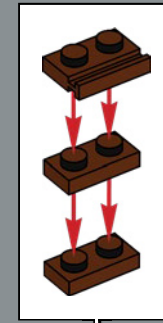

14

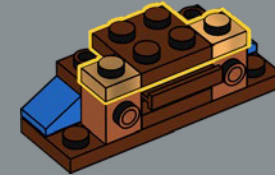



15

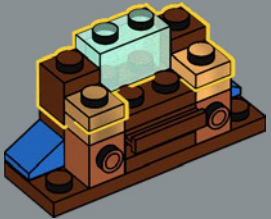

16

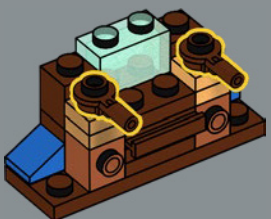

17

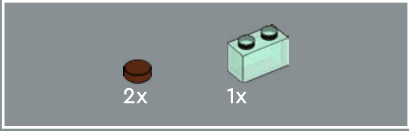
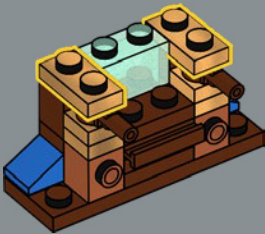

18

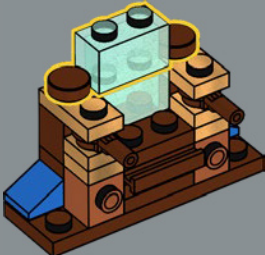

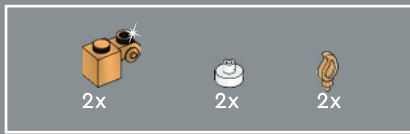

19

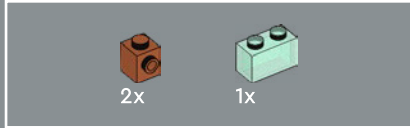
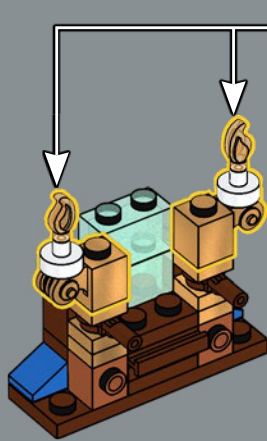
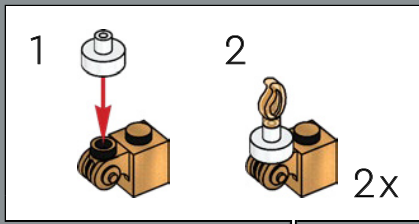

20

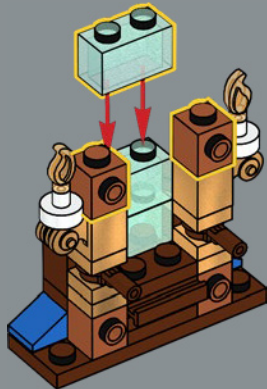

21

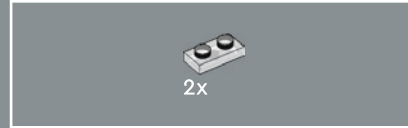

22



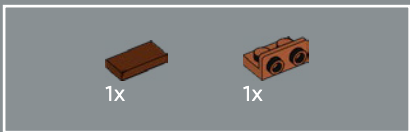

23

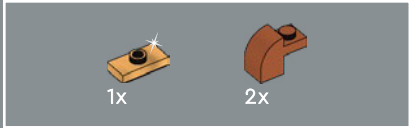

24



25

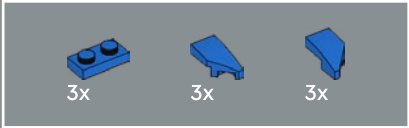

26

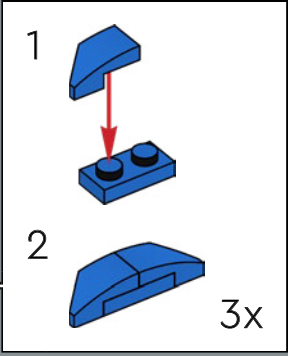

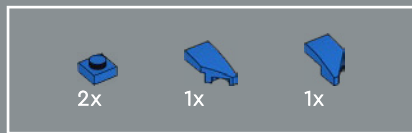

27

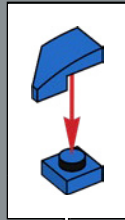
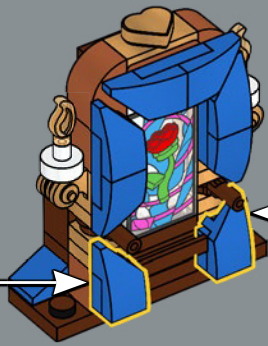
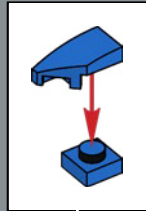

28

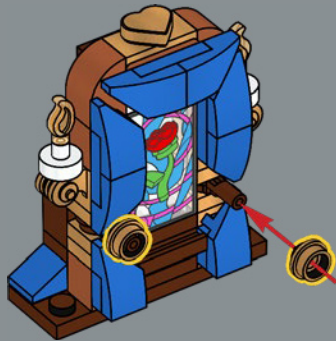

29

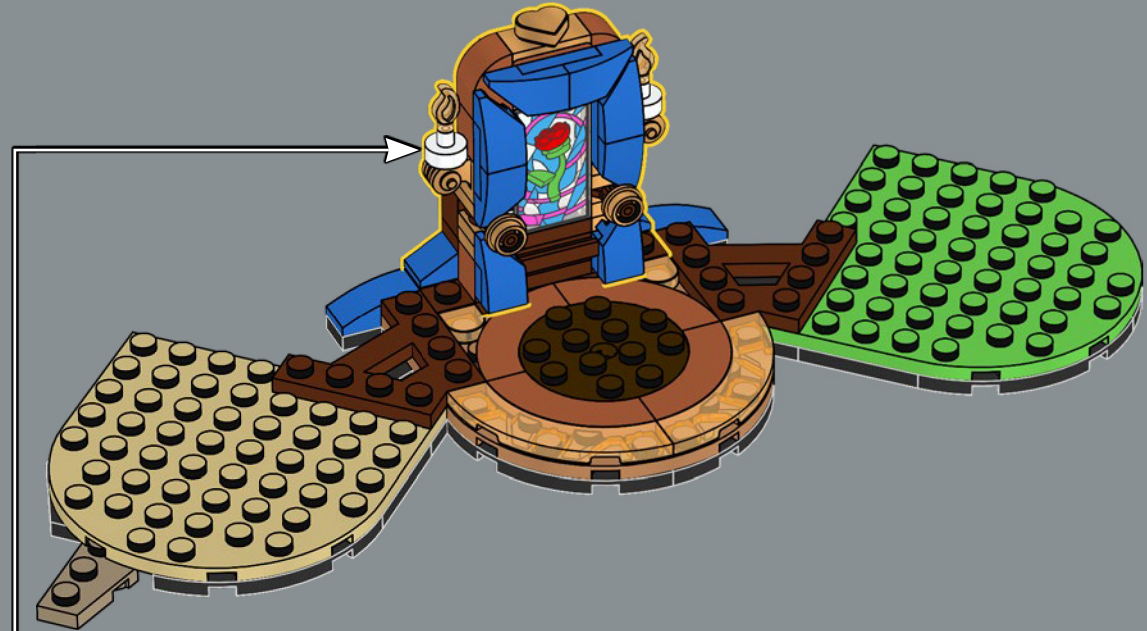

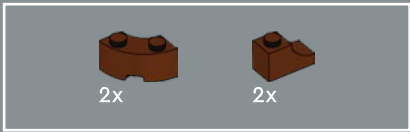

30

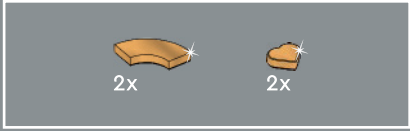

31





32

1



2

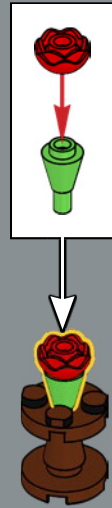

3

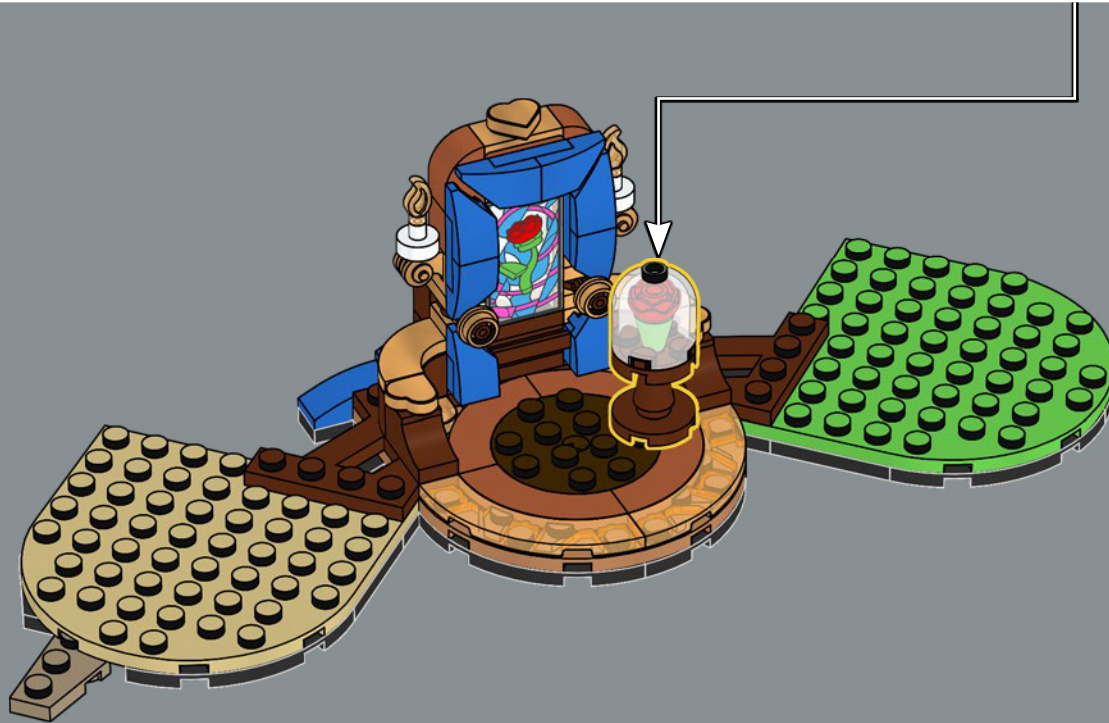

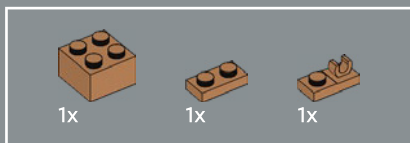

33

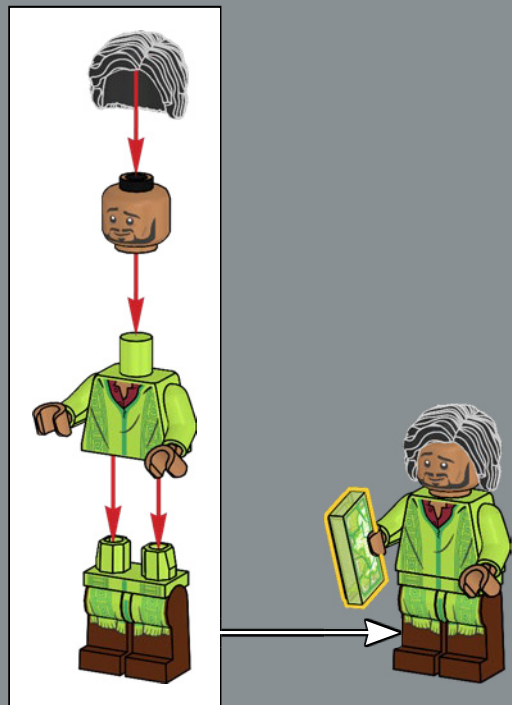

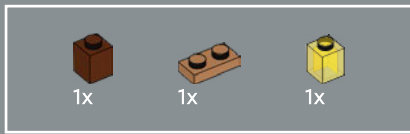

34

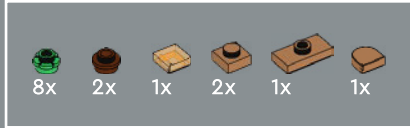

35





3x



1x



3x

36



5x



2x

37



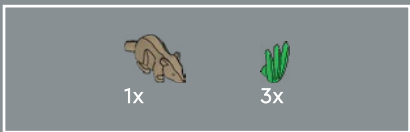

38

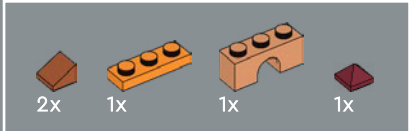

39

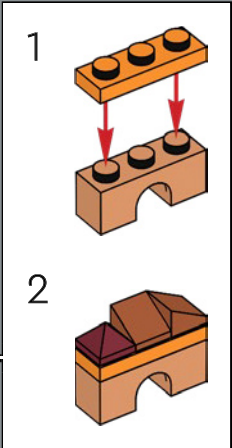



40

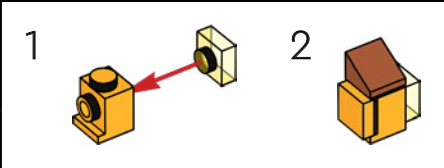
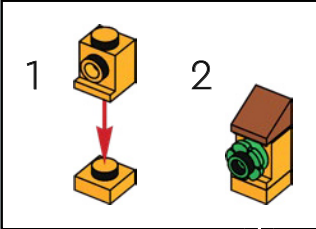

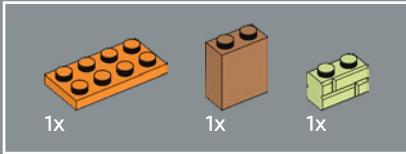
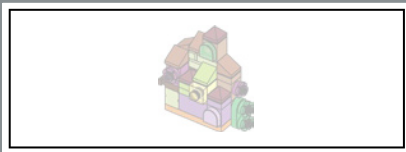

41

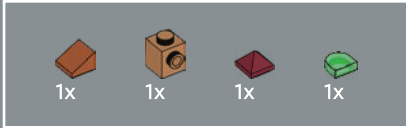
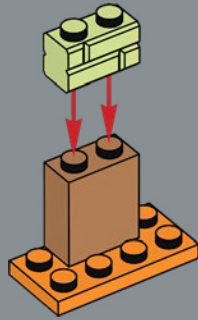

42

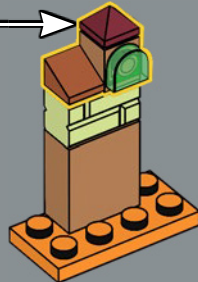
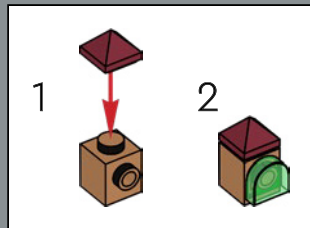

43

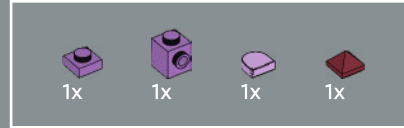
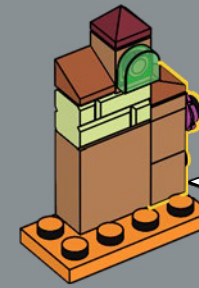
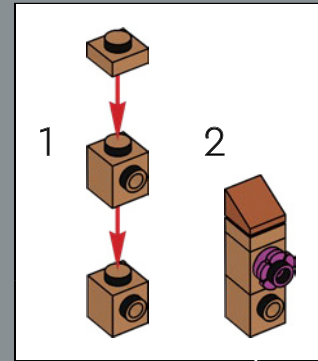

44

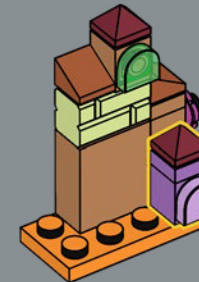
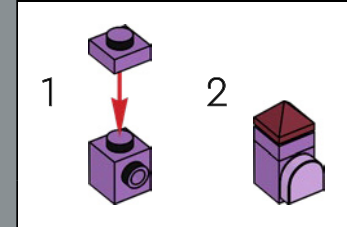

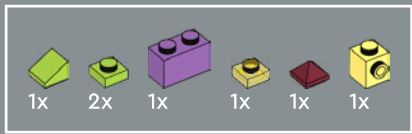

45

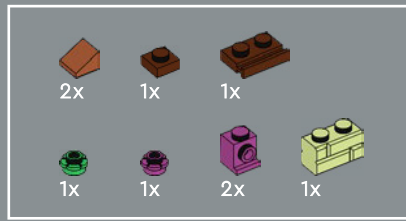
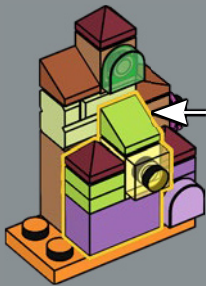
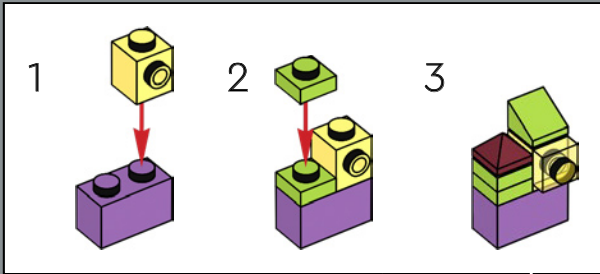

46

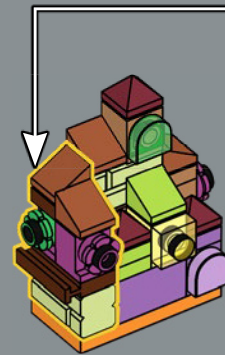
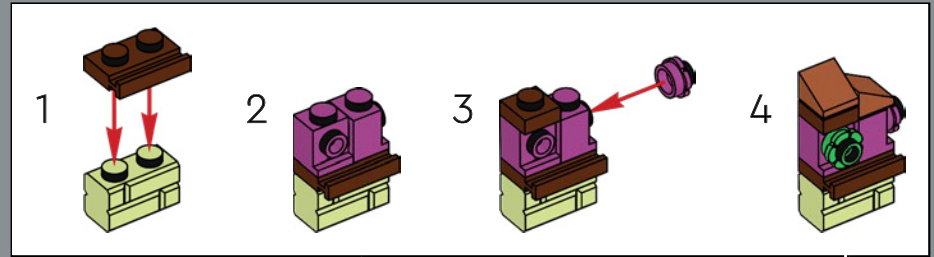

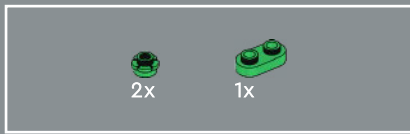

47

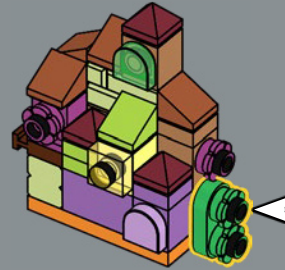
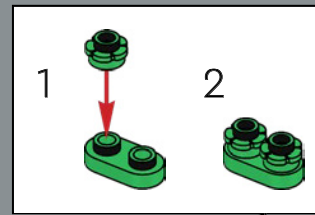

48





49

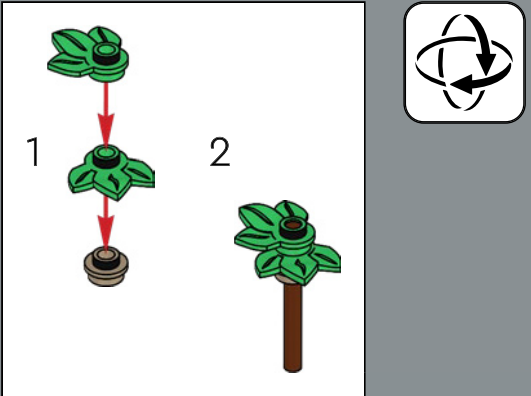



50

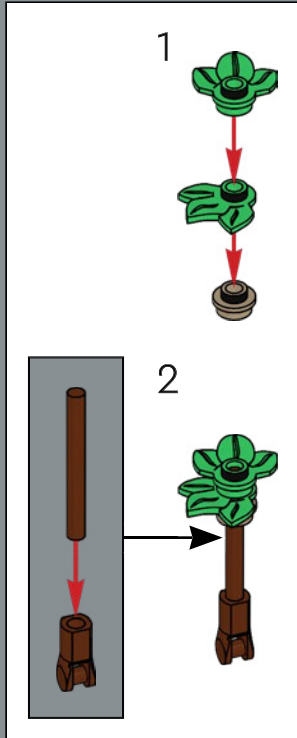
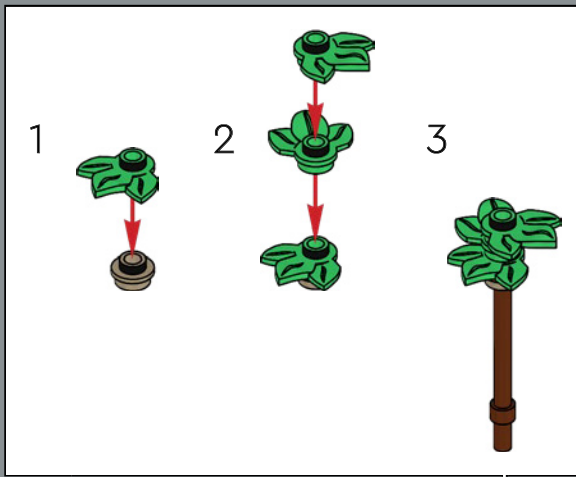

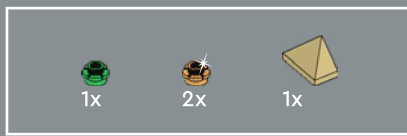

51

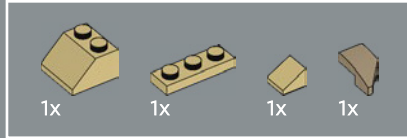
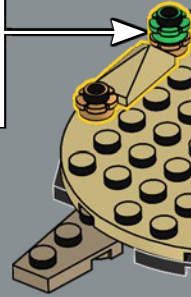
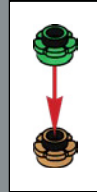

52



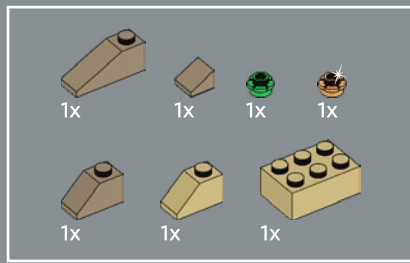

53

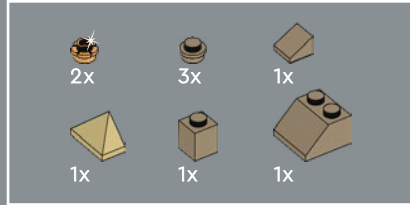

54





55

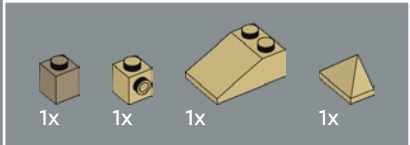

56



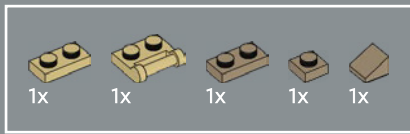

57

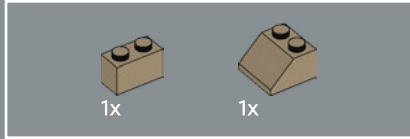
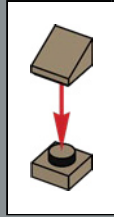
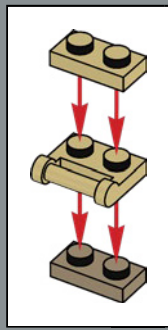

58



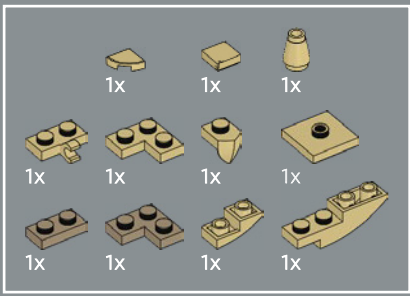

59

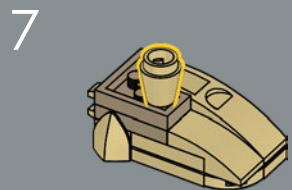
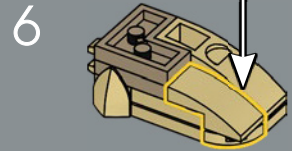
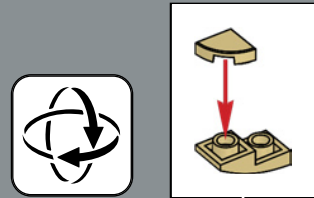
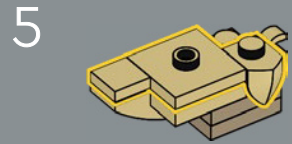
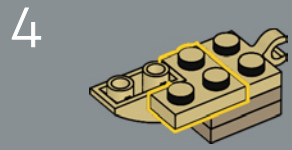
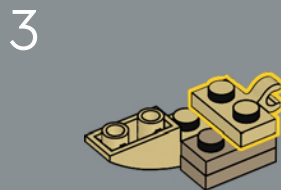
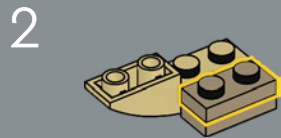
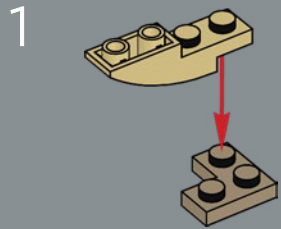

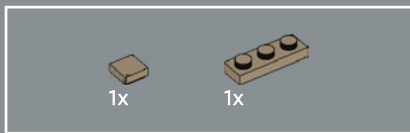

60

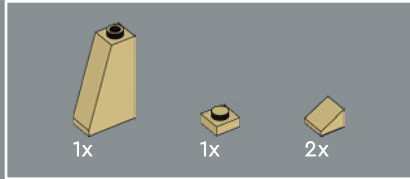

61

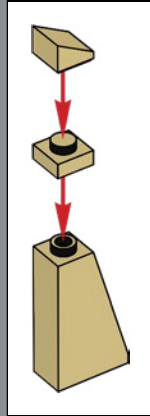

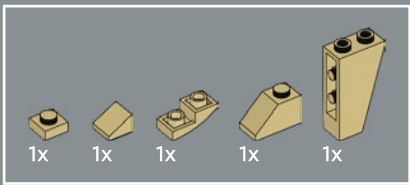

62

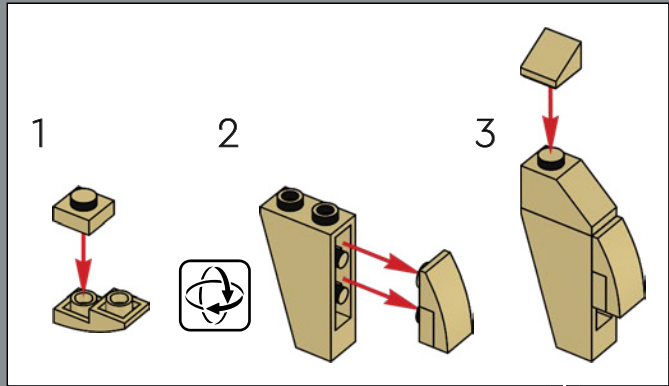

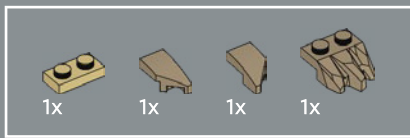

63

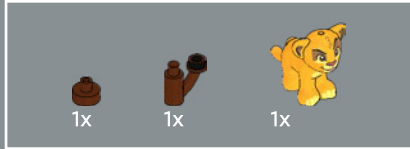
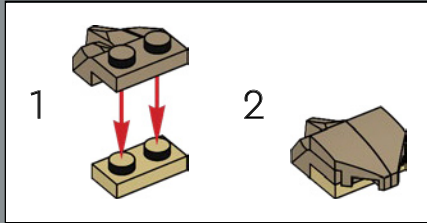

64

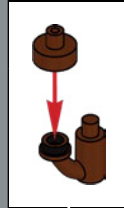



65



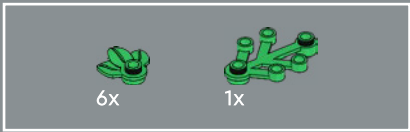

66

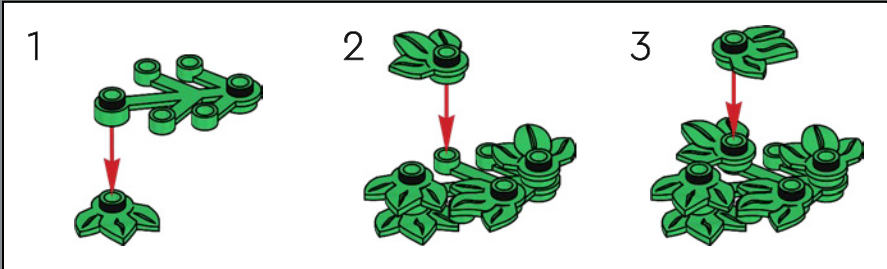

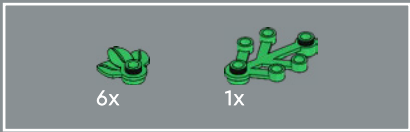

67

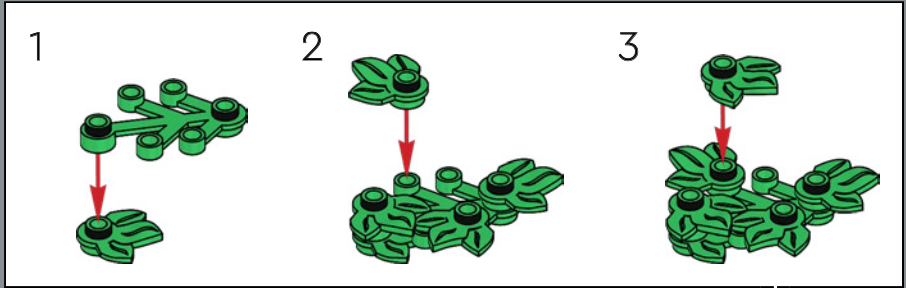

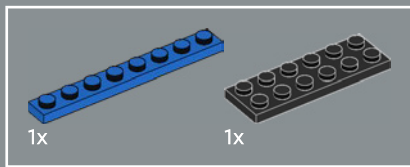

68

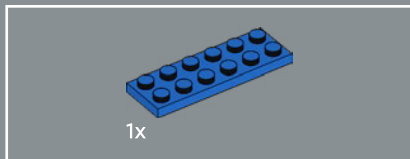
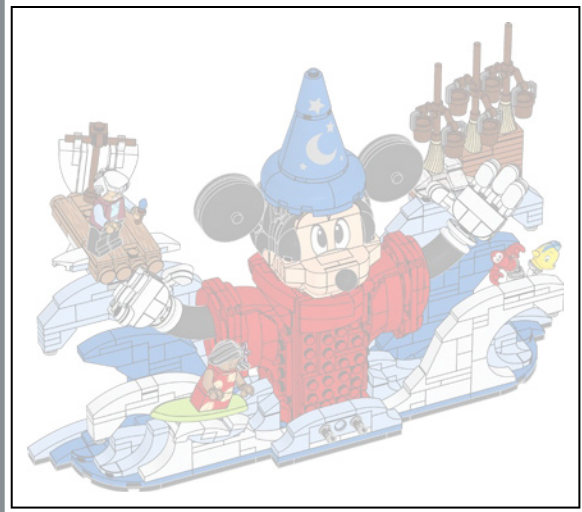
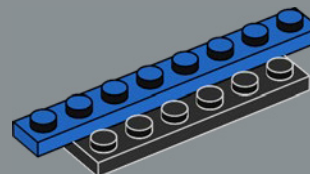

69

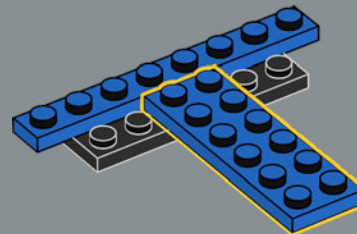

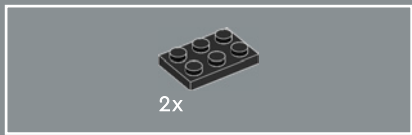

70

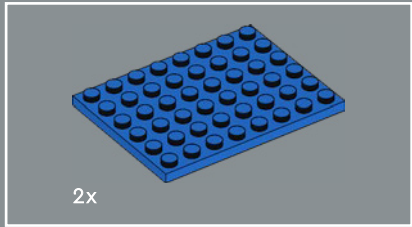
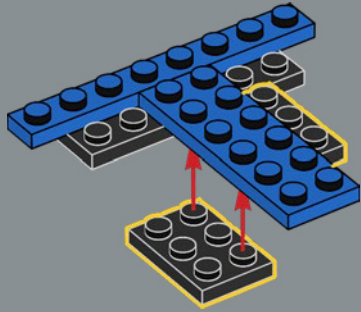

71

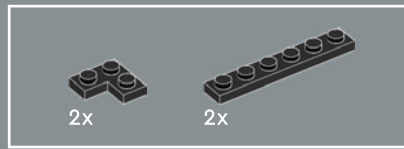
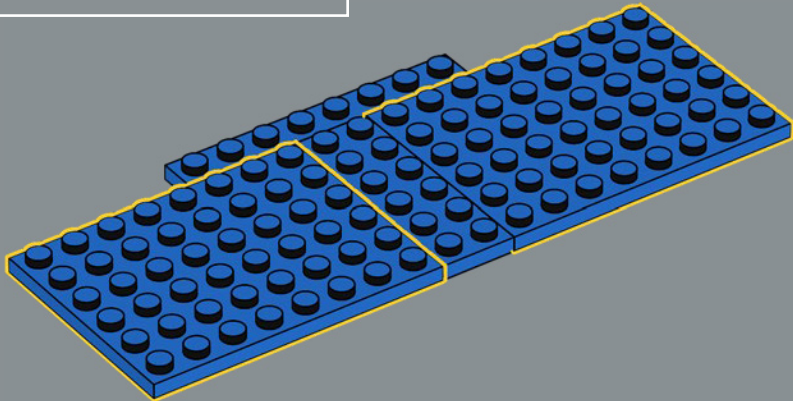

72

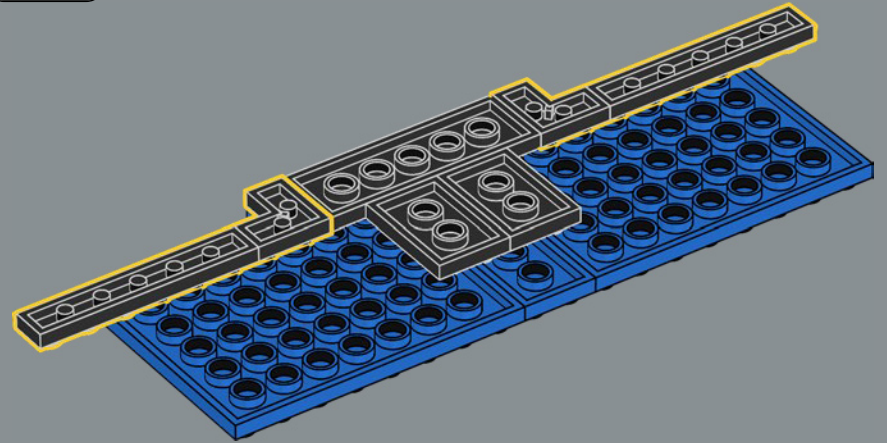

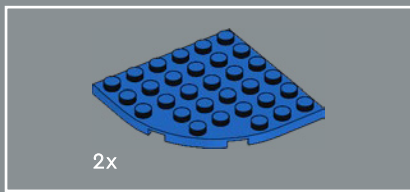

73

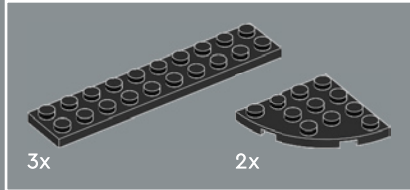
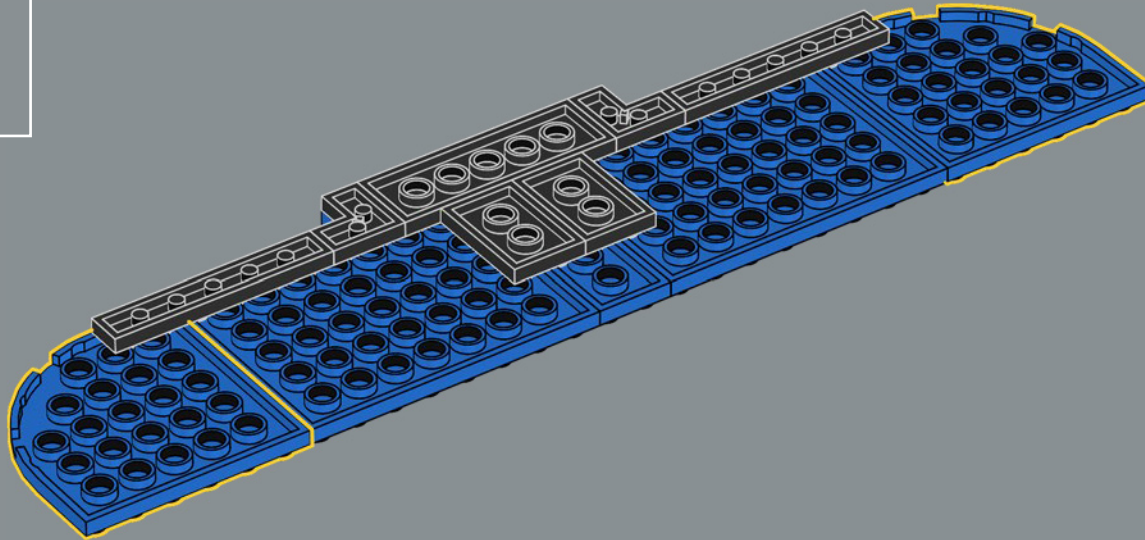

74

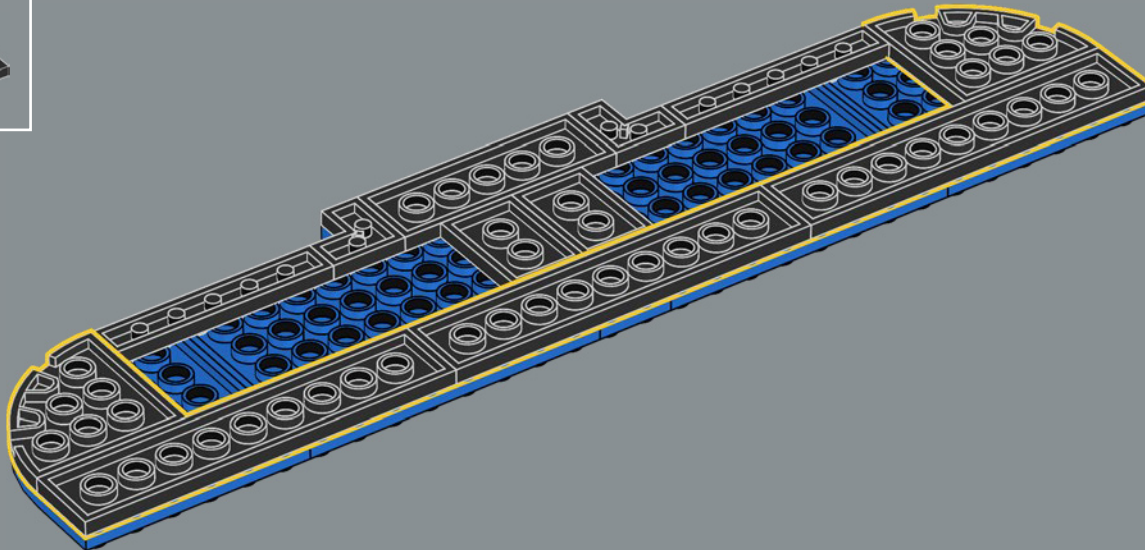



75

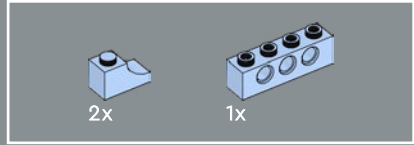
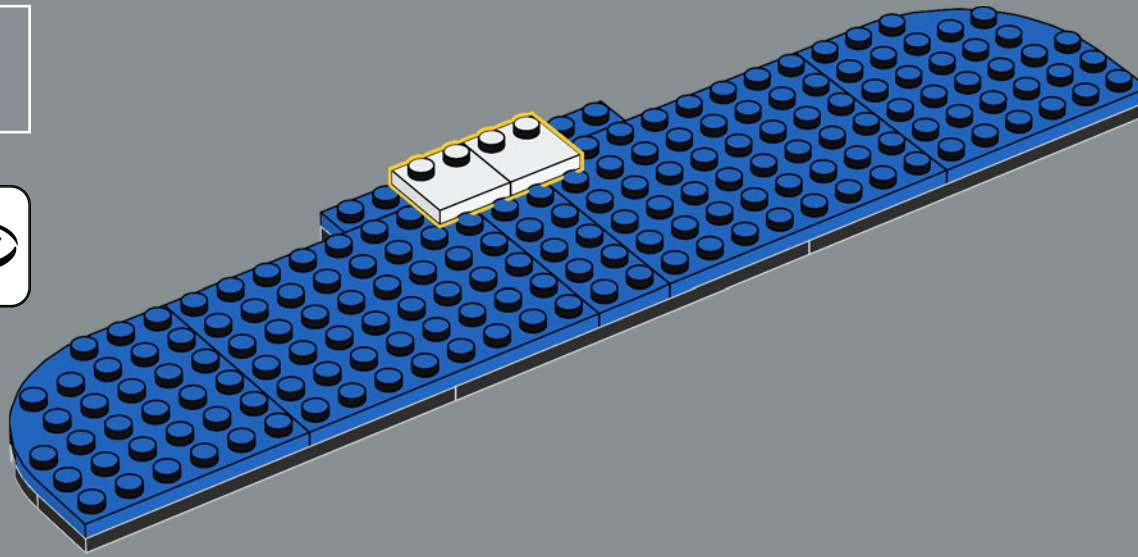

76

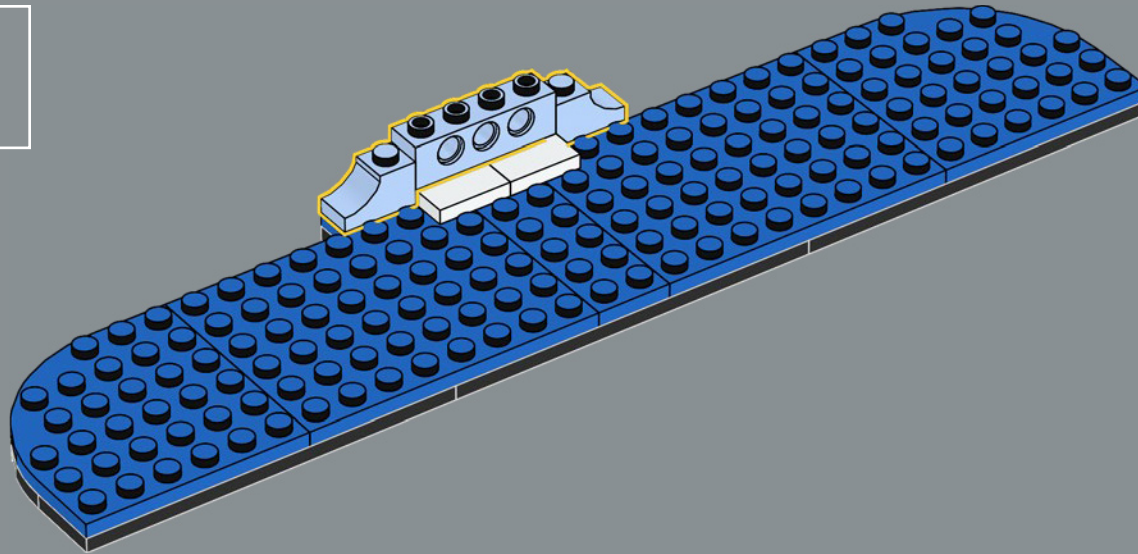

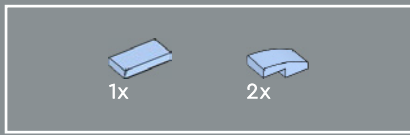

77

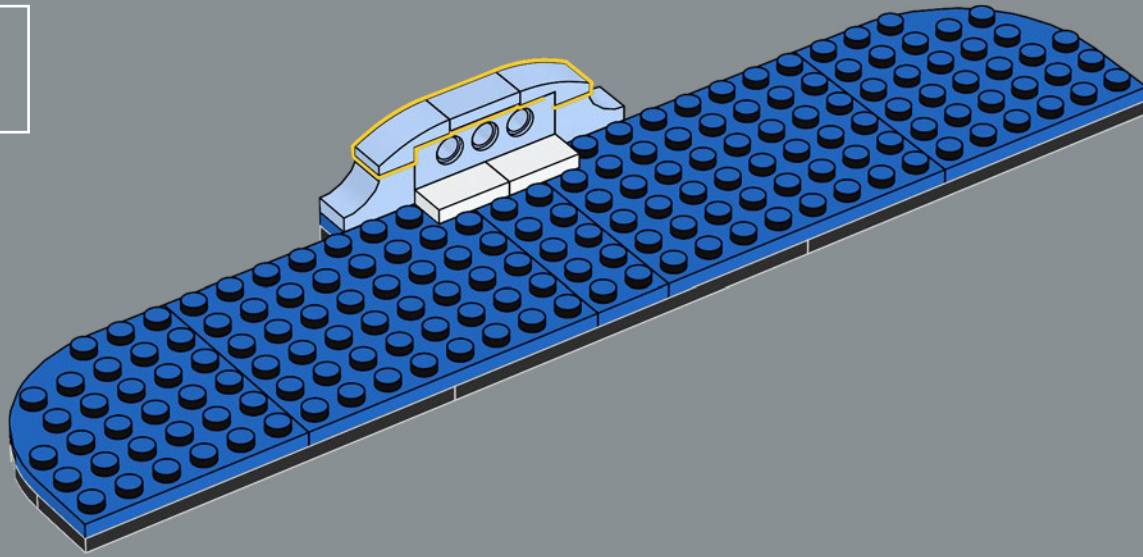

78

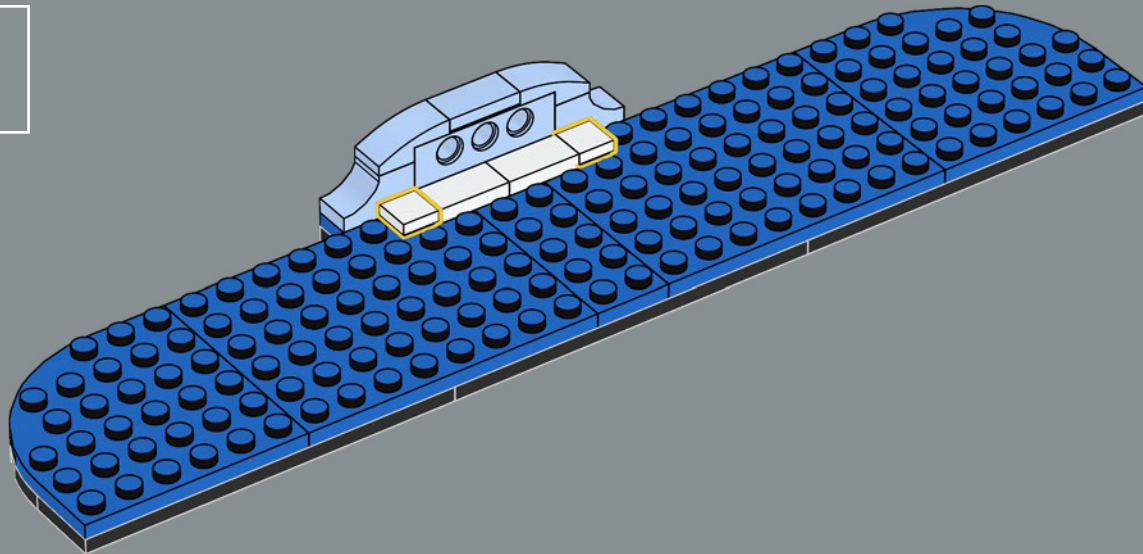

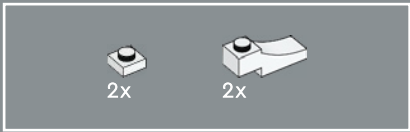

79

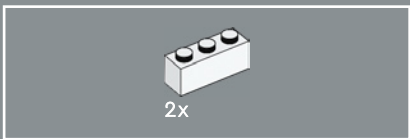
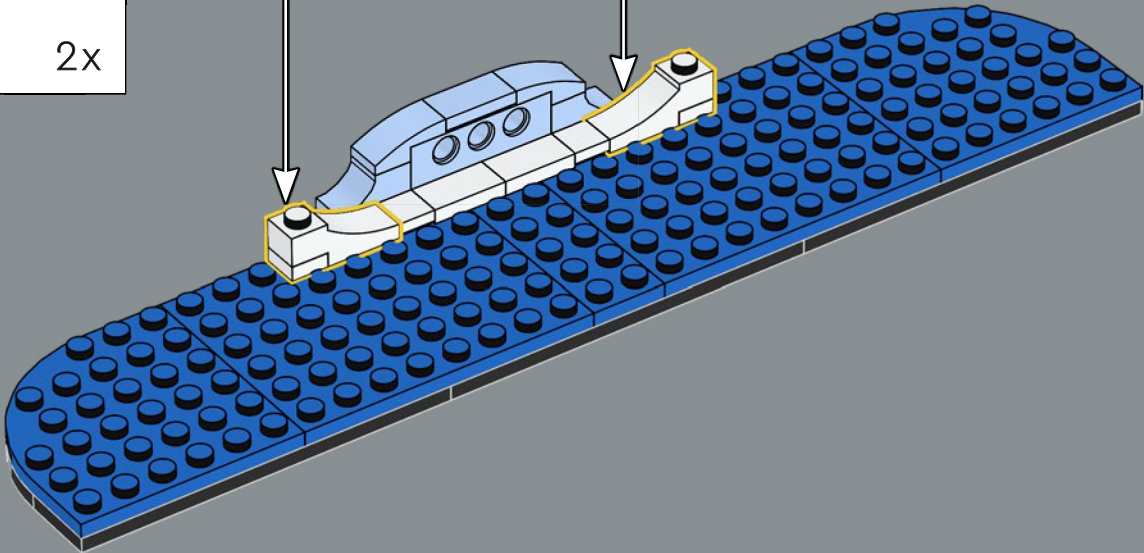
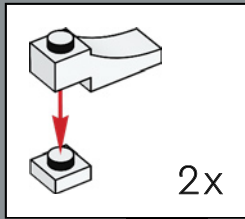

80

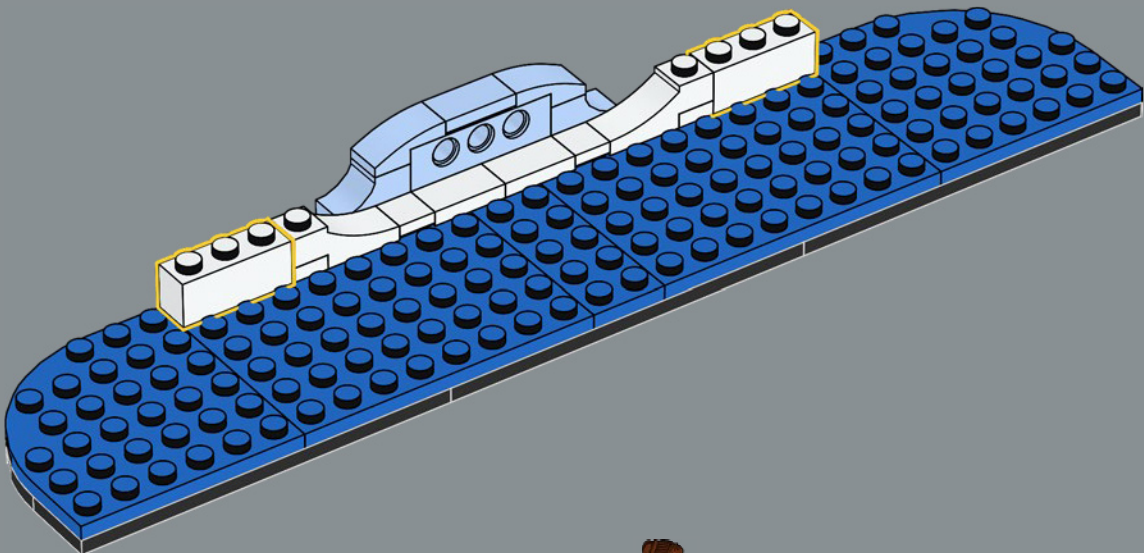

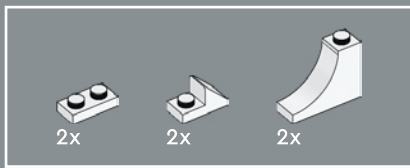

81

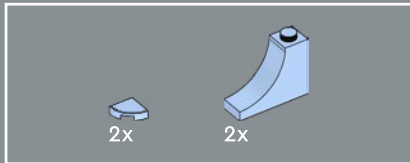
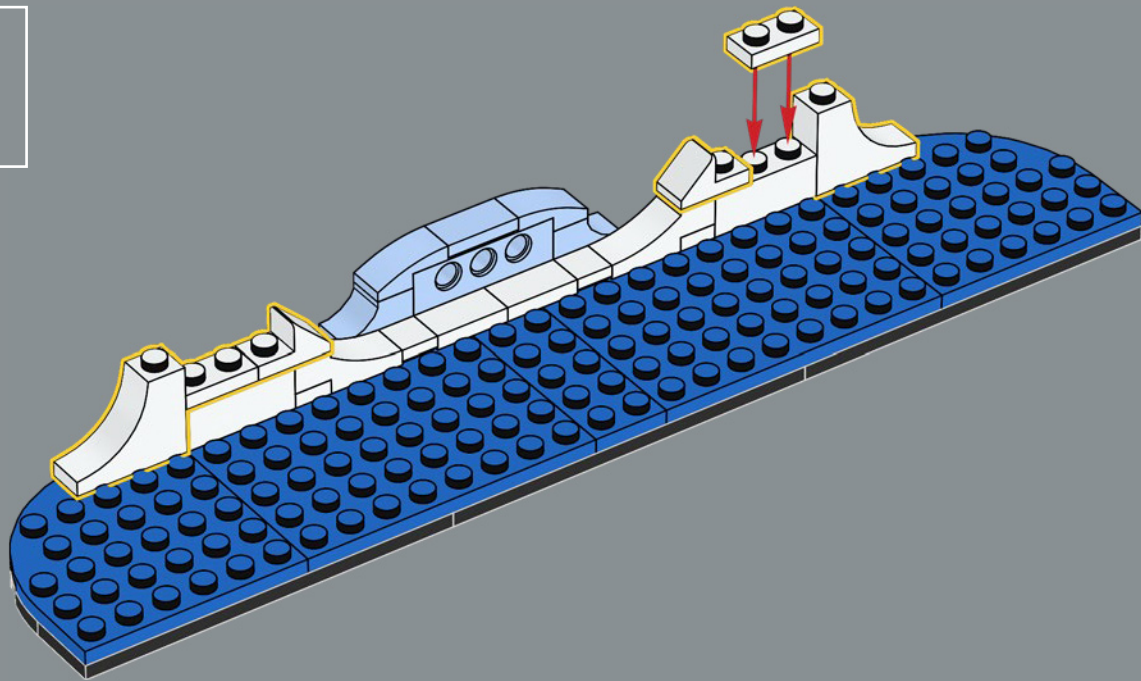

82

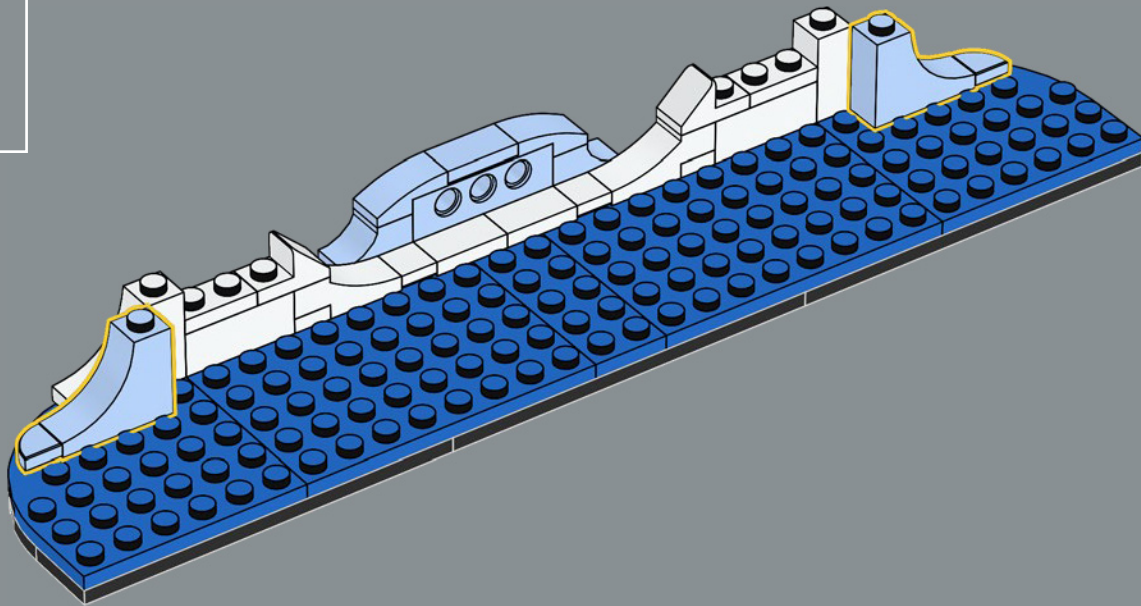

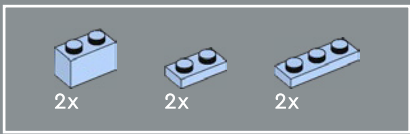

83

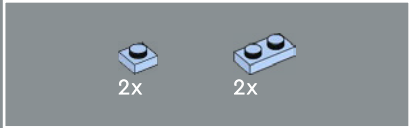
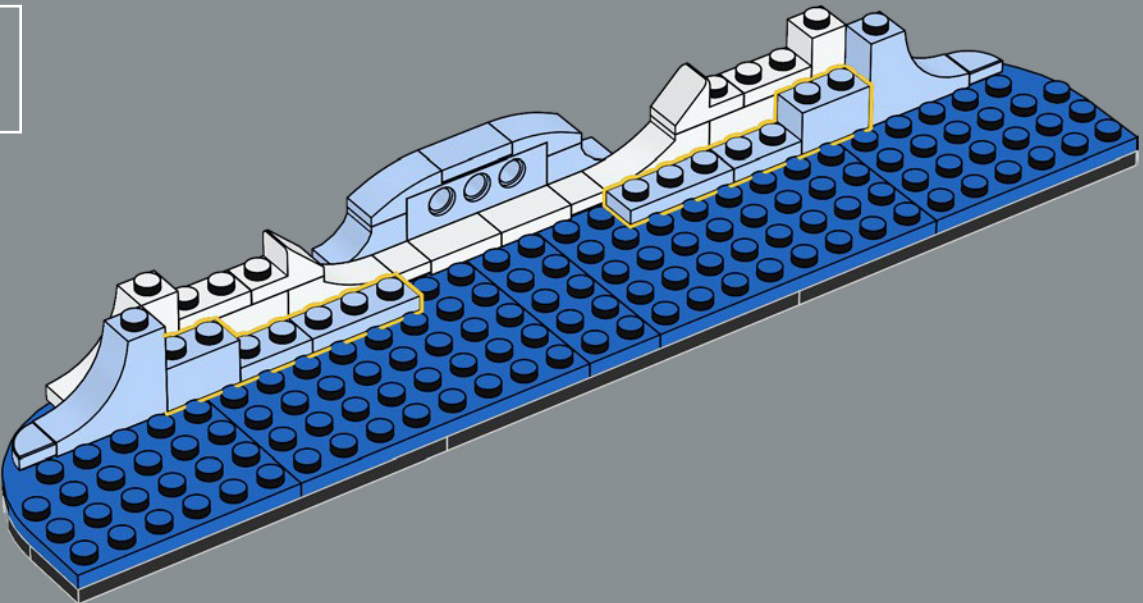

84

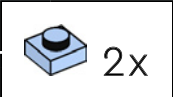
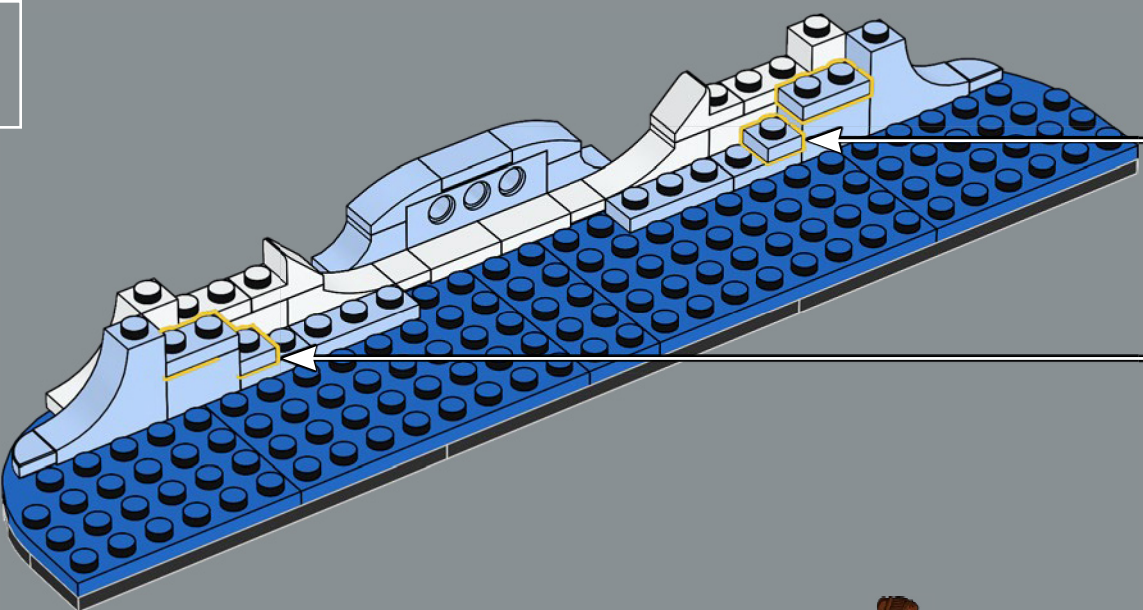

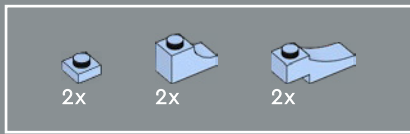

85

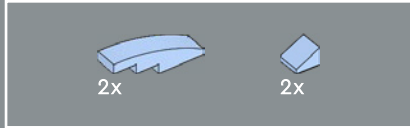
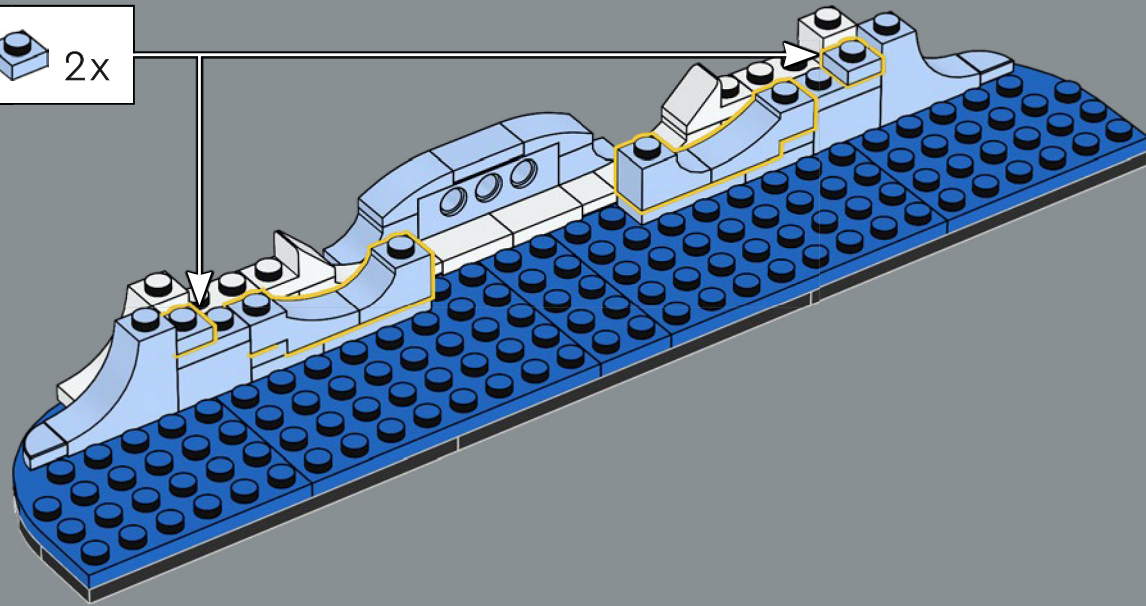
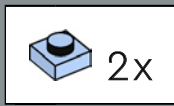

86

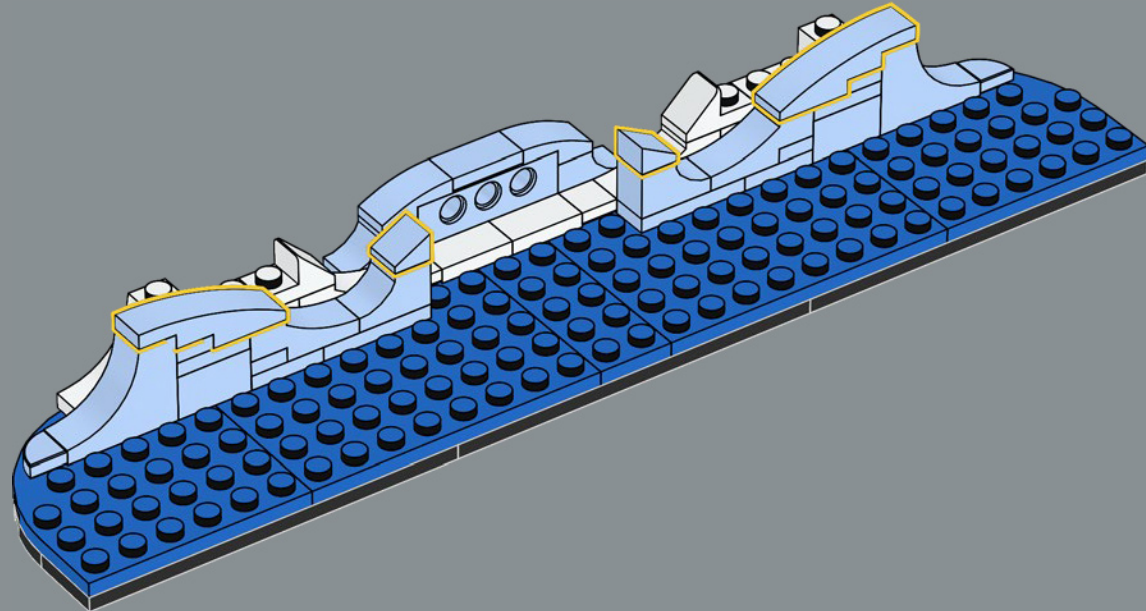

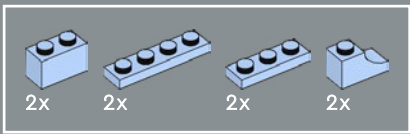

87

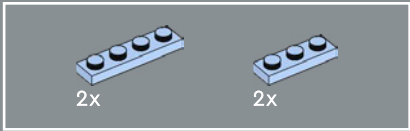
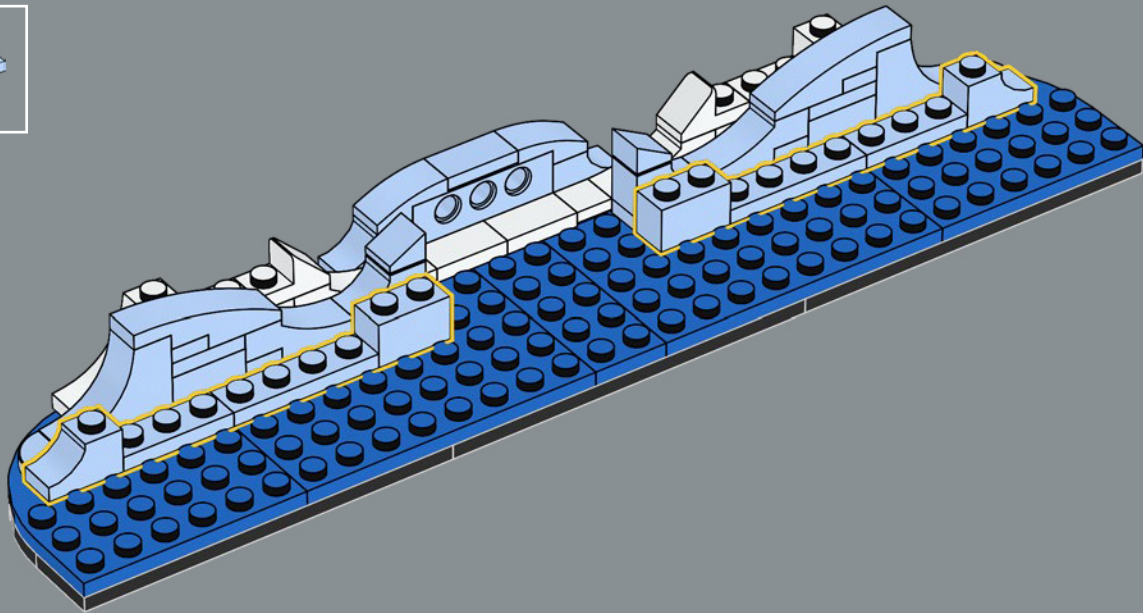

88

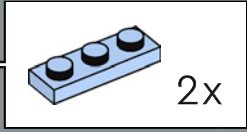
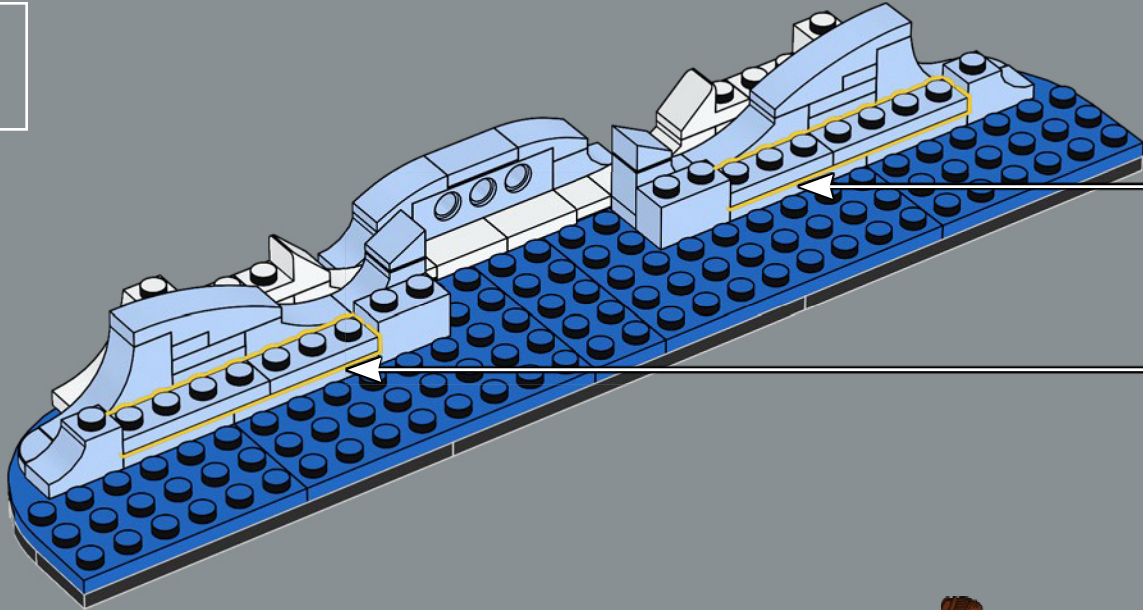

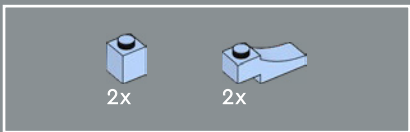

89

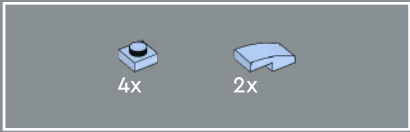
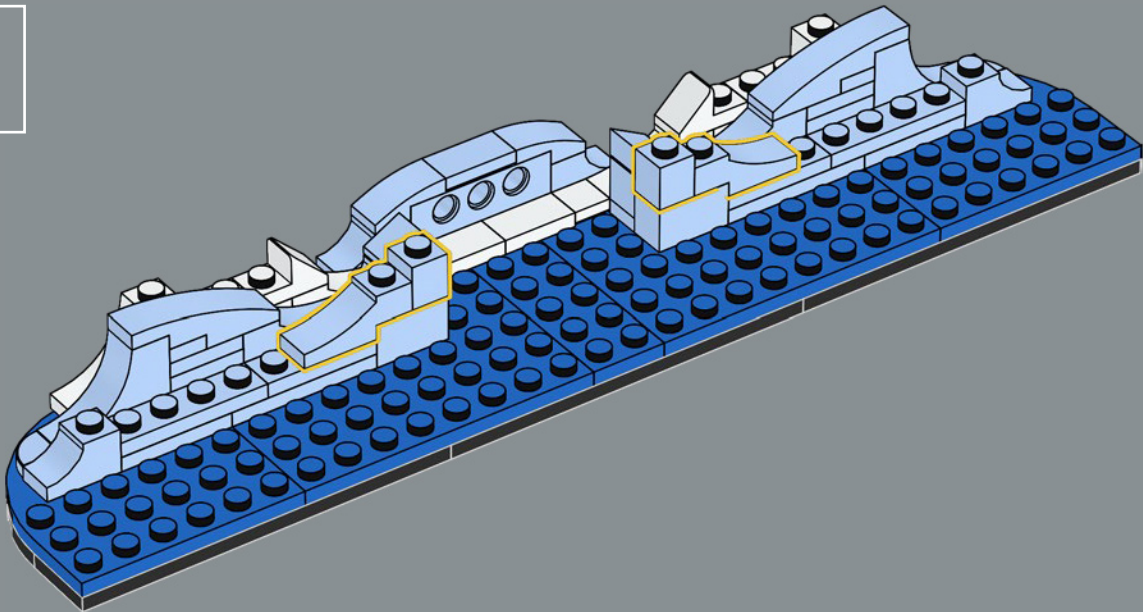

90

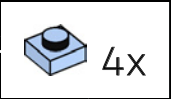
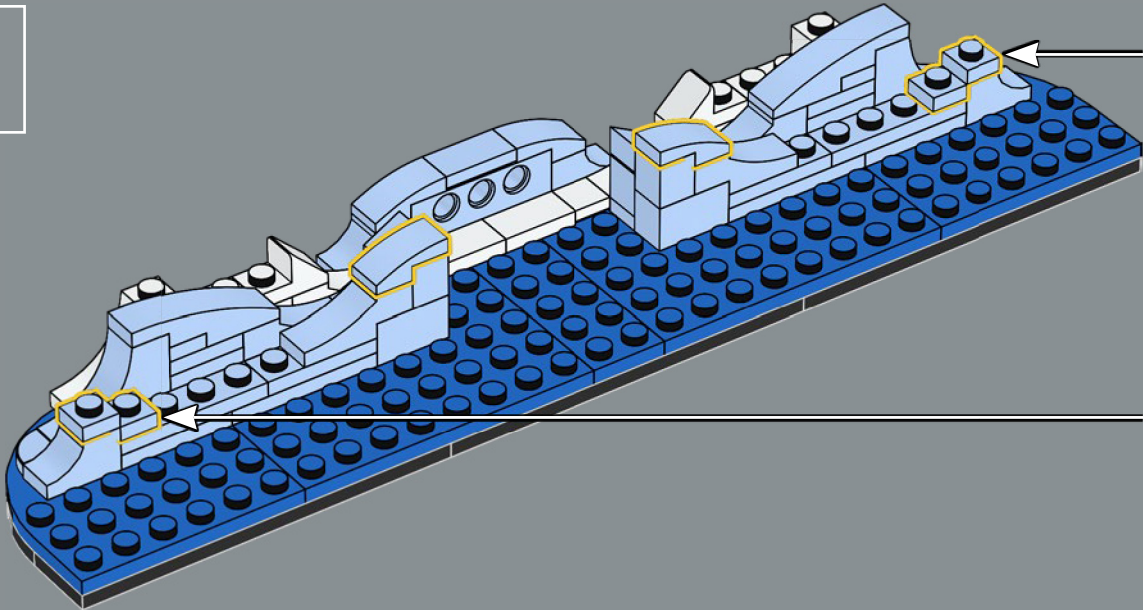

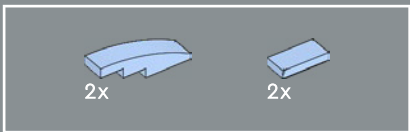

91

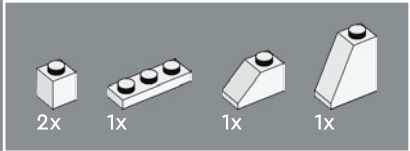
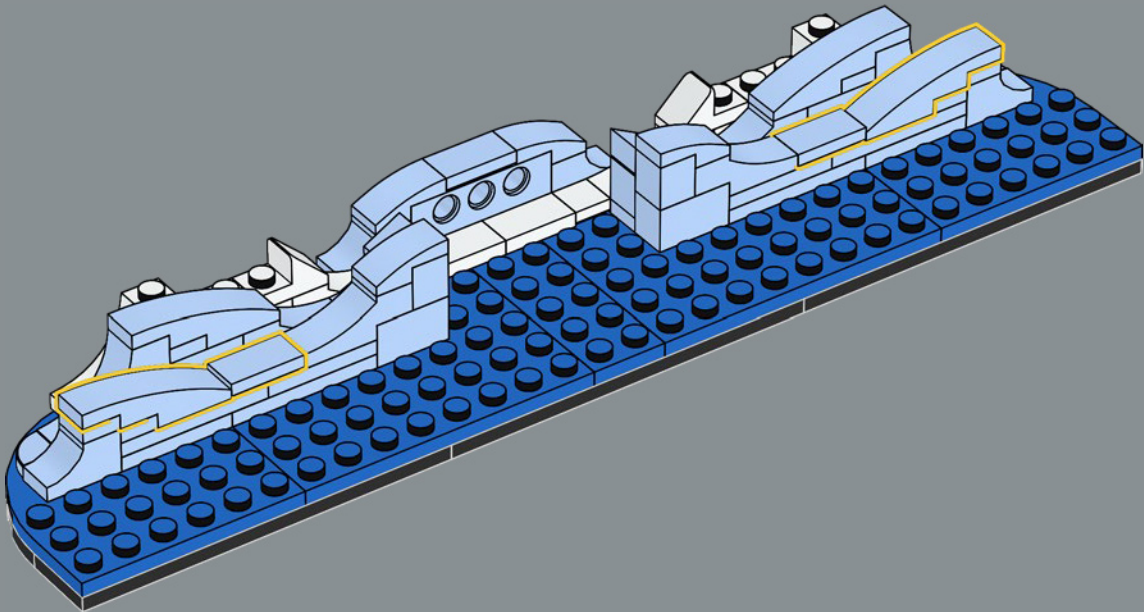

92

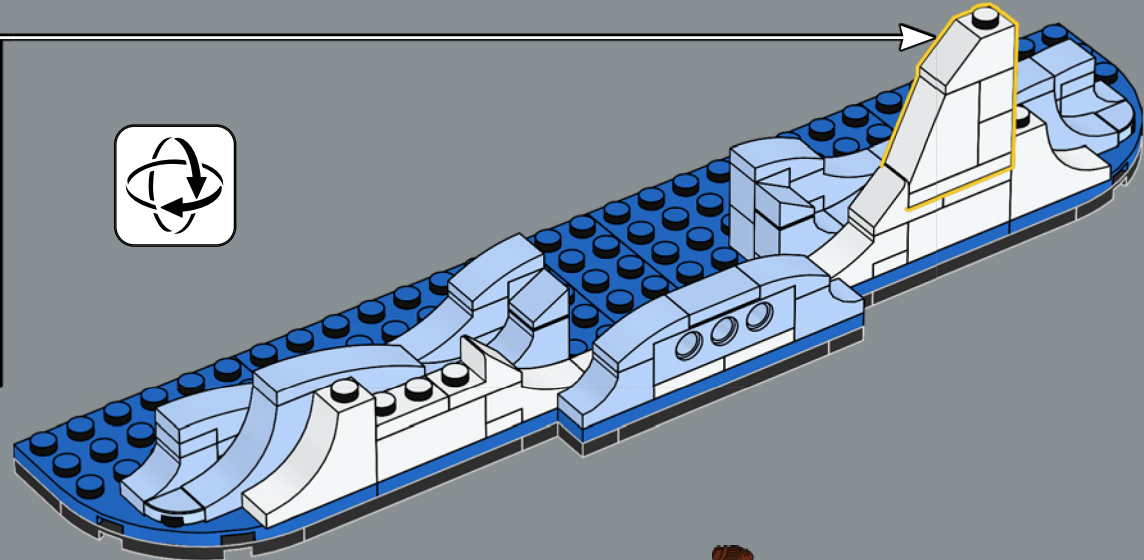
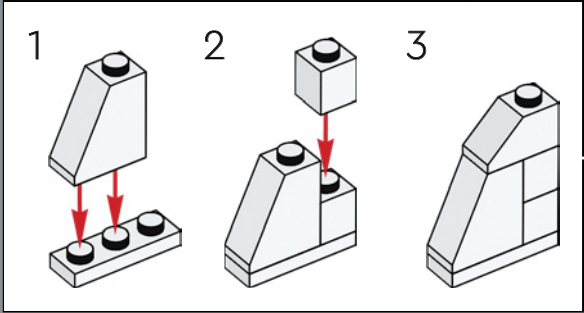

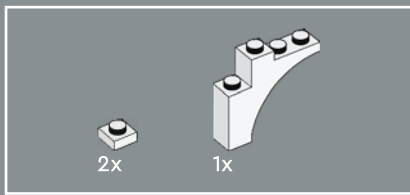

93

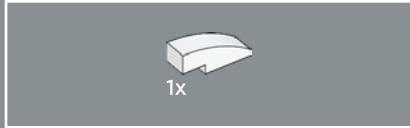
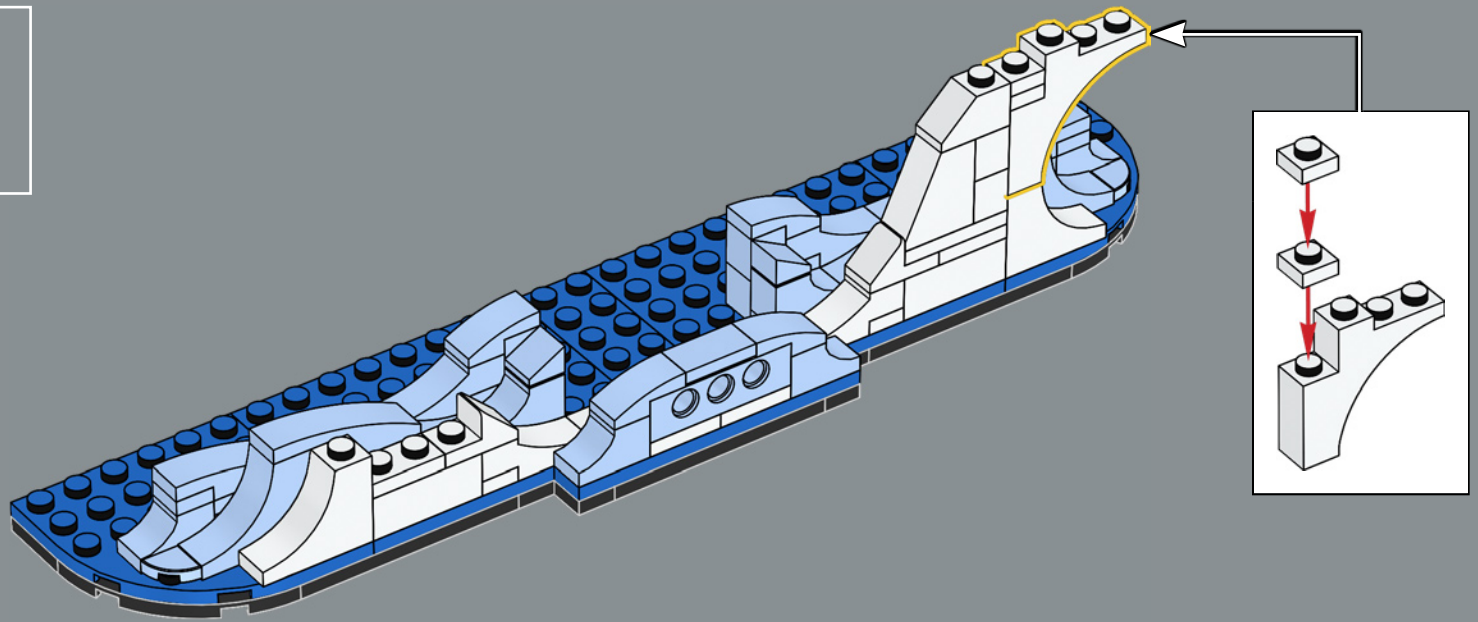

94

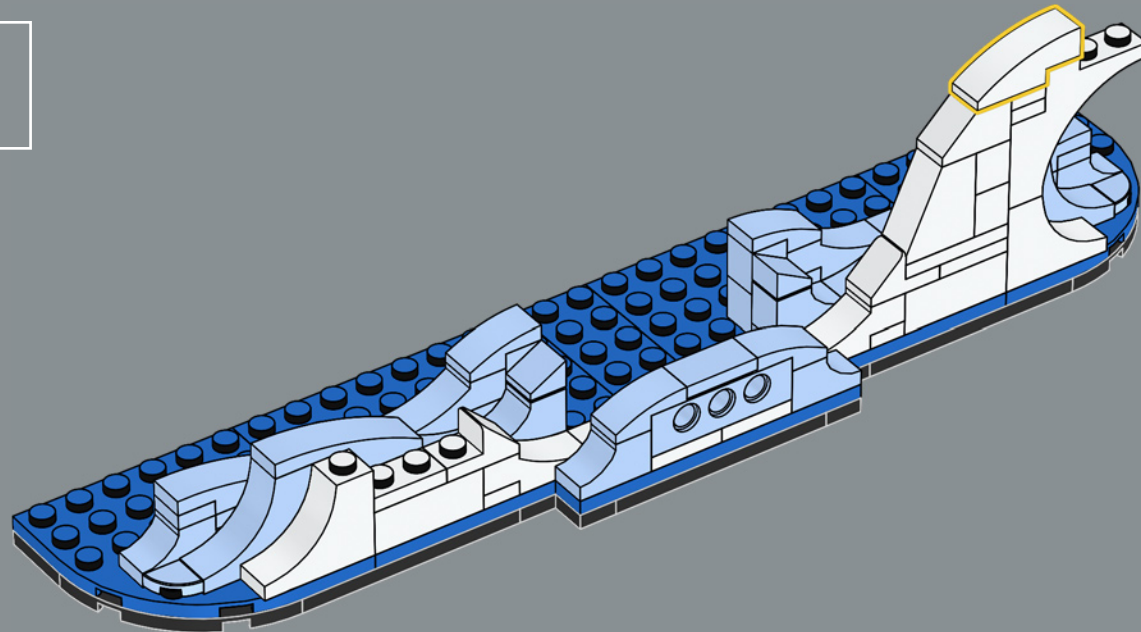

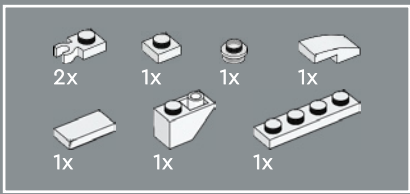

95

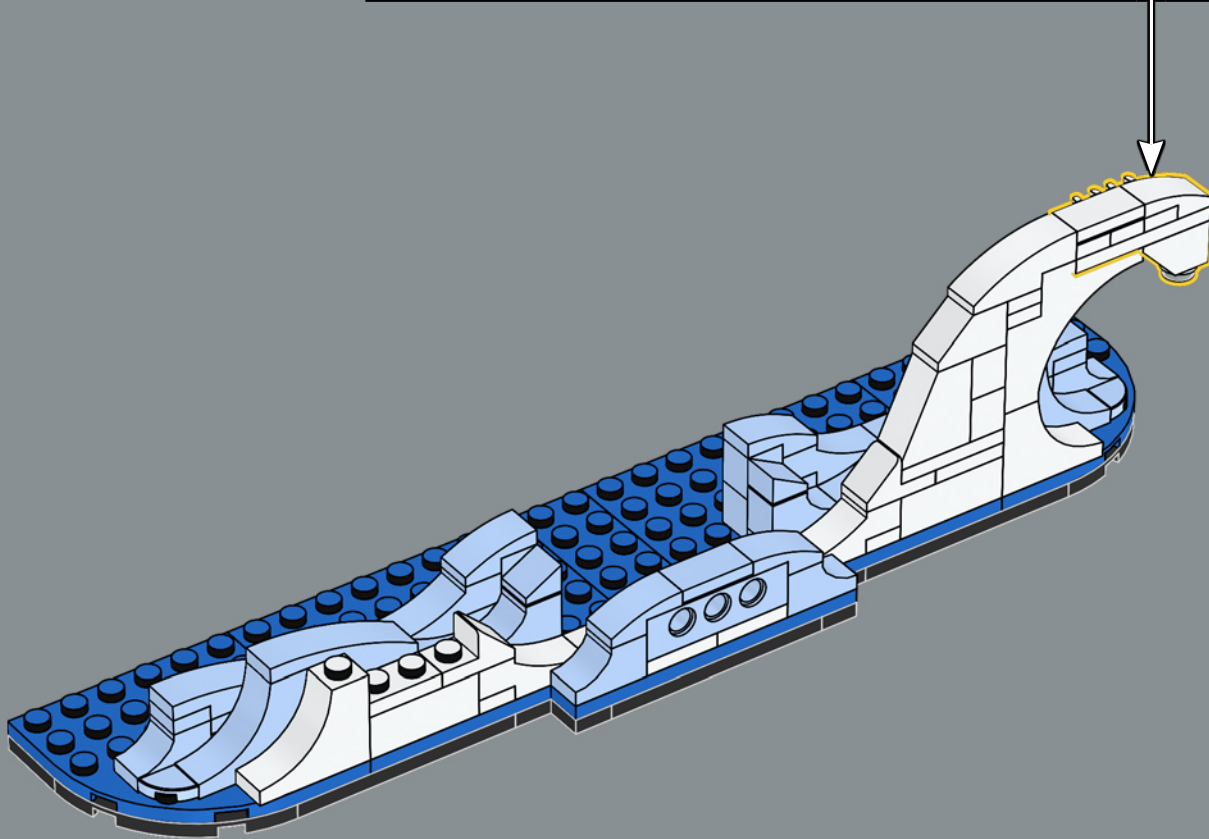
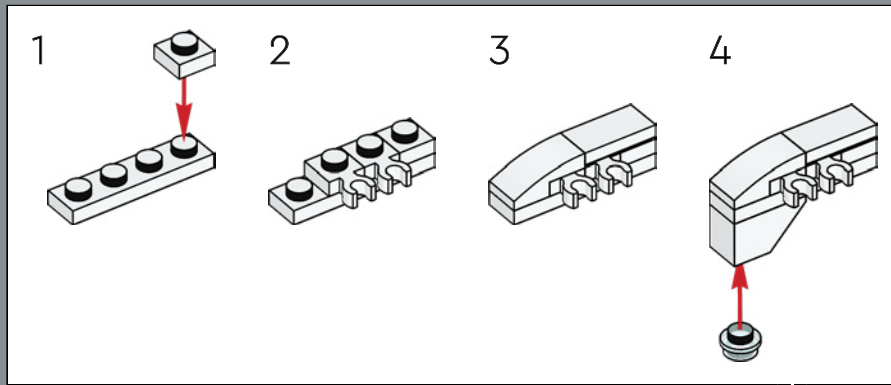

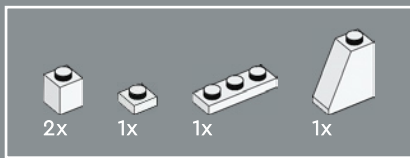

96

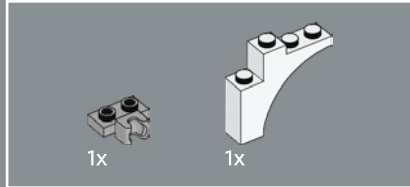
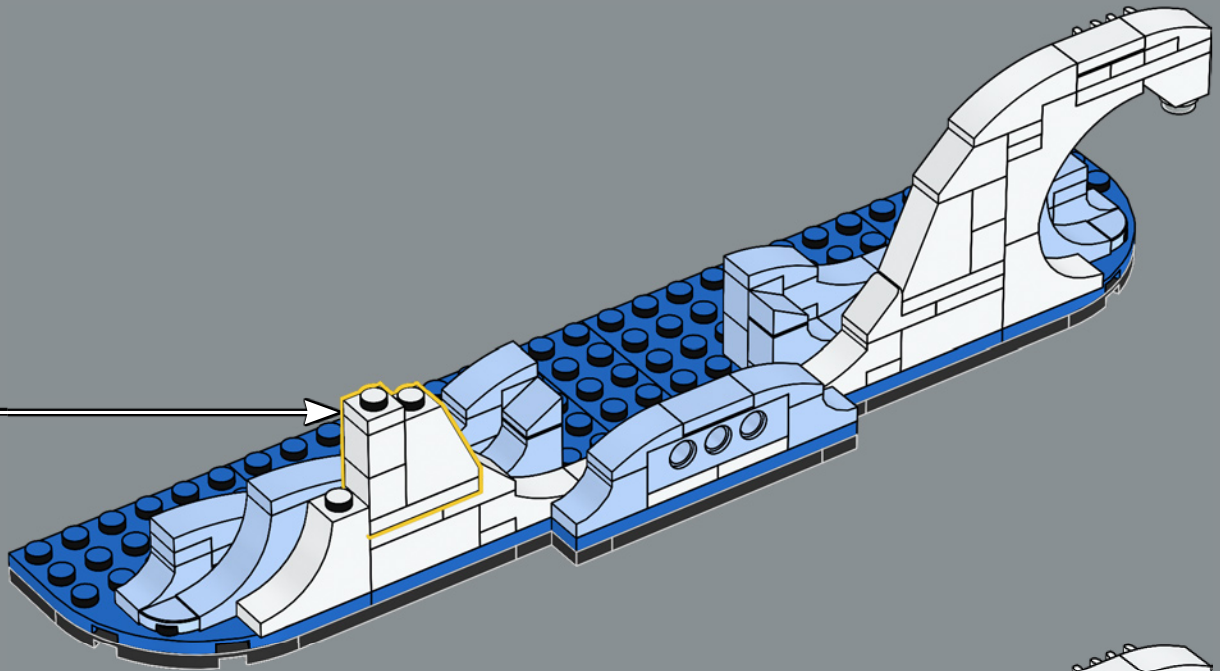
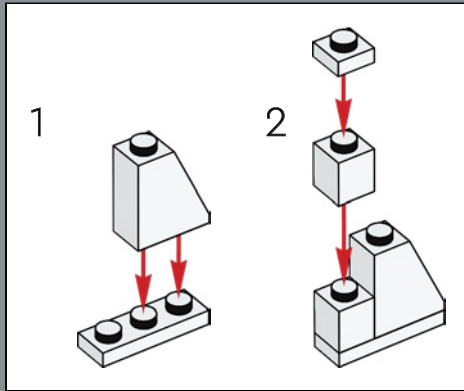

97

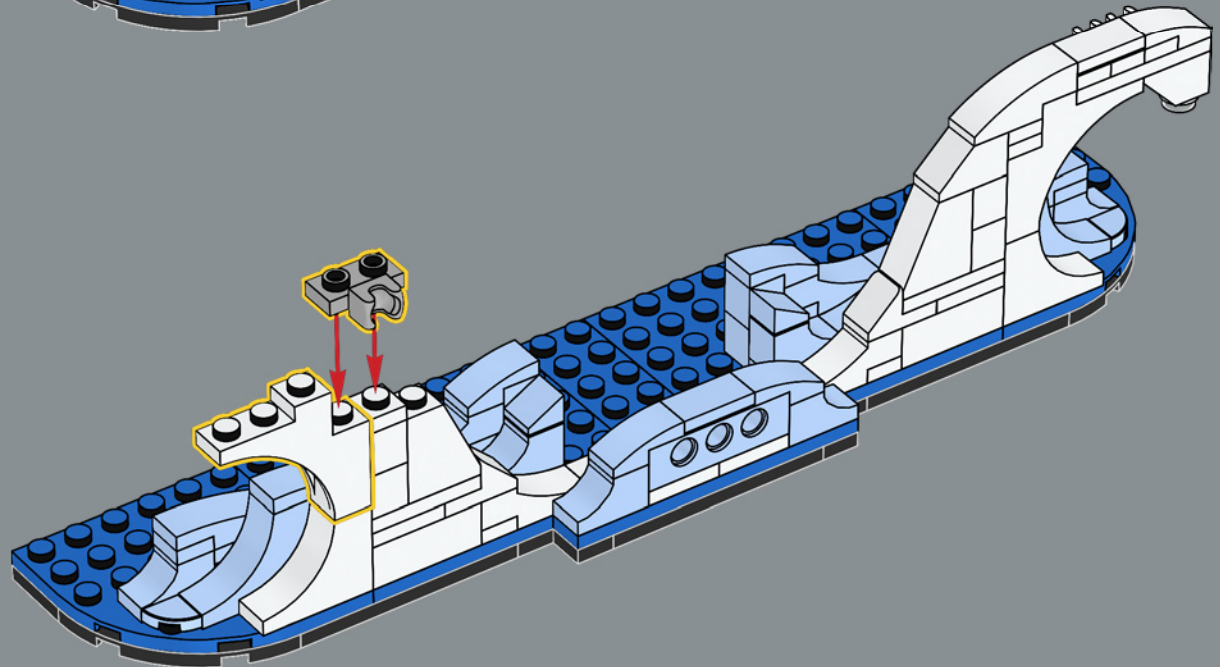

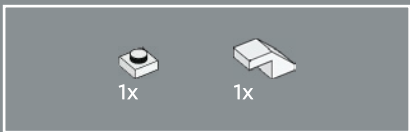

98

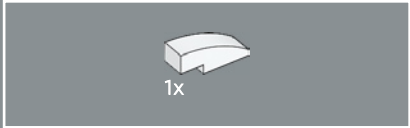
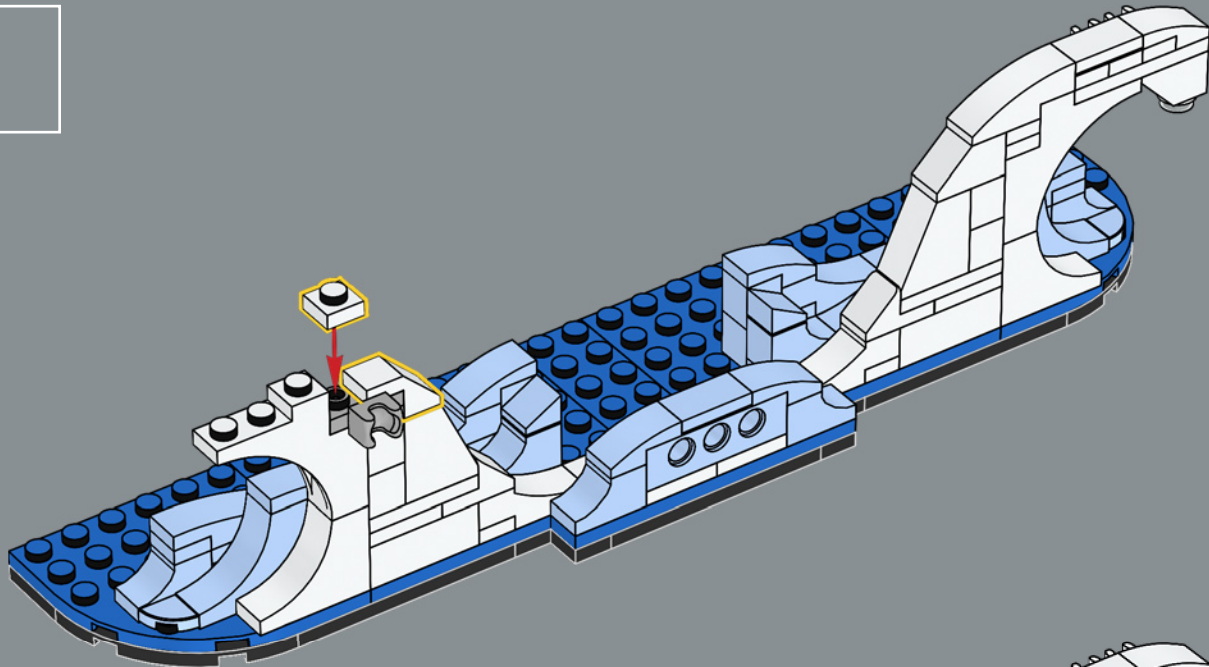

99

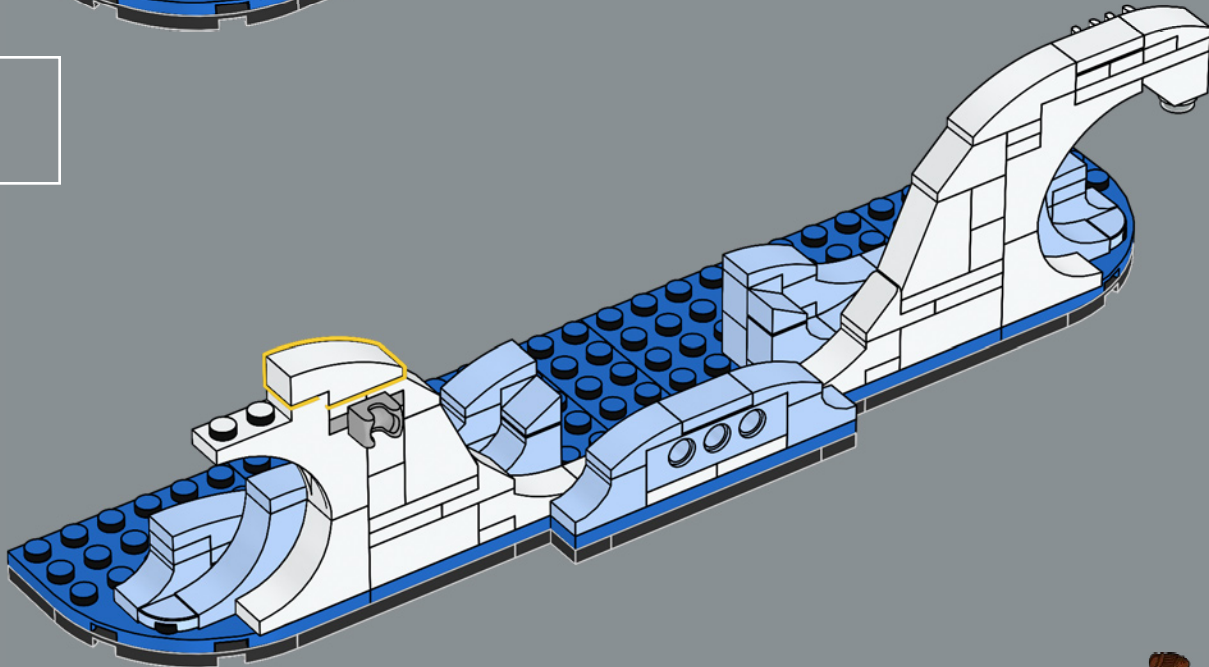

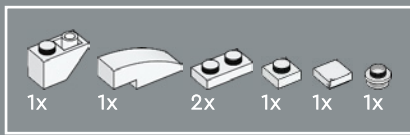

100

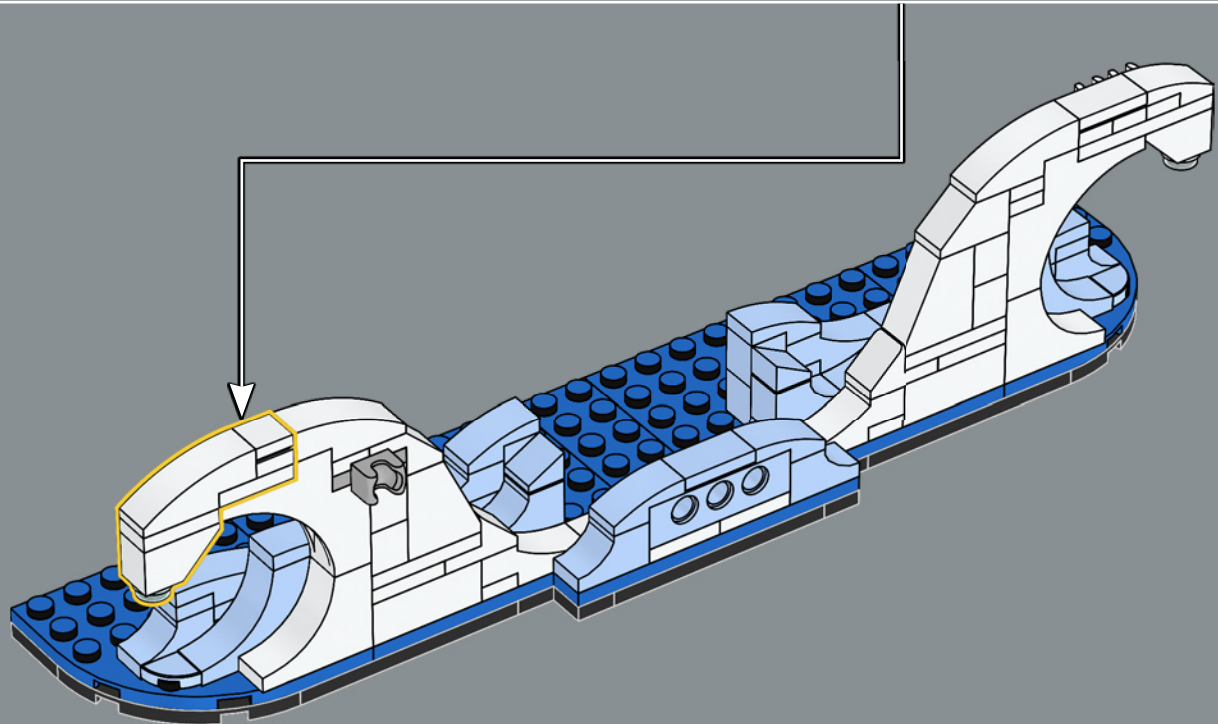
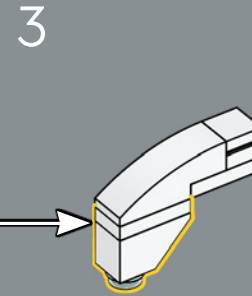
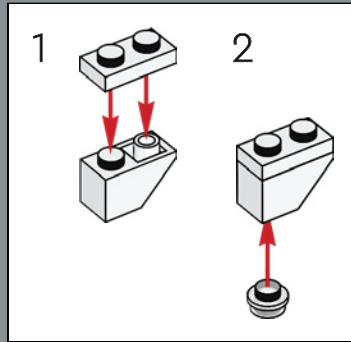
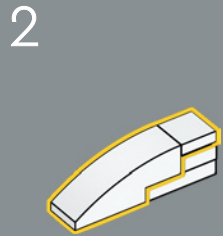
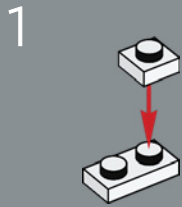

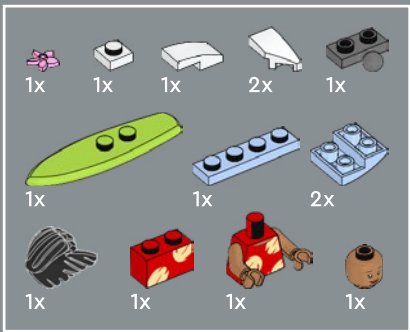

101

1

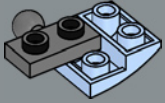

2

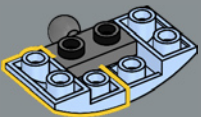

3

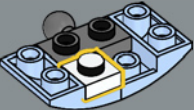

4

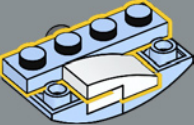

5

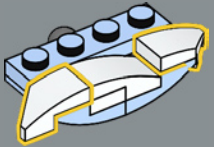

1

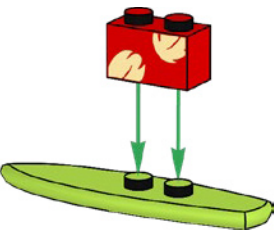

2

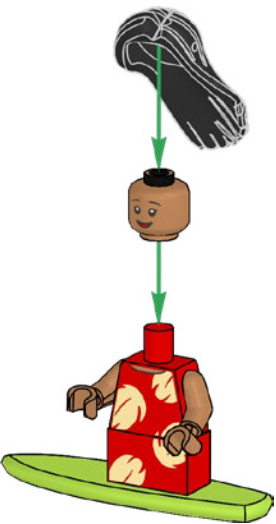





3

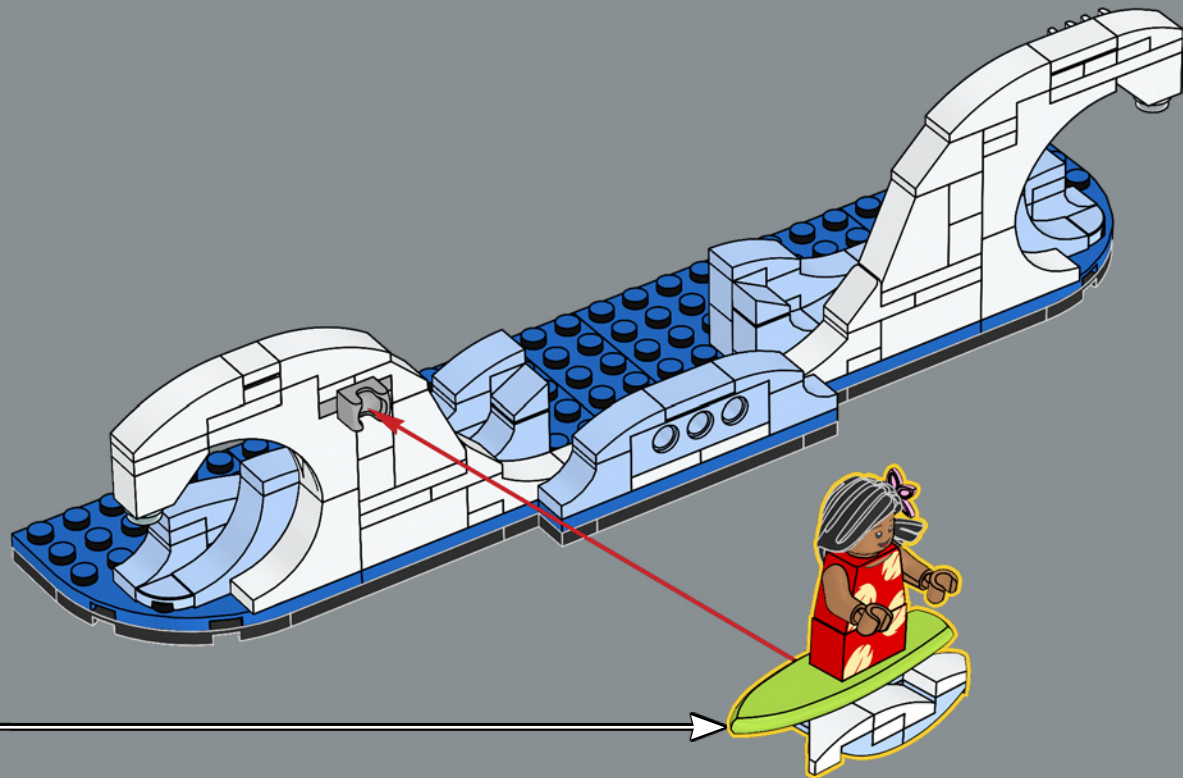

6





-  1x
-  1x
-  2x
-  1x
-  1x

102

| | |
|--|-------------------------------------|
|  | <input checked="" type="checkbox"/> |
|  | <input type="checkbox"/> |

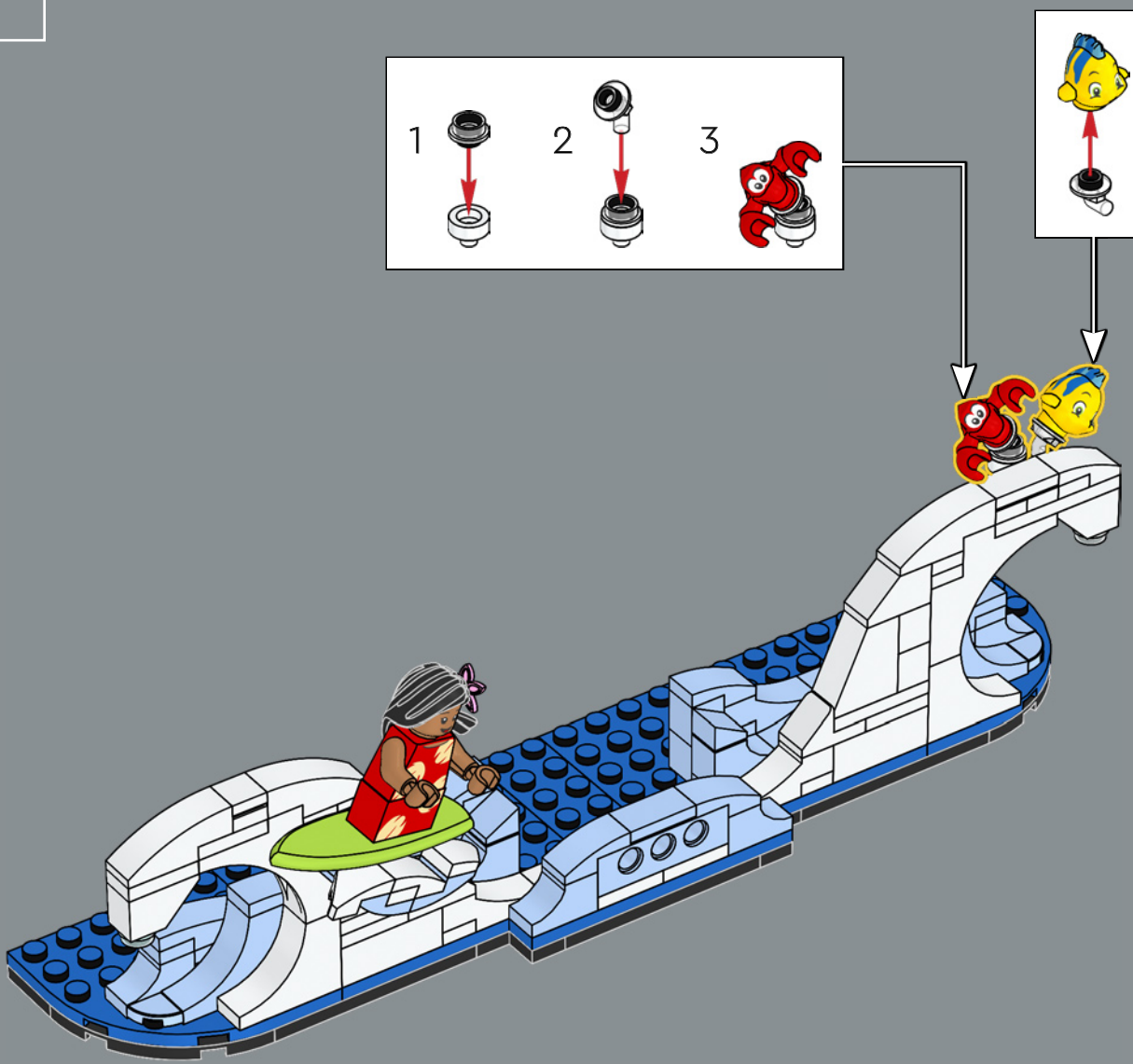
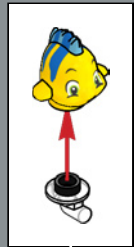
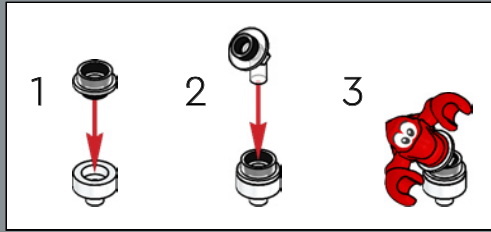

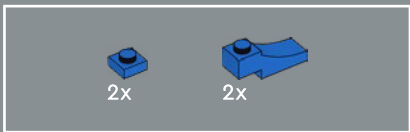

103

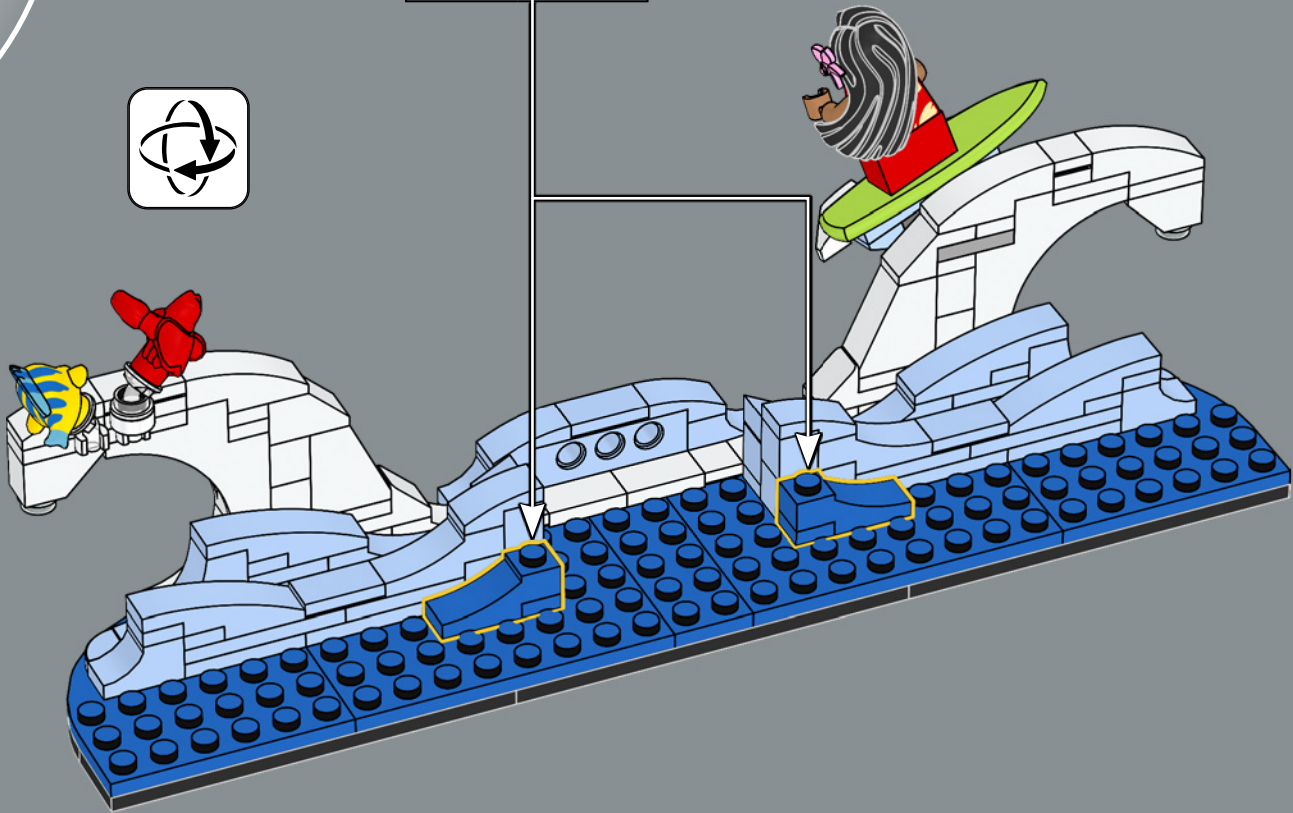
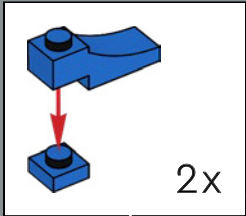

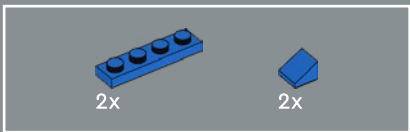

104

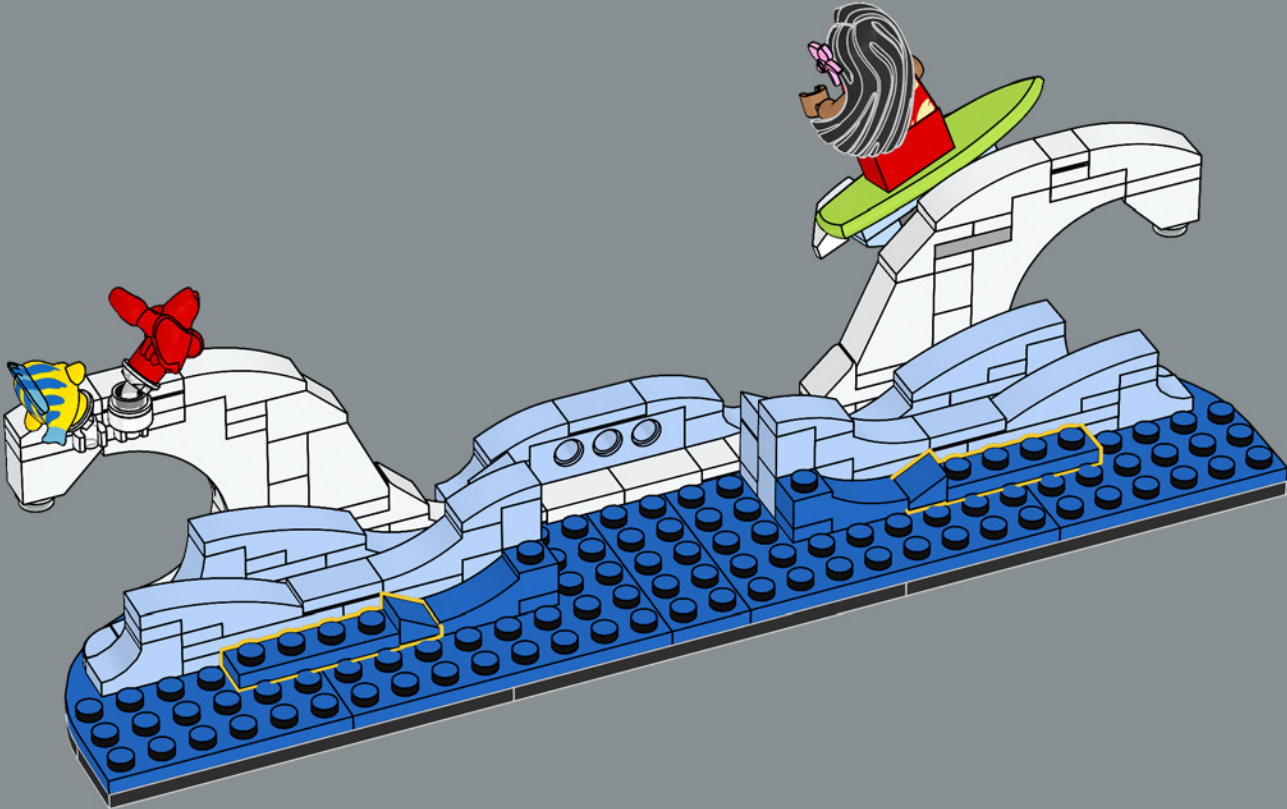

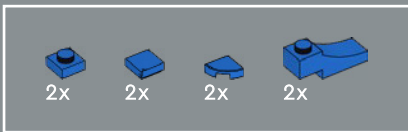

105

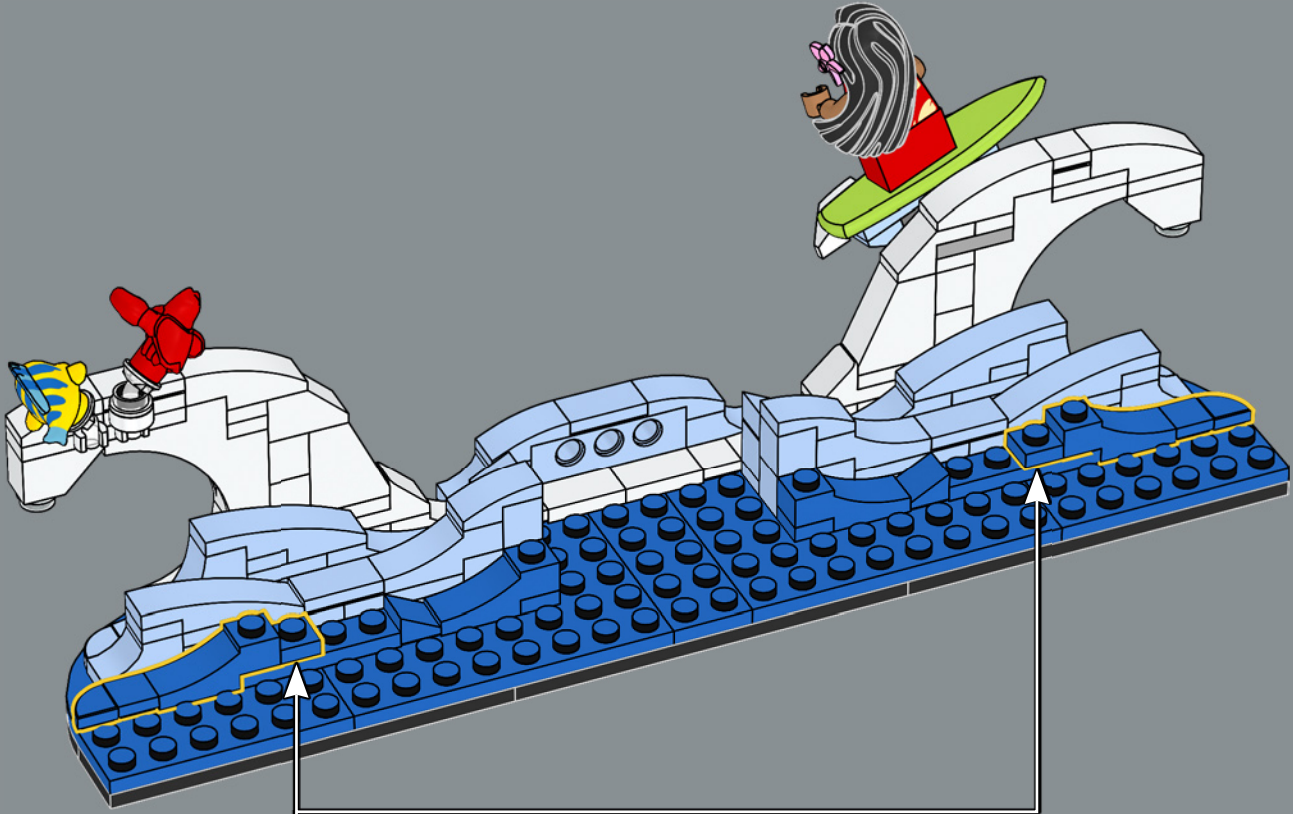

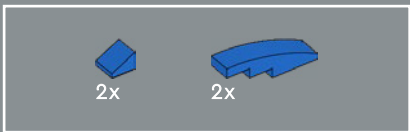

106

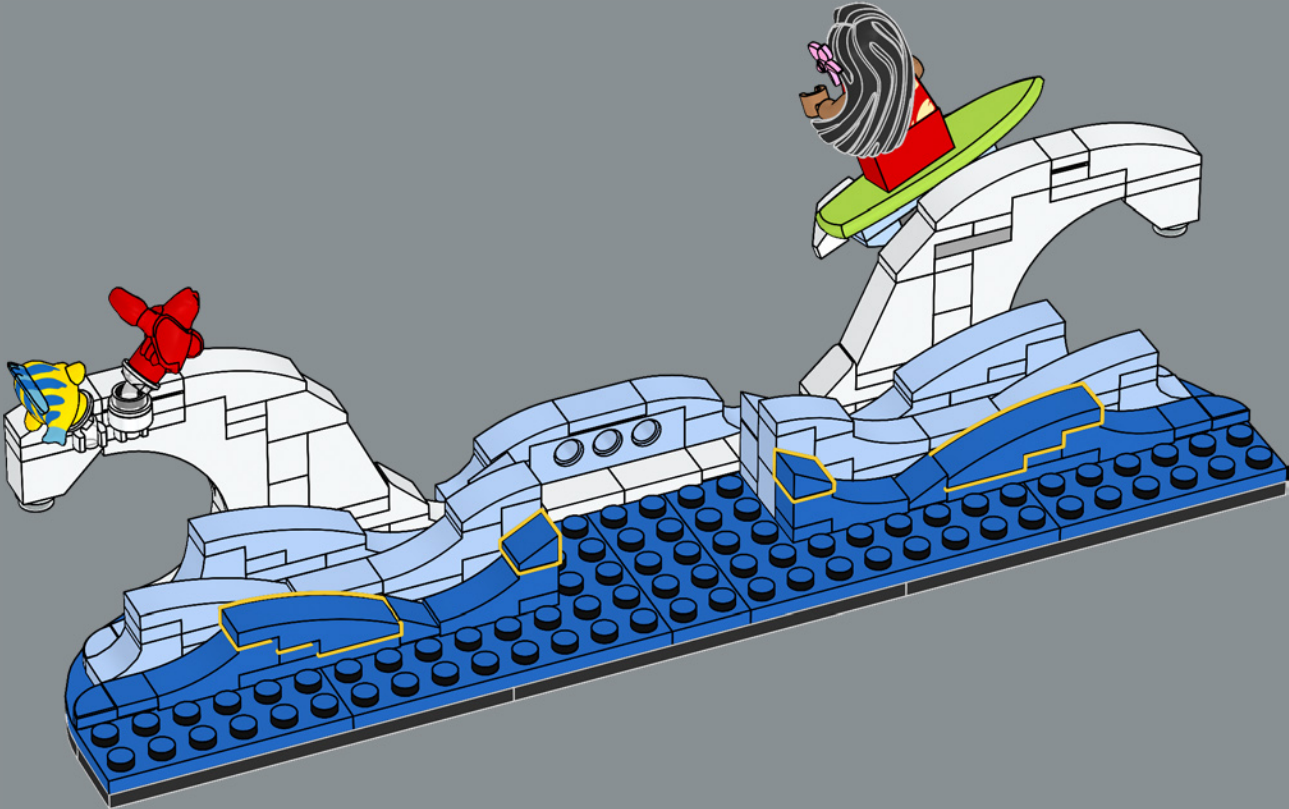

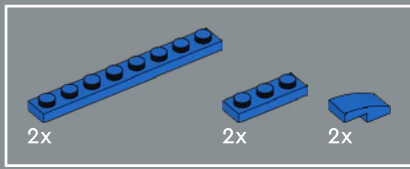

107

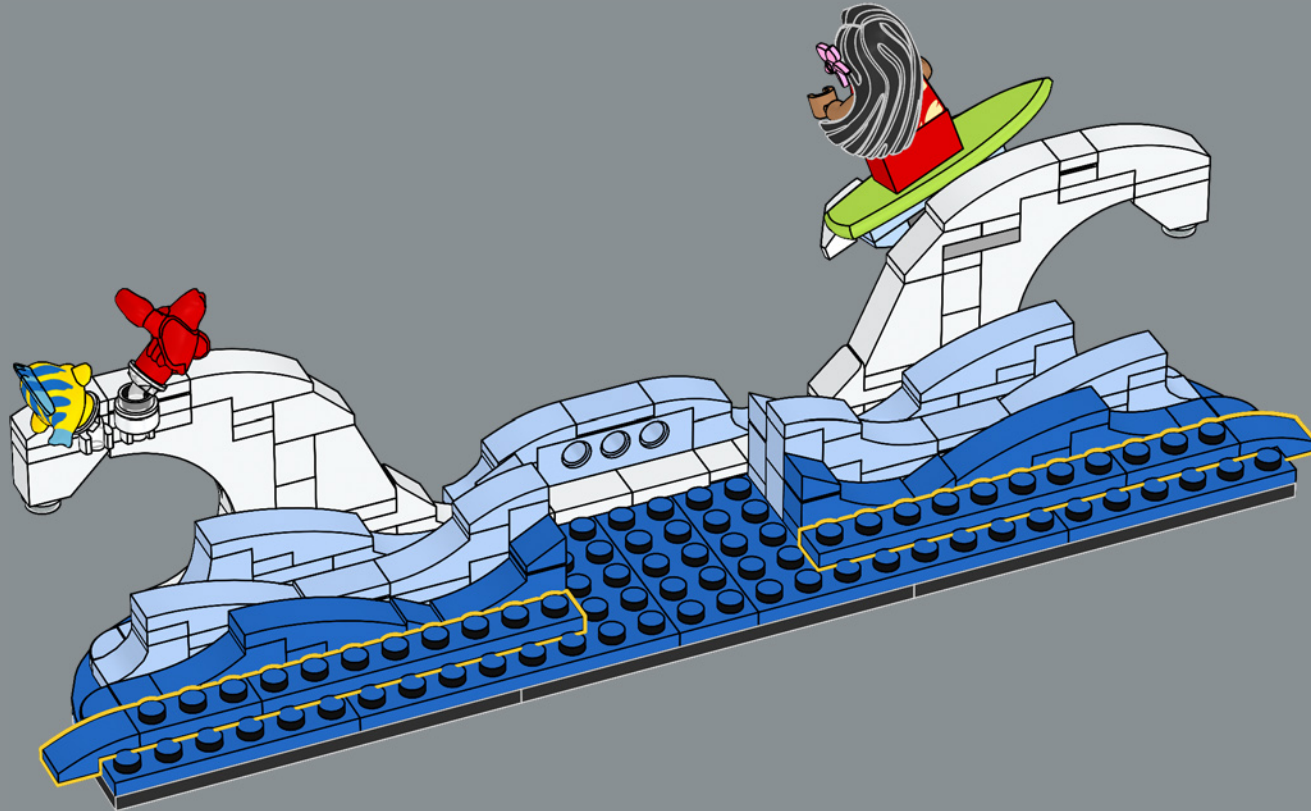

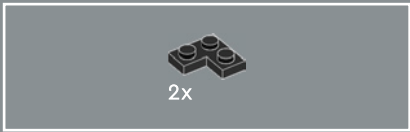

108

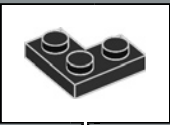
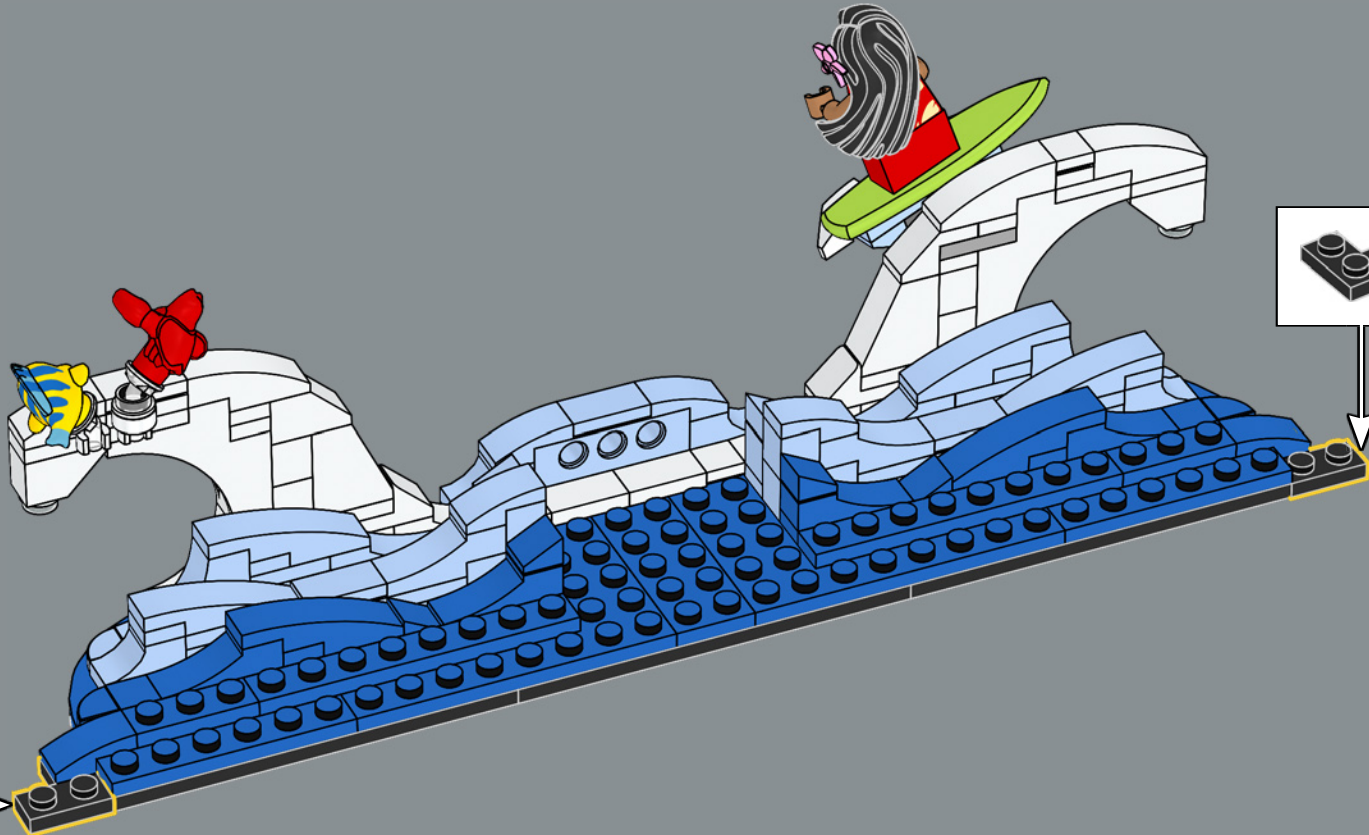

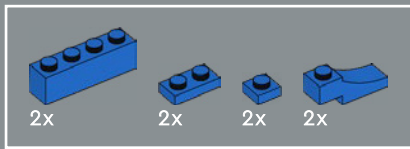

109

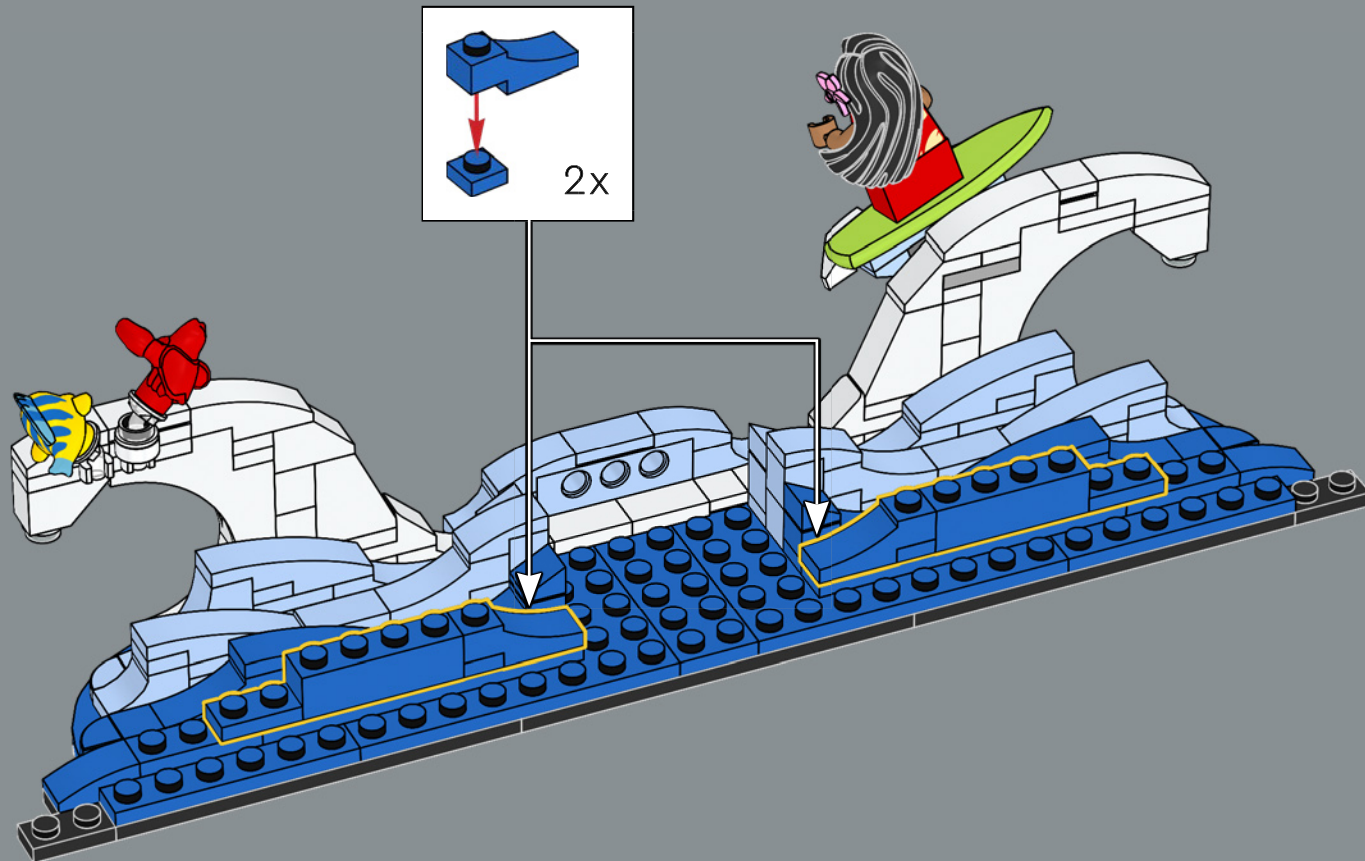

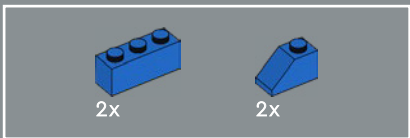

110

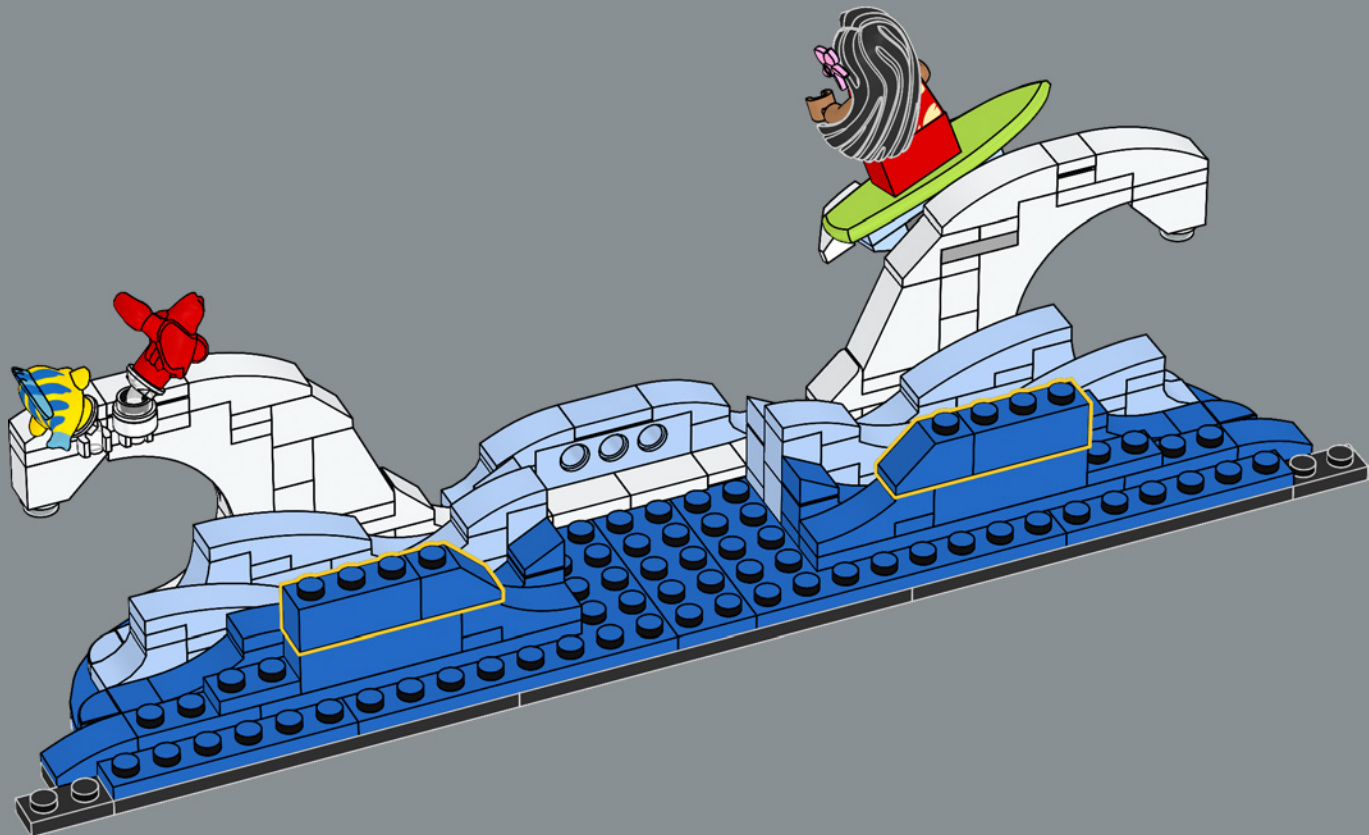



111

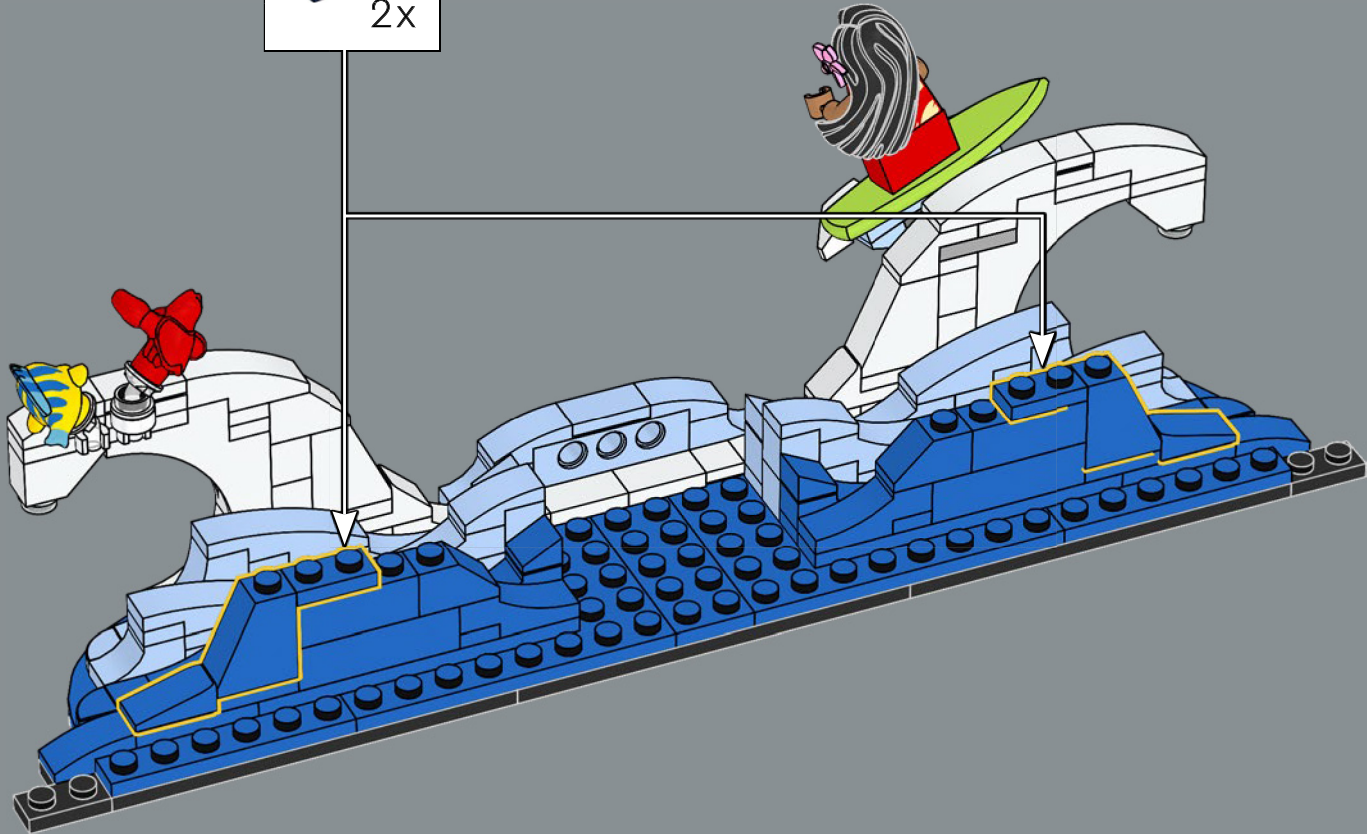
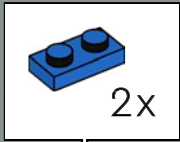

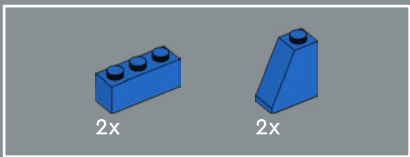

112

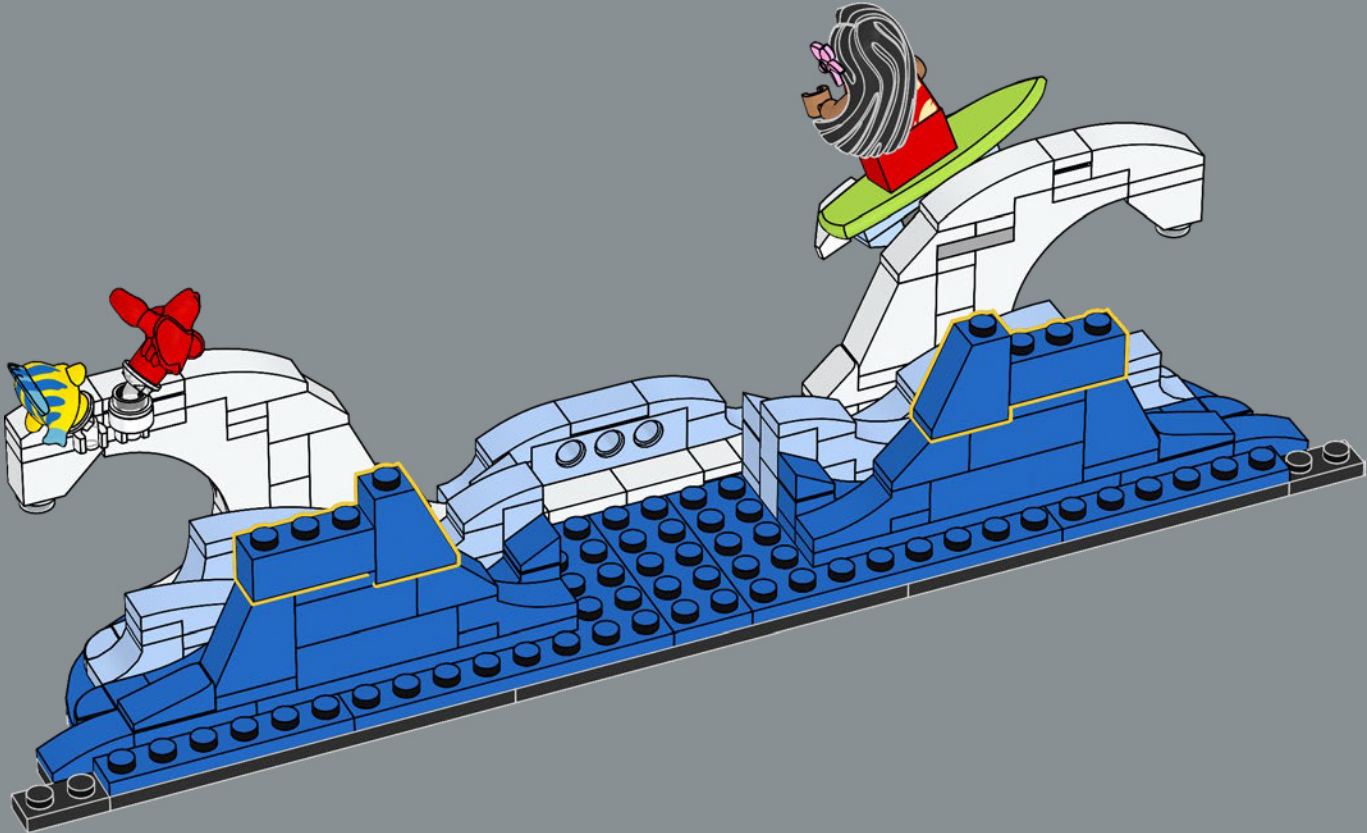

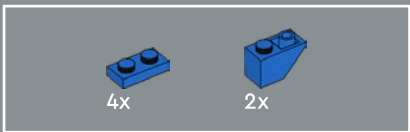

113

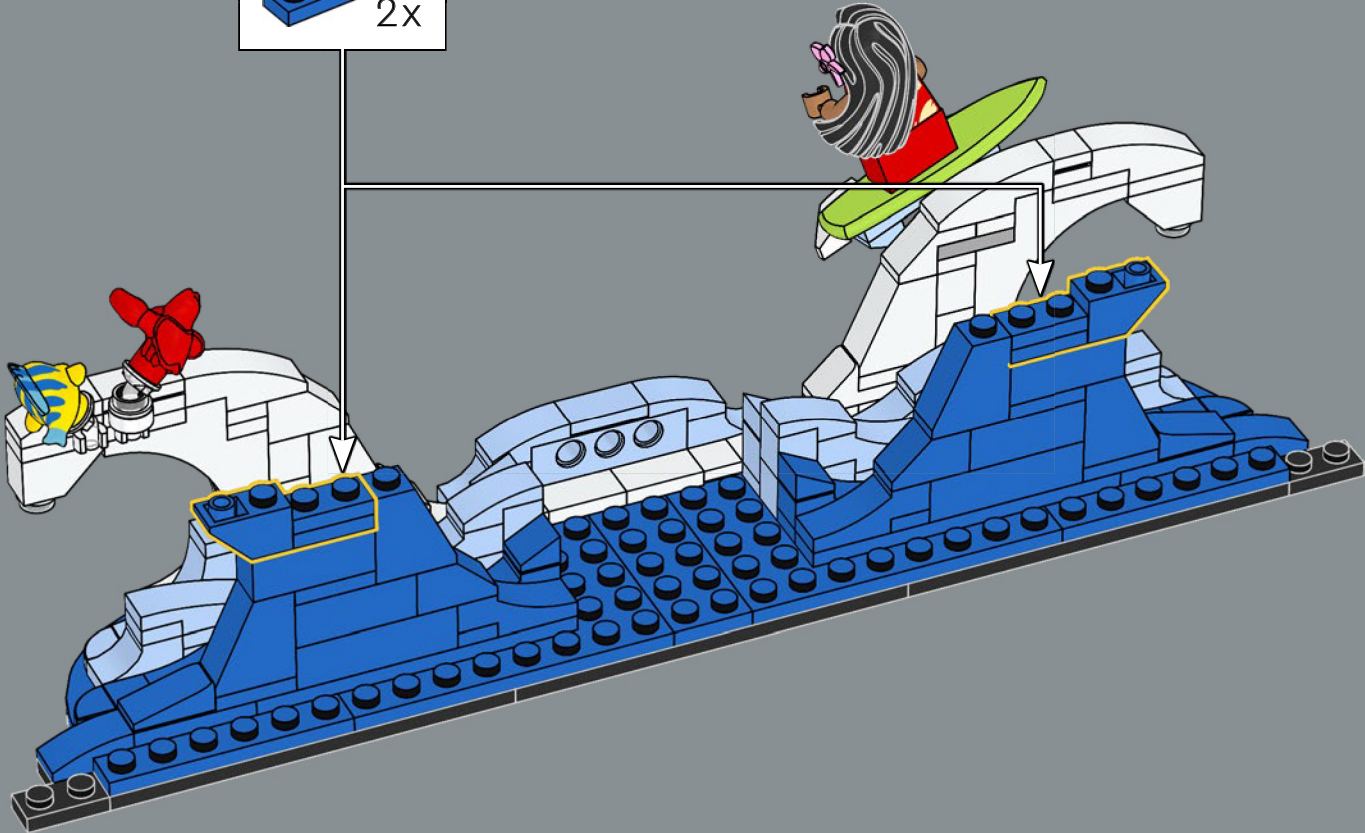
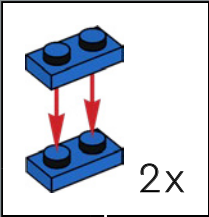

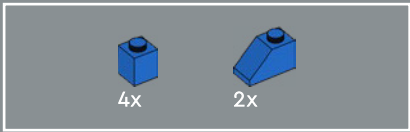

114

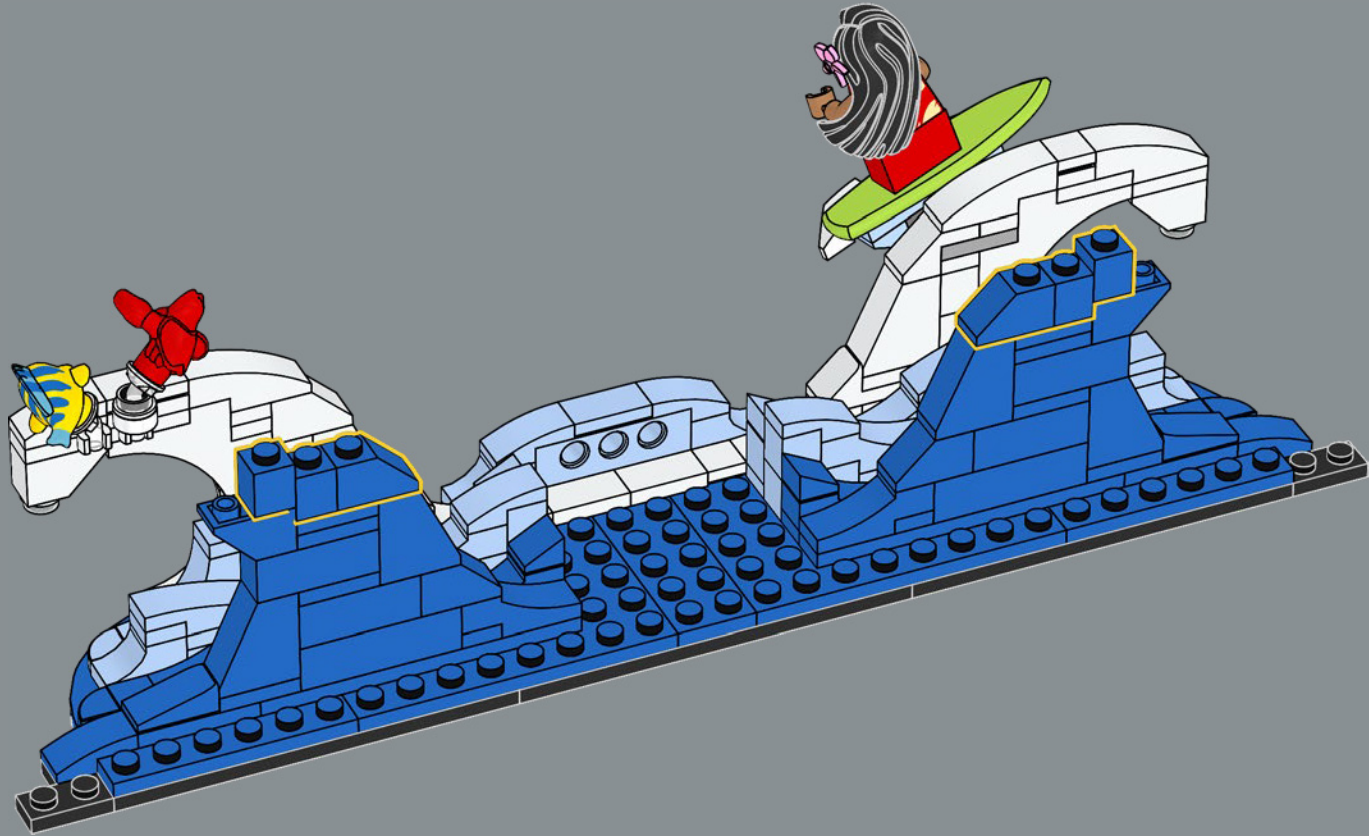

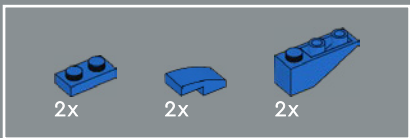

115

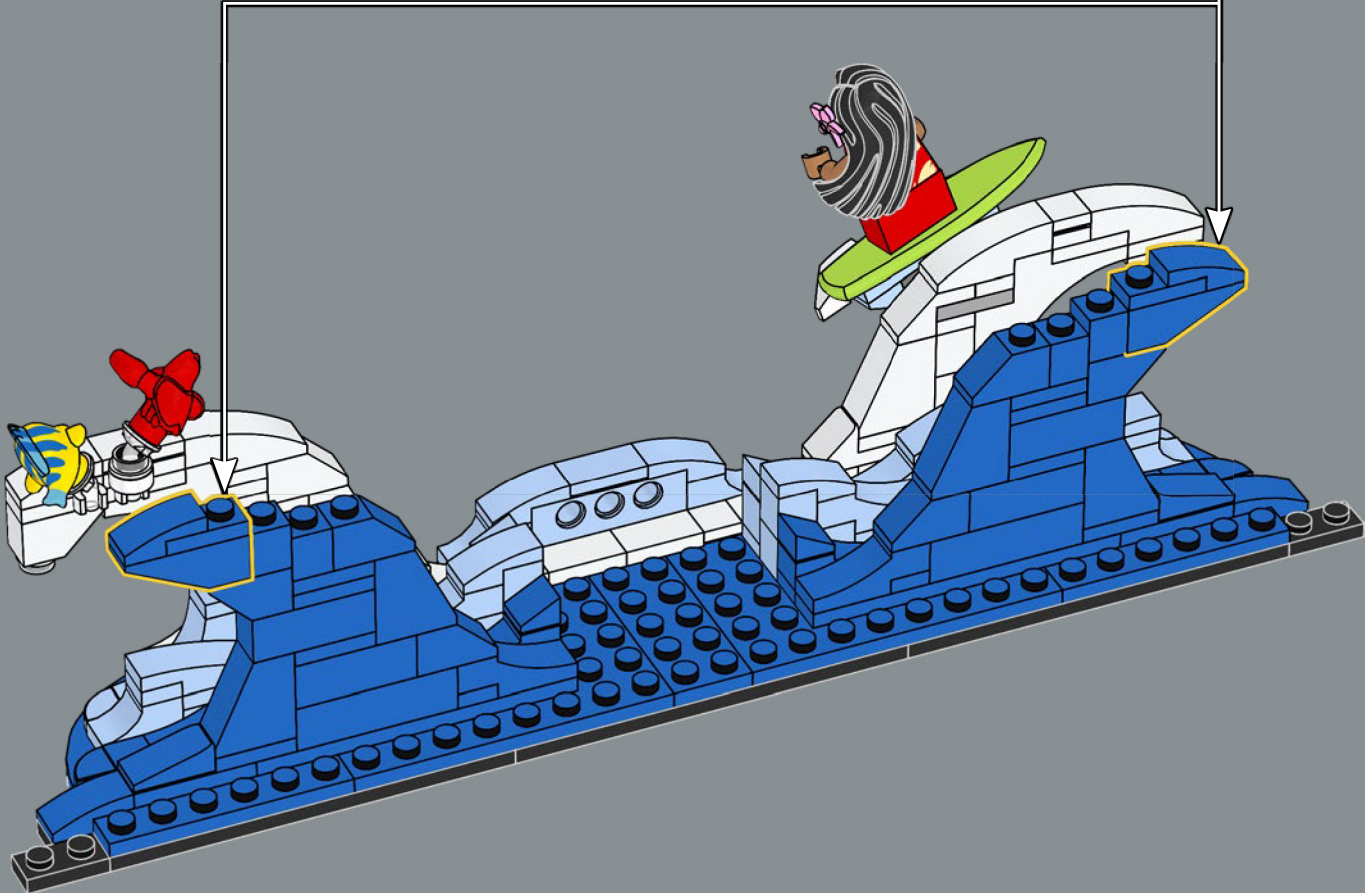
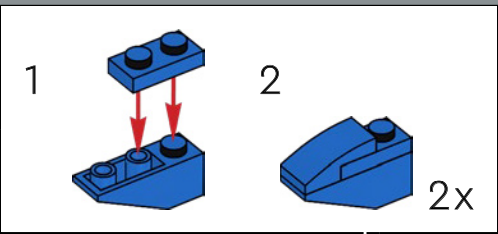

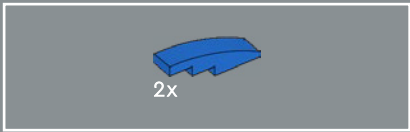

116

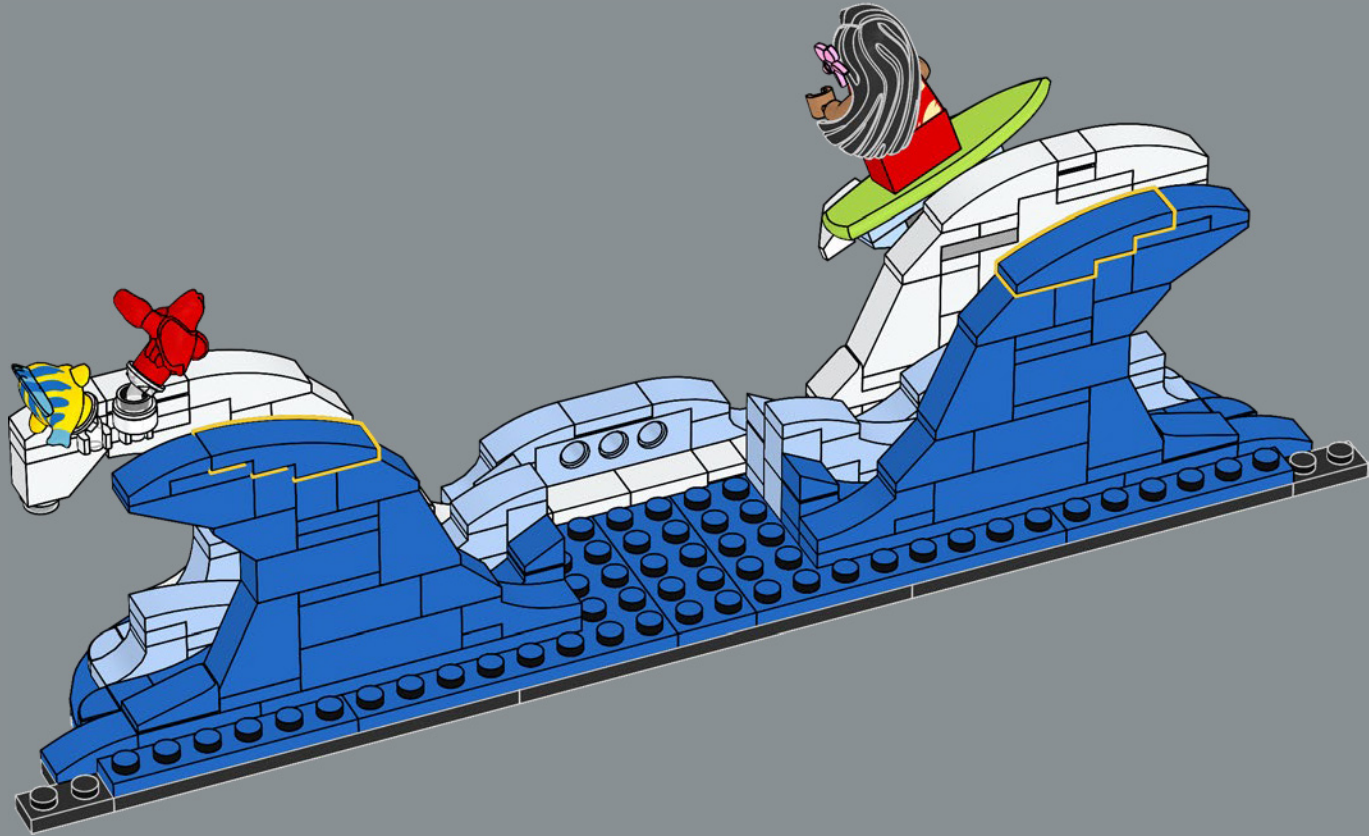

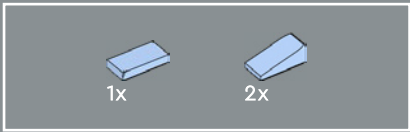

117

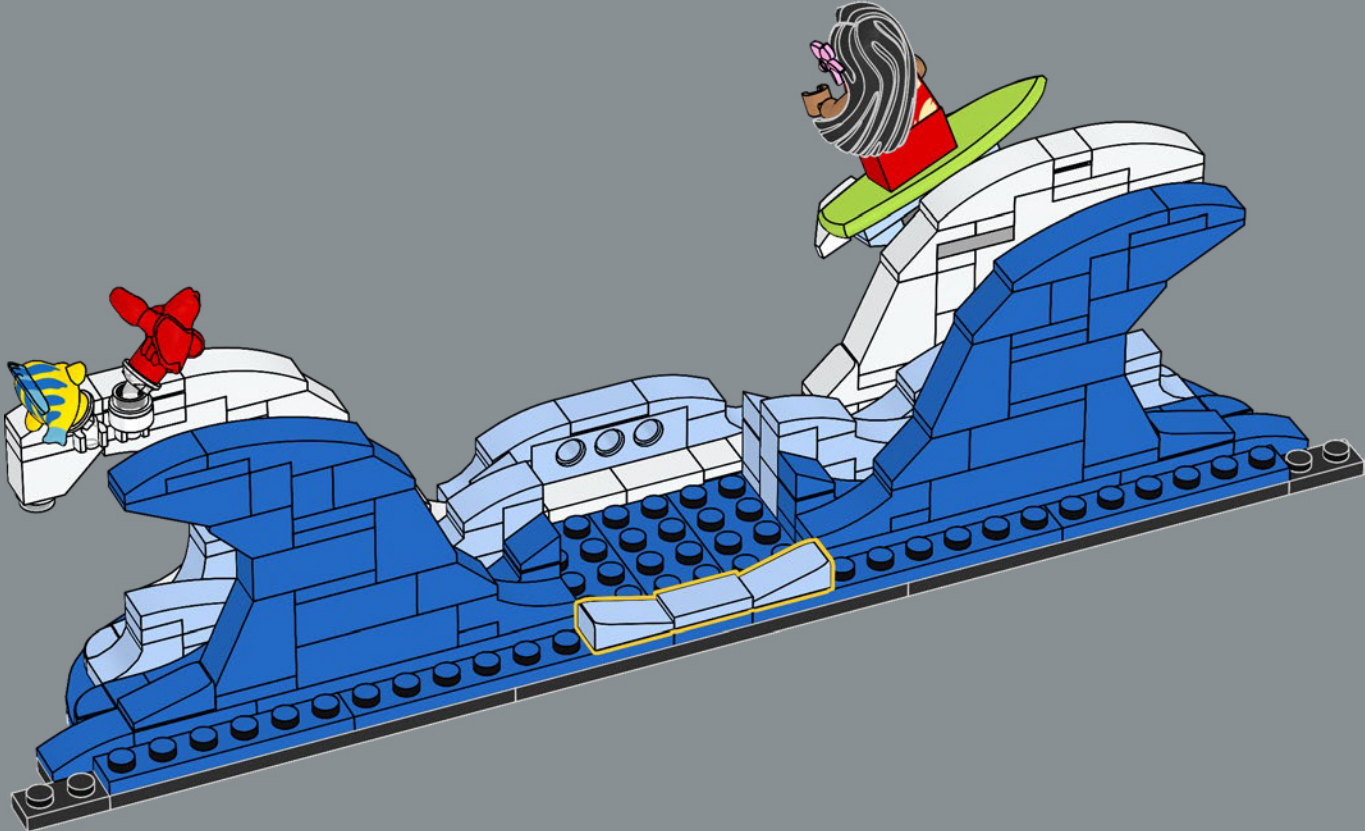

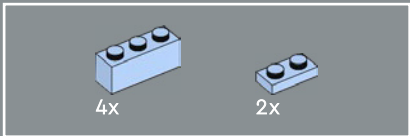

118

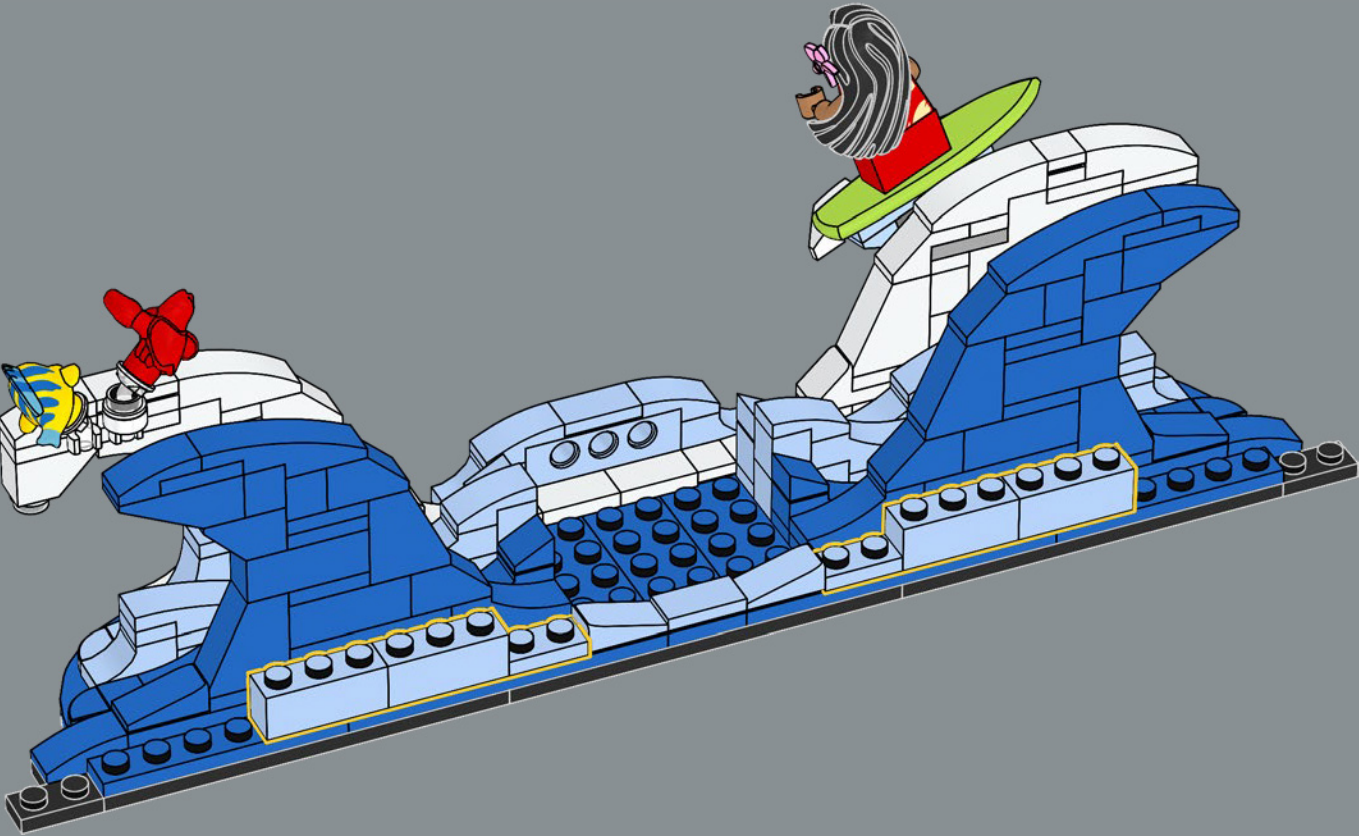

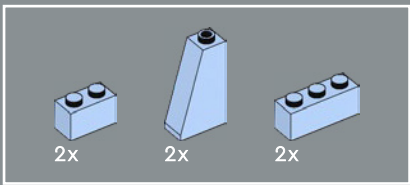

119

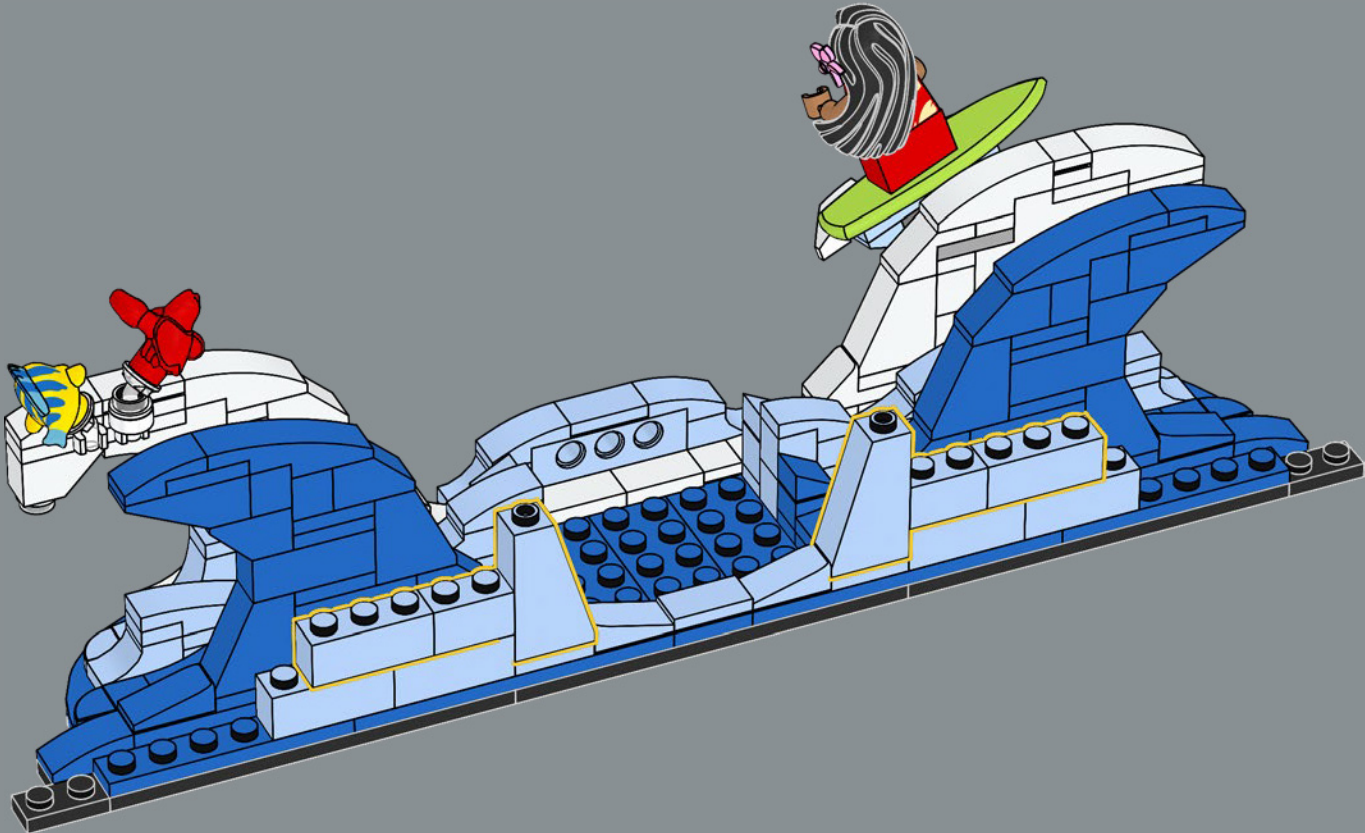

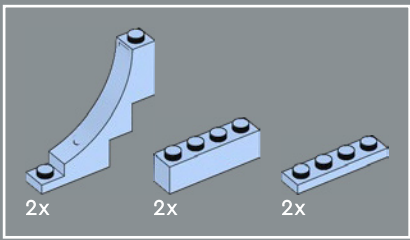

120

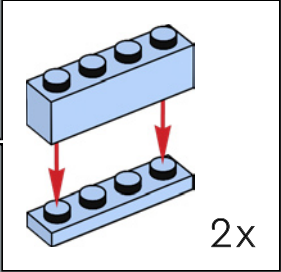
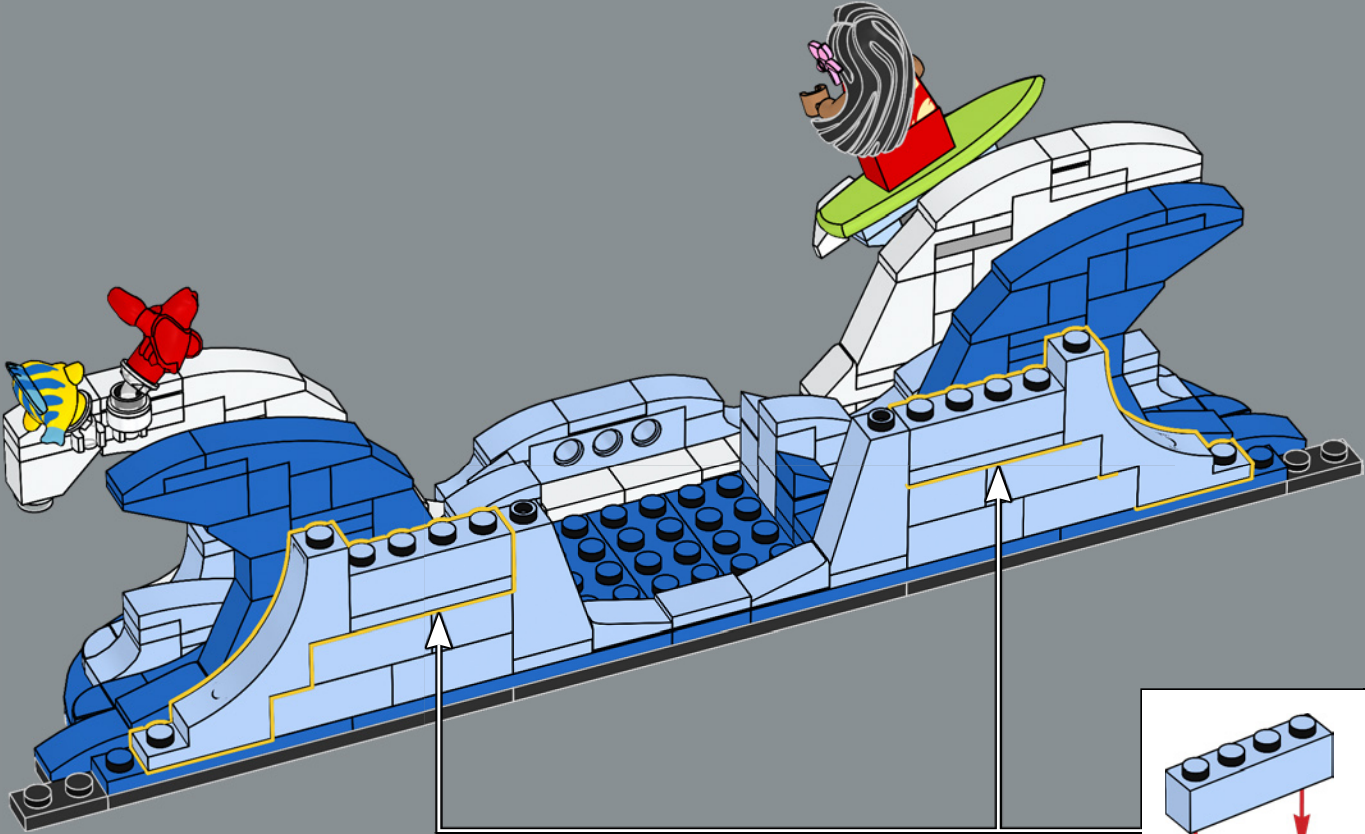

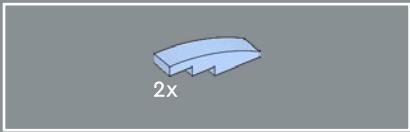

121

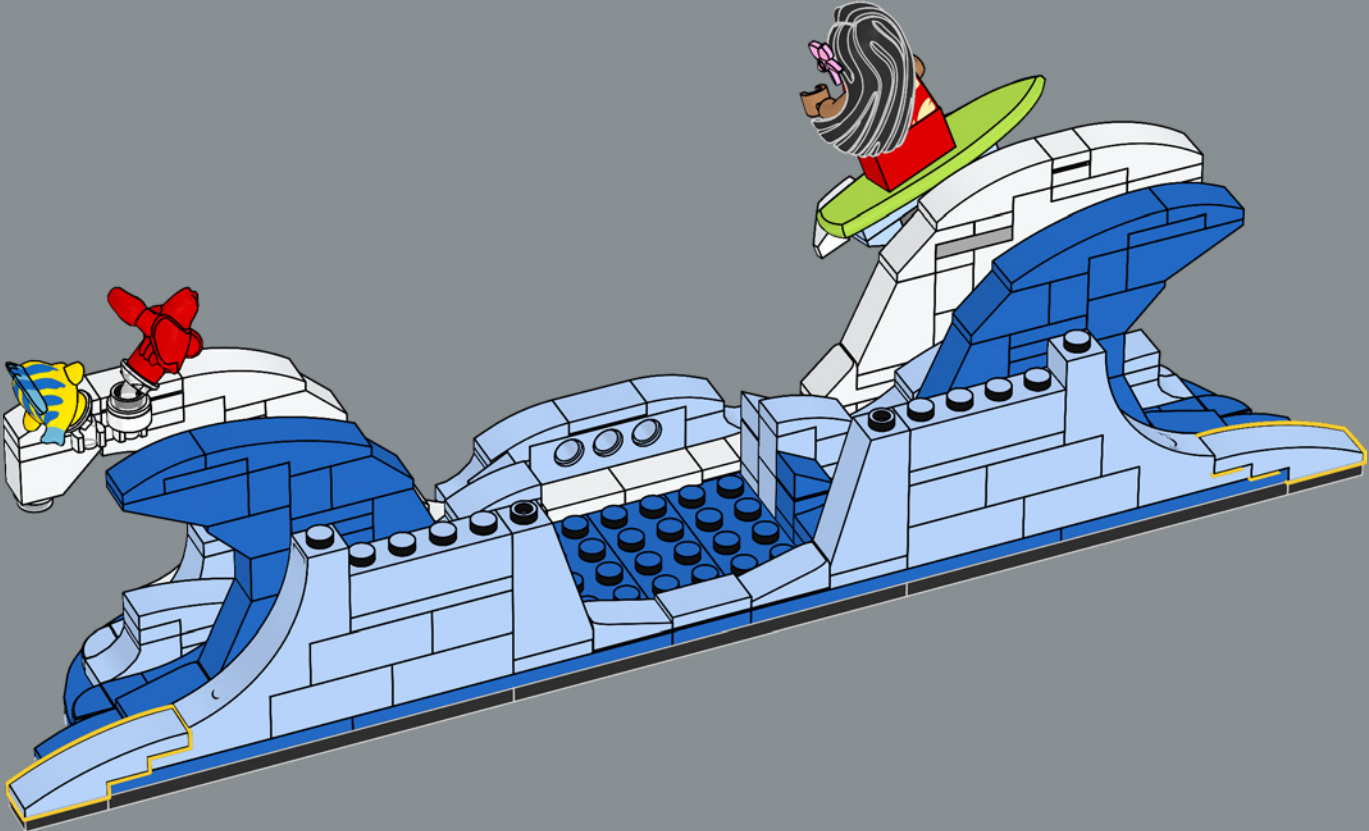

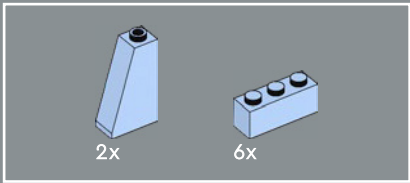

122

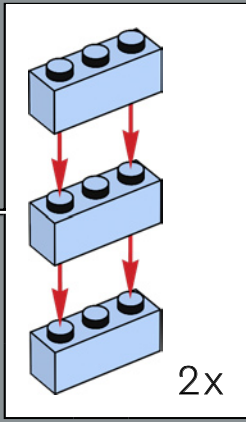
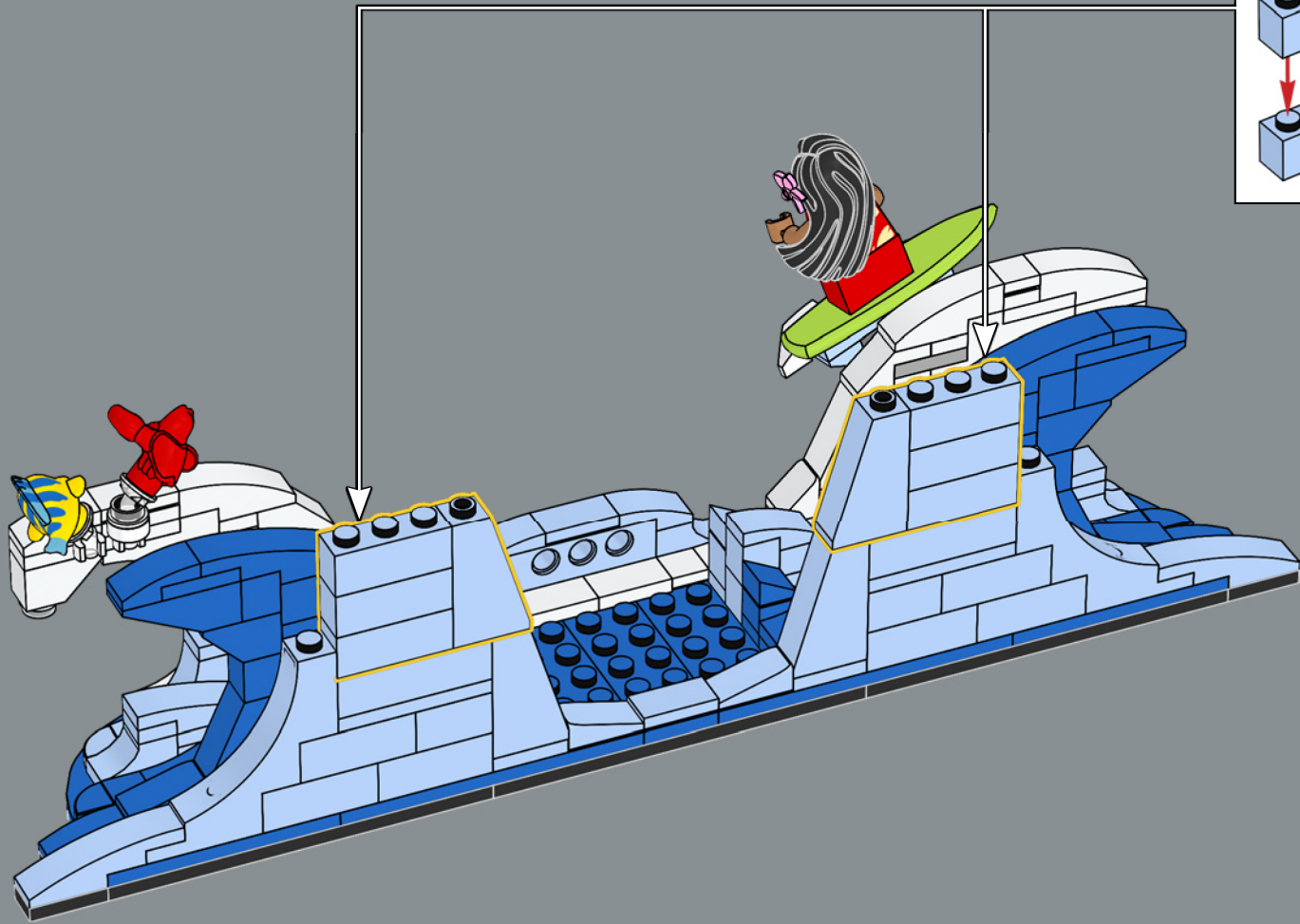

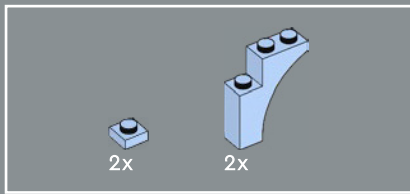

123

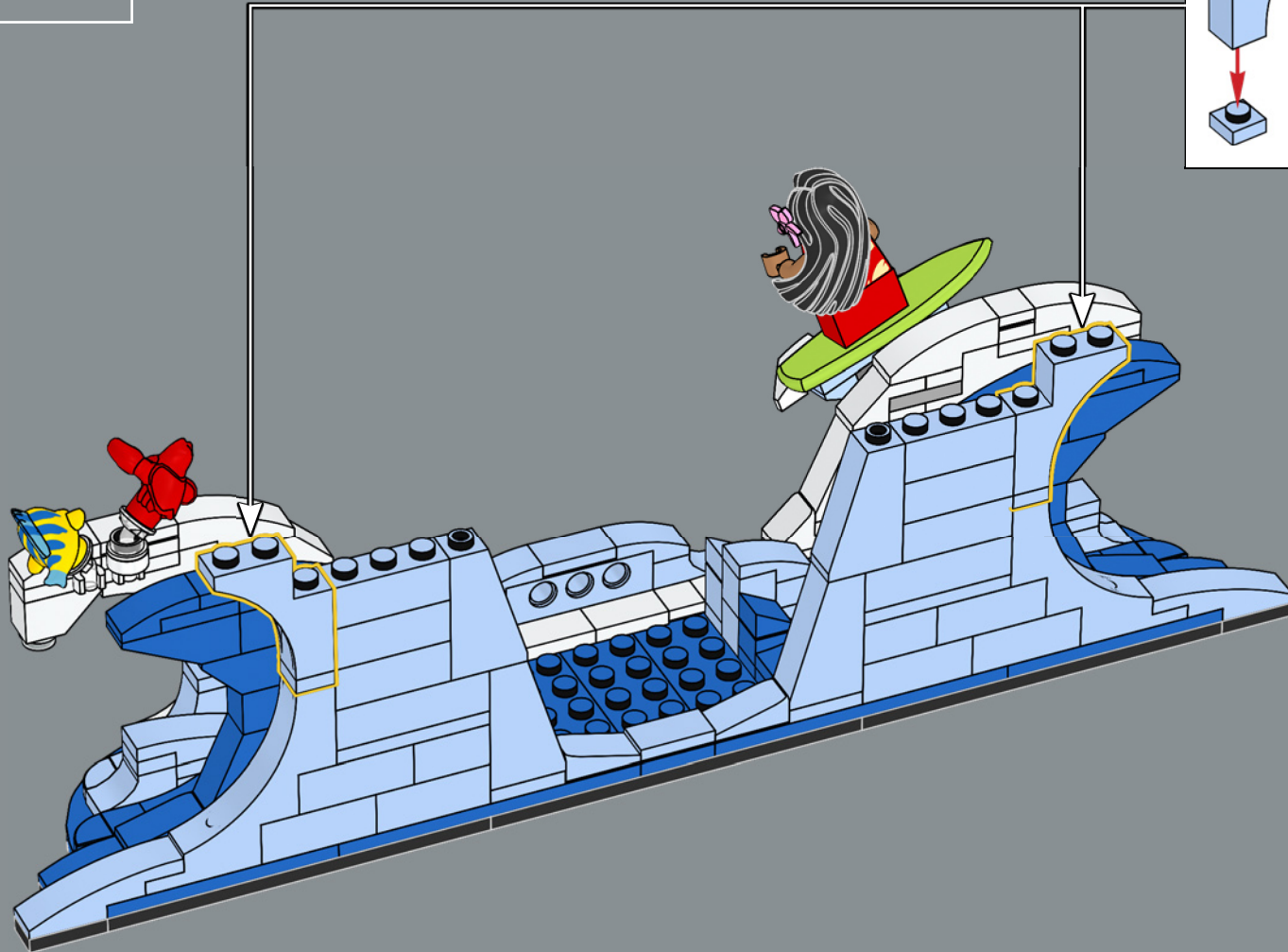
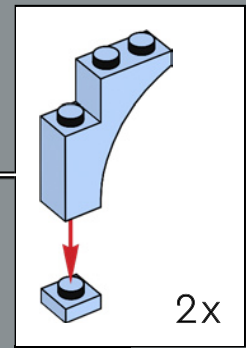

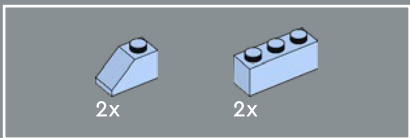

124

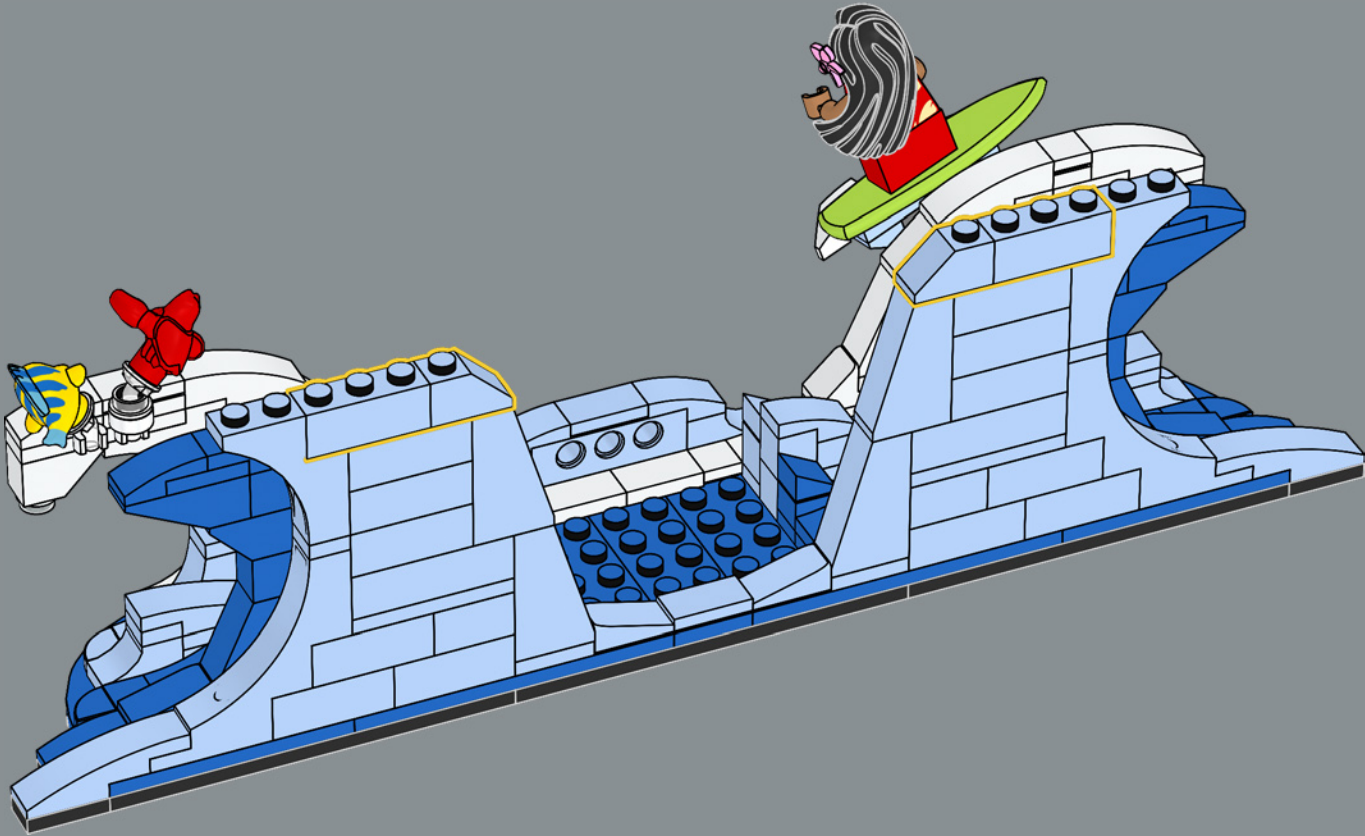

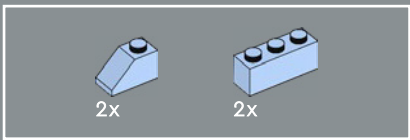

125

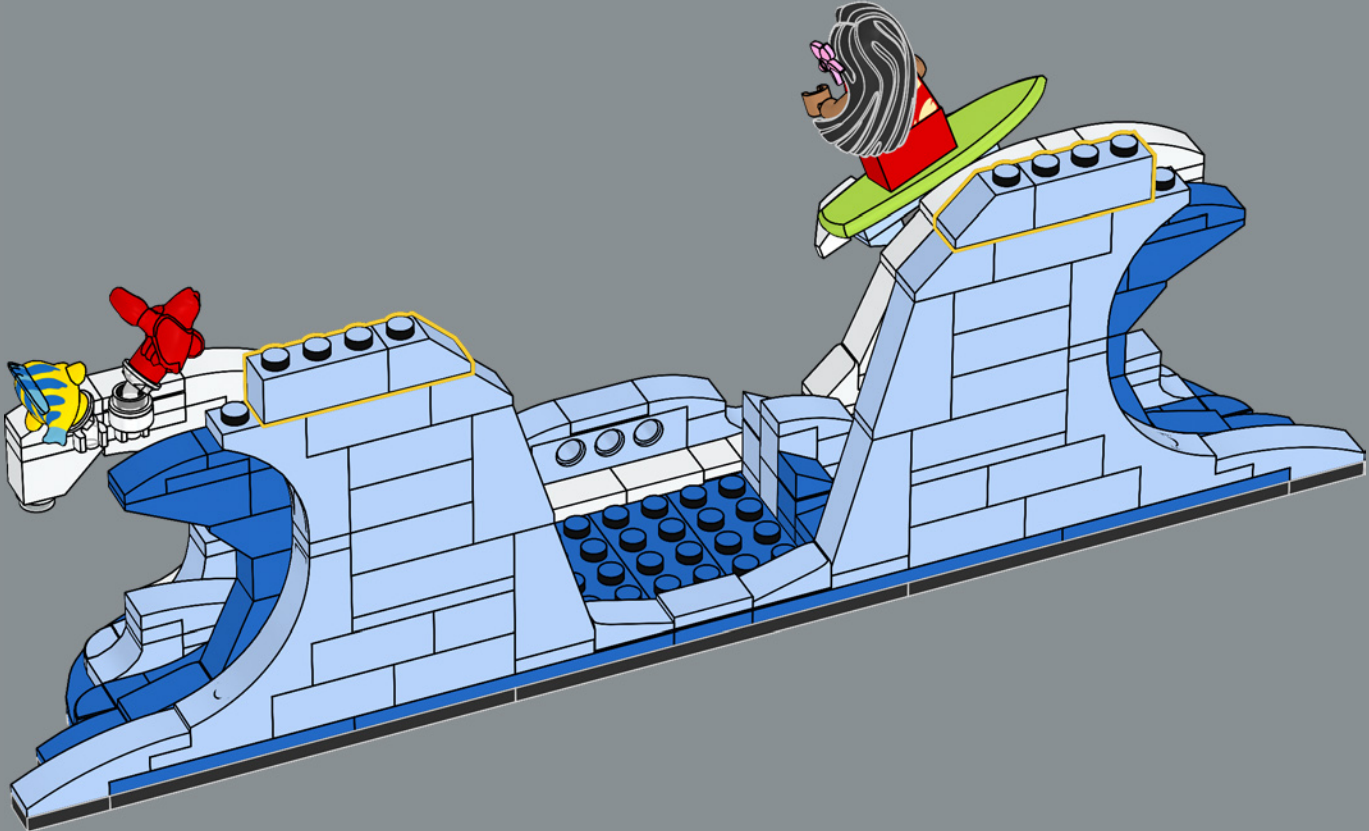

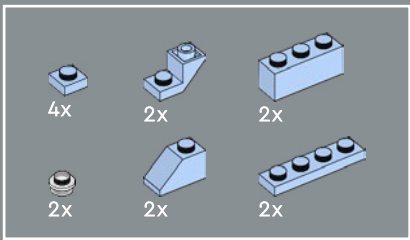

126

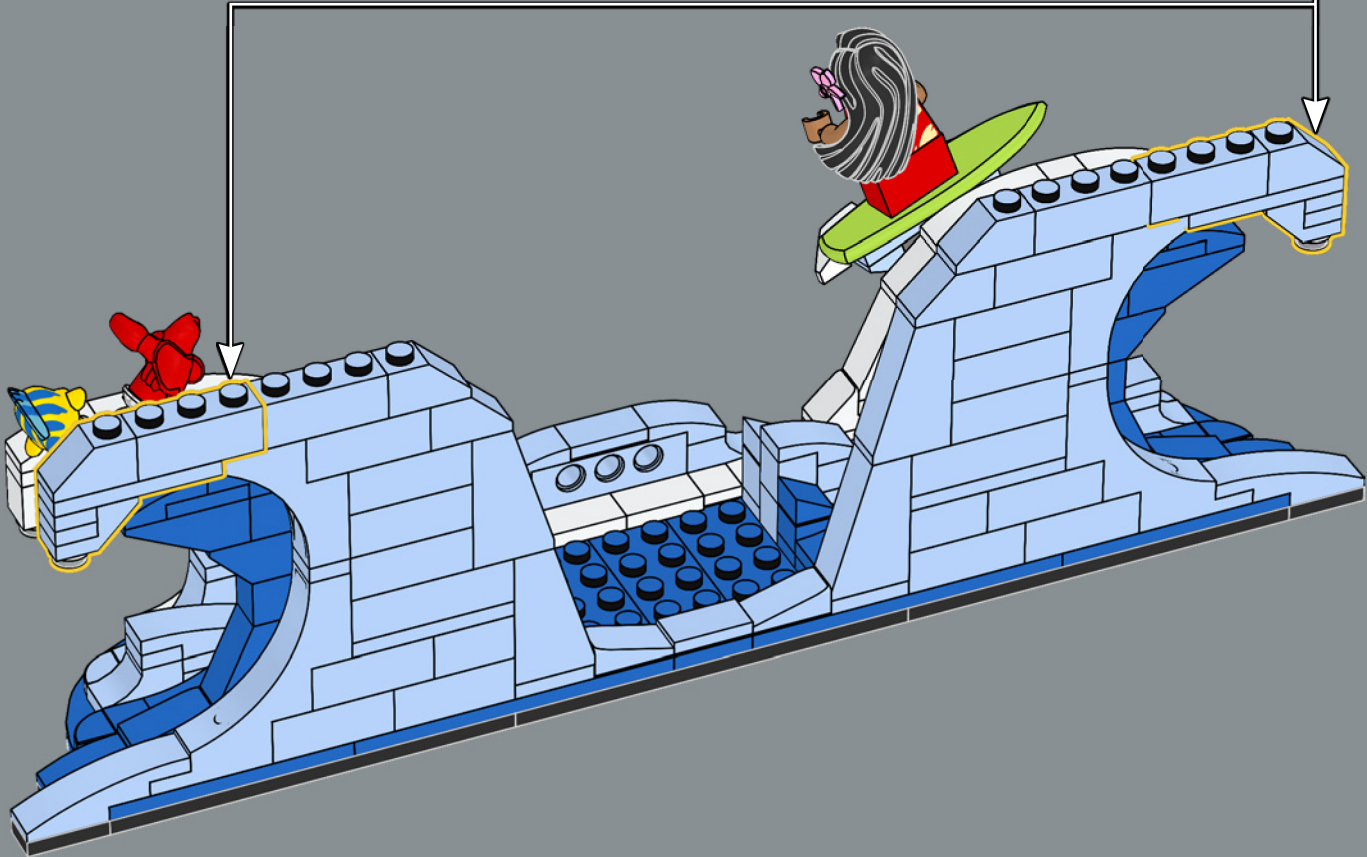
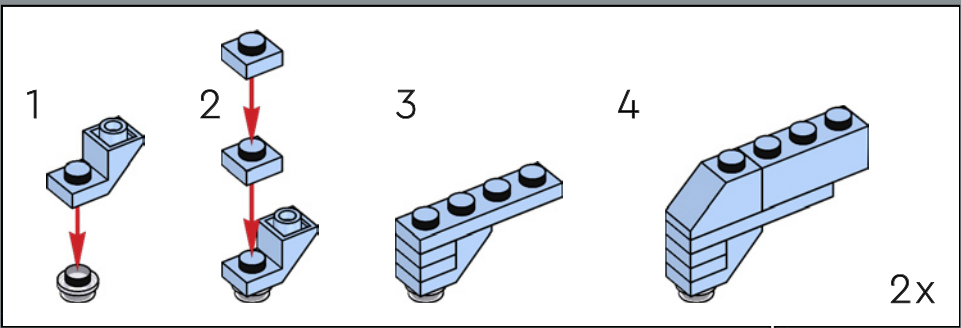

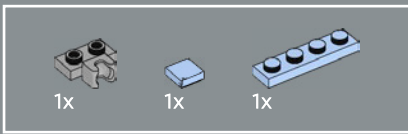

127

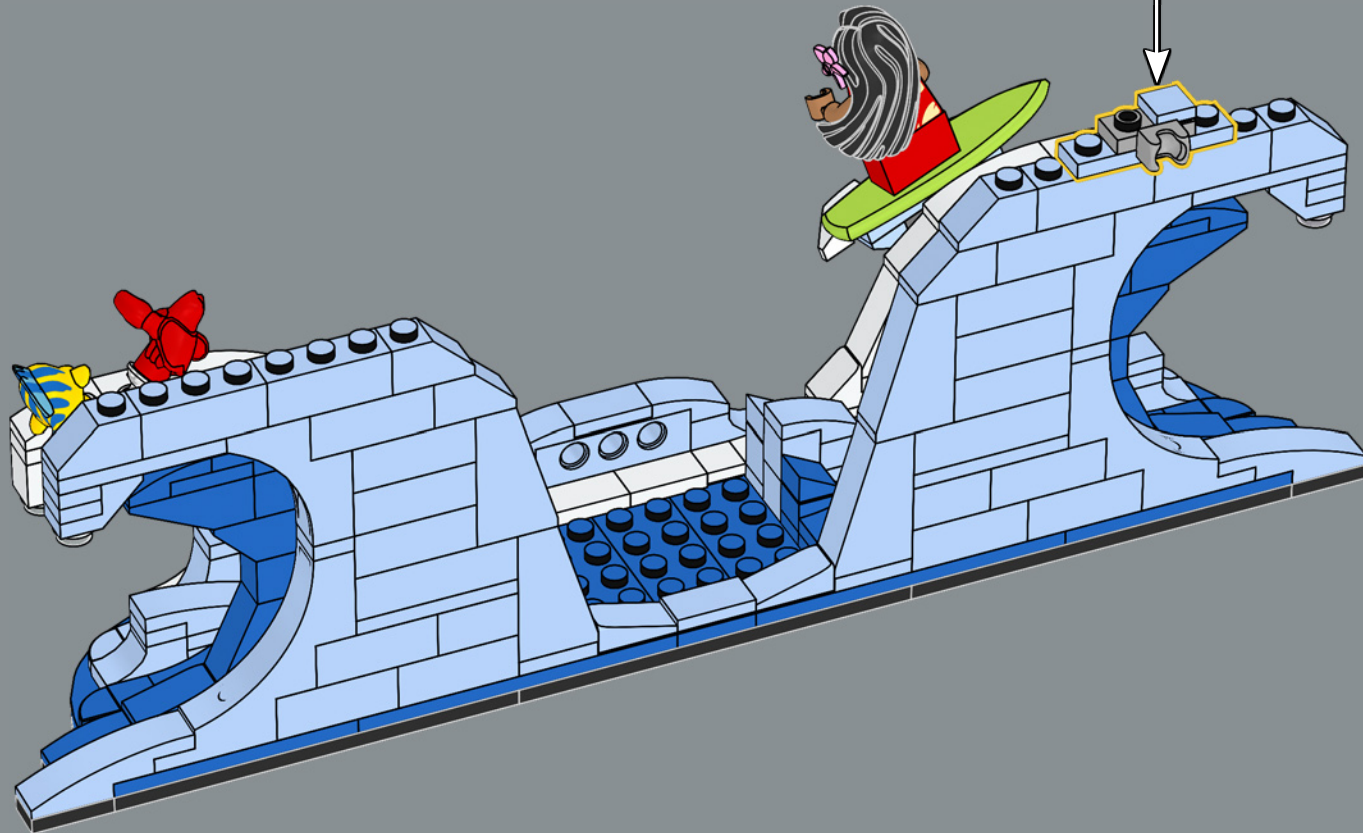
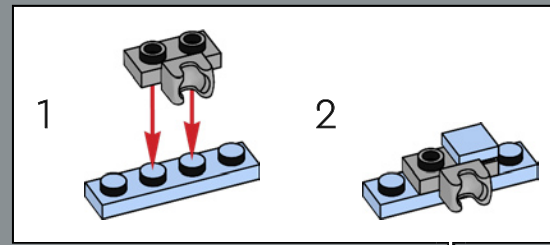

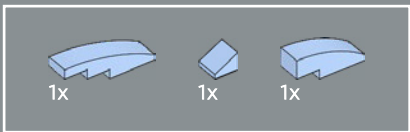

128

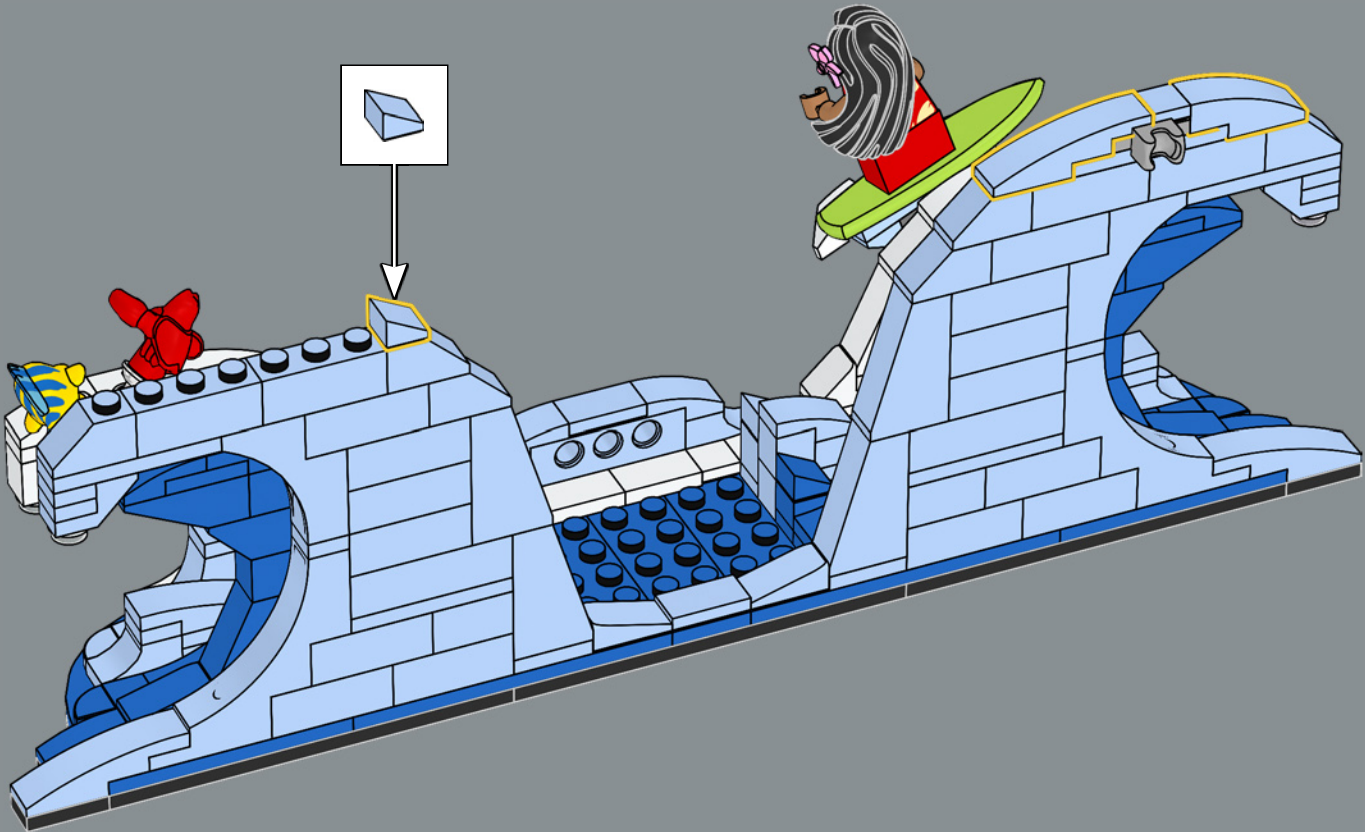

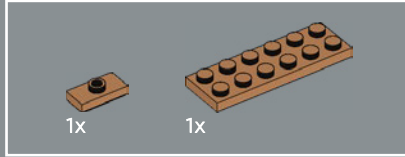
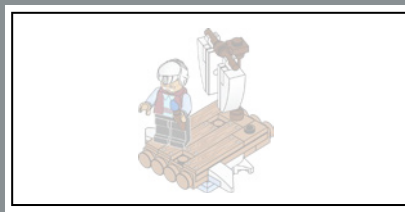

129

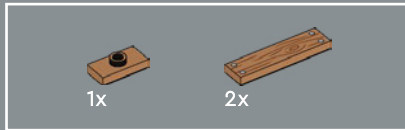
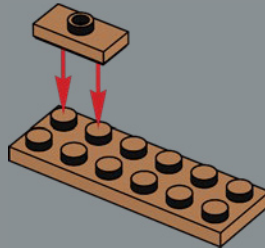

130

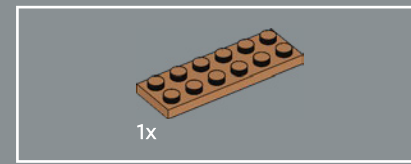
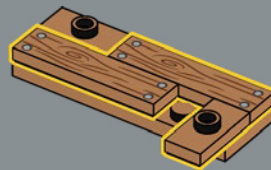

131

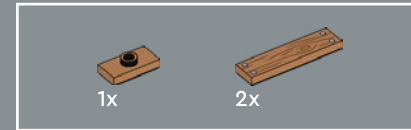
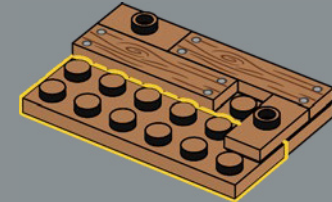

132

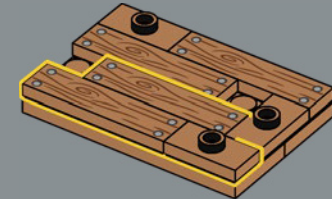

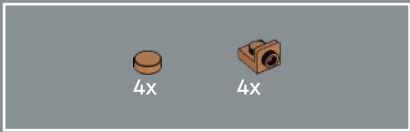

133

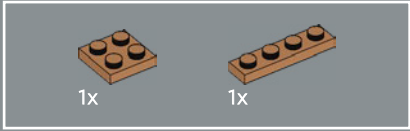
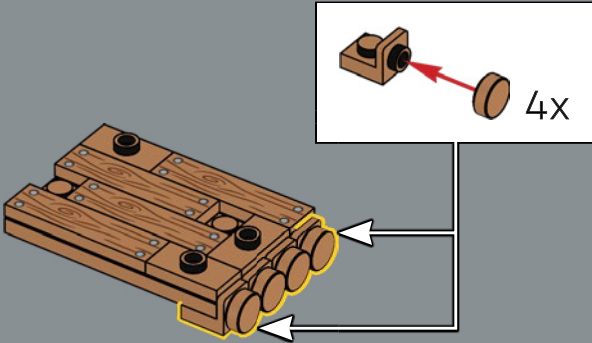

134

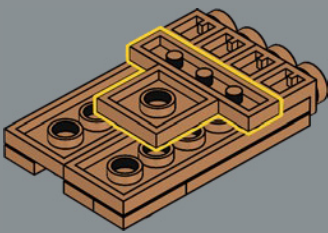

135

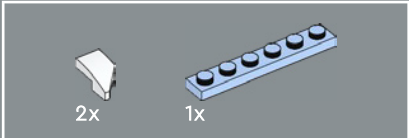
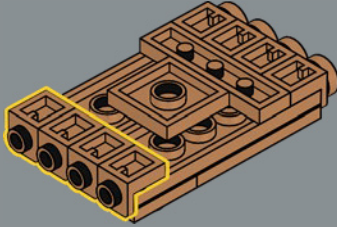

136

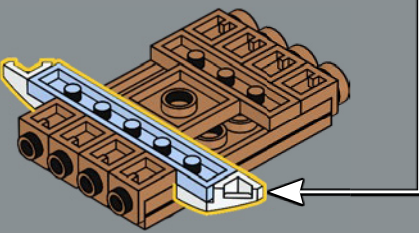
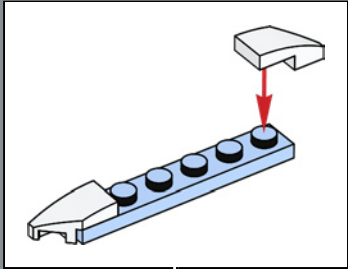

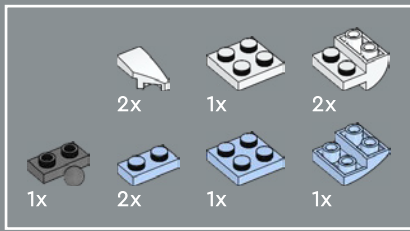

137

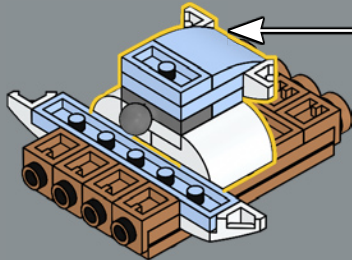
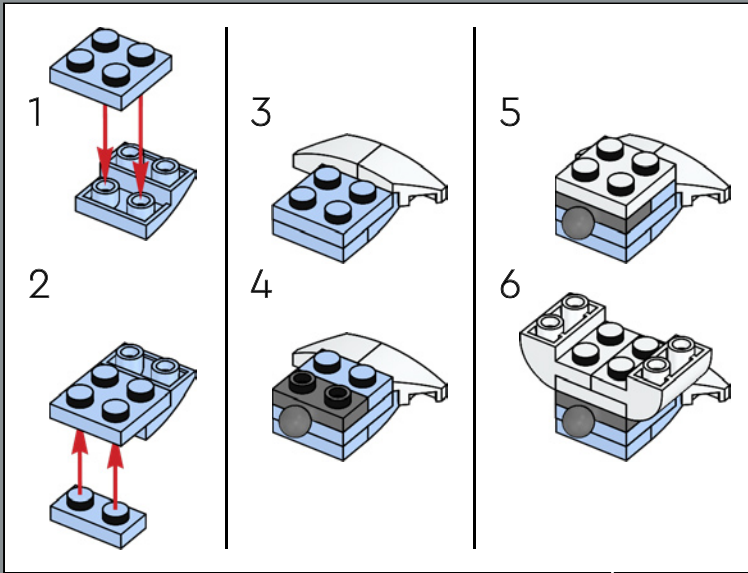

138

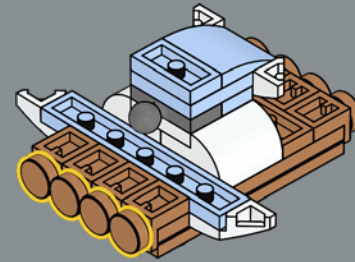

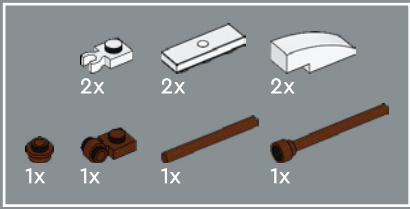

139

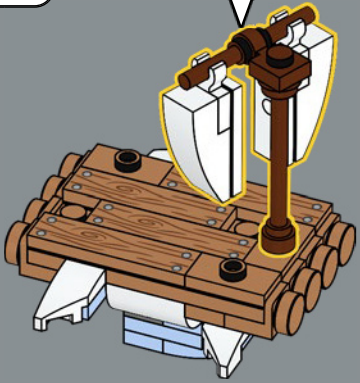
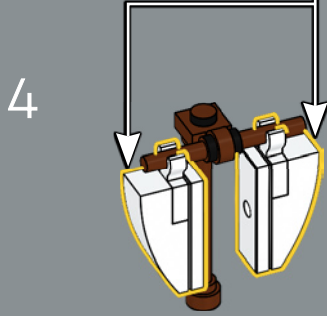
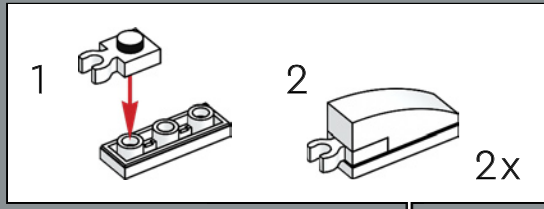
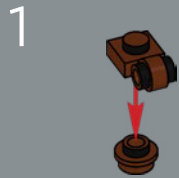

140

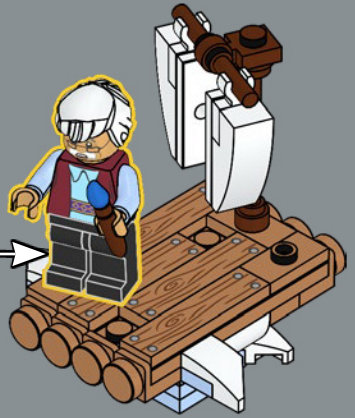
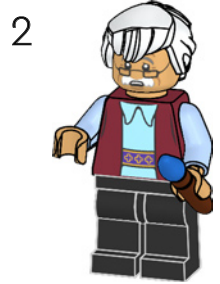
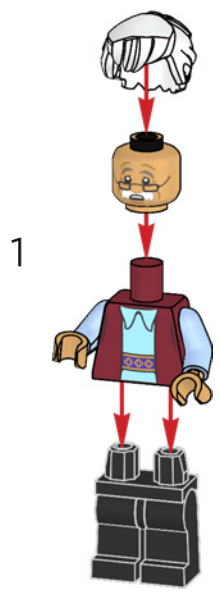

141

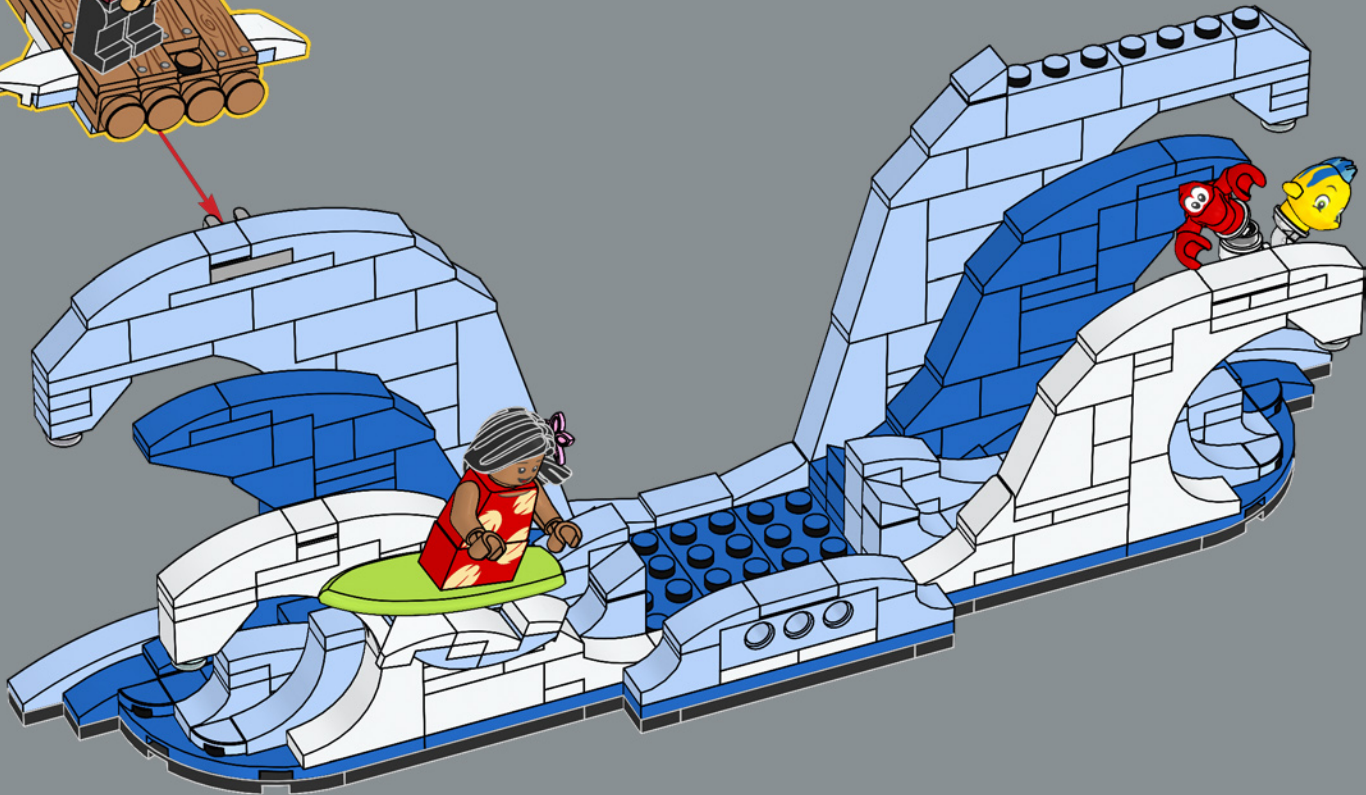

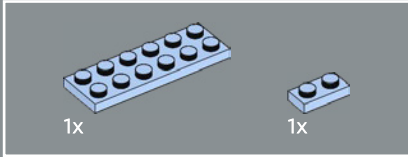
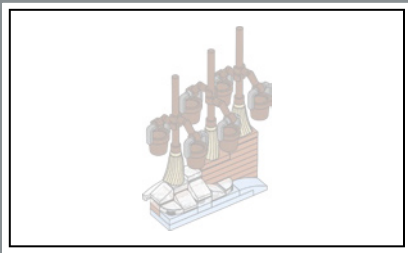

142

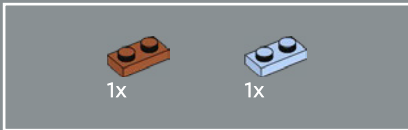
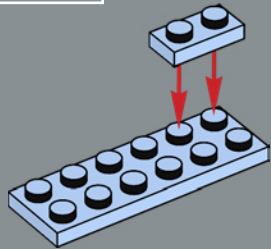

143

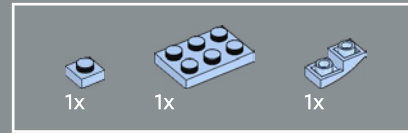
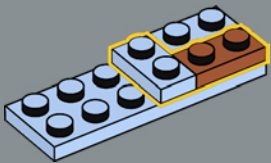

144

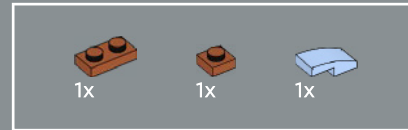
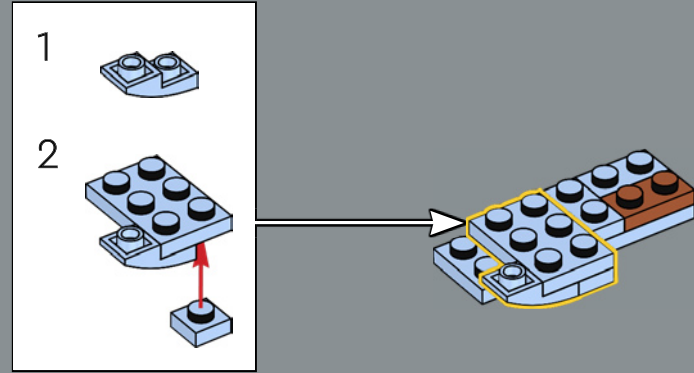

145

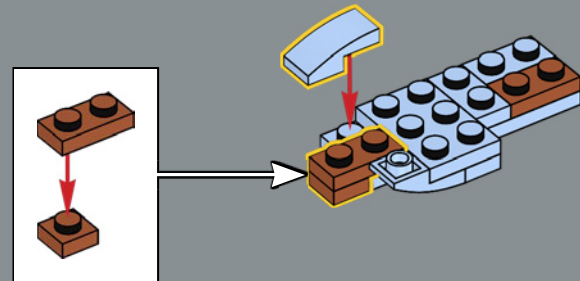

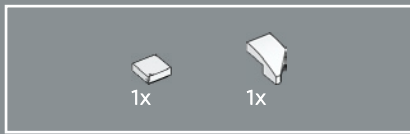

146

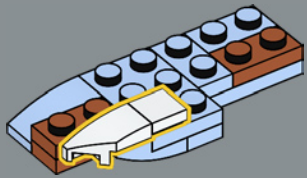

147

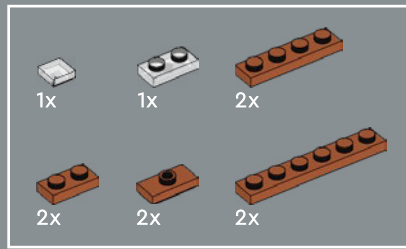
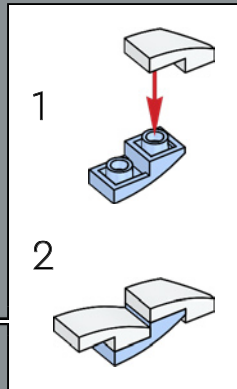
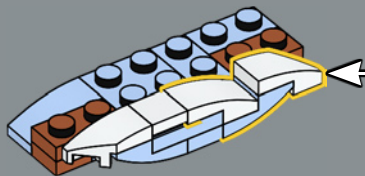

148

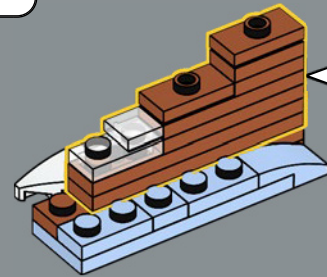
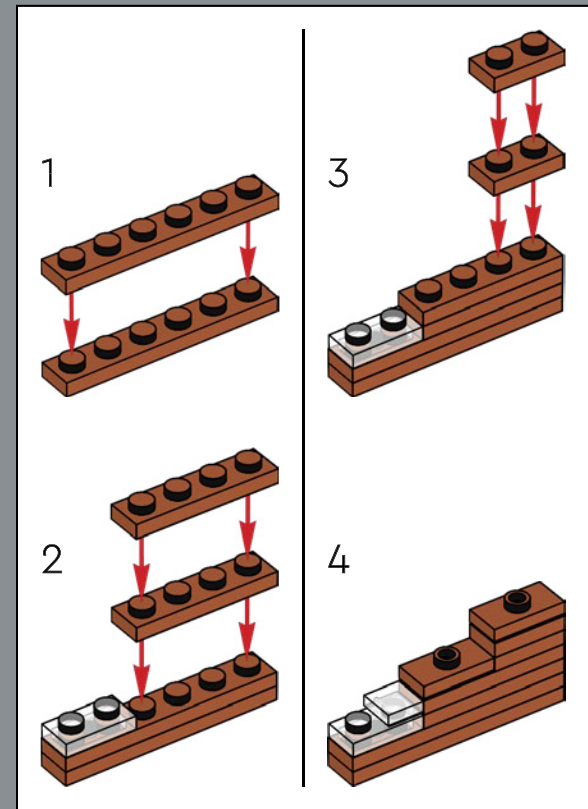



149

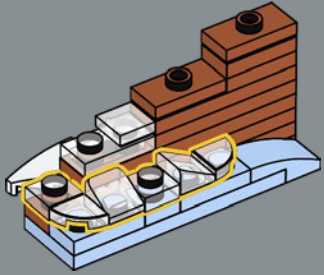

150

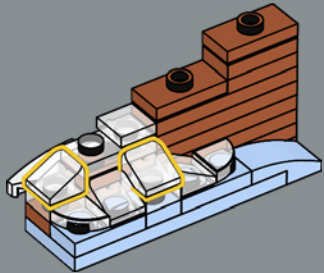

151

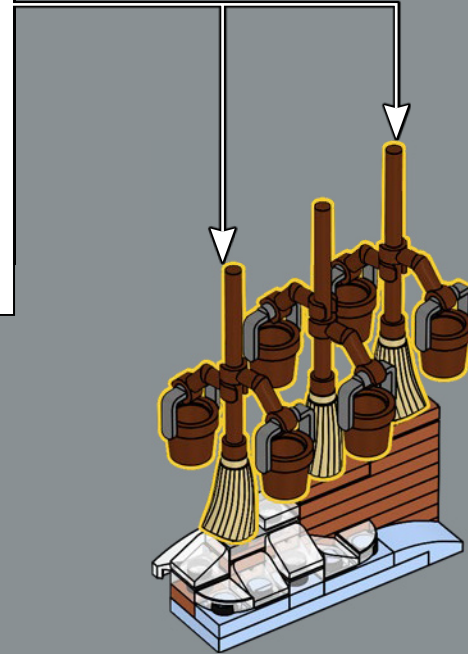
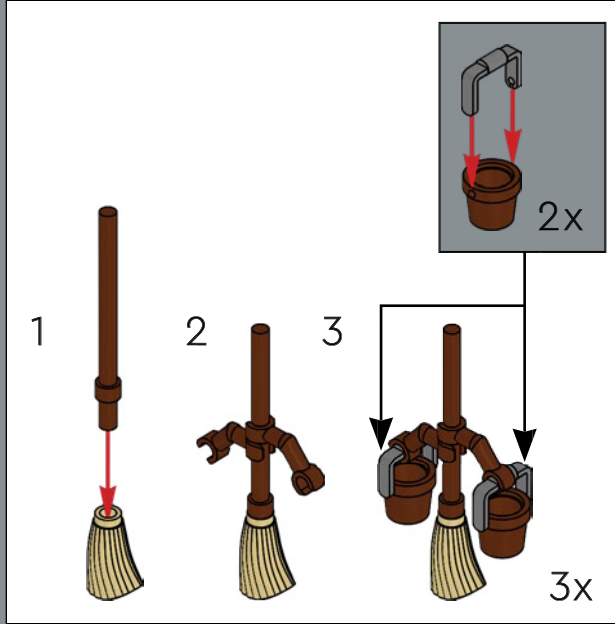

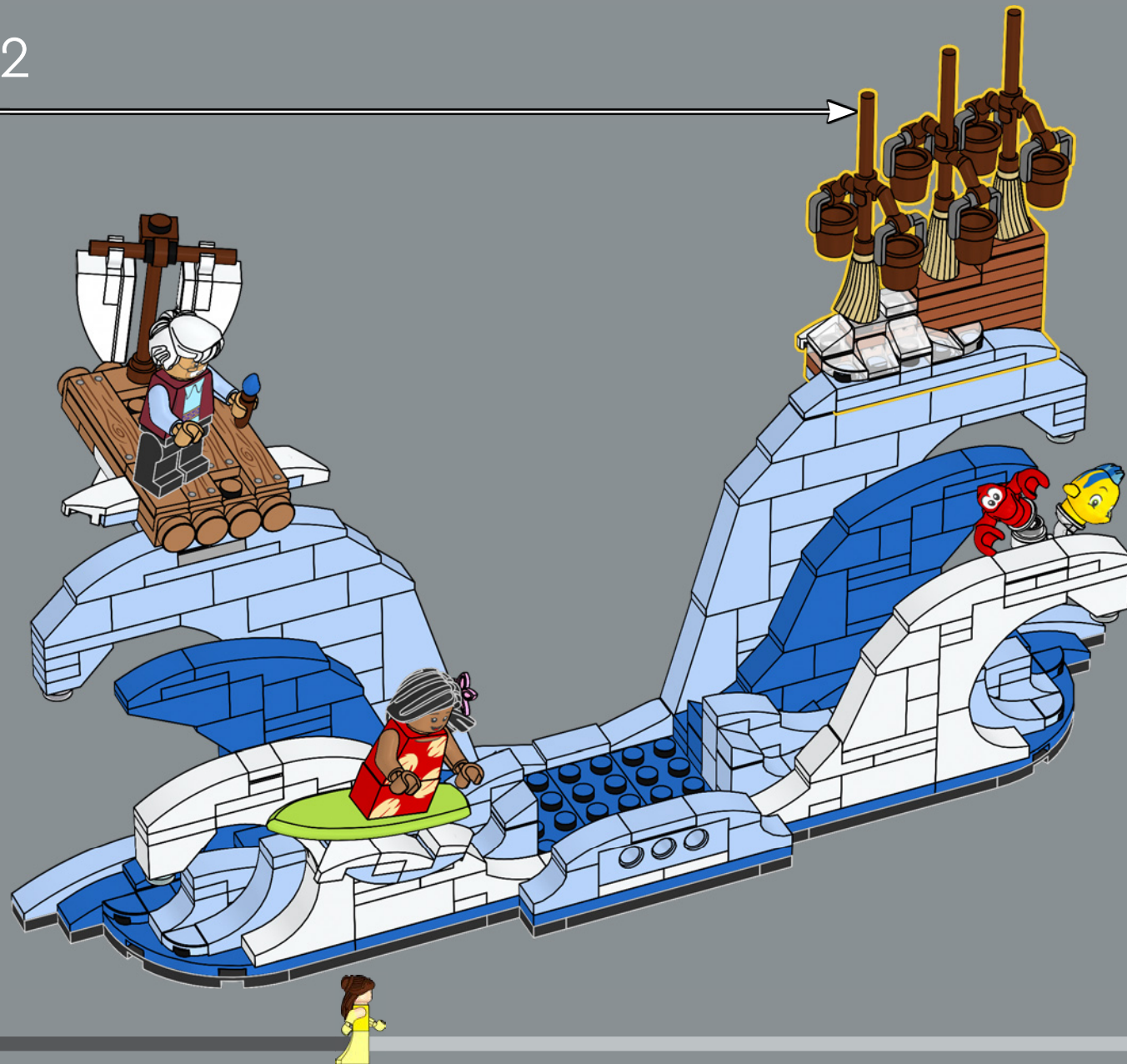

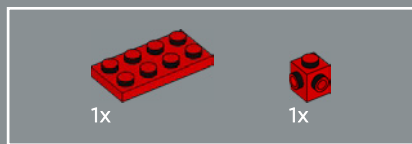
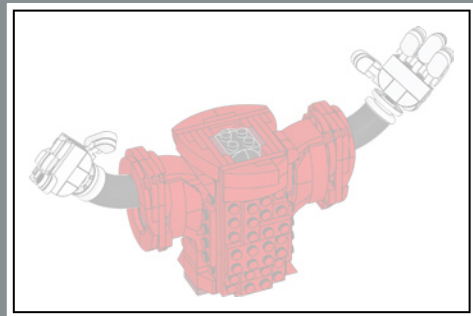

153

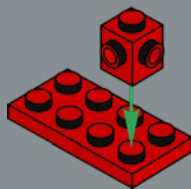

154

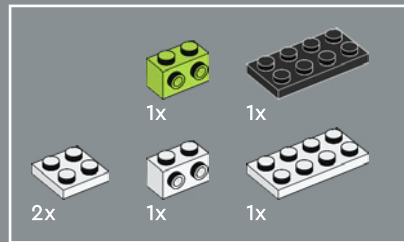

155

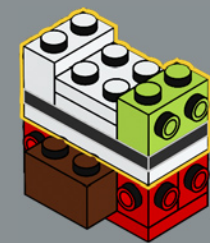
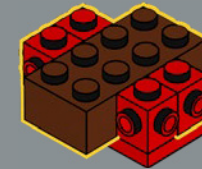
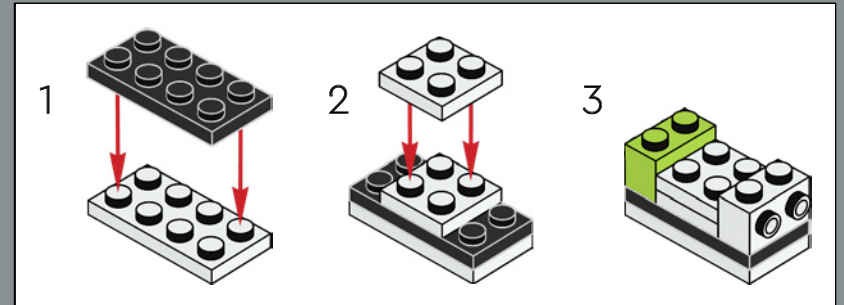

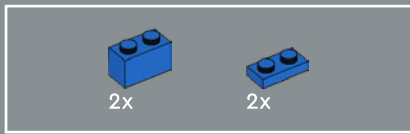

156

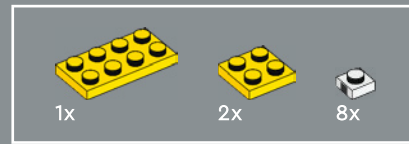
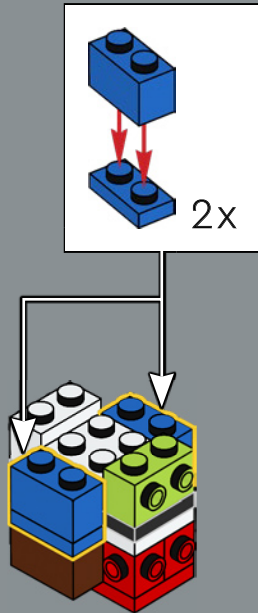

157

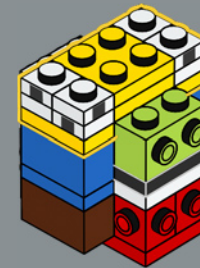
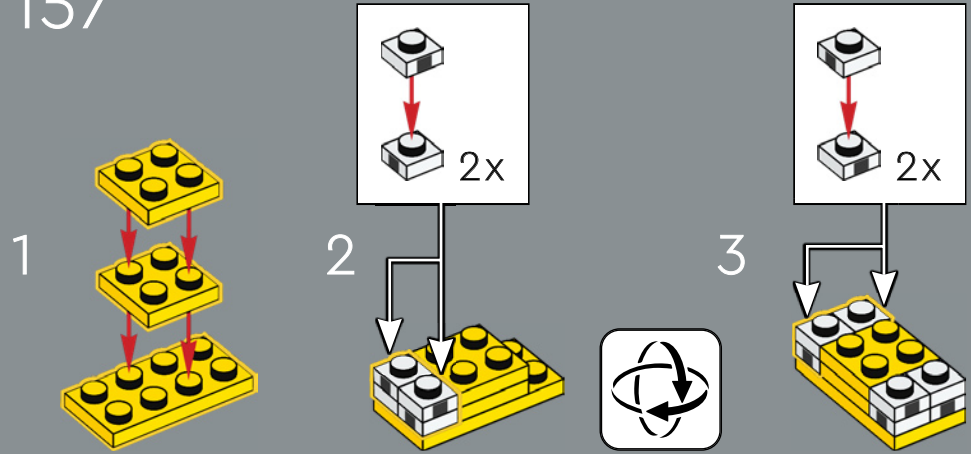

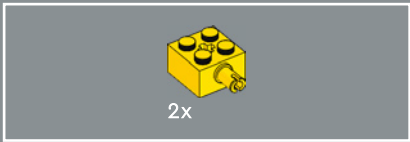

158

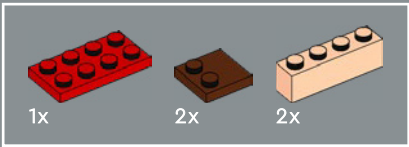
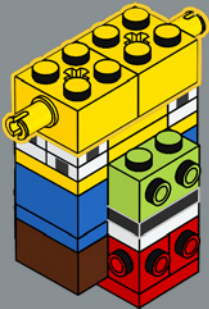

159

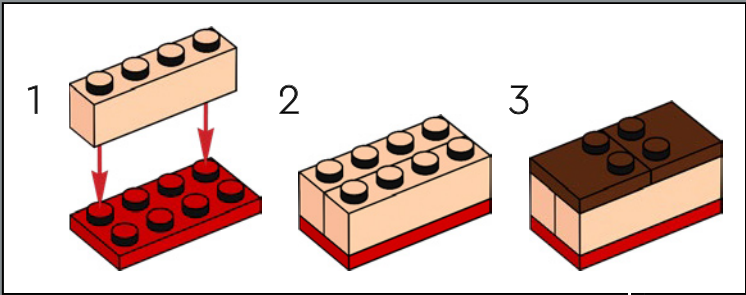



160

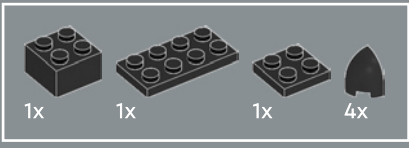
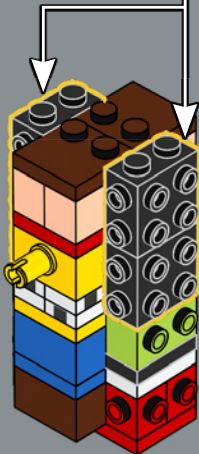
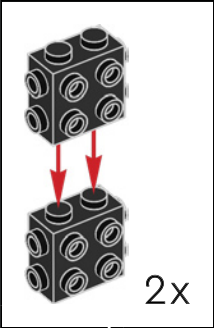

161

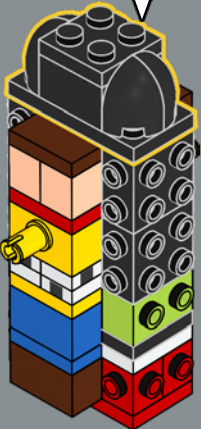
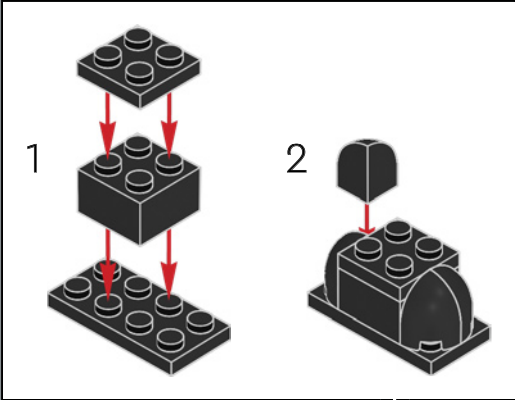

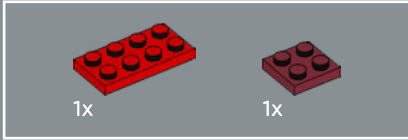
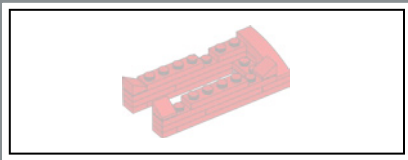

162

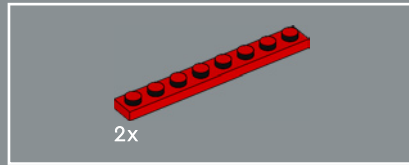
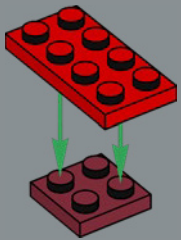

163

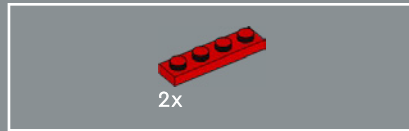
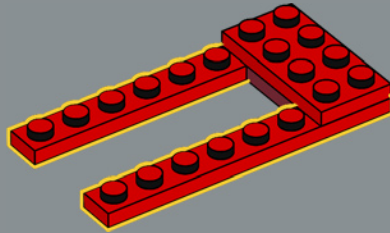

164

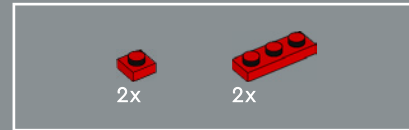
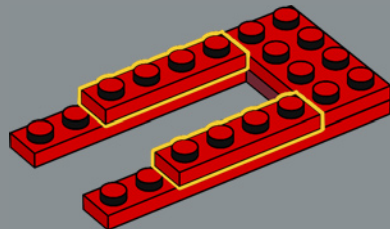

165

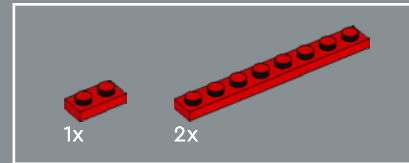
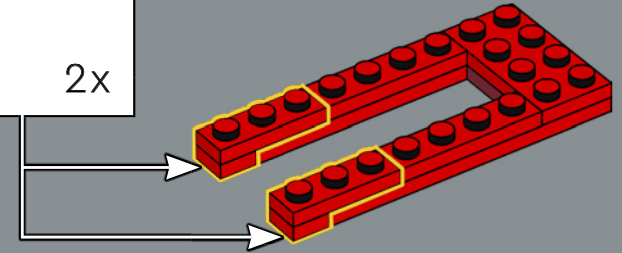
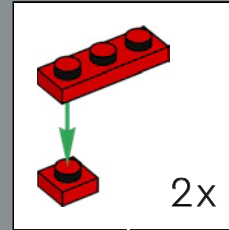

166

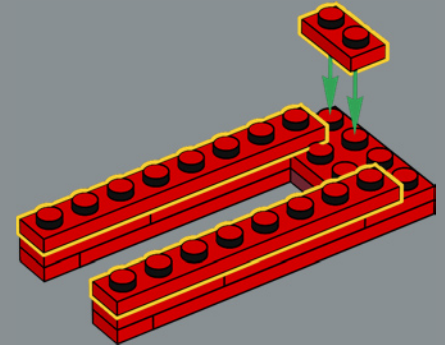

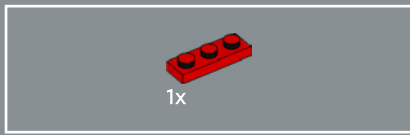

167

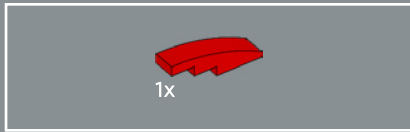
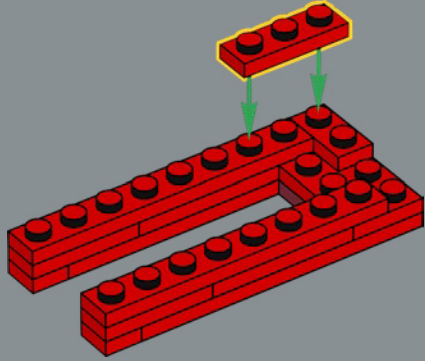

168

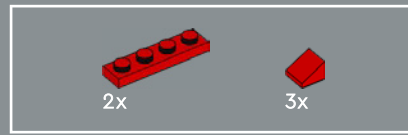
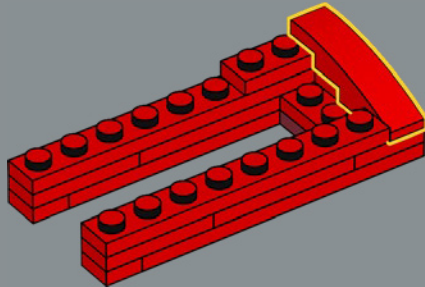

169

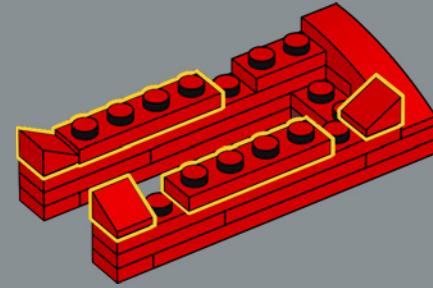

170

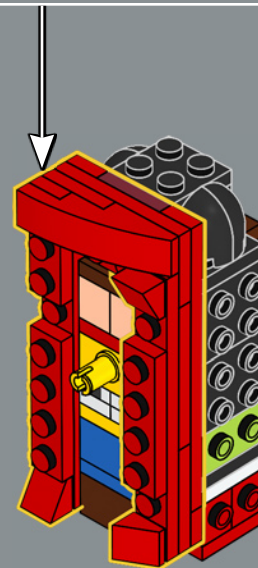

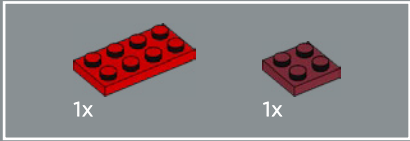
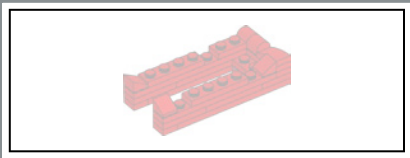

171

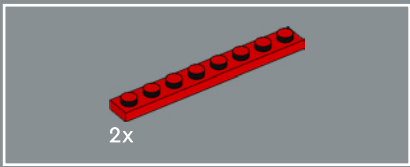
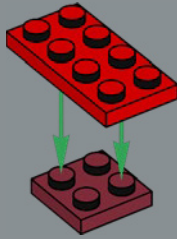

172

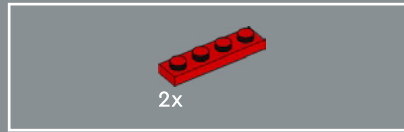
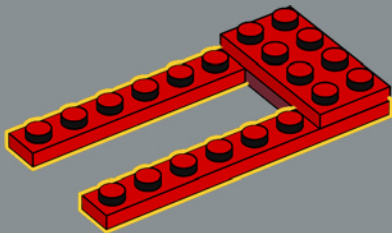

173

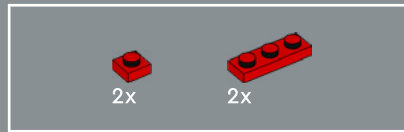
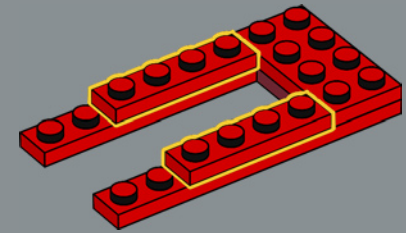

174

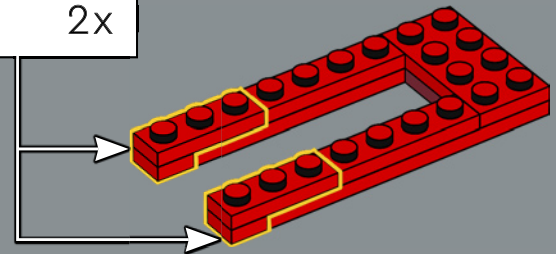
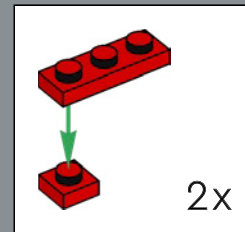

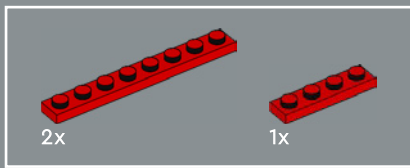

175

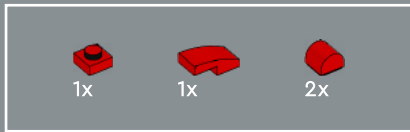
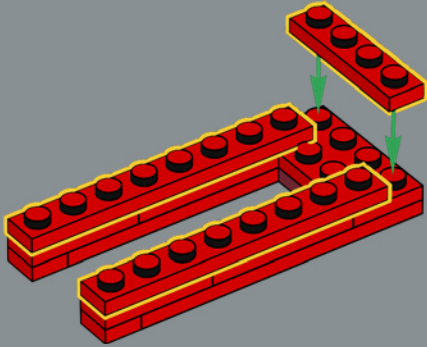

176

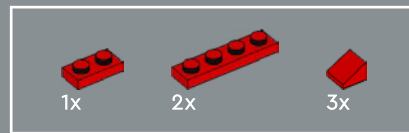
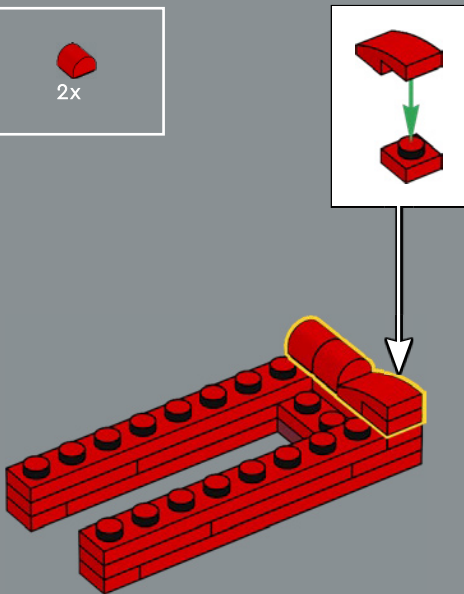

177

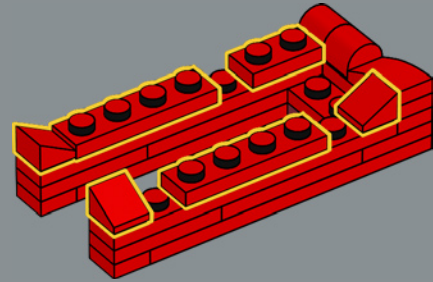

178



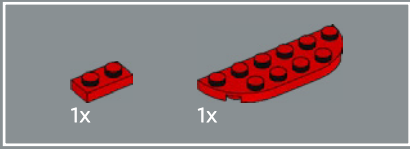

179

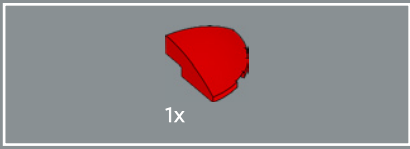
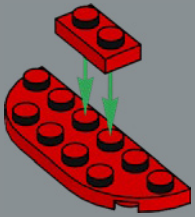

180

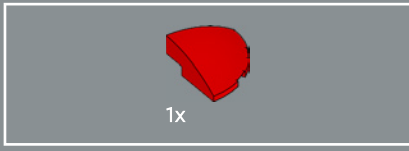
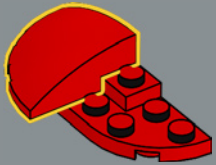

181

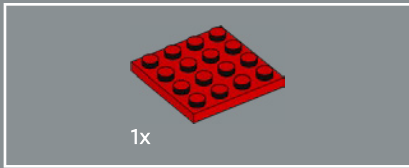
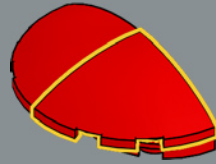

182

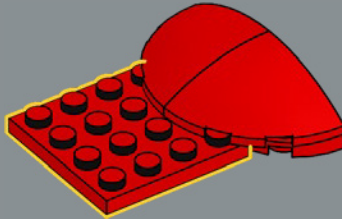

183

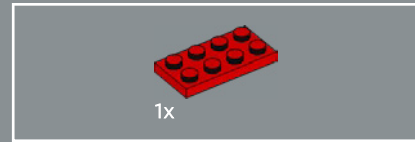
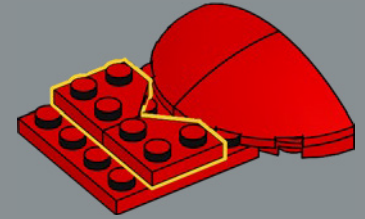

184

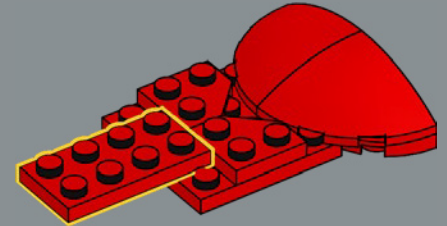

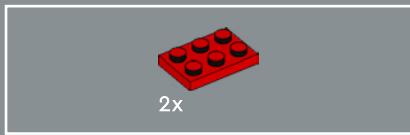

185

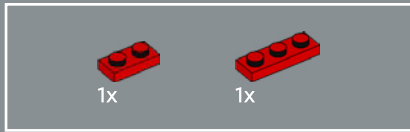
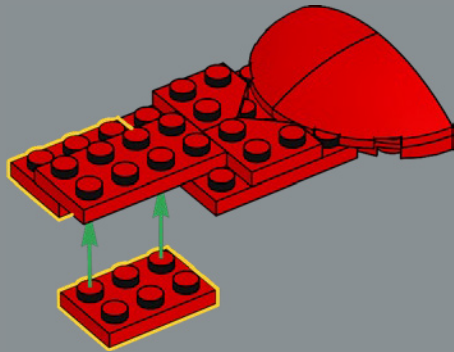

186

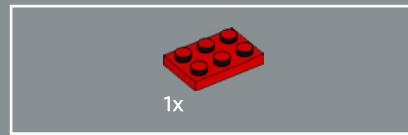
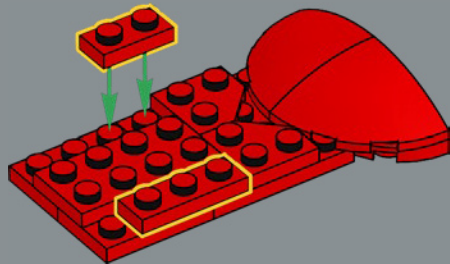

187

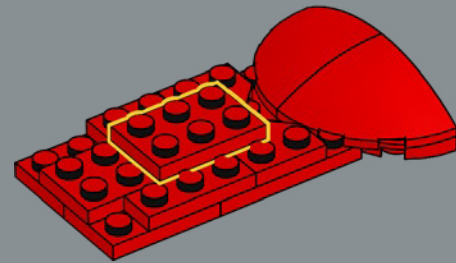

188

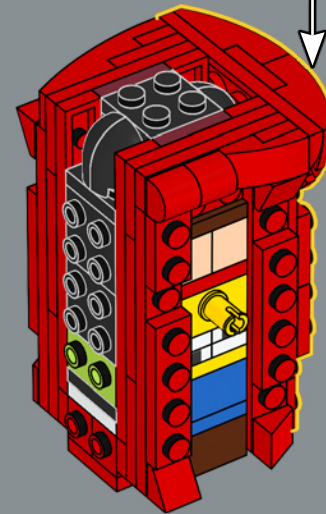

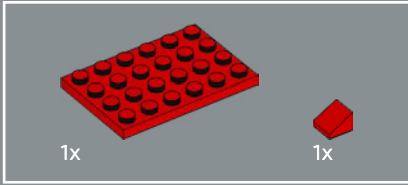

189

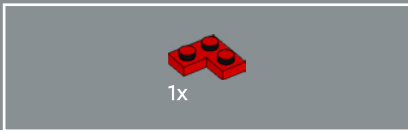
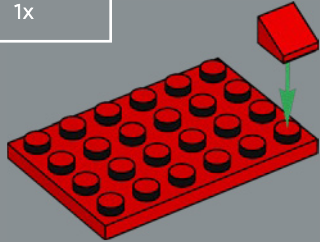

190

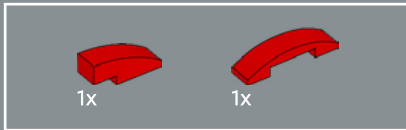
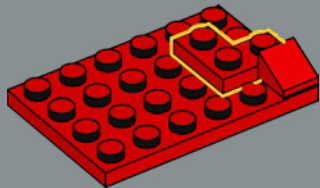

191

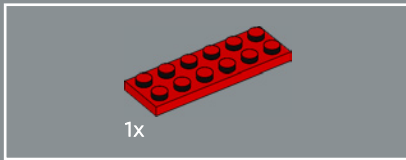
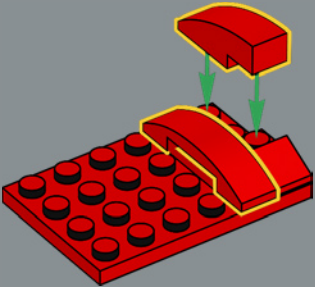

192

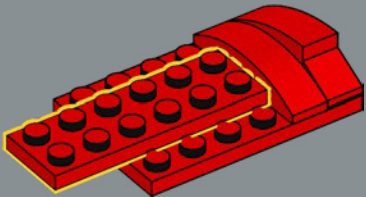

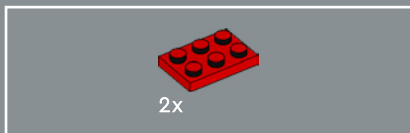

193

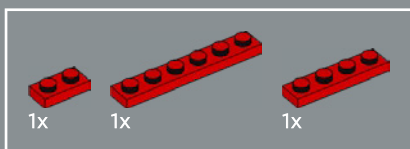
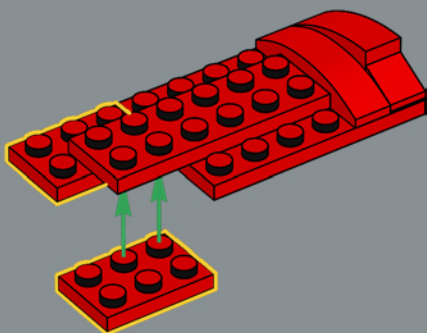

194

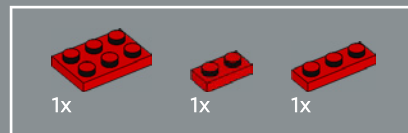
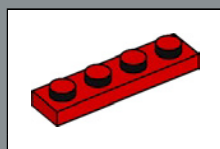
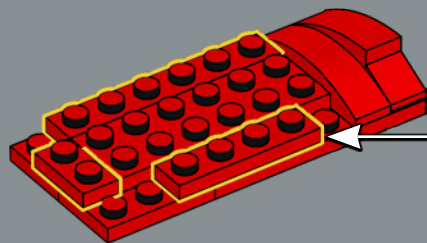

195

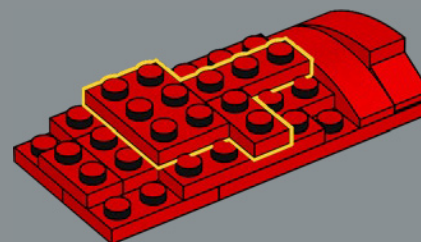

196

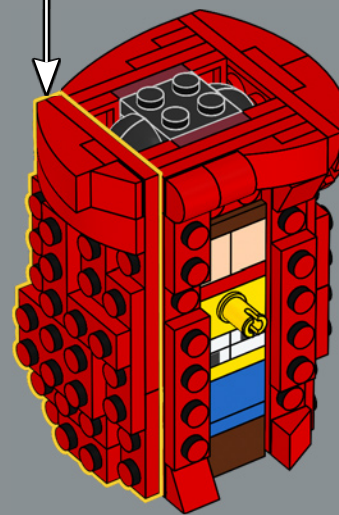

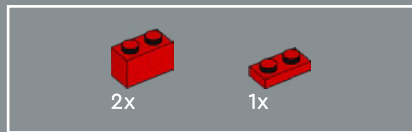
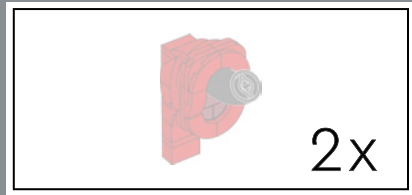

197

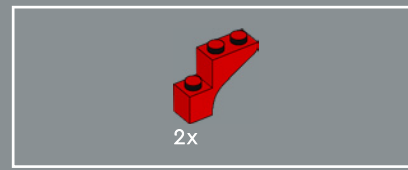
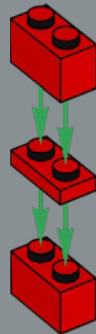

198

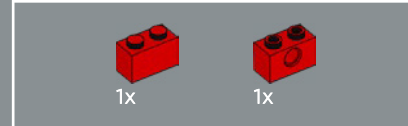
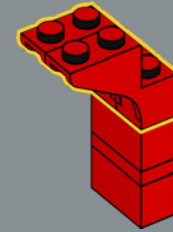

199

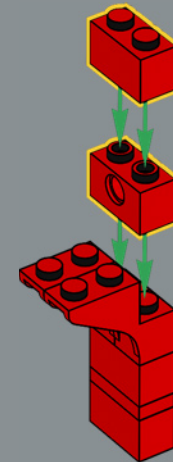

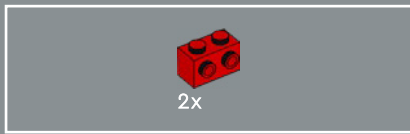

200

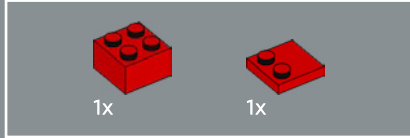
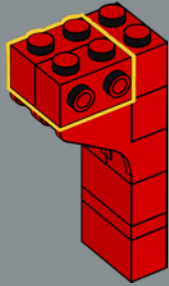

201

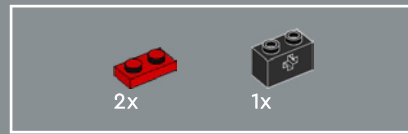
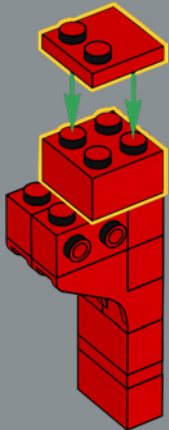

202

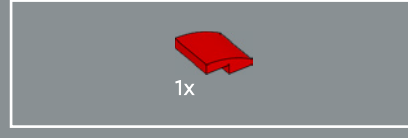
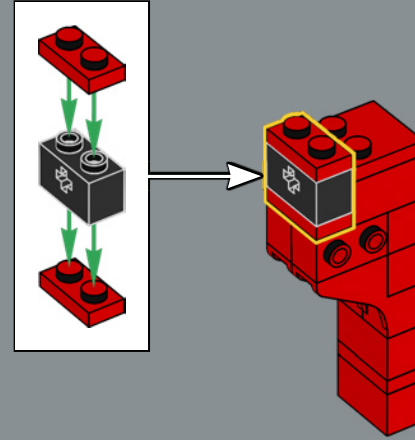

203

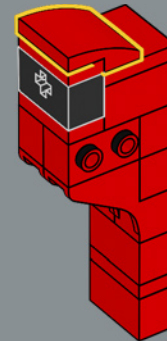

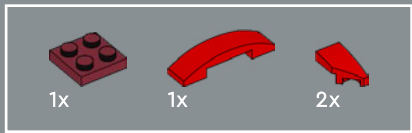

204

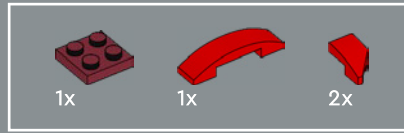
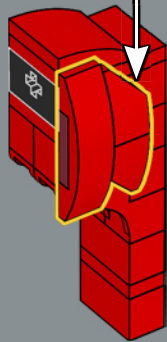
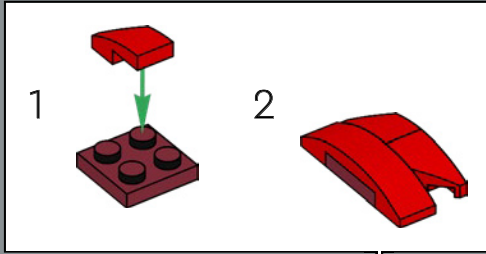

205

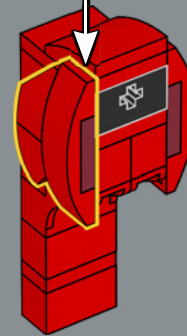
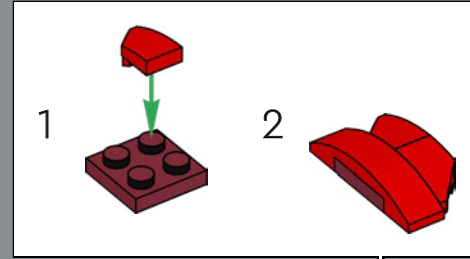

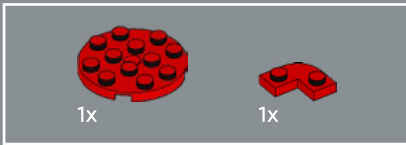
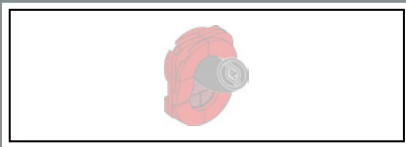

206

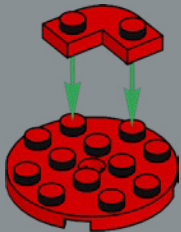

207

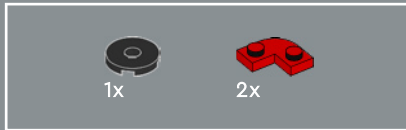

208

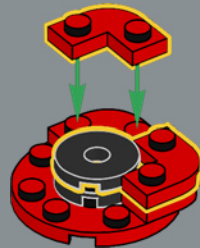

209

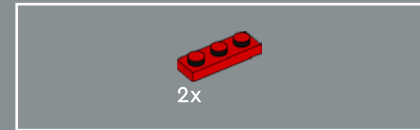
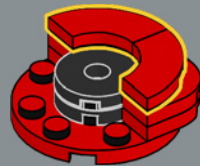

210

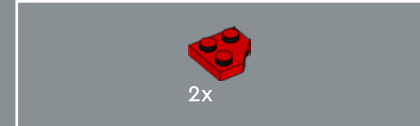
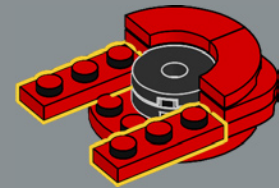

211

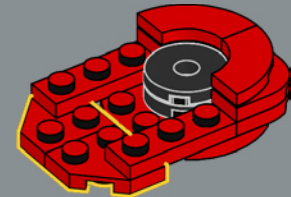



212

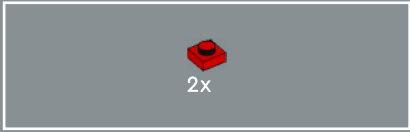
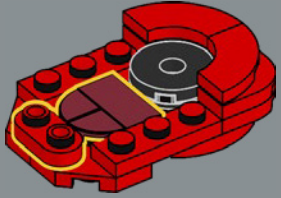

213

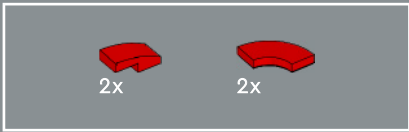
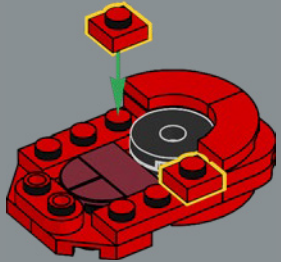

214

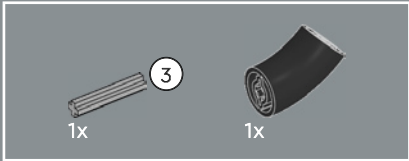
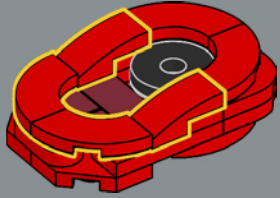

215

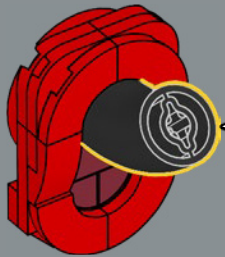
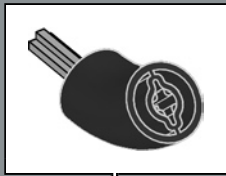

216

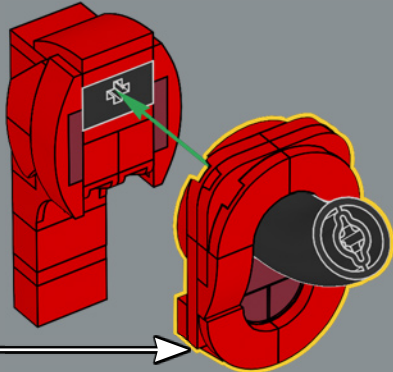

2x

217

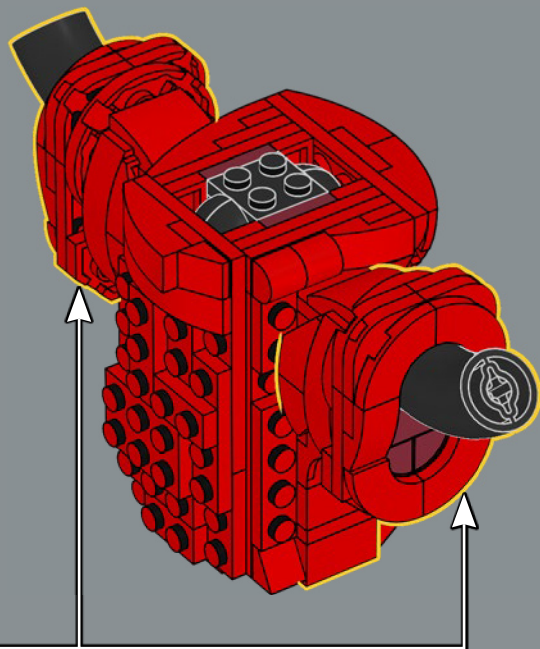

218

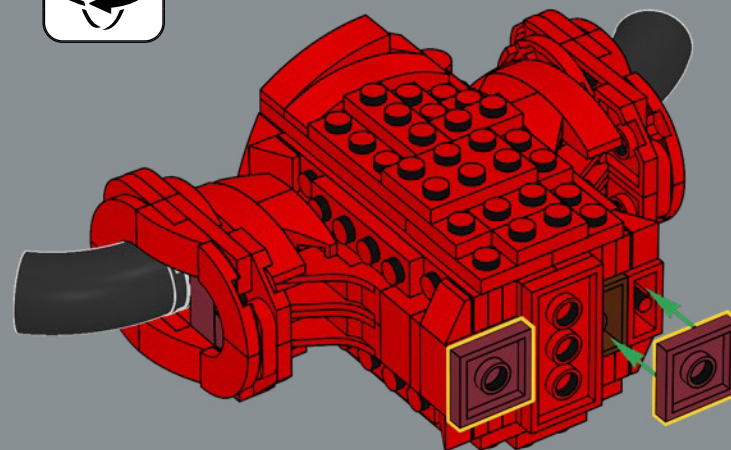
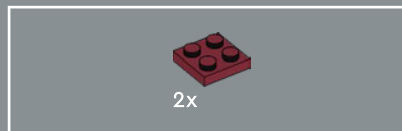



219

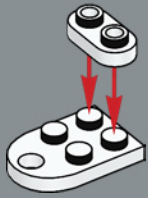

220

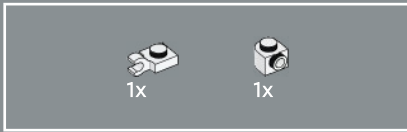

221

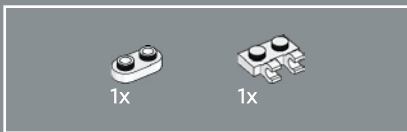

222

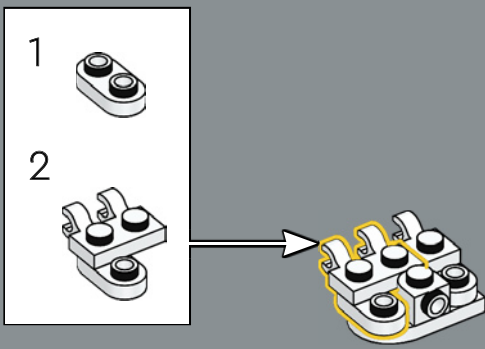

223

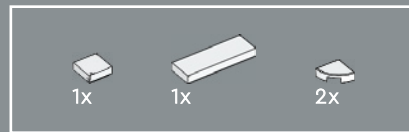
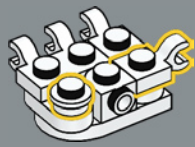

224

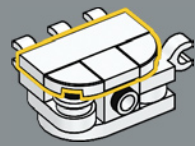



225

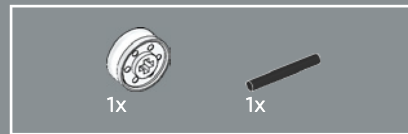
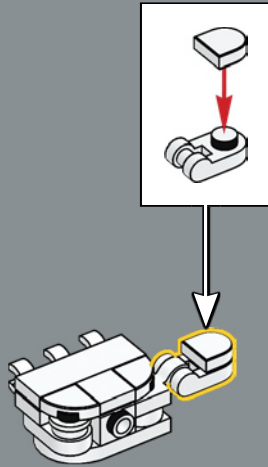

227

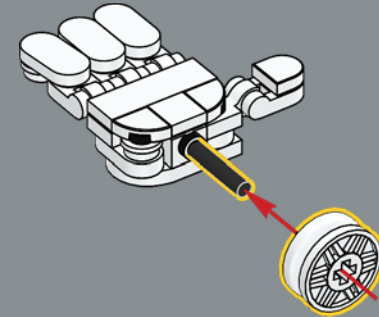

226

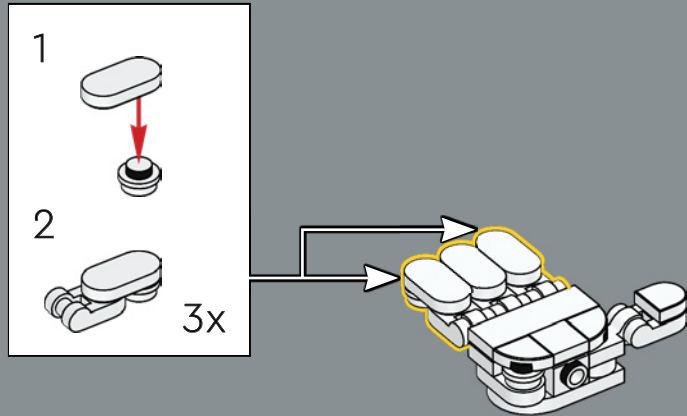

228

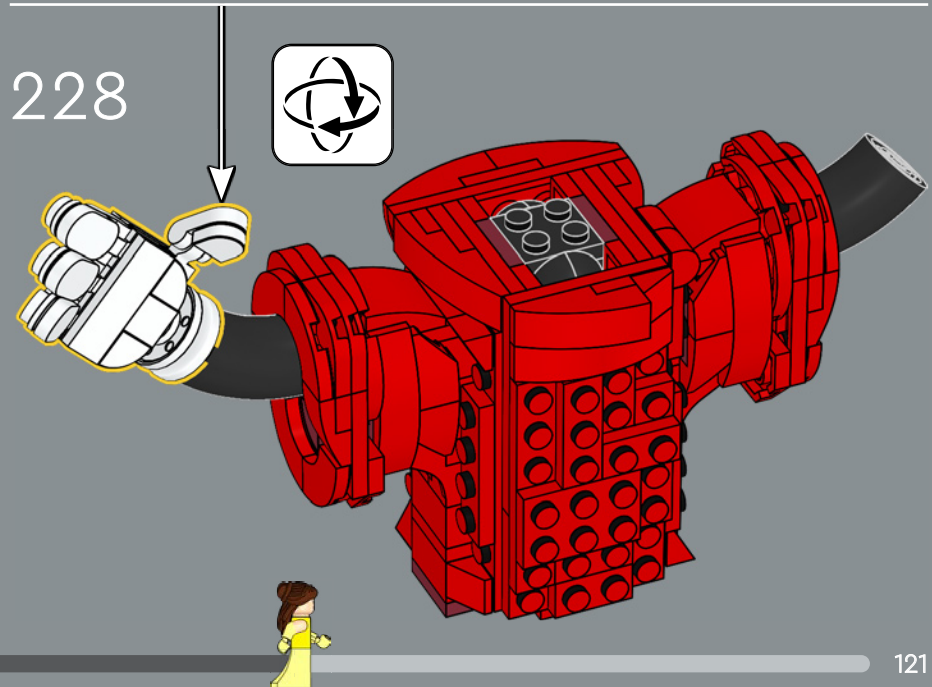

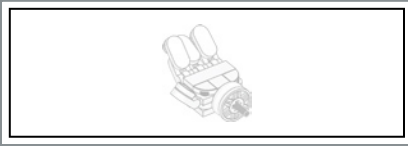

229

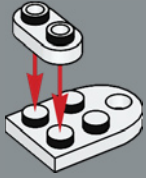

230

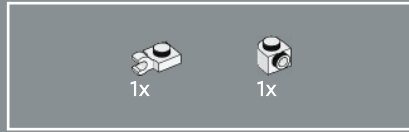

231

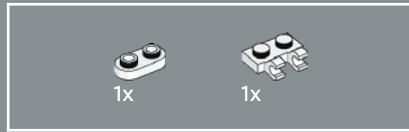
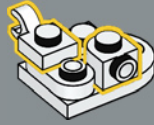

232

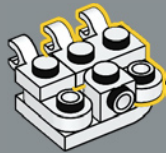
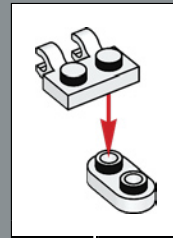

233

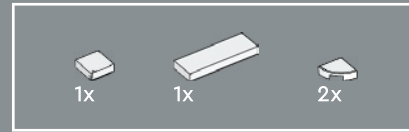
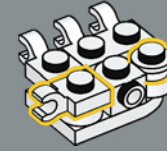

234

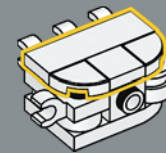

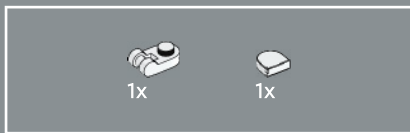

235

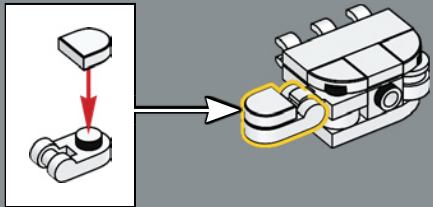

236

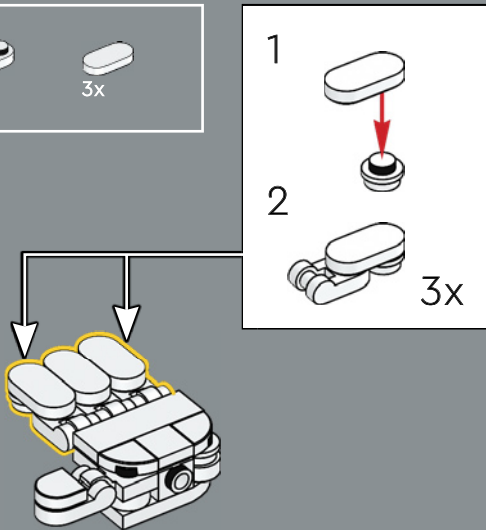

237

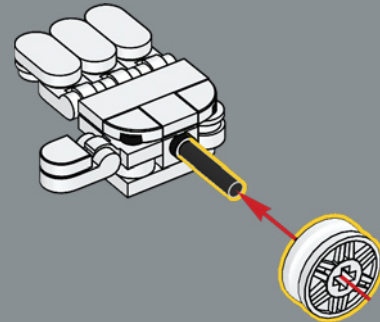

238

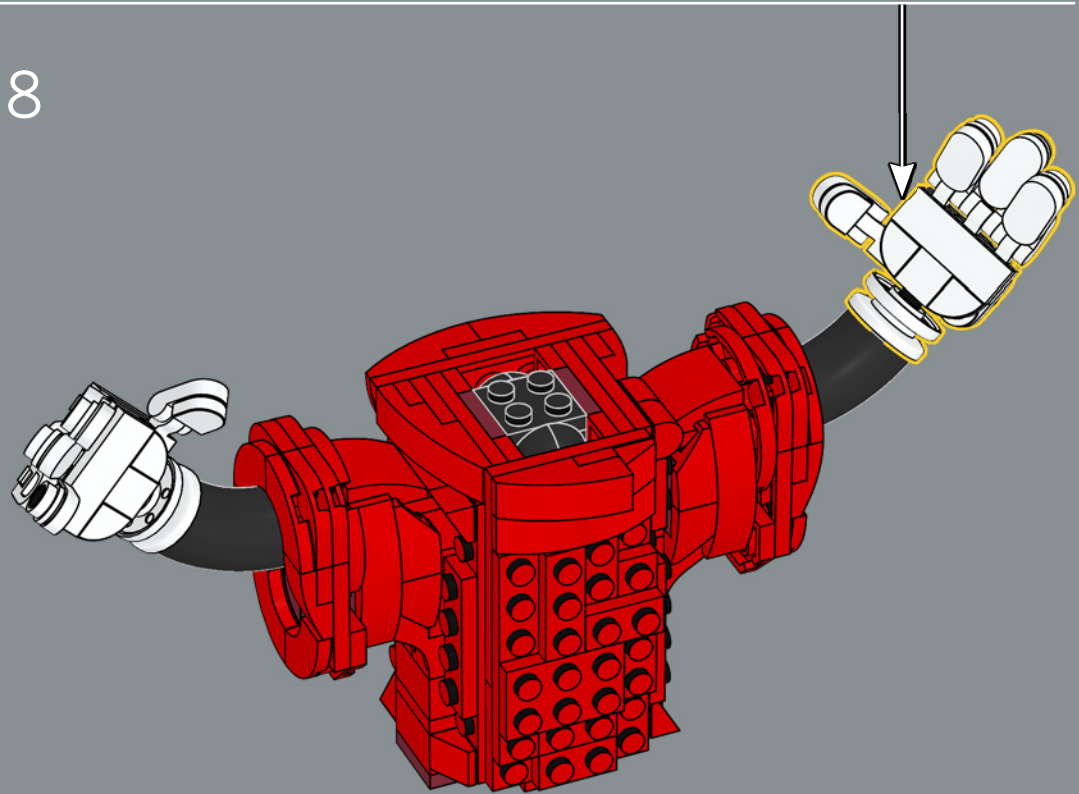

239

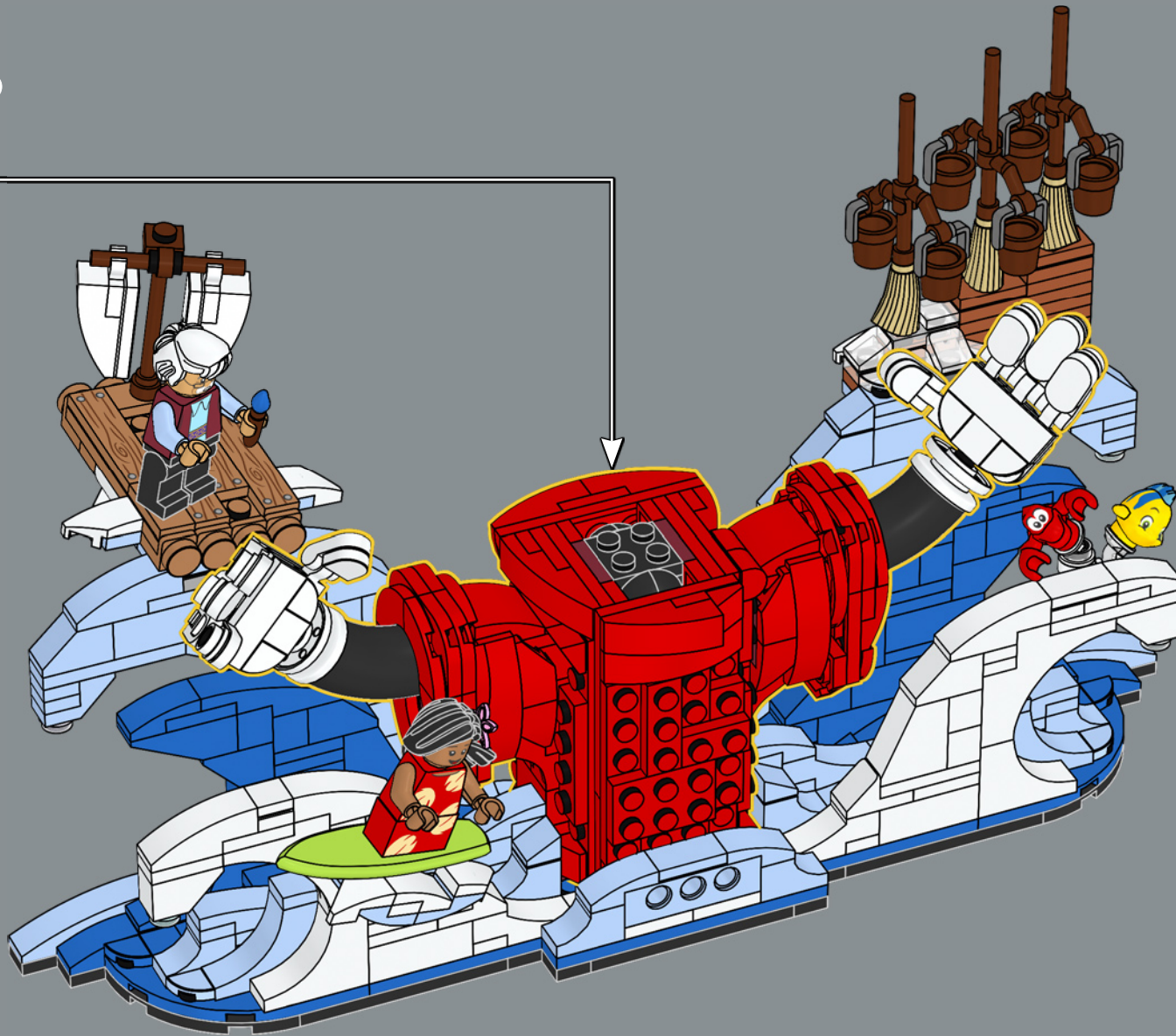

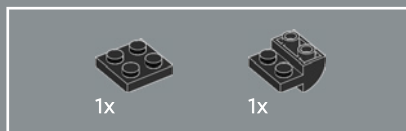

240

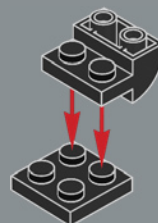

241

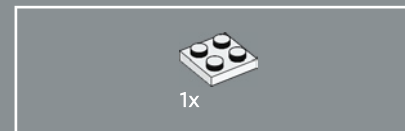
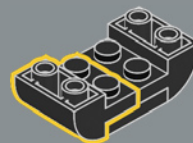

242

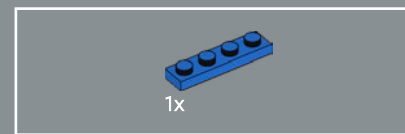
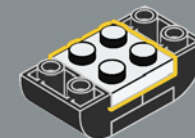

243

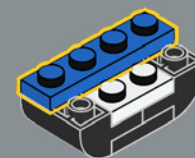

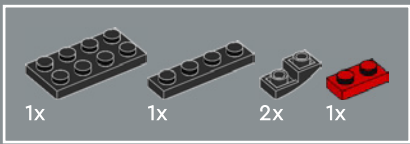

244

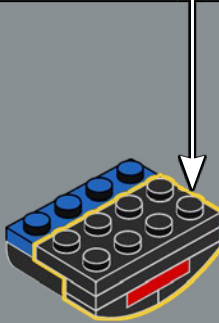
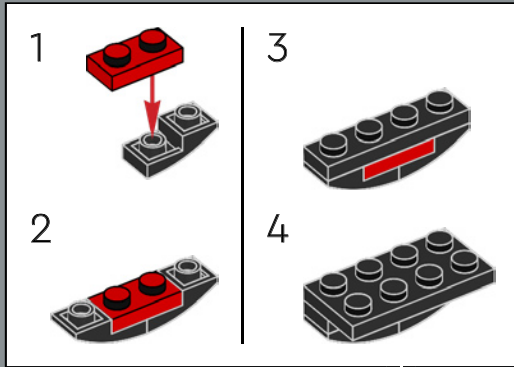

245

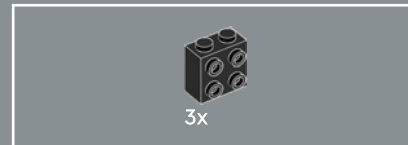
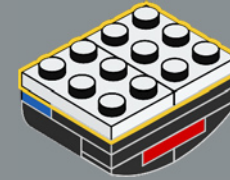

246

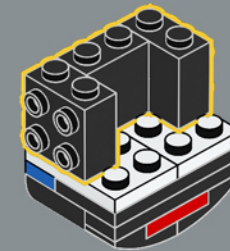

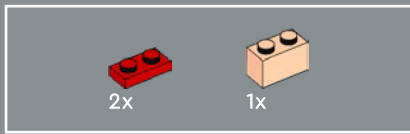

247

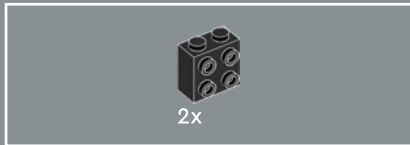
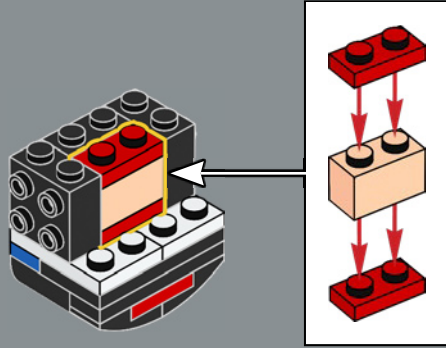

248

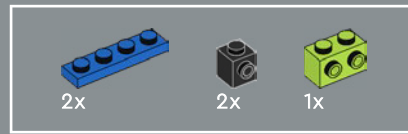
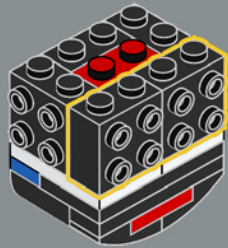

249

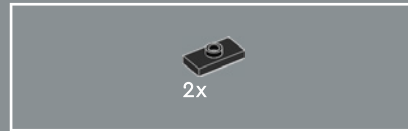
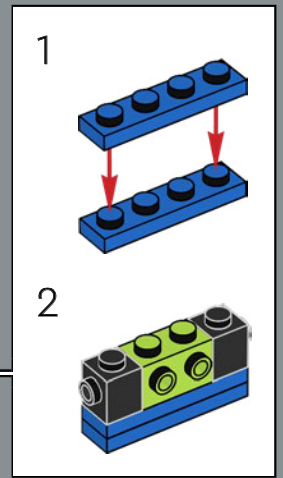
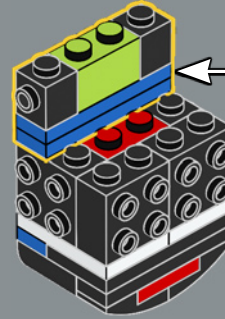

250

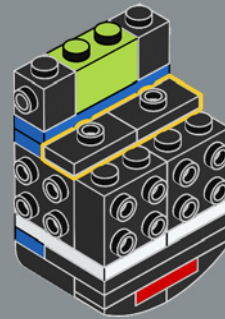

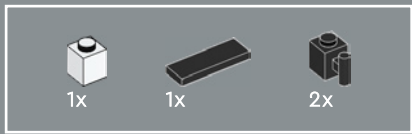

251

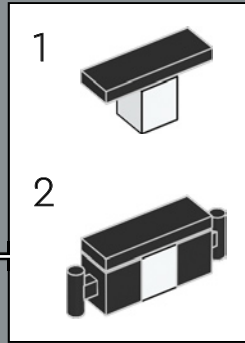
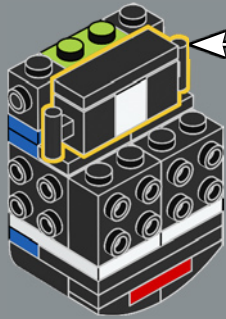

253

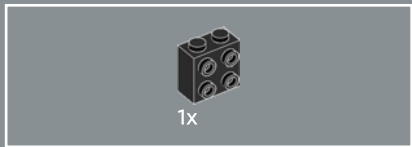
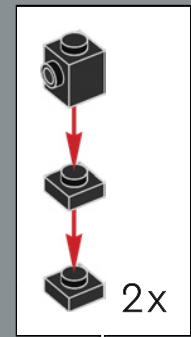
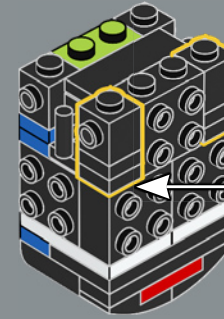

252

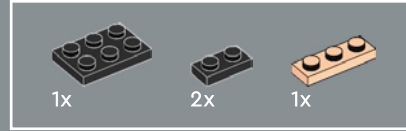
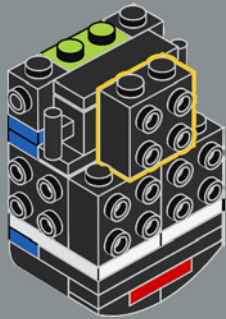

254

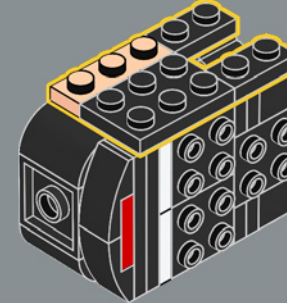



255

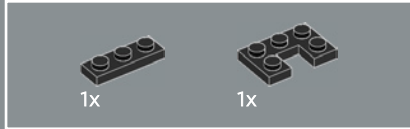
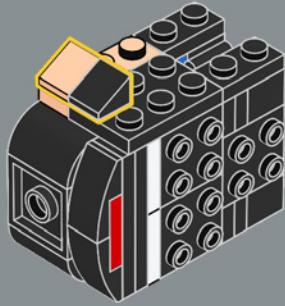

256

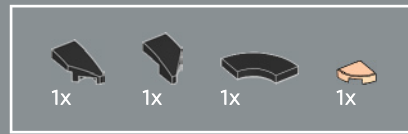
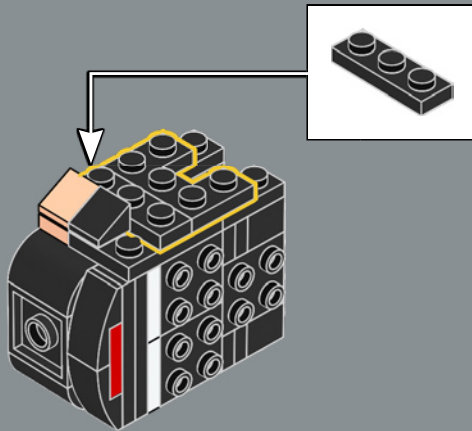

257

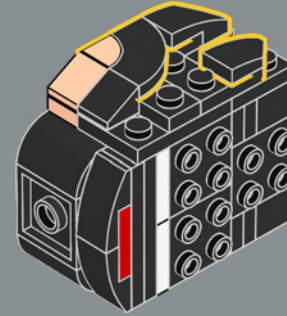

258

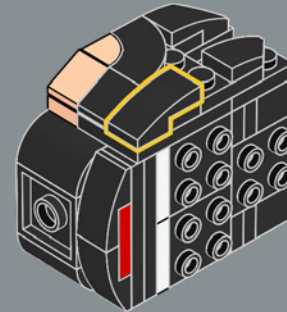

1x

259

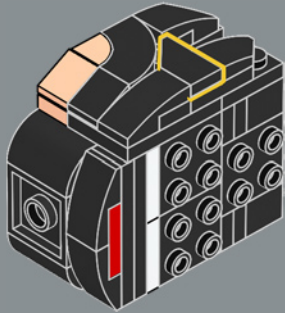

1x 2x 1x

260

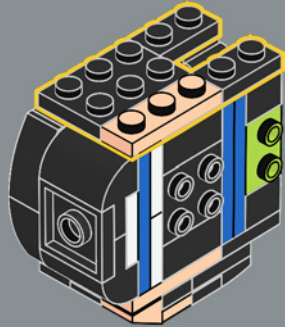

1x

1x

261

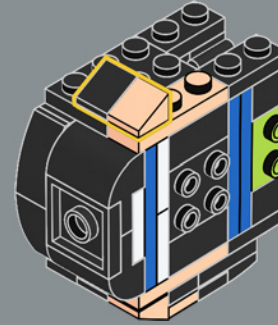

1x 1x

262

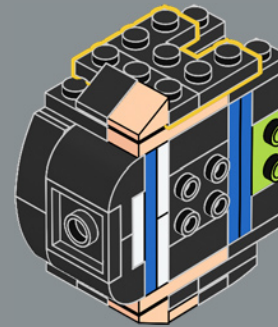

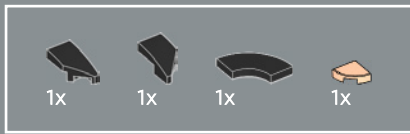

263

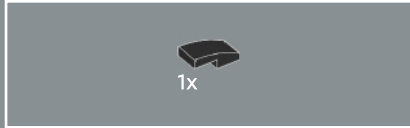
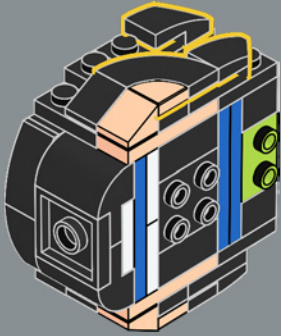

264

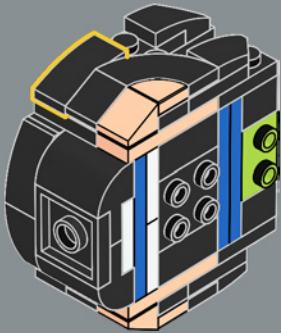

265

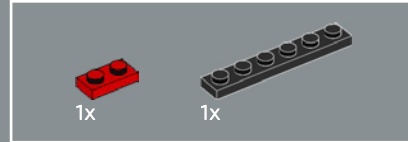
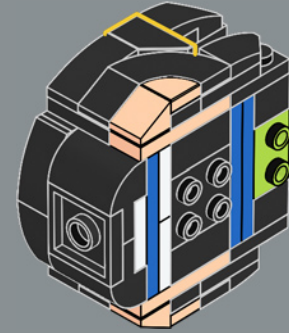

266

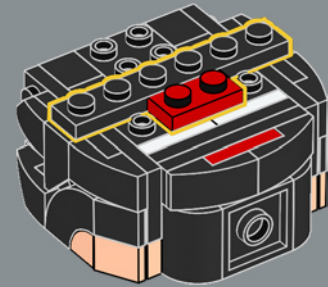

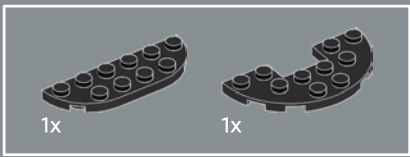

267

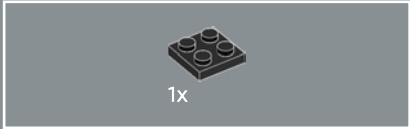
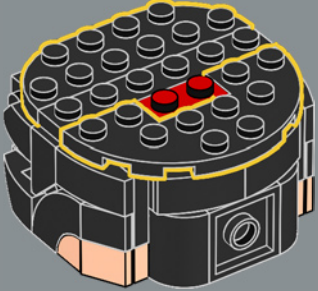

268

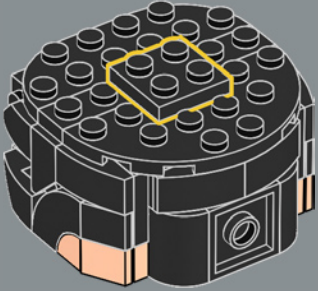

269

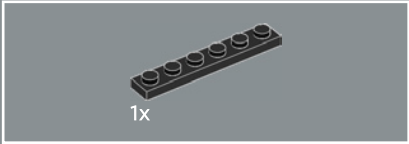
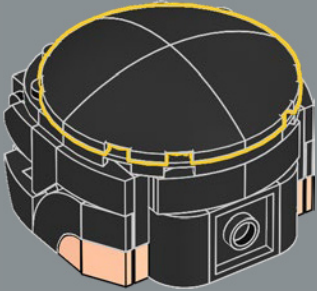

270

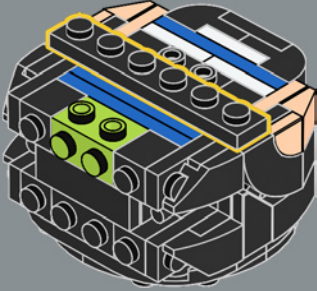

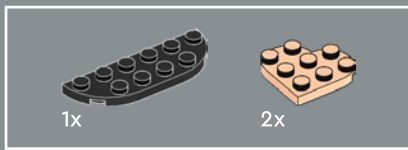

271

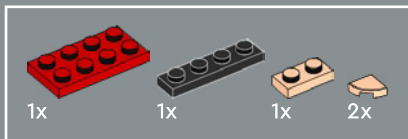
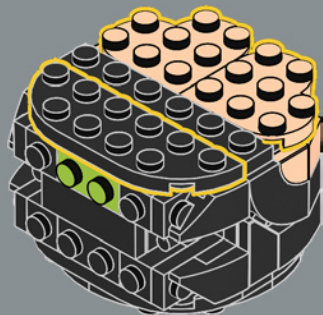

272

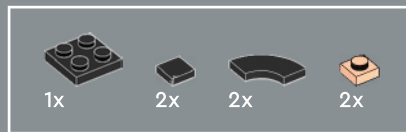
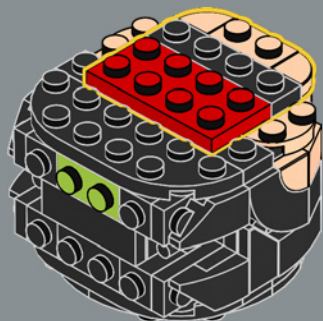

273

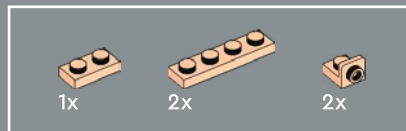
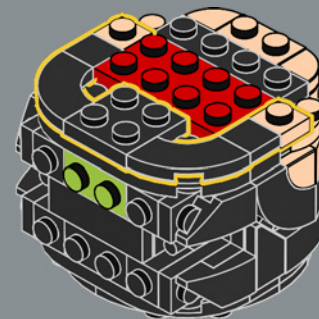

274

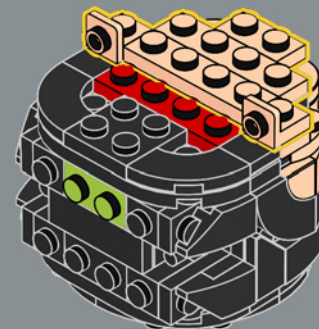

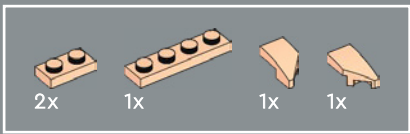

275

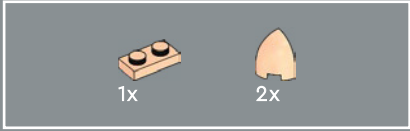
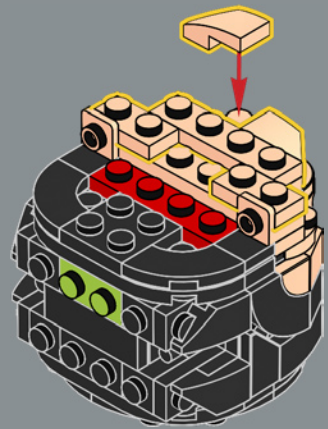

276

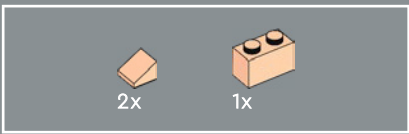
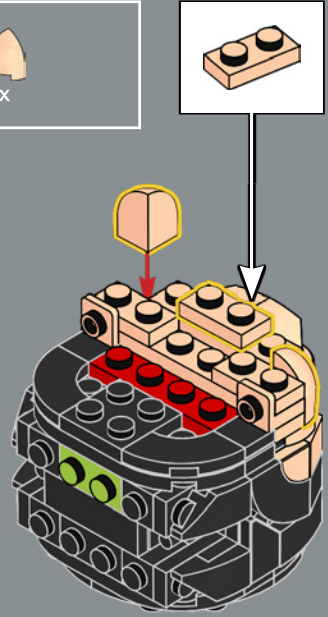

277

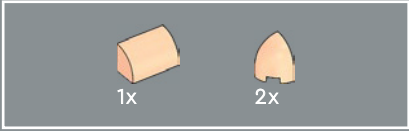
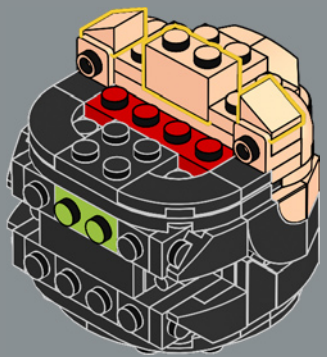

278

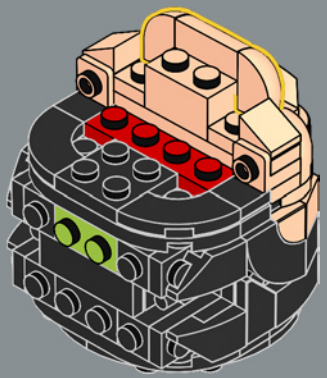



279

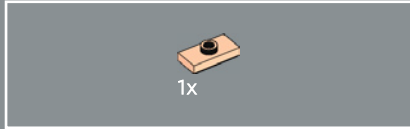
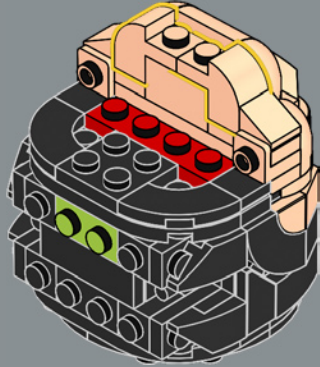

280

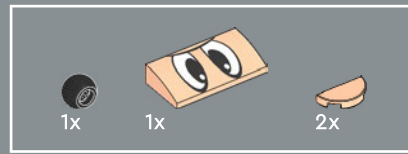
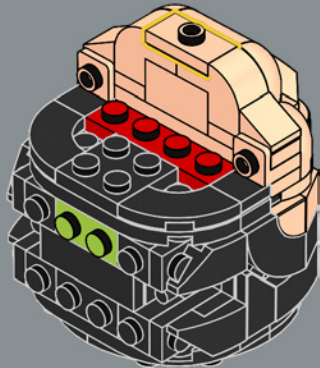

281

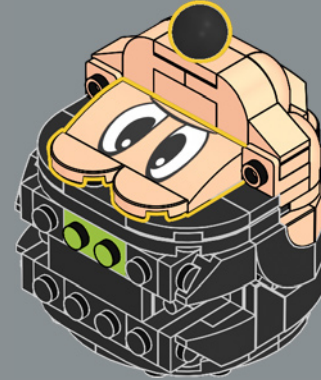

282

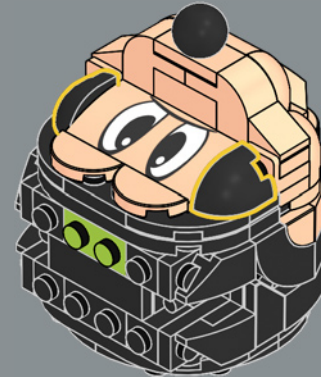

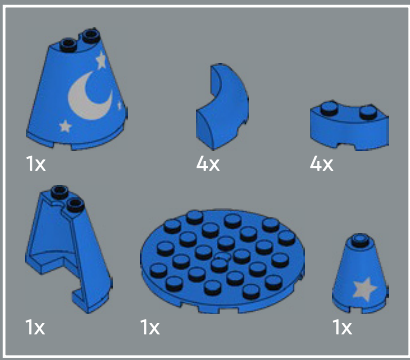

283

1

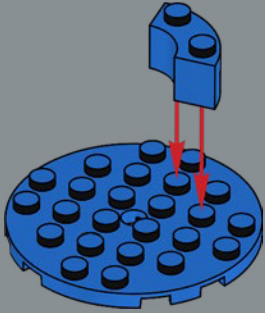

2

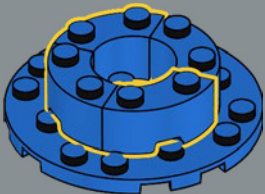

3

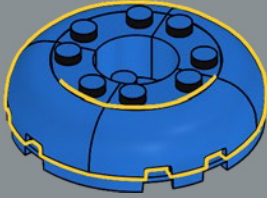

4

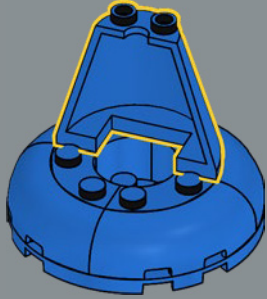

5



6

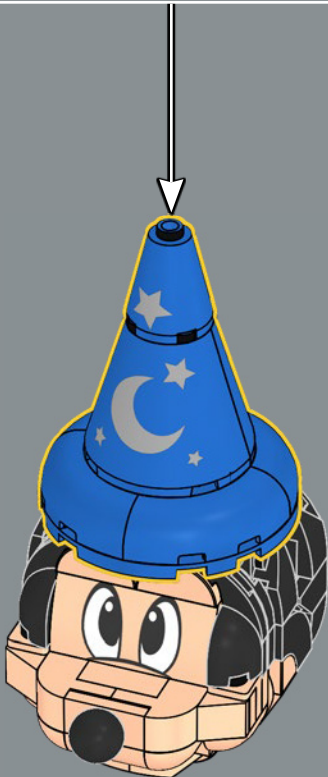

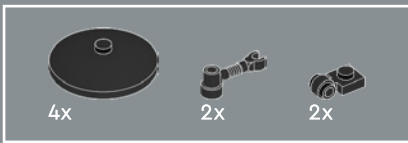

284

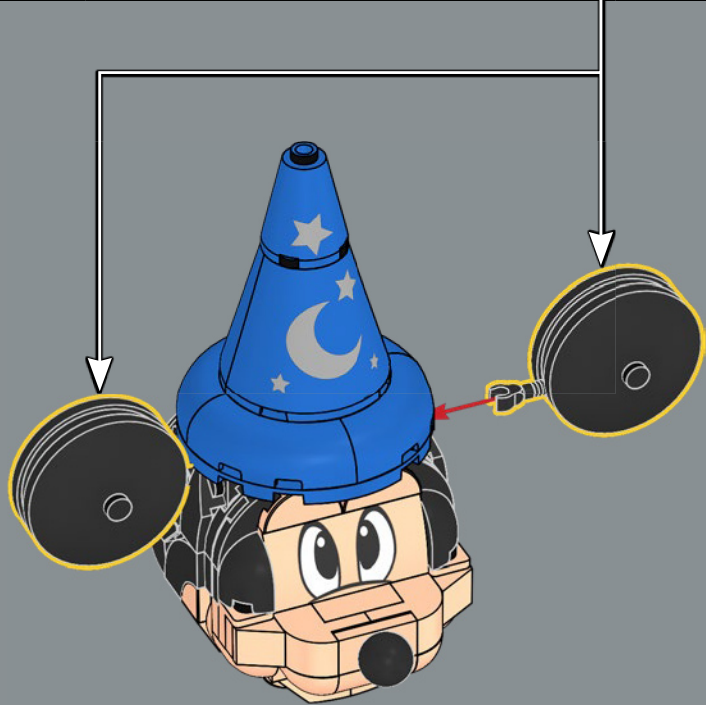
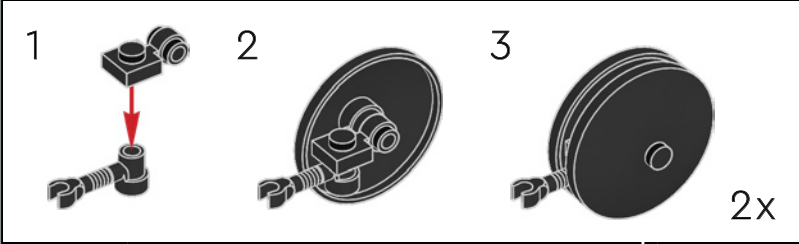

285





2x

286







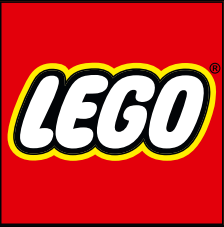

IDEAS

GATHER SUPPORT
OBTENEZ DE L'APPUI
OBTÉN APOYOS

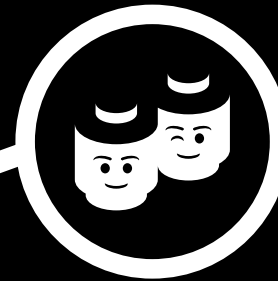

SHARE YOUR IDEA
PARTAGEZ VOTRE IDÉE
COMPARTE TU IDEA

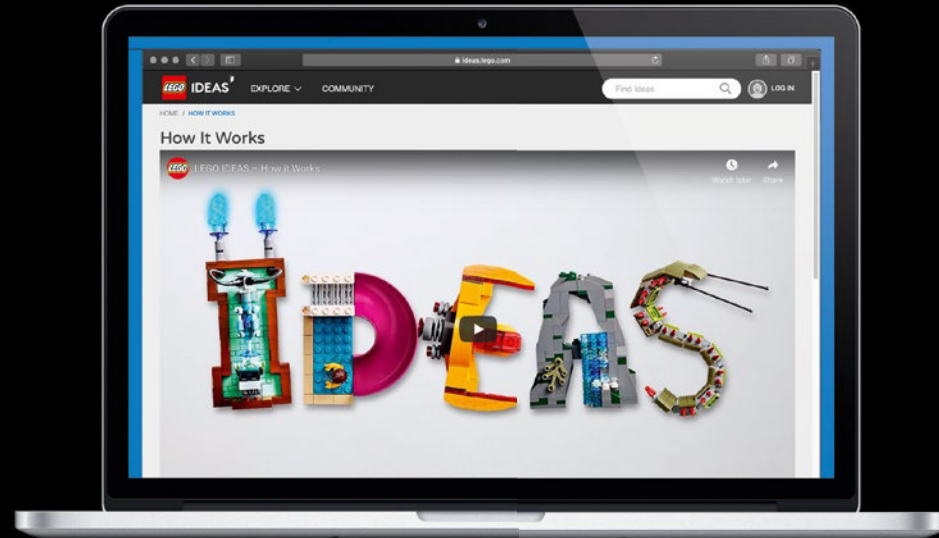
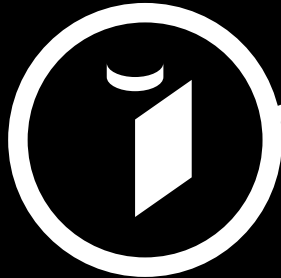

NEW LEGO® PRODUCT
NOUVEAU PRODUIT LEGO®
NUEVO PRODUCTO LEGO®

LEGO® REVIEW
EXAMEN LEGO®
REVISIÓN DE LEGO®



ideas.LEGO.com

| | | |
|---------------|---------------|---------------|
| | | |
| 5x 300501 | 2x 6417970 | 8x 6174937 |
| | | 4x 6330191 |
| 2x 362201 | 8x 6202501 | |
| | | 2x 6347287 |
| 1x 6058177 | 6x 307001 | |
| | | 2x 6223491 |
| 1x 4121932 | 11x 302401 | |
| | 1x 306901 | 2x 6089696 |
| 1x 6166894 | | |
| 2x 366501 | 4x 302301 | 8x 614101 |
| | | 2x 6250591 |
| 2x 4515370 | 4x 302201 | |
| | 2x 6218822 | 4x 6172366 |
| 2x 6069002 | | 6x 6507793 |
| | 2x 362301 | 4x 6210272 |
| 4x 6213880 | | |
| | 2x 4558168 | 1x 6515918 |
| 4x 6213881 | | |
| | 2x 302101 | 2x 6013484 |
| 3x 6034044 | | |
| | 1x 371001 | 2x 370021 |
| 2x 6400127 | | |
| | 1x 302001 | 16x 302321 |
| 2x 6110019 | | |
| | 3x 6186681 | 6x 300421 |
| 2x 6357598 | | |
| | 2x 6446788 | 2x 300321 |
| 5x 4249112 | | |
| 144 | 4x 6347293 | |

| | |
|---------------|---------------|
| | |
| 4x 6019155 | 4x 6473603 |
| | |
| 7x 4504379 | |
| | 4x 6177505 |
| | |
| 4x 302421 | 9x 6029946 |
| | |
| 2x 6278441 | 4x 6177507 |
| | 5x 6029946 |
| 4x 6177507 | 2x 6105976 |
| | |
| 5x 6029946 | 1x 4251162 |
| | |
| 2x 6105976 | 4x 6056816 |
| | |
| 1x 4251162 | 1x 6045937 |
| | |
| 4x 6056816 | 5x 4633914 |
| | |
| 1x 6045937 | 2x 6210269 |
| | |
| 5x 4633914 | 6x 6173961 |
| | |
| 2x 6210269 | 2x 6219819 |
| | |
| 6x 6173961 | 1x 242021 |
| | |
| 2x 6219819 | |
| | |
| 1x 242021 | |

| | |
|---------------|---------------|
| | |
| 8x 6384910 | 2x 4515348 |
| | |
| 8x 6310198 | 11x 362321 |
| | |
| | 6x 302121 |
| | |
| | 10x 371021 |
| | |
| | 6x 302021 |
| | |
| | 1x 4243814 |
| | |
| | 1x 366621 |
| | |
| | 1x 6108802 |
| | |
| | 1x 379521 |
| | |
| | 8x 346021 |
| | |
| | 1x 303221 |
| | |
| | |
| | 1x 6249092 |

| | |
|---------------|---------------|
| | |
| 1x 6512571 | 1x 6380346 |
| | |
| 1x 6380346 | 1x 6503441 |
| | |
| | 1x 6517019 |
| | |
| | 1x 6469438 |
| | |
| | 2x 4121972 |
| | |
| | 1x 4129996 |
| | |
| | 1x 6030731 |
| | |
| | 1x 4114322 |
| | |
| | 1x 6020375 |
| | |
| | 1x 4159739 |
| | |
| | 1x 6313119 |
| | |
| | 1x 4217562 |
| | |
| | 1x 6273851 |

| | |
|---------------|---------------|
| | |
| 1x 4529237 | 4x 4516055 |
| | |
| 1x 6145570 | |
| | 3x 6312460 |
| | 2x 4159553 |
| | |
| | 1x 4125253 |
| | |
| | 3x 6514488 |
| | |
| | 1x 6143058 |
| | |
| | 1x 4579260 |
| | |
| | 2x 4113917 |
| | |
| | 2x 6251252 |
| | |
| | 1x 4114077 |
| | |
| | 1x 4565387 |
| | |
| | 1x 4121921 |
| | |
| | 2x 366523 |
| | |
| | 4x 6189189 |
| | |
| | 2x 6513920 |

| | | | | | | | |
|---------------|---------------|---------------|---------------|---------------|---------------|---------------|---------------|
| 4x 300523 | 2x 6302961 | 1x 6382590 | 2x 6178922 | 2x 6281993 | 6x 6436425 | 1x 6396678 | 6x 6509268 |
| 2x 300423 | 8x 302423 | | 2x 4504382 | 1x 6141556 | | 3x 4211242 | 6x 4626196 |
| | 6x 4504380 | 1x 6517771 | 2x 6181720 | 2x 403226 | | | 6x 6426196 |
| 4x 362223 | 2x 4206330 | | 2x 6181713 | 2x 6143850 | 1x 6421735 | 1x 4529242 | 1x 6476174 |
| | 4x 6172414 | 2x 302224 | 2x 6181713 | 4x 6191630 | | 2x 6322211 | 2x 6186673 |
| 2x 301023 | 4x 6172414 | | 2x 6147050 | 2x 6143850 | 2x 6279875 | | 3x 6433717 |
| | 4x 6172411 | 1x 302024 | 2x 4141580 | 4x 6191630 | | 2x 6365885 | 2x 6306775 |
| 4x 6311259 | 6x 6055065 | | 2x 6047276 | 2x 6093525 | 2x 4221744 | | 2x 6365885 |
| | 16x 302323 | 1x 6147047 | 1x 4290713 | 4x 302126 | 4x 4558954 | 1x 4211151 | 1x 6365885 |
| 1x 6517277 | 2x 362323 | | 2x 302126 | 2x 6493691 | 2x 6170566 | 2x 4211150 | 1x 4211151 |
| | 1x 362323 | | 4x 302426 | 5x 371026 | 6x 6275806 | 1x 4211150 | 2x 4211150 |
| 4x 6307922 | 1x 379523 | | 1x 6510139 | 2x 6439175 | 4x 6308883 | 1x 4216695 | 2x 4216695 |
| | 1x 6509261 | | 1x 6510125 | 2x 6510152 | 4x 6385597 | 2x 6196221 | 1x 4216695 |
| 1x 6503450 | 1x 6509261 | | 2x 6092585 | 2x 396026 | 4x 6196221 | 1x 4267994 | 2x 6196221 |
| | 1x 6509261 | | 4x 302326 | 4x 396026 | 1x 300326 | 1x 4211201 | 1x 4211201 |
| 1x 6440085 | 4x 346023 | | 4x 242026 | 4x 302026 | 1x 9339 | 1x 4211247 | 1x 4211247 |
| | 2x 6093691 | | 6x 362326 | 2x 6054852 | | 4x 6170468 | 4x 6170468 |
| 4x 4121936 | 2x 6093691 | | 1x 4558170 | 4x 366626 | 1x 6503445 | 1x 4538252 | 1x 4538252 |
| 2x 6372038 | 2x 303623 | | 2x 6458098 | | 1x 6420726 | | |
| 6x 6439891 | | | | | | | |
| 4x 6045938 | | | | | | | |
| 5x 371023 | | | | | | | |

- 2x 6252045
- 1x 6277483
- 4x 4666322
- 8x 6104342
- 2x 6186021
- 1x 6186012
- 2x 6092602
- 4x 4570877
- 1x 6440767
- 4x 6468066
- 2x 6074892
- 2x 6253418
- 4x 6430373
- 1x 6507961
- 1x 6491319
- 2x 6510188
- 1x 6510164
- 2x 6404363
- 4x 6245250
- 1x 6254254
- 2x 6252041
- 3x 6514001
- 1x 6286876
- 1x 6517500
- 8x 6209682
- 2x 6443851
- 1x 4504372
- 2x 4621557
- 2x 6208291
- 1x 6517017
- 1x 6102906
- 4x 6311890
- 4x 6398466
- 2x 4539090
- 8x 4585479
- 1x 6516984
- 8x 6209691
- 2x 6190252
- 3x 6301811
- 4x 6069887
- 1x 6092594
- 2x 6218047
- 2x 6173654
- 2x 6112307
- 3x 6300322
- 4x 6315781
- 5x 6315781
- 1x 6055172
- 2x 4528604
- 1x 4550168
- 1x 6132768
- 1x 6338985
- 1x 6226594
- 1x 6401026
- 2x 6001824
- 1x 4521914
- 1x 4530678
- 2x 6184880
- 1x 6015454
- 2x 6258951
- 2x 6258949
- 1x 4549436
- 3x 6040126
- 2x 6514274
- 2x 6424623
- 1x 6065504
- 1x 6073040
- 1x 6503438
- 1x 6254252
- 2x 6507959
- 2x 6507986
- 2x 6316571
- 15x 6184484
- 3x 6372124
- 2x 6285271
- 6x 6100322
- 18x 6182777
- 2x 6287903
- 1x 6383136
- 2x 6486923
- 6x 6057389
- 4x 6097861
- 10x 6362254
- 1x 6099373
- 6x 6372138
- 1x 6361991
- 10x 6361988
- 1x 6316569
- 2x 6513917
- 4x 6136397
- 6x 6383091
- 2x 6372146
- 5x 6335524
- 3x 6336860
- 1x 6383112
- 4x 6392576
- 7x 6058766
- 2x 6383076
- 2x 6387467
- 2x 6383078
- 1x 6361985
- 1x 6132422
- 2x 6043656
- 2x 4211815
- 3x 6329651
- 1x 6331087
- 4x 6509875
- 4x 6357792
- 1x 6480356
- 1x 6480371
- 1x 6357793
- 2x 6509880
- 2x 6357797
- 1x 6440634
- 5x 6369188
- 1x 6329282
- 2x 6509879
- 4x 6275872
- 2x 6512570
- 2x 6369189
- 2x 6501239
- 2x 6509876
- 3x 6440965
- 2x 6378419
- 1x 6503449
- 8x 6284589
- 1x 6349124
- 1x 6503439
- 1x 6503446
- 3x 6215606
- 8x 6324205
- 3x 6314190
- 2x 6218360
- 1x 6347304
- 4x 6292154
- 1x 6096990
- 17x 6135287
- 1x 6210271
- 19x 6229130
- 2x 6268814
- 1x 6378799
- 1x 6401021
- 1x 6056383
- 1x 6058085
- 4x 6329605
- 1x 6167700
- 2x 6313600
- 1x 6301315
- 1x 6329119
- 1x 4619521
- 1x 6125776
- 1x 4623598
- 1x 6005030
- 3x 6514272
- 2x 6469891
- 1x 6503442
- 2x 6039479
- 6x 6245283

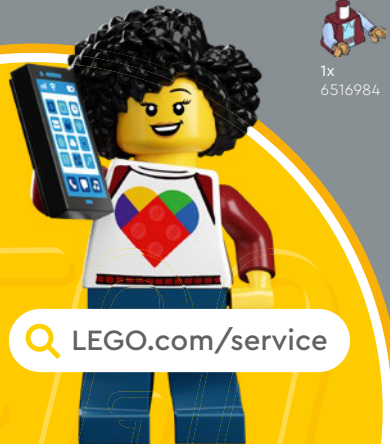

 [LEGO.com/service](https://www.LEGO.com/service)



YOU COULD WIN



YOU COULD WIN

Your feedback will help shape the future development of this product series.

Visit:

DU KÖNNTEST GEWINNEN

Dein Feedback trägt zur Weiterentwicklung dieser Produktreihe bei.

Geh auf:

VOUS POURRIEZ GAGNER

Vos commentaires nous aideront à concevoir les futurs produits de cette gamme.

Visitez :

POTRESTI VINCERE TU

La tua opinione ci aiuterà a migliorare la creazione futura di questa linea di prodotti.

Visita:

PUEDES GANAR

Tu opinión contribuirá al futuro de esta serie de productos.

Visita:

轻松获奖

您的反馈将有助于我们在今后改进本产品系列。

请访问:

[LEGO.com/productfeedback](https://www.lego.com/productfeedback)

You also have the chance to win a LEGO® set.

Terms and conditions apply.*

Außerdem hast du die Chance, ein LEGO® Set zu gewinnen.

Es gelten die Teilnahmebedingungen.*

Vous pourriez également gagner un ensemble LEGO®.

Des conditions s'appliquent.*

Hai anche la possibilità di vincere un set LEGO®.

Termini e condizioni sono applicabili.*

También tienes la oportunidad de ganar un set LEGO®.

Aplican términos y condiciones.*

您还有机会赢取乐高®套装。

条款和条件适用。*

*[LEGO.com/productfeedback-terms](https://www.lego.com/productfeedback-terms)

