



CITY

60439



Q LEGO® Builder

1



Get excited about our new packaging!

We're switching from plastic to paper-based packaging. That's why you might find a mix of paper and plastic in our boxes!

Nos nouveaux emballages vous emballeront !

Nous passons des emballages en plastique aux emballages à base de papier. C'est pourquoi vous pourriez trouver un mélange de papier et de plastique dans nos boîtes !

¡Te presentamos nuestros nuevos empaques!

Estamos sustituyendo las bolsas de plástico por bolsas con base de papel. ¡Por eso, puedes encontrar una mezcla de papel y de plástico en nuestras cajas!

[LEGO.com/sustainable-packaging](https://www.lego.com/sustainable-packaging)

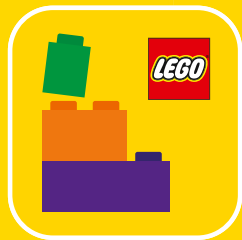

Q LEGO® Builder

BUILDER



Apple and the Apple logo are trademarks of Apple Inc., registered in the U.S. and other countries and regions. App Store is a service mark of Apple Inc. Google Play and the Google Play logo are trademarks of Google LLC. Tencent and the Tencent logo are trademarks of Tencent Inc.

Q LEGO.com/devicecheck

EN Ask parents' permission before going online | DE Eltern um Erlaubnis bitten, bevor du online gehst | FR Demande l'autorisation d'un parent avant d'aller en ligne | IT Chiedi il permesso ai tuoi genitori prima di andare online | ES Pídeles permiso a tus papás antes de conectarte a Internet | PT Pede autorização aos pais antes de acederes online | ZH 上网前应先征得父母的同意 | PL Poproś rodziców o zgodę, zanim wejdziesz do Internetu | CS Než půjdeš na internet, požádej rodiče o svolení | SK Skôr než pôjdeš na internet, vypýtaj si povolenie od rodičov | HU Kérj szülői engedélyt, mielőtt online csatlakoznál! | RO Cere permisiunea părinților înainte de a te conecta online | BG Поискайте разрешение от родител, преди да влезете онлайн | LV Pirms došanās tiešsaistē palūdz atļauju vecākiem | ET Enne Interneti kasutamist küsi vanematelt luba | LT Prieš prisijungdami prie interneto, atsiklauskite tėvų

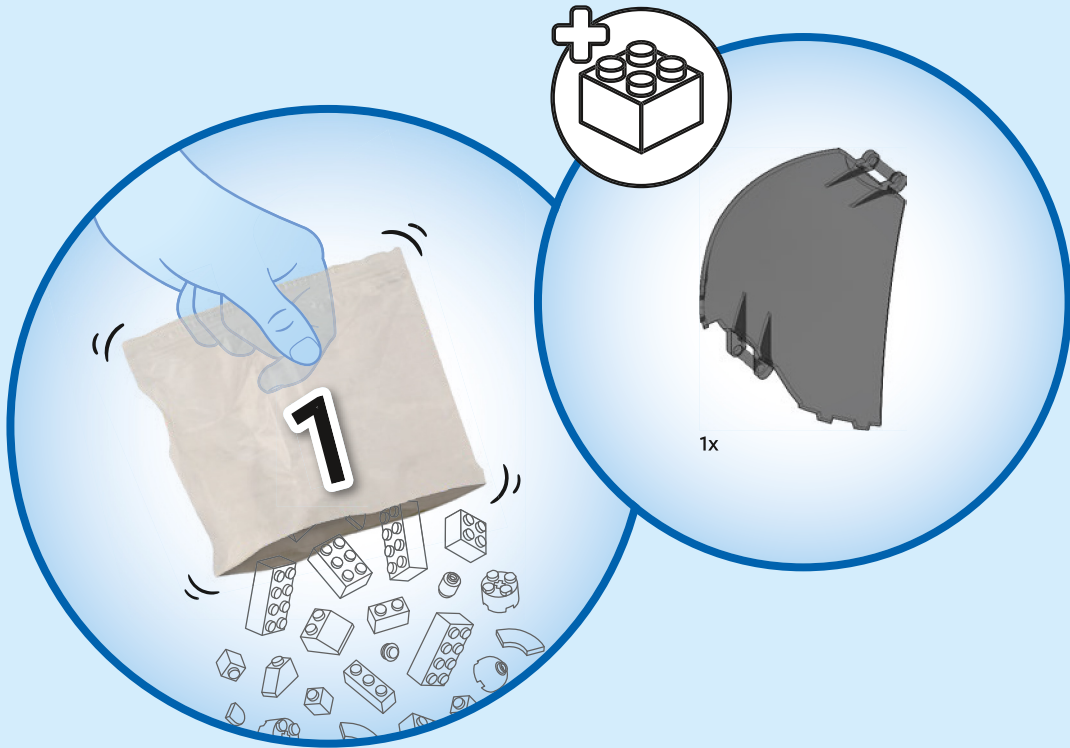

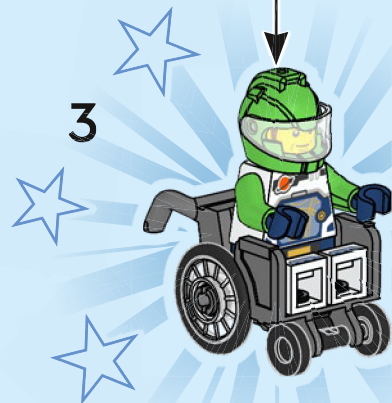
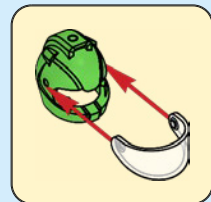
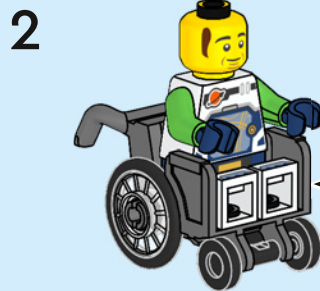
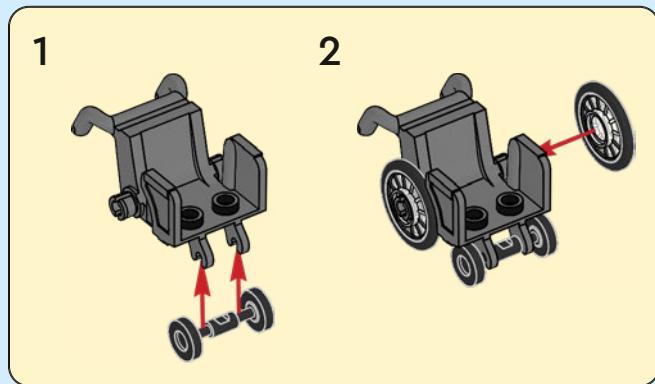
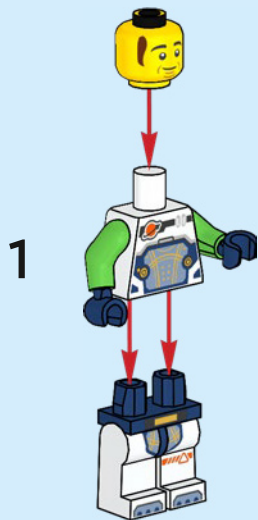

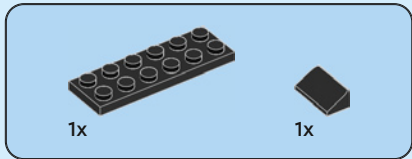
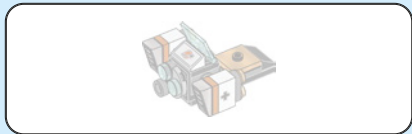

1

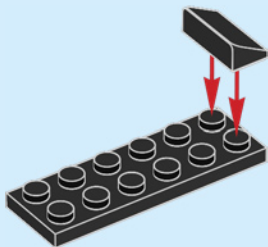

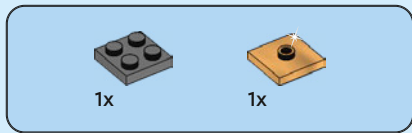

2

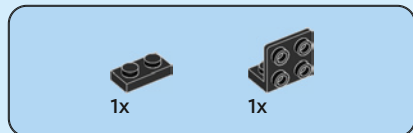
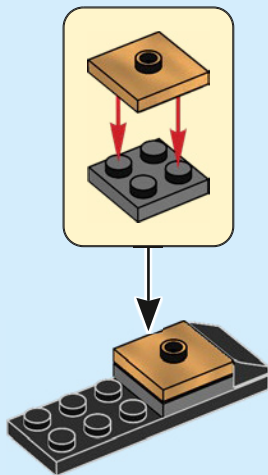

3

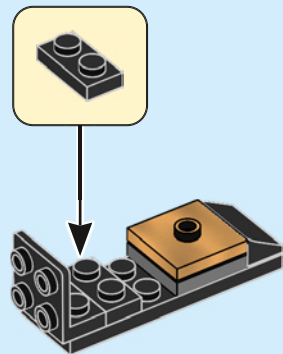



4

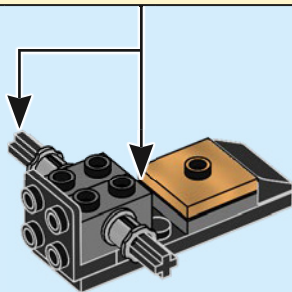
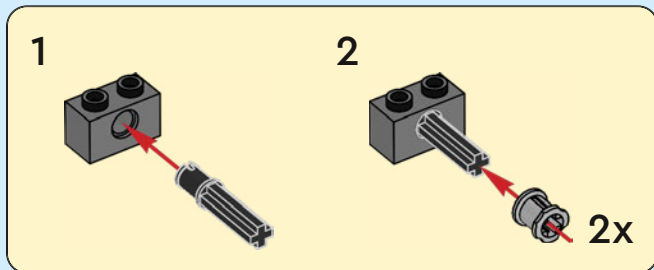



2x

5

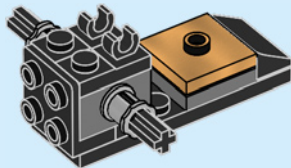

1x

6

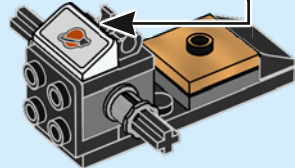
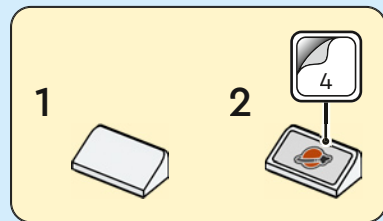



1x

7

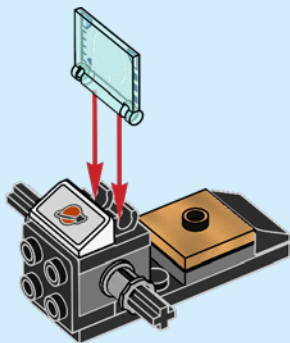

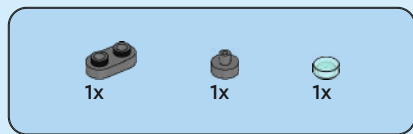

8

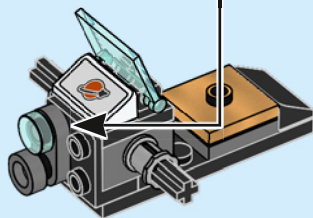
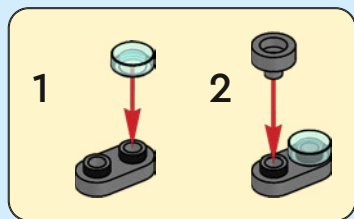

9

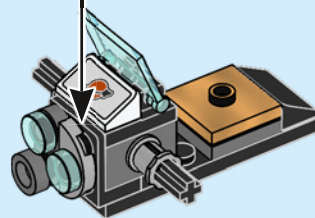
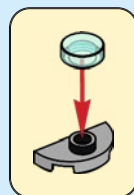

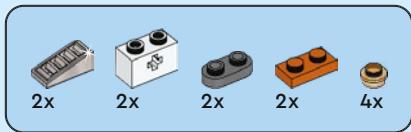

10

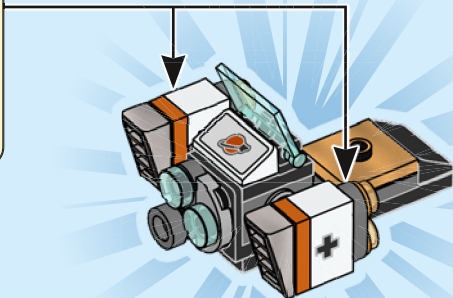
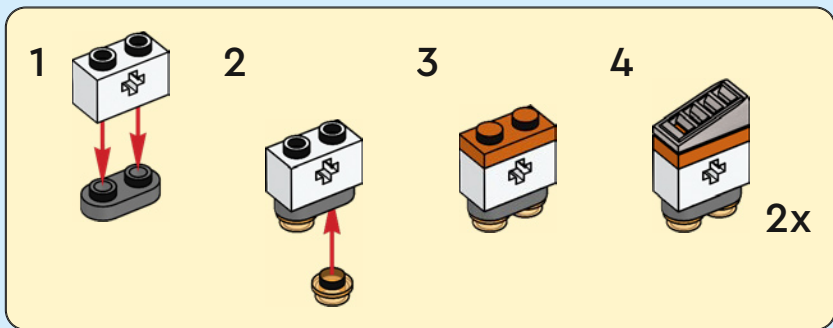



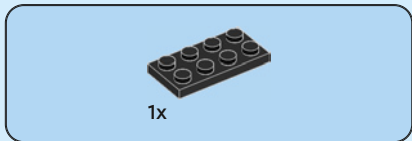

1

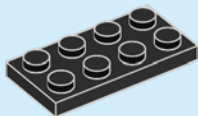

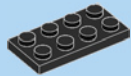

1x

2

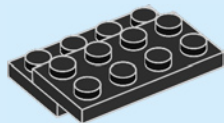

2x

3

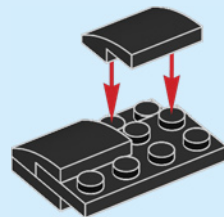

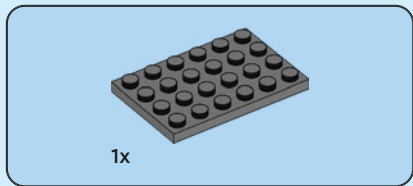

4

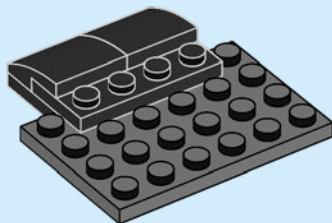

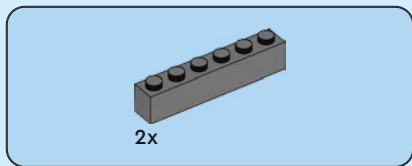

5

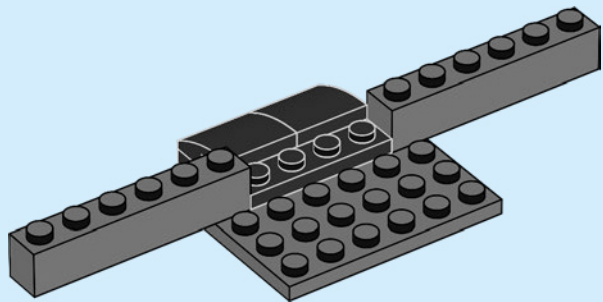

6

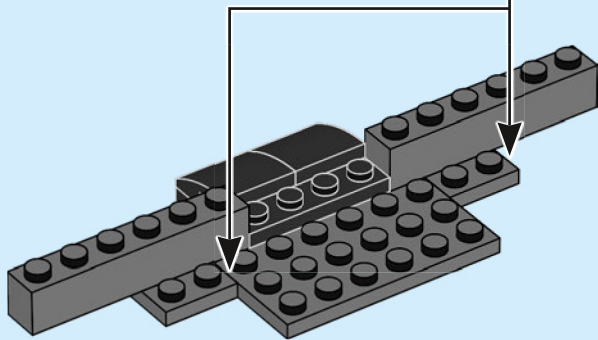
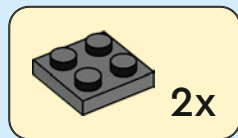

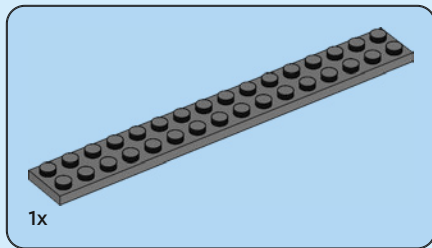

7

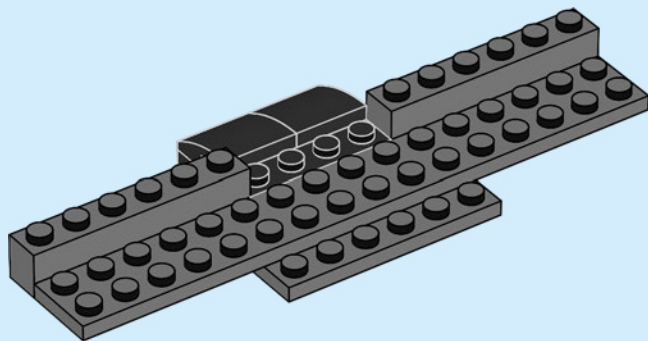

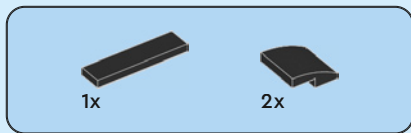

8

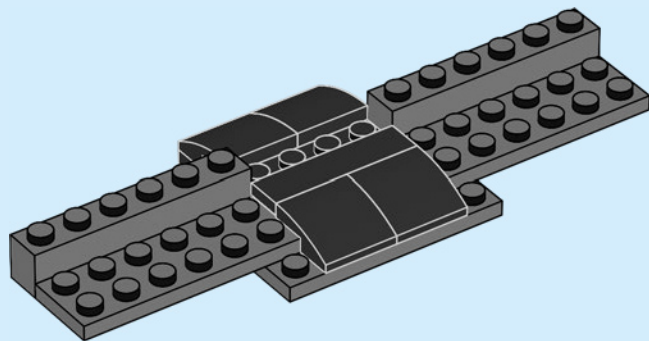



2x

9

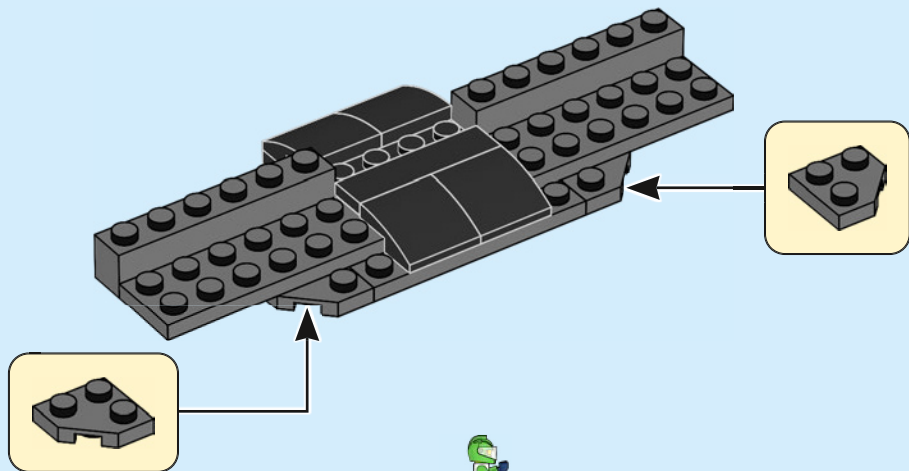



10

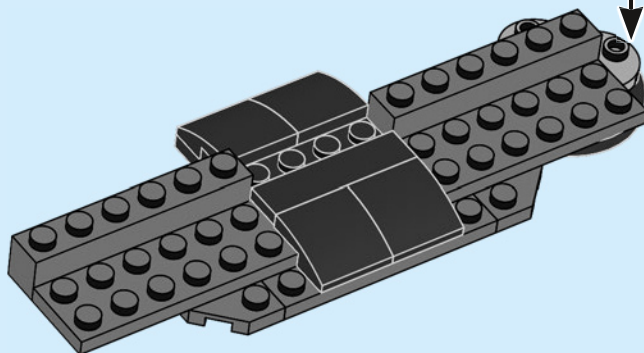
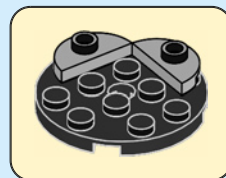

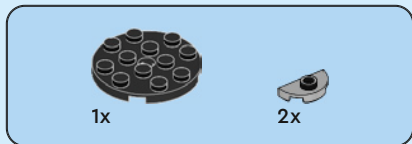

11

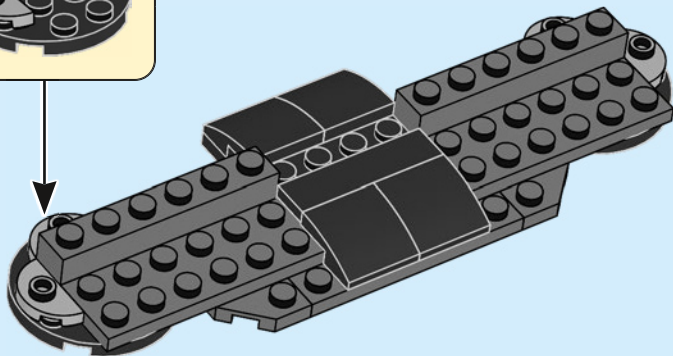

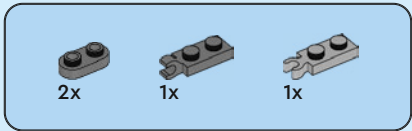

12

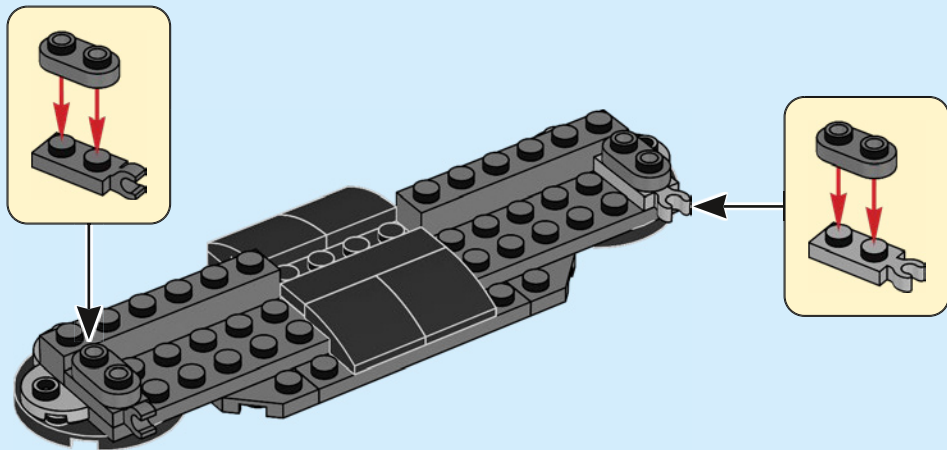



4x

13

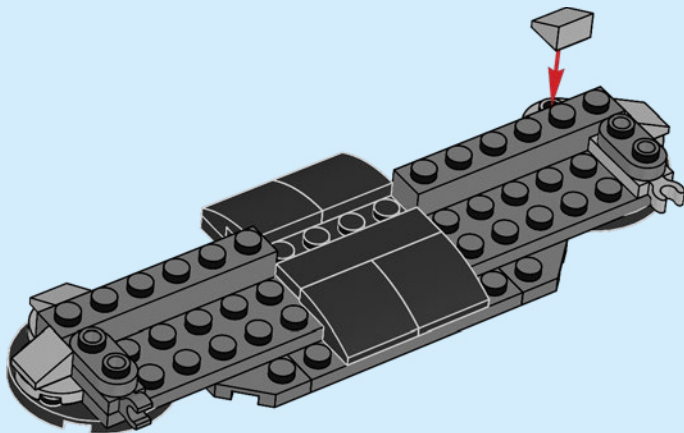



4x



2x

14

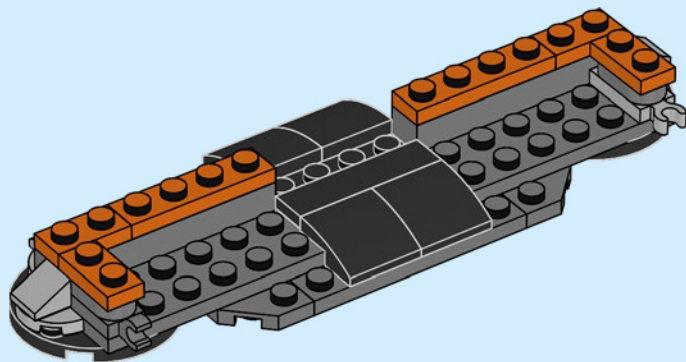

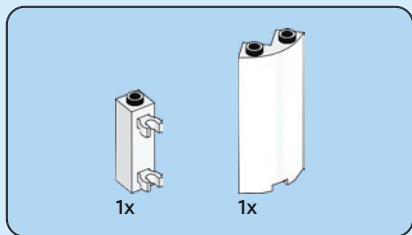

15

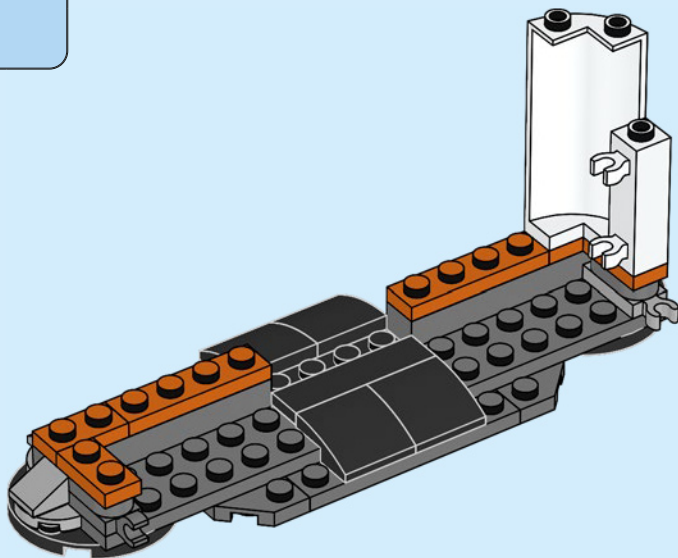

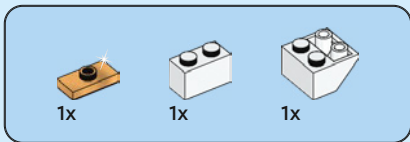

16

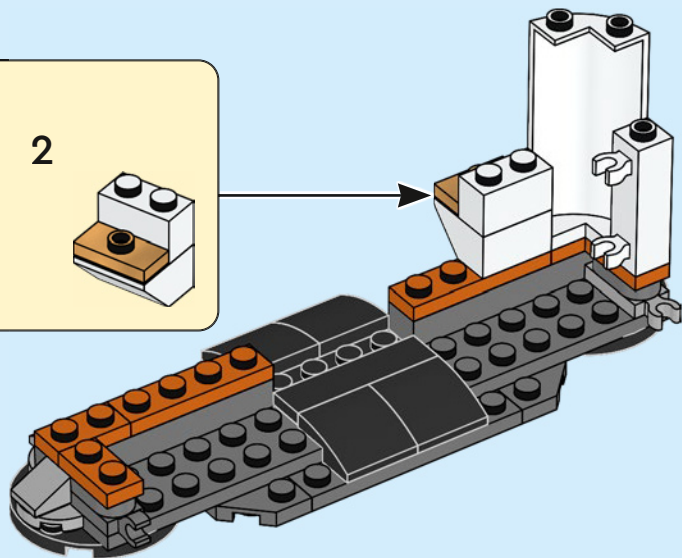
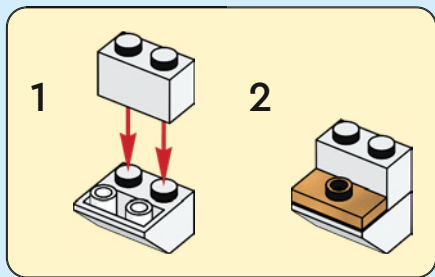

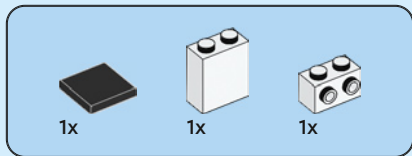

17

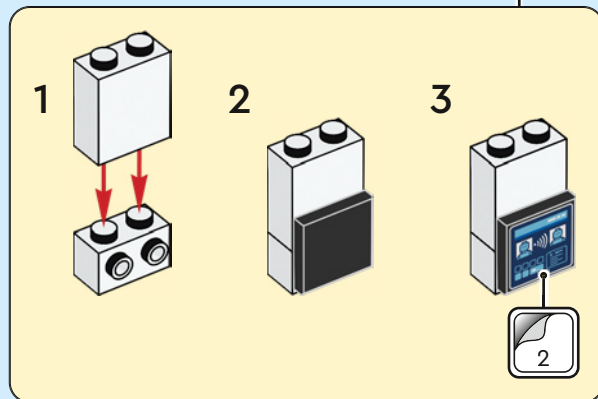
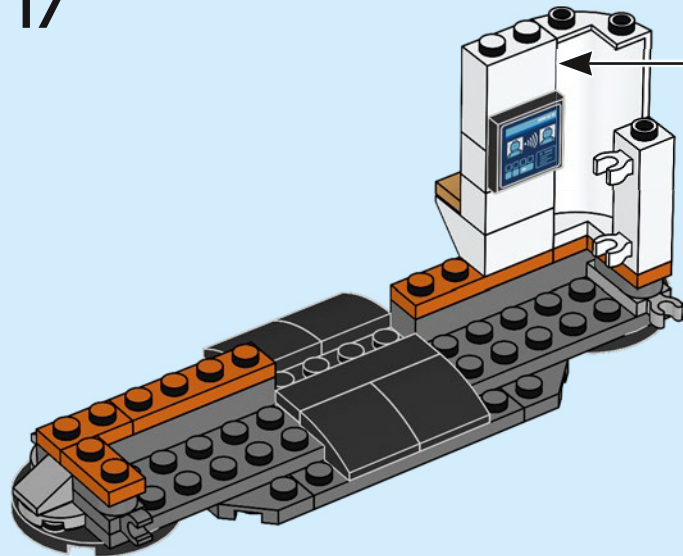



1x



1x



1x

18

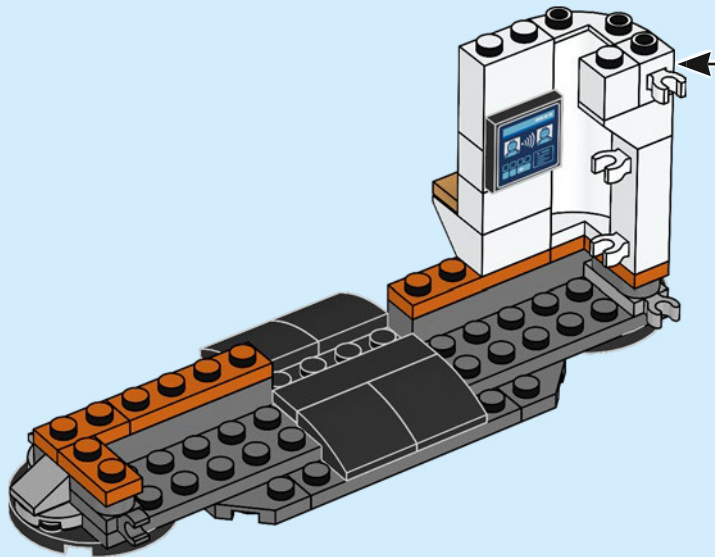

1

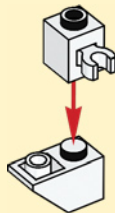

2

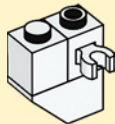



1x

19

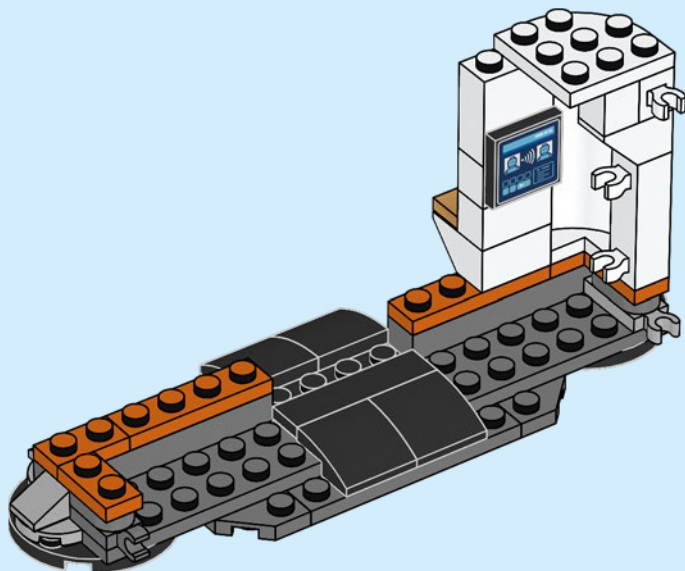

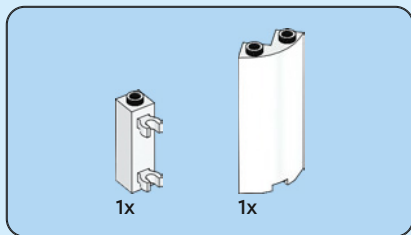

20

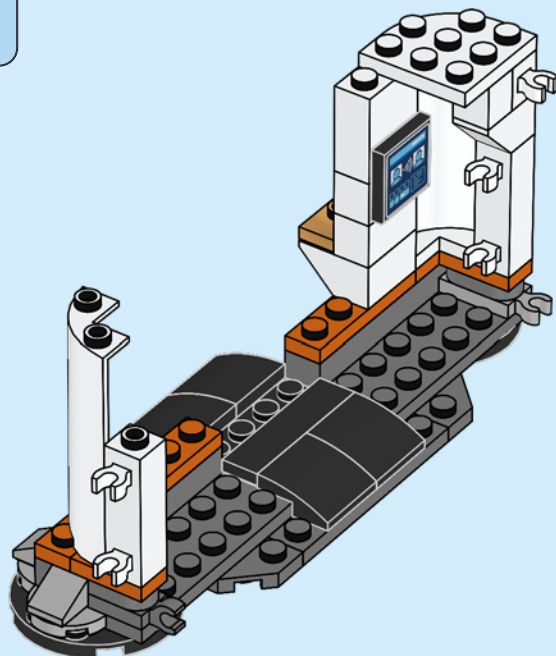

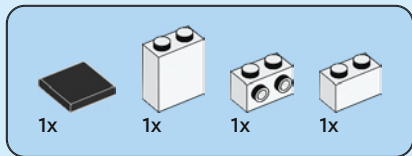

21

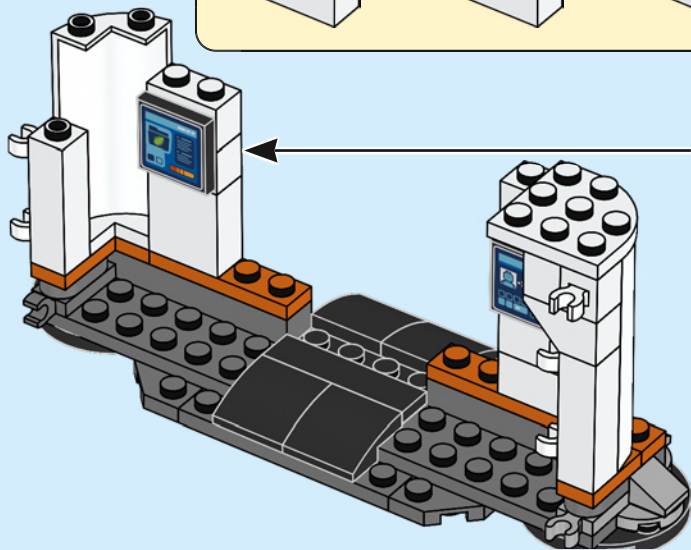
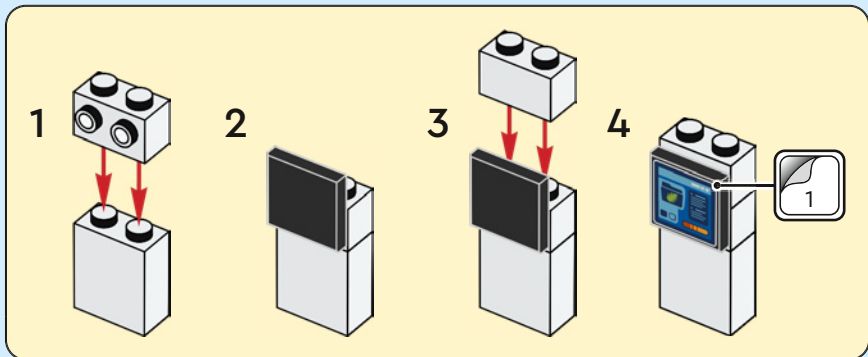



1x



1x

22

1

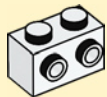

2

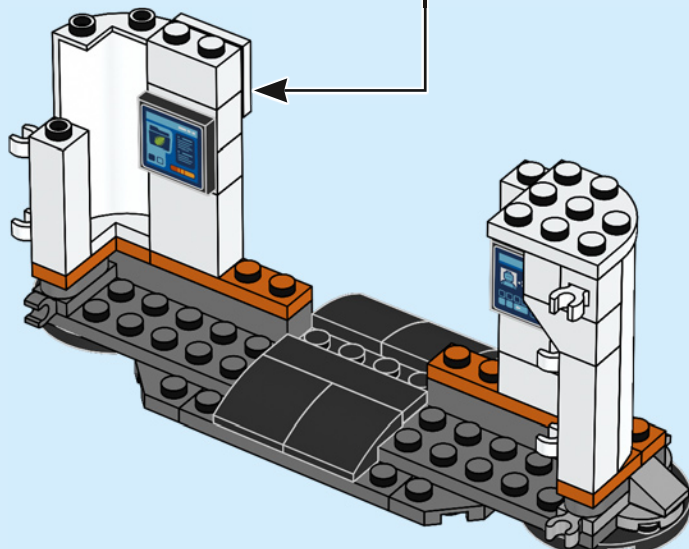



1x



1x

23

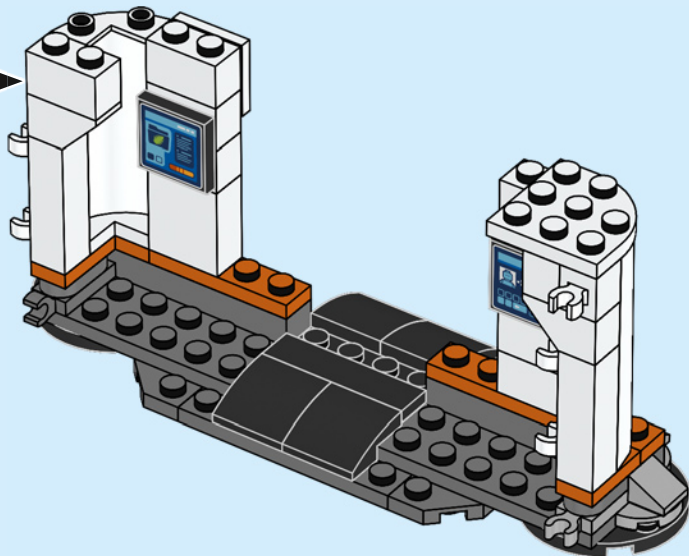
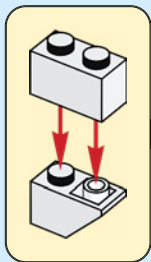



1x

24

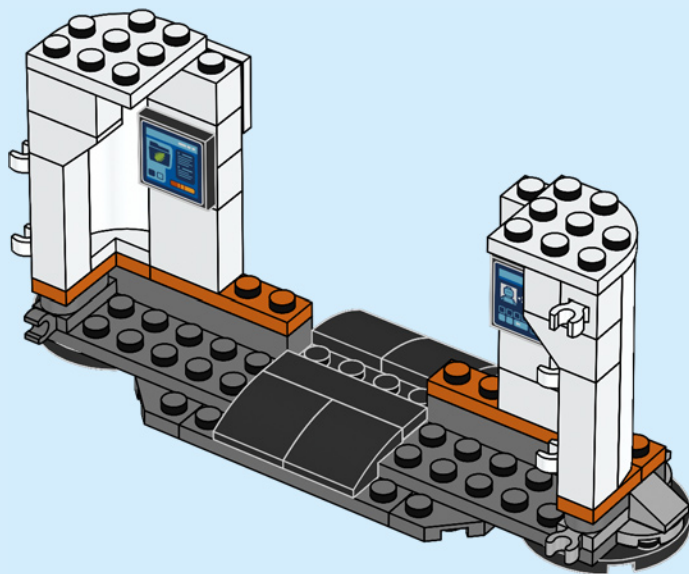

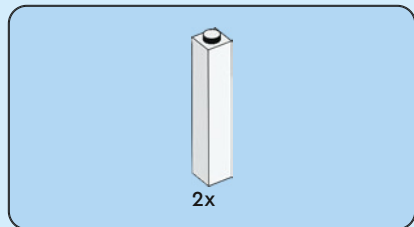

25

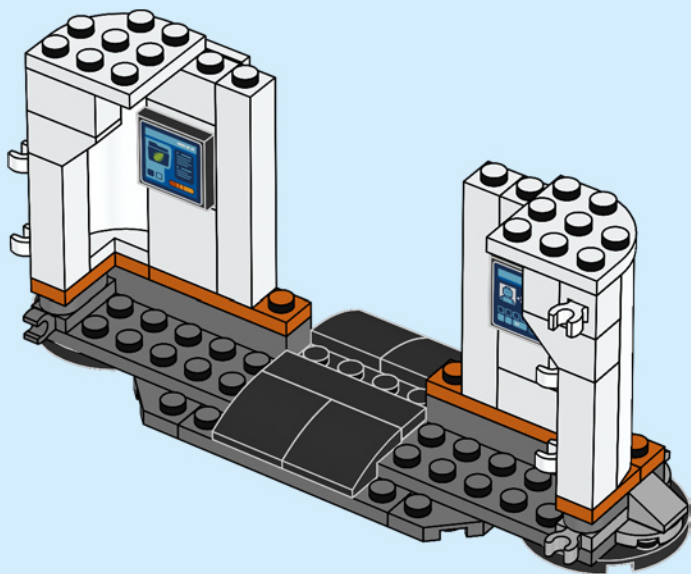



6x

26

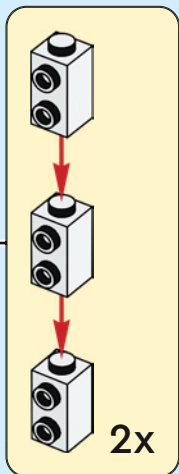
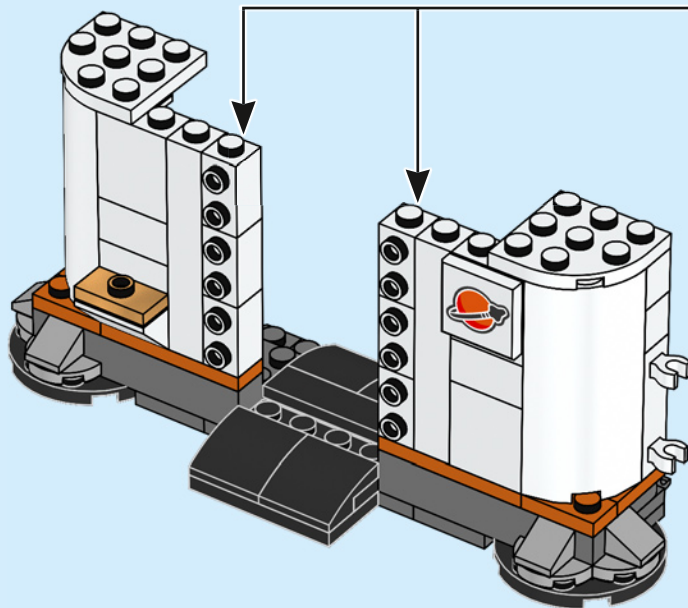

2x



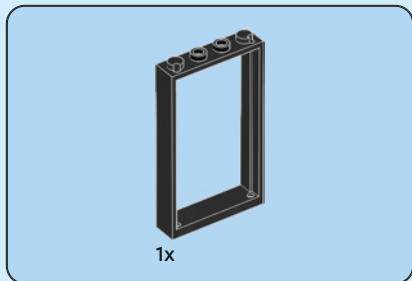

27

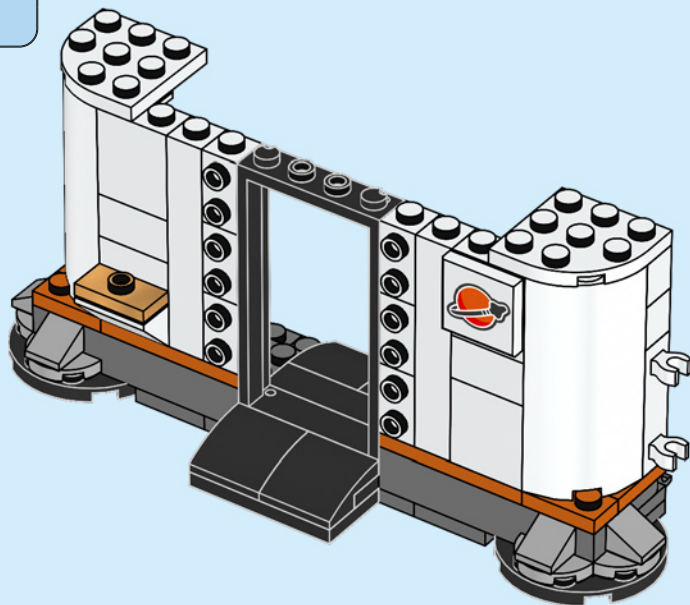

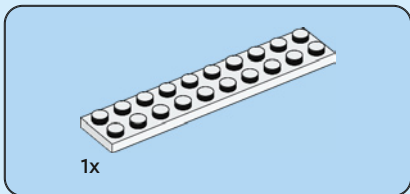

28

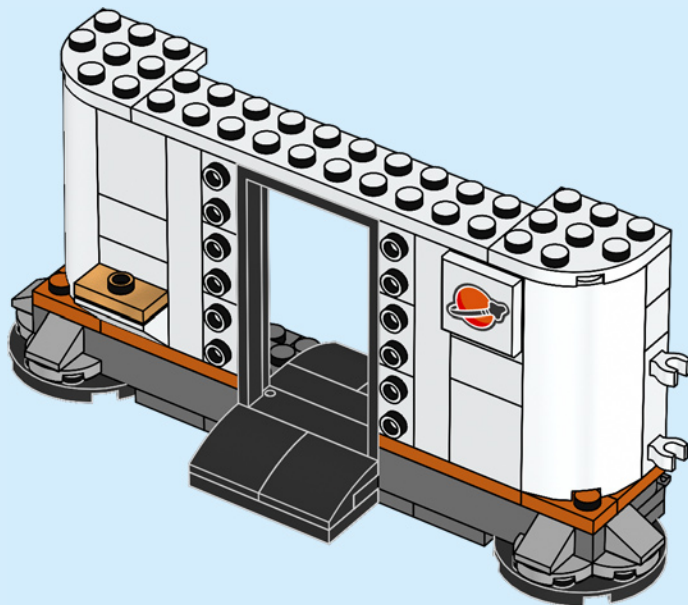



2x



2x

29

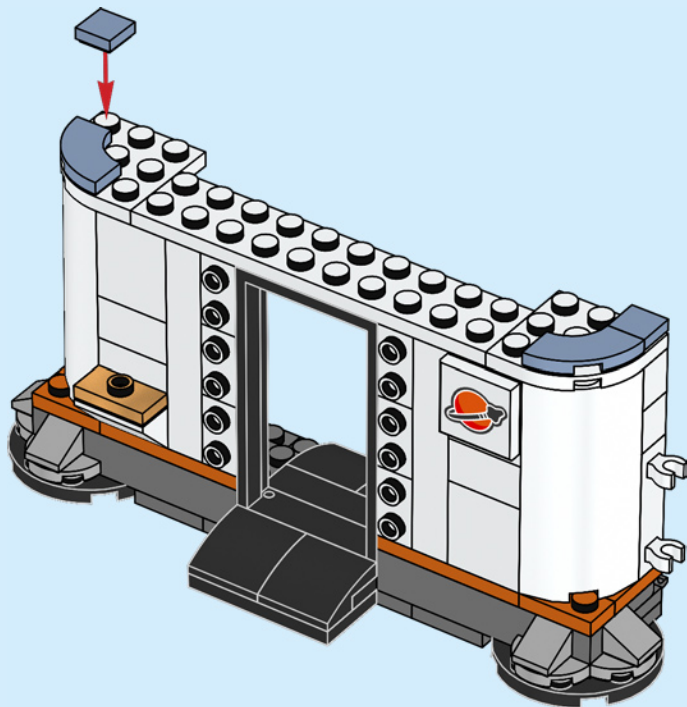

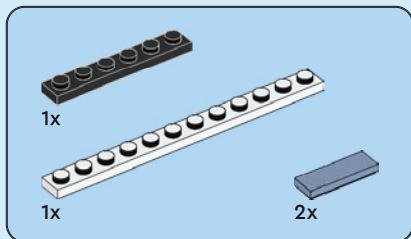

30

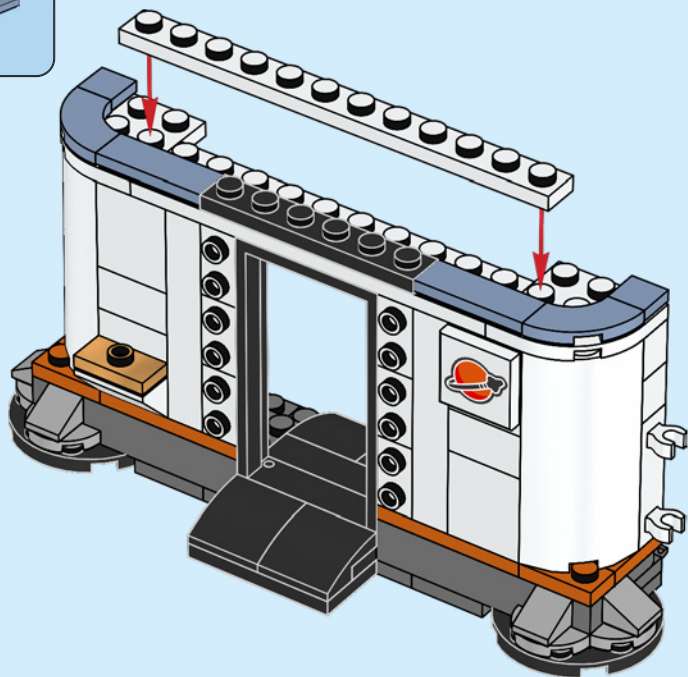



1x



2x



1x

31

1



2



3

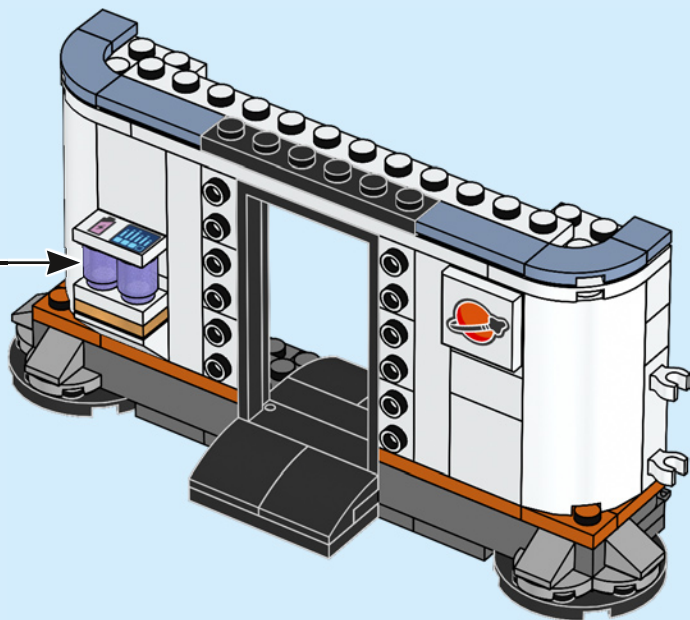

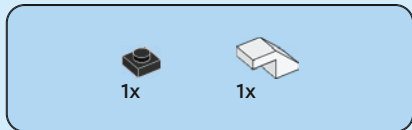
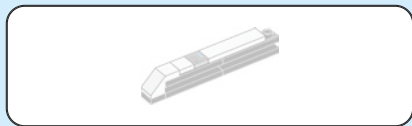

32

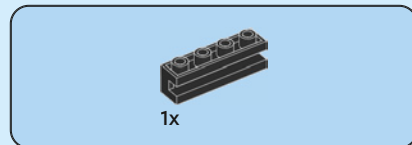
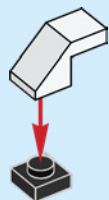

33

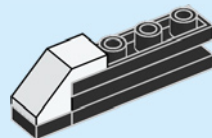



1x



1x

34

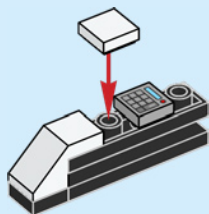

1x

35

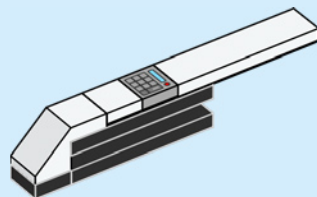

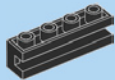

1x

36

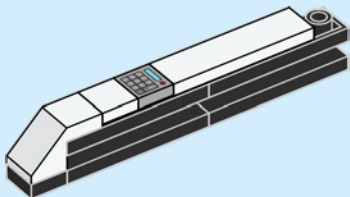

37

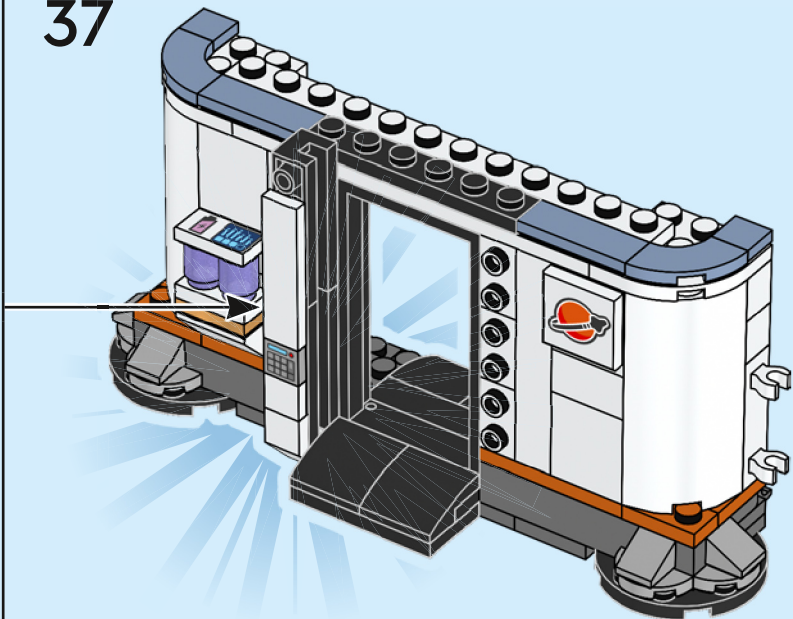

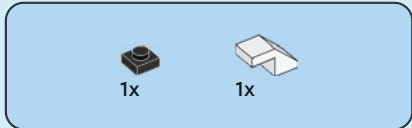
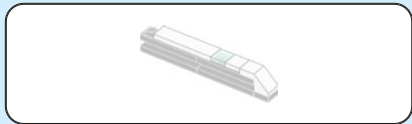

38

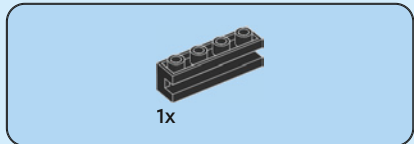
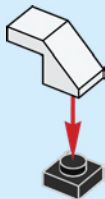

39

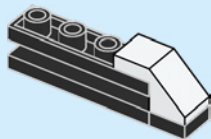



1x



1x

40

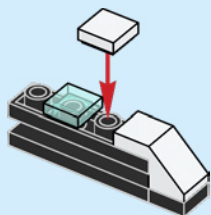

1x

41

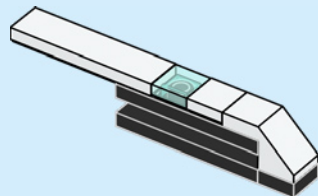

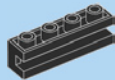

1x

42

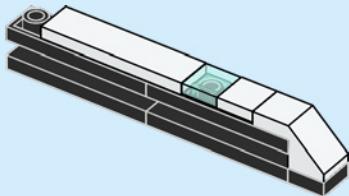

43

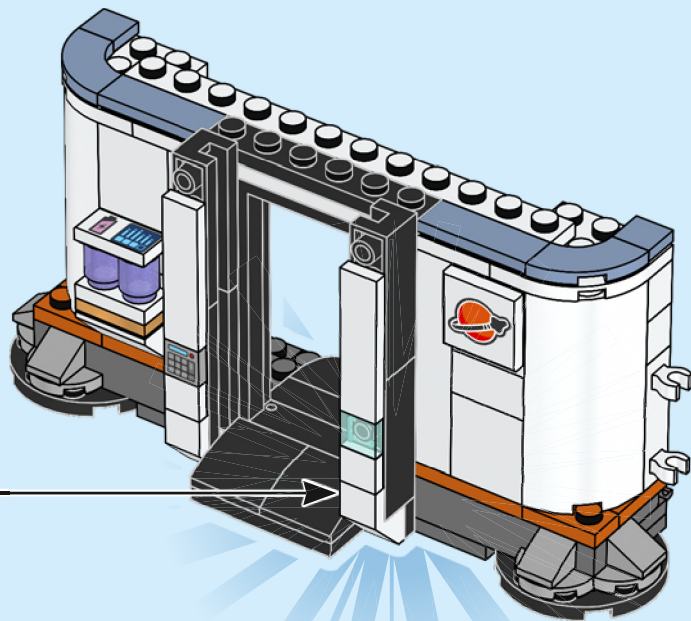



1x

44

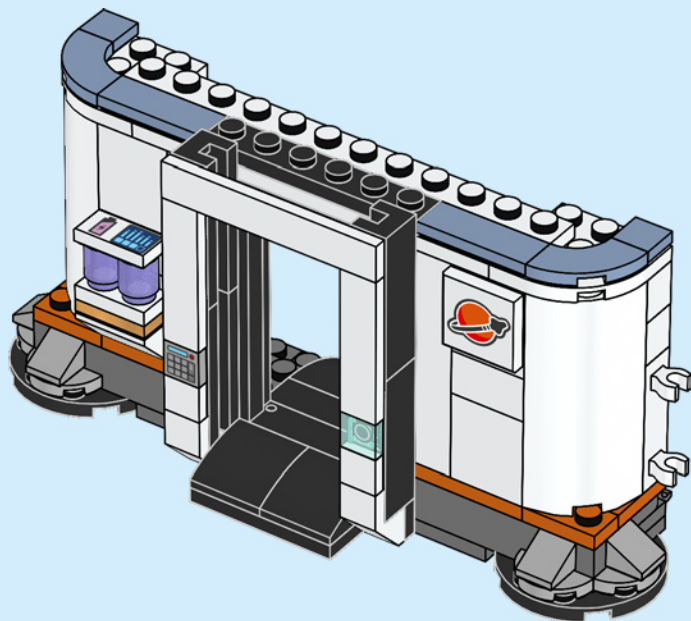

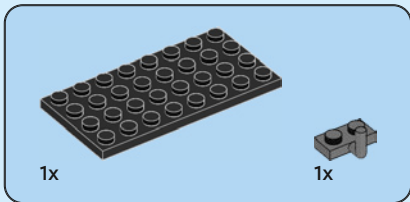

45

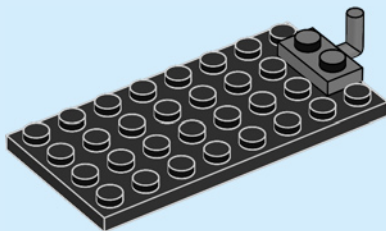

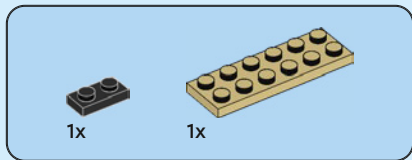

46

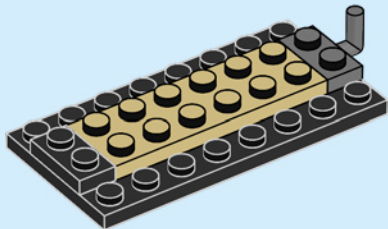

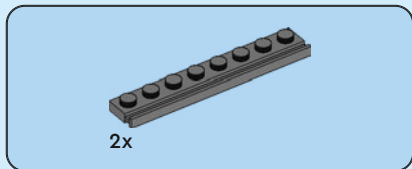

47

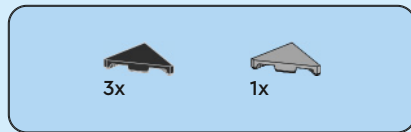
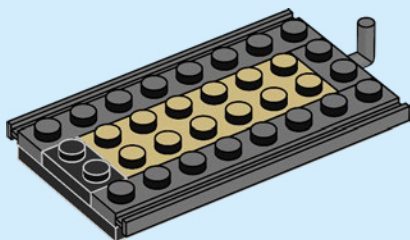

48

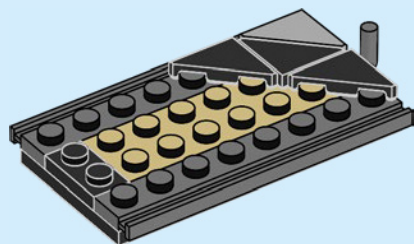



4x

49

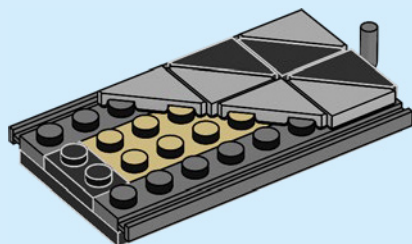



4x

50

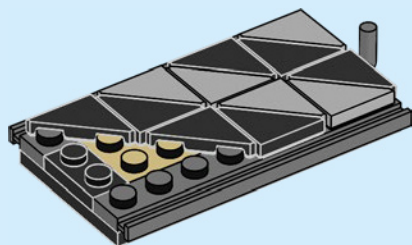

1x



3x

51

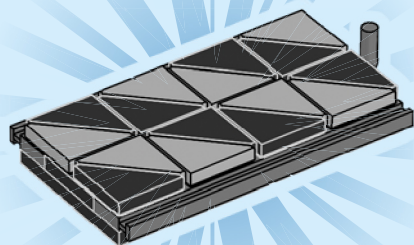

52

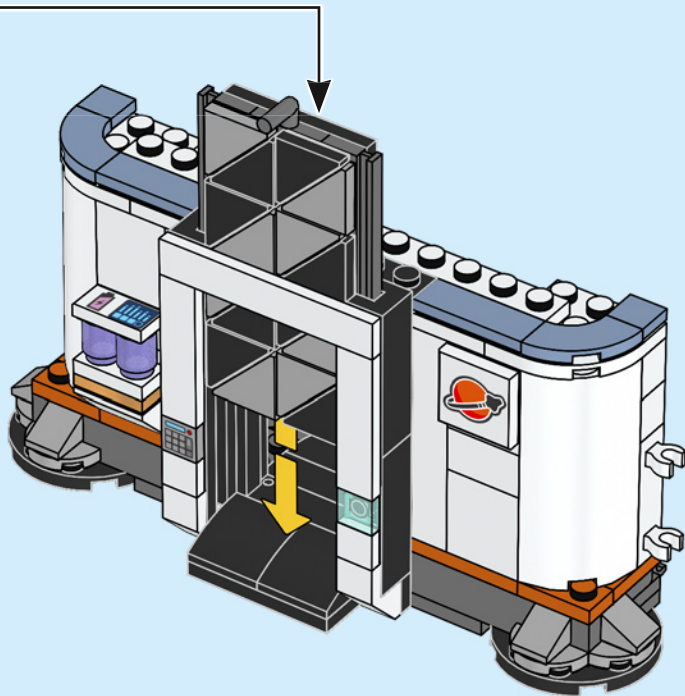

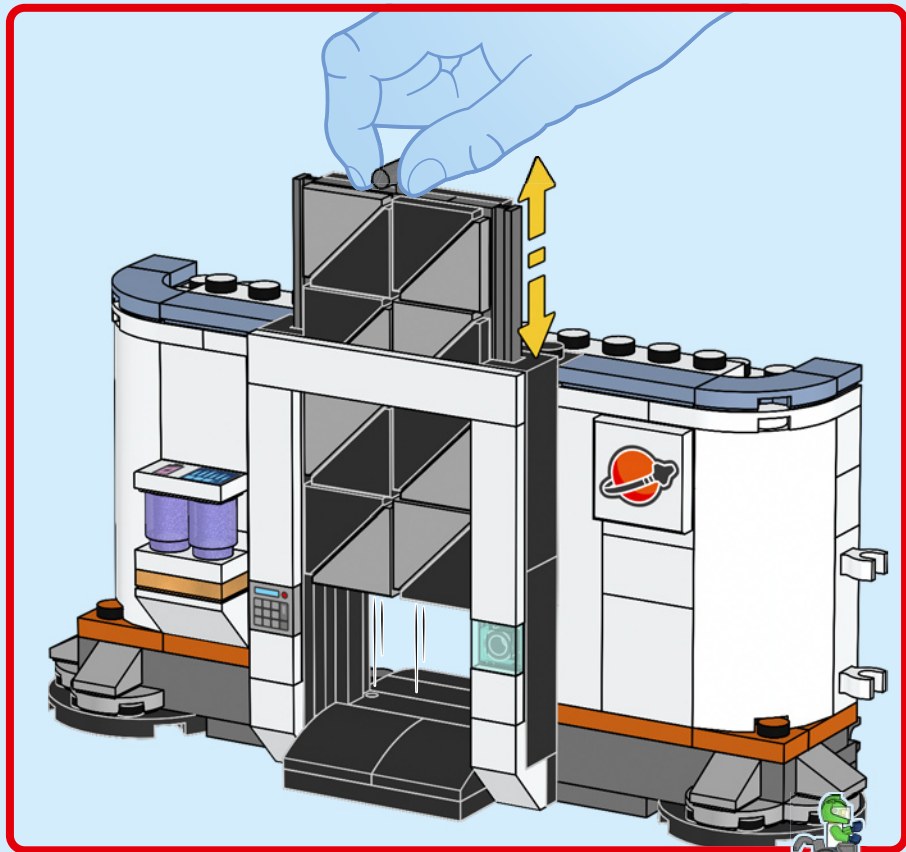



1x

53

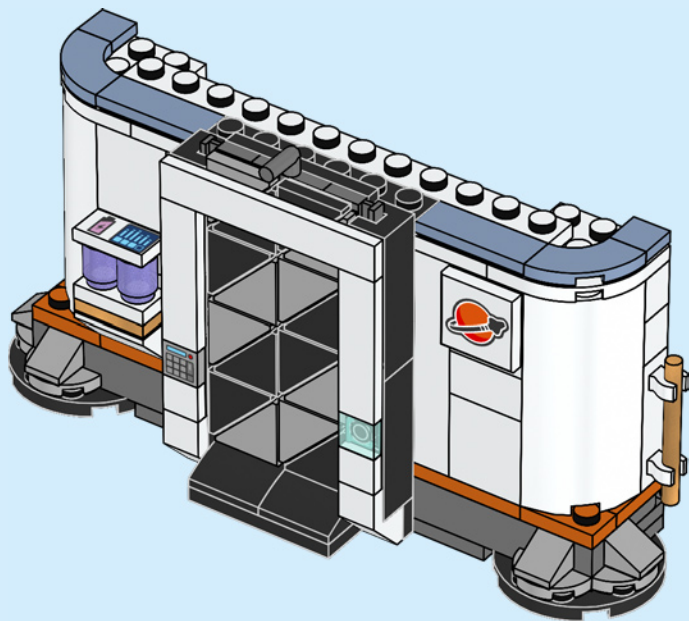



2x

54

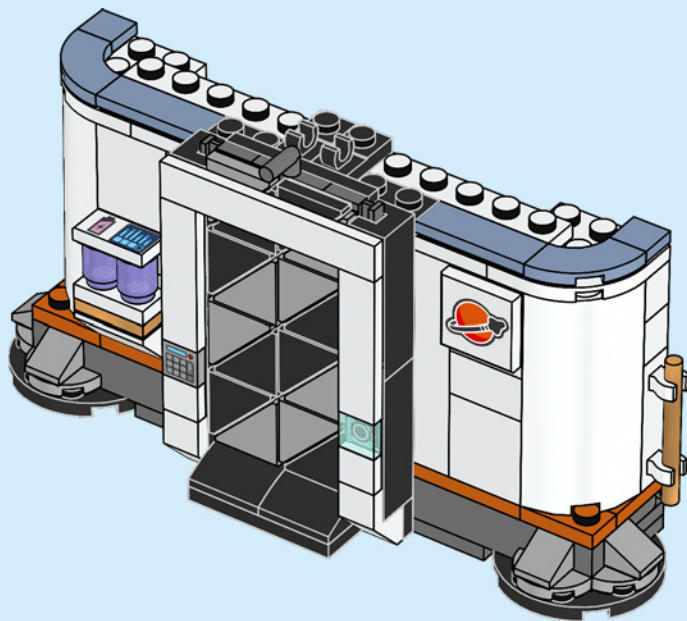



1x

55

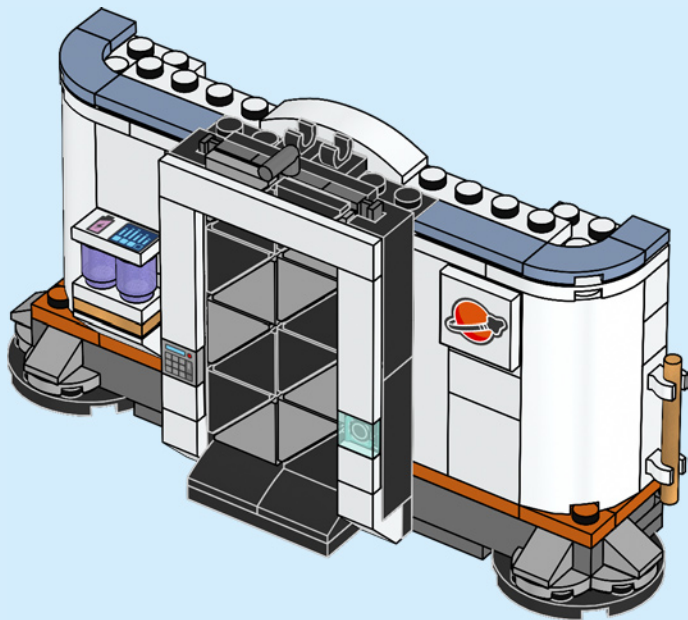



2x

56

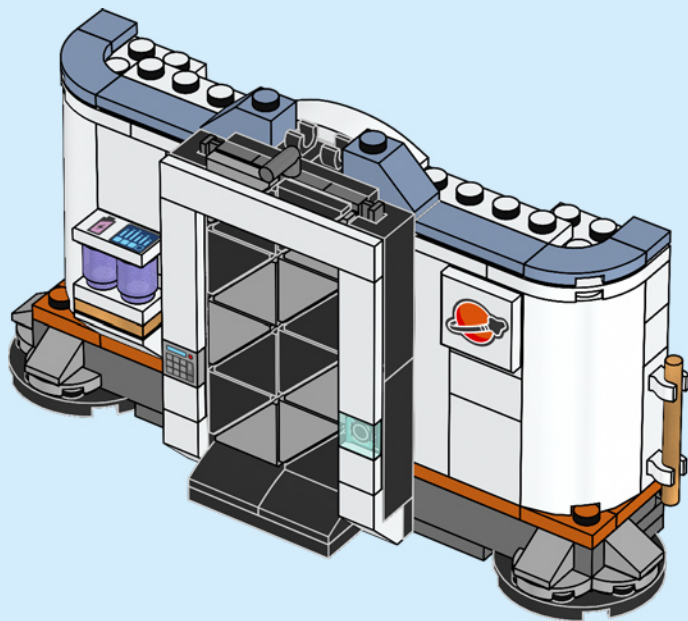

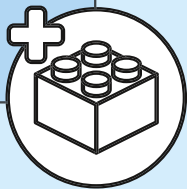
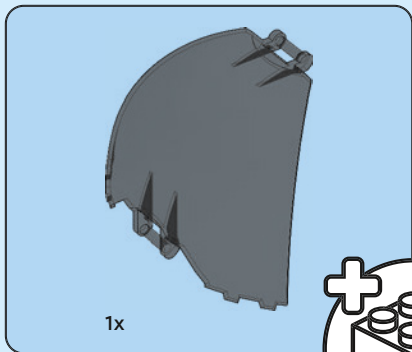

57

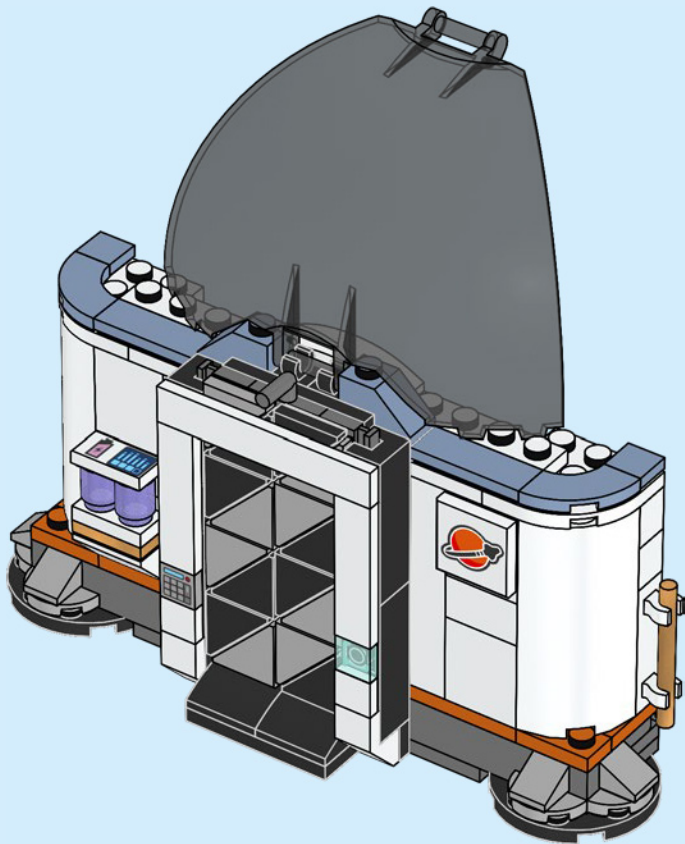

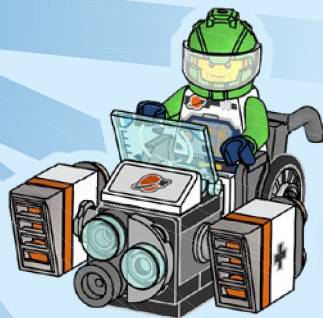
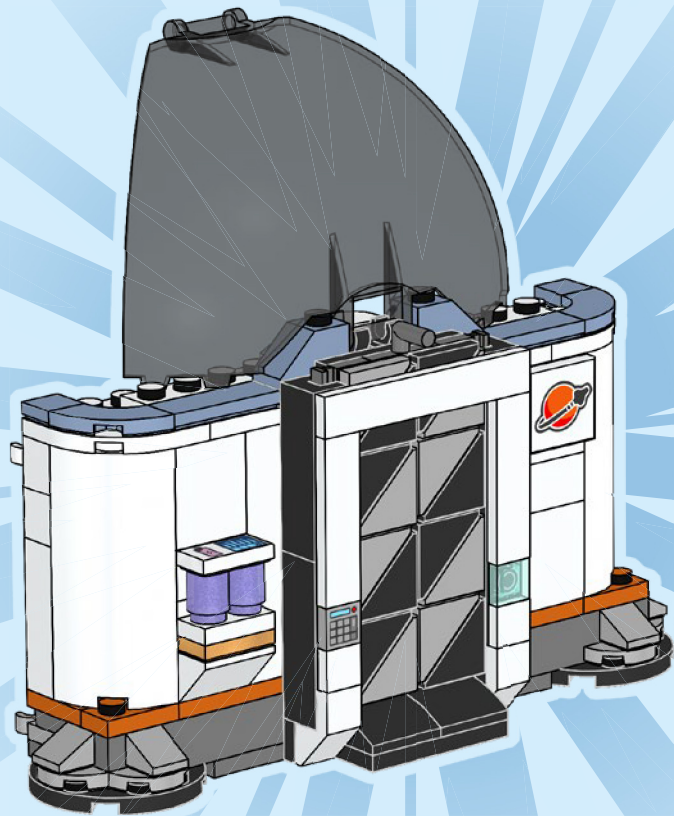



LEGO and the LEGO logo are trademarks of the/son des marques de commerce du/
son marcas registradas de LEGO Group. ©2024 The LEGO Group. 6515504

Rebuild
the
world™

