



CREATOR™



31156



LEGO® Builder



Get excited about our new packaging!

We're switching from plastic to paper-based packaging. That's why you might find a mix of paper and plastic in our boxes!

Nos nouveaux emballages vous emballeront !

Nous passons des emballages en plastique aux emballages à base de papier. C'est pourquoi vous pourriez trouver un mélange de papier et de plastique dans nos boîtes !

¡Te presentamos nuestros nuevos empaques!

Estamos sustituyendo las bolsas de plástico por bolsas con base de papel. ¡Por eso, puedes encontrar una mezcla de papel y de plástico en nuestras cajas!

[LEGO.com/sustainable-packaging](https://www.lego.com/sustainable-packaging)



Q LEGO® Builder

BUILDER



Apple and the Apple logo are trademarks of Apple Inc., registered in the U.S. and other countries and regions. App Store is a service mark of Apple Inc. Google Play and the Google Play logo are trademarks of Google LLC. Tencent and the Tencent logo are trademarks of Tencent Inc.

Q [LEGO.com/devicecheck](https://lego.com/devicecheck)

EN Ask parents' permission before going online | **DE** Eltern um Erlaubnis bitten, bevor du online gehst | **FR** Demande l'autorisation d'un parent avant d'aller en ligne | **IT** Chiedi il permesso ai tuoi genitori prima di andare online | **ES** Pídeles permiso a tus papás antes de conectarte a Internet | **PT** Pede autorização aos pais antes de acederes online | **ZH** 上网前应先征得父母的同意 | **PL** Poproś rodziców o zgodę, zanim wejdiesz do Internetu | **CS** Než půjdeš na internet, požádej rodiče o svolení | **SK** Skôr než pôjdeš na internet, vypýtaj si povolenie od rodičov | **HU** Kérj szülői engedélyt, mielőtt online csatlakoznál! | **RO** Cere permisiunea părinților înainte de a te conecta online | **BG** Поискайте разрешение от родител, преди да влезете онлайн | **LV** Pirms došanās tiešsaistē palūdz atļauju vecākiem | **ET** Enne Interneti kasutamist küsi vanematelt luba | **LT** Prieš prisijungdami prie interneto, atsiklauskite tėvų

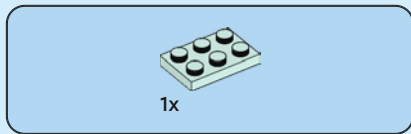

1

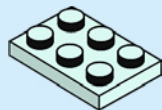

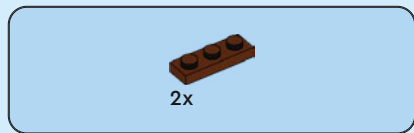

2

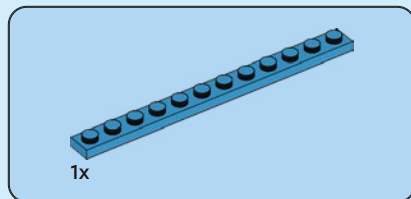
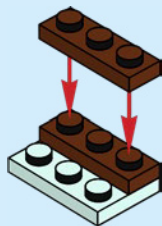

3

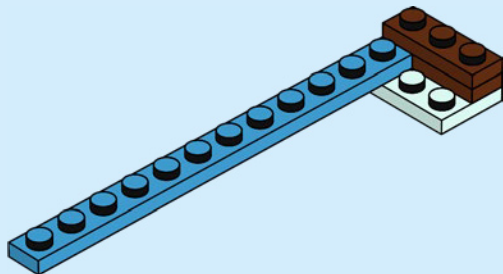



6x

4

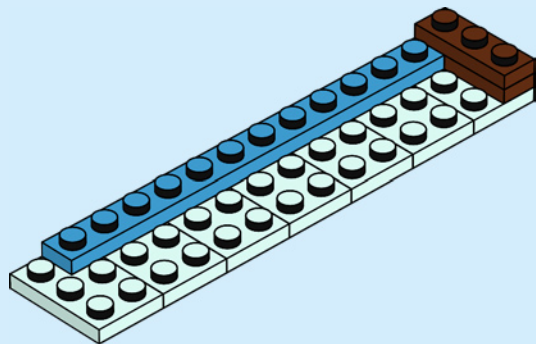

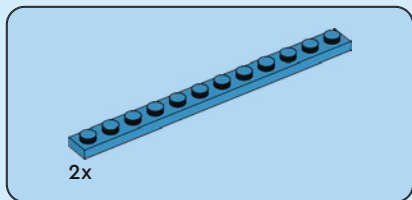

5

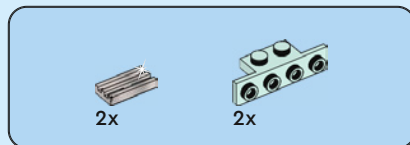
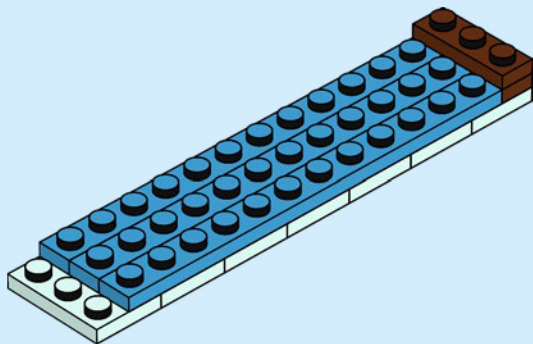

6

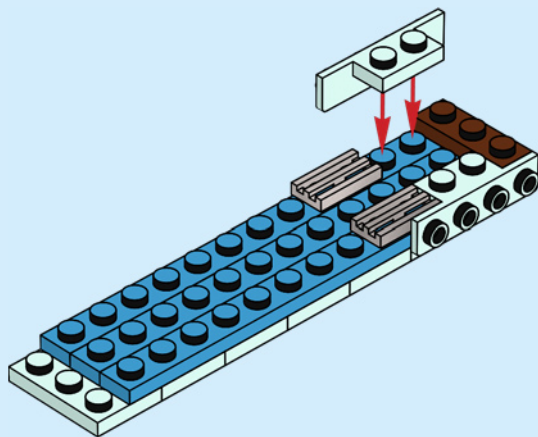

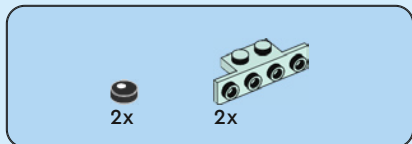

7

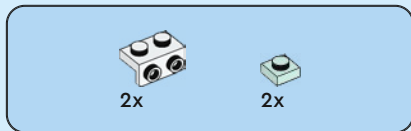
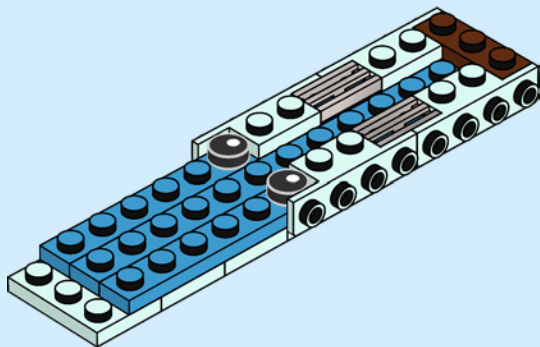

8

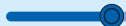
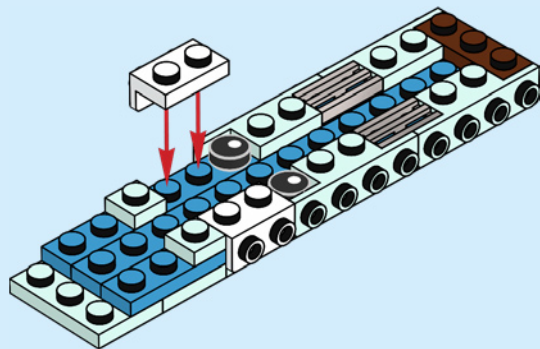

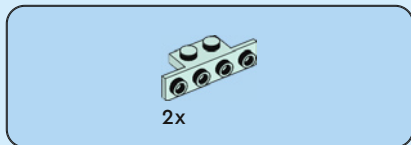

9

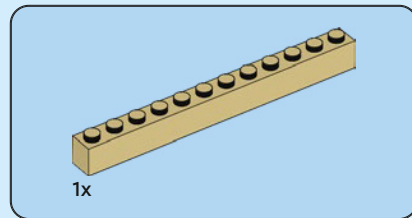
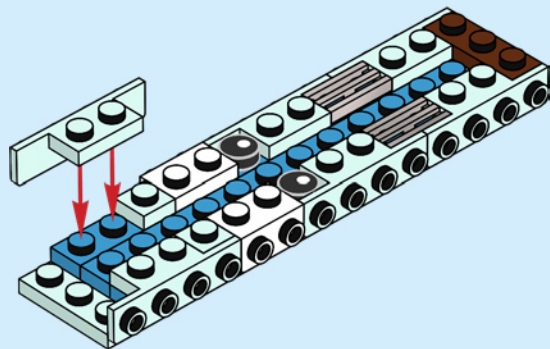

10

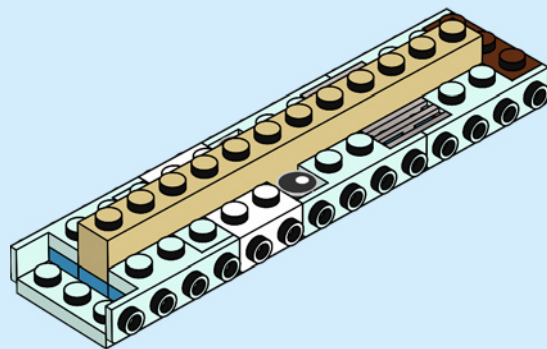

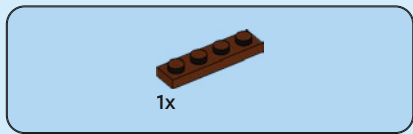
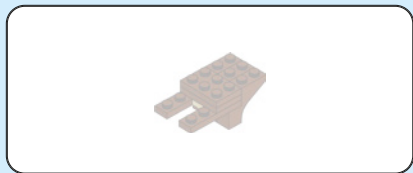

1x

11

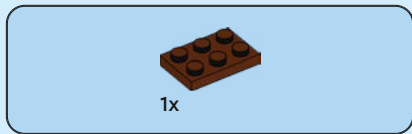

1x

12

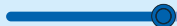
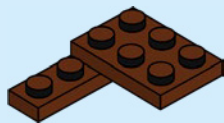

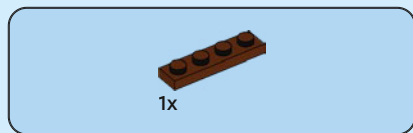

13

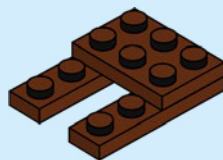

14

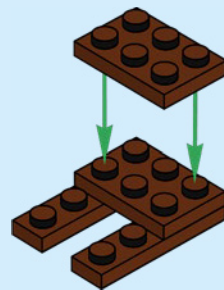



1x

15

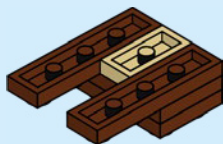

3x

16

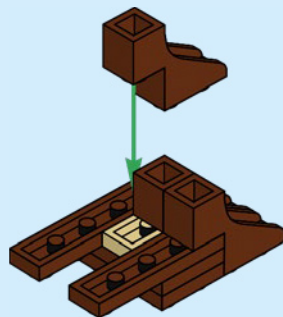

17

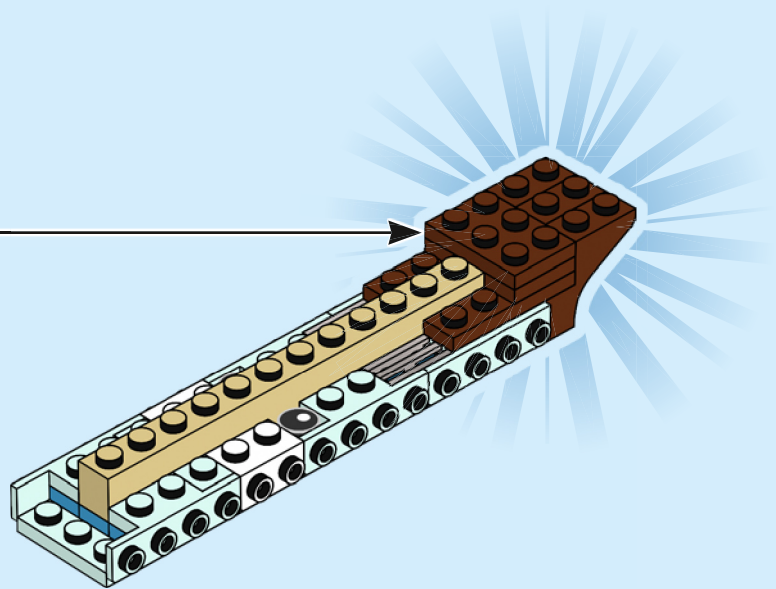

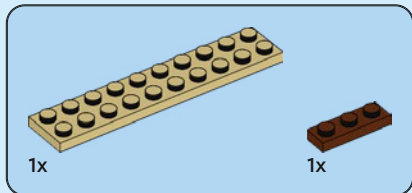
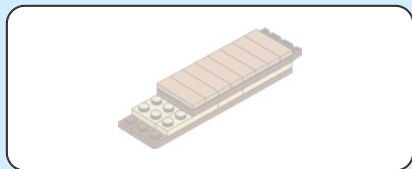

18

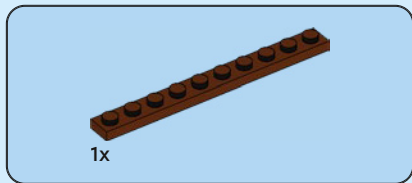
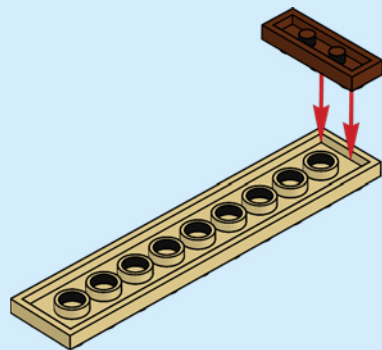

19

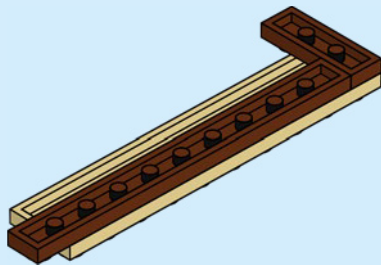

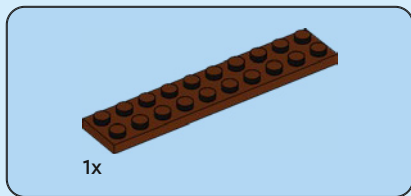

20

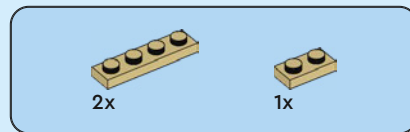
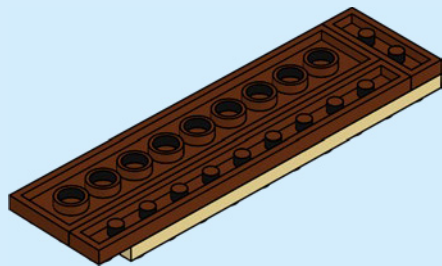

21

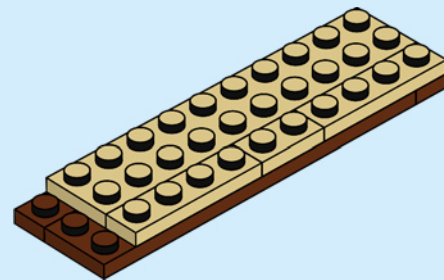
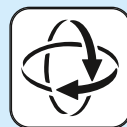



3x

22

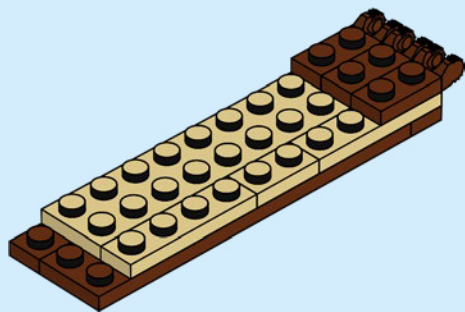

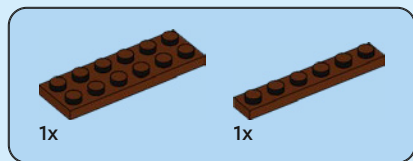

23

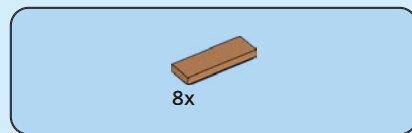
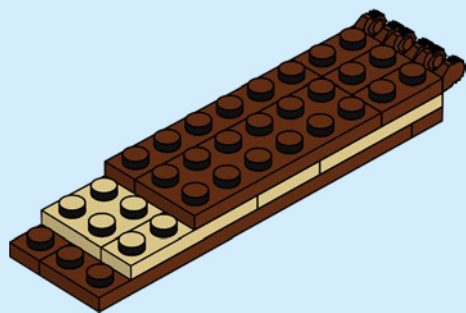

24

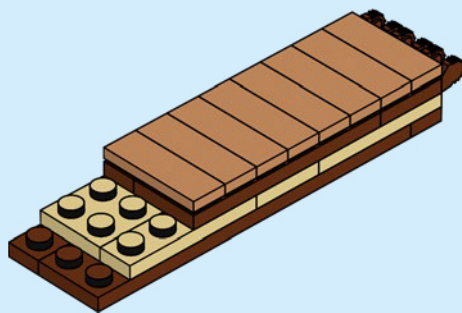

25

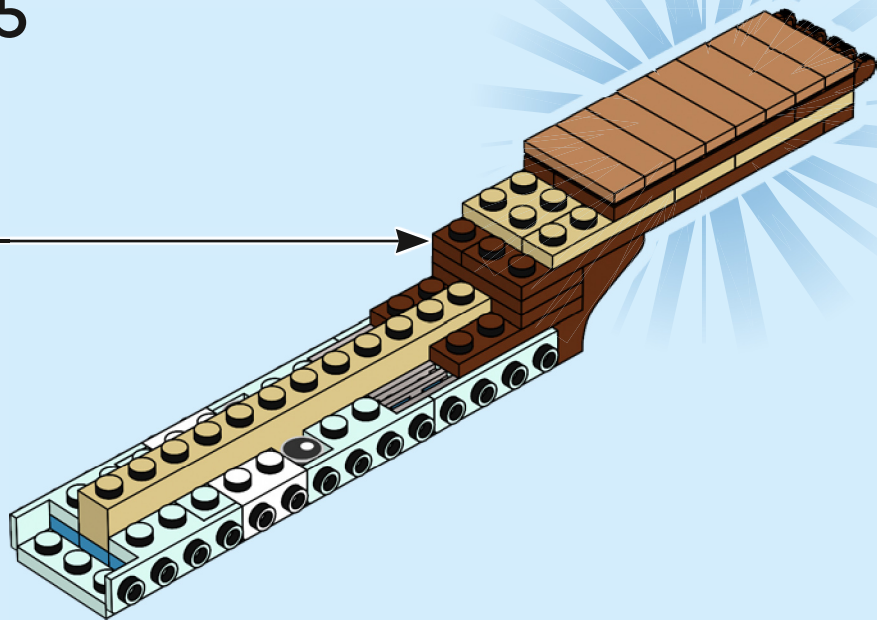



1x



2x

26

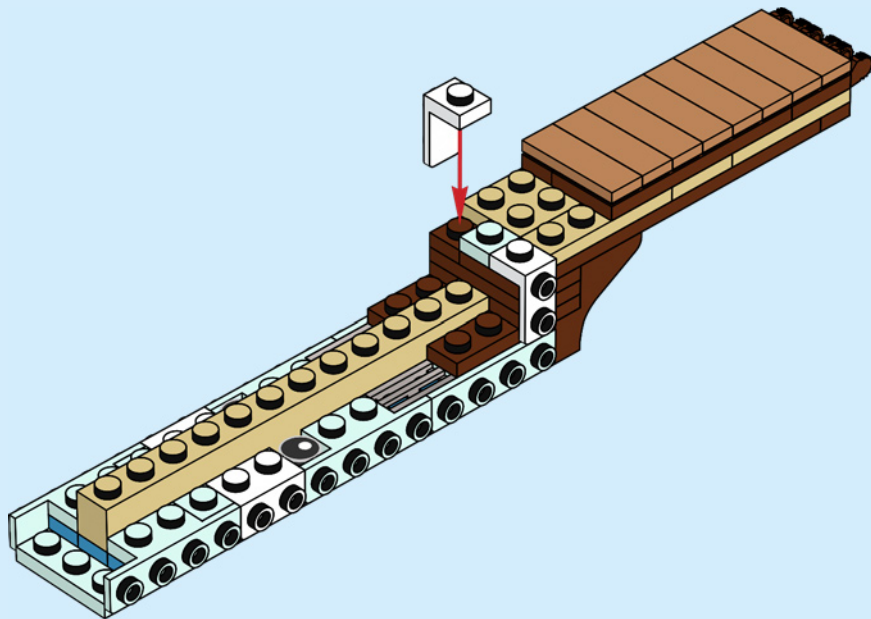



1x



1x

27

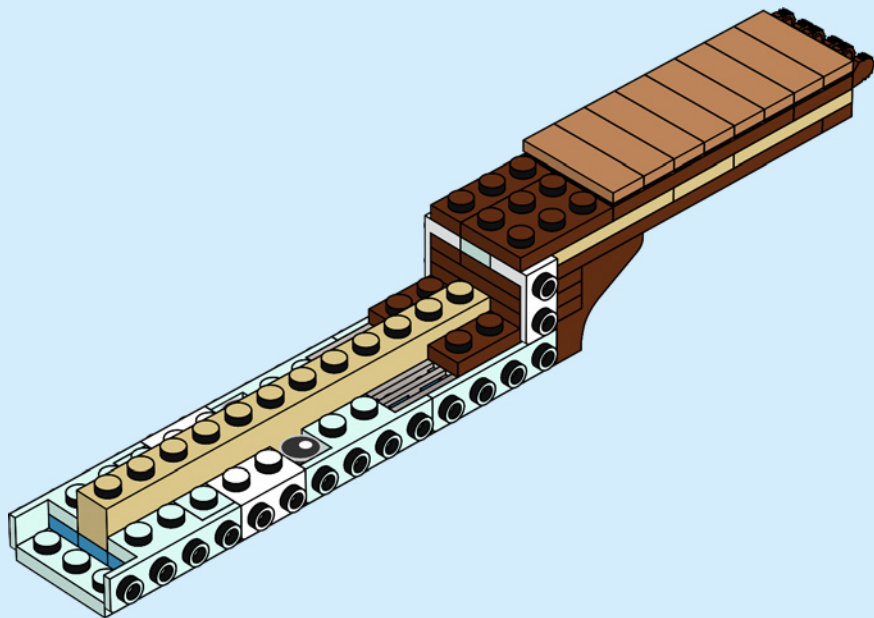

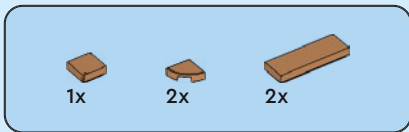

28

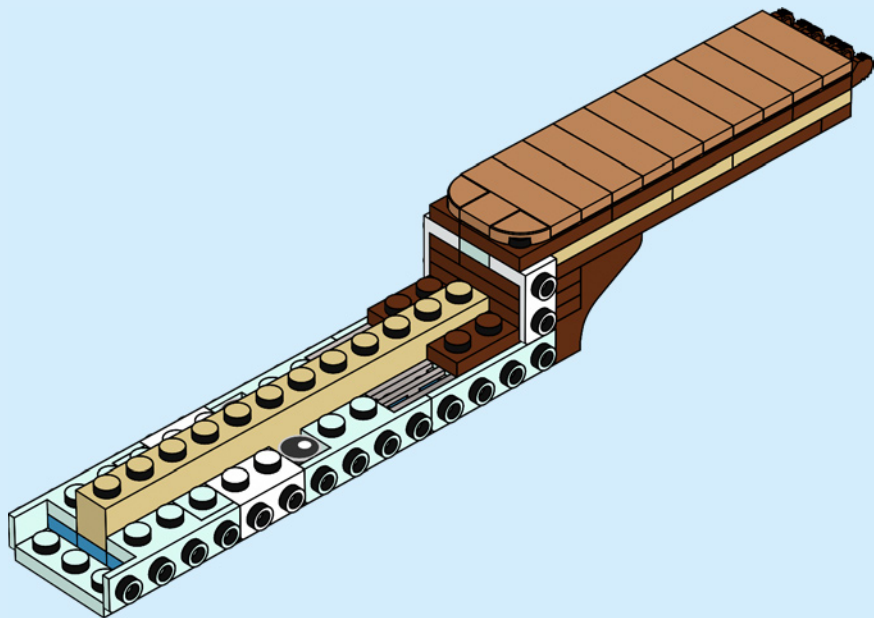

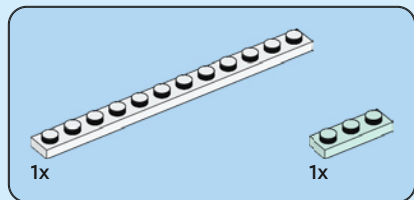

29

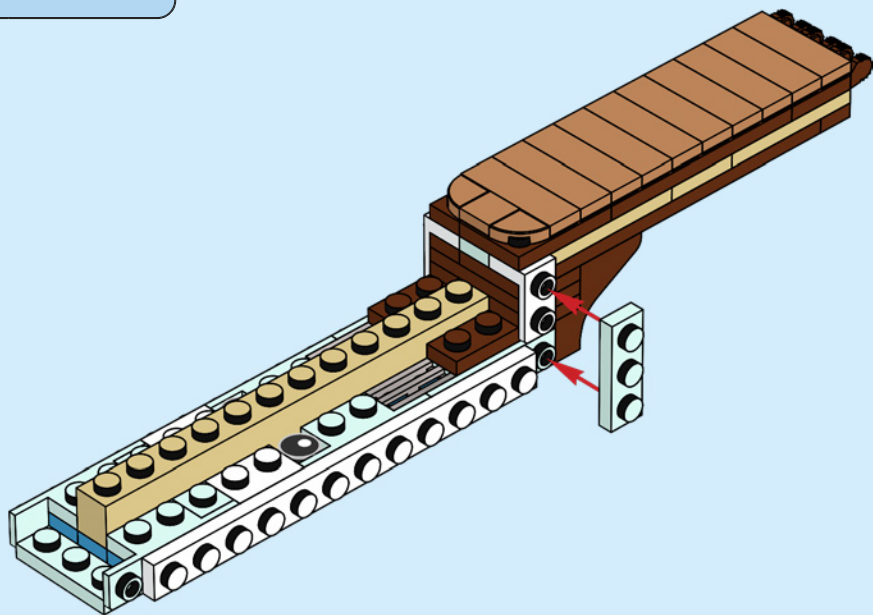

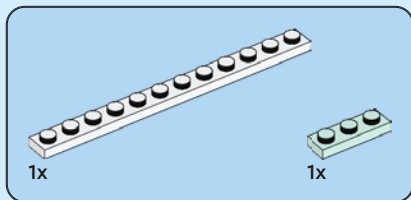

30

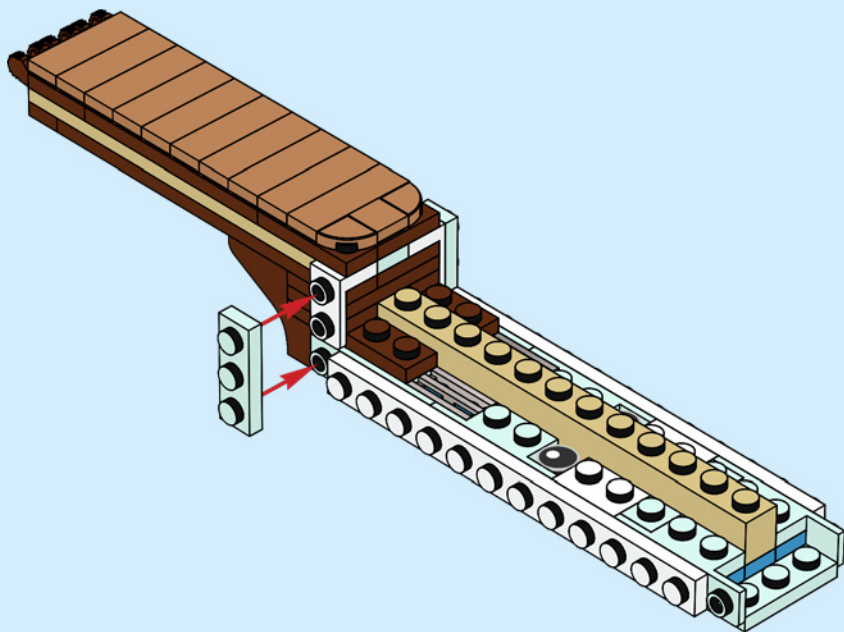



2x

31

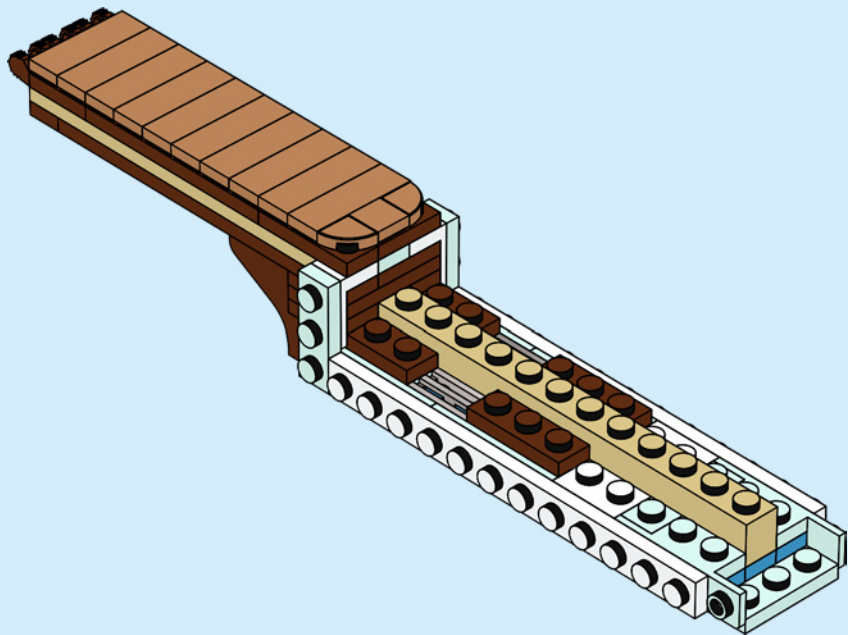



4x

32

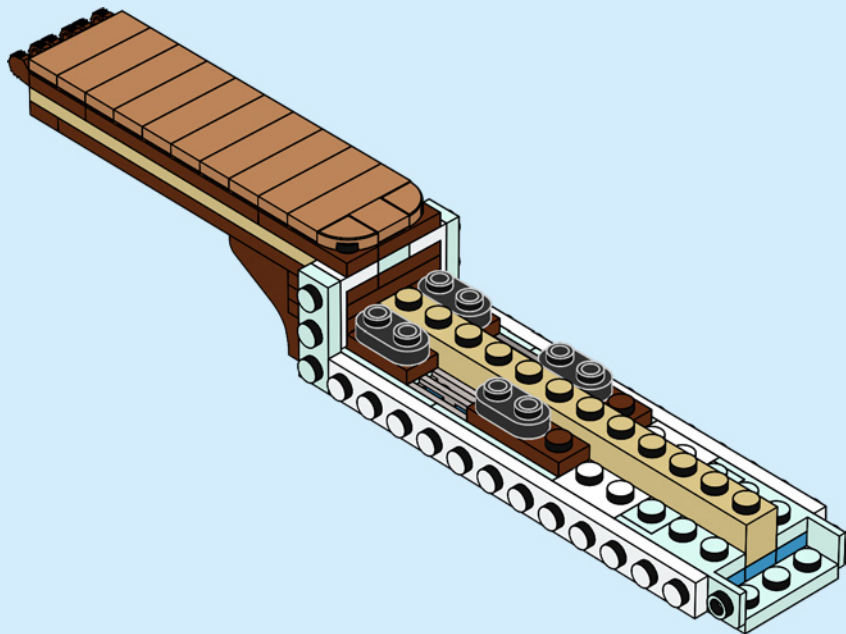



3x

33

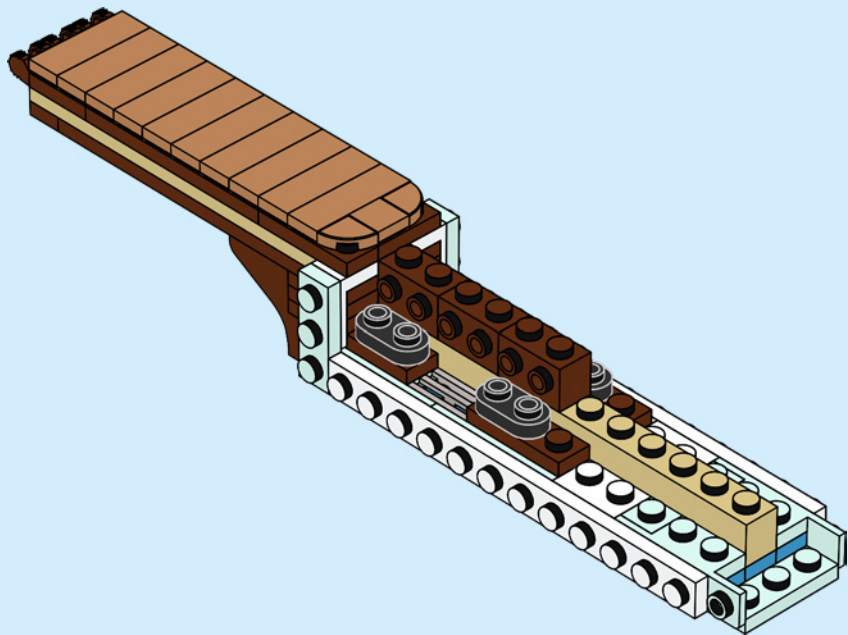



1x



2x

34

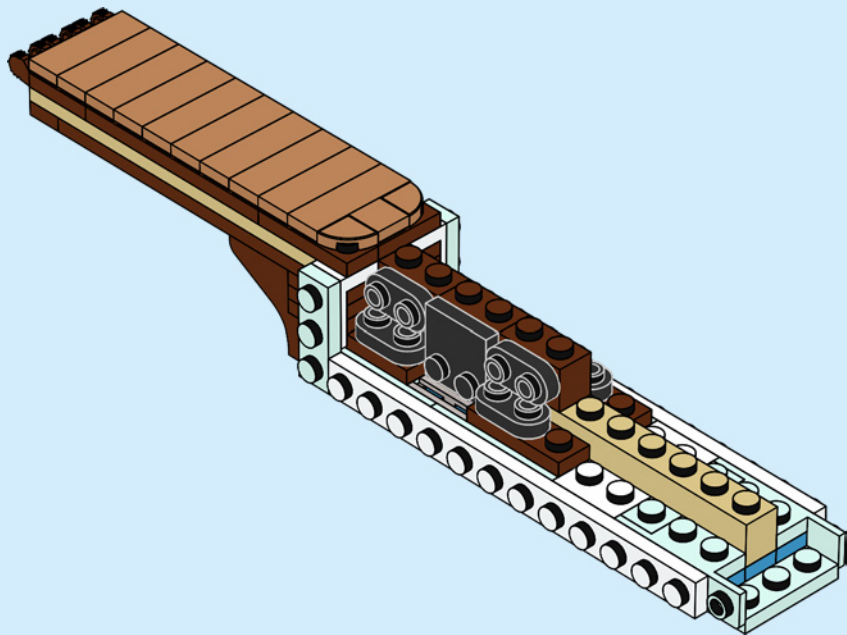



1x



2x

35

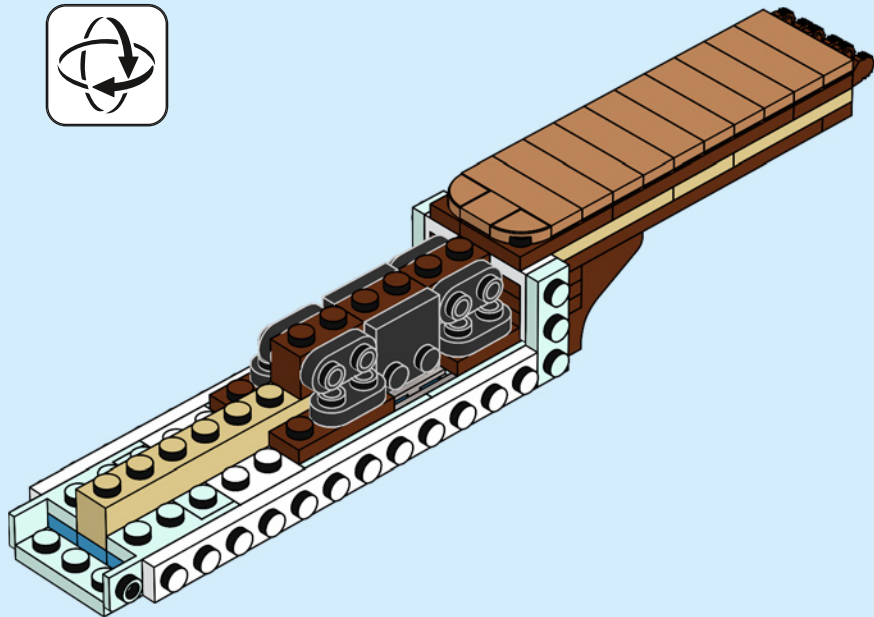

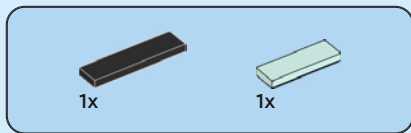

36

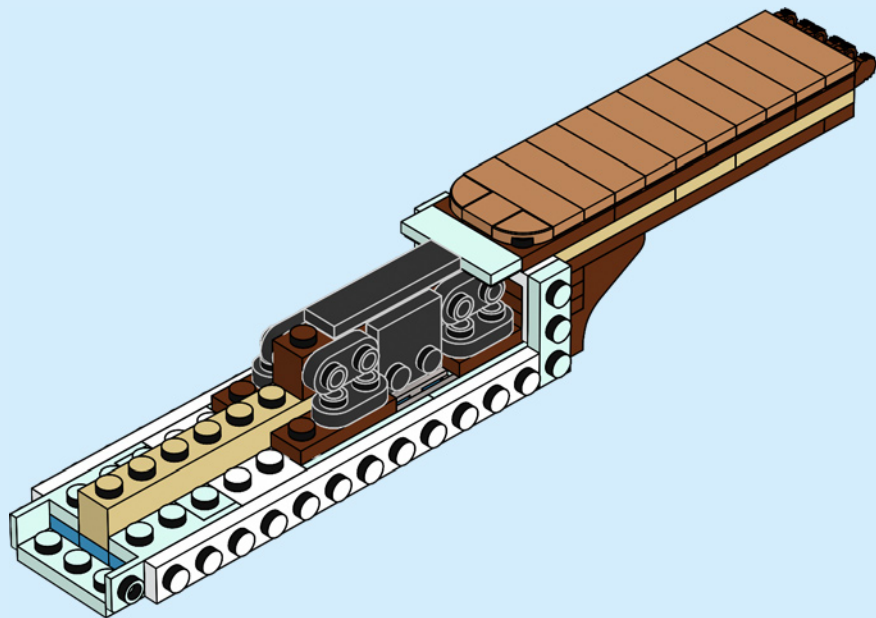



2x

37

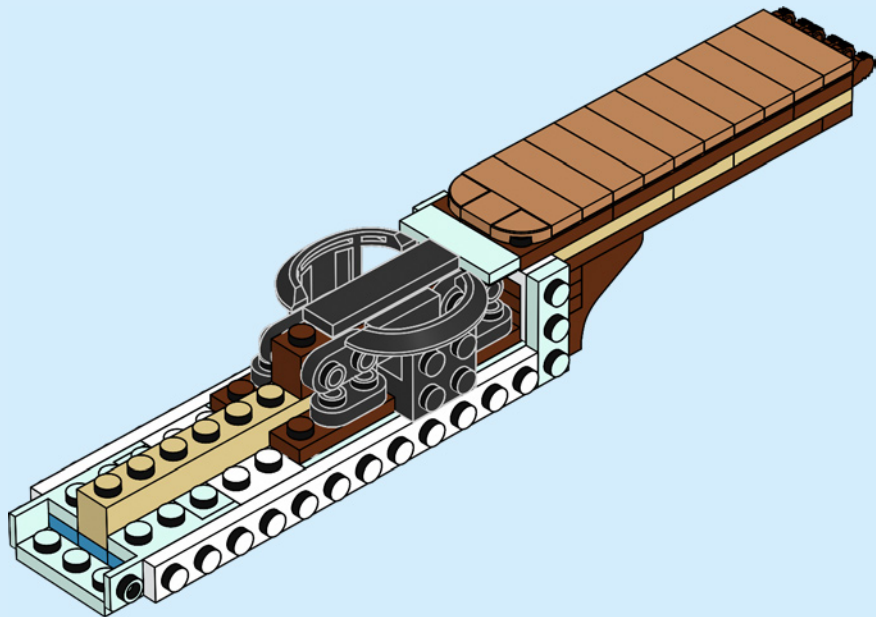



4x

38

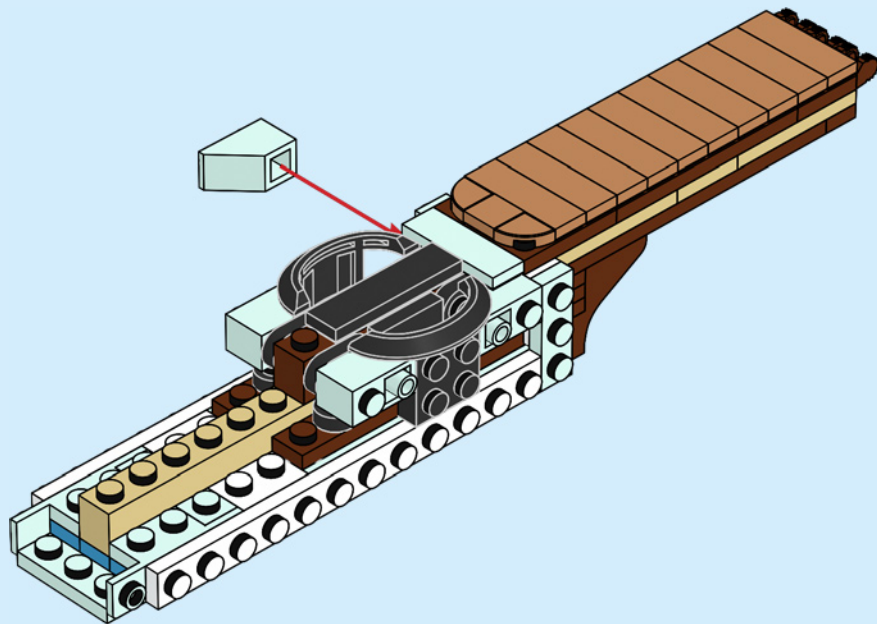



1x



2x

39

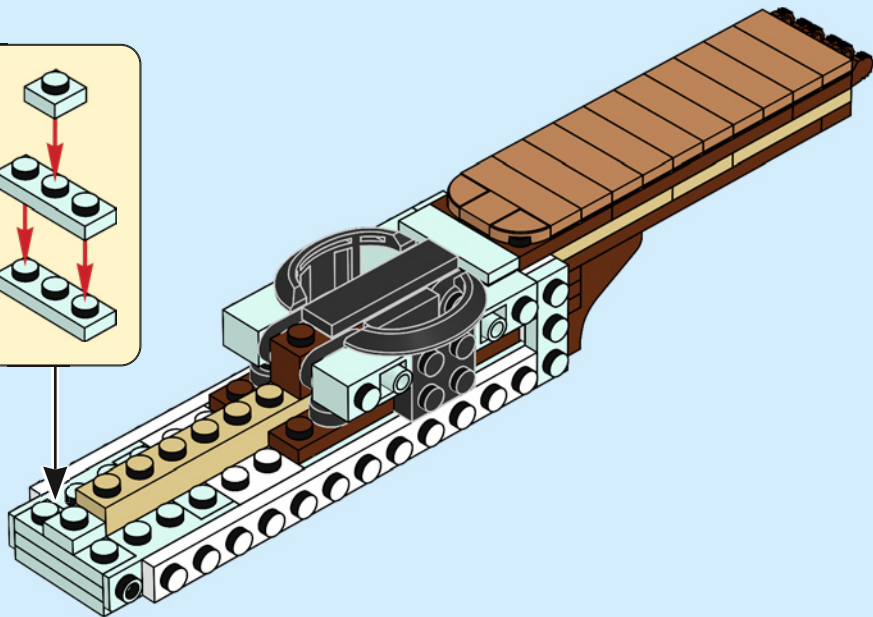
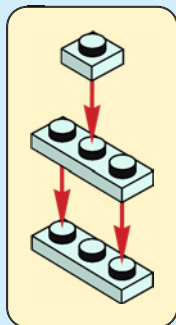



6x

40

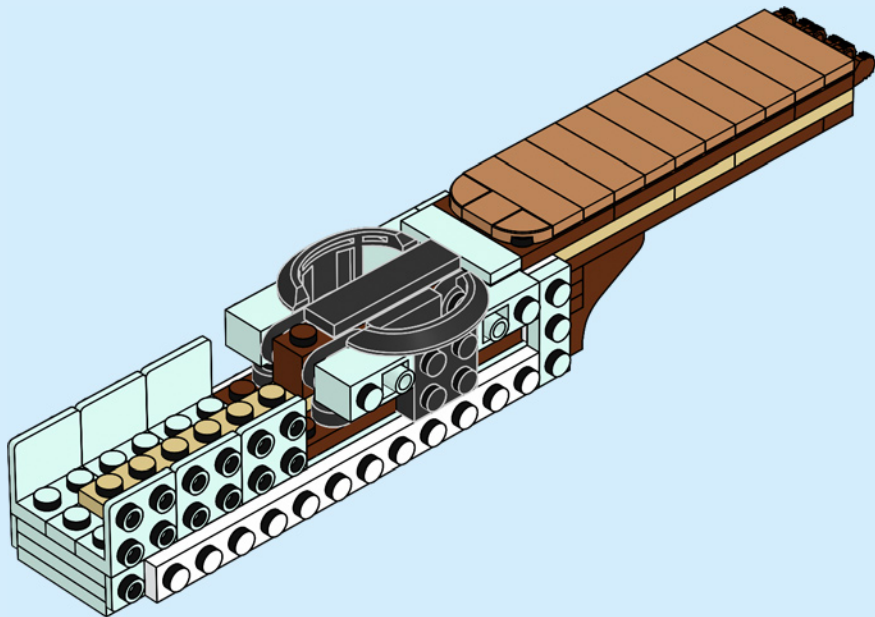



2x



1x

41

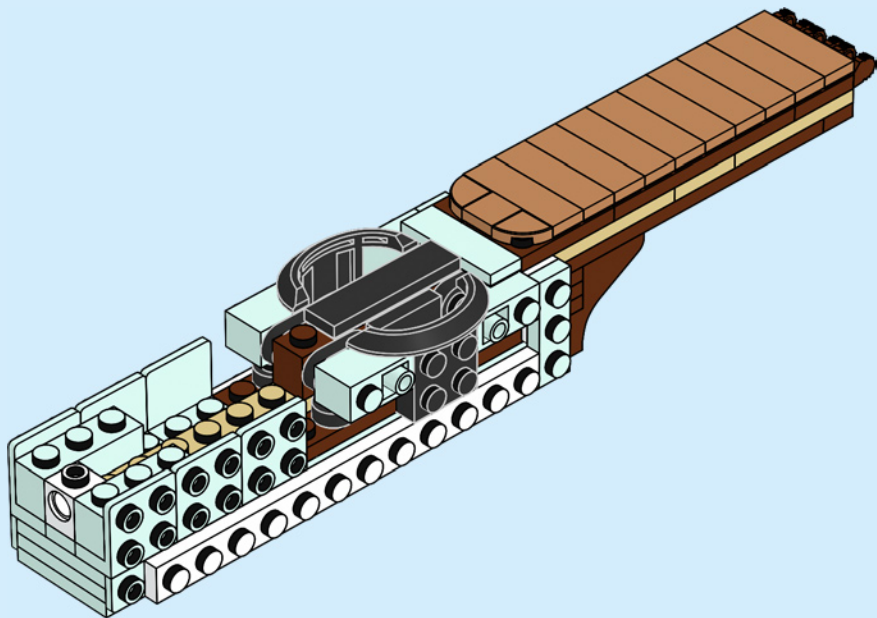

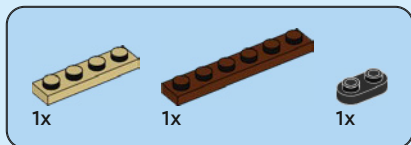

42

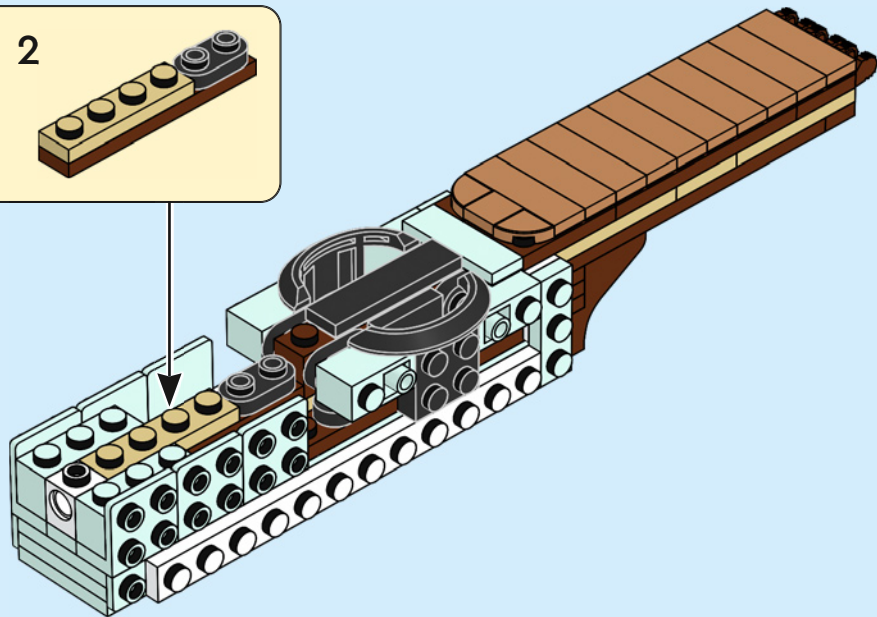
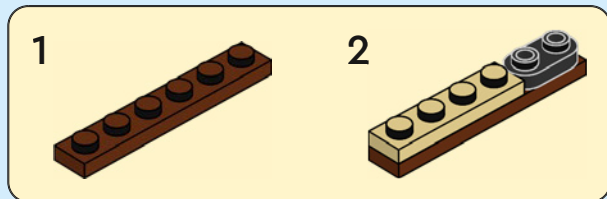



2x



4x

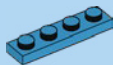

2x



4x

43

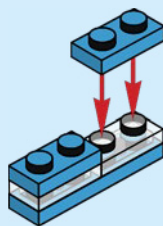
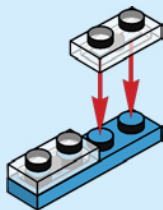
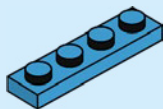

2x

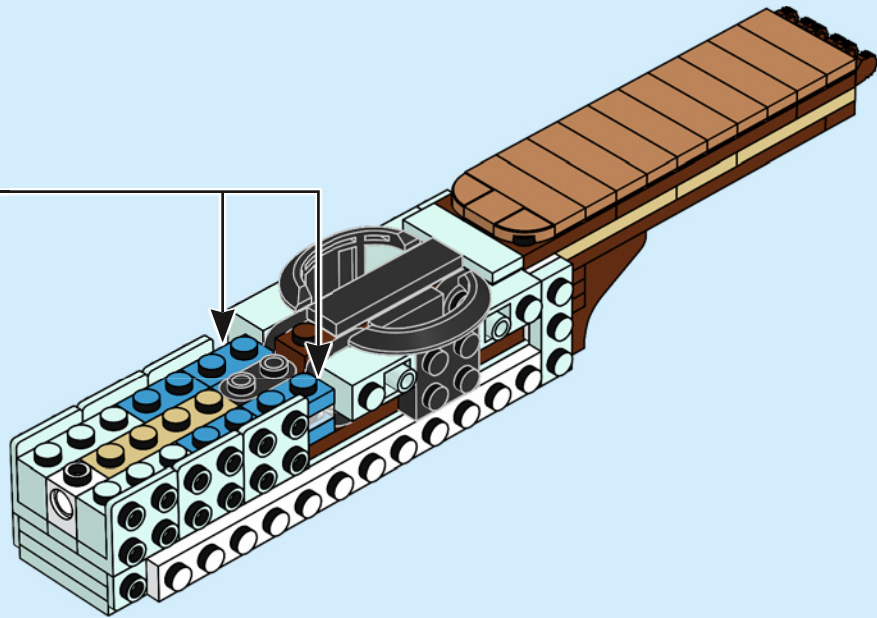

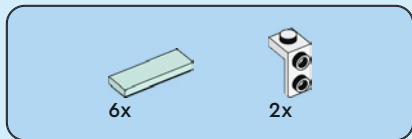

44

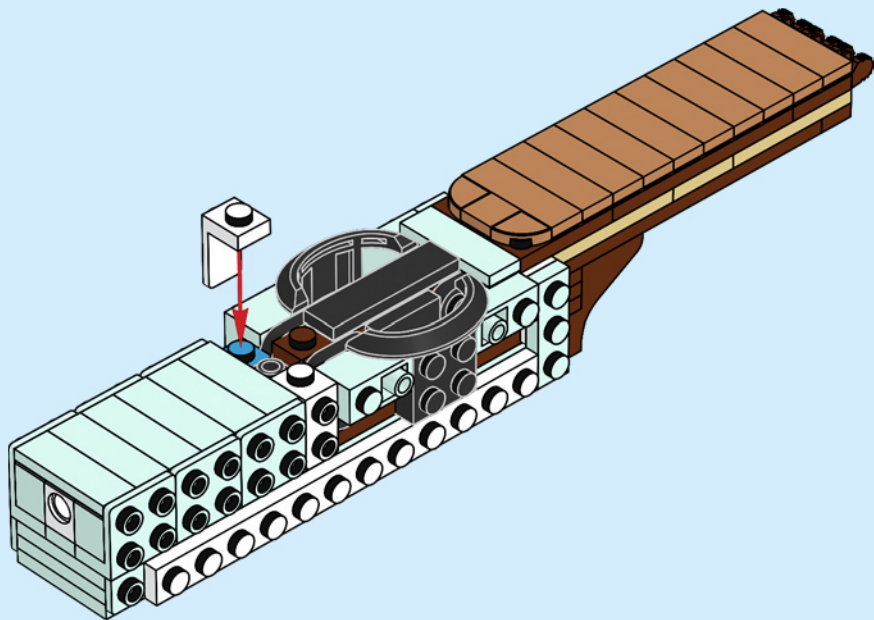



1x

45

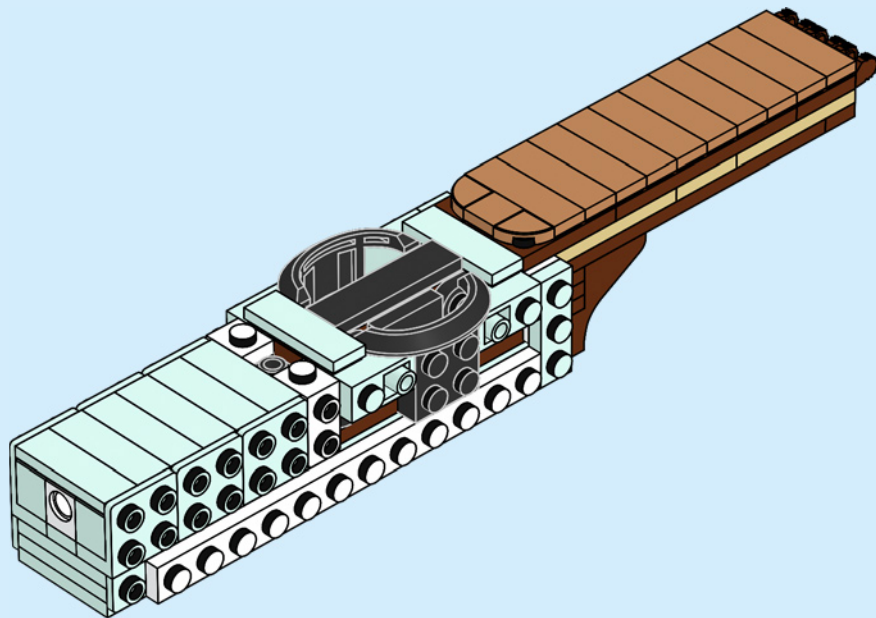

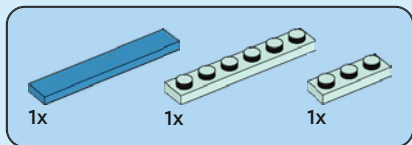

46

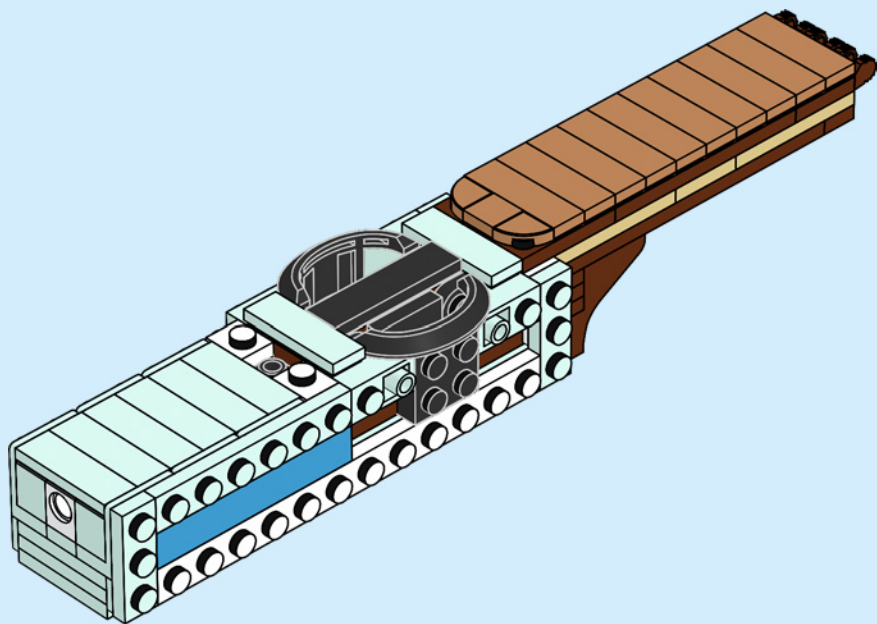

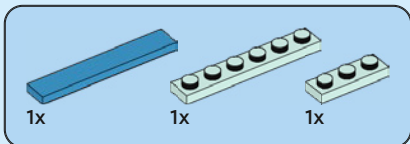

47

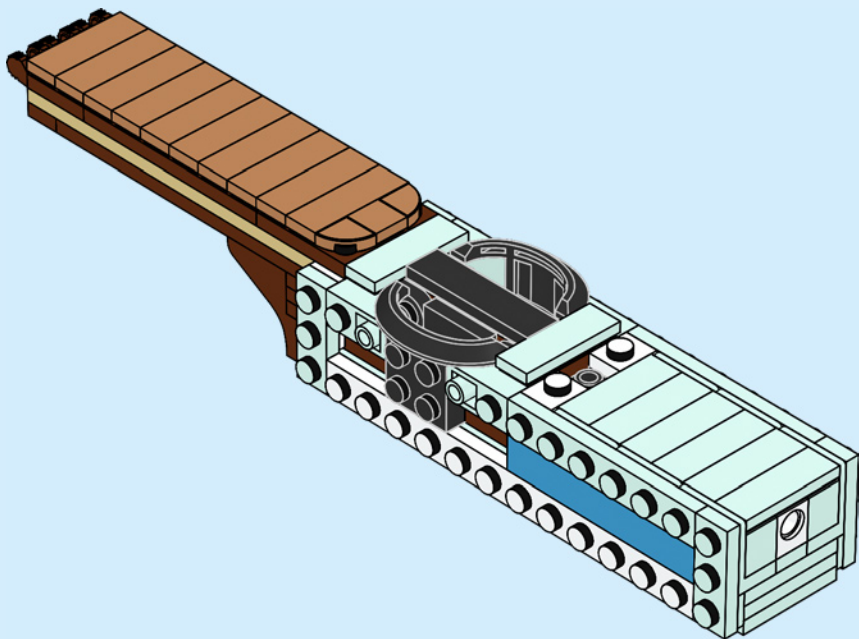



48

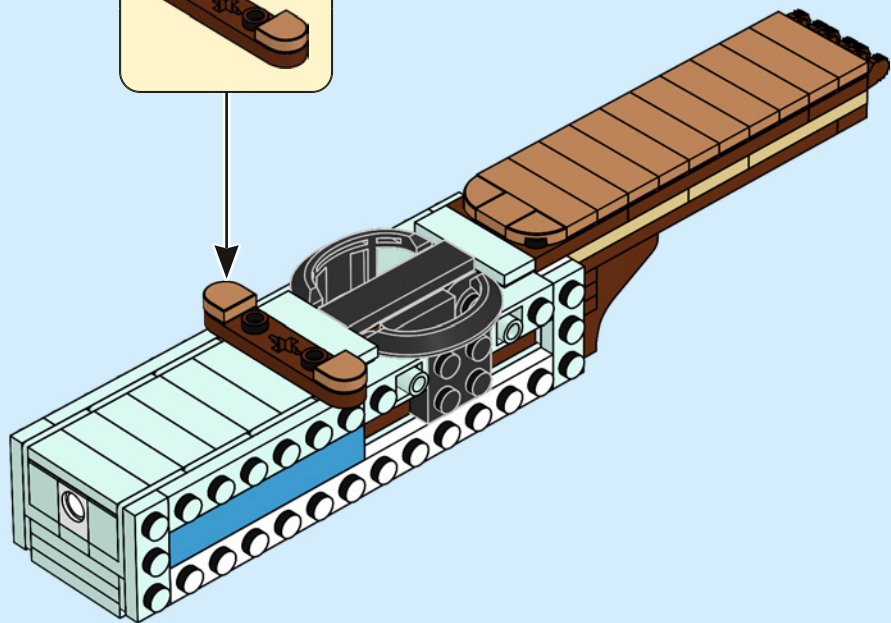
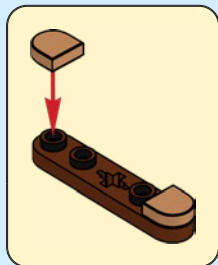

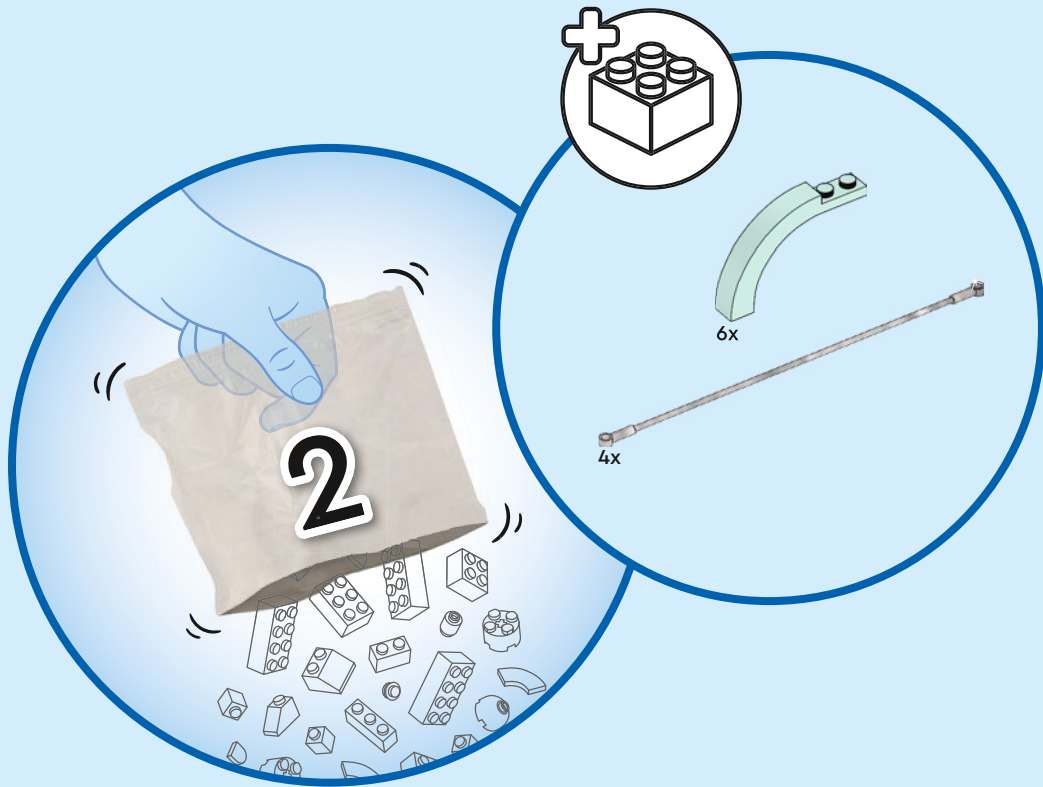

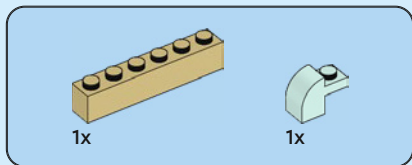
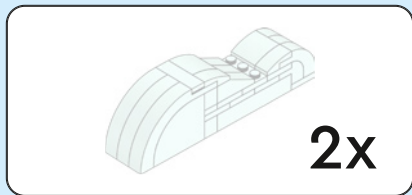

49

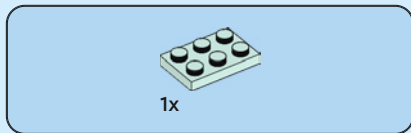
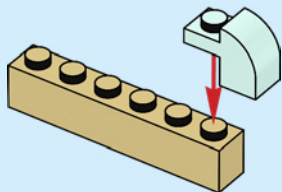

50

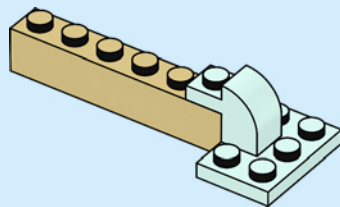

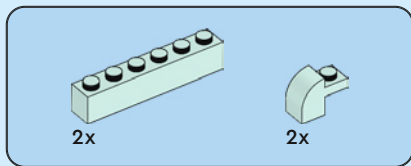

51

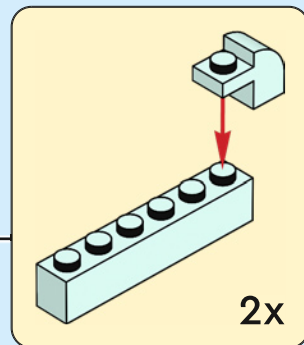
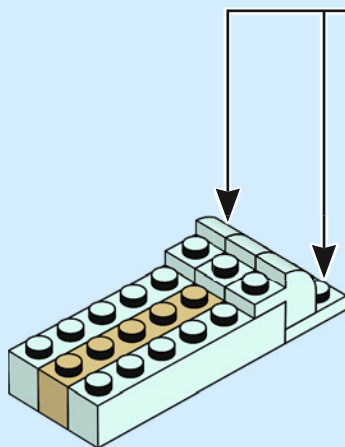



3x

52

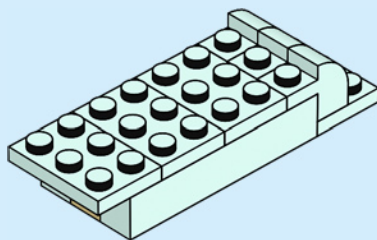



1x

53

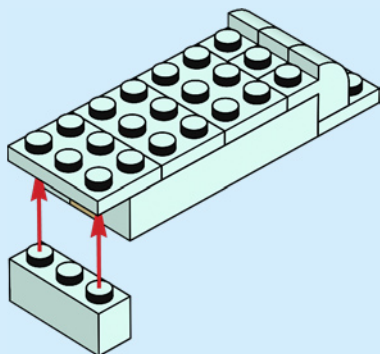

2x

54

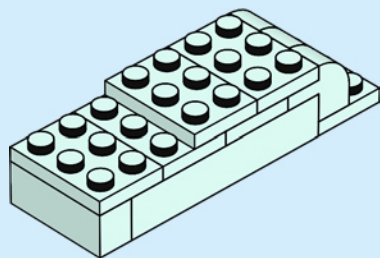



3x



1x

55

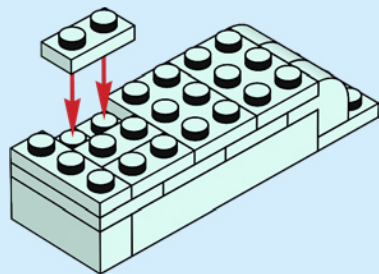

3x

56

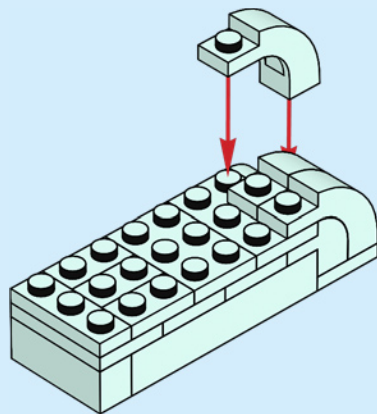

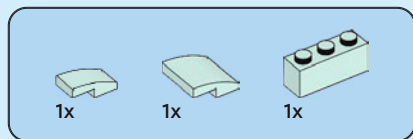

57

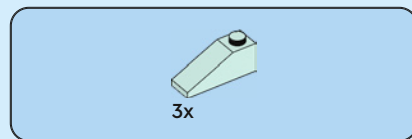
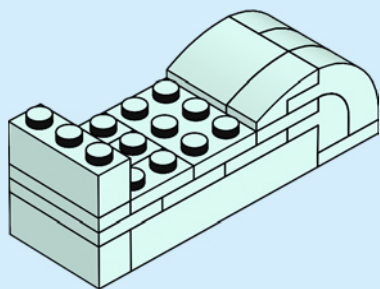

58

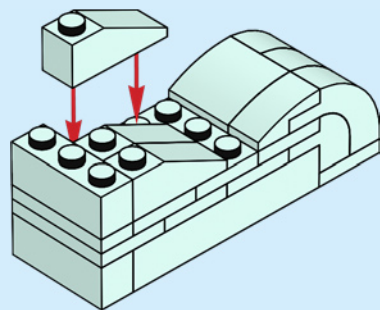

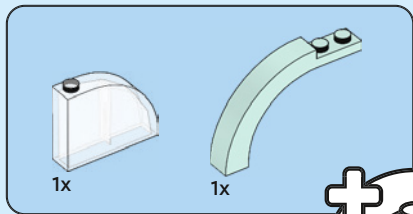

59

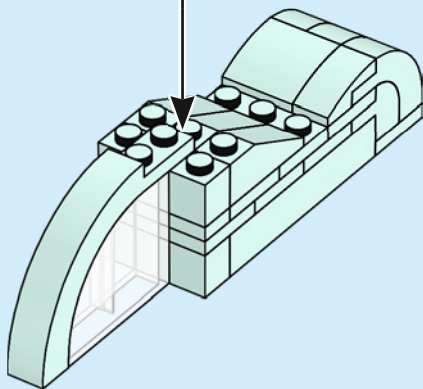
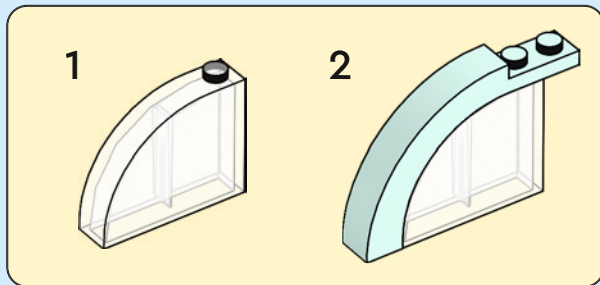
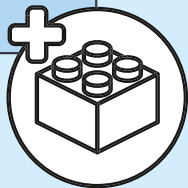

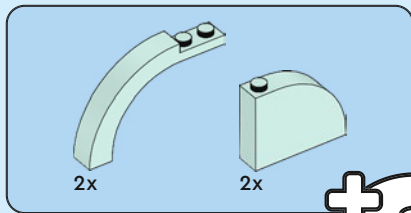

60

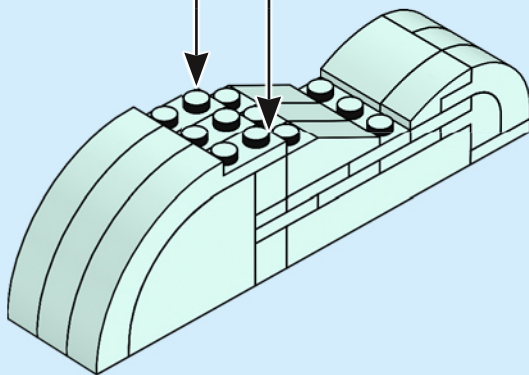
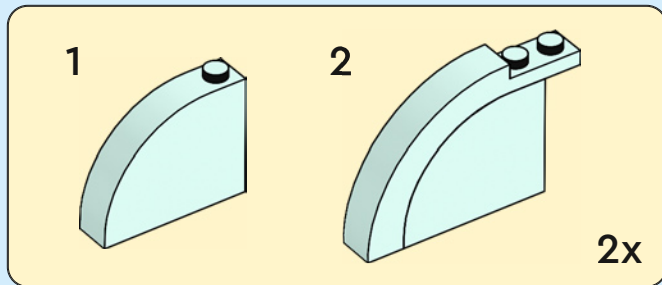
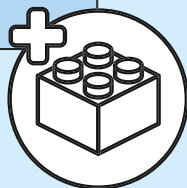



1x



1x



1x

61

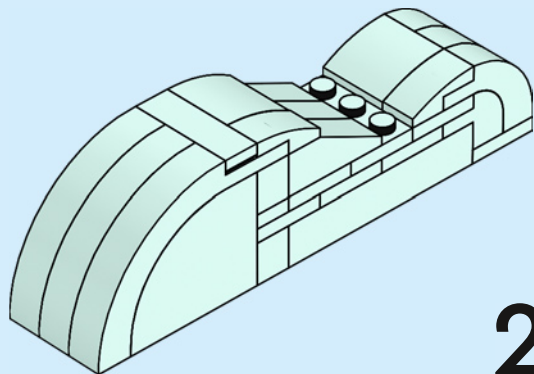

2x

62

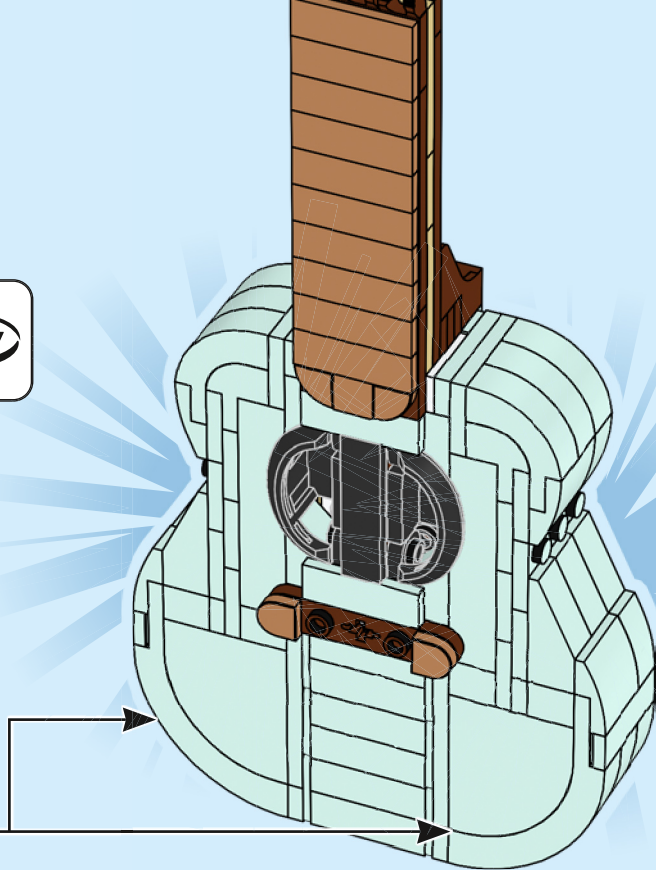

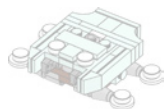

1x

63



2x



1x

64

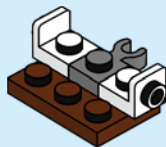



1x

65

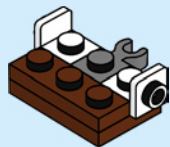

1x

66

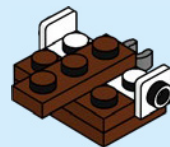



67

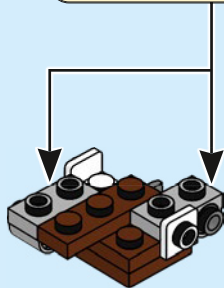
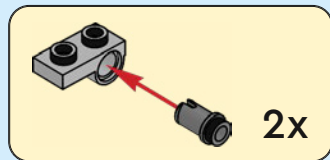

68

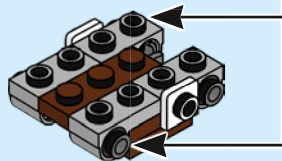
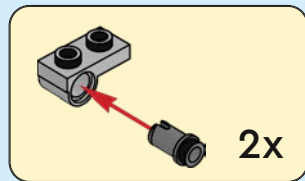



1x



1x

69



2x



1x

70

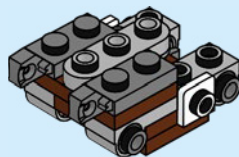



1x



1x

71

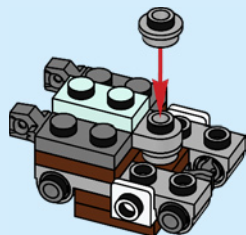

2x

72

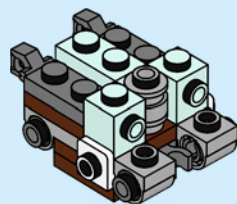

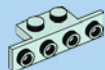

2x

73

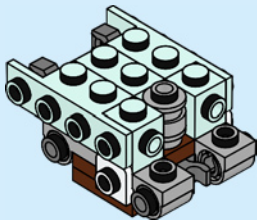

2x



1x



1x

74

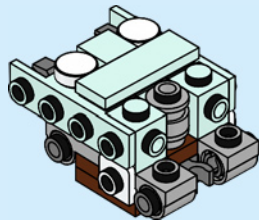



2x

75

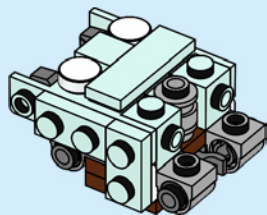

1x



1x

76

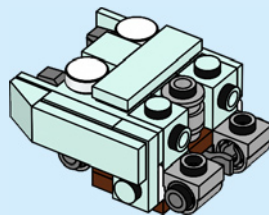



2x

77

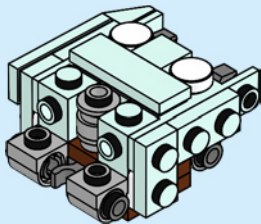

1x



1x

78

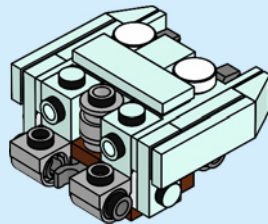

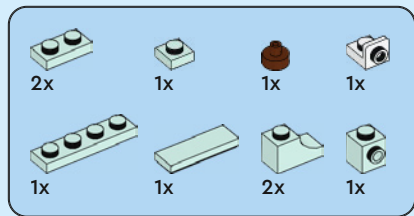

79

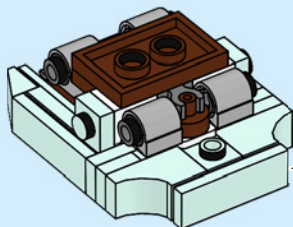
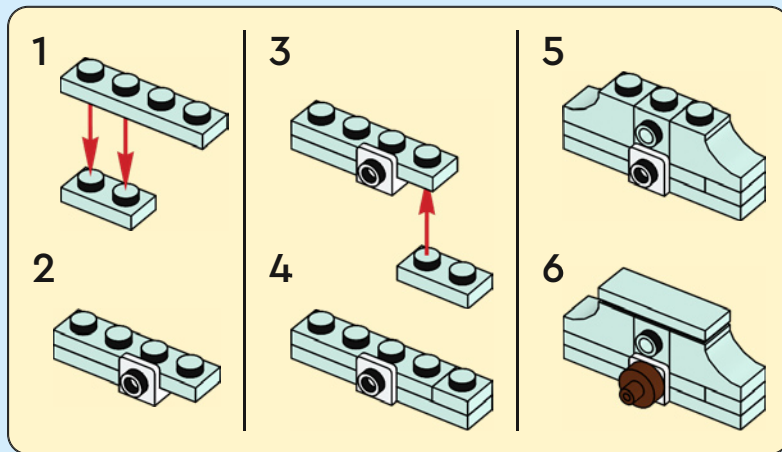

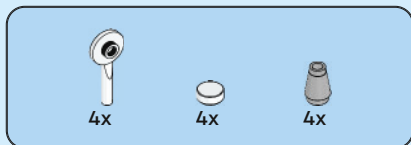

80

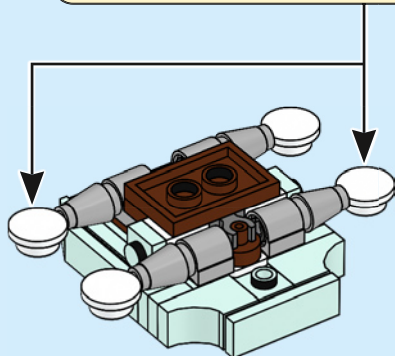
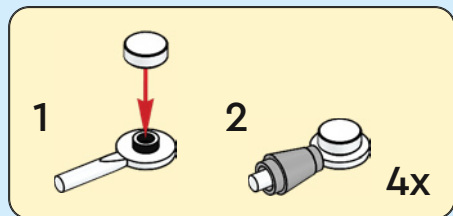

81

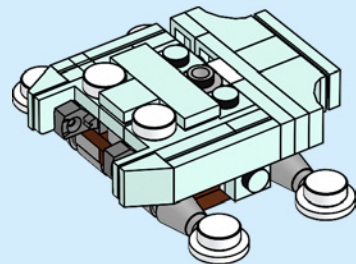

82

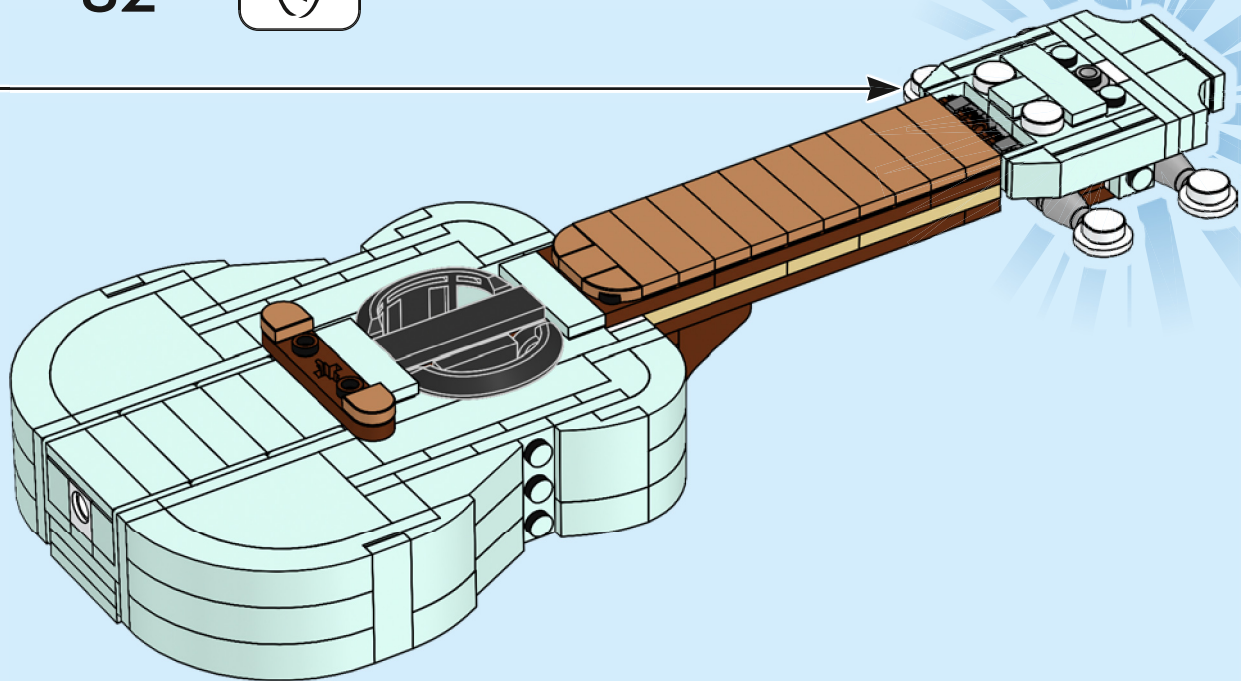

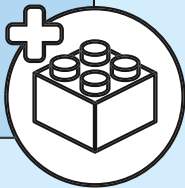
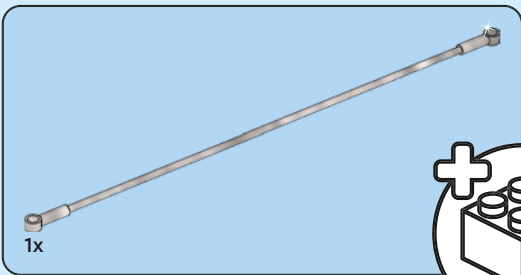
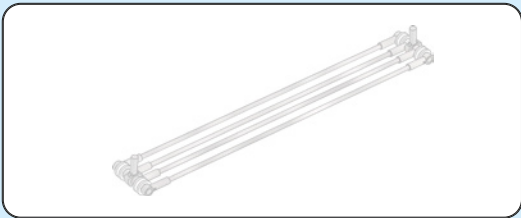

83

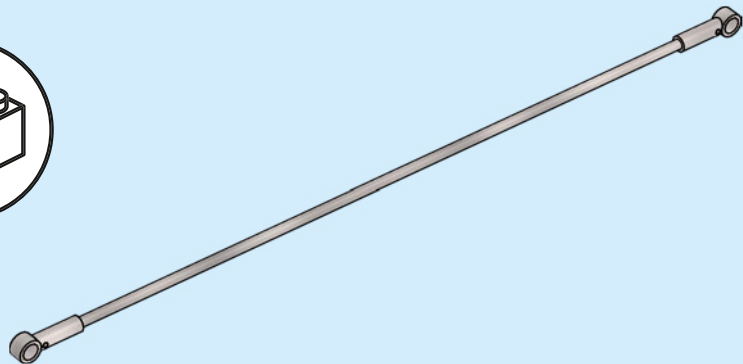



2x

84

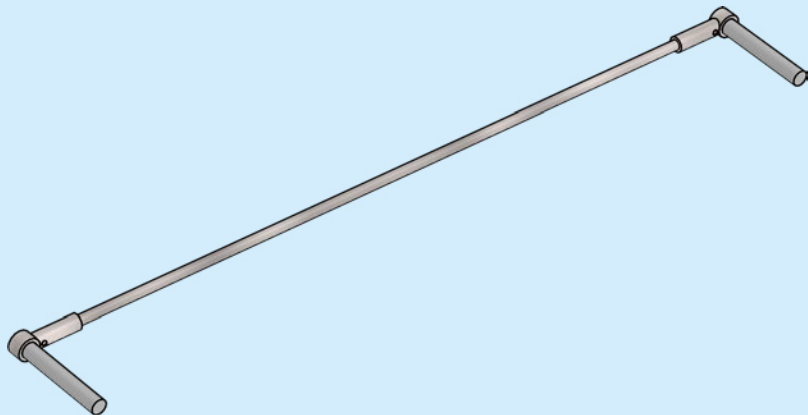

2x

85

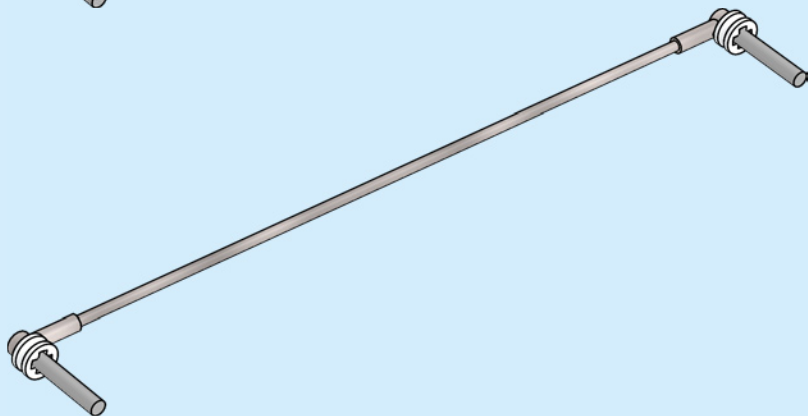

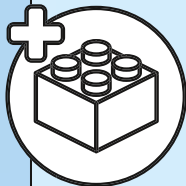
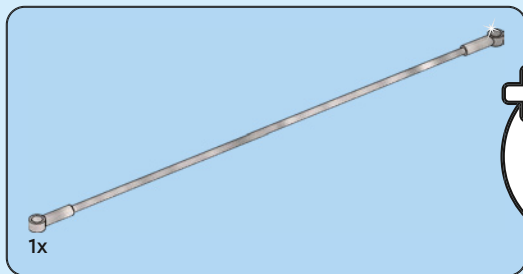

86

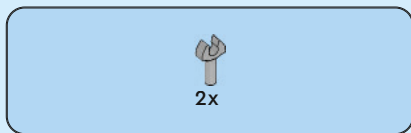
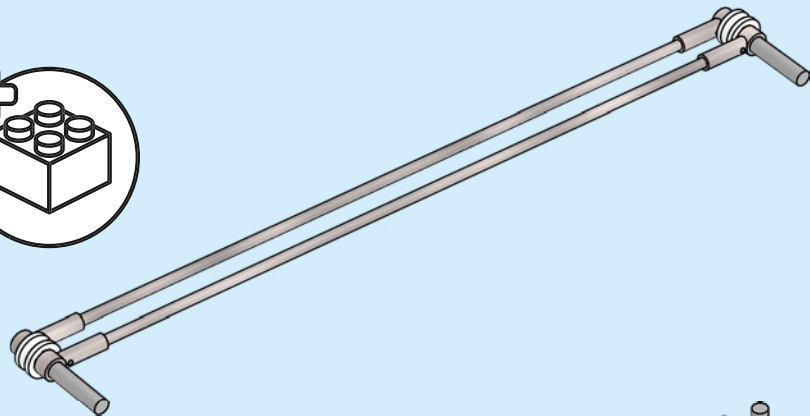

87

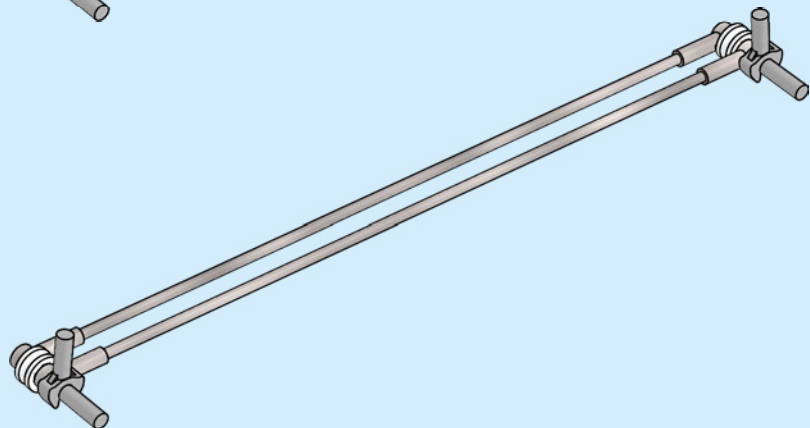

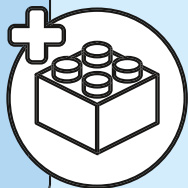
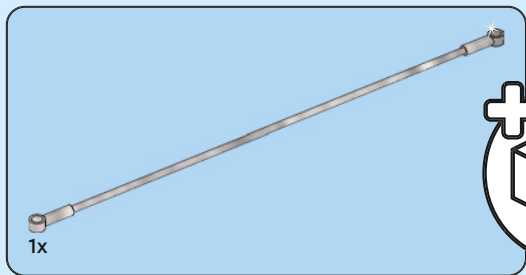

88

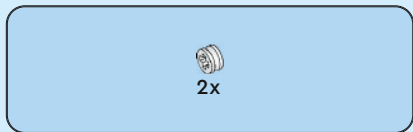
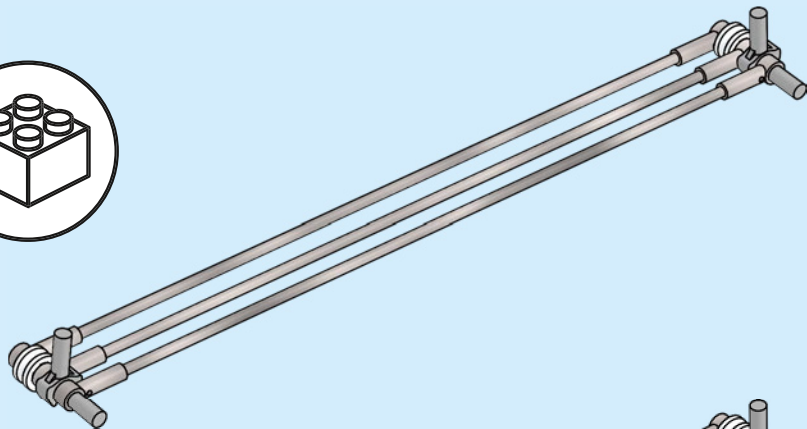

89

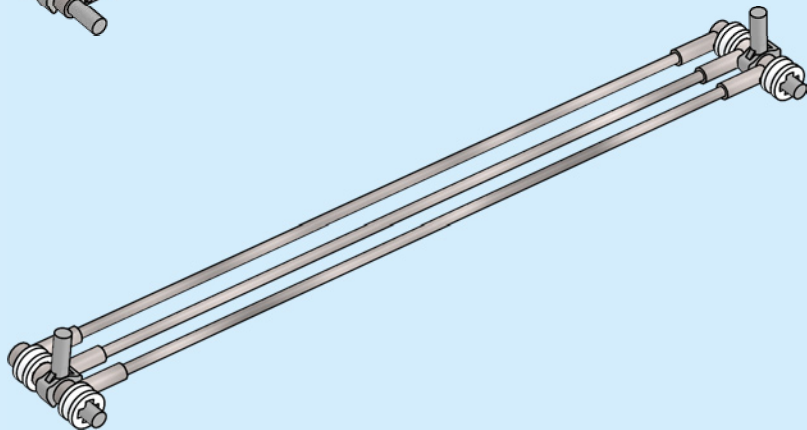

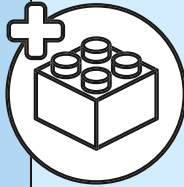
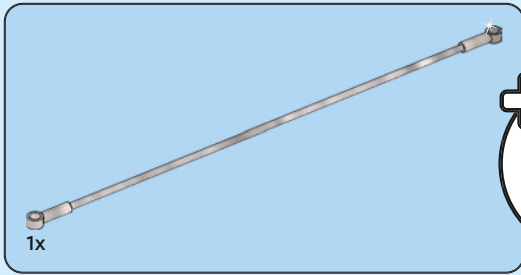

90

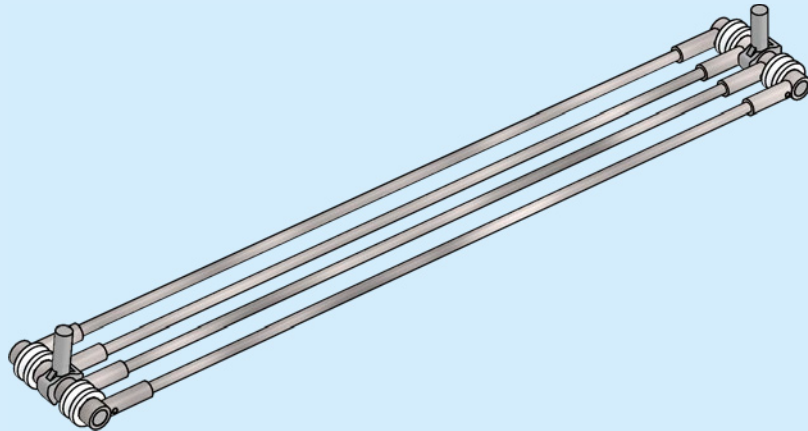

91

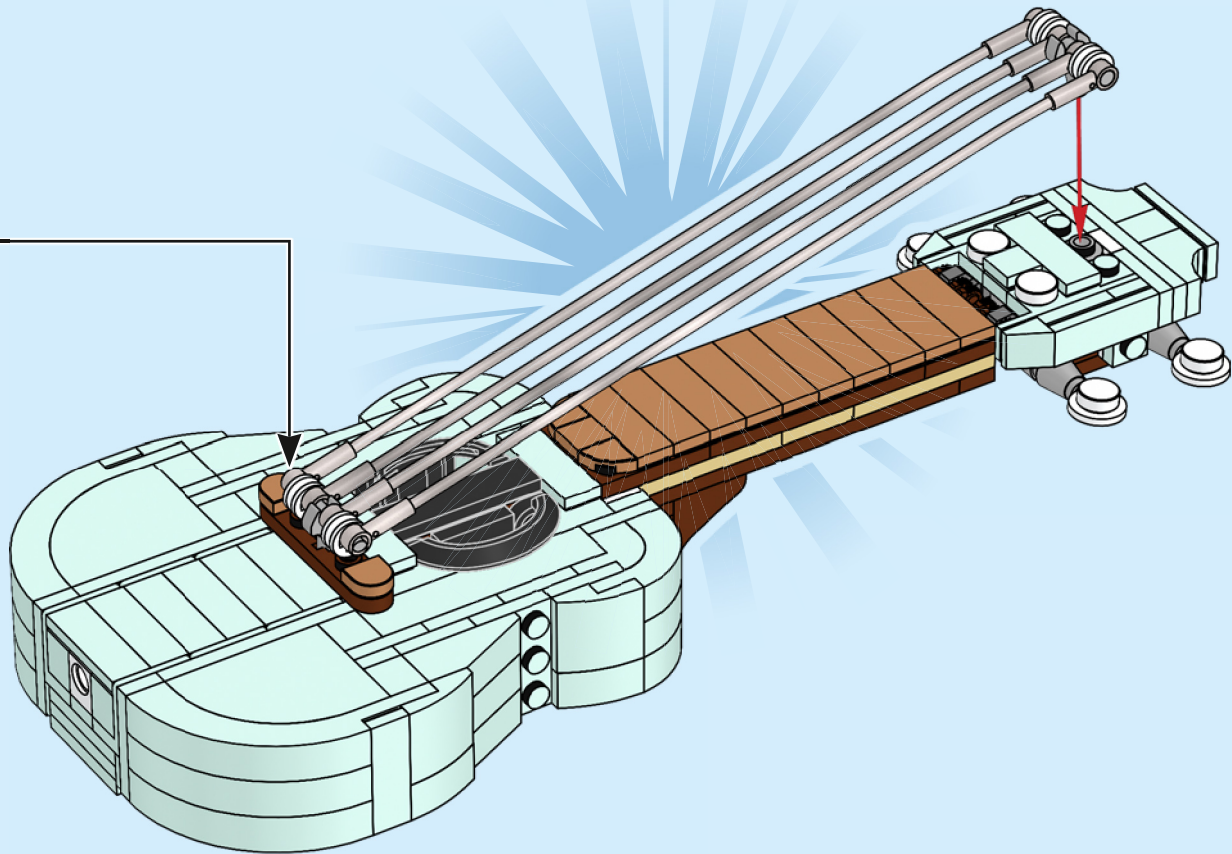

92

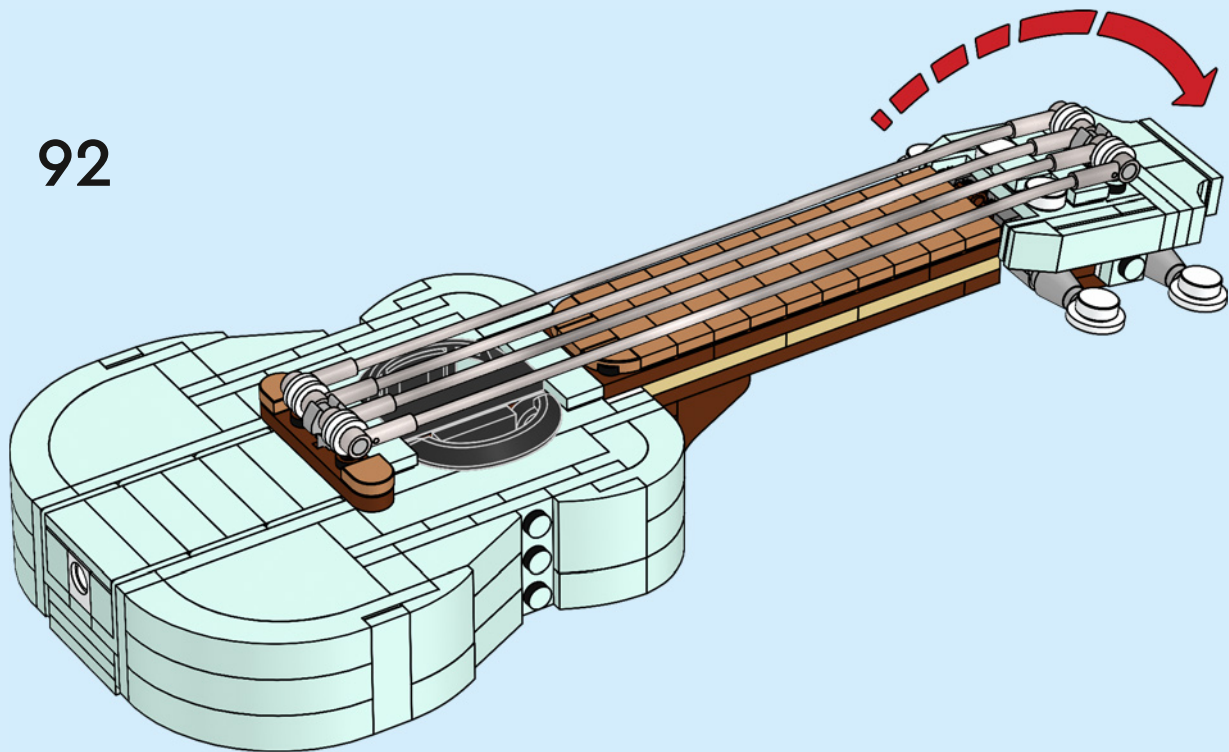

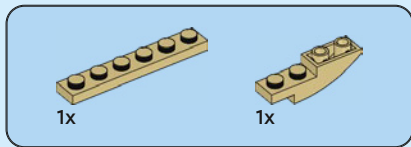
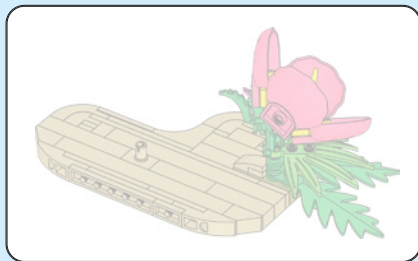

93

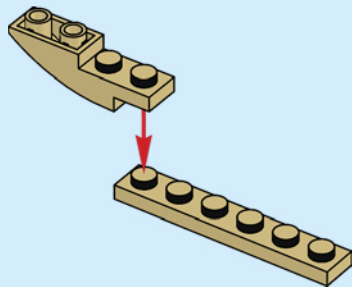

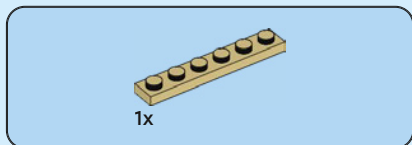

94

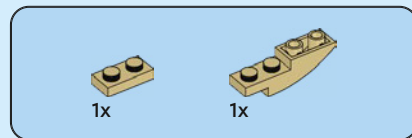
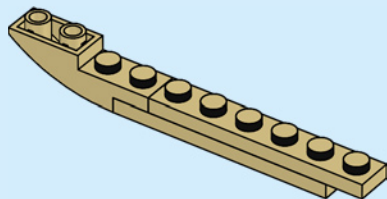

95

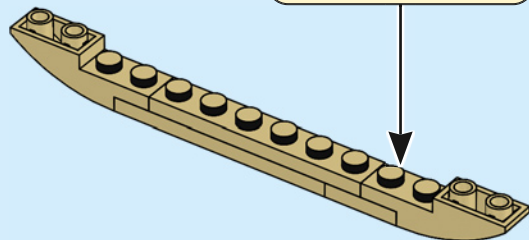
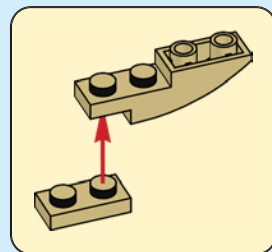

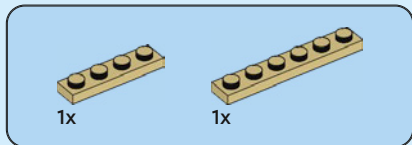

96

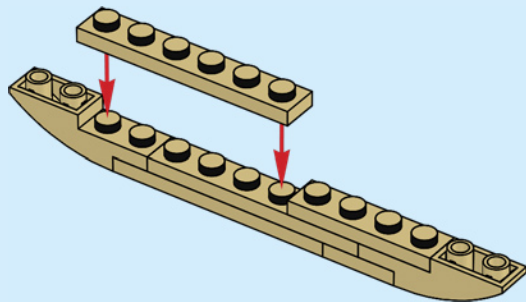

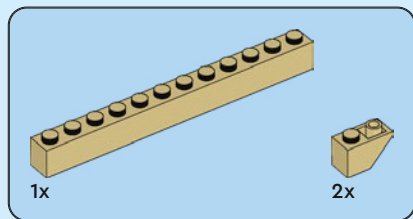

97

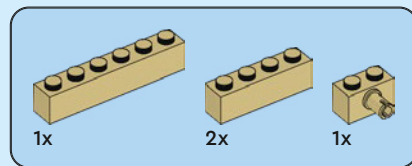
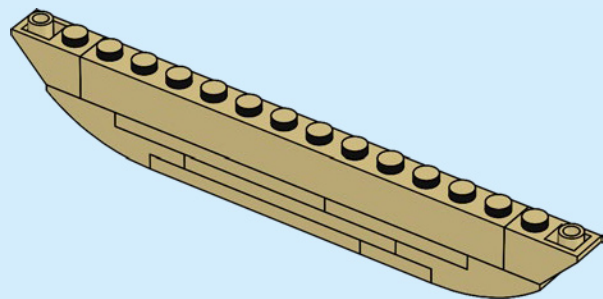

98

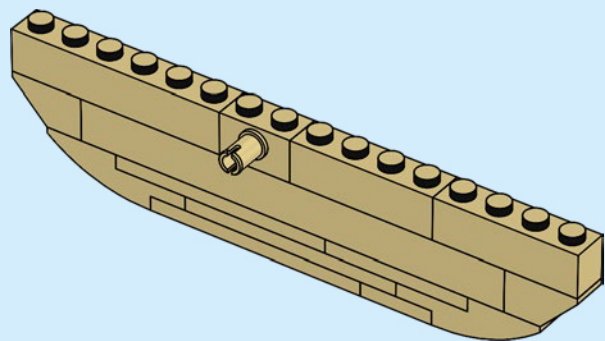

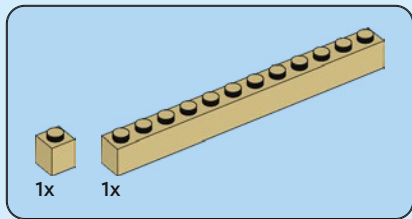

99

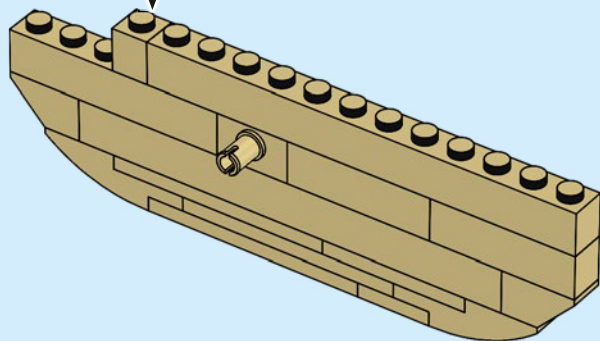

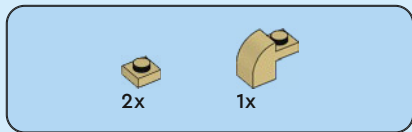

100

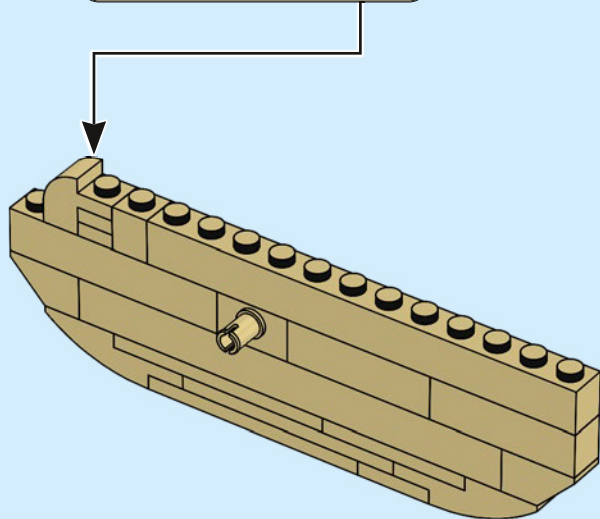
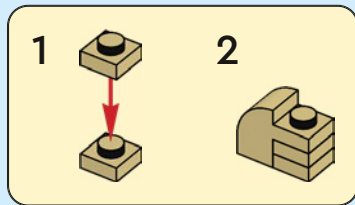

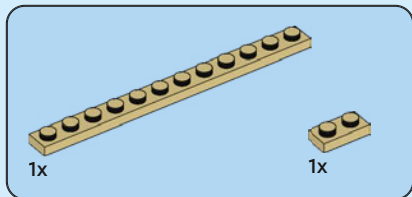

101

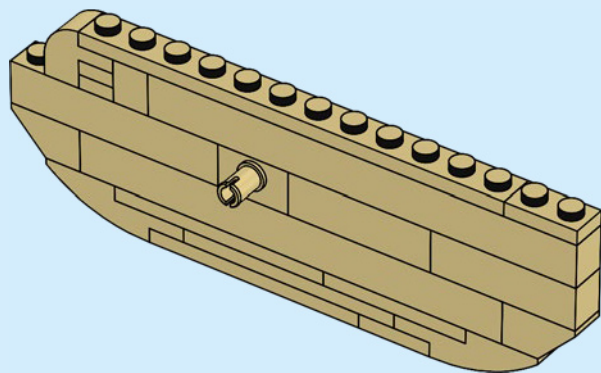

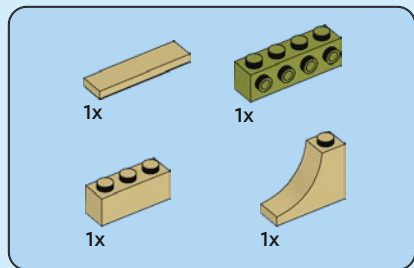

103

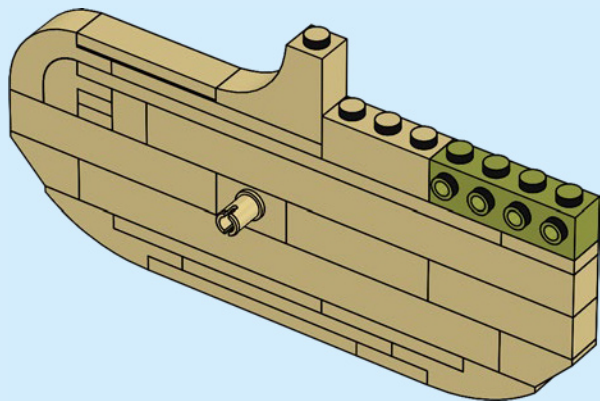

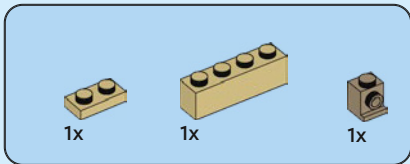

104

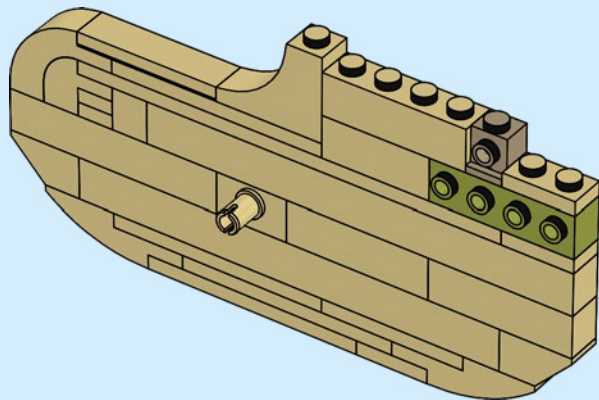

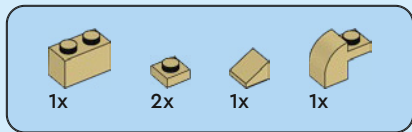

105

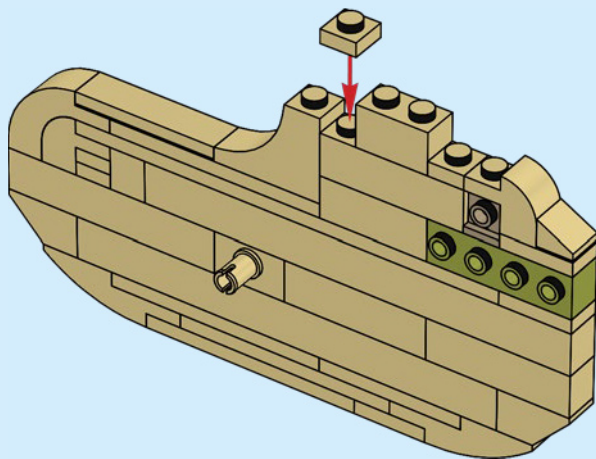



1x



2x

106

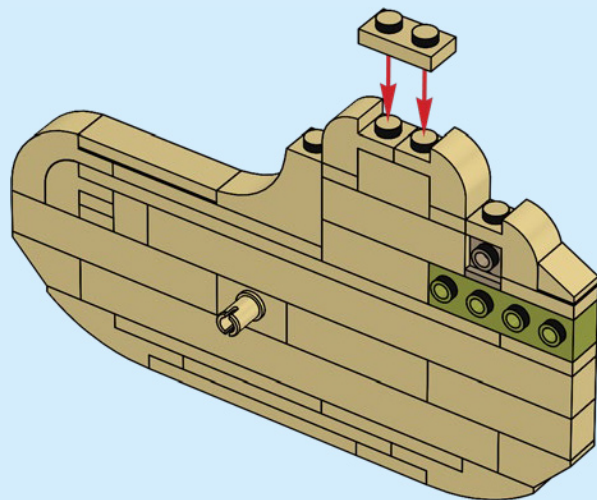

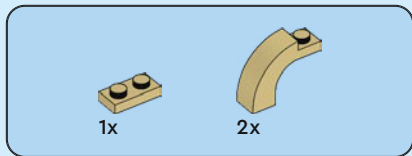

107

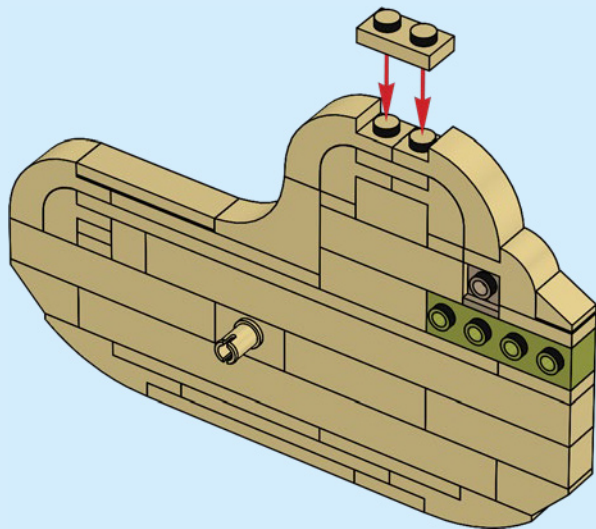



108

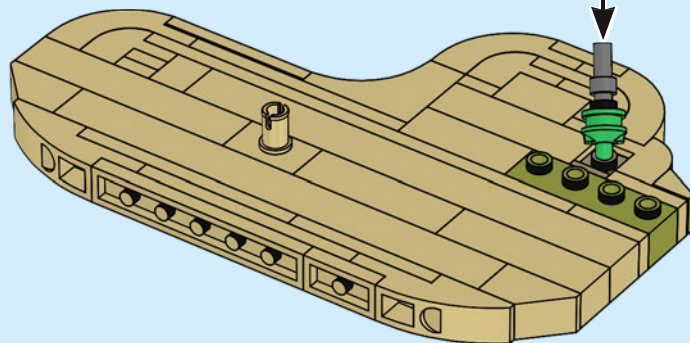
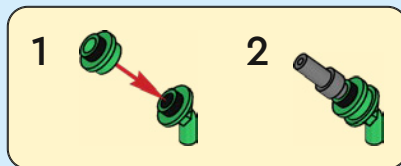
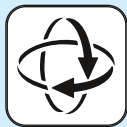



1x



1x

109

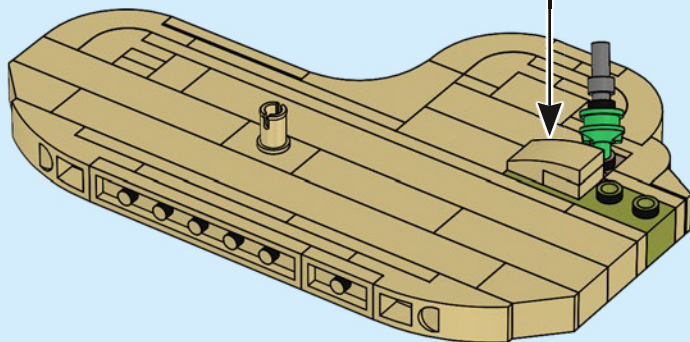
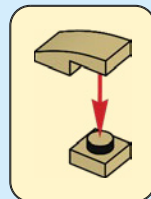



1x

110

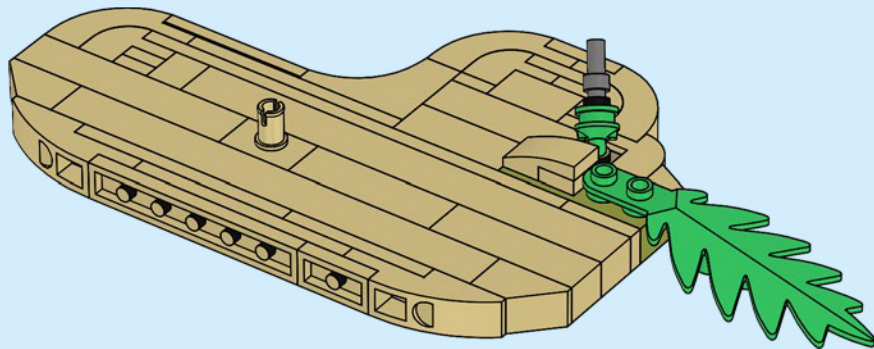



2x

111

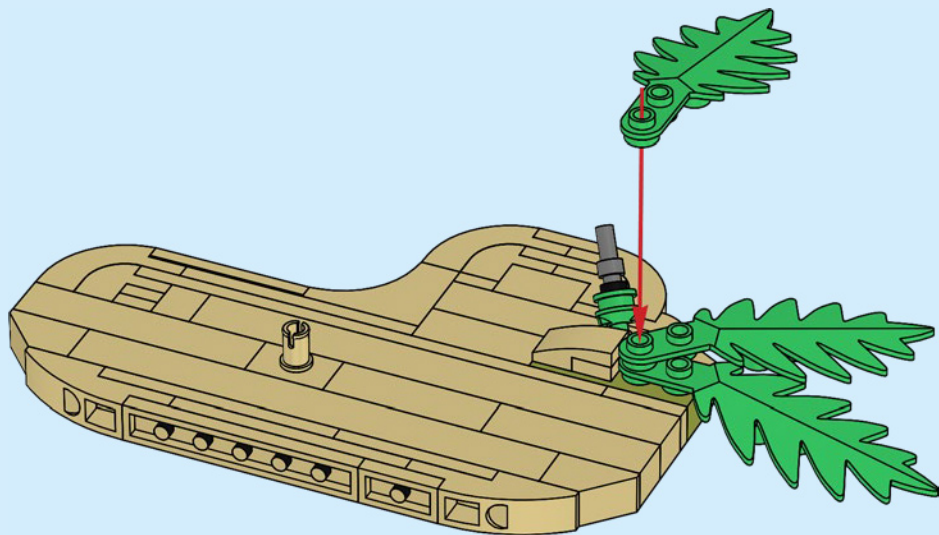

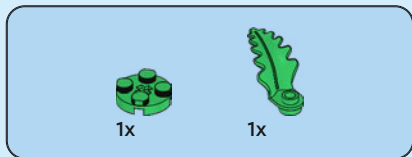

112

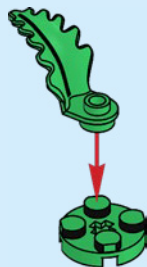

113



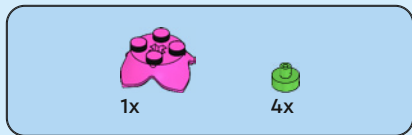

114

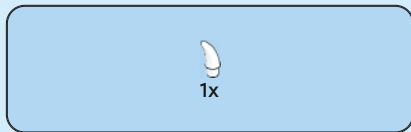
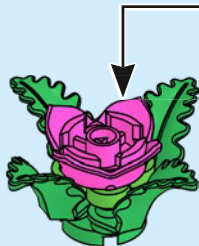
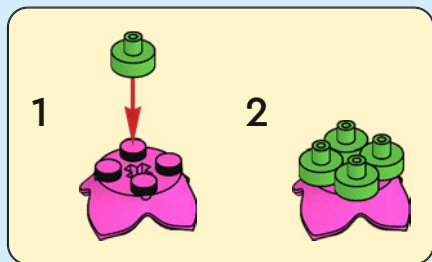

115

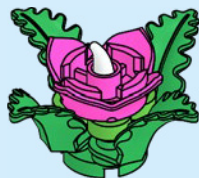

116

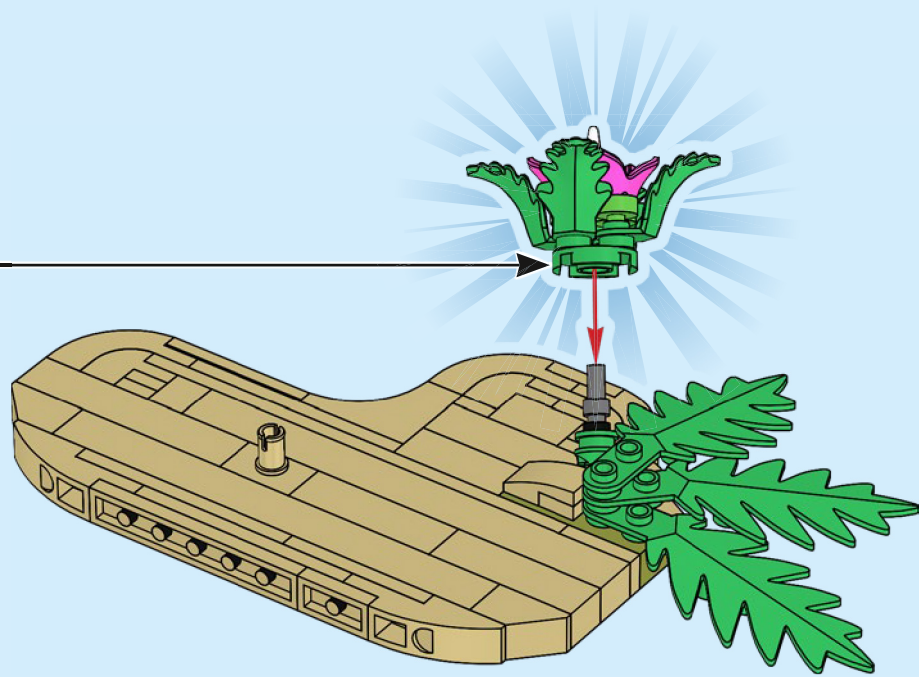

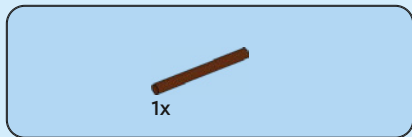

117

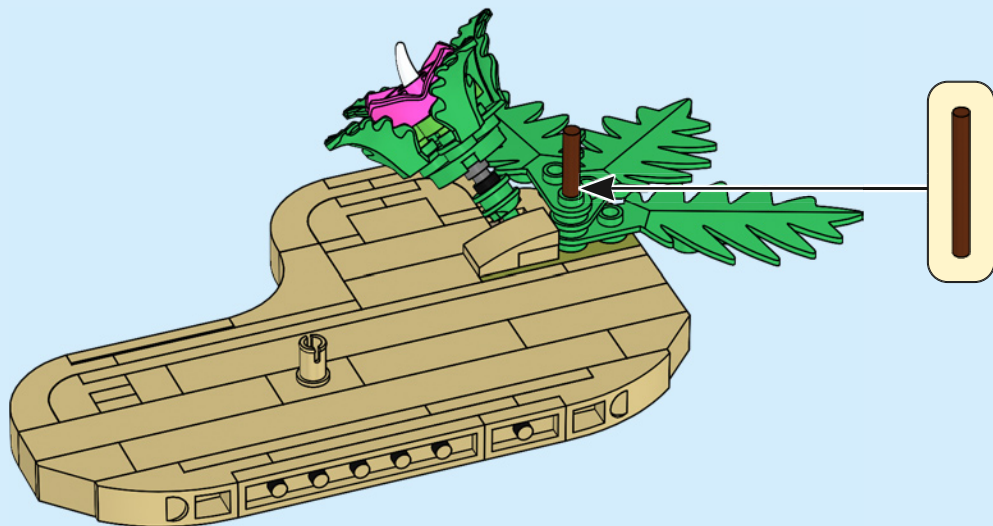

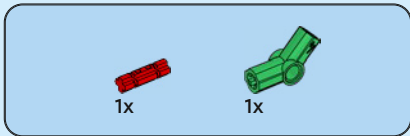
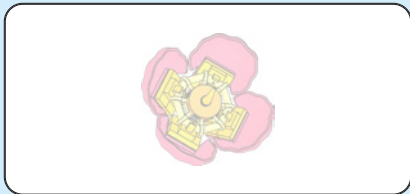

118

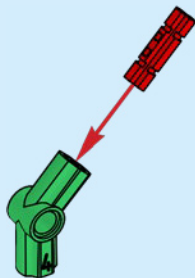

119

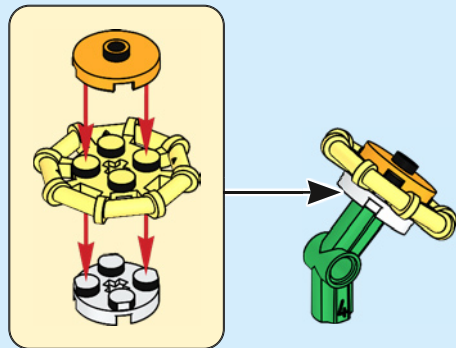



1x

120

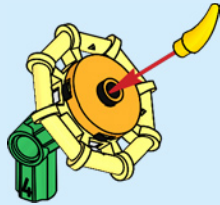

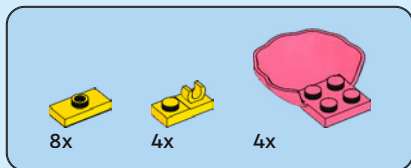

121

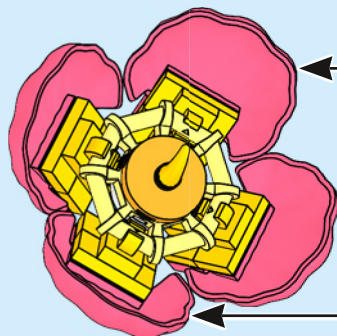
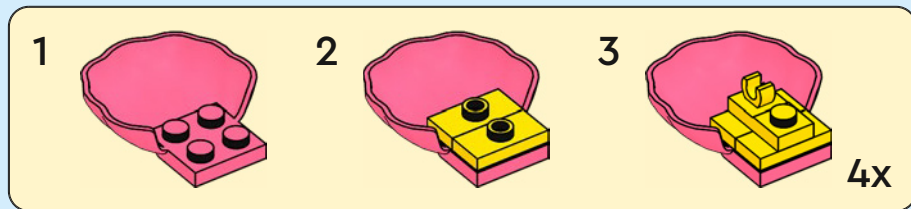

122

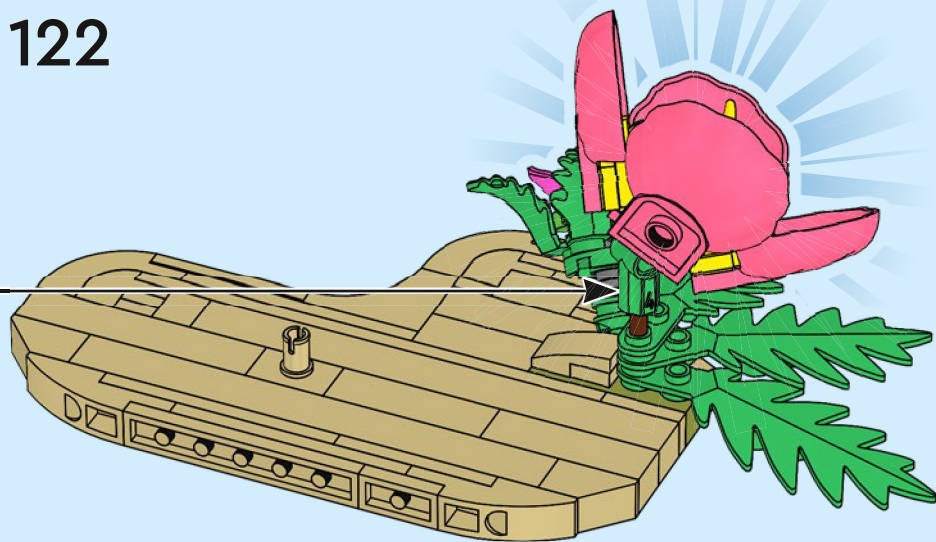



1x

123

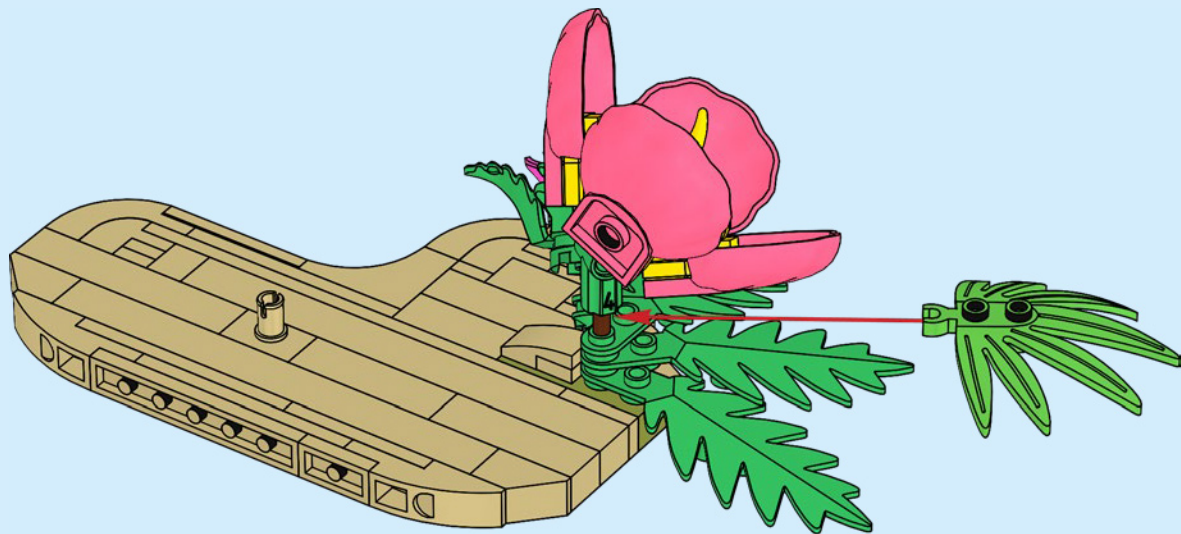

124

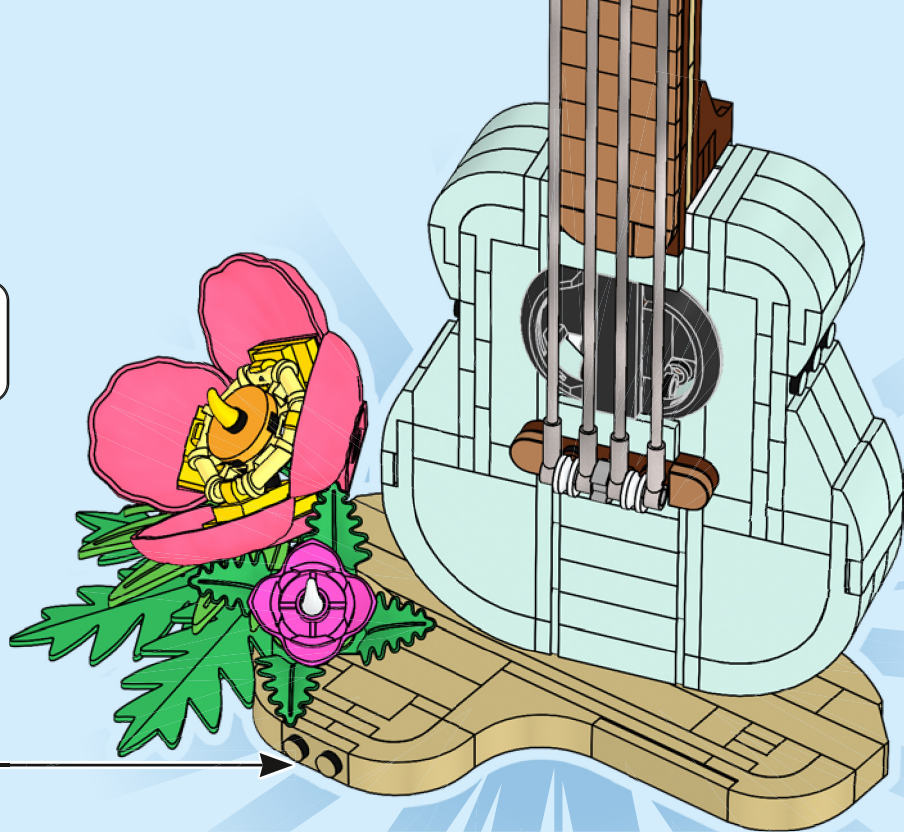

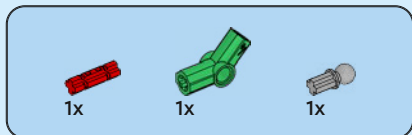
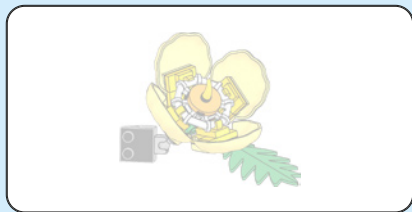

125

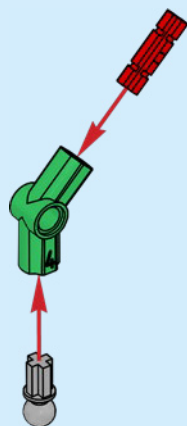



1x



1x



1x

126

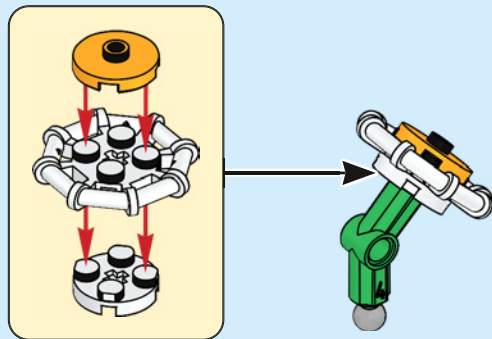

1x

127

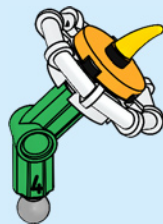

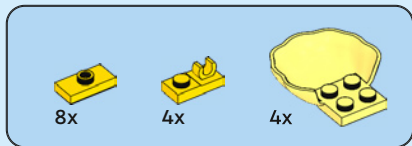

128

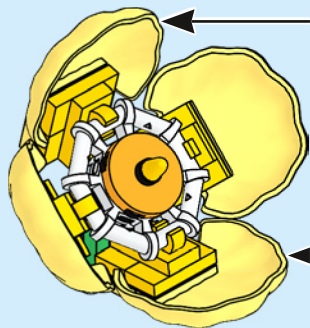

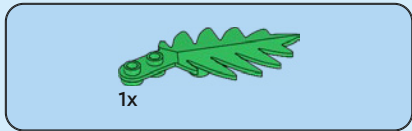

129

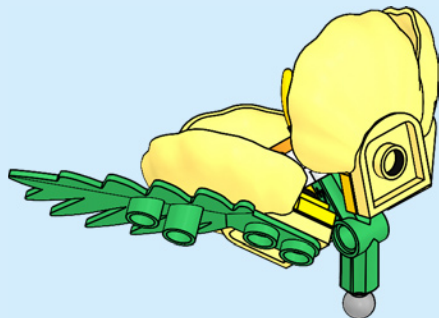

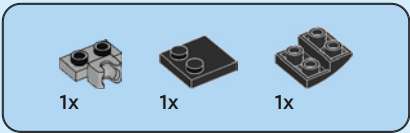

130

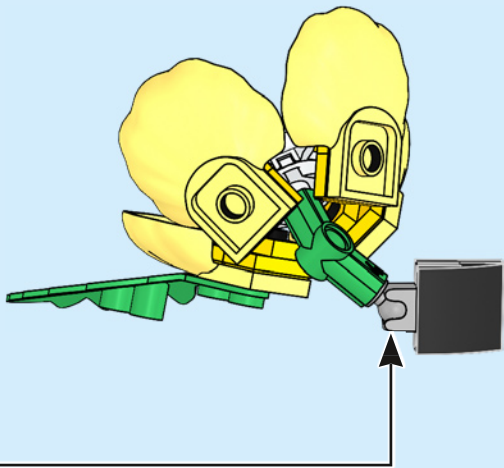
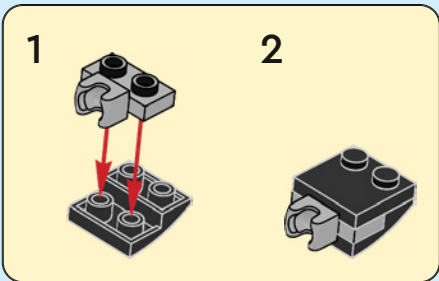

131

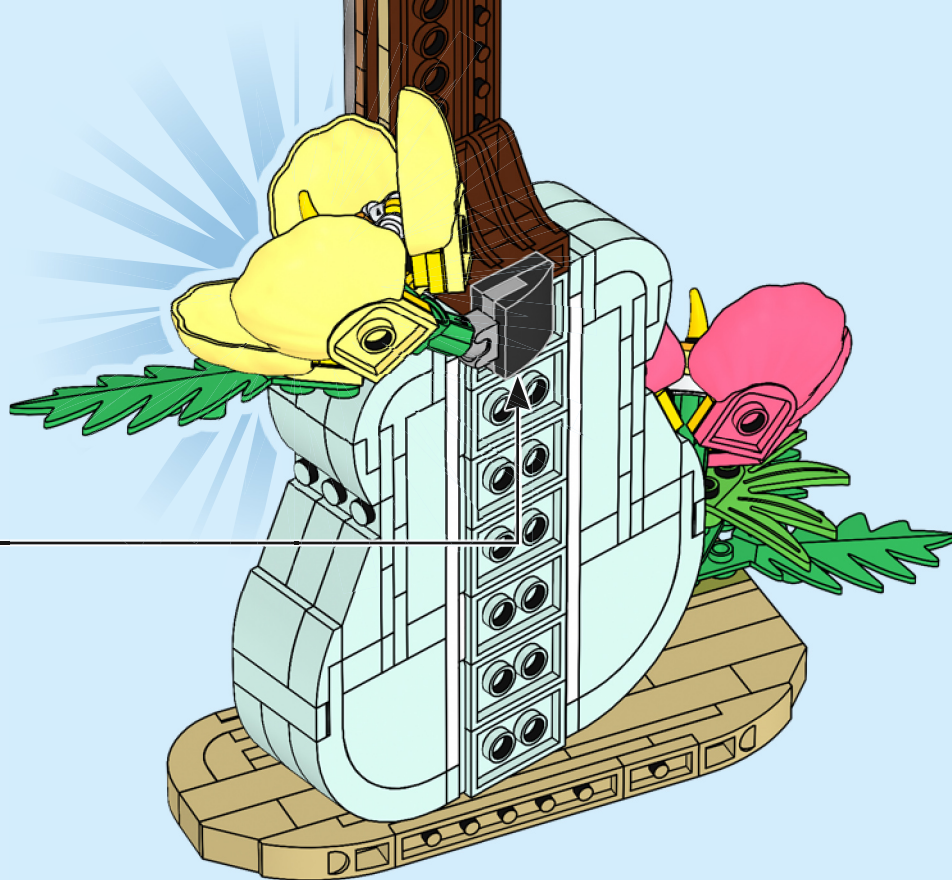



LEGO

CREATOR™

3 IN 1

31152



31150



31146



31149

31147



31145



31148



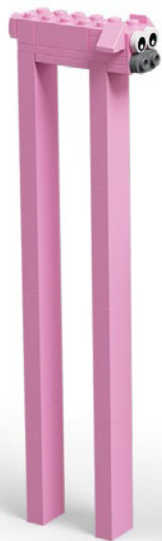

Rebuild
the
world™



YOU COULD **WIN**



Scan this QR code or go to **LEGO.COM/PRODUCTFEEDBACK** and give us your short feedback about this LEGO® set for a chance to win a cool LEGO prize.

Terms and Conditions apply*

EN: YOU COULD WIN. Terms and Conditions apply* **DE: Du könntest GEWINNEN.** Es gelten die Teilnahmebedingungen* **FR: Tu pourrais GAGNER.** Des conditions s'appliquent* **IT: Potresti VINCERE tu.** Termini e condizioni sono applicabili* **ES: Puedes GANAR.** Aplican términos y condiciones* **PT: Poderá GANHAR.** Aplicam-se termos e condições* **ZH: 轻松获奖. 条款和条件适用*** **PL: Szansa na WYGRANĄ.** Obowiązują warunki korzystania* **CS: Máte šanci VYHRÁT.** Platí všeobecné smluvní podmínky* **SK: Máte šancu VYHRAŤ.** Platia všeobecné zmluvné podmienky* **HU: TE IS NYERHETSZ.** Felhasználási feltételek érvényesek* **RO: Ai putea CÂȘTIGA.** Se aplică termeni și condiții* **BG: Можете да СПЕЧЕЛИТЕ.** Има определени правила и условия* **LV: Tu vari LAIMĒT.** Ir spēkā noteikumi un nosacījumi.* **ET: Sul on võimalus VÕITA.** Kehtivad tingimused* **LT: Jūs galite LAIMĖTI.** Taikomos sąlygos*

*[LEGO.com/productfeedback-terms](https://www.lego.com/productfeedback-terms)