



# Friends

42621







Q LEGO® Builder



[LEGO.com/sustainable-packaging](https://LEGO.com/sustainable-packaging)



 <sup>FR</sup> **DONNEZ**  
OU  
**RECYCLEZ**

 OU  OU 

ASSOCIATION    MAGASIN    DÉCHÈTERIE

Adresses sur [quefairedemesdechets.fr](https://quefairedemesdechets.fr)

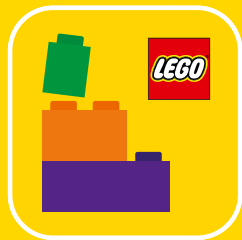

# BUILDER



Apple and the Apple logo are trademarks of Apple Inc., registered in the U.S. and other countries and regions. App Store is a service mark of Apple Inc. Google Play and the Google Play logo are trademarks of Google LLC. Tencent and the Tencent logo are trademarks of Tencent Inc.

Q [LEGO.com/devicecheck](https://LEGO.com/devicecheck)

**EN** Ask parents' permission before going online | **DE** Eltern um Erlaubnis bitten, bevor du online gehst | **FR** Demande l'autorisation d'un parent avant d'aller en ligne | **IT** Chiedi il permesso ai tuoi genitori prima di andare online | **ES** Pídeles permiso a tus papás antes de conectarte a Internet | **PT** Pede autorização aos pais antes de acederes online | **ZH** 上网前应先征得父母的同意 | **PL** Poproś rodziców o zgodę, zanim wejdiesz do Internetu | **CS** Než půjdeš na internet, požádej rodiče o svolení | **SK** Skôr než pôjdeš na internet, vypýtaj si povolenie od rodičov | **HU** Kérj szülői engedélyt, mielőtt online csatlakoznál! | **RO** Cere permisiunea părinților înainte de a te conecta online | **BG** Поискайте разрешение от родител, преди да влезете онлайн | **LV** Pirms došanās tiešsaistē palūdz atļauju vecākiem | **ET** Enne Interneti kasutamist küsi vanematelt luba | **LT** Prieš prisijungdami prie interneto, atsiklauskite tėvų

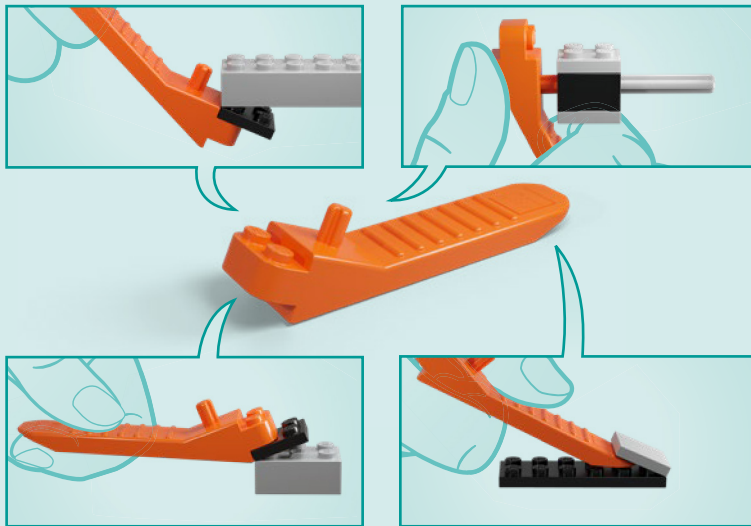

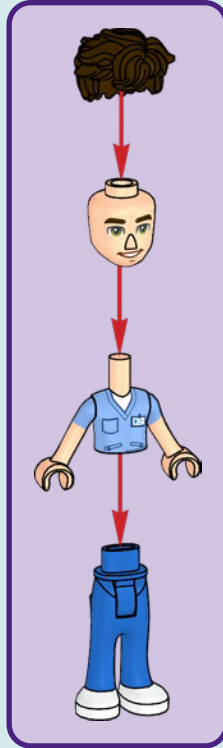

**BRENDAN**

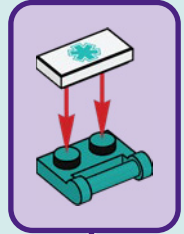

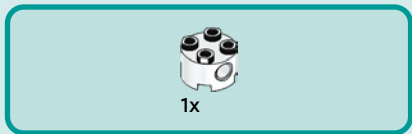
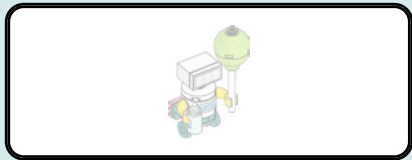

1



2



3

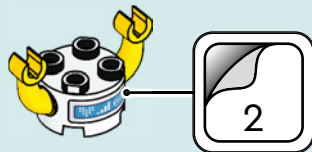



1x

4

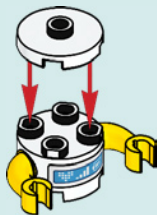

1x



1x



1x

5

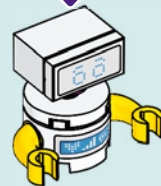
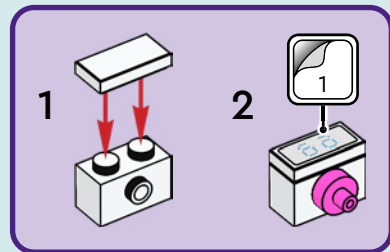

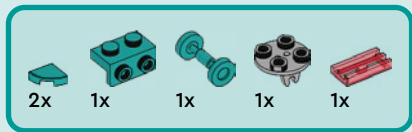

6

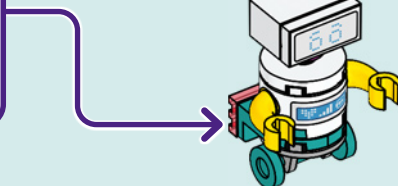
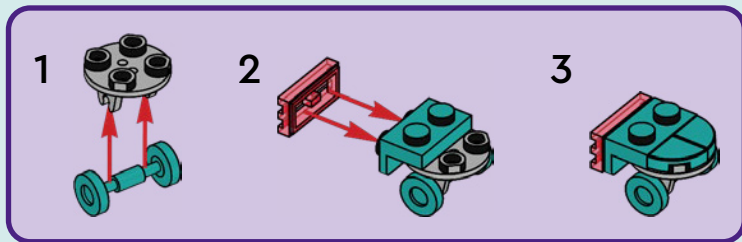





1x

7

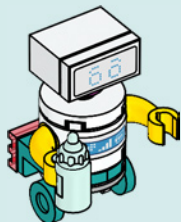

1x



1x



1x

8

1



2



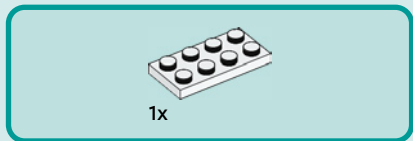
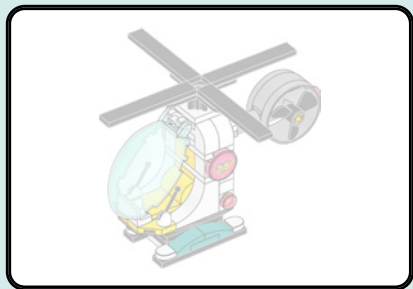

1

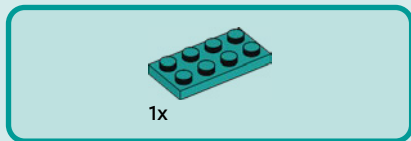
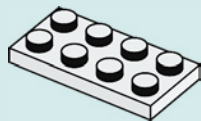

2

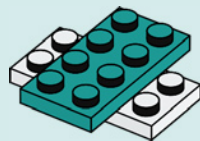



2x

3

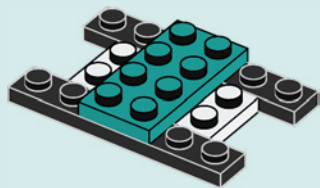

2x

4

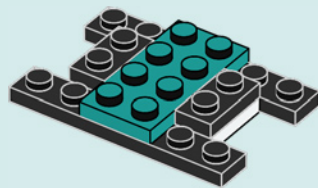



5

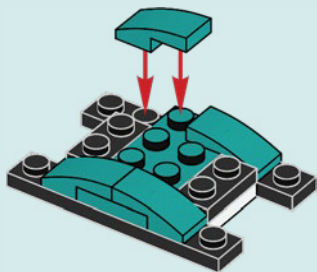

6

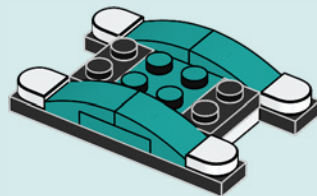



1x

7

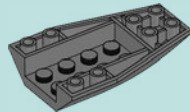
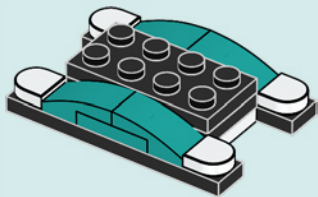

1x

8

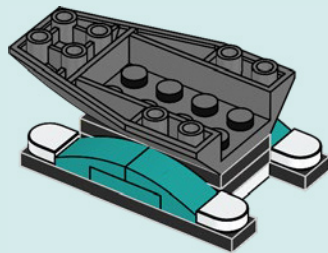



1x

9

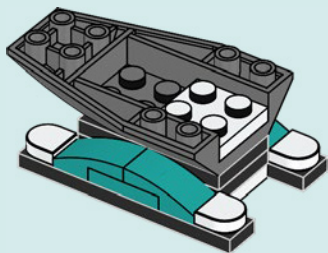

1x



1x



1x

10

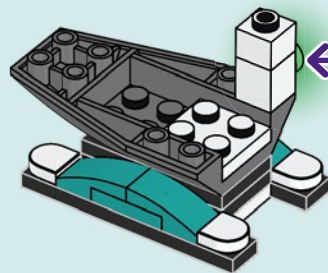
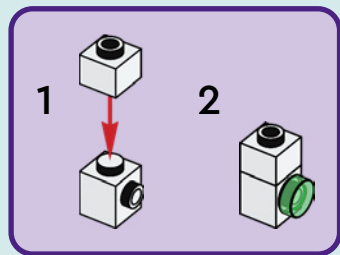

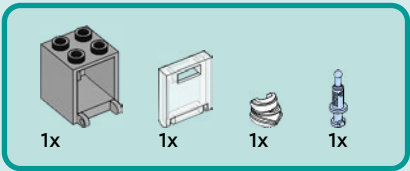

11

1

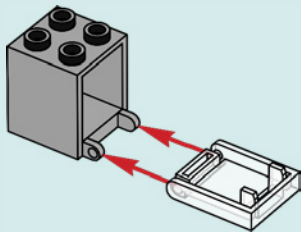

2

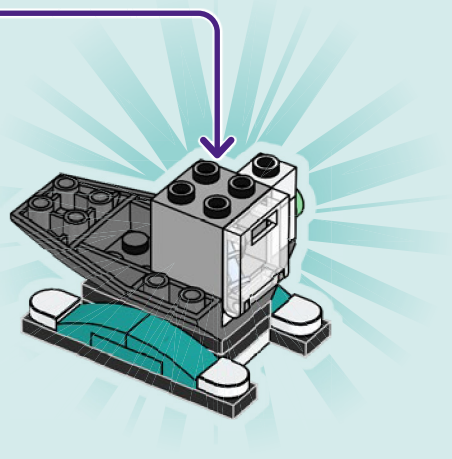
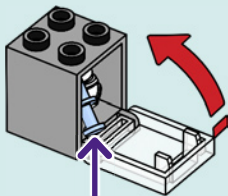

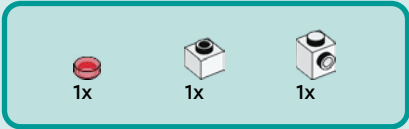

12

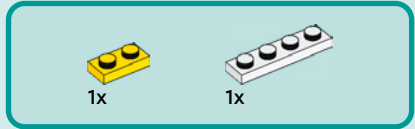
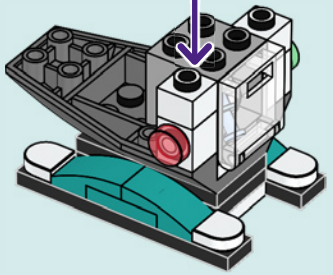
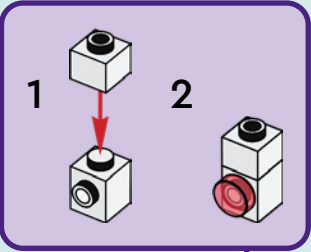

13

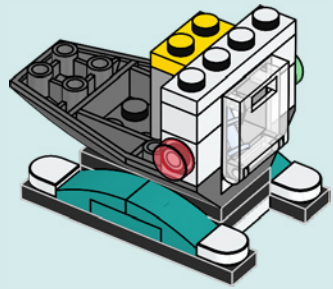



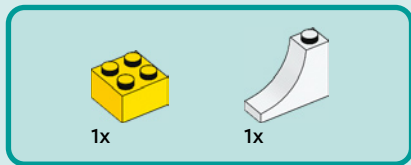

14

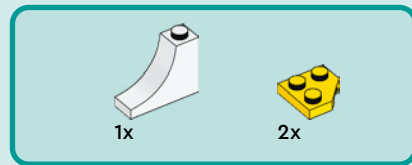
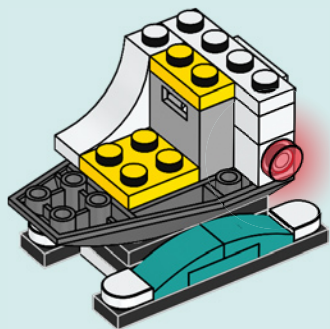

15

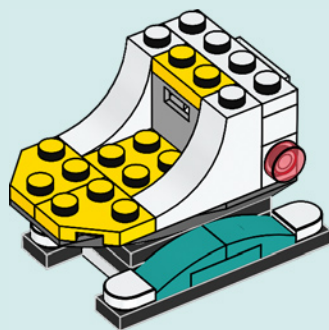



1x



1x

# 16

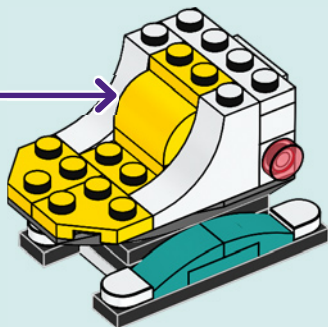
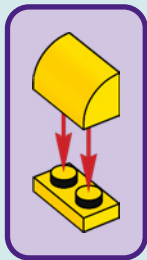

1x



1x

# 17

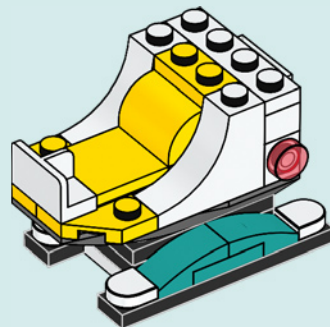



2x

18

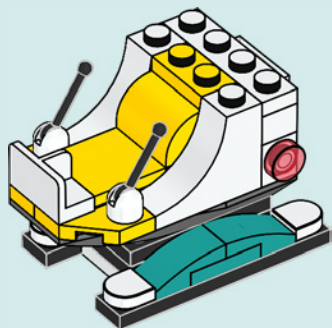

1x

19

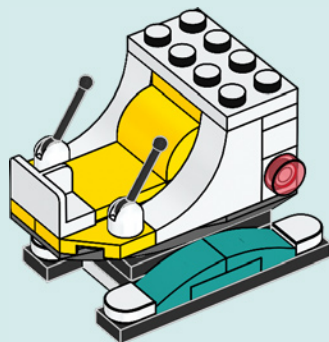



1x



2x

20

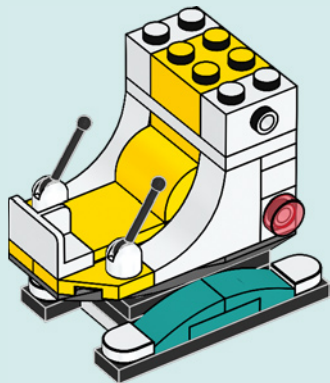

20



2x

21

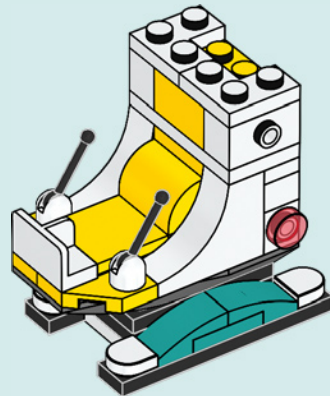



2x

# 22

1



2



2x

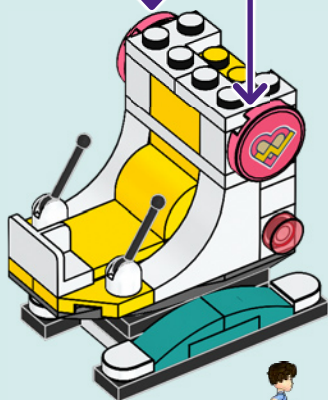

1x



1x

# 23

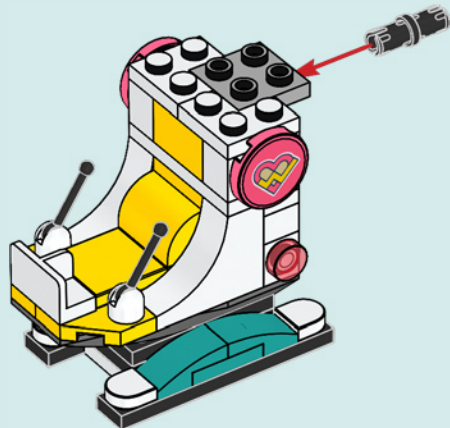



1x



1x

24

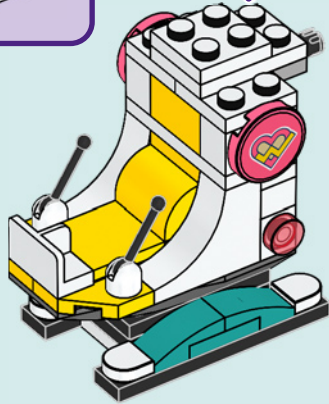
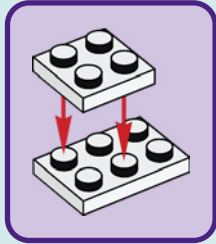

4x

25

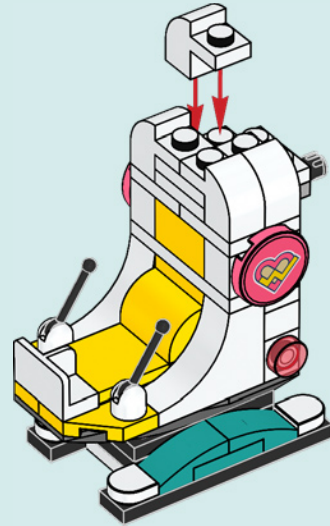



2x



1x

# 26

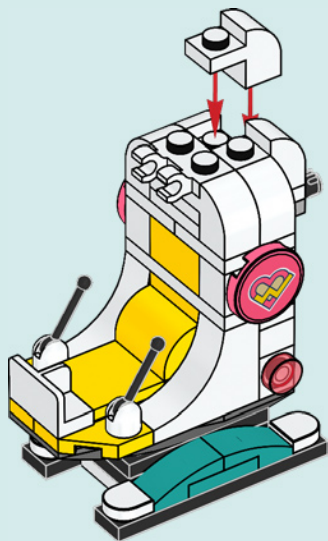

1x

# 27

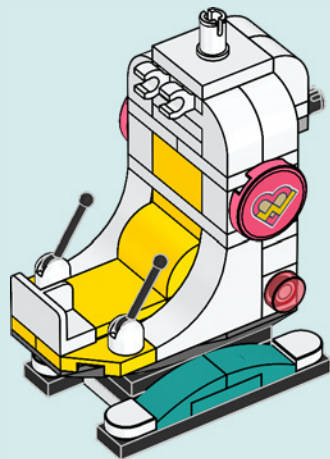

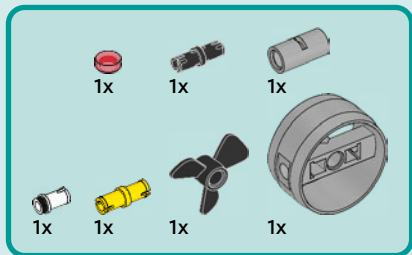

# 28

1

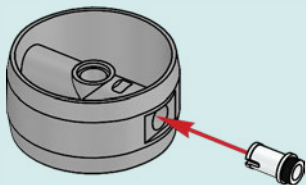

2

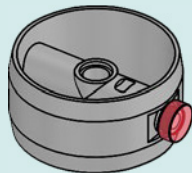

3

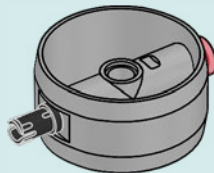

4

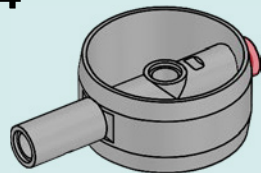



5

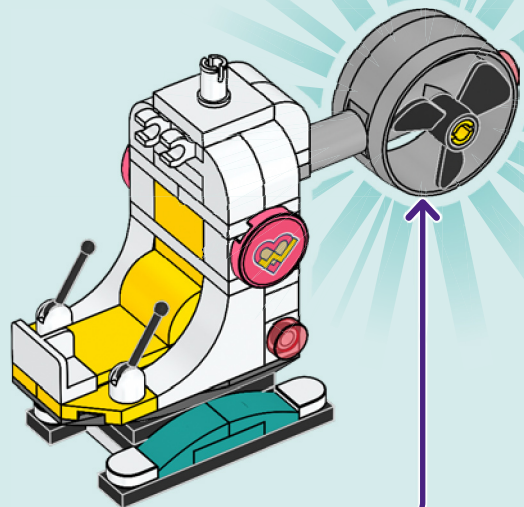
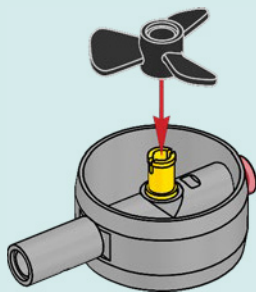

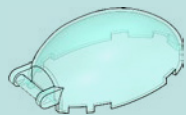

1x

29

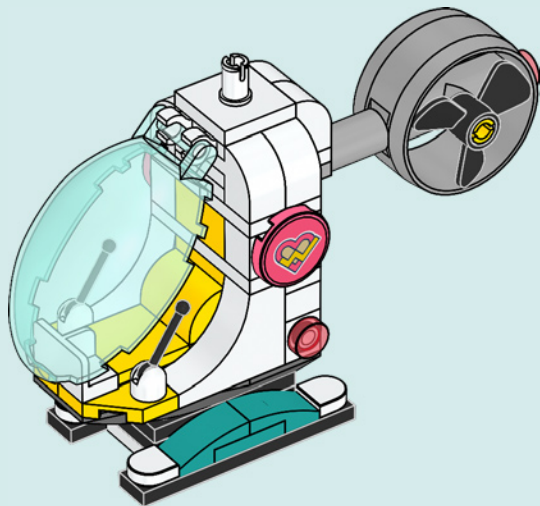

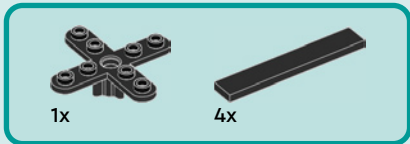

30

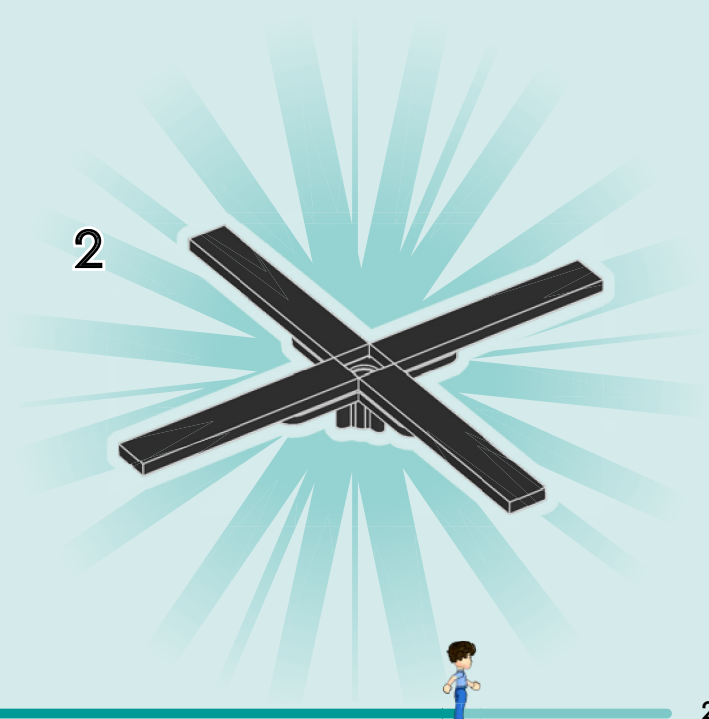
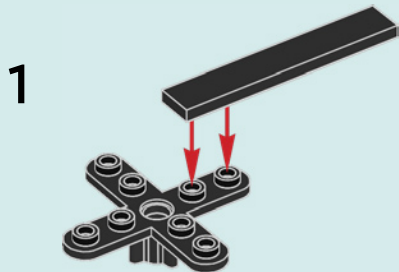

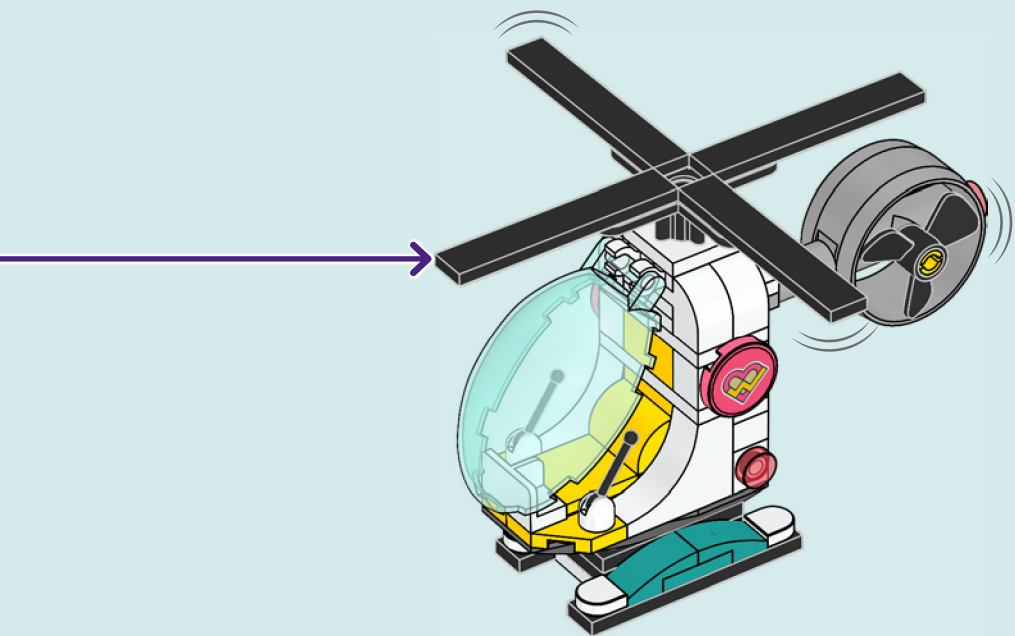

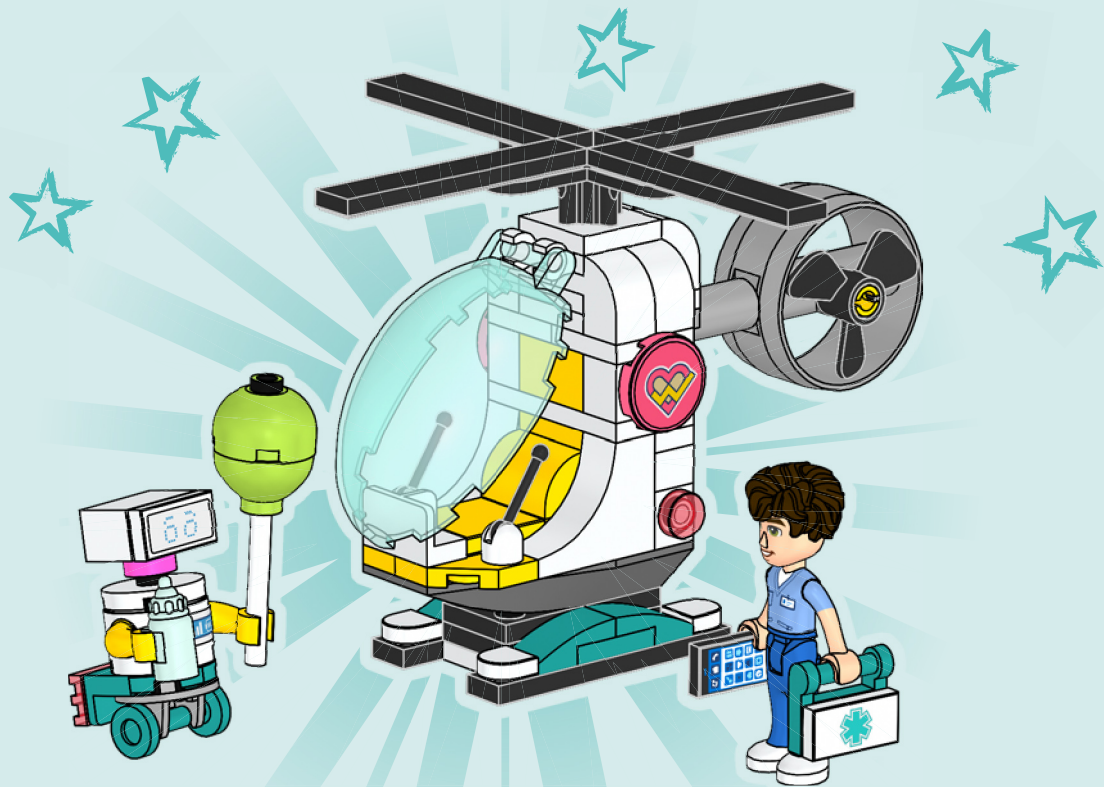

**LEGO** Friends



**LEGO** Friends

WATCH  
SERIES  
ONLINE



WATCH SERIES ONLINE / SCHAU DIR DIE SERIE ONLINE AN / REGARDE LA SÉRIE EN LIGNE / GUARDA LA SERIE ONLINE / MIRA LA SERIE EN INTERNET / ASSISTIR À SÉRIE ONLINE / 在线观看 /  
OGŁADAJ SERIAL W INTERNECIE / SLEDUJ SERIAL ONLINE / POZRI SI SERIAL ONLINE / NEZD A SOROZATOT ONLINE / VIZIONEAZĂ SERIALUL ONLINE / ГЛЕДАЙТЕ СЕРИАЛА ОНЛАЙН /  
SKATIES SĒRIĀLU TIEŠSAISTĒ / VAATA SARJA VEEBIST / ŽIURĒK SĒRIALĀ INTERNETU

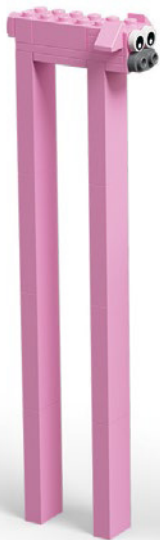

Rebuild  
the  
world™

