



CITY

60405



LEGO® Builder



Get excited about our new packaging!

We're switching from plastic to paper-based packaging. That's why you might find a mix of paper and plastic in our boxes!

Nos nouveaux emballages vous emballeront !

Nous passons des emballages en plastique aux emballages à base de papier. C'est pourquoi vous pourriez trouver un mélange de papier et de plastique dans nos boîtes !

¡Te presentamos nuestros nuevos empaques!

Estamos sustituyendo las bolsas de plástico por bolsas con base de papel. ¡Por eso, puedes encontrar una mezcla de papel y de plástico en nuestras cajas!

[LEGO.com/sustainable-packaging](https://www.lego.com/sustainable-packaging)

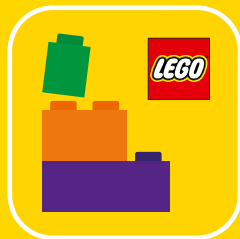

BUILDER



Apple and the Apple logo are trademarks of Apple Inc., registered in the U.S. and other countries and regions. App Store is a service mark of Apple Inc. Google Play and the Google Play logo are trademarks of Google LLC. Tencent and the Tencent logo are trademarks of Tencent Inc.

Q [LEGO.com/devicecheck](https://www.lego.com/devicecheck)

EN Ask parents' permission before going online | **DE** Eltern um Erlaubnis bitten, bevor du online gehst | **FR** Demande l'autorisation d'un parent avant d'aller en ligne | **IT** Chiedi il permesso ai tuoi genitori prima di andare online | **ES** Pídeles permiso a tus papás antes de conectarte a Internet | **PT** Peça autorização aos pais antes de acederes online | **ZH** 上网前应先征得父母的同意 | **PL** Poproś rodziców o zgodę, zanim wejdziesz do Internetu | **CS** Než půjdeš na internet, požádej rodiče o svolení | **SK** Skôr než pôjdeš na internet, vypýtaj si povolenie od rodičov | **HU** Kérj szülői engedélyt, mielőtt online csatlakoznál! | **RO** Cere permisiunea părinților înainte de a te conecta online | **BG** Поискайте разрешение от родител, преди да влезете онлайн | **LV** Pirms došanās tiešsaistē palūdz atļauju vecākiem | **ET** Enne Interneti kasutamist küsi vanematelt luba | **LT** Prieš prisijungdami prie interneto, atsiklauskite tėvų

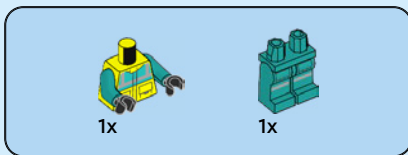
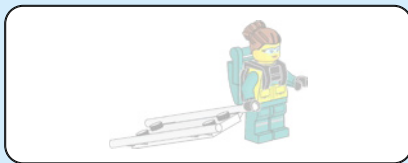

1

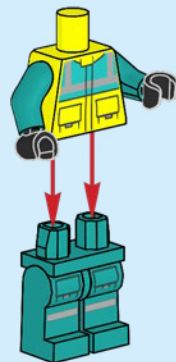



1x



1x



1x

2

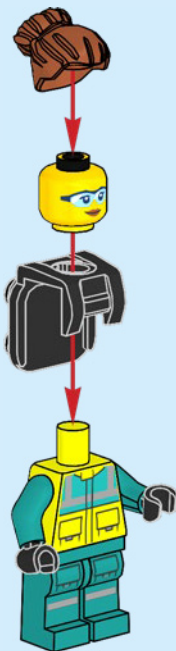

1x



1x

3

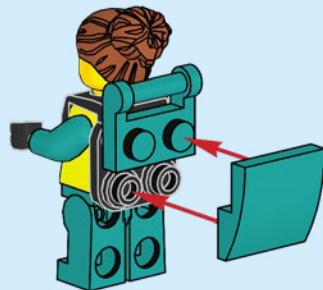
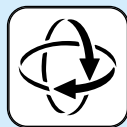

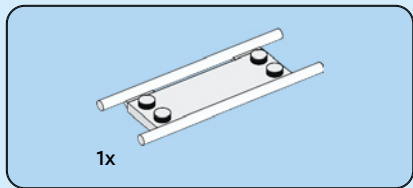

4

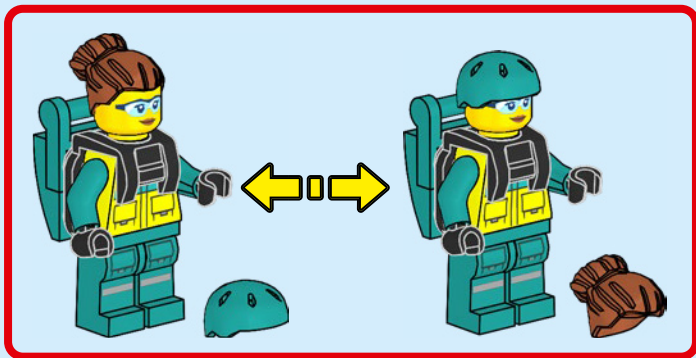
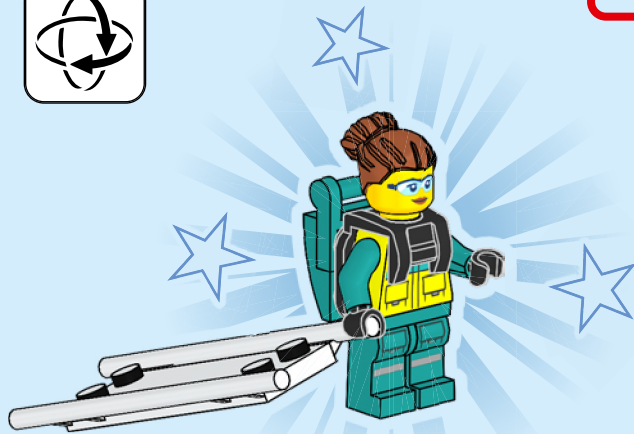
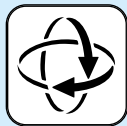

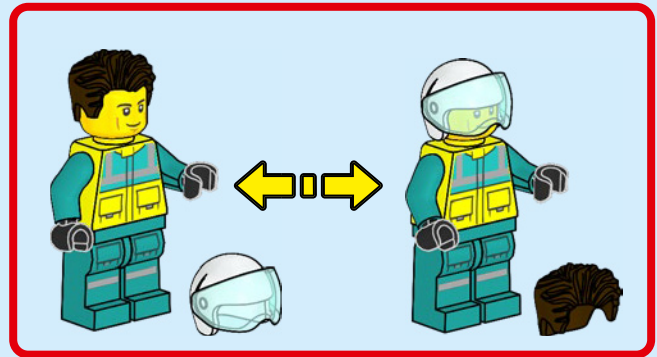
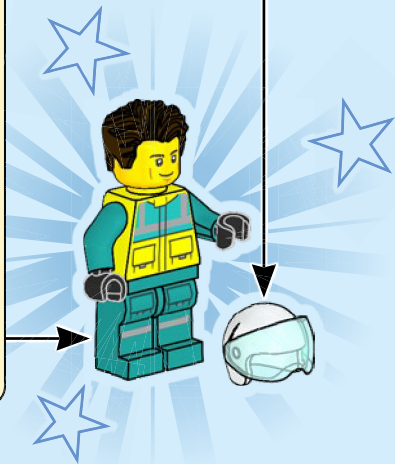
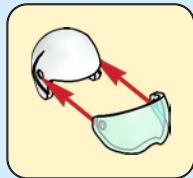
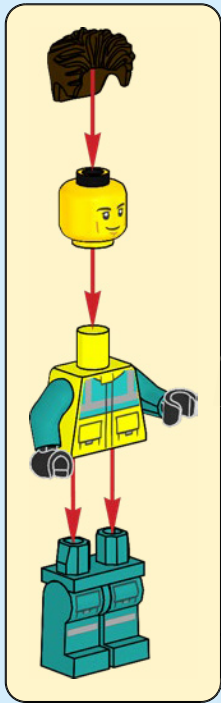

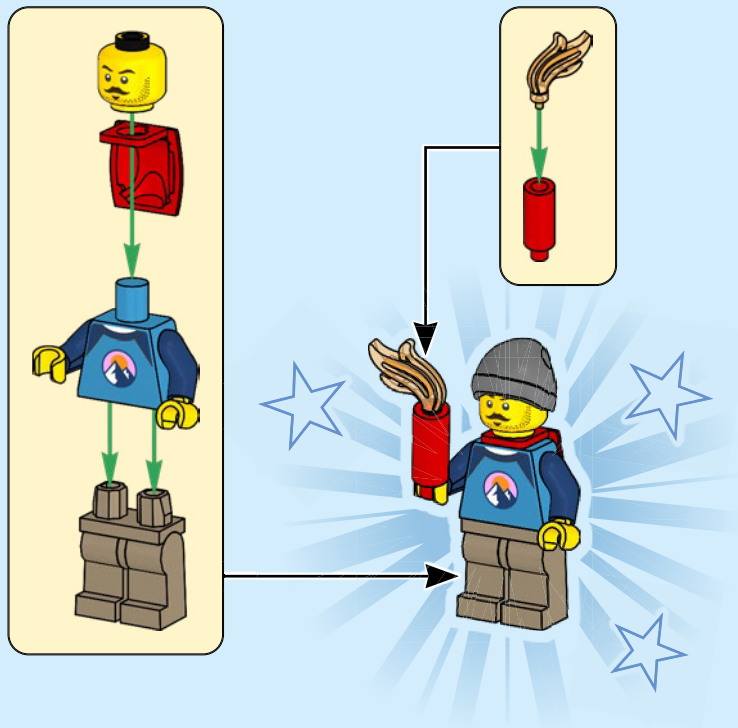

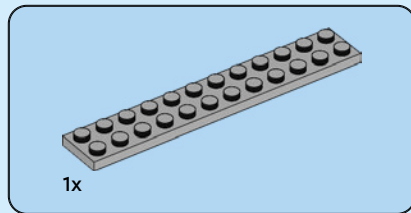
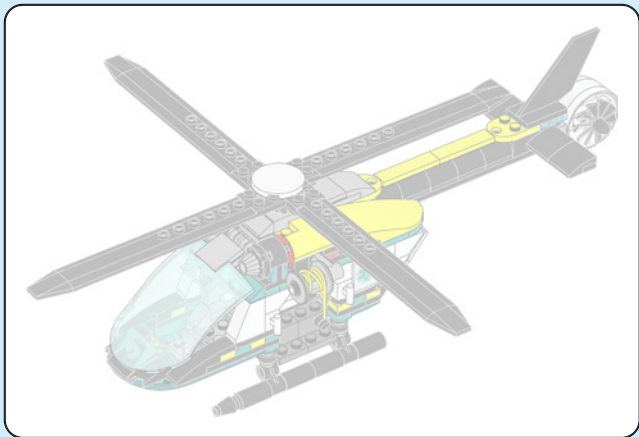

1

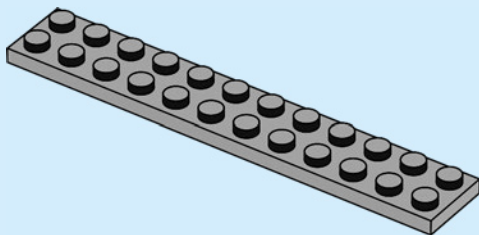

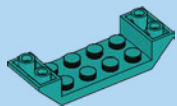

1x

2

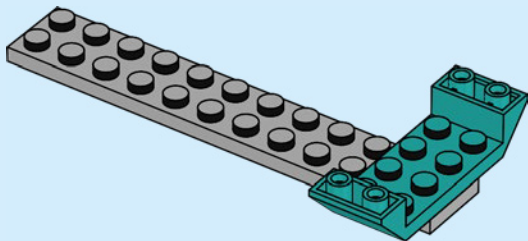

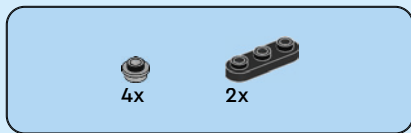

3

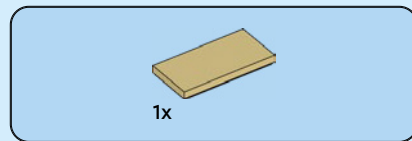
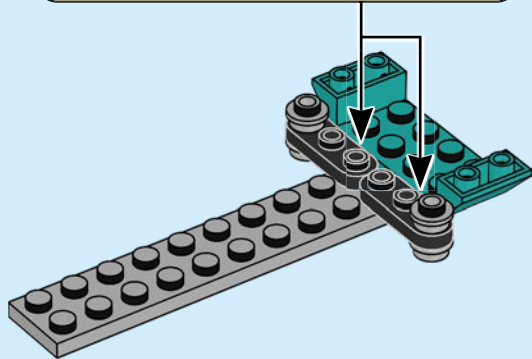
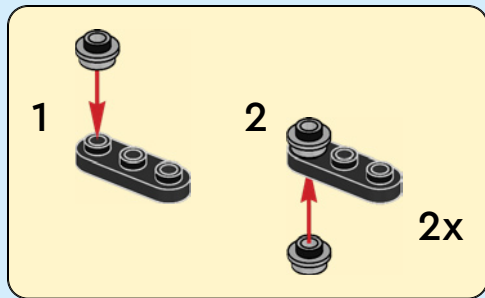

4

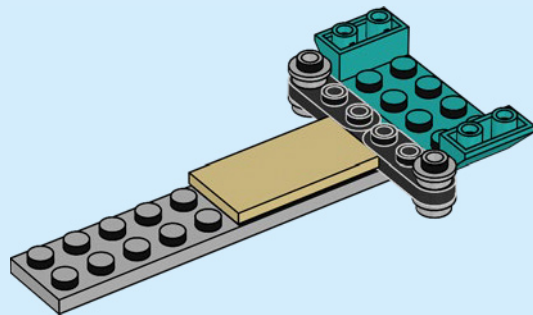

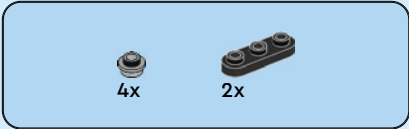

5

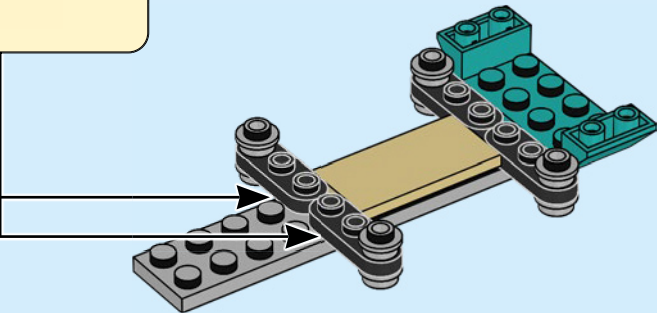
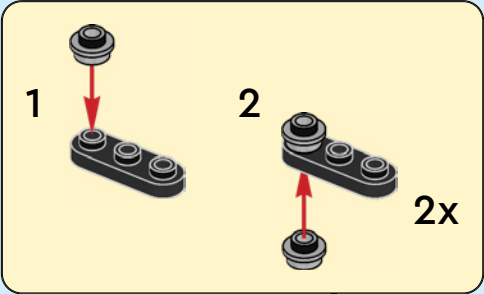

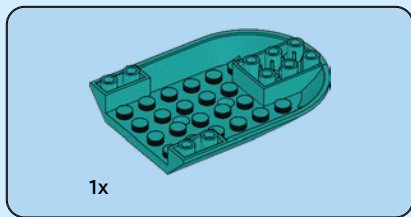

6

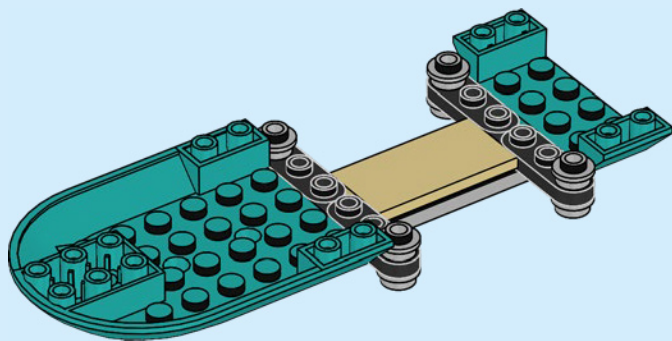



4x

7

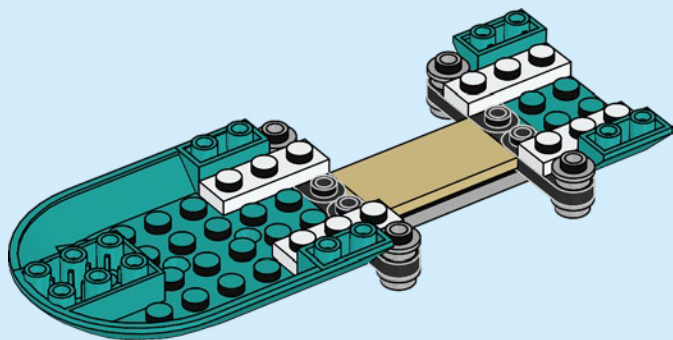

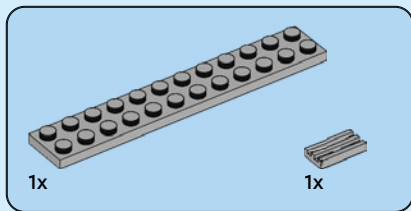

8

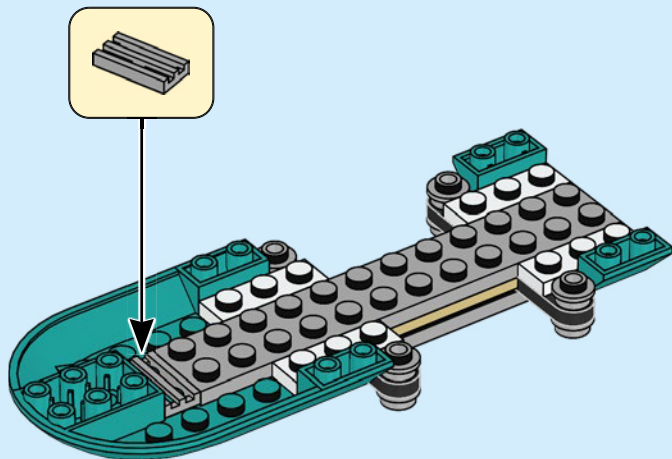



2x

9

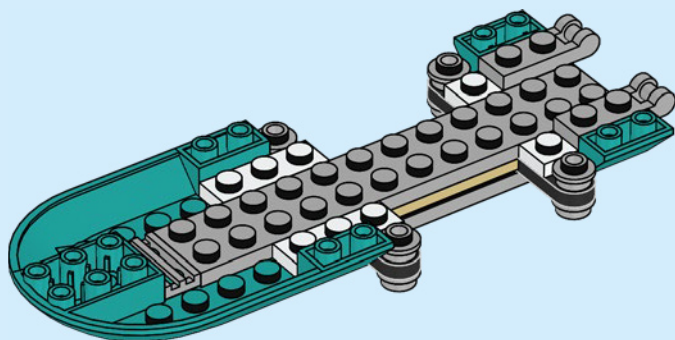



2x

10

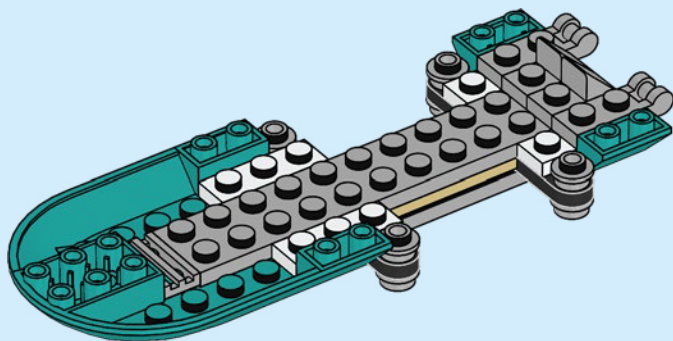

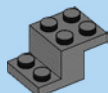

4x

11

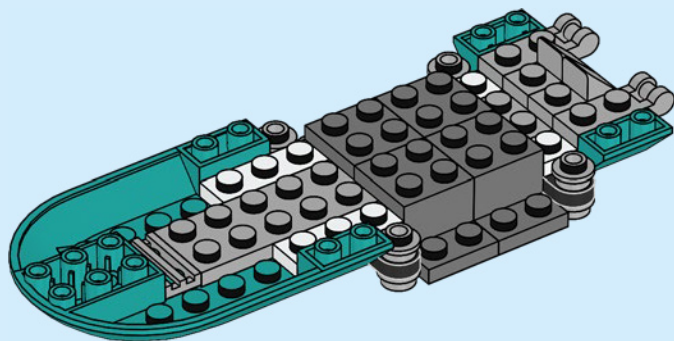

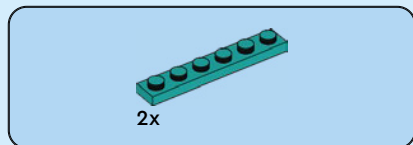

12

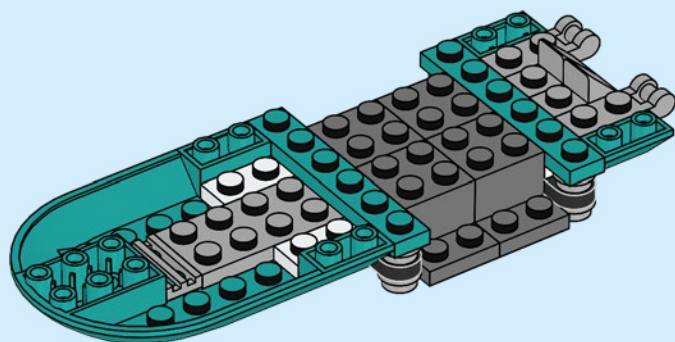

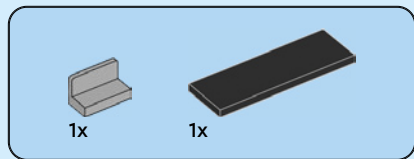

13

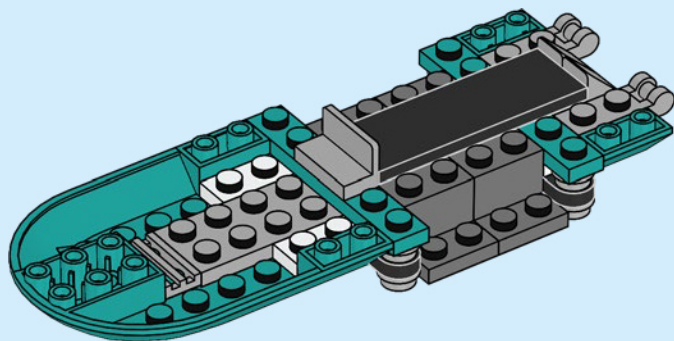



1x



2x

14

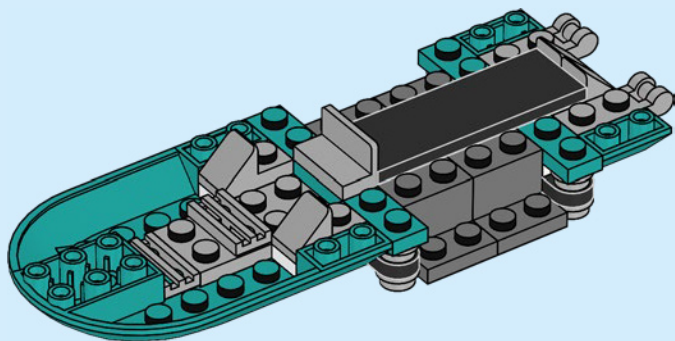



2x

15

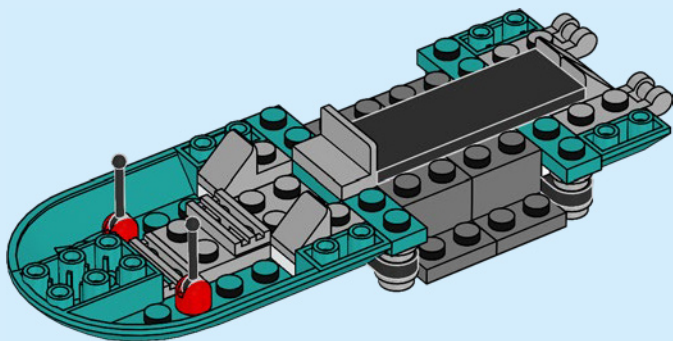

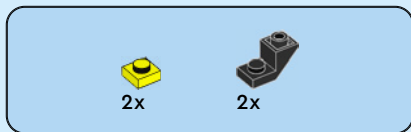

16

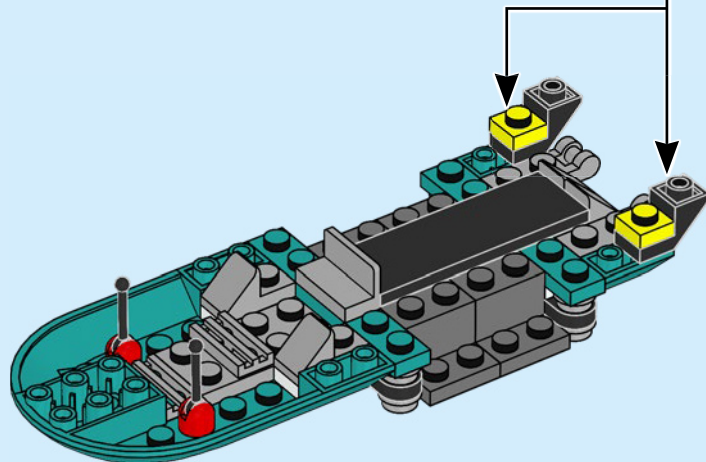
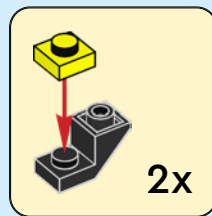



17

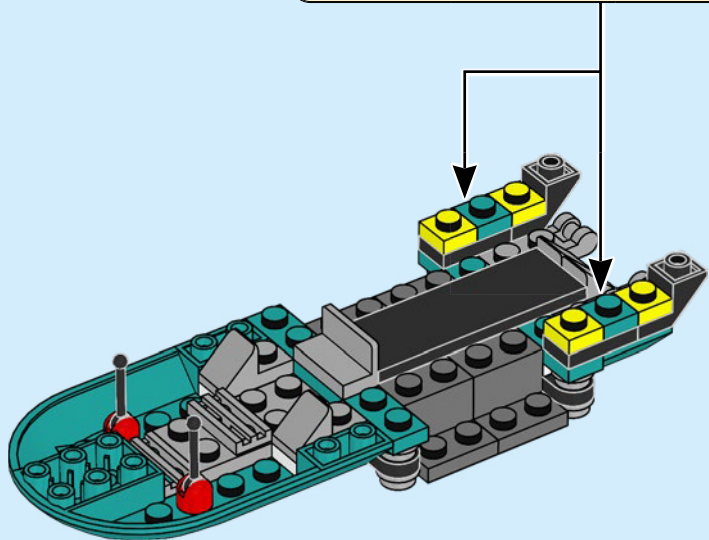
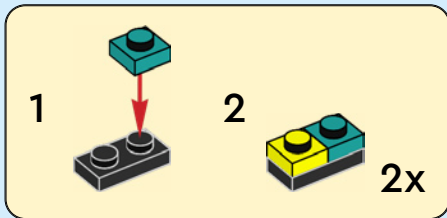



2x

18

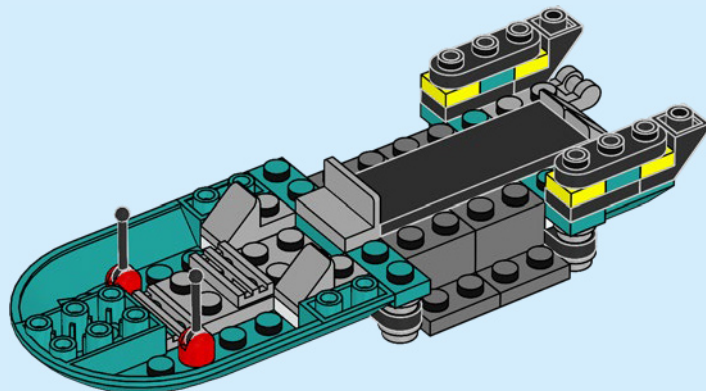

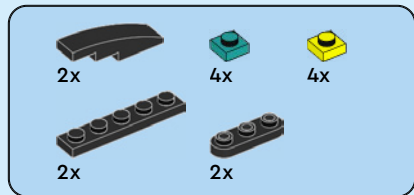

19

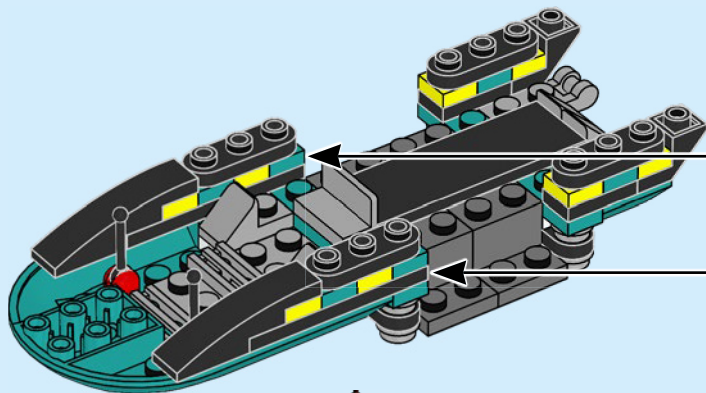
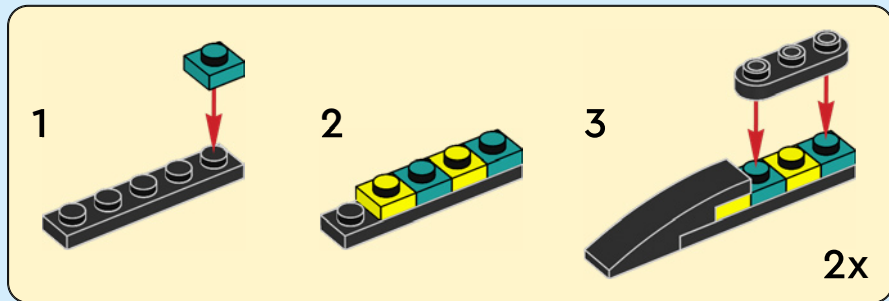

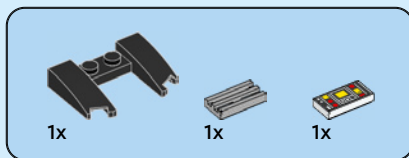

20

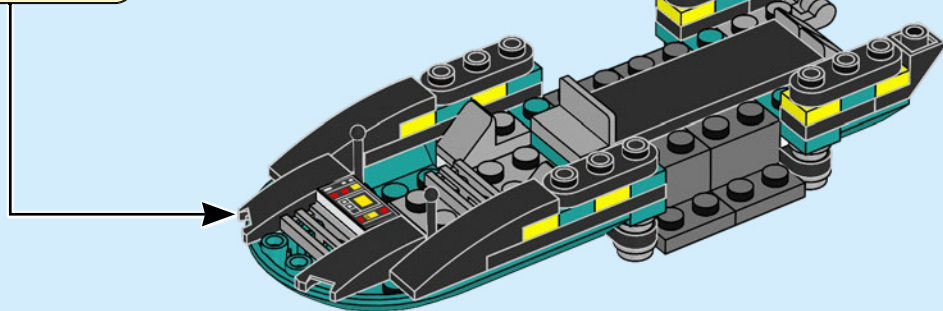
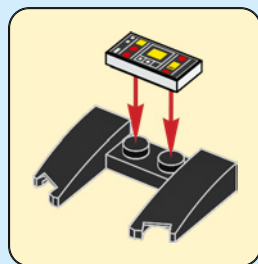



1x

21

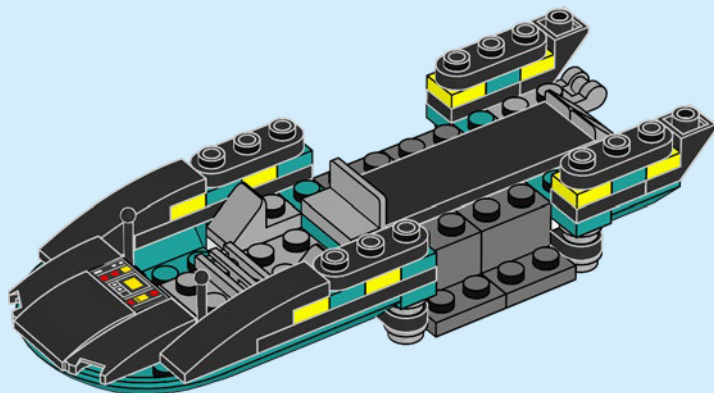



1x



1x

22

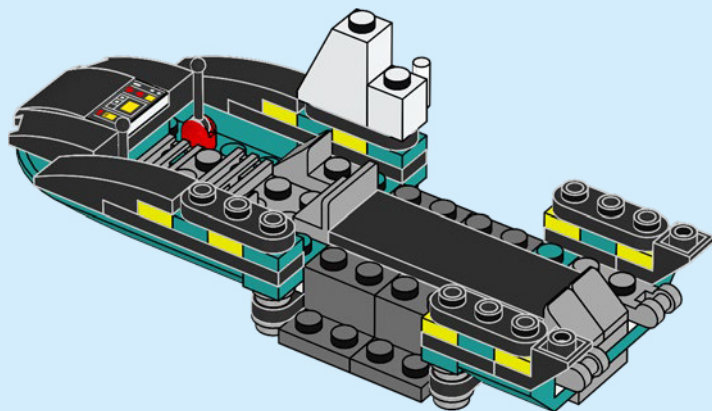



1x

23

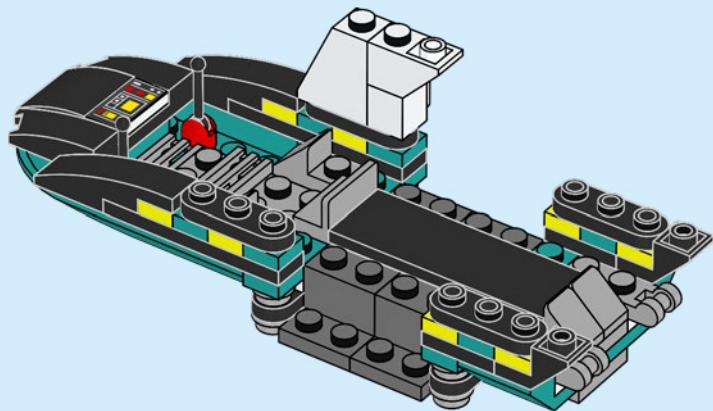

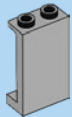

2x

24

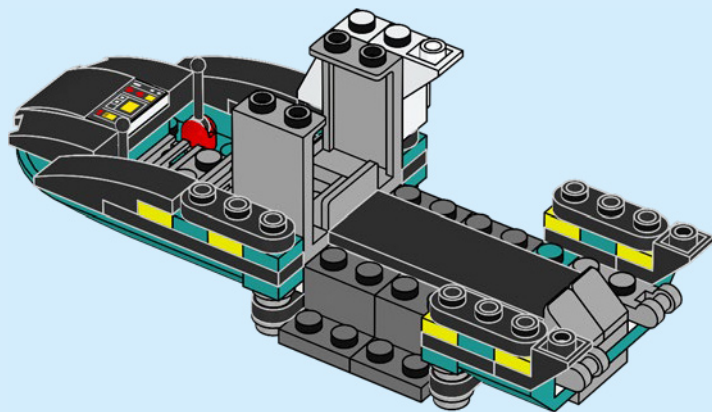



1x



1x

25

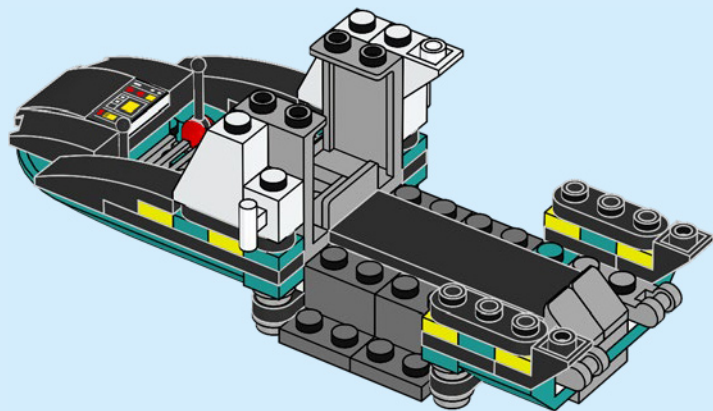



1x

26

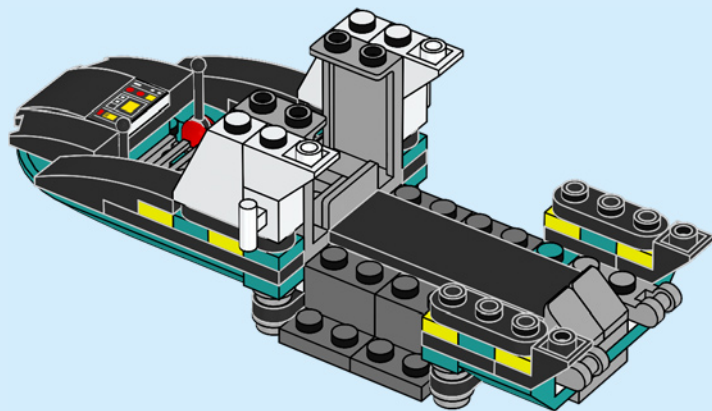



2x

27

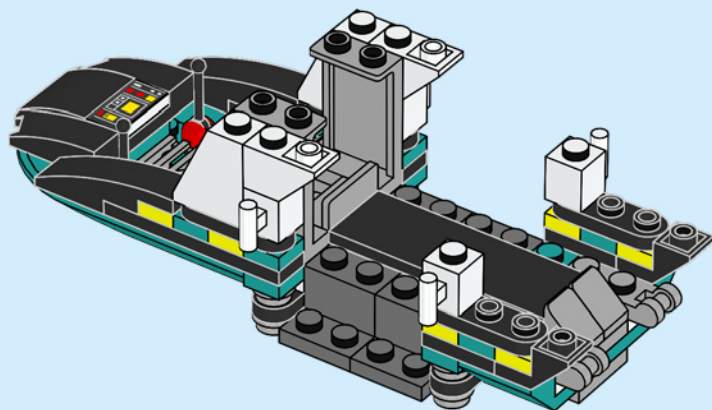



2x

28

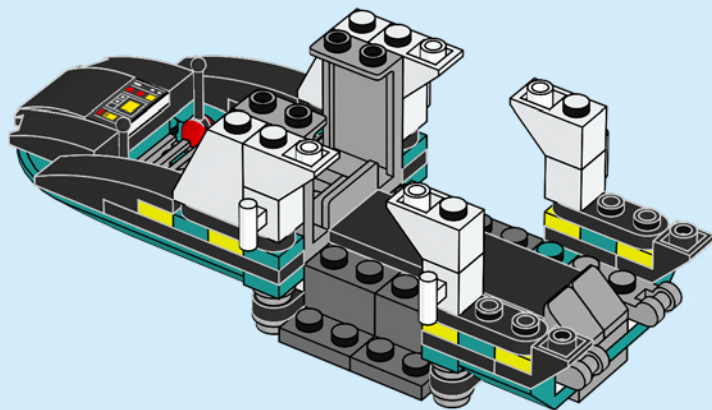

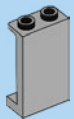

2x

29

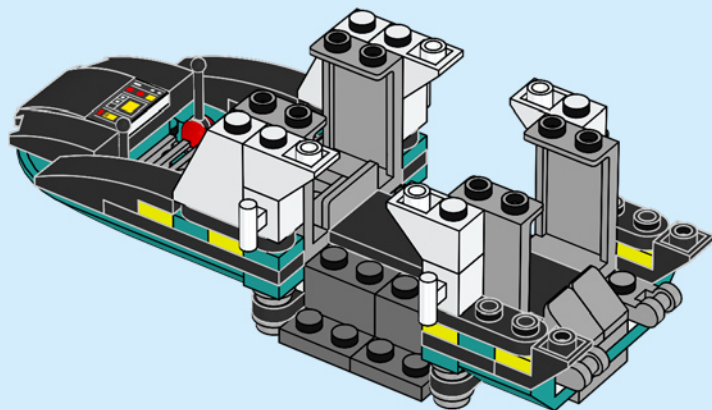



2x

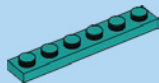

1x

30

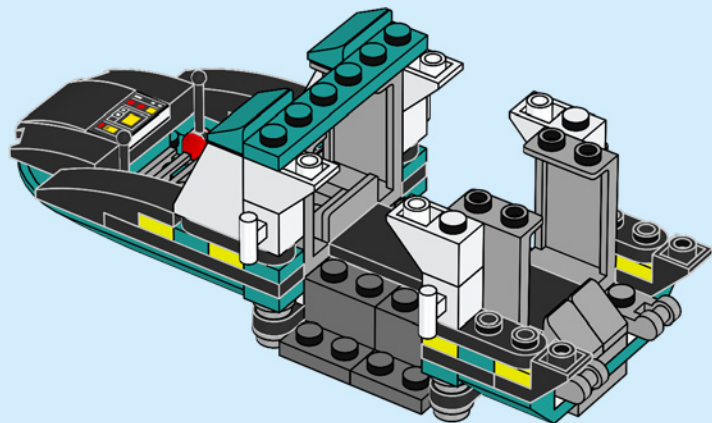

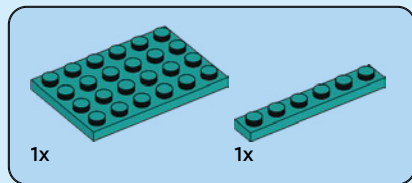

31

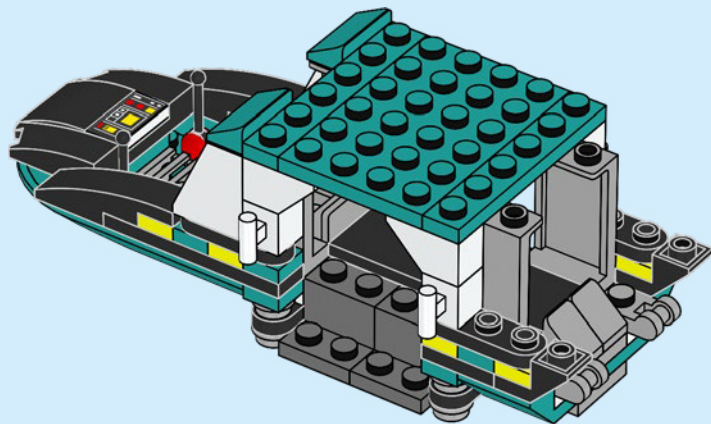



2x

32

1

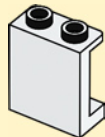

2



2x

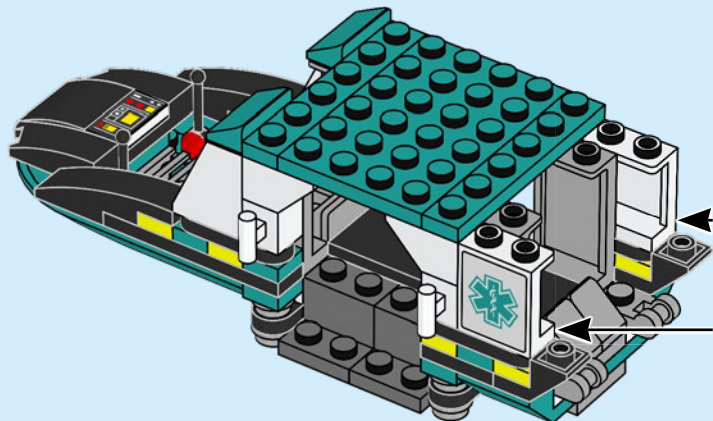



2x

33

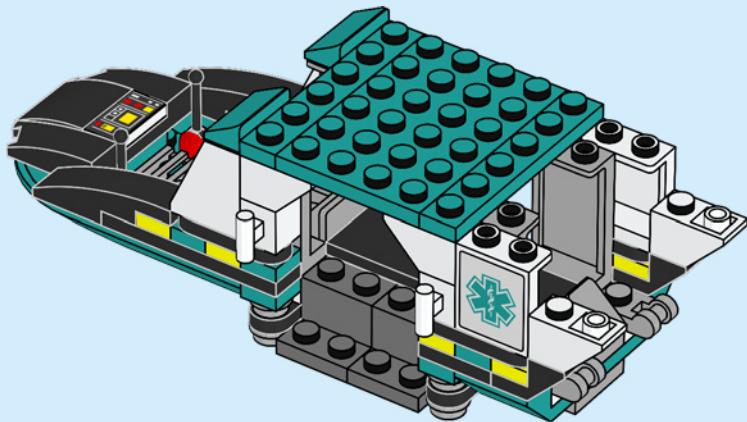



1x

34

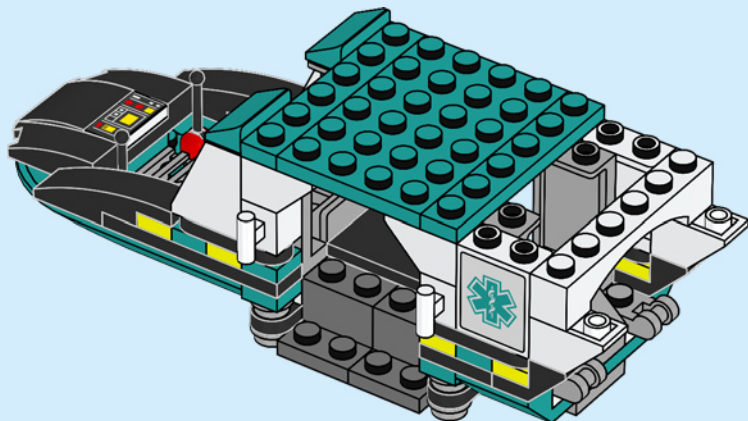



2x

35

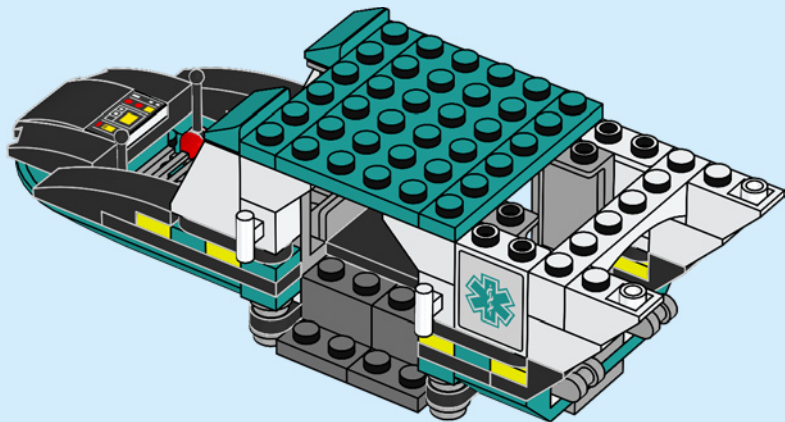

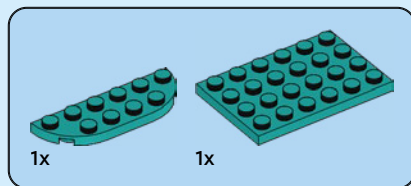

36

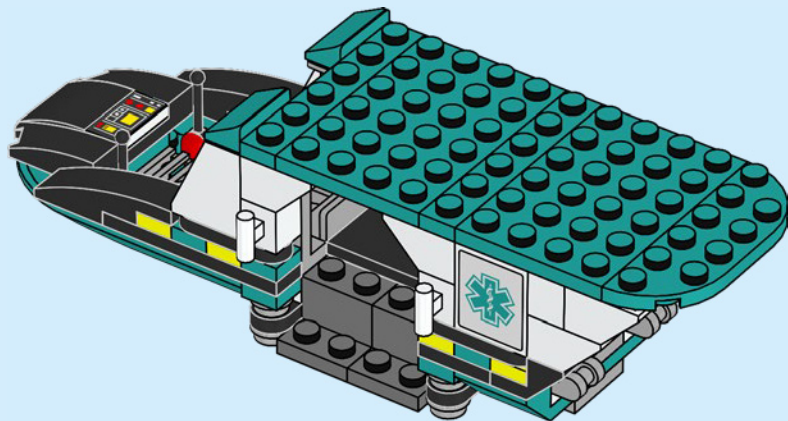



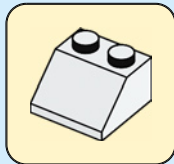
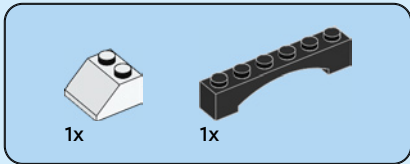

37

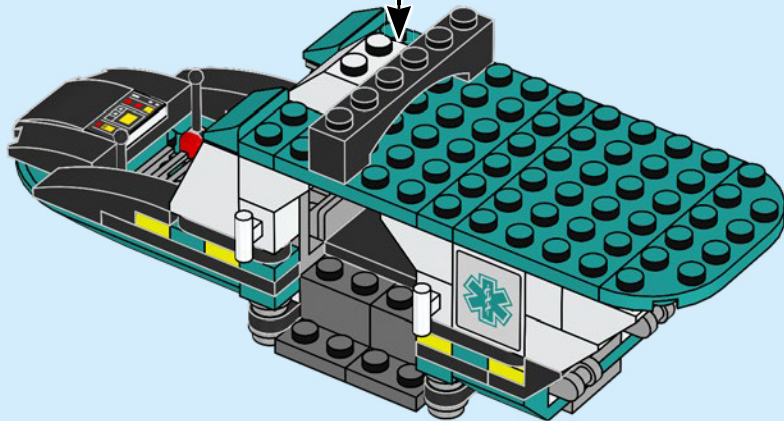



1x



2x

38

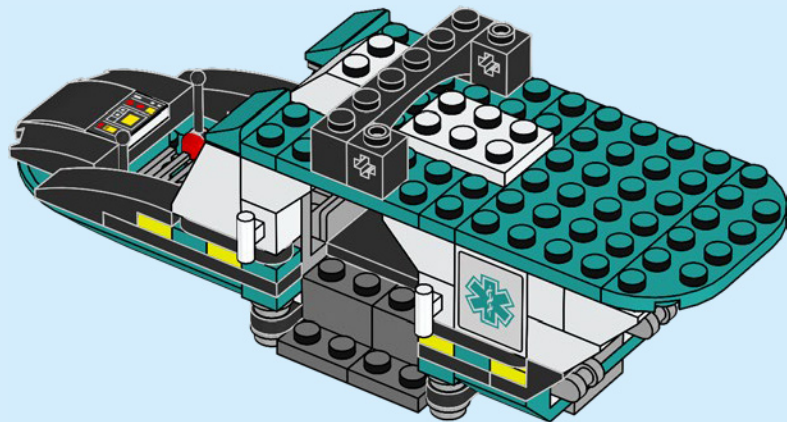



1x



1x

39

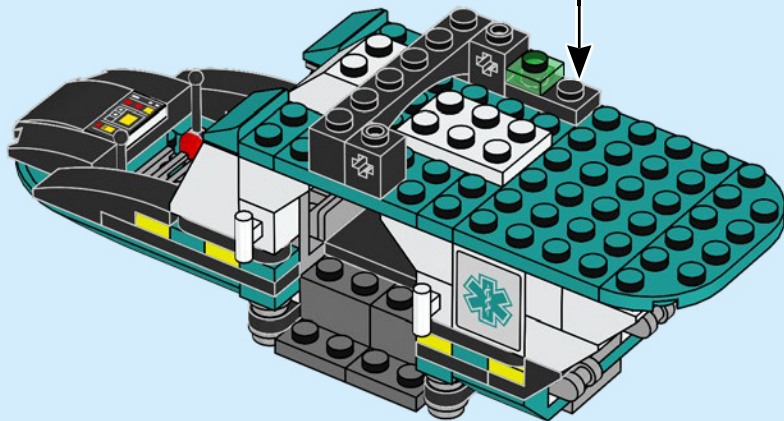
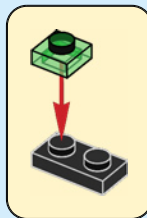



1x



1x

40

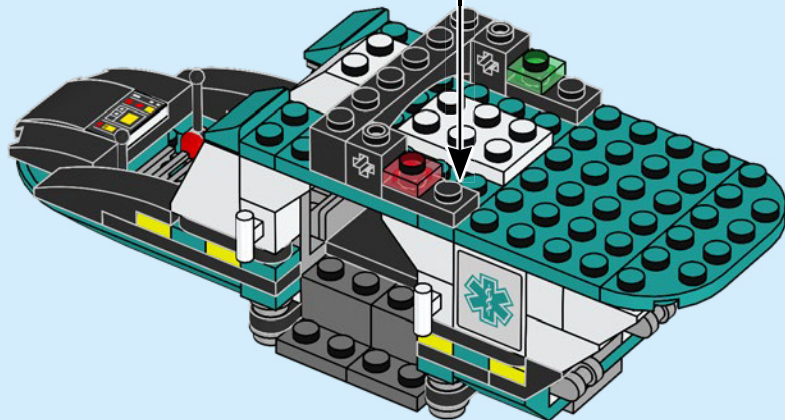
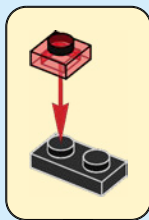



2x

41

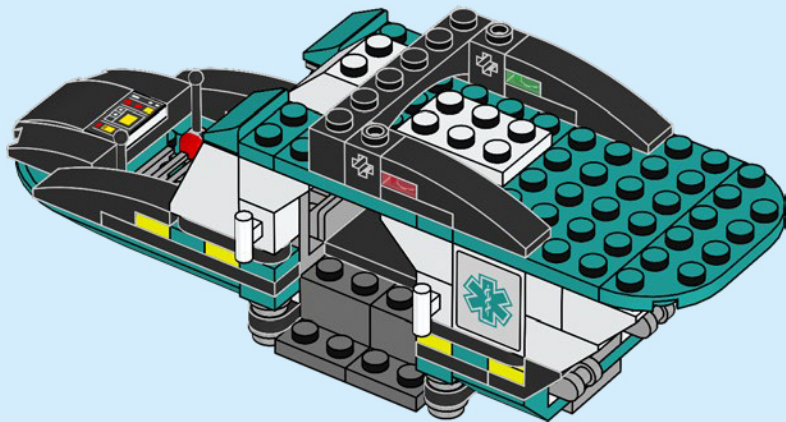



2x

42

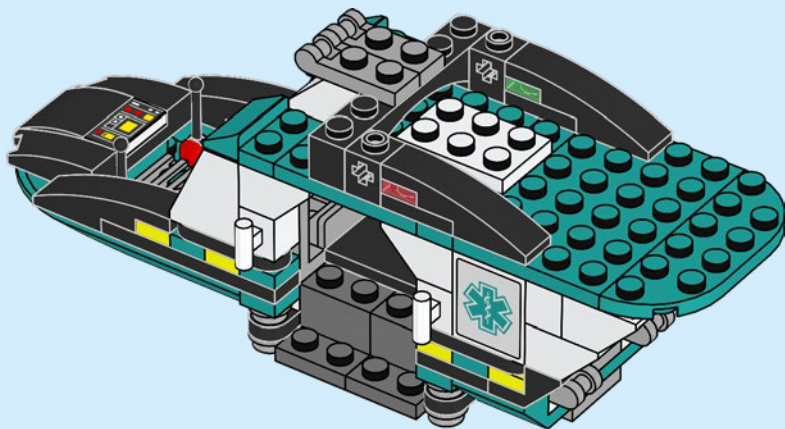



2x



1x



2x



1x



1x



1x



1x

43

1

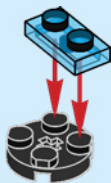

2



3

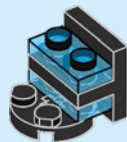

4



5

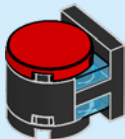

6

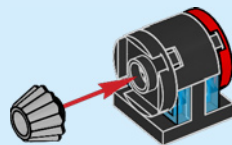
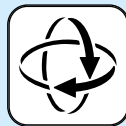

2x

44

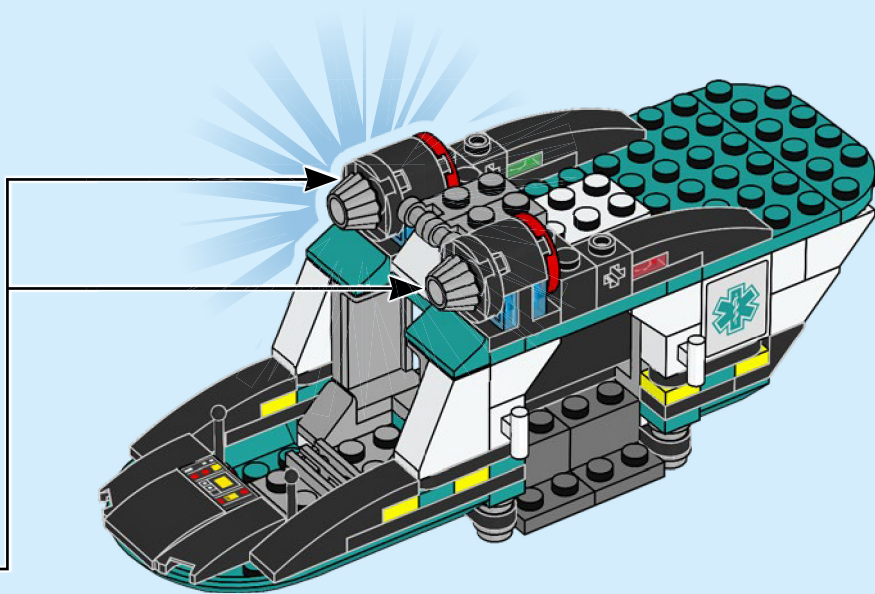

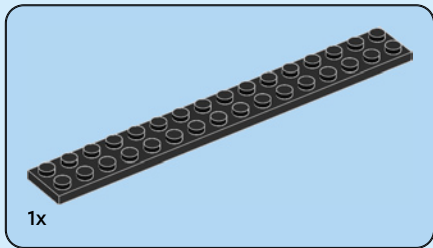
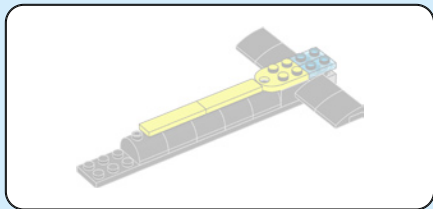

45

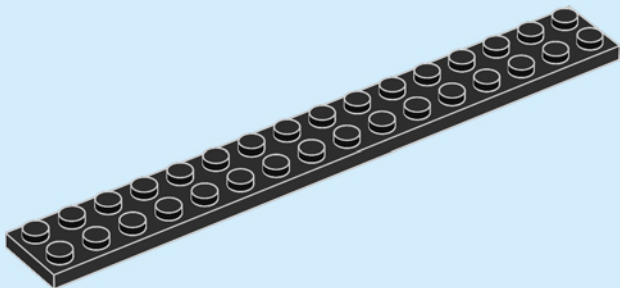



1x

46

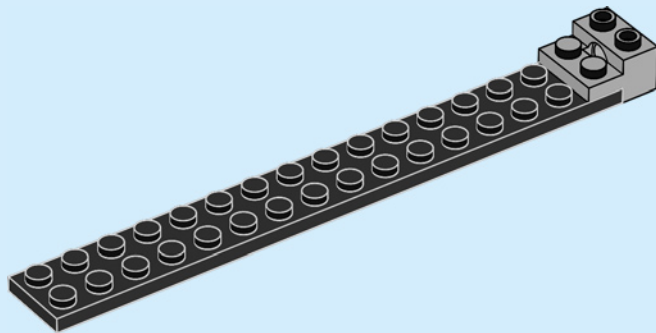

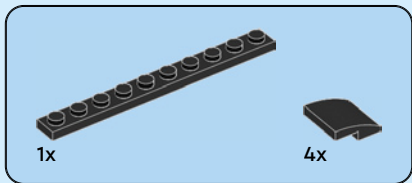
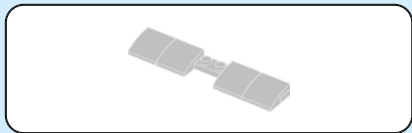

47

1

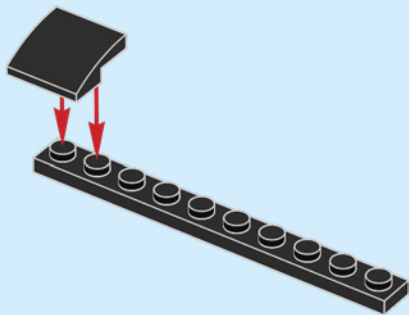

2

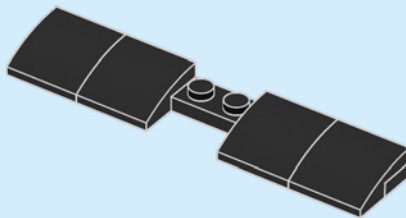

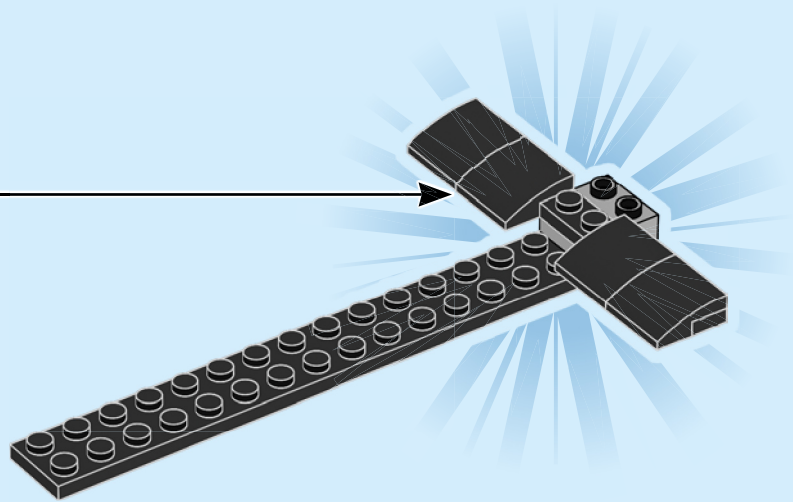

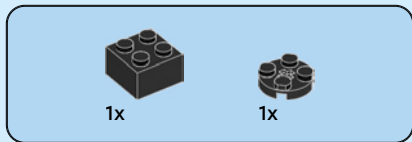

48

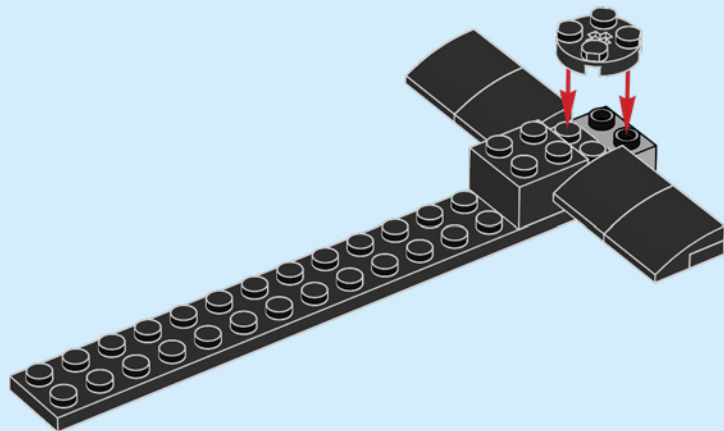



5x

49

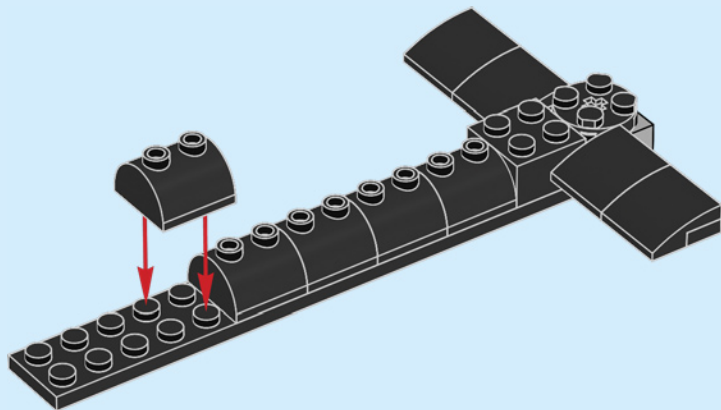



2x



1x

50

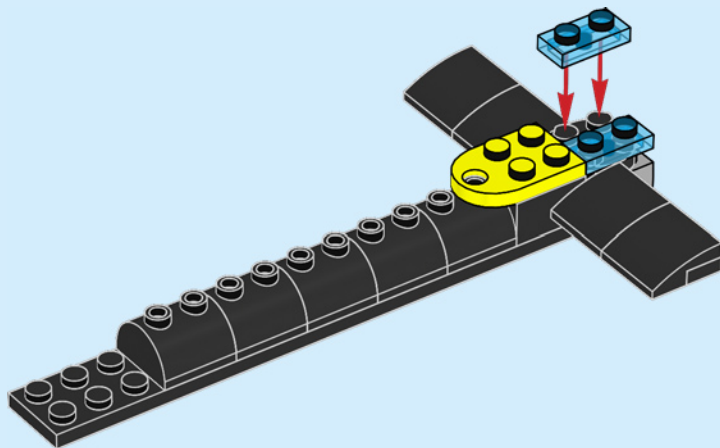

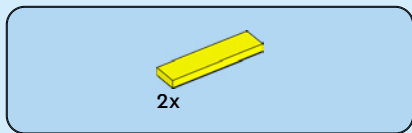

51

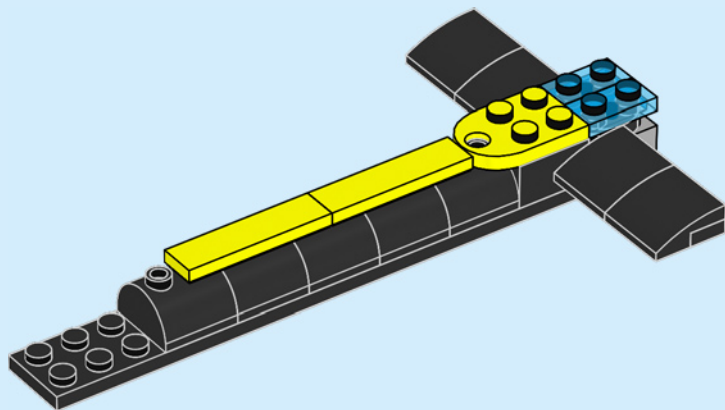

52

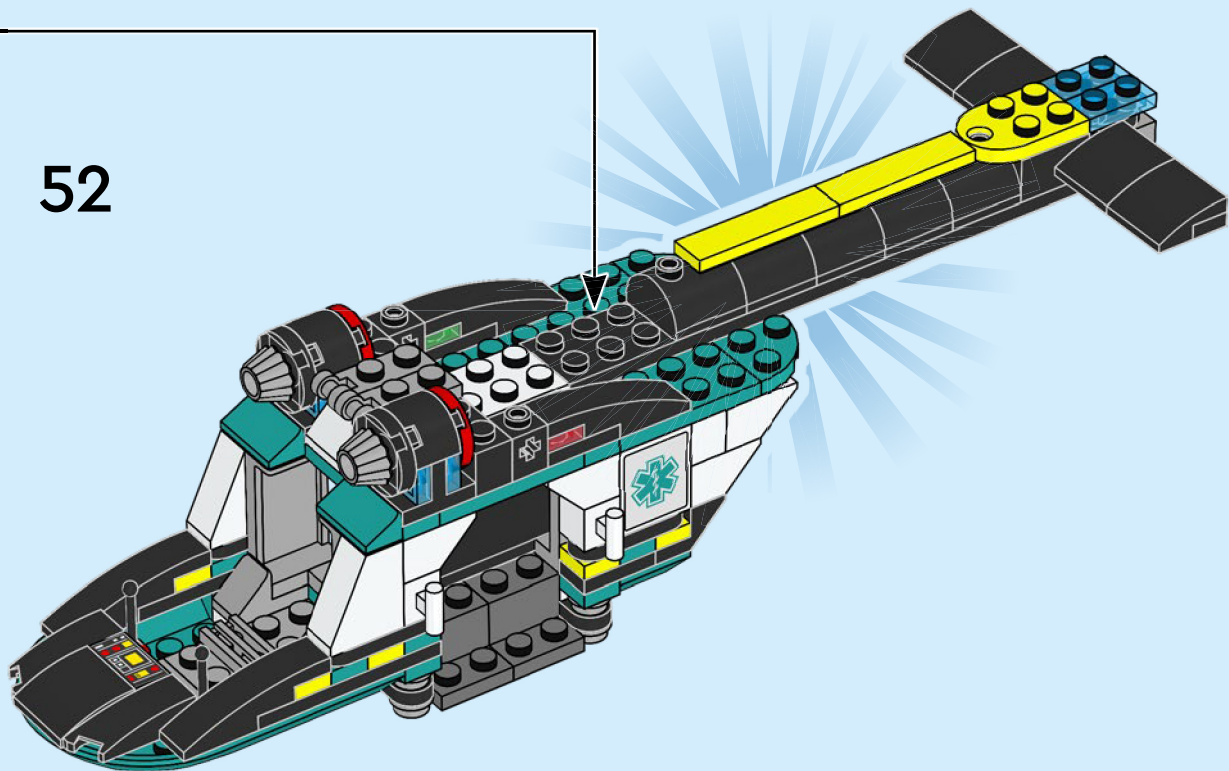

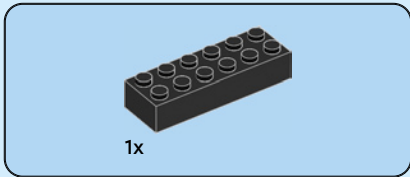

53

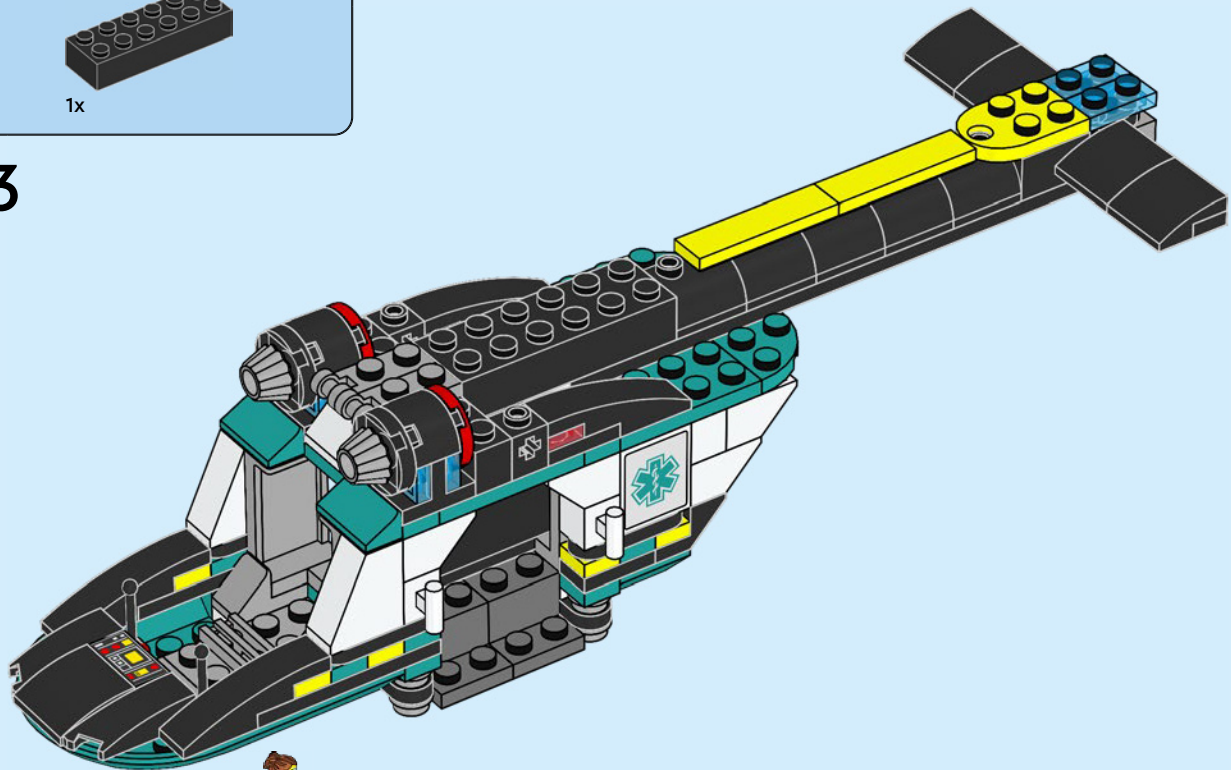



1x



1x

54

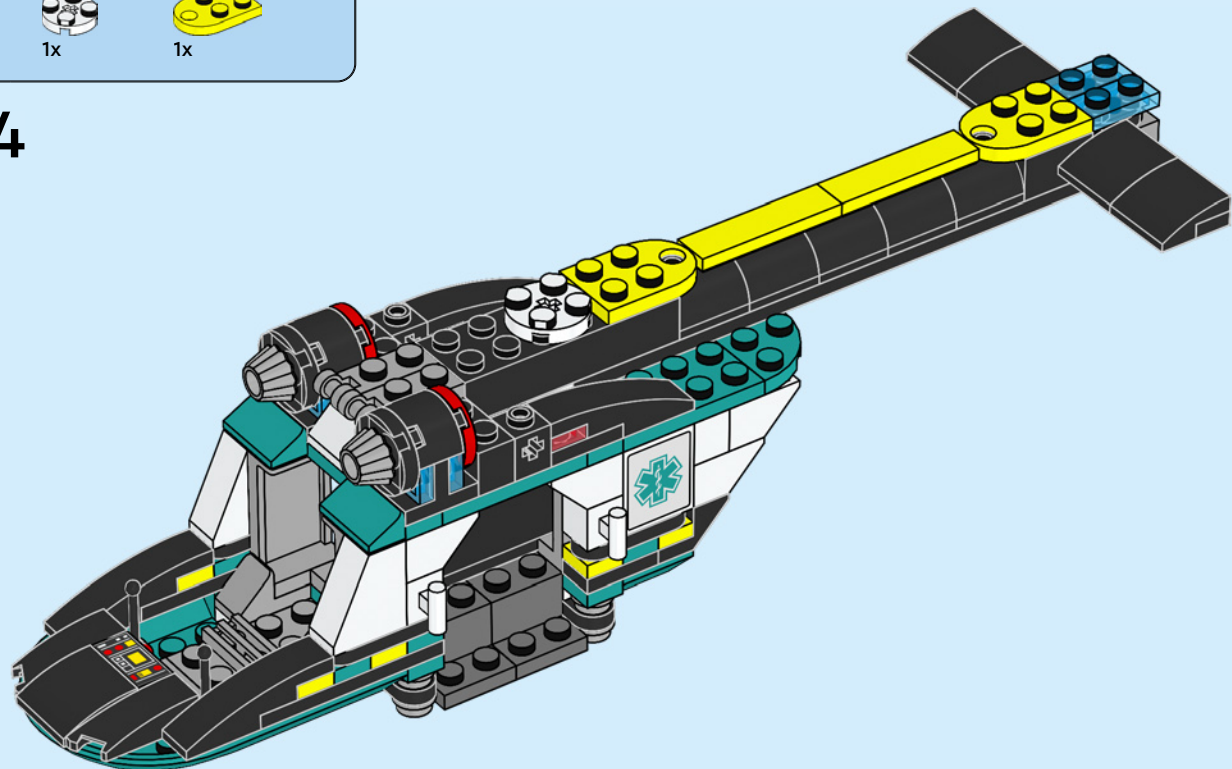

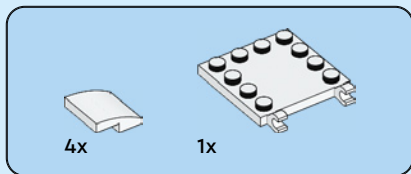

55

1

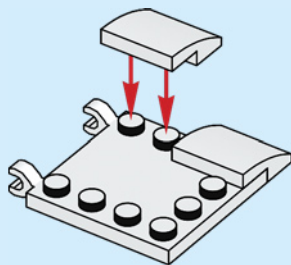

2

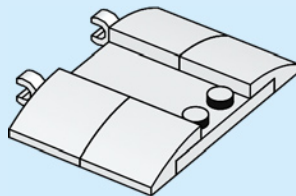

3

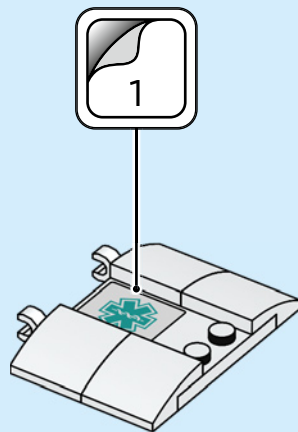

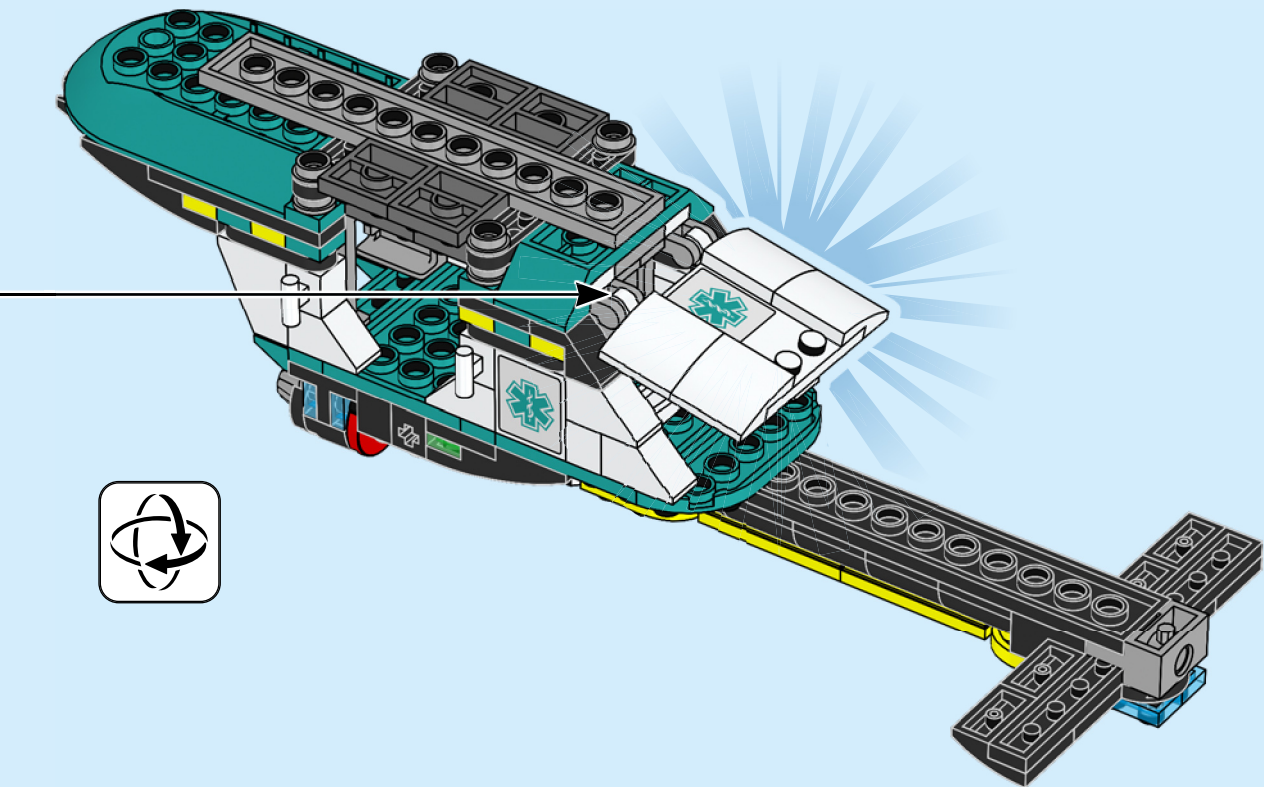

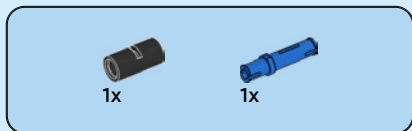
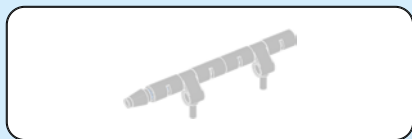

56

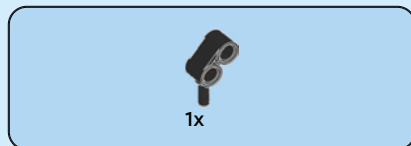
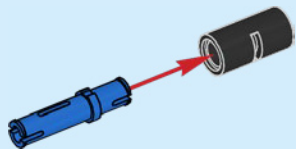

57

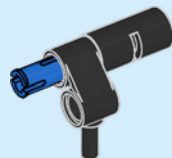

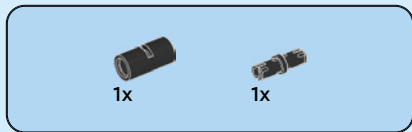

58

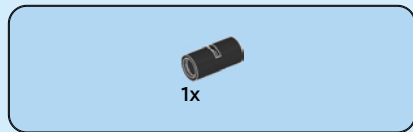
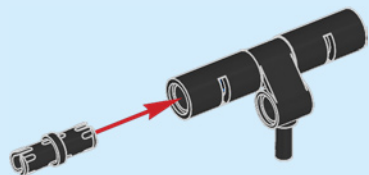

59

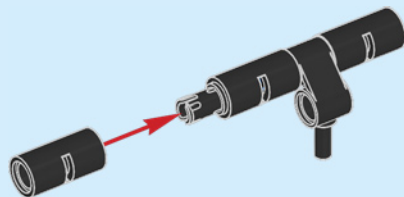

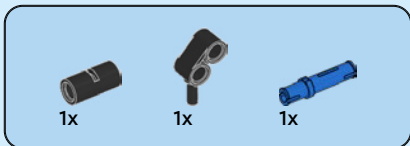

60

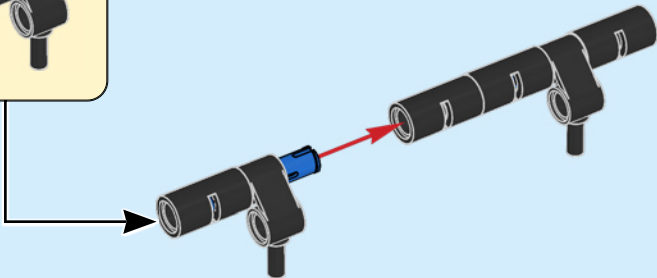
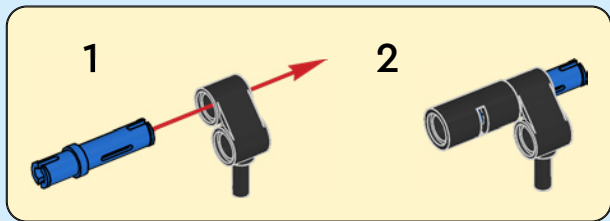



1x



1x

61

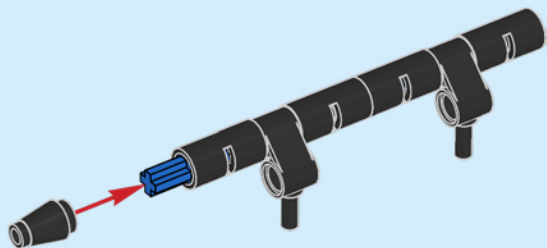

62

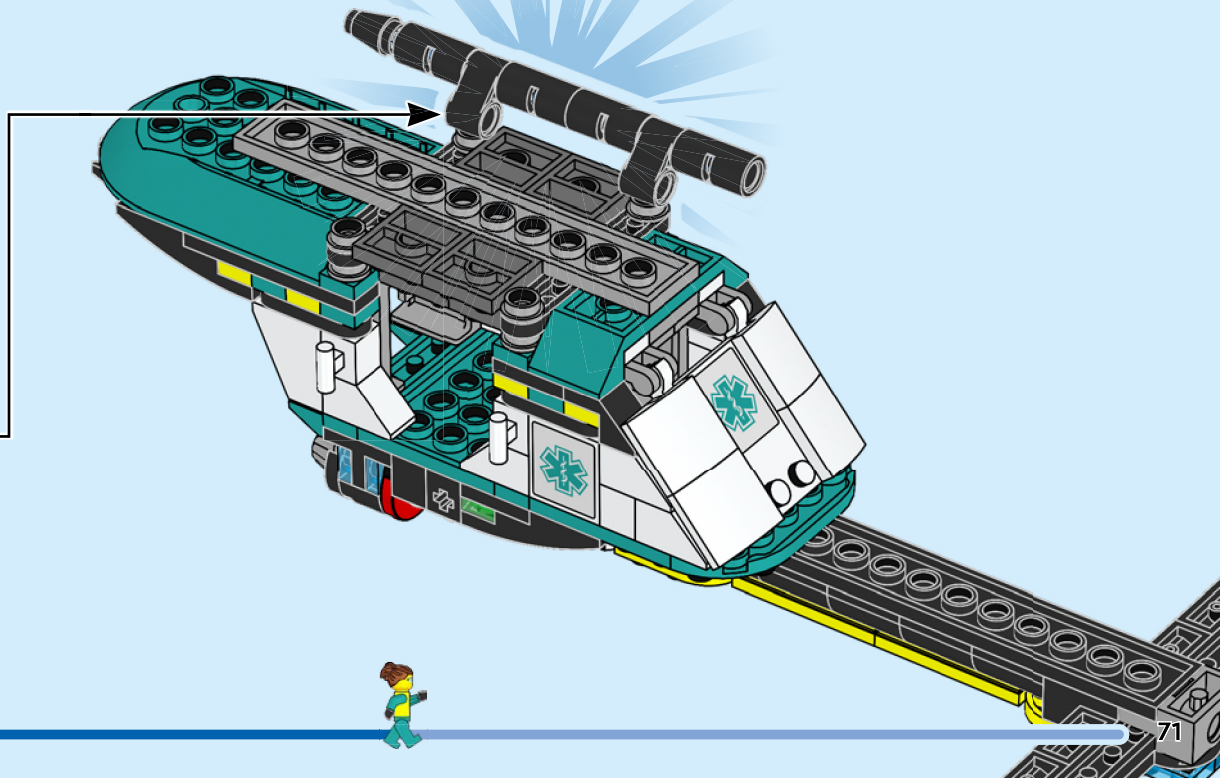

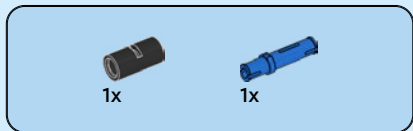
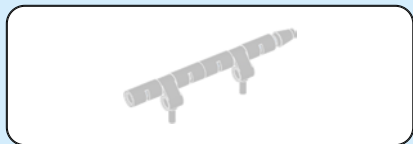

63

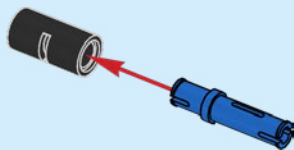



1x

64

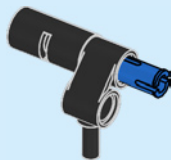

1x



1x

65

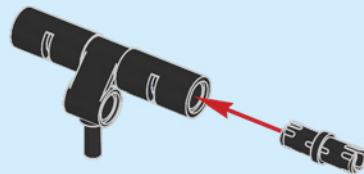



1x

66

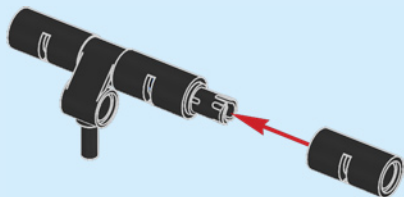

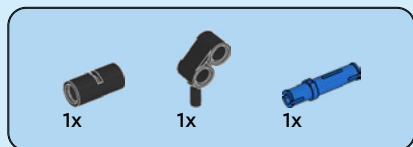

67

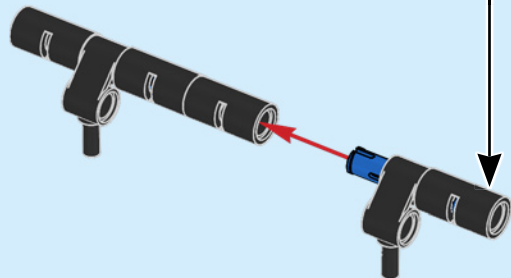
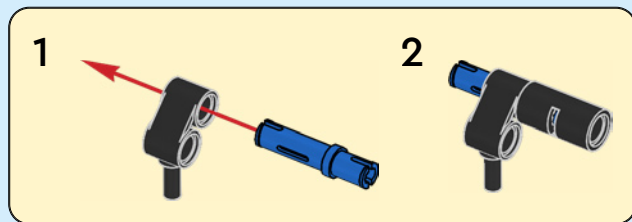

68

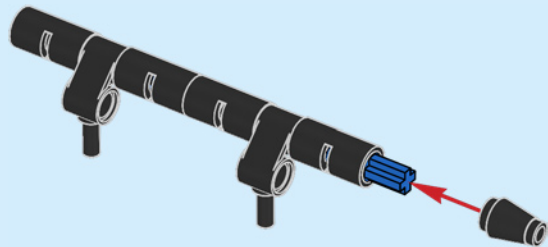

69

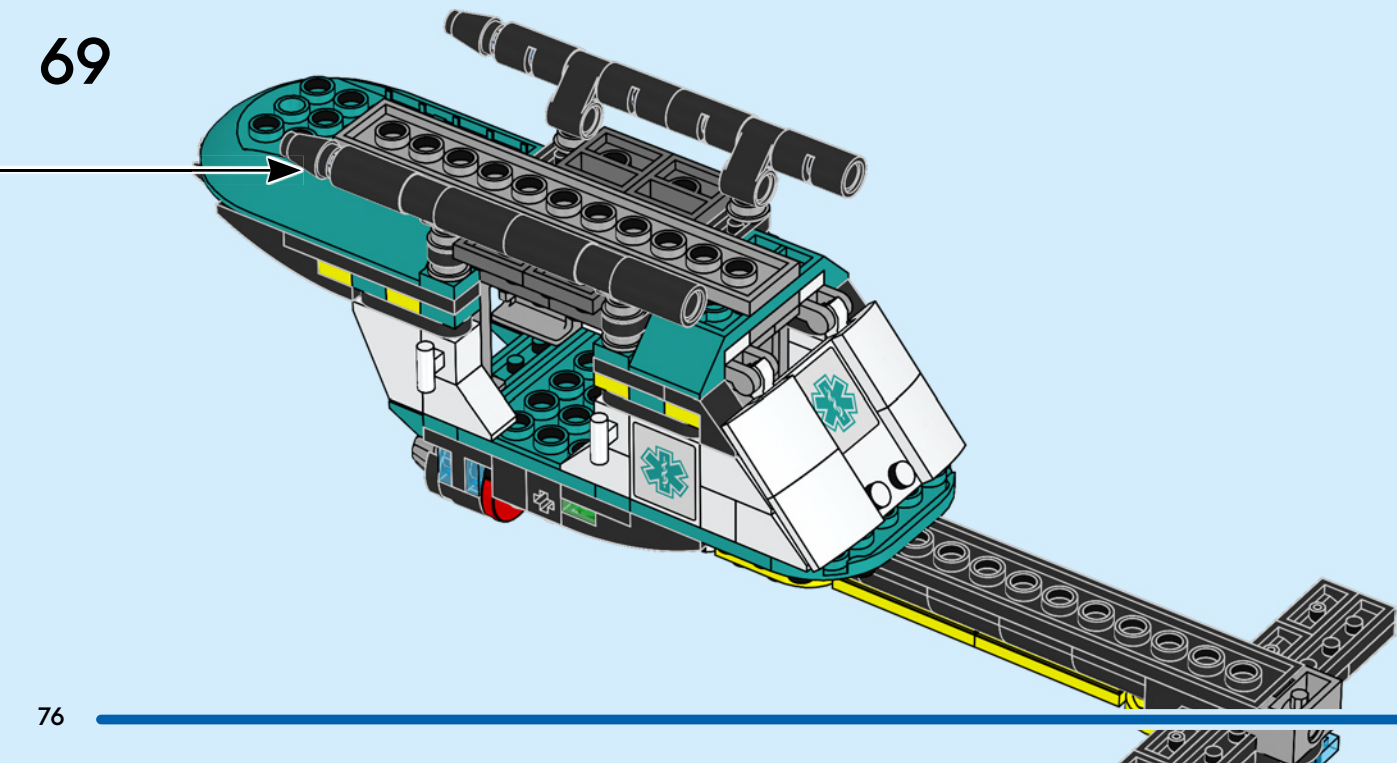

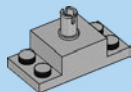

1x

70

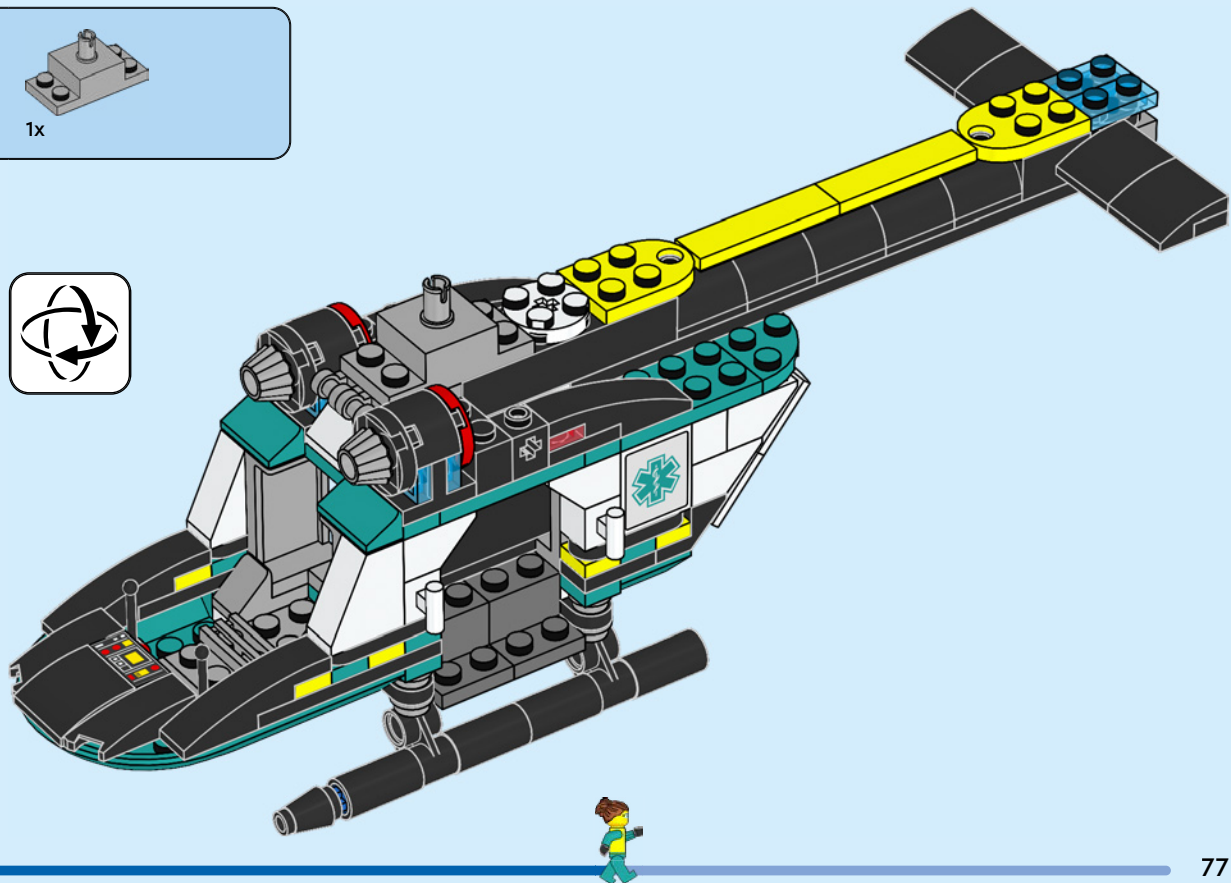

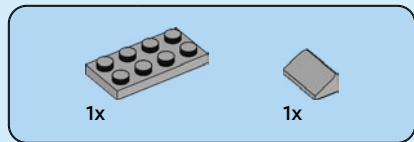

71

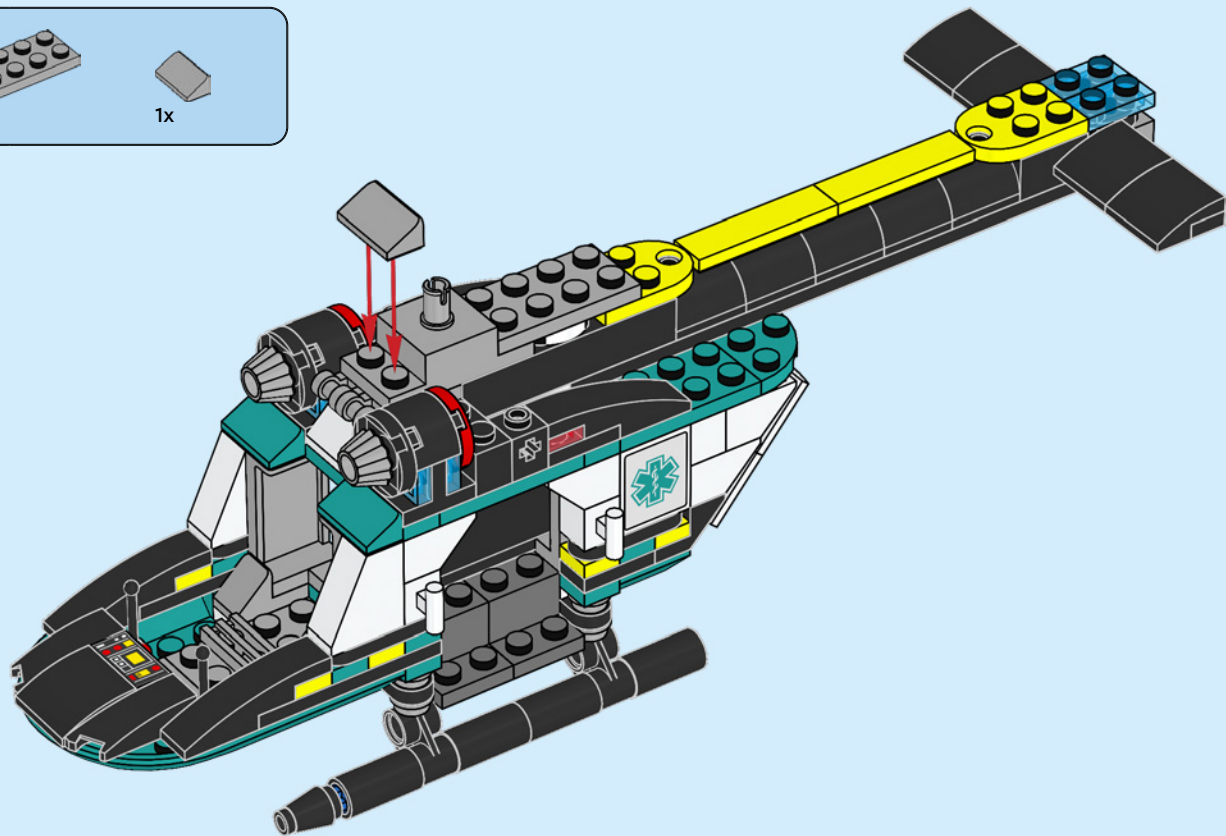

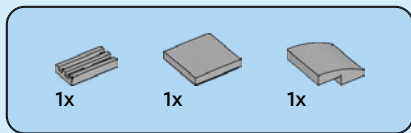

72

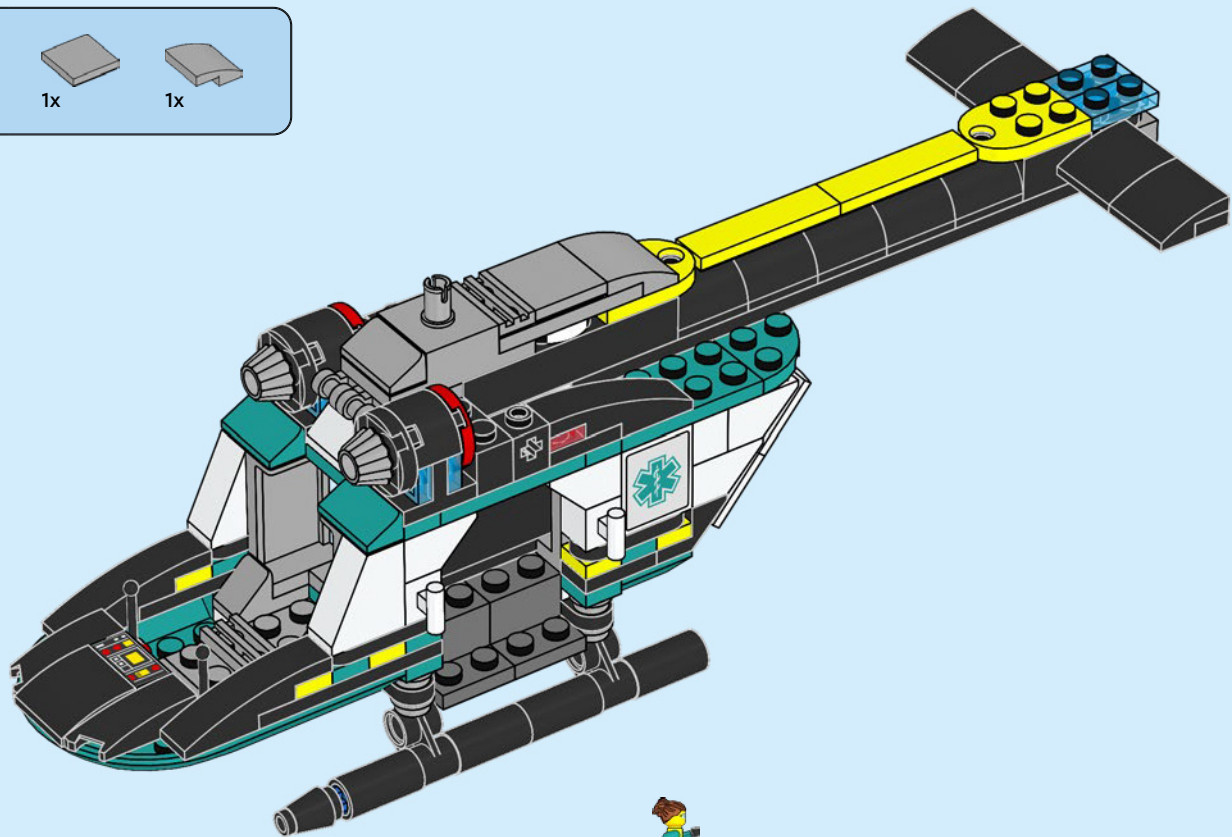

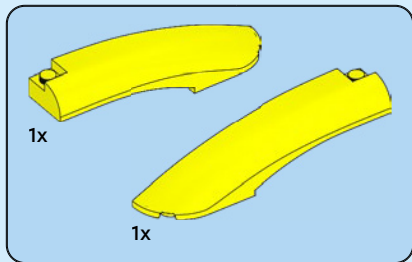

73

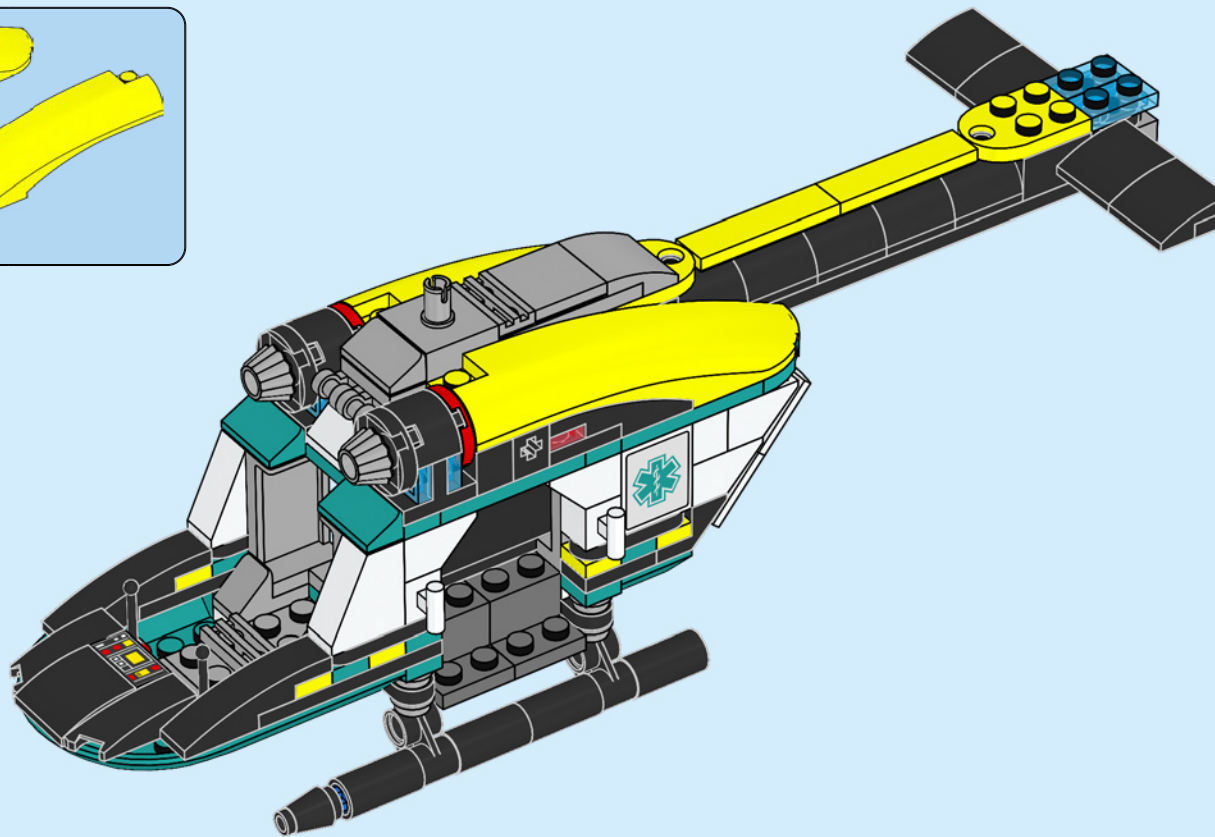

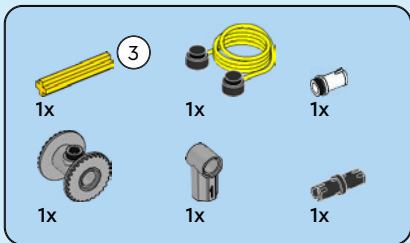
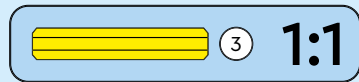
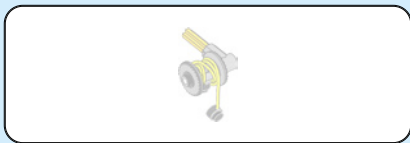

74

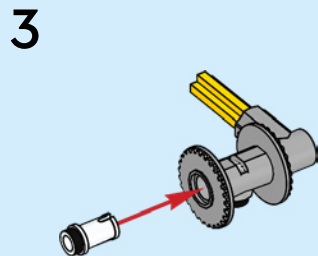
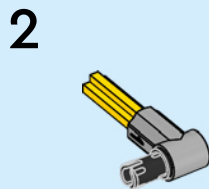
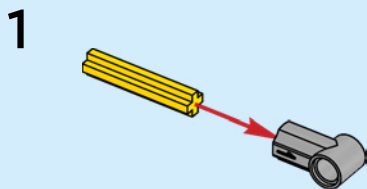



4

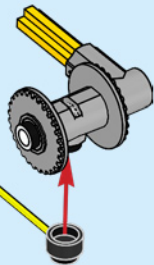

5

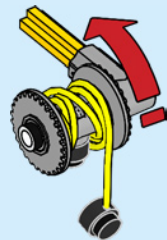

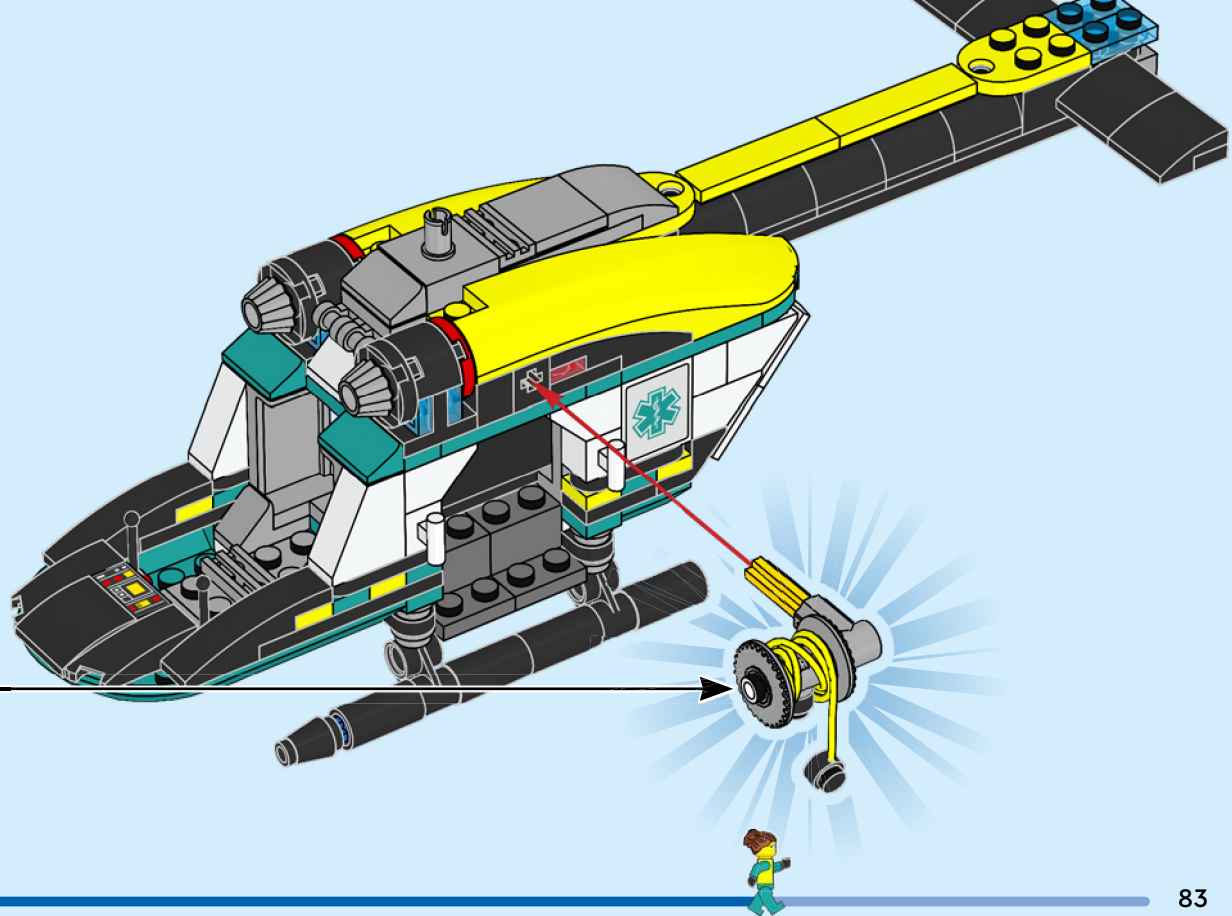

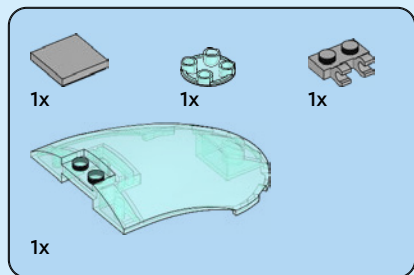

75

1

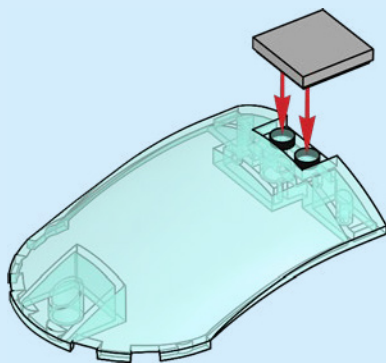

2

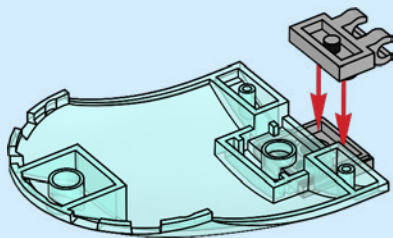

3

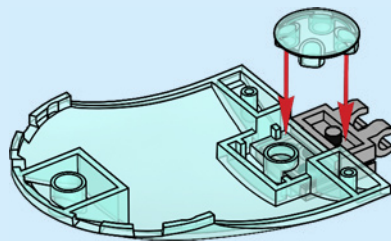

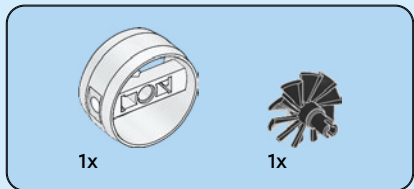

76

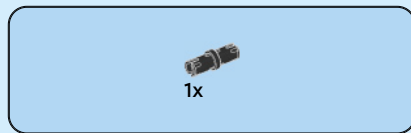
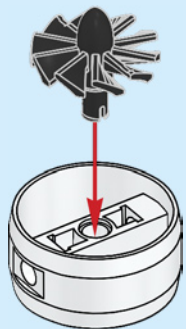

77

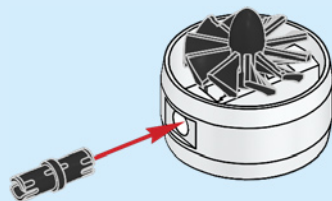



1x

78

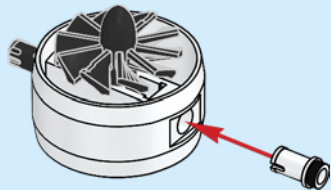

1x

79

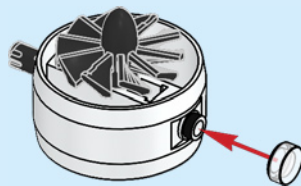

80

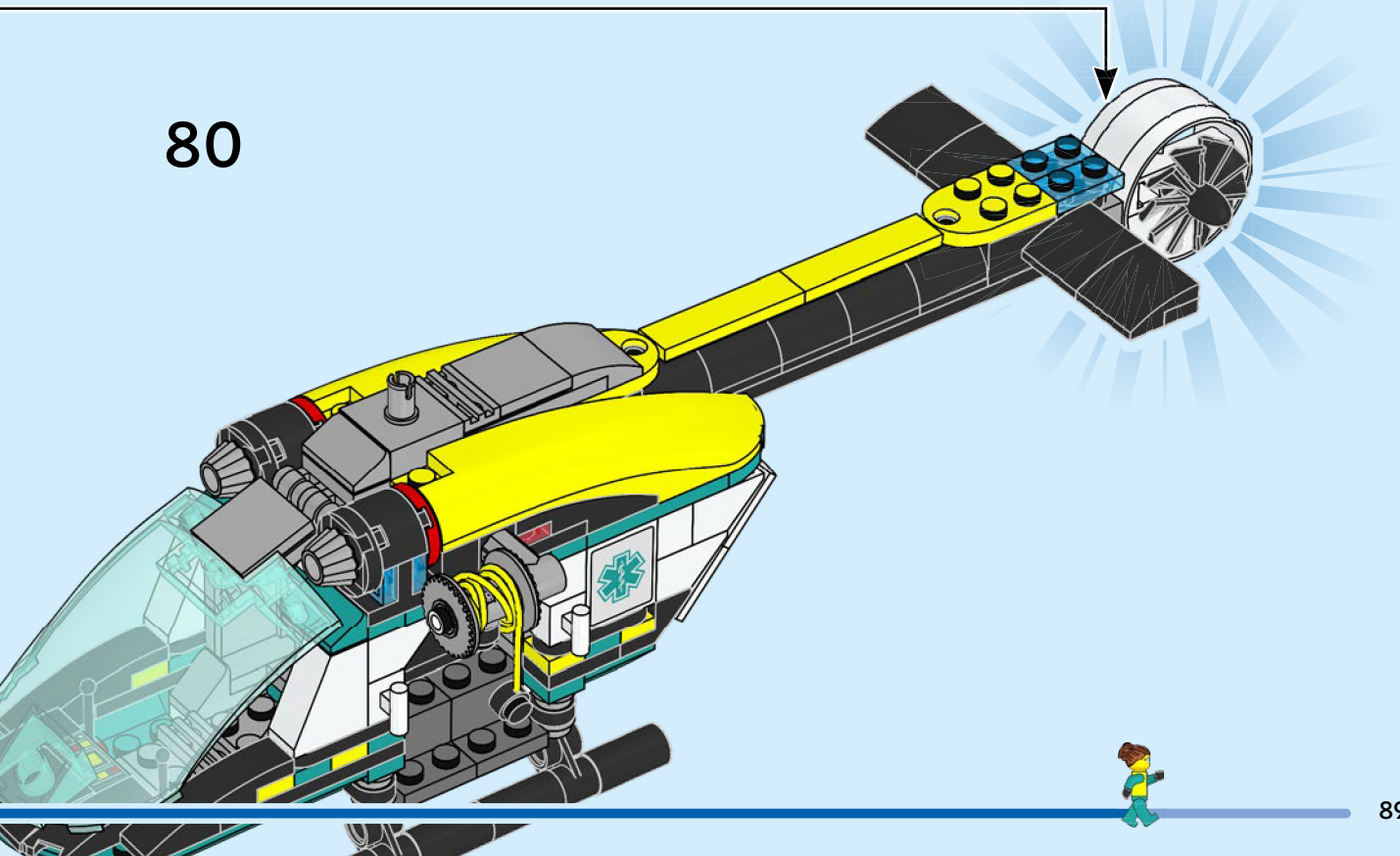

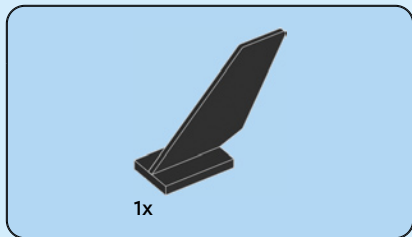

81

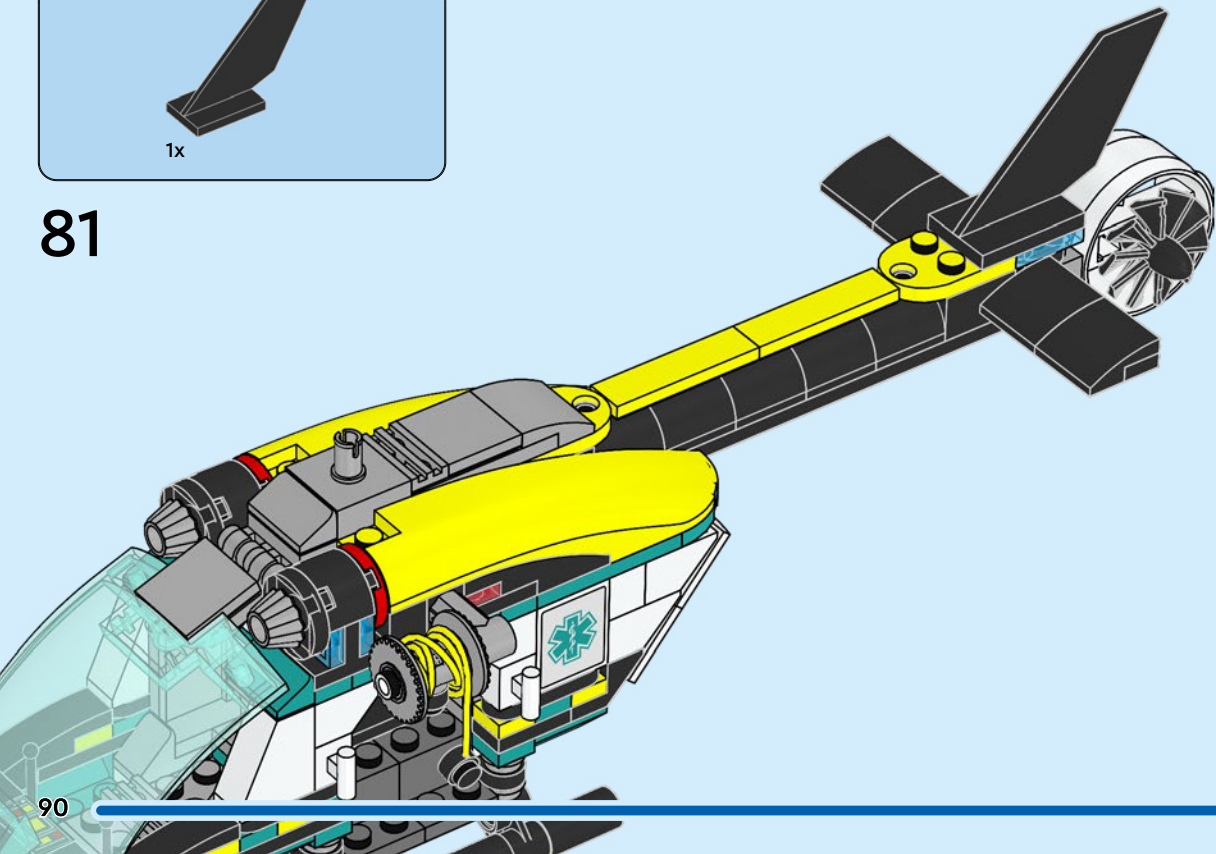

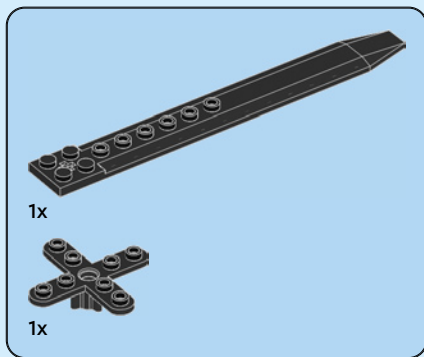
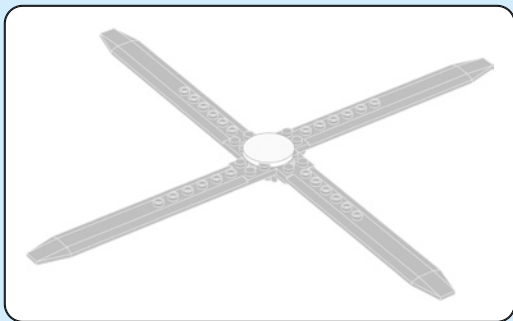

82

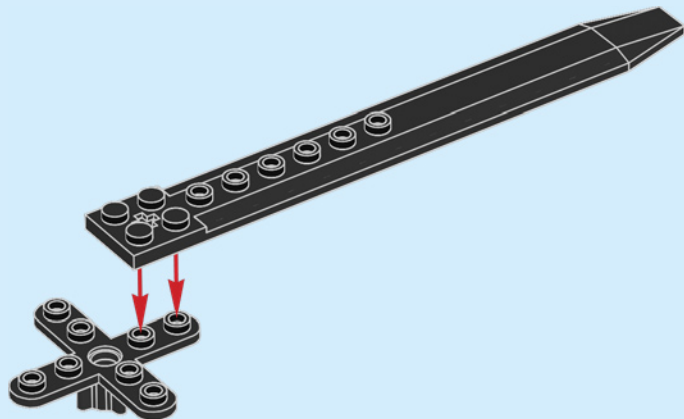

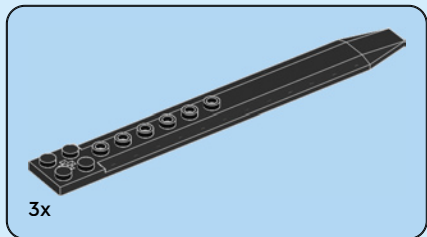

83

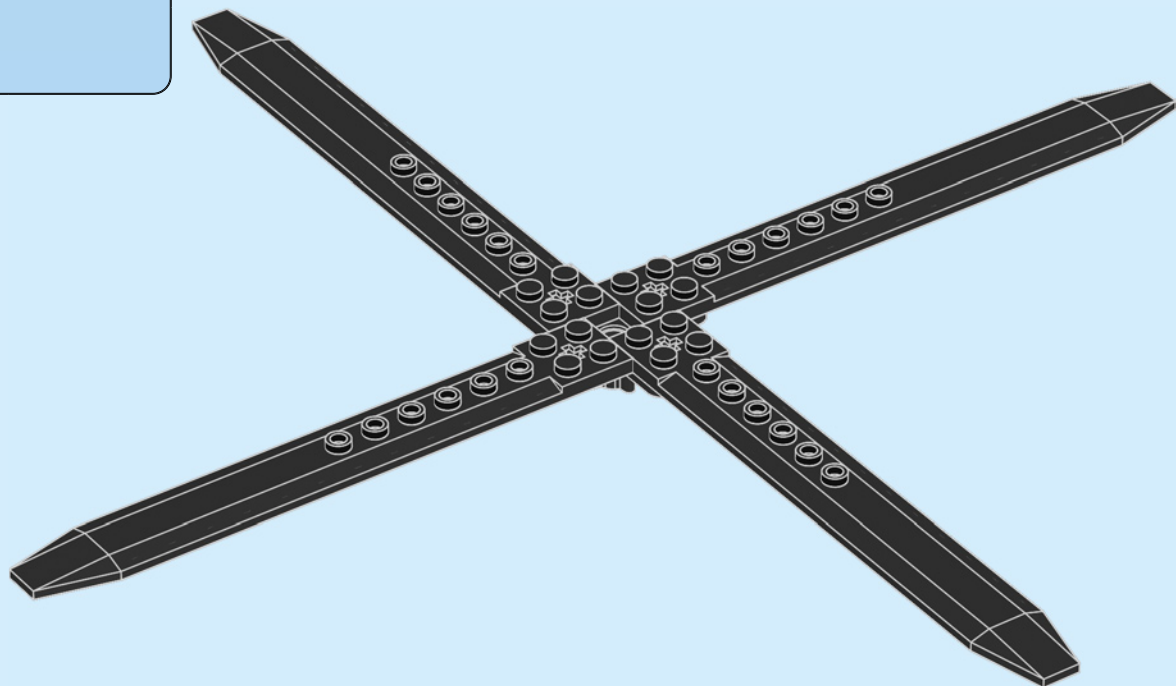

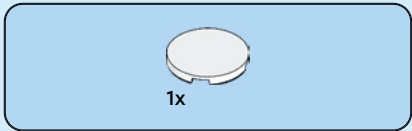

84

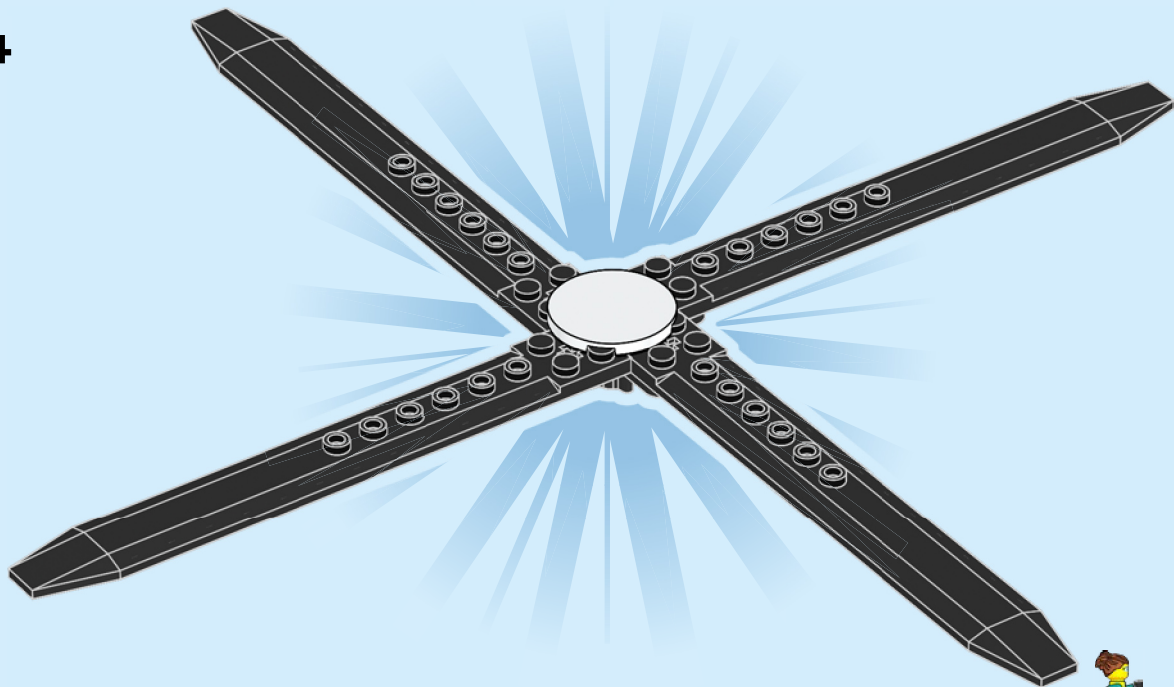

85

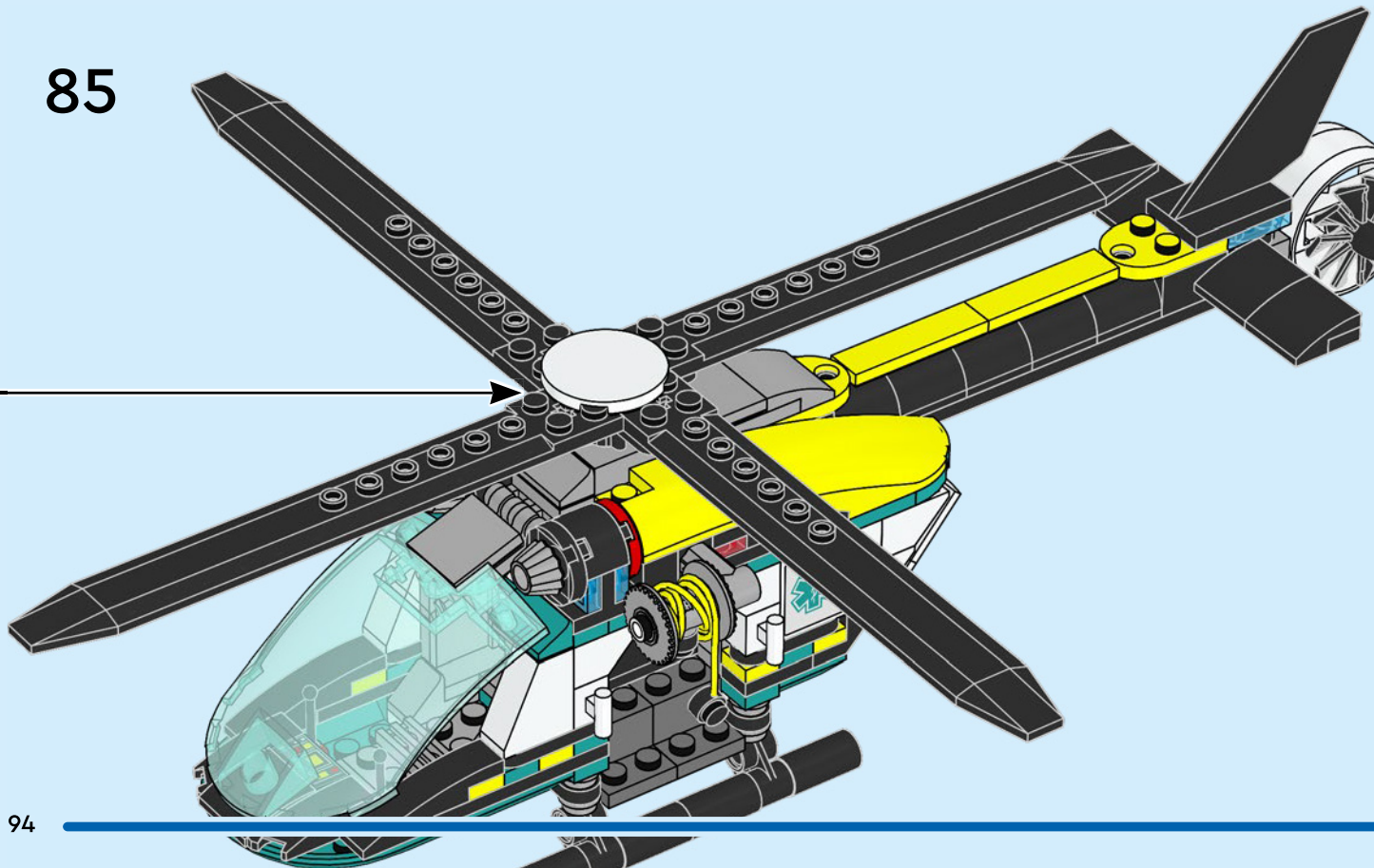

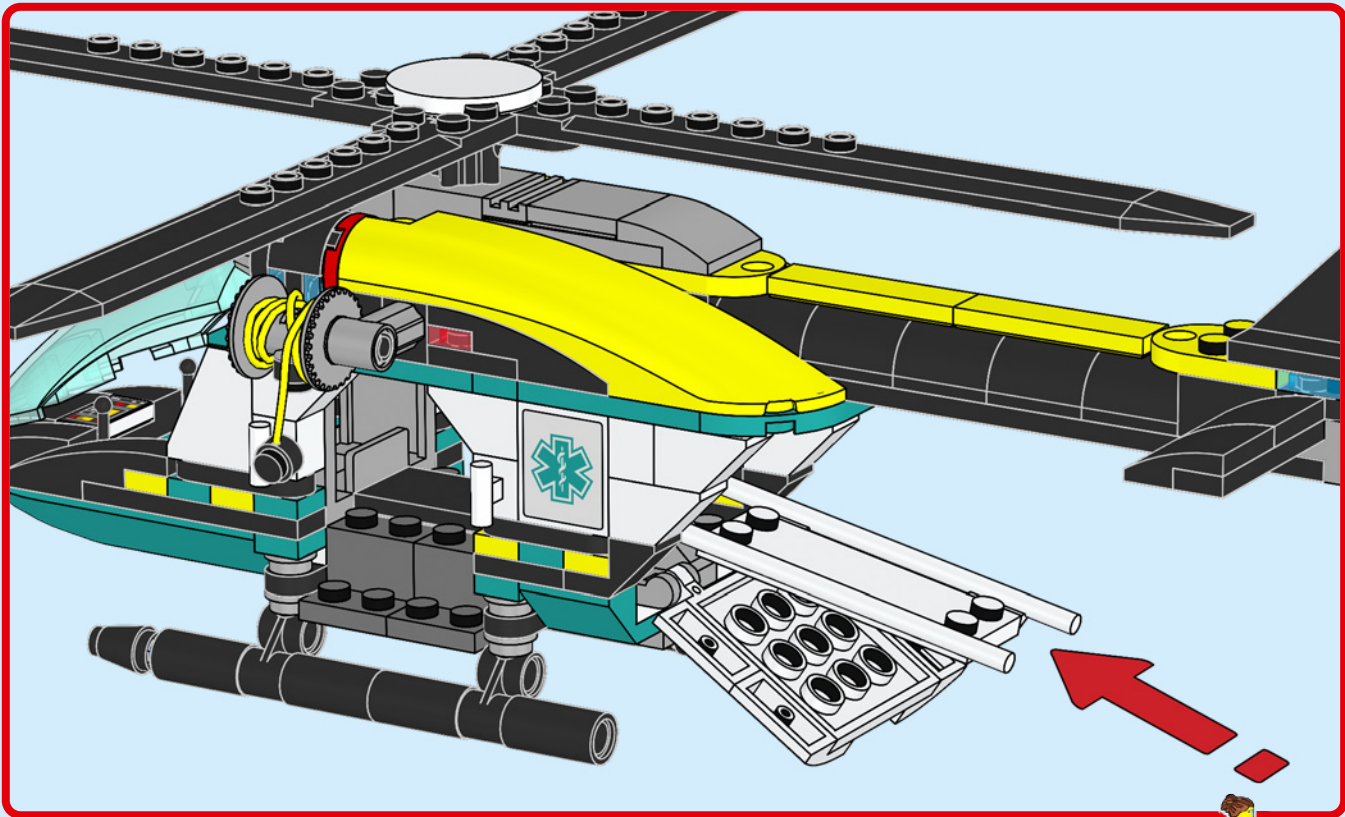





CITY



60402



60400

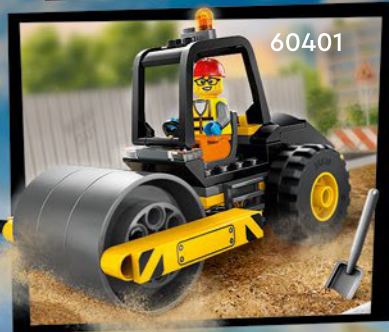

60401



60404



60399



60406

 2x 6388018	 4x 6047220	 1x 6122047	 1x 6130007	 1x 6248533	 1x 6324143	 1x 428226
 4x 6170567	 1x 6300017	 1x 6348148	 1x 6448794	 2x 6250020	 2x 6350415	
 1x 6252744	 4x 362301	 2x 74335	 2x 6344819	 8x 6428168	 1x 6179660	 4x 4527604
 1x 403201	 1x 302101	 1x 6415249	 2x 6308032	 1x 6313481	 1x 4620763	
 1x 6304928	 1x 6297272	 2x 6066342	 4x 6173124	 5x 6053077		
 2x 4585458	 1x 4620761	 2x 4206482	 4x 6279875	 5x 4200023	 1x 6093011	 1x 447726
 8x 366501	 1x 6310187	 4x 6299413	 3x 403226	 1x 300326		
 2x 4515370	 1x 6310187	 1x 6283875	 4x 302326	 1x 300326	 1x 6318582	 1x 6357937
 1x 303901	 1x 6422575	 1x 6419110	 2x 6465248	 2x 4529236		 6x 6240215
	 1x 6174454	 8x 6173119	 4x 6037746		 1x 6274738	 1x 6314353
		 1x 6174454		 4x 6037746	 1x 6252042	 1x 6252046

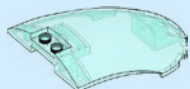

1x
6465637



1x
6248530



1x
6171733



6x
6213778



1x
6469022



2x
6228967



2x
6461945



1x
6210775



1x
6223665



1x
6474982



4x
6291782

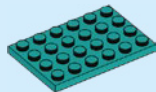

2x
6365027

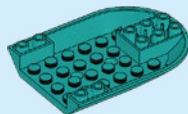

1x
6466783



1x
4524098



1x
6466784



8x
6168647



1x
6296859



2x
6465111



1x
4568637



4x
6093859



4x
4211350



1x
6146223



4x
4585429



4x
4585429



1x
6337268



1x
6343889



2x
4211413



1x
6102357



1x
6326478



4x
4515369



1x
4211395



1x
6301425

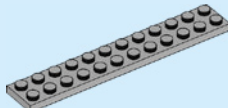

2x
4211360



1x
6155003



4x
6395363



1x
6152229



1x
6427516



2x
6378271



2x
6389817

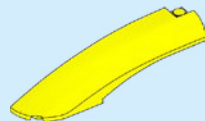

1x
6476428



1x
6467943



8x
6465247



2x
6442976



LEGO.com/service



YOU COULD **WIN**

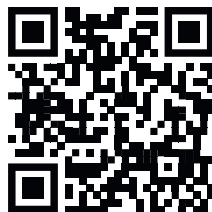

Scan this QR code or go to **LEGO.COM/PRODUCTFEEDBACK** and give us your short feedback about this LEGO® set for a chance to win a cool LEGO prize.

Terms and Conditions apply*

EN: YOU COULD WIN. Terms and Conditions apply* **DE: Du könntest GEWINNEN.** Es gelten die Teilnahmebedingungen* **FR: Tu pourrais GAGNER.** Des conditions s'appliquent* **IT: Potresti VINCERE tu.** Termini e condizioni sono applicabili* **ES: Puedes GANAR.** Aplican términos y condiciones* **PT: Poderá GANHAR.** Aplicam-se termos e condições* **ZH: 轻松获奖. 条款和条件适用*** **PL: Szansa na WYGRANĄ.** Obowiązują warunki korzystania* **CS: Máte šanci VYHRÁT.** Platí všeobecné smluvní podmínky* **SK: Máte šancu VYHRAŤ.** Platia všeobecné zmluvné podmienky* **HU: TE IS NYERHETSZ.** Felhasználási feltételek érvényesek* **RO: Ai putea CÂȘTIGA.** Se aplică termenii și condiții* **BG: Можете да СПЕЧЕЛИТЕ.** Има определени правила и условия* **LV: Tu vari LAIMĒT.** Ir spēkā noteikumi un nosacījumi.* **ET: Sul on võimalus VÕITA.** Kehtivad tingimused* **LT: Jūs galite LAIMĖTI.** Taikomos sąlygos*

*[LEGO.com/productfeedback-terms](https://www.lego.com/productfeedback-terms)

LEGO and the LEGO logo are trademarks of the/sont des marques de commerce du/son marcas registradas de LEGO Group. ©2024 The LEGO Group.

6492739