



40611





Get excited about our new packaging!

We're switching from plastic to paper-based packaging. That's why you might find a mix of paper and plastic in our boxes!

Nos nouveaux emballages vous emballeront !

Nous passons des emballages en plastique aux emballages à base de papier. C'est pourquoi vous pourriez trouver un mélange de papier et de plastique dans nos boîtes !

¡Te presentamos nuestros nuevos empaques!

Estamos sustituyendo las bolsas de plástico por bolsas con base de papel. ¡Por eso, puedes encontrar una mezcla de papel y de plástico en nuestras cajas!

[LEGO.com/sustainable-packaging](https://www.lego.com/sustainable-packaging)

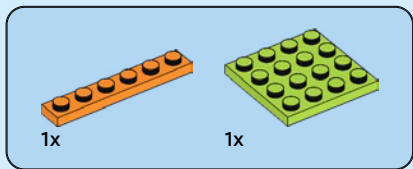

1

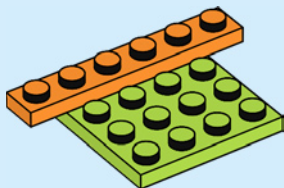



1x

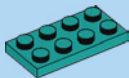

1x

2

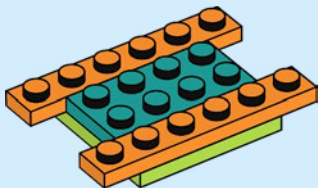

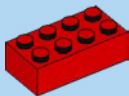

1x

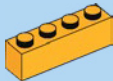

2x

3

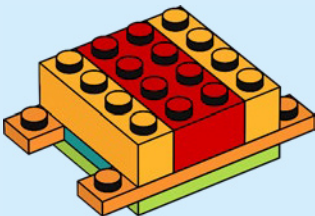



4x



4x



4x



4x

4

1

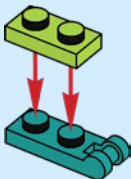

2

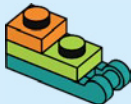

4x



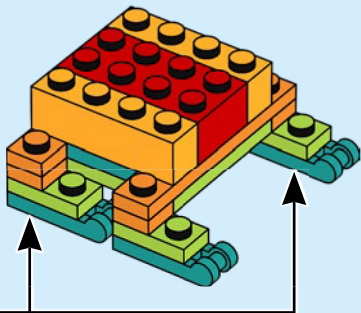



4x

5

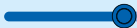
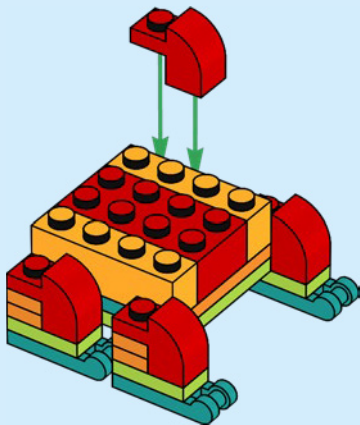



4x

6

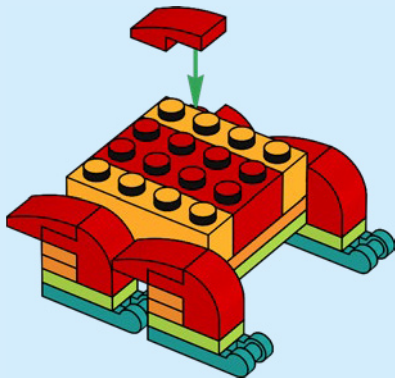



2x



2x

7

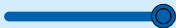
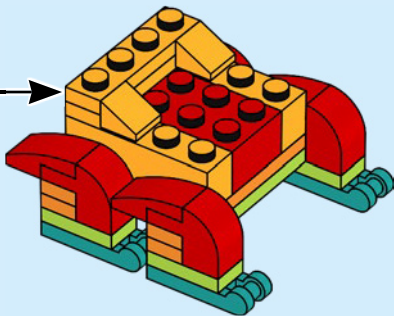
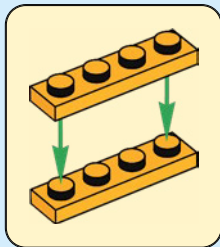



2x



2x

8

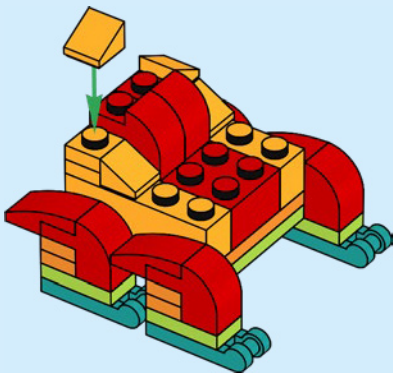



2x

9

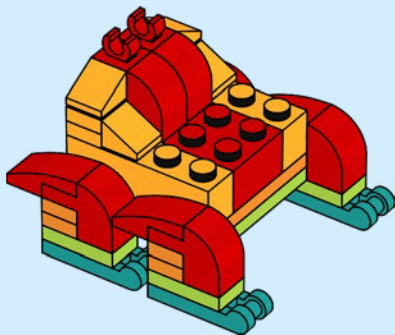



4x



1x

10

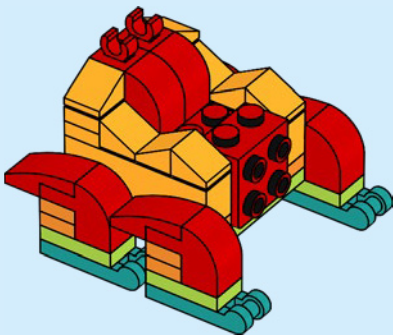



1x

11

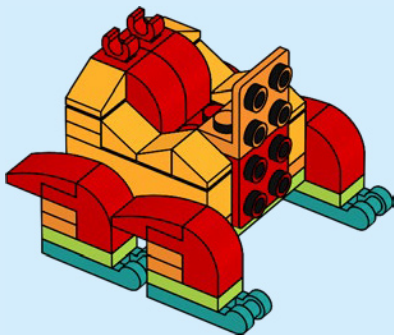



2x

12

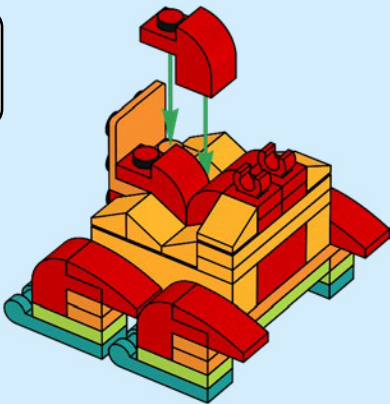
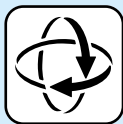



2x

13

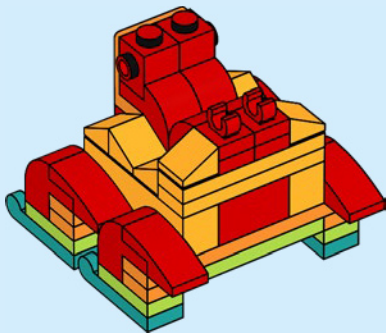



1x



1x



1x

14

1

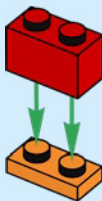

2



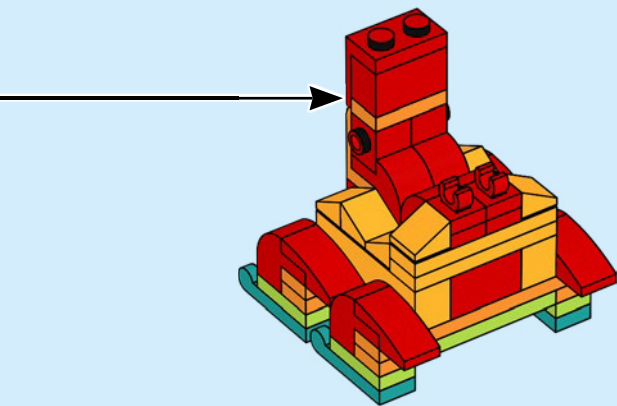

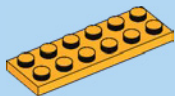

1x



1x

15

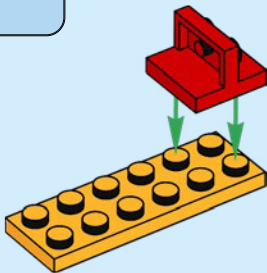



2x



6x

16

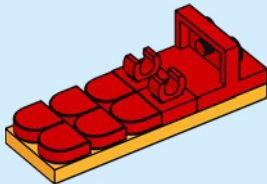



1x



1x



1x



1x



2x

17

1

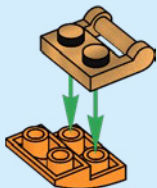

2



3

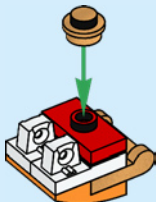

18

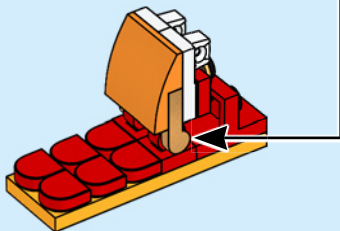

19

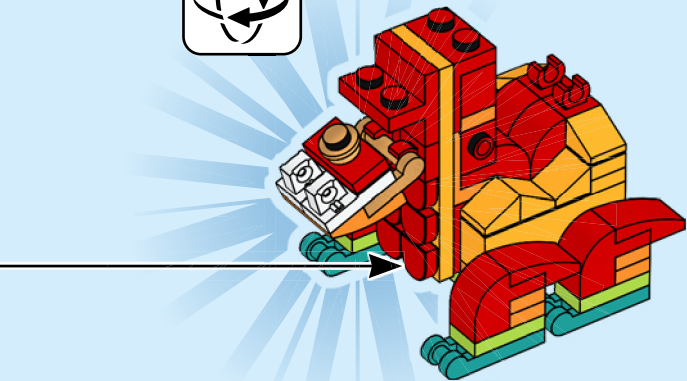



1x



1x

20

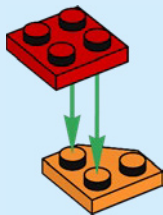



1x

21

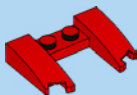

1x

22

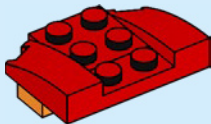



2x

23

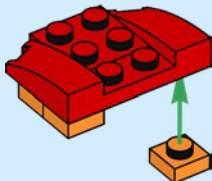

1x



1x

24

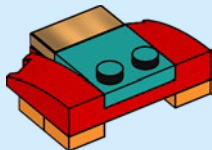

25

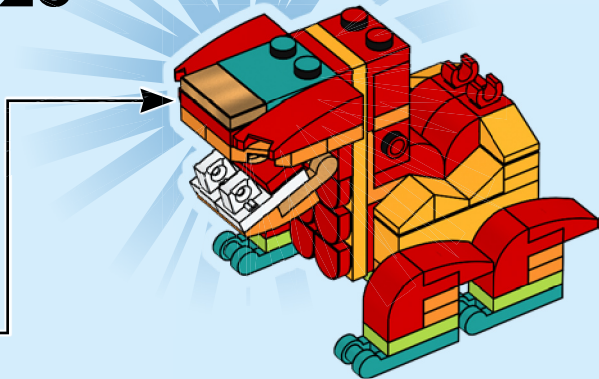



1x

26

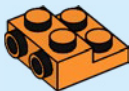



2x



2x

27

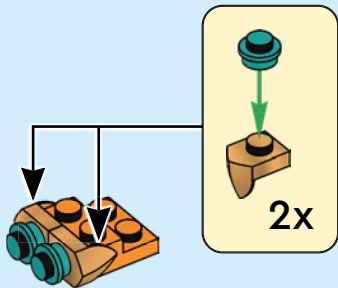

2x



1x



1x

28

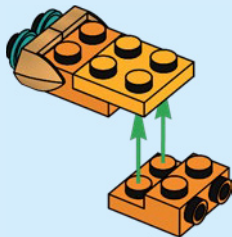



2x

29

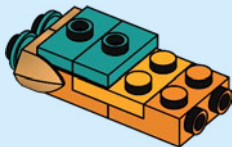

2x

30

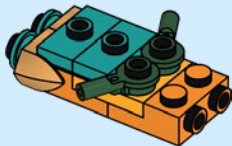



2x

31

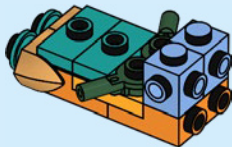

1x



1x

32

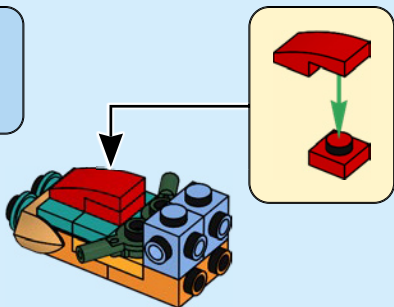



2x

33

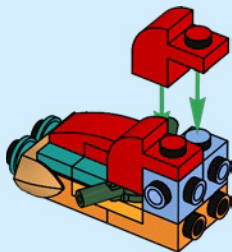

2x

34

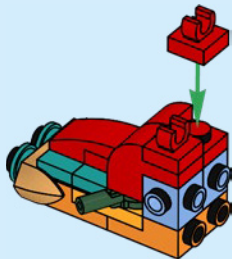

35

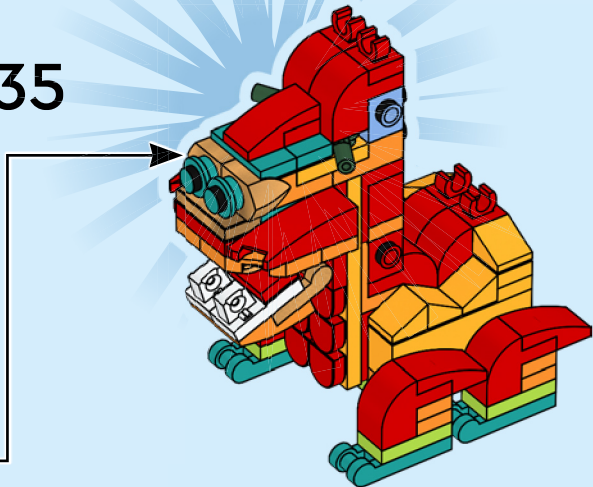

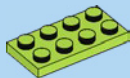

1x



4x



4x

36

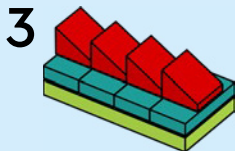
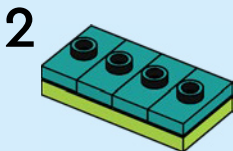
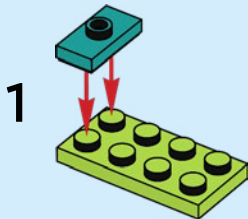

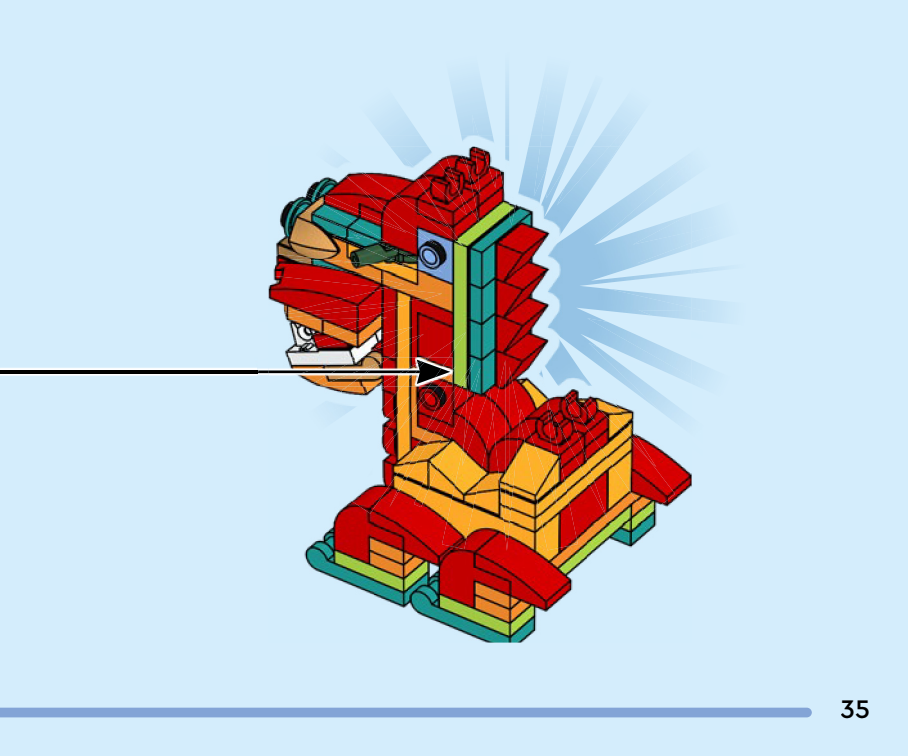



2x

37

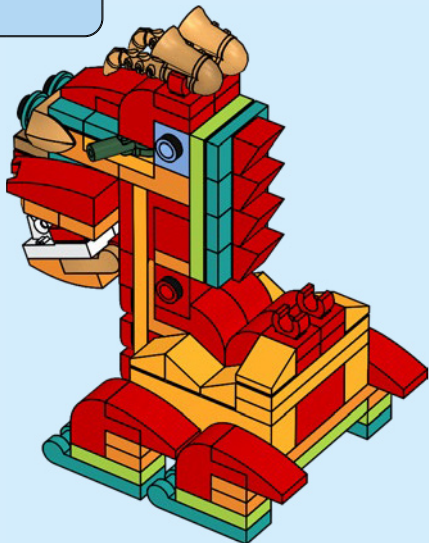

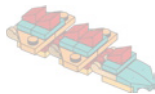

1x



1x

38

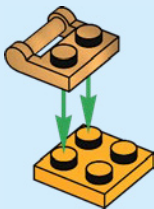



1x

39



2x

40





1x



1x



2x



1x

41

1



2



3

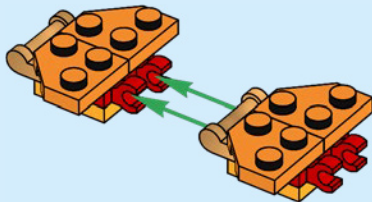



1x



1x



1x



1x

42

1

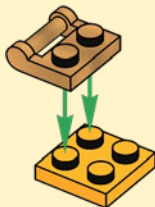

2

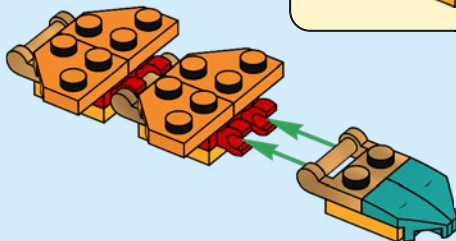



5x

43

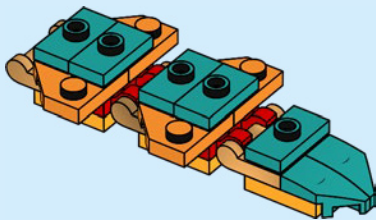



5x

44

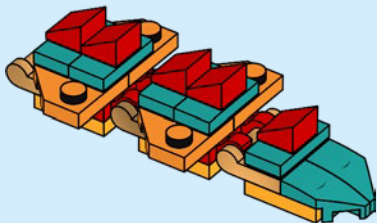

45

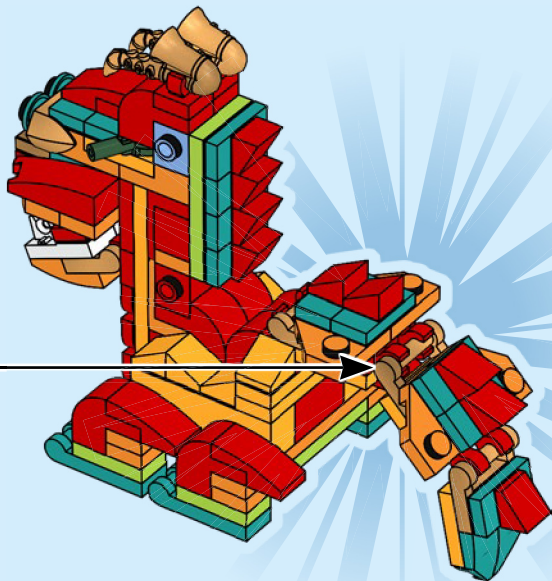



1x



1x

46





1x

47



1x

48

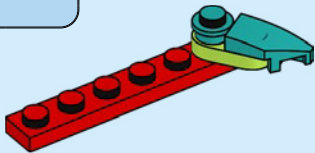



1x



1x

49

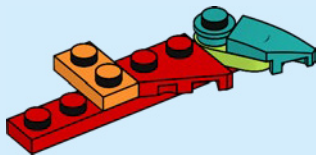

1x

50

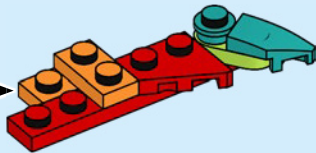



2x



2x



2x

51

1



2



2x

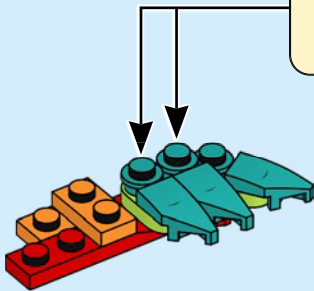



1x



1x



1x

52

1



2

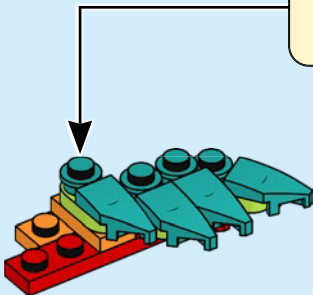



1x



1x



1x

53

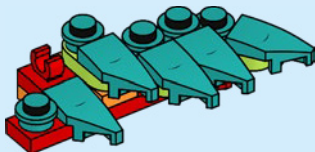

1x

54

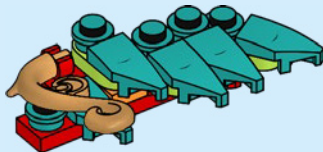

55

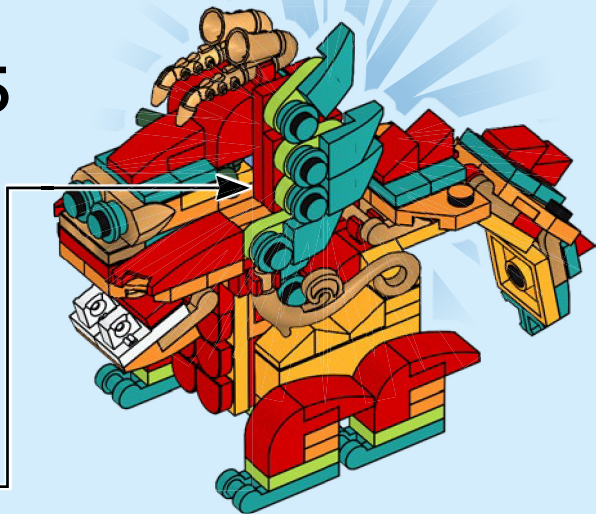



1x



1x

56





1x

57

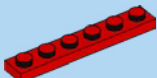
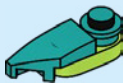

1x

58

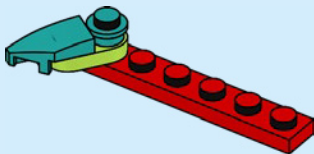



1x



1x

59

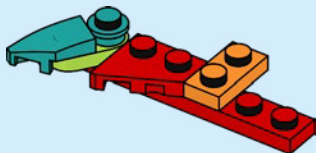

1x

60

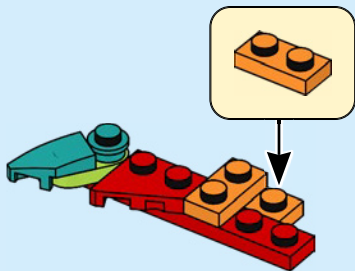



2x



2x



2x

61

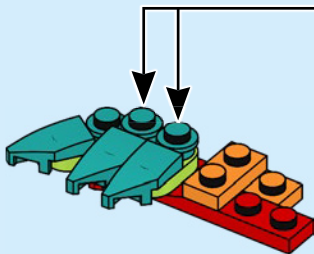

1



2

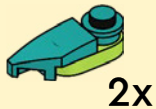



1x



1x



1x

62

1



2

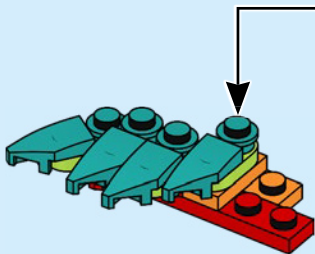



1x



1x



1x

63

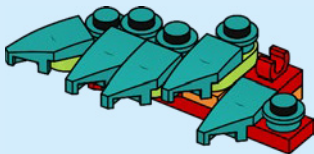

1x

64

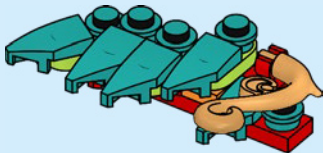

65

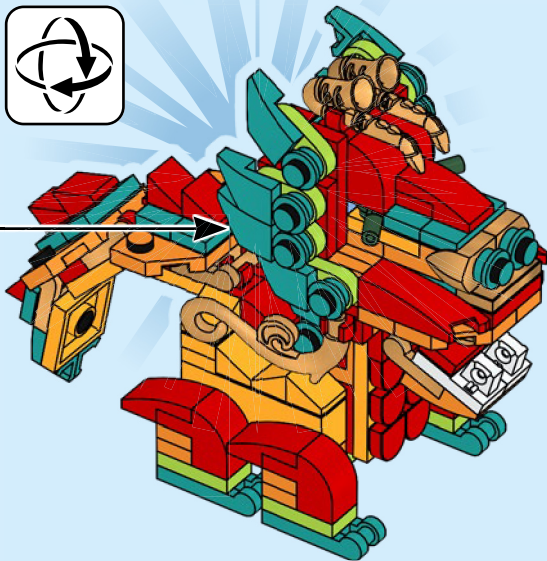



2x



2x



2x



2x

66



1



2

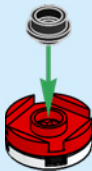

2x

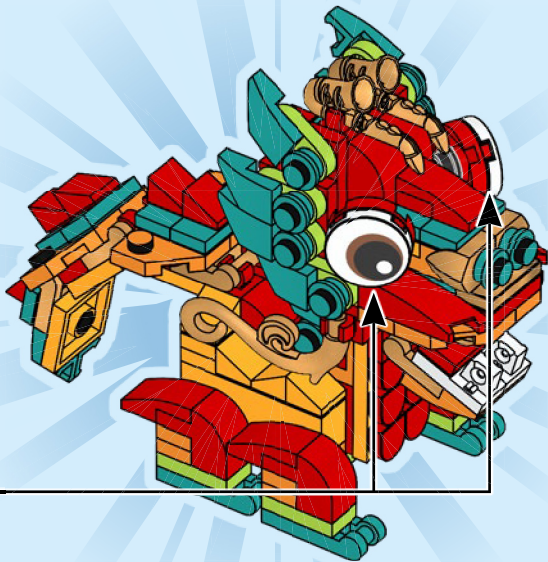

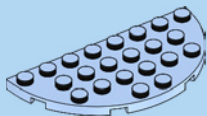
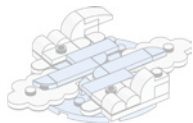

1x



1x

67

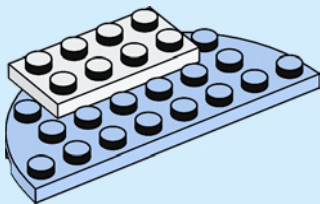



1x



1x

68

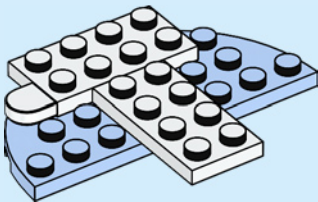

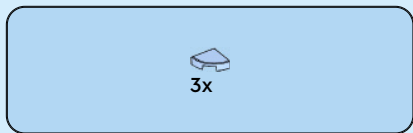

69

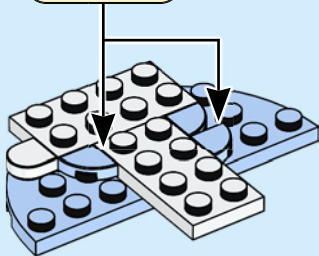
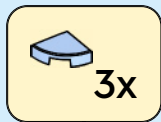



1x

70

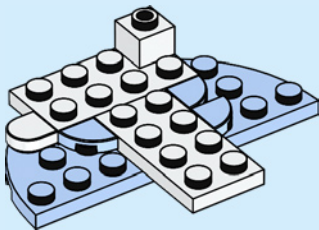



2x



1x

71

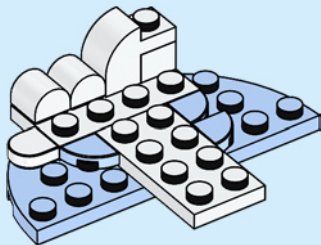



1x

72

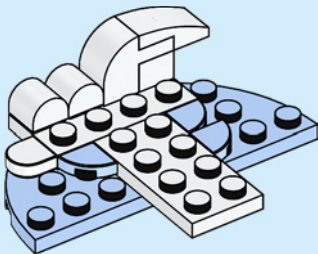



1x



2x



1x

73

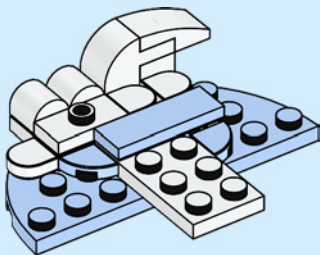



2x

75

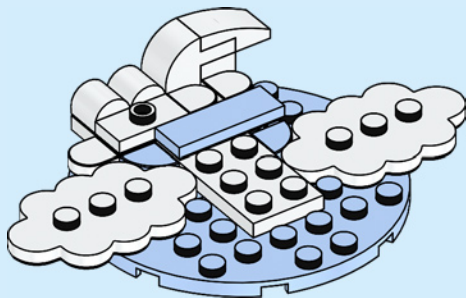



3x

76

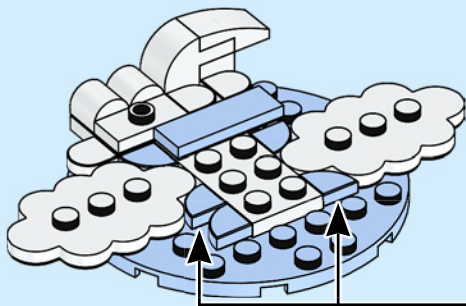

3x



1x



1x

77

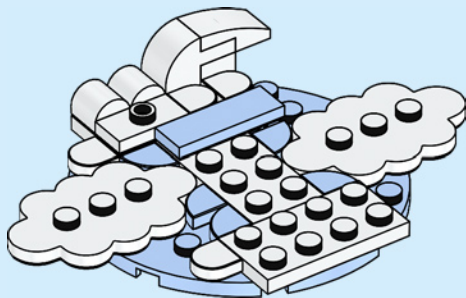



2x



1x

78

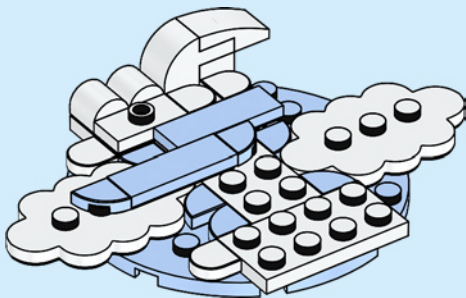



2x



1x

79

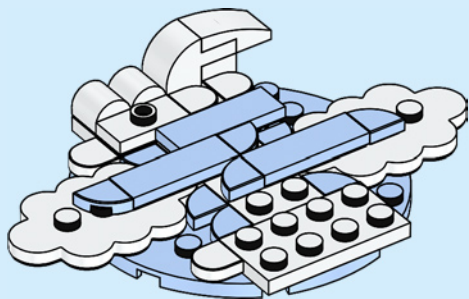



1x



2x



1x

80

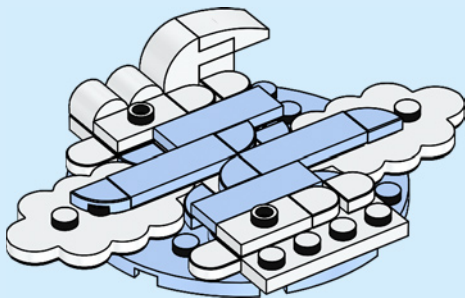



1x

81

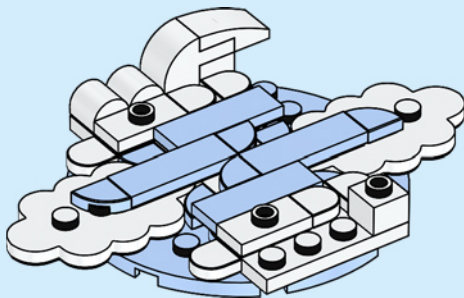



2x



1x

82

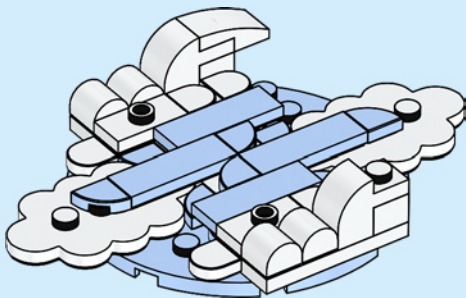



1x

83

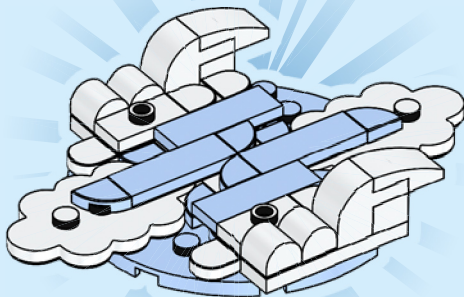



6x
6250591

2x
6383985

4x
6258135

2x
6253320

2x
6051511

2x
6285777

2x
6034044

2x
6265695

2x
6223667

3x
302001

6x
6258973

2x
4558886

9x
4504379

8x
6348058

1x
302421

1x
6141552

1x
6141553

2x
403221

1x
300421

10x
6184782

5x
6029946

1x
6092565

2x
6117974



2x
6360036

1x
6393287

1x
302221

1x
300121

1x
6179656

2x
366621

2x
6168646

2x
6195548

6x
4524929

5x
4177932

6x
6218367

1x
6061676

1x
6403875

2x
6469462



2x
4173332



12x
6325978



6x
6291018



6x
6291017



11x
6210399



1x
6422225



4x
6295286



1x
6338181



8x
6264062



4x
4164037



1x
4537936

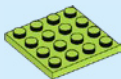

1x
4504850



2x
6392974



8x
6023173



4x
6003033



2x
6020073



2x
6003004



1x
6097509

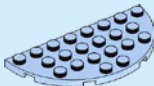

2x
6387468



10x
6316571



4x
6372225



1x
4523159



2x
6083975



2x
6038163



1x
6107197



4x
4585493



2x
6172437



[LEGO.com/service](https://www.lego.com/service)

YOU COULD **WIN**



Scan this QR code or go to
LEGO.COM/PRODUCTFEEDBACK and give us
your short feedback about this LEGO® set for
a chance to win a cool LEGO prize.

Terms and Conditions apply*



EN: YOU COULD WIN. Terms and Conditions apply* **DE: Du könntest GEWINNEN.** Es gelten die Teilnahmebedingungen* **FR: Tu pourrais GAGNER.** Des conditions s'appliquent* **IT: Potresti VINCERE tu.** Termini e condizioni sono applicabili* **ES: Puedes GANAR.** Aplican términos y condiciones* **PT: Poderá GANHAR.** Aplicam-se termos e condições* **ZH: 轻松获奖. 条款和条件适用*** **PL: Szansa na WYGRANĄ.** Obowiązują warunki korzystania* **CS: Máte šanci VYHRÁT.** Platí všeobecné smluvní podmínky* **SK: Máte šancu VYHRÁŤ.** Platia všeobecné zmluvné podmienky* **HU: TE IS NYERHETSZ.** Felhasználási feltételek érvényesek* **RO: Ai putea CÂȘTIGA.** Se aplică termenii și condiții* **BG: Можете да СПЕЧЕЛИТЕ.** Има определени правила и условия* **LV: Tu vari LAIMĒT.** Ir spēkā noteikumi un nosacījumi.* **ET: Sul on võimalus VÕITA.** Kehtivad tingimused* **LT: Jūs galite LAIMĖTI.** Taikomos sąlygos*

*[LEGO.com/productfeedback-terms](https://www.lego.com/productfeedback-terms)

LEGO and the LEGO logo are trademarks of the/son des marques de commerce du/
son marcas registradas de LEGO Group. ©2023 The LEGO Group.

6480146