



**BRICK  
HEADZ**

**40628**





[LEGO.com/sustainable-packaging](https://LEGO.com/sustainable-packaging)

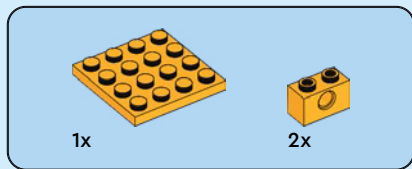

1

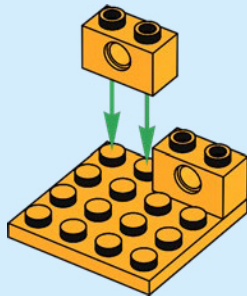



1x



1x

2

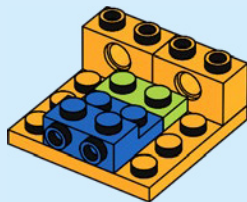

4x

3

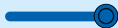
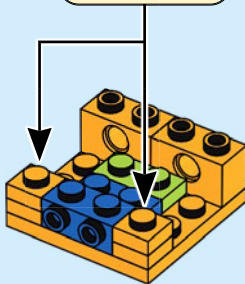
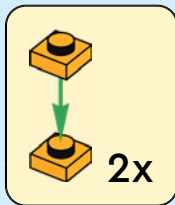



2x

4

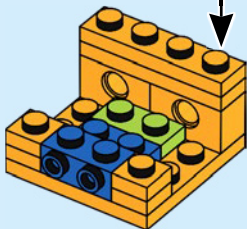
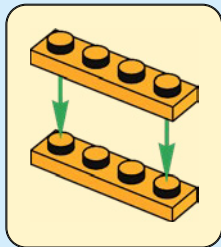

1x



1x

5

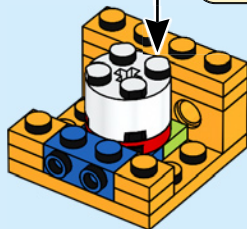
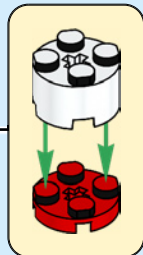

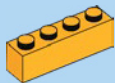

1x



2x

6

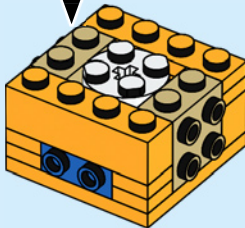
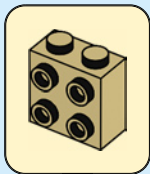

6



1x

7

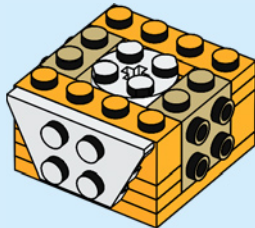

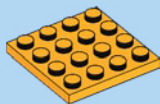

1x

8

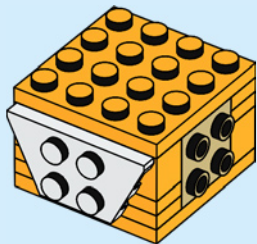

6x

9

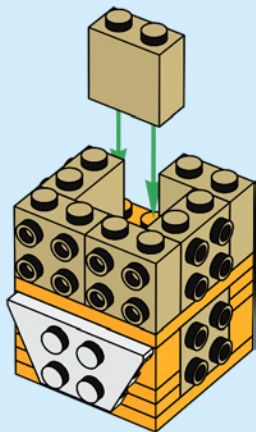



2x

10

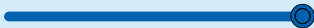
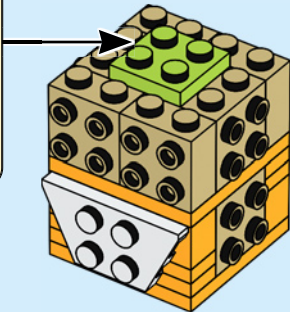
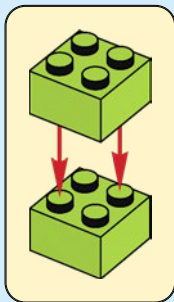



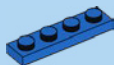

2x

11

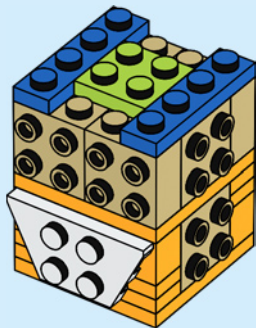

4x



4x

12

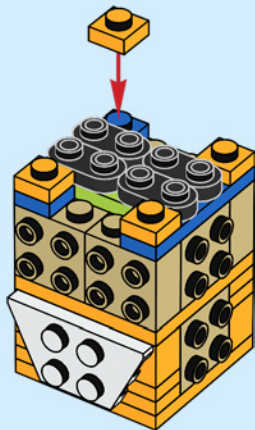



2x



1x



13

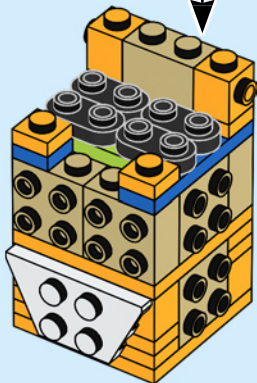



1x

14

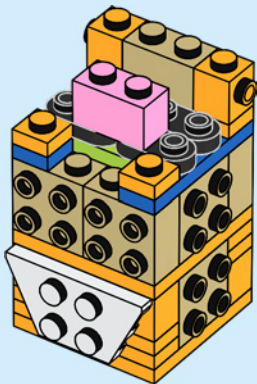

2x



1x

15

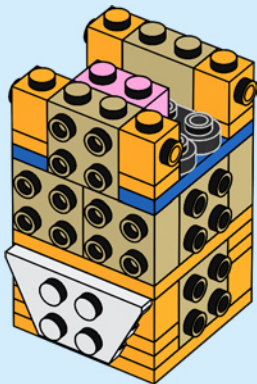

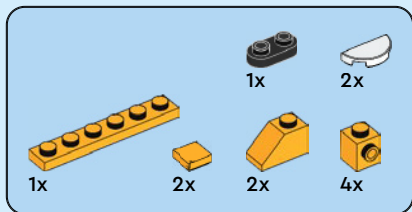

16

1

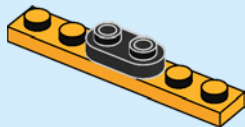

2

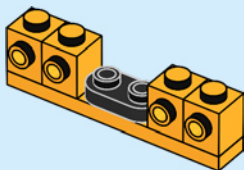

3

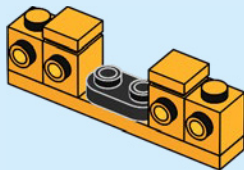

4

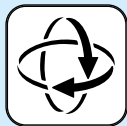
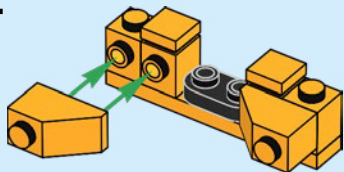

5

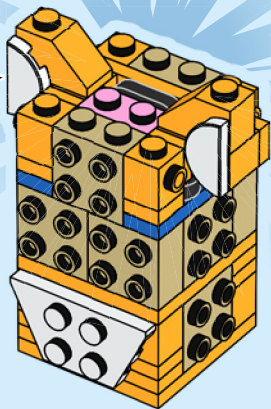
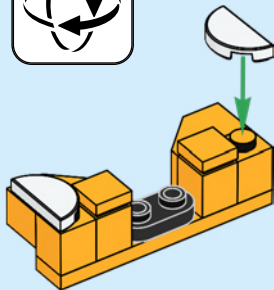



1x

17

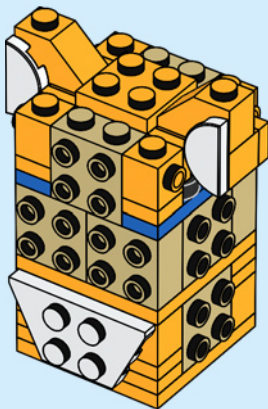

2x

18

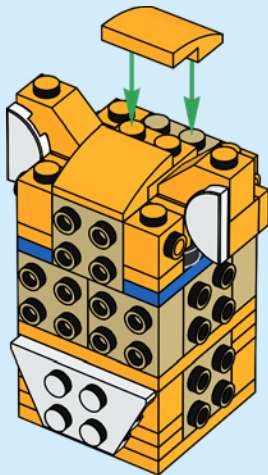

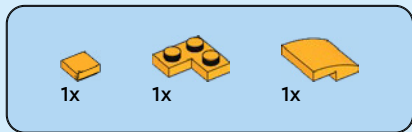

19

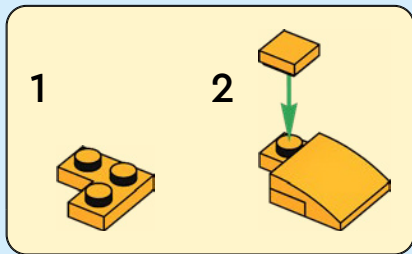
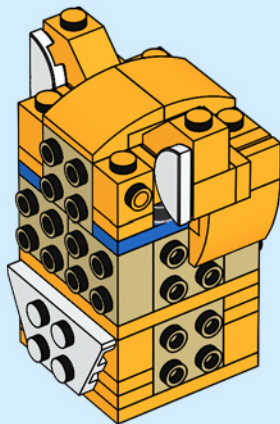



1x



1x



1x

# 20

1



2

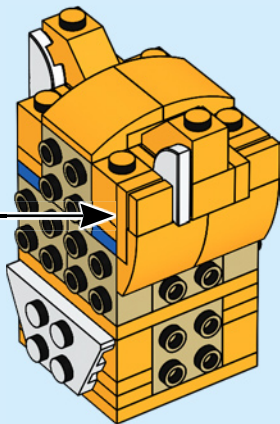
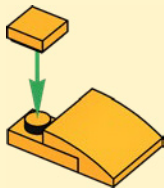





1x



1x

# 21

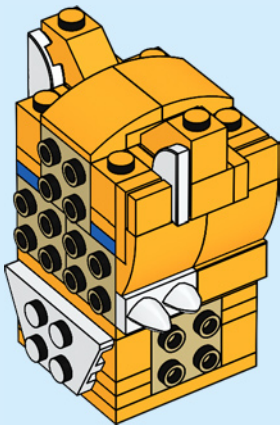

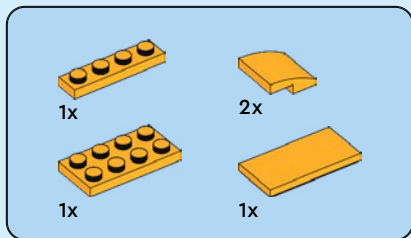

# 22

1

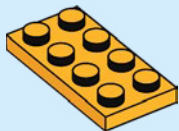

2

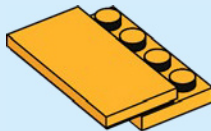

3

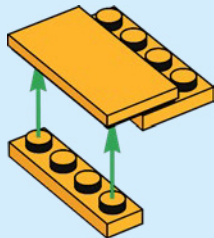

4

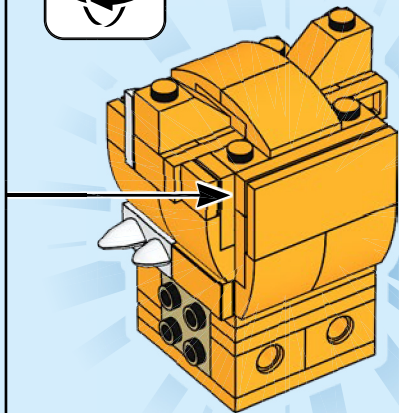
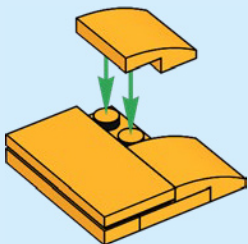

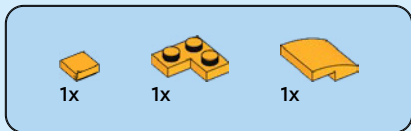

23

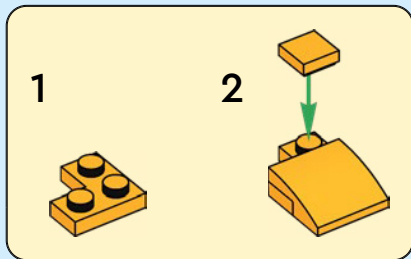
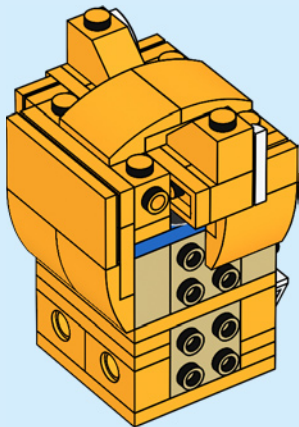

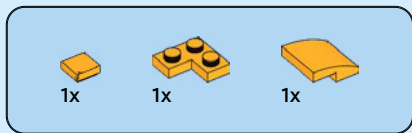

# 24

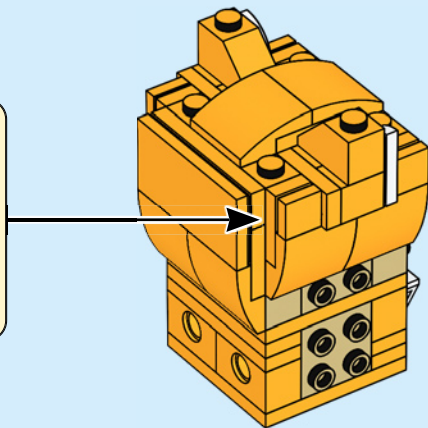
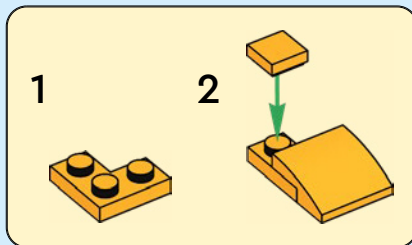



1x



1x

# 25

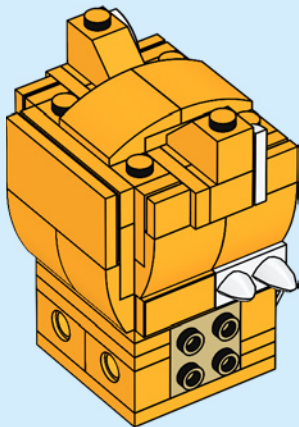



2x

26

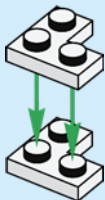

1x



1x

27

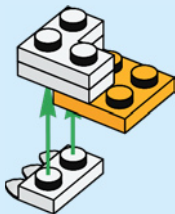



2x



1x

# 28

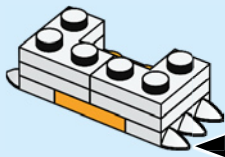
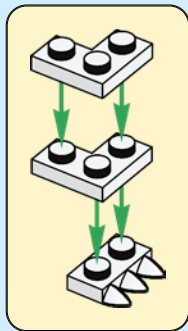

1x



2x

# 29

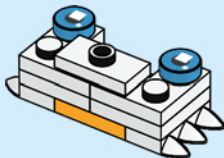





1x



2x

30

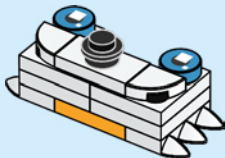

31

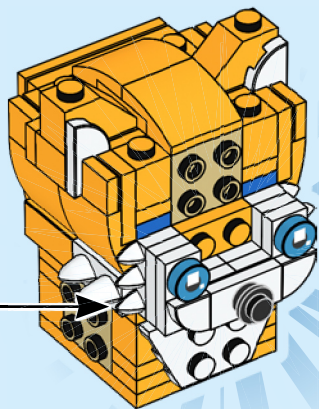
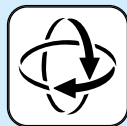

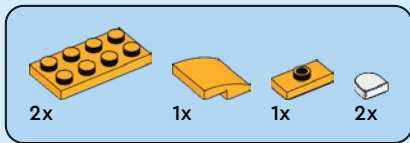

# 32

## 1

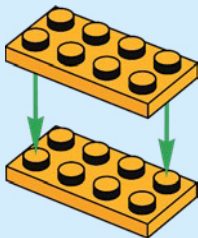

## 2

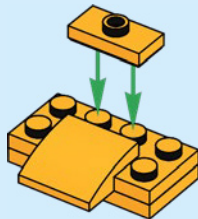

3

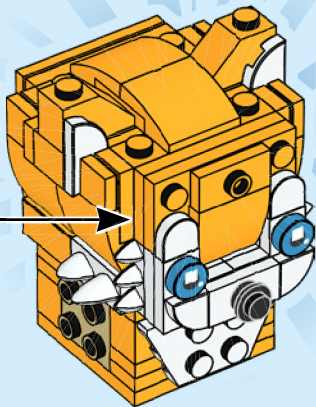
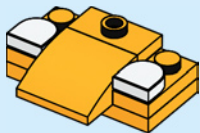

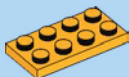

1x

33

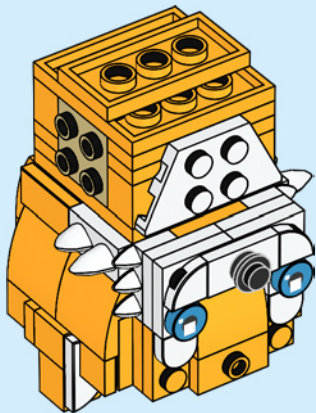
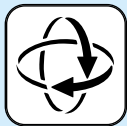



2x

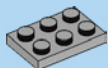

2x



2x



2x



4x

34

1

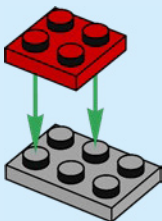

2



3



2x

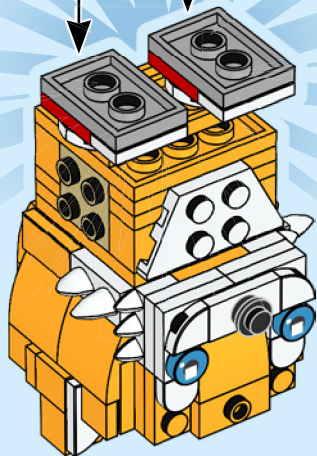



35

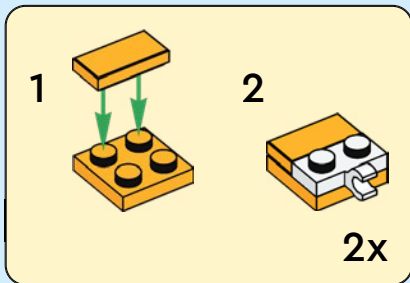
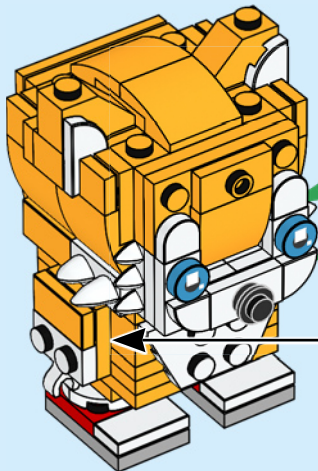



36

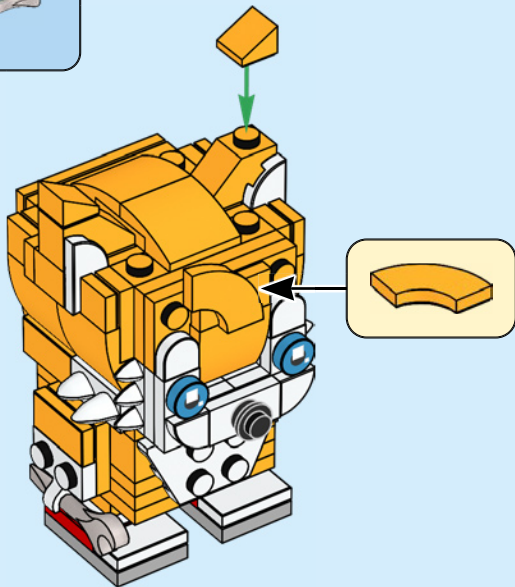





2x



2x



2x

3



2x



2x



3

1:1

37

1

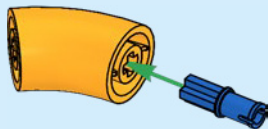

2

3

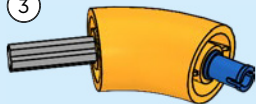

3

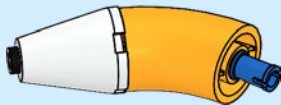

2x

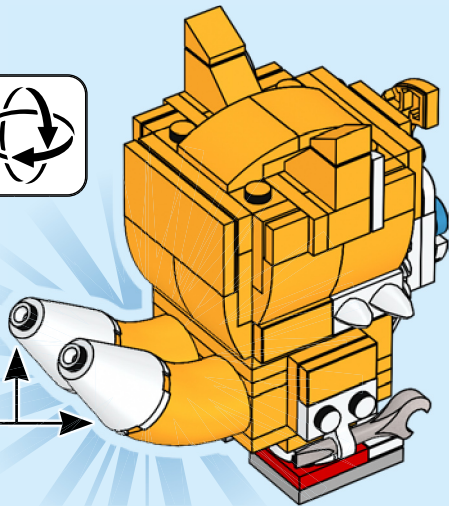
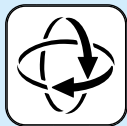

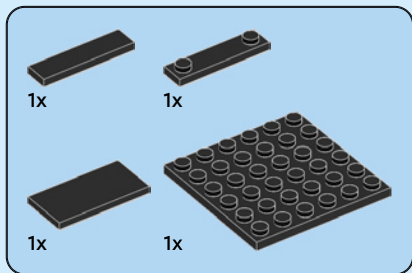

# 38

1

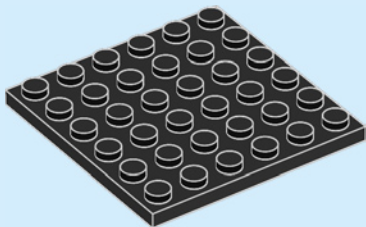

2

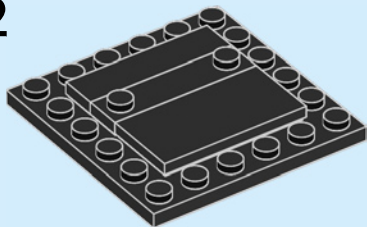

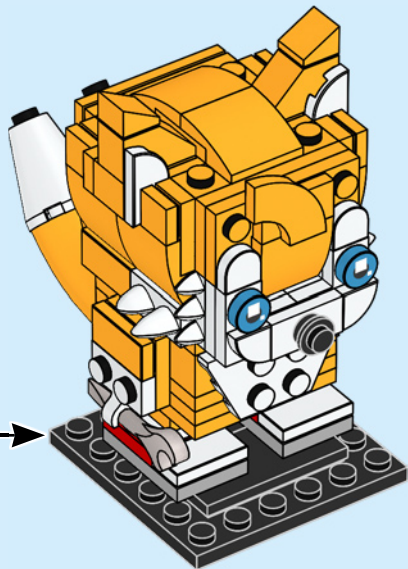

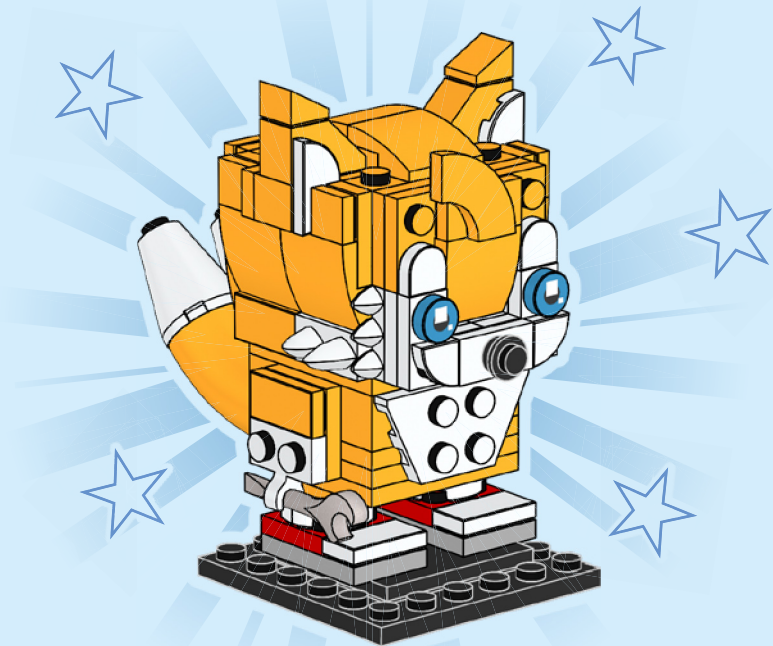



**BRICK  
'HEADZ**

40627



**SONIC**<sup>TM</sup>  
THE HEDGEHOG

SONIC THE HEDGEHOG<sup>TM</sup> 40627

**213**

- |               |   |               |               |               |               |                |               |               |
|---------------|---|---------------|---------------|---------------|---------------|----------------|---------------|---------------|
| 2x<br>4211815 | 3 | 6x<br>6065504 | 3x<br>6020073 | 8x<br>6092035 | 1x<br>6044601 | 1x<br>614301   | 1x<br>403221  | 2x<br>4206482 |
| 2x<br>4211396 |   | 2x<br>6023173 | 1x<br>6003004 | 9x<br>6099730 | 2x<br>6172366 | 10x<br>6214334 | 2x<br>302221  | 1x<br>6469450 |
| 1x<br>614126  |   | 8x<br>6073040 | 4x<br>6097511 | 4x<br>6003033 | 2x<br>6313115 | 1x<br>4164037  | 1x<br>4517993 | 2x<br>371023  |
| 5x<br>6210270 |   | 2x<br>6023157 | 4x<br>6097111 | 4x<br>6099714 | 1x<br>6051511 | 1x<br>4164037  | 1x<br>4517993 | 1x<br>371023  |
| 1x<br>6254045 |   | 2x<br>6186081 | 1x<br>4621543 | 1x<br>6099714 | 2x<br>6051511 | 2x<br>4220632  | 1x<br>4517993 | 1x<br>6167576 |
| 1x<br>243126  |   | 4x<br>4622062 | 1x<br>6020074 | 1x<br>6334203 | 2x<br>306901  | 2x<br>6455633  |               |               |
| 1x<br>4560182 |   | 1x<br>6122504 | 2x<br>6093272 | 2x<br>6250591 | 2x<br>6046384 |                |               |               |
| 1x<br>395826  |   |               | 2x<br>6093272 | 2x<br>6400114 | 2x<br>6046381 |                |               |               |
|               |   |               | 2x<br>6439715 | 4x<br>6462354 | 4x<br>242001  |                |               |               |
|               |   |               |               | 1x<br>4249506 |               |                |               |               |

 [LEGO.com/service](https://www.LEGO.com/service)



YOU COULD

WIN



Scan this QR code or go to  
**LEGO.COM/PRODUCTFEEDBACK** and give us  
your short feedback about this LEGO® set  
for a chance to win a cool LEGO prize.

Terms and Conditions apply\*

**EN: YOU COULD WIN.** Terms and Conditions apply\* **DE: Du könntest GEWINNEN.** Es gelten die Teilnahmebedingungen\* **FR: Tu pourrais GAGNER.** Des conditions s'appliquent\* **IT: Potresti VINCERE tu.** Termini e condizioni sono applicabili\* **ES: Puedes GANAR.** Aplican términos y condiciones\* **PT: Poderá GANHAR.** Aplicam-se termos e condições\* **ZH: 轻松获奖.** 条款和条件适用\* **PL: Szansa na WYGRANĄ.** Obowiązują warunki korzystania\* **CS: Máte šanci VYHRÁT.** Platí všeobecné smluvní podmínky\* **SK: Máte šancu VYHRÁT.** Platia všeobecné zmluvné podmienky\* **HU: TE IS NYERHETSZ.** Felhasználási feltételek érvényesek\* **RO: Ai putea CÂȘTIGA.** Se aplică termenii și condiții\* **BG: Можете да СПЕЧЕЛИТЕ.** Има определени правила и условия\* **LV: Tu vari LAIMĒT.** Ir spēkā noteikumi un nosacījumi.\* **ET: Sul on võimalus VÕITA.** Kehtivad tingimused\* **LT: Jūs galite LAIMĖTI.** Taikomos sąlygos\*

\*[LEGO.com/productfeedback-terms](https://www.lego.com/productfeedback-terms)

LEGO and the LEGO logo are trademarks of the LEGO Group. ©2023 The LEGO Group.  
©SEGA. All rights reserved. SEGA is registered in the U.S. Patent and Trademark Office. SEGA and  
SONIC THE HEDGEHOG are either registered trademarks or trademarks of SEGA CORPORATION.

6480142