



CITY

60391



1



[LEGO.com/sustainable-packaging](https://www.lego.com/sustainable-packaging)



# BUILDER



Apple and the Apple logo are trademarks of Apple Inc., registered in the U.S. and other countries and regions. App Store is a service mark of Apple Inc. Google Play and the Google Play logo are trademarks of Google LLC. Tencent and the Tencent logo are trademarks of Tencent Inc.

[LEGO.com/devicecheck](https://www.lego.com/devicecheck)

**EN** Ask parents' permission before going online | **DE** Eltern um Erlaubnis bitten, bevor du online gehst | **FR** Demande l'autorisation d'un parent avant d'aller en ligne | **IT** Chiedi il permesso ai tuoi genitori prima di andare online | **ES** Pídeles permiso a tus papás antes de conectarte a Internet | **PT** Peça autorização aos pais antes de acederes online | **ZH** 上网前应先征得父母的同意 | **PL** Poproś rodziców o zgodę, zanim wejdiesz do Internetu | **CS** Než půjdeš na internet, požádej rodiče o svolení | **SK** Skôr než pôjdeš na internet, vypýtaj si povolenie od rodičov | **HU** Kérj szülői engedélyt, mielőtt online csatlakoznál! | **RO** Cere permisiunea părinților înainte de a te conecta online | **BG** Поискайте разрешение от родител, преди да влезете онлайн | **LV** Pirms došanās tiešsaistē palūdz atļauju vecākiem | **ET** Enne Interneti kasutamist küsi vanematelt luba | **LT** Prieš prisijungdami prie interneto, atsklauskite tėvų



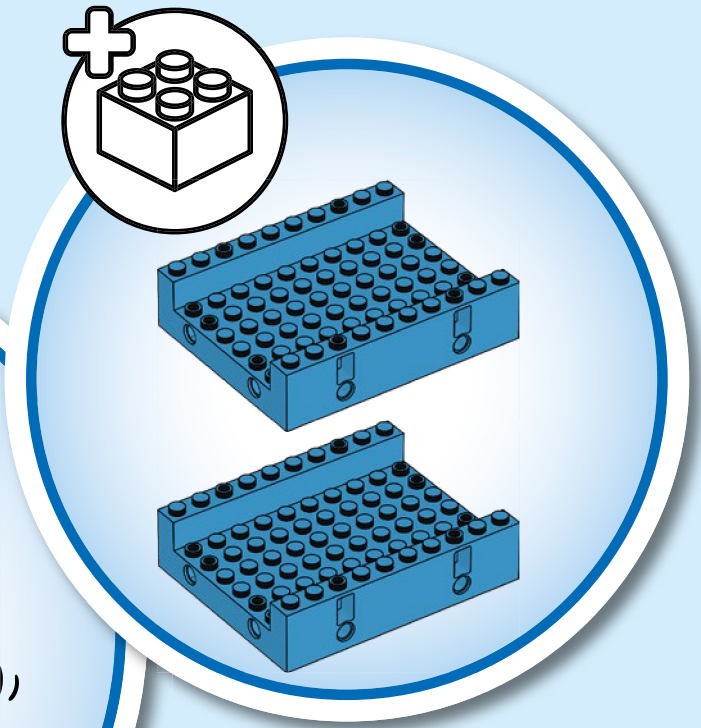

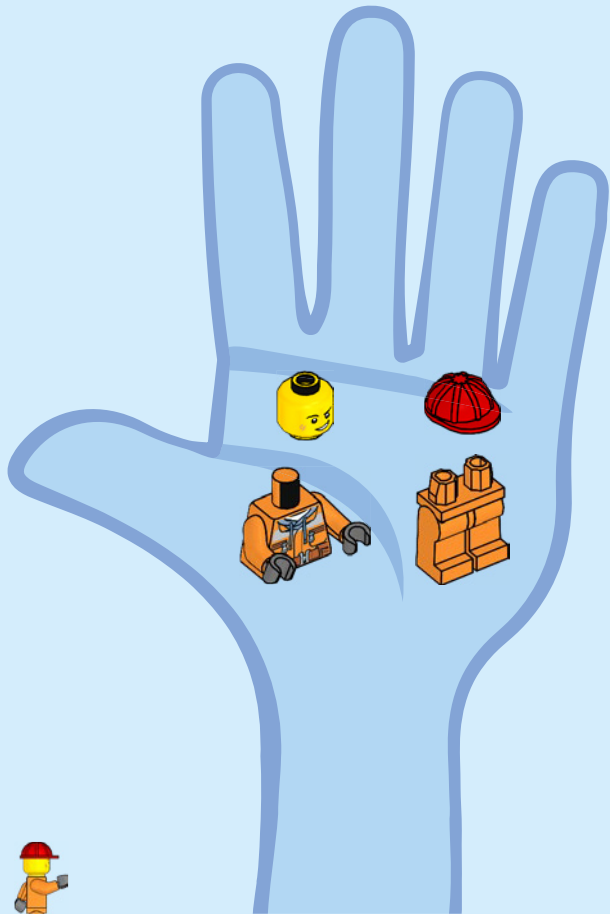

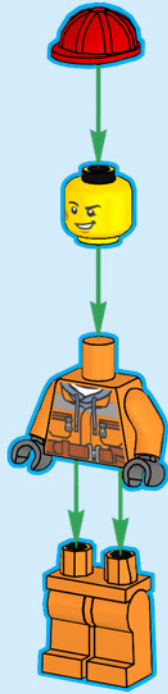

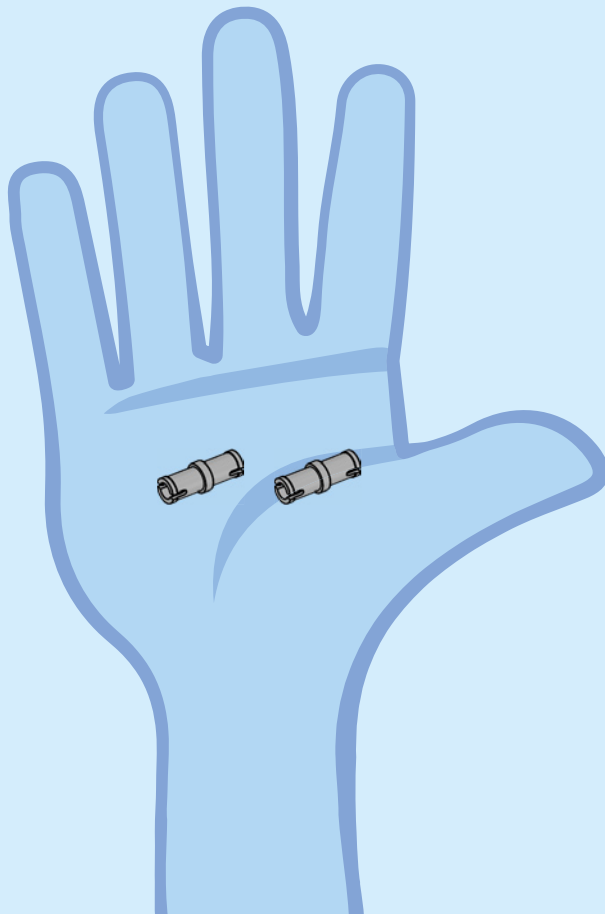
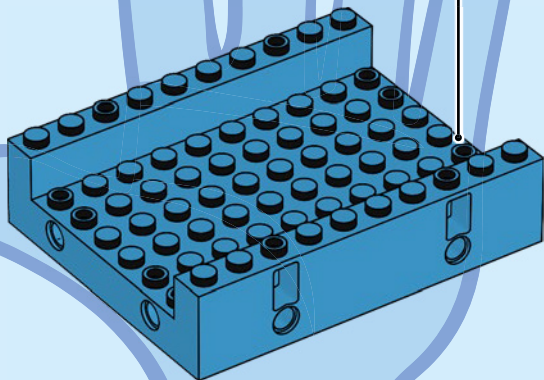
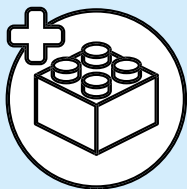
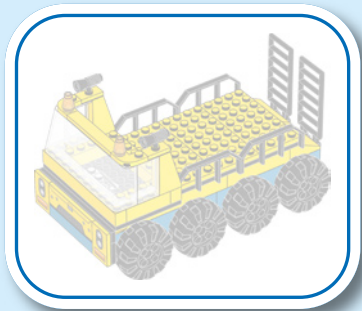



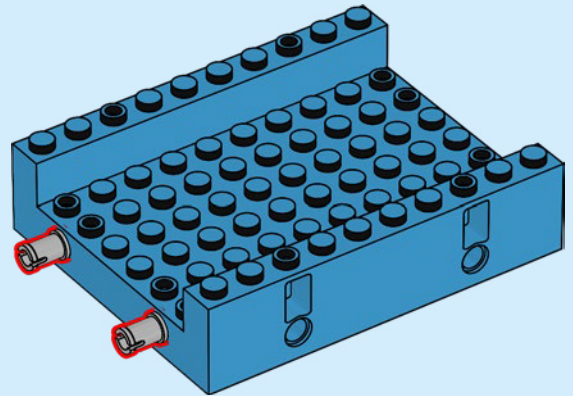
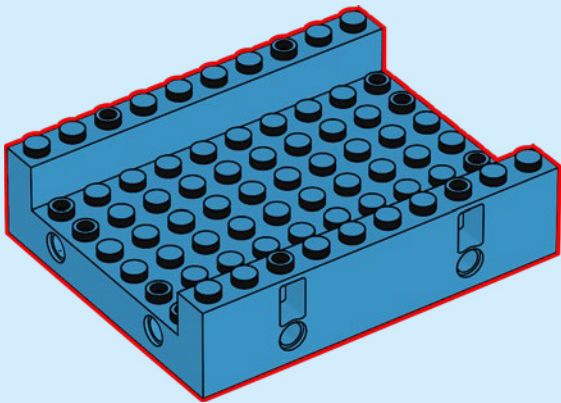

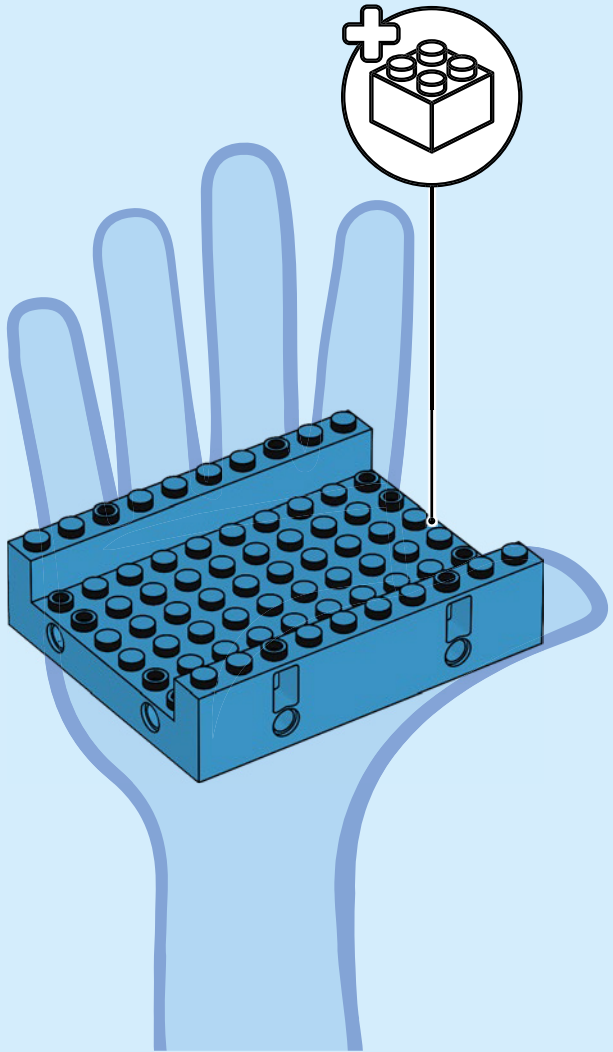

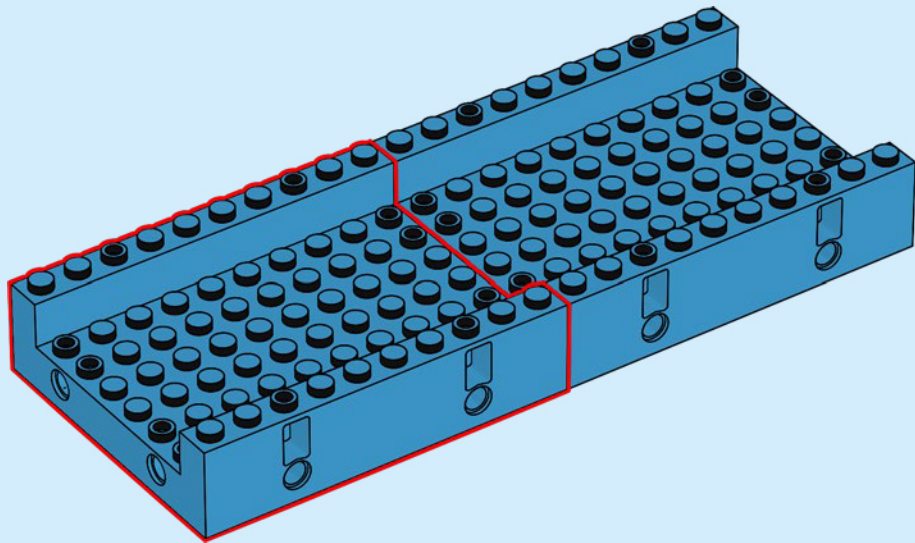

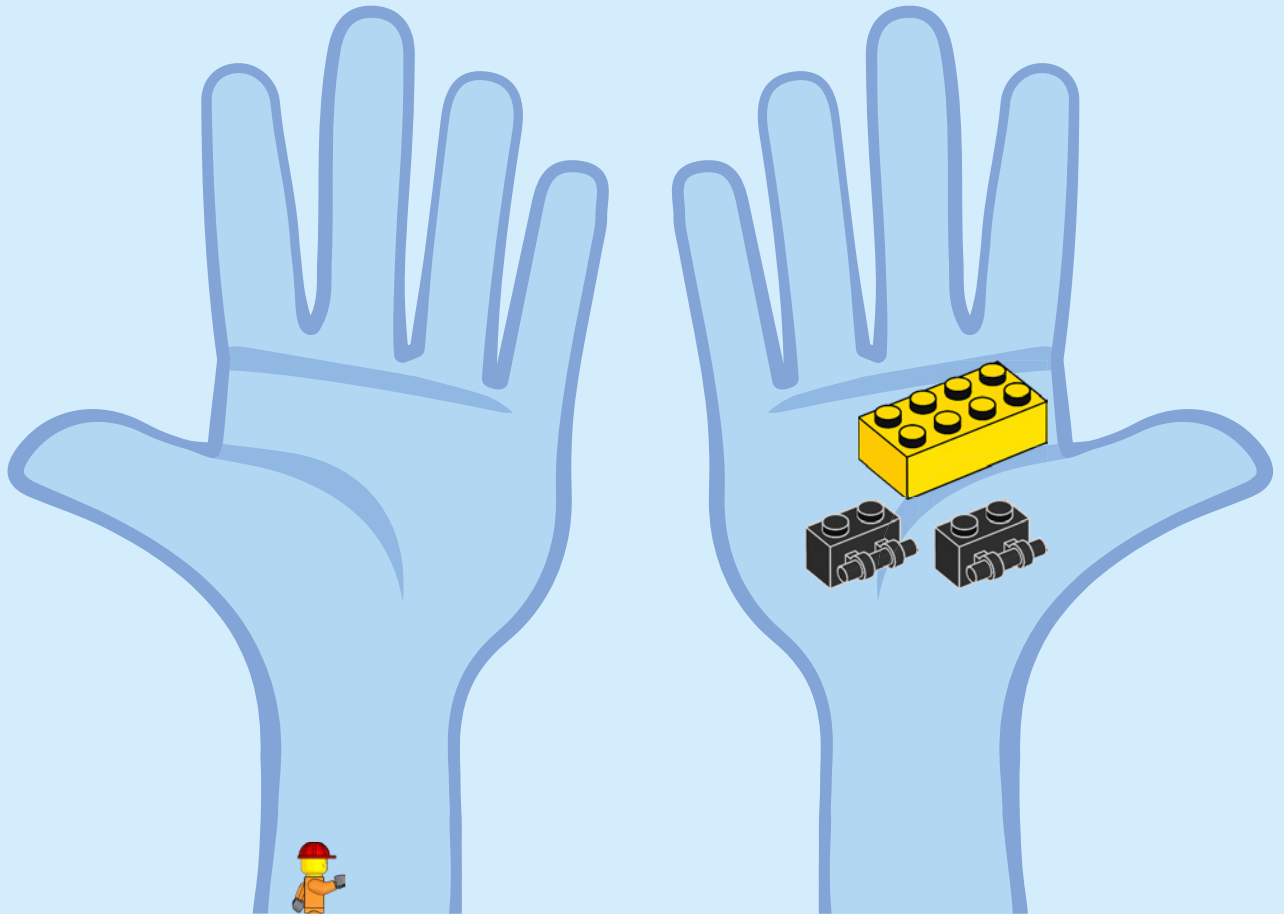

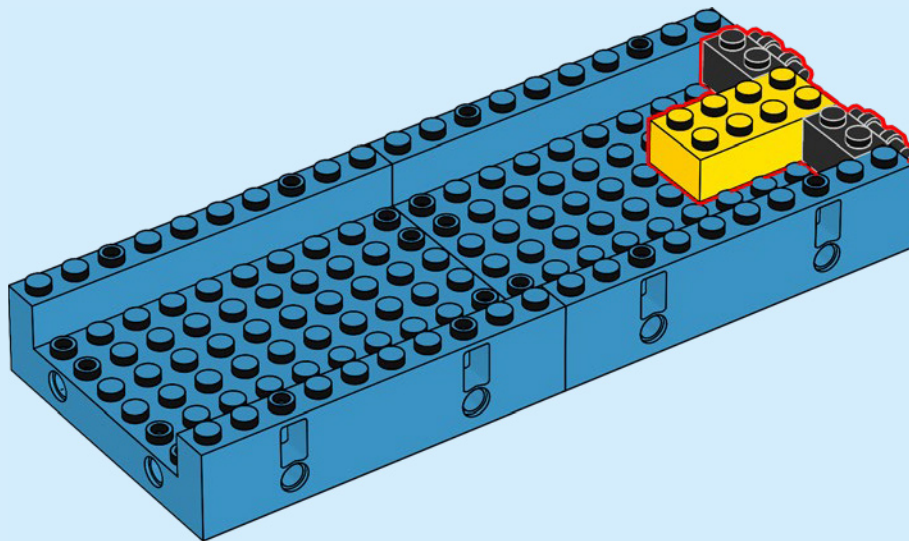

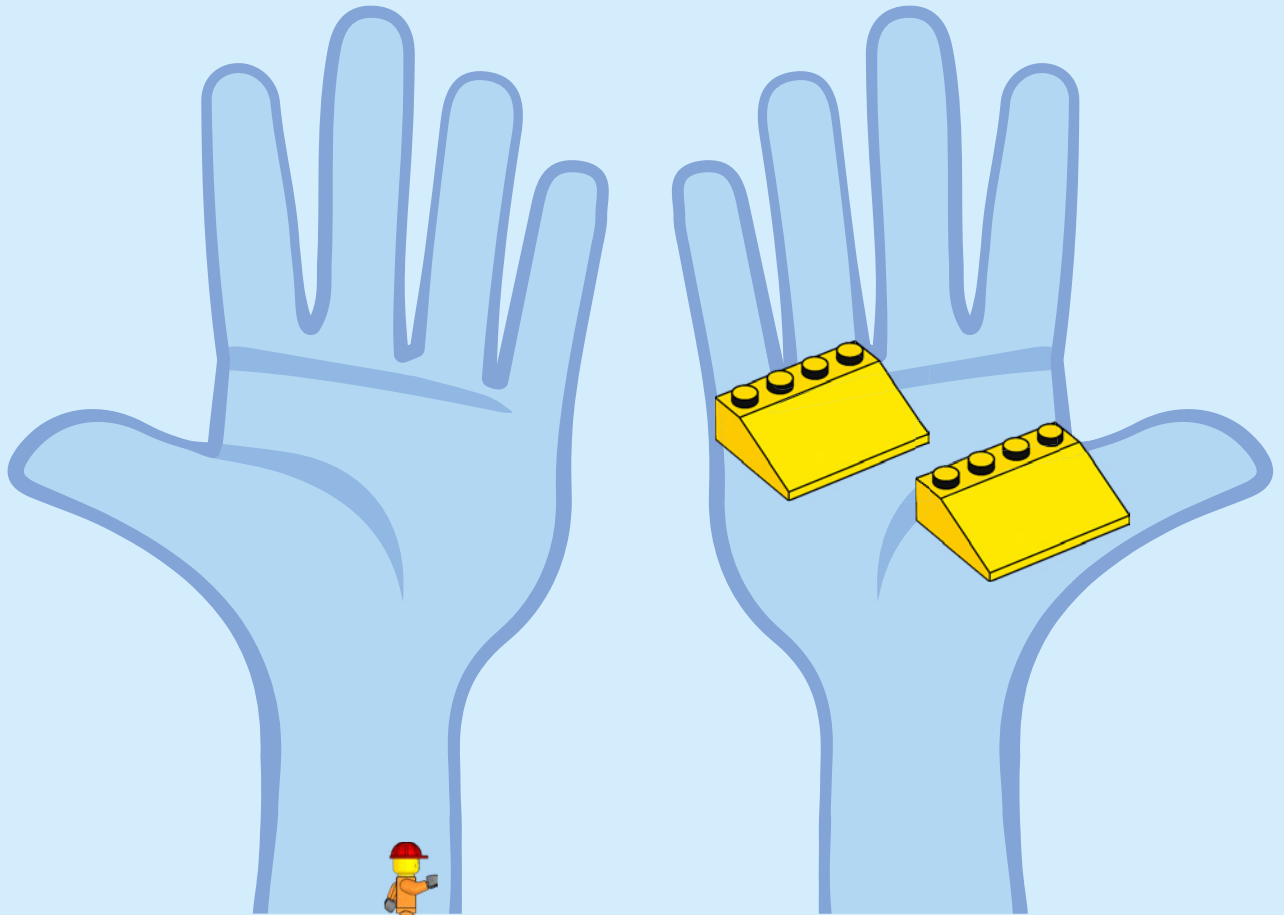

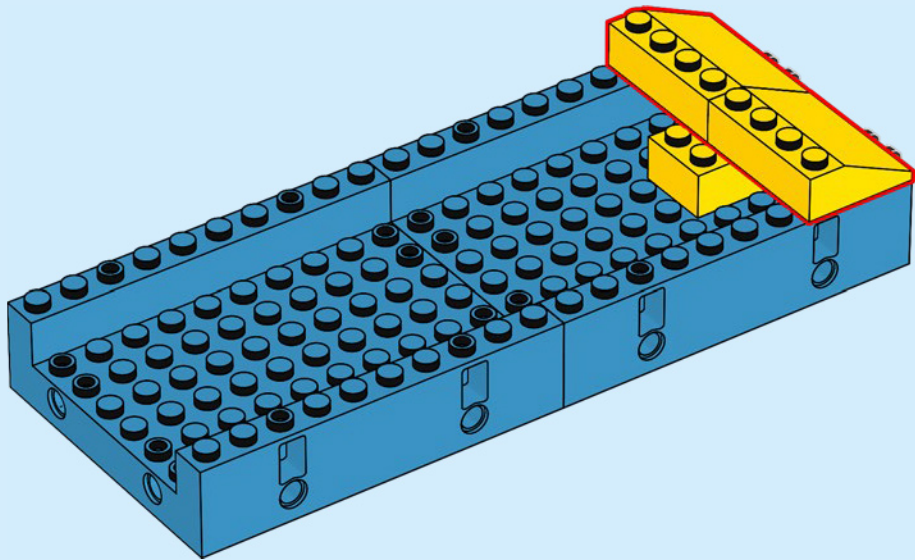

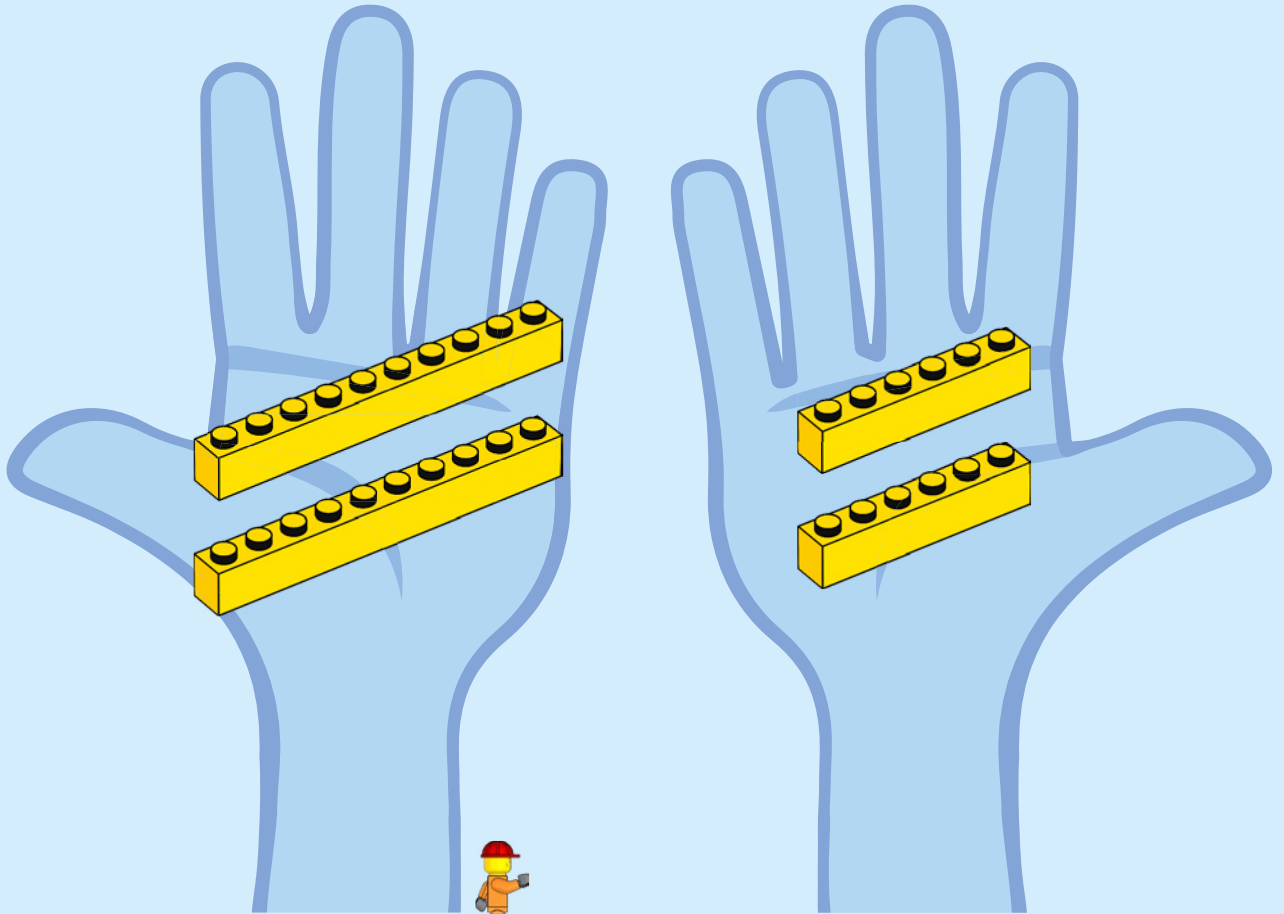



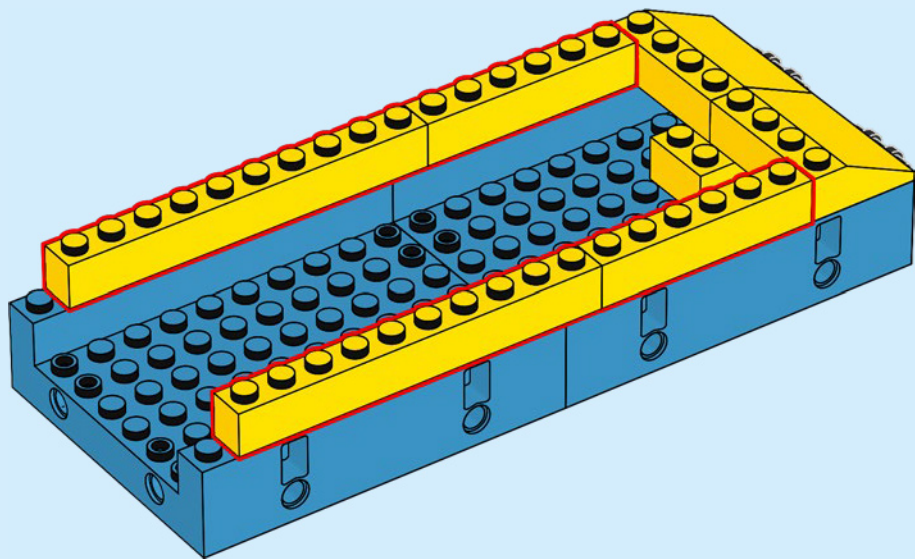

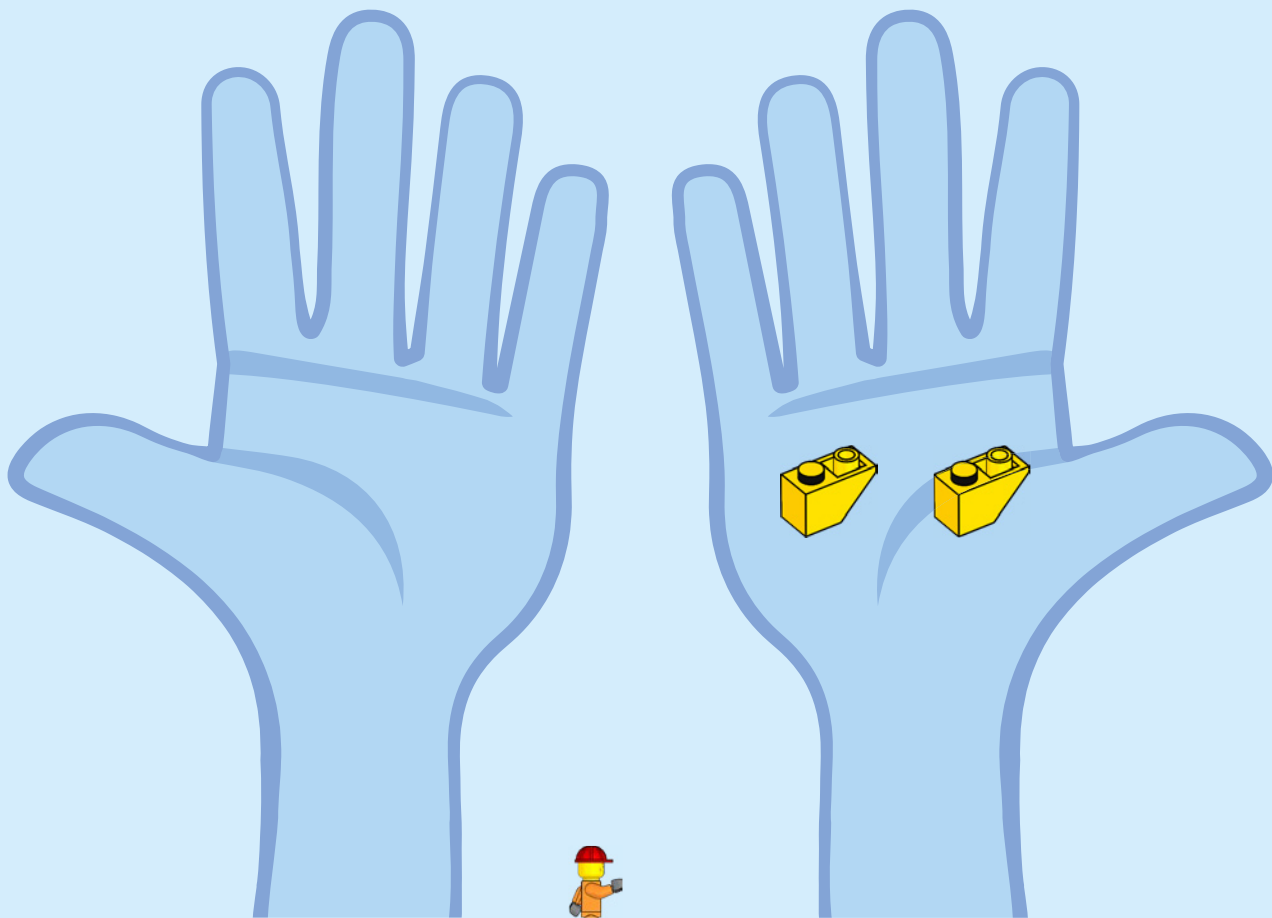



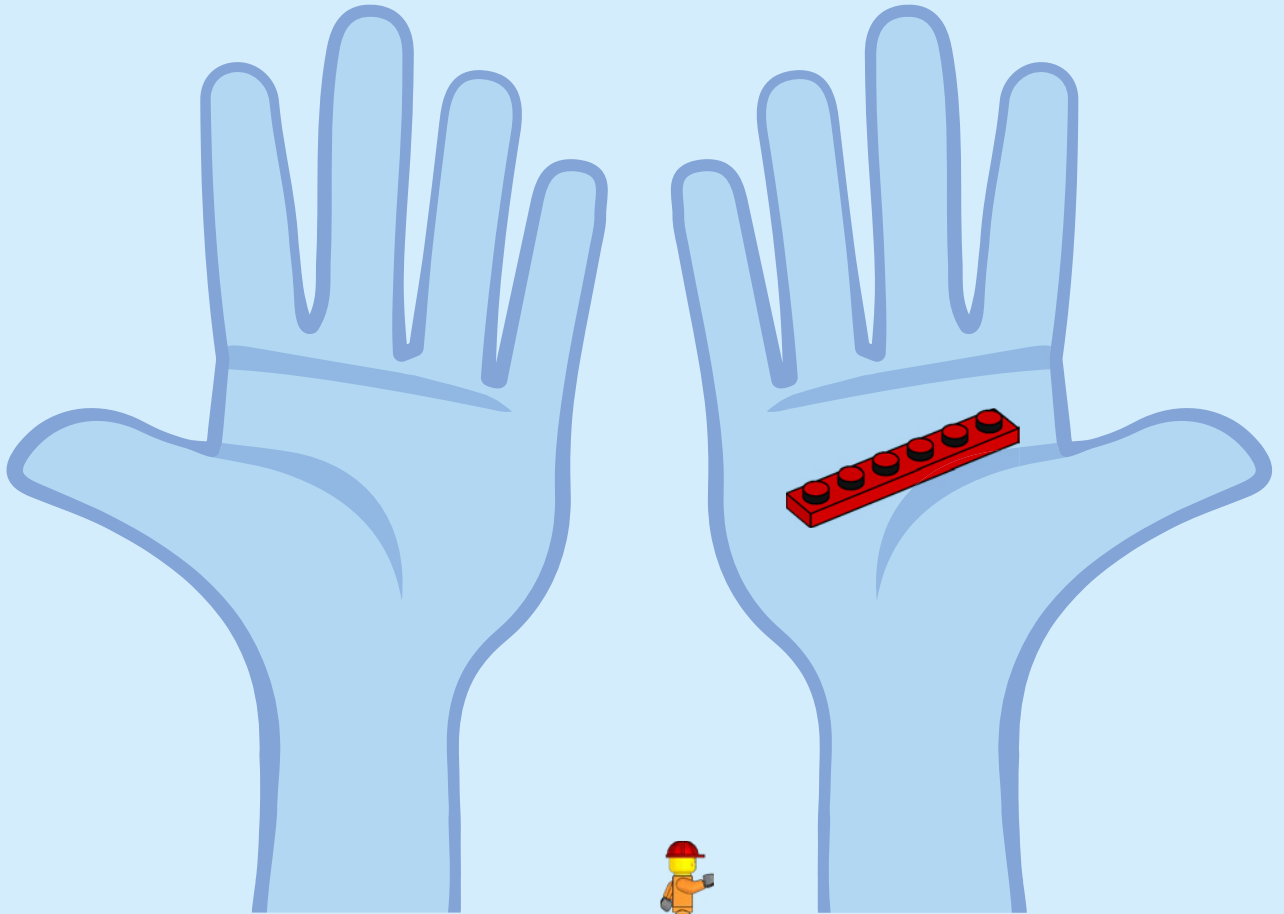

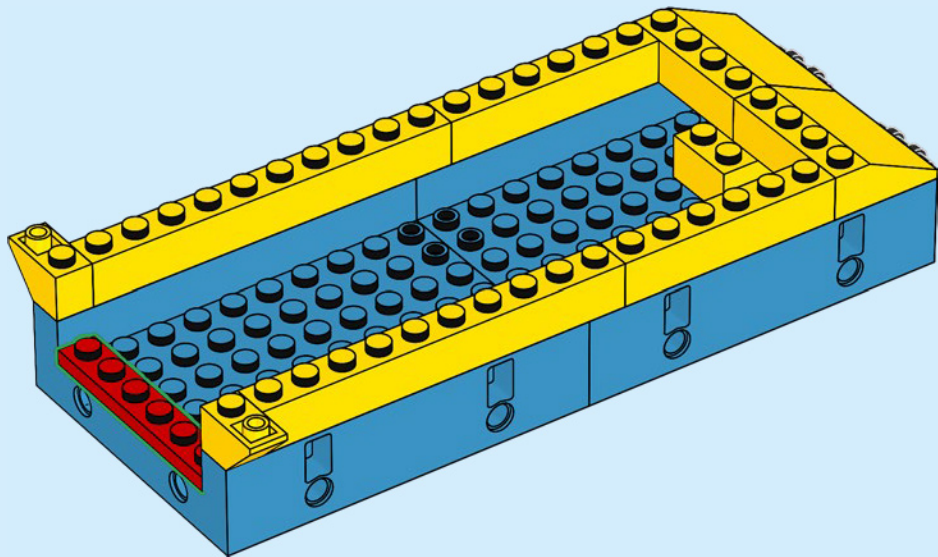

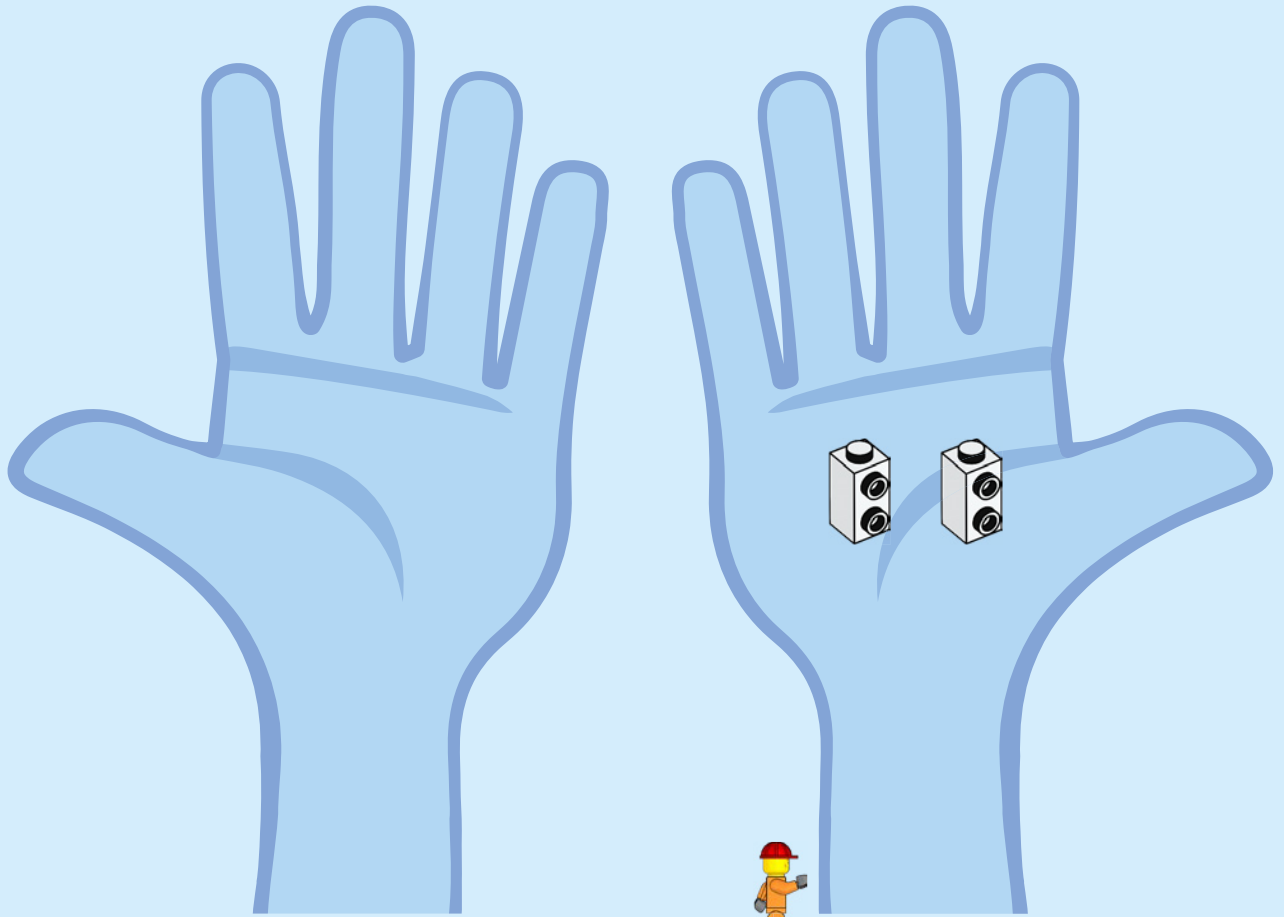

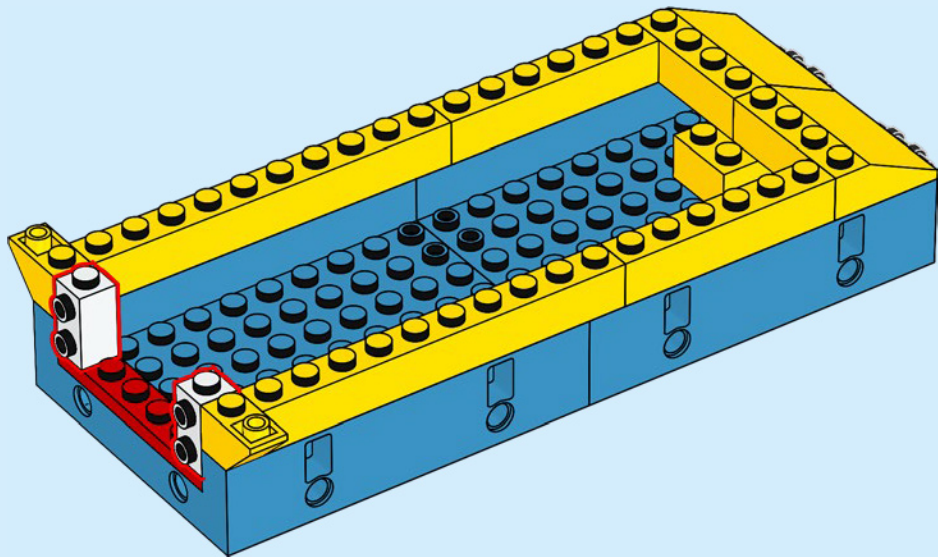

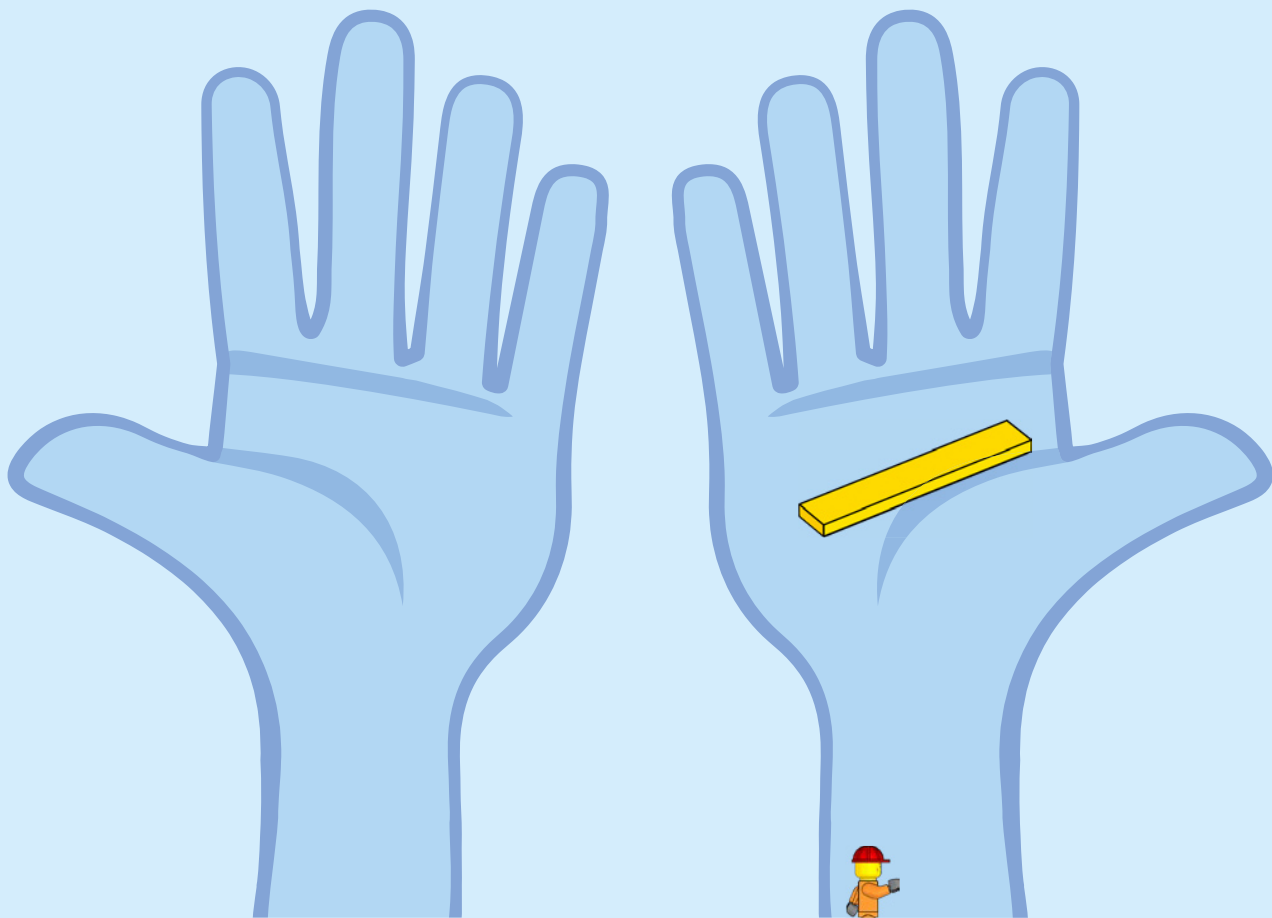



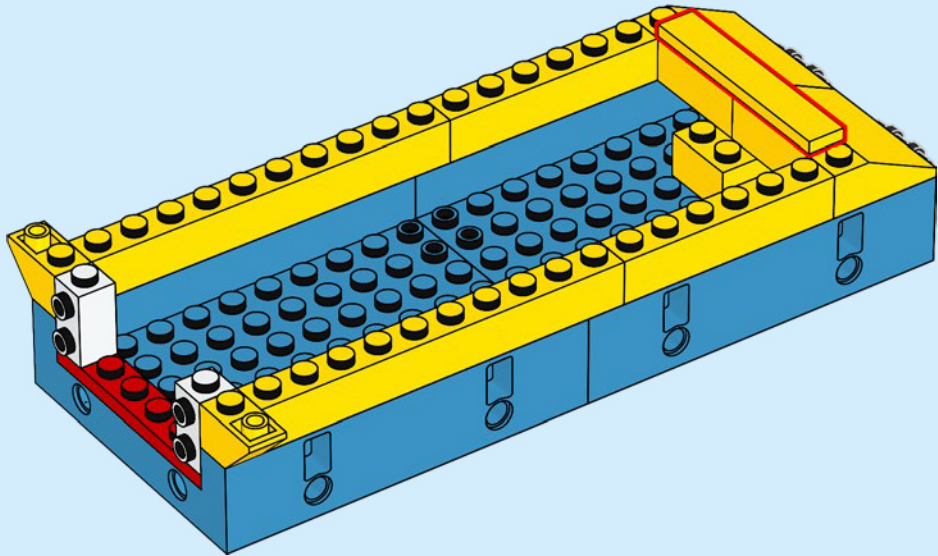

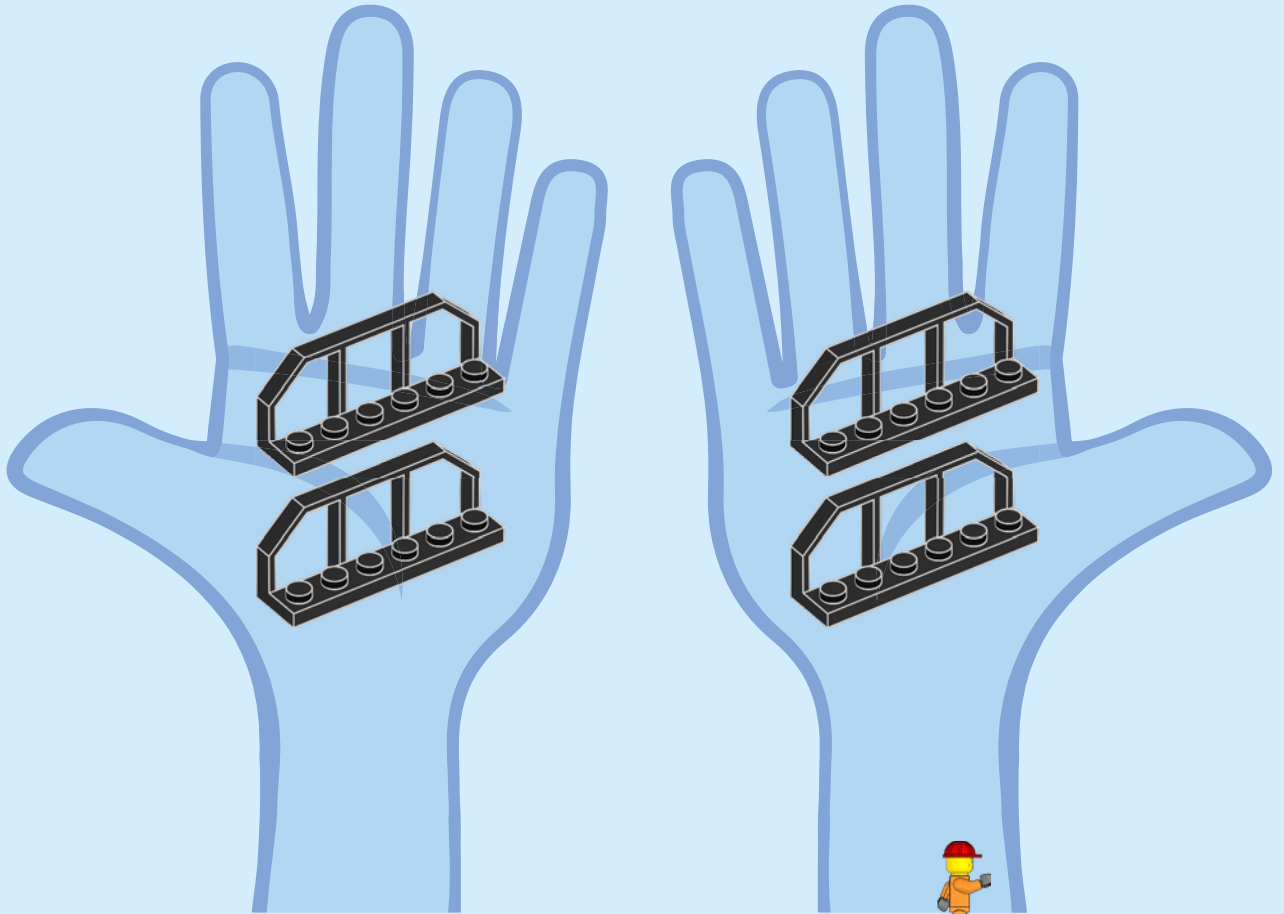

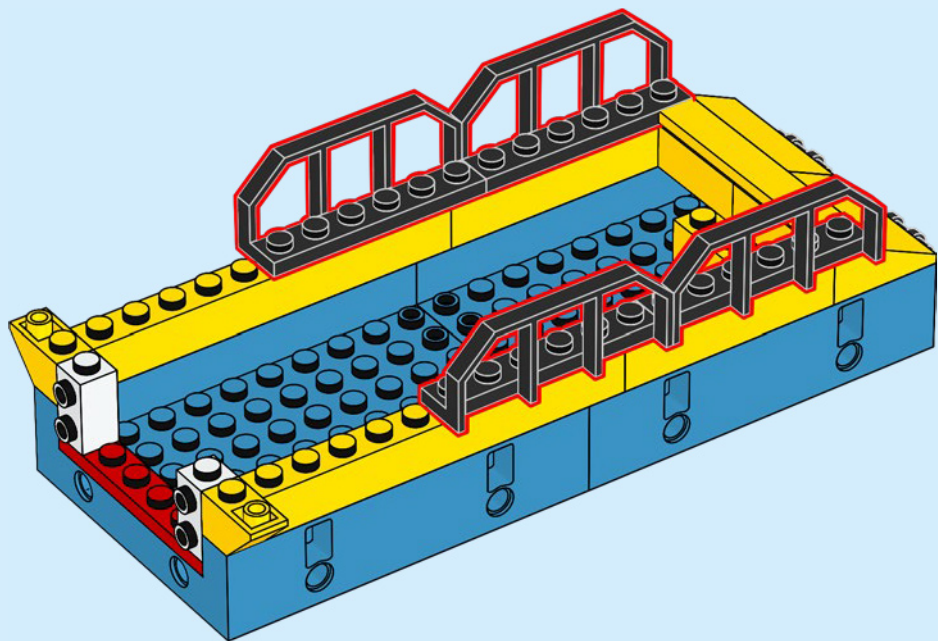

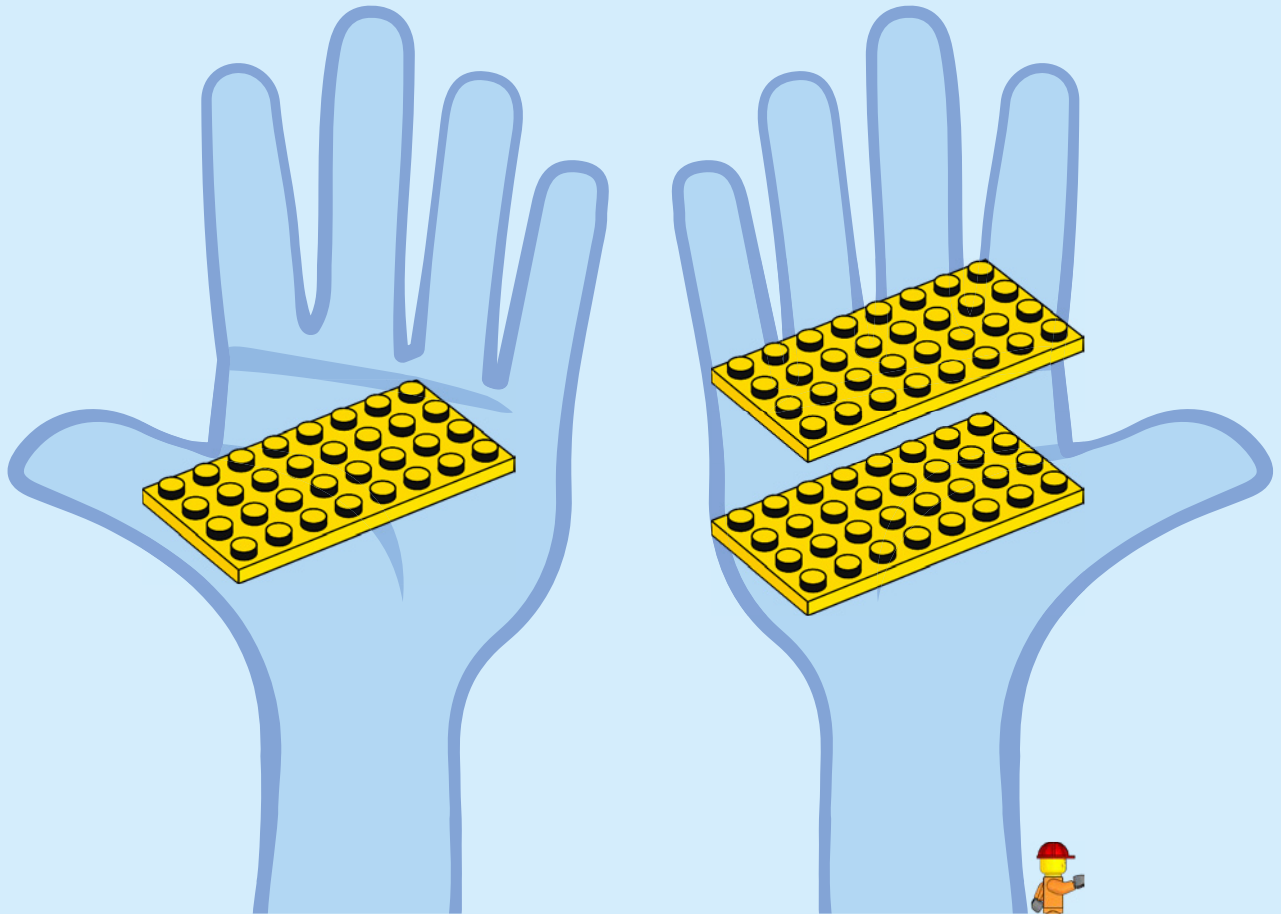

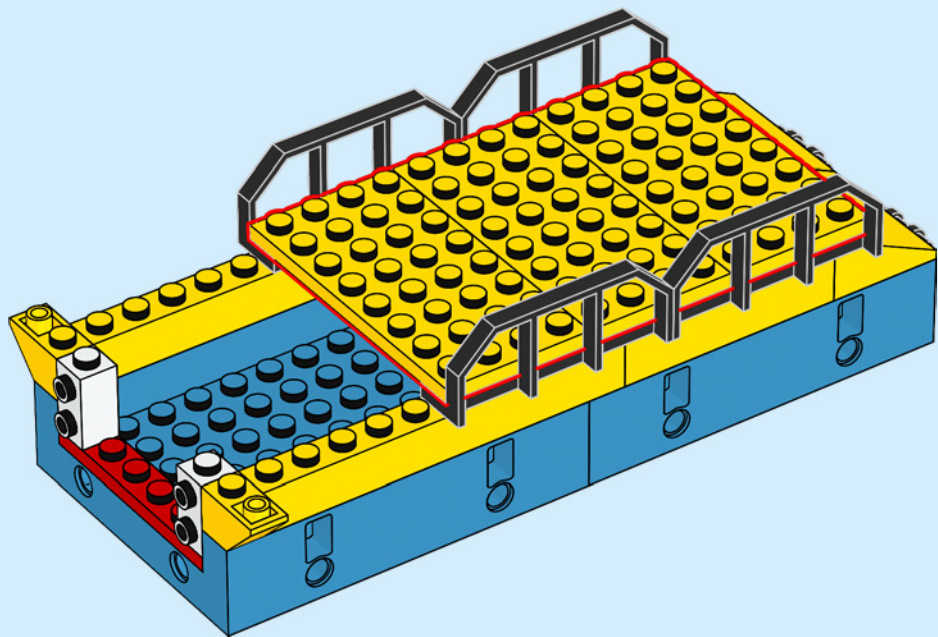

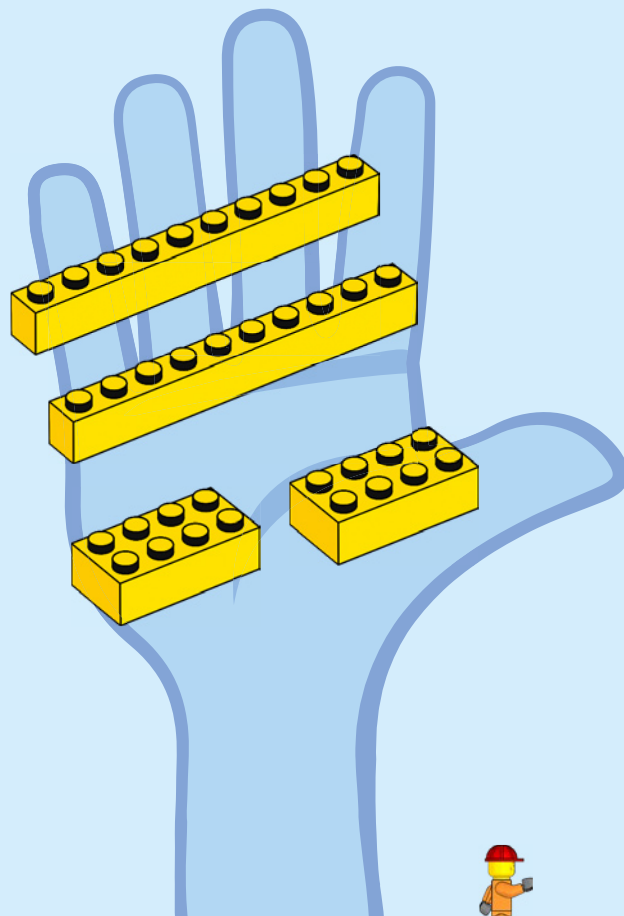
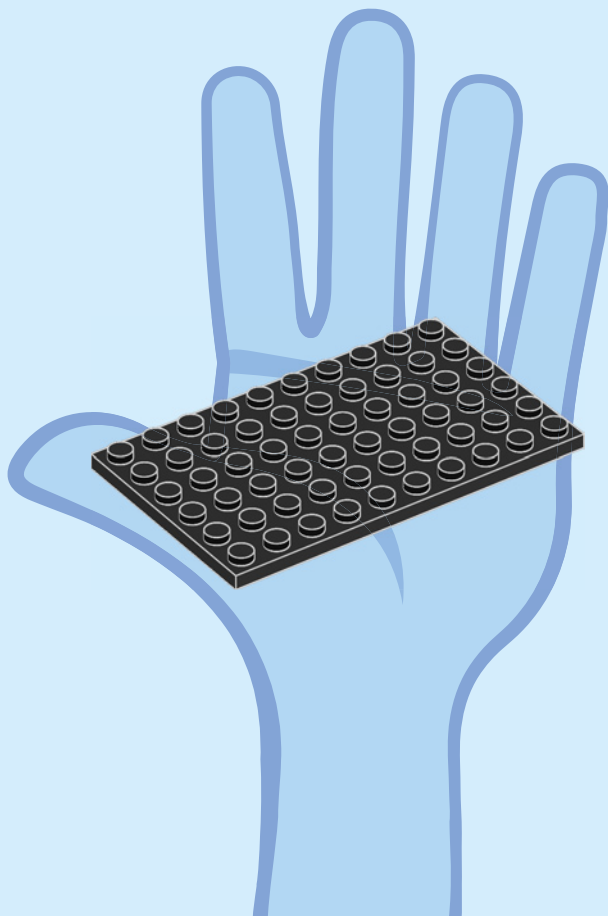
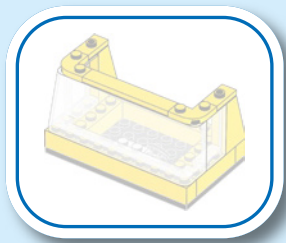

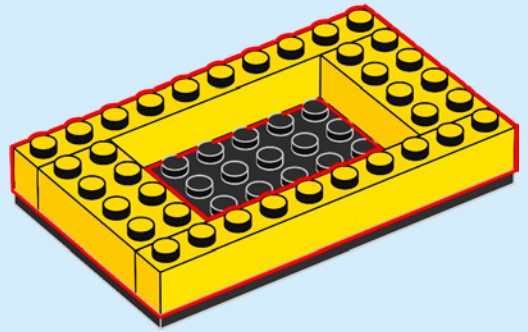
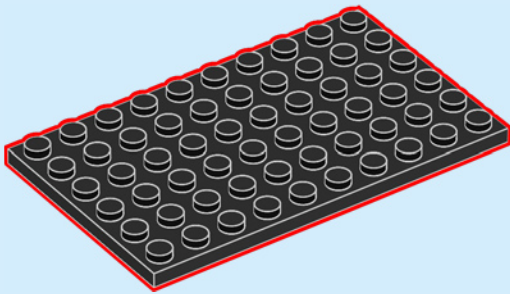

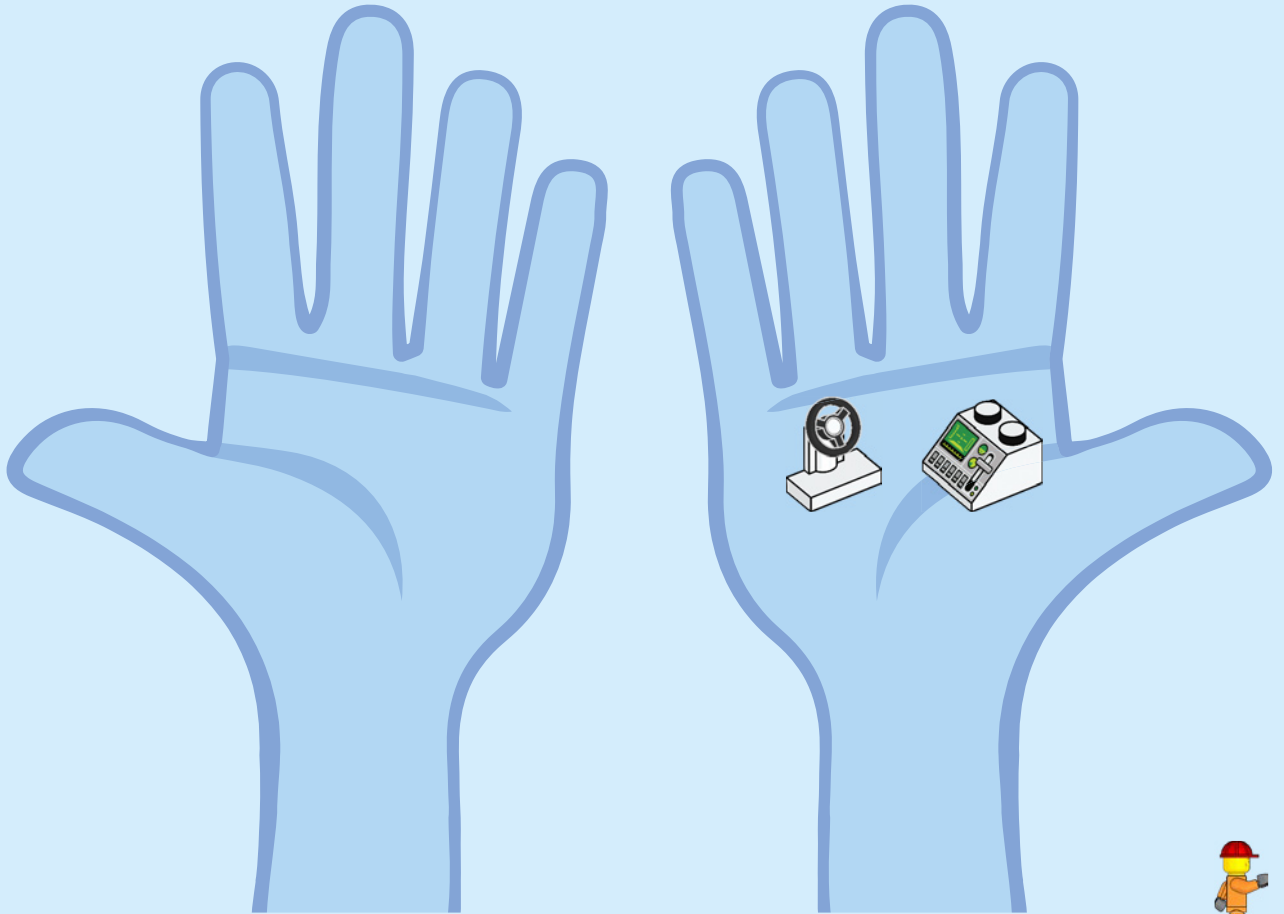



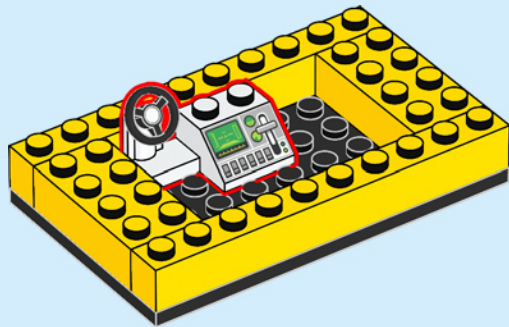

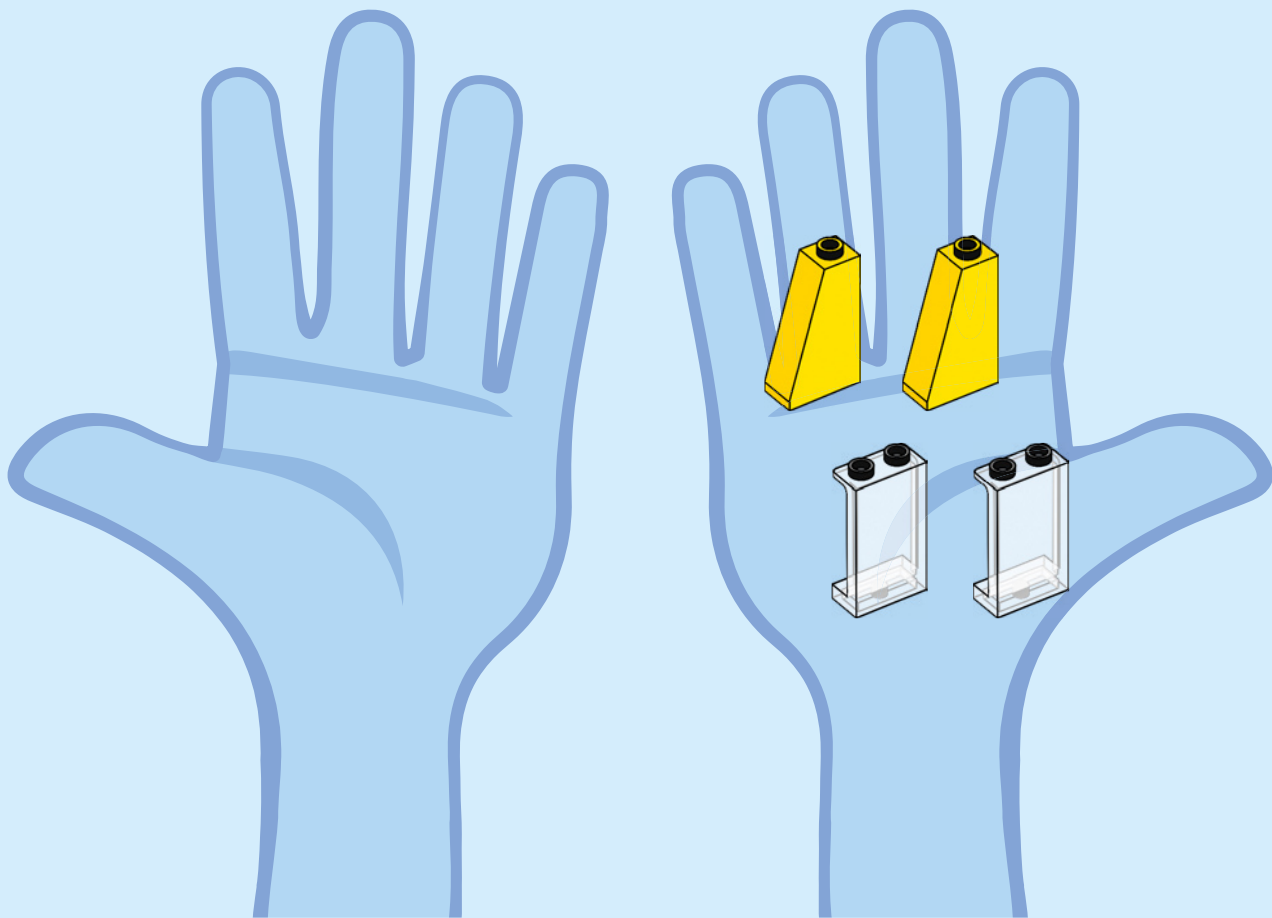

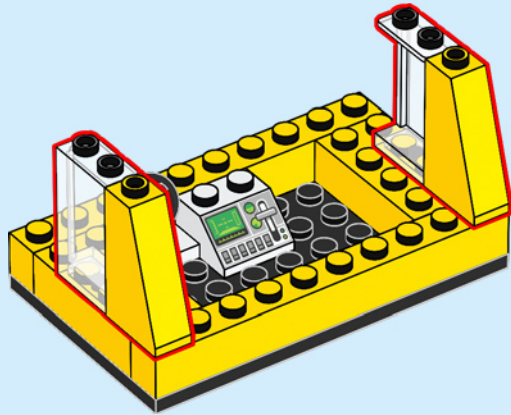

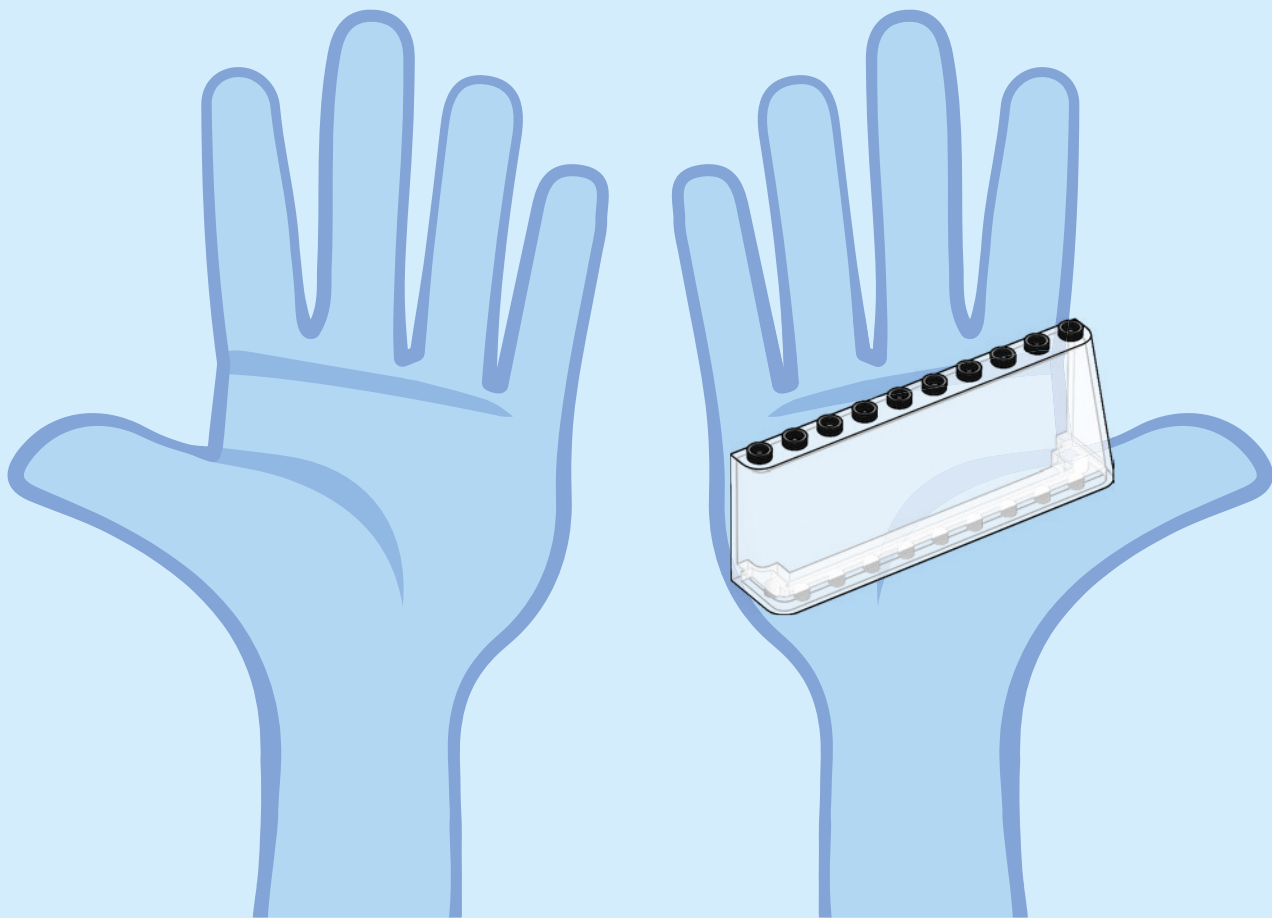

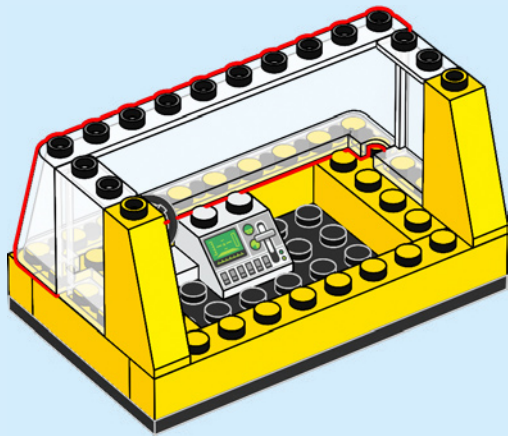

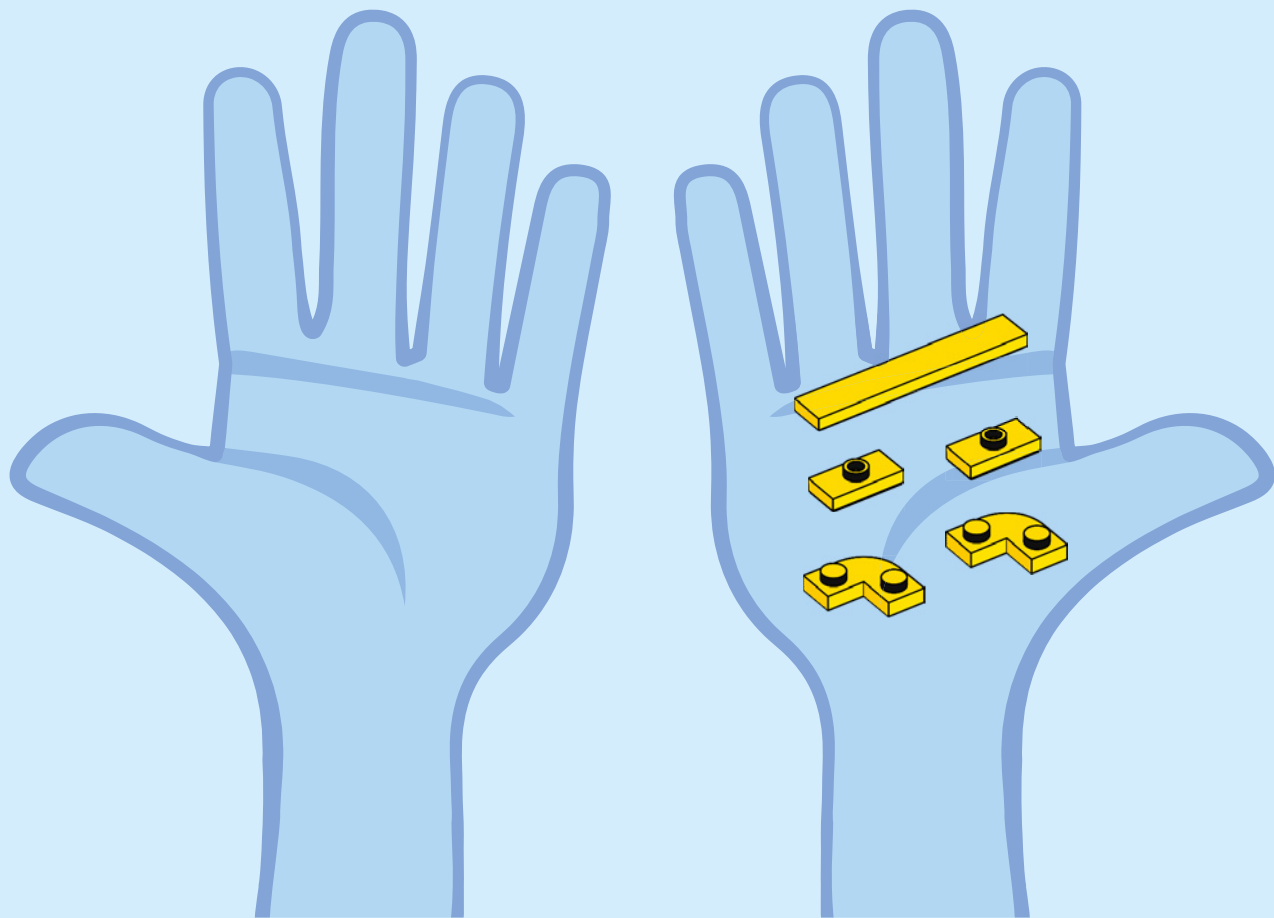

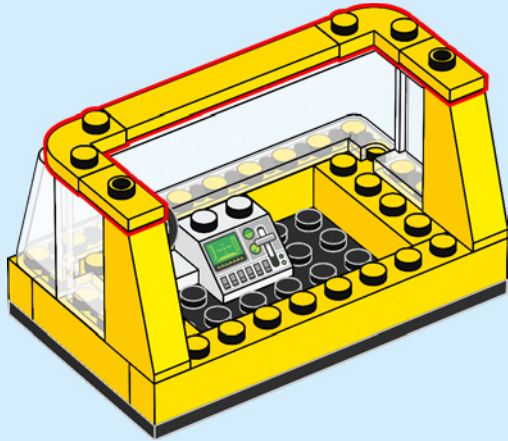

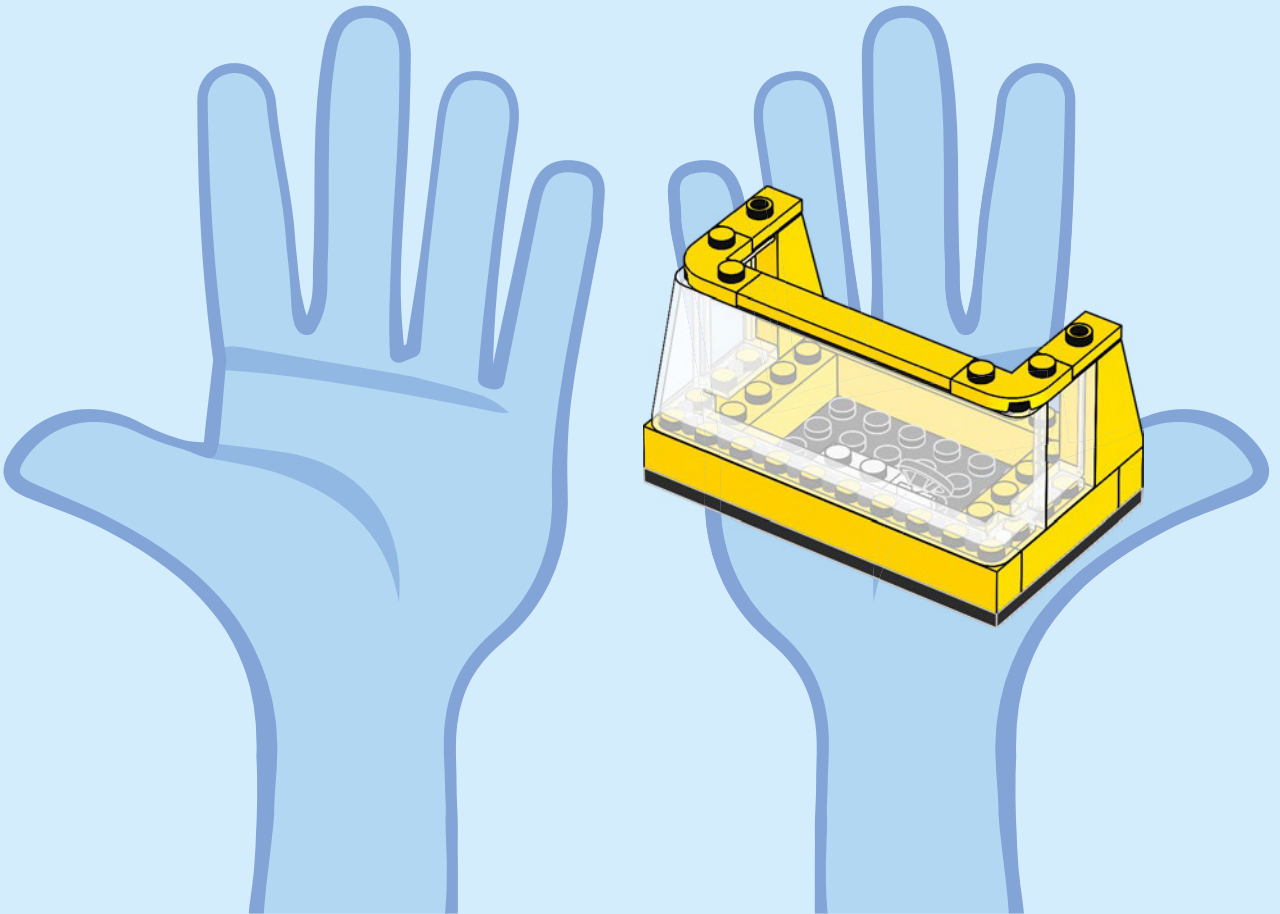



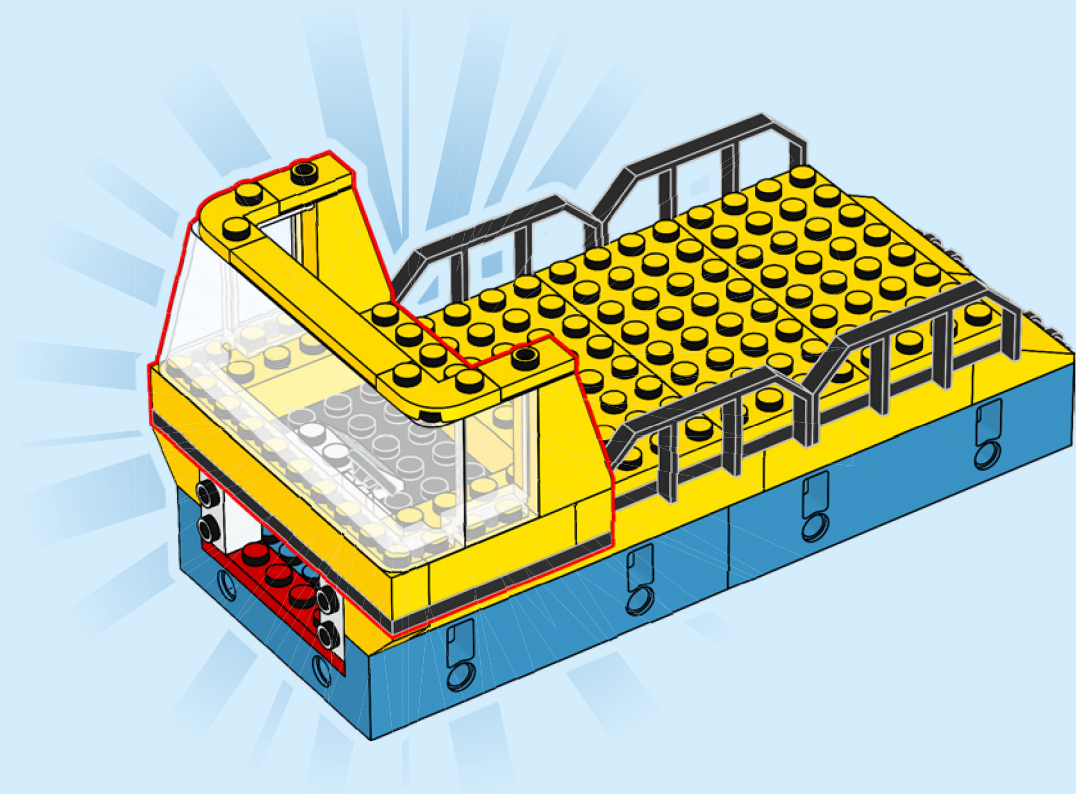

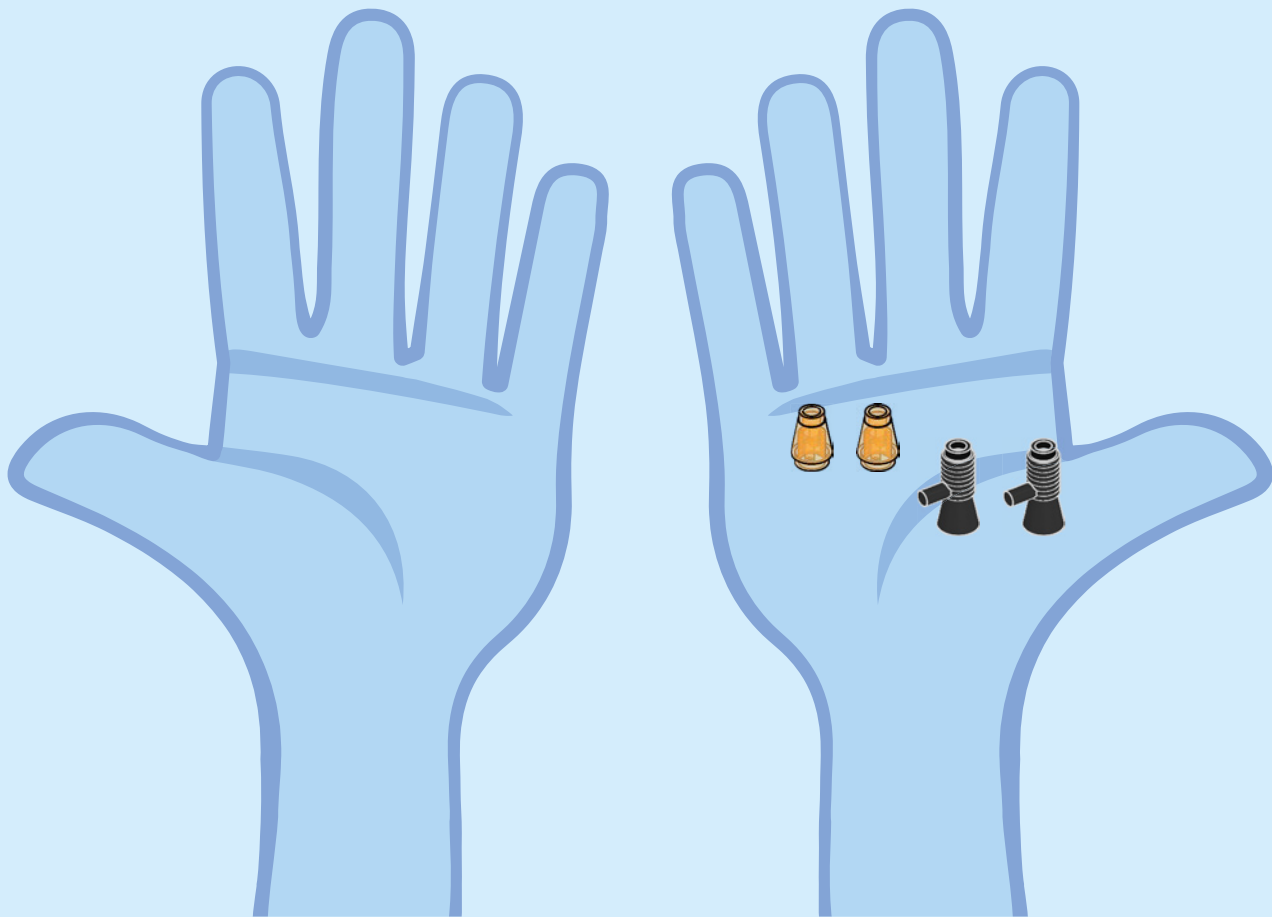

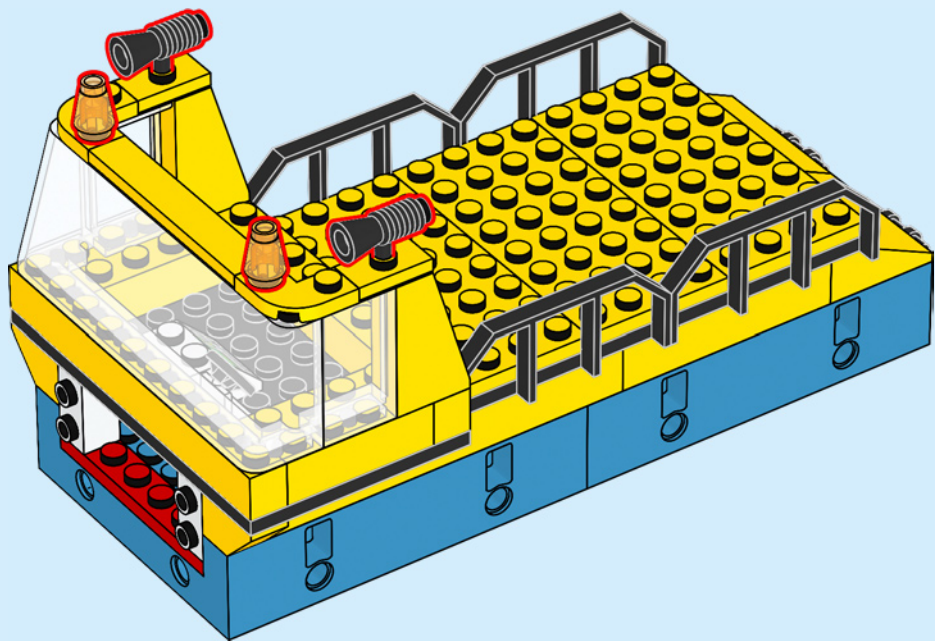

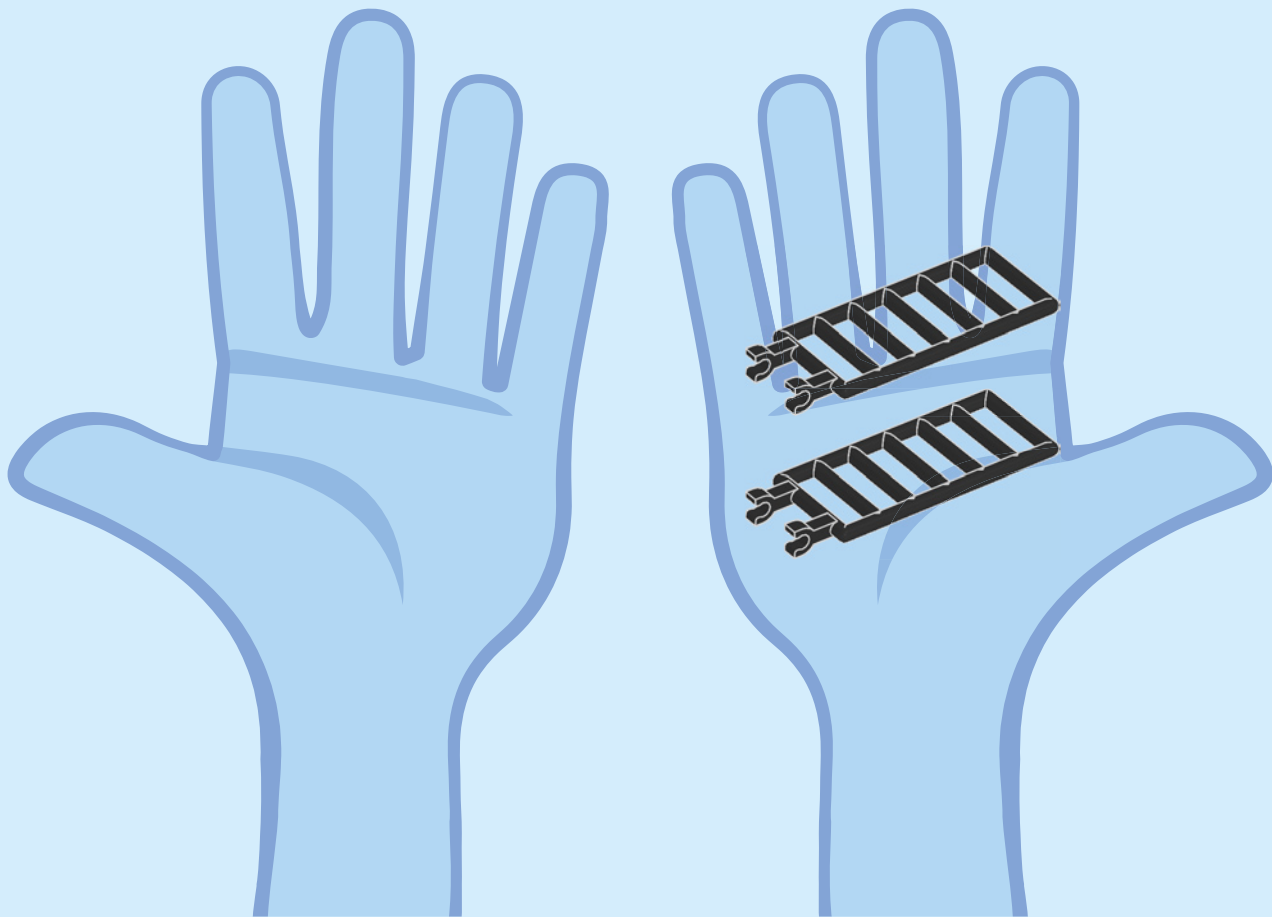

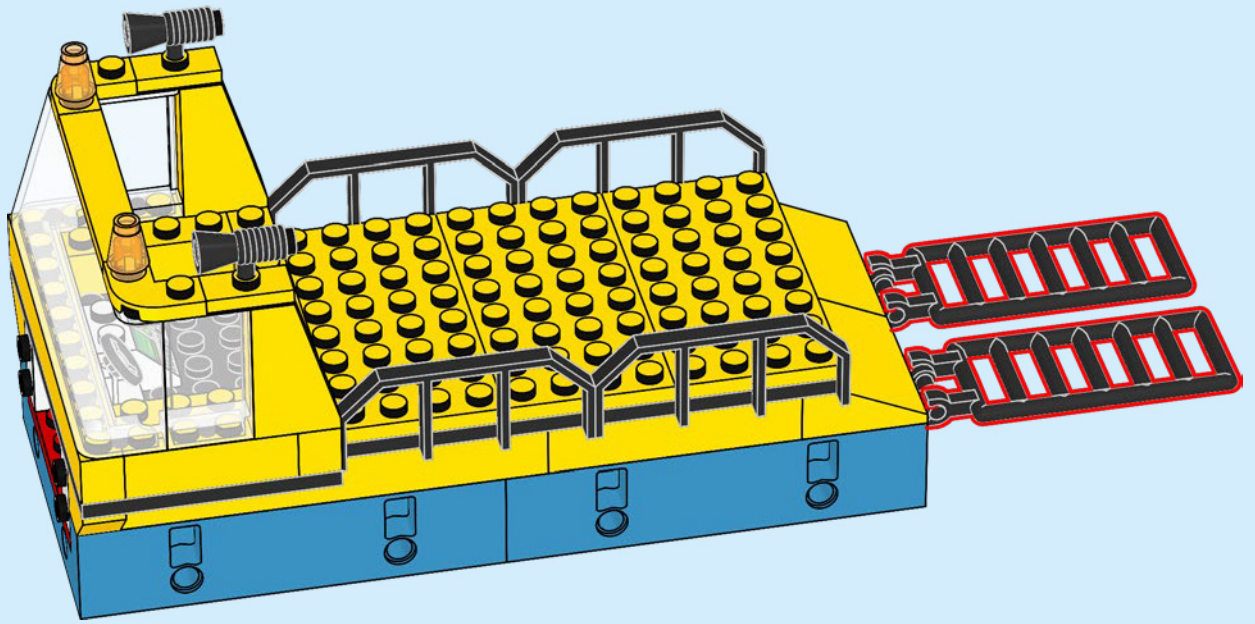

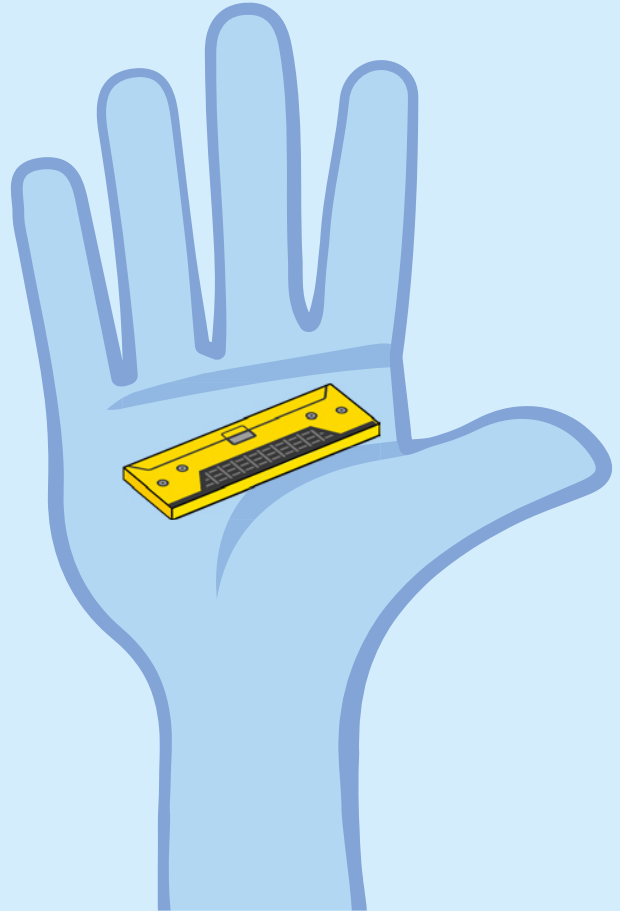
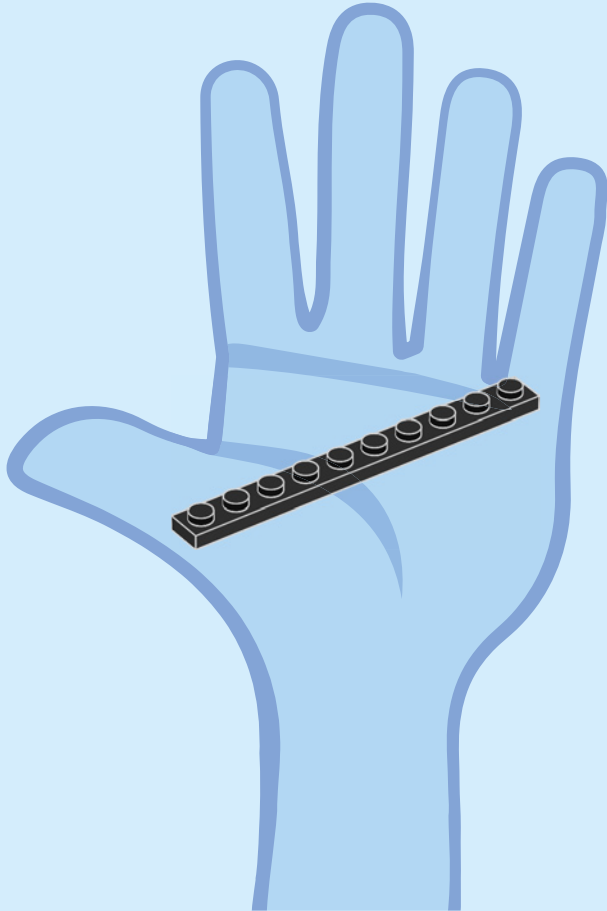
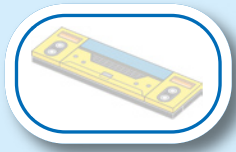

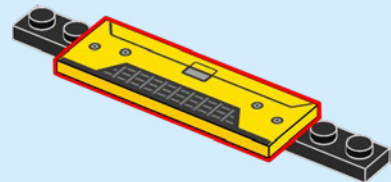
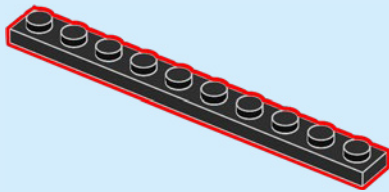

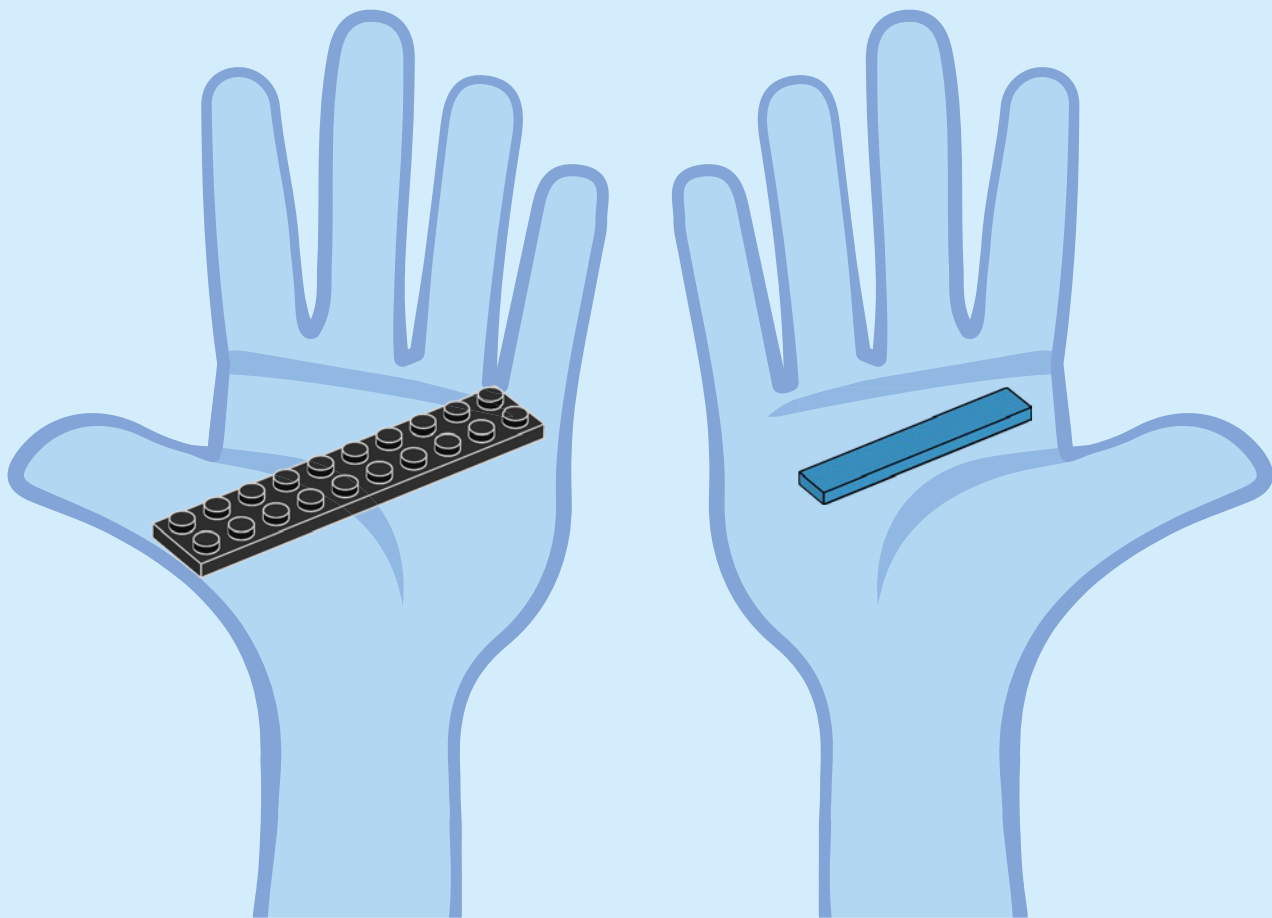



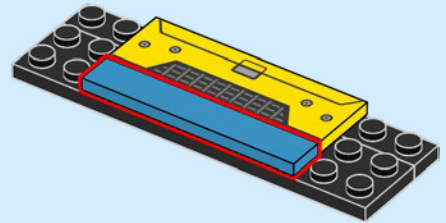
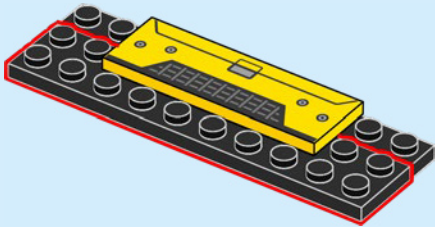

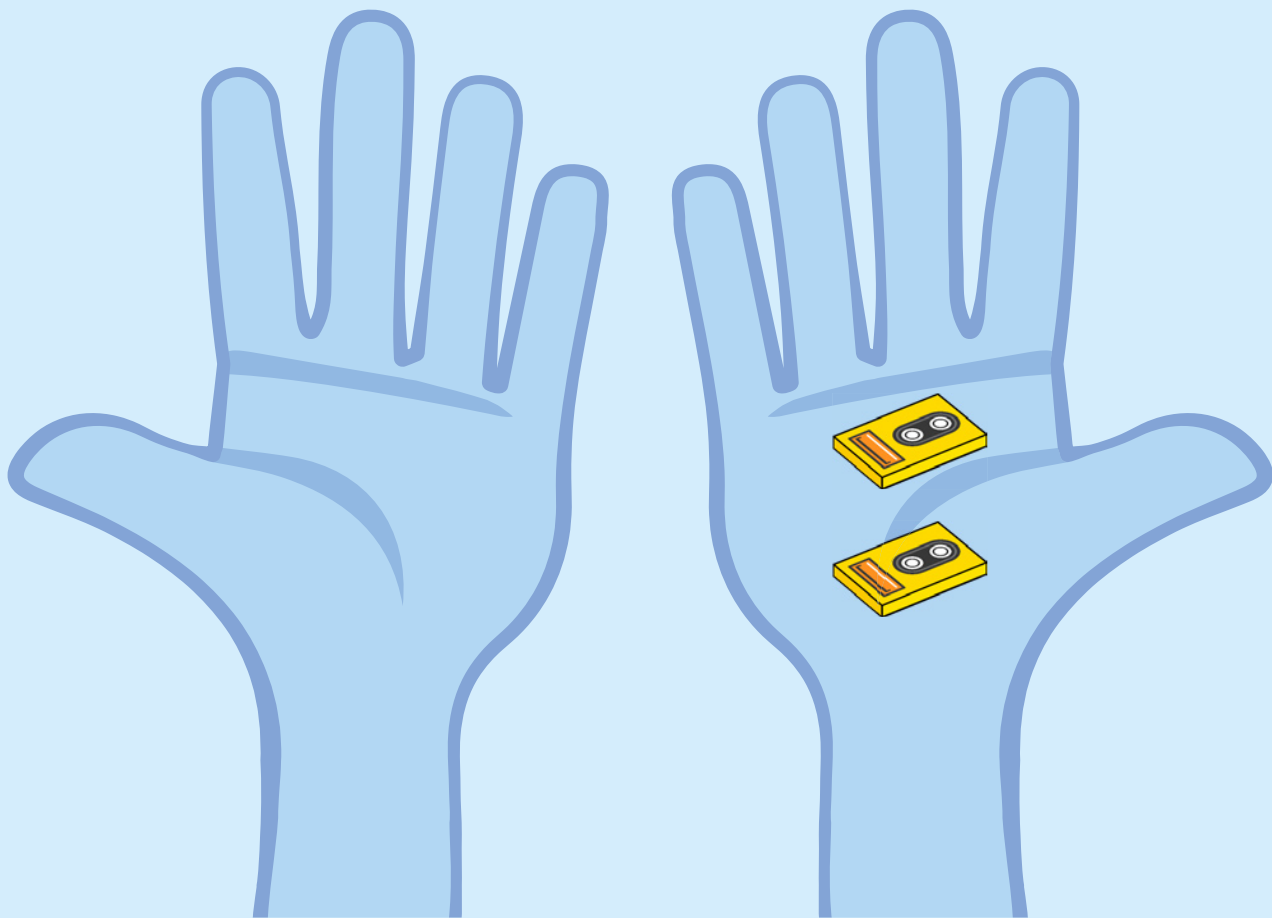

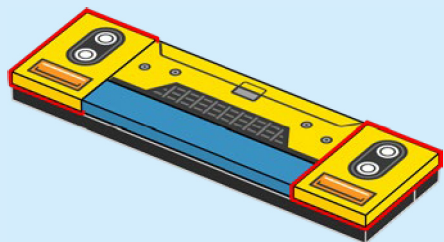

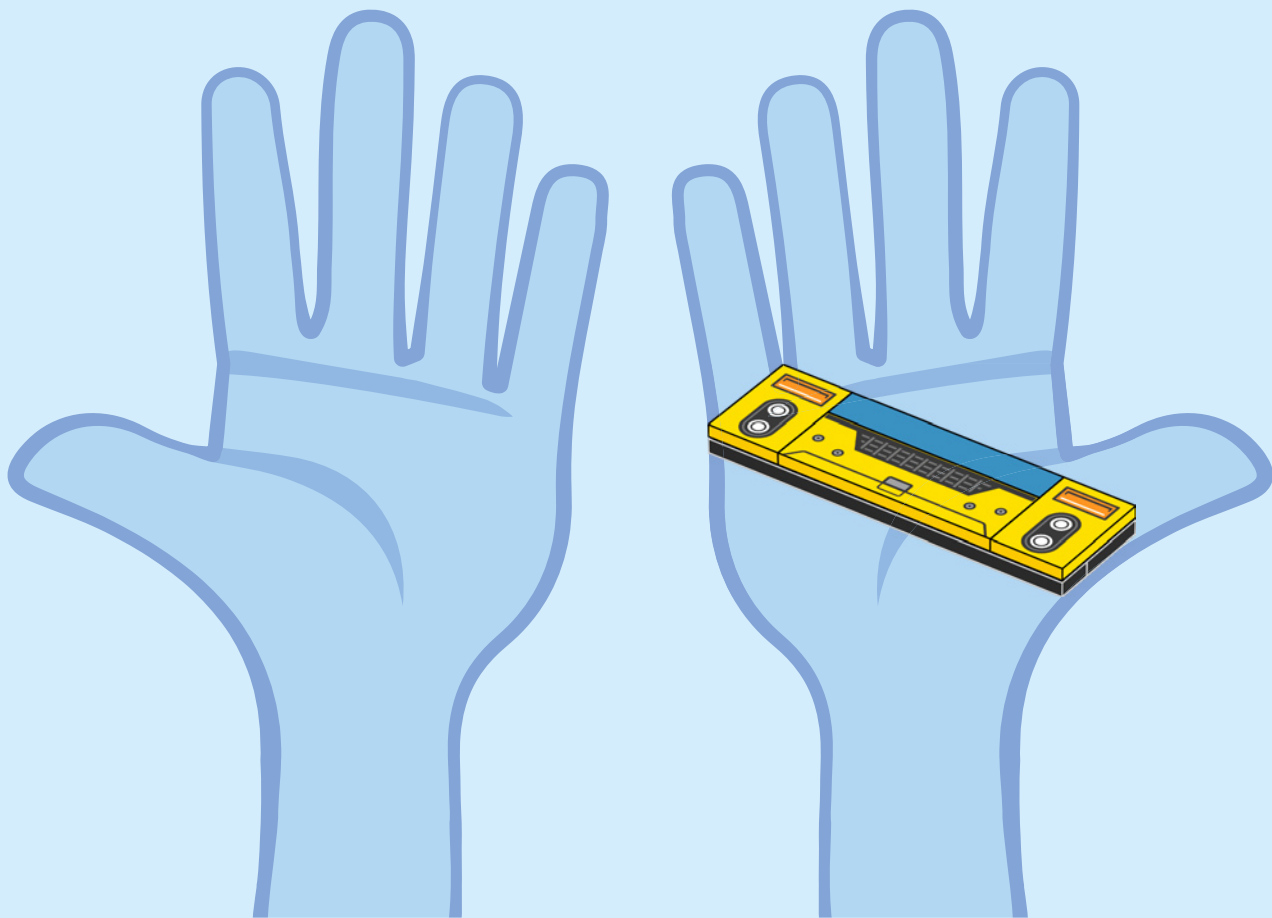

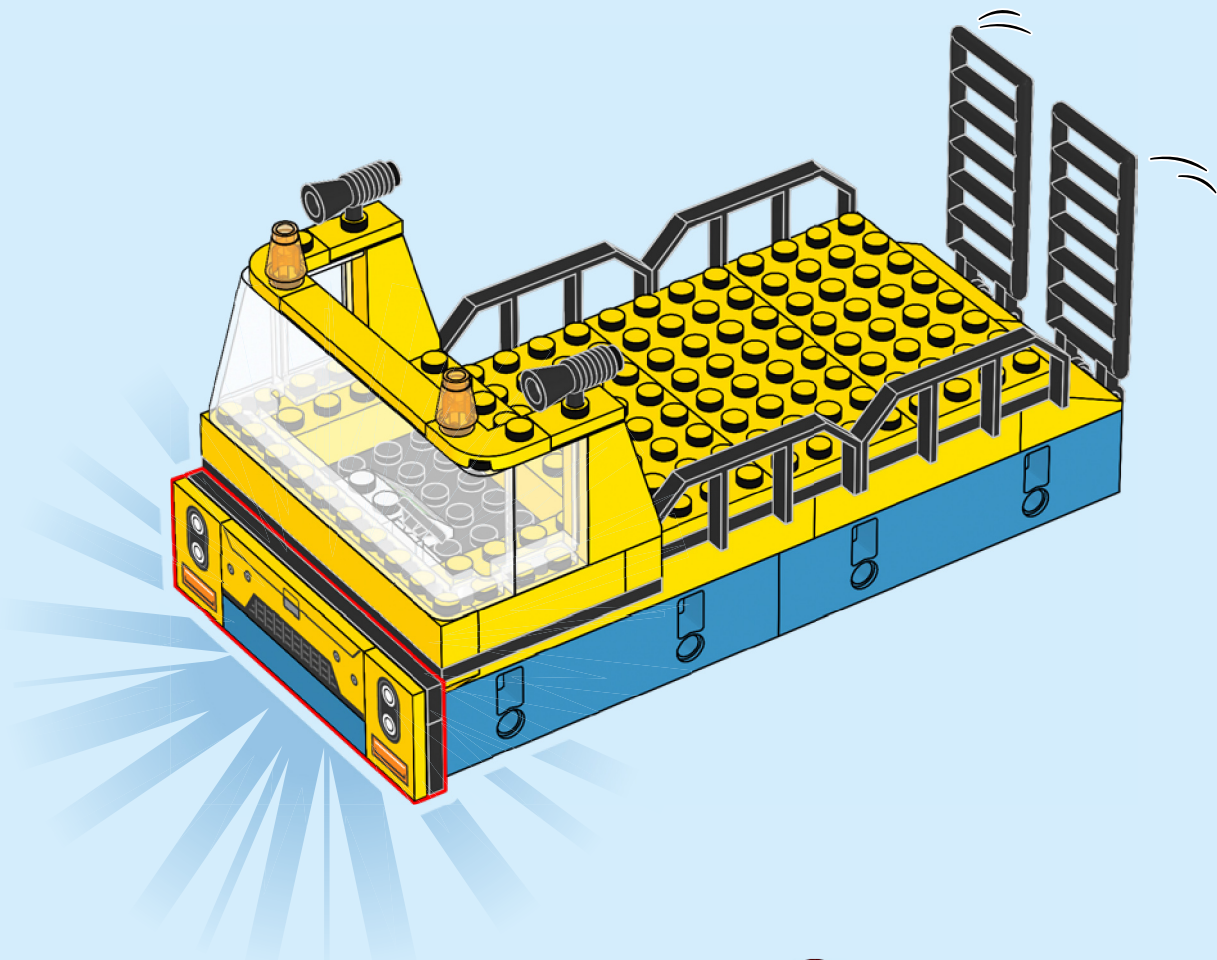

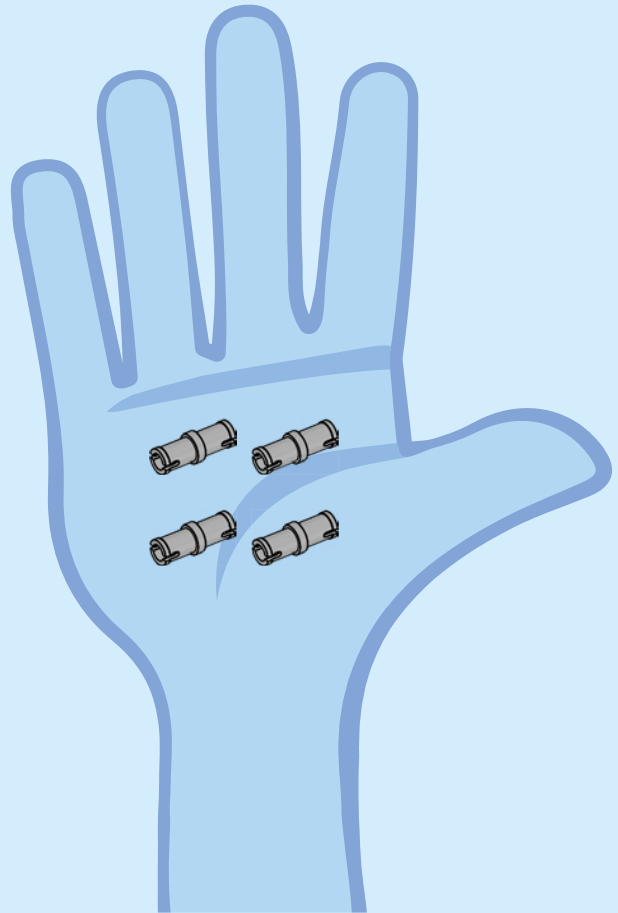
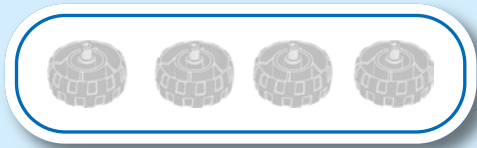

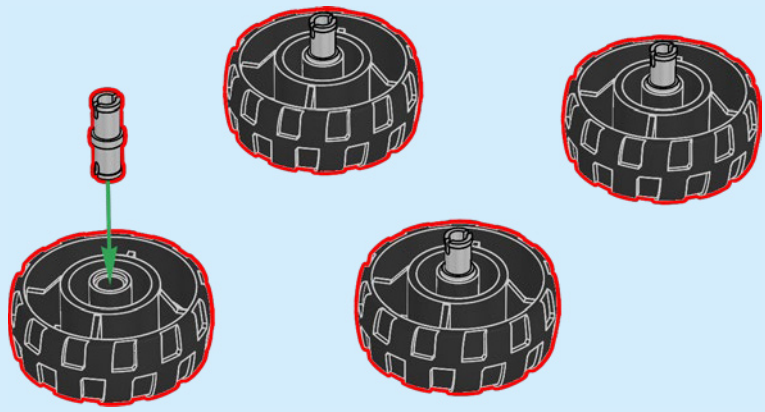

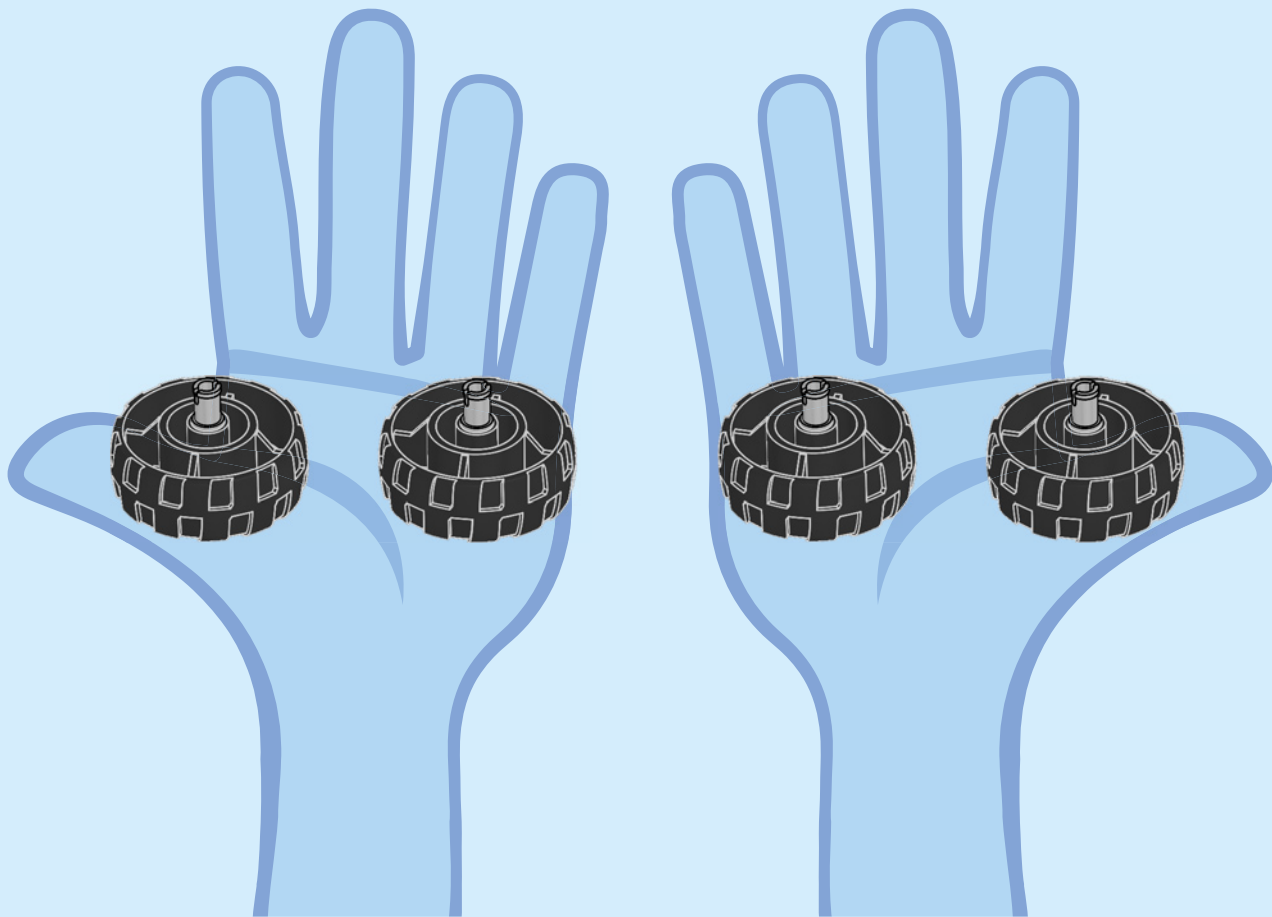



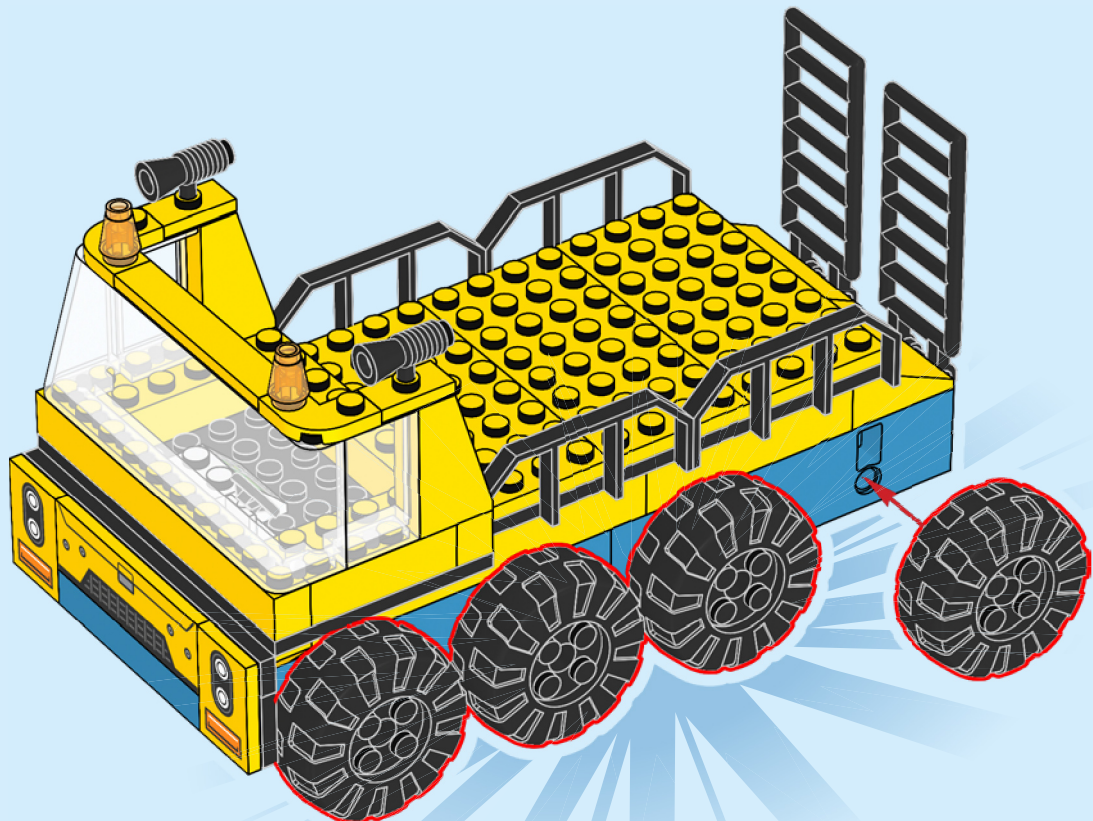

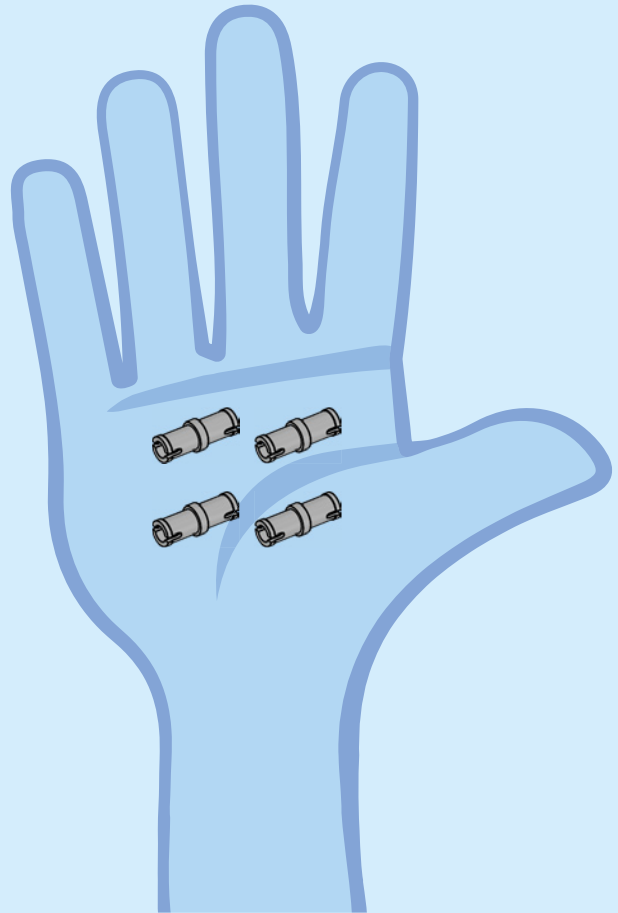
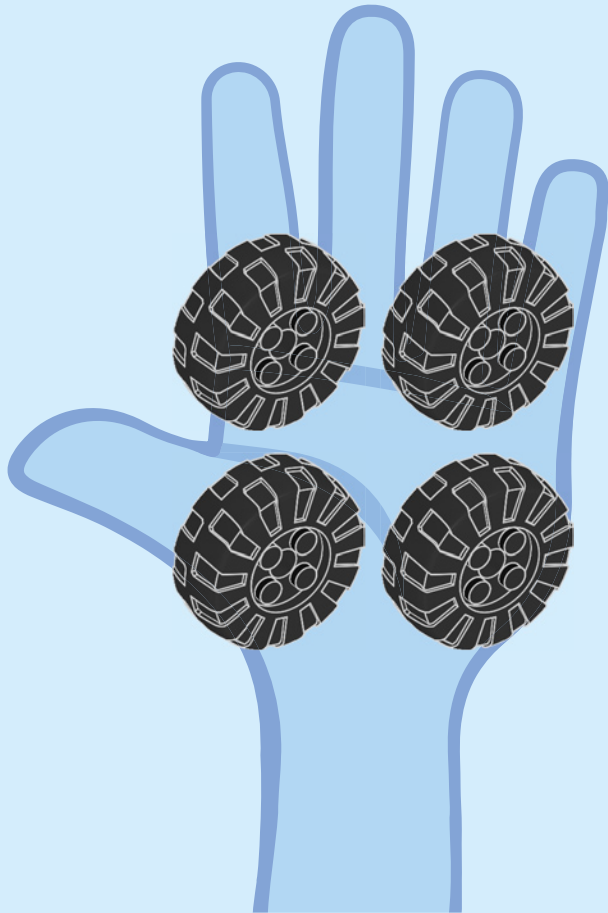
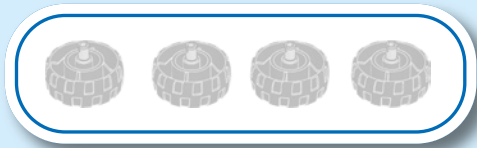

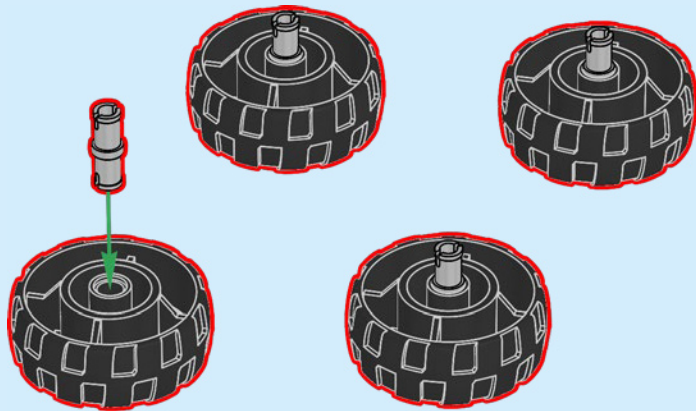

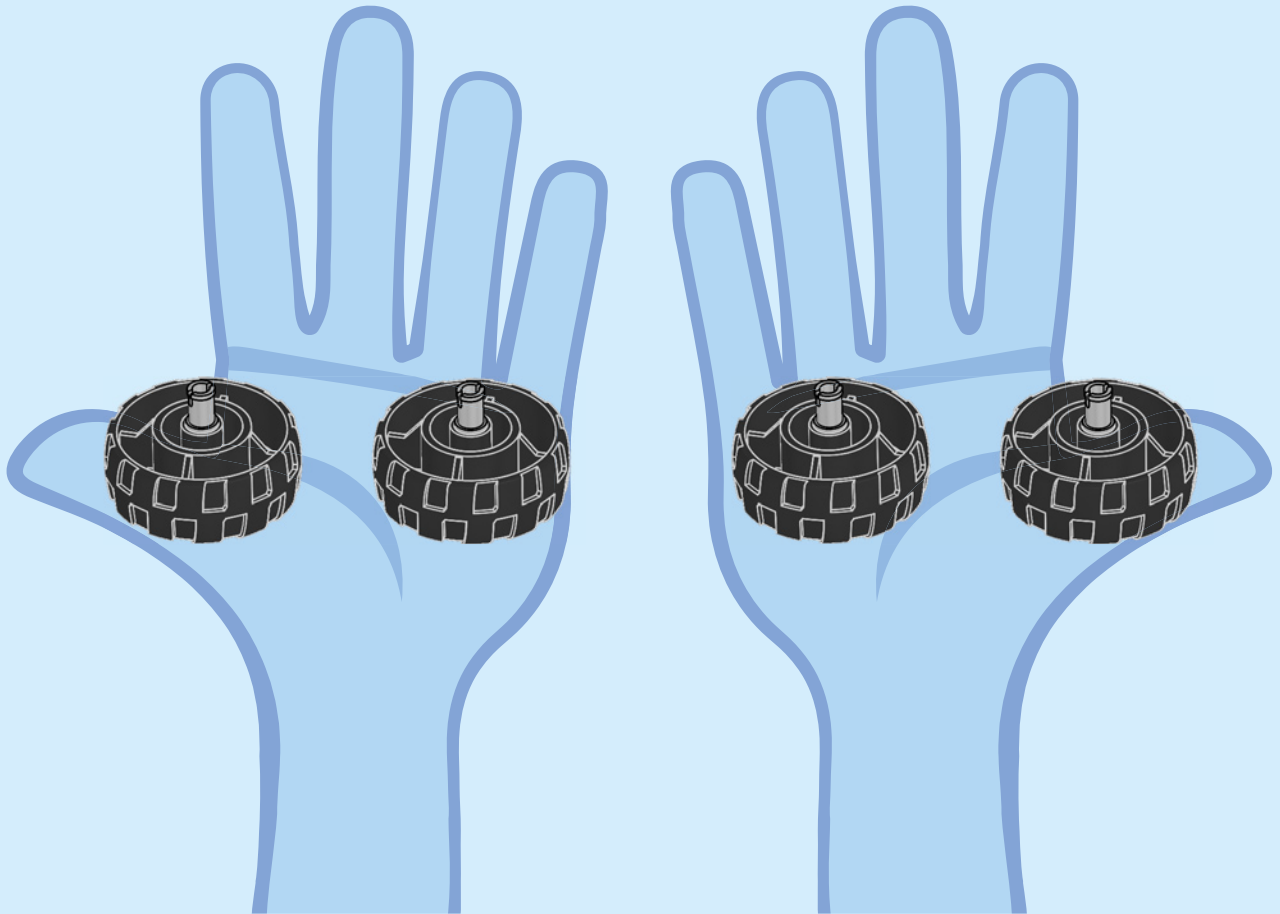

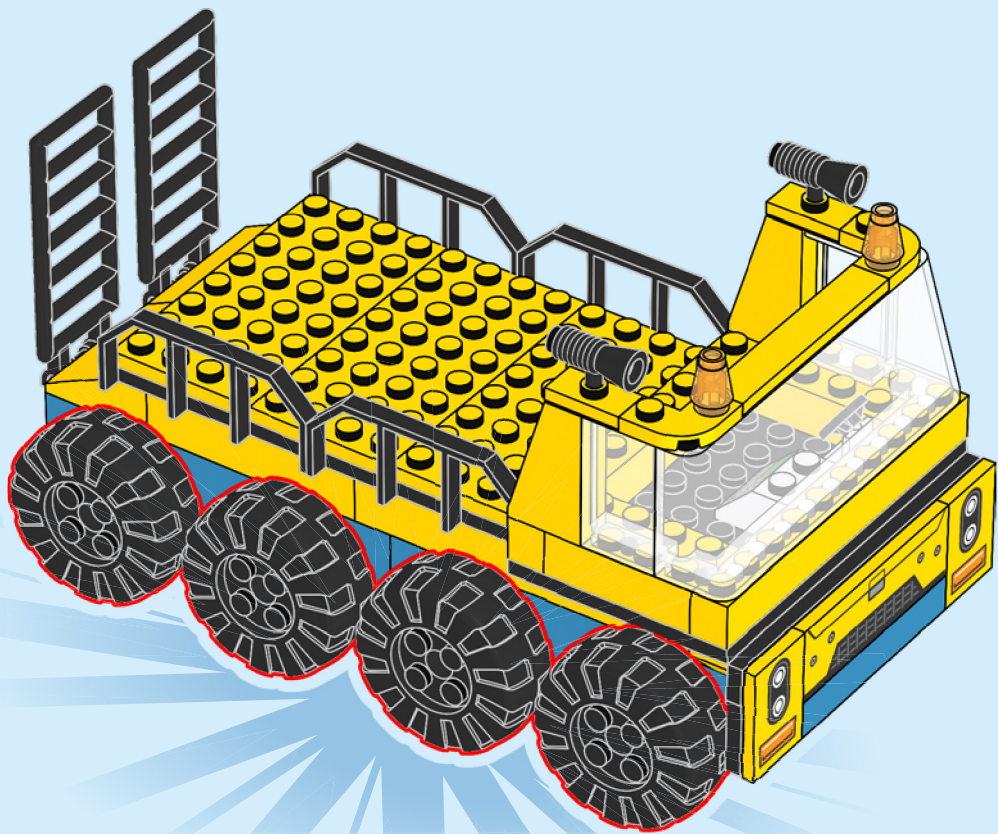

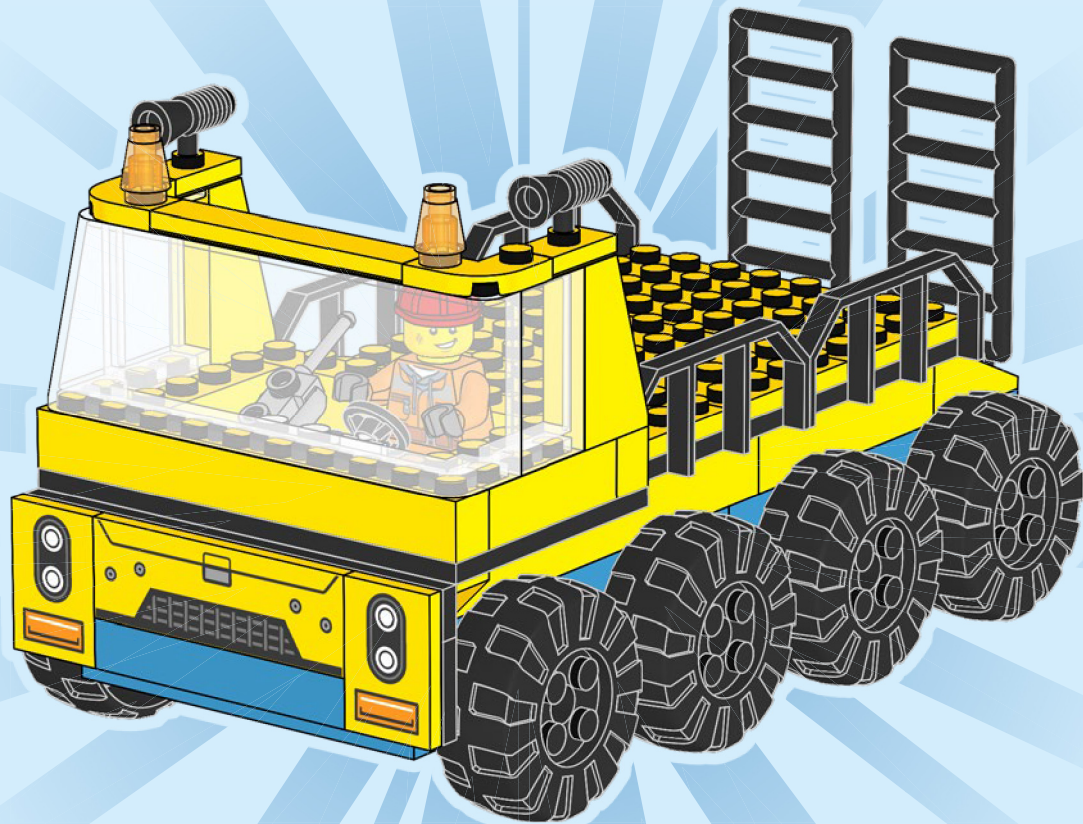

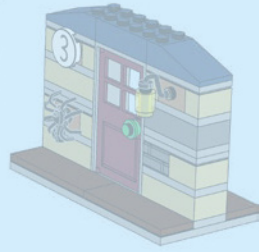
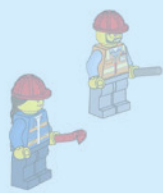
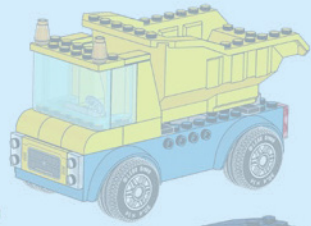
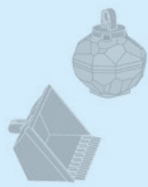
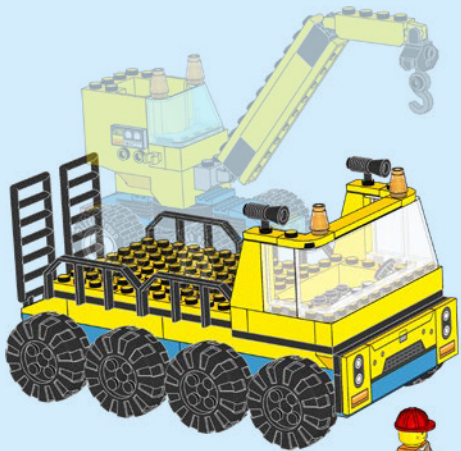

YOU COULD **WIN**



Scan this QR code or go to **LEGO.COM/PRODUCTFEEDBACK** and give us your short feedback about this LEGO® set for a chance to win a cool LEGO prize.

Terms and Conditions apply\*

**EN: YOU COULD WIN.** Terms and Conditions apply\* **DE: Du könntest GEWINNEN.** Es gelten die Teilnahmebedingungen\* **FR: Tu pourrais GAGNER.** Des conditions s'appliquent\* **IT: Potresti VINCERE tu.** Termini e condizioni sono applicabili\* **ES: Puedes GANAR.** Aplican términos y condiciones\* **PT: Poderá GANHAR.** Aplicam-se termos e condições\* **ZH: 轻松获奖. 条款和条件适用\*** **PL: Szansa na WYGRANĄ.** Obowiązują warunki korzystania\* **CS: Máte šanci VYHRÁT.** Platí všeobecné smluvní podmínky\* **SK: Máte šancu VYHRAŤ.** Platia všeobecné zmluvné podmienky\* **HU: TE IS NYERHETSZ.** Felhasználási feltételek érvényesek\* **RO: Ai putea CÂȘTIGA.** Se aplică termeni și condiții\* **BG: Можете да СПЕЧЕЛИТЕ.** Има определени правила и условия\* **LV: Tu vari LAIMĒT.** Ir spēkā noteikumi un nosacījumi.\* **ET: Sul on võimalus VÕITA.** Kehtivad tingimused\* **LT: Jūs galite LAIMĖTI.** Taikomos sąlygos\*

\*[LEGO.com/productfeedback-terms](https://www.lego.com/productfeedback-terms)