

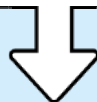

40346

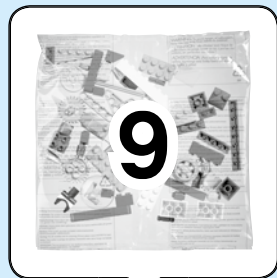

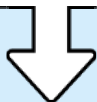
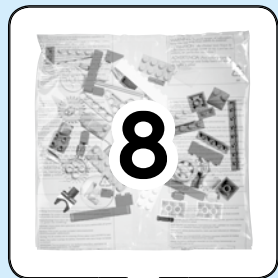
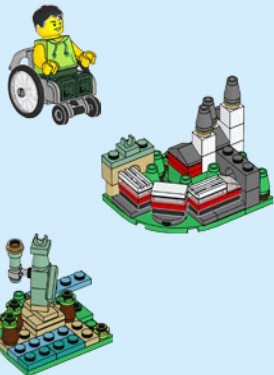
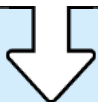
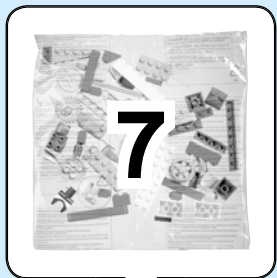

7

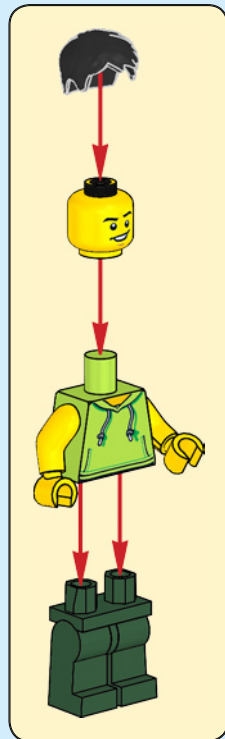
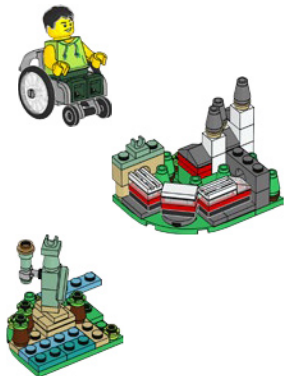
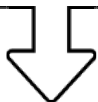

1

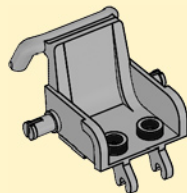

2



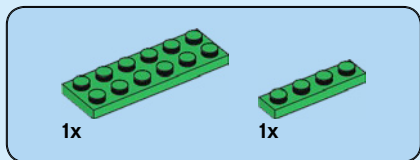
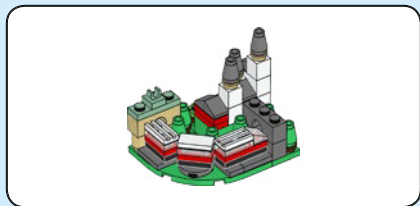

1

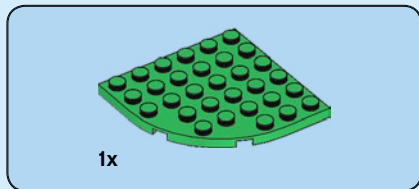
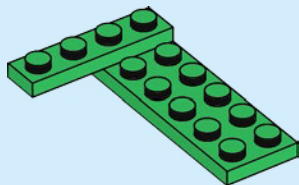

2

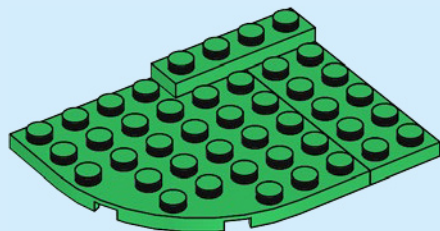

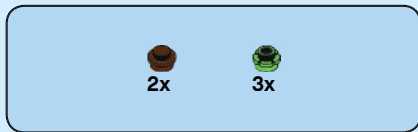

3

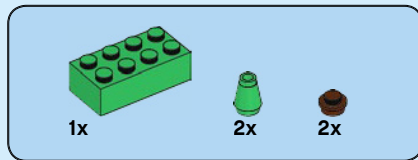
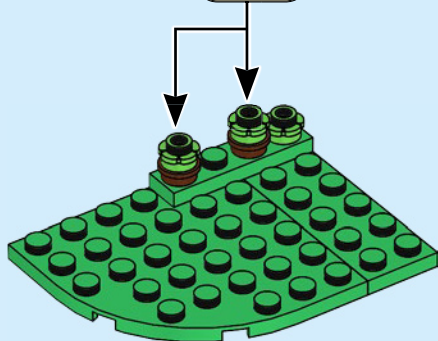
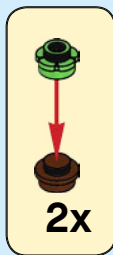

4

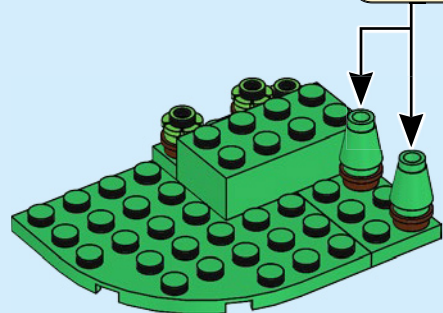
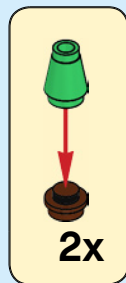



2x



2x

5

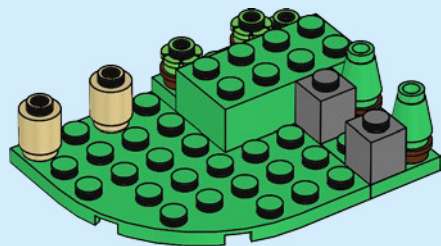

6



1x



1x



2x

6

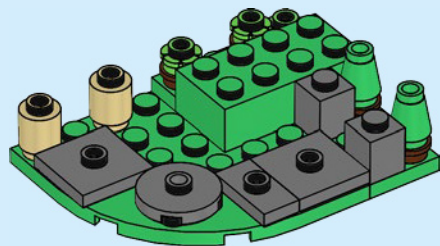



4x



4x

7



4x

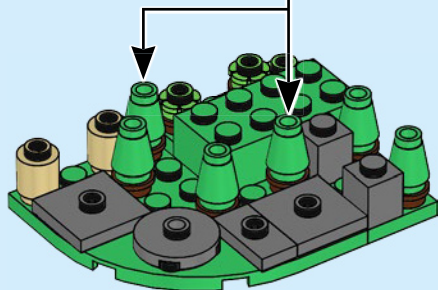

2x



2x

8

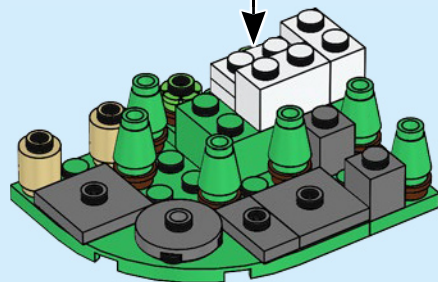
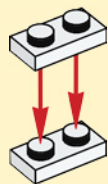

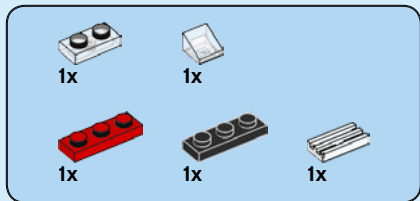

9

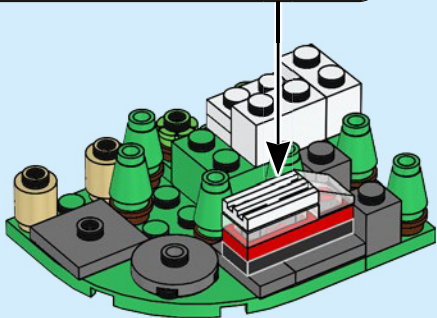
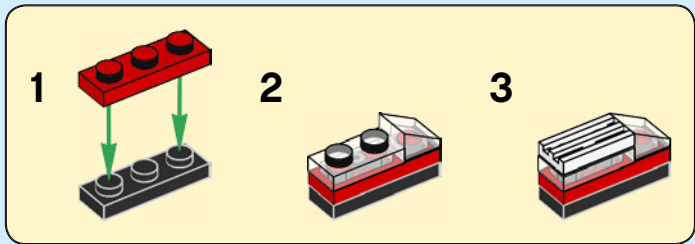

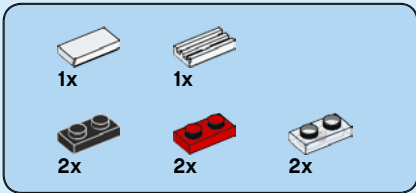

10

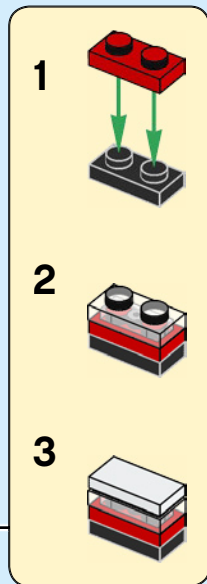
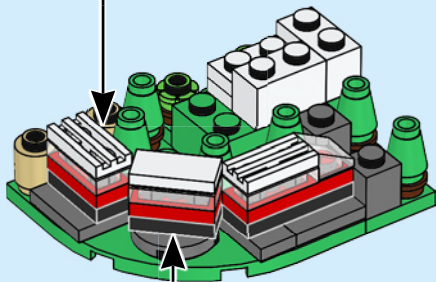

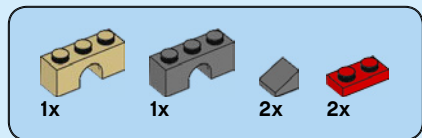

11

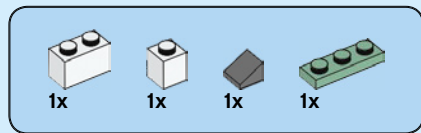
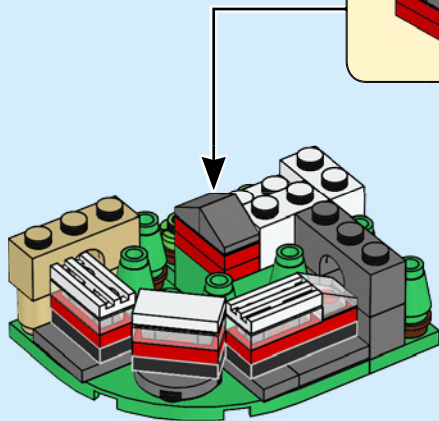
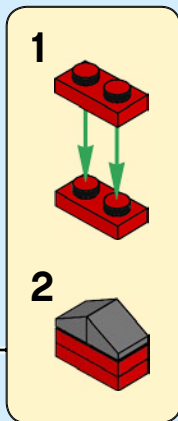

12

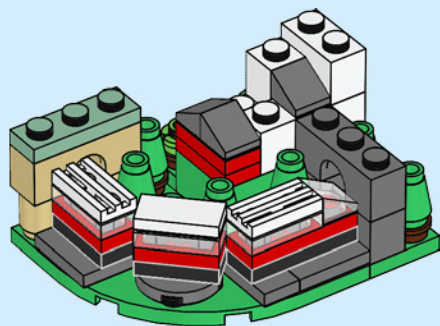



13

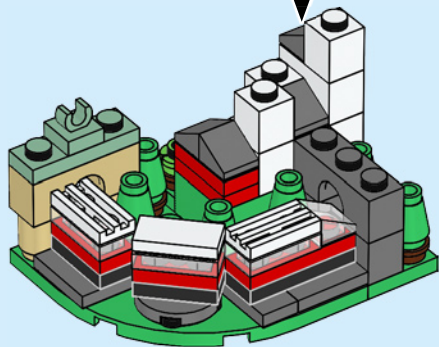
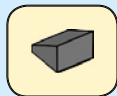

14

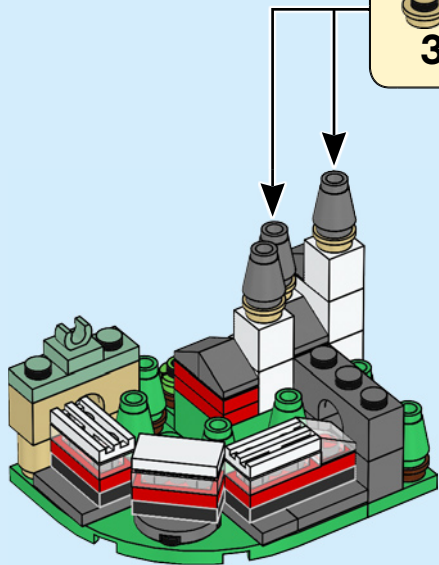
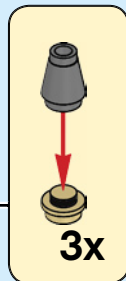

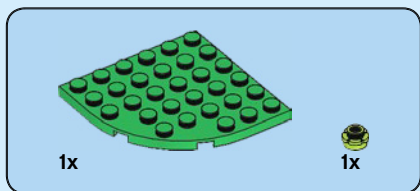

1

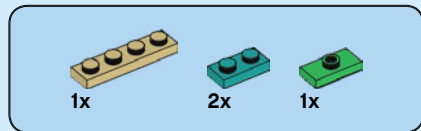
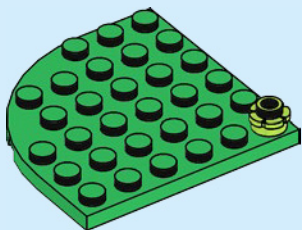

2

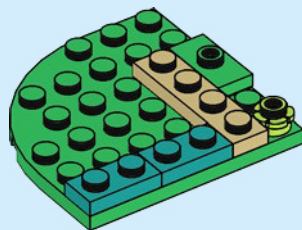

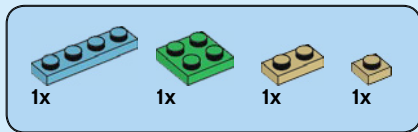

3

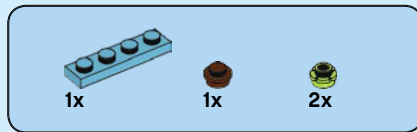
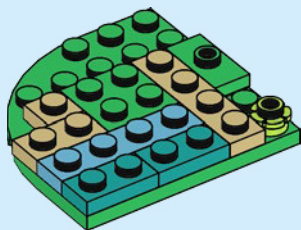

4

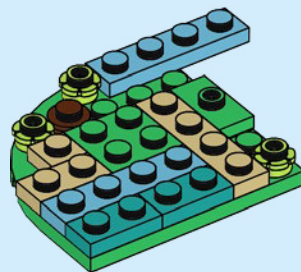

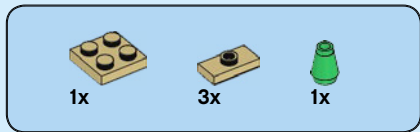

5

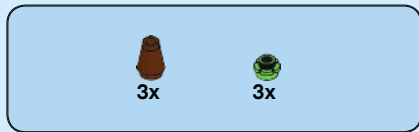
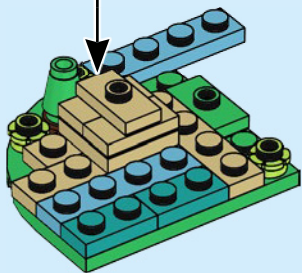
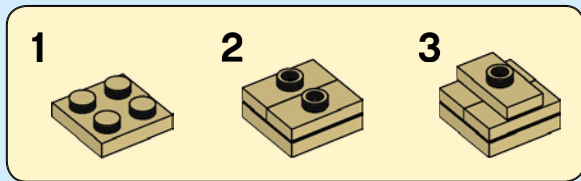

6

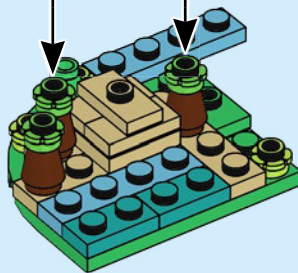
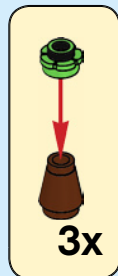

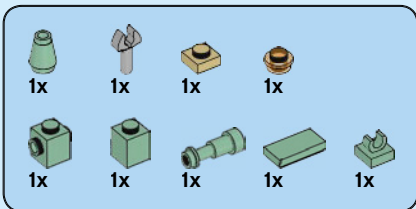

7

1

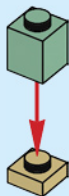

2



3



4



5

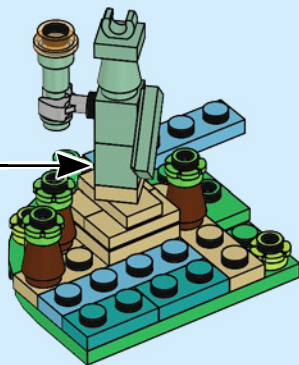
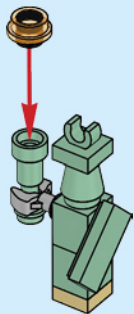

8

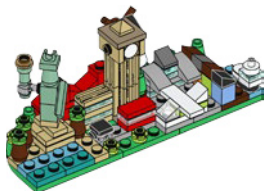
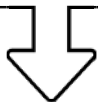
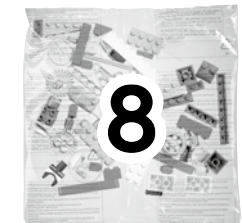

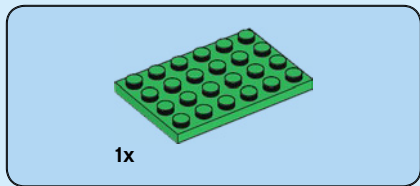

8

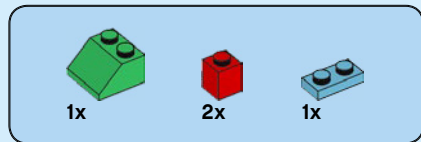
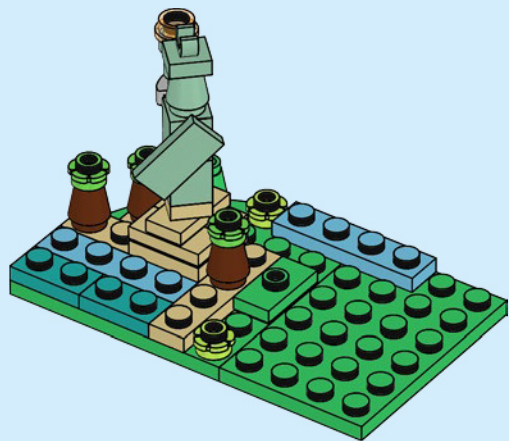

9

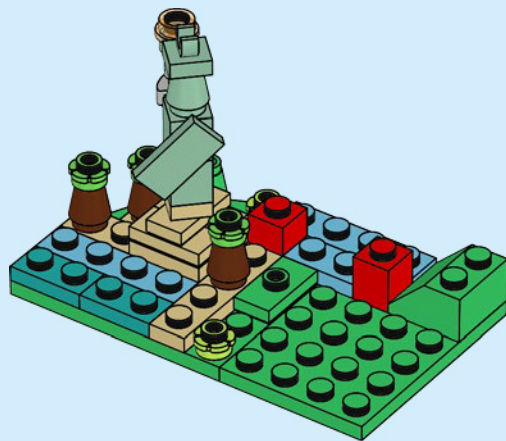

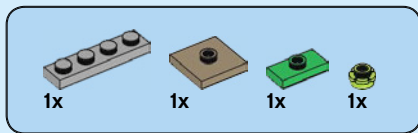

10

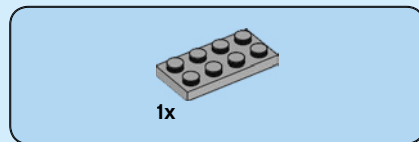
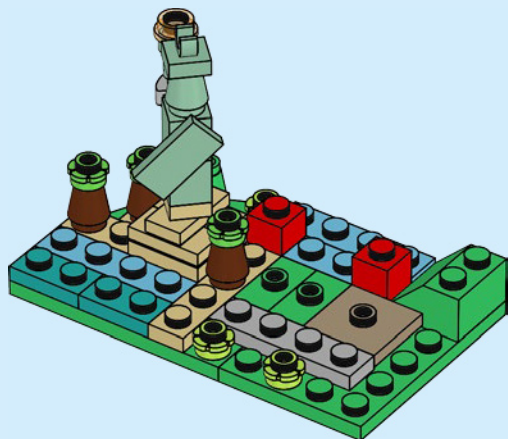

11

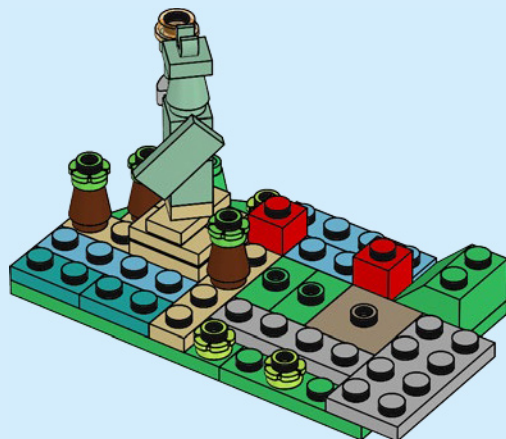

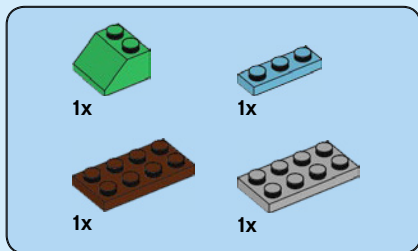

13

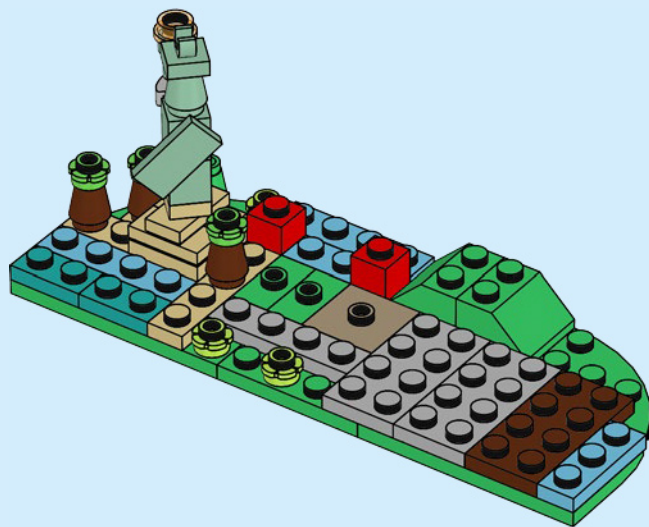

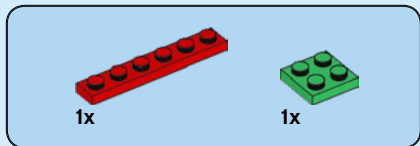

14

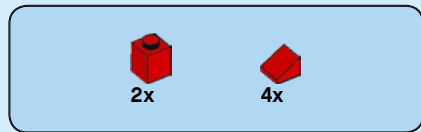
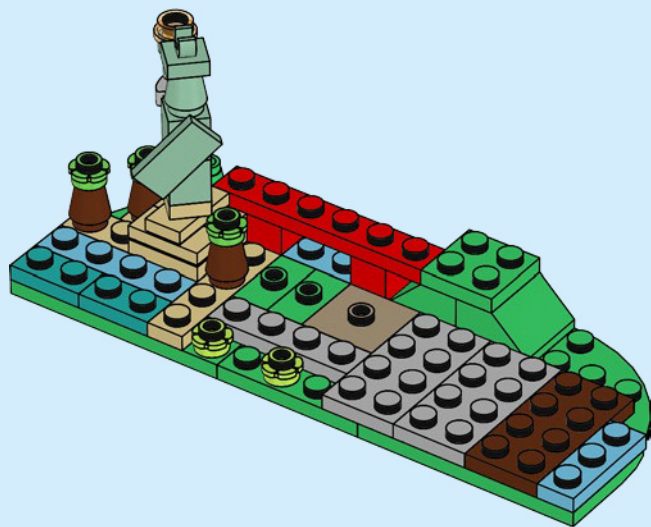

15

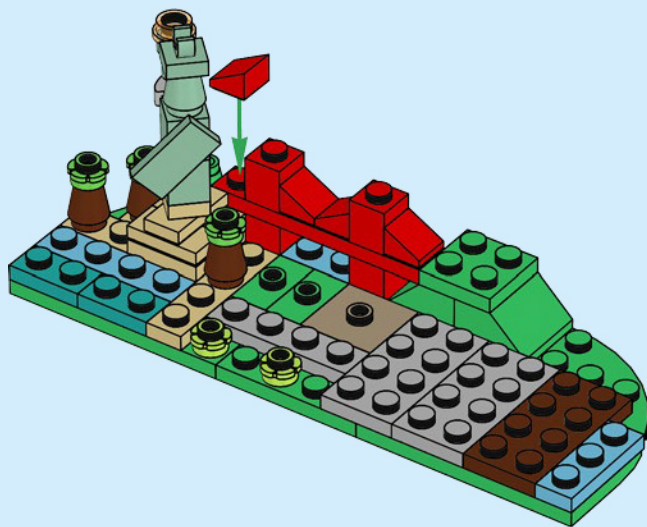



3x



3x



2x

16

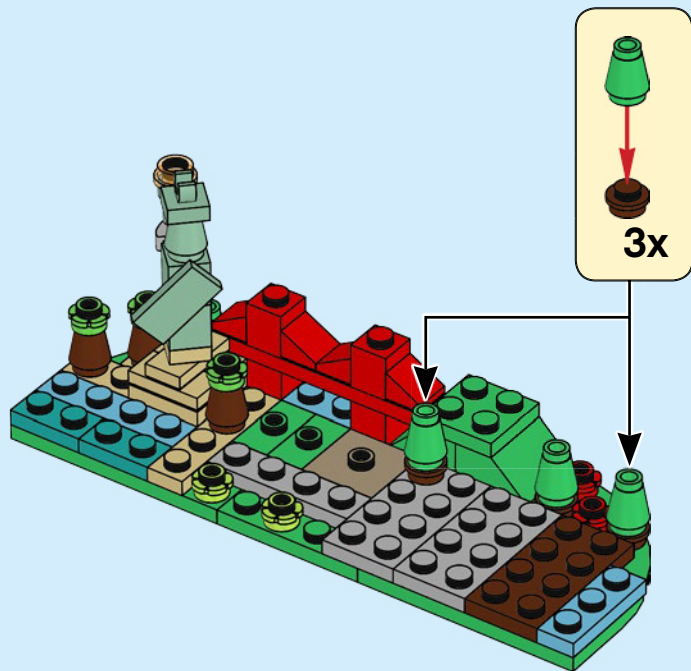

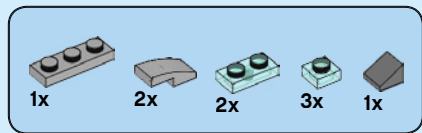

17

1

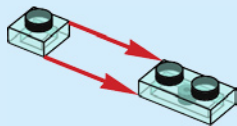

2

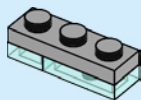

3

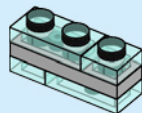

4

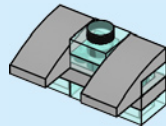

5

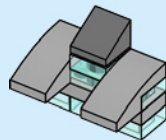

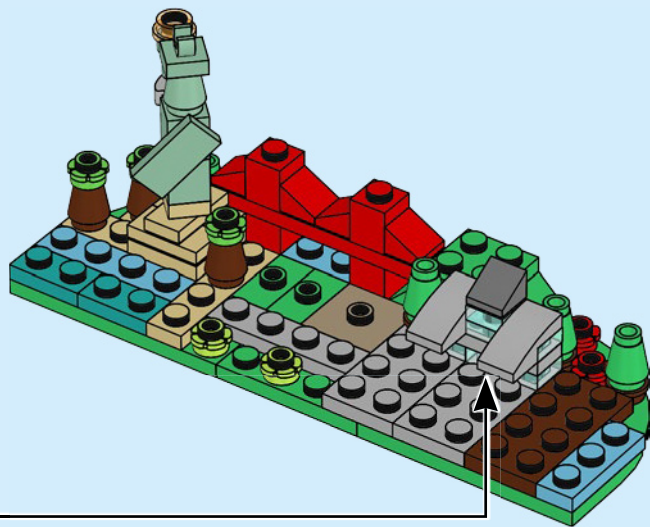

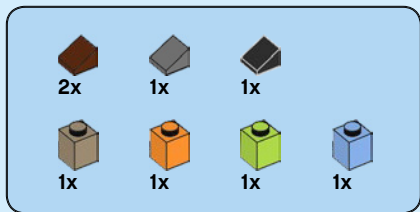

18

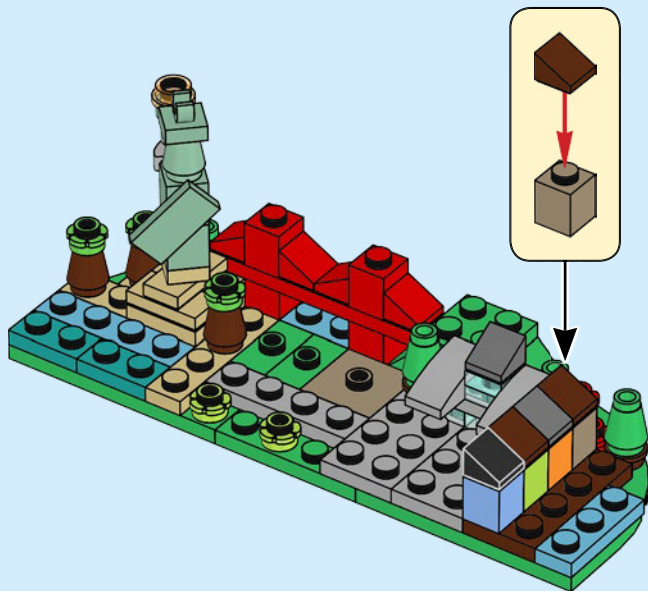

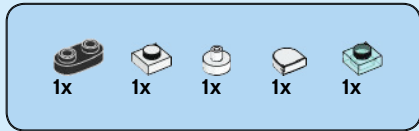

19

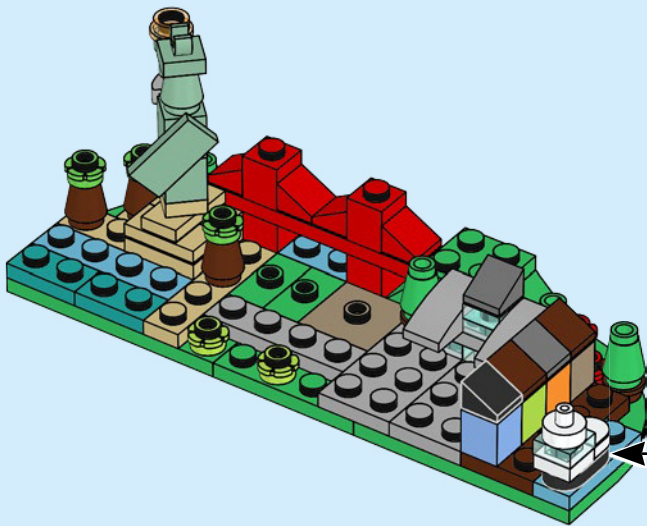
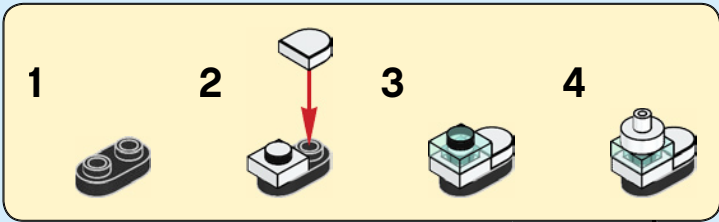

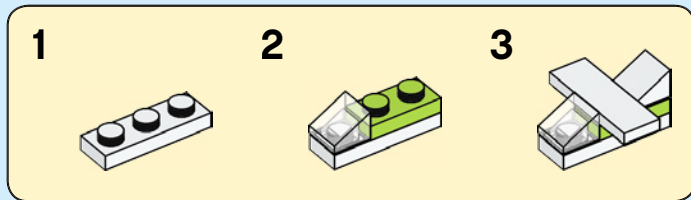
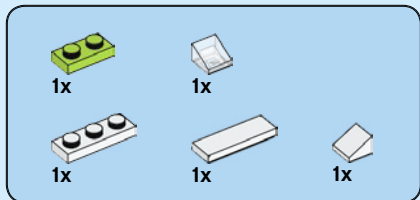

20

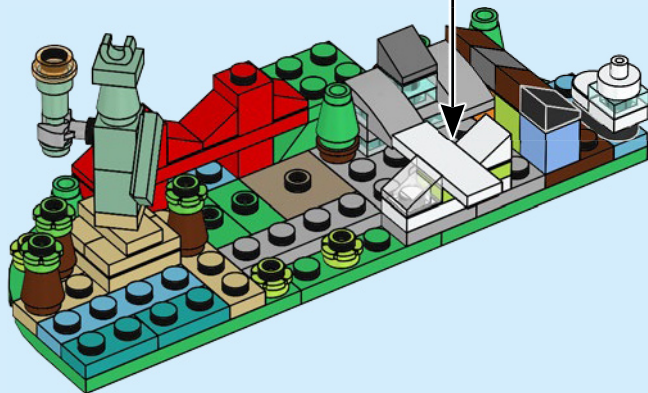

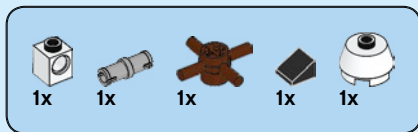

21

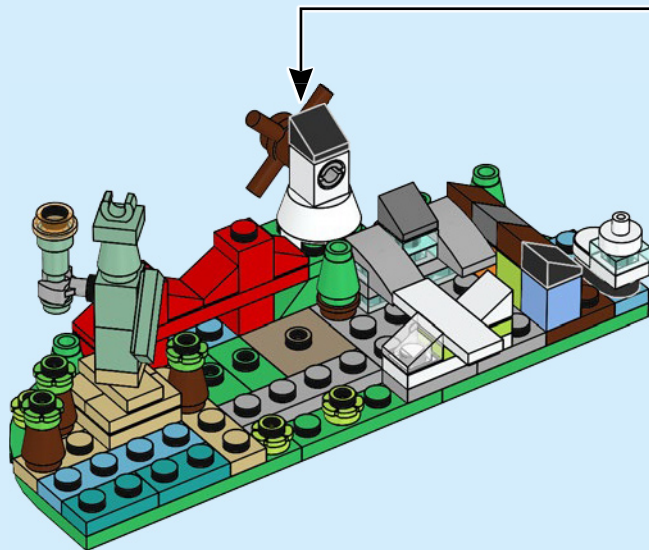
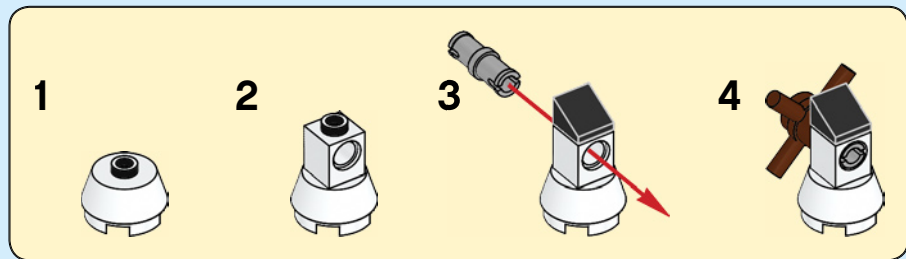

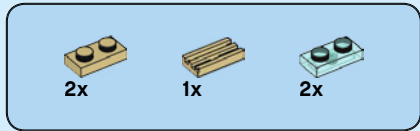

22

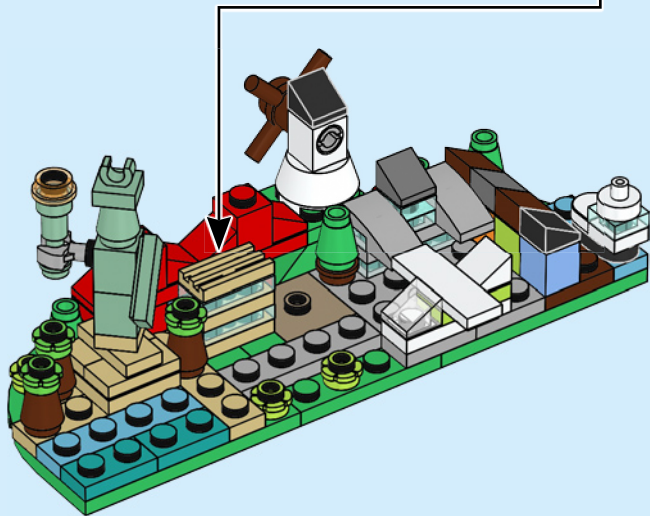
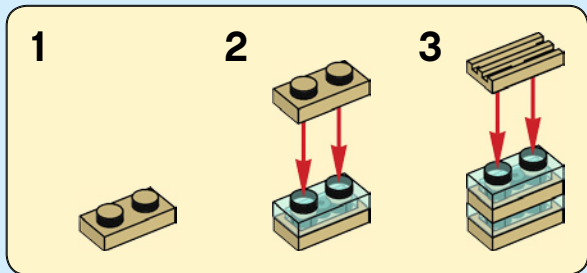

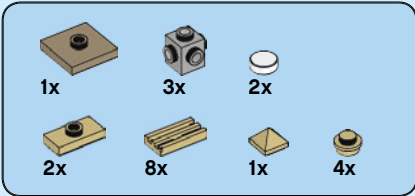

23

1



2



3



4



5



7

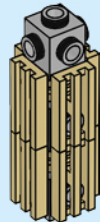

6

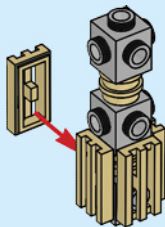

8

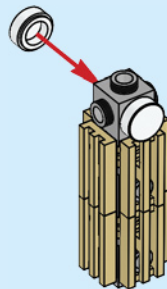

9

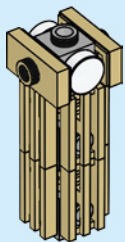

10

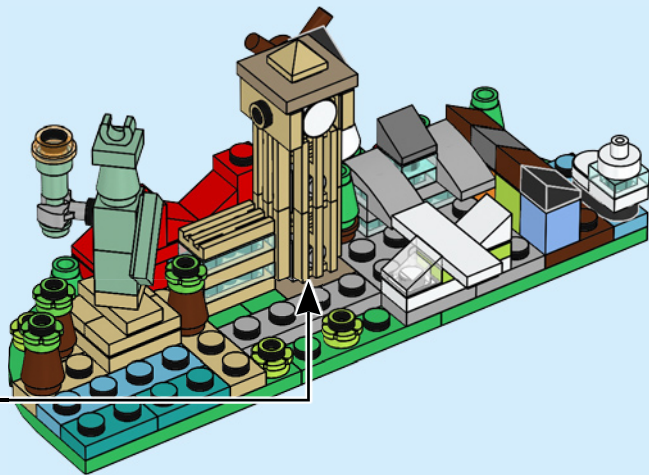
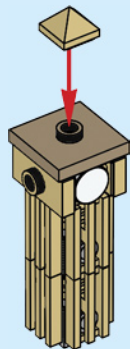

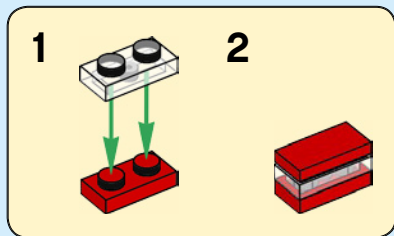
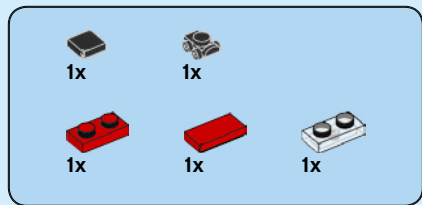

24

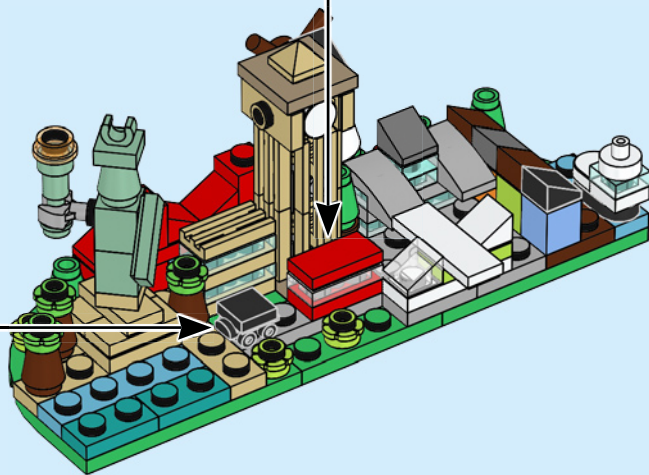
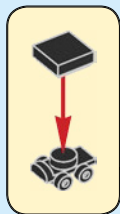

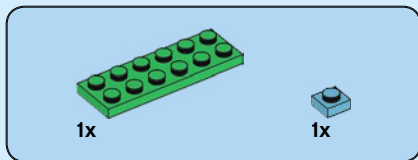
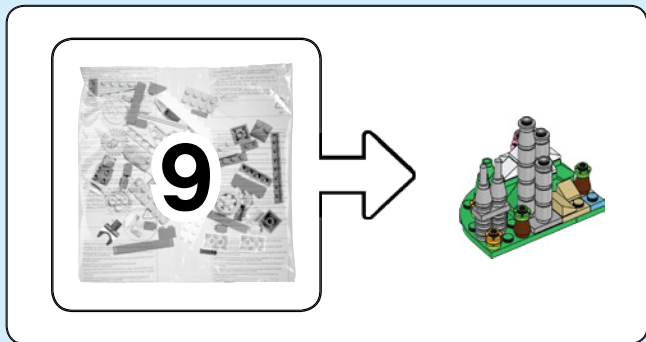

1

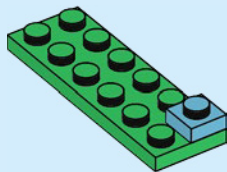

2

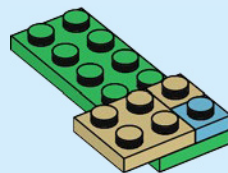

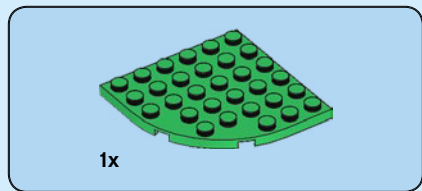

3

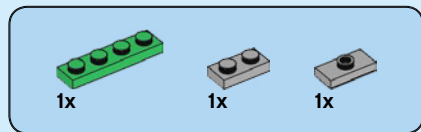
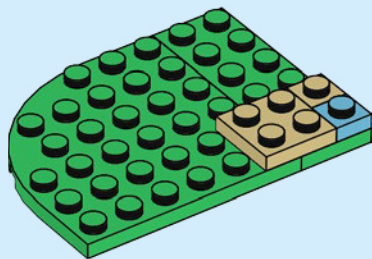

4

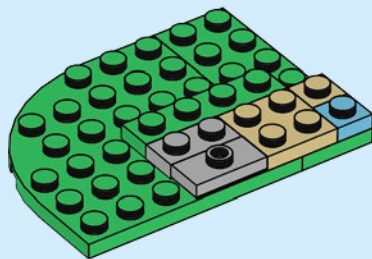

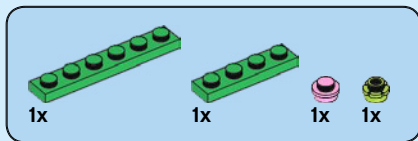

5

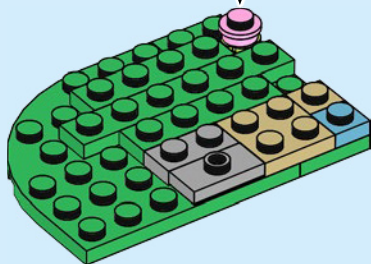
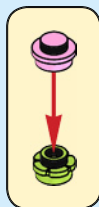

6

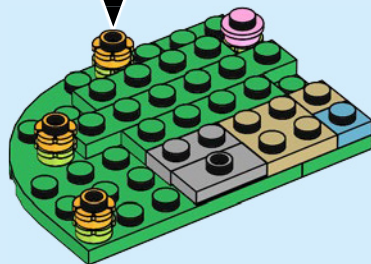
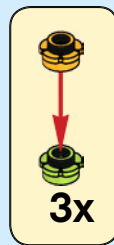



2x



2x

7

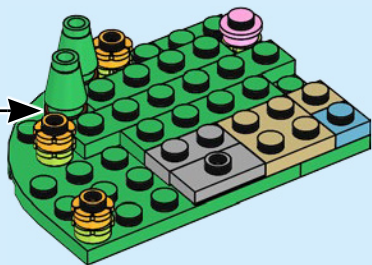
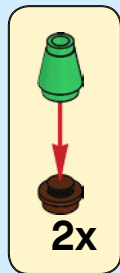

1x



4x

8

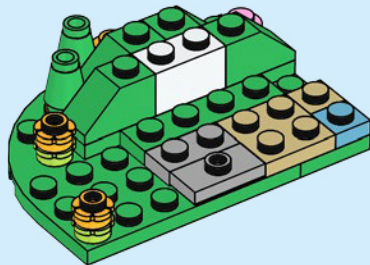



2x



1x



1x

9

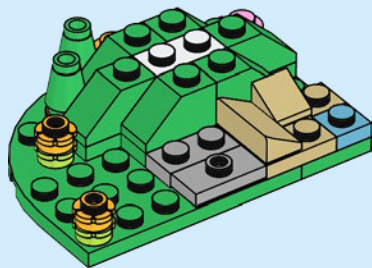

3x



3x

10



3x

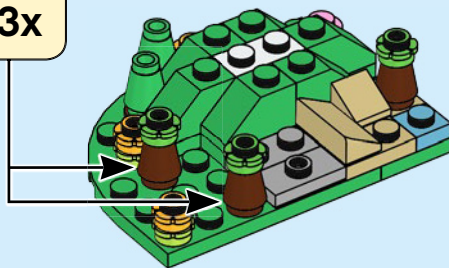



1x



2x

11

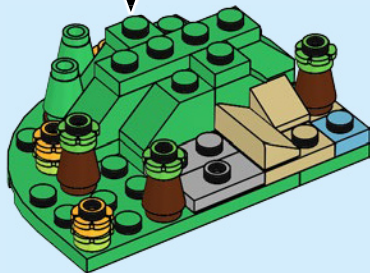

1x



2x

12

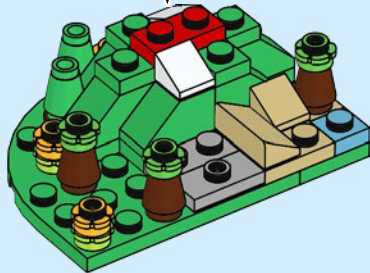



5x



1x



1x

13

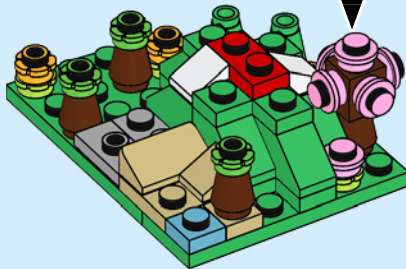



4x

14

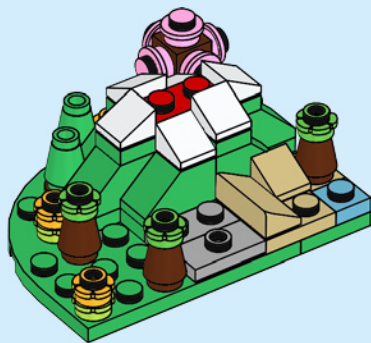

1x



2x

15

1



2





4x



1x

16

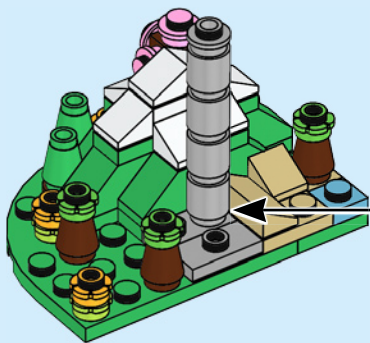
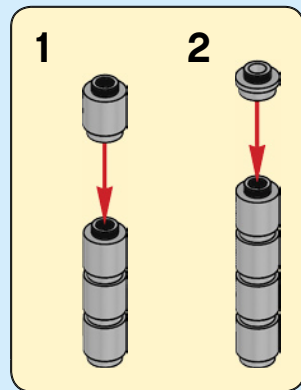



4x



1x



1x

17

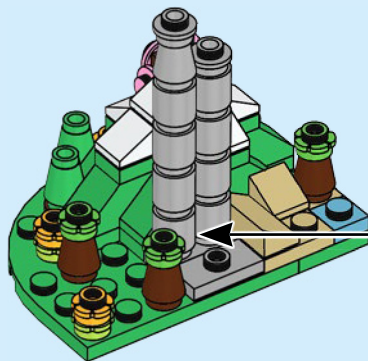

1



2



3





3x



1x

18

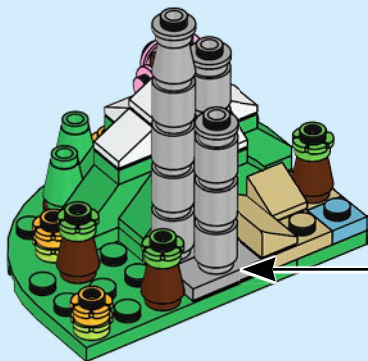
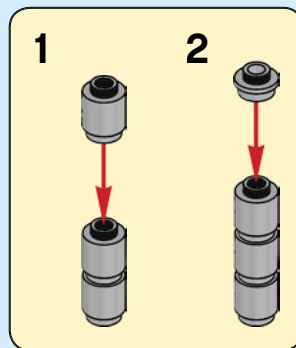



1x



2x



2x



10x

19

1

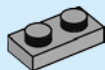

2

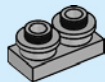

3

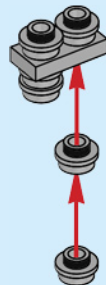

4

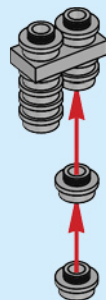

5

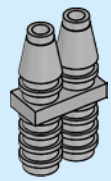

6

