



Ages/edades

6+
40287



6241464 / 6241465

Warning! Choking hazard. Small parts.
 Achtung! Erstickungsgefahr. Kleine Teile.
 Attention ! Danger d'étouffement. Petits éléments.
 Avvertenza! Rischio di soffocamento. Piccole parti.
 Waarschuwing! Verstikkingsgevaar. Kleine onderdelen.
 ¡Advertencia! Peligro de atragantamiento. Partes pequeñas.
 Advarsel! Kvælningfare. Små dele.
 Viðvörðun! Köfnunarfæta. Litlir hlutir.
 Varoitus! Tukehtumisvaara. Pieniä osia.
 Varning! Kvävningrisk. Små delar.
 Advarsel! Kvelningsfare. Små deler.
 Atenção! Risco de asfixia. Pequenas partes.
 Προειδοποίηση! Κίνδυνος πνιγμού. Μικρά μέρη.
 警告! 小部品があります。誤飲・窒息の危険があります。
 警告! 小心窒息。当心小物件。
 경고! 질식 위험. 작은 부품 포함.
 Внимание! Риск удушения. Мелкие детали.
 Ostrzeżenie! Niebezpieczeństwo udławienia się. Małe części.
 Upozornění! Nebezpečí zalknutí. Malé části.
 Upozornenie! Nebezpečenstvo dusenia. Malé časti.
 Figyelmeztetés! Fulladásveszély. Kis alkatrészek.
 Попередження! Ризик задихи. Дрібні деталі.
 Urožorenje! Opasnost od gušenja. Mali dijelovi.
 Упозорење! Опасност од гушења. Мали делови.
 Предупредување! Опасност од задушување. Мали делови.
 Opozorilo! Nevarnost zadušitve zaradi tujka. Majhni deli.
 Avertisment! Pericol de sufocare internă. Părți mici.
 Внимание! Опасност от задавяне. Малки части.
 Bridinājums! Aizsīšanas risks. Sīkas detaļas.
 Hoiatus! Kägistamisoht. Väikesed osad.
 Ispejimas! Pavojus užspringti. Smulkios detalės.
 Uyarı! Boğulma Tehlikesi (Havasızlıktan). Küçük Parçalar.
 تحذیر! خطر الاختناق. أجزاء صغيرة.
 Peringatan! Bahaya tersedak. Bagian kecil.
 Amaran! Bahaya tercekik. Bahagian kecil.

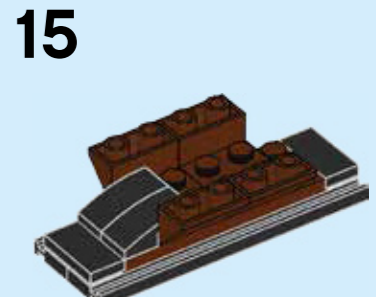
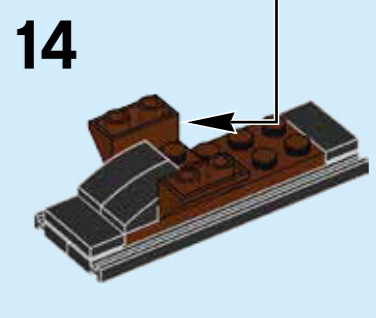
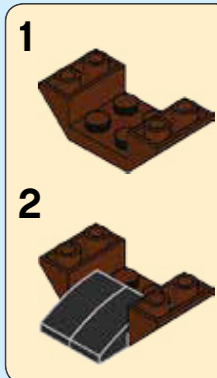
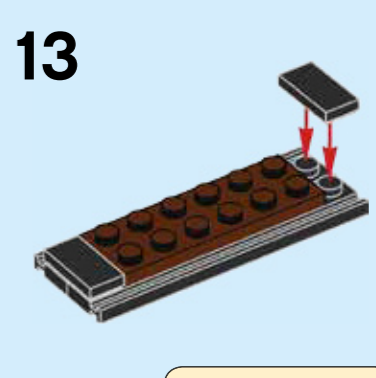
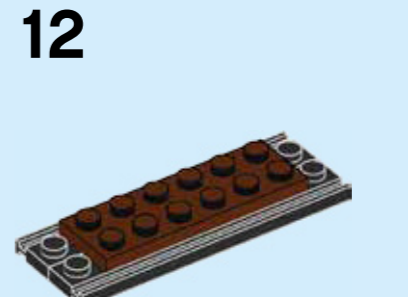
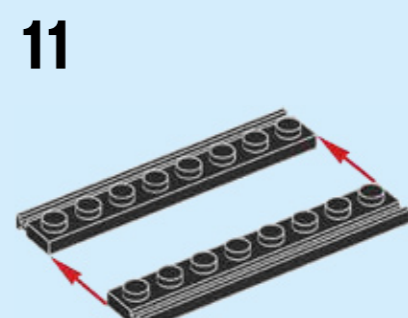
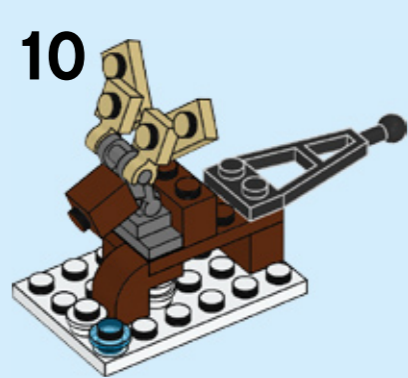
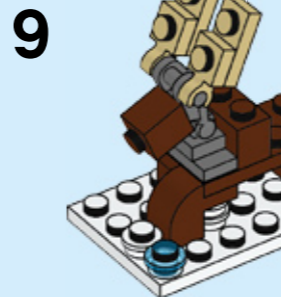
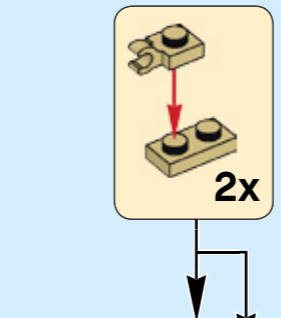
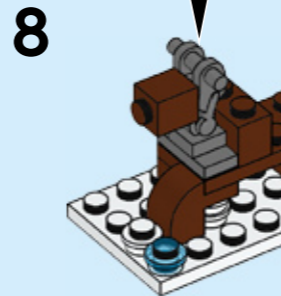
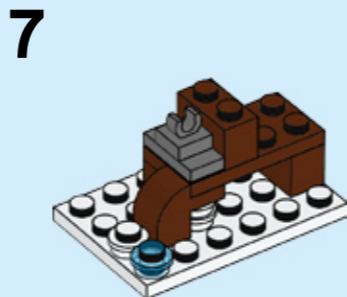
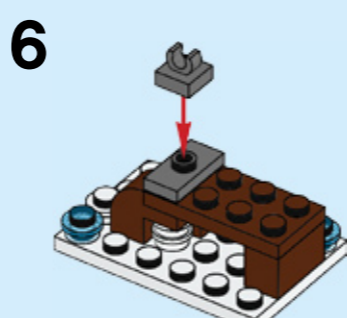
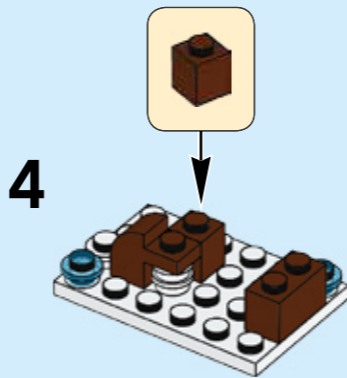
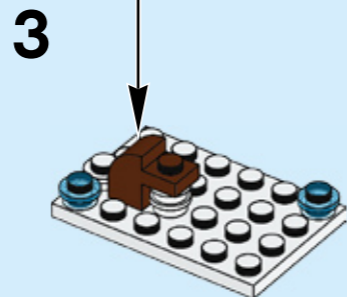
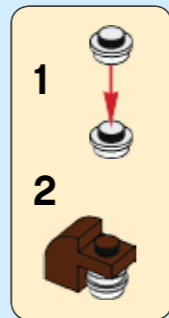
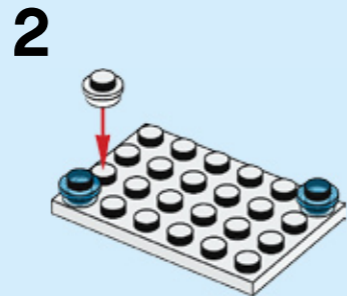
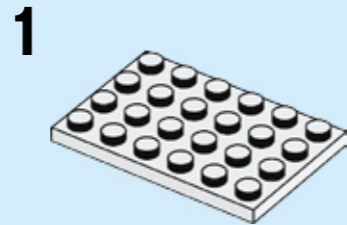

16

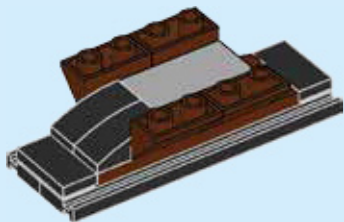

17

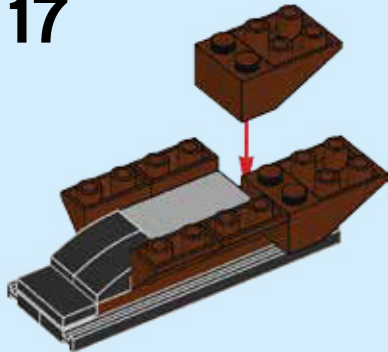

18

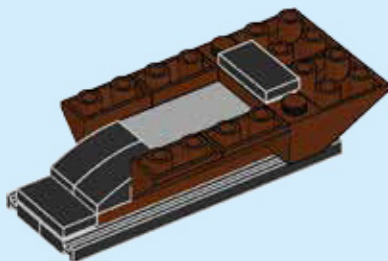

19

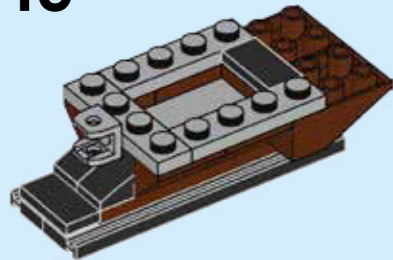

20

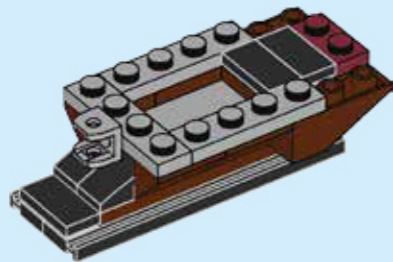

21

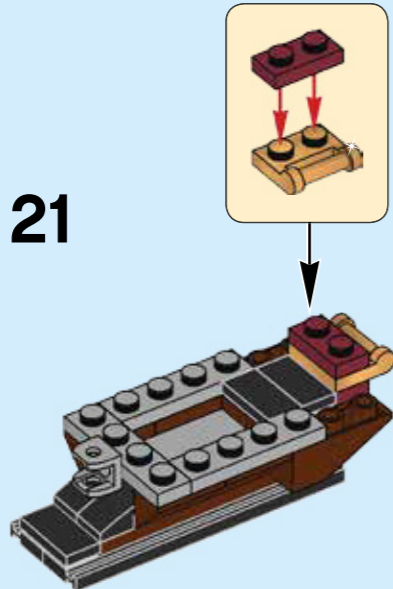

22

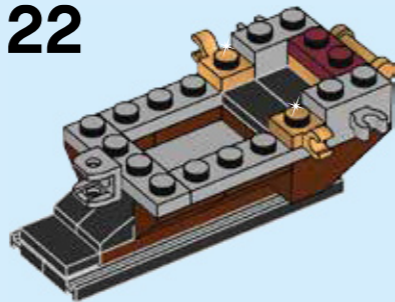

23

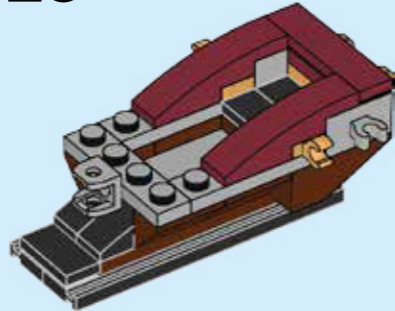

24

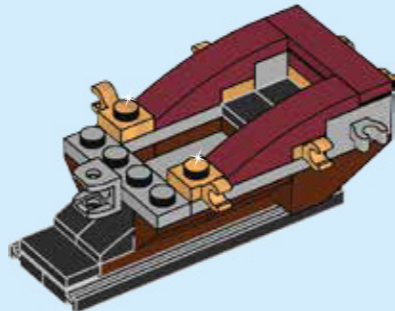

25

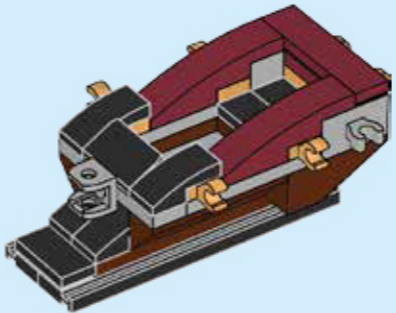

26

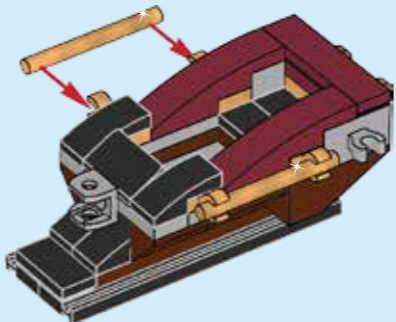

27

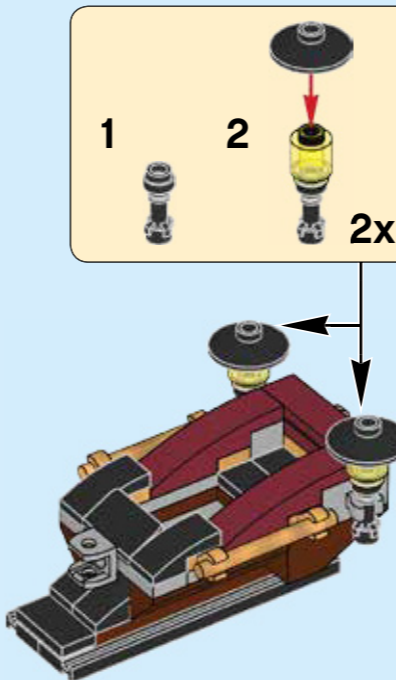

28

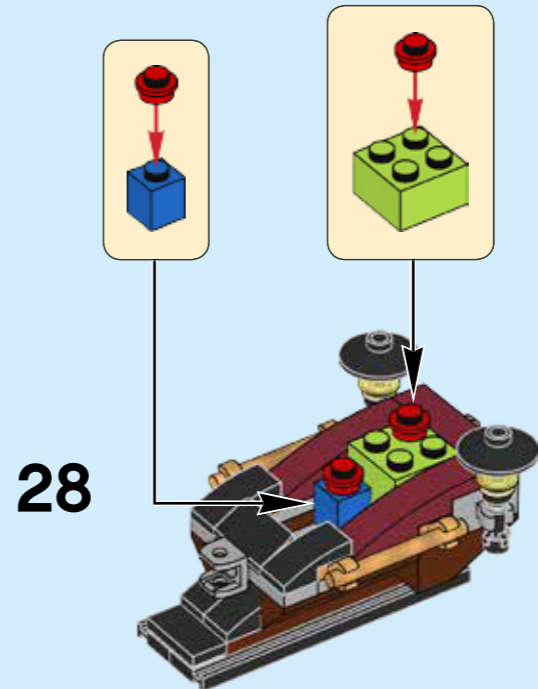

29

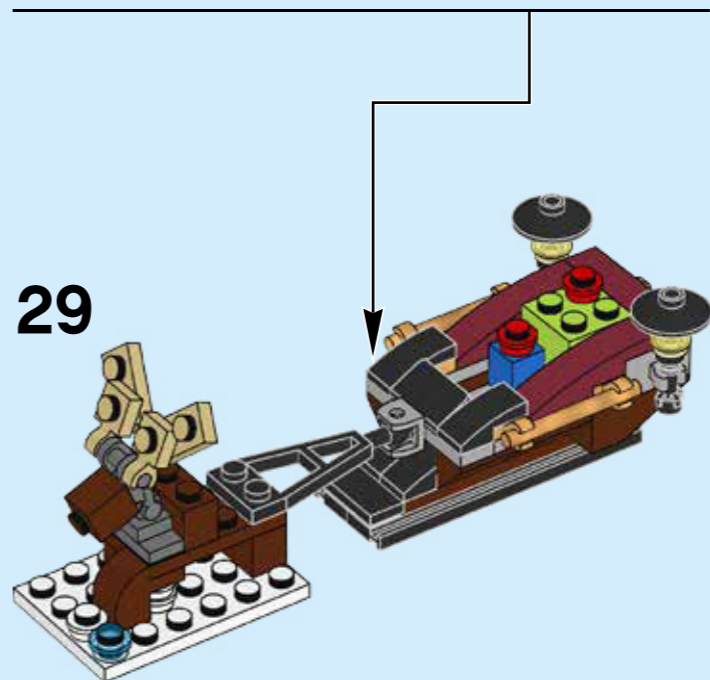

LEGO.com

LEGO and the LEGO logo are trademarks of the/son of the marques de commerce du/son The LEGO Group. ©2018 The LEGO Group. 6241464 / 6241465

- | | | |
|---------------|---------------|---------------|
| 3x
614101 | 2x
4539097 | 2x
3005743 |
| 1x
303201 | 2x
6042953 | 2x
3006844 |
| 2x
4520947 | 1x
4539060 | 2x
4641682 |
| 2x
4113917 | 1x
4220632 | 1x
6171894 |
| 2x
614121 | 2x
4211242 | 1x
4667166 |
| 1x
300523 | 2x
4211149 | 2x
4211445 |
| 2x
4598897 | 1x
6035547 | 1x
6071226 |
| 1x
4548180 | 2x
4508616 | 1x
4521512 |
| 2x
474026 | 1x
4211886 | 1x
6092572 |
| 4x
6047276 | 4x
4523160 | 4x
4523160 |
| 4x
306926 | 2x
6039192 | 1x
4585493 |
| 1x
4274405 | 1x
4286009 | 2x
6147169 |