

30540

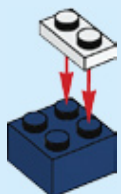

6226372

1



2



3

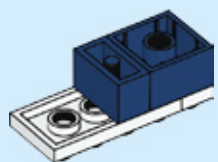

4

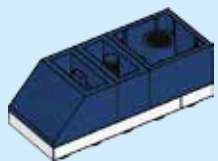

5

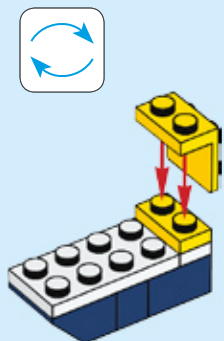

6

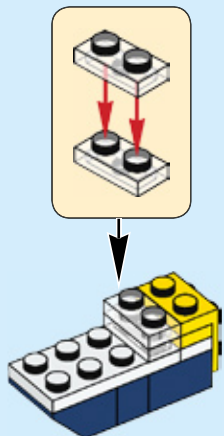

7

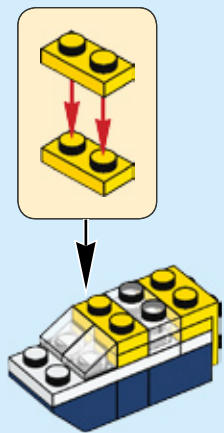

8

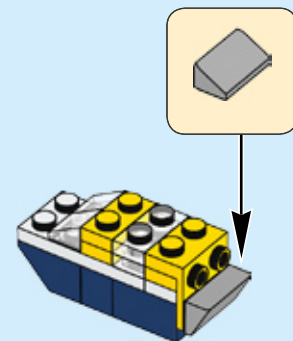

9

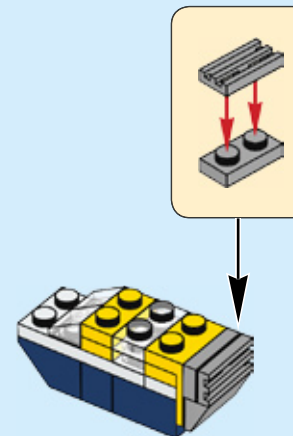

10

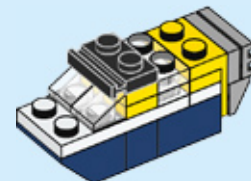

 [LEGO.com/creator](https://www.lego.com/creator)

[LEGO.com/service](https://www.lego.com/service)

LEGO and the LEGO logo are trademarks of the LEGO Group. ©2018 The LEGO Group. 6226372

11

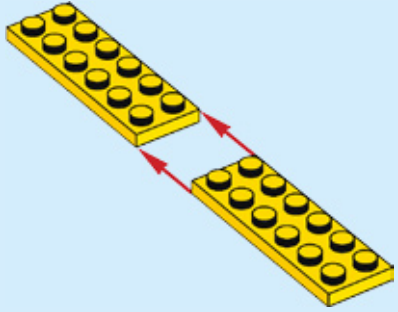

12

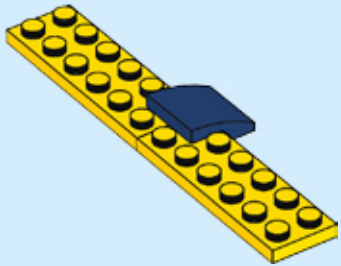

13

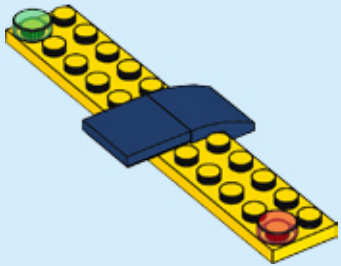

14

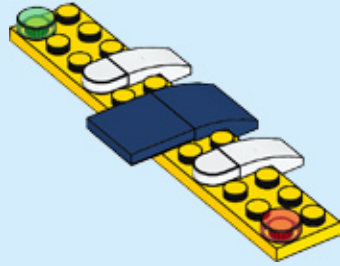

15

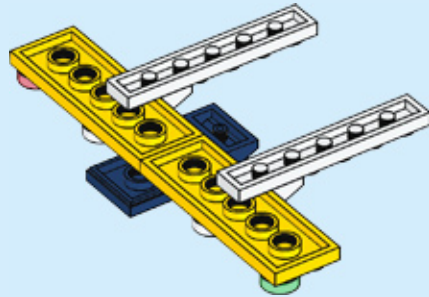

16

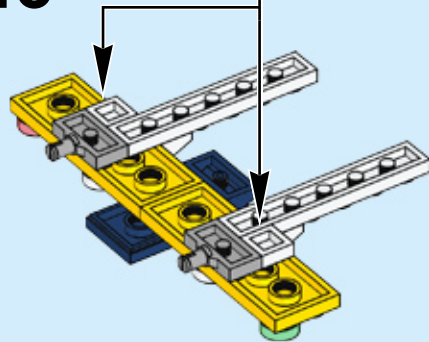

17

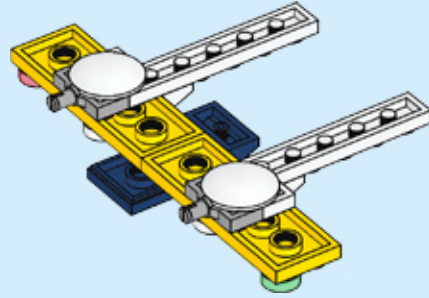

18

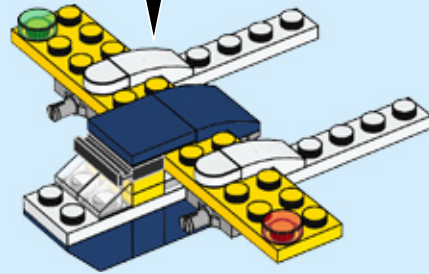

19

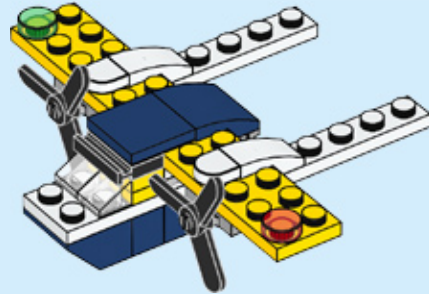

20

