

2

1

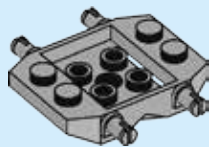

2

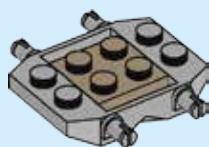

3

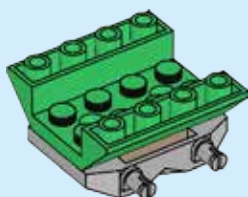

4

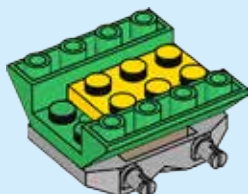

5

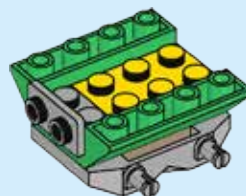

6

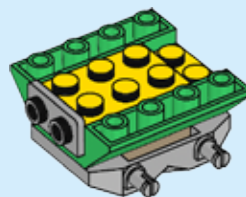

7

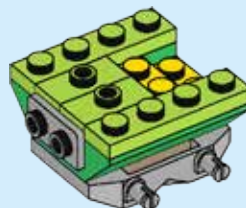

8

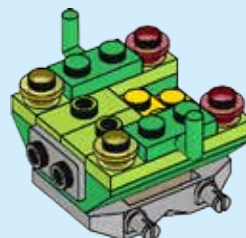

9

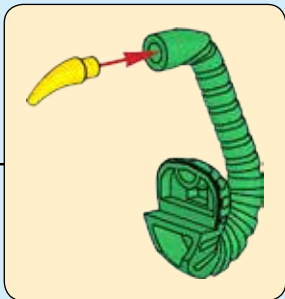
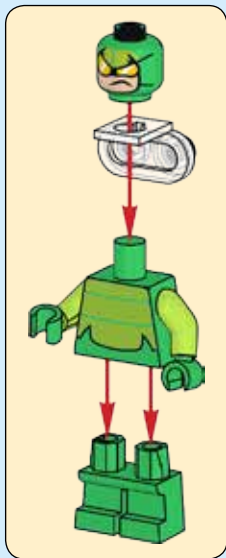
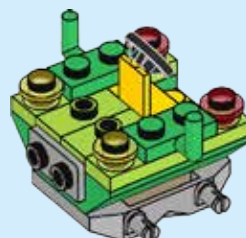

10

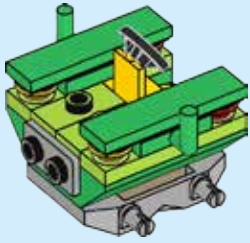

11

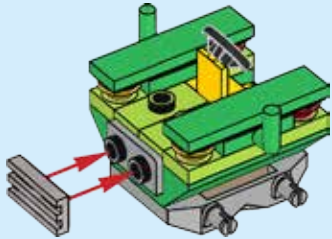

12

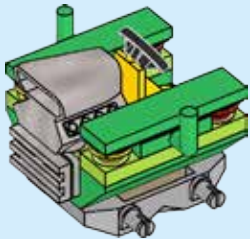

13

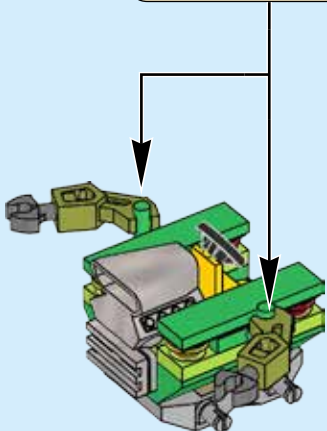
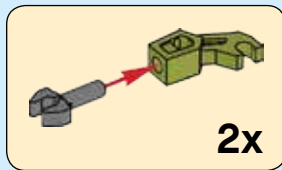

14

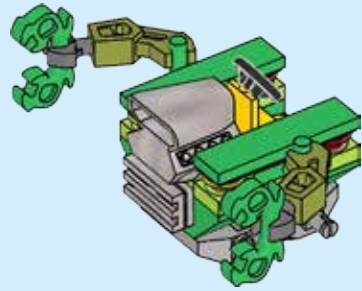

15

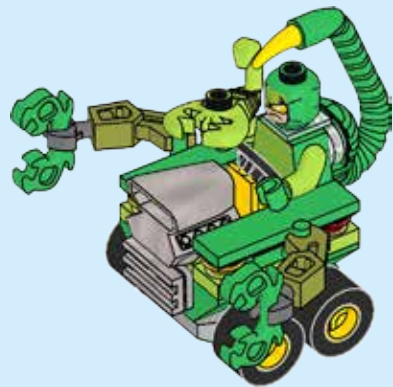
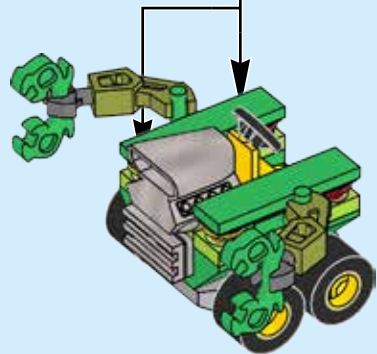
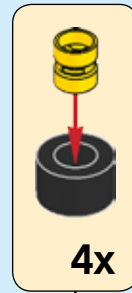

LEGO.com/service

LEGO and the LEGO logo are trademarks of the LEGO Group.
©2017 The LEGO Group. 6187796

MARVEL
marvelkids.com

© MARVEL