

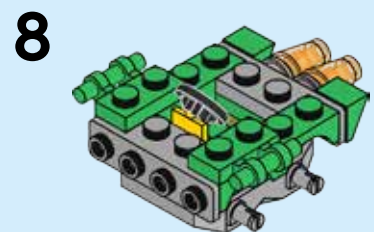

2

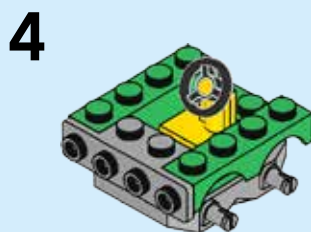

9

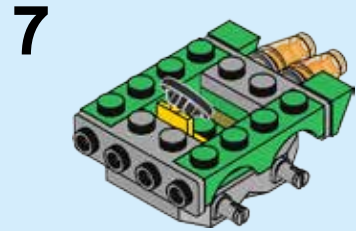
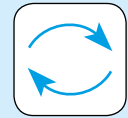
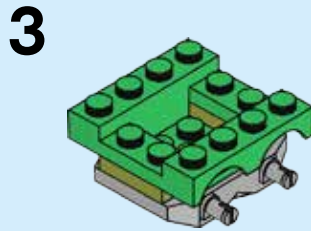
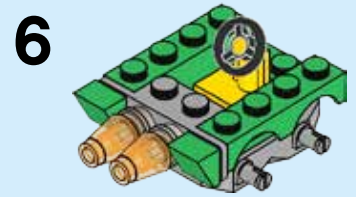
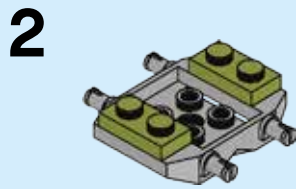
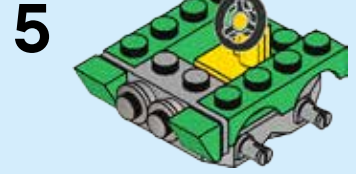
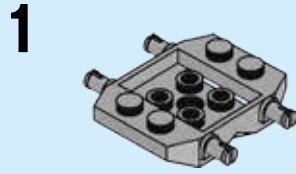
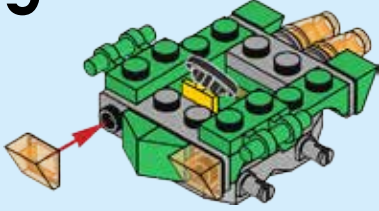

10

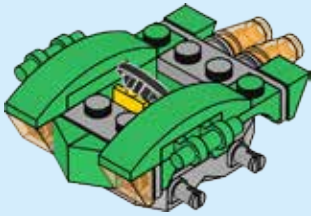

11

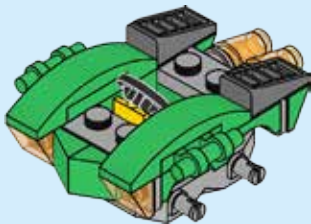

12

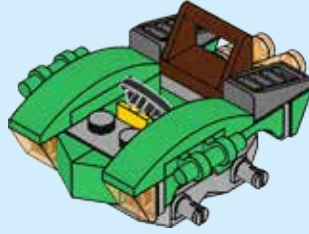

13

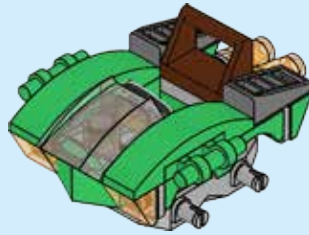

14

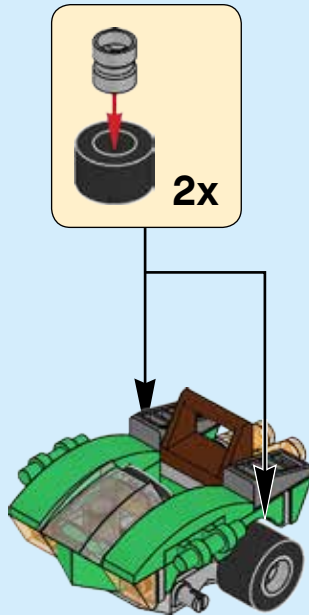

15

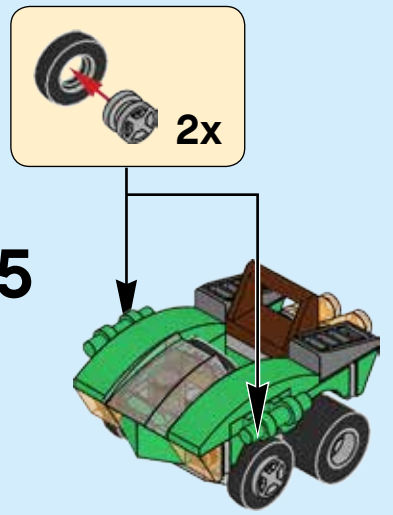

16

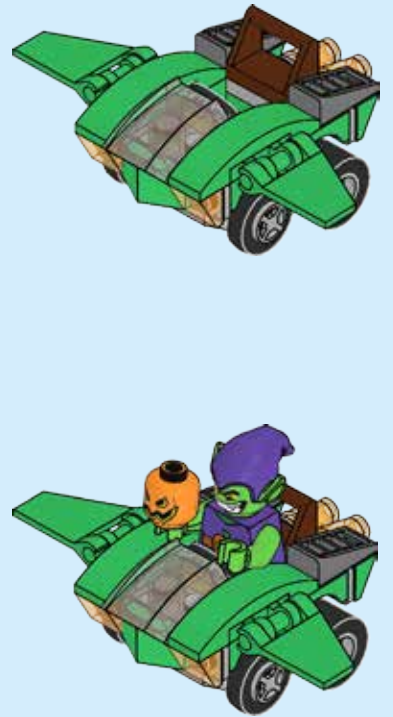

LEGO.com/service

LEGO and the LEGO logo are trademarks of the LEGO Group. ©2016 The LEGO Group. 6154204



© MARVEL