



CREATOR

10242



LEGO.com

EXPERT



LEGO.com/brickseparator

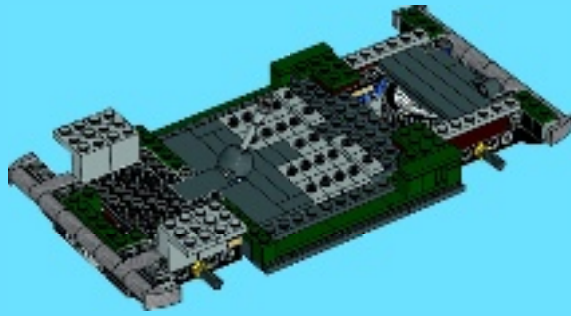

1

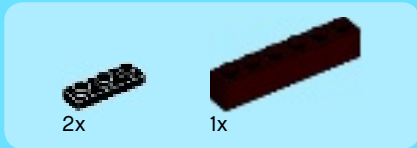

2

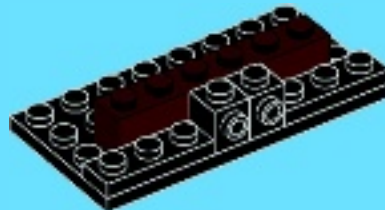



2x



2x

3

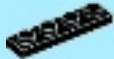
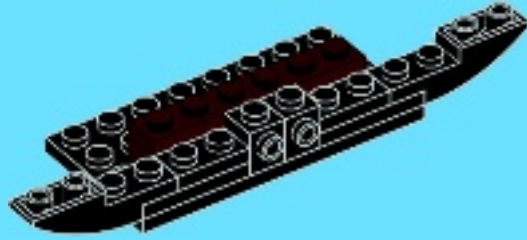

2x

4



1x

5



R682 AHS

/ HGCT487

/ EH 26 286

/ PJM 340

/ TOM 306



1



2





2x

3

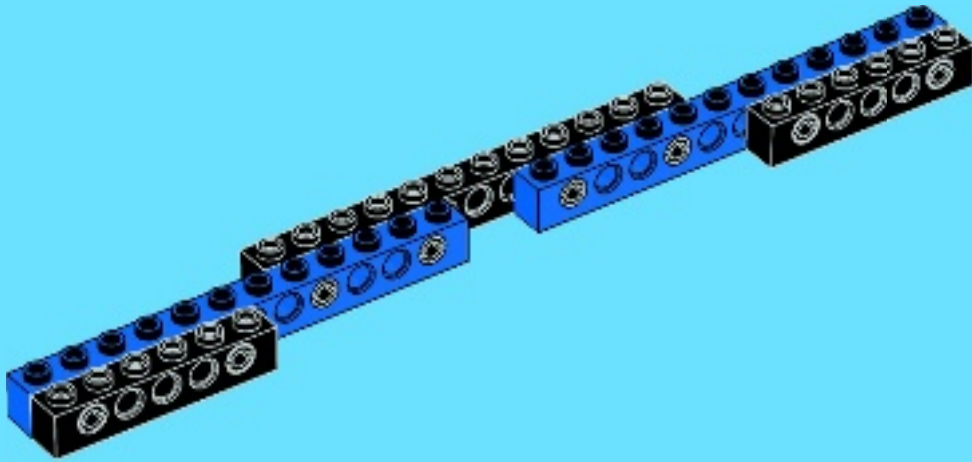

2x



2x

4



2x

6

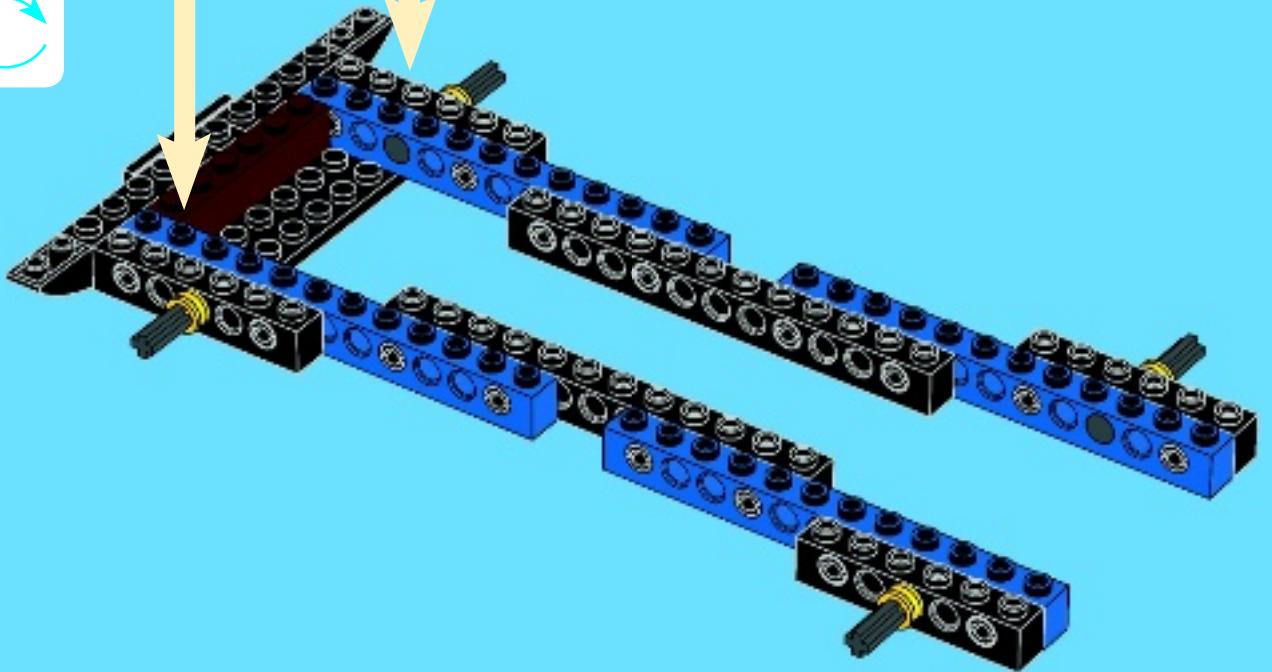

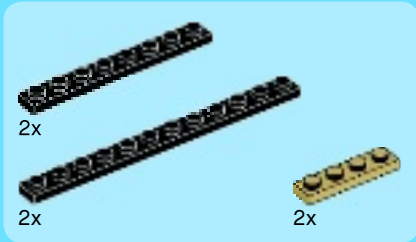

7

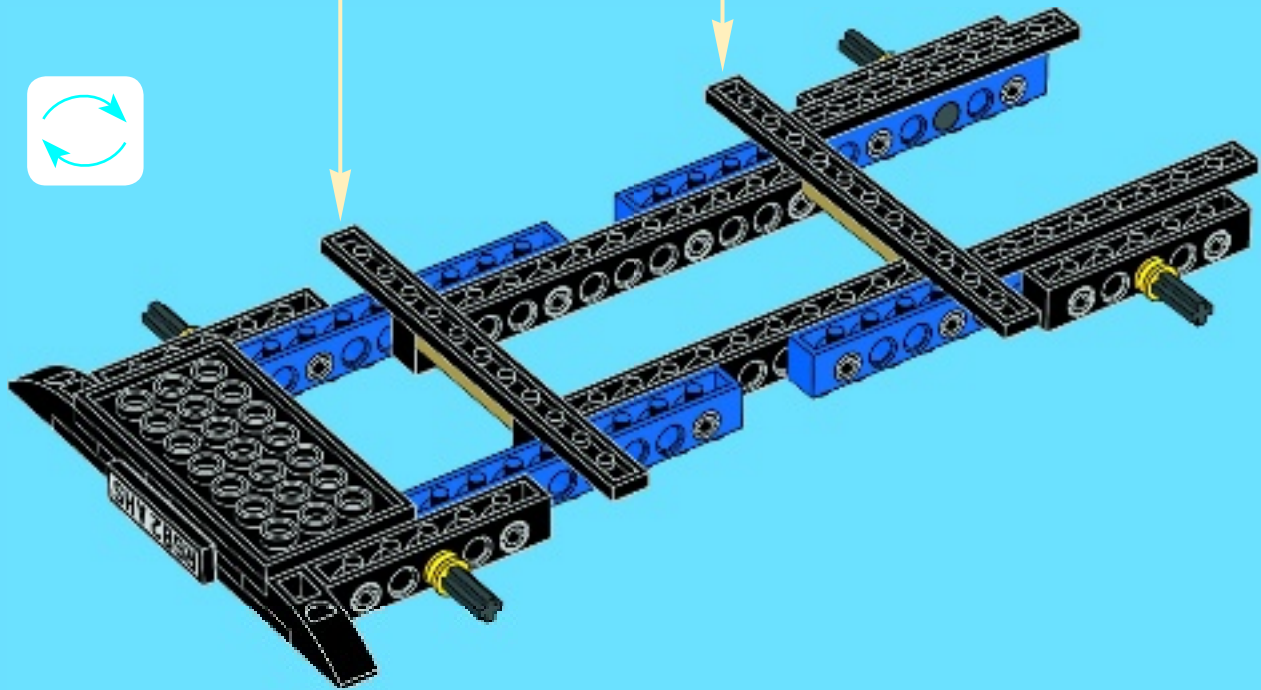
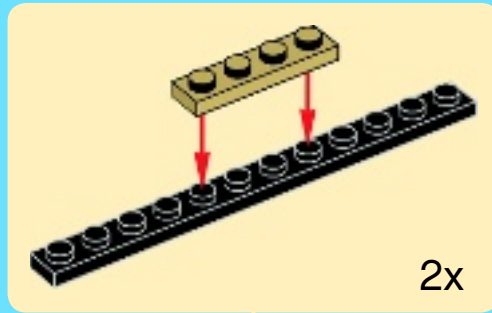

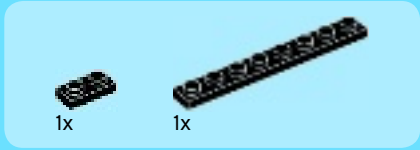
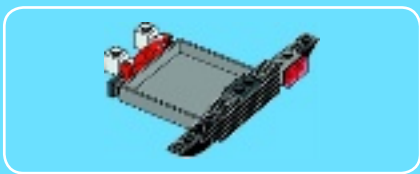

1

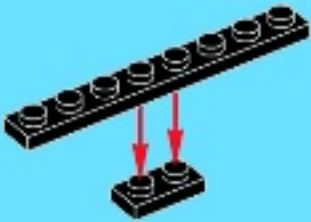

2

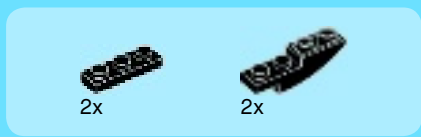
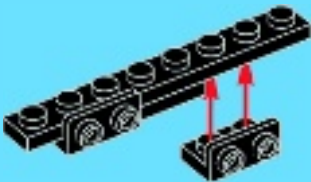

3

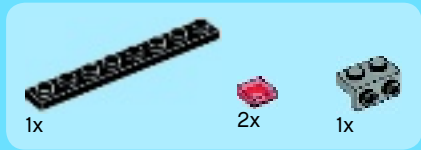
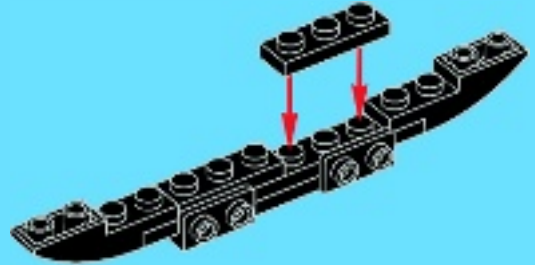

4

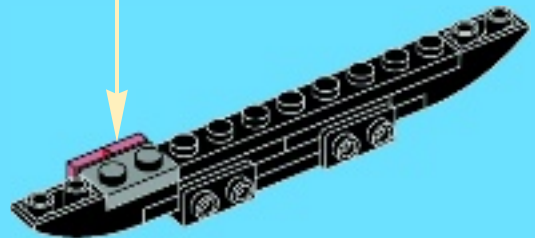
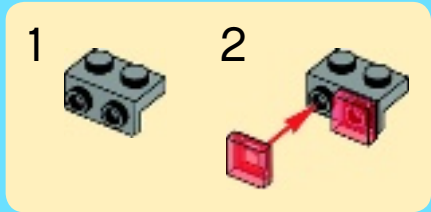



2x



1x

5

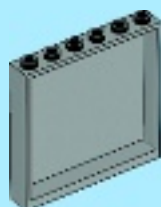
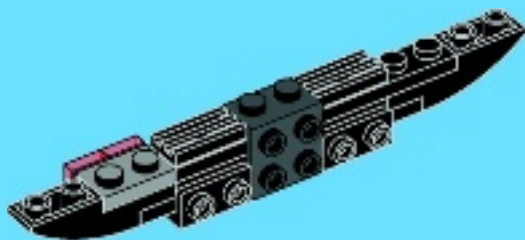

1x

6

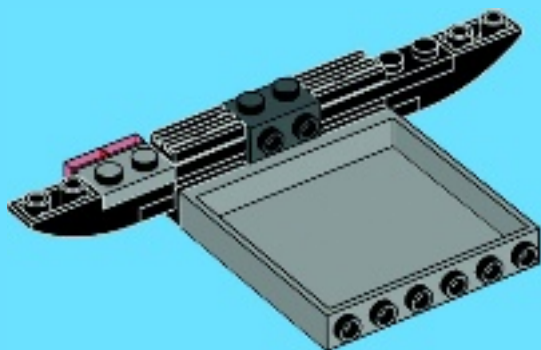

2x



2x

7

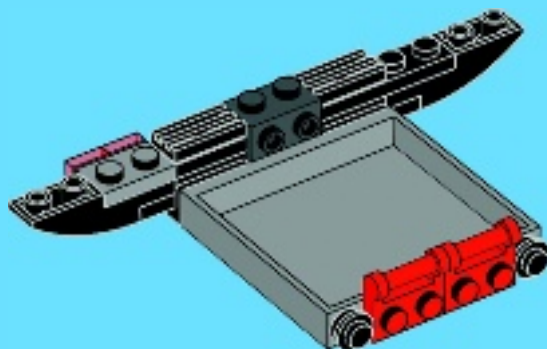

2x



2x

8

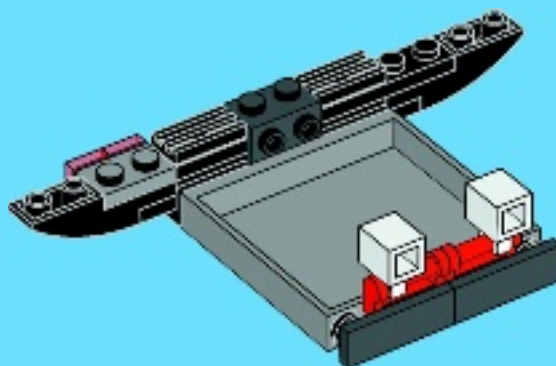

8

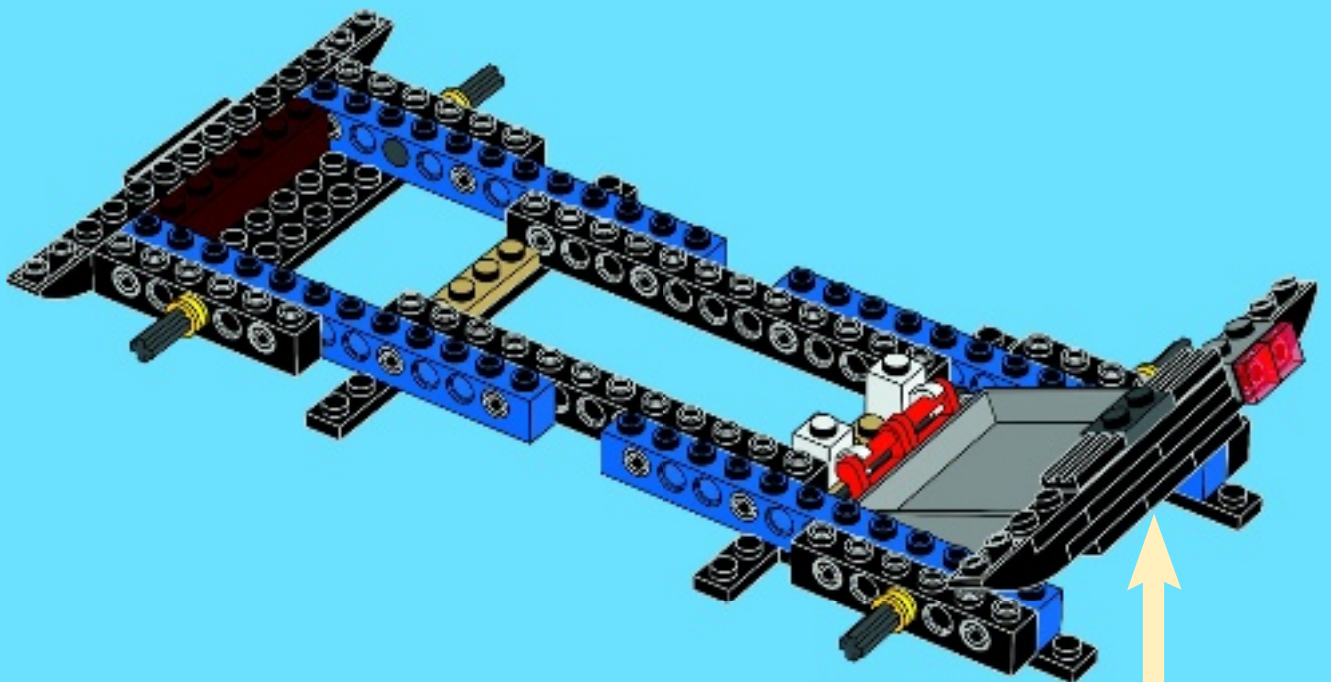



4x



2x

9

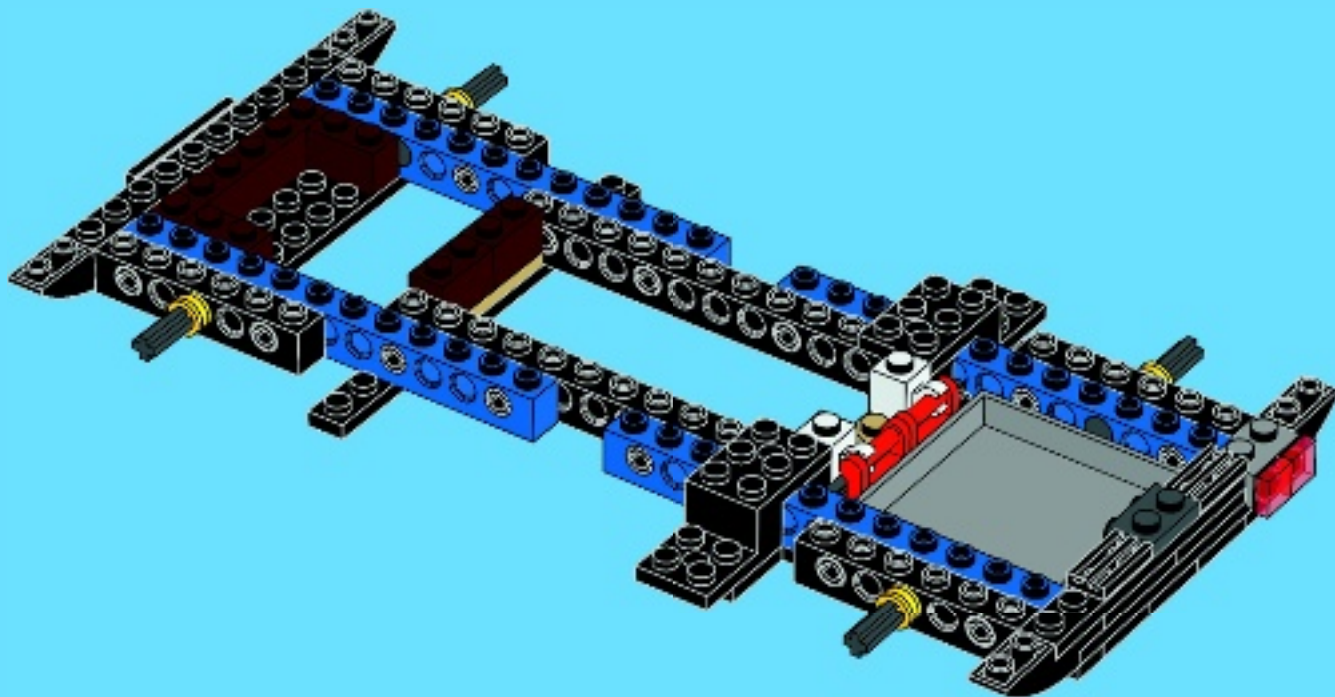

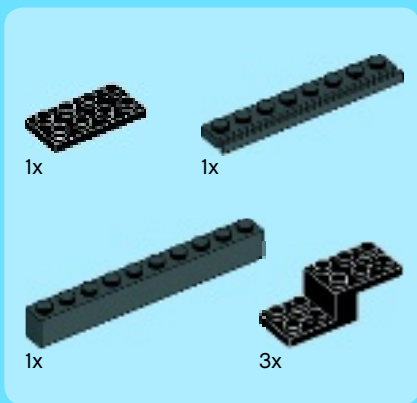

10

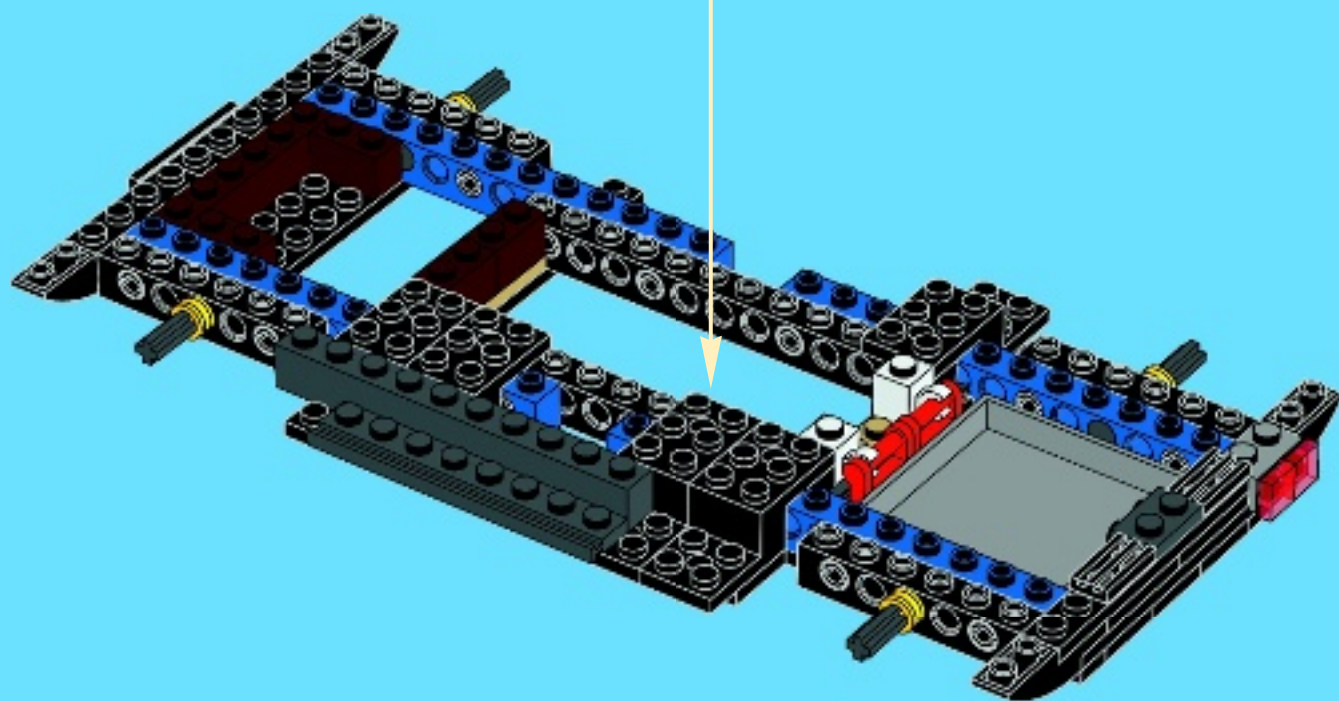
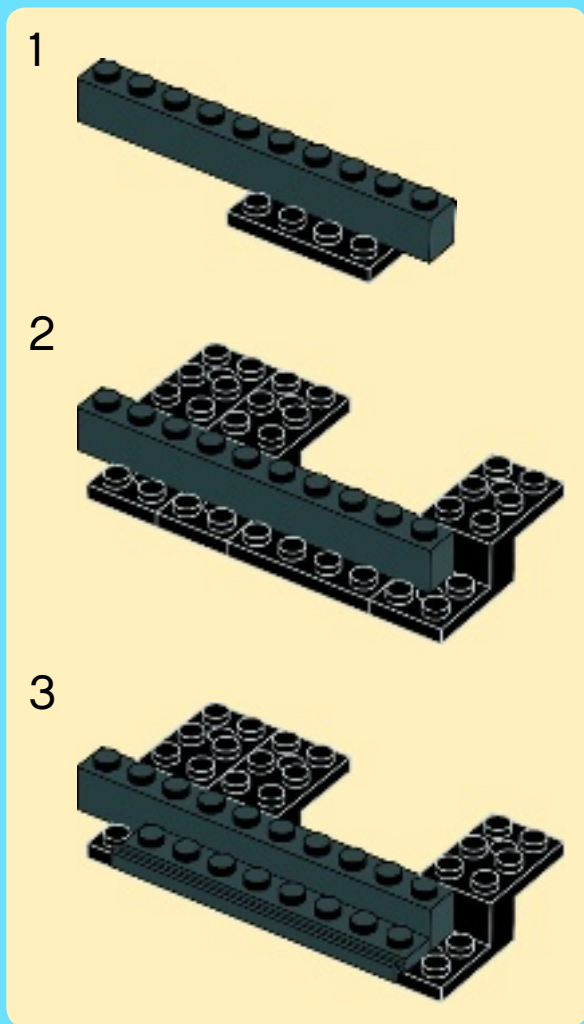

11

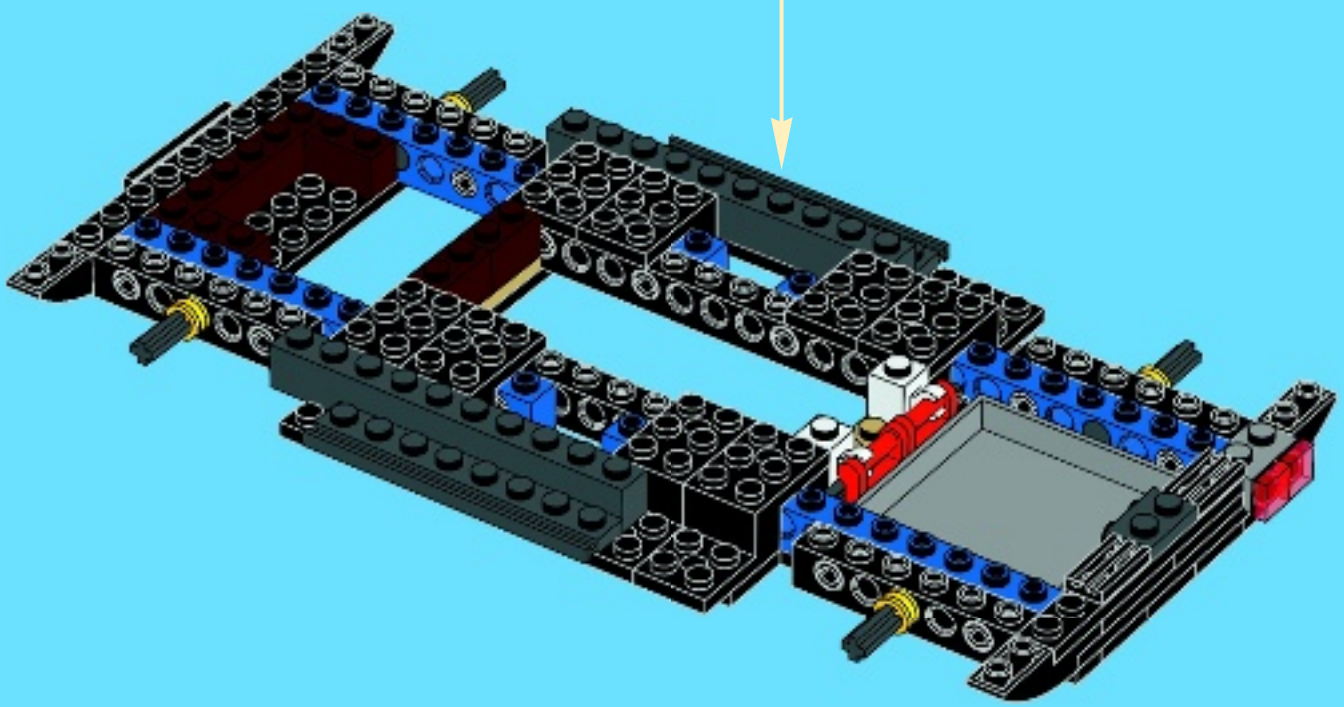
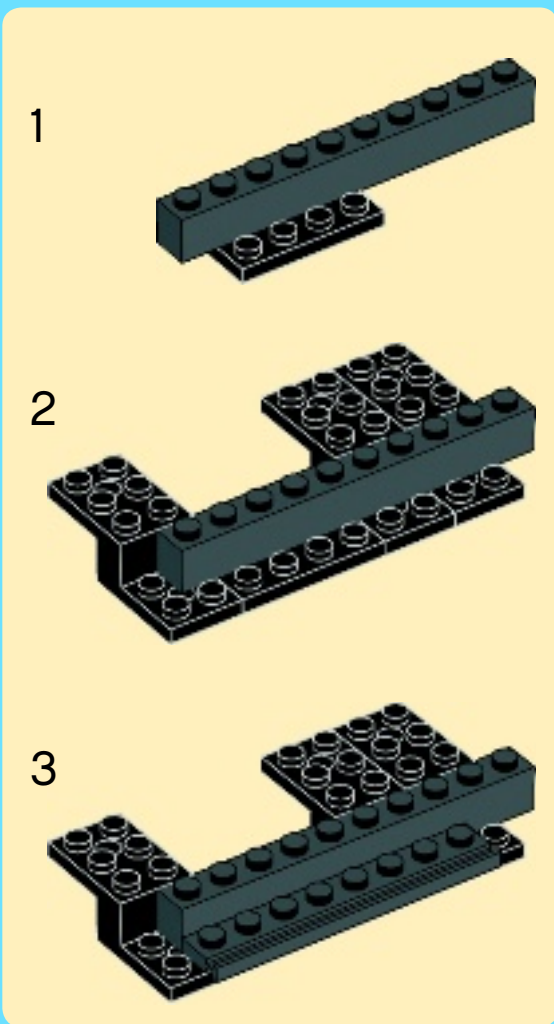
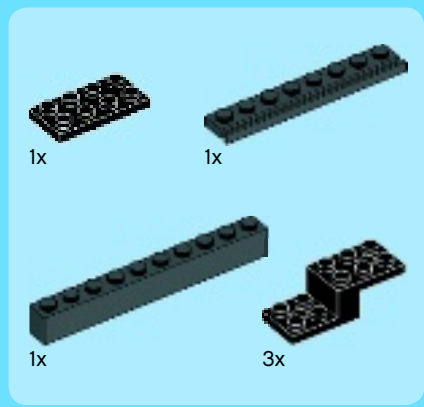

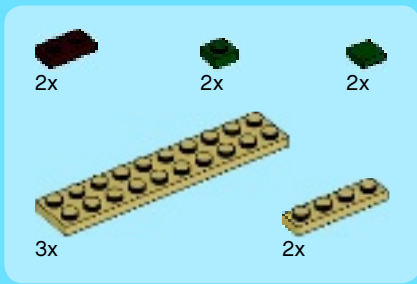

12

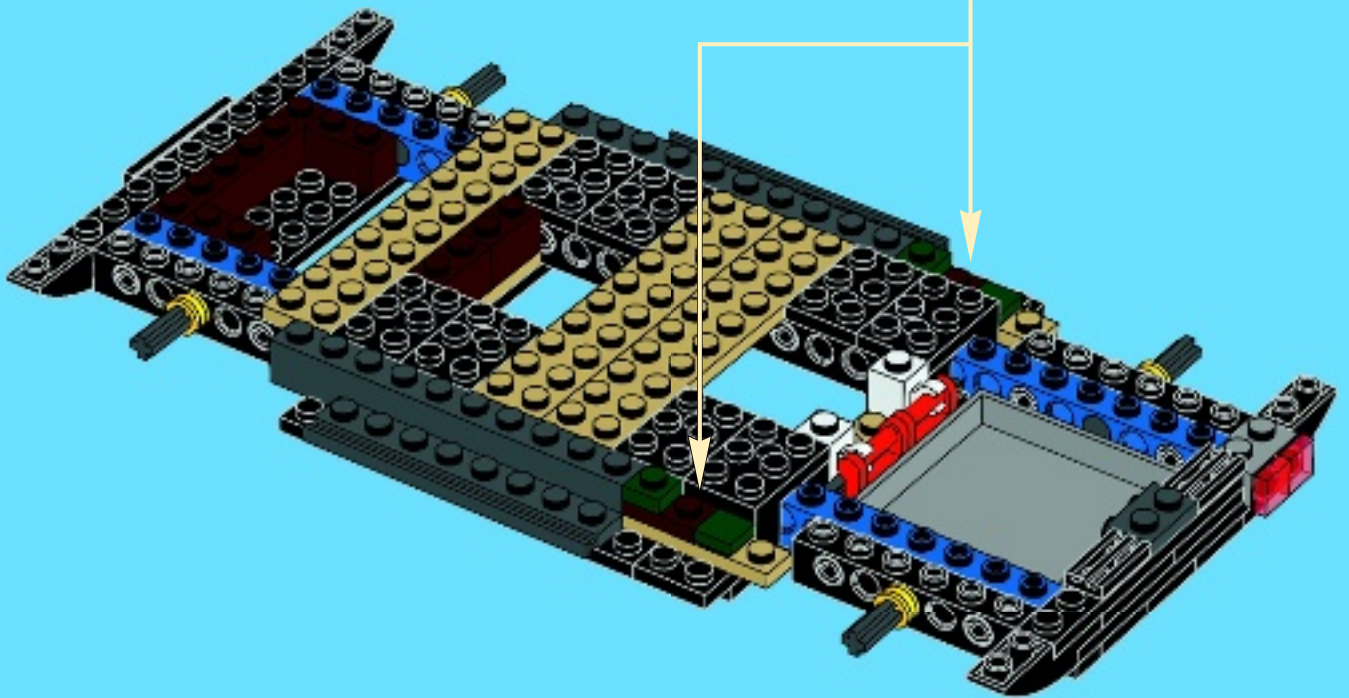
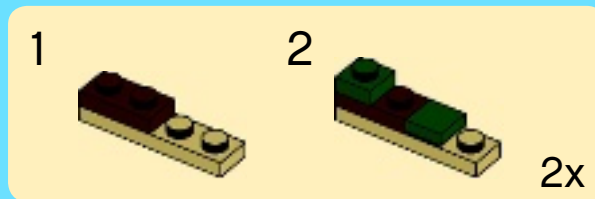



2x



1x



6x

13

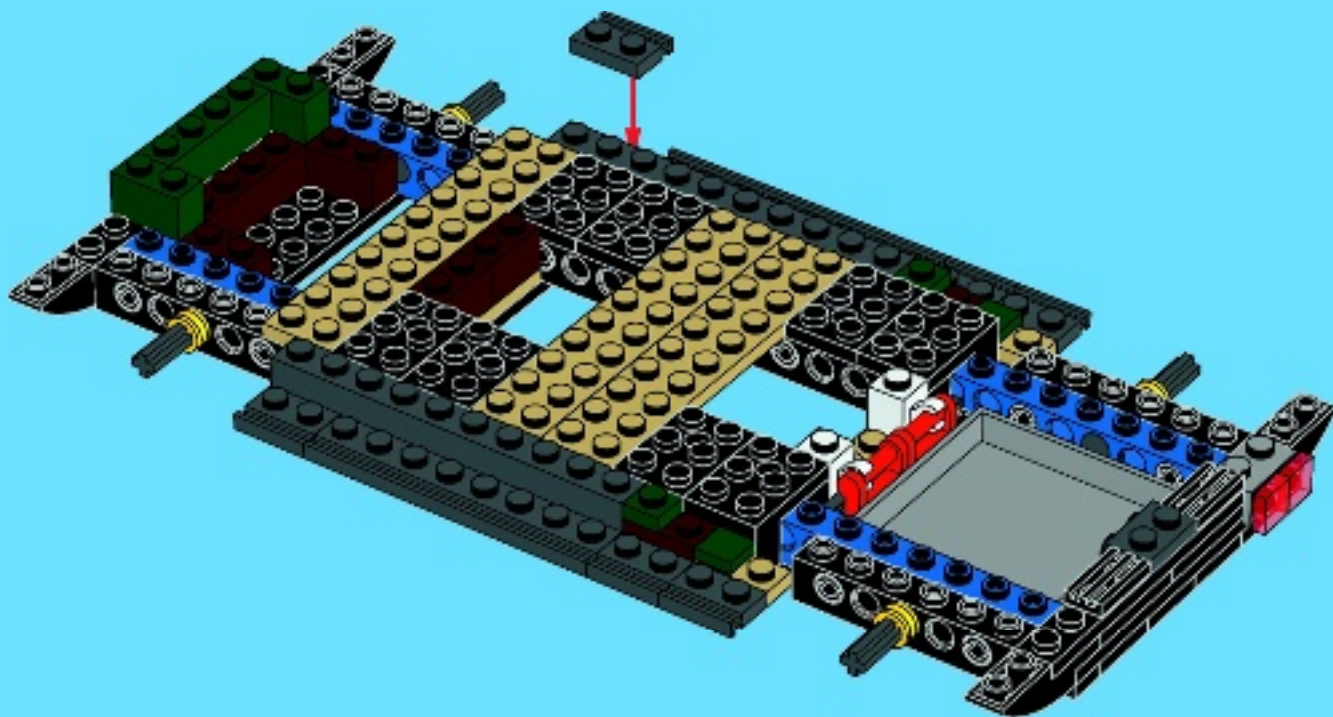

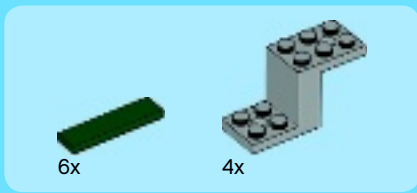

14

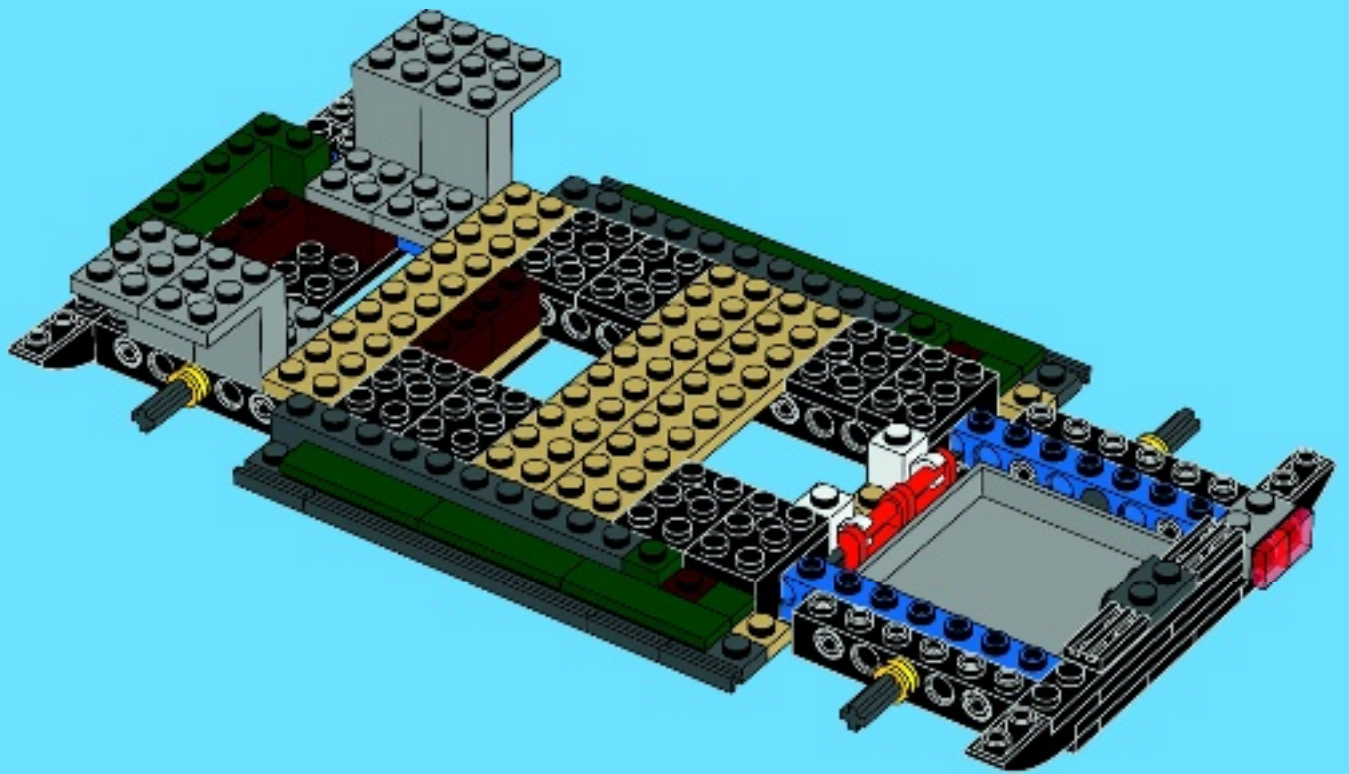

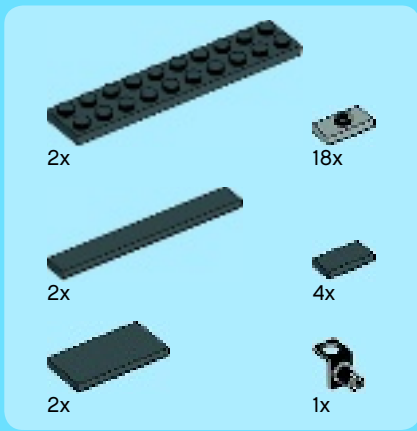

16

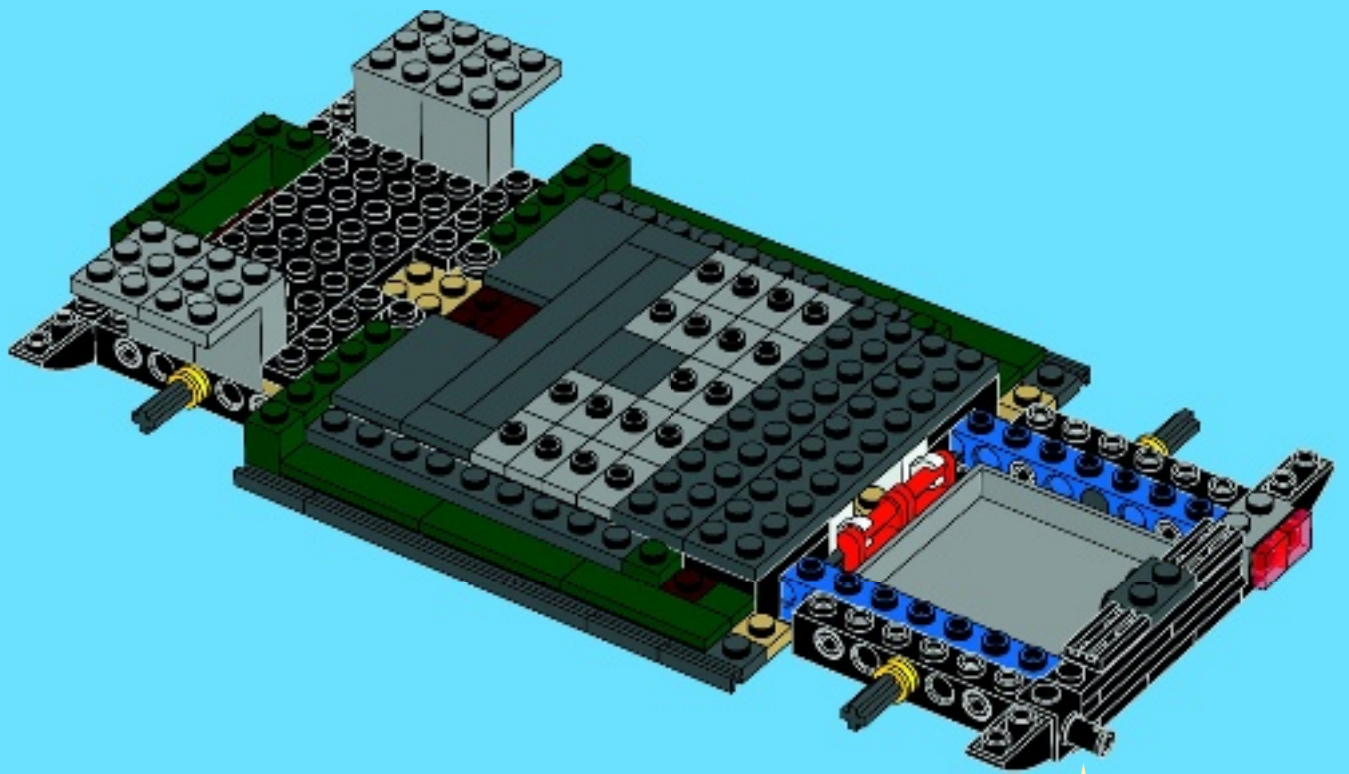



17

1



2



3

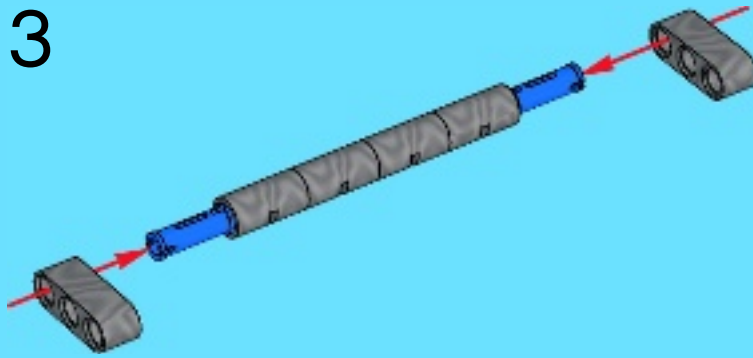

4



5

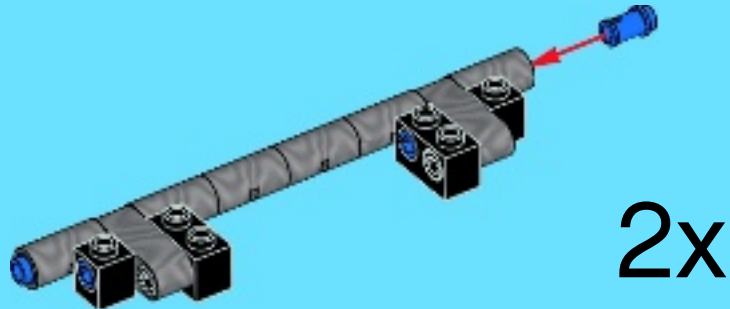

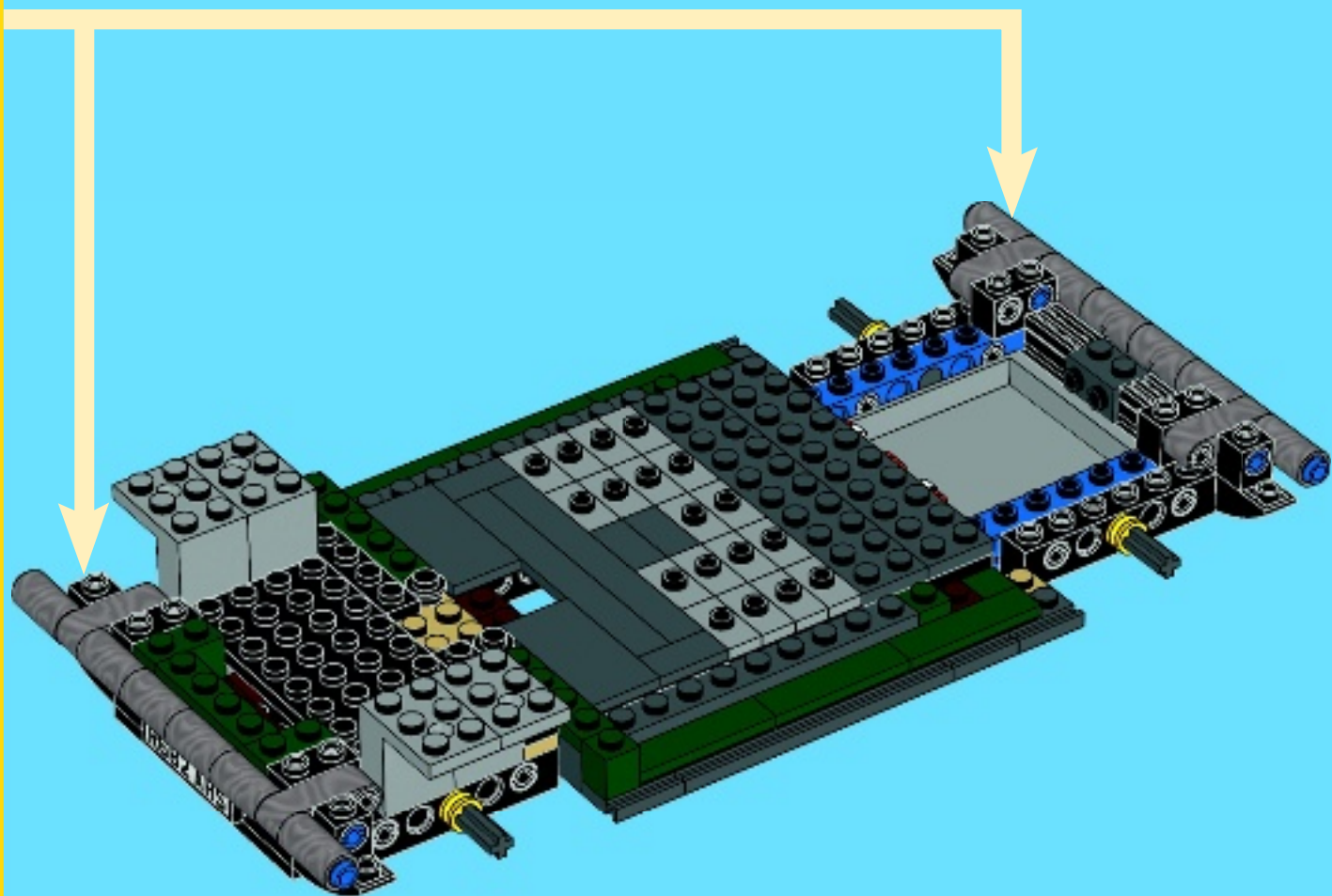



18

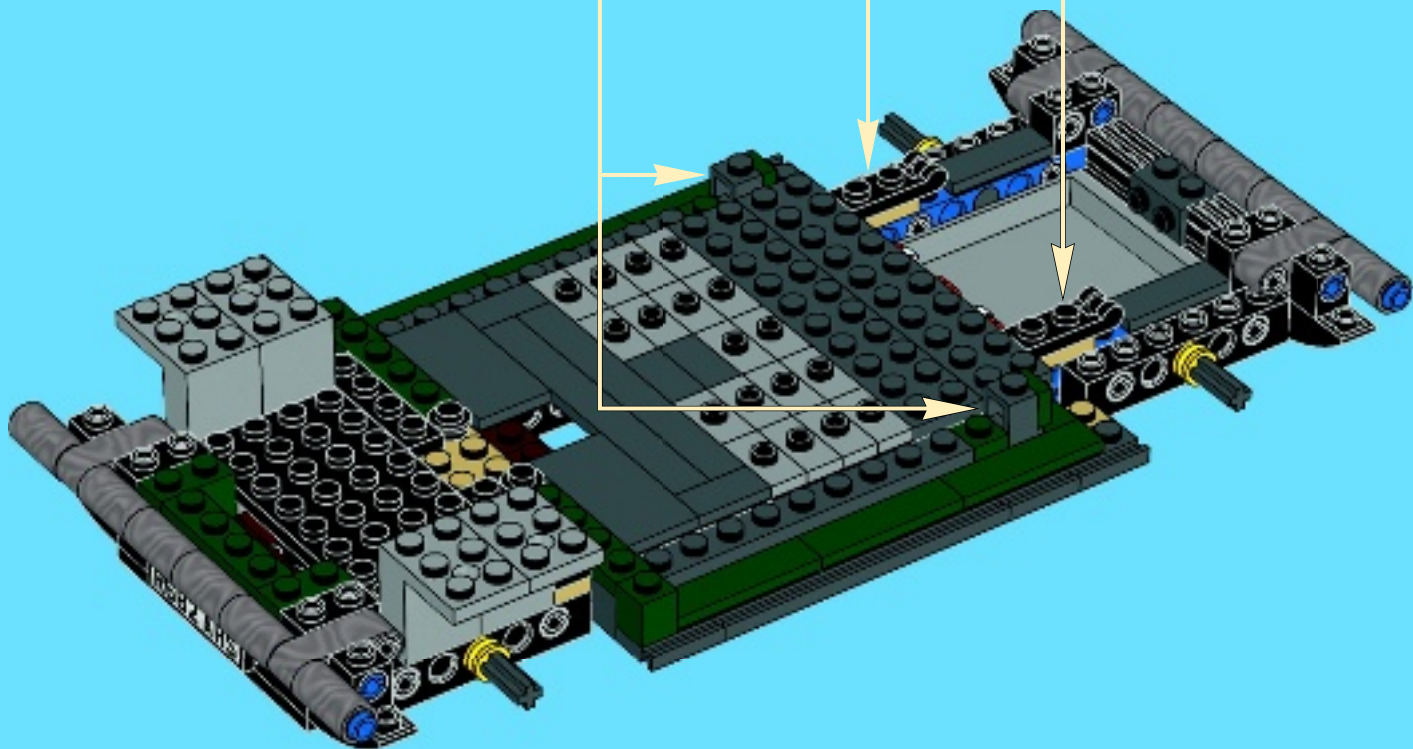
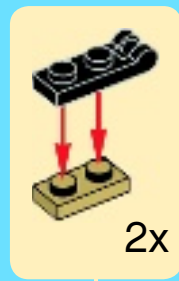
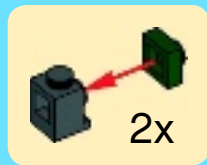

4x 2x 4x 4x 2x

1x 1x 2x

19

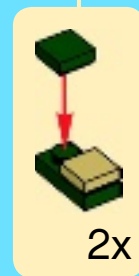
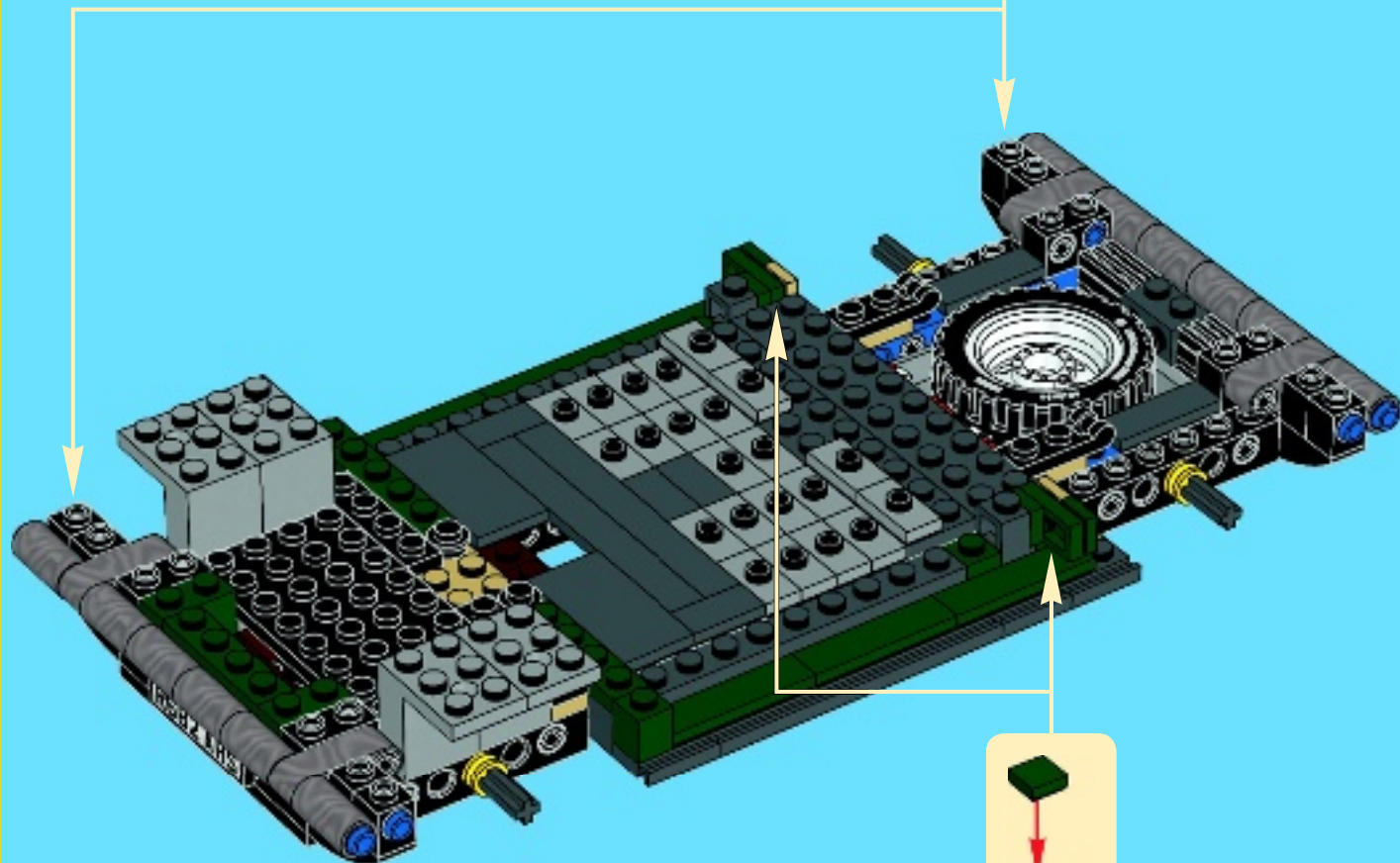
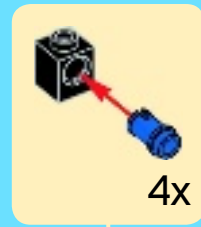



20

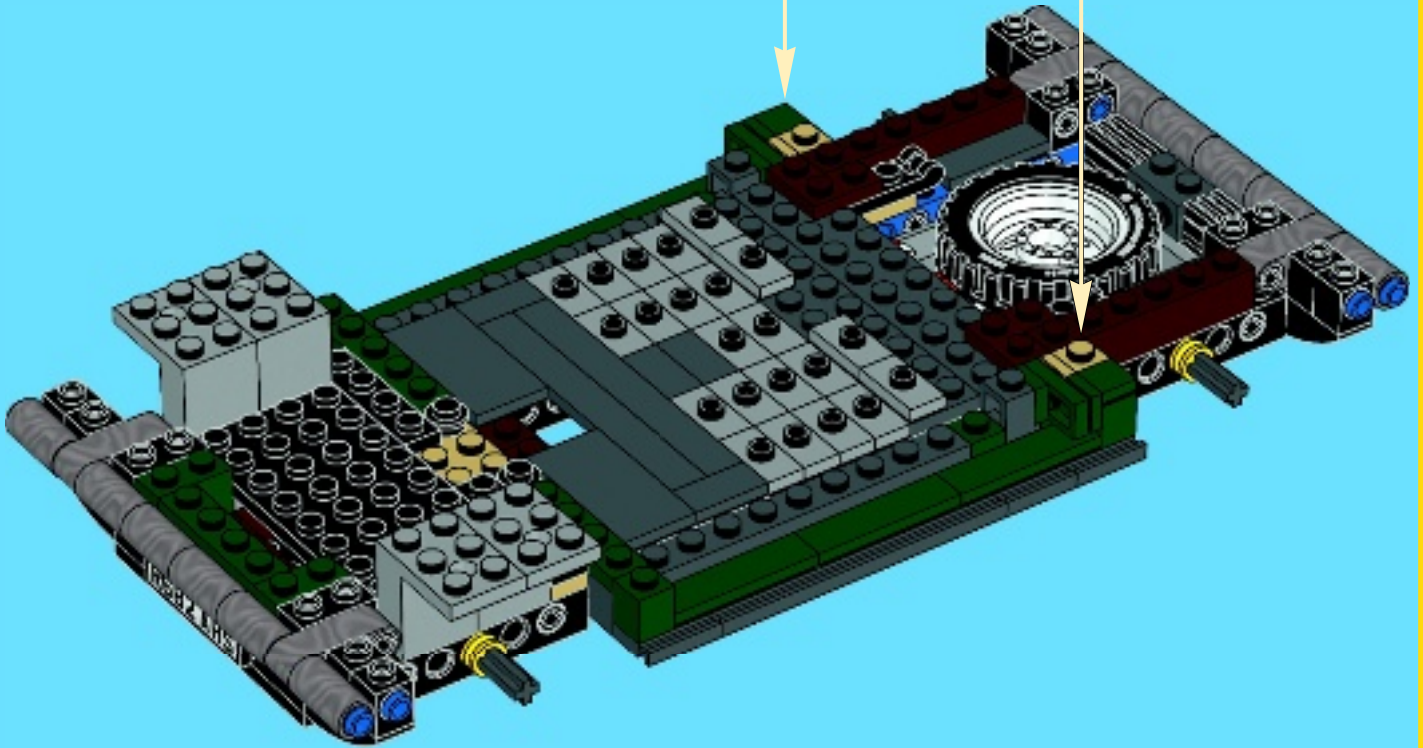
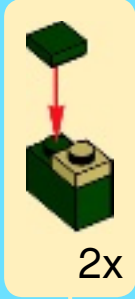

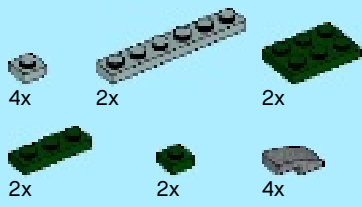

21

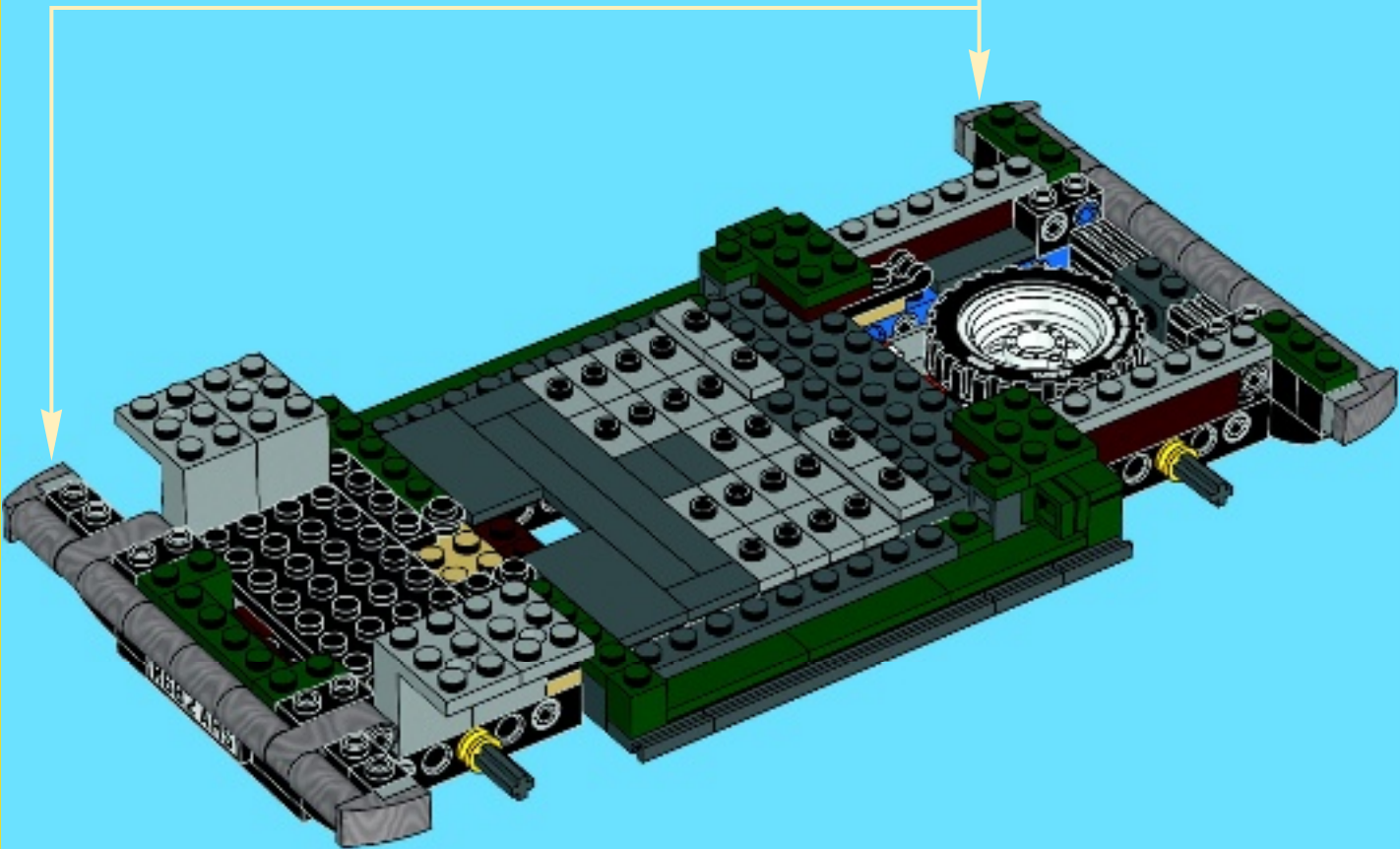
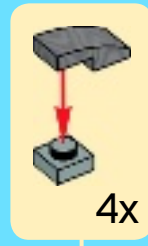

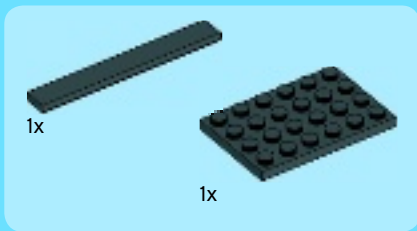

1



2

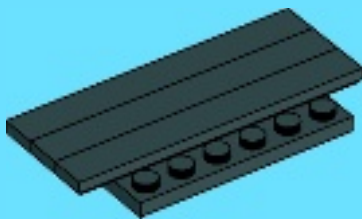

3

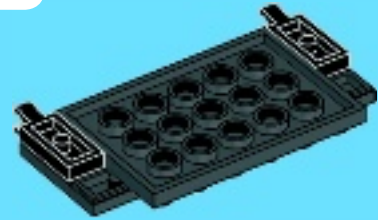

4

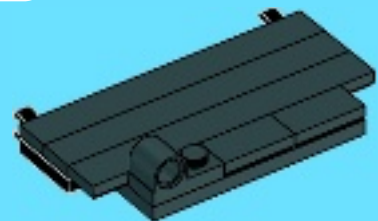

22

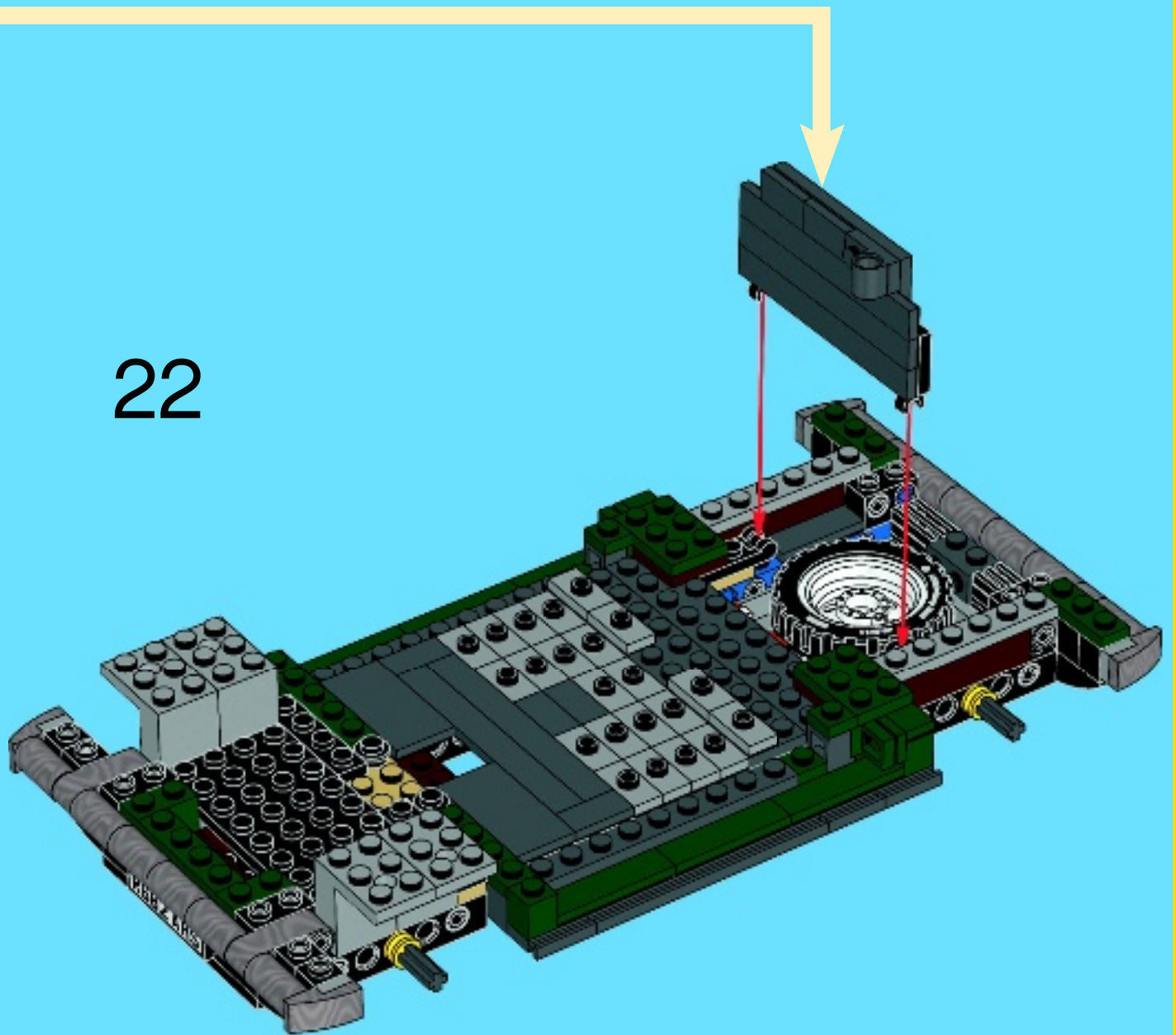



2x



2x



2x

23

1

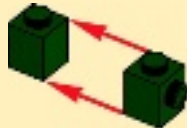

2



2x

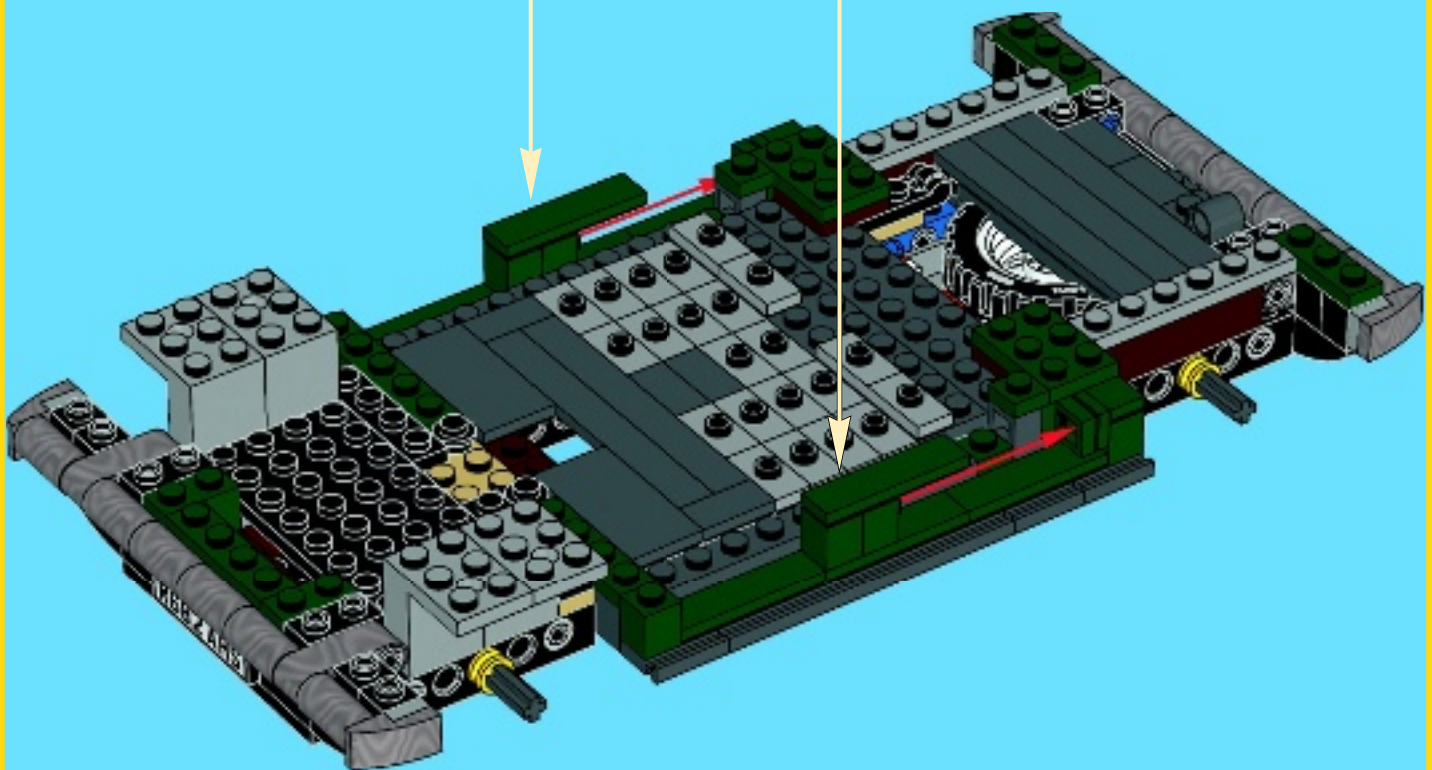



1x



1x



1x



1x



1x

24

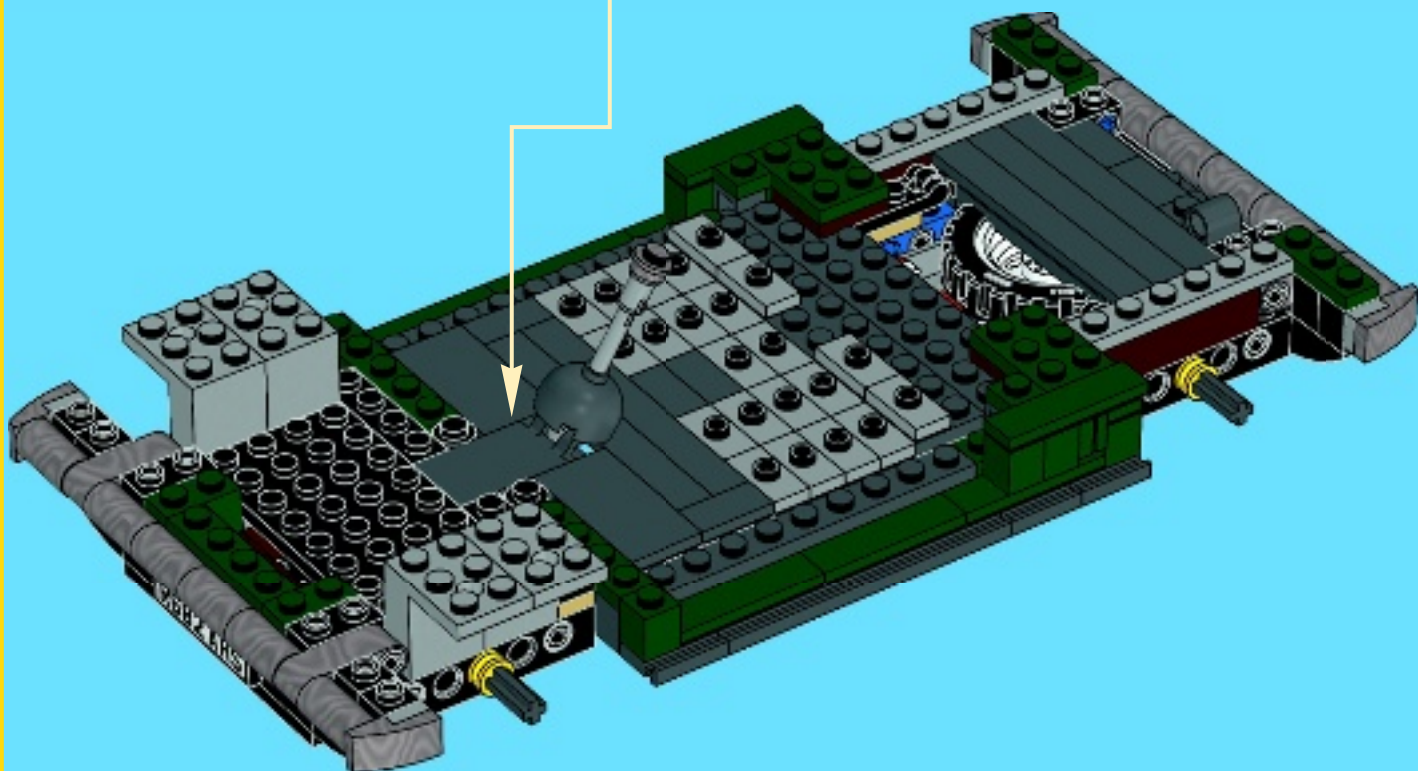
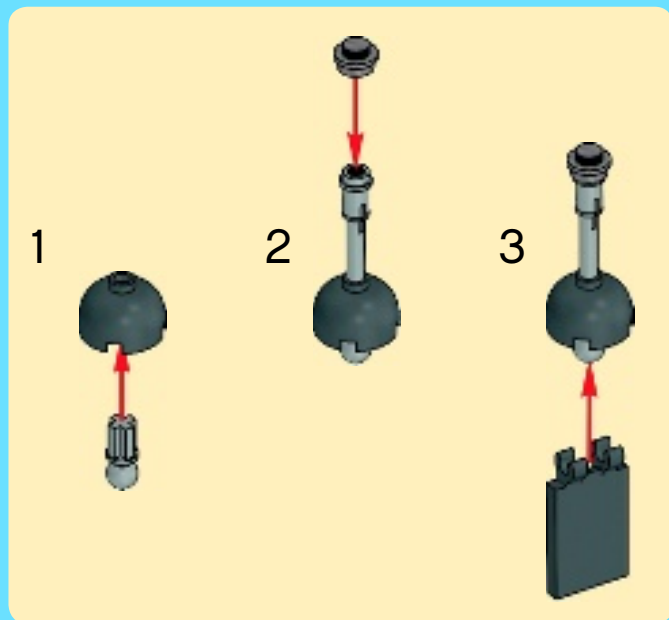

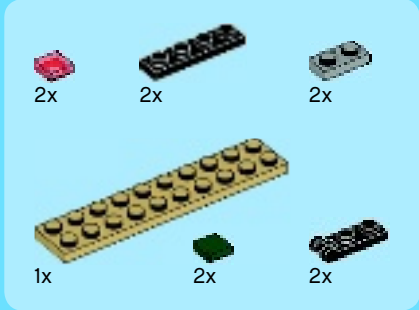
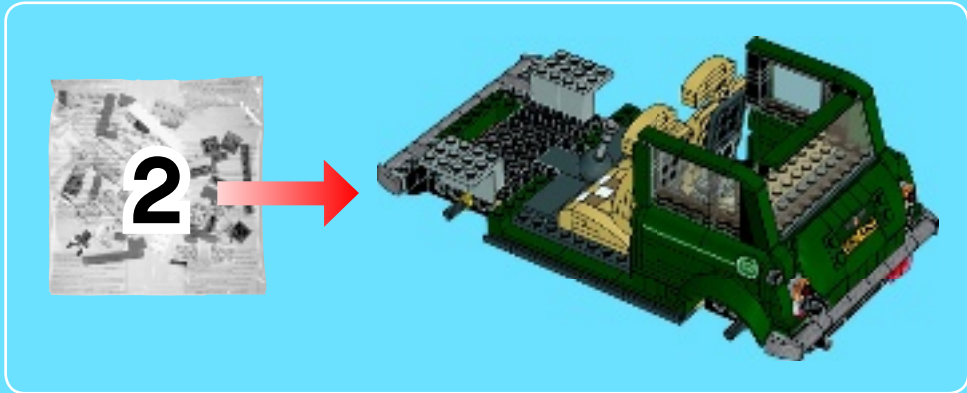

25

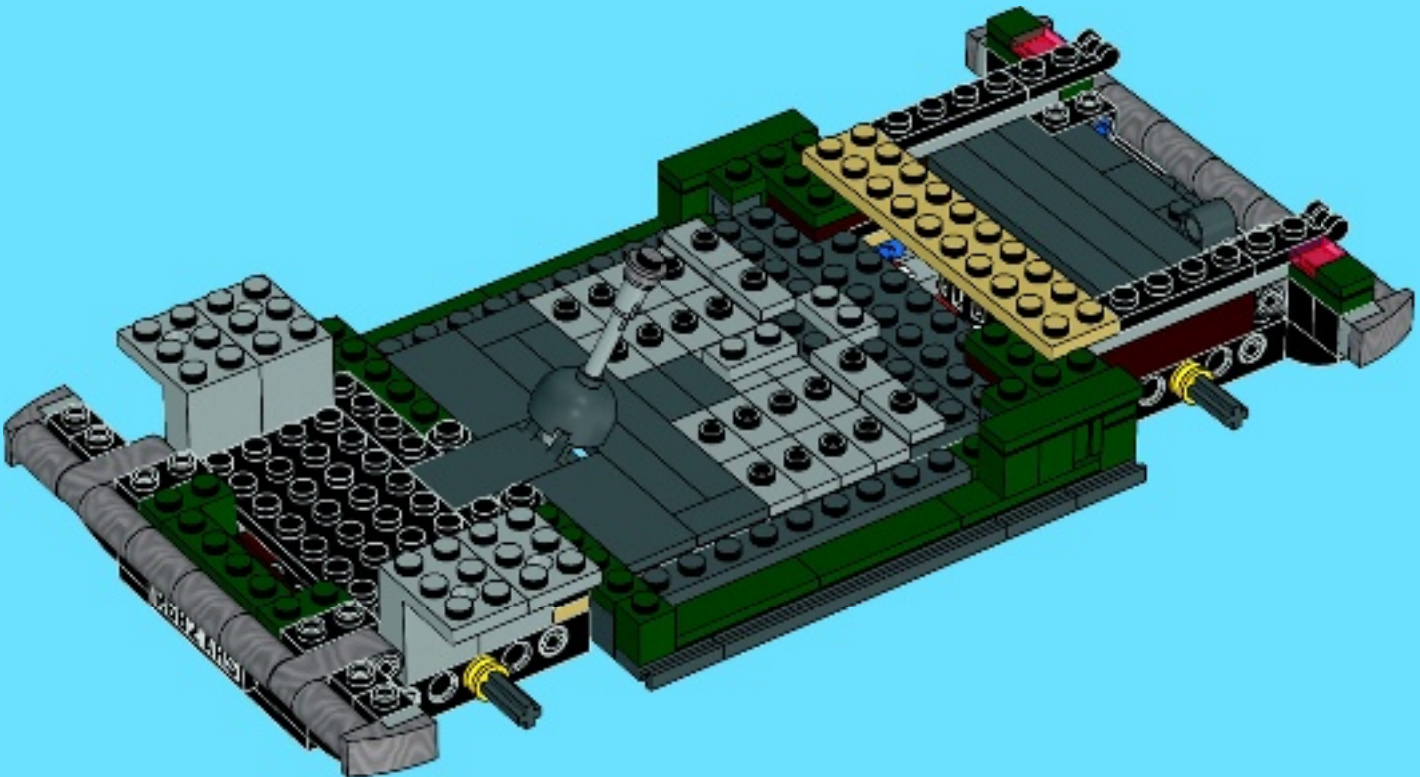



1x



1x



10x

26

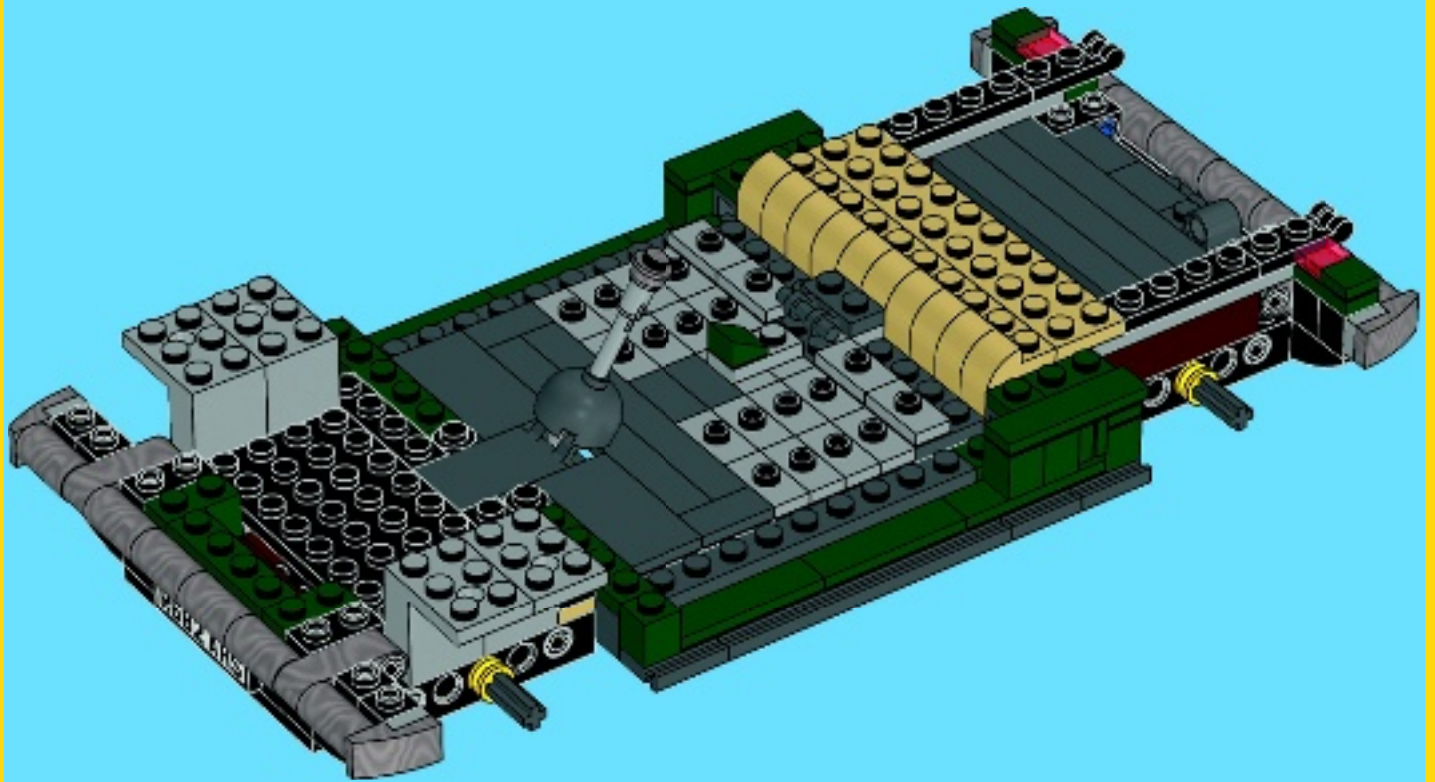



2x



2x



1x

1



2x

2





2x



1x



1x

3



2x



3x

4

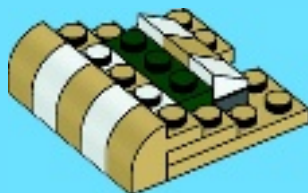

1x



2x



2x



3x

5



2x

27

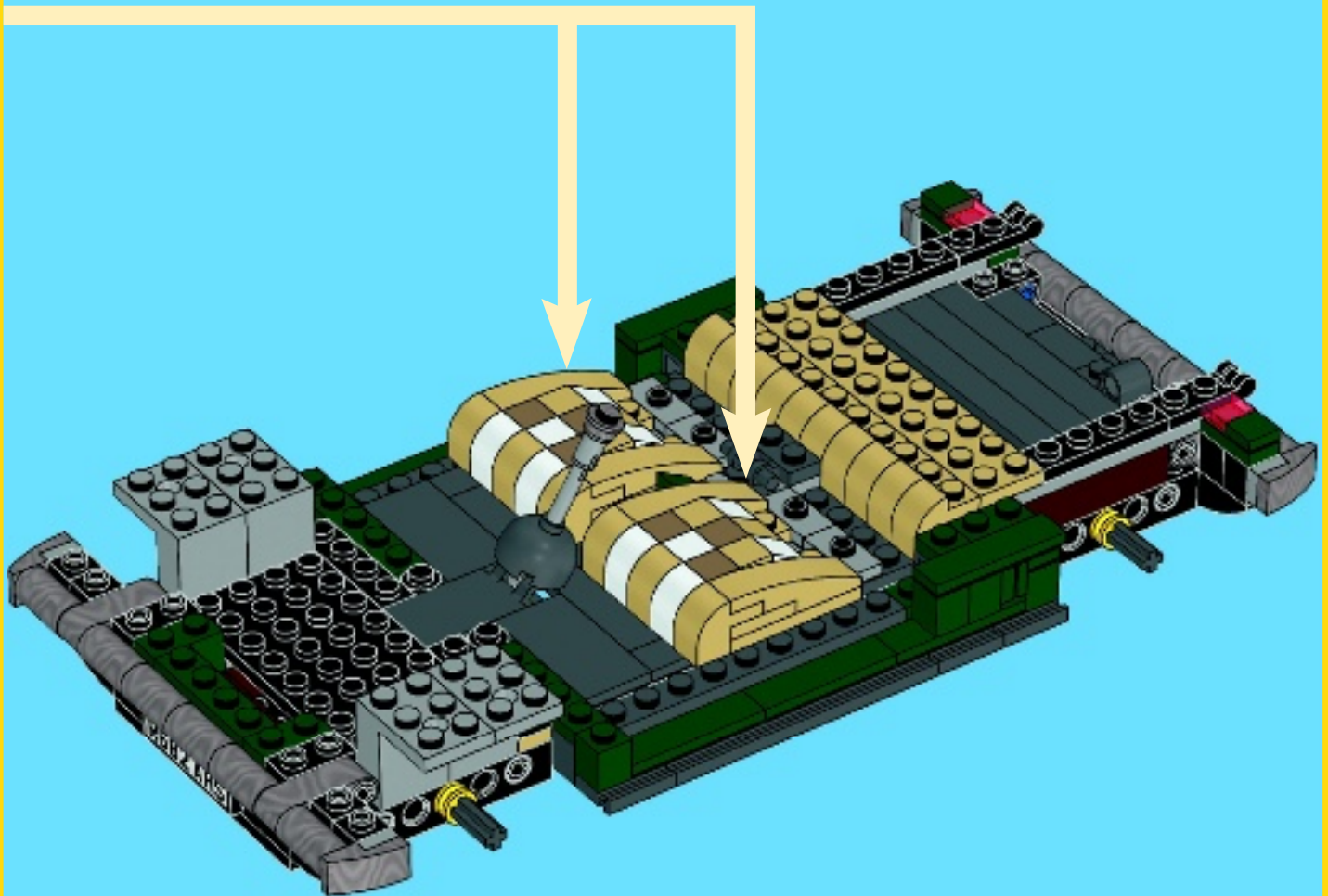



1x



4x



4x



1x

28

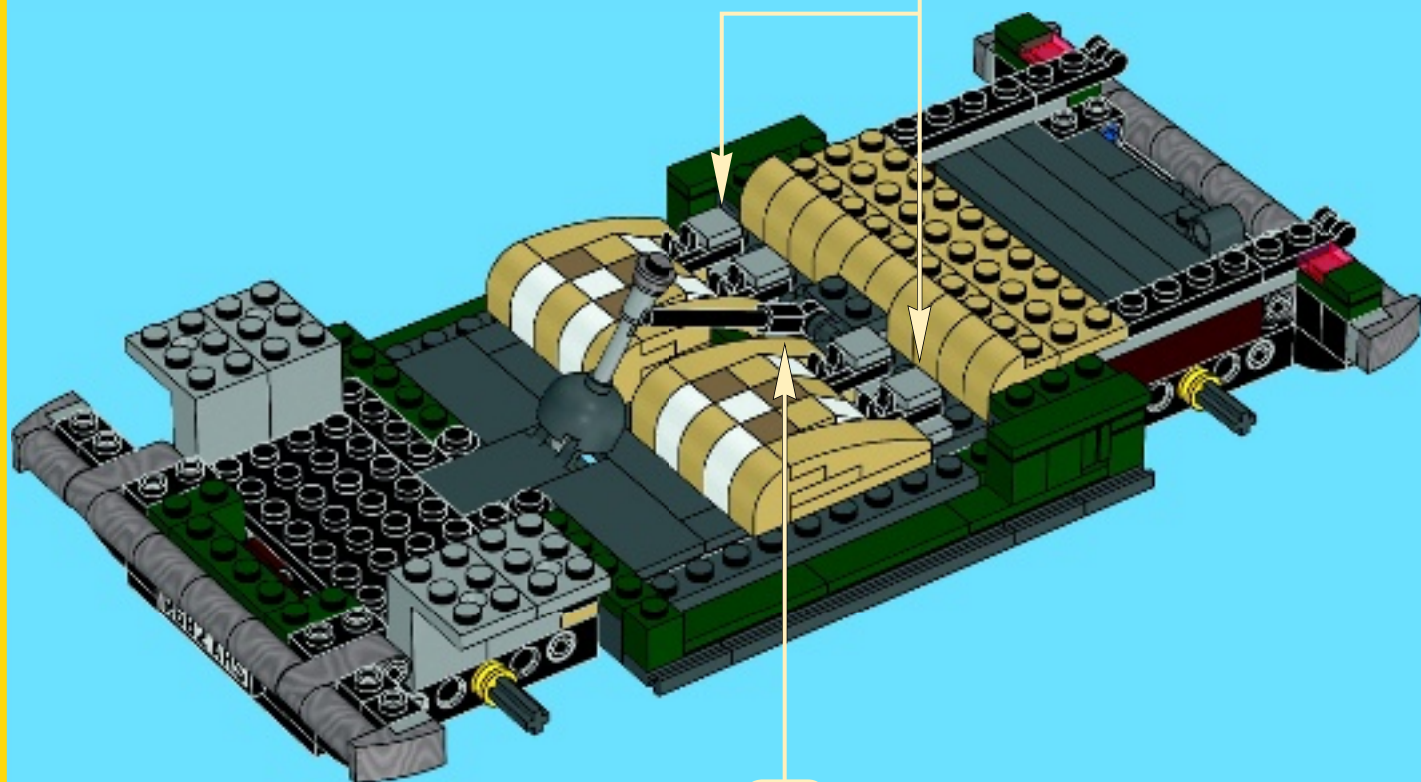
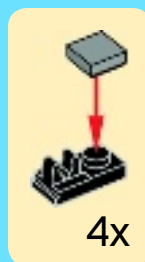

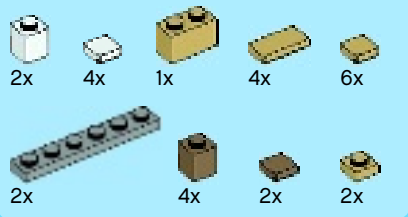

29

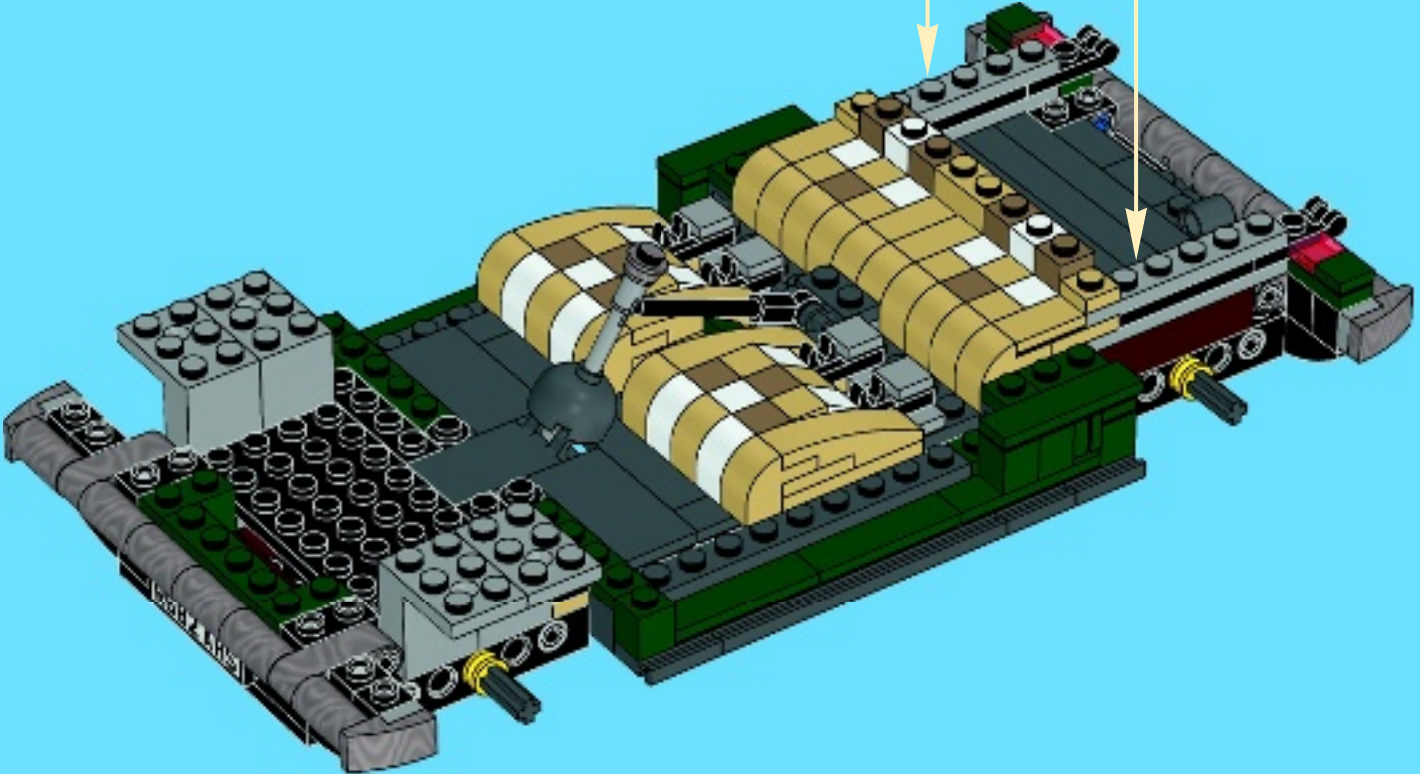
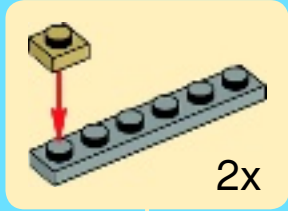



2x



1x



2x



3x



1x

30

1



2

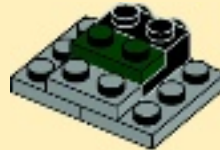

3

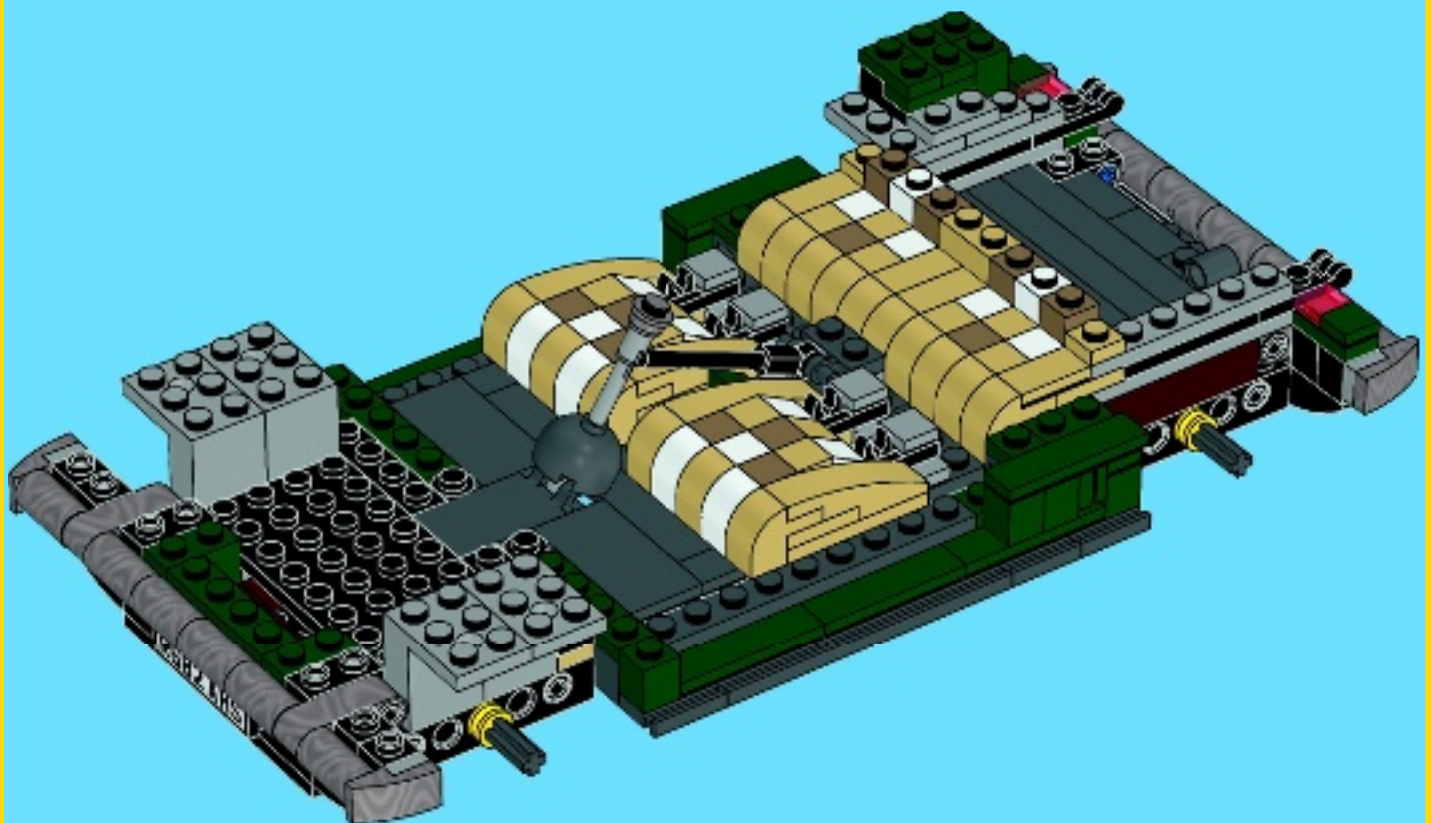
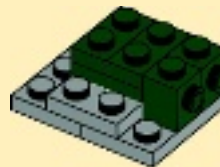

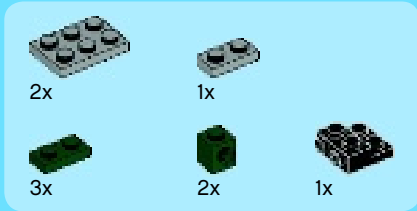

31

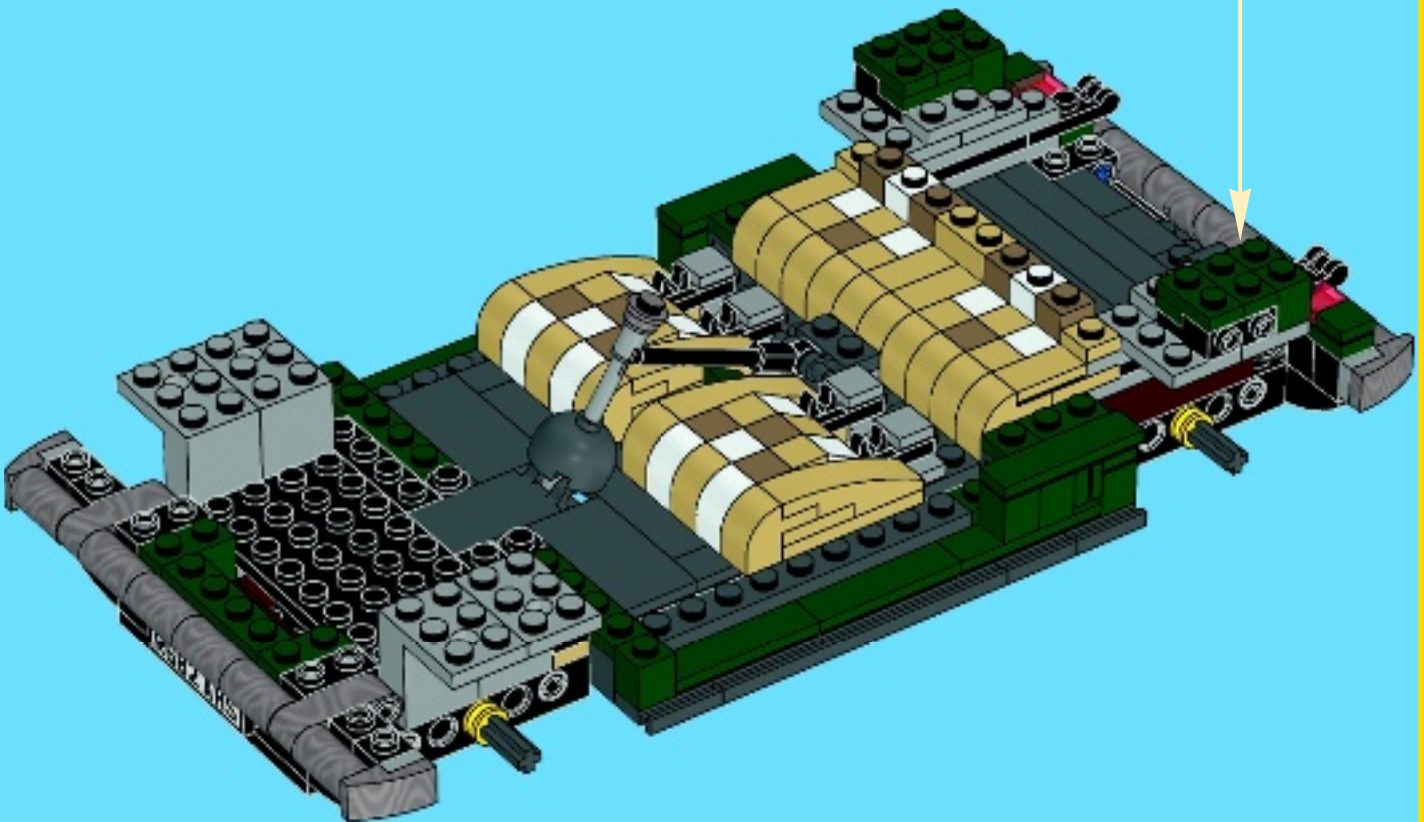
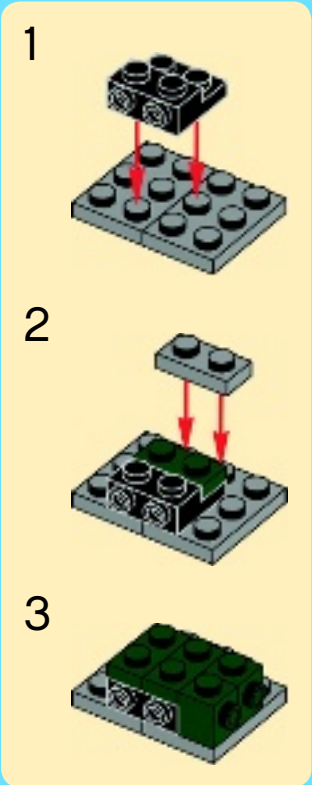

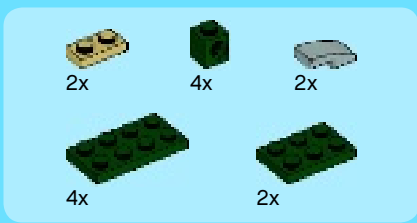

32

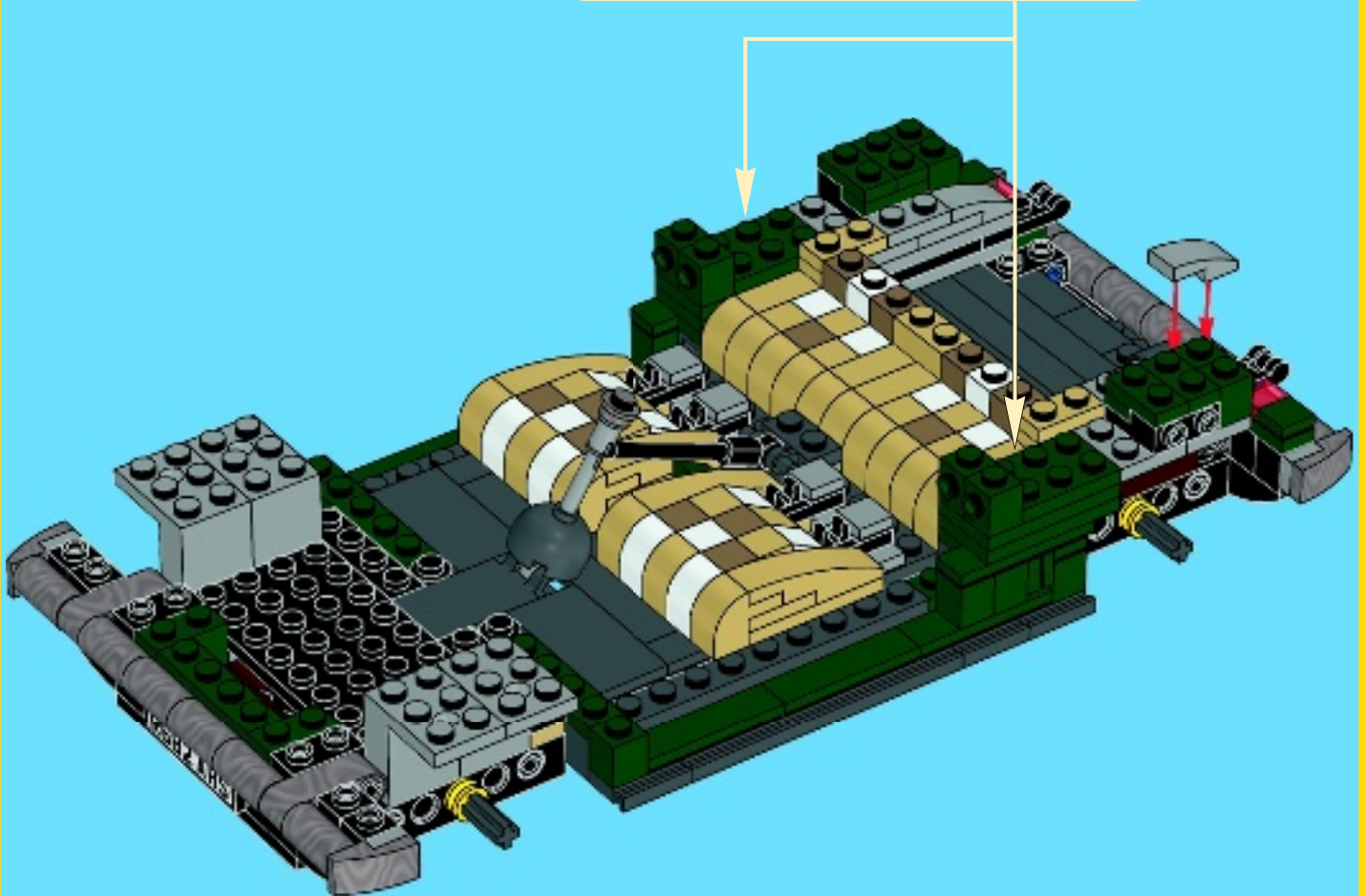
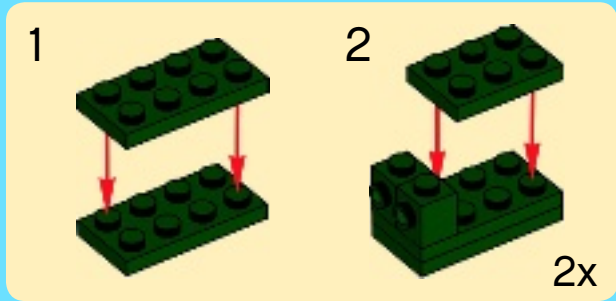



4x



2x



2x

33

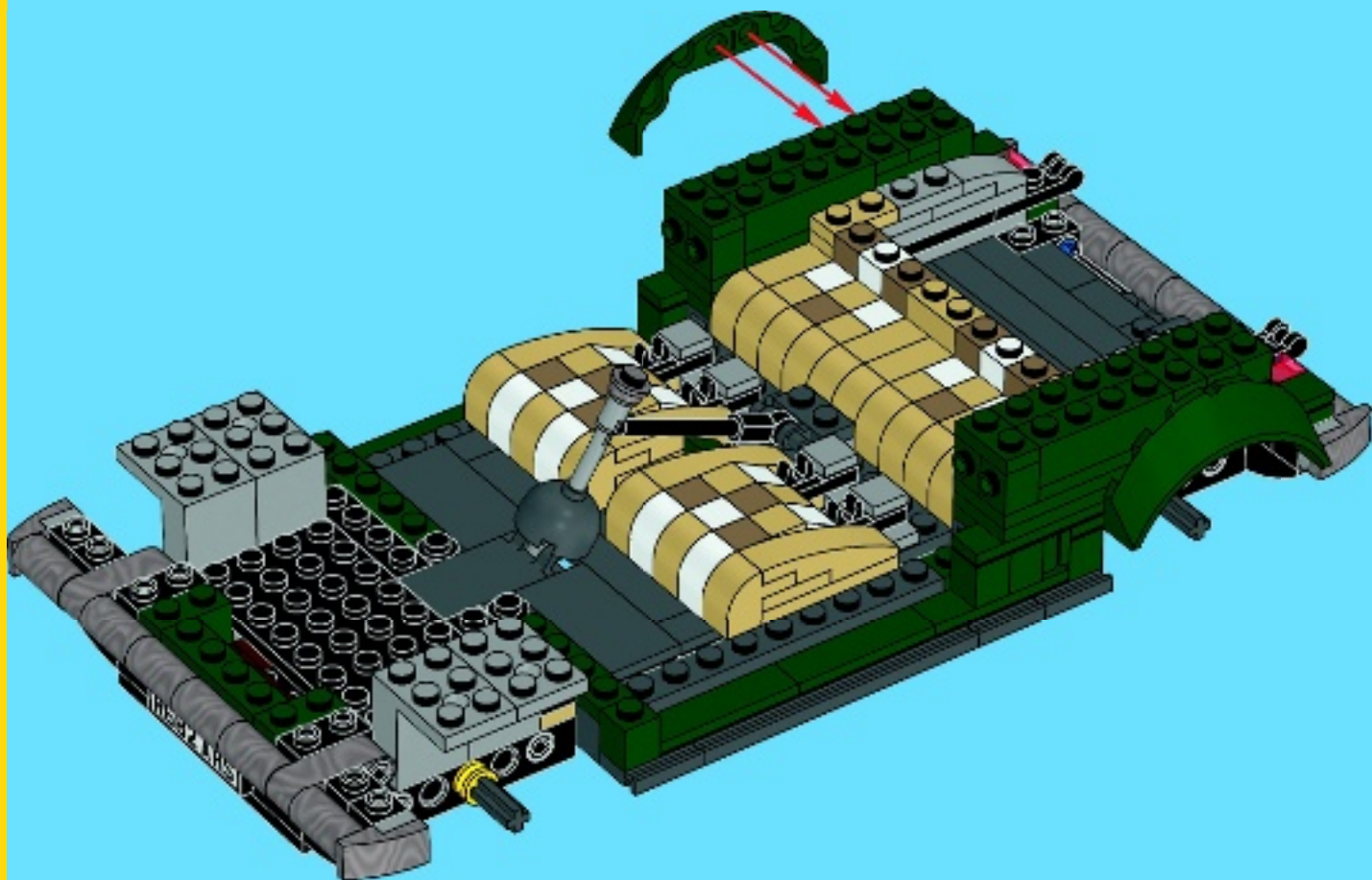

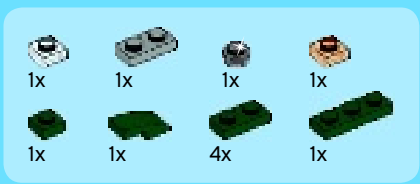

34

1

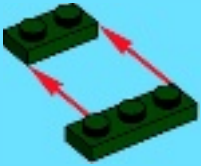

2

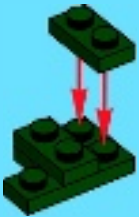

3

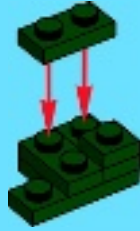

4



5



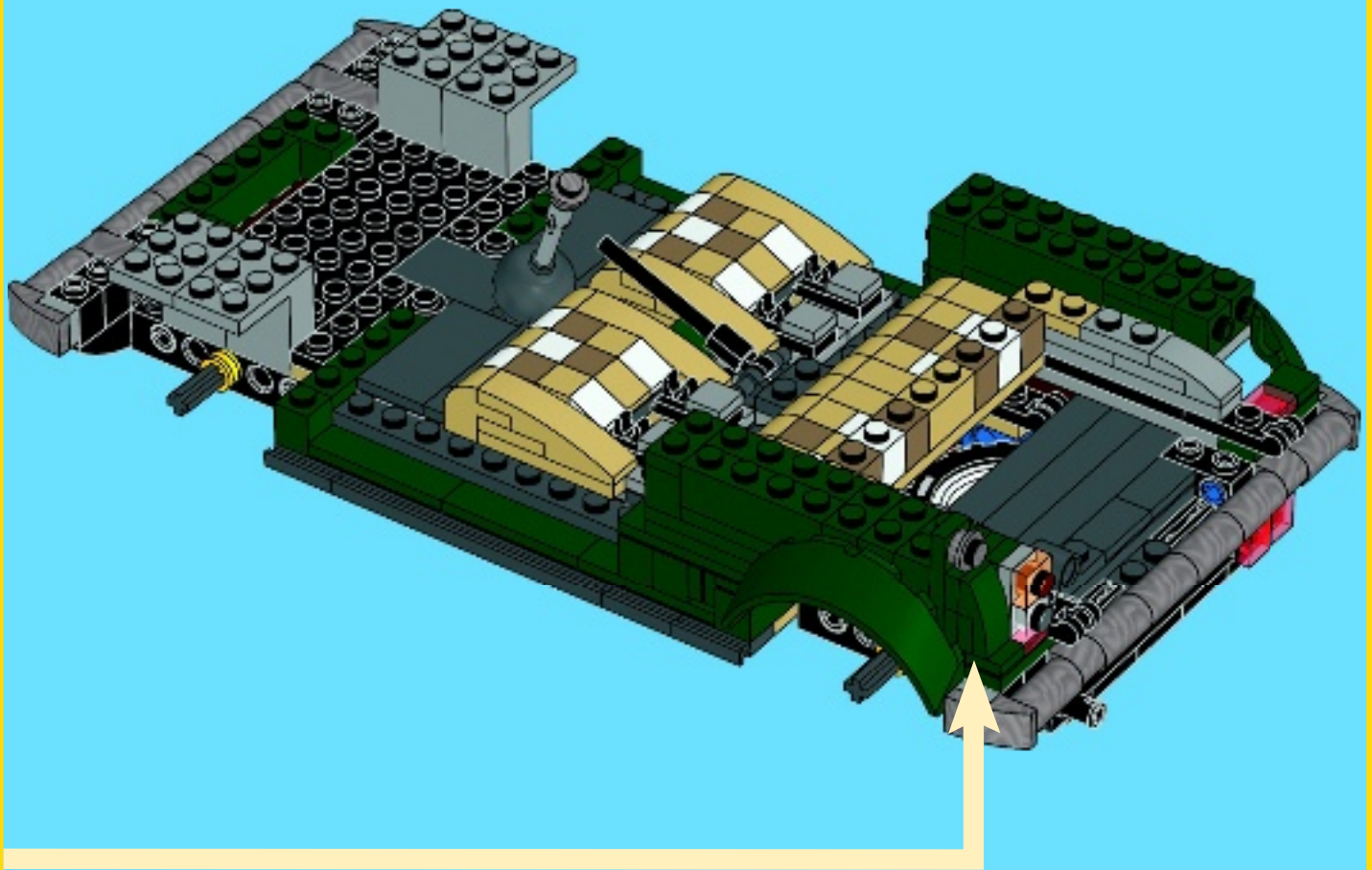



35

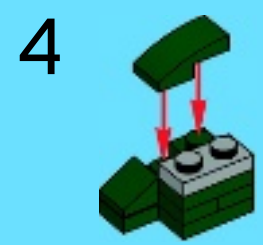
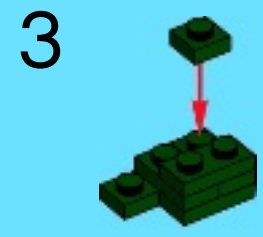
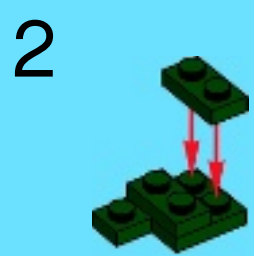
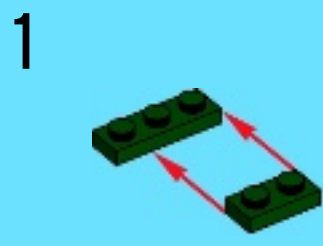

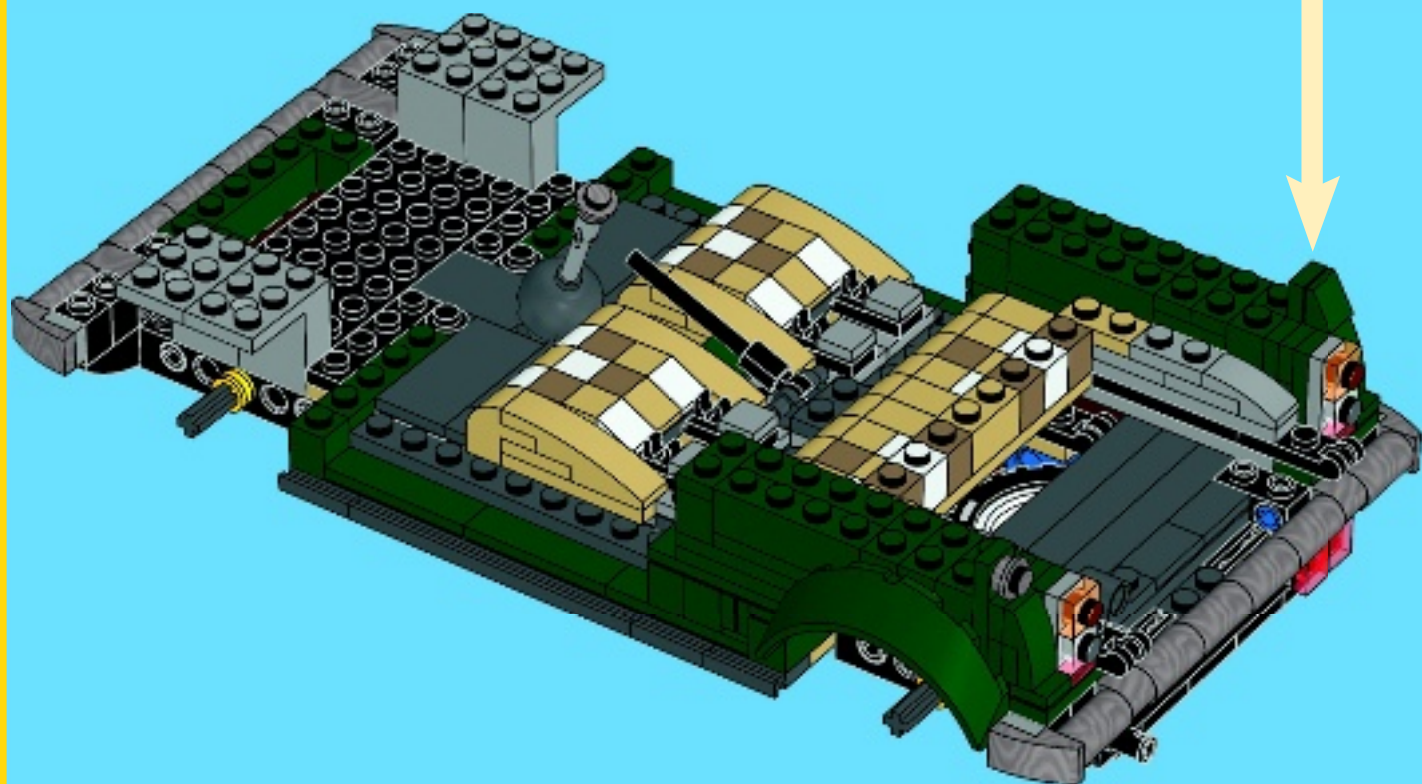



4x



2x



2x



2x



2x

36

1

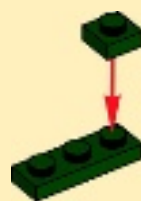

2

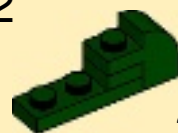

2x

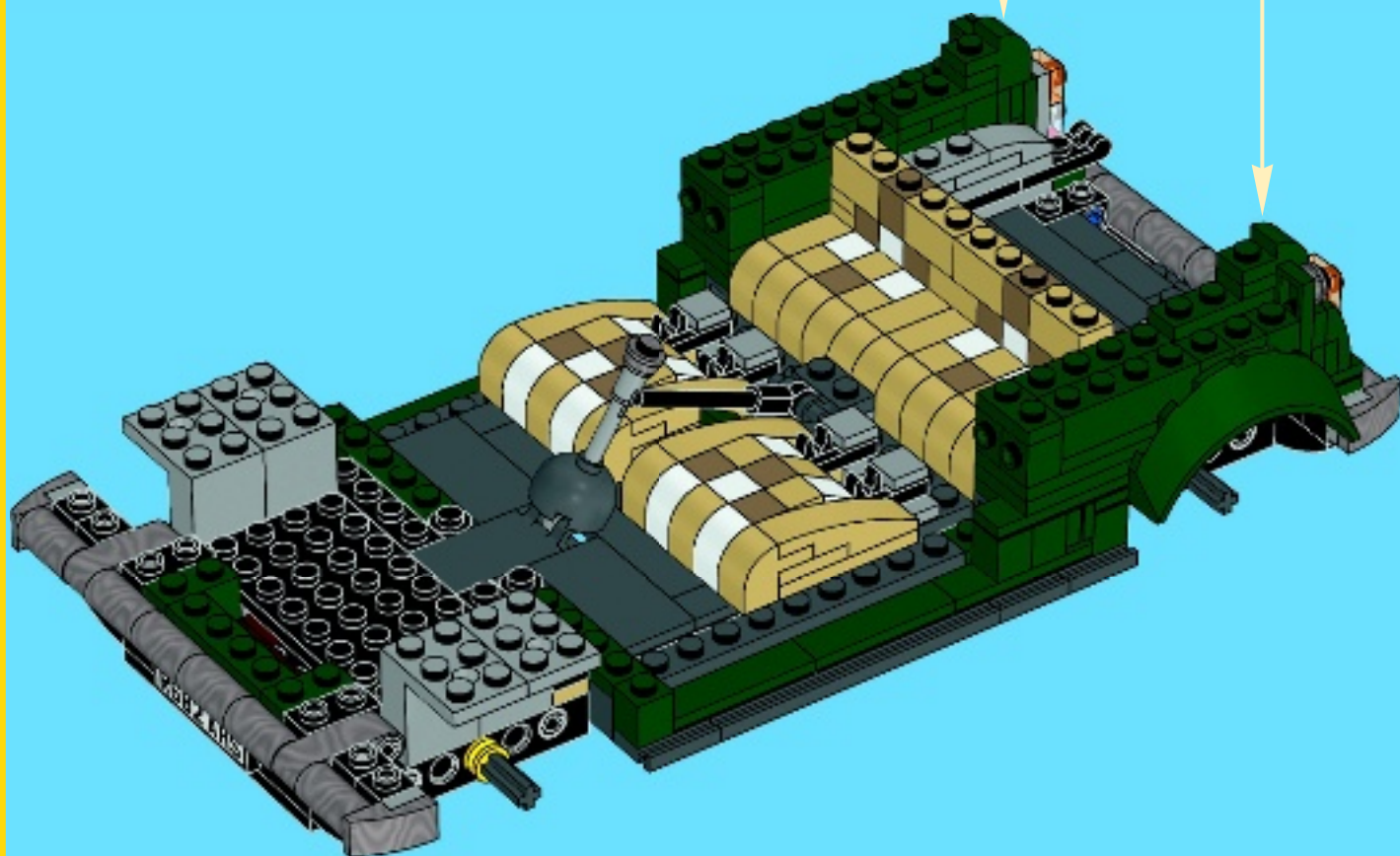

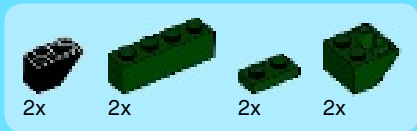

37

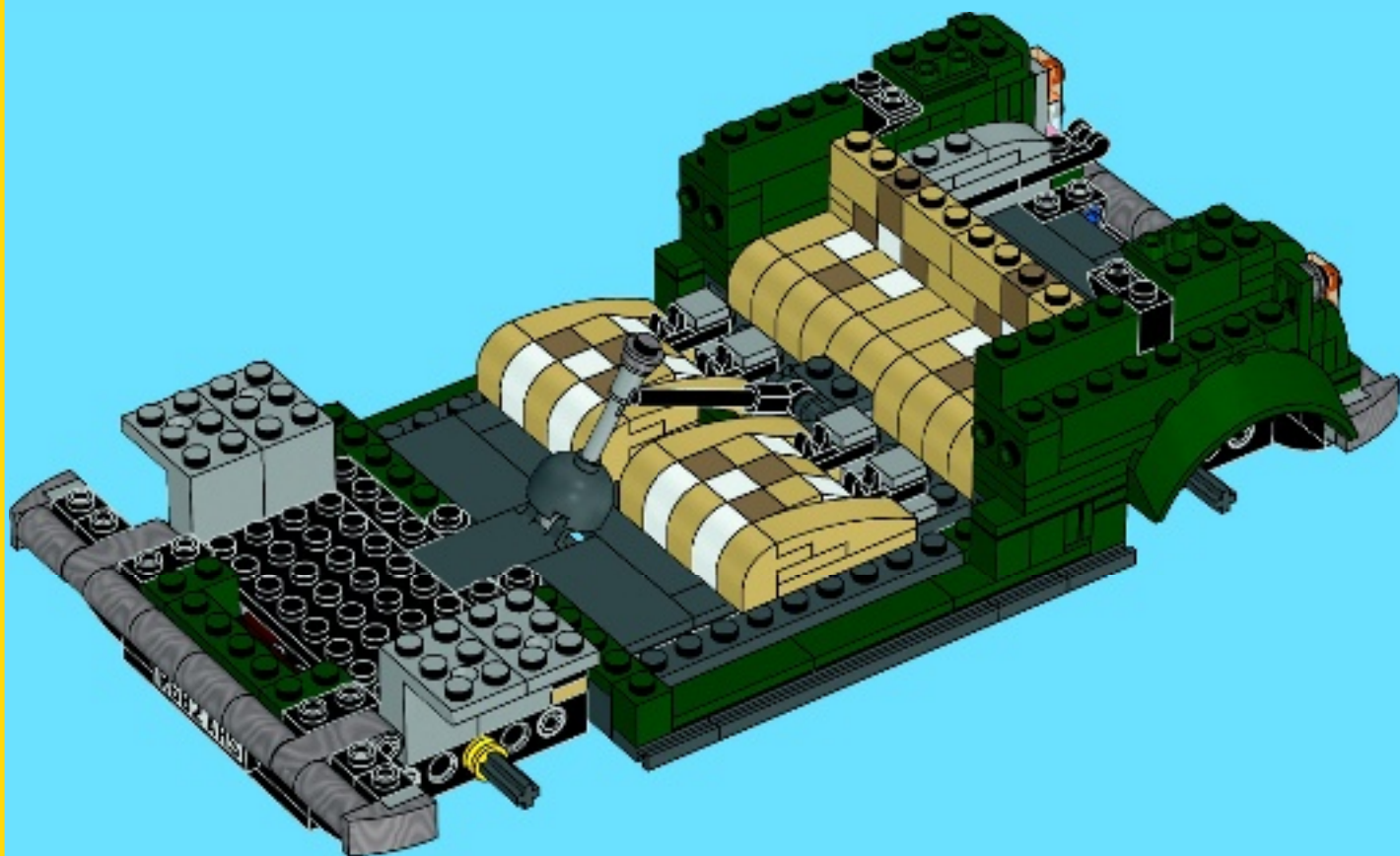



4x



6x



2x



2x

38

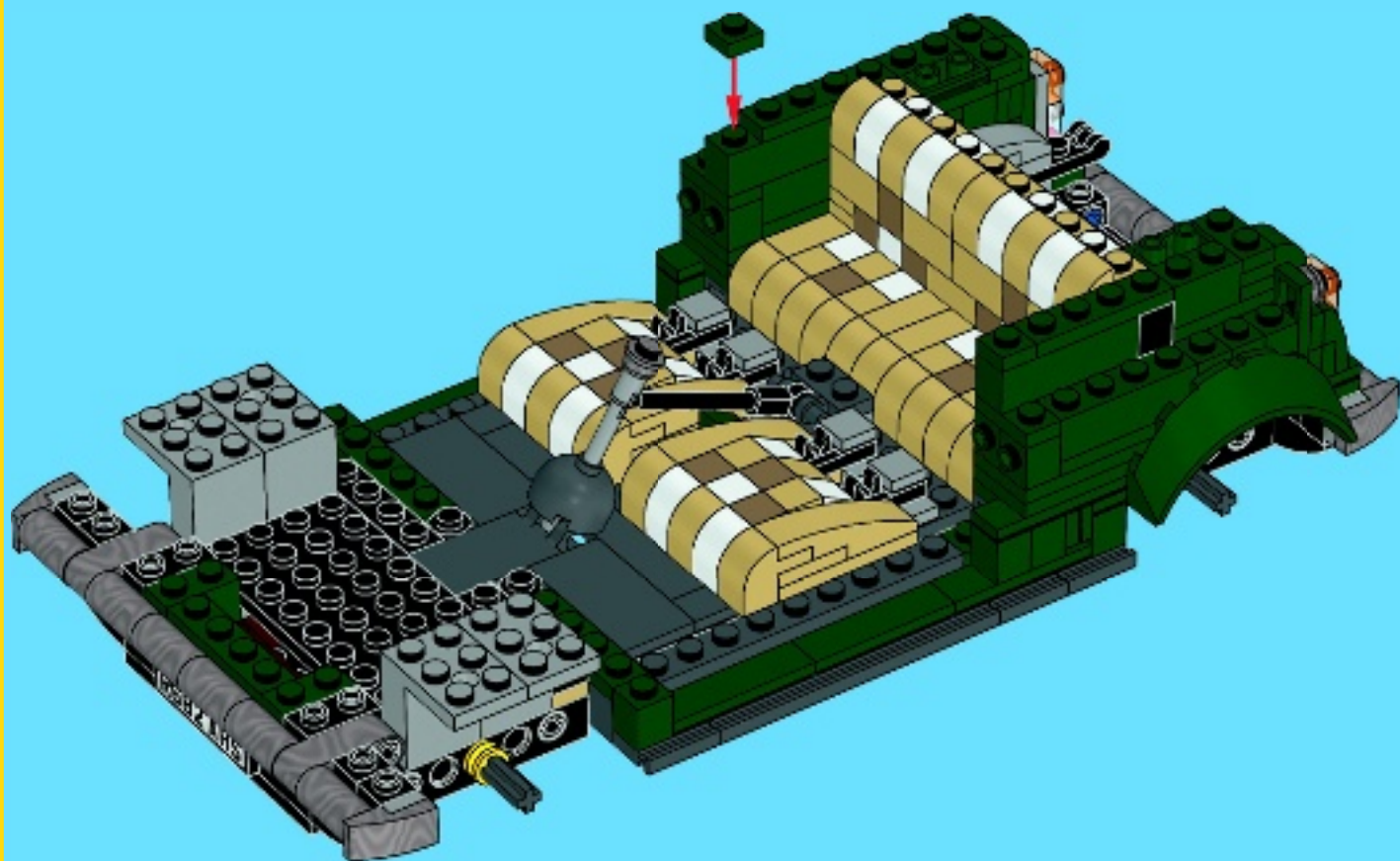

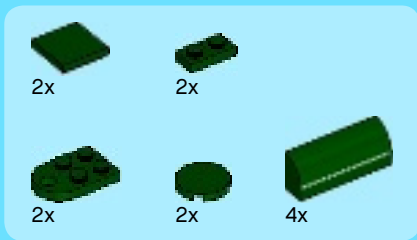

39

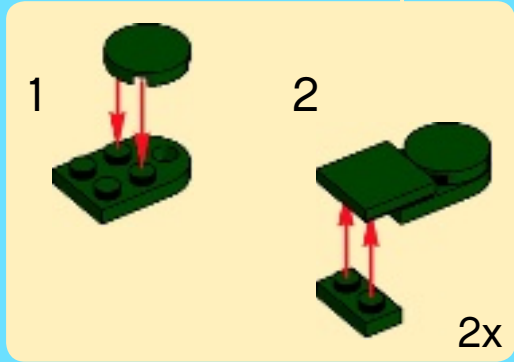
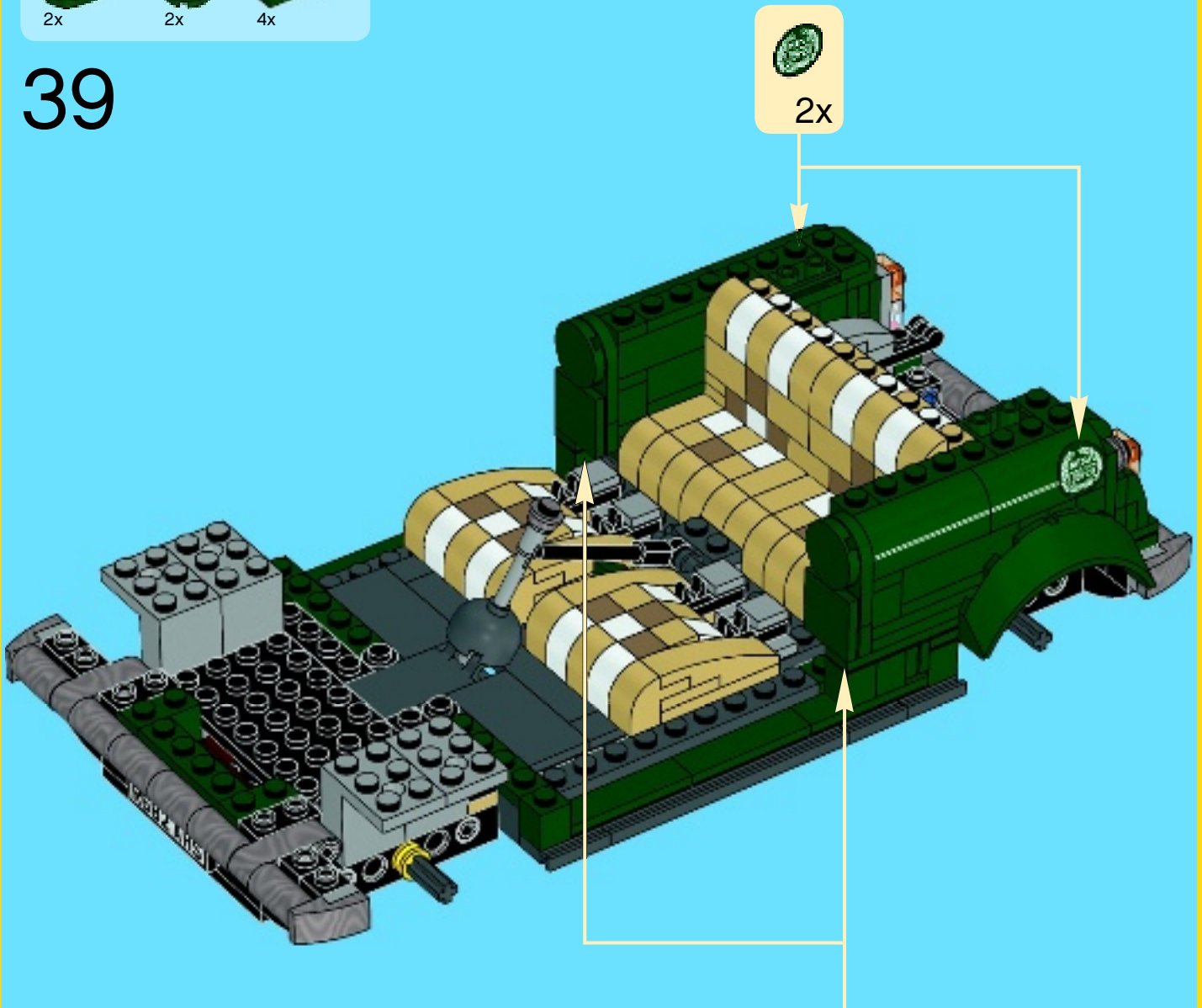

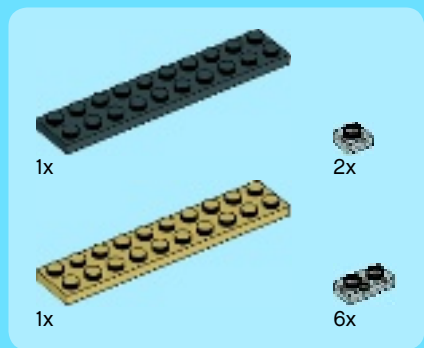

40

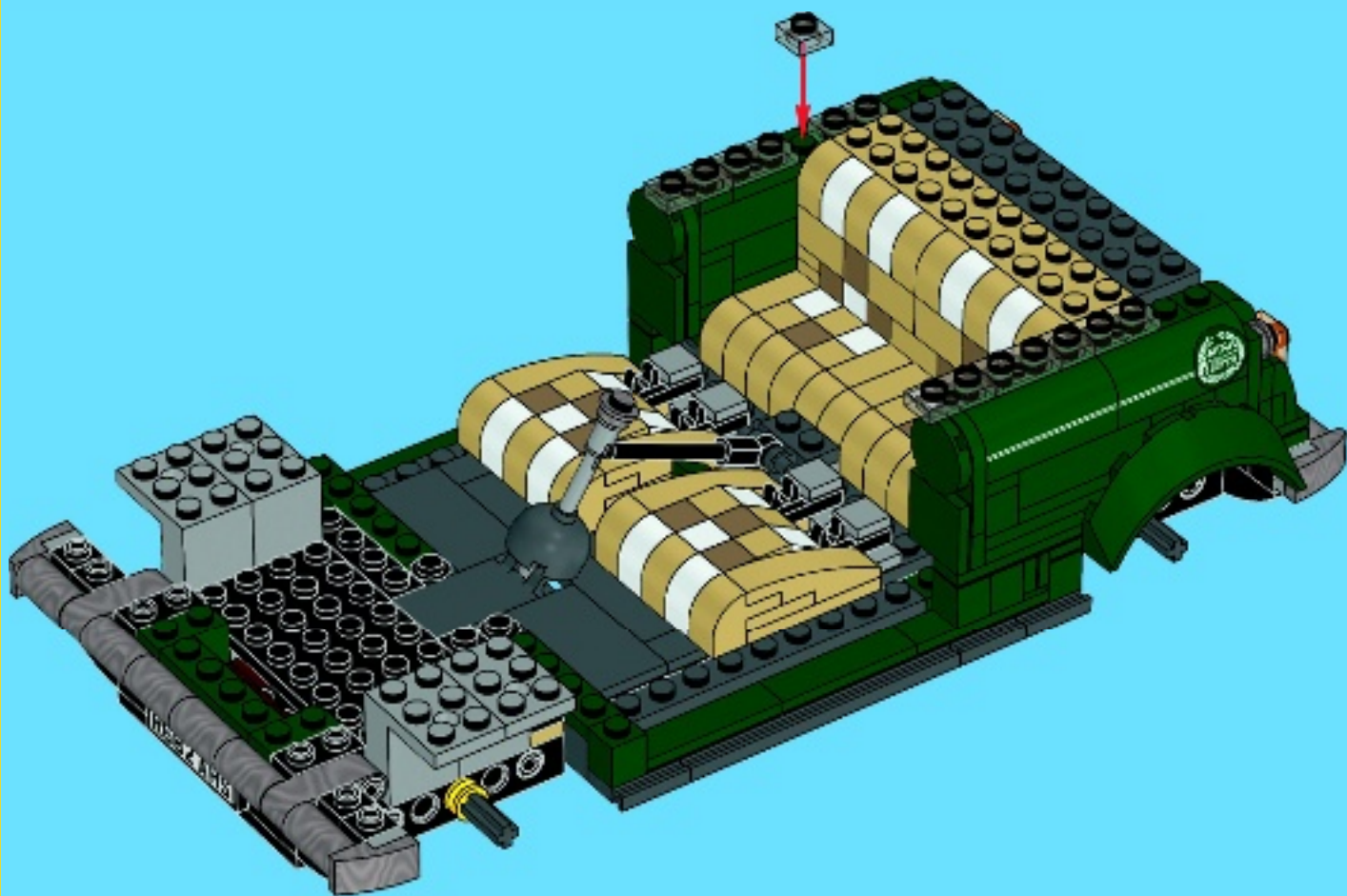

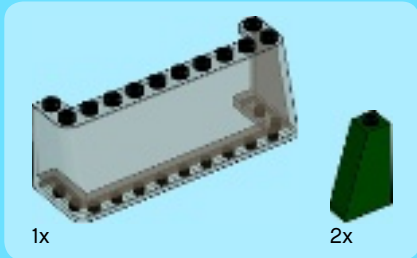

41

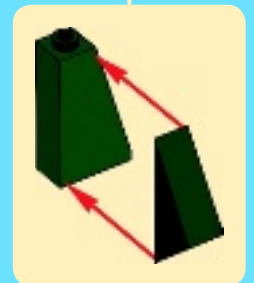
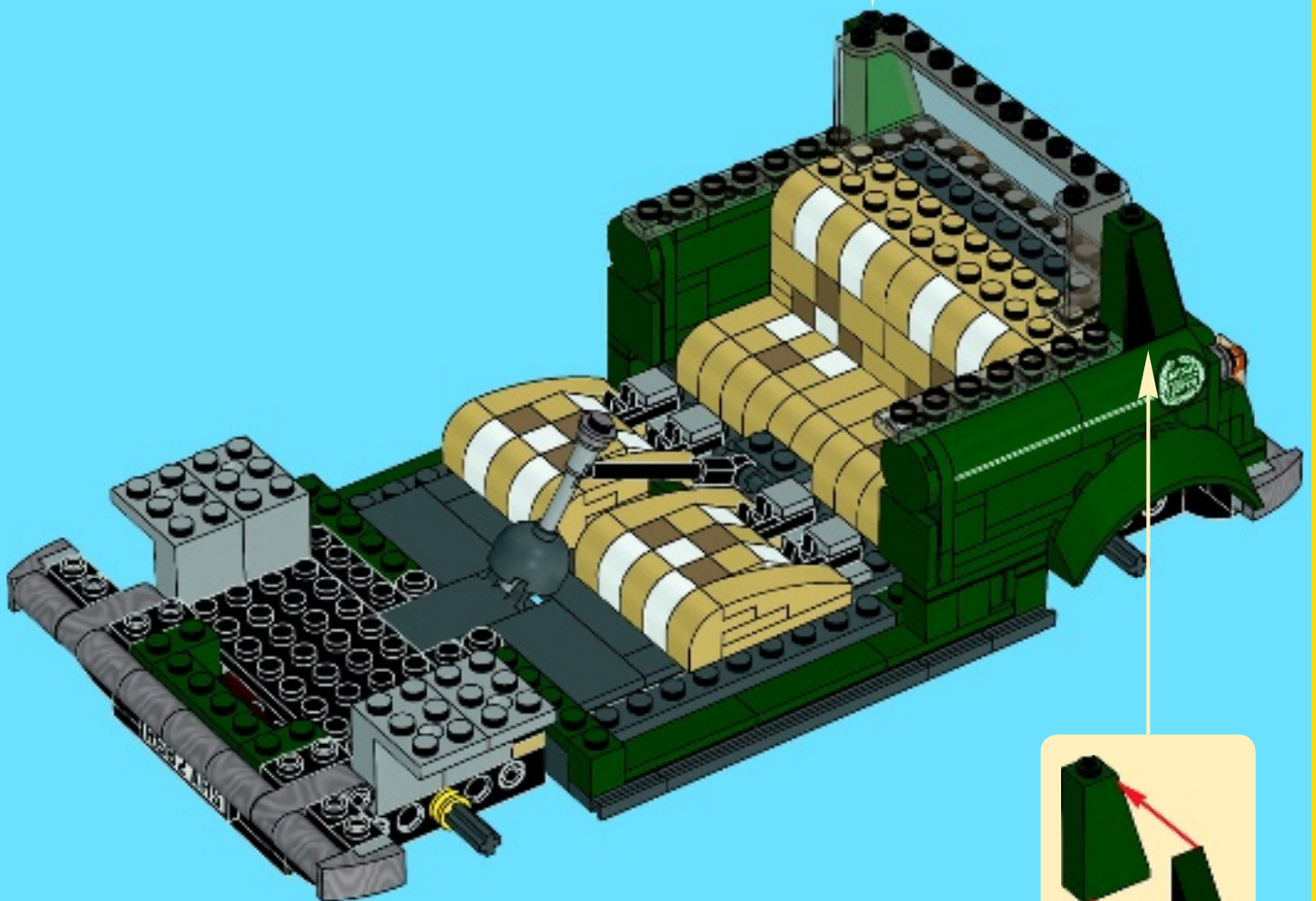
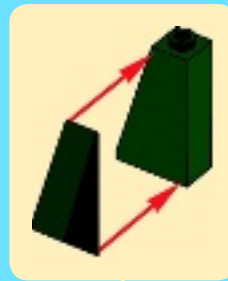

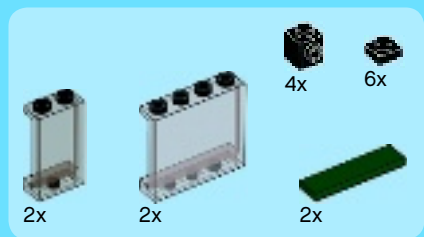

42

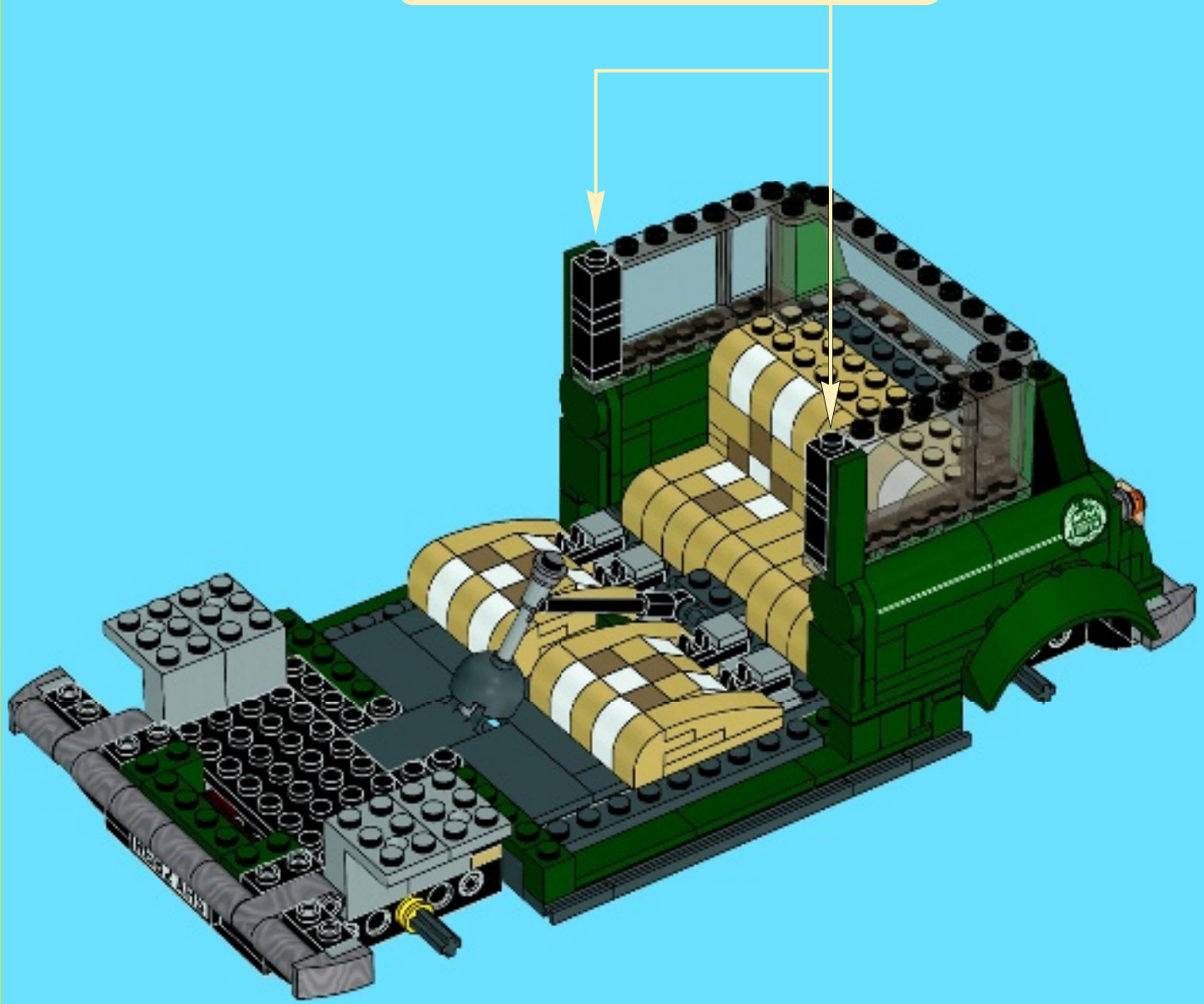
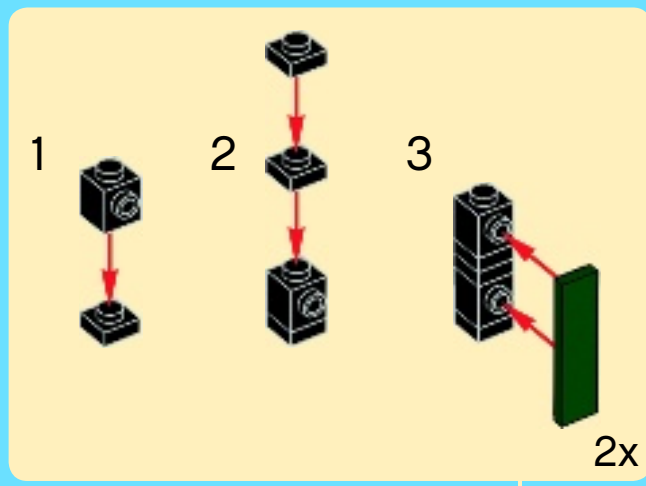

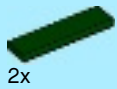

2x



4x



2x

43

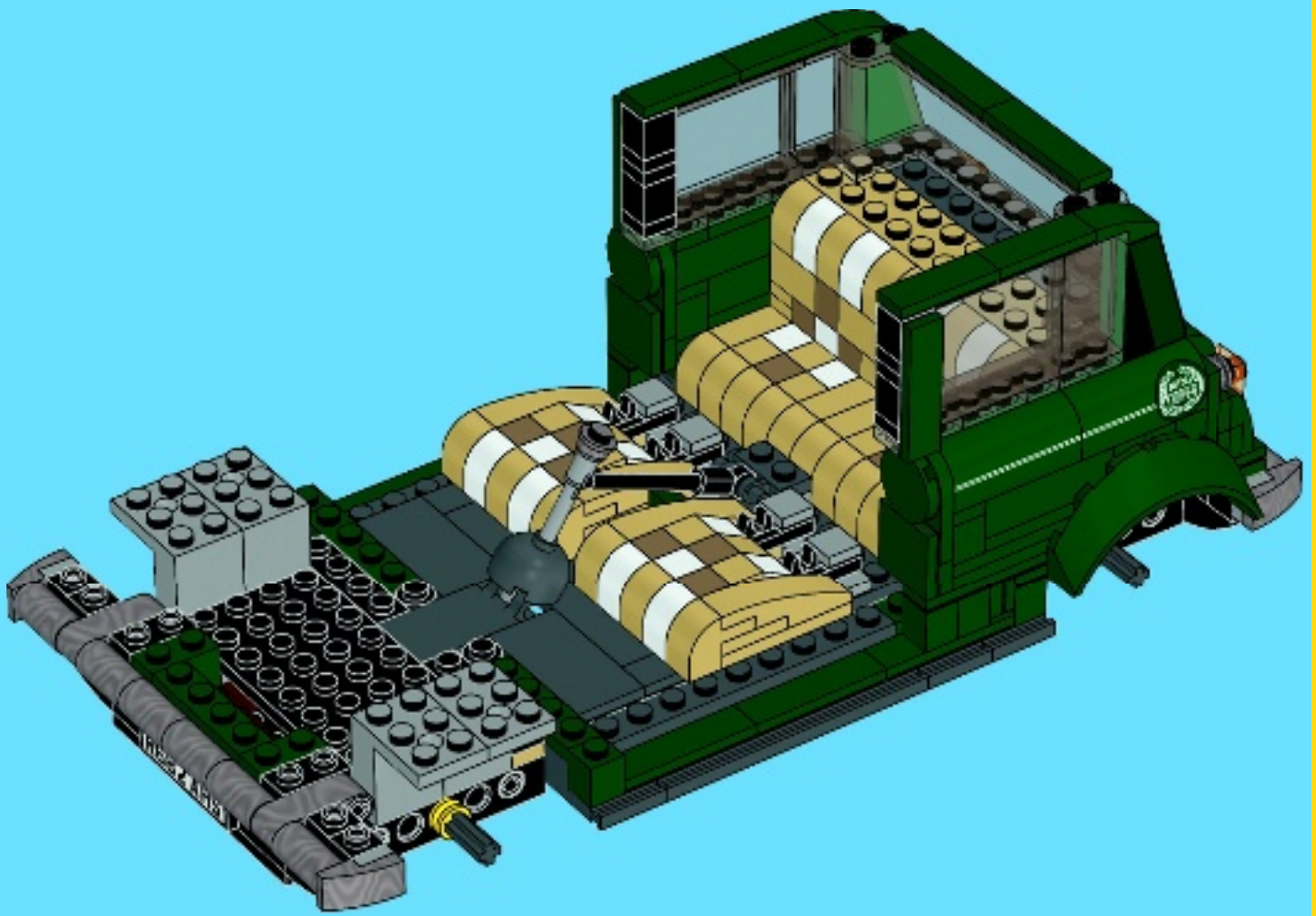



2x



1x



1x

1



1x



1x

2



2x

3

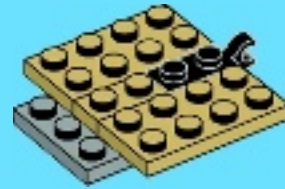

1x



1x



1x



2x

4





3x



2x

5

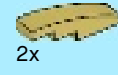

2x

7

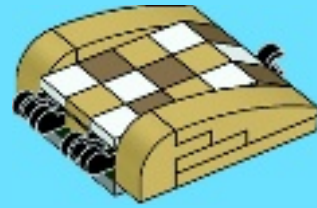

5x



4x



2x



3x

6



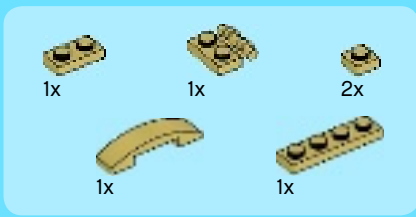

8

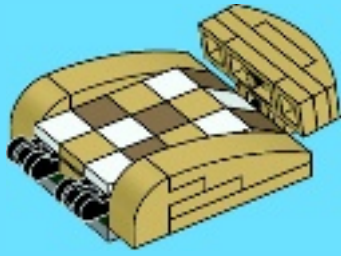
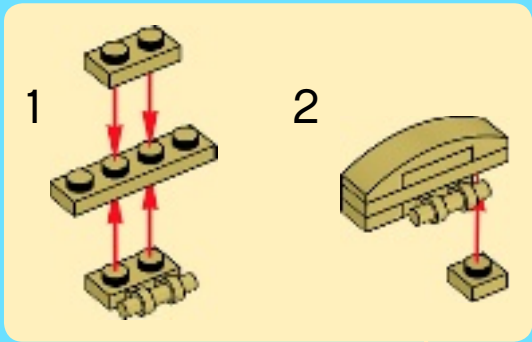

2x

44

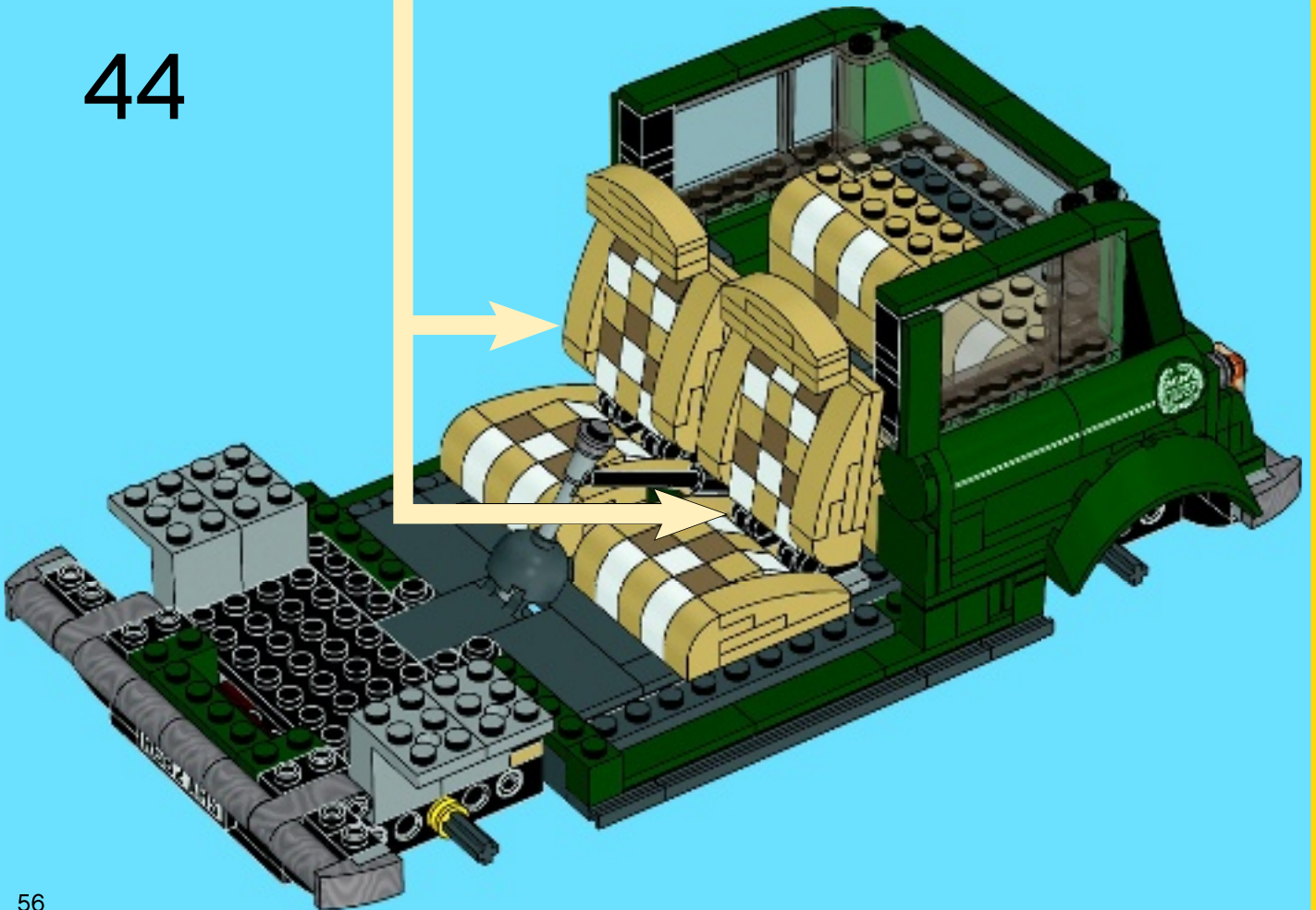

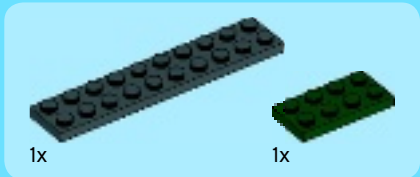

1

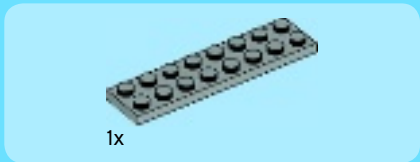
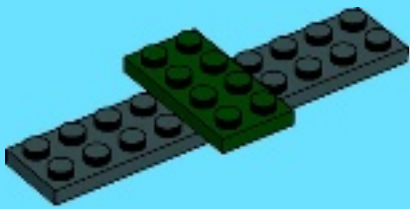

2

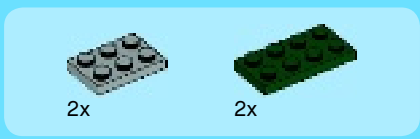
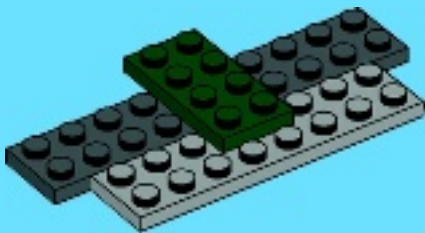

3

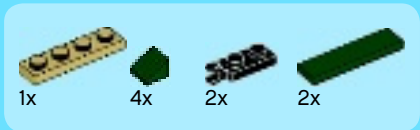
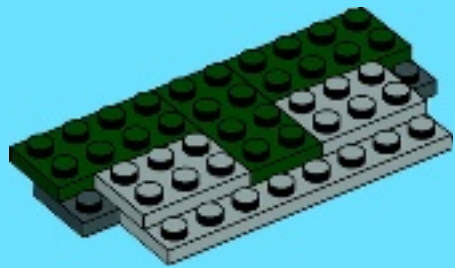

4

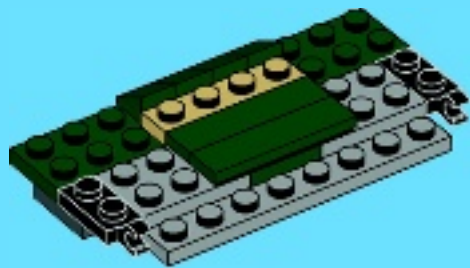

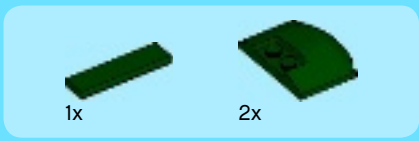

5

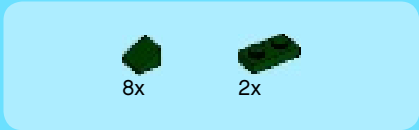
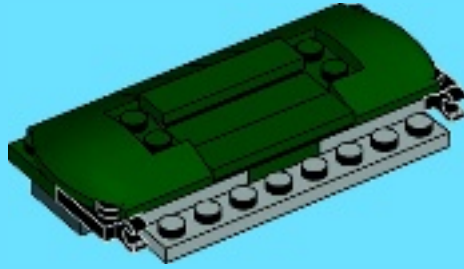

6

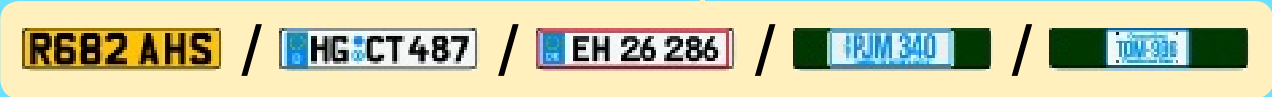
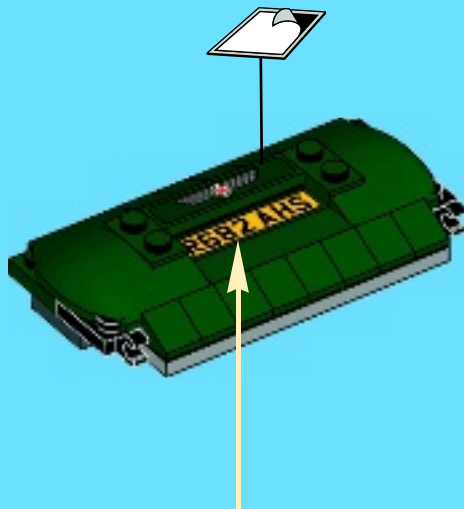

45

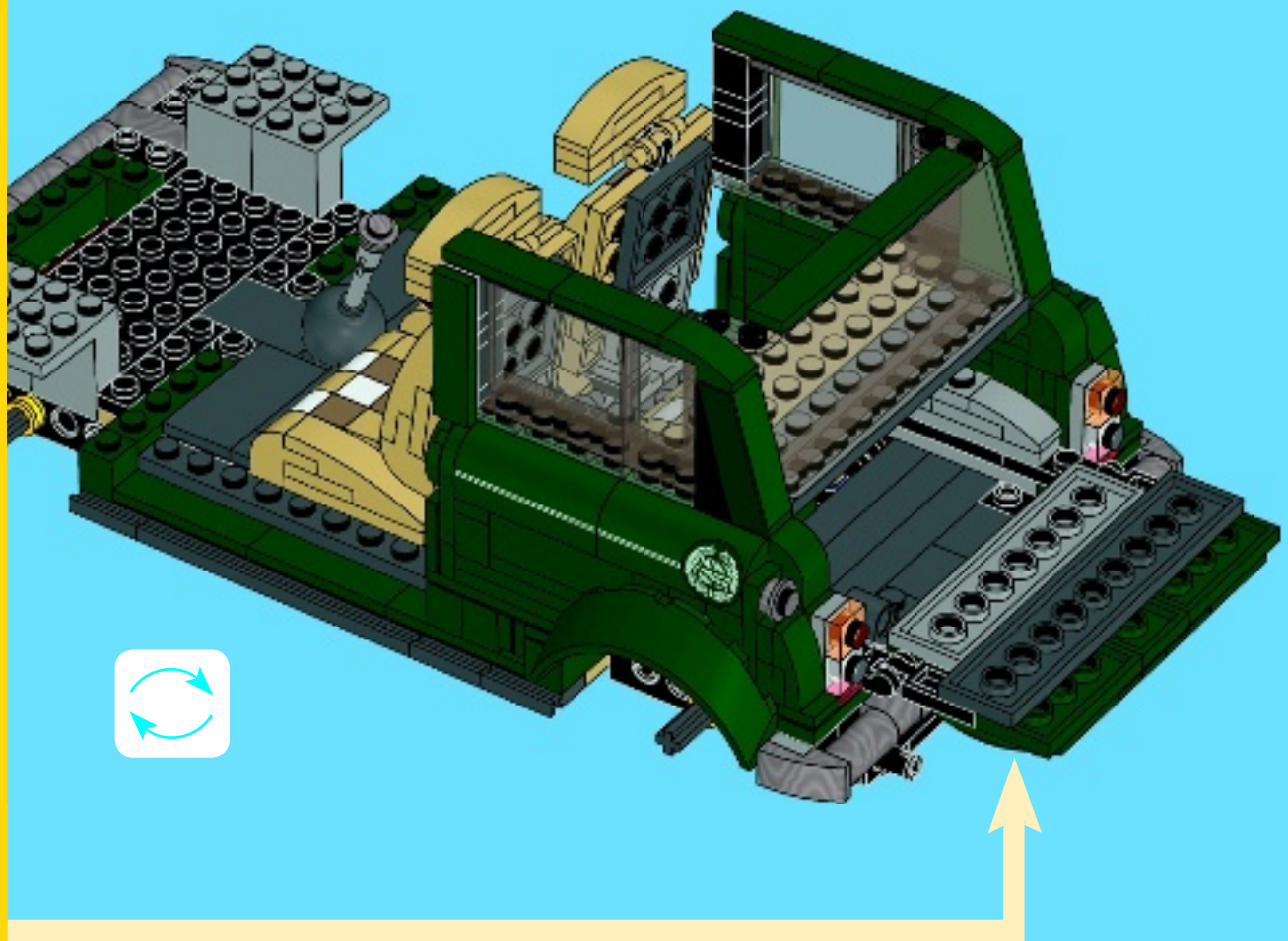



1x



1x

1



3x

2

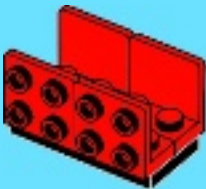

1x

3

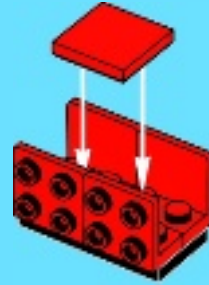

1x



4x

4

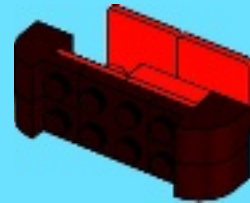



4x

5

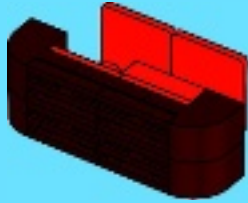

1x



1x



2x

6

1



2



1x



1x



1x



2x

7

1



2

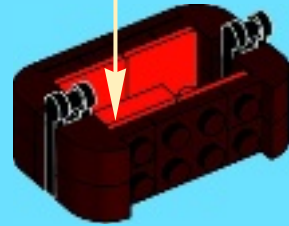

4x

8

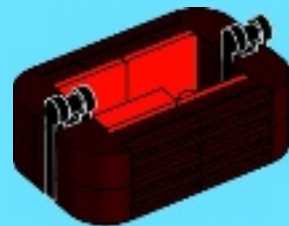

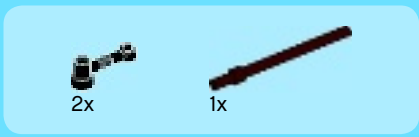

9

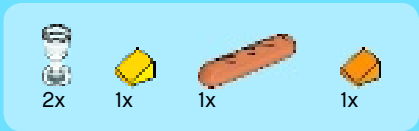
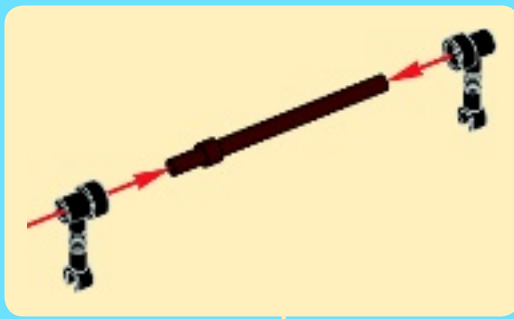

10



46

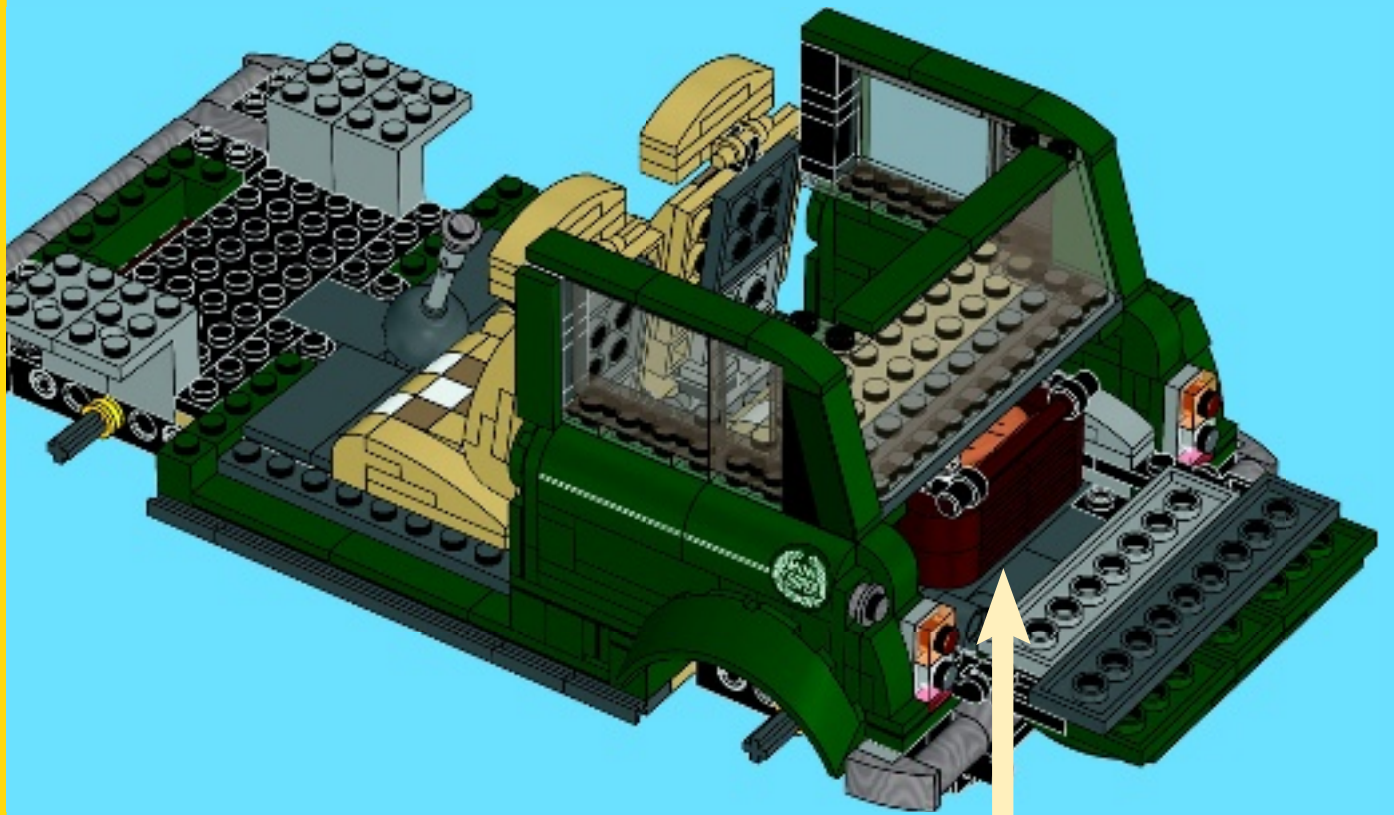

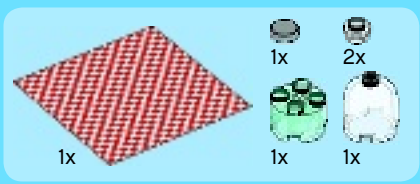

47

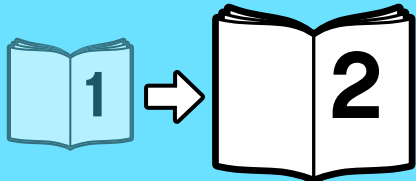
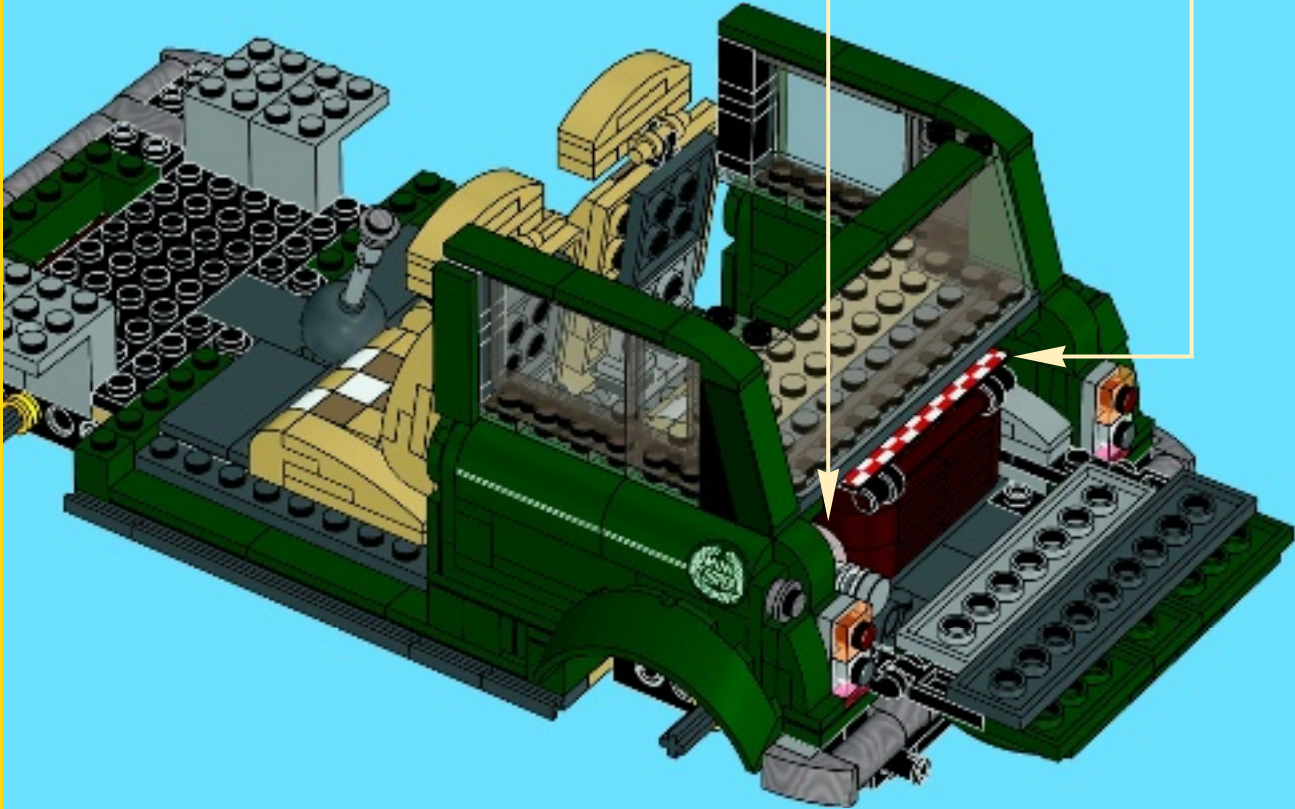
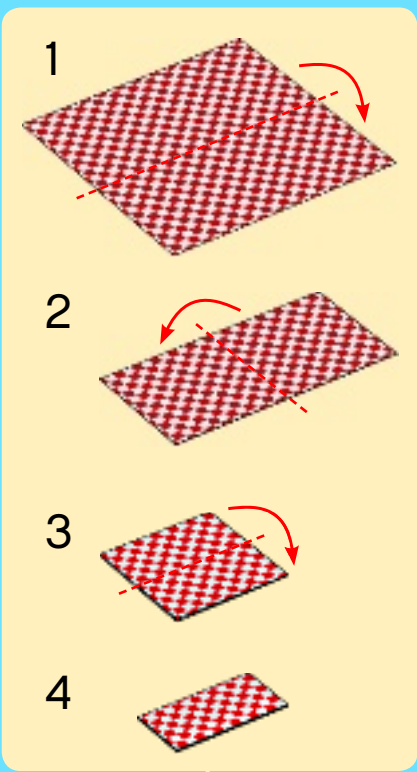
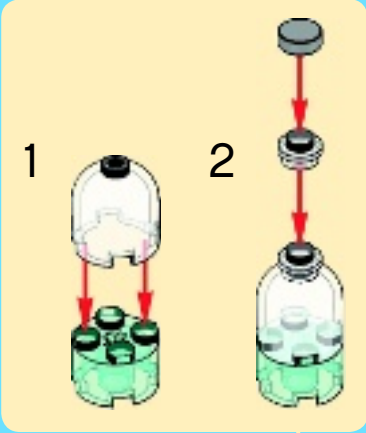



CREATOR

10224

10232

10243



EXPERT



CREATOR

10244



EXPERT



CREATOR

31024





CREATOR

LEGO and the LEGO logo are trademarks of the/son des marques de commerce de/son marcas registradas de LEGO Group. ©2014 The LEGO Group. 6092144 / 6092145



LEGO.com/creator

The MINI logo, the MINI word mark and model designation are trademarks of BMW and are used under license. Le logo MINI, la marque verbale et la désignation de modèle MINI sont des marques déposées de BMW et sont utilisés sous licence. El logotipo de MINI, la marca textual MINI y la denominación del modelo son marcas comerciales de BMW usadas con autorización.

