

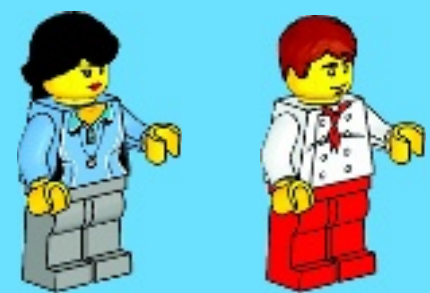

40078

CREATOR

6050586



1

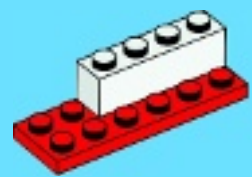

2

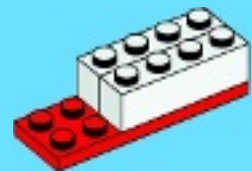

3

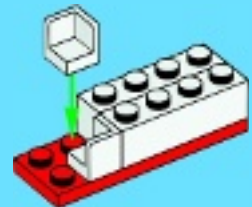

4



5



6

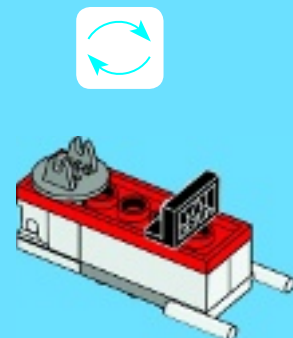

7

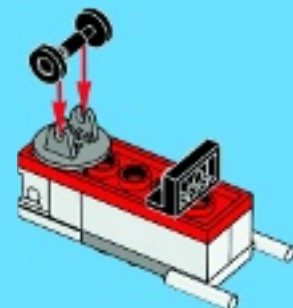

8

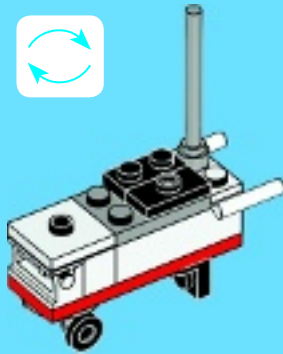

9

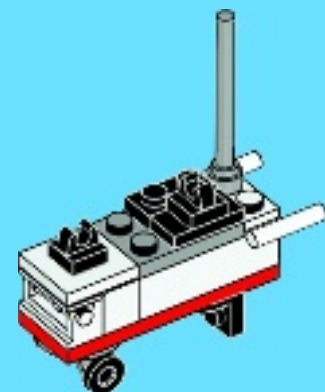

10



11

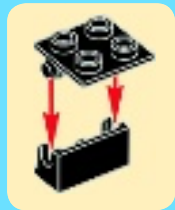

12

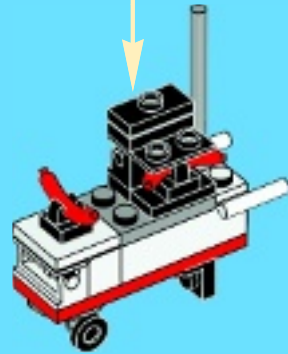
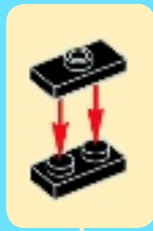

13



14



10224

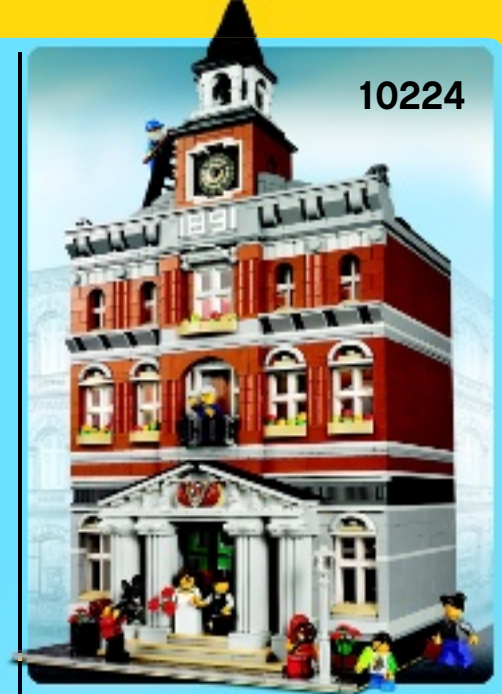

10232



LEGO.com/service

LEGO and the LEGO logo are trademarks of the/son des marques de commerce de/son marcas registradas de LEGO Group. ©2013 The LEGO Group. 6050586