



NINJAGO

Masters of Spinjitzu



9455



1

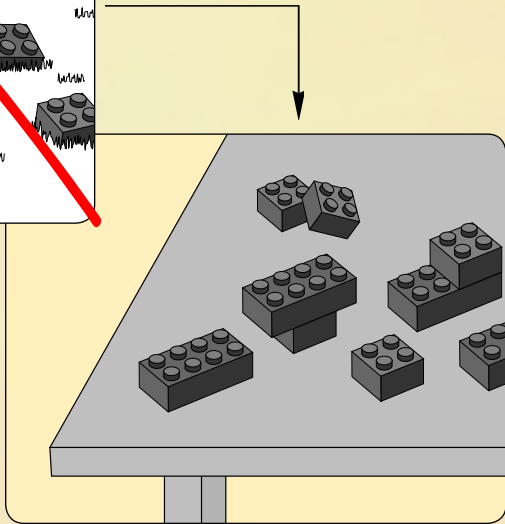
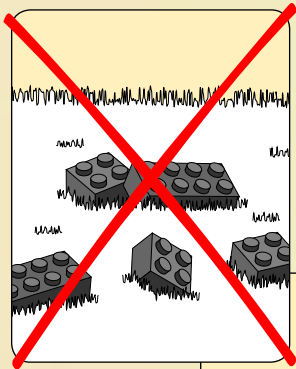

2

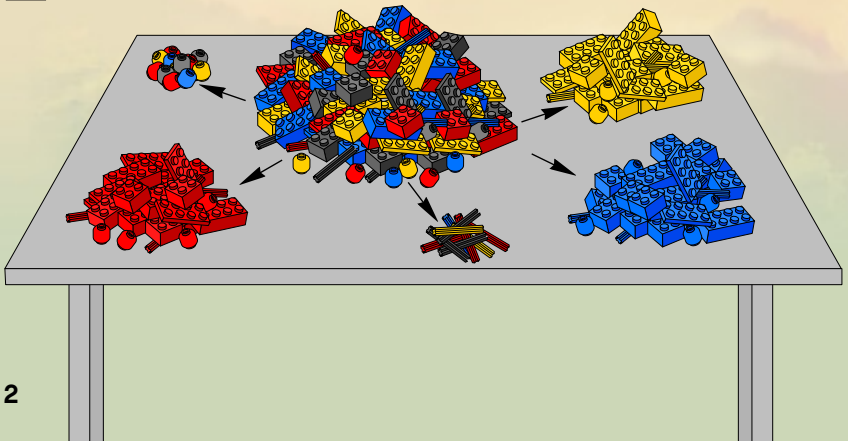

2

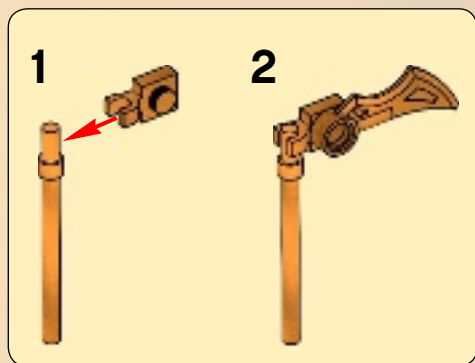
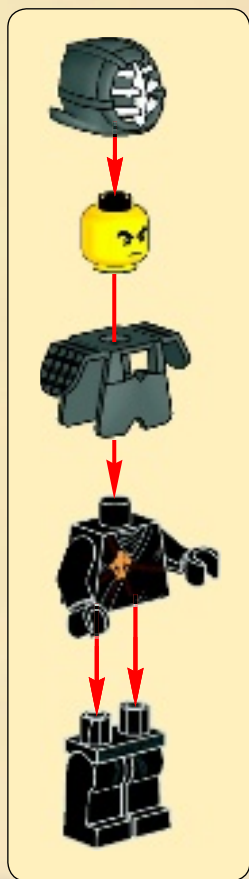



1x

1



1x

2





1x



2x

3



2x

4





1x

5



1x



1x

6





1x



1x

7

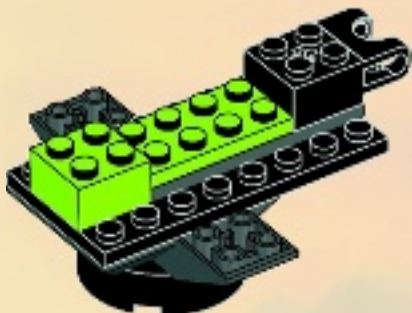

2x



2x

8





9

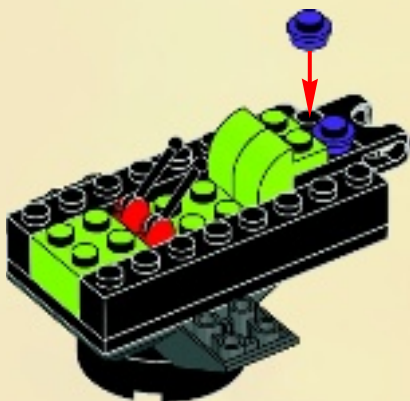

10

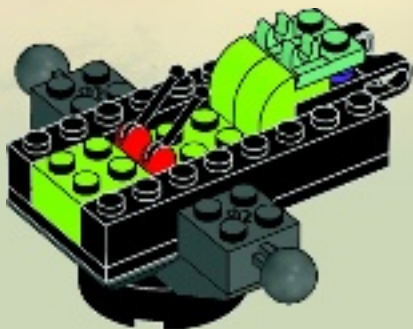



2x



2x

11

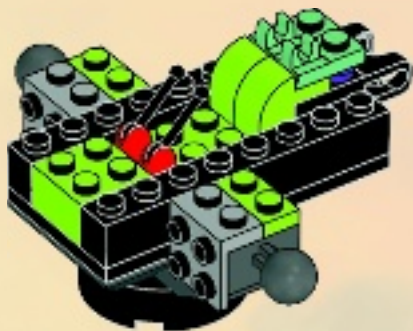

2x



1x



1x

12

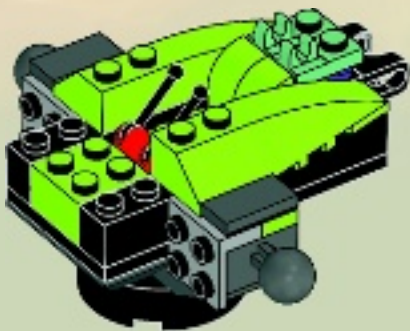



2x

13

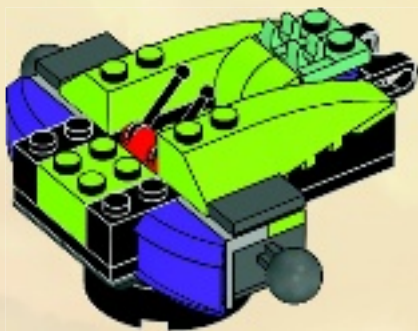



2x



2x

14

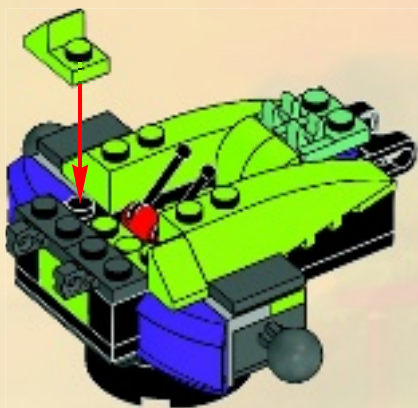



1x

15

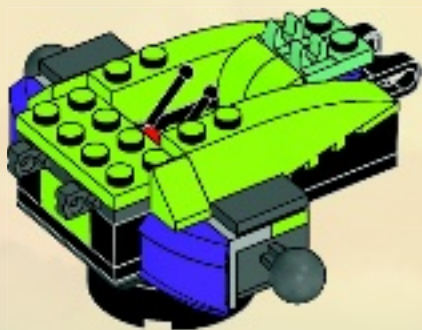

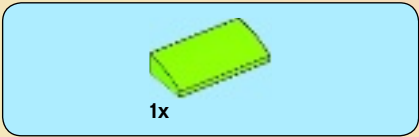

16

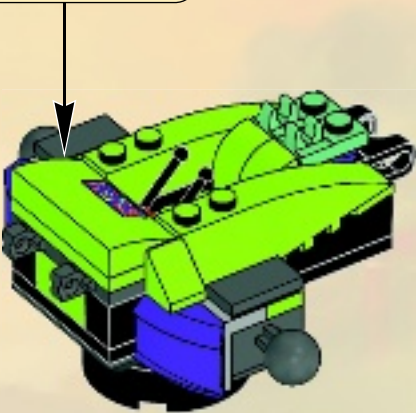
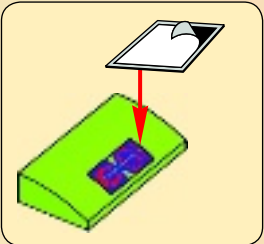



2x

17

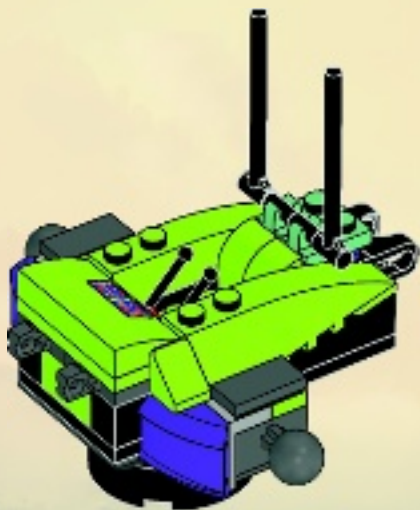



2x

18

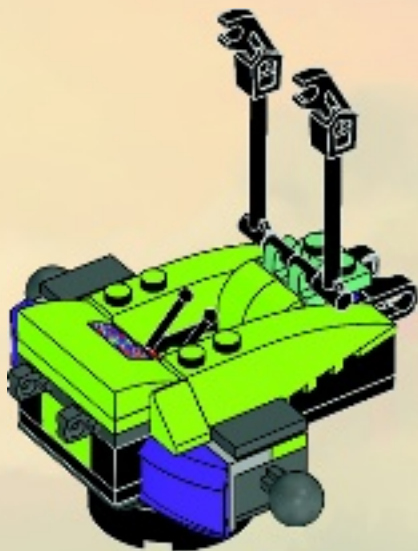



1x

19

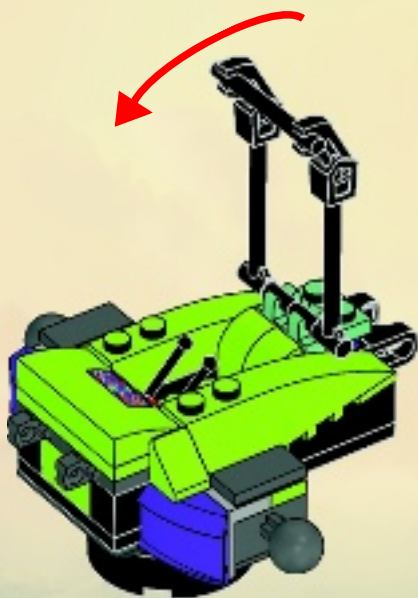



2x

1

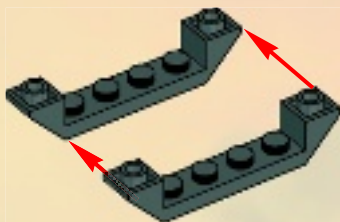

1x

2





4x

3



1x

4





4x



1x

5

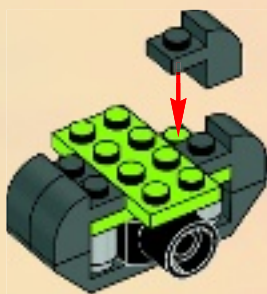

1x

6



20

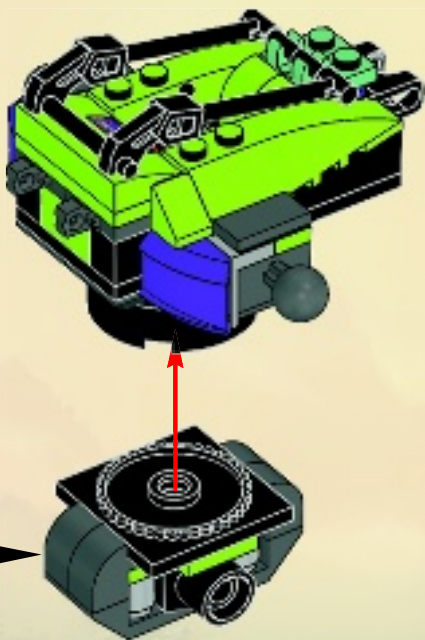



1x

1

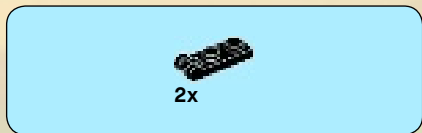

2x

2





1x

3



1x

4





1x

5



4x

6



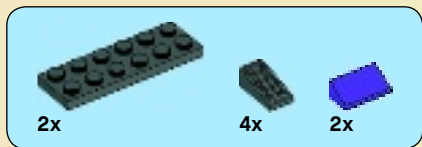

7

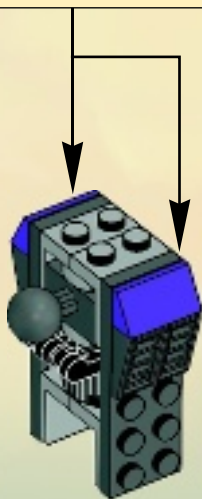
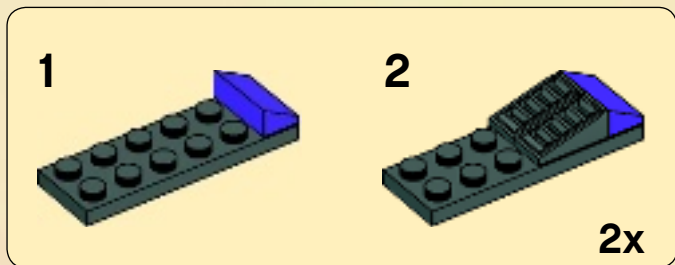



2x

8

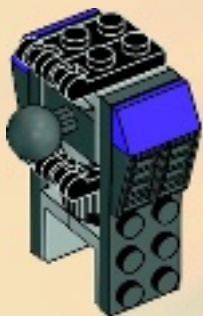

1x

9

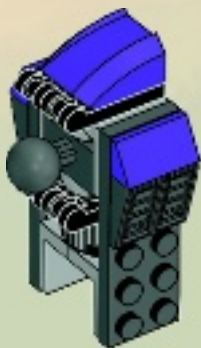



1



2

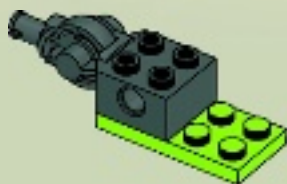



2x

3

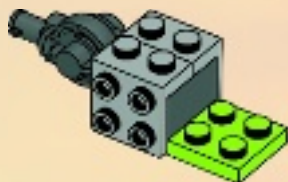

1x

4

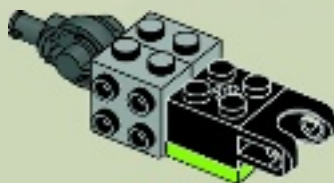



1x

5

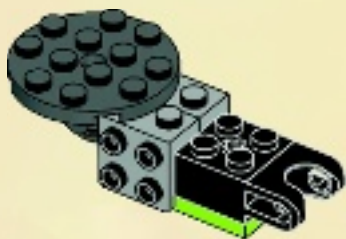

1x



1x

6





7

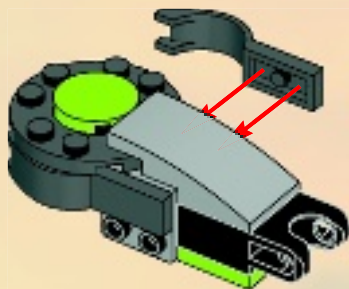

8

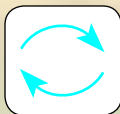

10

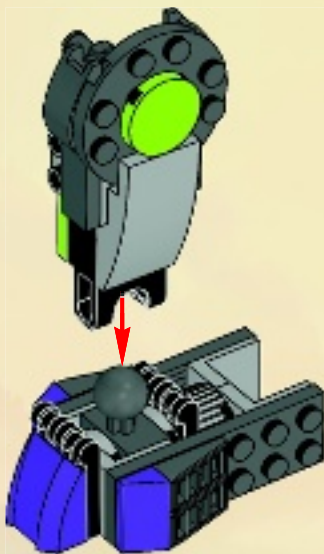

2x

21

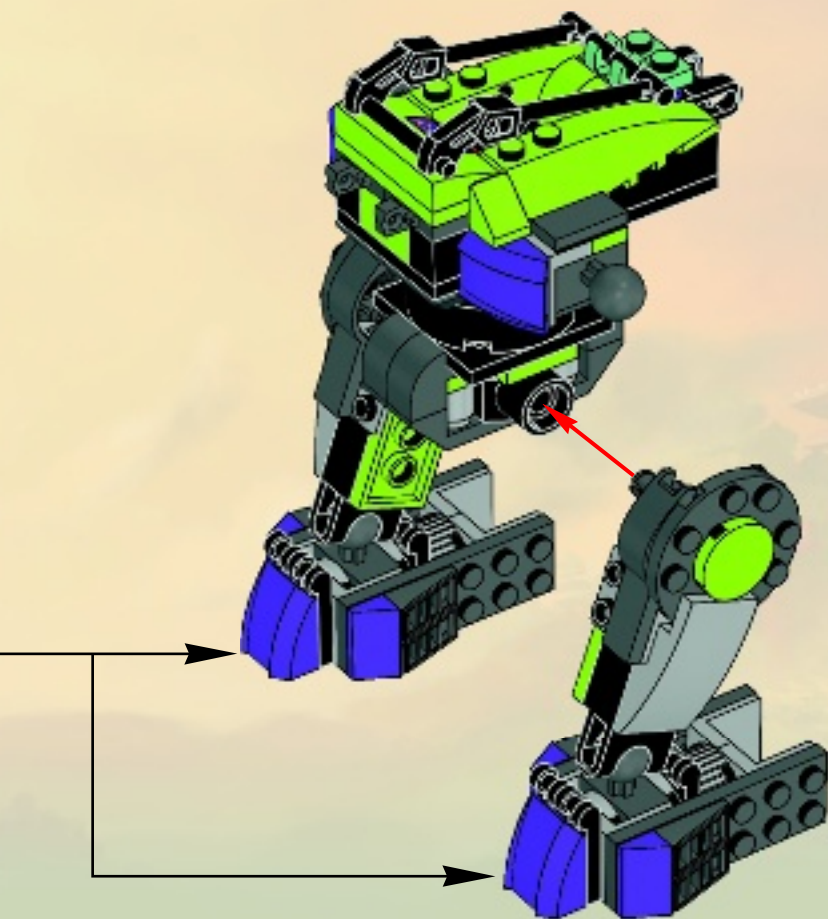



2x

22

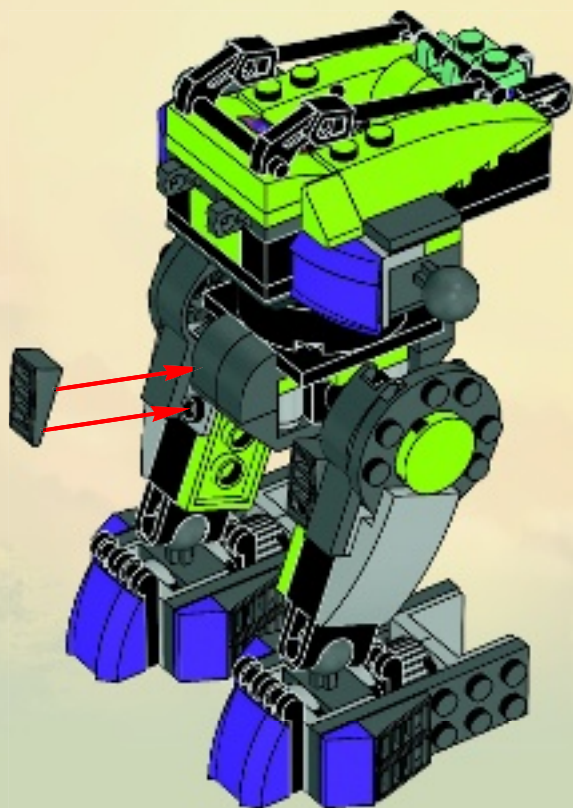



1

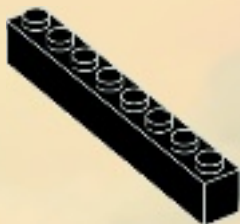

2





1x

3

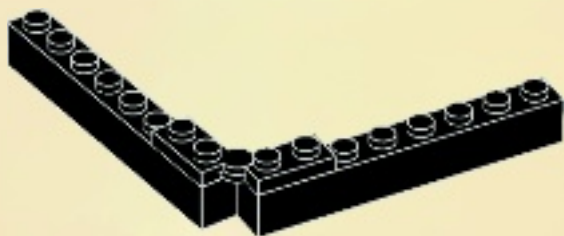

2x

4

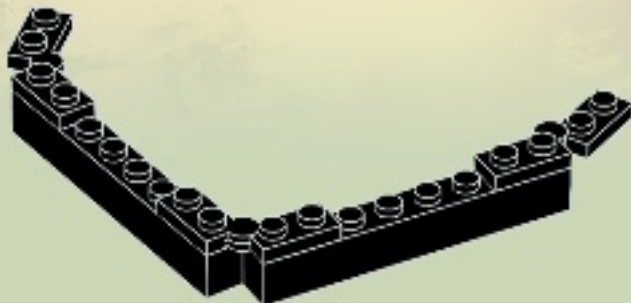



4x

5

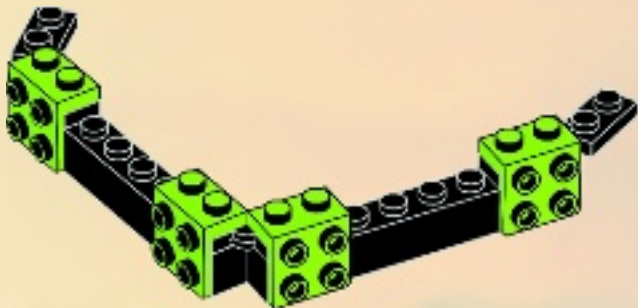

2x

6

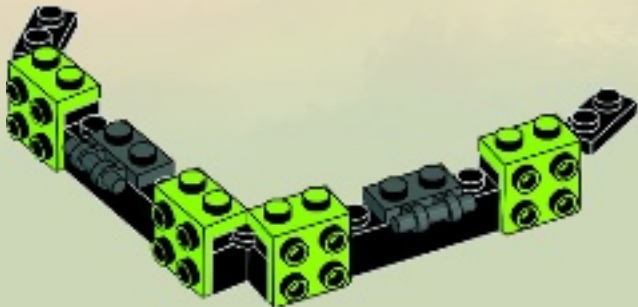



1x

7



2x



2x

8



2x

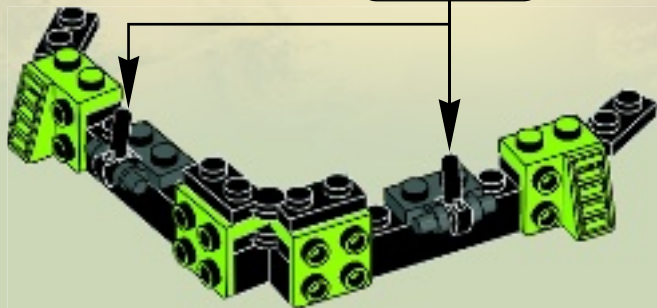



2x

9

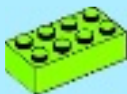

1x

10

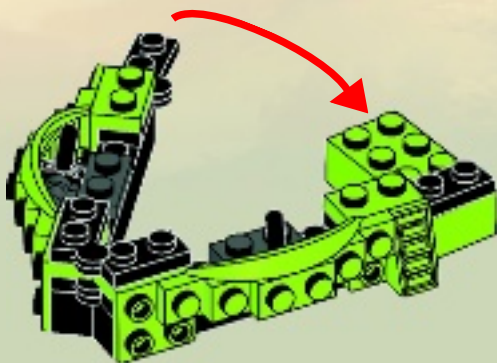



2x



2x

11

1

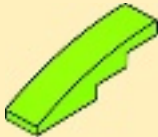

2

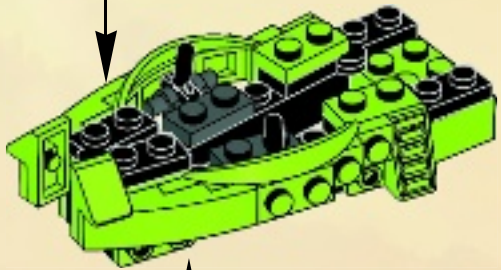
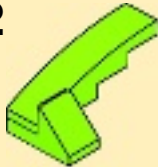

1



2

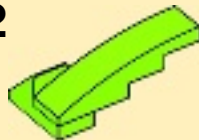



NINJAGO

Masters of Spinjitzu



NINJAGO.COM



NINJAGO

Masters of Spinjitzu



9445



9442



9443



9446



9567
9552



9564



9563



9561



9552



9566



9566



9441
9558
9579



9444



9441
9558



9441
9444
9446



9579



9562
9440



9444
9566



9551



9440
9445
9446
9553
9558



9562



9558



9563
9567



9564



9551



9443



9446



9446



9443



9446



9552



9444
9579



9561
9553



9442
9558



9579
9558



9562



9564



9443



9442
9445



9446



9446
9551
9558
9561



9558
9579



9579



9567



9553



9440



9445



NINJAGO

Masters of Spinjitzu





1x

12

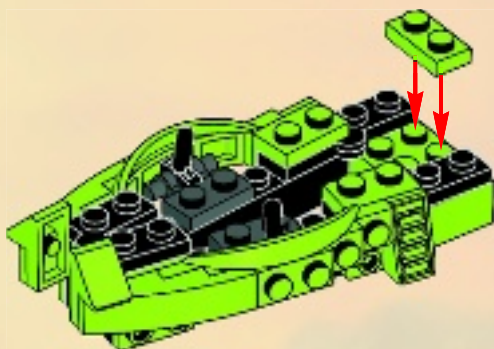

1x



2x

13

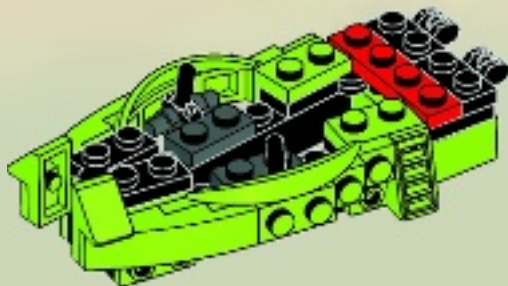



1x



2x

14

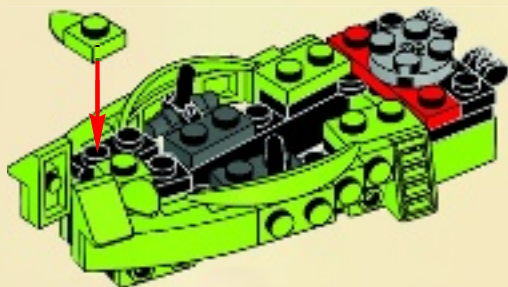

2x

15

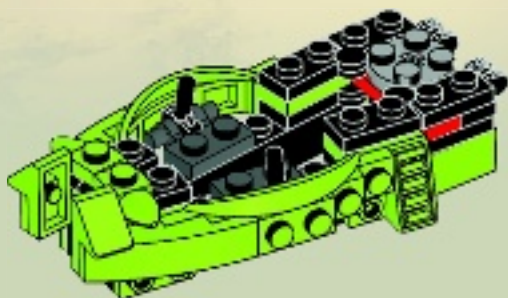



1x



2x



2x

16

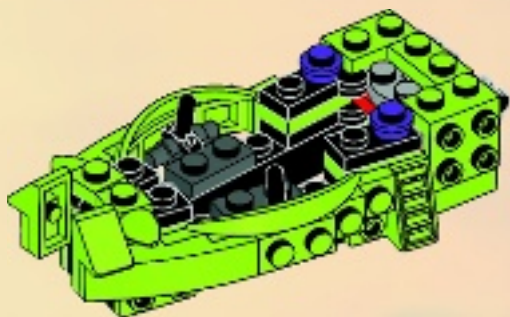

2x

17

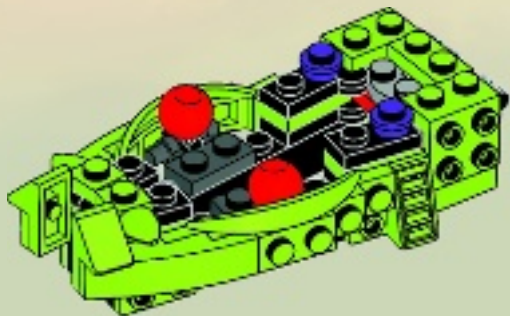



2x

18

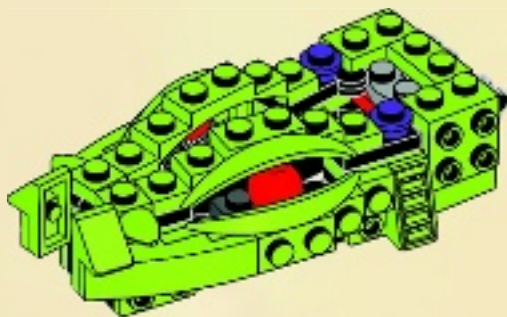

1x

19

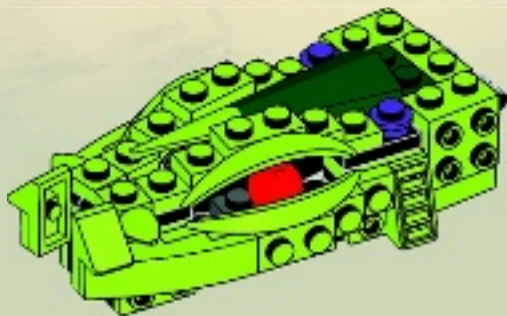



4x



4x

20

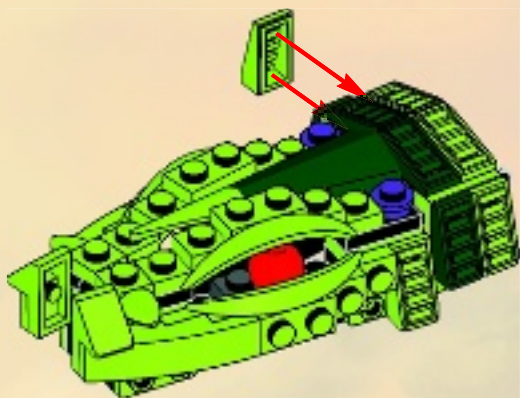



4x

21

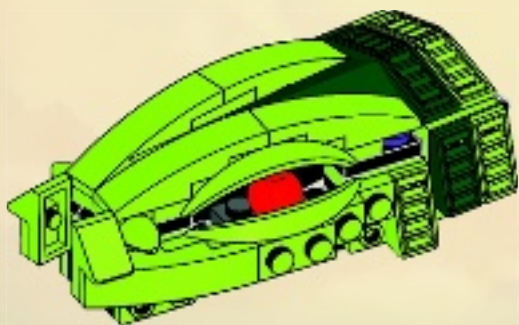



1x



2x

22

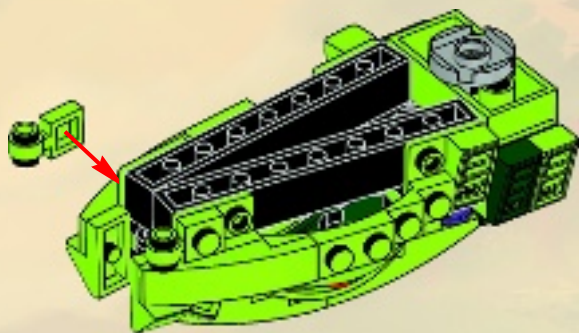
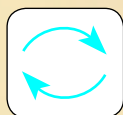

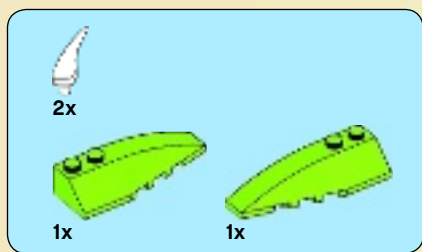

23

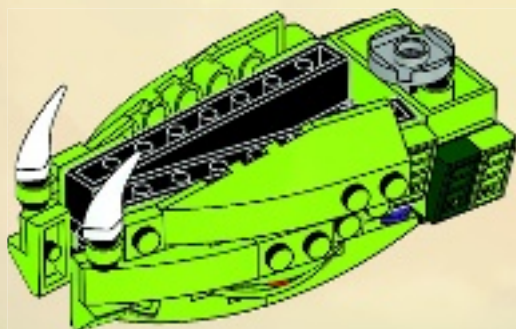

24

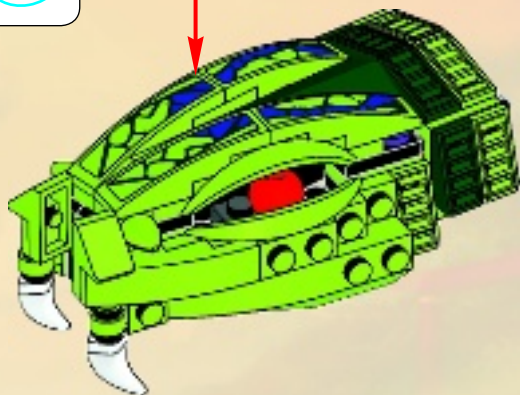
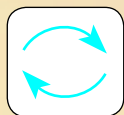

25

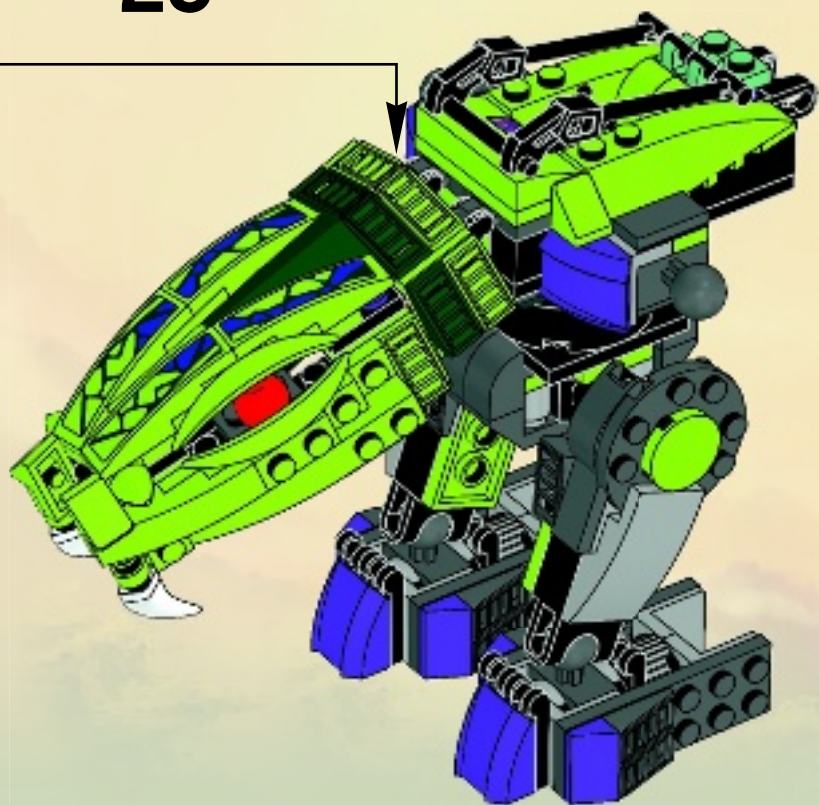



1x

1



2x

2





1x



1x

3

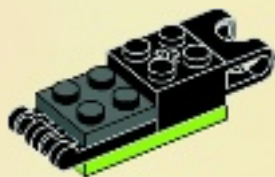

2x

4

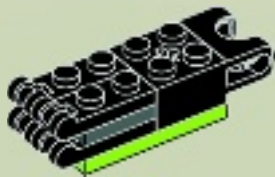



1x

5



2x



1x

6

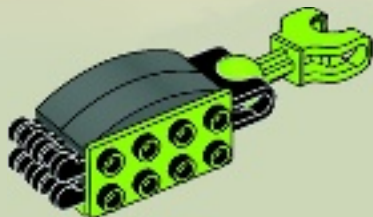



2x

7

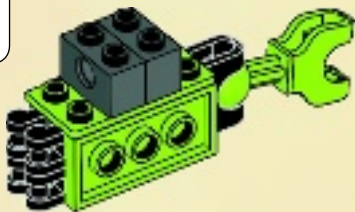
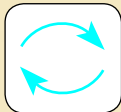

1x

8

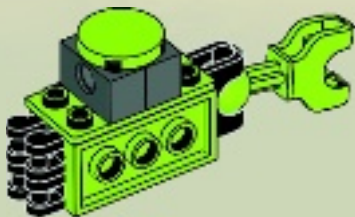

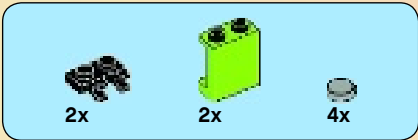

9

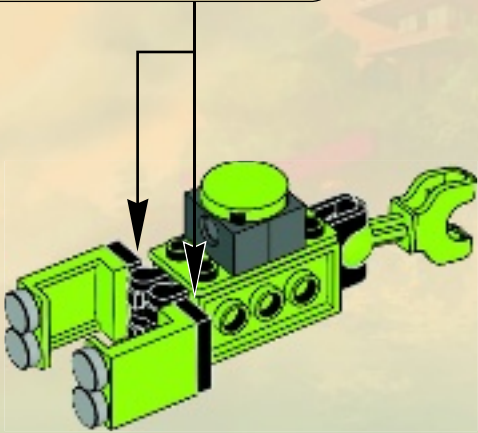
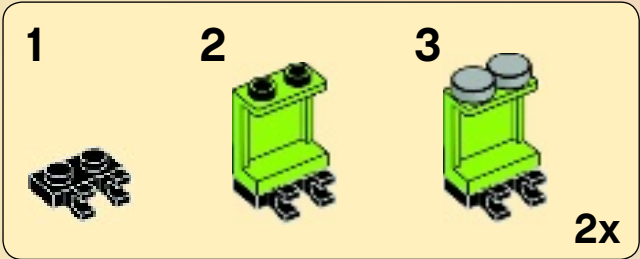



10

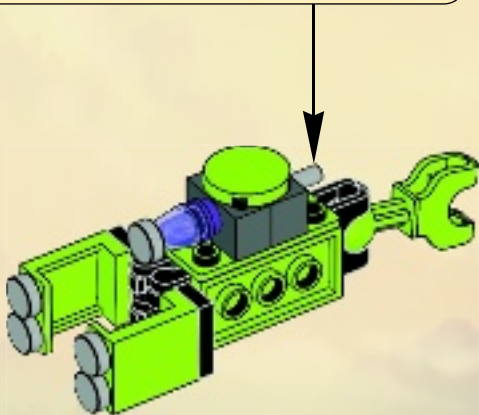
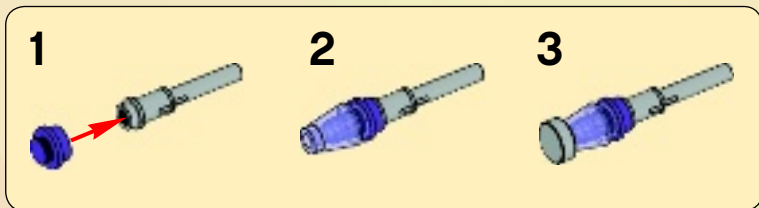

26

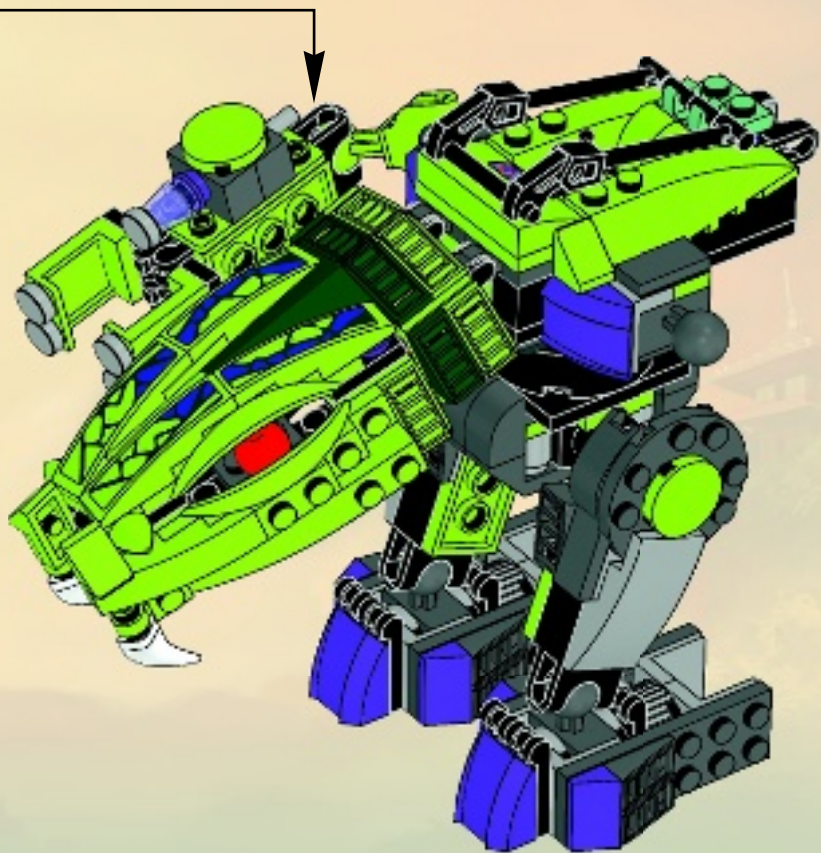



27

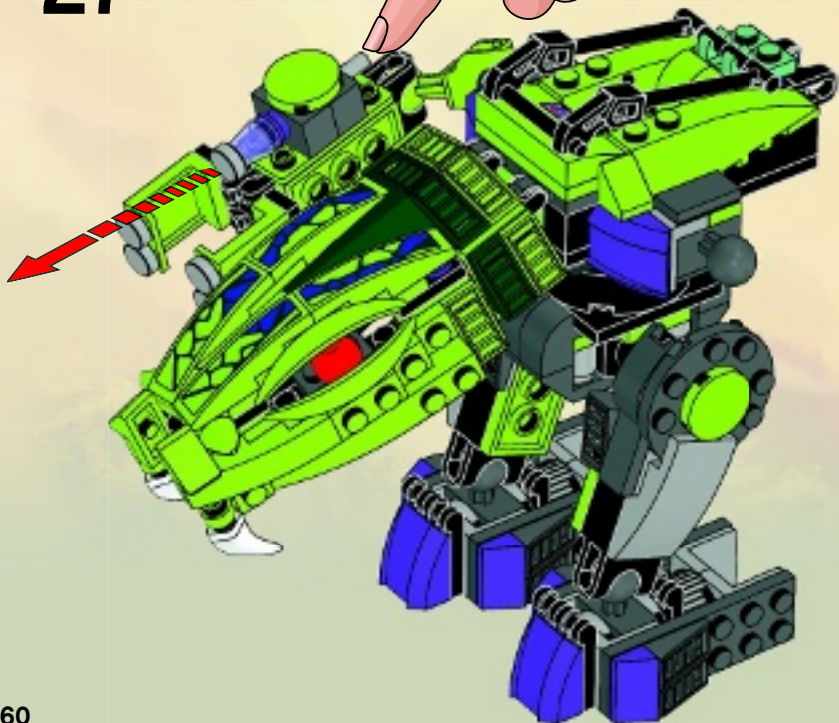

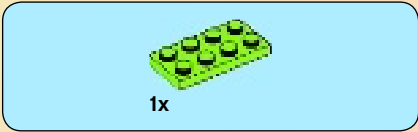

1

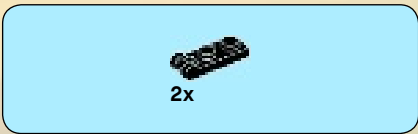

2





1x



1x

3

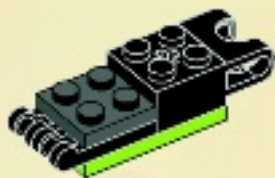

2x

4

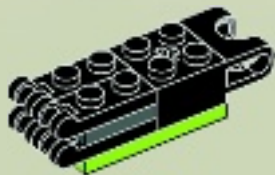



1x

5

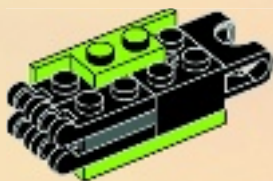

2x



1x

6





1x

7

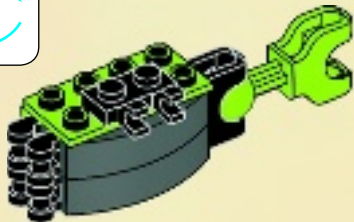
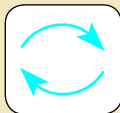

2x

8

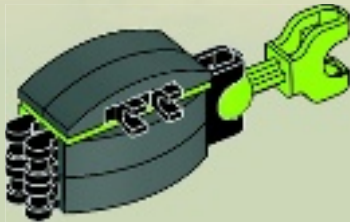

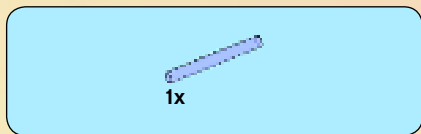

9

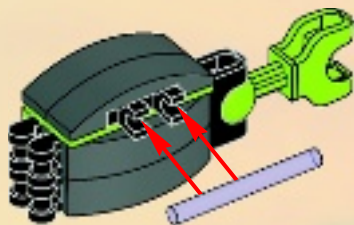

10

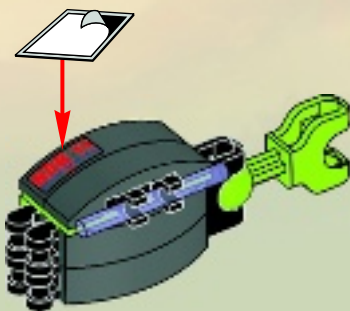

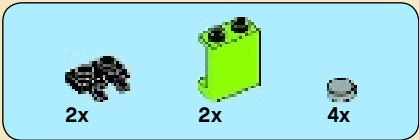

11

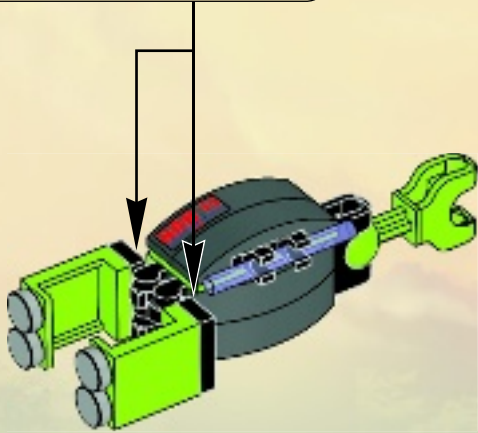
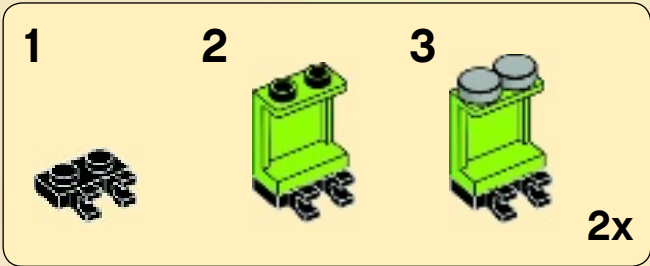

28

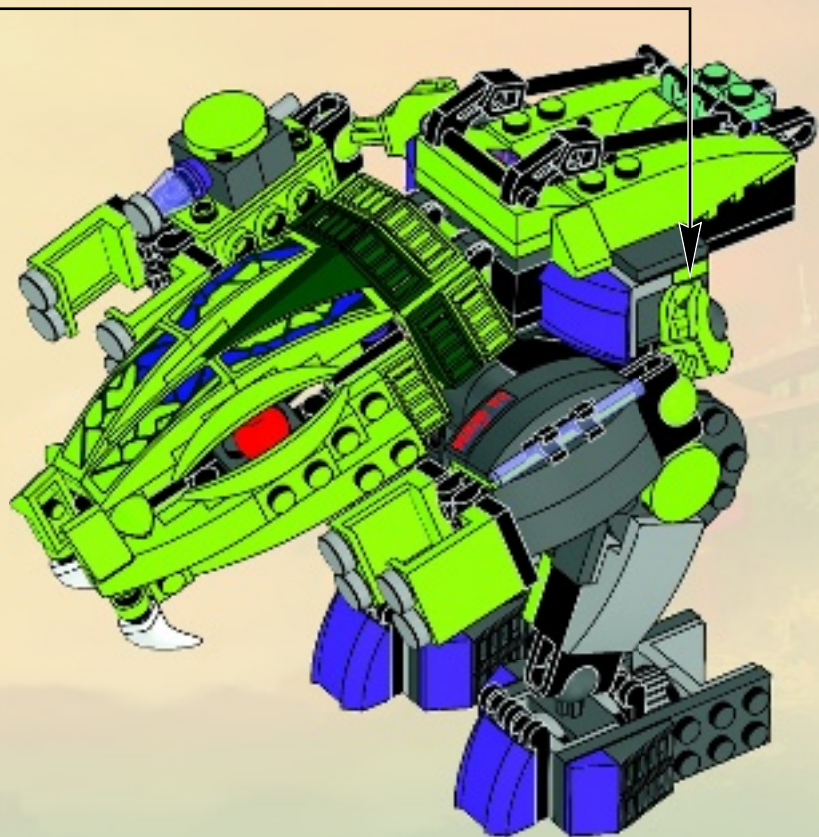

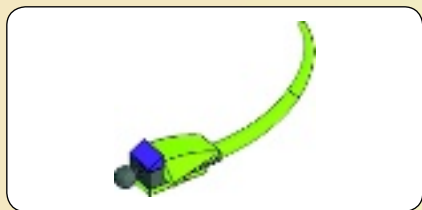

1

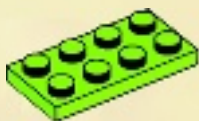

2





1x



1x

3

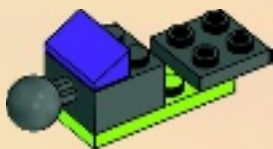

1x

4

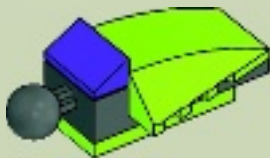

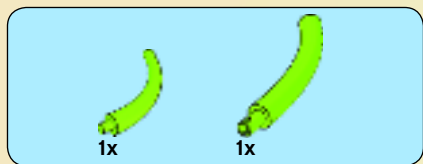

5

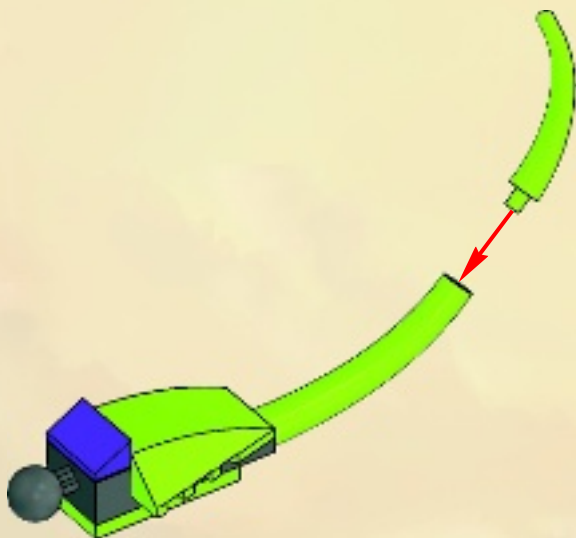

29

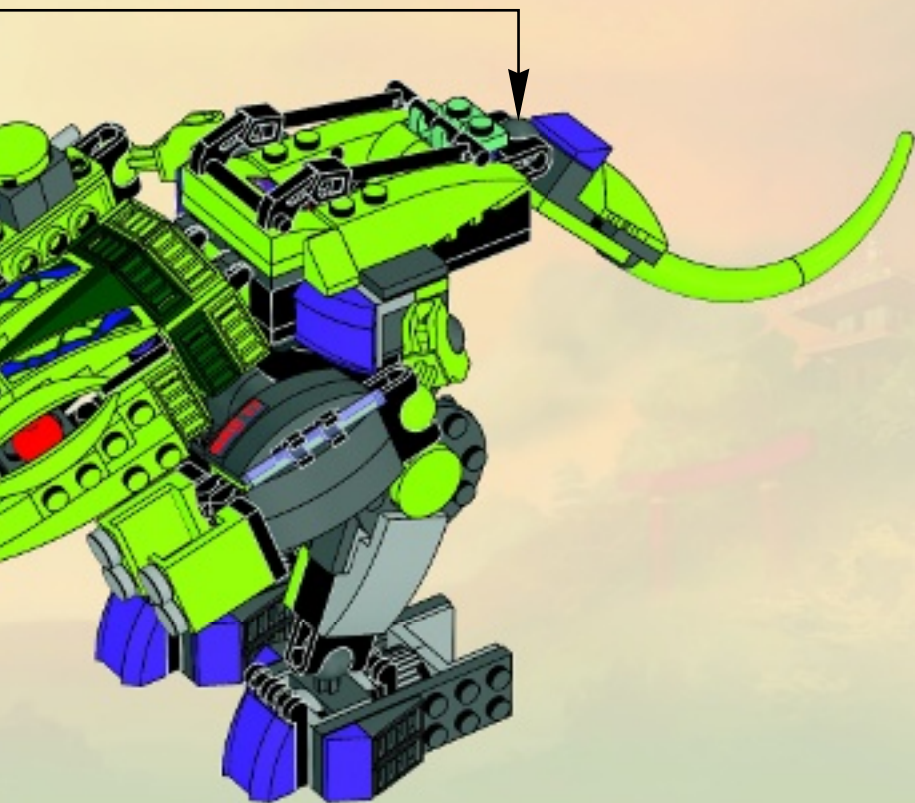





1x
4648338



1x
4647445



2x
4566256



1x
371021



2x
74335



1x
4648363



2x
4290714



1x
4611426



1x
4114584



4x
300826



5x
4619763



1x
4275826



1x
4558957



1x
303526



2x
4515340



5x
4556158



16x
4515368



6x
74011



1x
4140303



2x
4623113



1x
4612652



1x
4667794



2x
4650022



2x
4289538



1x
4517986



2x
4220632



1x
4165967



4x
4648274



2x
4212446



6x
4537927



1x
4653662



2x
4538167



2x
4538168



4x
4164037



9x
4537936



3x
4541957



2x
4632576



6x
4569452



2x
4617067



4x
4625625



1x
4650634



1x
4650635



4x
4610474



2x
4611784



6x
4540385



1x
4597561



2x
4652387



4x
4211412



1x
4612797



2x
4210892



4x
4651834



2x
4650645



2x
4210862



2x
4211052



2x
4625236



2x
4622742



3x
4211064



2x
4528323



1x
4658071



14x
4277927



2x
4294180



10x
4540386



5x
4566607



9x
4650260



4x
4210797



2x
4522784



5x
4566522



6x
4211475



6x
4648256



5x
4497253



4x
4566523



1x
4520320



2x
4211094



2x
4225975



1x
4567340



1x
4649635



5x
4211002



2x
4210660



1x
4544069



Customer Service

Kundenservice

Service Consommateurs

Servicio Al Consumidor

www.lego.com/service or dial



00800 5346 5555 :



1-800-422-5346 :



1x
4196768



1x
4523160



4x
4500903



1x
4600270



2x
4211111



1x
4649287

CUSTOMISE YOUR SPINNERS

BAUE DEINE EIGENEN, VERÄNDERBAREN SPINNERS

PERSONALISE TES TOUPIES

PERSONALIZA TUS SPINNERS

PERSONALIZA AS TUAS RODAS

TÉDŐ EGYEDIVÉ A PŐRGETTYŐDŐT!



RATTLE



COLE



9551

9552

9553

CUSTOMISE WITH BOOSTER PACKS

Noch mehr Action mit den Booster Packs

Personnalise grâce aux boosters

Personalizalo con los packs de expansión

Personaliza com pacotes de expansão

Tedd egyedivé kiegészítő készletekkel!

NINJAGO.COM

ARENA INCLUDED
INCLUSIVE ARENA · PISTE INCLUDE
INCLUYE ÁREA DE COMBATE
ARENA INCLŪIDA · ARÉNAVAL

9579



COLE VS RATTLE

LASHA

MENDO ZANE

SNAGGAR

SAMIRAJI X

KAI ZX

FANG-SUEI

9579

9562

9563

9564

9566

9561

9567



NINJAGO

Masters of Spinjitzu



KENDO ZANE
9563 - 9446



KENDO KAI
9568



KENDO COLE
9551



COLE ZX
9579 - 9444



ZANE ZX
9440
9445



JAY ZX
9553
9442
9445



SAMURAI X
9566



LLOYD GARMADON
9562 - 9443



FANG-SUEI
9567 - 9443



FANGDAM
9445



LASHA
9562



RATTLA
9579 - 9441



SNAPPA
9564 - 9442

LEGO

NINJAGO
Masters of Spinjitzu



NINJAGO.COM



NINJAGO

Masters of Spinjitzu



NINJAGO.COM

LEGO club™

FREE! GRATIS! GRATUIT!



www.LEGOclub.com



LEGO® Club Magazine





LEGO® Club Email

SIGN UP ONLINE!
www.LEGOclub.com

VISIT THE WORLD'S
BIGGEST LEGO® SHOP!
www.LEGOshop.com

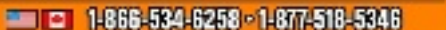
00800 5346 5555



 1-866-534-6258 • 1-877-518-5346

UK & Canada only

SWEDEN & DENMARK



* Freephone. Mobile charges may apply. * Numéro sans frais. Des frais peuvent s'appliquer avec les téléphones cellulaires. * Gebührenfrei, Kosten für Anrufe aus Mobilfunknetzen können abweichen. * Gratis telefoonnummer vanaf vaste lijn. * Det er et gratis nummer, når du ringer fra fasttelefon. * Det är gratis, när du ringer från en fast telefon. * Numéro sans frais. Des frais peuvent s'appliquer avec les téléphones portables.



WIN!

Go to www.LEGOsurvey.com/product to fill out a survey for a chance to win a cool LEGO® Product.

No purchase necessary.

Open to all residents where not prohibited.



www.LEGO.com



www.LEGOsurvey.com/product

GEWINNE!

Nimm an der Umfrage auf www.LEGOsurvey.com/product teil und hab die Chance ein cooles LEGO® Produkt zu gewinnen!

Die Teilnahme am Gewinnspiel führt zu keinerlei Kaufverpflichtungen. Teilnahme in allen nicht ausgeschlossenen Ländern möglich.

WIN!

Ga naar www.LEGOsurvey.com/product, vul een enquêteformulier in en maak kans op een cool LEGO® product.

Geen aankoopverplichting. Iedereen mag deelnemen, uitgezonderd ingezetenden van landen waar een enquêteverbod geldt.

GAGNE !

Visite www.LEGOsurvey.com/product pour répondre à un questionnaire et avoir une chance de gagner un produit LEGO® très cool !

Aucune obligation d'achat. Ouvert à tous les résidents des pays autorisés.

当てよう!

www.LEGOsurvey.com/product にアクセスして、アンケートにご記入ください。当選者にはレゴ製品を差し上げます。

お買い上げの必要はありません。禁止されていない限り、すべての皆様にご利用いただけます。