



# PIRATES

6253

*Treasure bay*



**WARNING: CHOKING HAZARD.**  
Small parts. Not for children under 3 years.

# 1

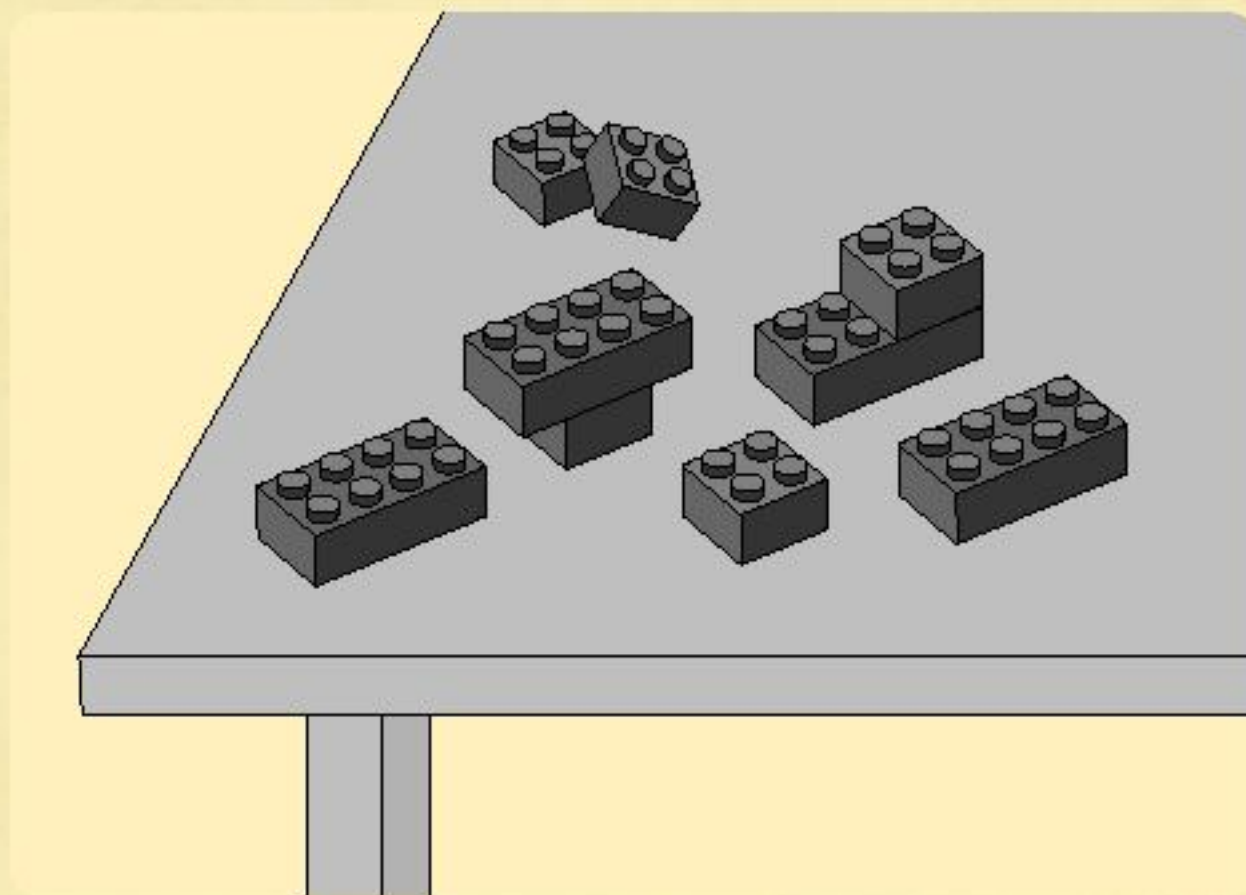
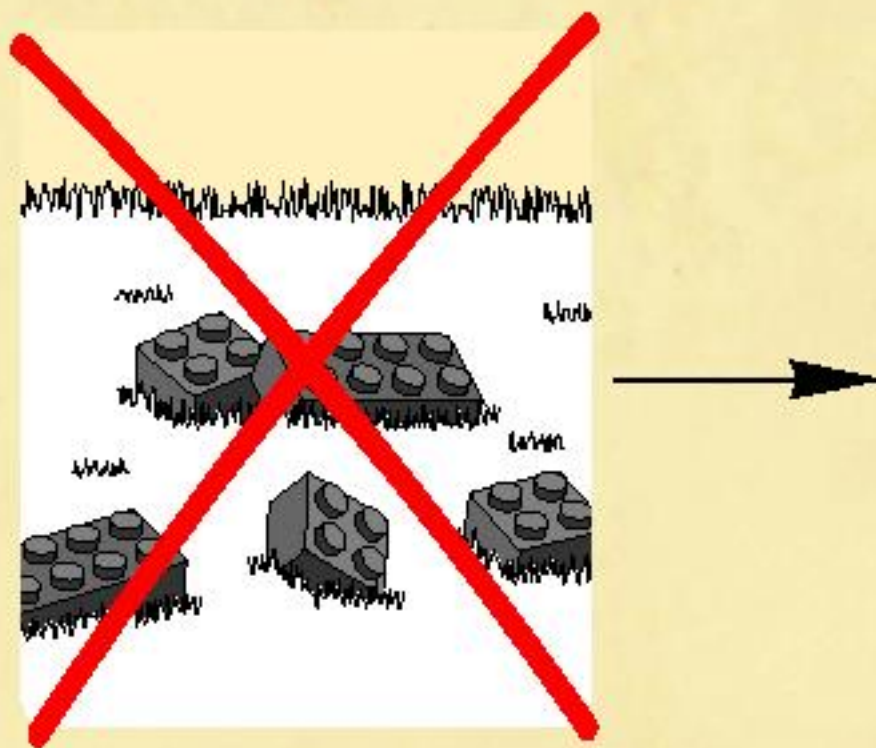

# 2

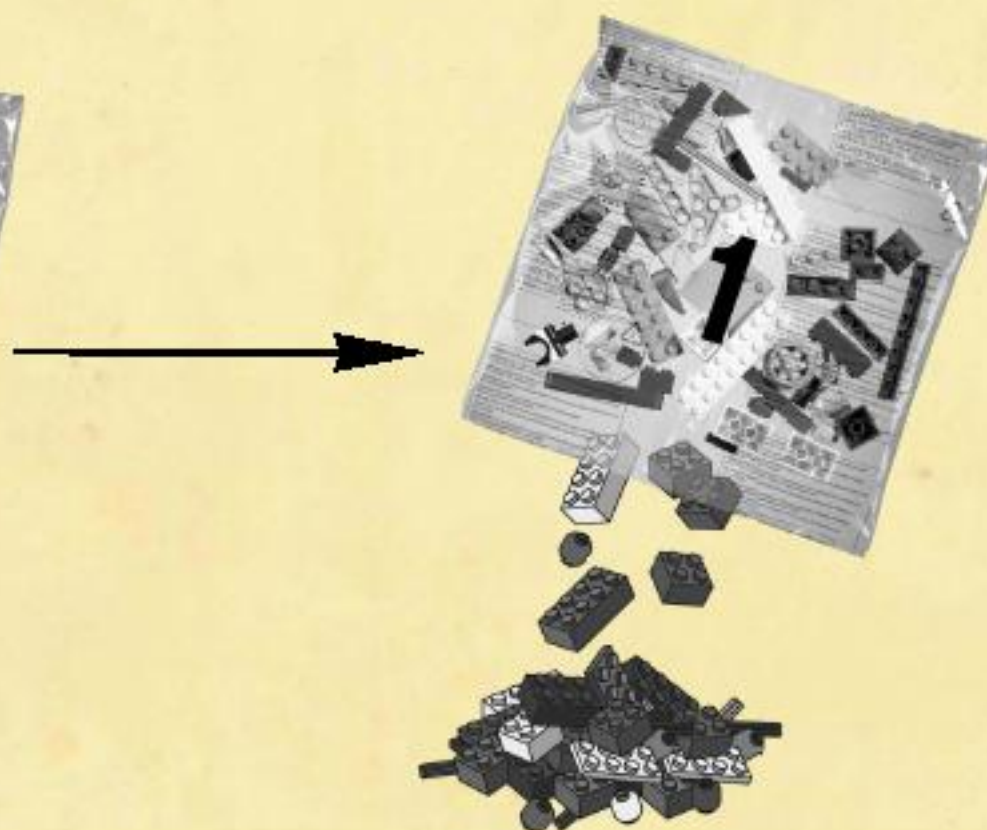

**AVERTISSEMENT : RISQUE D'ÉTOUFFEMENT.**  
Contient des petites pièces. Ne convient pas aux enfants de moins de 3 ans.



**ADVERTENCIA: PELIGRO DE ASFIXIA.**  
No recomendado para niños menores de 3 años. Contiene piezas pequeñas.

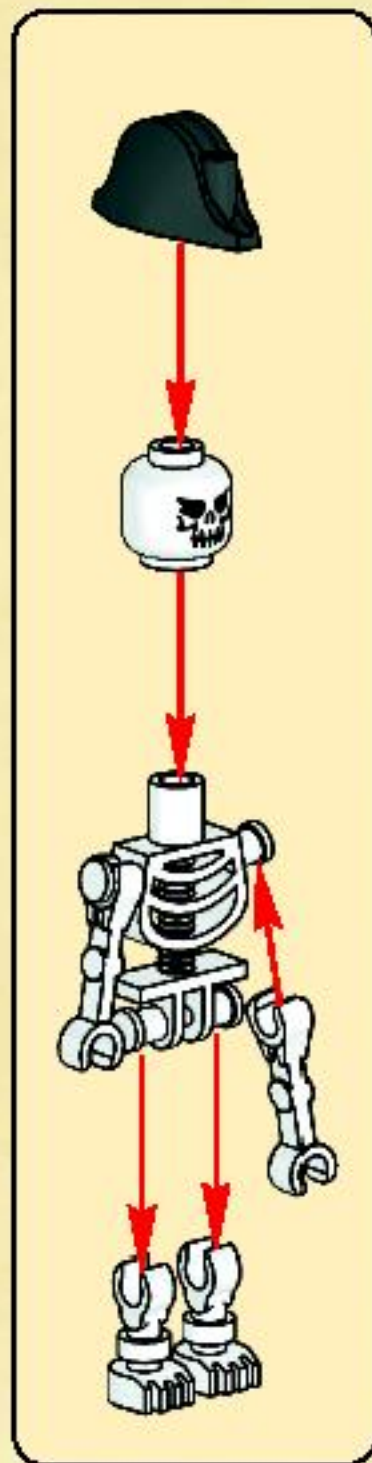
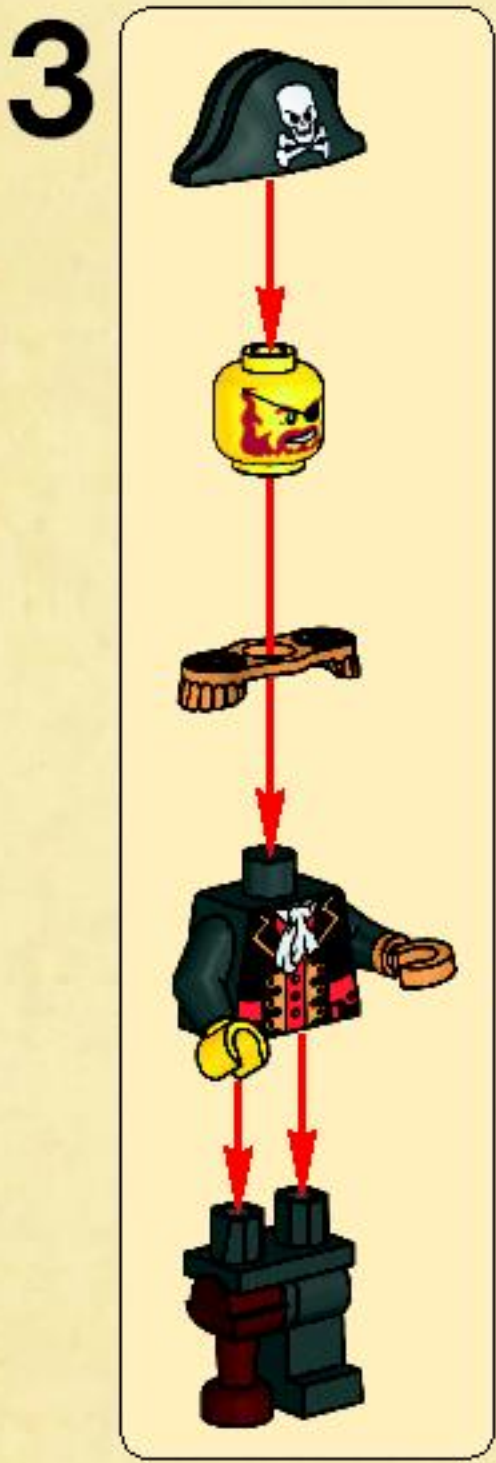
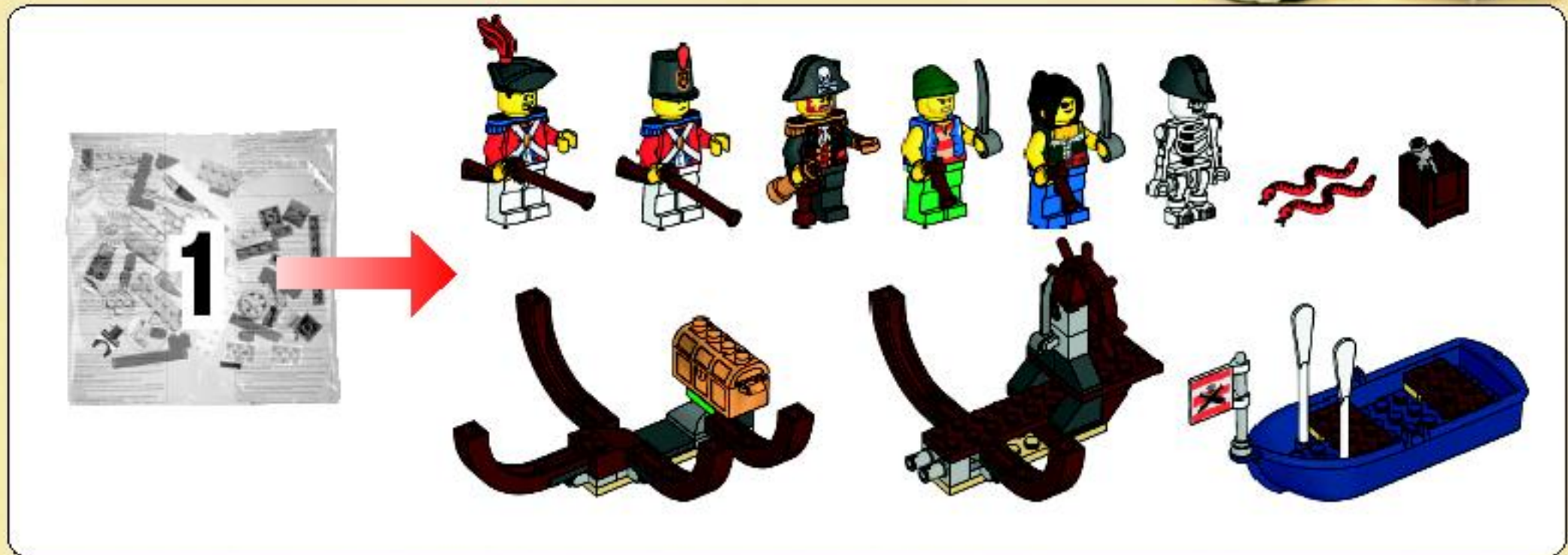

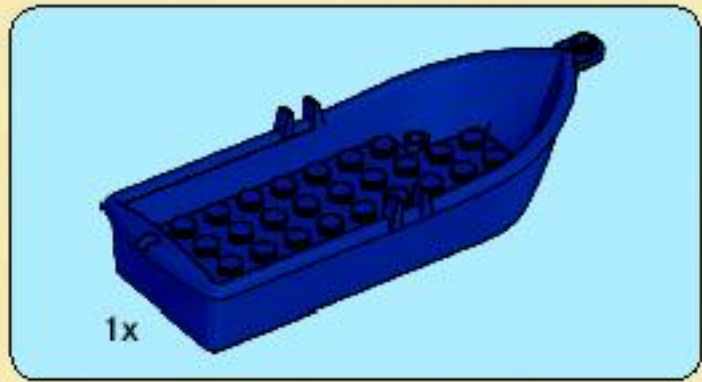
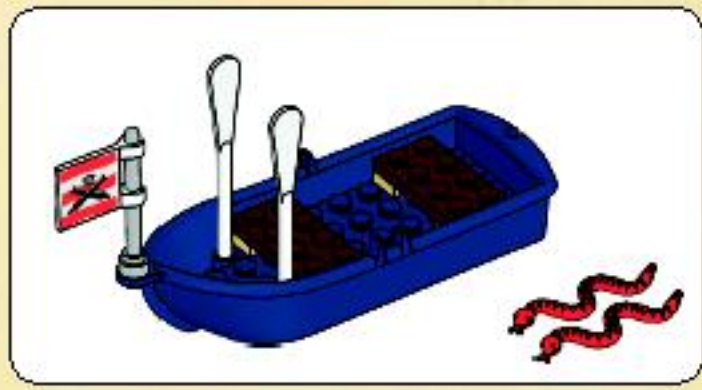

1

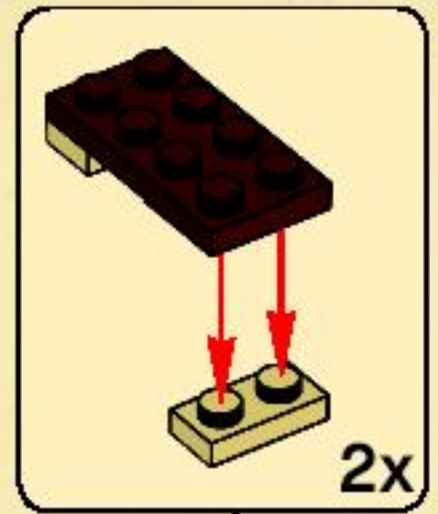
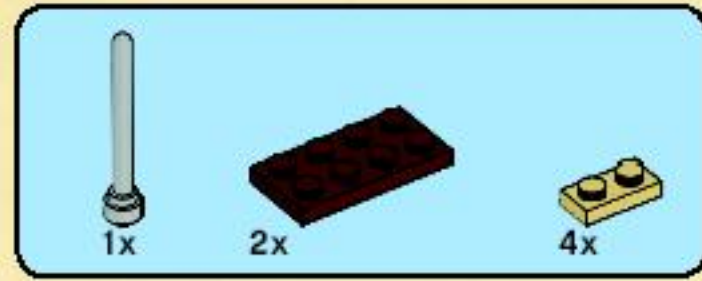
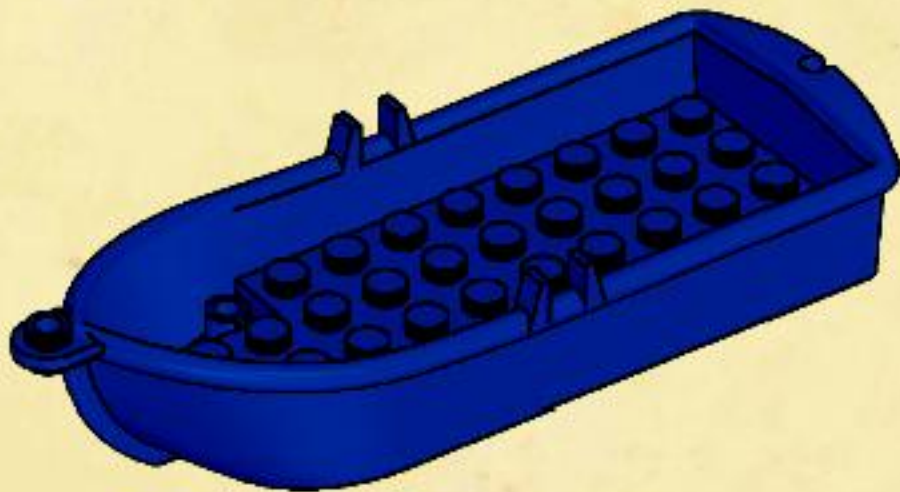

2

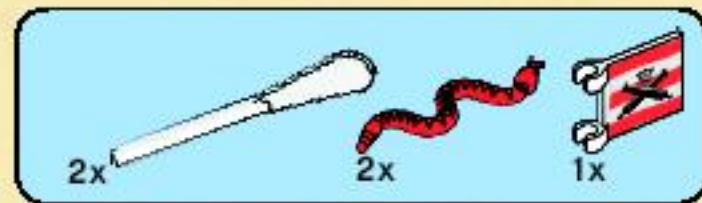
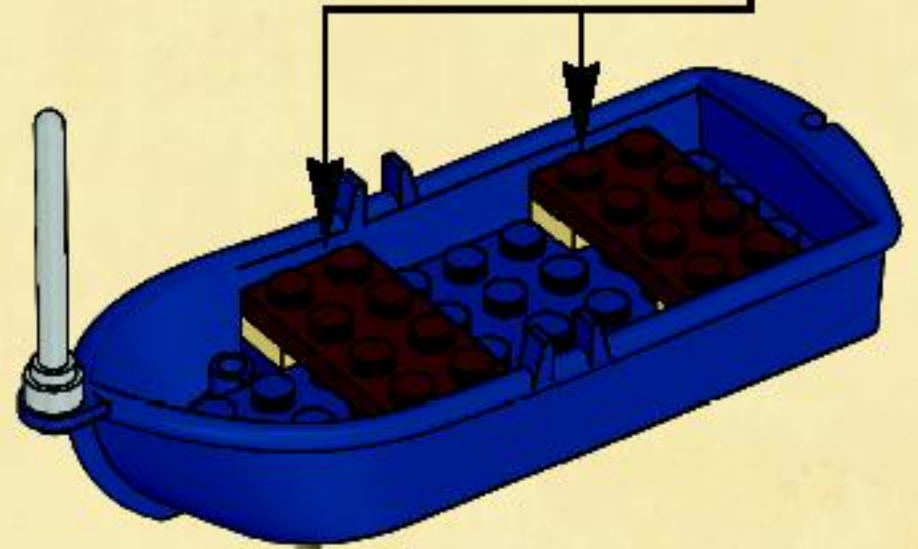

3



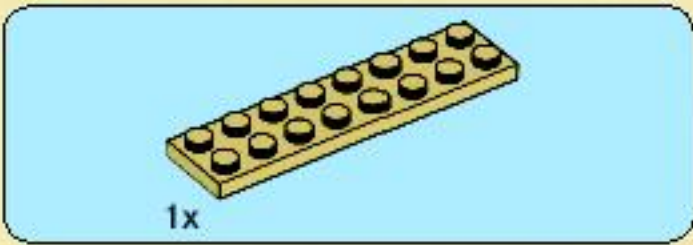
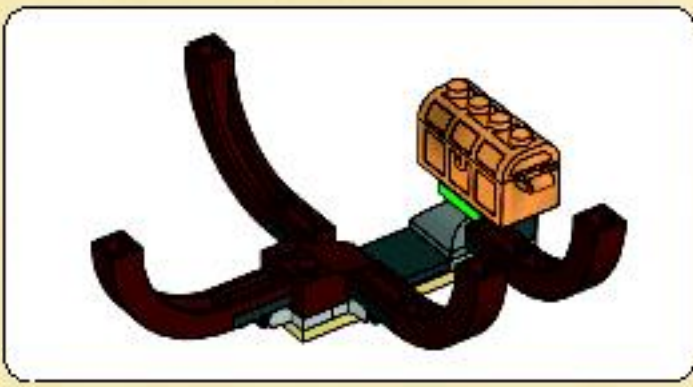

1

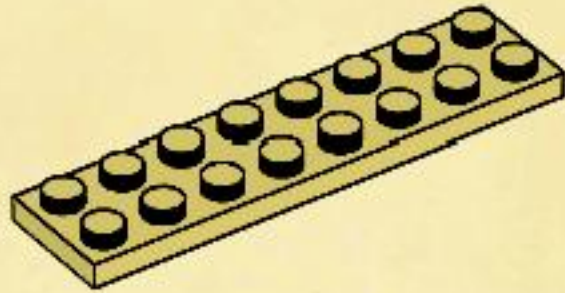

2

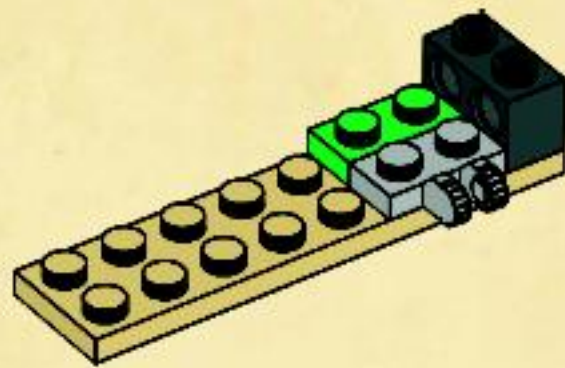

3

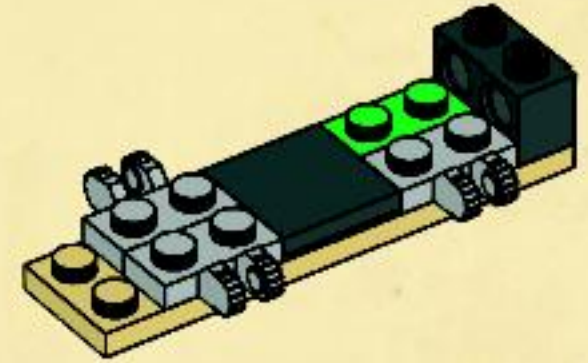

4

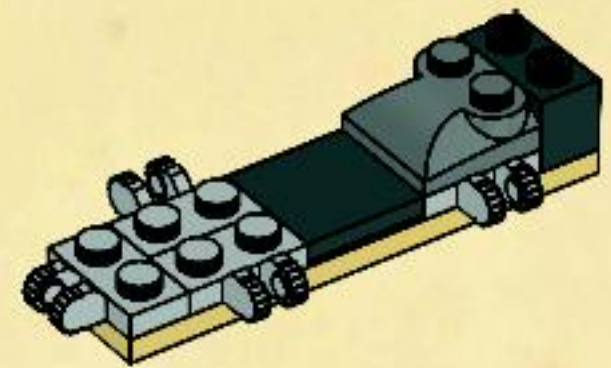



5

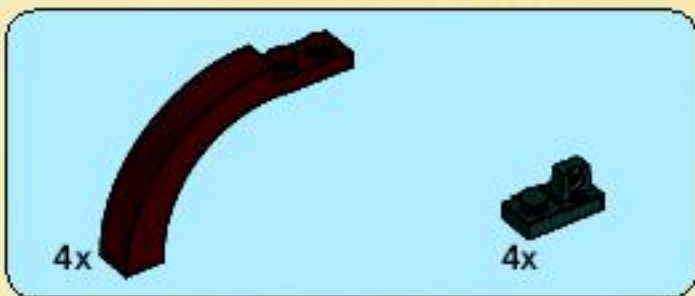
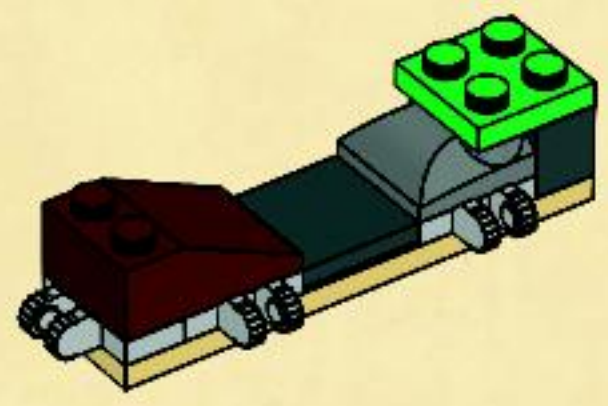

6

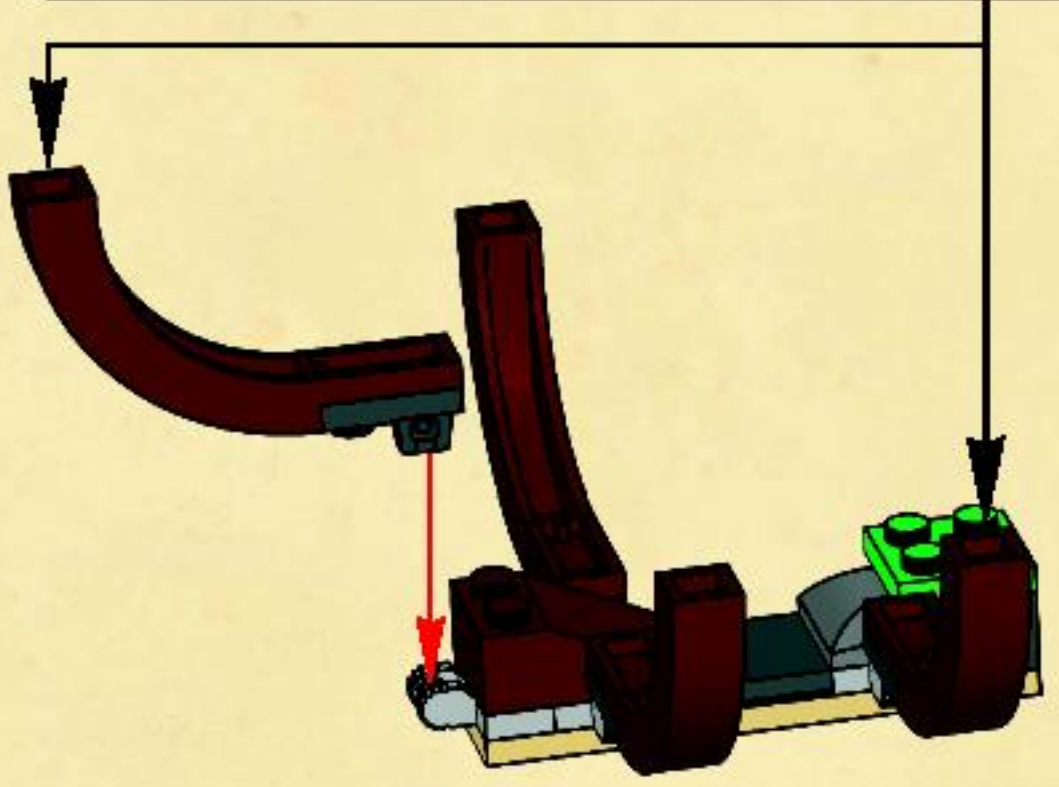
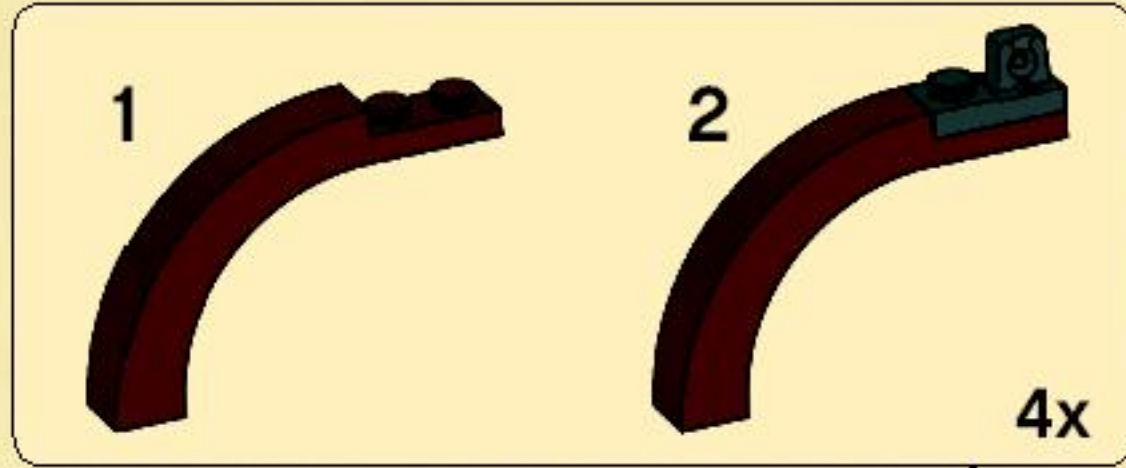

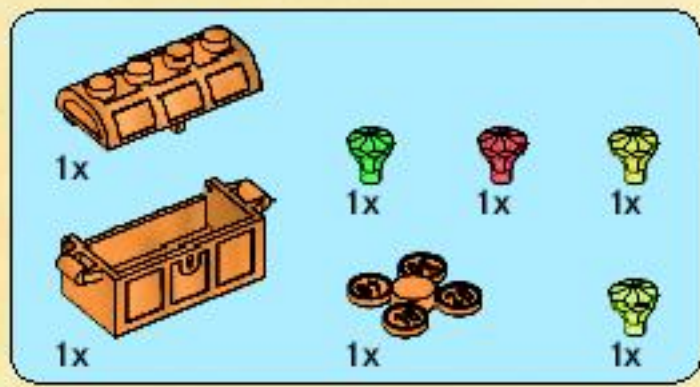

7

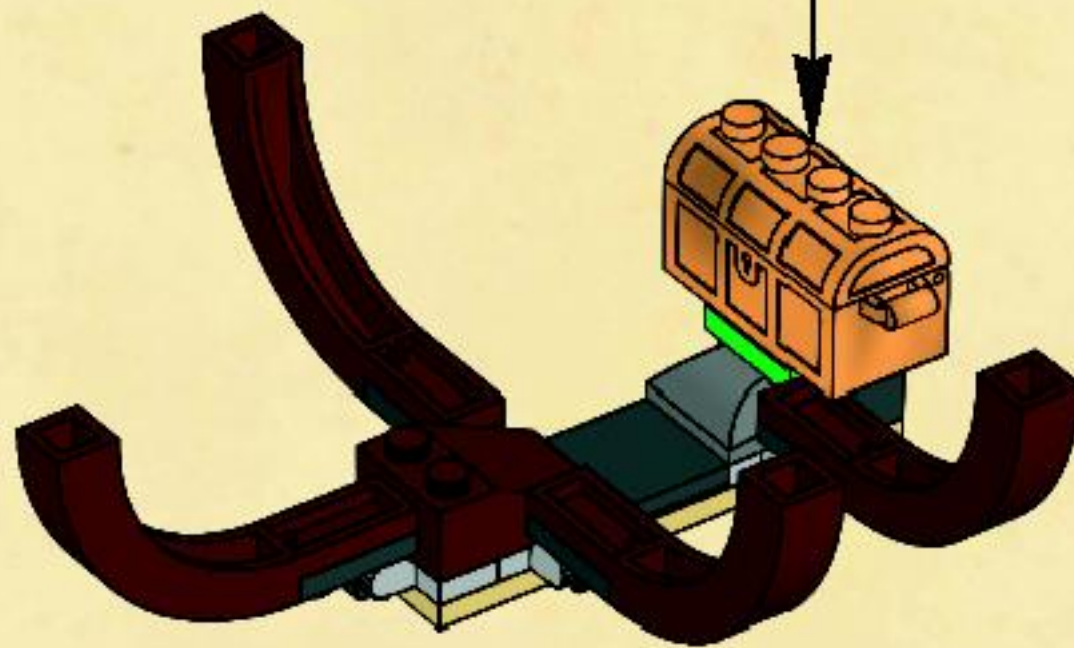
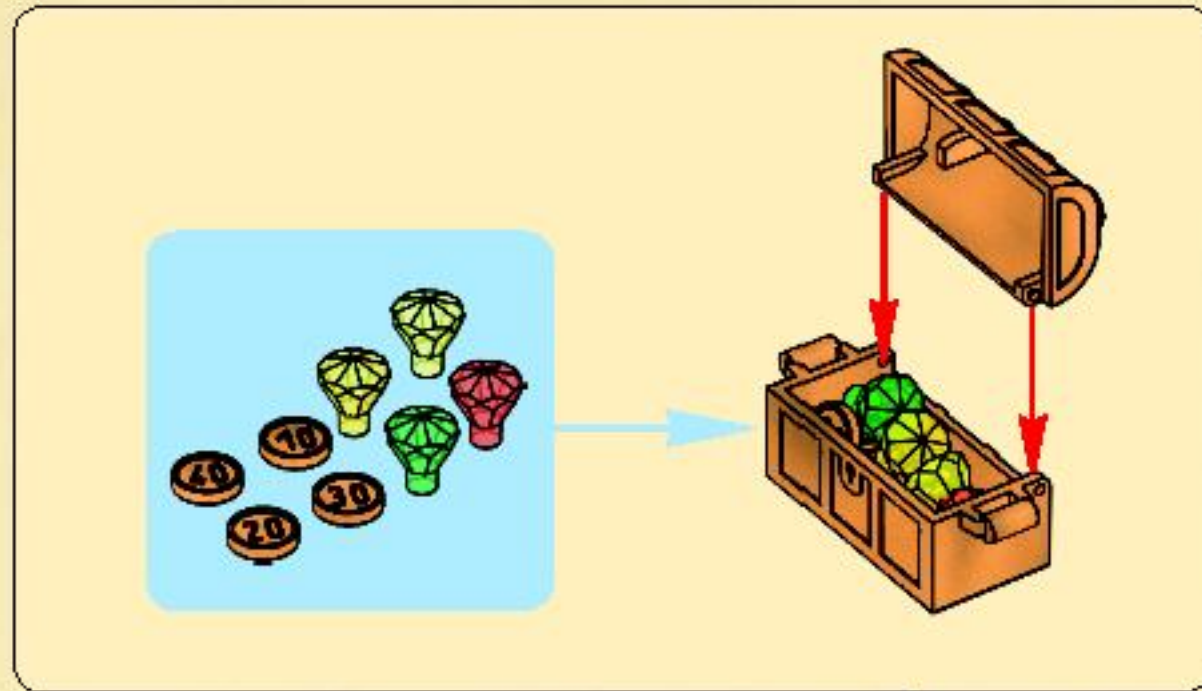

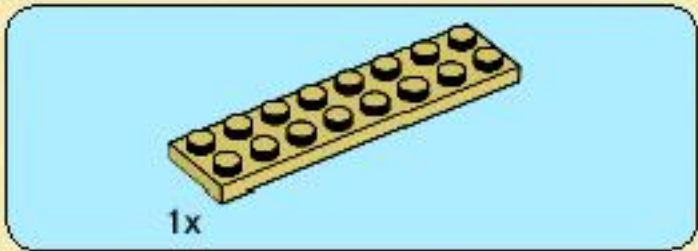
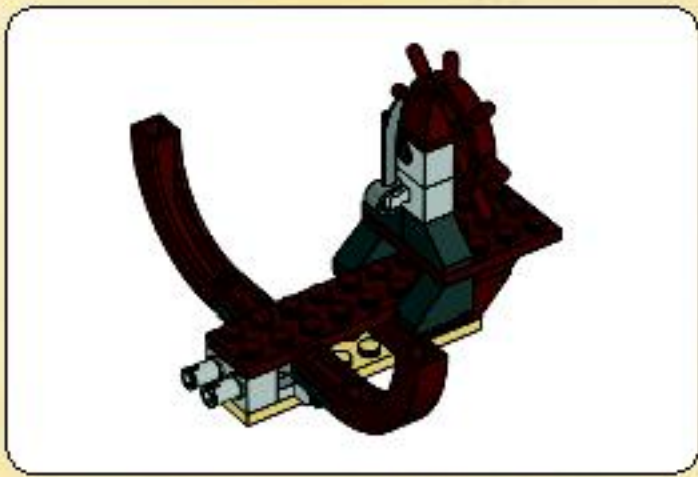

1

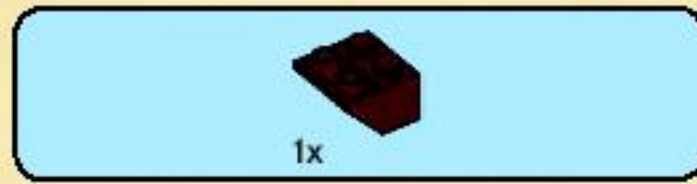
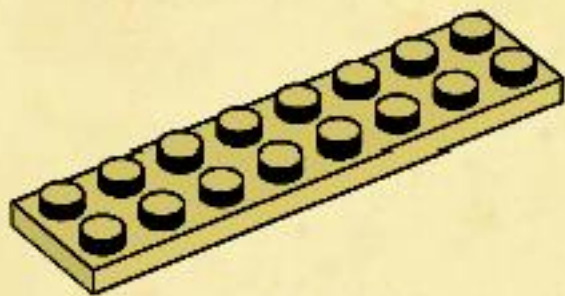

2

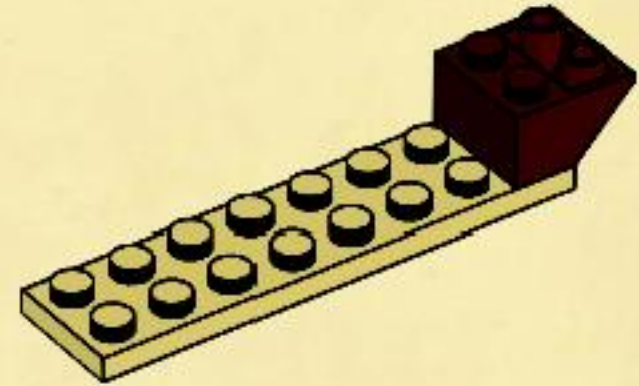

3

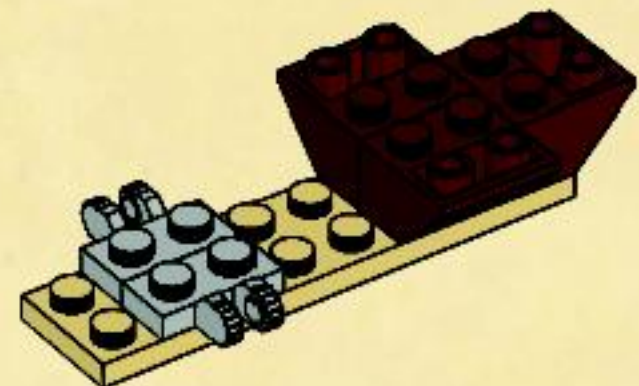





4

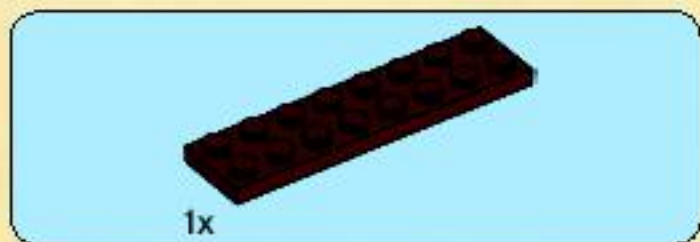
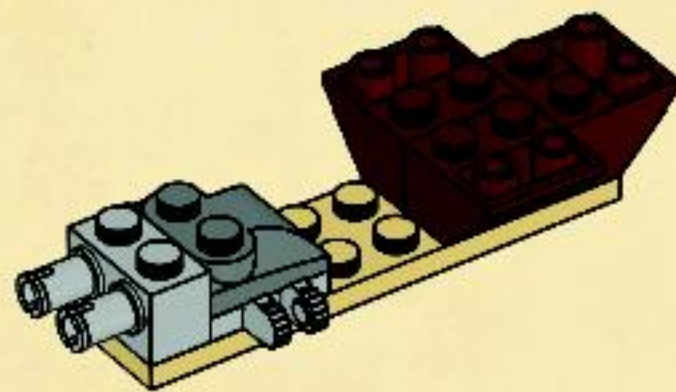

5

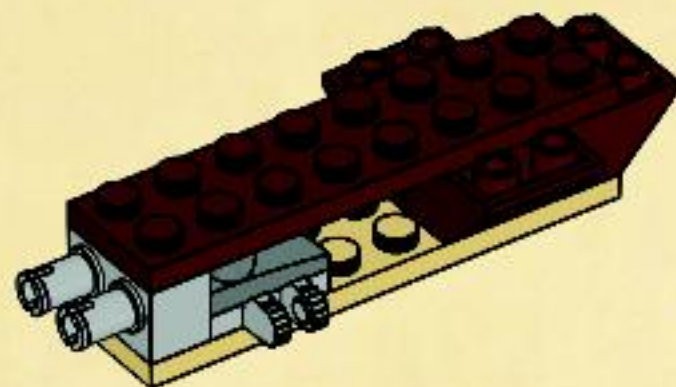

6

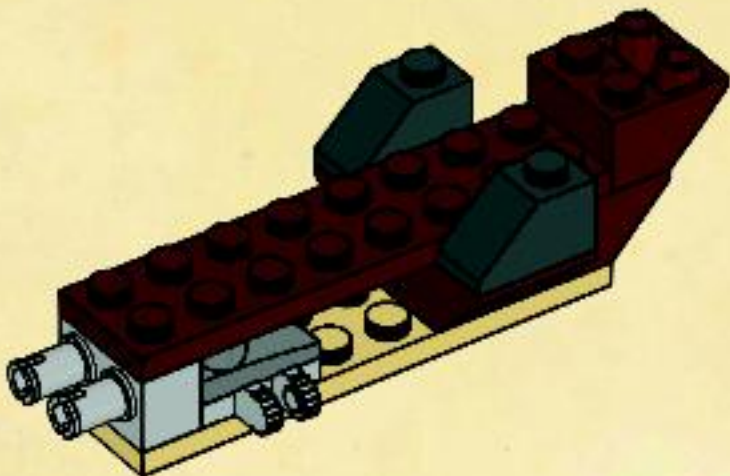



7

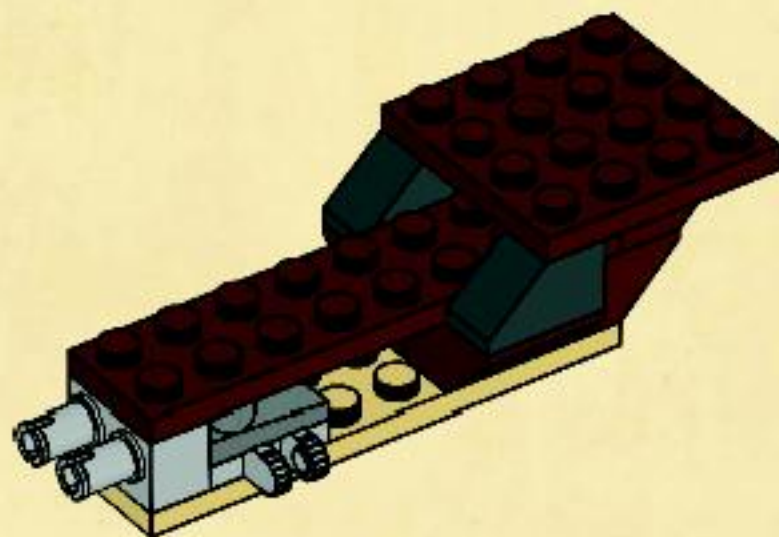

8

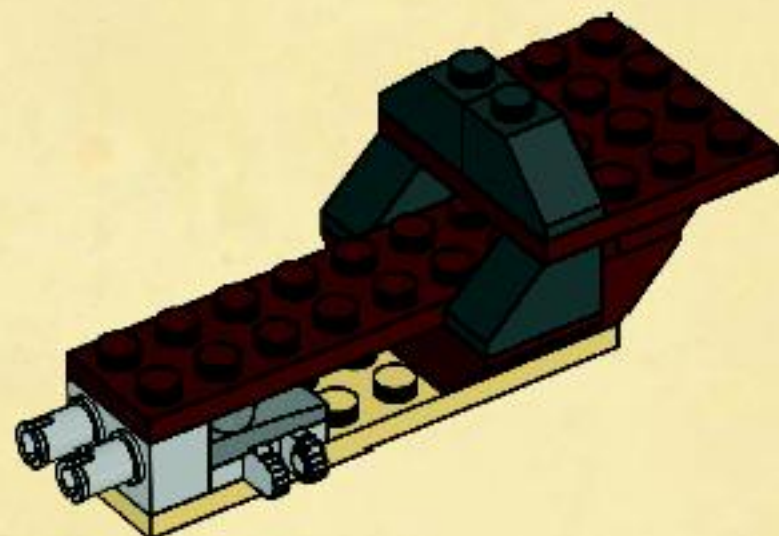

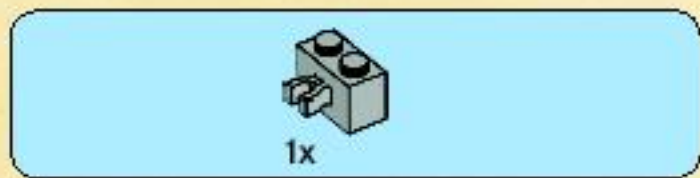

9

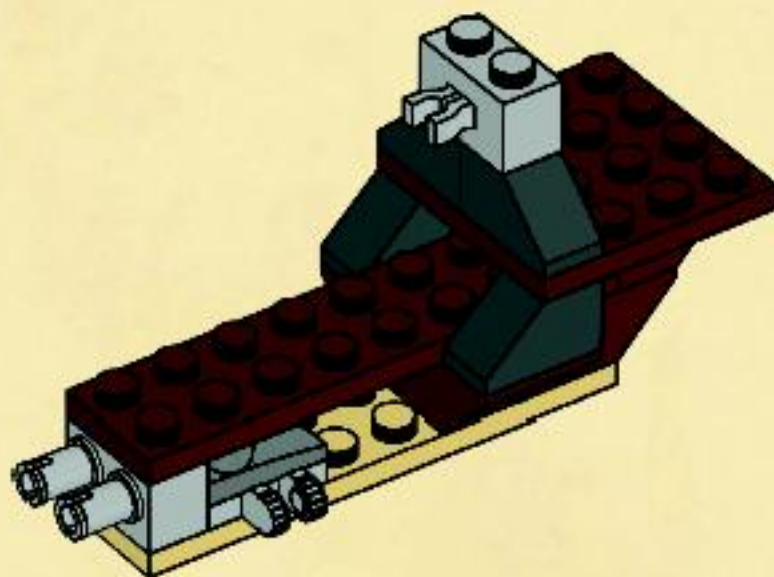

10

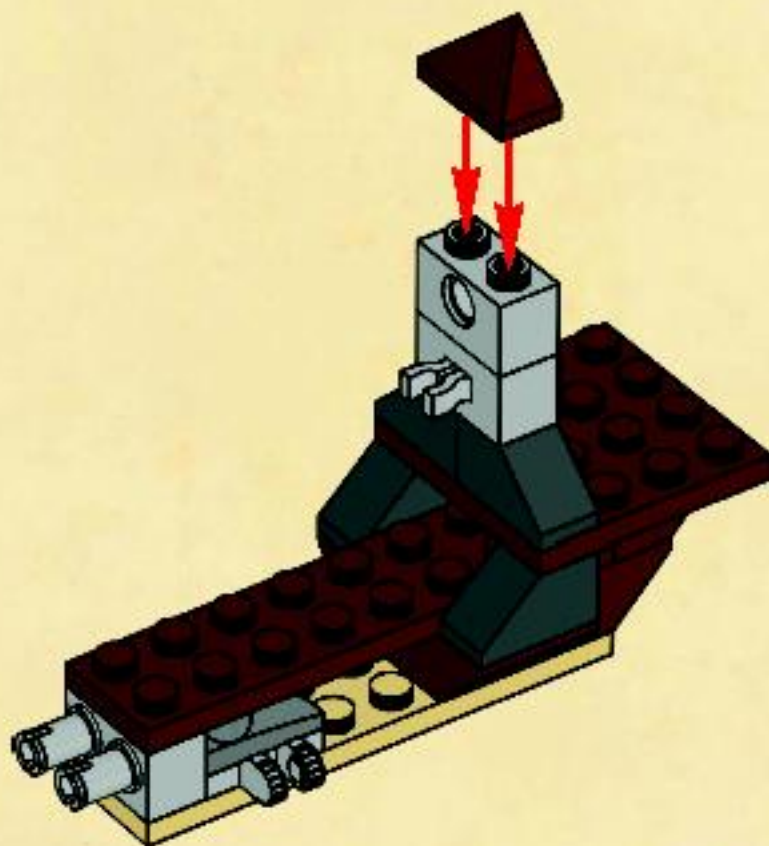



11

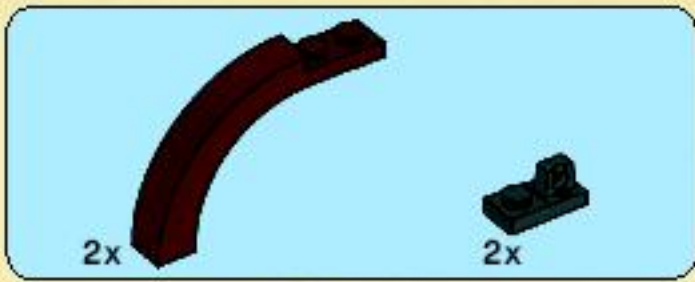
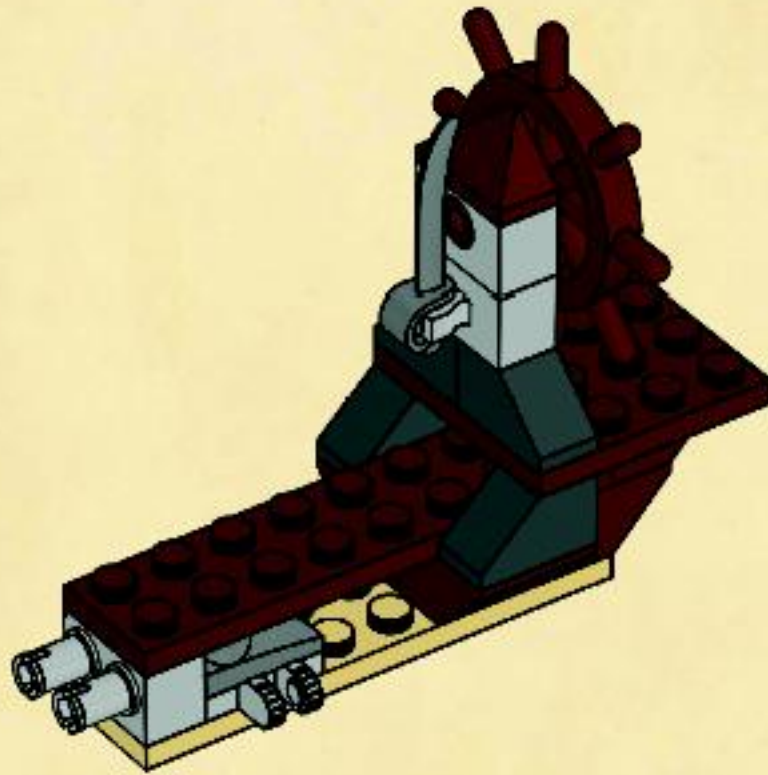

12

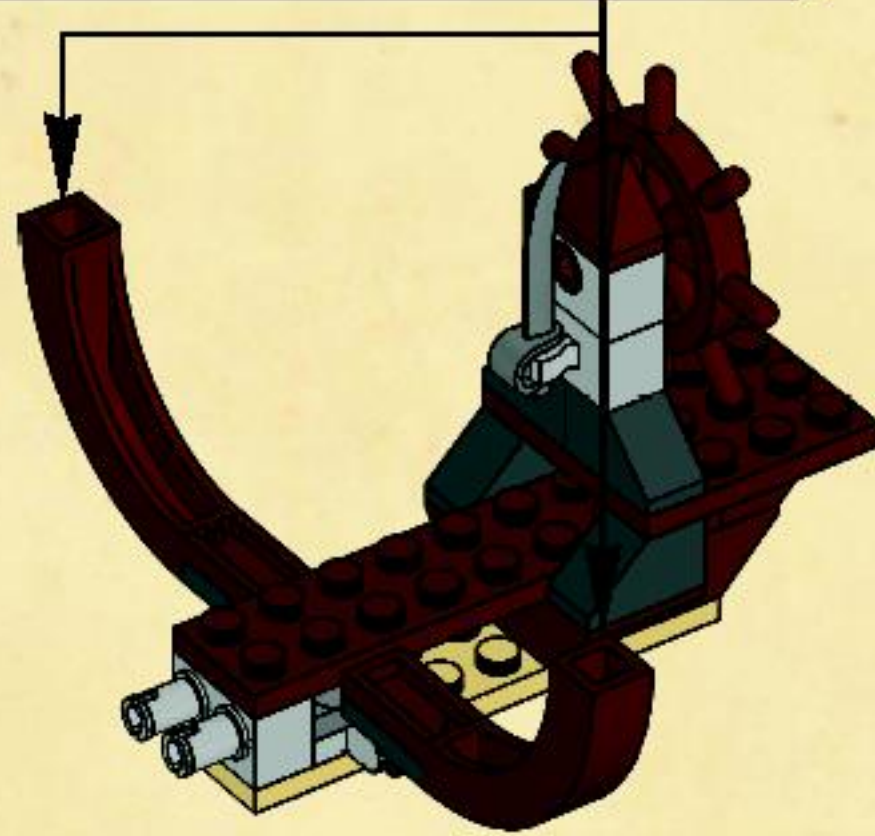
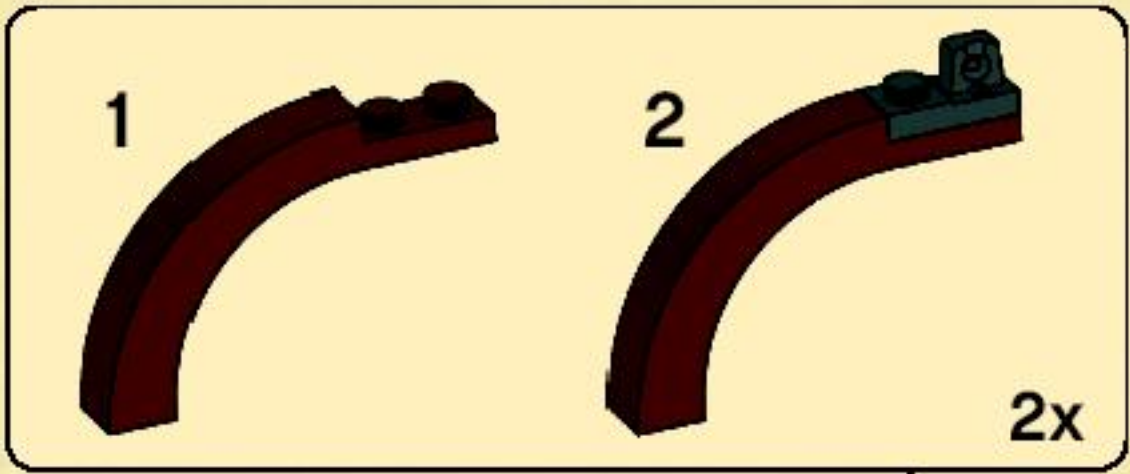



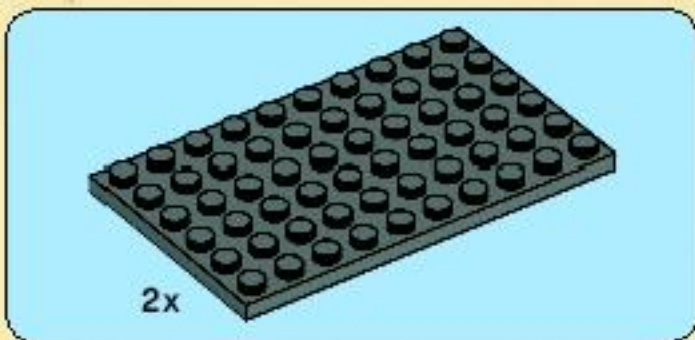
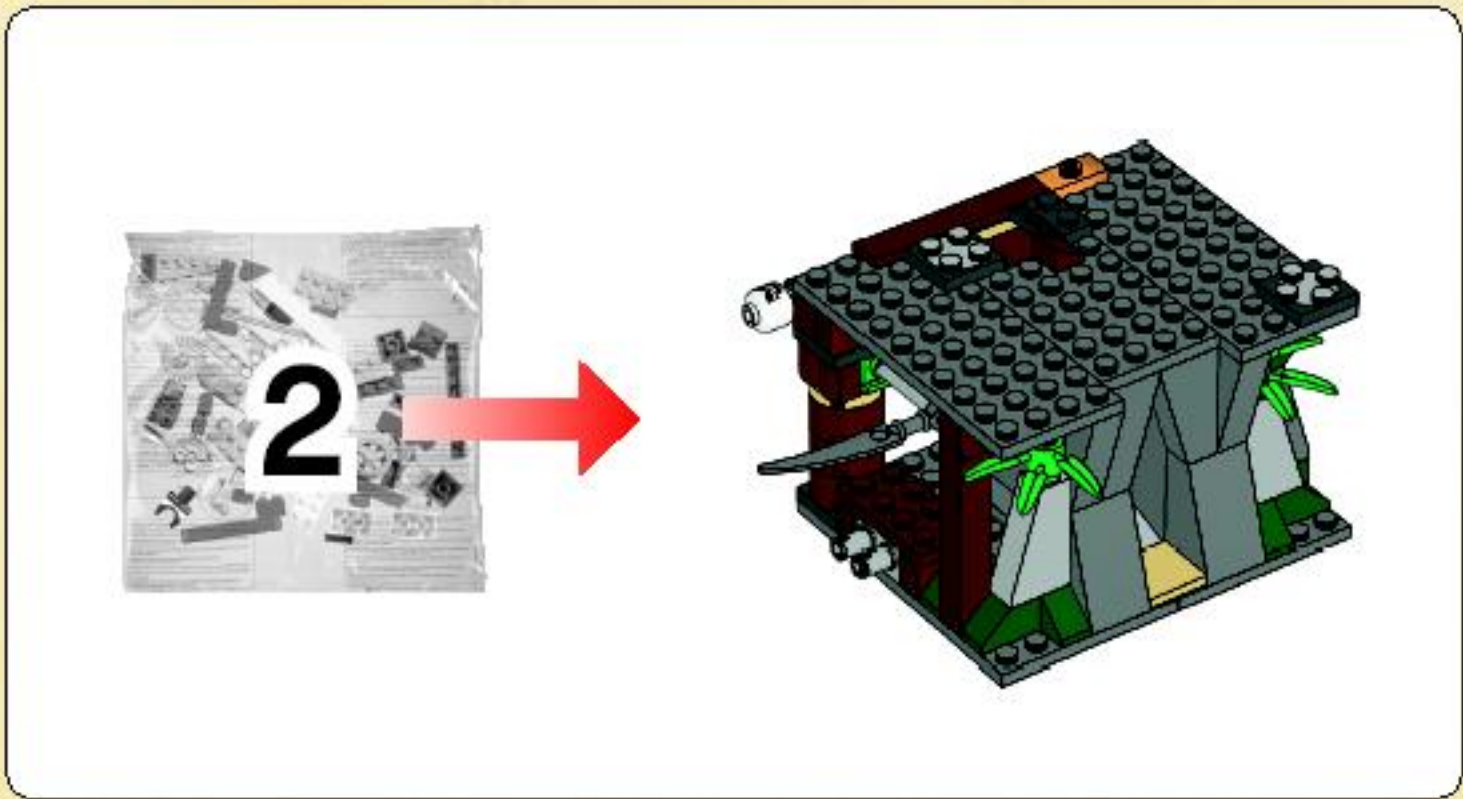

1

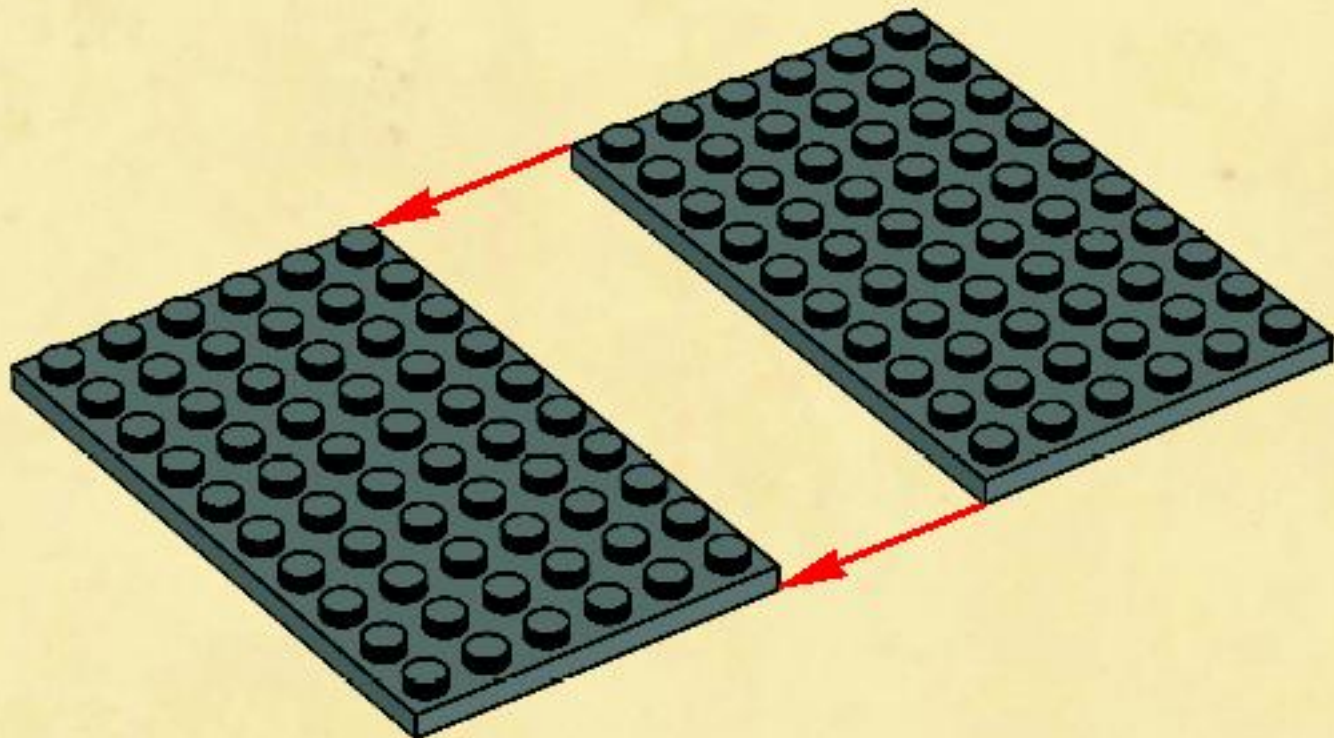

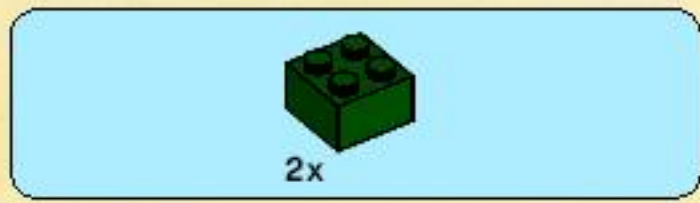

2

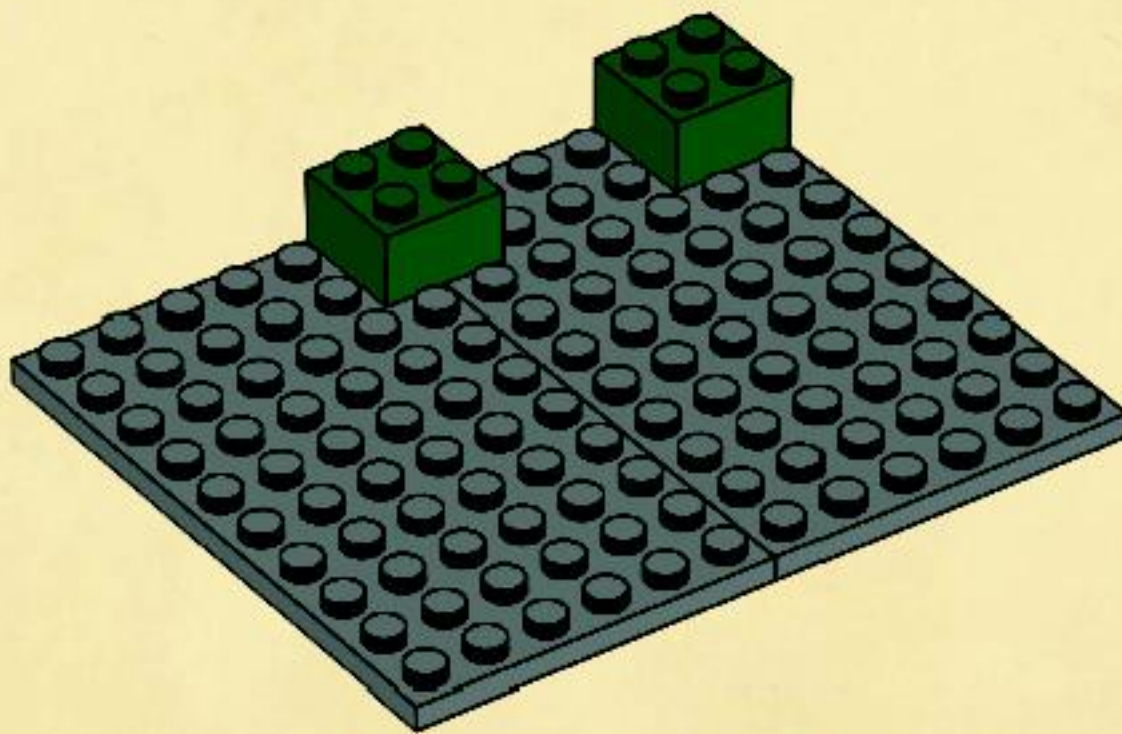

3

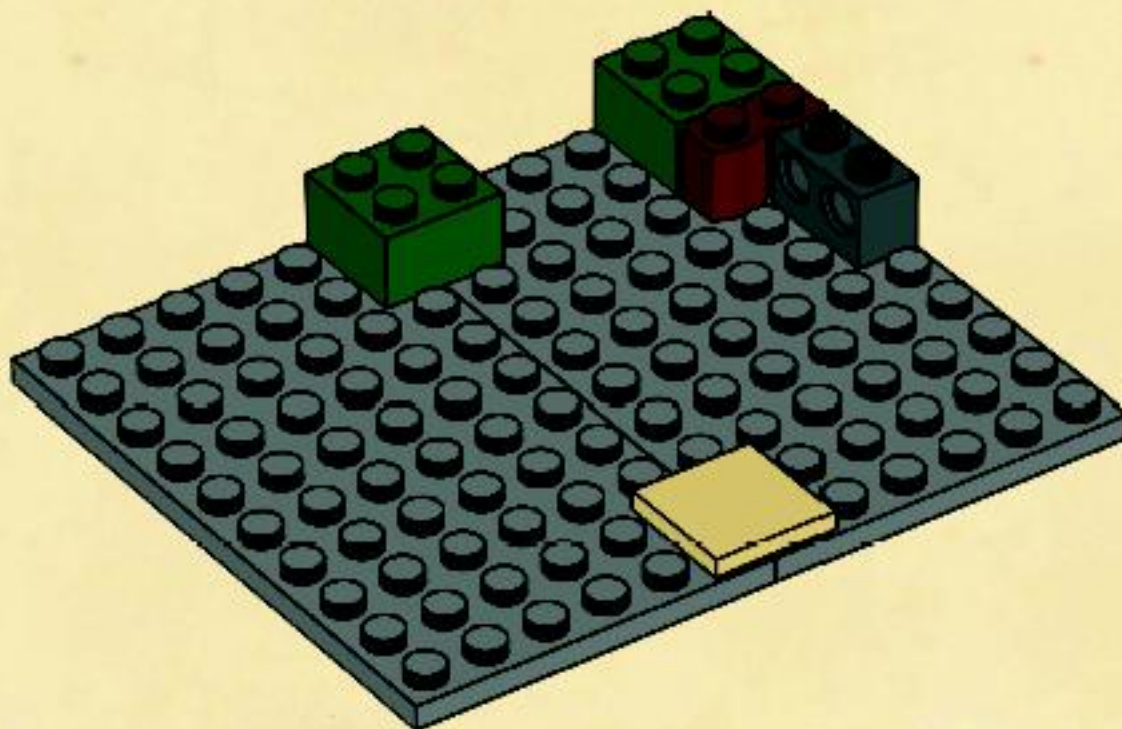

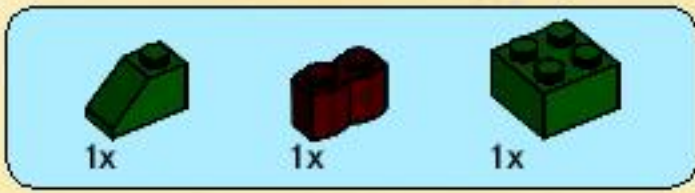

4

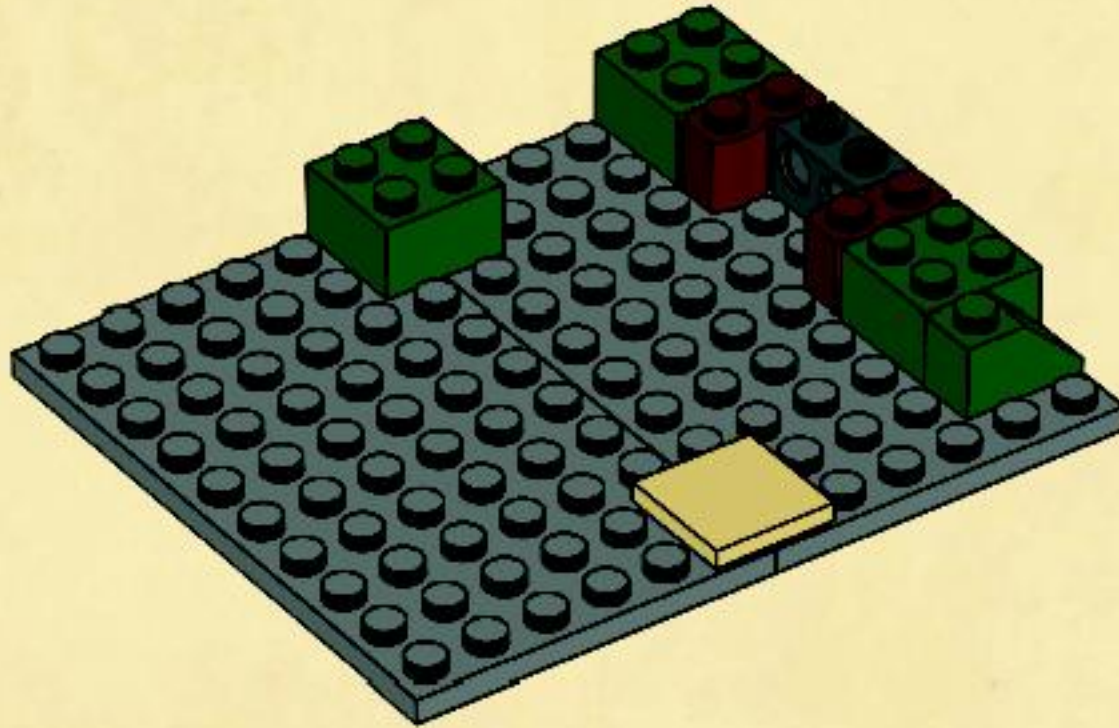

5

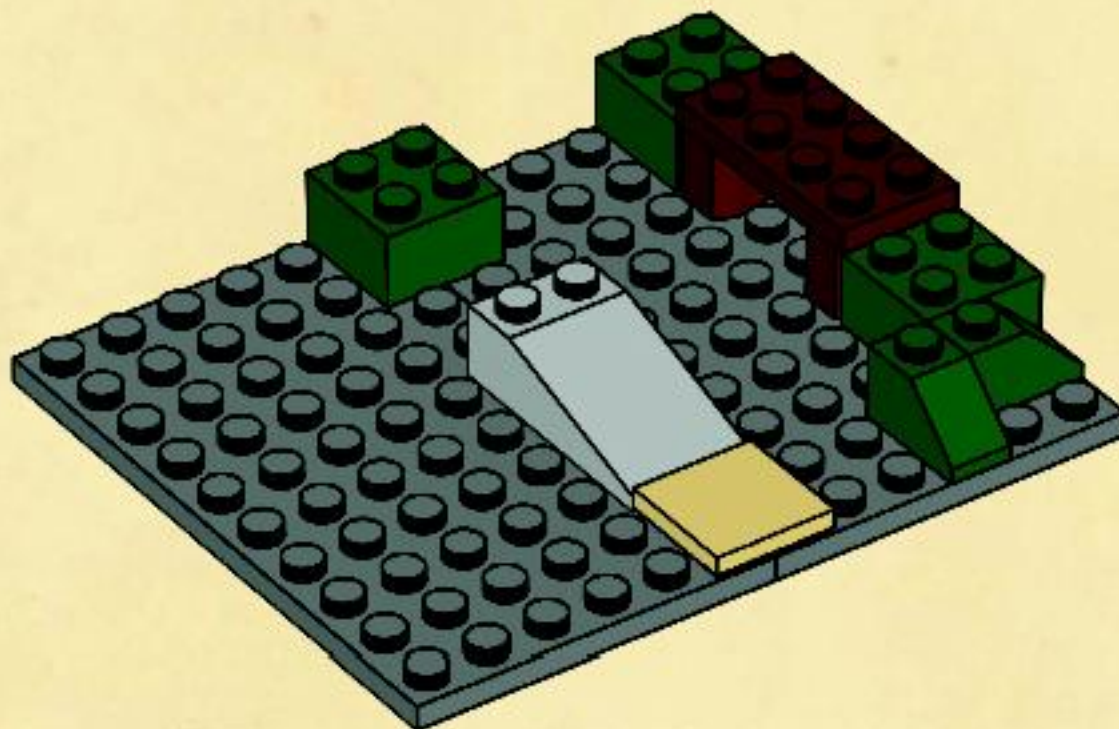



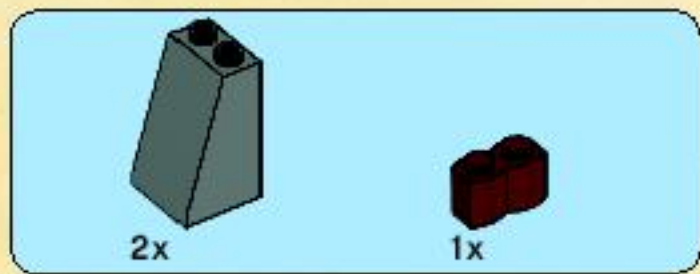

6

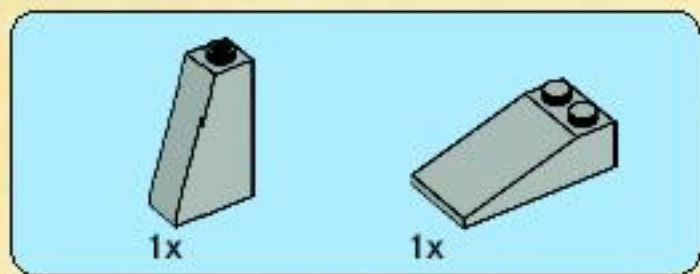
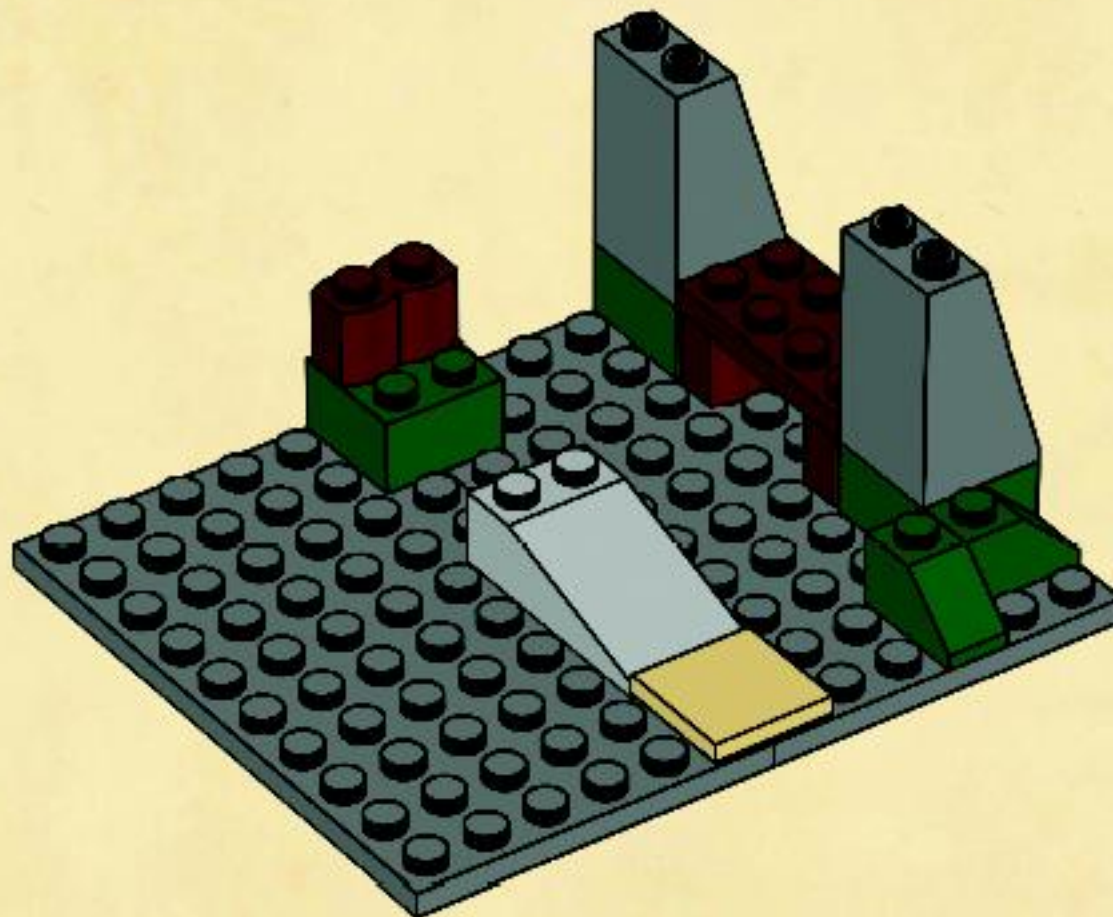

7

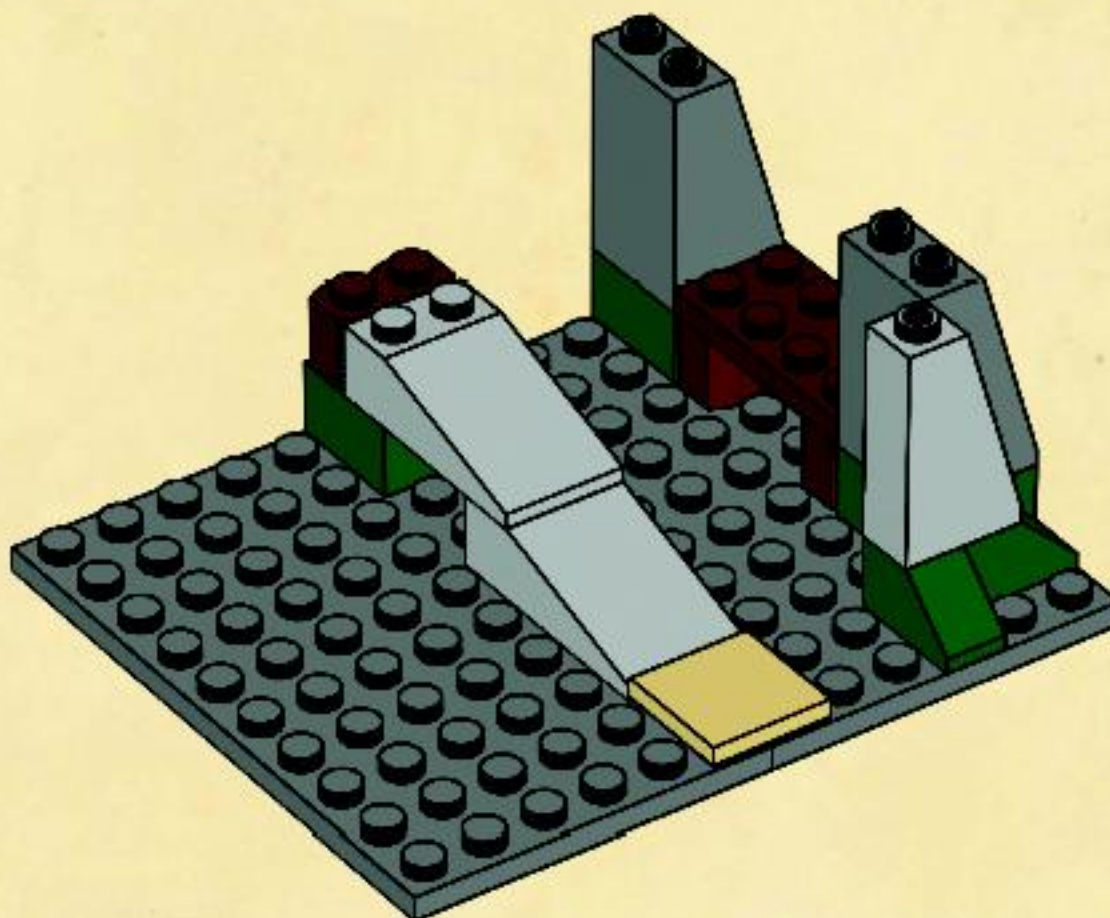

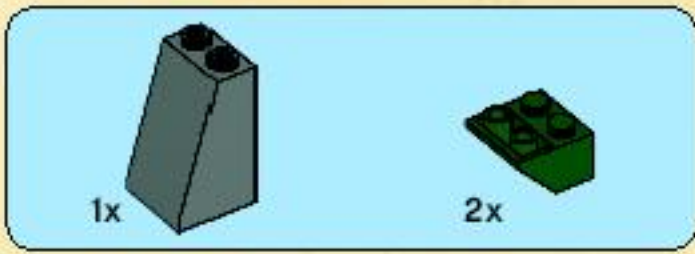

8

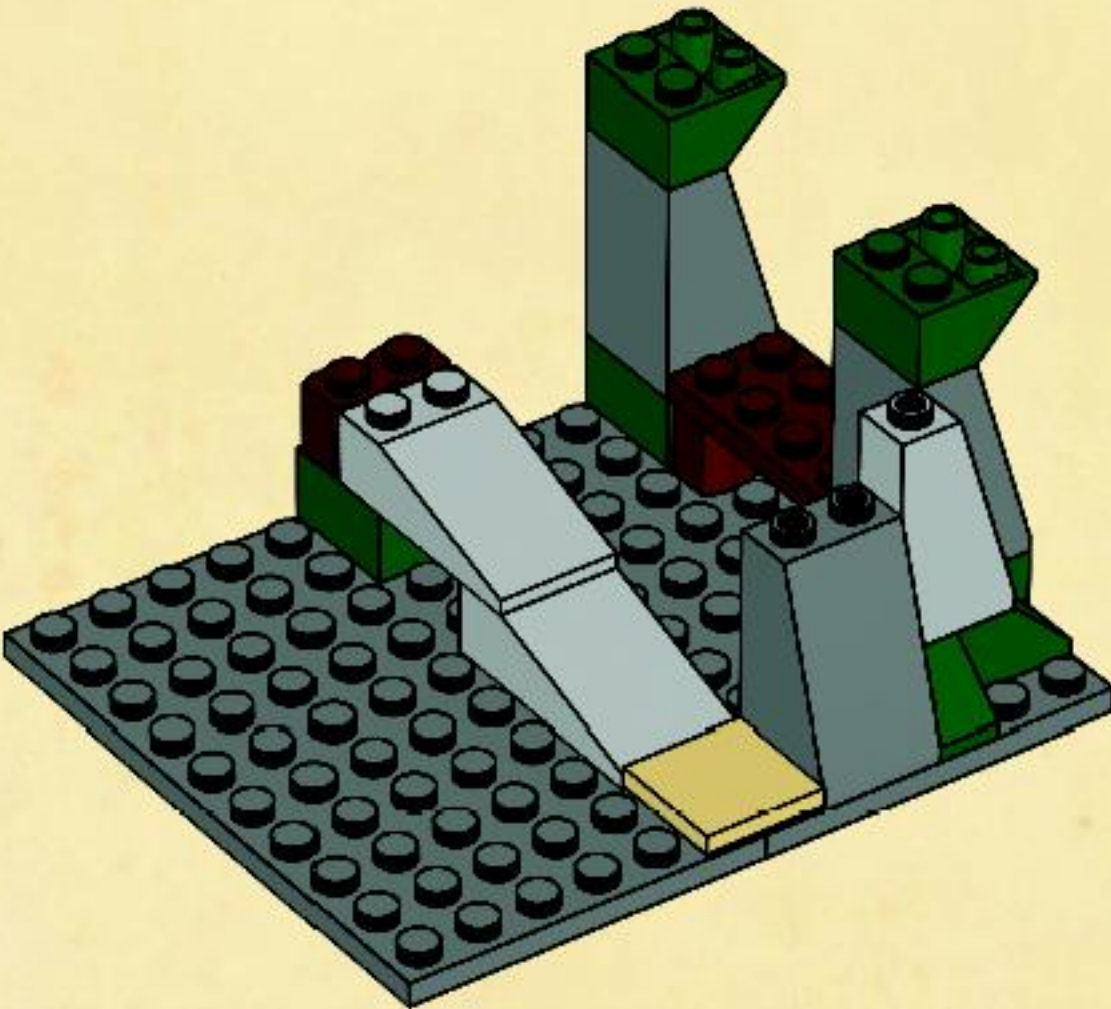

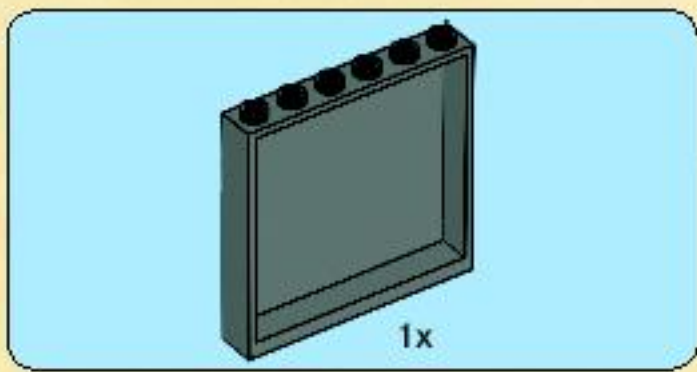

9

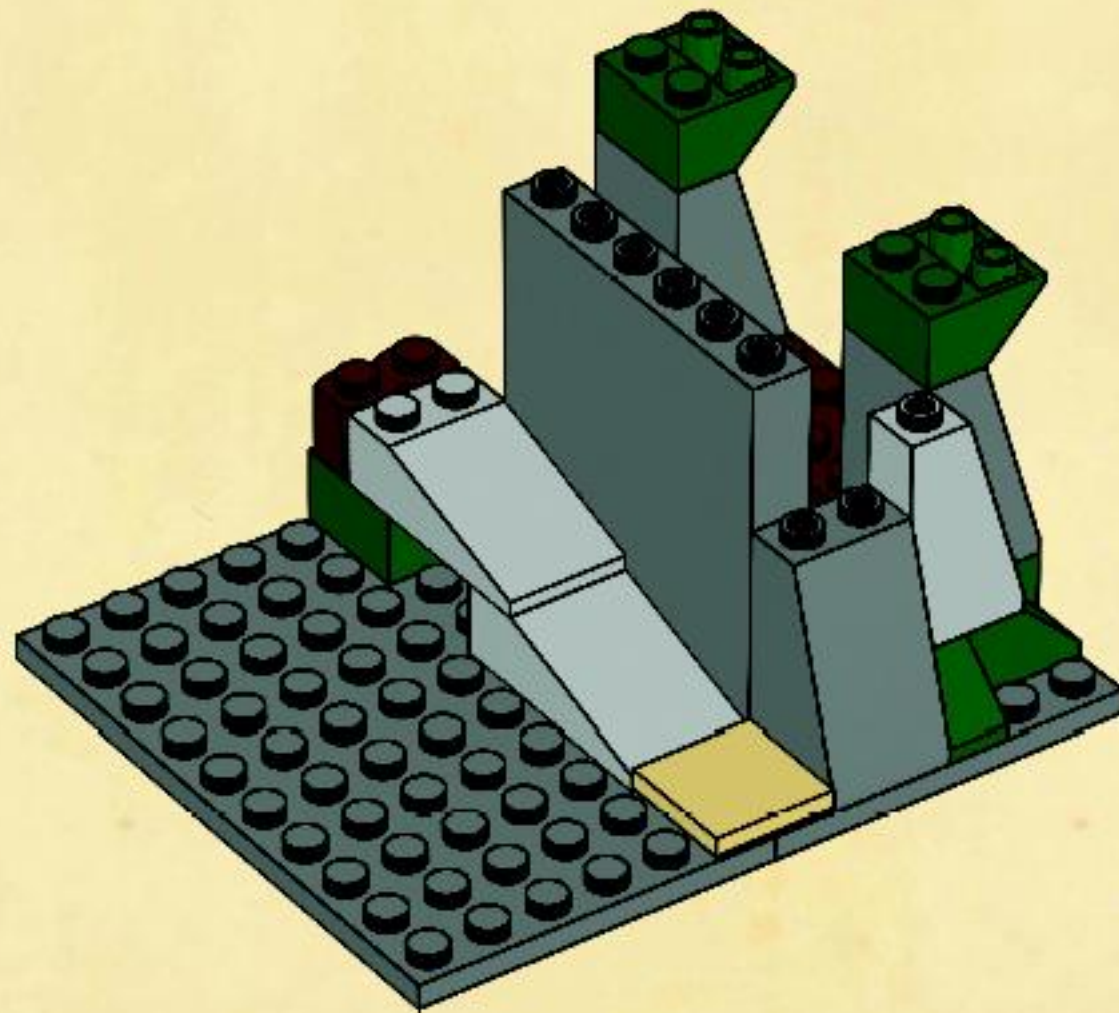

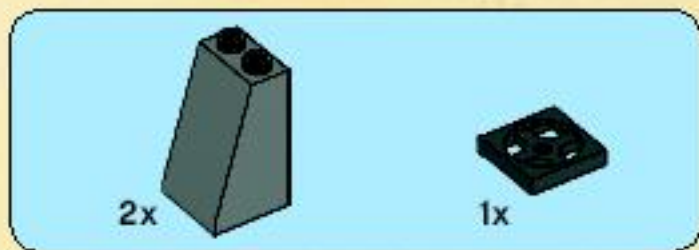

10

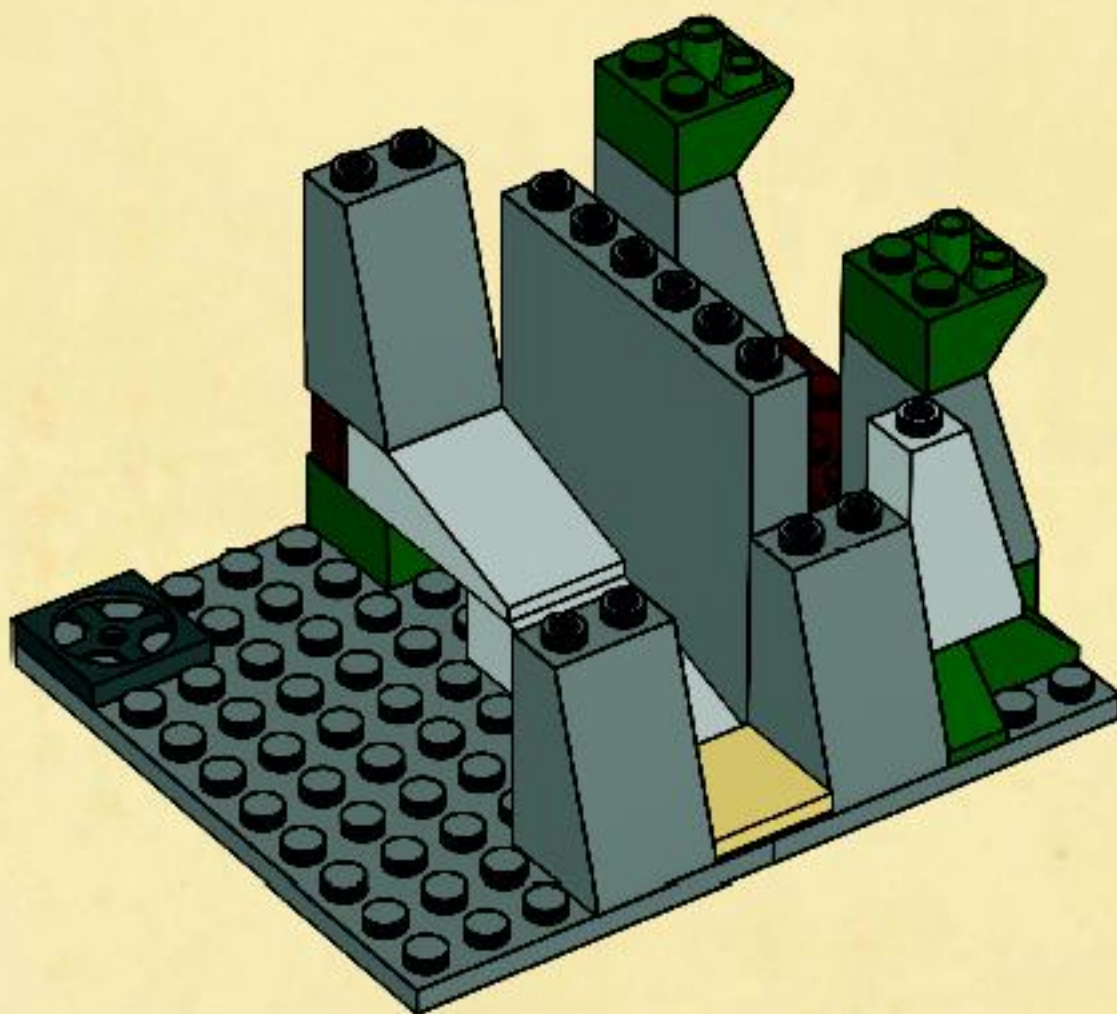

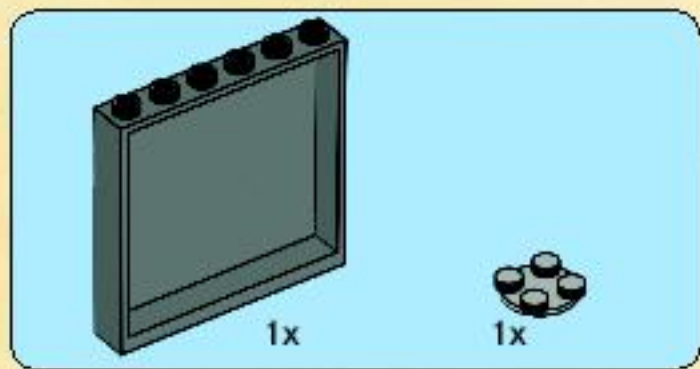

11

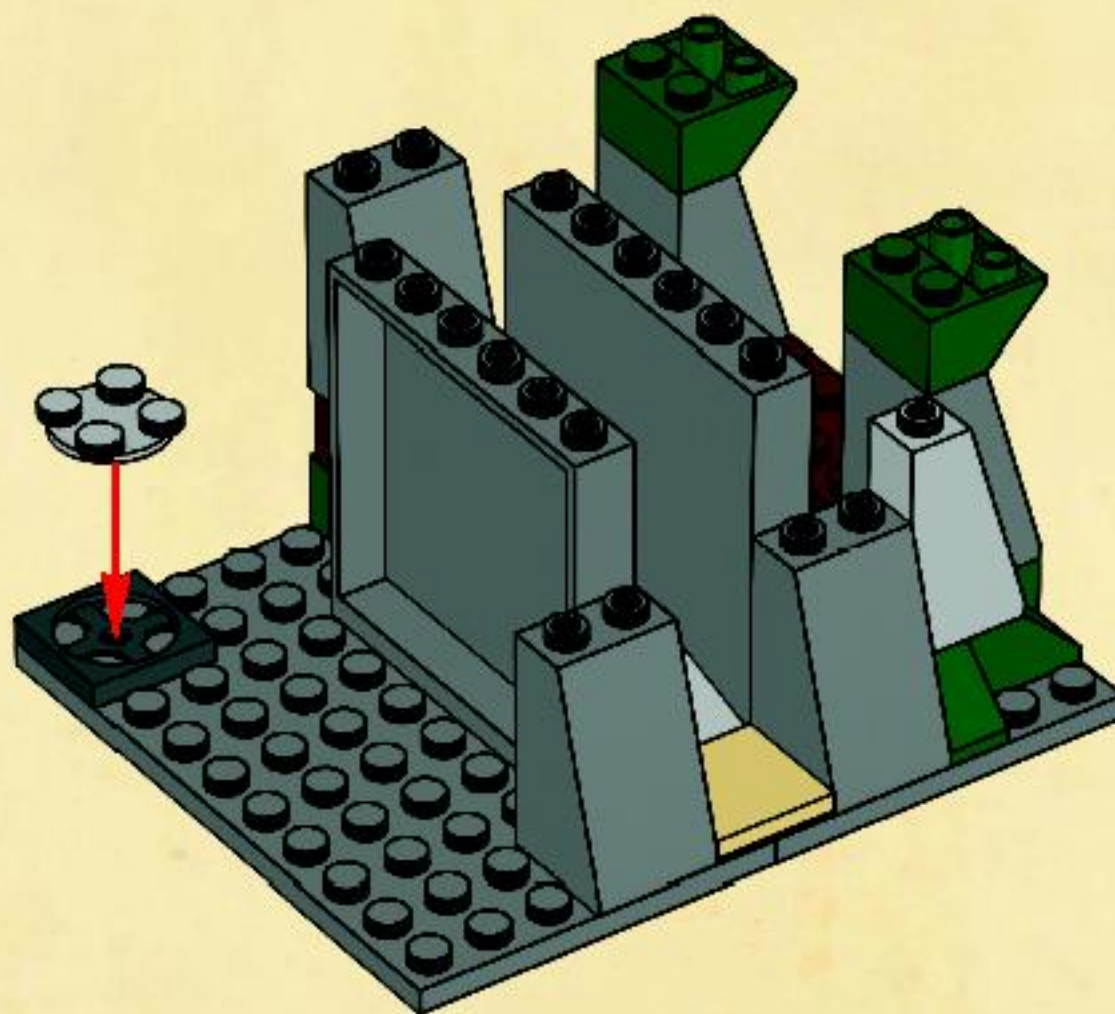



# 12

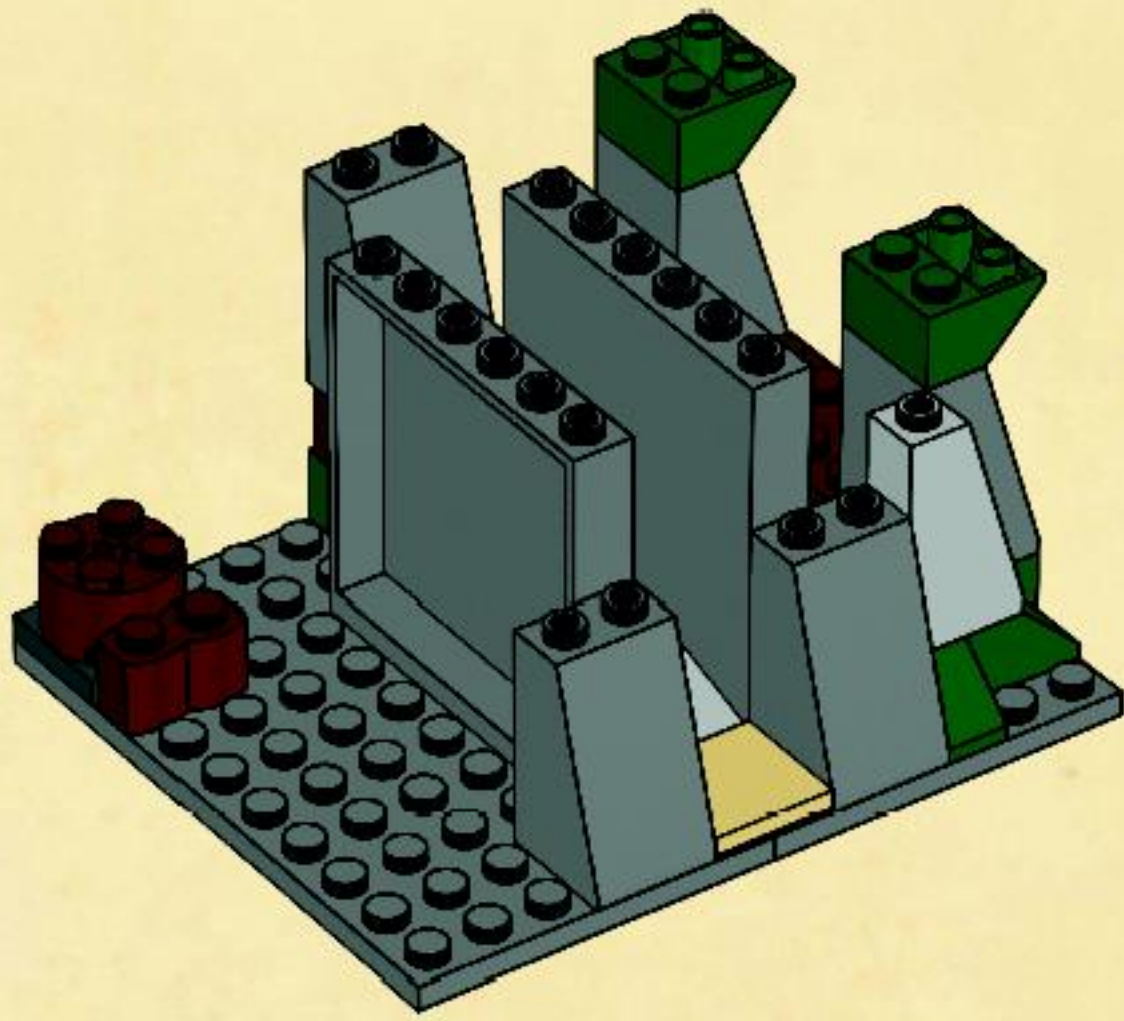



1x



1x

# 13

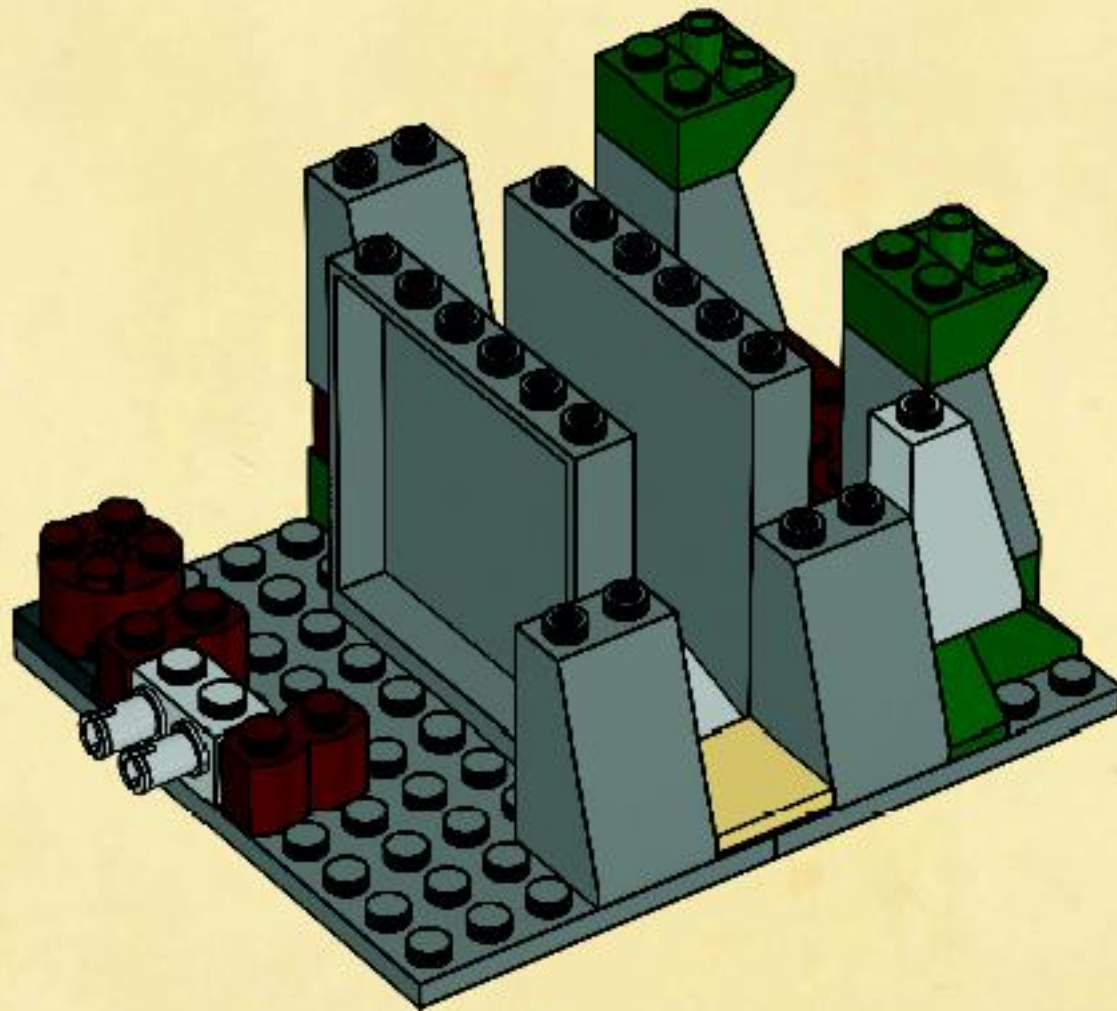



14

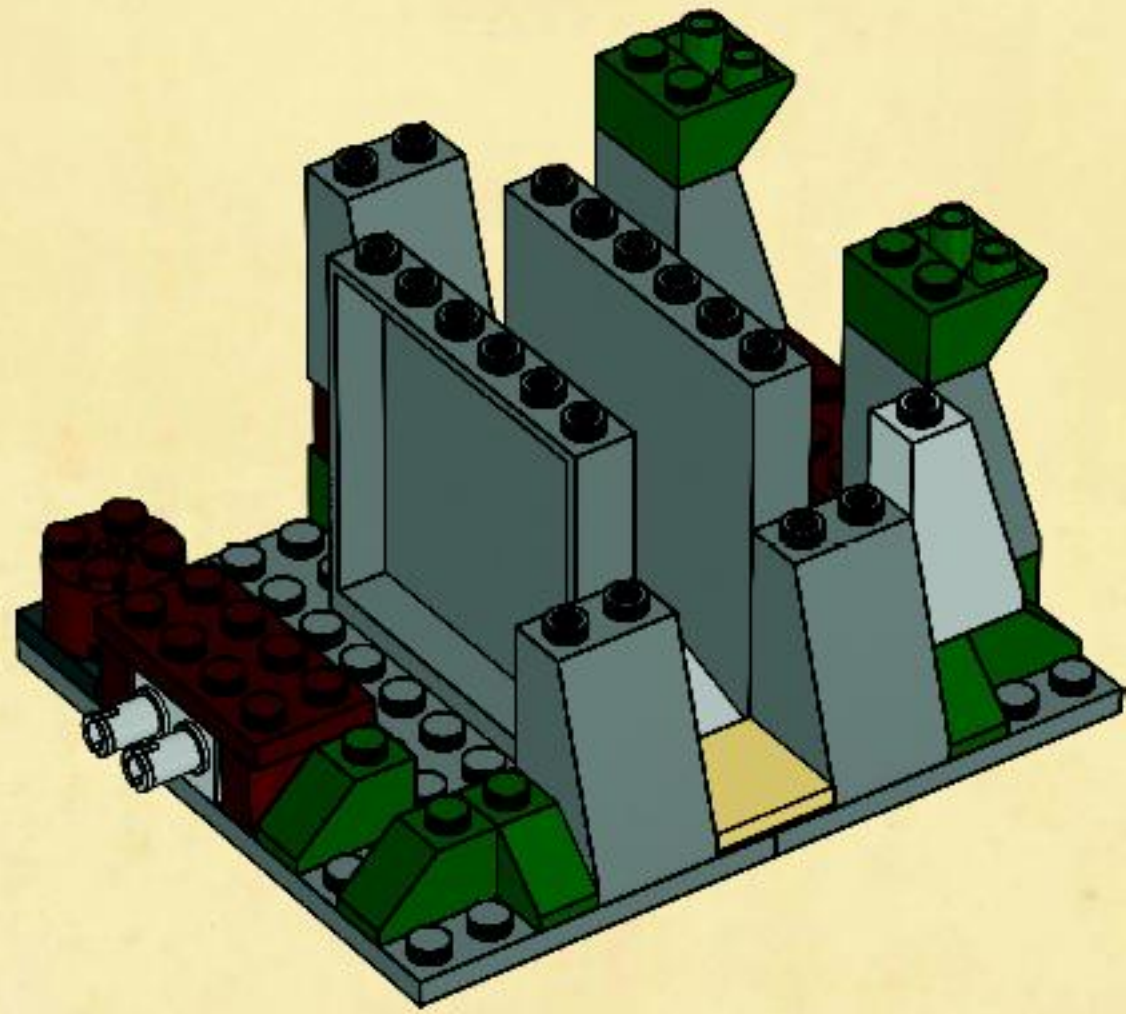



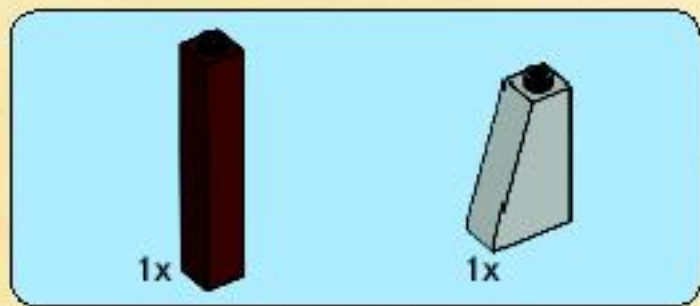

15

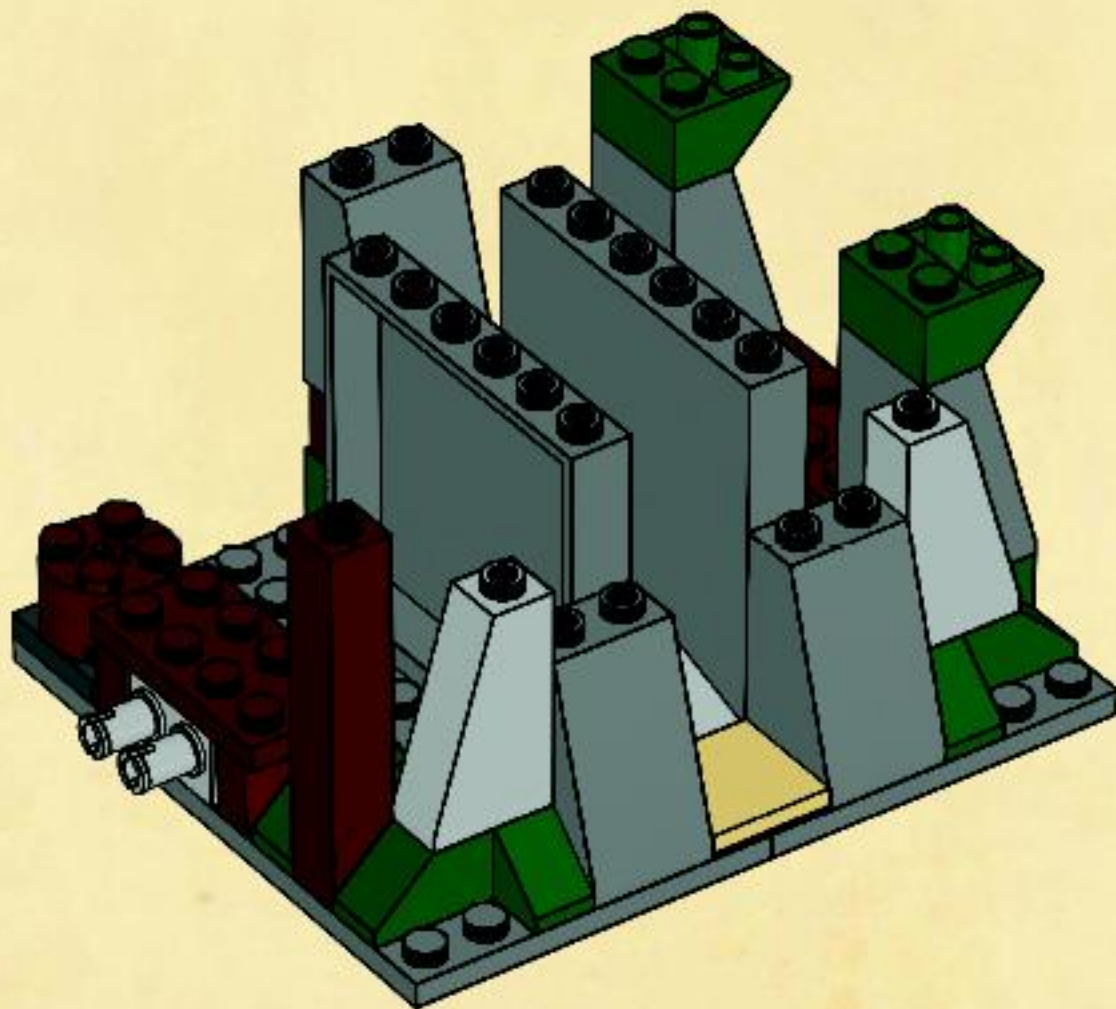

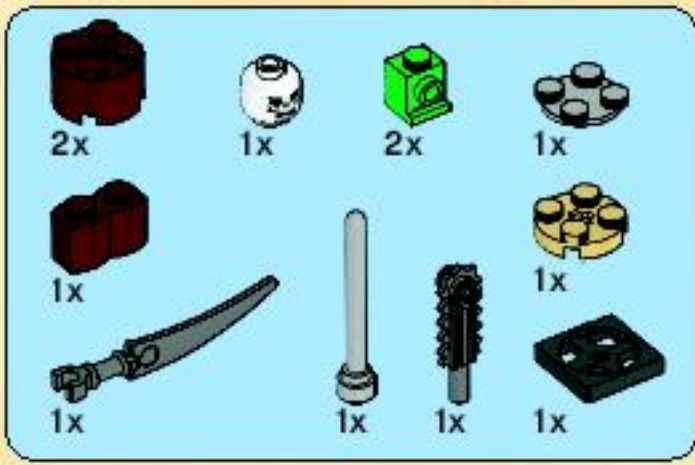

# 16

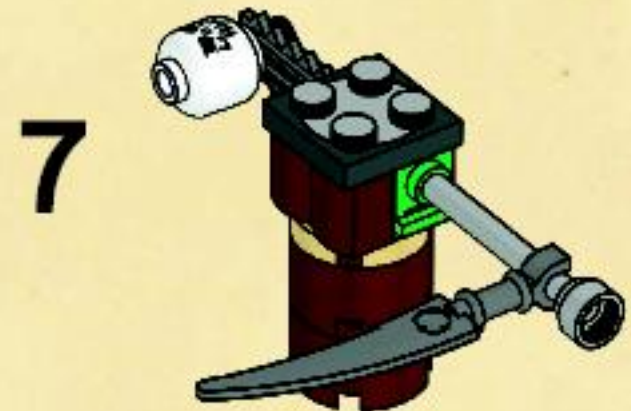
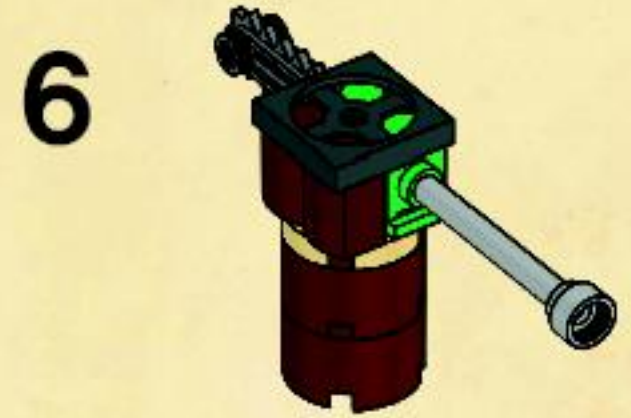
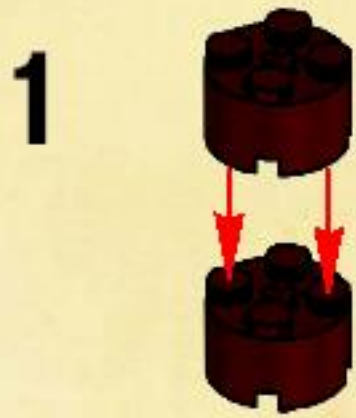

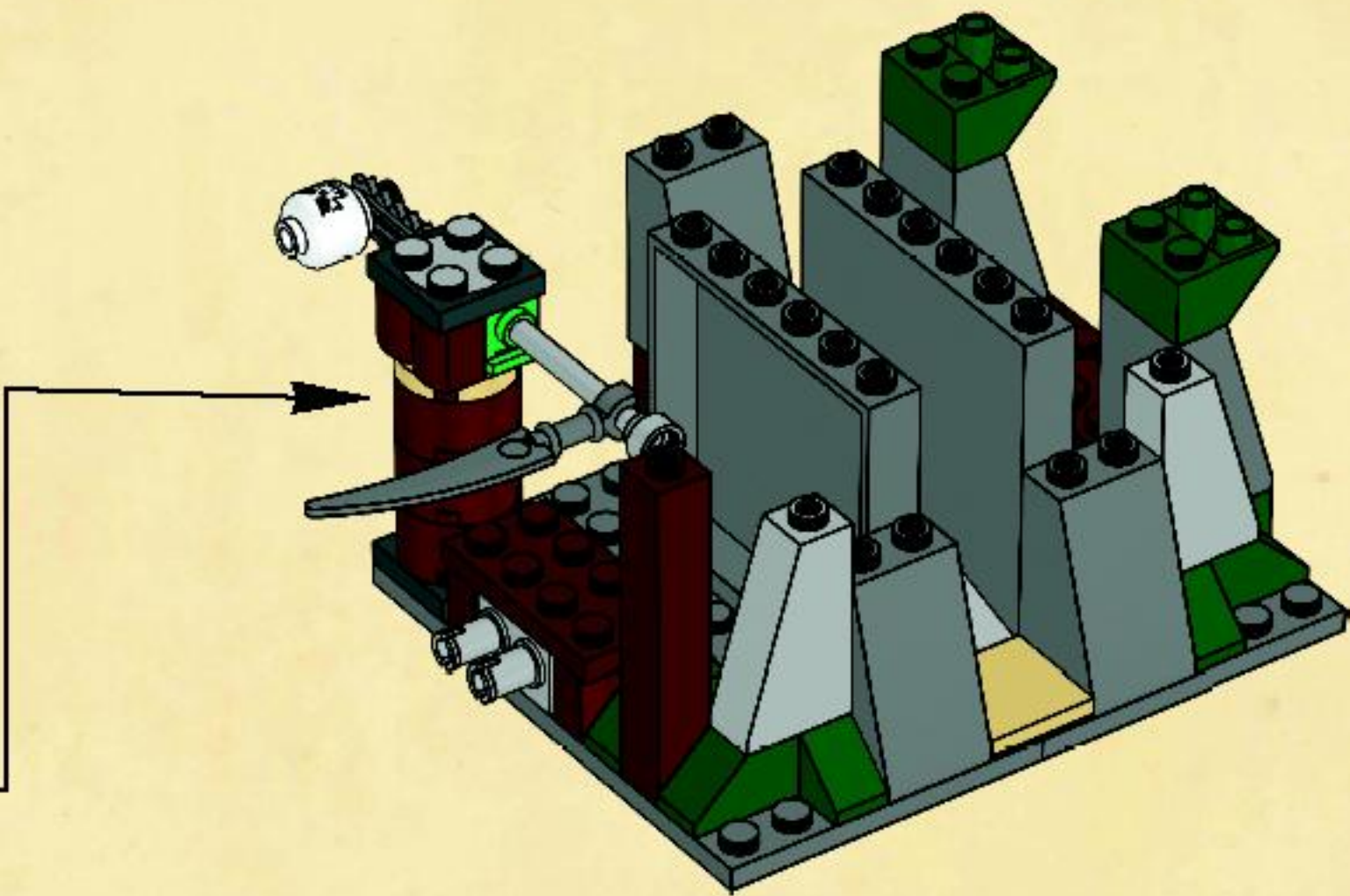

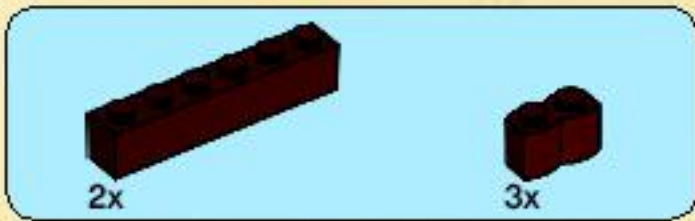

17

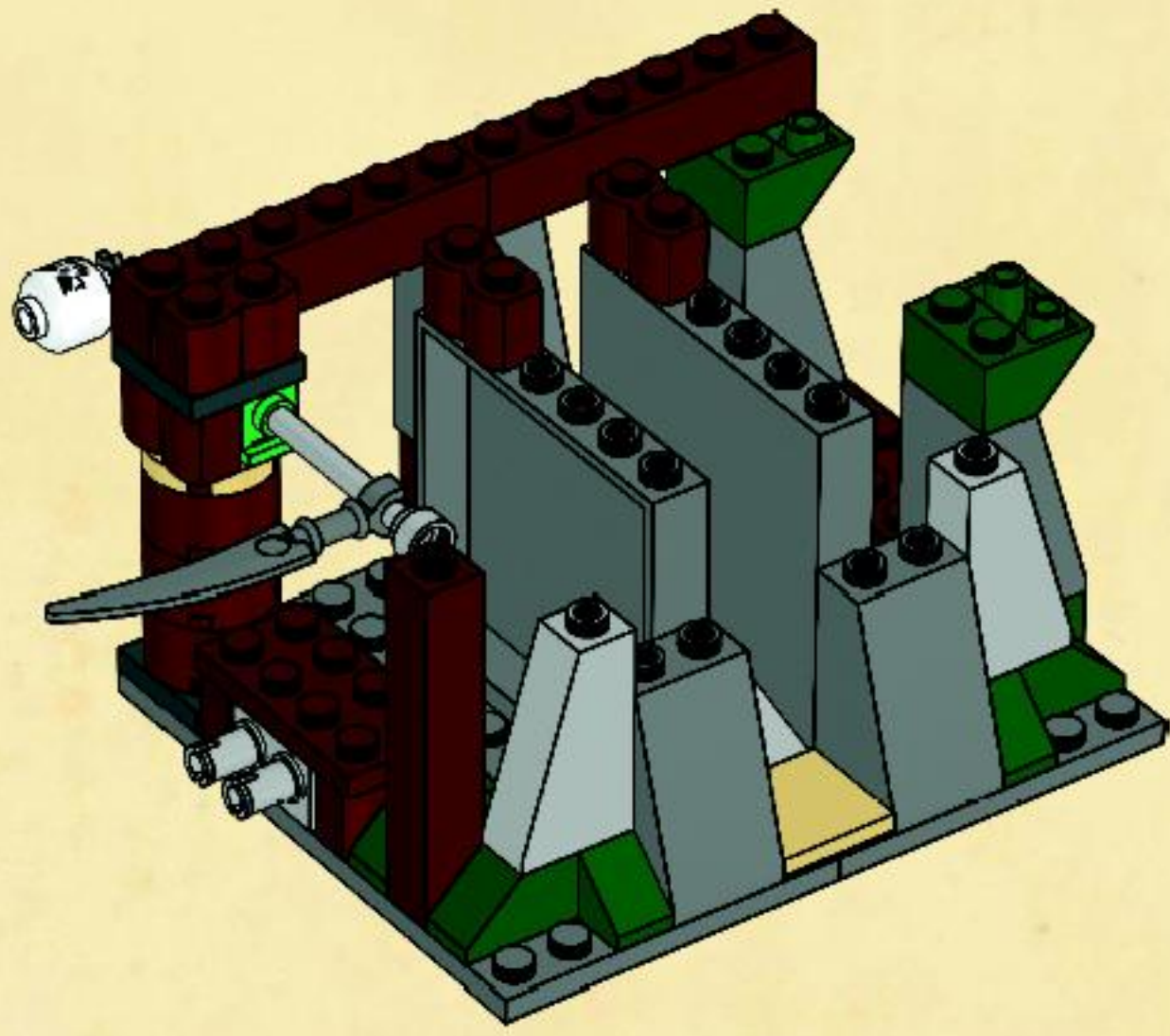

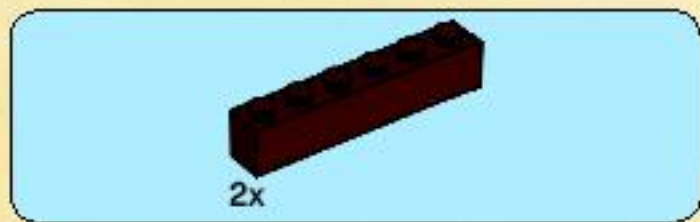

18

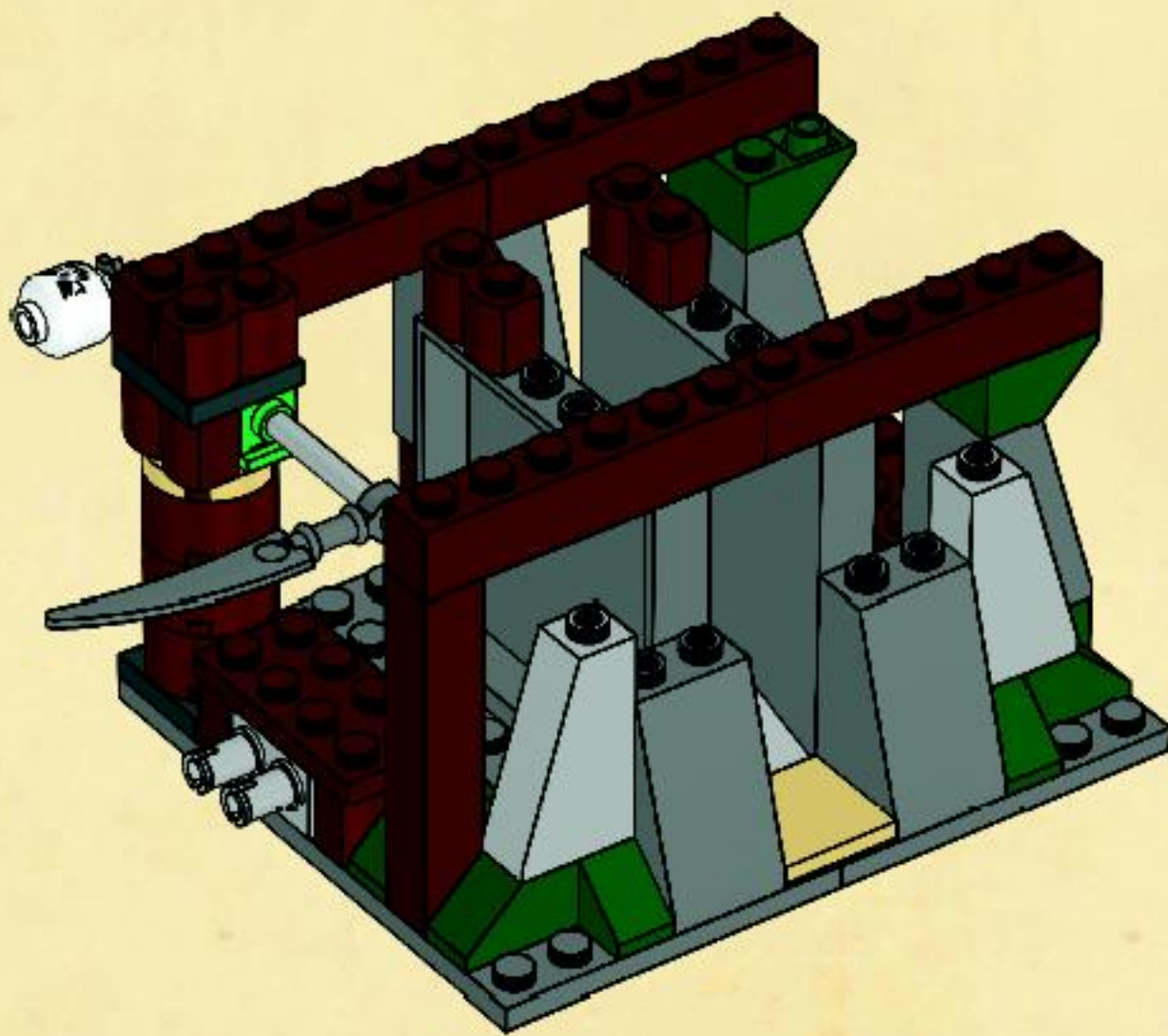

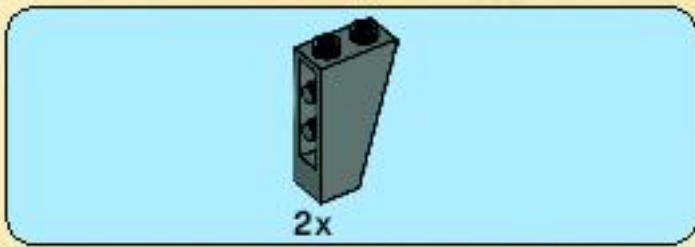

# 19

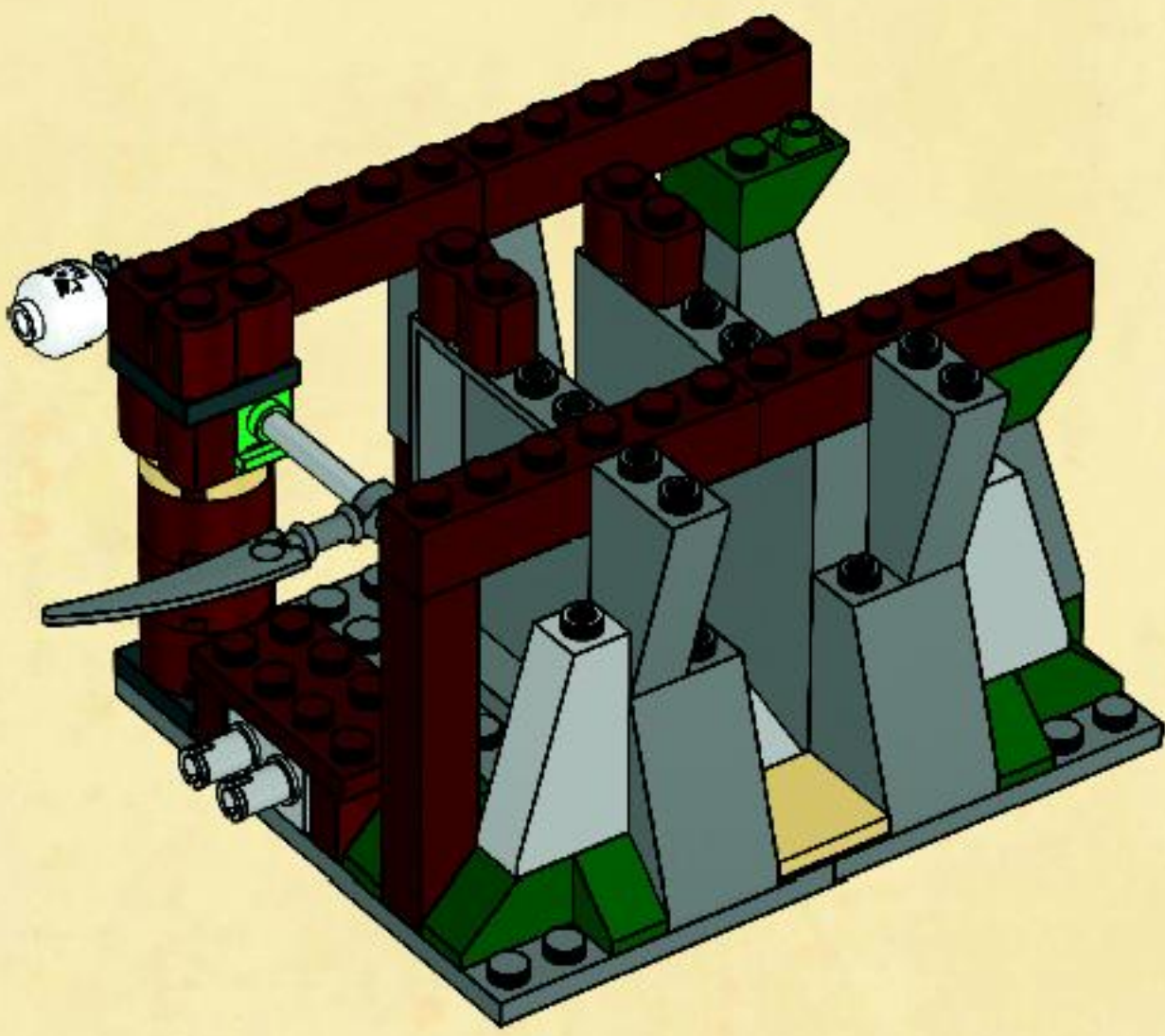

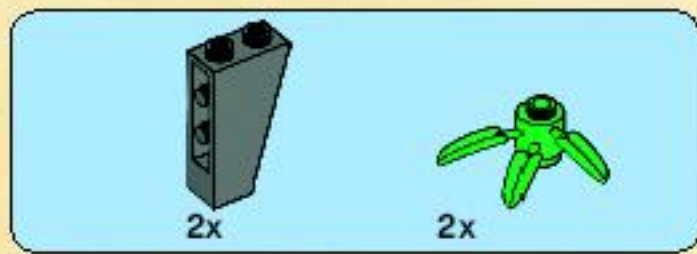

20

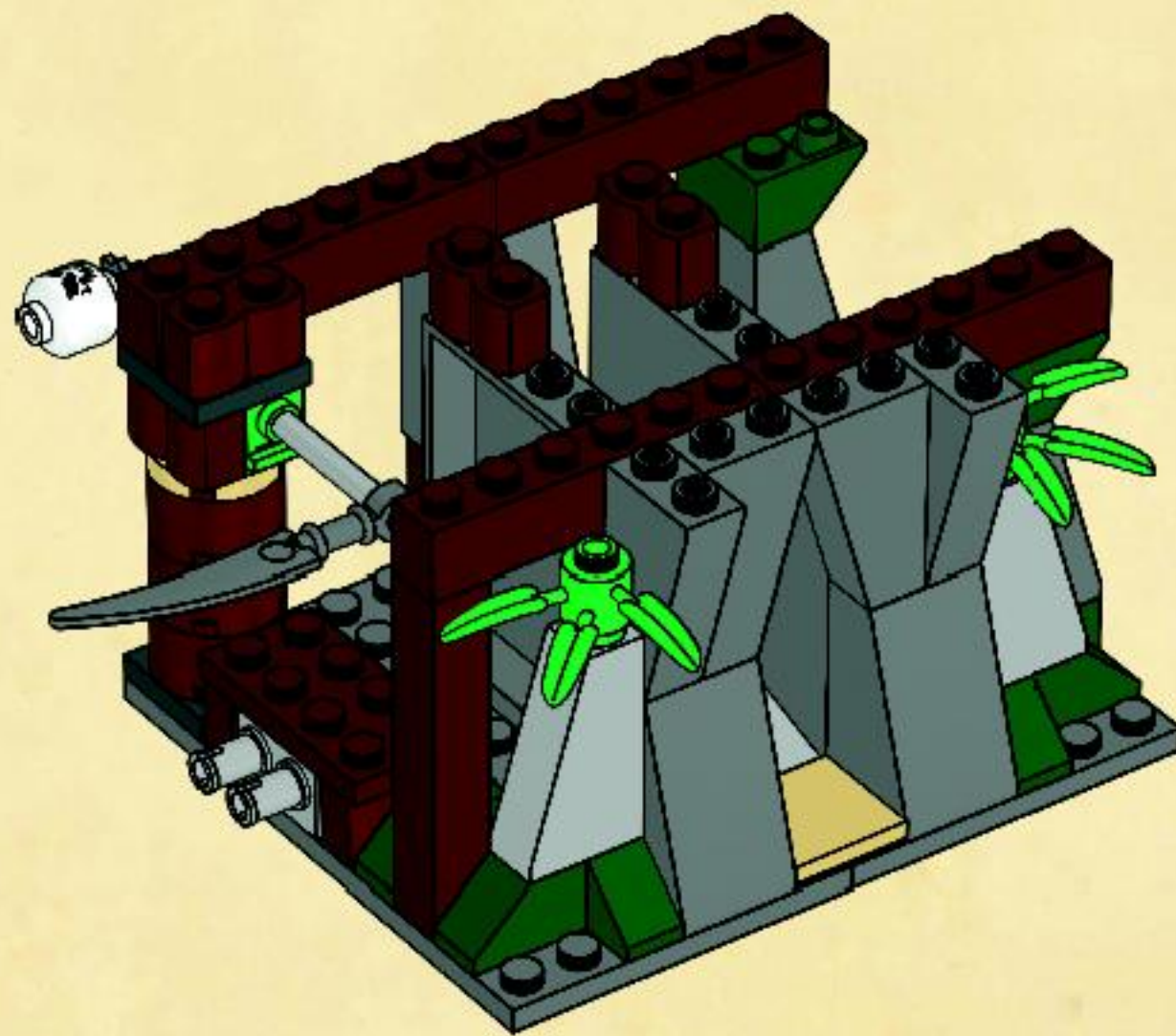

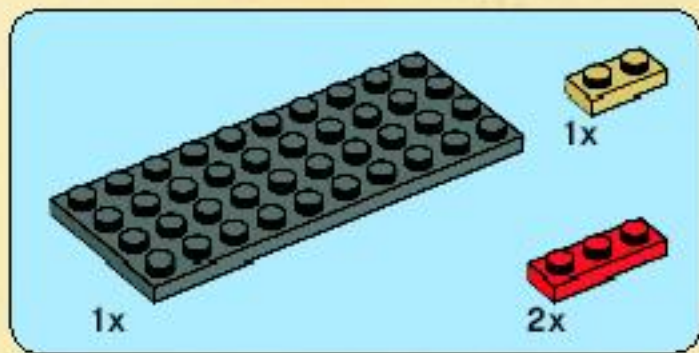

21

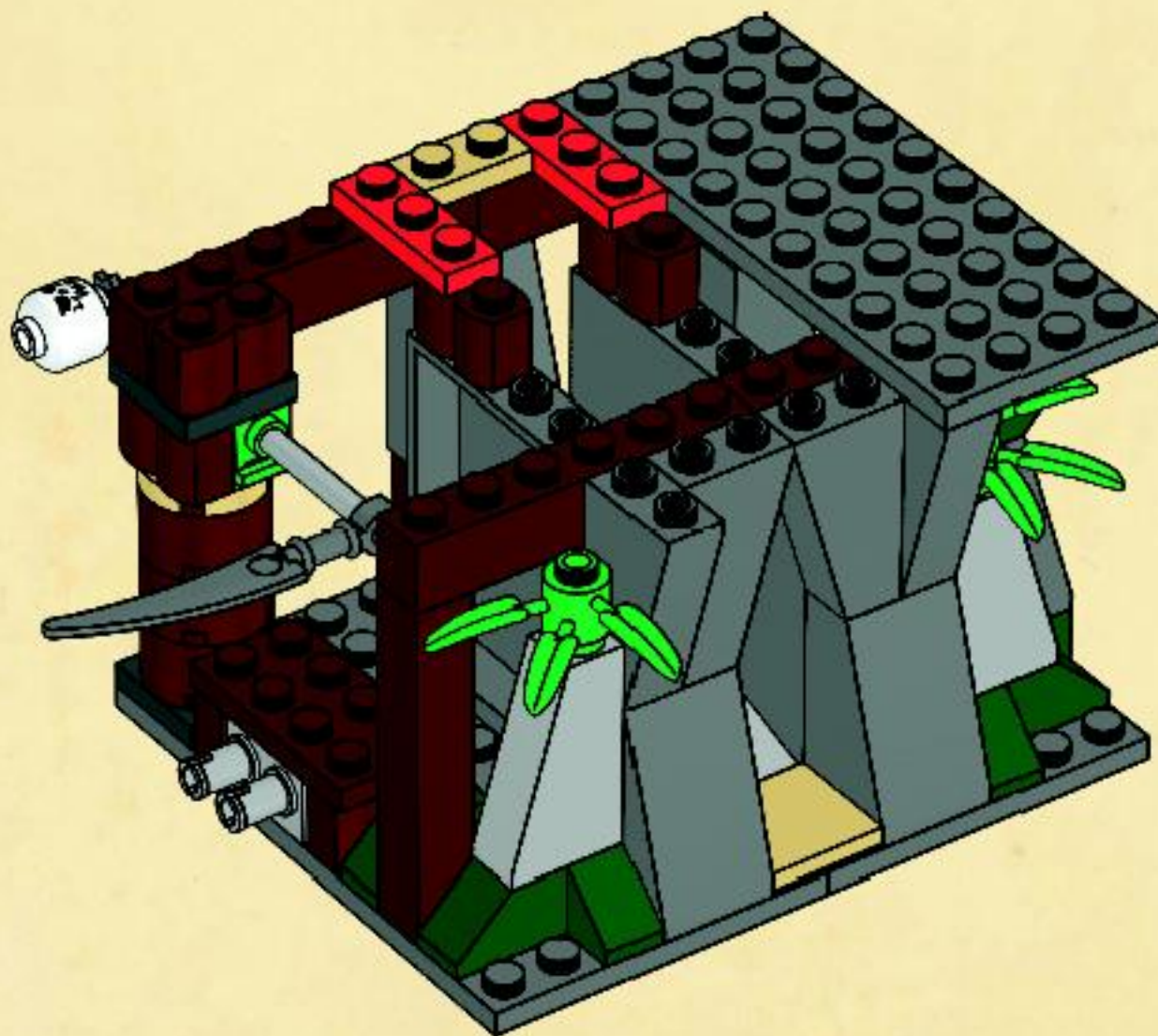



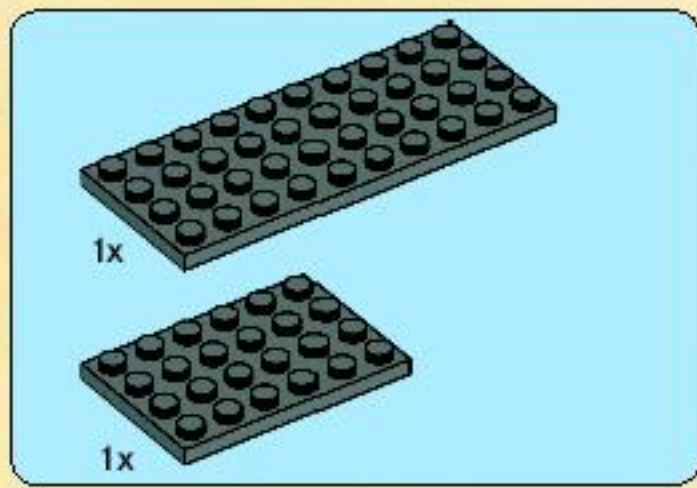

22

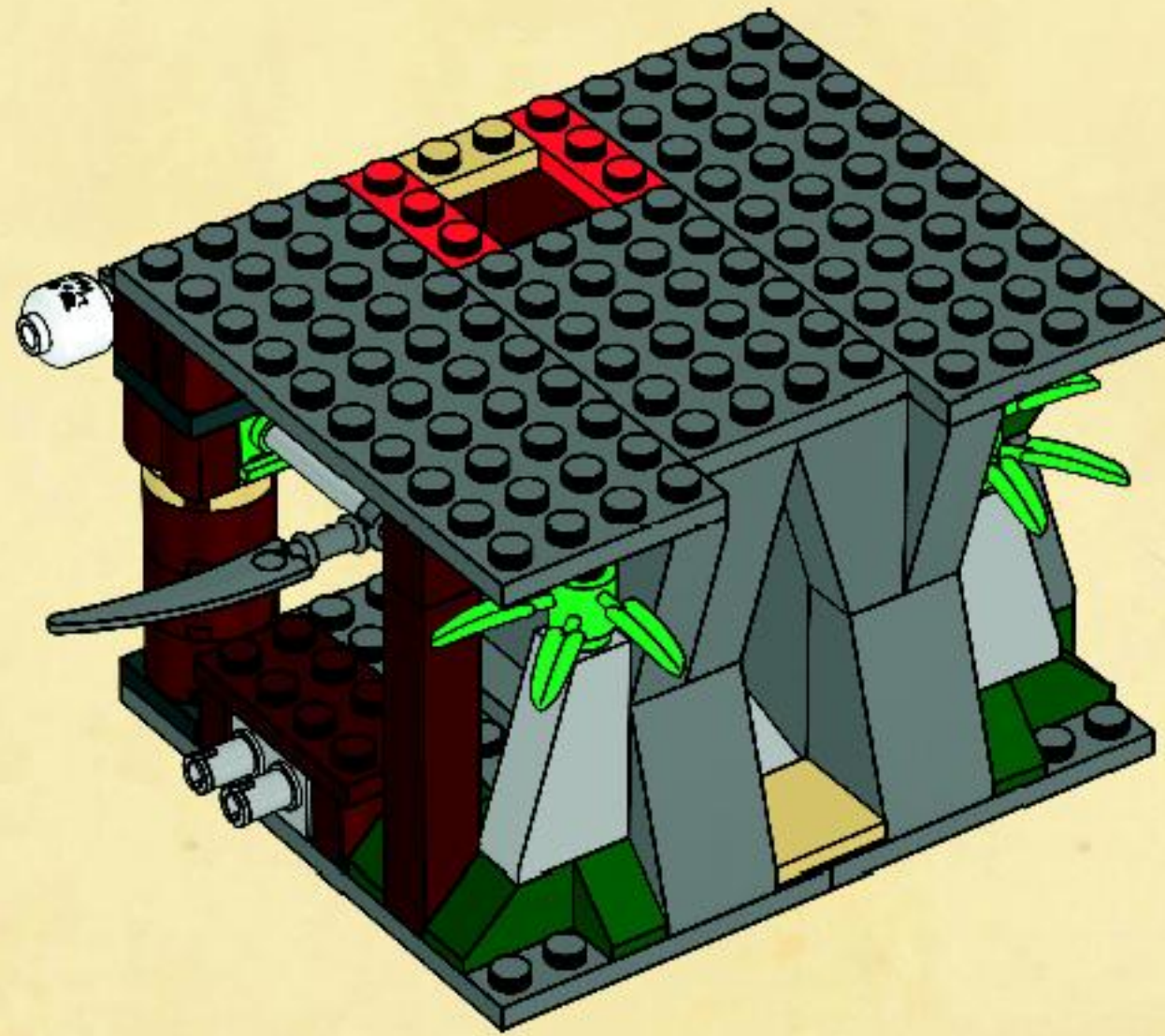

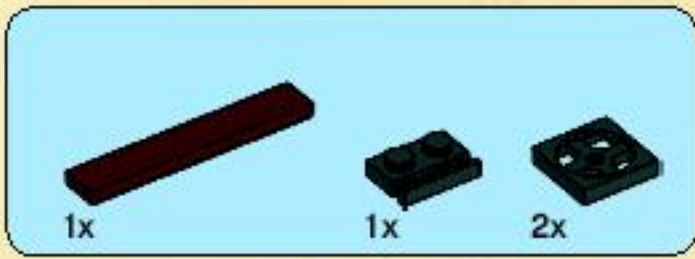

# 23

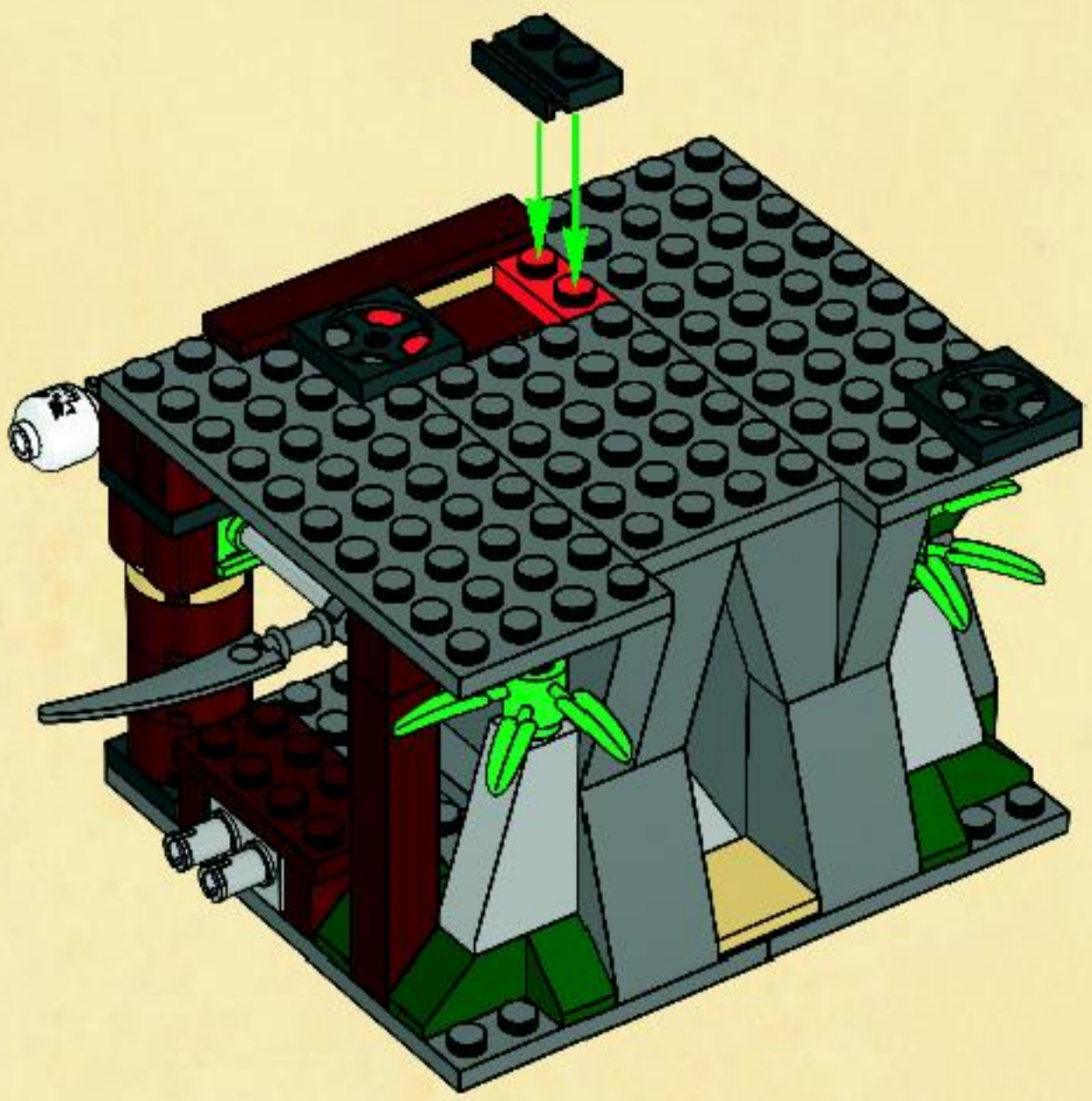



1x



2x



1x

# 24

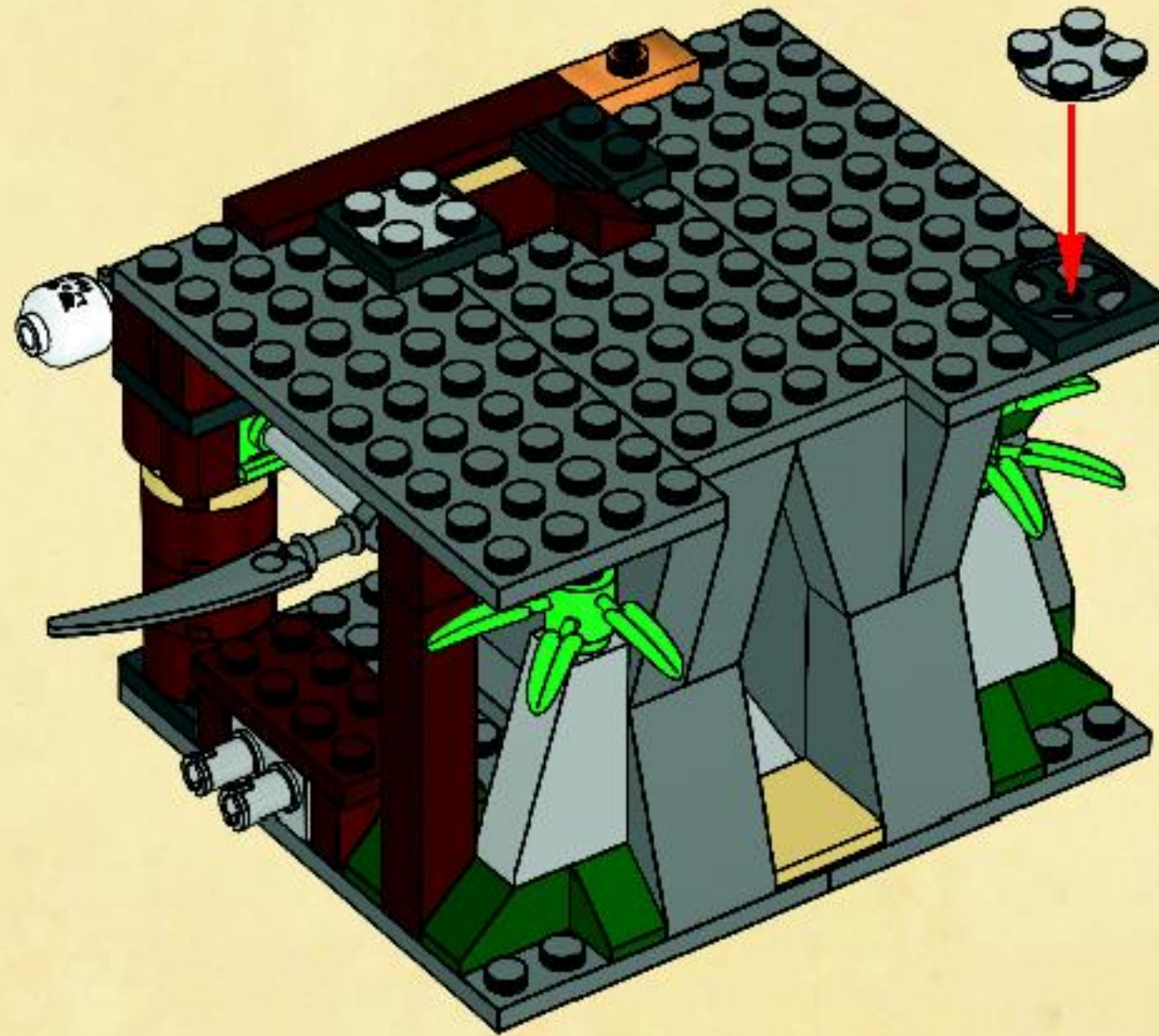

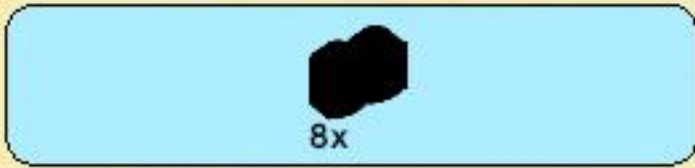
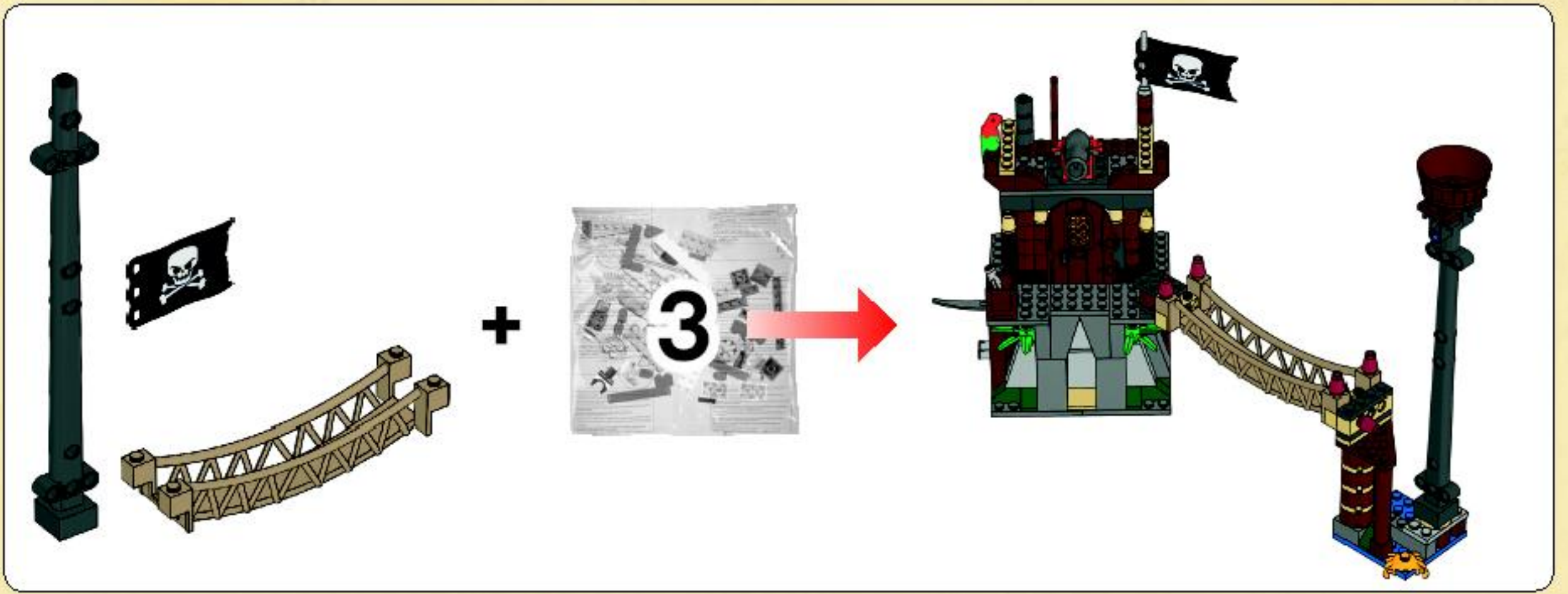

25

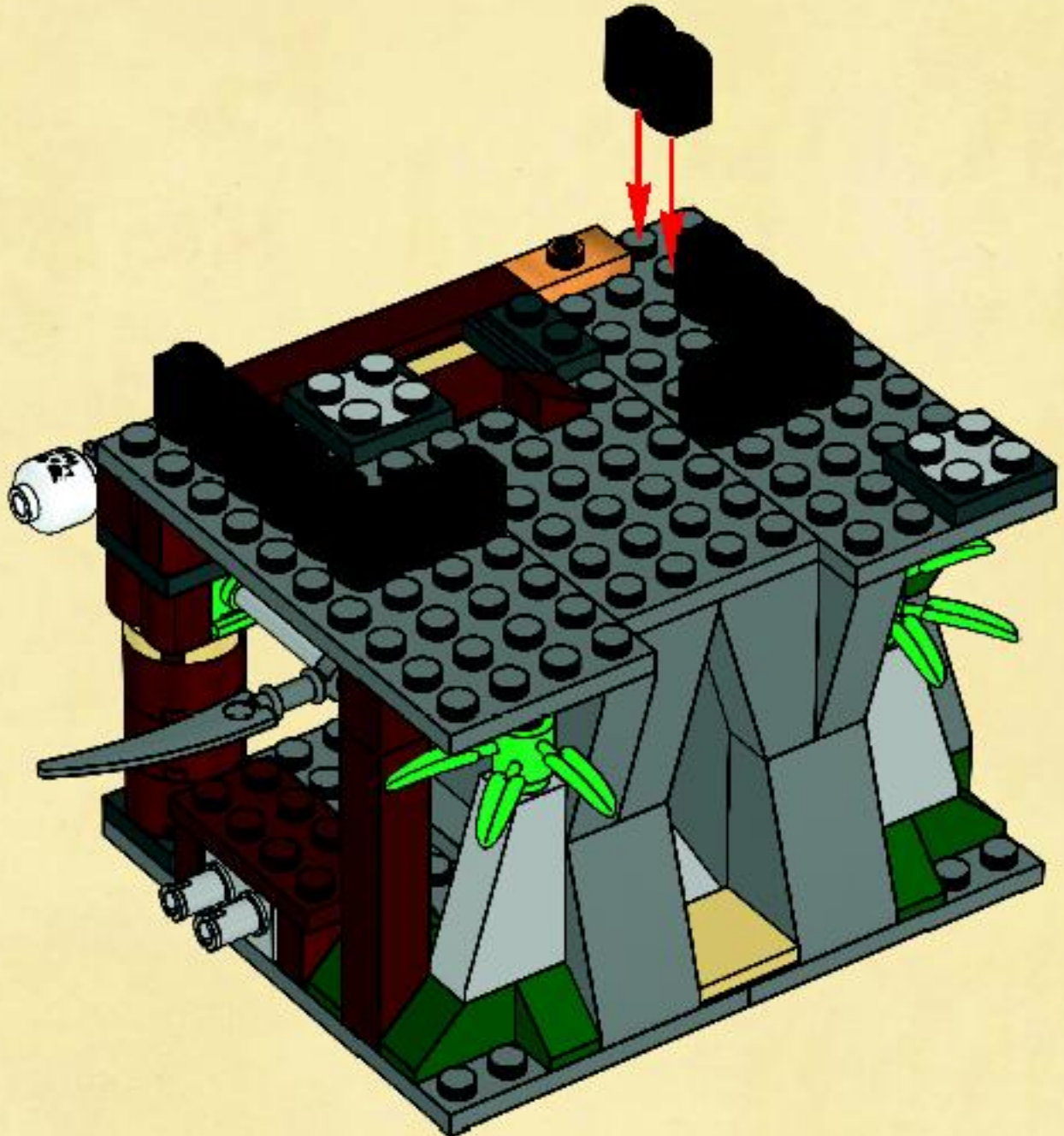

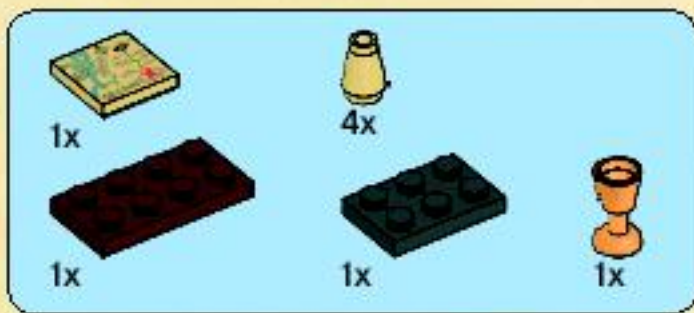

# 26

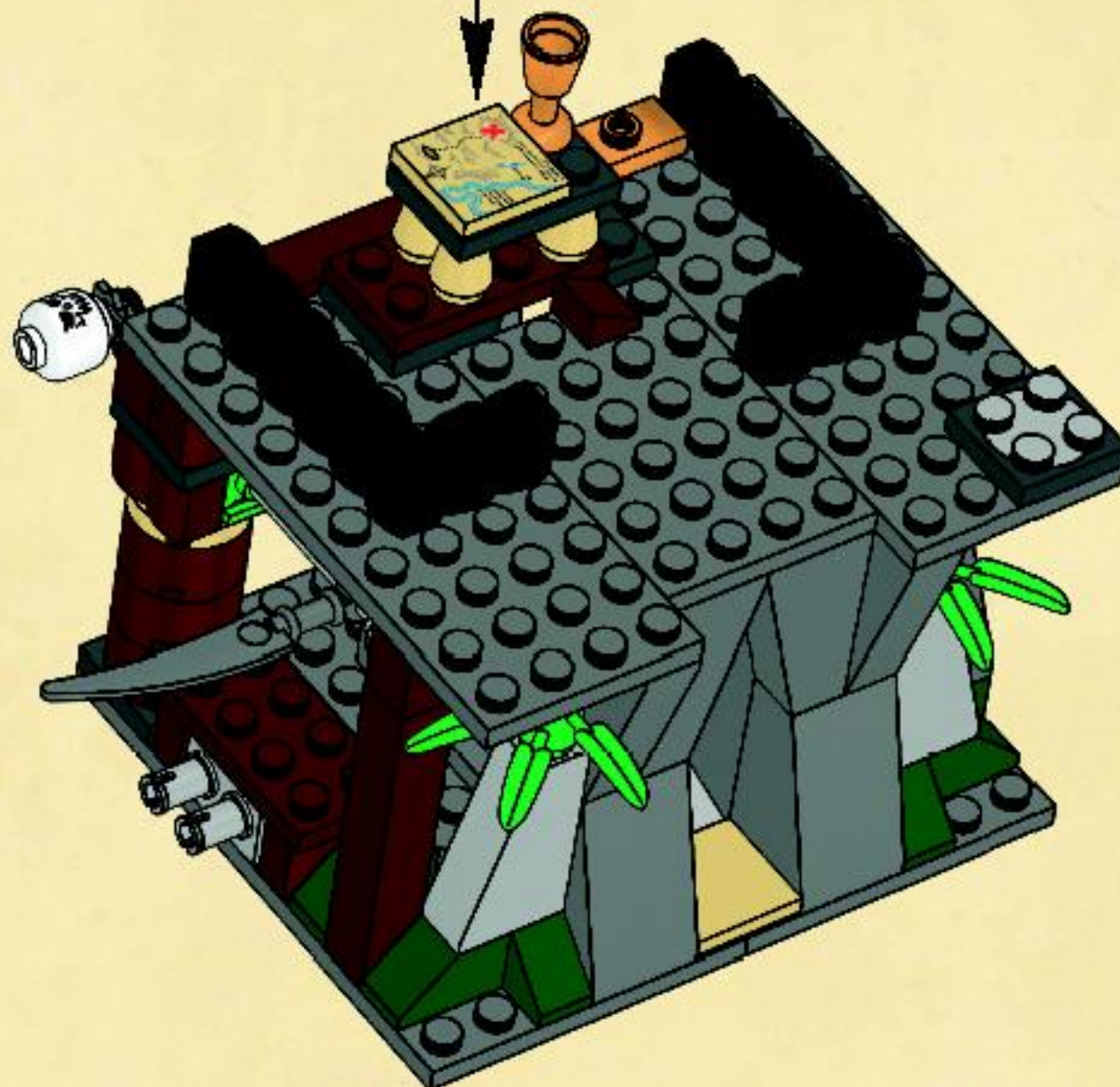
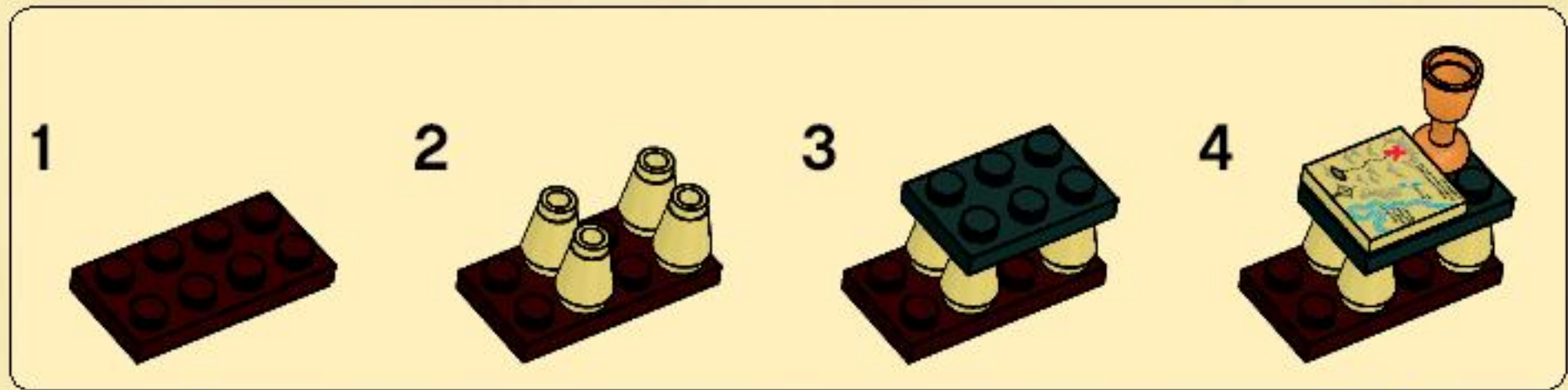

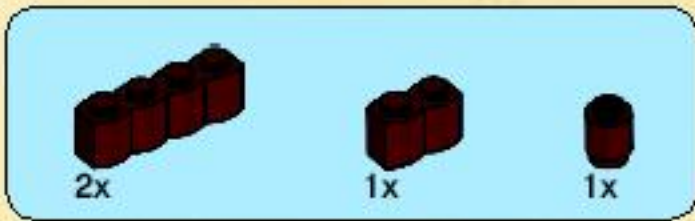

27

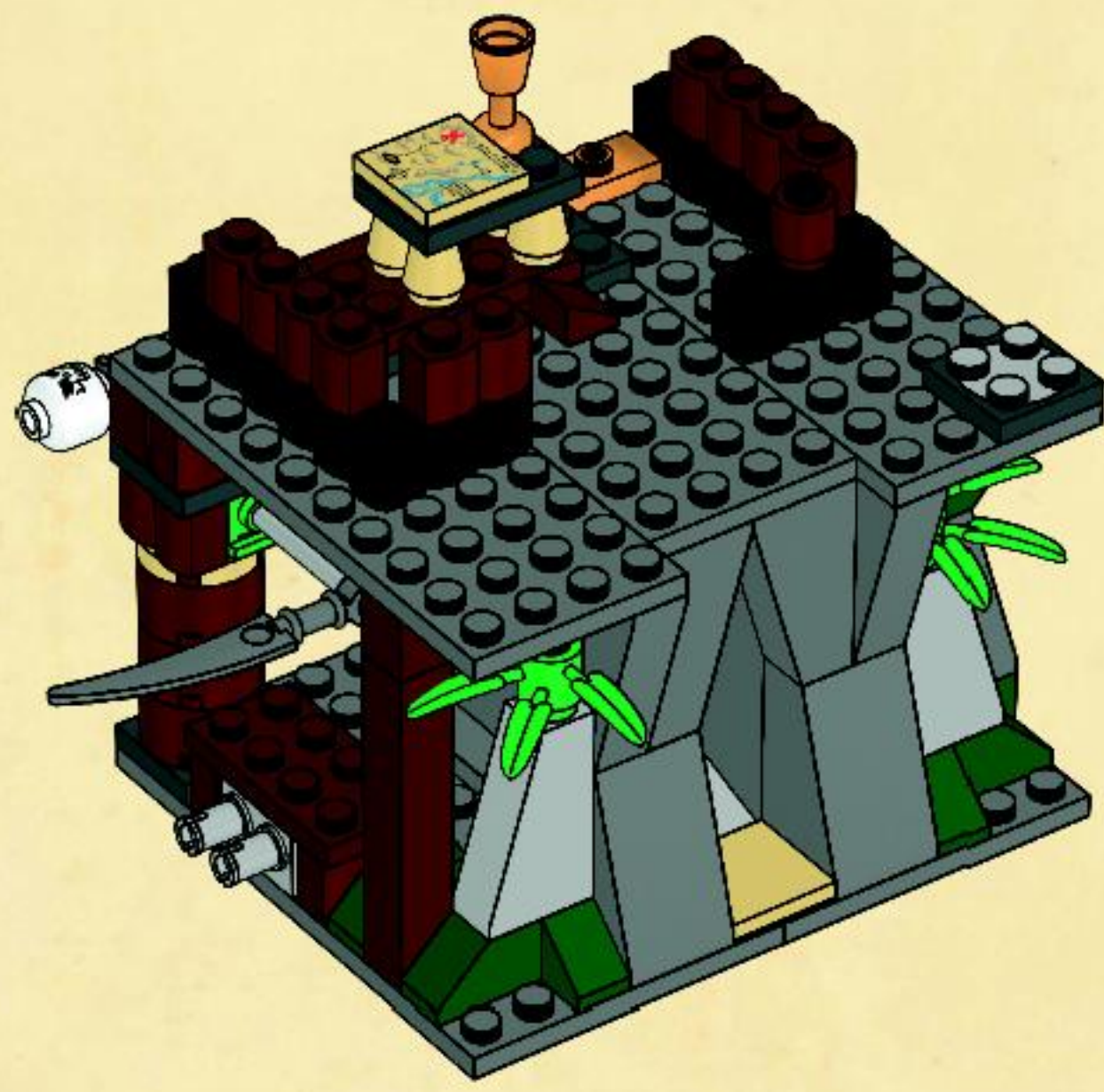

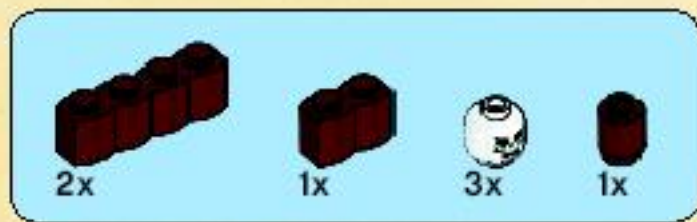

28

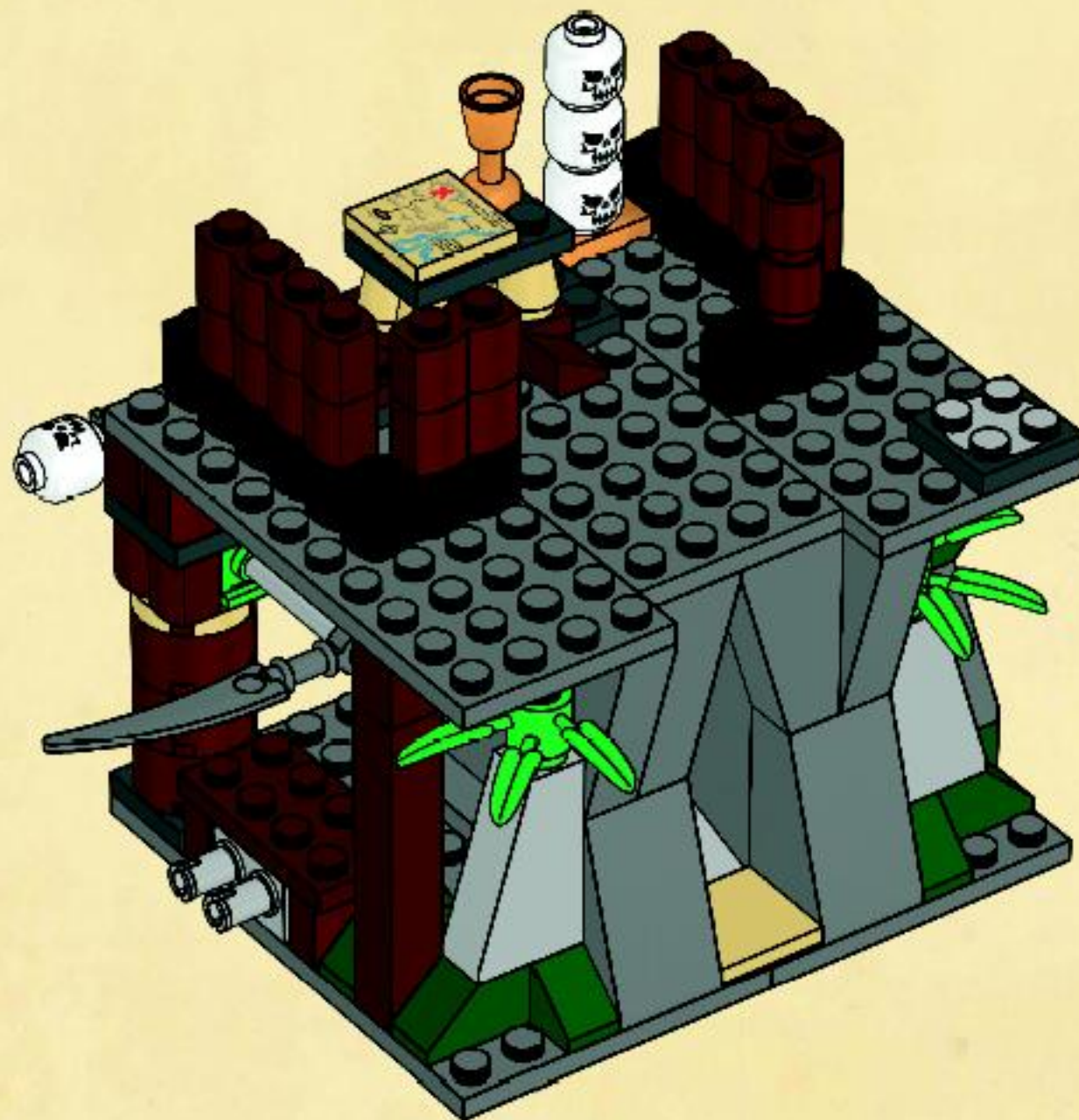



4x

# 29

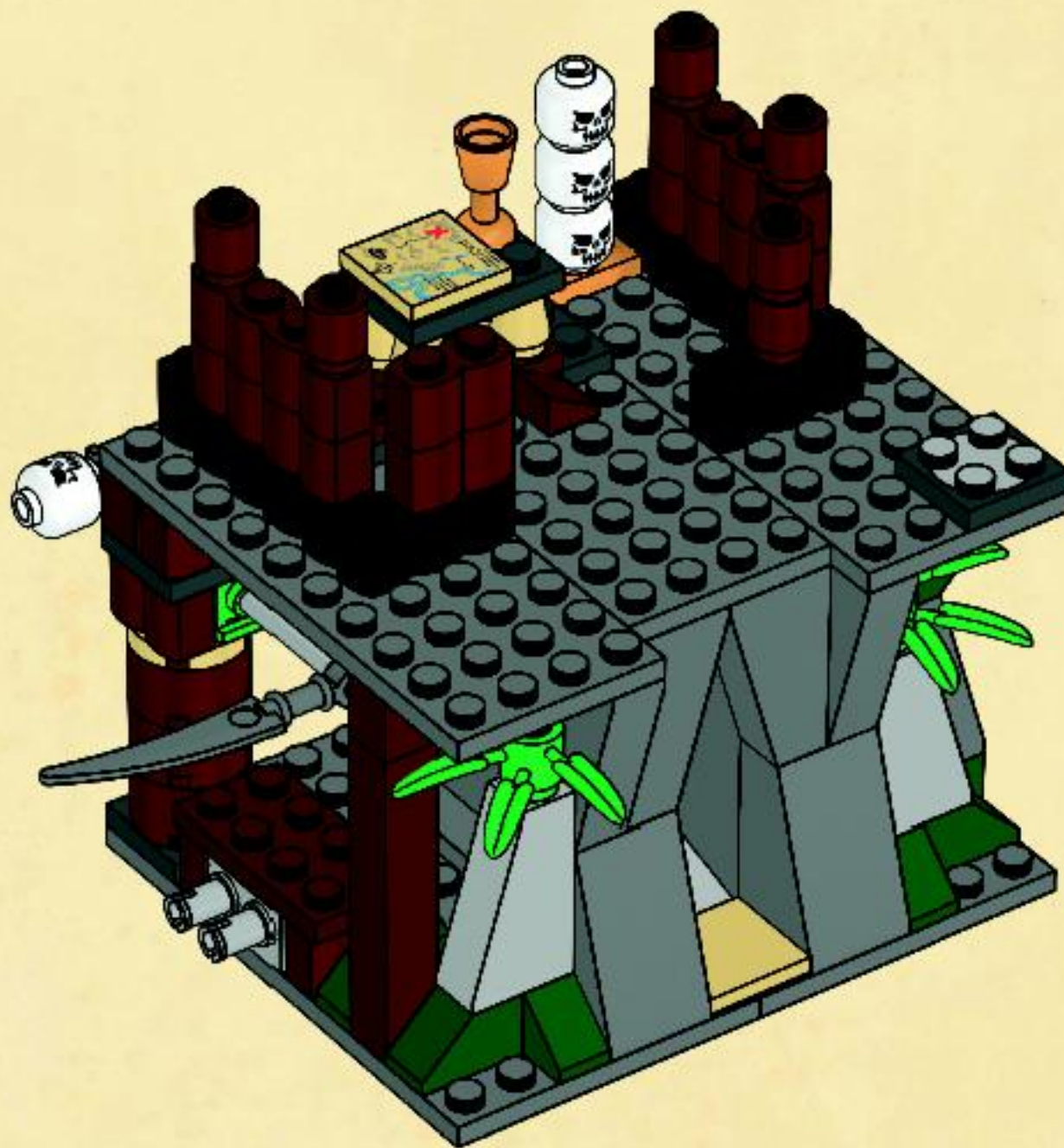



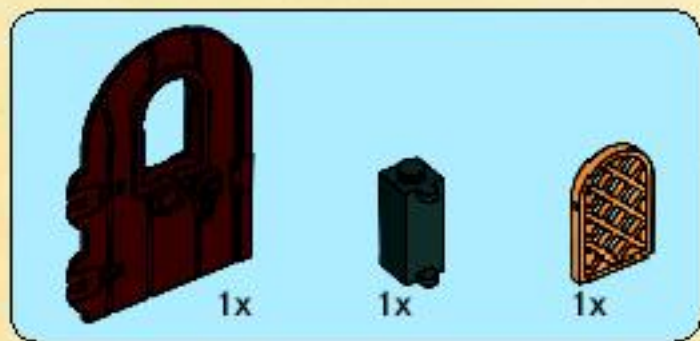

30

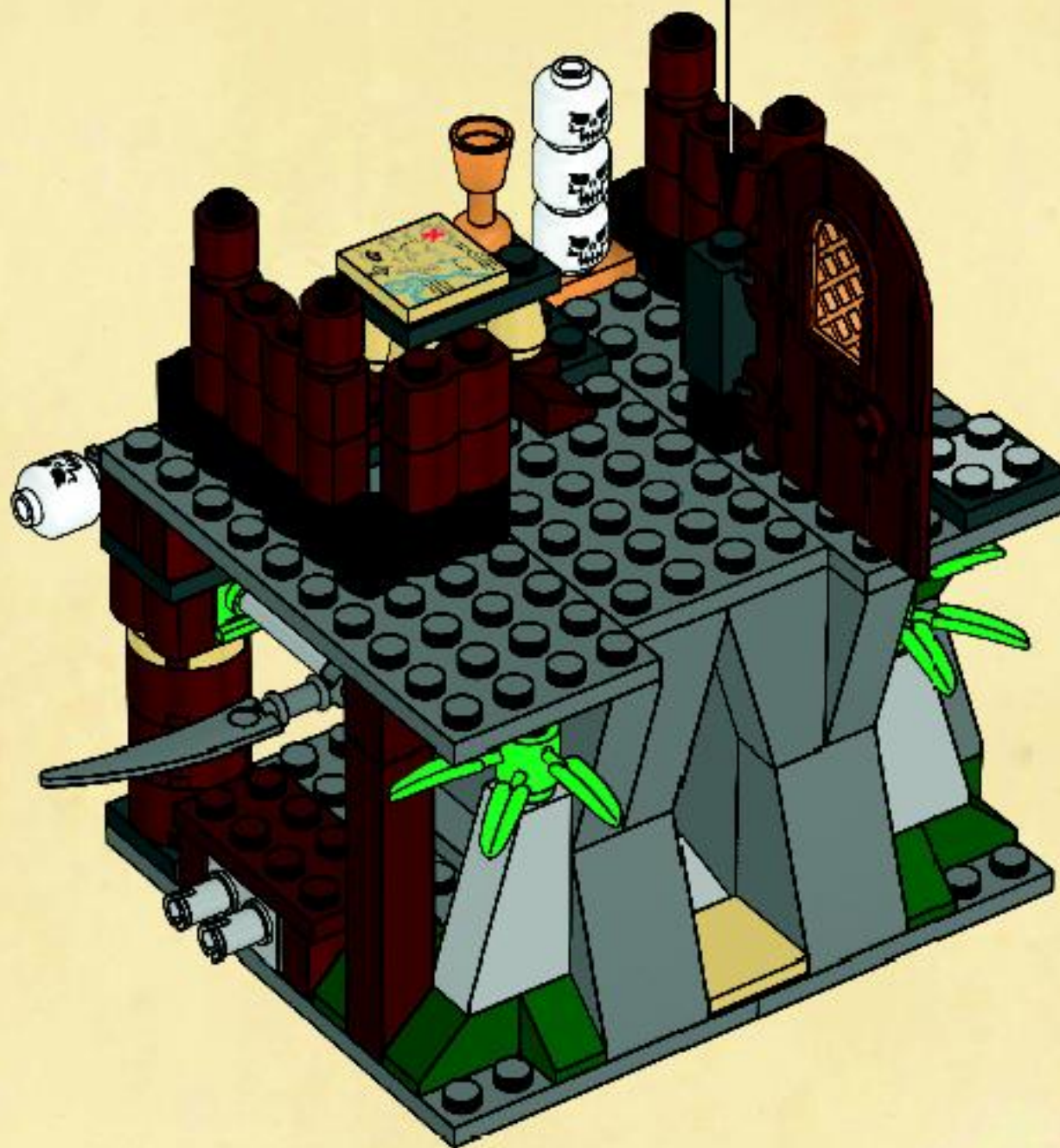
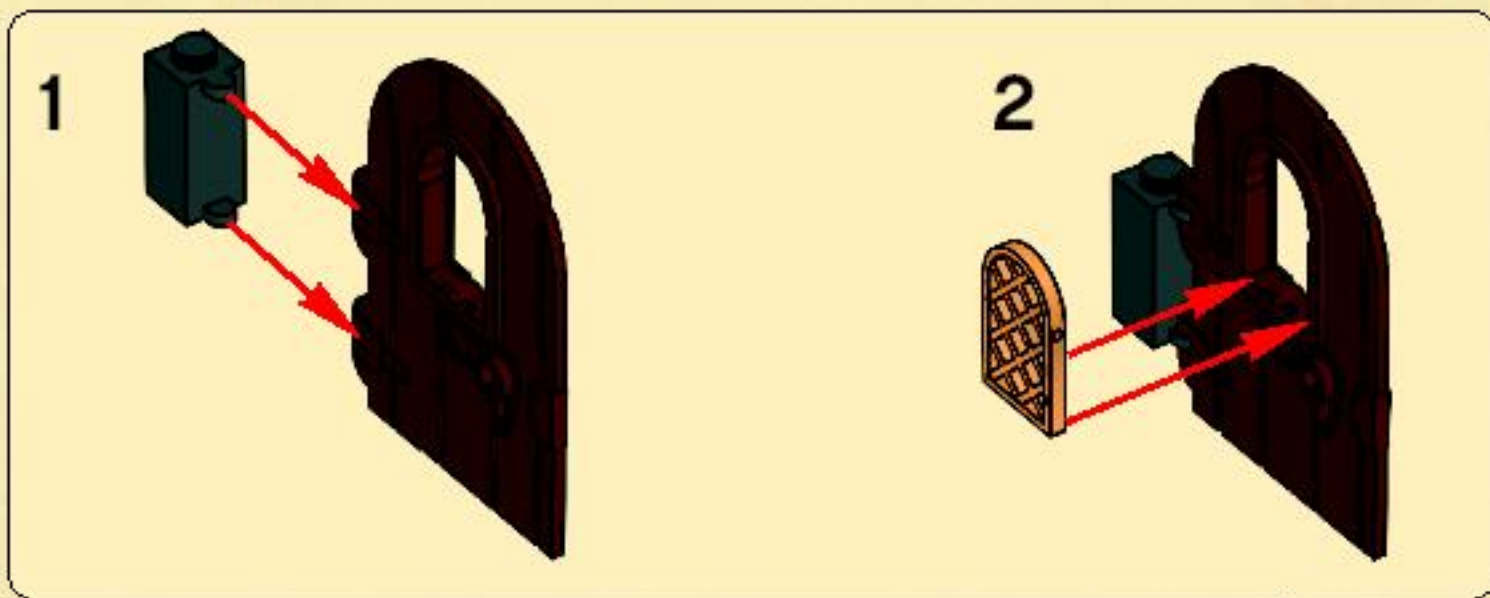



2x

# 31

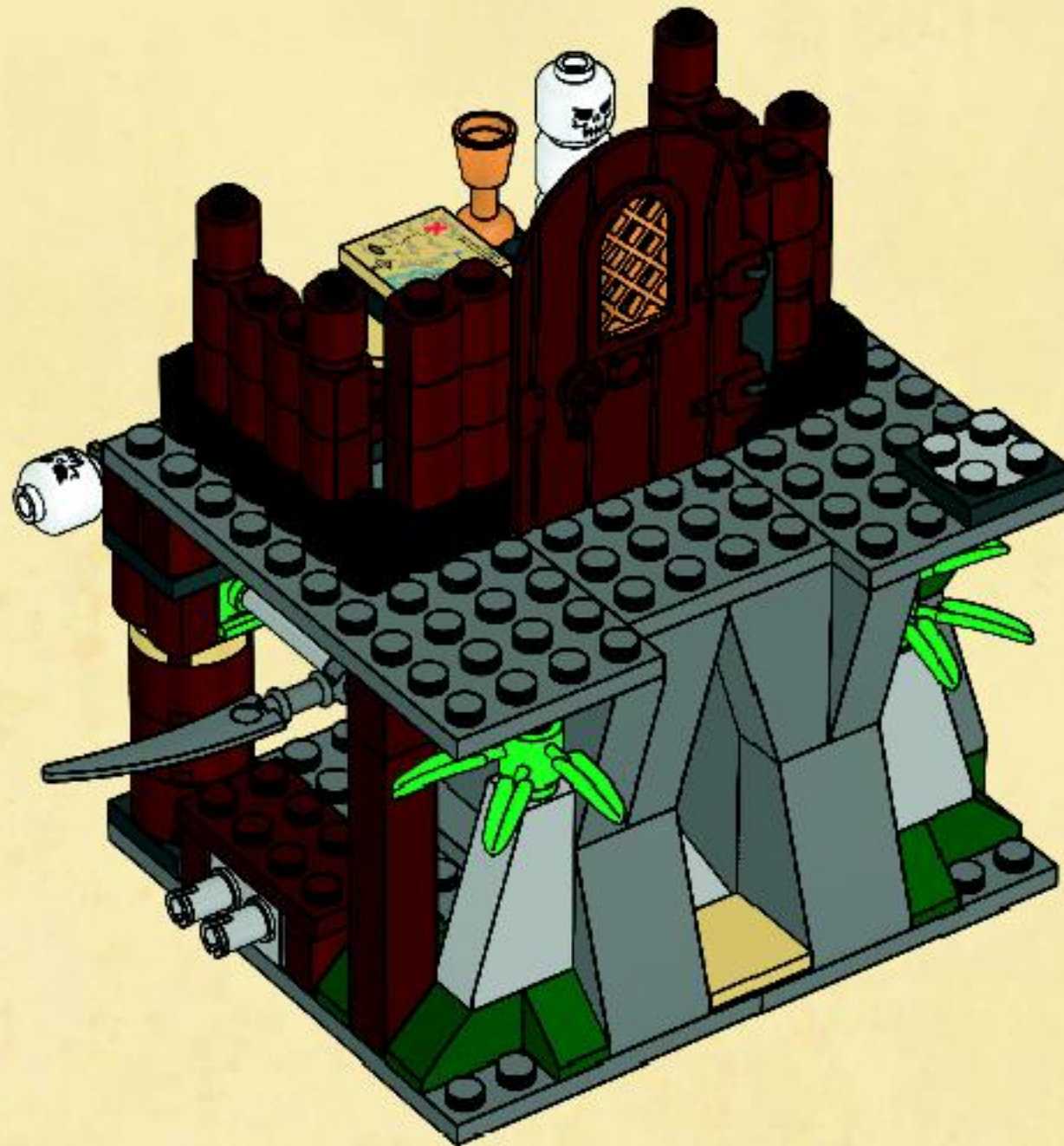

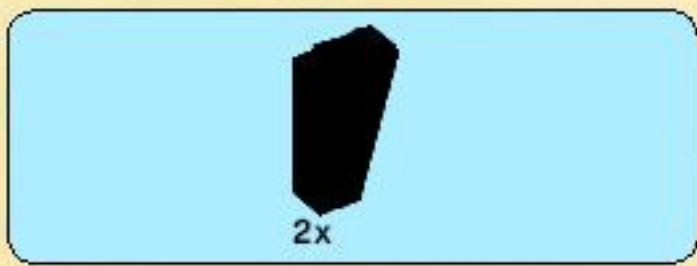

32

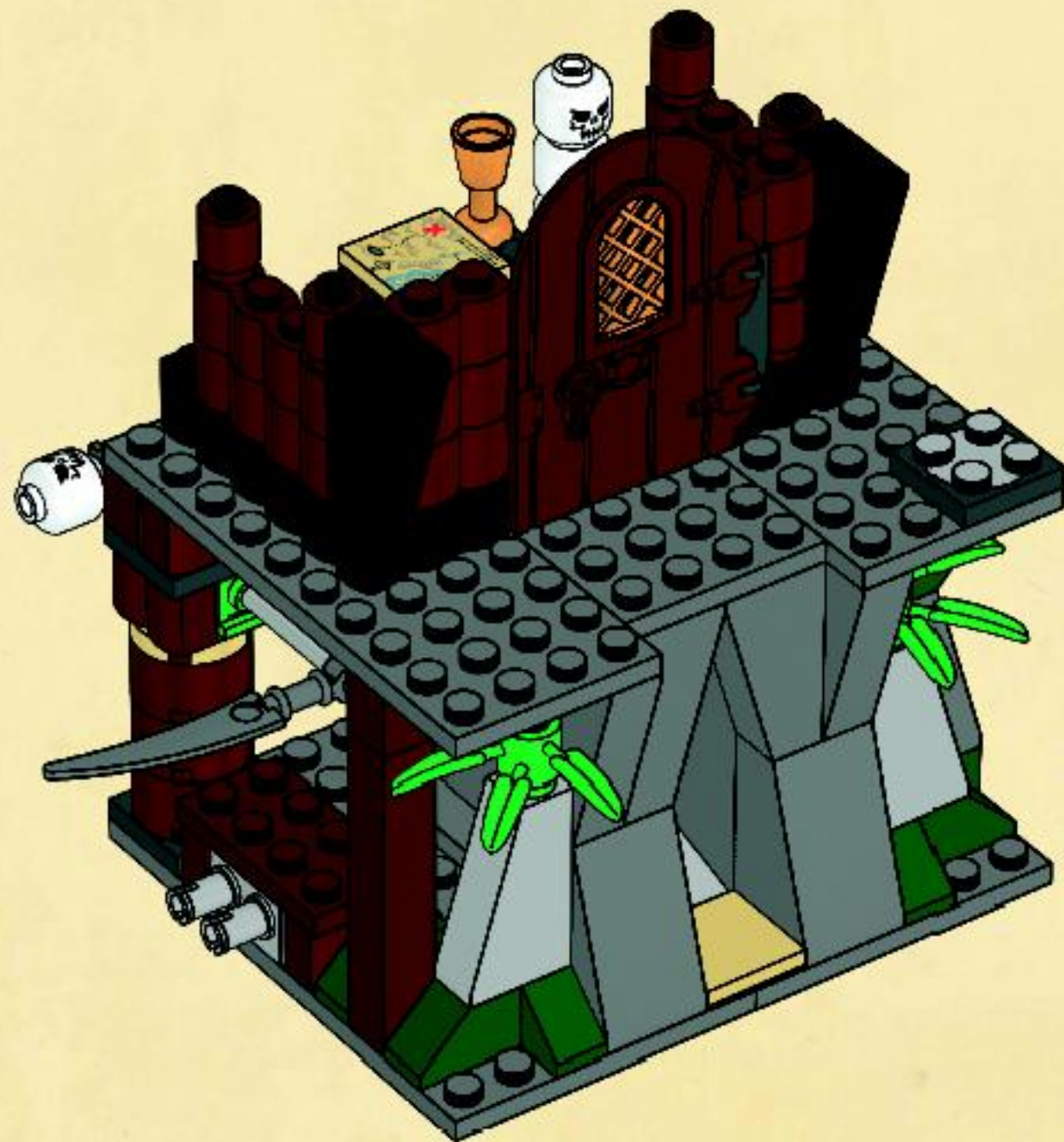



4x

# 33

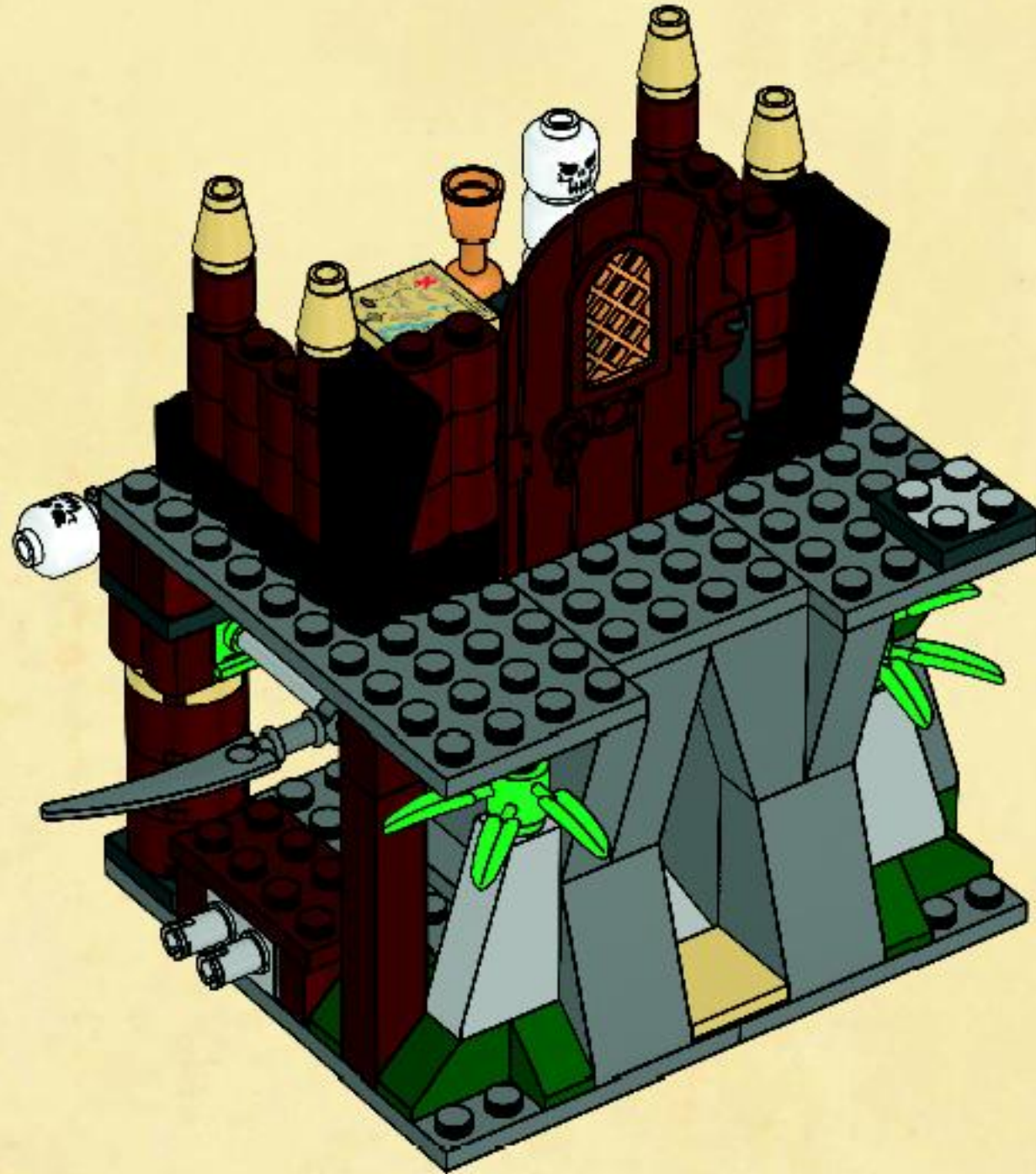



2x



2x

# 34

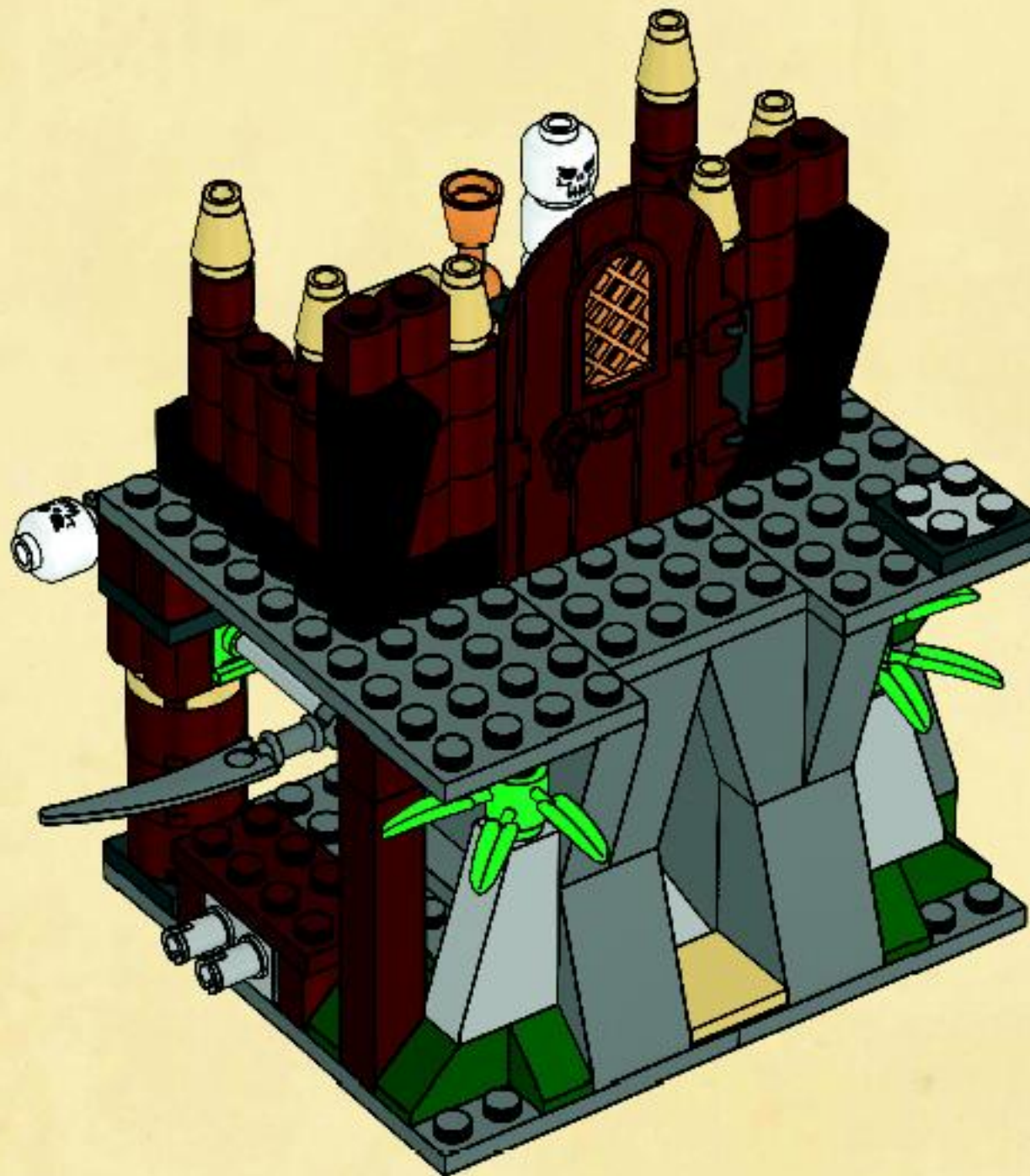

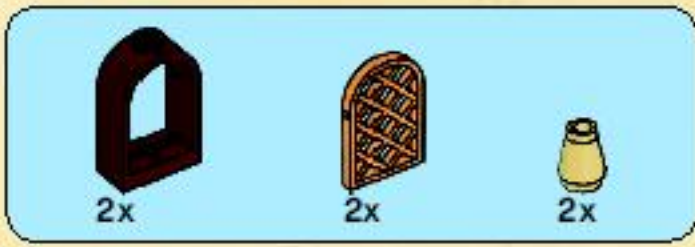

35

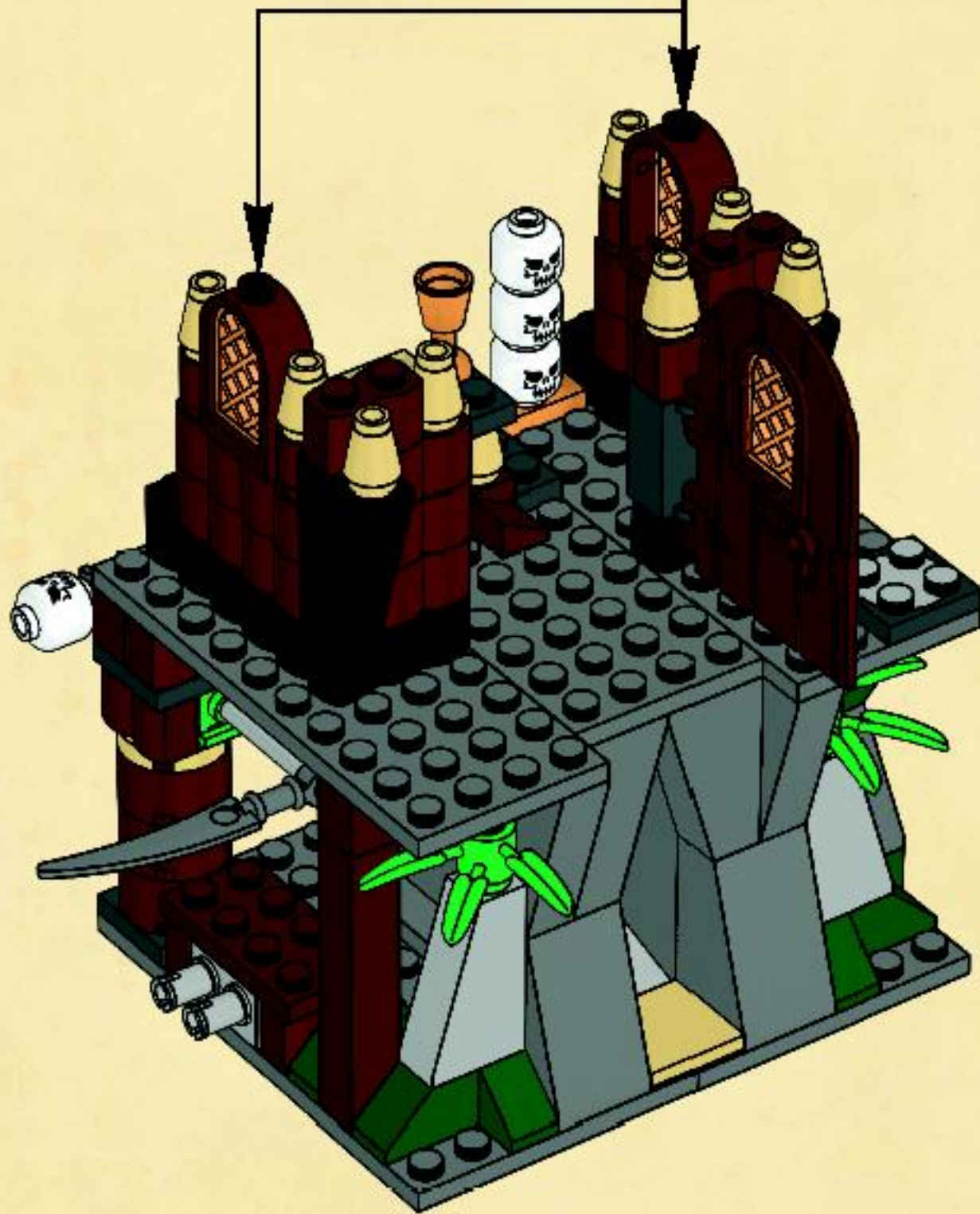
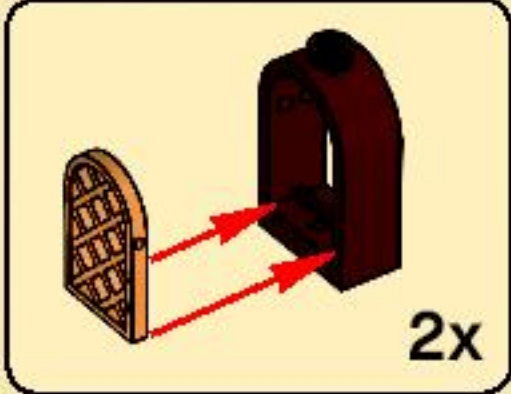



36

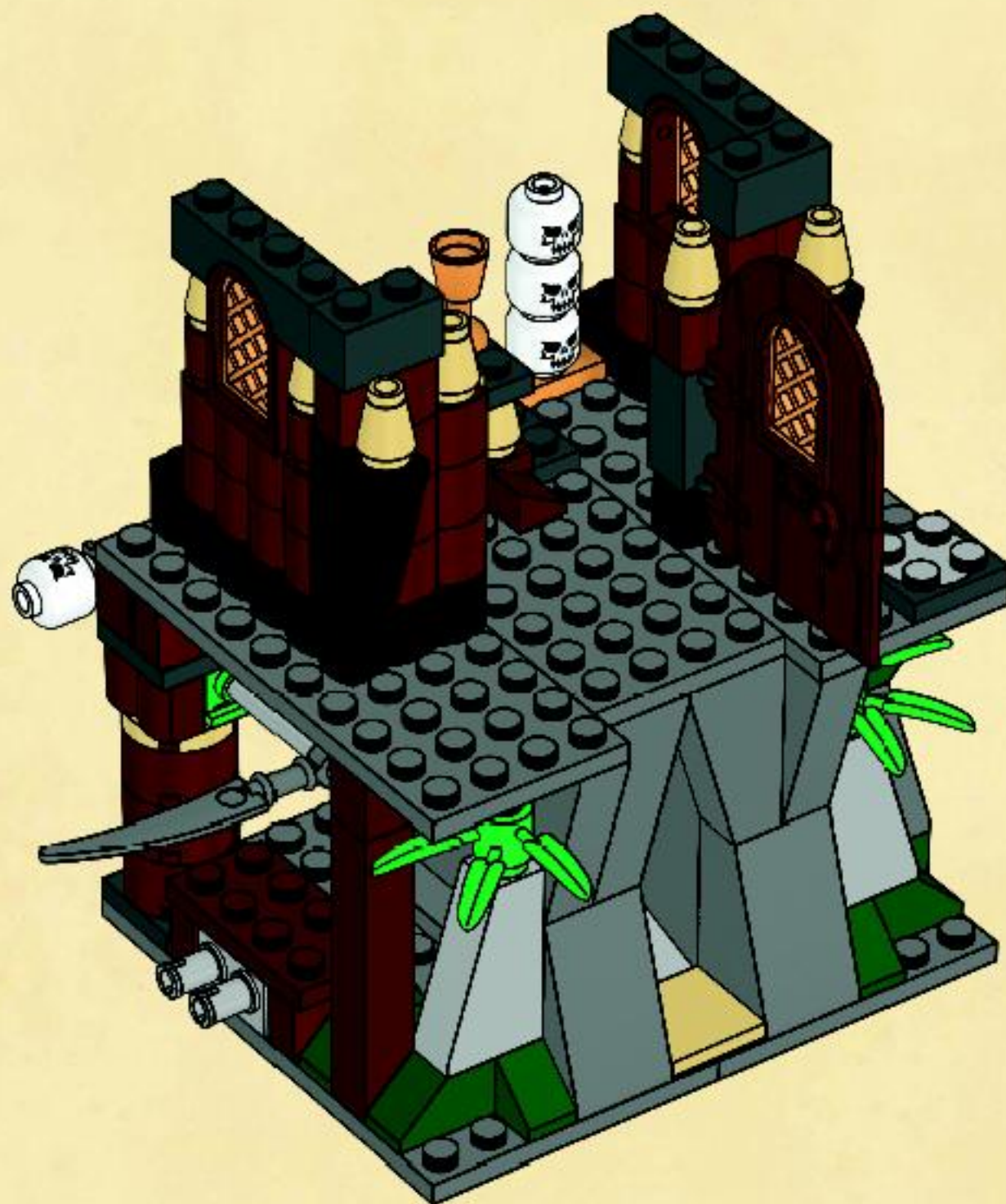

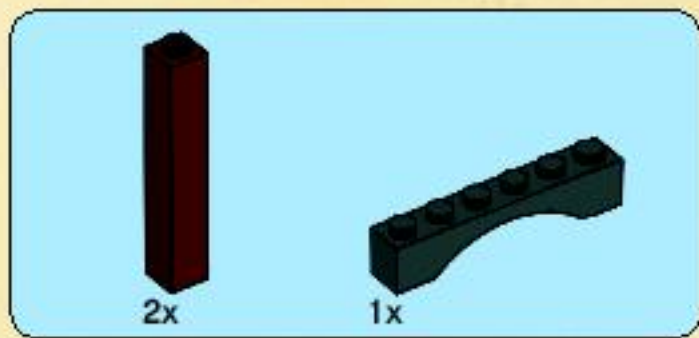

37

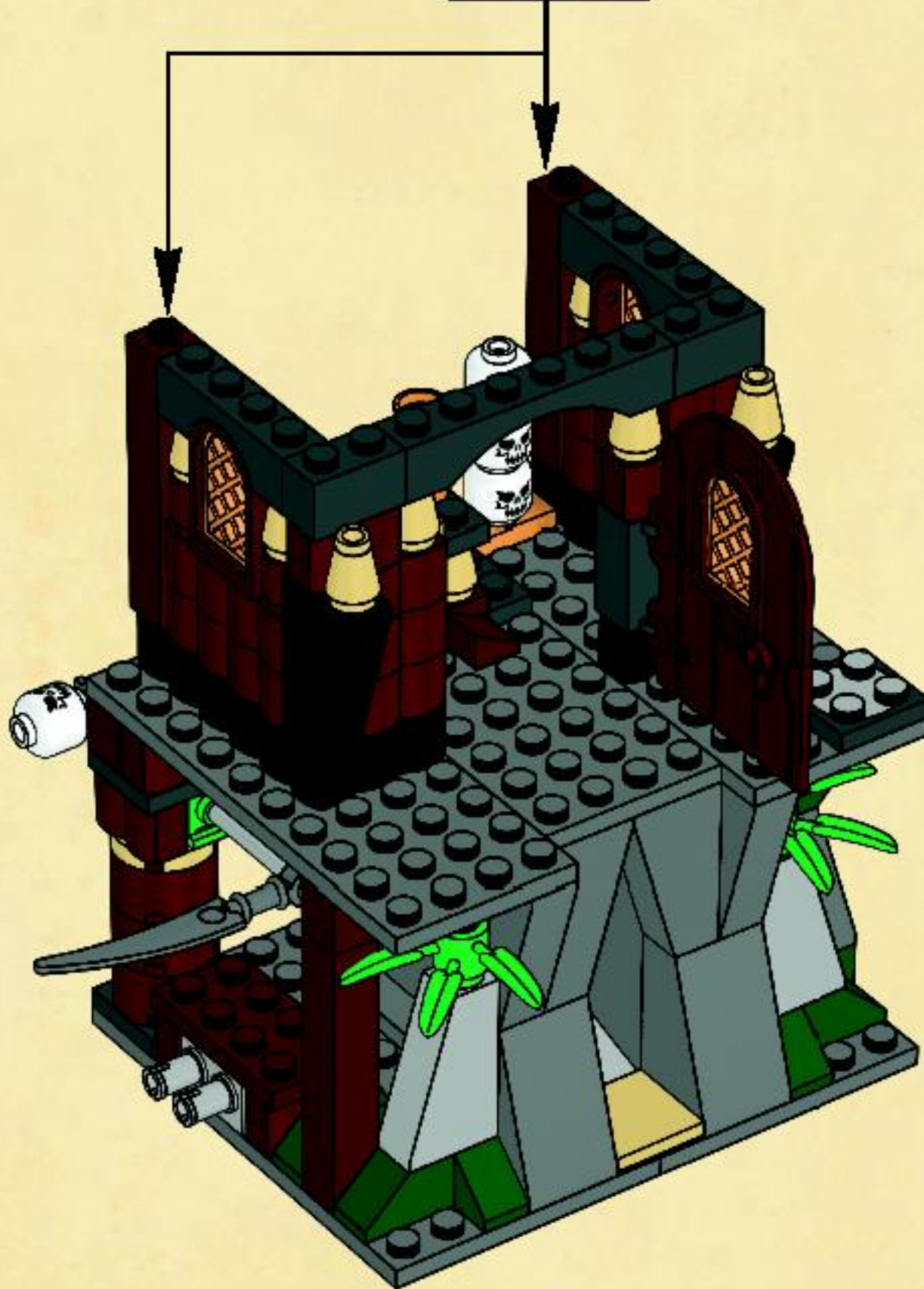
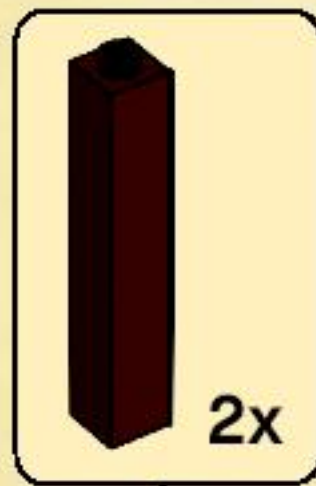



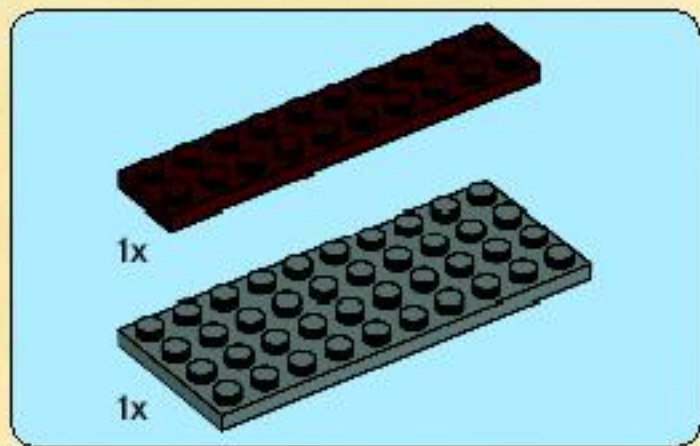

38

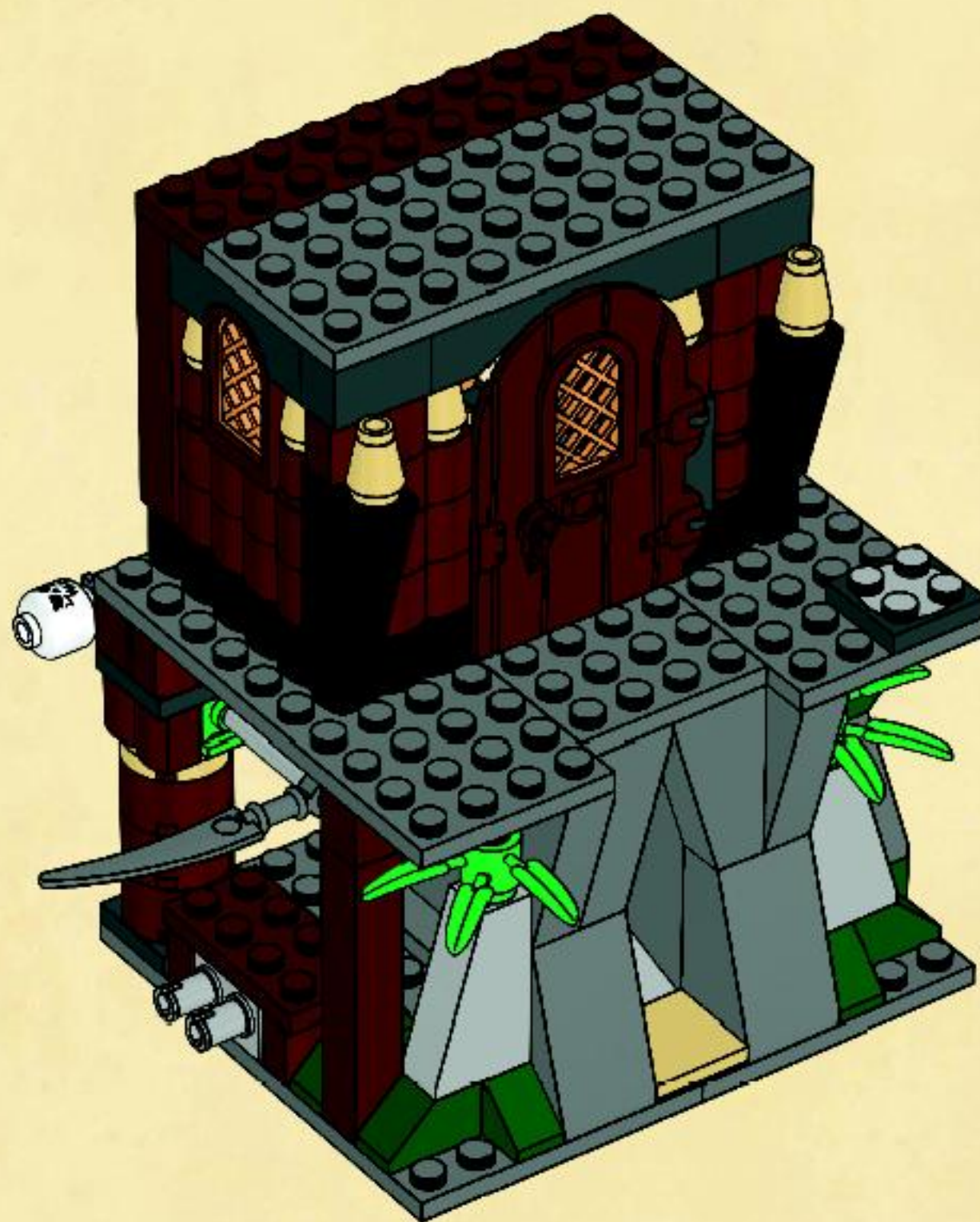



# 39





2x

# 40



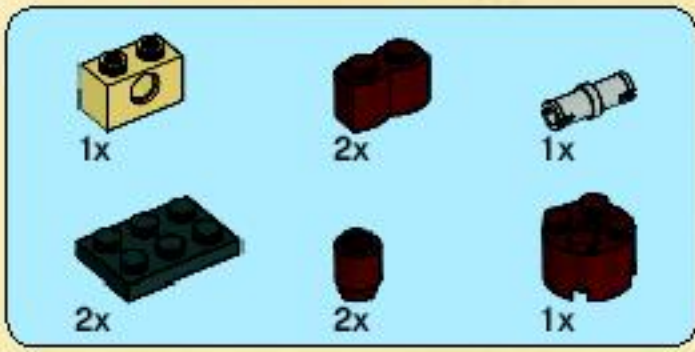

# 41

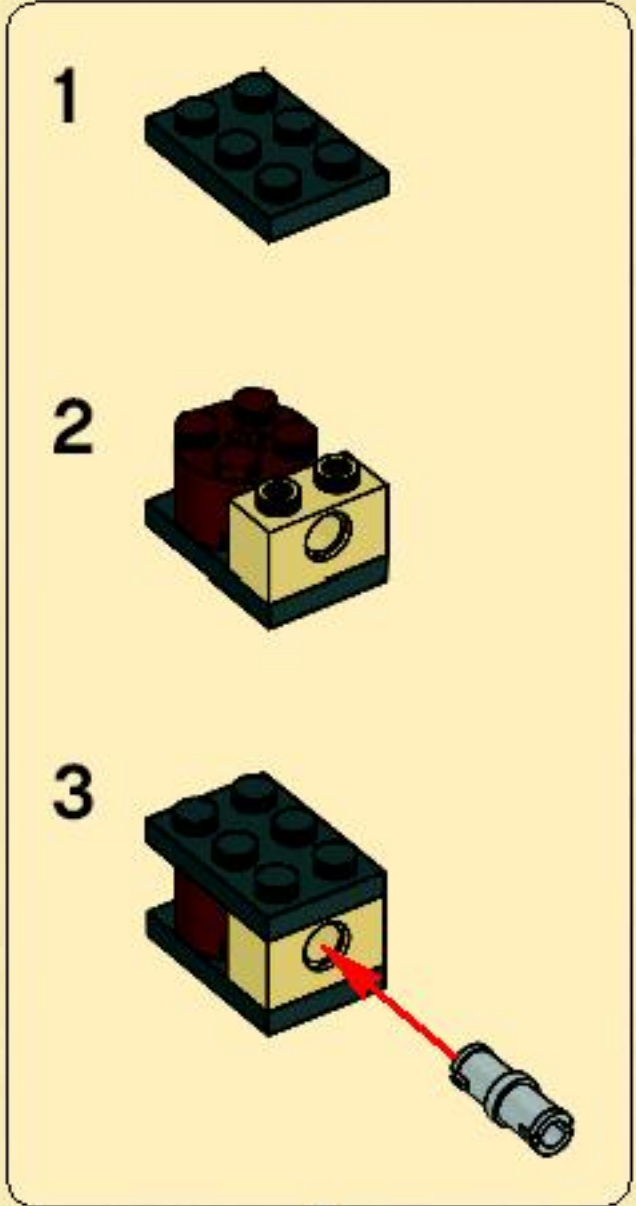

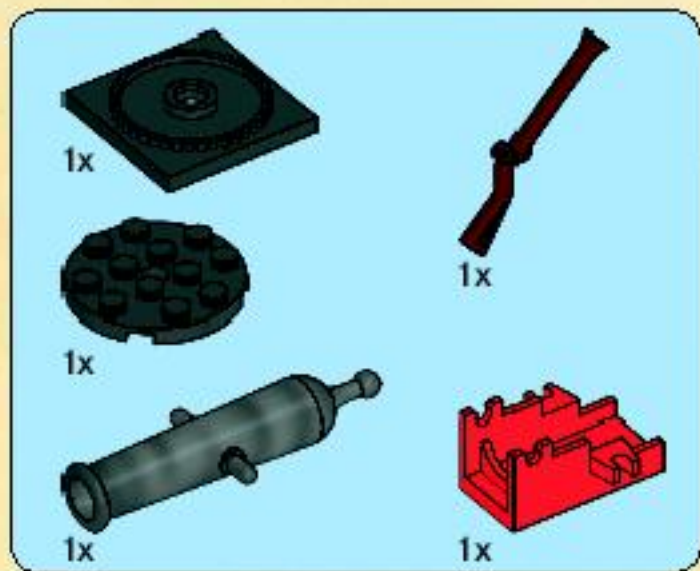

# 42

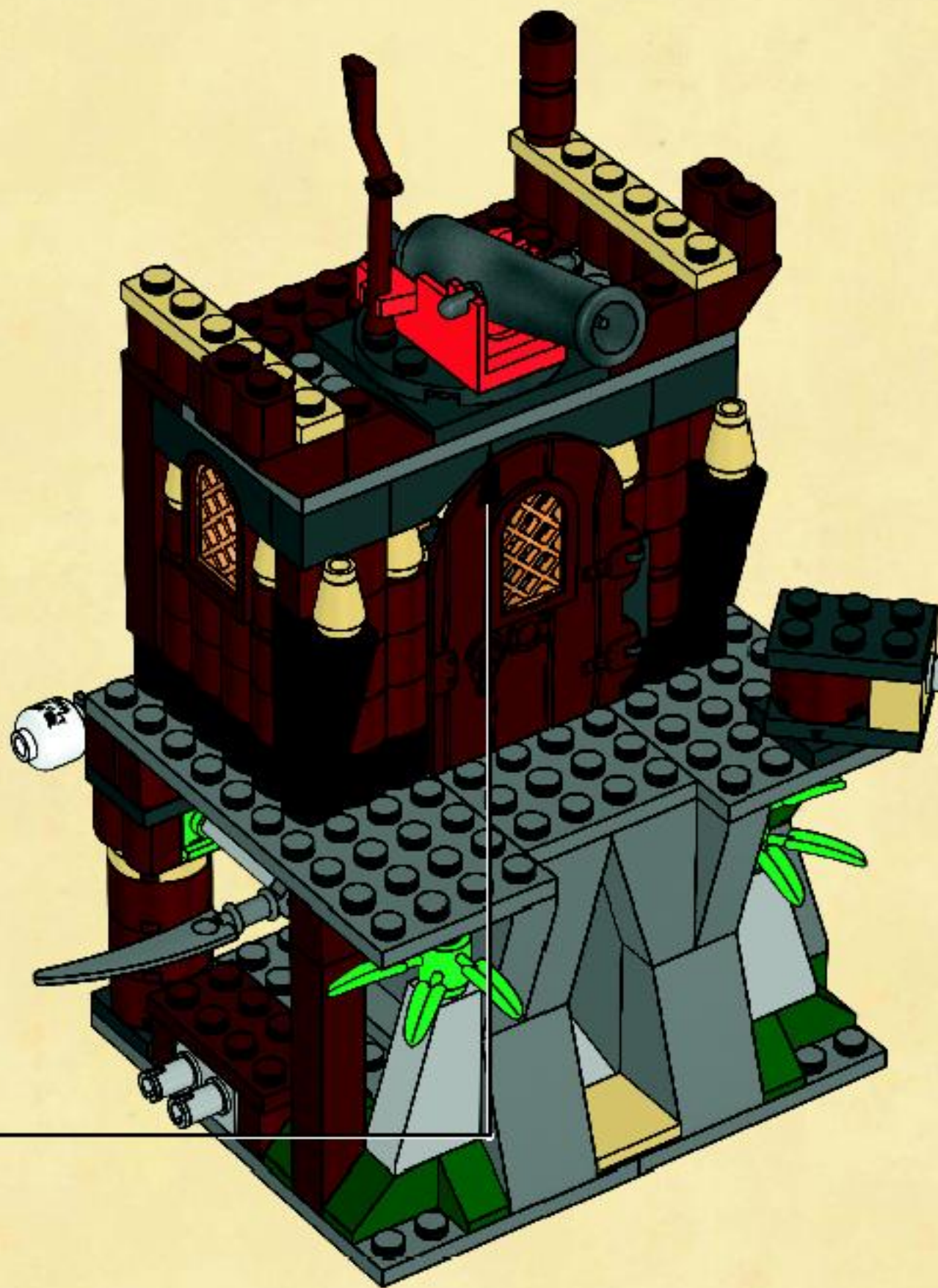
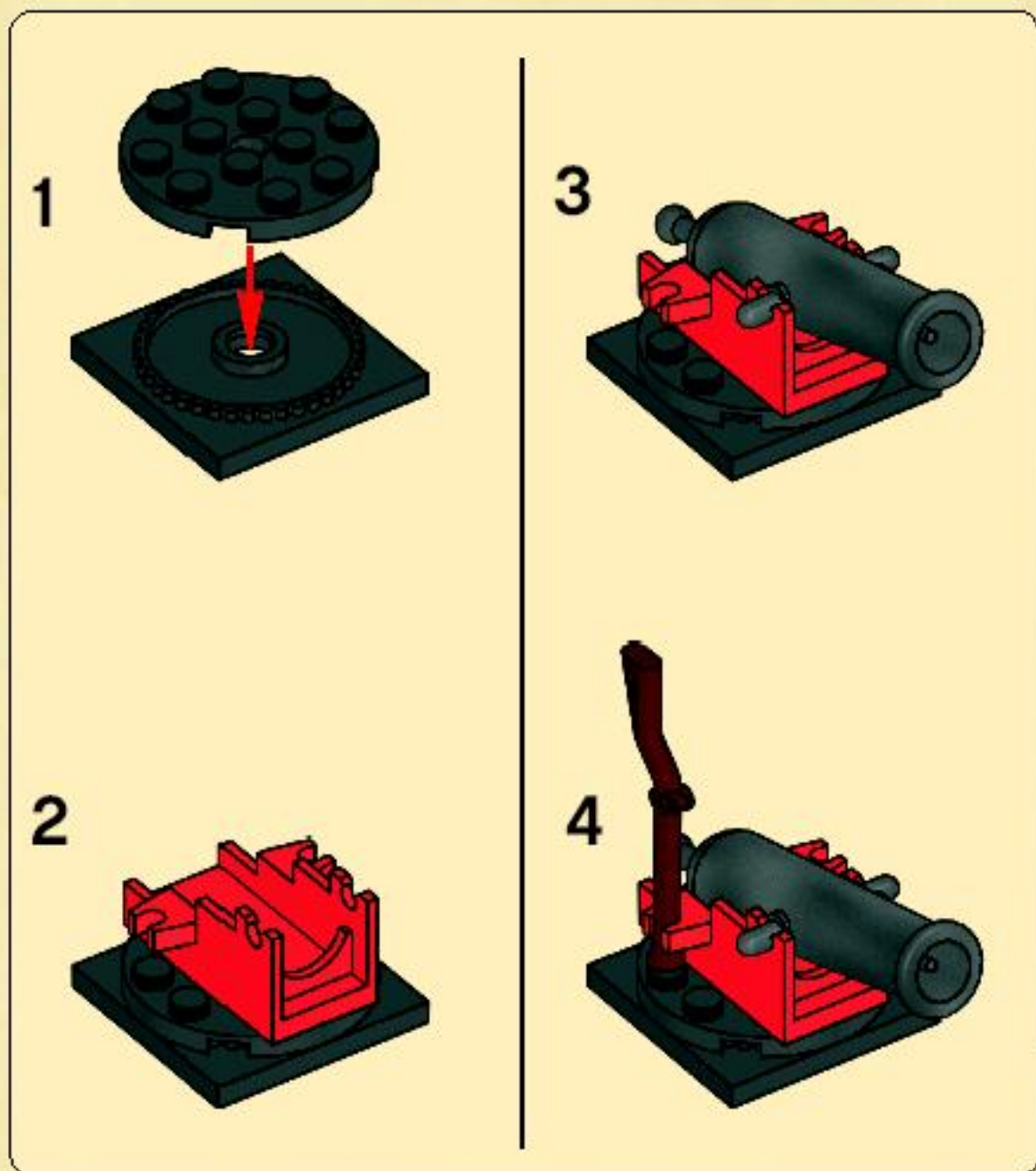



43

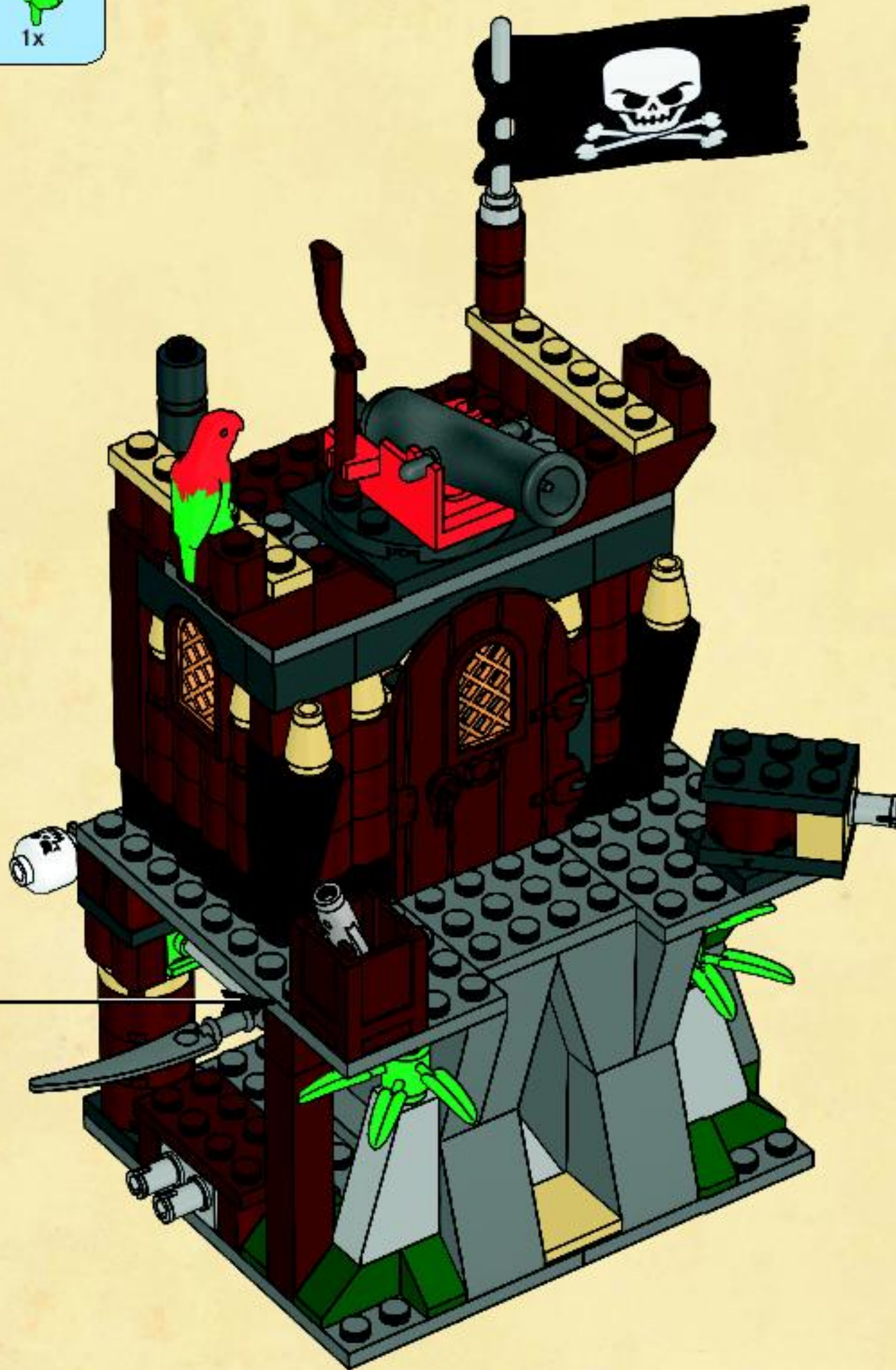
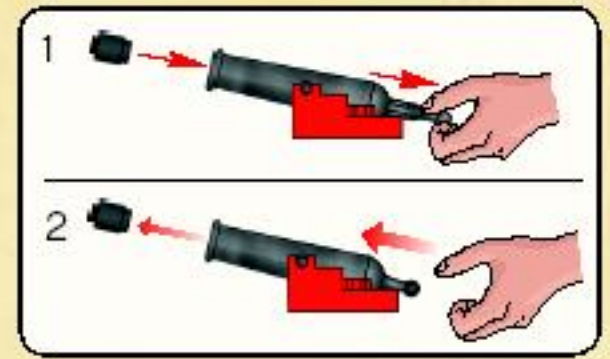

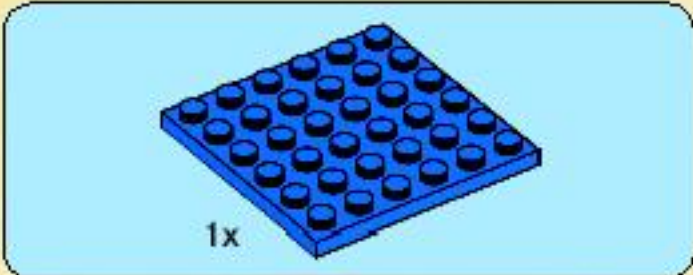

1

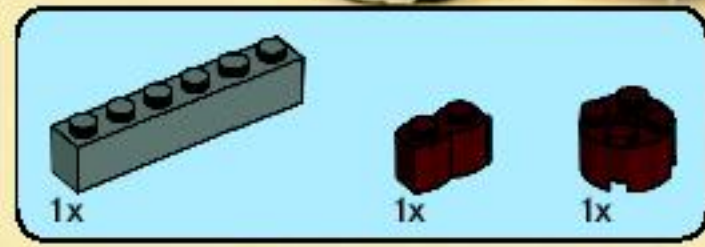
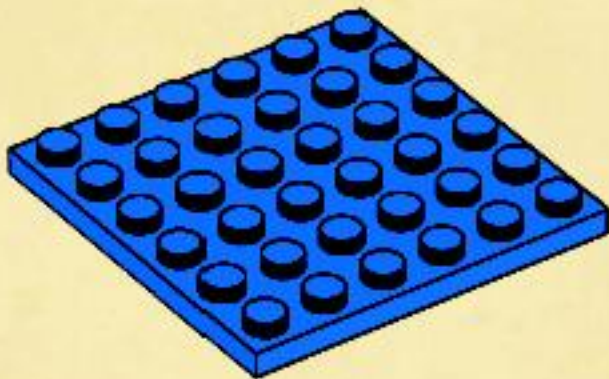

2

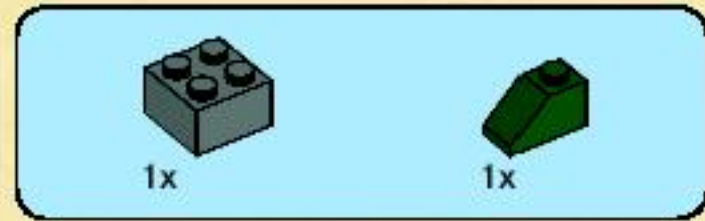
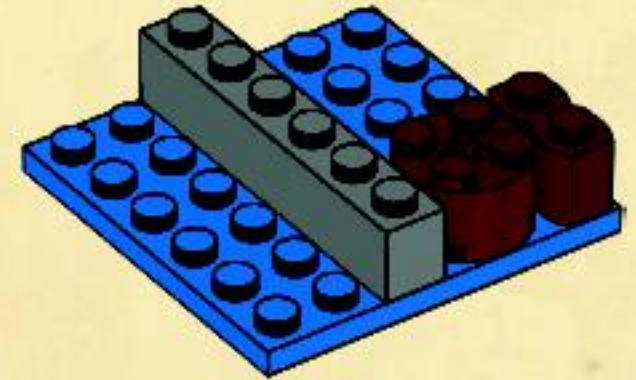

3

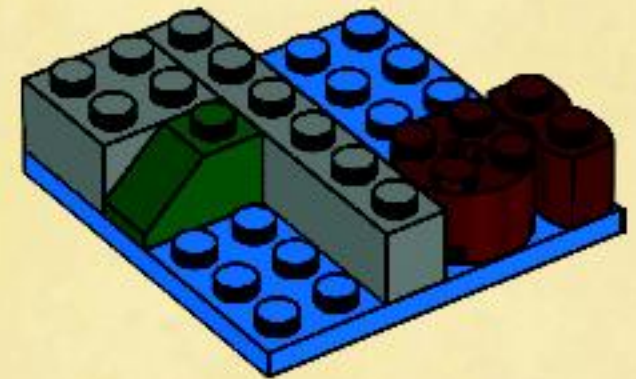



4

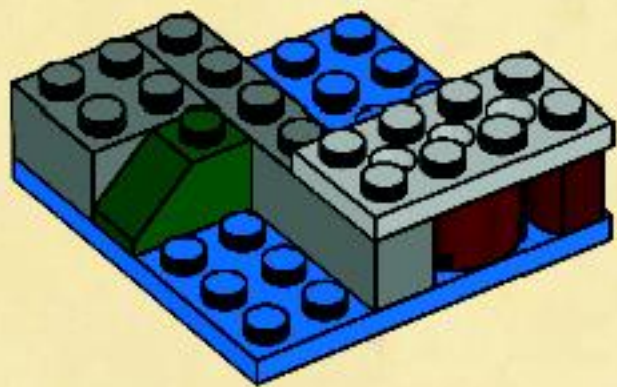

5

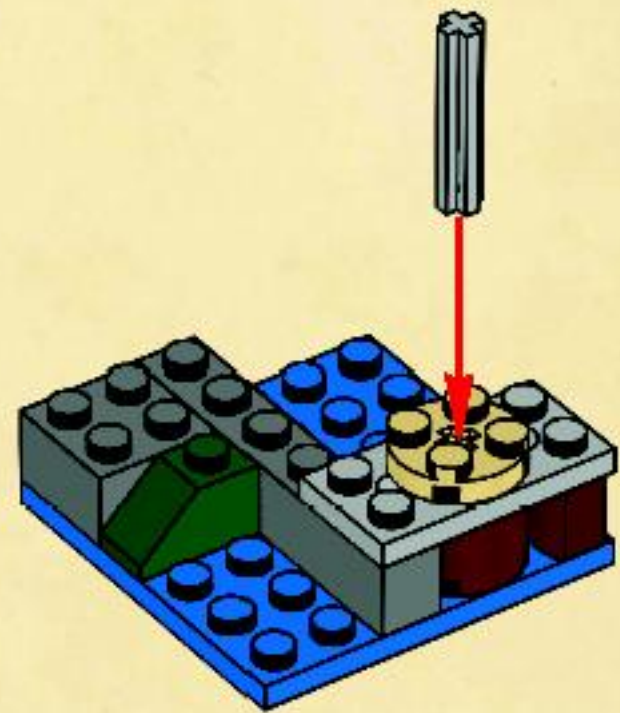



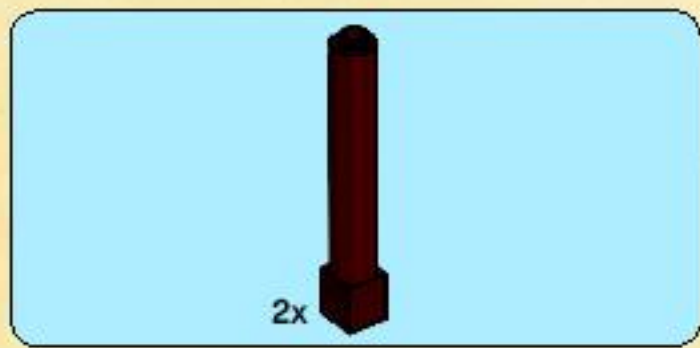

6

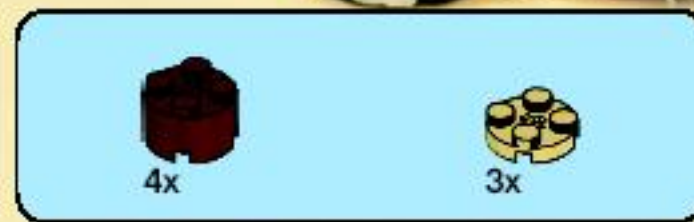
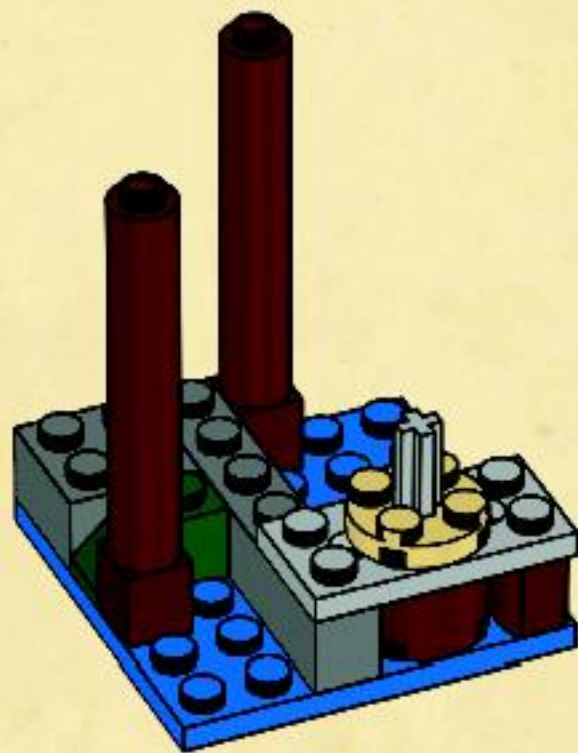

7

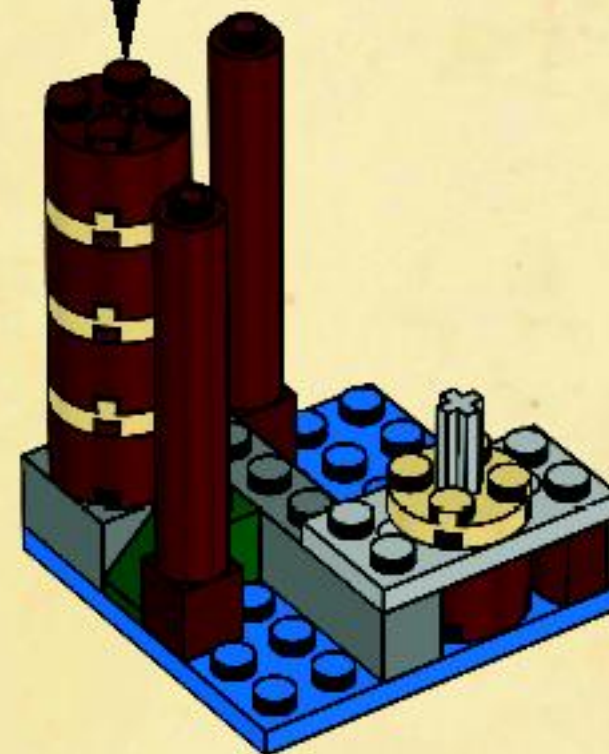
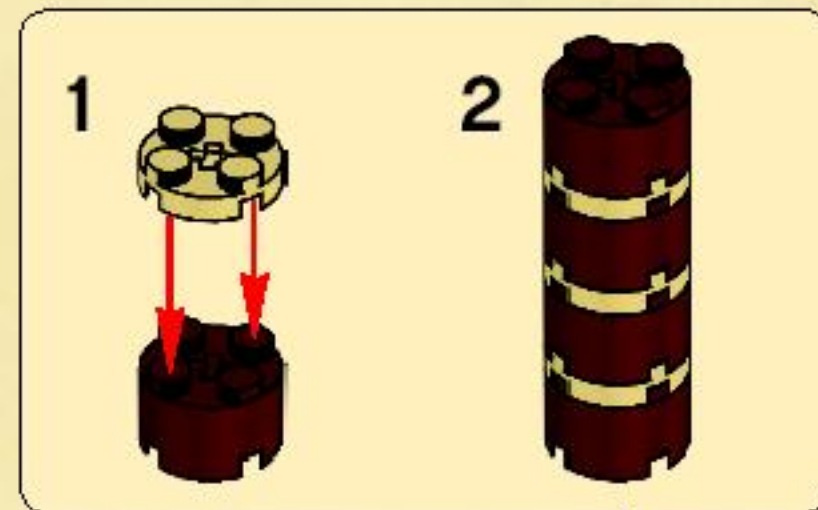



8

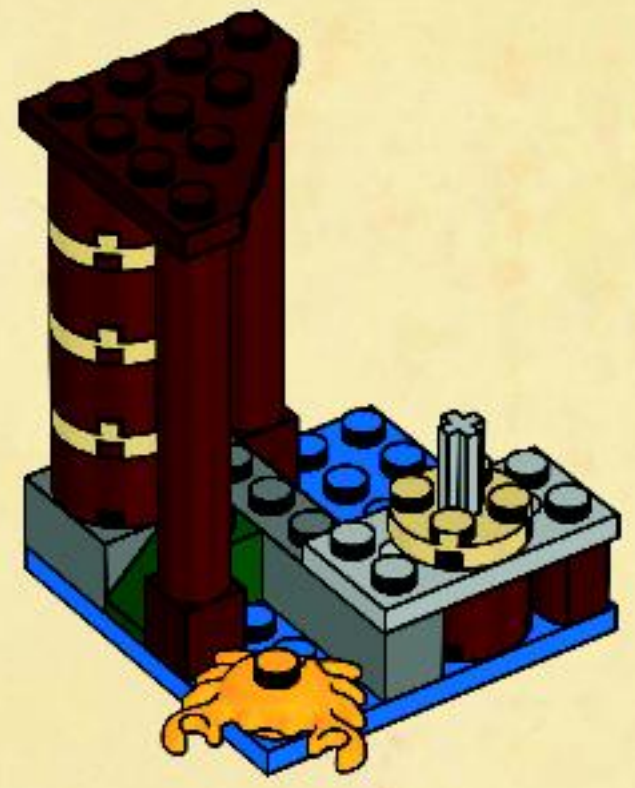

9

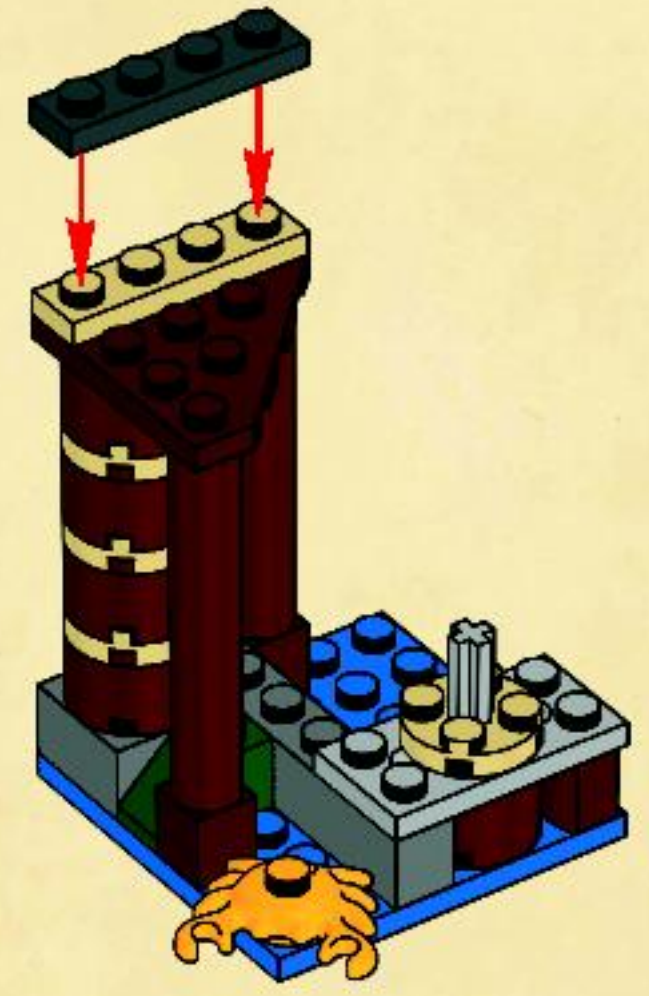

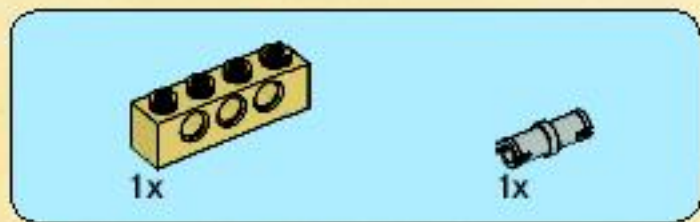

10



11

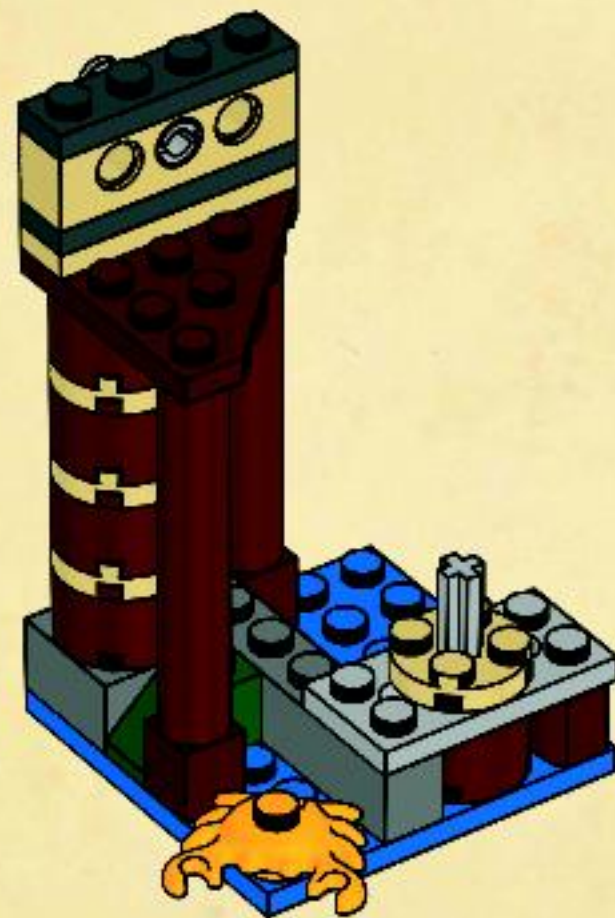

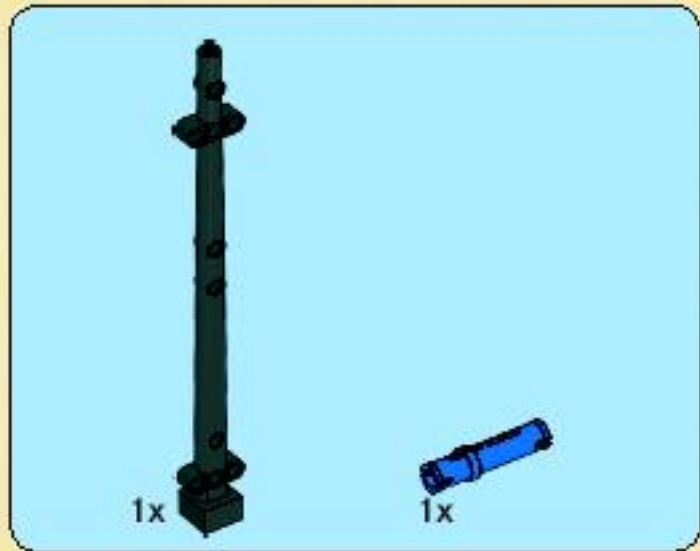

1





2



3



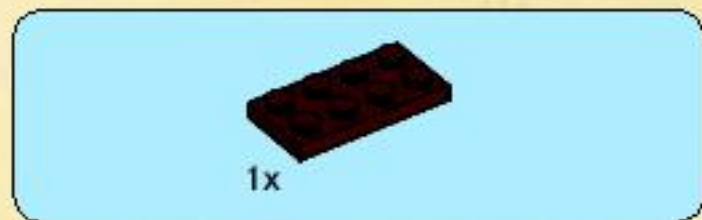

4



5



12



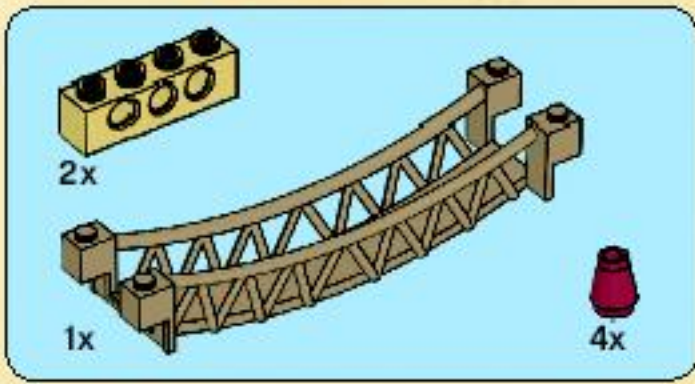

# 13

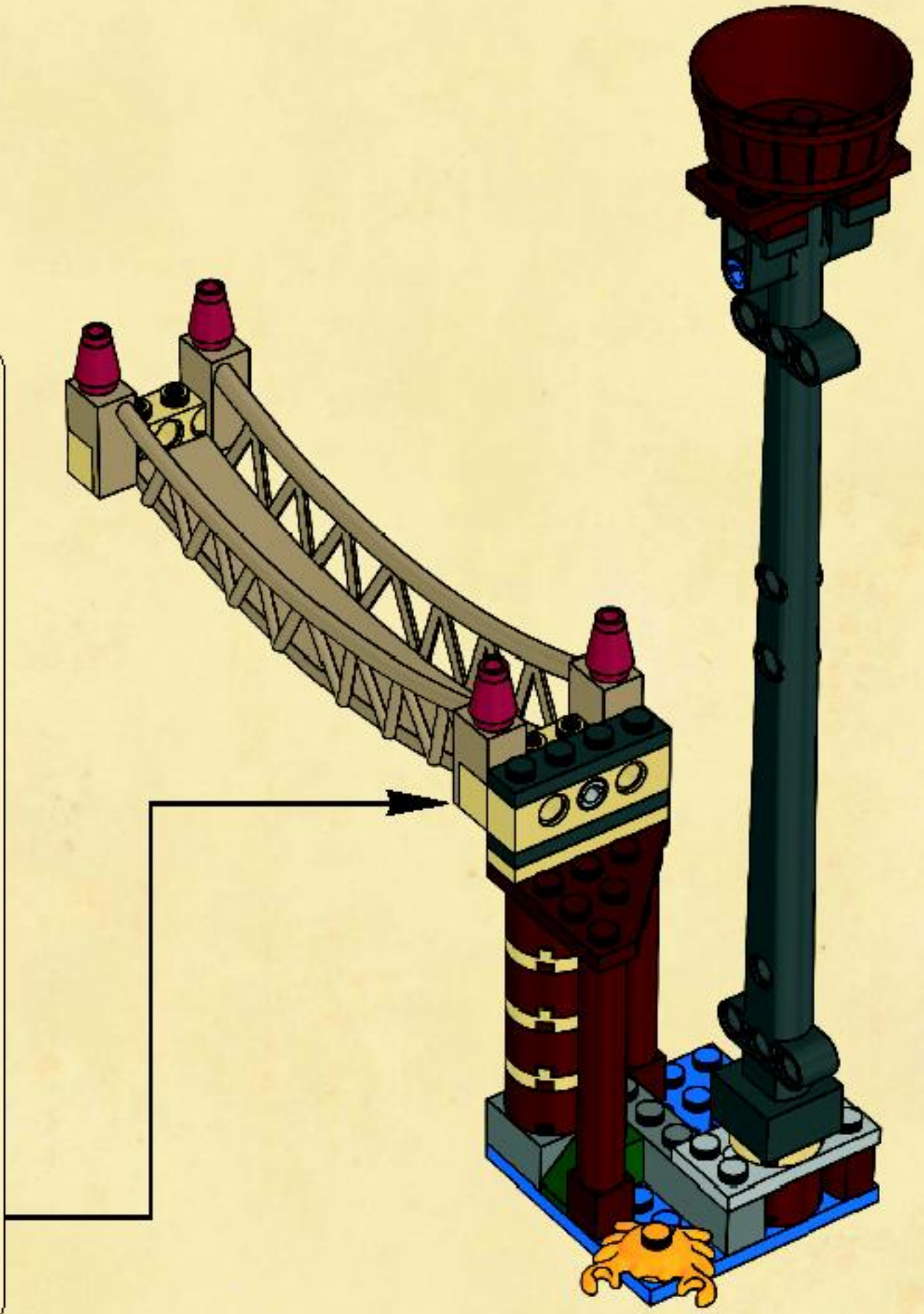
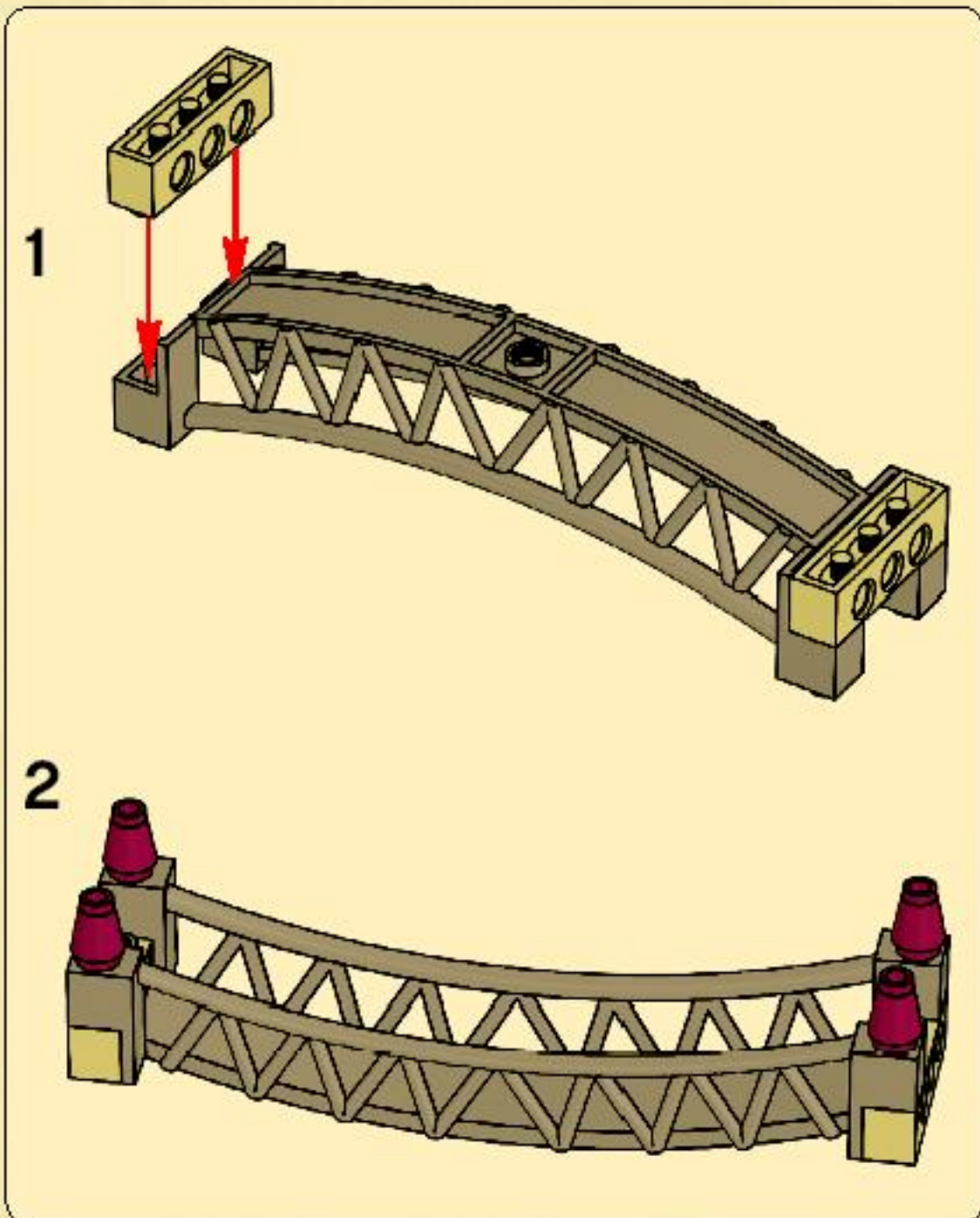



14



1x  1x 

15

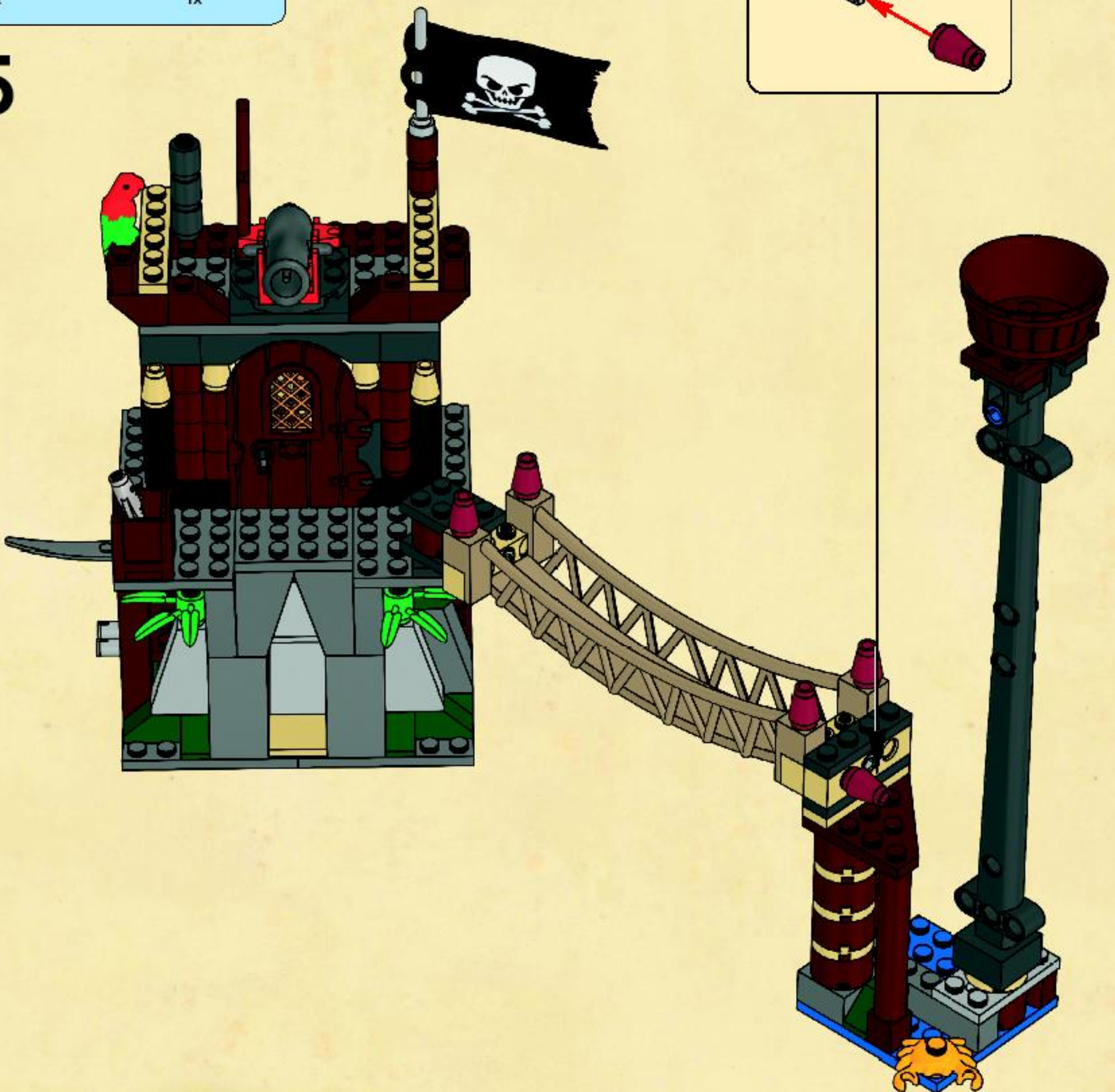
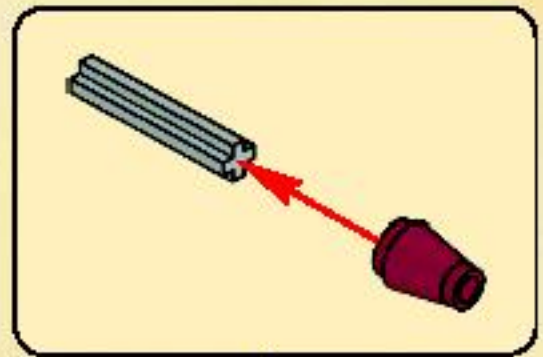

16

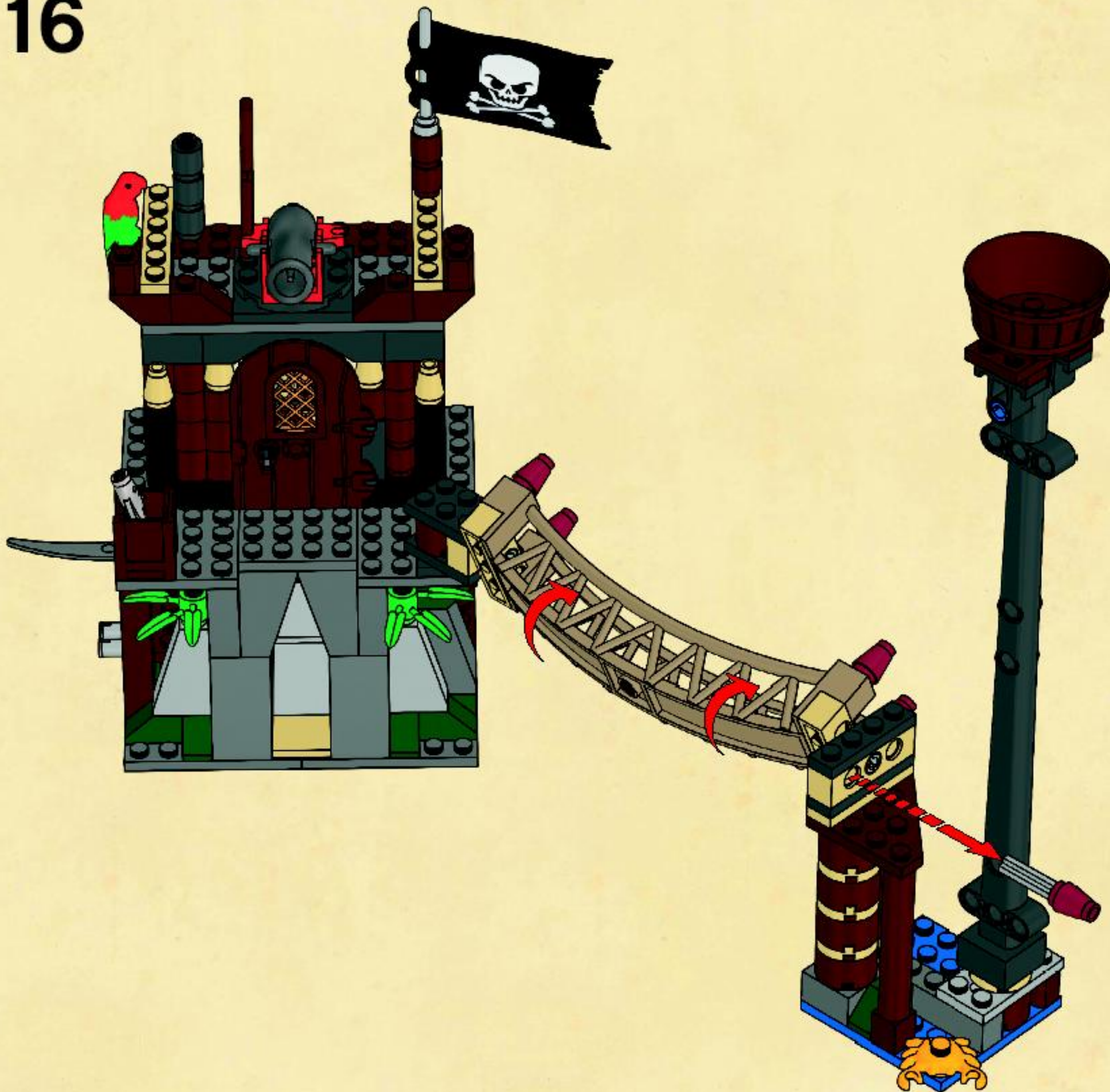

17

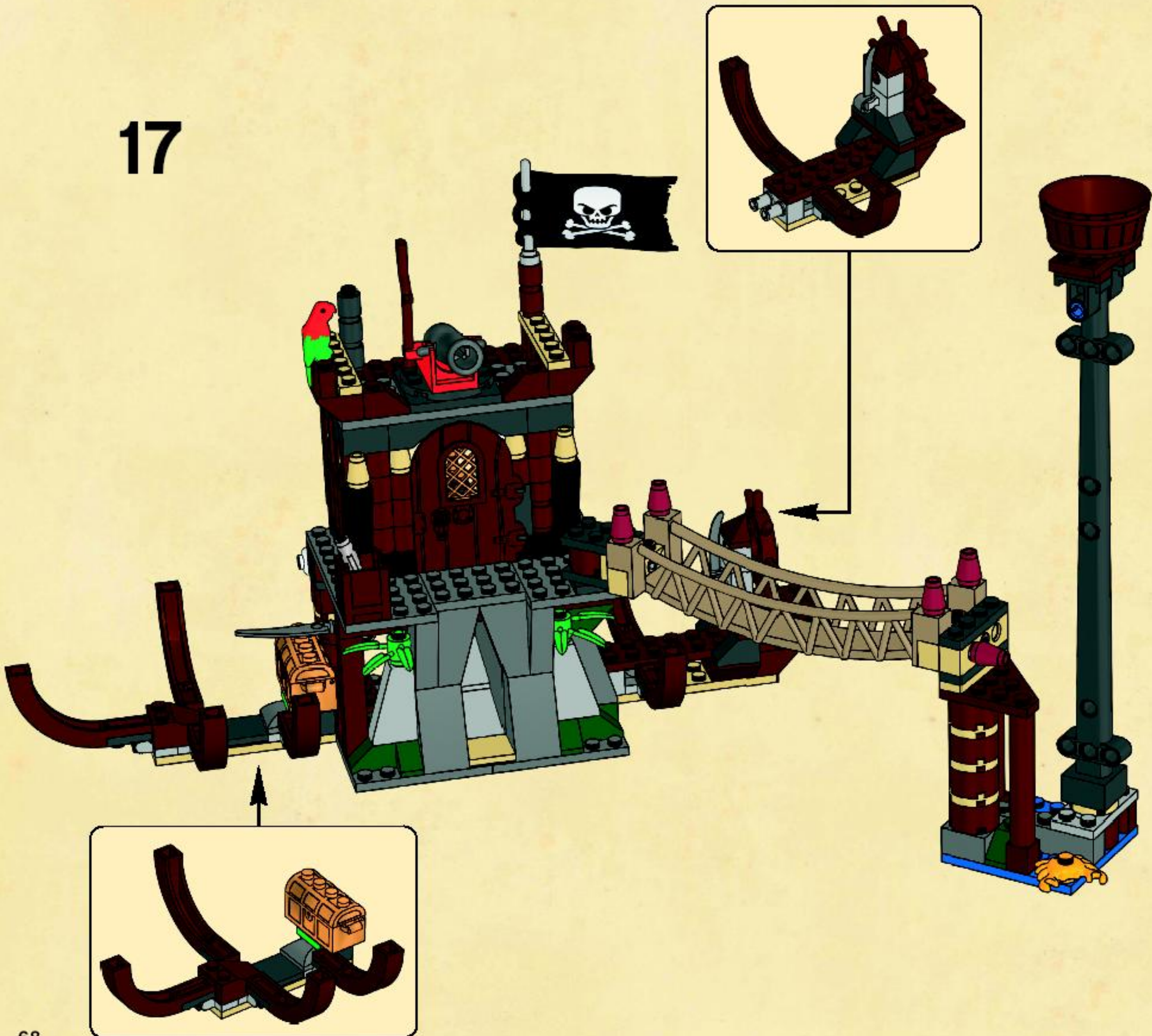





Treasure Map







# PIRATES

6239



6240



6242







6241

6243



1x  
4540610



2x  
9327



5x  
4162427



2x  
4538969



2x  
626601



2x  
4505109



1x  
4508143



1x  
4277338



1x  
4520638



3x  
4226966



2x  
4219726



8x  
4211183

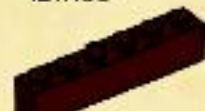

4x  
4211193



6x  
4541894



9x  
4211166



2x  
4520612



1x  
4224732



1x  
4219729



1x  
4211251



1x  
4541893



1x  
4211204



2x  
4536847



3x  
4211311



18x  
4211180



6x  
4211181



1x  
4211214



6x  
4211186



1x  
4211211



1x  
4243838



1x  
4504376



2x  
4211199



6x  
4211221



1x  
4216625



1x  
4541875



2x  
4542131



1x  
4540552



1x  
4540534



2x  
4540514



2x  
362321



2x  
4114052



1x  
4113954



5x  
4541498



1x  
4514553



2x  
4541677



1x  
9341



1x  
4540446



1x  
4199519



1x  
4185177



1x  
4524449



12x  
4529237



5x  
4113917



1x  
4113233



2x  
4124067



5x  
4140562



2x  
4113988



1x  
4205107



3x  
4234365



1x  
4528206



1x  
4225875



1x  
4539507



1x  
4539520



1x  
4259916



1x  
4128576



1x  
4539951



1x  
4540699



1x  
4517986



2x  
300426



2x  
3200026

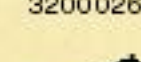

2x  
365926

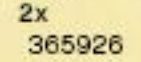

2x  
345526



1x  
306826



1x  
4540696



1x  
4263506



1x  
4540656



1x  
4541678



1x  
4541064



1x  
4540698



6x  
4144575



1x  
4107761



2x  
371026



3x  
302126

1x 4515350  
 4x 4121966  
 3x 306226  
 1x 4541684  
 2x 4144023  
 4x 368026  
 2x 4187334  
 2x 4114348  
 1x 74040  
 1x 302328  
 1x 302228  
 1x 4113955  
 1x 4114505

3x 4266895  
 1x 4541096  
 6x 4255624  
 2x 4529174  
 1x 4541846  
 2x 4211660  
 1x 4211598  
 2x 4211807  
 2x 4211815  
 6x 4515341  
 1x 4211444  
 2x 4211494

2x 4509915  
 1x 4211440  
 4x 4540203  
 3x 4211473  
 1x 4211100  
 1x 4211060  
 1x 4211048  
 3x 4211122  
 1x 4211115  
 2x 4211114  
 2x 4218696

4x 4500975  
 5x 4210696  
 1x 4509194  
 3x 4210789  
 2x 4505068  
 1x 4540070  
 1x 4540642  
 1x 4539486  
 2x 4518561  
 1x 4527065

3x 4541895  
 1x 4541393  
 1x 4541394  
 1x 4505990

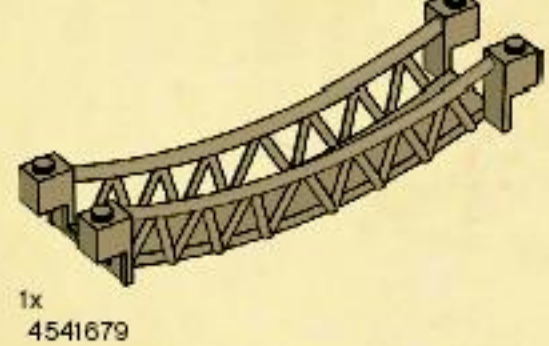

1x 4523157  
 1x 4538126  
 8x 4519970  
 1x 70501  
 1x 4540700

1x 4537989  
 1x 4541679

Customer Service  
 Kundenservice  
 Service Consommateurs  
 Servicio Al Consumidor  
 www.lego.com/service or dial  
 : 00800 5346 5555  
 : 1-800-422-5346



[www.nielsen.com/LEGO](http://www.nielsen.com/LEGO)



## WIN LEGO® PRODUCTS

Fill out a survey and you might WIN a cool LEGO product!  
NO PURCHASE NECESSARY  
Open to all residents where not prohibited  
Go to [www.acnielsen.com/dk/LEGO](http://www.acnielsen.com/dk/LEGO) to fill out a survey for a chance to win a LEGO product.

## WIN LEGO® PRODUCTEN

Vul een enquêteformulier in en maak kans op een cool LEGO® product!  
Kopen niet nodig  
Iedereen uit landen waar geen enquêteverbod geldt mag deelnemen.  
Ga naar [www.acnielsen.com/dk/LEGO](http://www.acnielsen.com/dk/LEGO), vul een enquêteformulier in en maak kans op een LEGO product.

## GEWINNE LEGO® PRODUKTE

Nimm an der Umfrage teil und GEWINNE ein tolles LEGO® Produkt!  
Die Teilnahme am Gewinnspiel führt zu keinerlei Kaufverpflichtungen  
Teilnahme in allen nicht ausgeschlossenen Ländern möglich  
Wir verlosen unter allen Teilnehmern der Umfrage auf [www.acnielsen.com/dk/LEGO](http://www.acnielsen.com/dk/LEGO) LEGO Produkte.

## GAGNE DES PRODUITS LEGO®

Réponds à un questionnaire et tu pourrais GAGNER un produit LEGO® très cool !  
Aucune obligation d'achat.  
Ouvert à tous les résidents des pays autorisés.  
Visite [www.acnielsen.com/dk/LEGO](http://www.acnielsen.com/dk/LEGO) pour répondre à un questionnaire et avoir une chance de gagner un produit LEGO.

**レゴ®製品を「当てよう」**  
アンケートに記入して、カッコいいレゴ®製品を当てよう！  
お買い上げの必要はありません。  
禁止されていない限り、すべての皆様にご利用いただけます。  
[www.acnielsen.com/dk/LEGO](http://www.acnielsen.com/dk/LEGO)にアクセスして、アンケートにご記入ください。当選者にはレゴ®製品を差し上げます。



 [www.LEGO.com](http://www.LEGO.com)

©2009 The LEGO Group. 4550197