

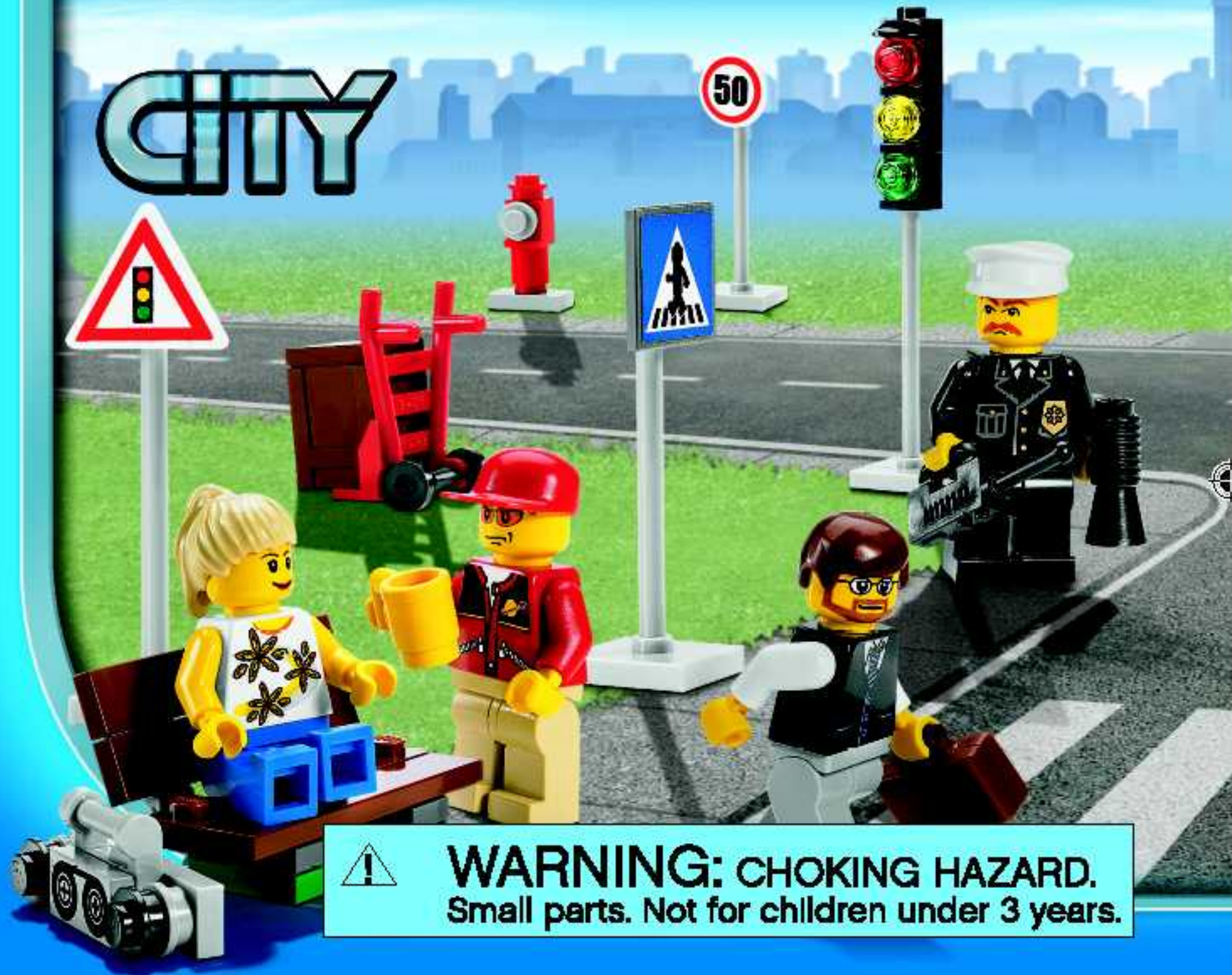

8401

CITY



WARNING: CHOKING HAZARD.
Small parts. Not for children under 3 years.





AVERTISSEMENT : RISQUE D'ÉTOUFFEMENT.

Contient des petites pièces. Ne convient pas aux enfants de moins de 3 ans.



ADVERTENCIA: PELIGRO DE ASFIXIA.

No recomendado para niños menores de 3 años. Contiene piezas pequeñas.



1



2

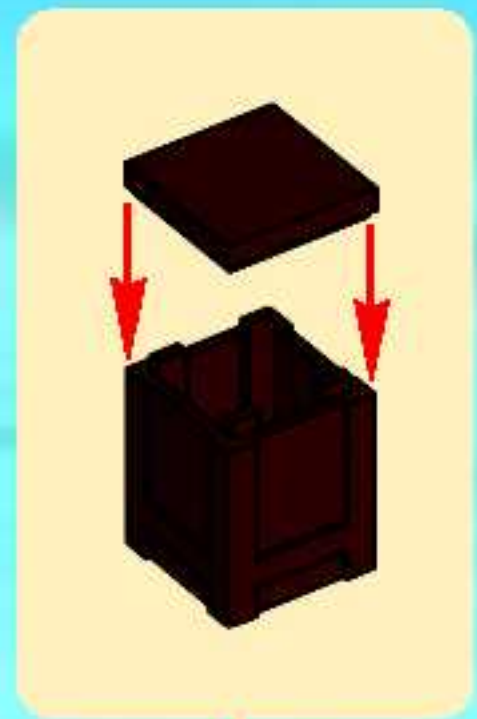

1

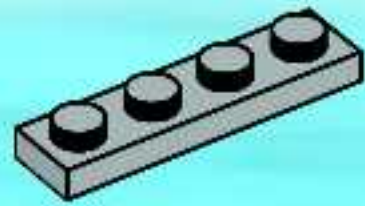

3



2

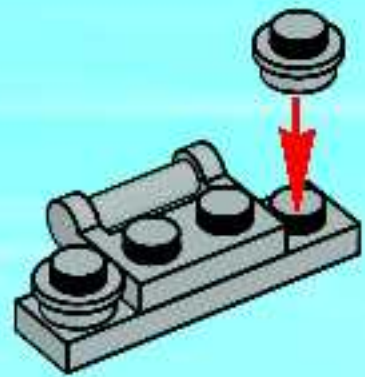

4

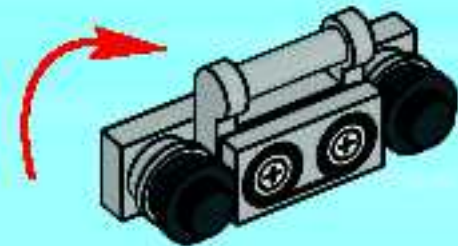

1

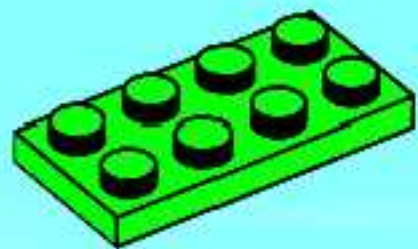

2

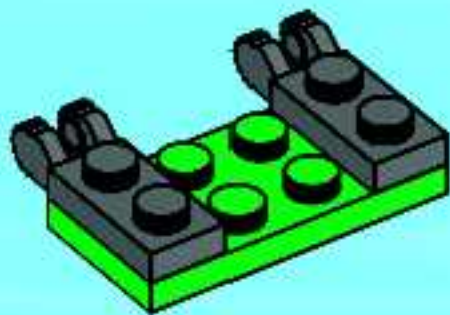

3

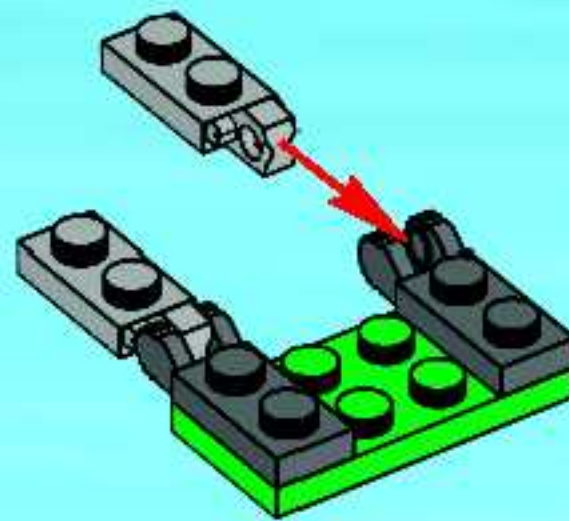

4

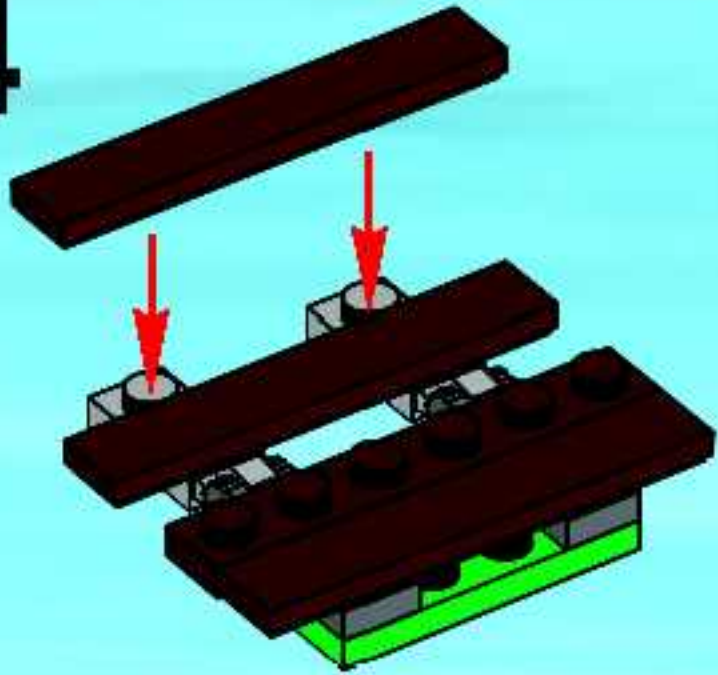

5

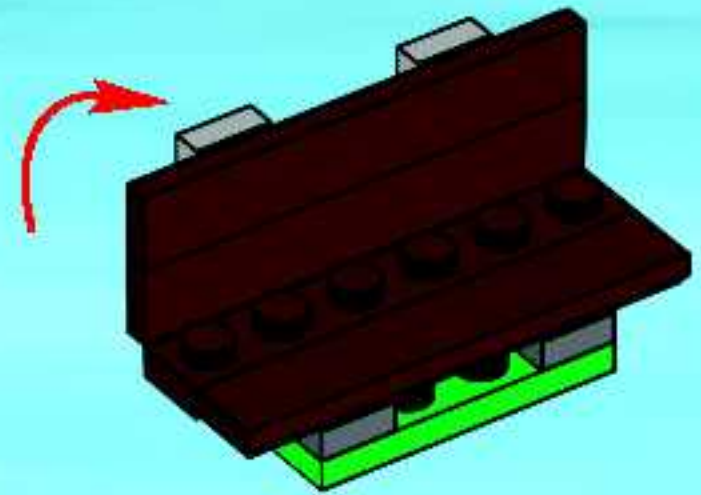

1

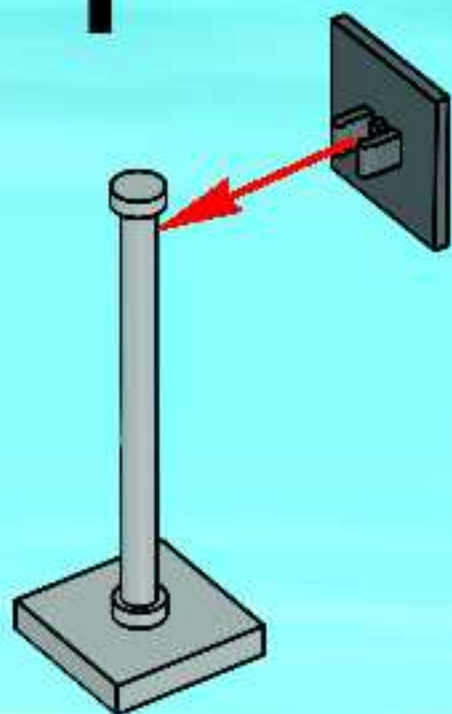

2

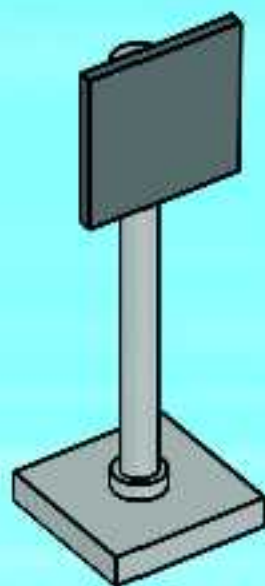

3



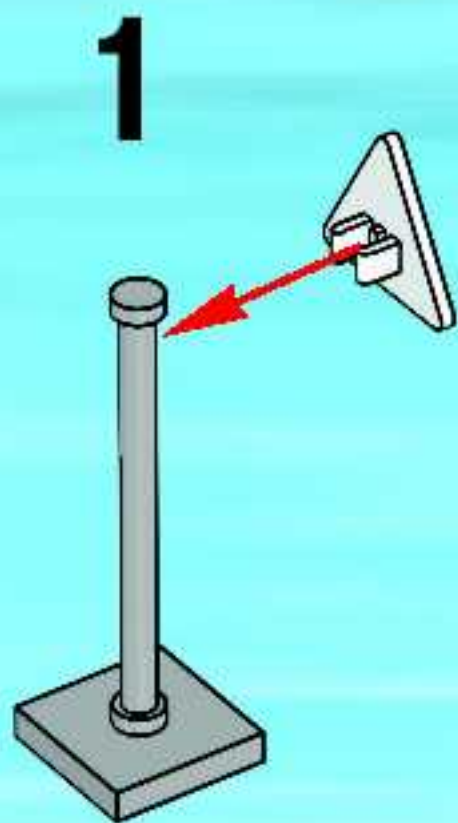

1

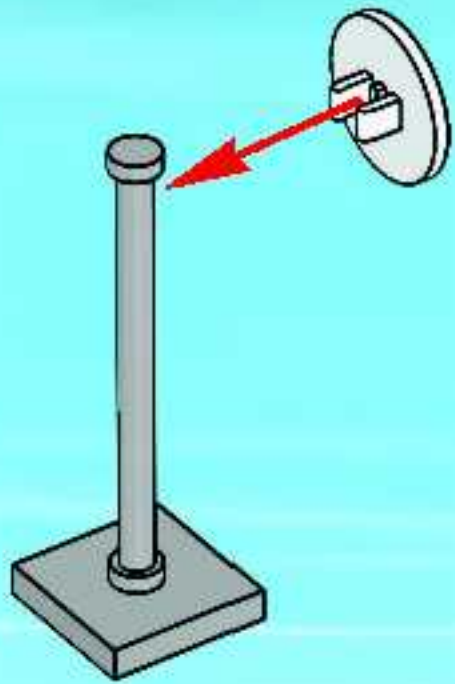

2

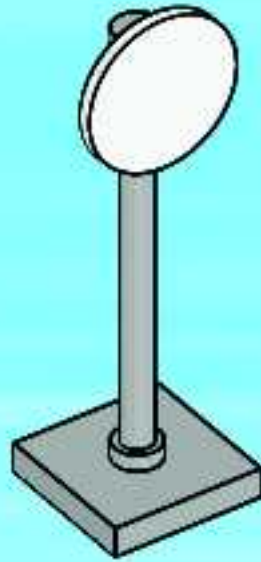

3

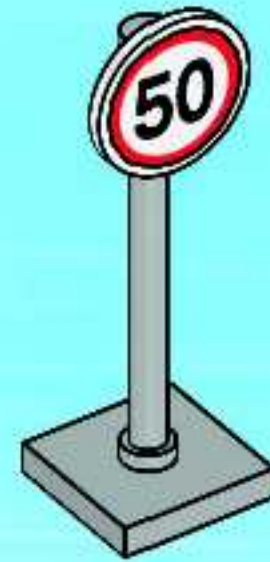



1

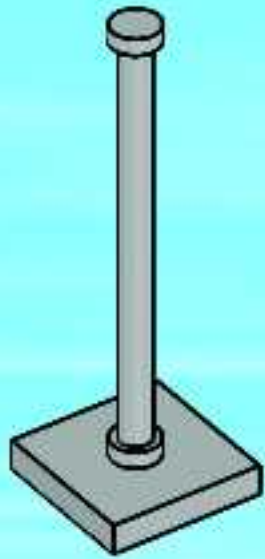

2



3

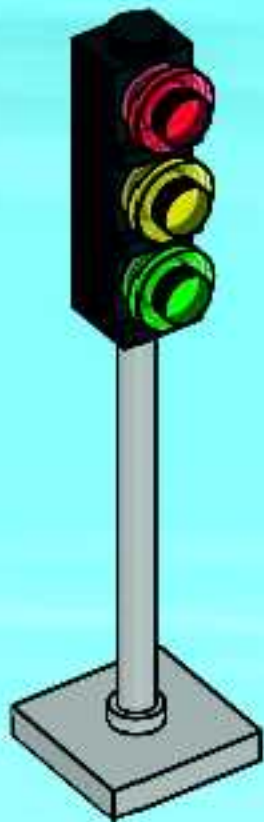

4



5

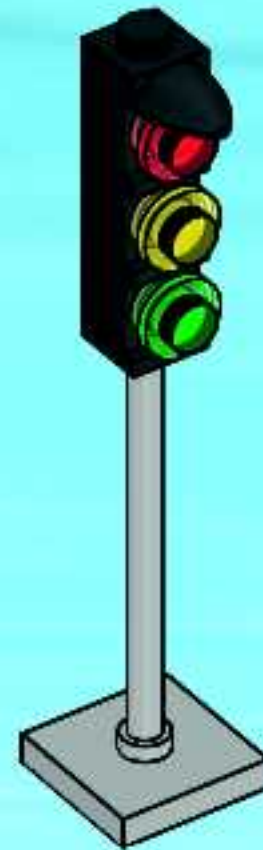

1



2



3





1x
4275536



1x
362401



1x
4116816



1x
4540294



1x
9341



1x
4107623

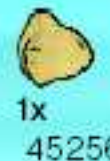

1x
4525656



1x
3005744



1x
4289265



1x
4194395



1x
4261301



1x
4293369



1x
389924



1x
4271949



1x
4211235



1x
4211158



1x
4221590



3x
4211204



1x
4520638



1x
4275868



1x
448521



1x
407021



1x
306221



1x
614121



1x
249521



1x
396226



1x
4275401



1x
4275535



1x
9339



3x
407026



1x
249626



1x
4273590



2x
614126



1x
434926



3x
4211525



1x
4211451



1x
4244627

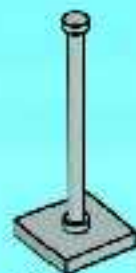

4x
4542264



1x
4224701



1x
4227657



2x
4211803



1x
4211445



1x
302028



1x
3005748



1x
3005741



1x
4210701



2x
4210884



Customer Service

Kundenservice

Service Consommateurs

Servicio Al Consumidor

www.lego.com/service or dial



00800 5346 5555 :

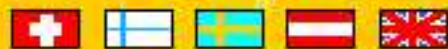

1-800-422-5346 :



LEGO CITY

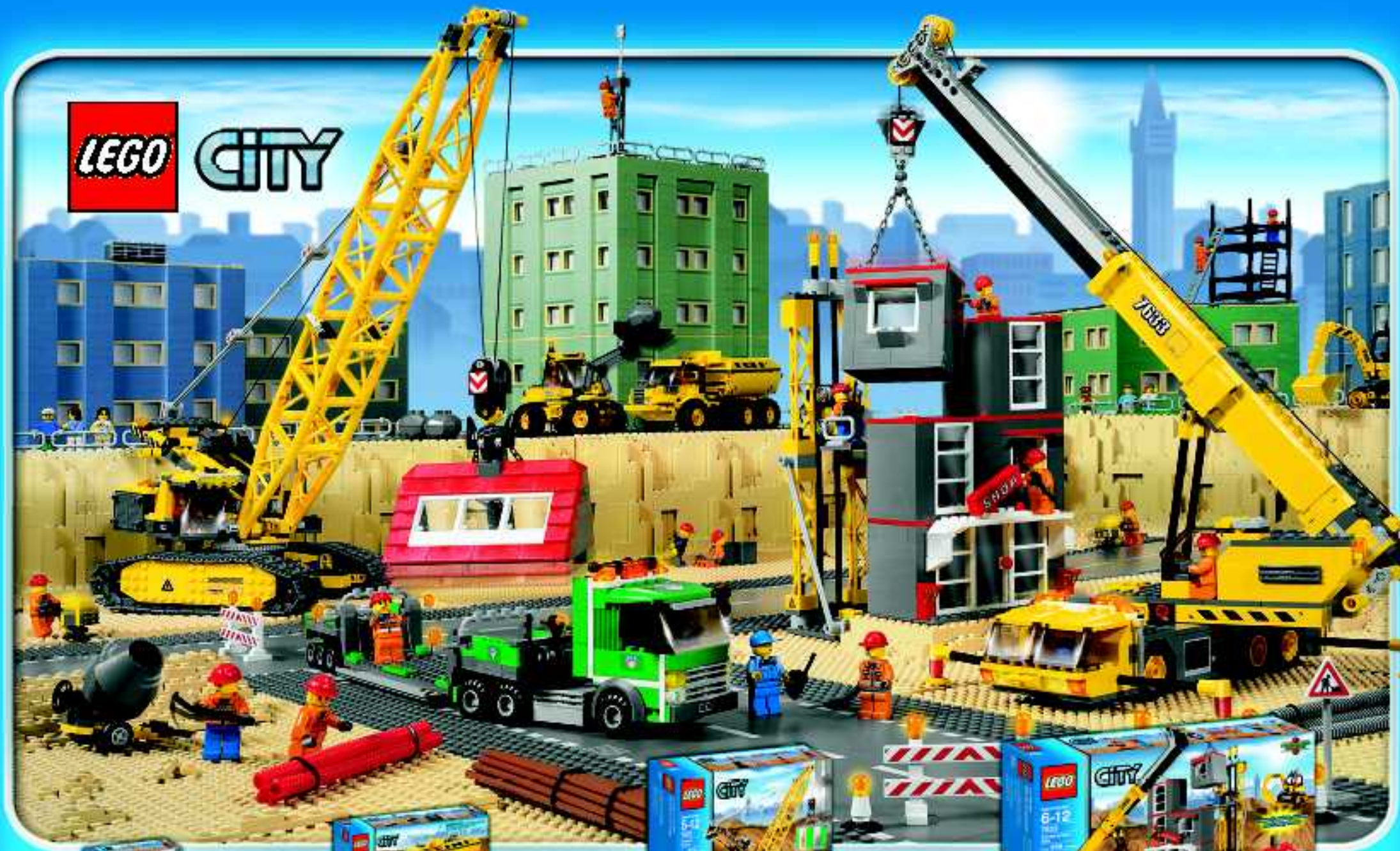

7630



7631



7632



7633

15

www.nielsen.com/LEGO



WIN LEGO® PRODUCTS

Fill out a survey and you might WIN a cool LEGO product
NO PURCHASE NECESSARY

Open to all residents where not prohibited

Go to www.nielsen.com/LEGO to fill out a survey for a chance to win a LEGO product.

WIN LEGO® PRODUCTEN

Vul een enquêteformulier in en maak kans op een cool LEGO® product

Kopen niet nodig

Iedereen uit landen waar geen enquêteverbod geldt mag deelnemen.

Ge naar www.nielsen.com/LEGO, vul een enquêteformulier in en maak kans op een LEGO product.

GEWINNE LEGO® PRODUKTE

Nimm an der Umfrage teil und GEWINNE ein tolles LEGO® Produkt
Die Teilnahme am Gewinnspiel führt zu keinerlei Kaufverpflichtungen
Teilnahme in allen nicht ausgeschlossenen Ländern möglich
Wir verlosen unter allen Teilnehmern der Umfrage auf www.nielsen.com/LEGO LEGO Produkte.

GAGNE DES PRODUITS LEGO®

Réponds à un questionnaire et tu pourrais GAGNER un produit LEGO® très cool !

Aucune obligation d'achat.

Ouvert à tous les résidents des pays autorisés.

Visite www.nielsen.com/LEGO pour répondre à un questionnaire et avoir une chance de gagner un produit LEGO.

レゴ®製品を「当てよう」

アンケートに記入して、カッコいいレゴ®製品を当てよう！

お買い上げの必要はありません。

禁止されていない限り、すべての管轄にご利用いただけます。

www.nielsen.com/LEGOにアクセスして、アンケートにご記入ください。当選者にはレゴ®製品を差し上げます。



 www.LEGO.com

©2009 The LEGO Group. 4546679