

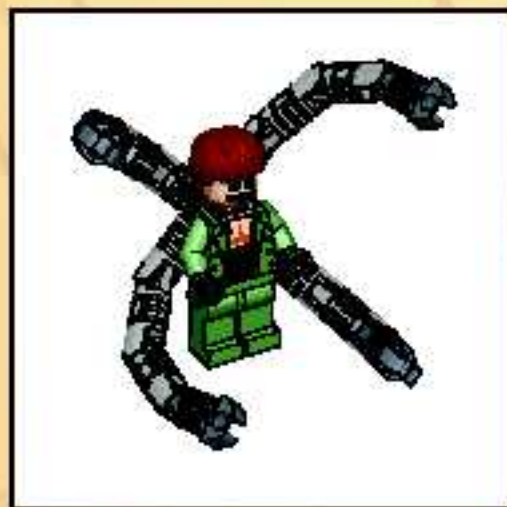

4856

SPIDER-MAN 2

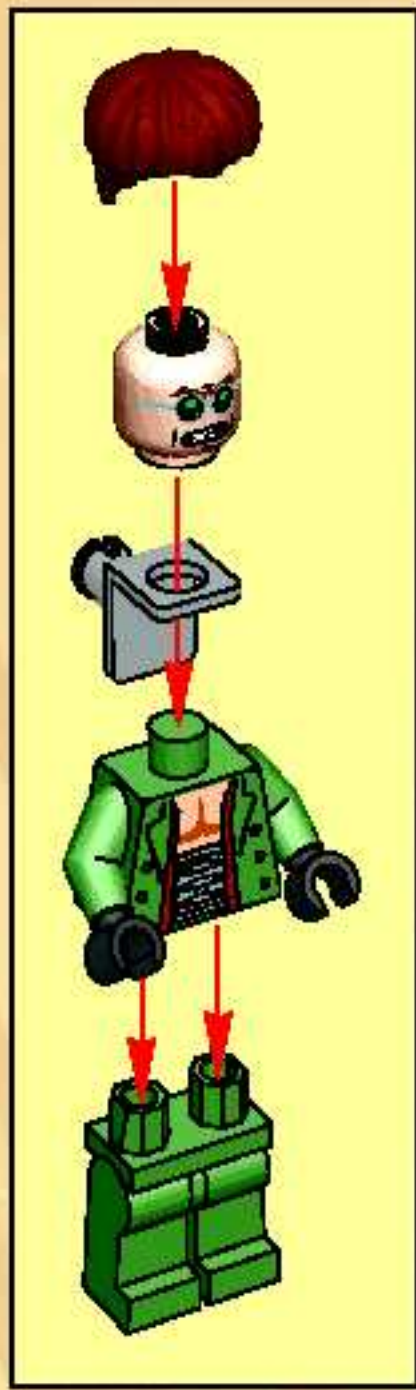



1

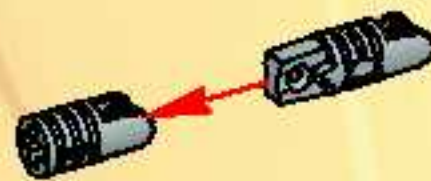

2

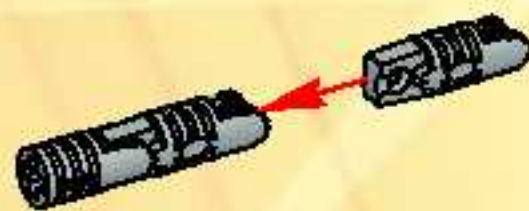

3

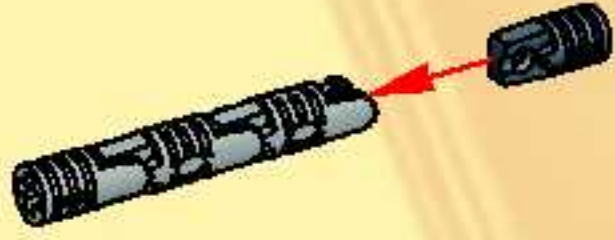

4



4x

5

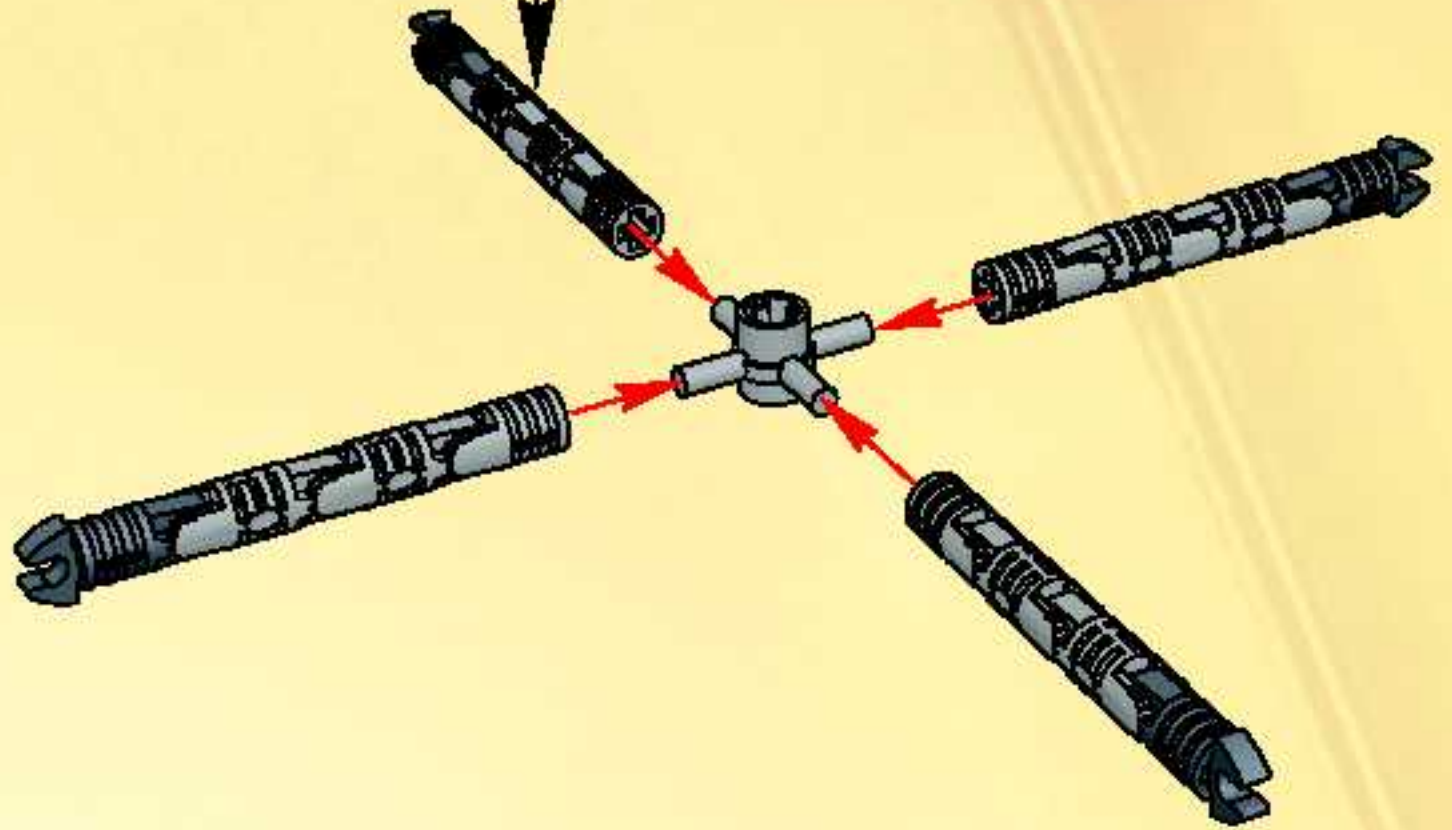

6





1



2

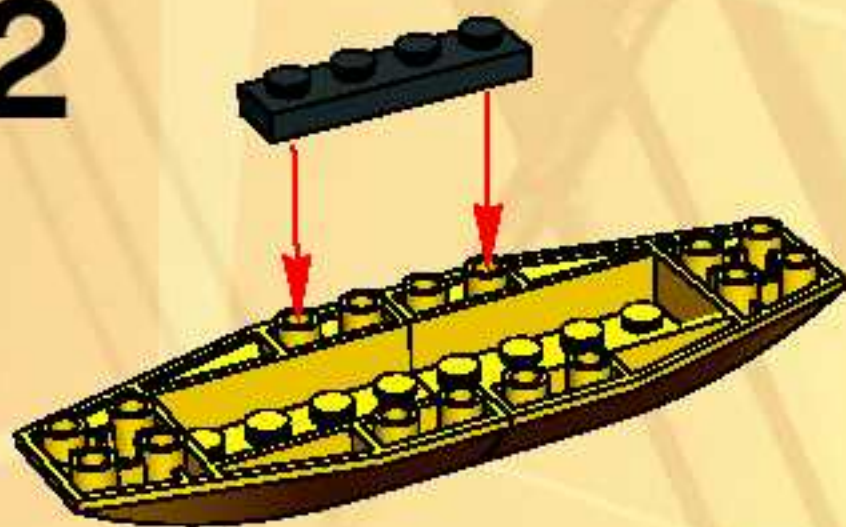

3



4



5

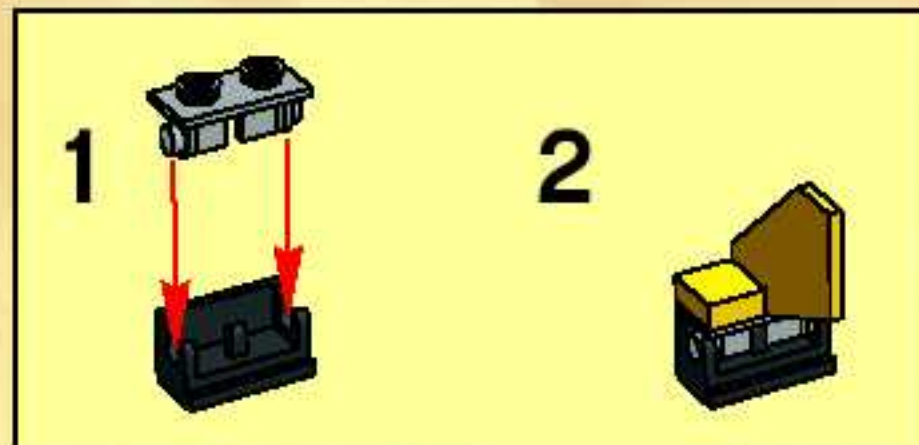

6



7



8





1



2



3

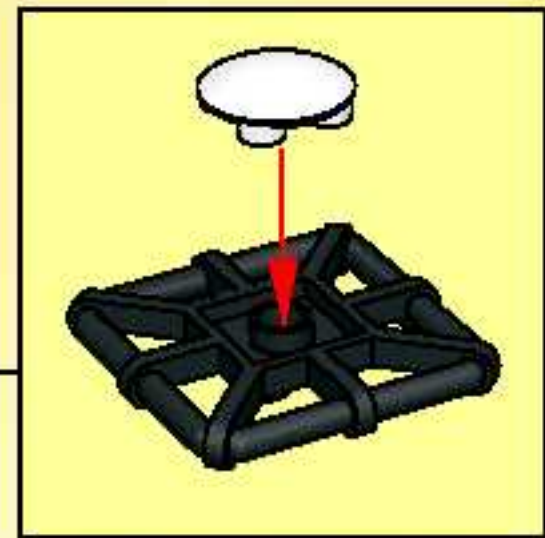
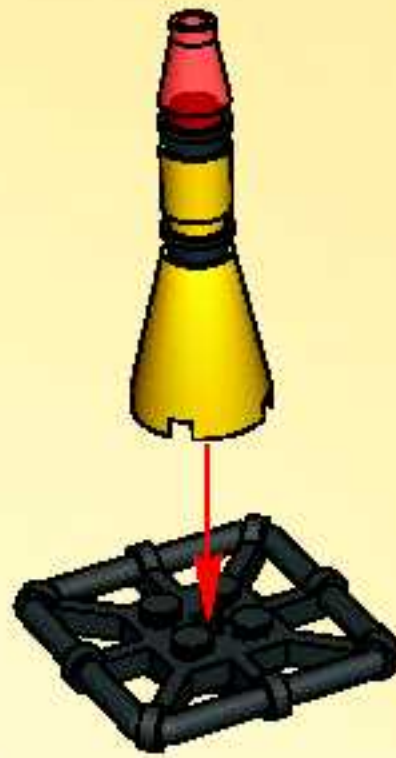

4



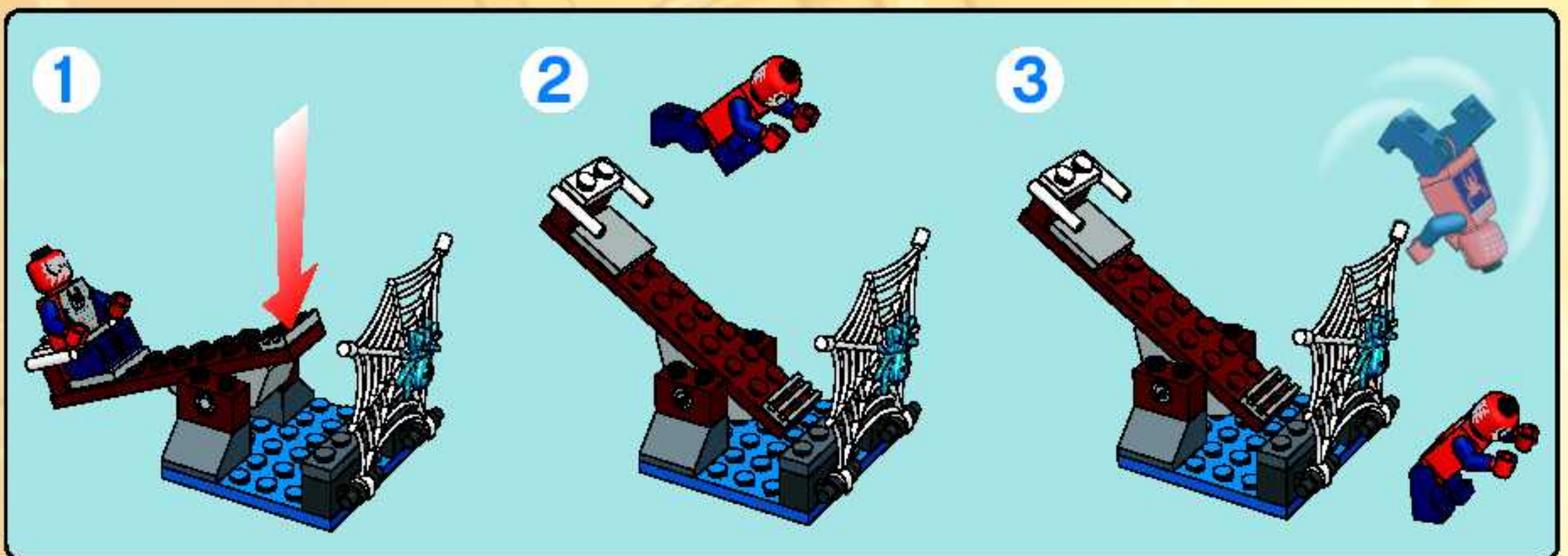
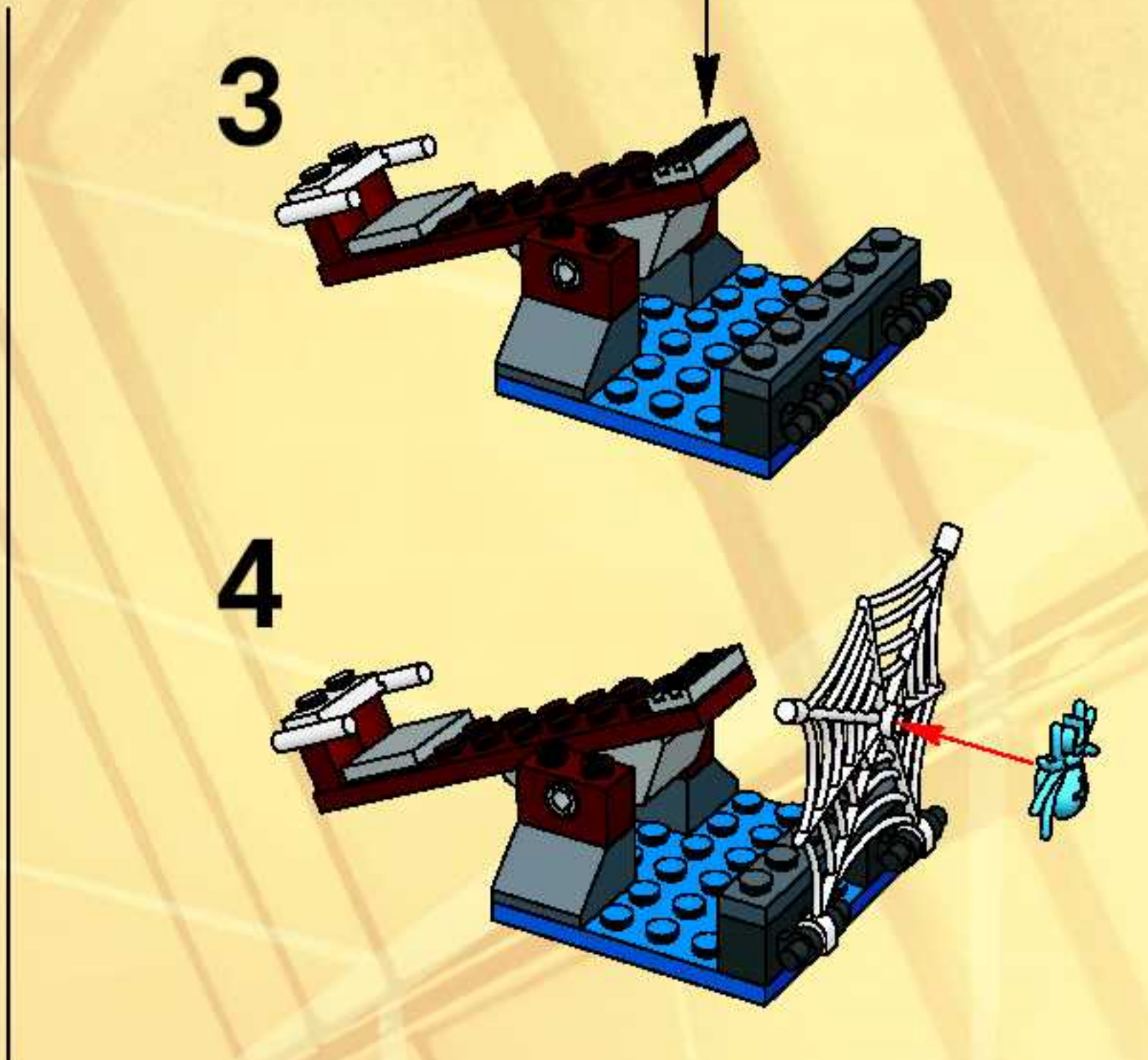
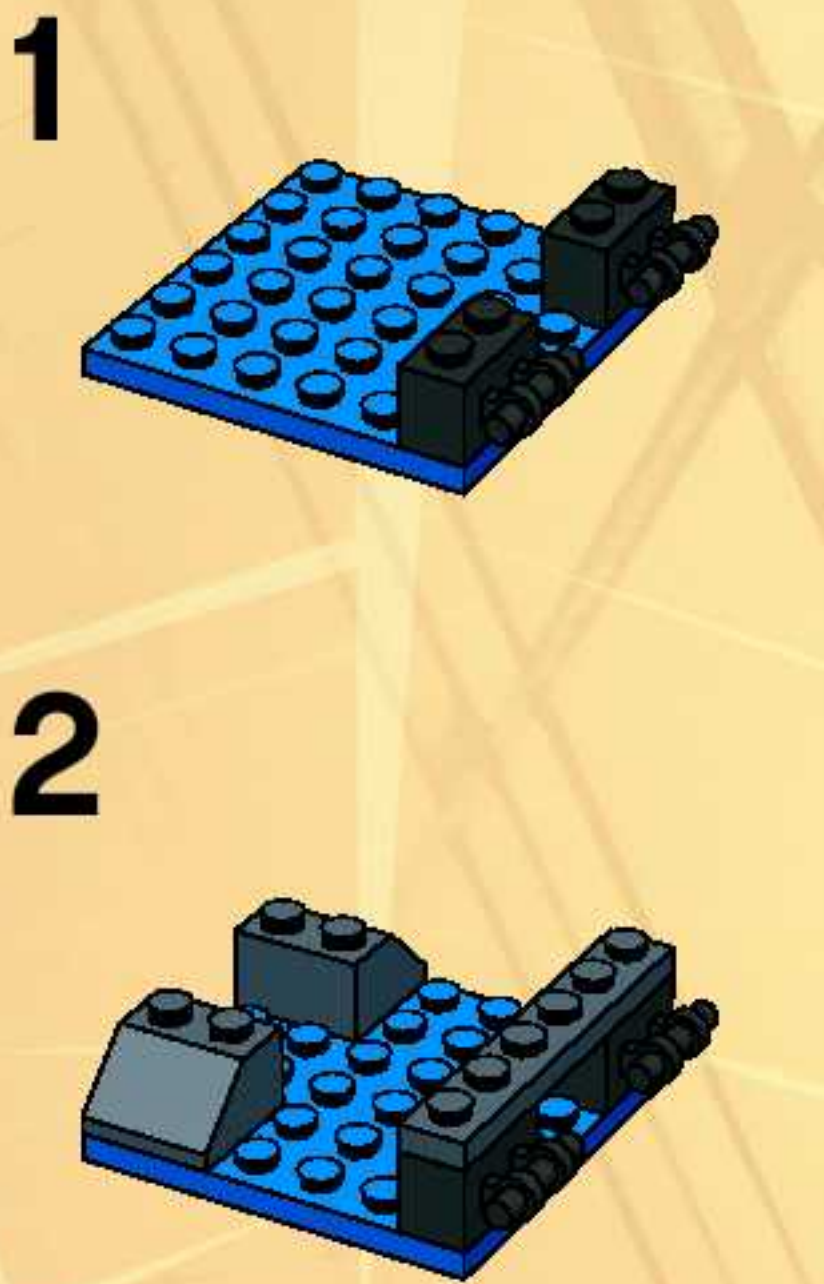
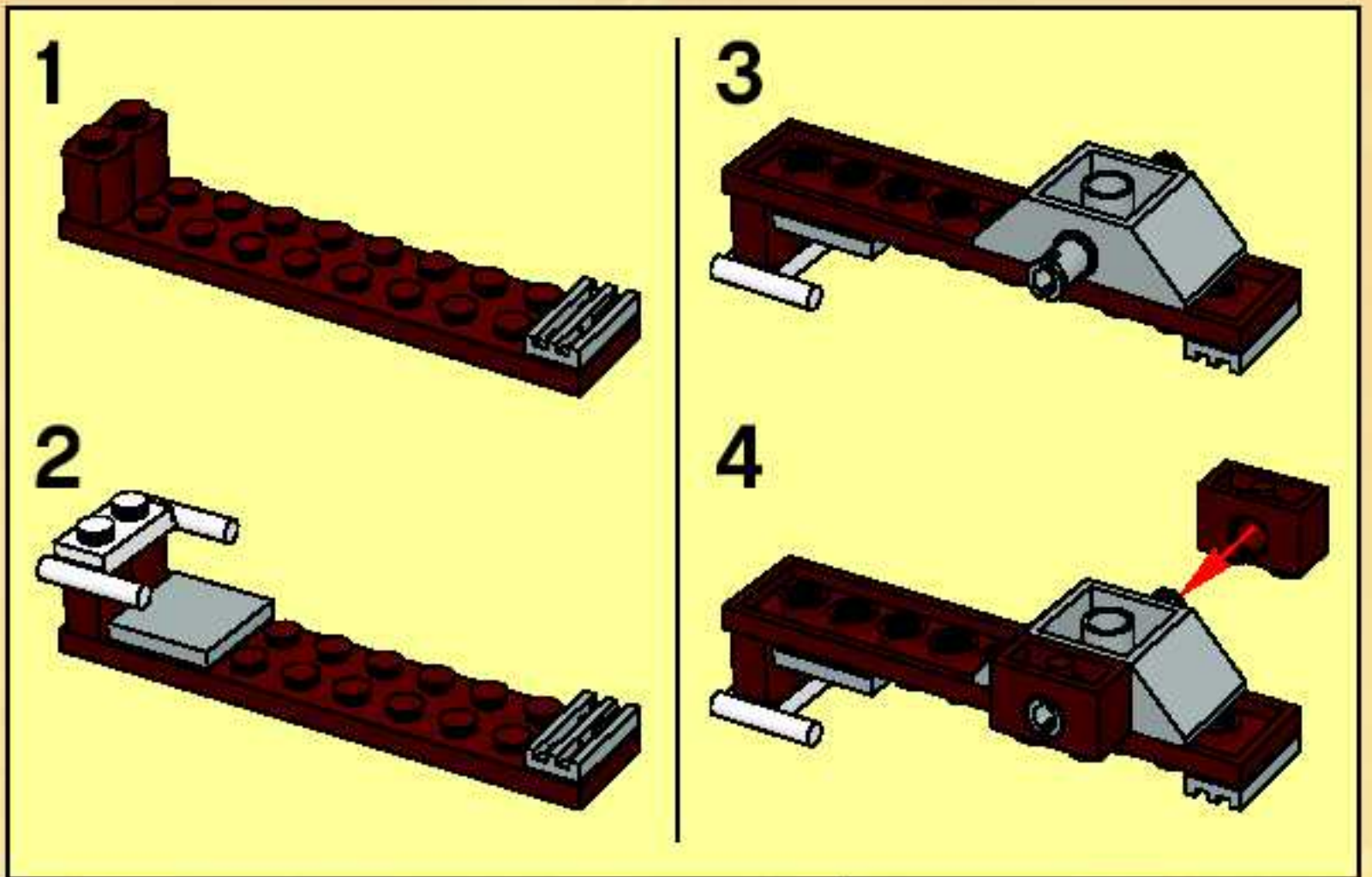

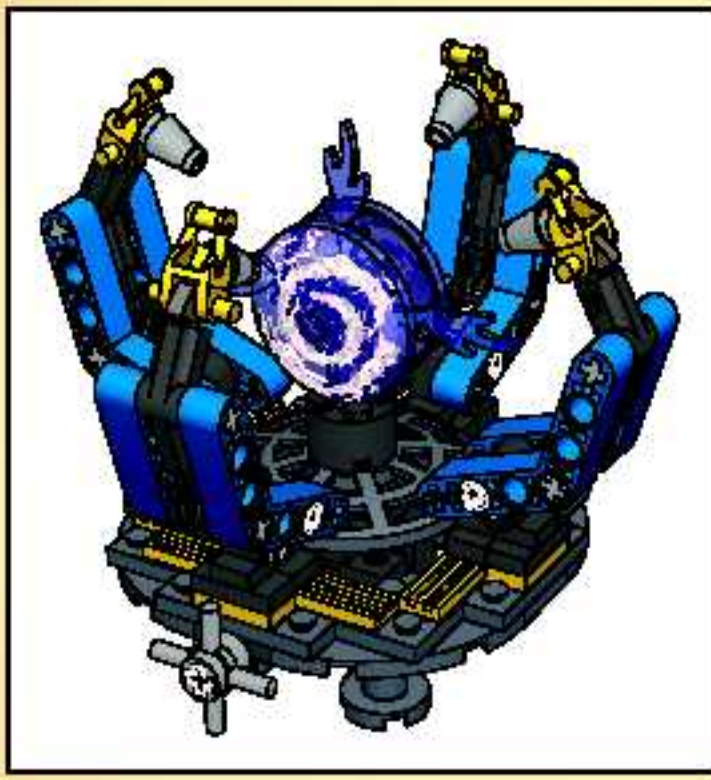

1

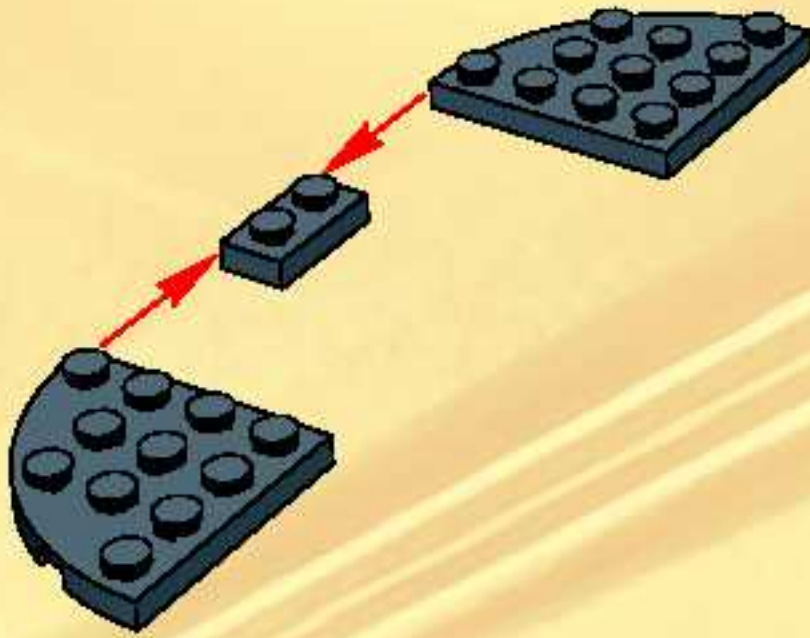

2

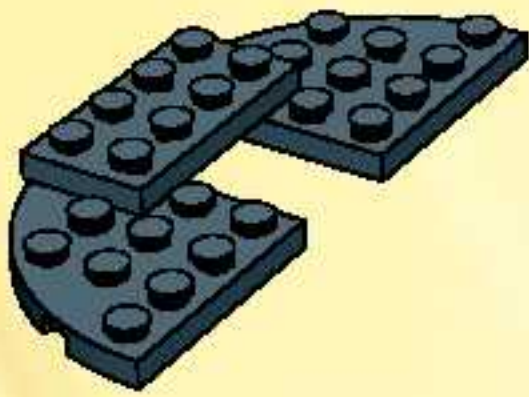

3

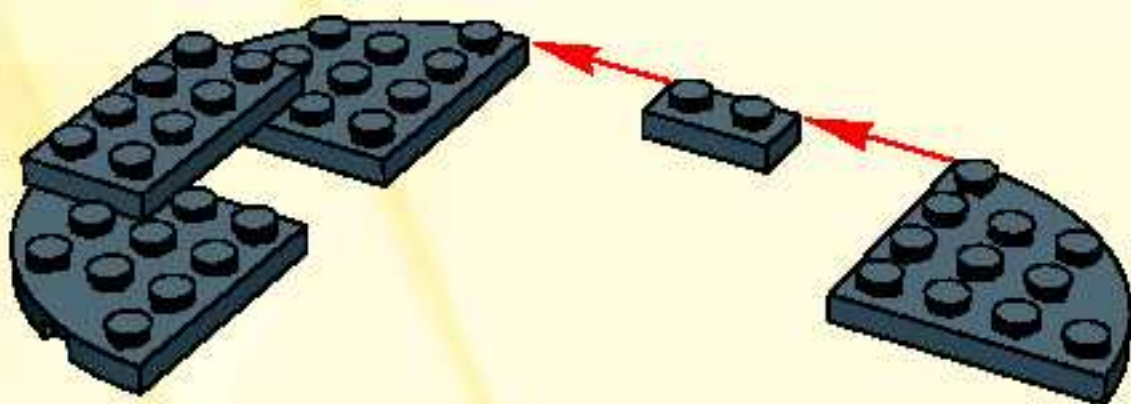

4



5

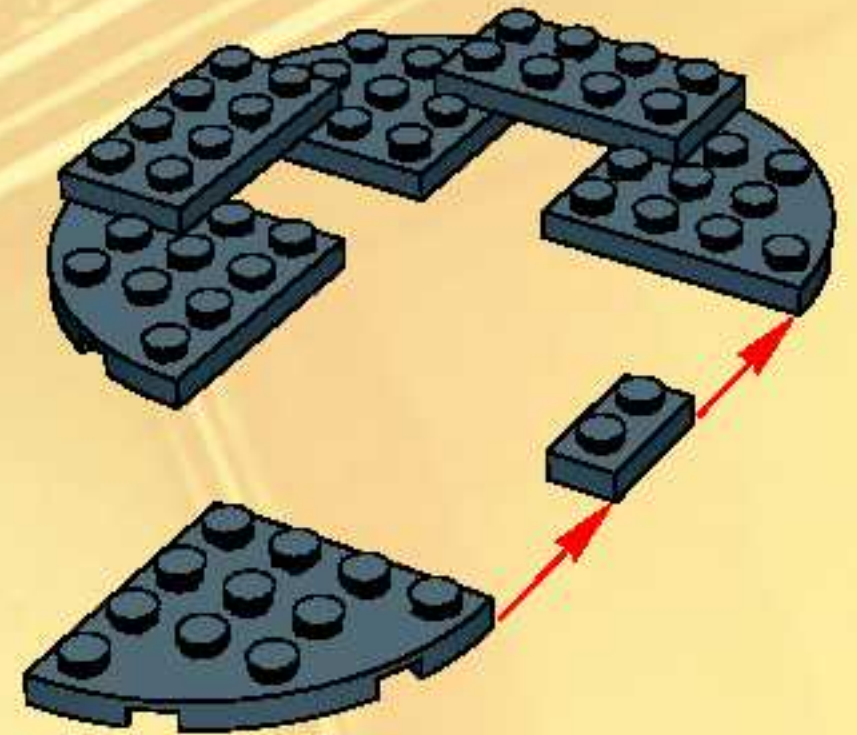

6

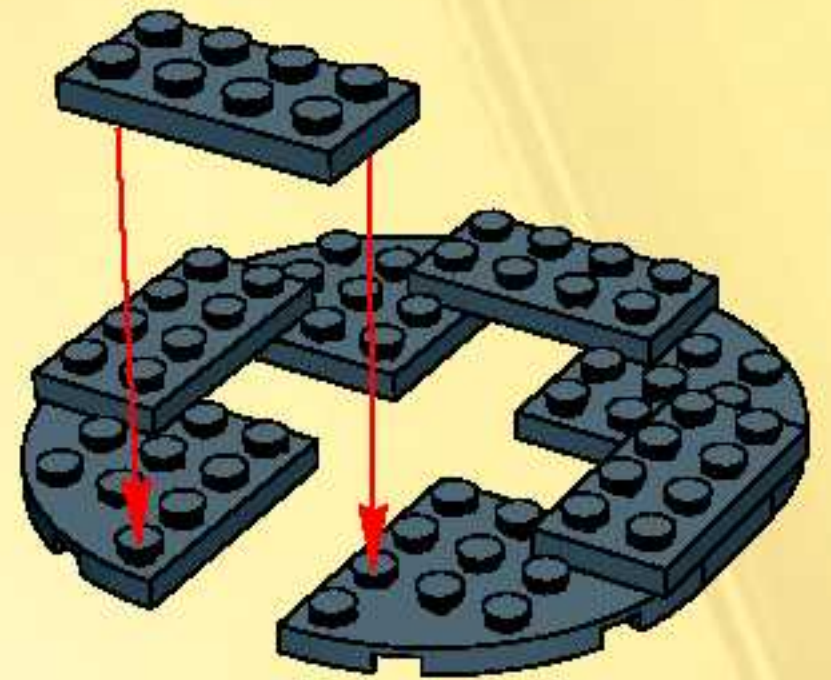

7

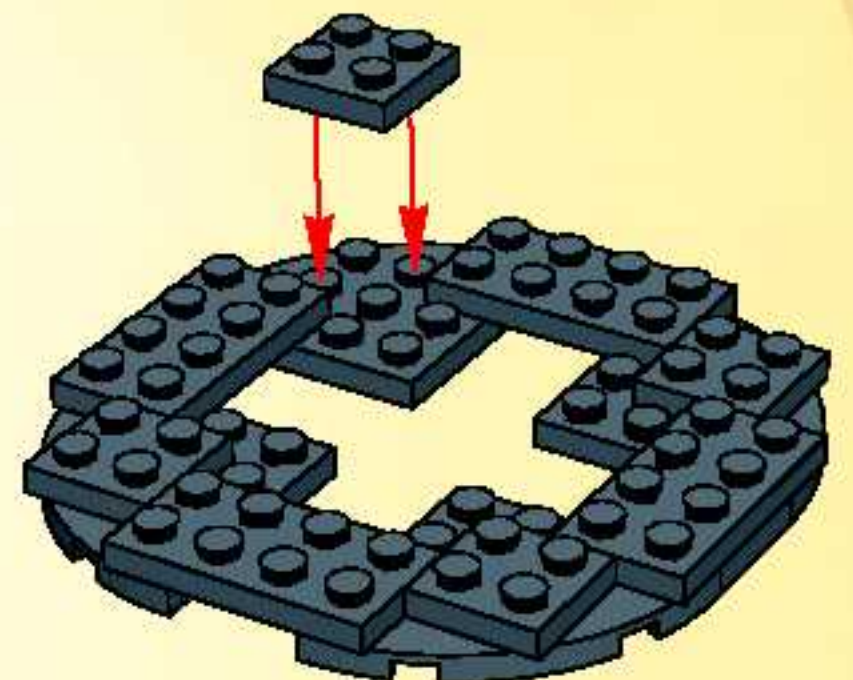

8

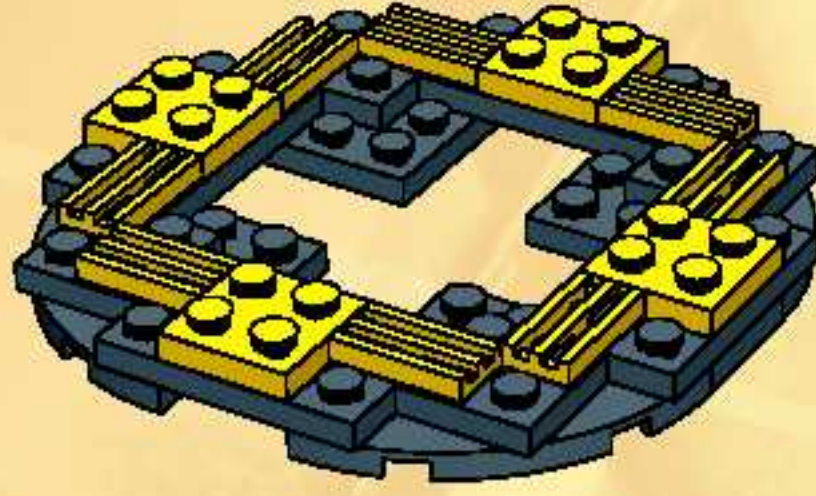

9

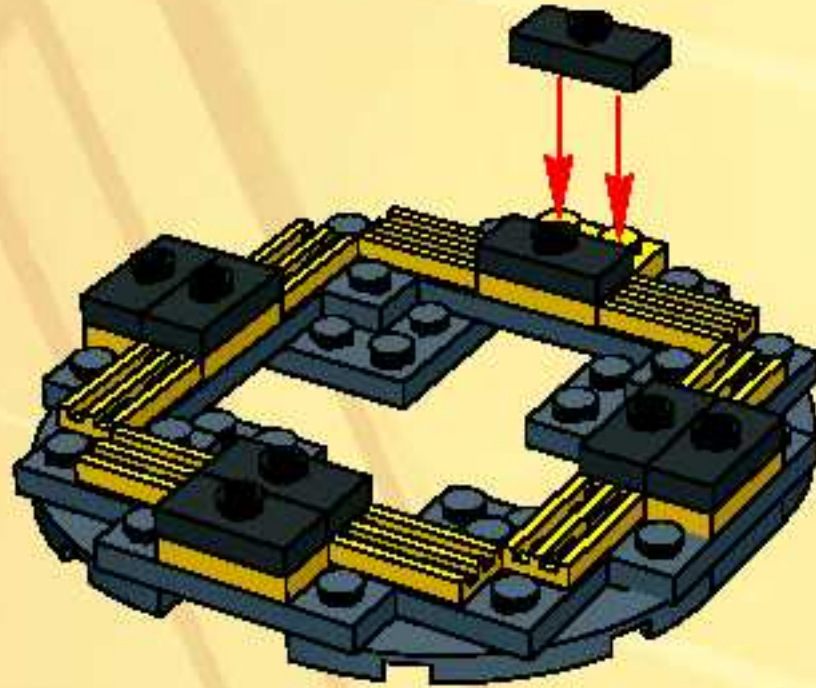

10



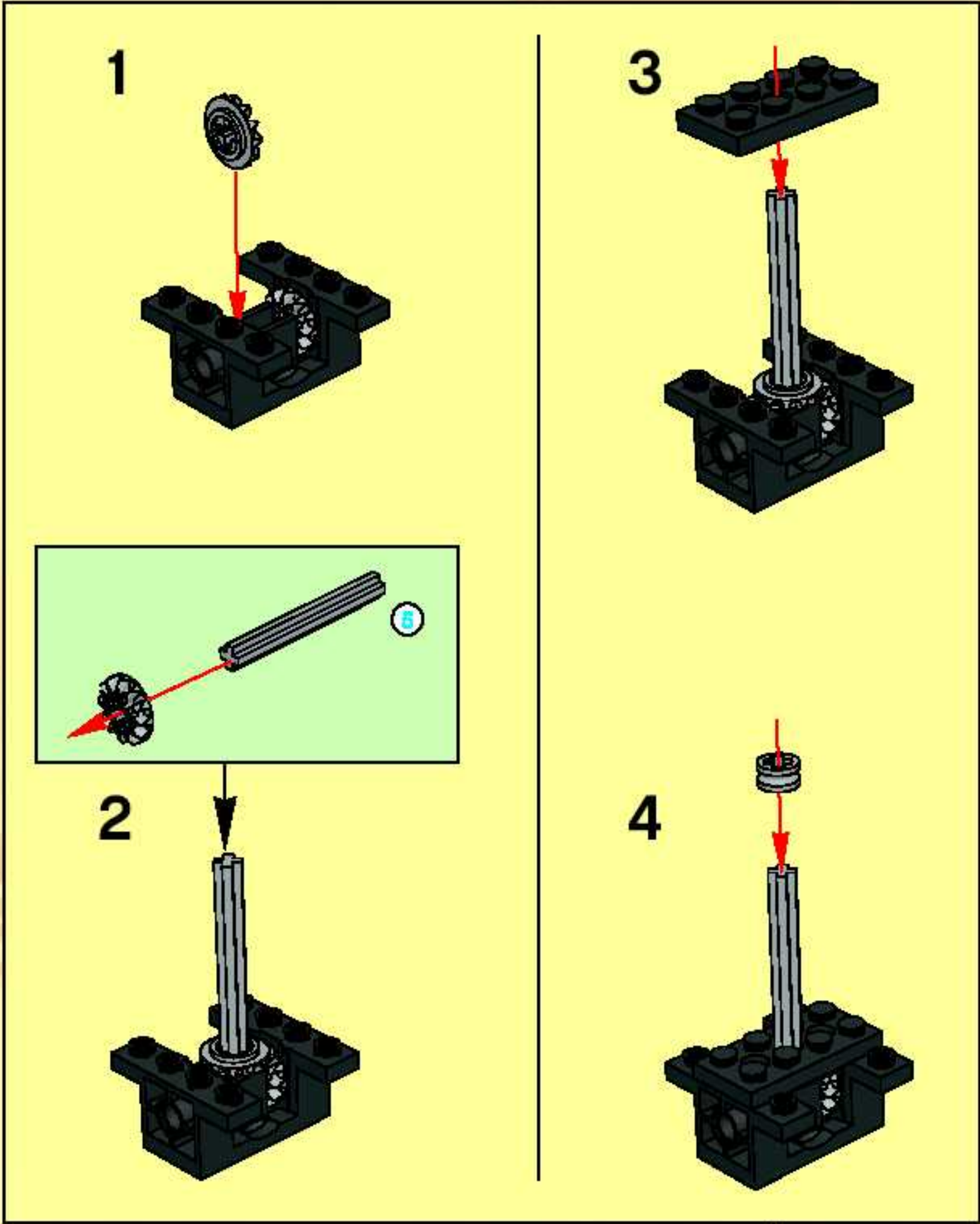

11

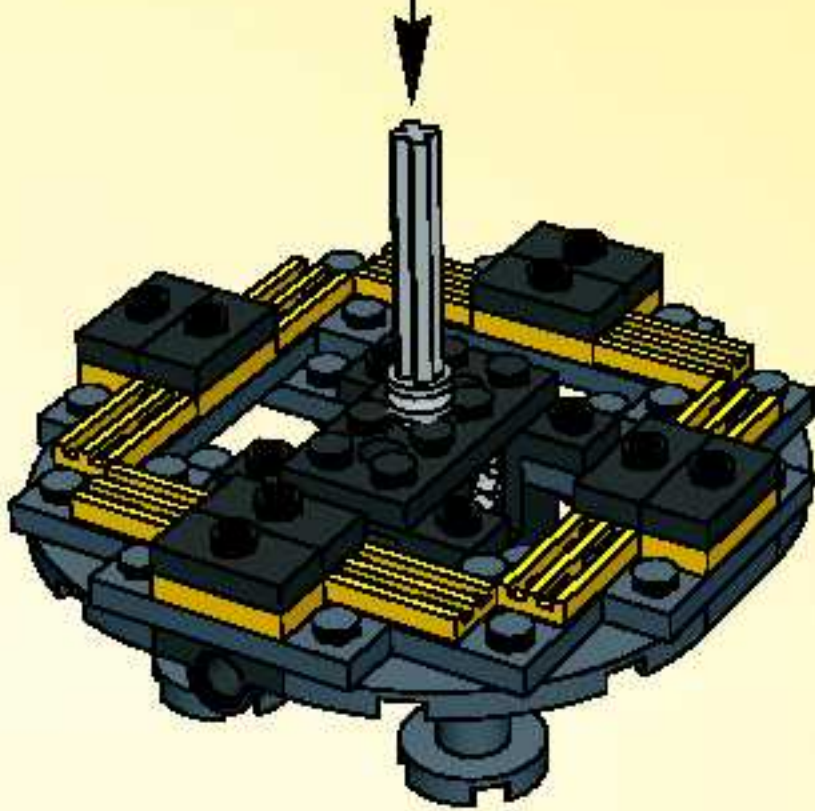

12

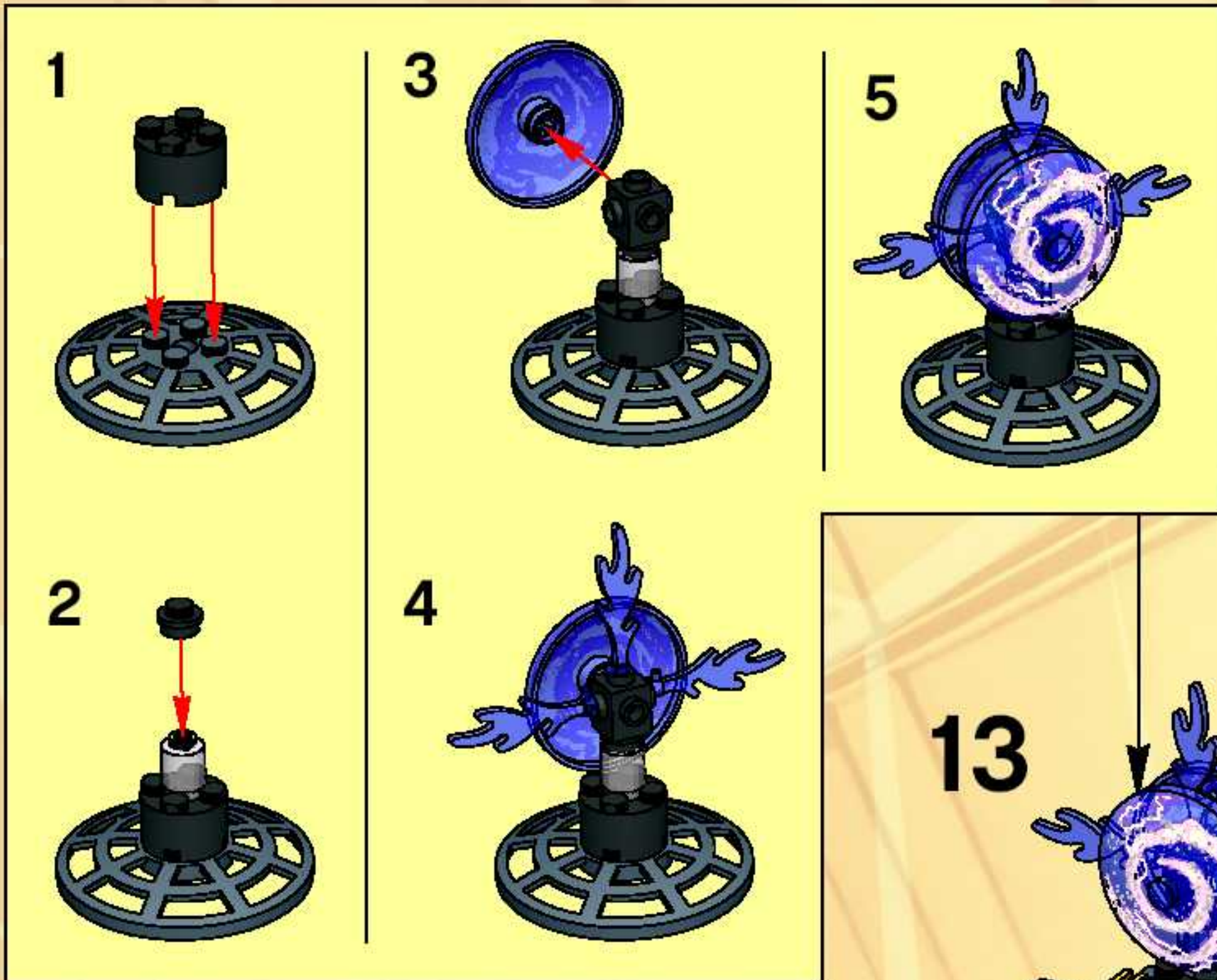
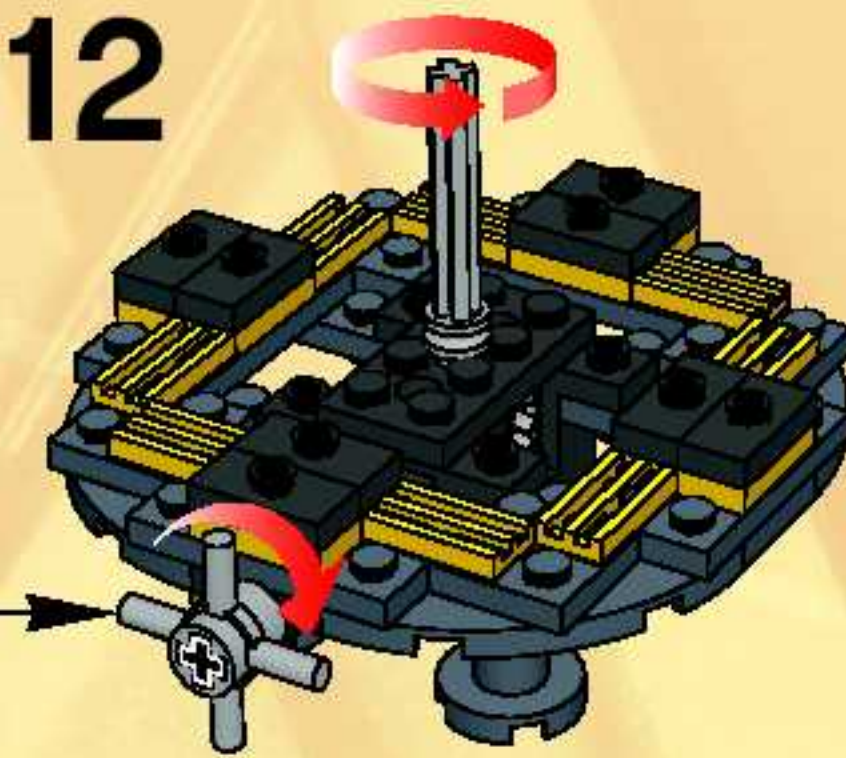
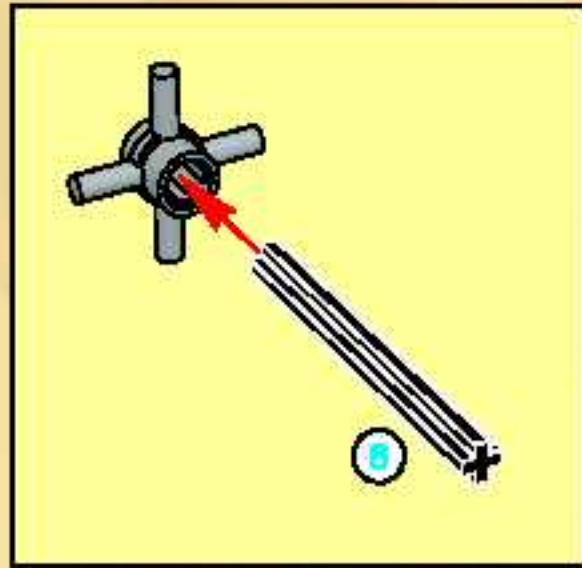

13

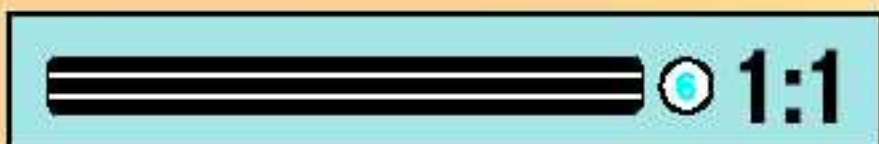

1

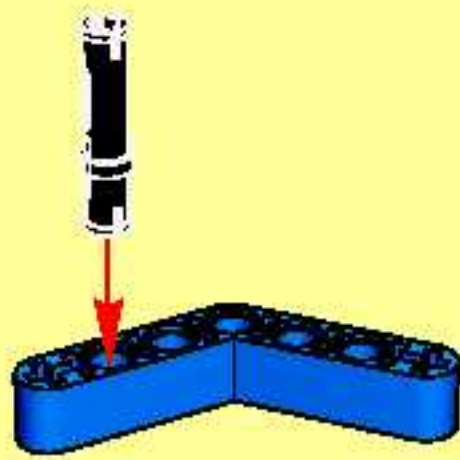

2

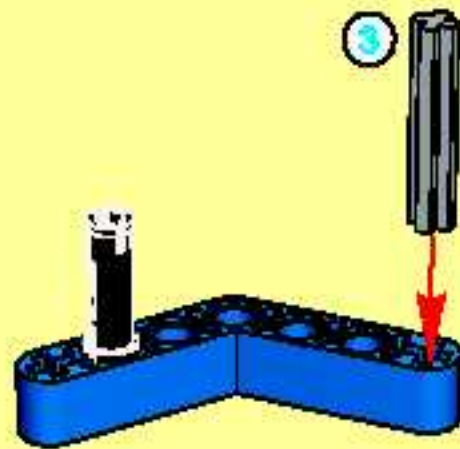

3

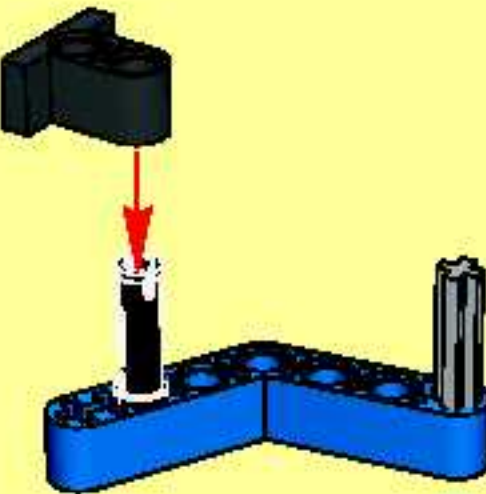

1

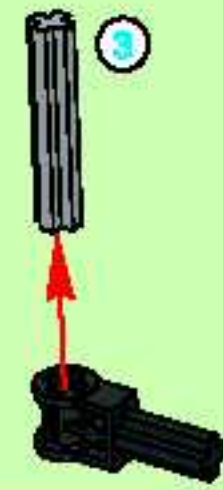

2

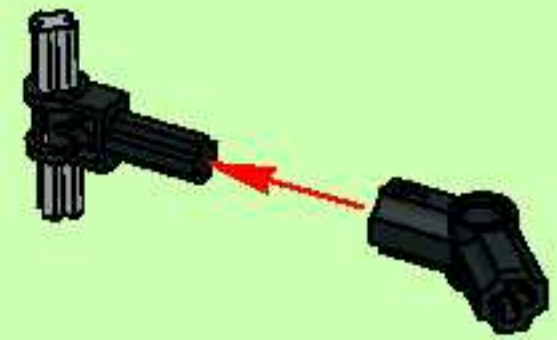

4

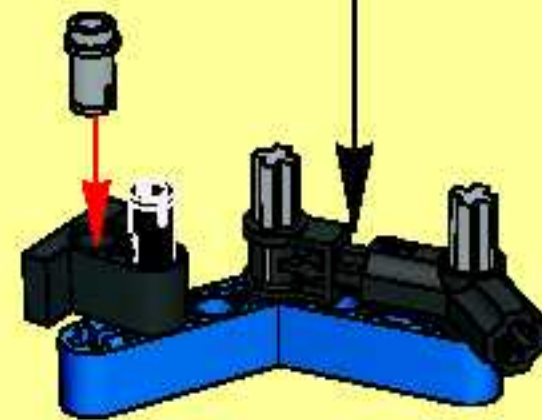

5

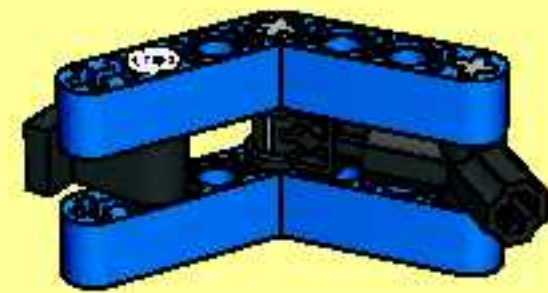

4x

14

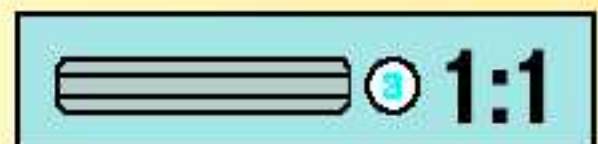
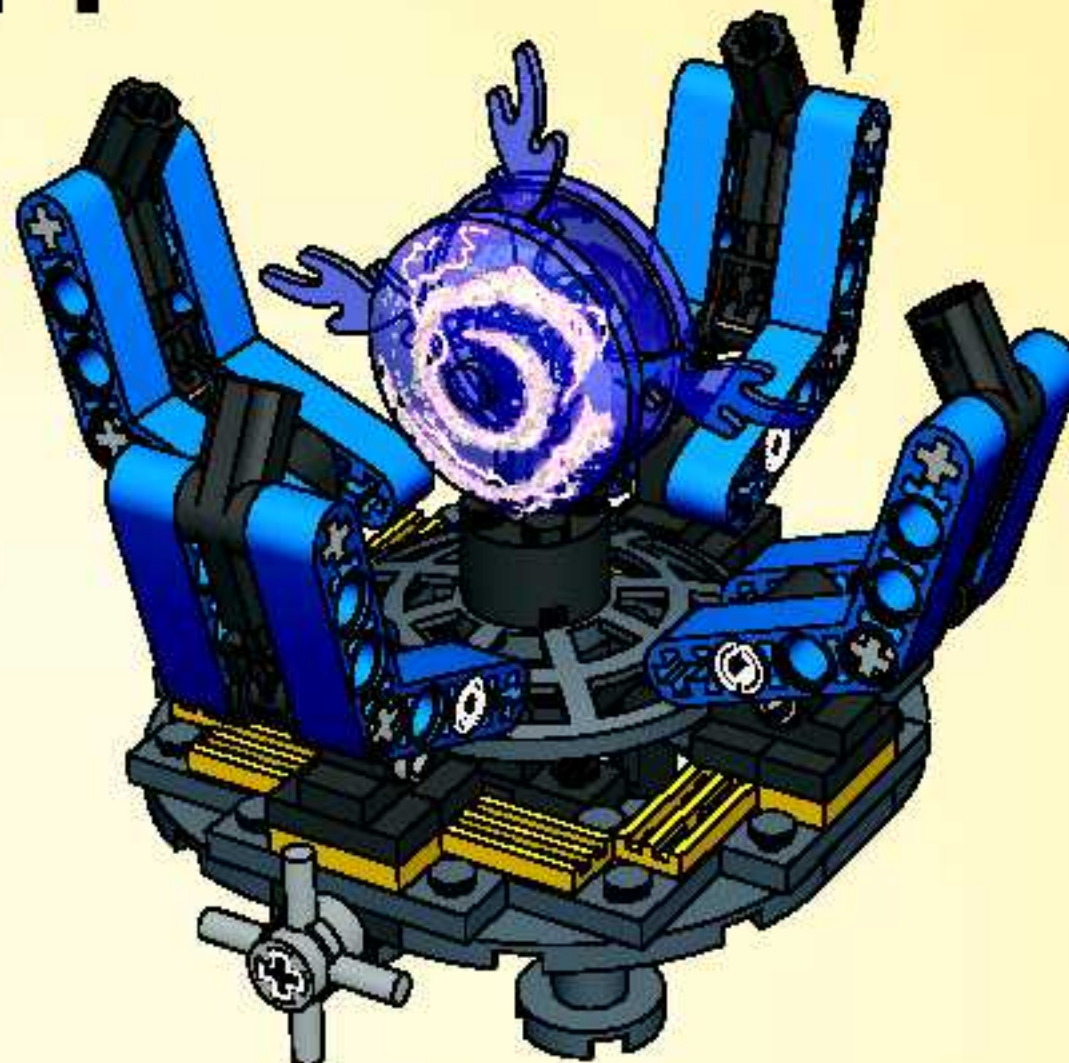

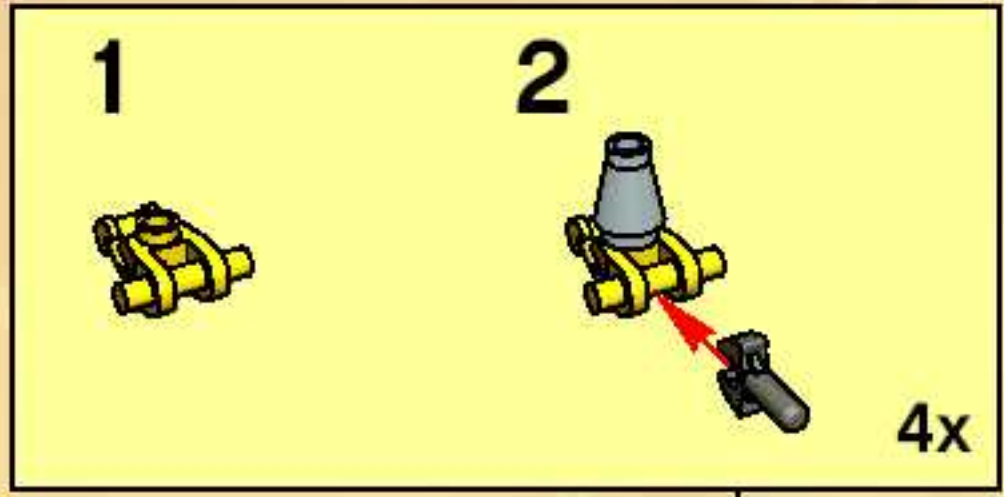

15



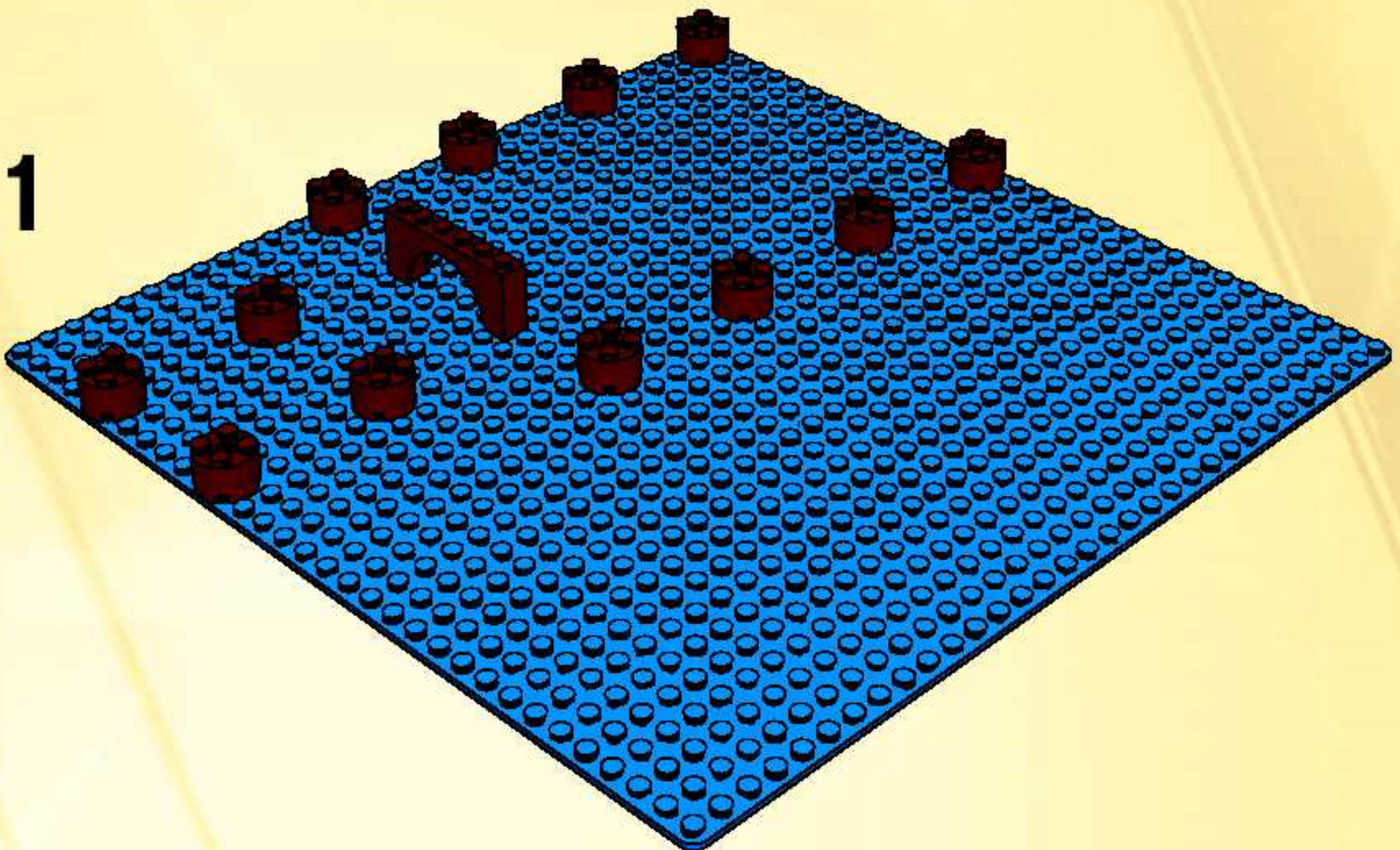
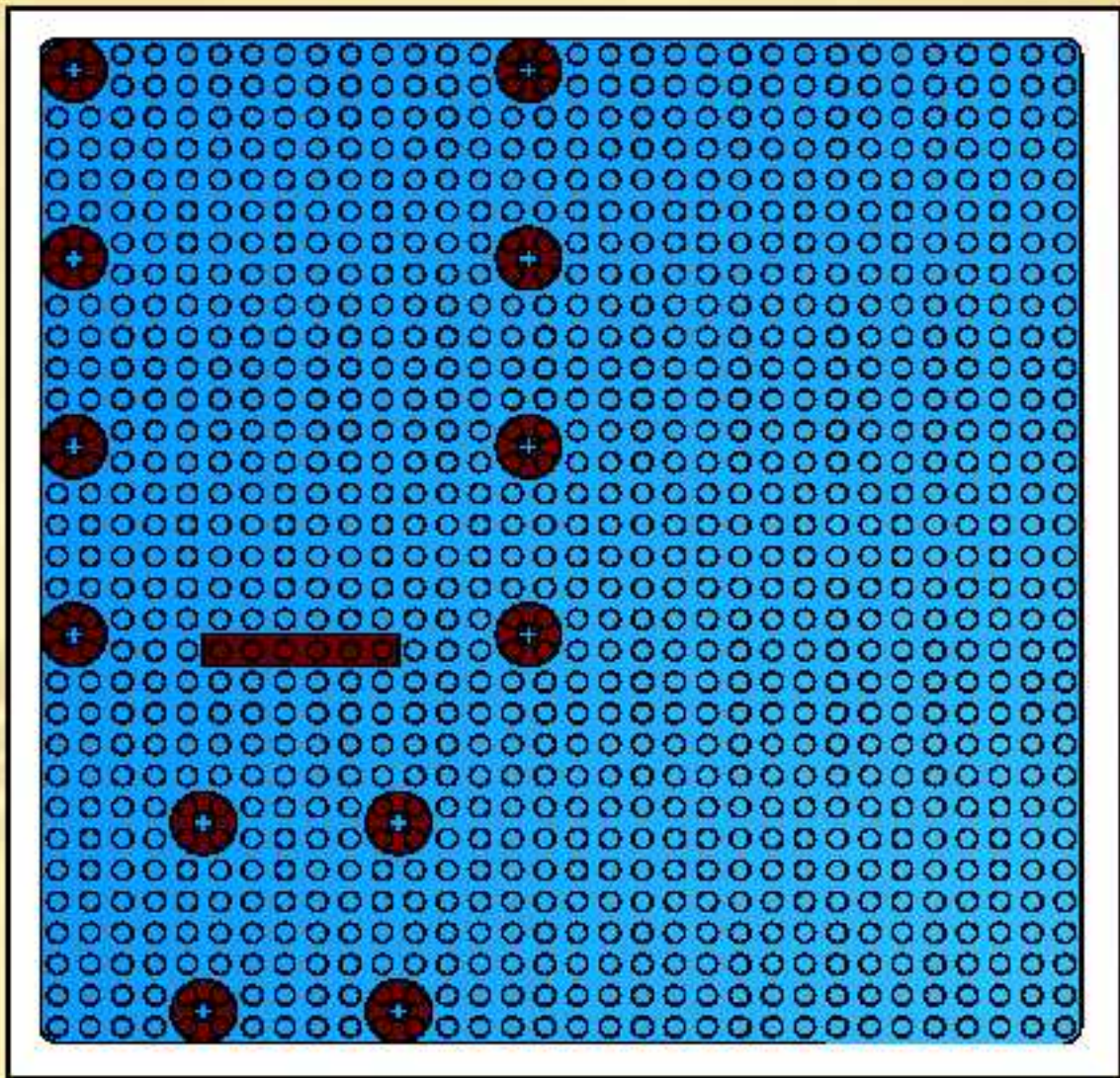
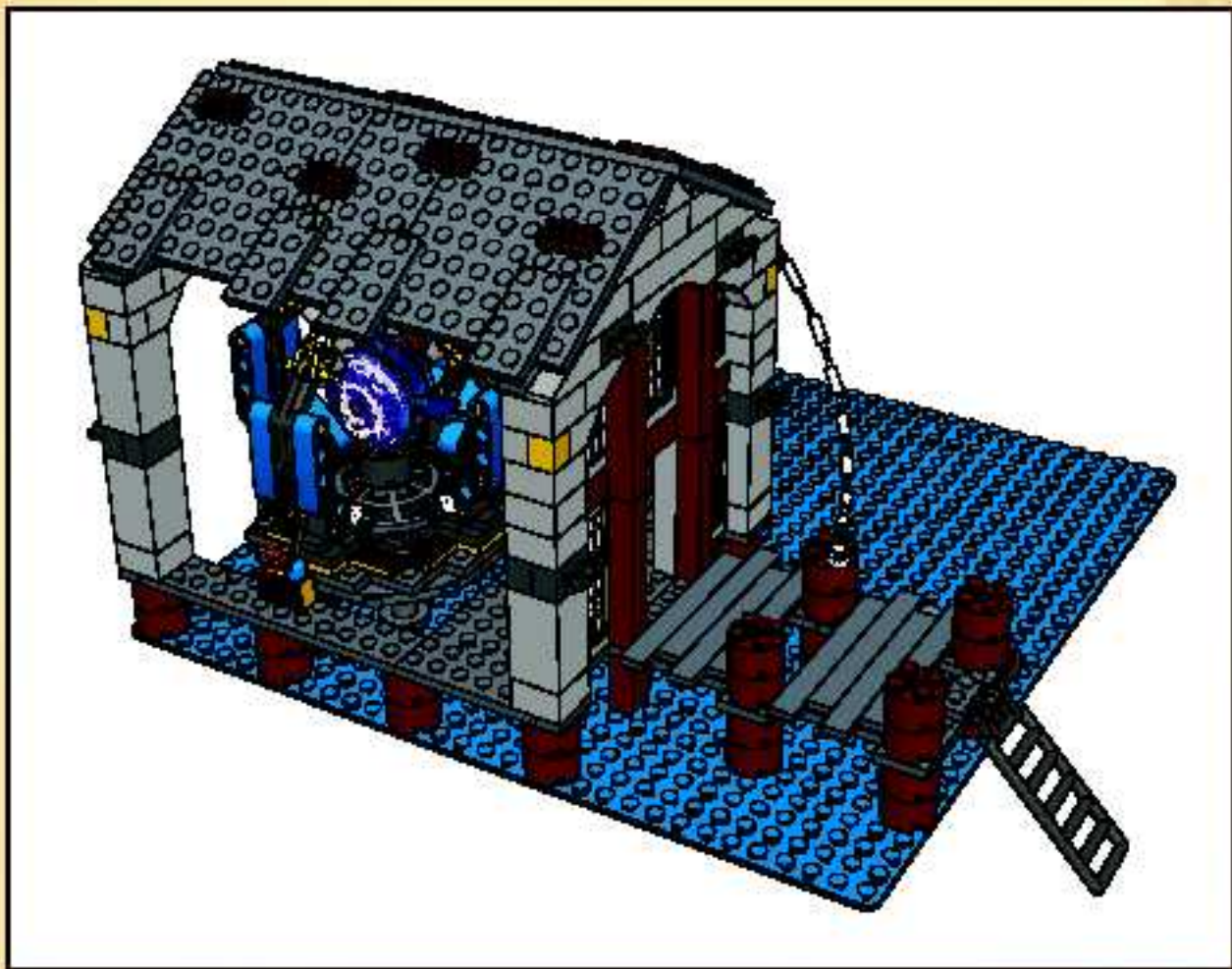

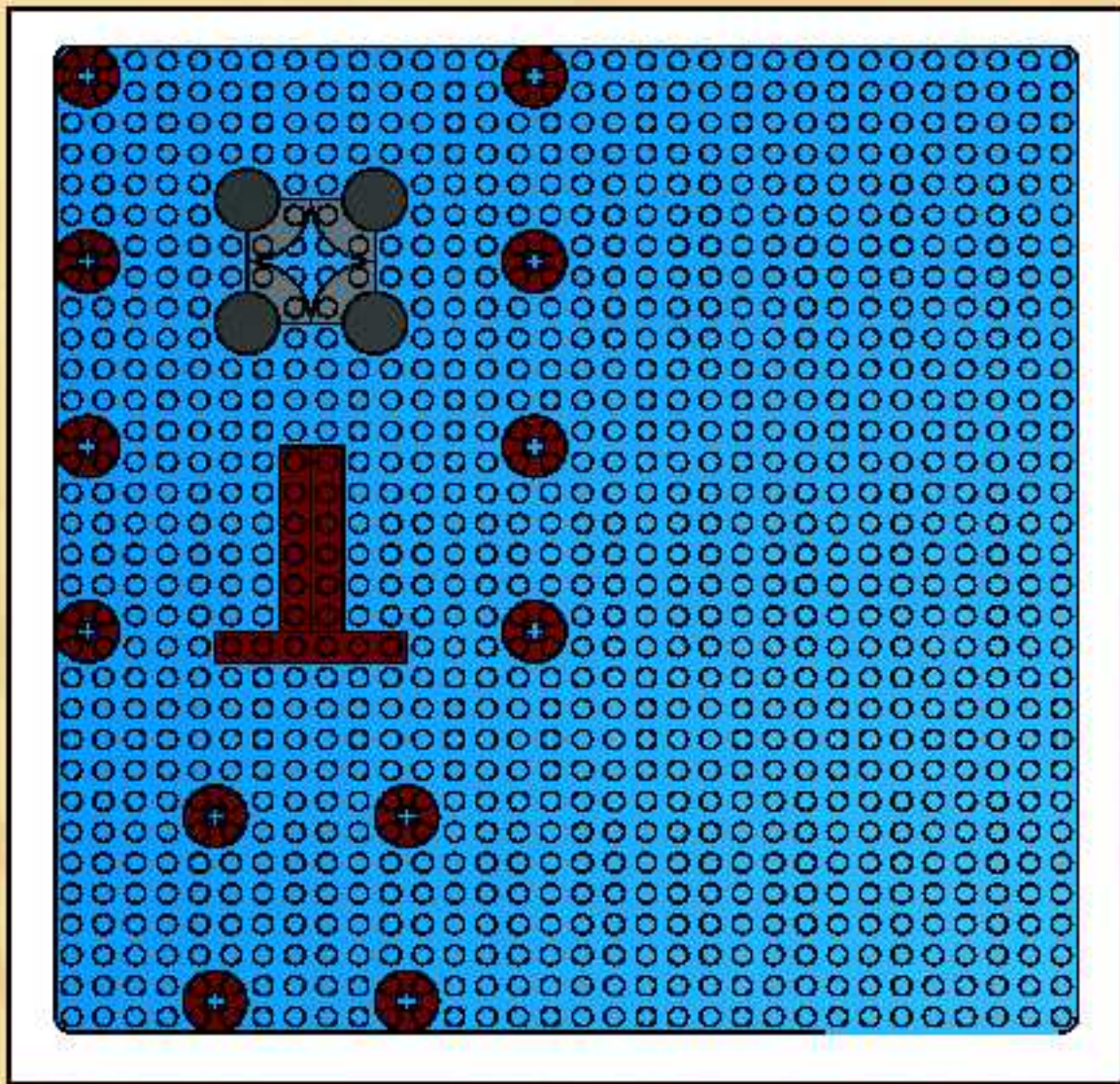

2

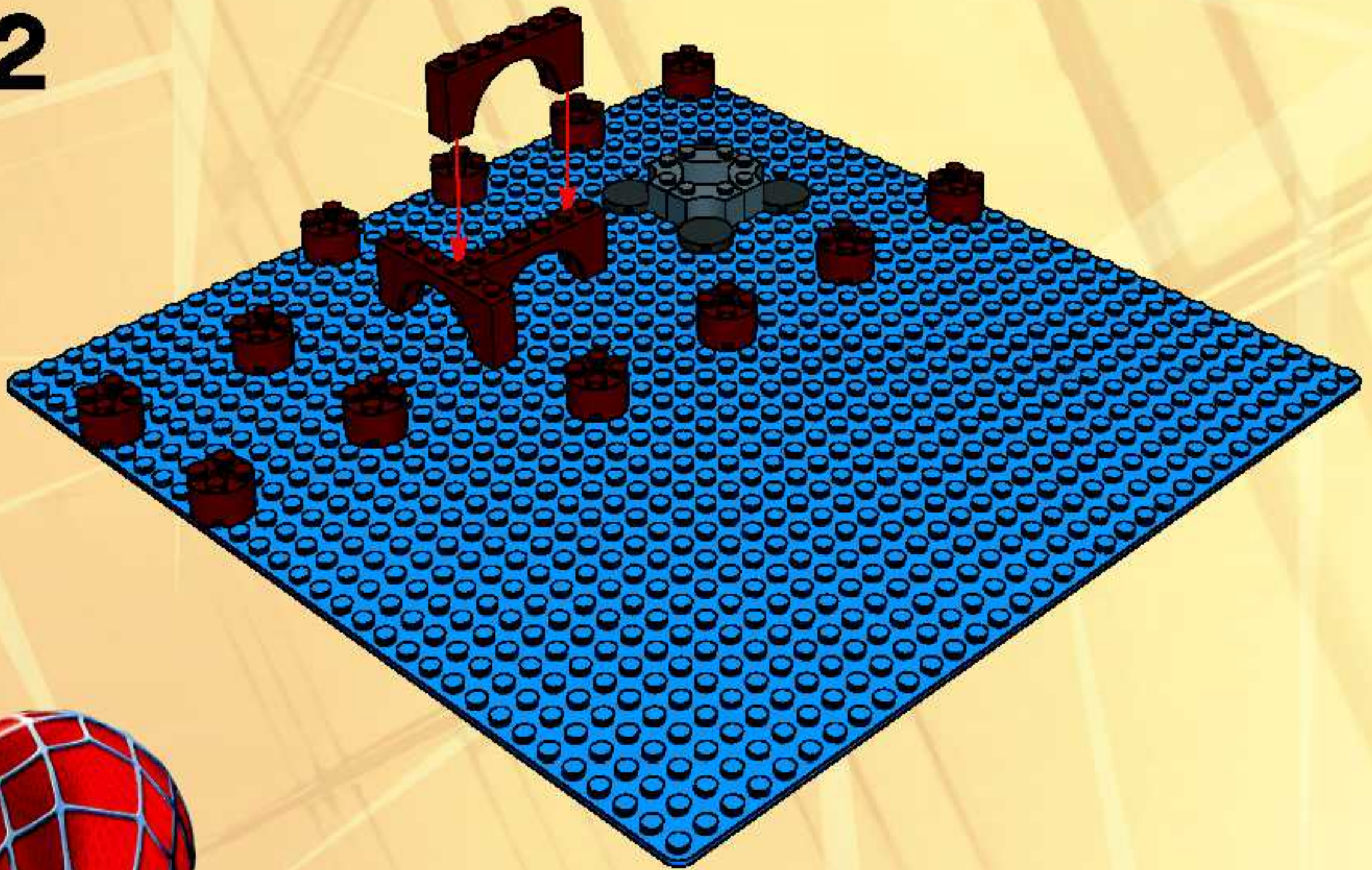

3

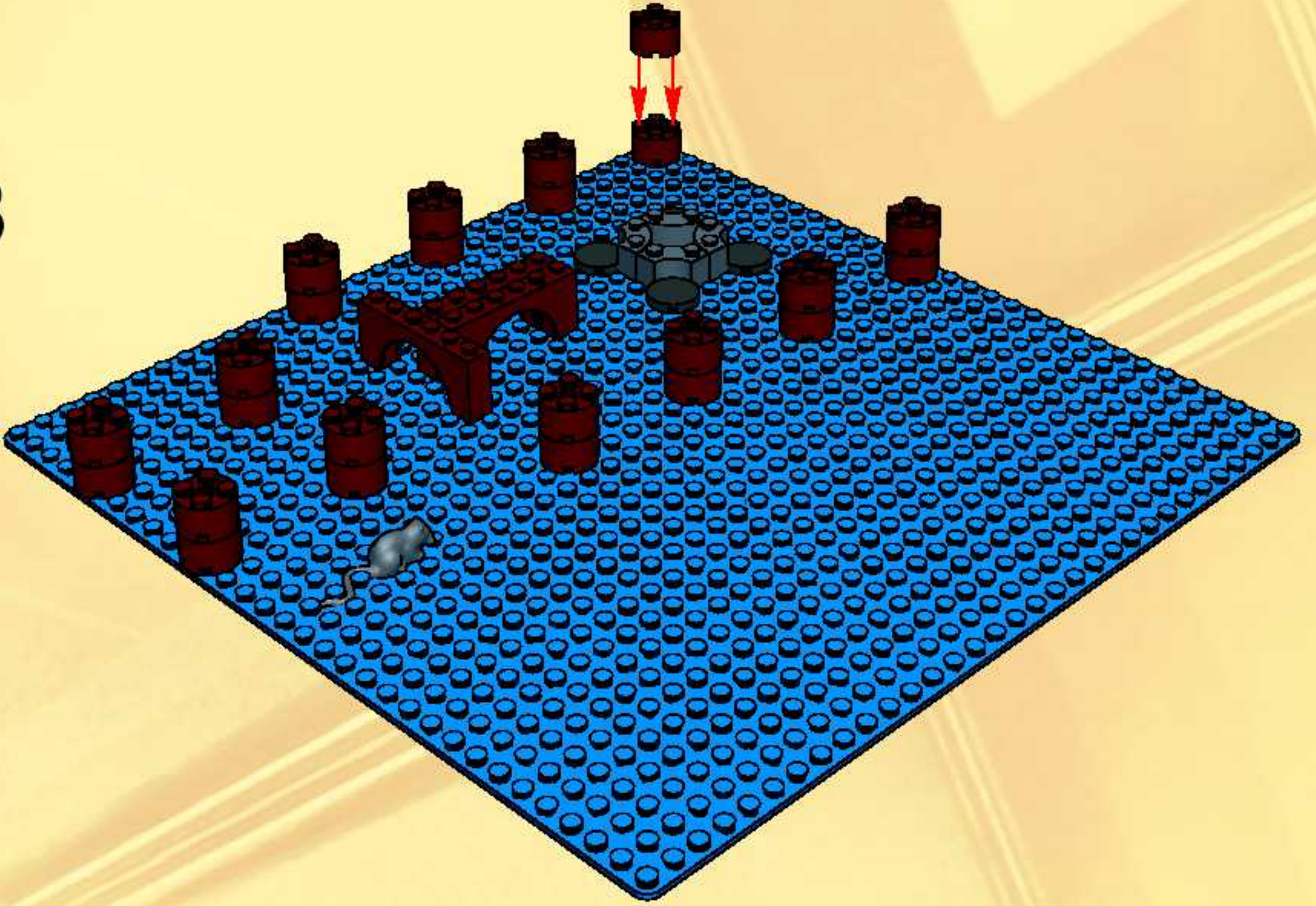

4

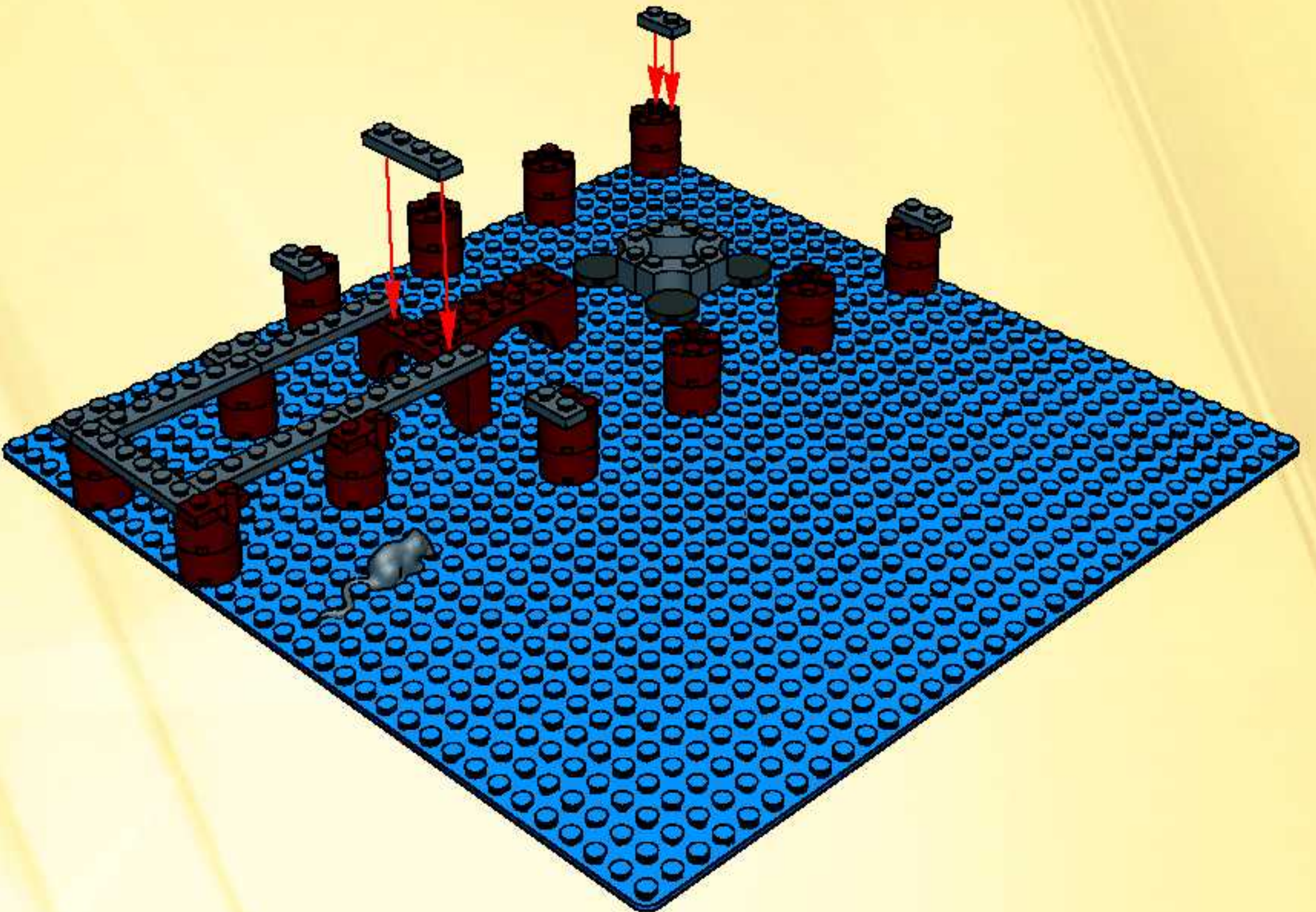

5

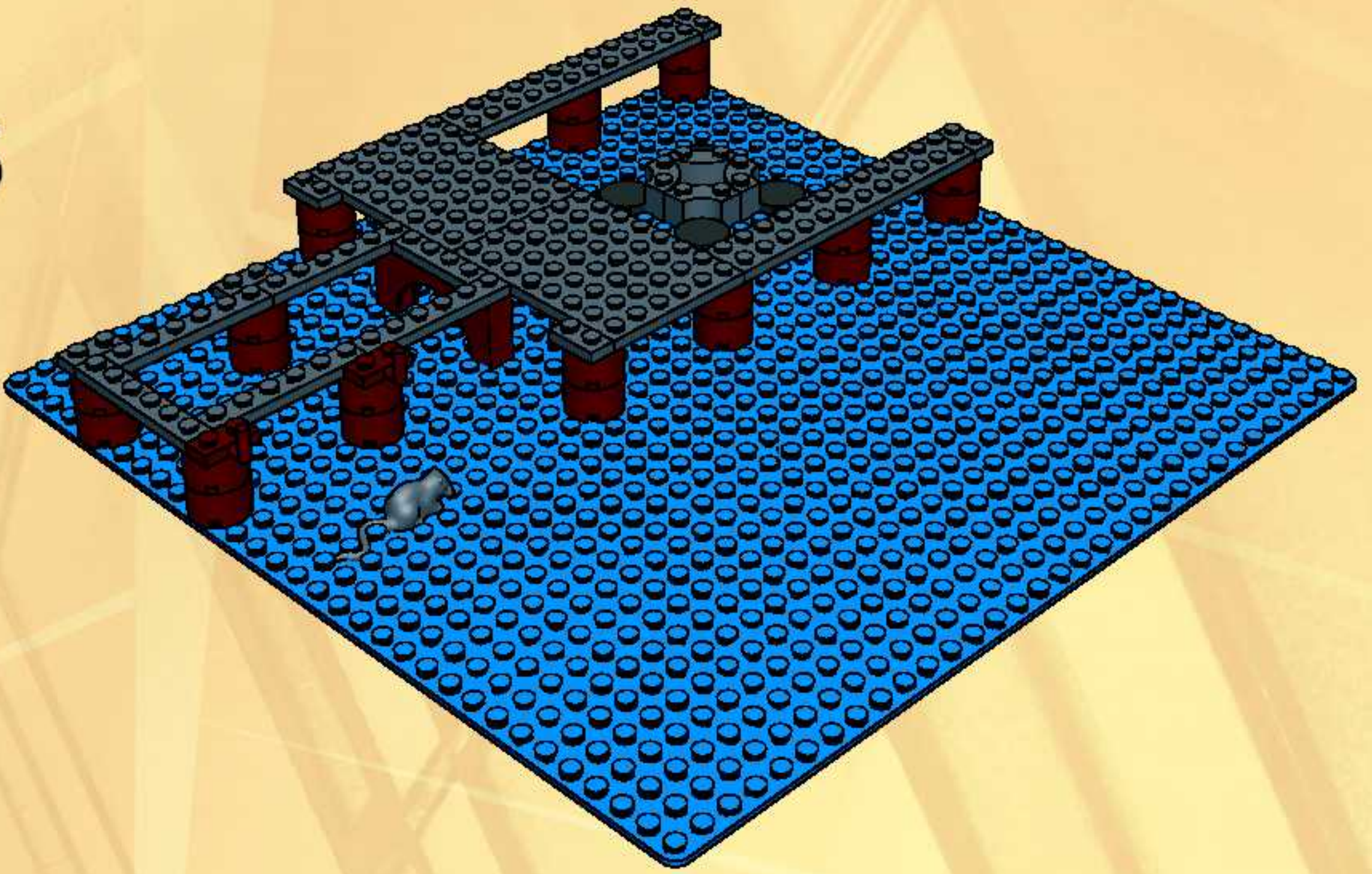

6

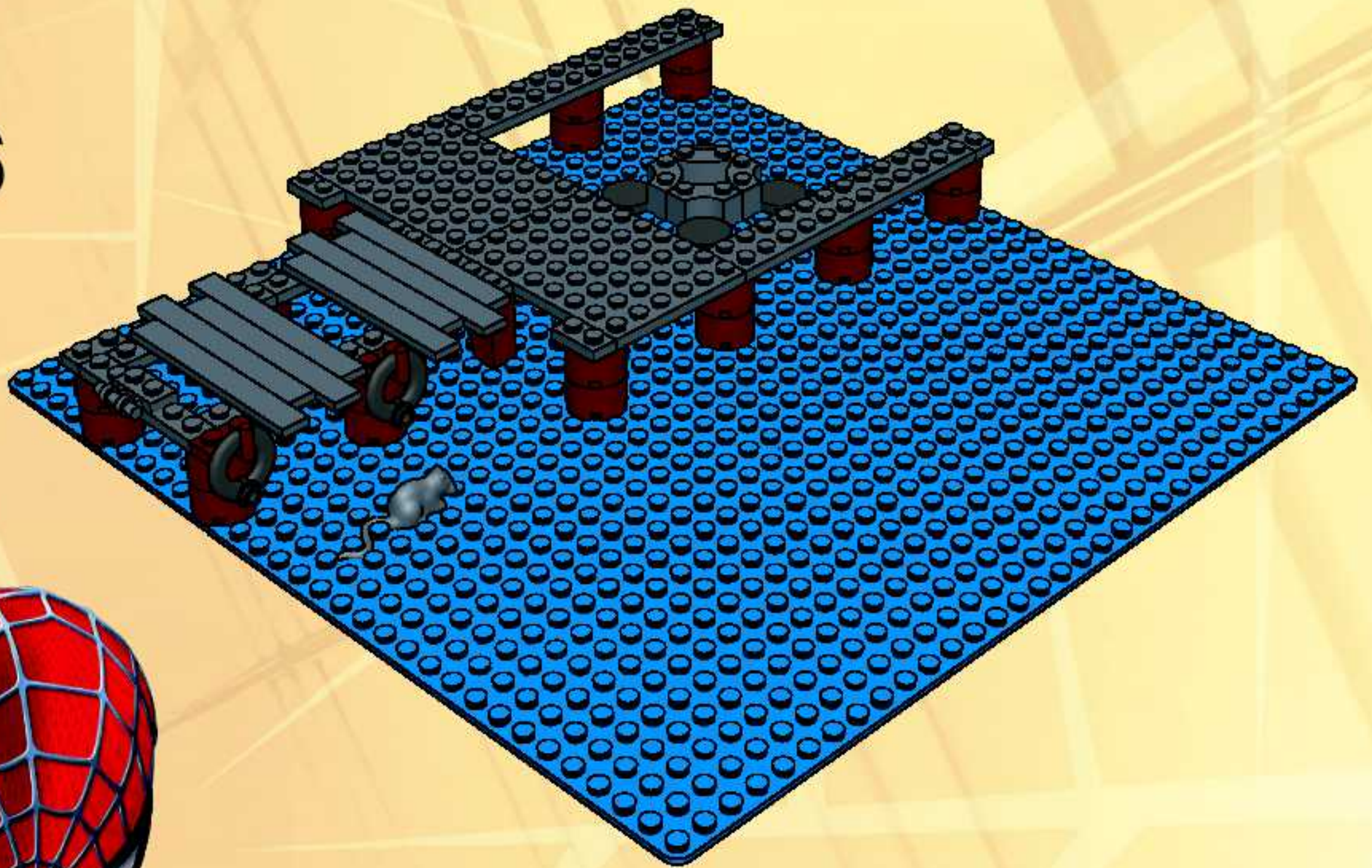

7

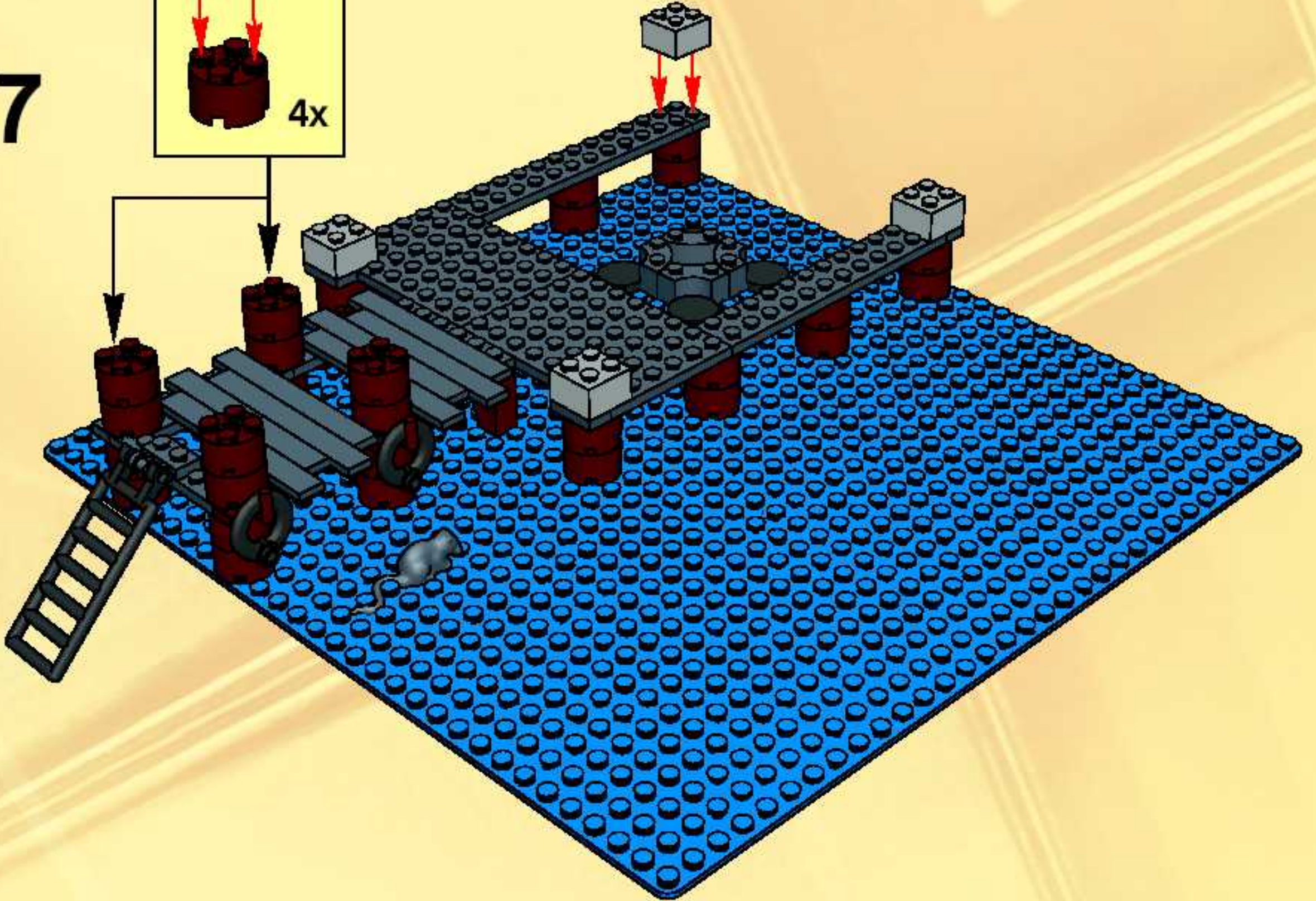
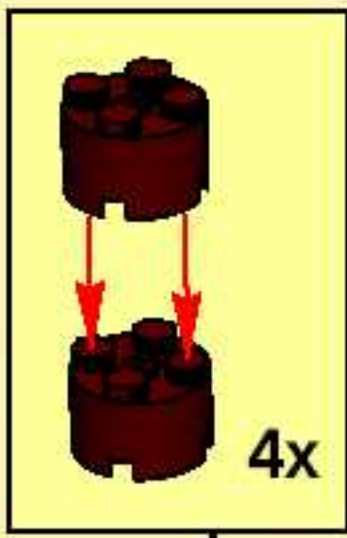

8

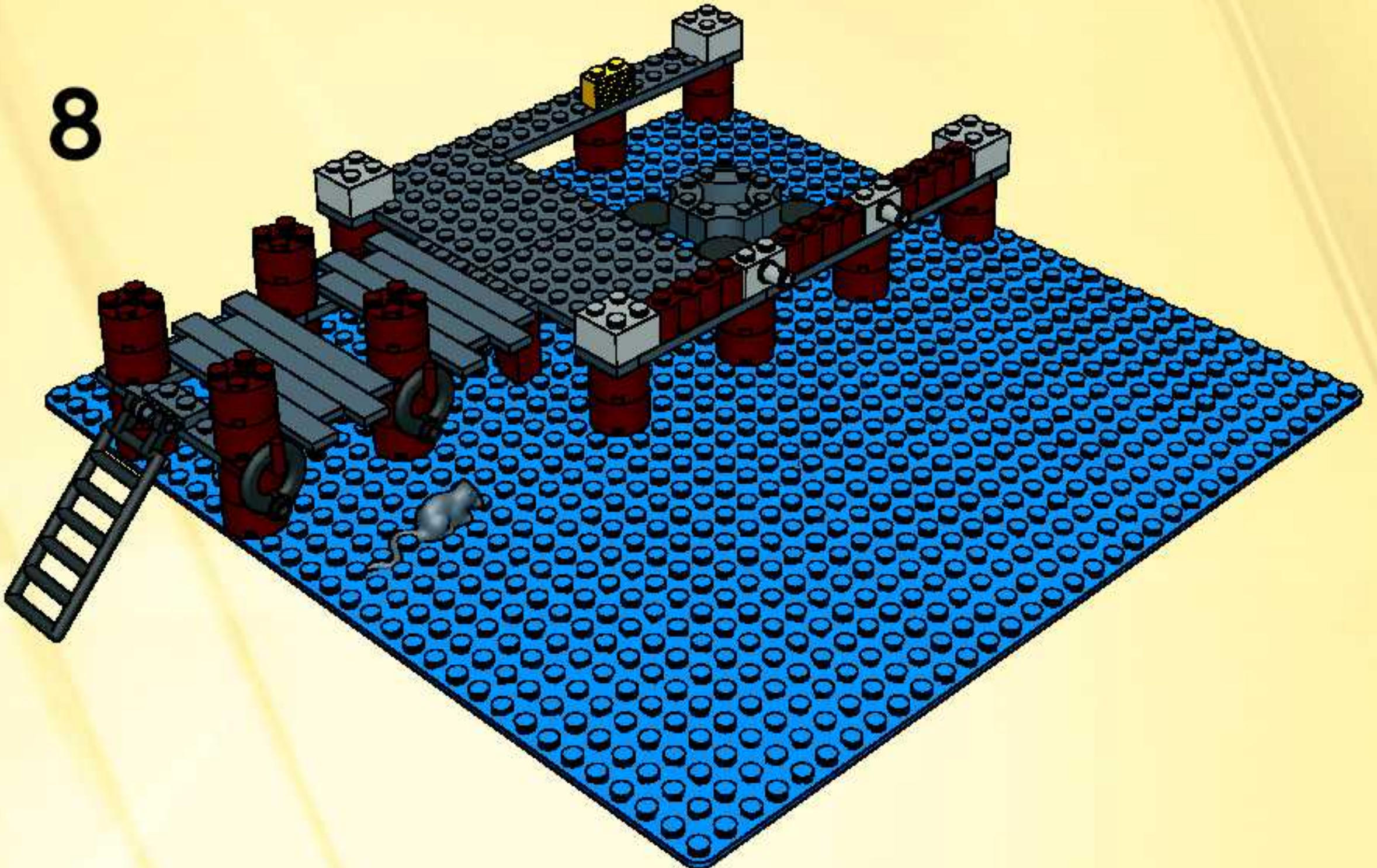

9

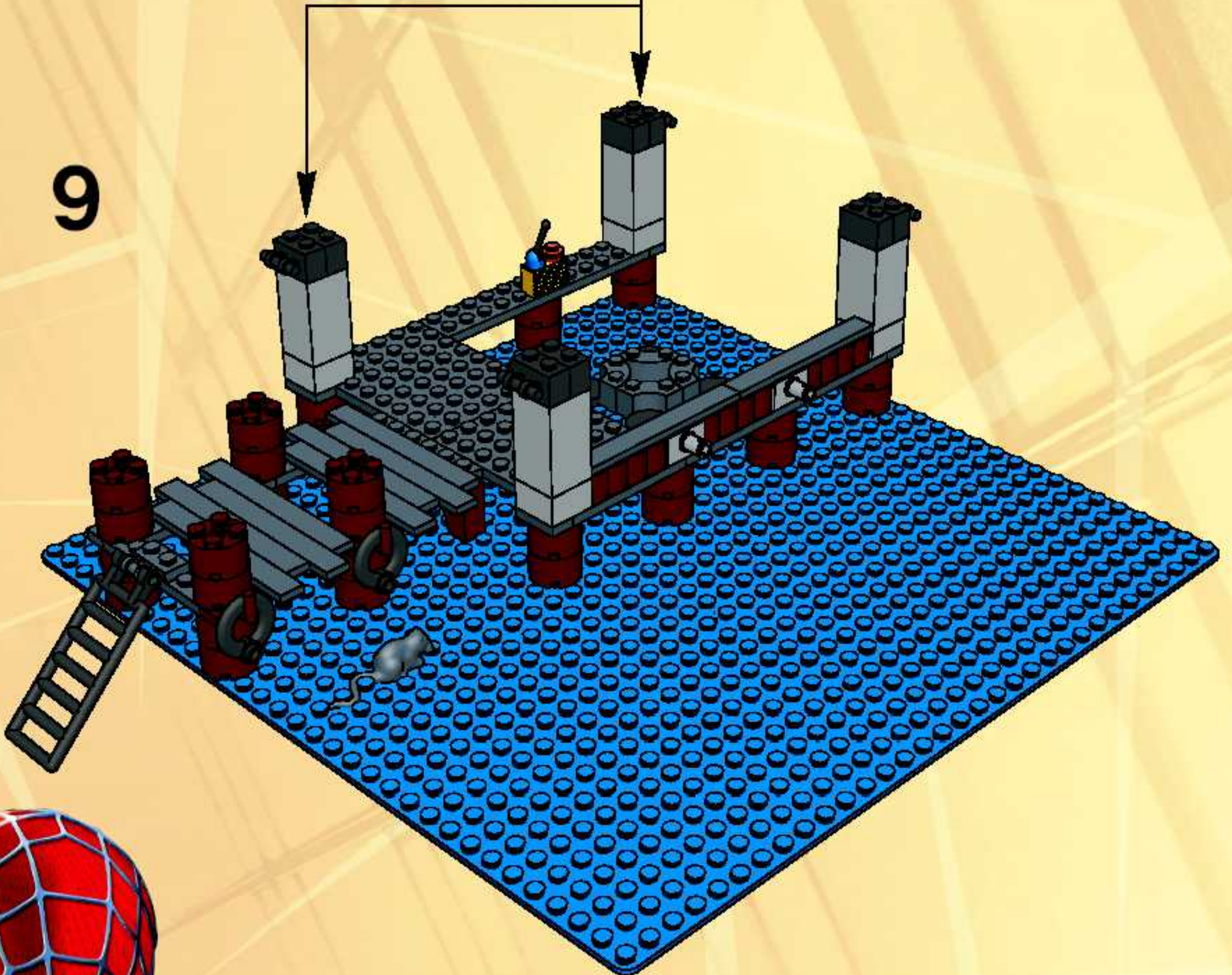
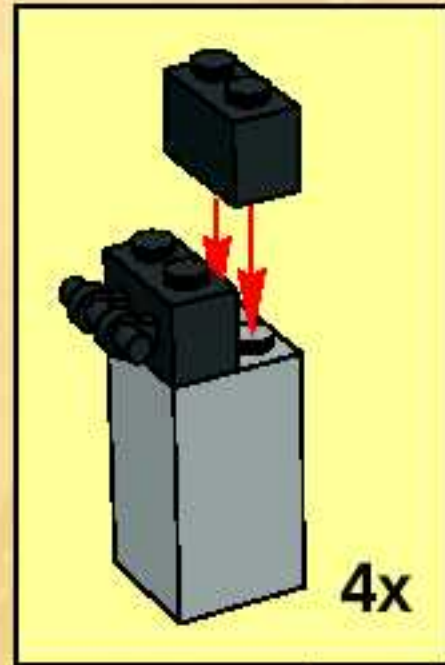

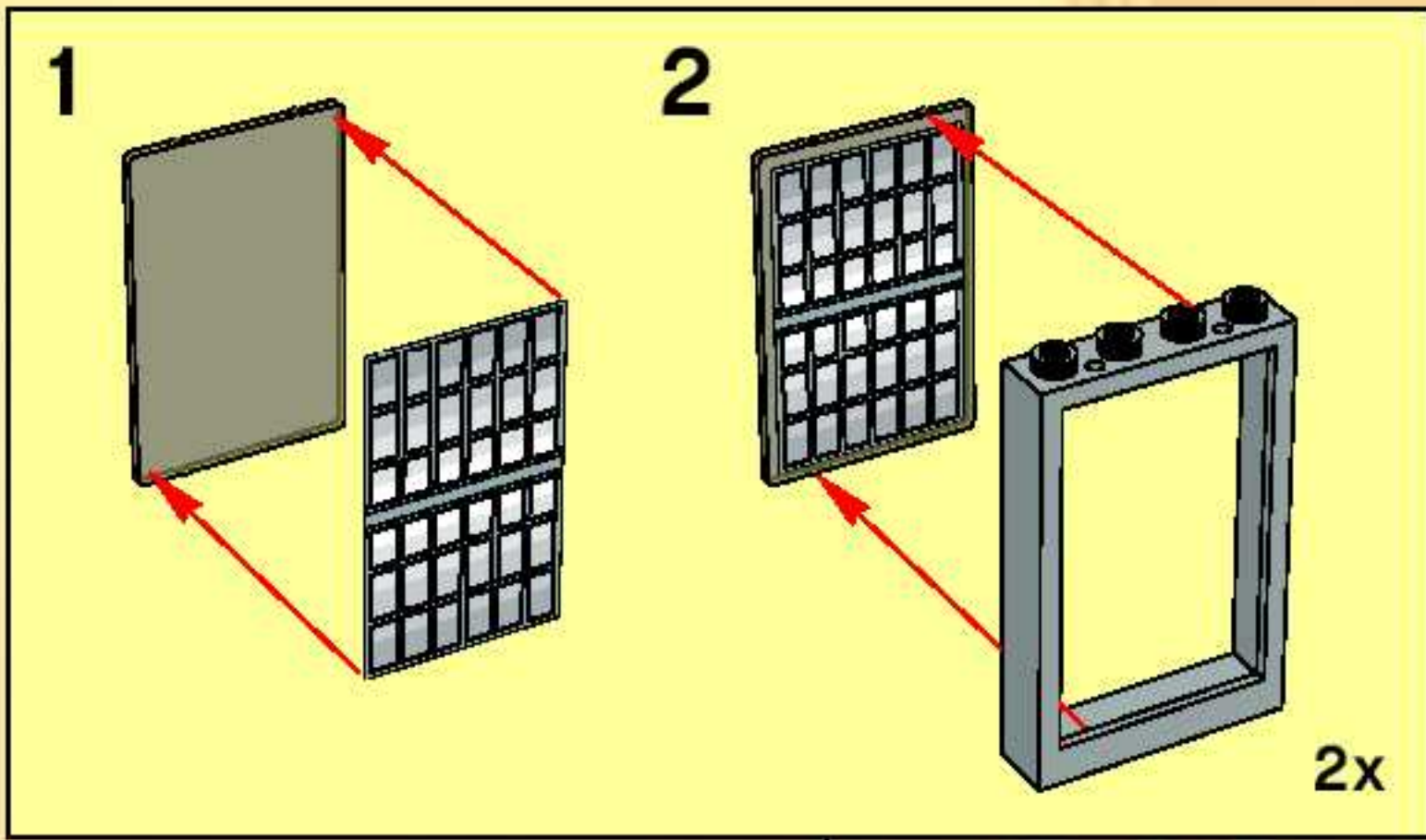

10

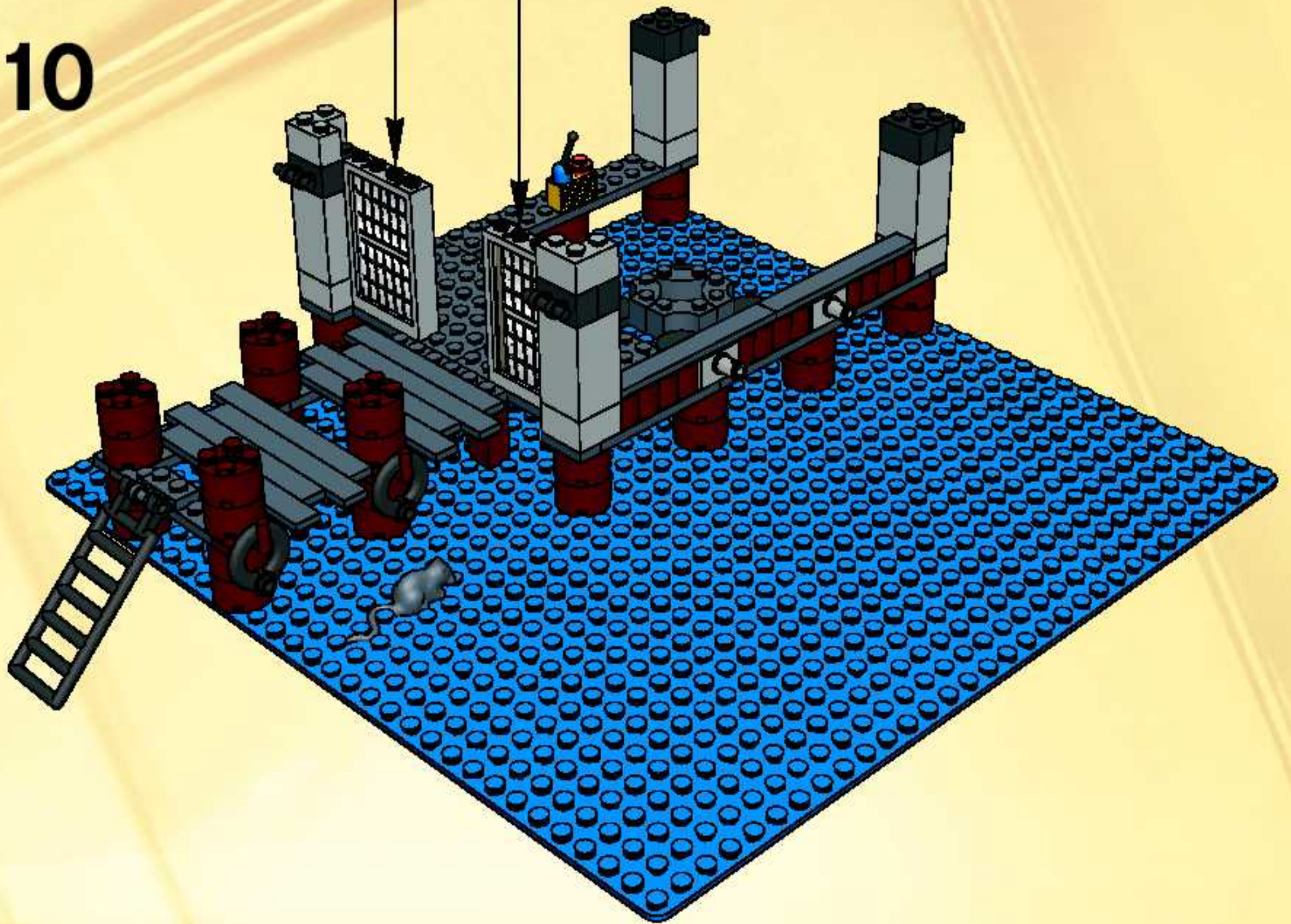

11

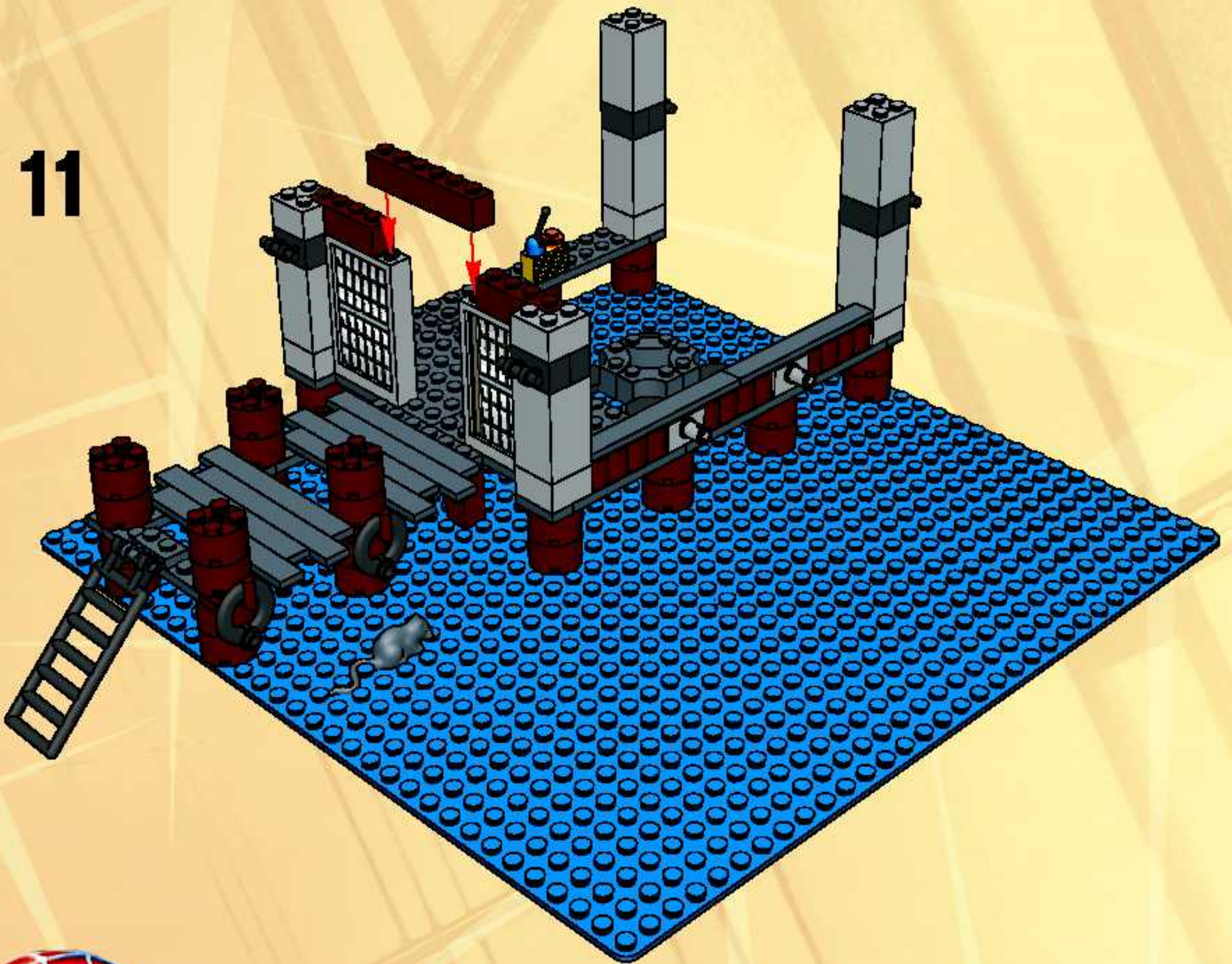

12

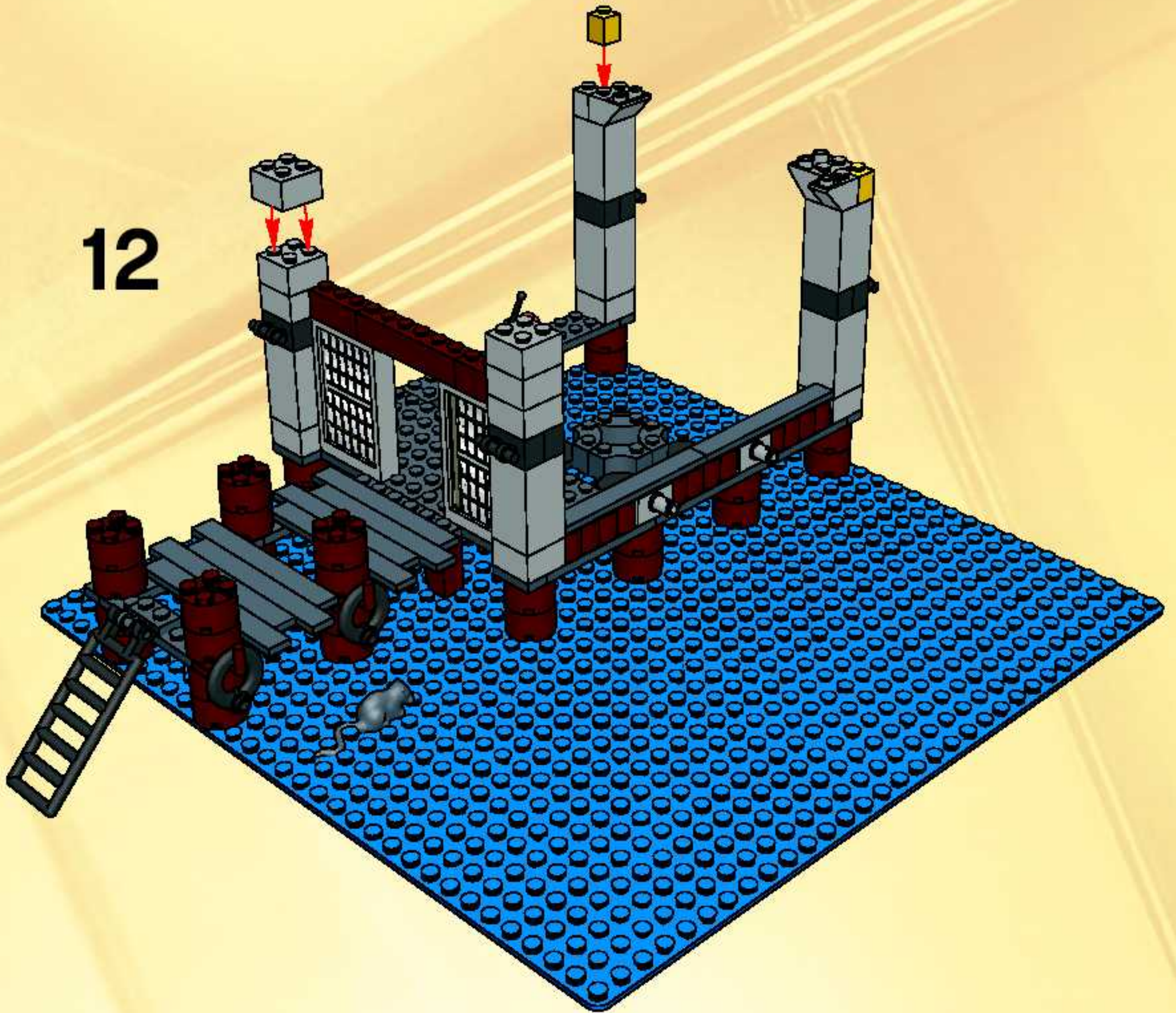

13

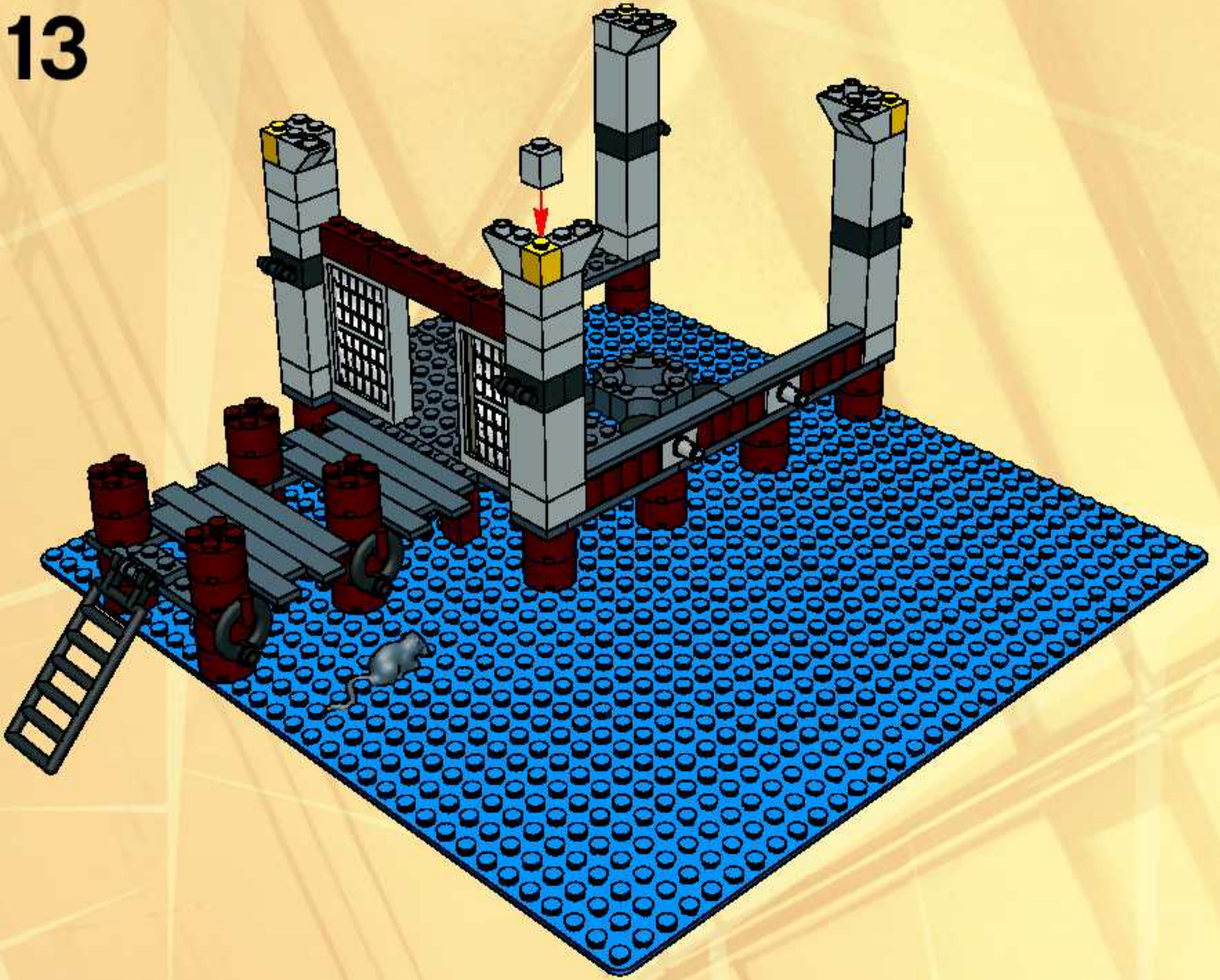

14

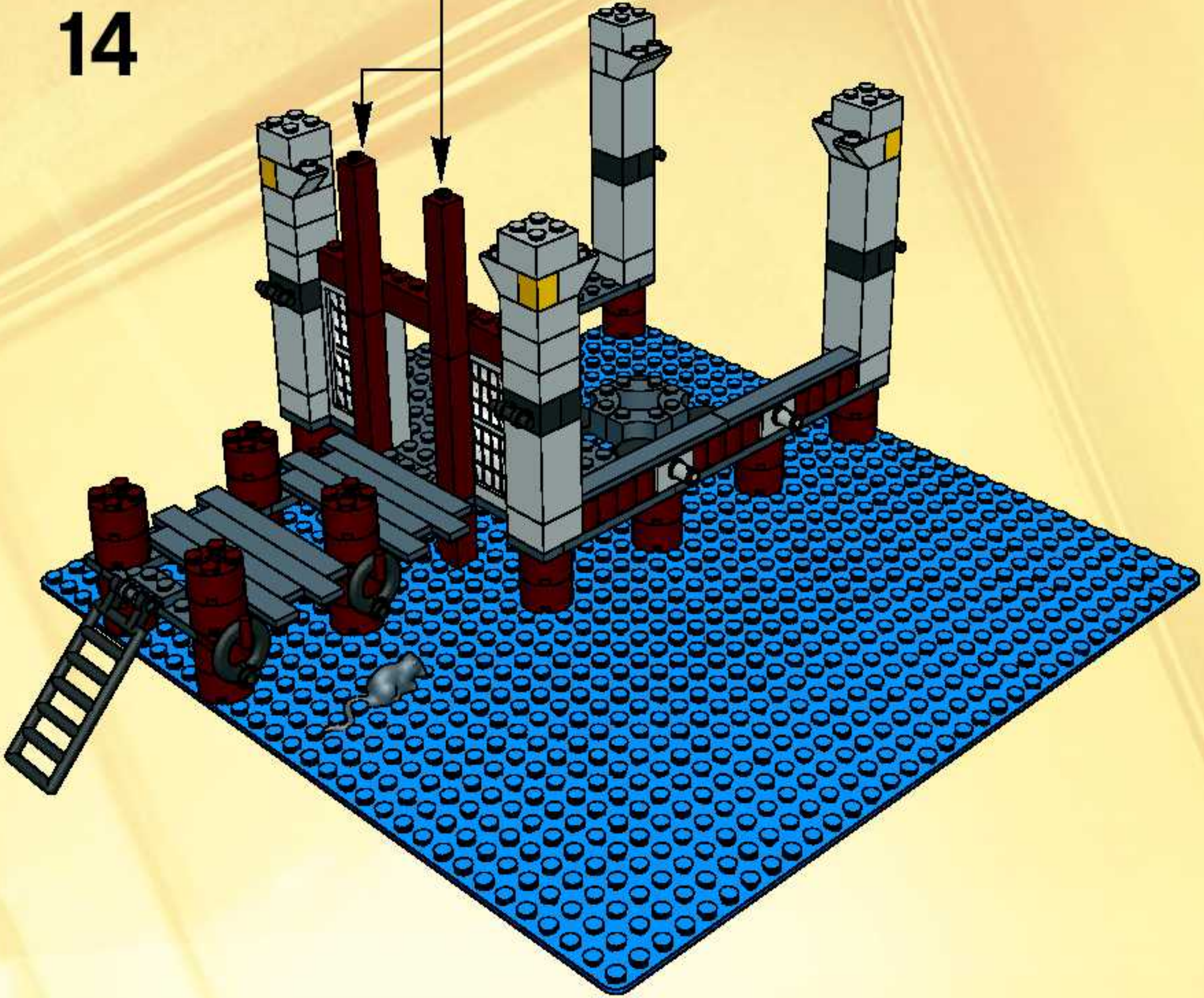
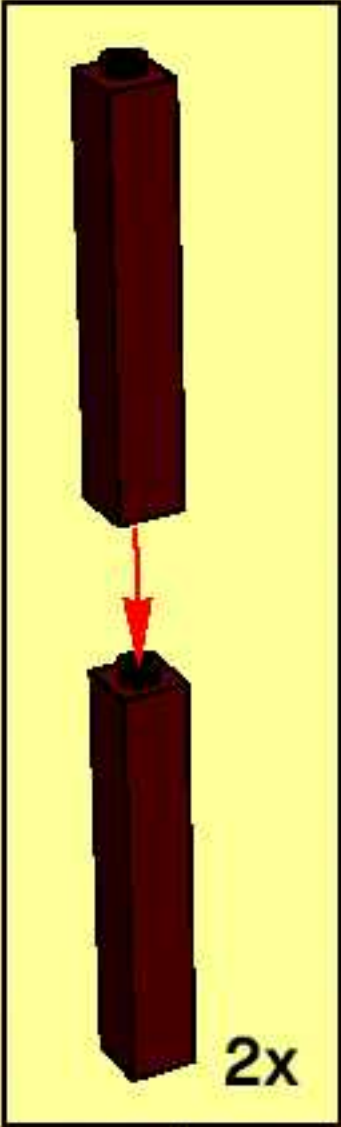

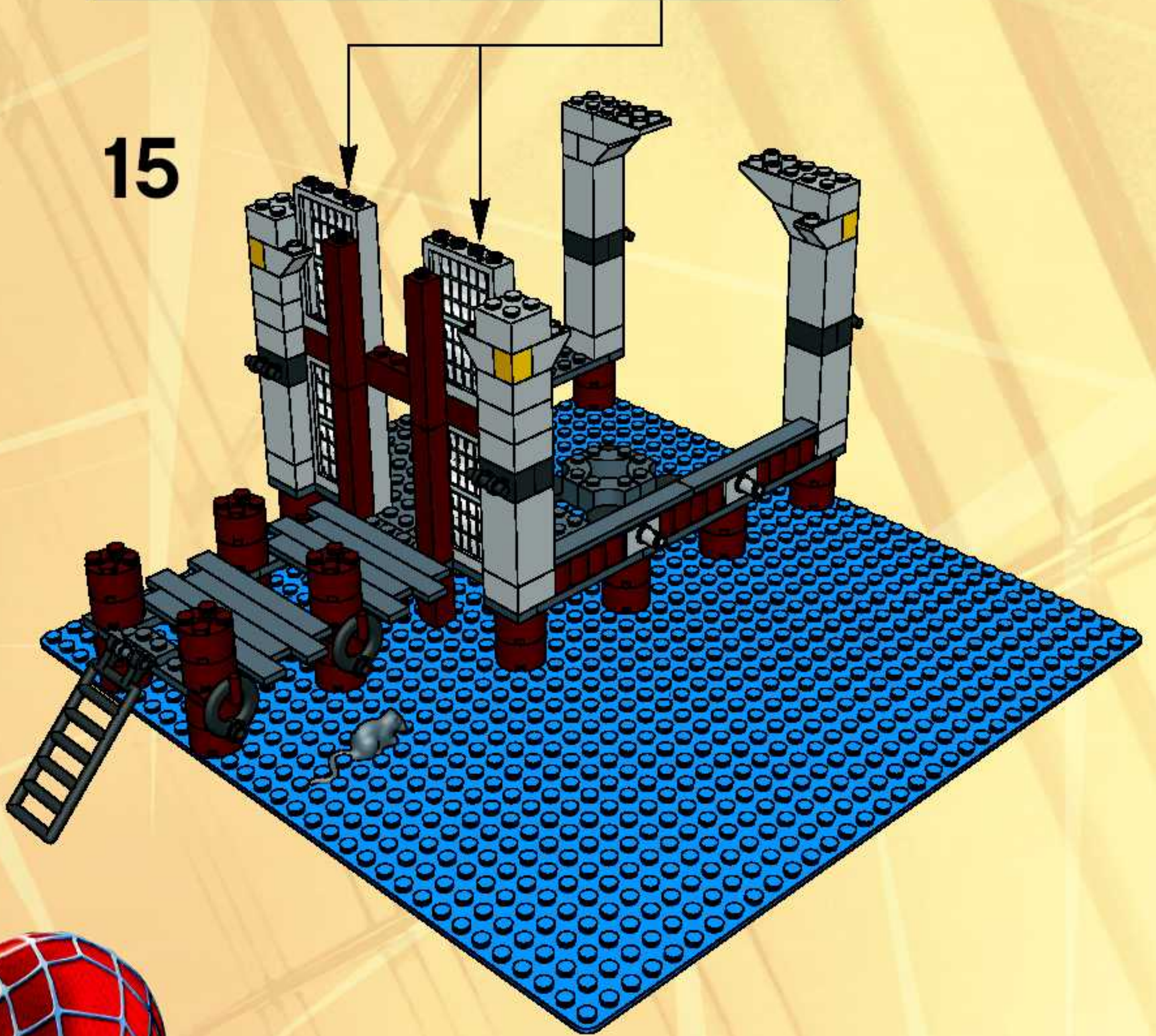
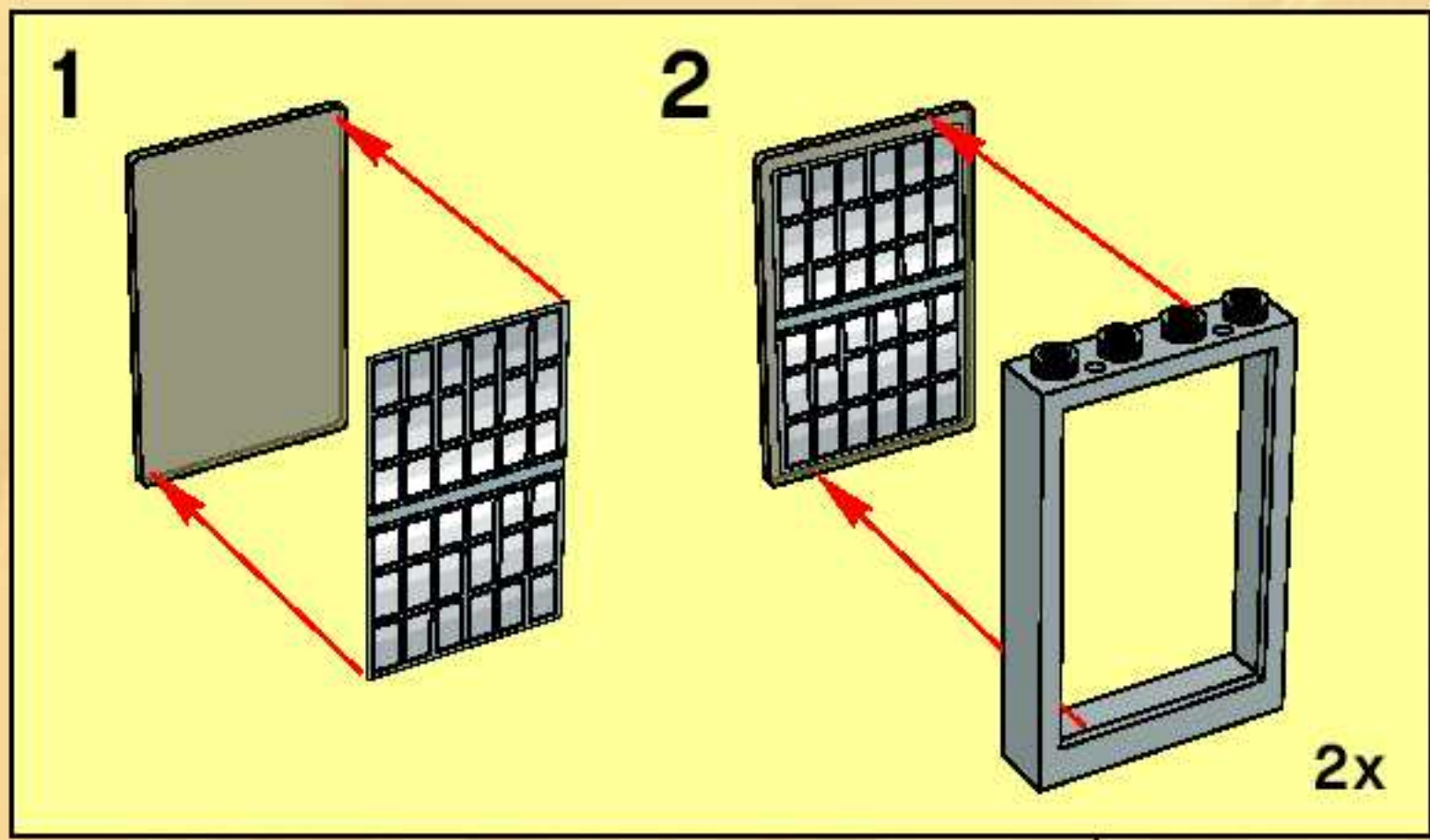

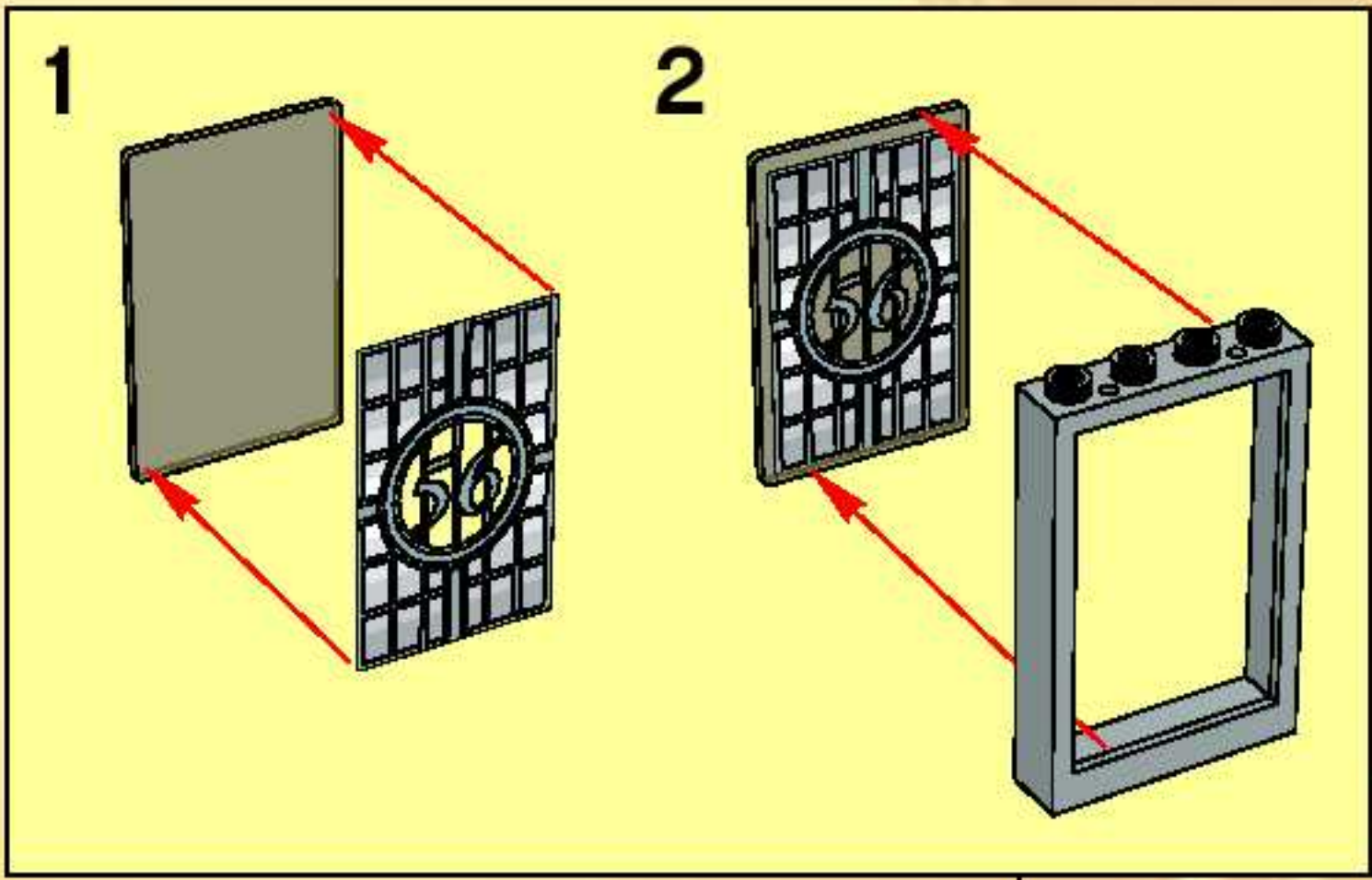

16

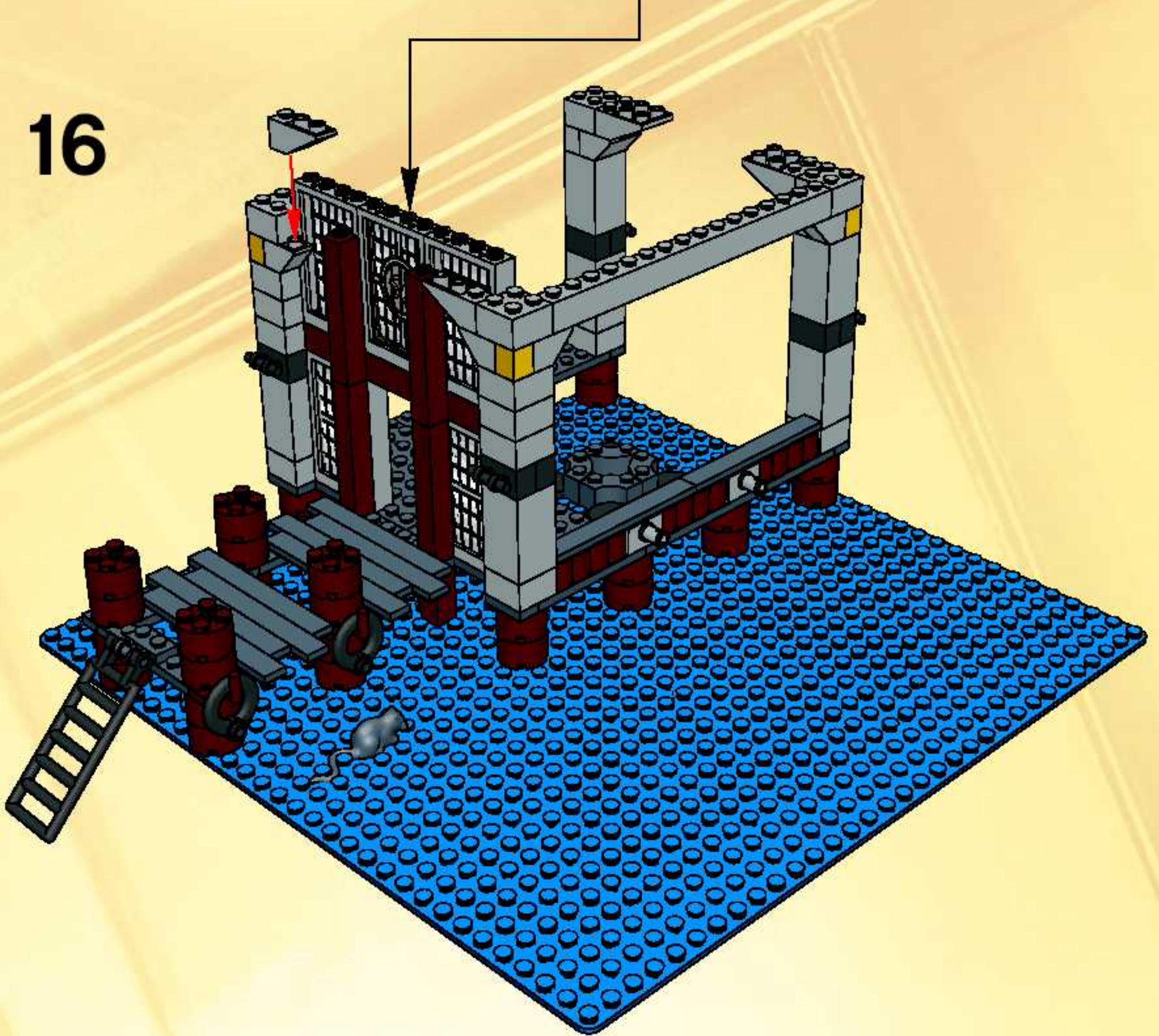

17

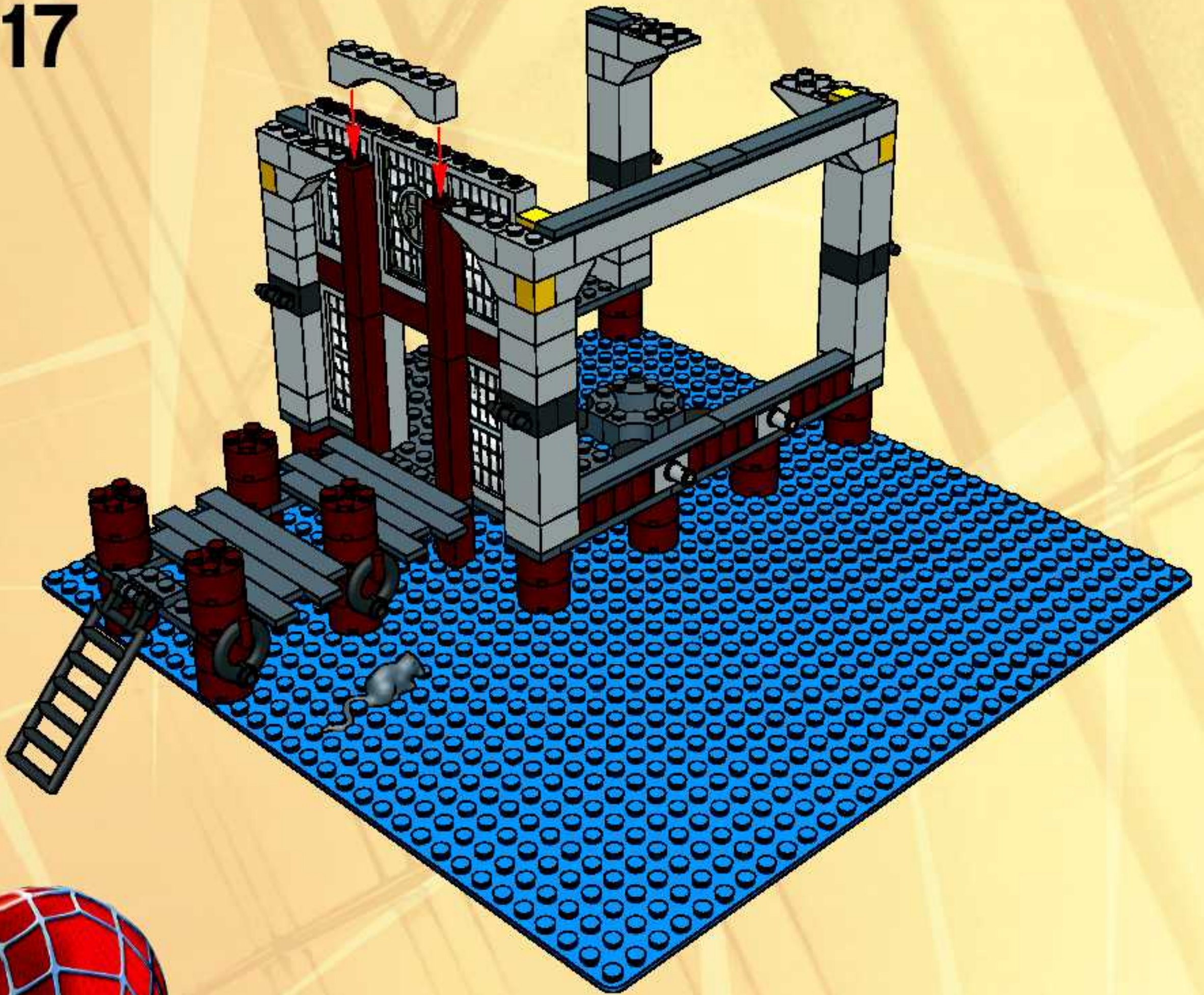

18

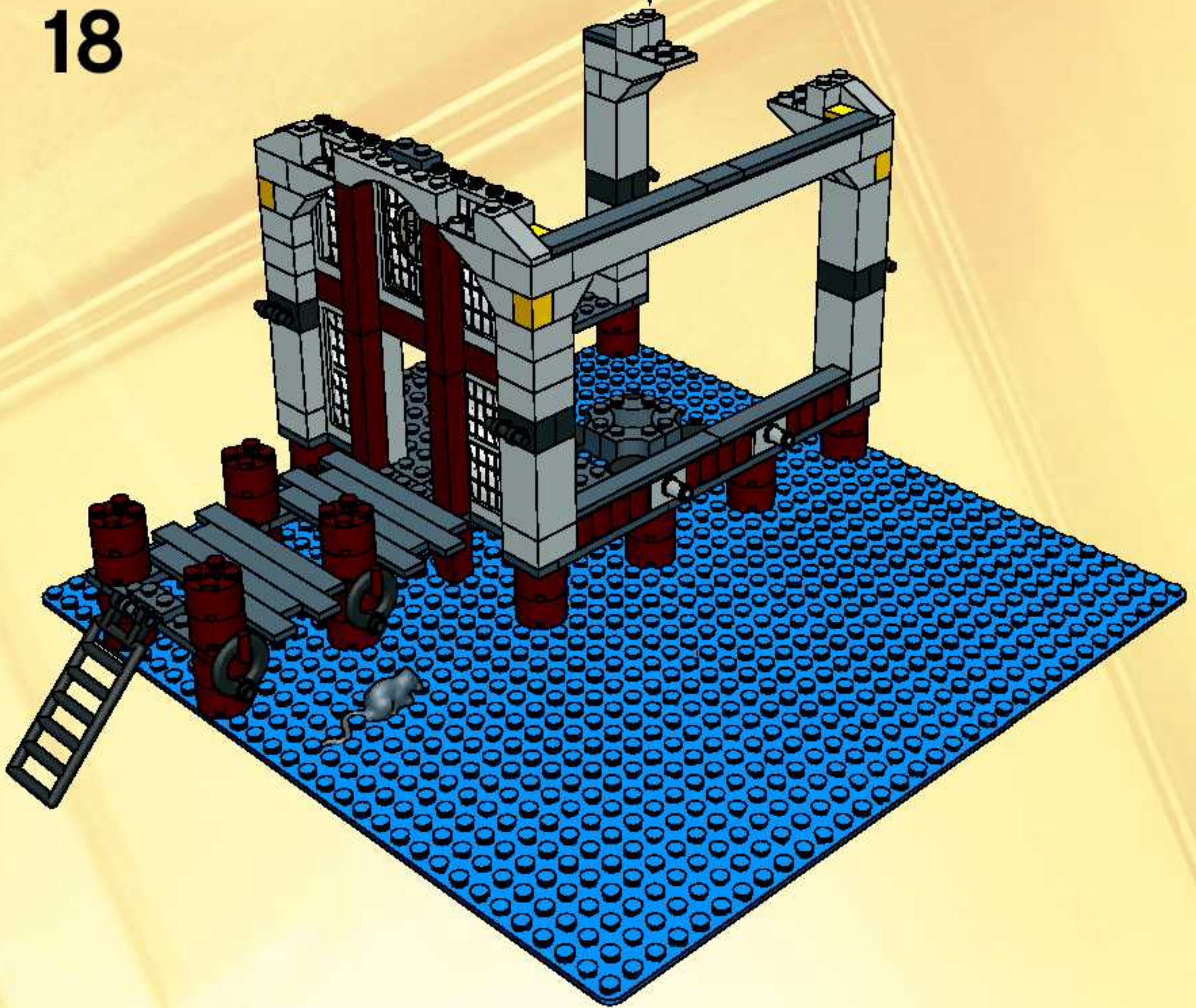
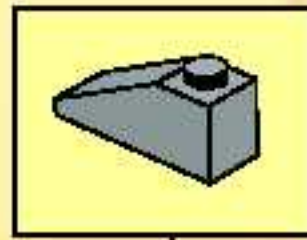

19

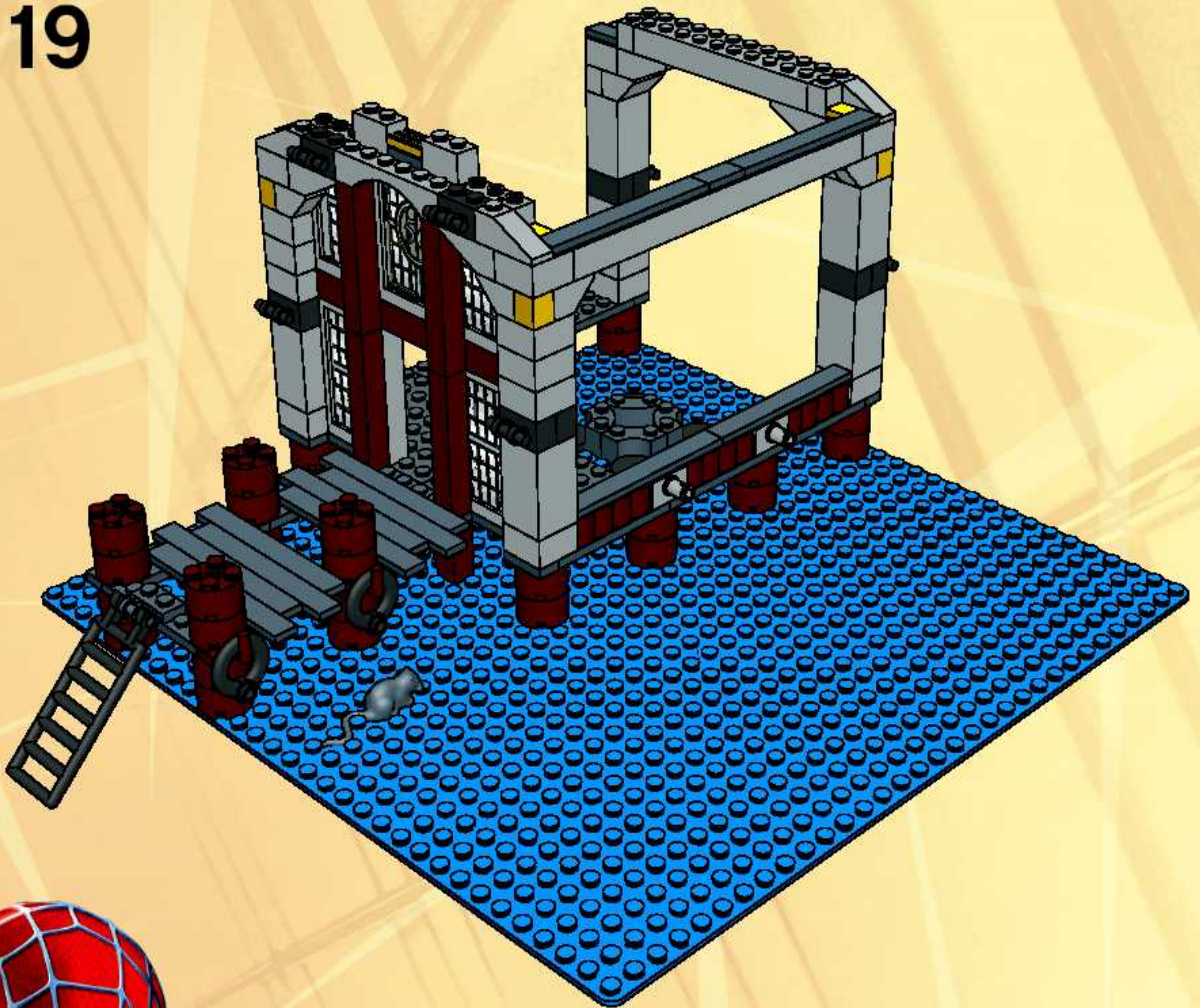

20

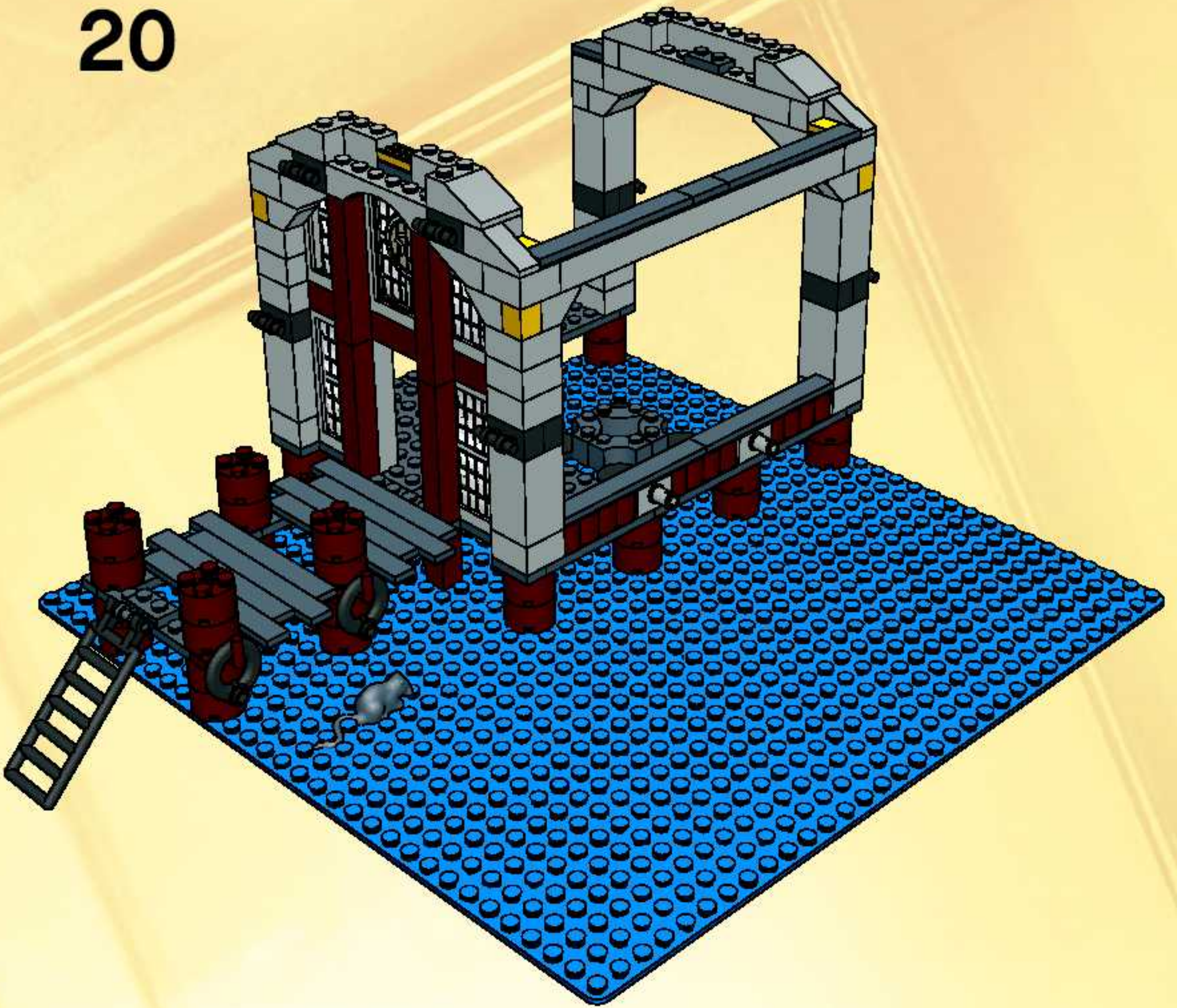

21

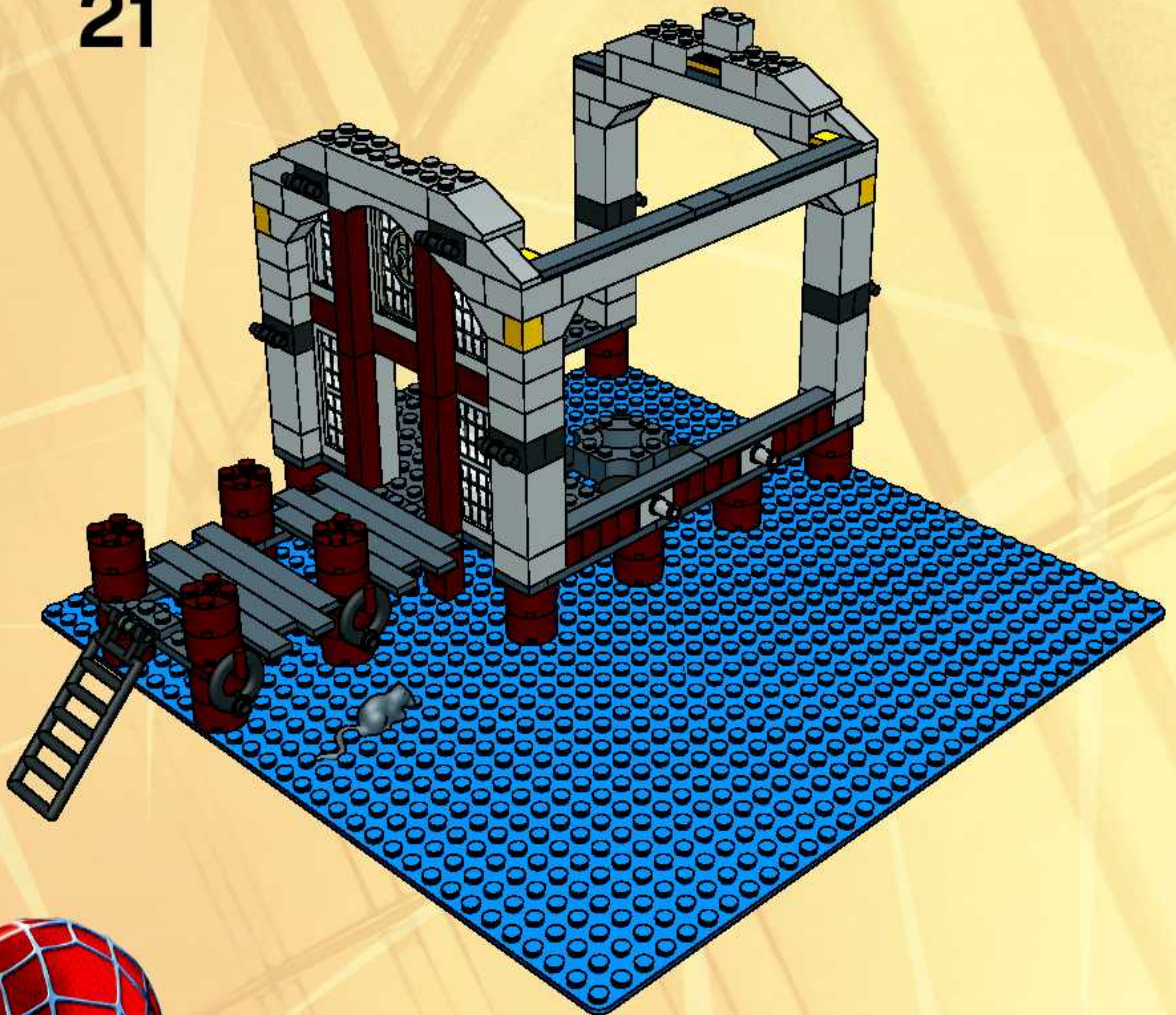

22

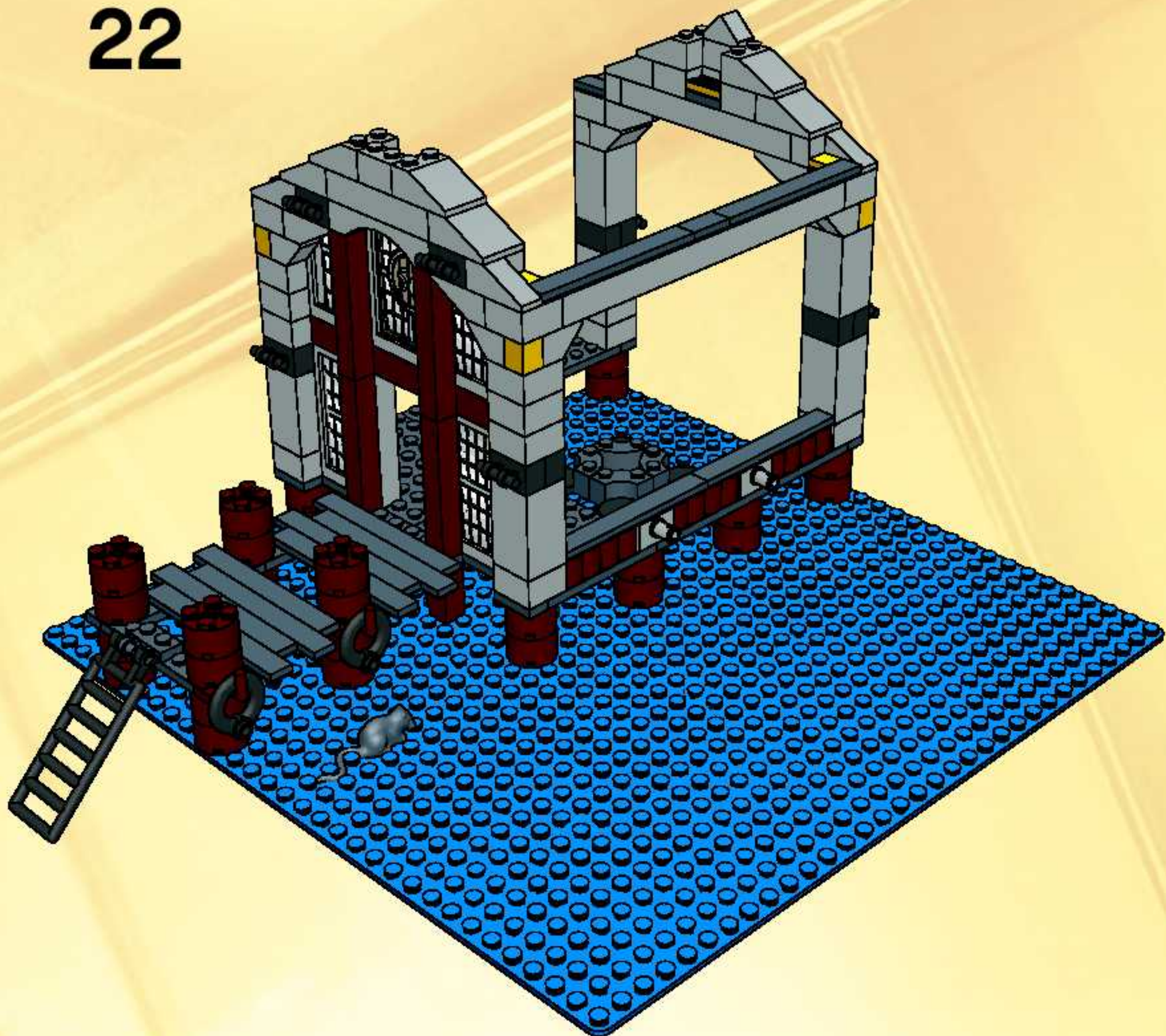

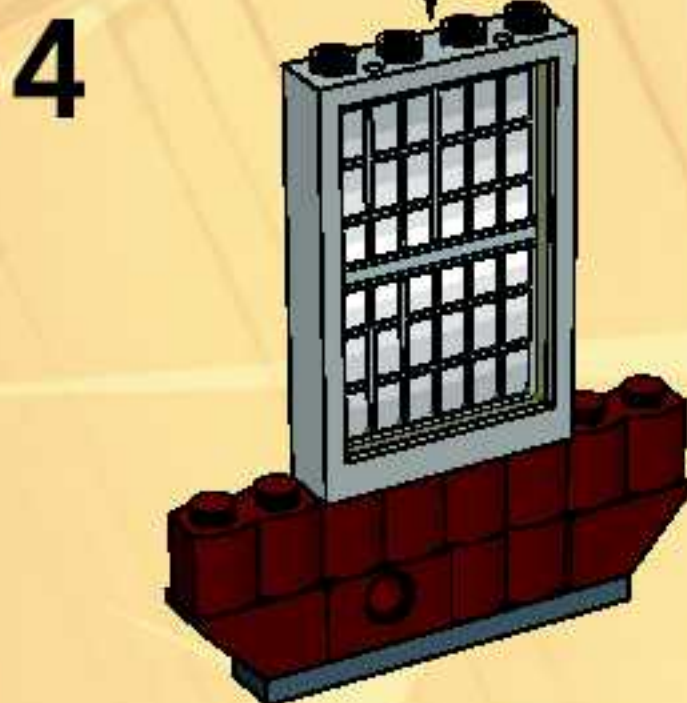
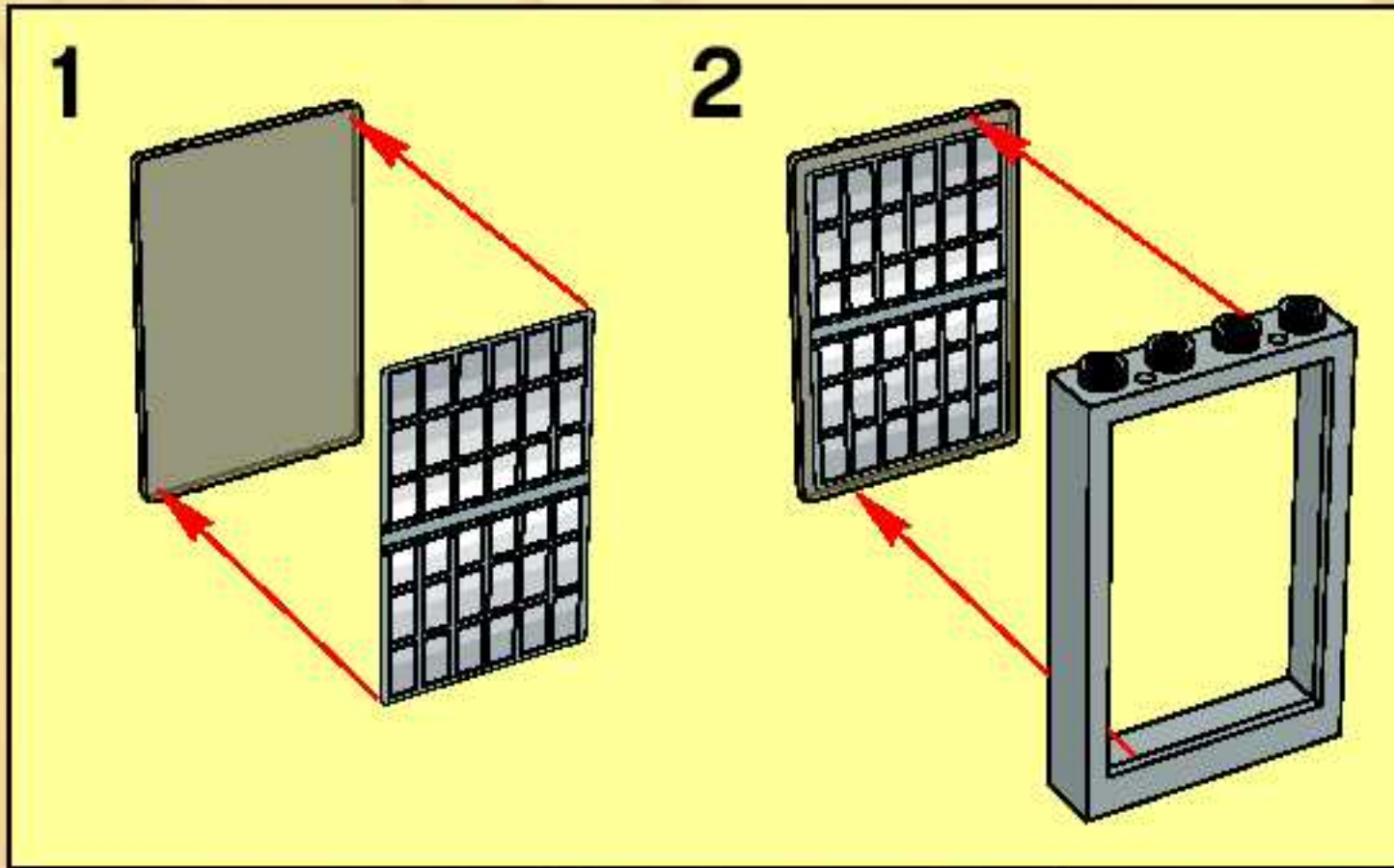
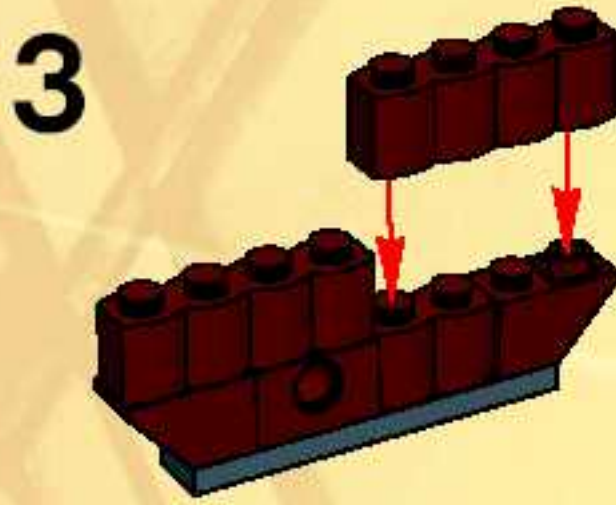
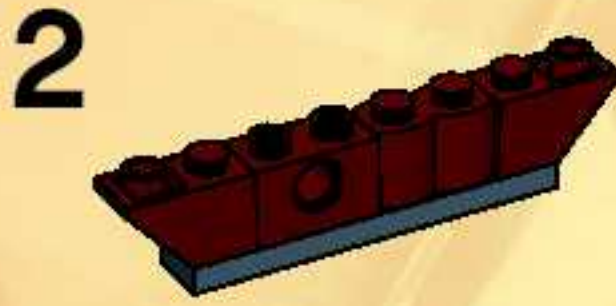
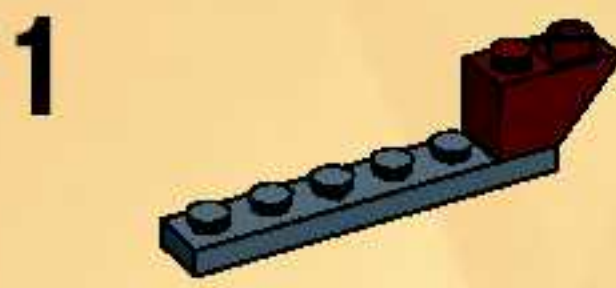

5

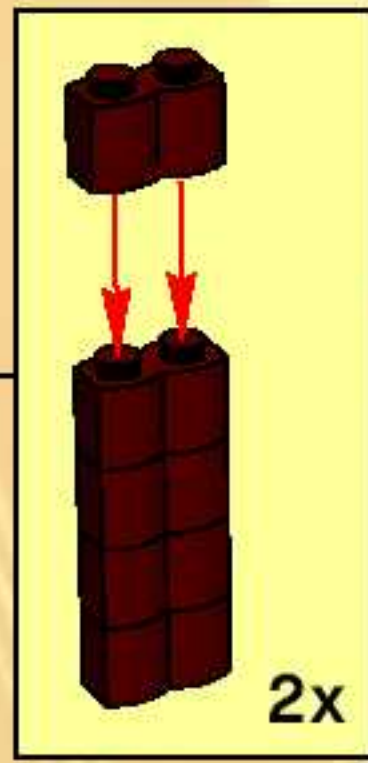
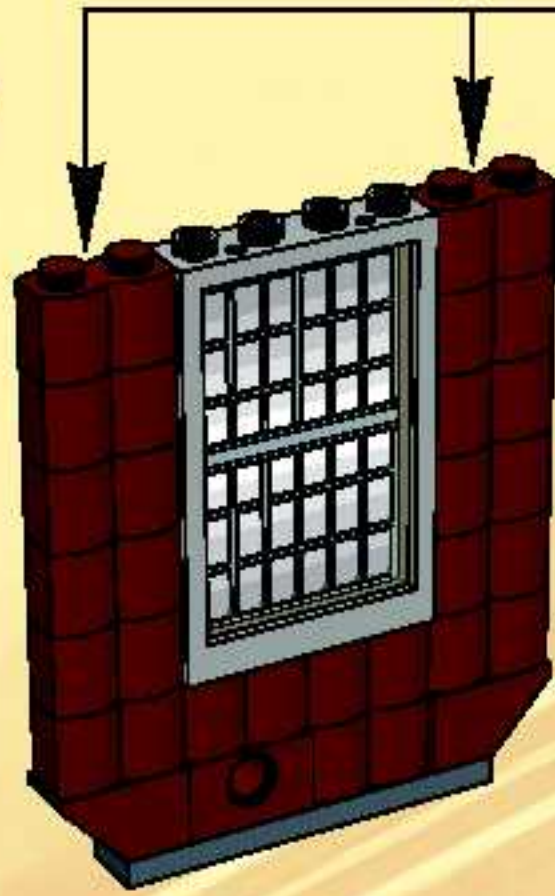

6

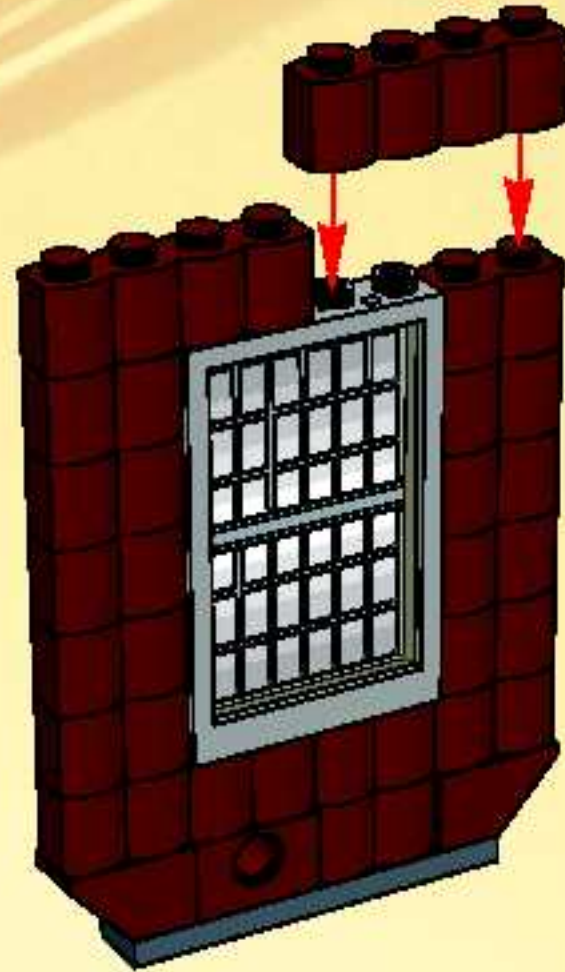

7

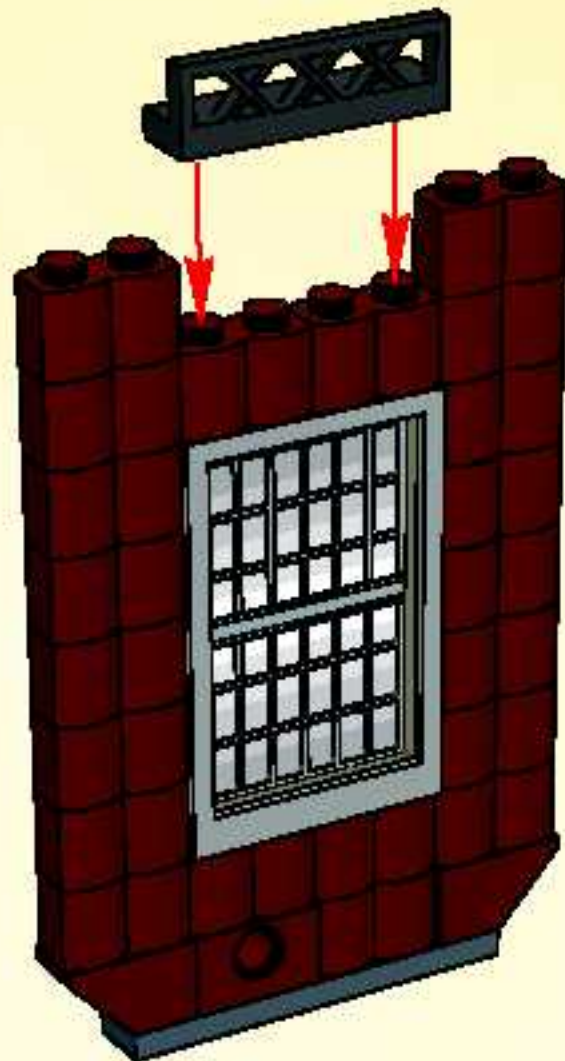

8

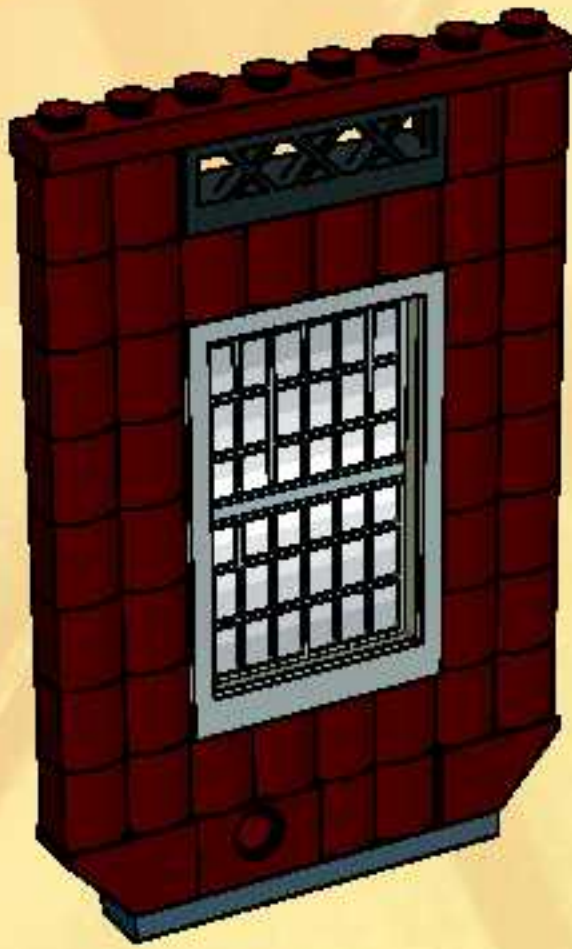

23

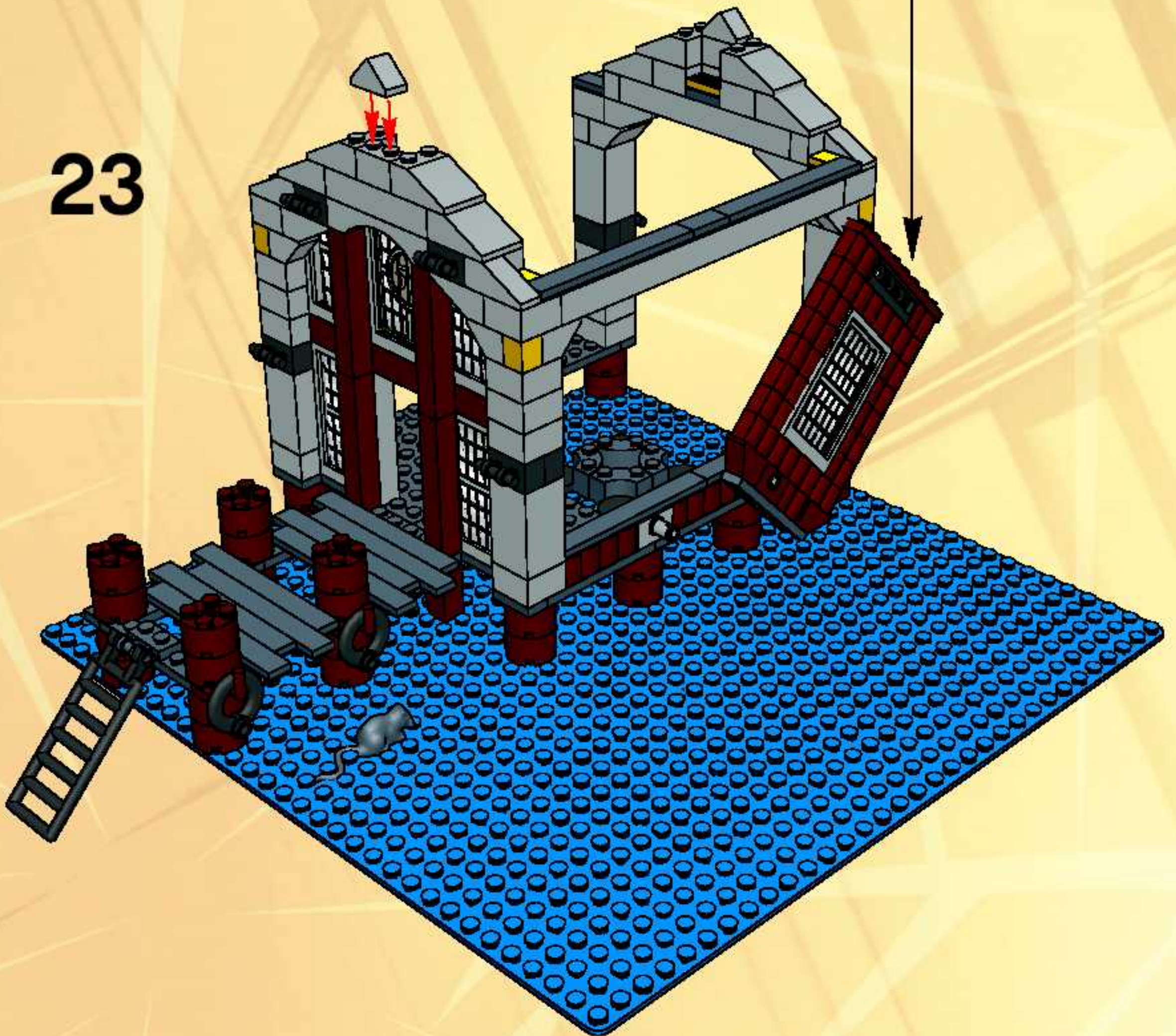

1

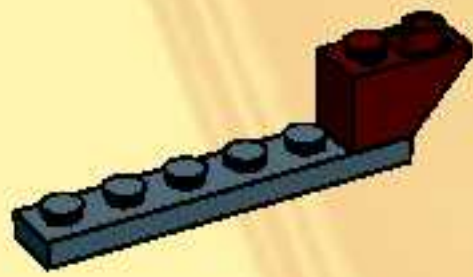

2

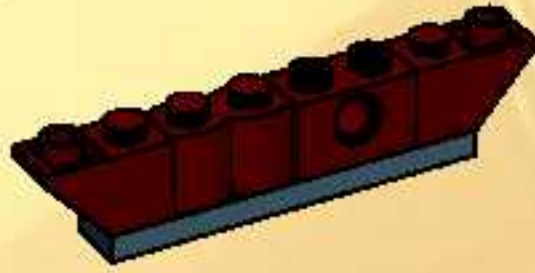

3

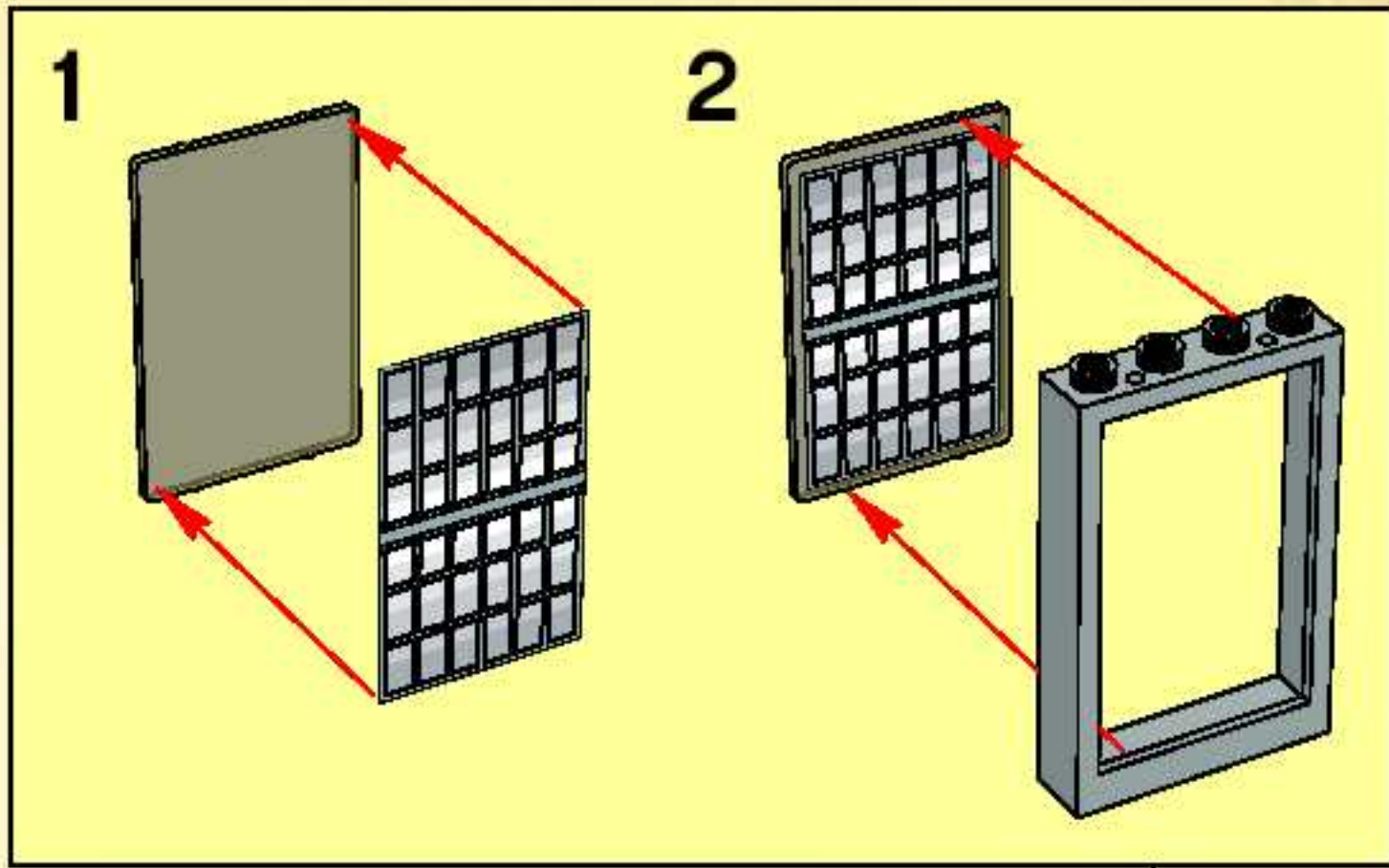
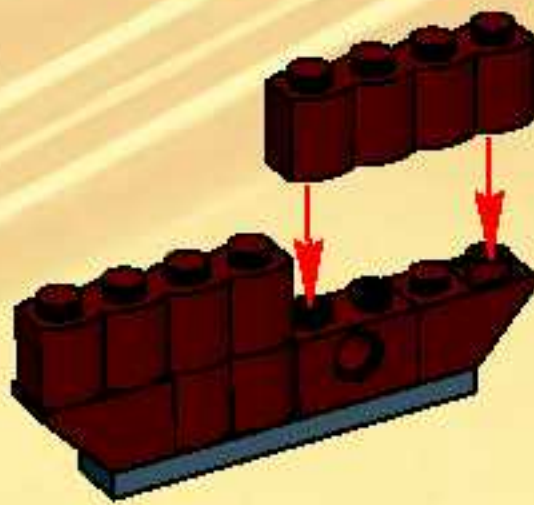

4

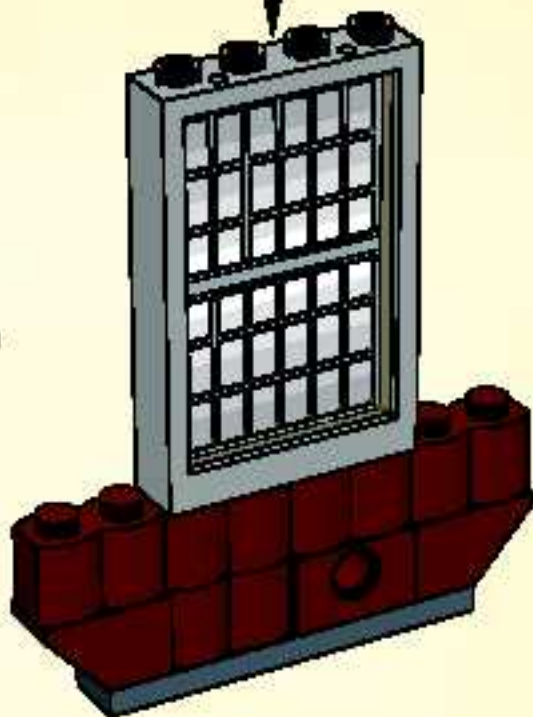

5

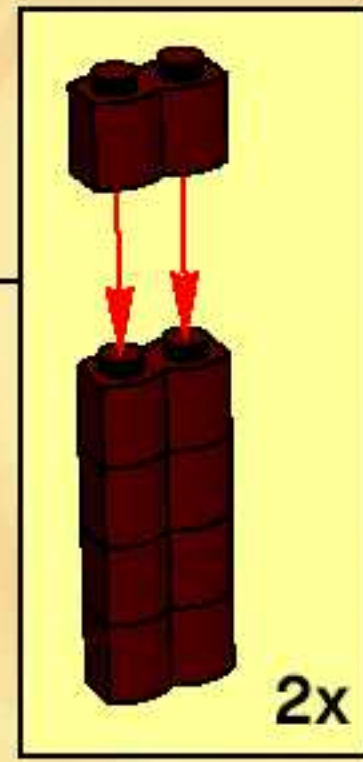
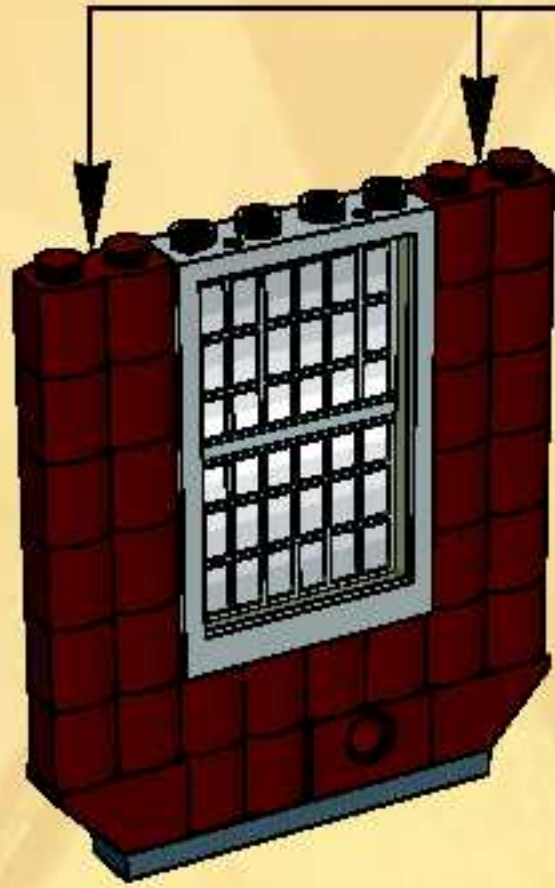

6

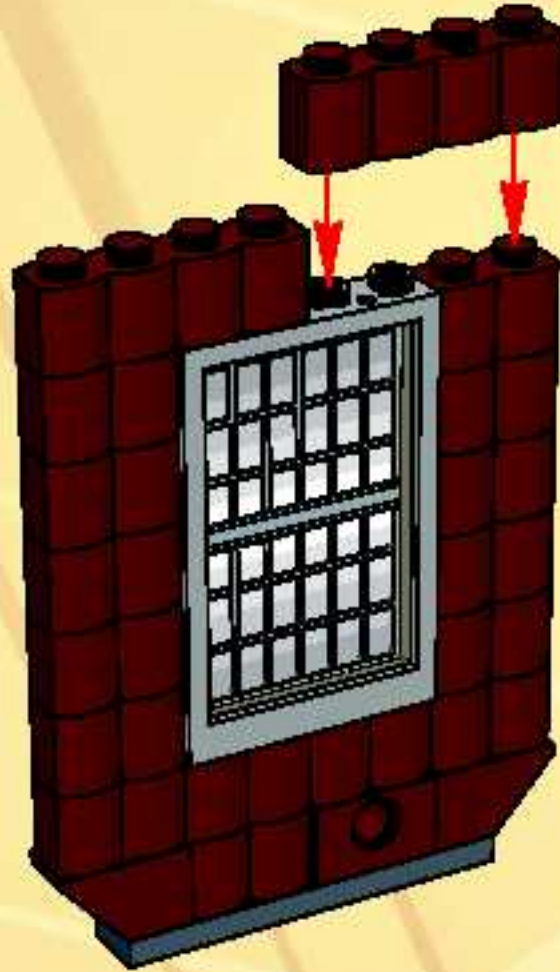

7

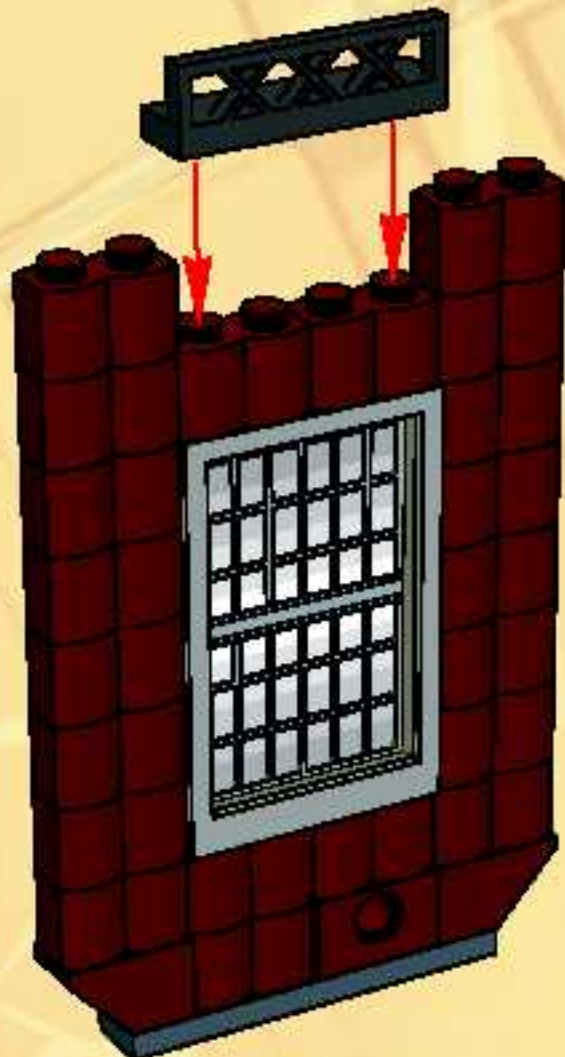

8

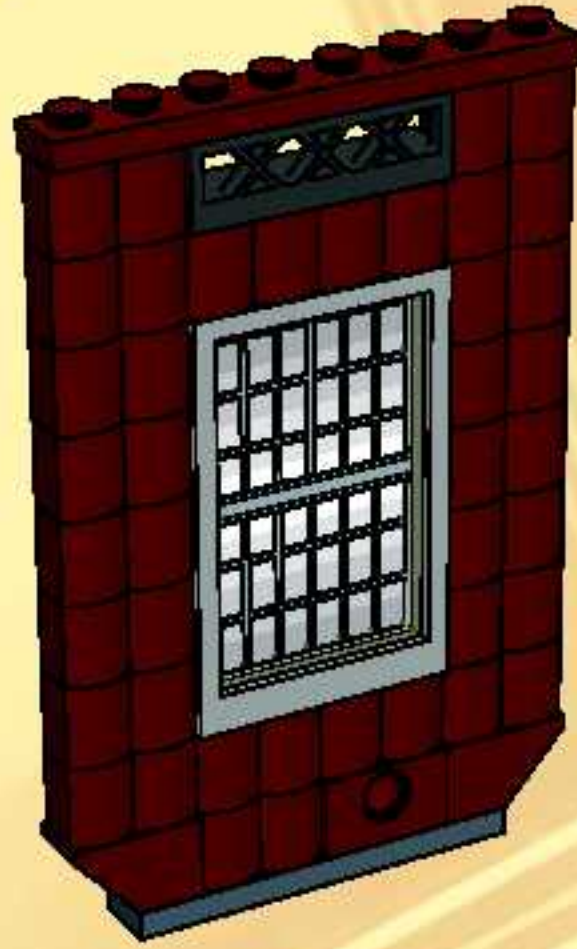

24

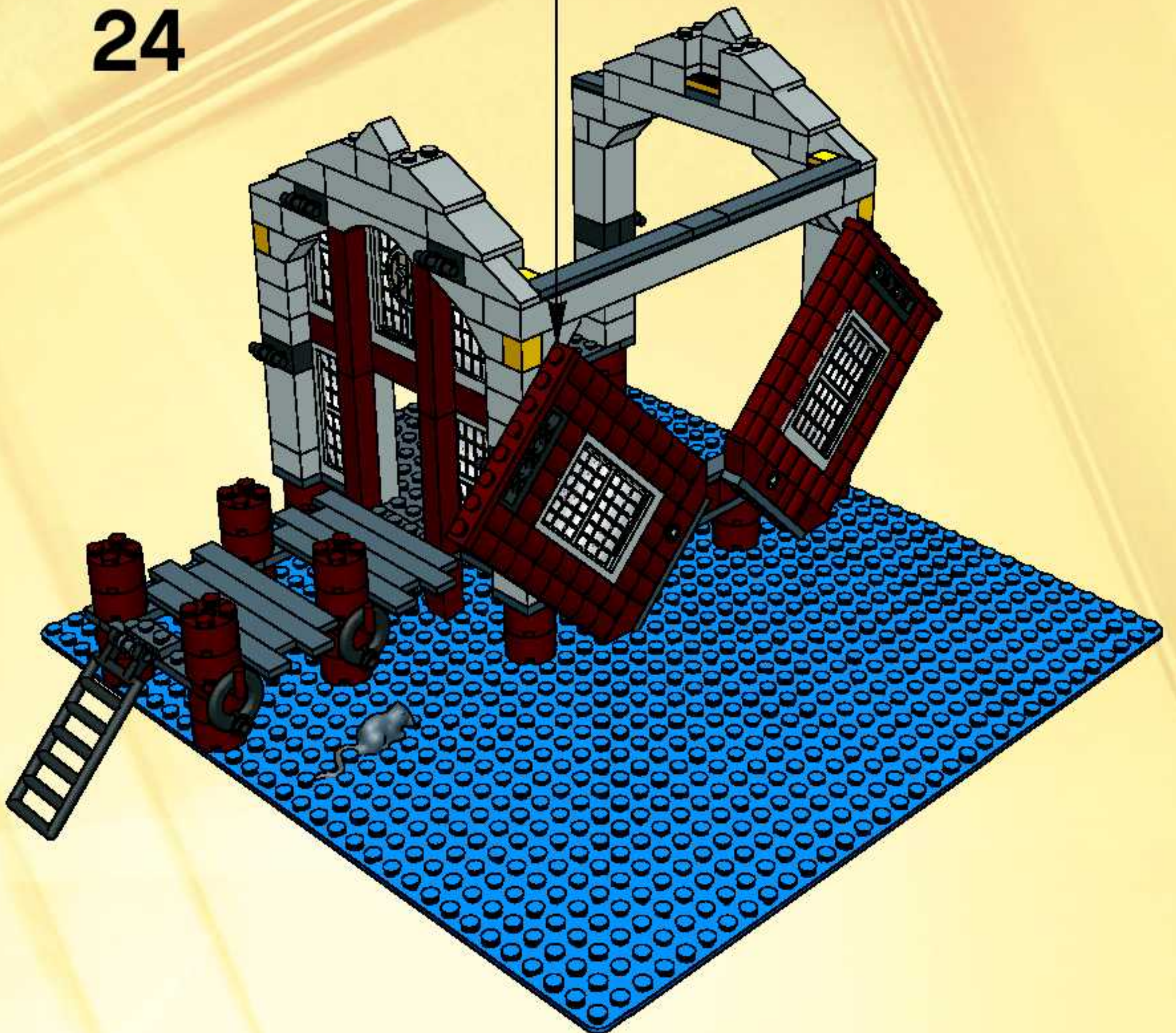

25

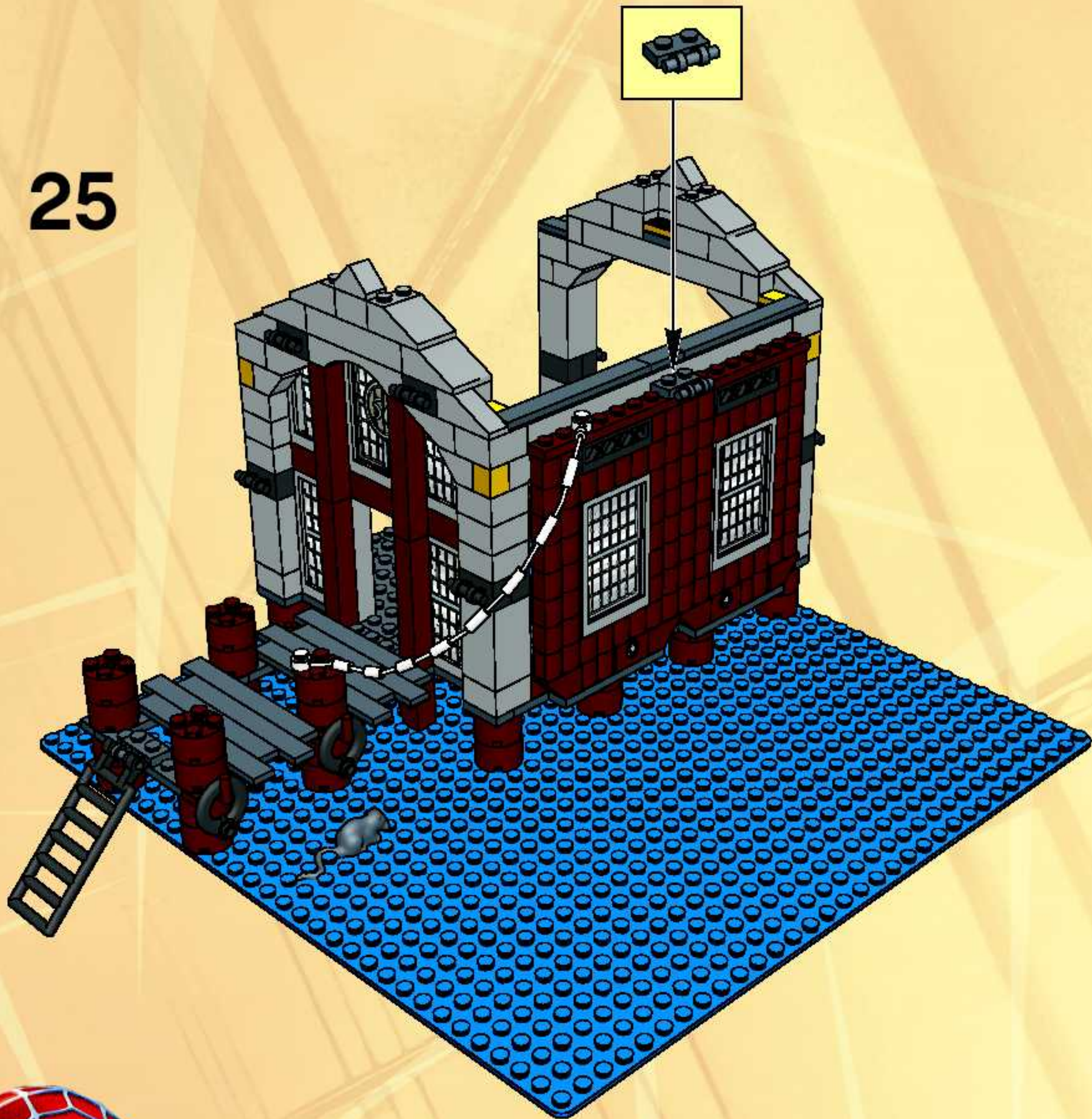

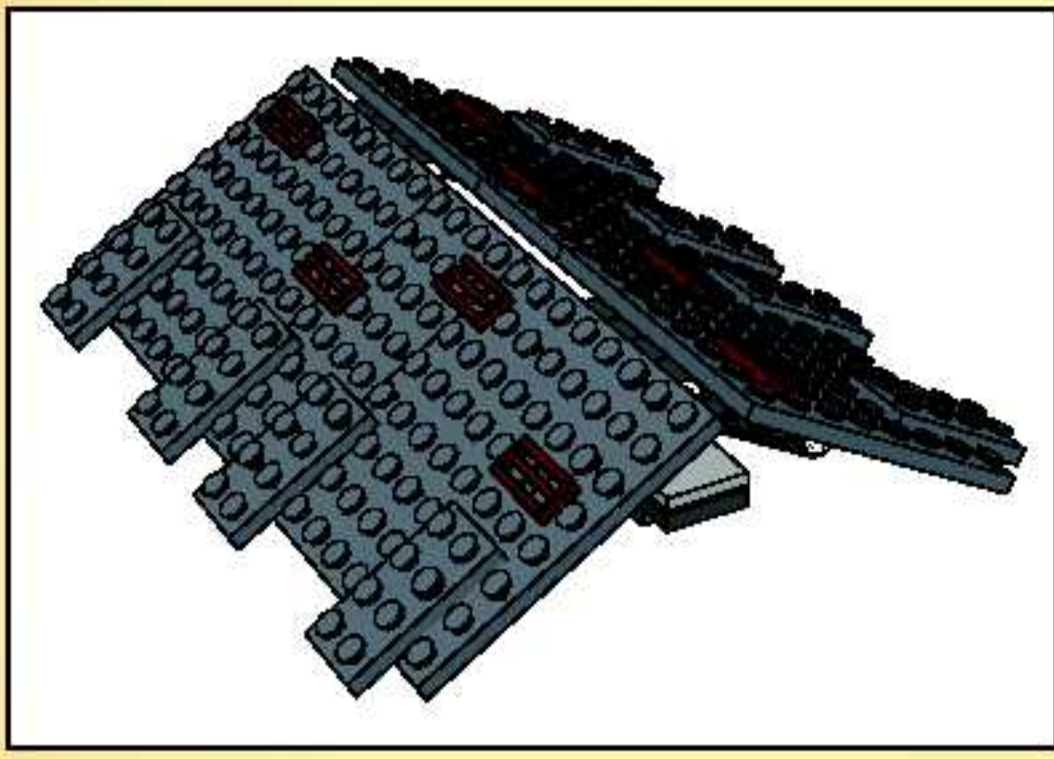

1

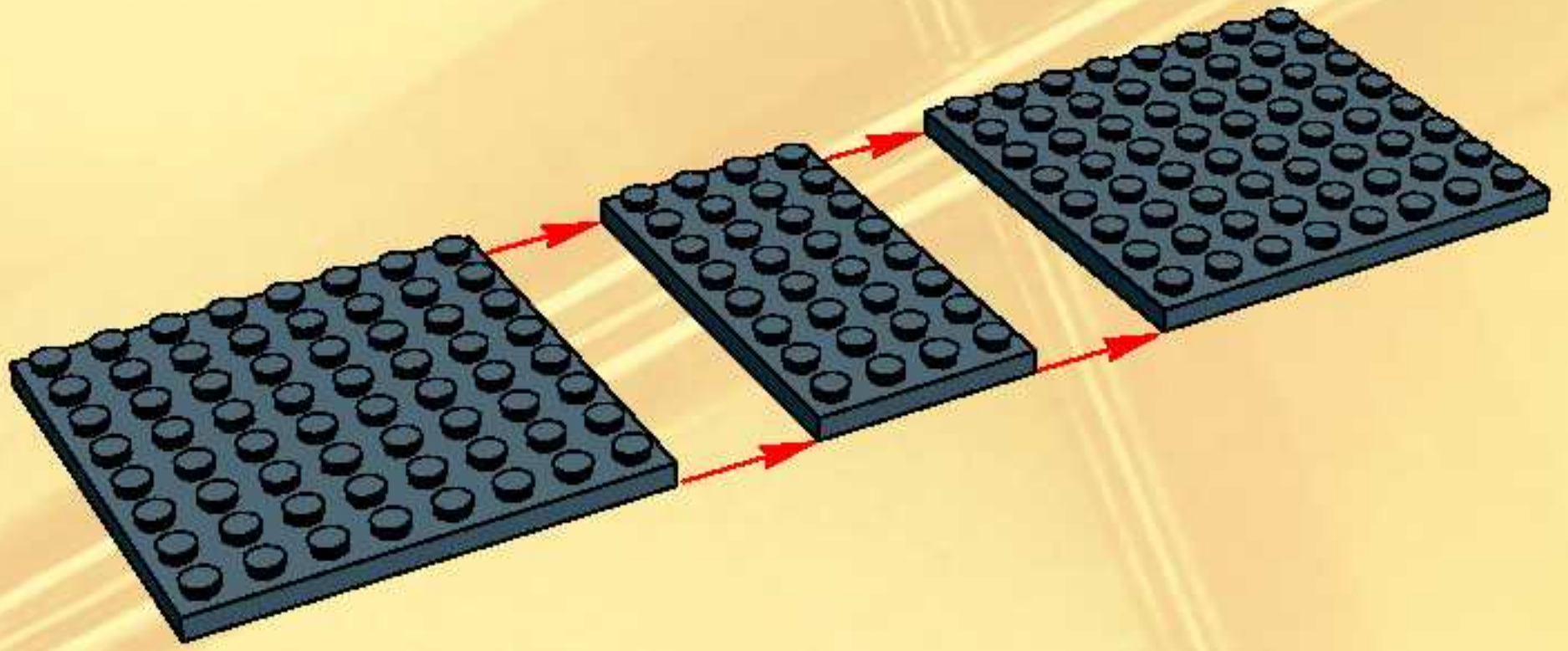

2

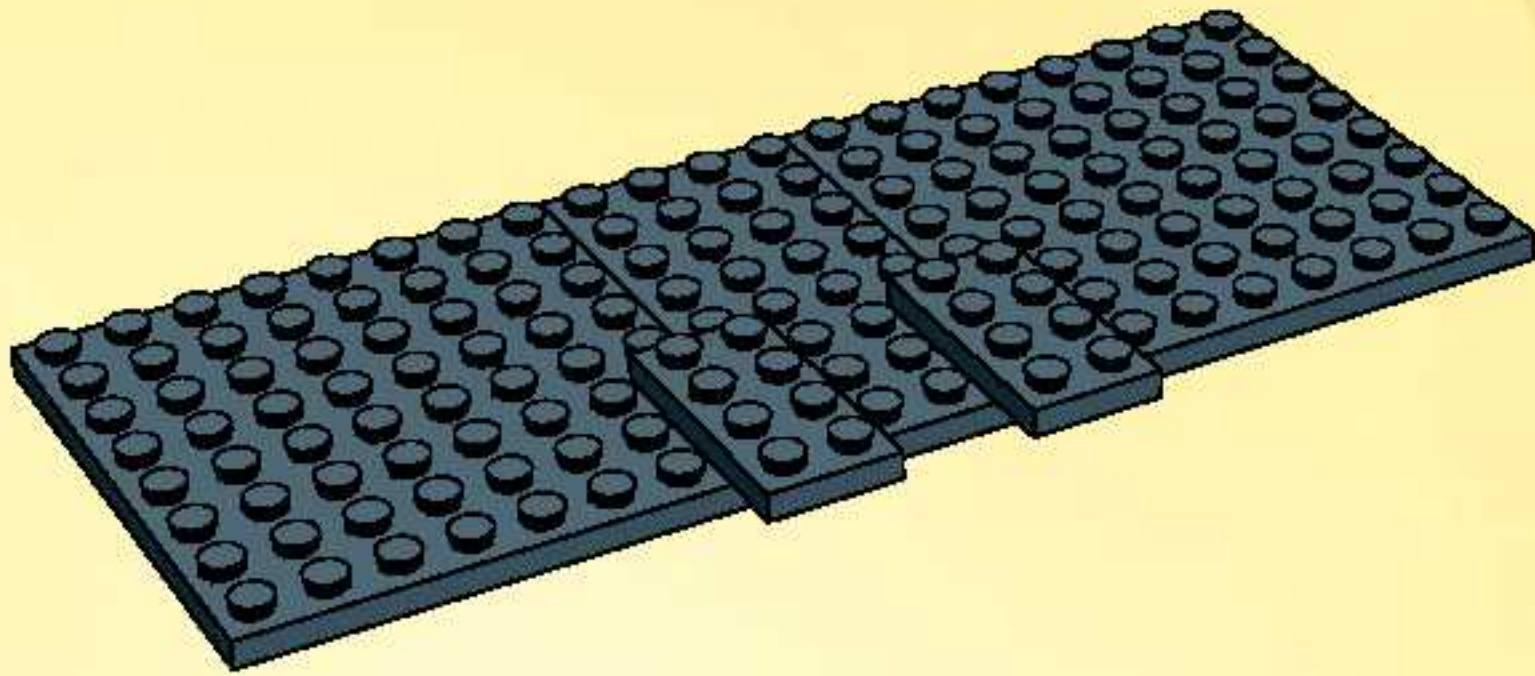

3

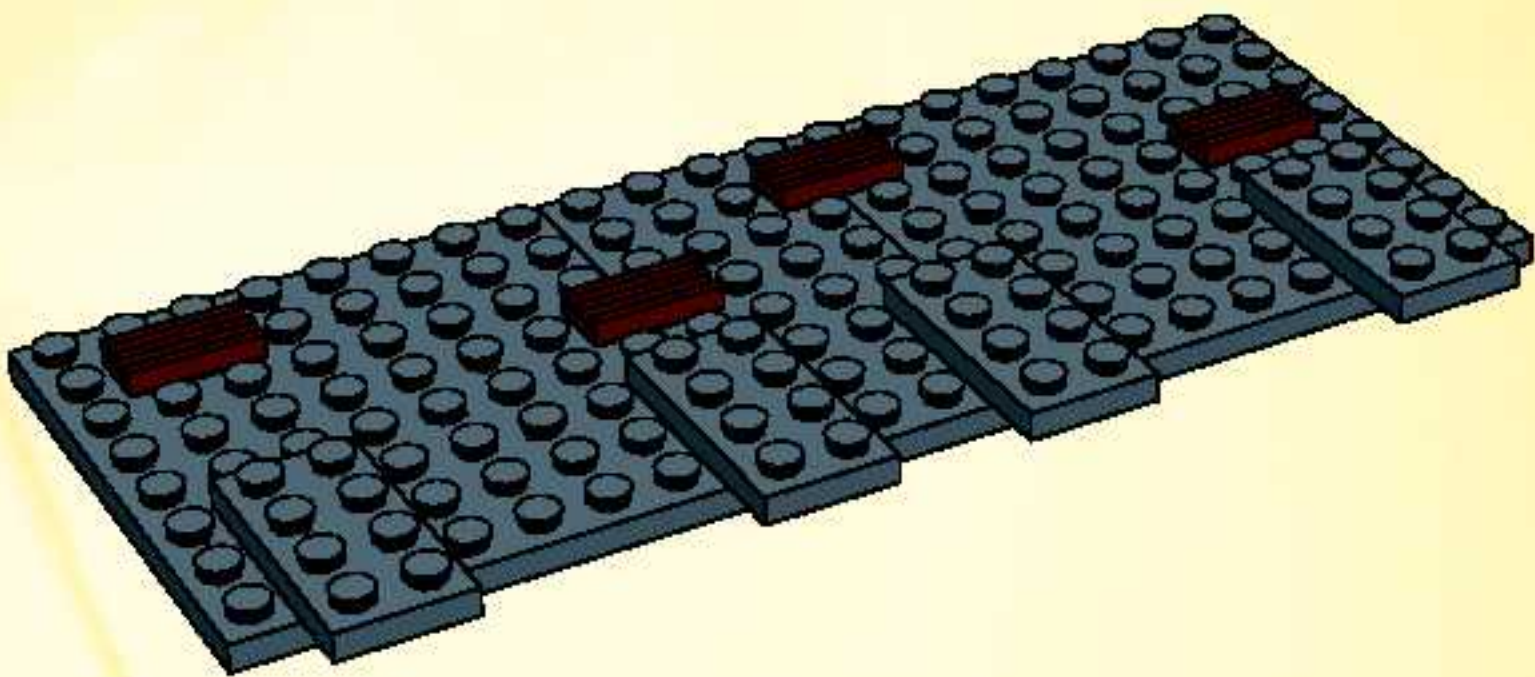

4

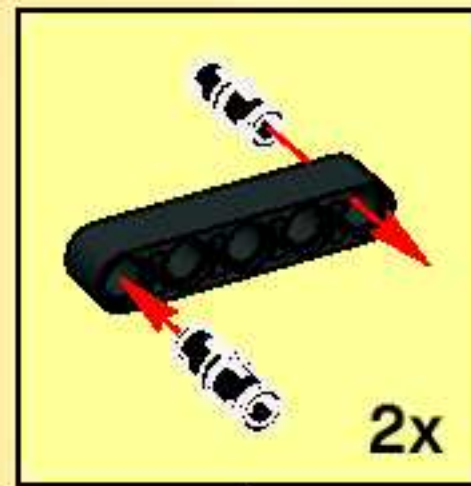
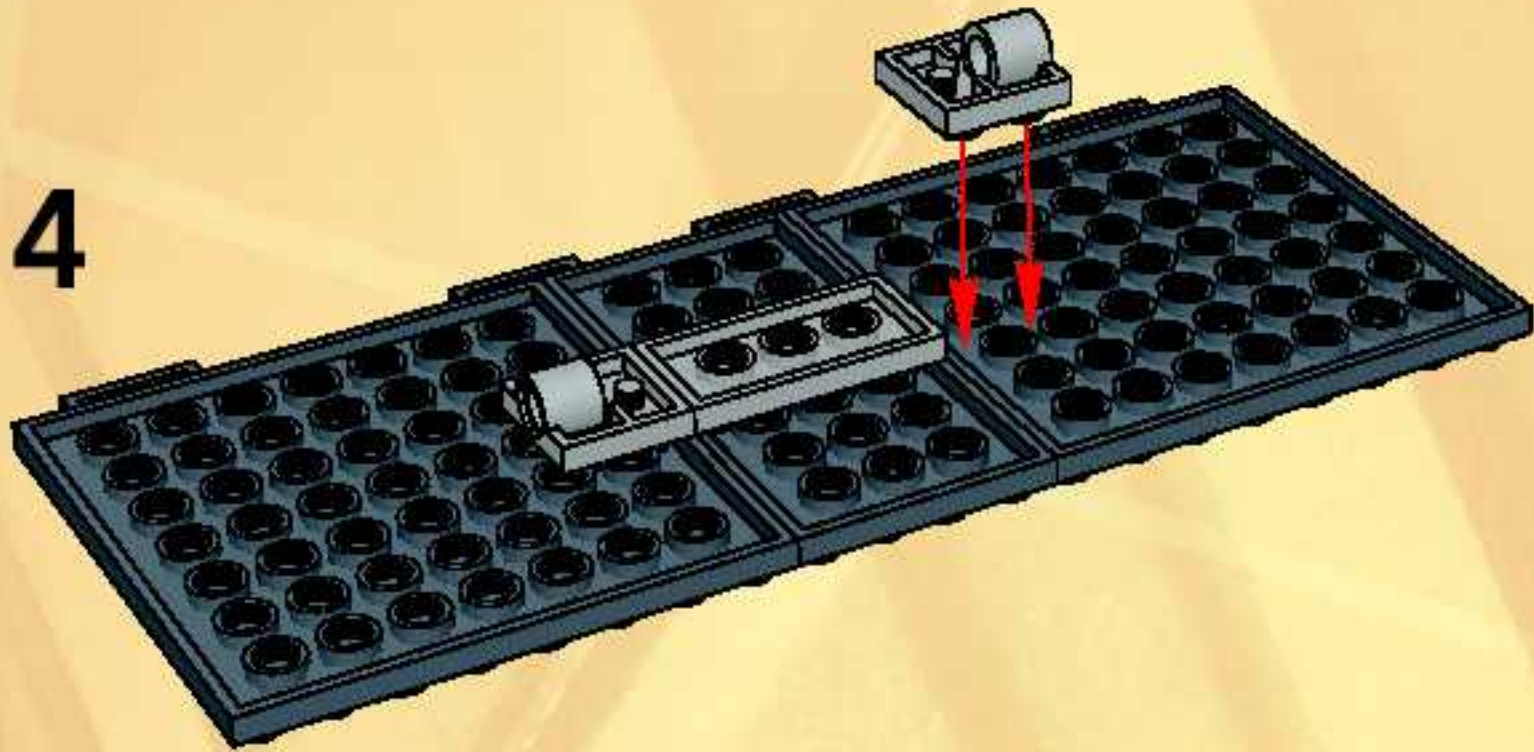

5

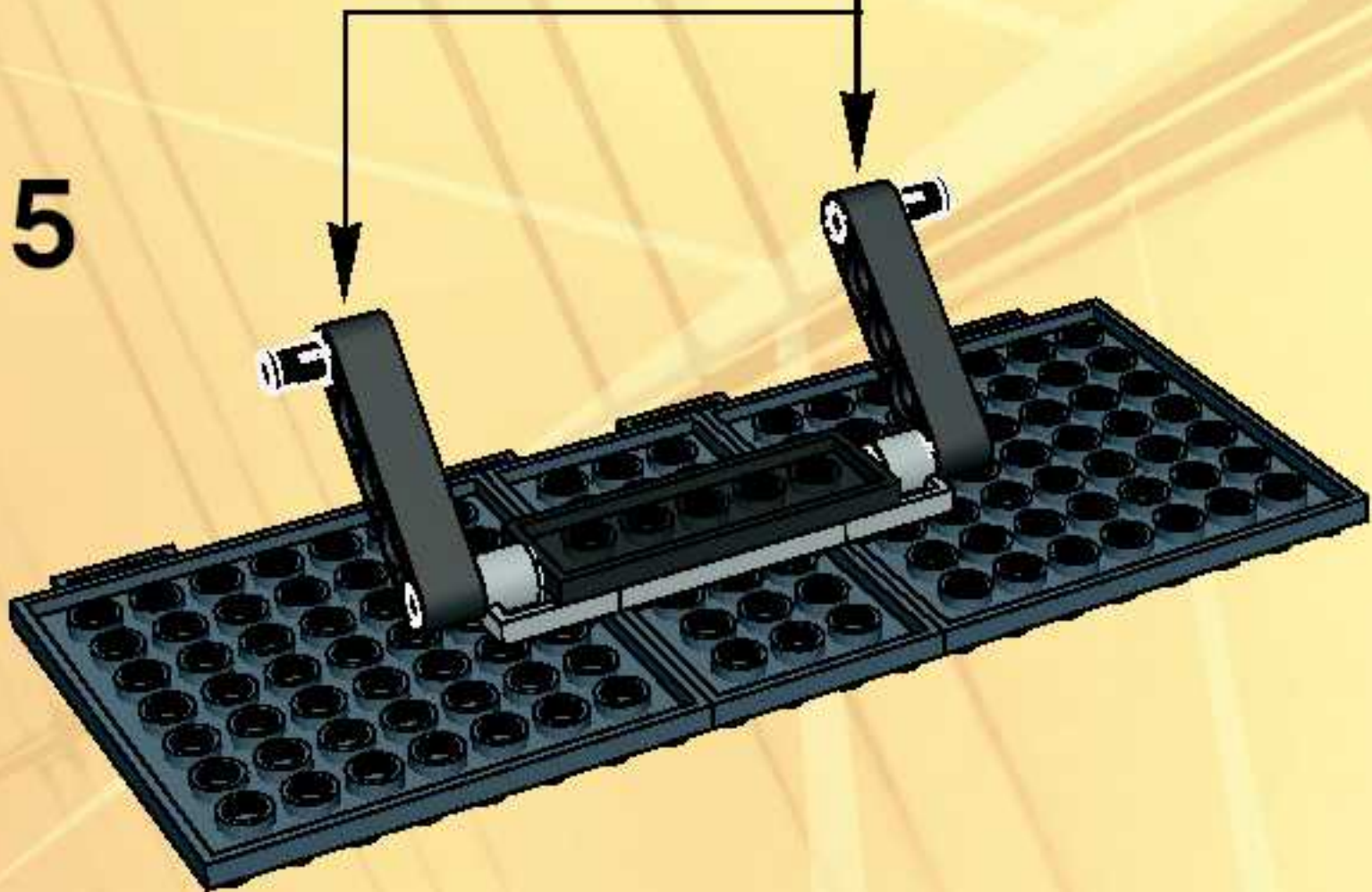

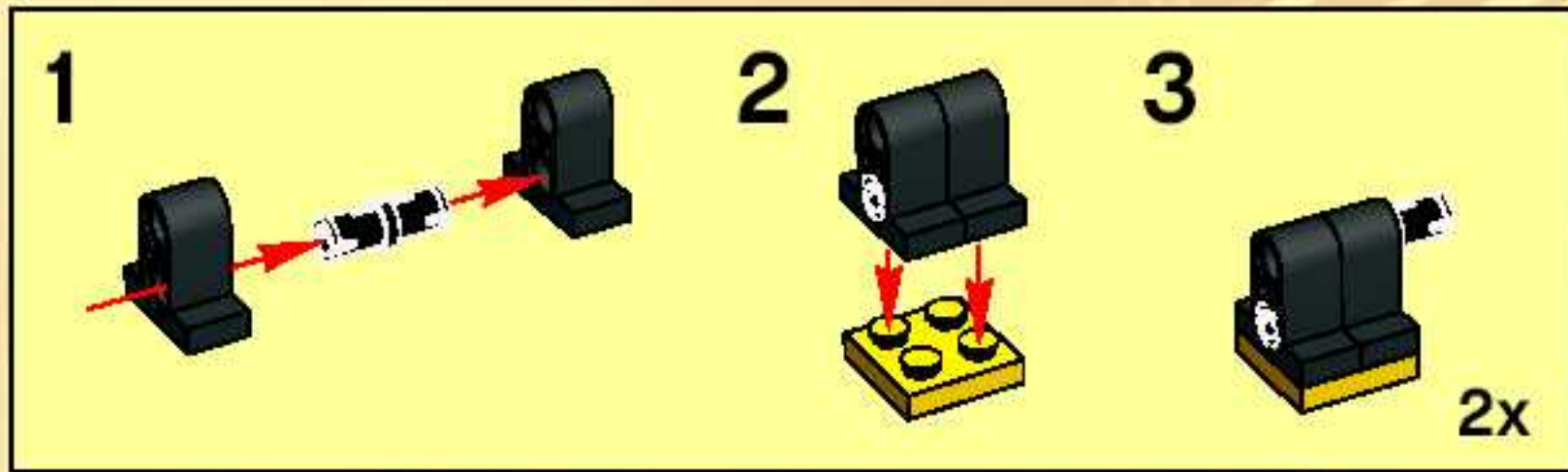

6

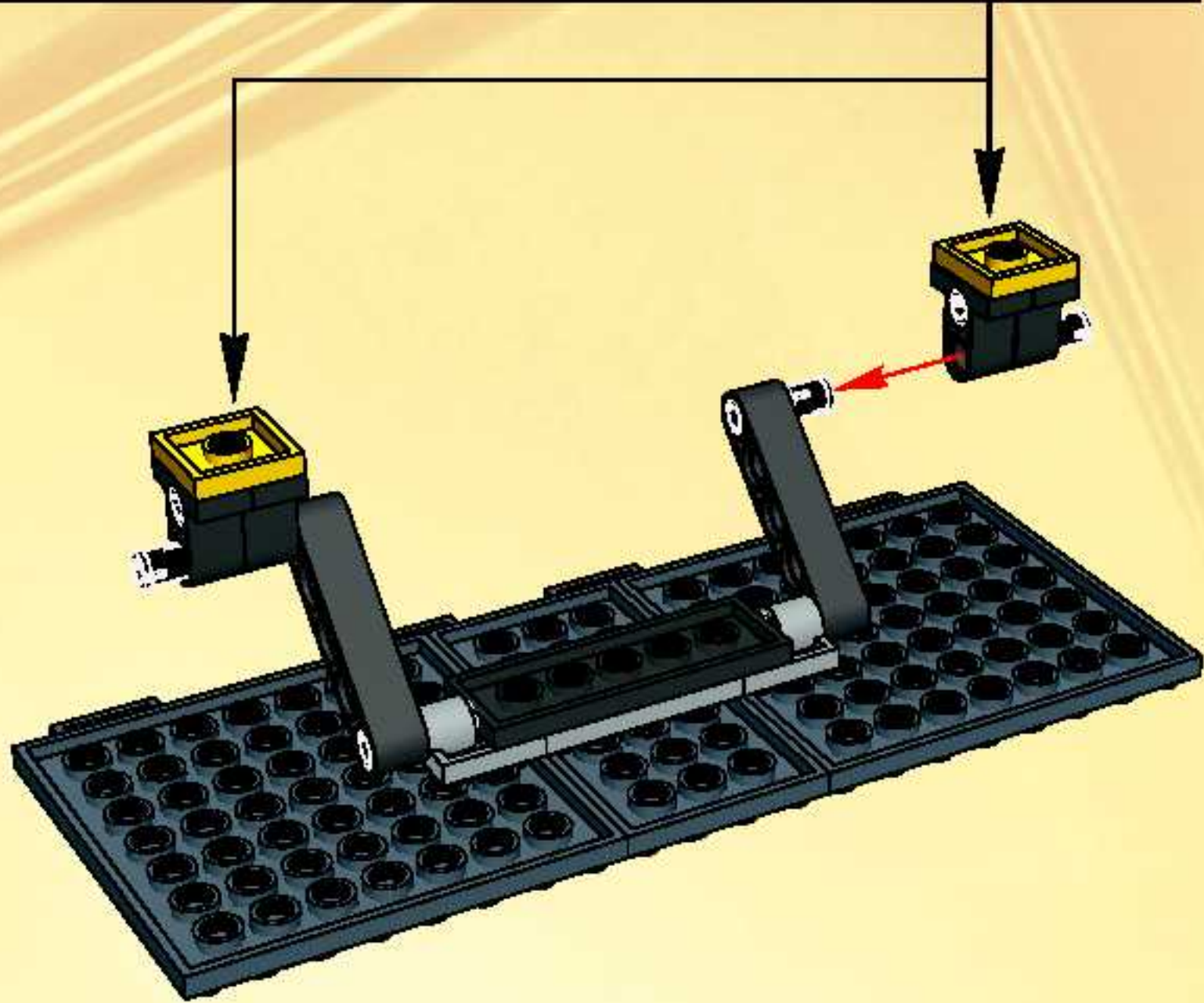

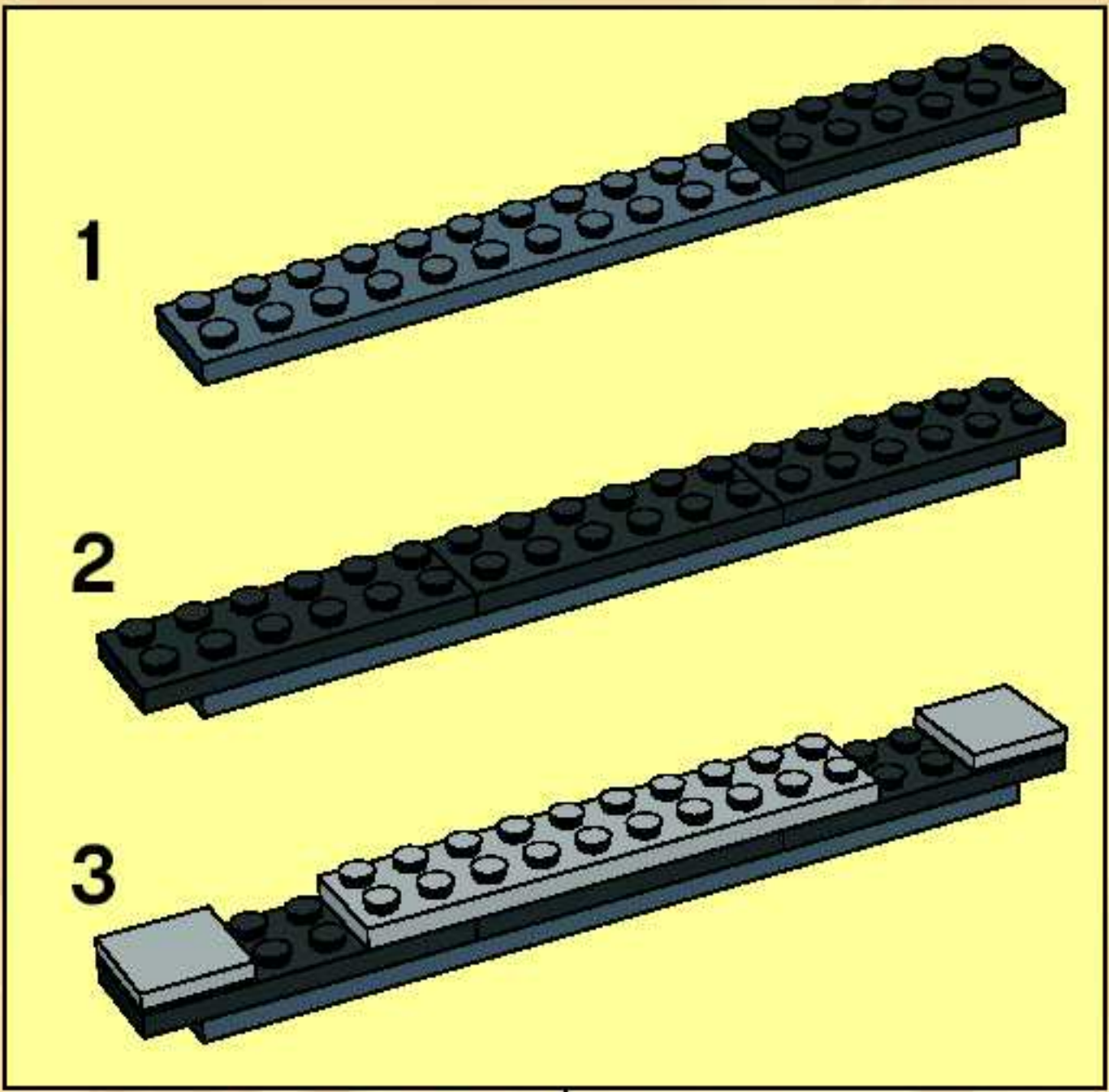

7

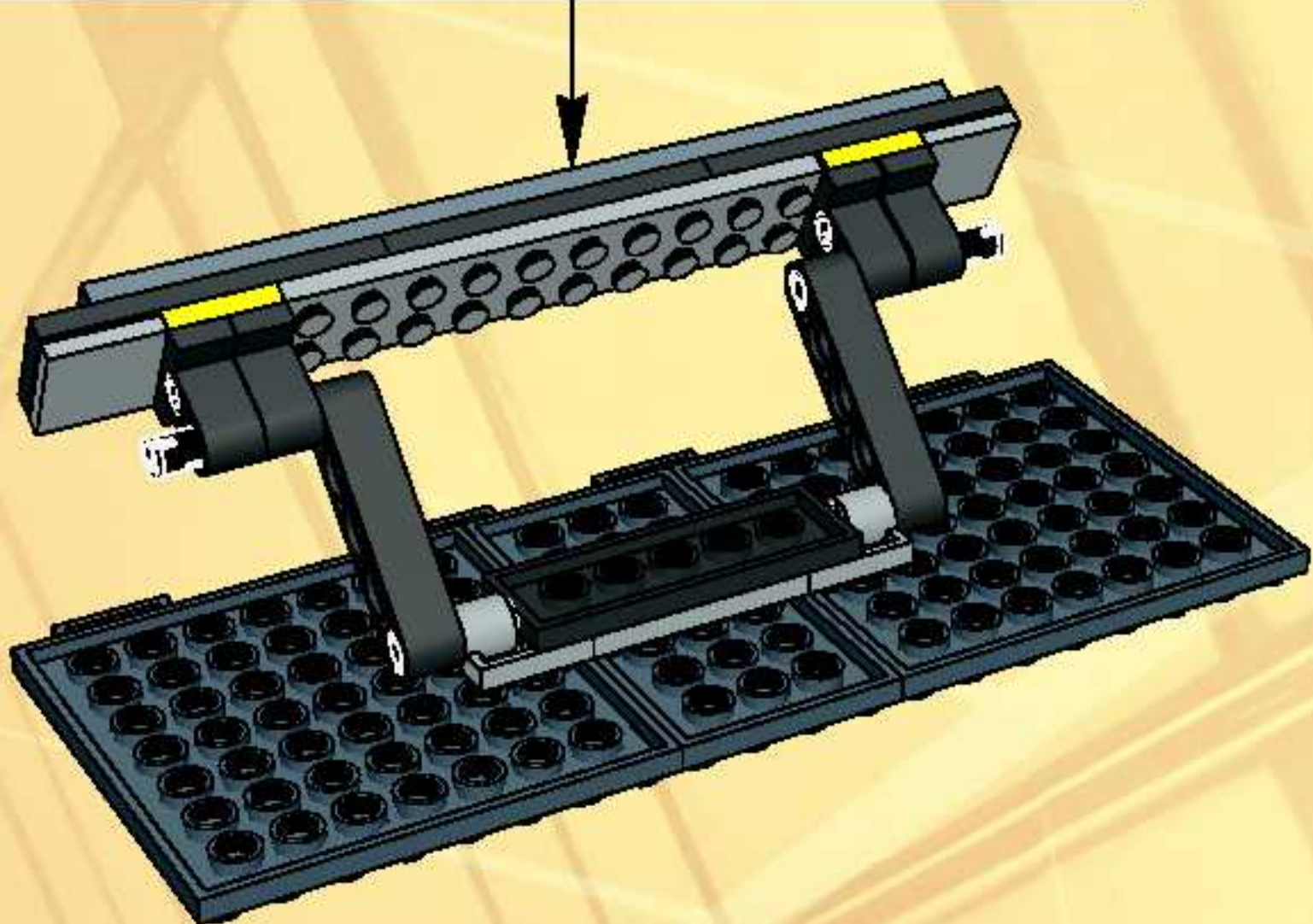

8

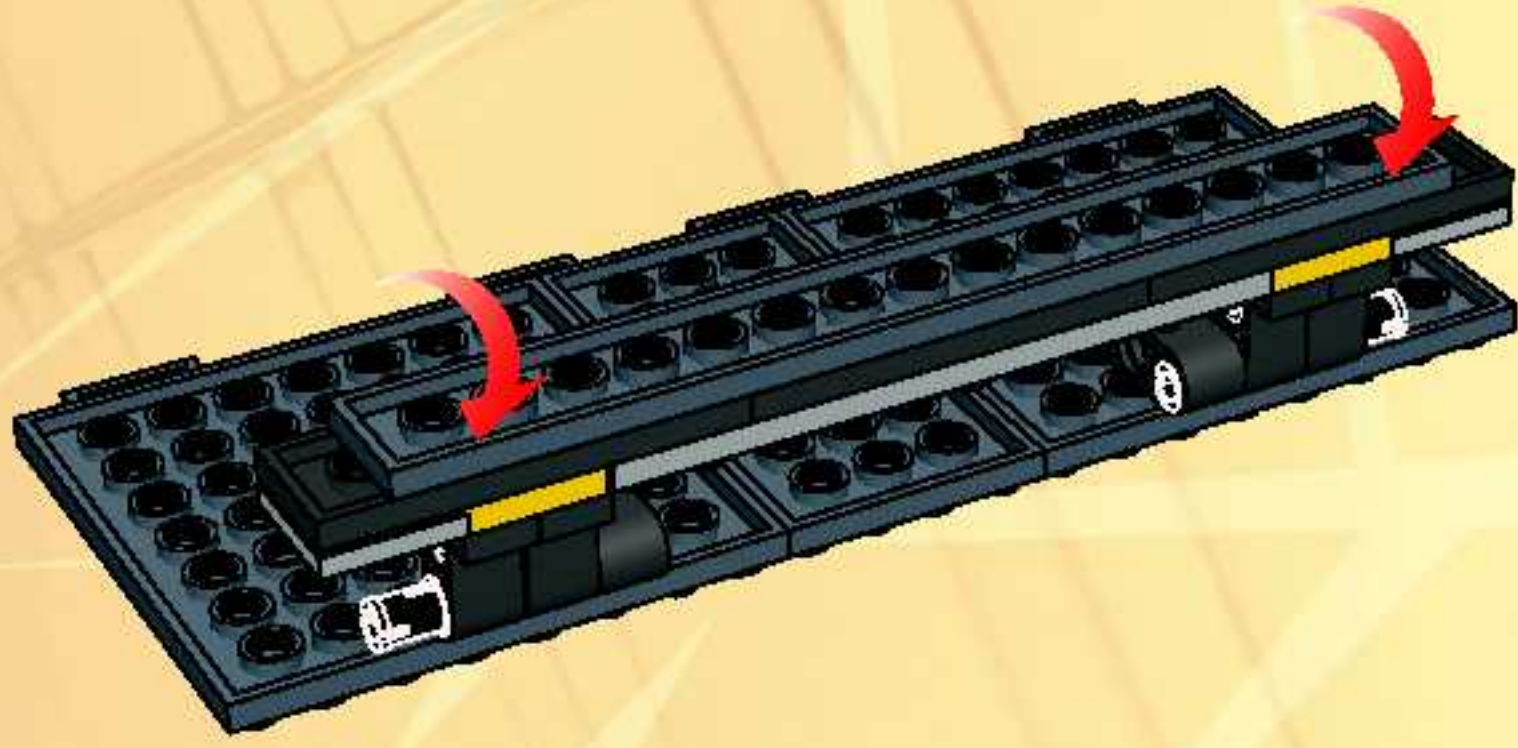

1

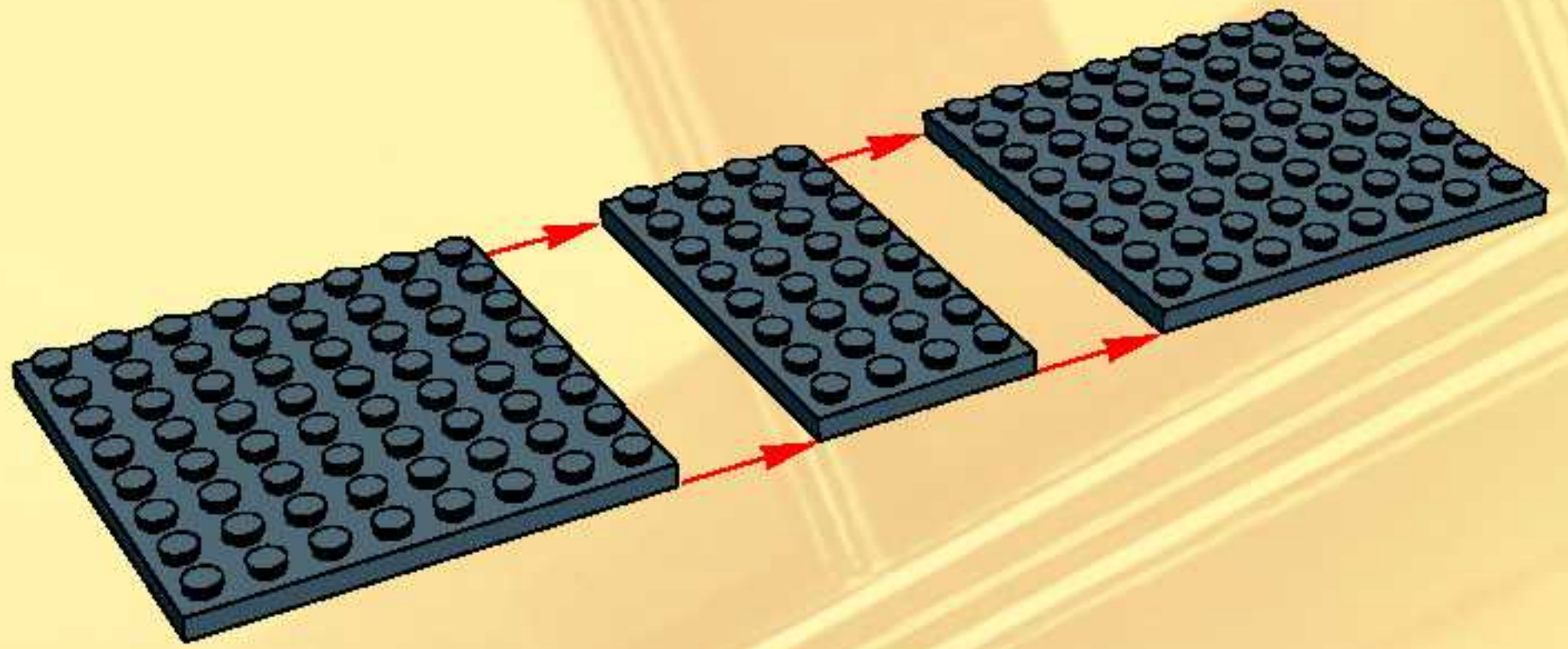

2

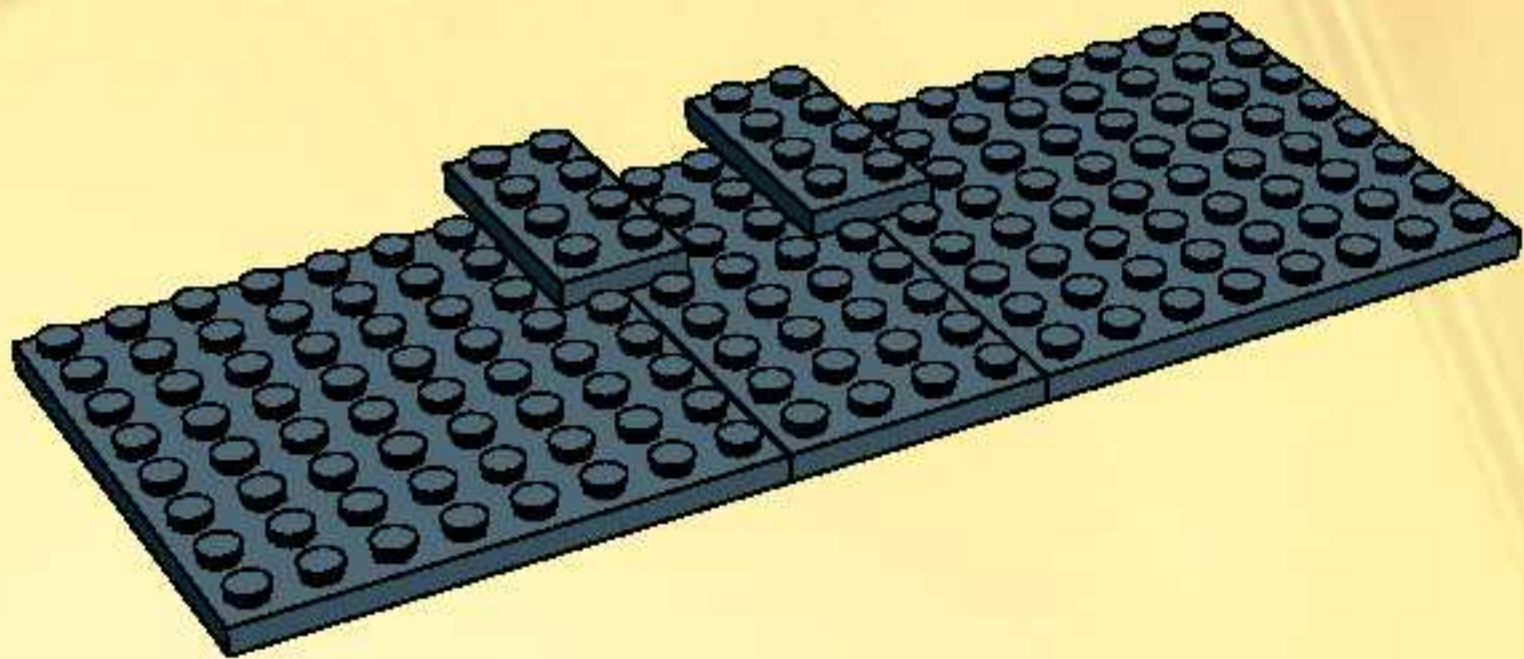

3

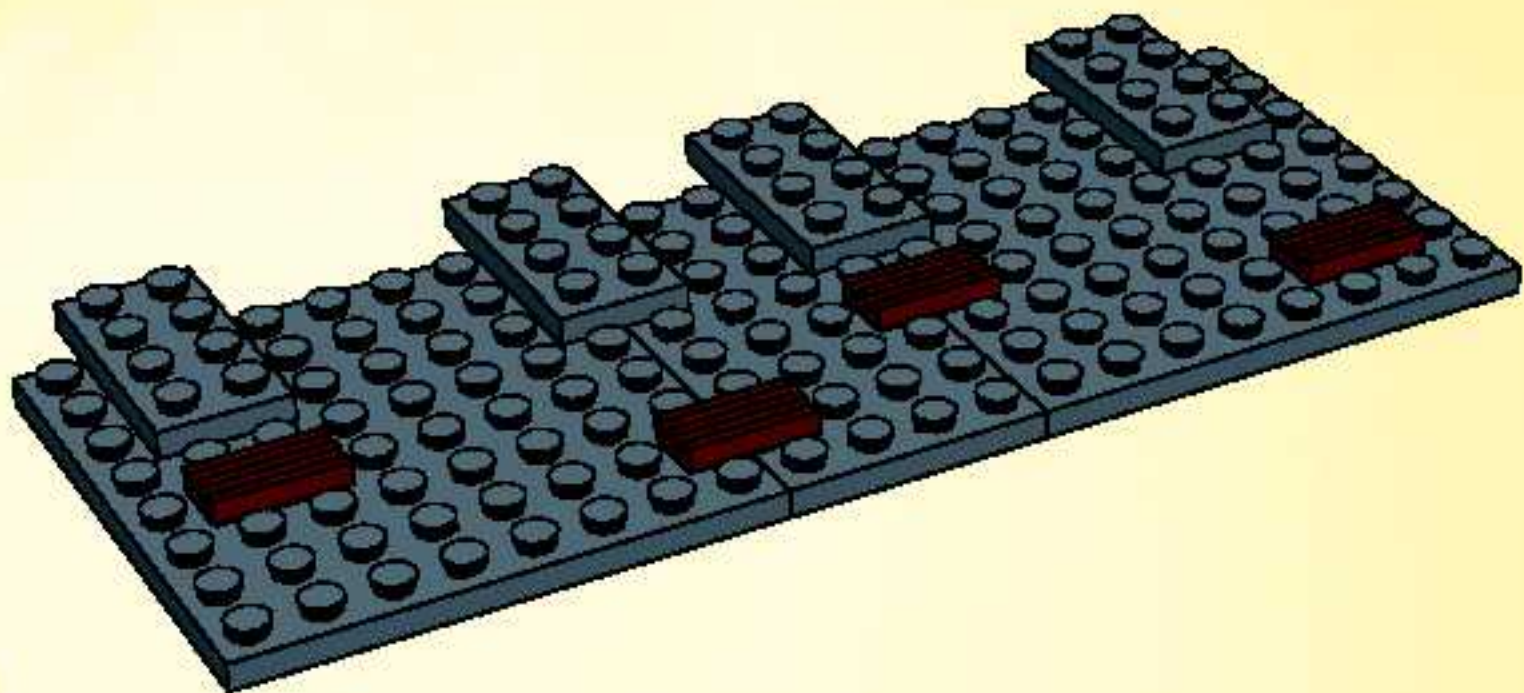

4

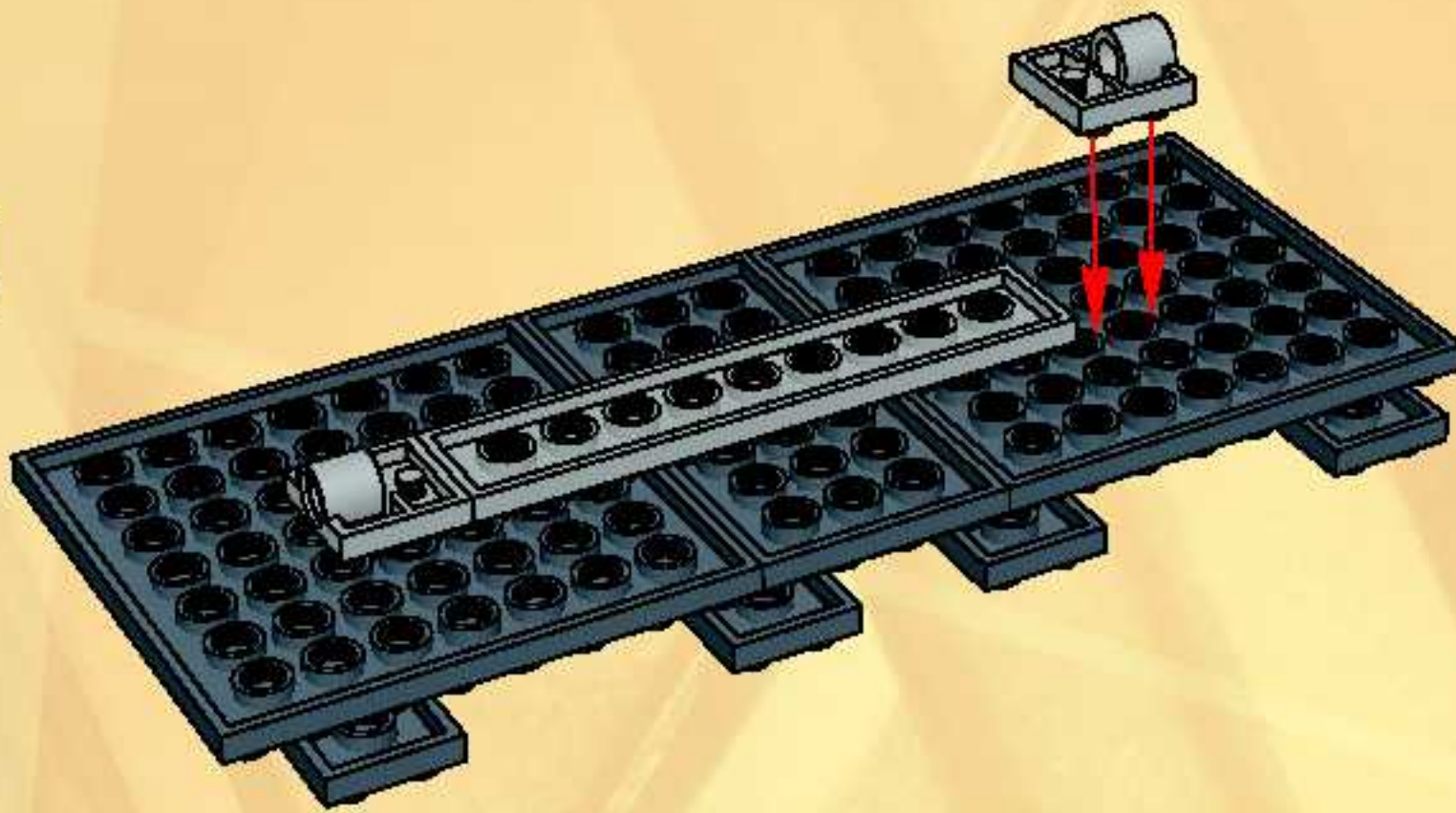

5

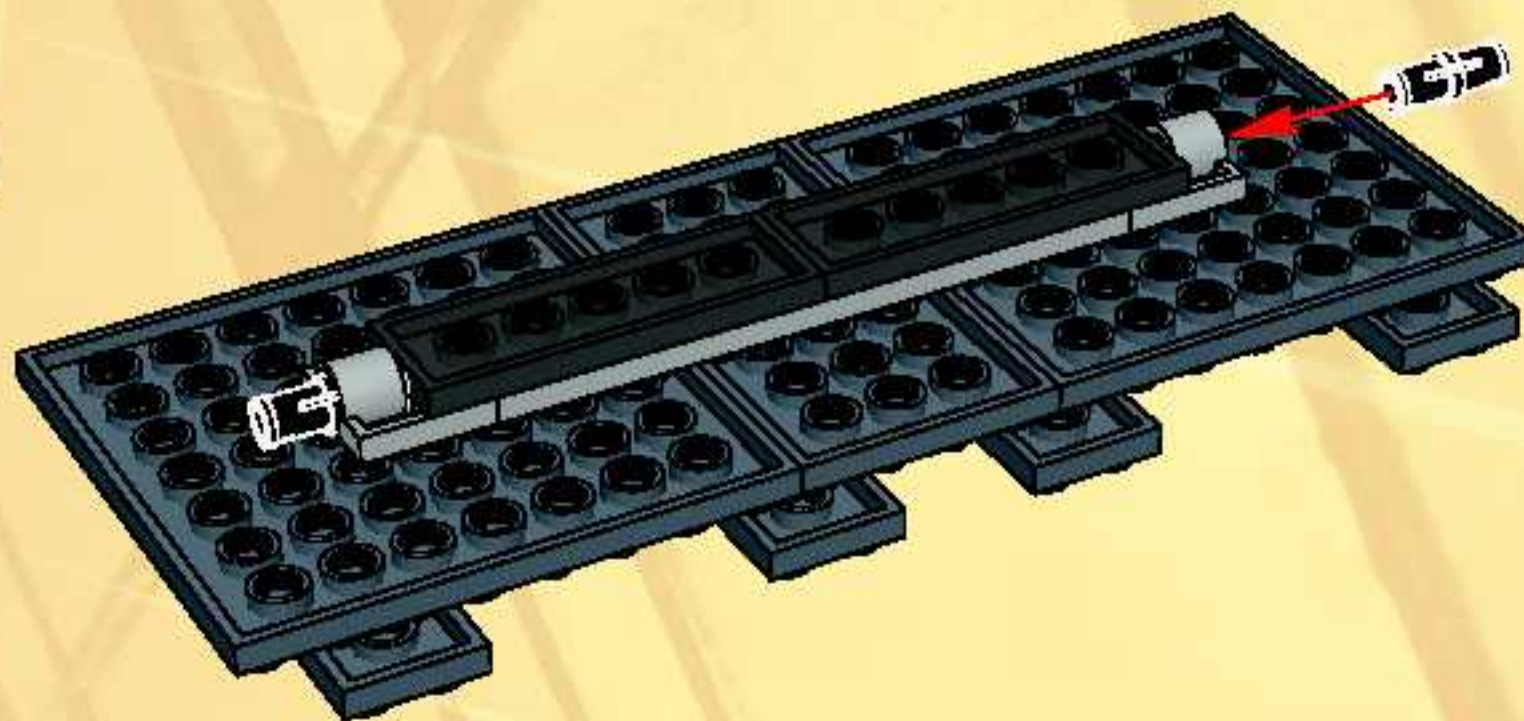

9

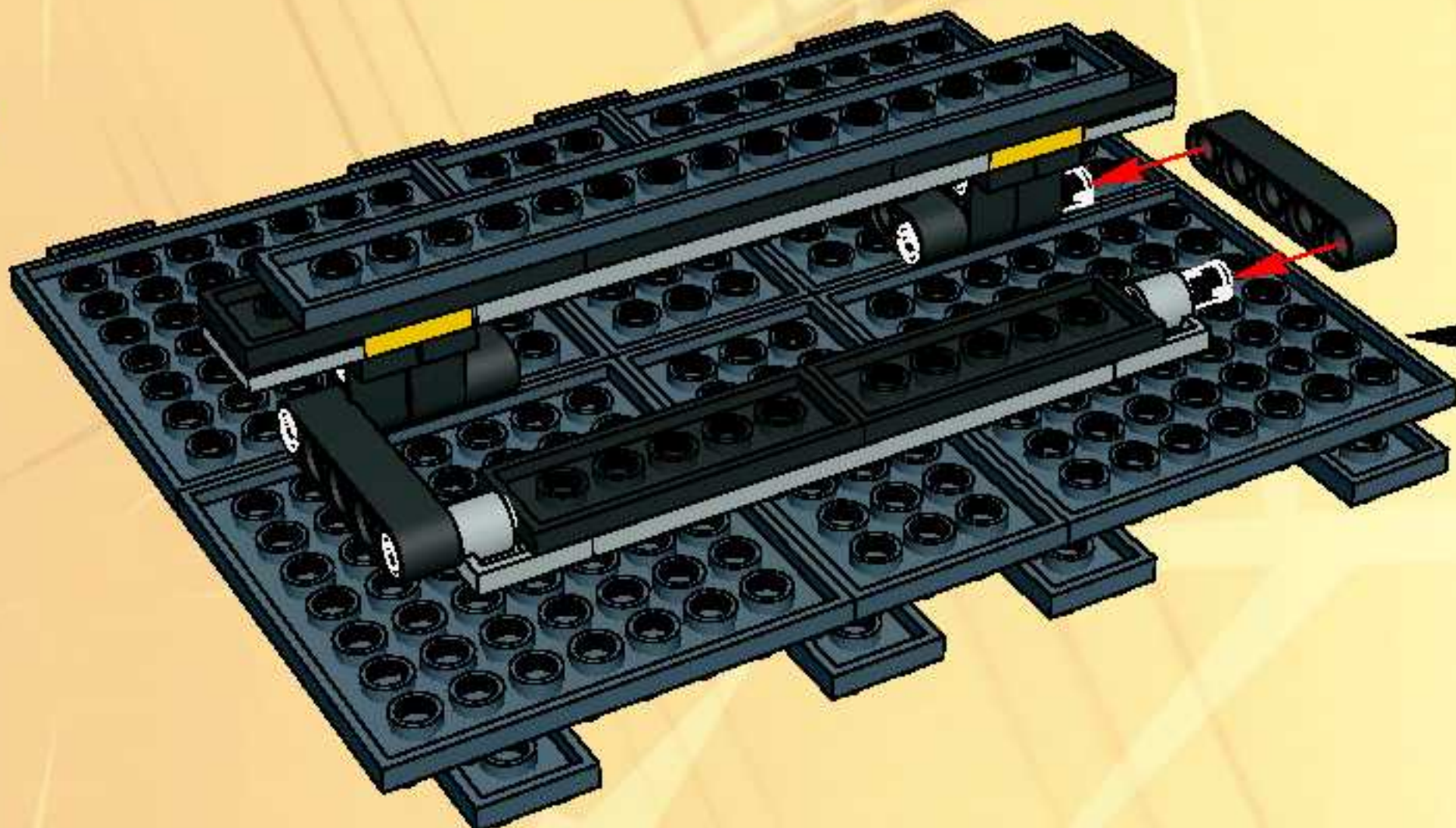

26

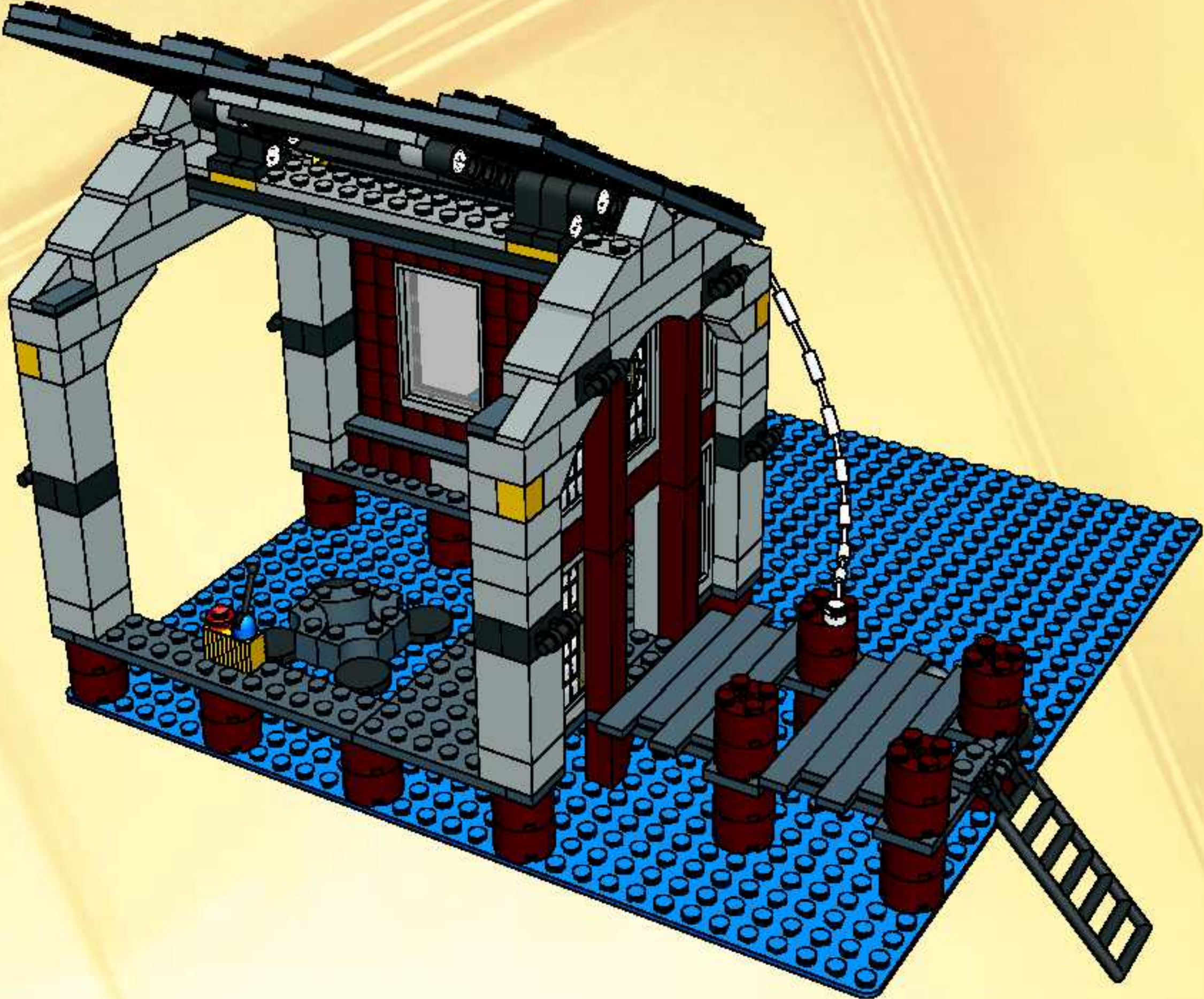

27

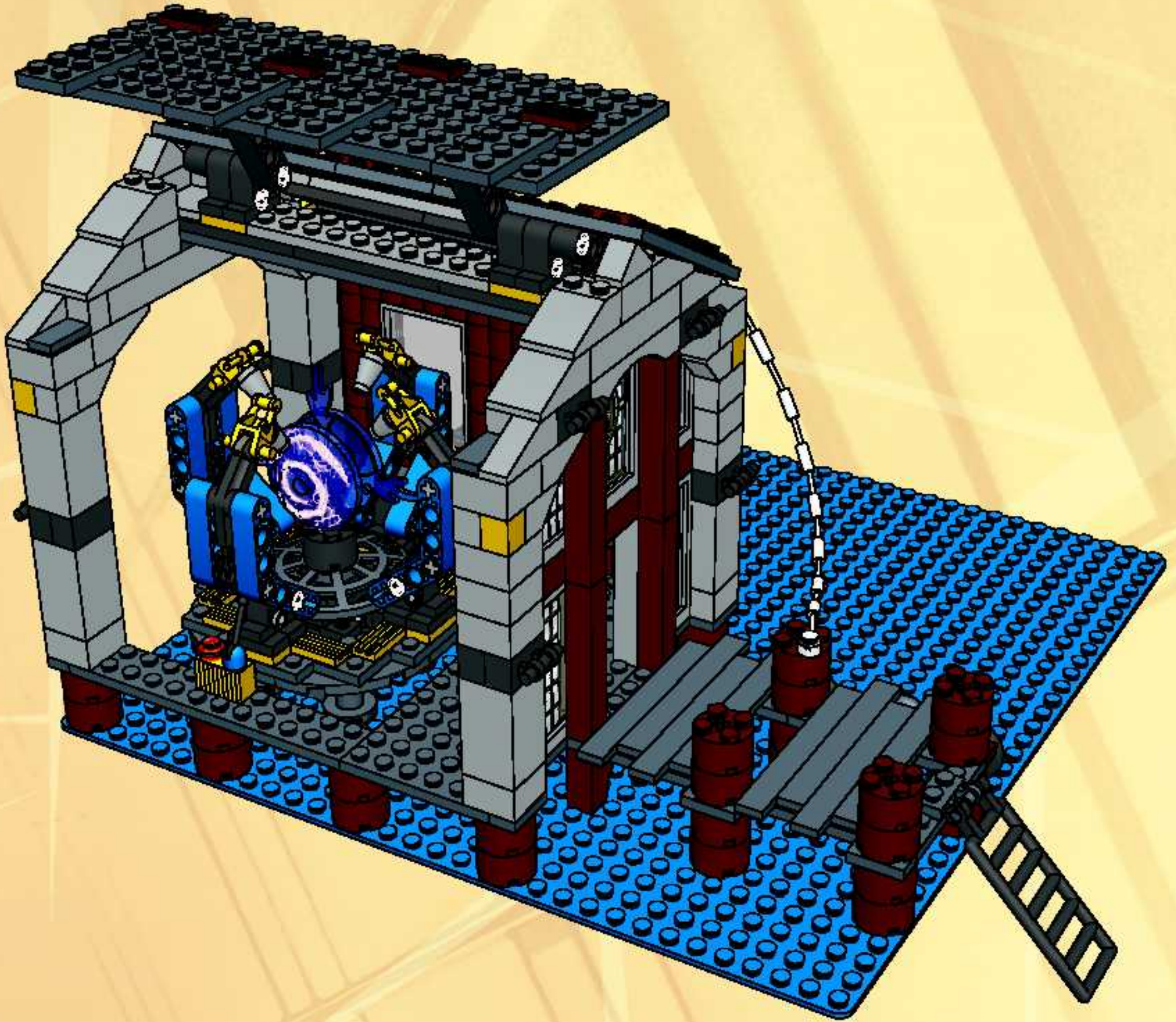

28

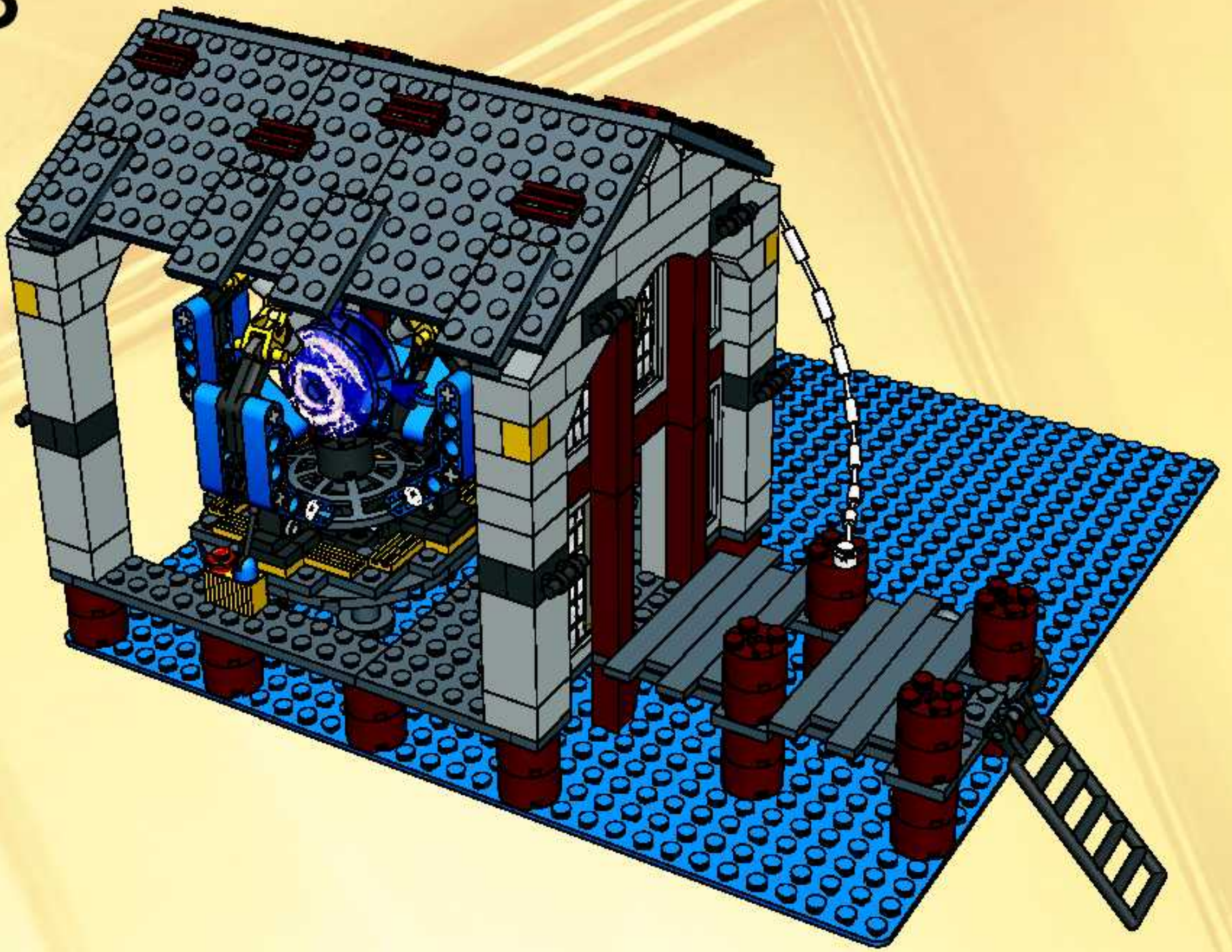

29







Win!
Gagne!
Gewinne!
当たります



WIN LEGO® PRODUCTS

We would like to know what you think about our new LEGO® product. If you could help us by answering a few questions you are in with a chance of winning an exciting LEGO prize. It will only take you about 3 minutes! Log on to the web address below for further instructions.



GAGNE DES PRODUITS LEGO®

Nous aimerions savoir ce que tu penses de ton nouveau produit LEGO®. Si tu veux bien nous aider en répondant à quelques questions, tu recevras peut-être bientôt un fantastique prix LEGO. Et cela ne te prendra que 3 minutes environ! Tu obtiendras davantage d'informations en visitant le site Internet indiqué ci-dessous.



GEWINNE LEGO® PRODUKTE

Wir sind sehr an deiner Meinung über dein neues LEGO® Produkt interessiert. Wenn du uns den Gefallen tust und ein paar Fragen beantwortest, kannst du einen tollen LEGO Preis gewinnen. Das Ganze dauert nur etwa 3 Minuten! Gehe einfach zu der unten angegebenen Webadresse - dort findest du weitere Informationen.



Estimado usuario LEGO®

Al contestar algunas preguntas en inglés, francés, alemán o japonés, en el sitio www.acnielsen.aim.dk/lego, podrás participar en el sorteo de algunos valiosos premios LEGO®.



Caro Consumidor da LEGO®

Ao responder a algumas perguntas em Inglês, Francês, Alemão ou Japonês no endereço www.acnielsen.aim.dk/lego irá participar num concurso para ganhar valiosos prémios da LEGO®.



Kedves Ifjú LEGO® Vásárló

Ha ellátogatsz a www.acnielsen.aim.dk/lego honlapra és ott angol, francia, német vagy japán nyelven megválaszolsz néhány kérdést, akkor részt veszel egy versenyben, amelyben értékes LEGO® díjakat nyerhetsz.



抽選でレゴ®製品が当たります

私たちは、皆さんがお買い求めのレゴ®製品についてどんな感想をお持ちか、知りたいと思っています。質問に答えて、楽しいレゴ®製品の抽選に応募しませんか。アンケートの回答には、ほんの3分ほどしかかかりません! 詳しくは、以下のウェブアドレスまでアクセスしてください。

www.acnielsen.aim.dk/LEGO





4856



4855



4854



4853

MARVEL

SPIDER-MAN
MERCHANDISING

COLUMBIA
PICTURES

Spider-Man and all related characters: TM & © 2004
Marvel Characters, Inc.

Spider-Man 2, the movie © 2004 Columbia
Pictures Industries, Inc. All rights reserved.

