

The LEGO logo is displayed in its characteristic white font with a black outline, set against a red rectangular background.

 **WARNING:** CHOKING HAZARD.  
Toy contains small parts and a small ball.  
Not for children under 3 years.

 **AVERTISSEMENT :** RISQUE D'ÉTOUFFEMENT.  
Le jouet contient des petites pièces ainsi qu'une petite boule.  
Il ne convient pas aux enfants de moins de 3 ans.

 **ADVERTENCIA:** PELIGRO DE ASFIXIA.  
Juguete que contiene partes pequeñas y una pelota  
pequeña. No recomendado para niños menores de 3 años.

4726

# Harry Potter



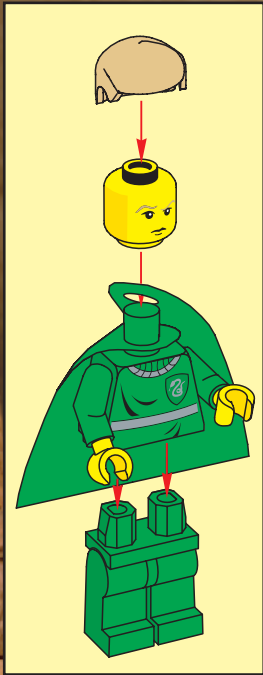

1

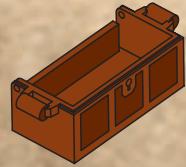

2

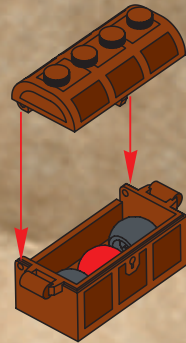



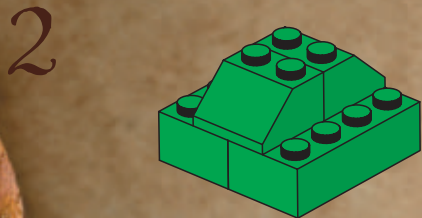
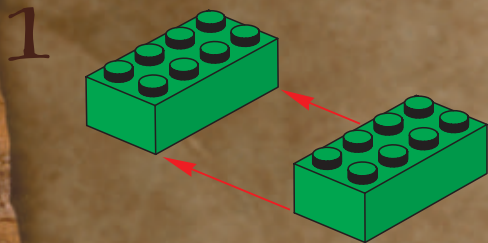
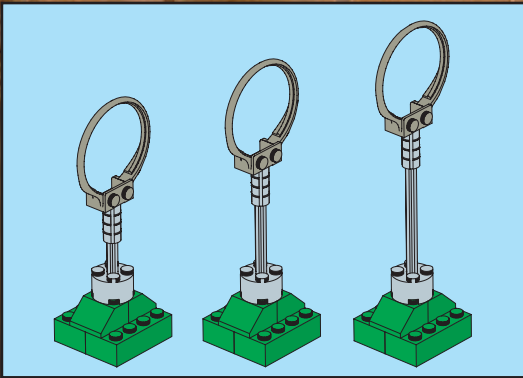

3

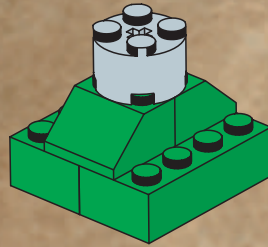

4

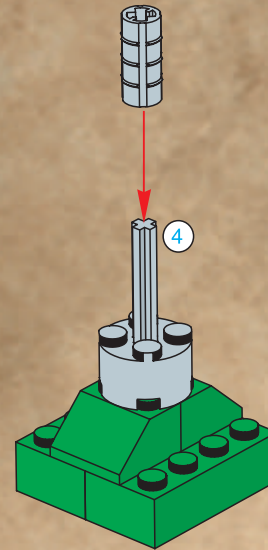

5

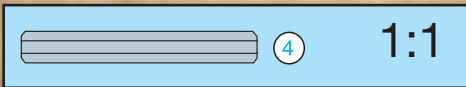
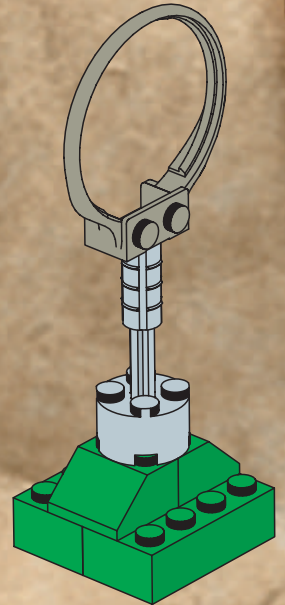

1

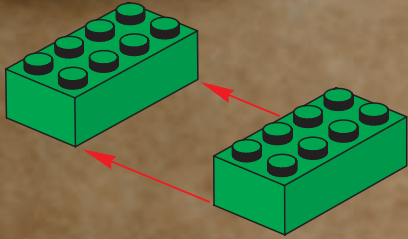

2

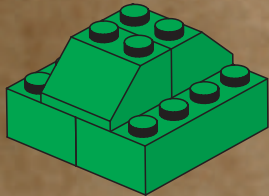

3

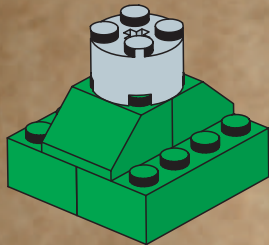

4

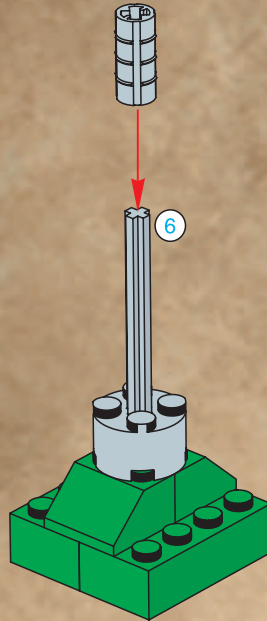

5

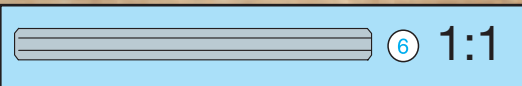
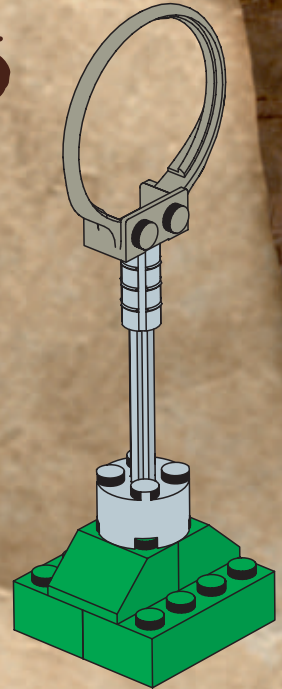



1

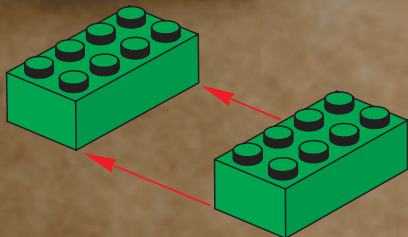

2

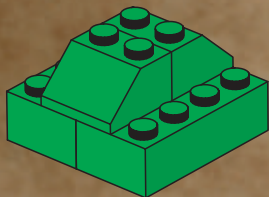

3

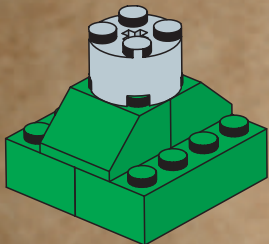

4

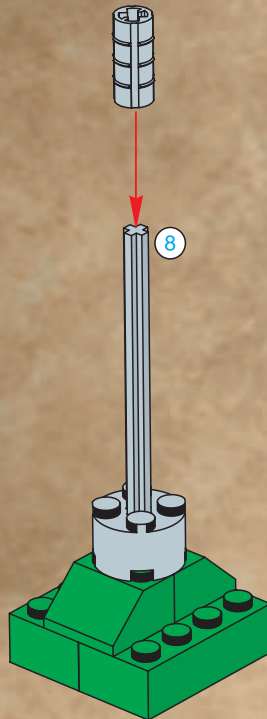

5

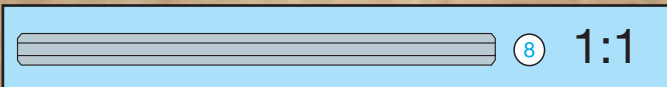
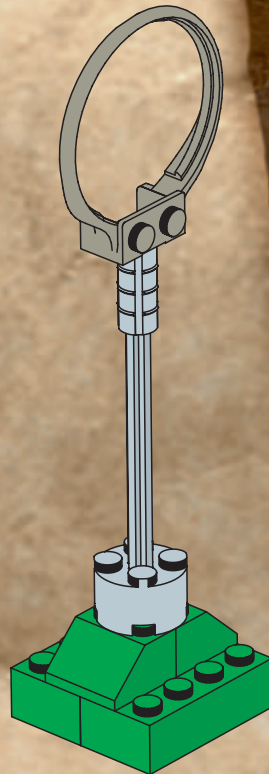

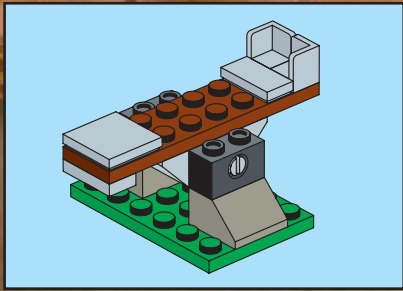

1

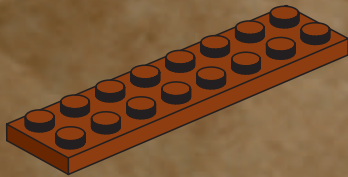

2

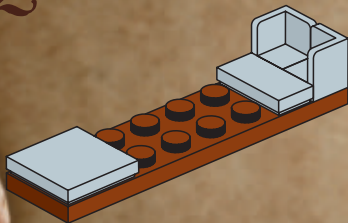

3

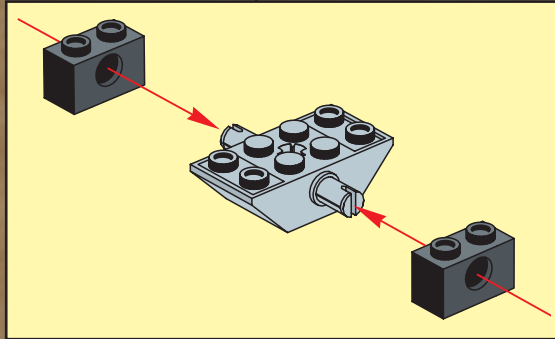
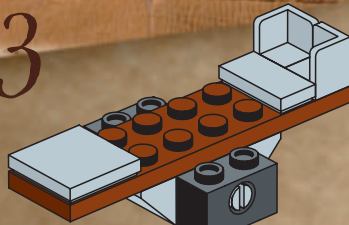

4

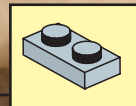
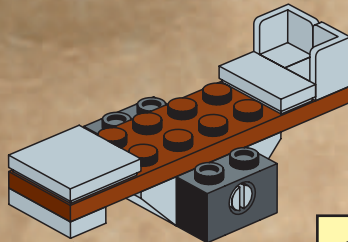

5

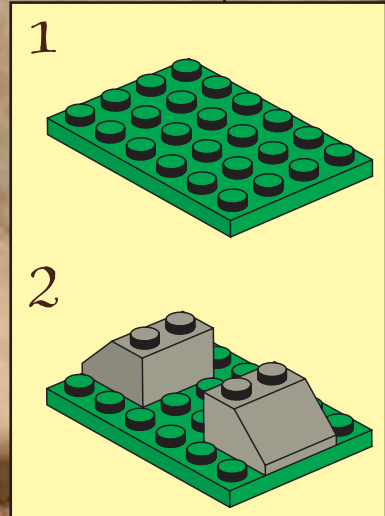
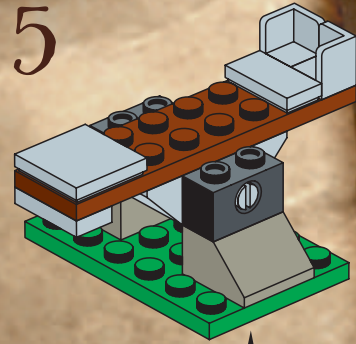

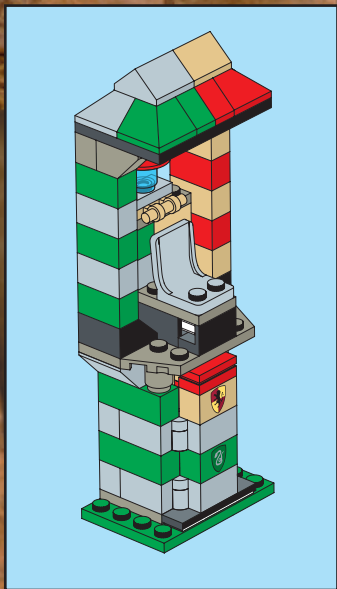

1

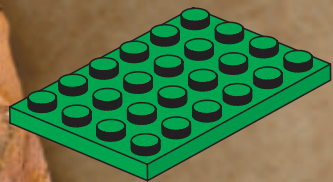

2

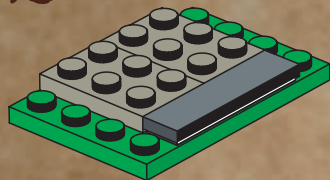

3

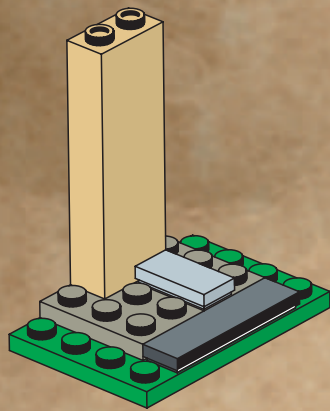

4

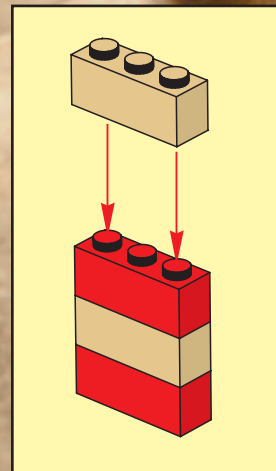
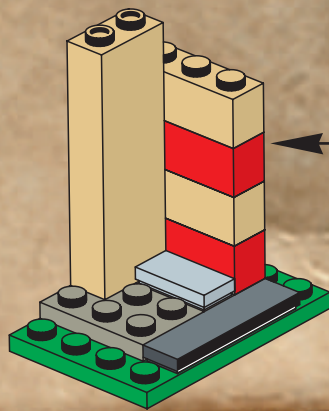



5

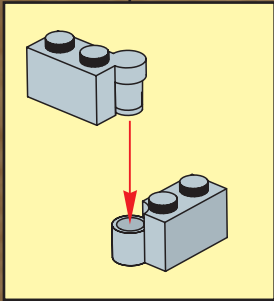
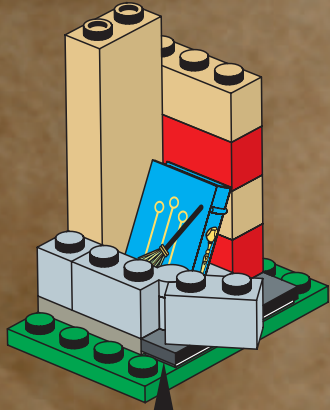

6

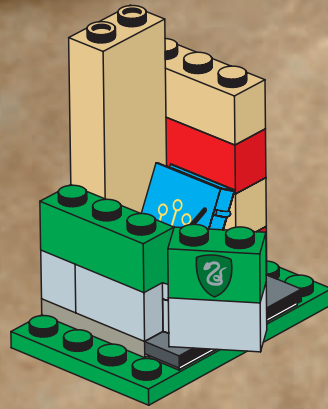

7

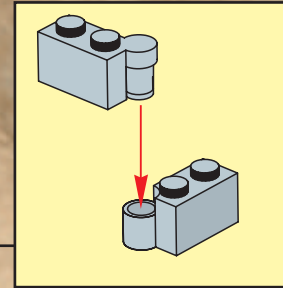
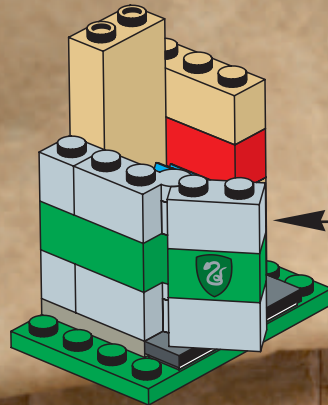



8

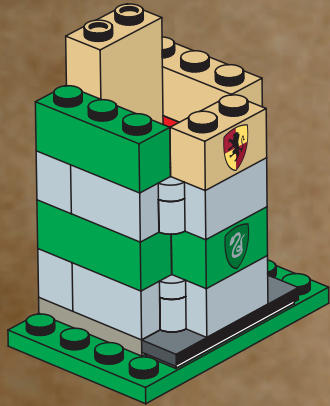

9

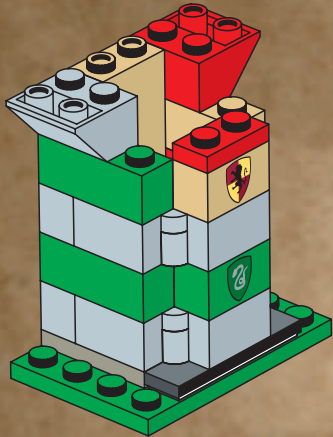

10

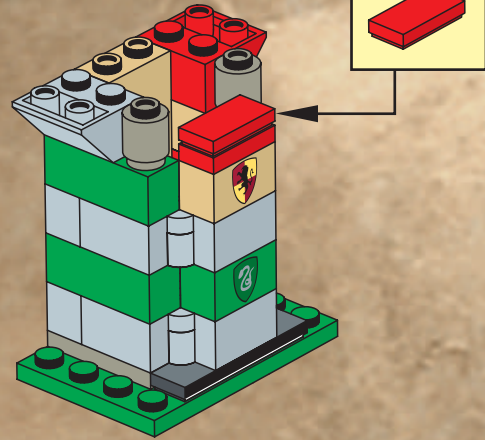

11

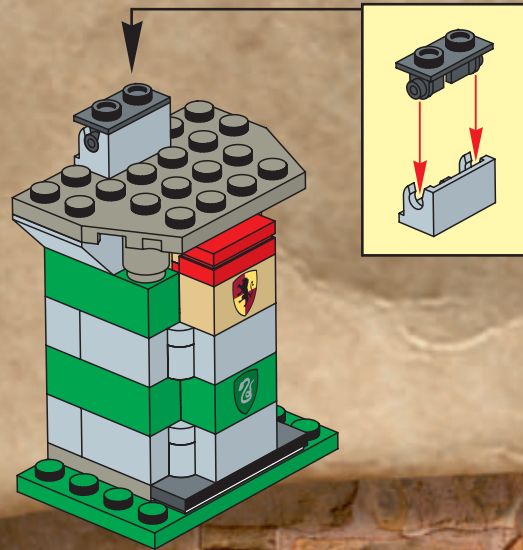

12

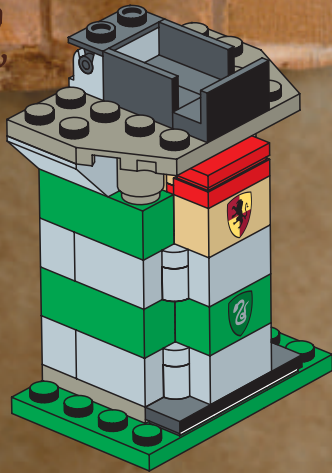

13

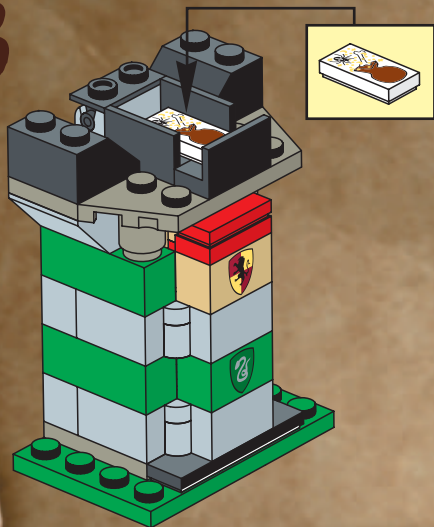

14

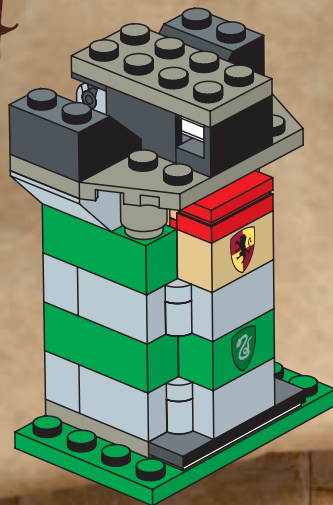

15

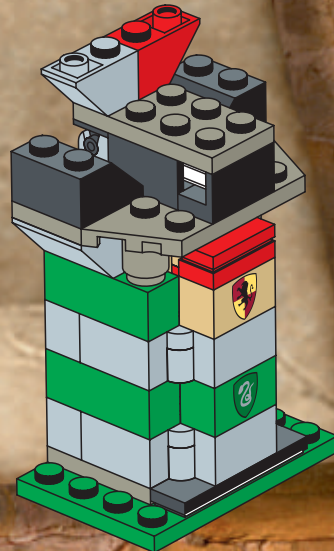



16

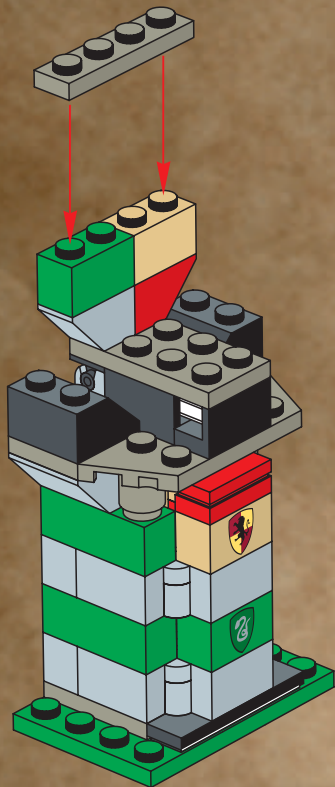

1



3

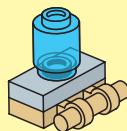

2

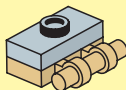

4



17

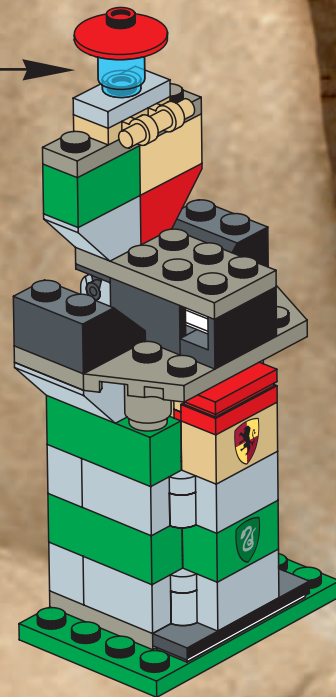

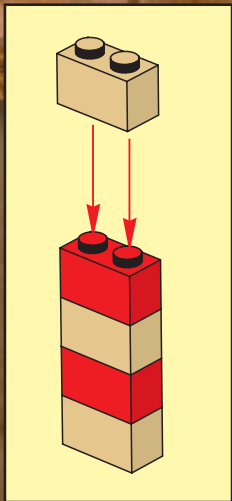

18

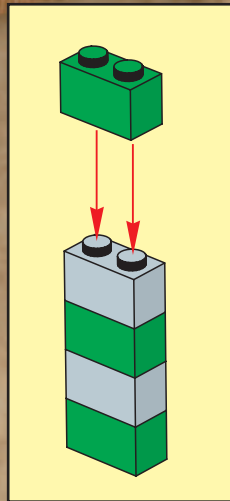
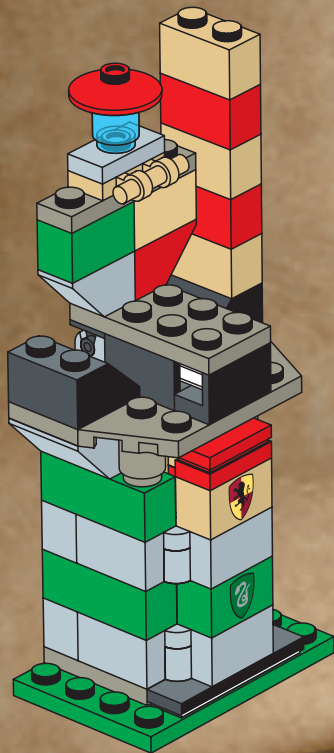

19

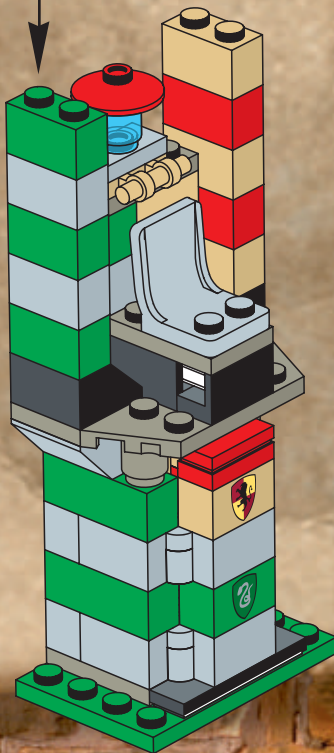



20

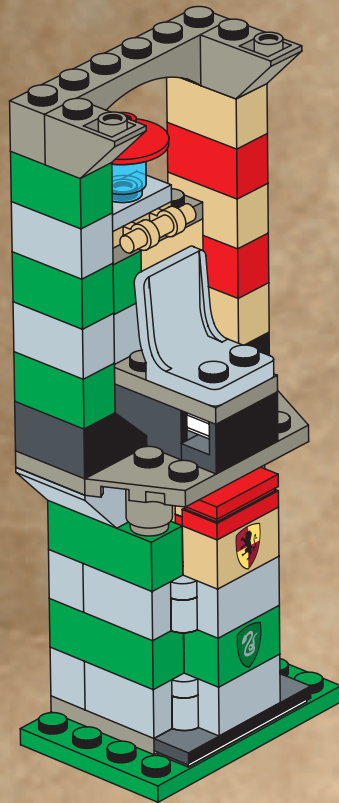

1

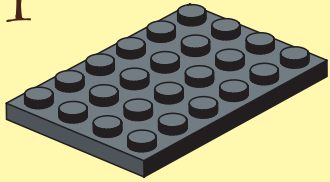

2

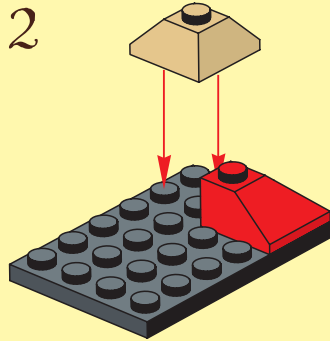

3

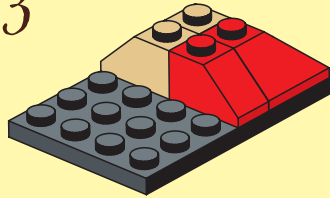

4

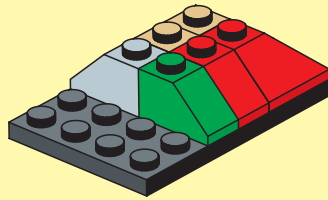

5

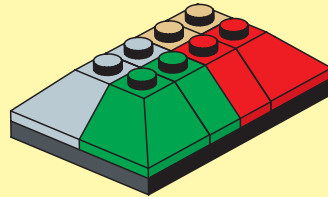

6

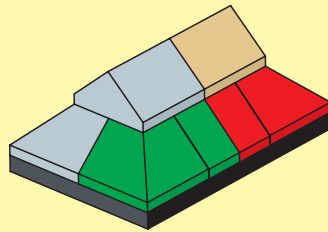

21

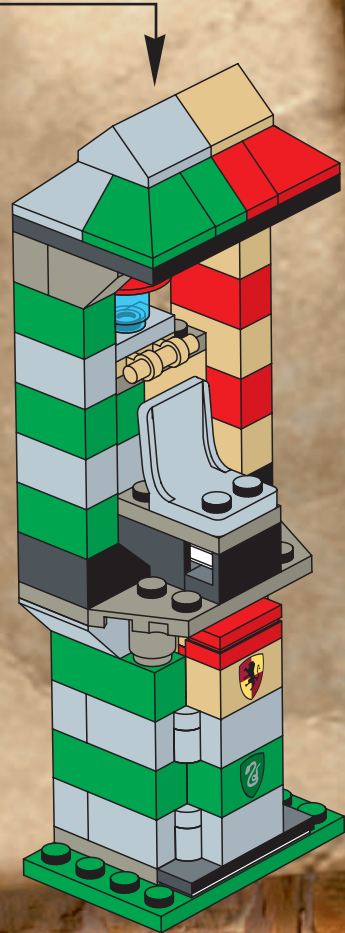





LEGO and the LEGO logo are trademarks of the LEGO Group.  
©2002 The LEGO Group.

HARRY POTTER, characters, names and related indicia are trademarks of  
and © Warner Bros.  
Harry Potter Publishing Rights © J.K. Rowling.  
(s02)





4728



4730



4709



4707

4733



4731



4726



4730



4712



4729



4709

4705

4726



4727



LEGO and the LEGO logo are trademarks of the LEGO Group.  
©2002 The LEGO Group.

HARRY POTTER, characters, names and related indicia are trademarks of and © Warner Bros.

WB SHIELD: TM & © Warner Bros.  
Harry Potter Publishing Rights © J.K. Rowling.  
(s02)

[www.harrypotter.com](http://www.harrypotter.com)

GO [www.LEGO.com](http://www.LEGO.com)  
JOIN THE FUN!