

# BIONICLE™

AGES/EDADES

8+



10023

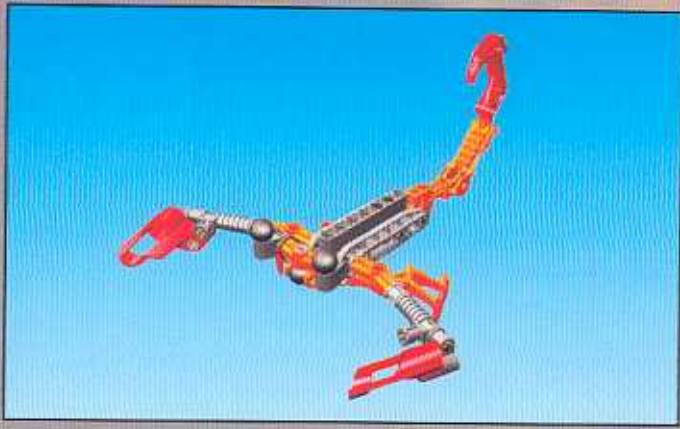

2

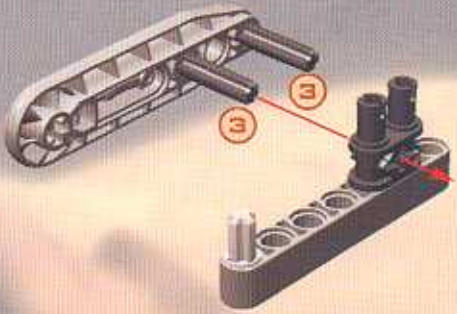

1

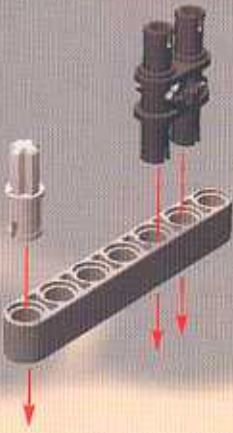

3

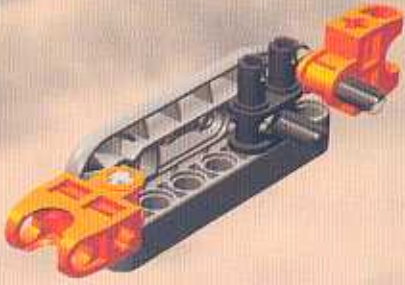

4

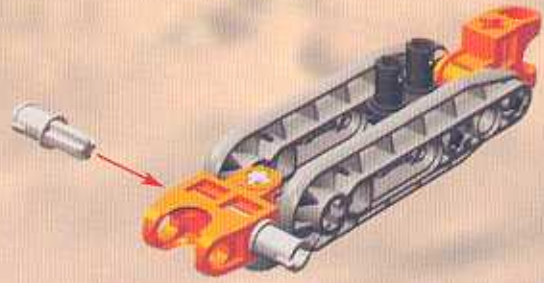

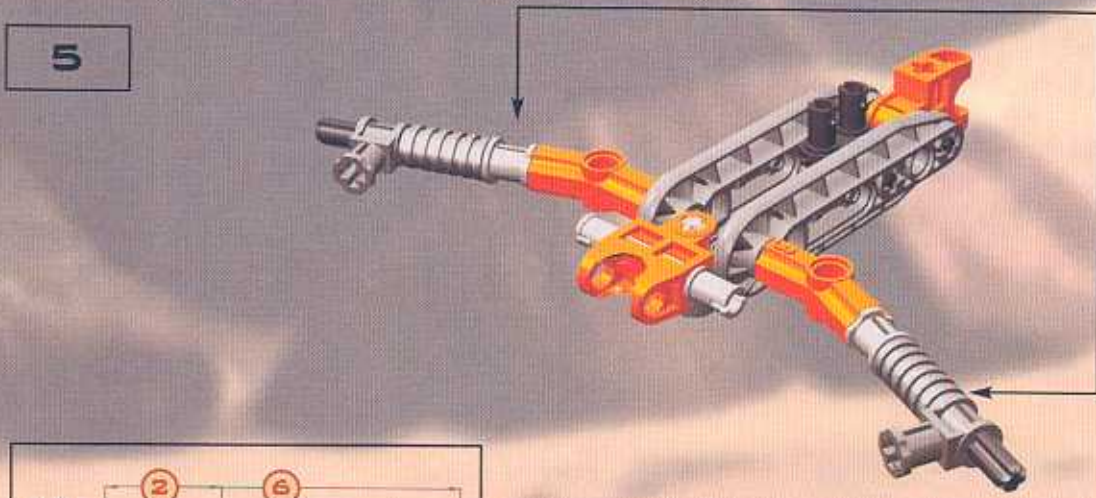
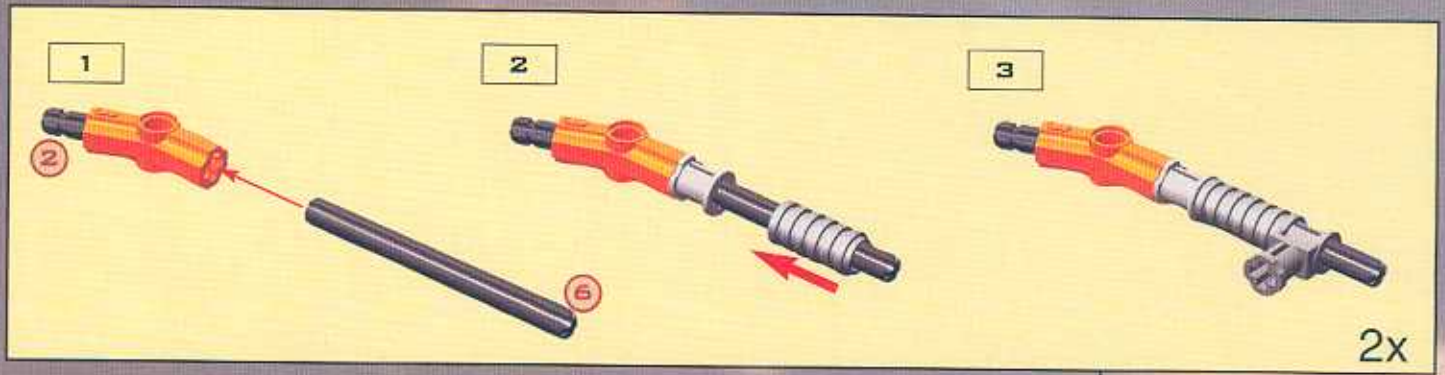

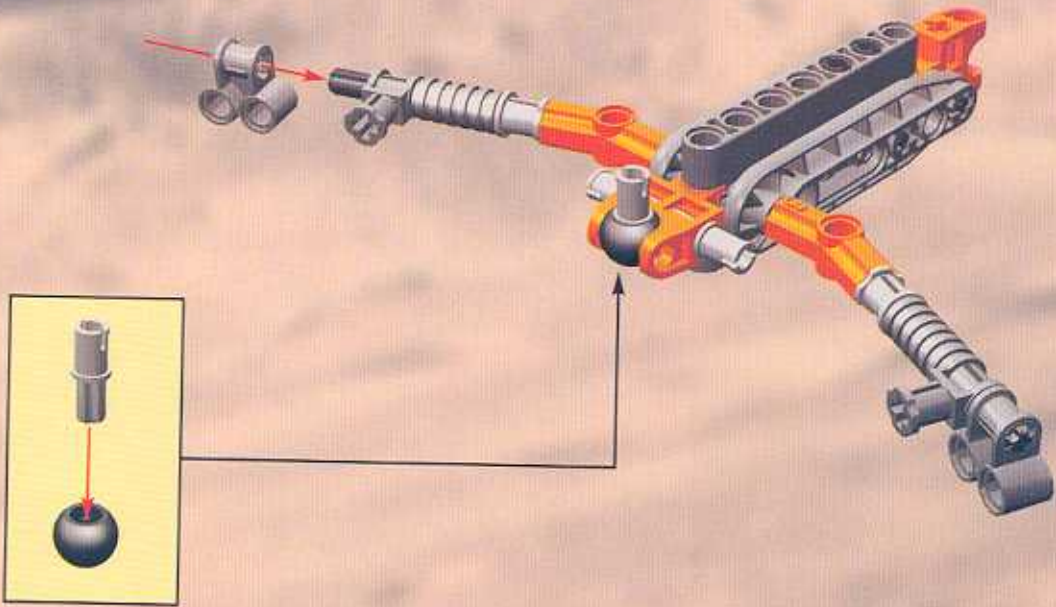

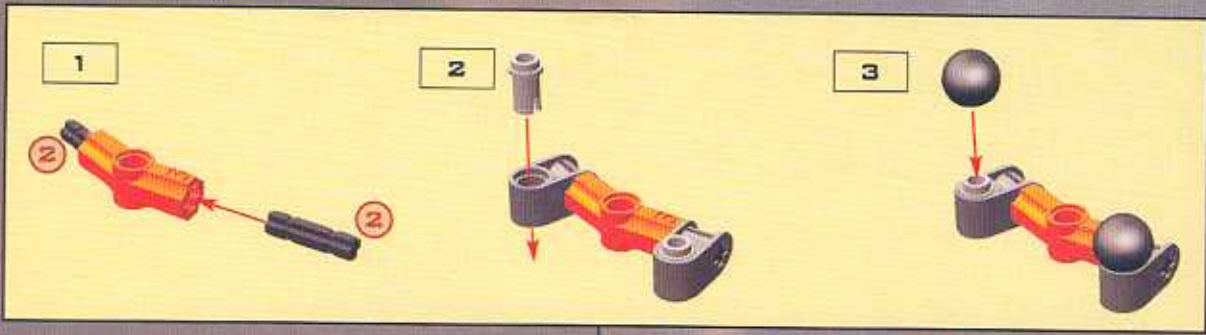

7

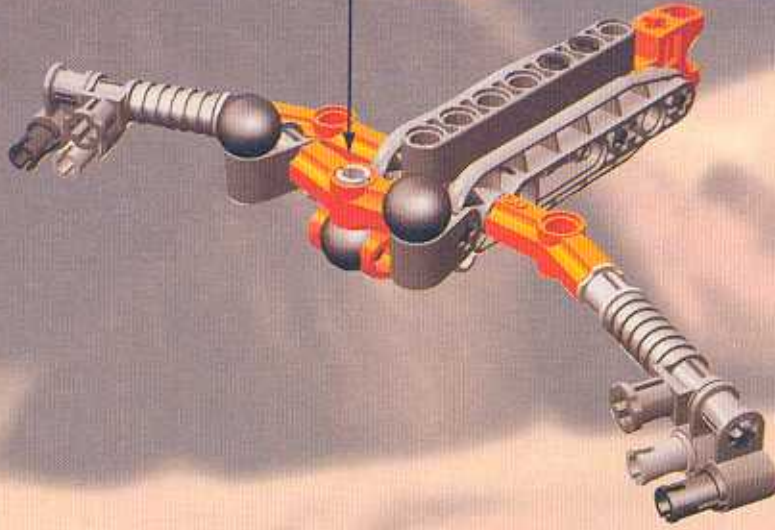

8

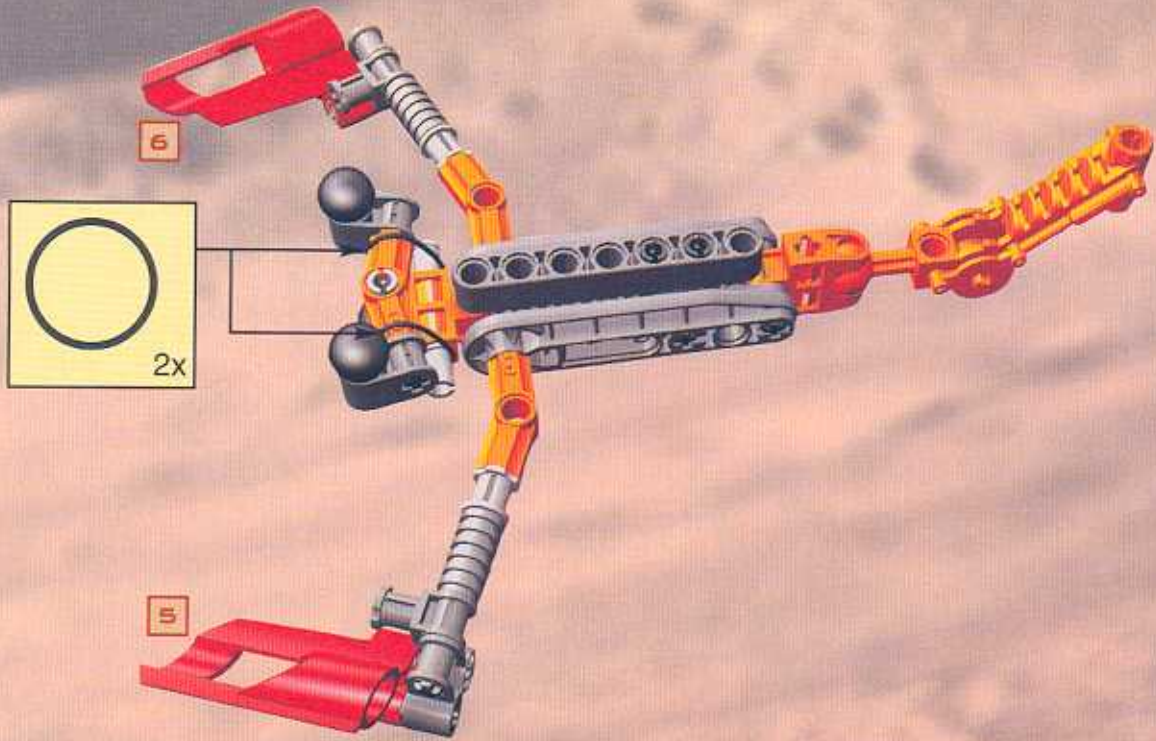

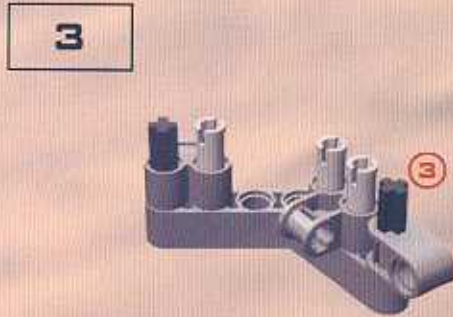
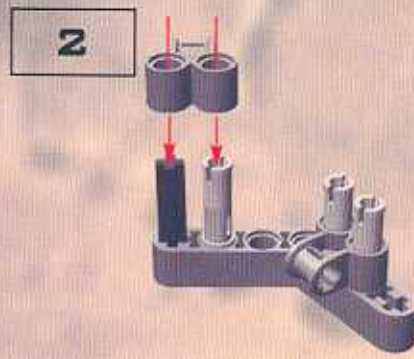
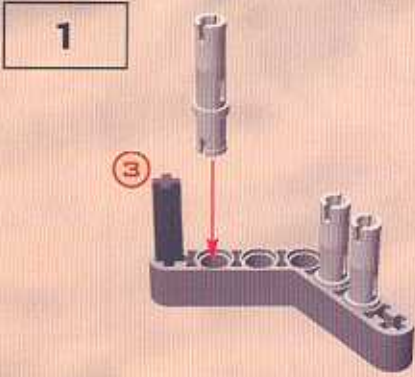
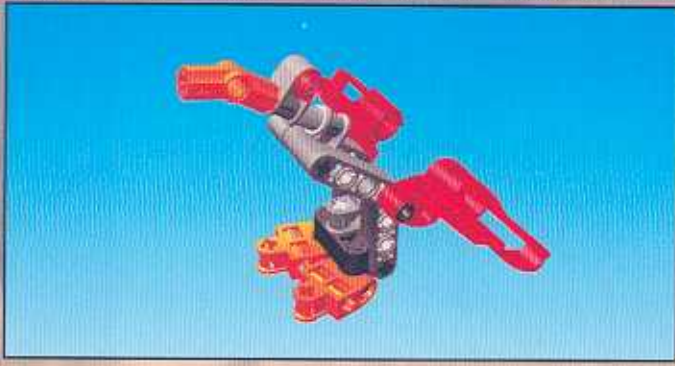



4

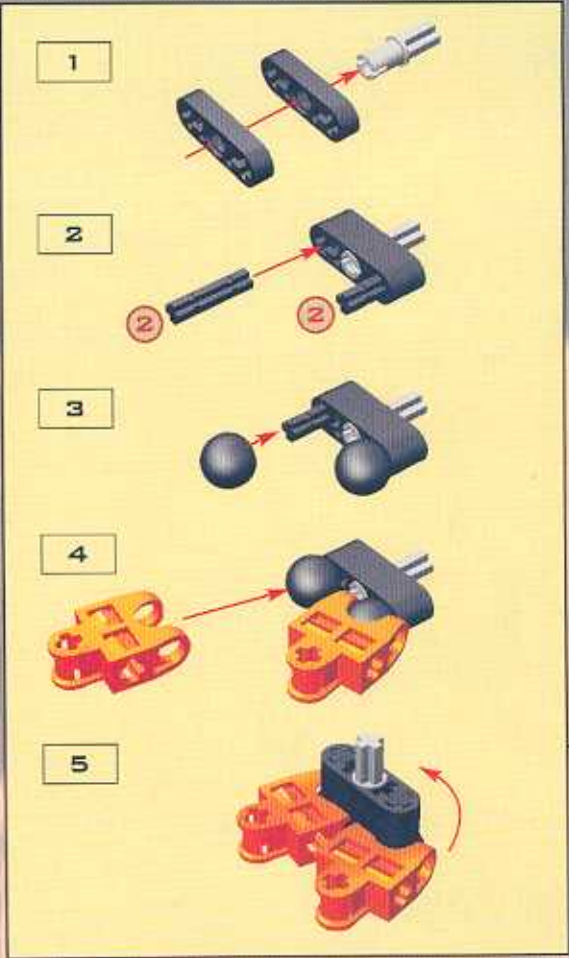
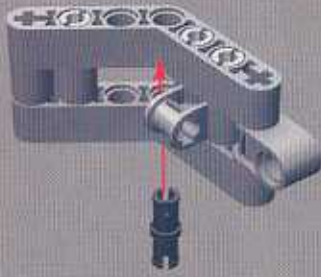

5



6

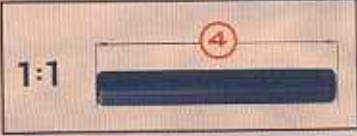
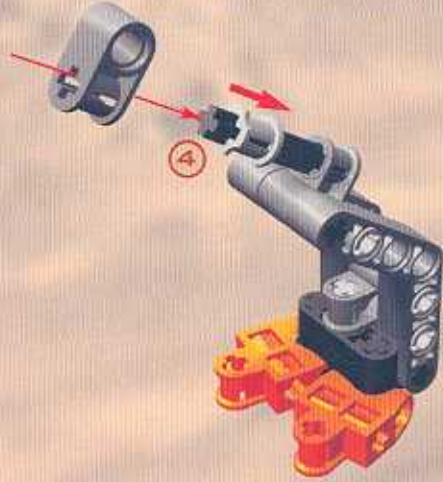

7

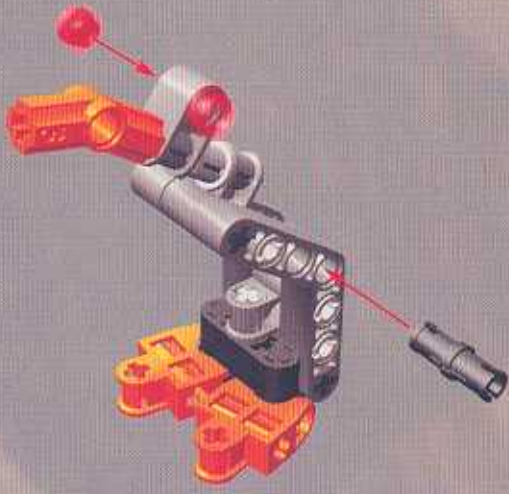

8

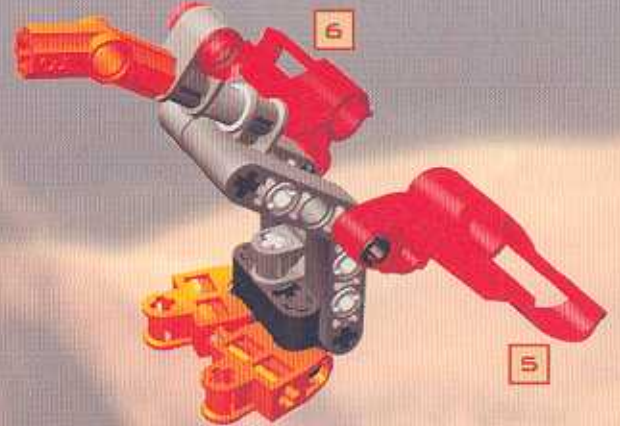



1

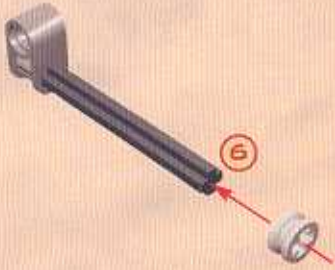

2

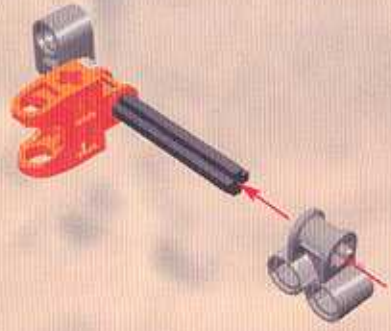

3



4



5

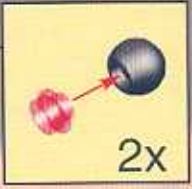
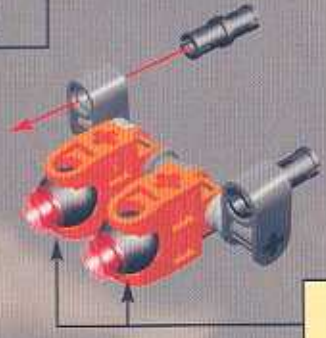

6

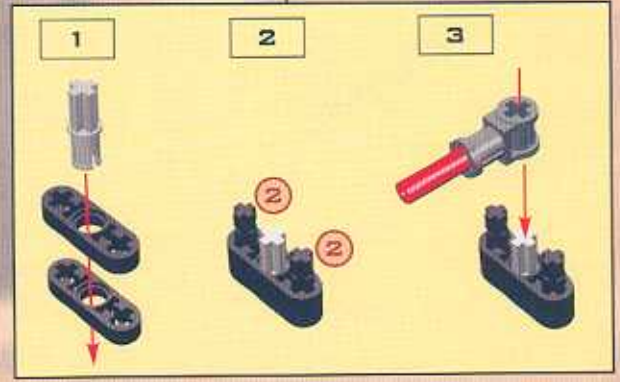

7



8



1

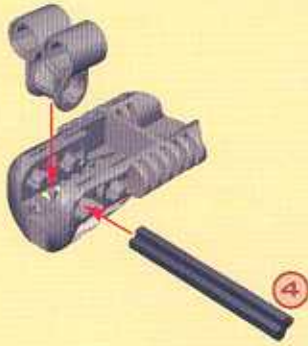

2

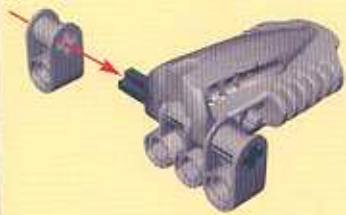

1

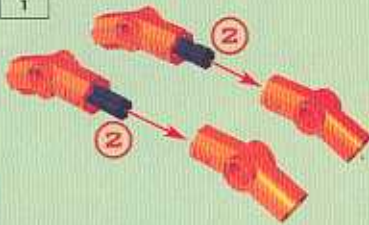

2

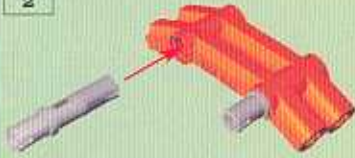

3

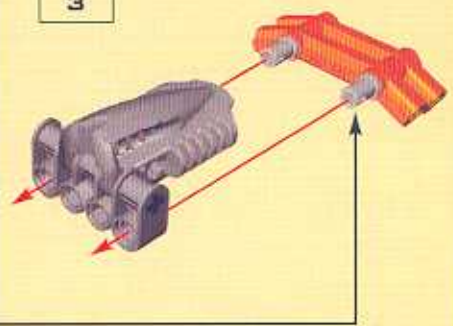

4

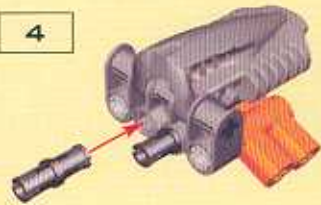

1:1



9

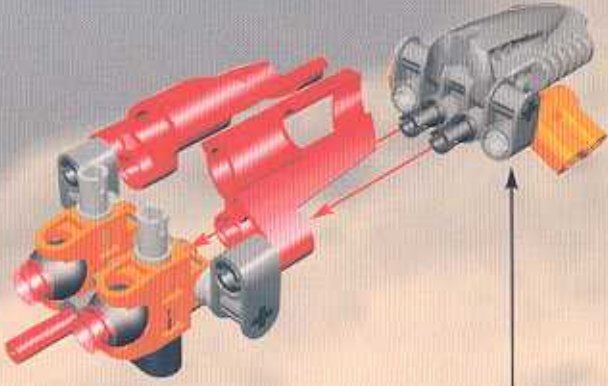

10







1



2

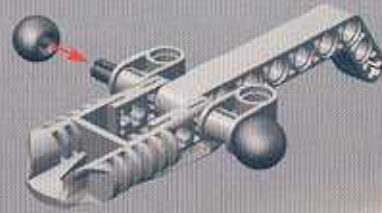

3

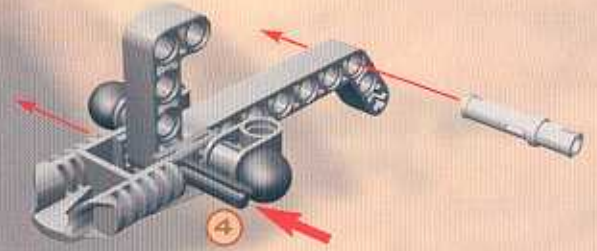

4

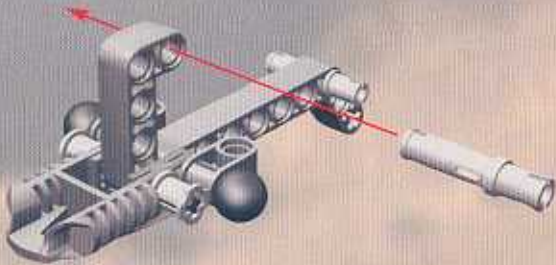

5

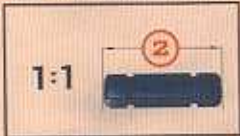
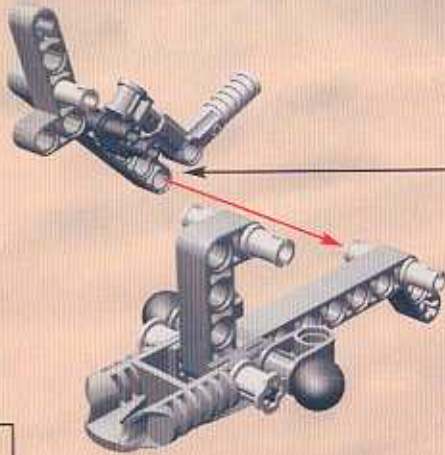

1

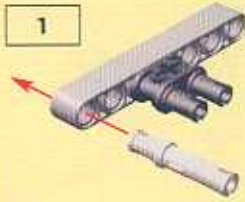

2

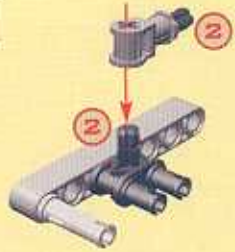

3



6

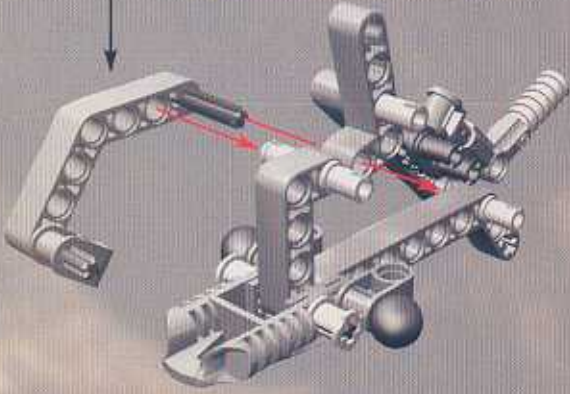

1:1

3



7

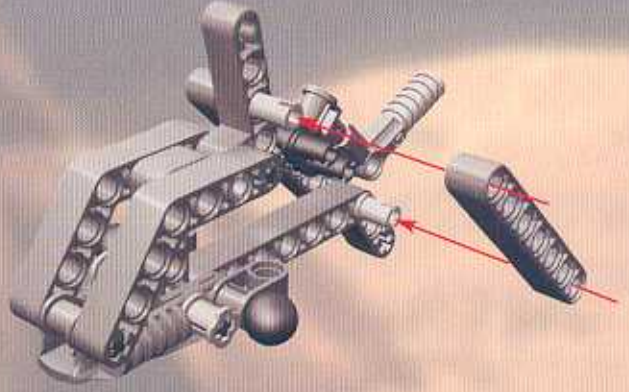

8

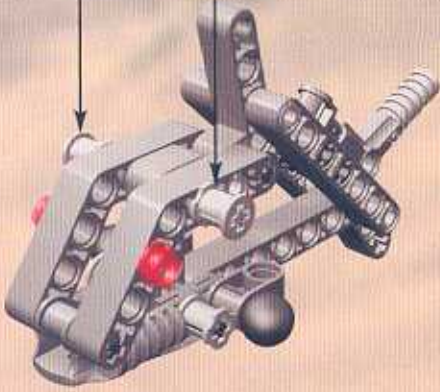
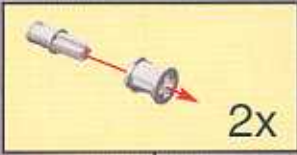

9

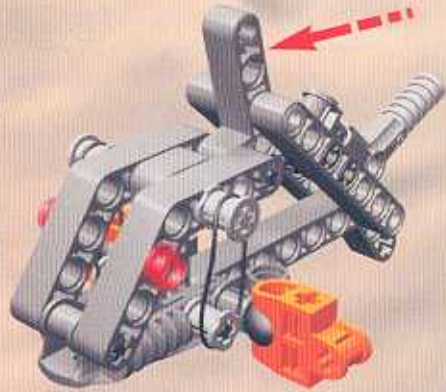



1



2



3



4



5

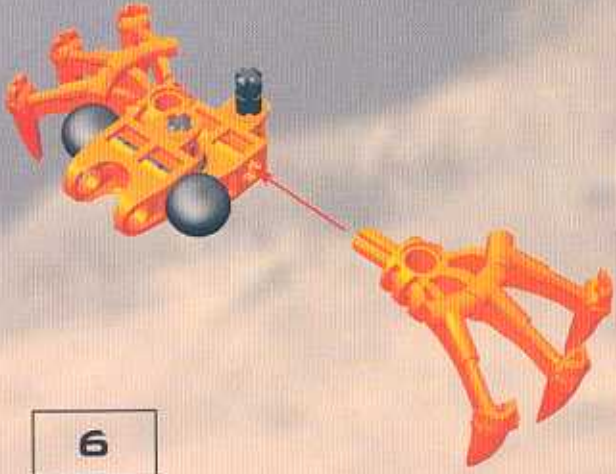

6

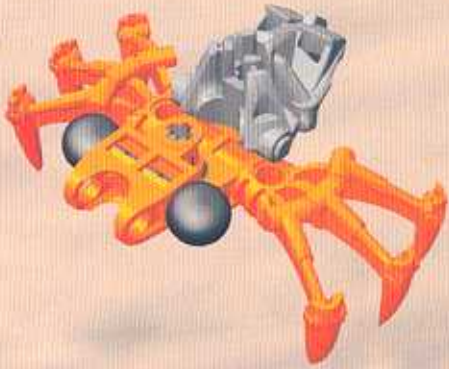

7





1



2



3



4



5



6

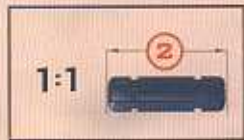
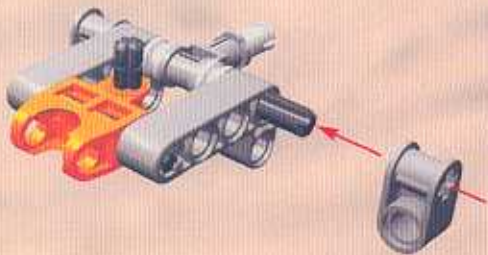

7



8





9

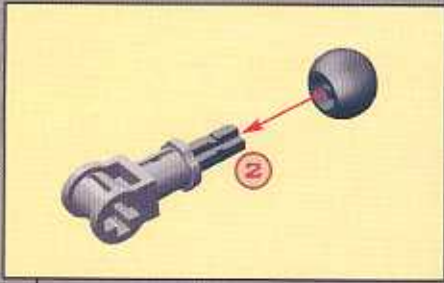

1:1



10



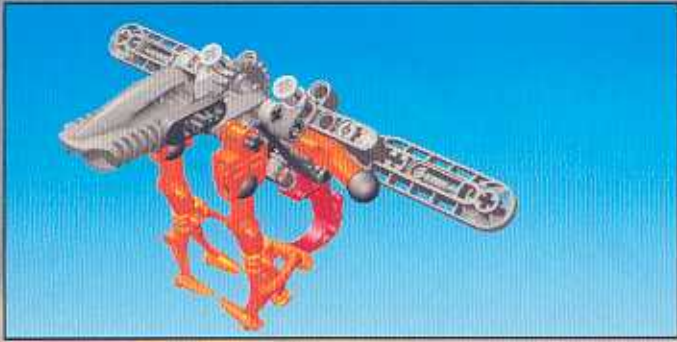

1



2



3



4

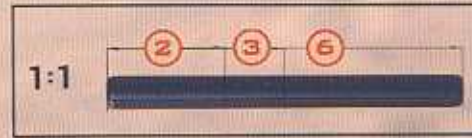
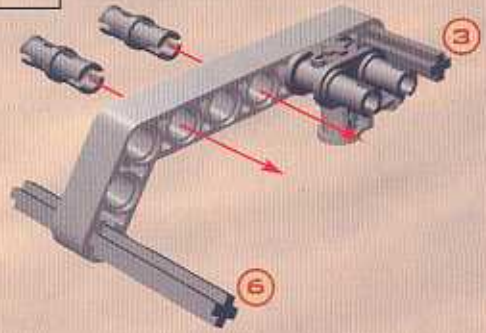

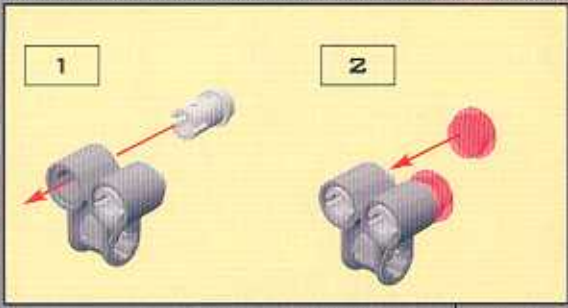

5

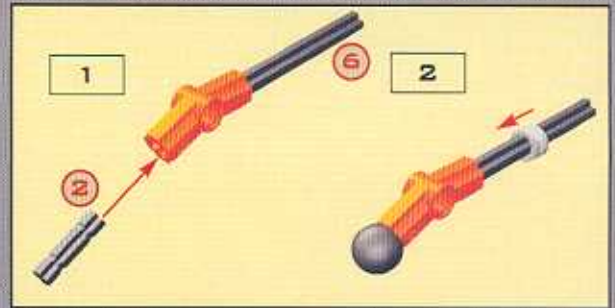
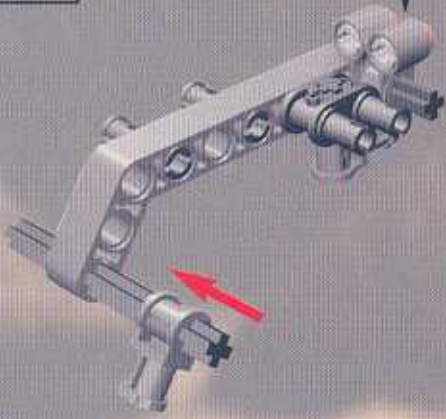

6

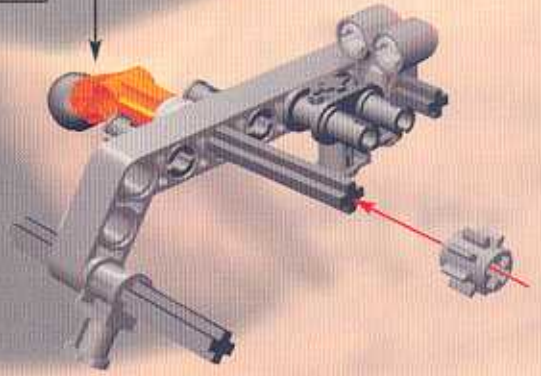

7

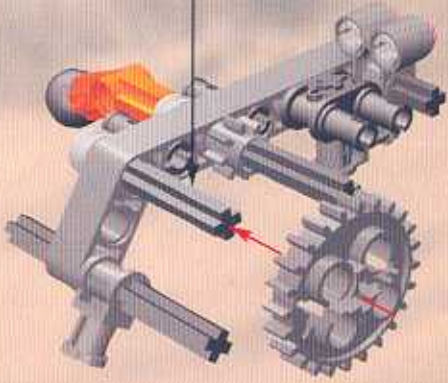
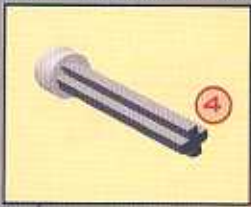

8

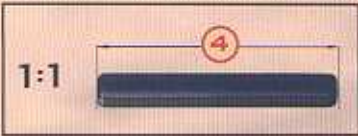
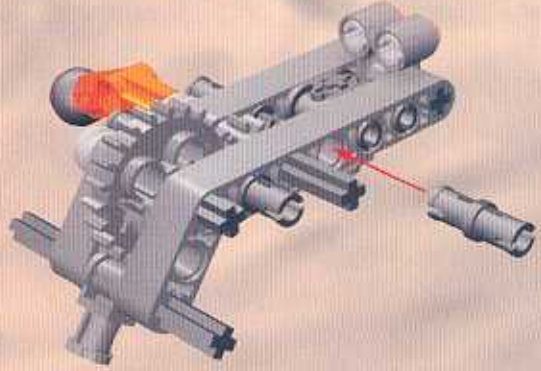

9

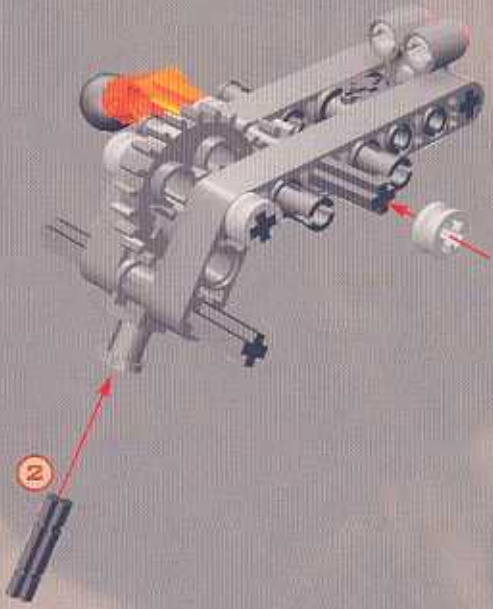

10

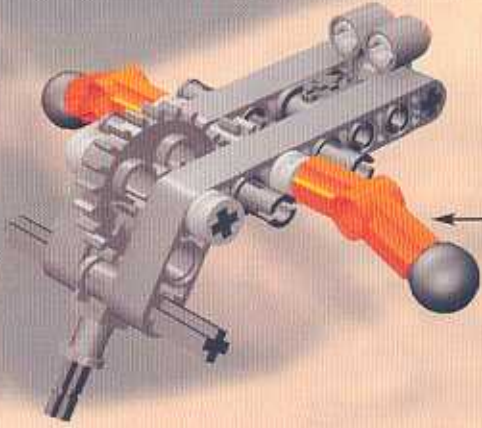
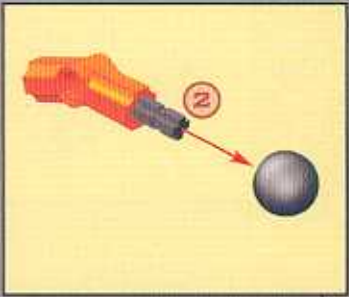

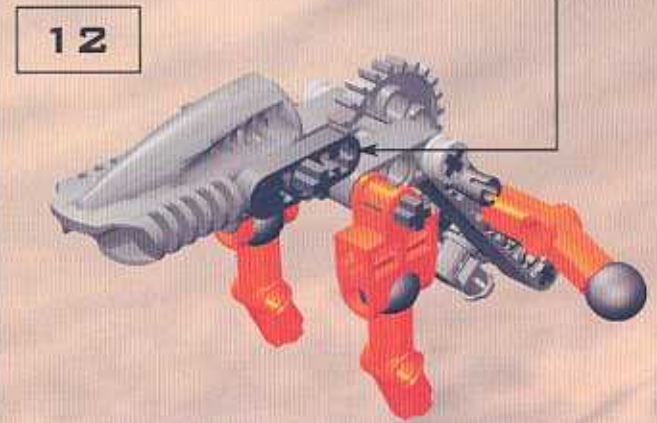
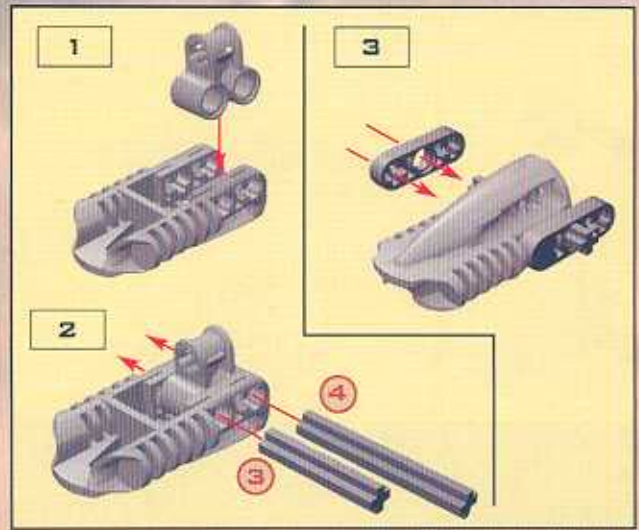
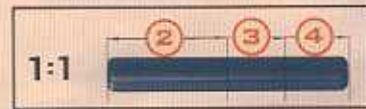
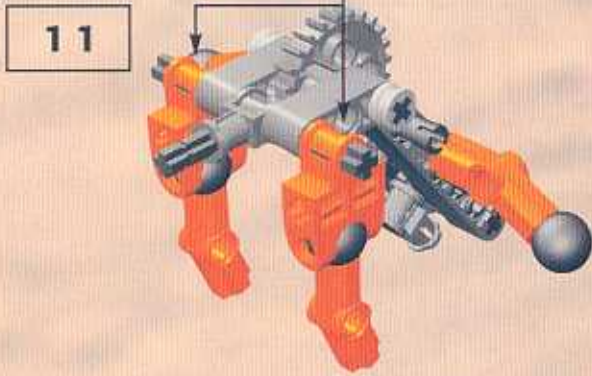
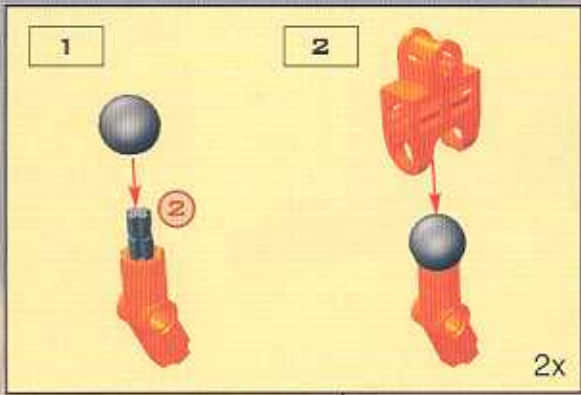

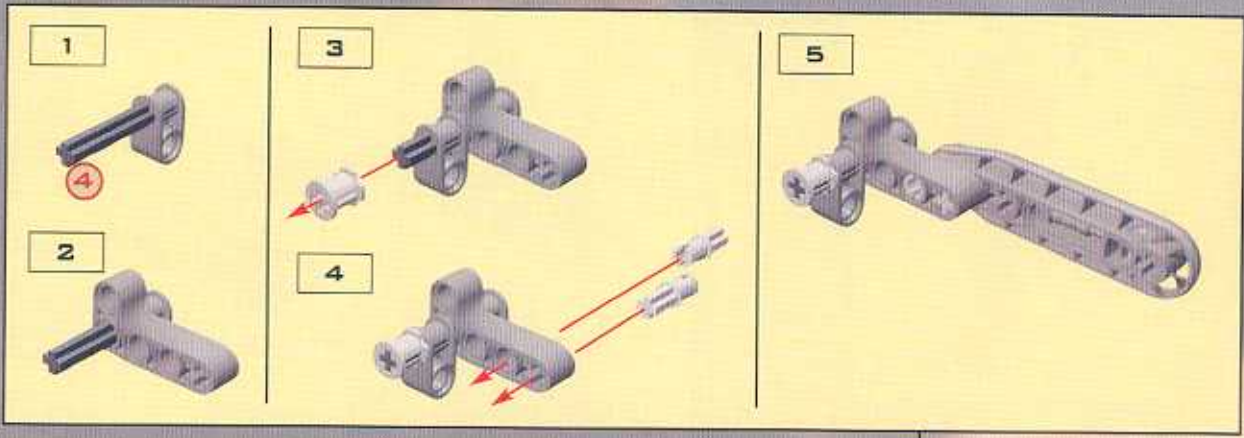

13

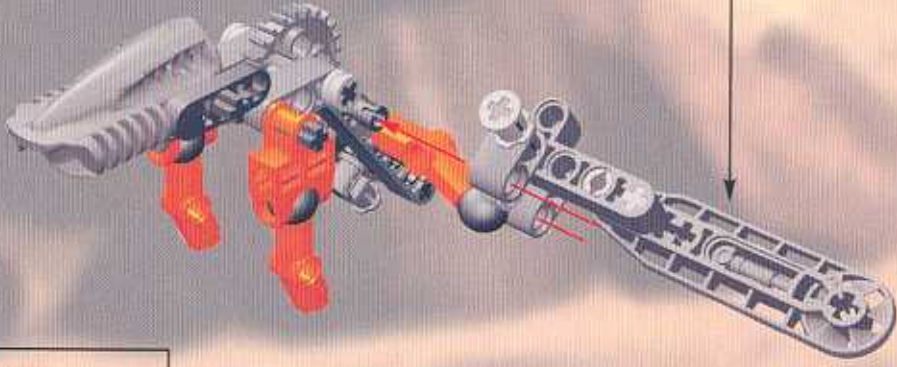

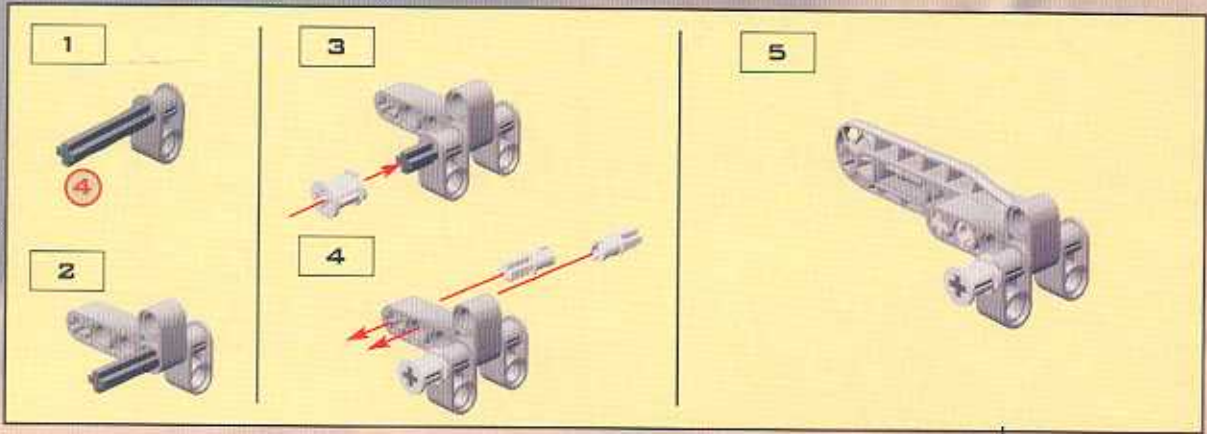

14

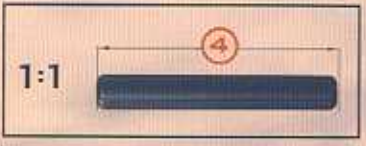
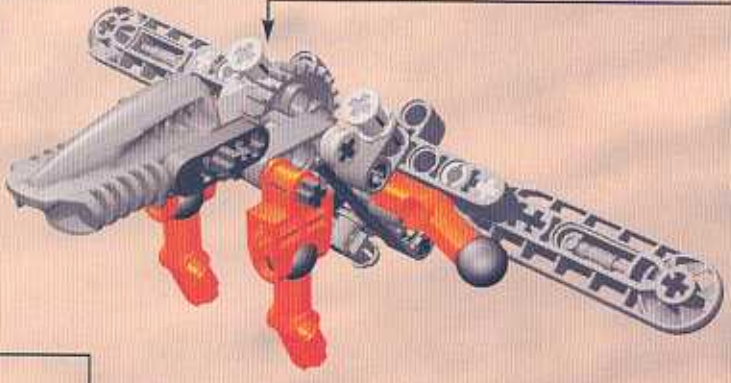



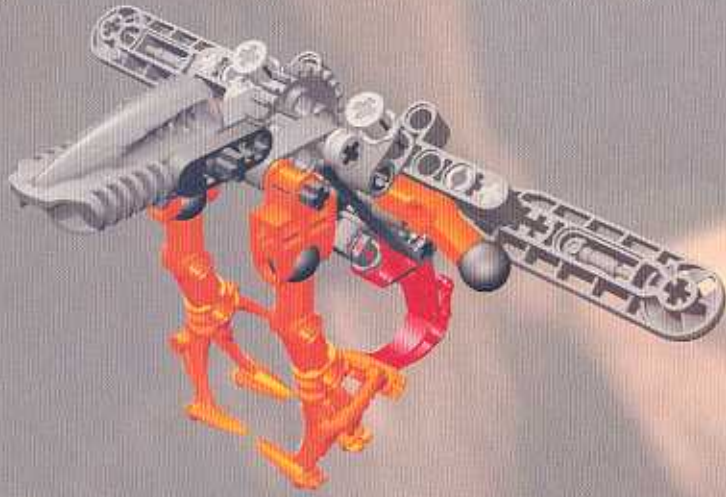

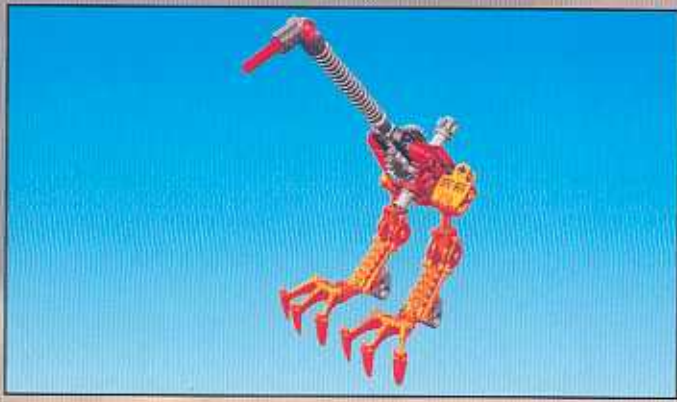

1



2

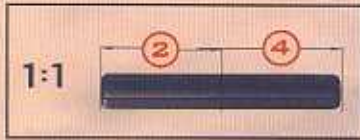

3



4

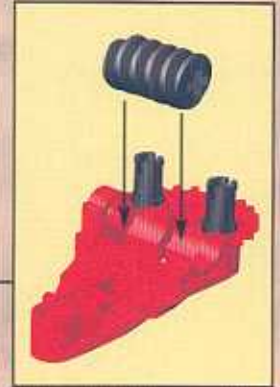
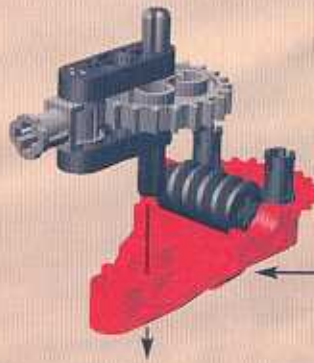

5



6



7



8



9

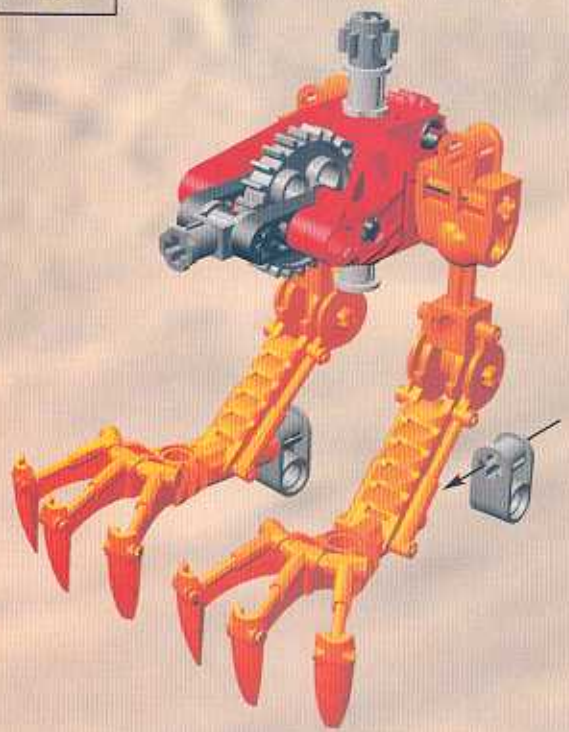

1:1



10

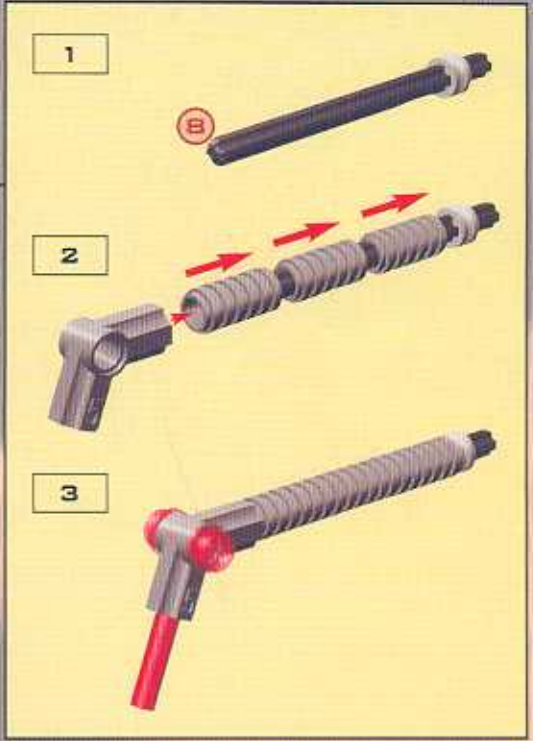
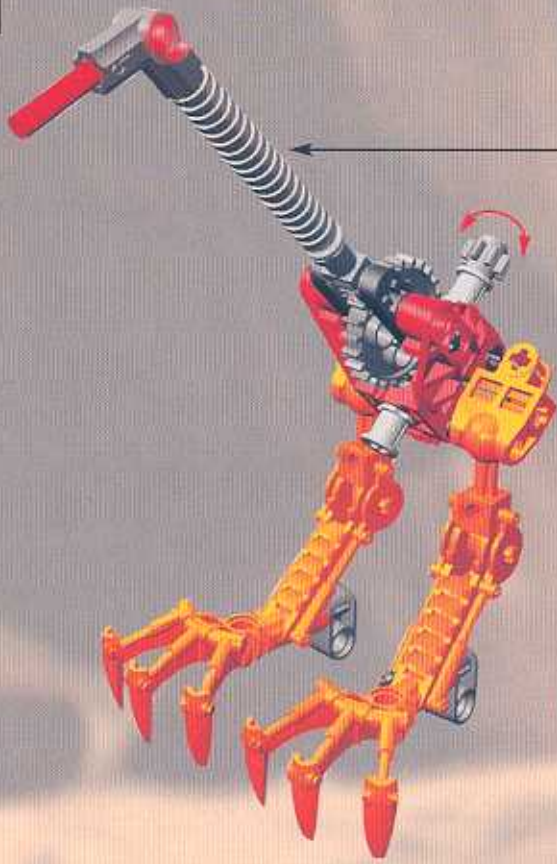

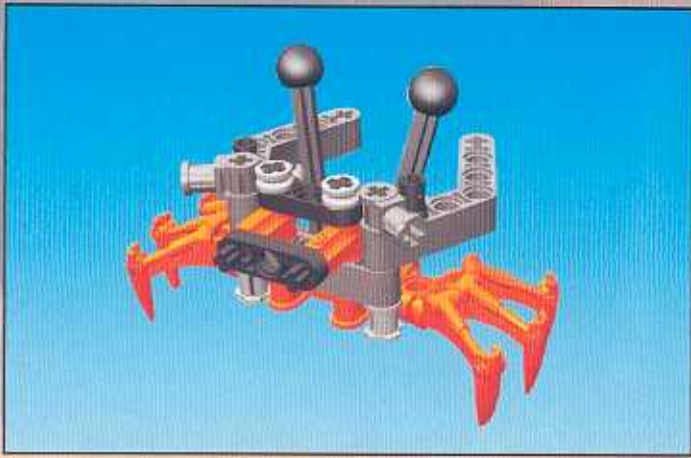

1

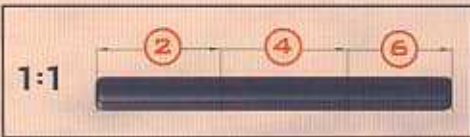
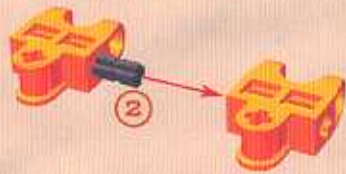

2

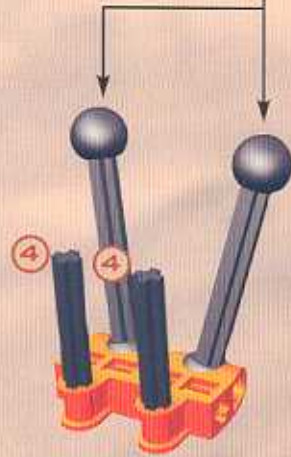
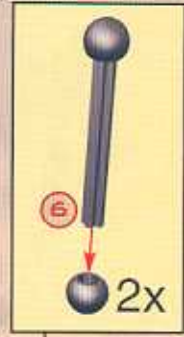

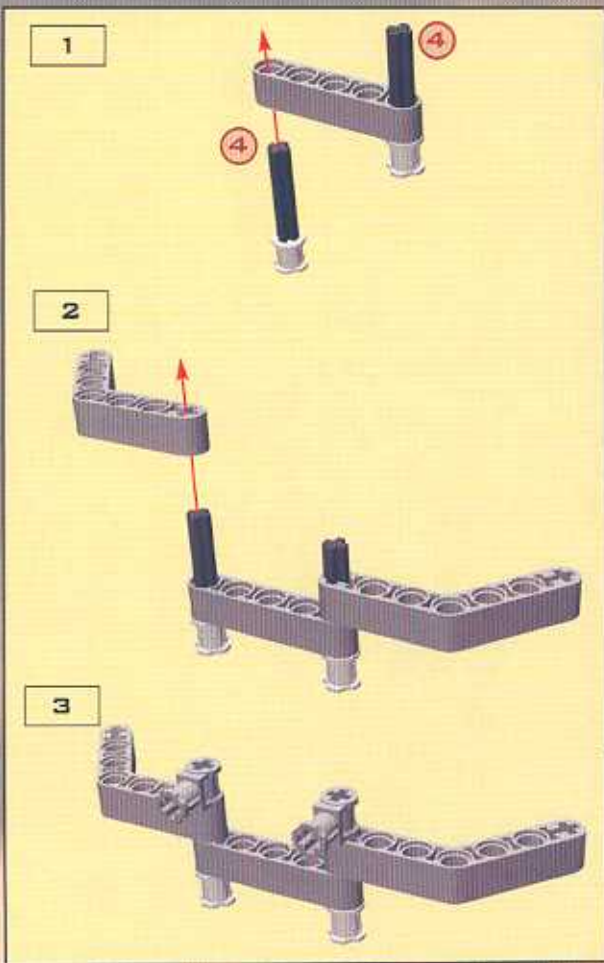

3

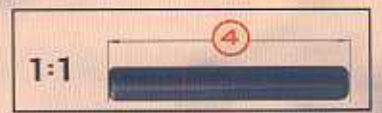
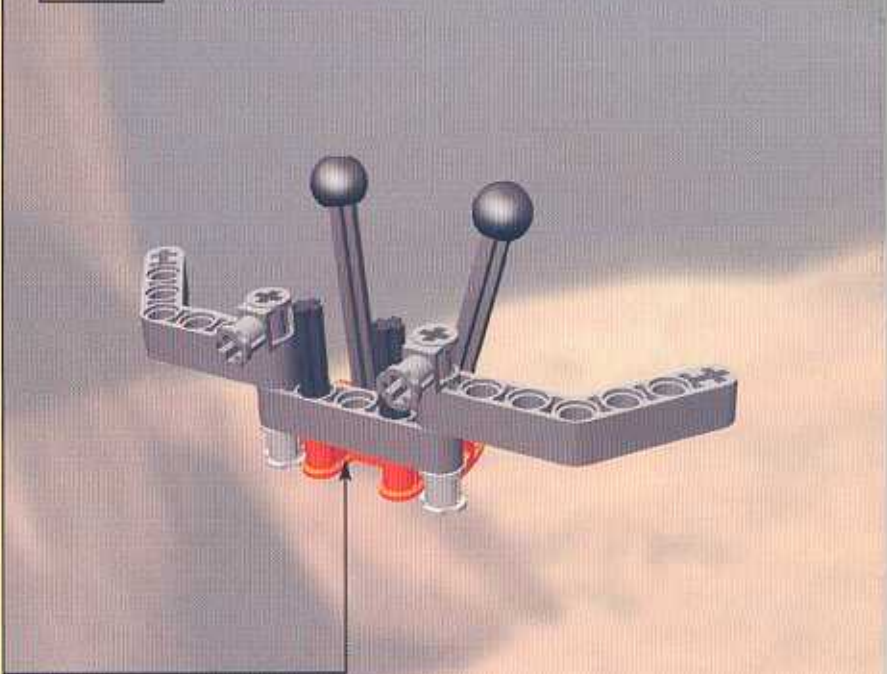

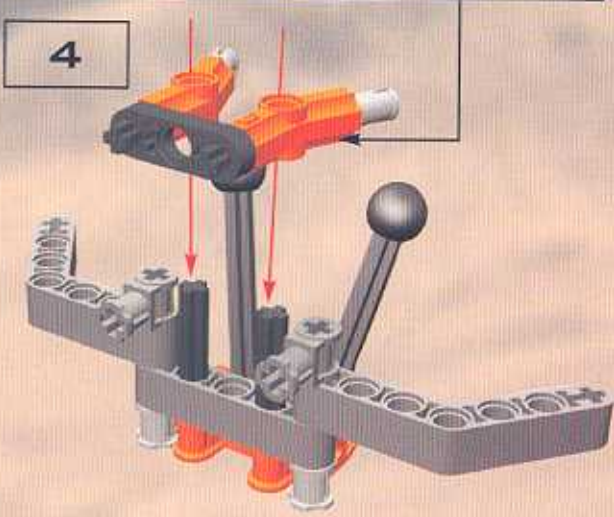
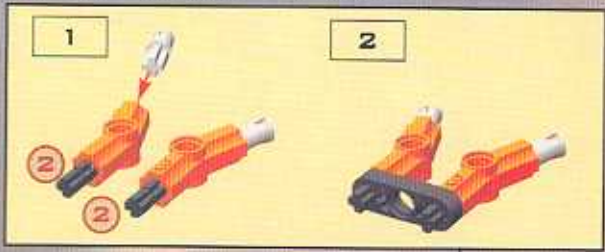

5

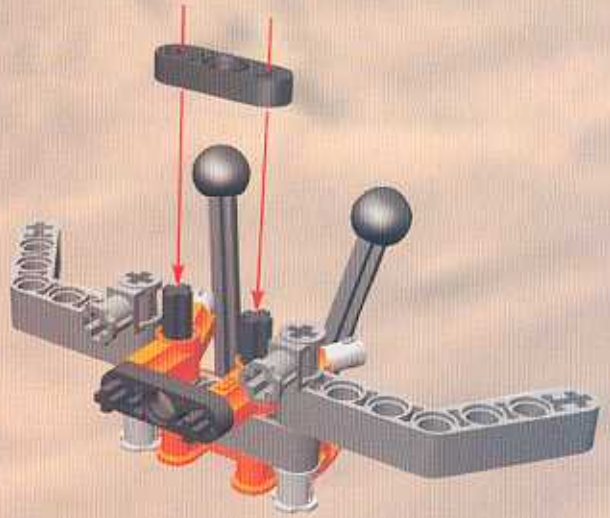



6

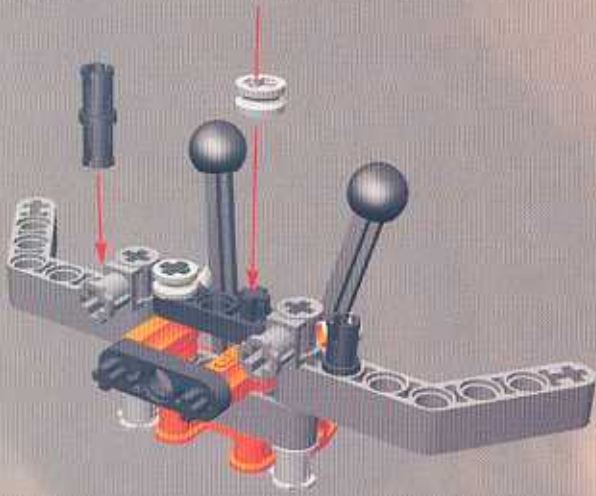

7

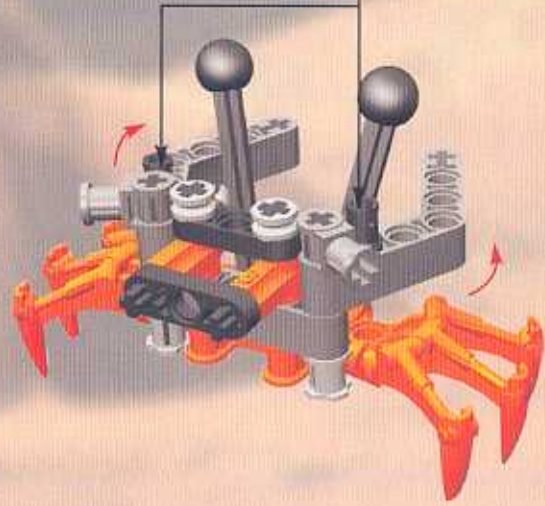

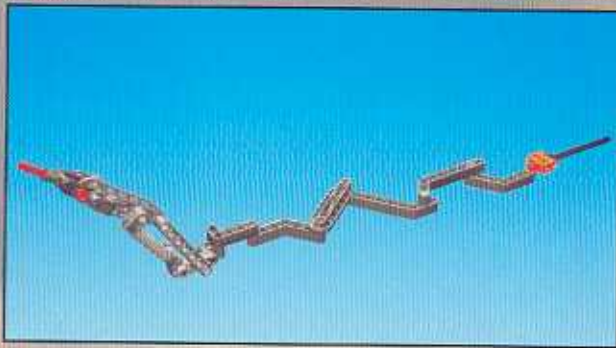

1

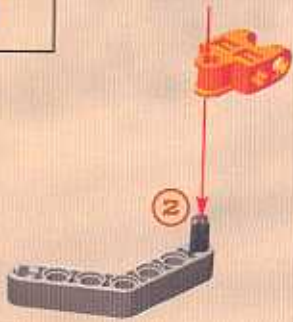

2

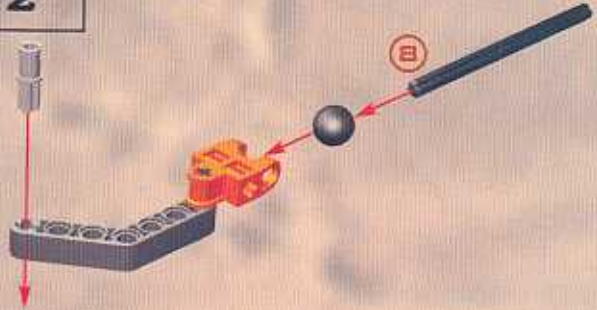

3

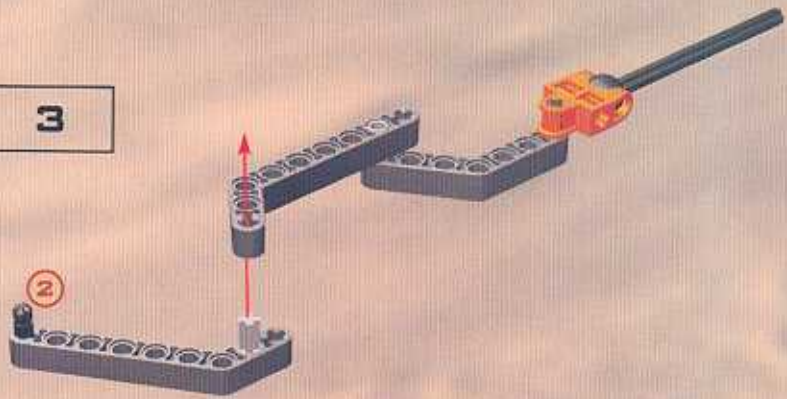

4

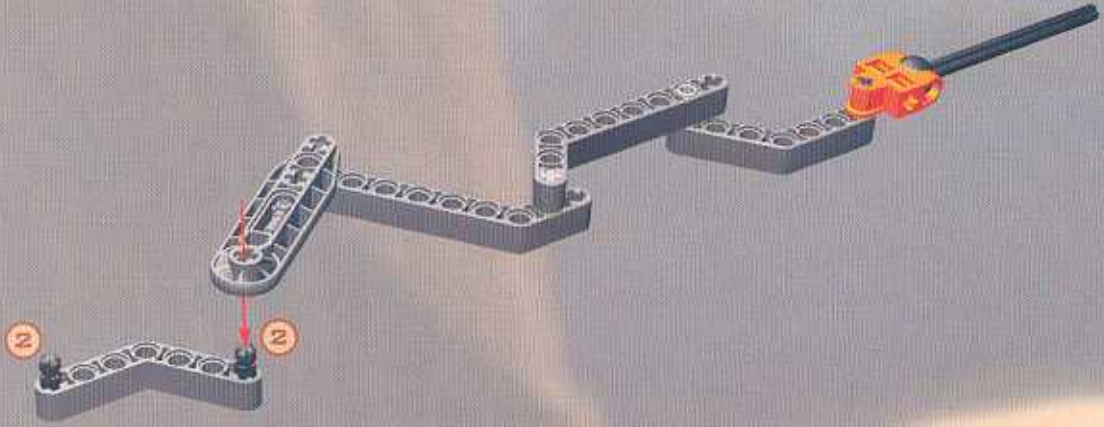

5

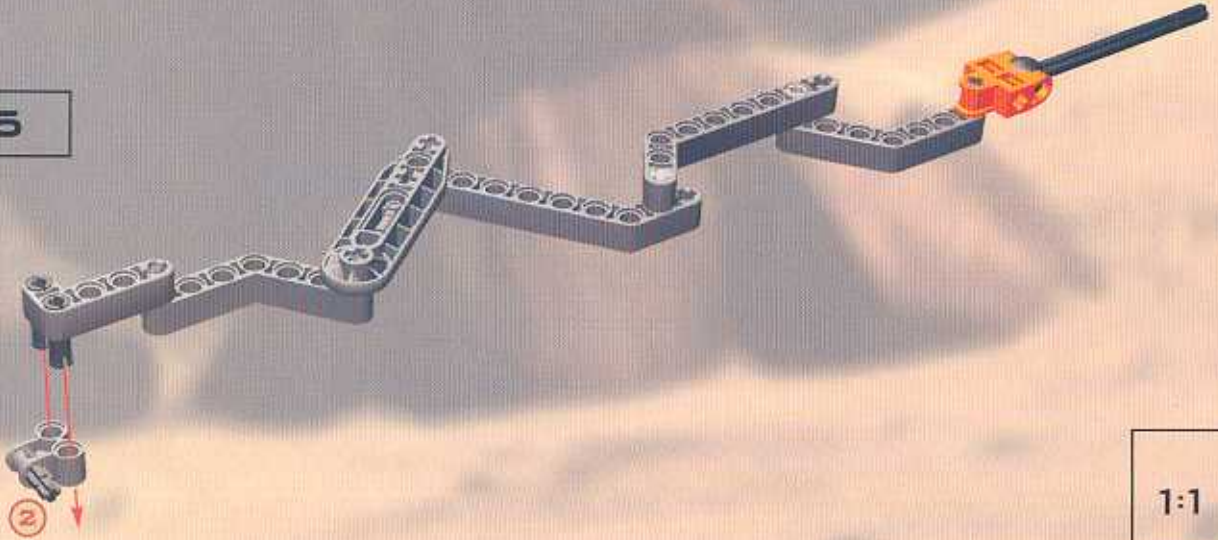

6

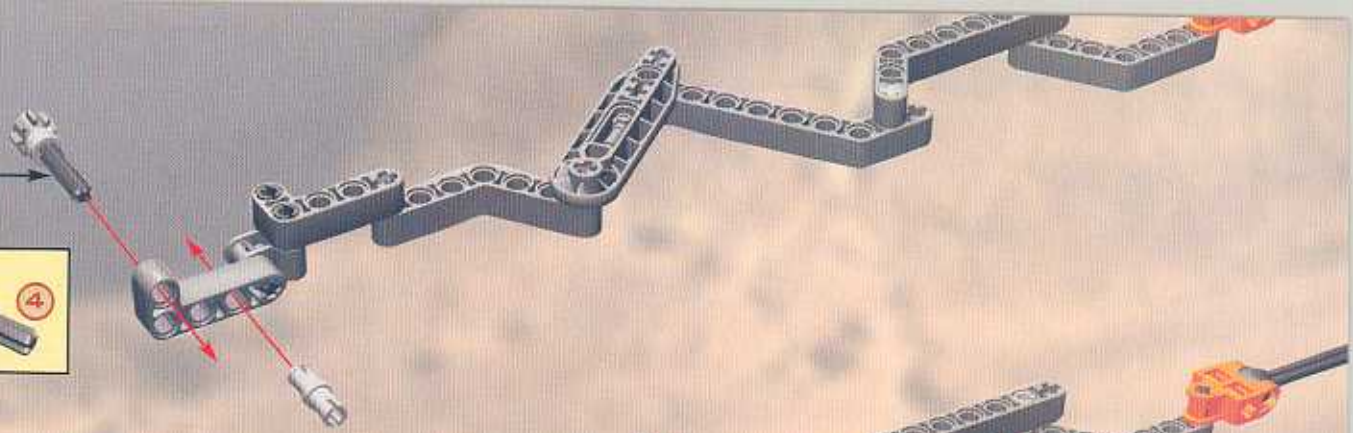

7

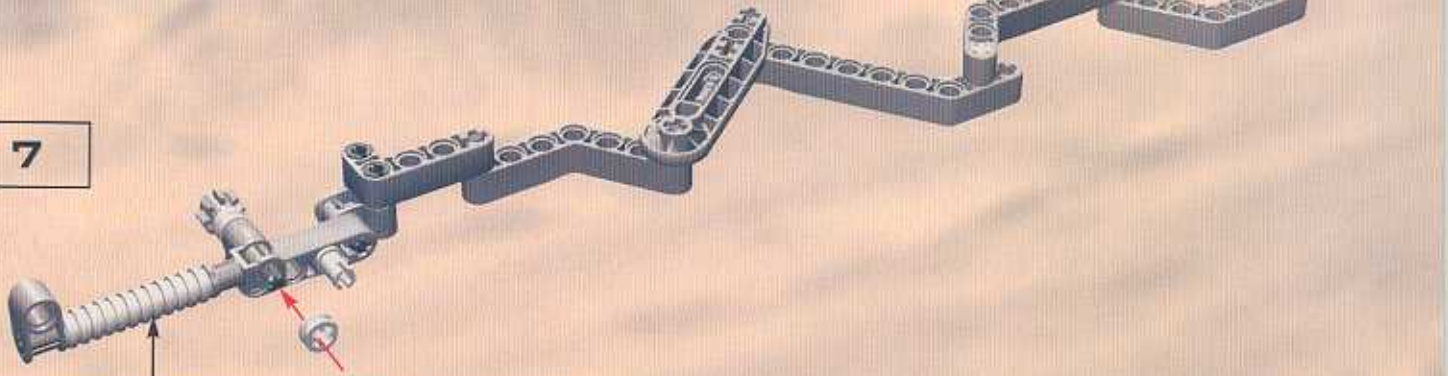
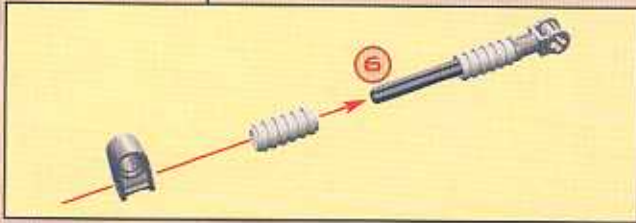

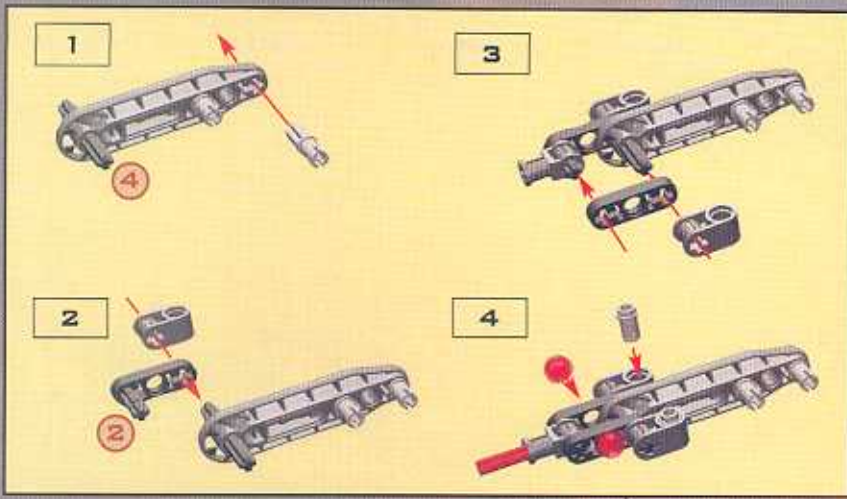

8

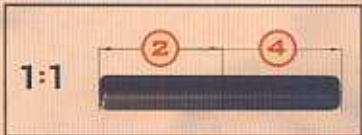
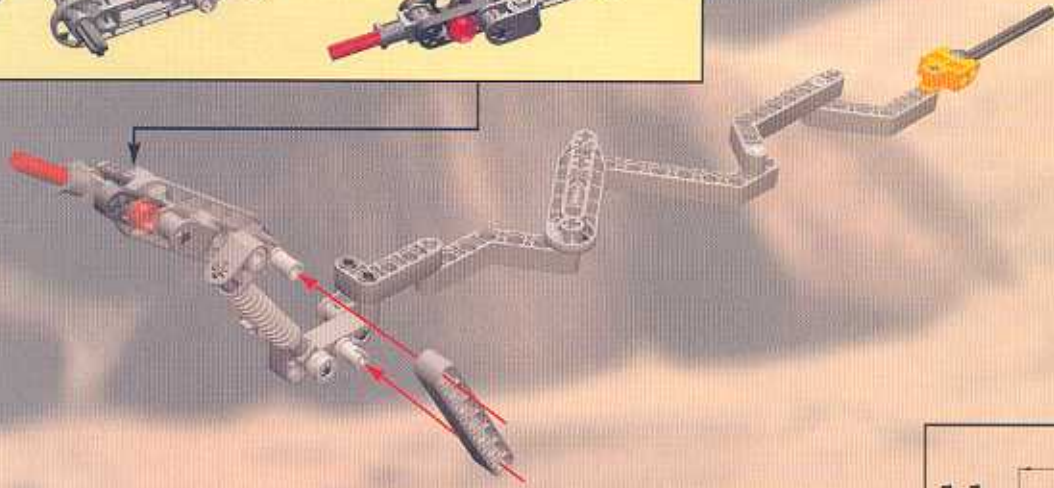

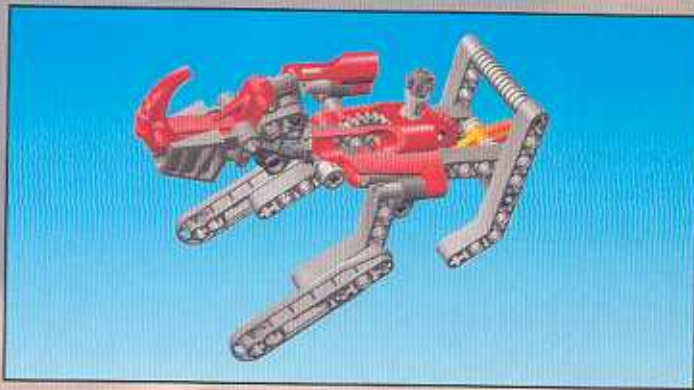

1



2



3

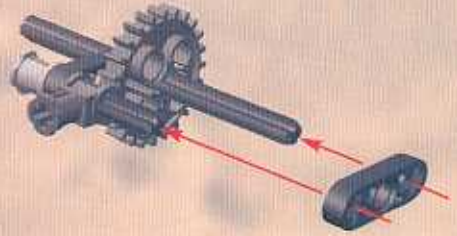

4

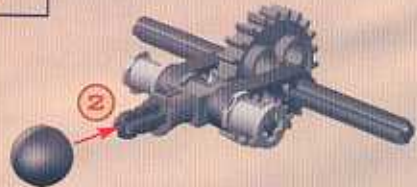

5



6



7

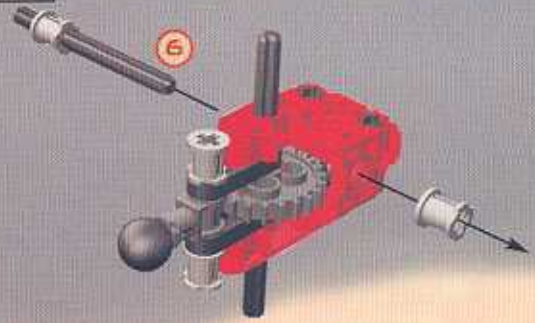

8

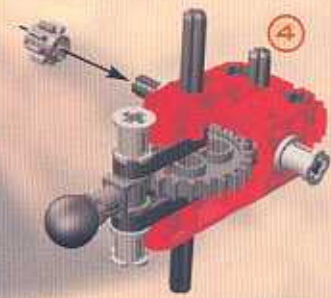

9

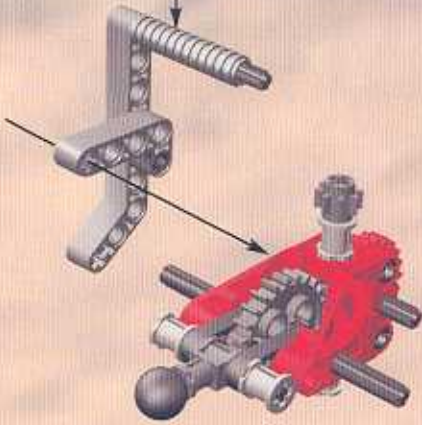
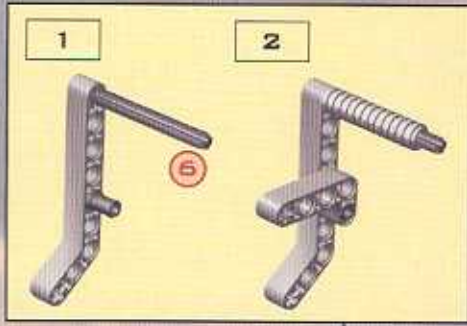

10

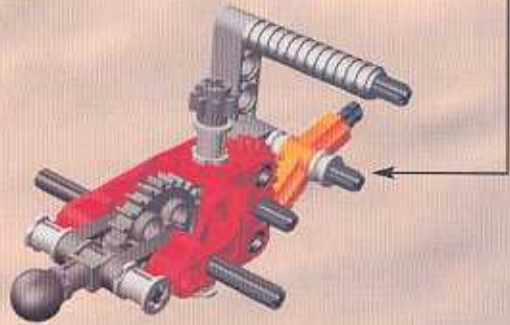
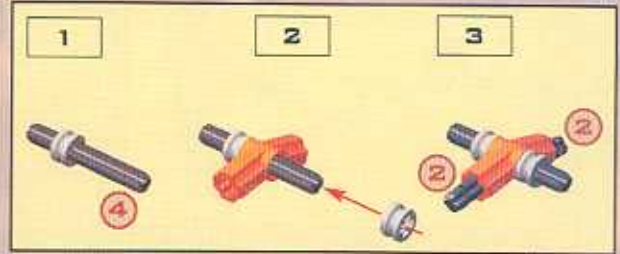



11

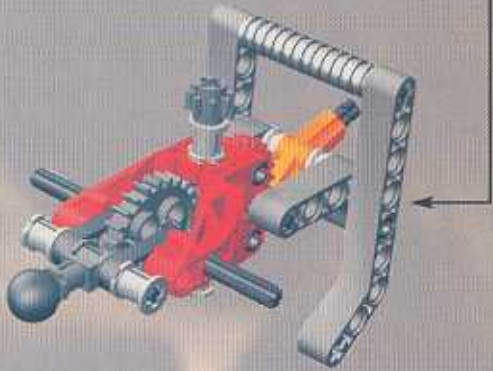
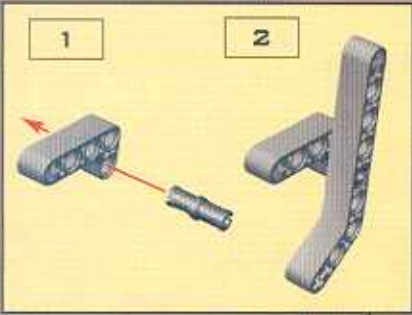

12

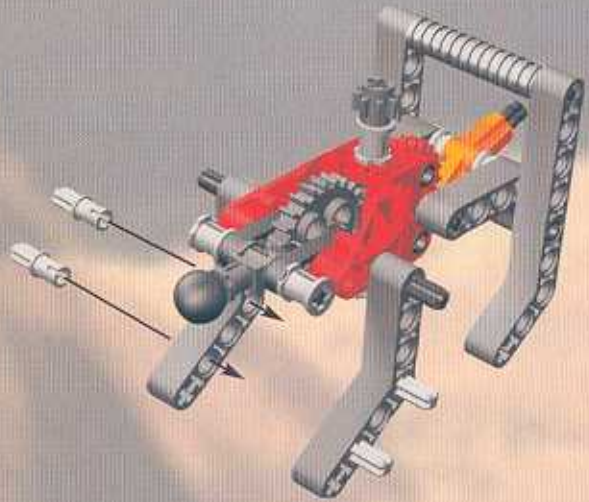

13

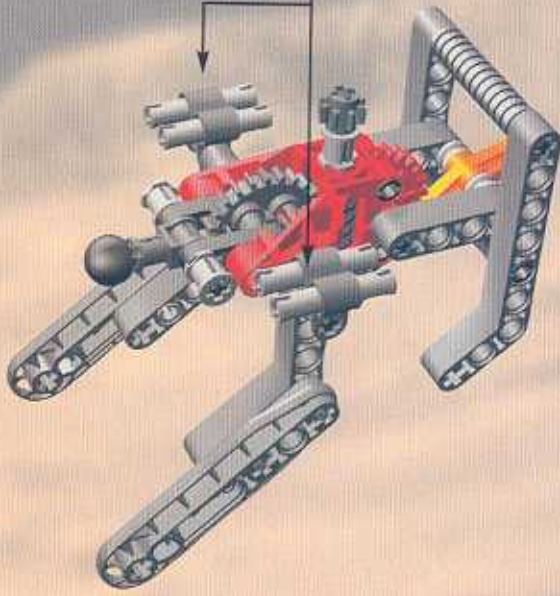
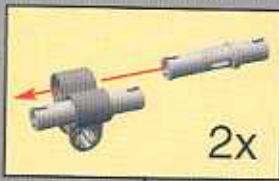

14

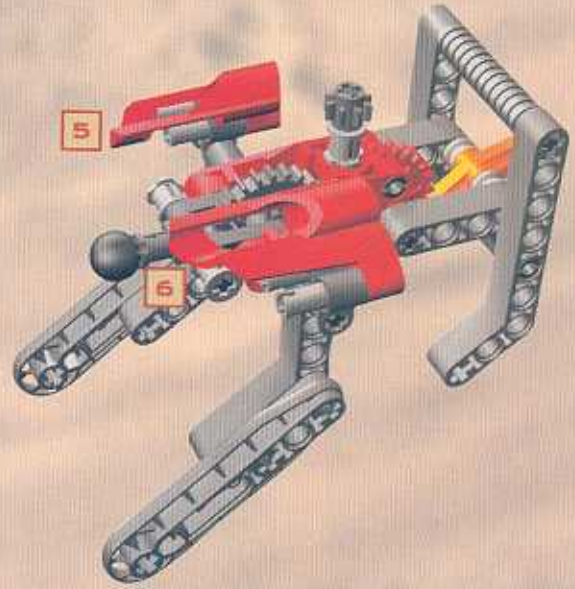

1



2



3



2

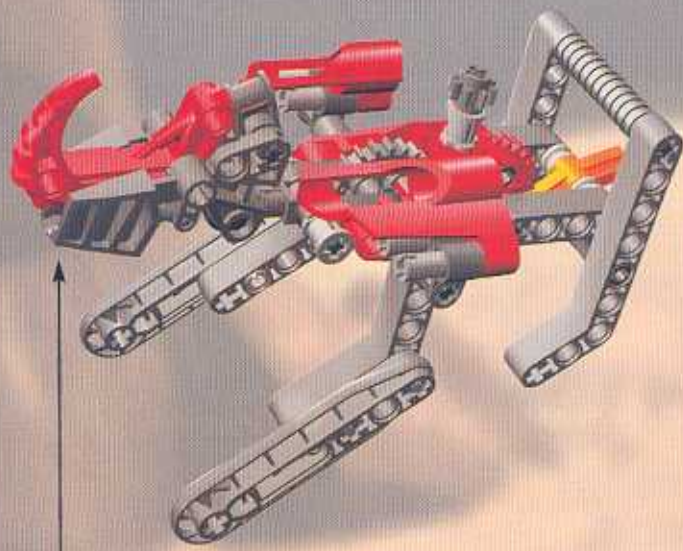

1:1



2

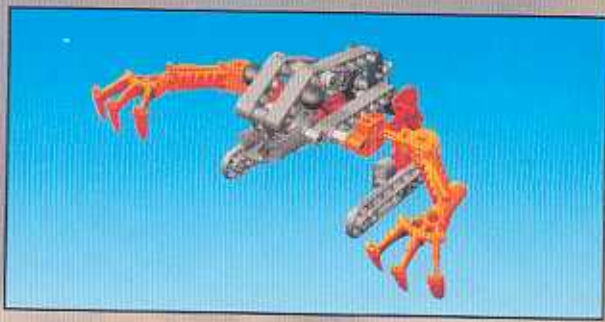

1



2



3



4

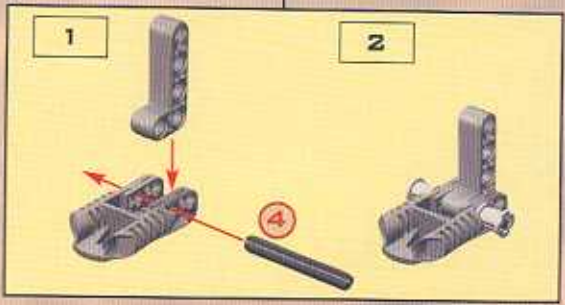
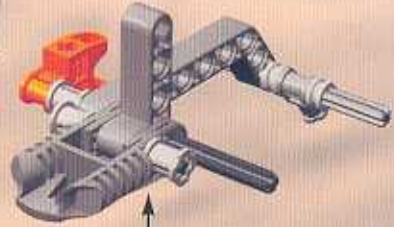

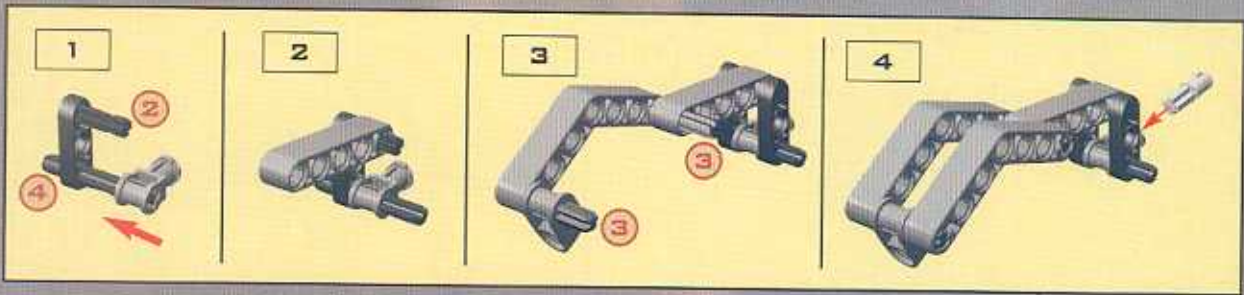

5

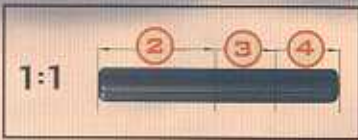
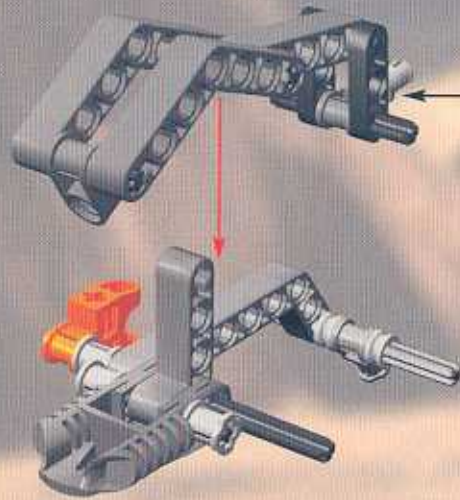

6



7

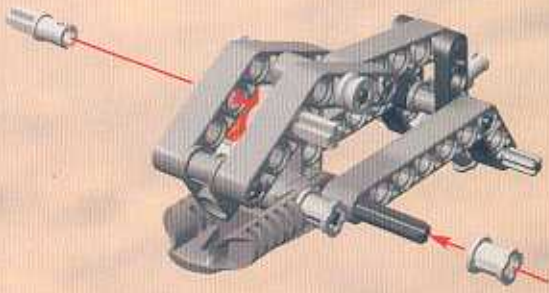

8



9

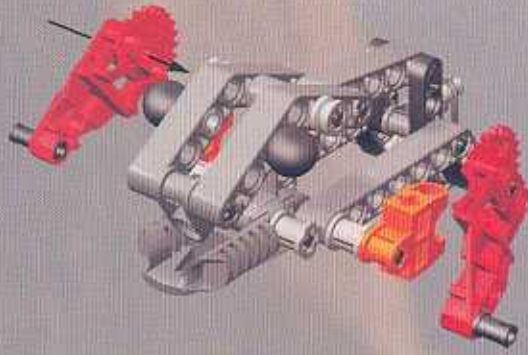

1:1

2



10

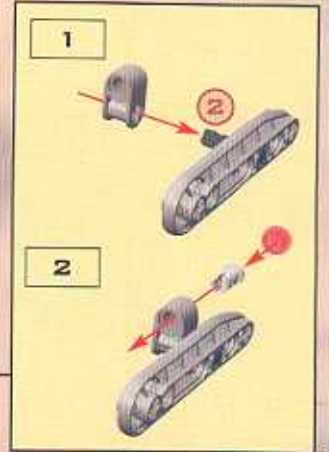
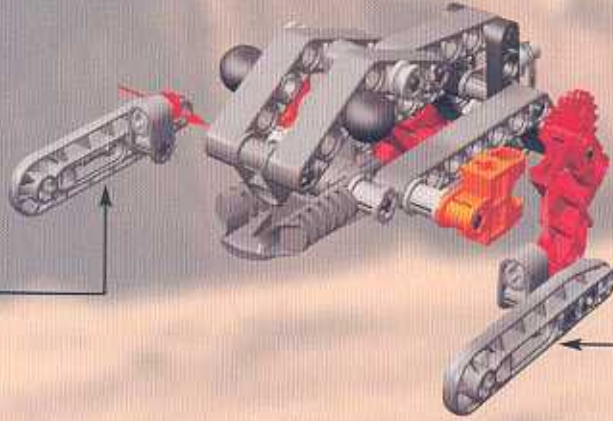
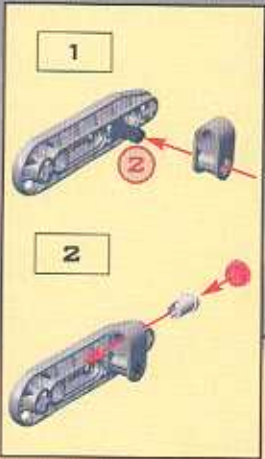

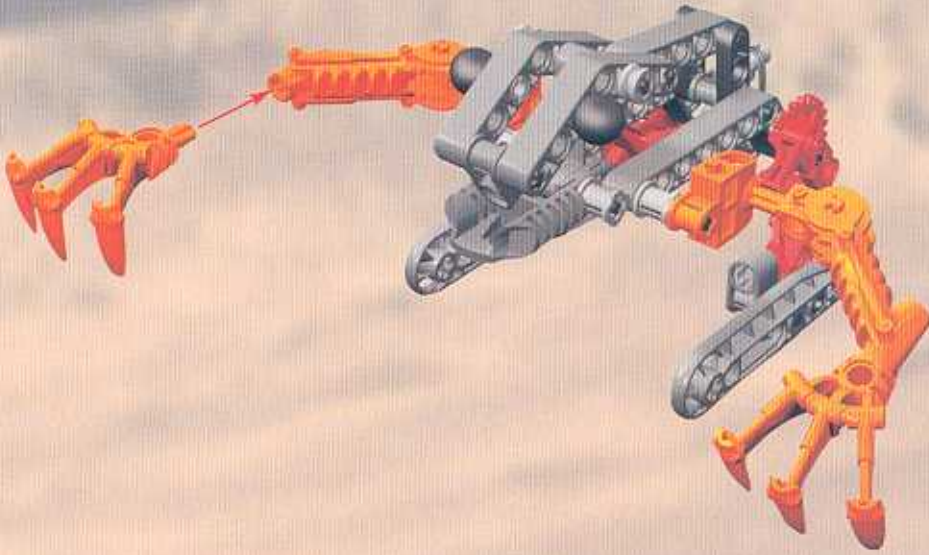





1



2

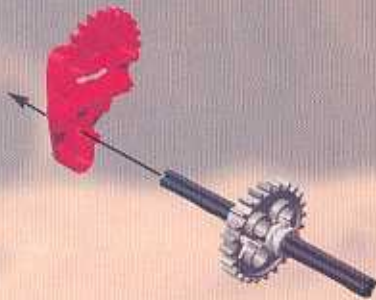

3



4

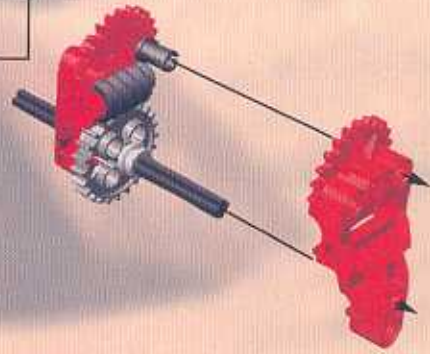

5



6

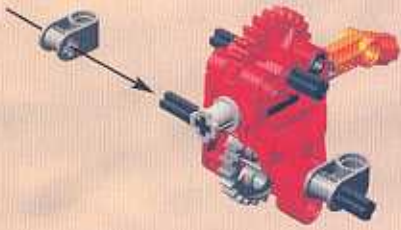

7

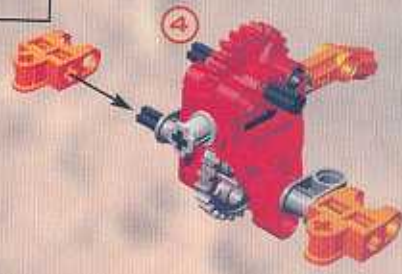

8

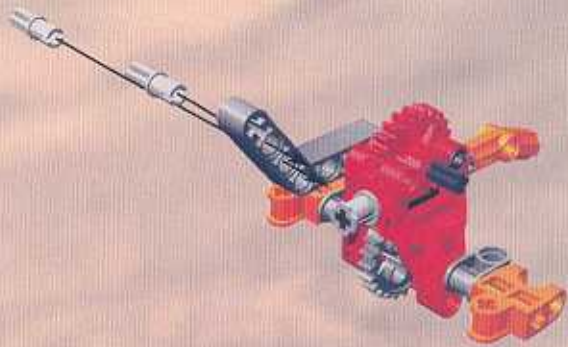

9

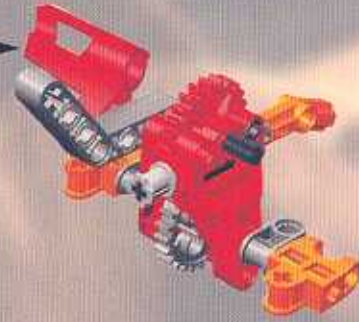

10

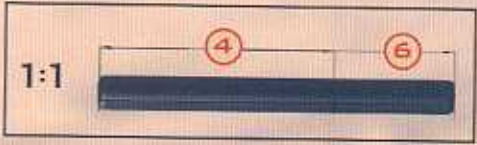
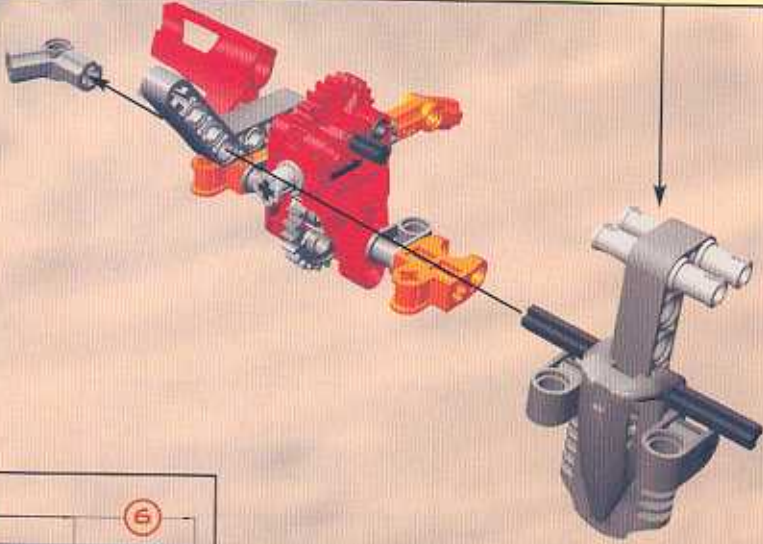
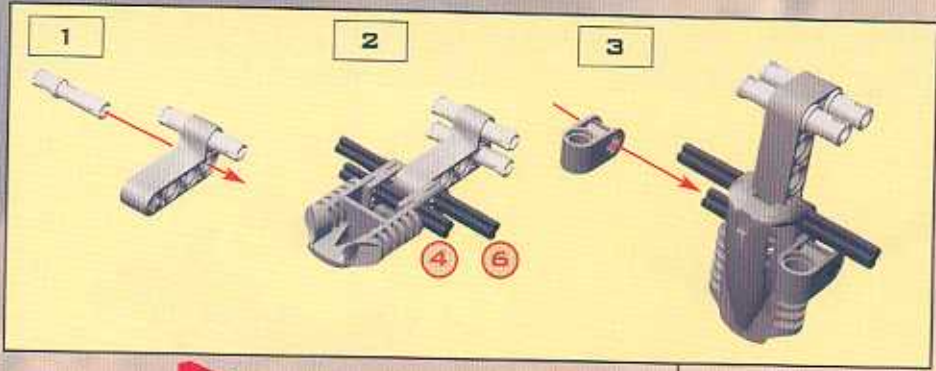

1



2



3

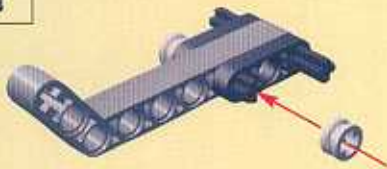

4

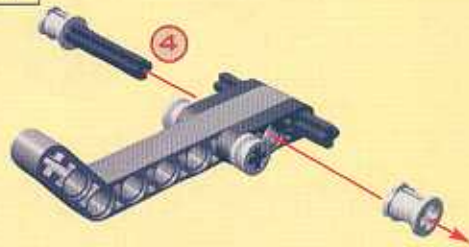

5

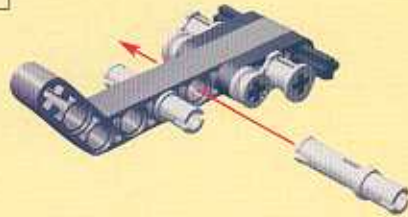

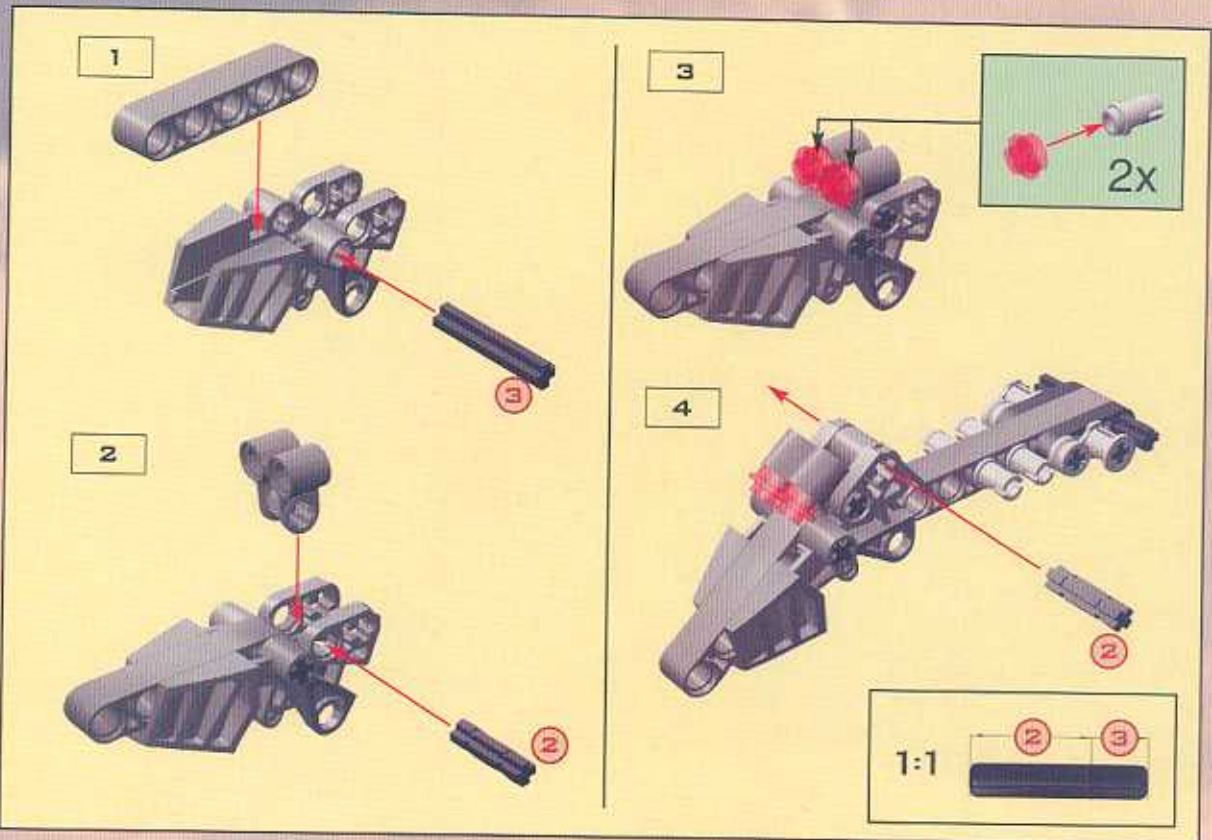

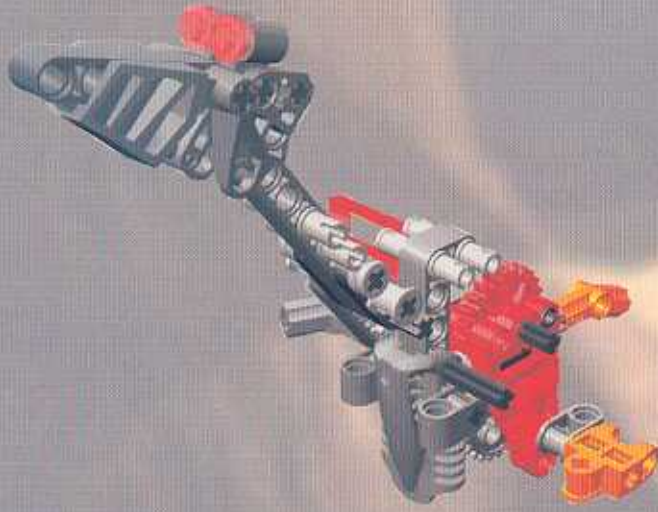

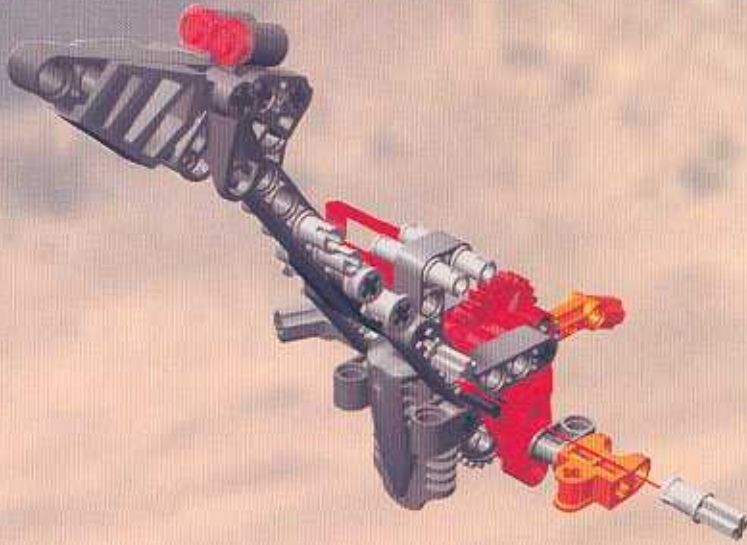



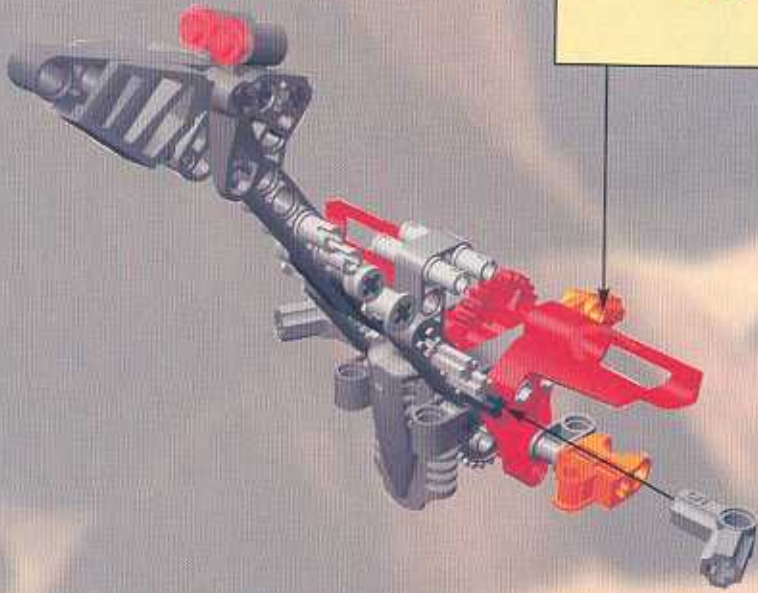
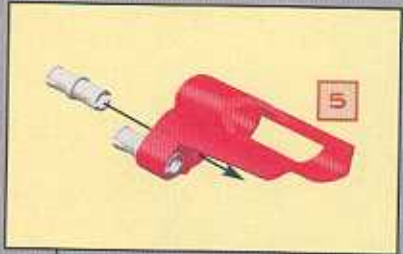

14

1



2



3



2x

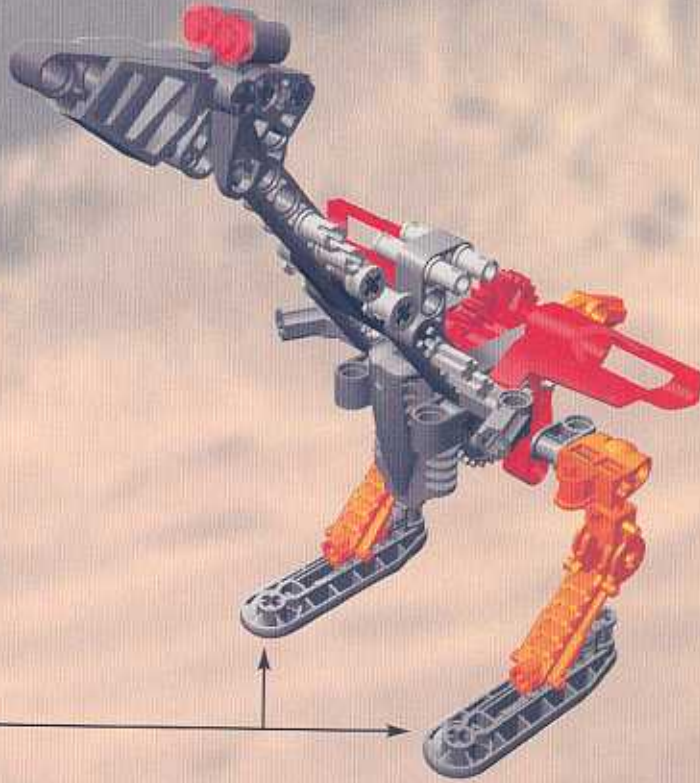

1:1





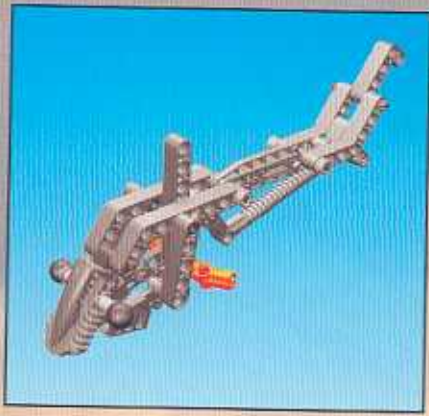

1

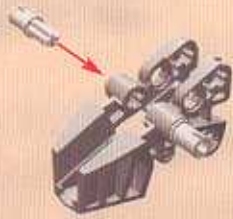

2

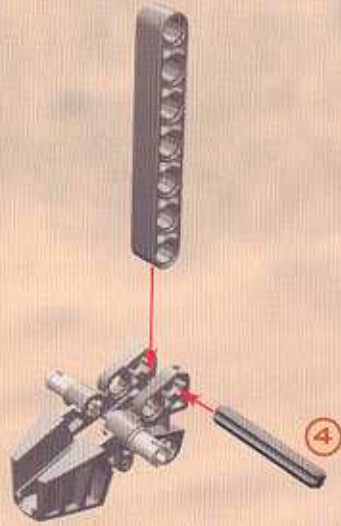

3

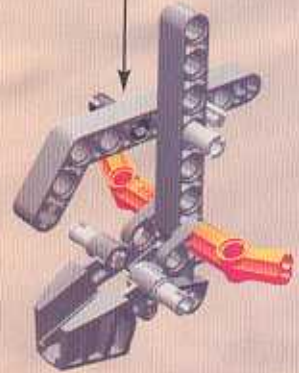
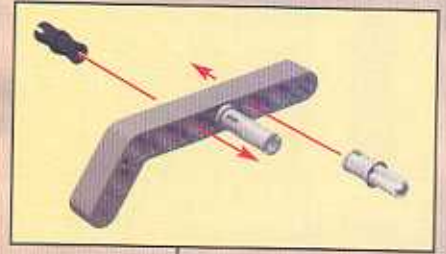

4



5

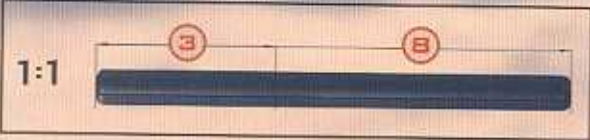
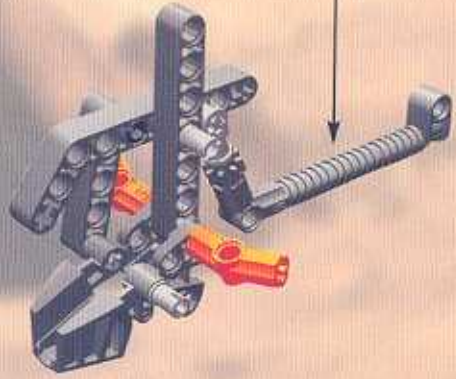
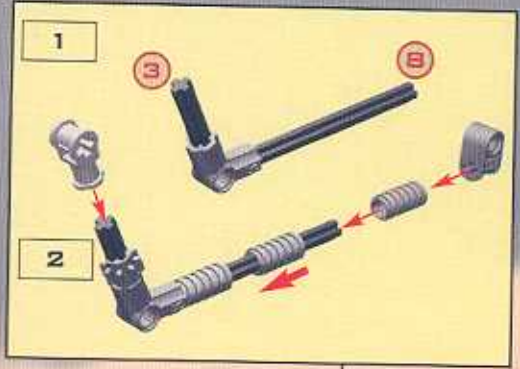

6

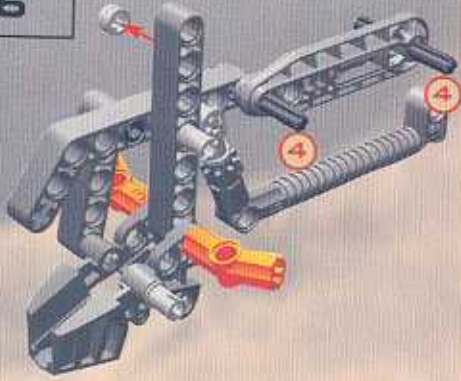

7

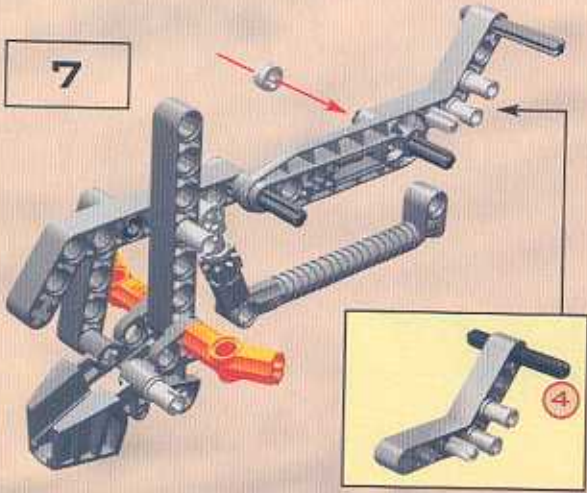

8

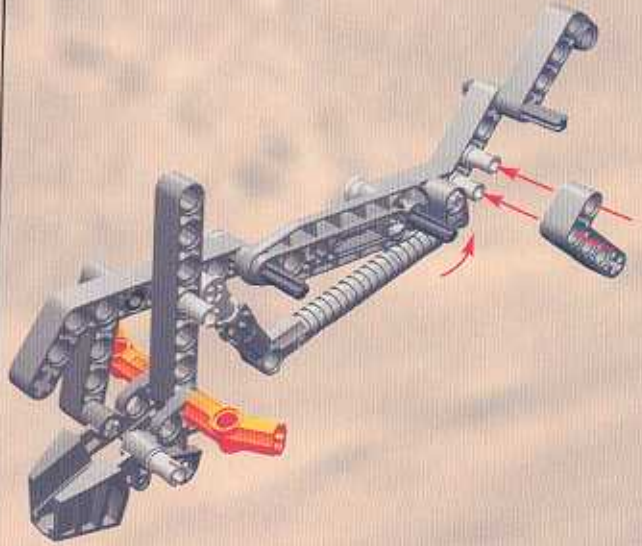

9

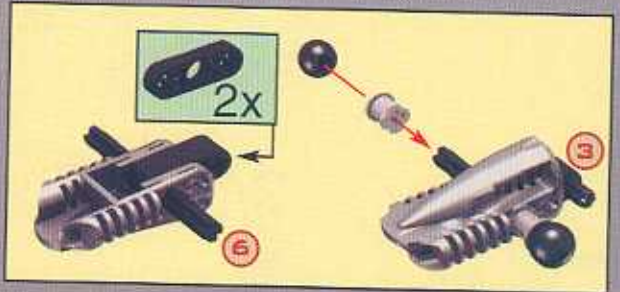
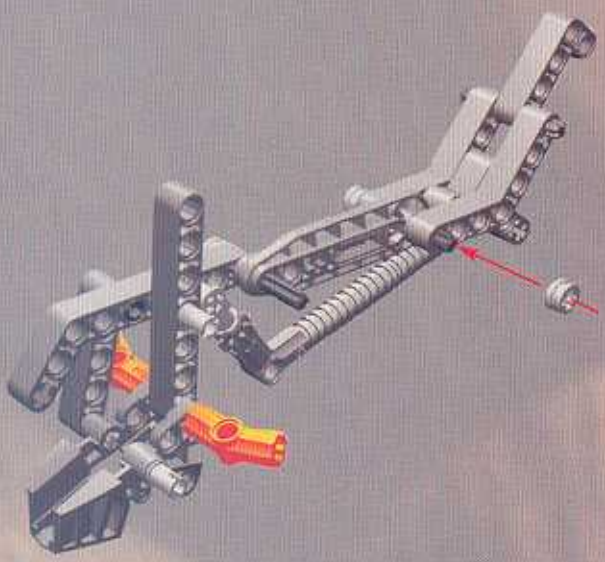

10

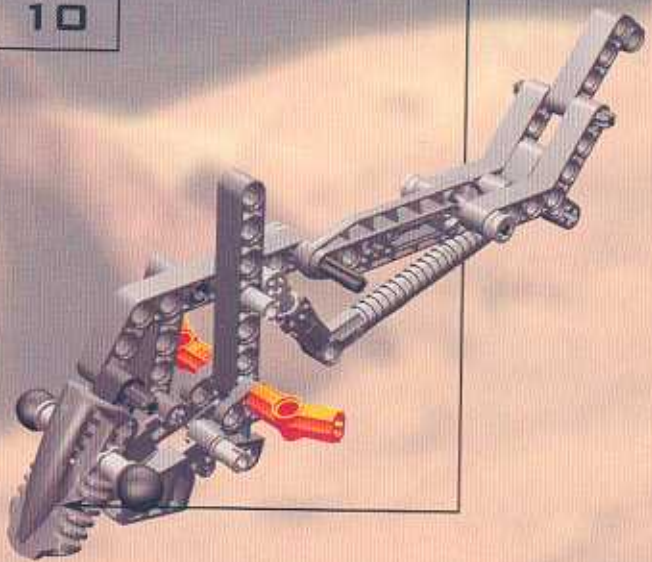

11

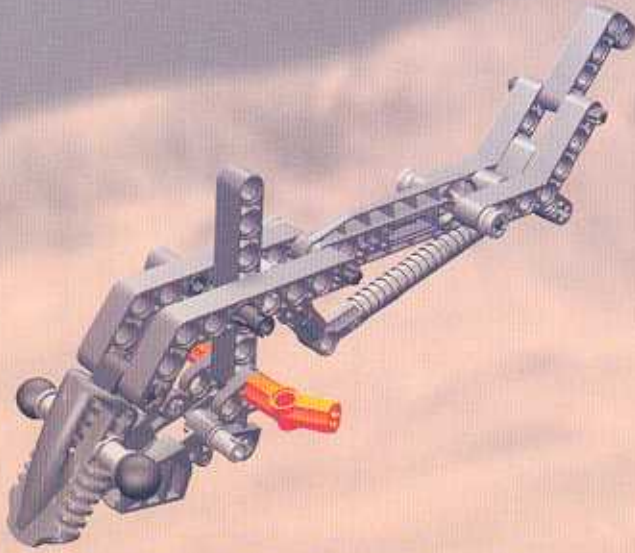

12

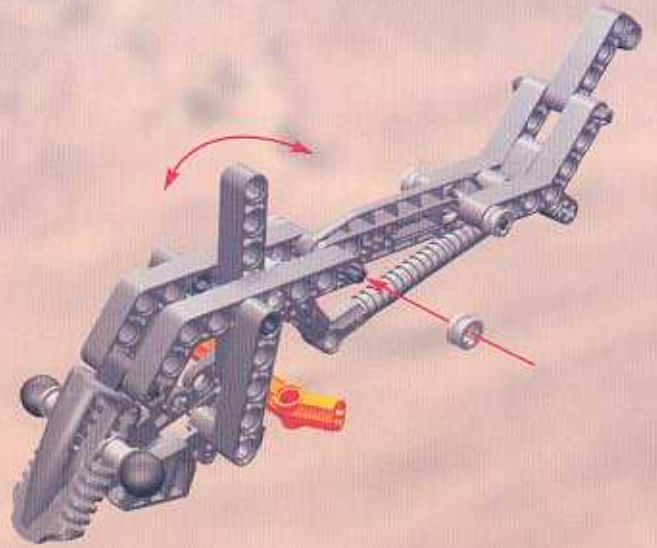





1

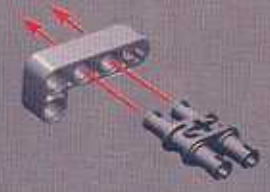

2



3

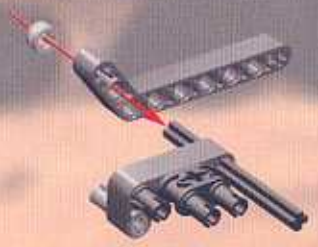

4

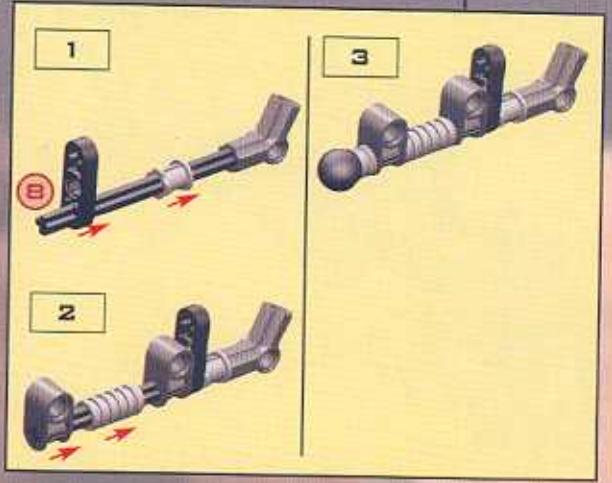
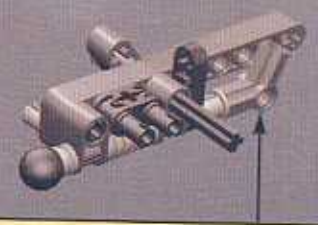

5

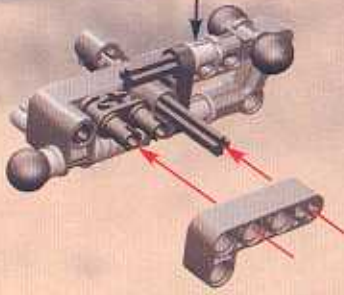

6

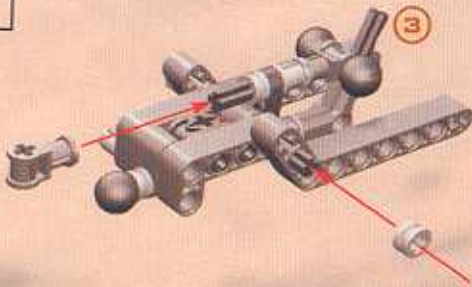

7

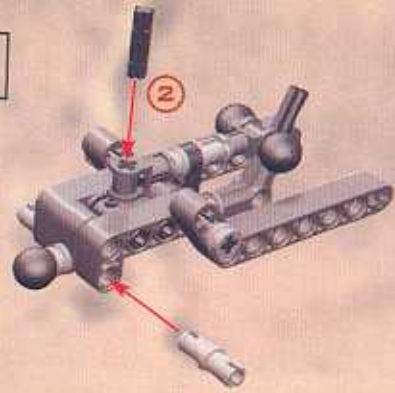

8

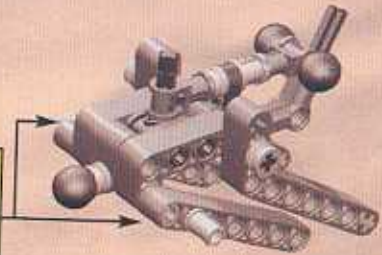
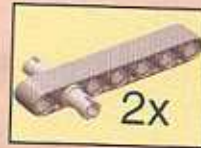

1:1



9

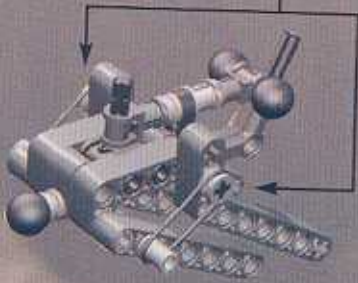
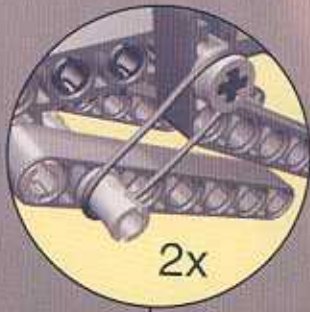

10

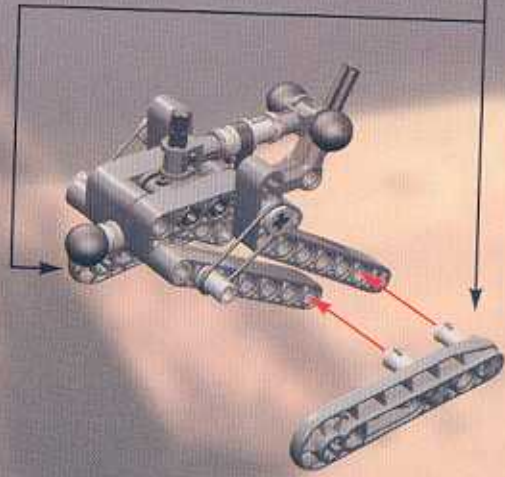
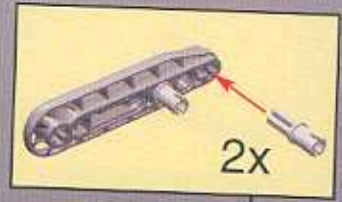

1



2



3



4

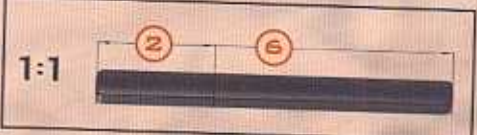

5

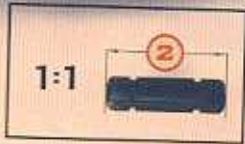
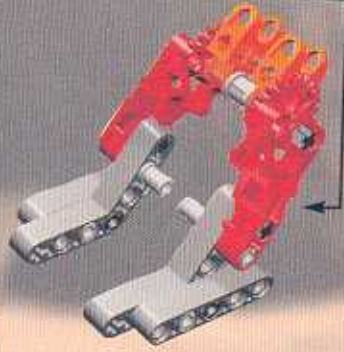
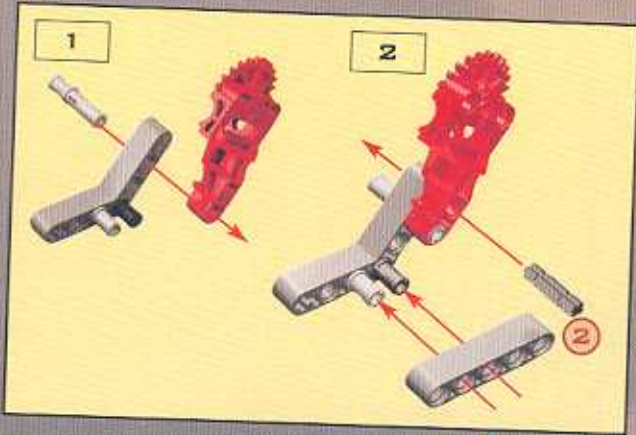

11



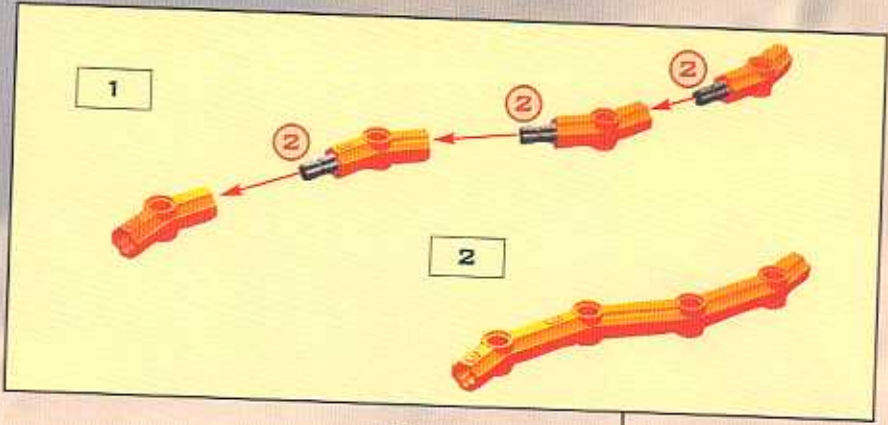

13

