

1

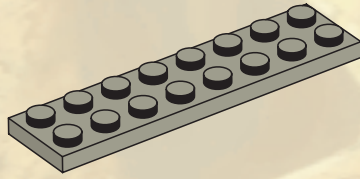

2

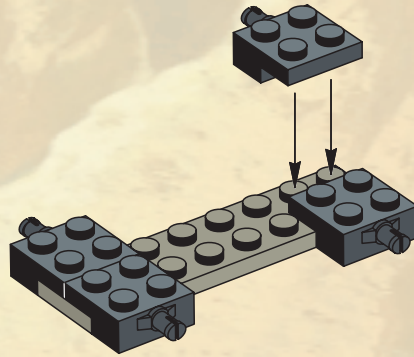

3

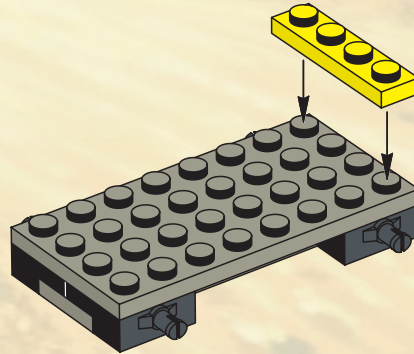

4

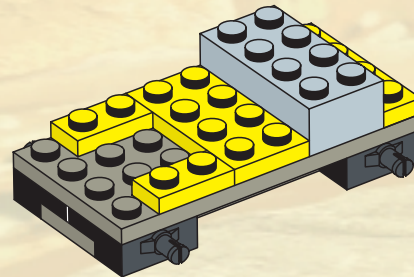

5

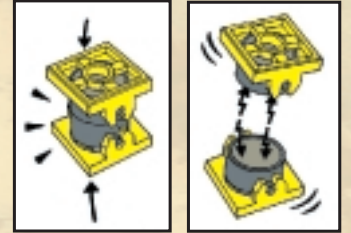
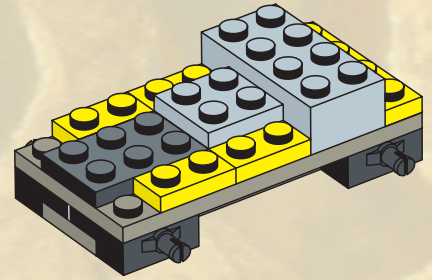

6

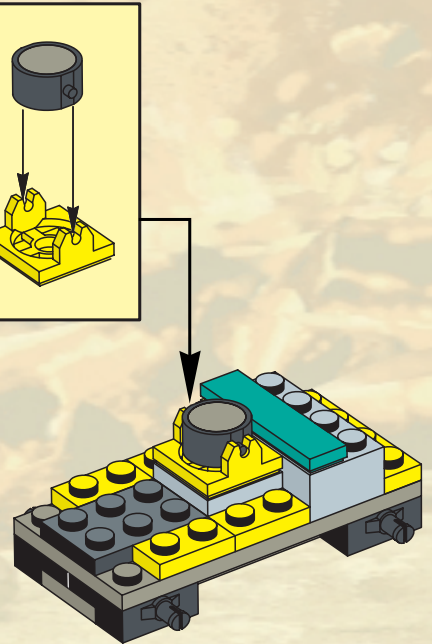

7

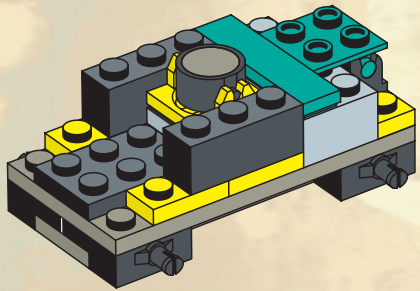

8

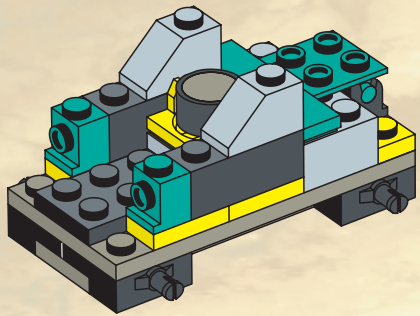

9

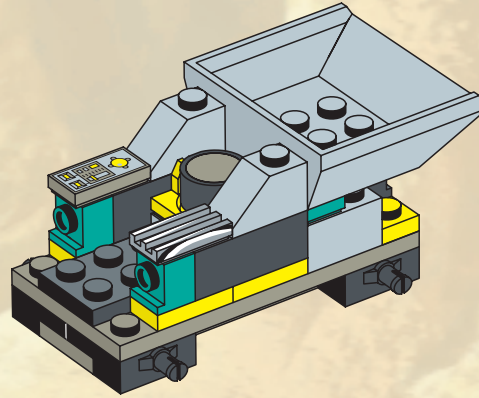

10

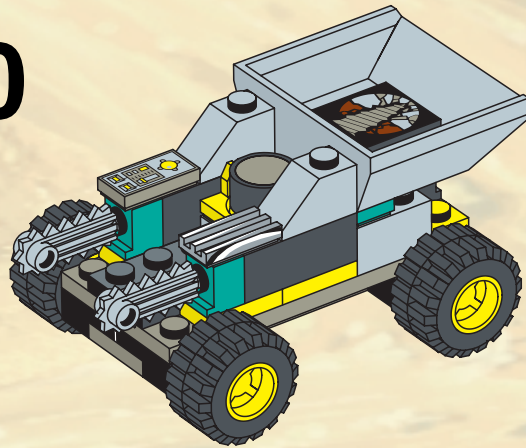

11

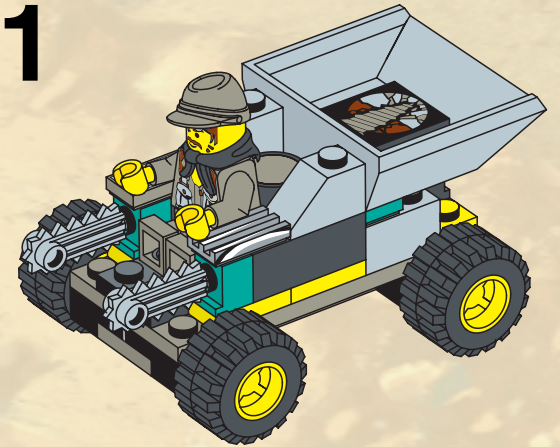

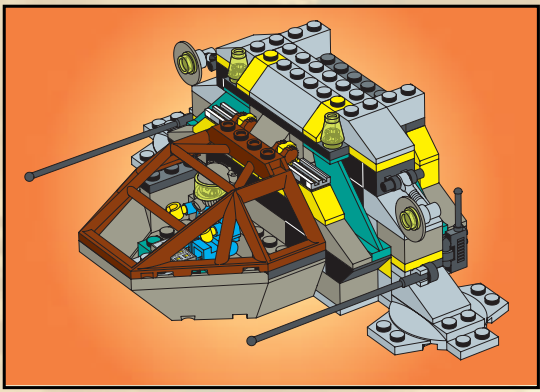

1

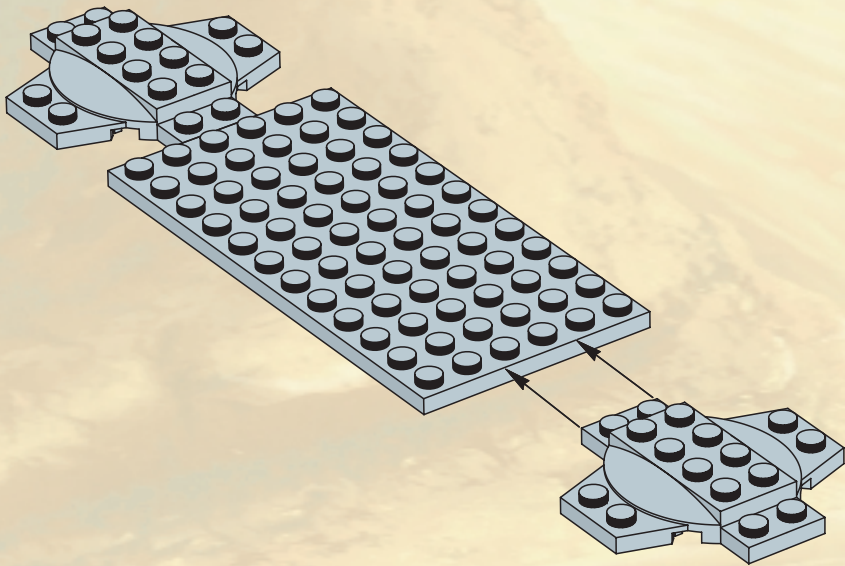

2

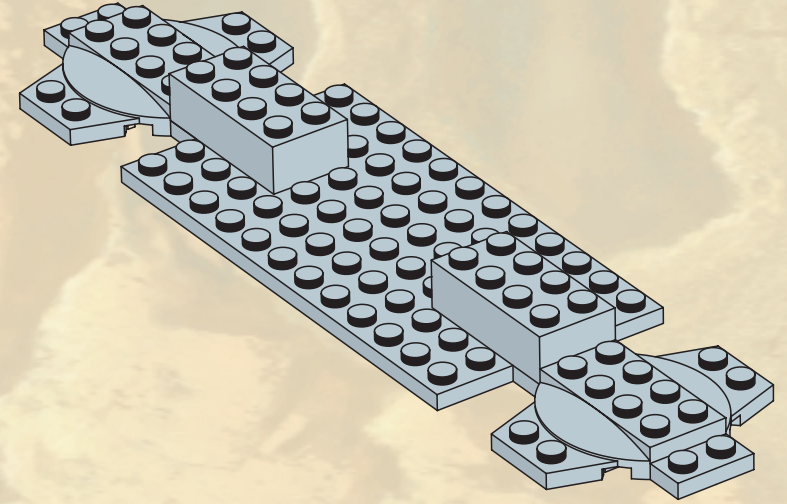

3

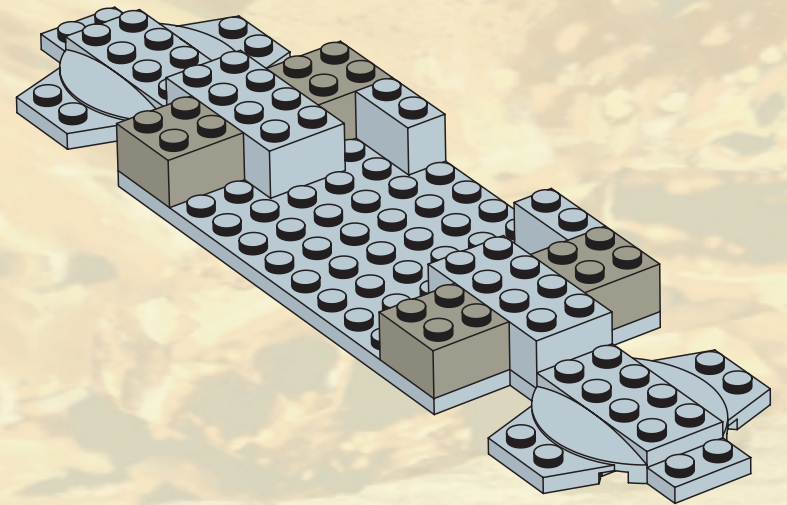

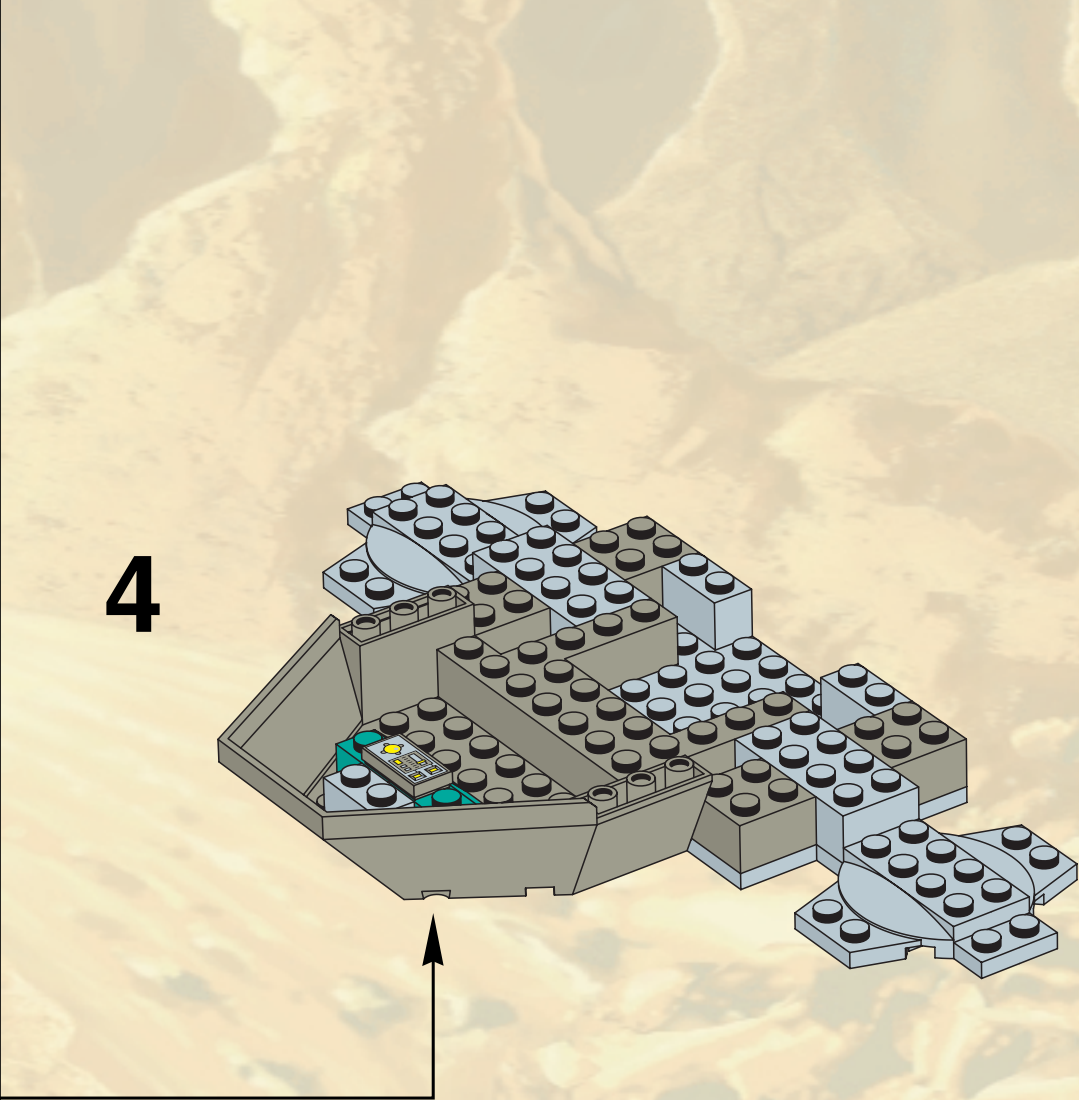
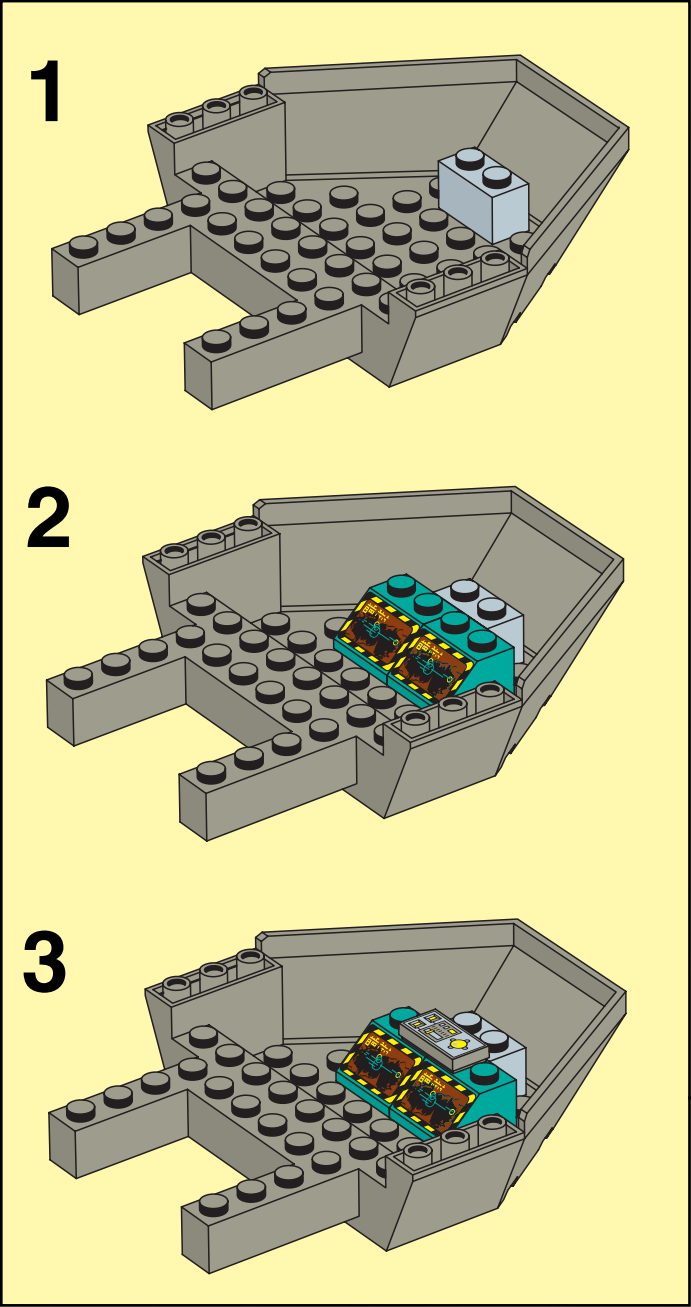

5

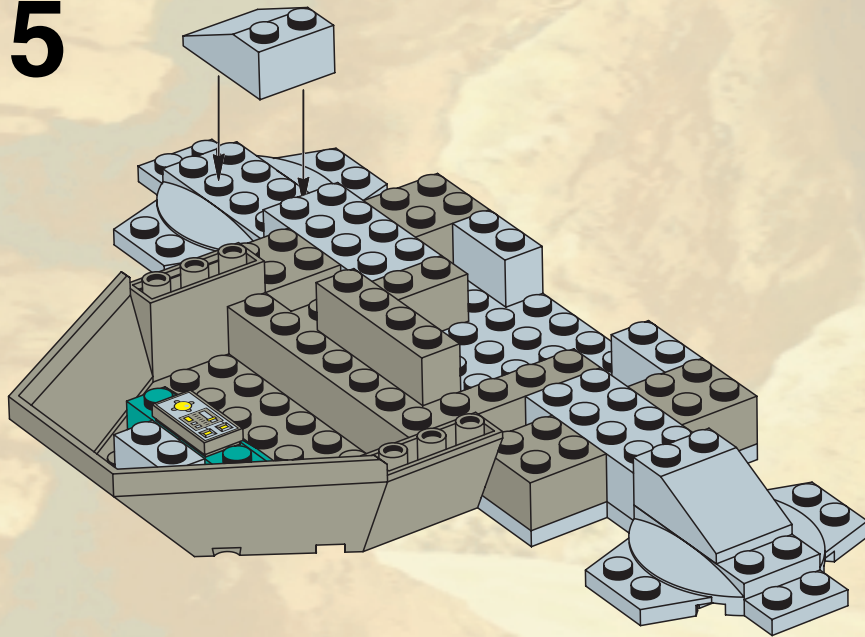

6

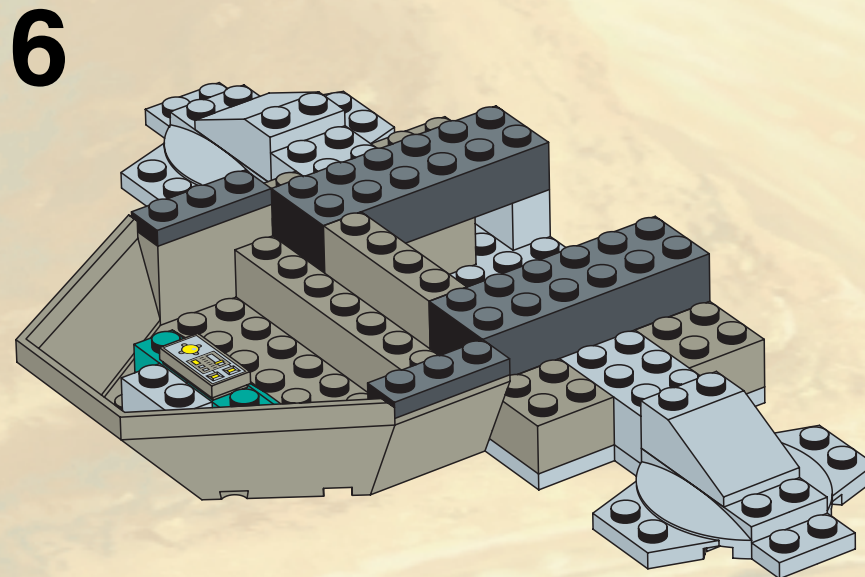

7

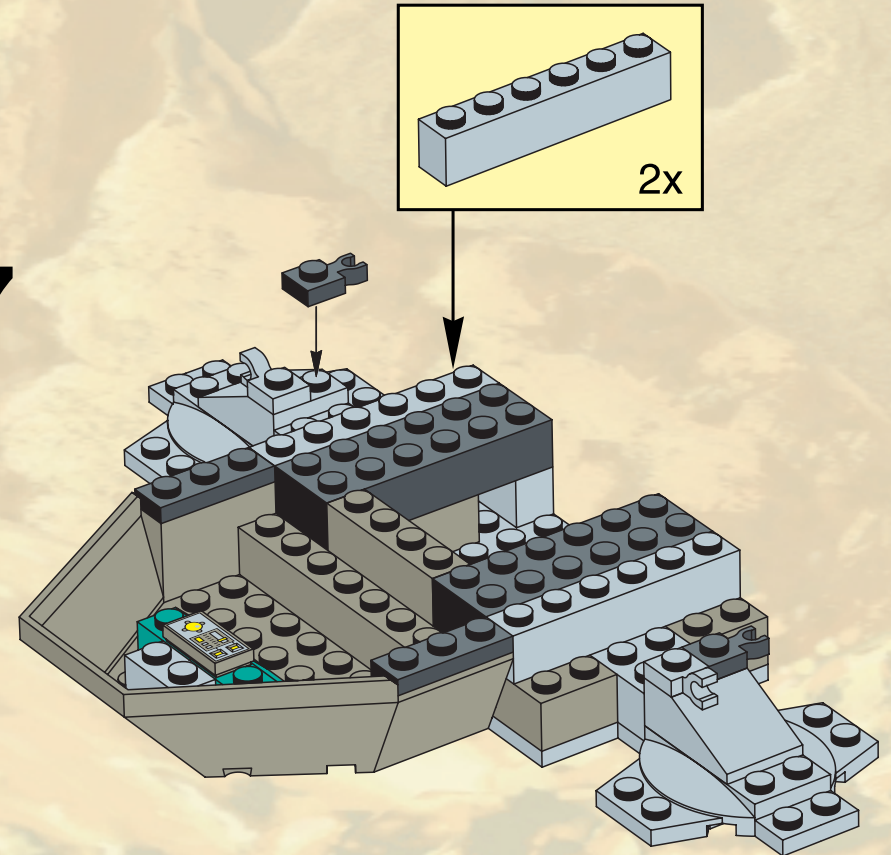

8

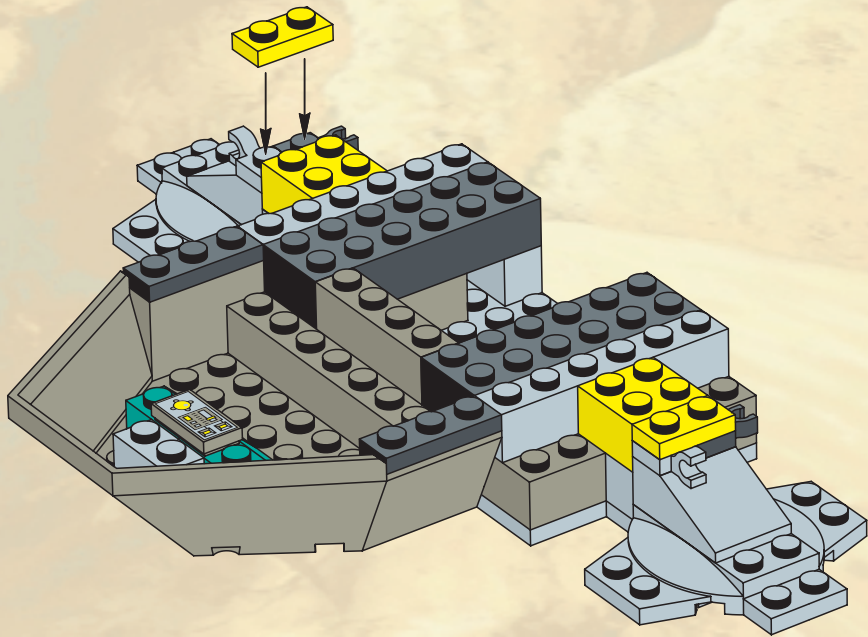

9

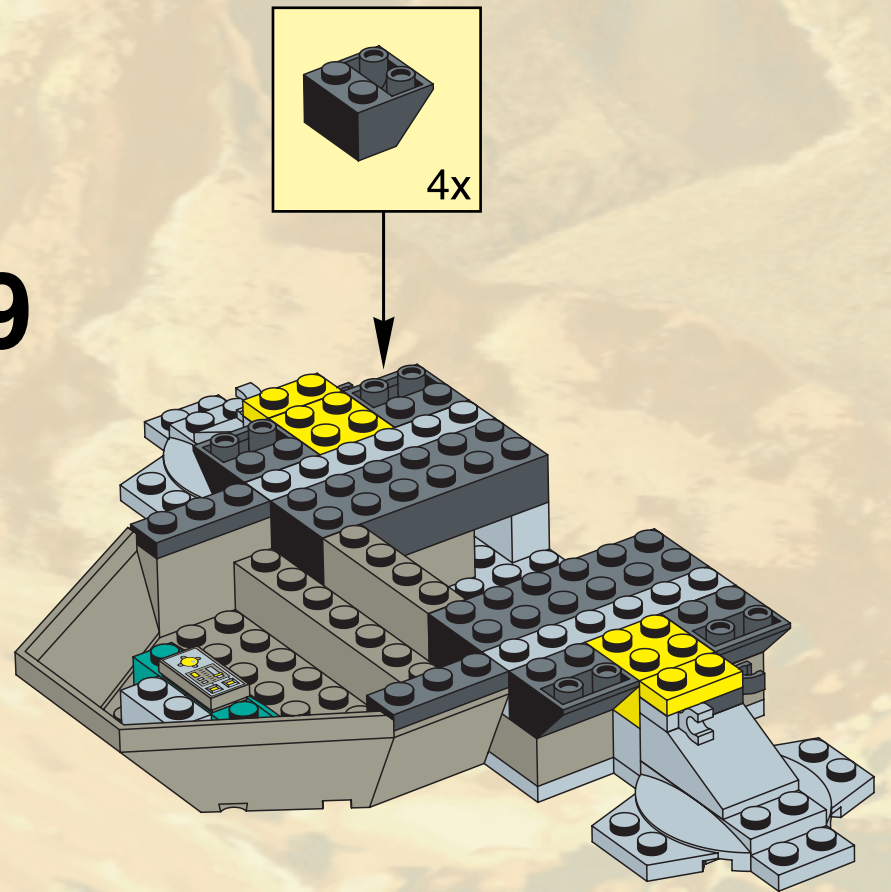

10

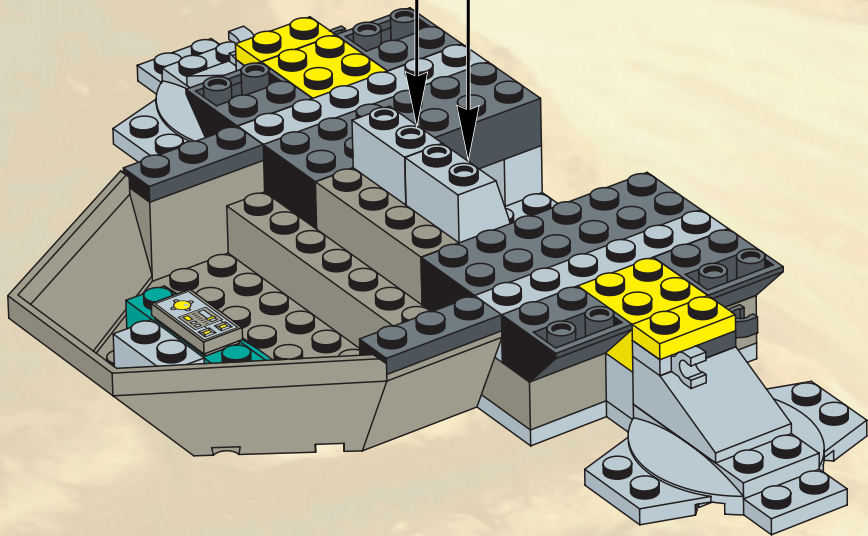
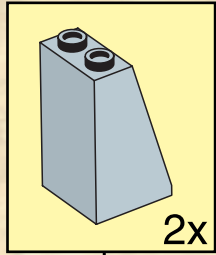

11

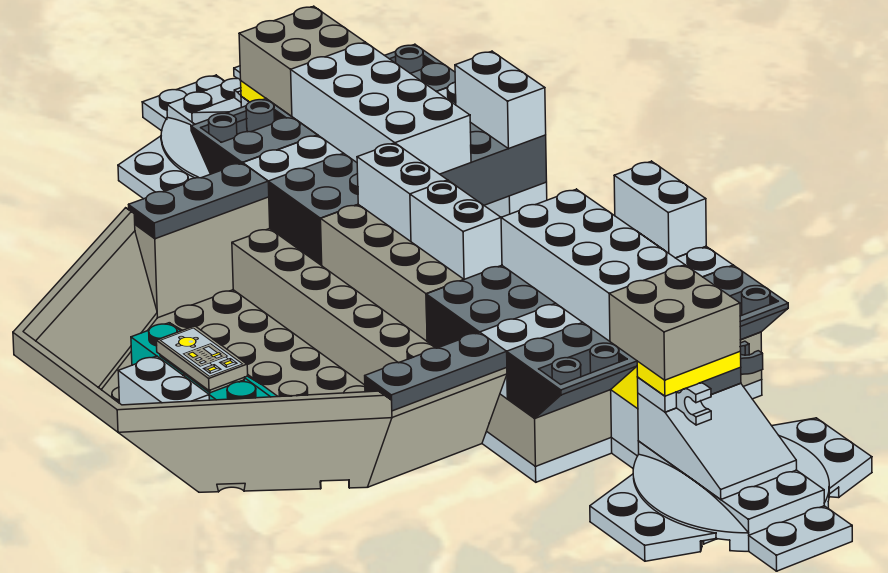

12

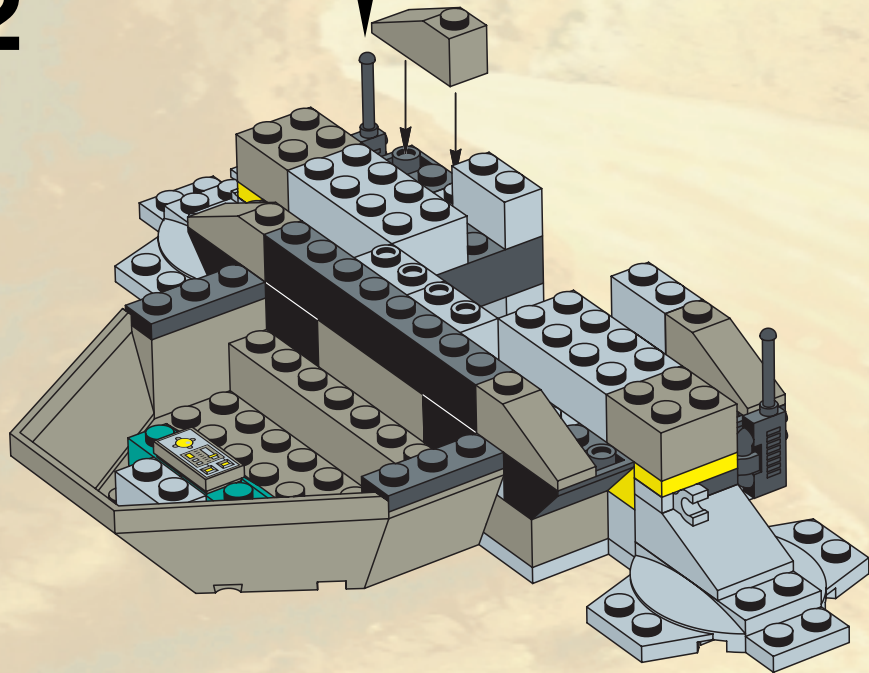
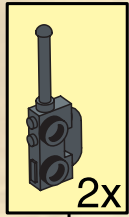

13

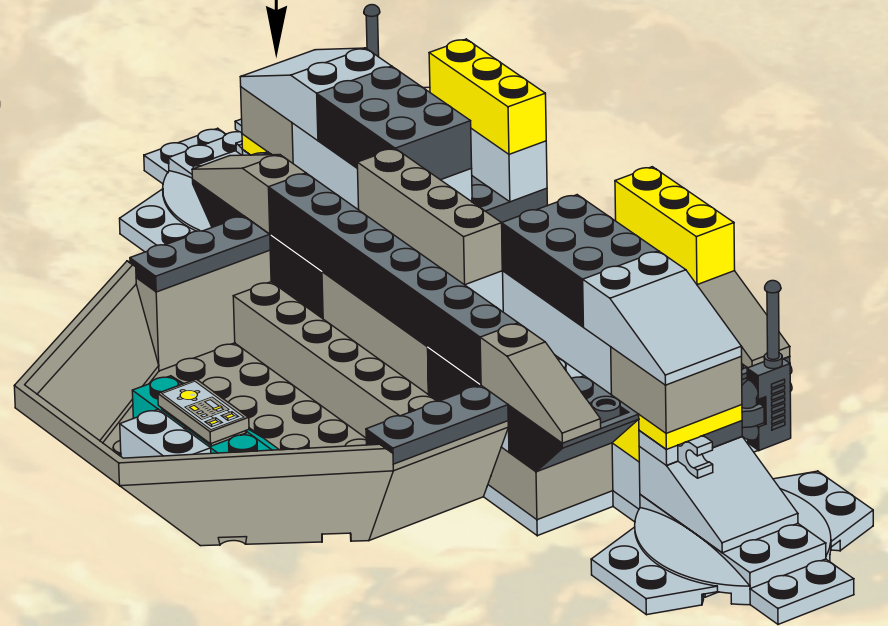
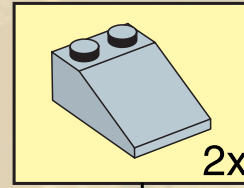

14

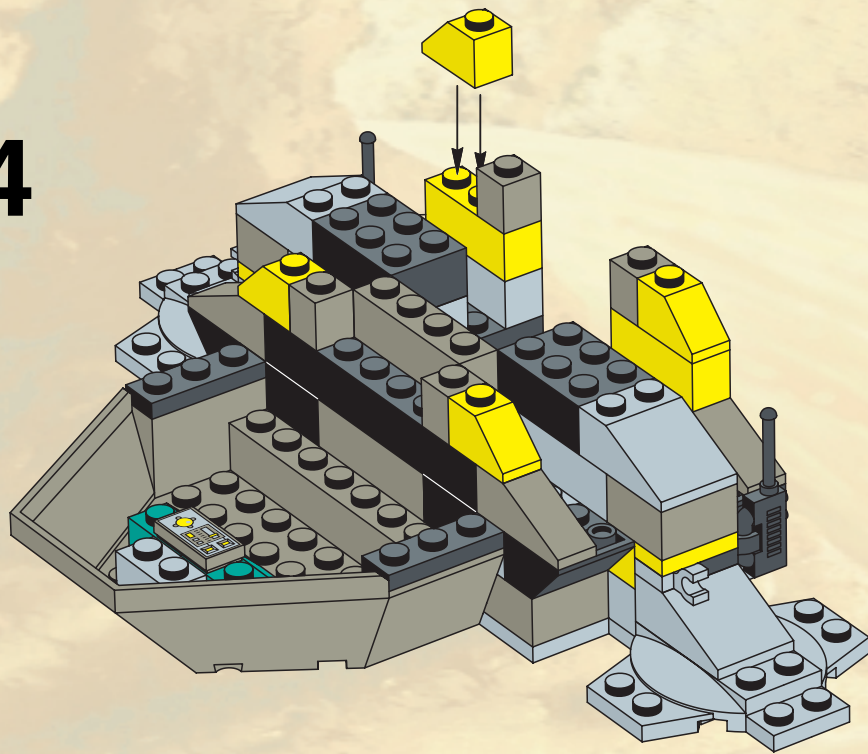

15

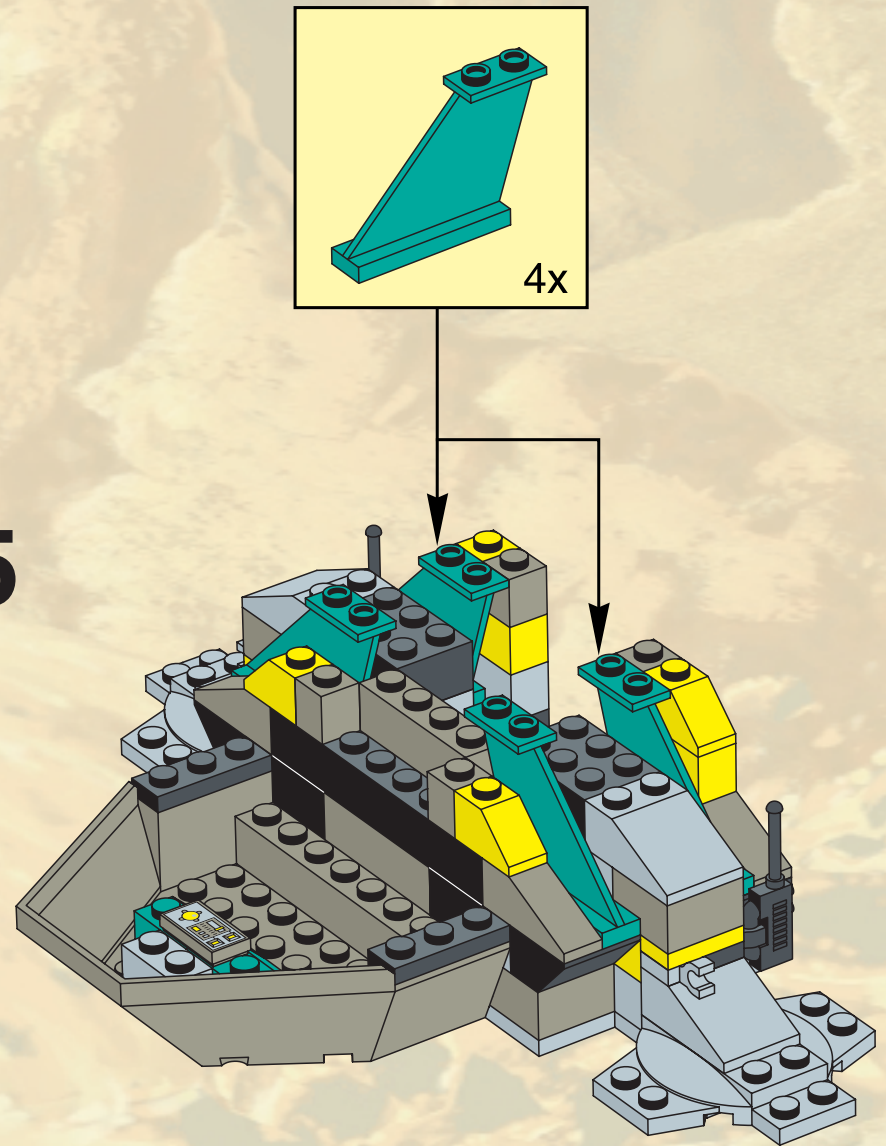

16

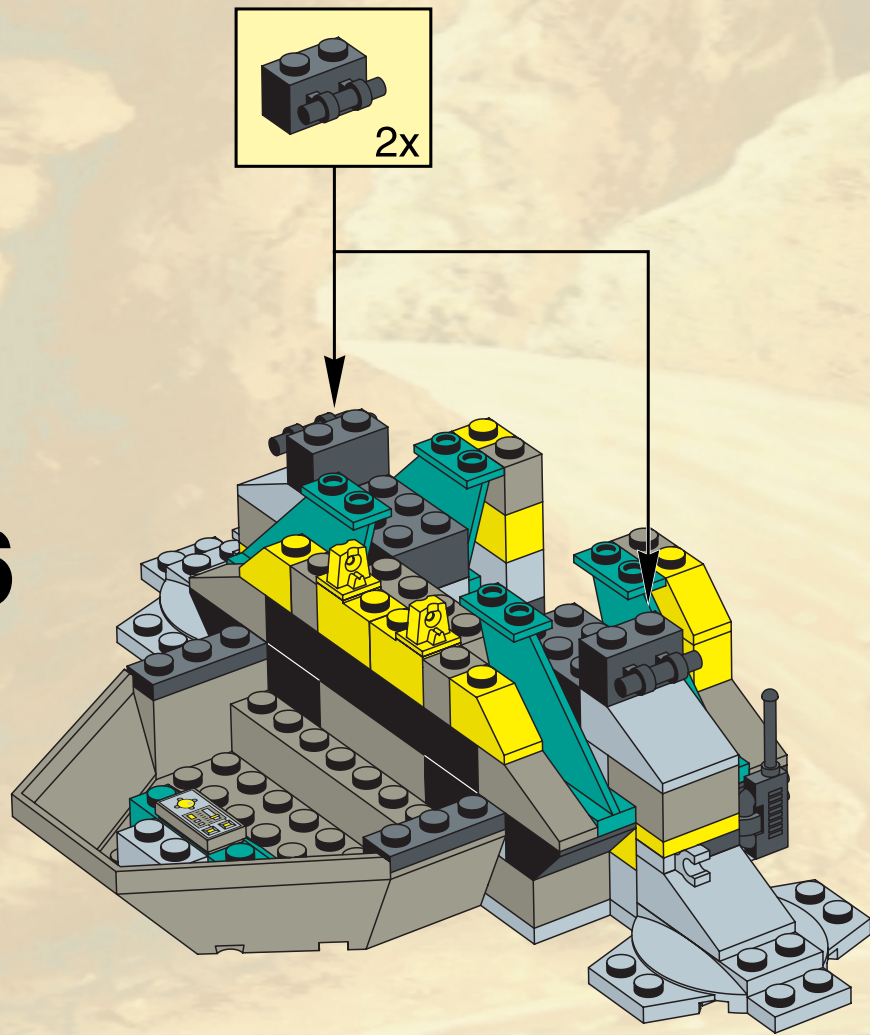

17

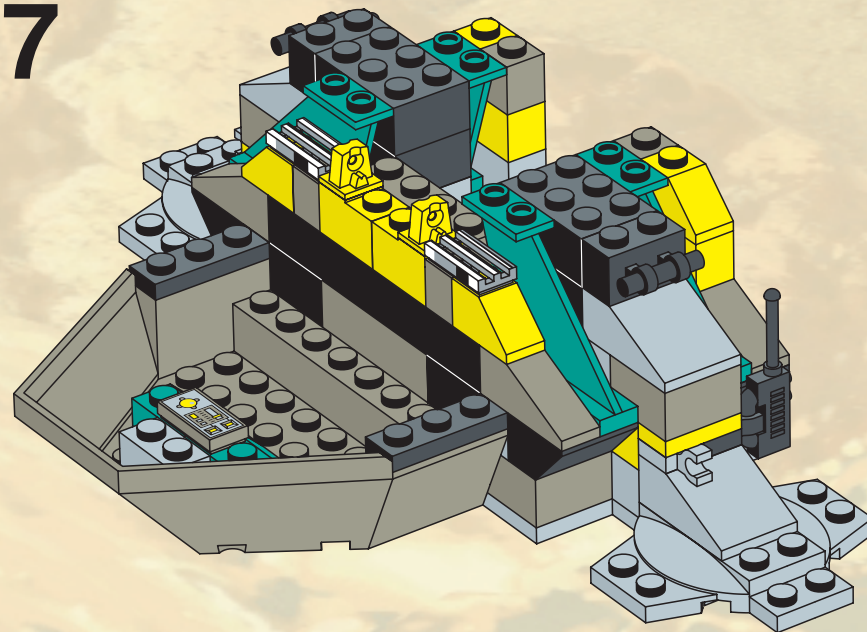

18

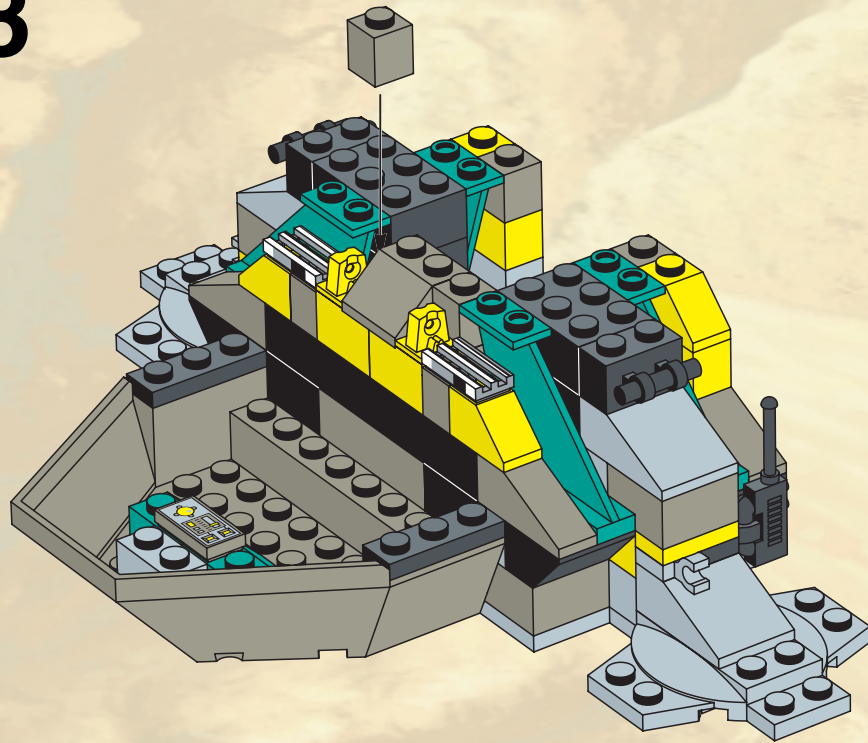

19

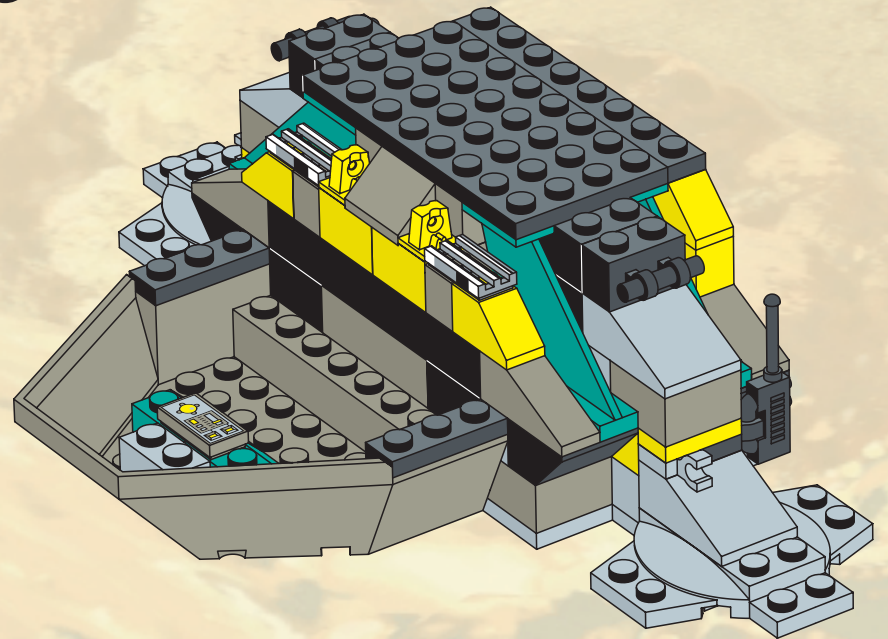

20

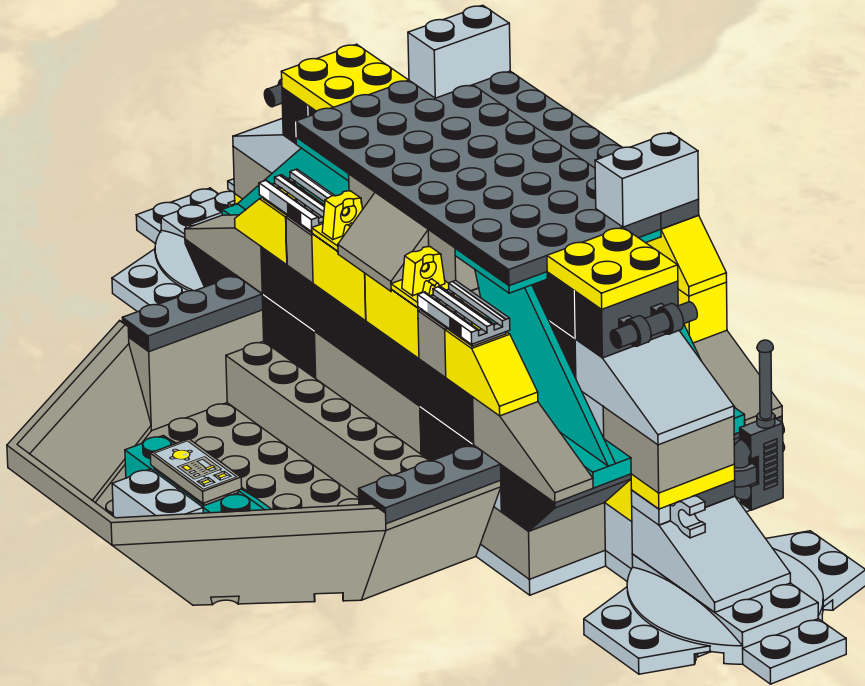

21

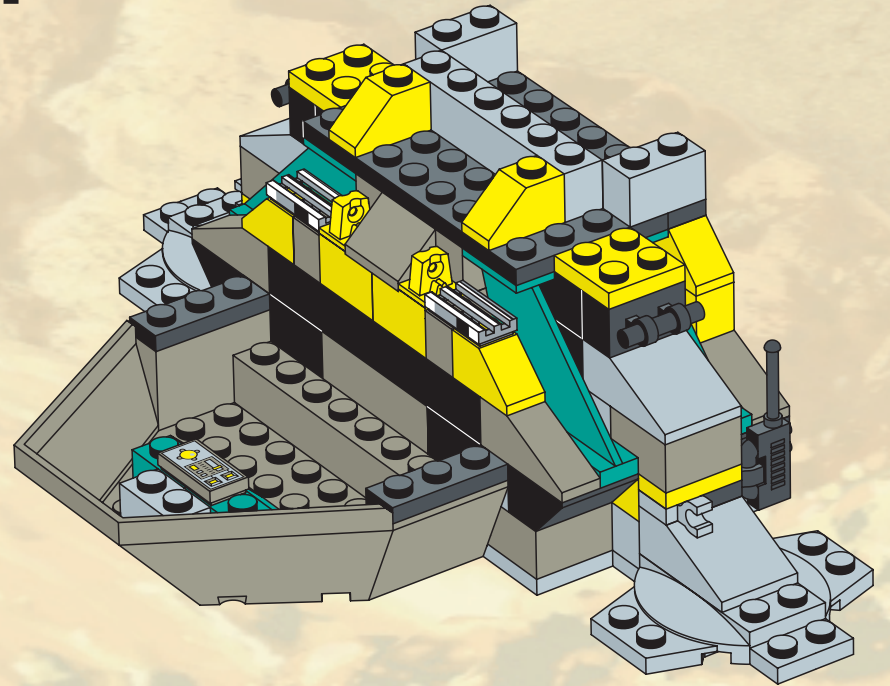

22

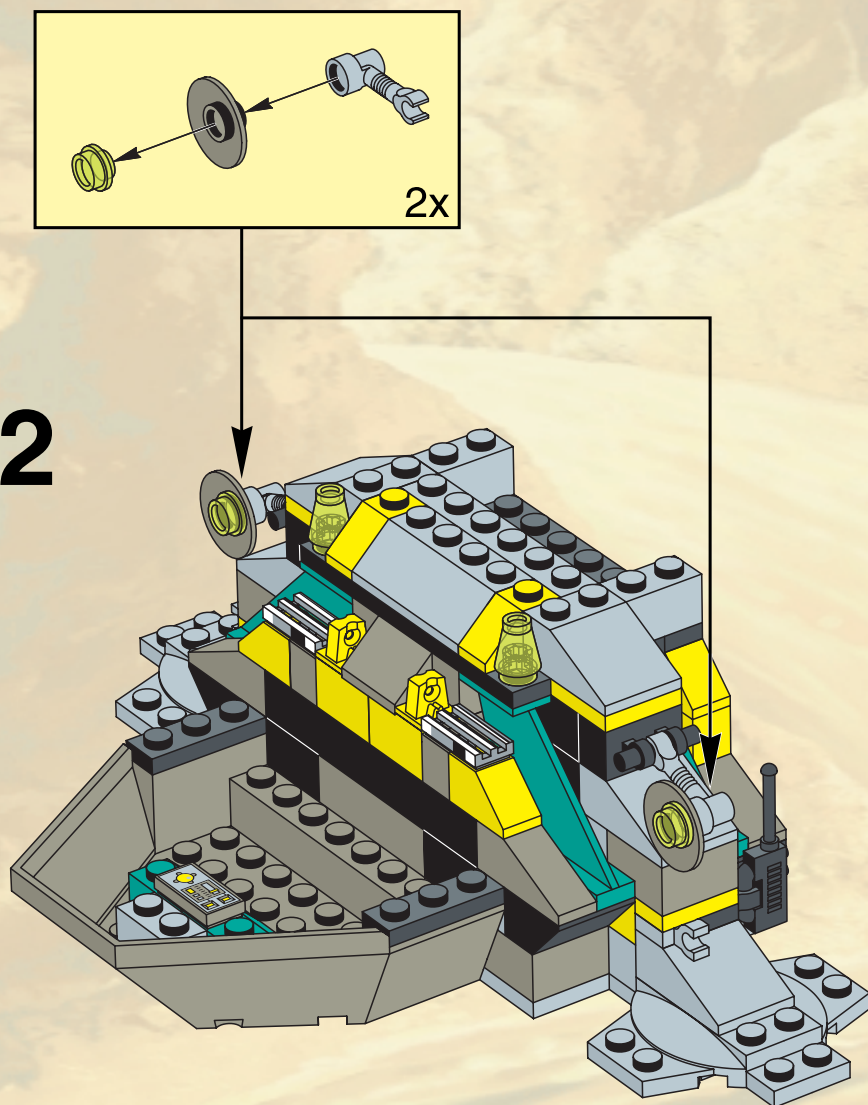

23

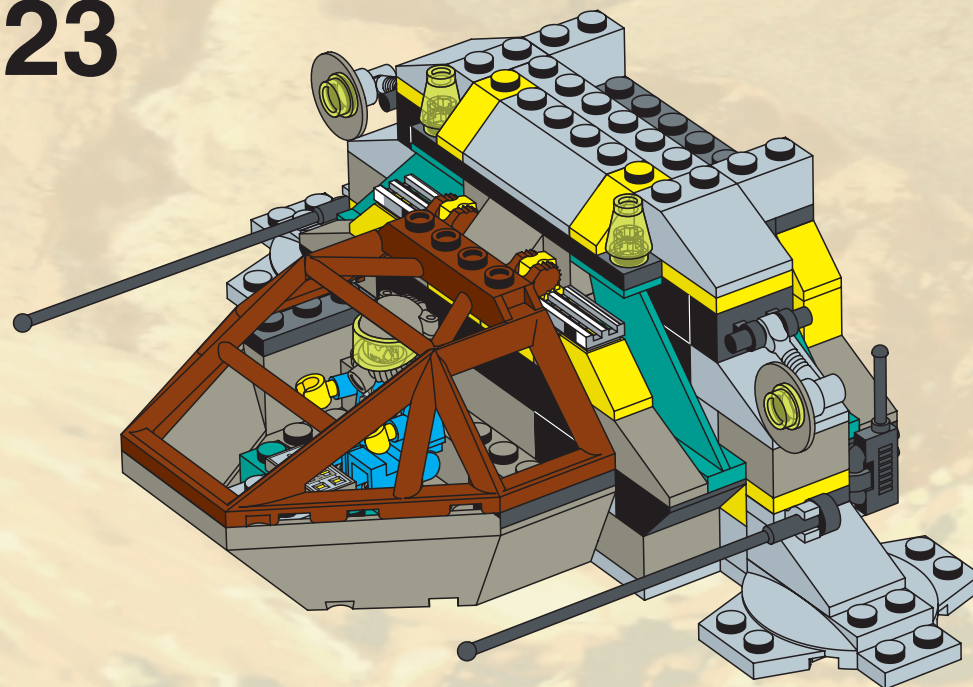

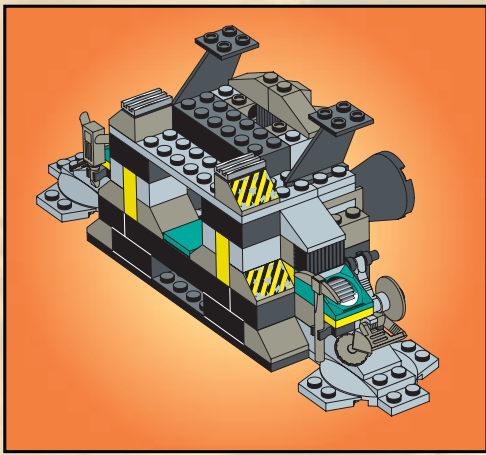

1

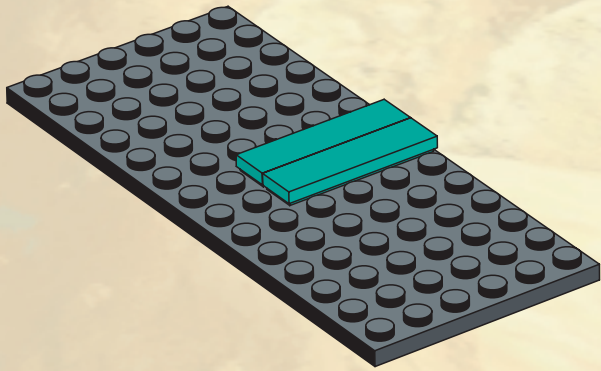

2

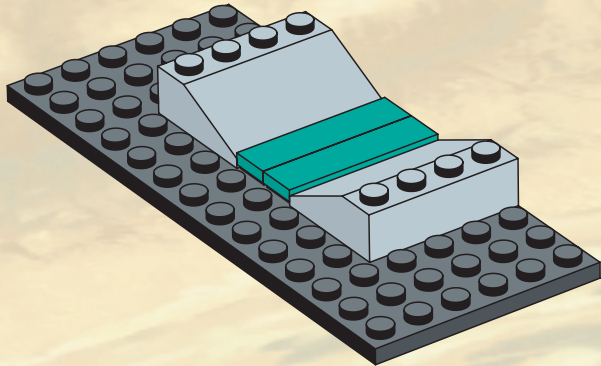

3

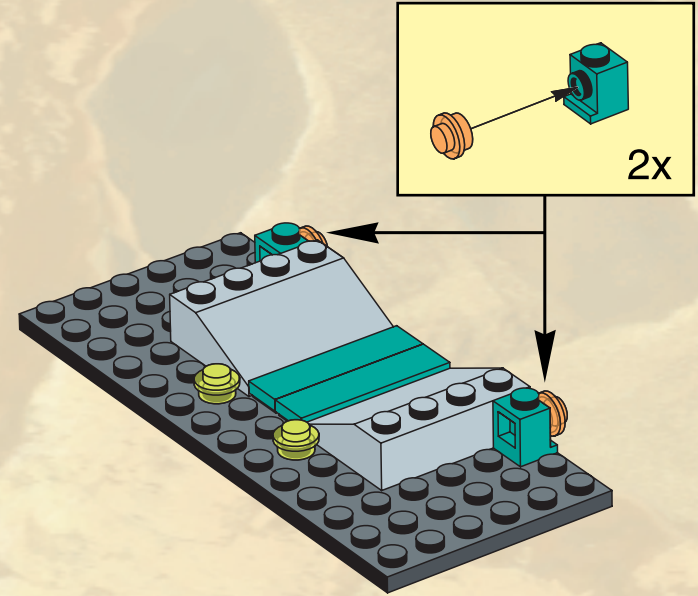

4

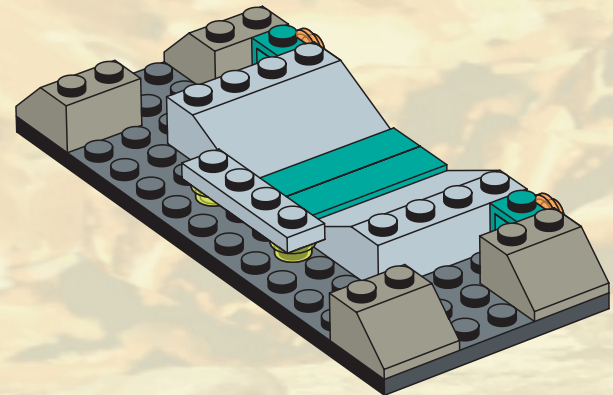

5

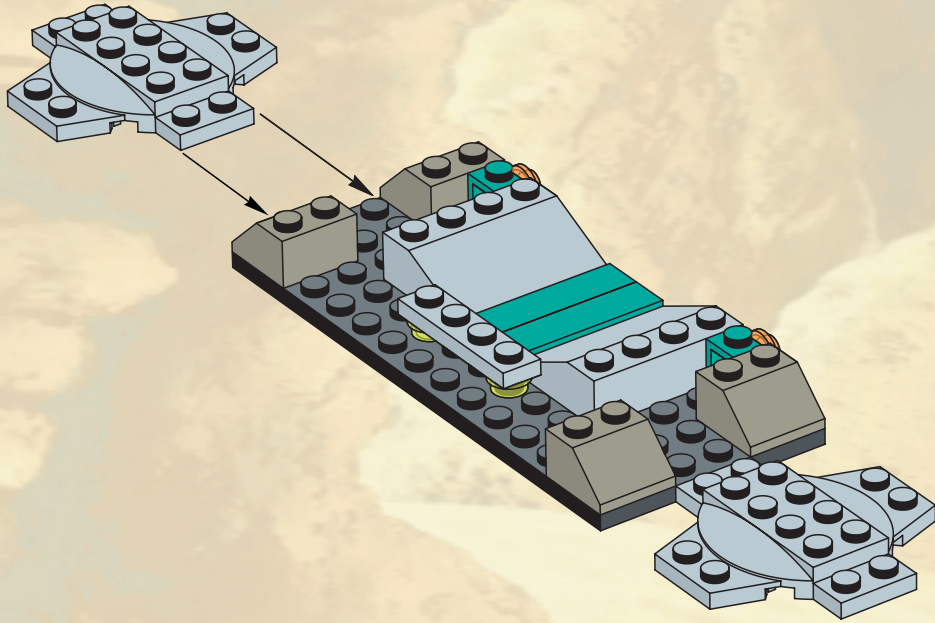

6

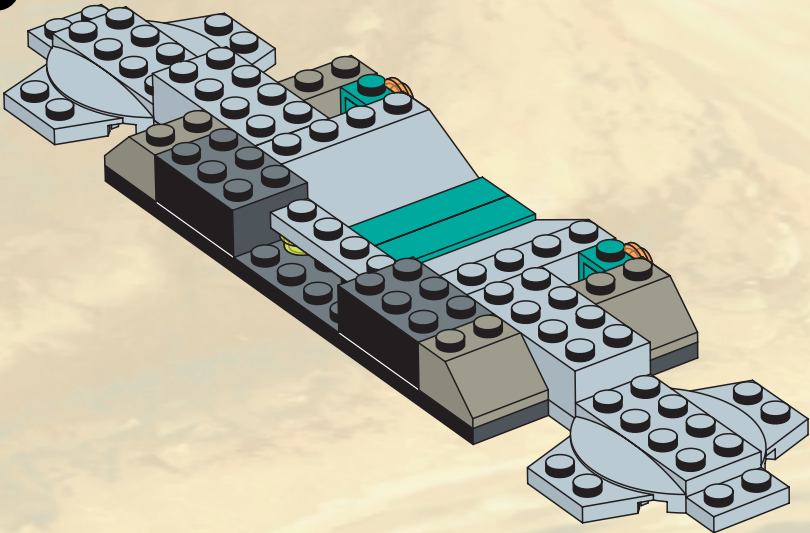

7

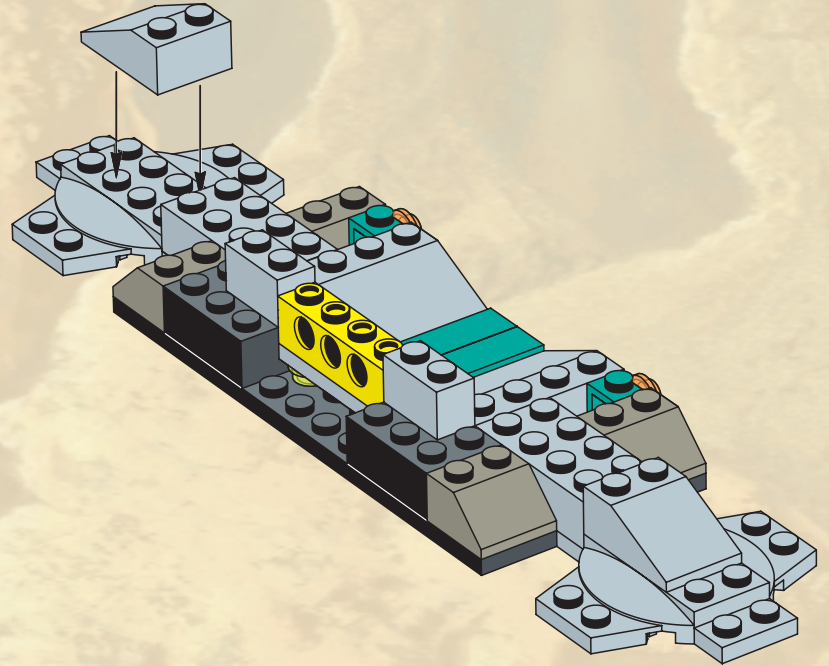

8

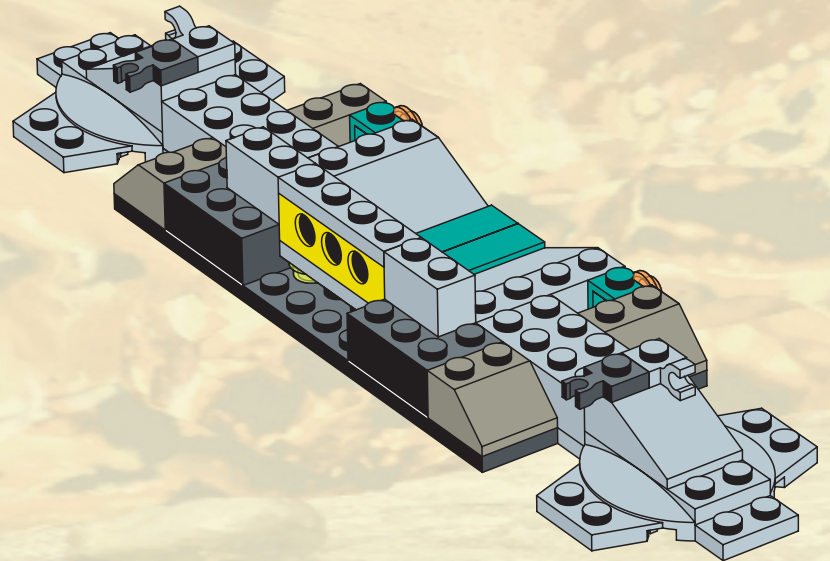

9

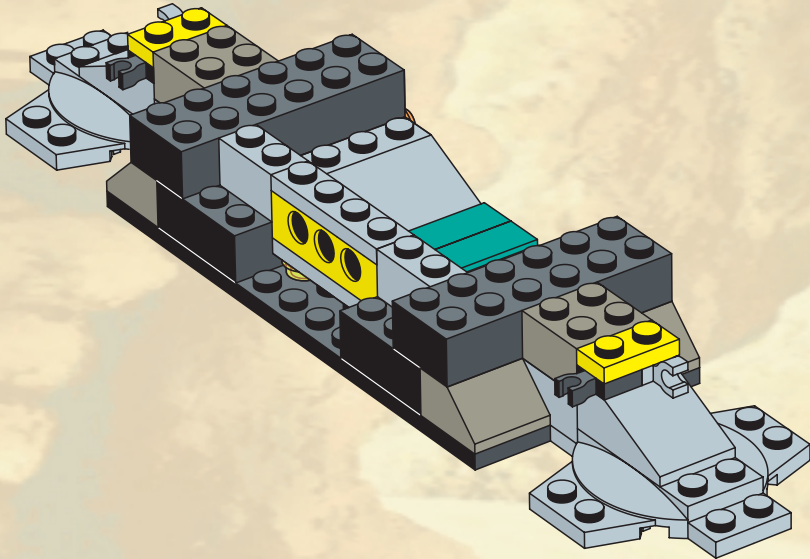

10

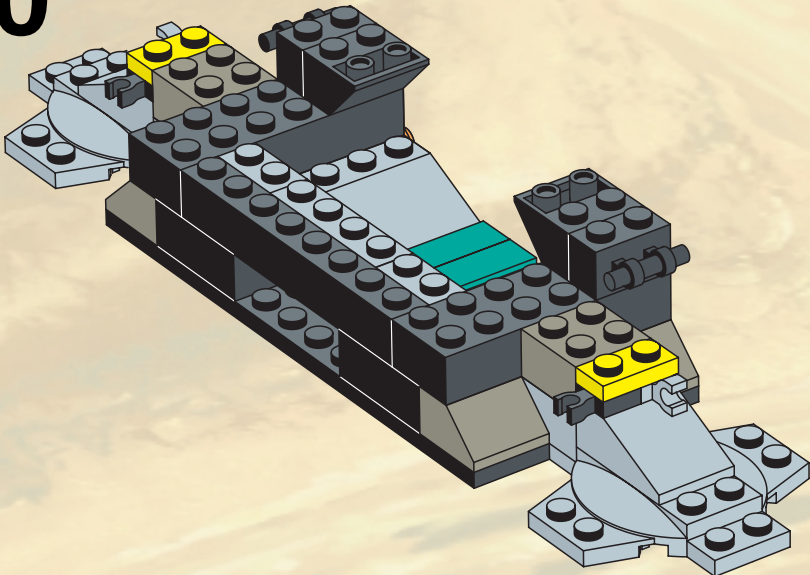

11

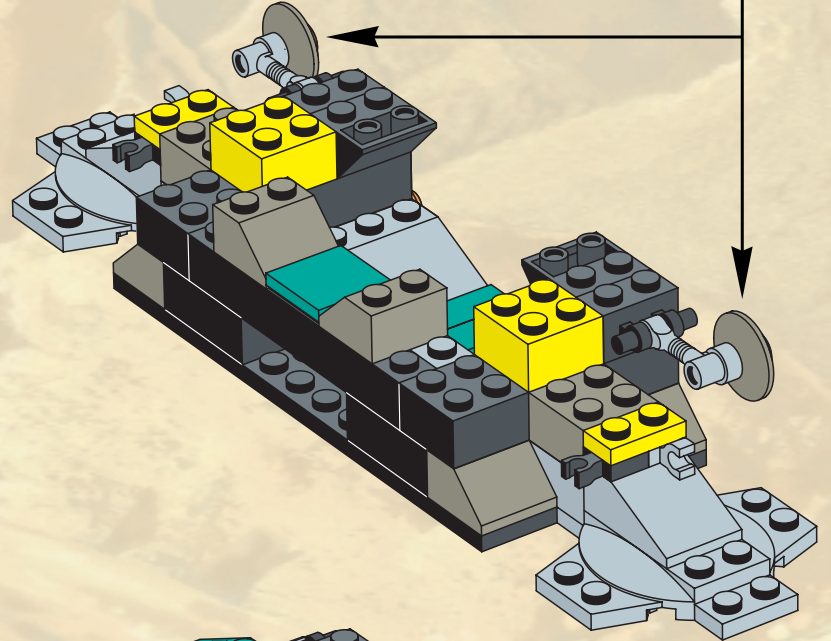

12

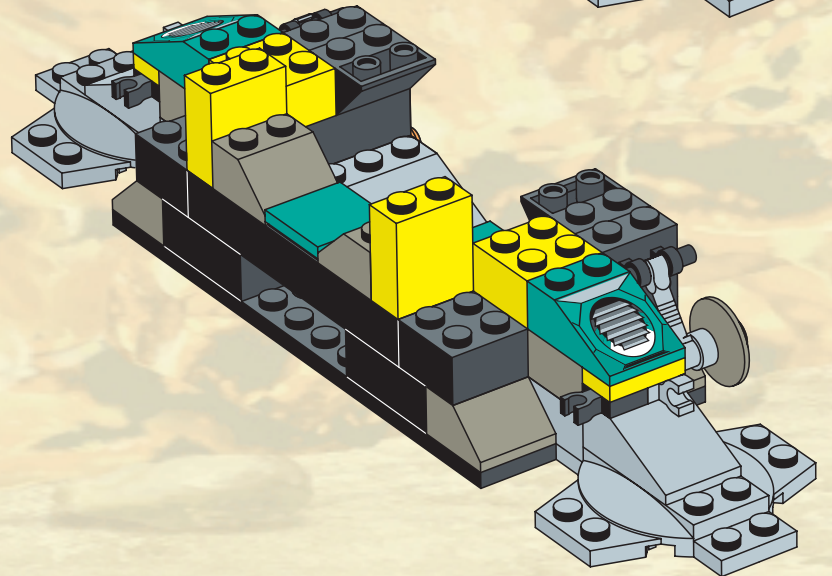

13

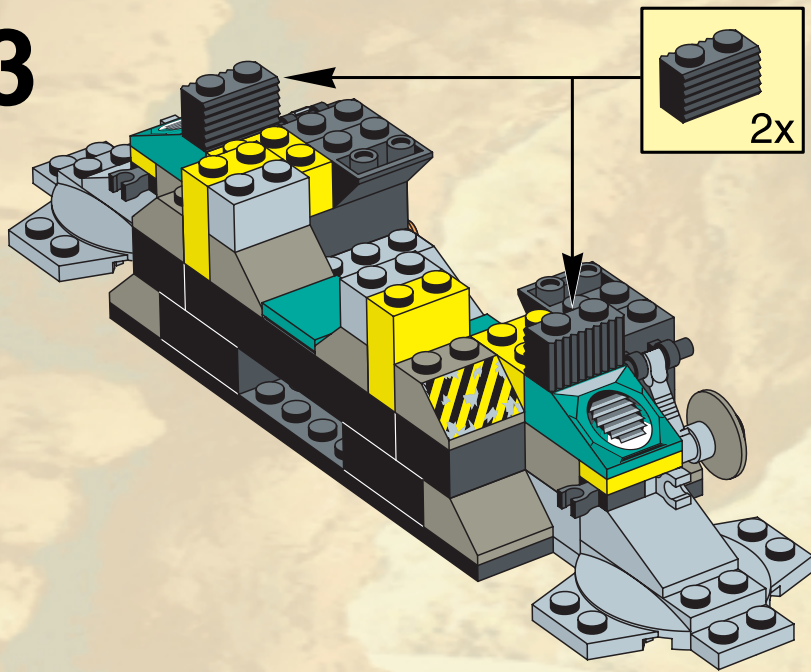

14

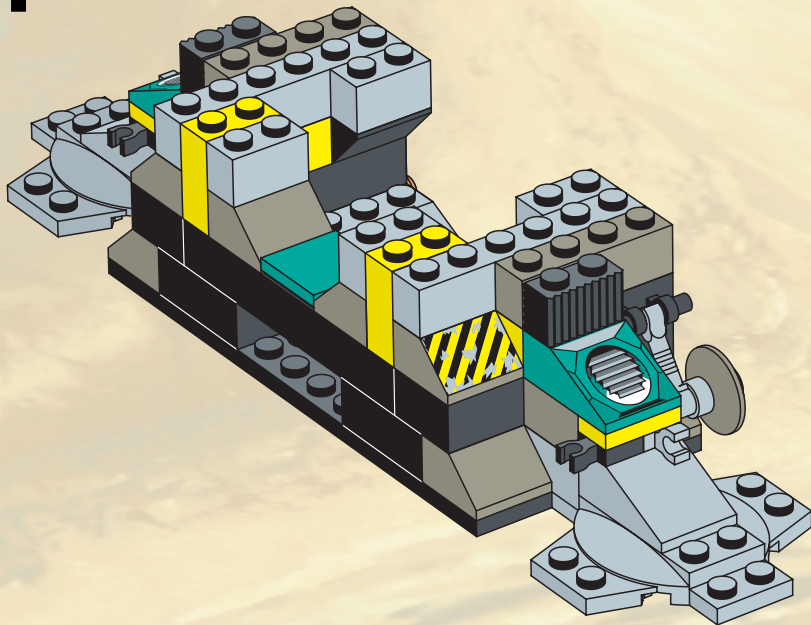

15

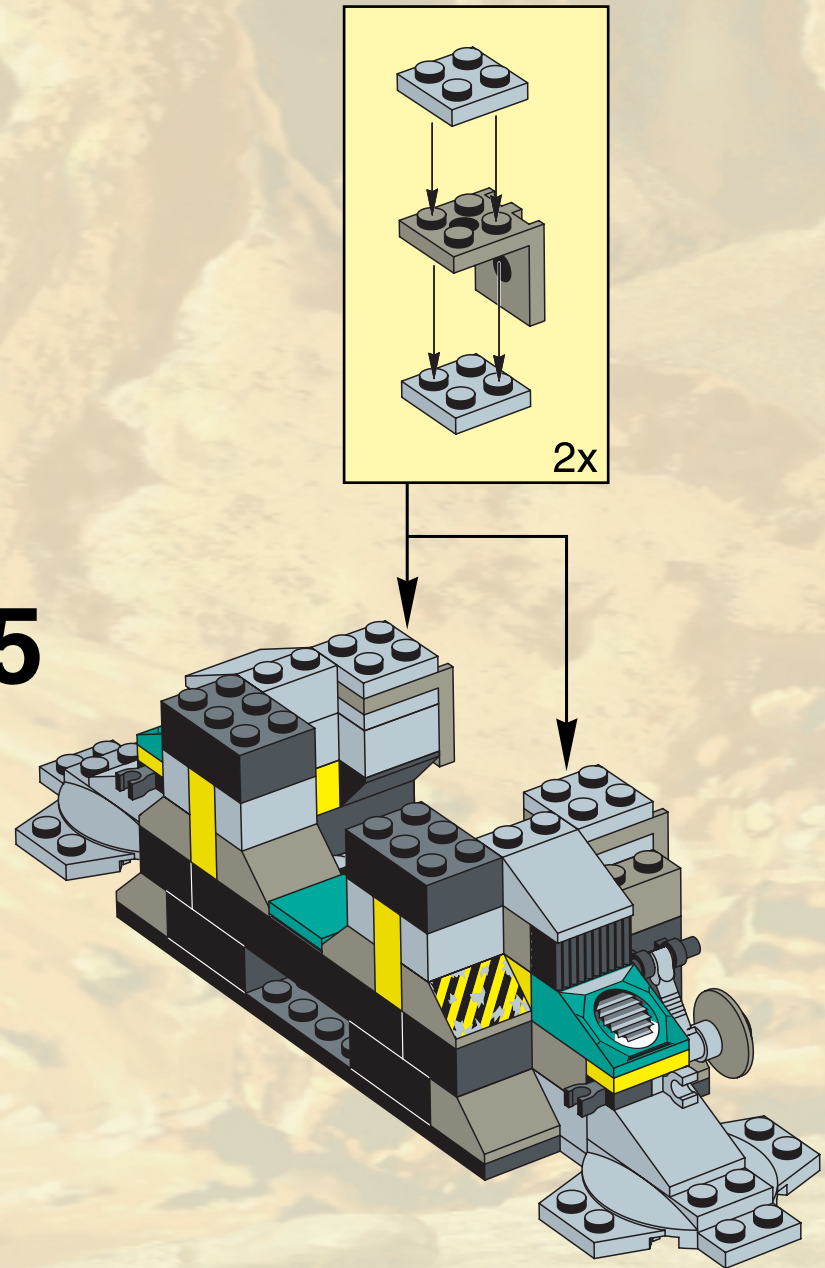

16

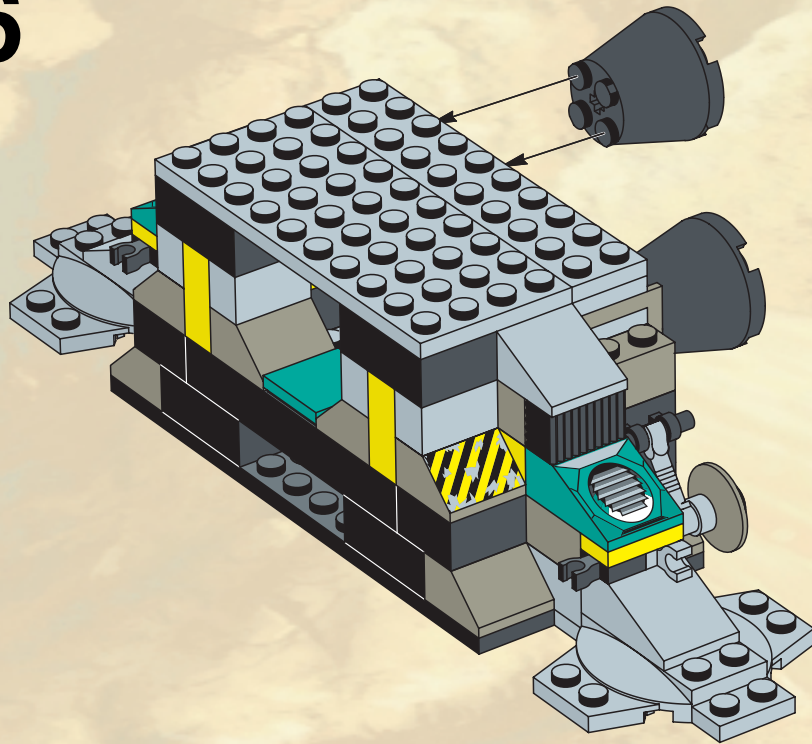

17

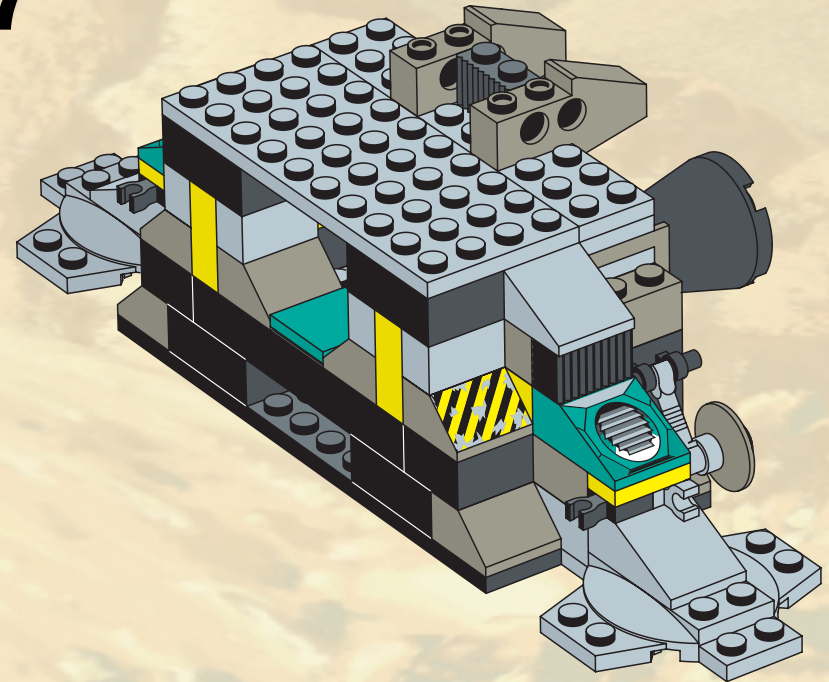

18

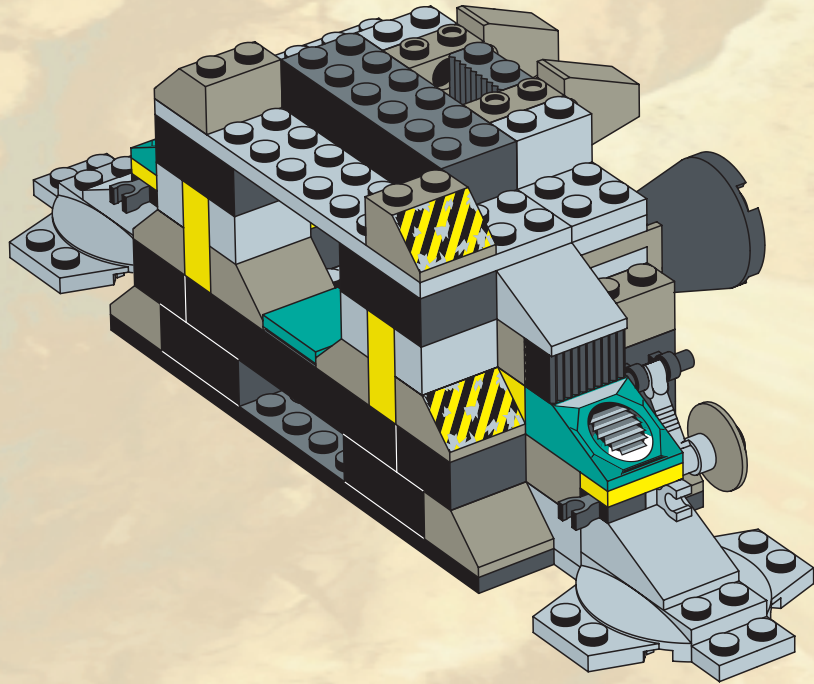

19

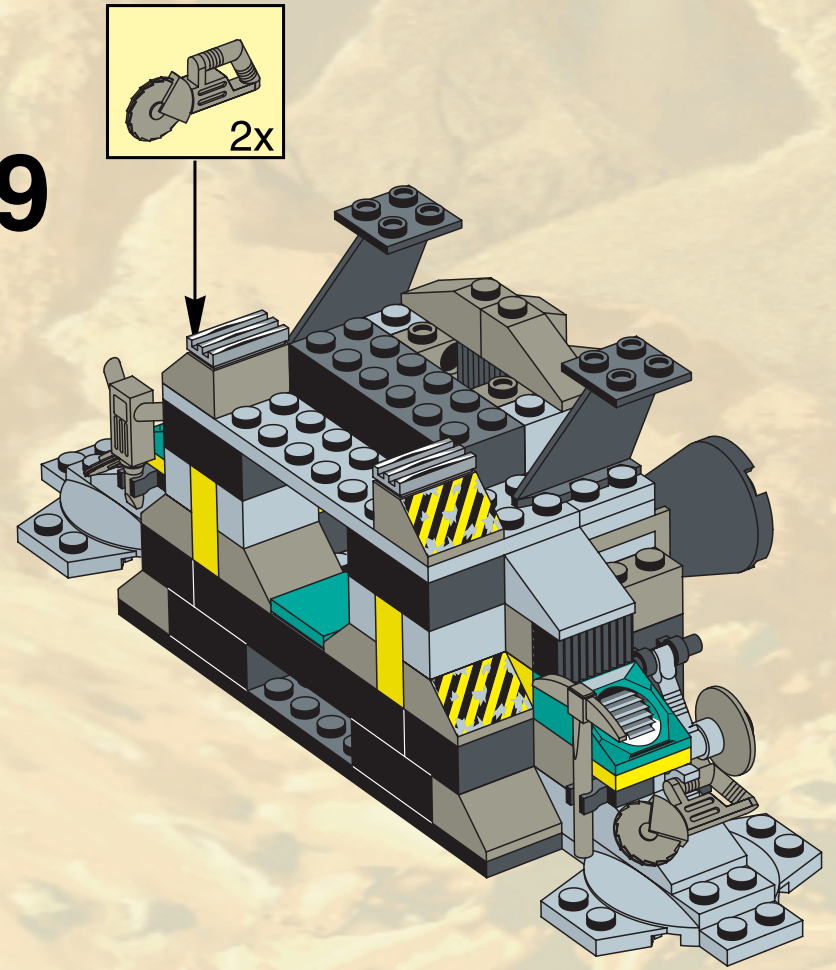

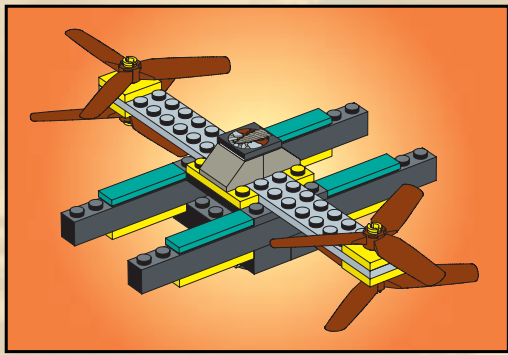

1

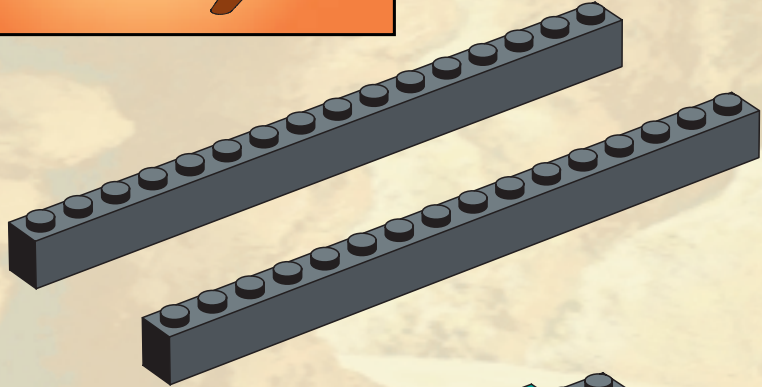

2

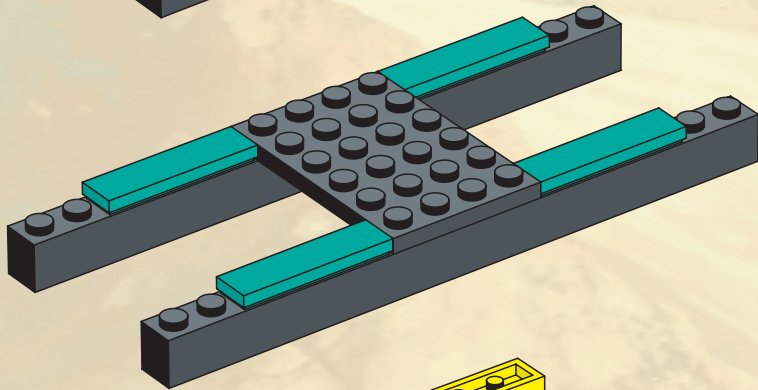

3

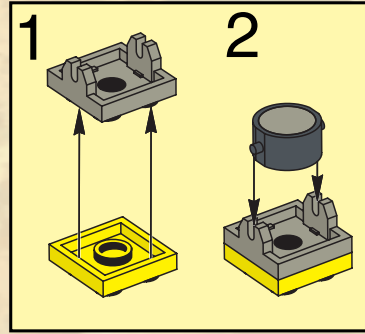
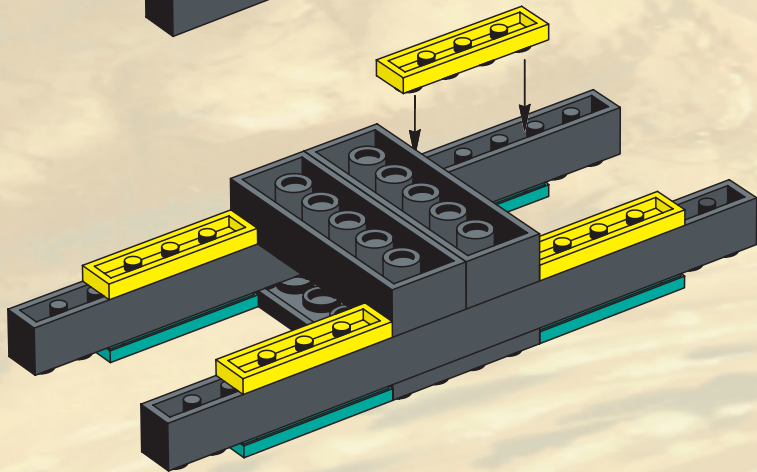

4

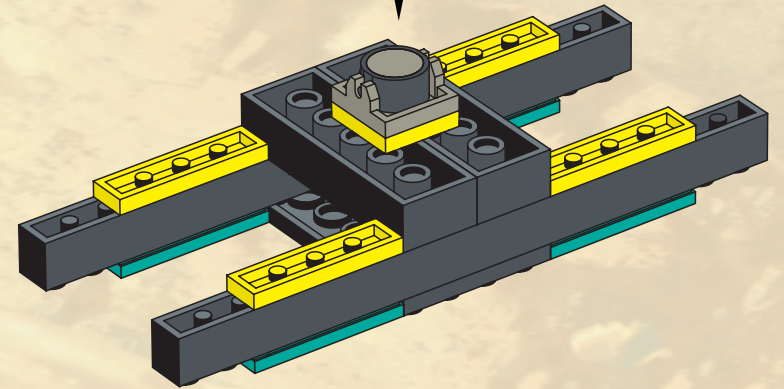

5

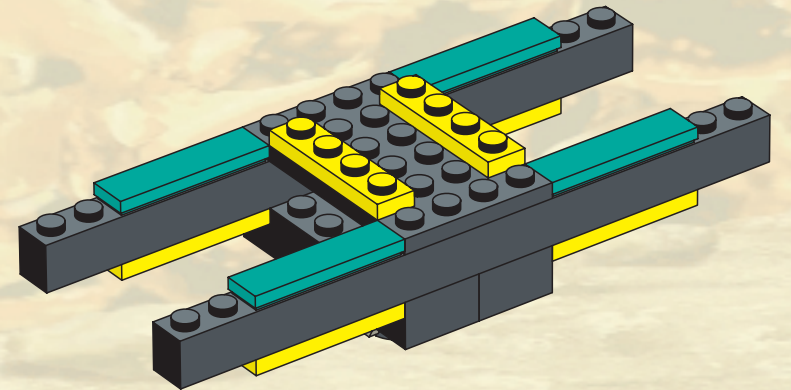

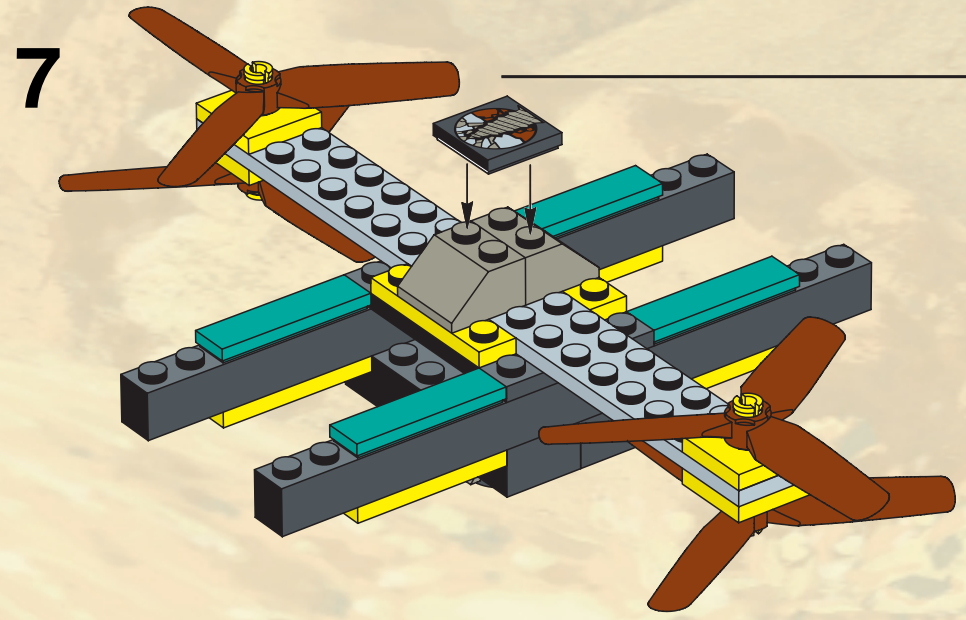
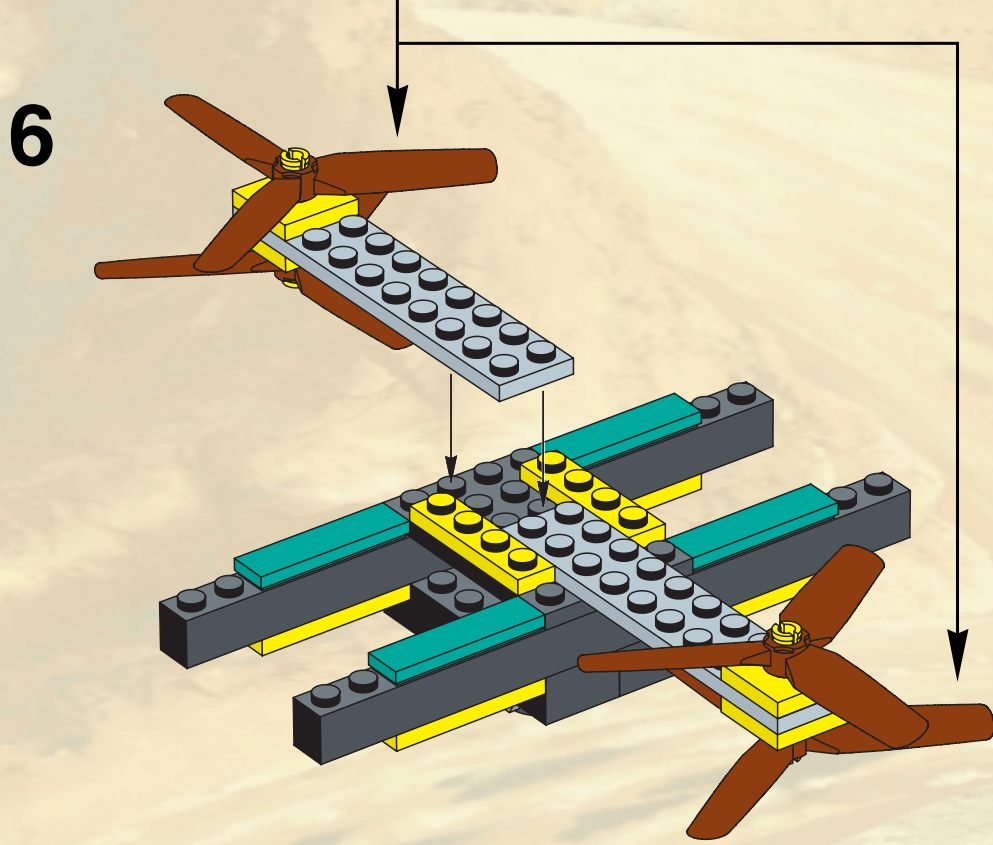
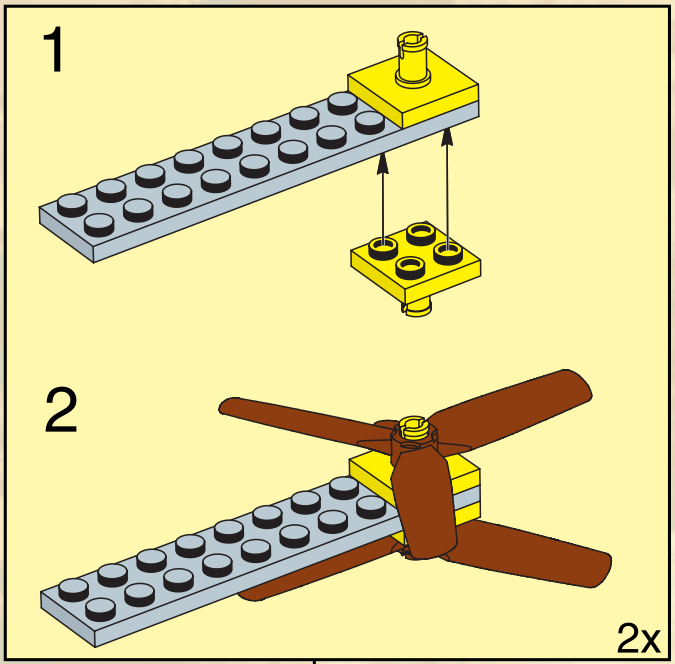

20

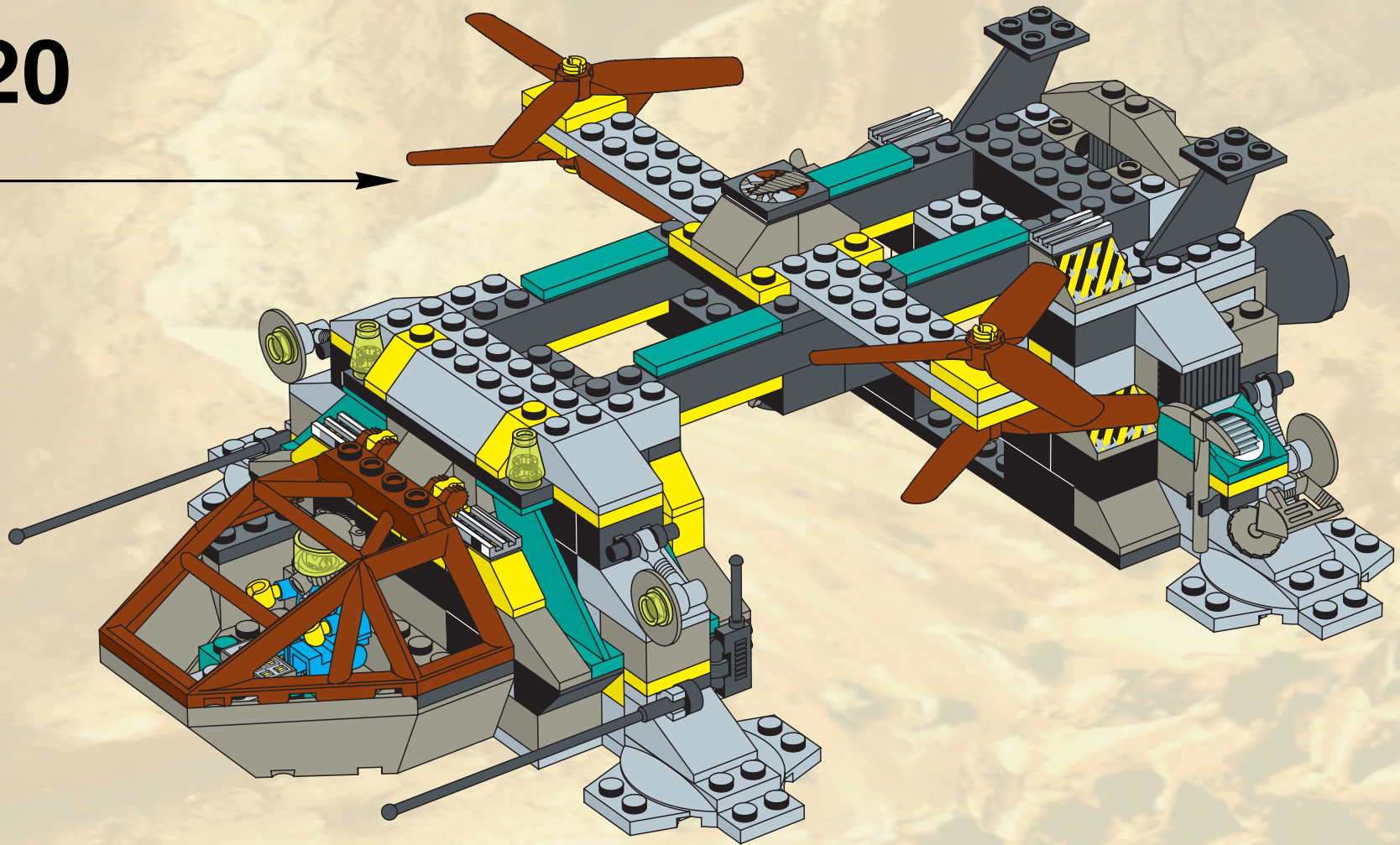

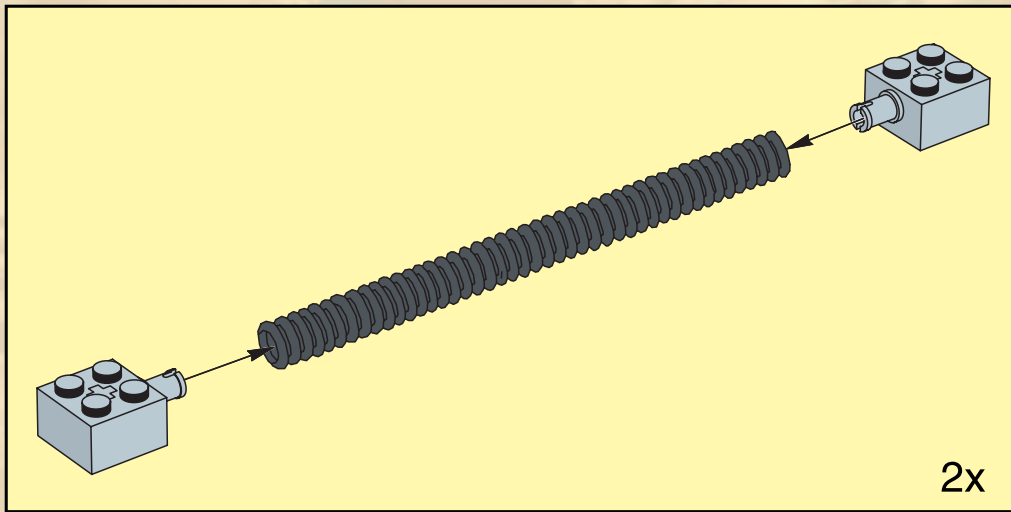

21

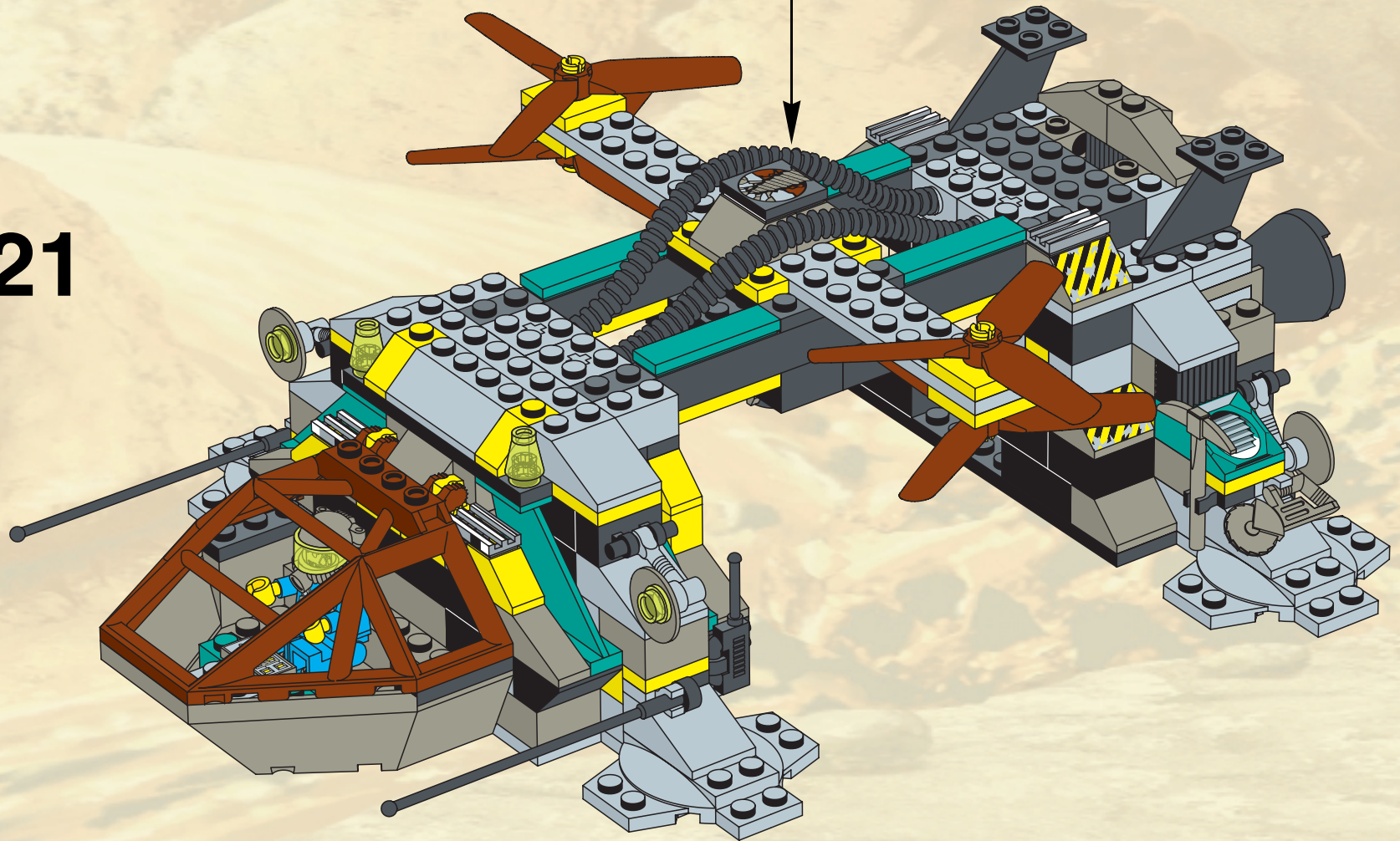

22

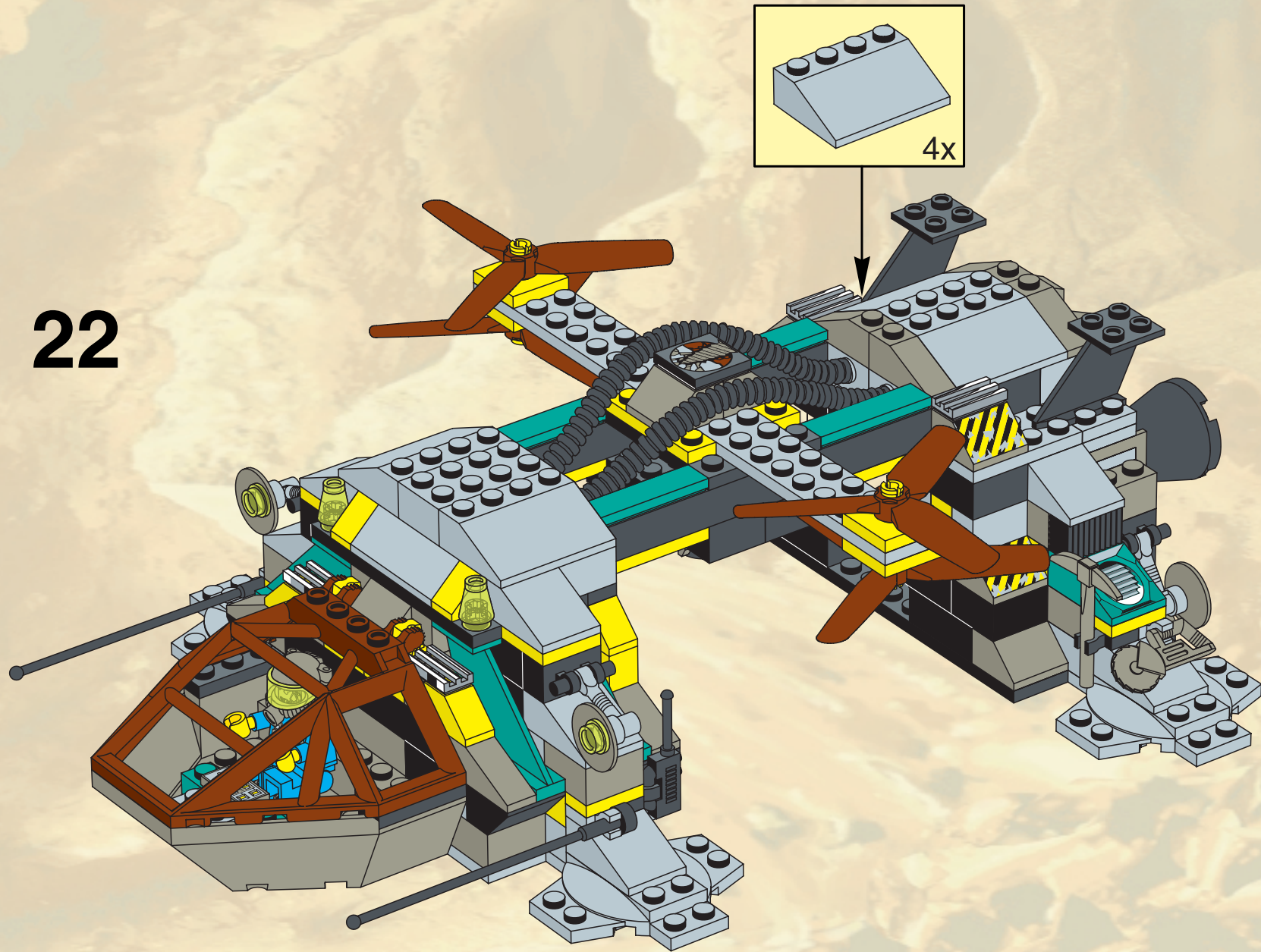

23

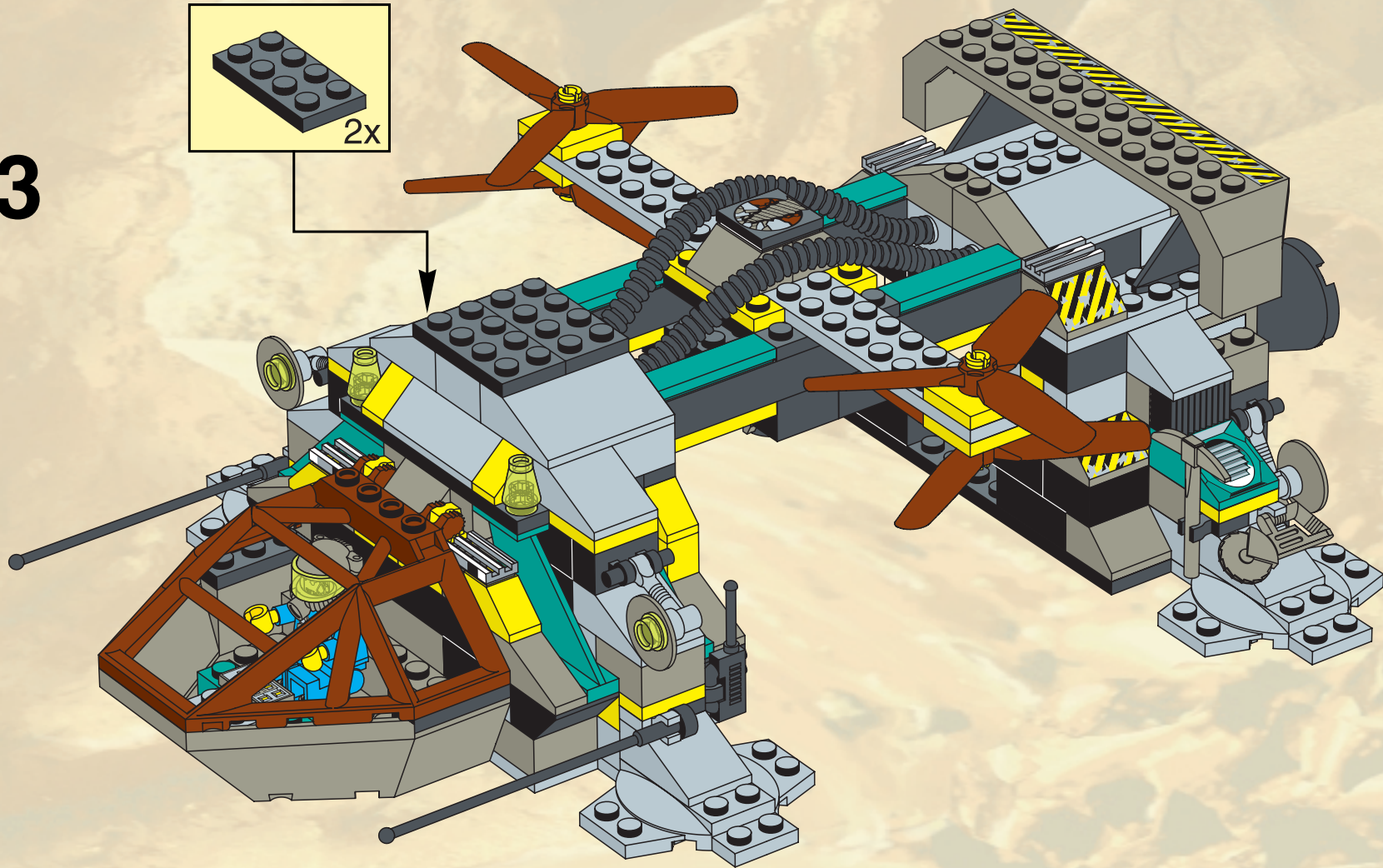

24

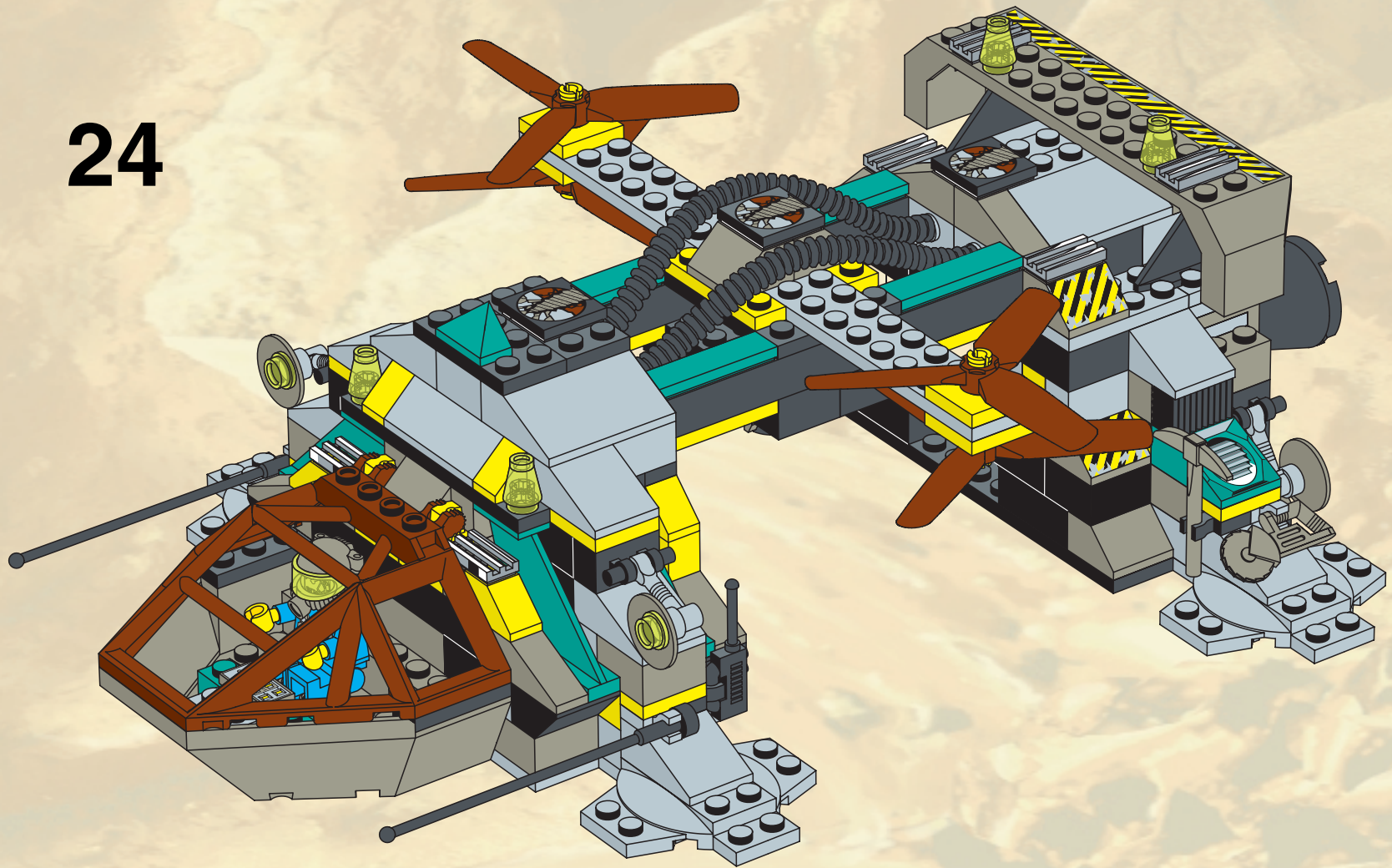

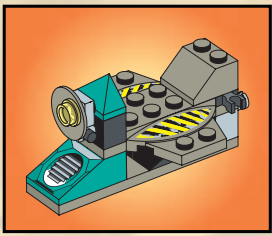

1

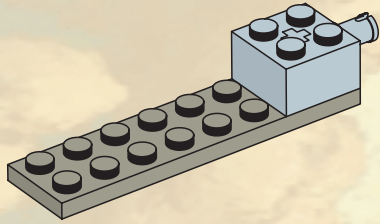

2

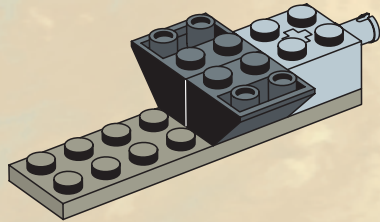

3

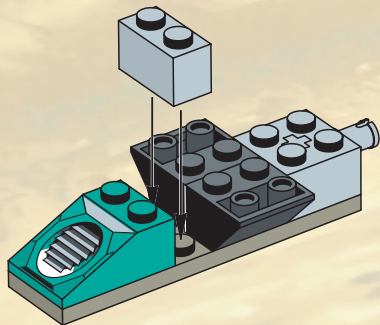

4

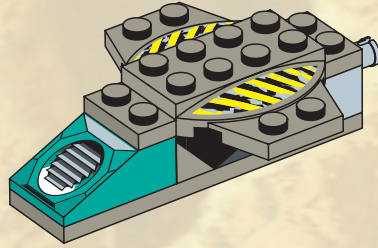

5

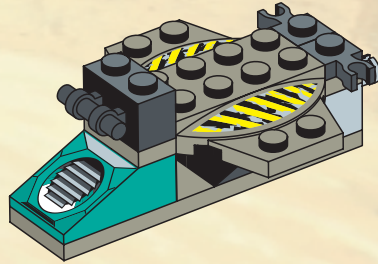

6

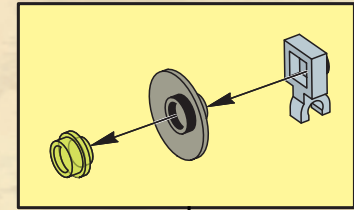
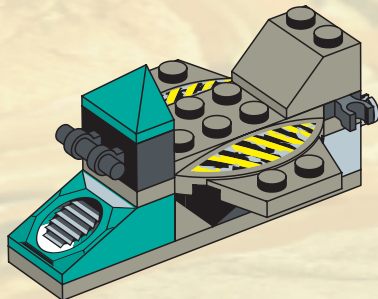

7

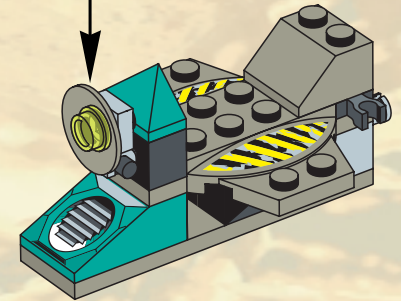

25

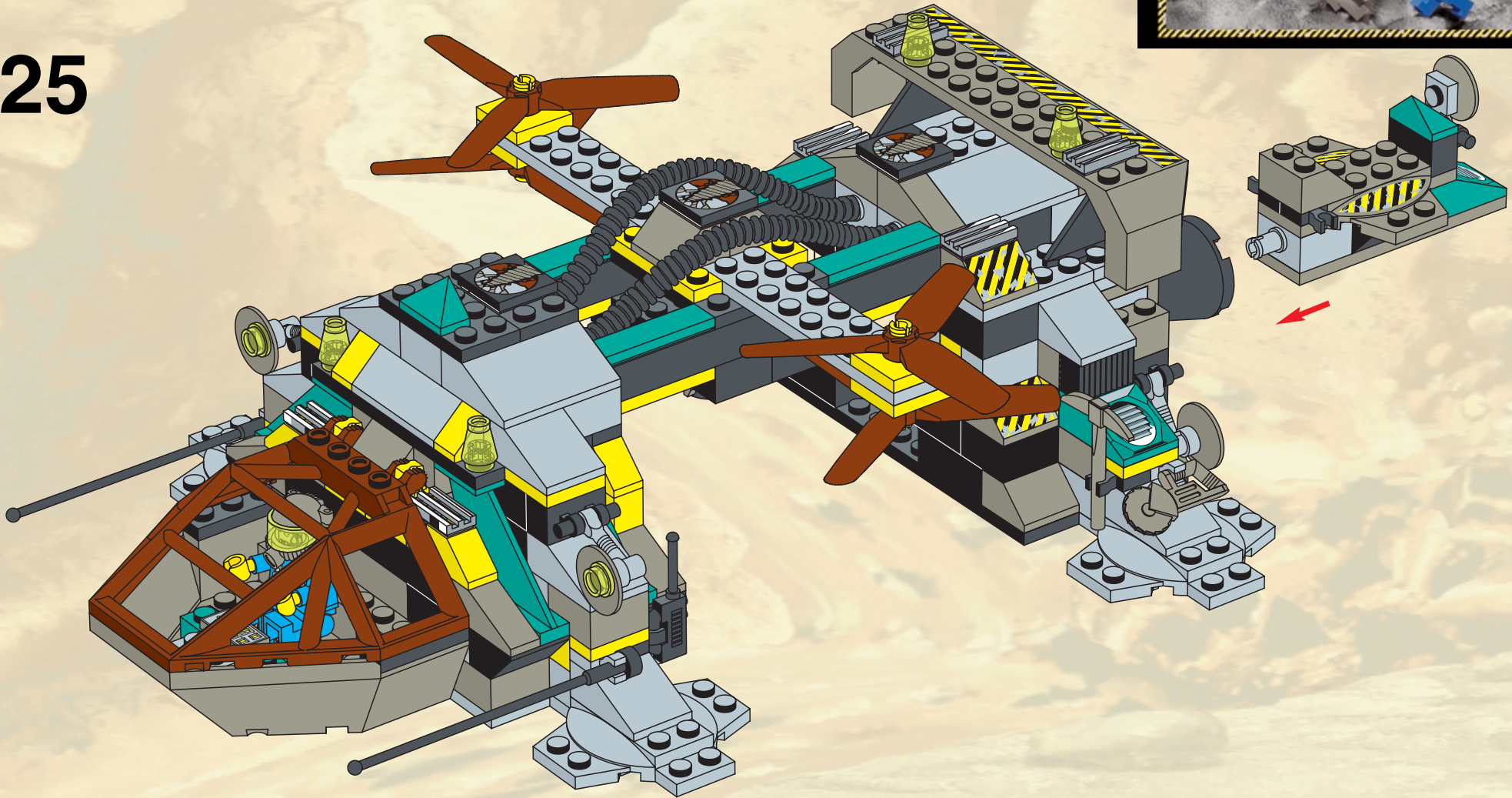

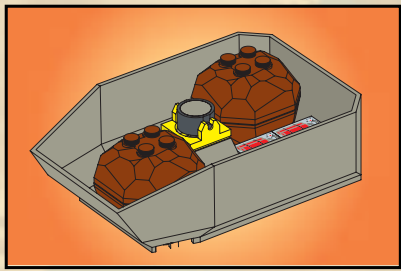

1

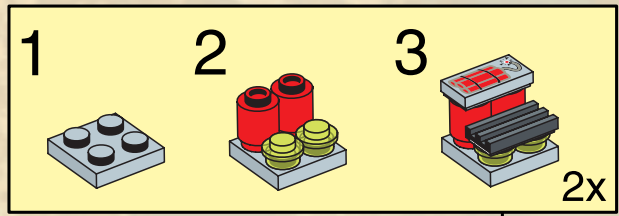
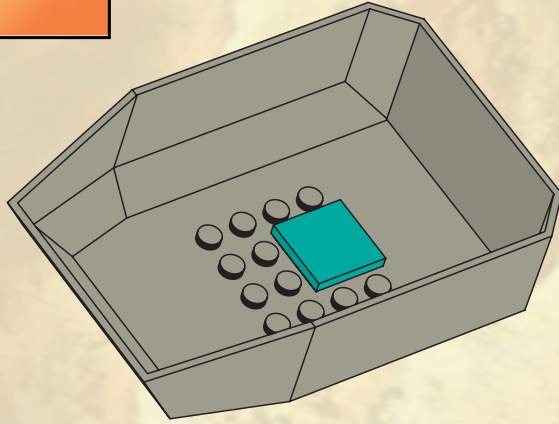

3

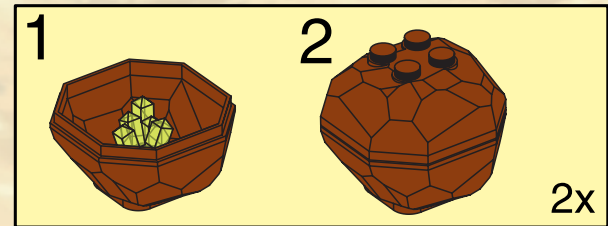
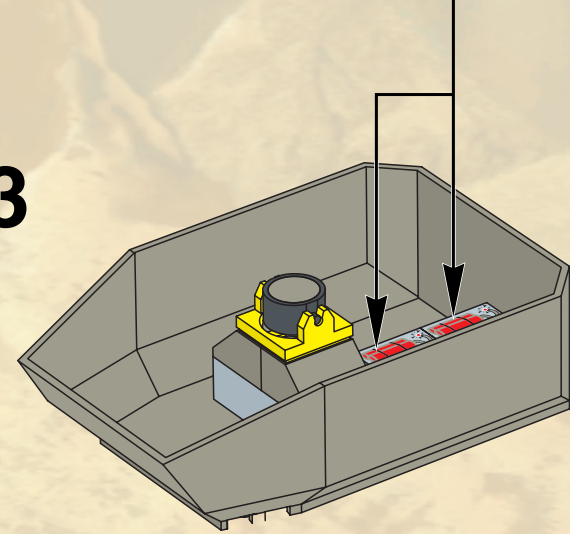

4

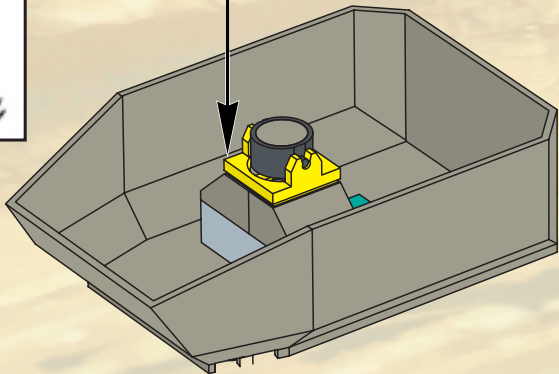
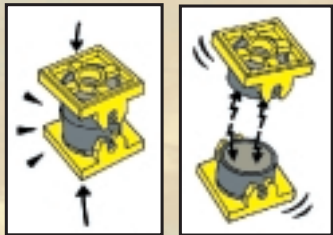
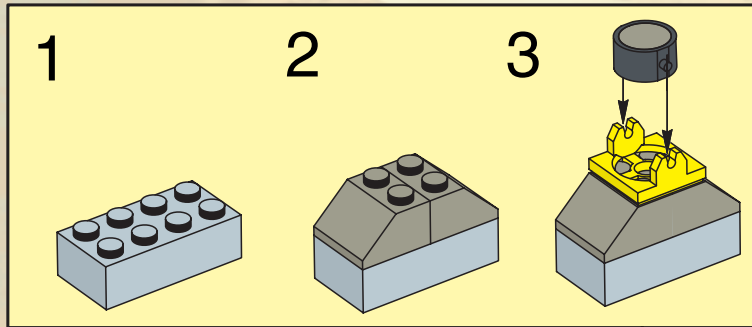
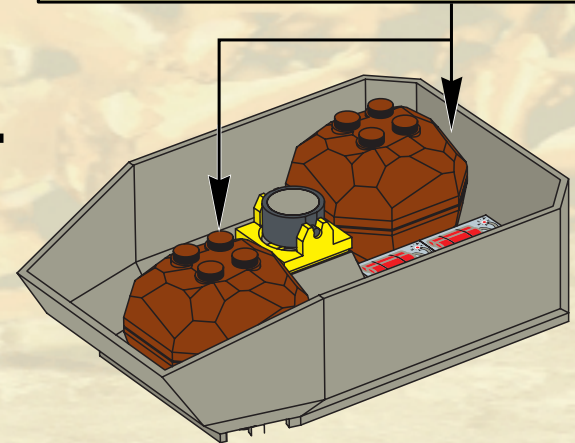

26

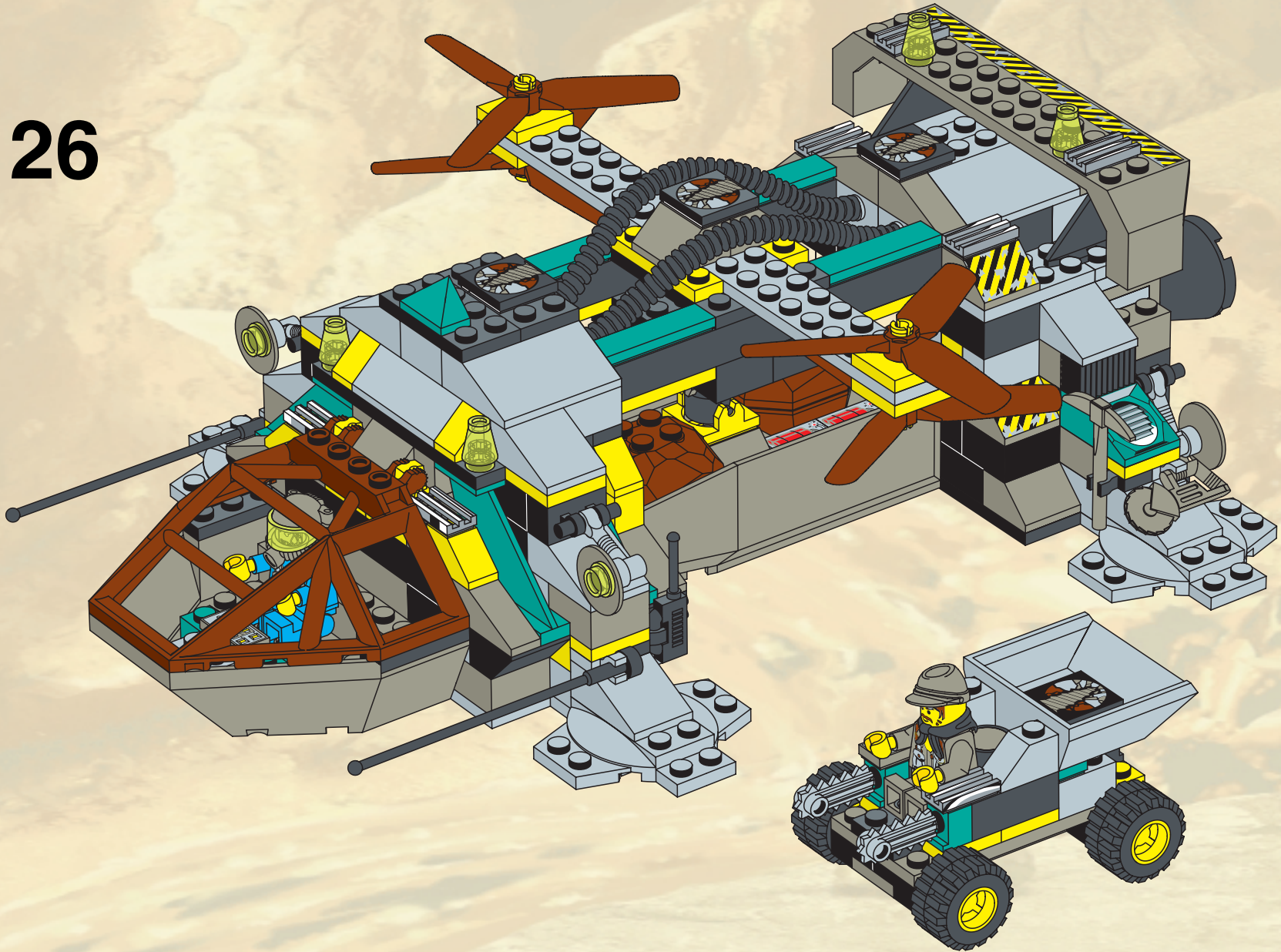

46800
1999

