



43302

Disney





[LEGO.com/sustainable-packaging](https://www.lego.com/sustainable-packaging)



FR
**DONNEZ
OU
RECYCLEZ**



OU



OU



ASSOCIATION MAGASIN DÉCHÈTERIE

Adresses sur quefairedemesdechets.fr



Build
Together

 1-5
Builders

BUILD TOGETHER | GEMEINSAM BAUEN | CONSTRUIRE ENSEMBLE | COSTRUIRE INSIEME | CONSTRUYE EN COMPAÑÍA | CONSTRUIR JUNTOS | 一起来拼搭 | WSPÓLNE BUDOWANIE | STAVĚJTE SPOLEČNĚ | STAVAJTE SPOLOČNE | ÉPÍTSETEK EGYÜTT! | ЗБИРАЙТЕ РАЗОМ | CONSTRUIM ÎMPREUNĂ | ДА СТРОИМ ЗАЕДНО | BŮVĚJIET KOPÁ | EHITAGE KOOS | KONSTRUOKITE DRAUGE | BIRLIKTE YAPIN

1-5 BUILDERS | 1-5 BAUMEISTER | 1-5 CONSTRUCTEURS | 1-5 COSTRUTTORI | 1-5 CONSTRUCTORES | 1 A 5 CONSTRUTORES | 1-5 名拼搭者 | 1-5 KONSTRUKTORÓW | 1 AŽ 5 STAVITELŮ | 1 AŽ 5 STAVITELŮV | 1-5 ÉPÍTŐ | 1-5 БУДИВЕЛЬНИКІВ | 1-5 CONSTRUCTORI | 1-5 СТРОИТЕЛИ | 1-5 BŮVĚTĀJI | 1-5 EHITAJAT | 1-5 KONSTRUOTOJAI | 1-5 MODEL SEVER

[LEGO.com/devicecheck](https://www.lego.com/devicecheck)



LEGO® Builder



Apple and the Apple logo are trademarks of Apple Inc., registered in the U.S. and other countries and regions. App Store is a service mark of Apple Inc. Google Play and the Google Play logo are trademarks of Google LLC. Tencent and the Tencent logo are trademarks of Tencent Inc.



欢迎来到乐高®迪士尼乐园大街

还记得你第一次踏上迪士尼乐园大街的时候吗？
从1955年起，游客便一直沉浸在华特·迪士尼构建的、充满
温情与热忱的美国小镇之梦里。它欢快的建筑和怀旧的魅力
可激发想象力，点燃欢乐的冒险。



每个人都受欢迎

现在，你可以用一个充满迪士尼细节的模型重现并庆祝这个永恒的地方。
这套积木邀请大家一起搭建，重温这条著名街道、商店和角色那充满活力的
精神所带来的特殊时刻与回忆。

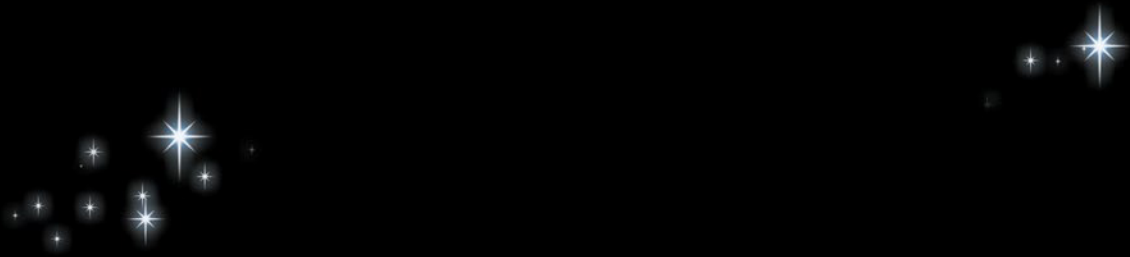



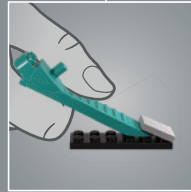
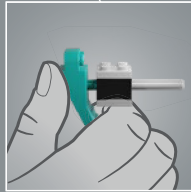
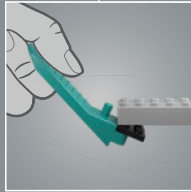
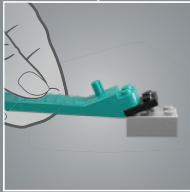
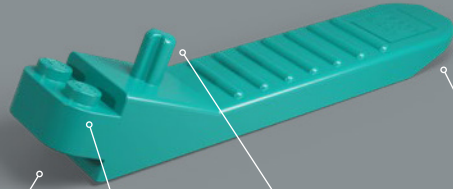

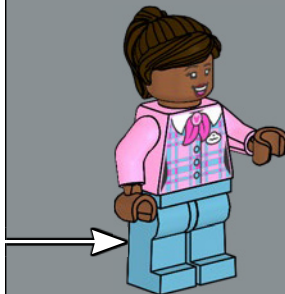

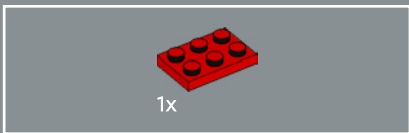

1x

1

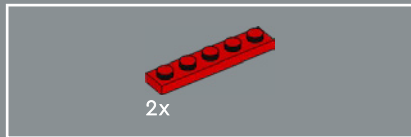

2x

2

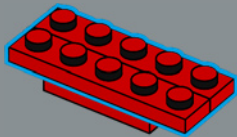

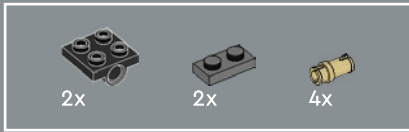

3

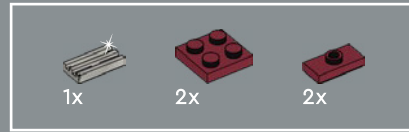
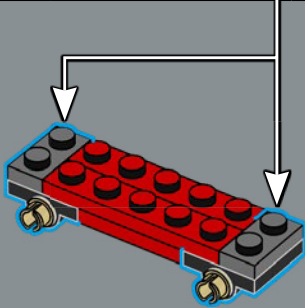
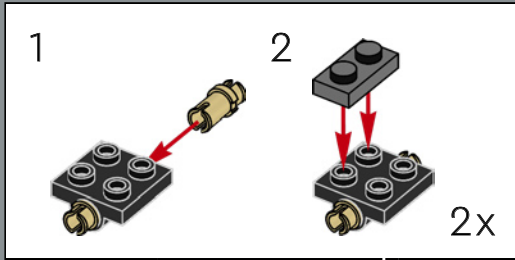

4

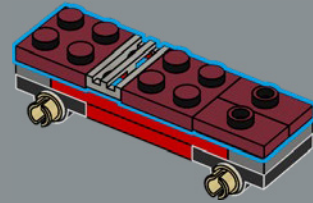

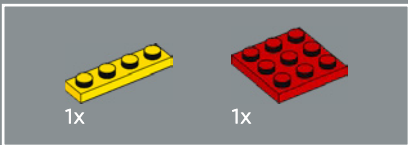
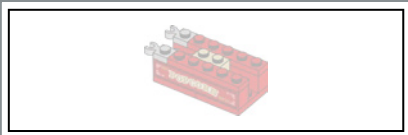

5

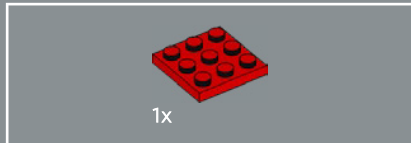

6

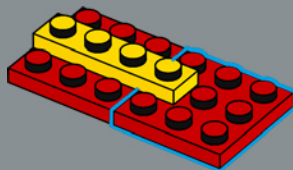

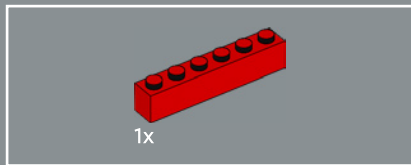

7

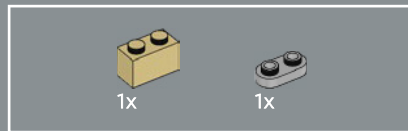
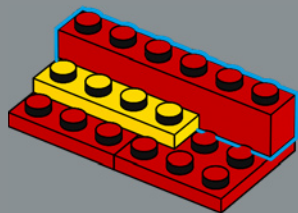

8

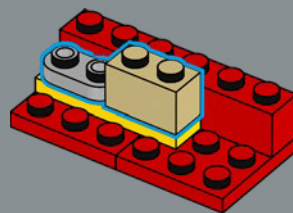

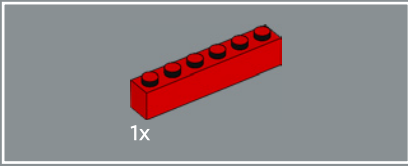

9



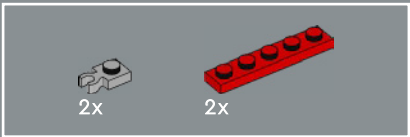

10

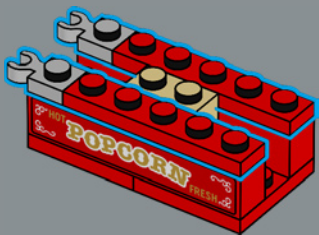

11

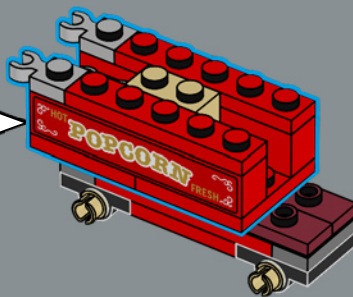

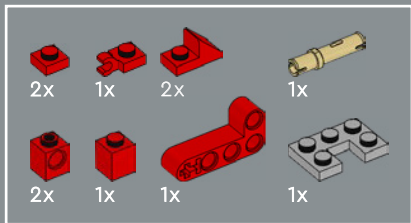

12

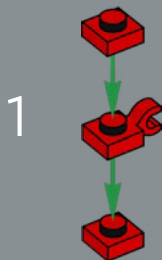

2

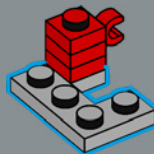

3

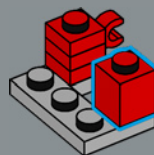

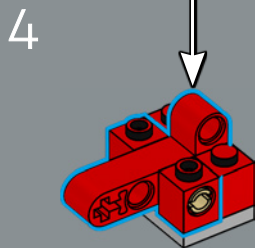
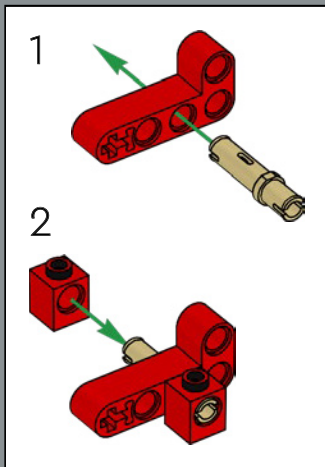

5

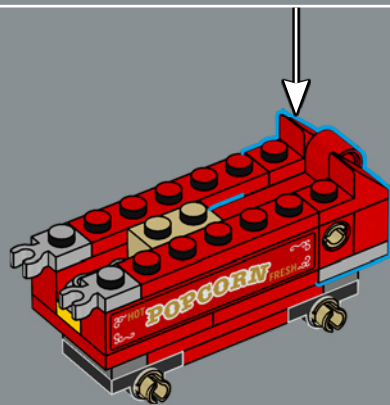
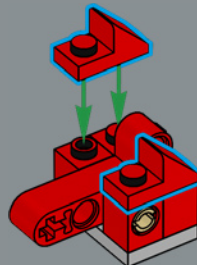

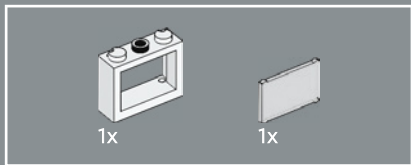

13

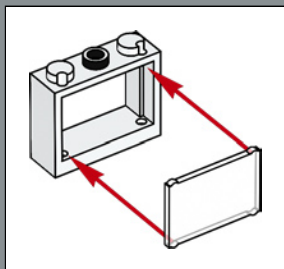

14

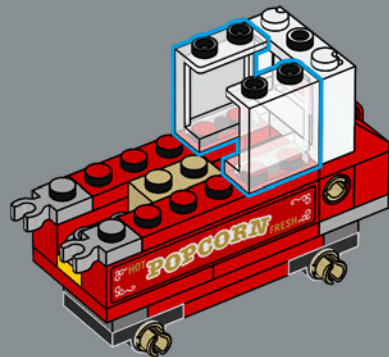

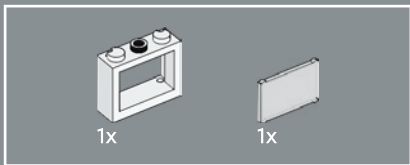

15

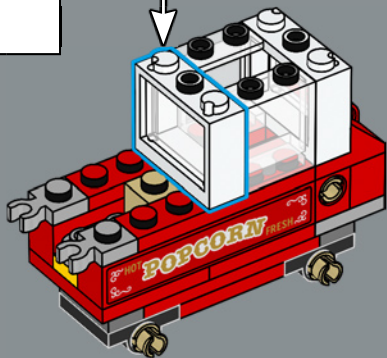
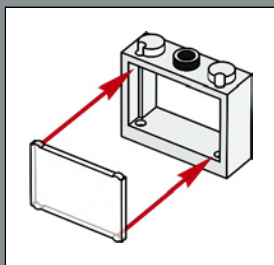

16

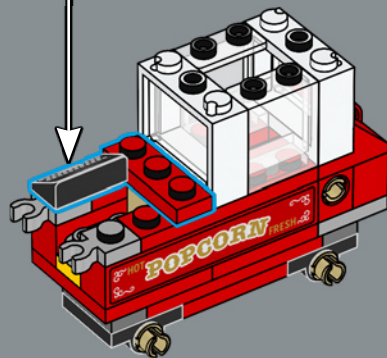

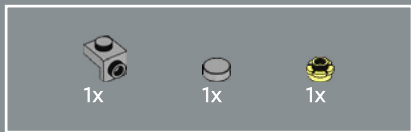

17

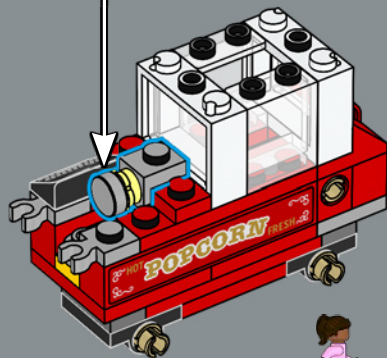
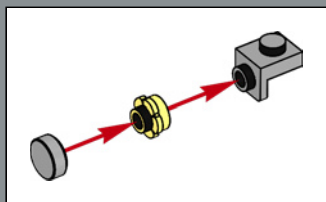

18

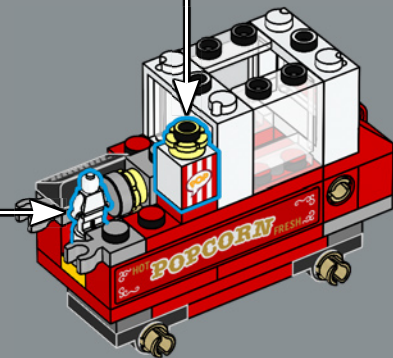
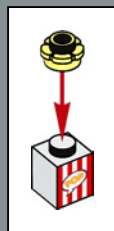



1x

19

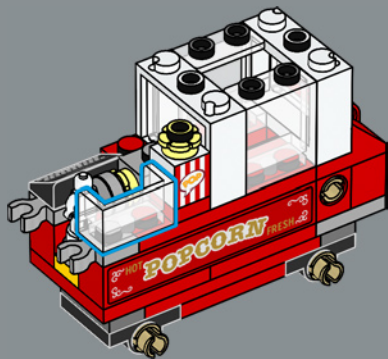

4x



4x

20



4x



4x



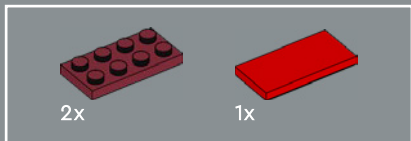

21

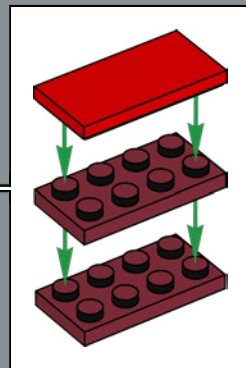

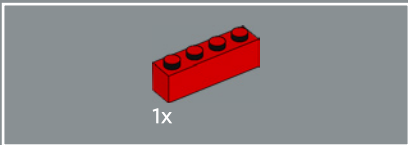

22

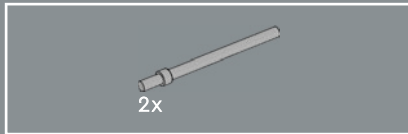
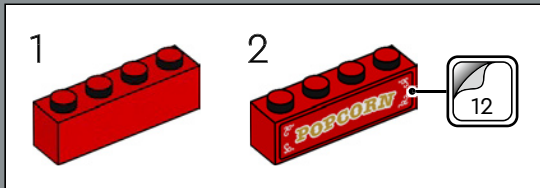

23

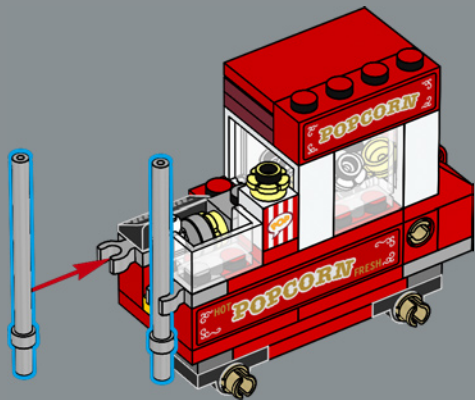

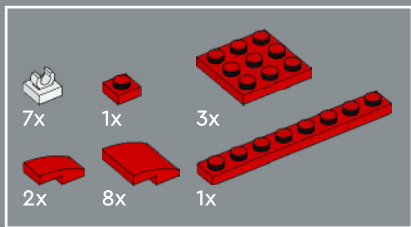

24

1

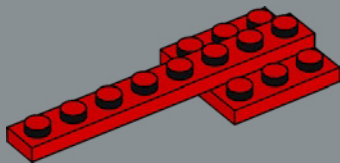

2

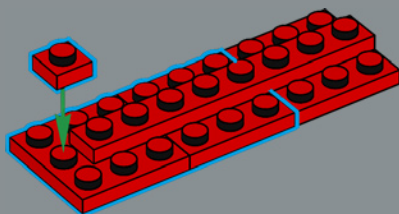

3

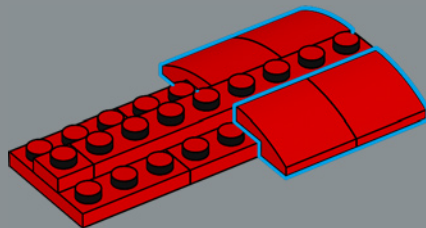

4

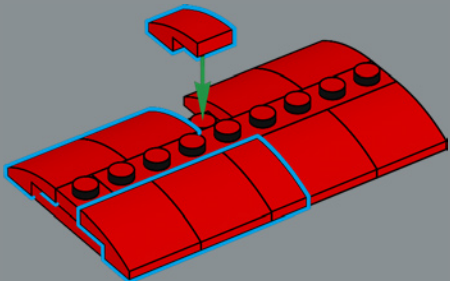

5

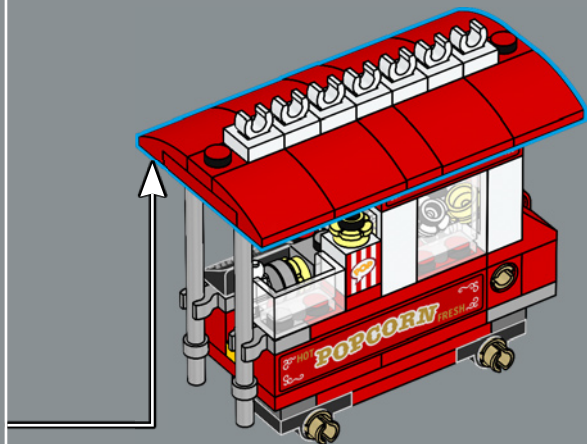
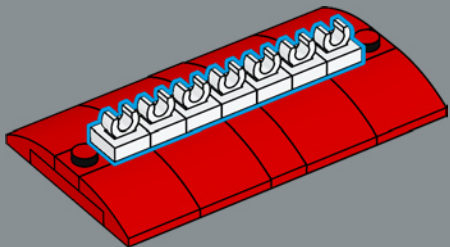



25

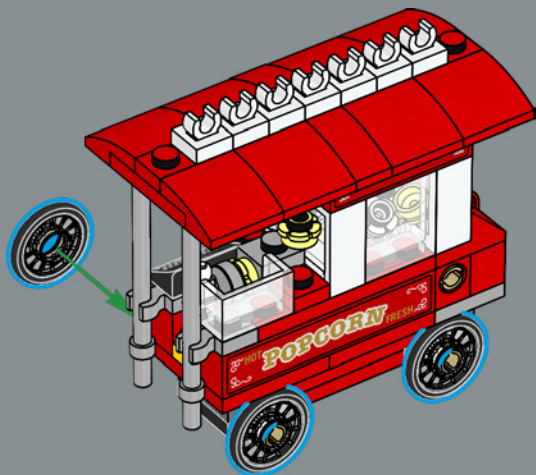

白色和黄色的乐高®花朵零件代表爆米花 kernels。
轻敲小车侧面的拉杆，就能爆出爆米花！





26

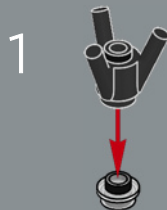
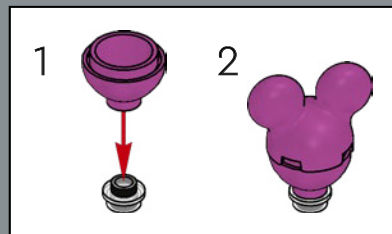

2

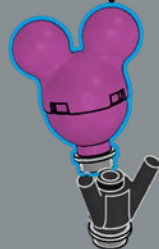

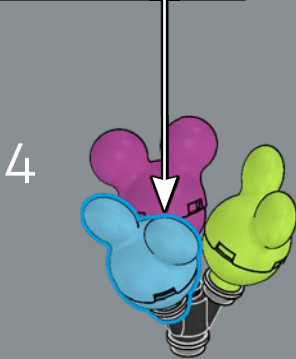
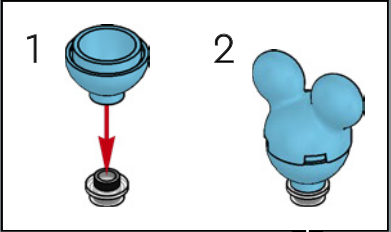
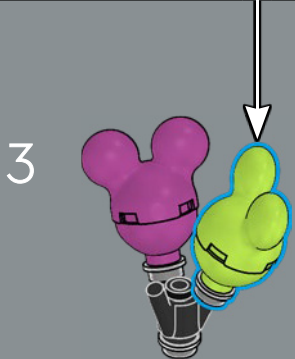
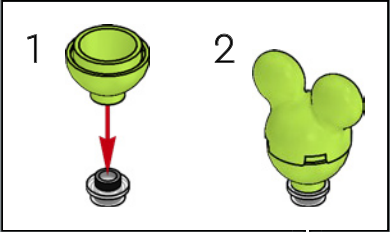

公园里很多爆米花车都配有小型动画玩偶（每个园区的玩偶都独一无二），它们会摇动爆米花桶。乐高®版本使用一个小小的迷你小人仔奖杯零件来重现它们。

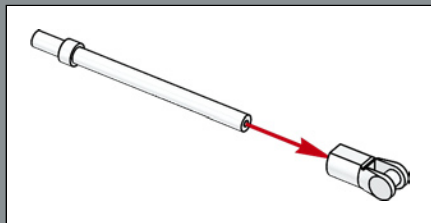

5

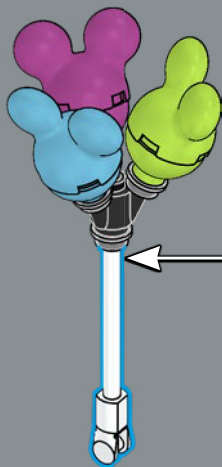

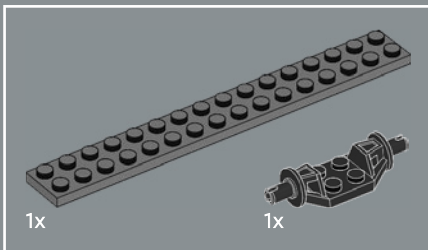
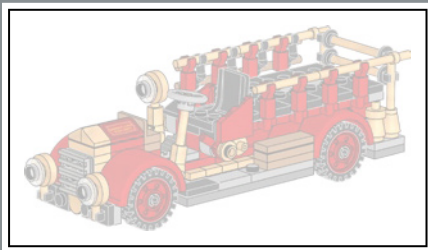

1

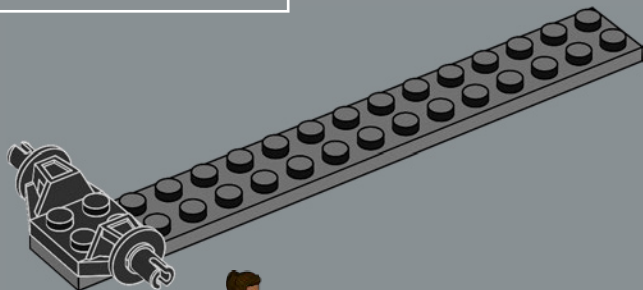



2

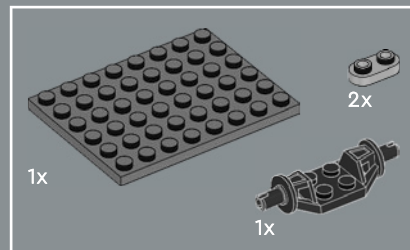
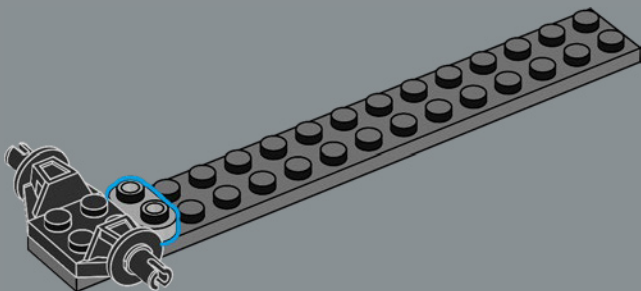

3

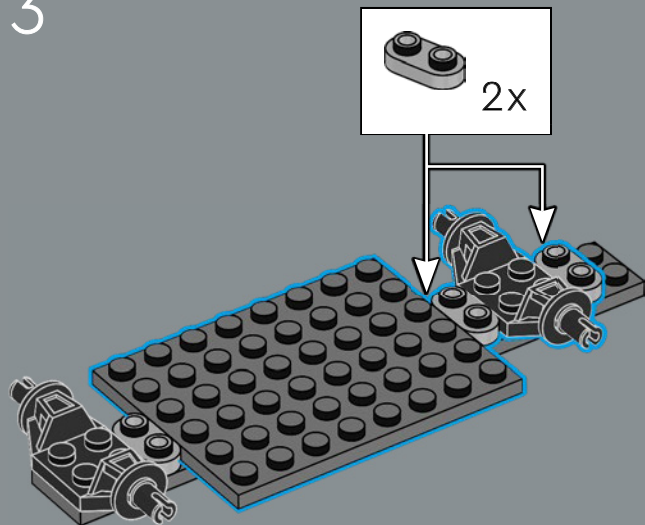

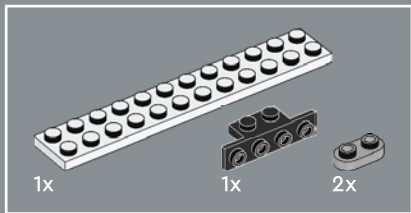

4

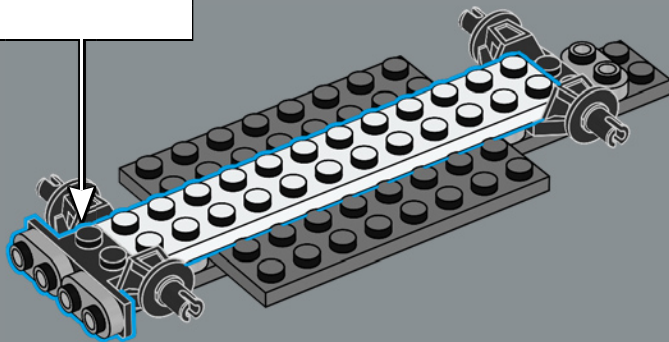
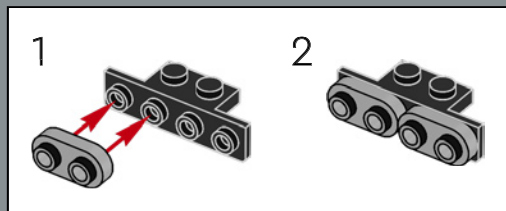

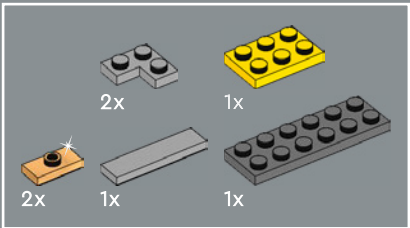

5

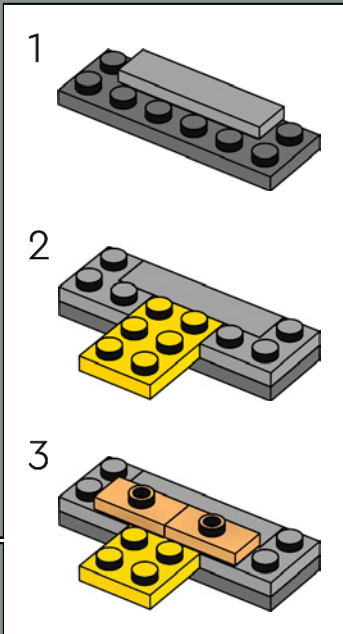
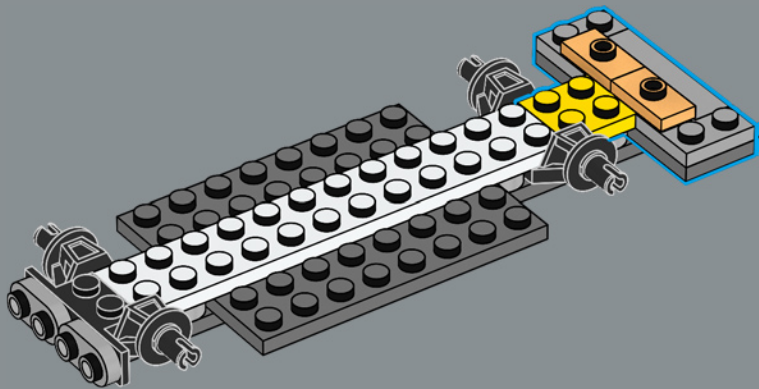



7

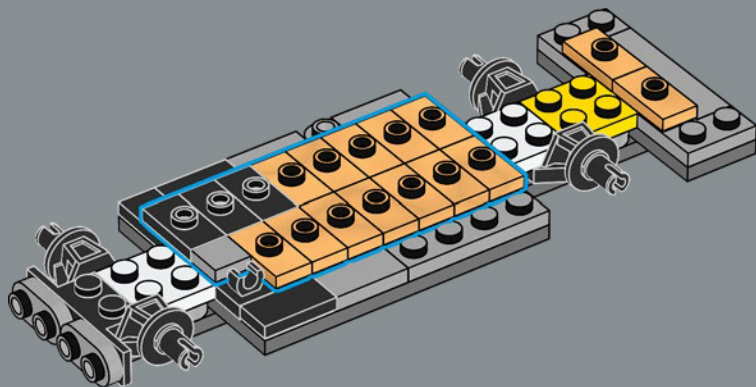

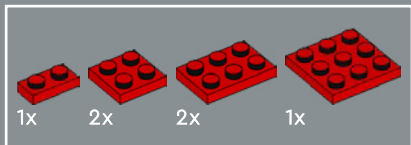

8

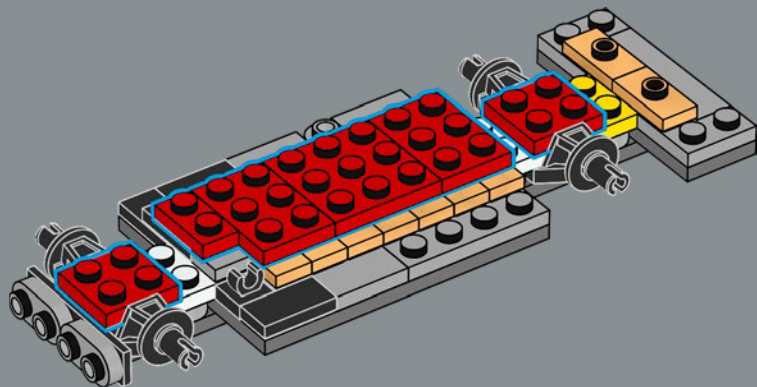

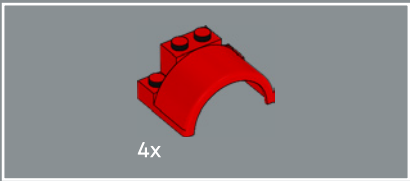

9

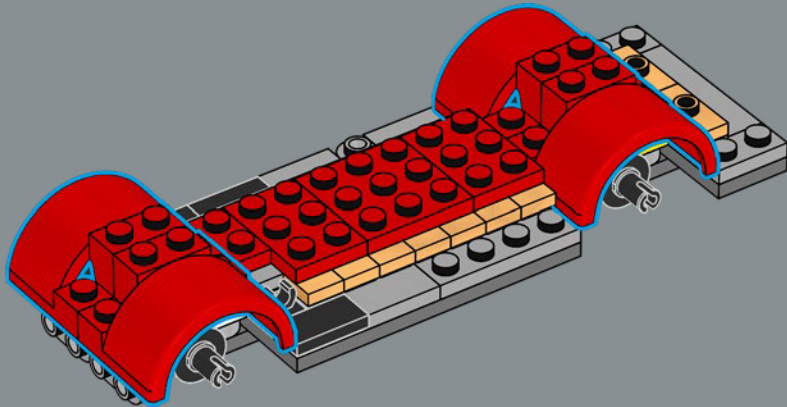



10

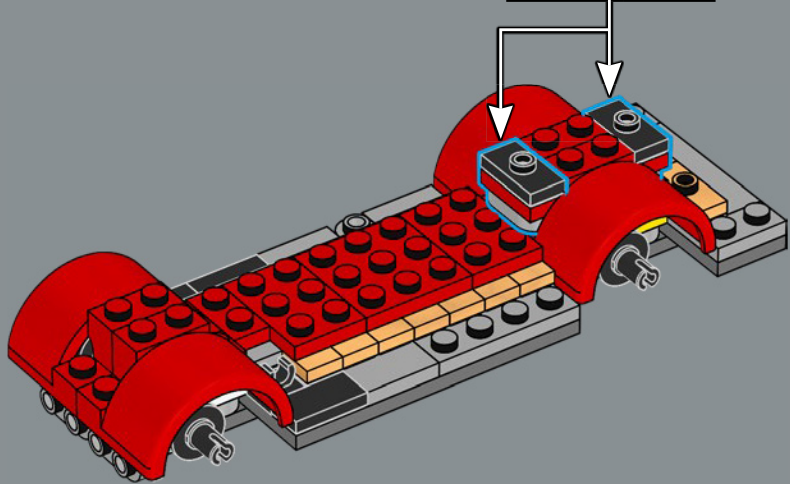
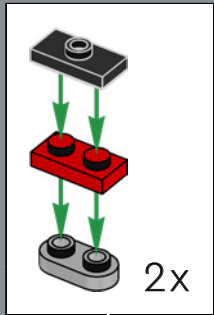

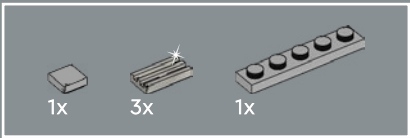

11

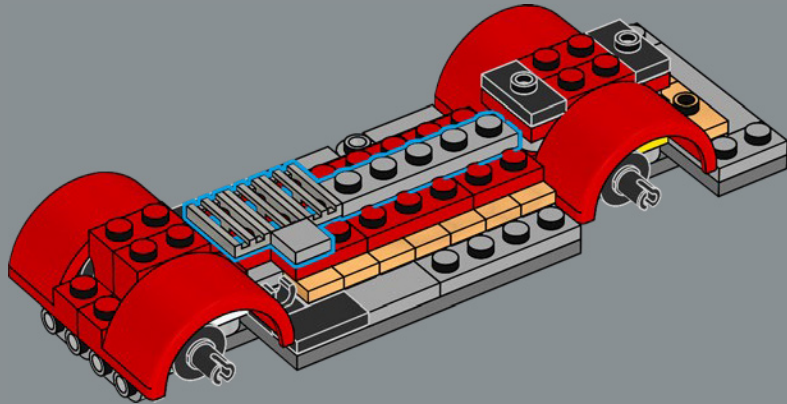

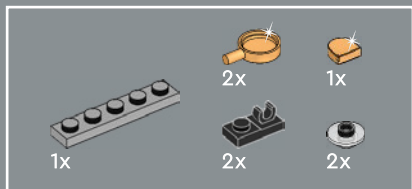

12

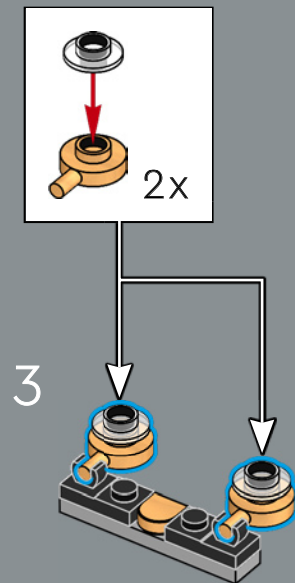
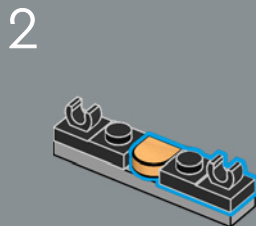
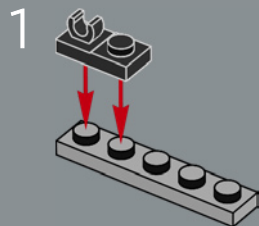

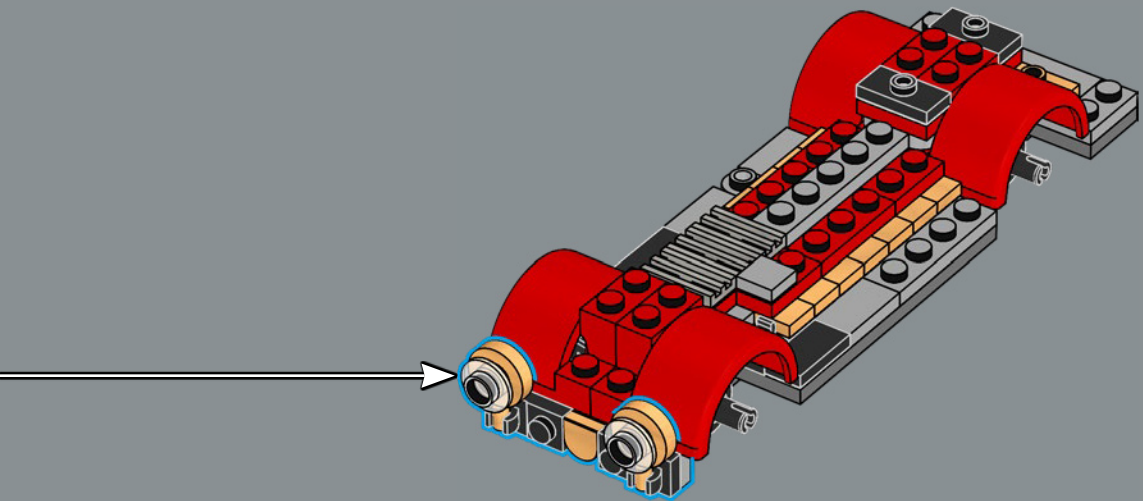

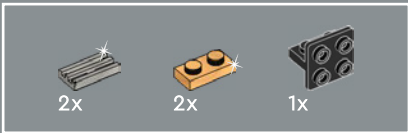

13

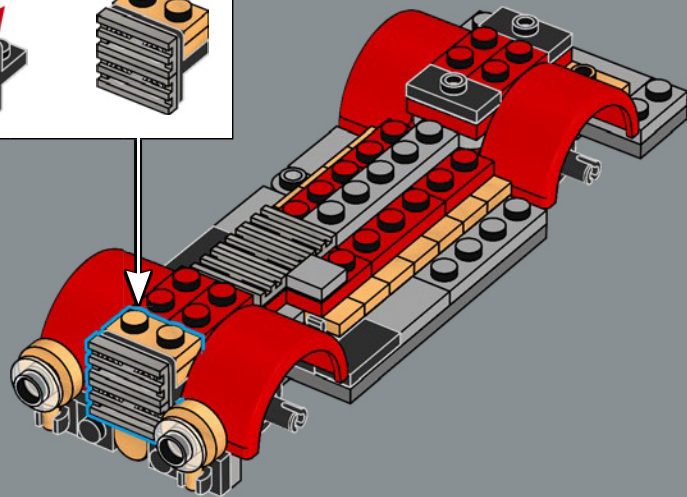
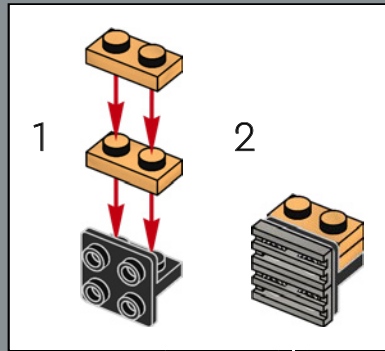

1958年引入园区的美国大街消防车基于1916年的
American LaFrance消防车，由鲍勃·格设计，
他以创造园区众多标志性景点而闻名。

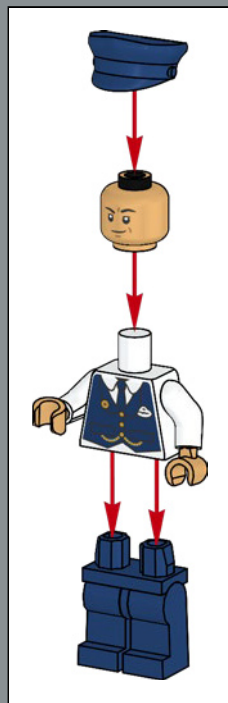

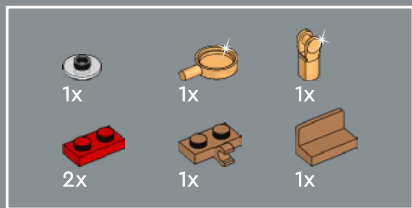

14

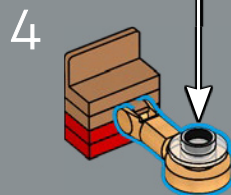
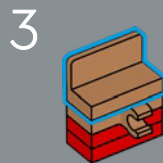
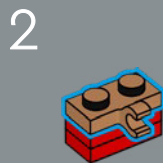
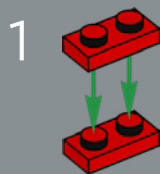
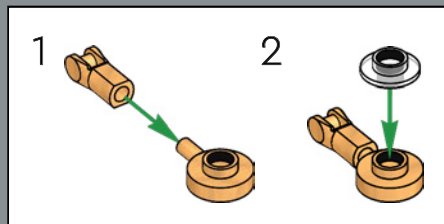



5

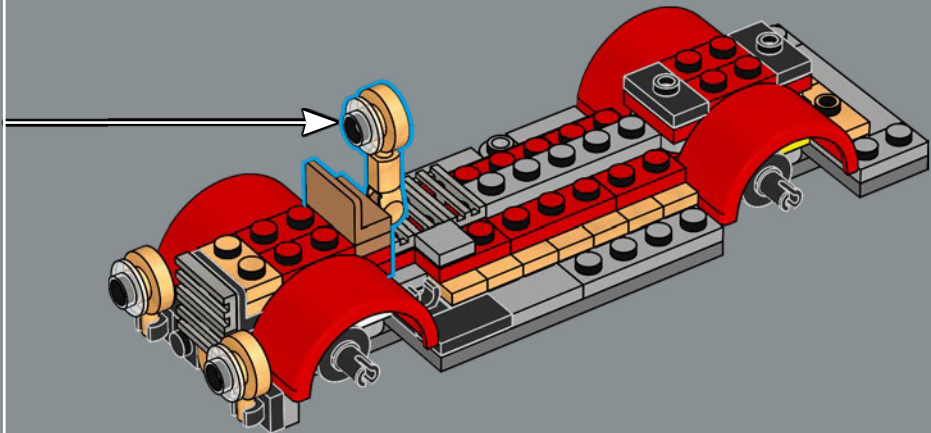

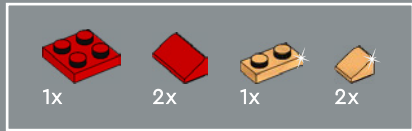

15

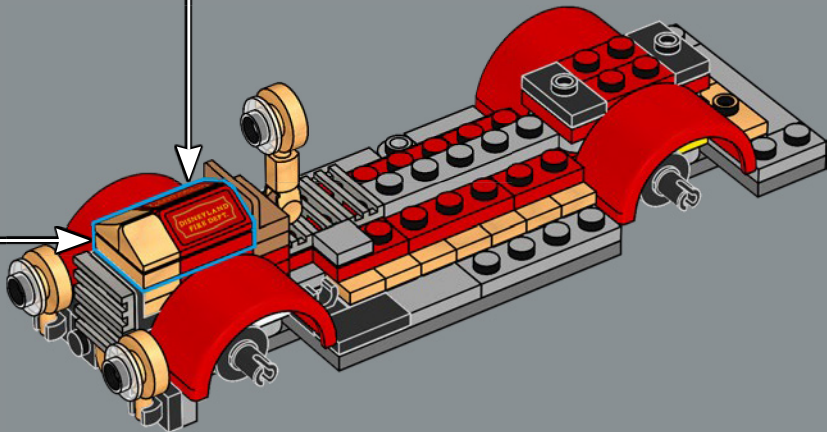
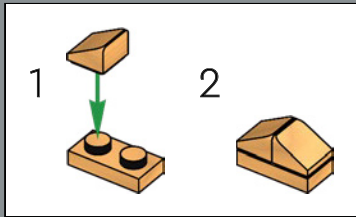
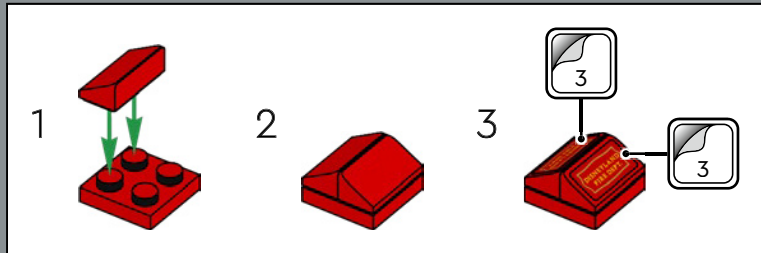

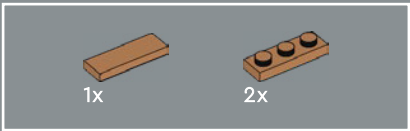

16

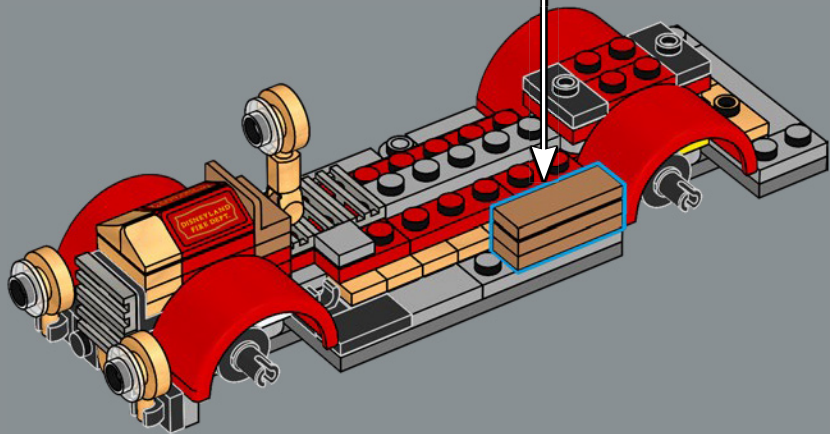
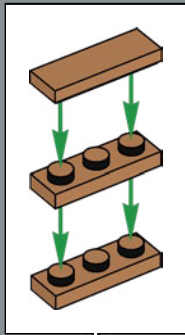

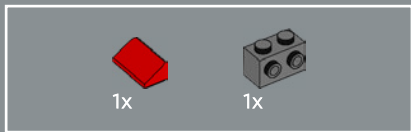

17

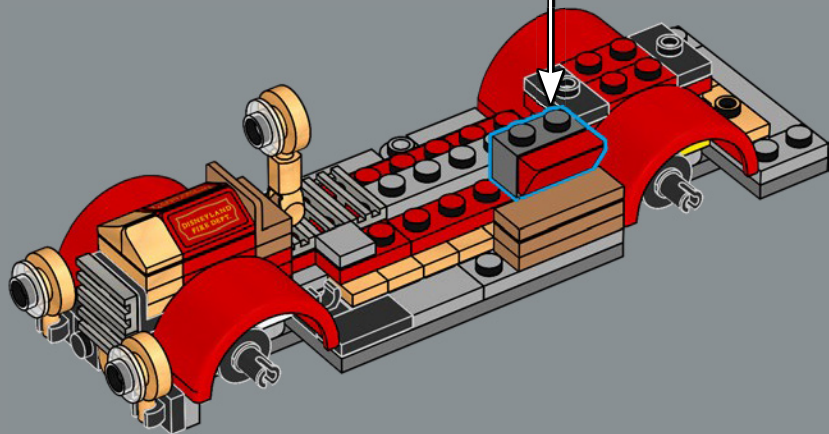
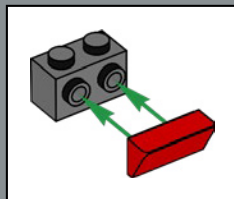

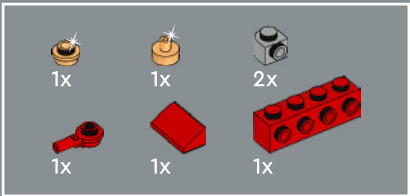

18

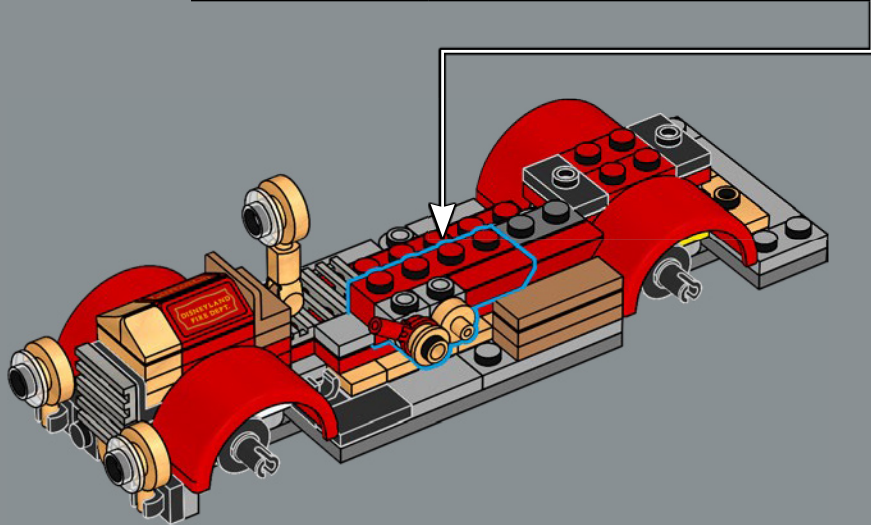
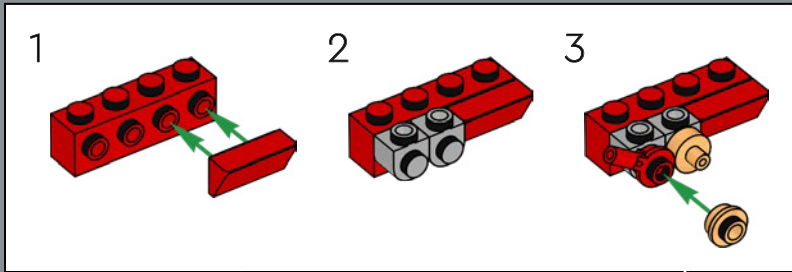

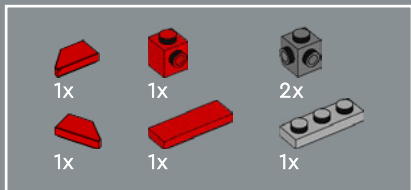

19

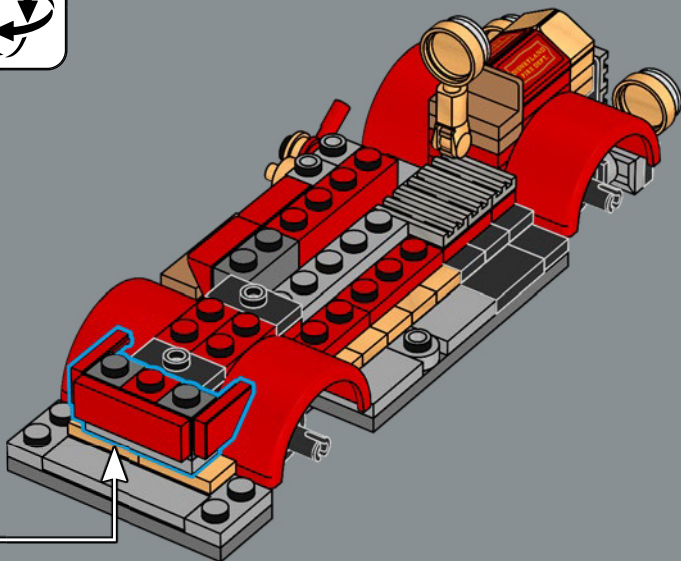
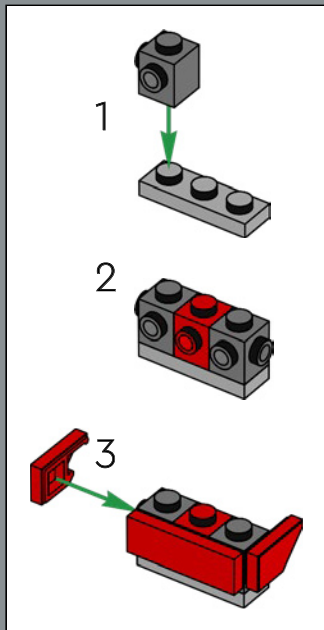



20

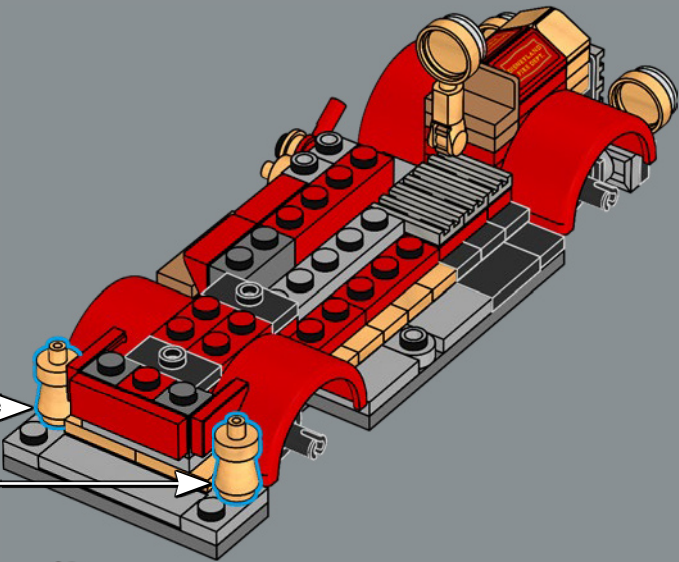
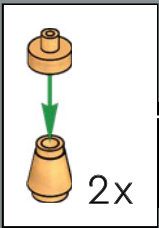

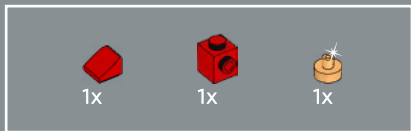

21

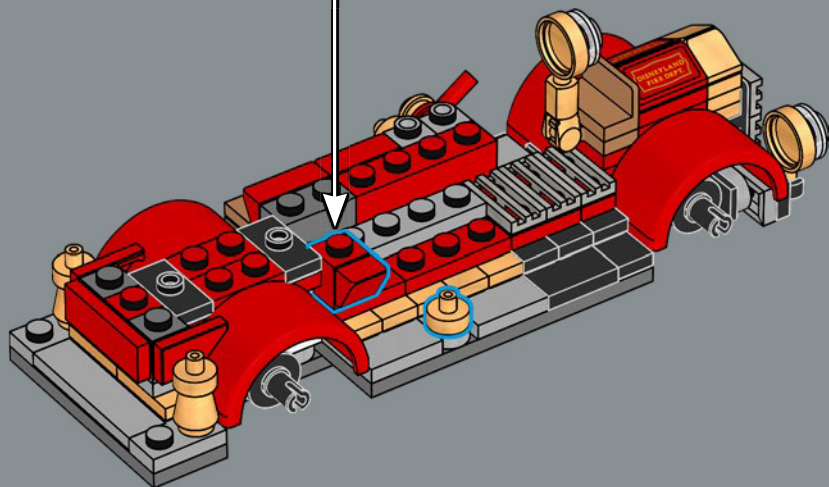
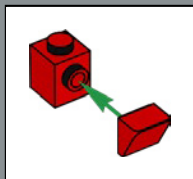

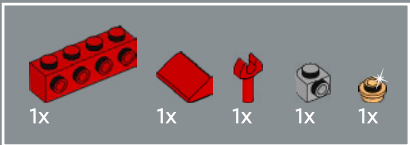

22

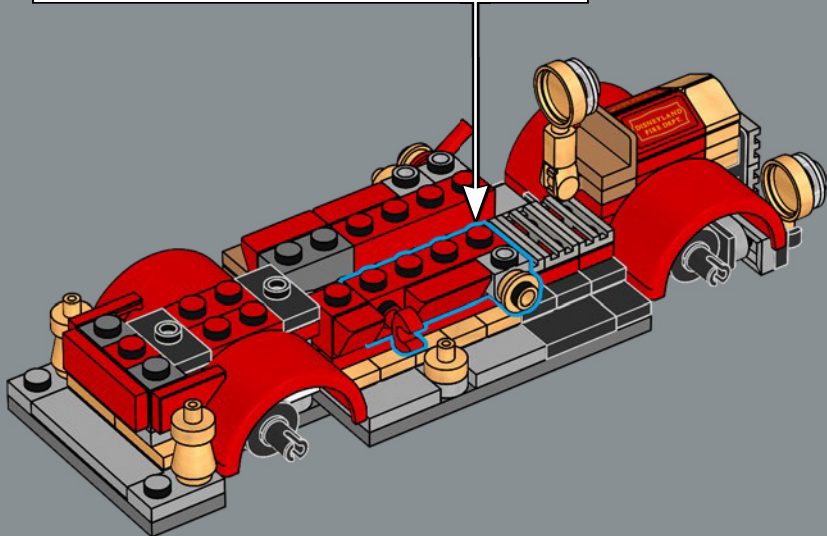
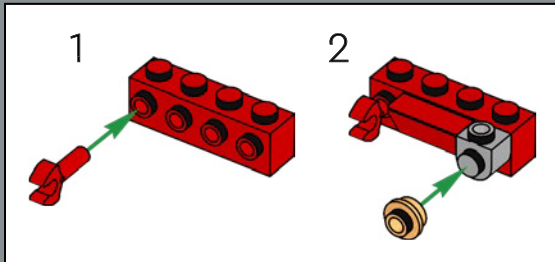

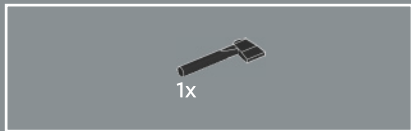

23

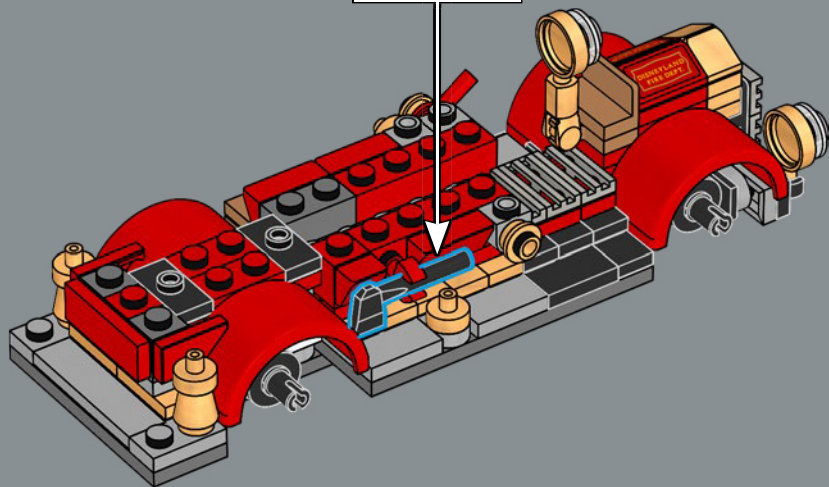

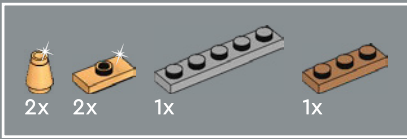

24

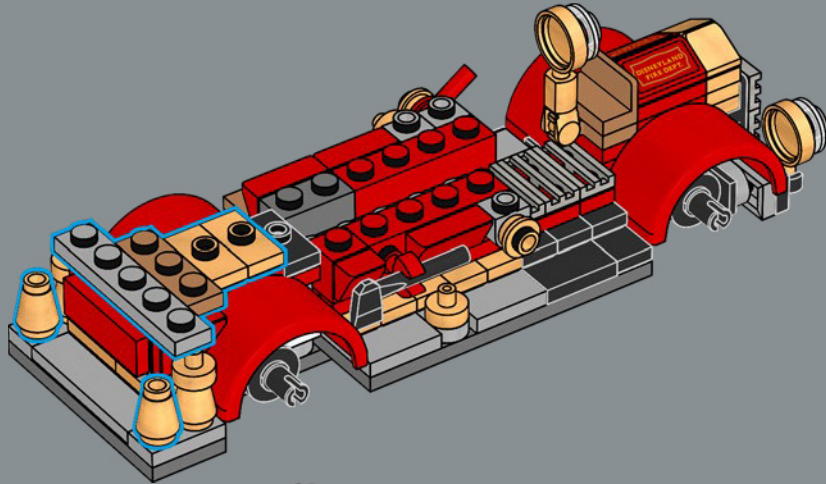

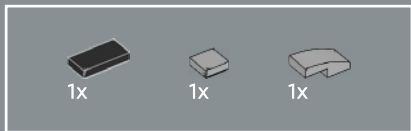

25

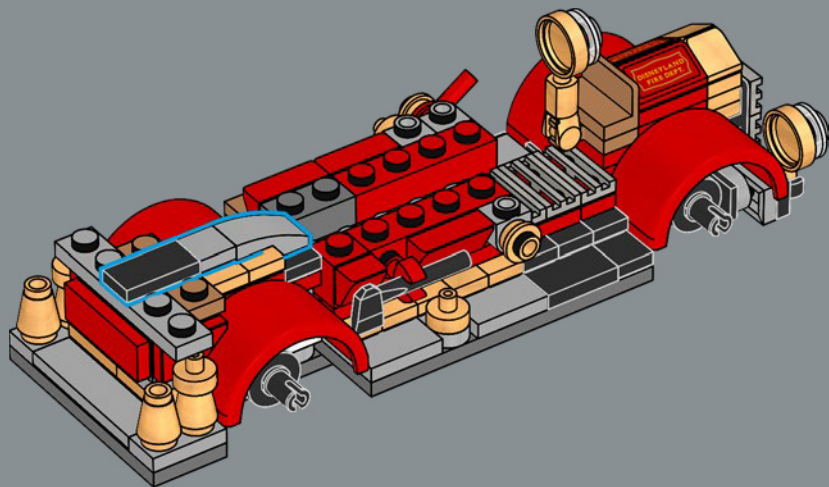

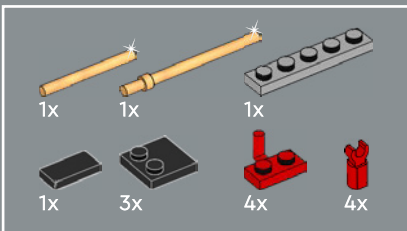
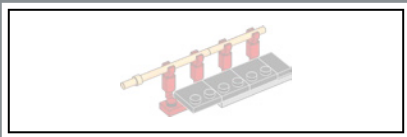

26

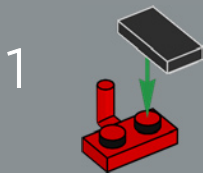

2

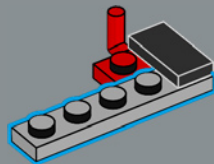

3

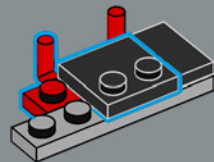

4

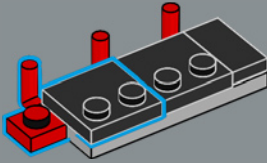

5

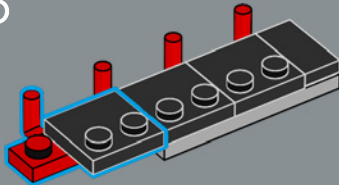

6

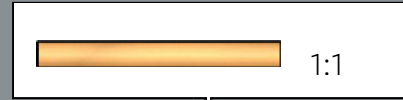
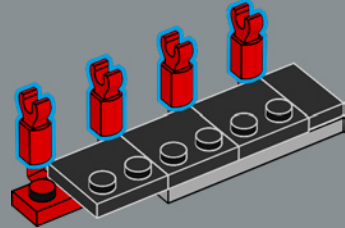

7

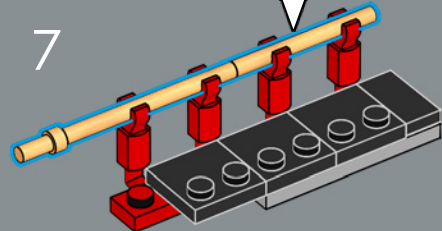

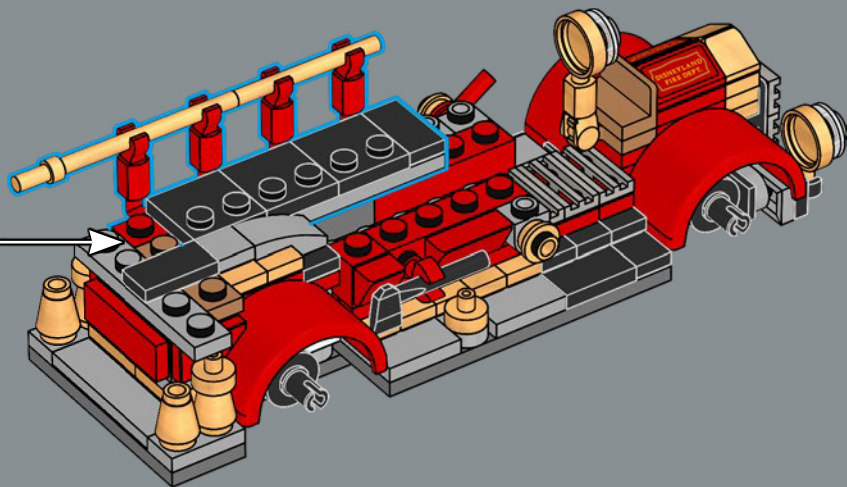

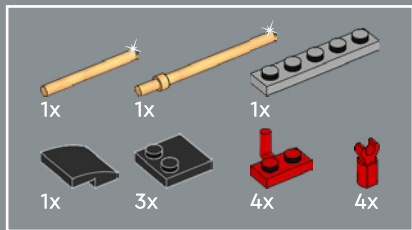
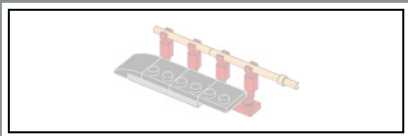

27

1

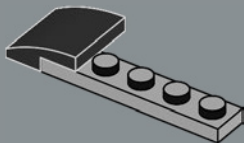

2

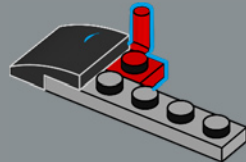

3

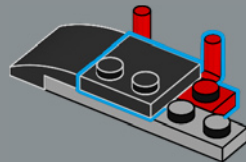

4

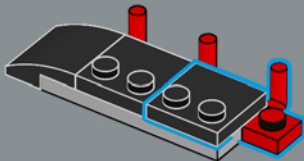

5

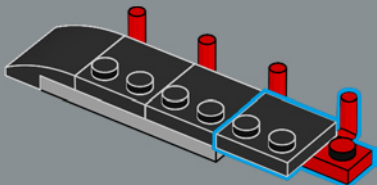

6

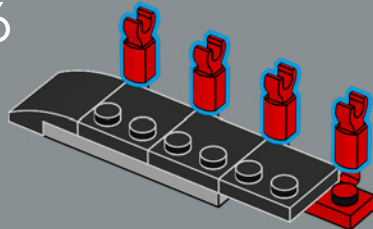

7

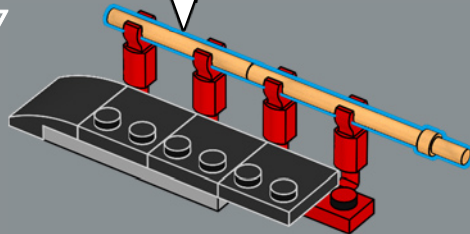

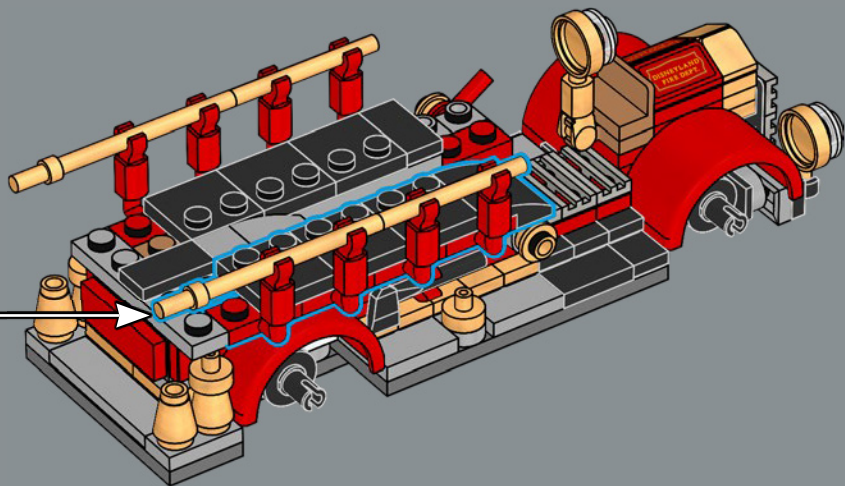



2x

28

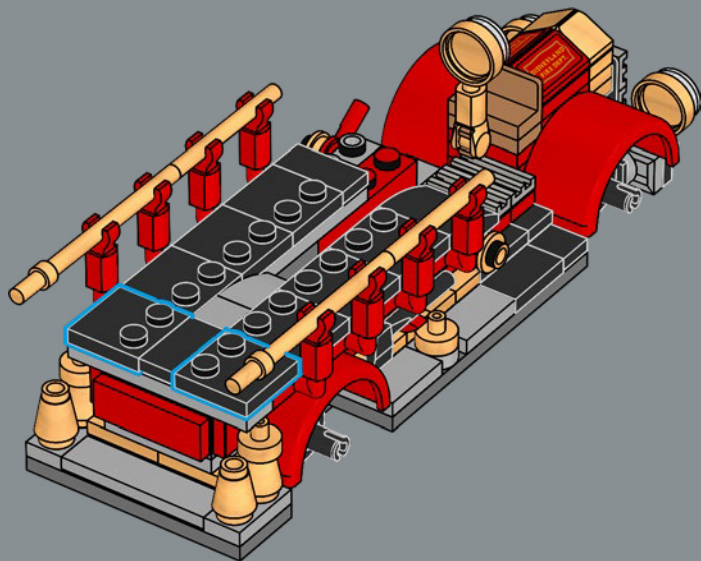

如今的园区游客仍能乘坐消防车沿美国大街行驶。





29

1

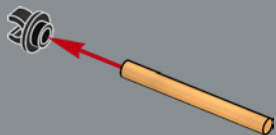

2



3

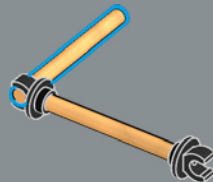

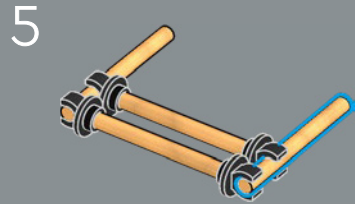
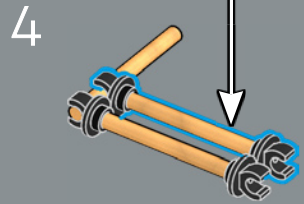
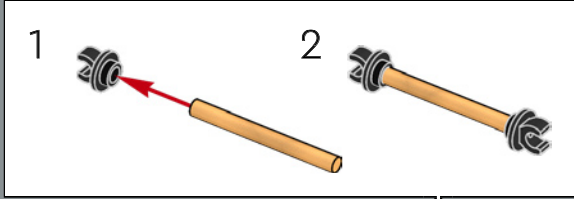

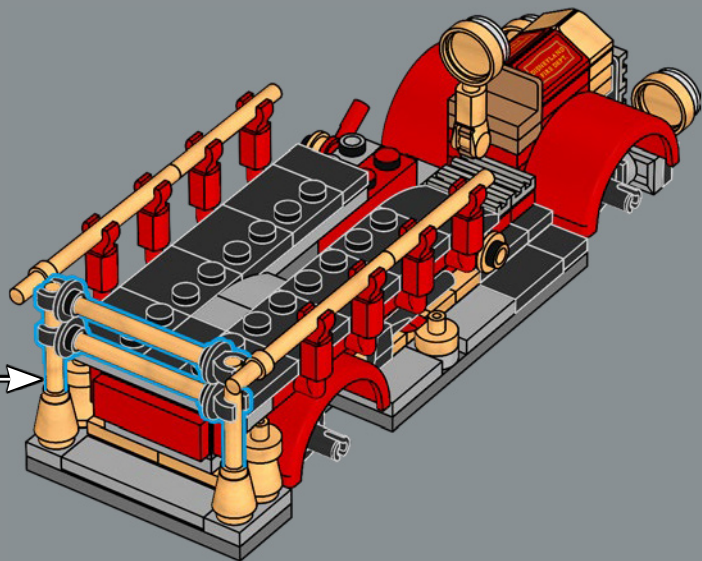

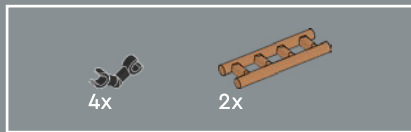

30

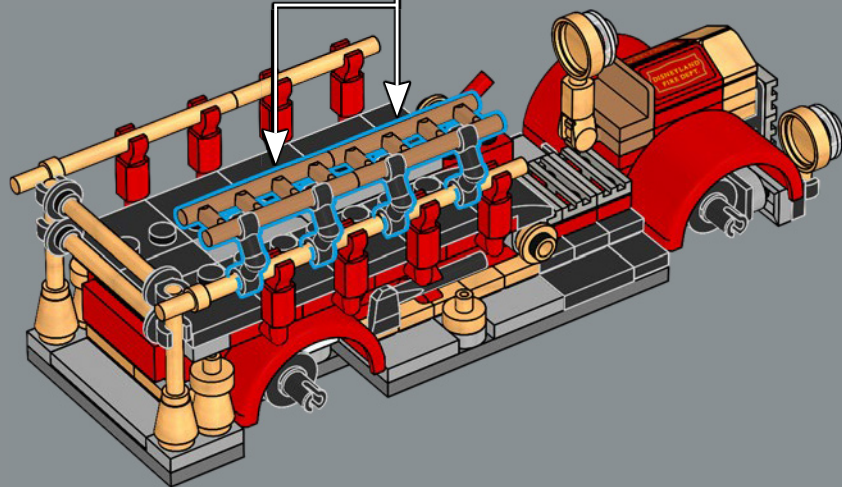
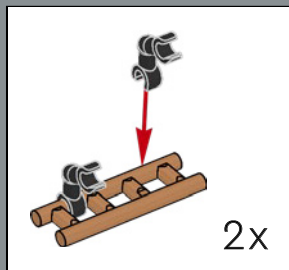

31

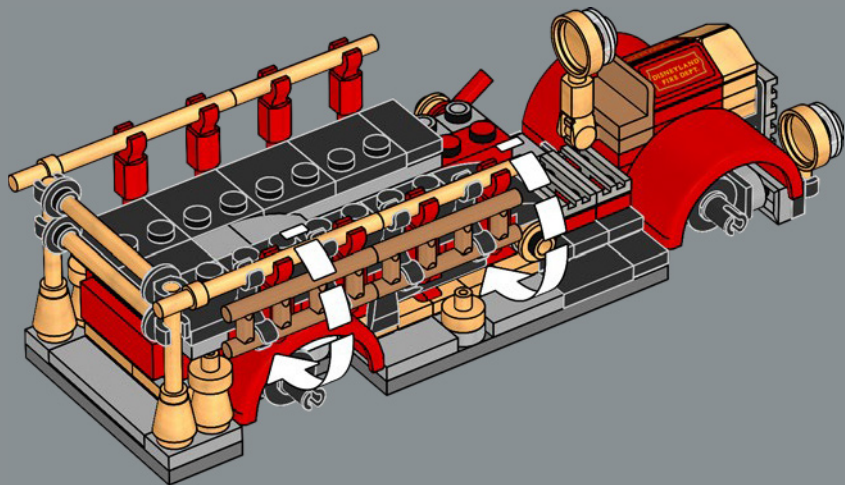

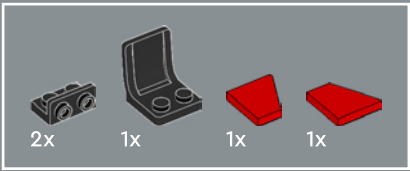

32

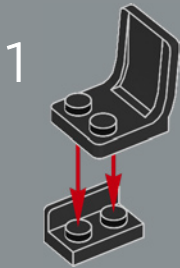

2

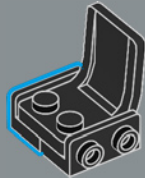

3

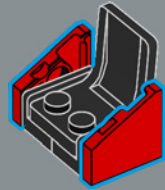

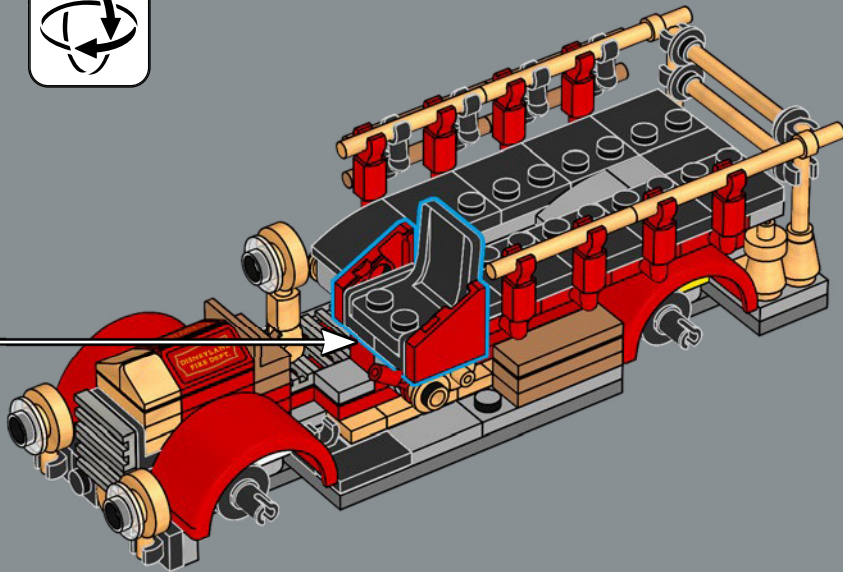



33

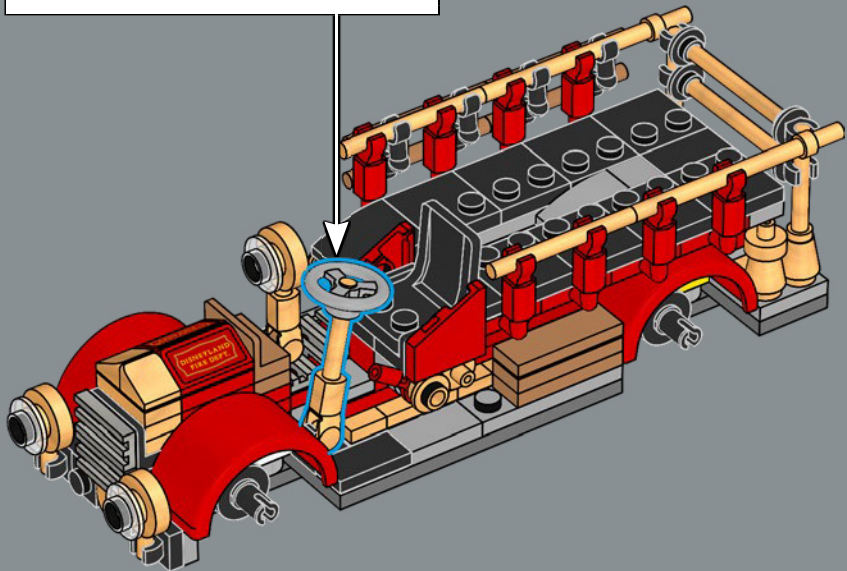
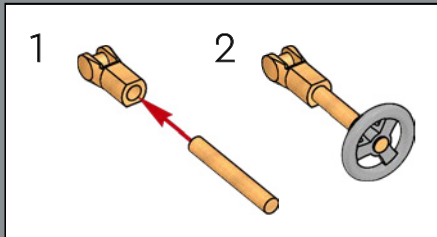

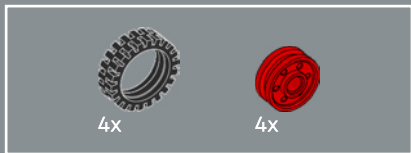

34

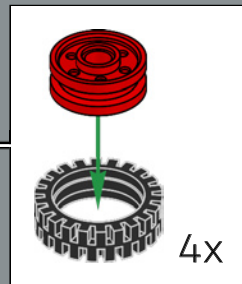
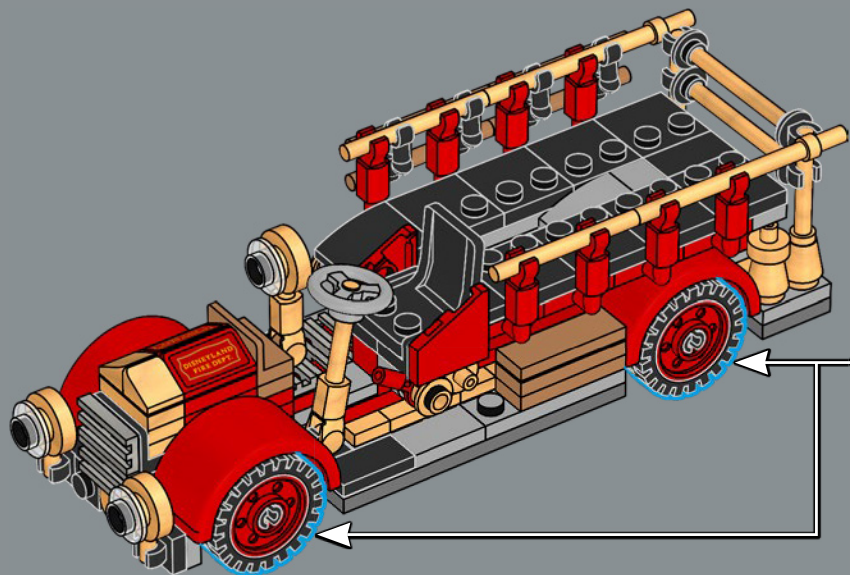





LEGO and the LEGO logo are trademarks of the LEGO Group. ©2026 The LEGO Group.
© Disney © Disney/Pixar © & TM Lucasfilm Ltd © 2026 MARVEL