



40955



MAERSK





LEGO.com/sustainable-packaging



FR

**DONNEZ
OU
RECYCLEZ**



OU



OU



ASSOCIATION MAGASIN DÉCHÈTERIE

Adresses sur quefairedemesdechets.fr

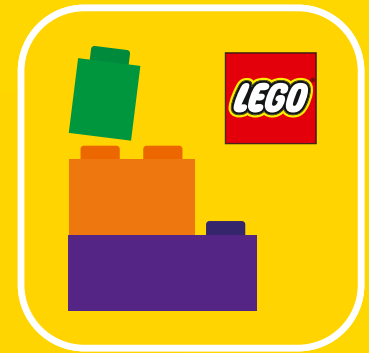

🔍 LEGO® Builder

BUILDER



Apple and the Apple logo are trademarks of Apple Inc., registered in the U.S. and other countries and regions. App Store is a service mark of Apple Inc. Google Play and the Google Play logo are trademarks of Google LLC. Tencent and the Tencent logo are trademarks of Tencent Inc.

🔍 LEGO.com/devicecheck

EN Ask parents' permission before going online | DE Eltern um Erlaubnis bitten, bevor du online gehst | FR Demande l'autorisation d'un parent avant d'aller en ligne | IT Chiedi il permesso ai tuoi genitori prima di andare online | ES Pídeles permiso a tus papás antes de conectarte a Internet | PT Peça autorização aos pais antes de acederes online | ZH 上网前应先征得父母的同意 | PL Poproś rodziców o zgodę, zanim wejdiesz do Internetu | CS Než půjdeš na internet, požádej rodiče o svolení | SK Skôr než pôjdeš na internet, vypoťaj si povolenie od rodičov | HU Kérj szülői engedélyt, mielőtt online csatlakoznál! | UA Запитуйте дозволу батьків, перш ніж користуватися інтернетом | RO Cere permisiunea părinților înainte de a te conecta online | BG Поискайте разрешение от родител, преди да влезете онлайн | LV Pirms došanās tiešsaistē palūdz atļauju vecākiem | ET Enne Interneti kasutamist küsi vanematelt luba | LT Prieš prisijungdami prie interneto, atsiklauskite tėvų



ПРЕДСТАВЛЯЄМО ANE MÆRSK

ANE MÆRSK — це перше судно у своєму роді, тобто перше велике контейнерне судно, яке може працювати на паливі з низьким рівнем викидів, такому як біо- та е-метанол. З моменту спуску на воду судна ANE MÆRSK у січні 2024 року було спущено на воду ще багато суден із подвійним типом палива, що стало новим важливим етапом у процесі декарбонізації судноплавства та світової торгівлі.

ANE MÆRSK має довжину 350 метрів (1148,2 фута) та ширину 53,5 метри (175,5 футів). Порожній корабель важить 47 700 тонн (52 580,25 тонни), а повністю завантажений вантажем, паливом та екіпажем він може перевозити неймовірні 190 000 тонн (209 439,1 тонни), що еквівалентно 29 000 африканських слонів.

Судно може завантажити 16 592 контейнери TEU (двадцятифутовий еквівалент), і якщо викласти їх у ряд, вони простягнуться на 100,5 км (62,4 милі), що дорівнює довжині 959 футбольних полів.





 MAERSK

ALL THE 10 ZERO WAY



КРИЗЬ ЗМІНИ — ІСТОРІЯ СУДНОПЛАВСТВА

Люди перевозять товари морем вже понад 5000 років, але до промислової революції та винаходу парової машини ми були залежні від погоди. Немає вітру, немає переправи. З появою парової енергії екіпаж корабля вперше в історії людства перестав залежати від погоди та ручного приводу. Цей винахід повністю революціонізував морський транспорт, відкривши нові маршрути та надавши значного поштовху морській торгівлі.

Хоча парові двигуни були значним вдосконаленням вітрил, вони все ще були неефективними, і незабаром морський транспорт знову зазнав змін завдяки винаходу дизельного двигуна. Однак зміни в судноплаванні вимагають часу, тож минуло кілька десятиліть, перш ніж дизель повністю замінив парову енергію. Компанія Maersk придбала своє перше судно з дизельним двигуном, LEISE MÆRSK, у 1921 році, всього через дев'ять років після спуску на воду першого в історії торгового судна з дизельним двигуном, призначеного для морських перевезень.



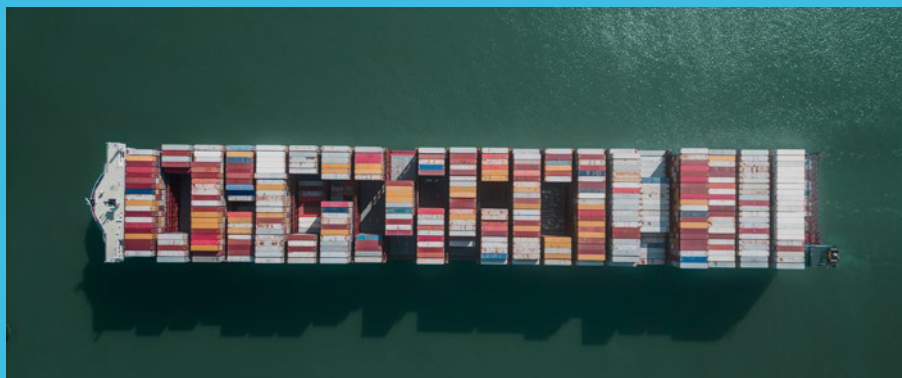

У 1956 році галузь знову зазнала змін, коли було впроваджено ефективну систему «контейнерних вантажів», за якою причепи вантажних автомобілів завантажуються безпосередньо на судна. Впровадження контейнерів скоротило час, необхідний для завантаження та розвантаження суден, з декількох днів до декількох годин.

Завдяки контейнерам і штрих-кодам, прихованим рушіям світової торгівлі, виробник у будь-якій частині світу може продавати свої товари на всіх ринках, що робить глобалізацію фізично можливою. Світ, яким ми його знаємо сьогодні, безпосередньо залежить від глобальних ланцюгів постачання. Від фермера, що вирощує банани в Колумбії, до данської дитини, яка чистить банан на обід, ланцюги постачання забезпечують зв'язок між країнами світу та гарантують постачання харчових продуктів, ліків, товарів та матеріалів людям у всьому світі.





 MAER

 MAERS

 MAERSK

 MAERSK

ЯК ЩОДО НАЗВИ?

З 1906 року всі судна флоту Maersk мають у своїй назві слово «MÆRSK». Більшість ранніх суден мали назви, пов'язані з родом засновників, але коли флот переріс кількість доступних прізвищ, традицію найменування довелося змінити. Сьогодні ви також можете побачити судна Maersk, названі, наприклад, на честь міст і річок.

Приймаючи рішення про назву нової серії суден з подвійним типом палива, компанія Maersk повернулася до традиції називати судна на честь членів родини засновників — цього разу починаючи з літери A, щоб ознаменувати нову еру.

ANE MÆRSK названо на честь Ане Мерск Мак-Кінні Уґла, голови A.P. Moller Holding, яка є материнською компанією A.P. Moller - Maersk. Компанія A.P. Moller – Maersk була заснована в 1904 році Арнольдом Петер Мьоллером. Ане є онукою засновника групи, Арнольда Петера Мьоллера, та його дружини, Частін Мак-Кінні Мьоллер.



ANE MAERSK





БІЛА ЗІРКА — ПРОМІНЬ НАДІЇ

Легендарна біла семикутна зірка є частиною спадщини Maersk ще з часів до заснування компанії в 1904 році і є незмінним символом міцних сімейних зв'язків, які й через 100 років залишаються в основі діяльності компанії.

На початку своєї кар'єри капітан Петер Мерск Мьоллер, батько А.П. Мьоллера, працював на англійського судновласника, а його дружина Анна іноді супроводжувала його в подорожах. Саме під час однієї з таких подорожей Анна тяжко захворіла. Побоюючись, що вона не виживе, Петер Мерск Мьоллер піднявся на палубу й помолився Богу, щоб той дав йому знак, що його дружина одужає. Саме тоді він побачив єдину зірку, що освітлювала сіре небо.

Анна одужала, і в 1886 році, коли Петер Мерск Мьоллер придбав свій перший пароплав LAURA, він прикрасив димар корабля білою семикутною зіркою на блакитному тлі, як данину поваги своїй коханій дружині. Для Петера Мерска Мьоллера зірка стала символом її одужання та їхньої удачі.

З того часу біла семикутна зірка на символічному блакитному тлі стала синонімом компанії Maersk, але сам логотип за ці роки зазнав певних змін. Існувало багато версій логотипа Maersk, але сучасний з'явився на початку 1970-х років, коли було вирішено, що необхідний більш сучасний підхід.



ALL THE WAY
TO ZERO



ПОКРАЩЕННЯ ЖИТТЯ ДЛЯ ВСІХ ШЛЯХОМ СВІТОВОЇ ІНТЕГРАЦІЇ

Як світовий лідер у сфері логістичних послуг, Maersk має понад 100 000 клієнтів, працює майже в 130 країнах і має понад 100 000 співробітників. Починаючи з невеликої пароплавної компанії, Maersk перетворилася на інтегровану логістичну компанію, яка працює над об'єднанням та спрощенням ланцюгів постачання своїх клієнтів. Maersk використовує понад 700 суден і транспортує майже 20% світових продовольчих товарів, матеріалів та інших товарів.





MAERSK
MAERSK
MAERSK
MAERSK
MAERSK
MAERSK

MAERSK
MAERSK
MAERSK
MAERSK
MAERSK
MAERSK

ALL
THE
WAY

ANE MAERSK

SPREADERS
TSP98
MAERSK
MAERSK

PTP
T414
P423 PTP

ПОВНИЙ ПЕРЕХІД НА НУЛЬОВІ ВИКИДИ — ЗОБОВ'ЯЗАННЯ ЩОДО ДЕКАРБОНІЗОВАНОГО МАЙБУТНЬОГО

У той час, як світ бореться з кліматичними надзвичайними ситуаціями, майбутнє ланцюгів постачання та світової торгівлі залежить від здатності впроваджувати інновації та просувати нові джерела енергії. Компанія Maersk взяла на себе серйозне зобов'язання досягти нульового рівня викидів парникових газів до 2040 року в усьому своєму бізнесі. Одночасно з декарбонізацією власних операцій компанія Maersk також взяла на себе соціальне зобов'язання стати лідером у боротьбі з кліматичною кризою шляхом декарбонізації глобальних ланцюгів постачання та забезпечення справедливого переходу до економіки з нульовим рівнем викидів.

Компанія Maersk поставила амбітні цілі до 2040 року, щоб забезпечити значний прогрес у цьому десятилітті: на морі, на суші, в повітрі та на наших терміналах. А завдяки замовленню та постачанню великої кількості суден із подвійним типом палива, які можуть використовувати паливо з низьким рівнем викидів, такому як біо- та е-метанол, а також біометан, наразі місія з декарбонізації флоту успішно реалізується.



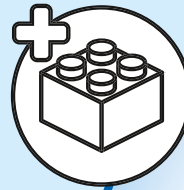
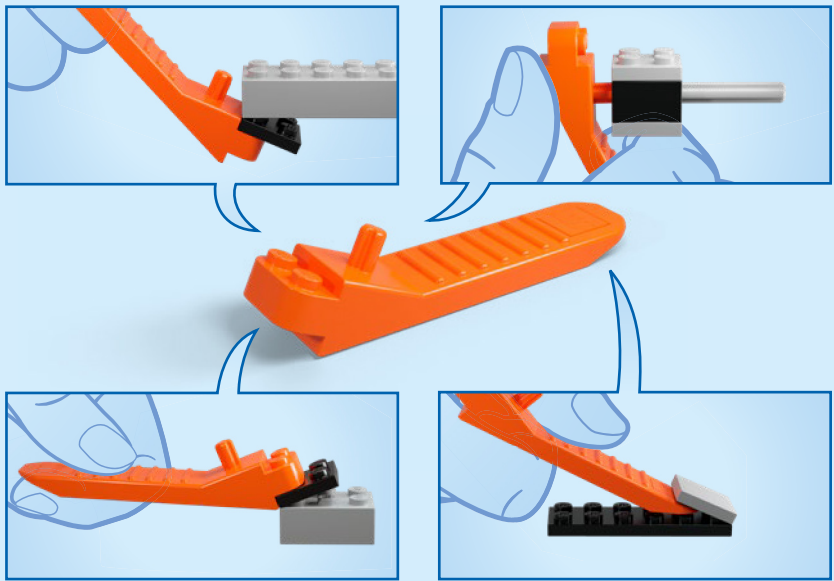

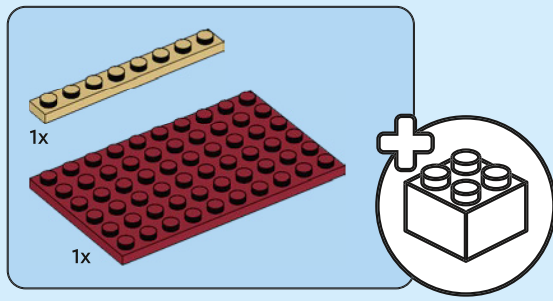

1

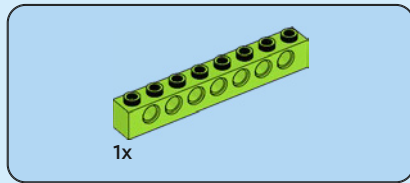
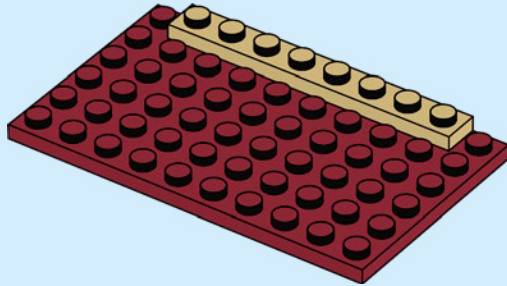

2

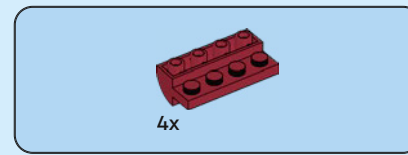
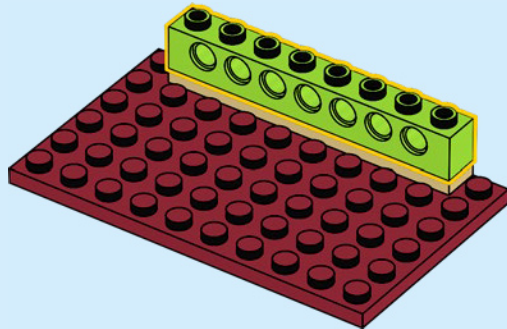

3

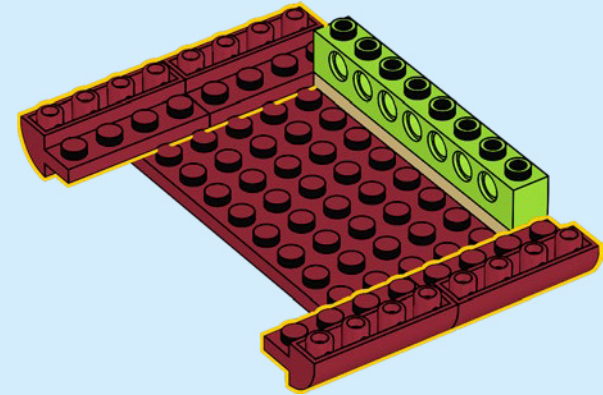

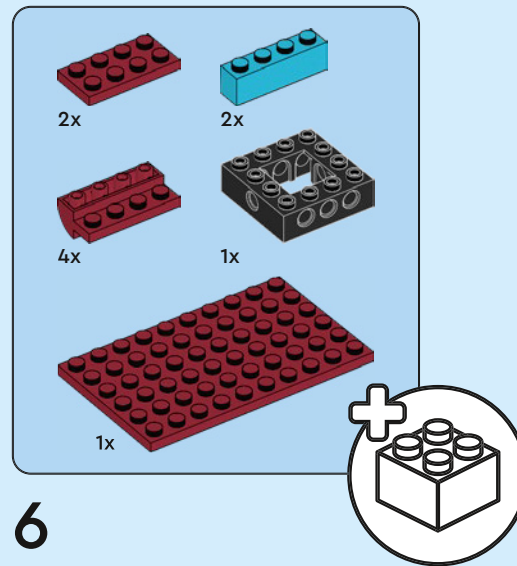
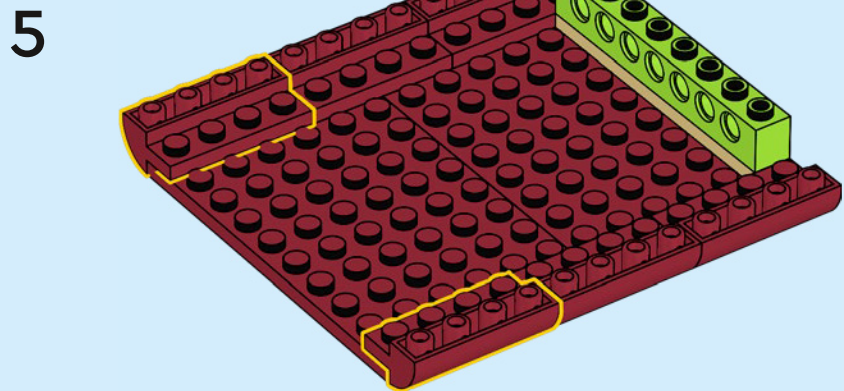
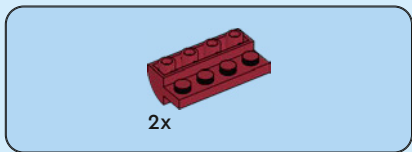
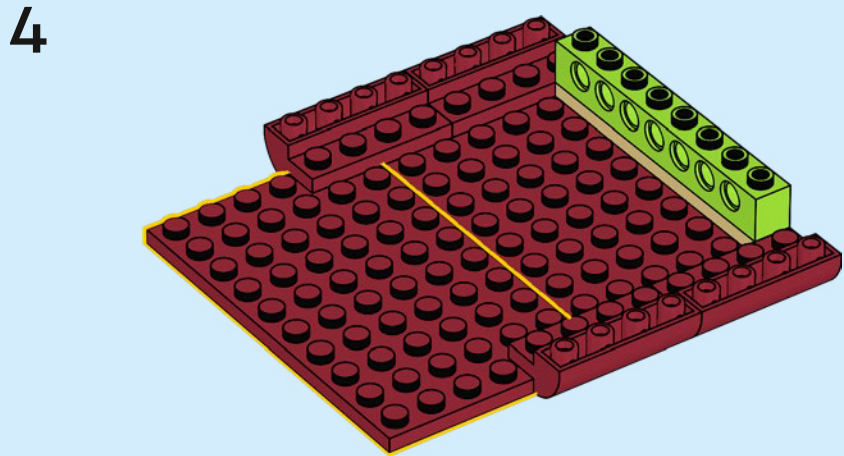
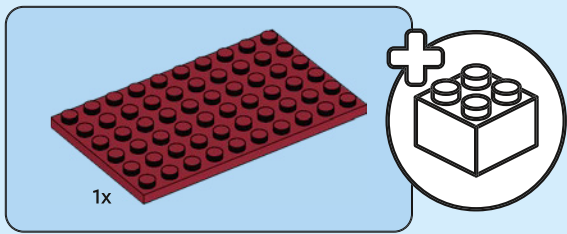

6

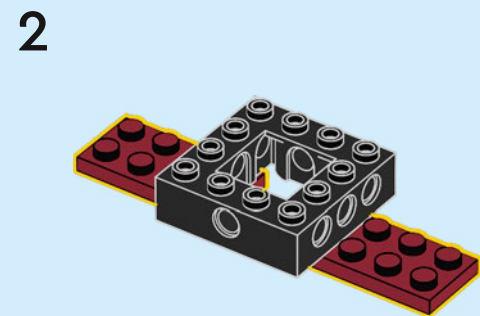
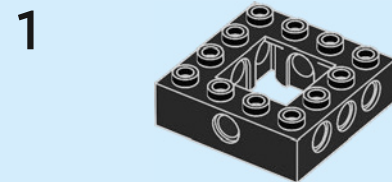

3

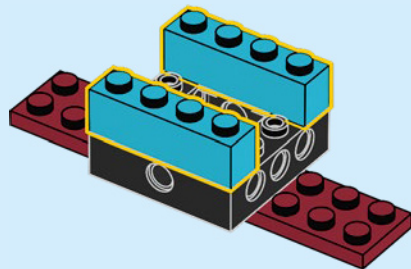

4

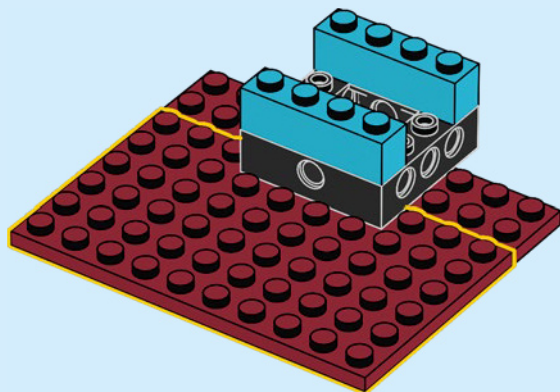

5

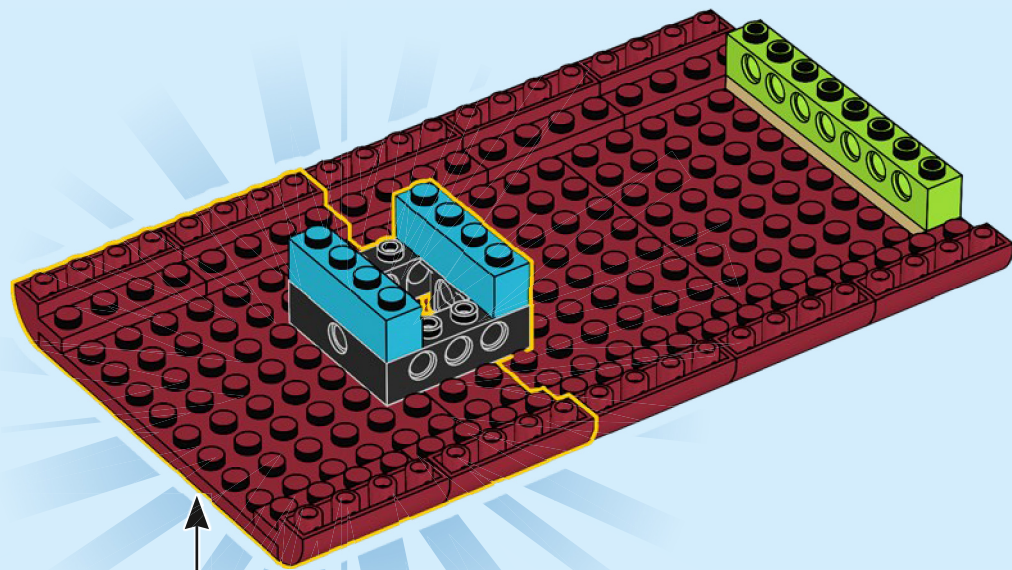
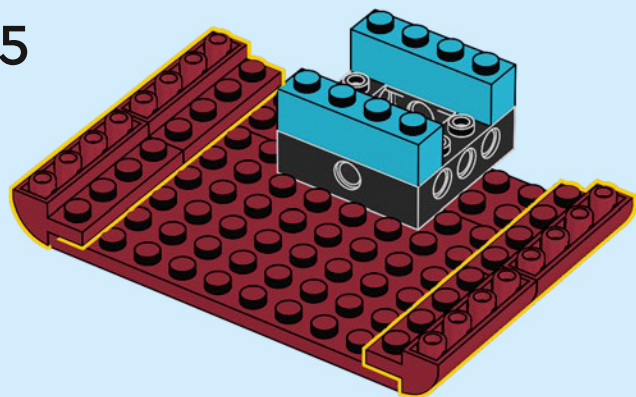

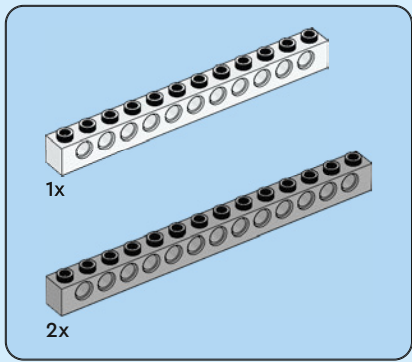

7

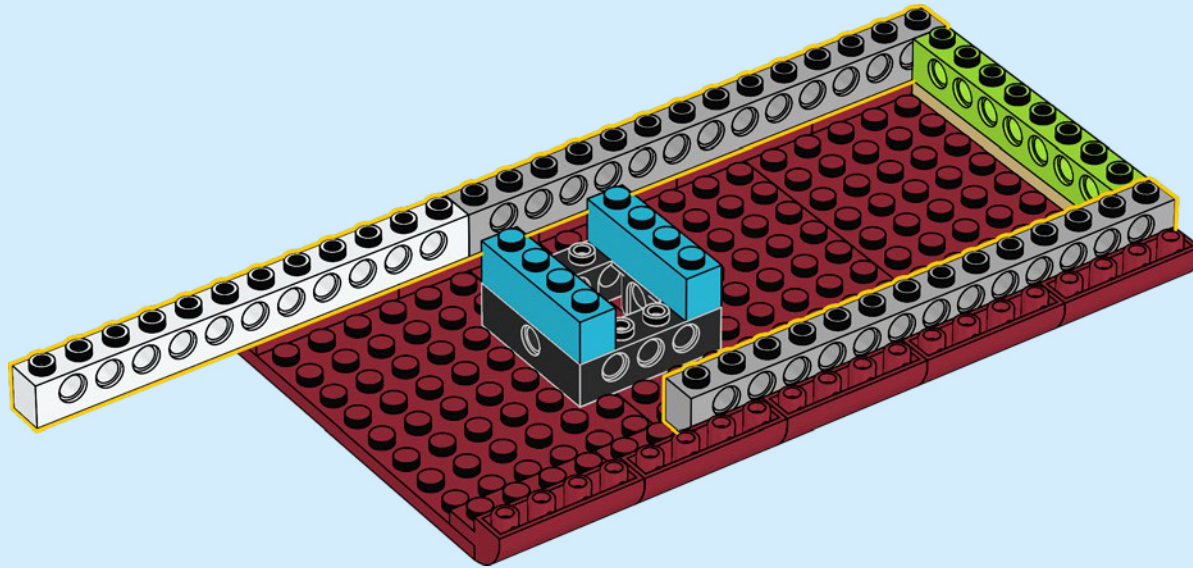

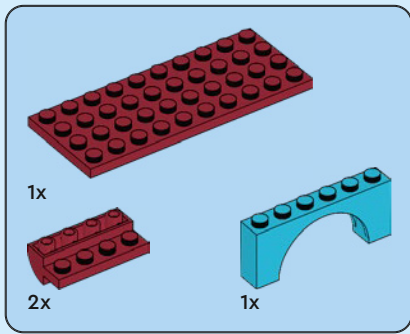

8

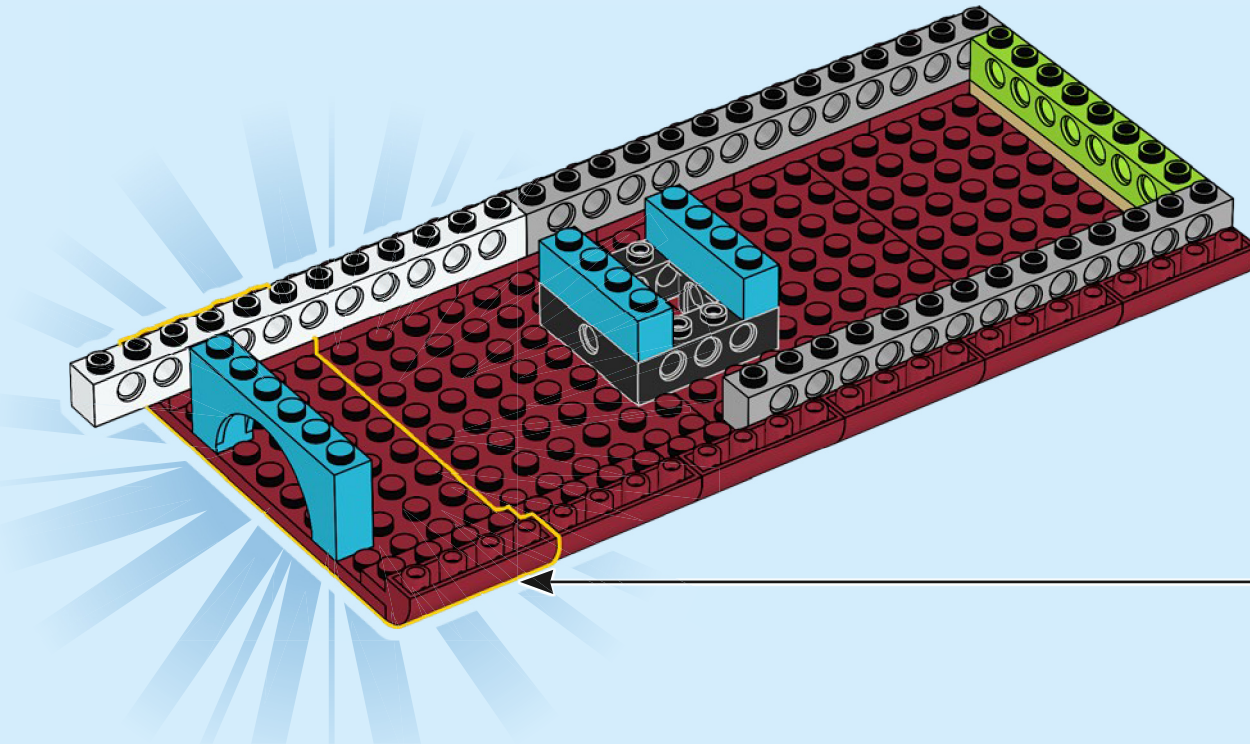
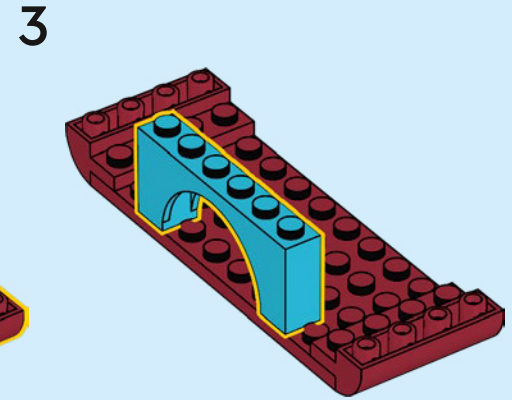
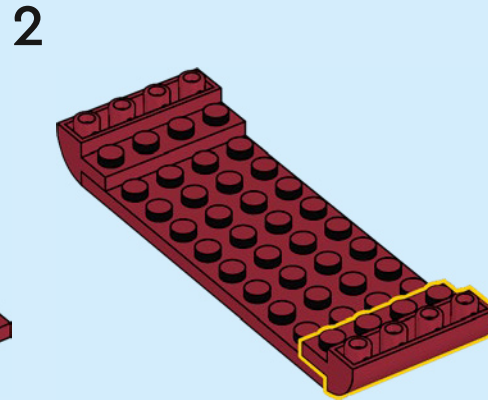
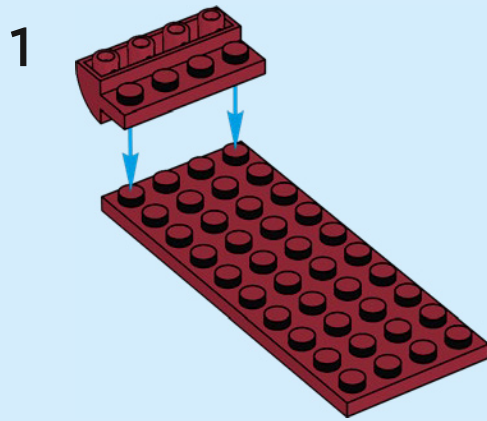

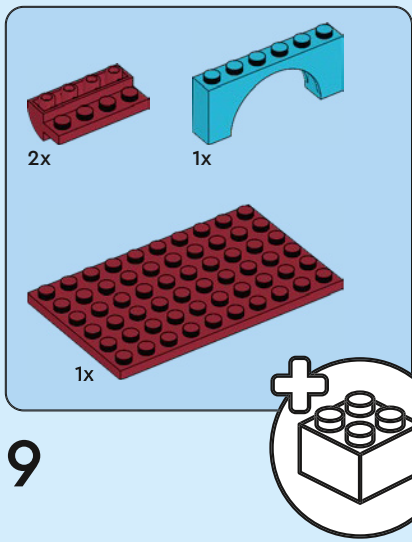

9

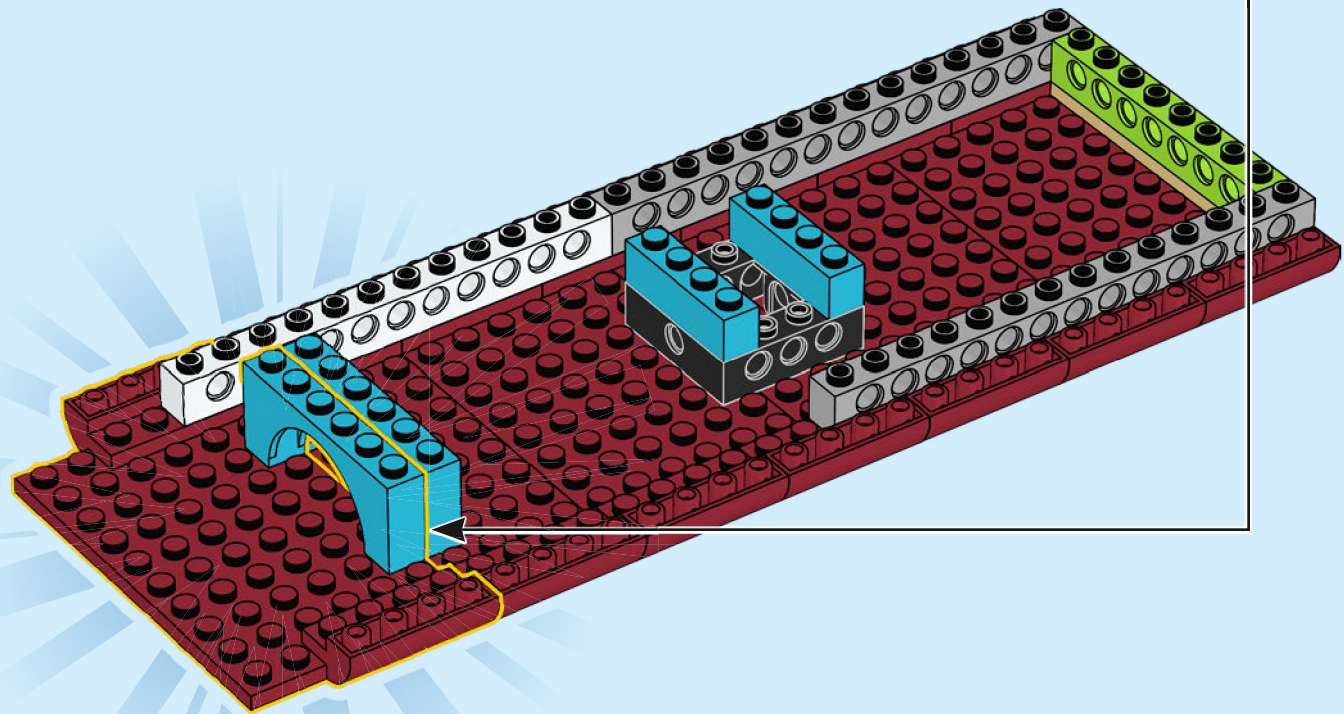
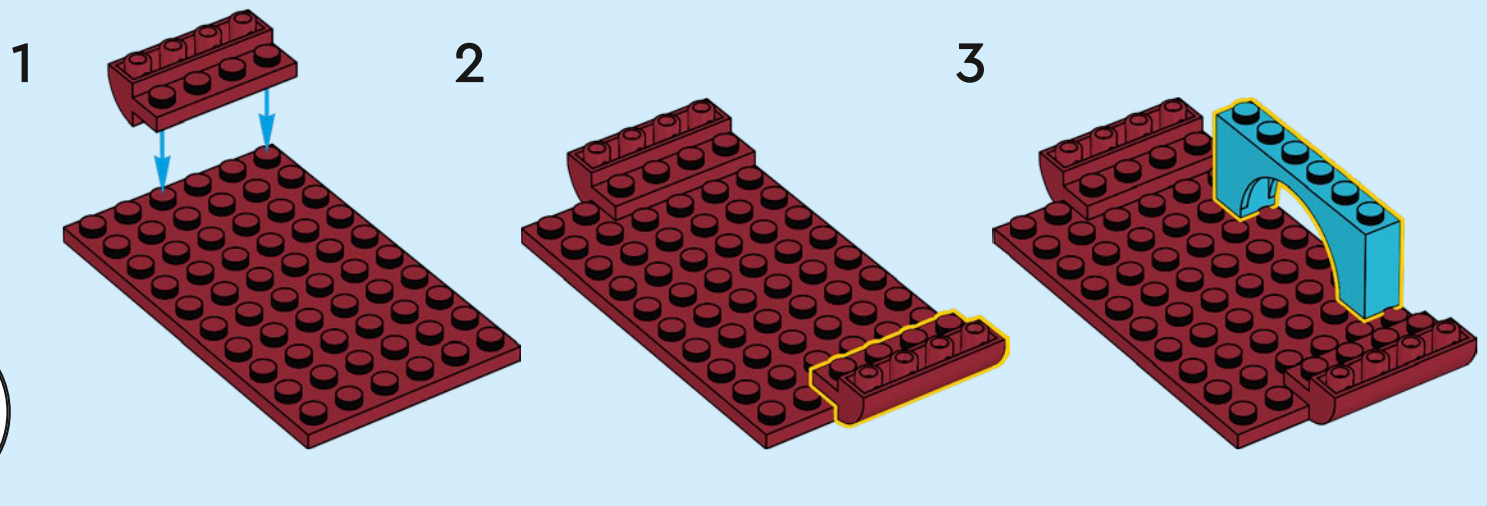

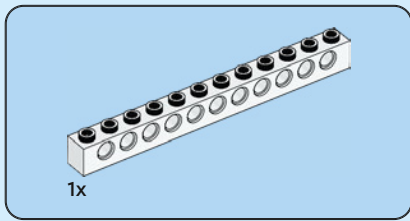

10

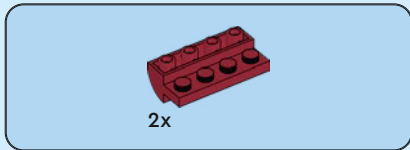
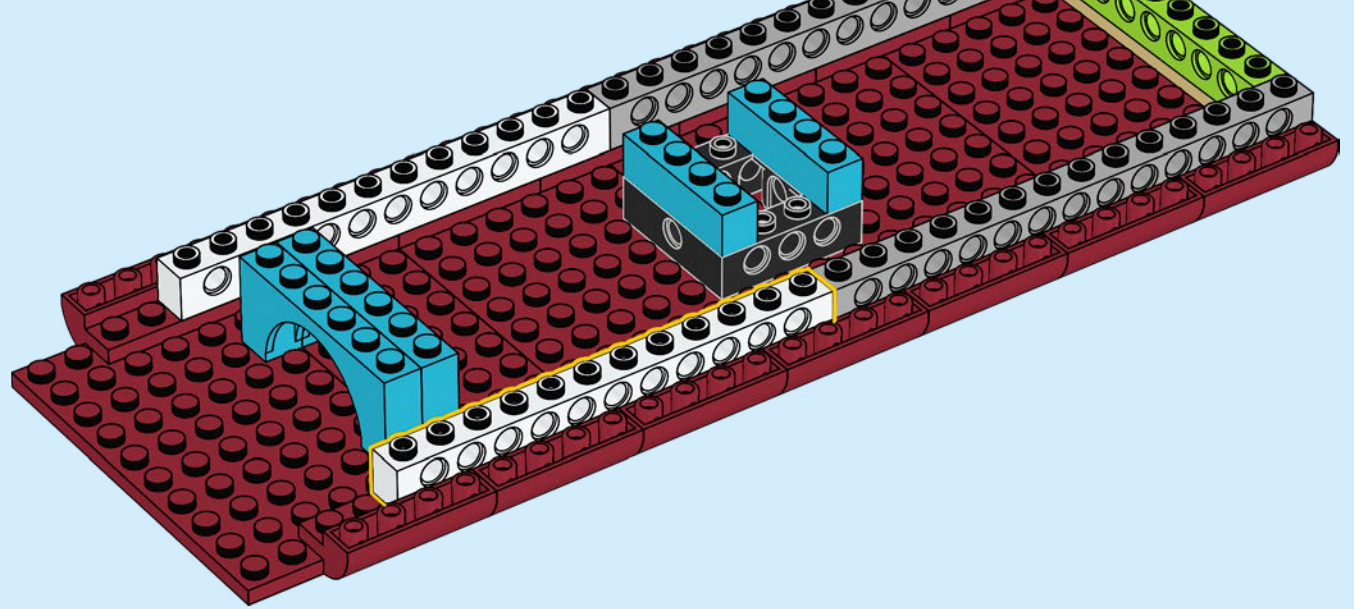

11

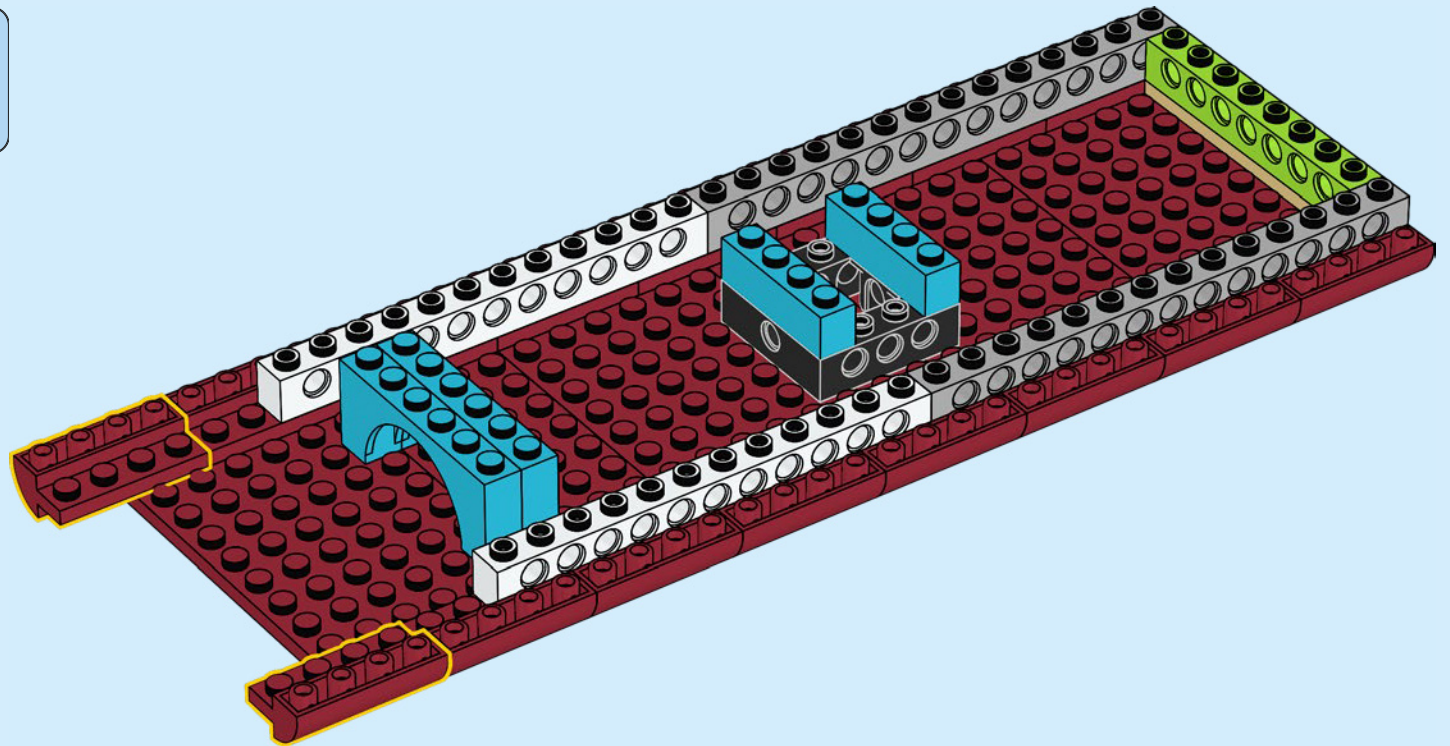

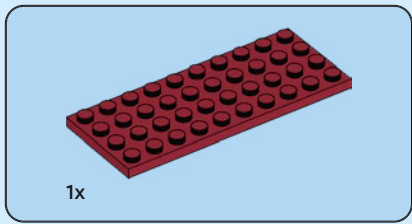

12

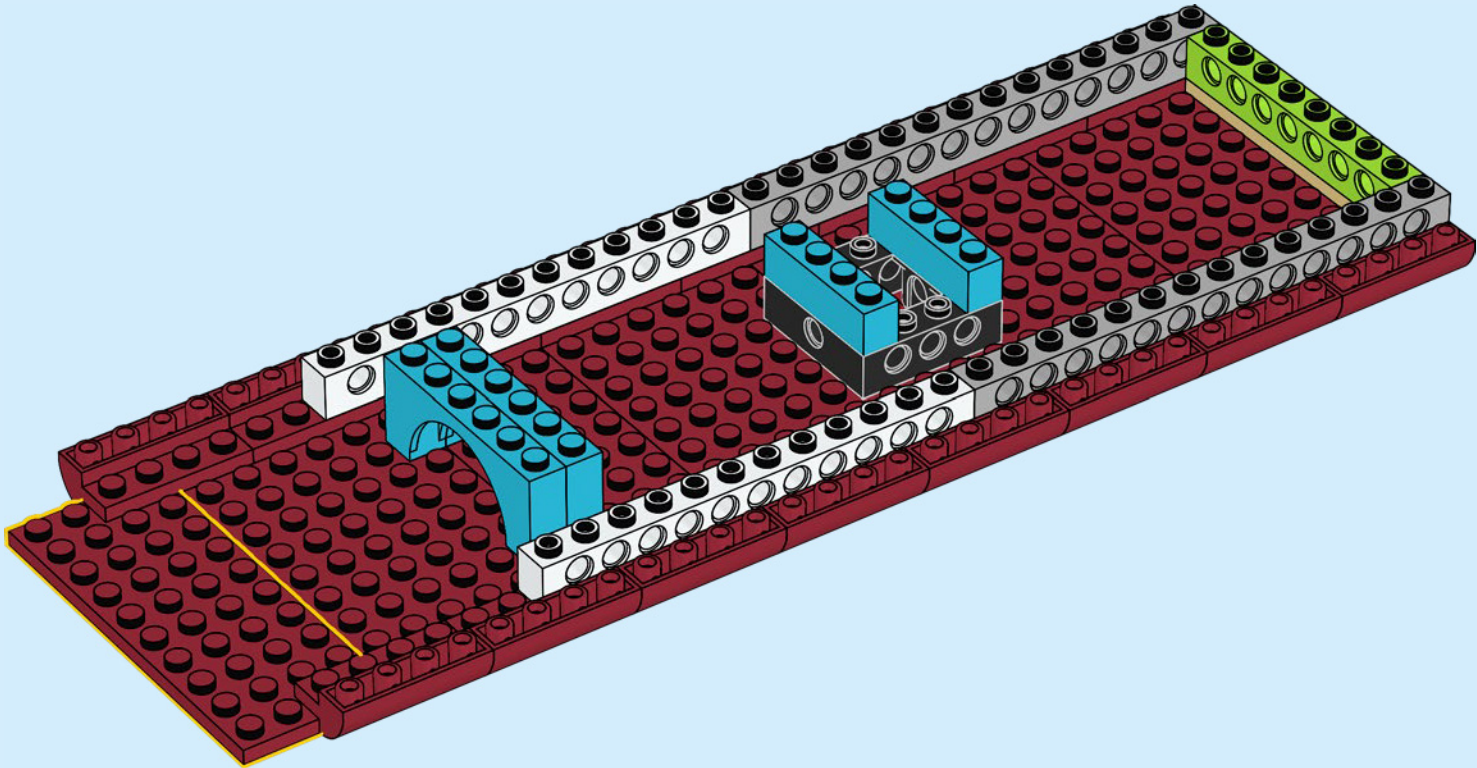

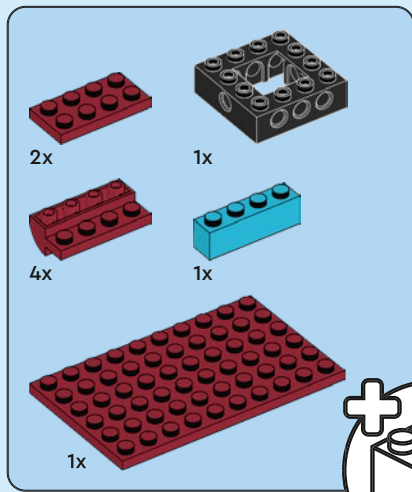

13

1

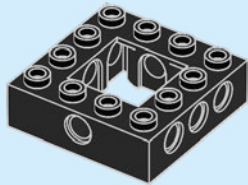

2

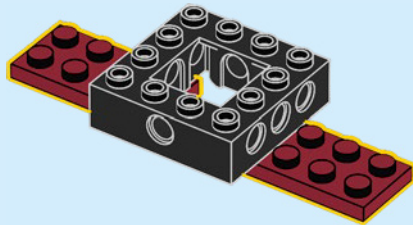

3

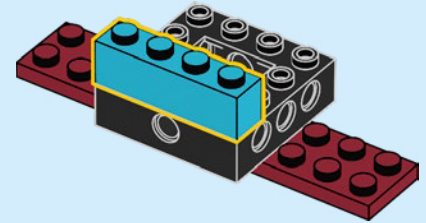

4

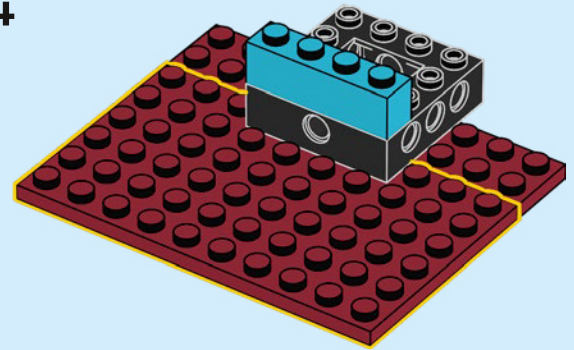

5

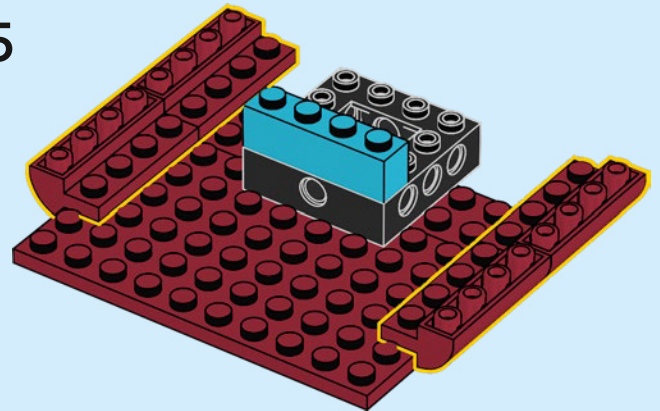

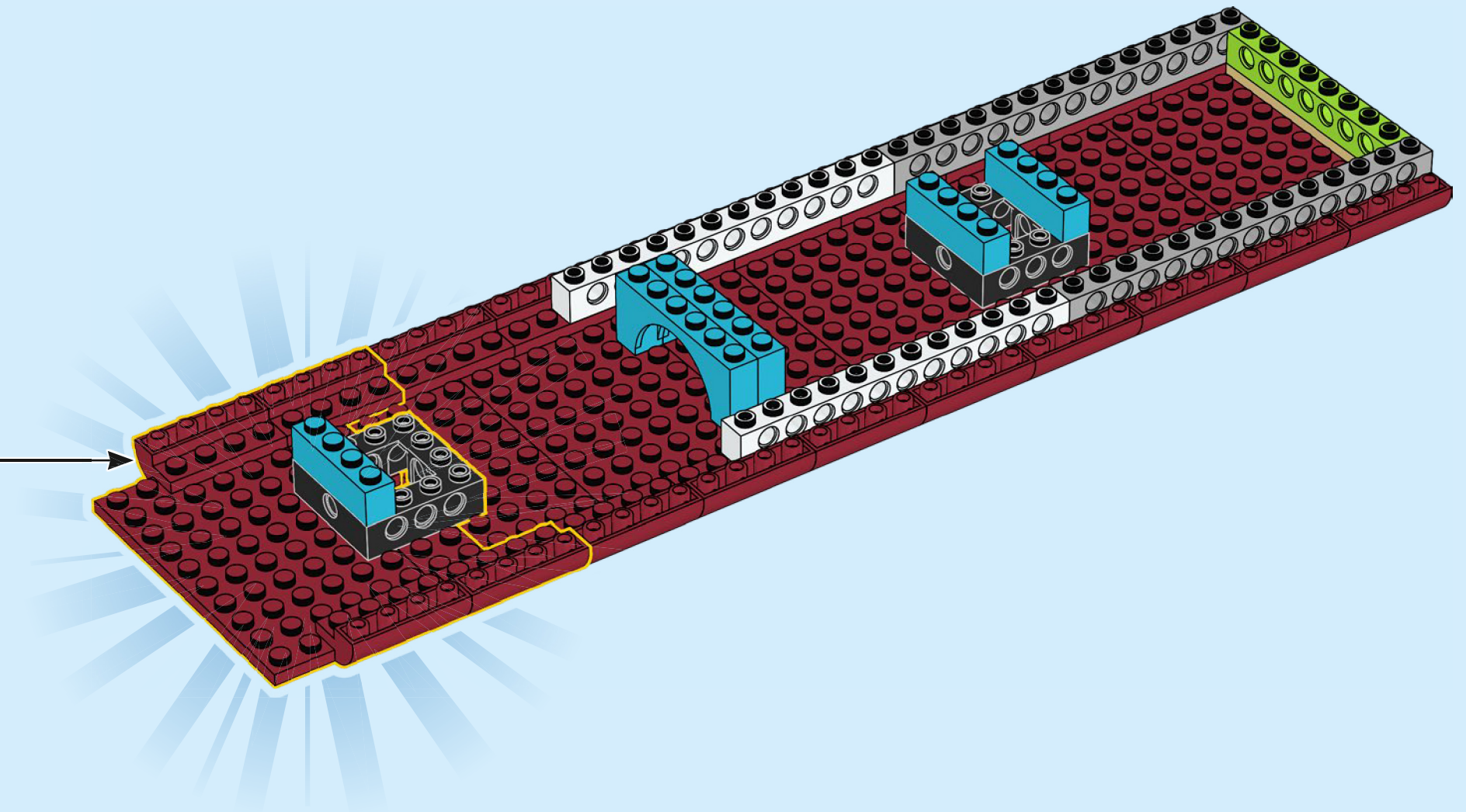

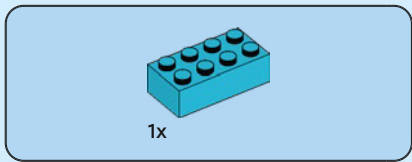

14

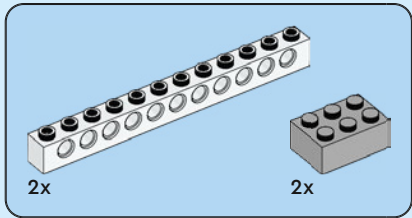
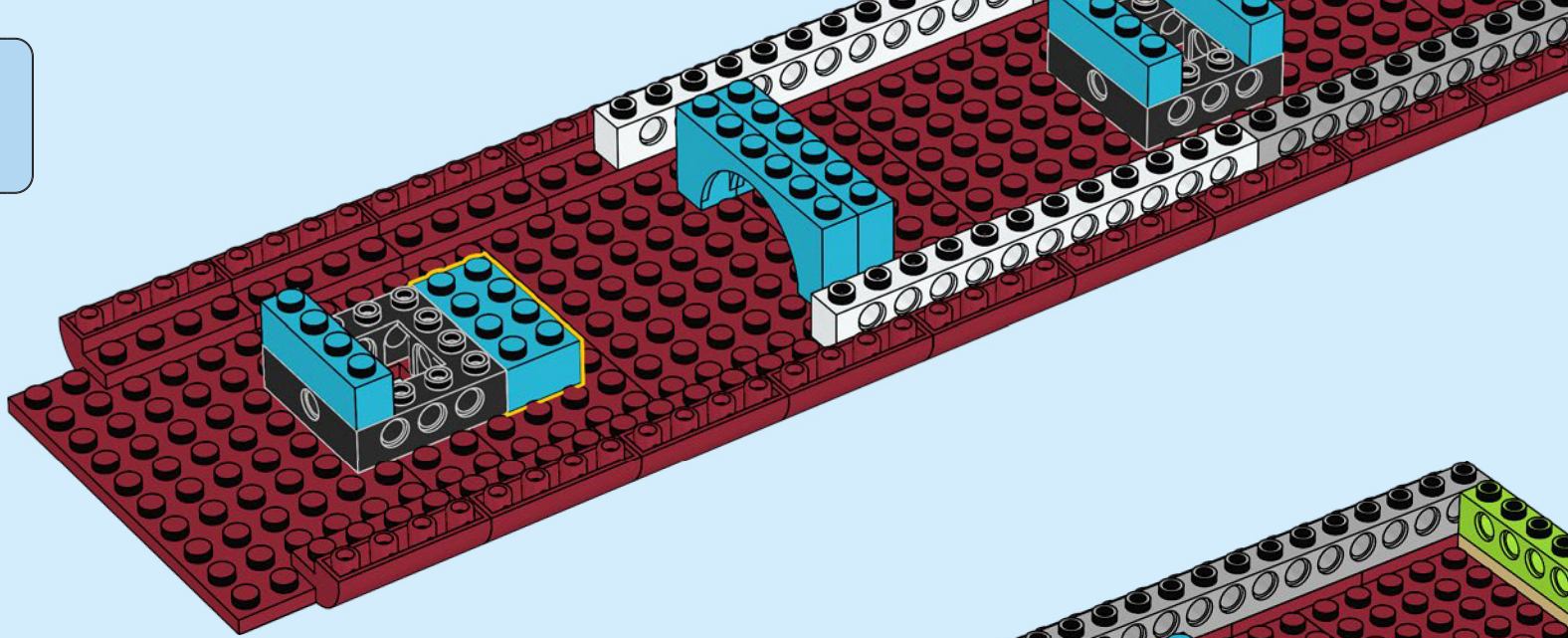

15

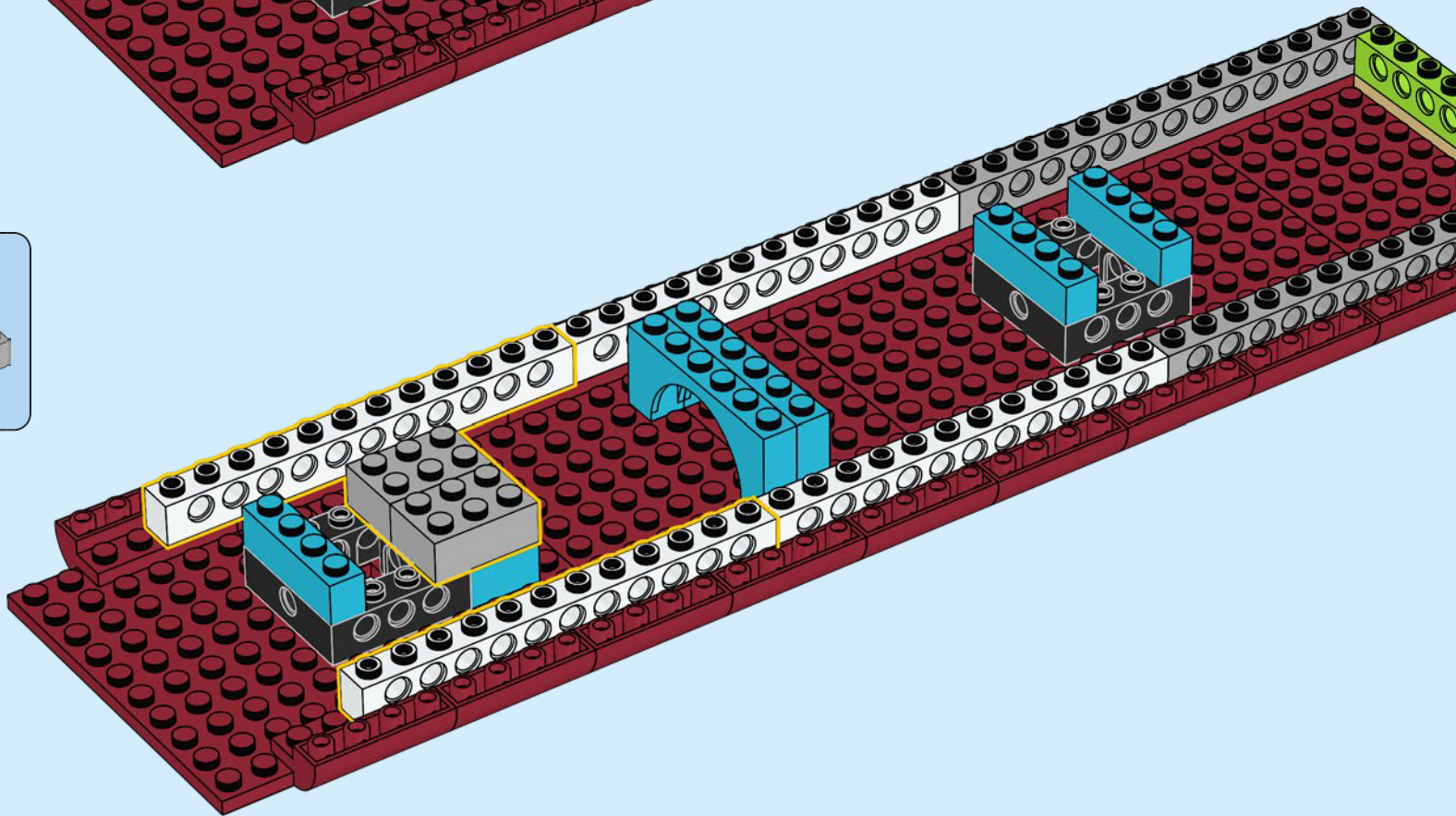

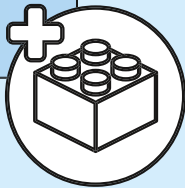
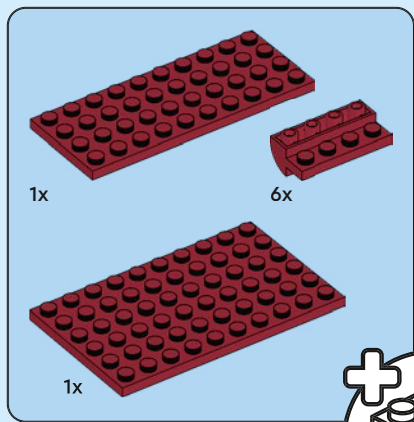

16

1

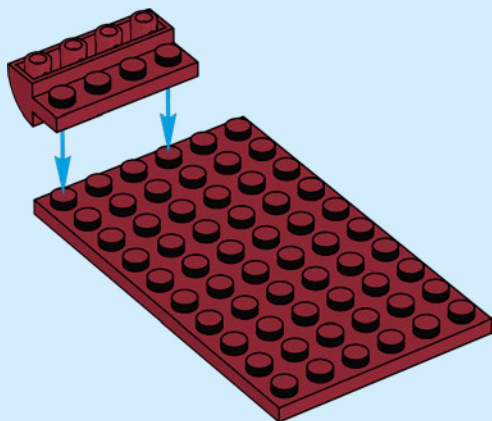

2

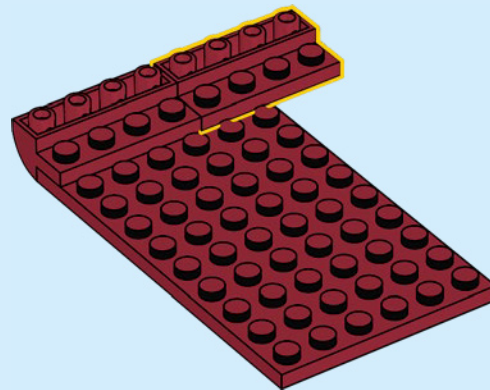

3

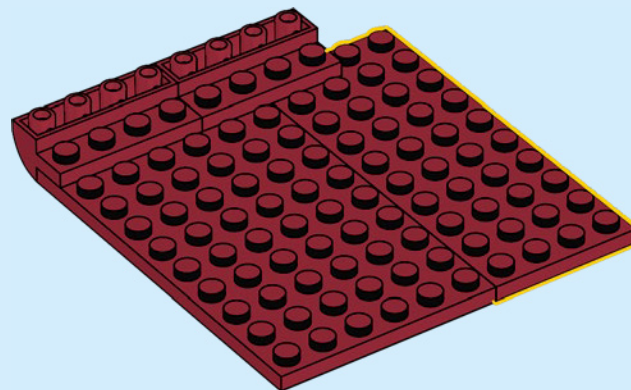

4

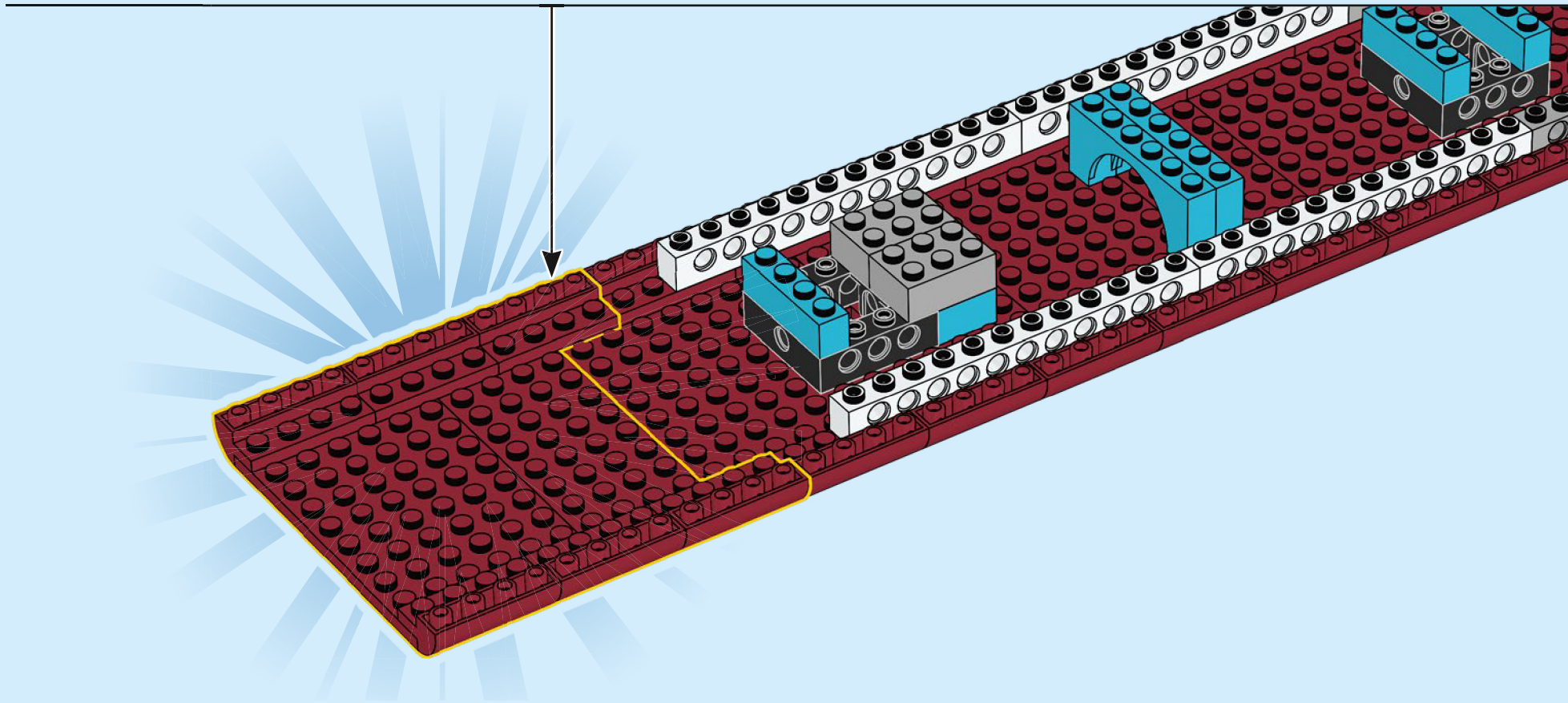
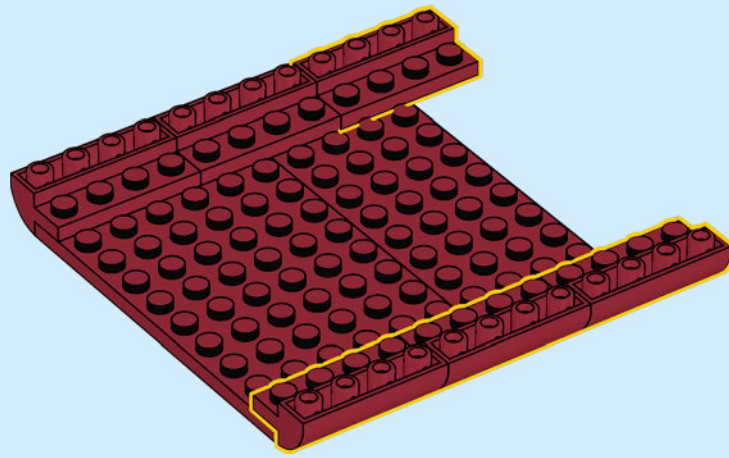

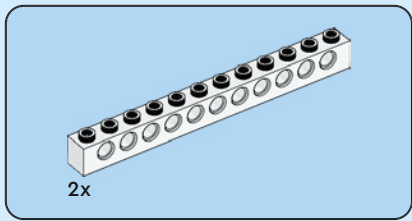

17

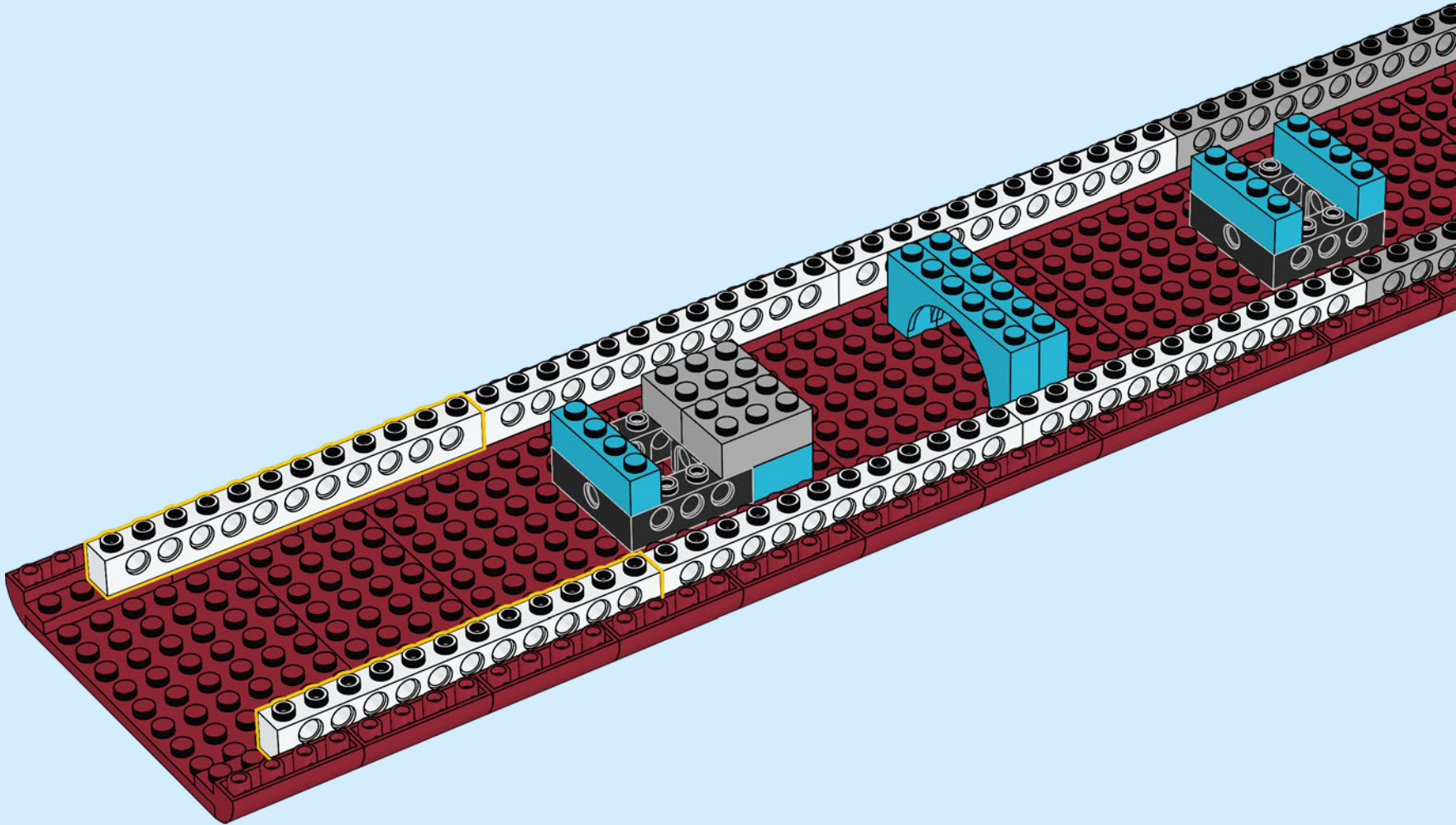

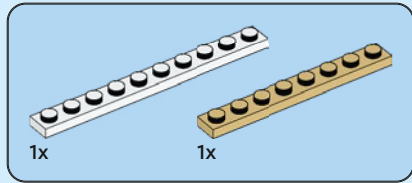

18

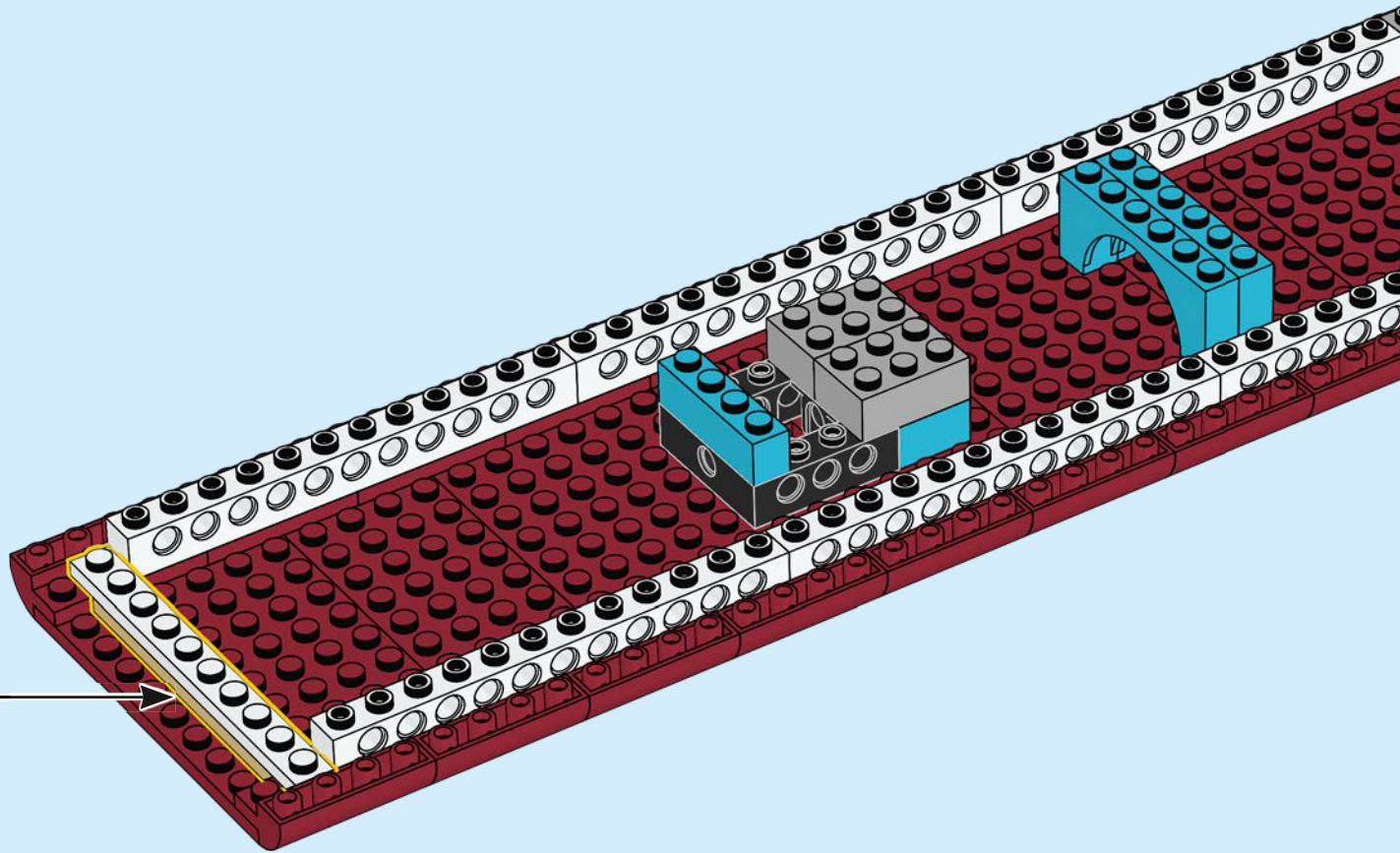
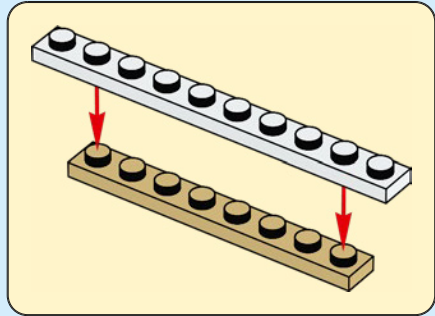

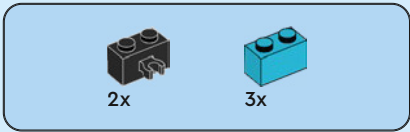

19

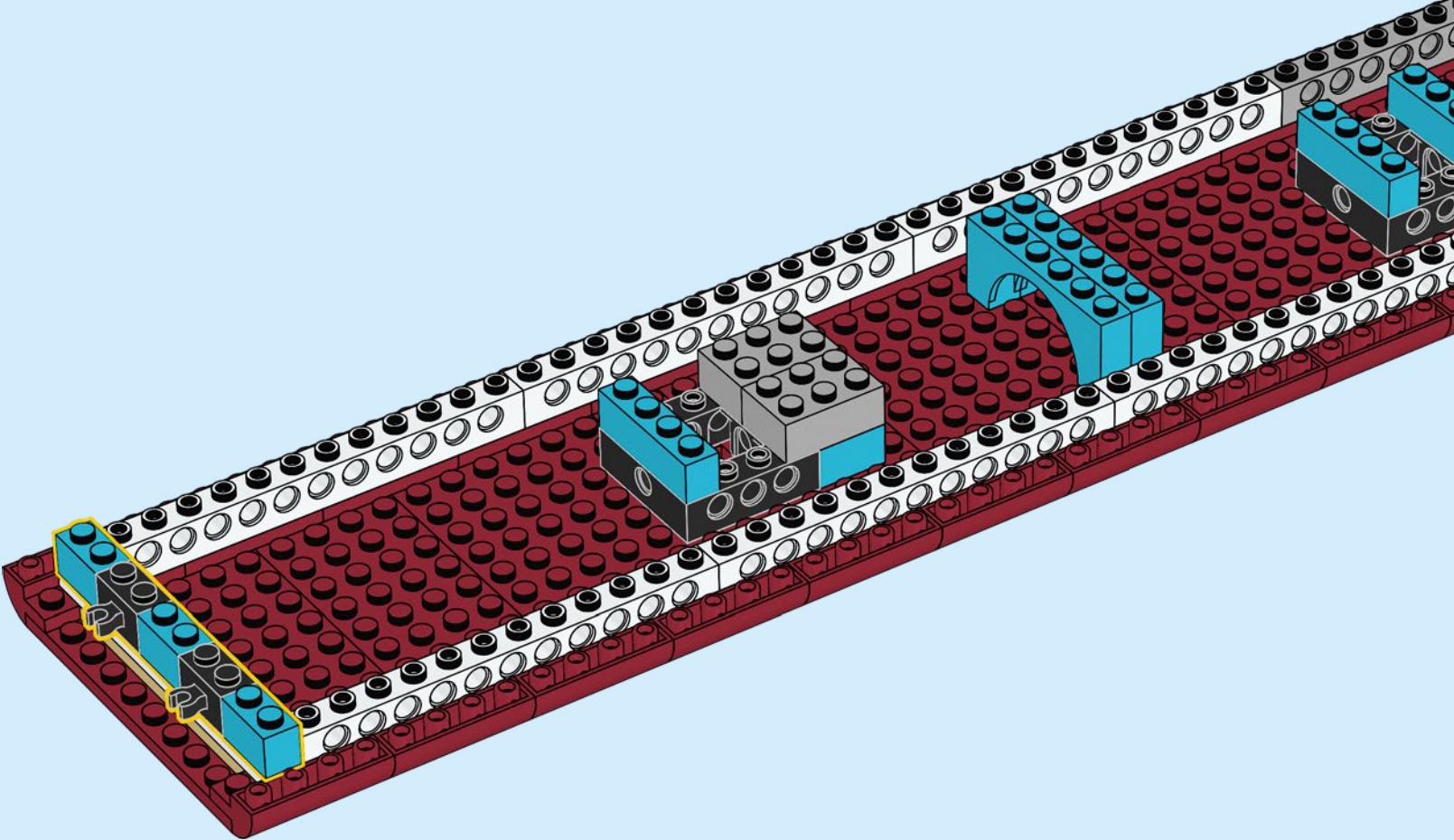

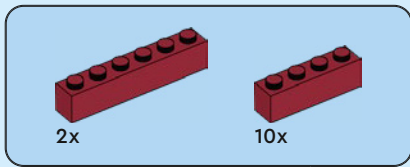

20

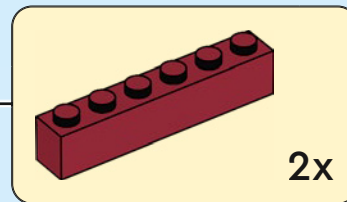
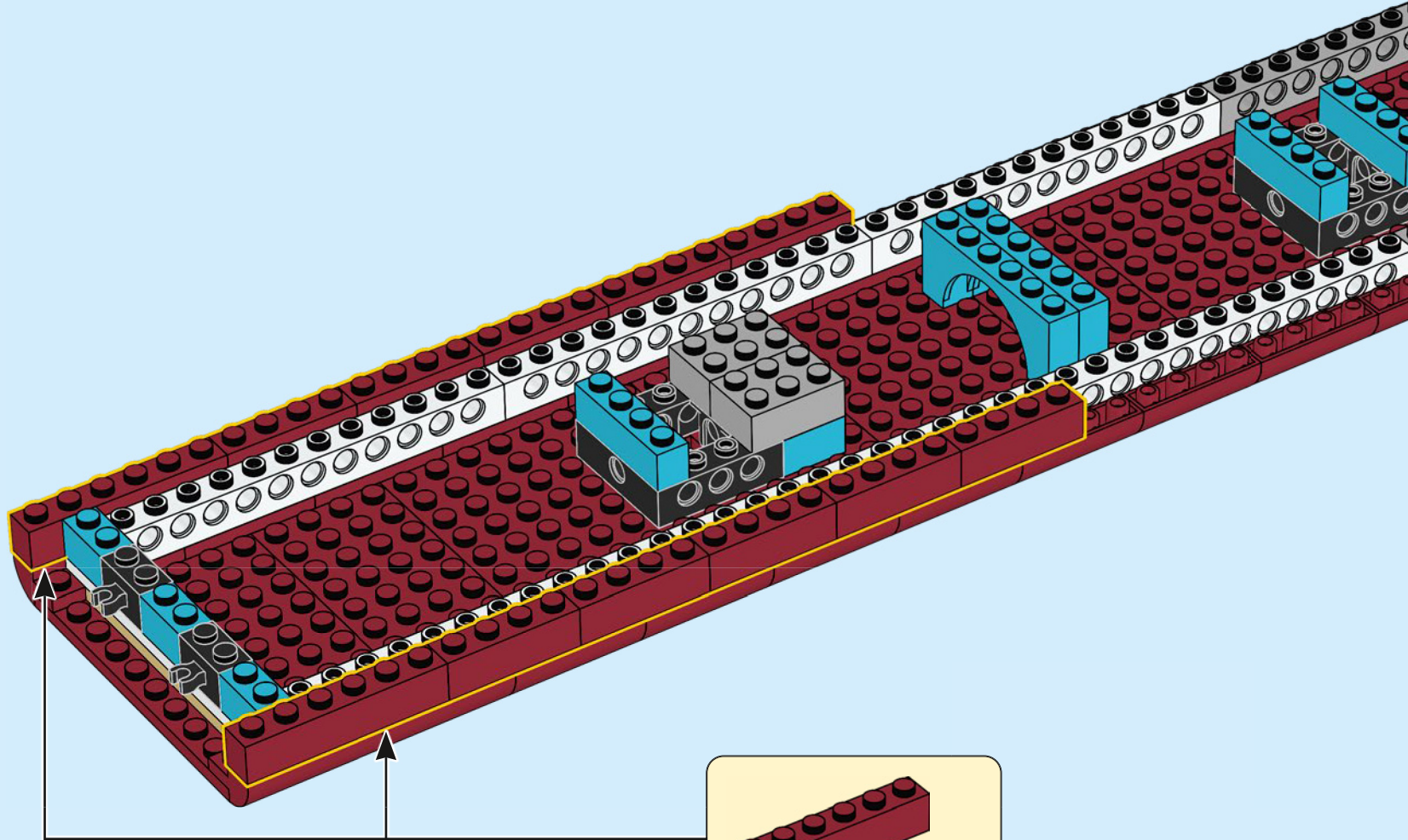

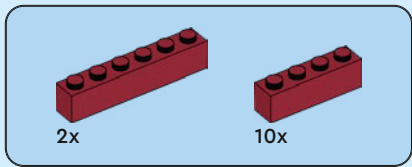

21

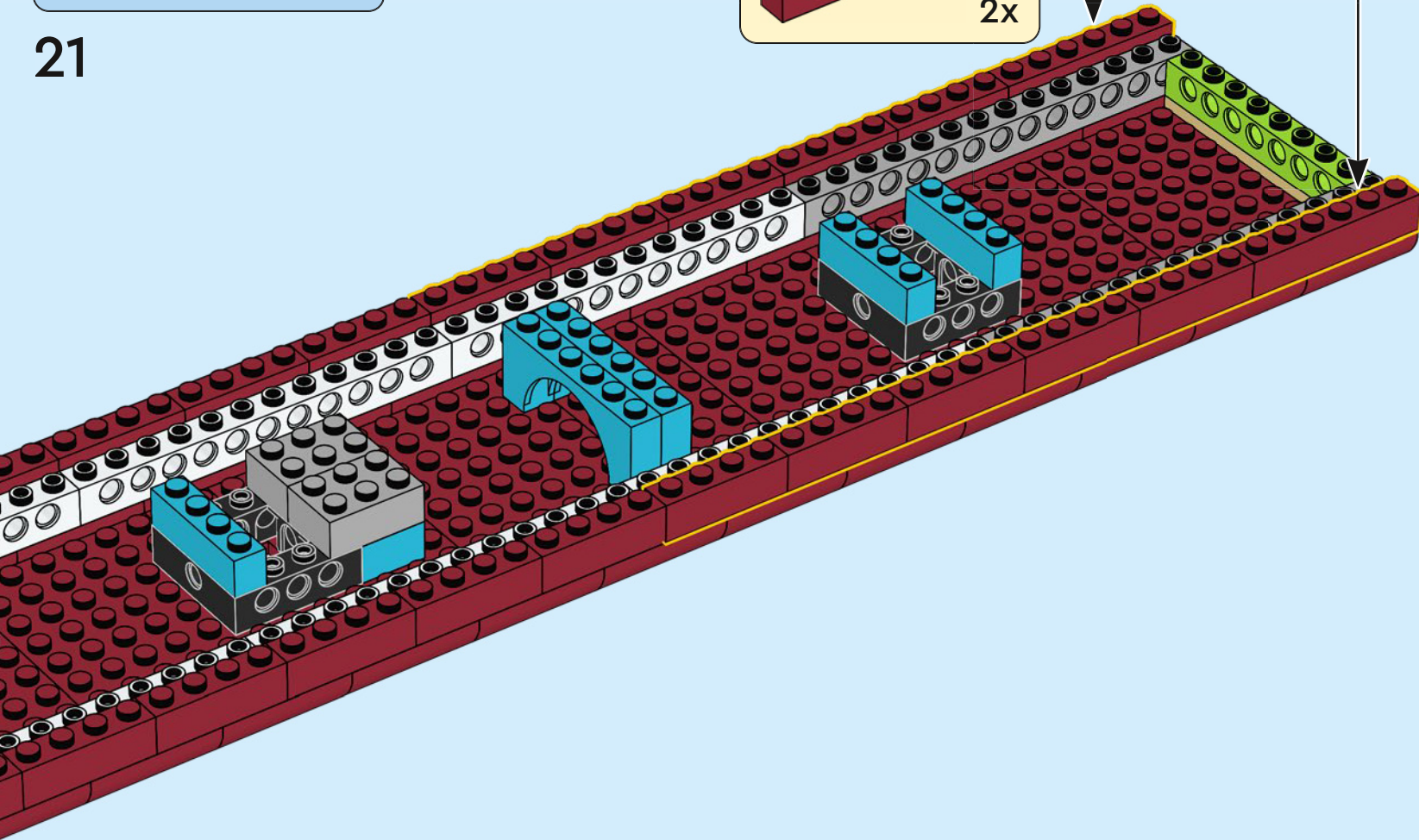
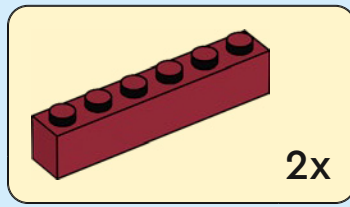

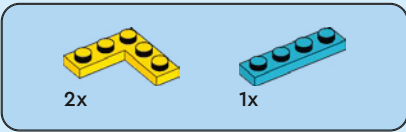

22

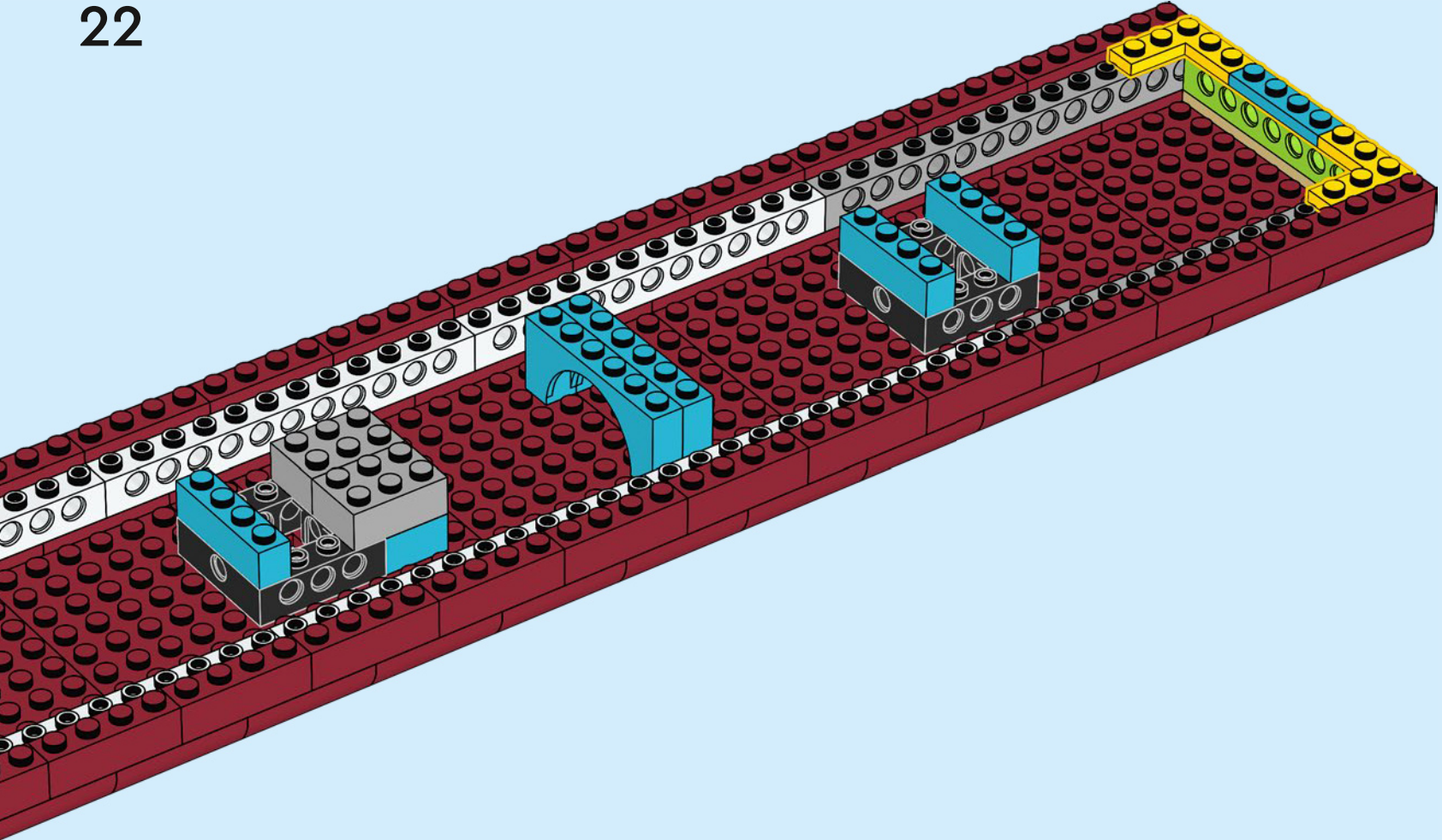

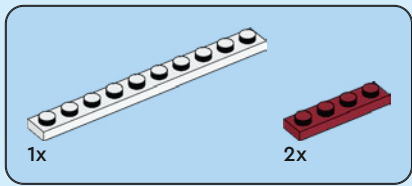

23

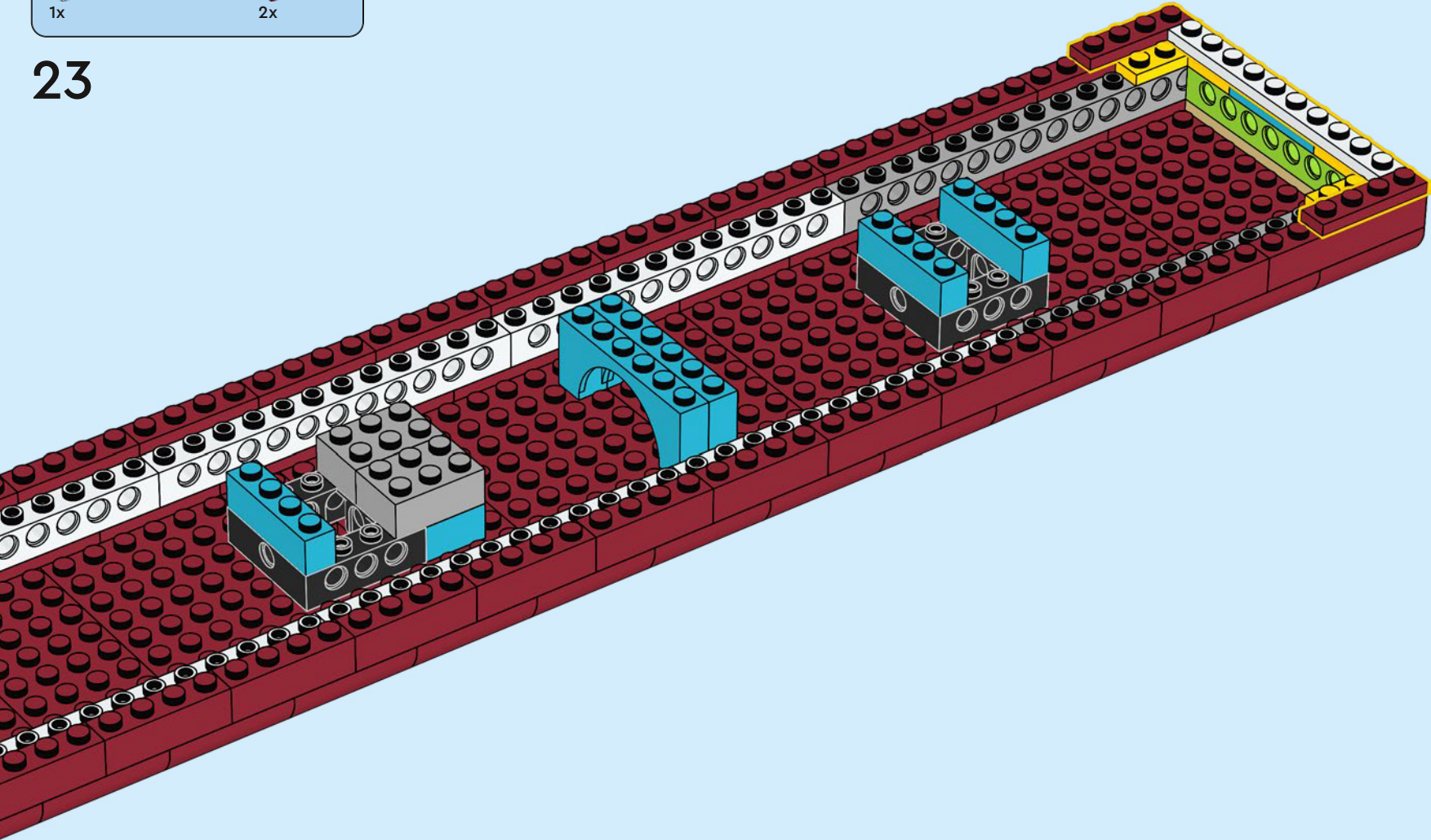

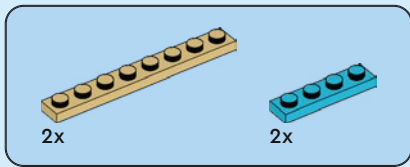

24

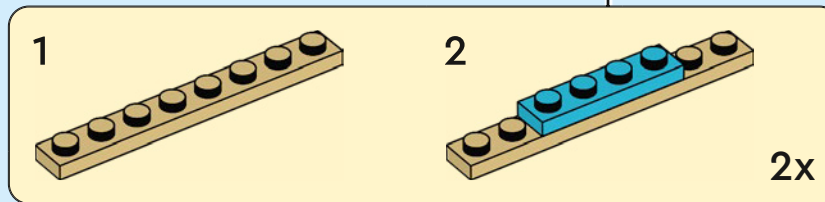
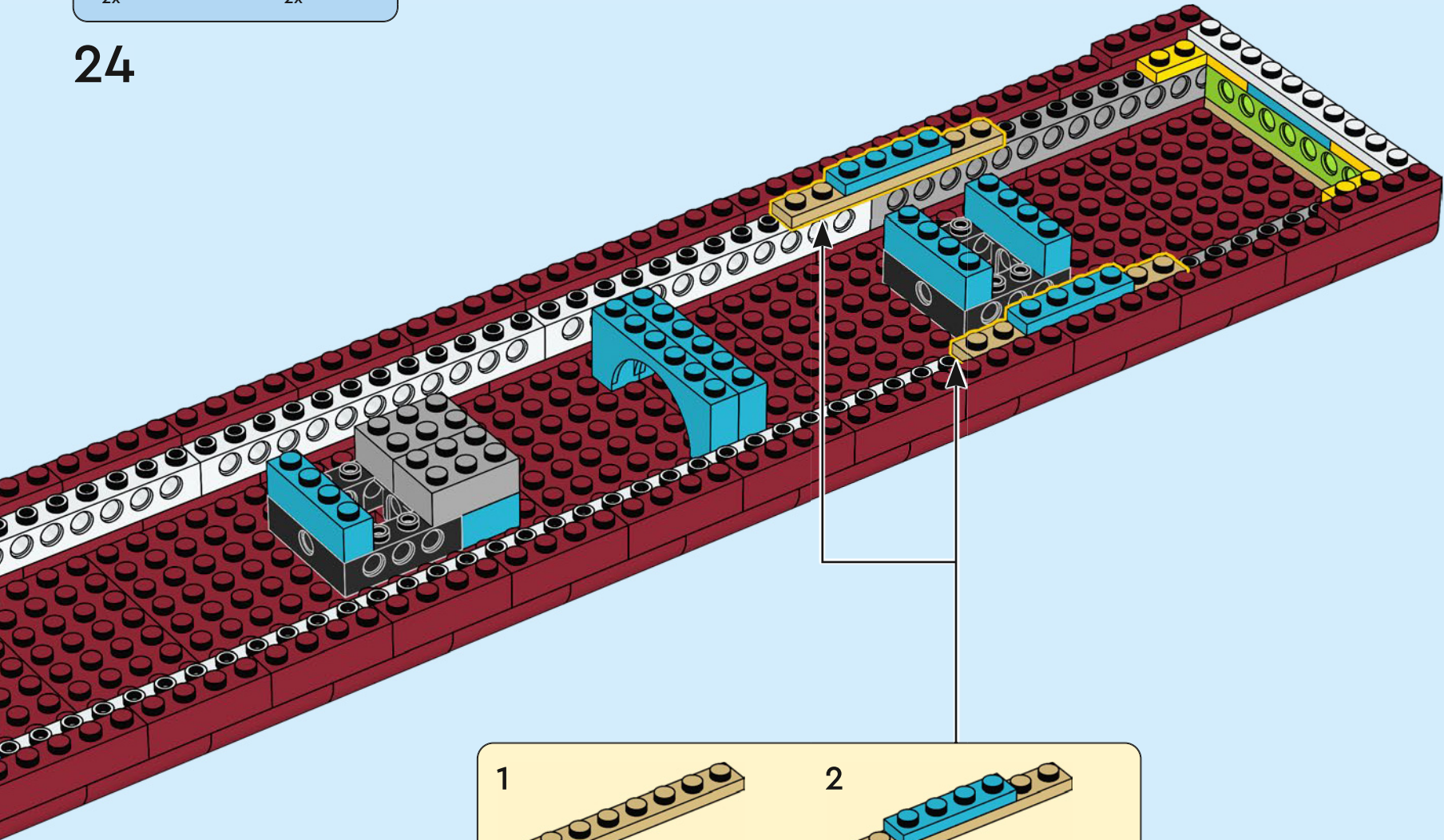

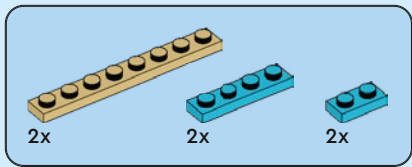

25

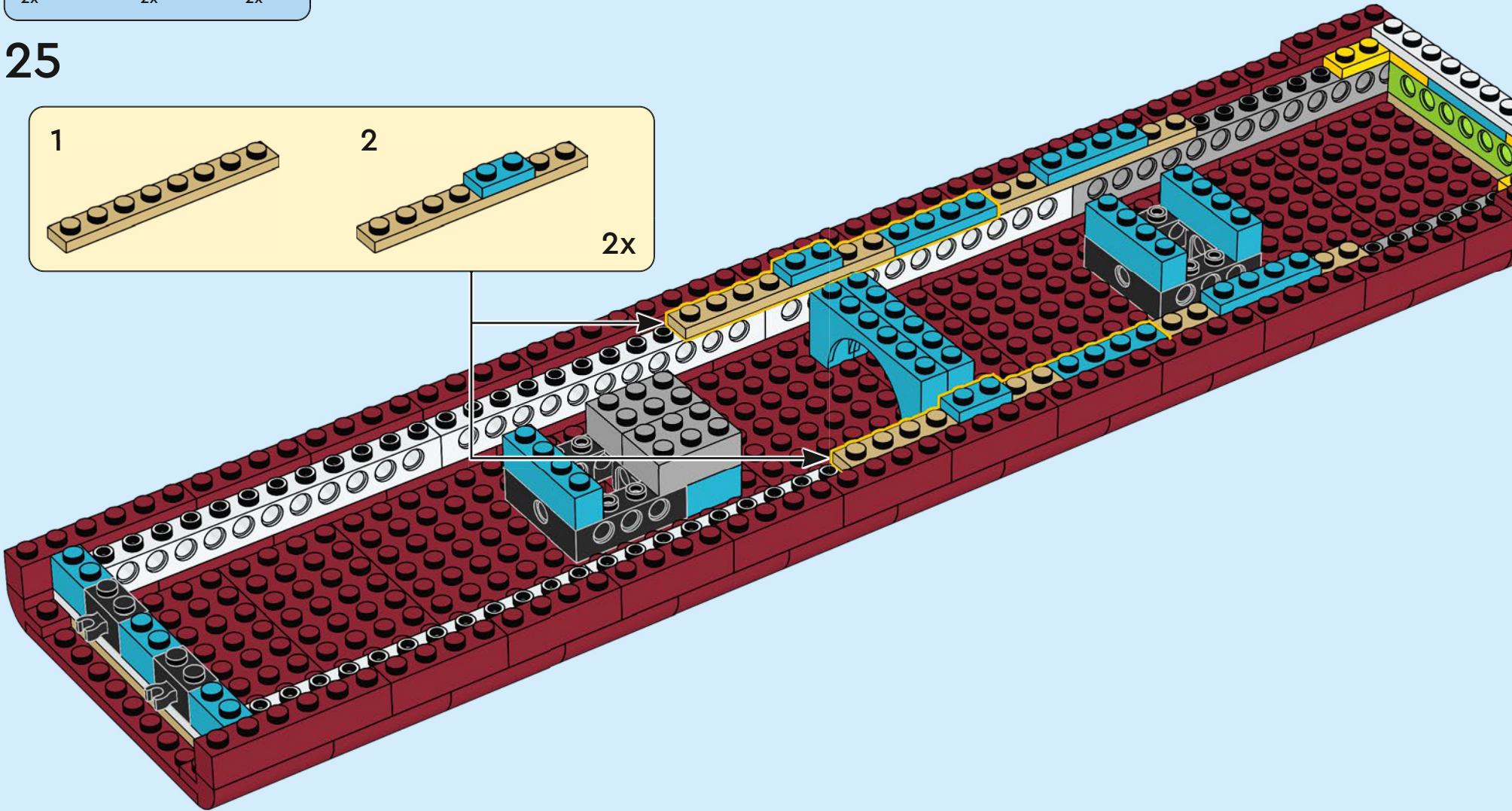
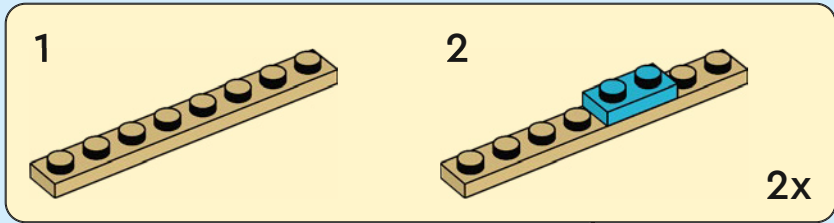

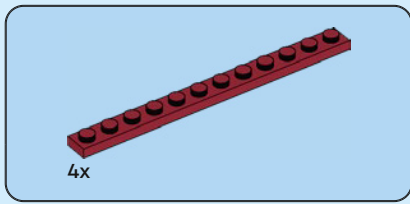

26

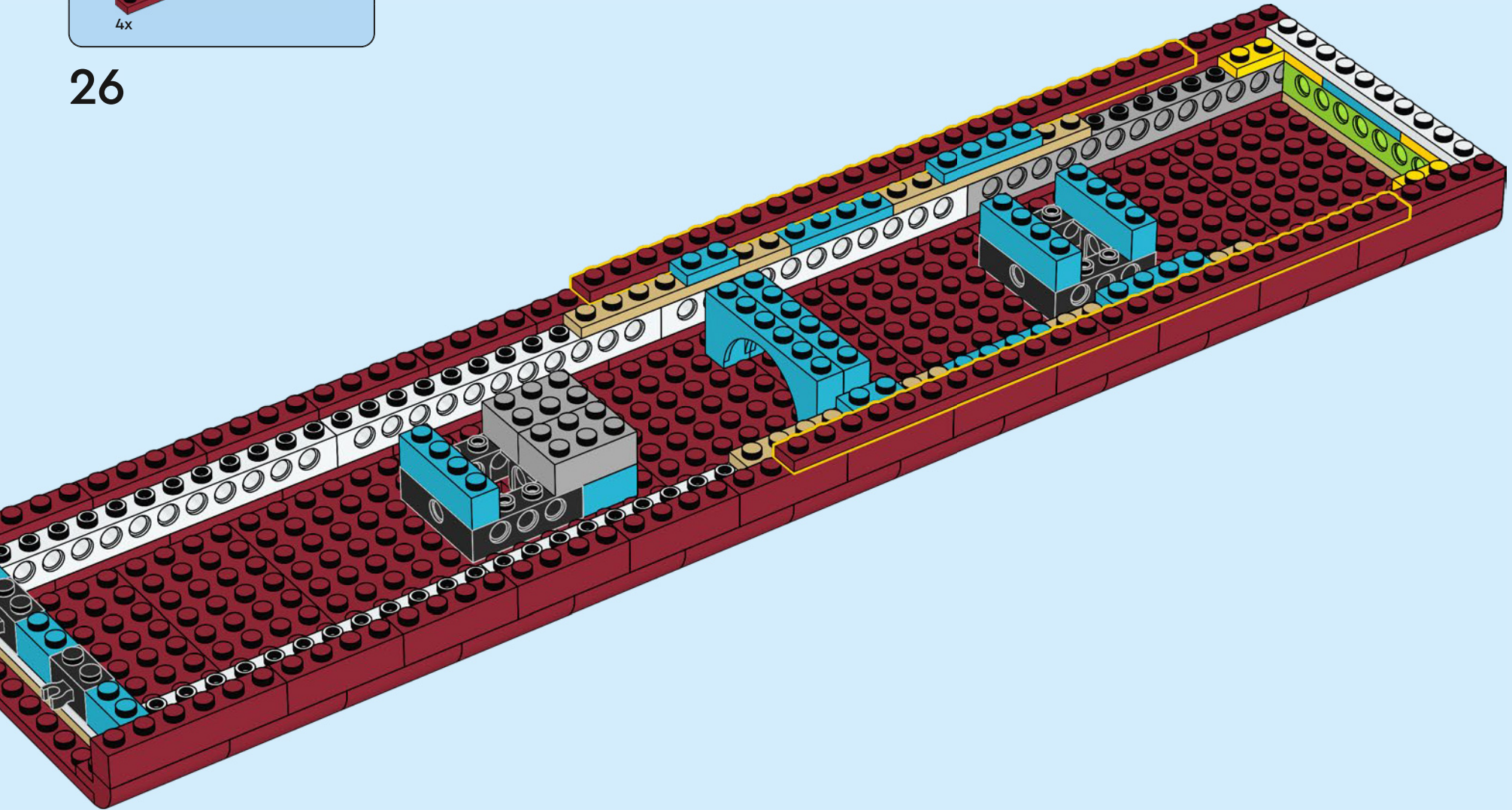

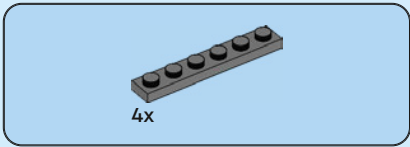

27

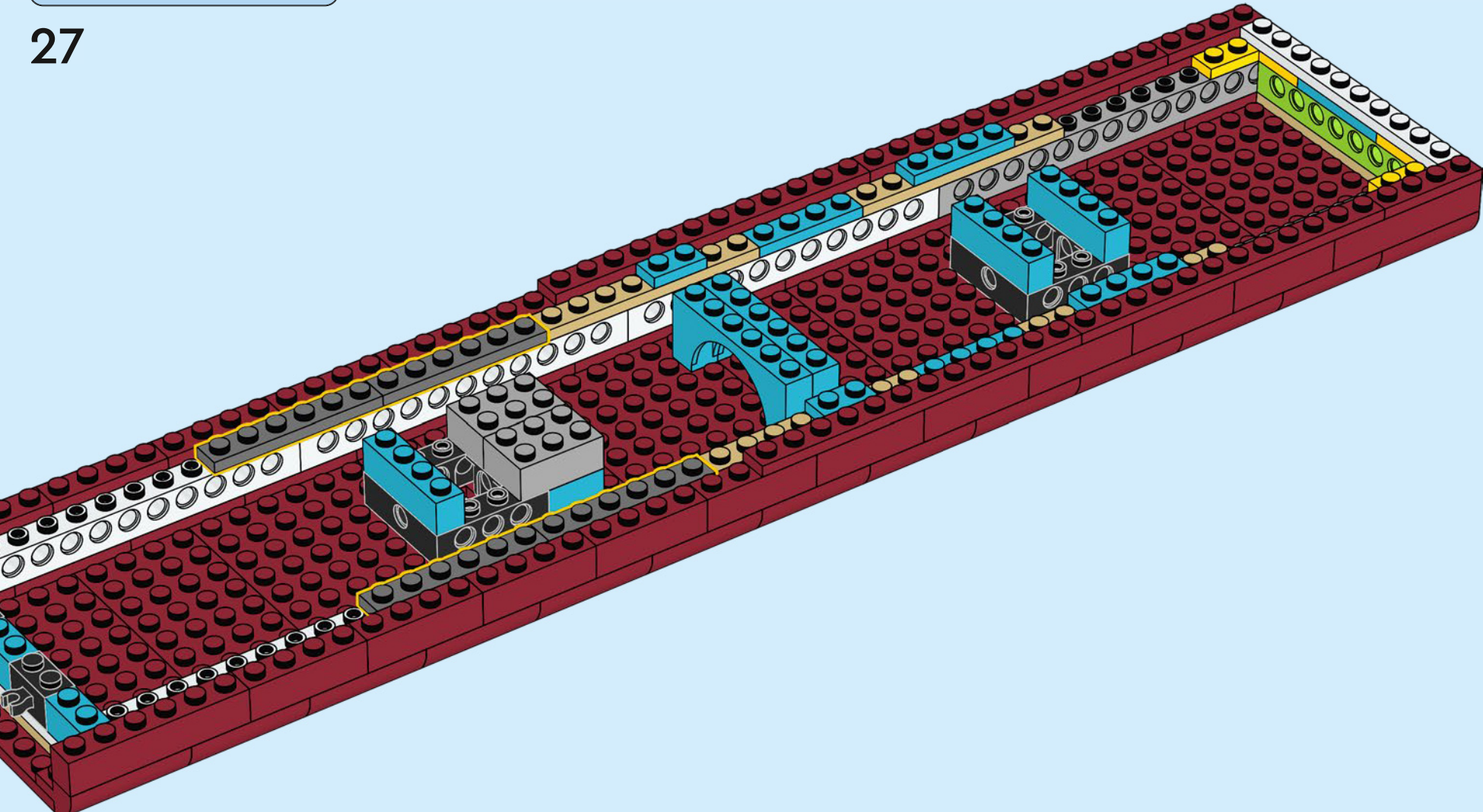

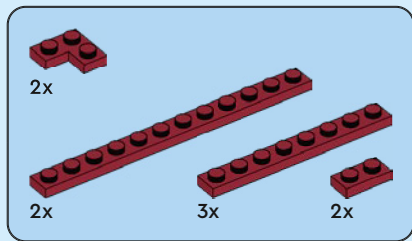

28

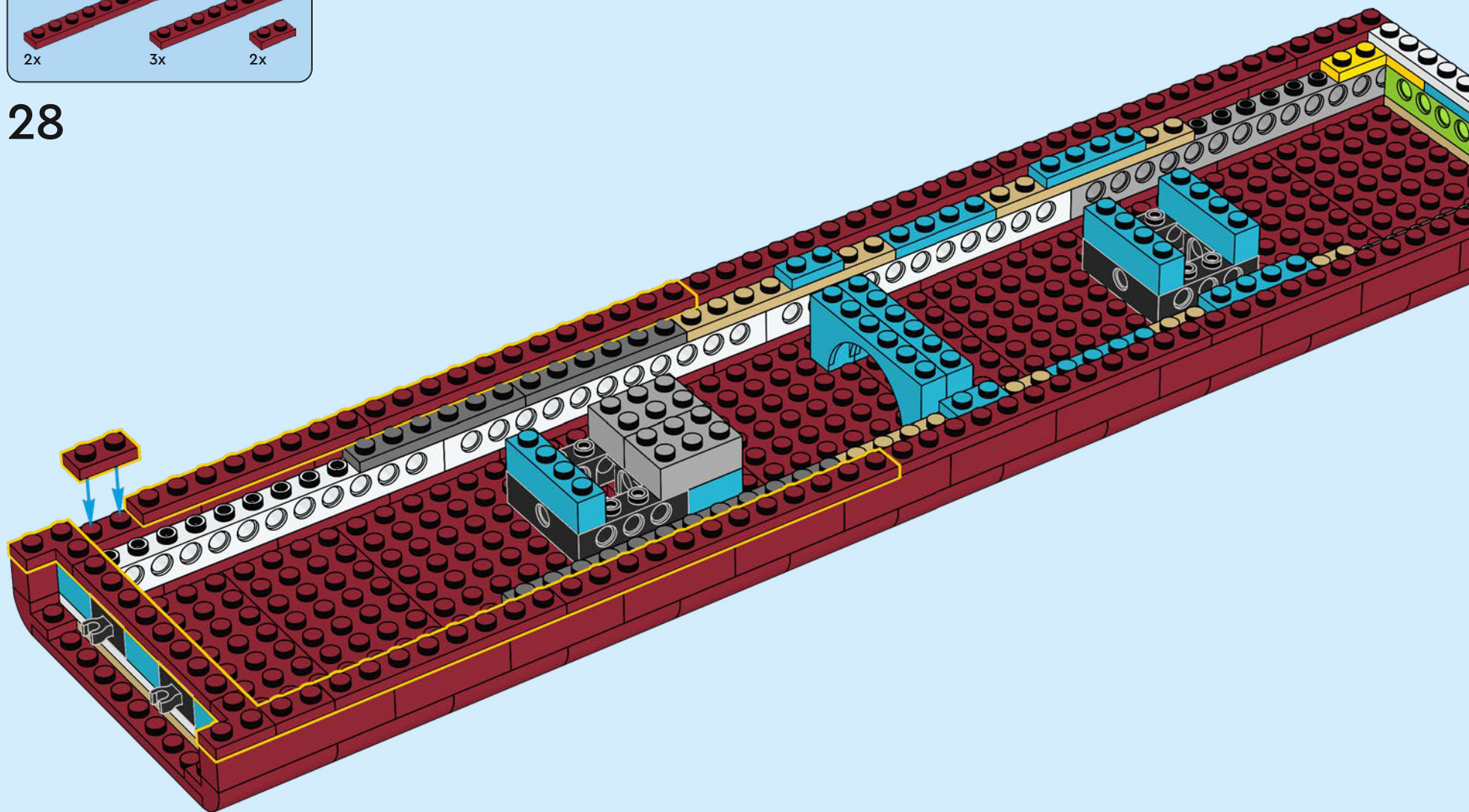

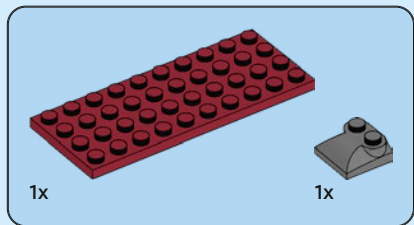
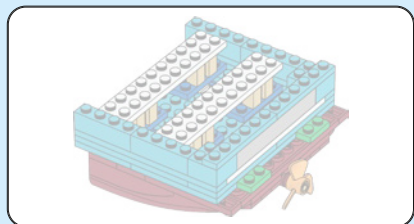

29

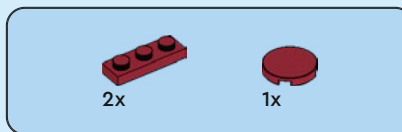
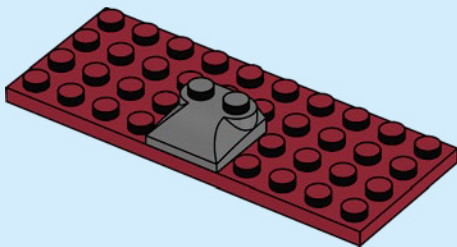

30

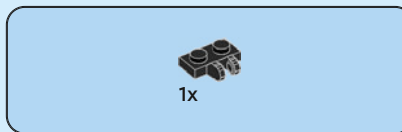
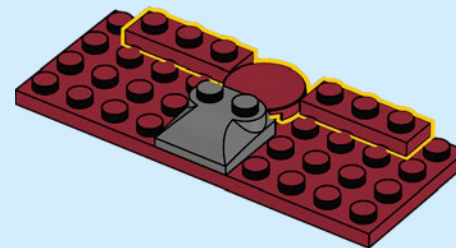

31

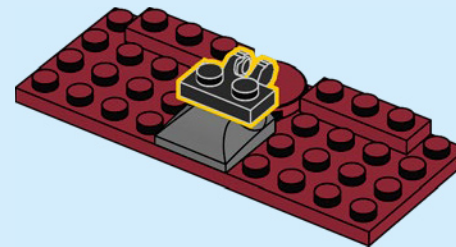

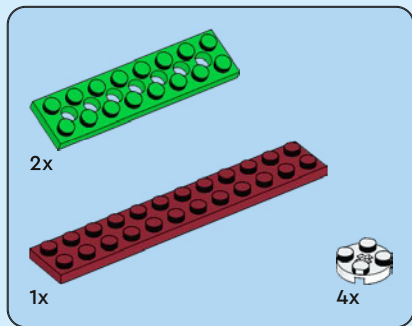

32

1

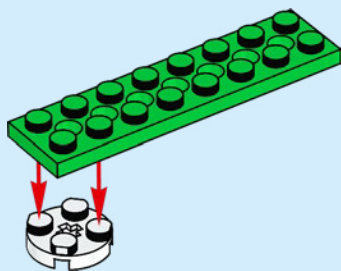

2

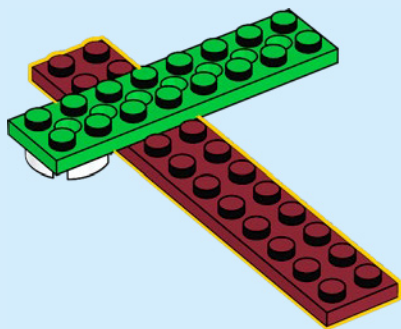

3

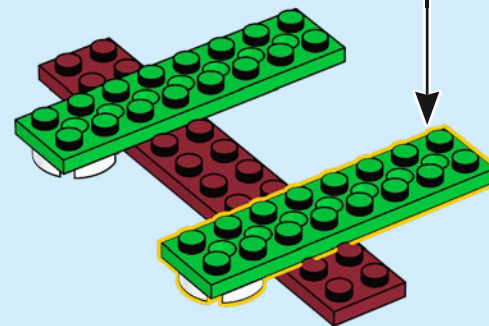
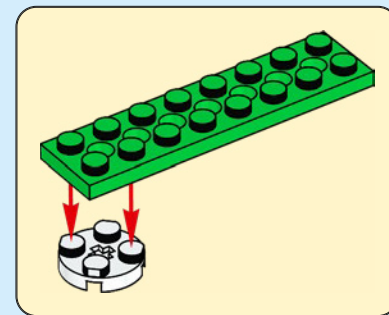

4

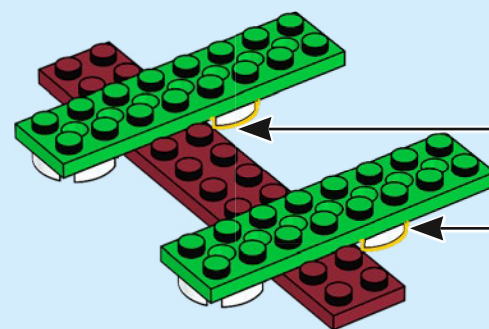

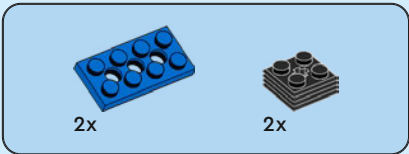

33

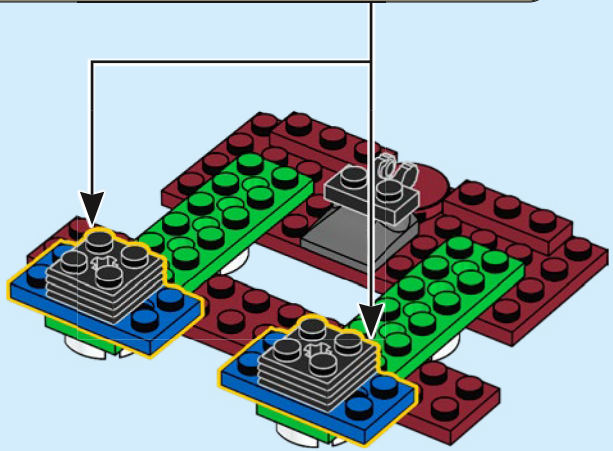
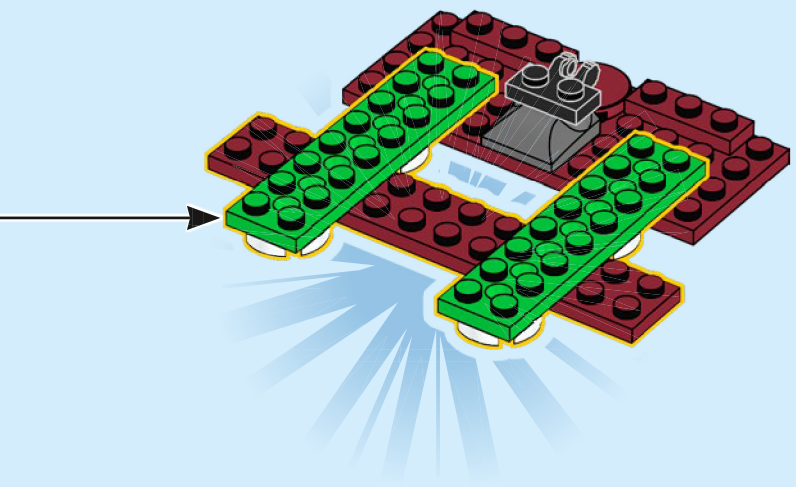
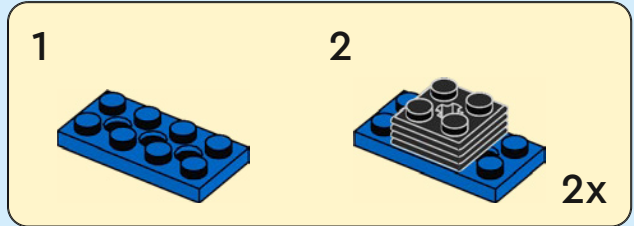

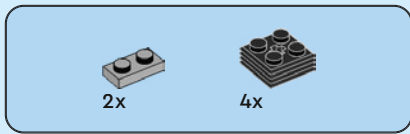

34

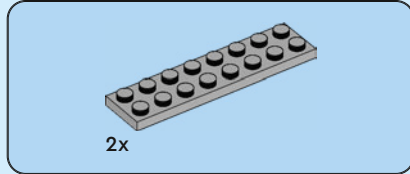
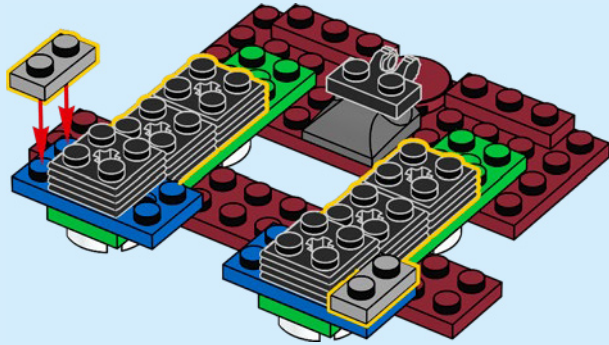

35

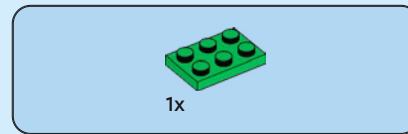
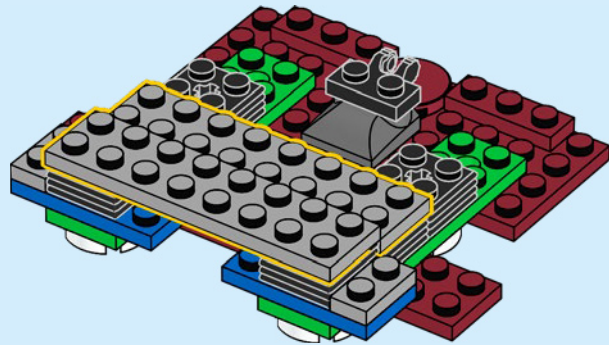

36

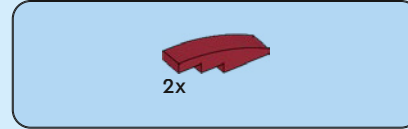
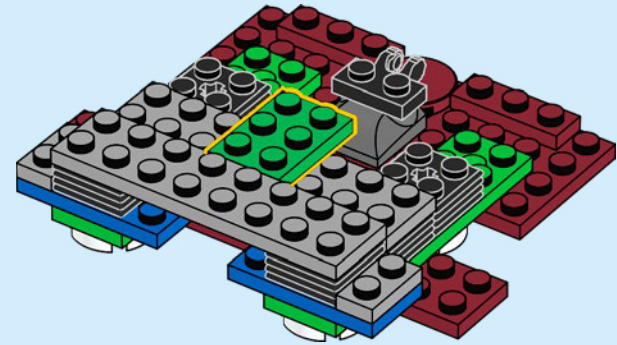

37

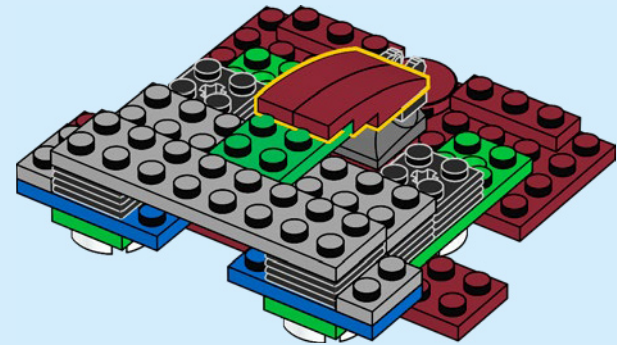

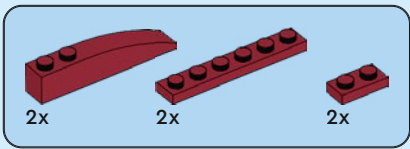

38

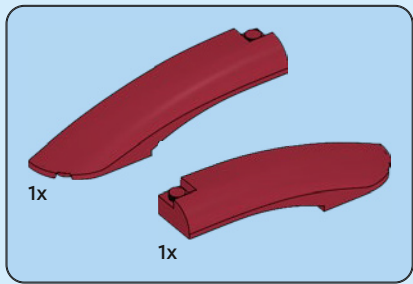
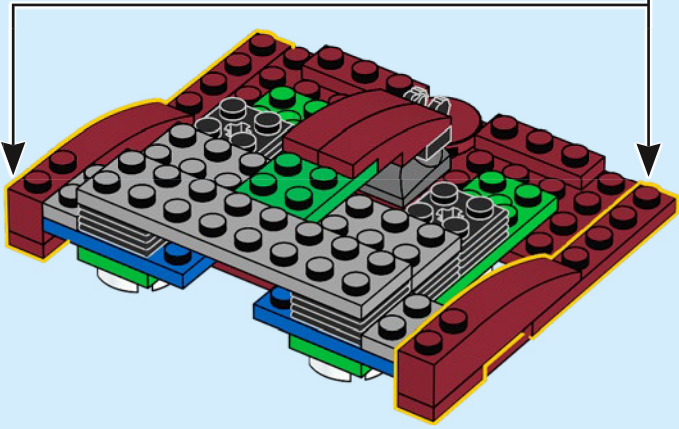
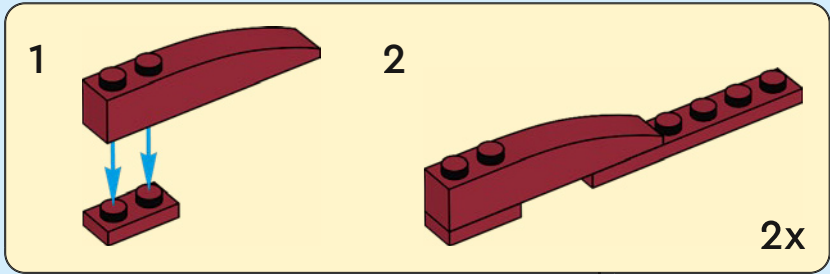

39

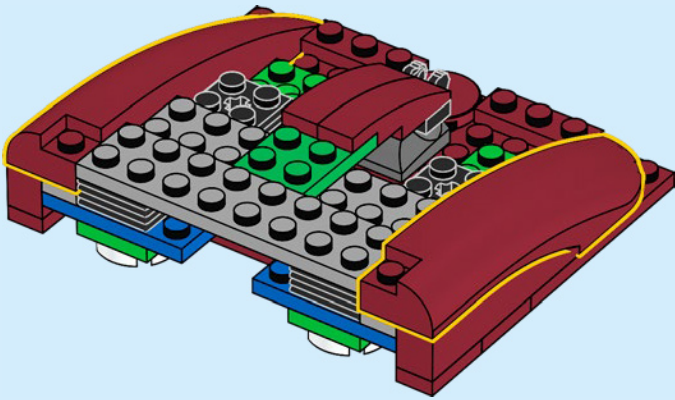

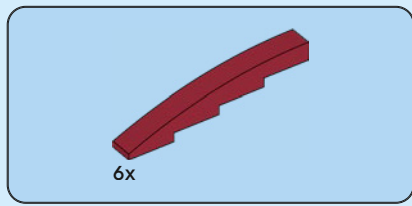

40

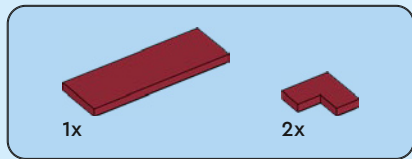
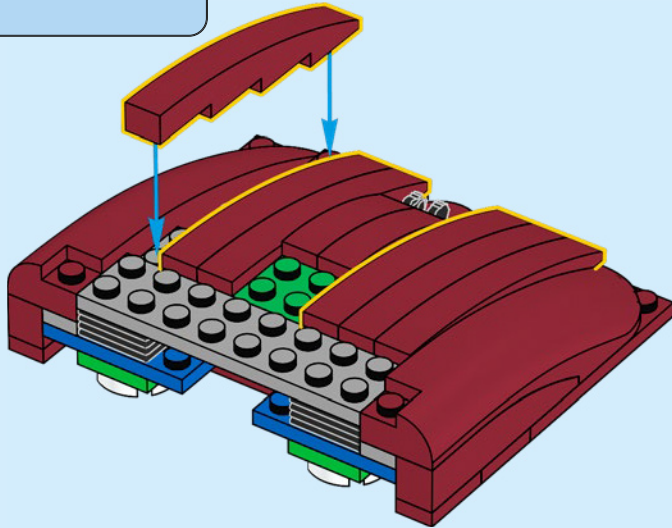

41

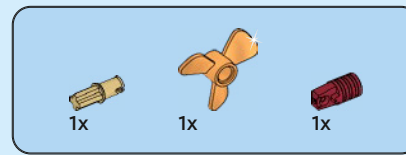
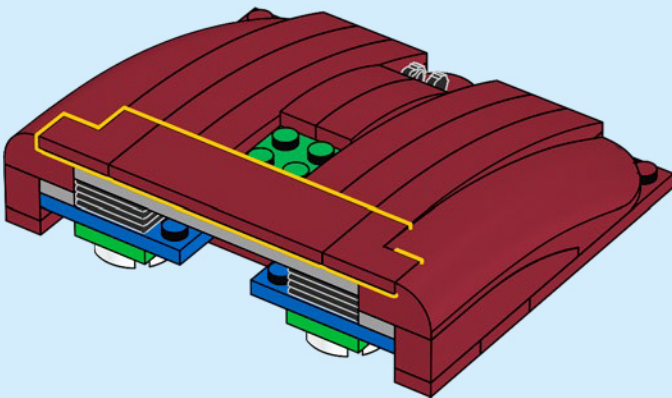

42

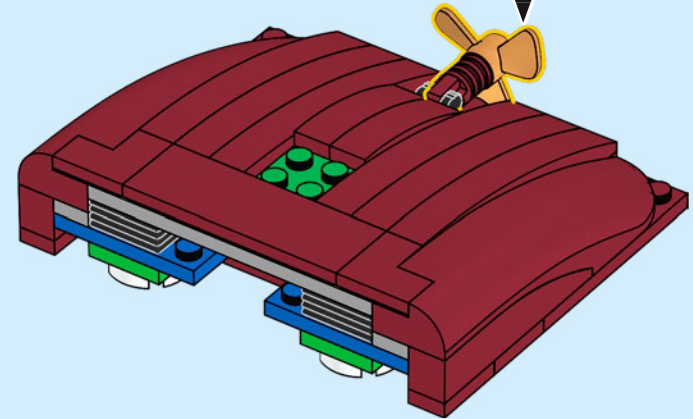
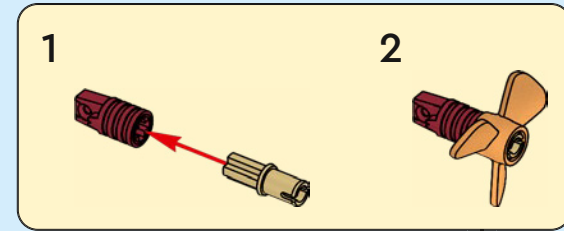

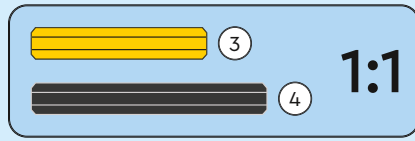
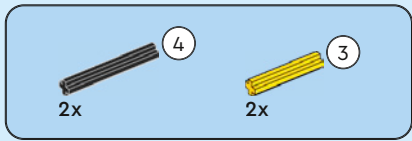

43

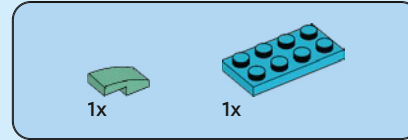
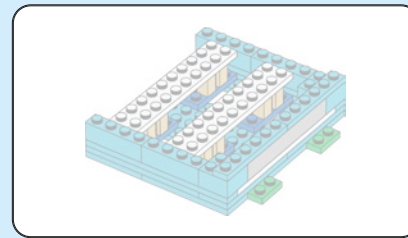
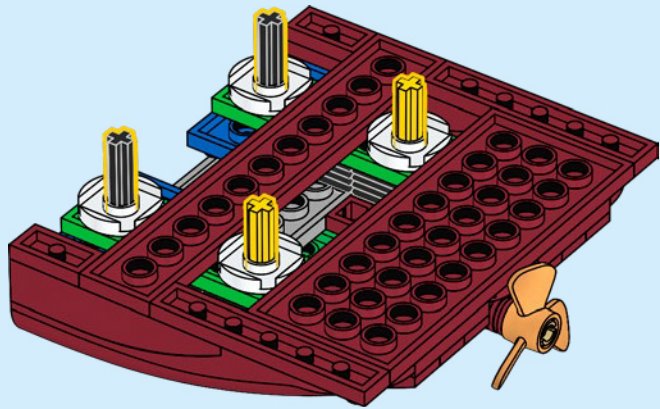

44

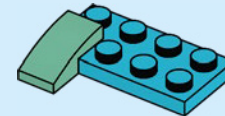

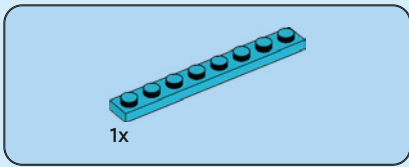

45

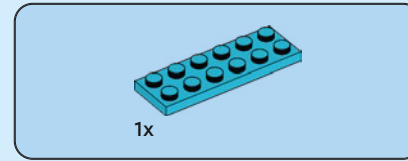
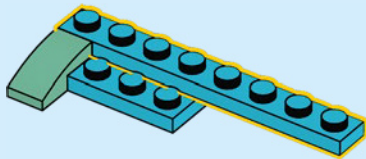
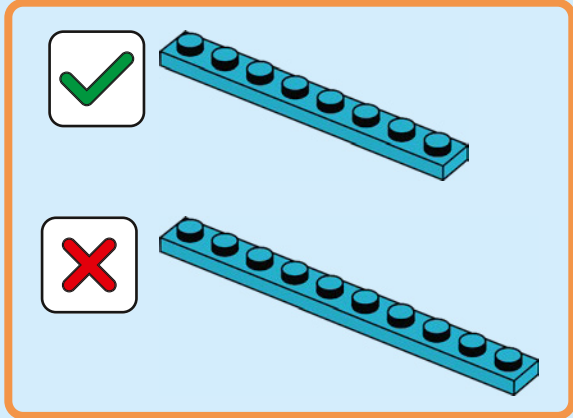

46

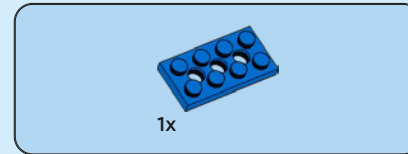
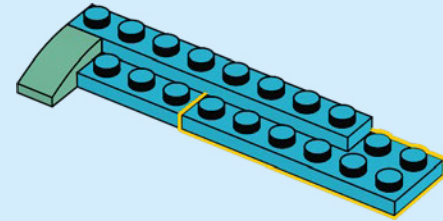

47

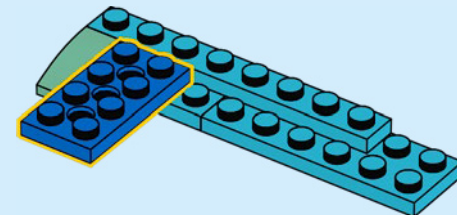

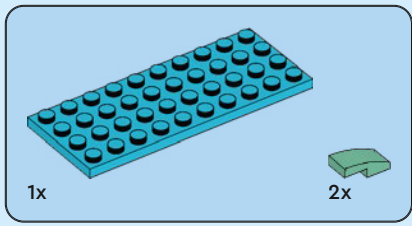

48

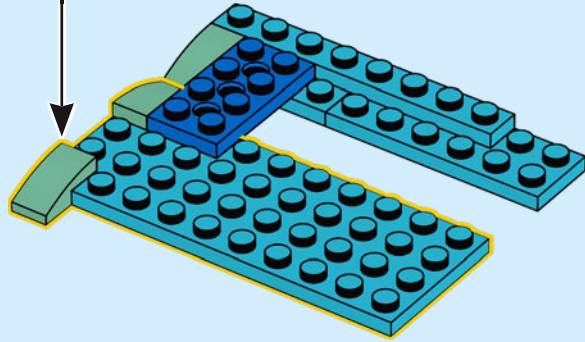
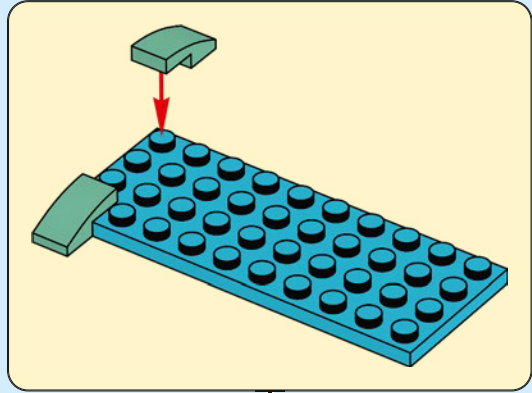

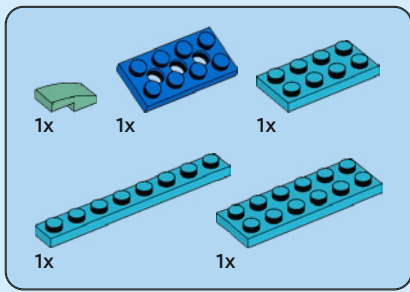

49

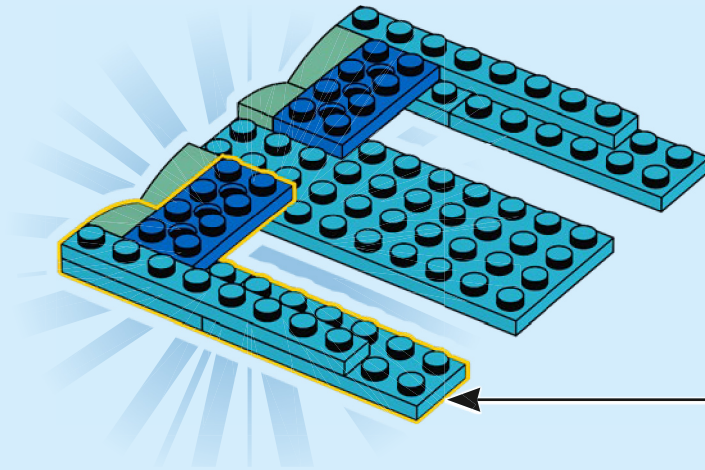
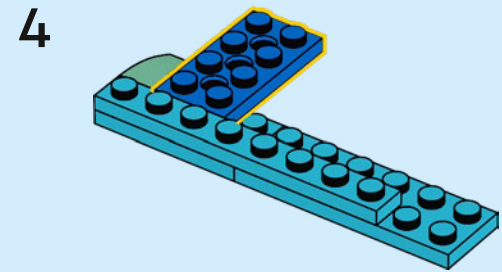
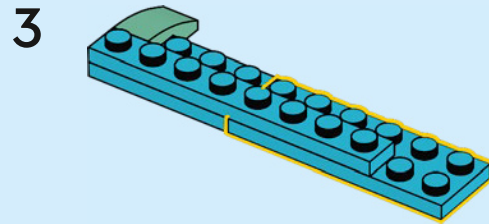
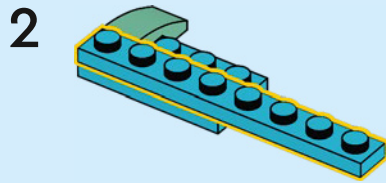
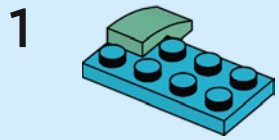
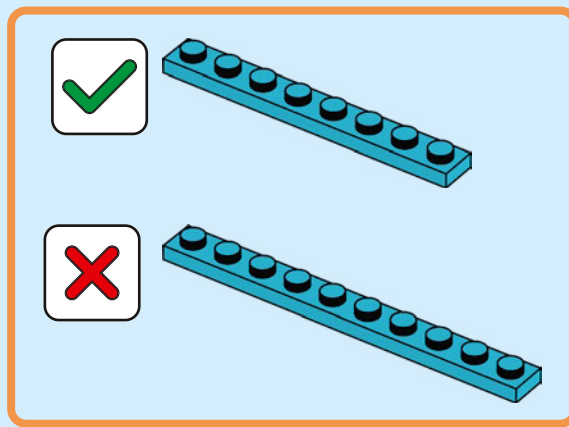



50

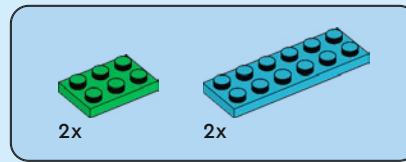
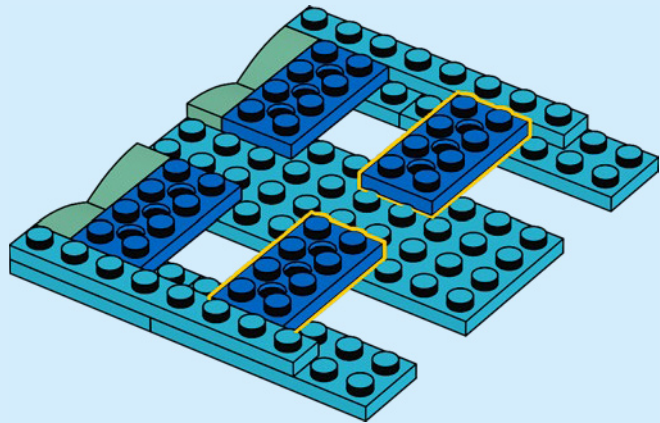

51

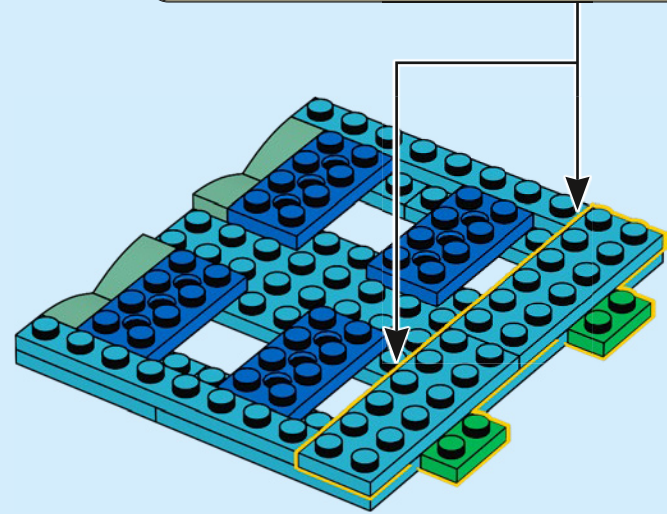
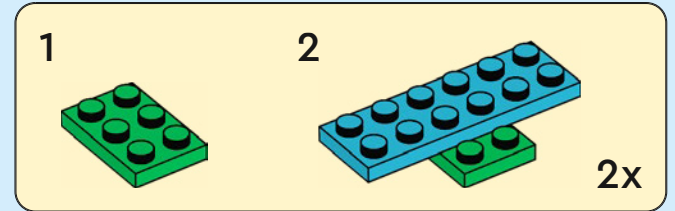

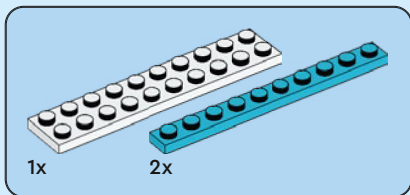

52

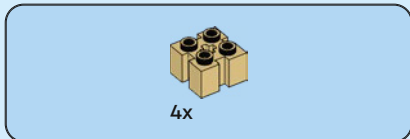
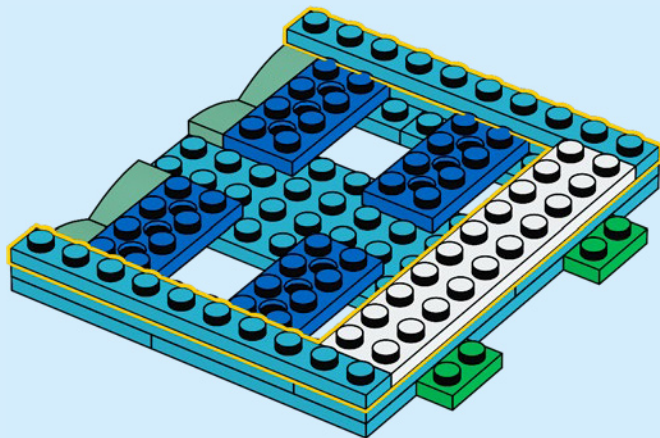

53

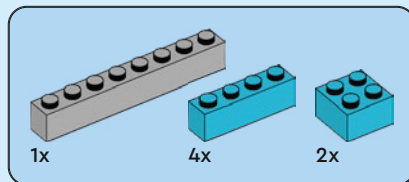
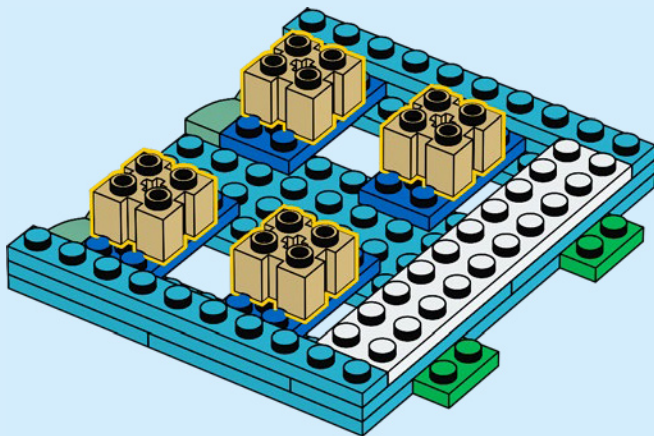

54

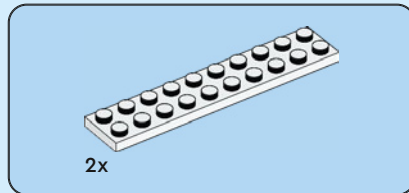
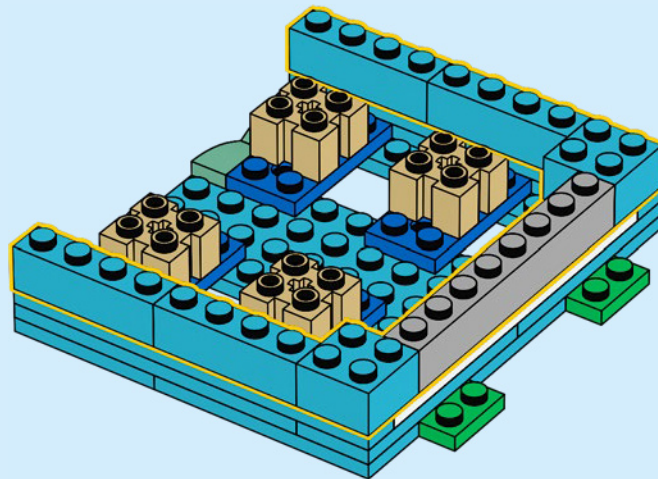

55

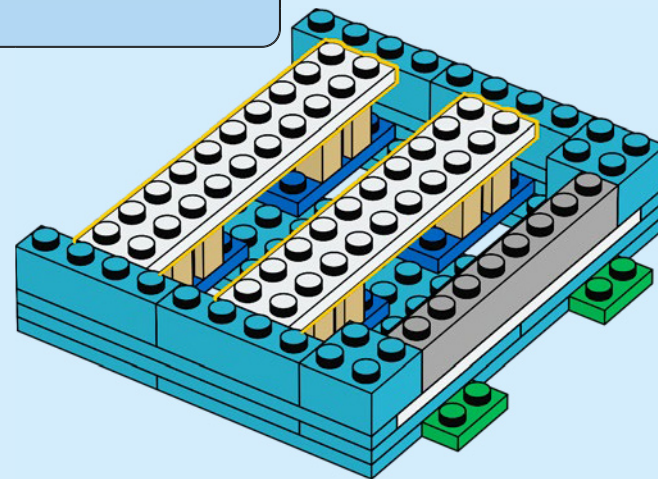

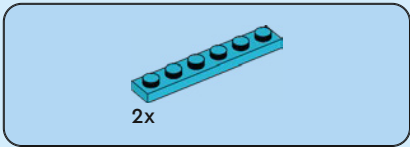

56

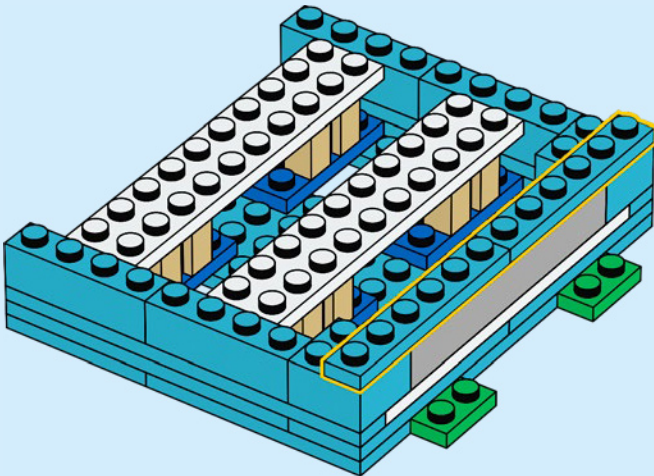

57

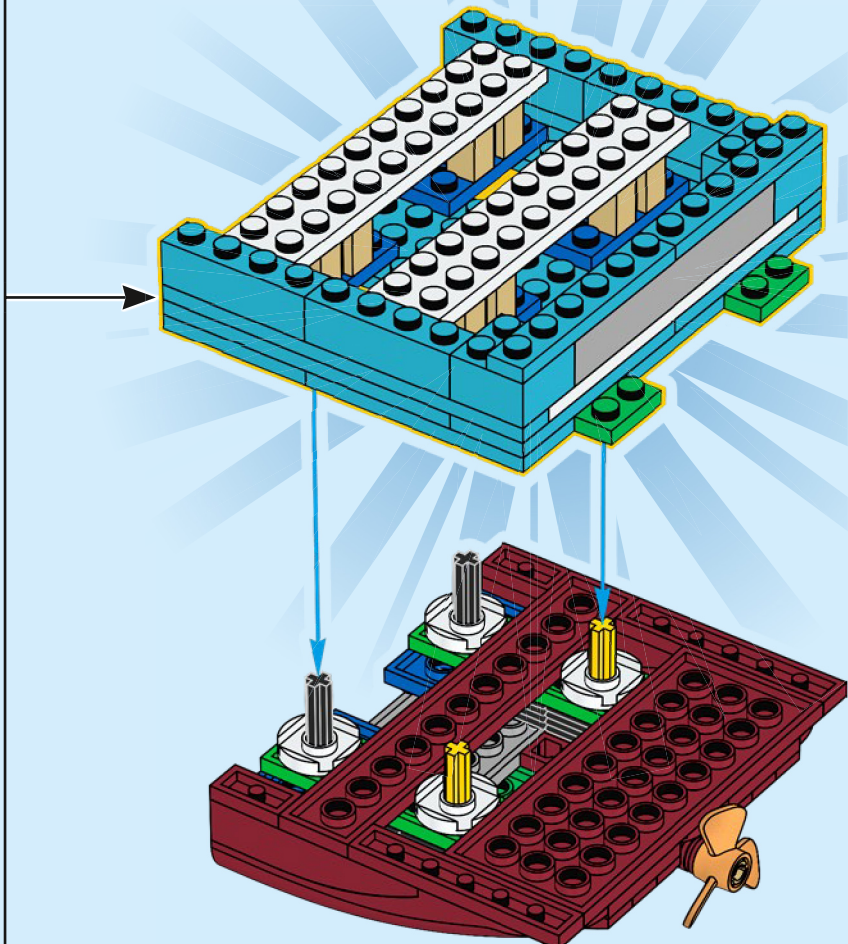

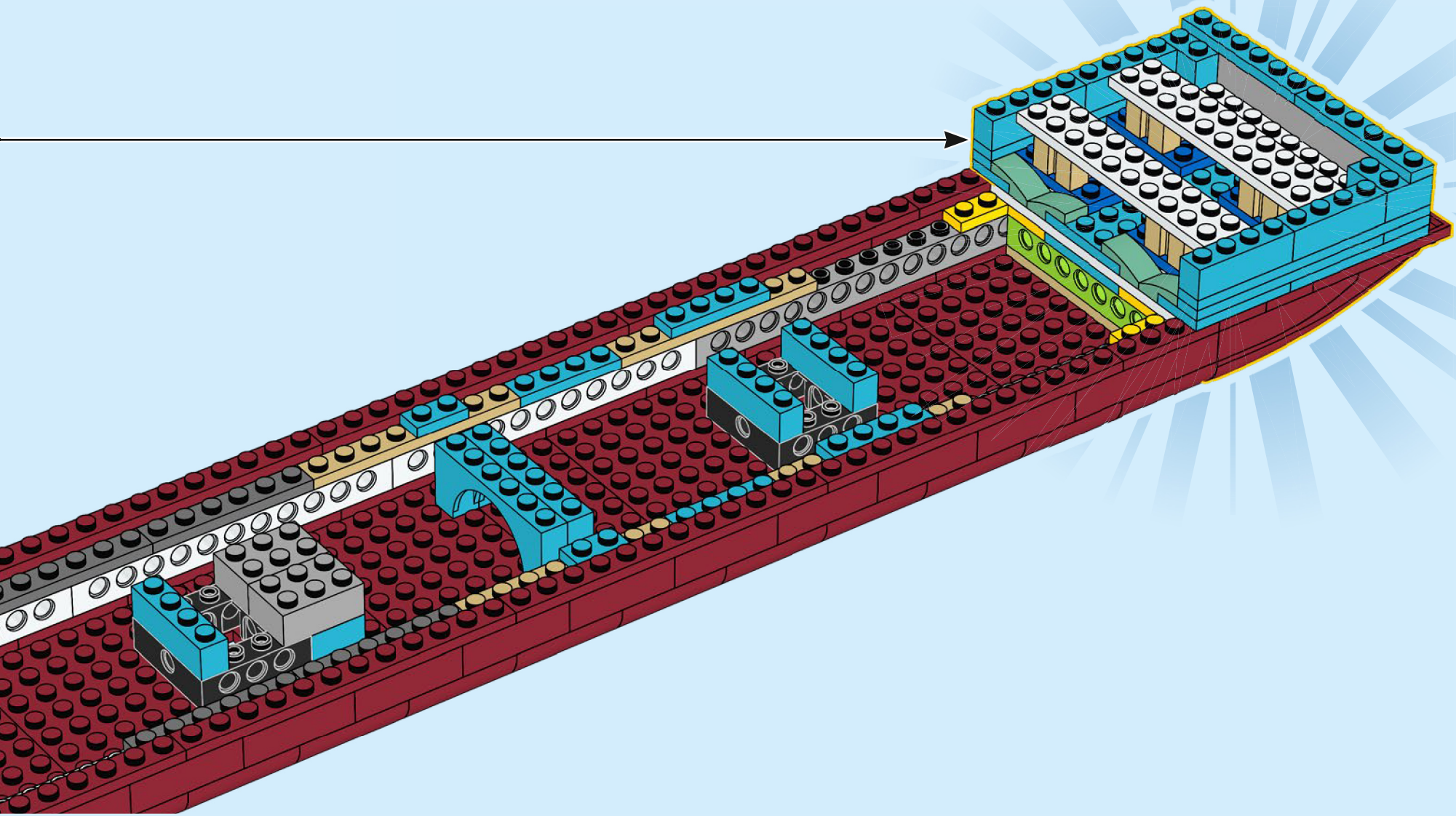

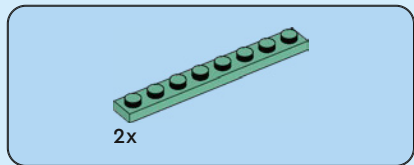
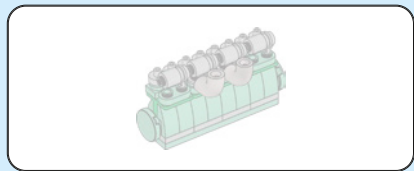

59

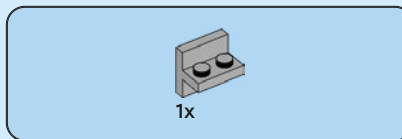
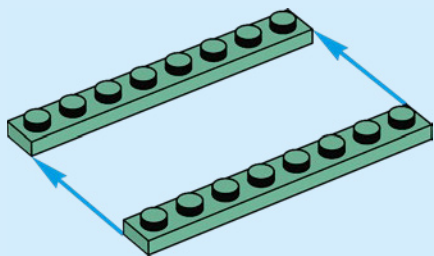

60

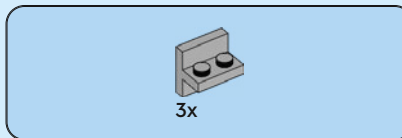
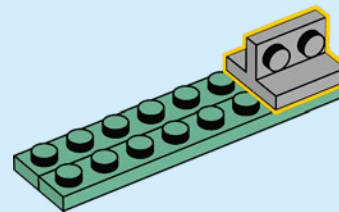

61

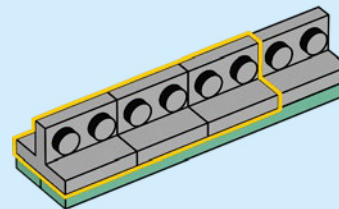



62

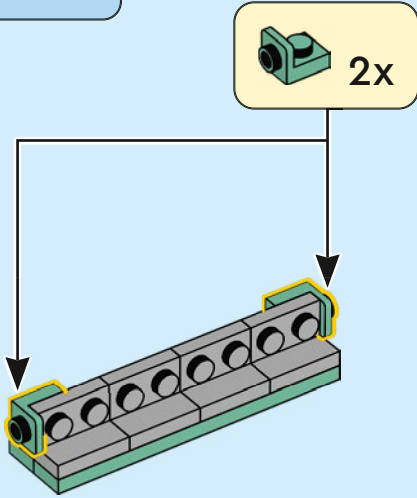

63

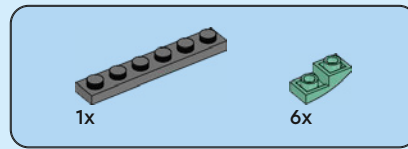
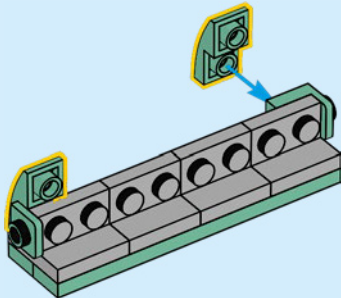

64

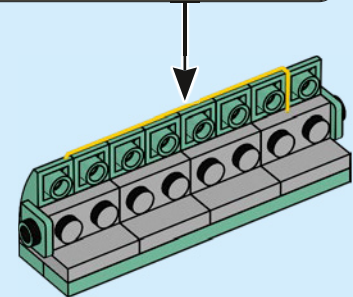
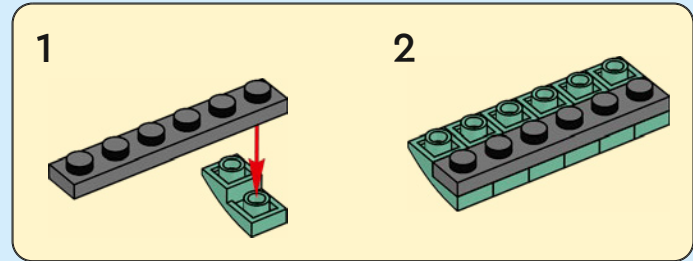

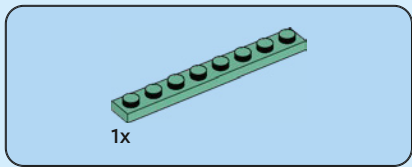

65

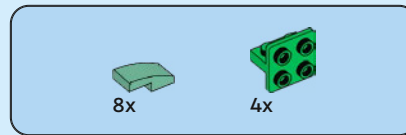
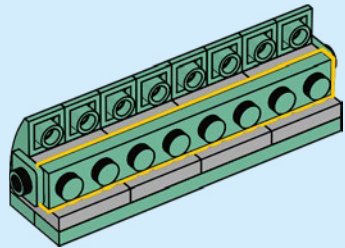

66

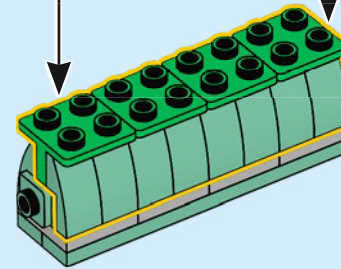
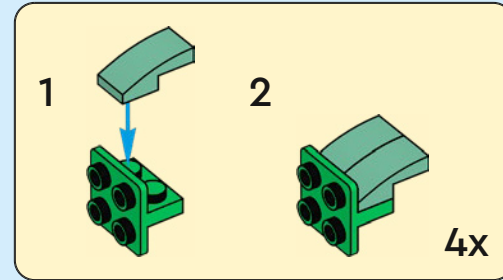

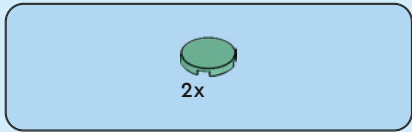

67

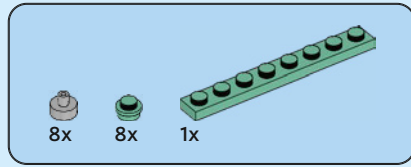
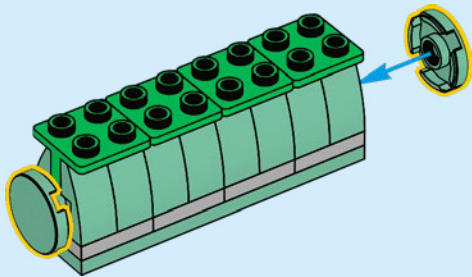

68

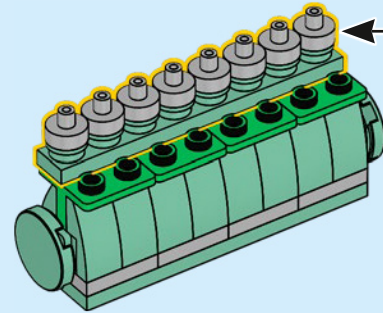
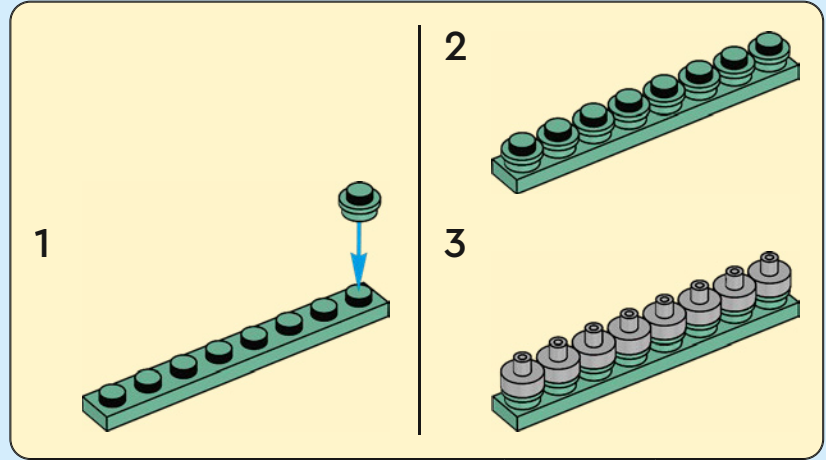



2x

69

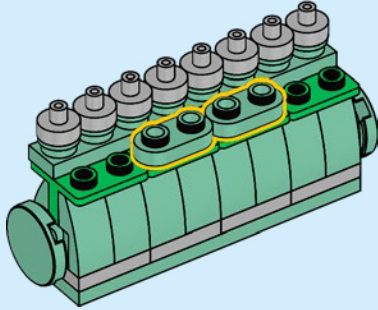

2x



2x

70

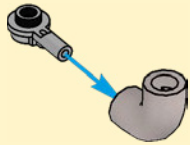
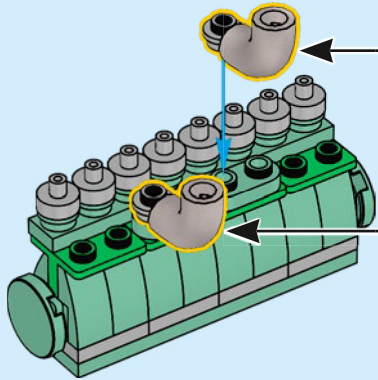

2x



2x

71

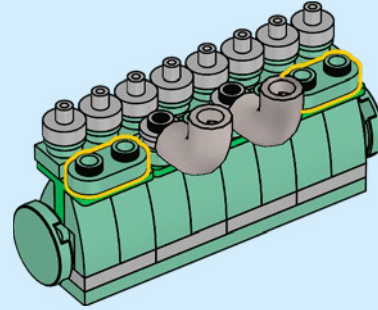

4x



4x

72

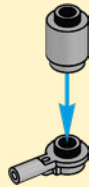
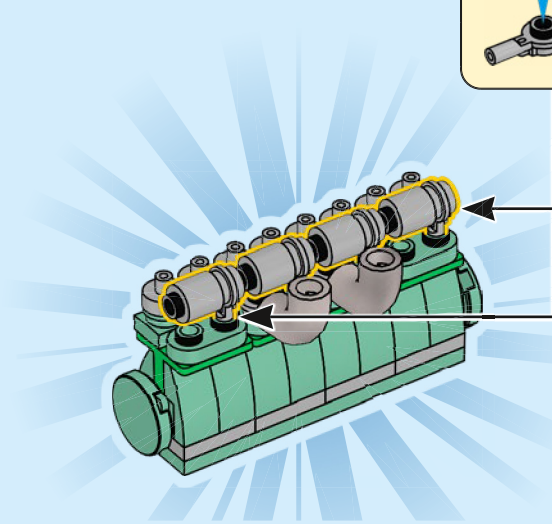

4x

73

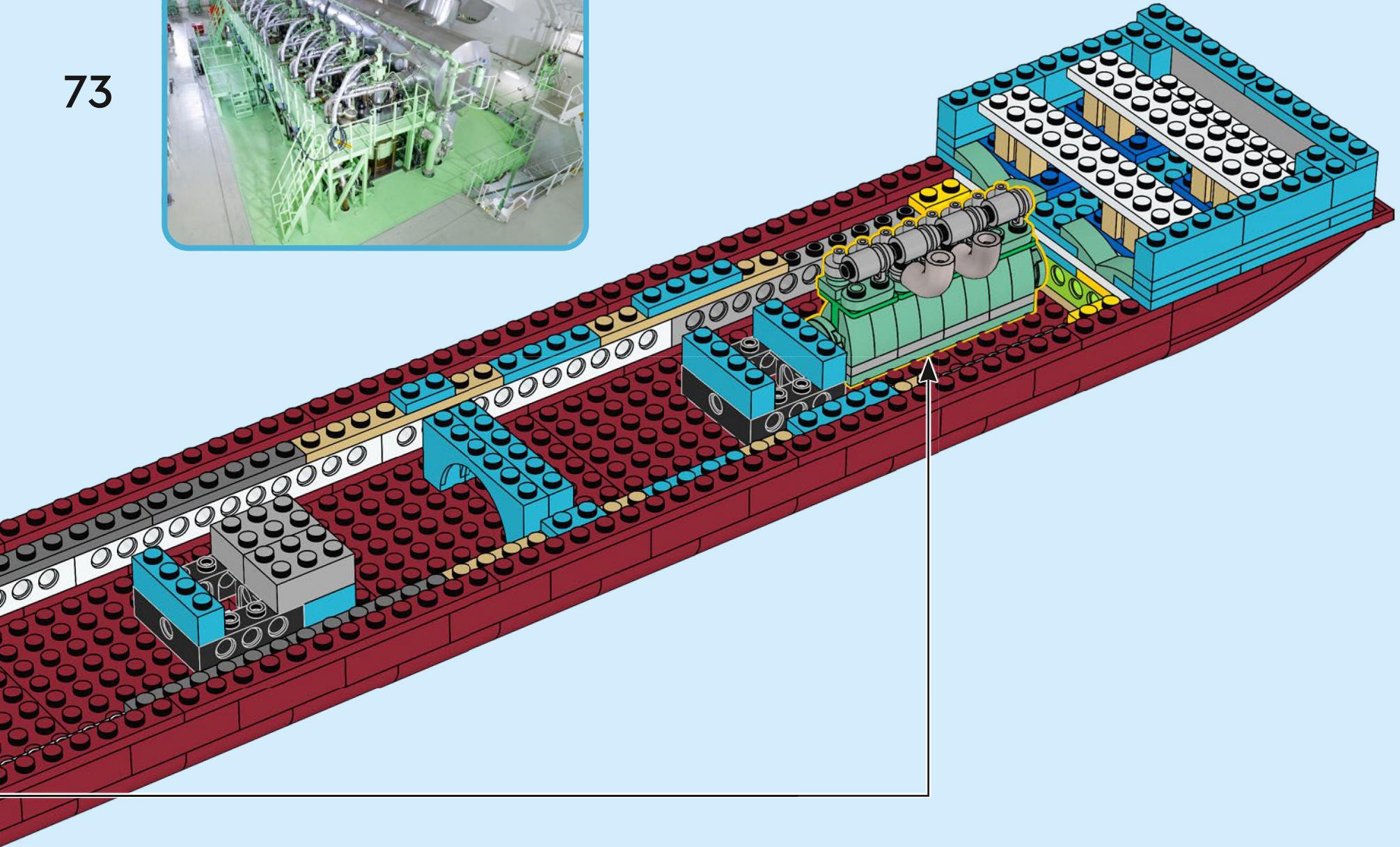
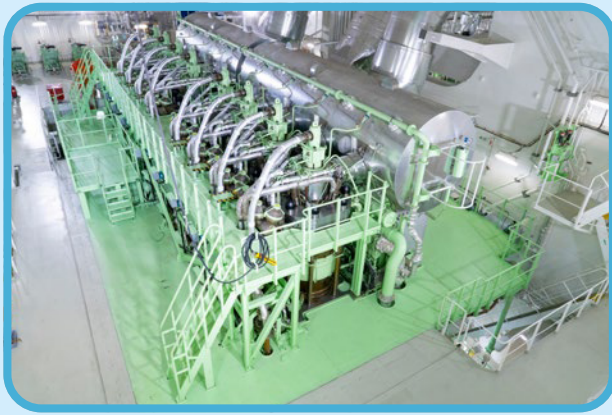

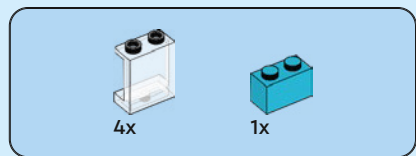

74

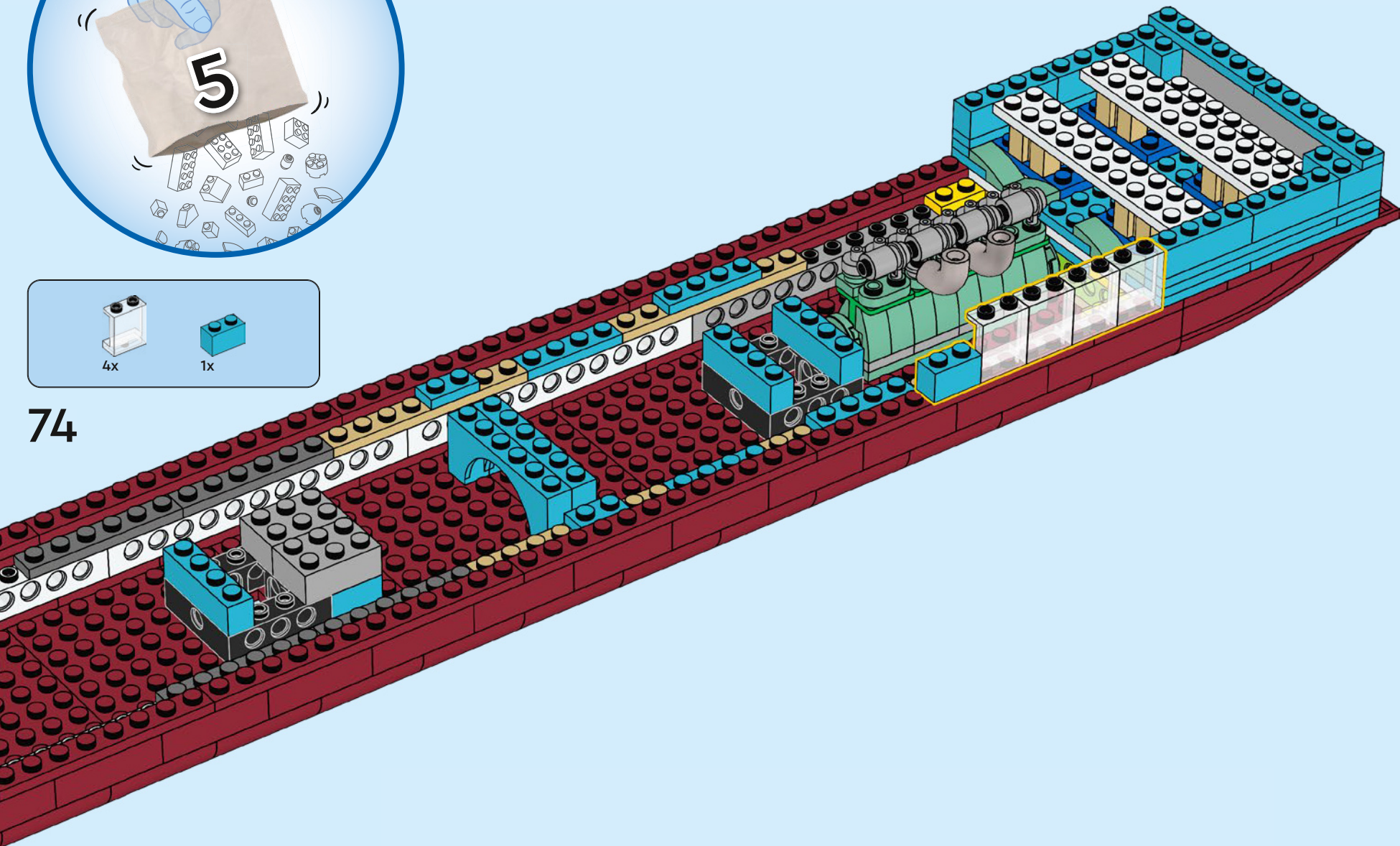

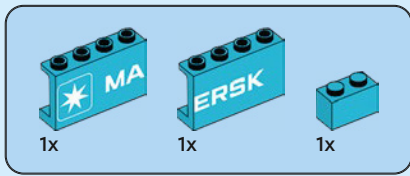

75

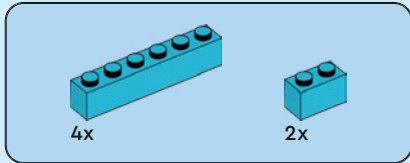
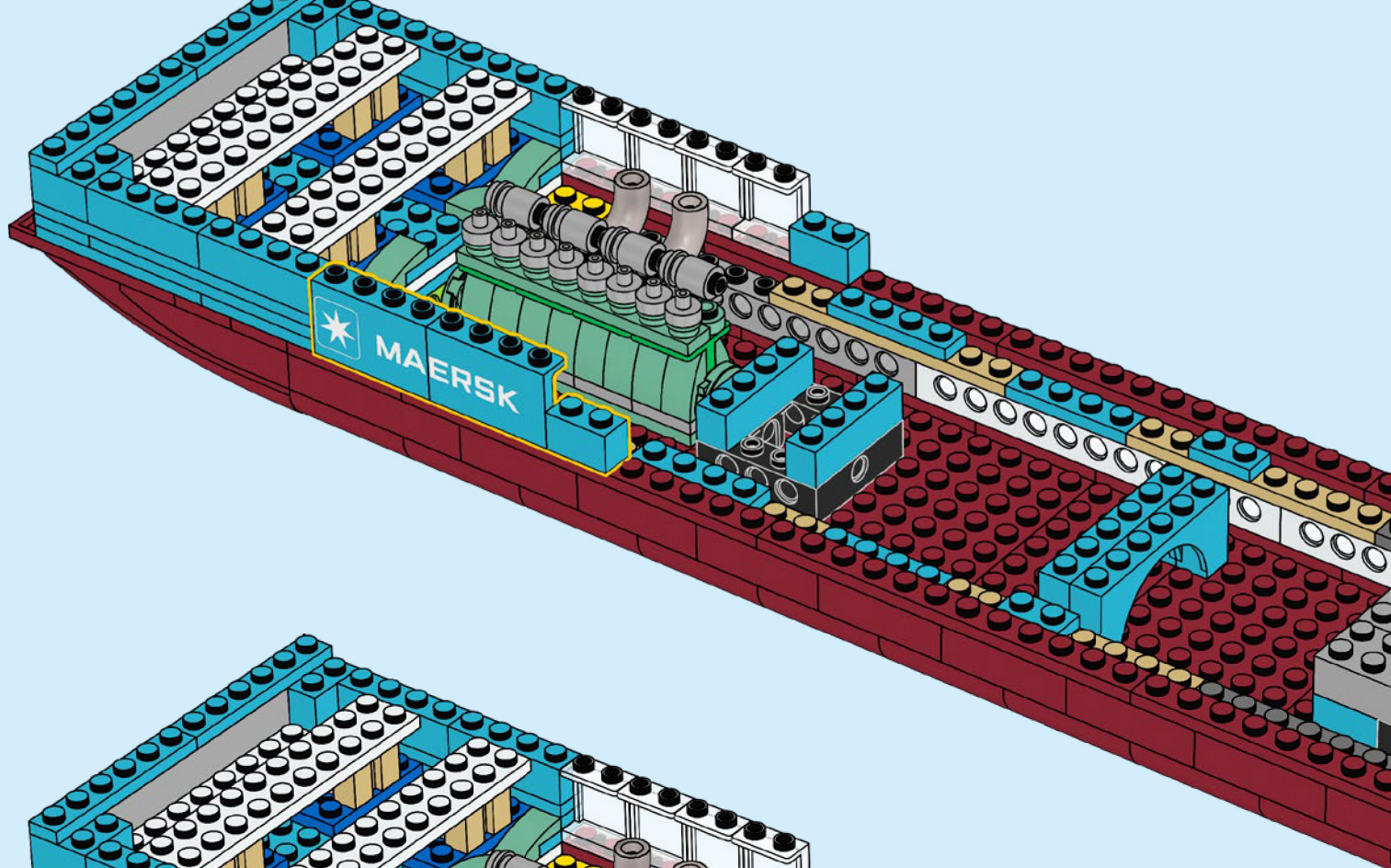

76

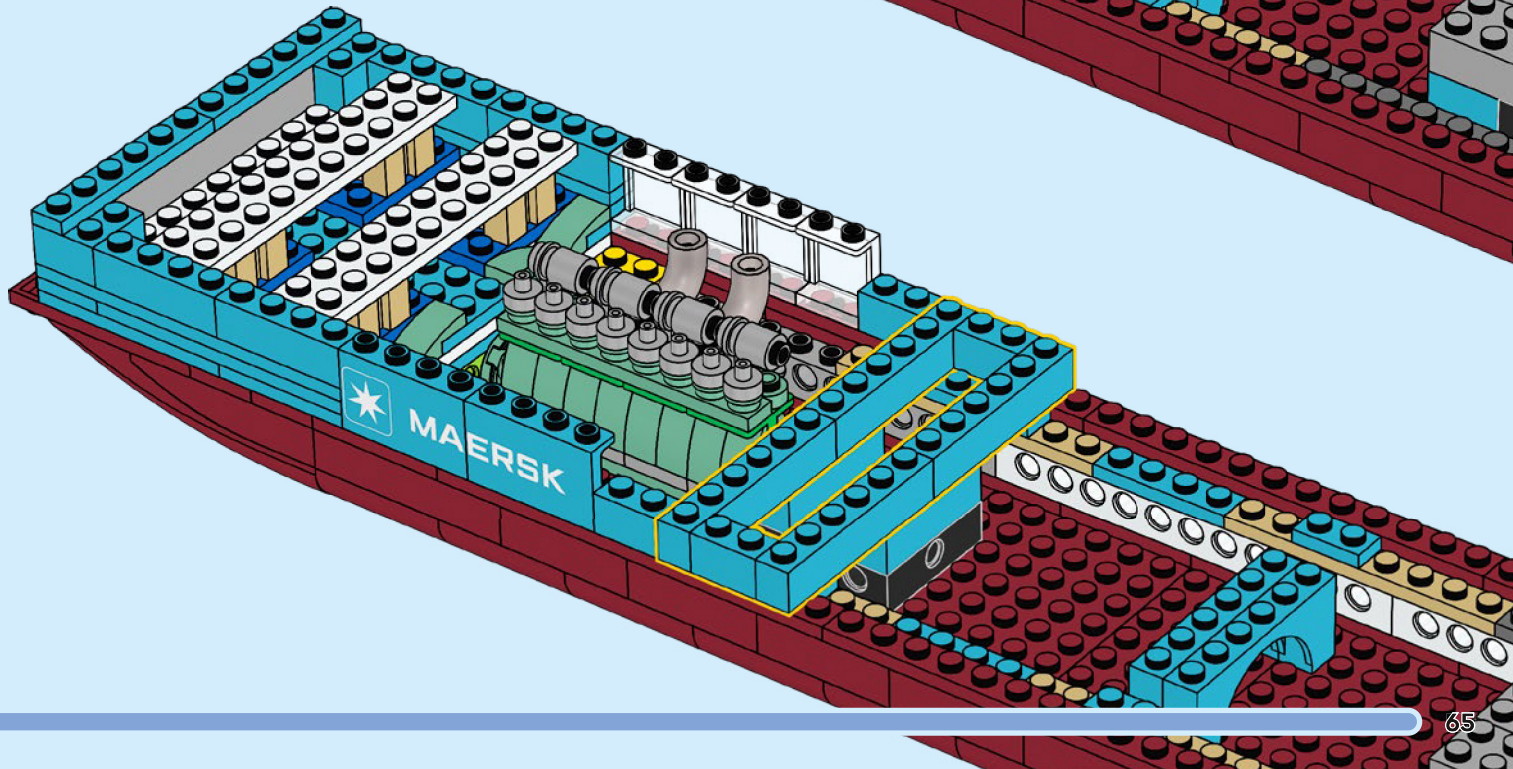

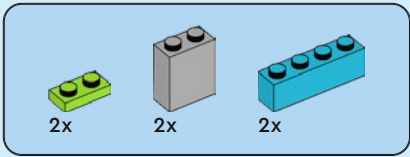

77

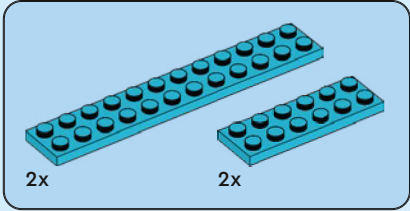
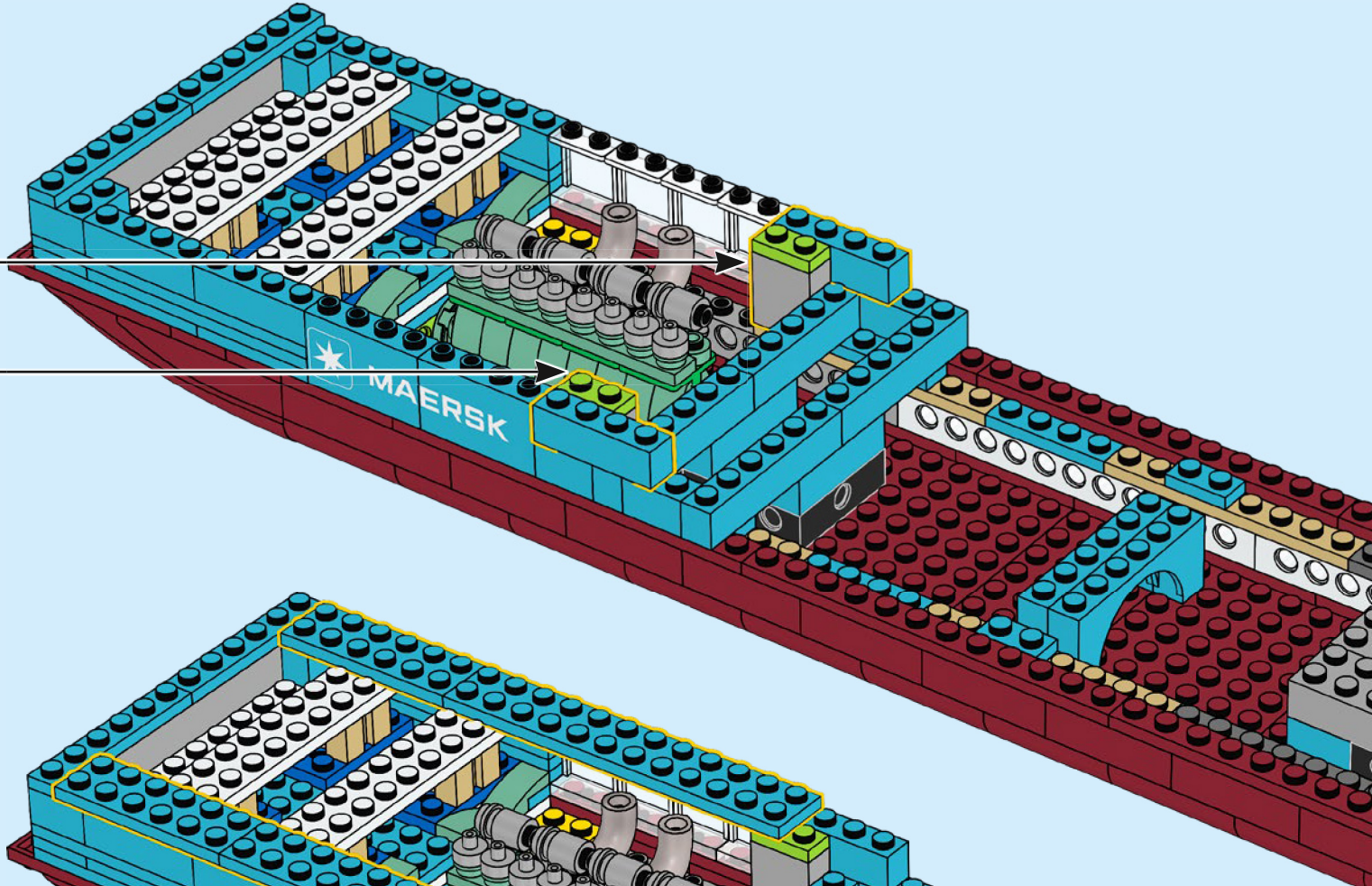
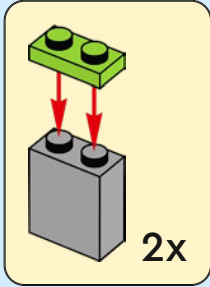

78

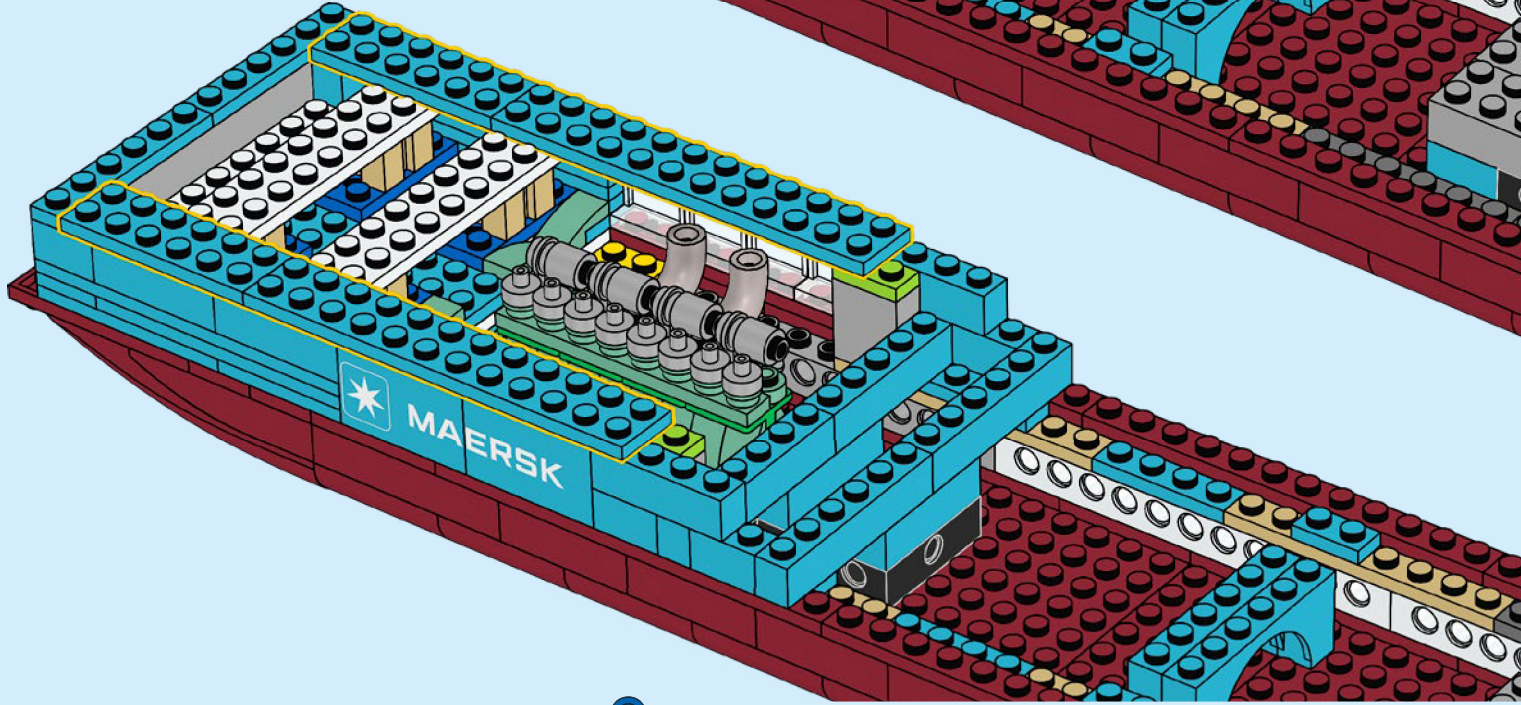

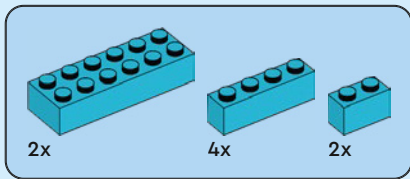

79

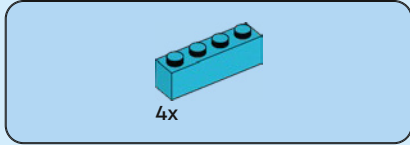
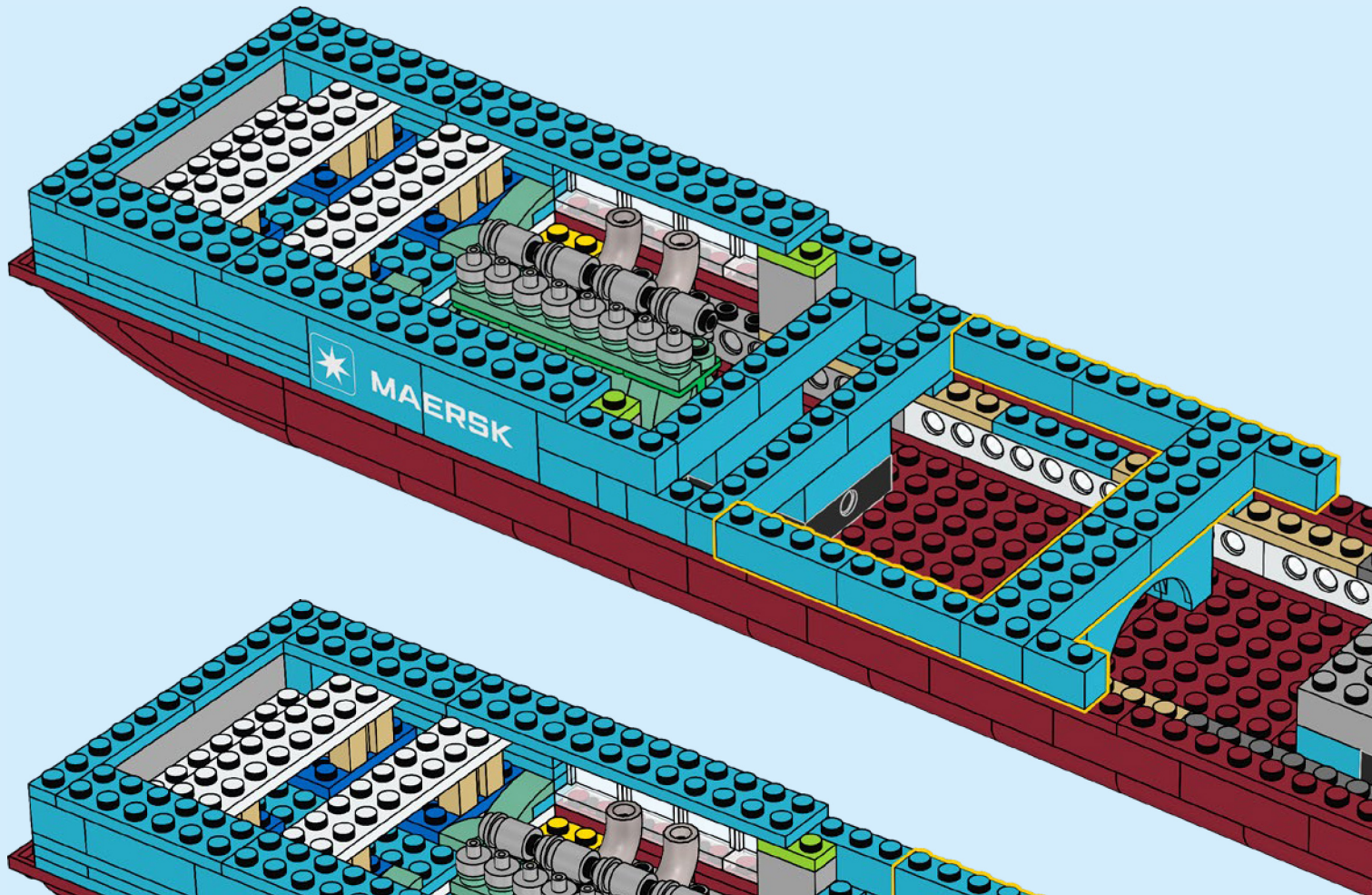

80

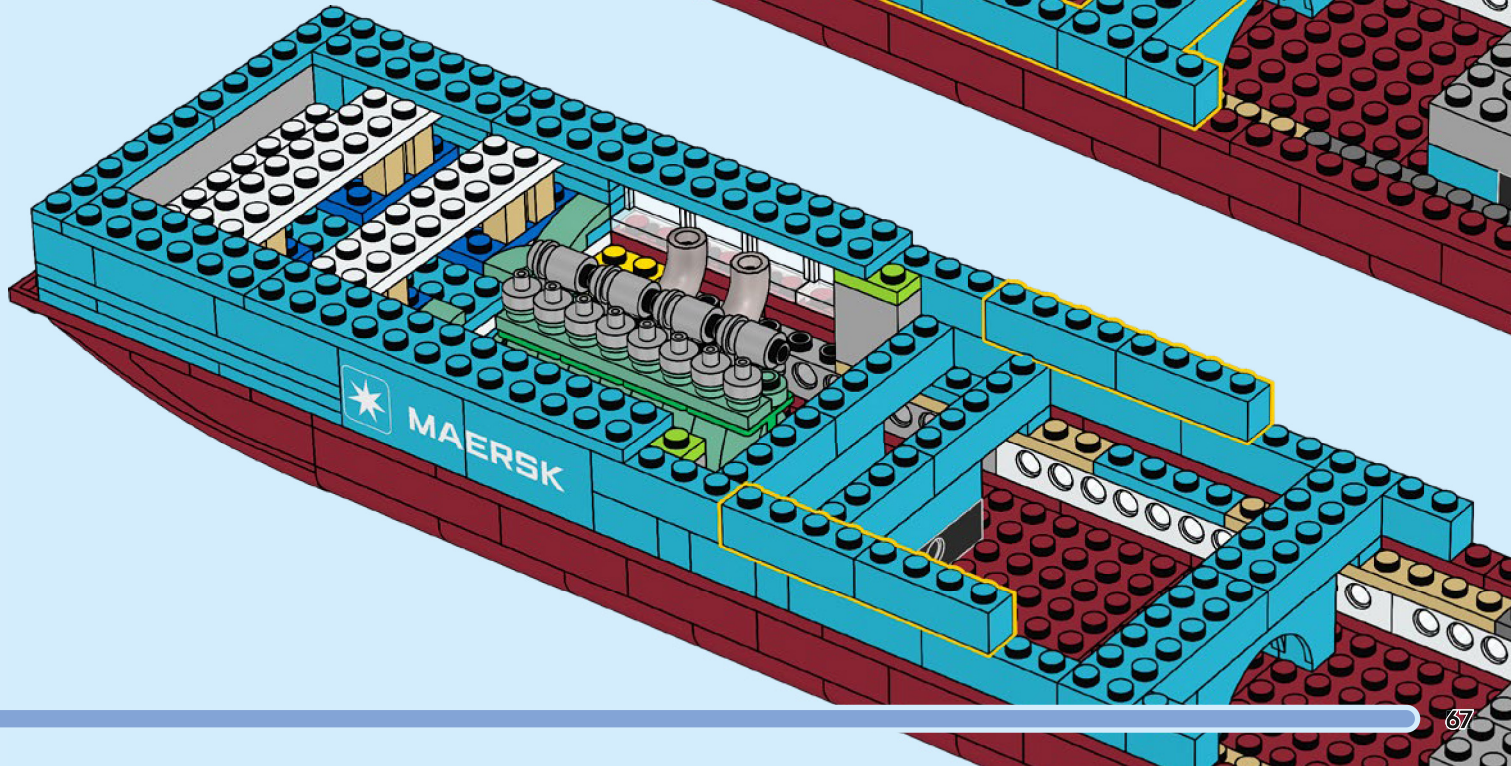

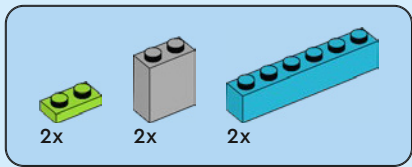

81

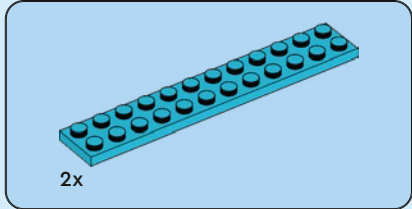
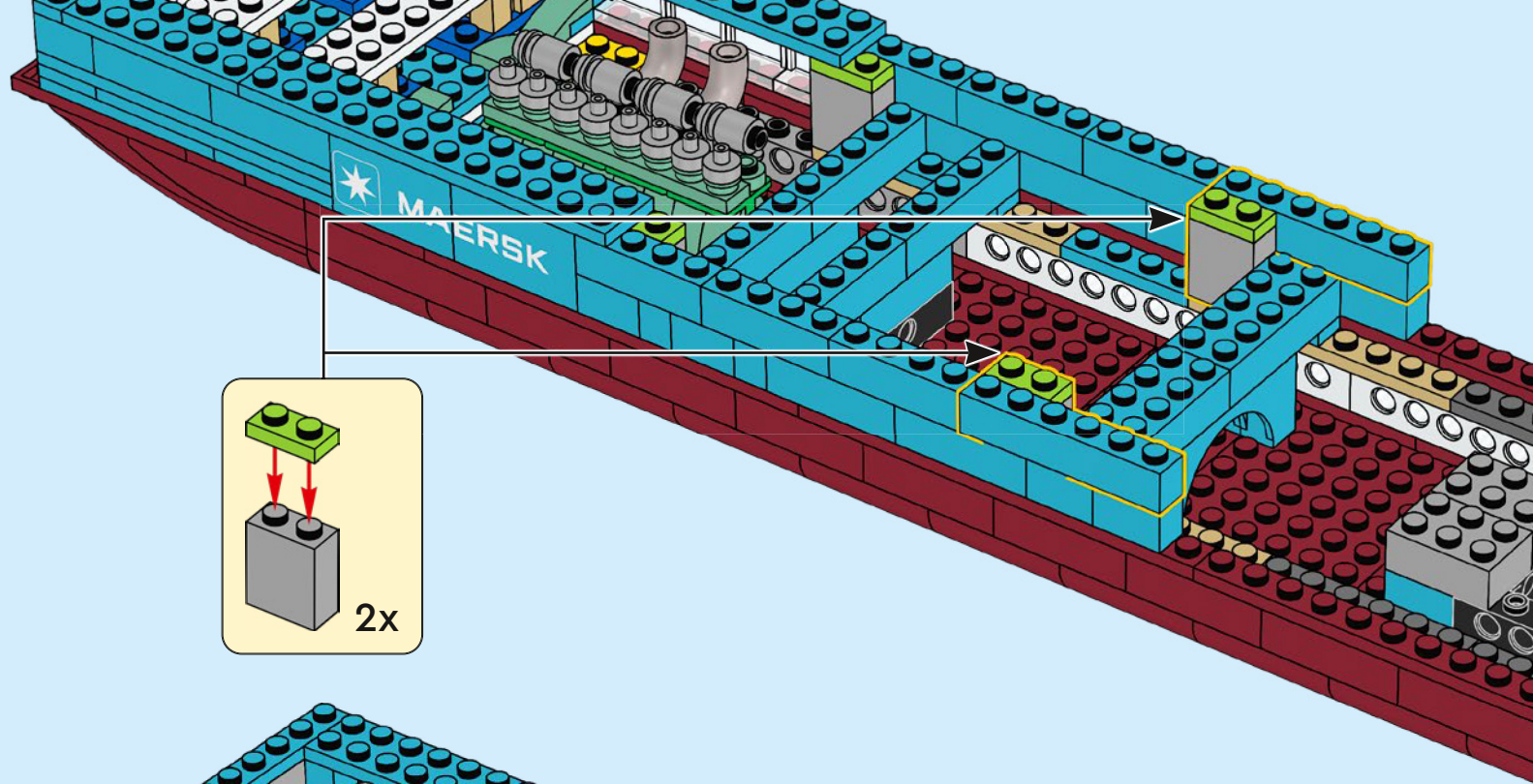

82

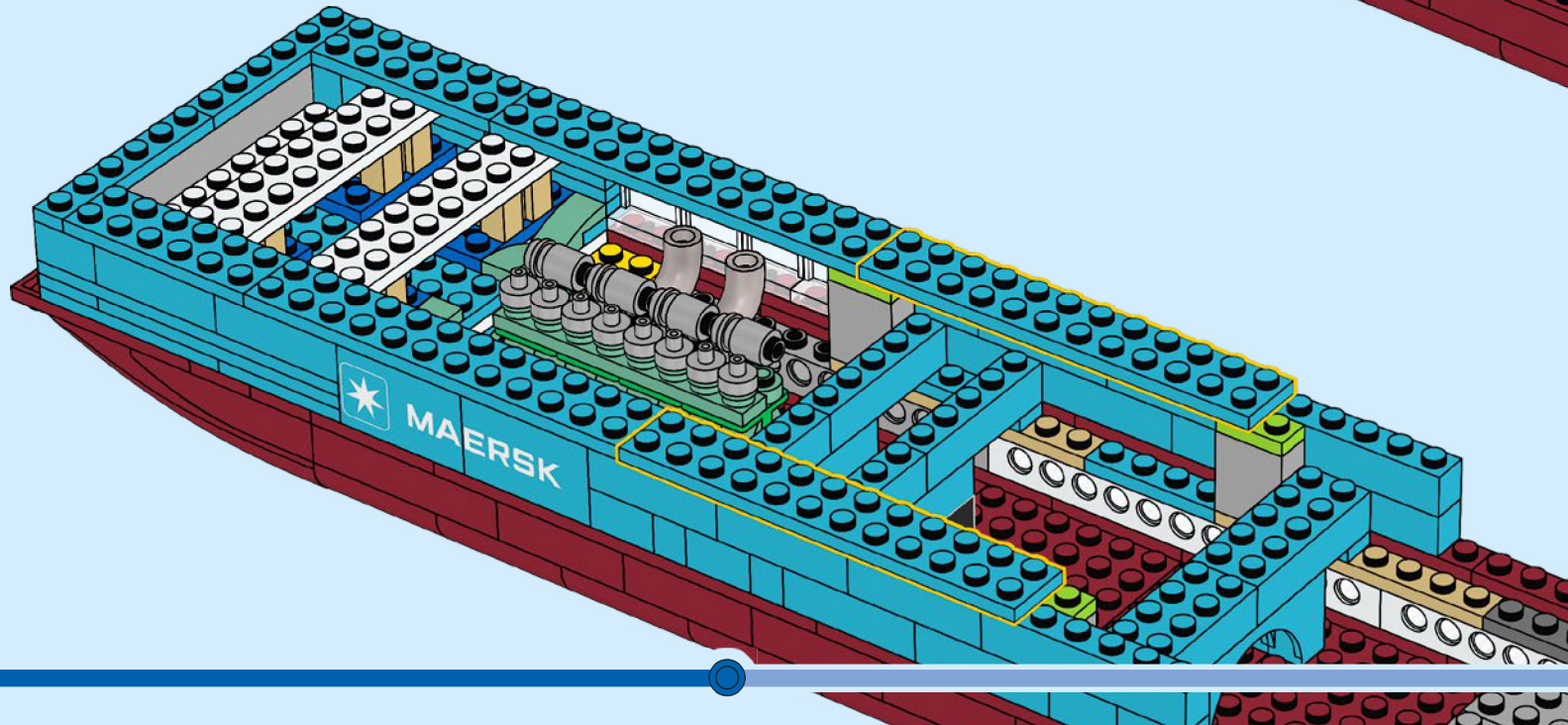

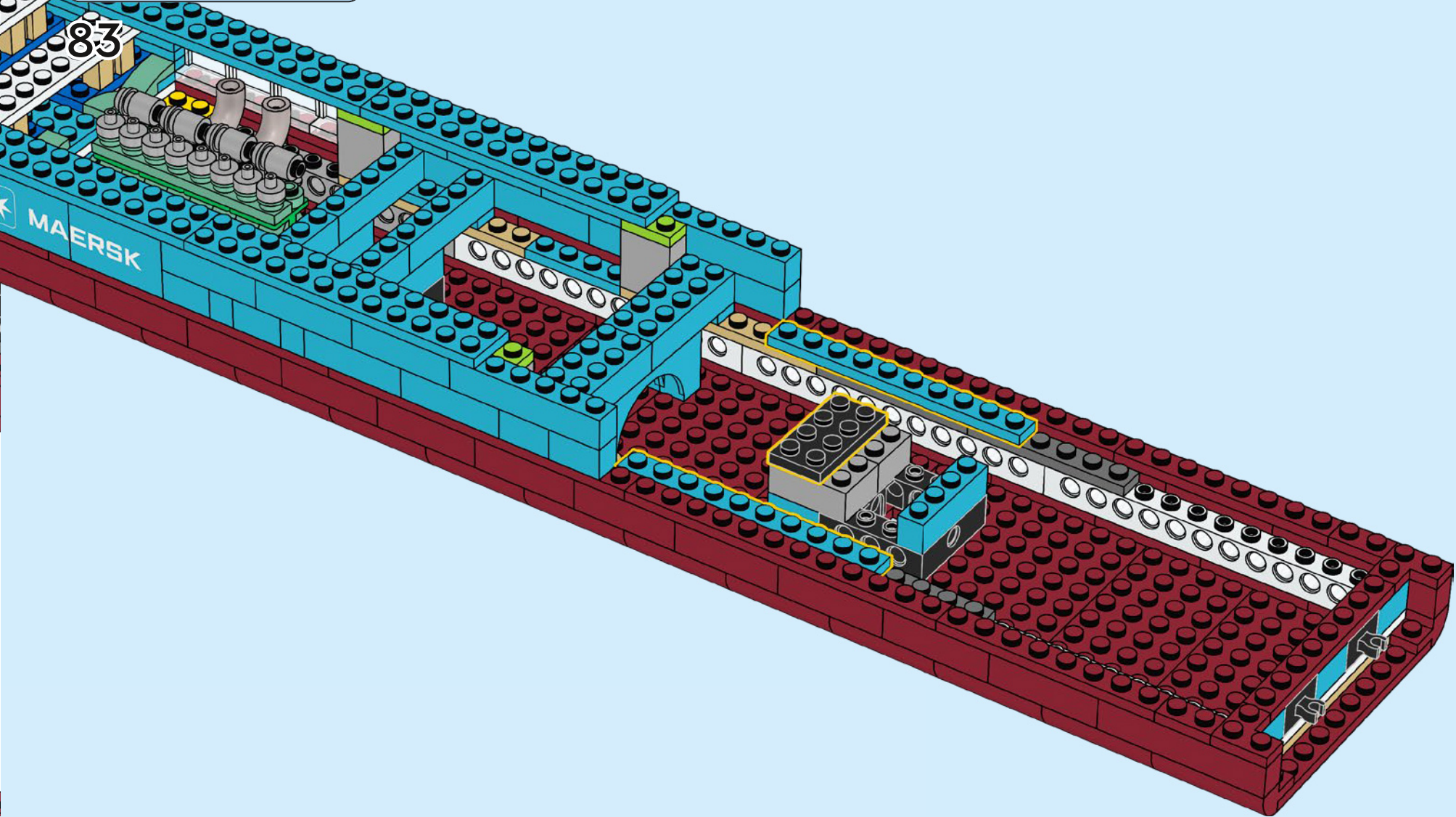
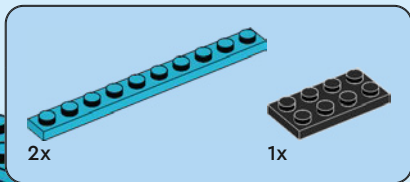

84

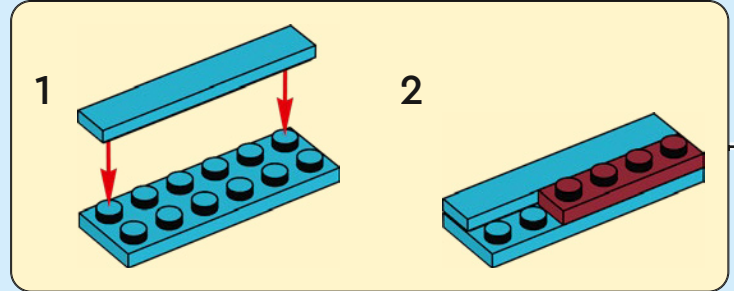
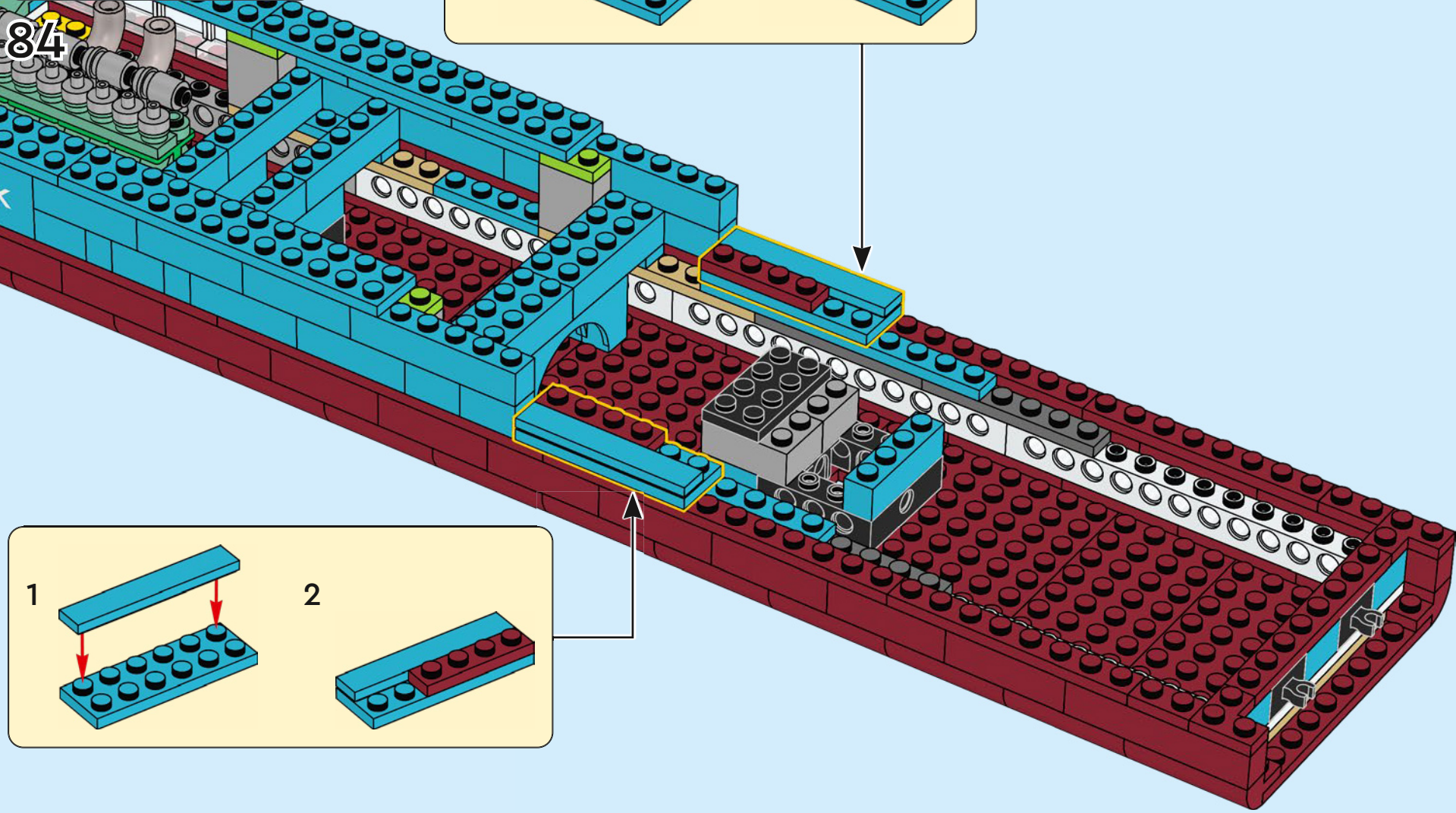
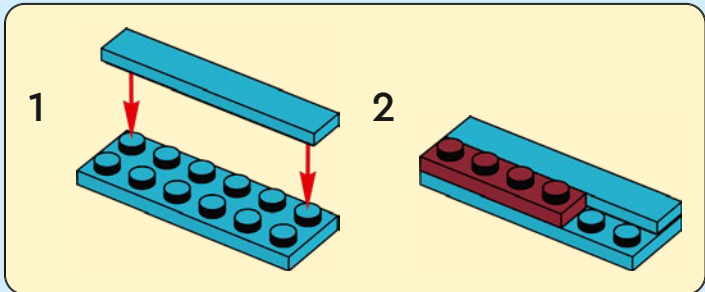
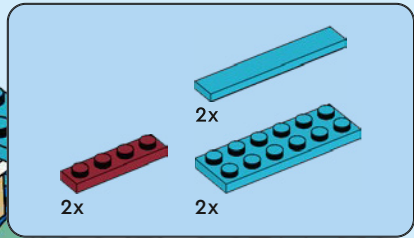

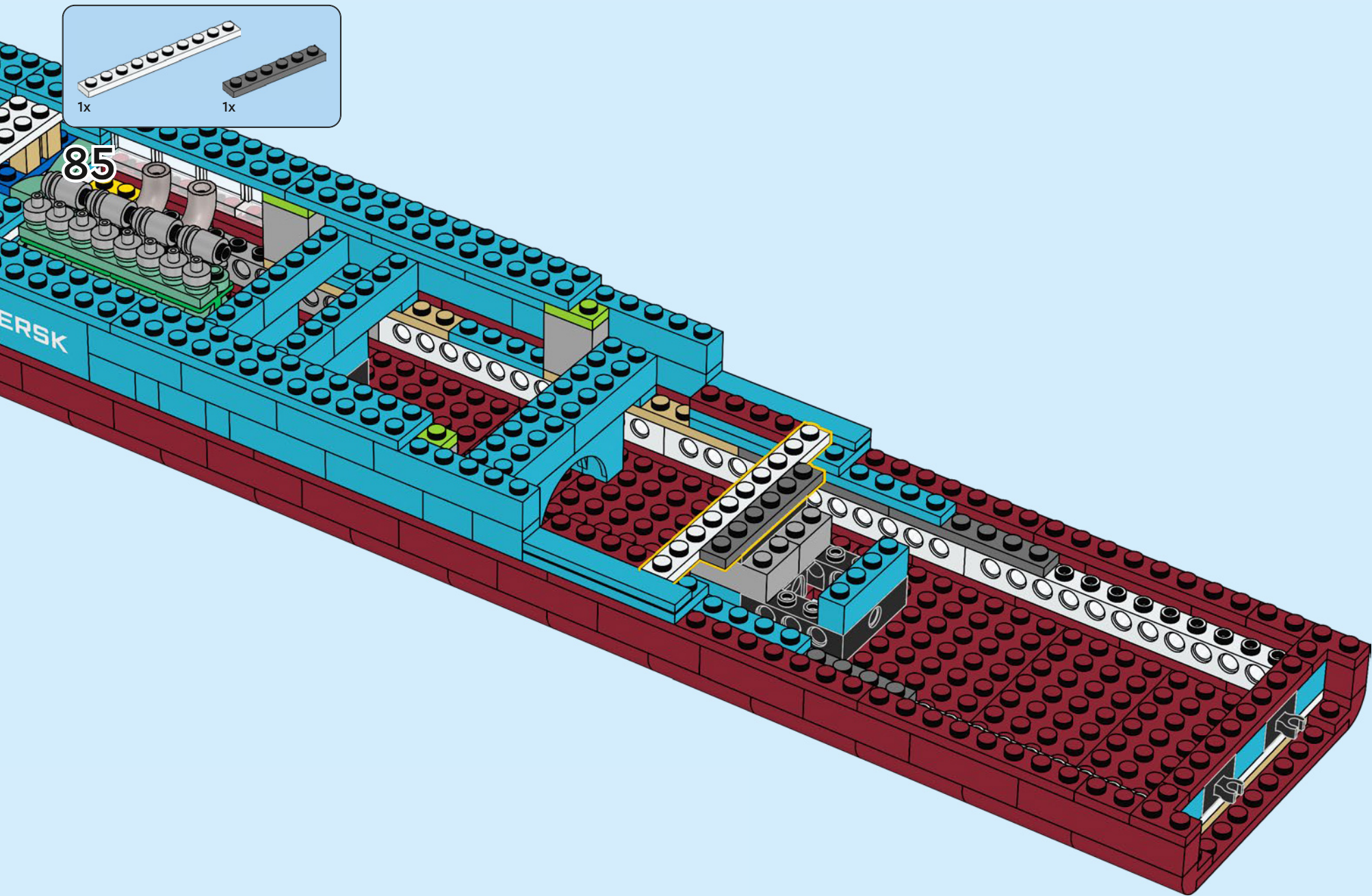

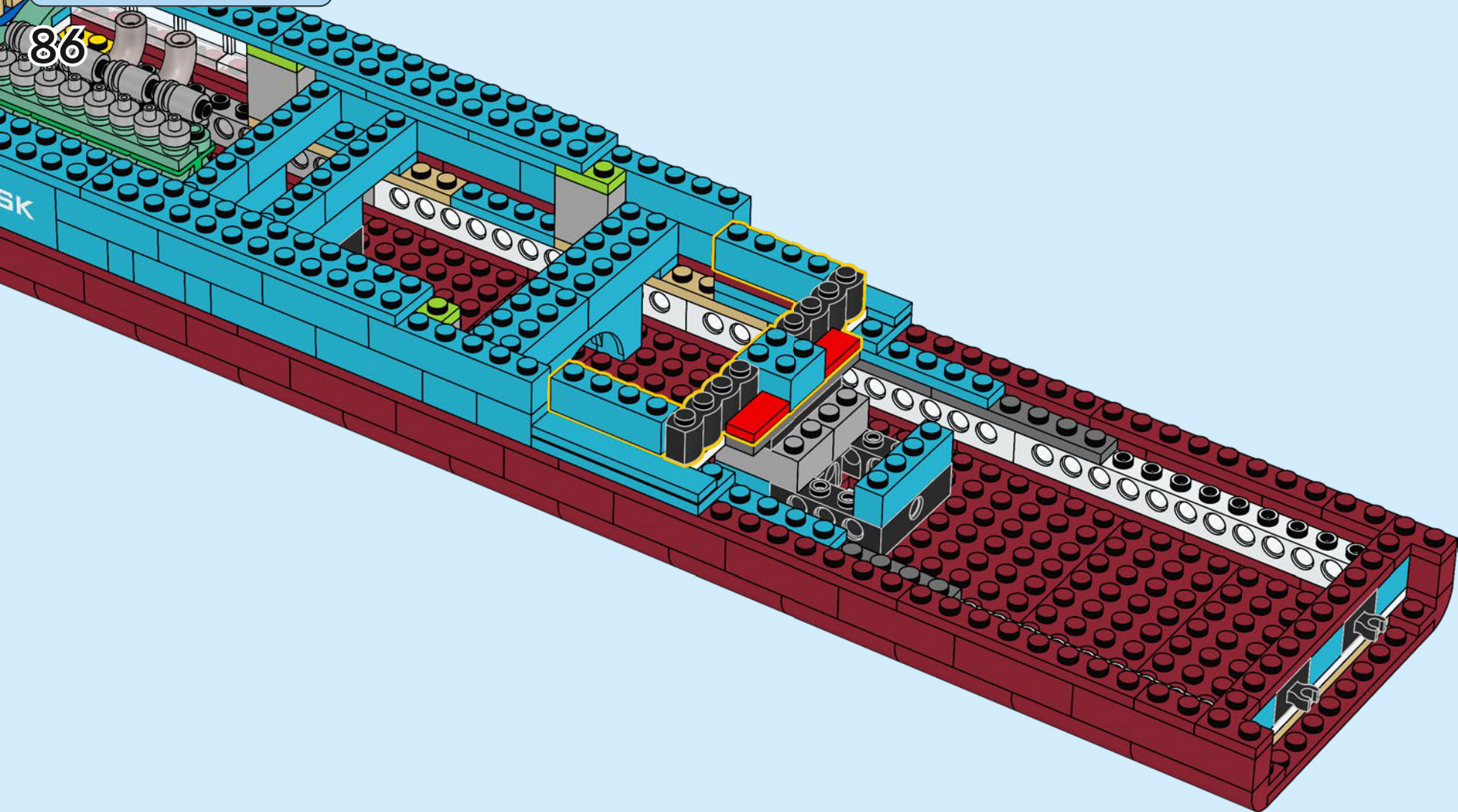
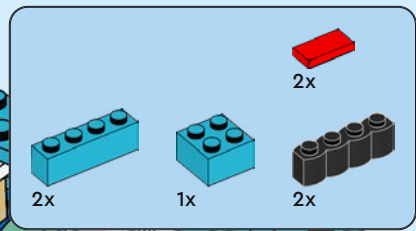

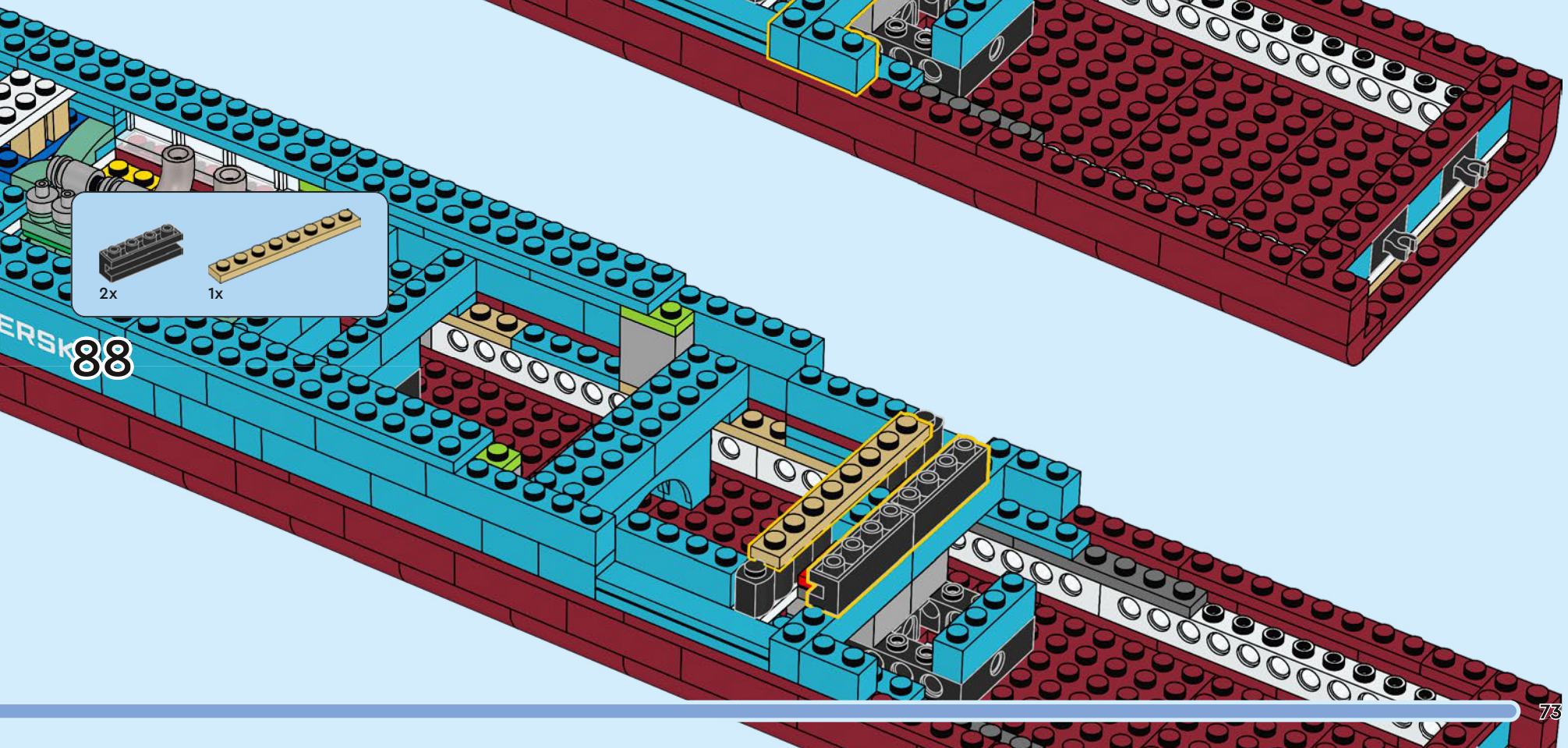
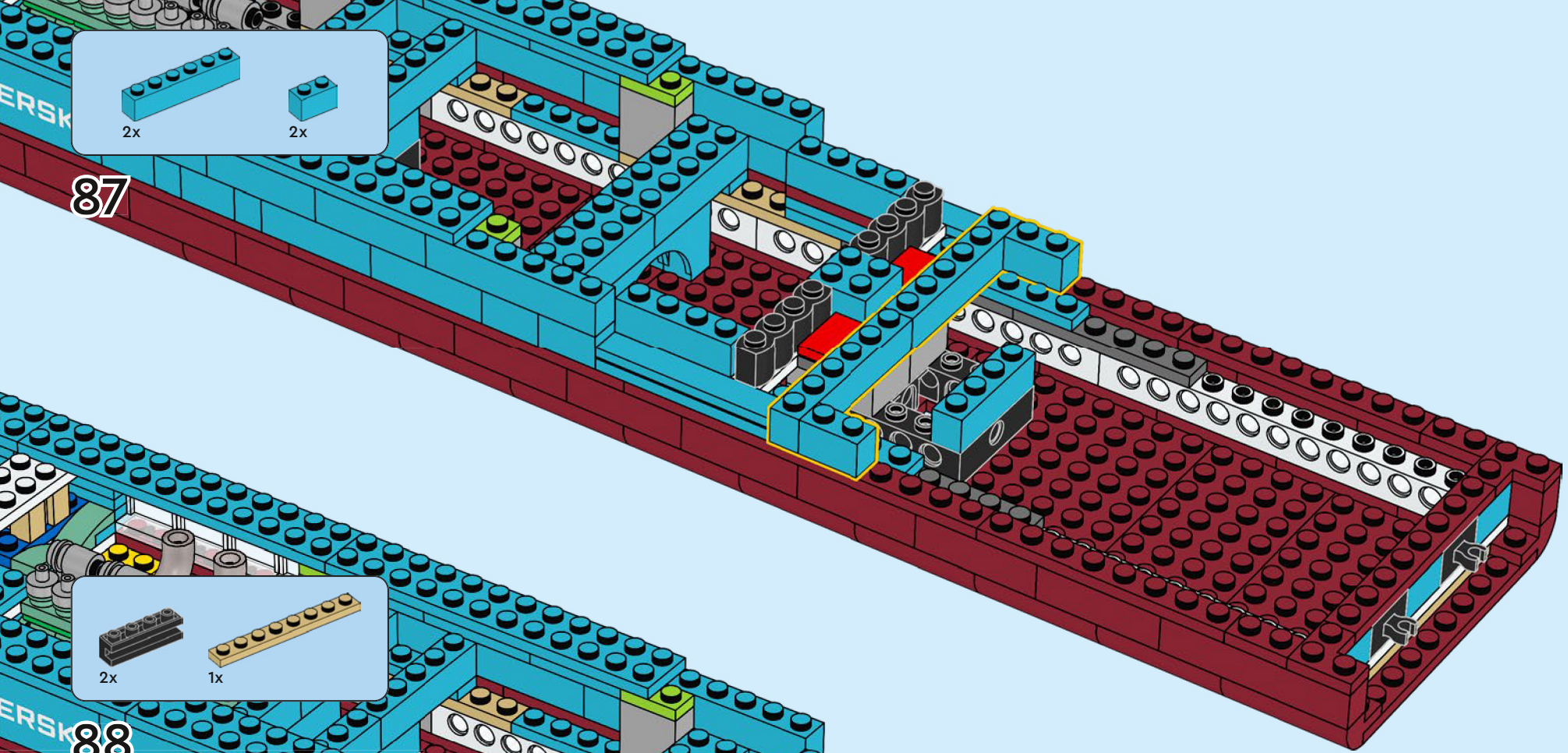

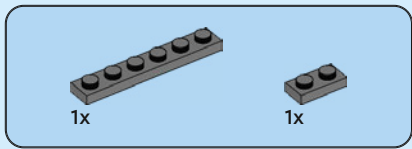

89

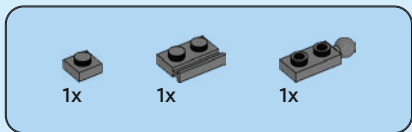
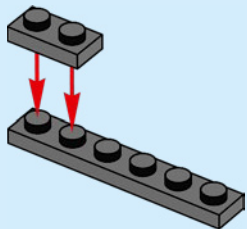

90

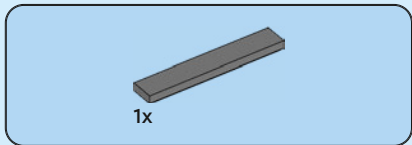
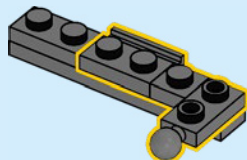

91

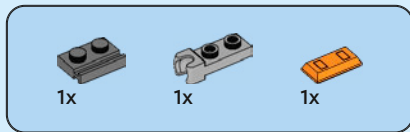
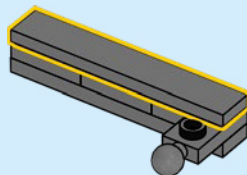

92

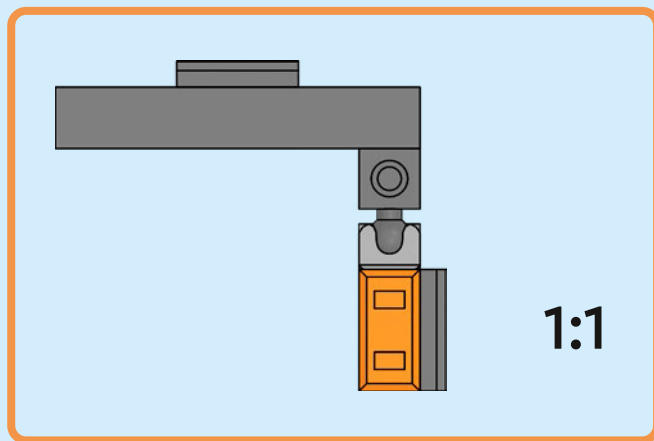
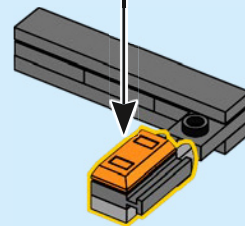
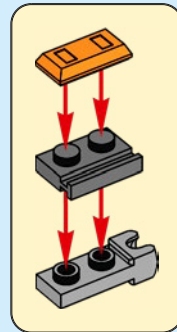

93

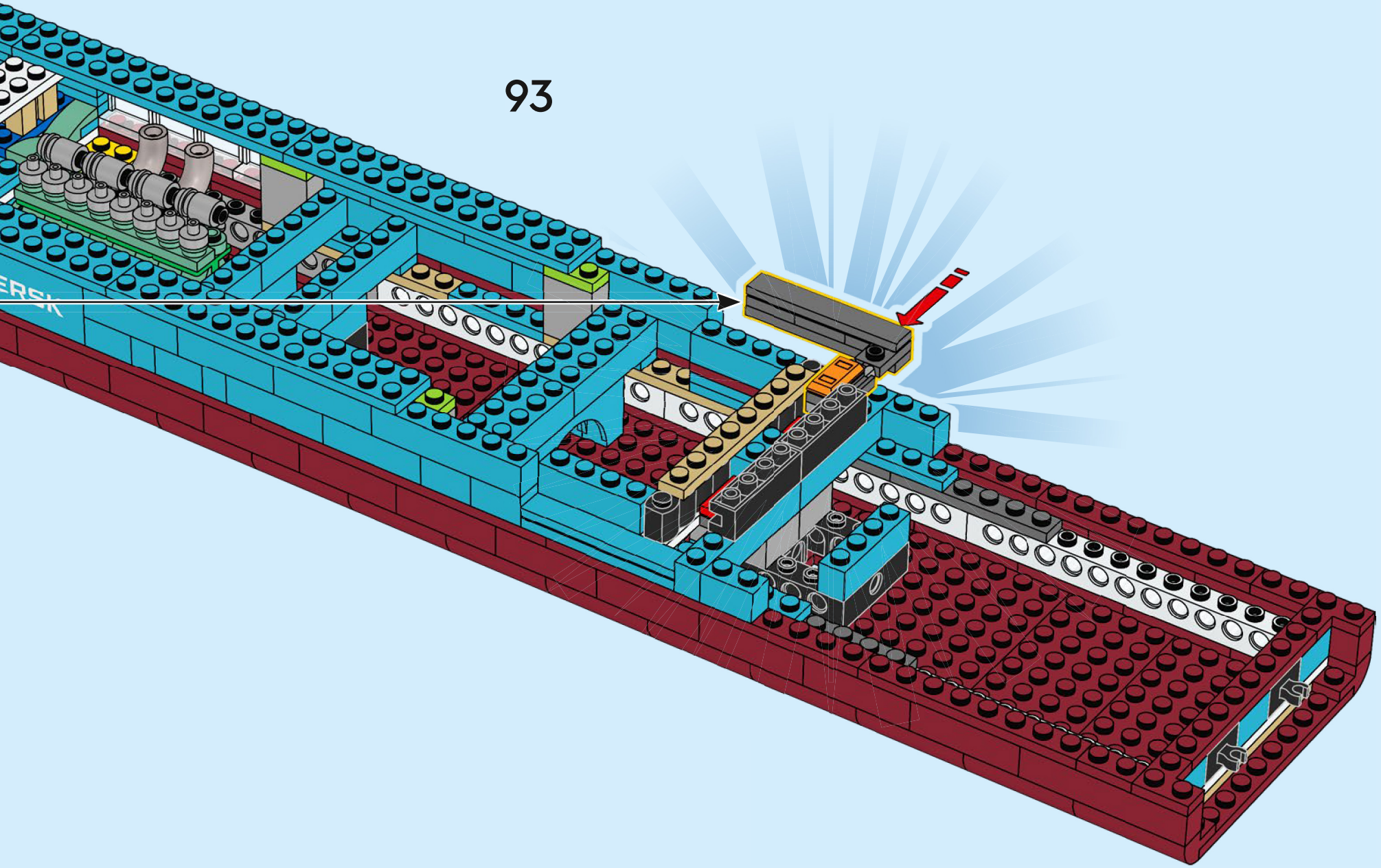

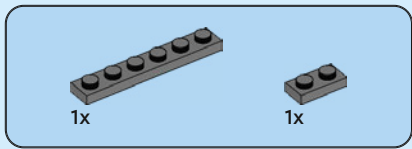

94

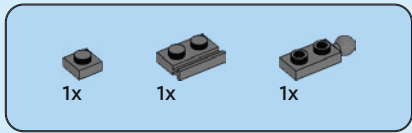
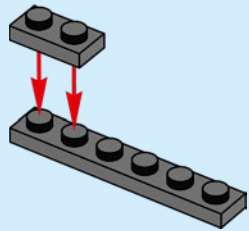

95

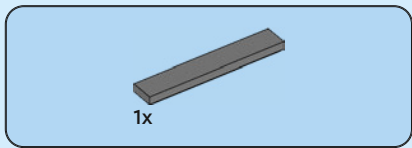
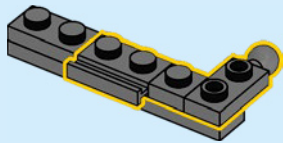

96

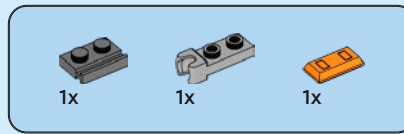
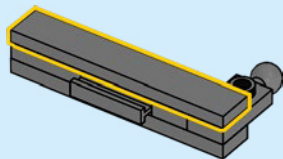

97

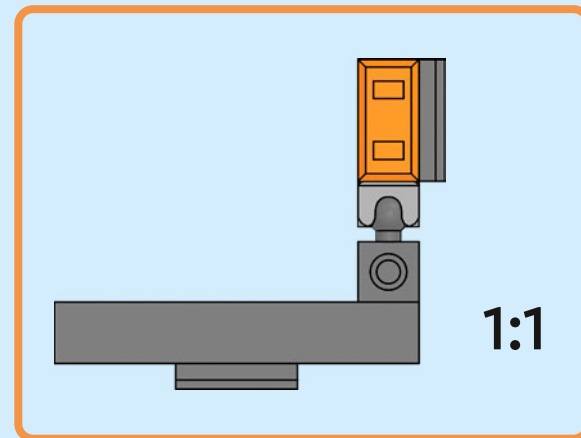
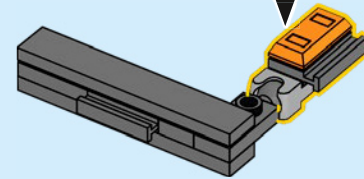
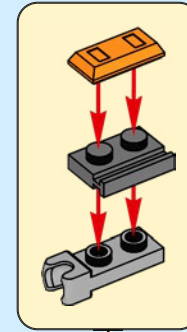

1:1

98

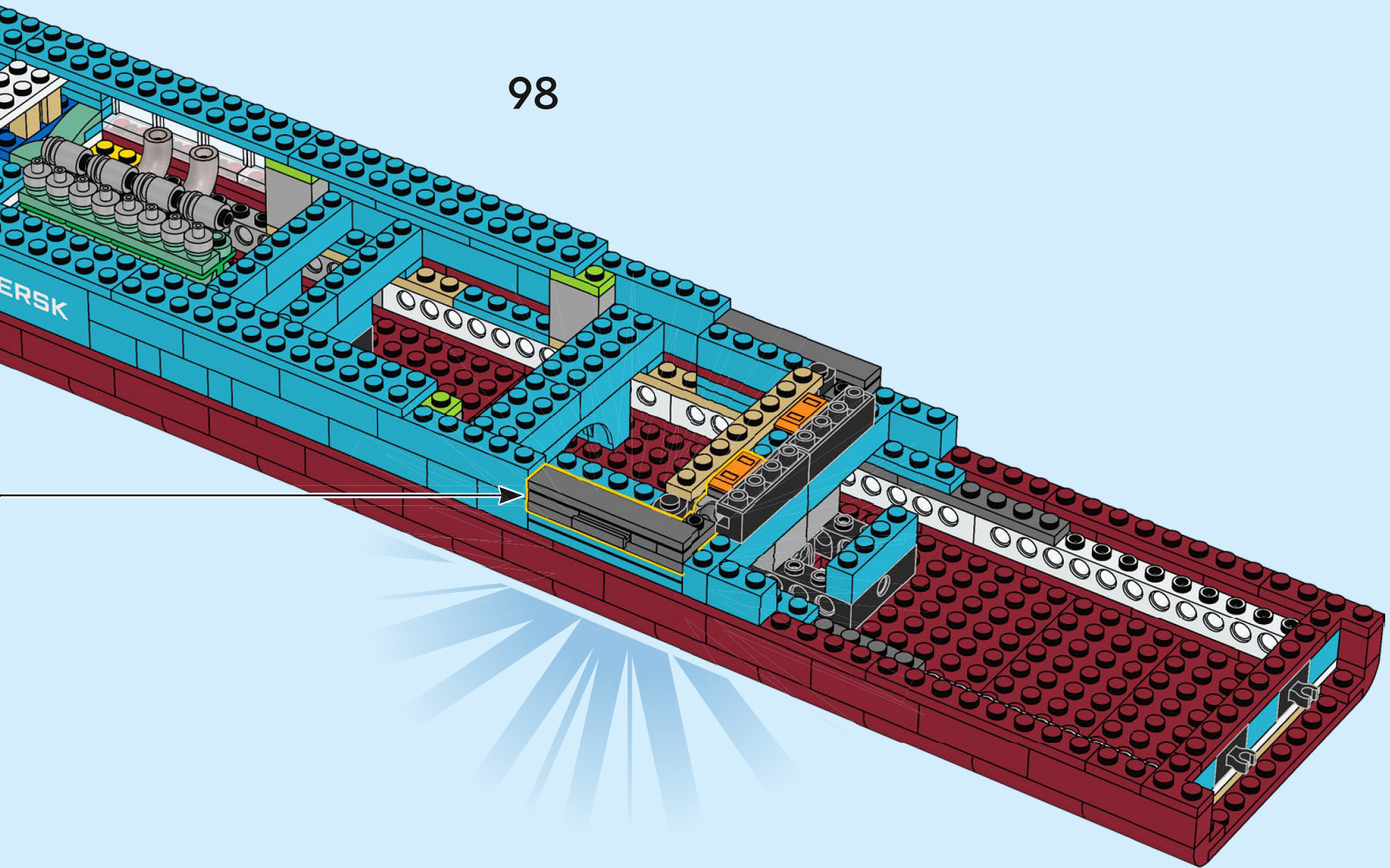

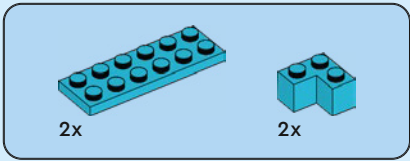

99

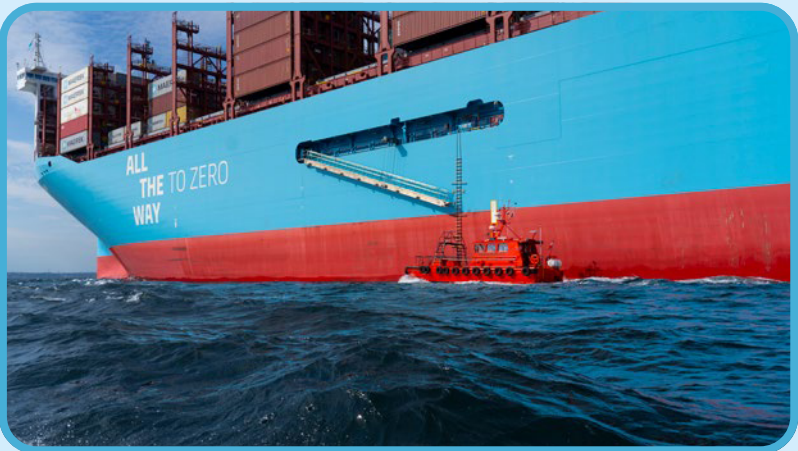
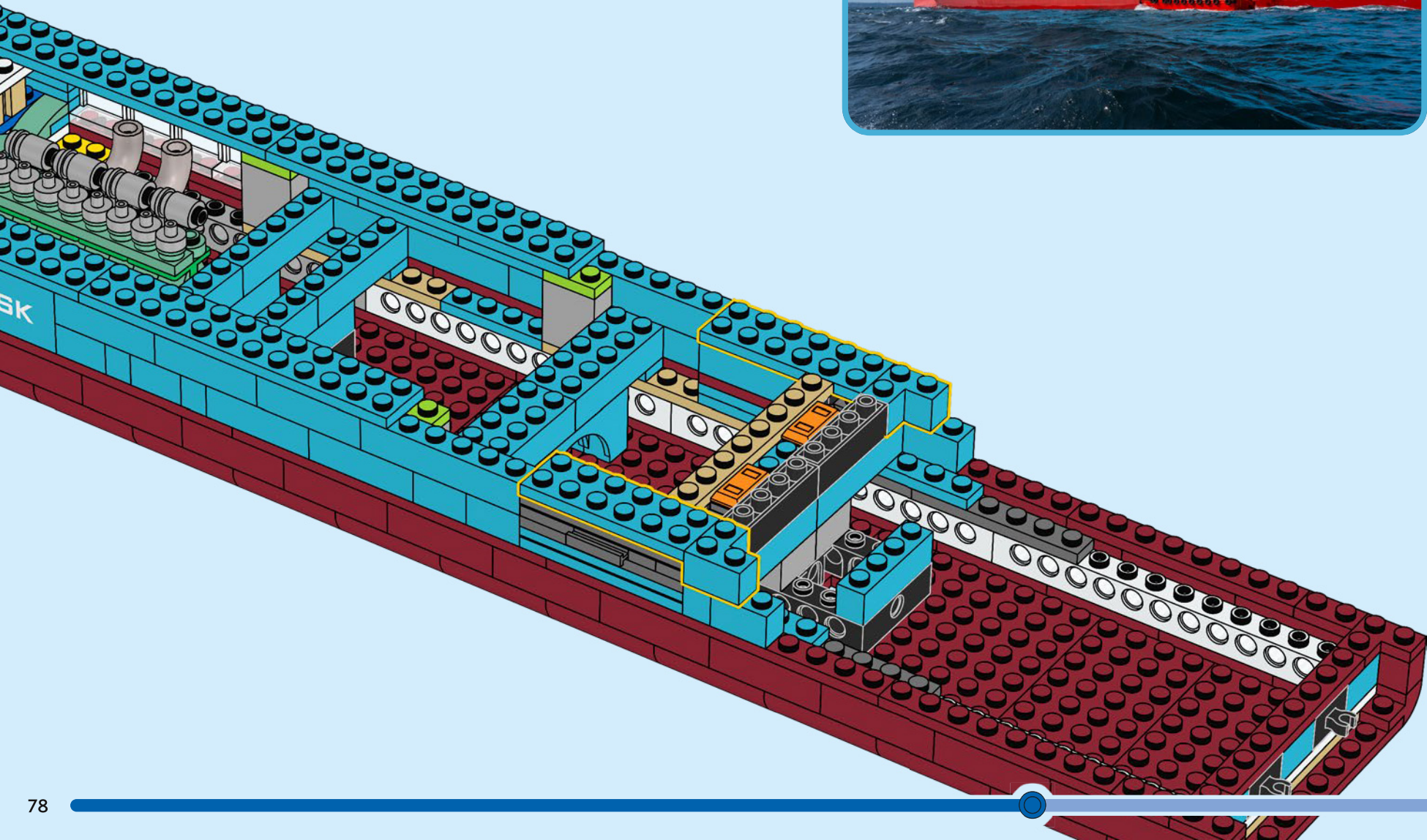

1

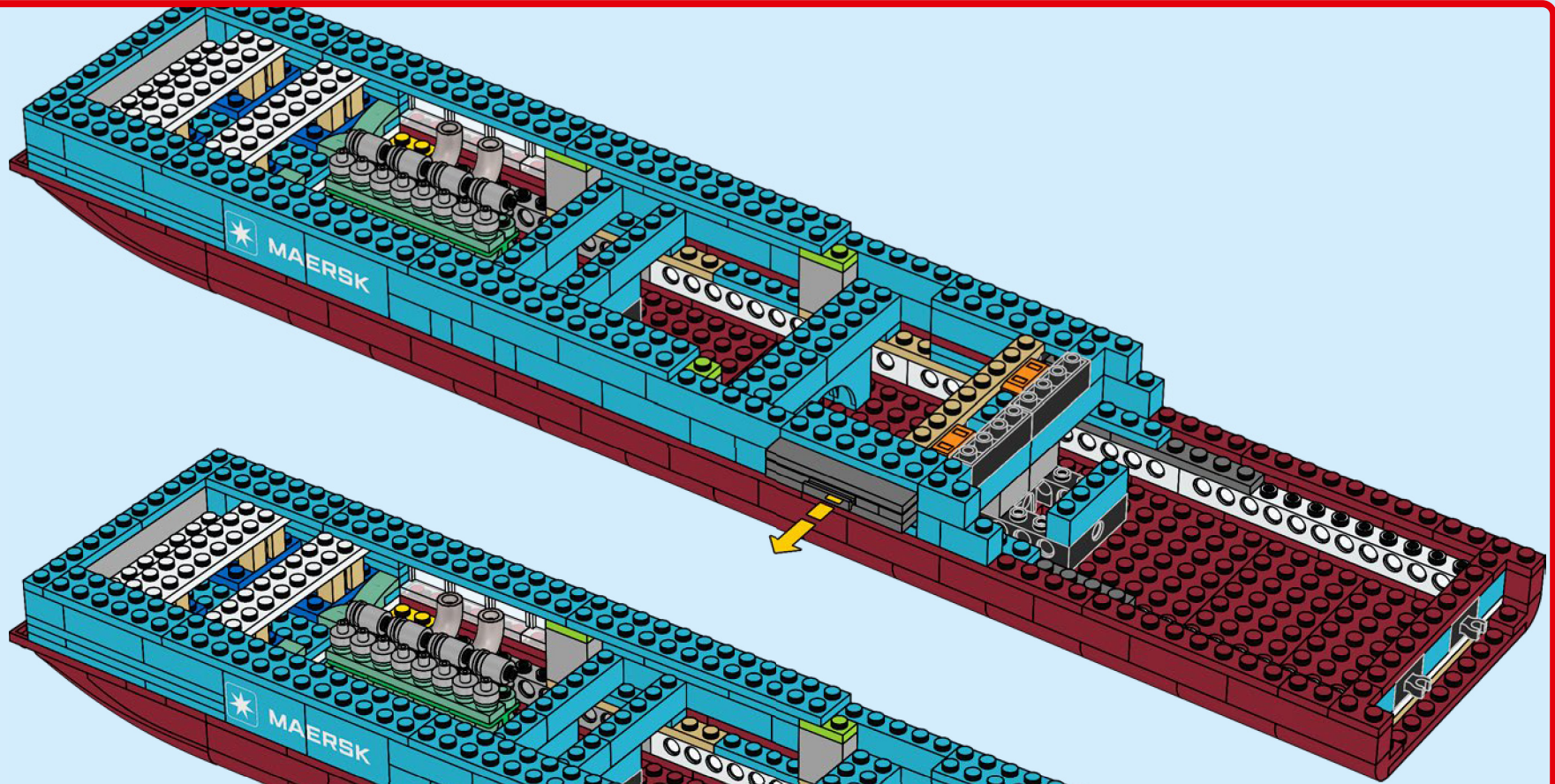

2

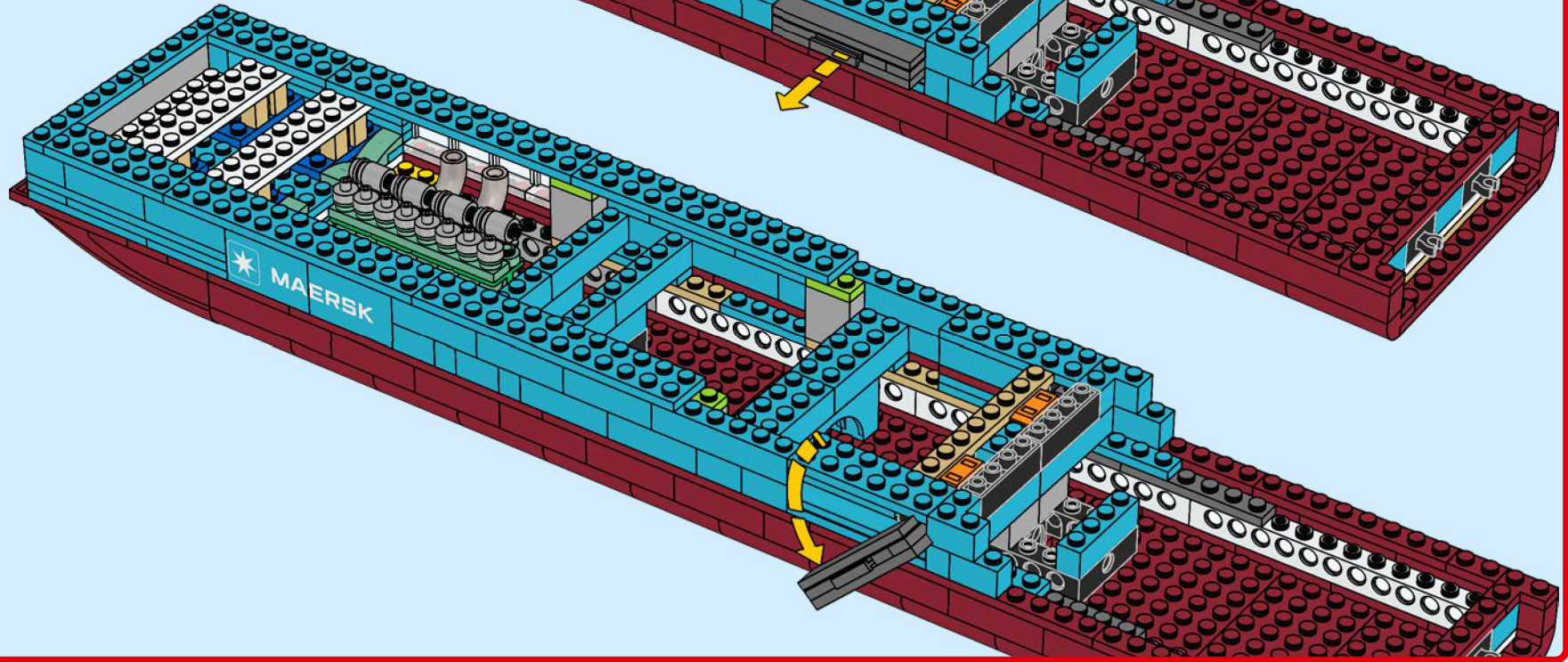

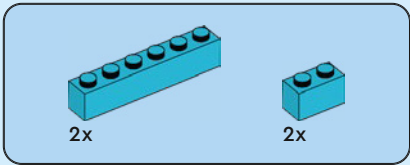

100

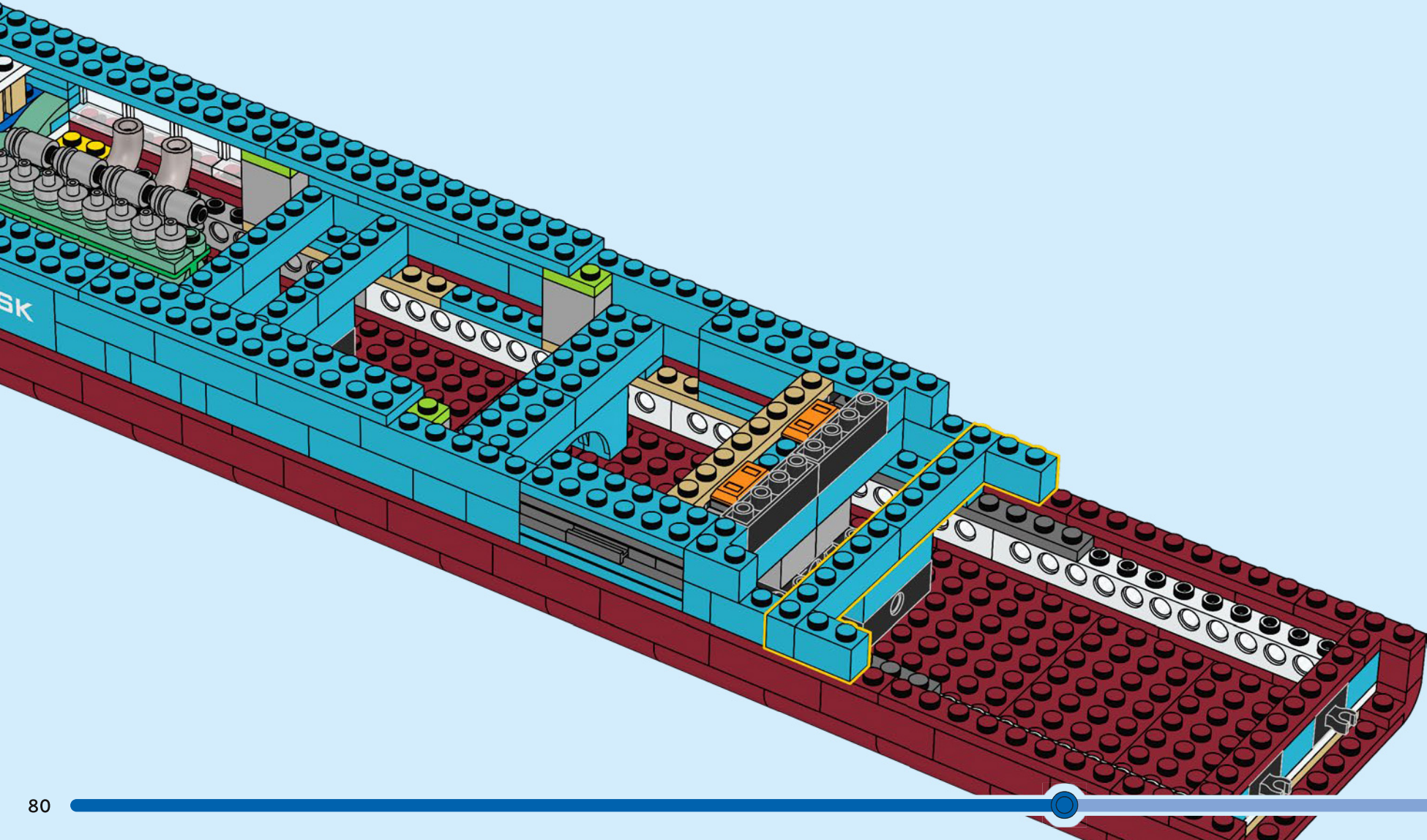

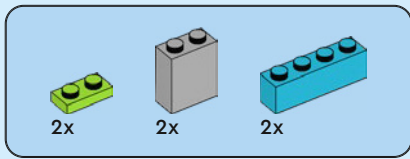

101

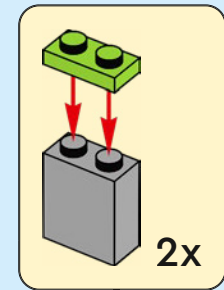
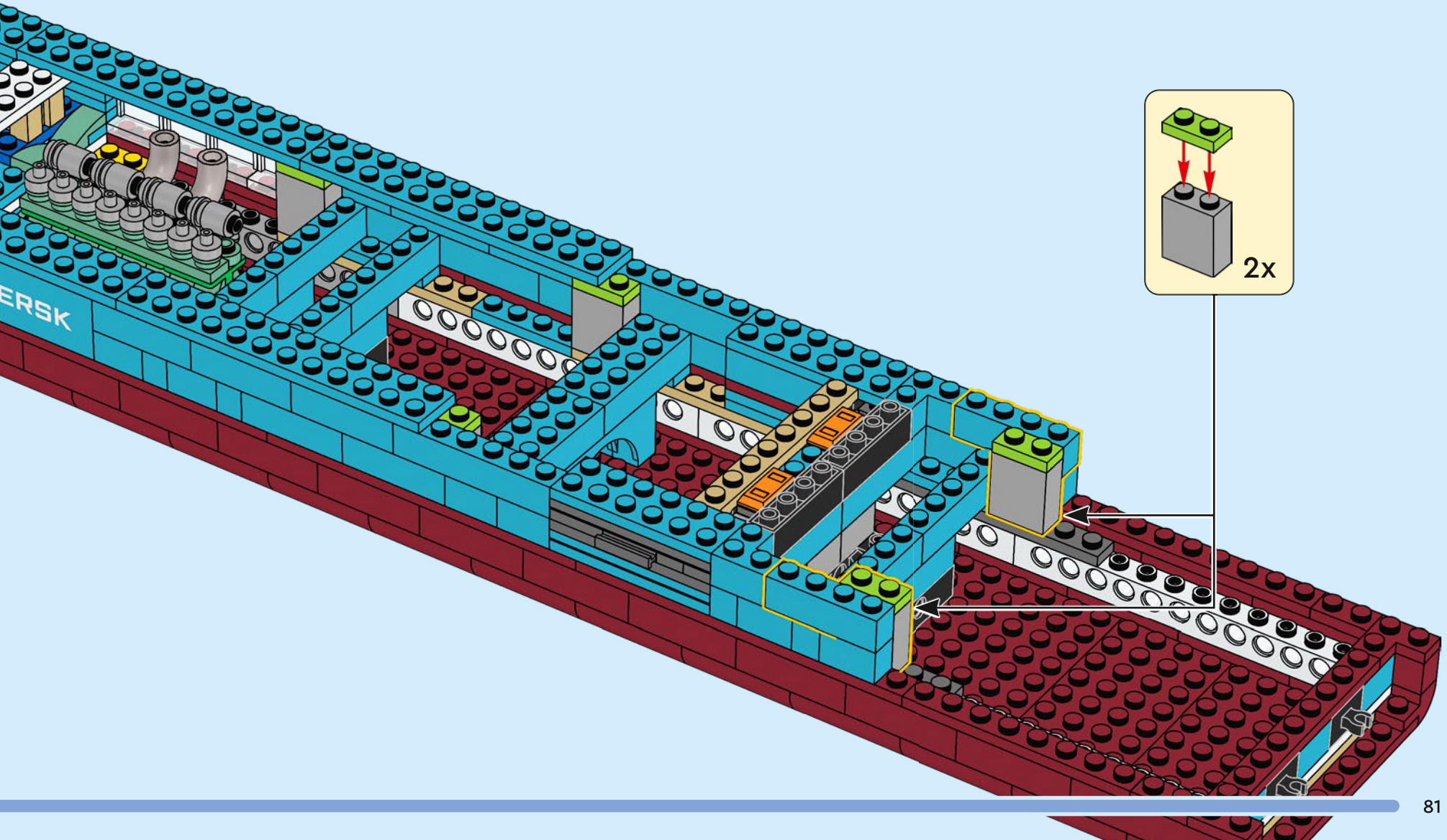

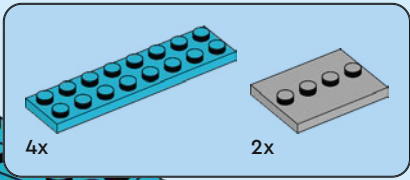

102

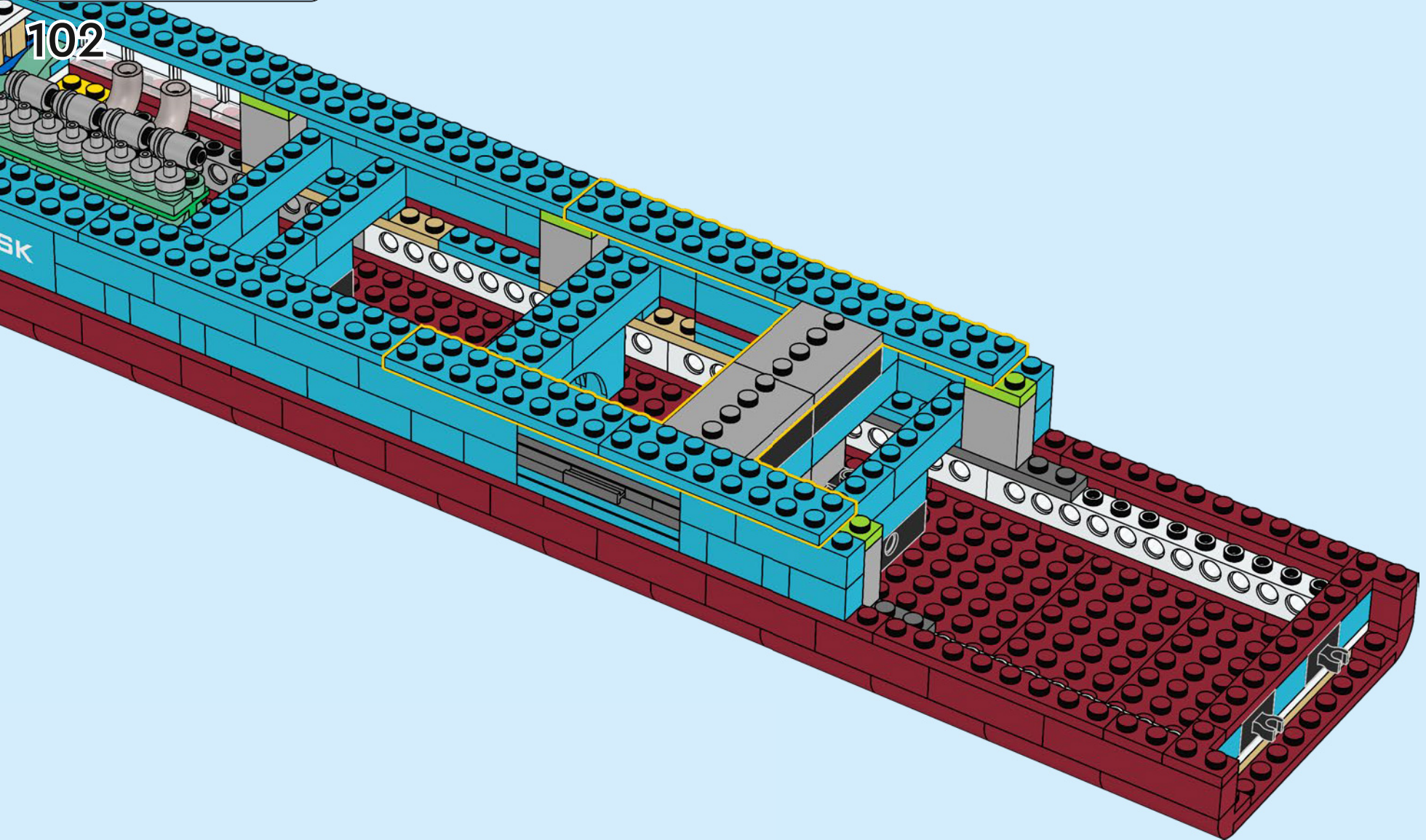

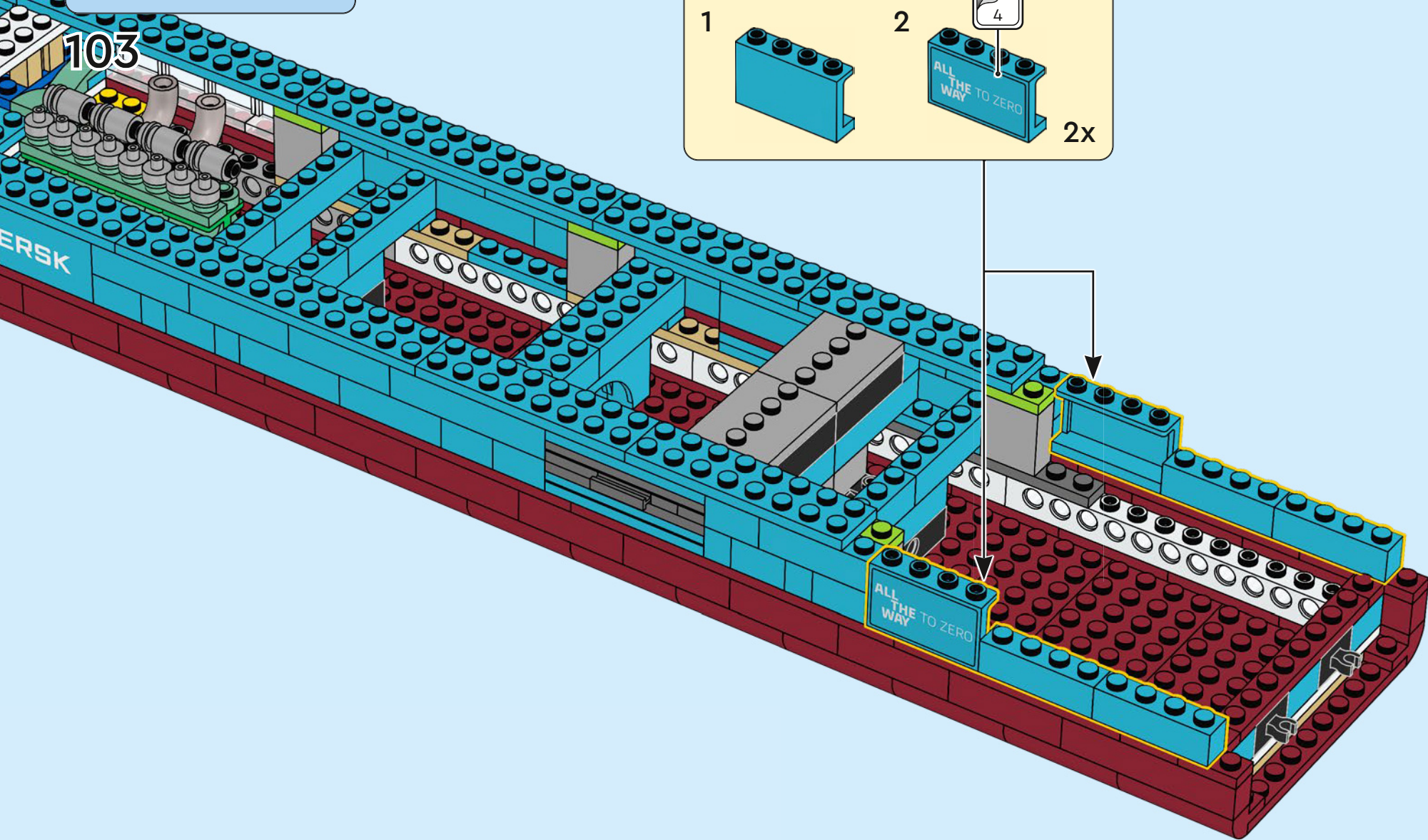
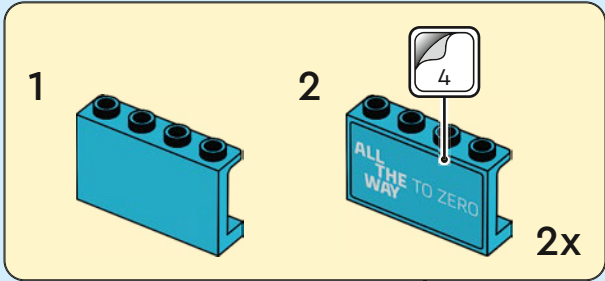
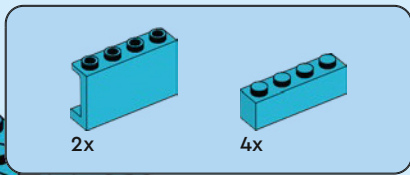

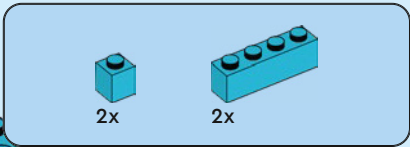

104

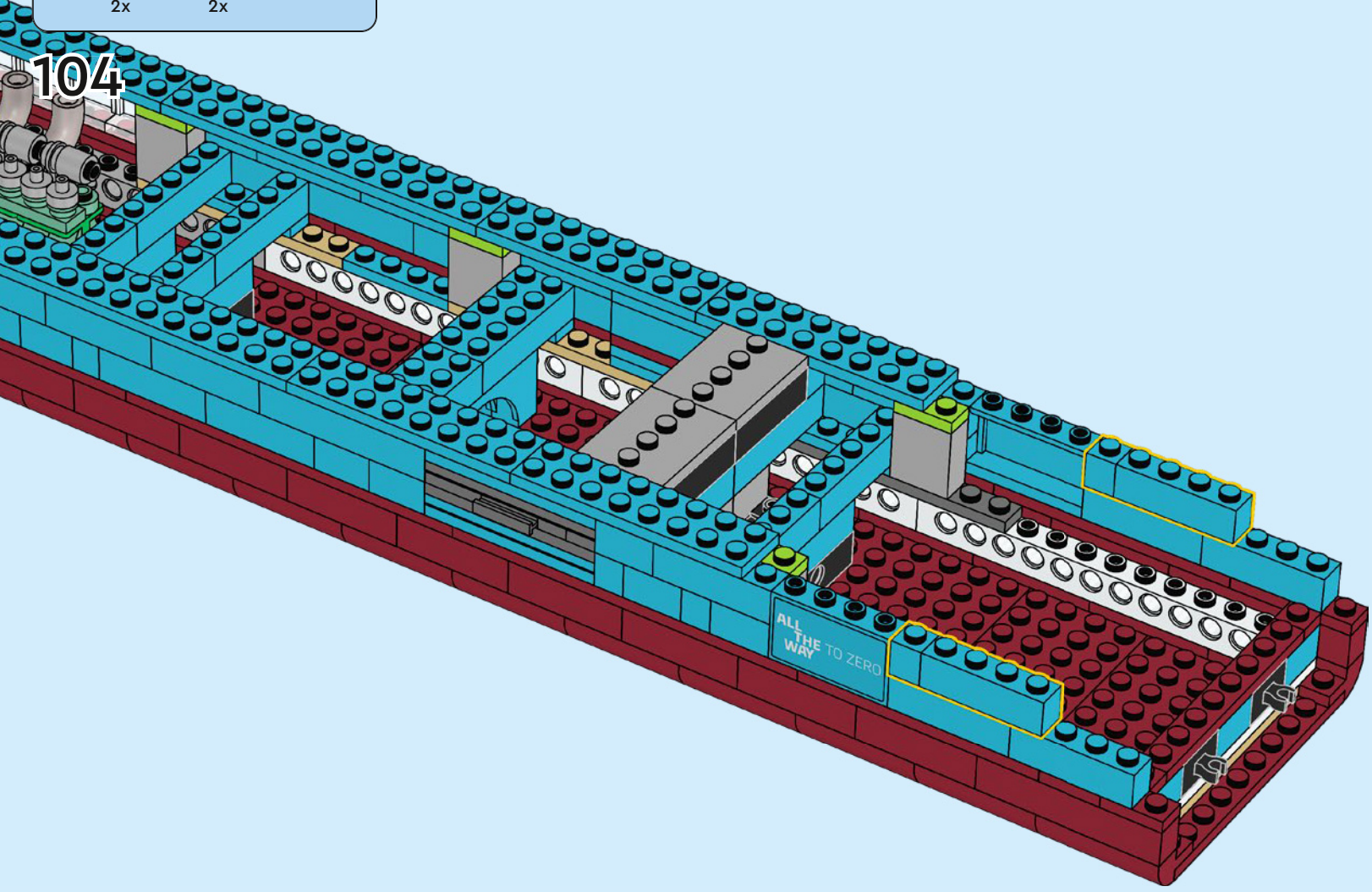

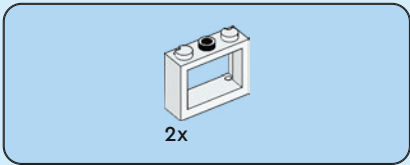

105

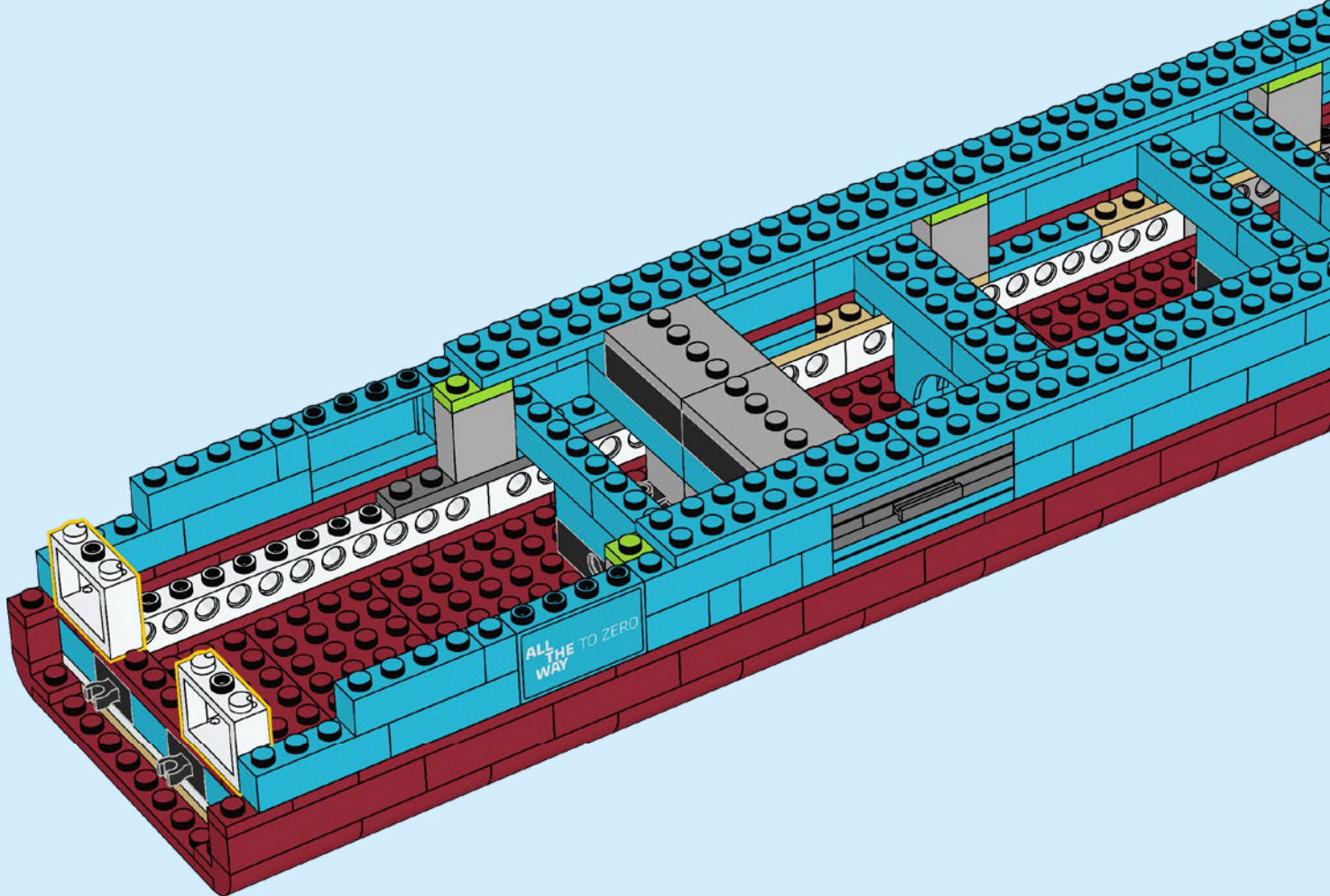

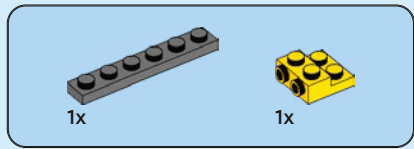
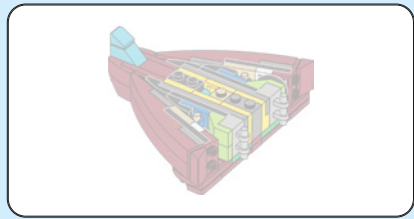
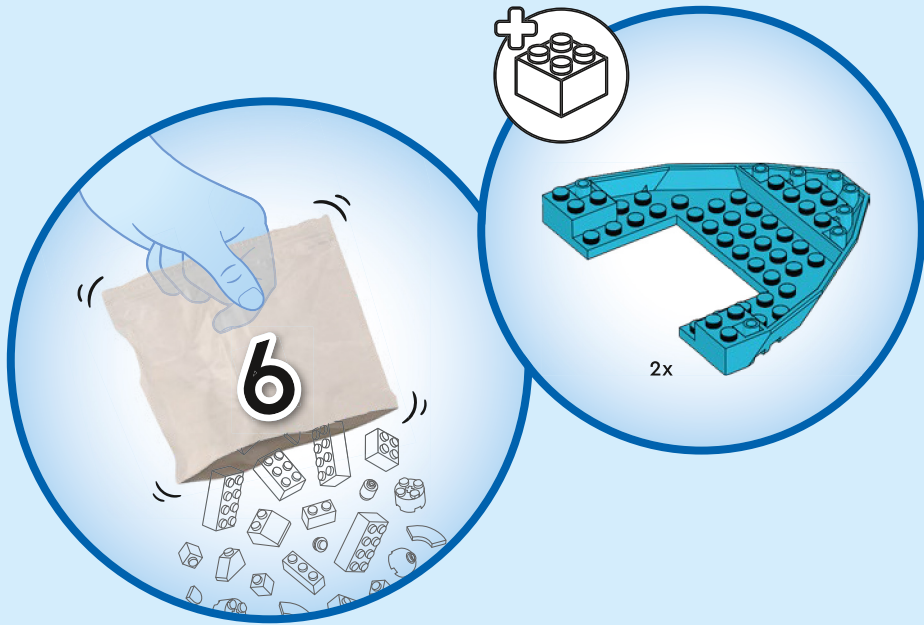

106

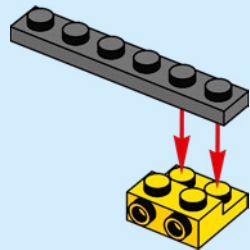

107

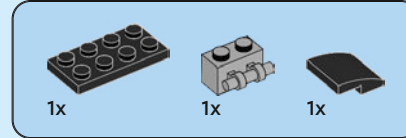
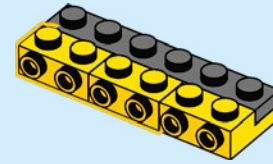

108

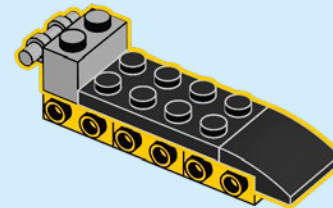

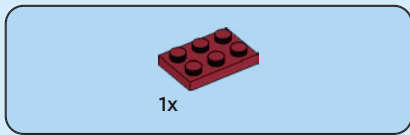

109

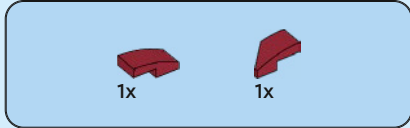
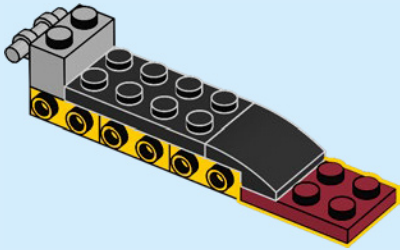

110

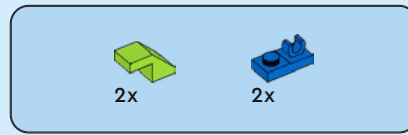
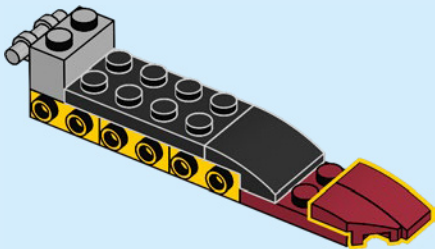

111

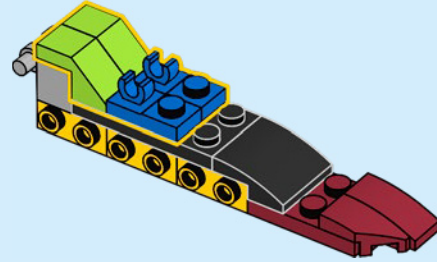

112

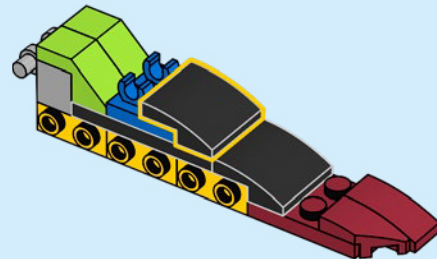

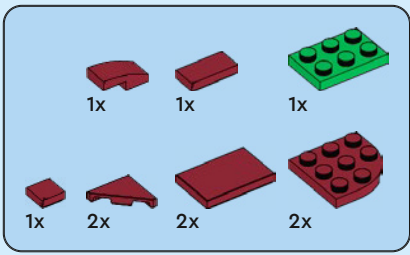

113

1

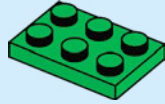

2

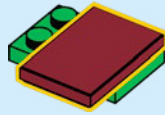

3

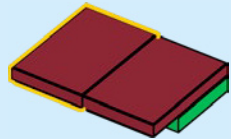

4

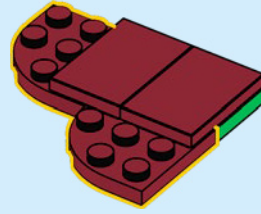

5

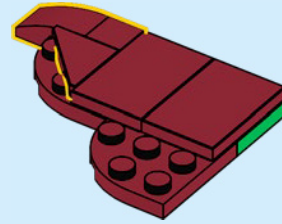

6

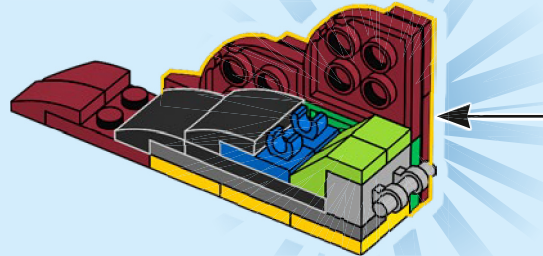
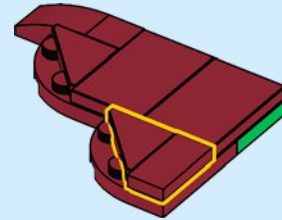

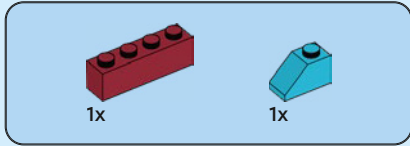
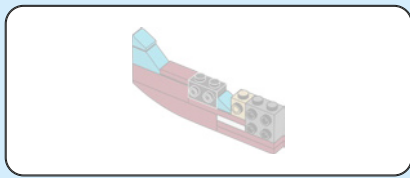

114

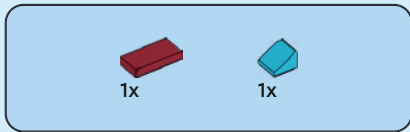
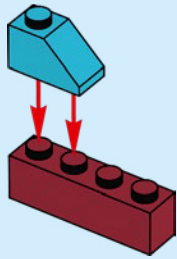

115

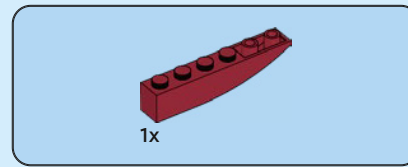
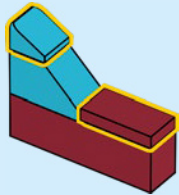

116

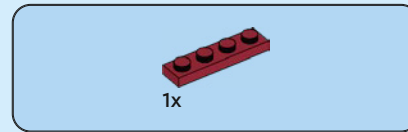
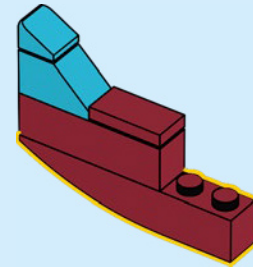

117

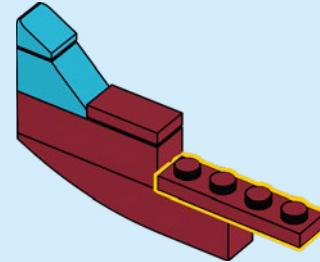

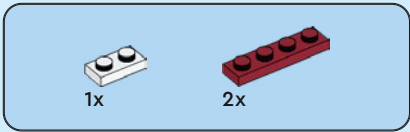

118

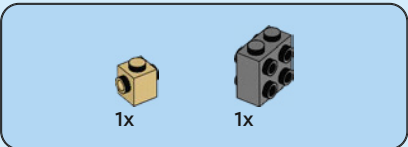
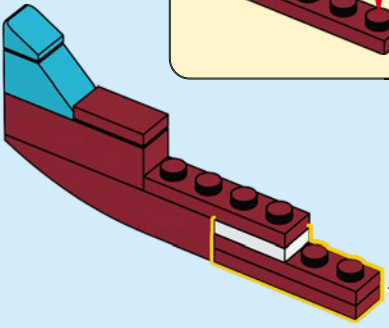
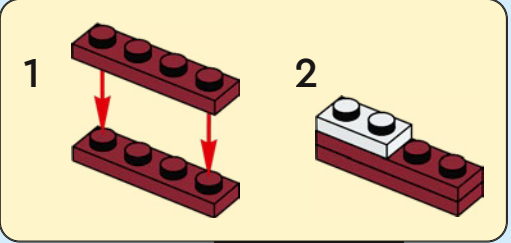

120

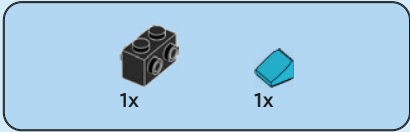
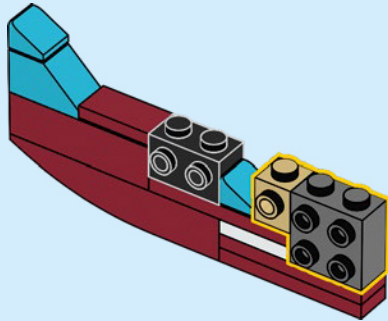

119

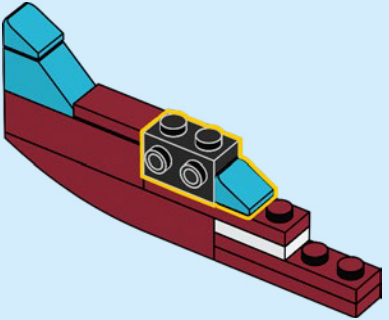

121

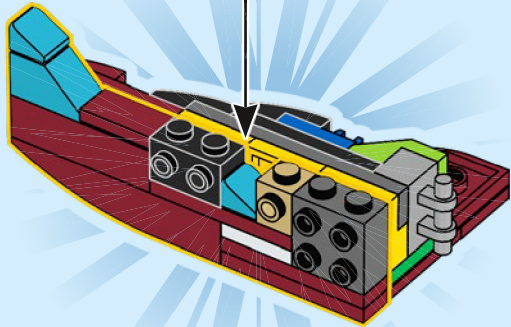

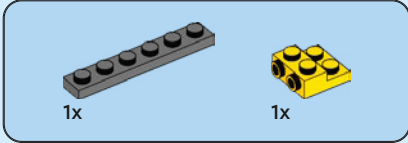
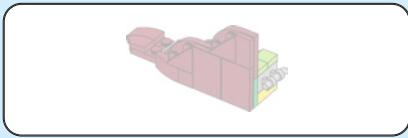

122

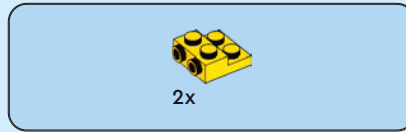
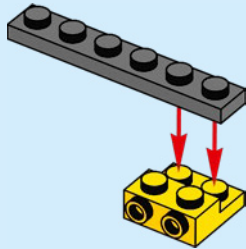

123

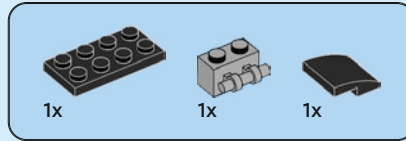
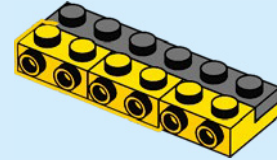

124

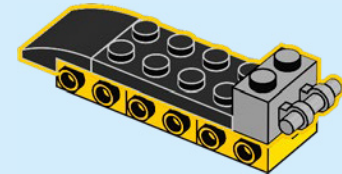

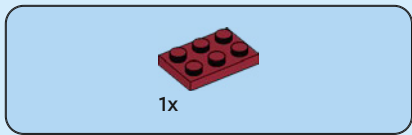

125

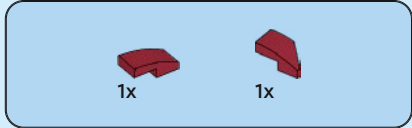
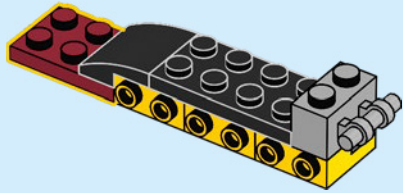

126

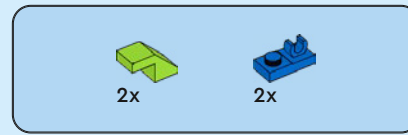
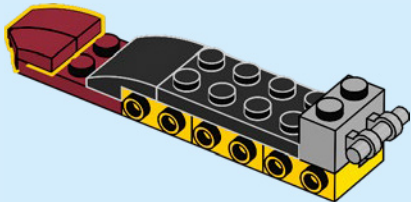

127

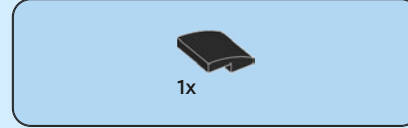
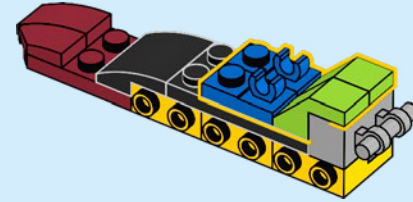

128

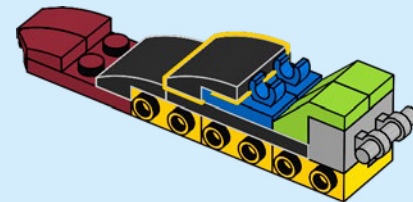

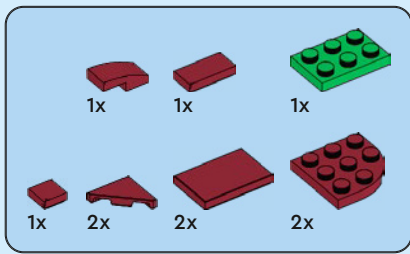

129

1

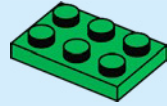

2

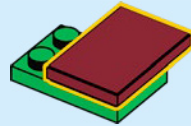

3

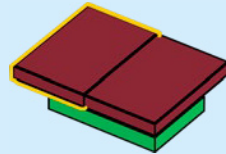

4

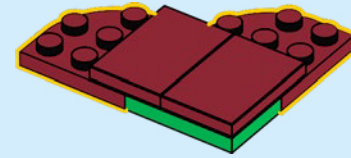

5

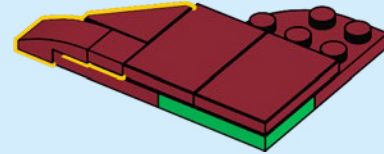

6

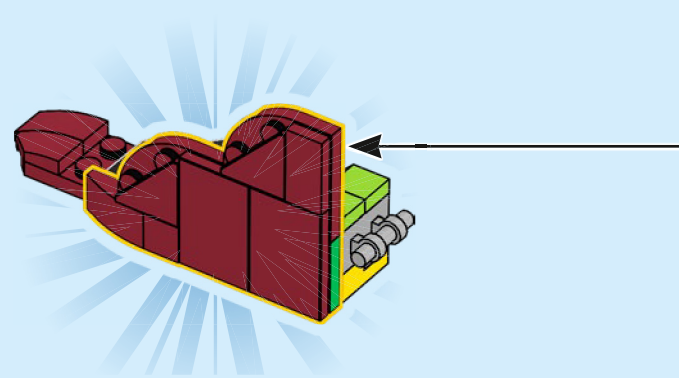
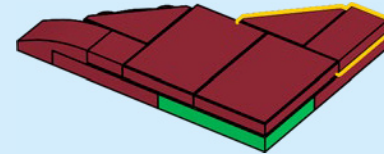

130

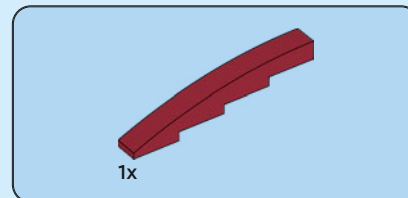
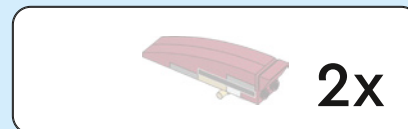
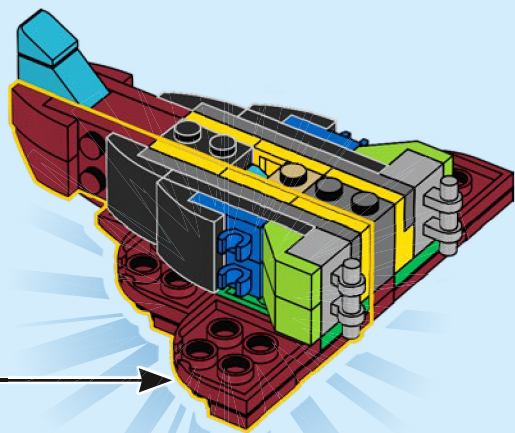

131

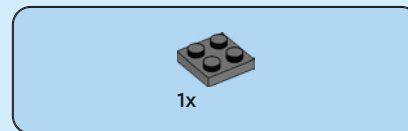
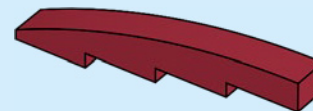

132

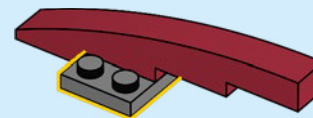

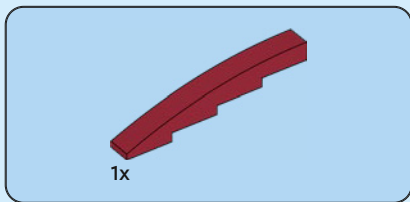

133

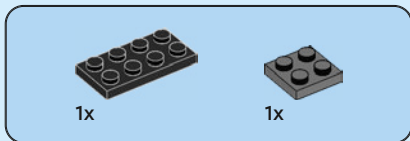
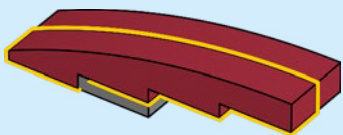

134

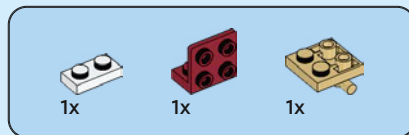
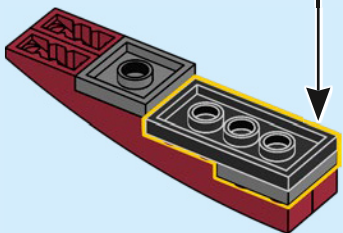
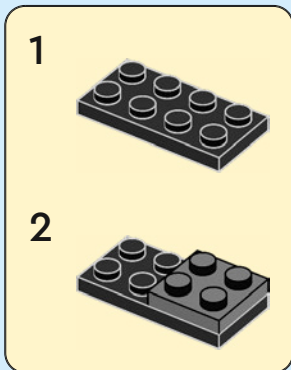

135

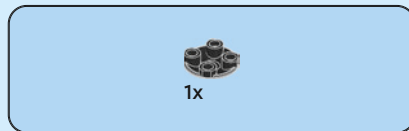
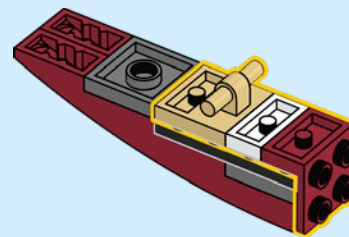

136

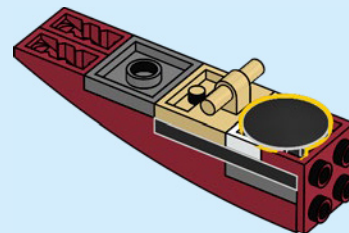



1x

137

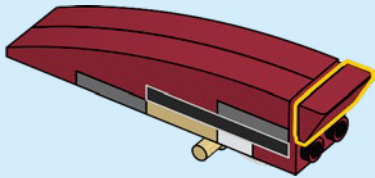

2x

138

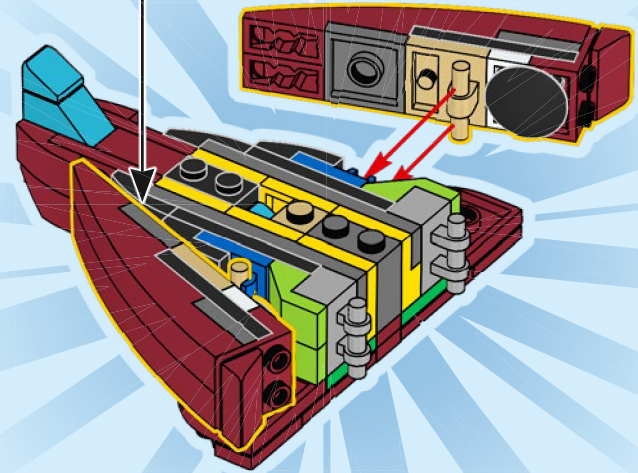

139

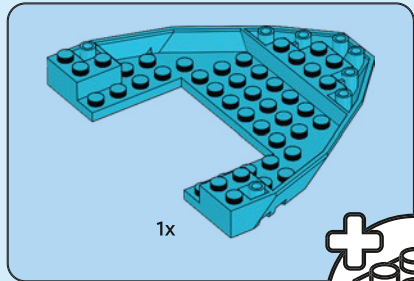
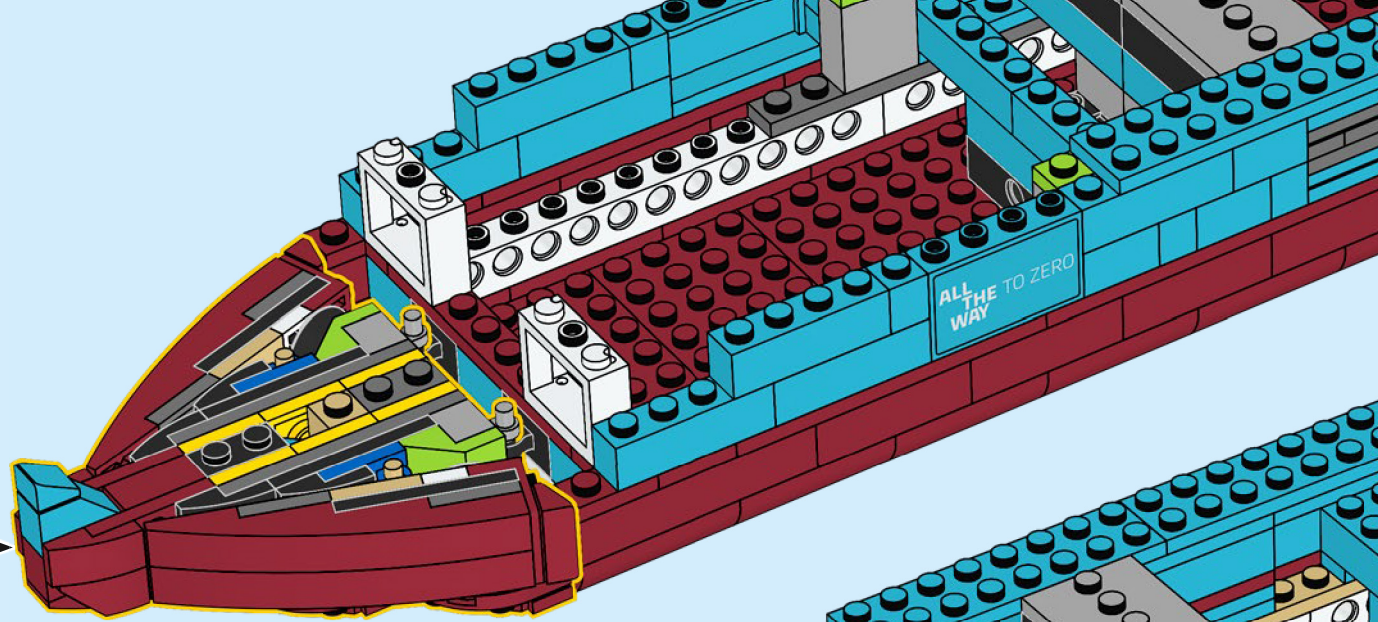

1x

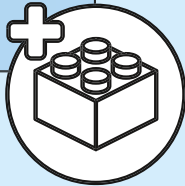

140

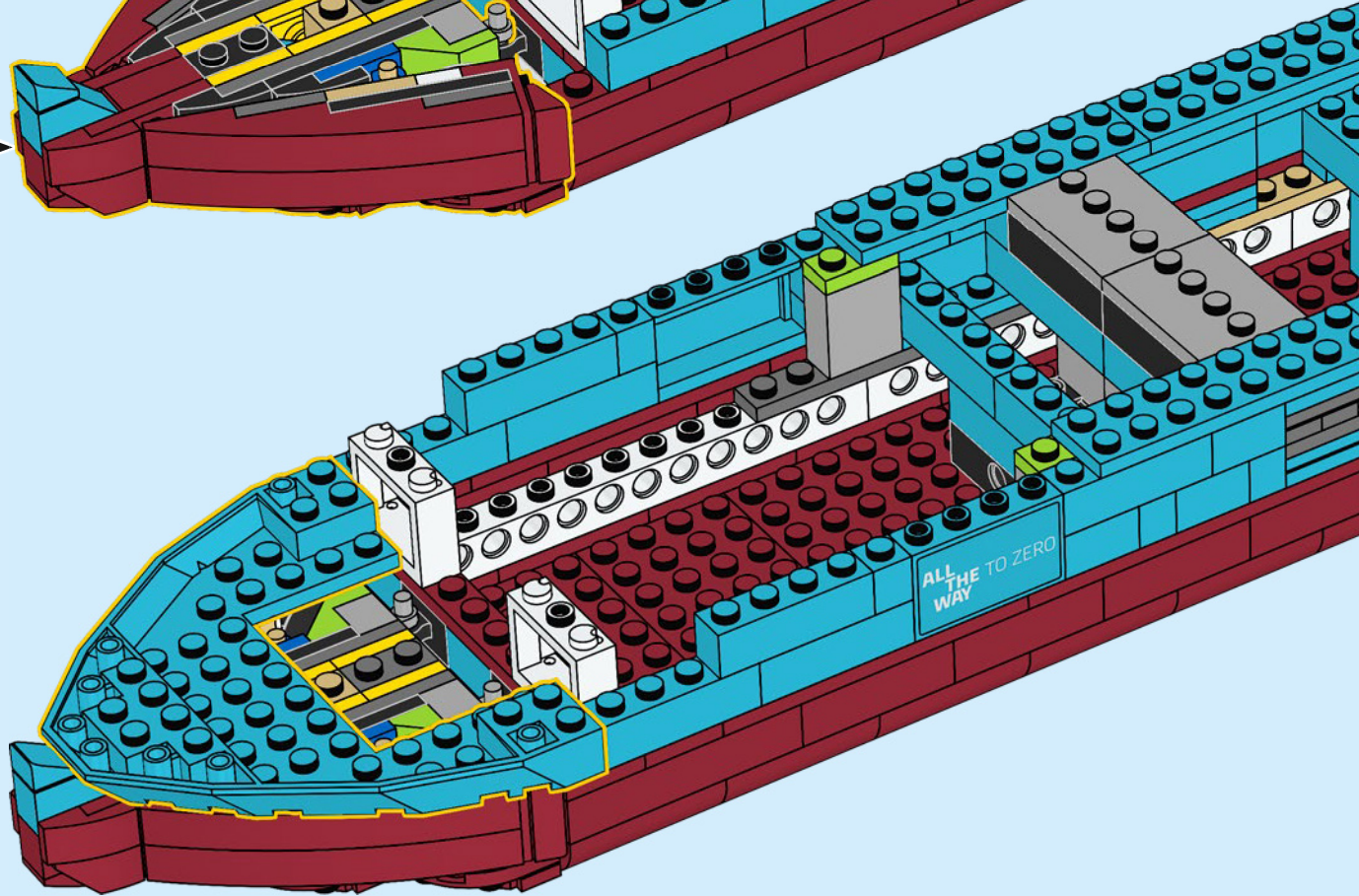

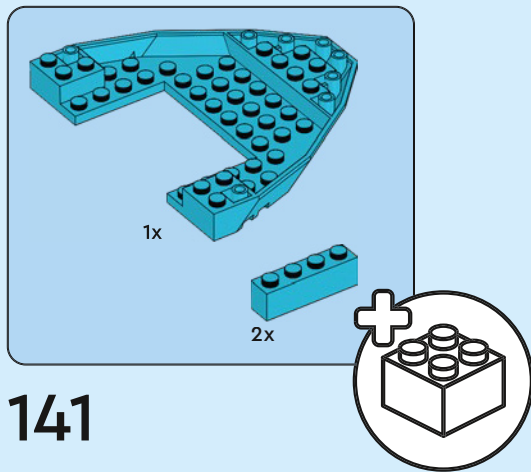

141

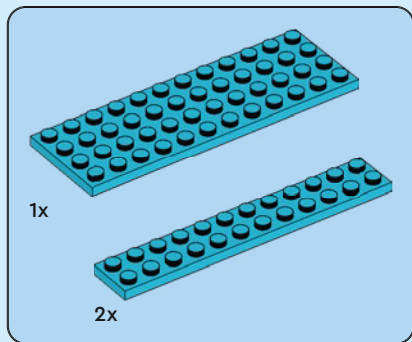
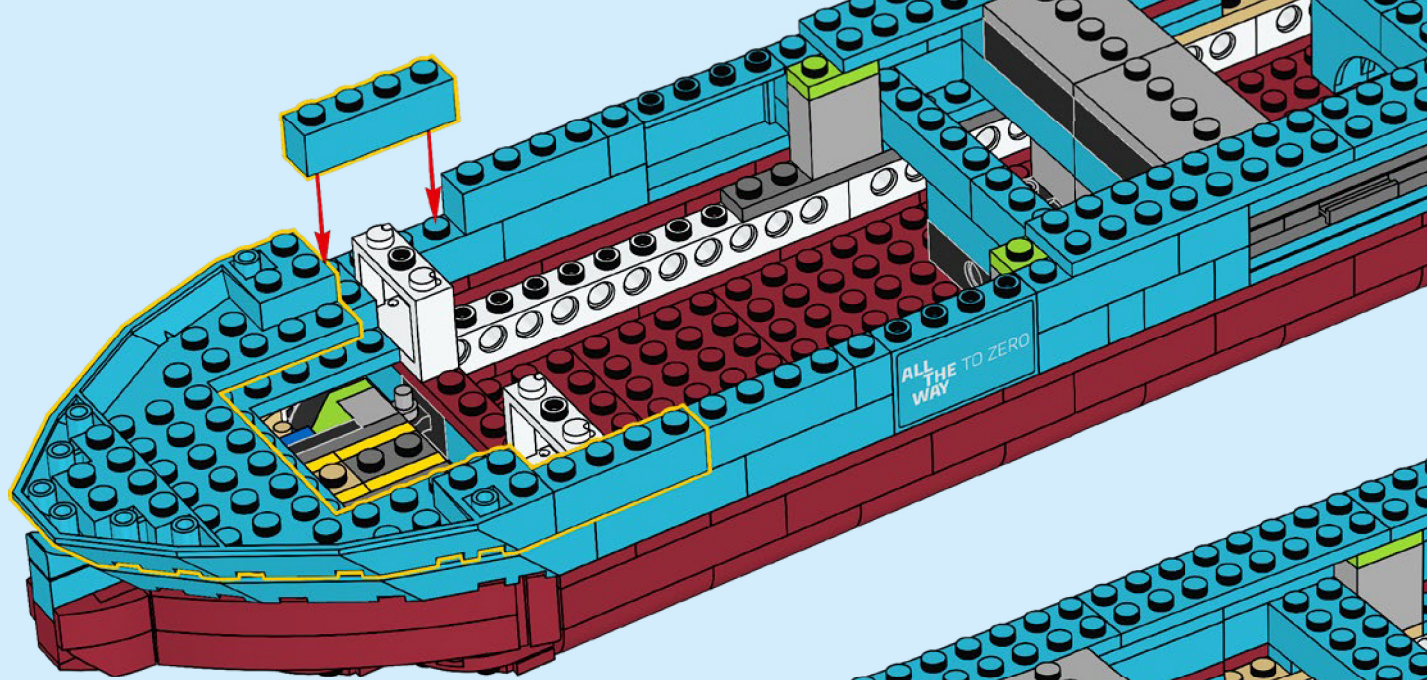

142

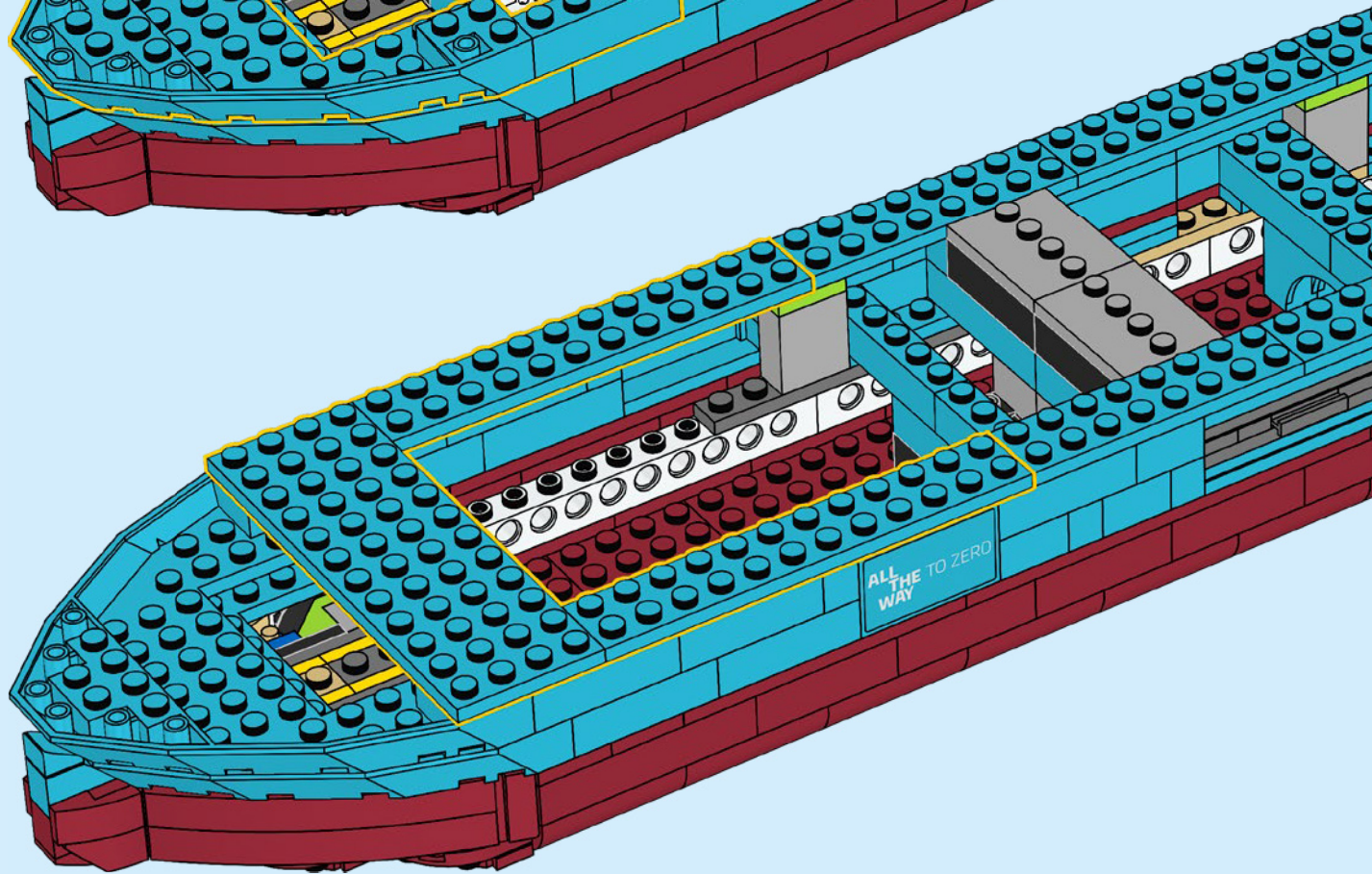

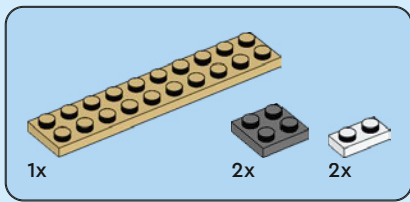

143

1

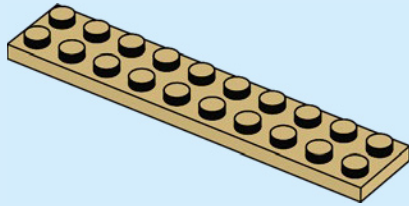

2

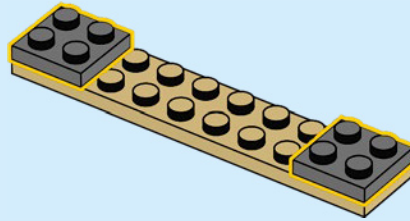

3

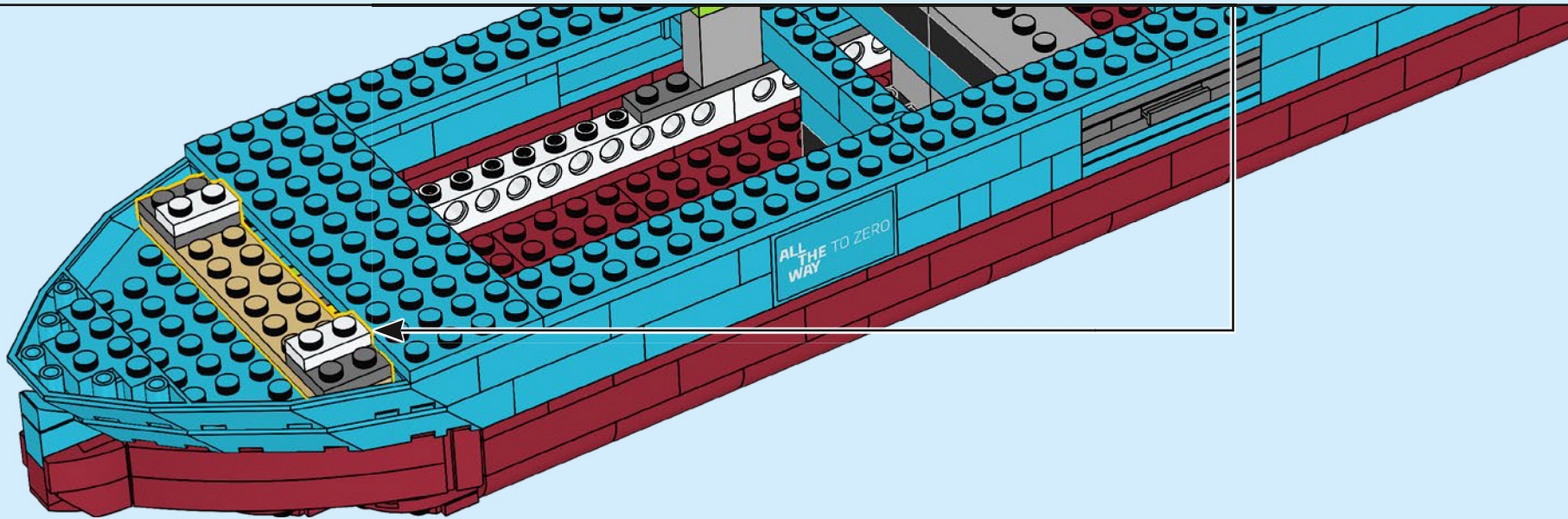
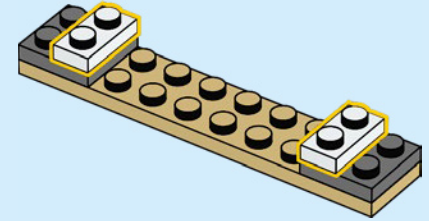

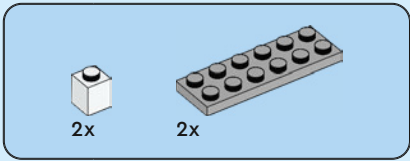

144

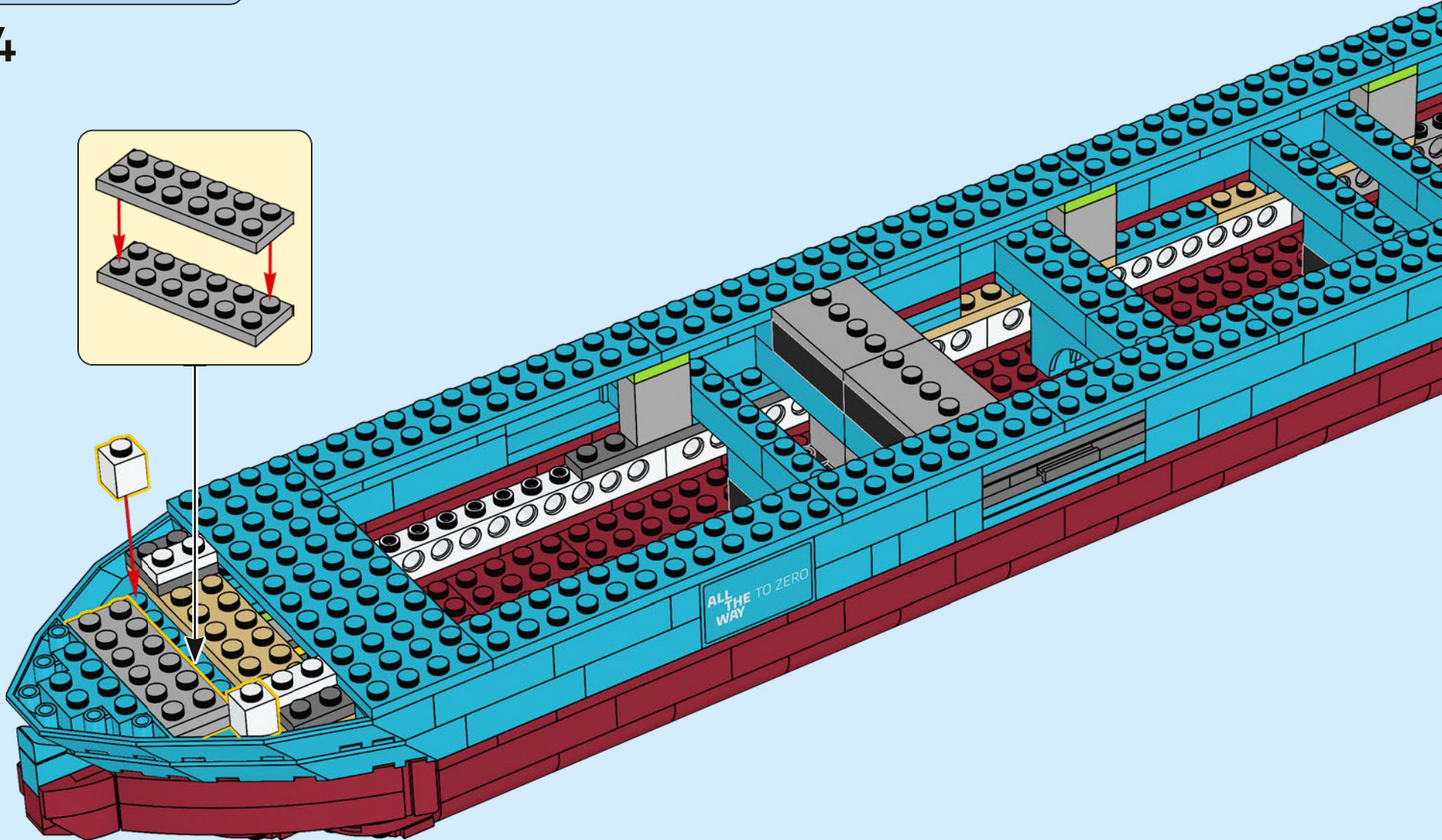
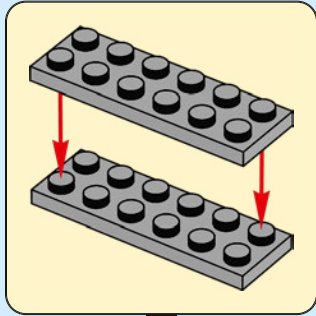

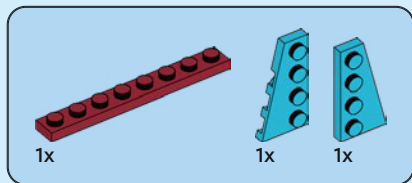

145

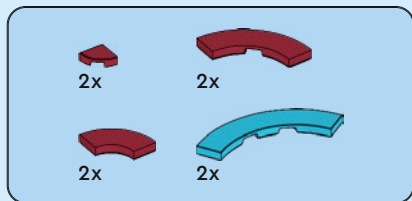
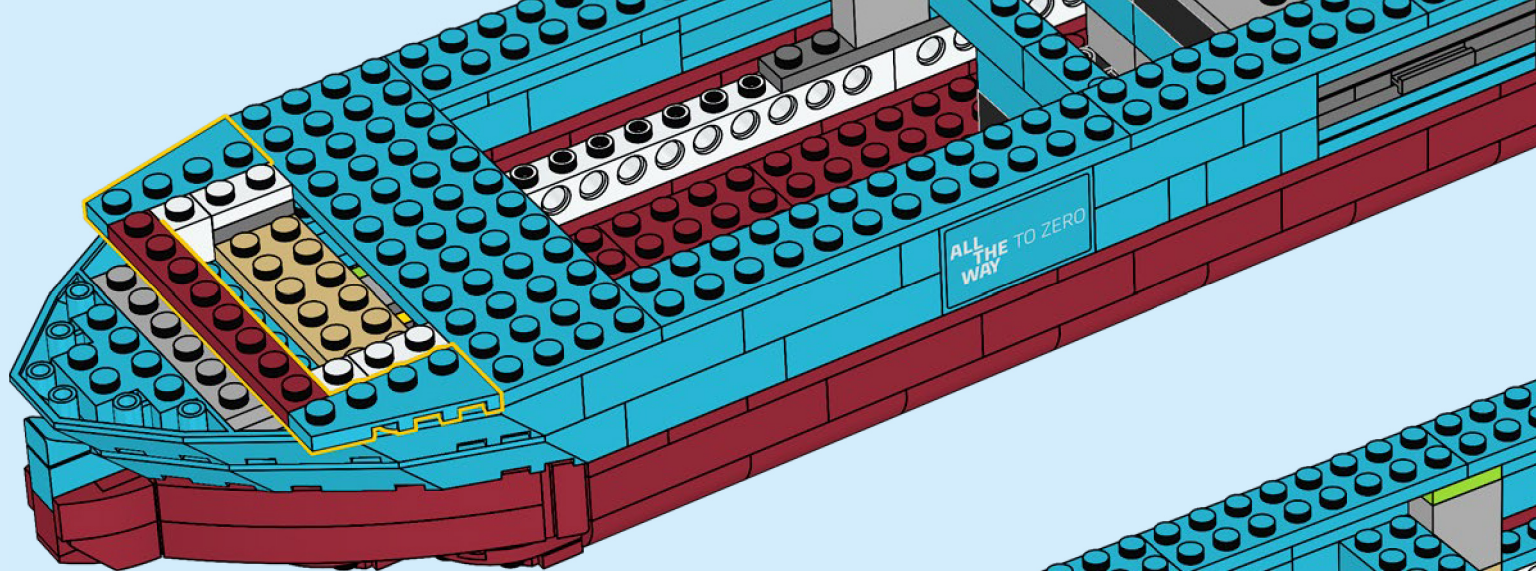

146

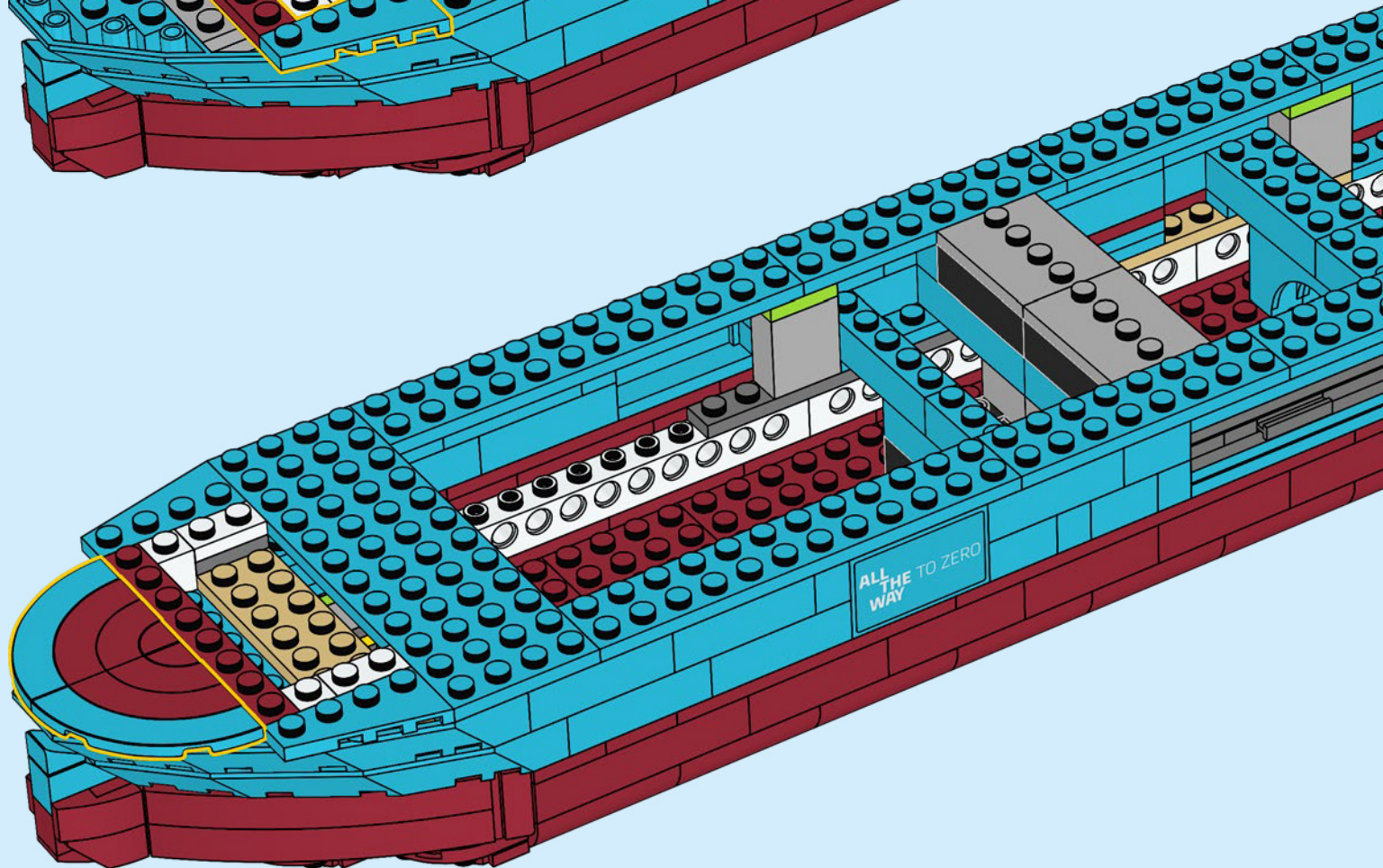

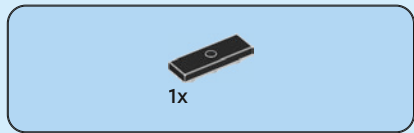

147

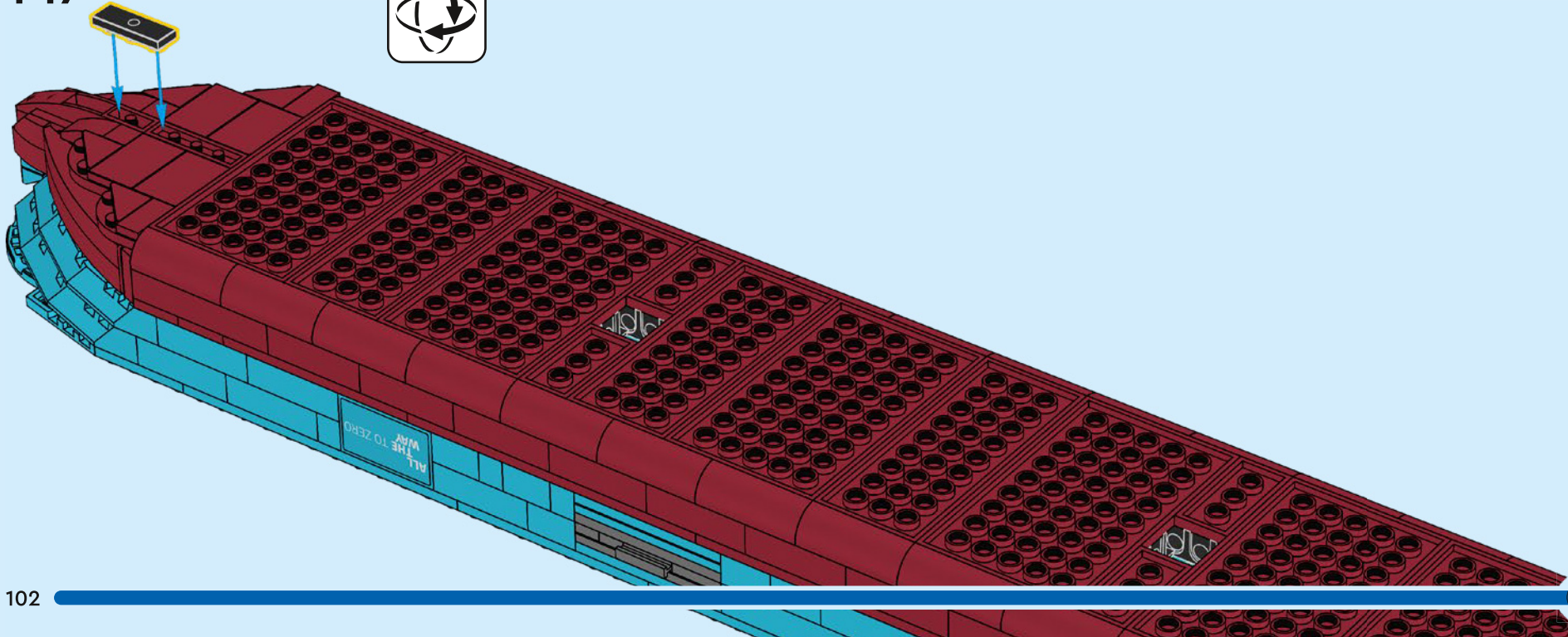



24x

148

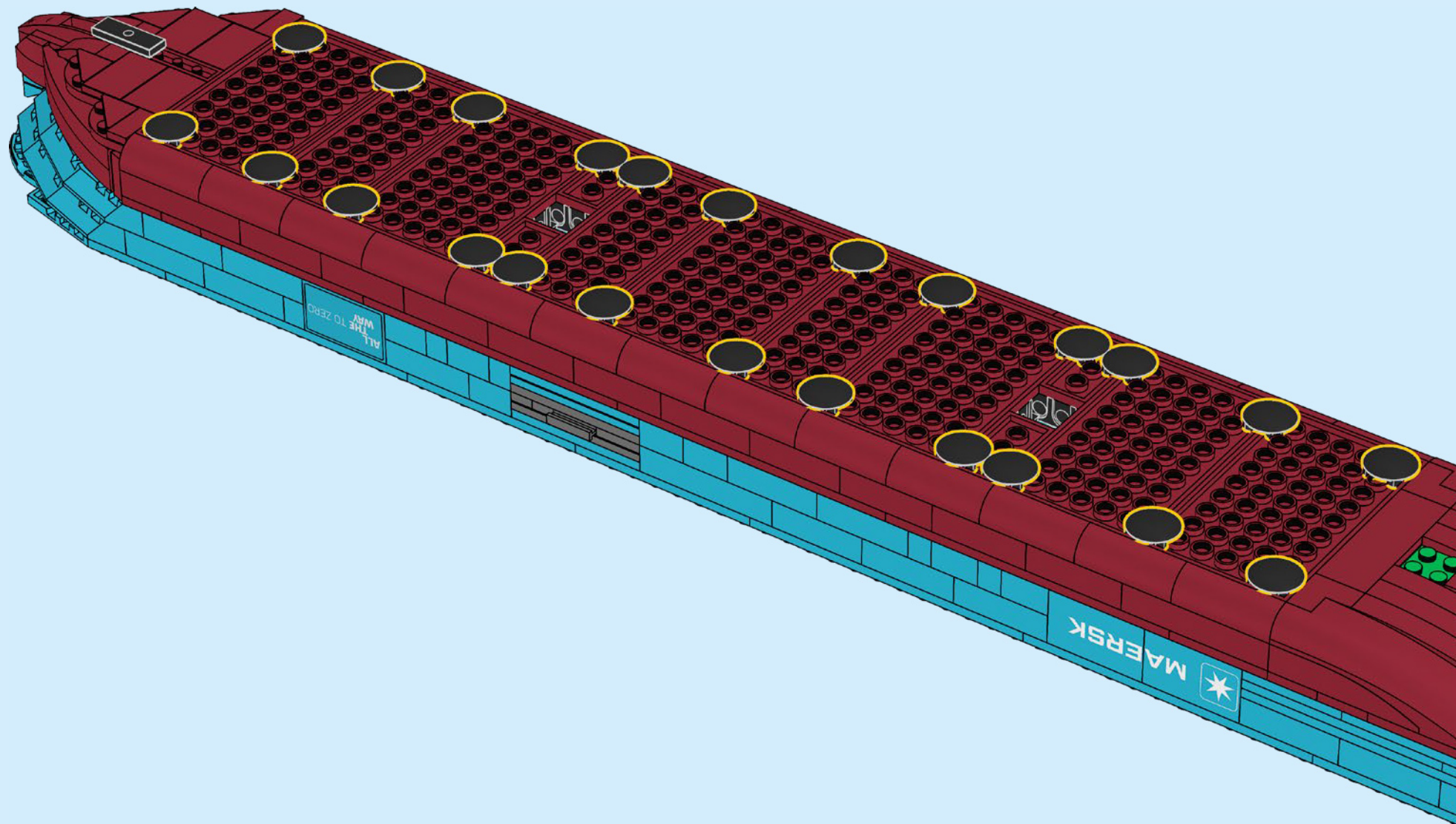

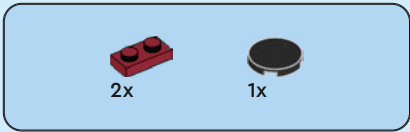

149

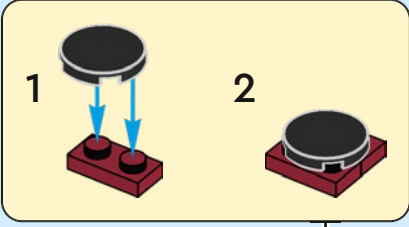
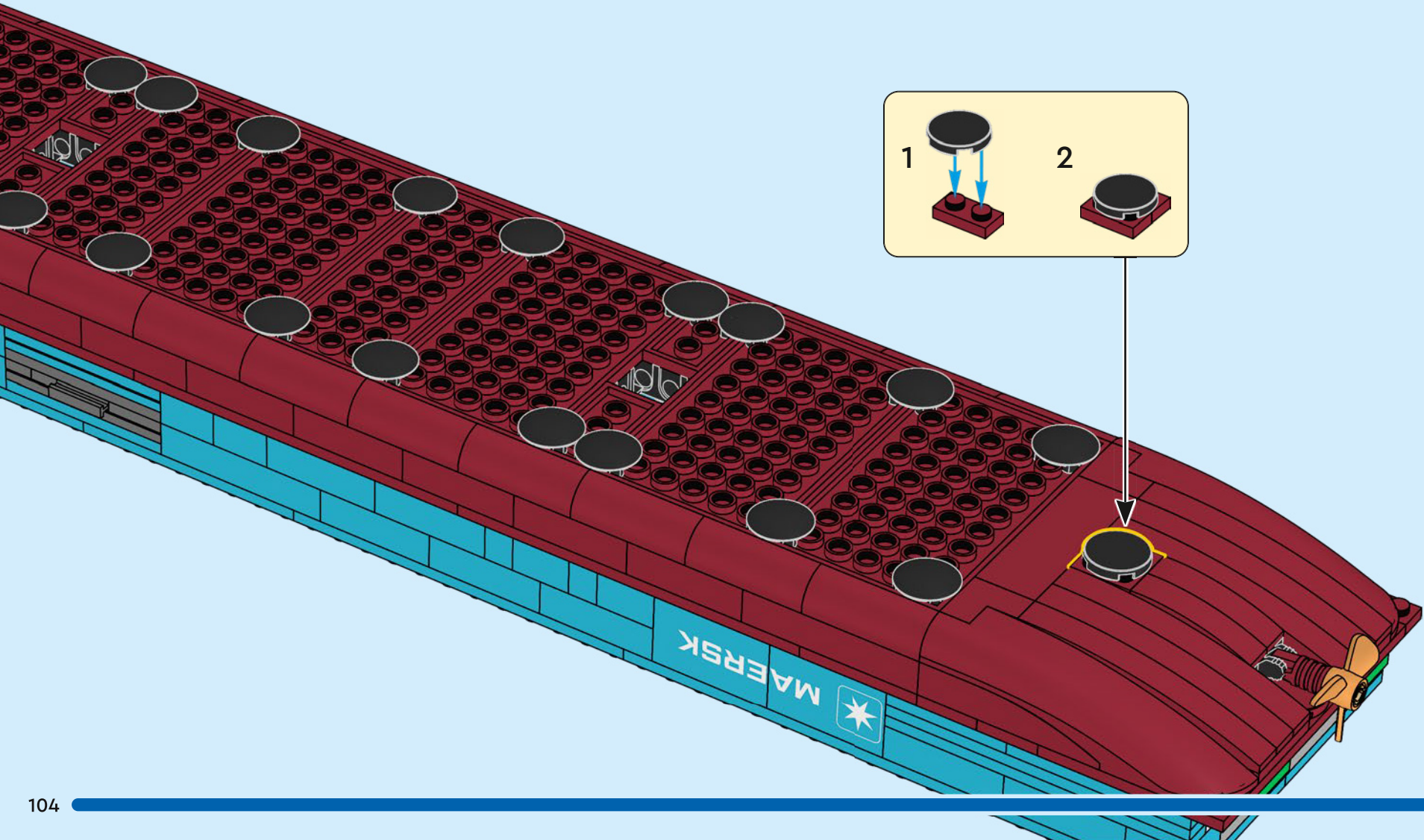

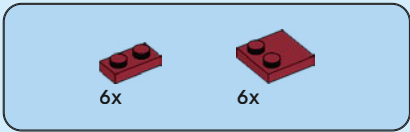

150

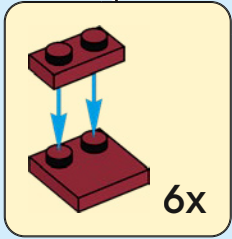
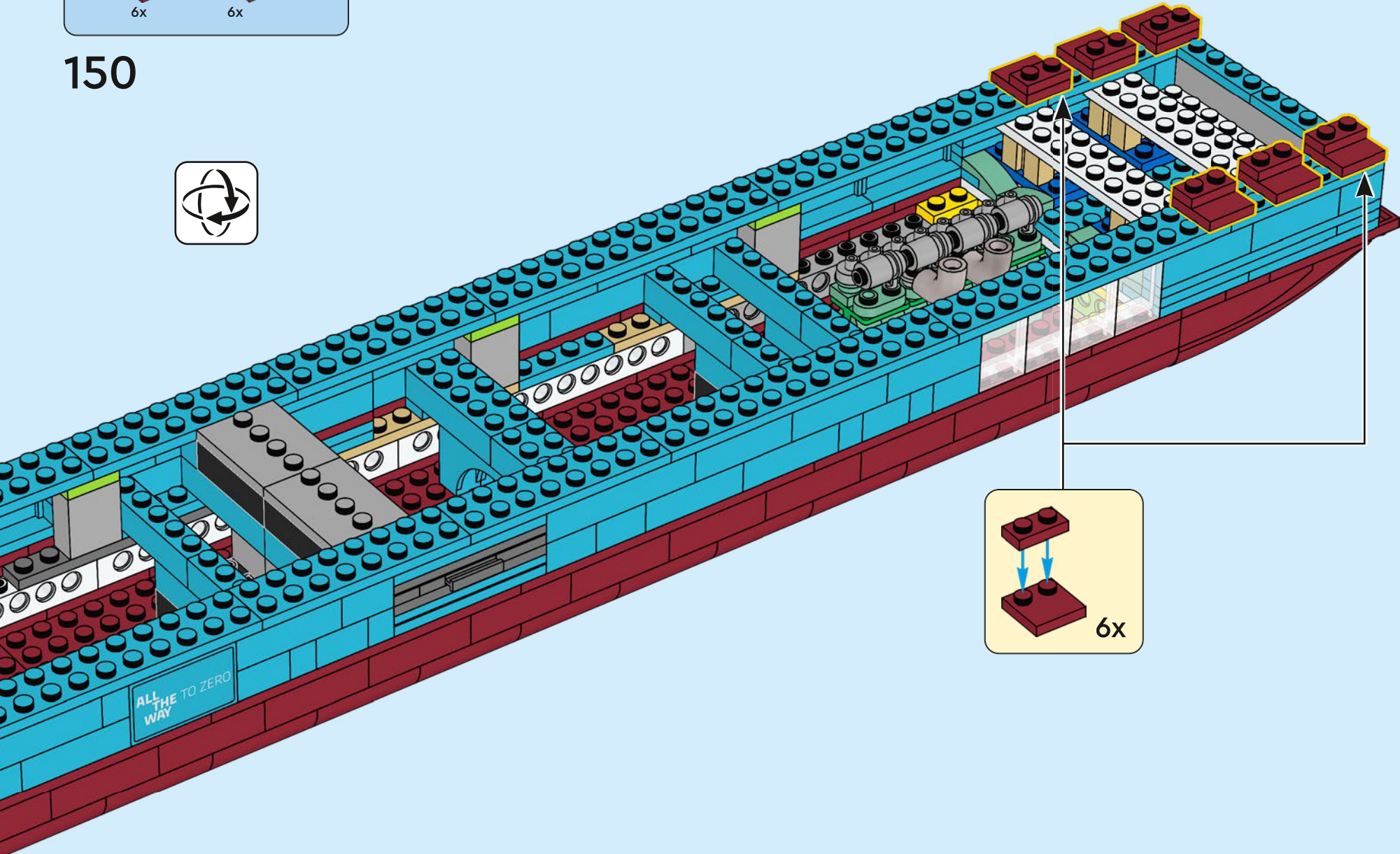

ALL
THE
WAY TO ZERO

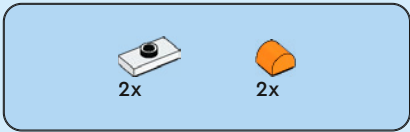

151

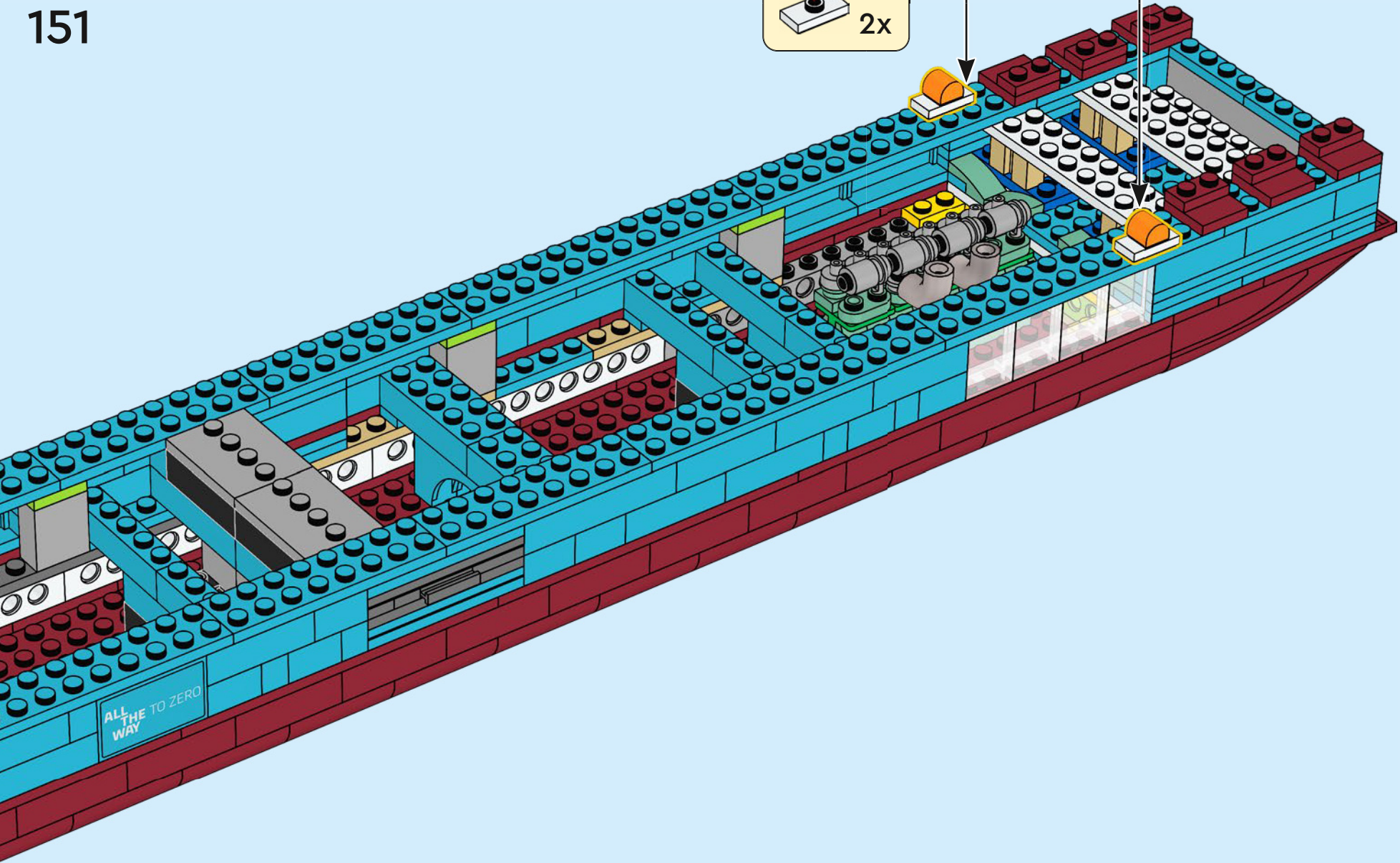
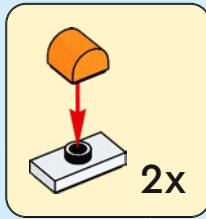

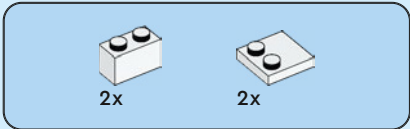

152

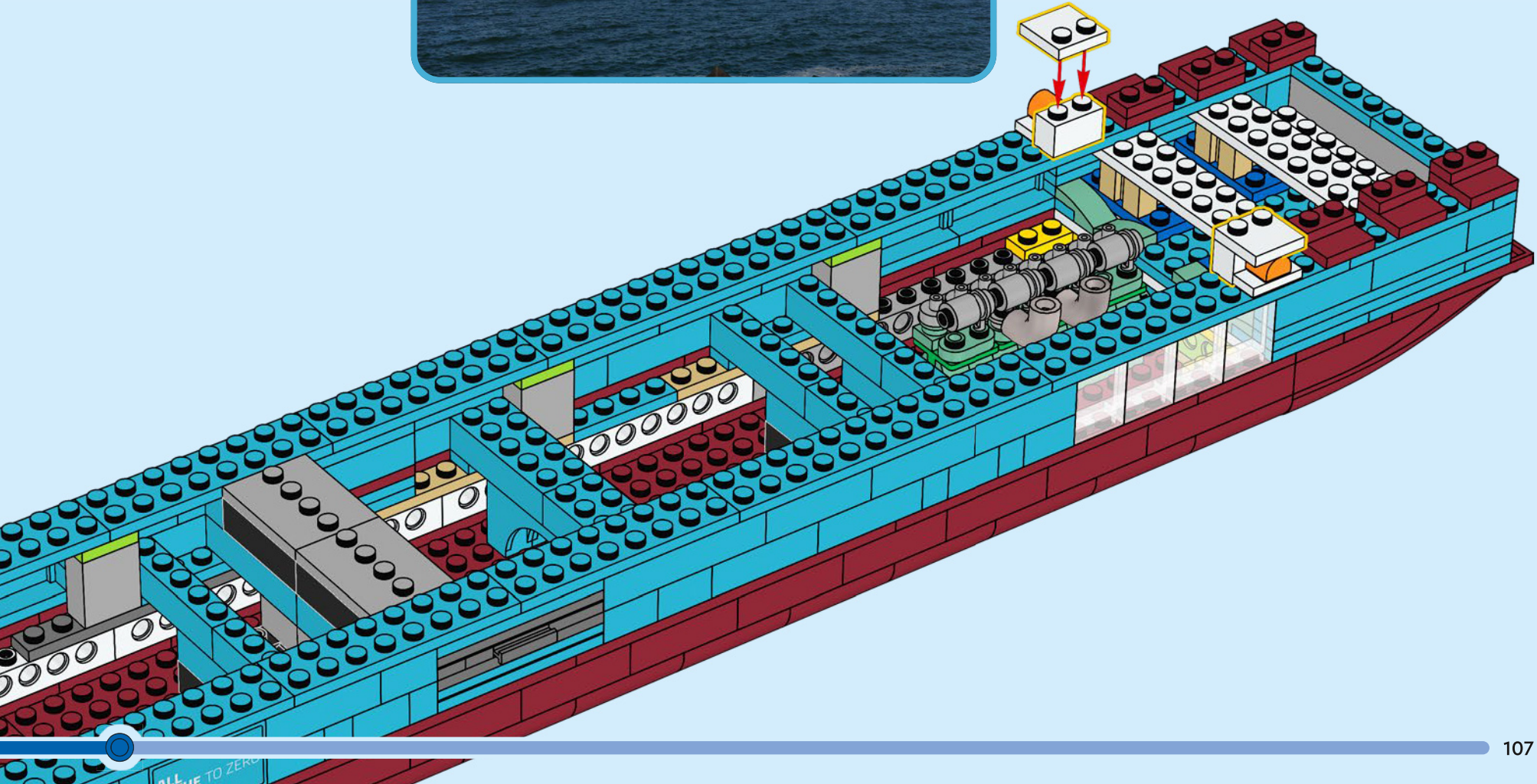
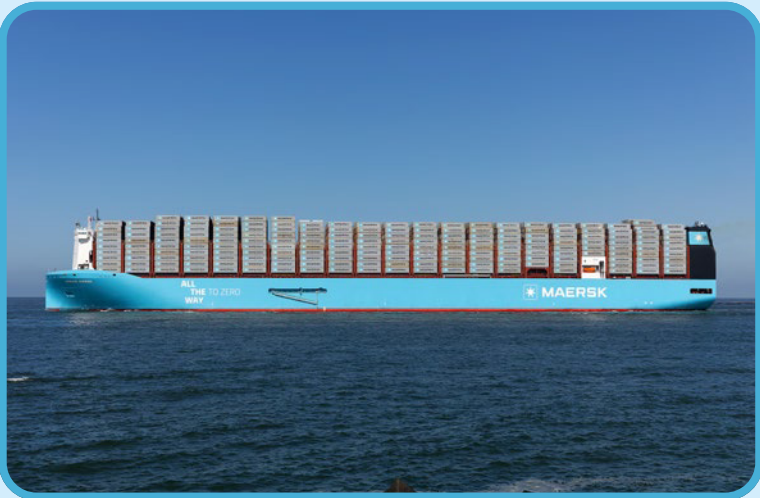

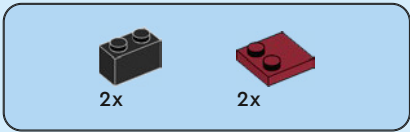

154

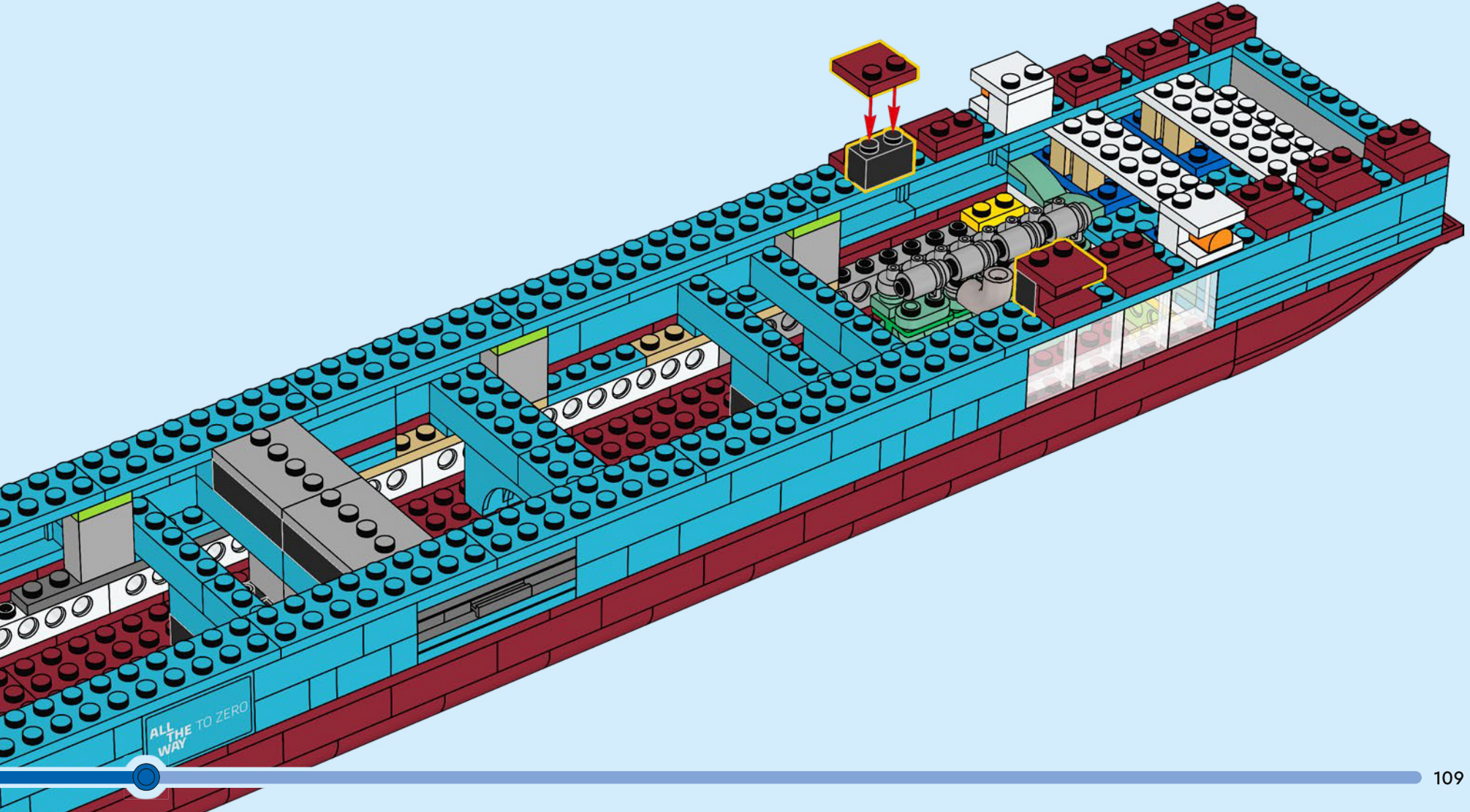

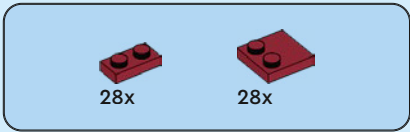

155

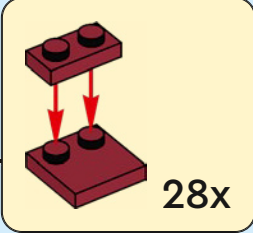
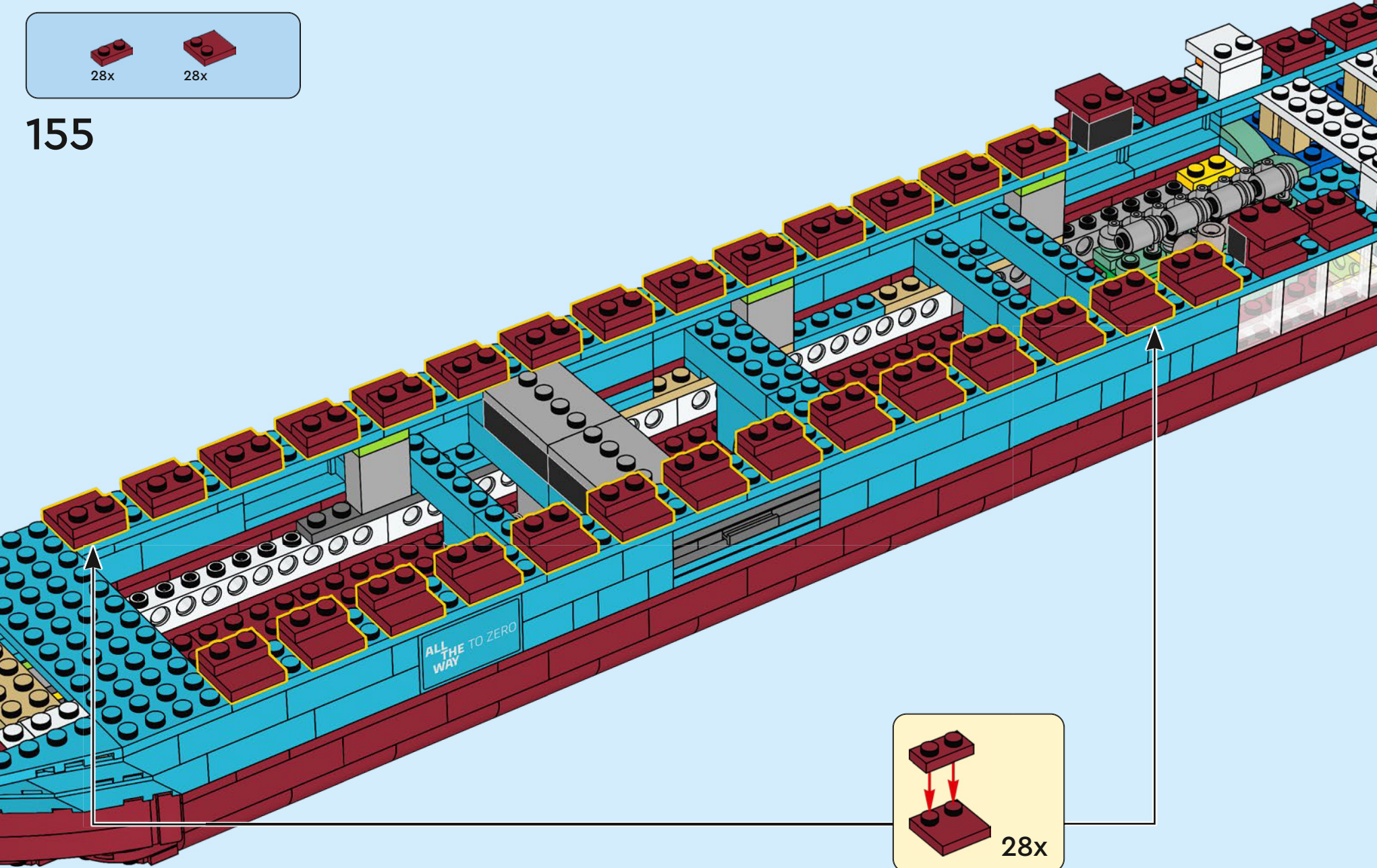

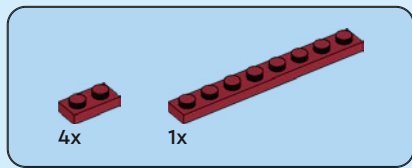

156

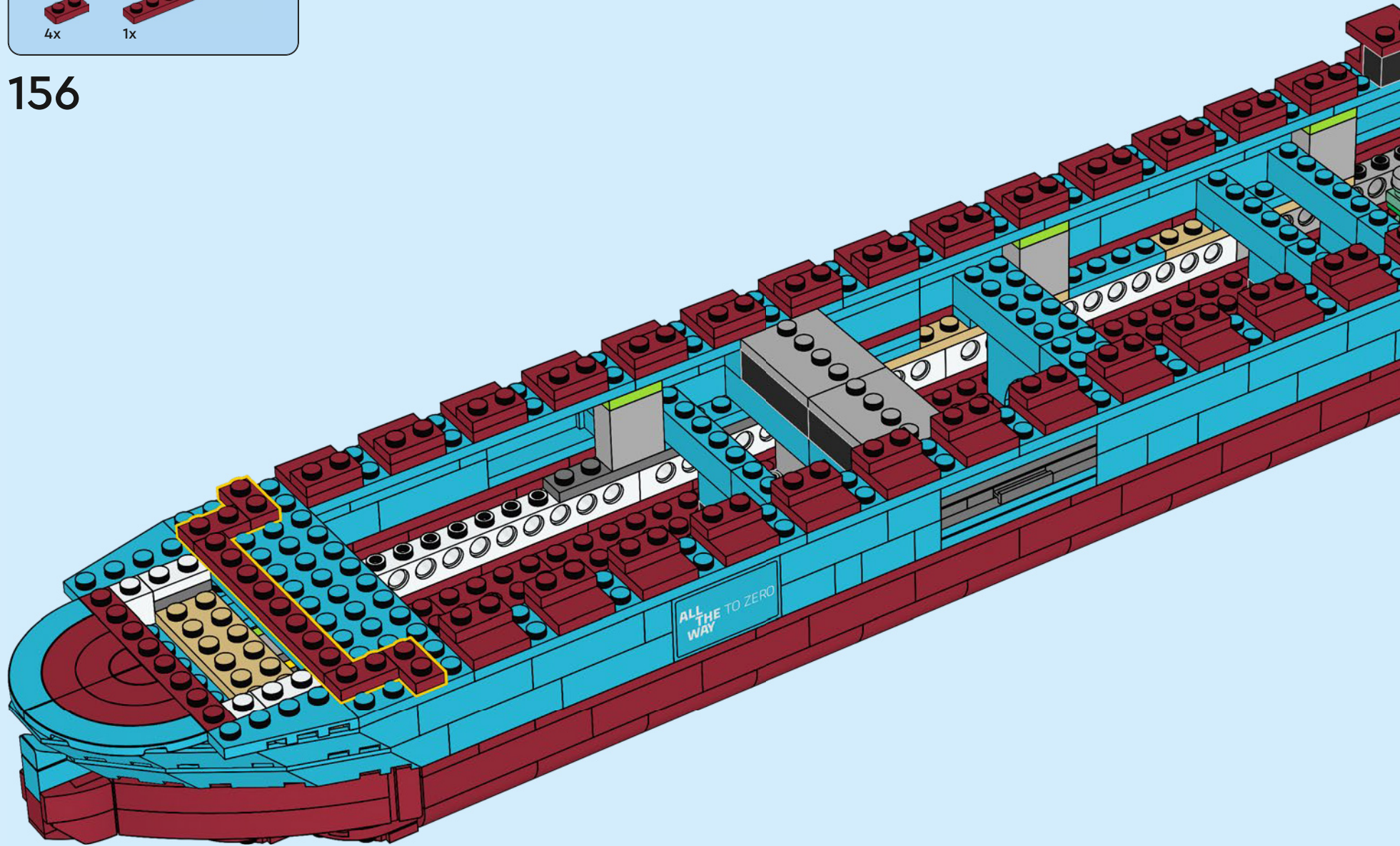

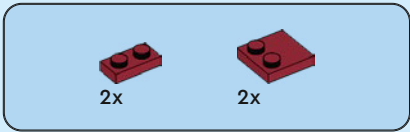

157

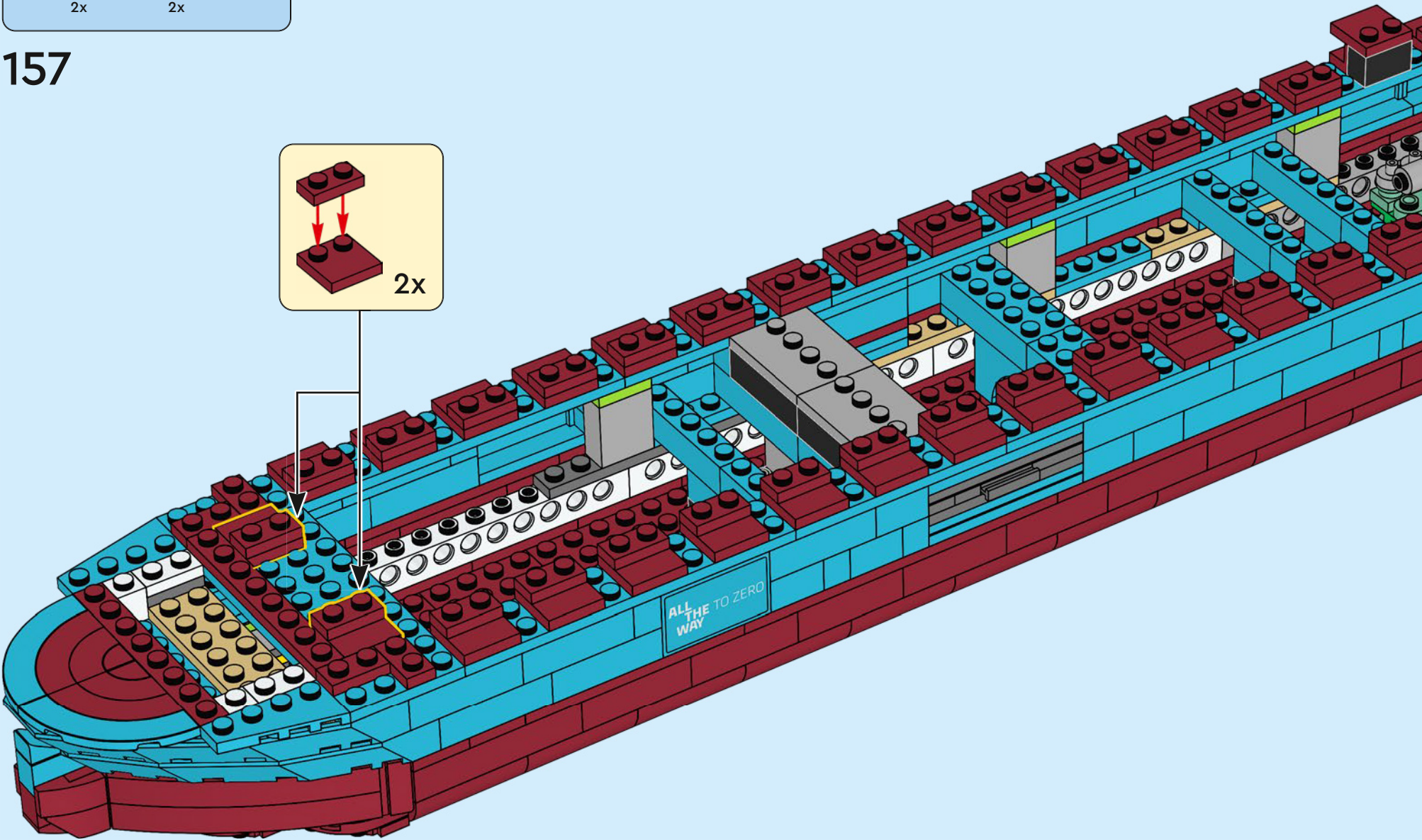
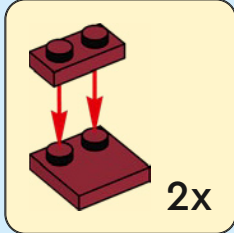

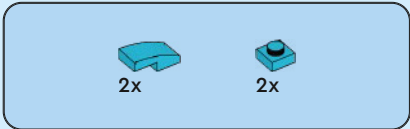

158

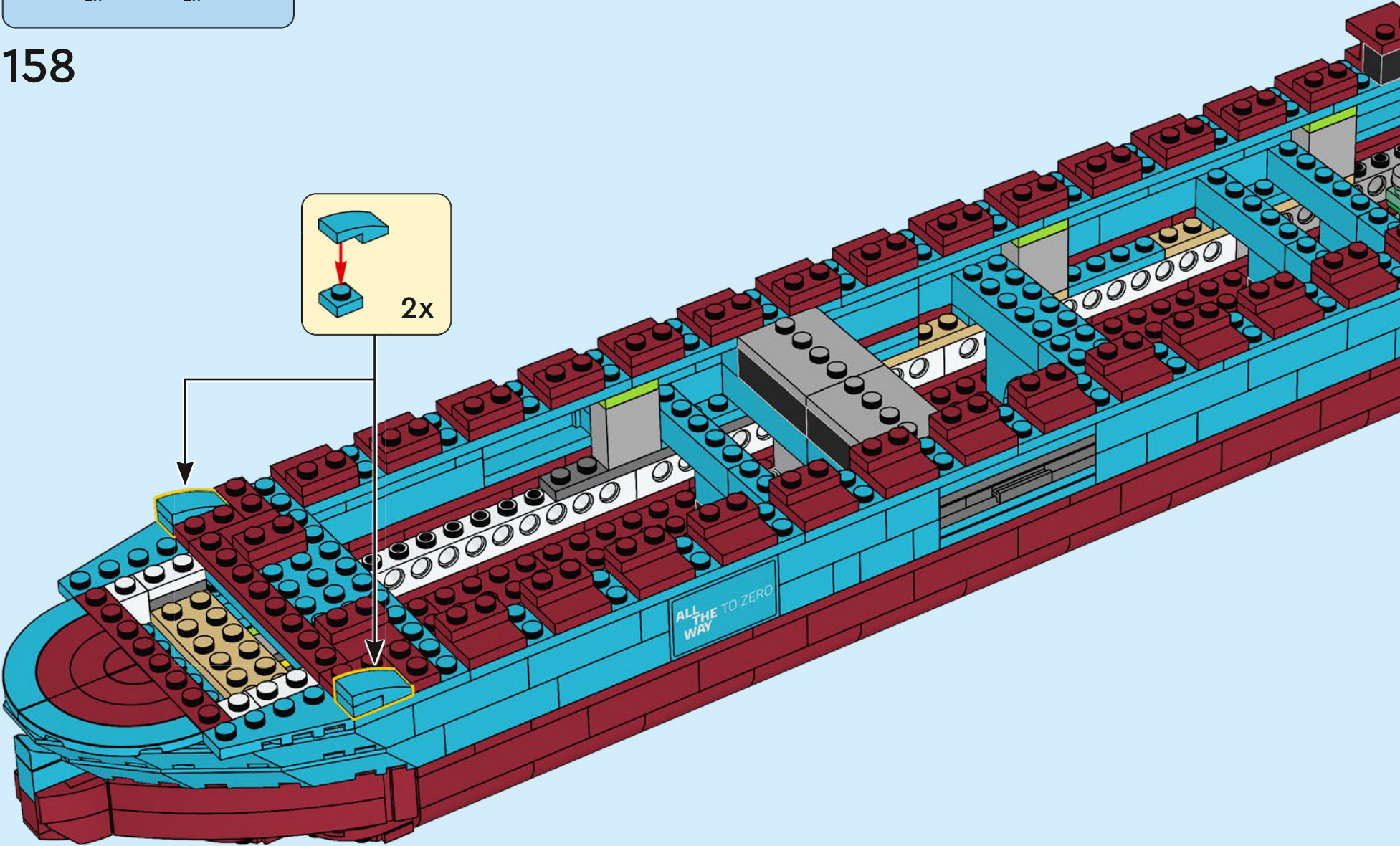
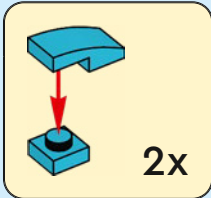

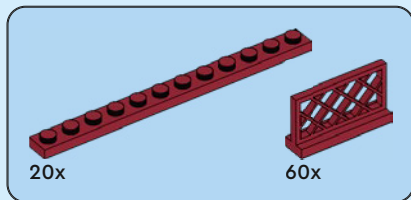
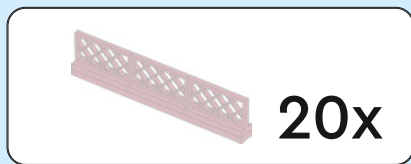

159

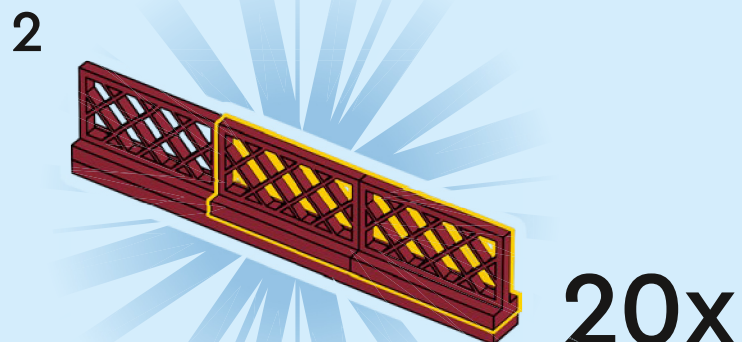
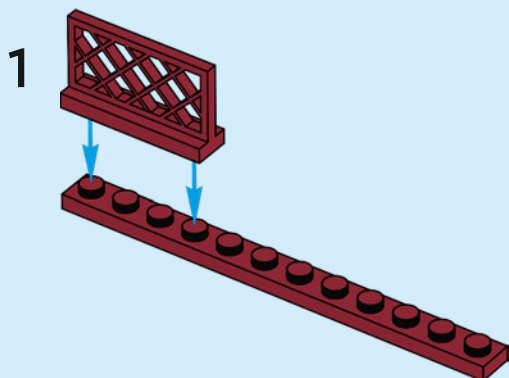
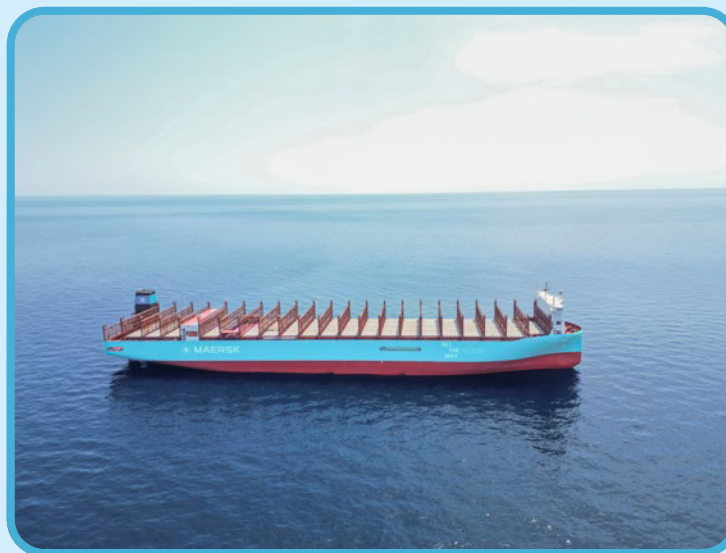

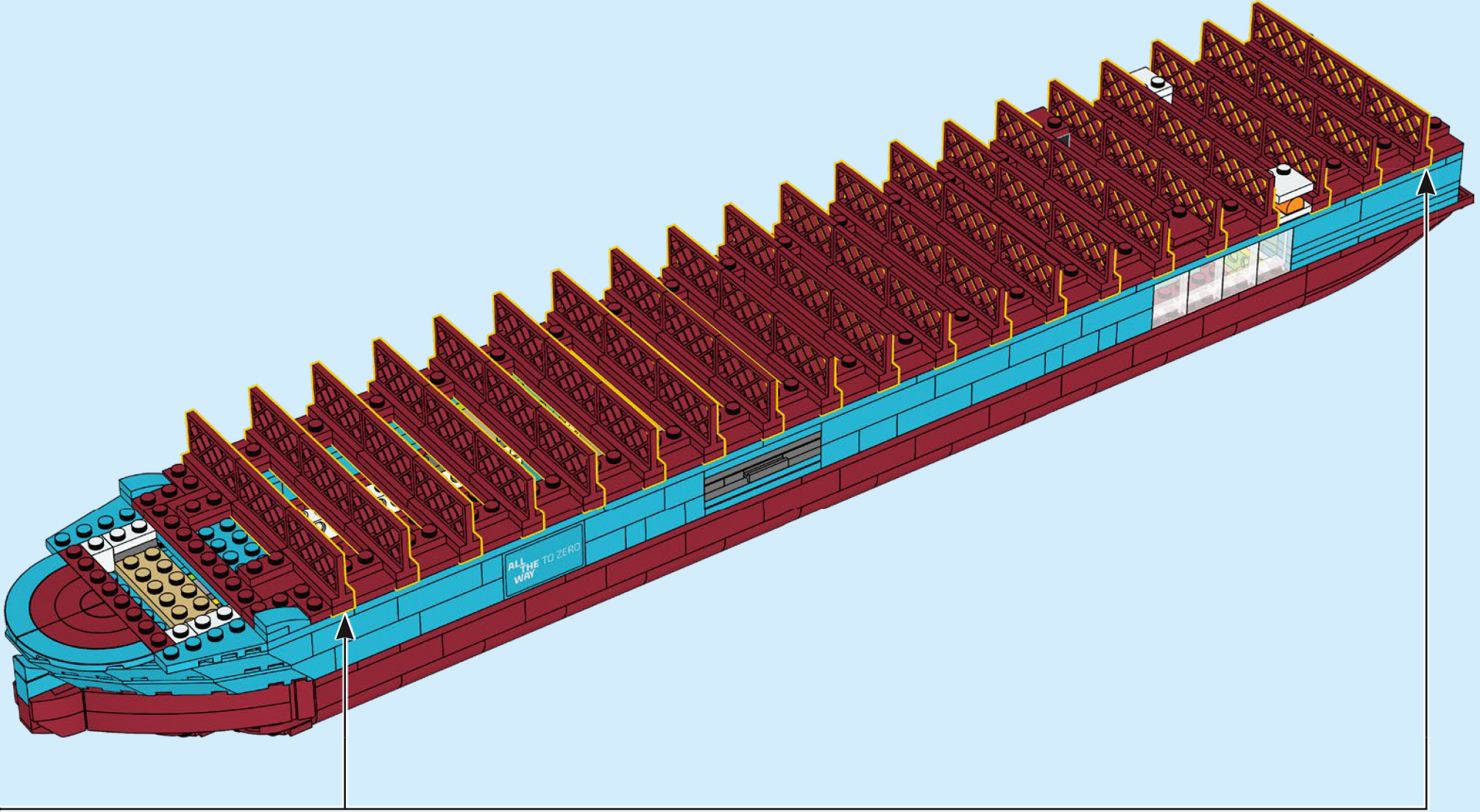

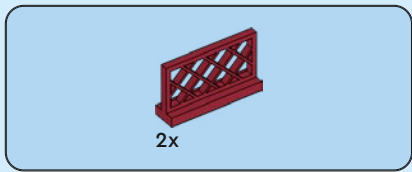

160

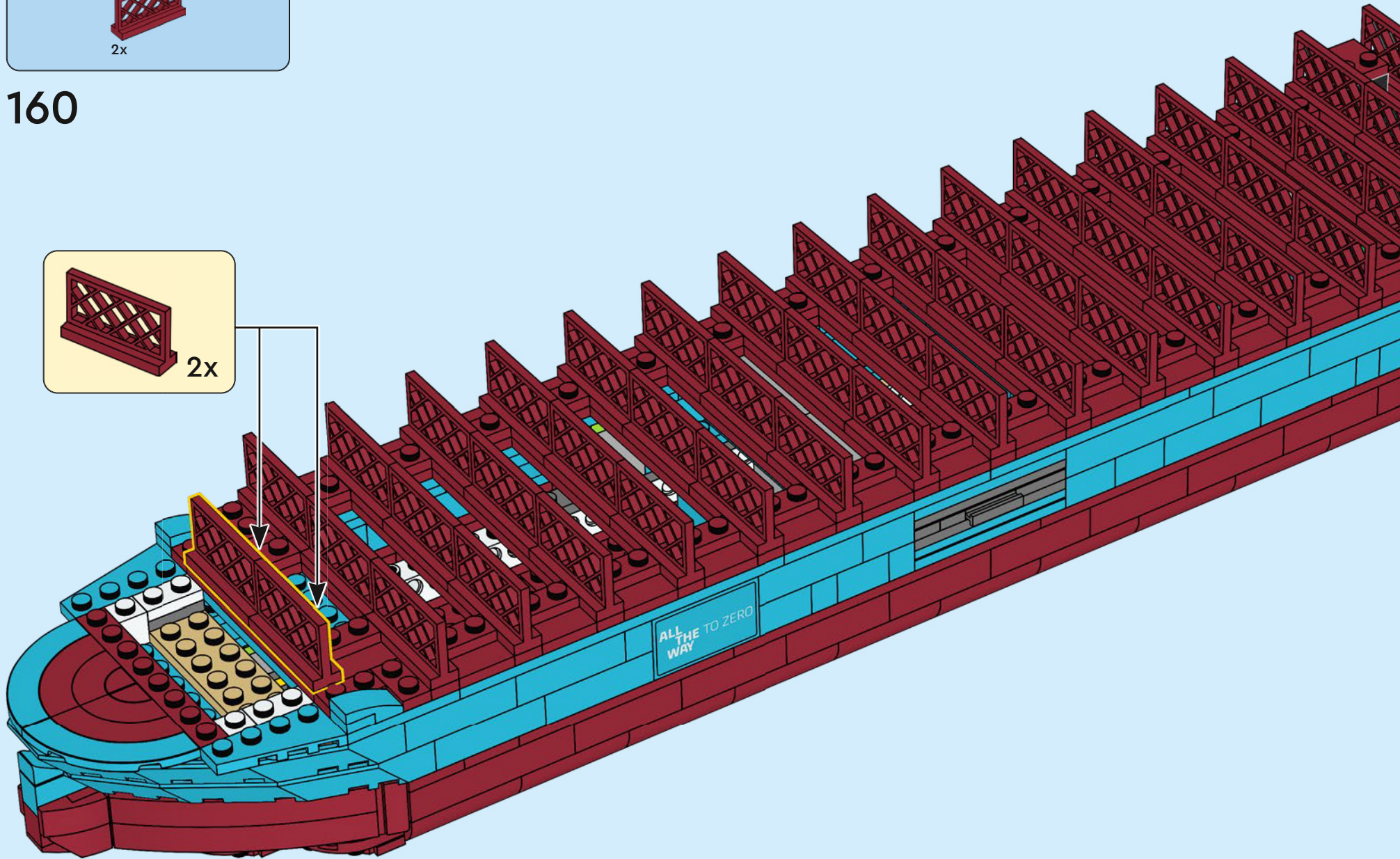
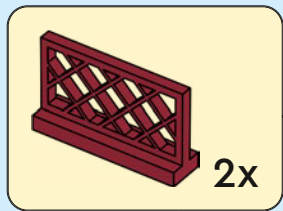

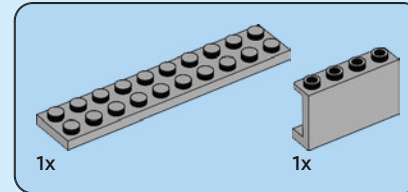
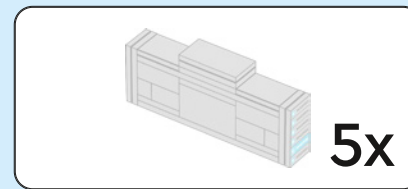

161

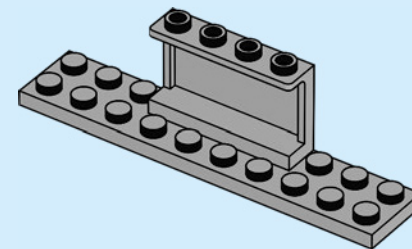
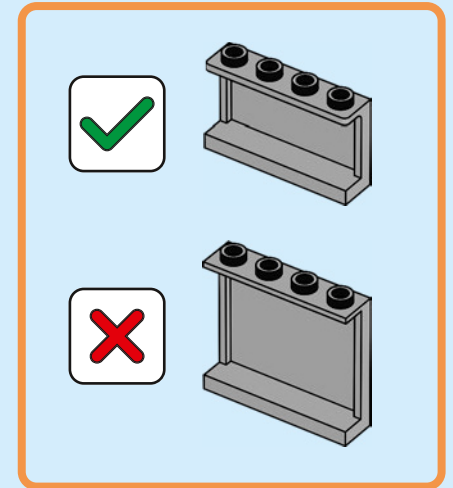

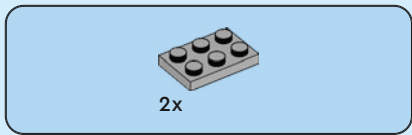

162

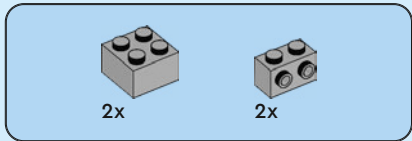
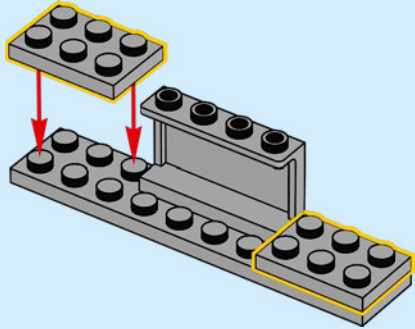

163

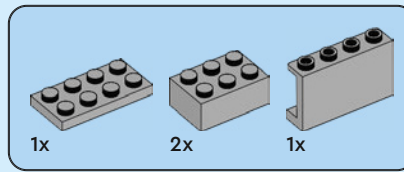
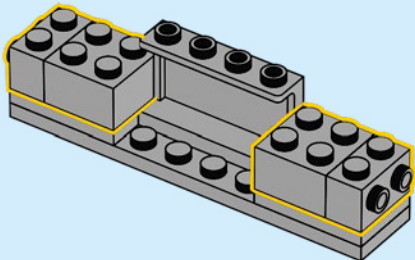

164

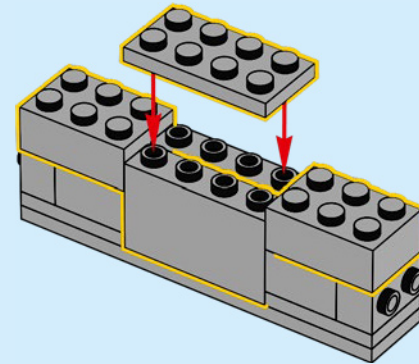

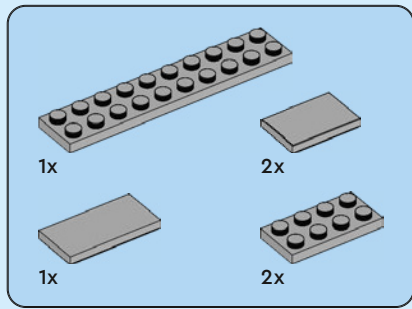

165

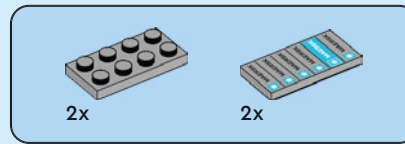
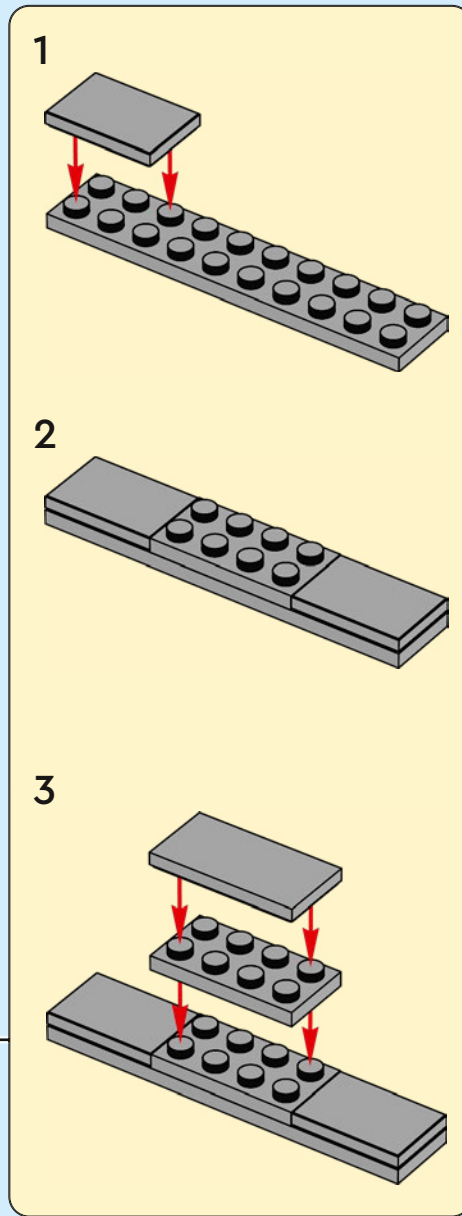
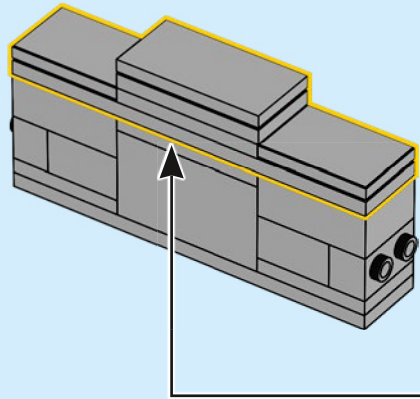

166

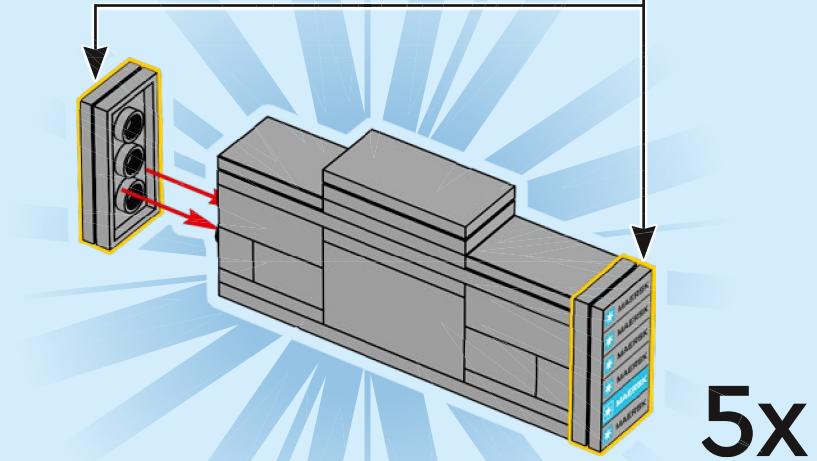
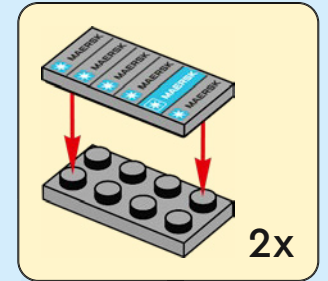

5x



167

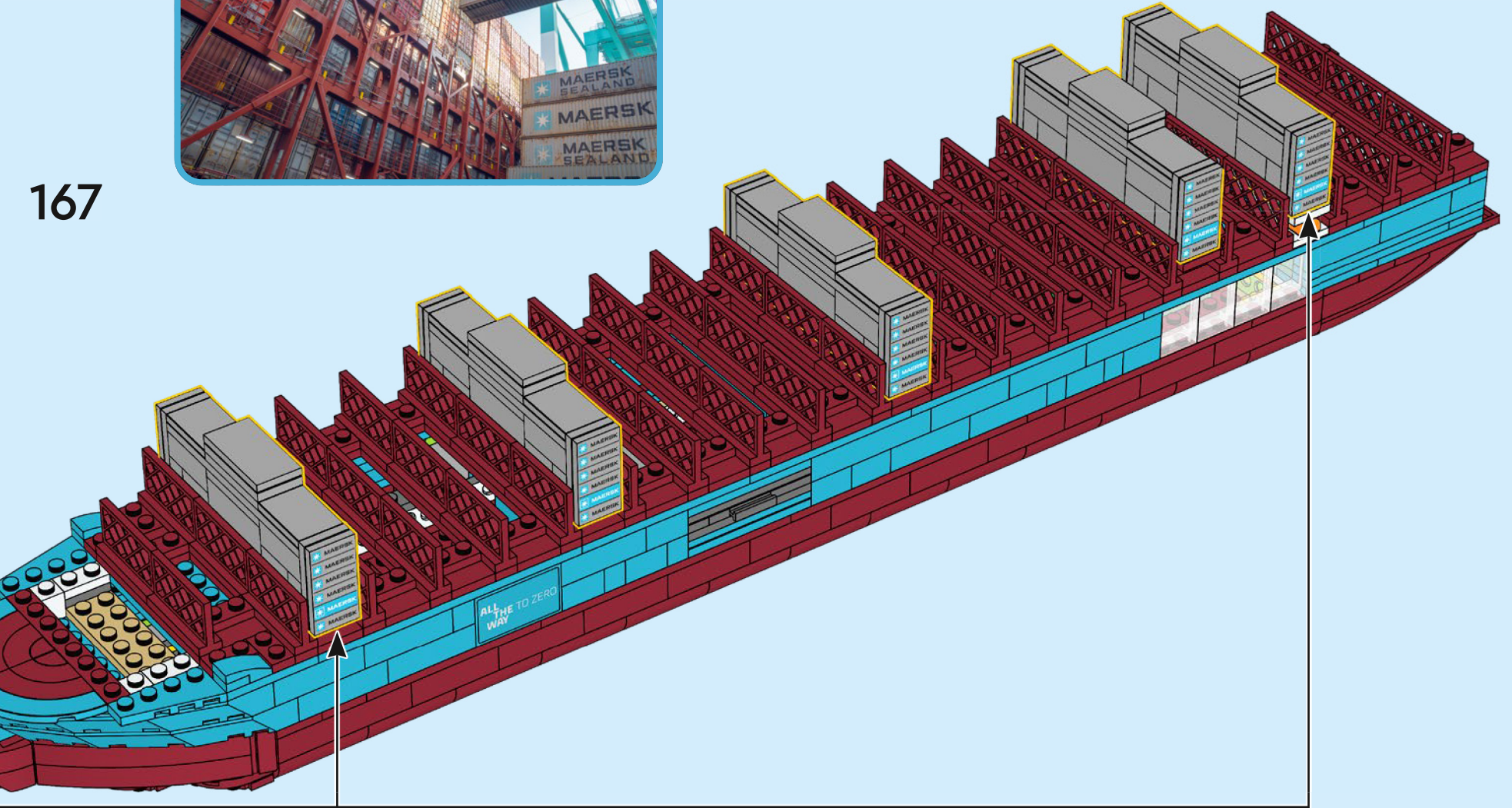

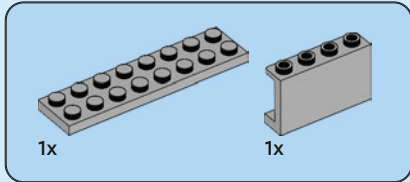
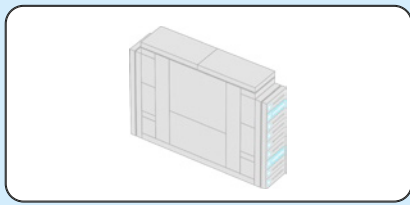

168

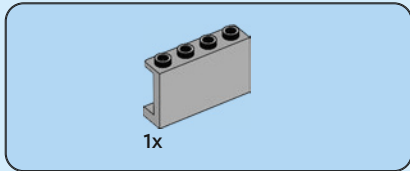
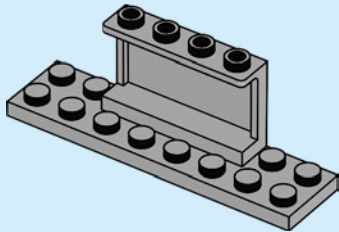

169

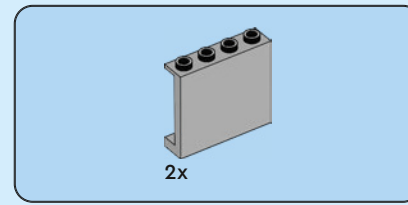
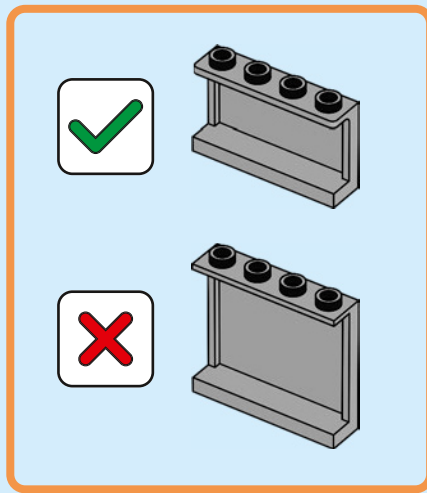
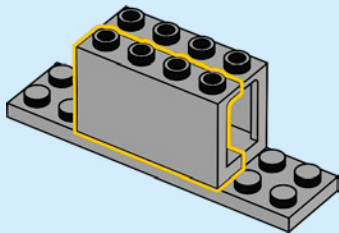

170

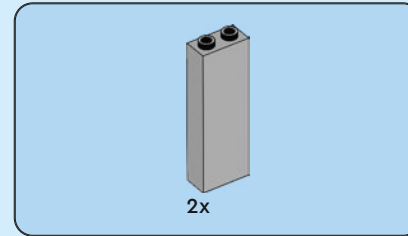
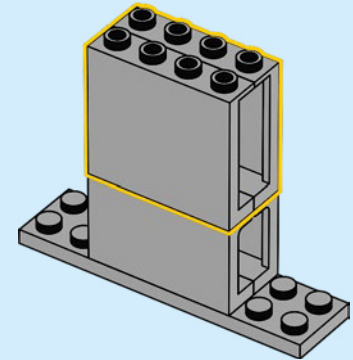

171

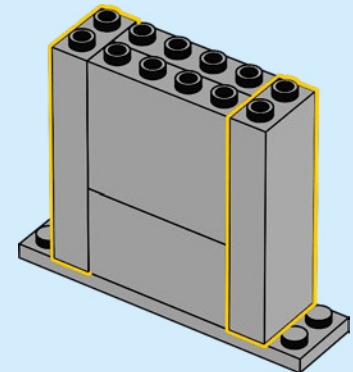

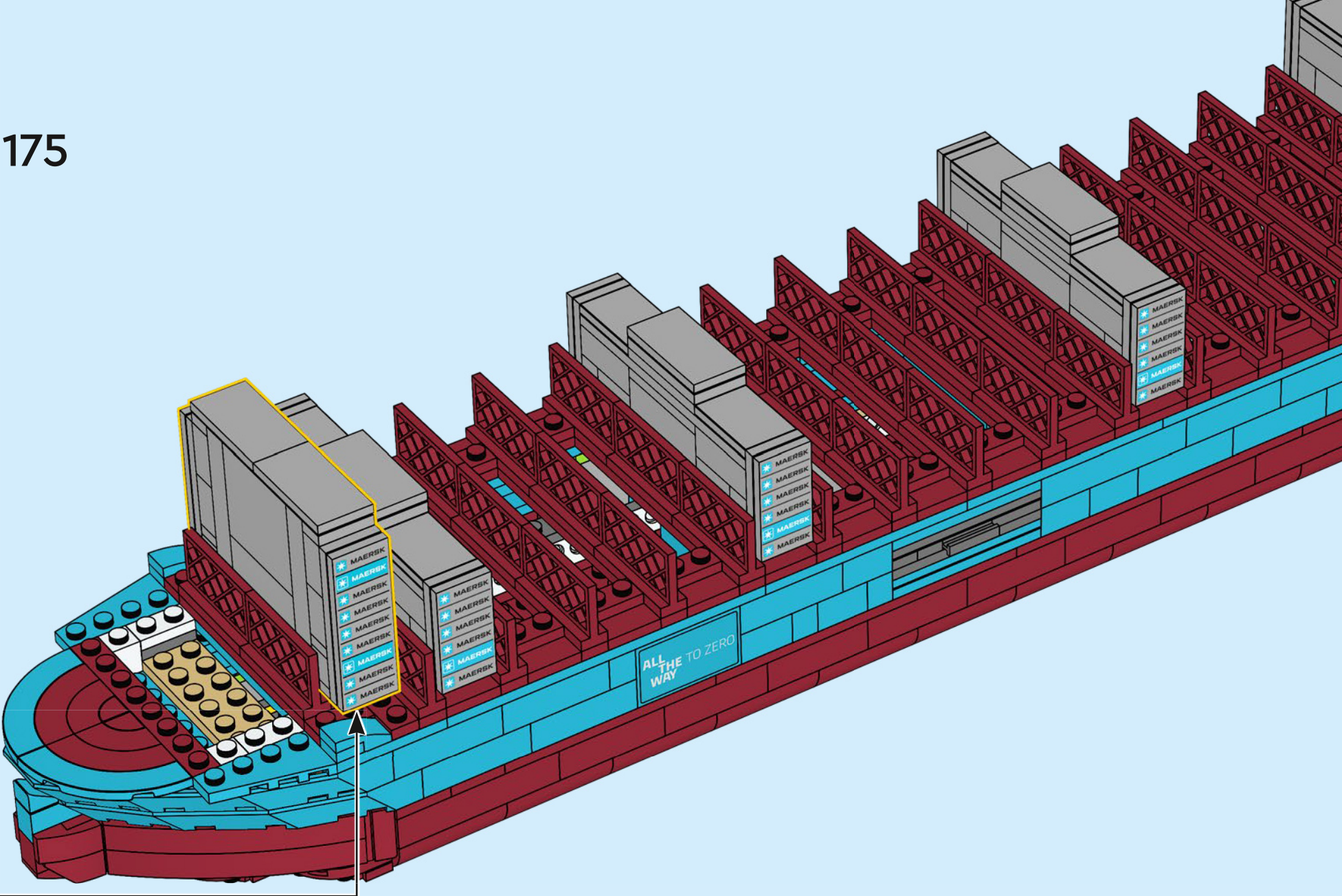

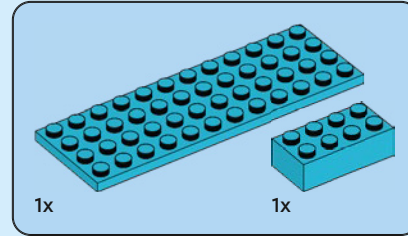
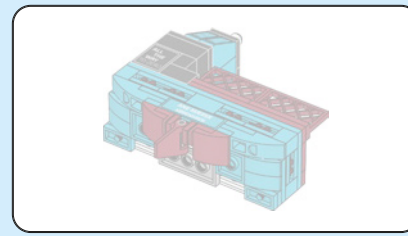

176

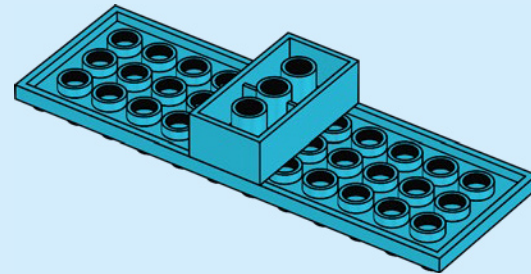

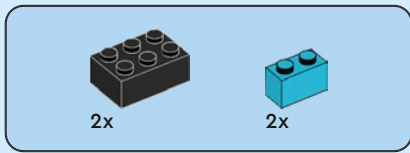

177

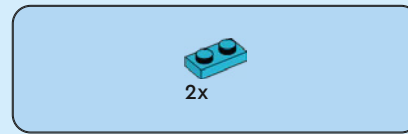
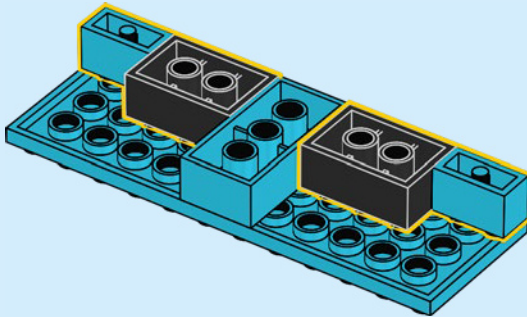

178

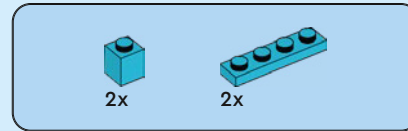
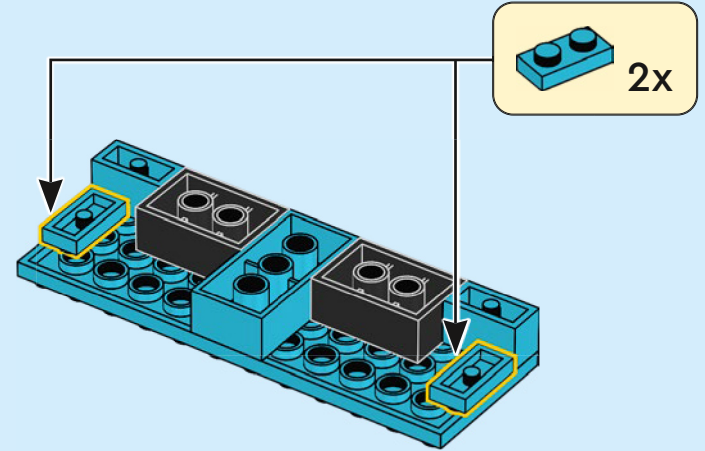

179

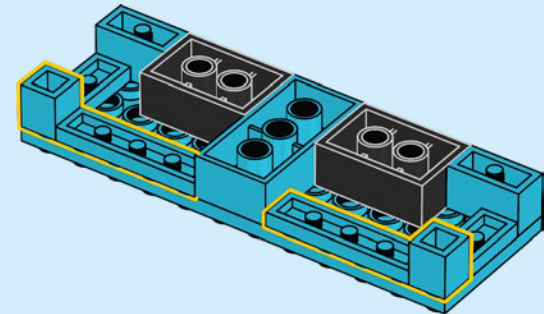

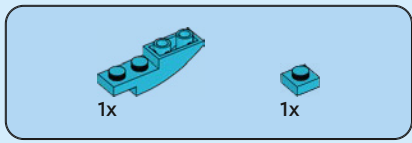

180

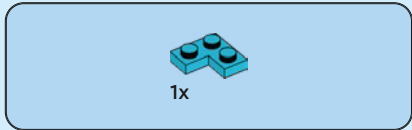
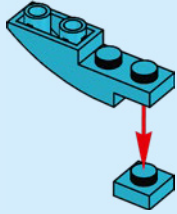

181

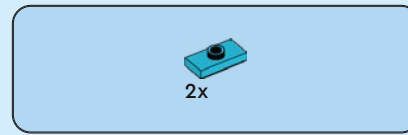
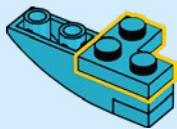

182

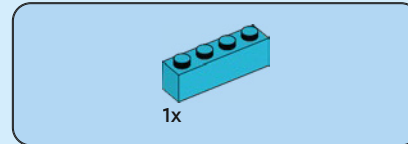
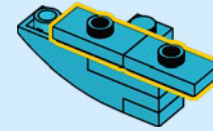

183

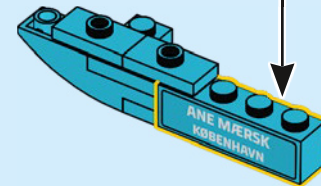
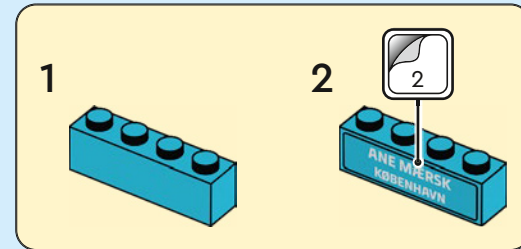

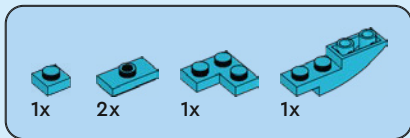

184

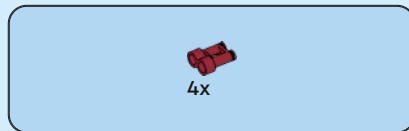
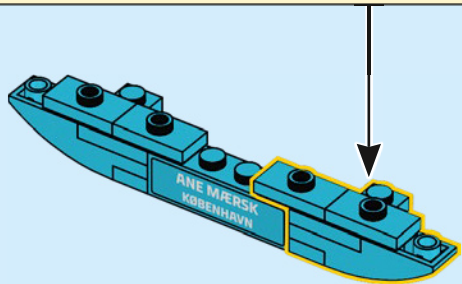
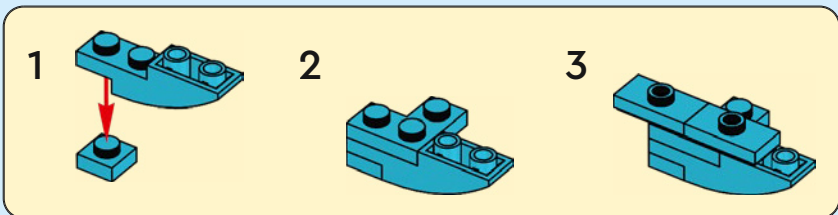

185

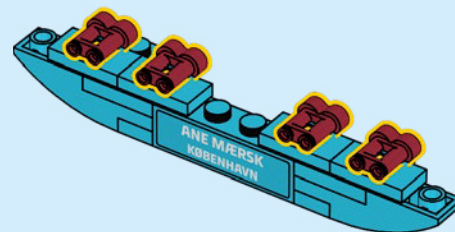

186

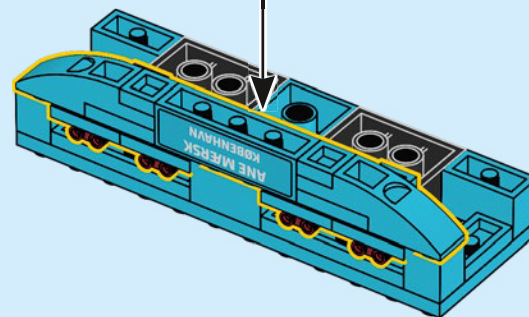

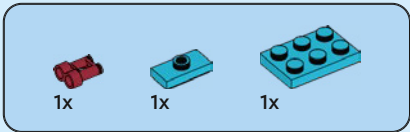

187

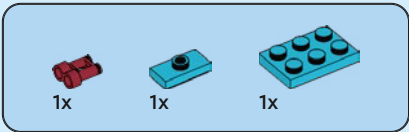
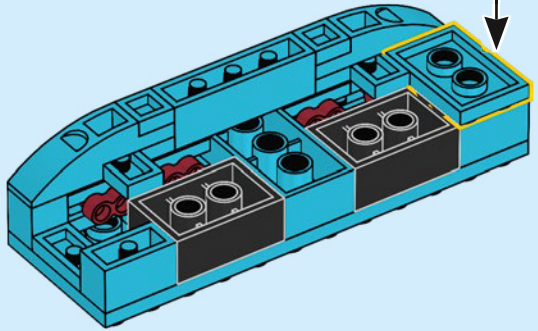
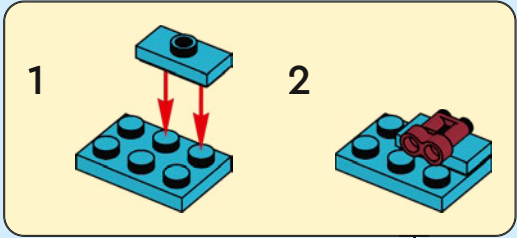

188

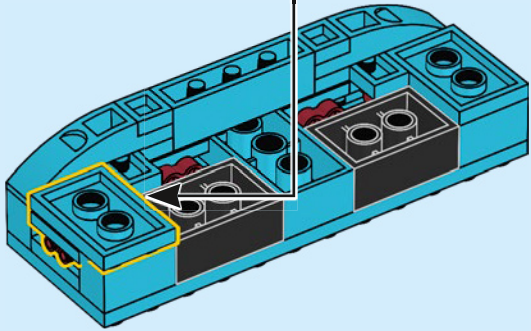
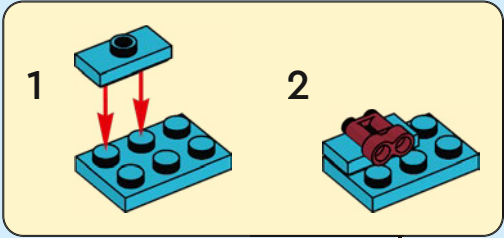

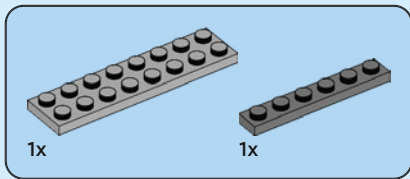

189

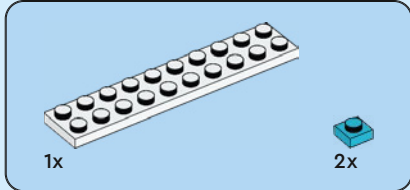
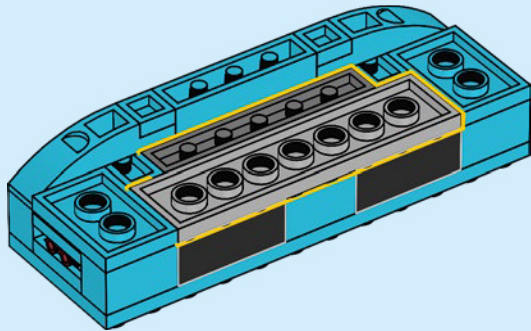

190

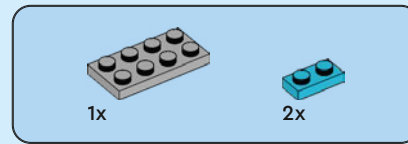
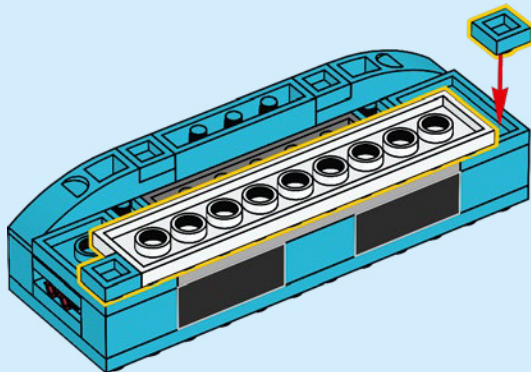

191

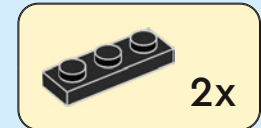
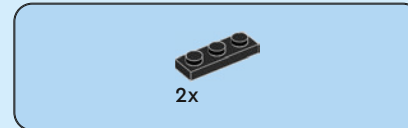
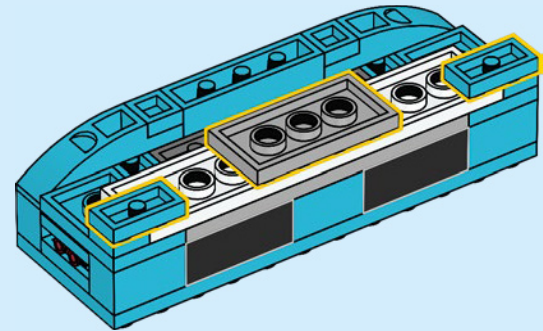

192

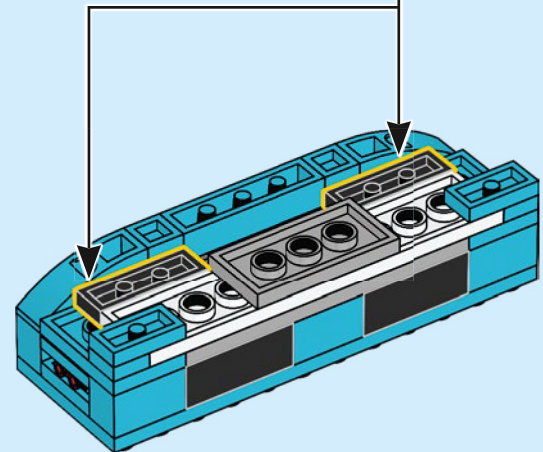



4x

193

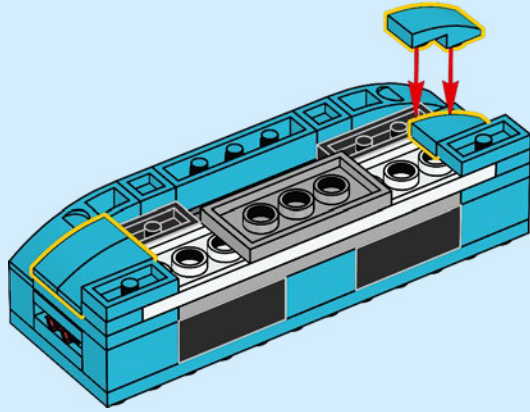

2x

194

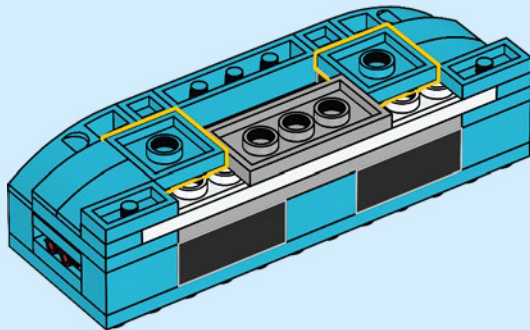

1x

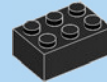

1x



1x

195

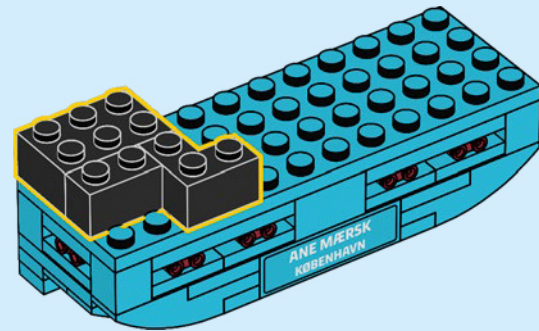

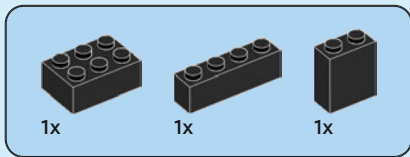

196

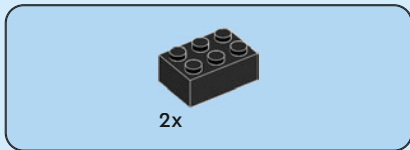
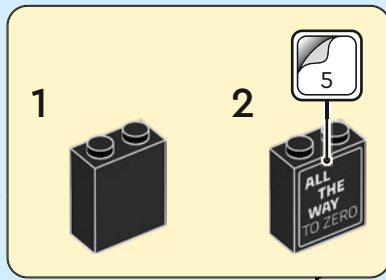
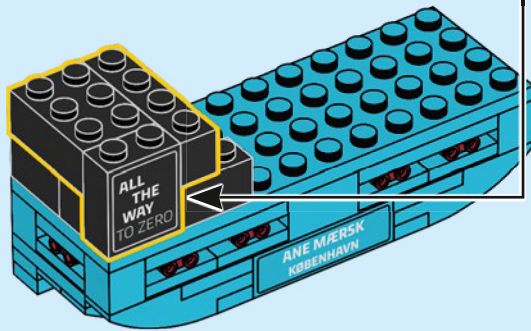

197

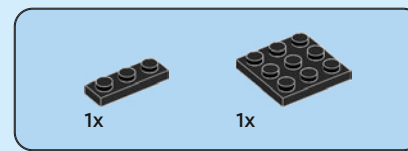
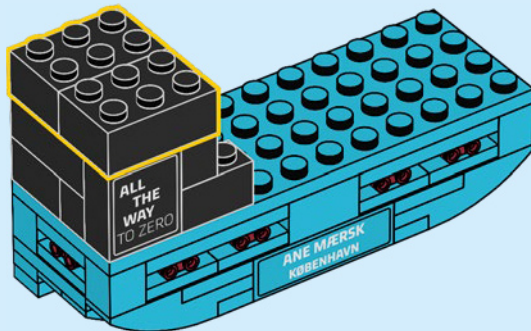

198

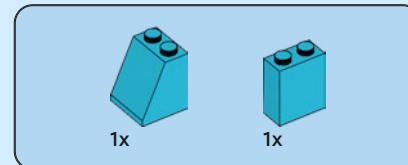
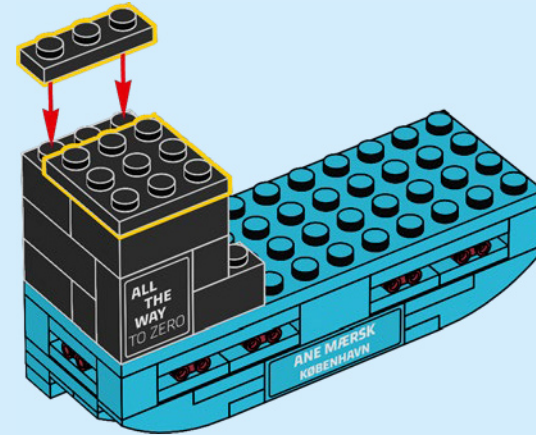

199

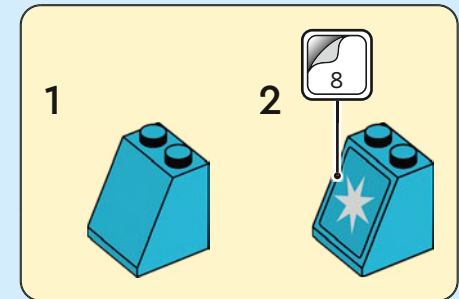
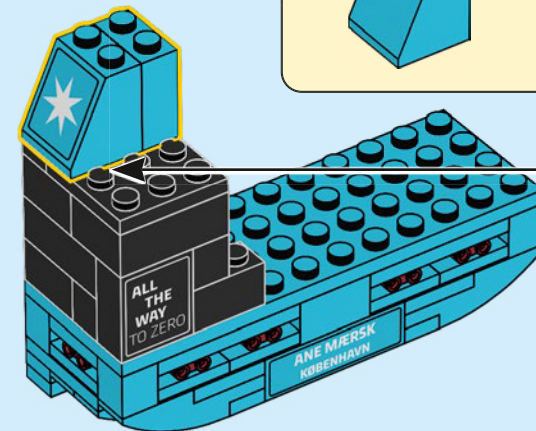

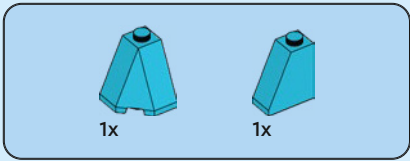

200

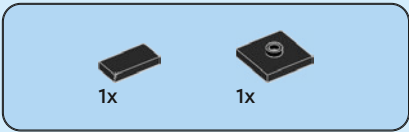
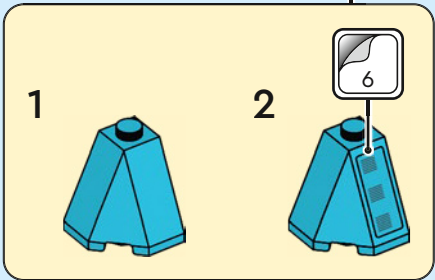
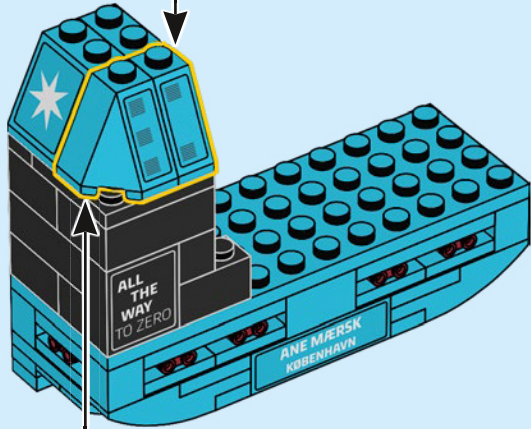
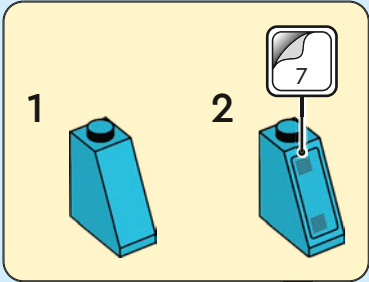

201

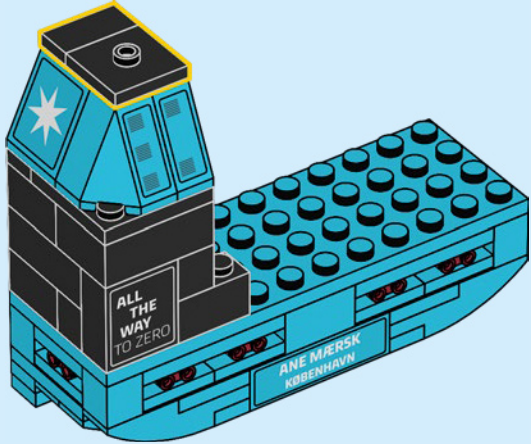



1x



1x

202

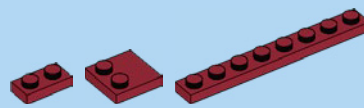
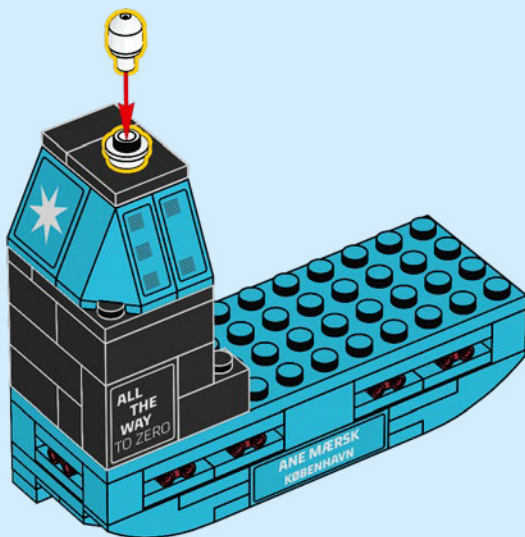

1x

2x

1x

203

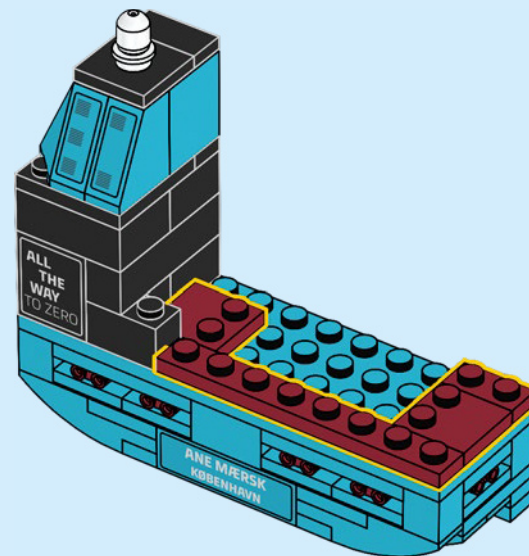



2x

204

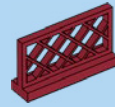
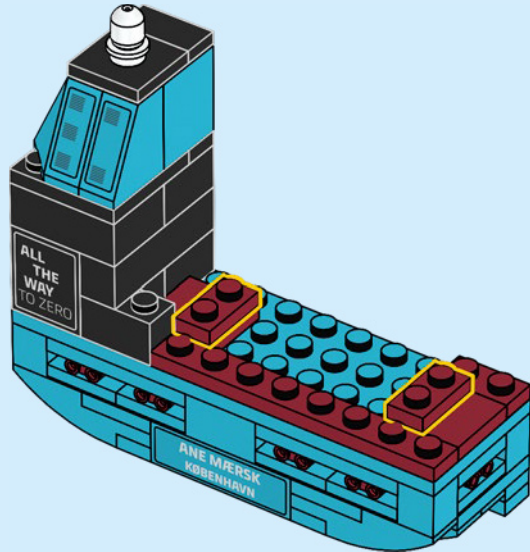

2x

205

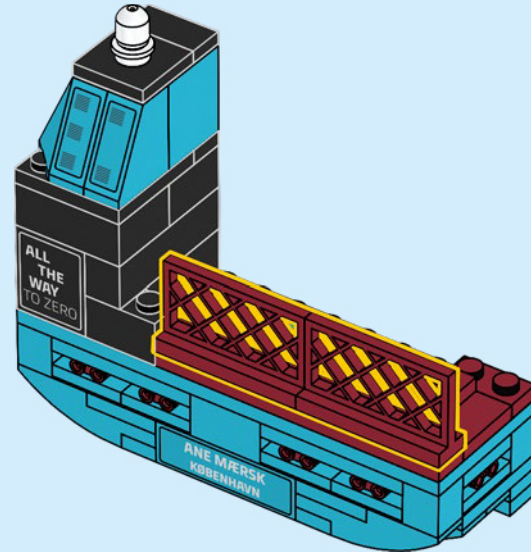

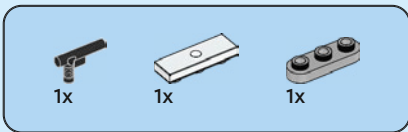

206

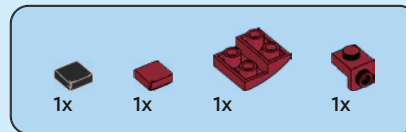
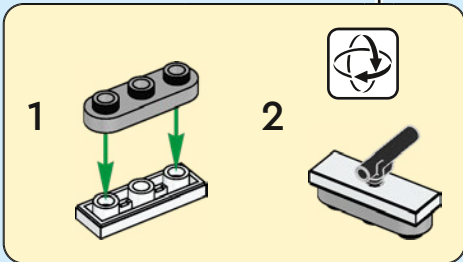
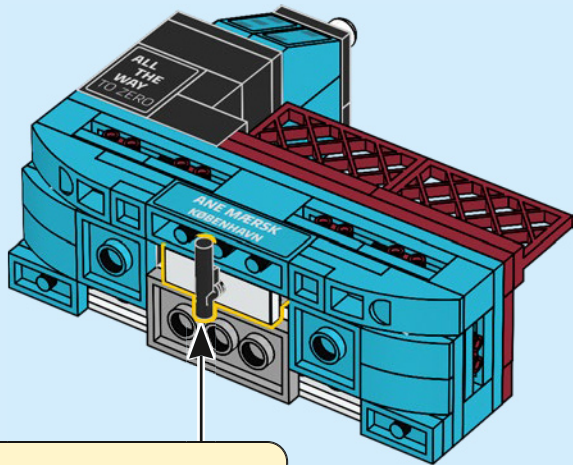

207

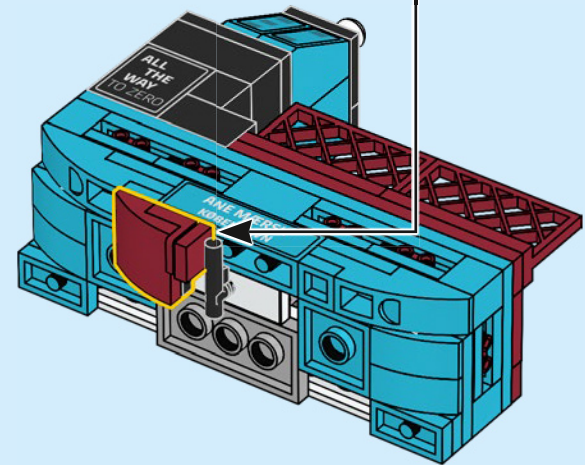
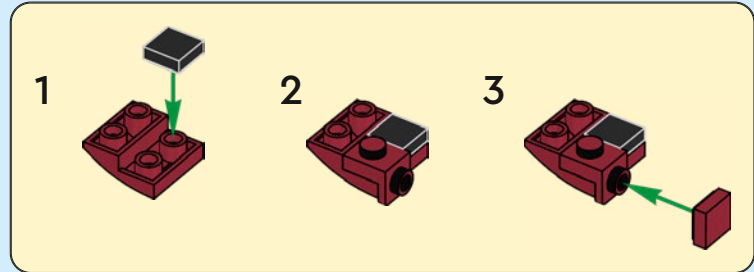

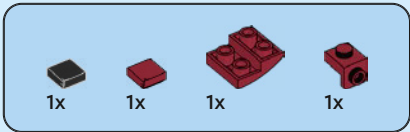

208

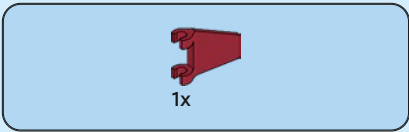
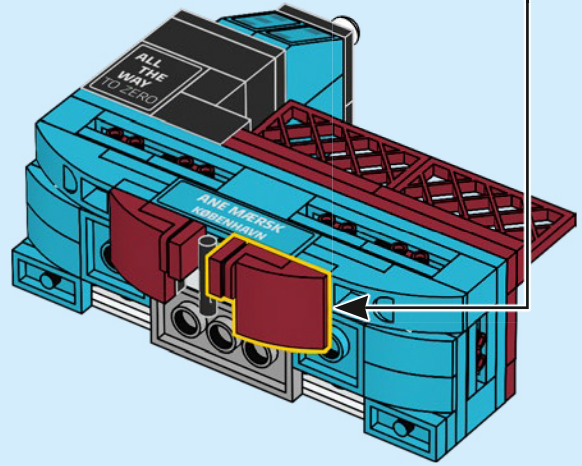

209

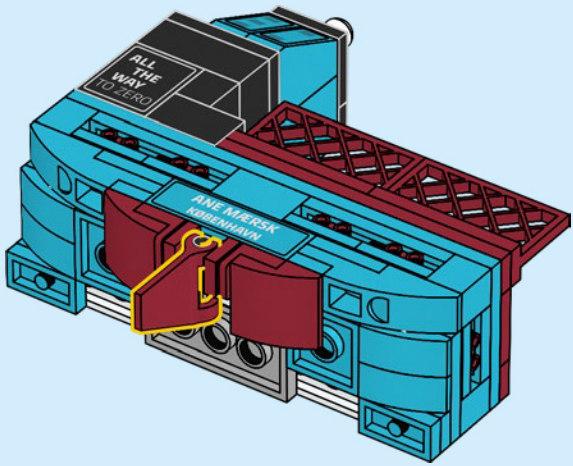

210

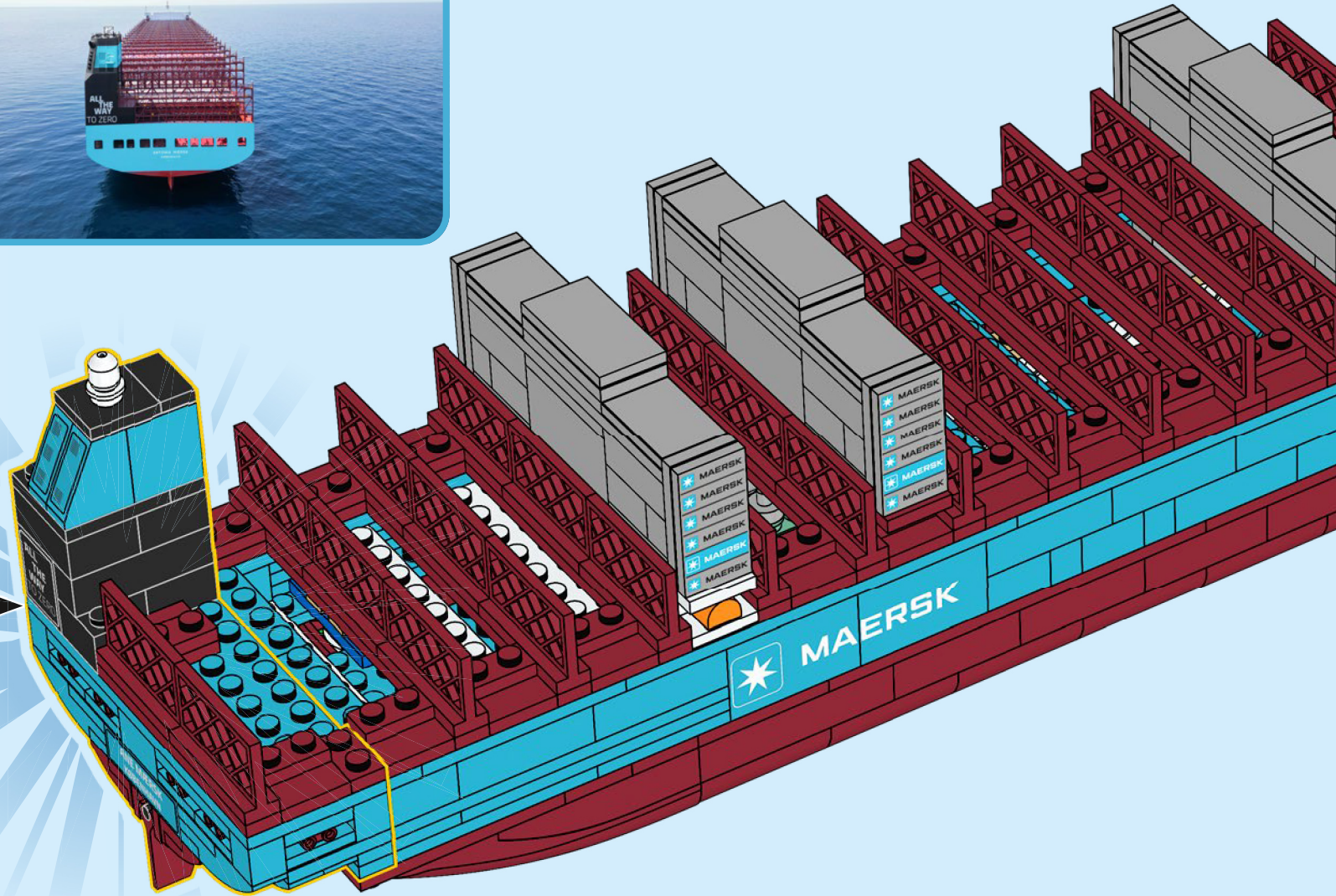
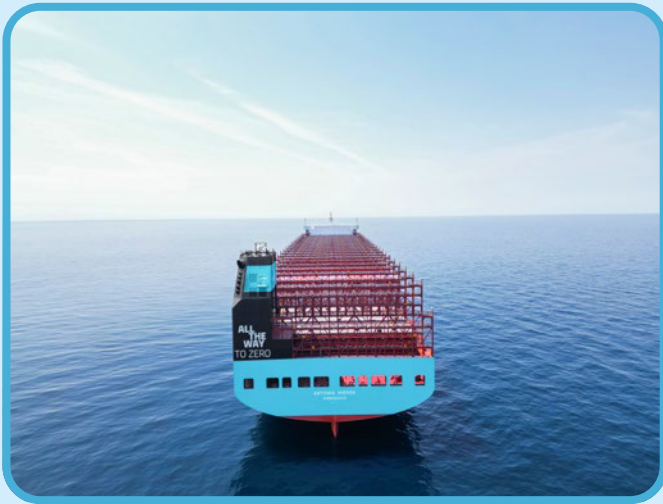

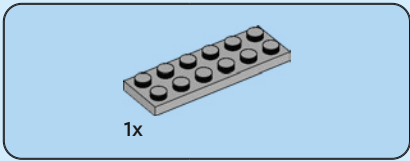

211

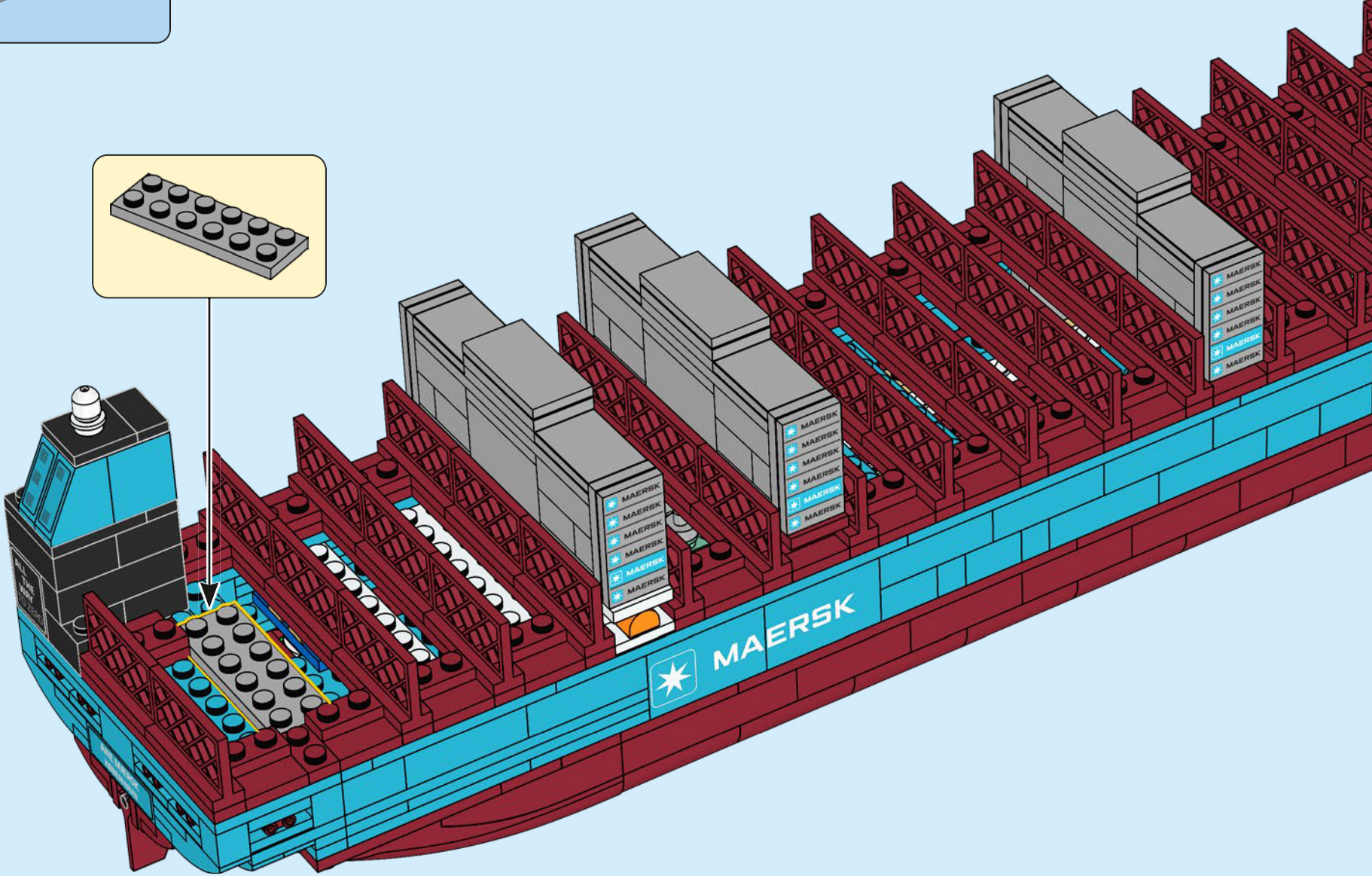
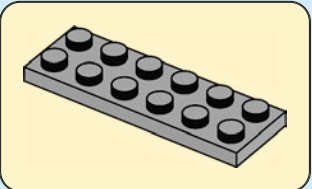

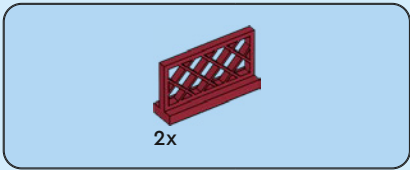

212

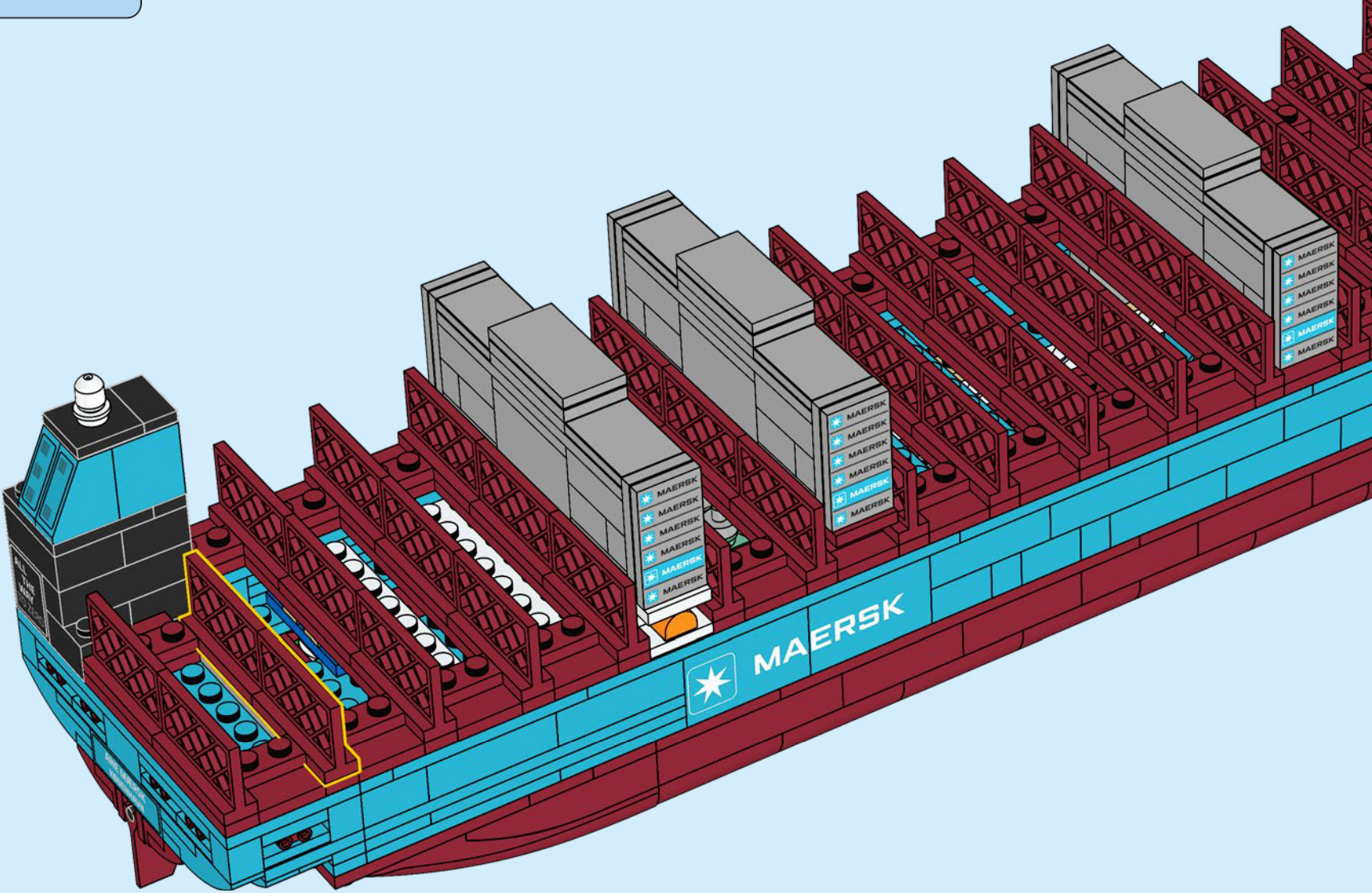

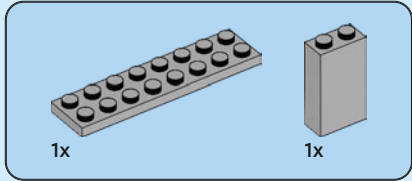
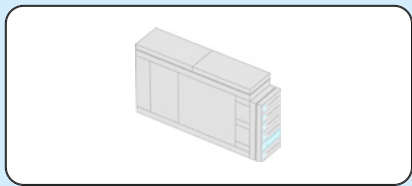

213

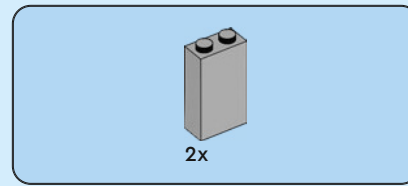
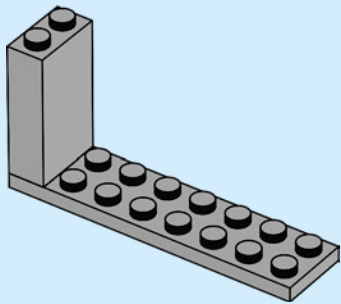

214

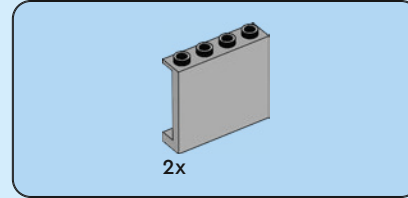
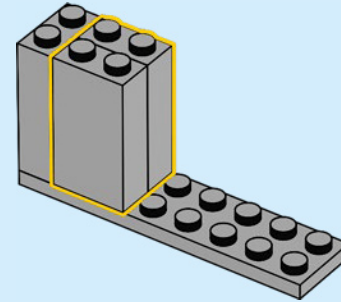

215

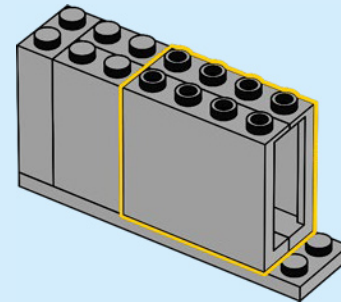

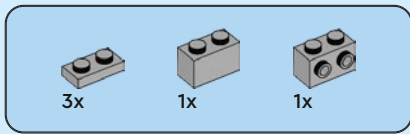

216

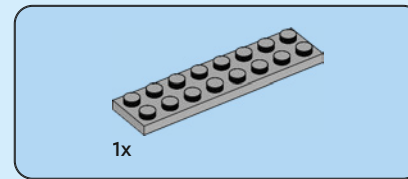
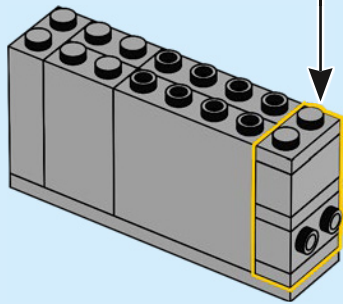
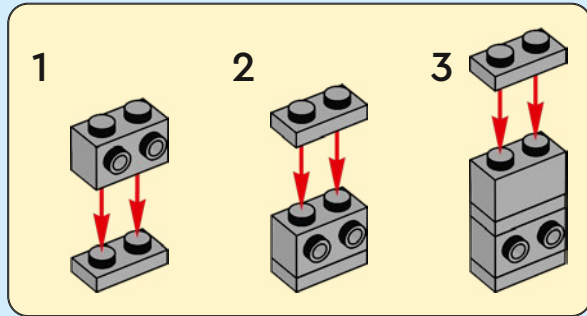

217

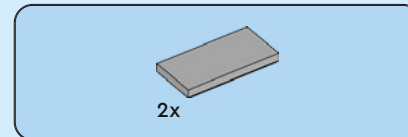
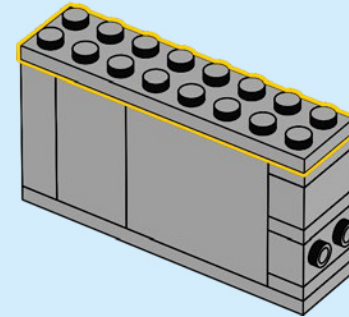

218

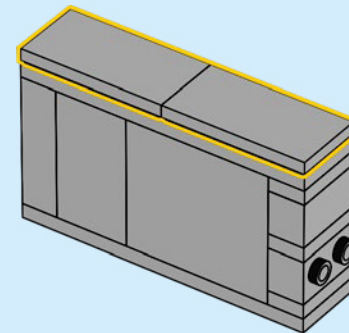

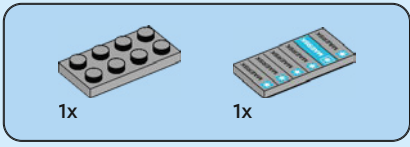

219

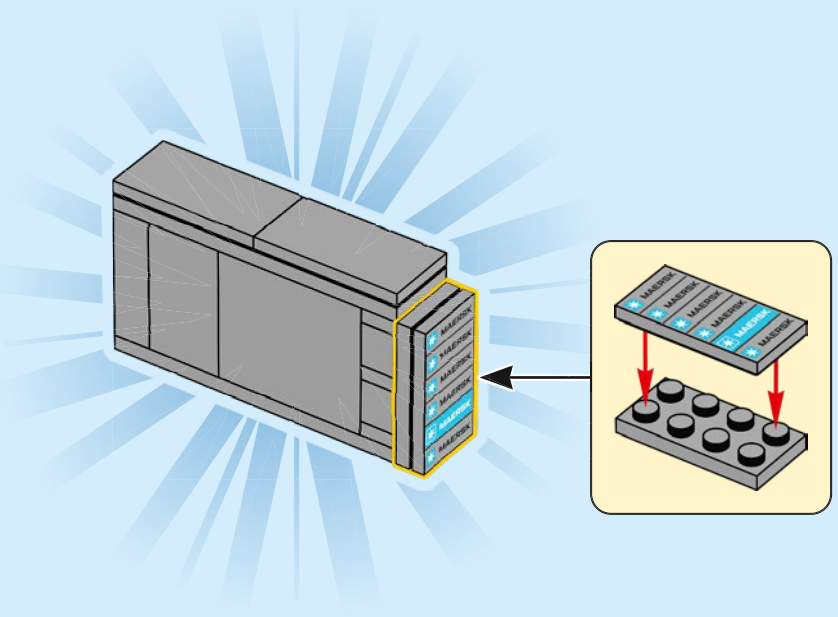

220

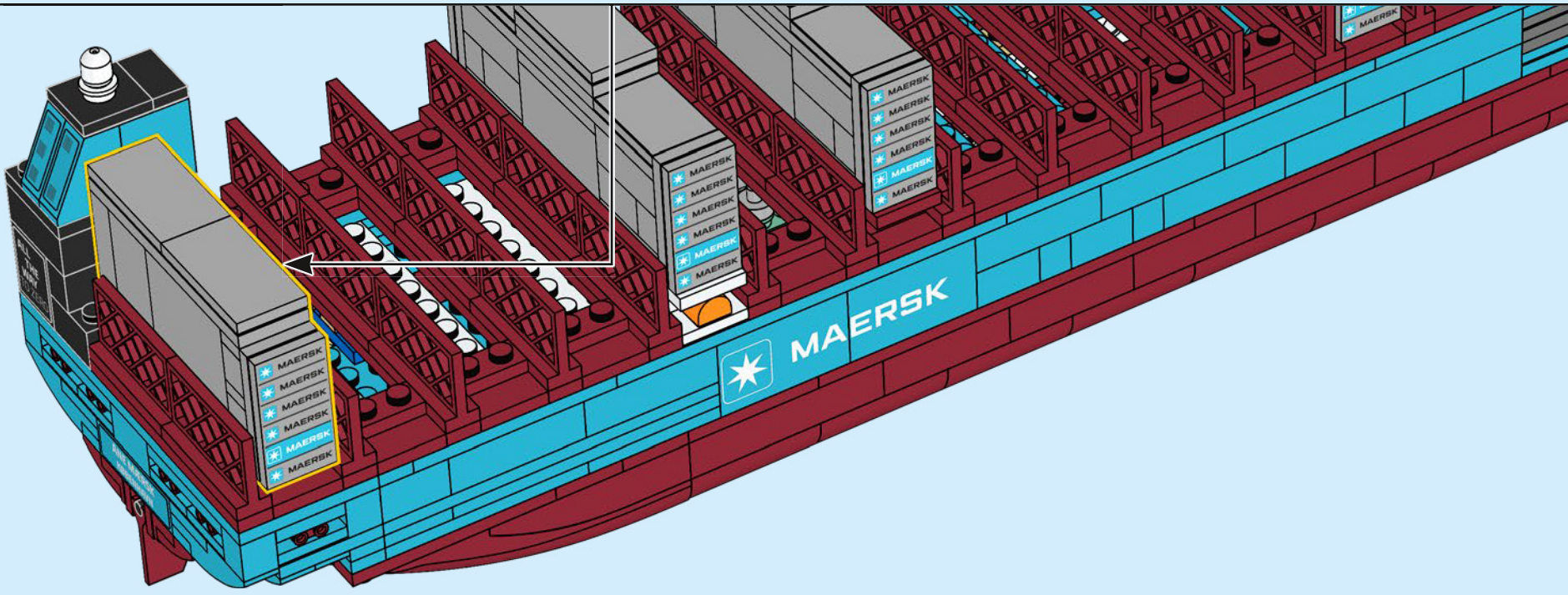

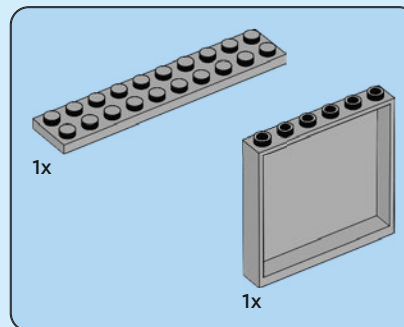
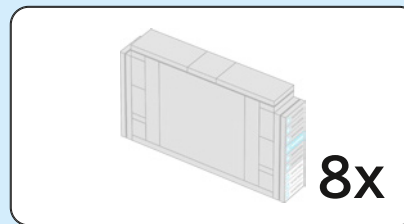

221

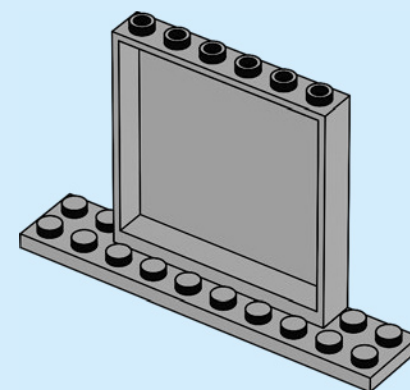

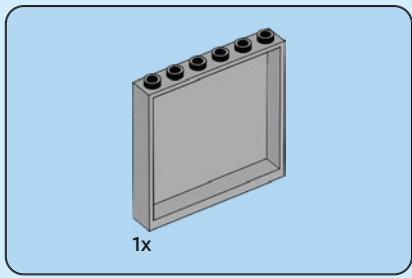

222

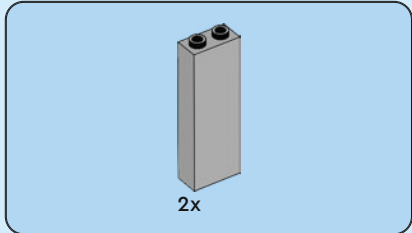
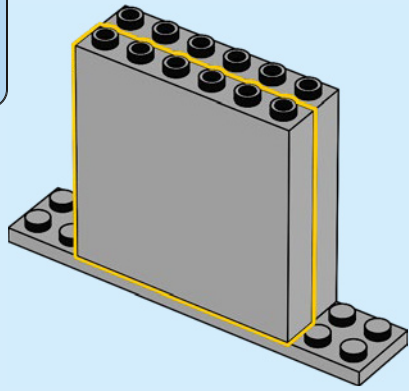

223

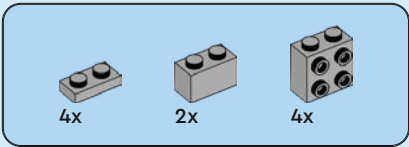
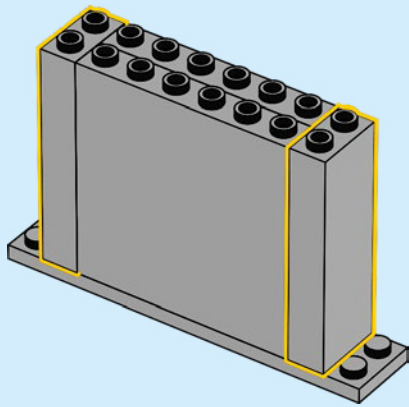

224

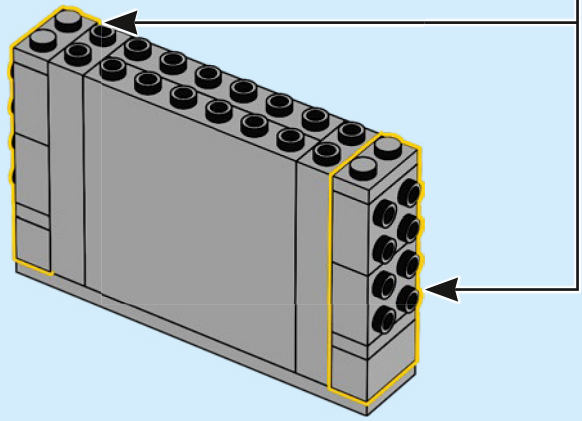
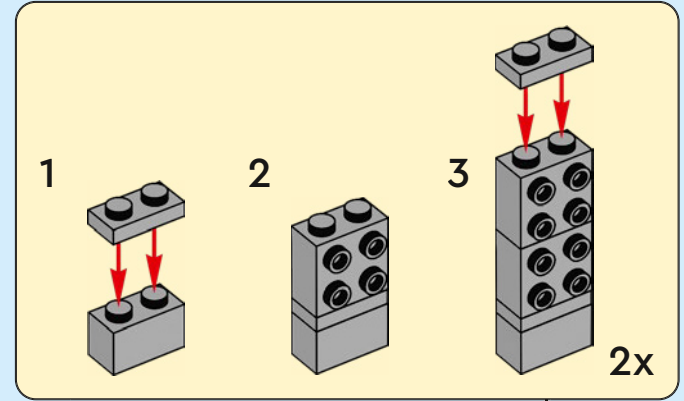

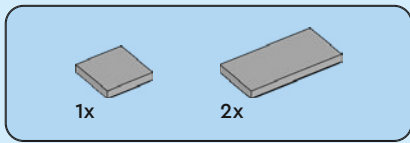

225

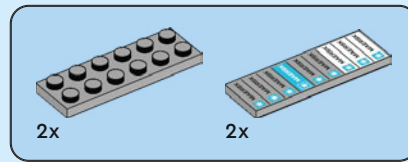
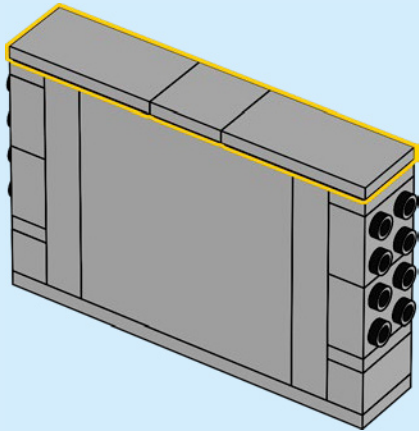

226

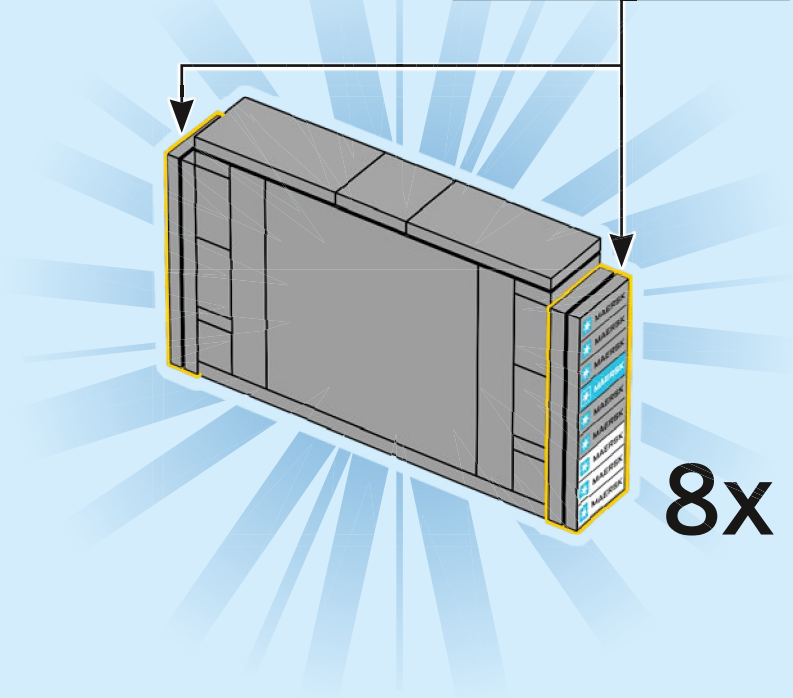
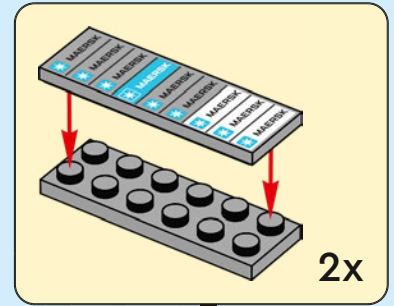

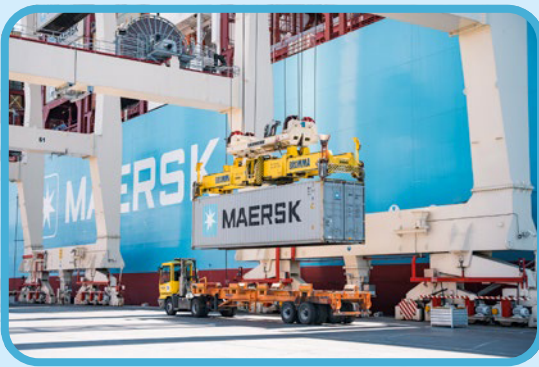

227

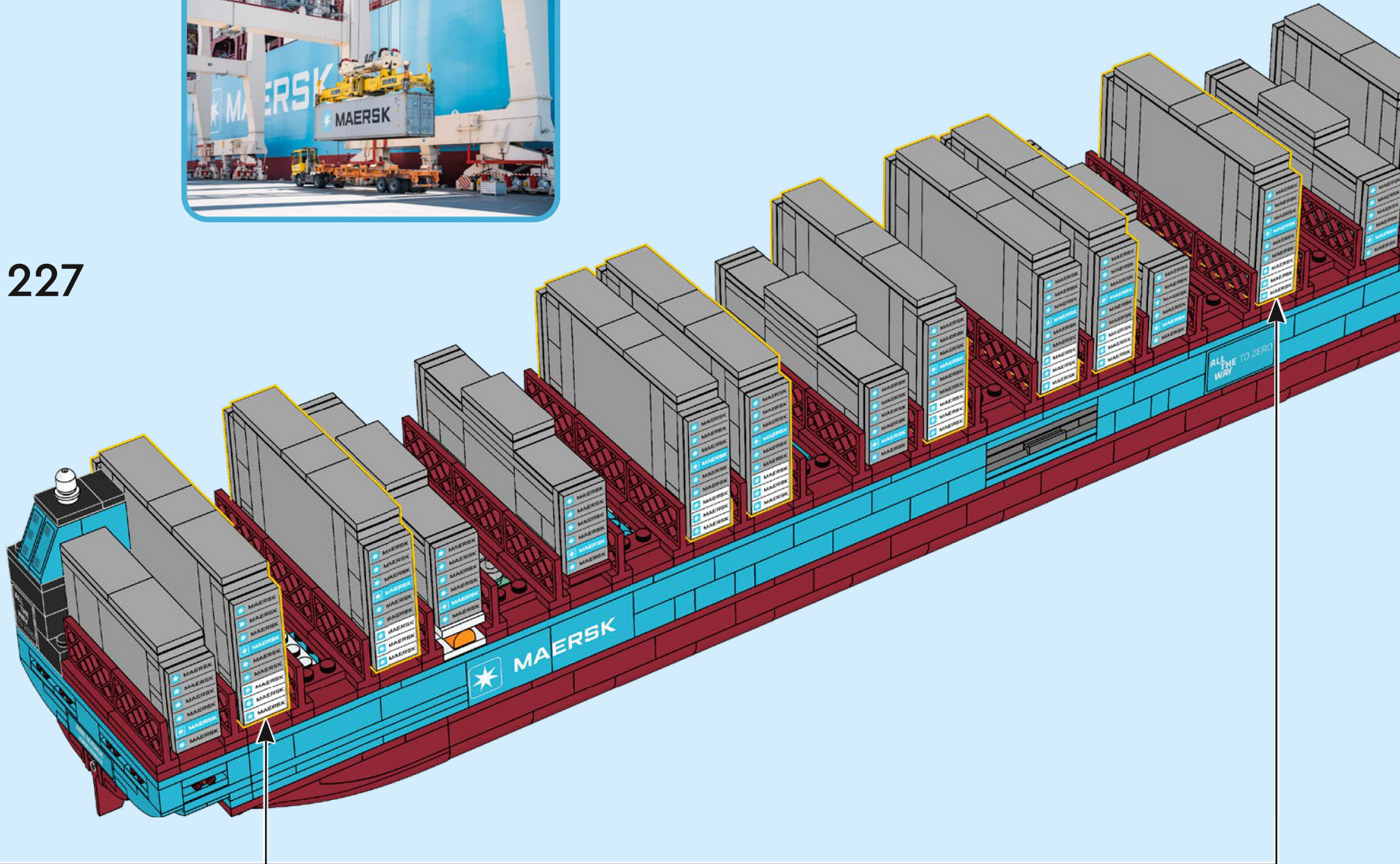





228

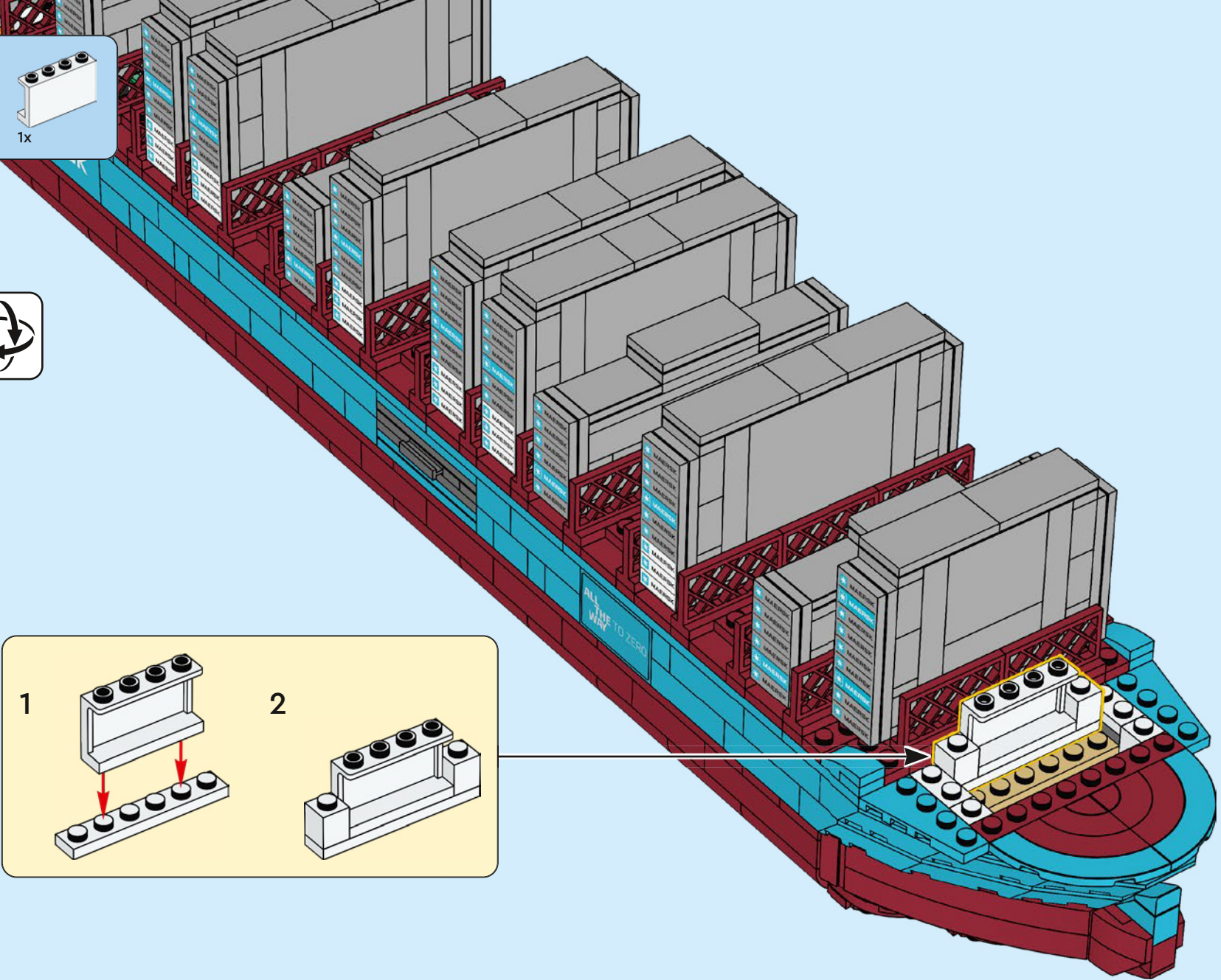
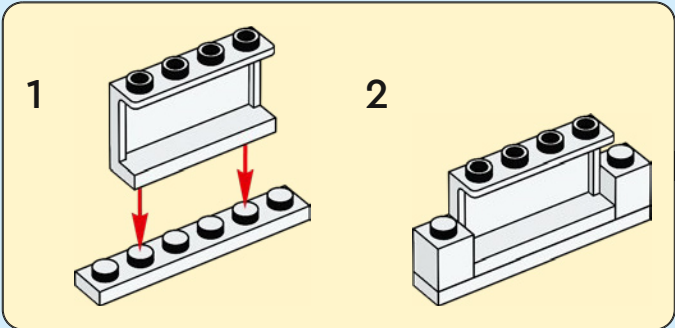

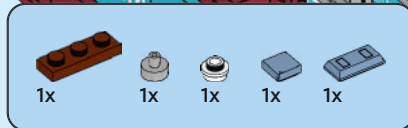

229

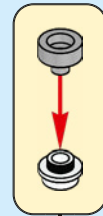
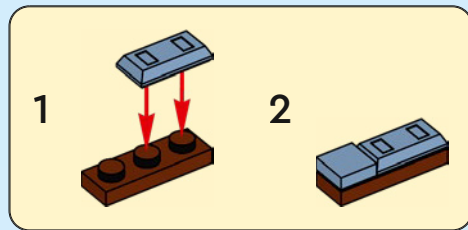



4x

230

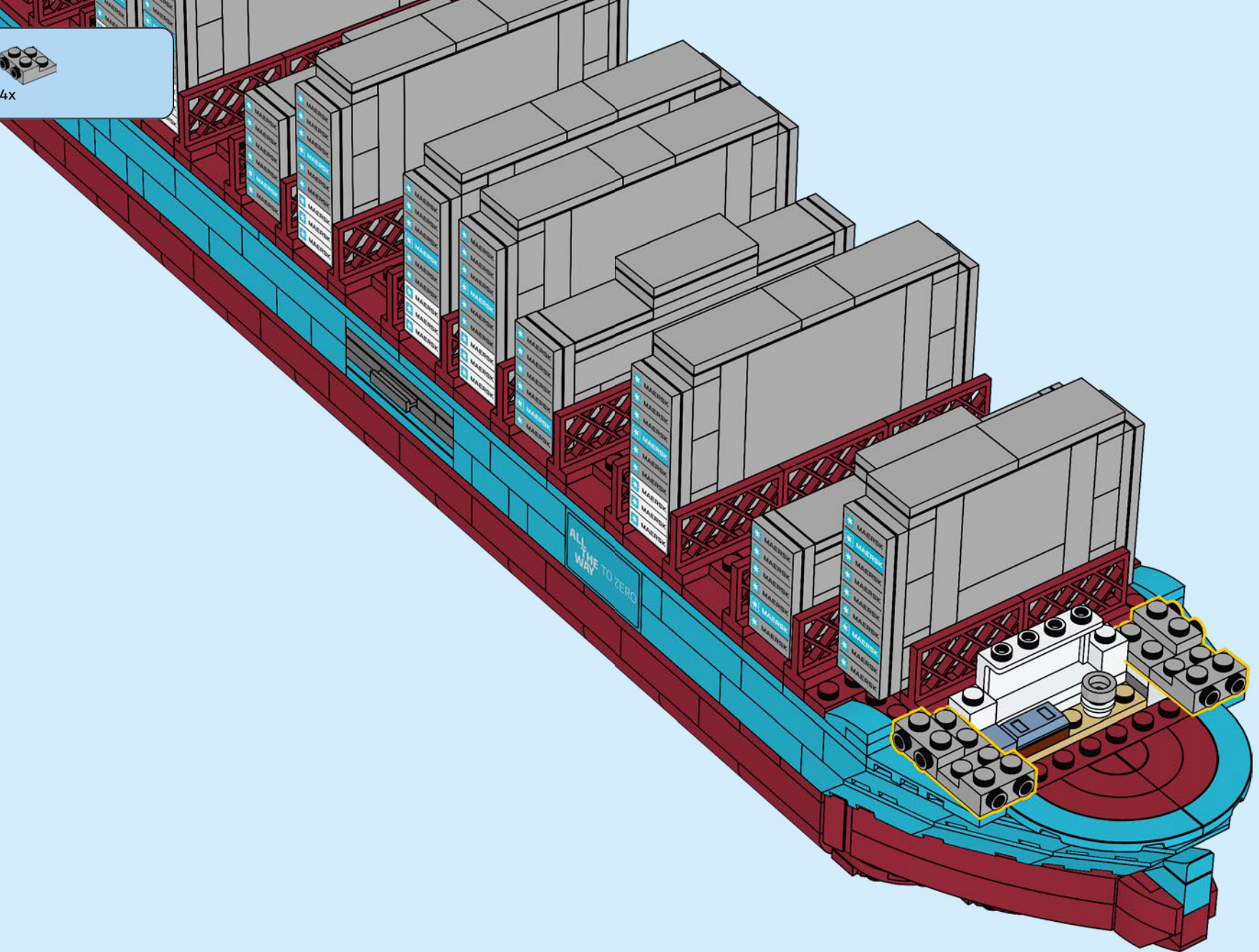

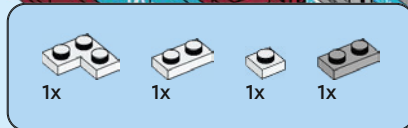

231

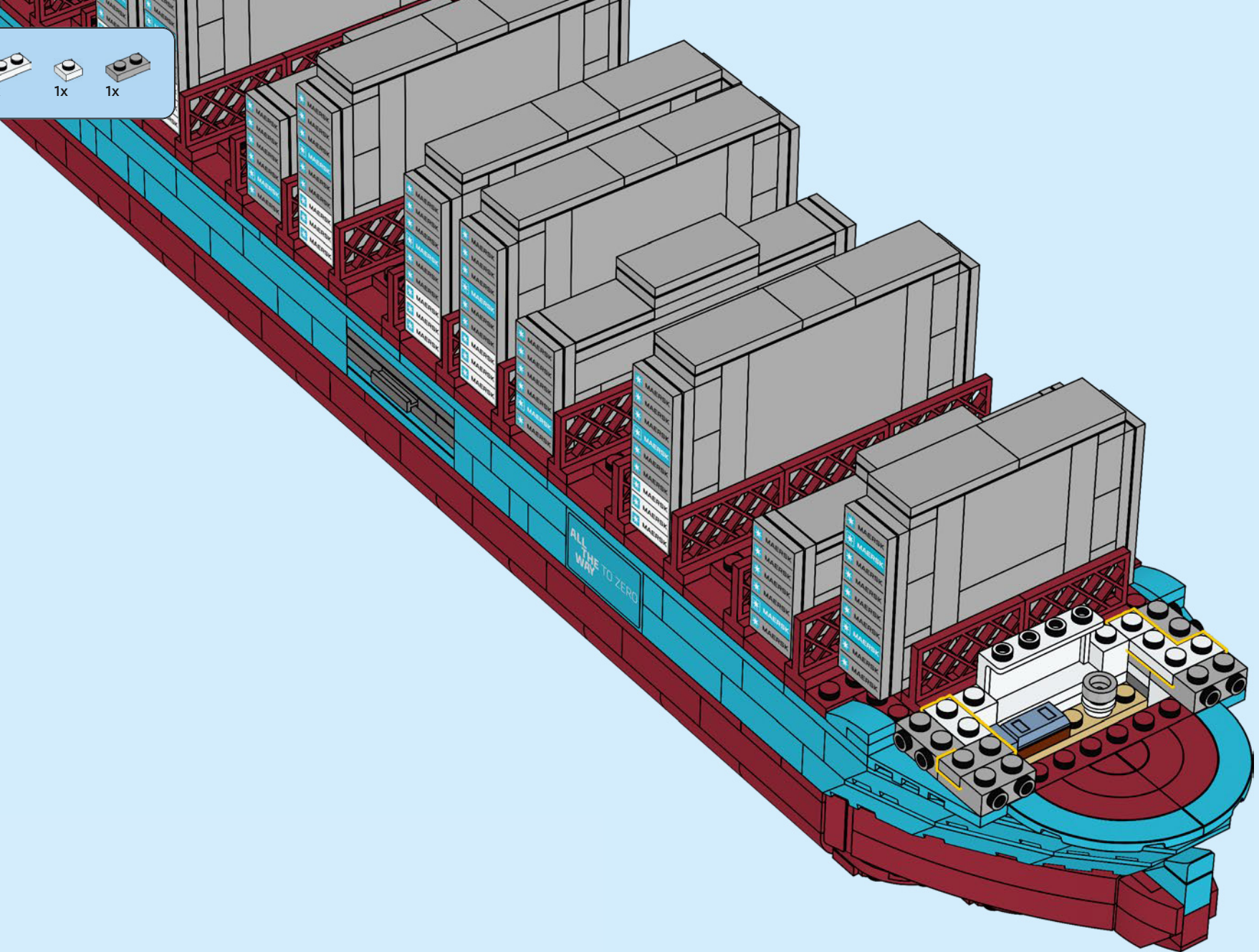

1x 1x 1x 2x

232

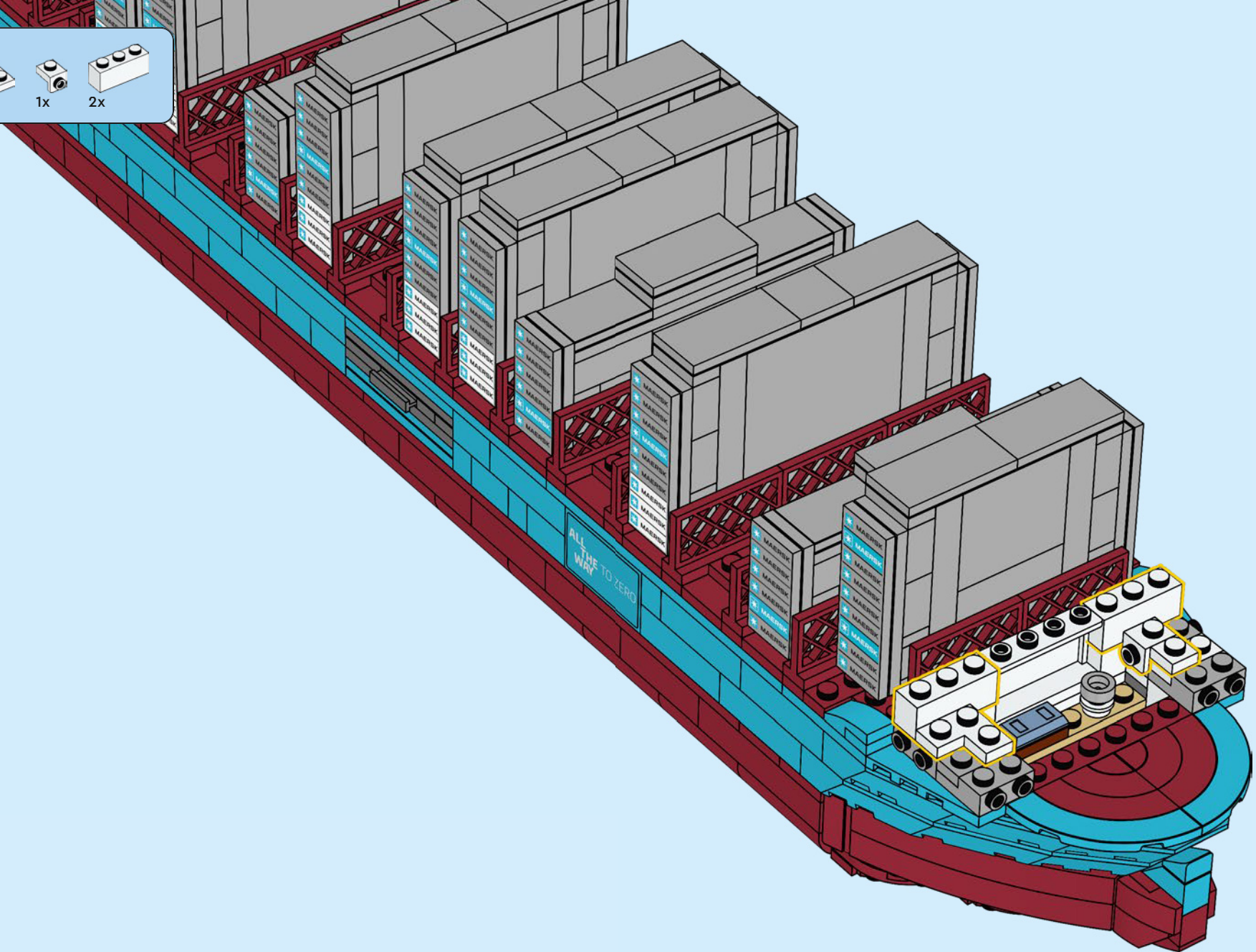

1x 1x 4x

233

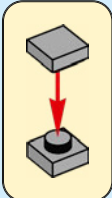
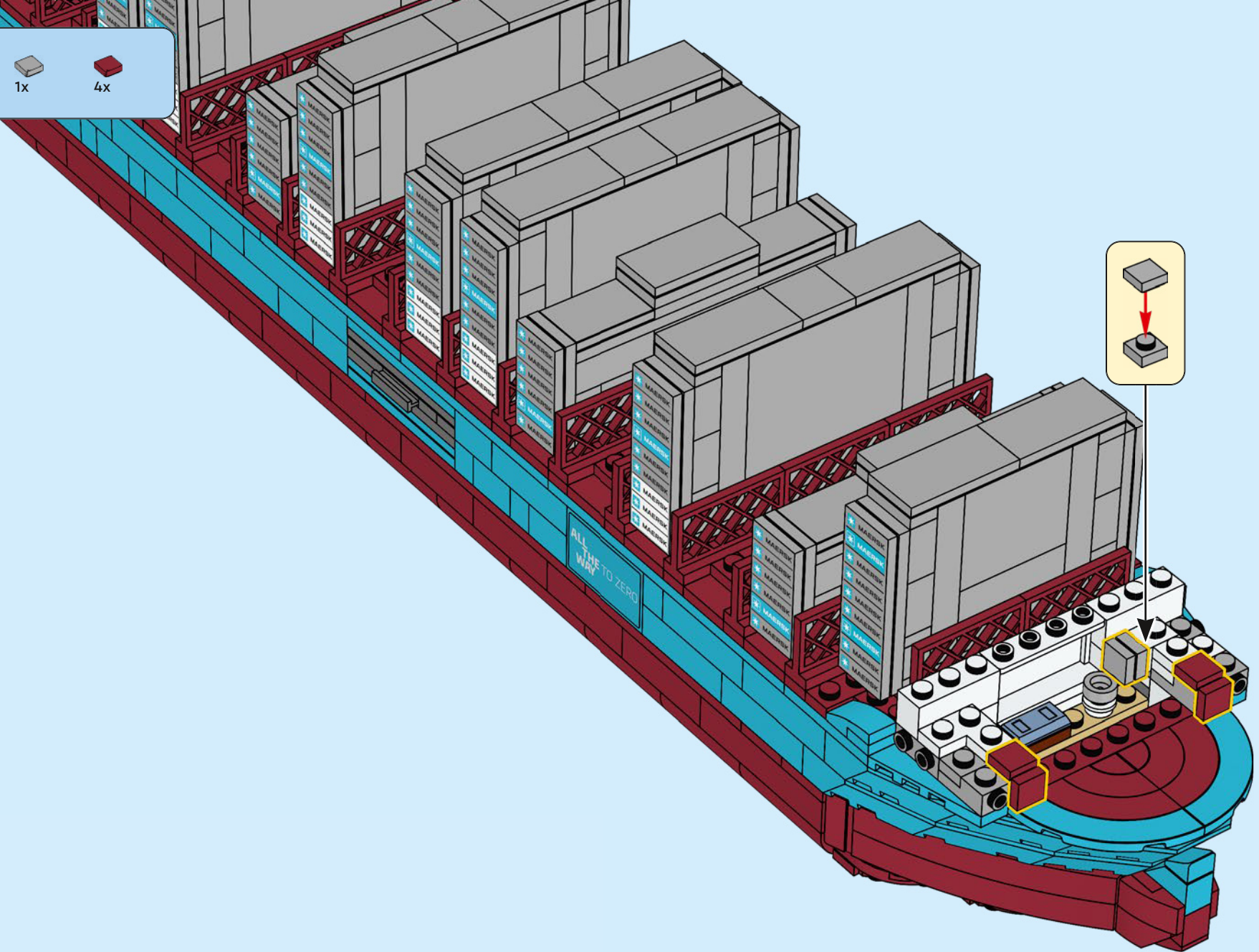

3x 2x 2x

234

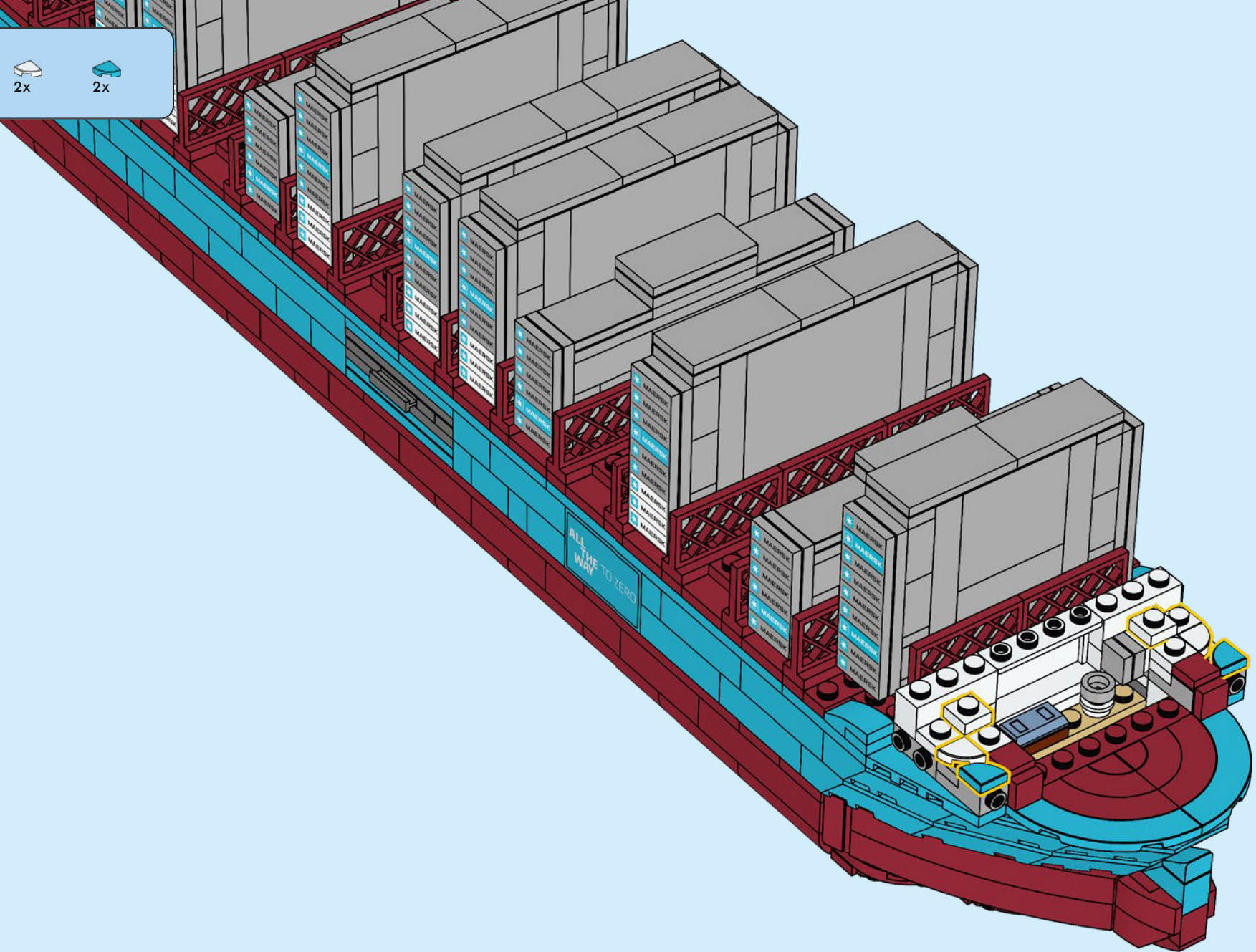

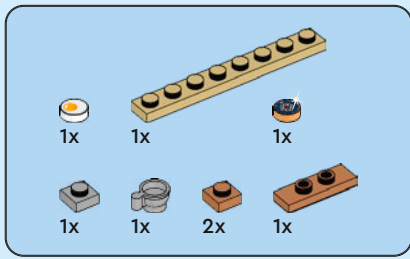

235

1

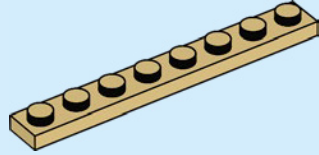

2

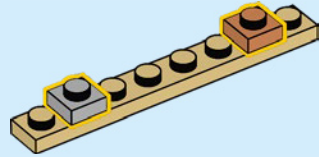

3

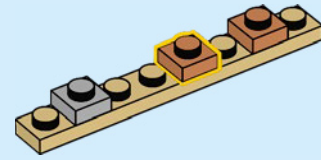

4

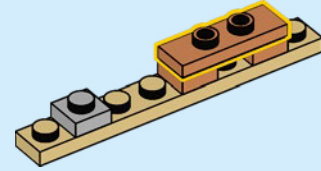

5

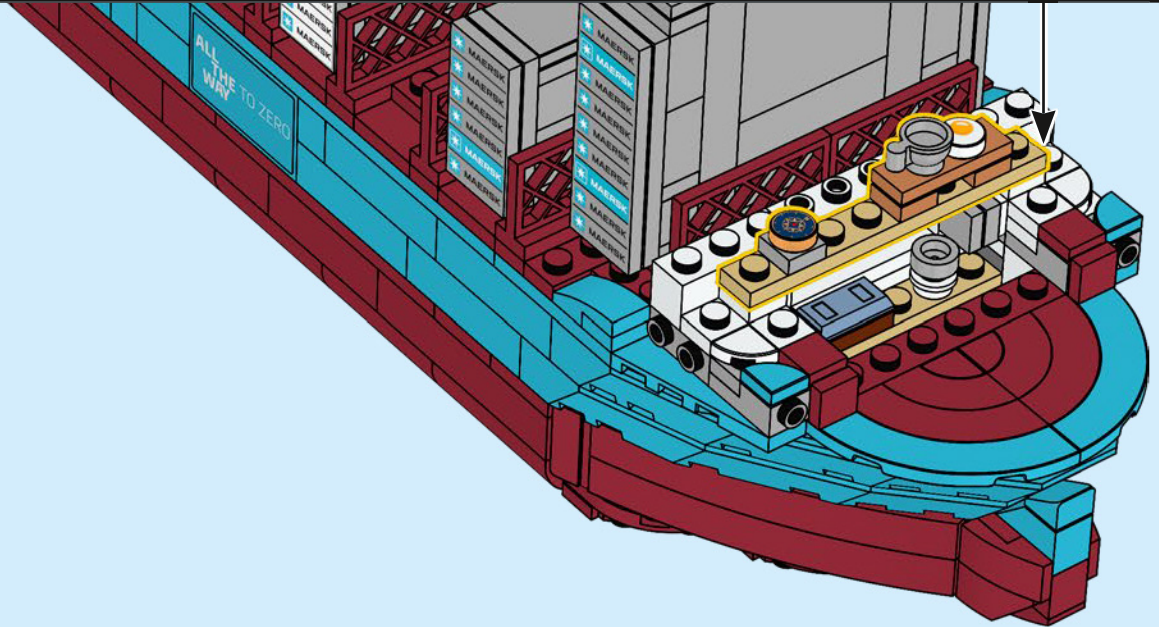

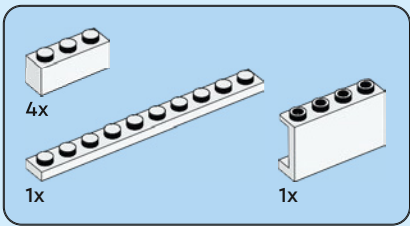

236

1

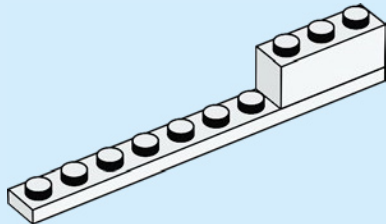

2

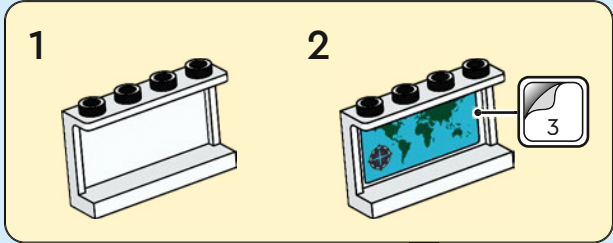
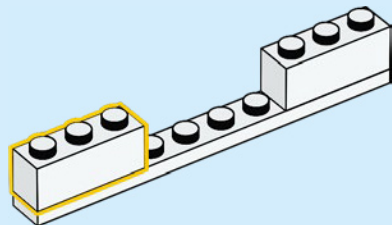

3

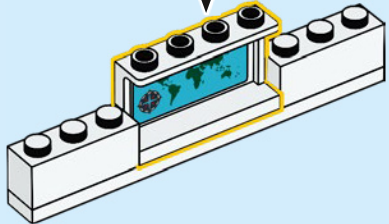

4

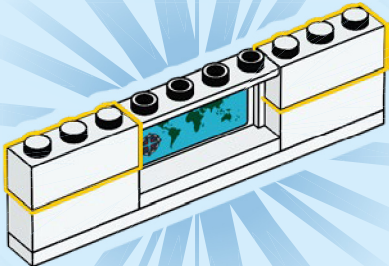

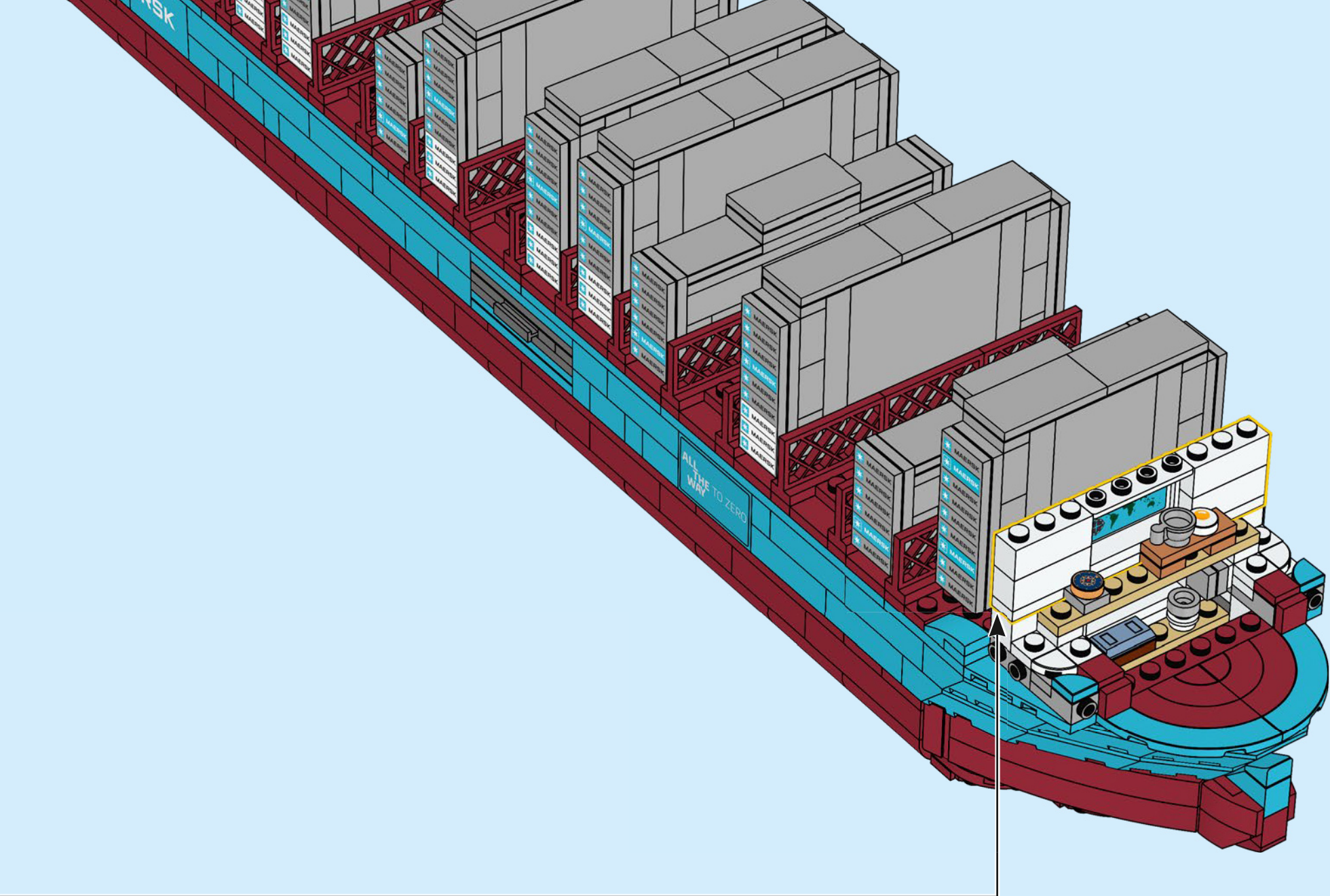

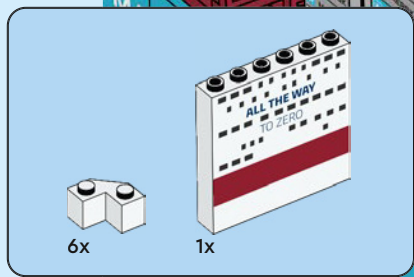

237

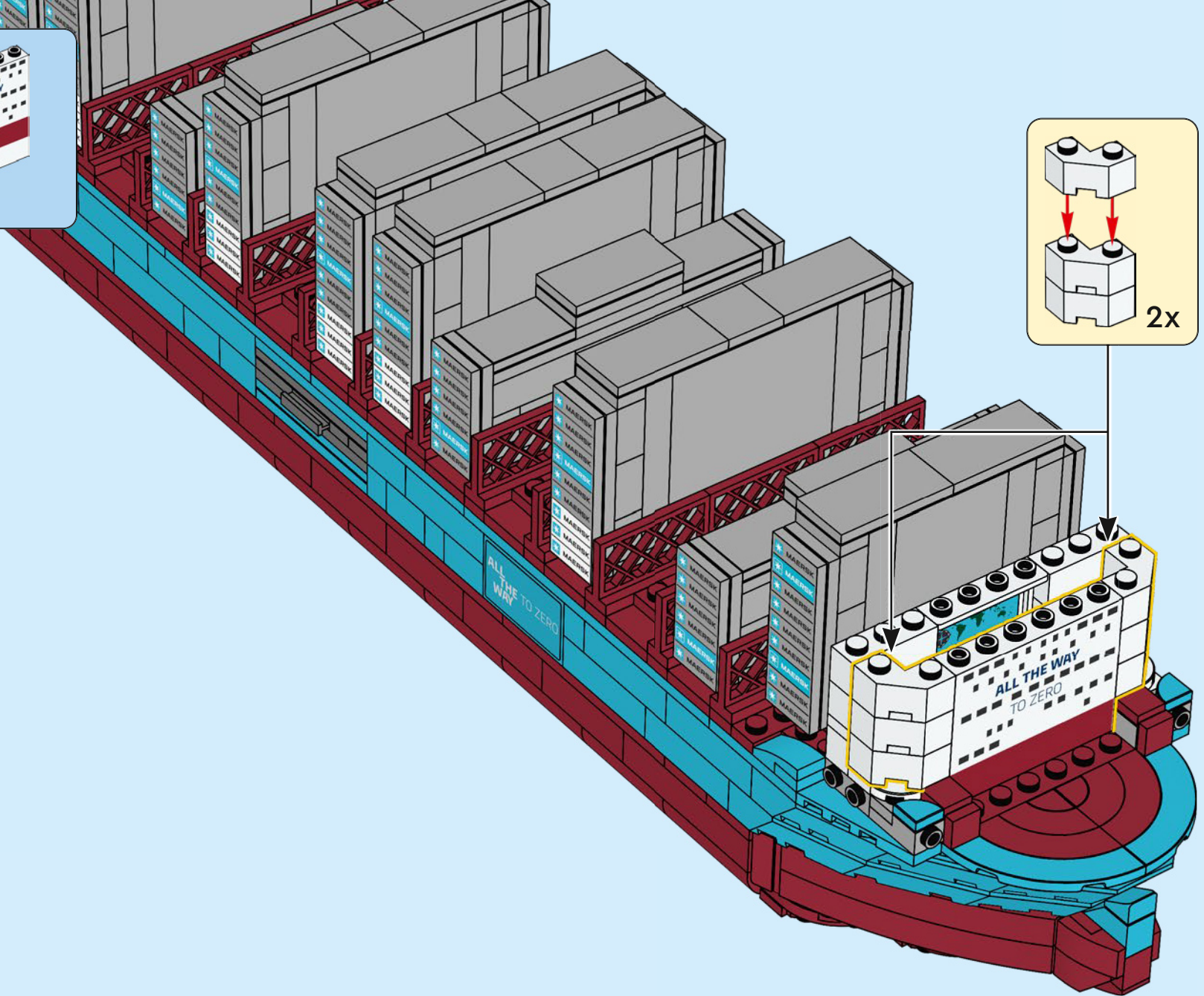

2x 1x

238

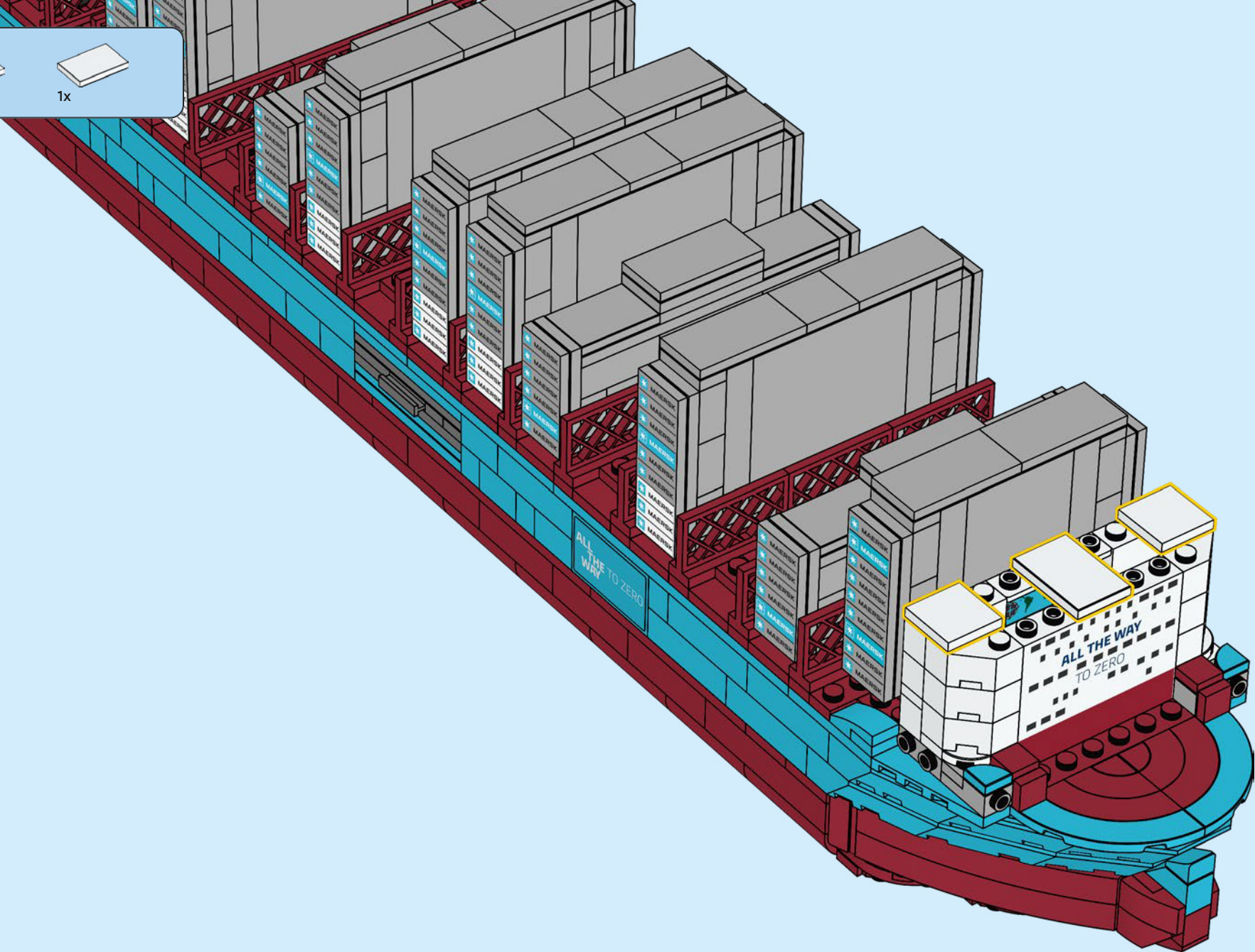

2x 1x 1x

239

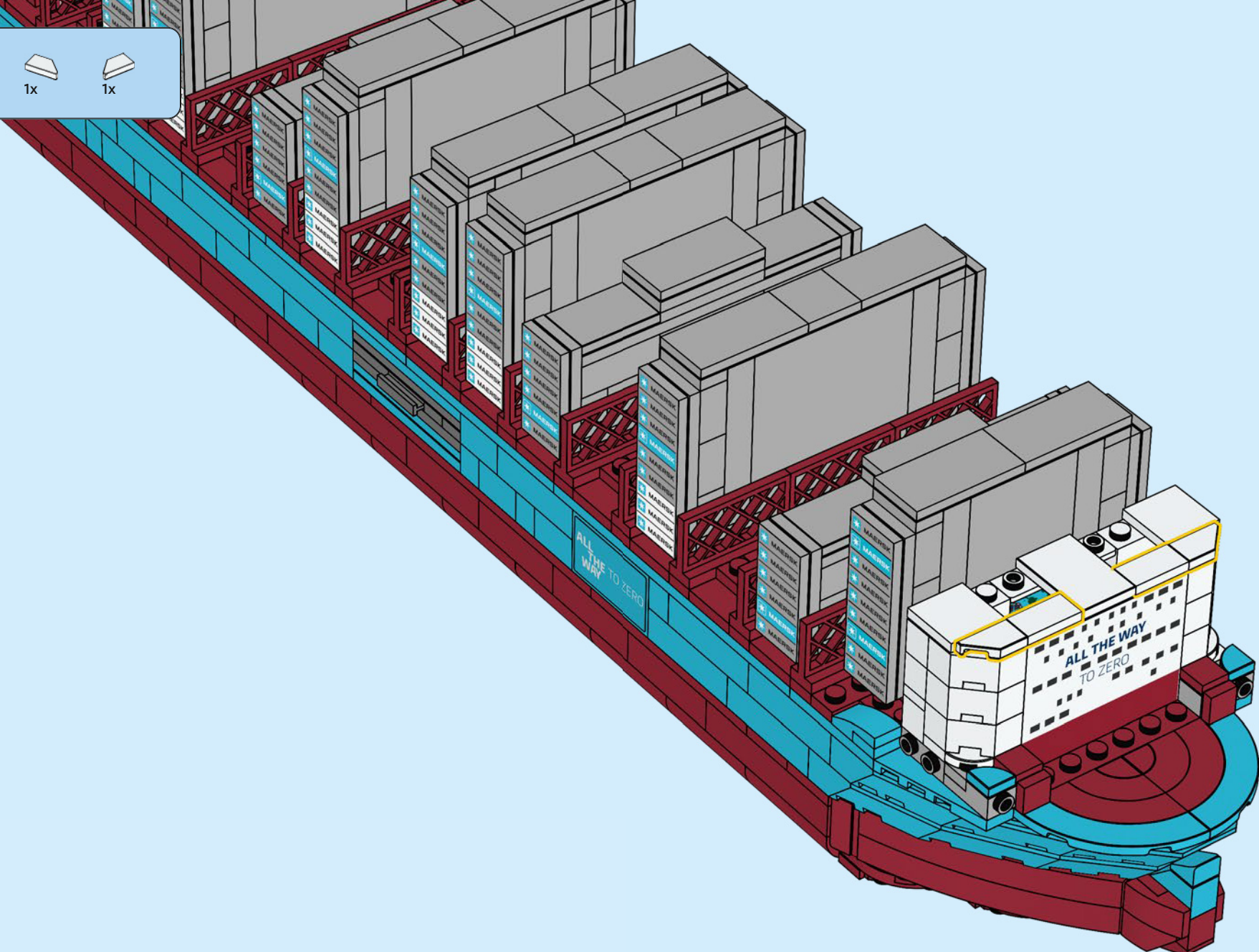

2x 2x 2x

240

1 2 2x

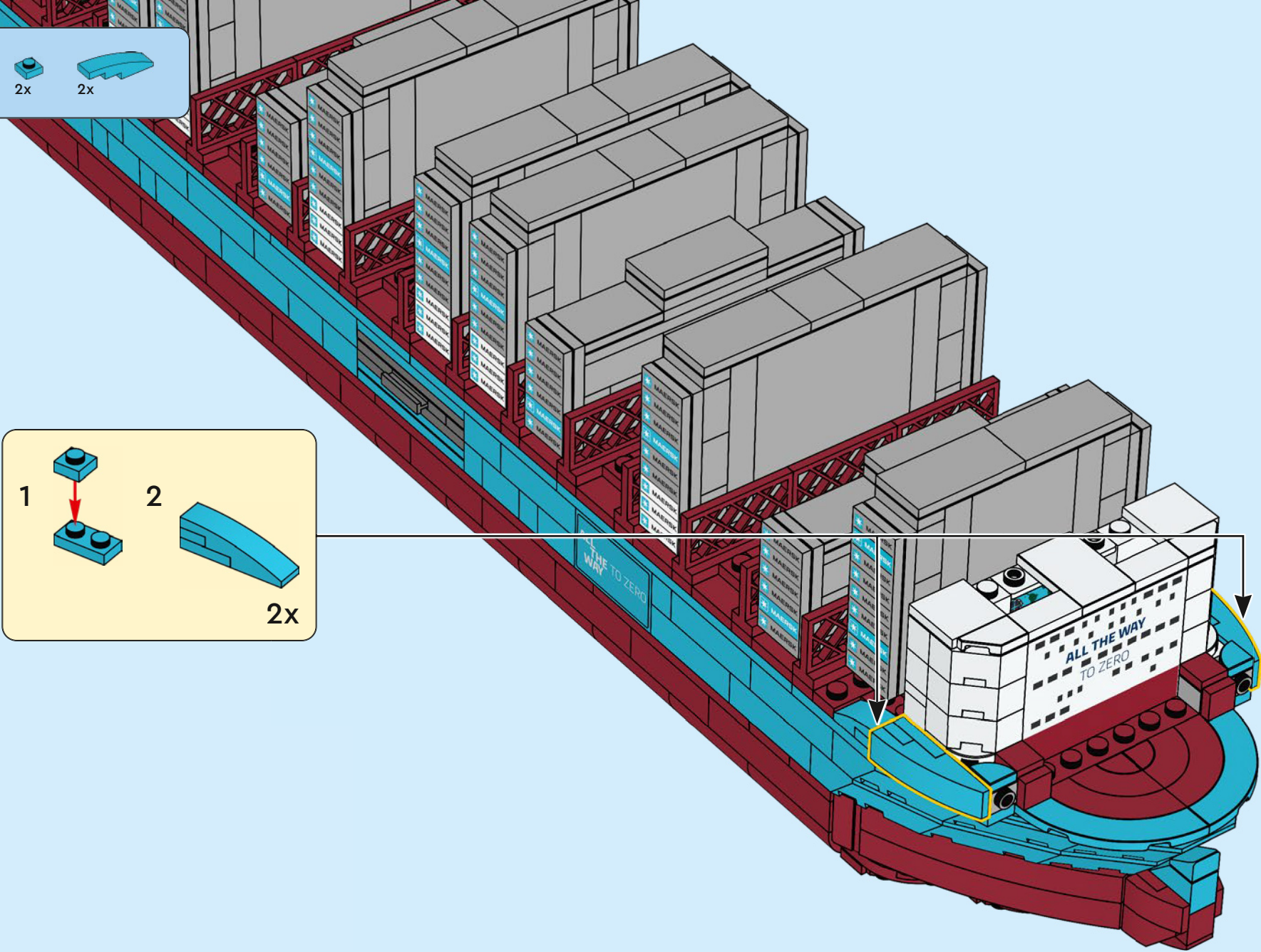

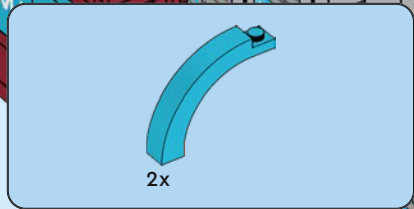

241

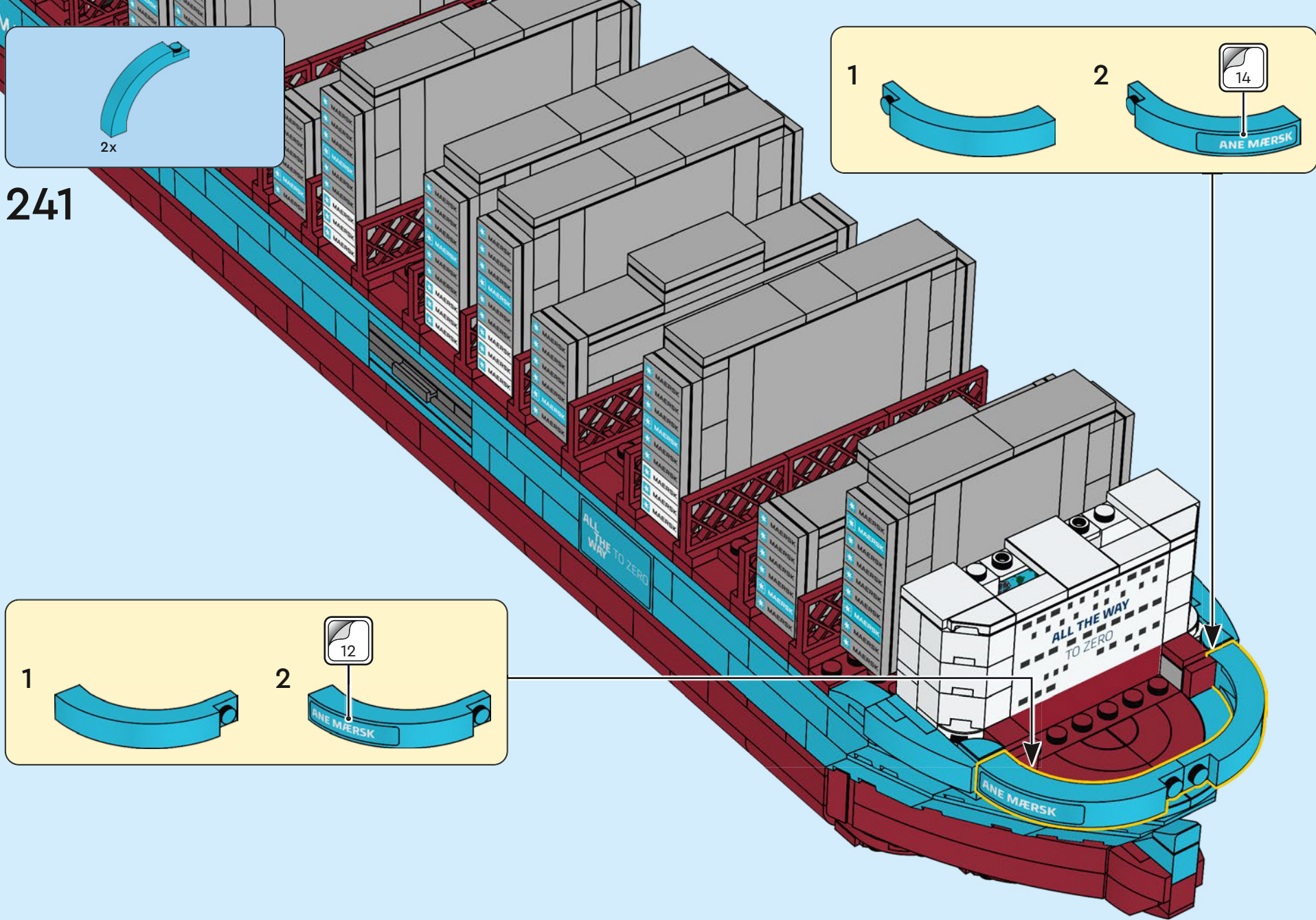
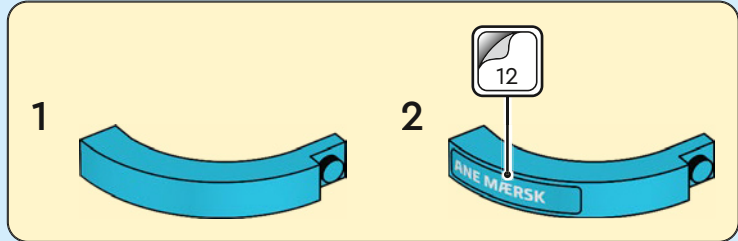
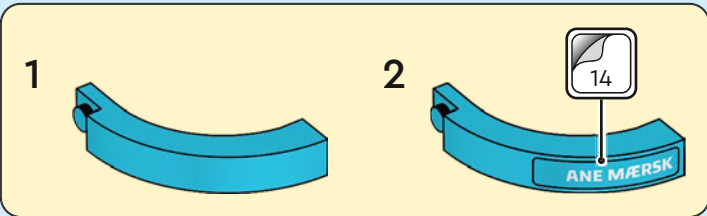

1x

242

1

2

13

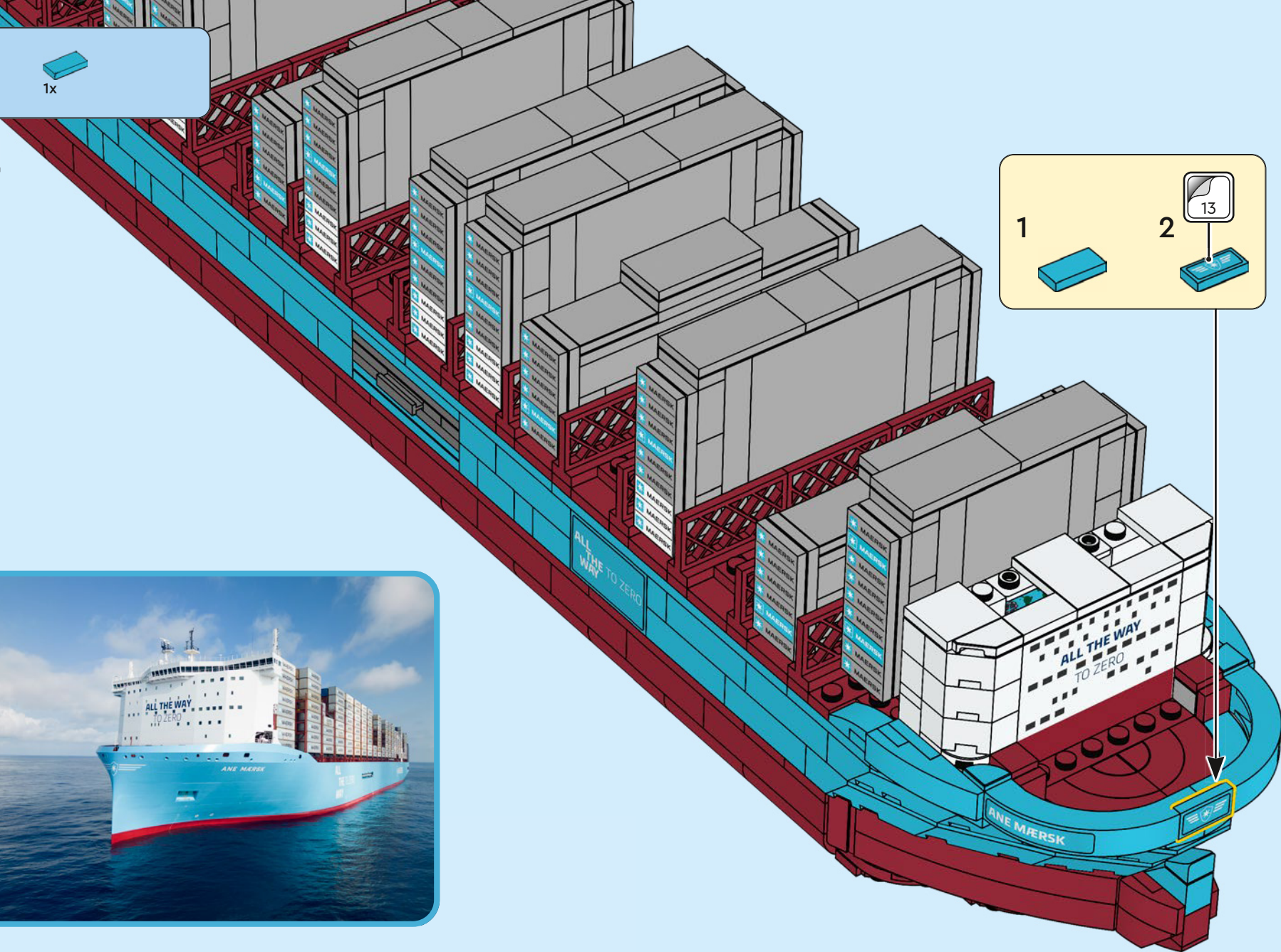

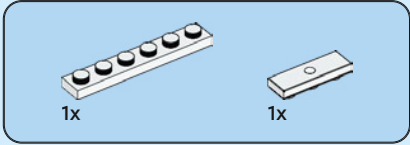
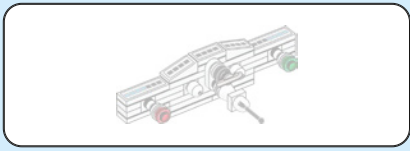

243

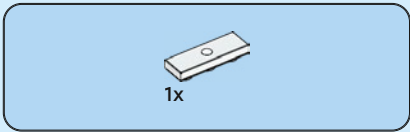
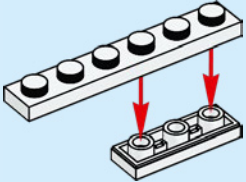

244

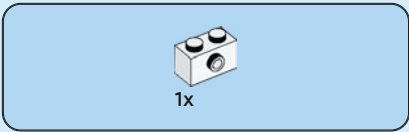
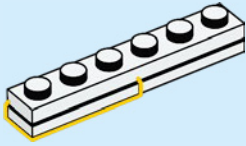

245

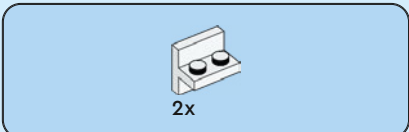
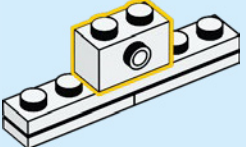

246

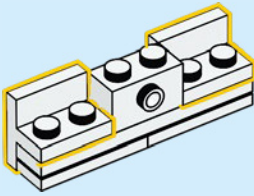



2x

247

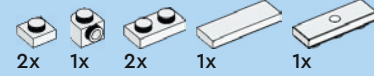
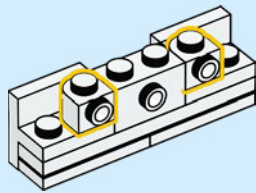

248

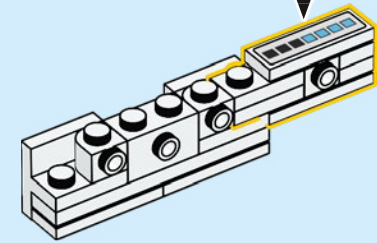
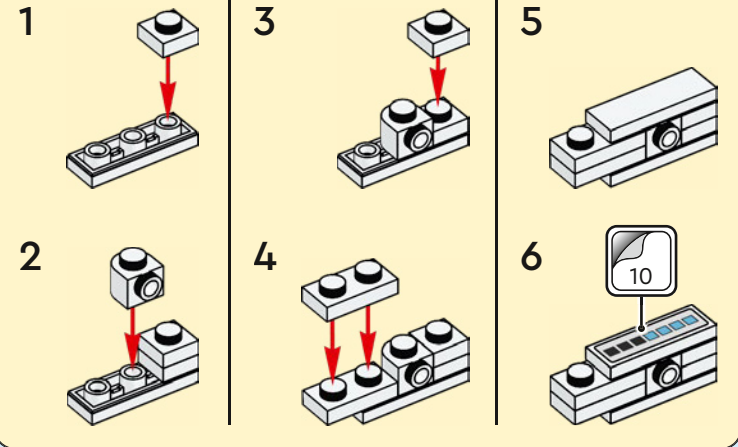

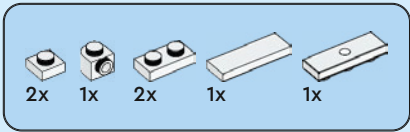

249

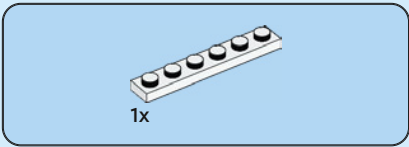
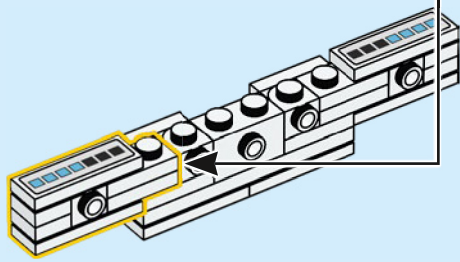
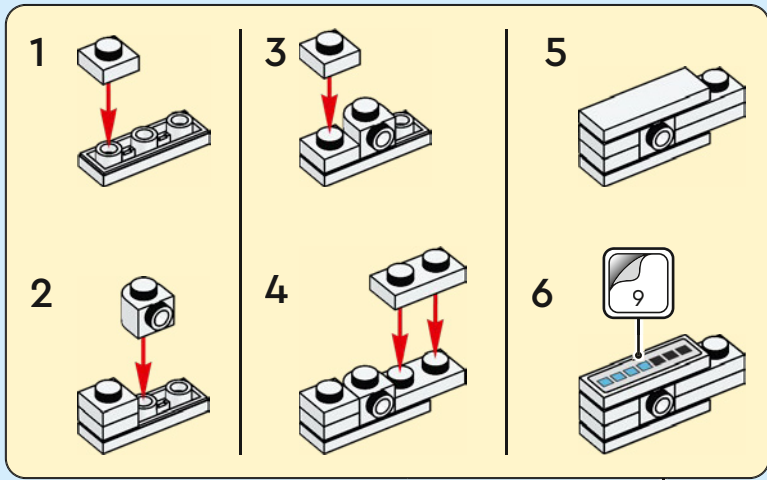

250

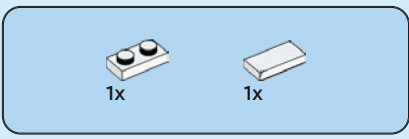
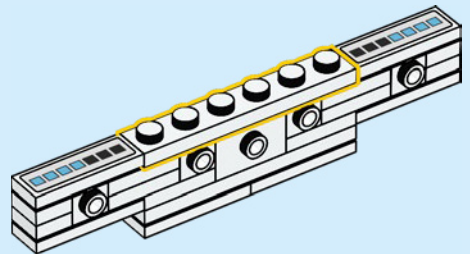

251

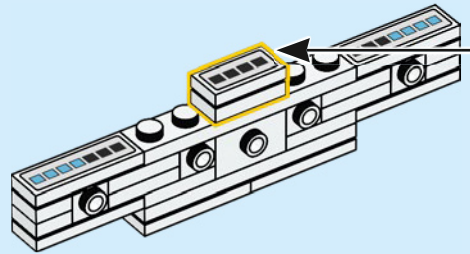
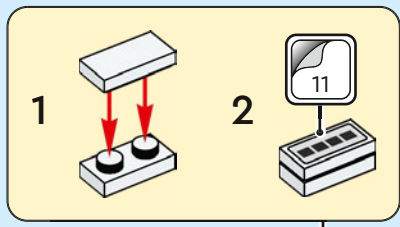

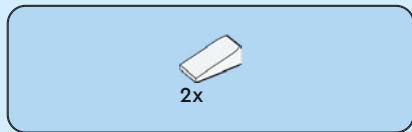

252

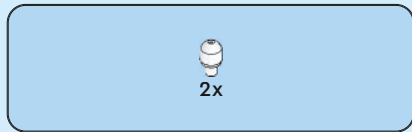
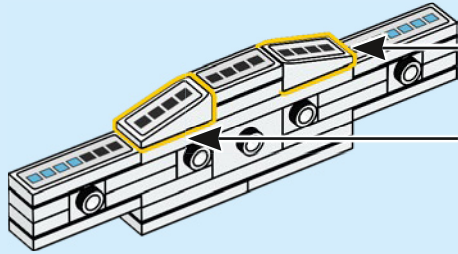
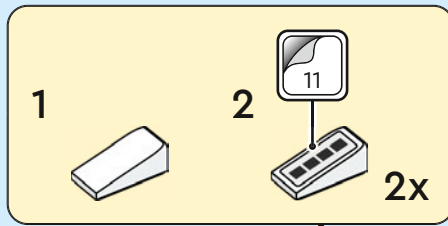

253

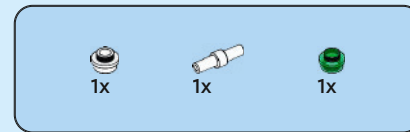
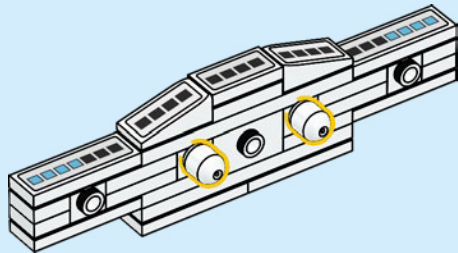

254

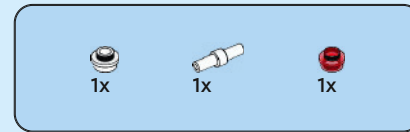
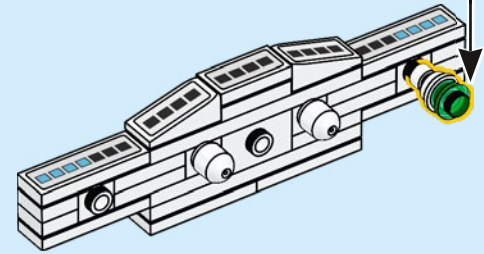
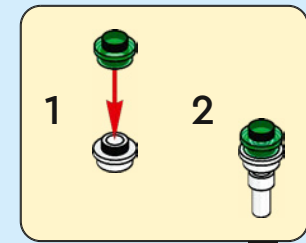

255

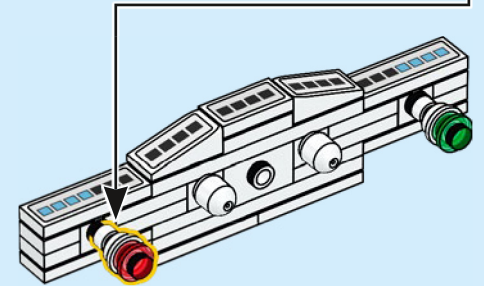
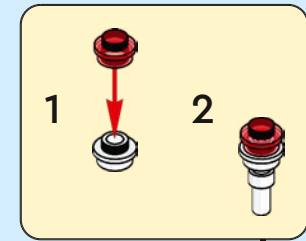

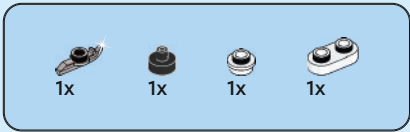

256

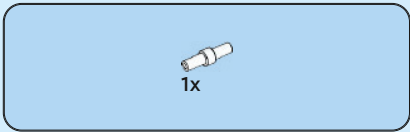
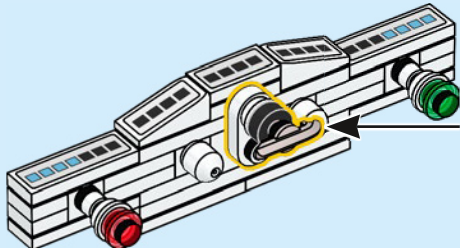
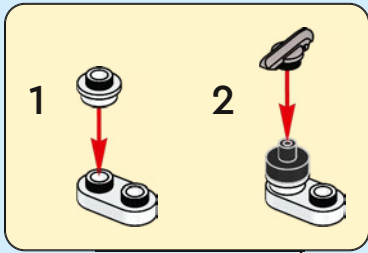

257

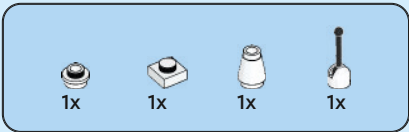
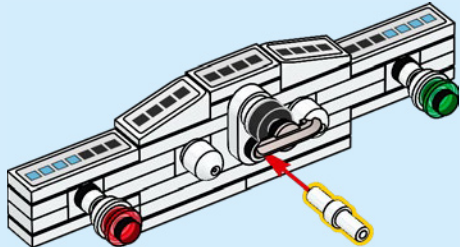

258

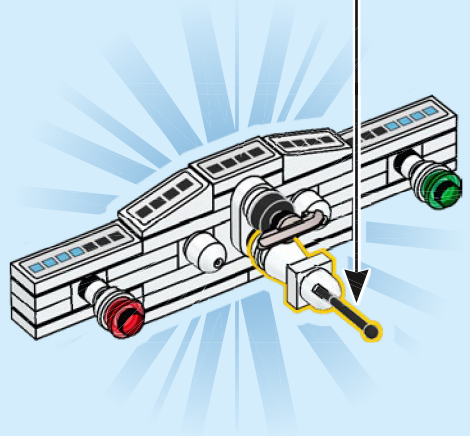
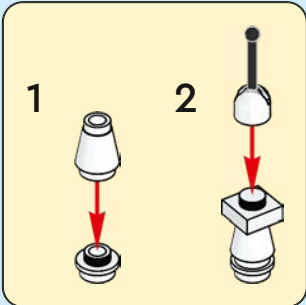

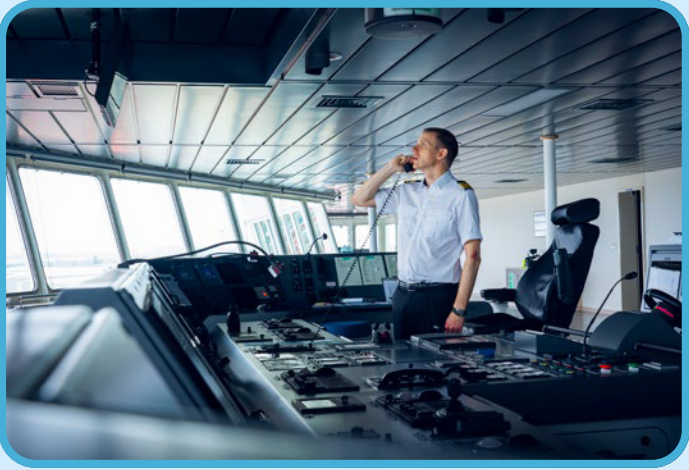
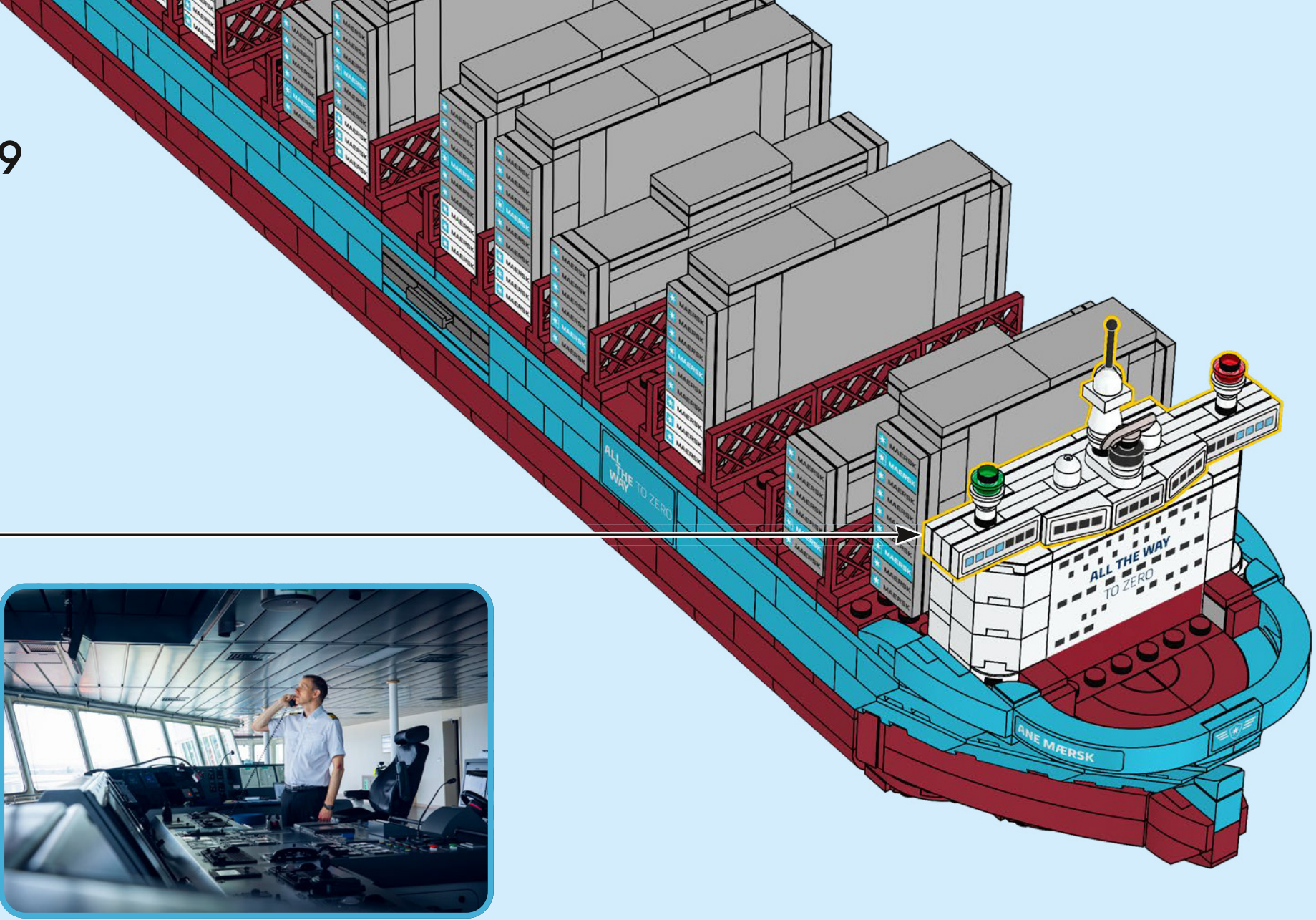

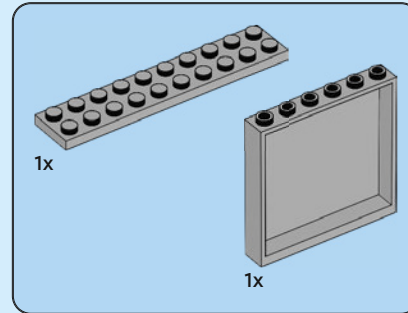
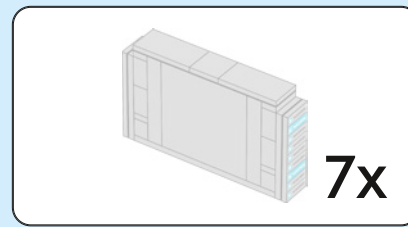

260

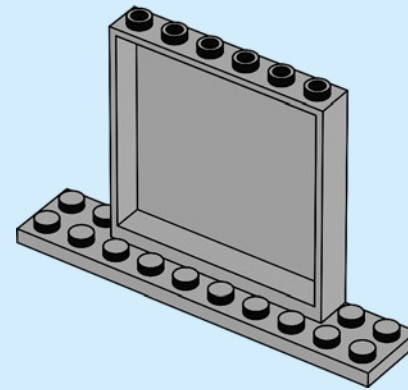

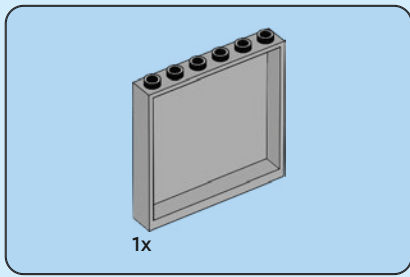

261

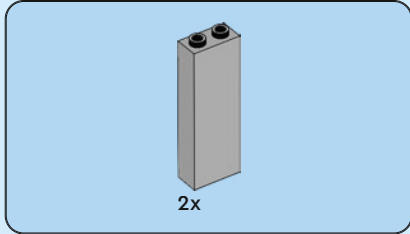
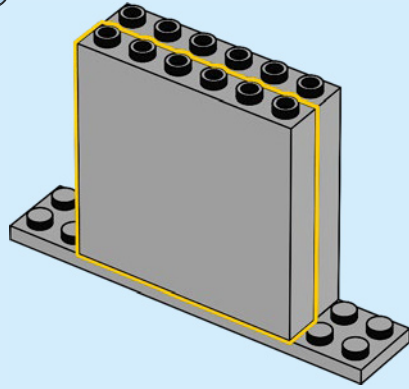

262

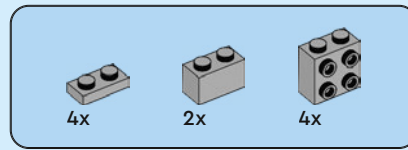
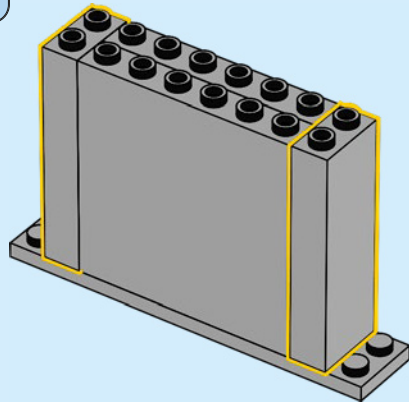

263

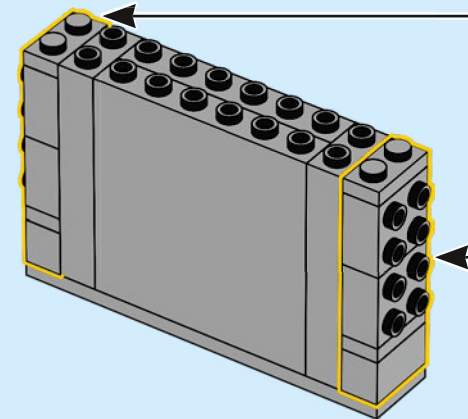
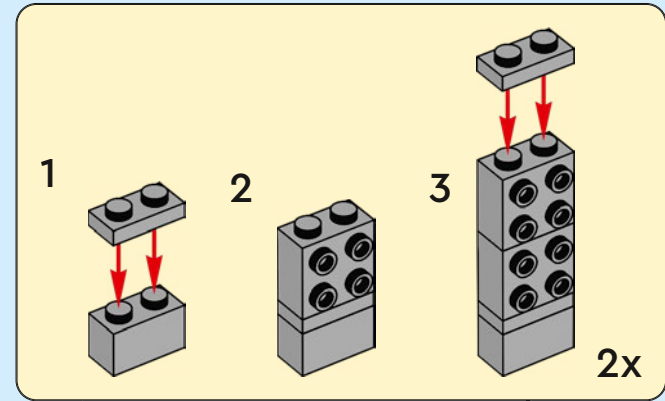

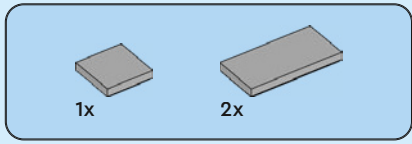

264

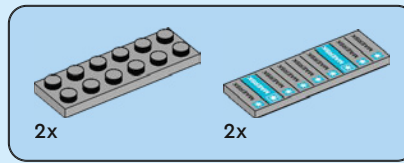
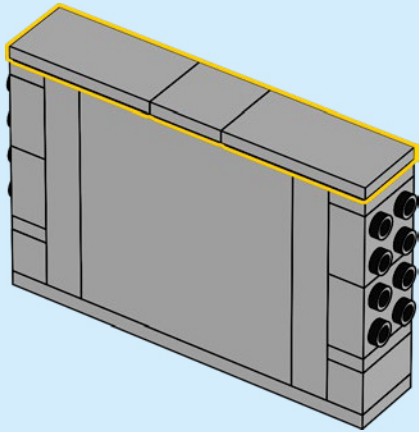

265

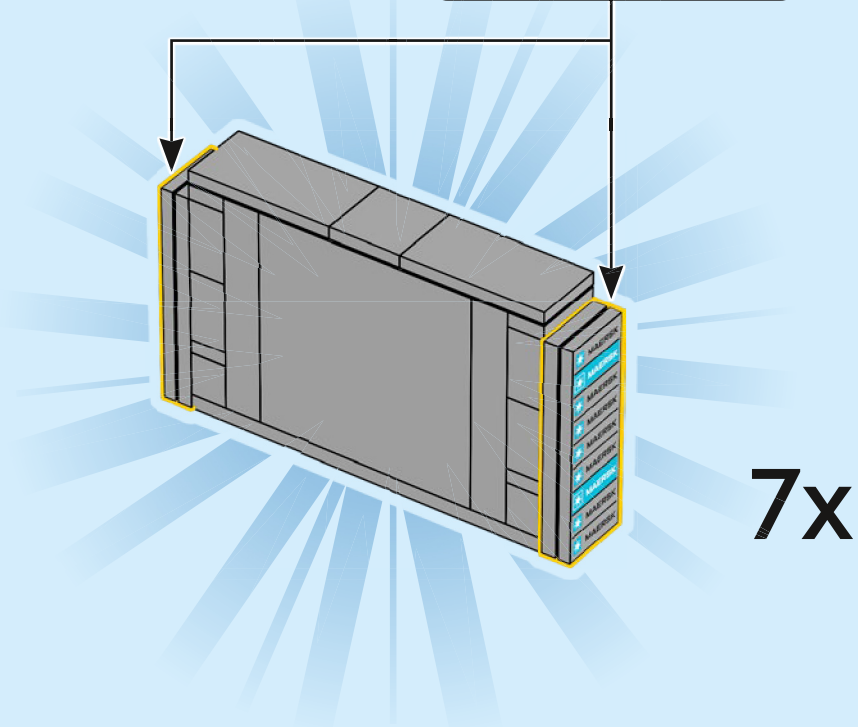
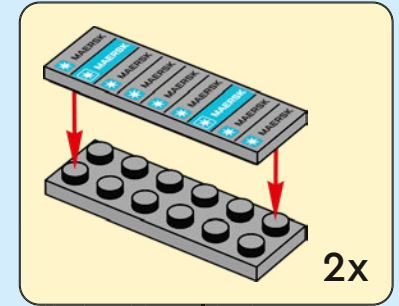

266

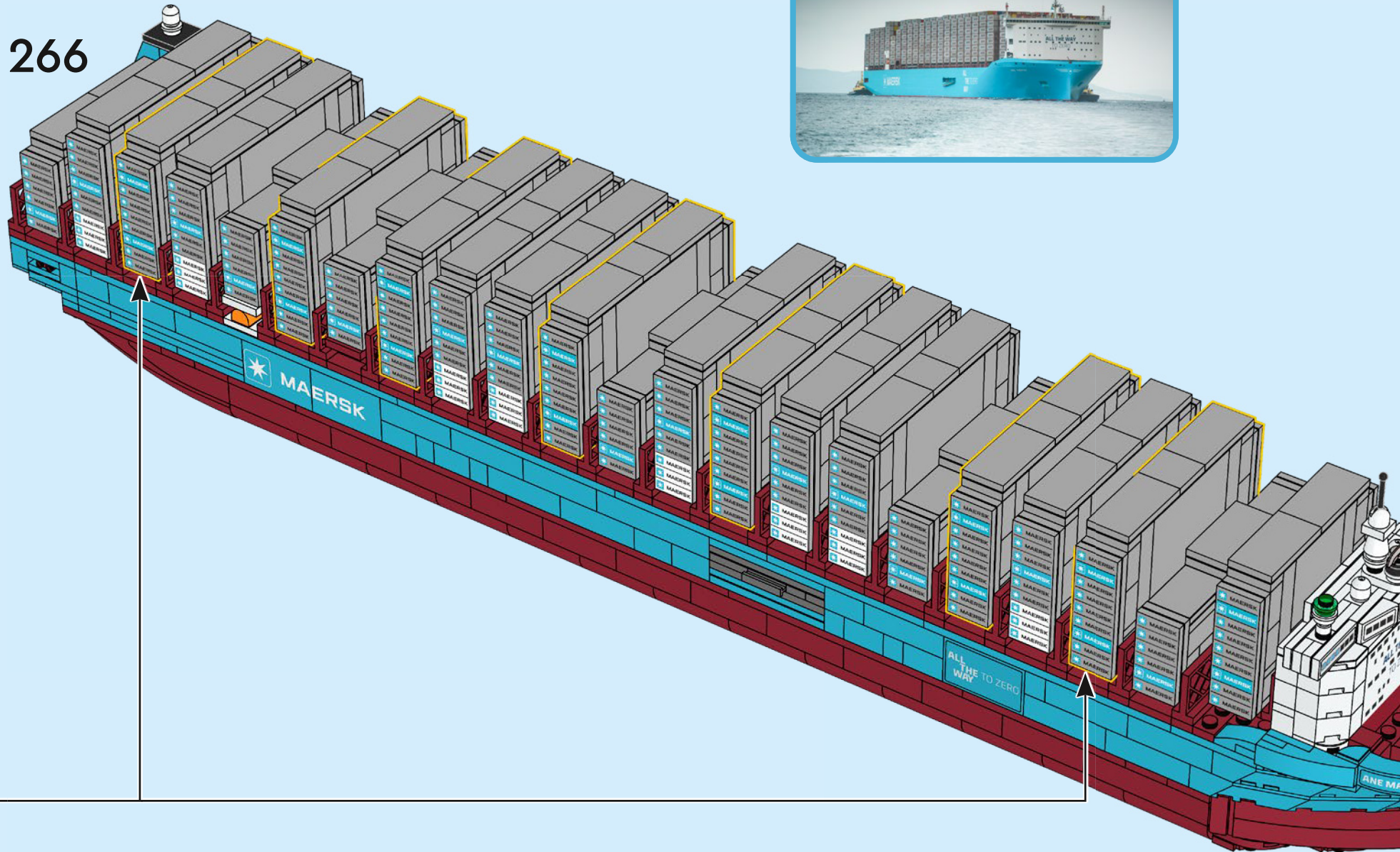

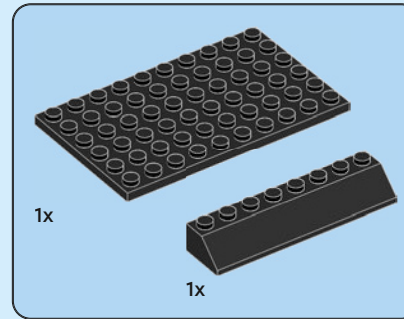
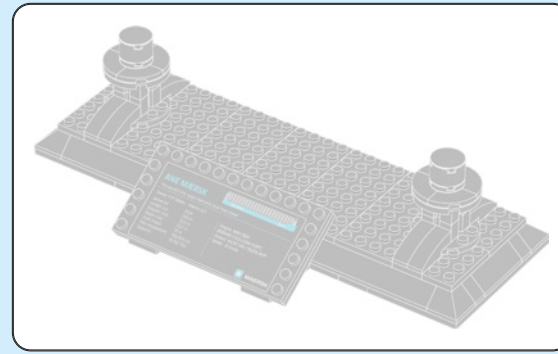

267

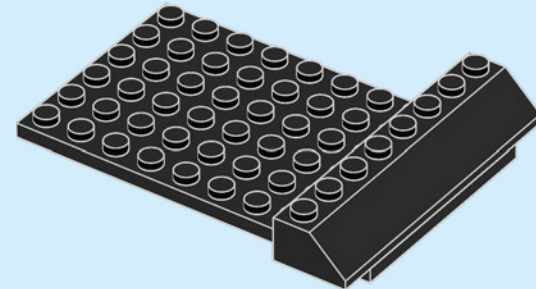

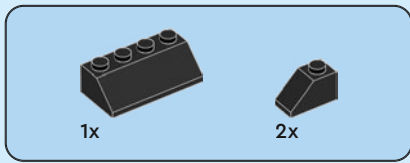

268

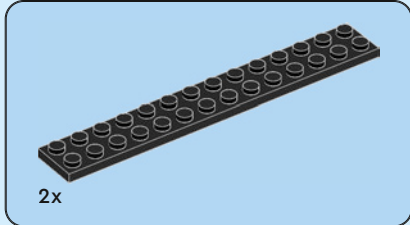
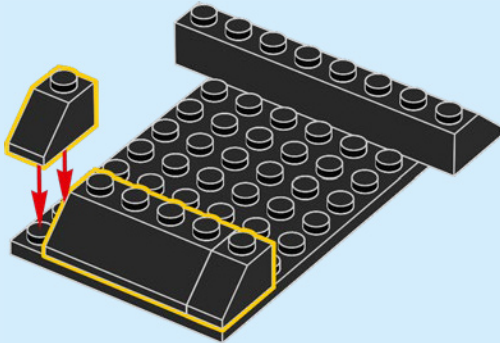

269

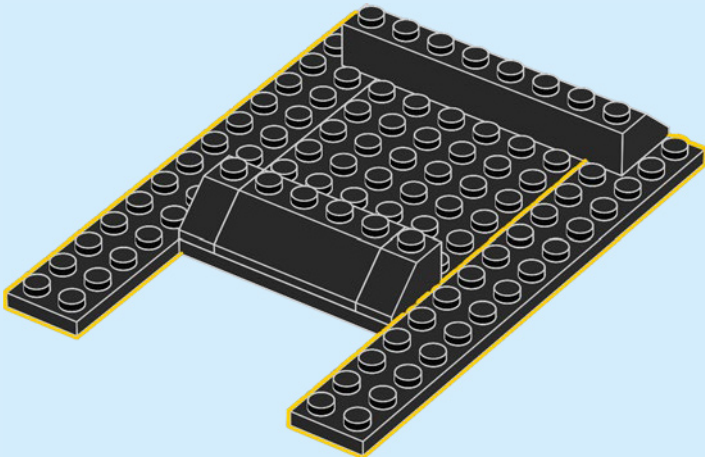

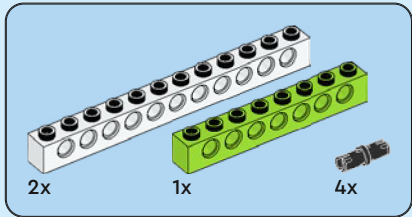
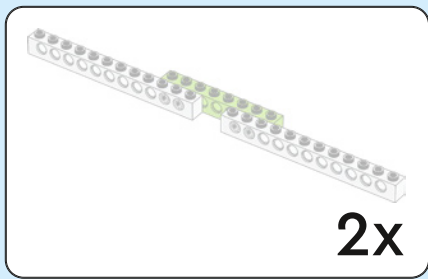

270

1

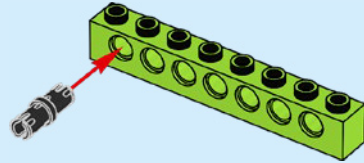

2

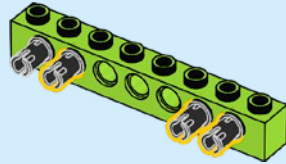

3

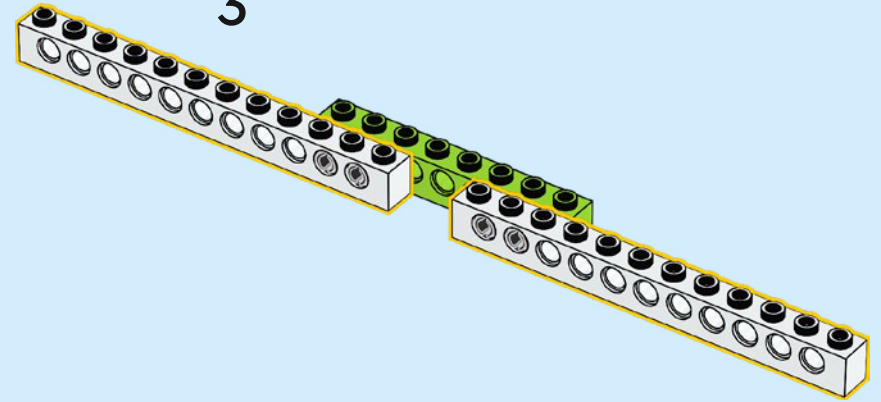

2x

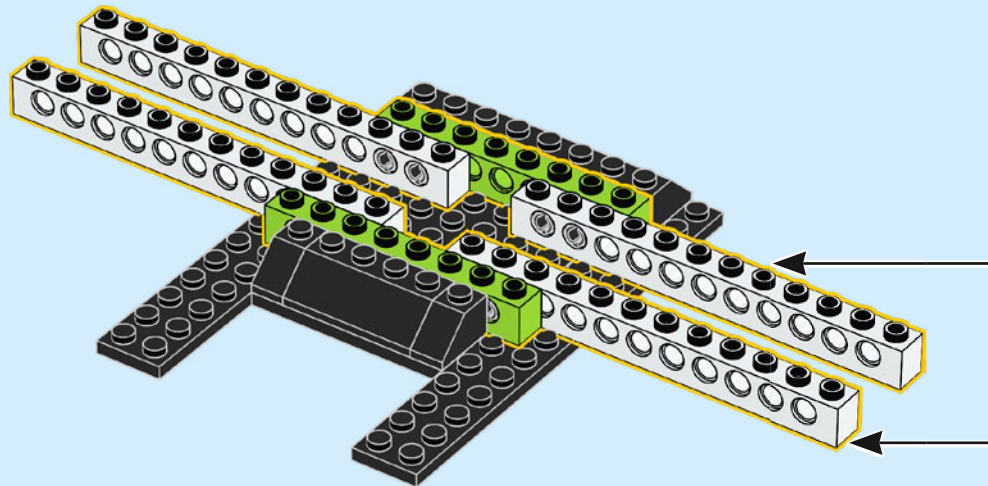

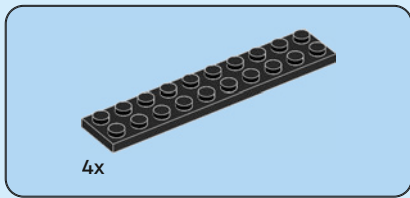

271

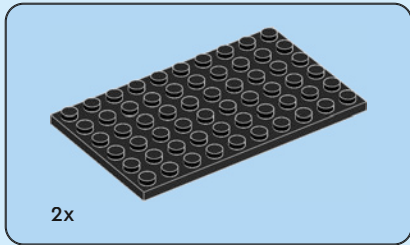
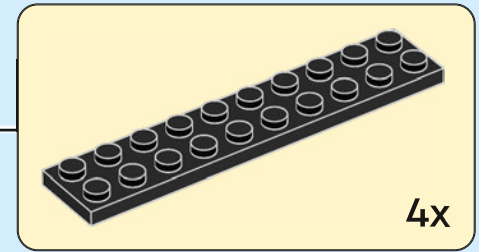
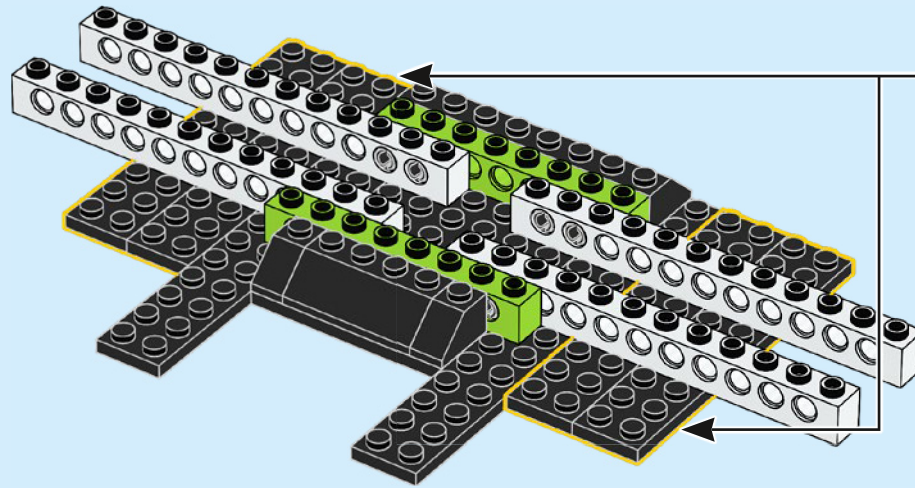

272

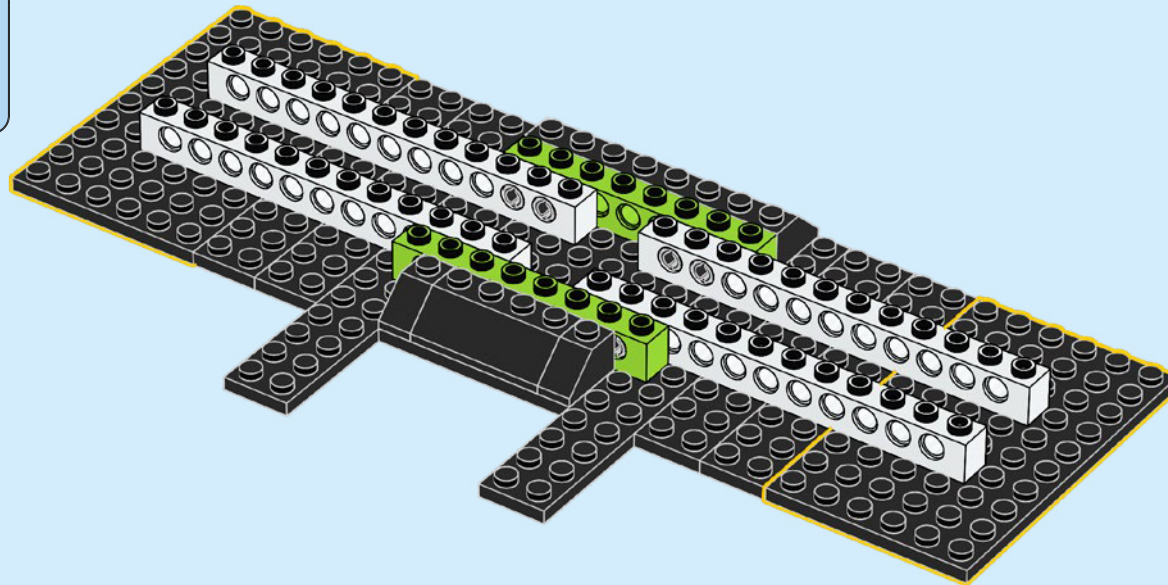

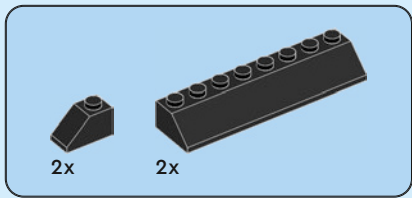

273

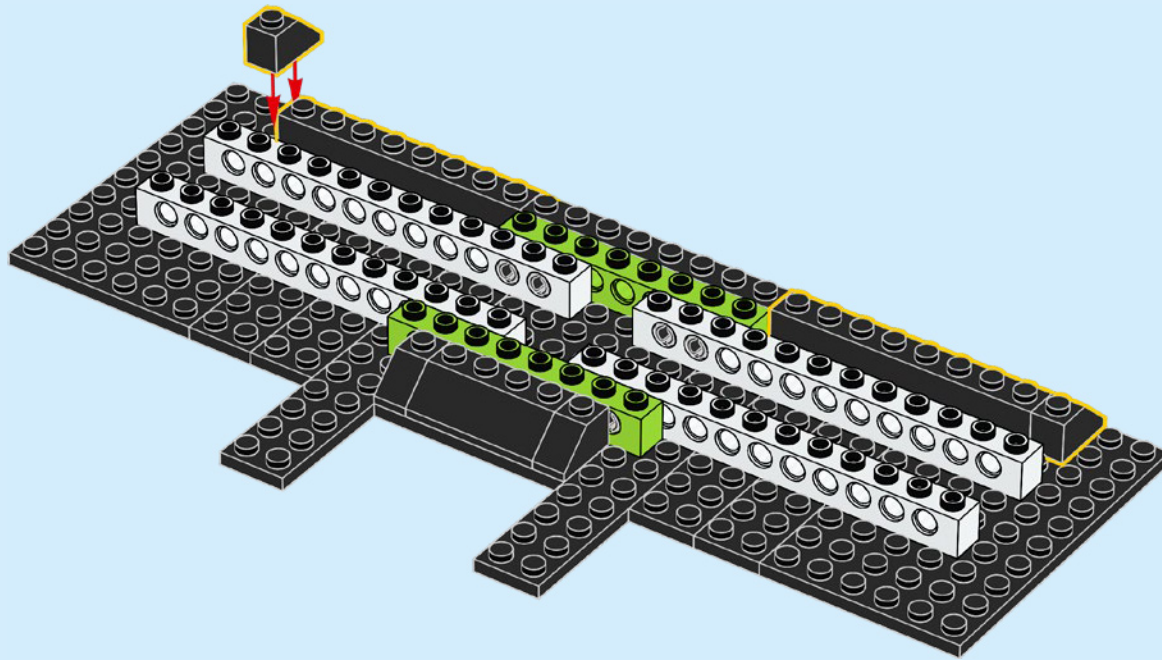

274

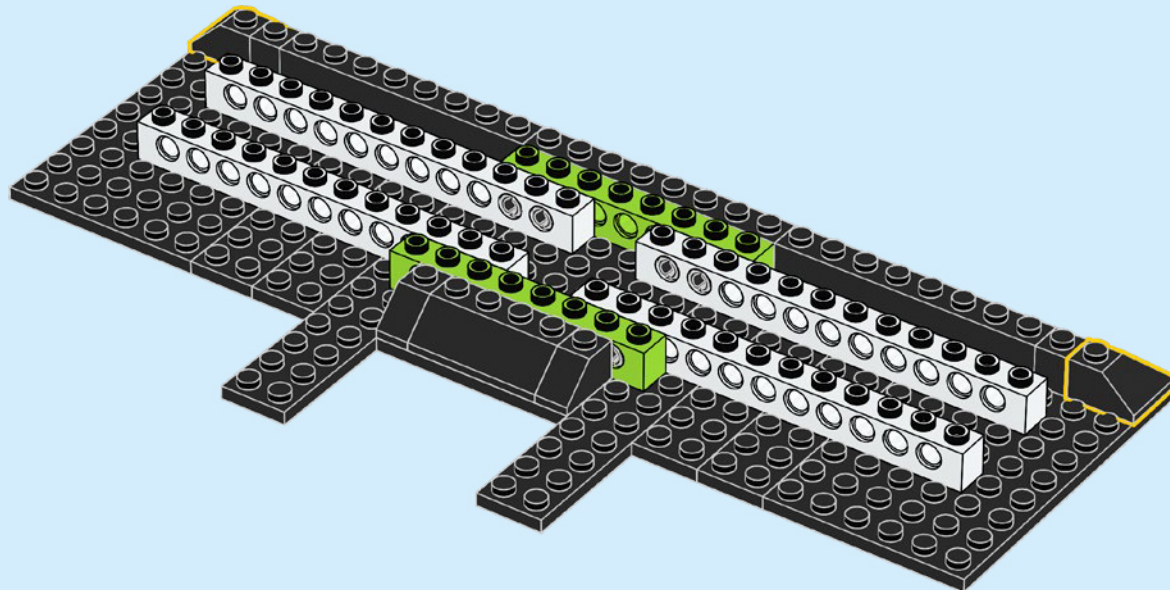

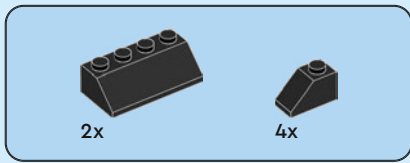

275

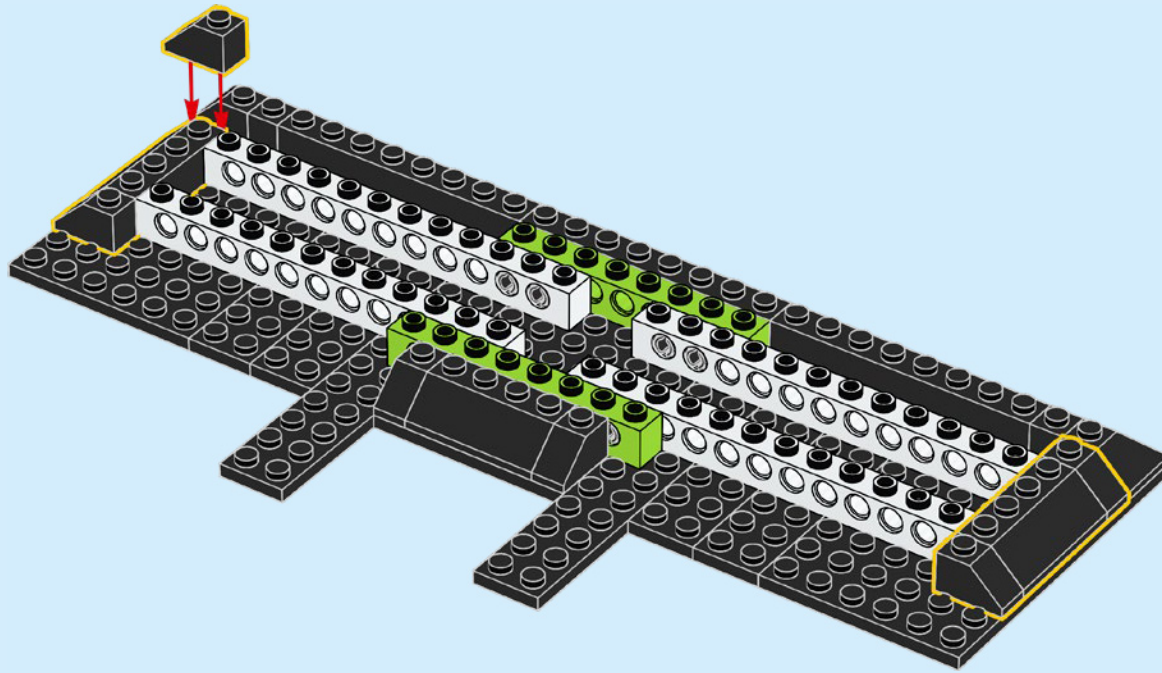

276

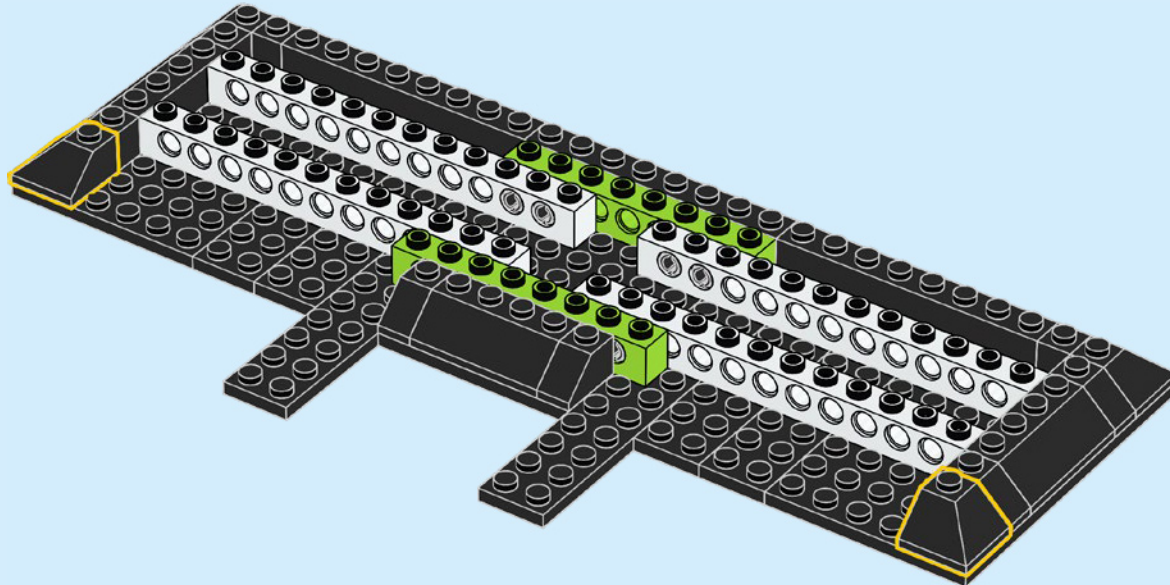



2x



2x

277

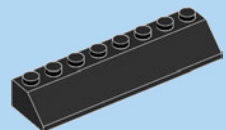
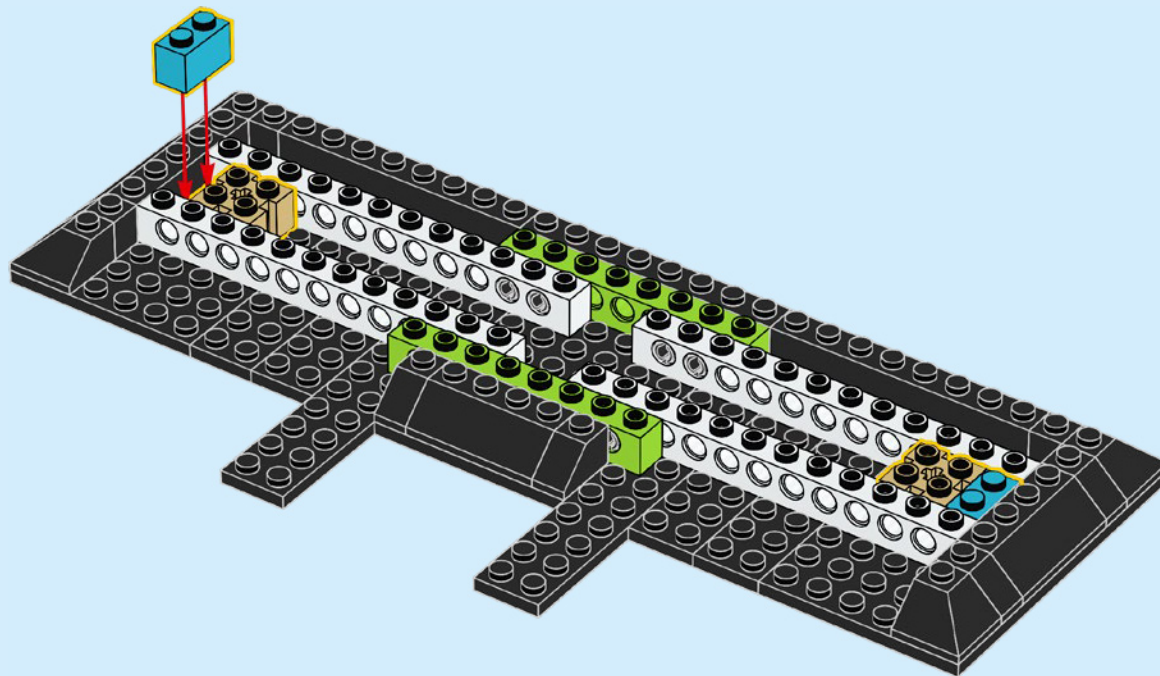

2x

278

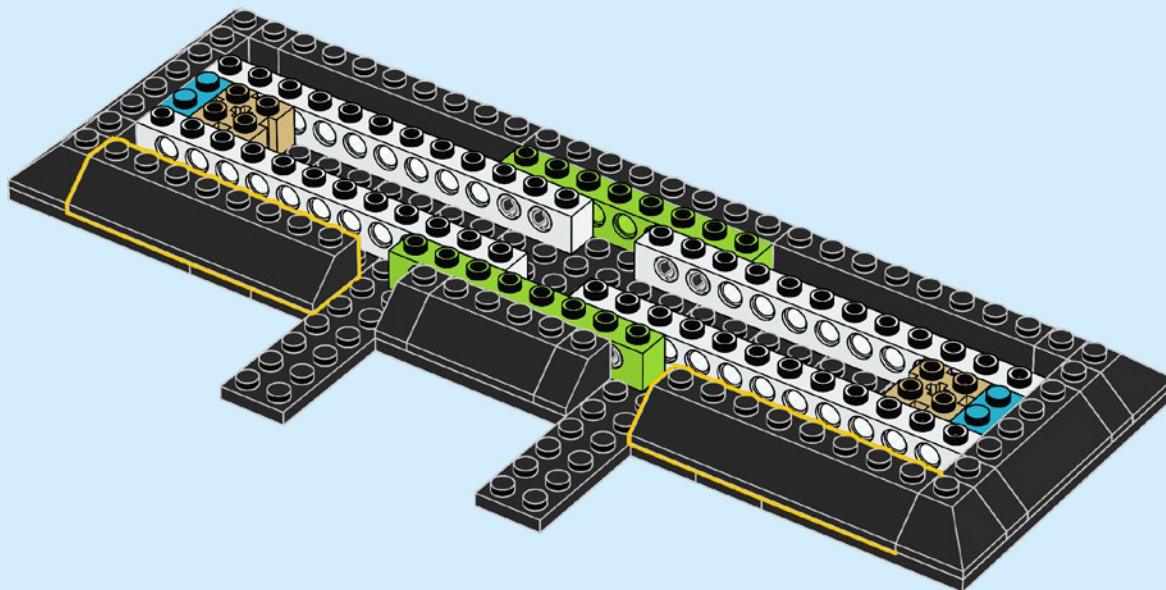

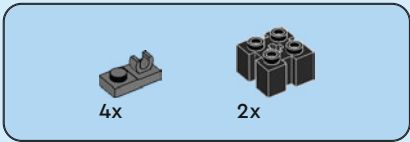

279

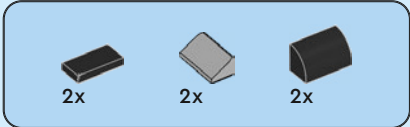
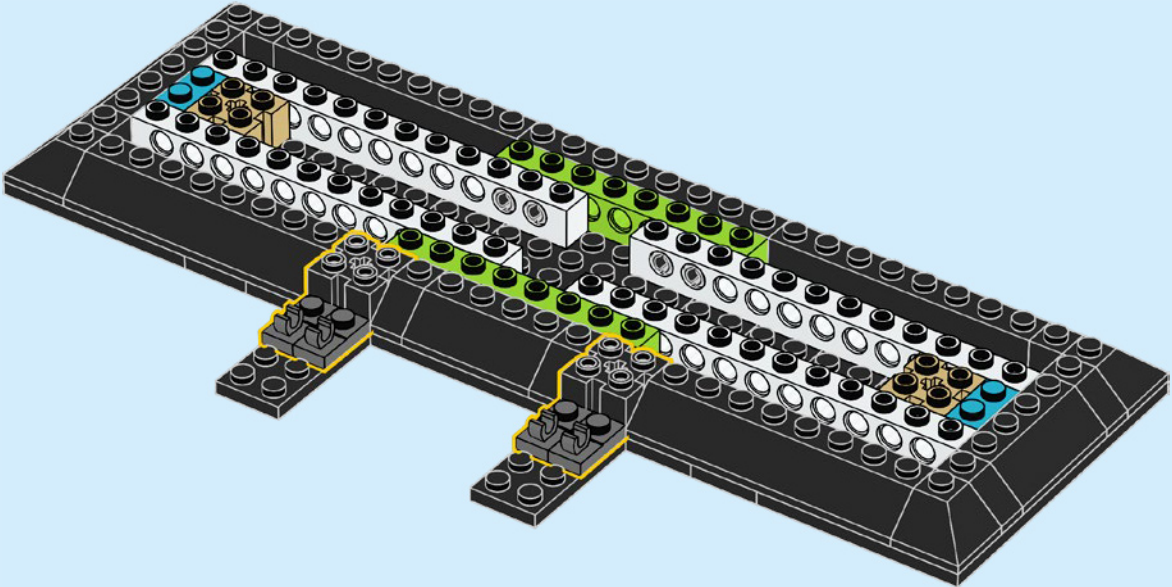

280

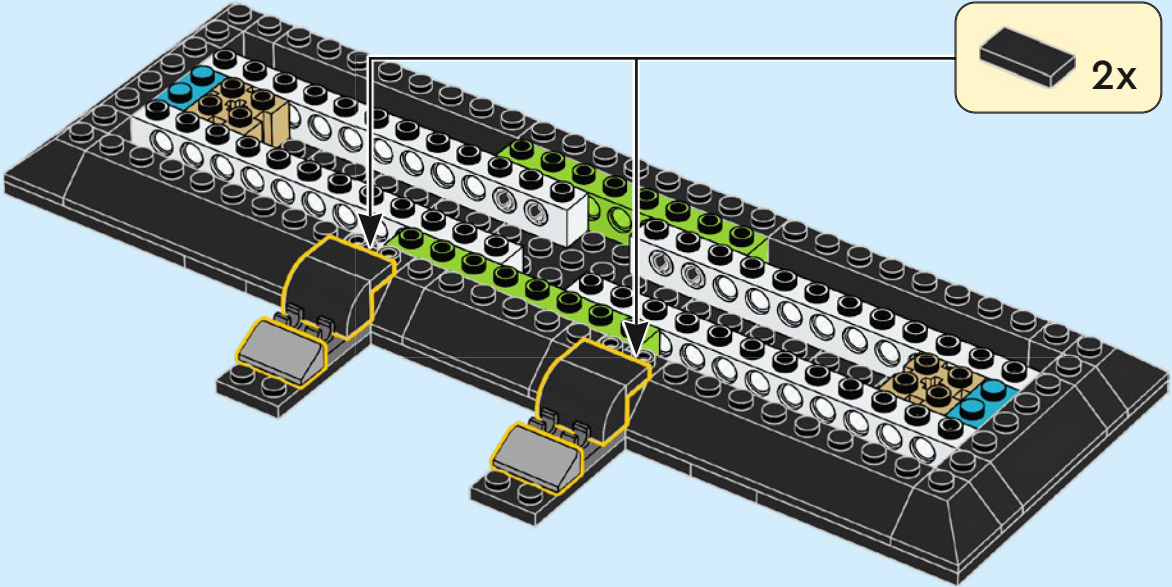

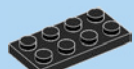

4x

281

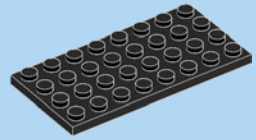
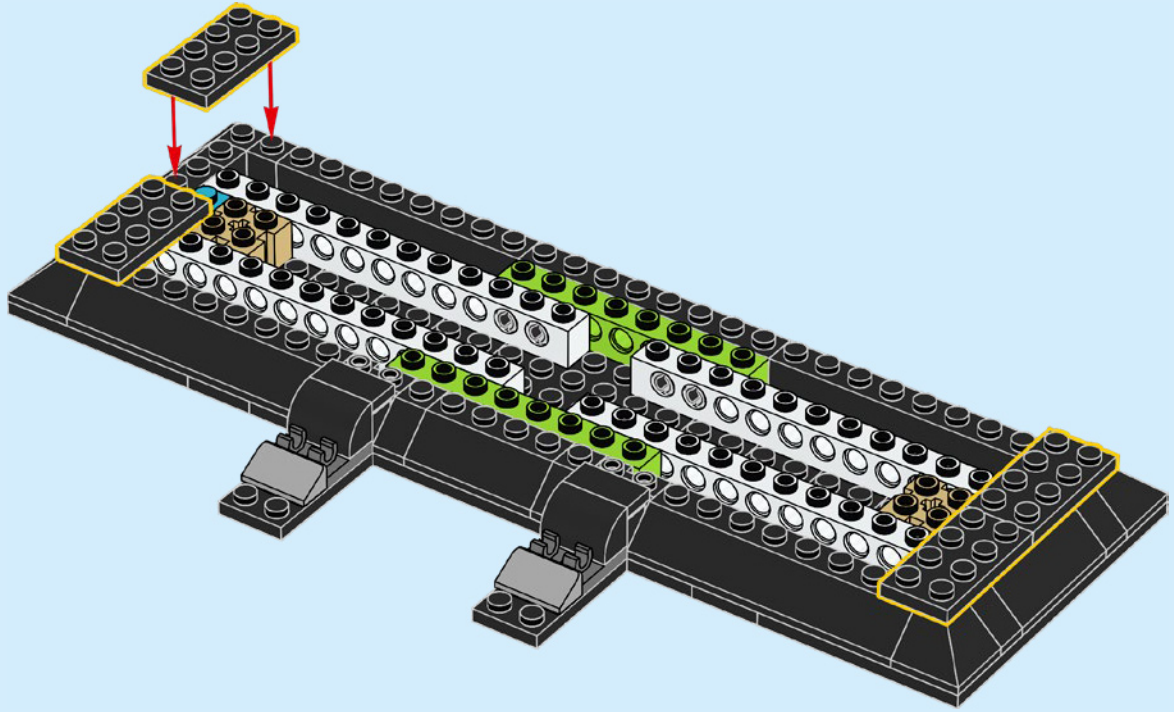

5x

282

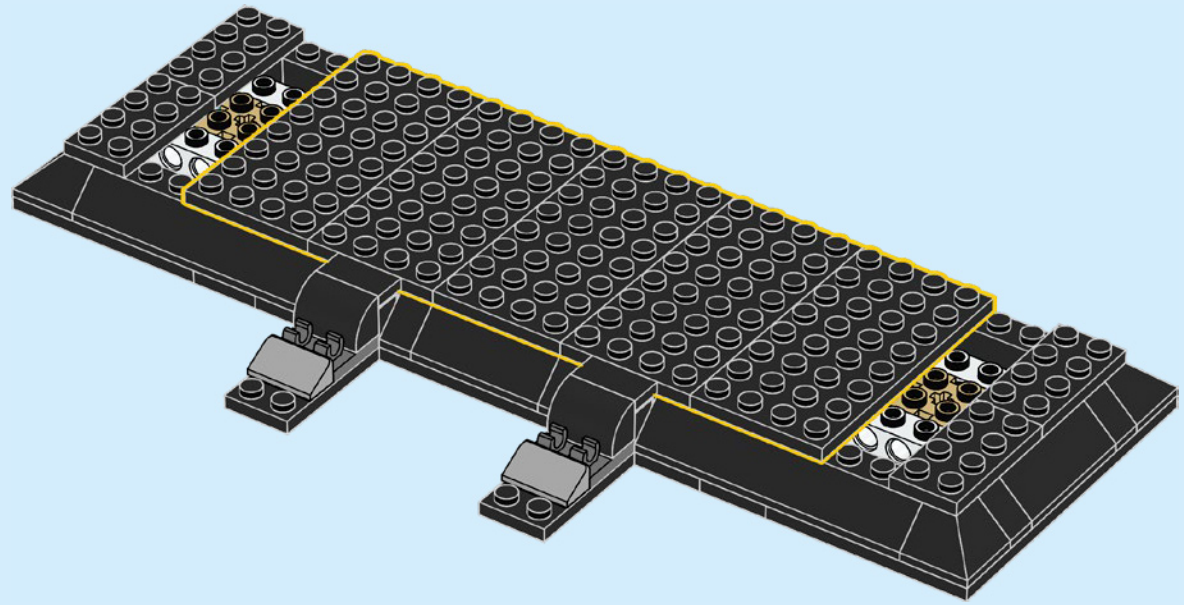

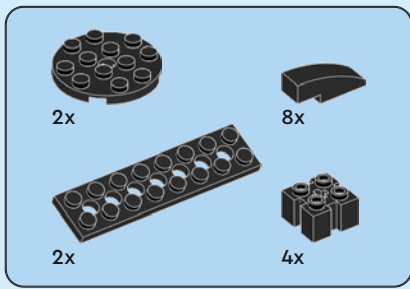

283

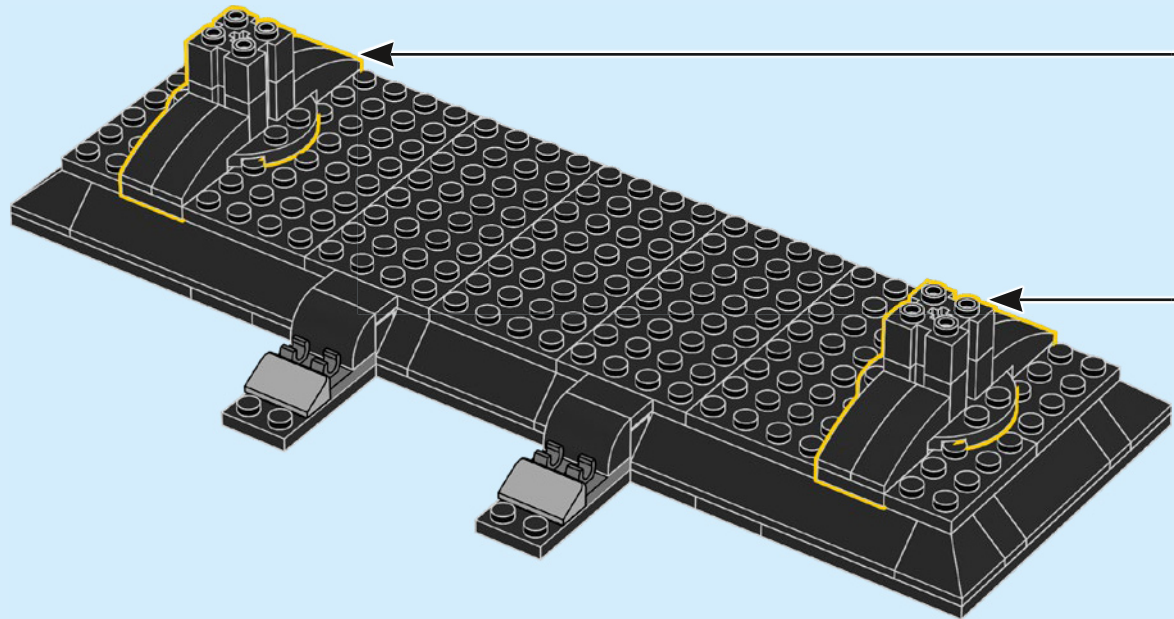
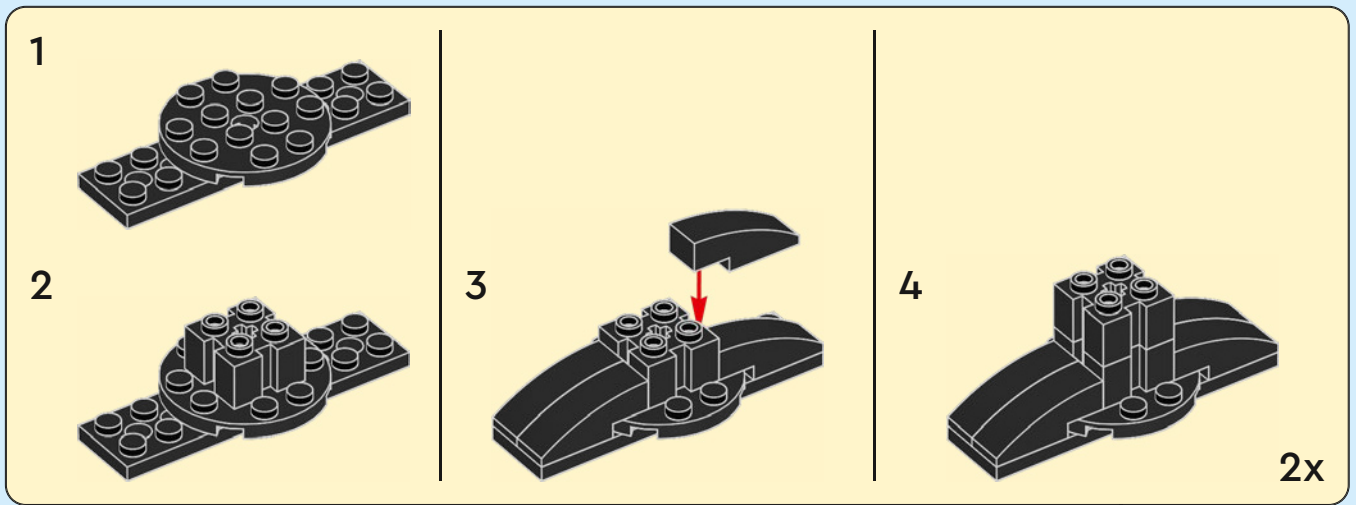

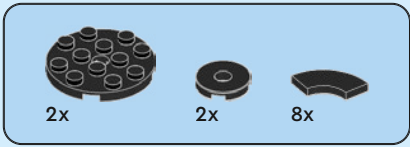

284

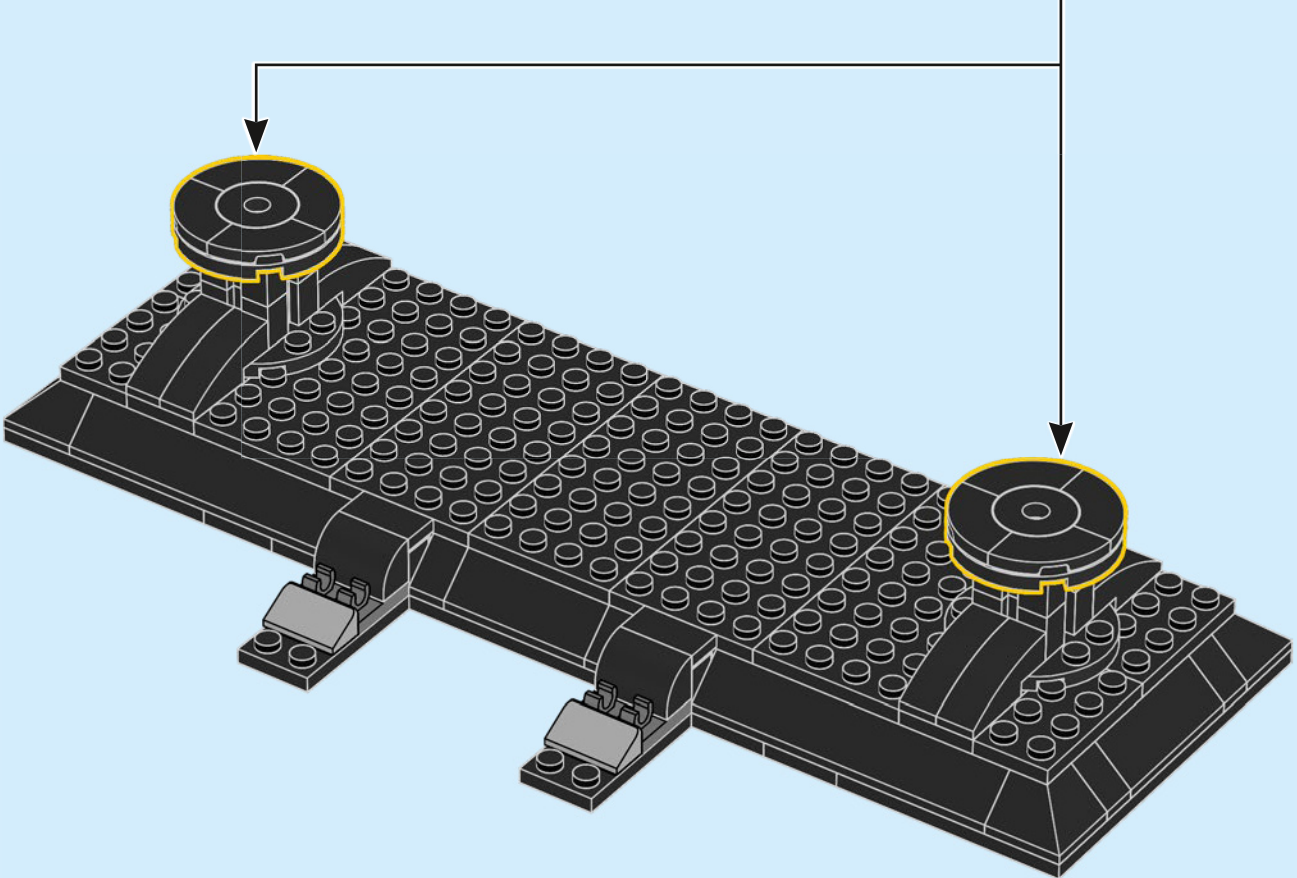
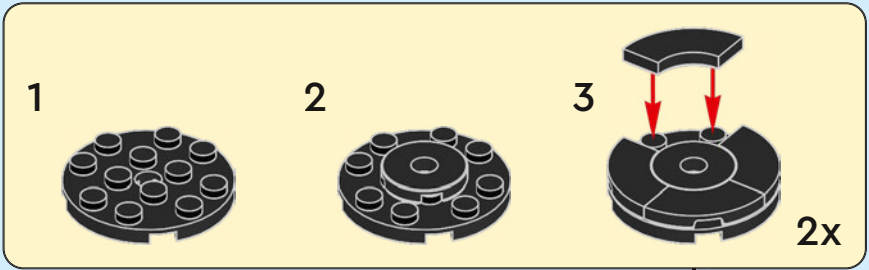

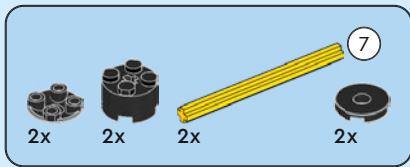

285

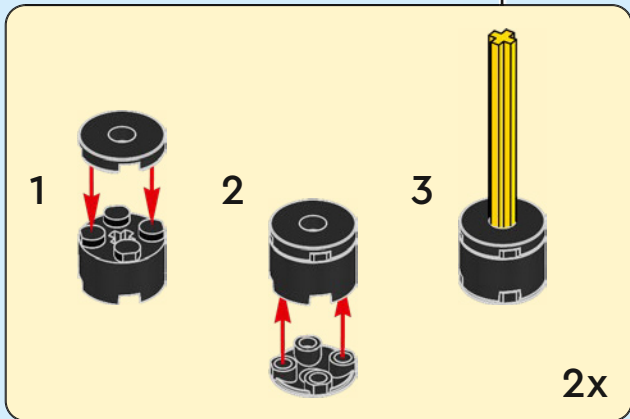
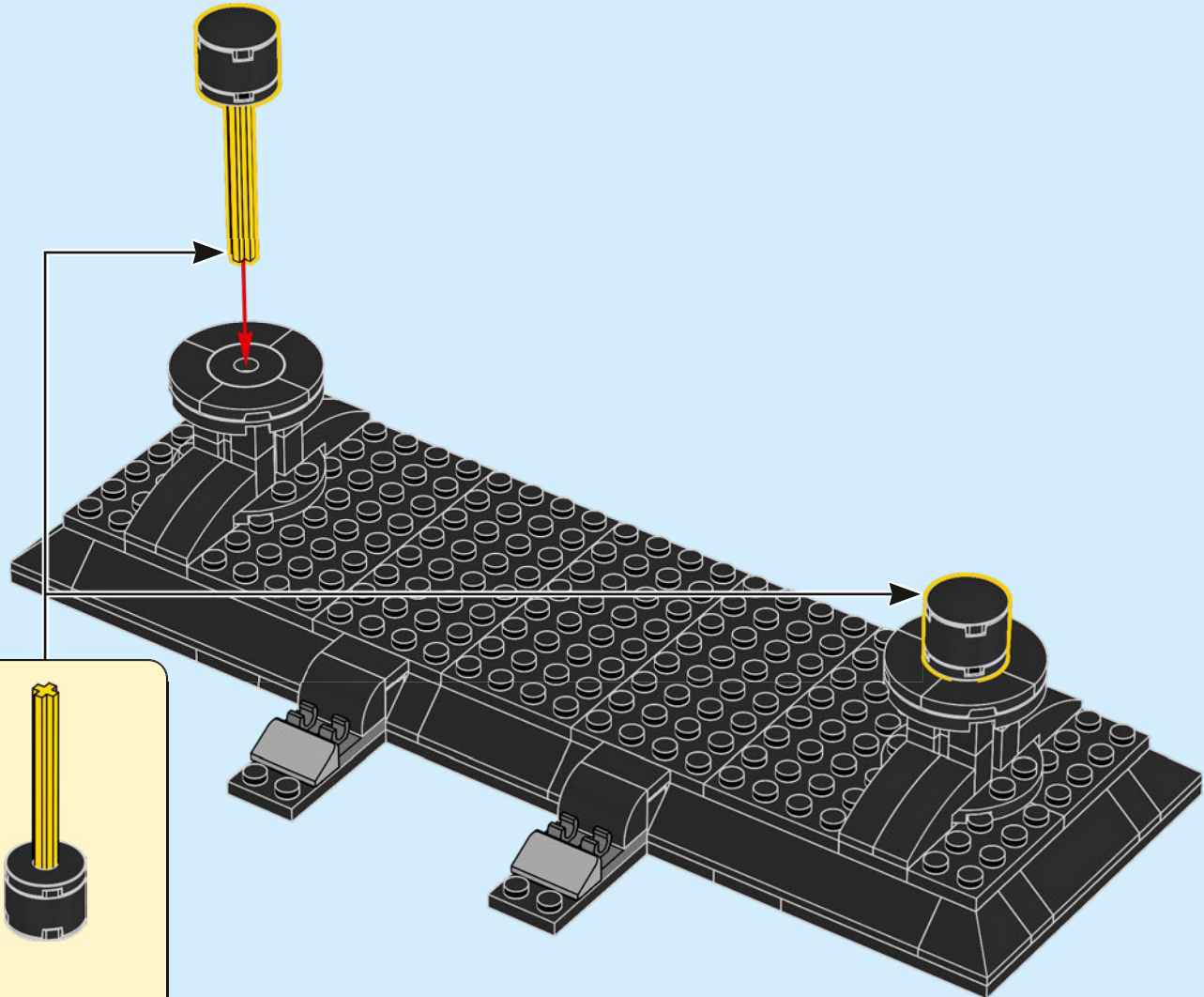

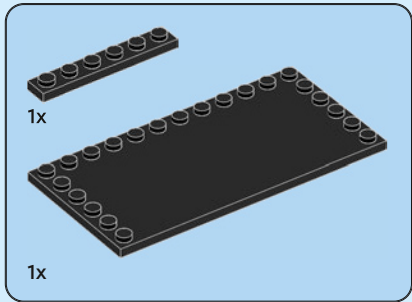

286

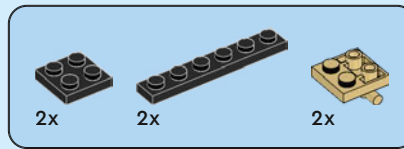
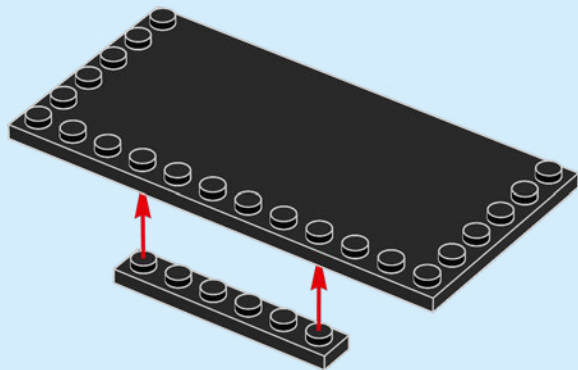

287

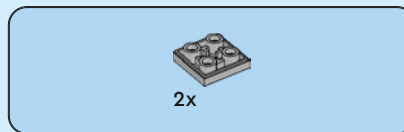
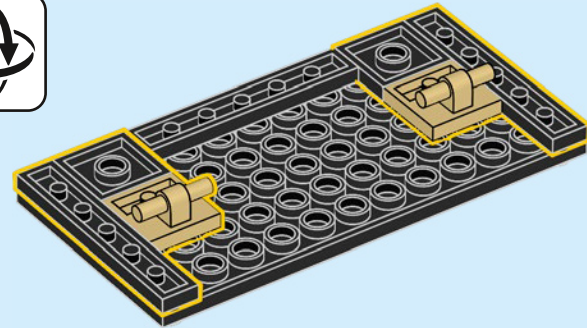

288

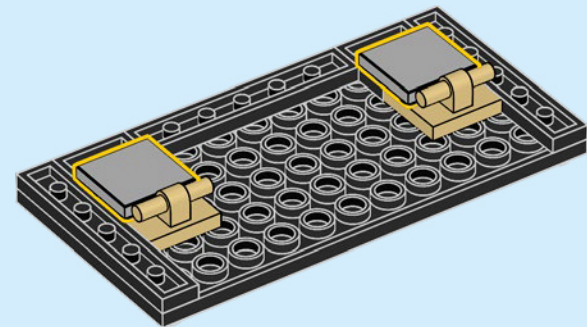

289

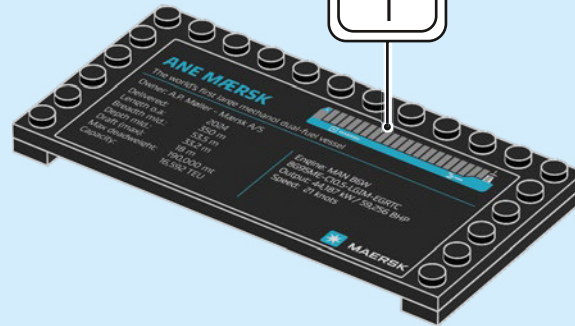

290

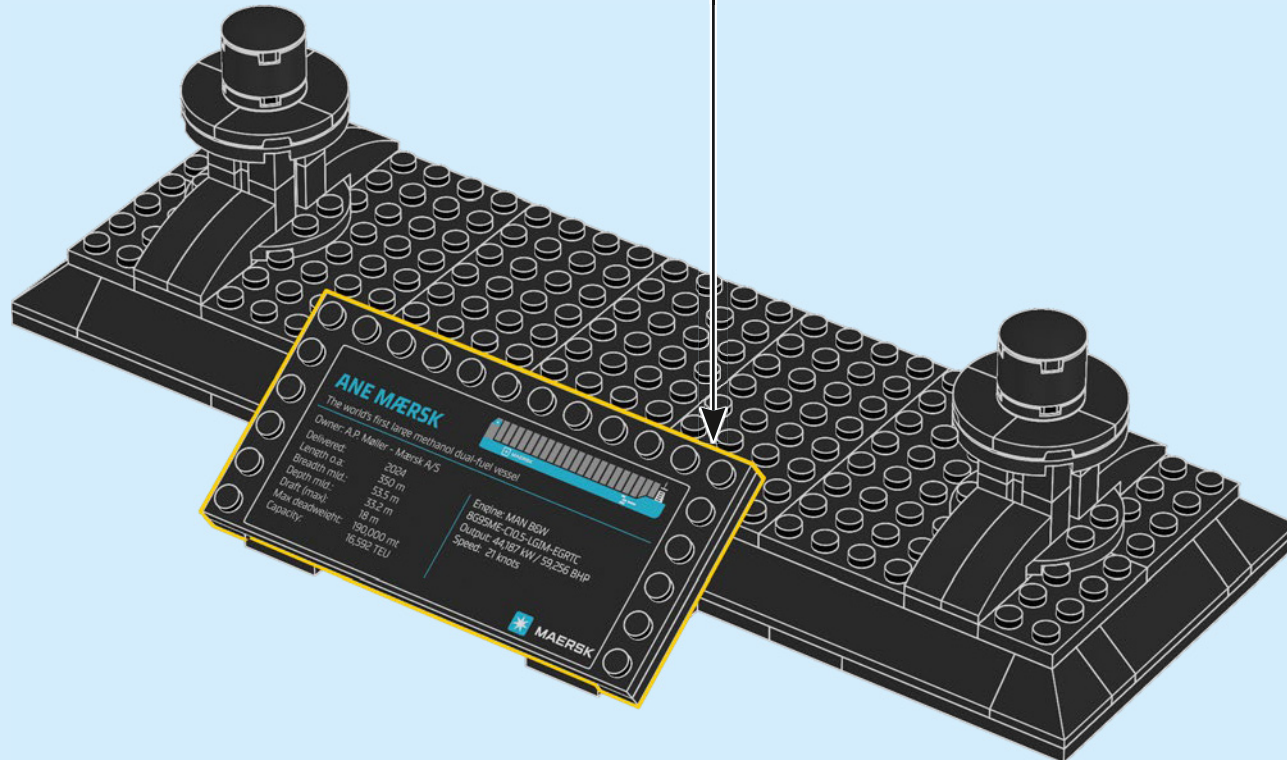

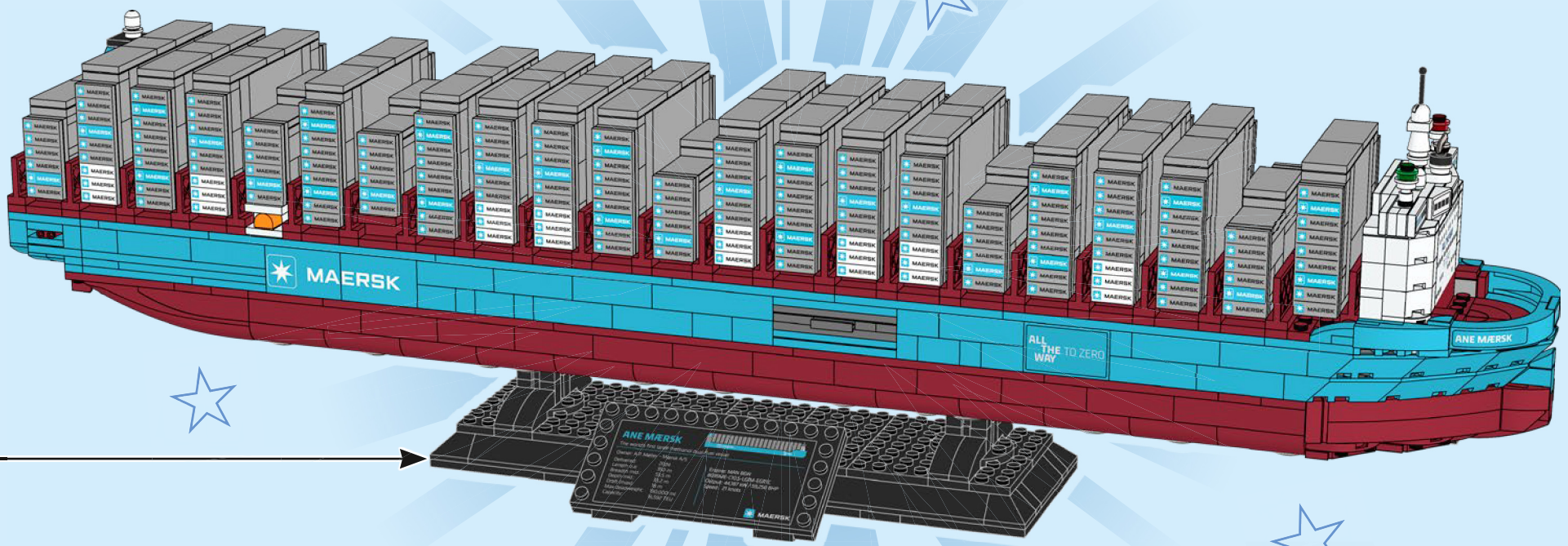
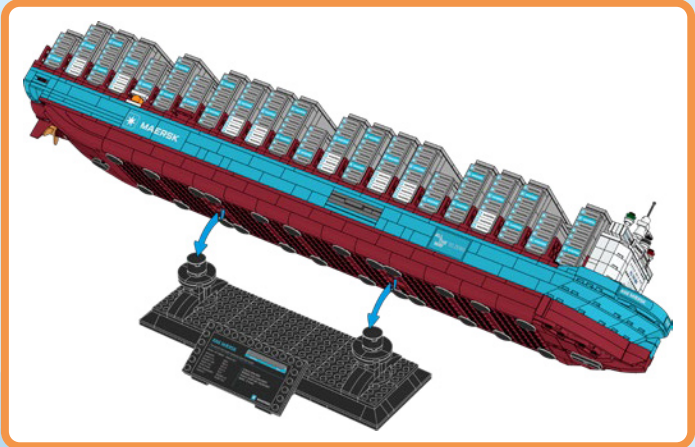

ANE MÆRSK
The world's first large container ship with zero emissions.
Owner: A.P. Møller - Mærsk A/S
Delivered: 2016
Length: 349.6 m
Beam: 48 m
Draft: 14.5 m
Max. Speed: 22.5 knots
Capacity: 11,000 TEU

1700hp 5000 RPM
2x MAN B&W 6ESD 50/60
2x MAN B&W 6ESD 50/60
2x MAN B&W 6ESD 50/60
2x MAN B&W 6ESD 50/60

MAERSK

- 4x 6584062
- 4x 4541528
- 2x 6586652
- 1x 6335319
- 21x 6052777
- 6x 4541507
- 4x 4539071
- 10x 6576807
- 66x 6584063
- 1x 6465734
- 2x 6602414
- 2x 4539062
- 1x 6476042
- 1x 6350339
- 26x 6253142
- 4x 6186106
- 1x 6544174
- 6x 6440979
- 1x 4211392
- 6x 4211406
- 25x 4211462
- 2x 4211705
- 1x 6539385
- 11x 6015344
- 9x 6258831
- 2x 4568637
- 1x 4211415
- 2x 4568637
- 4x 4211412
- 33x 4211388
- 2x 4211399
- 11x 6598026
- 6x 6227897
- 70x 4211398
- 27x 4211395
- 12x 6061675
- 4x 6059033
- 2x 6079461
- 30x 4527174
- 16x 6598025
- 16x 6595947
- 35x 4211452
- 64x 6123809
- 6x 4211564
- 3x 6170387
- 32x 4211363
- 4x 6469440
- 1x 6446028
- 2x 6132886
- 2x 6043639
- 2x 4211580
- 15x 4211413
- 4x 6258820
- 10x 4211387
- 10x 6171894
- 10x 4211396
- 12x 4211386
- 1x 6514057
- 1x 6514051
- 2x 4210719
- 2x 4211063
- 4x 6344754
- 1x 6514456
- 2x 6123814
- 4x 4543086
- 1x 4218696
- 6x 4211094
- 11x 4211056
- 2x 4210651
- 1x 6287847
- 1x 6322046
- 2x 6215606
- 1x 6292145
- 1x 6088641
- 2x 6335563
- 1x 6593293
- 2x 6603341
- 8x 6603339
- 2x 6603283
- 4x 6603285
- 6x 6603587
- 8x 6603337
- 2x 6603334
- 1x 6603315
- 4x 6603598
- 17x 6603336
- 1x 6603301
- 1x 6603600
- 1x 6603591
- 1x 6603586
- 1x 6603585
- 2x 6603590
- 2x 6603344
- 2x 6603309
- 3x 6603316
- 1x 6593286
- 2x 6604733
- 2x 6603601
- 7x 6603965
- 30x 6603319
- 2x 6603317
- 2x 6576809
- 2x 6603313
- 1x 6598028
- 2x 6576810
- 1x 6598027
- 2x 6603599
- 2x 6603596
- 2x 6603342
- 2x 6603312
- 10x 6603286
- 2x 6603333
- 10x 6603340
- 2x 6603318
- 4x 6603343
- 2x 6603335
- 4x 6603595
- 1x 6603594
- 6x 6603589
- 2x 6603332
- 2x 6576813



[LEGO.com/service](https://www.LEGO.com/service)

YOU COULD WIN



Scan this QR code or go to
LEGO.COM/PRODUCTFEEDBACK and give us
your short feedback about this LEGO® set
for a chance to win a cool LEGO prize.

Terms and Conditions apply*

EN: YOU COULD WIN. Terms and Conditions apply* **DE: Du könntest GEWINNEN.** Es gelten die Teilnahmebedingungen* **FR: Tu pourrais GAGNER.** Des conditions s'appliquent* **IT: Potresti VINCERE tu.** Termini e condizioni sono applicabili* **ES: Puedes GANAR.** Aplican términos y condiciones* **PT: PODERÁ GANHAR.** Aplicam-se Termos e Condições* **ZH: 轻松获奖.** 条款和条件适用* **PL: Szansa na WYGRANA.** Obowiązuje regulamin* **CS: Máte šanci VYHRÁT.** Platí všeobecné smluvní podmínky* **SK: Máte šancu VYHRÁT.** Platia všeobecné zmluvné podmienky* **HU: TE IS NYERHETSZ.** Felhasználási feltételek érvényesek* **UA: ВИ МОЖЕТЕ ВИГРАТИ.** Застосовуються загальні положення та умови* **RO: Ai putea CÂȘTIGA.** Se aplică termenii și condiții* **BG: Можете да СПЕЧЕЛИТЕ.** Има определени правила и условия* **LV: Tu vari LAIMĒT.** Ir spēkā noteikumi un nosacījumi.* **ET: Sul on võimalus VÕITA.** Kehtivad tingimused* **LT: Jūs galite LAIMĖTI.** Taikomos sąlygos*

*[LEGO.com/productfeedback-terms](https://www.lego.com/productfeedback-terms)

