



40955



# MAERSK





[LEGO.com/sustainable-packaging](https://LEGO.com/sustainable-packaging)



FR

**DONNEZ  
OU  
RECYCLEZ**



OU



OU



ASSOCIATION    MAGASIN    DÉCHÈTERIE

Adresses sur [quefairedemesdechets.fr](https://quefairedemesdechets.fr)

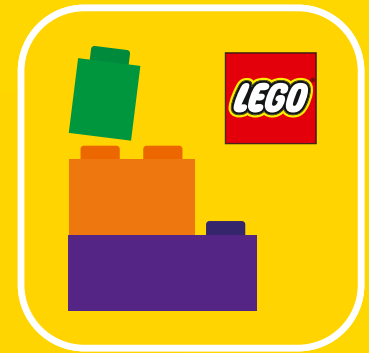

🔍 LEGO® Builder

# BUILDER



Apple and the Apple logo are trademarks of Apple Inc., registered in the U.S. and other countries and regions. App Store is a service mark of Apple Inc. Google Play and the Google Play logo are trademarks of Google LLC. Tencent and the Tencent logo are trademarks of Tencent Inc.

🔍 [LEGO.com/devicecheck](https://LEGO.com/devicecheck)

EN Ask parents' permission before going online | DE Eltern um Erlaubnis bitten, bevor du online gehst | FR Demande l'autorisation d'un parent avant d'aller en ligne | IT Chiedi il permesso ai tuoi genitori prima di andare online | ES Pídeles permiso a tus papás antes de conectarte a Internet | PT Peça autorização aos pais antes de acederes online | ZH 上网前应先征得父母的同意 | PL Poproś rodziców o zgodę, zanim wejdiesz do Internetu | CS Než půjdeš na internet, požádej rodiče o svolení | SK Skôr než pôjdeš na internet, vypoťaj si povolenie od rodičov | HU Kérj szülői engedélyt, mielőtt online csatlakoznál! | UA Запитуйте дозволу батьків, перш ніж користуватися інтернетом | RO Cere permisiunea părinților înainte de a te conecta online | BG Поискайте разрешение от родител, преди да влезете онлайн | LV Pirms došanās tiešsaistē palūdz atļauju vecākiem | ET Enne Interneti kasutamist küsi vanematelt luba | LT Prieš prisijungdami prie interneto, atsiklauskite tėvų



## KARŞINIZDA ANE MÆRSK

ANE MÆRSK, biyo-metanol ve e-metanol gibi düşük emisyonlu yakıtlarla çalışabilen, türünün ilk örneği olan ilk büyük konteyner gemisidir. ANE MÆRSK, 2024 yılının Ocak ayında ilk kez denize açıldığından bu yana, çok daha fazla çift yakıtlı gemi suya indi ve böylece deniz taşımacılığında ve küresel ticaretin karbonsuzlaştırılmasında yeni ve önemli bir sayfa açıldı.

ANE MÆRSK, 350 metre (1.148,2 ft) uzunlukta ve 53,5 metre (175,5 ft) genişliktedir. Geminin kuru ağırlığı 47.700 ABD tonu (52.580,25 metrik ton) olup, kargo, yakıt ve mürettebatla tam yüklükten gemi 29.000 Afrika filine eşdeğer olan 190.000 ABD tonu (209.439,1 metrik ton) gibi şaşırtıcı bir yük taşıyabilir.

Gemiye 16.592 TEU (yirmi fitlik konteyner) konteyner yüklenebilir ve bunları yan yana dizerseniz 100,5 km (62,4 mil) ve 959 futbol sahası uzunluğā ulaşabilir.





 MAERSK

ALL THE 10 ZERO WAY



# DEĞİŞİMİN ŞEYRİ – DENİZ TAŞIMACILIĞININ TARİHİ

İnsanlar 5.000 yılı aşkın bir süredir deniz yoluyla mal taşımaktadır ancak Sanayi Devrimi'ne ve buhar makinesinin icadına kadar hava koşullarına bağımlıydık. Rüzgar yoksa seyir yok. Buhar gücünden yararlanmaya başlanmasıyla, gemilerin mürettebatı insanlık tarihinde ilk kez hava koşullarına veya manuel tahrik gücüne bağımlı olmaktan kurtuldu. Bu icat, deniz taşımacılığında devrim yarattı, yeni rotaların açılmasını sağladı ve deniz ticaretine büyük bir ivme kazandırdı.

Buhar makineleri yelkenlere göre büyük bir gelişme olsa da, yine de verimsizdi ve kısa süre sonra dizel motorun icadıyla deniz taşımacılığı yeniden dönüşüme uğrayacaktı. Ancak deniz taşımacılığındaki devrimler zaman alır ve dizelin, buhar gücünün yerini tamamen alması için onlarca yıl geçecekti. Maersk, ilk dizel motorlu gemisi LEISE MÆRSK'i, ilk dizel motorlu okyanus aşırı ticaret gemisinin denize indirilmesinden sadece dokuz yıl sonra, 1921 yılında satın aldı.



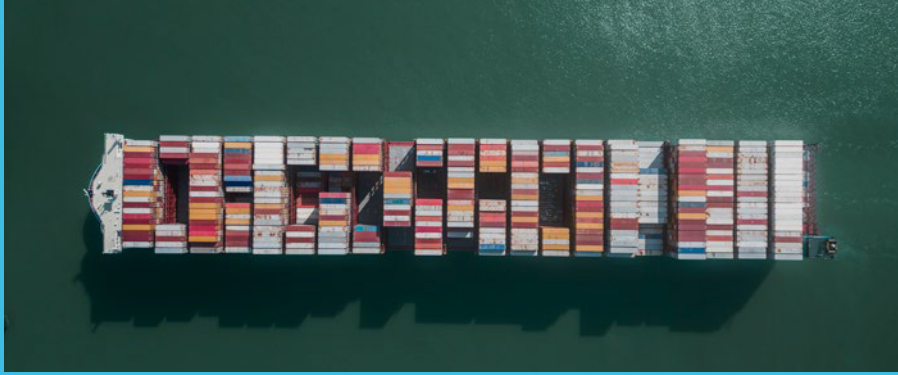

1956 yılında, kamyon römorklarının doğrudan gemilere yüklendiği "konteynerli kargo" sisteminin verimliliği ile sektör bir kez daha dönüşüm geçirdi. Konteynerle birlikte gemilerin yükleme ve boşaltma süresi birkaç günden birkaç saate indi.

Dünya ticaretinin gizli destekçileri olan konteyner ve barkod sayesinde, dünyanın herhangi bir yerindeki bir üretici, ürünlerini tüm pazarlarda satabiliyor ve böylece küreselleşmeyi fiziksel olarak mümkün hale geliyor. Bugün bildiğimiz dünya, büyük ölçüde küresel tedarik zincirlerine bağımlıdır. Kolombiya'daki muz üreticisinden, öğle yemeğinde muz yiyen Danimarkalı çocuğa kadar, tedarik zincirleri dünyayı birbirine bağlar ve gıda, ilaç, mal ve malzemelerin dünyanın her yerindeki insanlara ulaşmasını sağlar.





 MAER

 MAERS

 MAERSK

 MAERSK

# ADIN NE ÖNEMİ VAR?

1906 yılından bu yana, Maersk filosundaki tüm gemilerin adlarında "MÆRSK" ifadesi yer alıyor. İlk gemilerin çoğunun adı kurucu aileyle ilgiliydi ancak filo, aile bireylerinin sayısını aştıkça isim verme geleneğın deęiřmesi gerekti. Bugün, örneğın şehir ve nehir adlarına sahip Maersk gemilerini de görecekşiniz.

Yeni çift yakıtlı gemi serisine nasıl isim vereceğine karar verirken Maersk gemilere kurucu aile bireylerinin adlarını verme geleneğine geri döndü; bu sefer yeni bir dönemi simgelemek için A harfiyle başlayan adlar seçildi.

ANE MÆRSK'e, A.P. Moller - Maersk'in ana şirketi olan A.P. Moller Holding'in başkanı Ane Mærsk Mc-Kinney Ugglanın adı verildi. A.P. Moller - Maersk, 1904 yılında Arnold Peter Møller tarafından kuruldu. Ane, Grubun kurucusu Arnold Peter Møller ve eři Chastine Mc-Kinney Møller'in torunudur.



# ANE MAERSK





# BEYAZ YILDIZ – UMUDUN IŞIĞI

Simgeleşmiş beyaz yedi köşeli yıldız, şirketin 1904 yılında kurulmasından önce de Maersk'in mirasının bir parçasıydı ve 100 yılı aşkın bir süre sonra hala şirketin kalbinde yer alan güçlü aile bağlarının kalıcı bir sembolüdür.

Kariyerinin başlarında, A.P. Møller'in babası Kaptan Peter Mærsk Møller, bir İngiliz gemi sahibine çalışıyordu ve eşi Anna bazen seyahatlerinde ona eşlik ediyordu. Anna, bu yolculuklardan birinde ağır hastalandı. Karısının hayatta kalamayacağından korkan Peter Mærsk Møller güverteye çıktı ve karısının iyileşeceği yönde bir işaret vermesi için Tanrı'ya dua etti. O anda, gri gökyüzünü aydınlatan tek bir yıldız gördü.

Anna iyileşti ve Peter Mærsk Møller, 1886 yılında LAURA adlı ilk buharlı gemisini satın aldığı anda, sevgili karısına vefa göstergesi olarak geminin bacasını soluk mavi zemin üzerine beyaz yedi köşeli bir yıldızla süsledi. Peter Maersk Møller için yıldız, karısının iyileşmesini ve iyi talihlerini simgelemeye başladı.

O zamandan beri, simgesel gök mavisi arka plan üzerindeki beyaz yedi köşeli yıldız Maersk ile özdeşleşti ancak logonun kendisi yıllar içinde bazı değişiklikler geçirdi. Logonun birçok versiyonu geliştirildi ancak bugünkü Maersk logosu, daha modern bir yaklaşıma ihtiyaç olduğu karar verilen 1970'lerin başına dayanmaktadır.



ALL THE WAY  
TO ZERO



# DÜNYAYI BİRLEŞTİREREK HERKESİN YAŞAMINI İYİLEŞTİRİYORUZ

Lojistik hizmetlerinde dünya lideri olan Maersk, 100.000'den fazla müşteriye sahiptir, yaklaşık 130 ülkede faaliyet göstermektedir ve 100.000'den fazla kişiyi istihdam etmektedir. Buharlı gemi şirketi olarak mütevazı başlangıcından, müşterilerinin tedarik zincirlerini birbirine bağlamak ve basitleştirmek için çalışan entegre bir lojistik şirketine dönüşen Maersk, 700'den fazla gemi işletmekte ve dünyadaki gıda, malzeme ve malların neredeyse %20'sini taşımaktadır.





MAERSK  
MAERSK  
MAERSK  
MAERSK  
MAERSK  
MAERSK  
MAERSK

MAERSK  
MAERSK  
MAERSK  
MAERSK  
MAERSK  
MAERSK  
MAERSK

ALL  
THE T  
WAY

ANE MAERSK

SPREADERS  
TSP98  
MAERSK  
MAERSK

PTP T414  
P423 PTP



# SIFIRA ULAŞANA KADAR KARBONSUZ BİR GELECEK TAAHHÜDÜ

Dünya iklim sorunlarıyla boğuşurken, tedarik zincirlerinin ve küresel ticaretin geleceği, yenilik yapmaya ve yeni enerji kaynaklarını teşvik etmeye bağlı. Maersk, 2040 yılına kadar tüm iş kollarında net sıfır sera gazı emisyonuna ulaşma konusunda ciddi bir taahhütte bulundu. Maersk, kendi faaliyetlerini karbonsuzlaştırırken, aynı zamanda küresel tedarik zincirlerini karbonsuzlaştırarak ve net sıfır ekonomiye adil bir geçişi mümkün kılarak iklim krizinin çözümünde öncü rol üstlenmeyi taahhüt etti.

Maersk, bu on yılda önemli ilerlemeler sağlamak için 2040 yılına kadar ulaşmak üzere deniz, kara, hava ve terminallerimizde iddialı hedefler belirledi. Biyometan, biyo-metanol ve e-metanol gibi düşük emisyonlu yakıtlarla seyir yapabilen birçok çift yakıtlı geminin siparişi ve teslimatı ile, filonun karbonsuzlaştırılması misyonu şu ana kadar iyi bir şekilde ilerliyor.



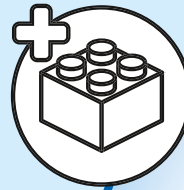
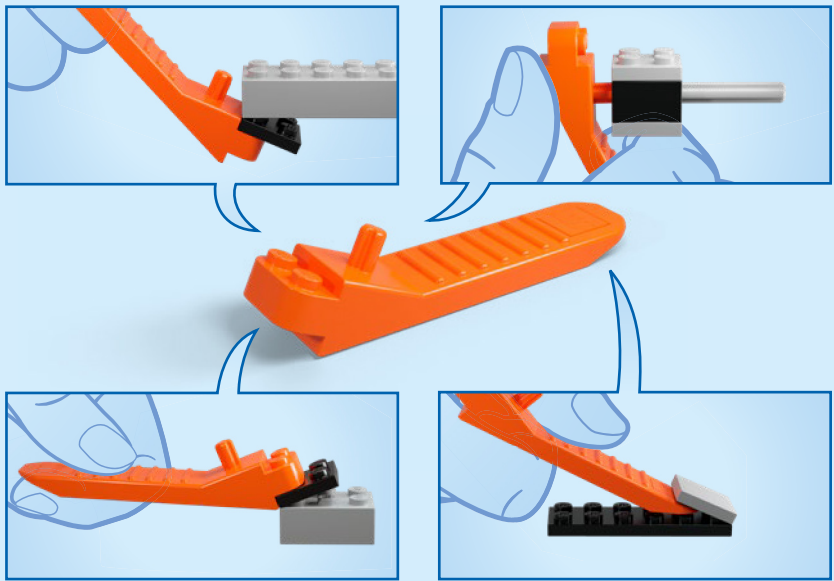

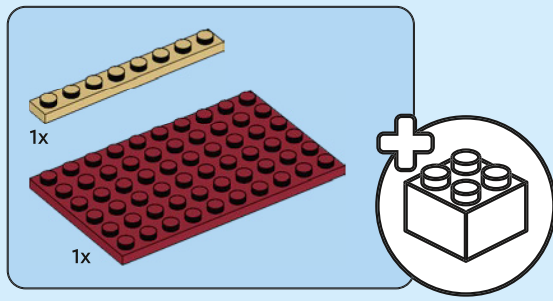

1

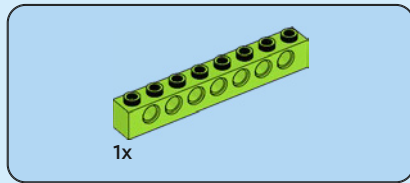
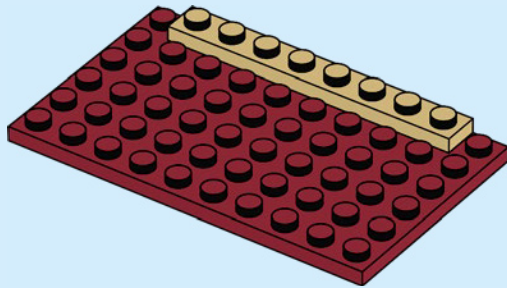

2

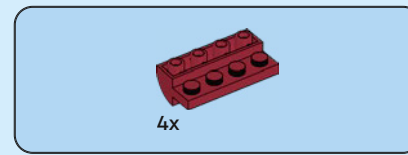
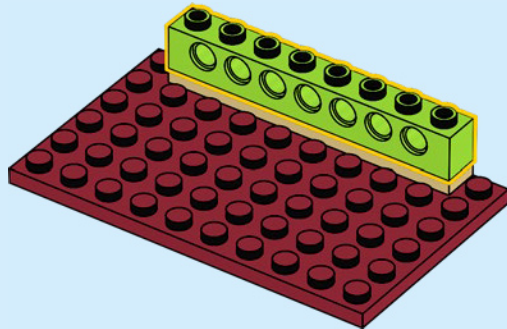

3

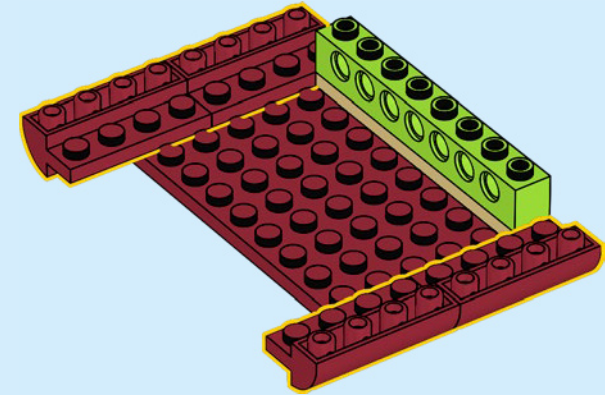

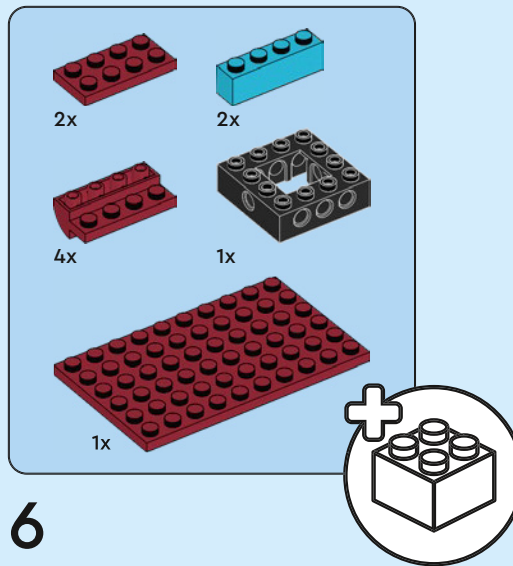
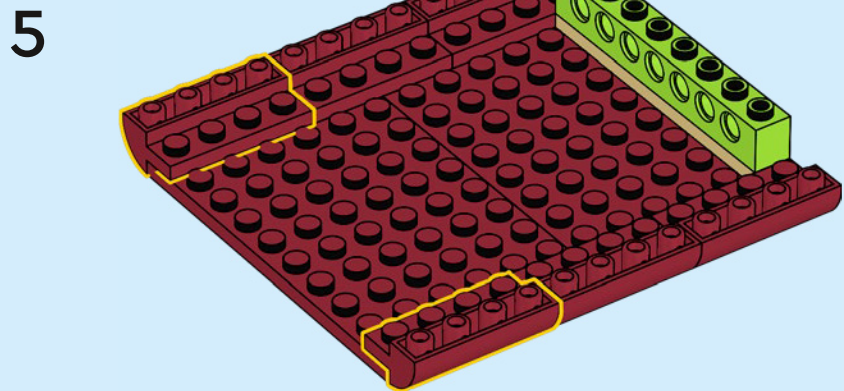
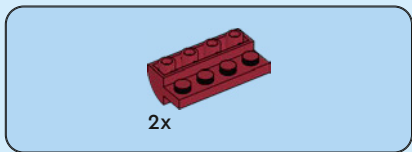
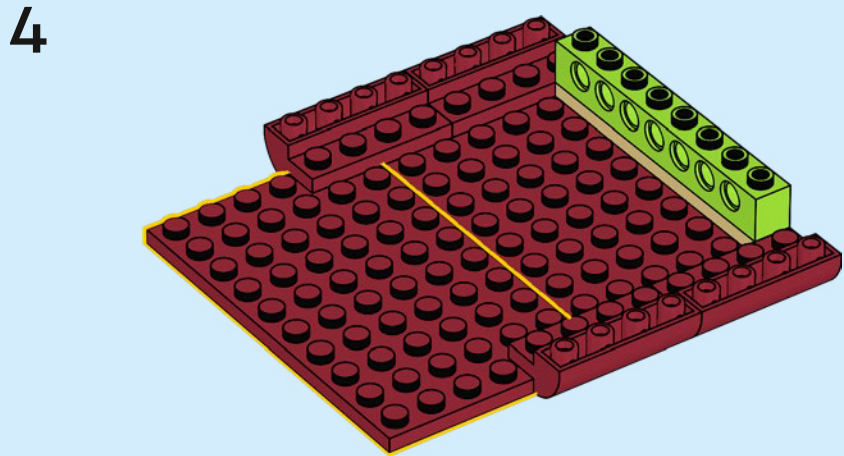
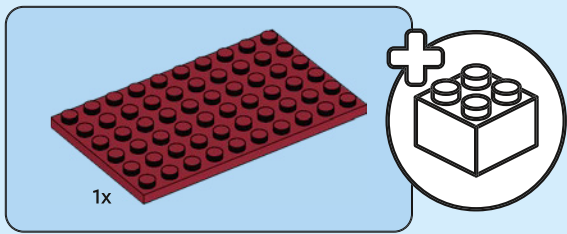

6

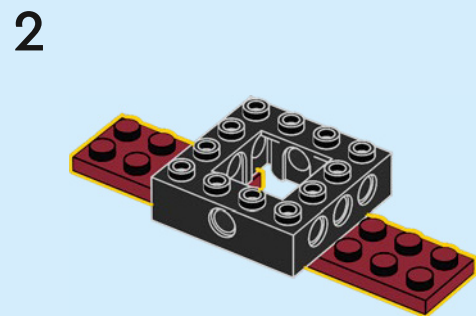
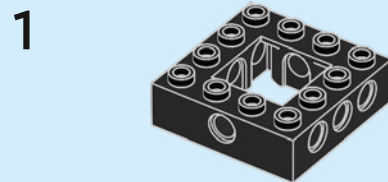

3

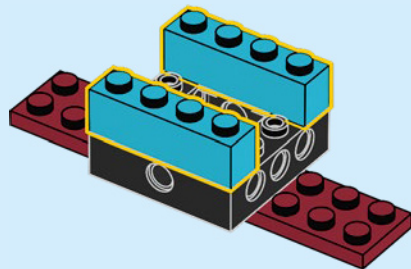

4

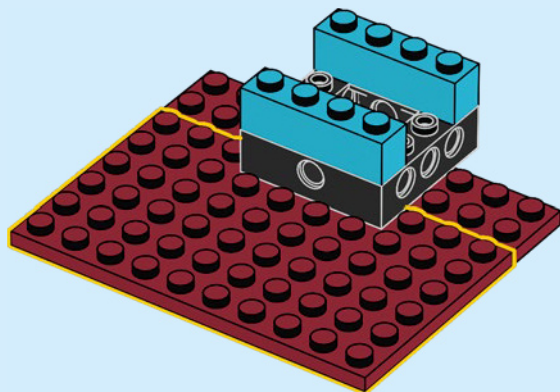

5

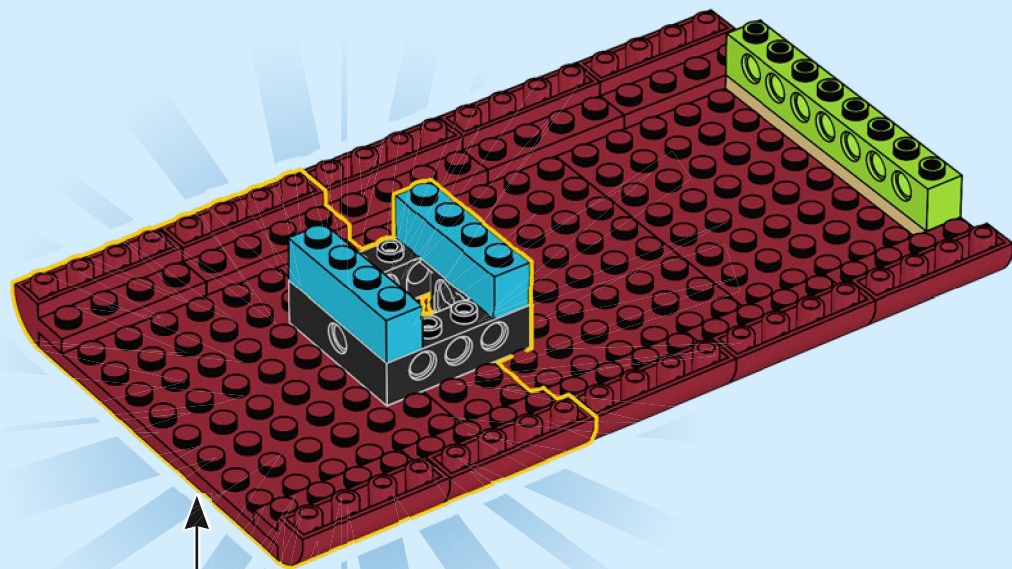
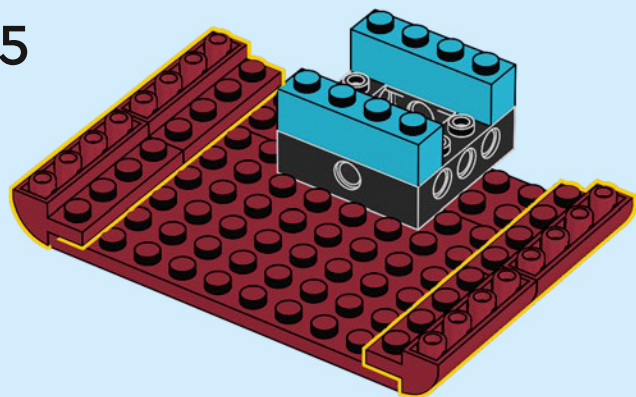

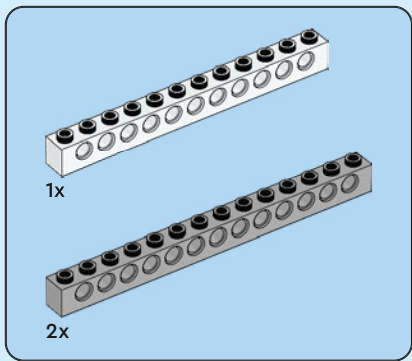

7

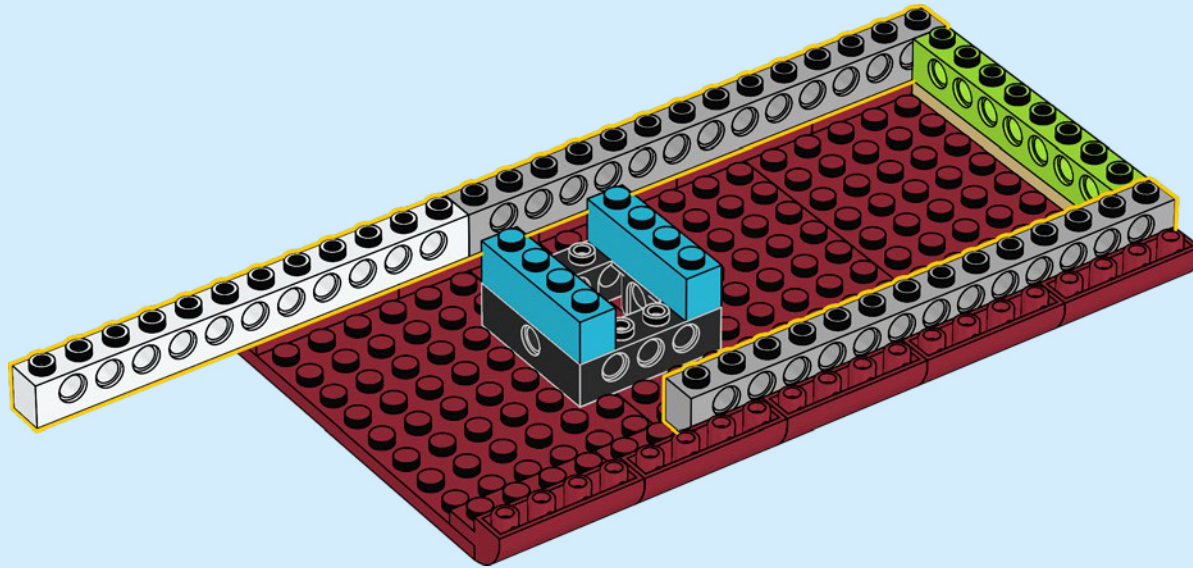

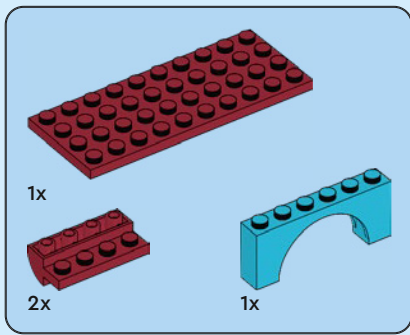

8

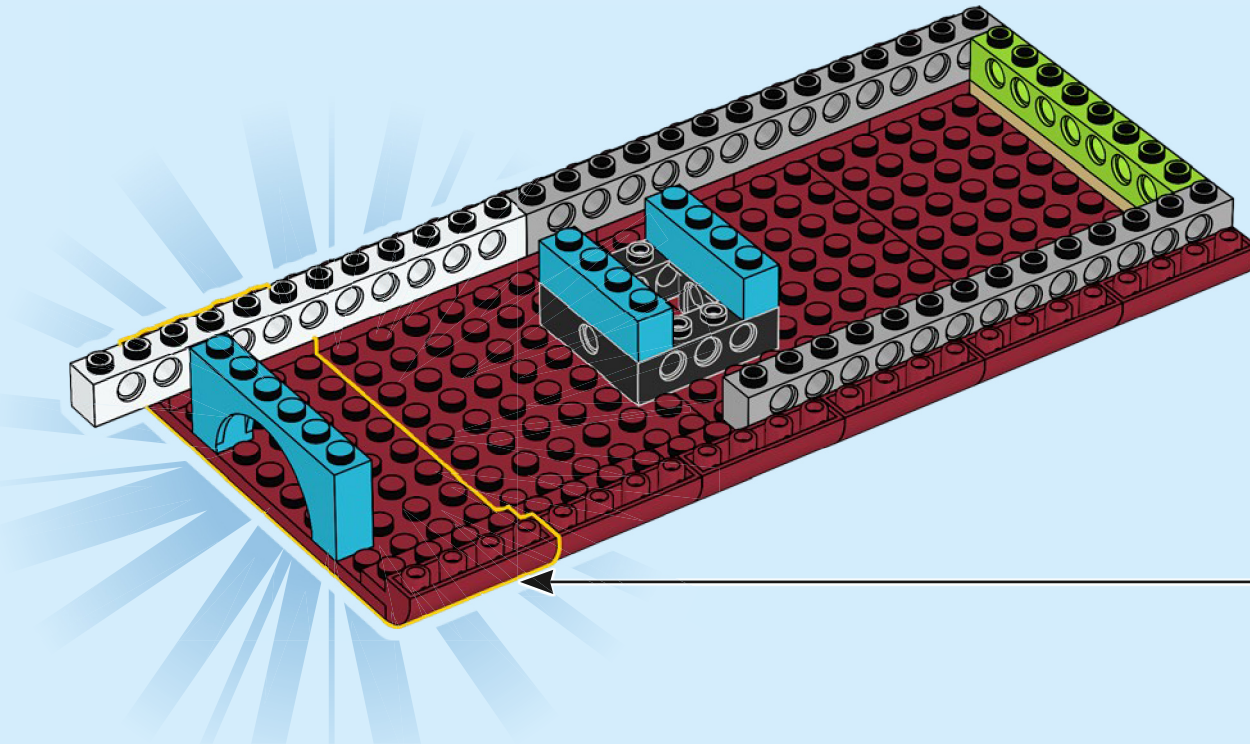
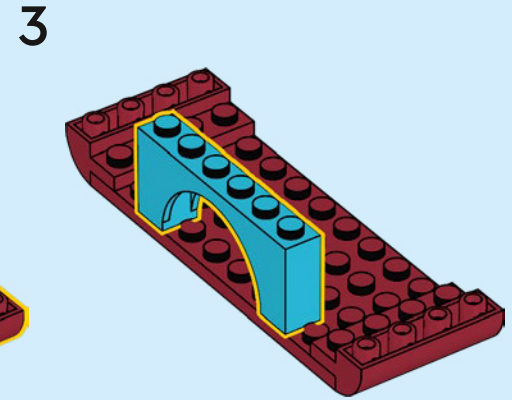
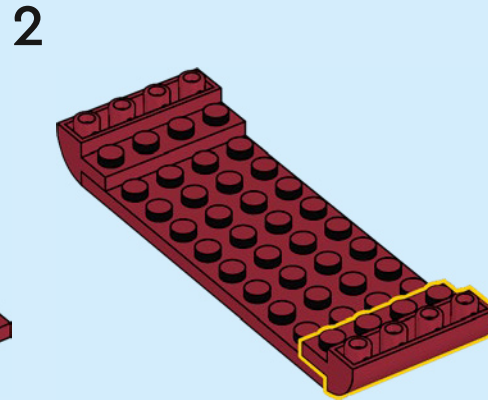
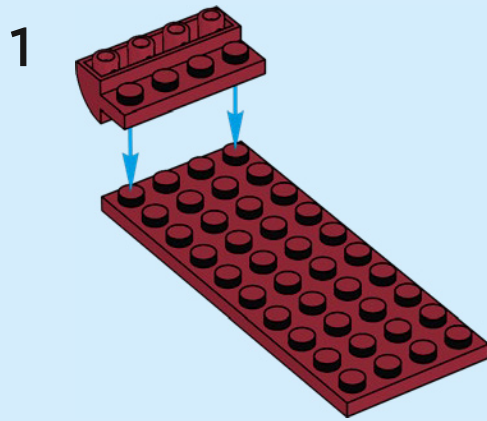

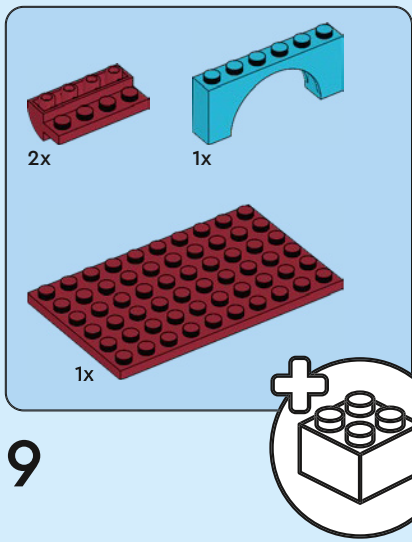

9

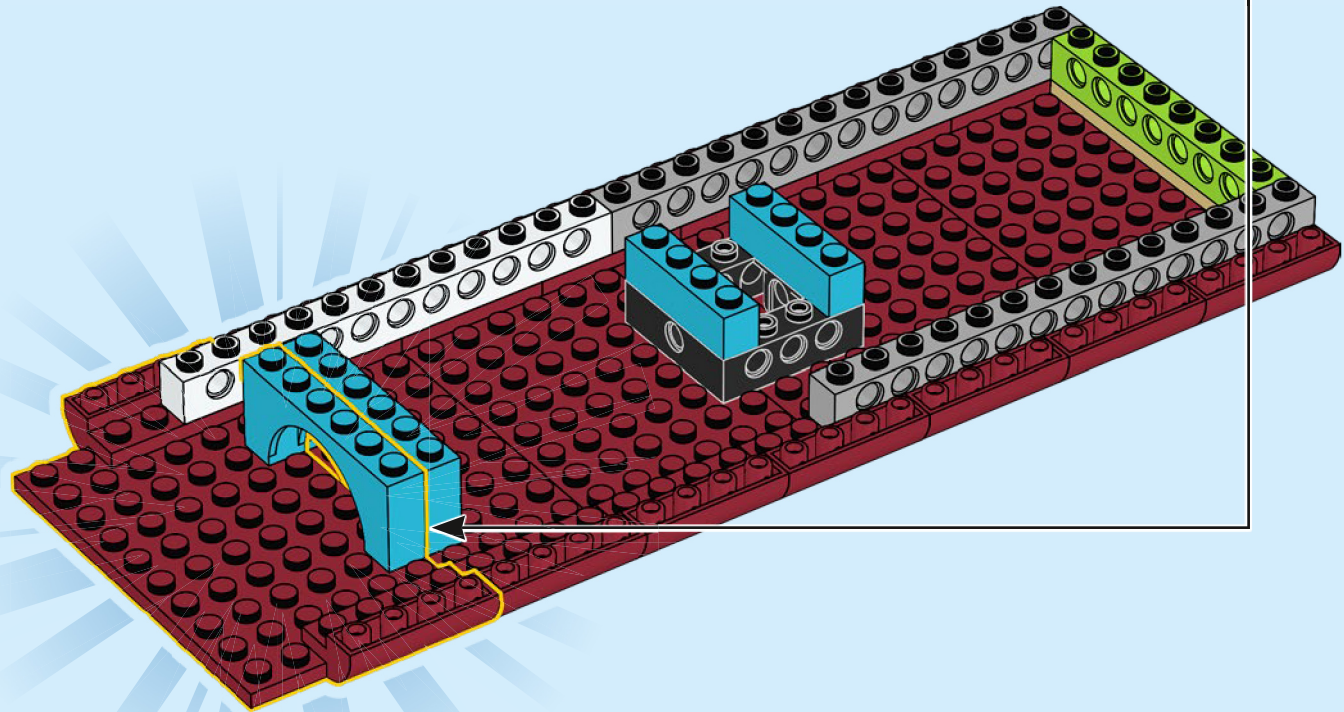
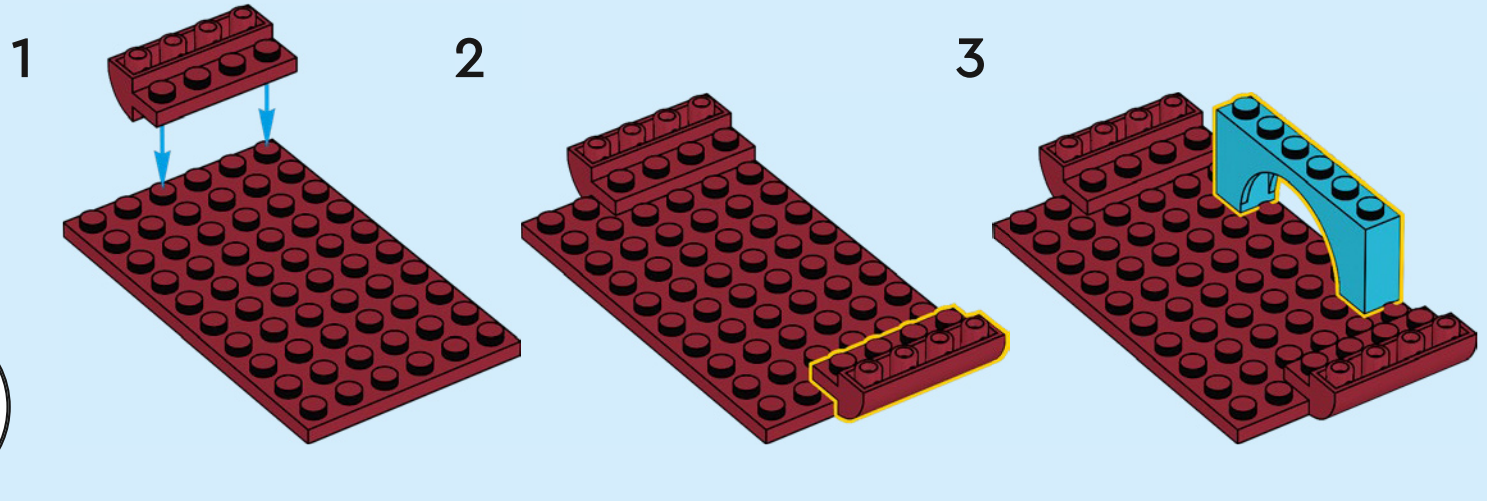

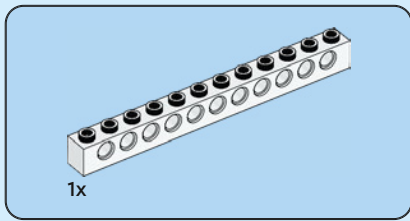

10

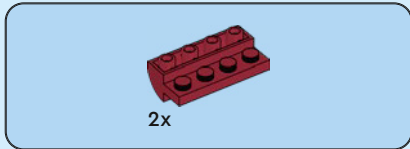
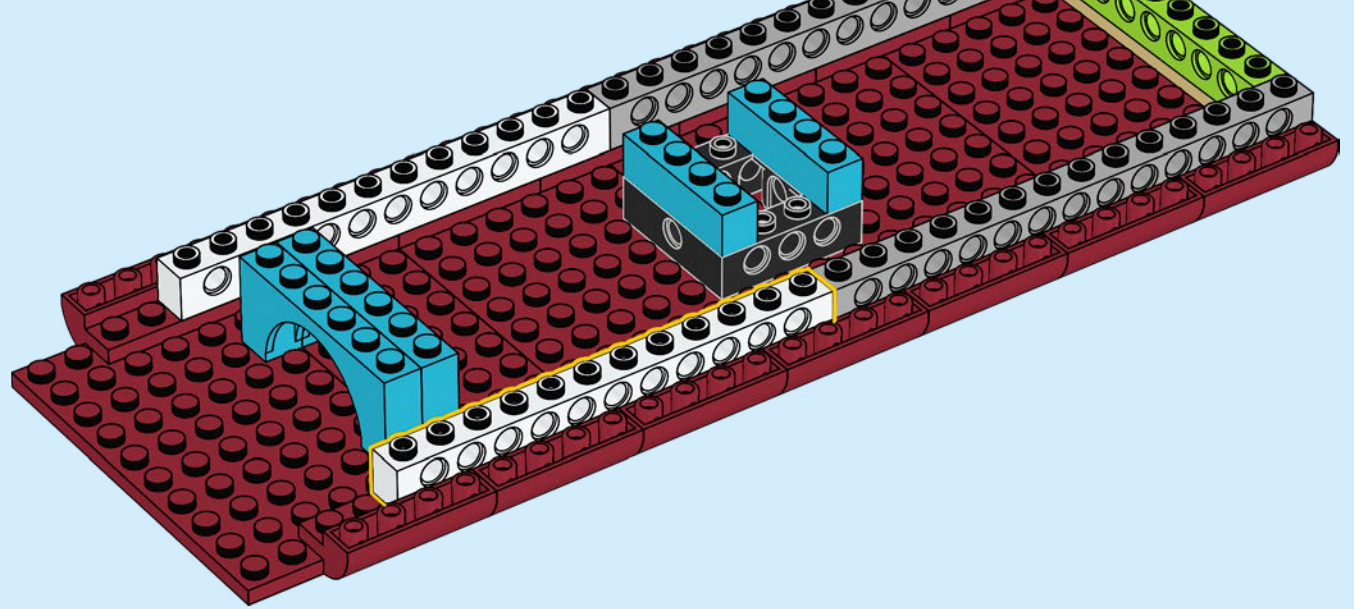

11

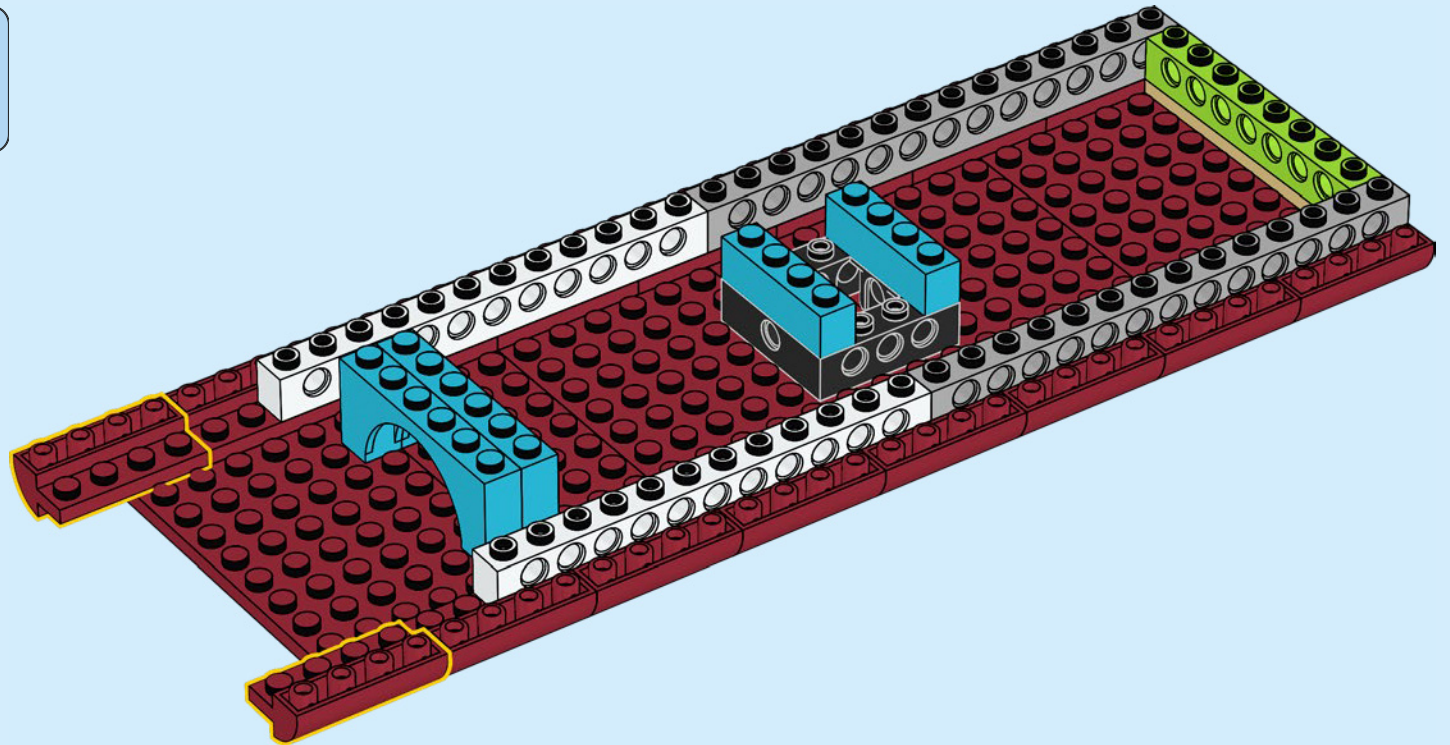

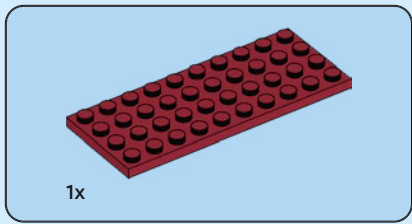

12

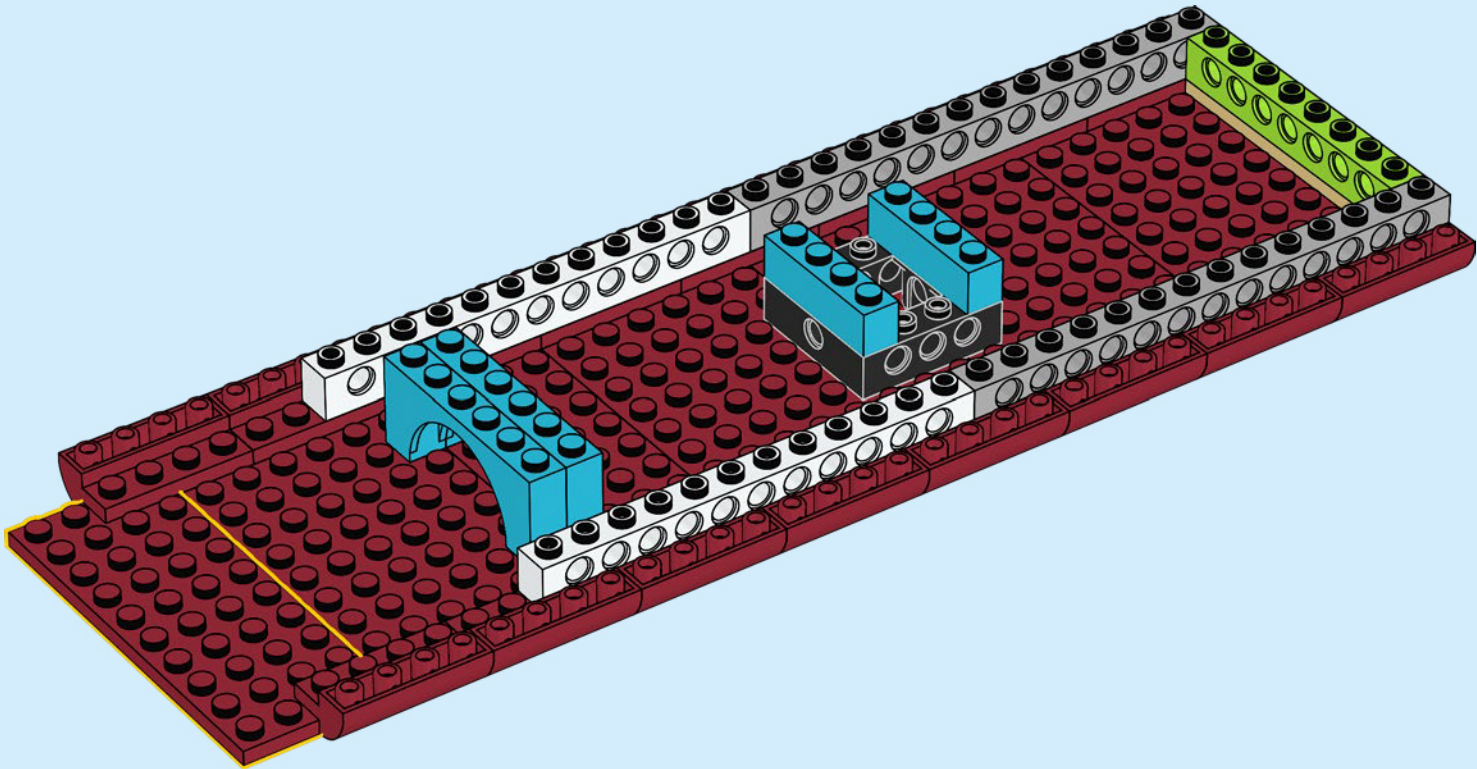

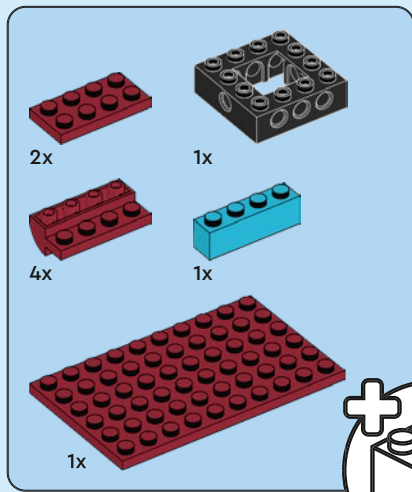

13

1

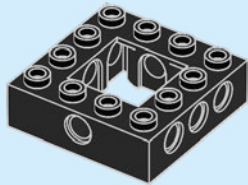

2

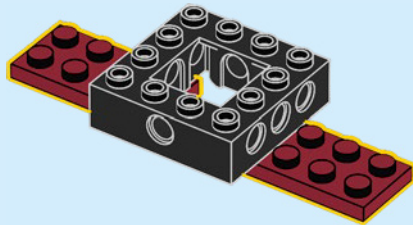

3

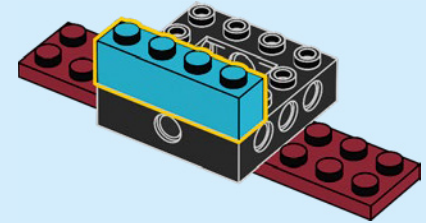

4

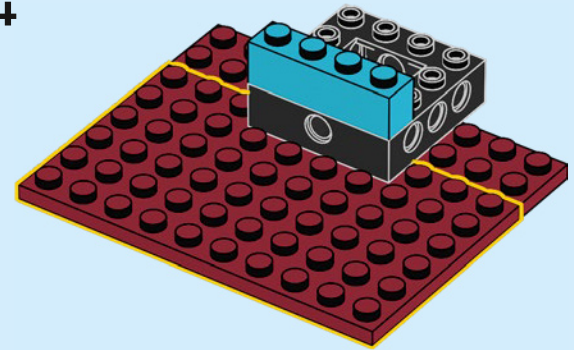

5



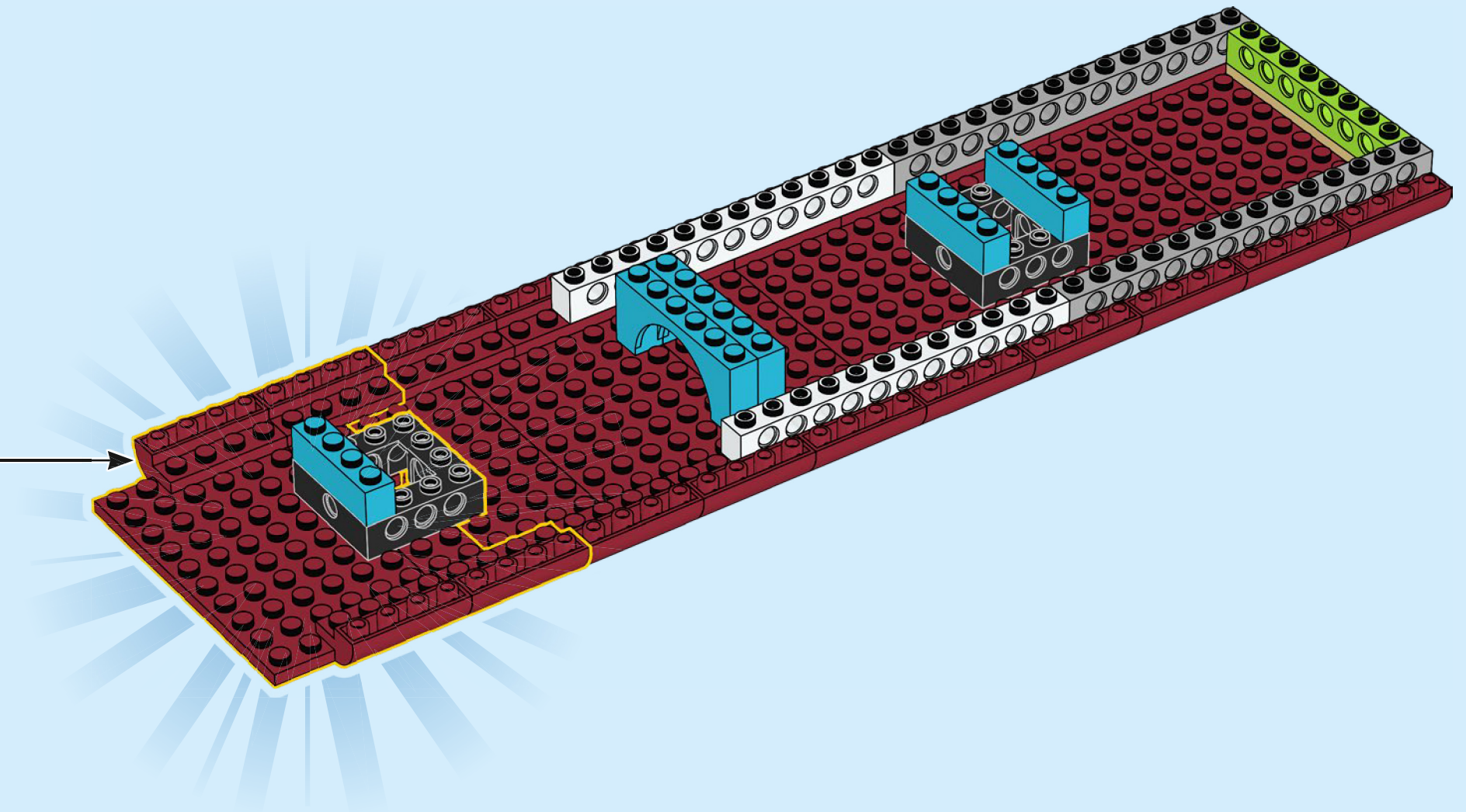

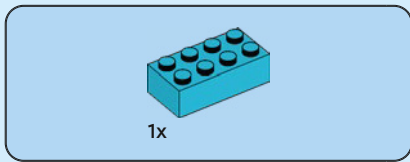

14

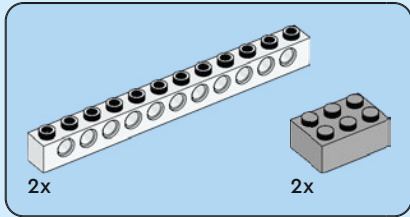
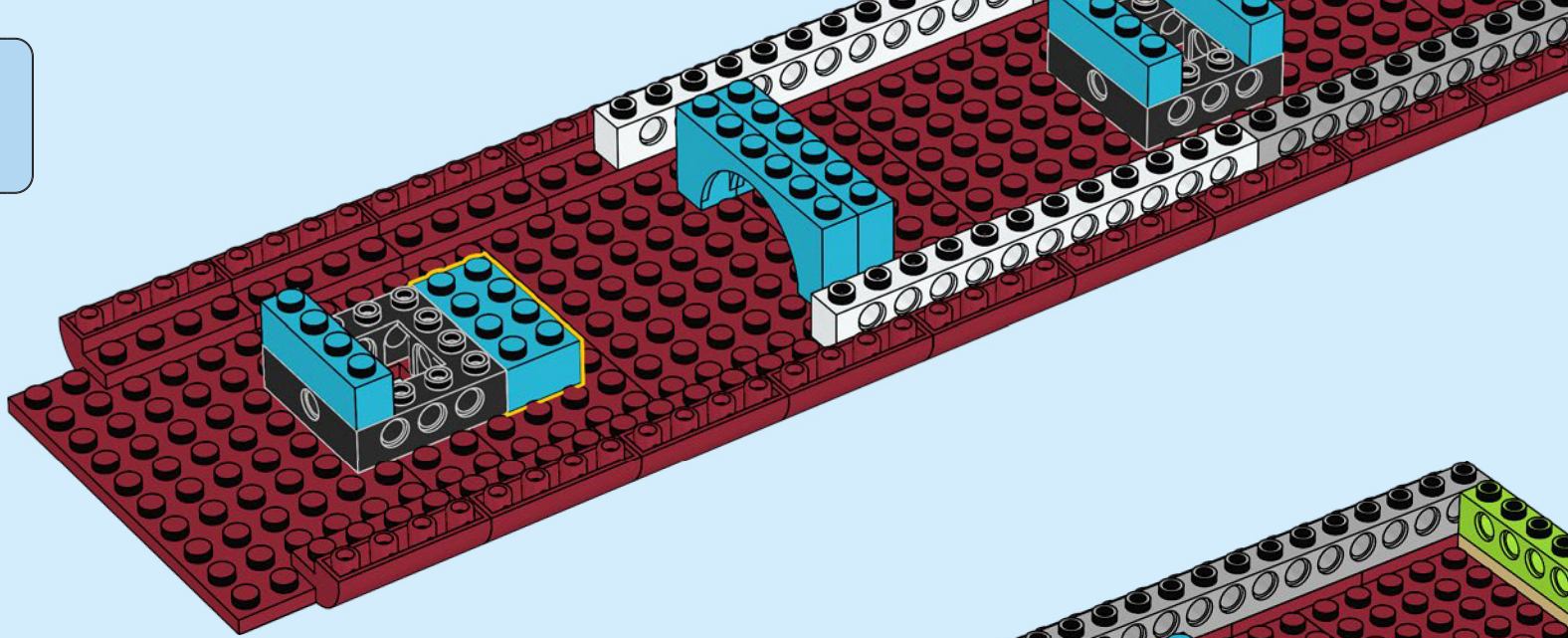

15

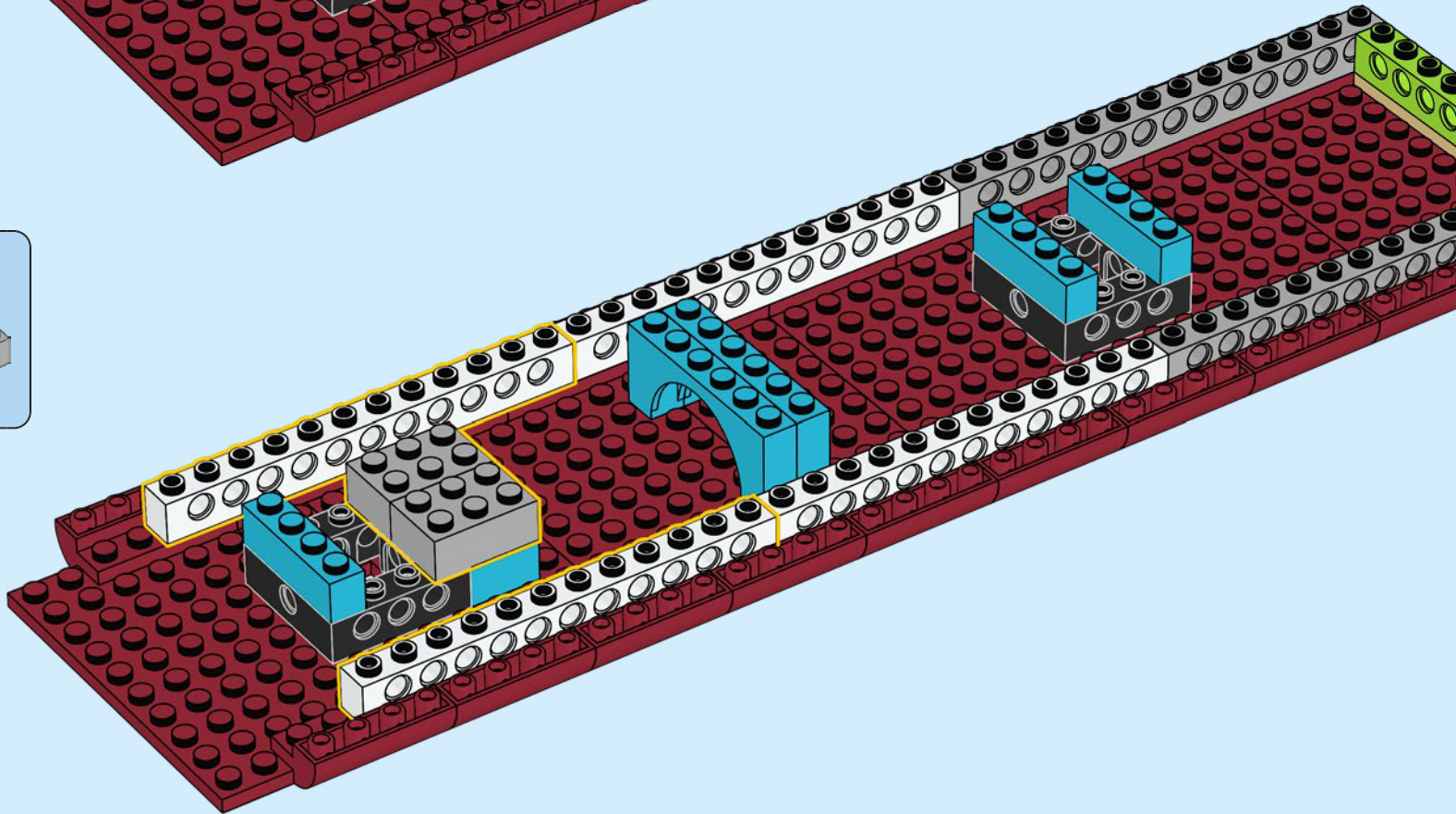

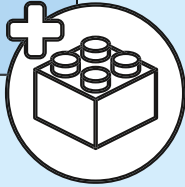
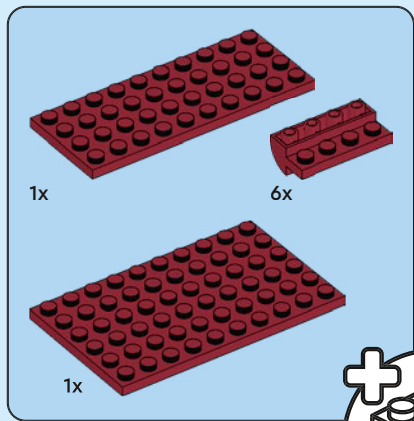

16

1

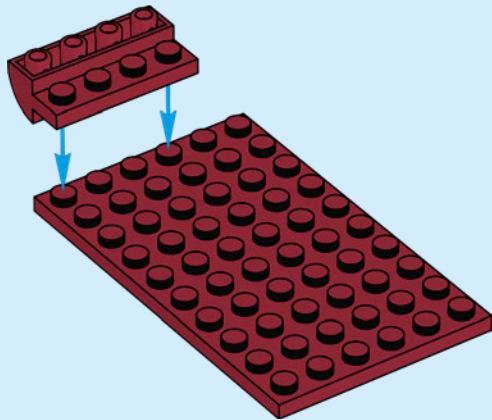

2

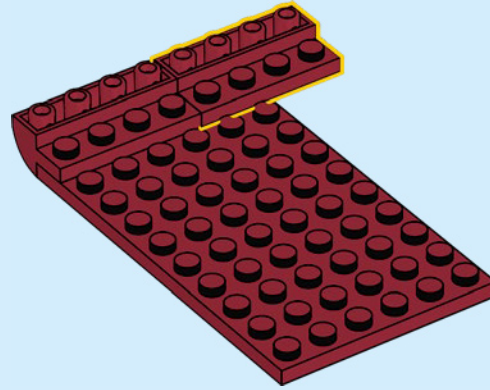

3

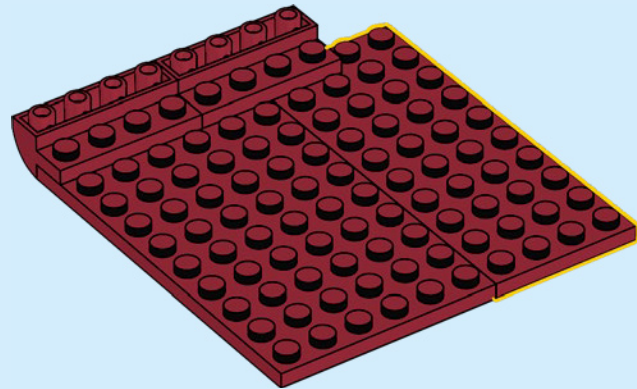

4

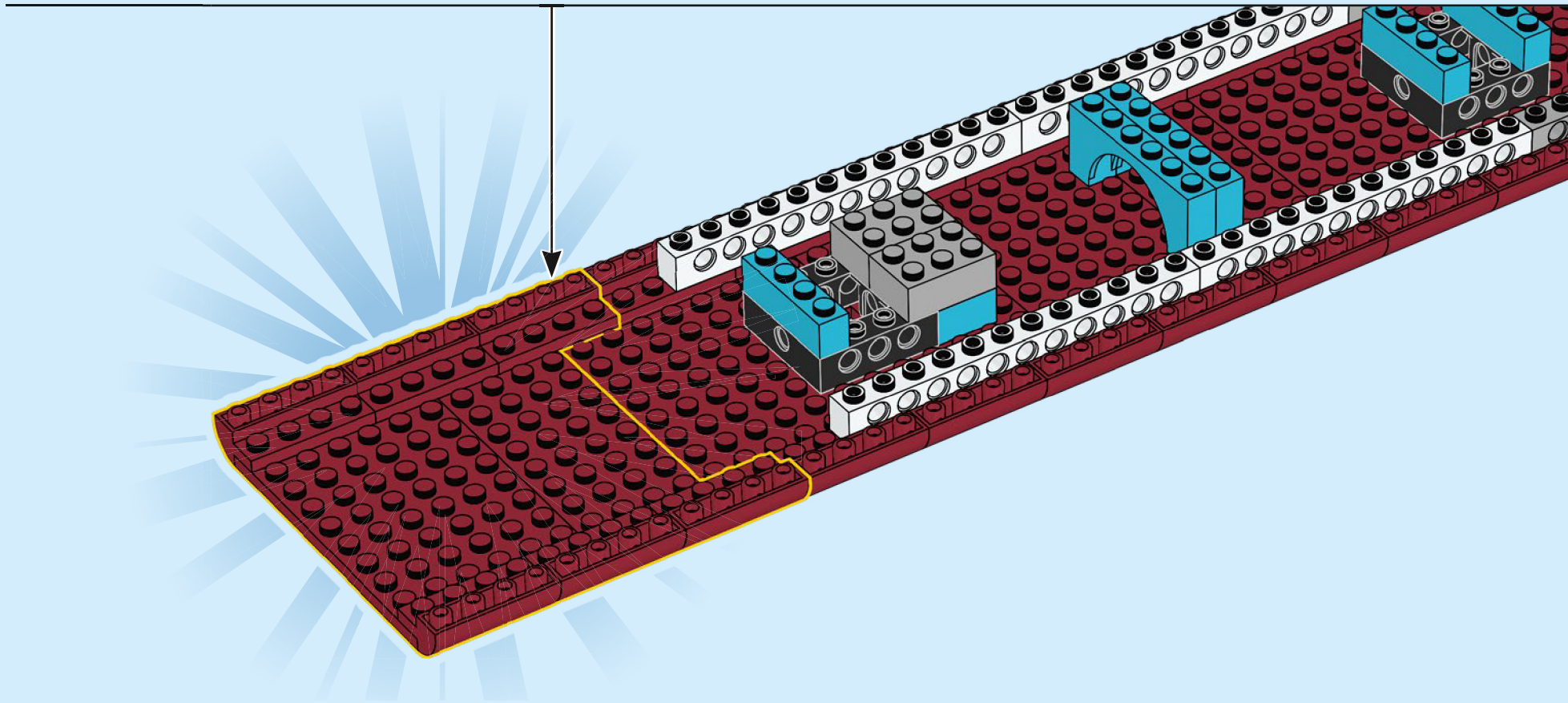
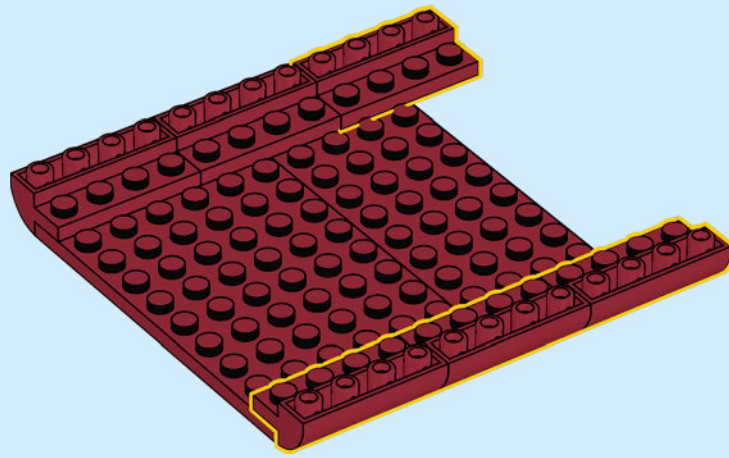

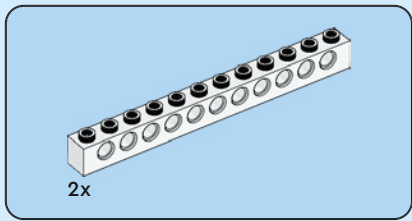

17

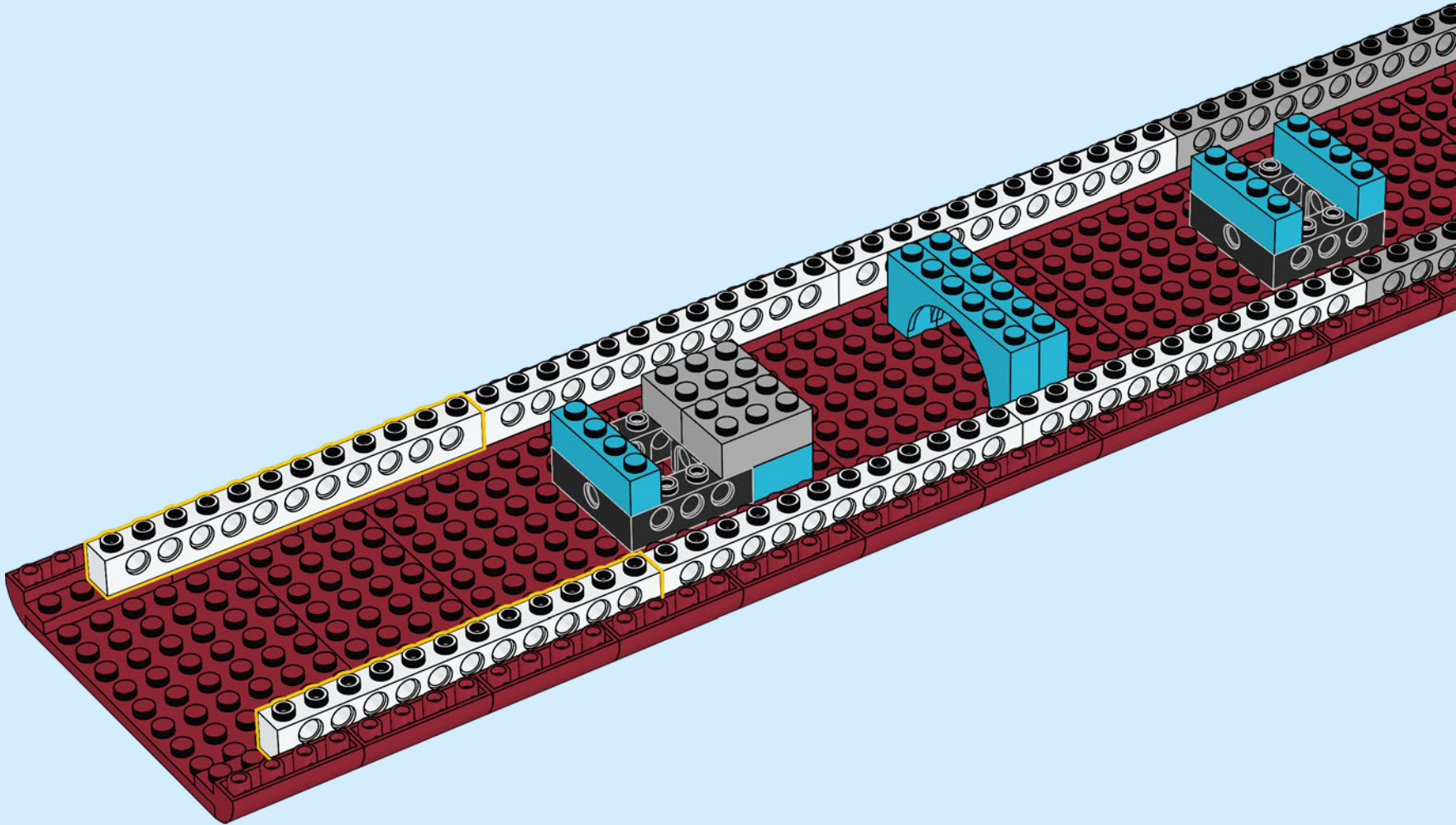

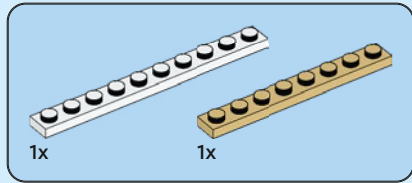

18

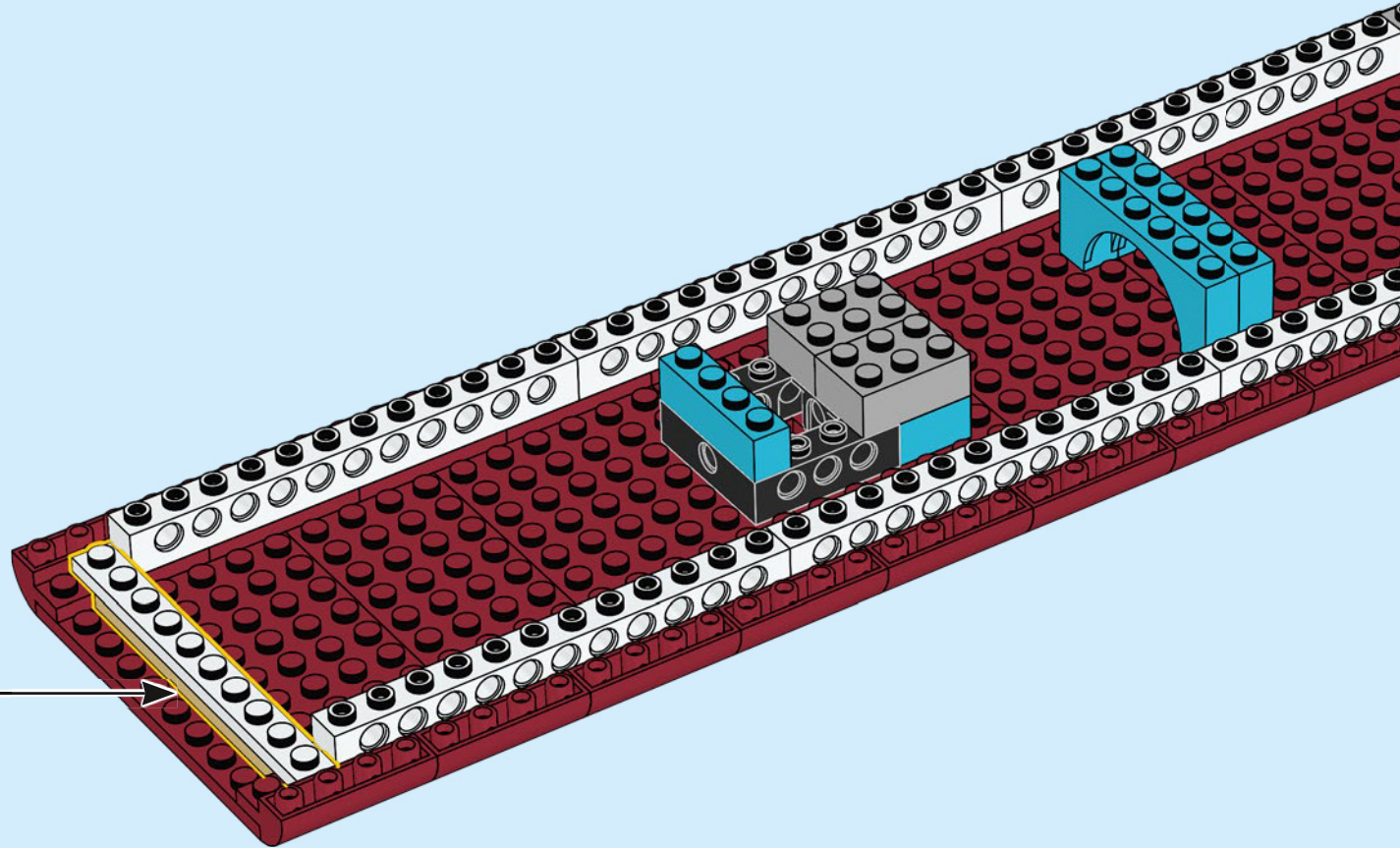
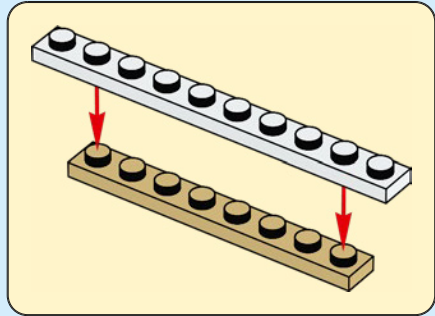

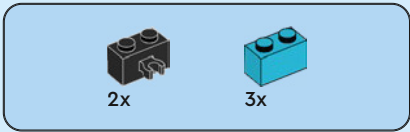

19

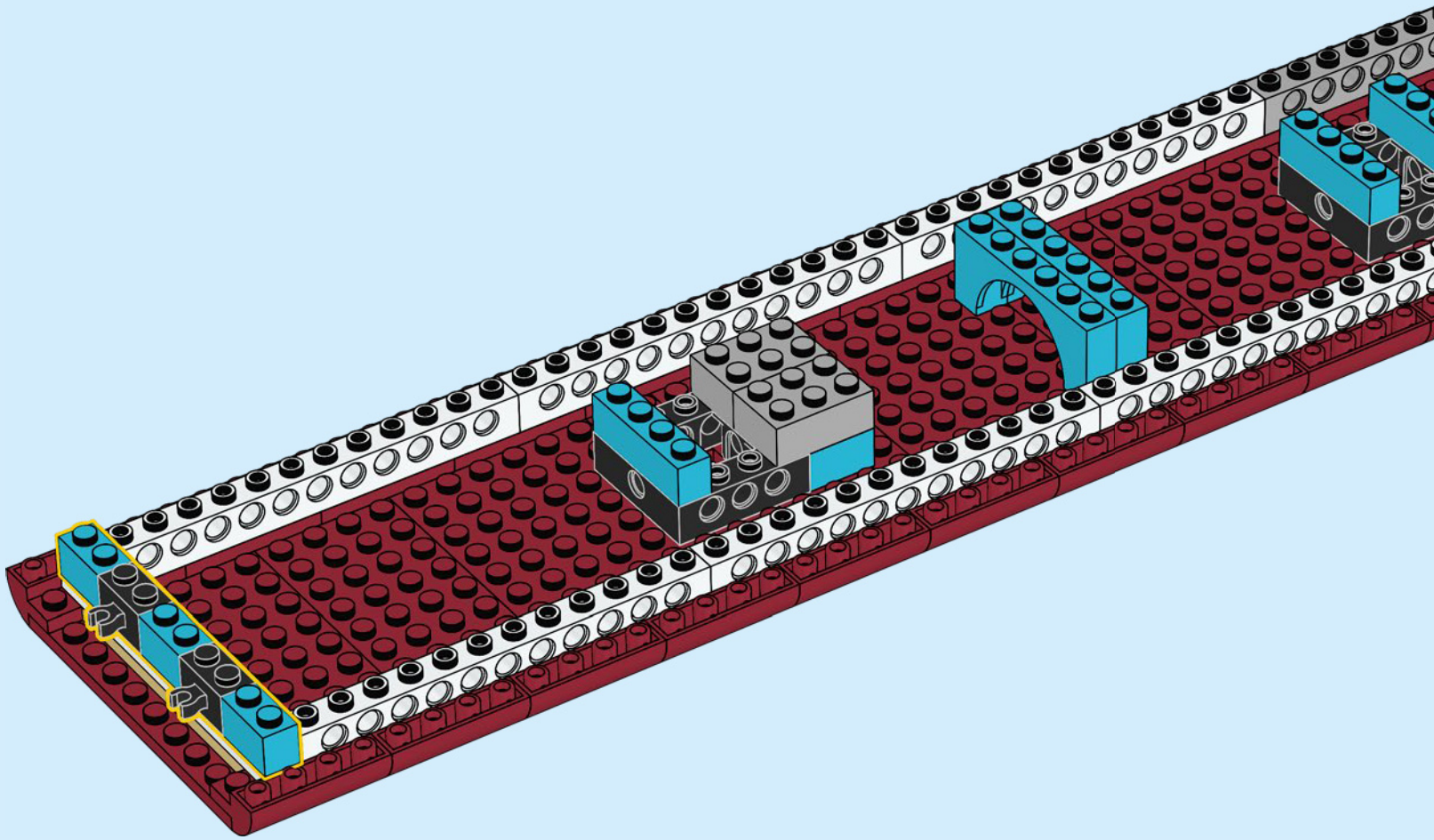

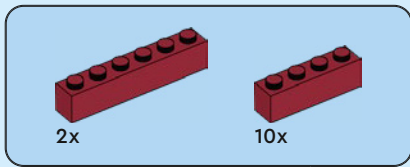

20

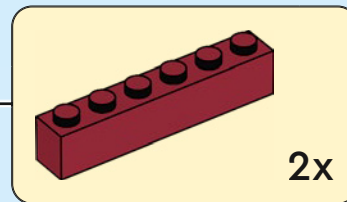
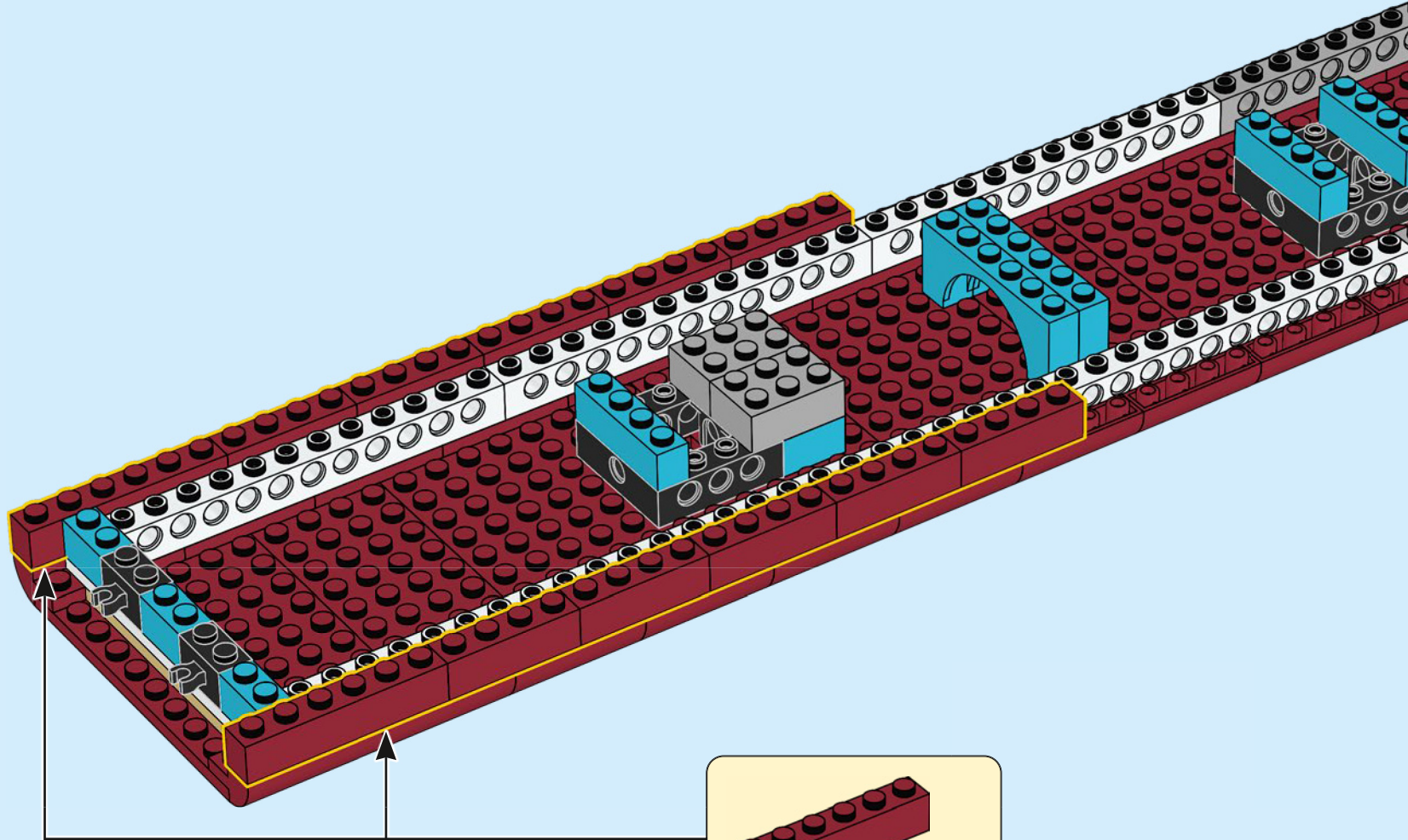

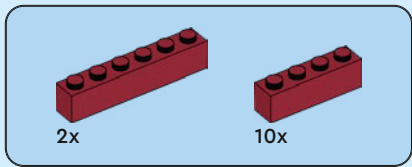

21

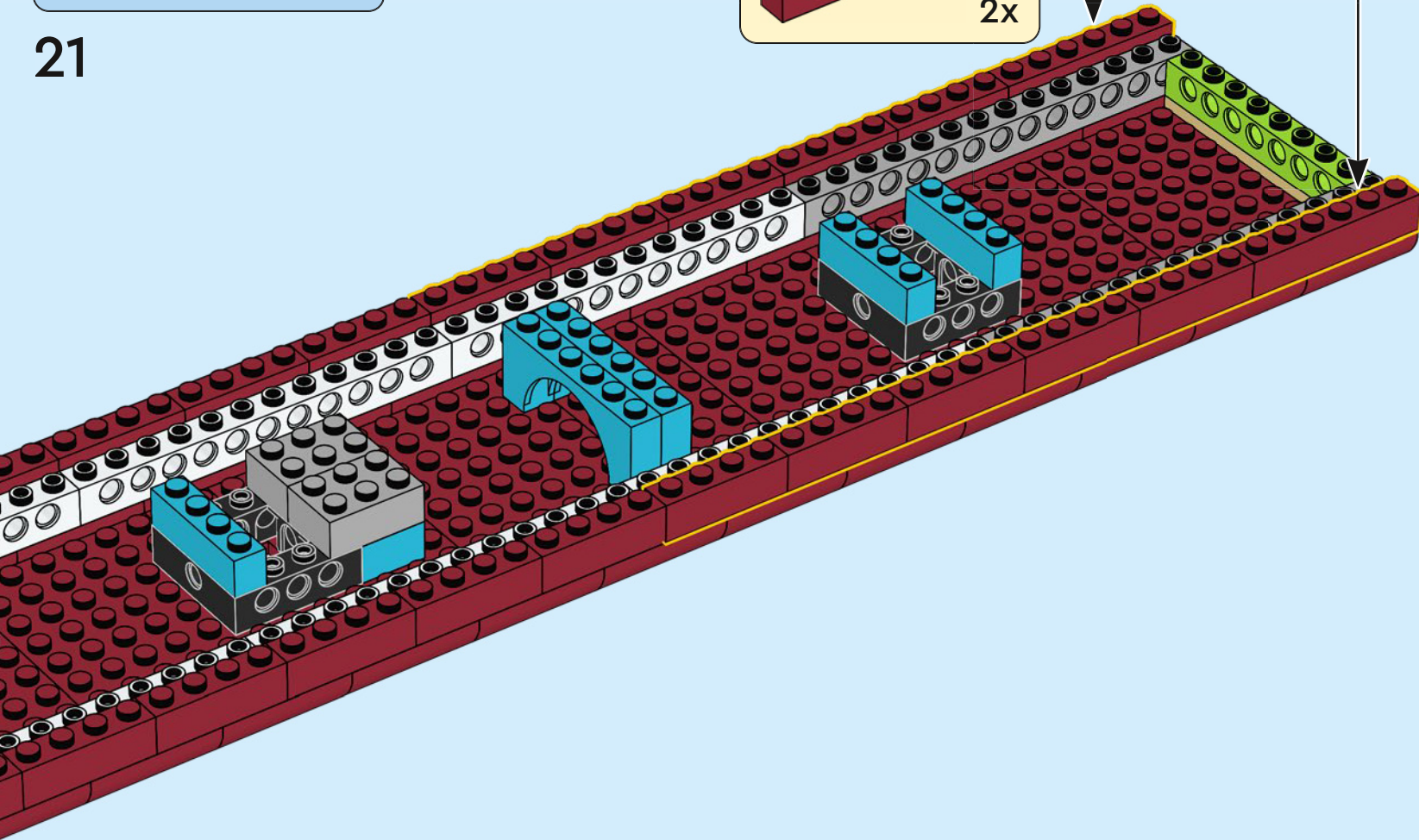
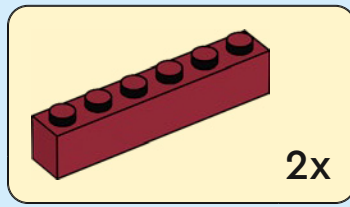

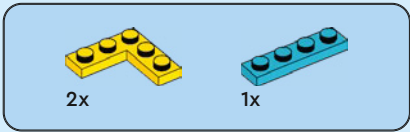

22

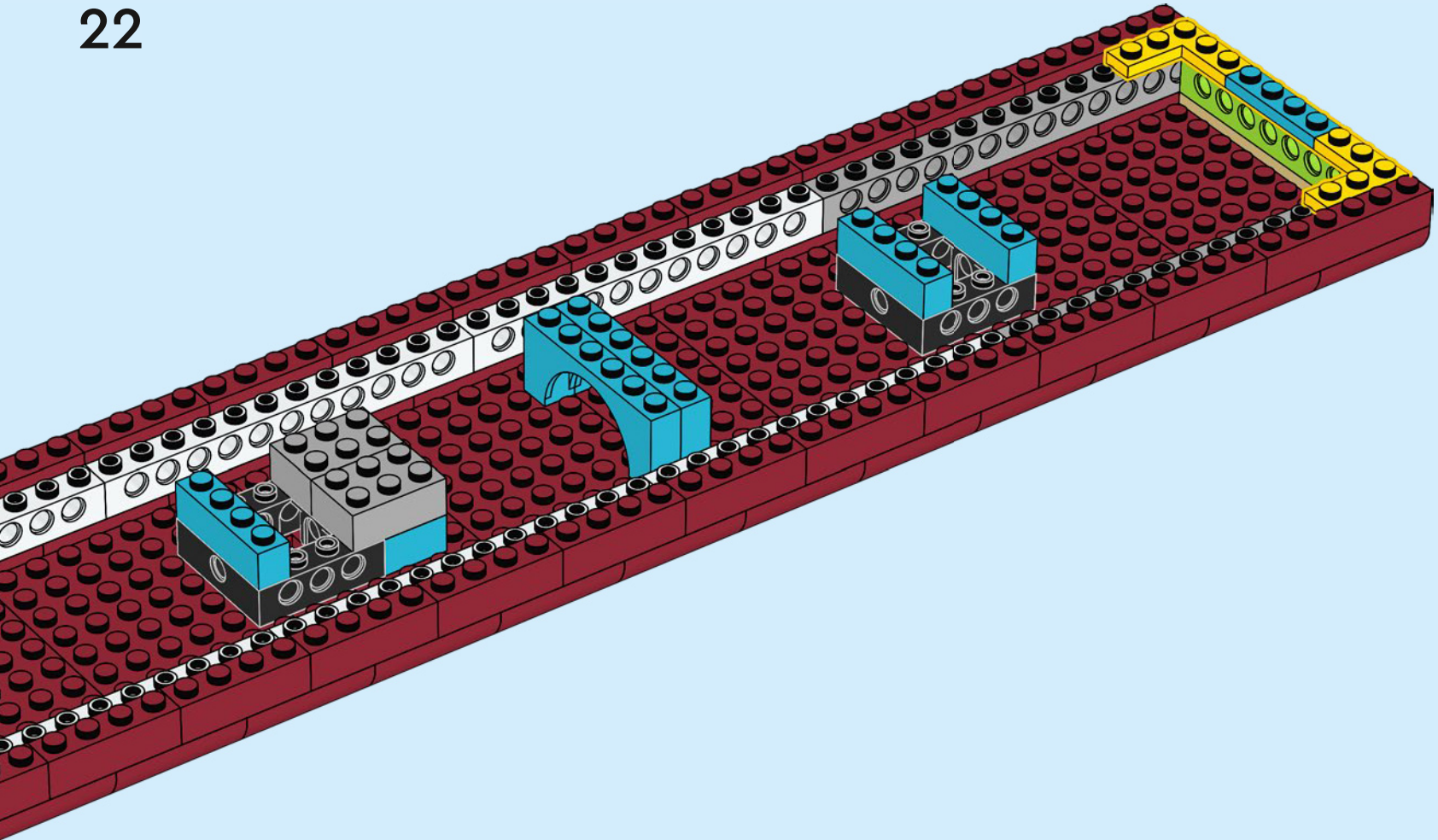

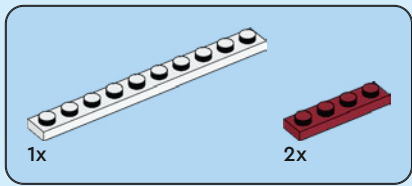

23

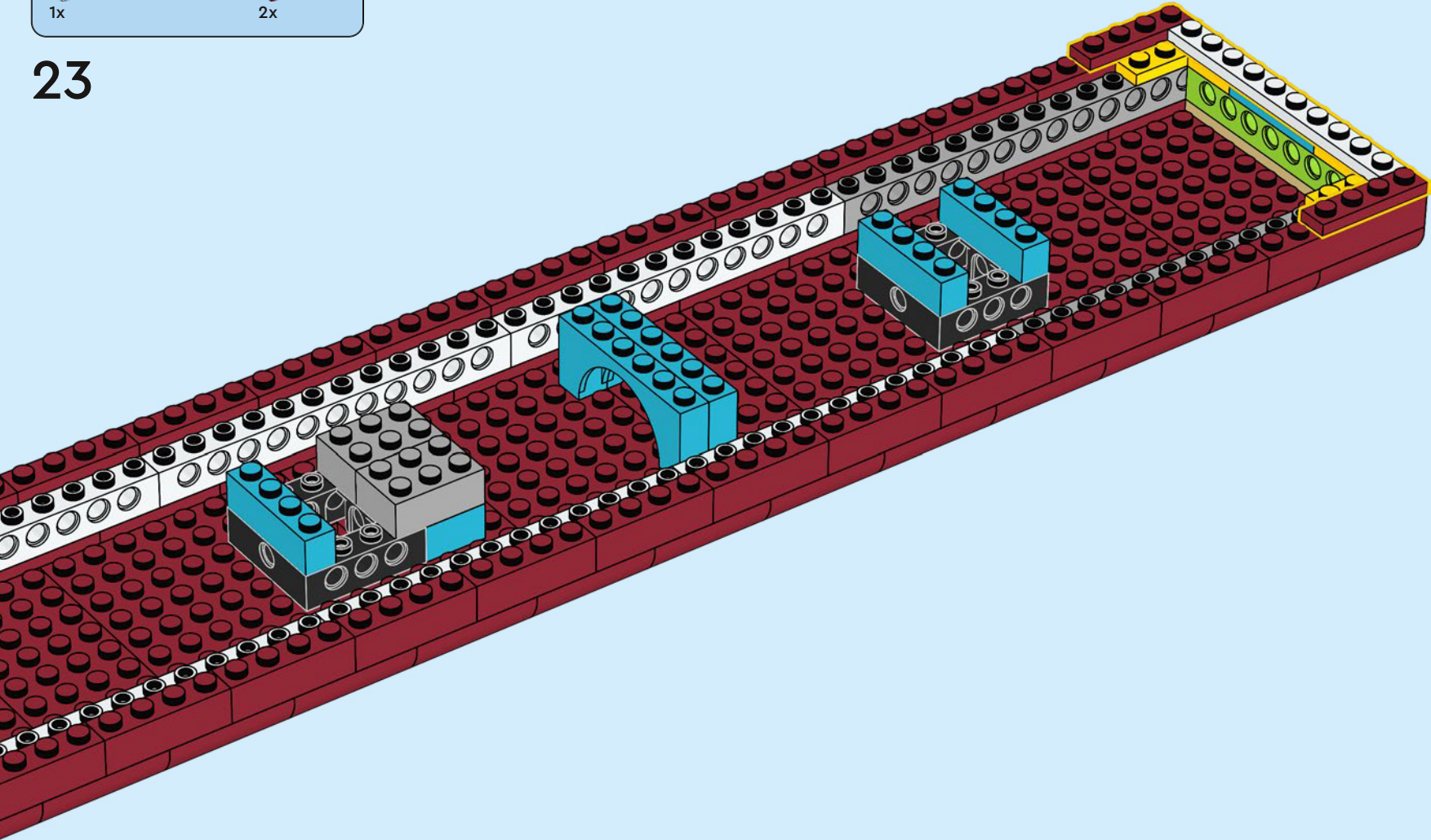

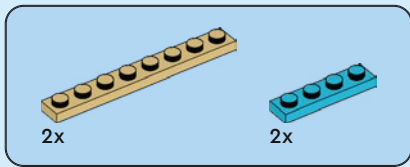

24

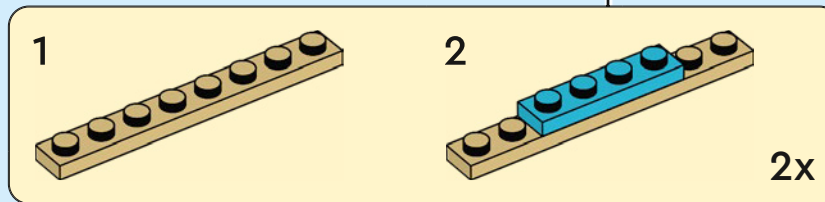
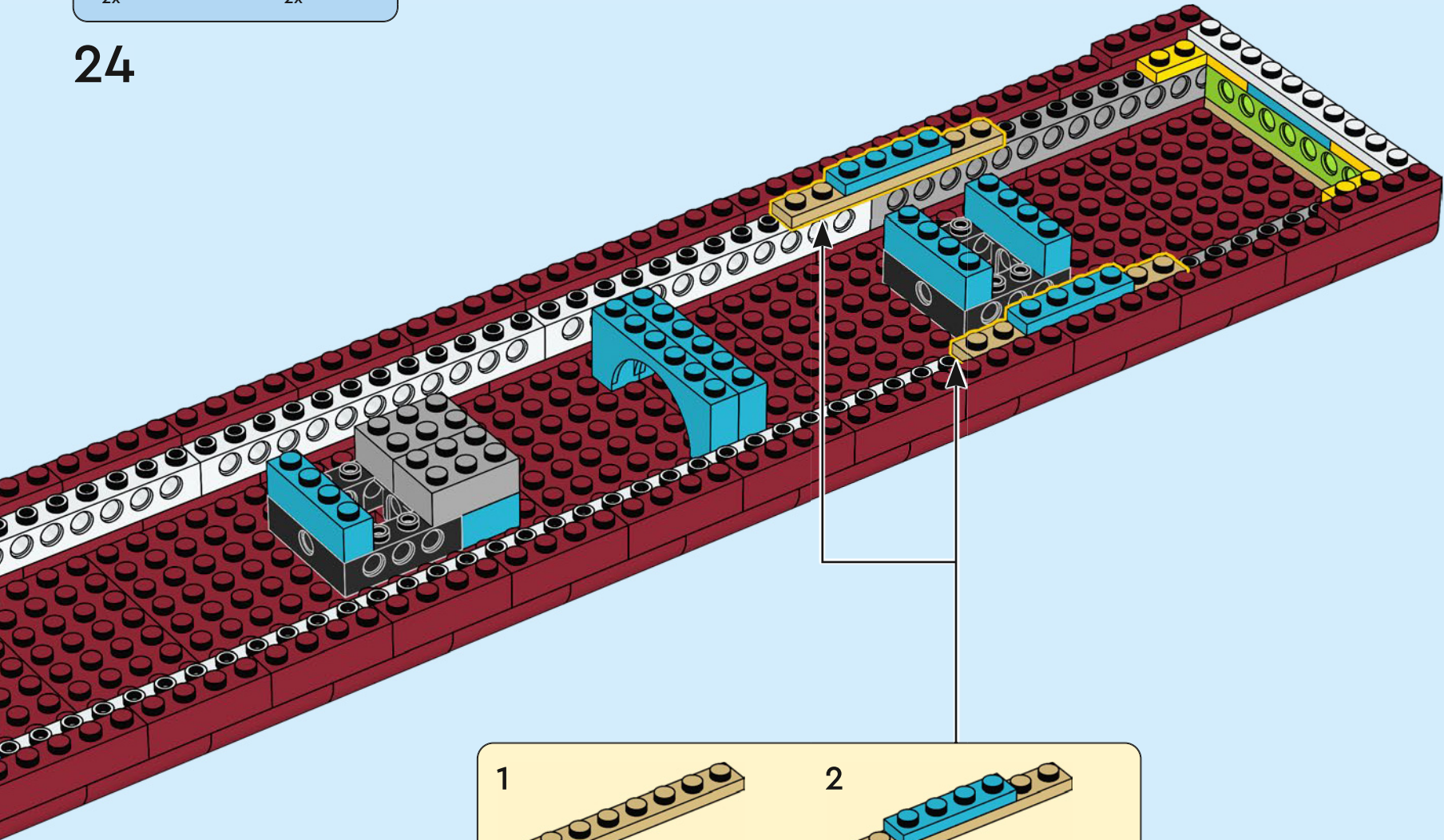

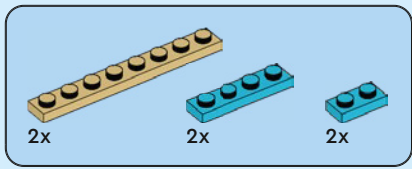

25

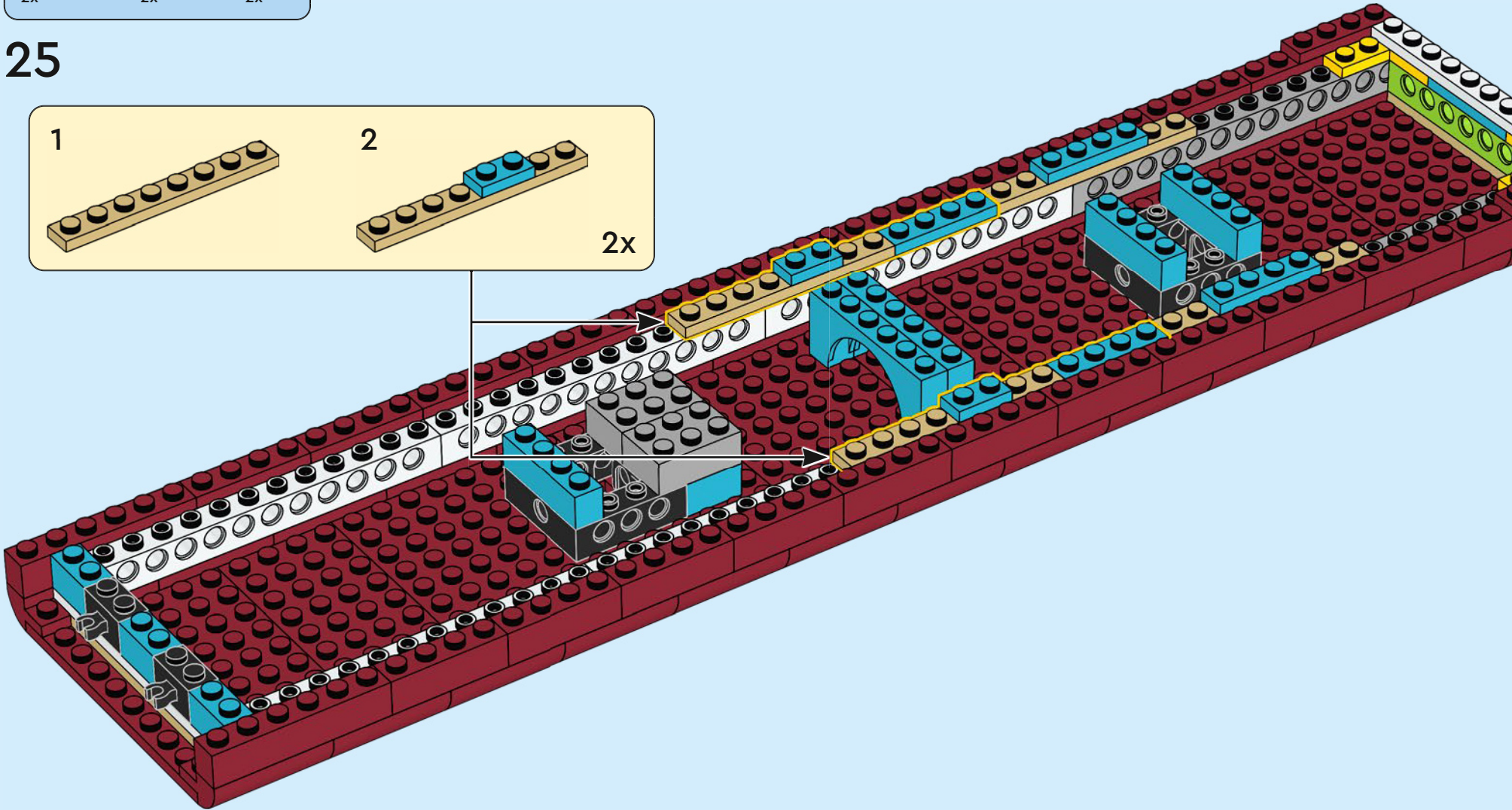
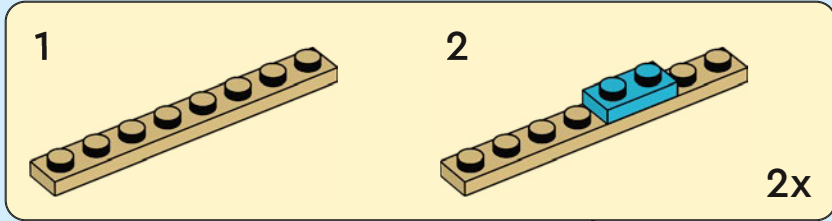

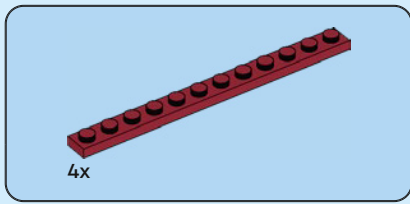

26

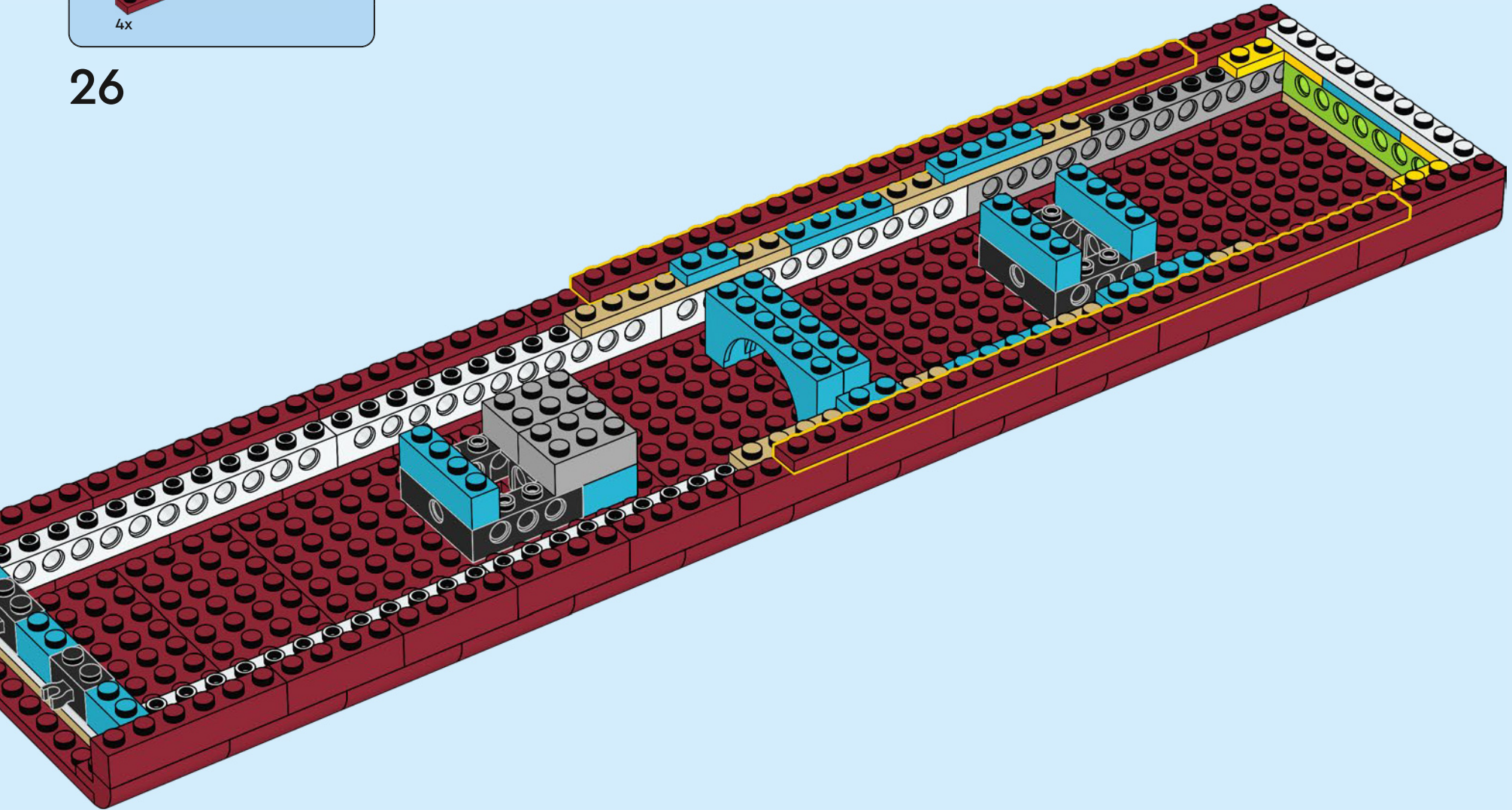

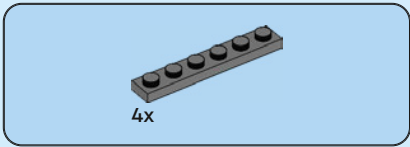

27

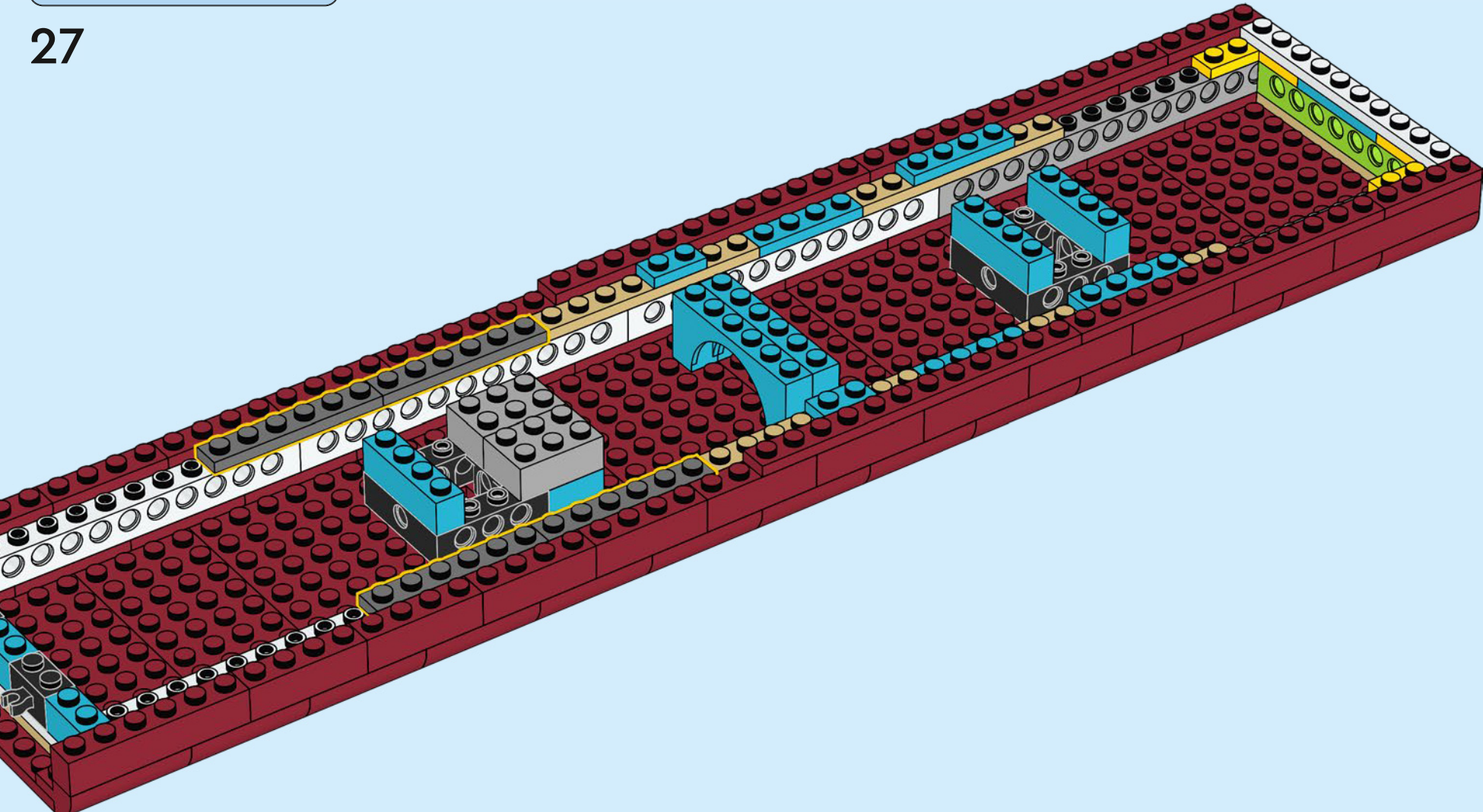

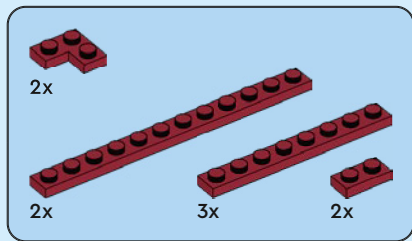

28

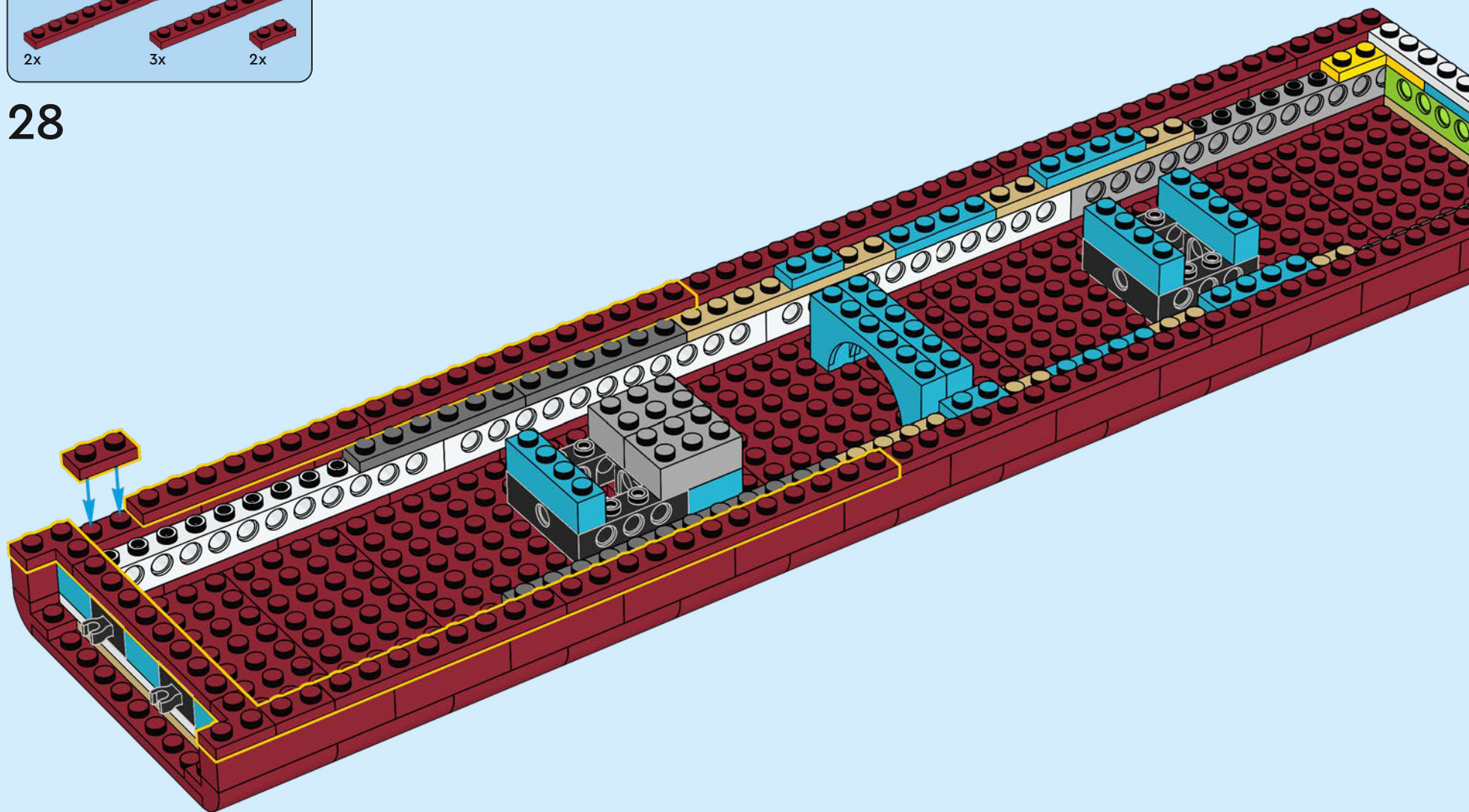

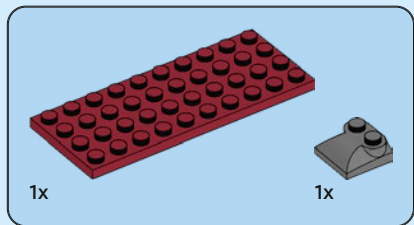
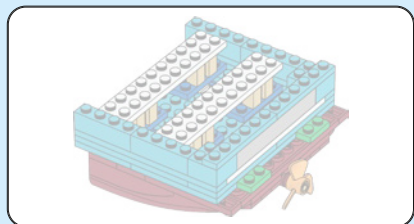

29

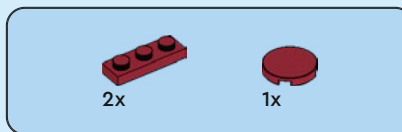
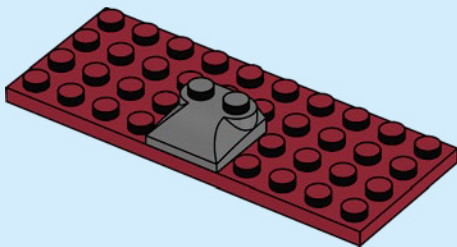

30

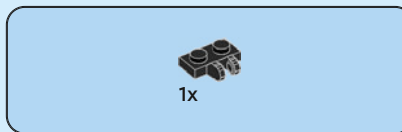
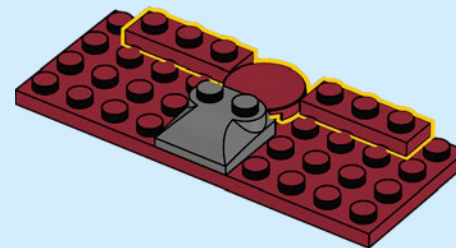

31

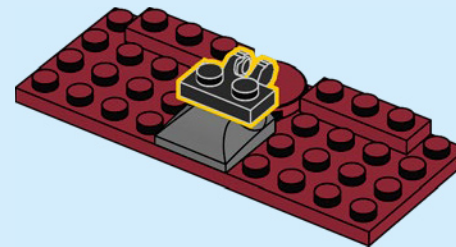

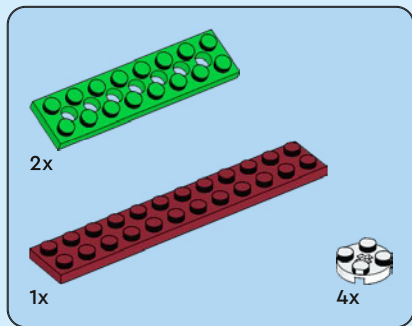

32

1

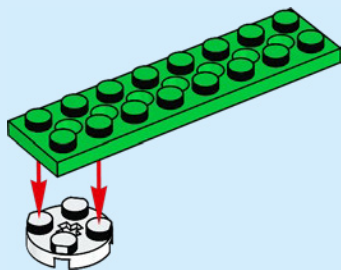

2

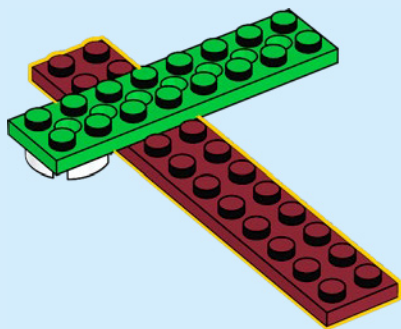

3

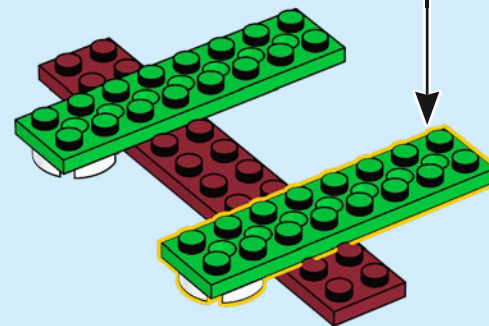
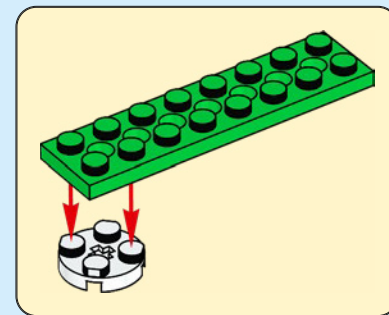

4

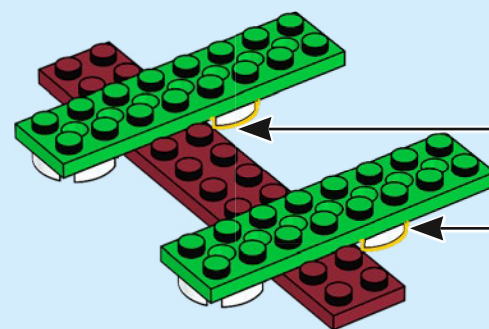

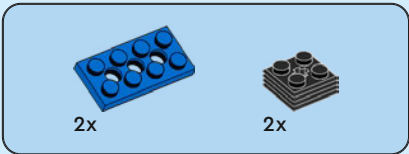

# 33

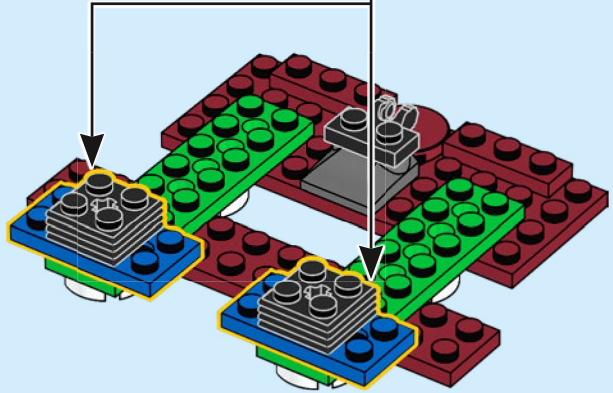
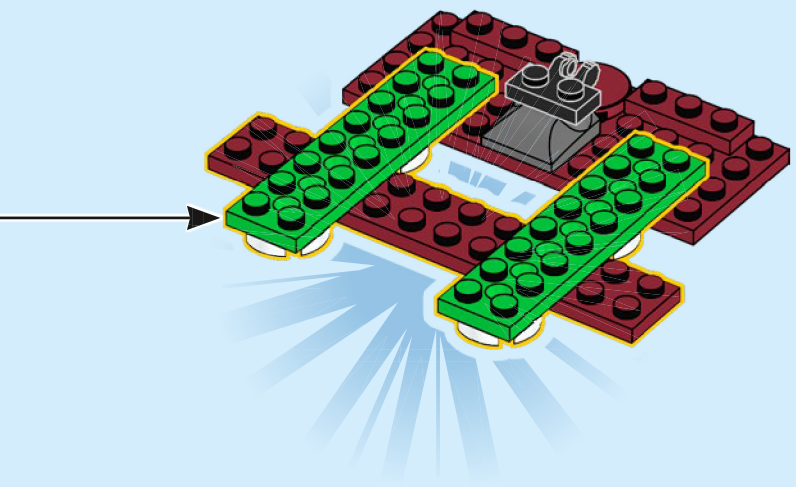
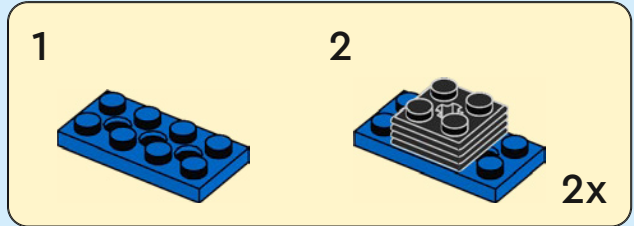



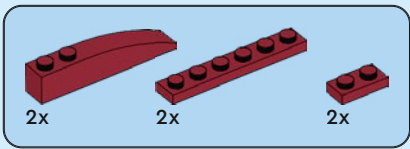

38

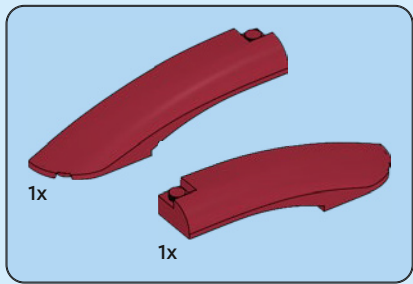
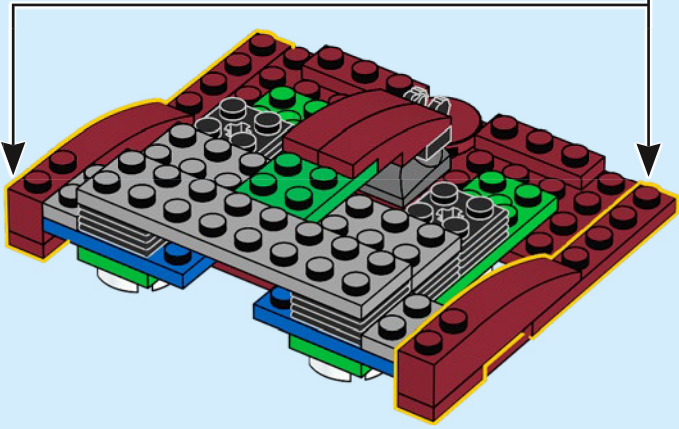
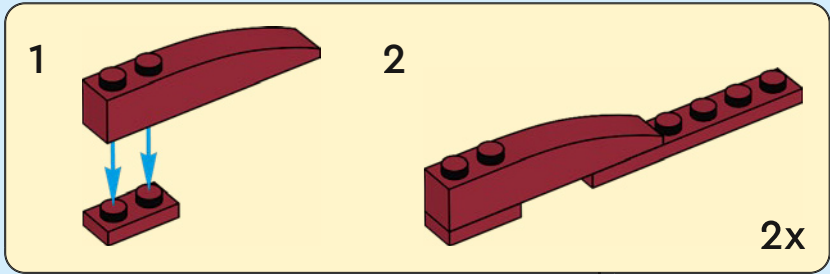

39

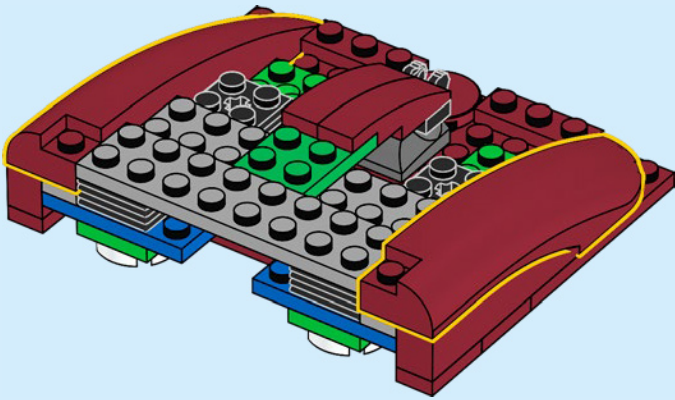

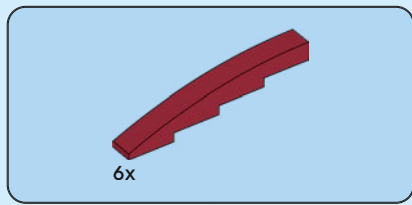

40

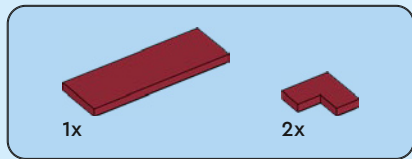
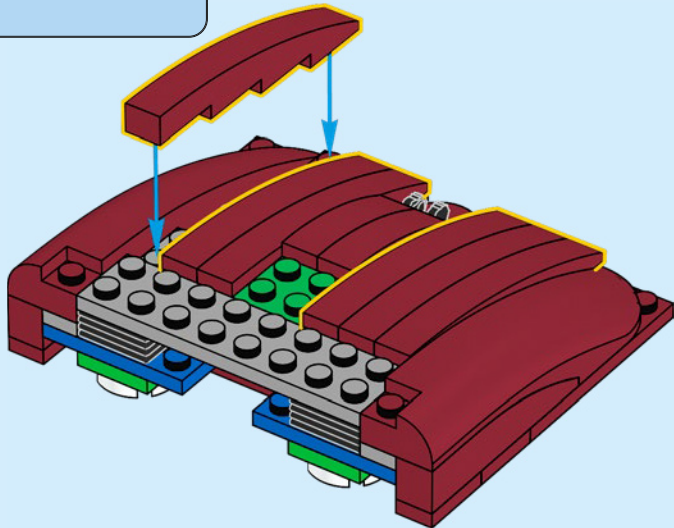

41

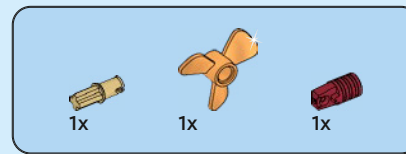
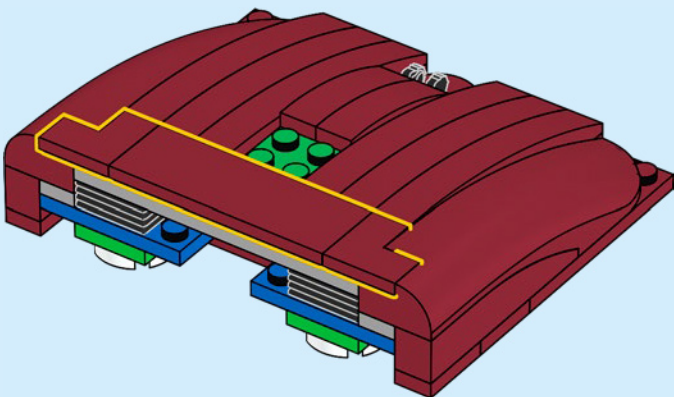

42

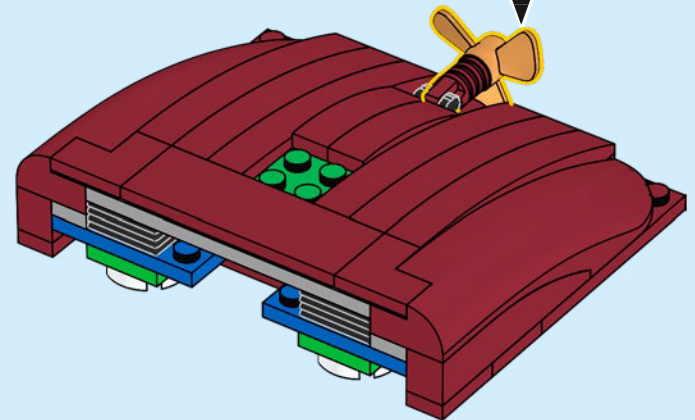
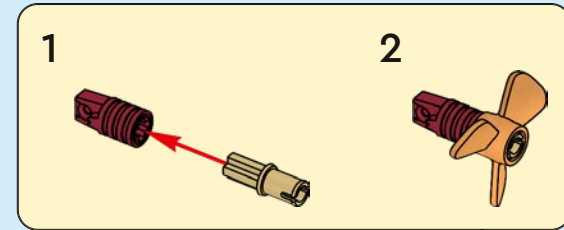

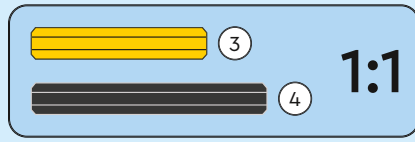
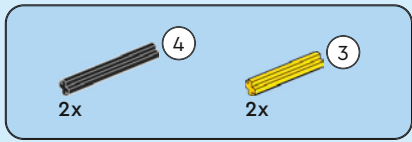

43

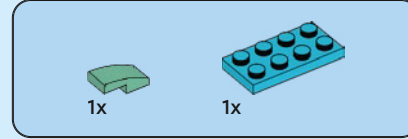
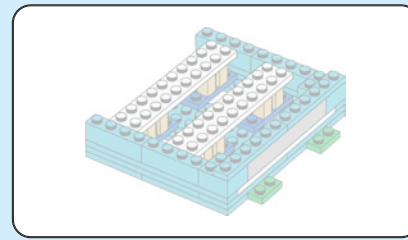
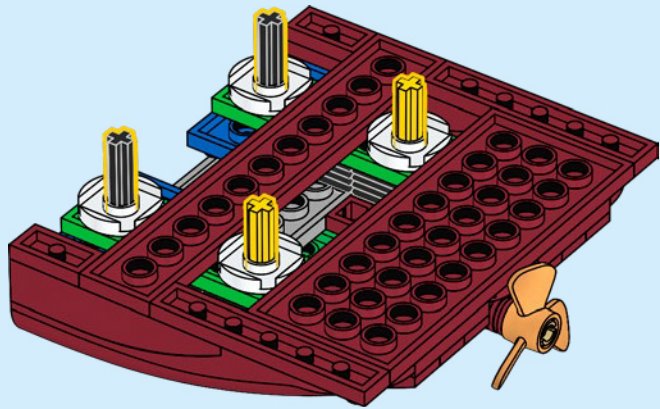

44

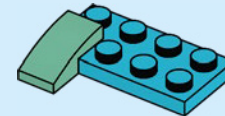

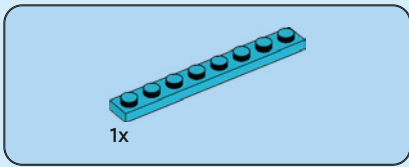

45

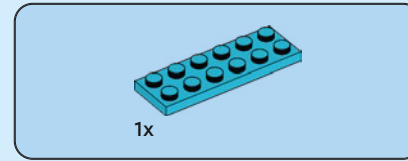
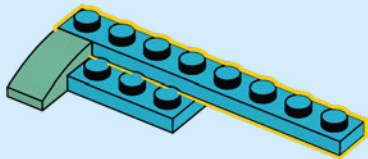
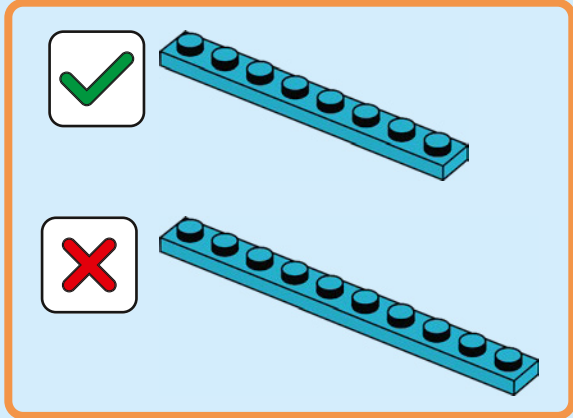

46

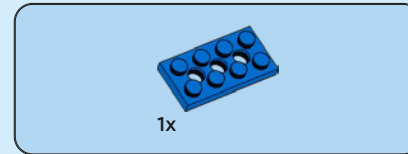
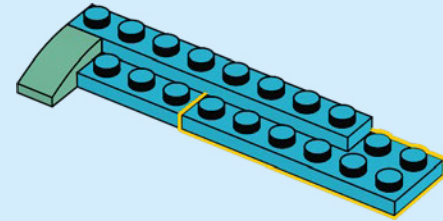

47

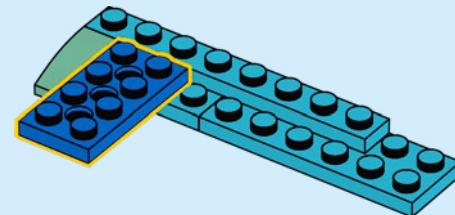

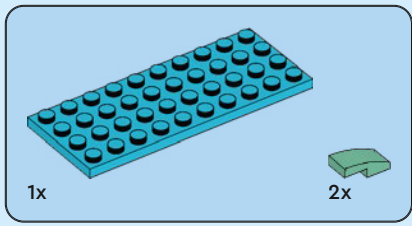

48

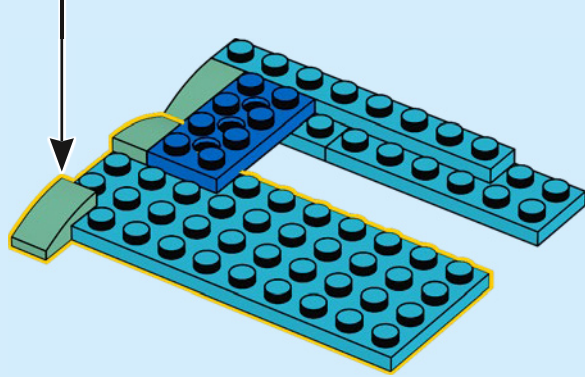
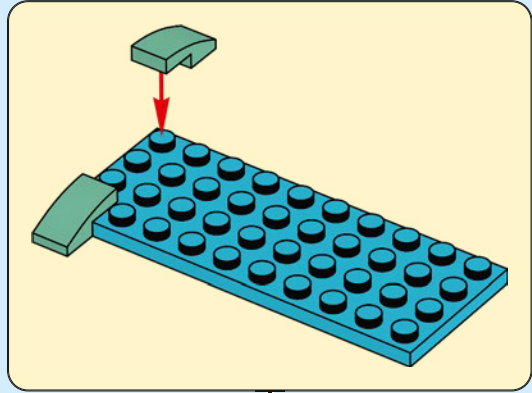

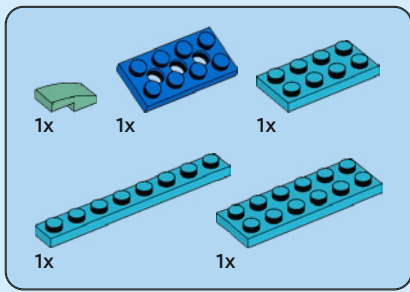

49

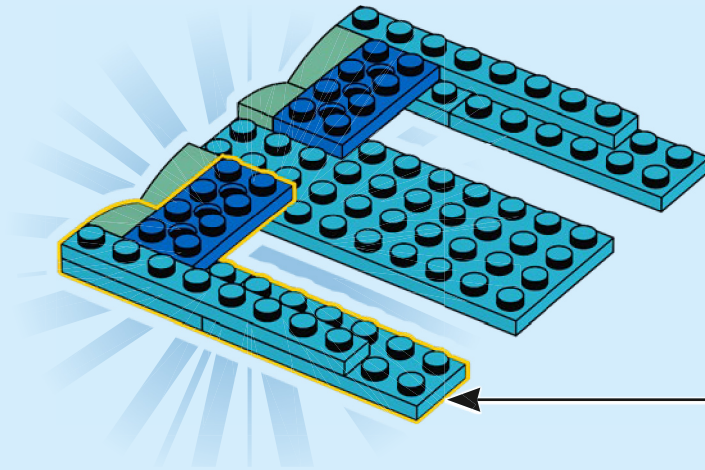
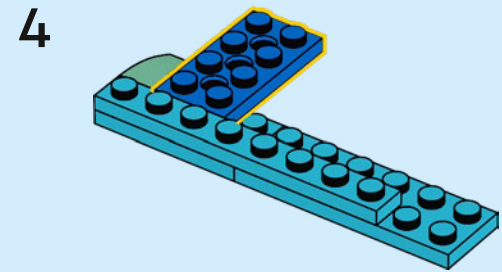
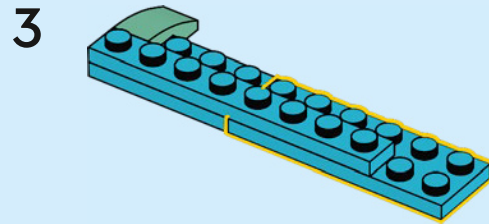
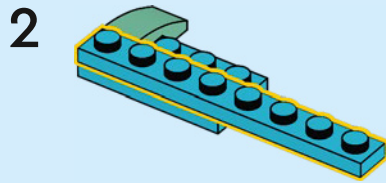
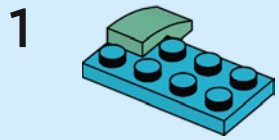
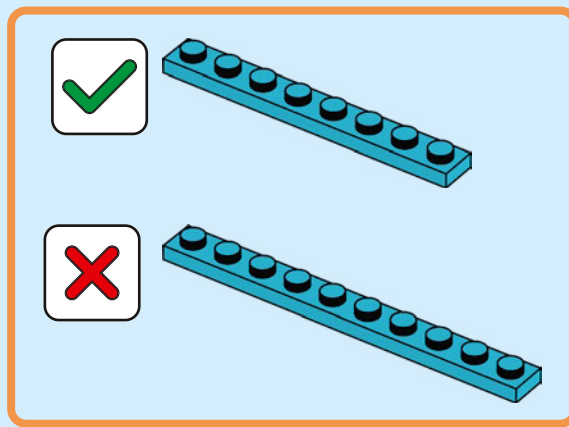



50

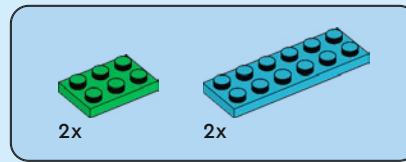
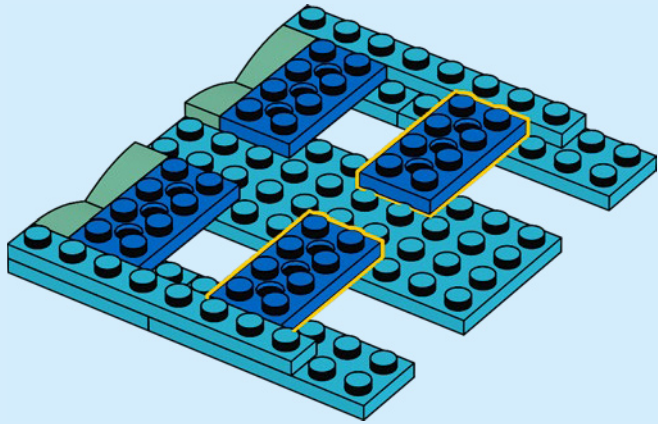

51

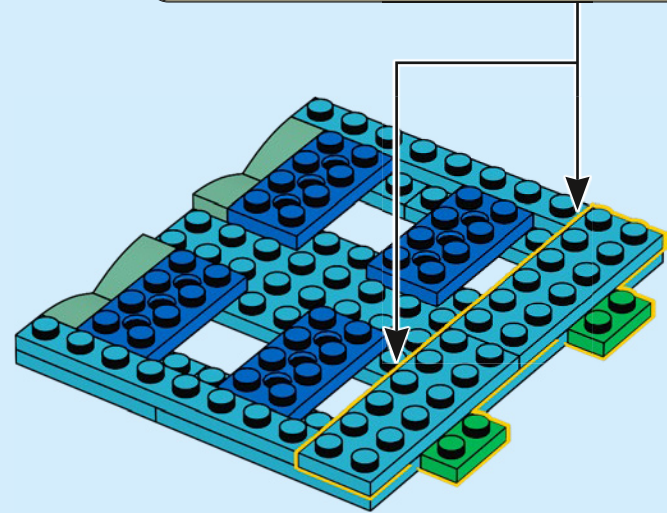
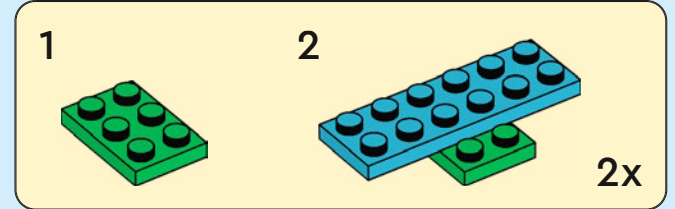

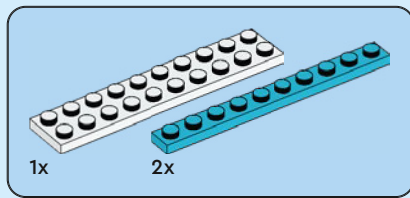

52

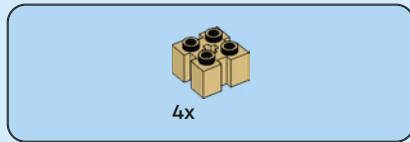
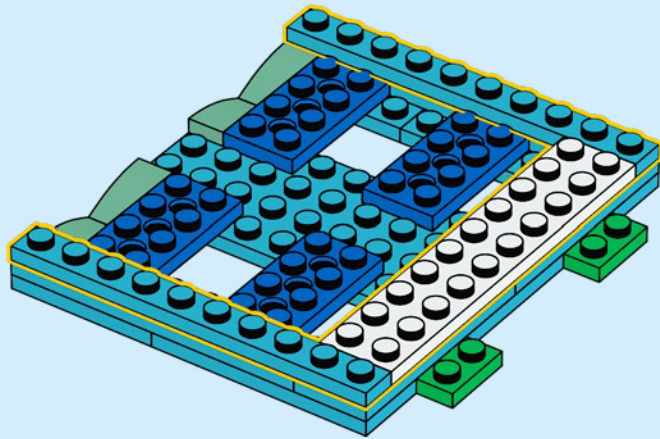

53

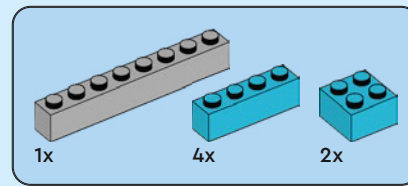
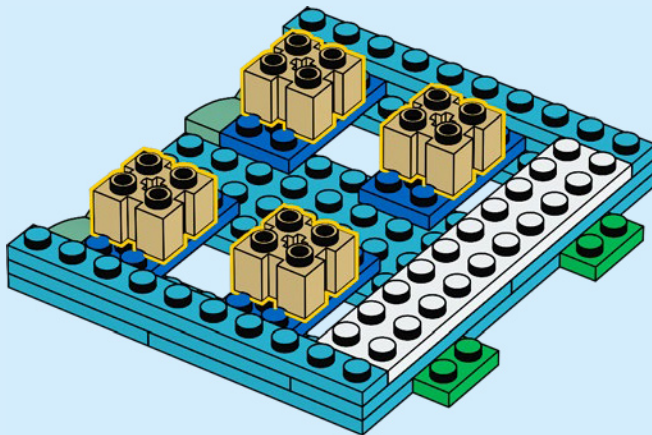

54

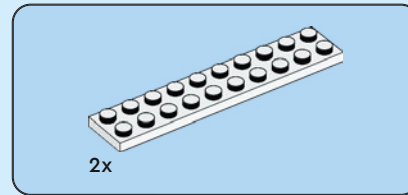
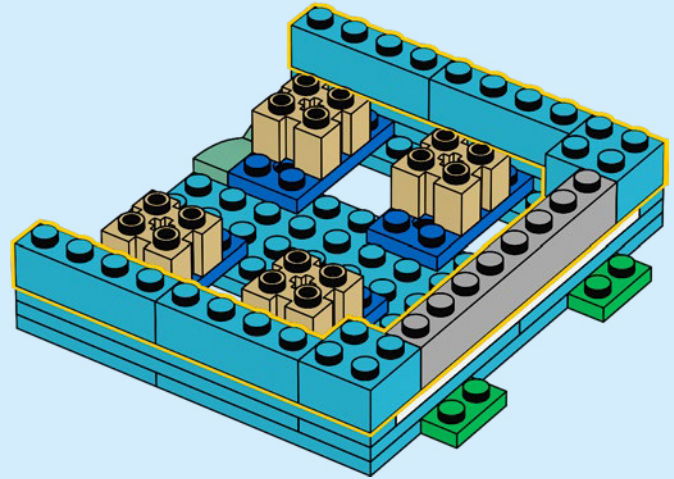

55

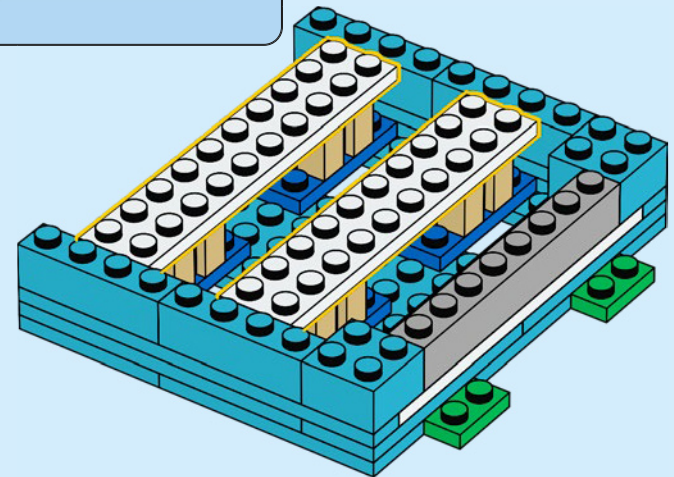

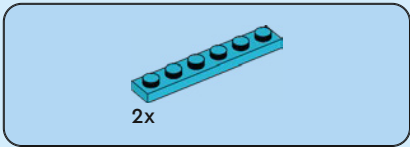

56

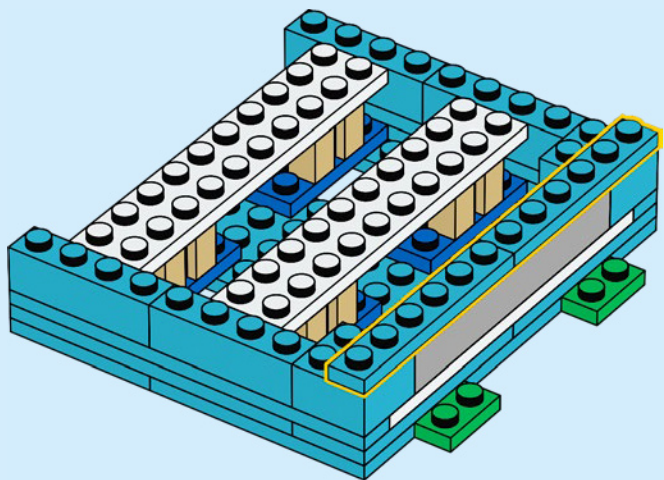

57

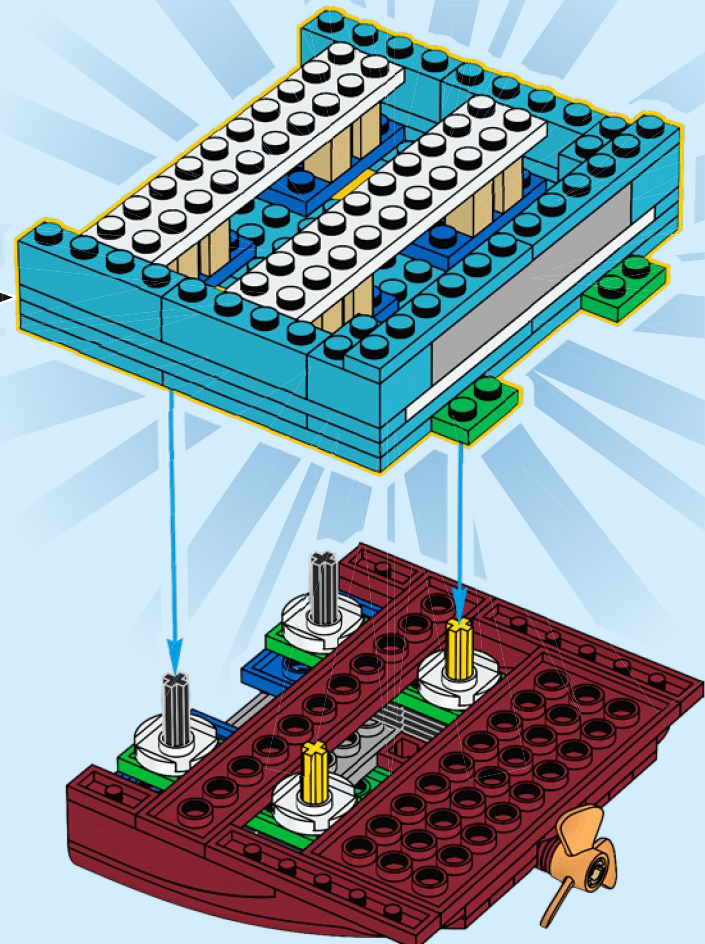



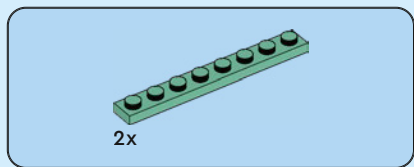
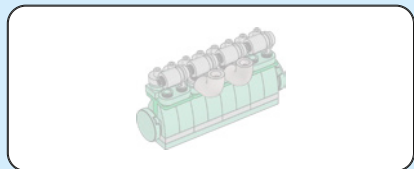

2x

59

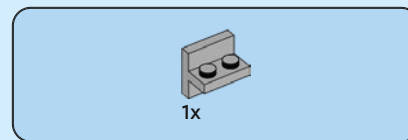
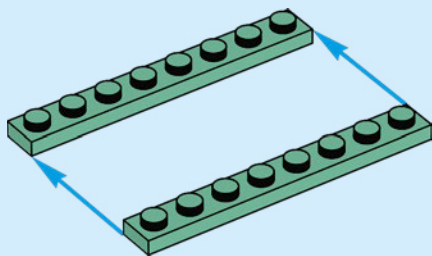

1x

60

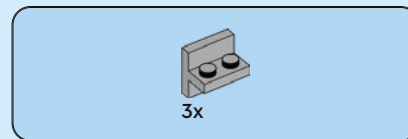
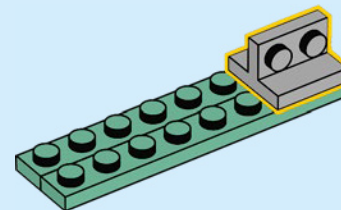

3x

61

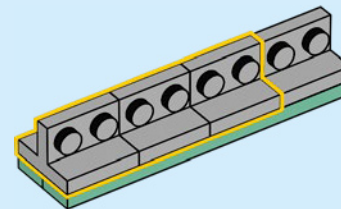



62

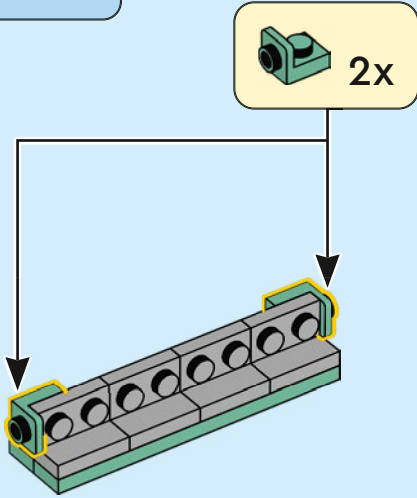

63

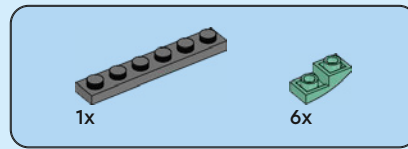
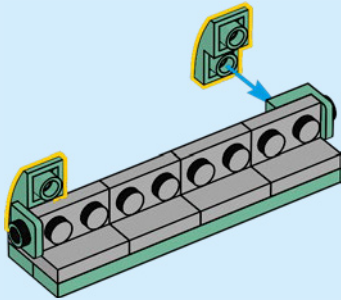

64

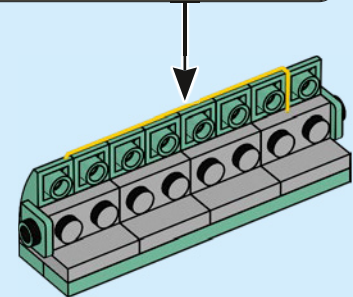
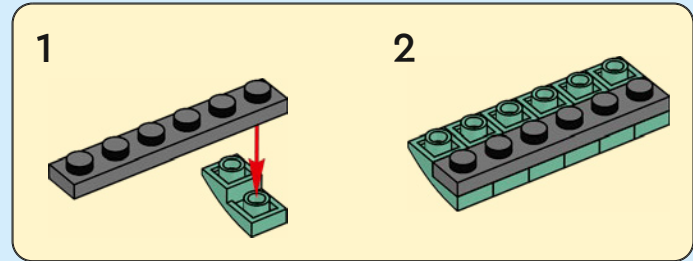

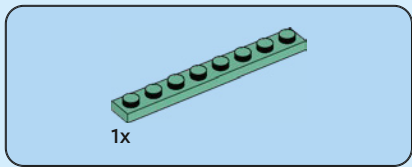

65

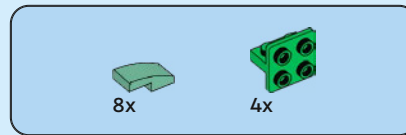
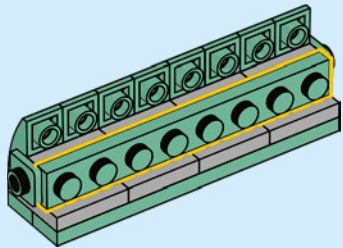

66

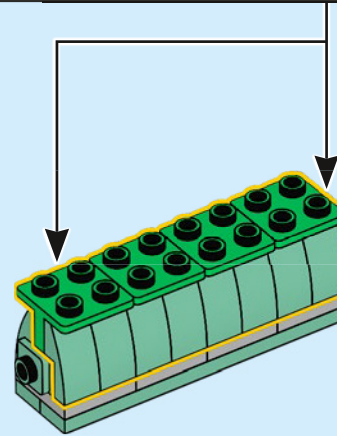
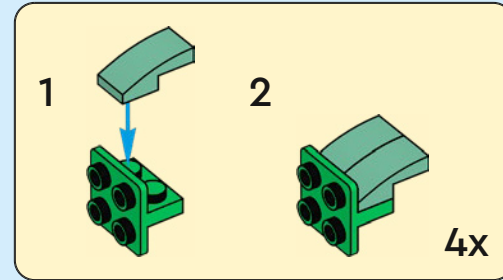

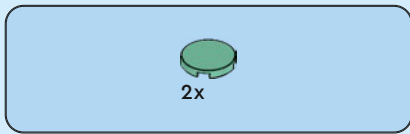

67

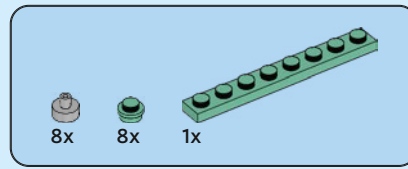
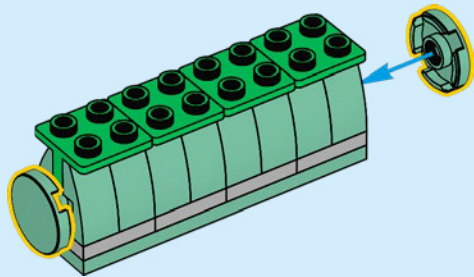

68

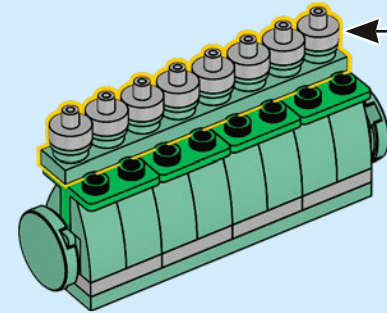
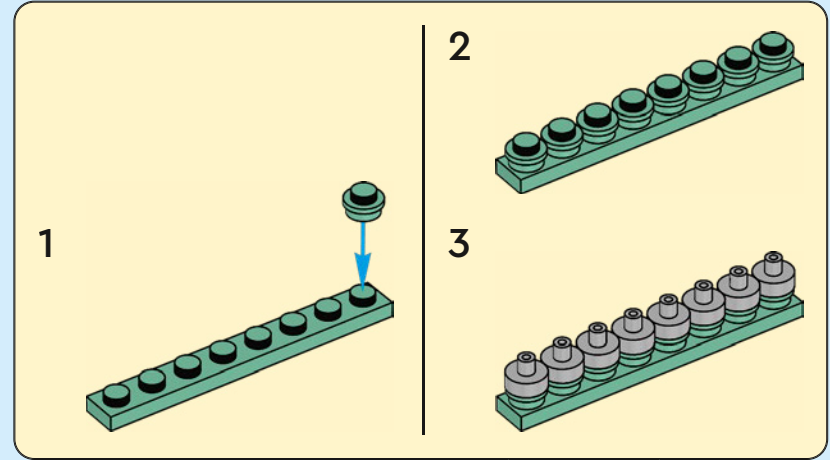



2x

69

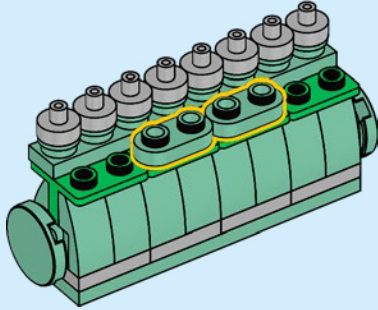

2x



2x

70

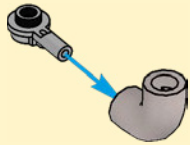
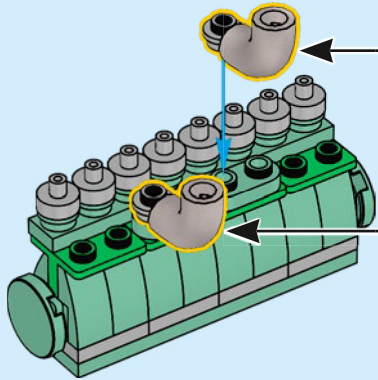

2x



2x

71

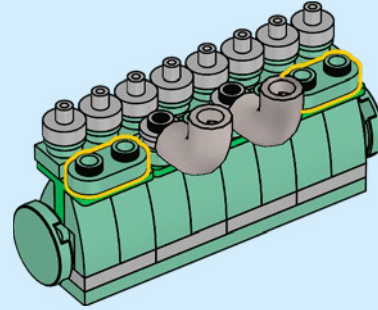

4x



4x

72

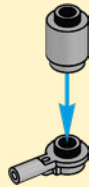
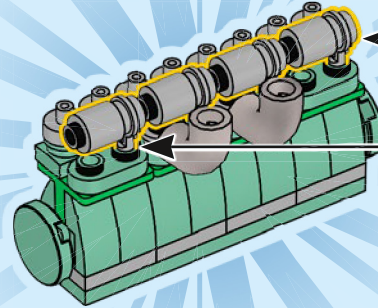

4x



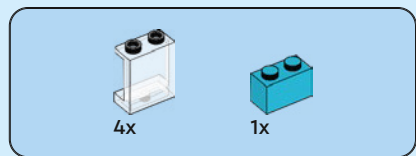

74

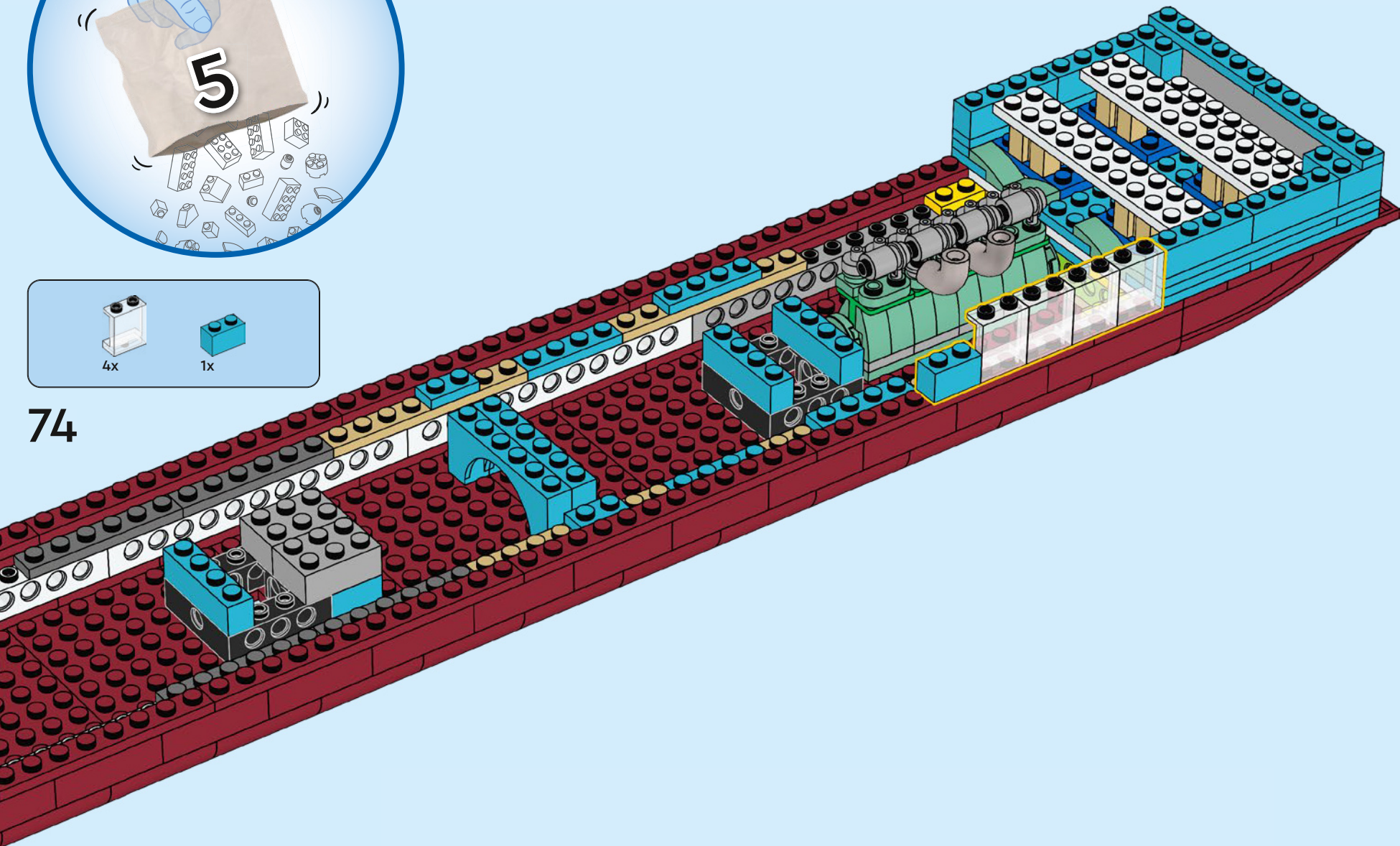

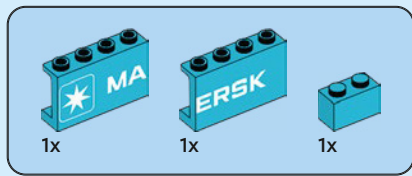

75

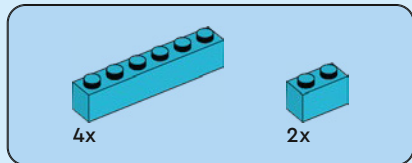
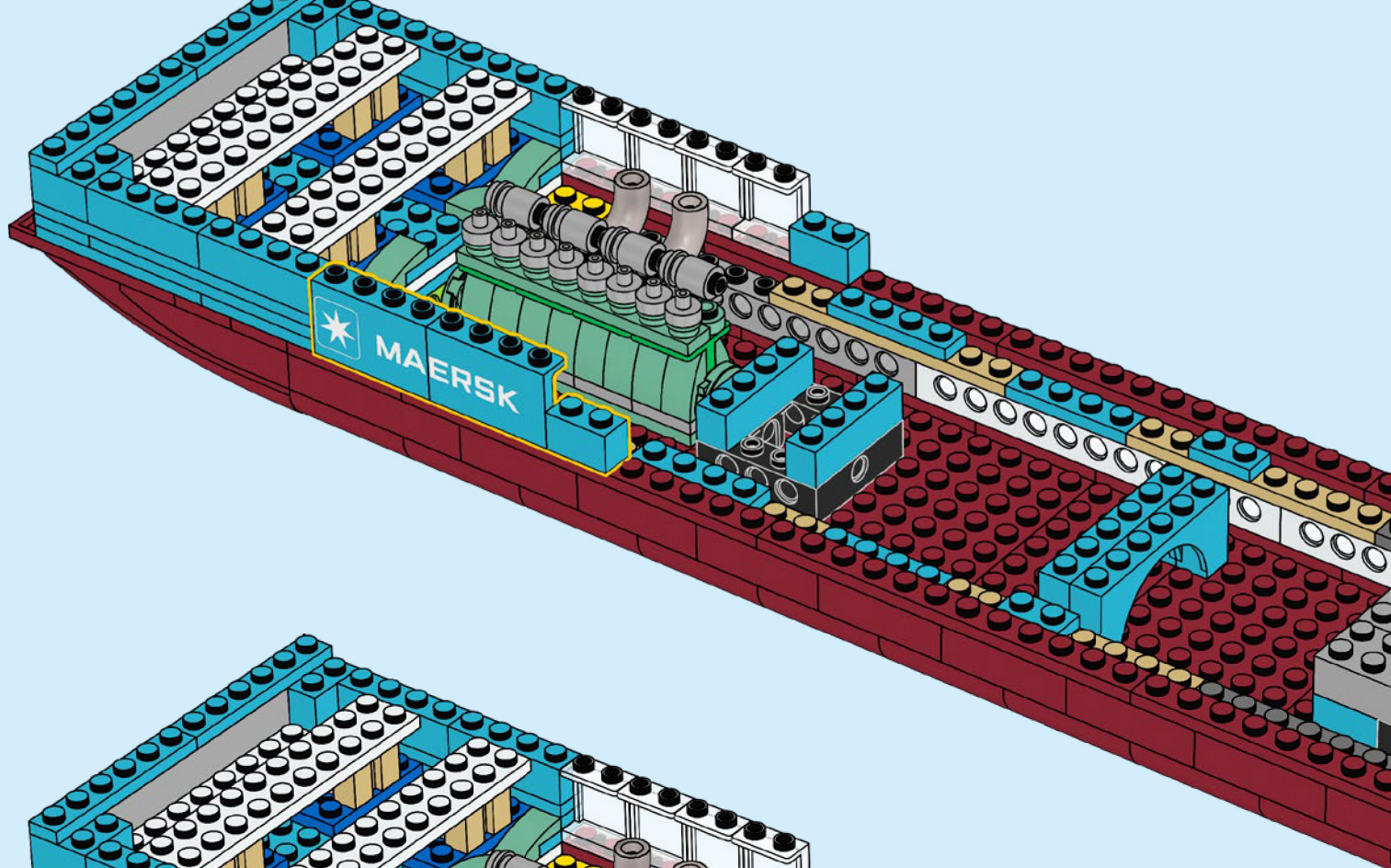

76

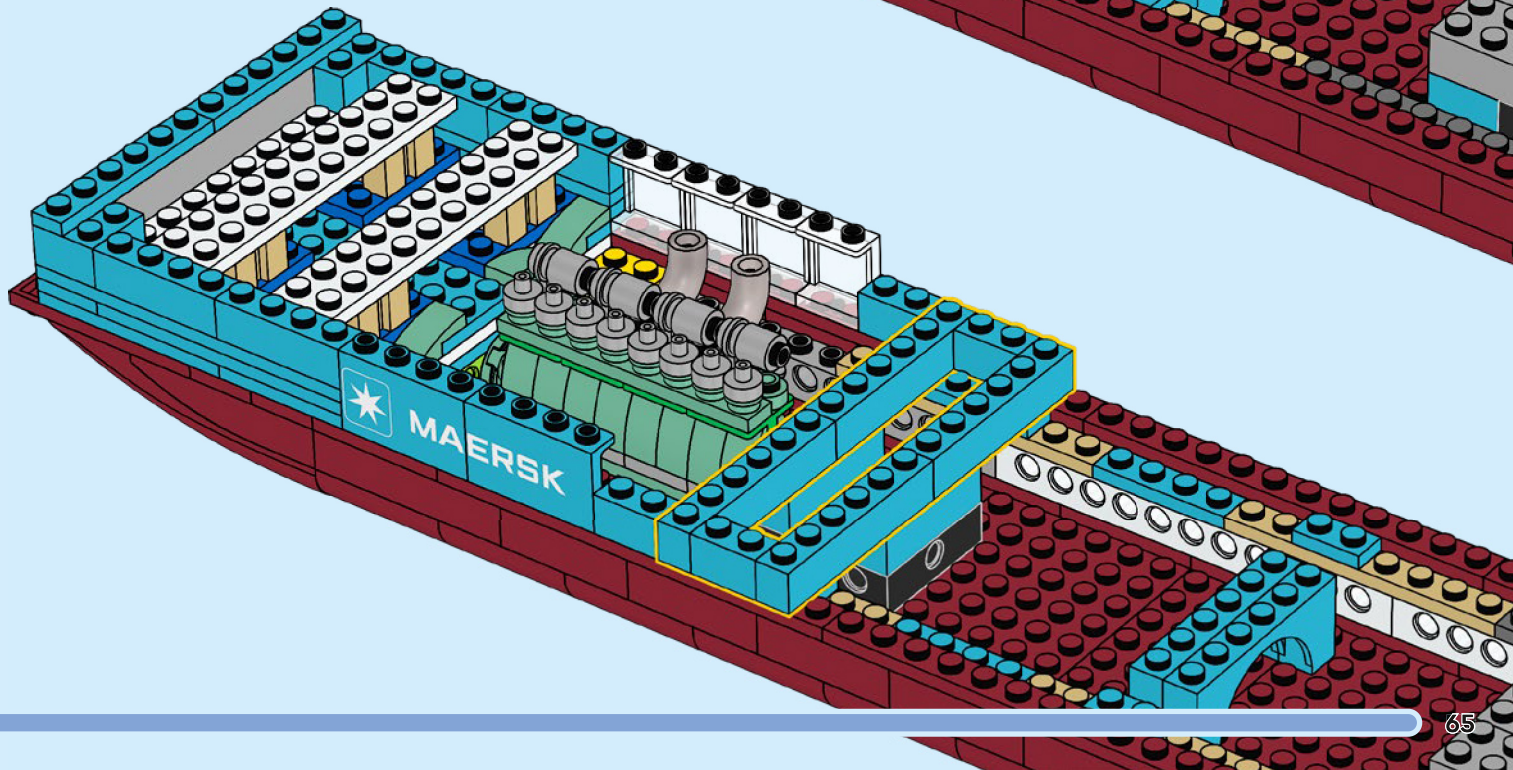

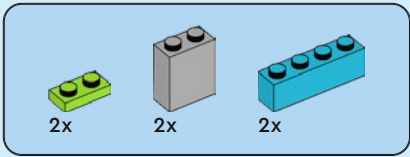

77

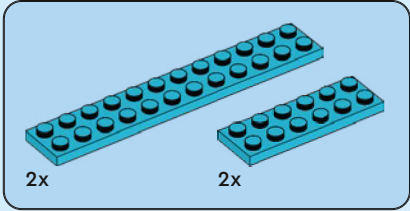
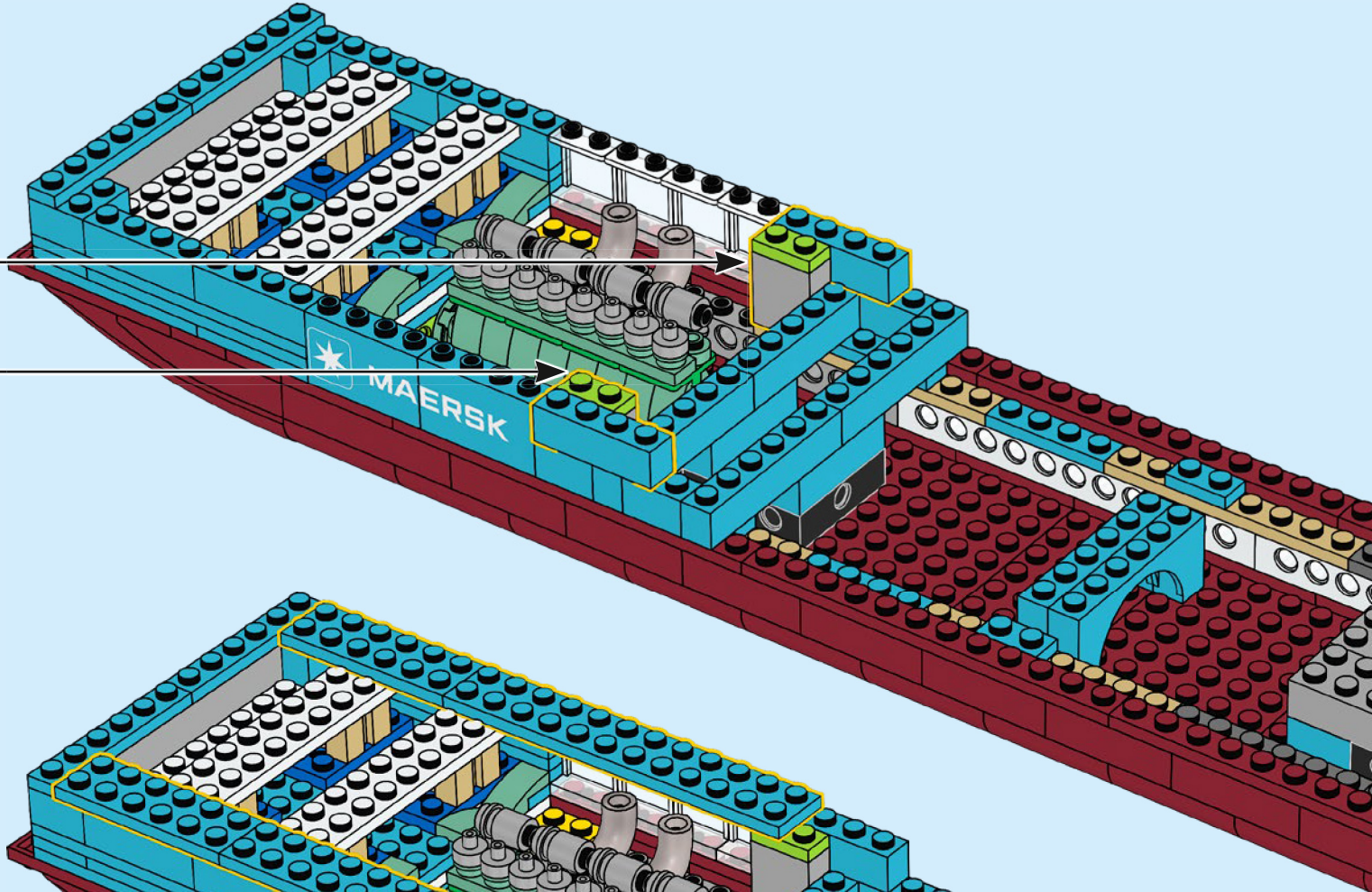
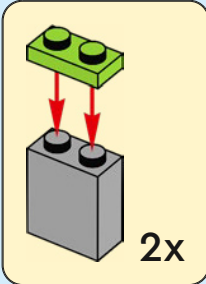

78

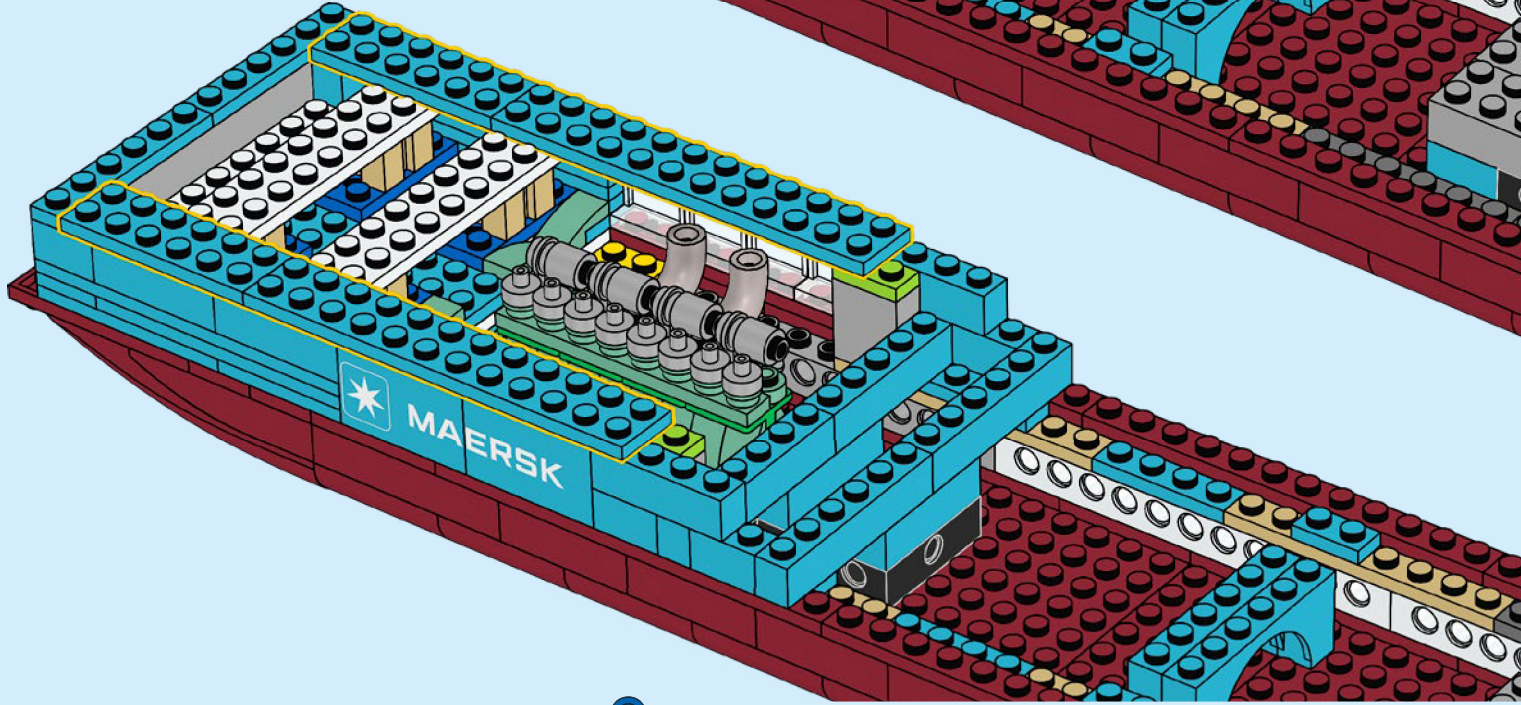

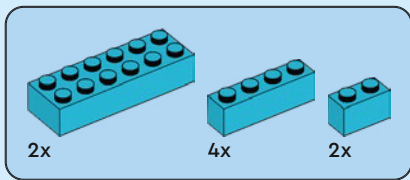

79

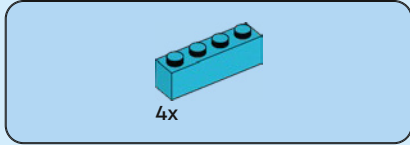
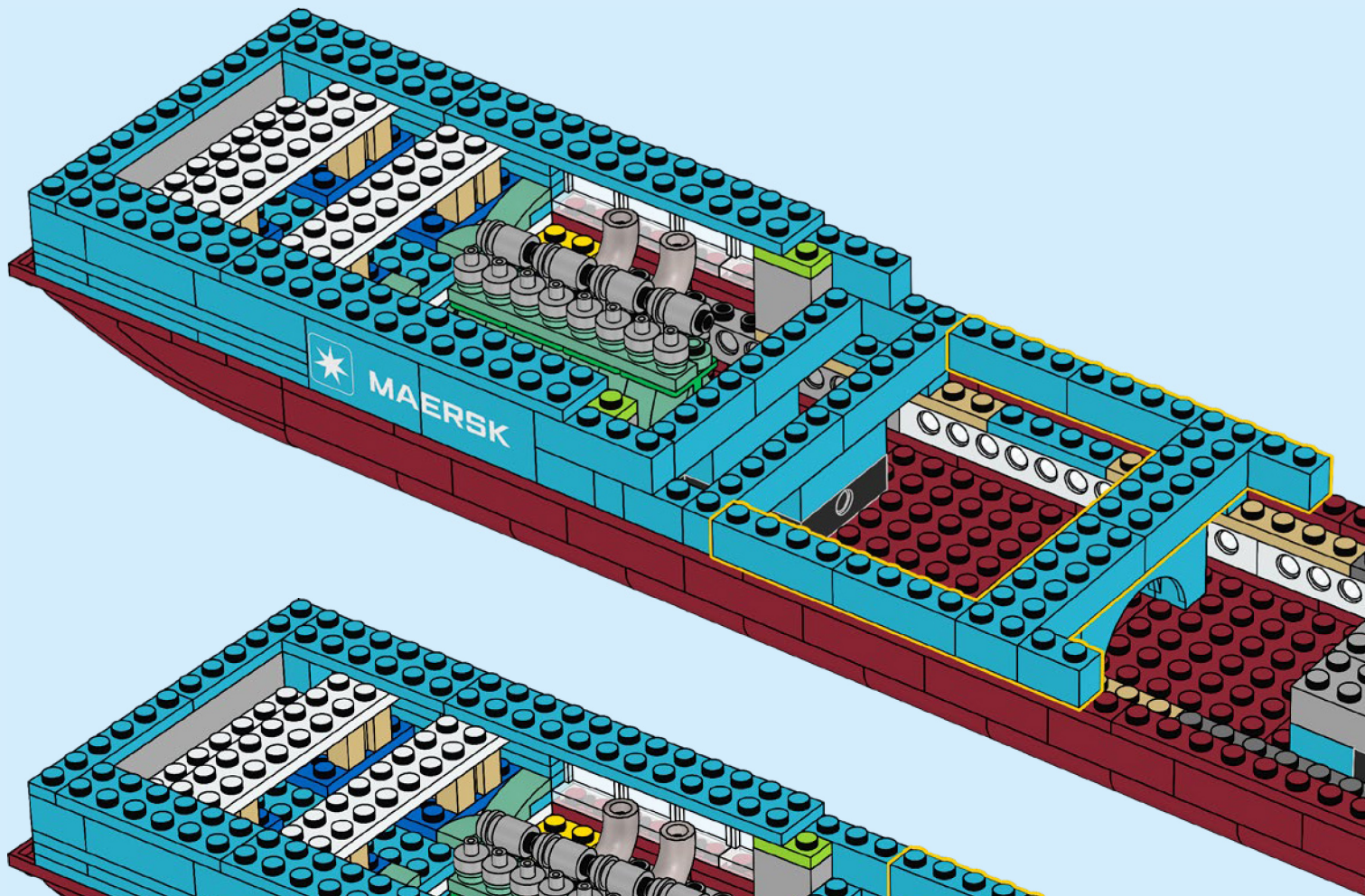

80

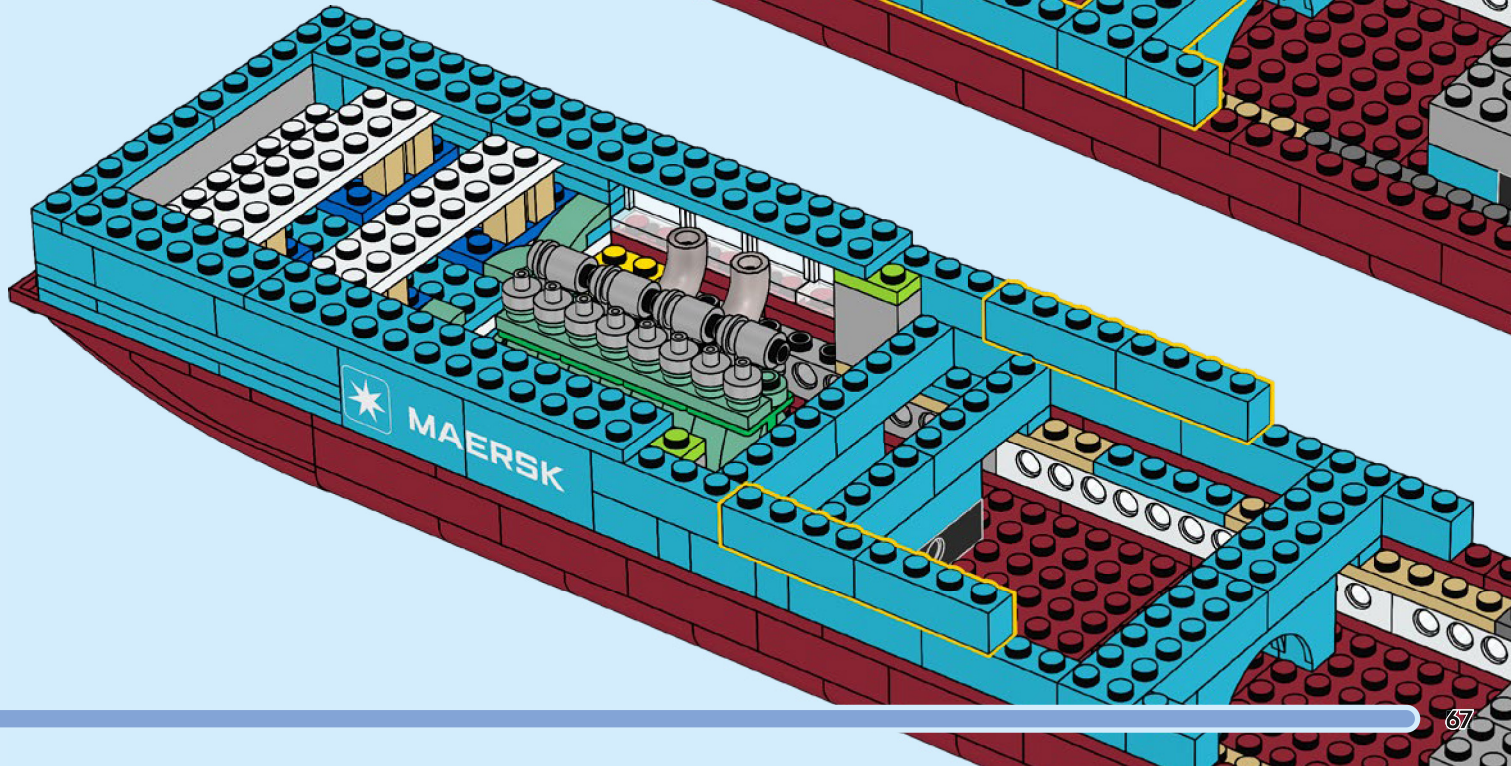

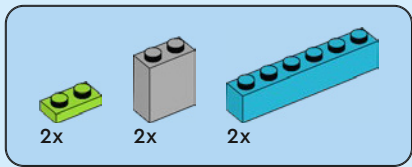

81

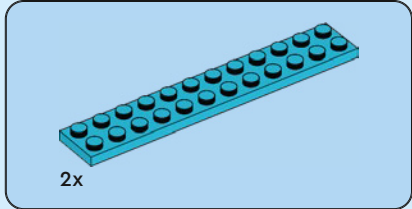
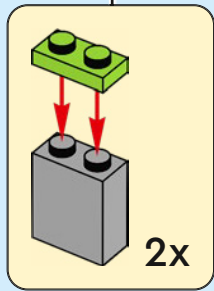
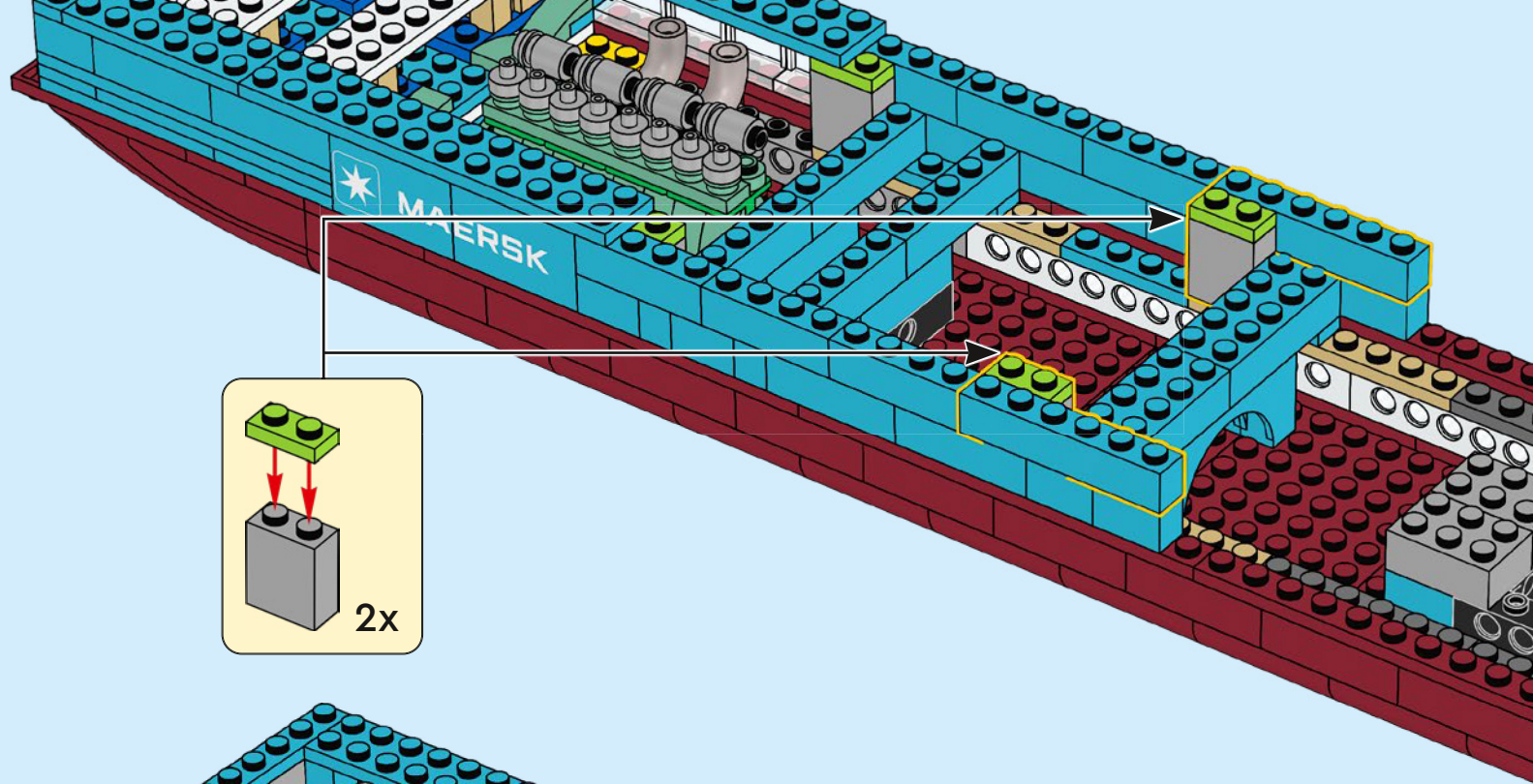

82

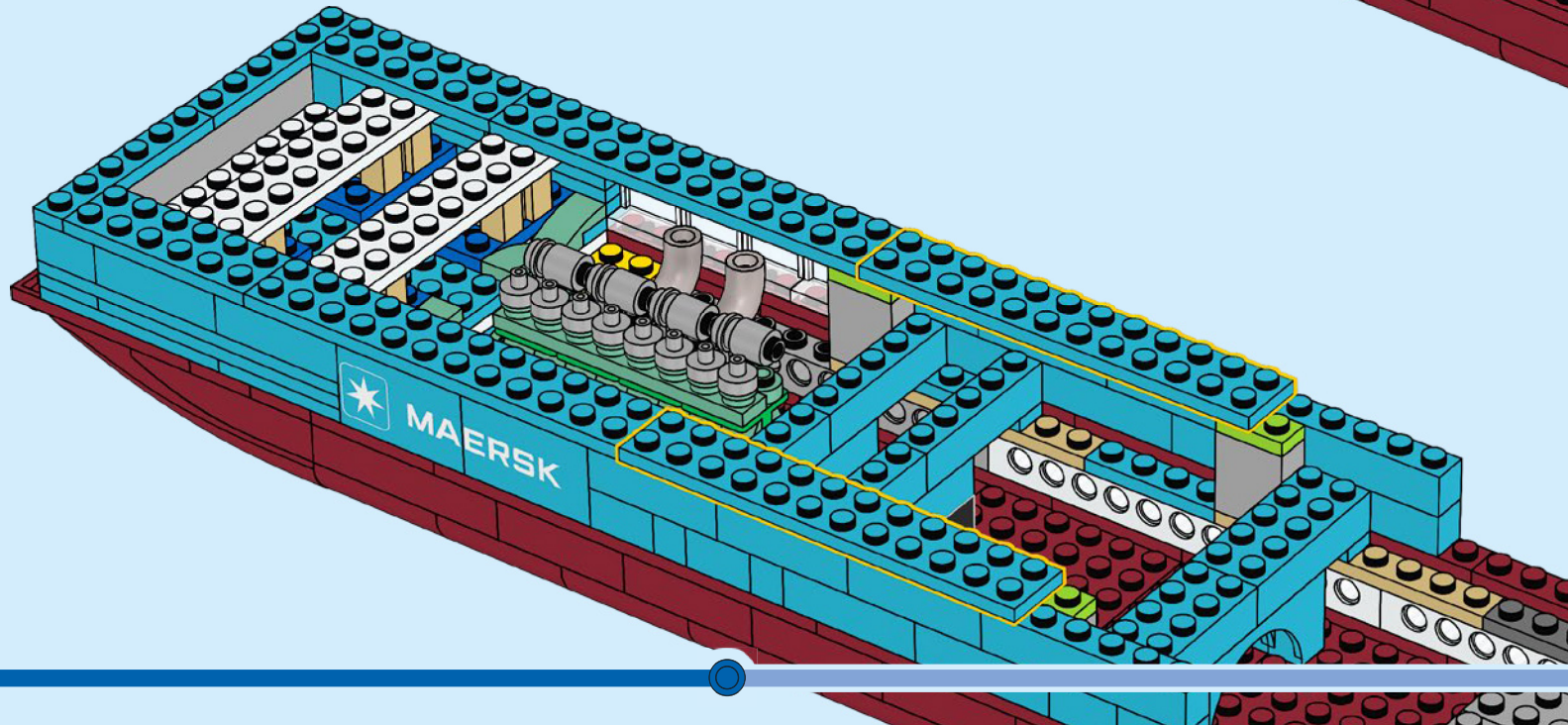

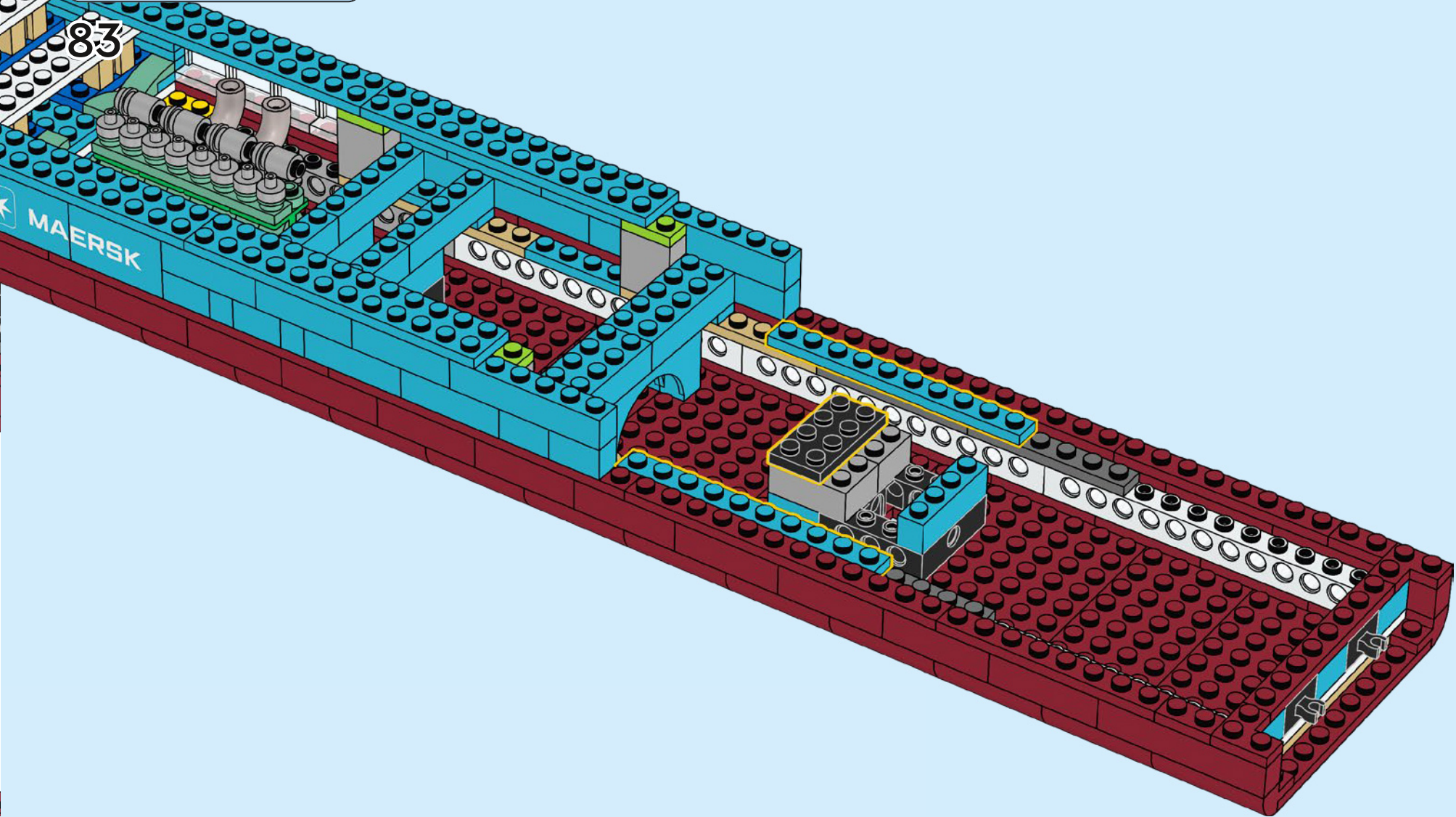
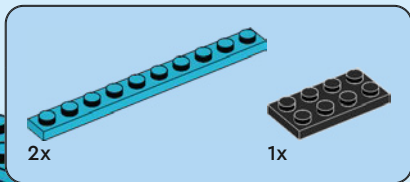



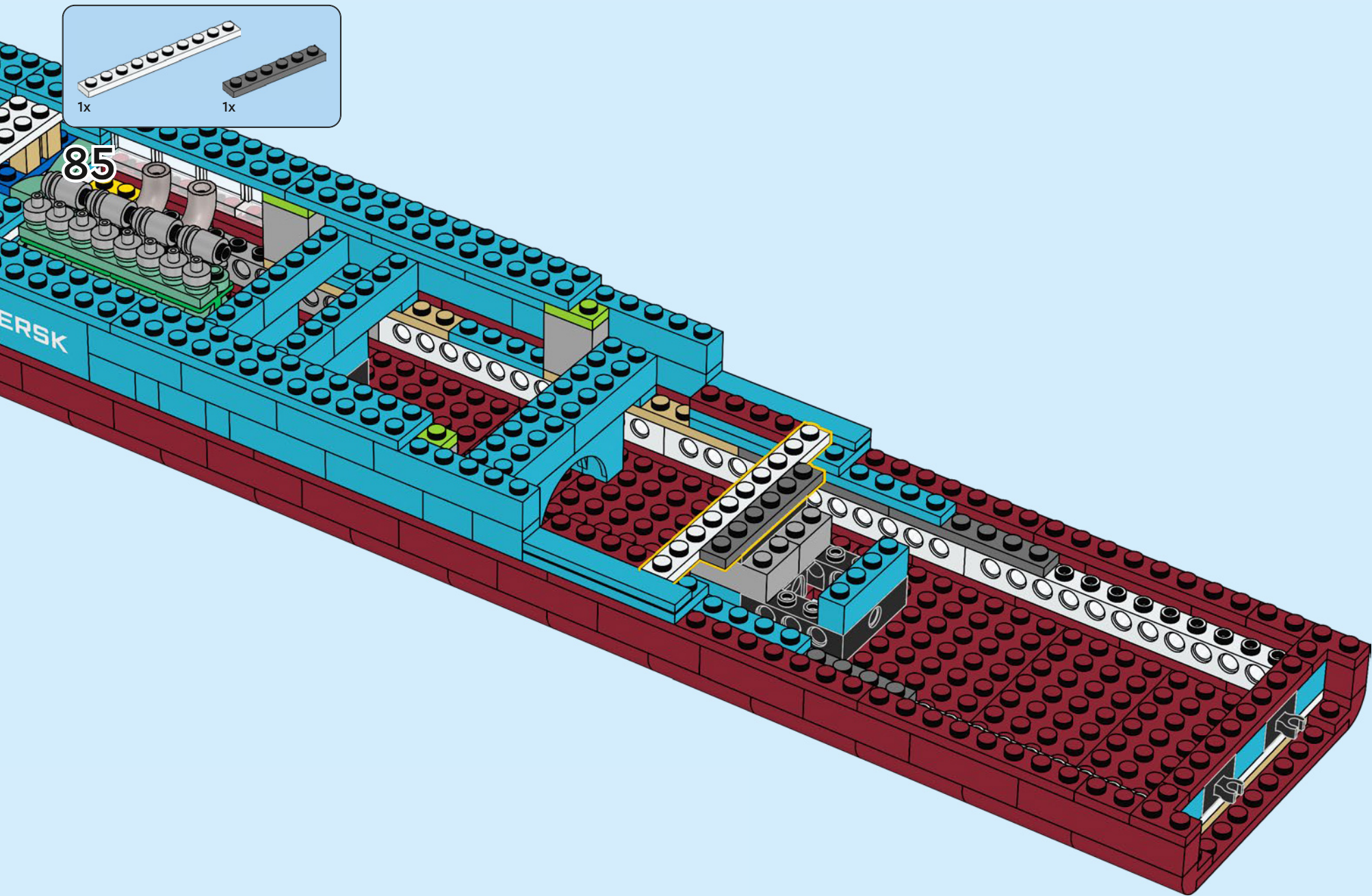

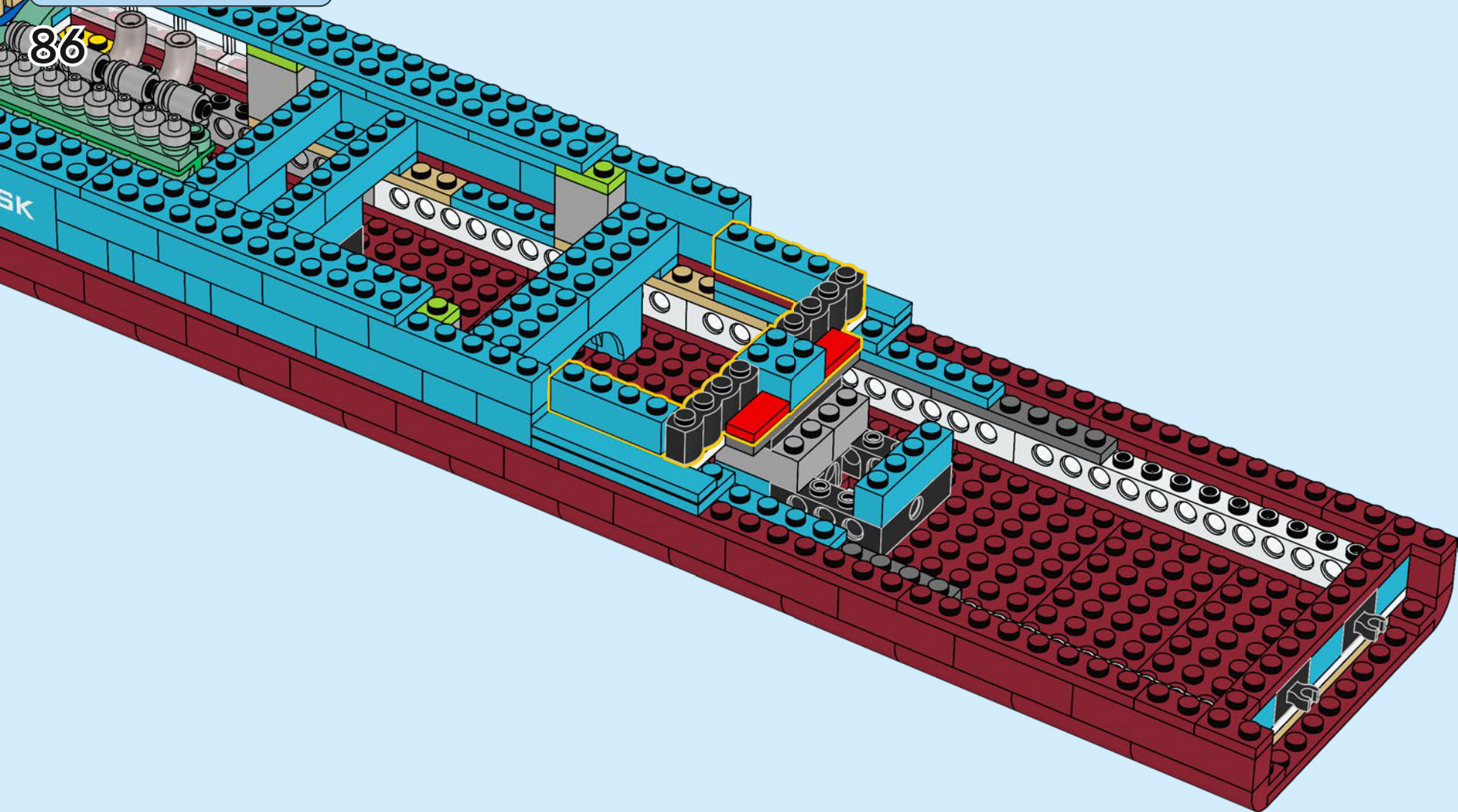
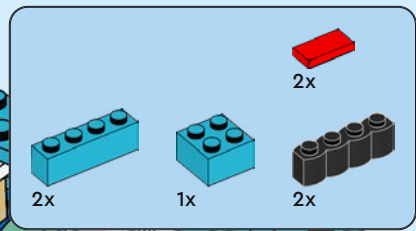

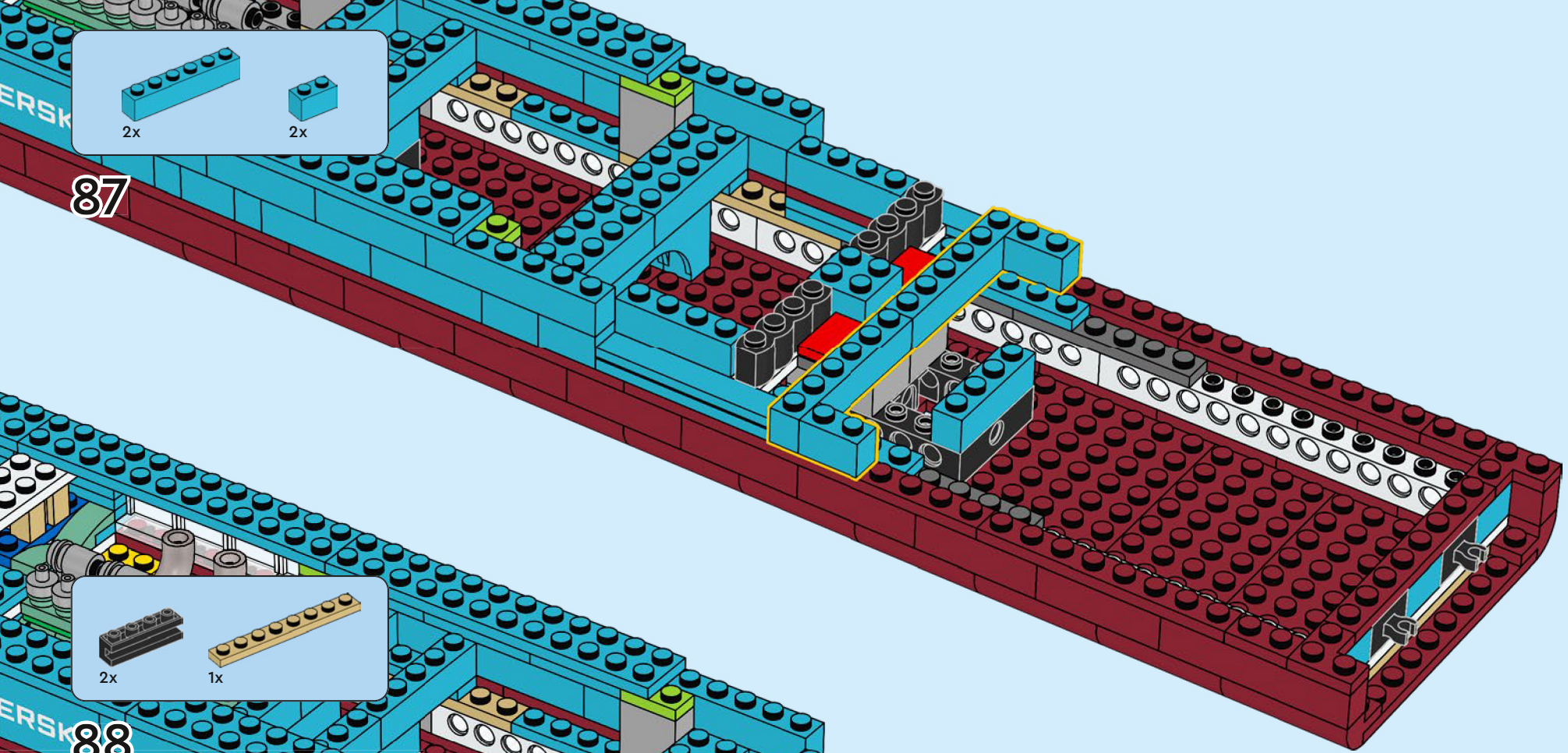

87

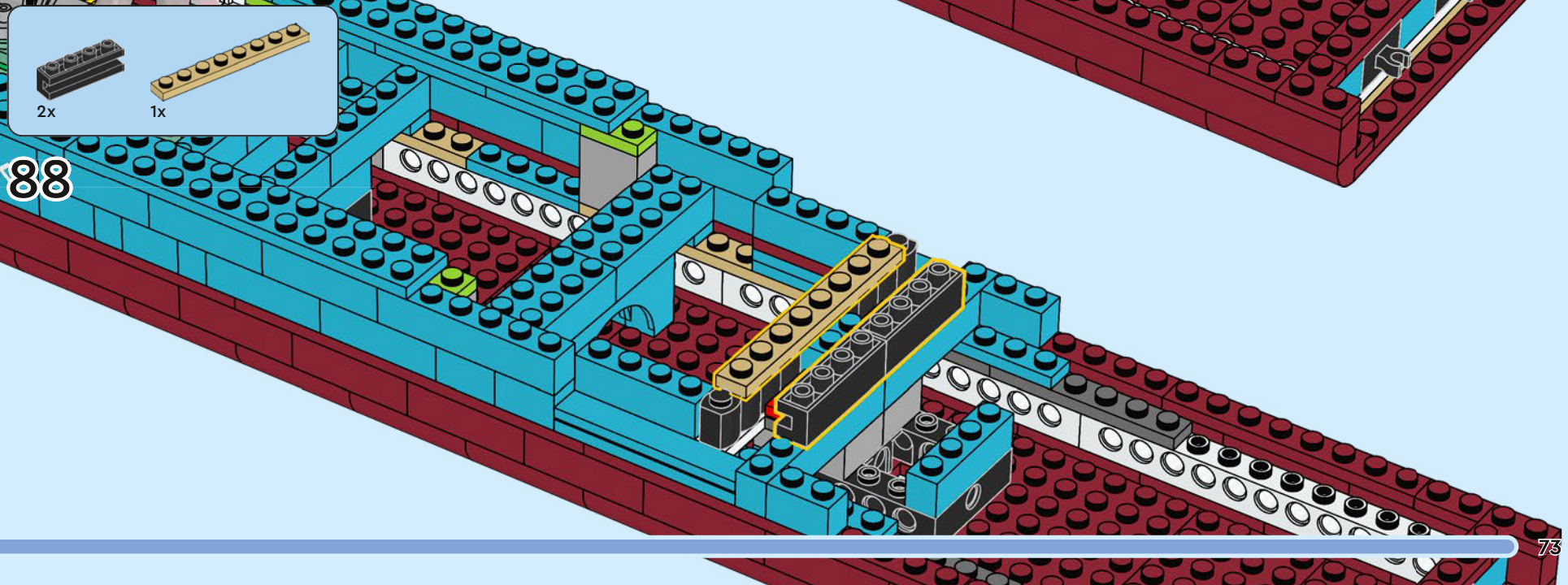

88

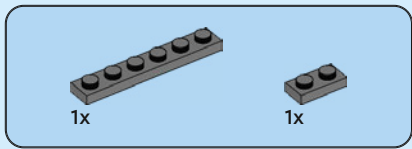

89

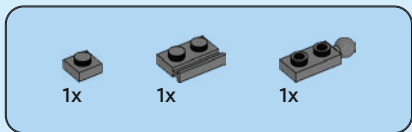
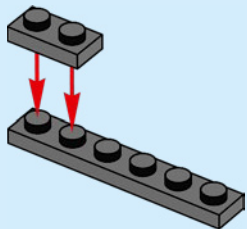

90

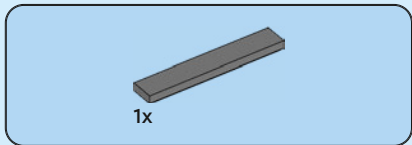
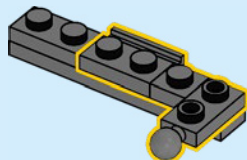

91

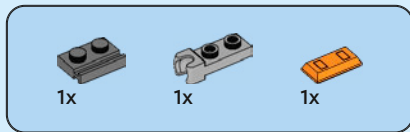
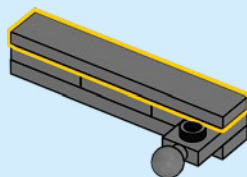

92

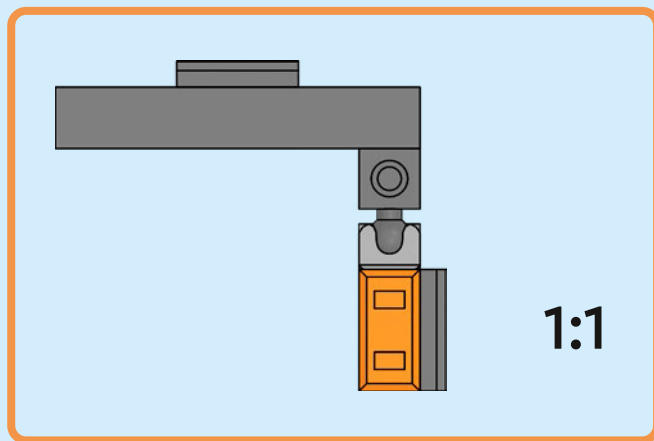
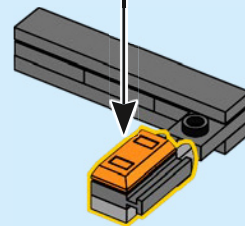
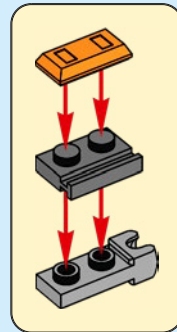

93

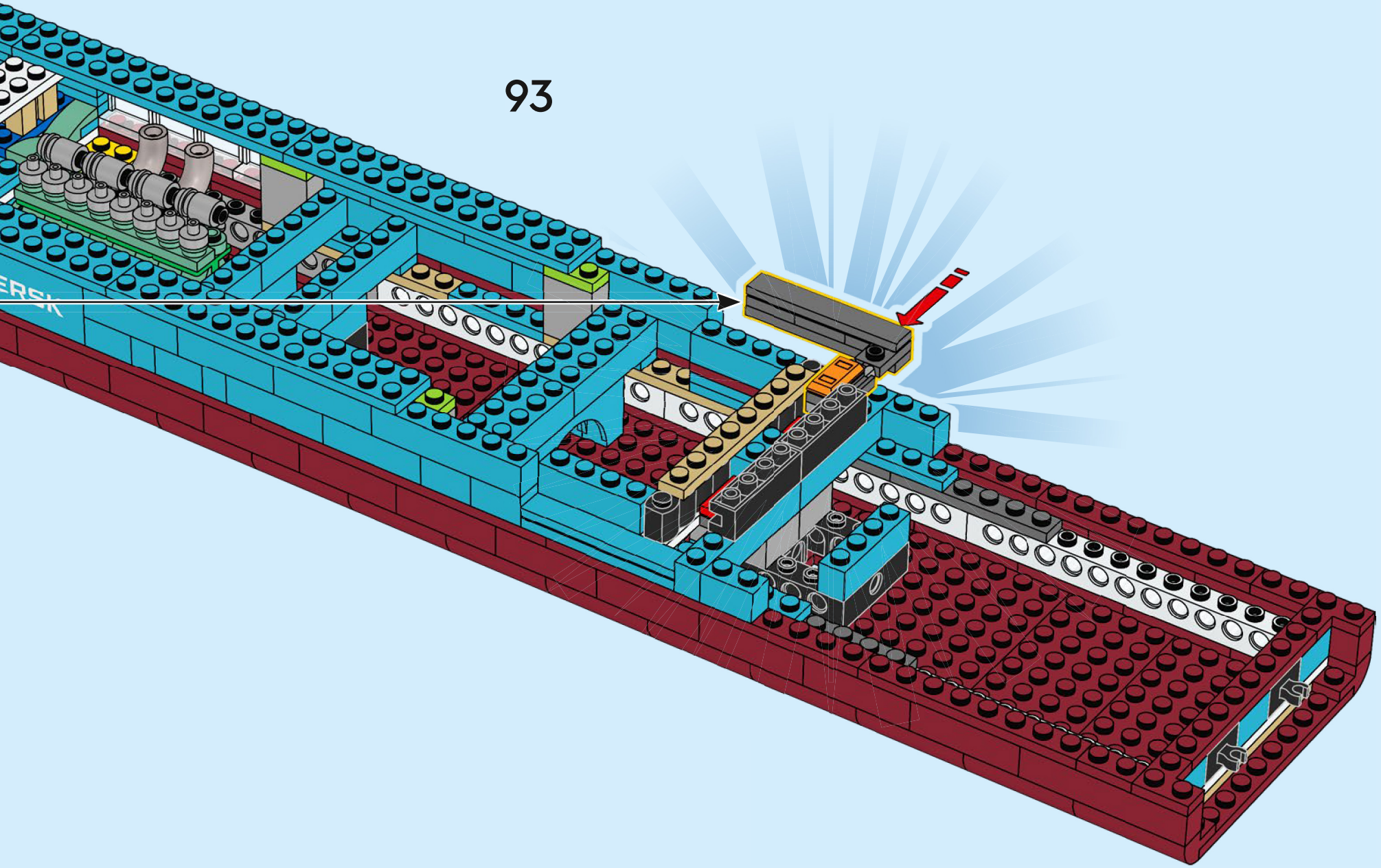

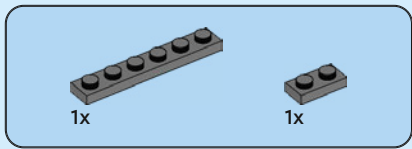

94

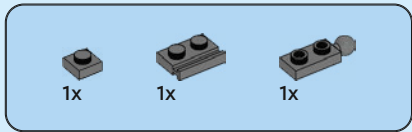
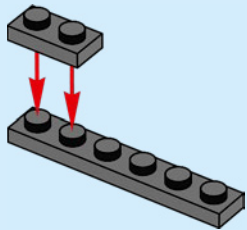

95

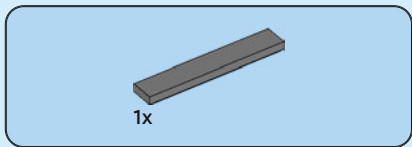
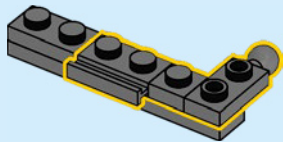

96

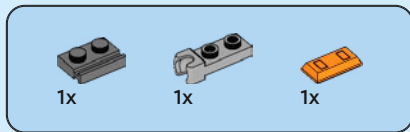
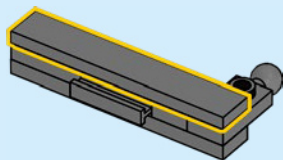

97

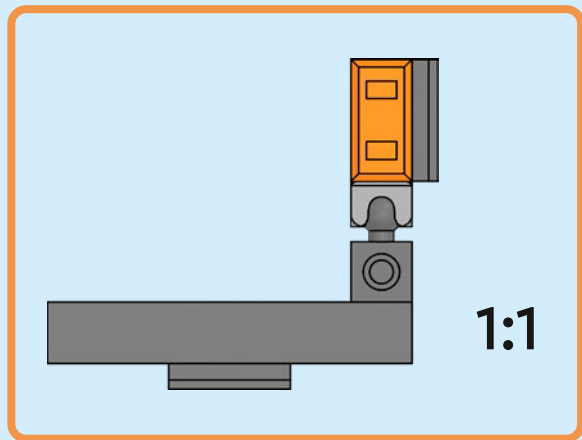
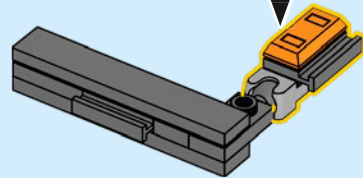
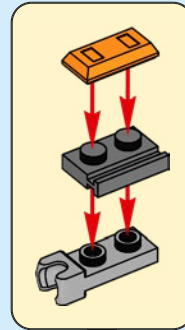

98

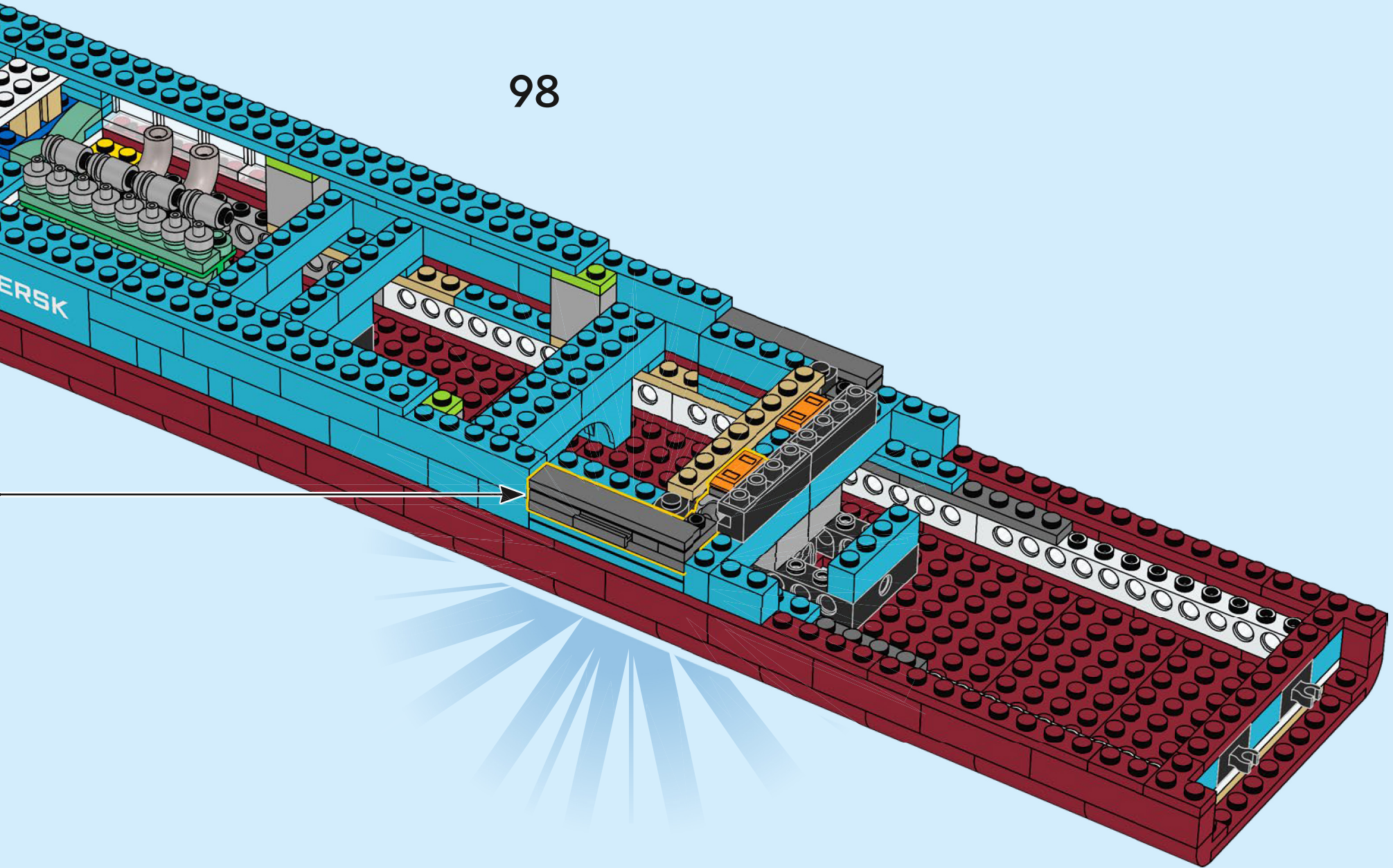

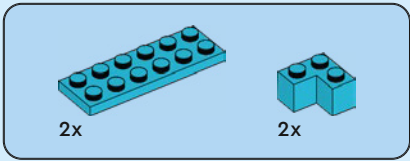

99

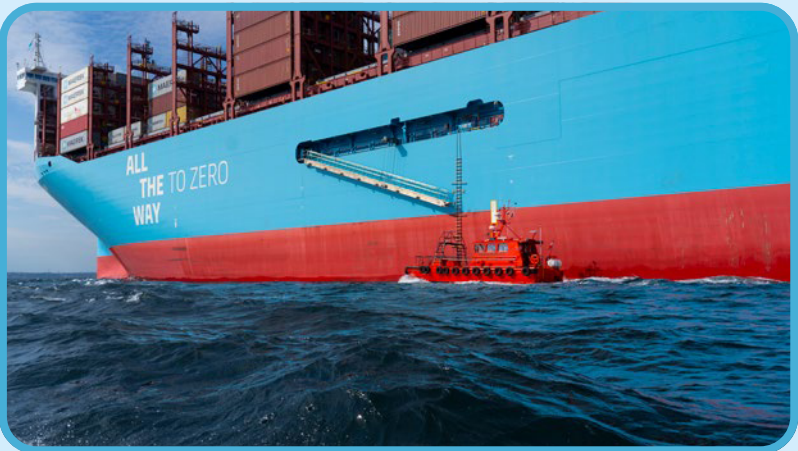
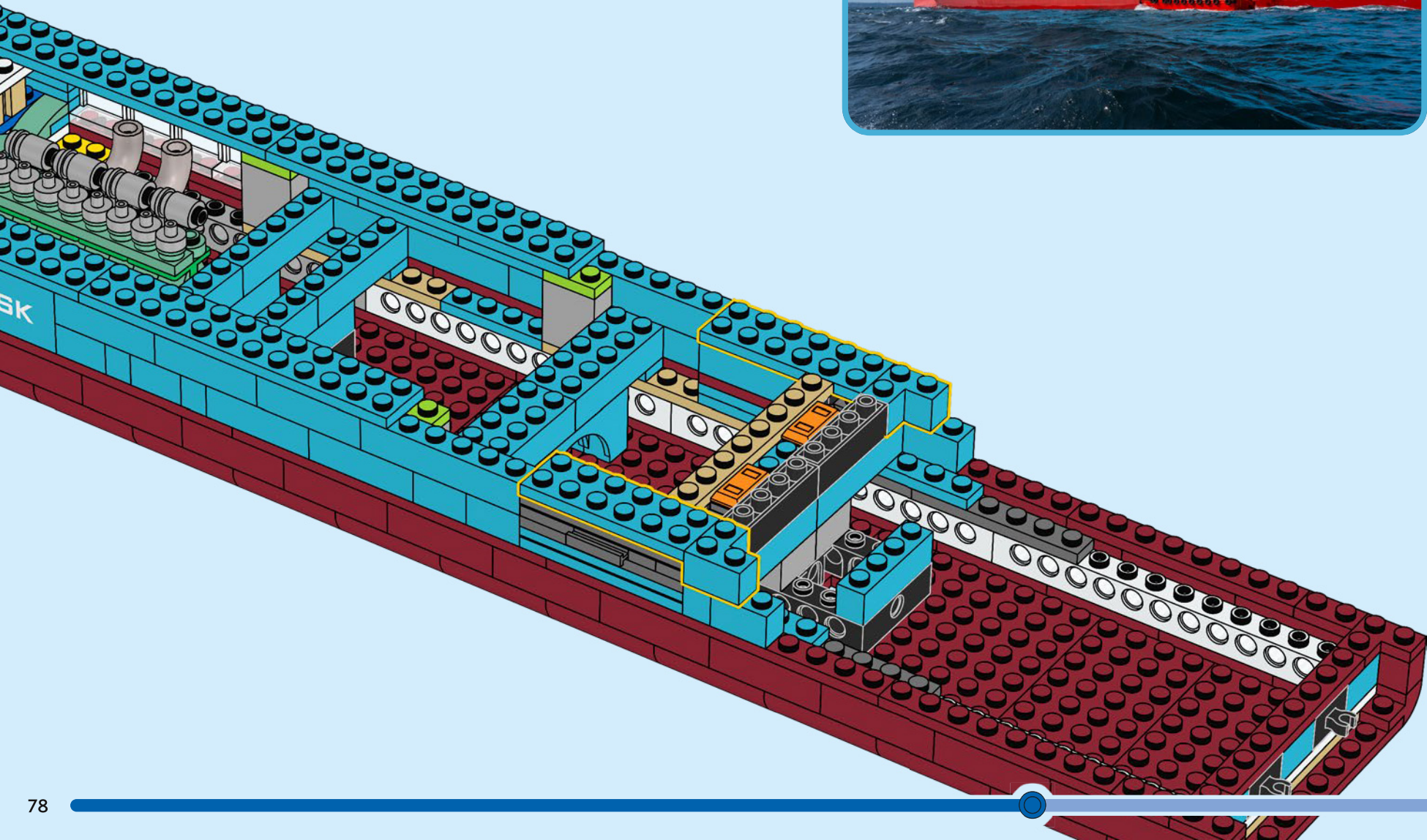

1

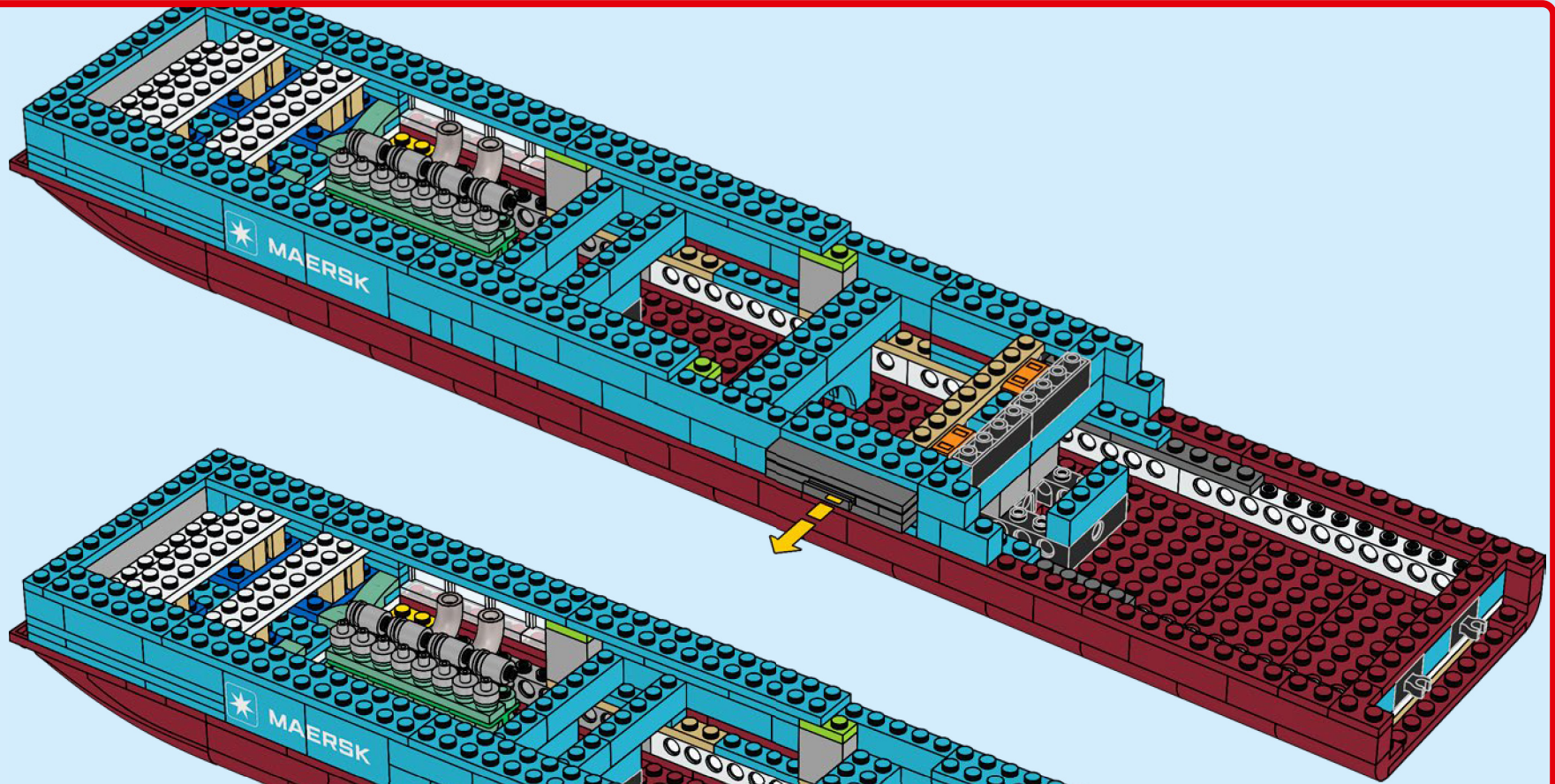

2

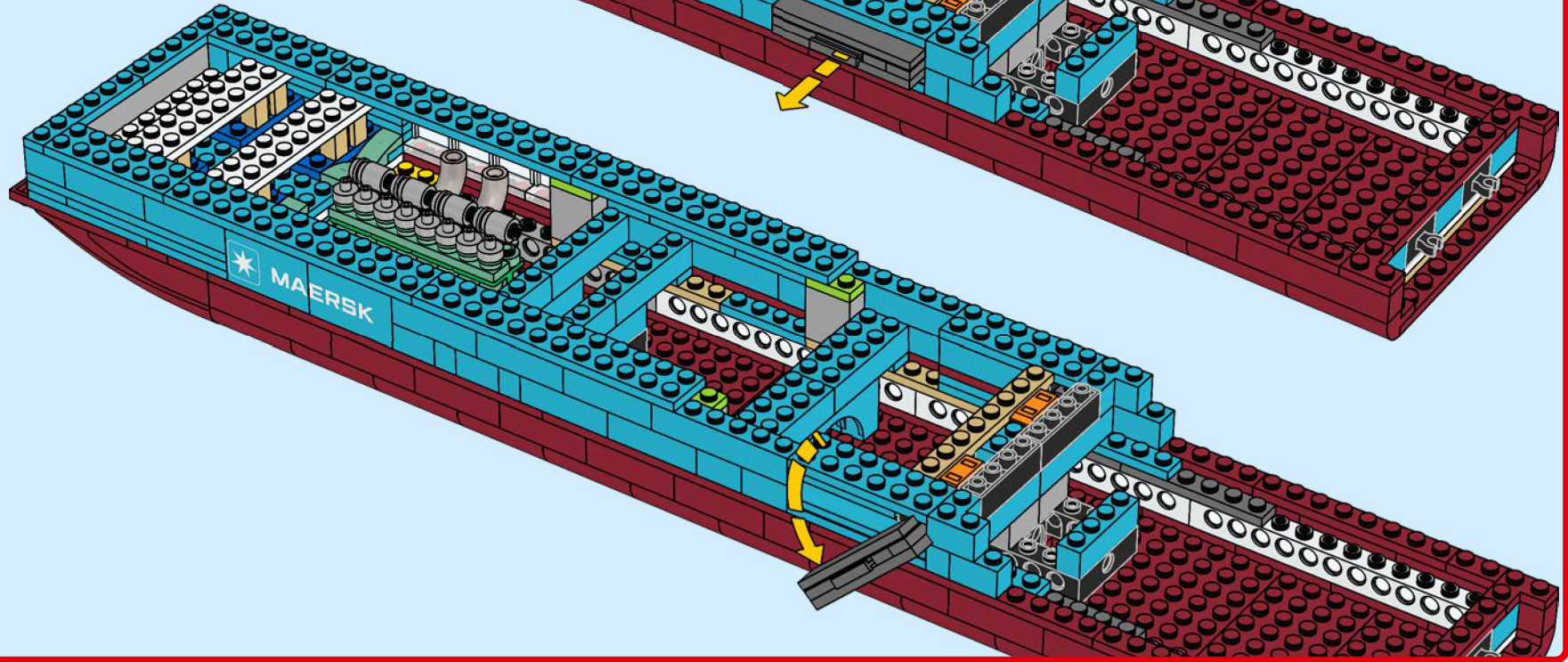

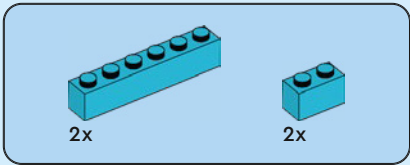

100

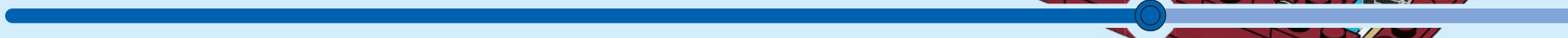
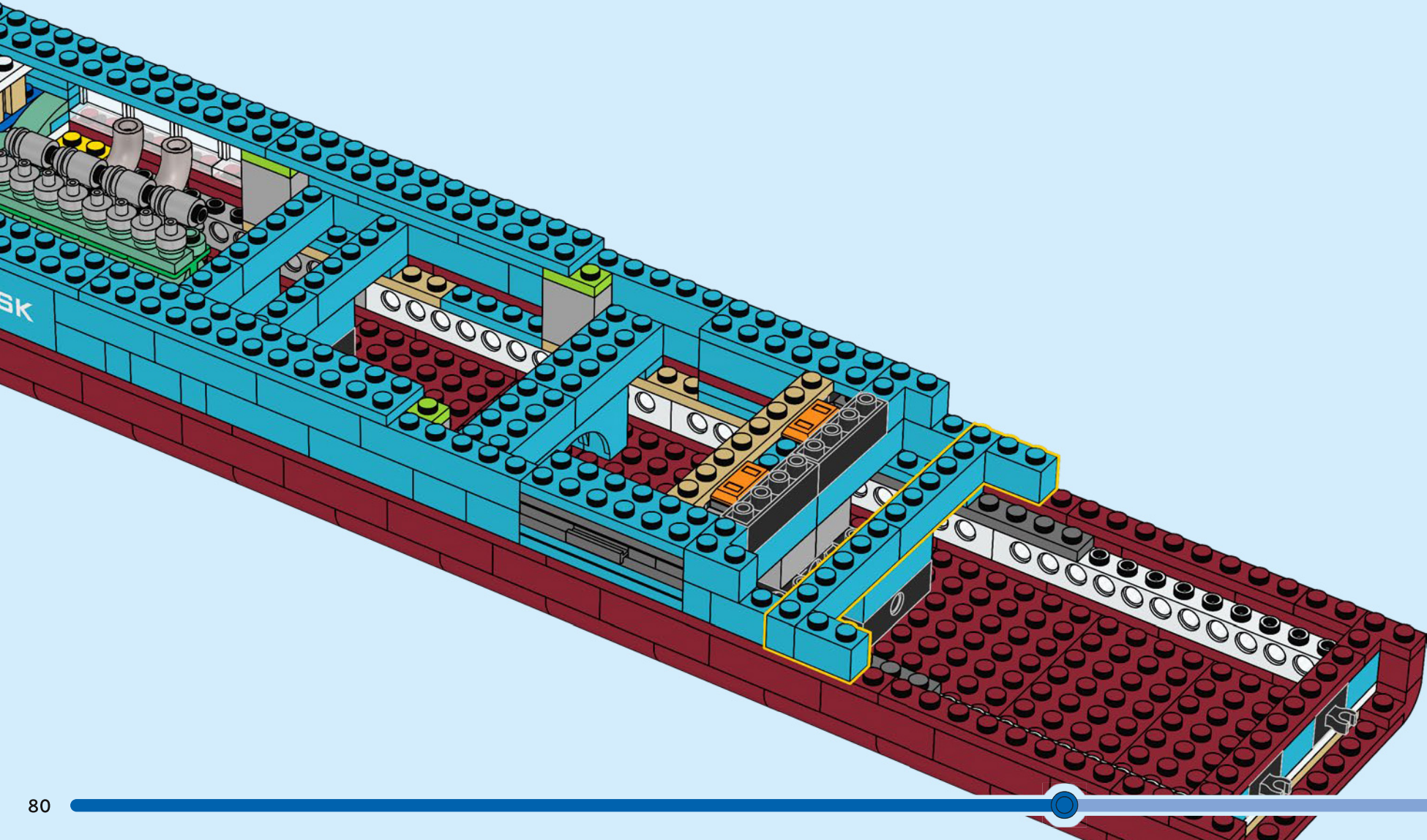

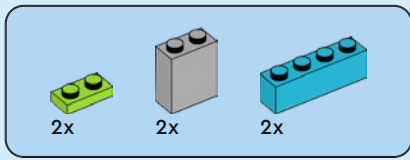

101

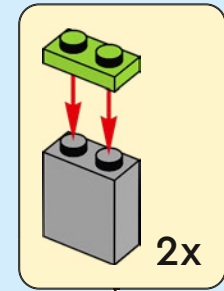
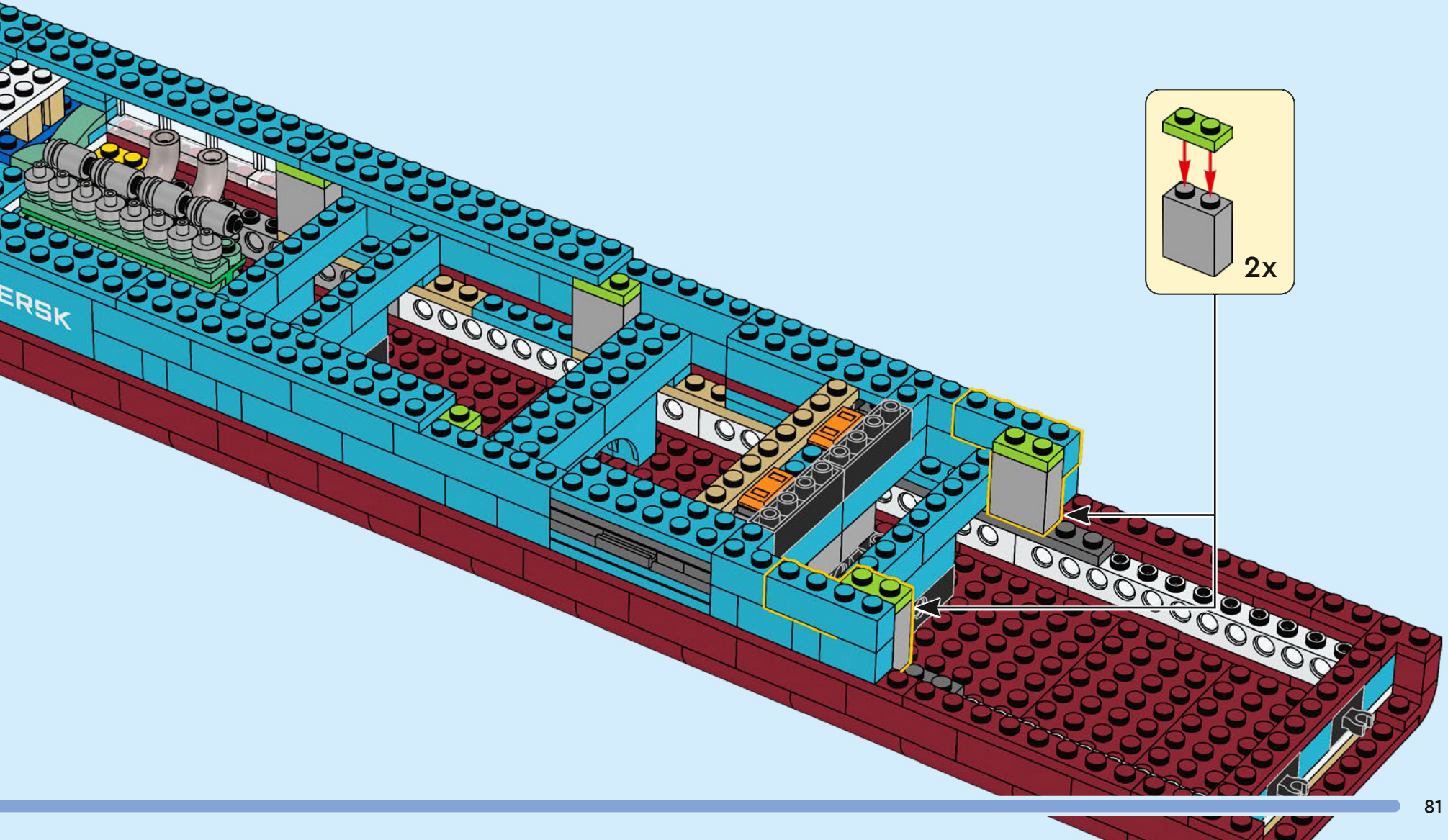

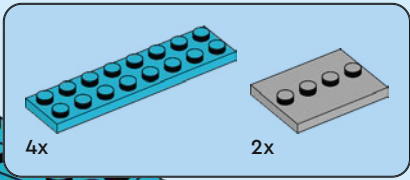

102

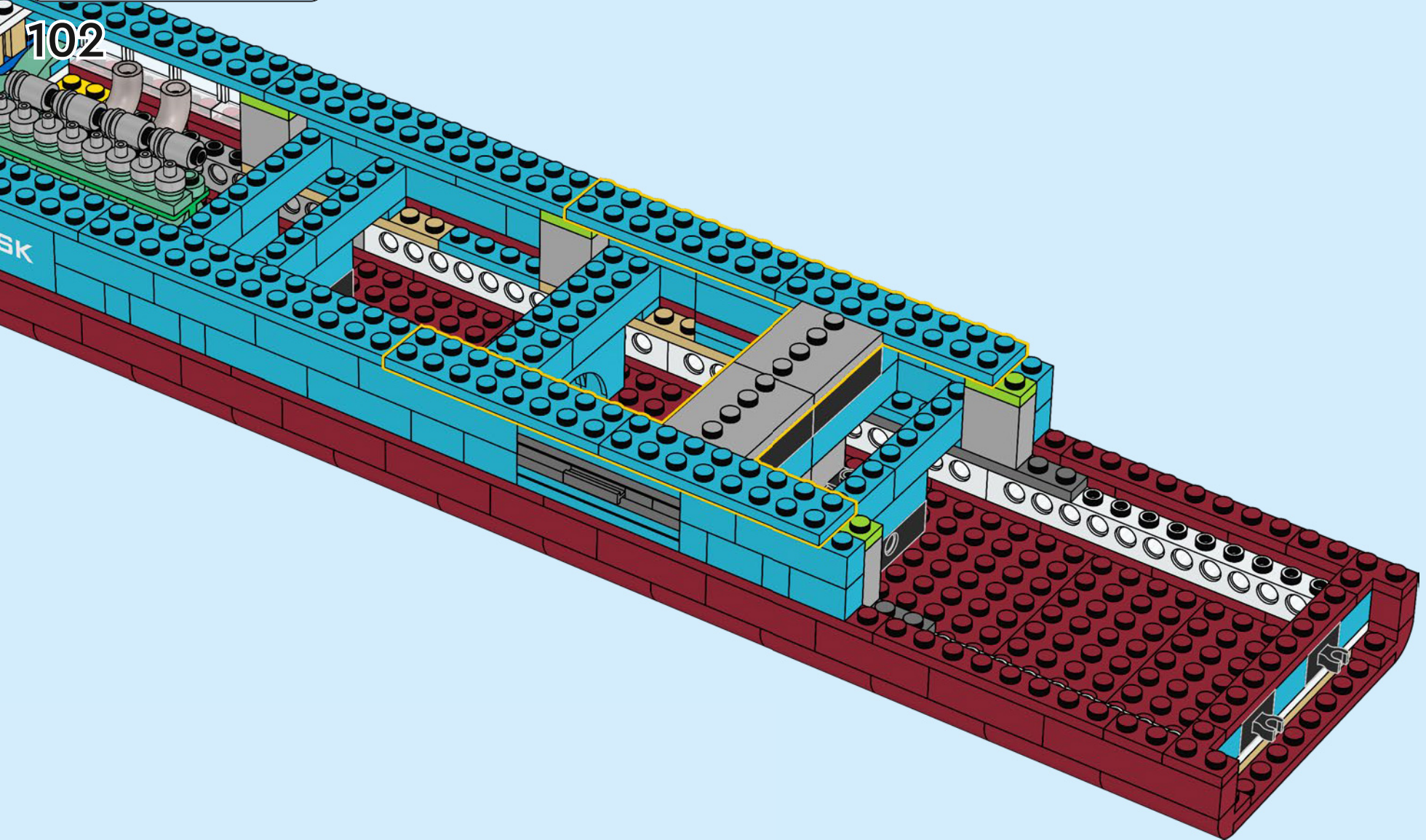

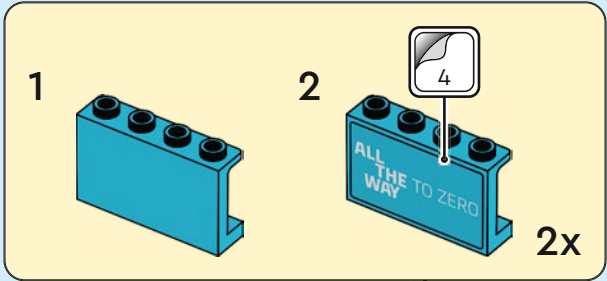
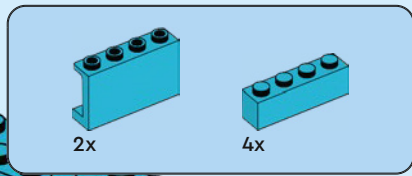

103  
ERSK

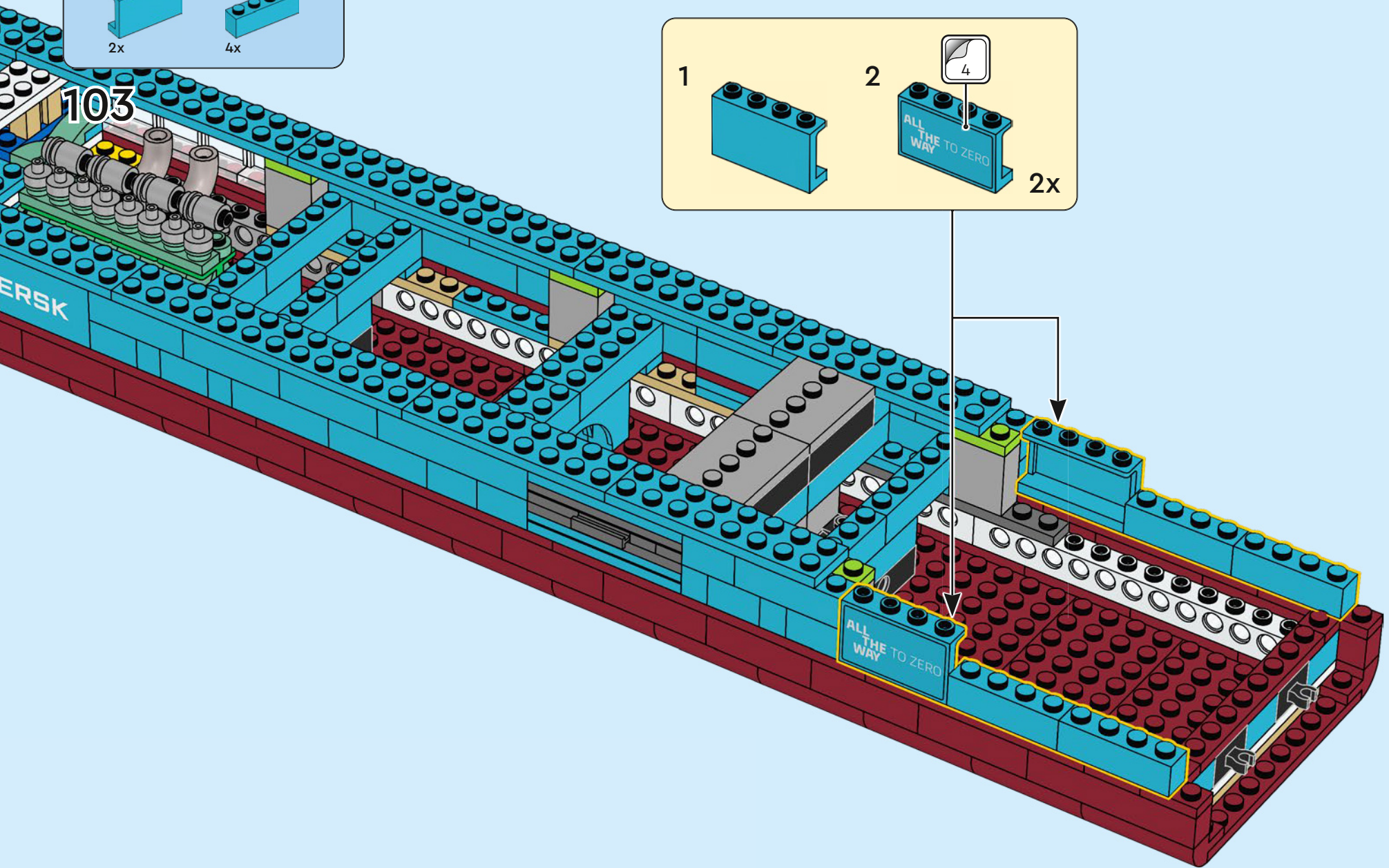



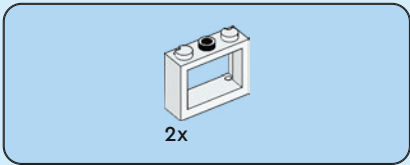

105

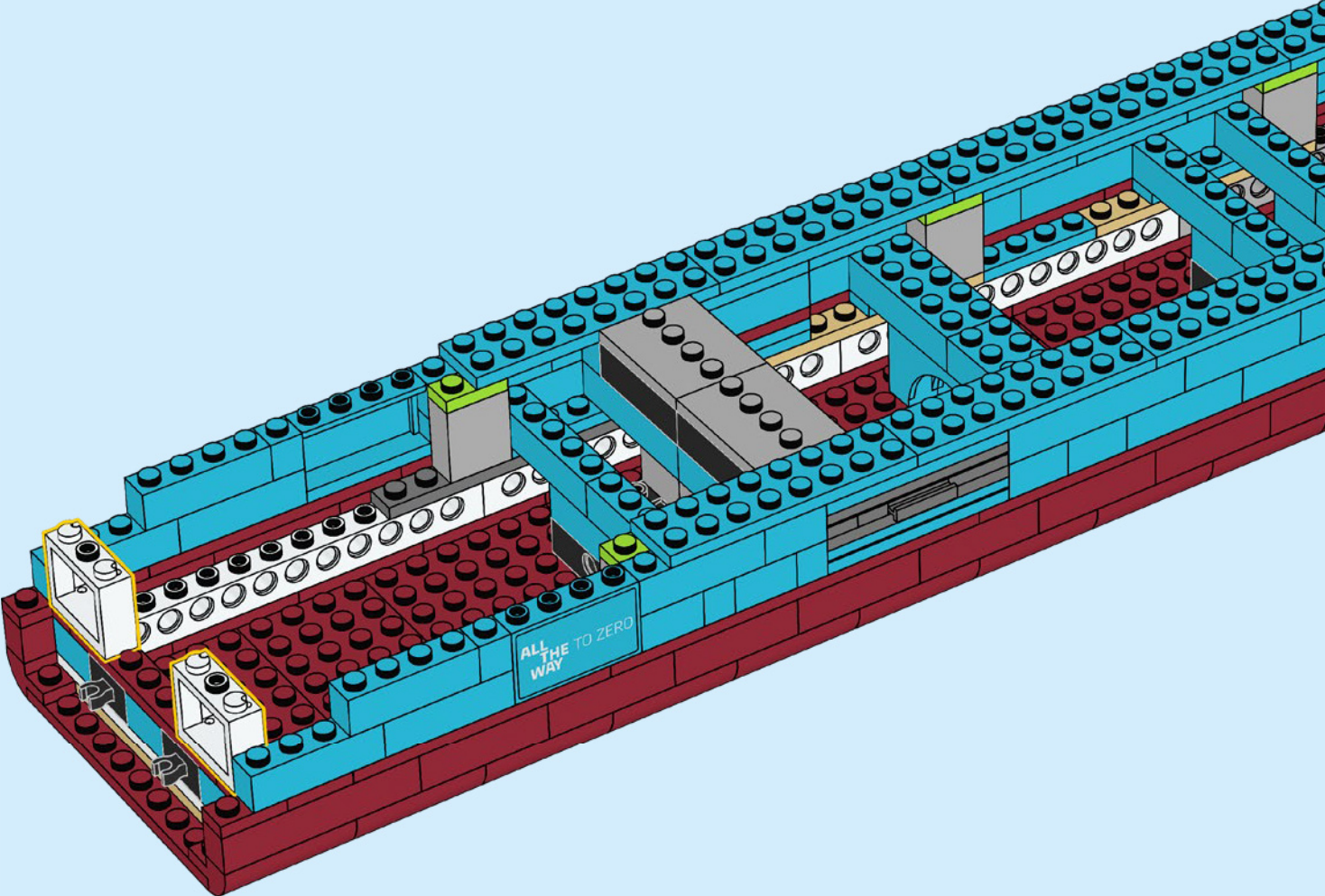

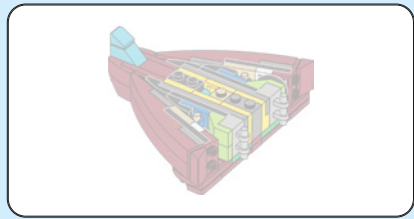
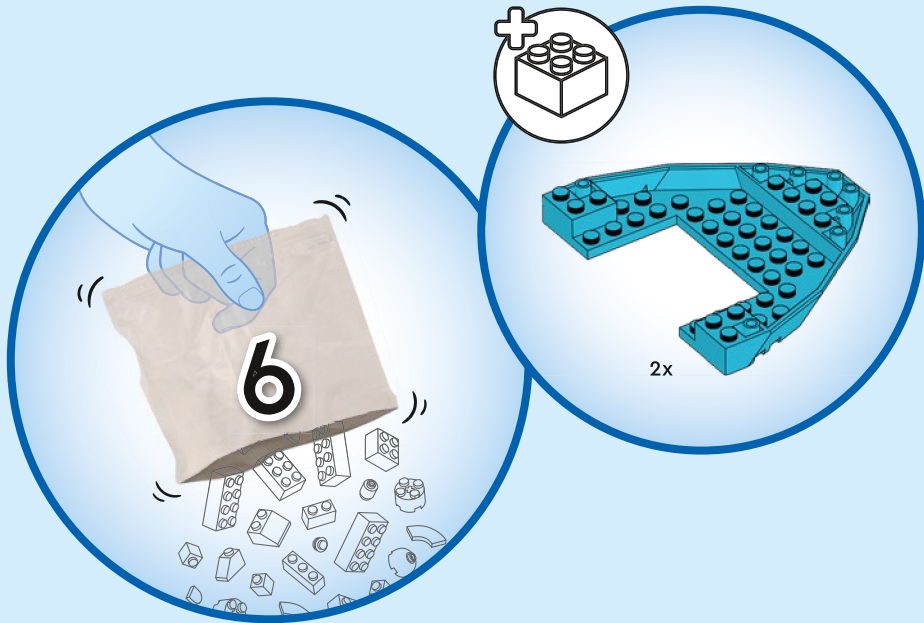

106

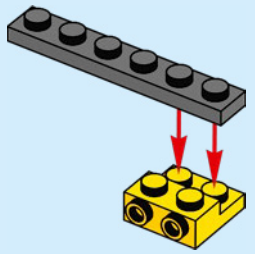

107

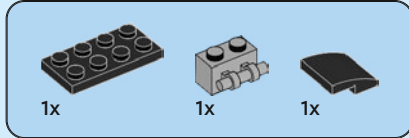
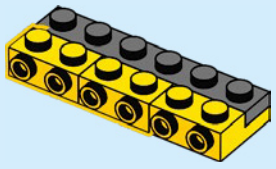

108

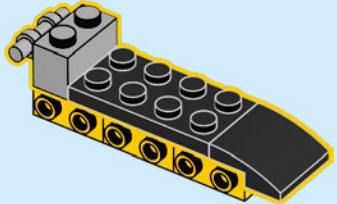

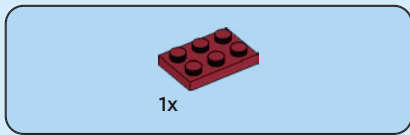

109

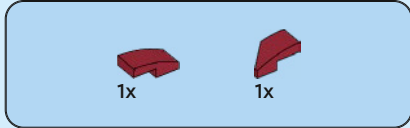
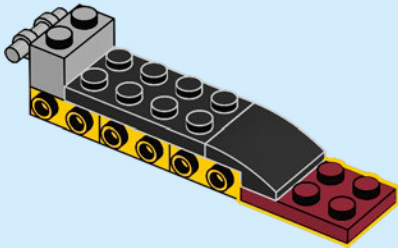

110

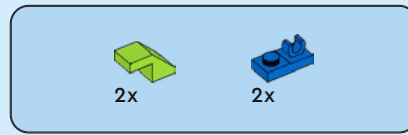
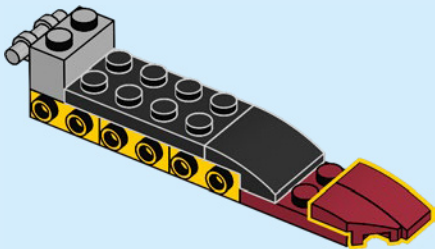

111

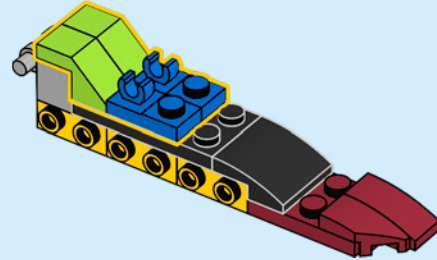

112

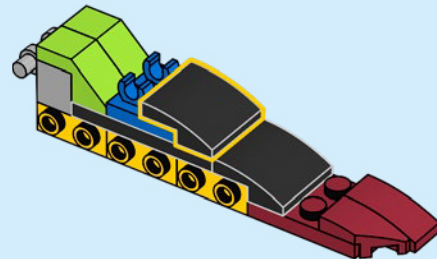

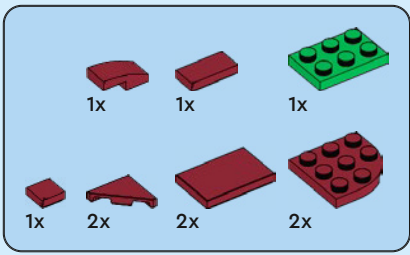

# 113

1

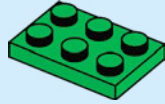

2

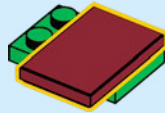

3

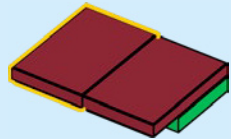

4

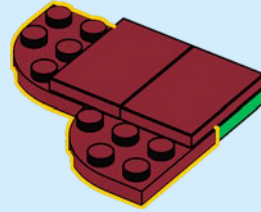

5

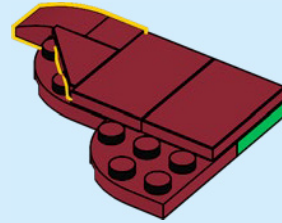

6

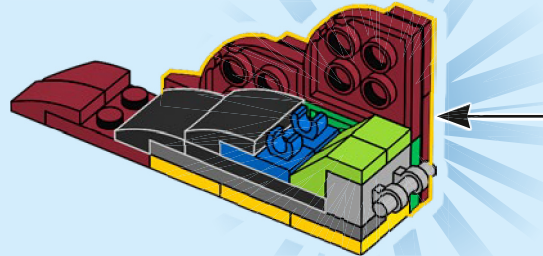
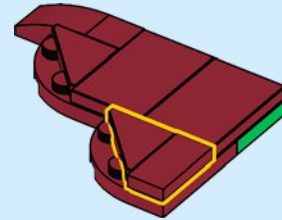

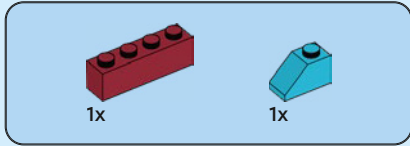
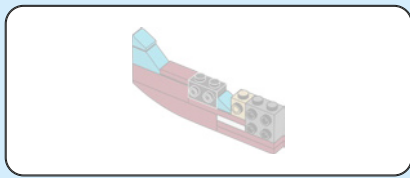

114

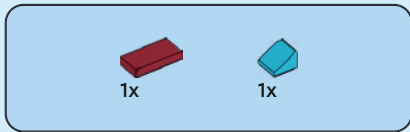
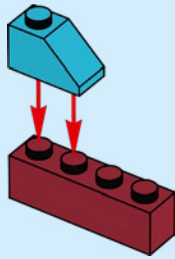

115

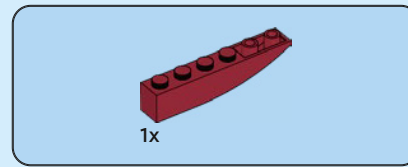
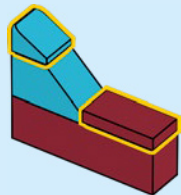

116

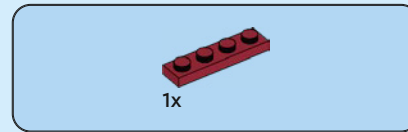
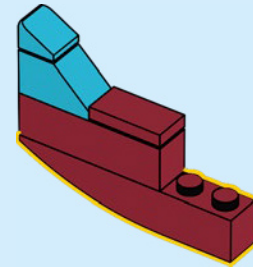

117

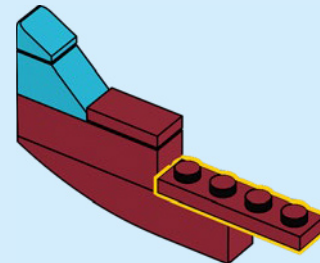

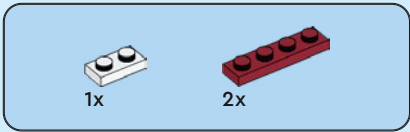

118

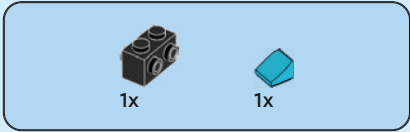
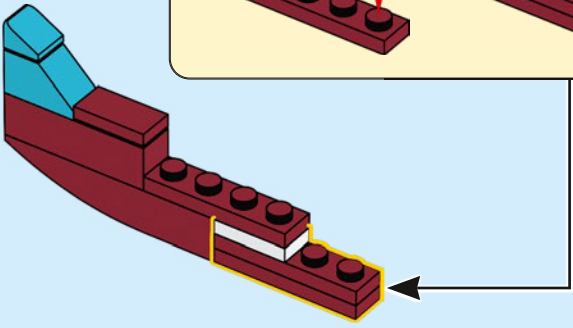
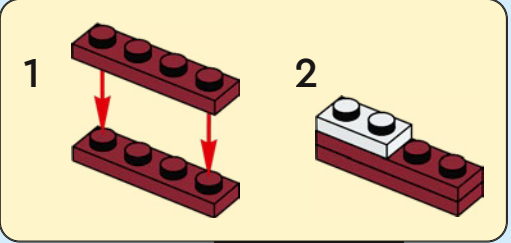

119

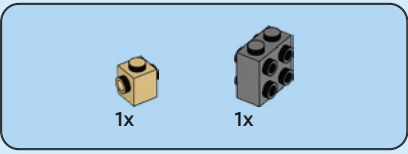
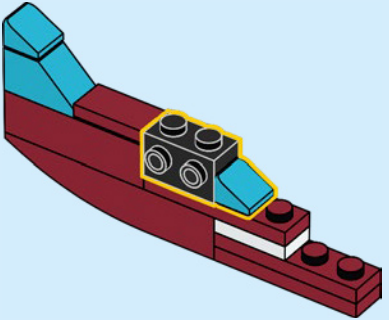

120

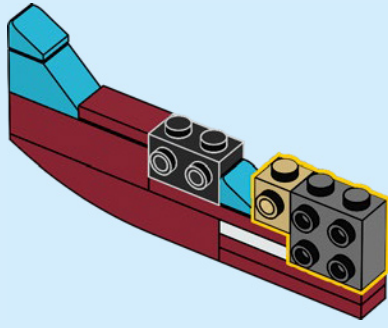

121

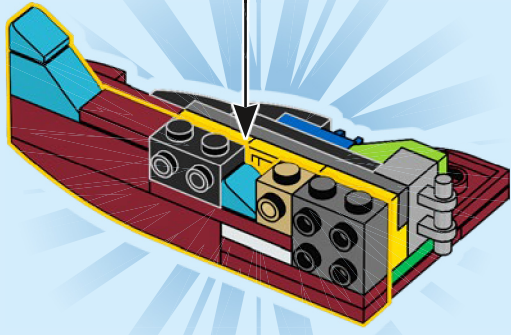

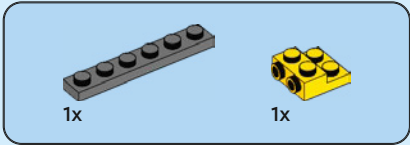
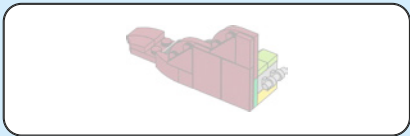

122

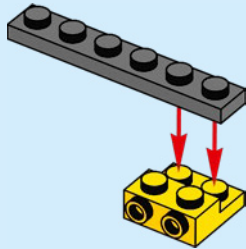

123

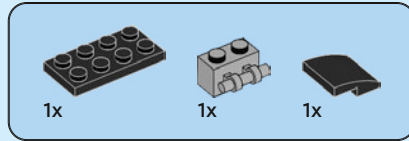
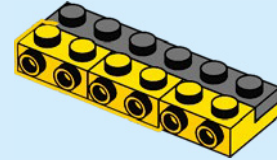

124

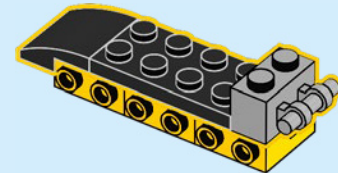

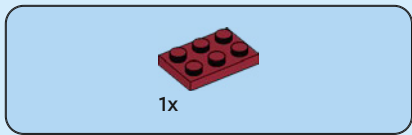

125

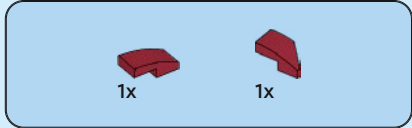
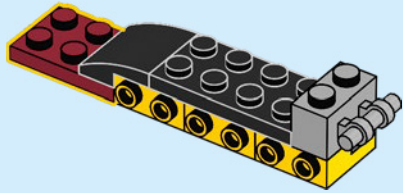

126

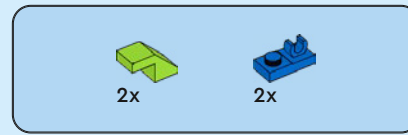
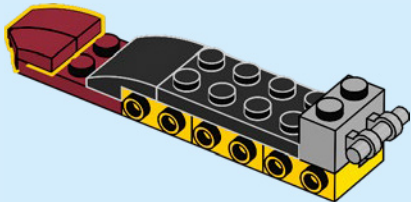

127

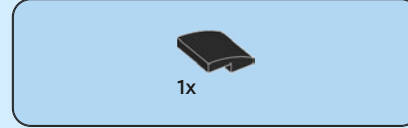
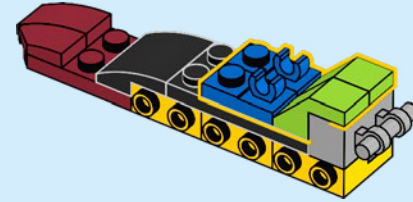

128

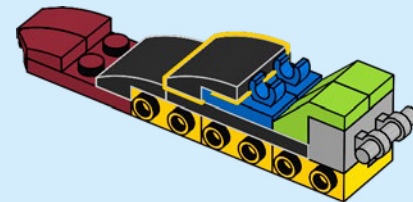

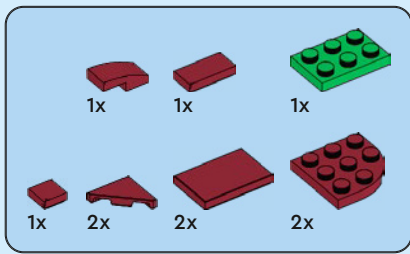

129

1

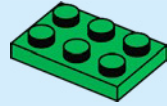

2

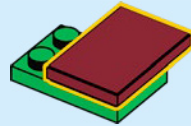

3

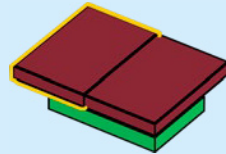

4

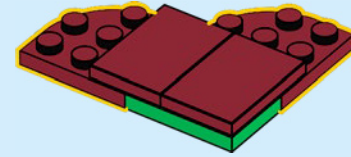

5

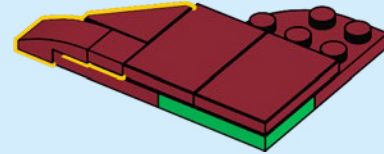

6

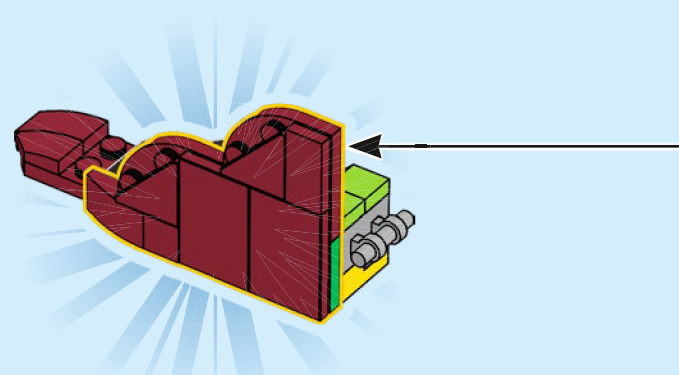
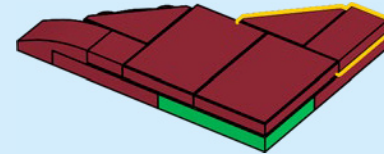

130

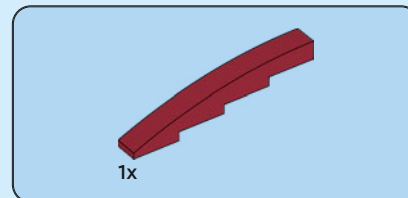
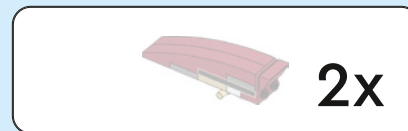
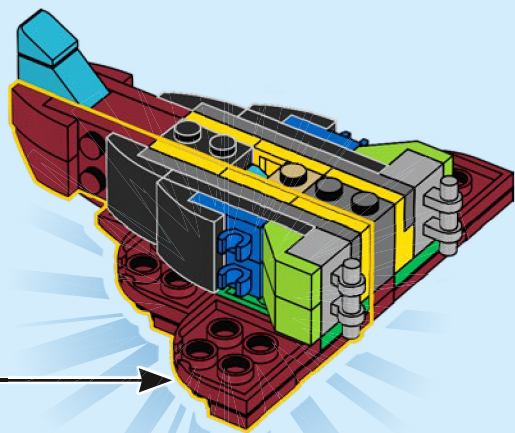

131

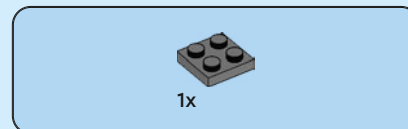
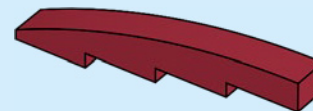

132

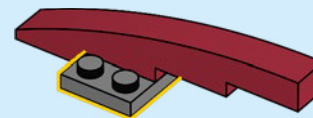





1x

137

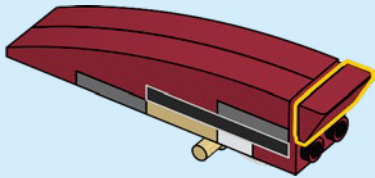

2x

138

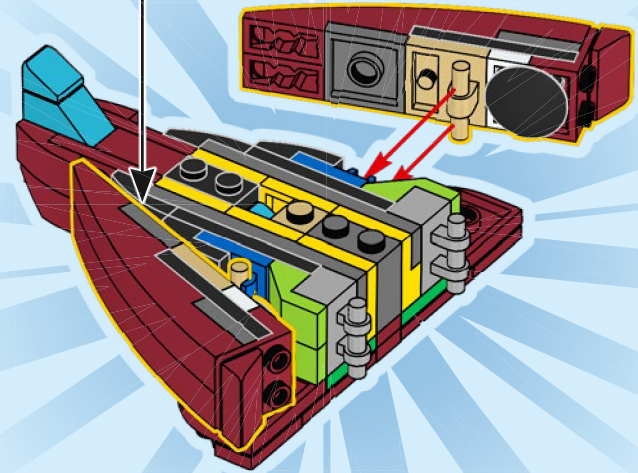

139

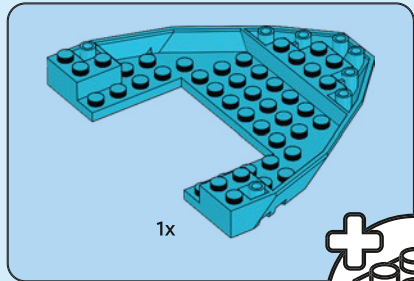
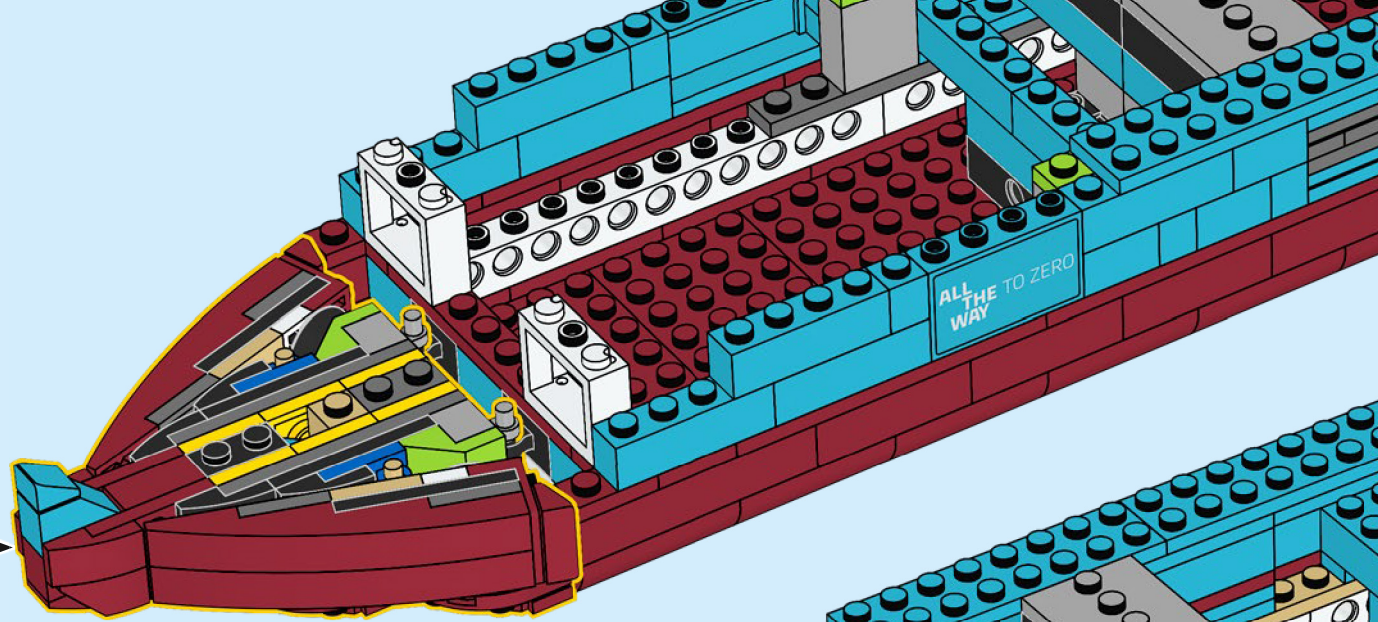

1x

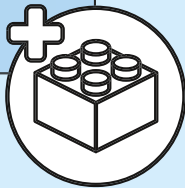

140

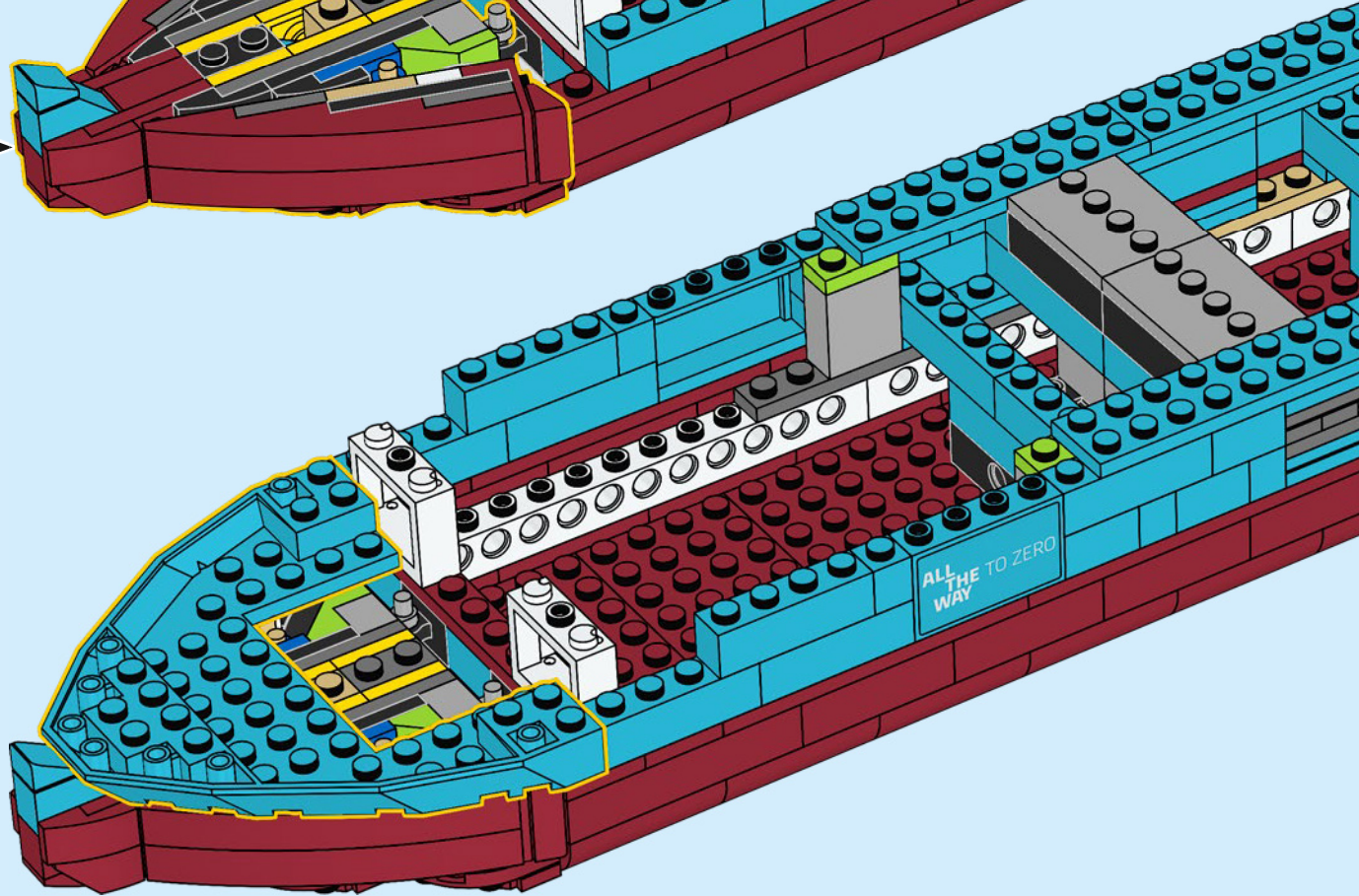

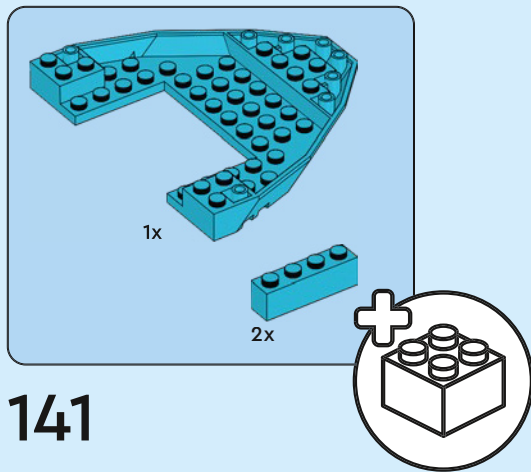

141

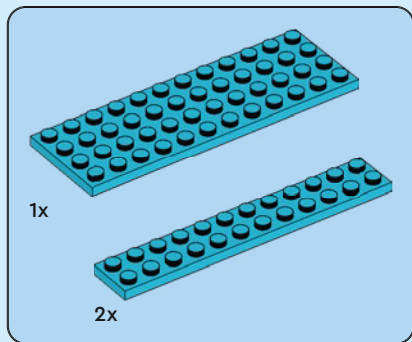
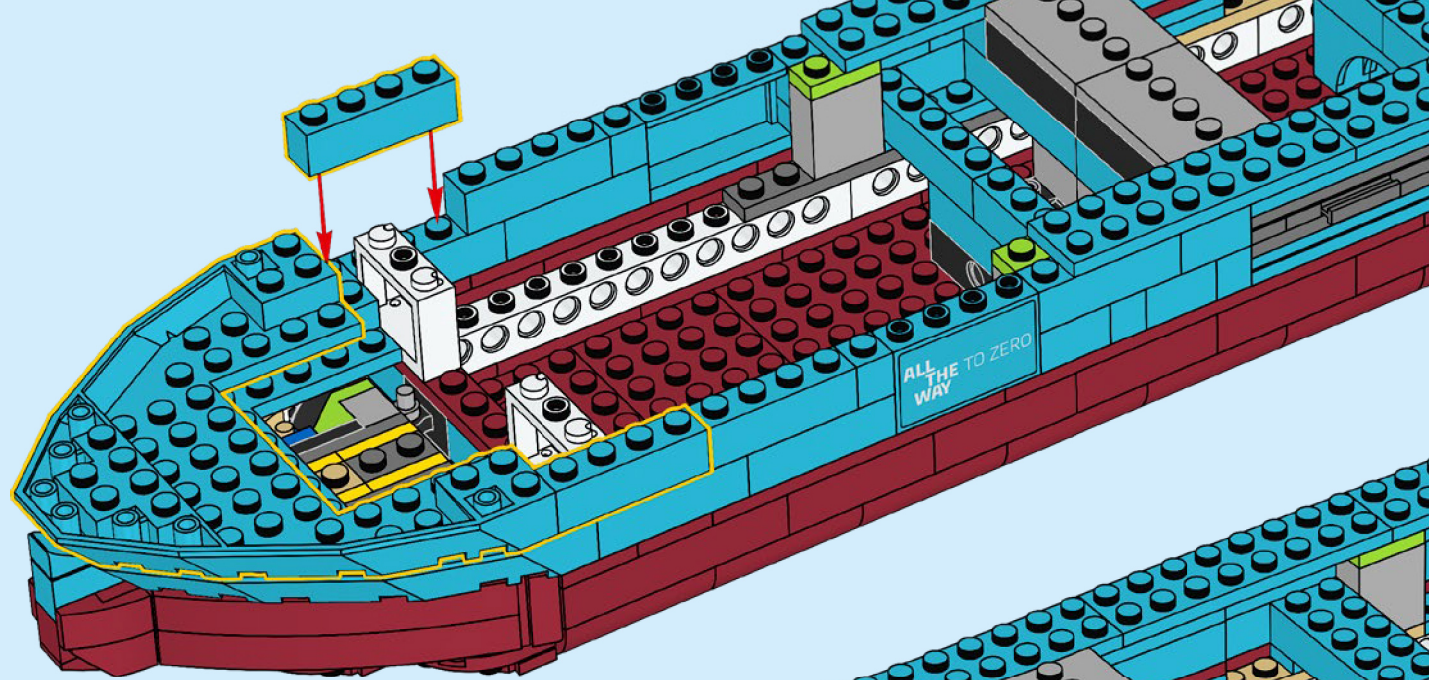

142

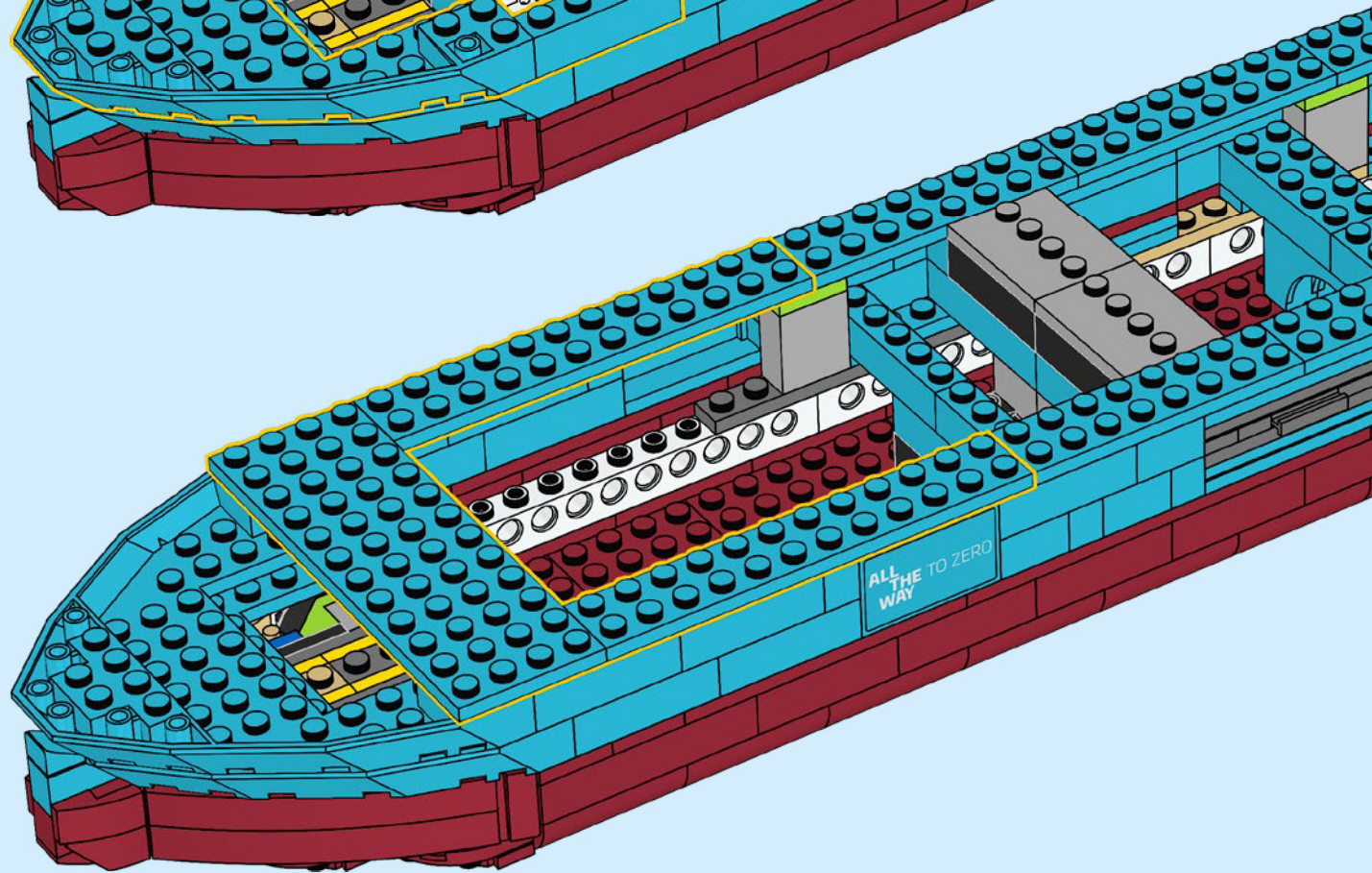

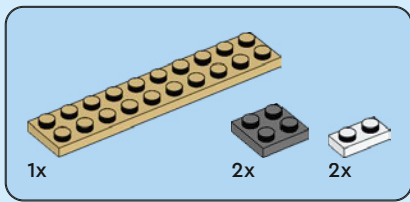

143

1

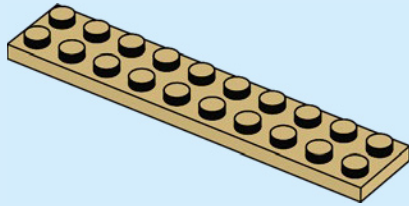

2

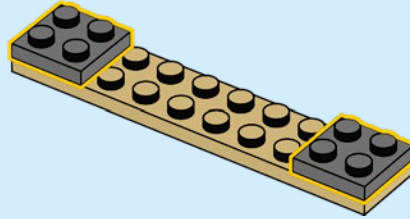

3

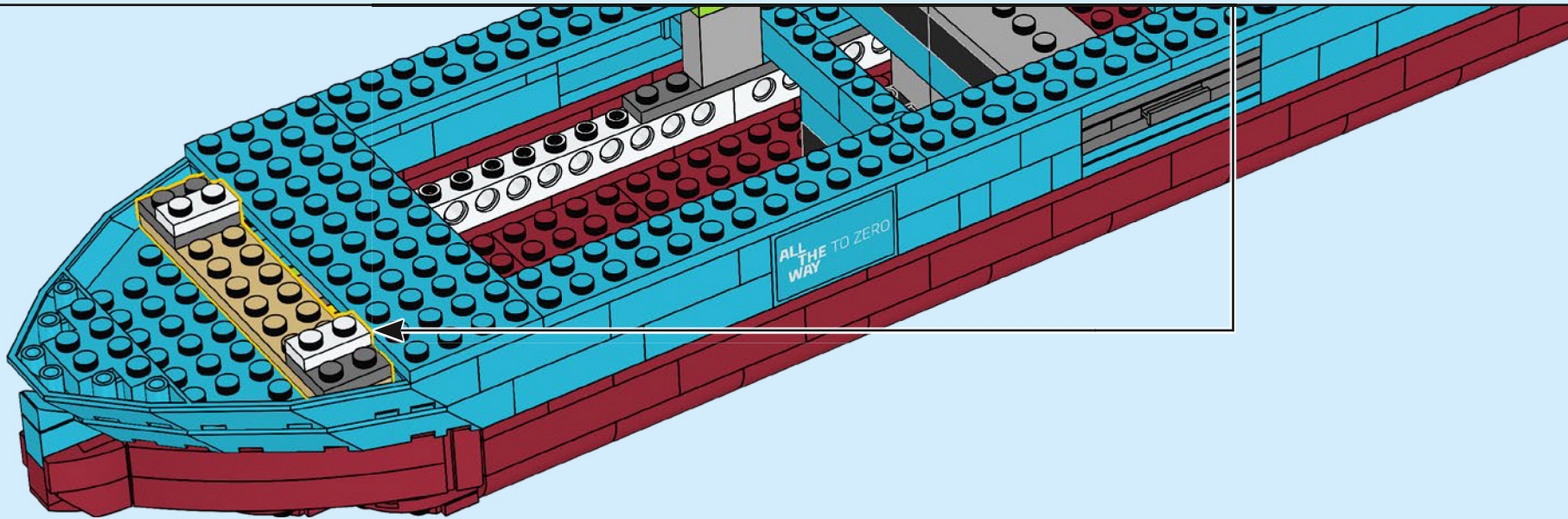
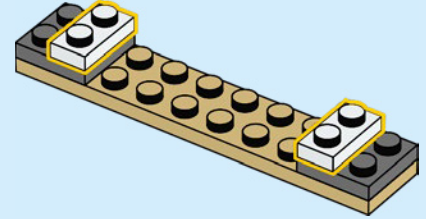

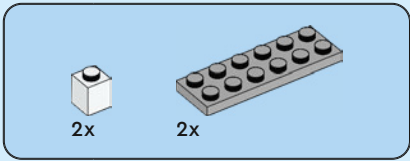

144

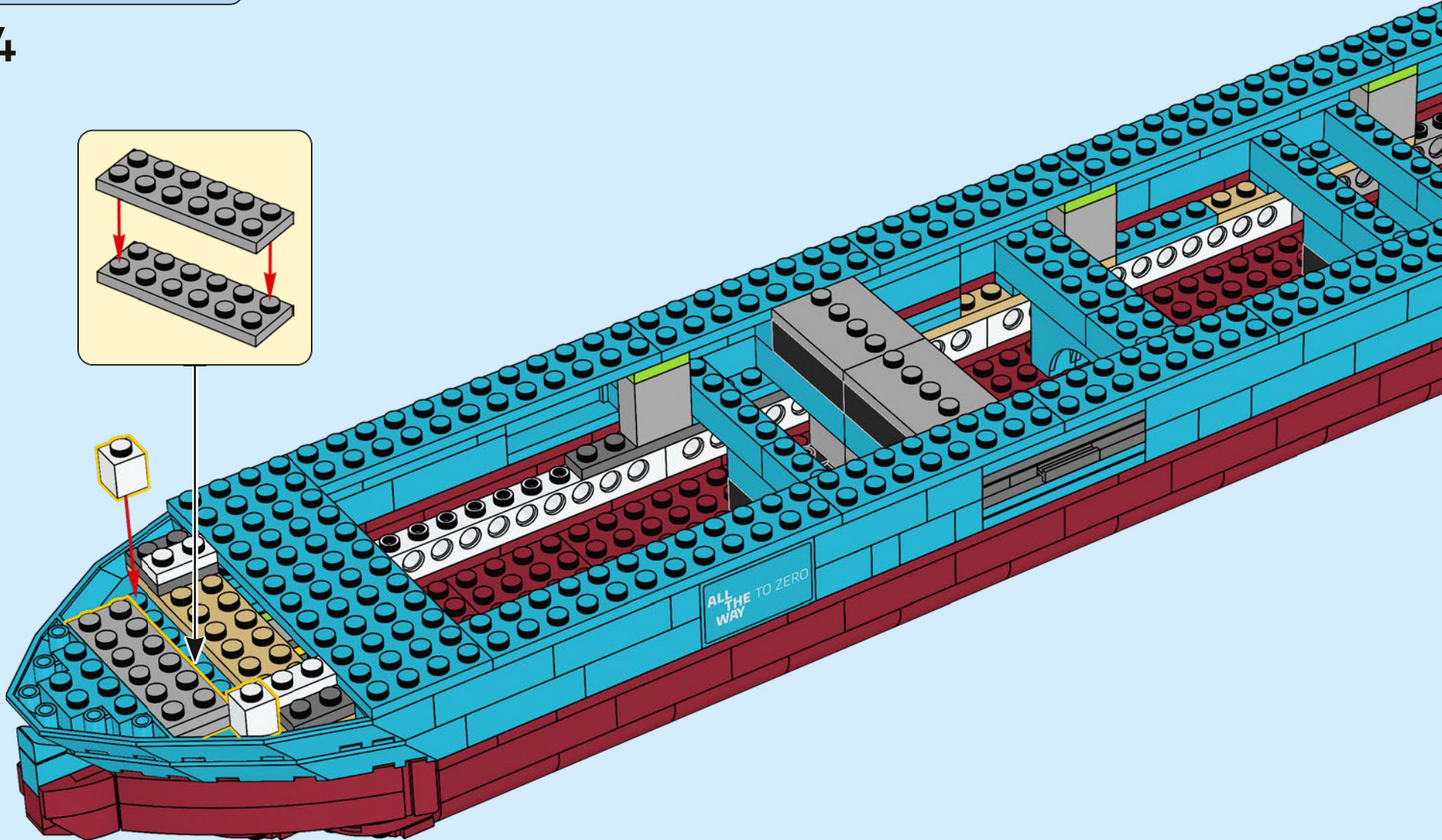
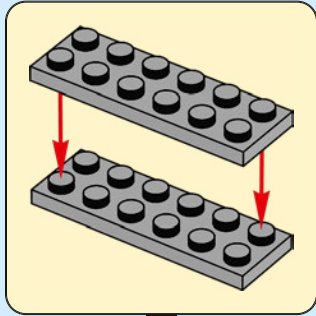

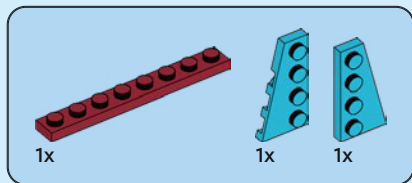

145

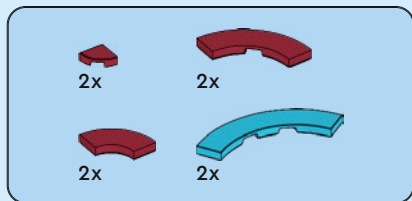
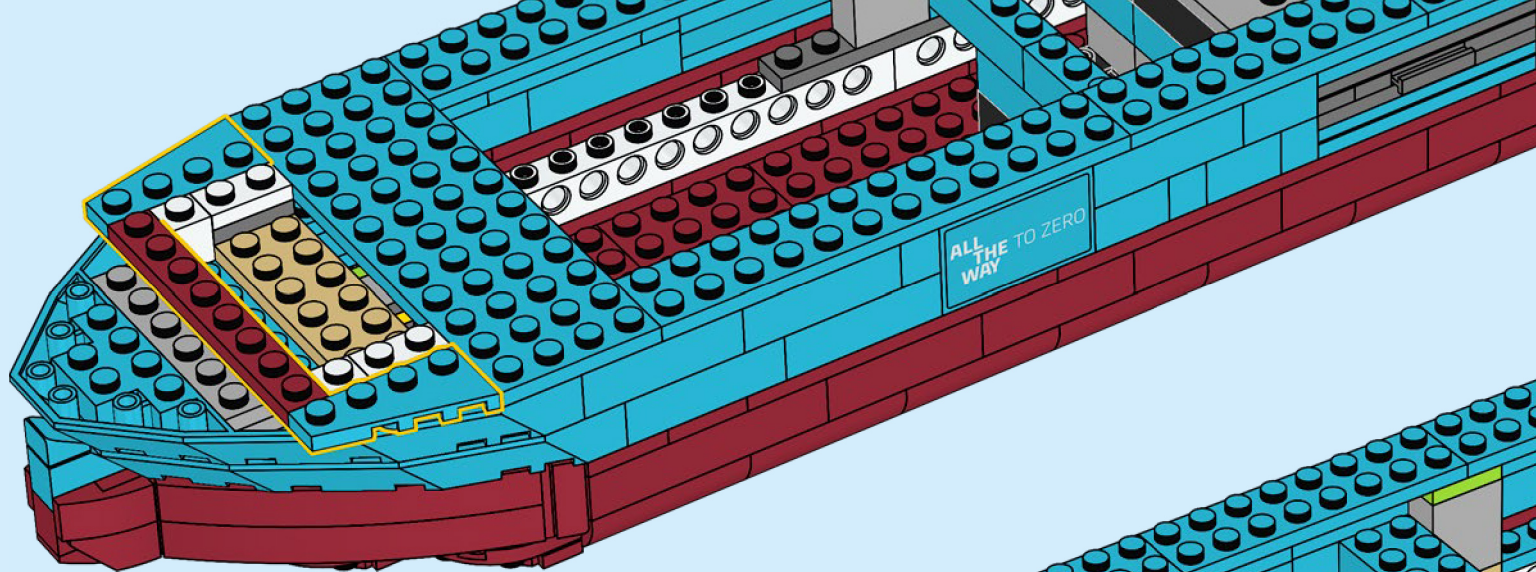

146

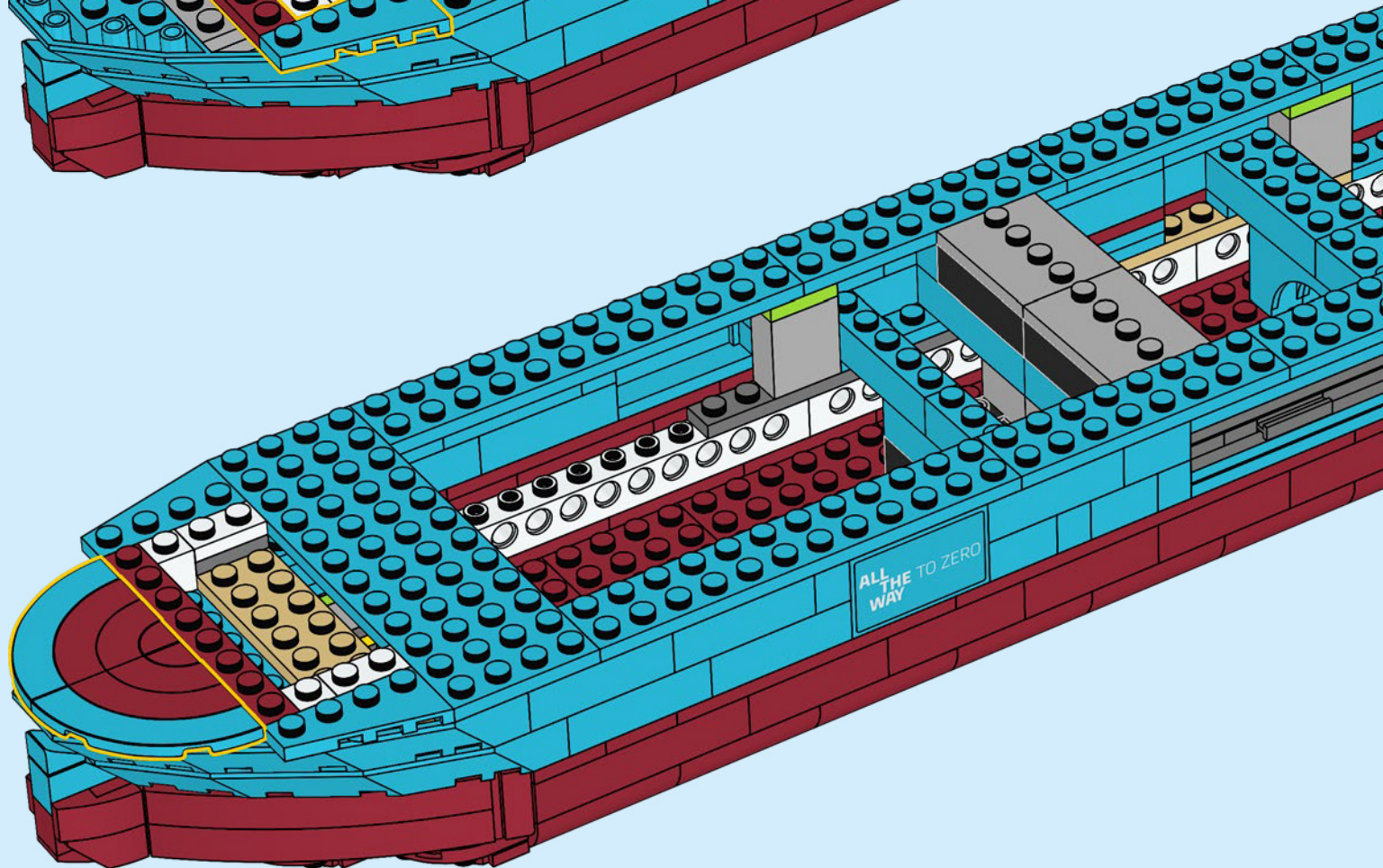

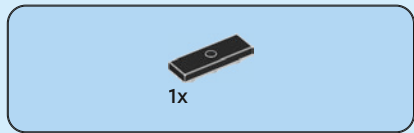

147

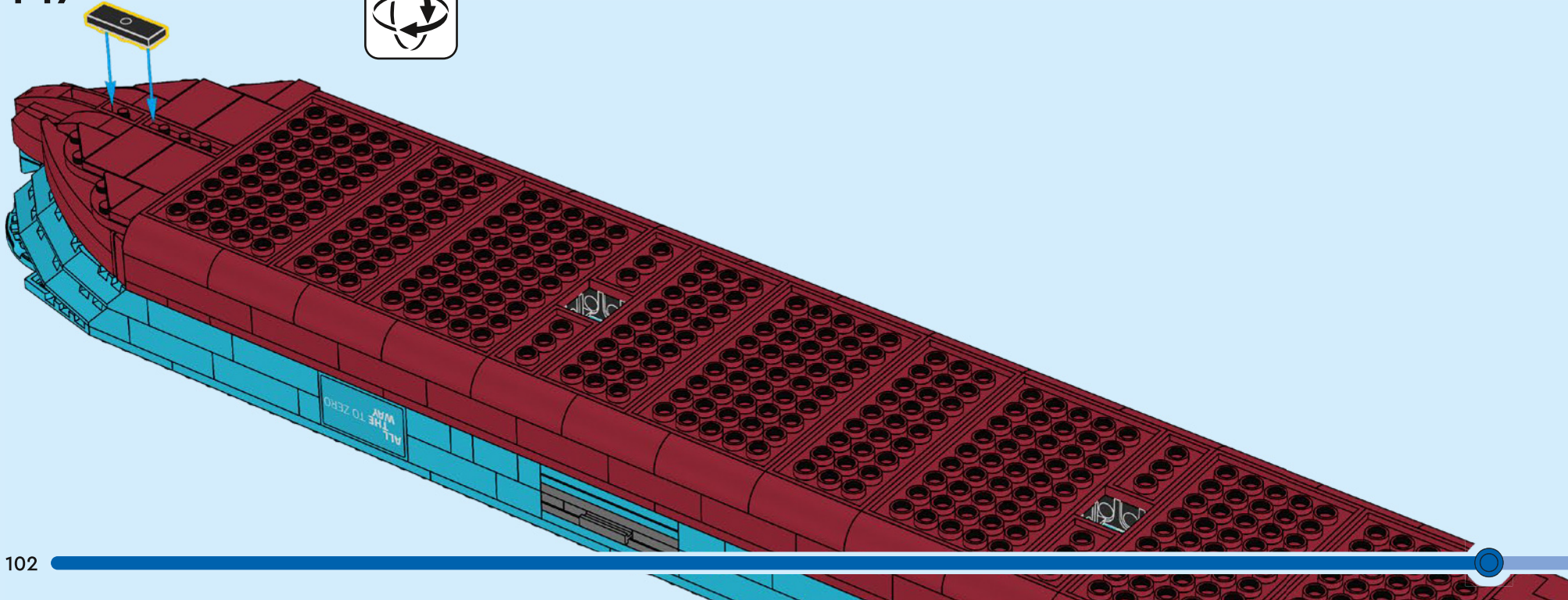



24x

148

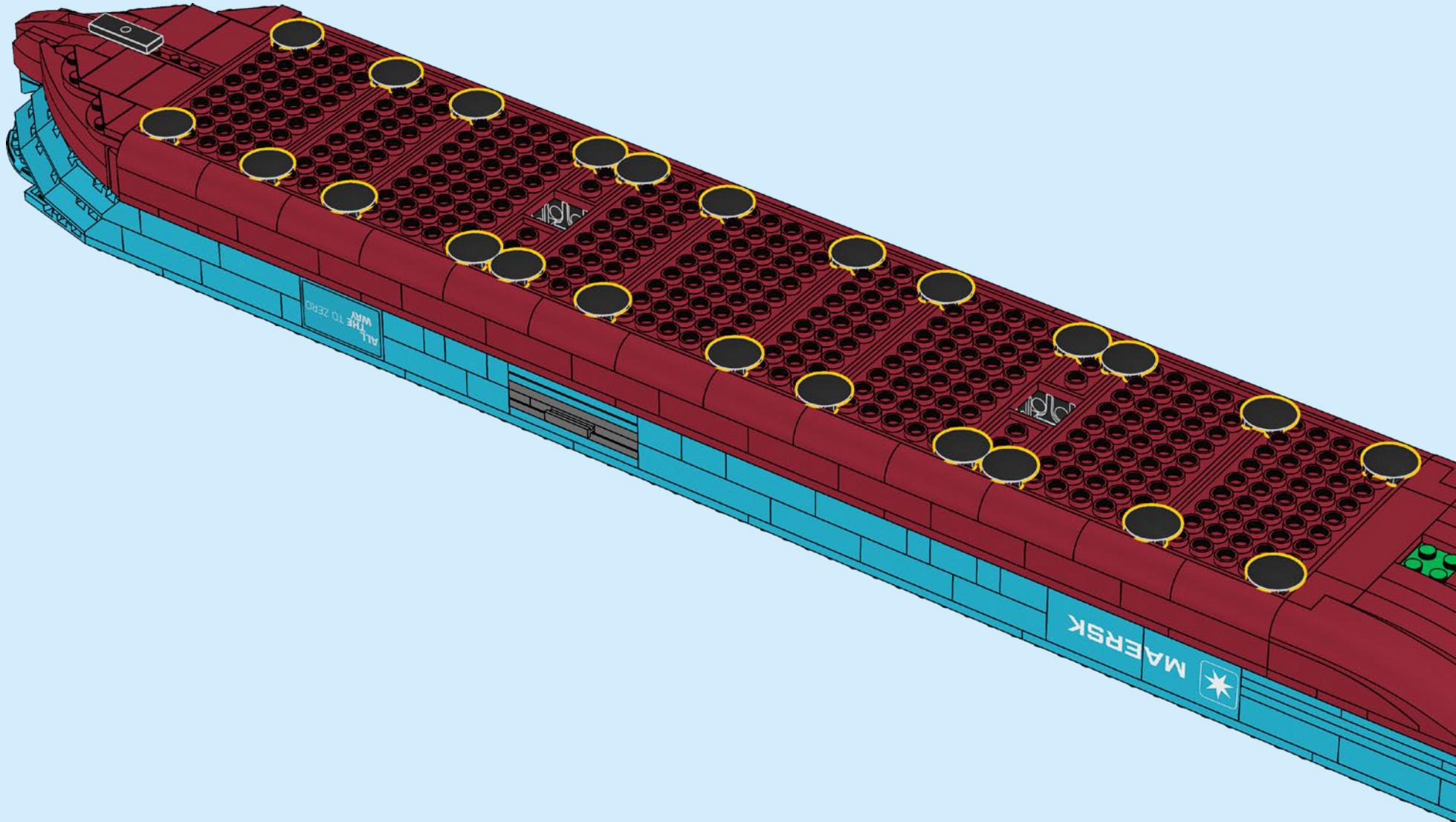

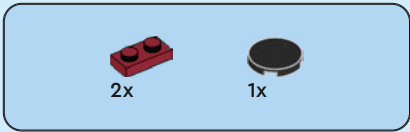

149

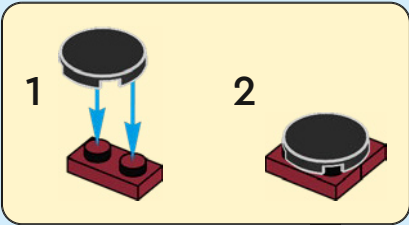
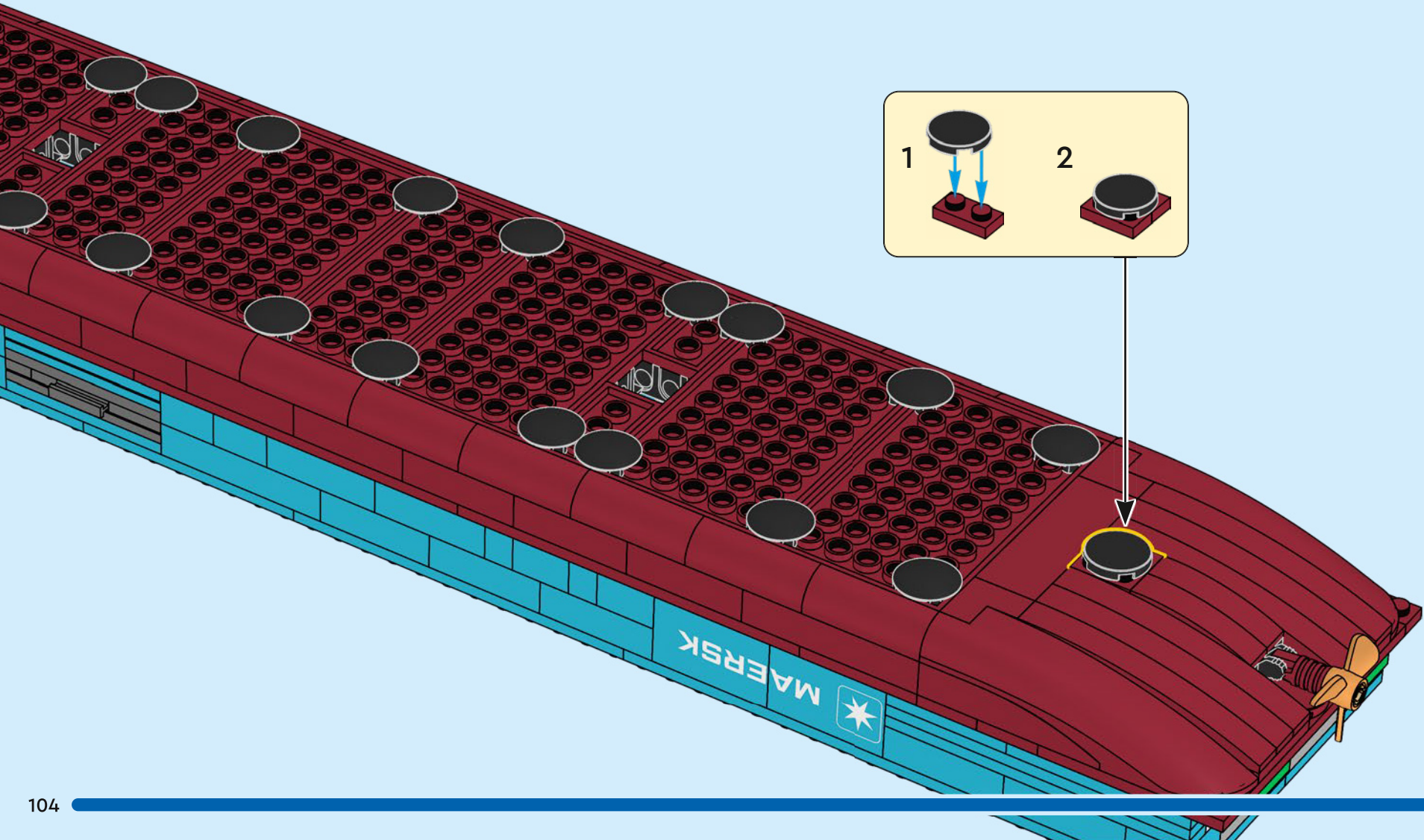

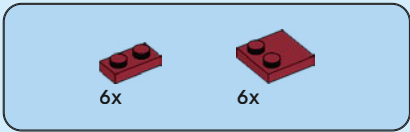

150

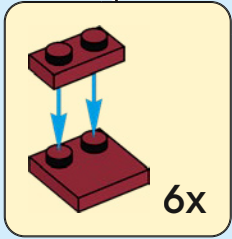
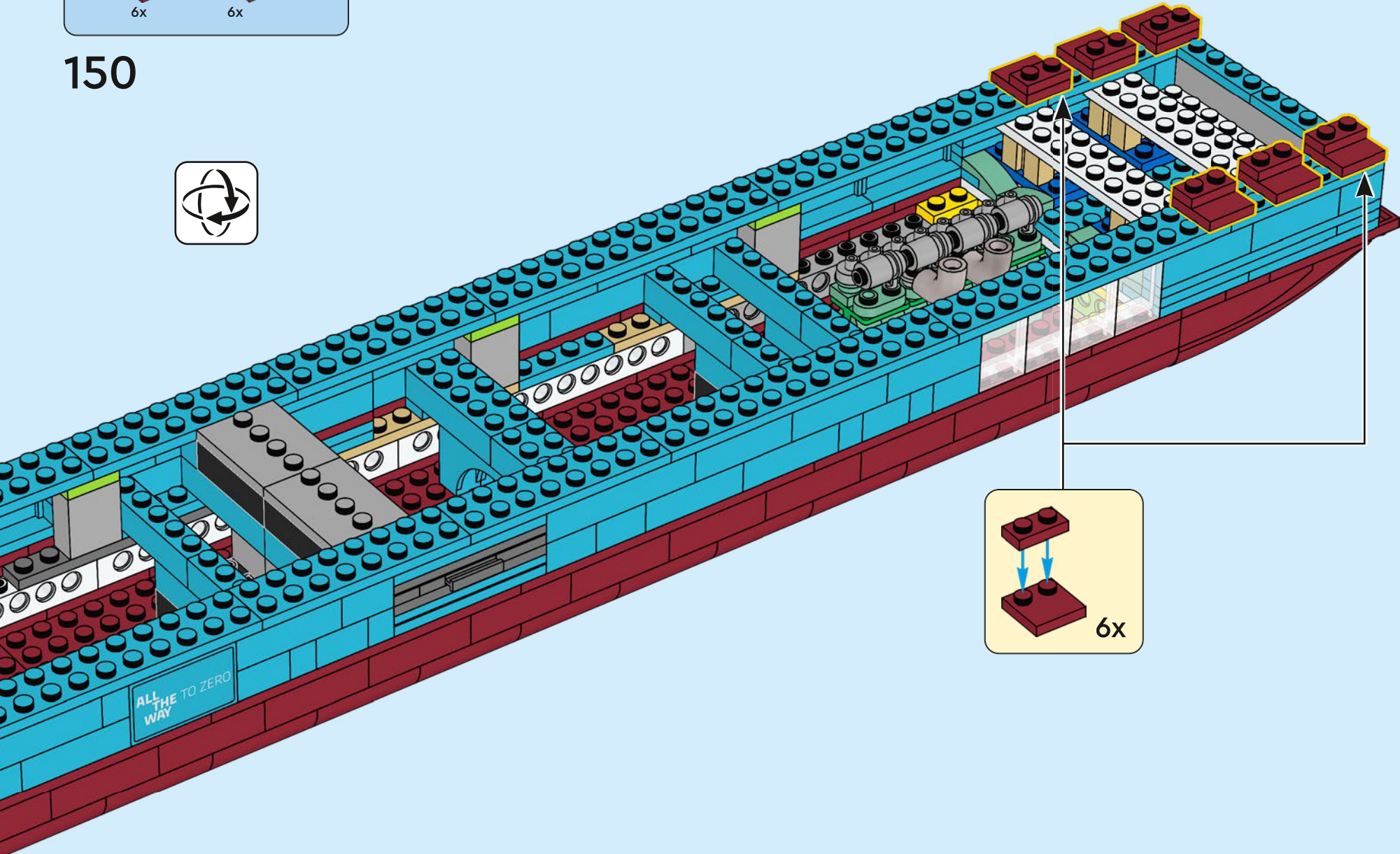

ALL  
THE  
WAY TO ZERO

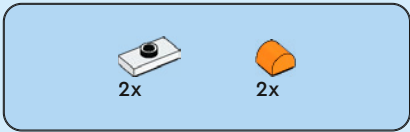

151

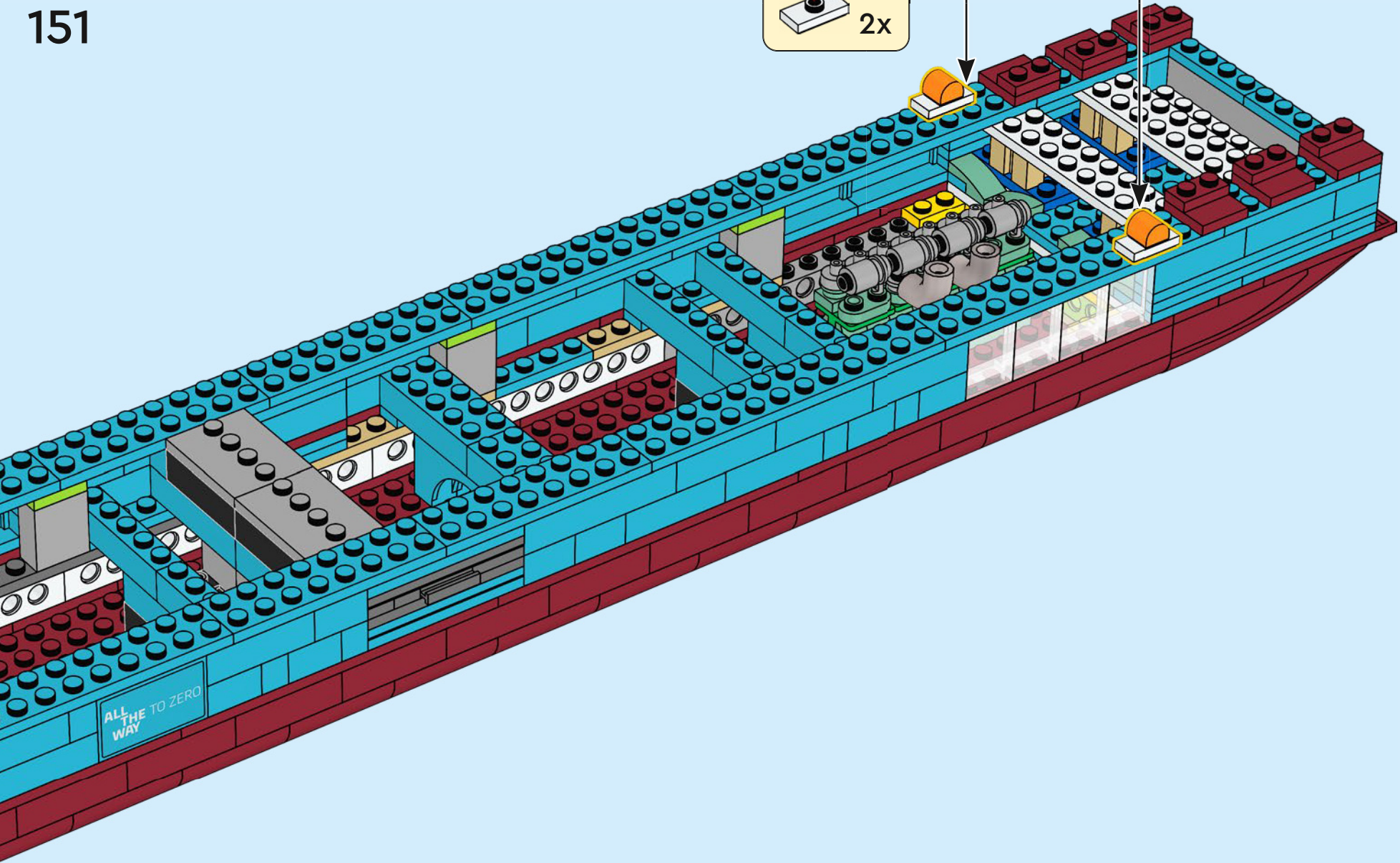
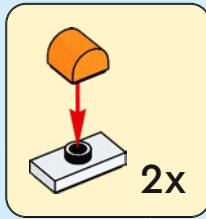

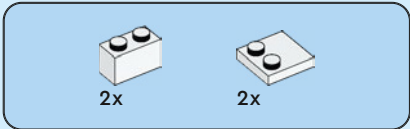

152

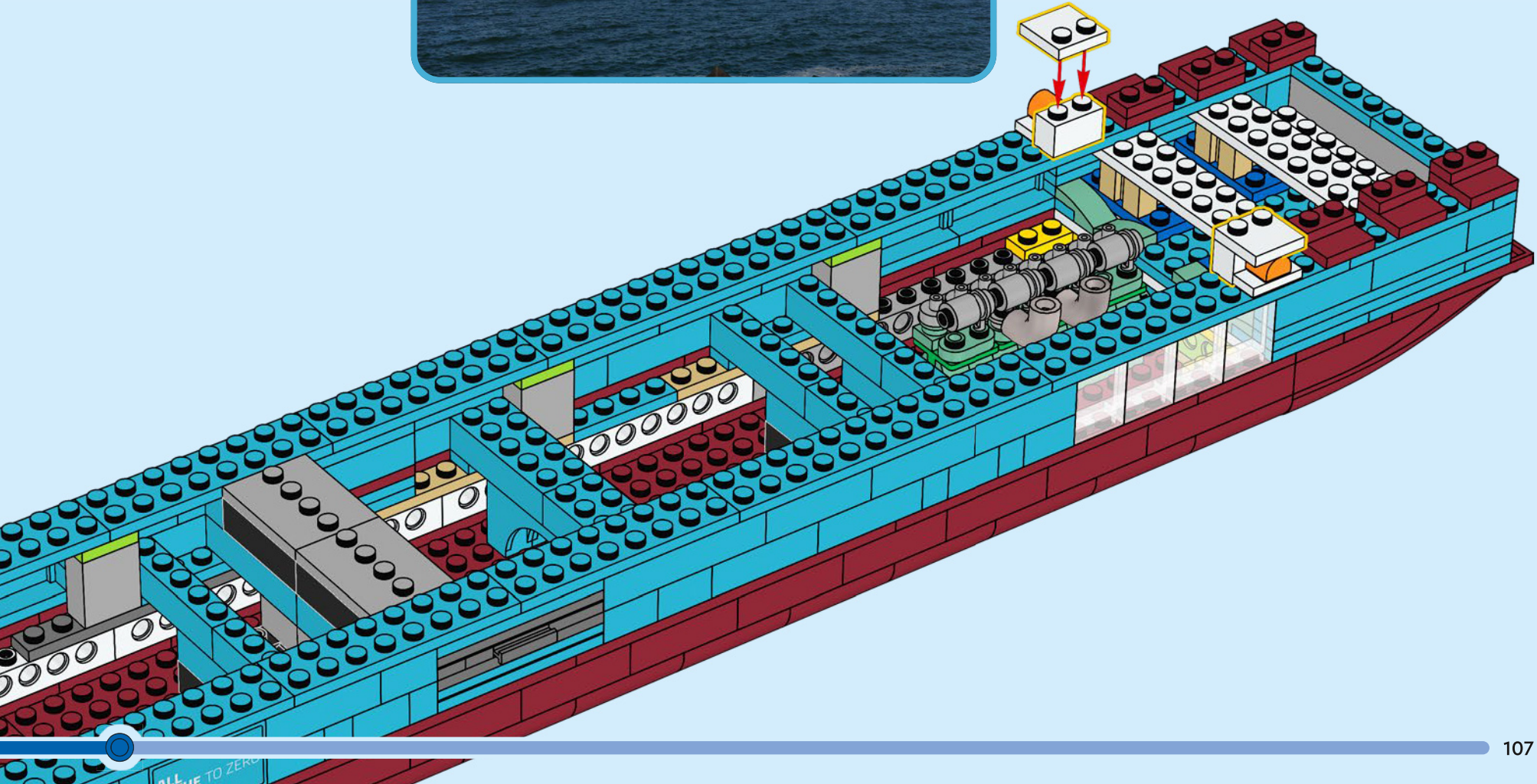
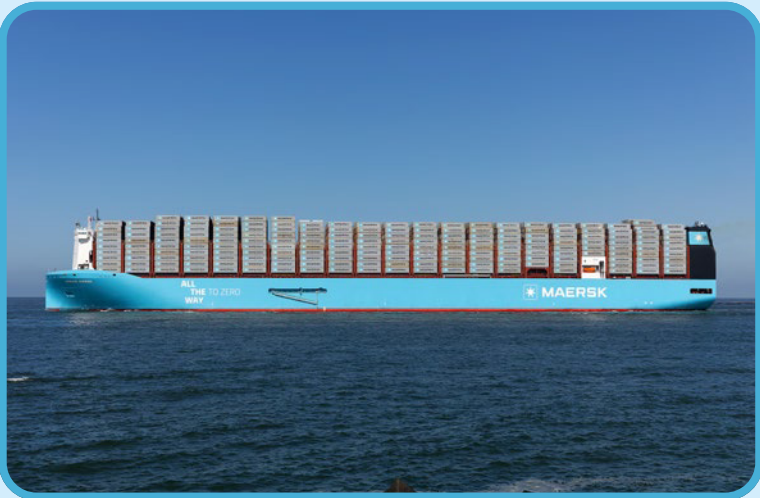



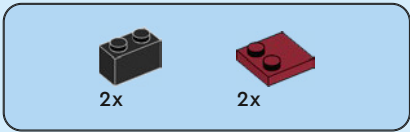

154

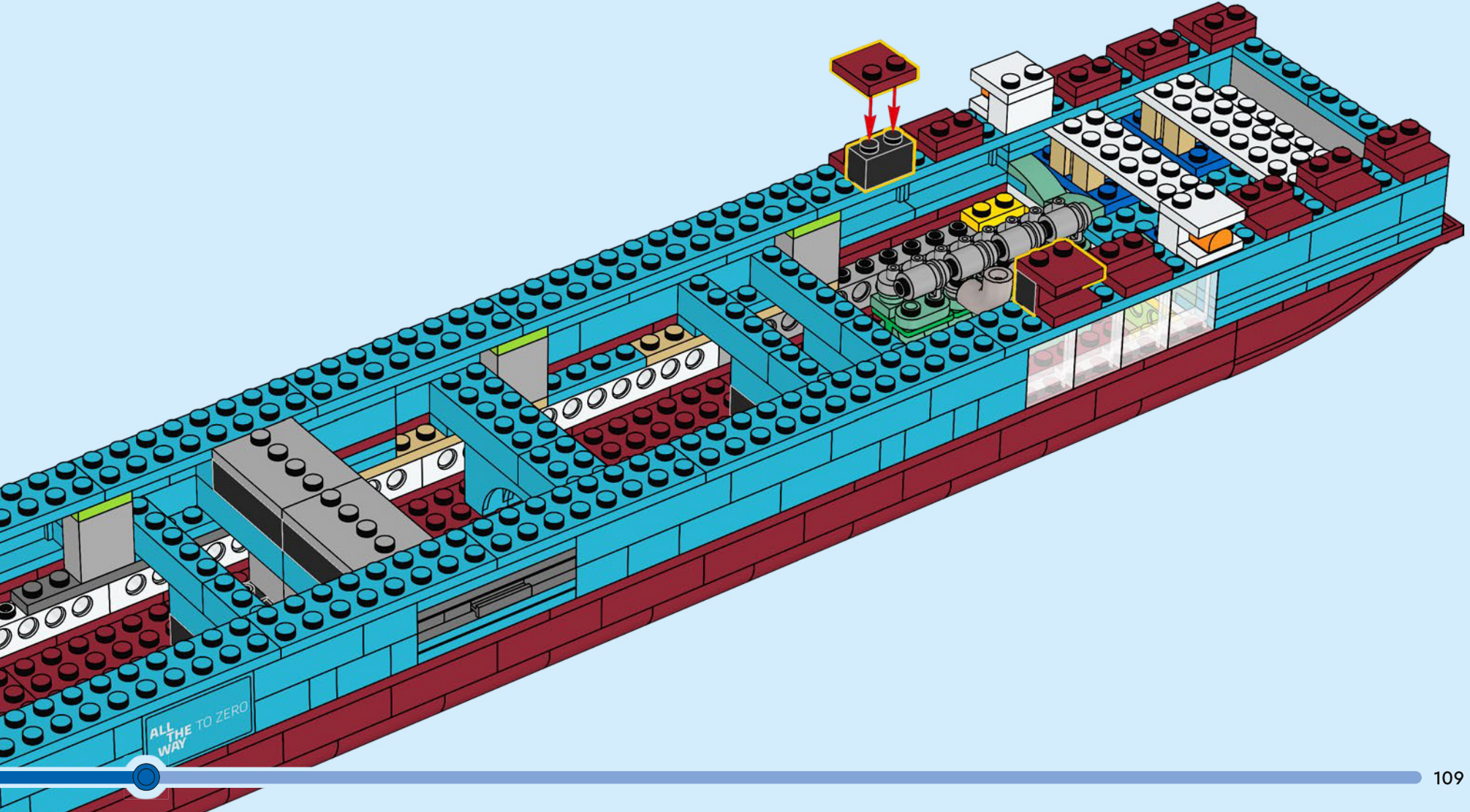

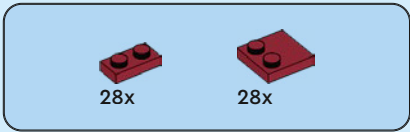

155

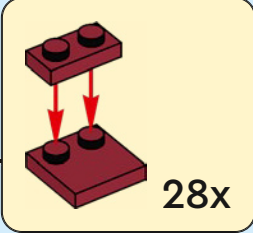
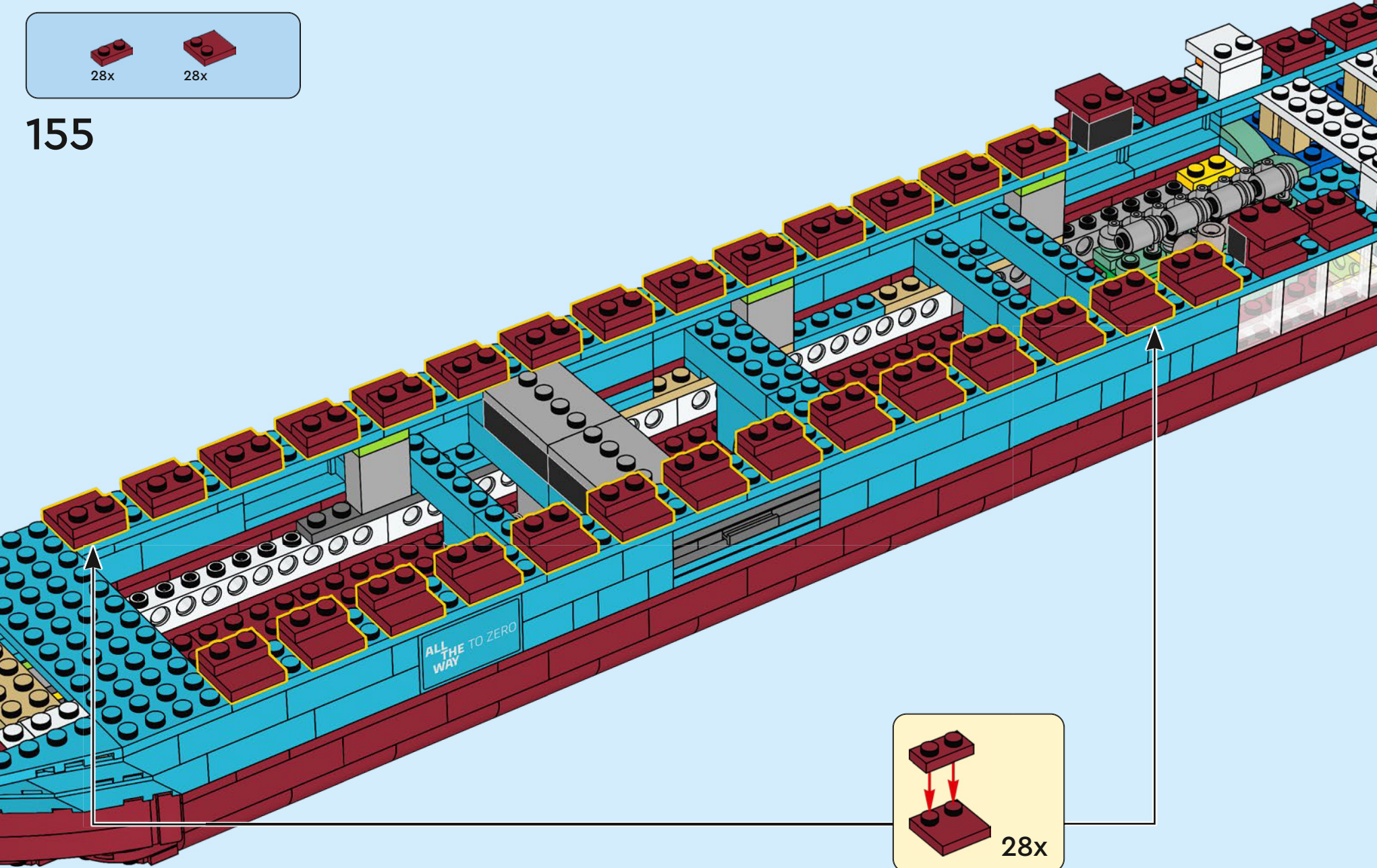

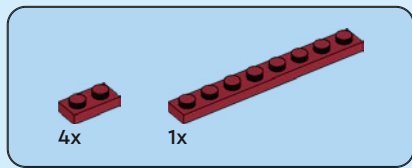

156

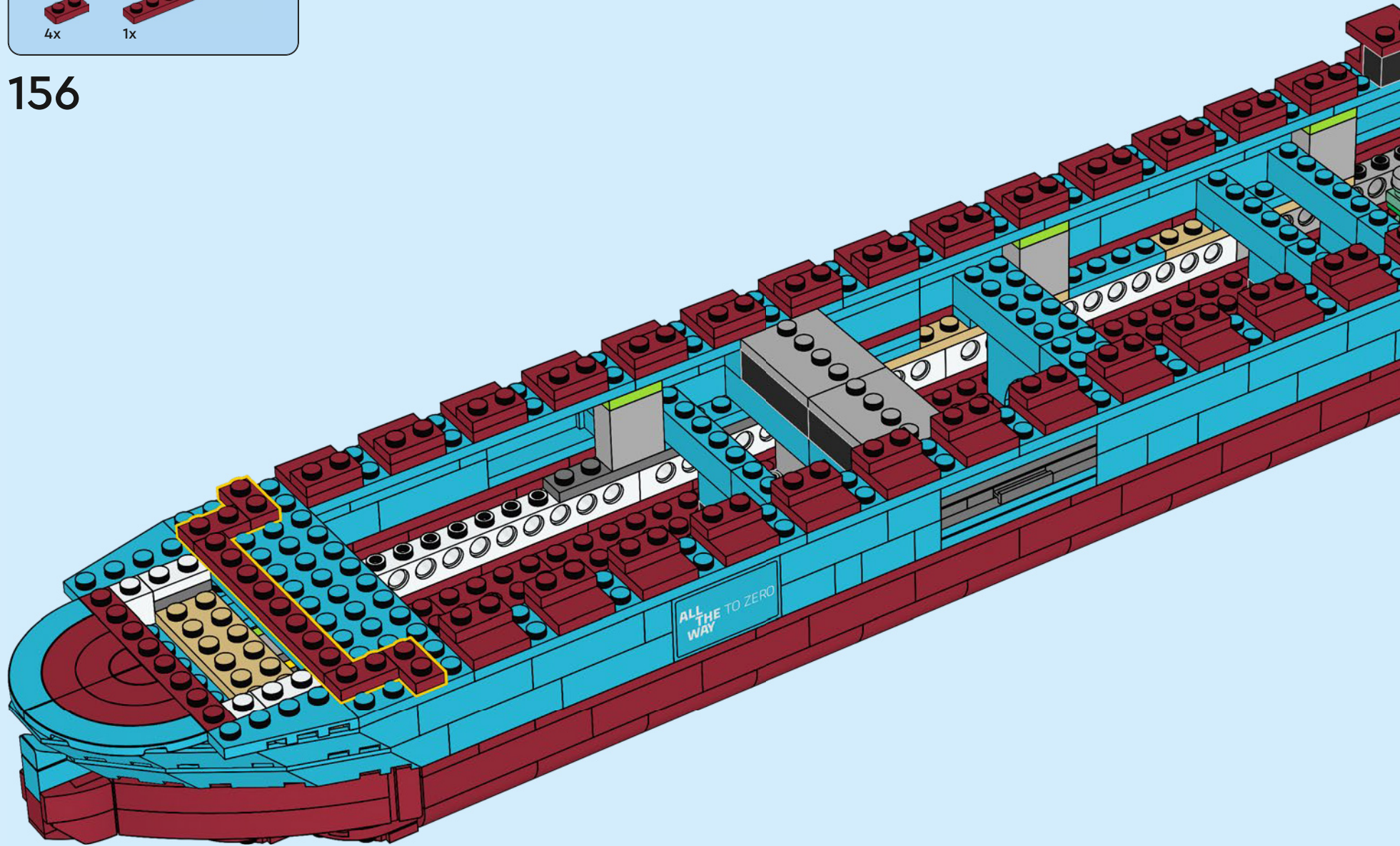

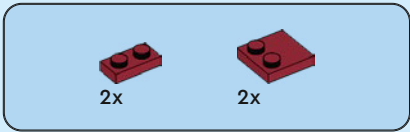

157

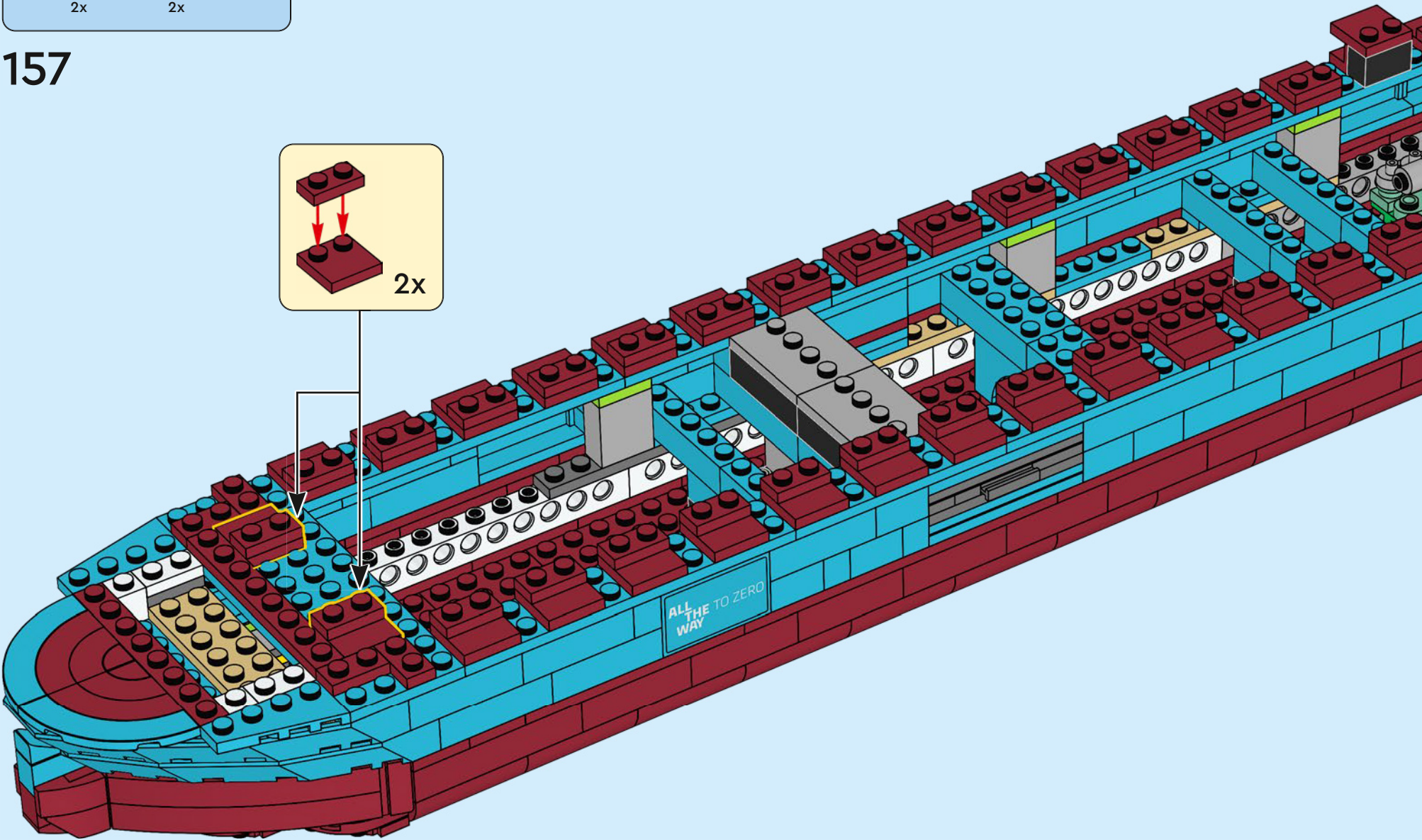
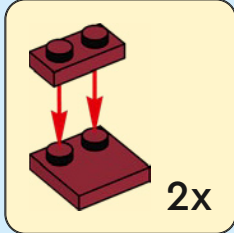

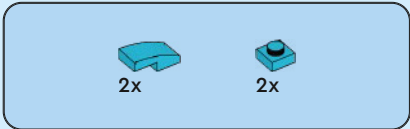

158

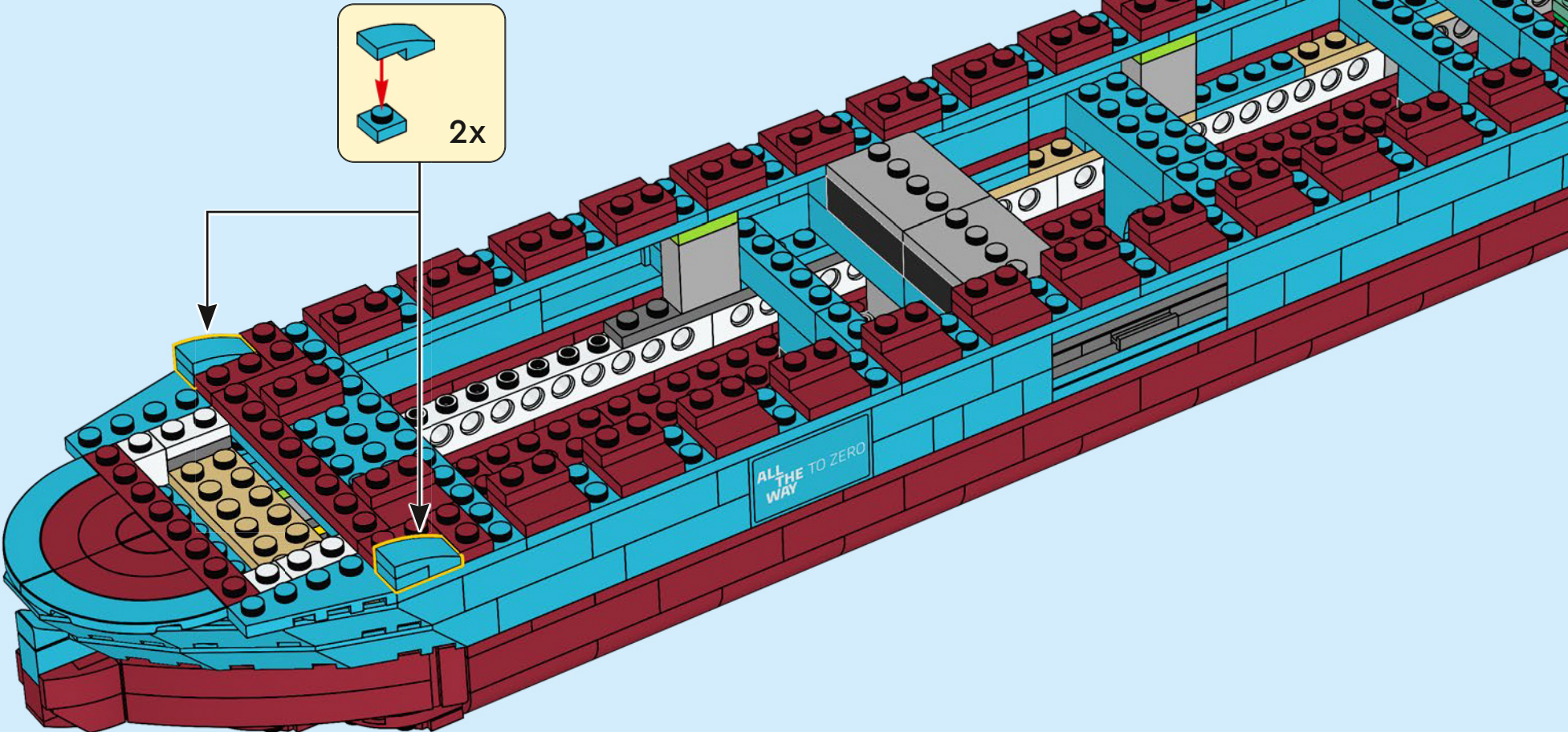

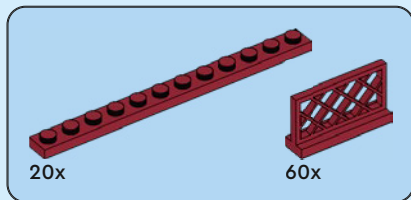
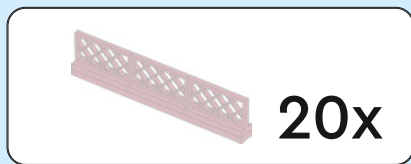

159

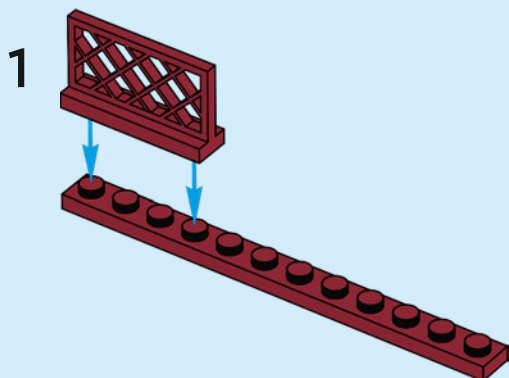
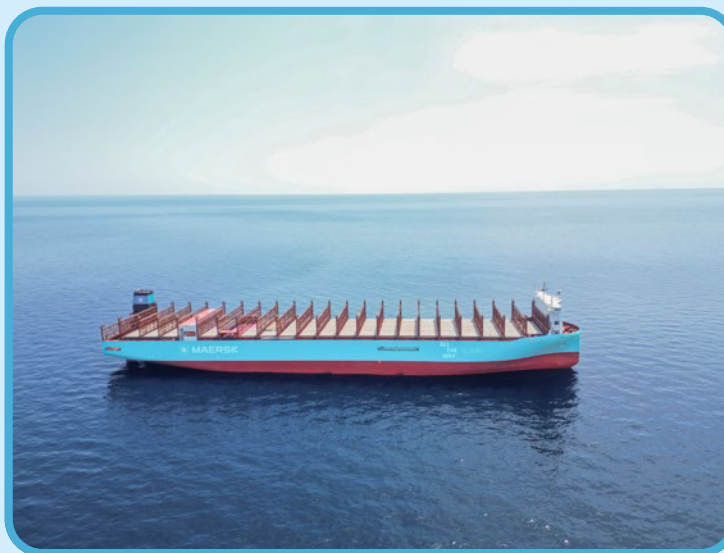

2



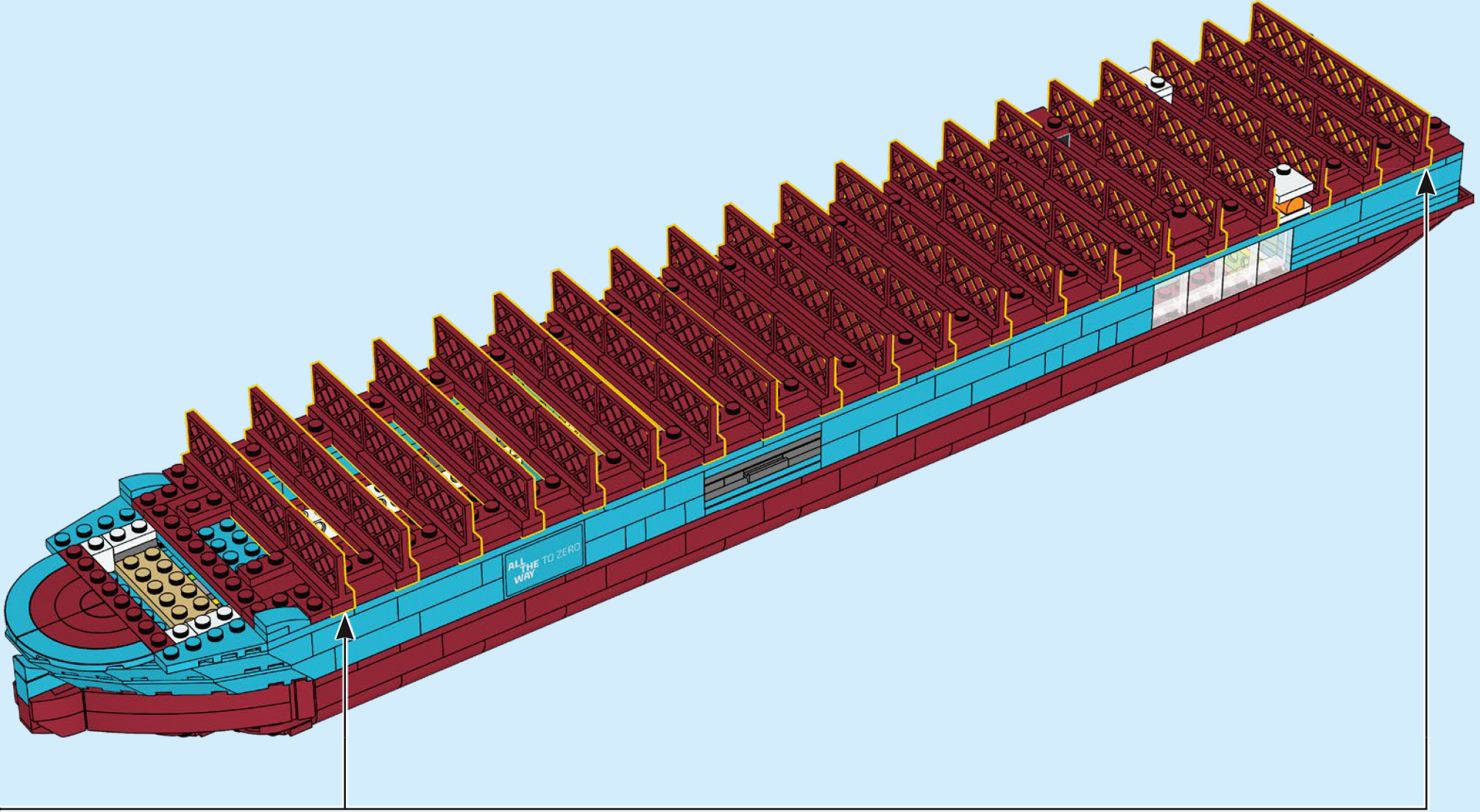

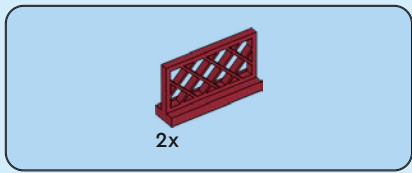

160

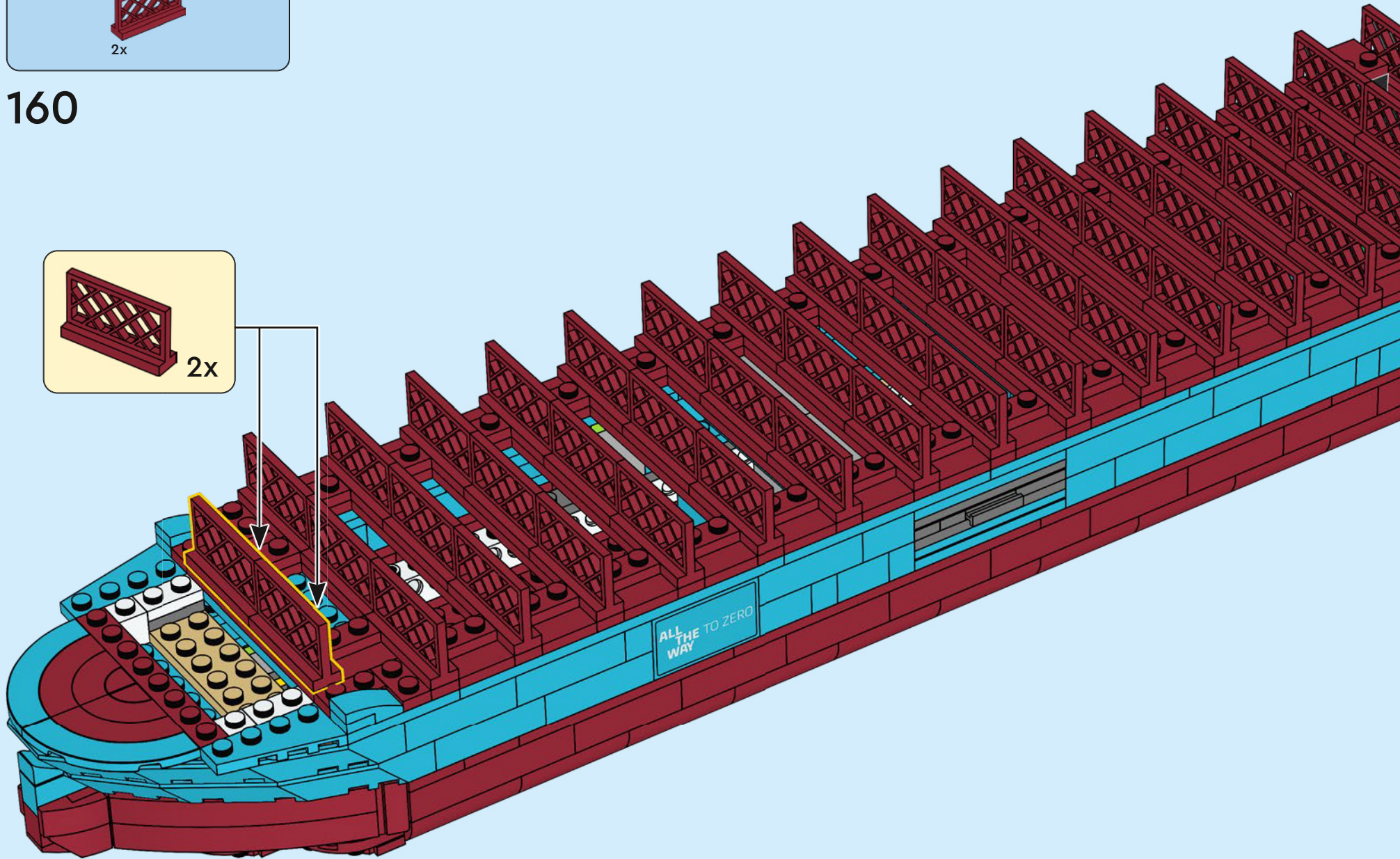
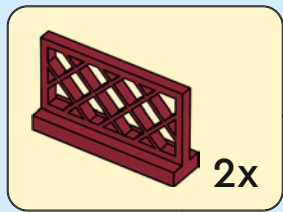

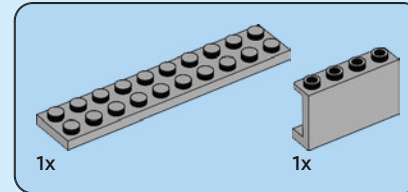
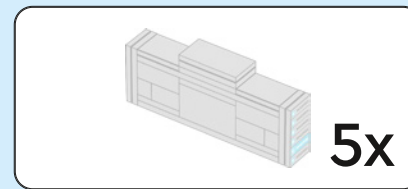

161

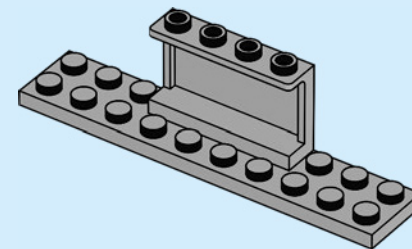
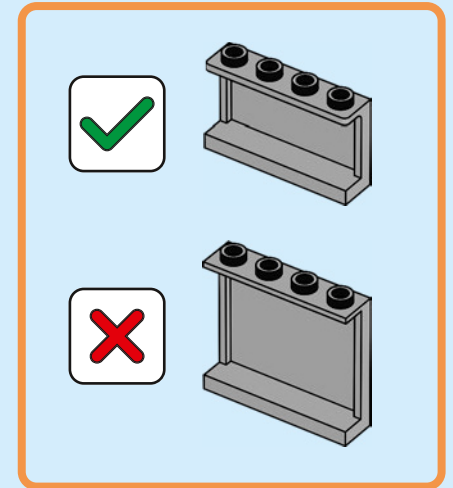

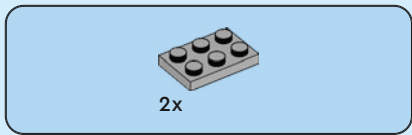

162

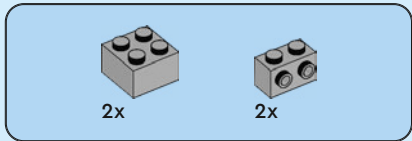
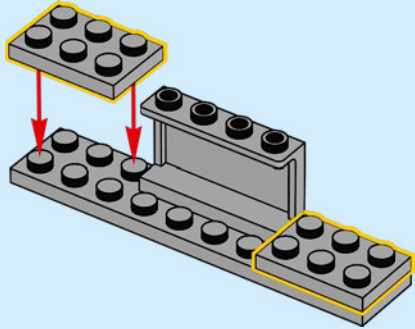

163

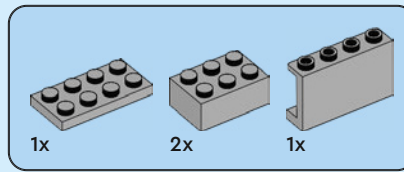
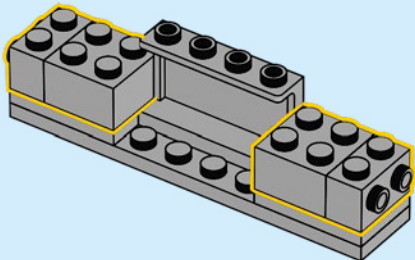

164

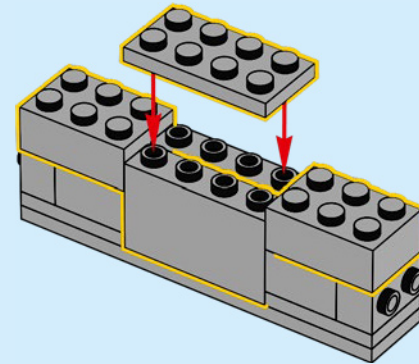

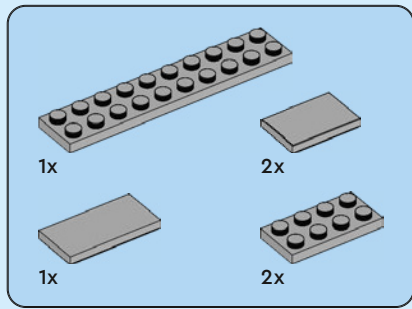

165

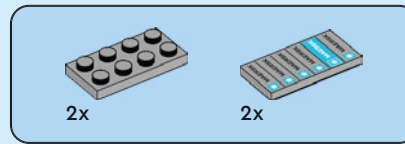
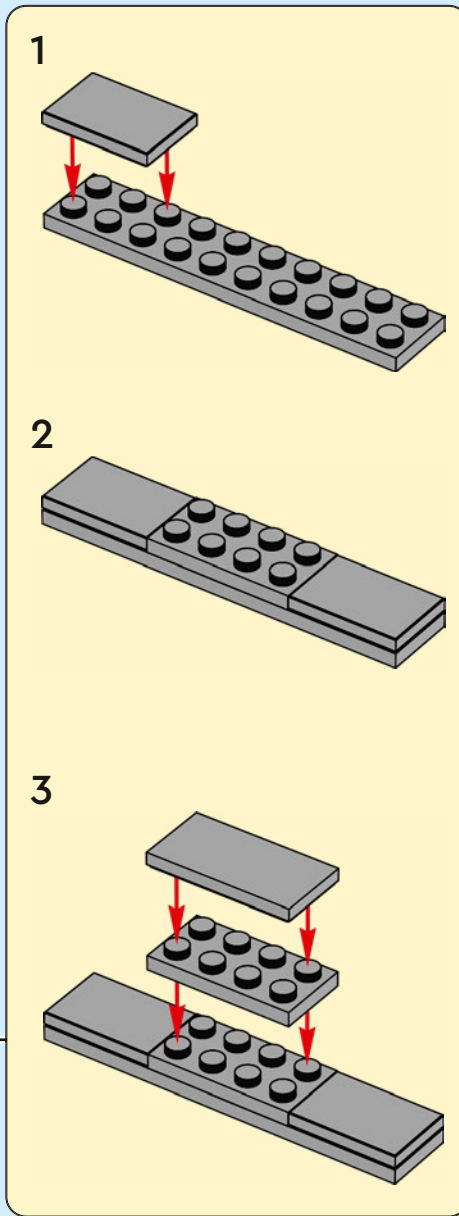
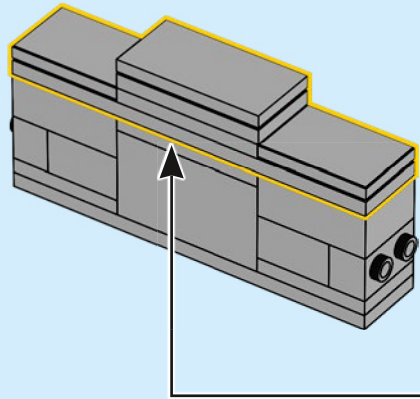

166

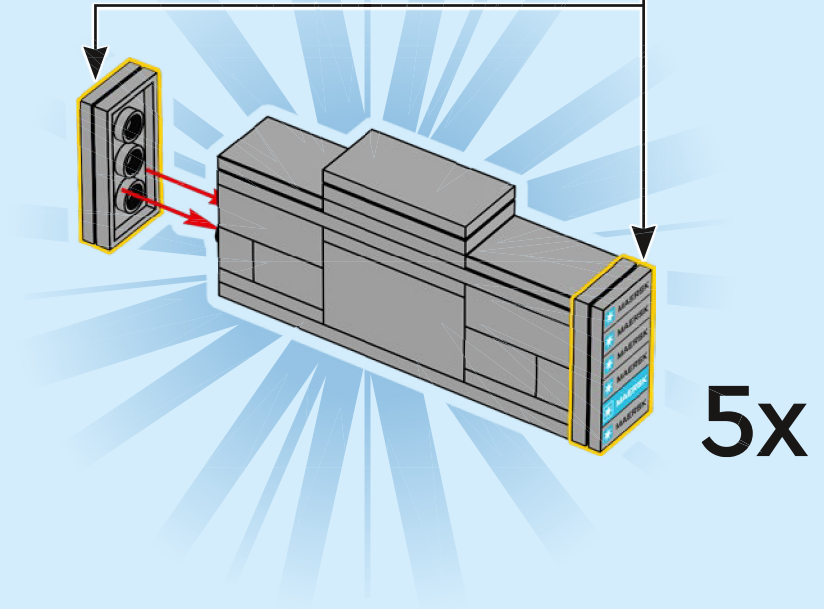
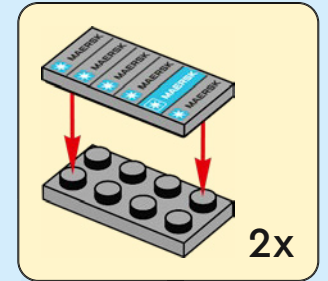

5x



167

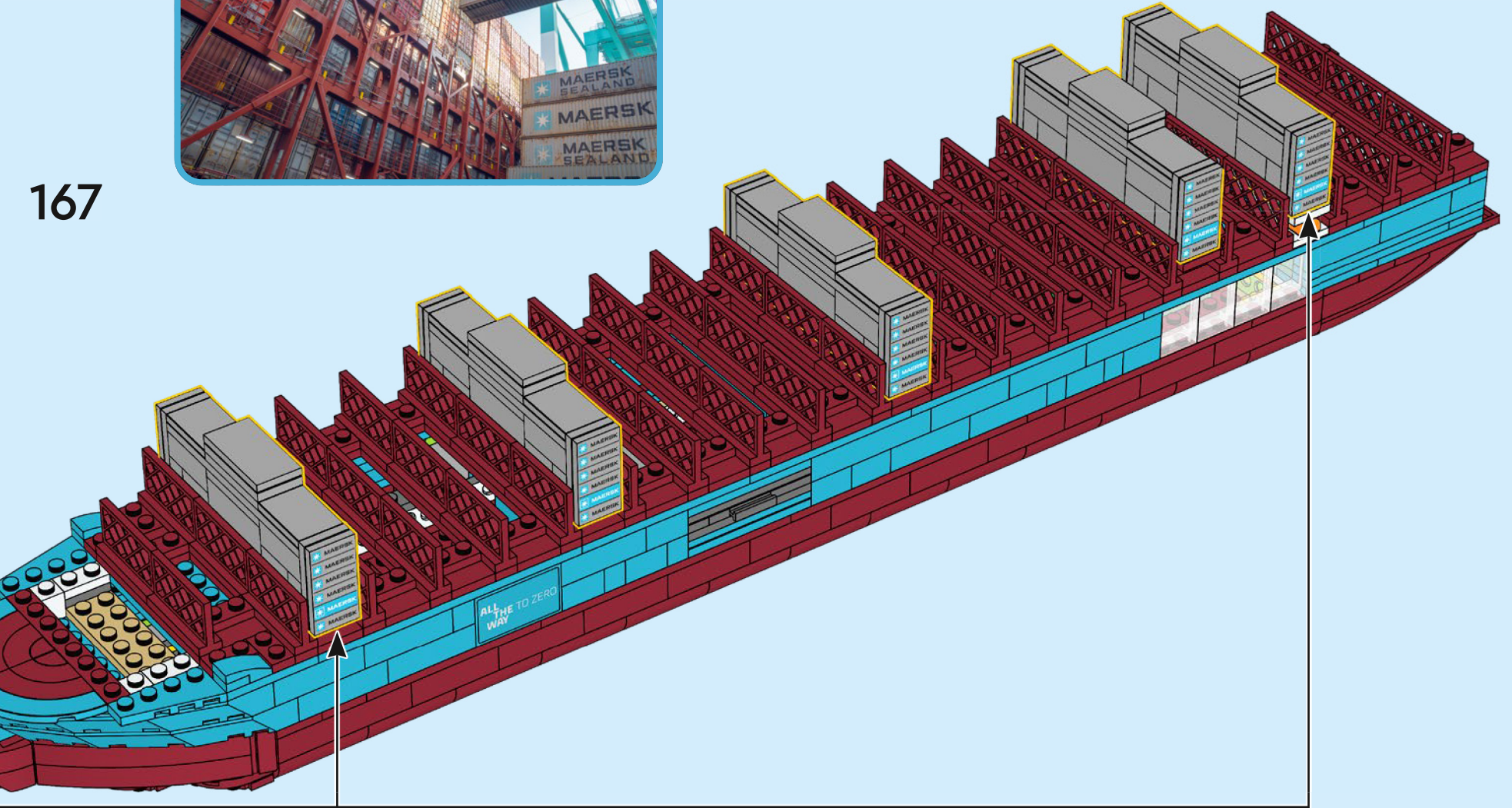

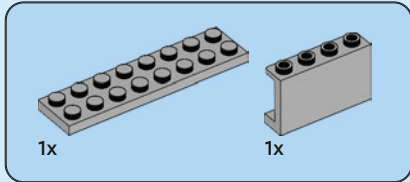
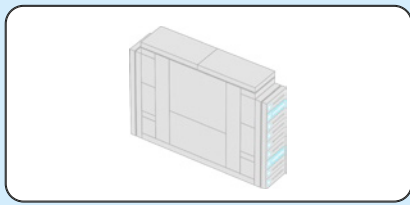

168

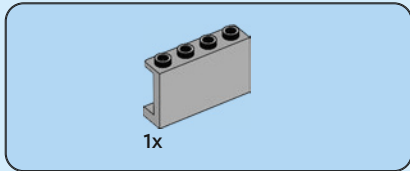
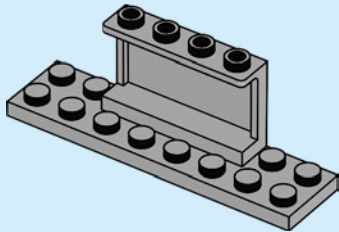

169

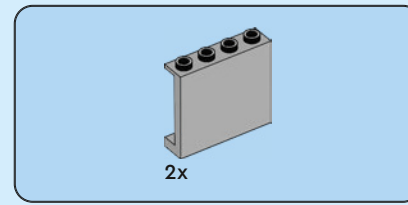
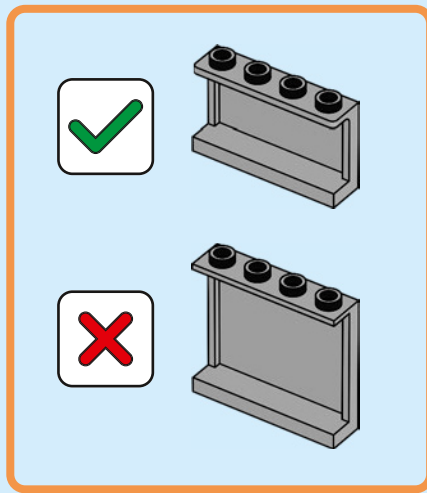
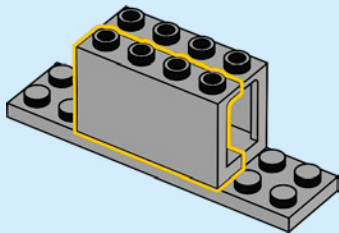

170

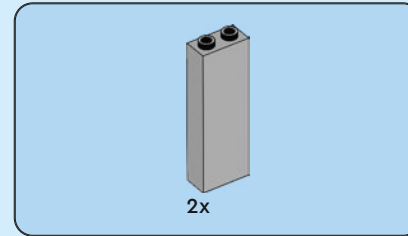
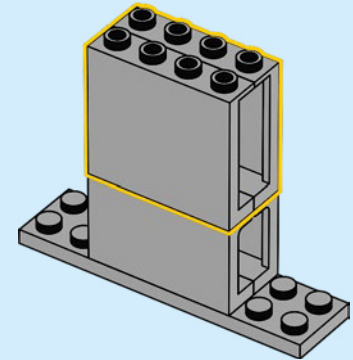

171

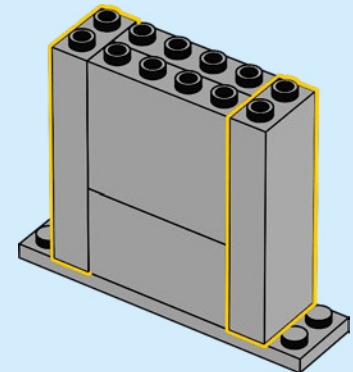



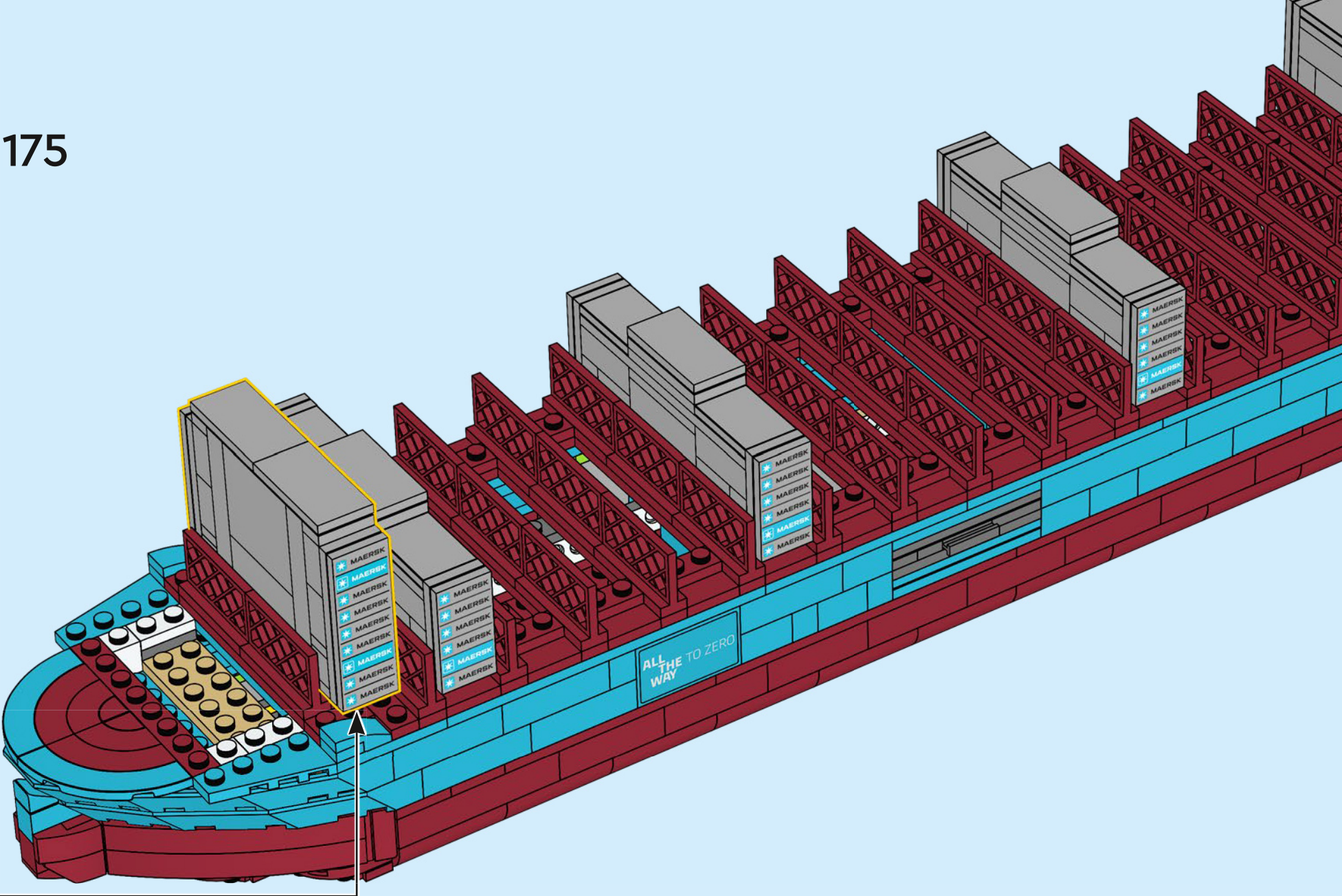

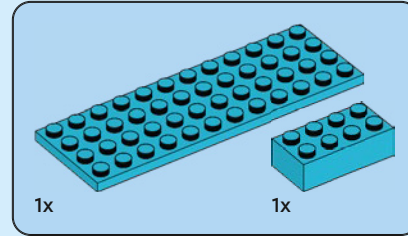
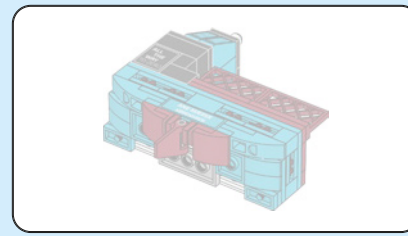

176

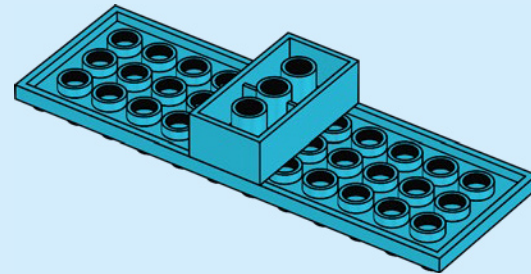

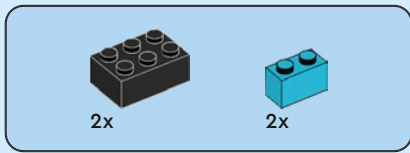

177

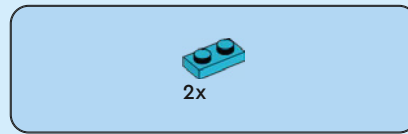
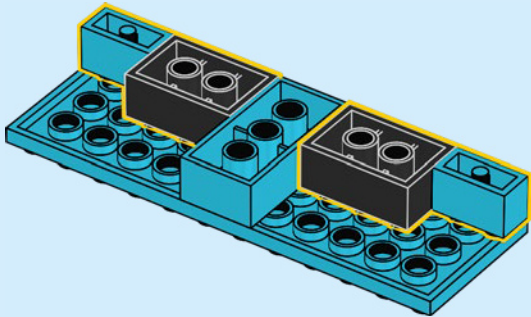

178

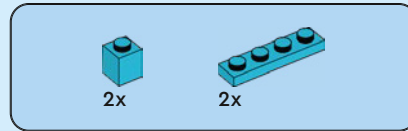
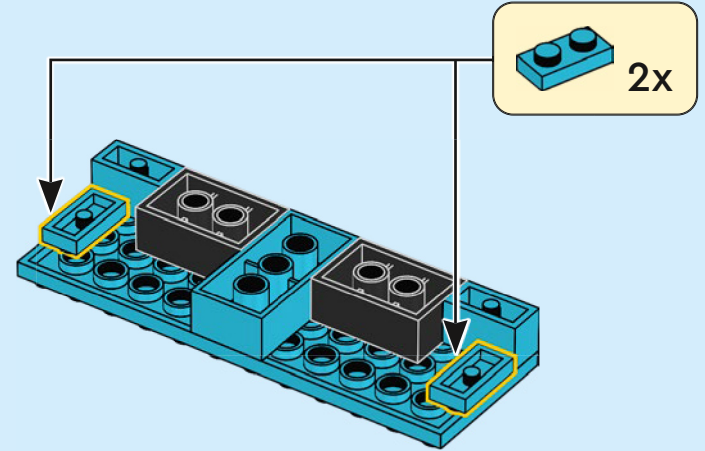

179

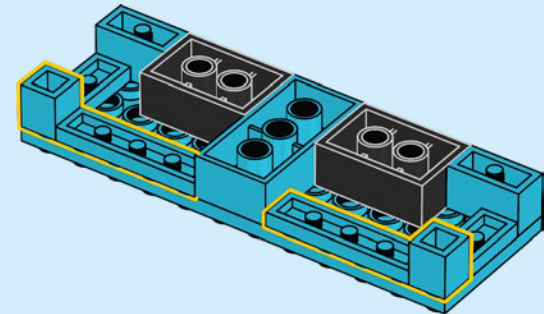

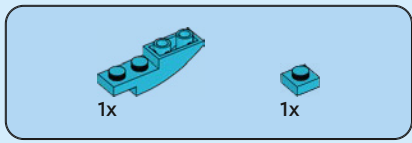

180

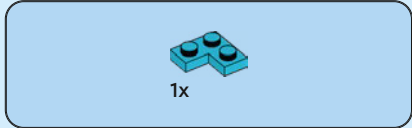
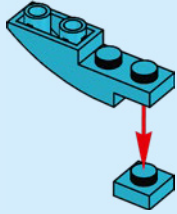

181

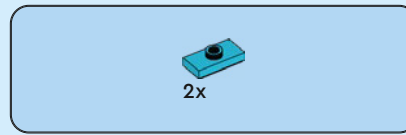
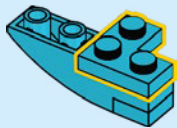

182

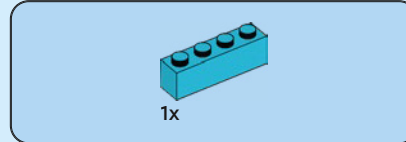
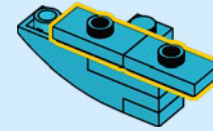

183

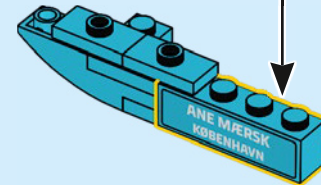
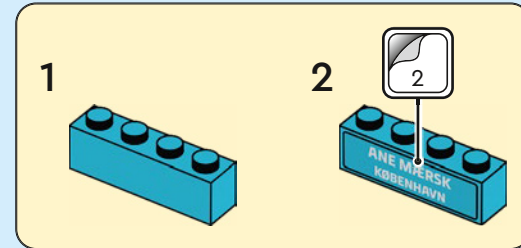

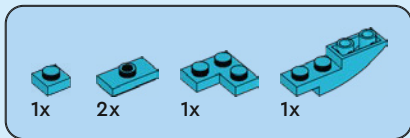

184

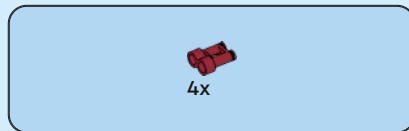
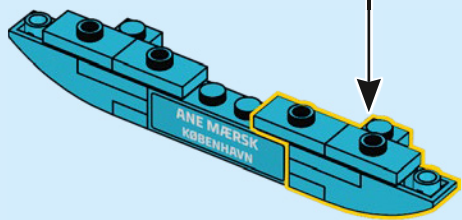
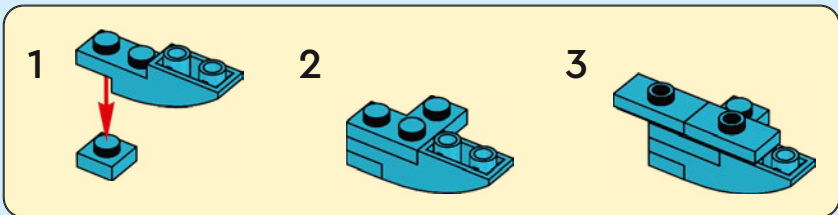

185

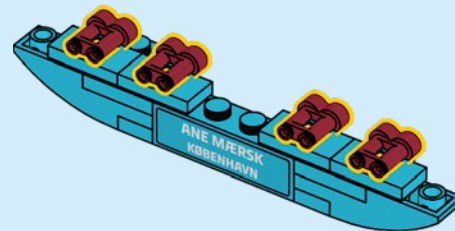

186

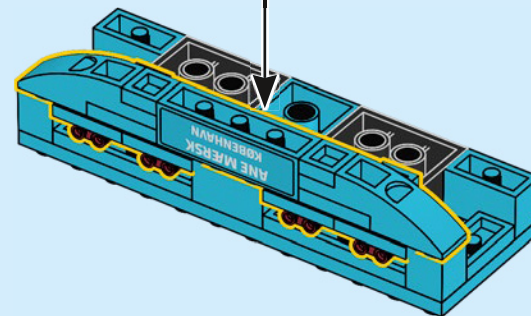

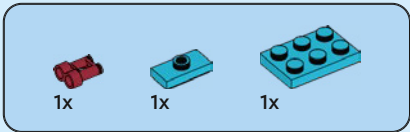

187

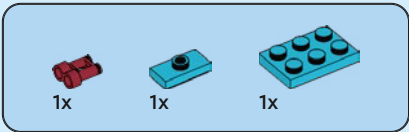
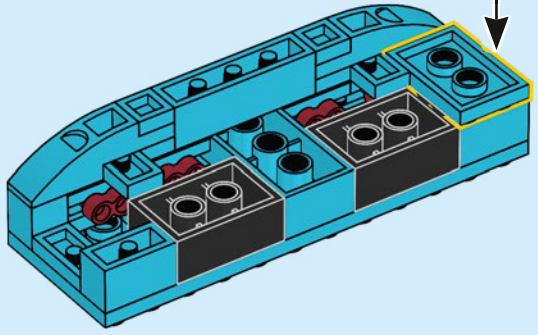
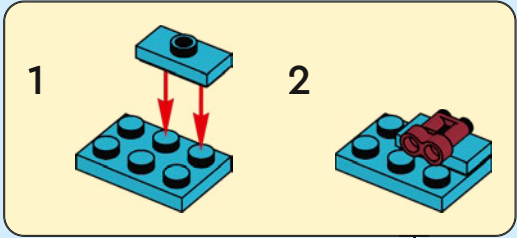

188

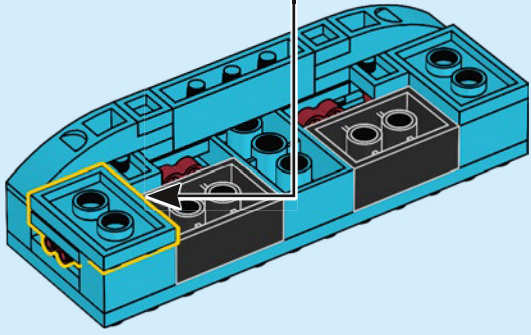
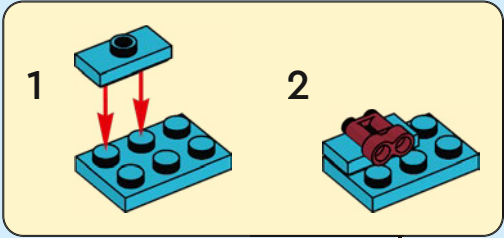

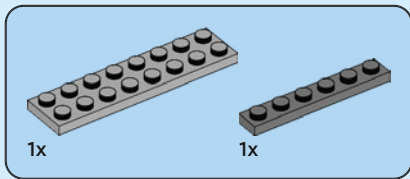

189

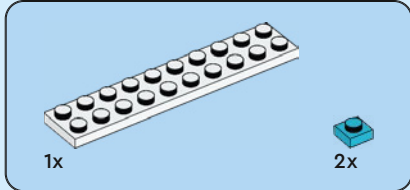
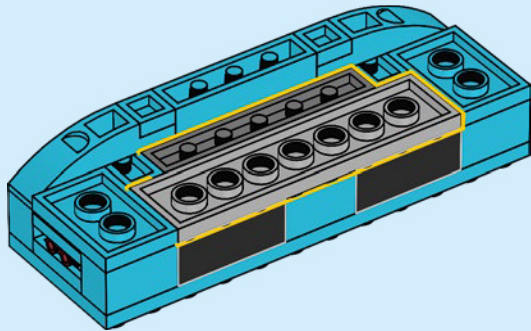

190

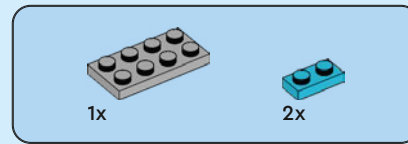
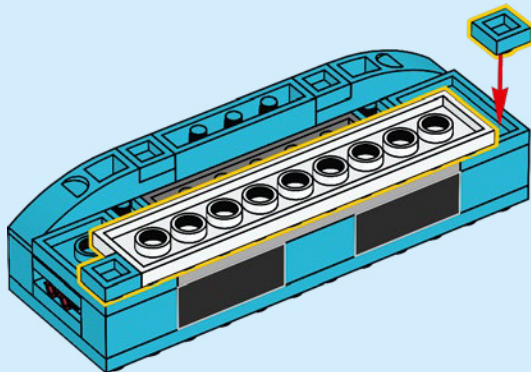

191

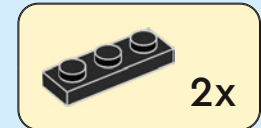
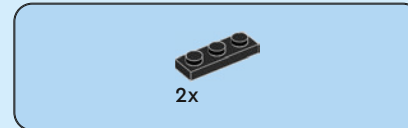
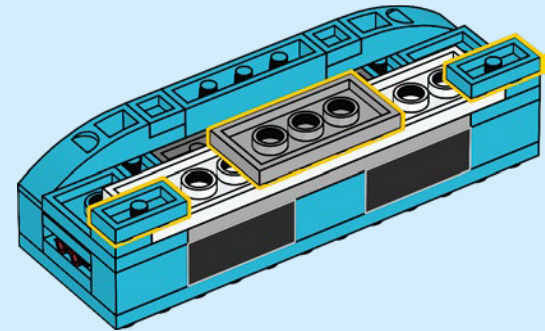

192

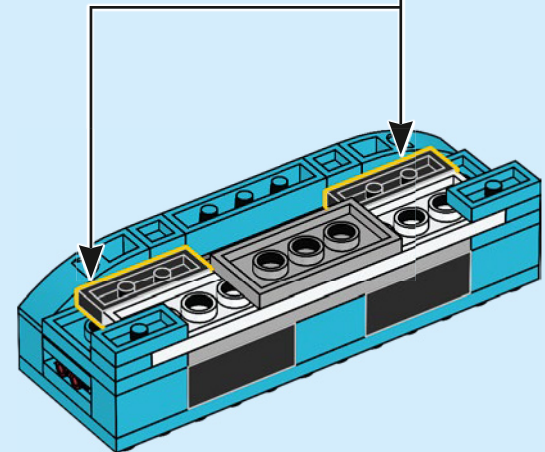



4x

# 193

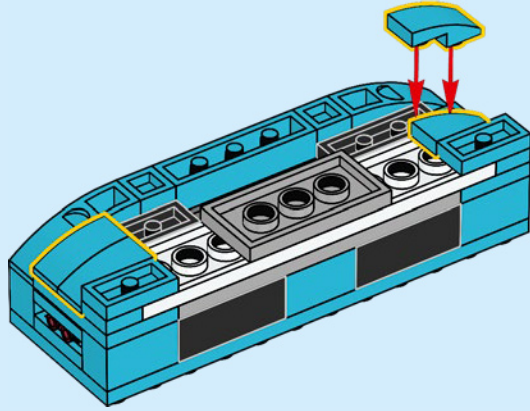

2x

# 194

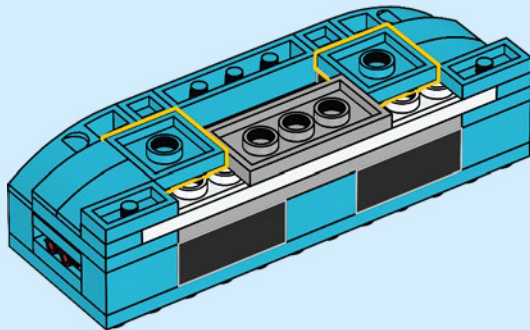

1x



1x



1x

# 195

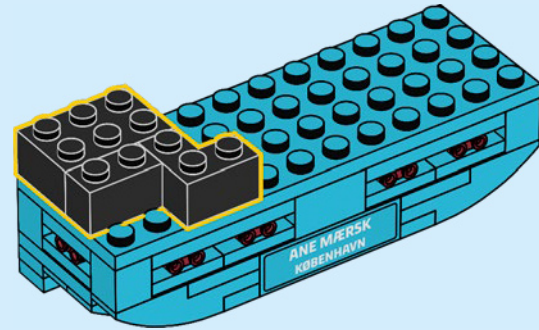
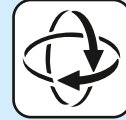

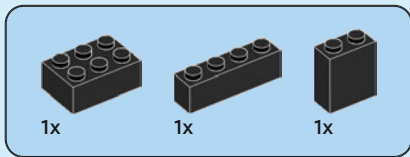

196

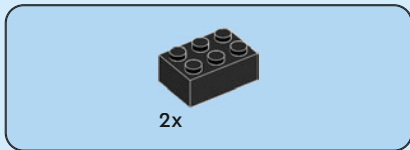
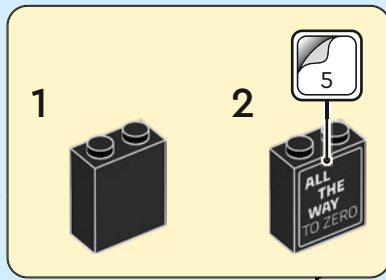
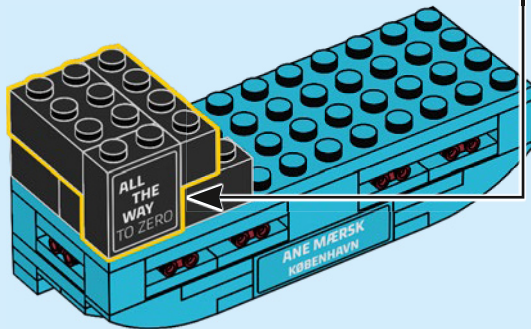

197

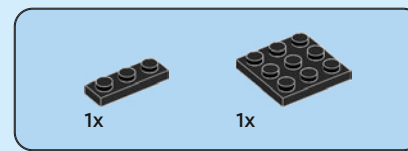
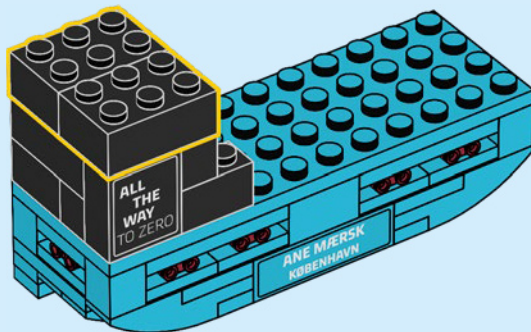

198

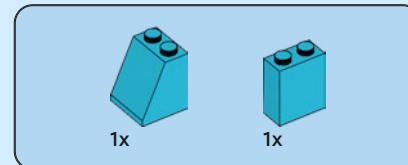
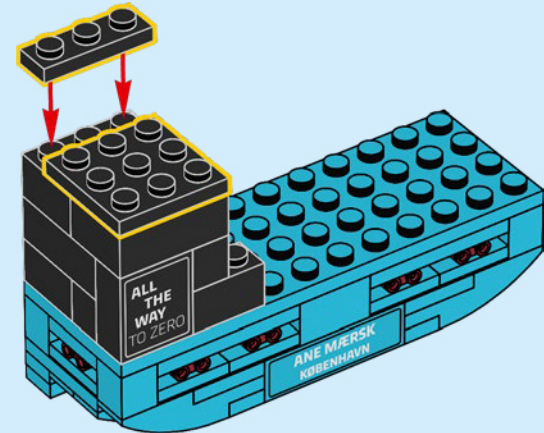

199

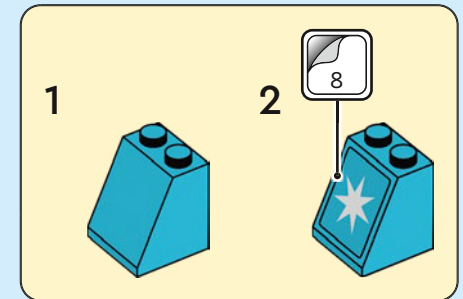
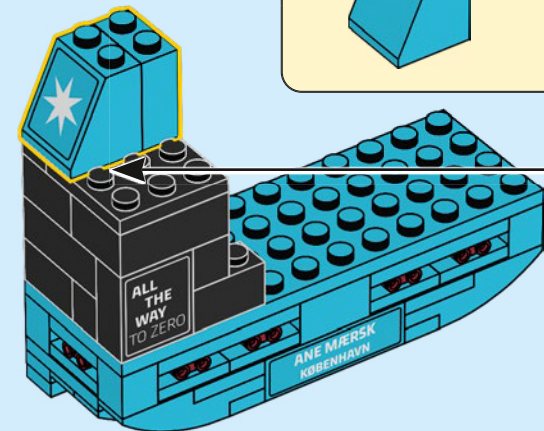

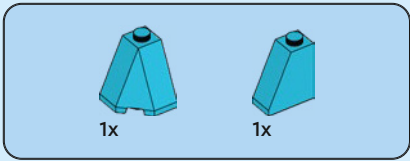

# 200

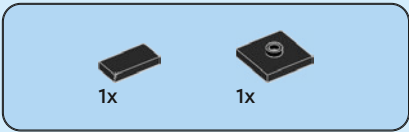
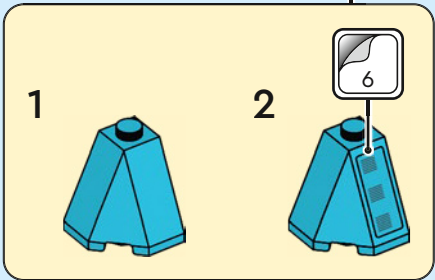
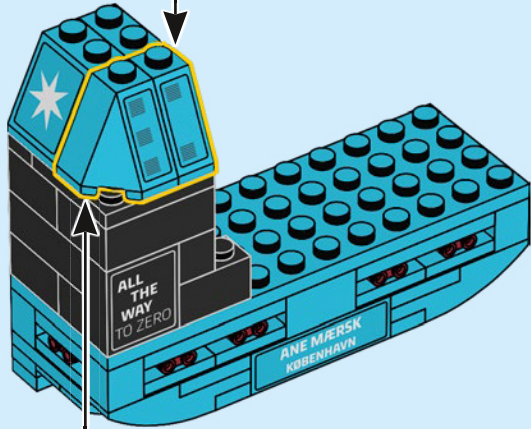
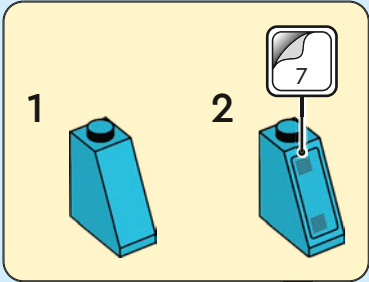

# 201

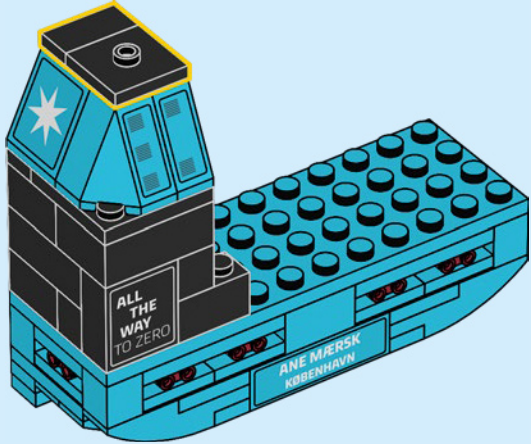



1x



1x

# 202

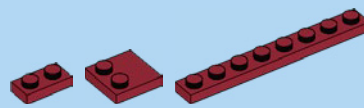
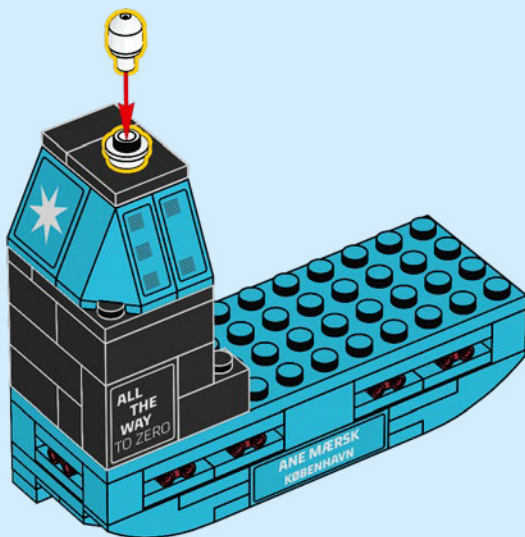

1x

2x

1x

# 203

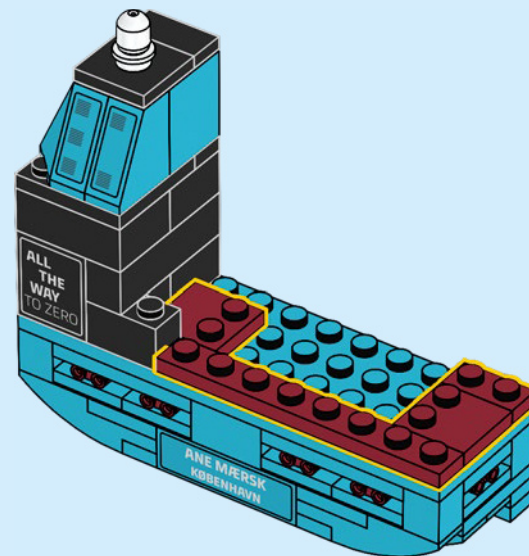



2x

# 204

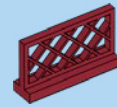
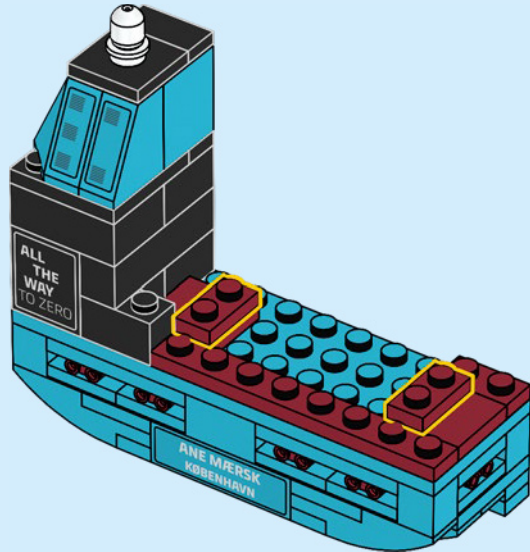

2x

# 205

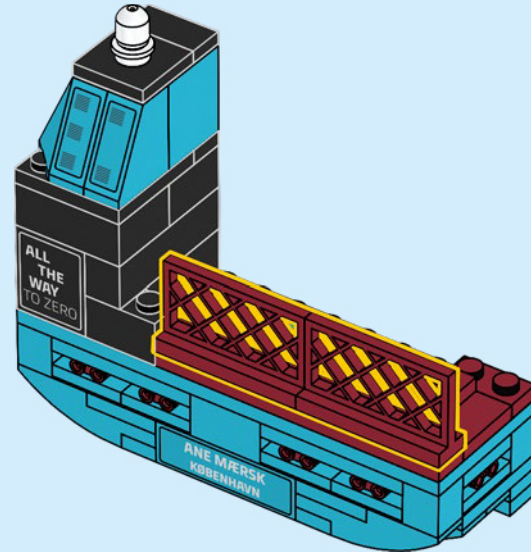

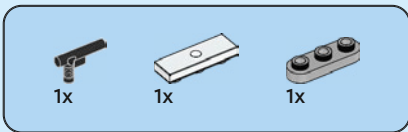

206

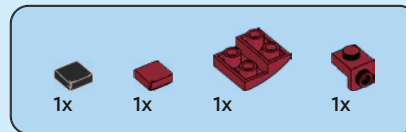
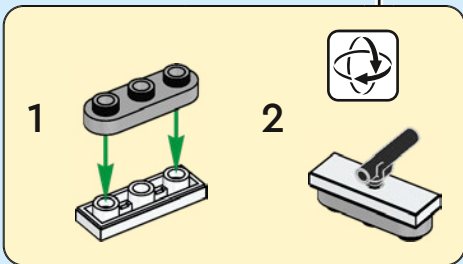
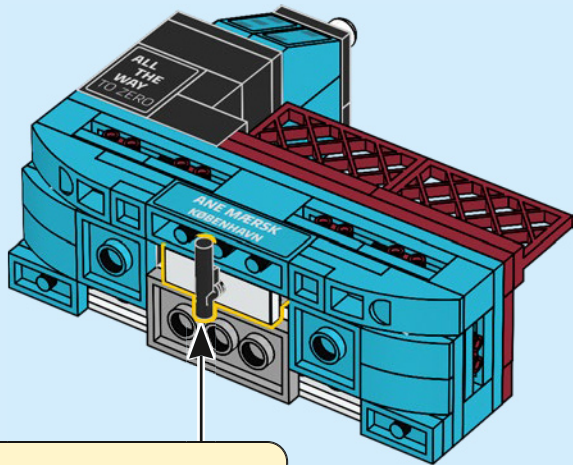

207

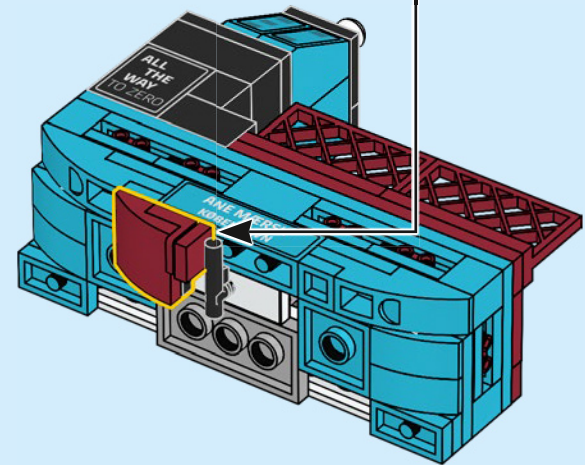
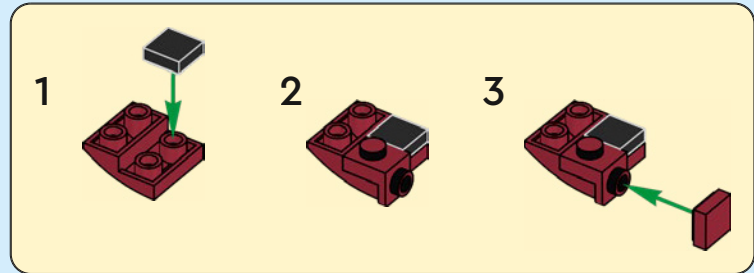

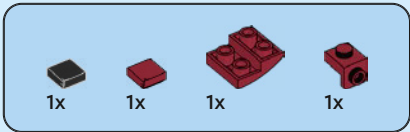

# 208

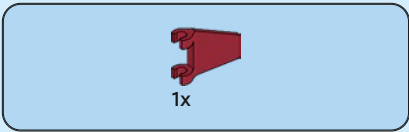
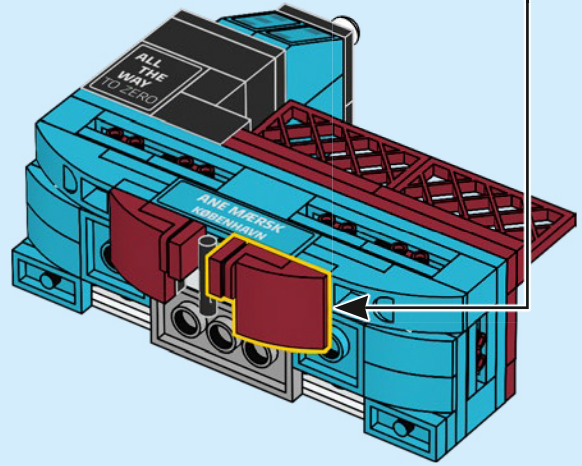

# 209

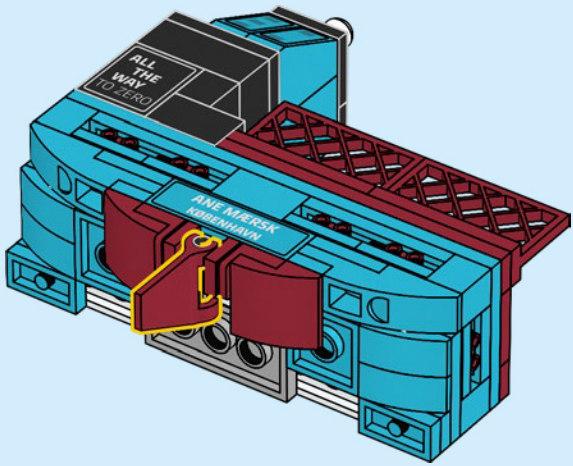

210

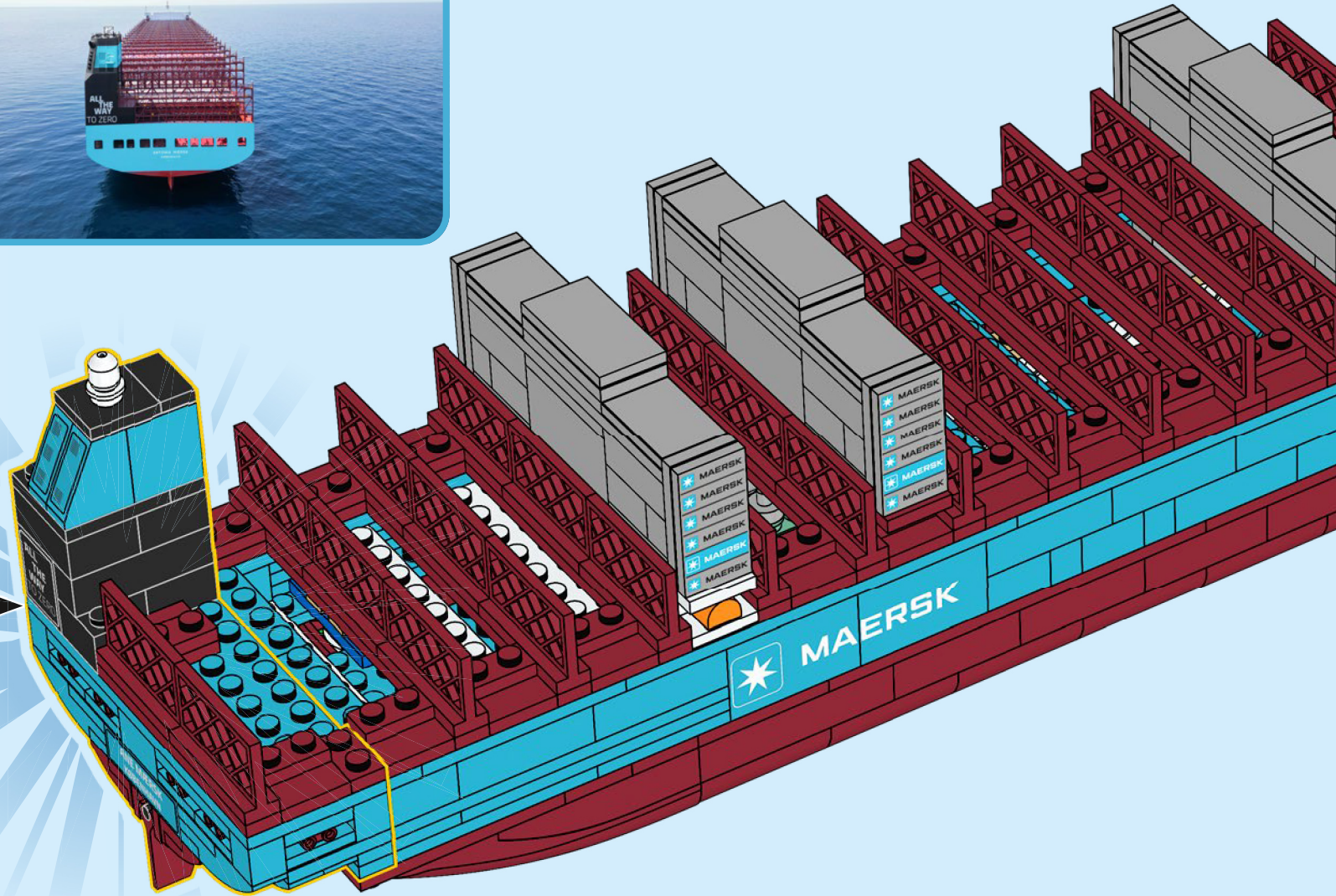
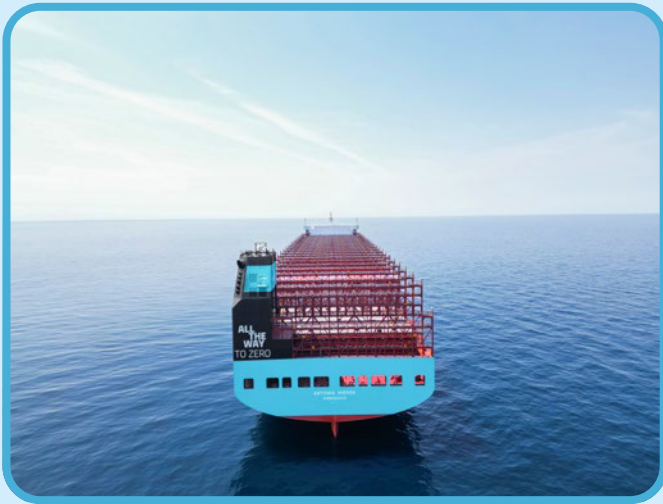

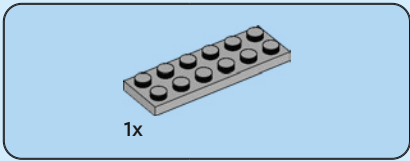

211

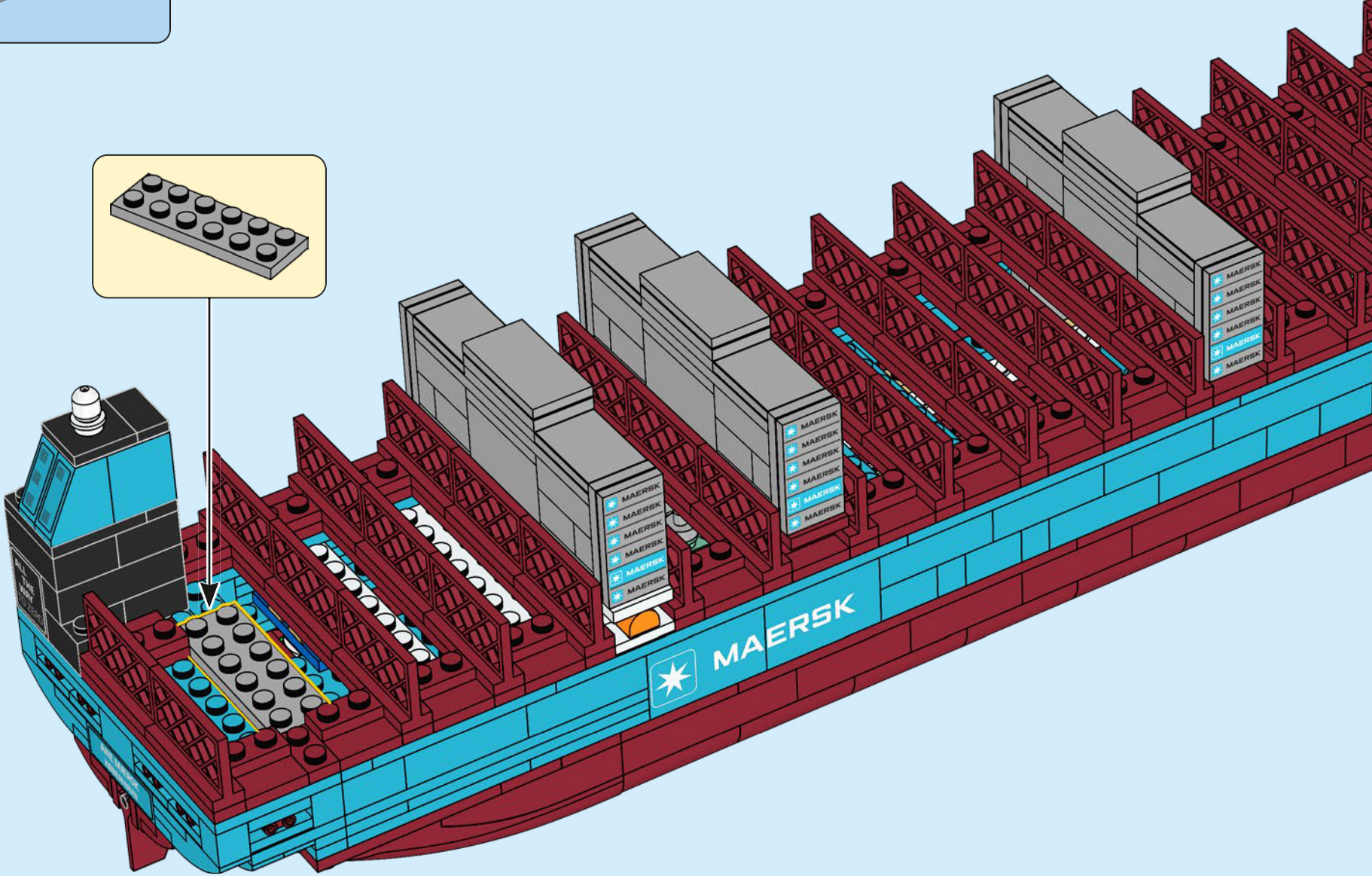
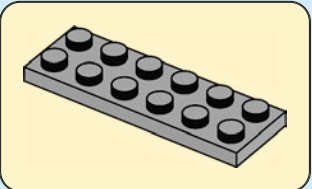

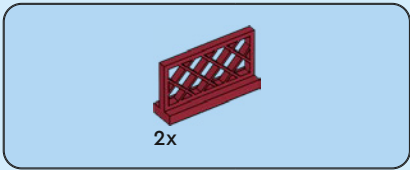

212

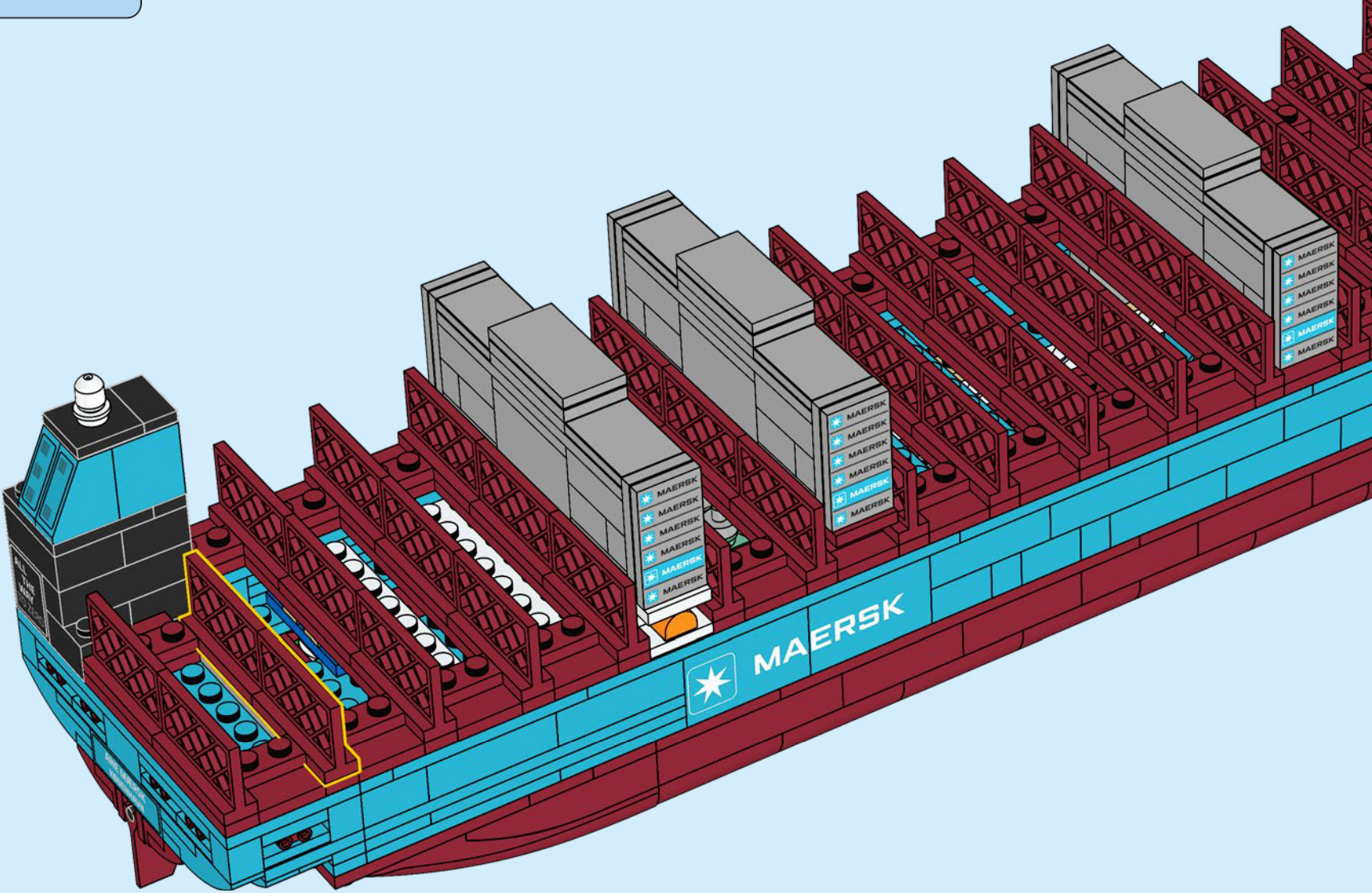

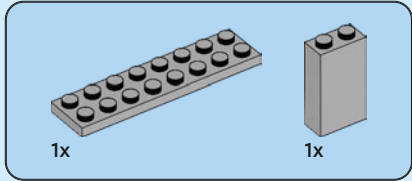
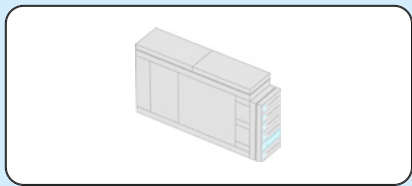

213

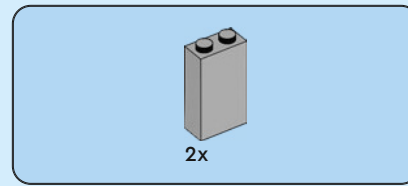
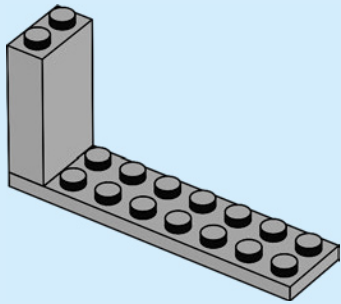

214

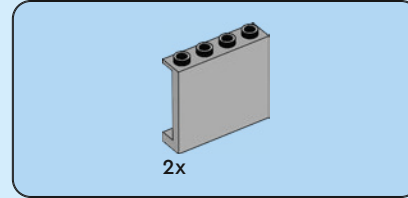
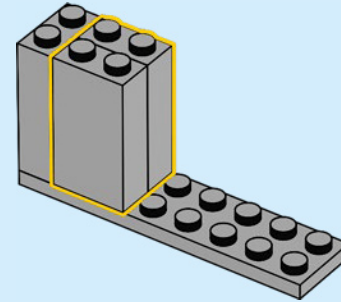

215

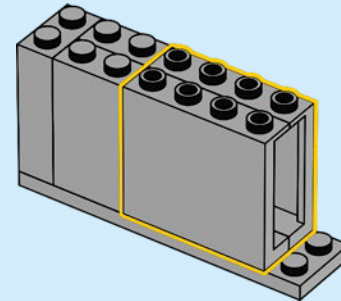

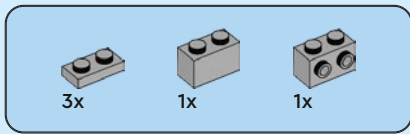

216

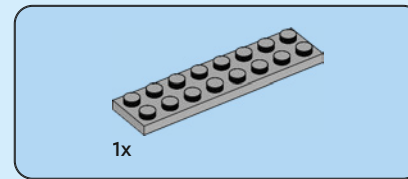
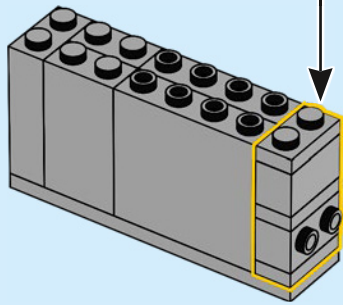
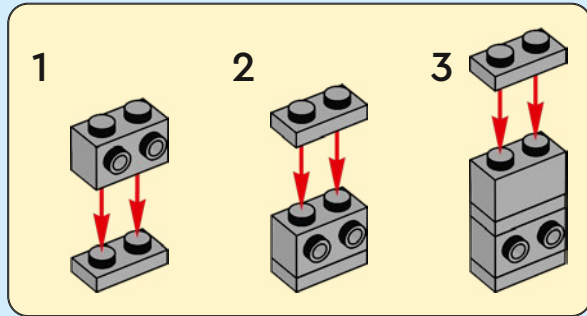

217

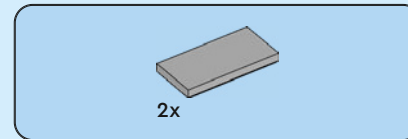
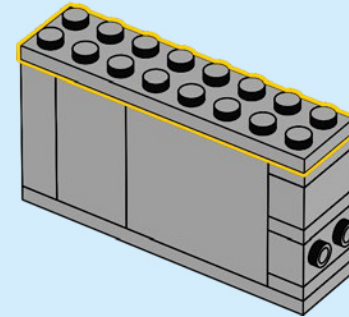

218

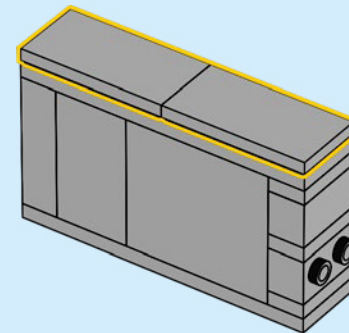

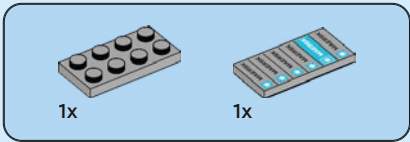

219

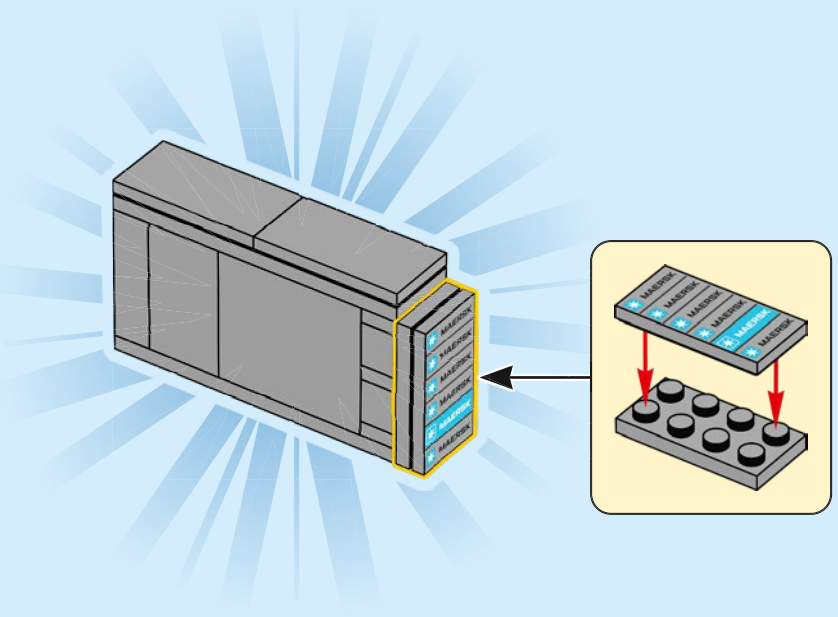

220

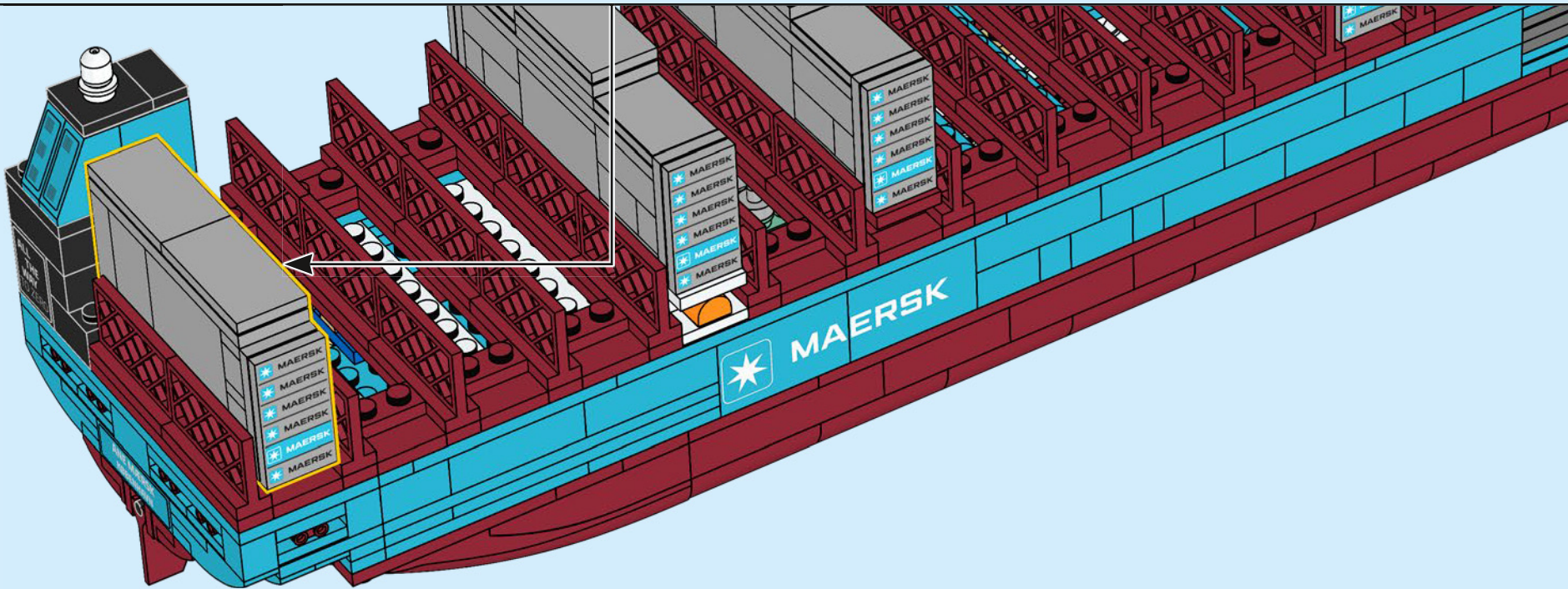

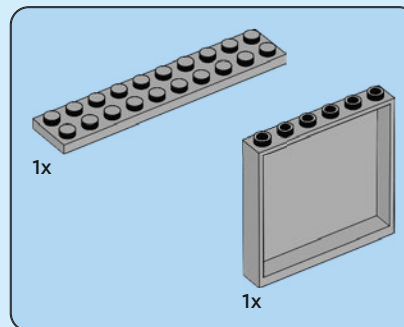
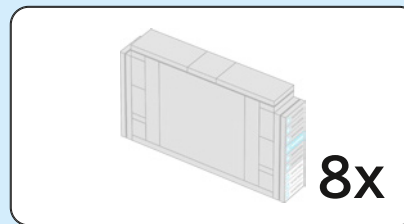

221

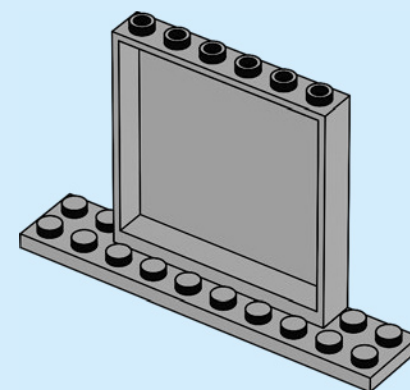

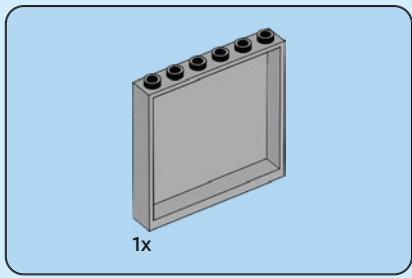

222

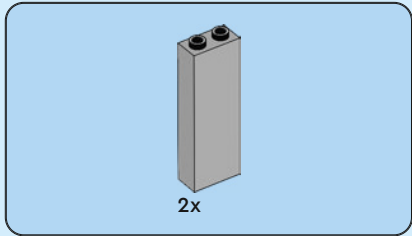
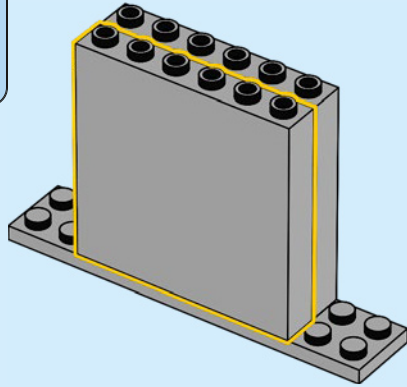

223

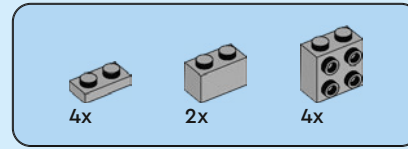
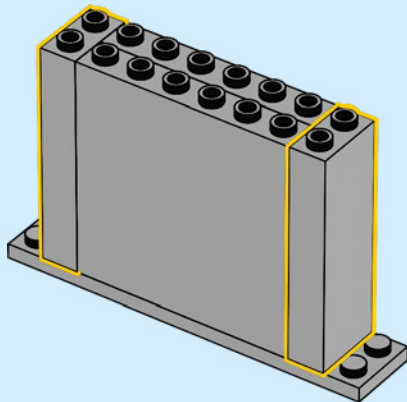

224

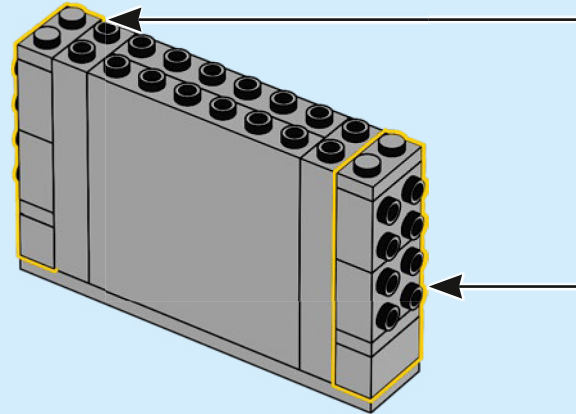
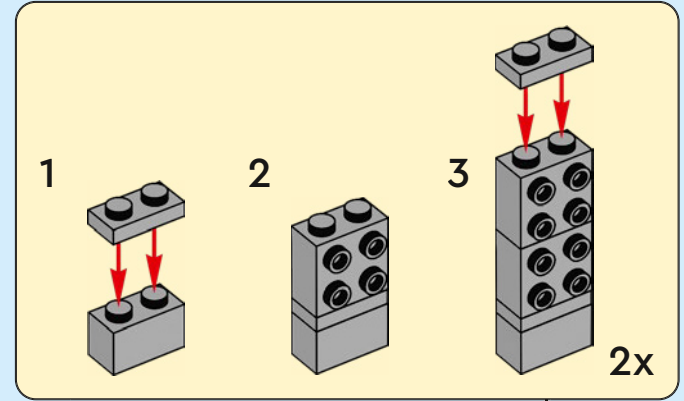

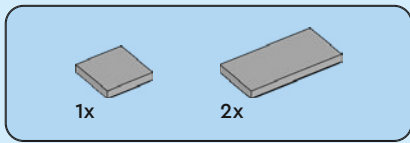

225

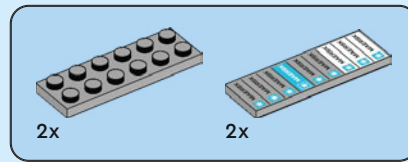
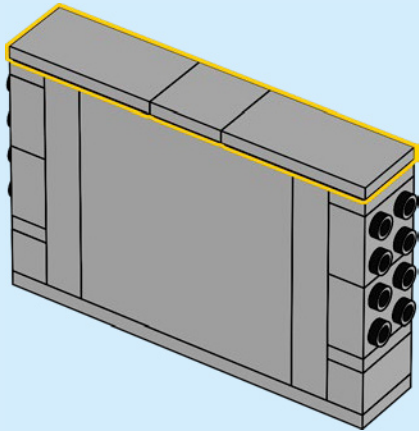

226

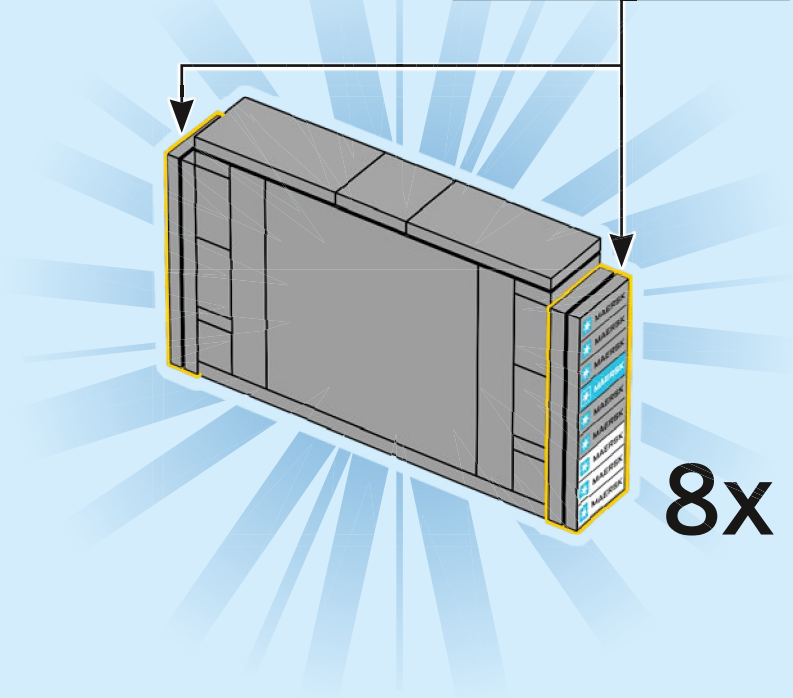
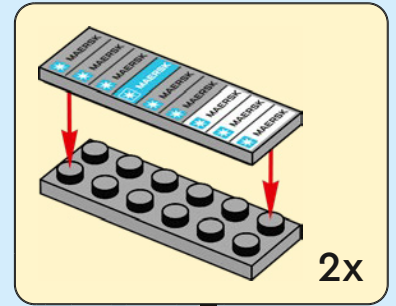

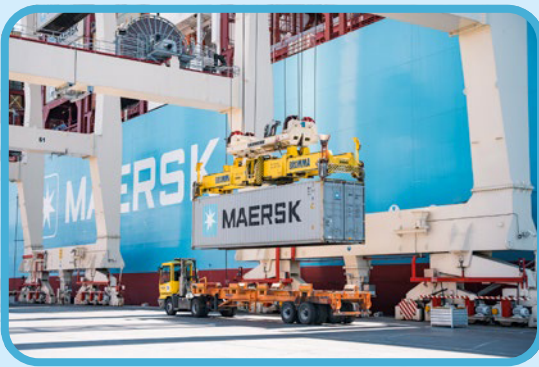

227

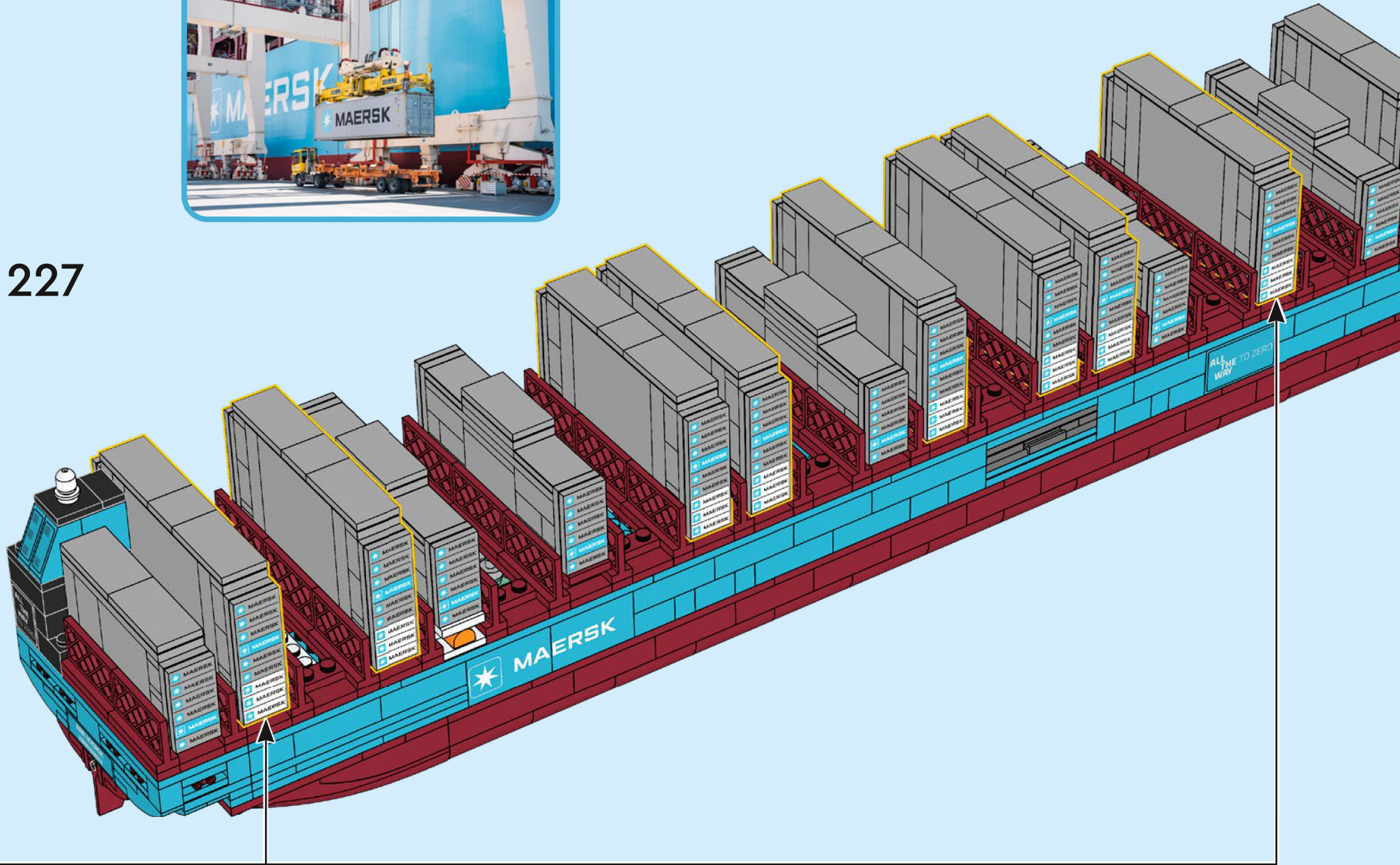





228

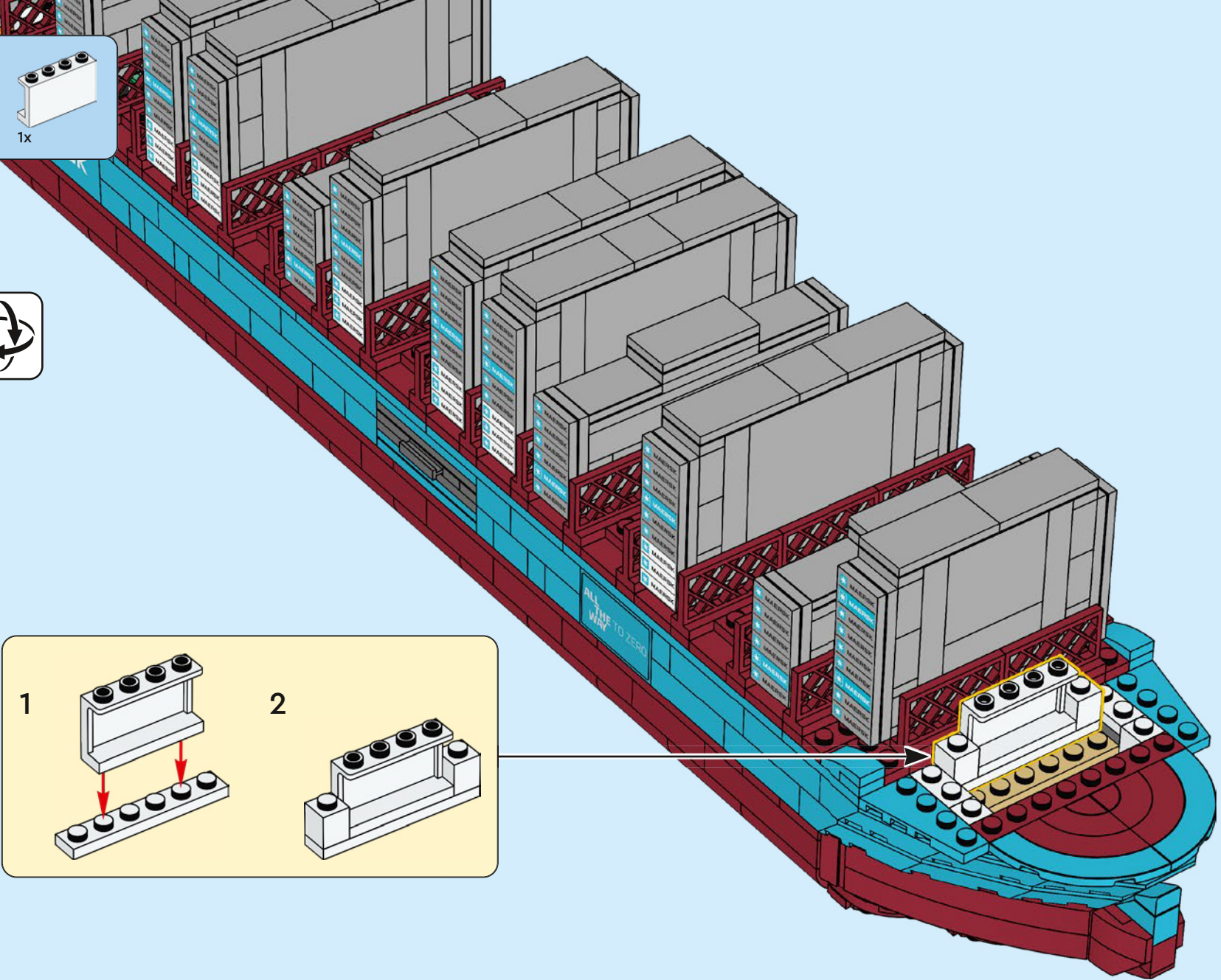
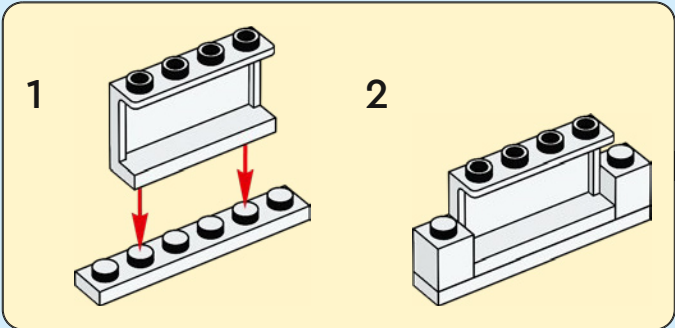

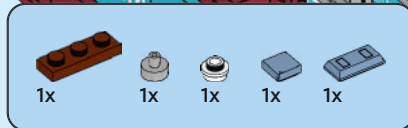

229

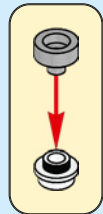
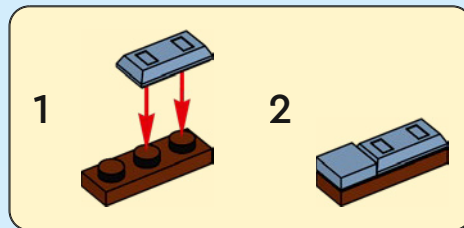



4x

230

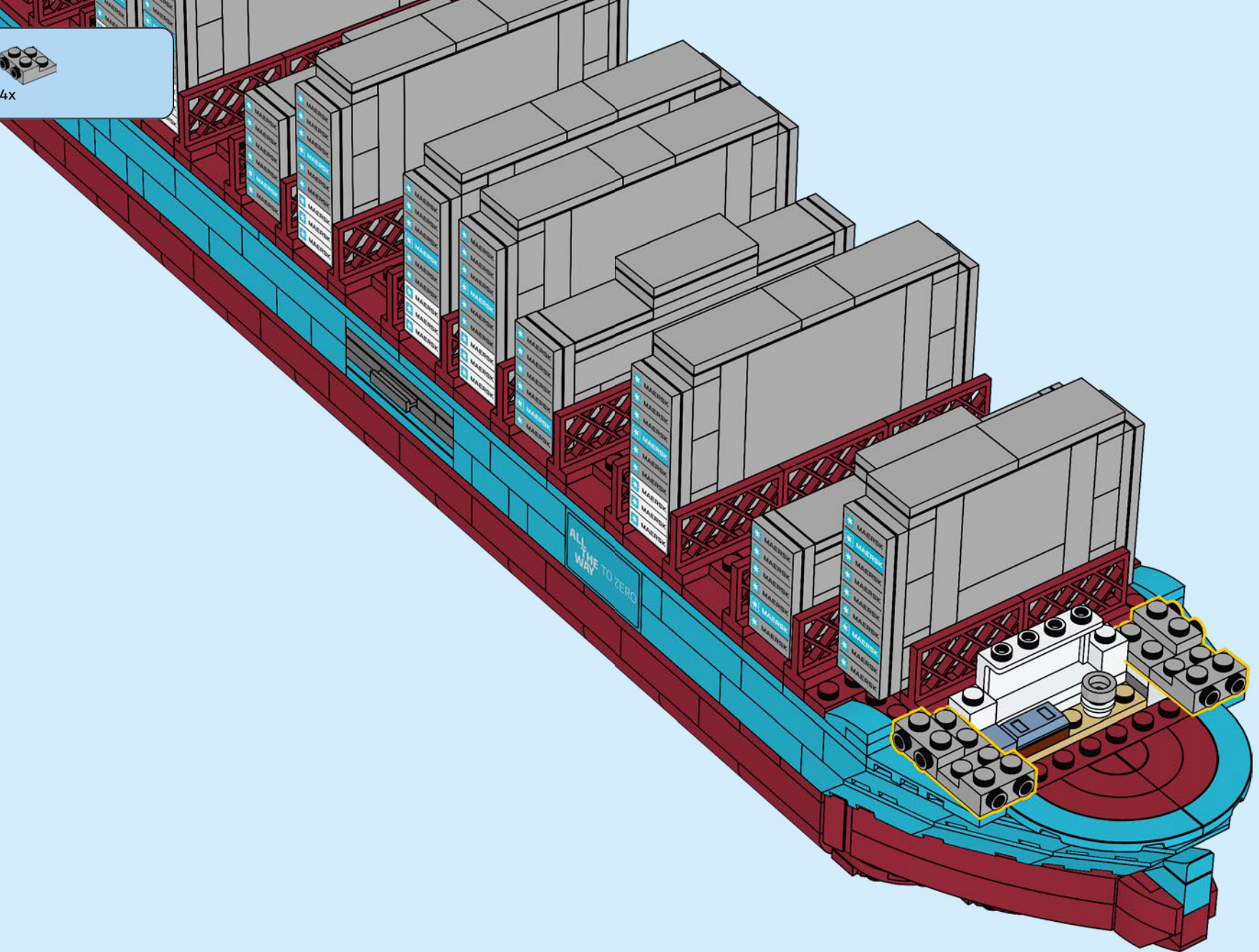

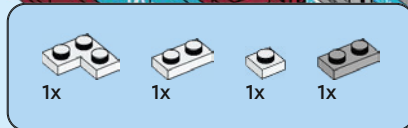

231

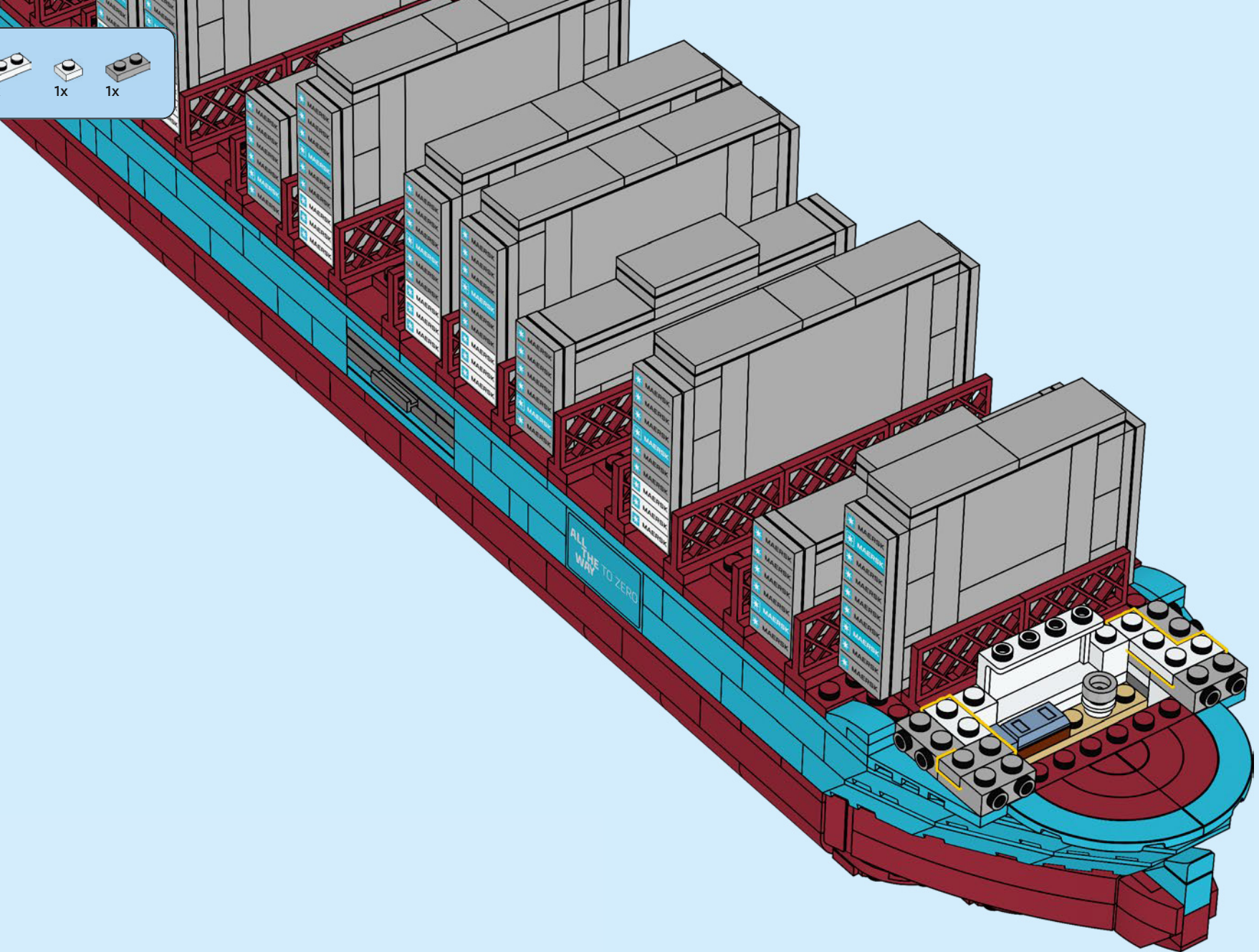

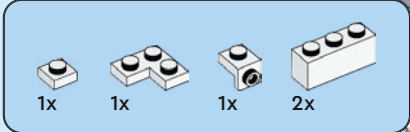

232

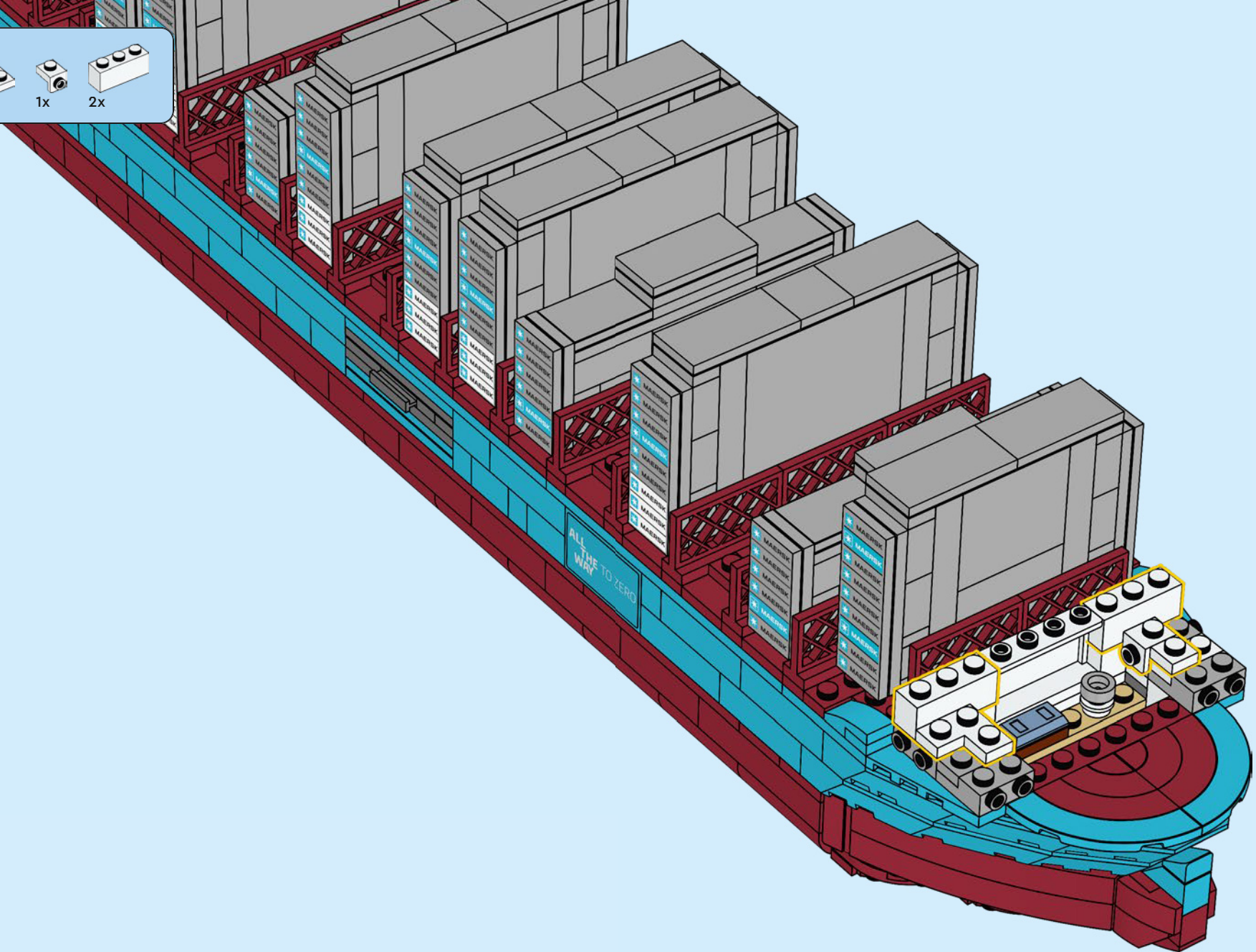

1x 1x 4x

233

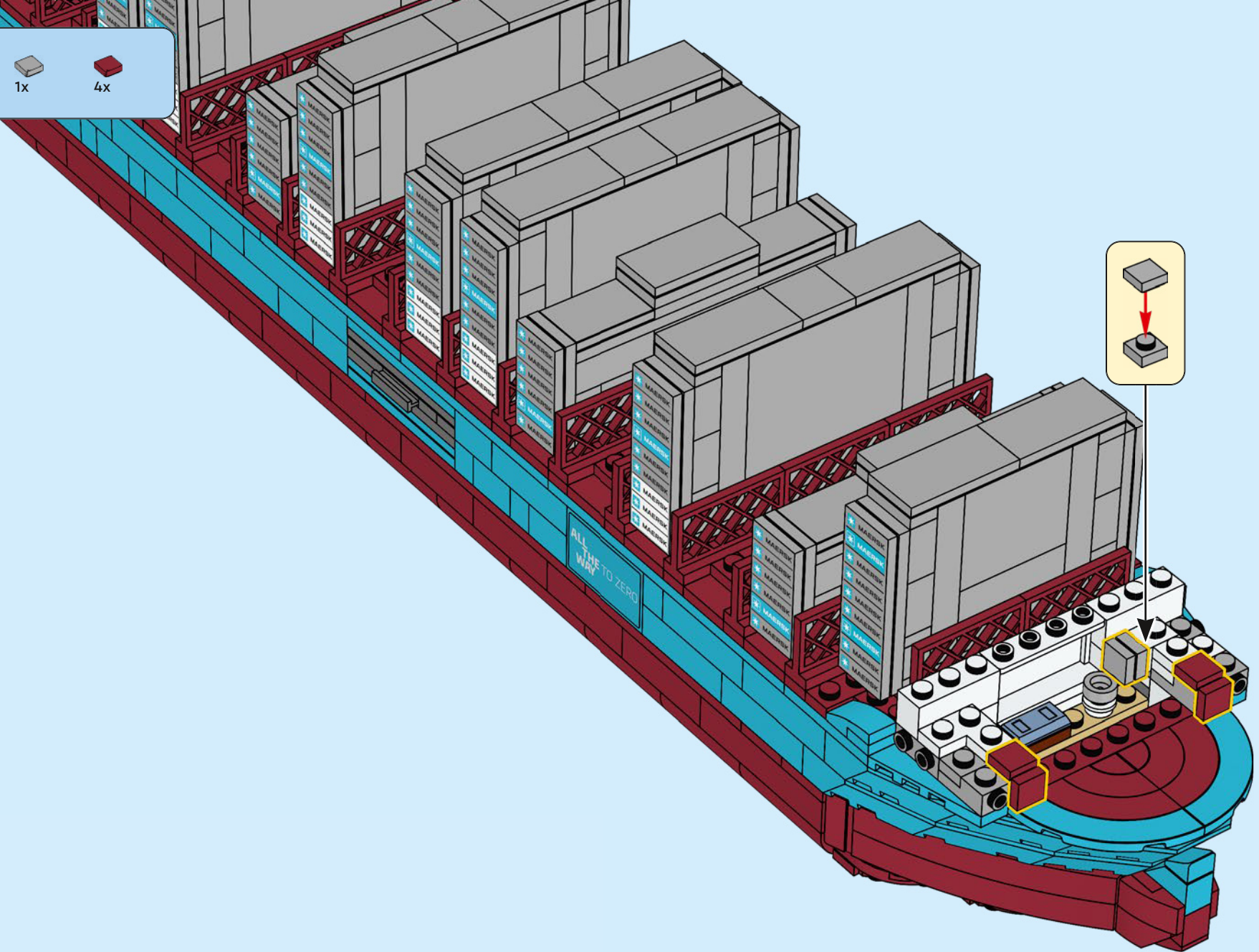

3x 2x 2x

234

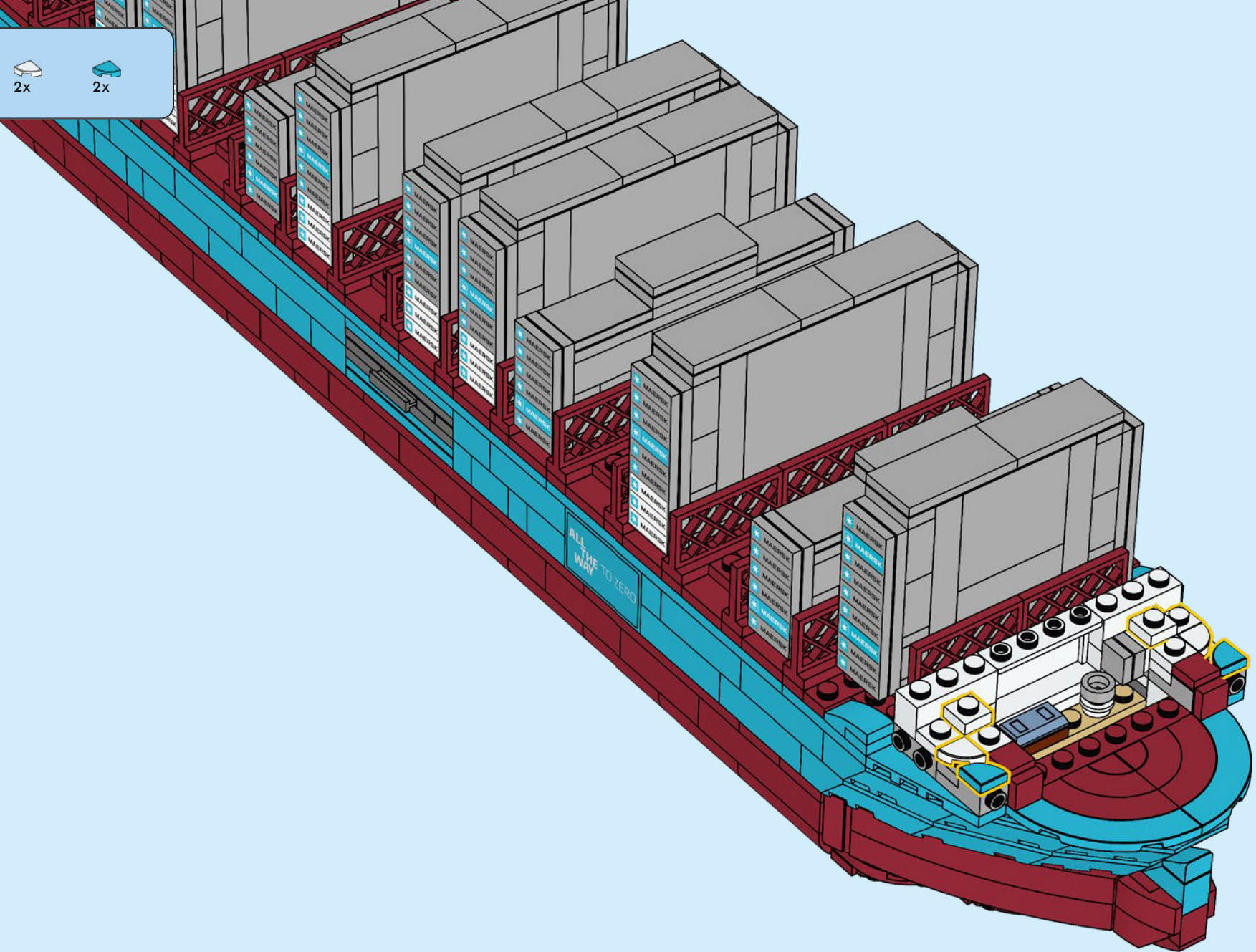

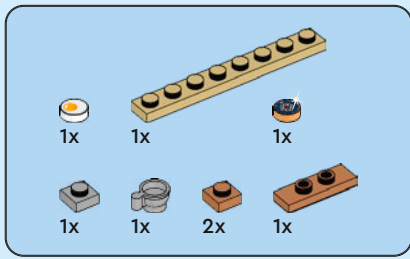

235

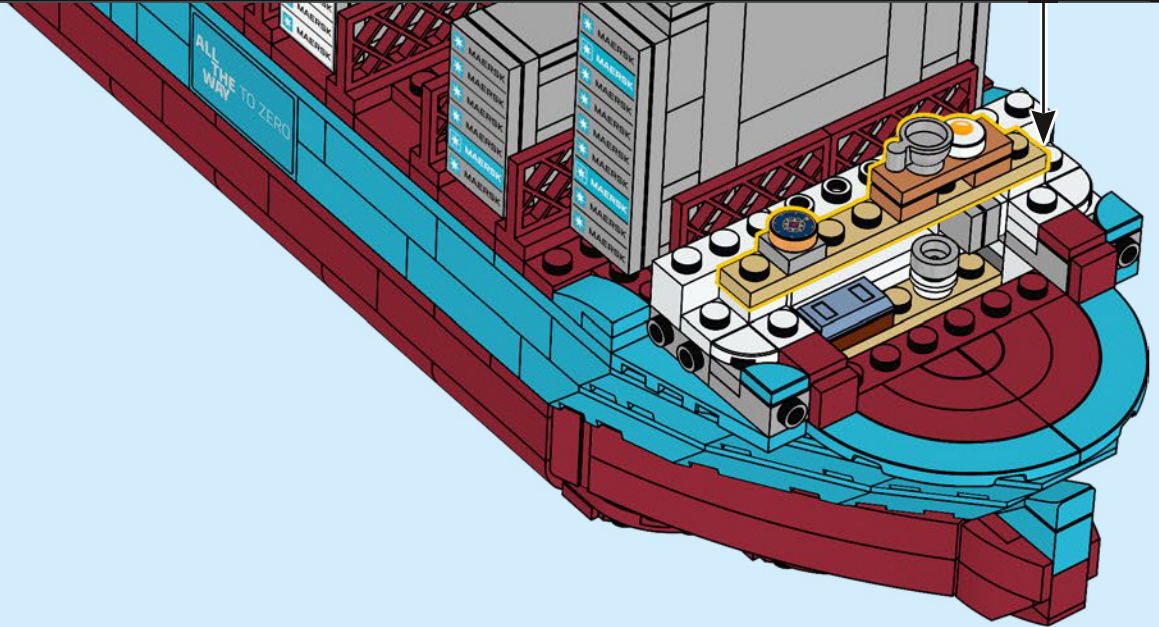
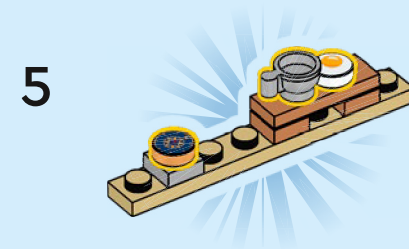
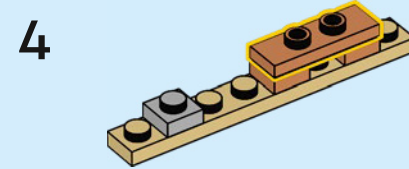
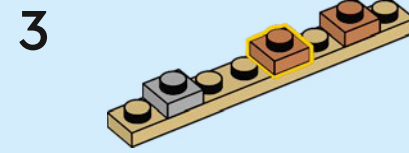
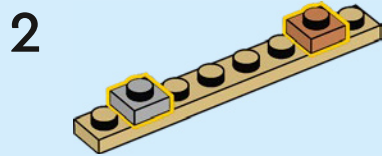
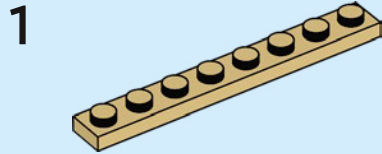

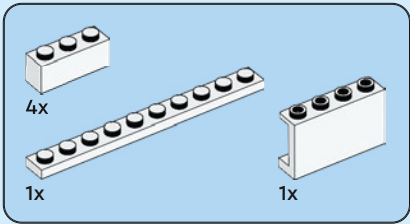

# 236

1

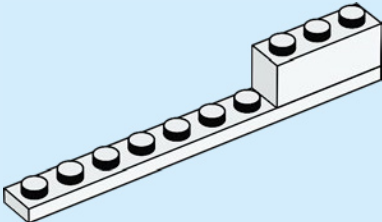

2

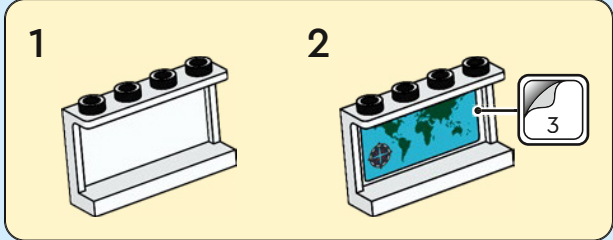
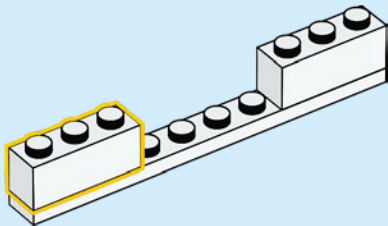

3

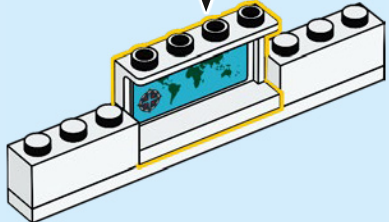

4

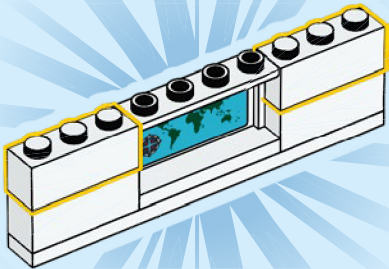

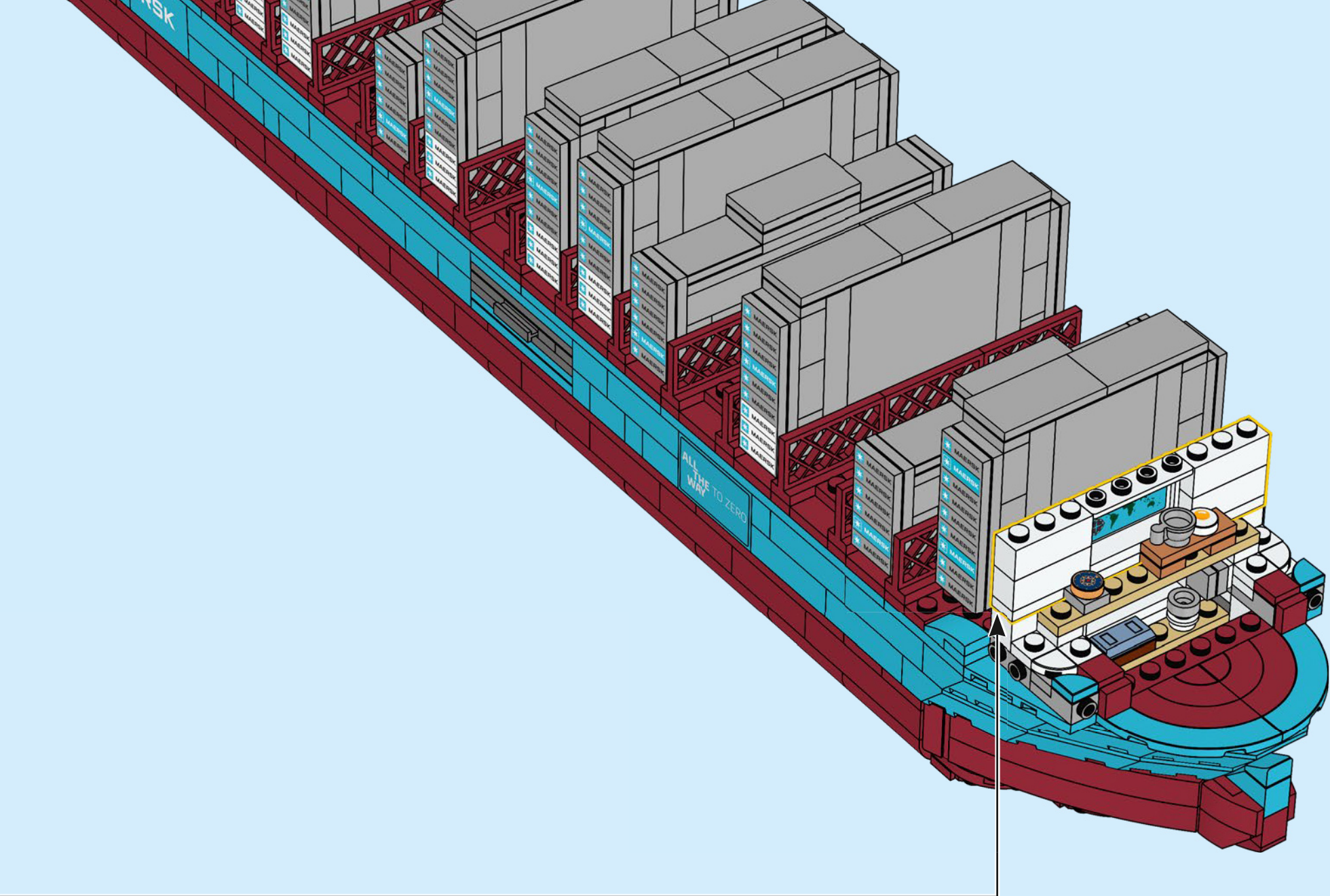

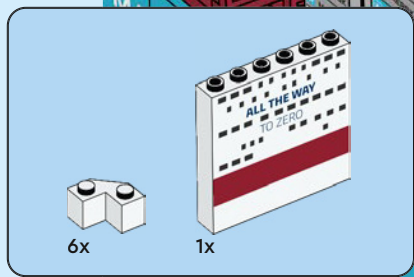

237

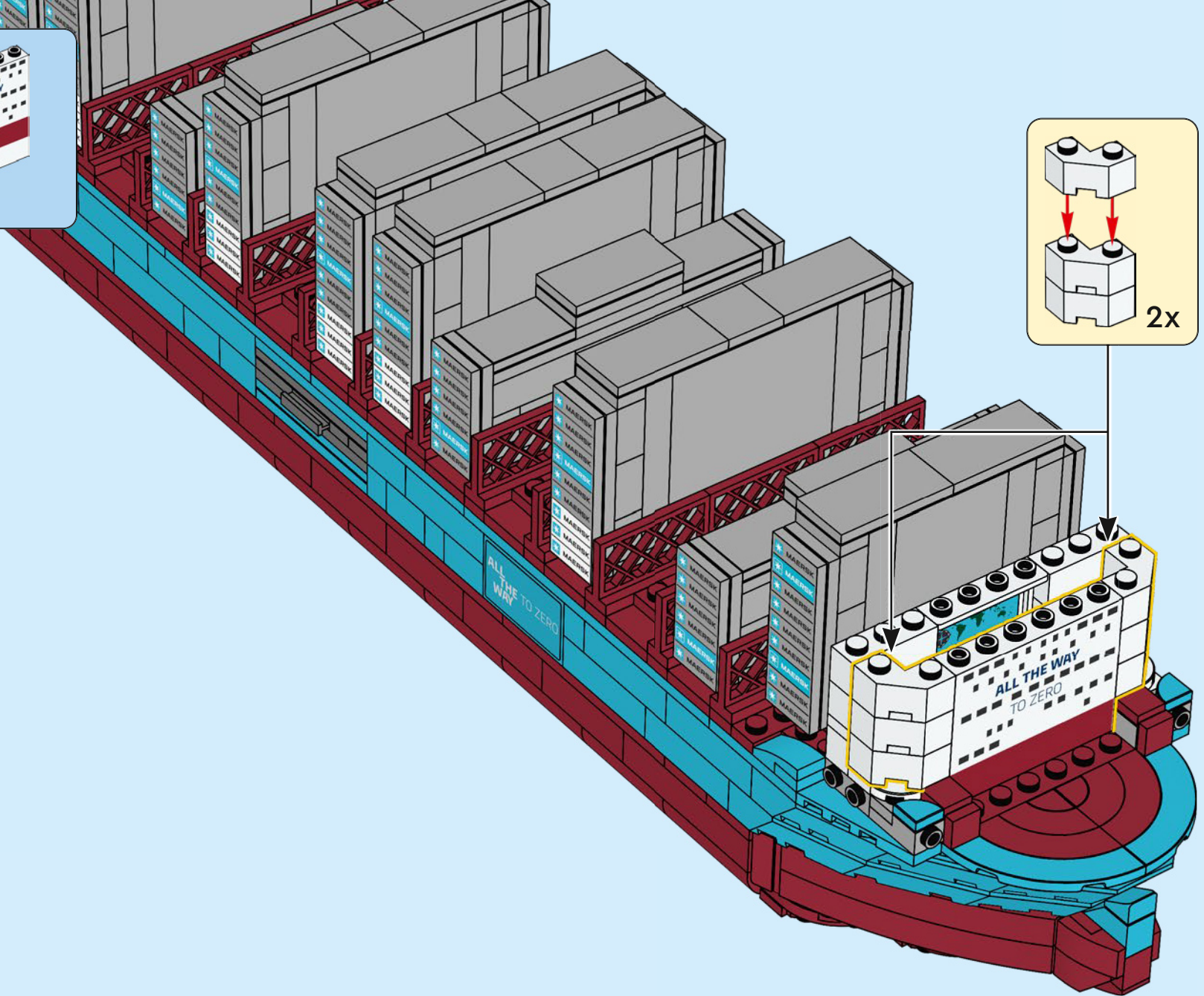



238

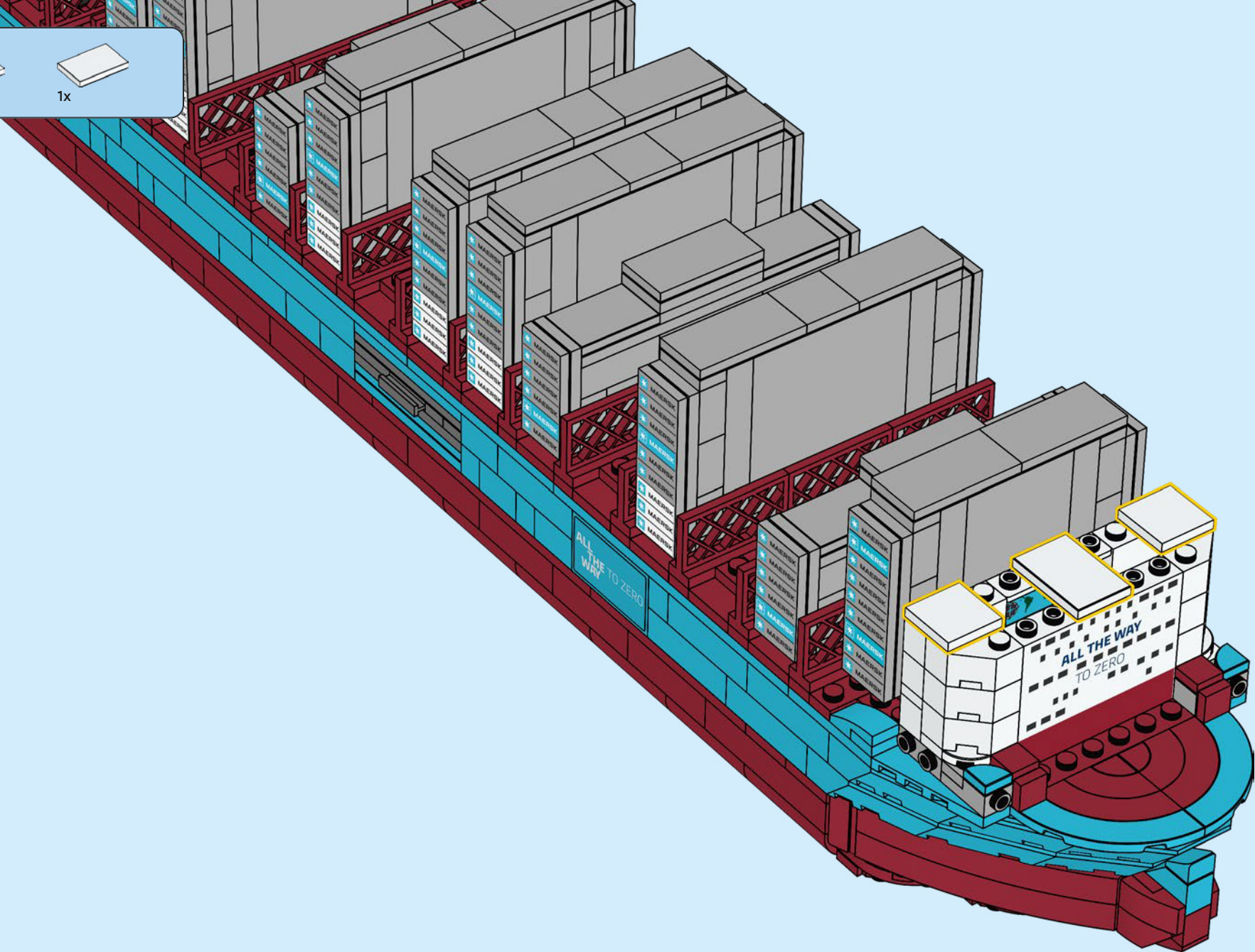

2x 1x 1x

239

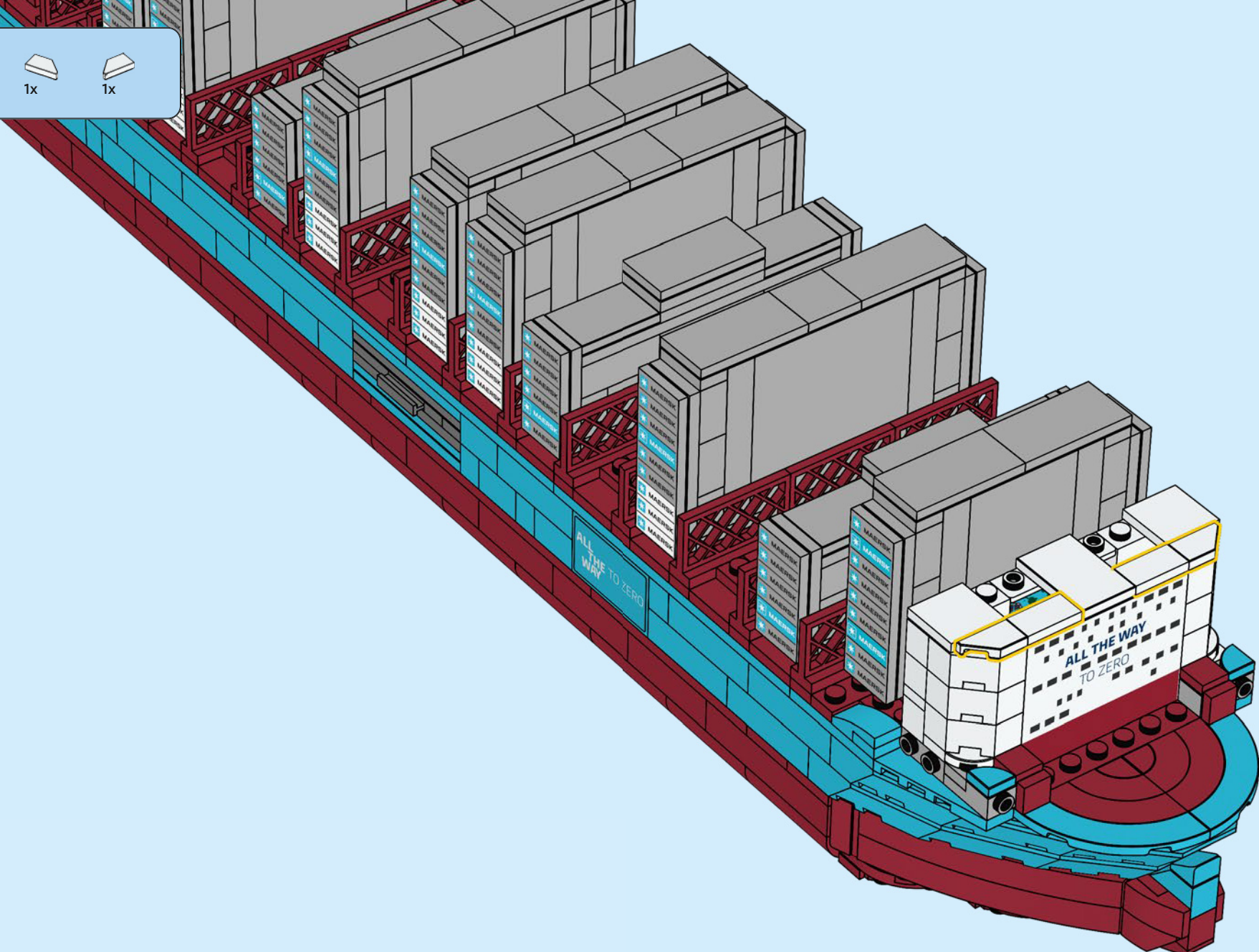

2x 2x 2x

240

1 2 2x

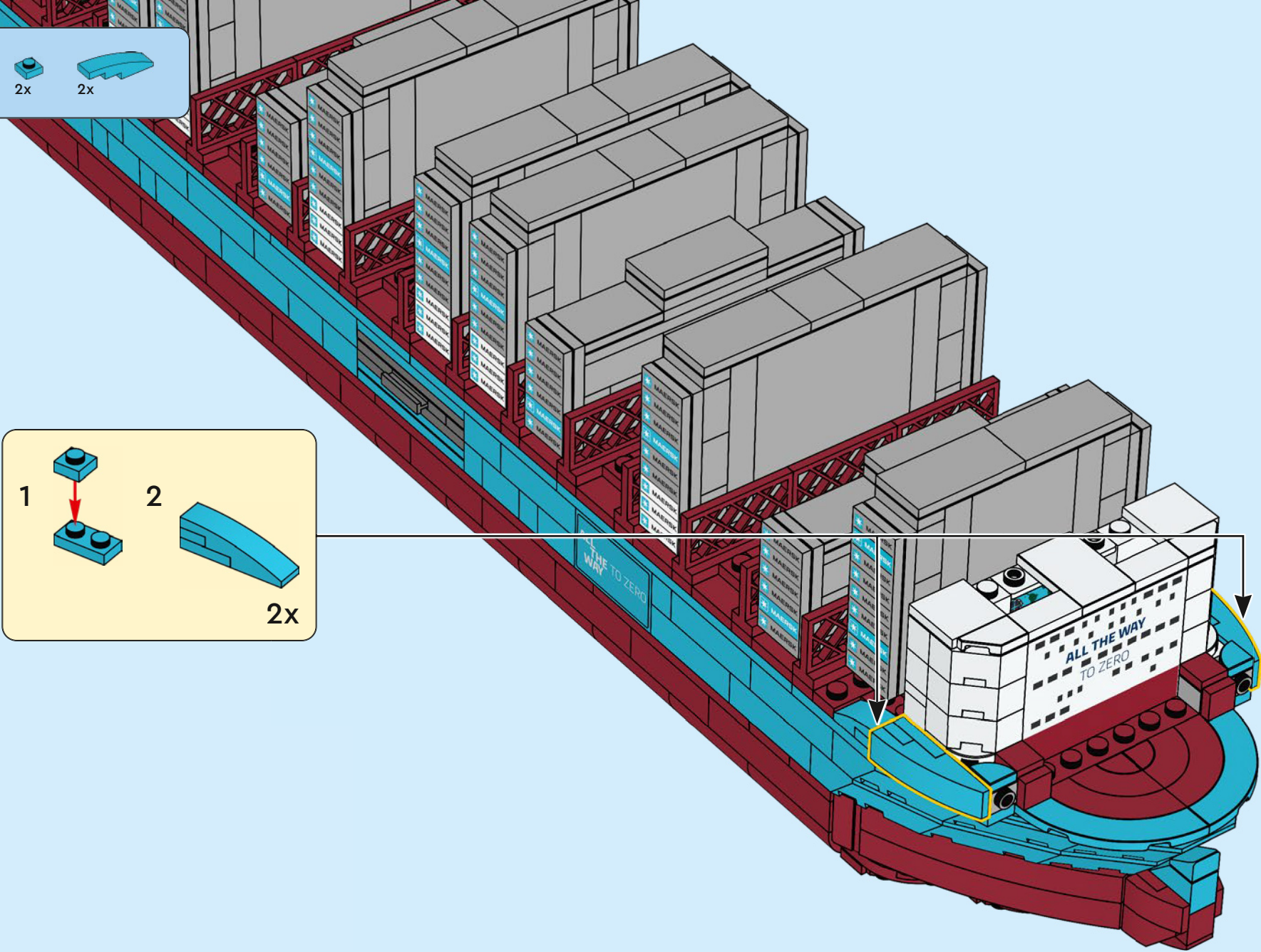

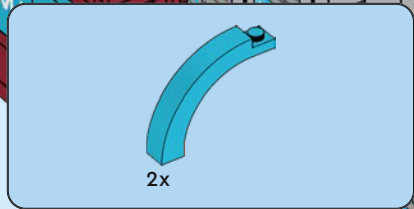

241

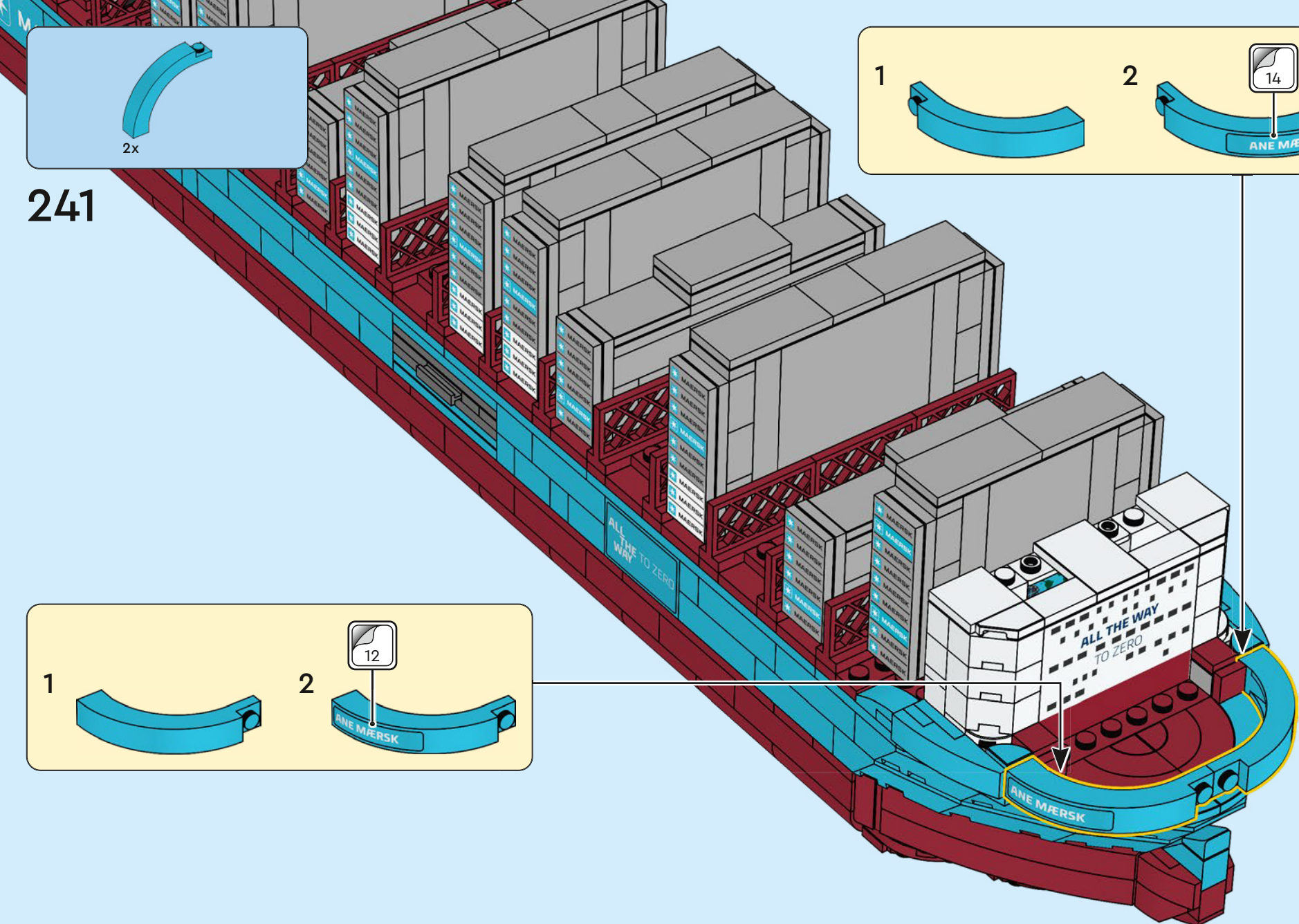
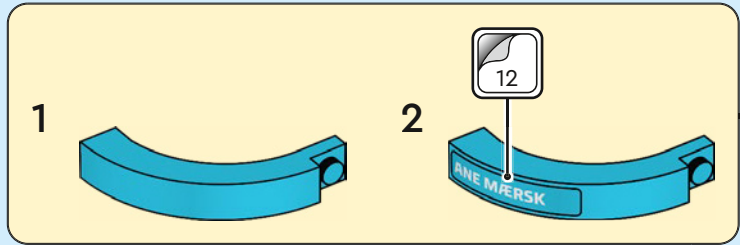
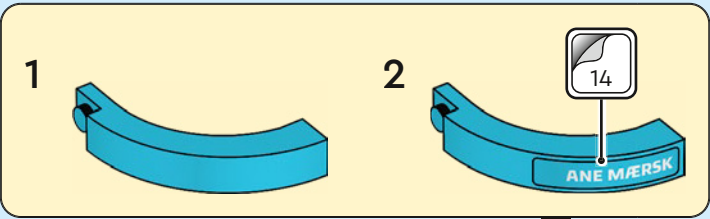

1x

242

1

2

13

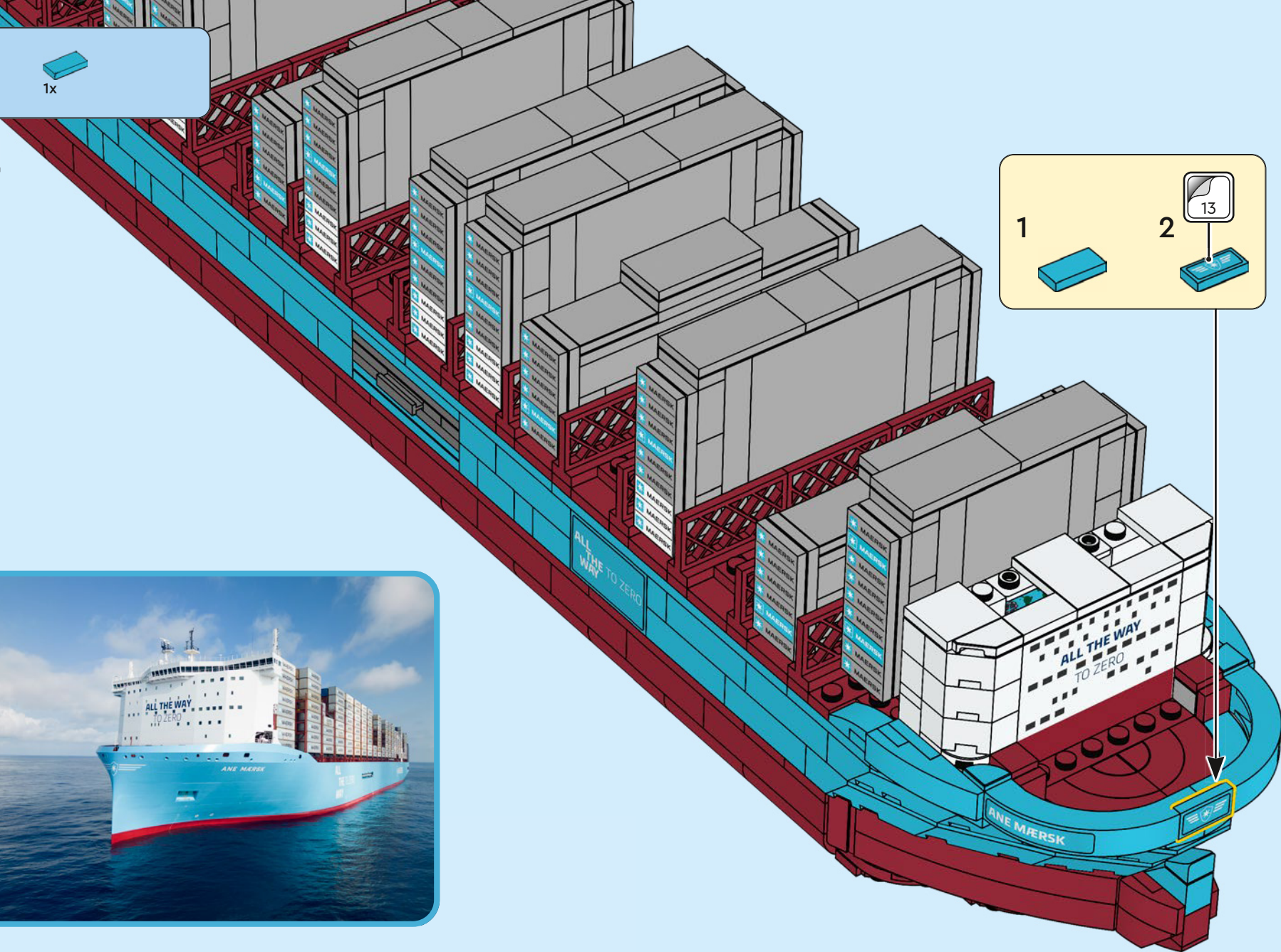

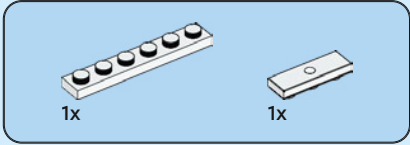
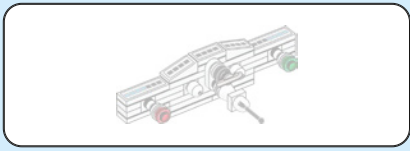

243

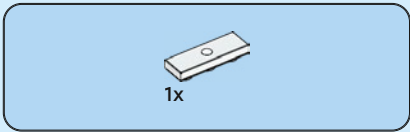
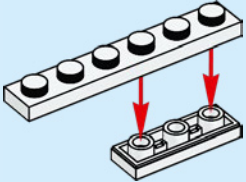

244

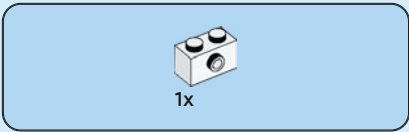
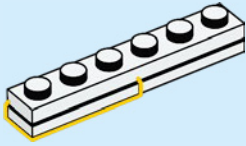

245

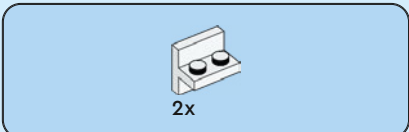
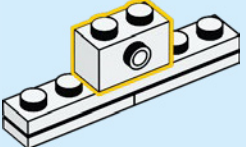

246

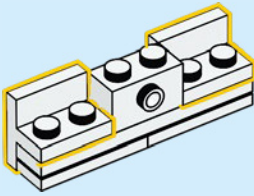



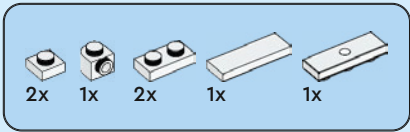

# 249

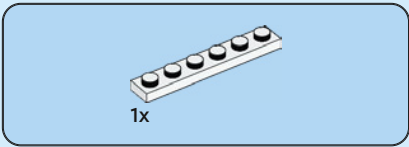
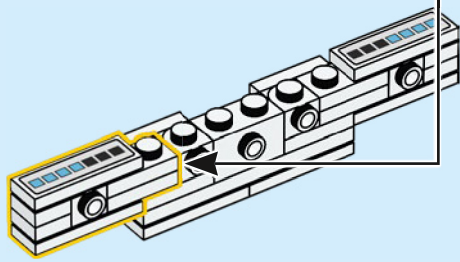
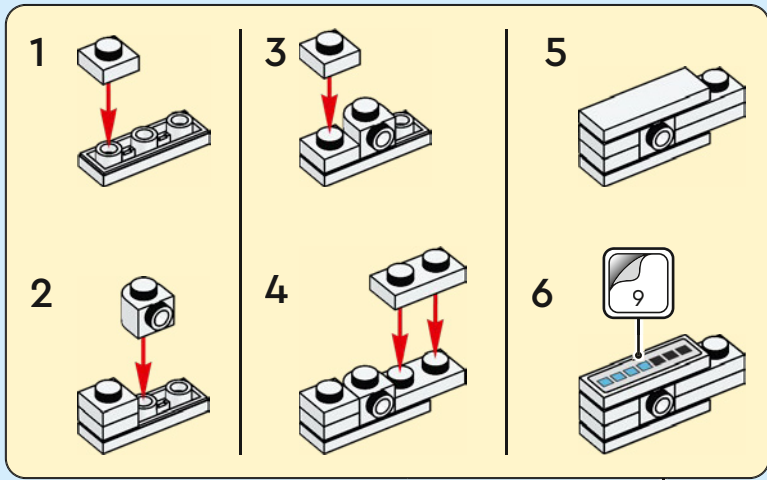

# 250

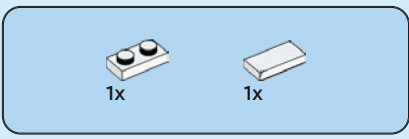
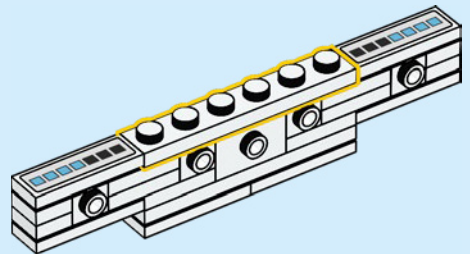

# 251

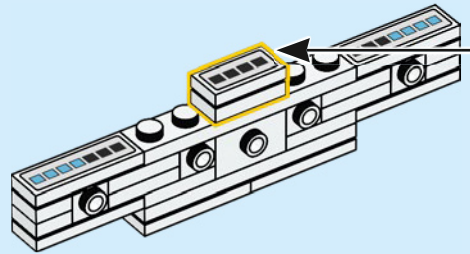
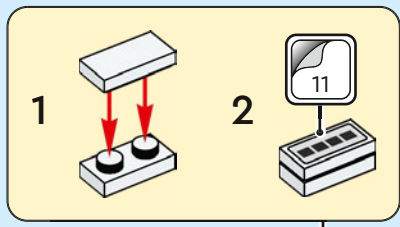

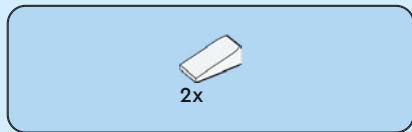

252

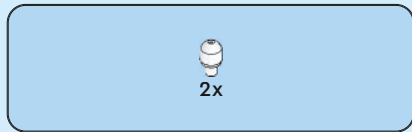
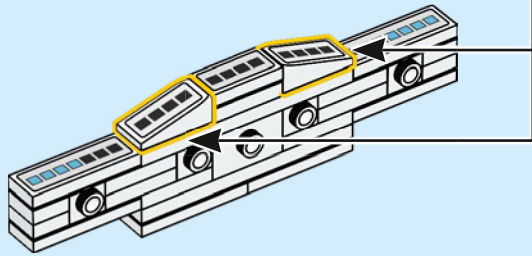
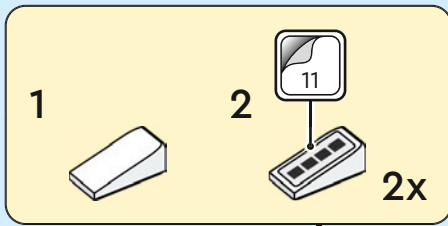

253

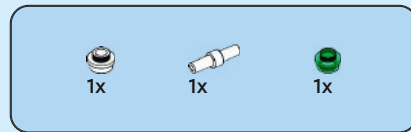
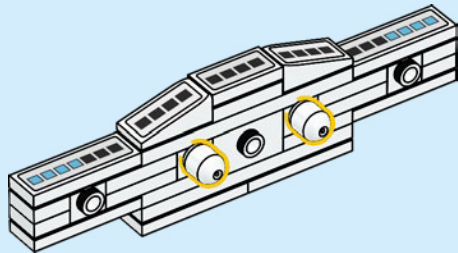

254

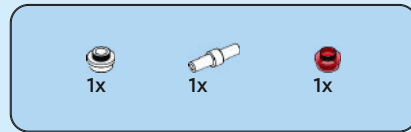
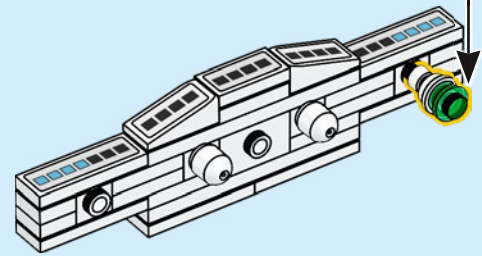
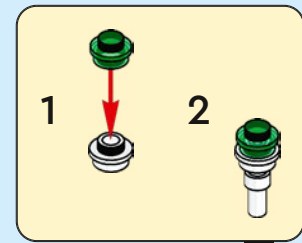

255

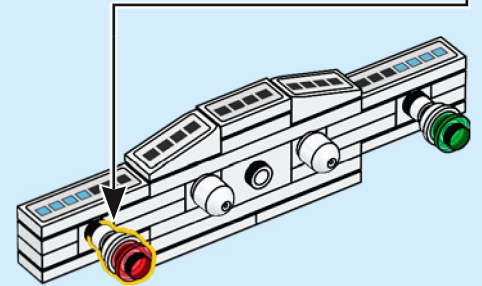
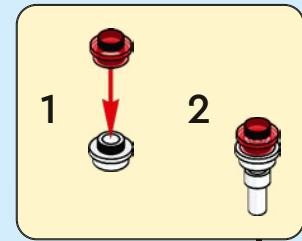

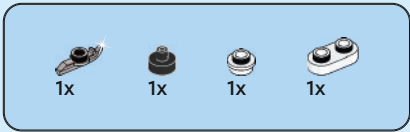

256

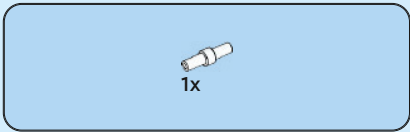
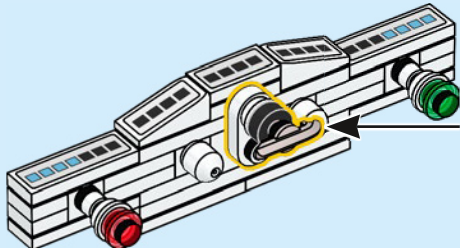
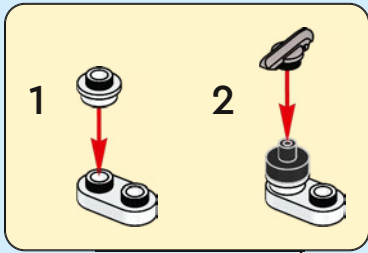

257

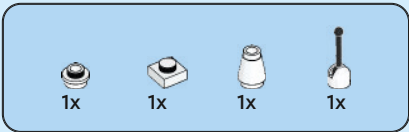
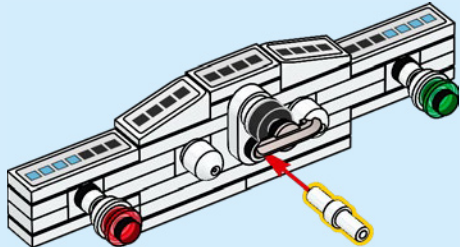

258

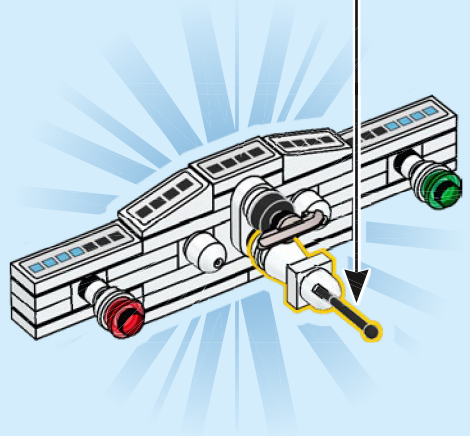
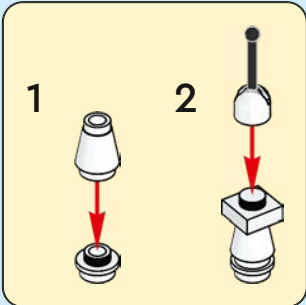

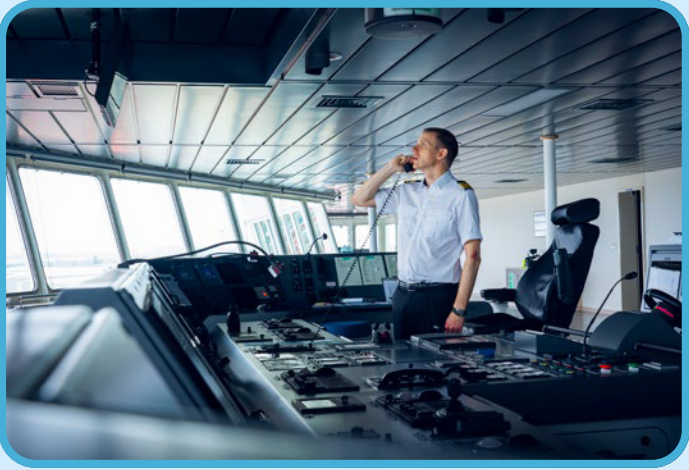
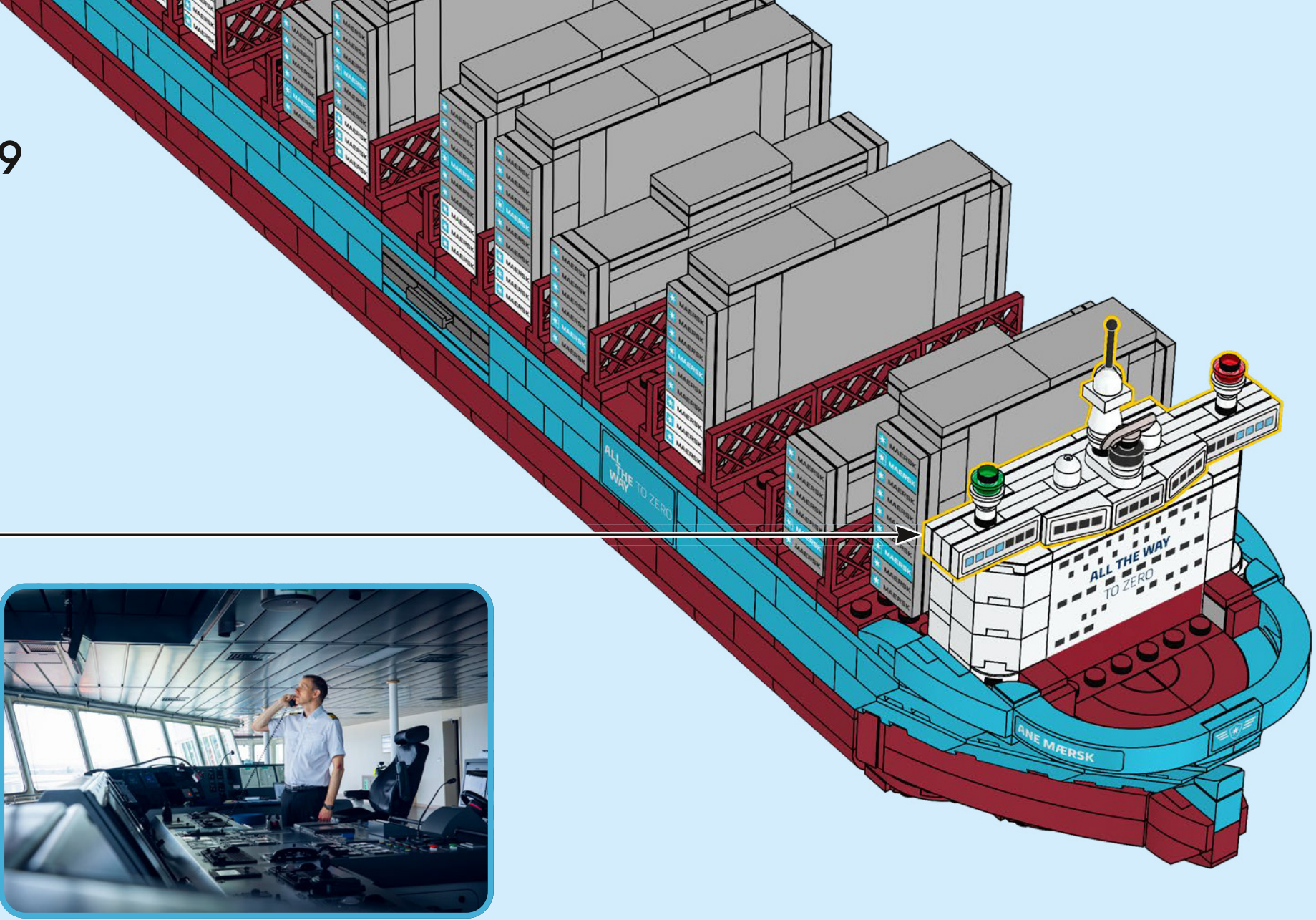

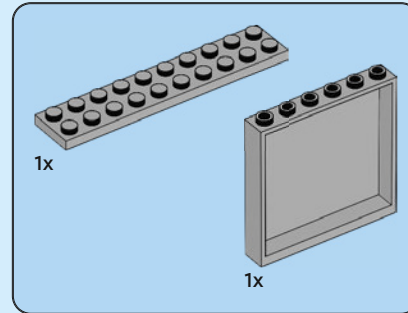
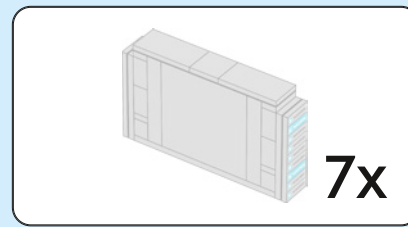

260

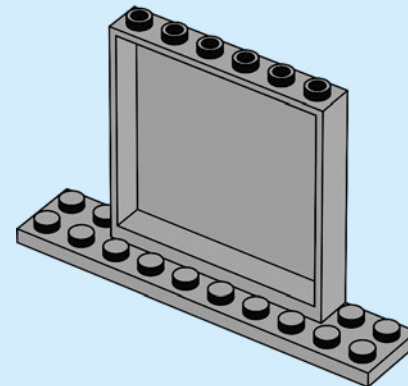

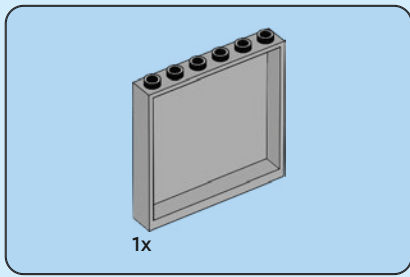

261

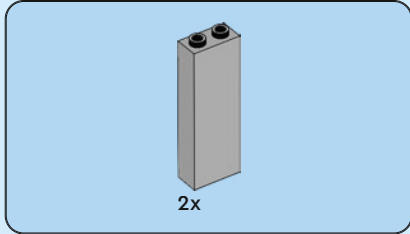
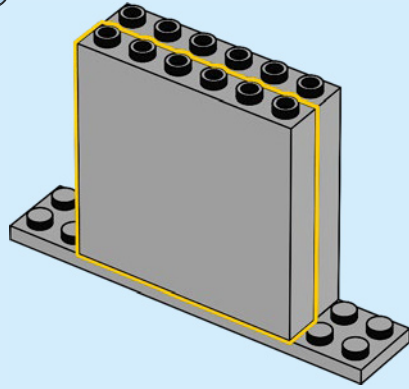

262

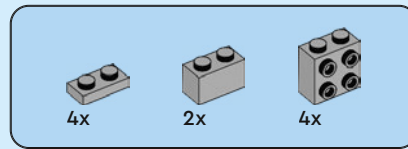
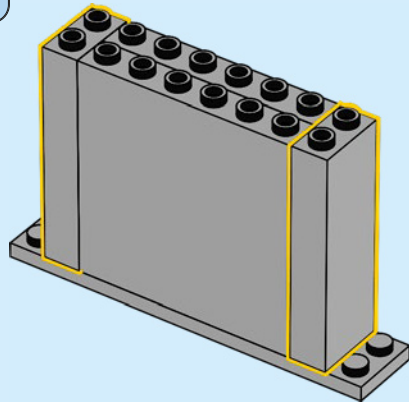

263

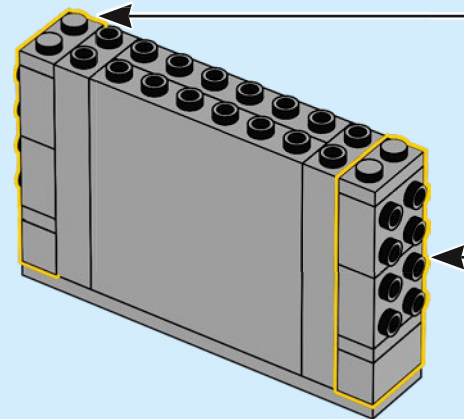
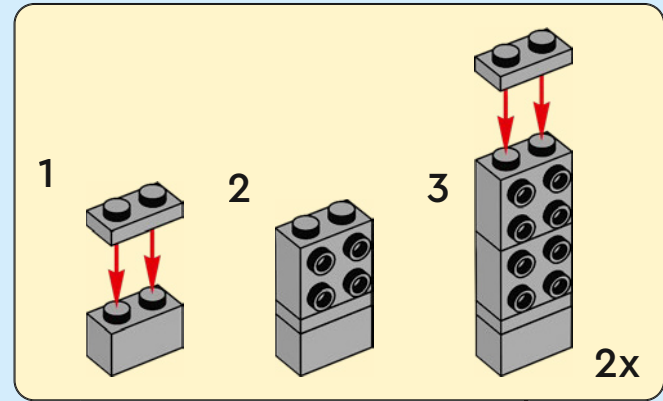

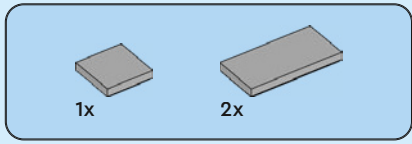

264

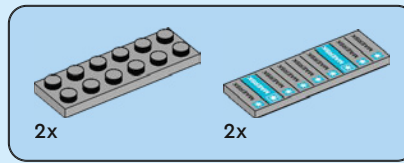
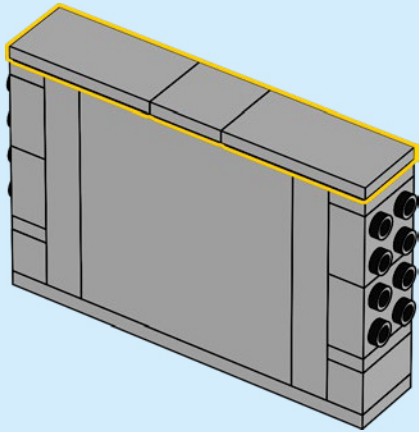

265

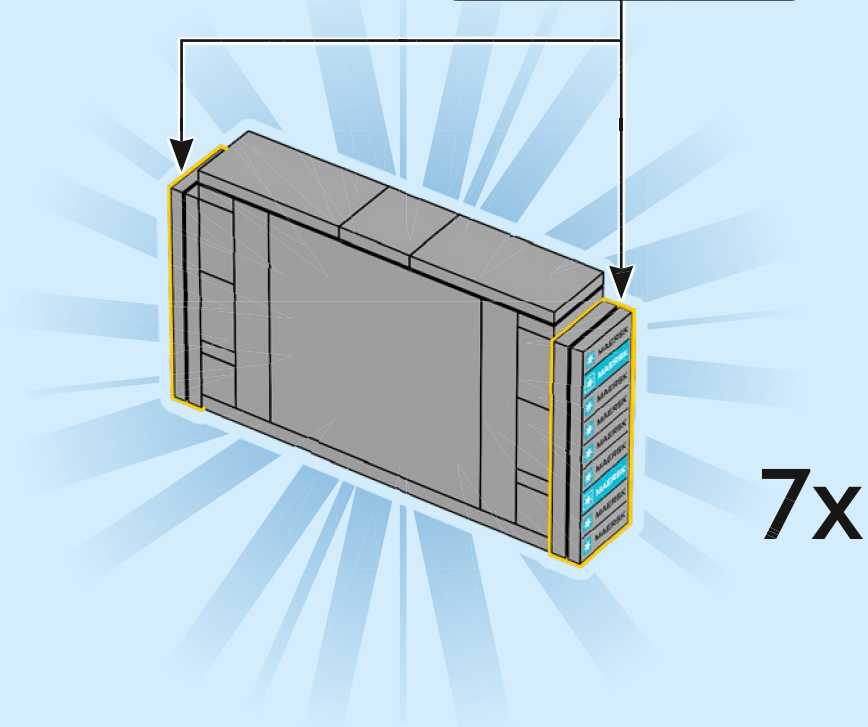
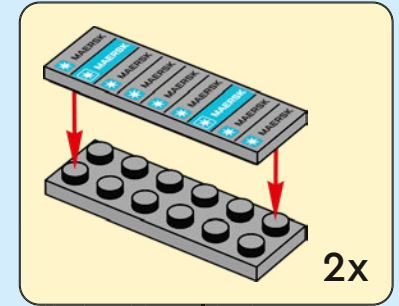

266

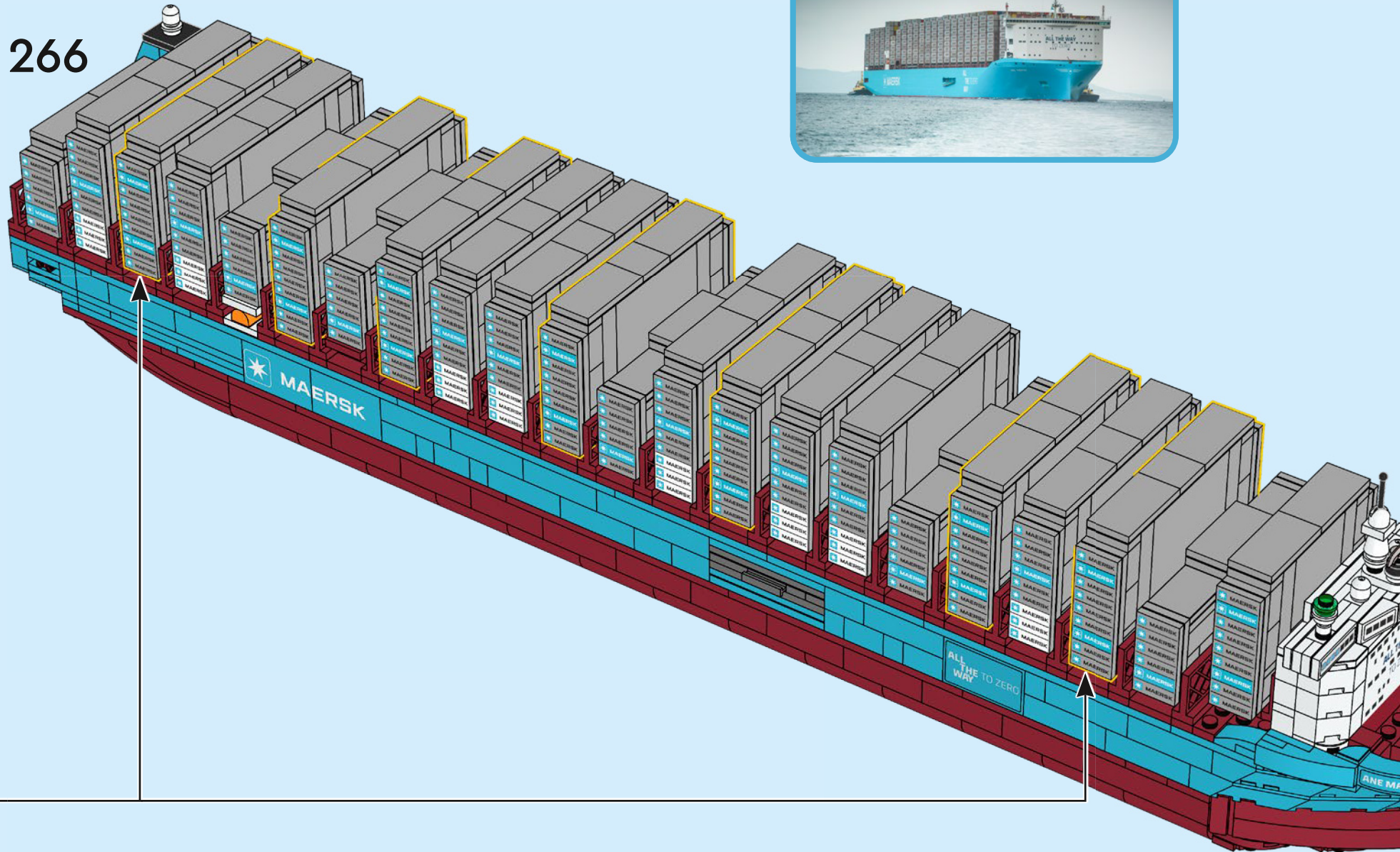

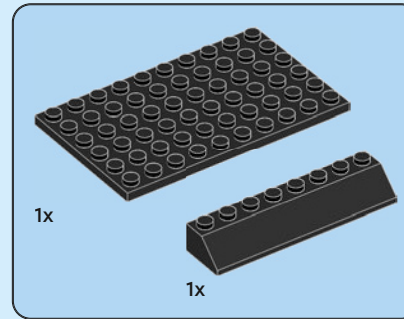
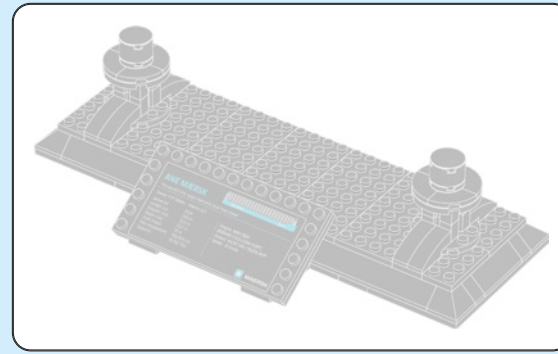

267

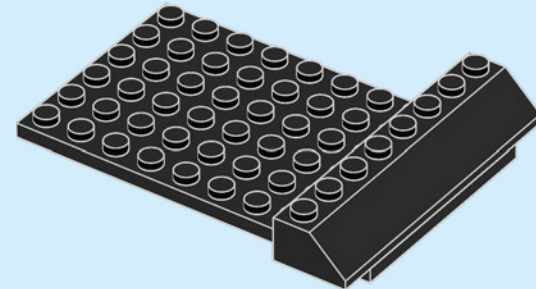

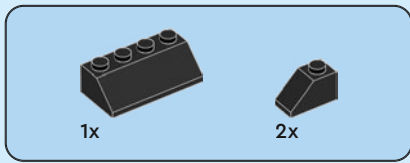

268

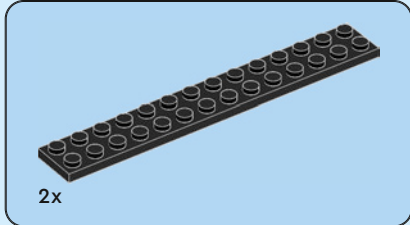
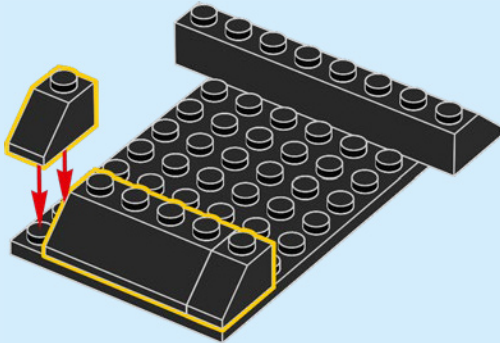

269

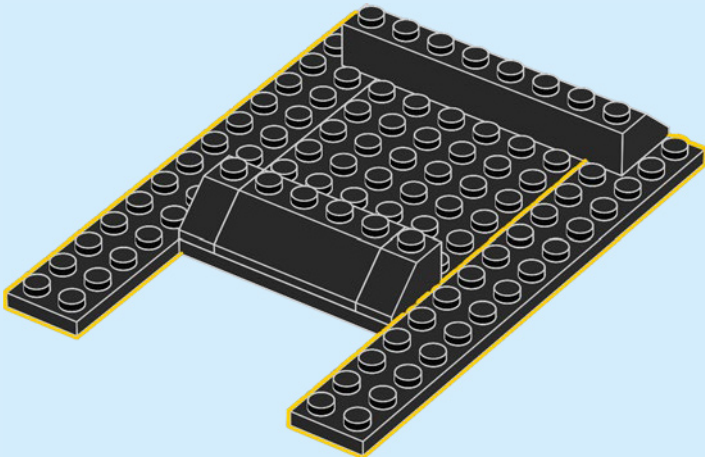

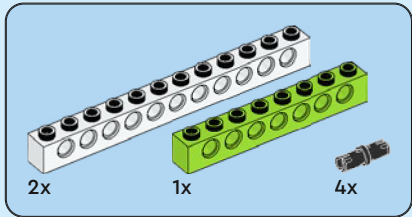
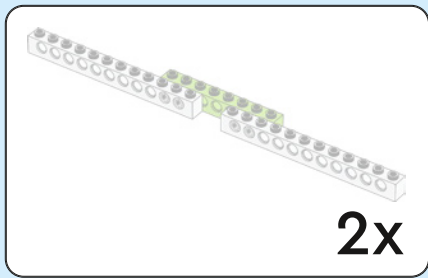

270

1

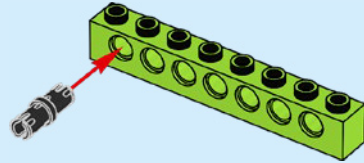

2

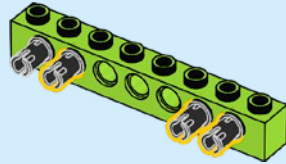

3

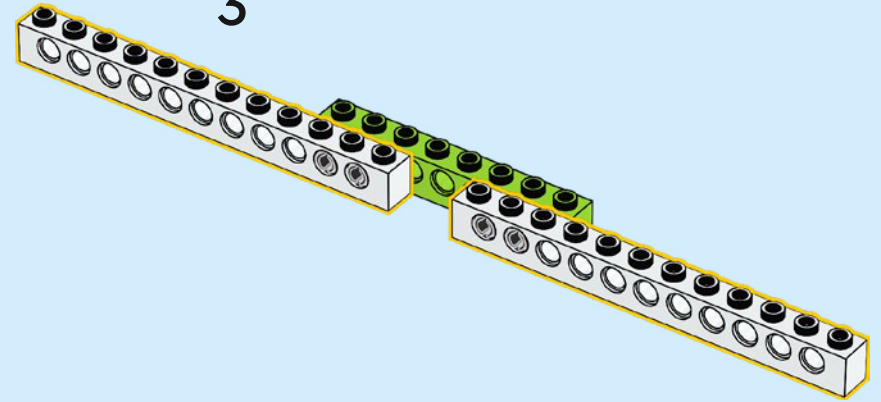

2x

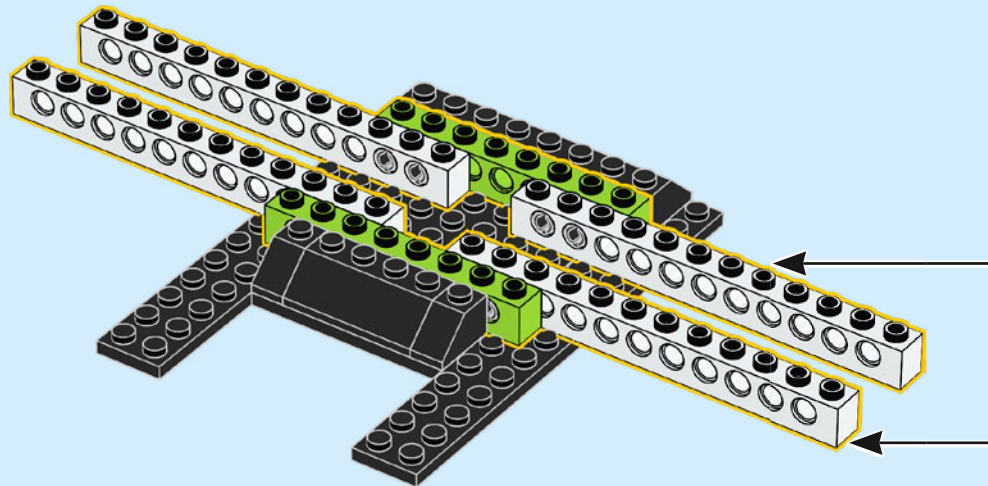

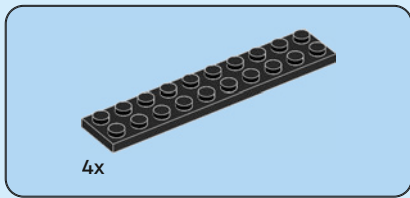

271

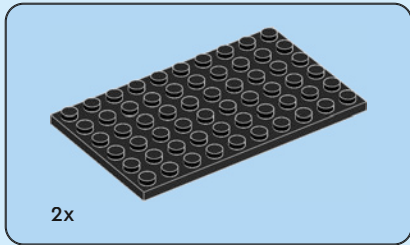
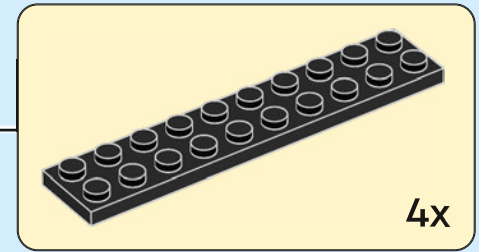
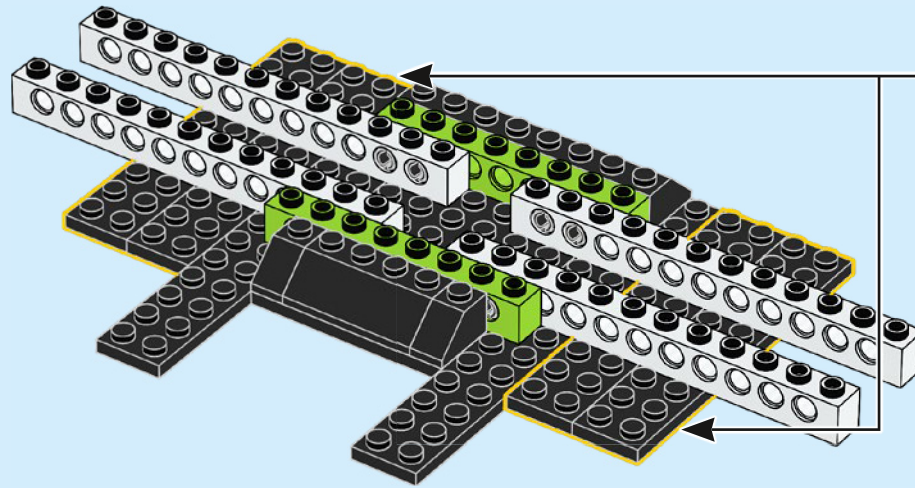

272

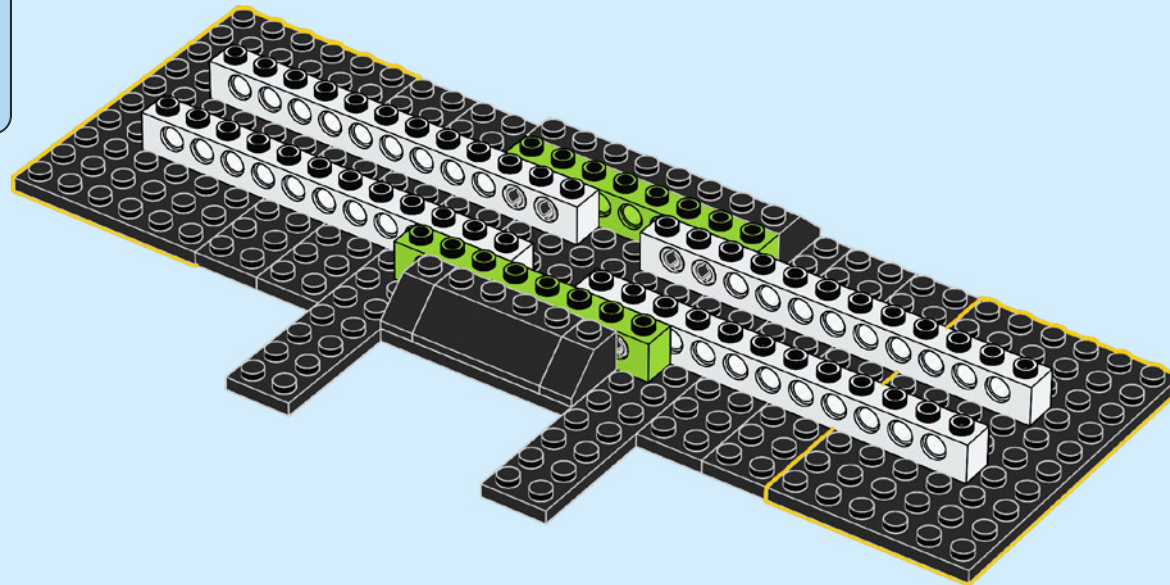

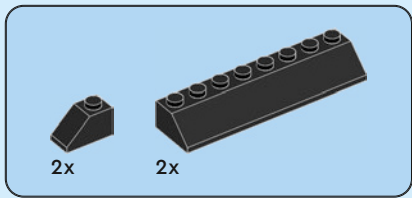

273

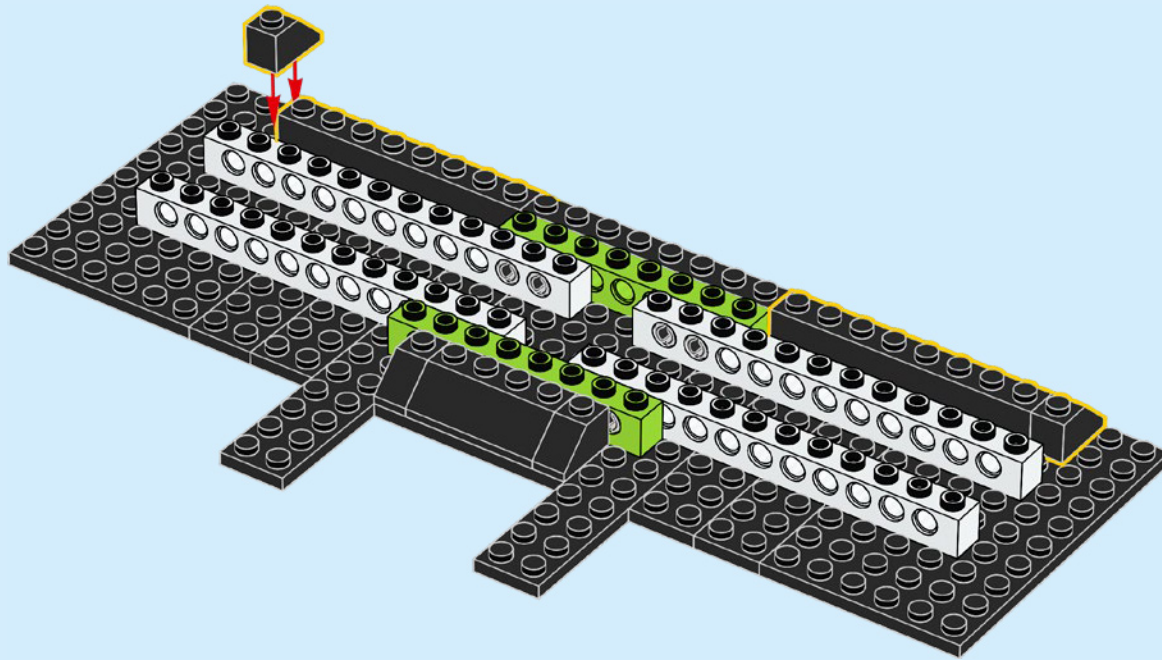

274

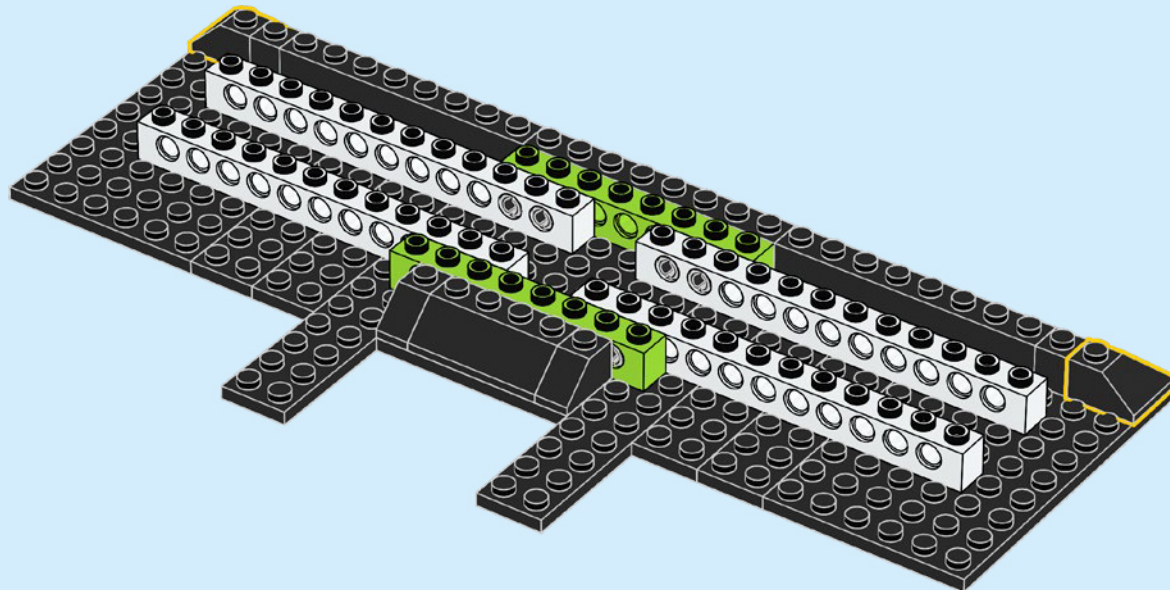

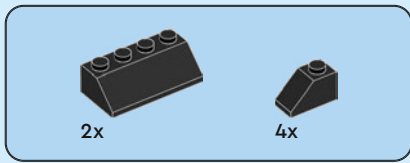

275

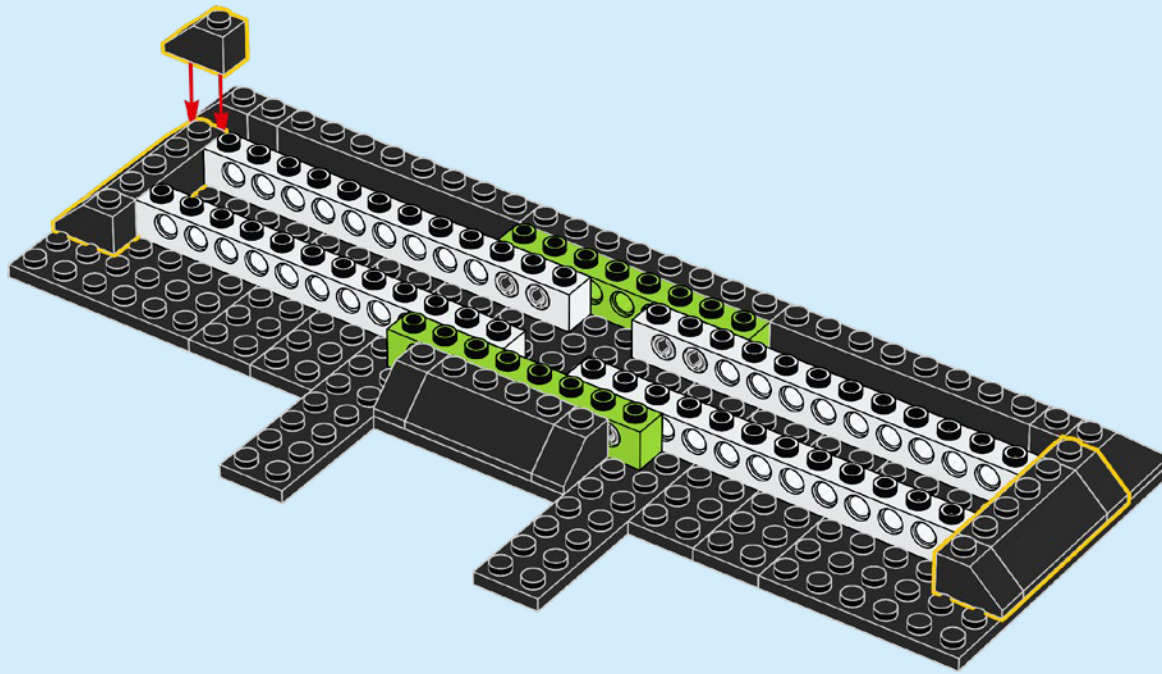

276

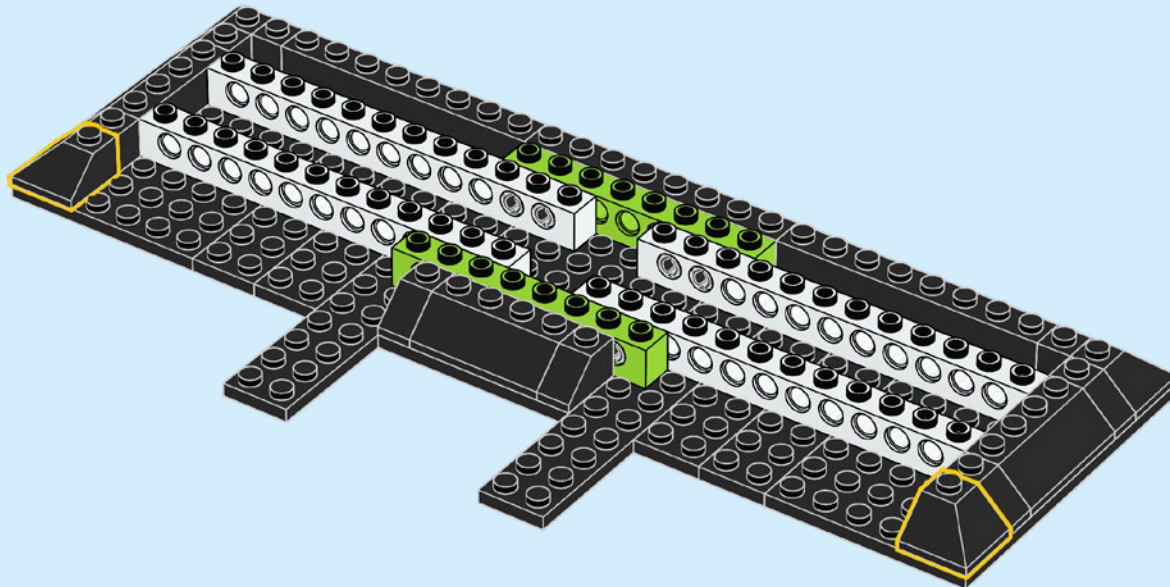



2x



2x

# 277

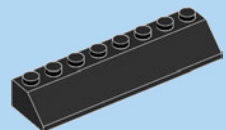
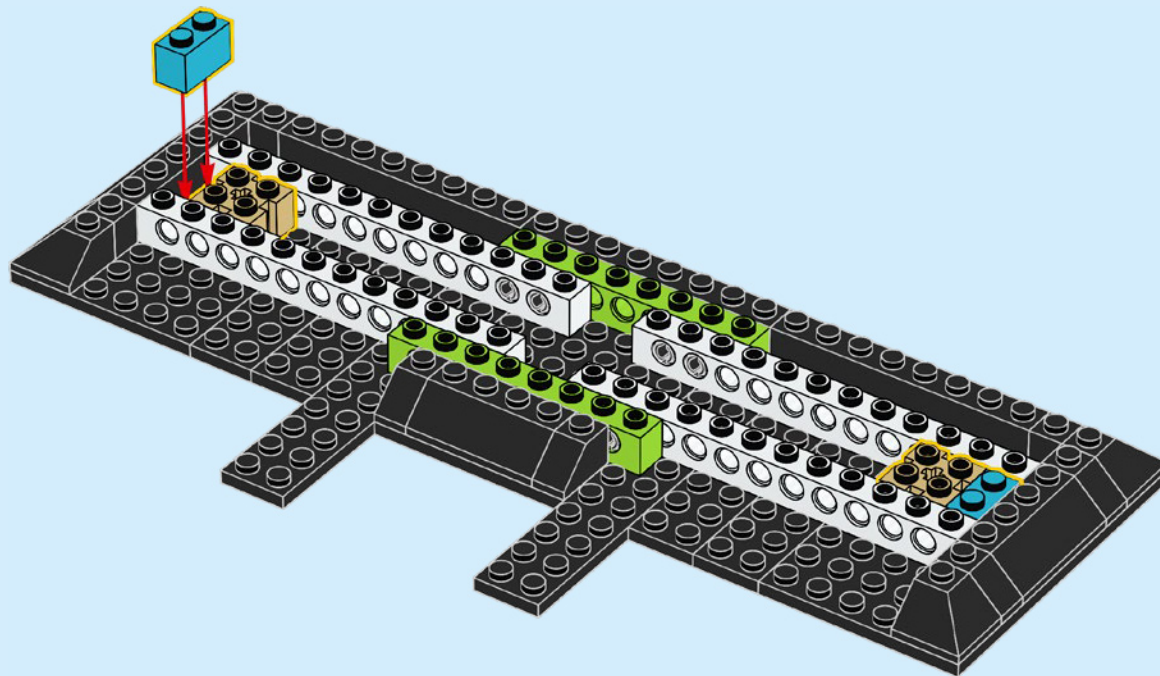

2x

# 278

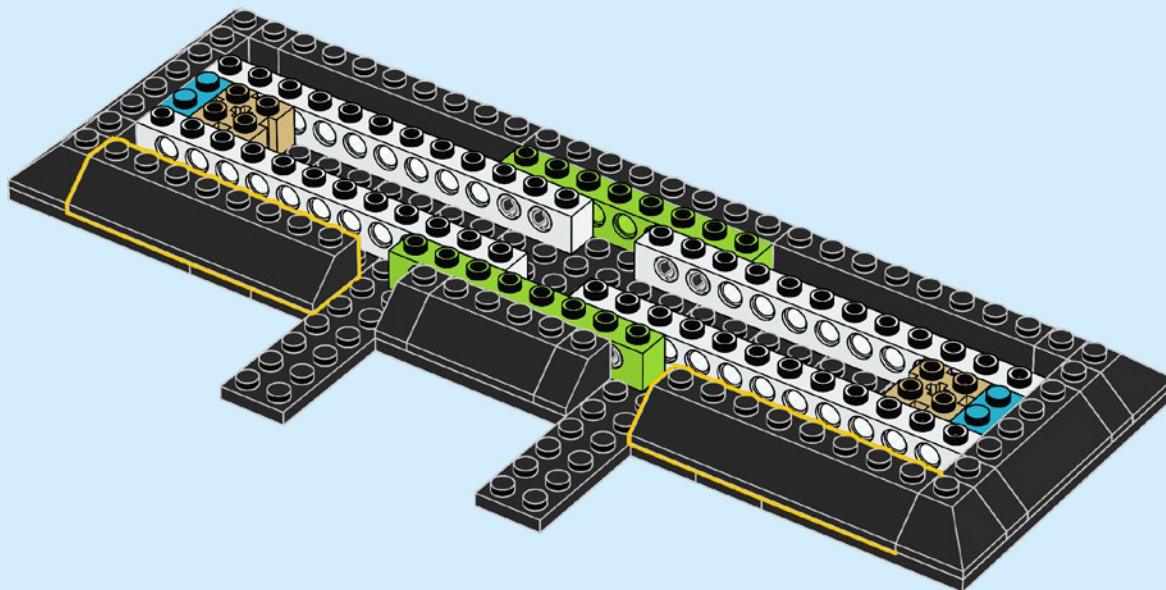

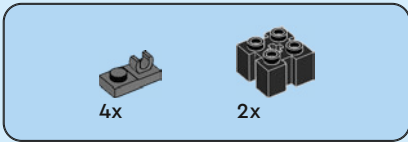

279

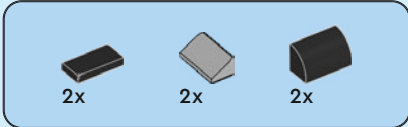
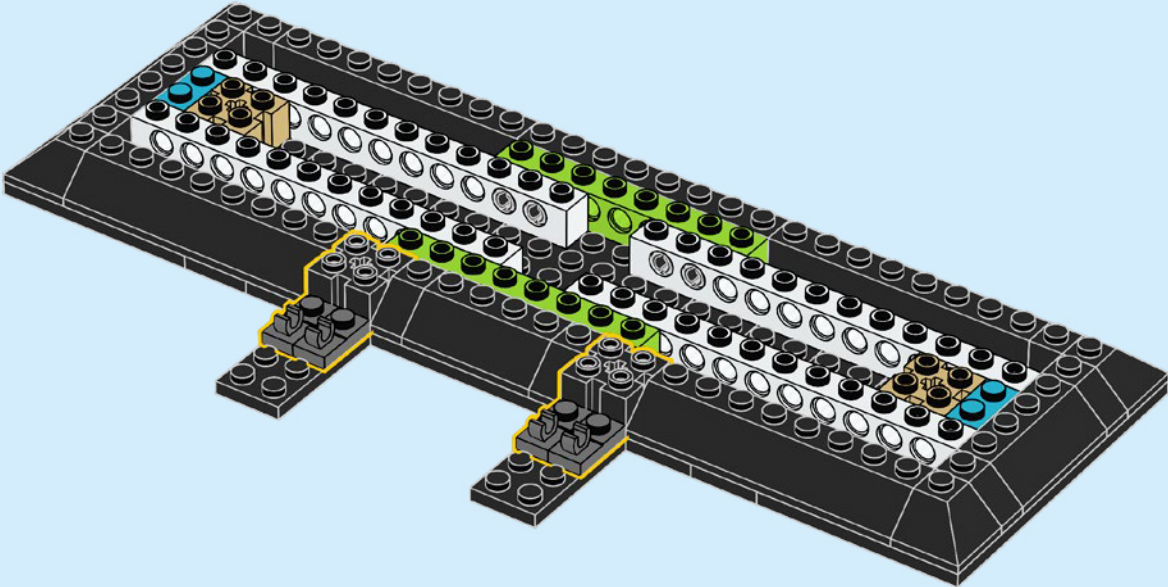

280

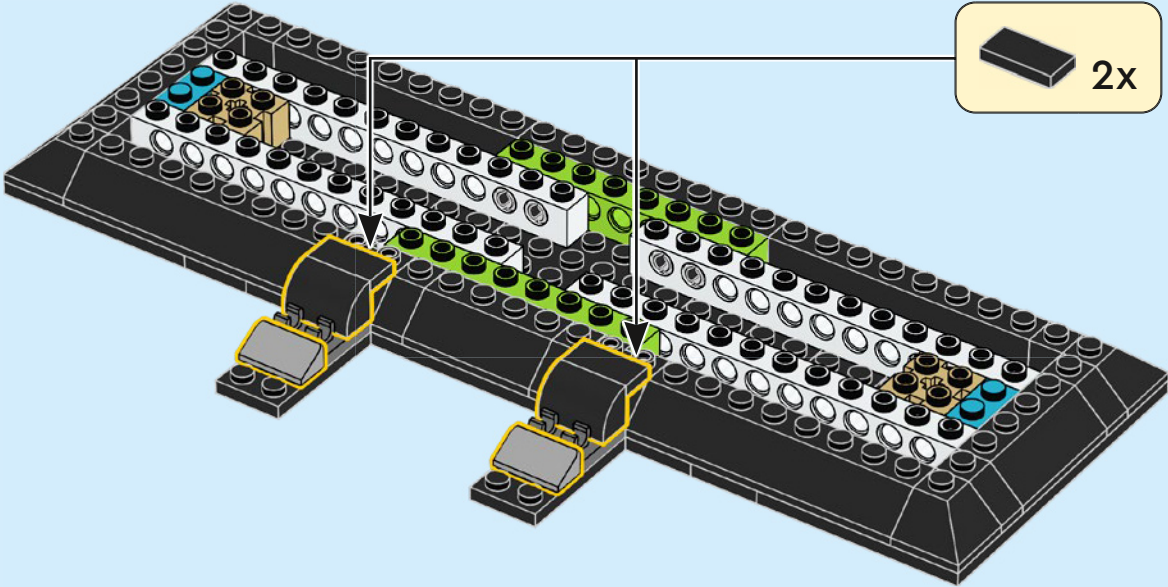

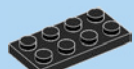

4x

281

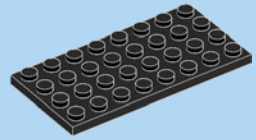
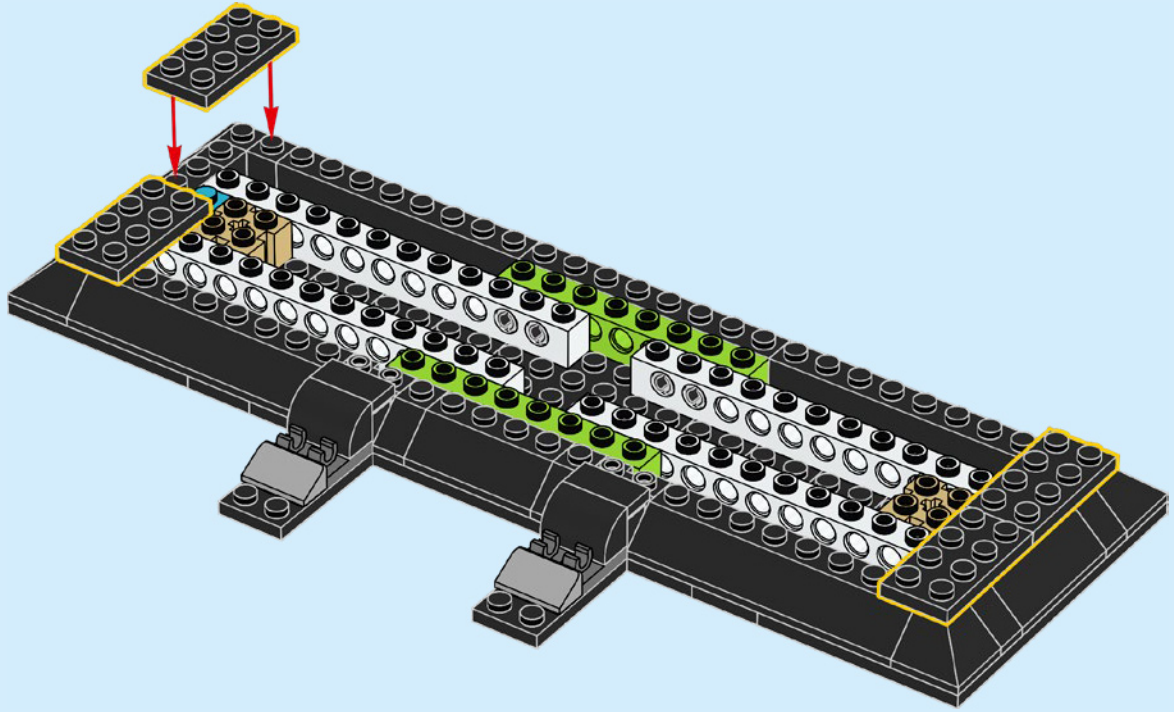

5x

282

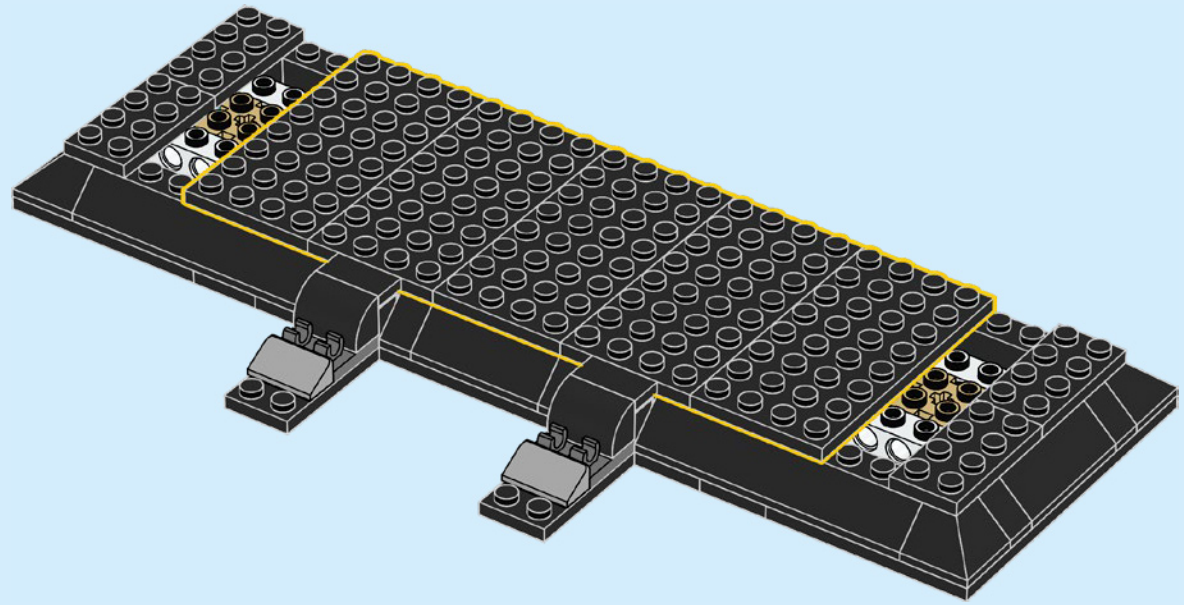

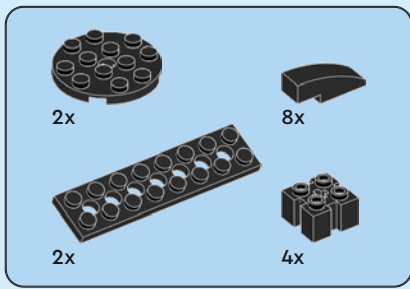

283

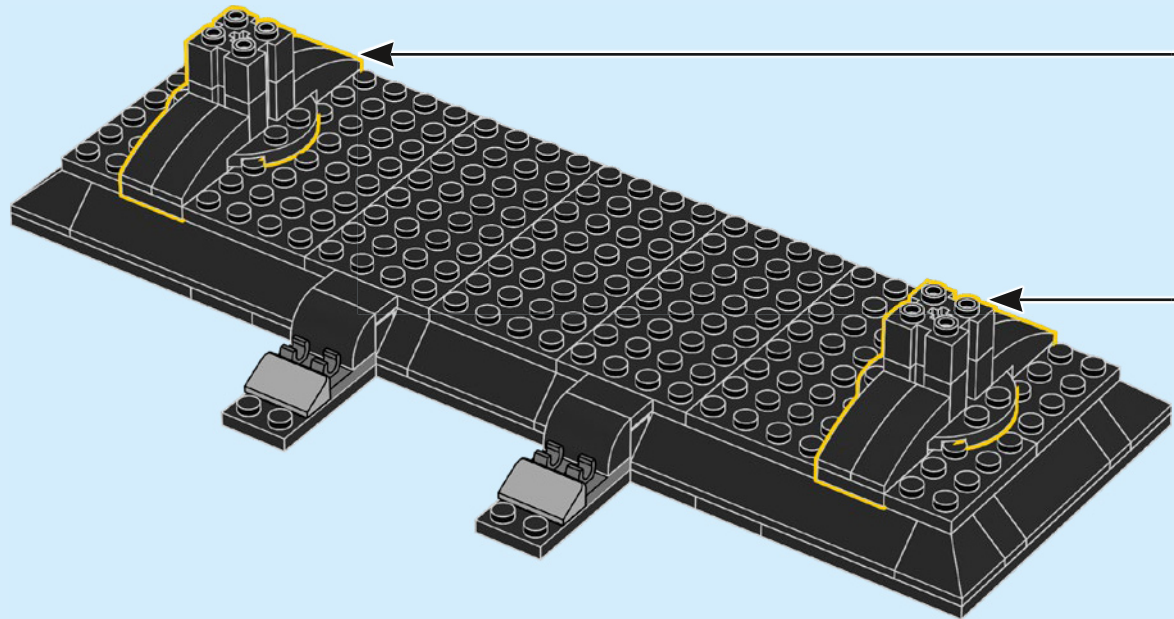
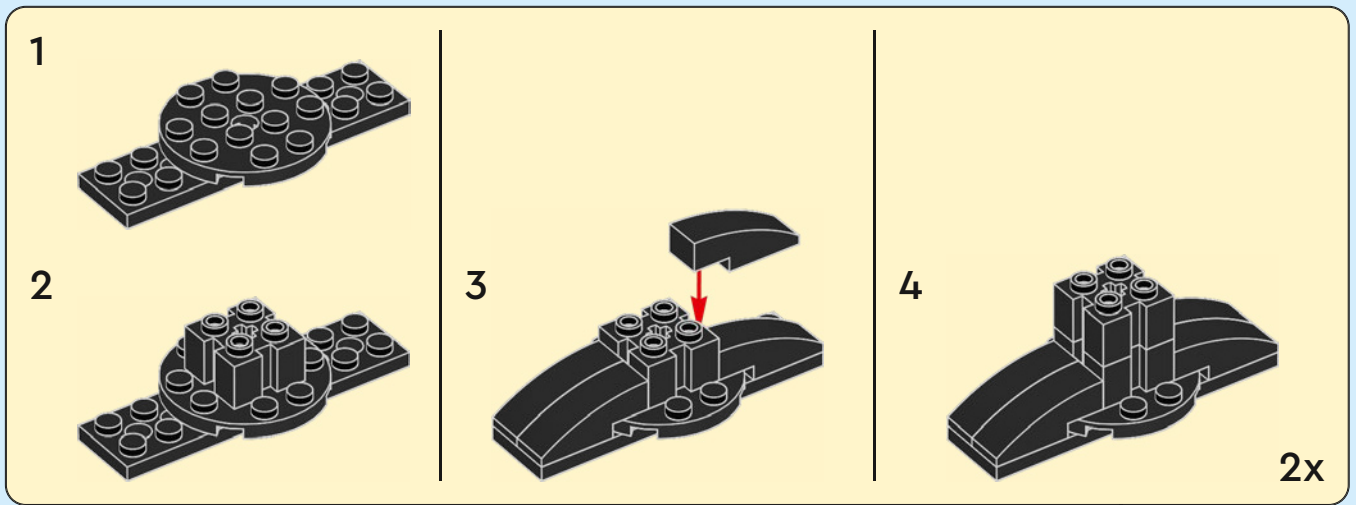

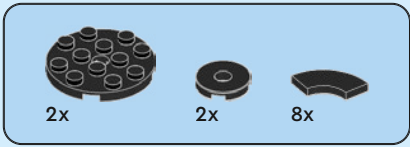

284

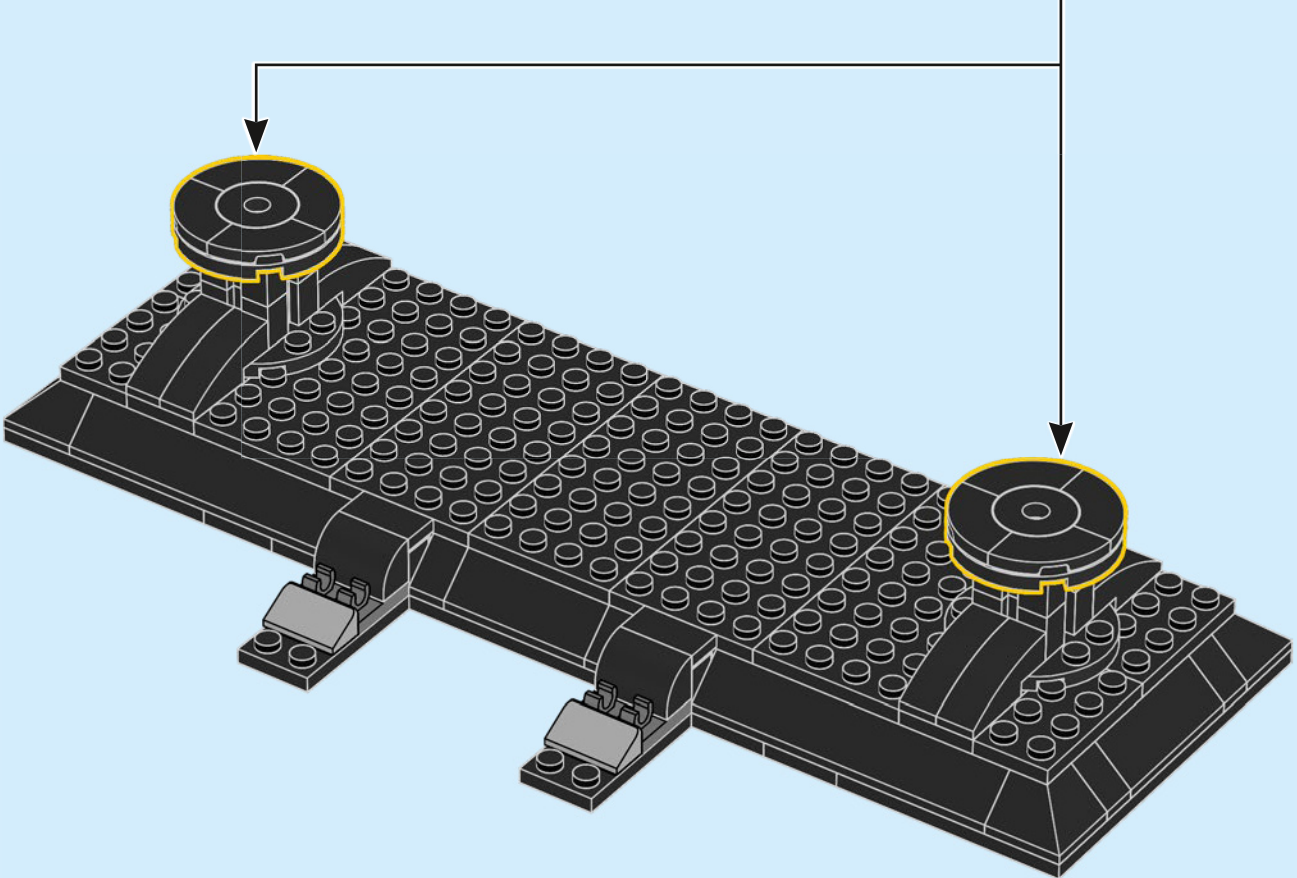
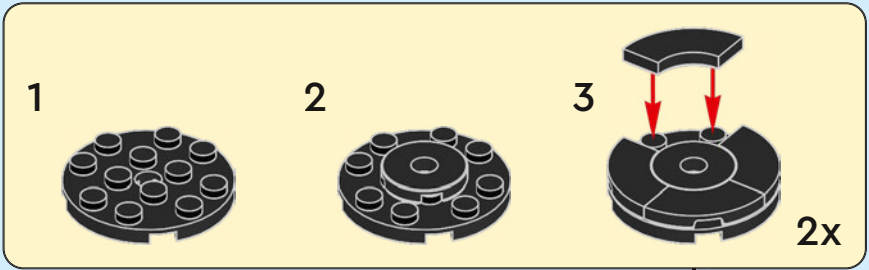

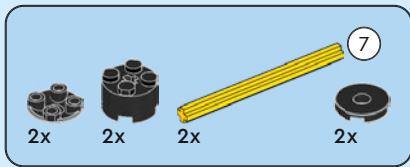

285

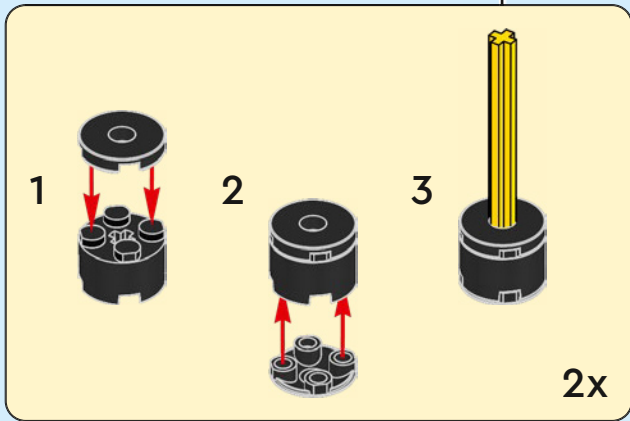
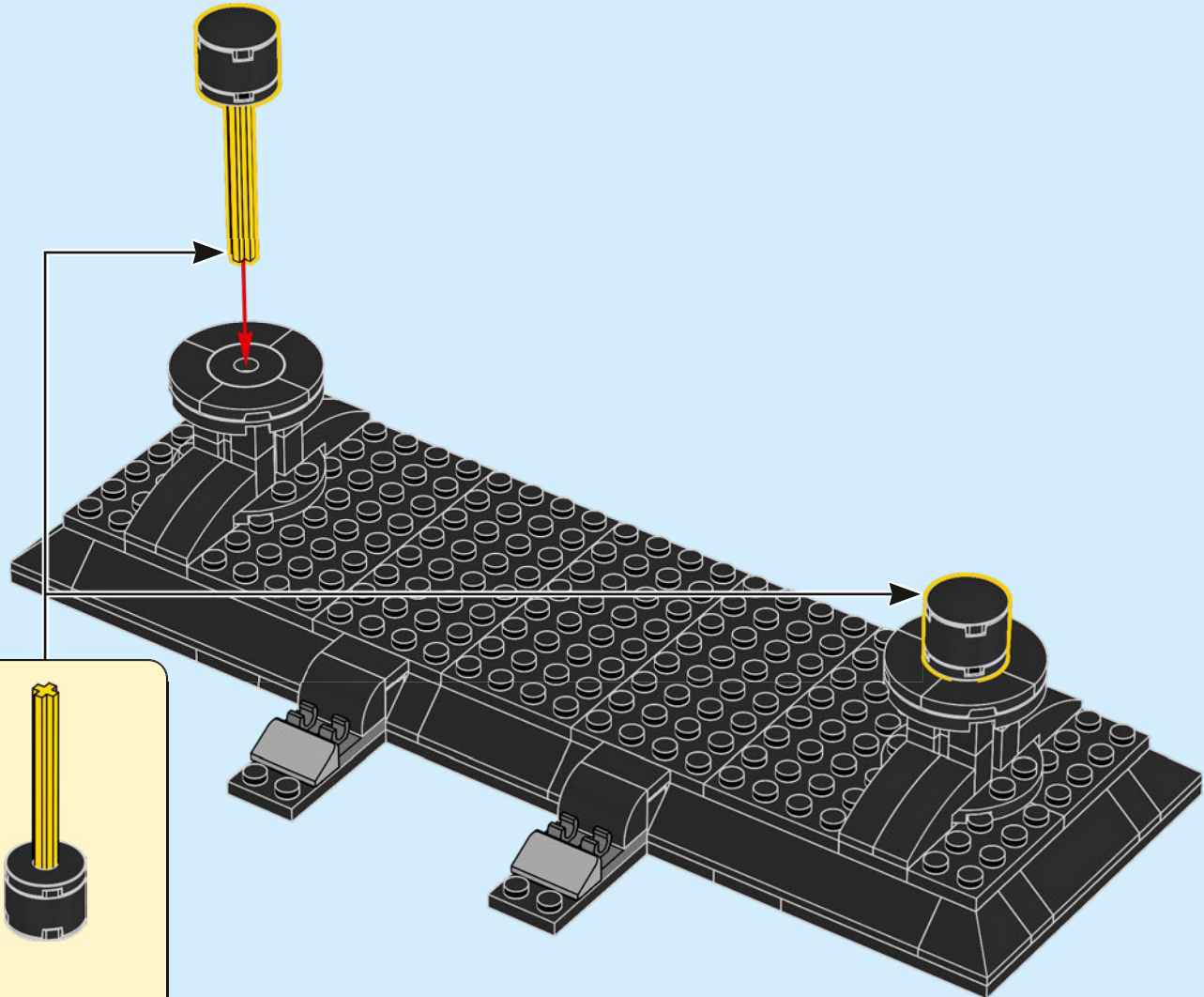

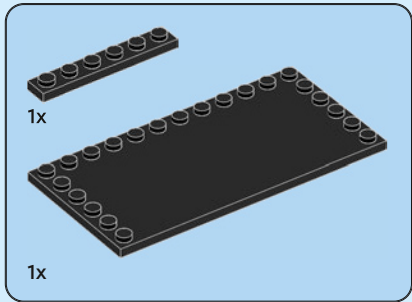

286

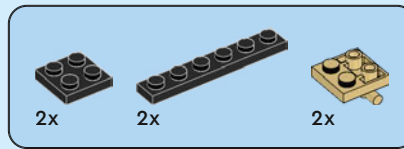
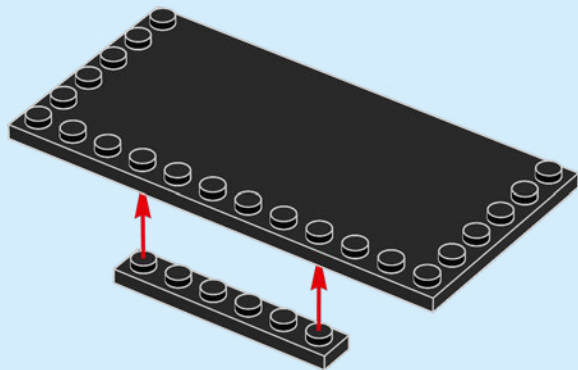

287

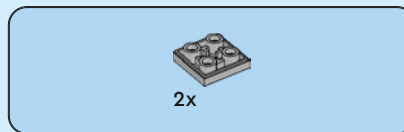
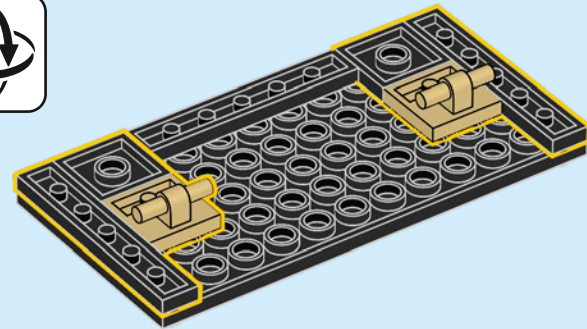

288

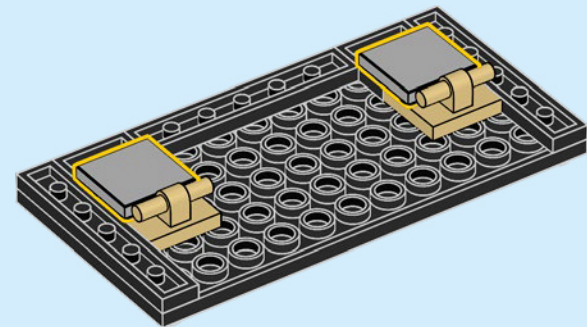

289

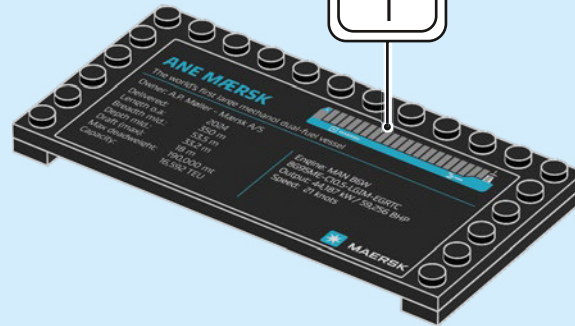

290

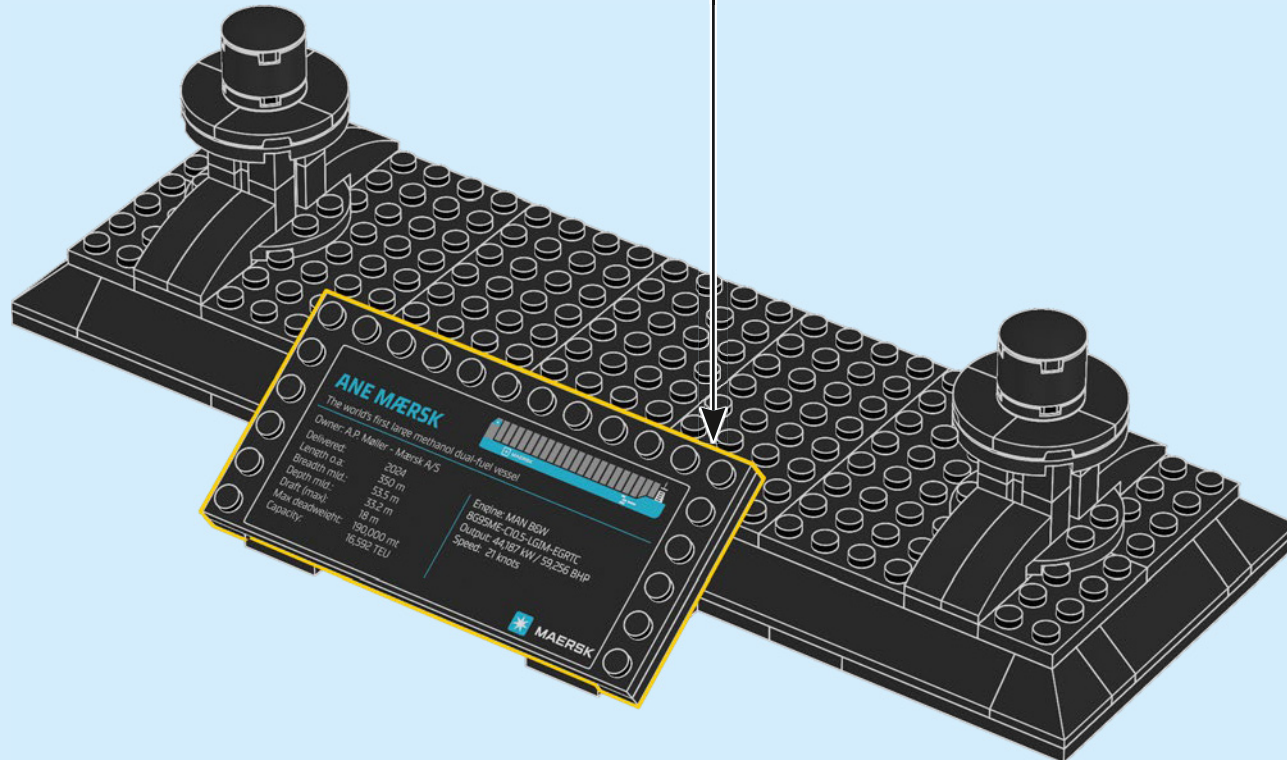

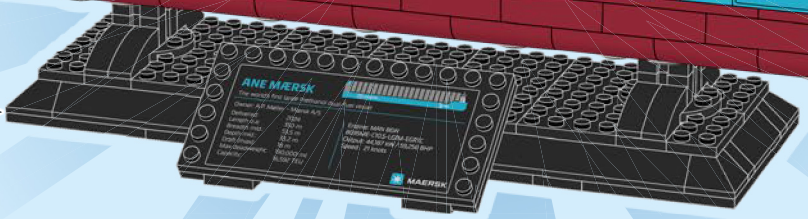
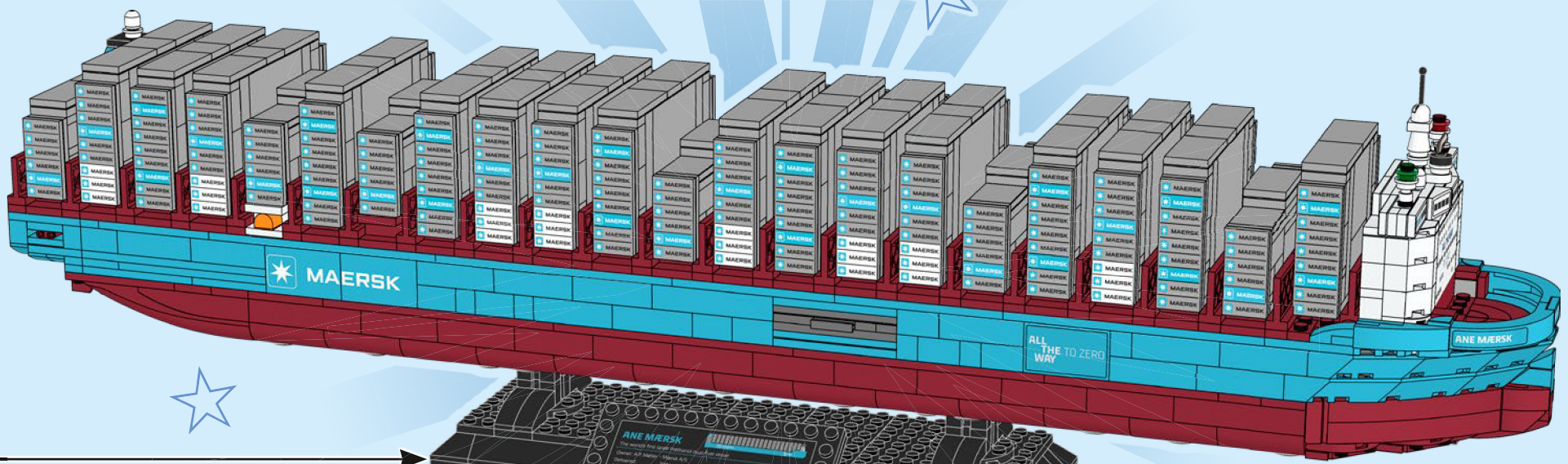
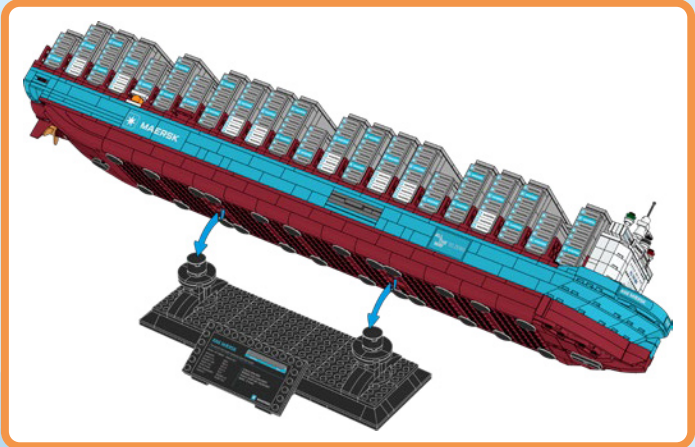

**ANE MÆRSK**  
The world's first large container ship with a zero-emission engine.  
Capacity: 11,000 TEU  
Length: 369 m  
Width: 50 m  
Max speed: 23.5 knots  
Max range: 25,000 nautical miles  
Engine: Wärtsilä 12V46DF  
Power: 100,000 kW  
Fuel: Liquefied Natural Gas (LNG)  
Emission: Zero CO2, SOx, NOx  
MAERSK



- 4x 6584062
- 4x 4541528
- 2x 6586652
- 1x 6335319
- 21x 6052777
- 6x 4541507
- 4x 4539071
- 10x 6576807
- 66x 6584063
- 1x 6465734
- 2x 6602414
- 2x 4539062
- 1x 6476042
- 1x 6350339
- 26x 6253142
- 4x 6186106
- 1x 6544174
- 6x 6440979
- 1x 4211392
- 6x 4211406
- 25x 4211462
- 2x 4211705
- 1x 6539385
- 11x 6015344
- 9x 6258831
- 2x 4568637
- 1x 4211415
- 2x 4568637
- 4x 4211412
- 33x 4211388
- 2x 4211399
- 11x 6598026
- 6x 6227897
- 70x 4211398
- 27x 4211395
- 12x 6061675
- 4x 6059033
- 2x 6079461
- 30x 4527174
- 16x 6598025
- 16x 6595947
- 35x 4211452
- 64x 6123809
- 6x 4211564
- 3x 6170387
- 32x 4211363
- 4x 6469440
- 1x 6446028
- 2x 6132886
- 2x 6043639
- 2x 4211580
- 15x 4211413
- 4x 6258820
- 10x 4211387
- 10x 6171894
- 10x 4211396
- 12x 4211386
- 1x 6514057
- 1x 6514051
- 2x 4210719
- 2x 4211063
- 4x 6344754
- 1x 6514456
- 2x 6123814
- 4x 4543086
- 1x 4218696
- 6x 4211094
- 11x 4211056
- 2x 4210651
- 1x 6287847
- 1x 6322046
- 2x 6215606
- 1x 6292145
- 1x 6088641
- 2x 6335563
- 1x 6593293
- 2x 6603341
- 8x 6603339
- 2x 6603283
- 4x 6603285
- 6x 6603587
- 8x 6603337
- 2x 6603334
- 1x 6603315
- 4x 6603598
- 17x 6603336
- 1x 6603301
- 1x 6603600
- 1x 6603591
- 1x 6603586
- 1x 6603585
- 2x 6603590
- 2x 6603344
- 2x 6603309
- 3x 6603316
- 1x 6593286
- 2x 6604733
- 2x 6603601
- 7x 6603965
- 30x 6603319
- 2x 6603317
- 2x 6576809
- 2x 6603313
- 1x 6598028
- 2x 6576810
- 1x 6598027
- 2x 6603599
- 2x 6603596
- 2x 6603342
- 2x 6603312
- 10x 6603286
- 2x 6603333
- 10x 6603340
- 2x 6603318
- 4x 6603343
- 2x 6603335
- 4x 6603595
- 1x 6603594
- 6x 6603589
- 2x 6603332
- 2x 6576813



[LEGO.com/service](https://www.LEGO.com/service)

**YOU COULD WIN**



Scan this QR code or go to  
**LEGO.COM/PRODUCTFEEDBACK** and give us  
your short feedback about this LEGO® set  
for a chance to win a cool LEGO prize.

Terms and Conditions apply\*

**EN: YOU COULD WIN.** Terms and Conditions apply\* **DE: Du könntest GEWINNEN.** Es gelten die Teilnahmebedingungen\* **FR: Tu pourrais GAGNER.** Des conditions s'appliquent\* **IT: Potresti VINCERE tu.** Termini e condizioni sono applicabili\* **ES: Puedes GANAR.** Aplican términos y condiciones\* **PT: PODERÁ GANHAR.** Aplicam-se Termos e Condições\* **ZH: 轻松获奖.** 条款和条件适用\* **PL: Szansa na WYGRANA.** Obowiązuje regulamin\* **CS: Máte šanci VYHRÁT.** Platí všeobecné smluvní podmínky\* **SK: Máte šancu VYHRÁT.** Platia všeobecné zmluvné podmienky\* **HU: TE IS NYERHETSZ.** Felhasználási feltételek érvényesek\* **UA: ВИ МОЖЕТЕ ВИГРАТИ.** Застосовуються загальні положення та умови\* **RO: Ai putea CÂȘTIGA.** Se aplică termenii și condiții\* **BG: Можете да СПЕЧЕЛИТЕ.** Има определени правила и условия\* **LV: Tu vari LAIMĒT.** Ir spēkā noteikumi un nosacījumi.\* **ET: Sul on võimalus VÕITA.** Kehtivad tingimused\* **LT: Jūs galite LAIMĖTI.** Taikomos sąlygos\*

\*[LEGO.com/productfeedback-terms](https://www.lego.com/productfeedback-terms)

