



40955



# MAERSK





LEGO.com/sustainable-packaging



FR

**DONNEZ**  
OU  
**RECYCLEZ**



OU



OU



ASSOCIATION

MAGASIN

DÉCHÈTERIE

Adresses sur [quefairedemesdechets.fr](http://quefairedemesdechets.fr)

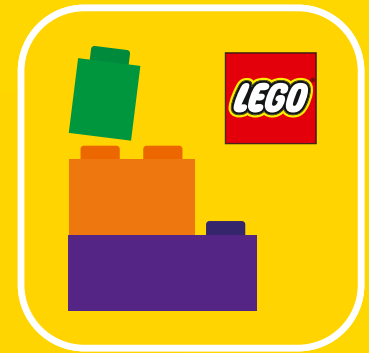

🔍 LEGO® Builder

# BUILDER



Apple and the Apple logo are trademarks of Apple Inc., registered in the U.S. and other countries and regions. App Store is a service mark of Apple Inc. Google Play and the Google Play logo are trademarks of Google LLC. Tencent and the Tencent logo are trademarks of Tencent Inc.

🔍 [LEGO.com/devicecheck](https://LEGO.com/devicecheck)

EN Ask parents' permission before going online | DE Eltern um Erlaubnis bitten, bevor du online gehst | FR Demande l'autorisation d'un parent avant d'aller en ligne | IT Chiedi il permesso ai tuoi genitori prima di andare online | ES Pídeles permiso a tus papás antes de conectarte a Internet | PT Peça autorização aos pais antes de acederes online | ZH 上网前应先征得父母的同意 | PL Poproś rodziców o zgodę, zanim wejdiesz do Internetu | CS Než půjdeš na internet, požádej rodiče o svolení | SK Skôr než pôjdeš na internet, vypoťaj si povolenie od rodičov | HU Kérj szülői engedélyt, mielőtt online csatlakoznál! | UA Запитуйте дозволу батьків, перш ніж користуватися інтернетом | RO Cere permisiunea părinților înainte de a te conecta online | BG Поискайте разрешение от родител, преди да влезете онлайн | LV Pirms došanās tiešsaistē palūdz atļauju vecākiem | ET Enne Interneti kasutamist küsi vanematelt luba | LT Prieš prisijungdami prie interneto, atsiklauskite tėvų



## PREDSTAVUJEME ANE MÆRSK

ANE MÆRSK je prvou loďou svojho druhu – prvým veľkým kontajnerovým plavidlom, ktoré dokáže využívať palivo s nízkymi emisiami, ako je biometanol a e-metanol. Od januára 2024, keď loď ANE MÆRSK prvýkrát vyplávala, brázdí vody množstvo ďalších dvojpalivových plavidiel, čo predstavuje novú a dôležitú kapitolu v dekarbonizácii lodnej dopravy a globálneho obchodu.

ANE MÆRSK má 350 metrov na dĺžku a 53,5 metra na šírku. Prázdne plavidlo váži 47 700 ton a plne naložené nákladom, palivom a posádkou dokáže prepraviť neuveriteľných 190 000 ton, čo zodpovedá 29 000 afrických slonov.

Lod' môže naložiť 16 592 kontajnerov TEU (s dĺžkou približne 6 metrov), a ak by ste ich všetky zoradili do radu, dosiahli by dĺžku 100,5 km, ktorá zodpovedá dĺžke 959 futbalových ihrísk.





 MAERSK

ALL THE 10 ZERO WAY



# CESTA PLNÁ ZMIEN – HISTÓRIA LODNEJ DOPRAVY

Ľudia prepravujú tovar po mori už viac ako 5 000 rokov, ale až do priemyselnej revolúcie a vynálezu parného stroja sa museli spoliehať na počasie. Ak nebol vietor, nikam sa nešlo. Po zavedení parnej energie posádka lode po prvýkrát v histórii ľudstva prestala byť závislá od počasia alebo manuálneho pohonu. Tento vynález spôsobil úplnú revolúciu v námornej doprave, umožnil vznik nových trás a výrazne podporil obchod realizovaný po mori.

Hoci boli parné stroje oproti plachtám obrovským zlepšením, stále neboli dosť efektívne a netrvalo dlho, kým sa námorná doprava opäť zmenila vďaka vynálezu dieselového motora. Revolúcie v lodnej doprave však potrebujú čas, takže trvalo niekoľko desaťročí, kým diesel plne nahradil parný pohon. Spoločnosť Maersk zakúpila svoju prvú loď s dieselovým pohonom, LEISE MÆRSK, v roku 1921, len deväť rokov po spustení prvej zaoceánskej obchodnej lode s dieselovým pohonom.



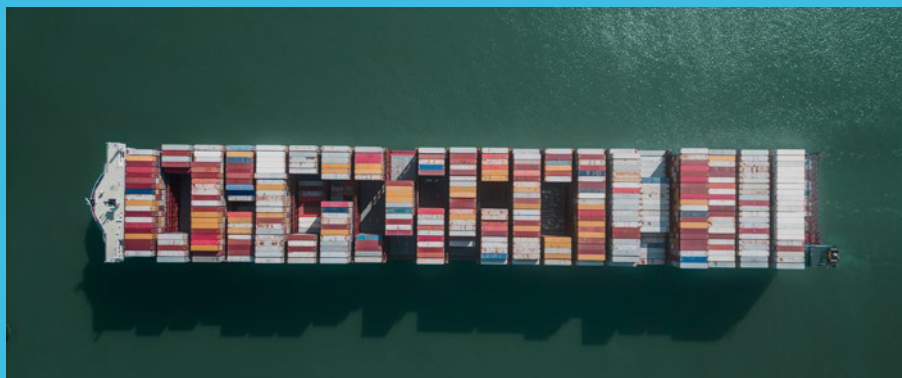

V roku 1956 sa toto odvetvie opäť zmenilo, keď sa zaviedla efektívnosť „kontajnerového nákladu“ a návesy nákladných vozidiel sa začali nakladať priamo na lode. Zavedenie kontajnerov skrátilo čas potrebný na nakládku a vykládku plavidiel z niekoľkých dní na niekoľko hodín.

Vďaka kontajnerom a čiarovému kódu – skrytým kráľom svetového obchodu – môže výrobca v ktorejkoľvek časti sveta predávať svoj tovar na všetkých trhoch, čo fyzicky umožňuje globalizáciu. Svet, ako ho poznáme dnes, je výrazne závislý od globálnych dodávateľských reťazcov. Od pestovateľa banánov v Kolumbii až k dánskému dieťaťu, ktoré si lípe banán na desiatu, dodávateľské reťazce udržiavajú svet v spojení a zabezpečujú tok potravín, liekov, tovaru a materiálov k ľuďom na celom svete.





 MAER

 MAERS

 MAERSK

 MAERSK

# ČO ZNAČÍ MENO?

Od roku 1906 majú všetky lode flotily Maersk v názve označenie „MÆRSK“. Väčšina prvých lodí mala krstné mená súvisiace s rodinou zakladateľa, ale keď flotila prerástla dostupné rodinné mená, tradícia vymýšľania názvov sa musela upraviť. Dnes môžete vidieť aj lode Maersk pomenované napríklad podľa miest a riek.

Pri rozhodovaní, ako pomenovať novú sériu dvojpalivových plavidiel, sa spoločnosť Maersk vrátila k tradícii určovania mien plavidiel podľa členov zakladajúcej rodiny – tentokrát začali písmenom A, ktoré signalizuje novú éru.

ANE MÆRSK je pomenovaná po Ane Mærsk Mc-Kinney Uggla, predsedníčke spoločnosti A.P. Moller Holding, ktorá je materskou spoločnosťou spoločnosti A.P. Moller-Maersk. Spoločnosť A.P. Moller-Maersk založil v roku 1904 Arnold Peter Møller. Ane je vnučkou zakladateľa skupiny Arnolda Petera Møllera a jeho manželky Chastine Mc-Kinney Møllerovej.



# ANE MAERSK





## BIELA HVIEZDA – SYMBOL NÁDEJE

Ikonická biela sedemcípá hviezda je súčasťou dedičstva spoločnosti Maersk od čias pred jej založením v roku 1904 a je stálym symbolom silných rodinných väzieb, ktoré aj po viac ako 100 rokoch pretrvávajú v srdci spoločnosti.

Na začiatku svojej kariéry pracoval kapitán Peter Mærsk Møller, otec A. P. Møllera, pre anglického lodného majiteľa a jeho manželka Anna ho občas sprevádzala na plavbách. Počas jednej z týchto plavieb Anna vážne ochorela. Peter Mærsk Møller sa obával, že jeho žena neprežije, a tak vyšiel na palubu a modlil sa k Bohu o znenávanie, že sa uzdraví. Vtedy uvidel jedinú hviezdu, ktorá rozžiarila inak sivú oblohu.

Anna sa uzdravila a v roku 1886, keď Peter Mærsk Møller kúpil svoju prvú parnú loď, parník LAURA, vyzdobil komín lode bielou sedemcípou hviezdou na bledomodrom pozadí ako poctu svojej milovanej manželke. Pre Petra Maerska Møllera hviezda znamenala jej uzdravenie a ich šťastie.

Odvtedy je biela sedemcípá hviezda na symbolickom nebesky modrom pozadí synonymom spoločnosti Maersk, hoci samotné logo prešlo v priebehu rokov určitým vývojom. Existovalo množstvo jeho verzií, no dnešné logo Maersk pochádza zo začiatku 70. rokov 20. storočia, keď sa rozhodlo, že je potrebný modernejší prístup.



ALL THE WAY  
TO ZERO



# ZLEPŠENIE ŽIVOTA INTEGROVANÍM SVETA

Ako globálny líder v oblasti logistických služieb má spoločnosť Maersk viac ako 100 000 zákazníkov, pôsobí v takmer 130 krajinách a zamestnáva viac ako 100 000 ľudí. Maersk sa prebojoval zo svojich skromných začiatkov ako spoločnosť s parníkmi až na integrovanú logistickú spoločnosť, ktorá sa snaží prepojiť a zjednodušiť dodávateľské reťazce svojich zákazníkov, využíva pritom viac ako 700 plavidiel a prepravuje takmer 20 % svetových potravín, materiálov a tovaru.







# SMEROM K NULE – ZÁVÄZOK K DEKARBONIZOVANEJ BUDÚCNOSTI

Kedže svet zápasí s klimatickými problémami, budúcnosť dodávateľských reťazcov a globálneho obchodu závisí od schopnosti inovovať a podporovať nové zdroje energie. Spoločnosť Maersk prijala vážny záväzok dosiahnuť do roku 2040 čistú nulovú bilanciu emisií skleníkových plynov v rámci celého podniku. Pri dekarbonizácii vlastných prevádzok Maersk uviedla aj sociálny záväzok, že bude lídrom v riešení klimatickej krízy prostredníctvom dekarbonizácie globálnych dodávateľských reťazcov a umožnenia spravodlivého prechodu na hospodárstvo s nulovou bilanciou emisií.

Spoločnosť Maersk si stanovila smerom do roku 2040 ambiciózne ciele, aby v tomto desaťročí zabezpečila významný pokrok: na oceánoch, na súši, vo vzduchu a v našich termináloch. A keďže sa objednalo a dodalo množstvo dvojpalivových plavidiel, ktoré sú schopné využívať palivo s nízkymi emisiami, ako je biometanol, e-metanol a biometán, zatiaľ je ich misia na dekarbonizáciu flotily na dobrej ceste.





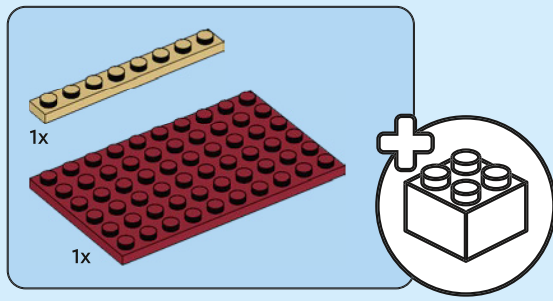

1

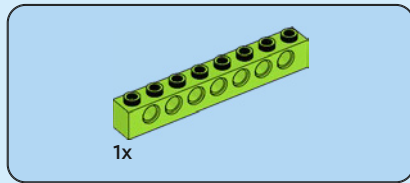
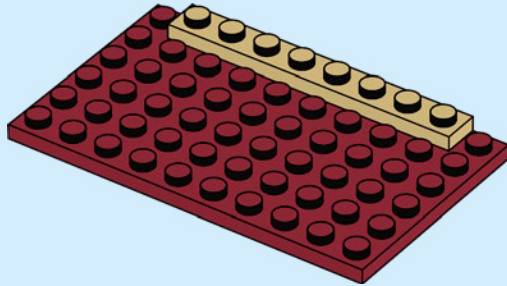

2

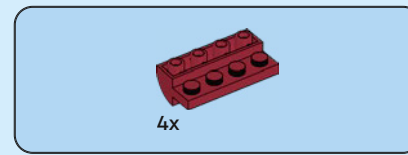
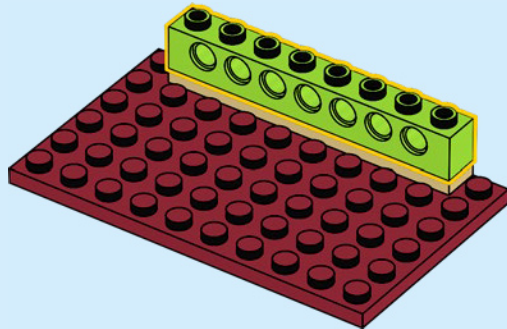

3

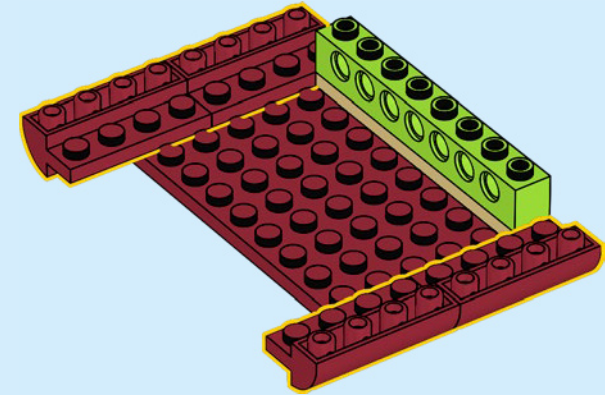

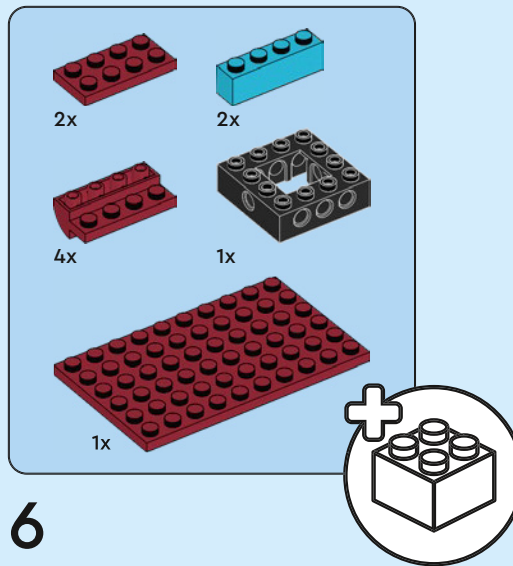
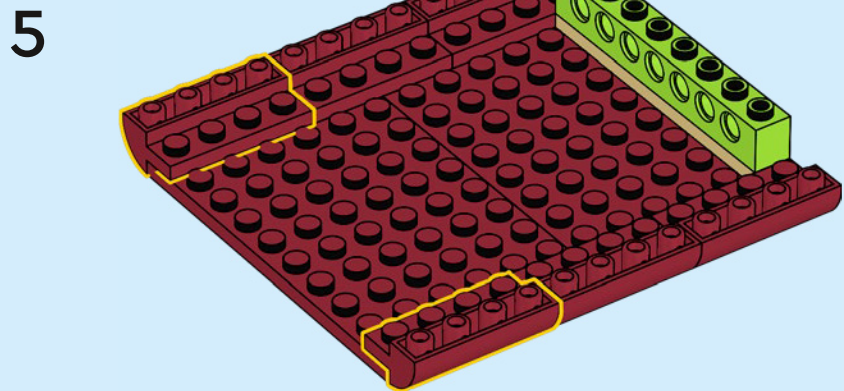
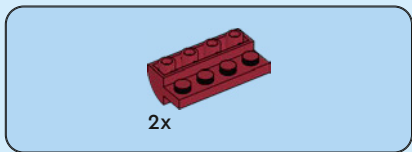
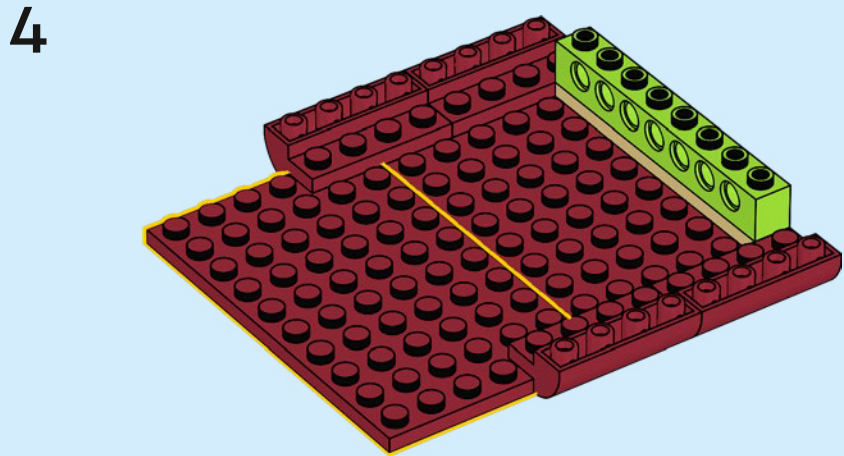
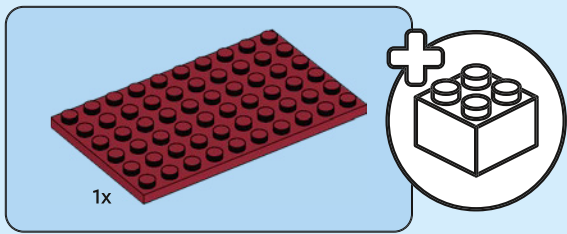

6

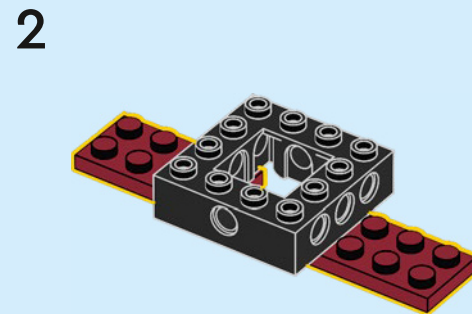
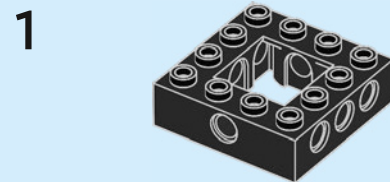

3

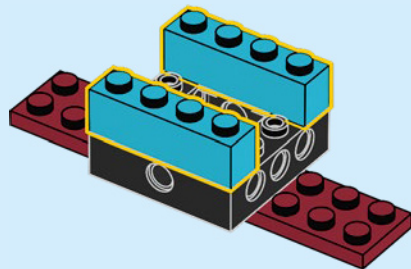

4

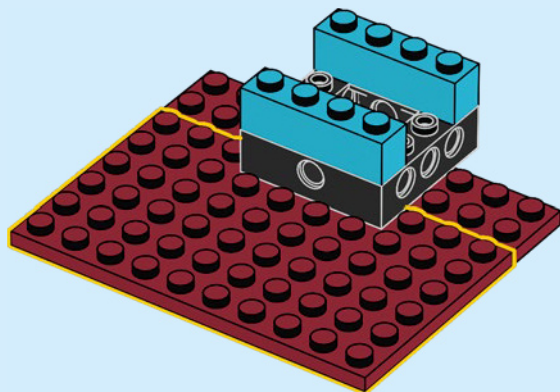

5

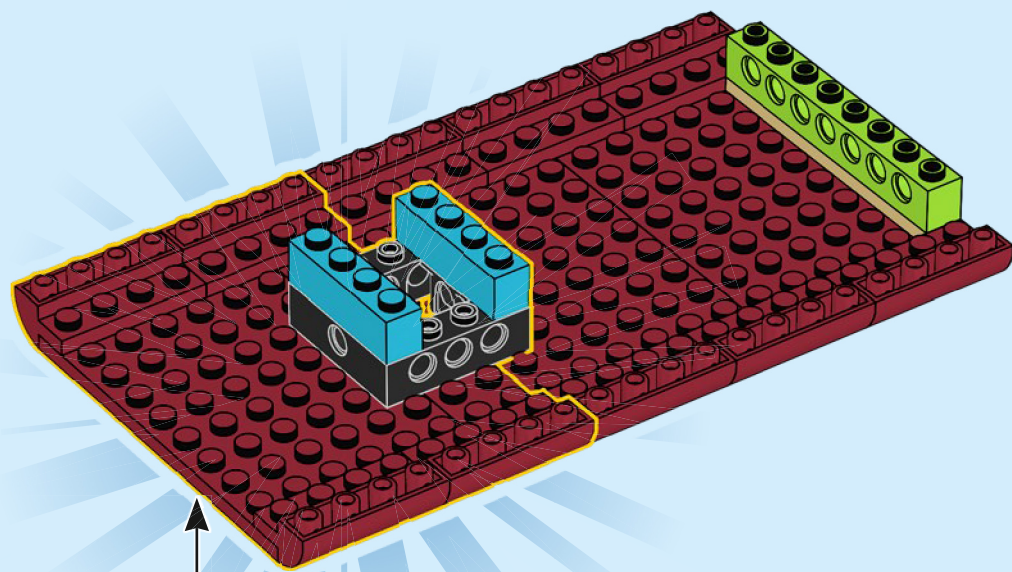
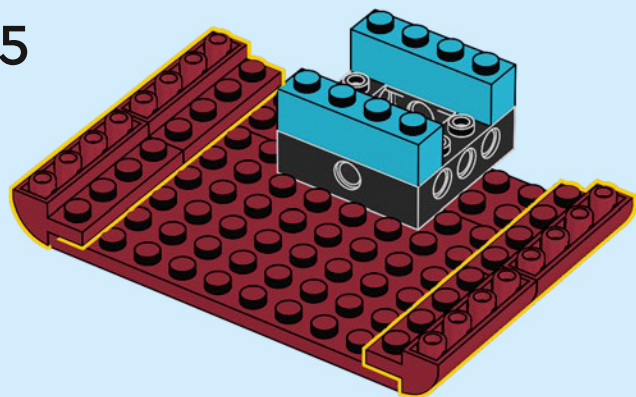

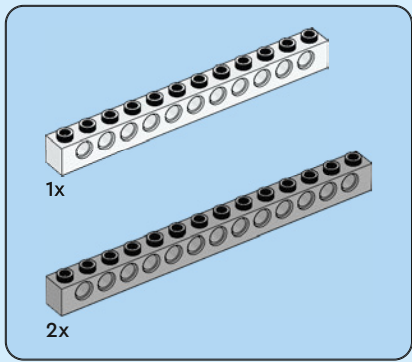

7

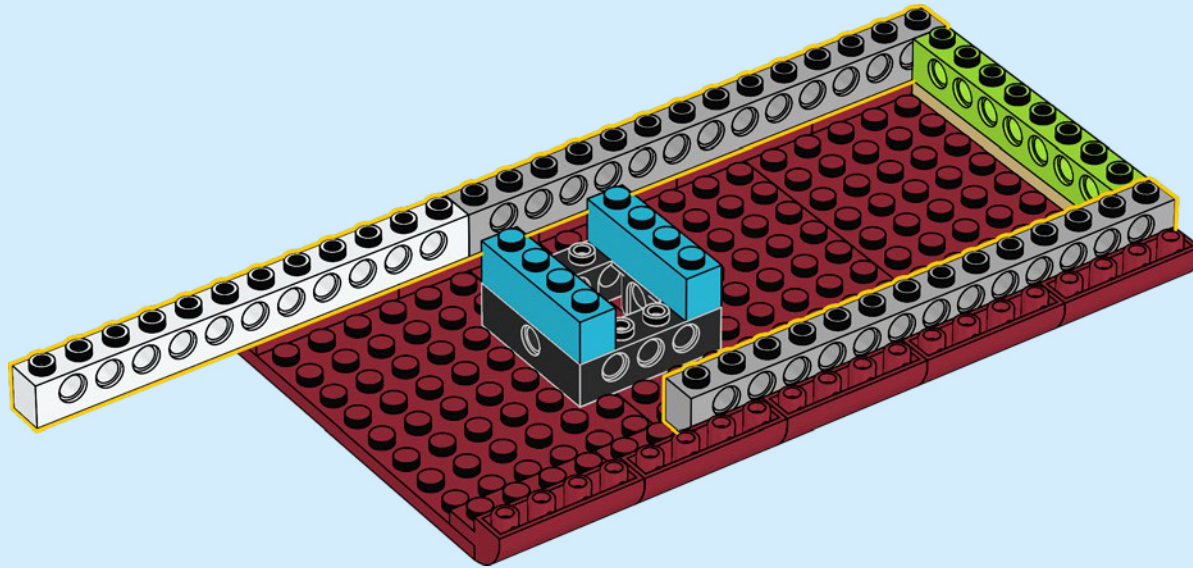

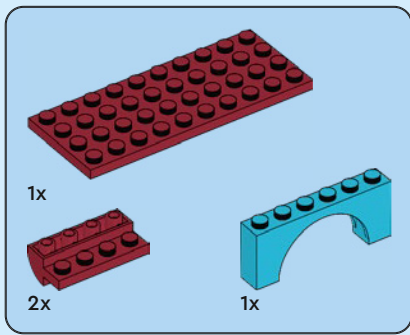

8

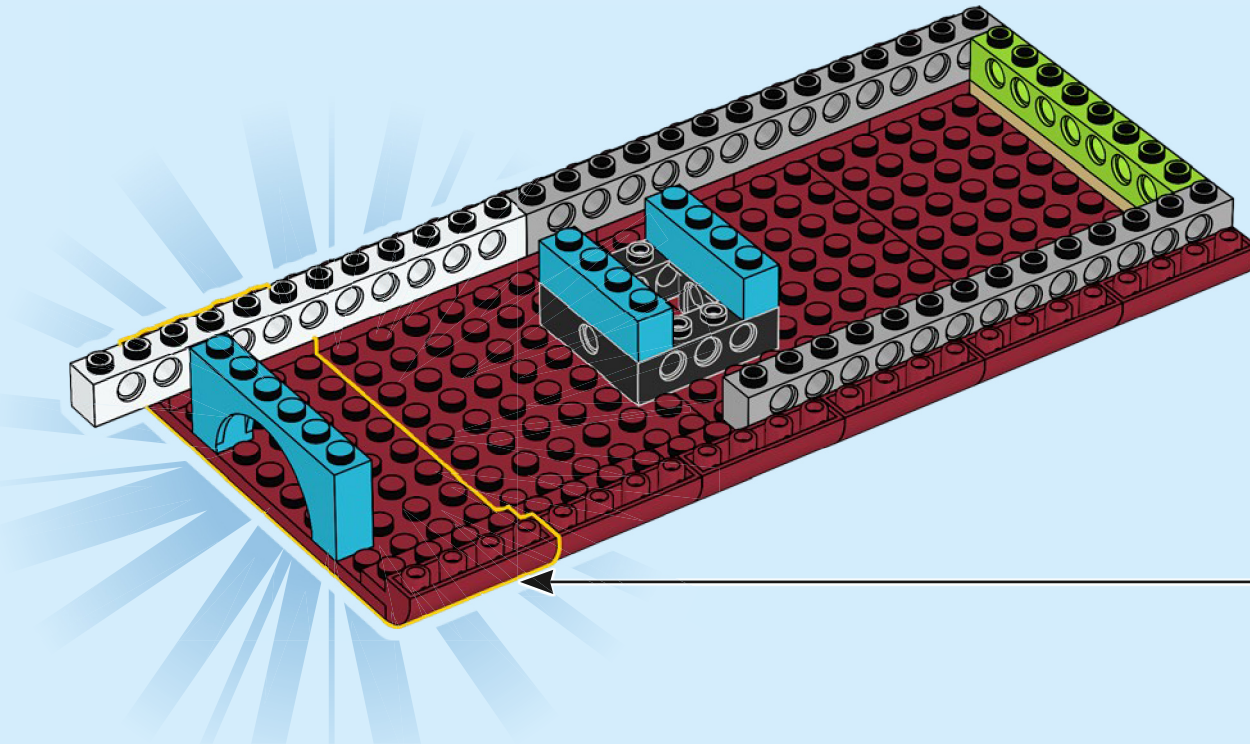
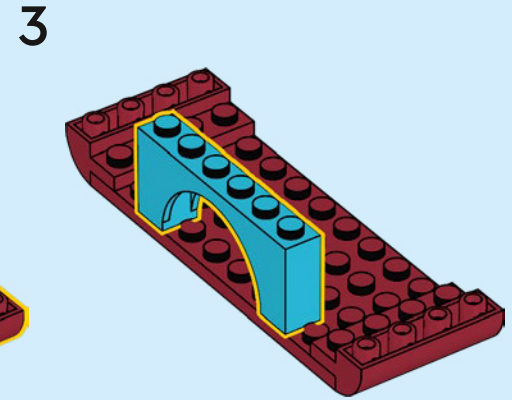
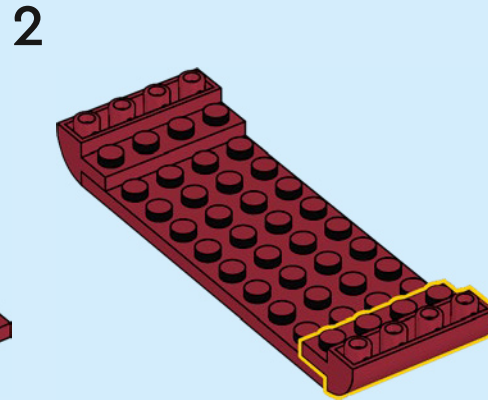
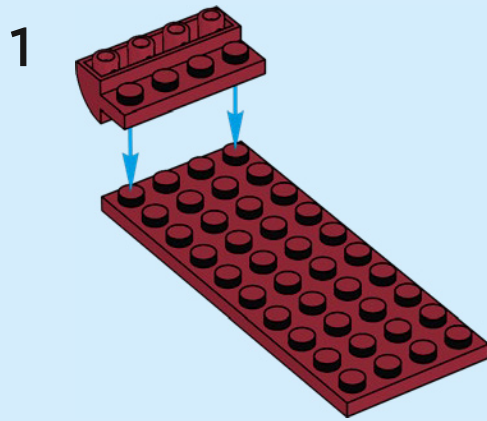

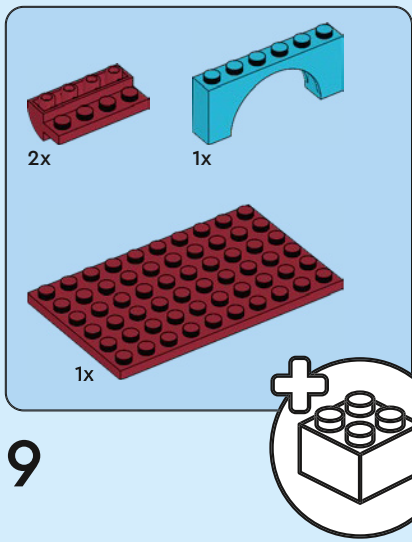

9

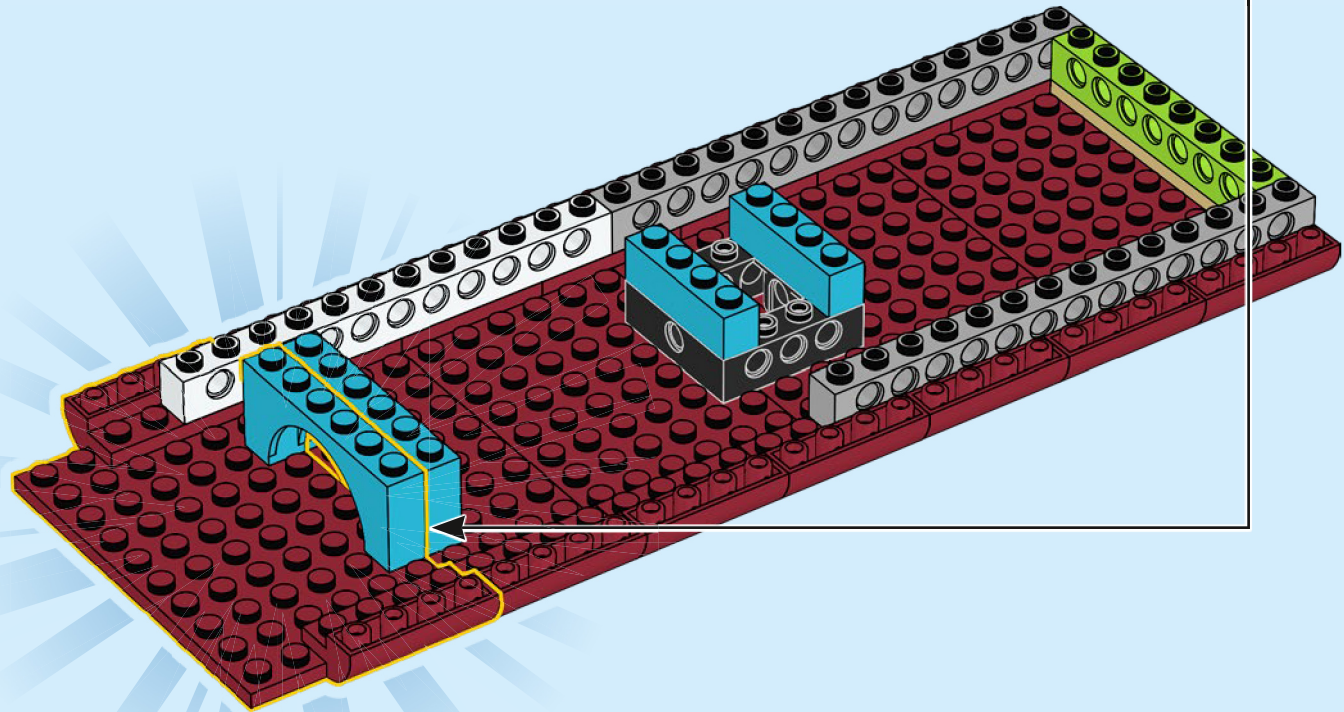
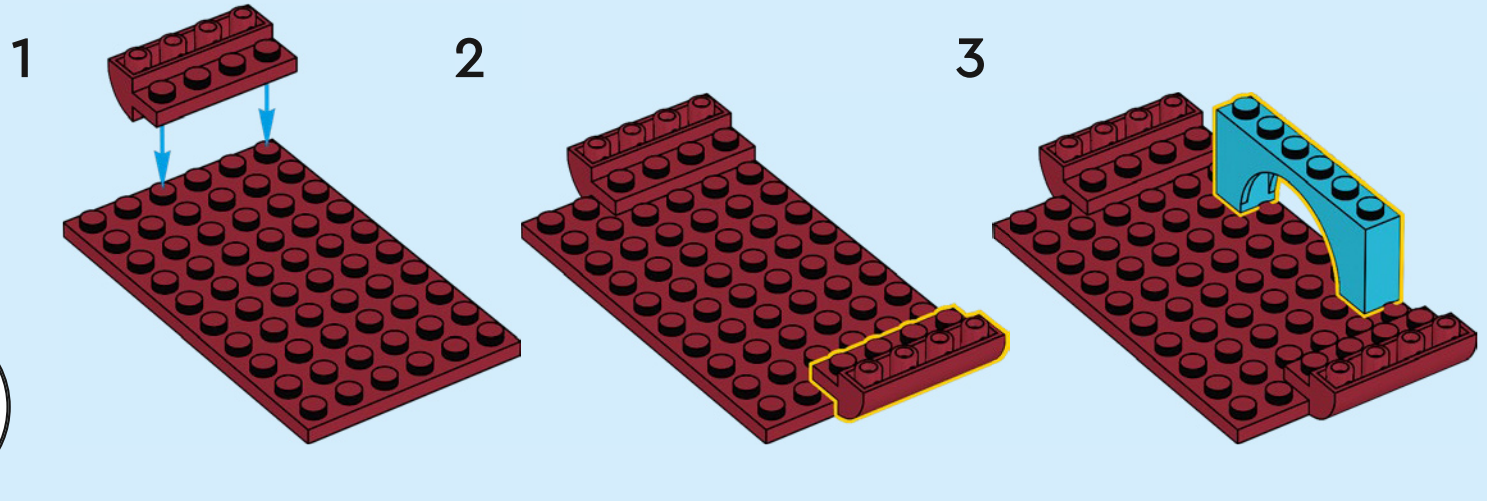

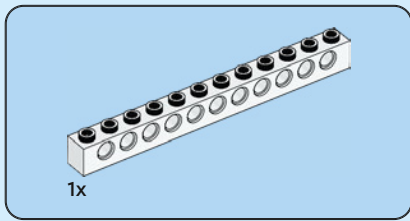

10

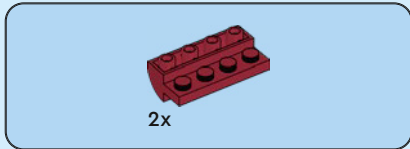
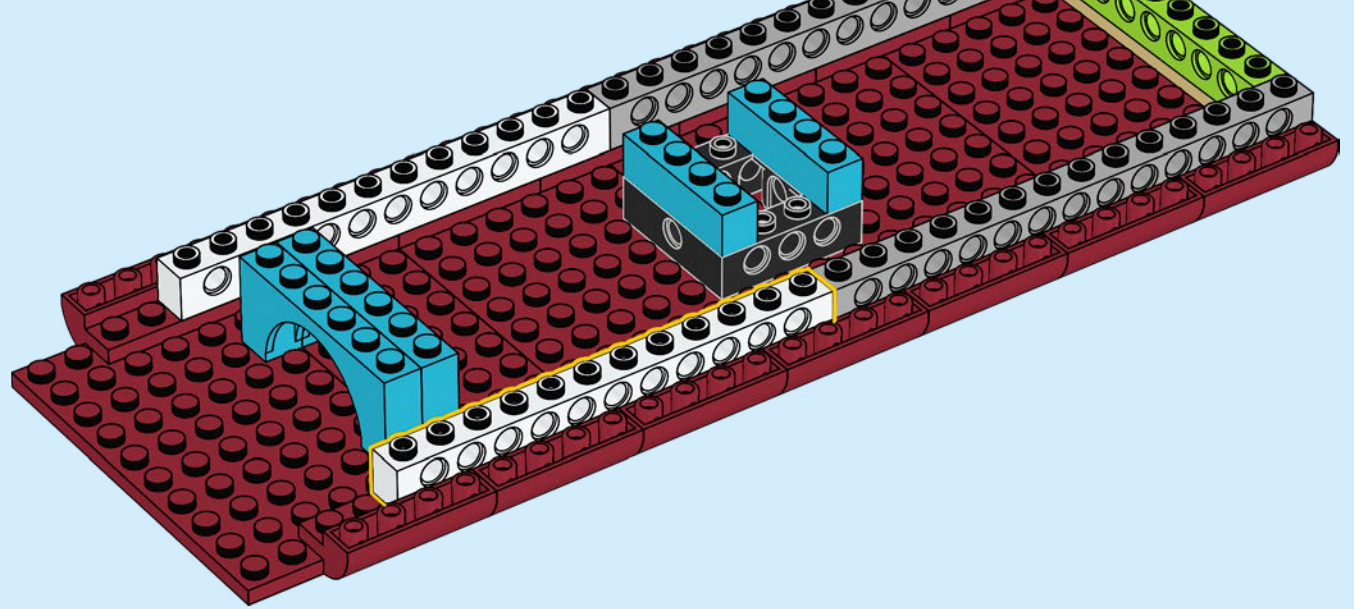

11

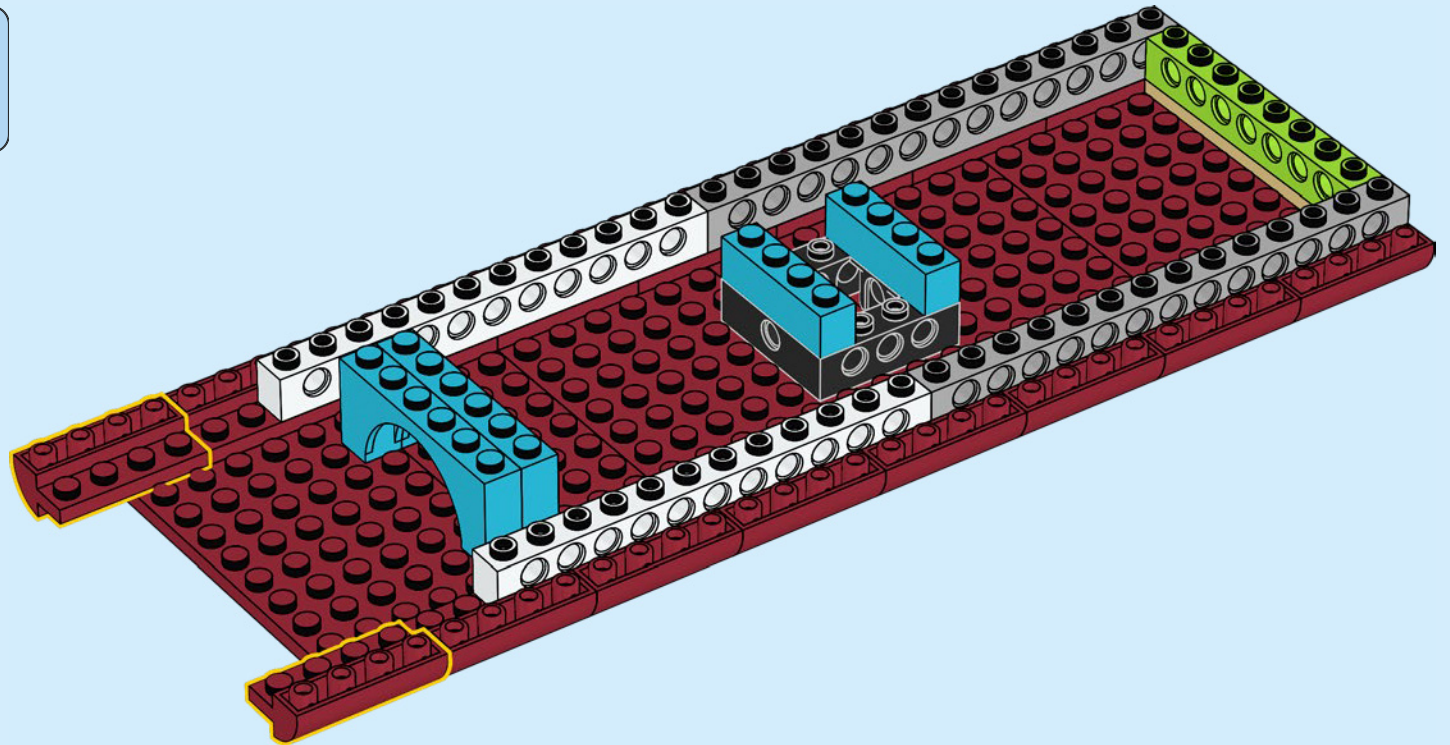

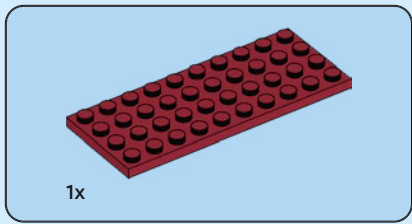

12

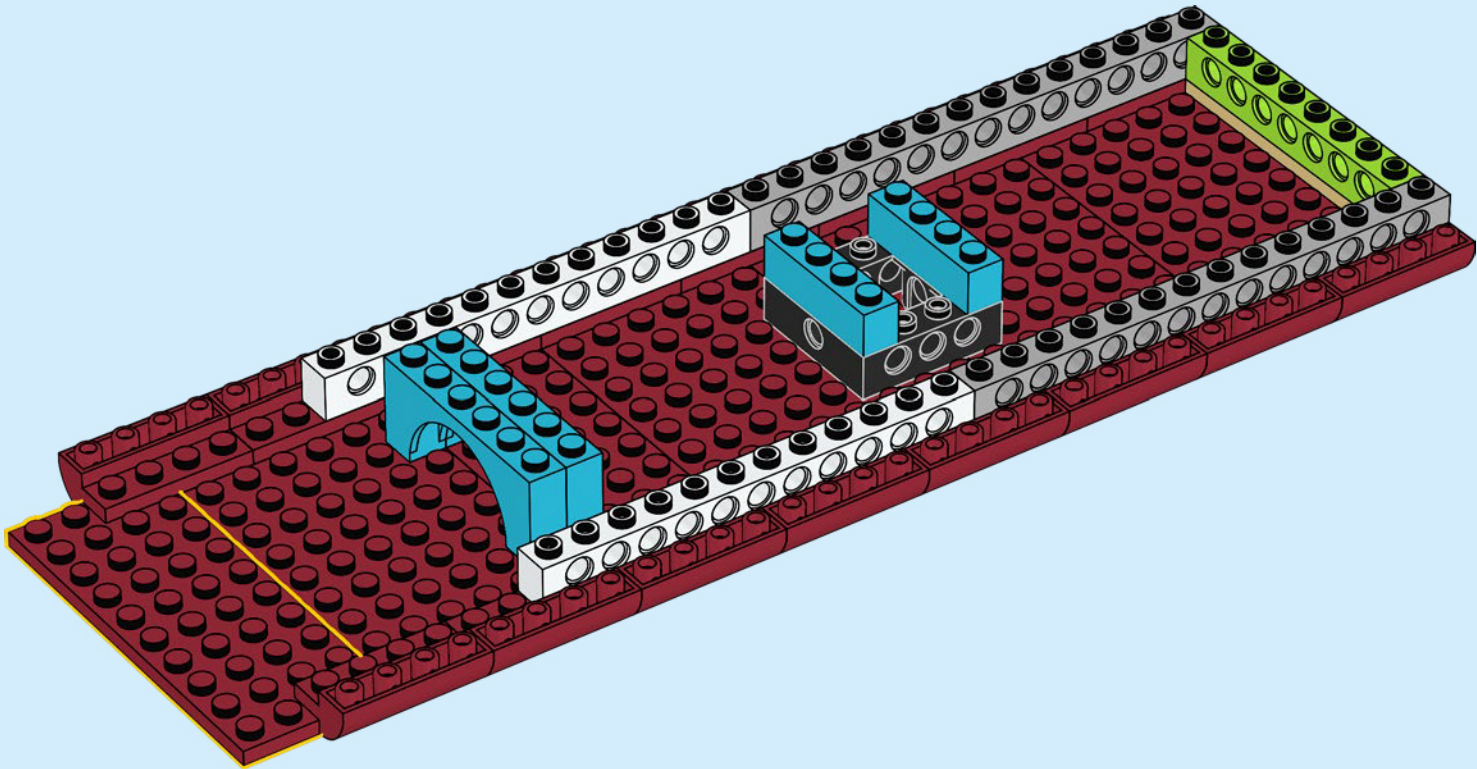

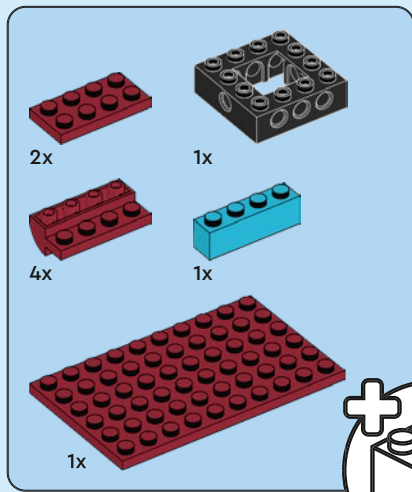

13

1

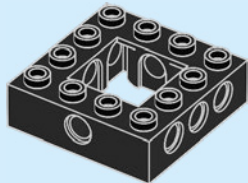

2

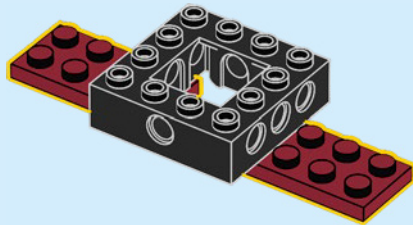

3

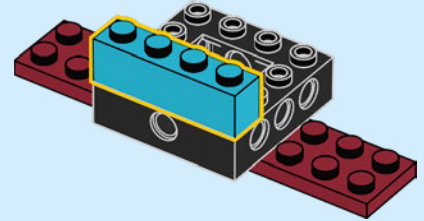

4

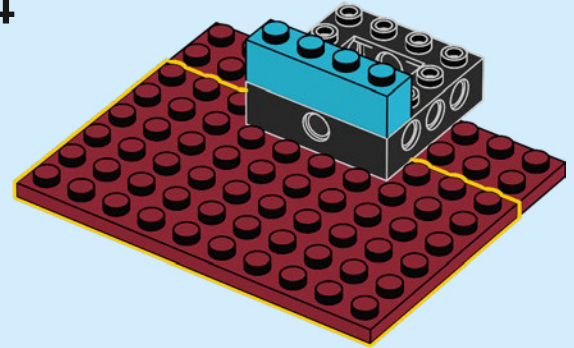

5

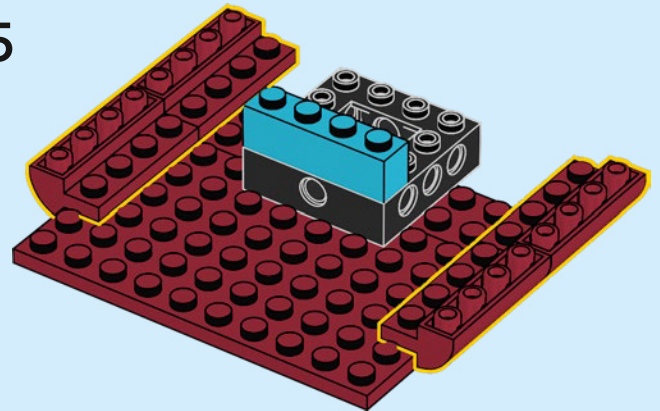

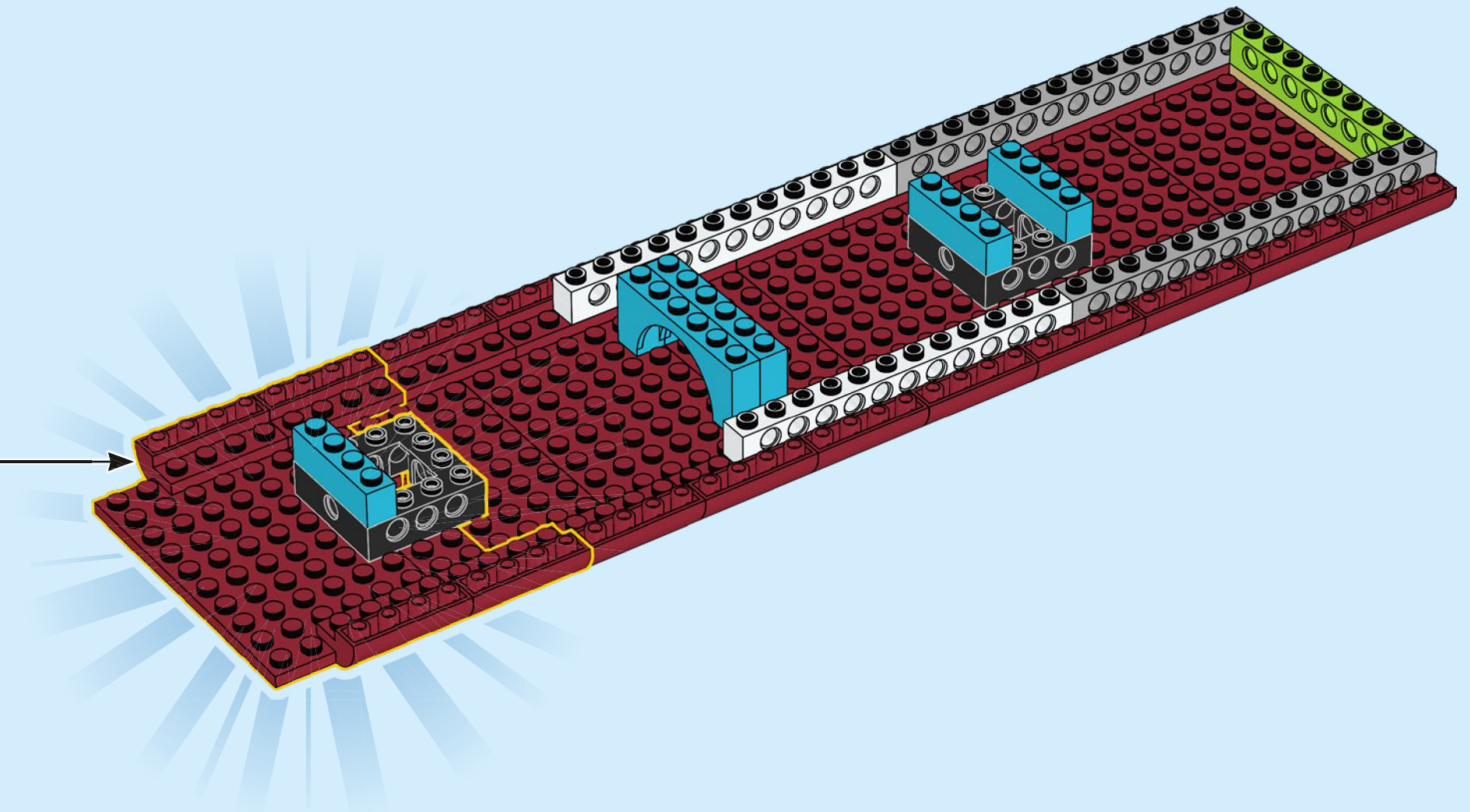

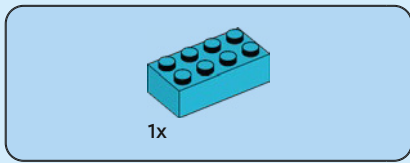

14

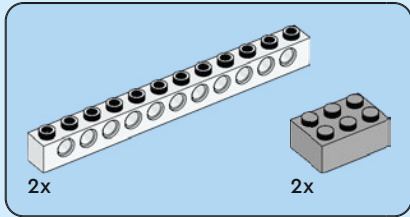
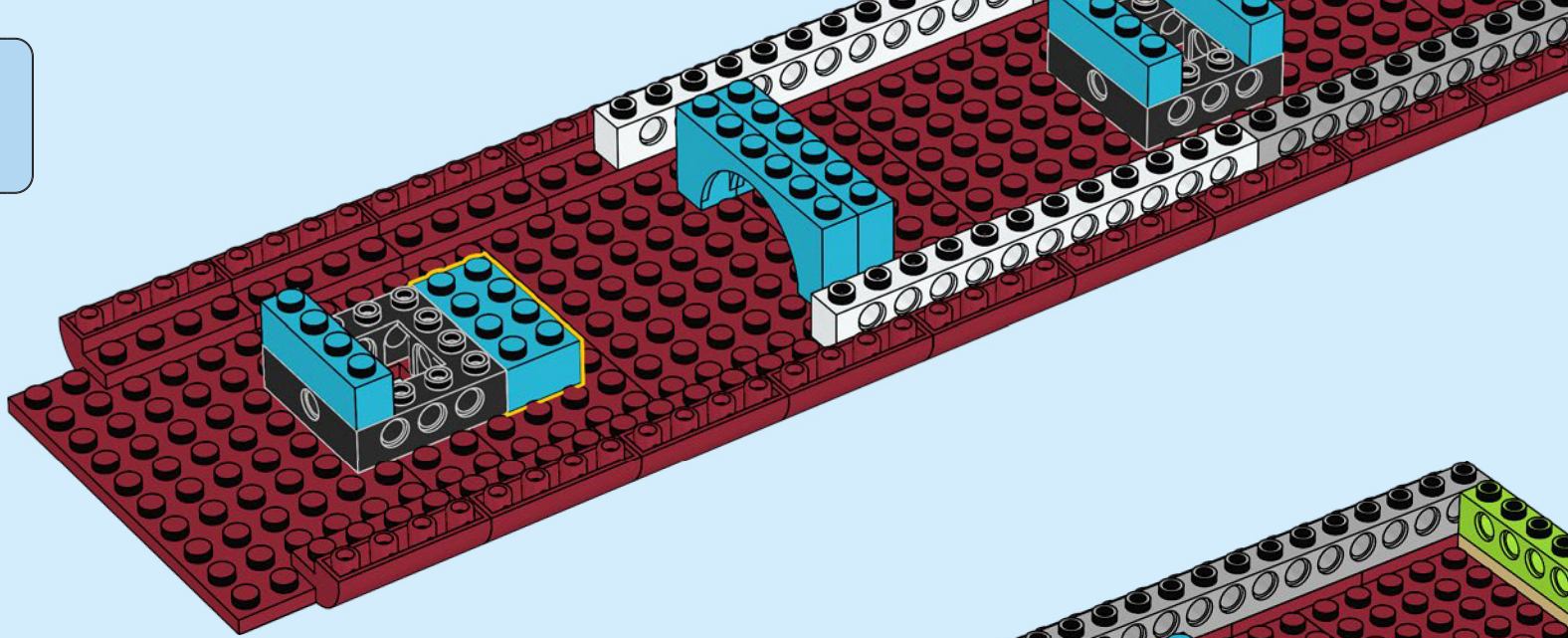

15

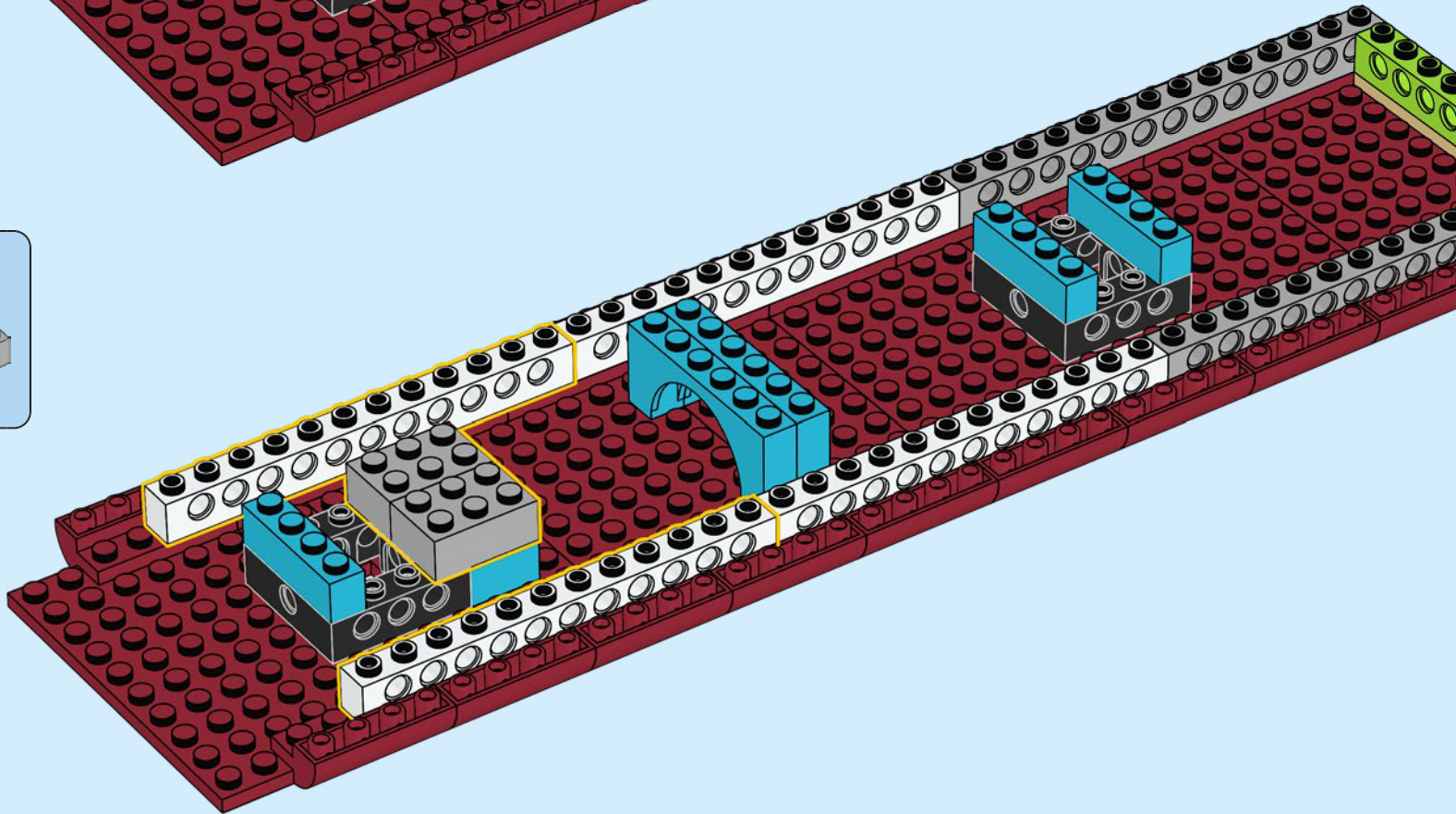

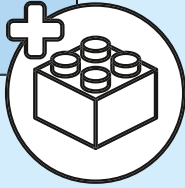
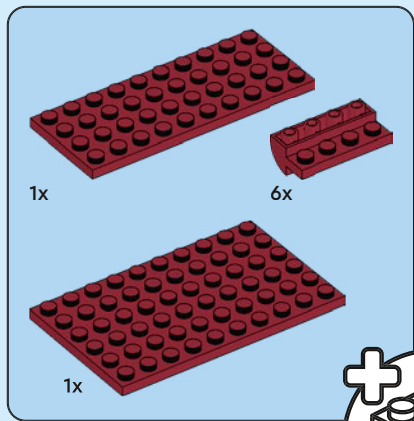

16

1

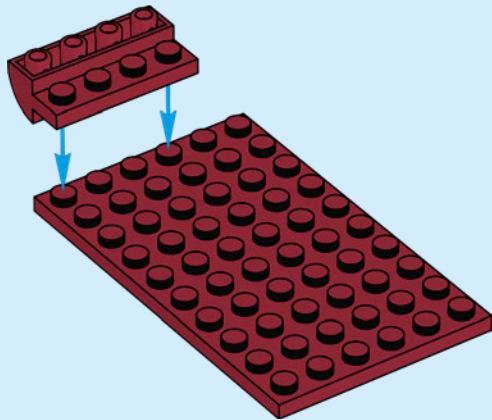

2

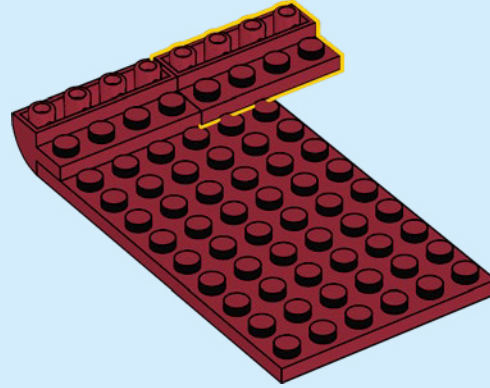

3

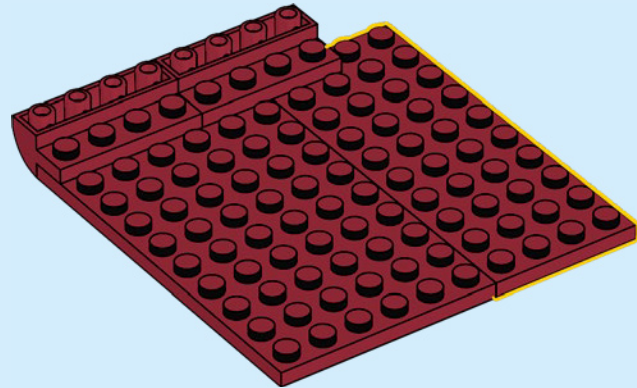

4

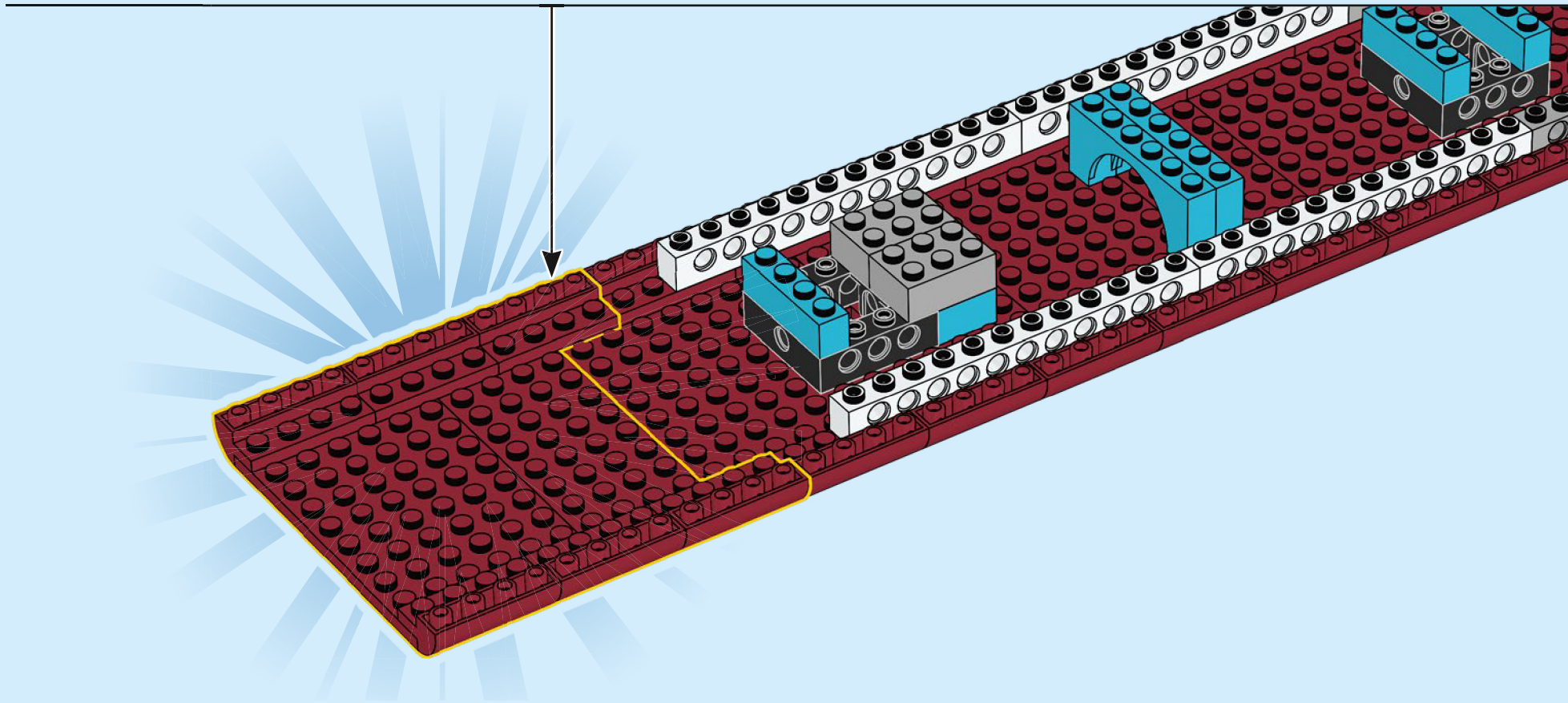
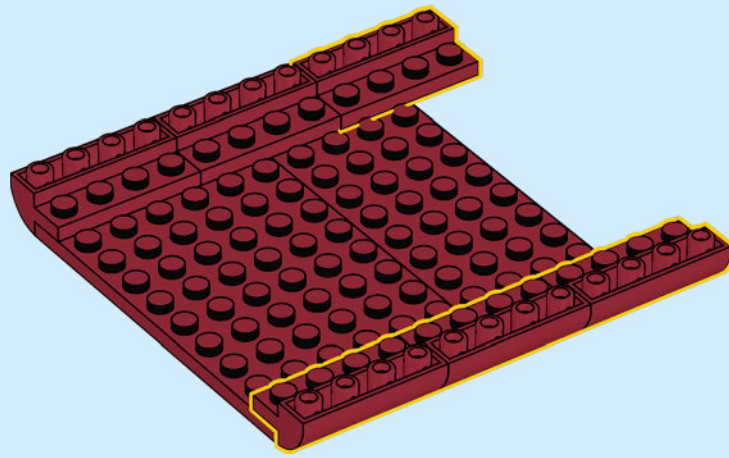

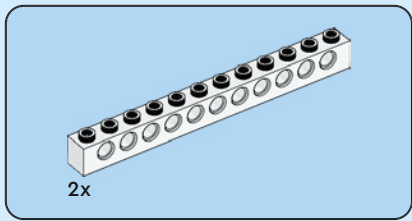

17

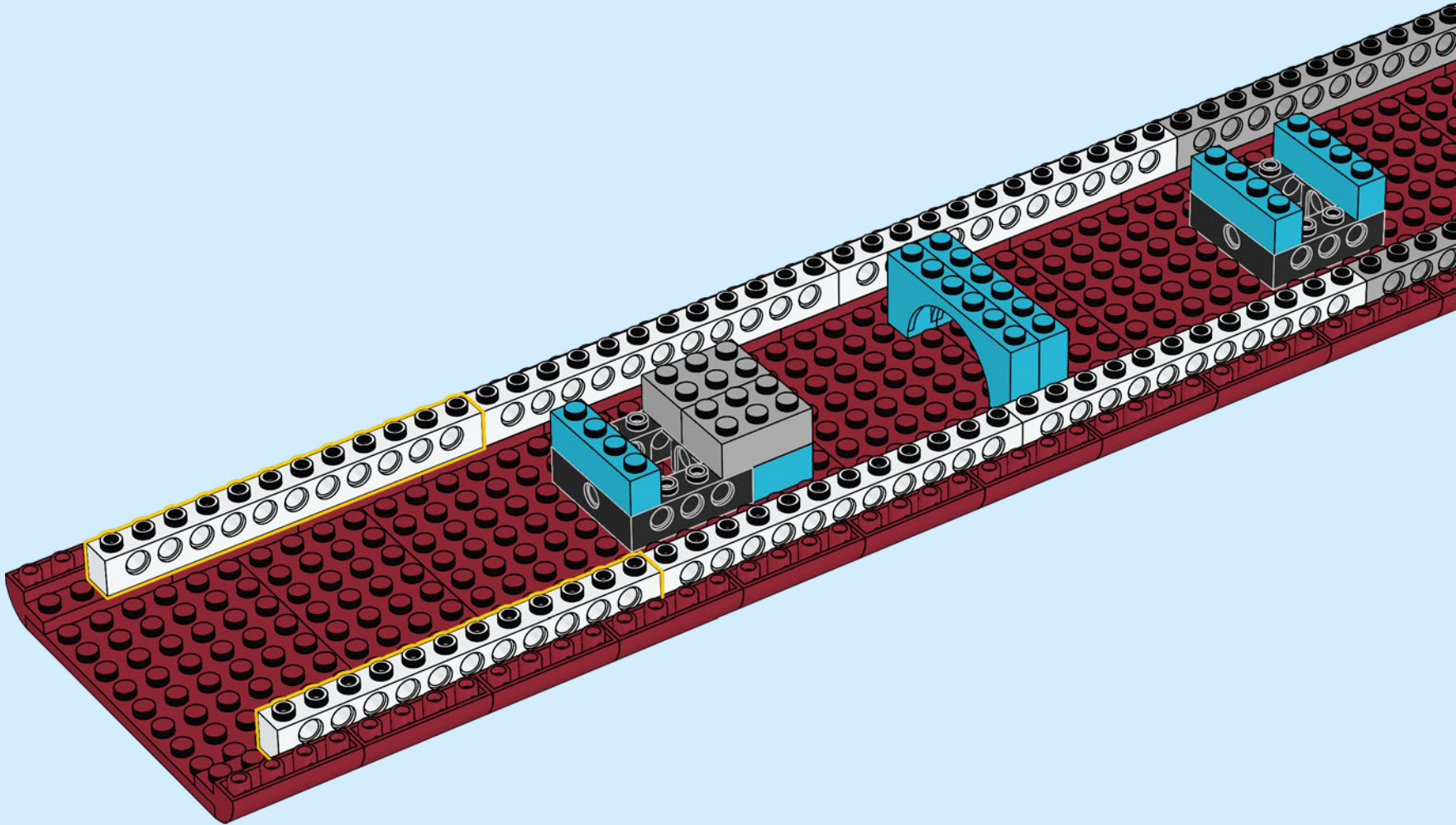

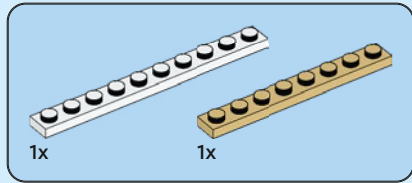

18

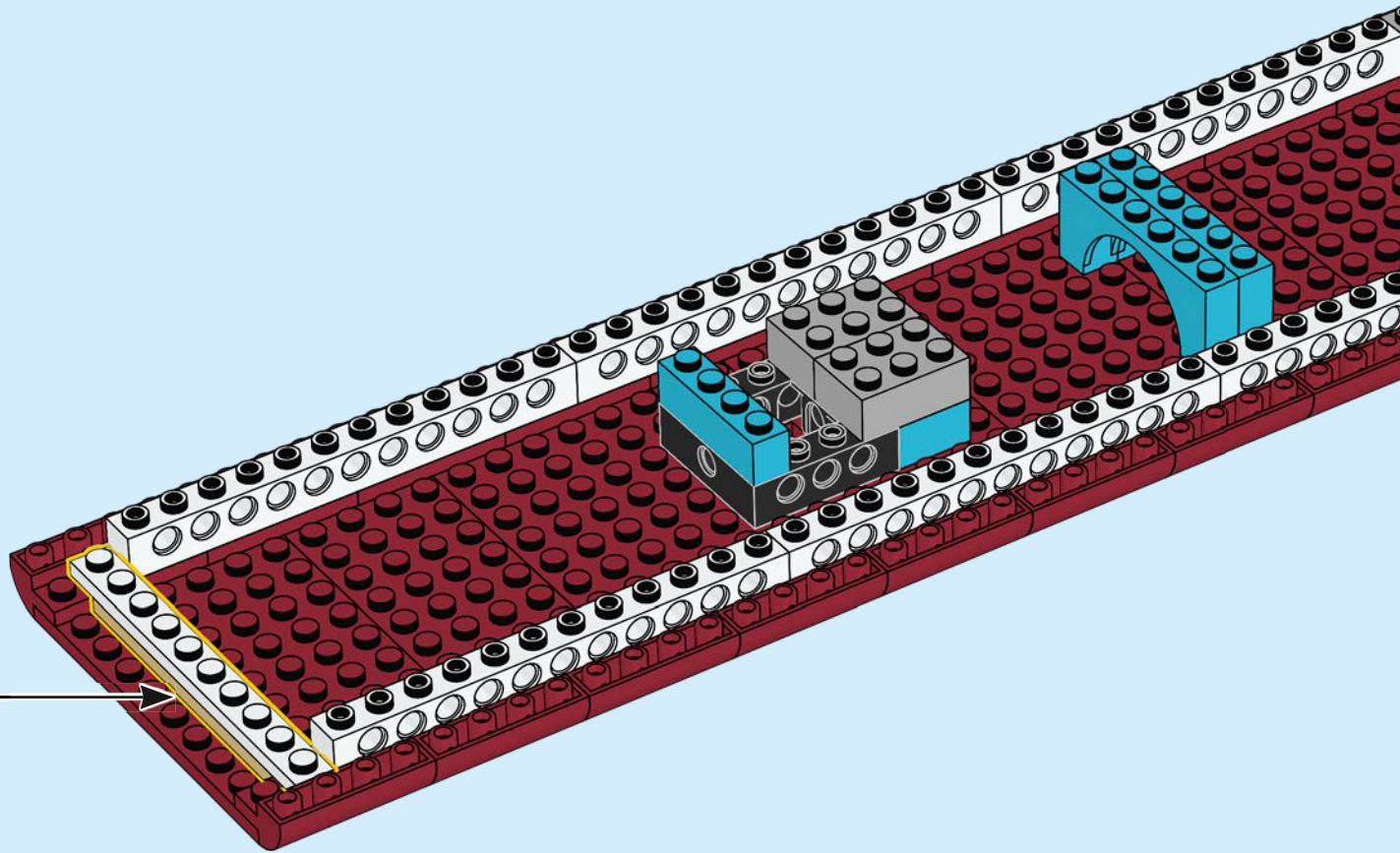
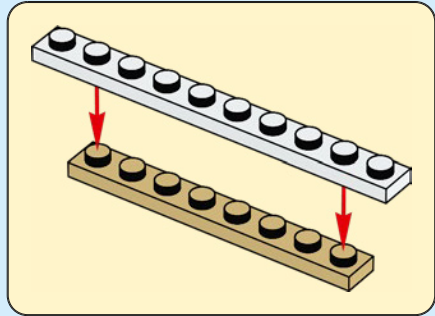

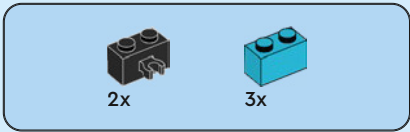

19

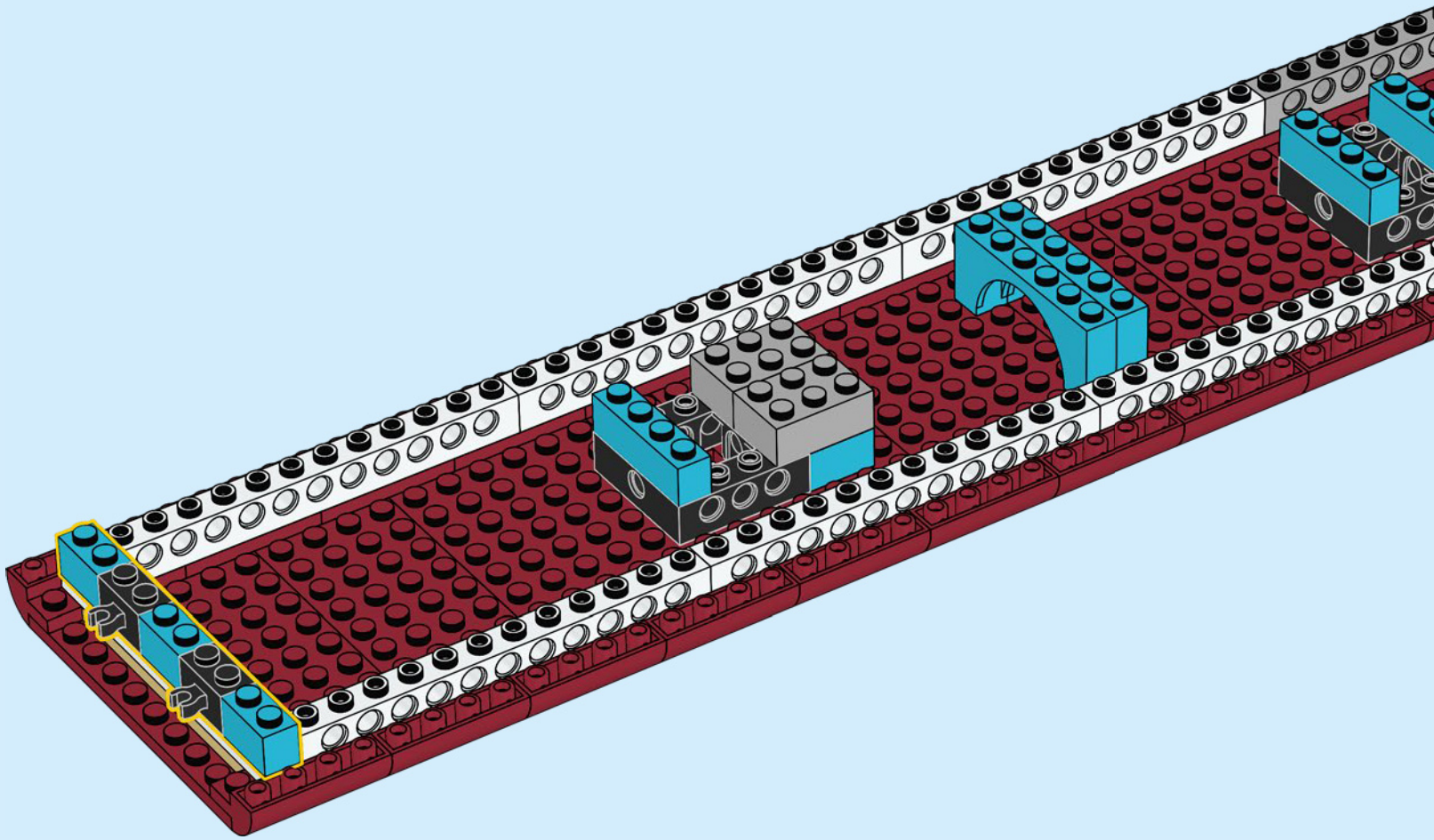

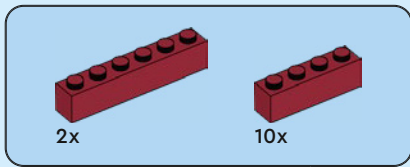

20

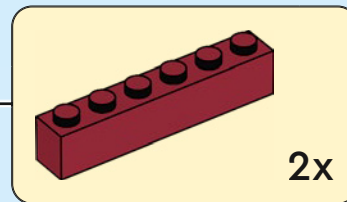
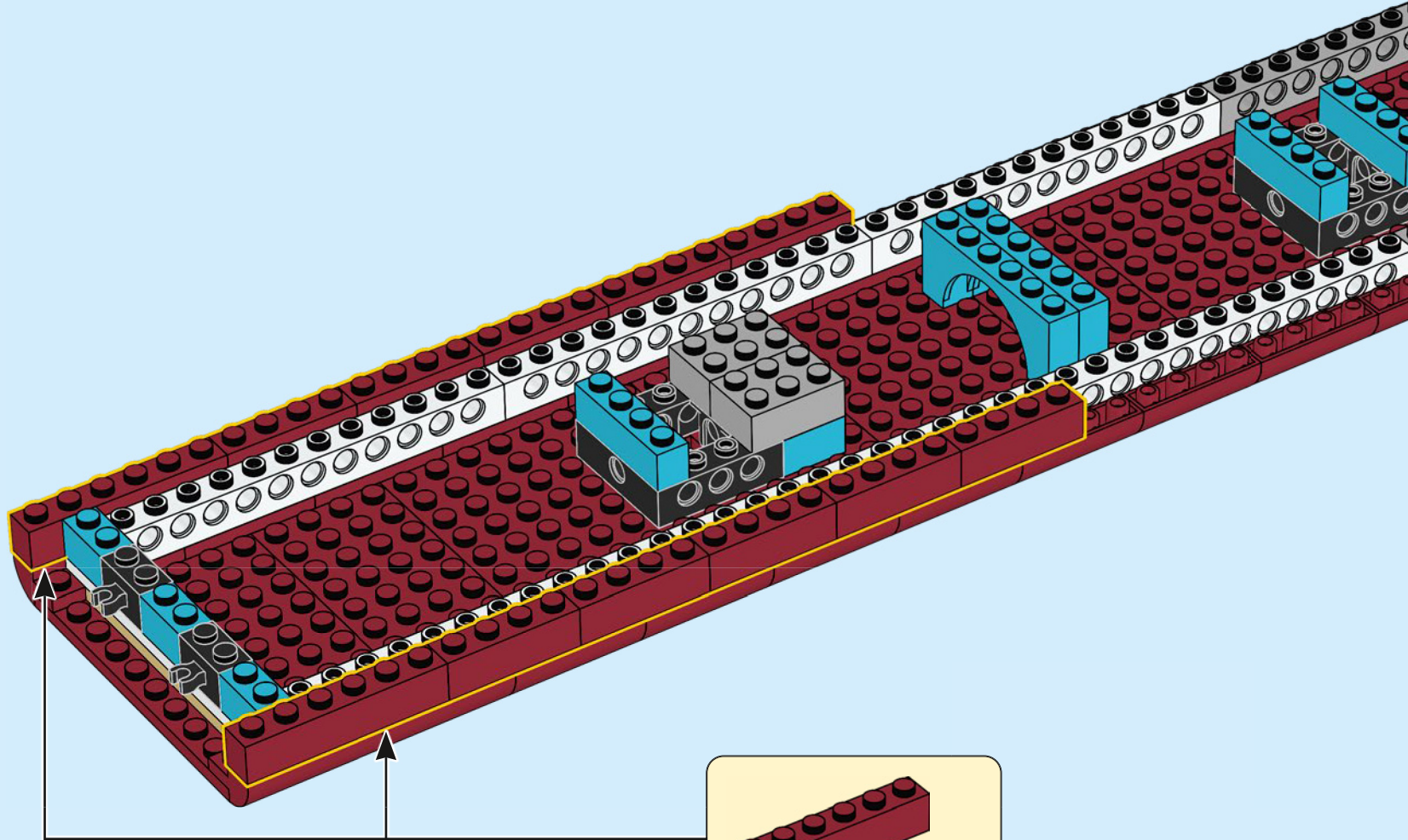

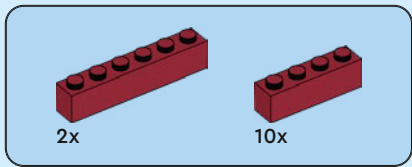

21

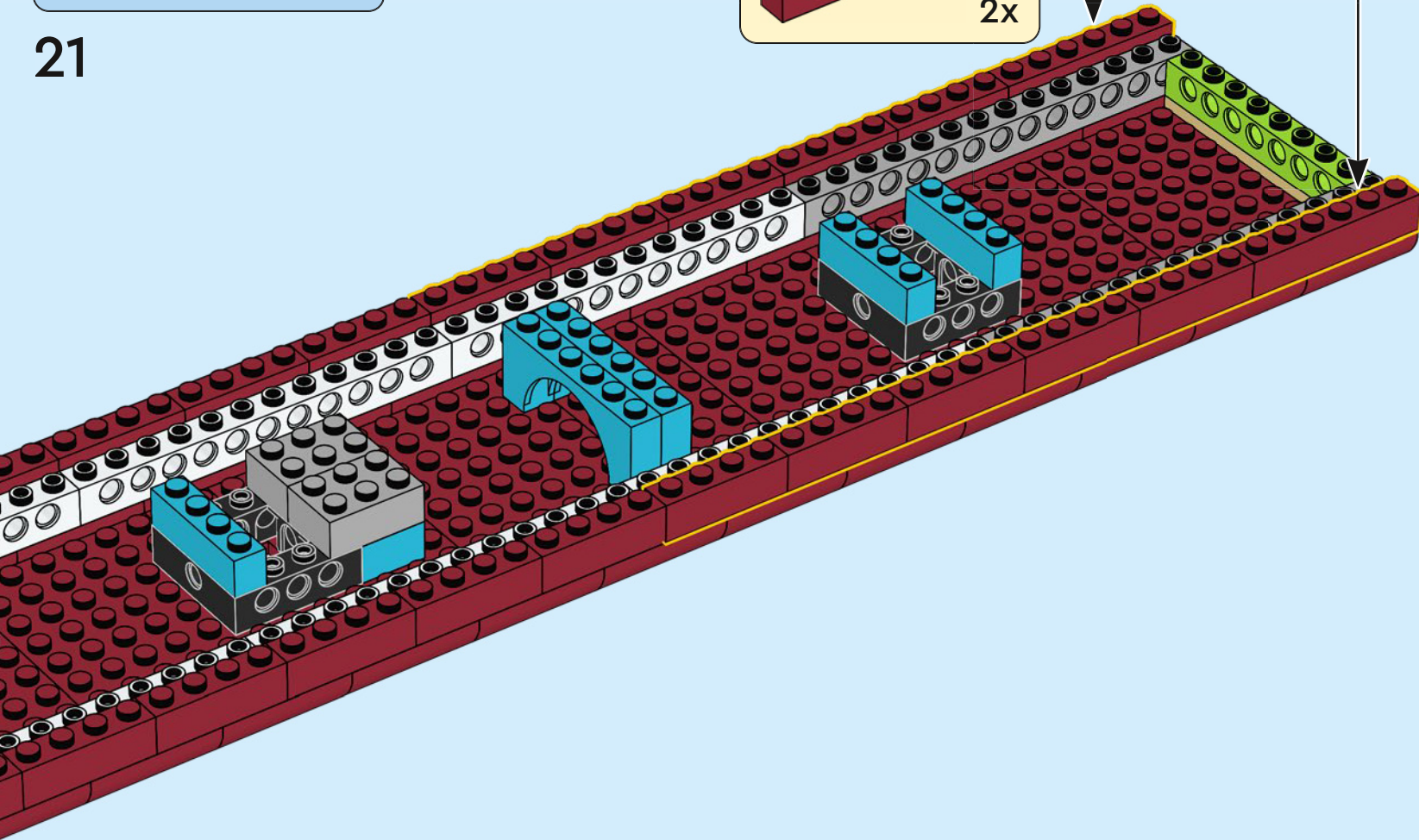
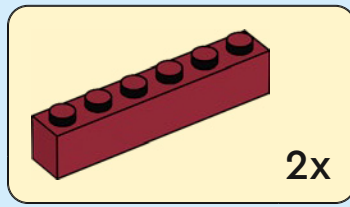

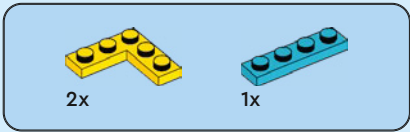

22

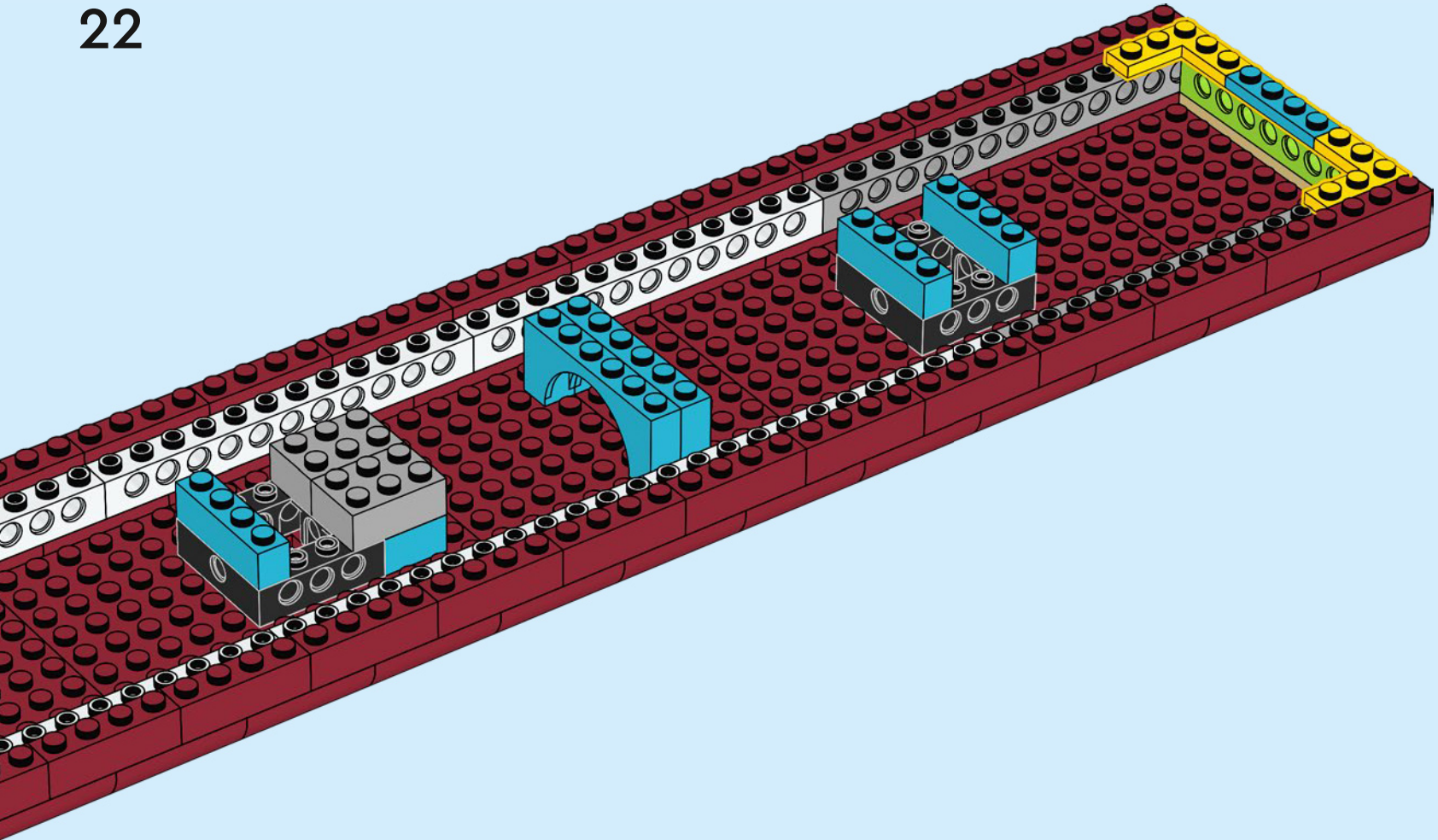

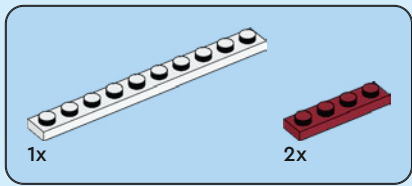

23

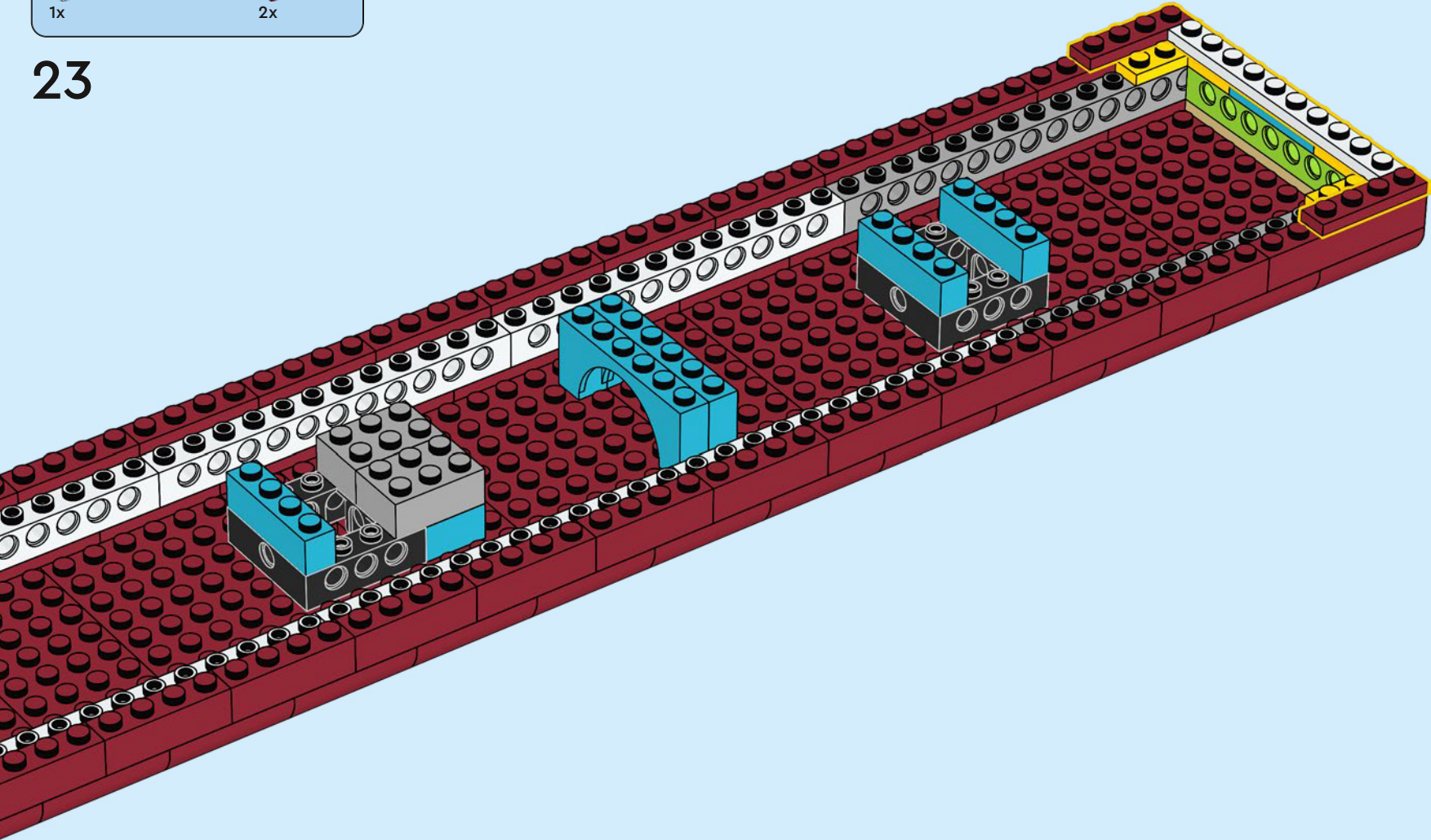

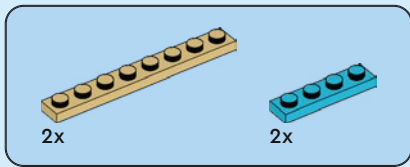

24

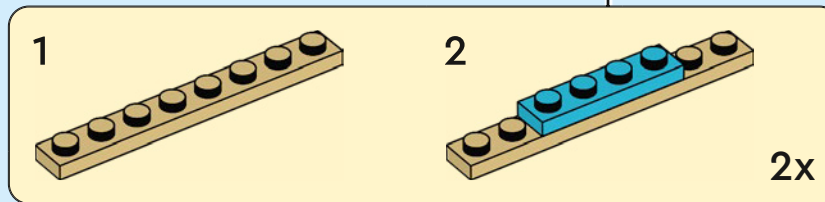
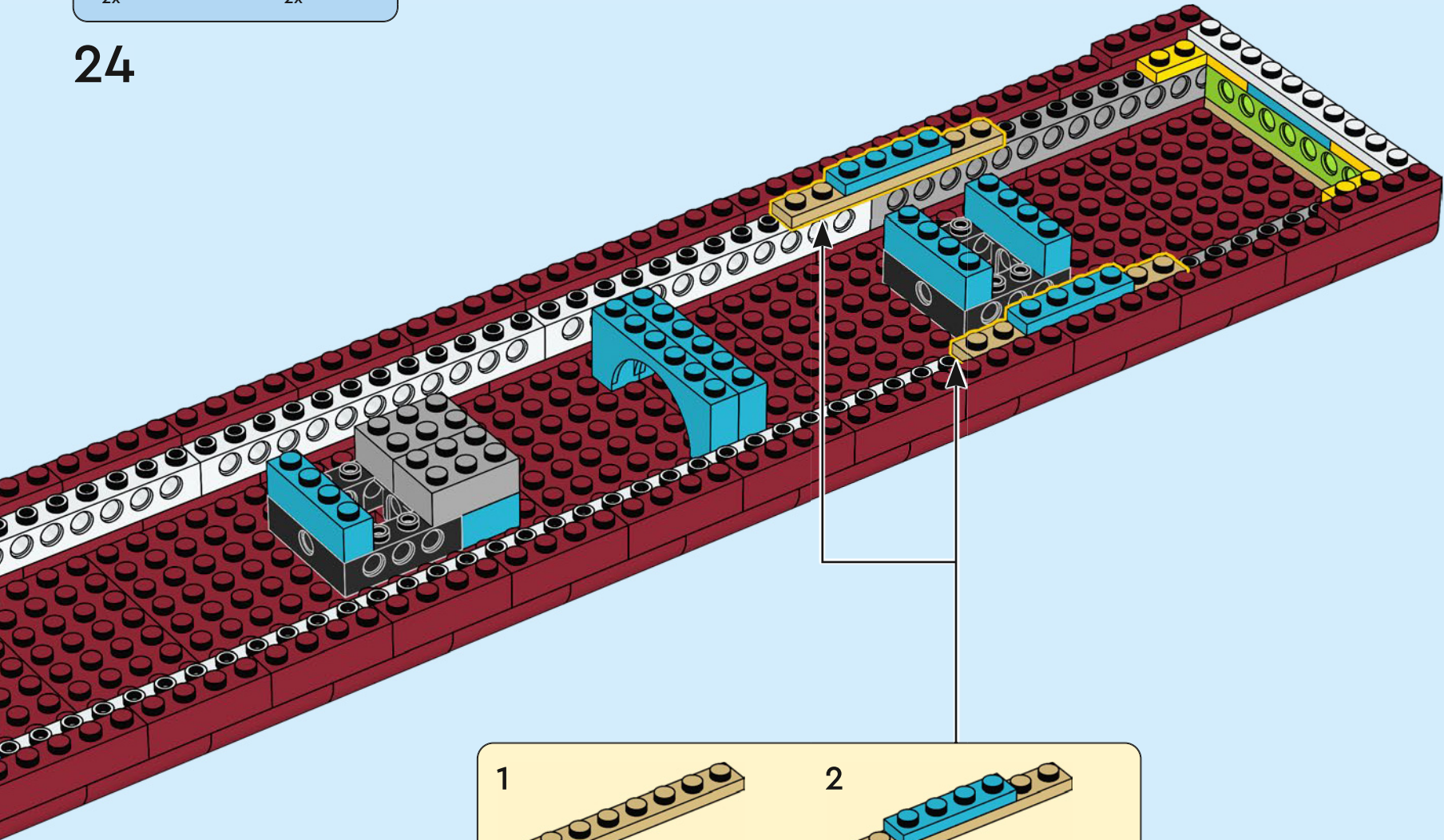

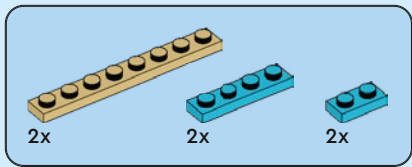

25

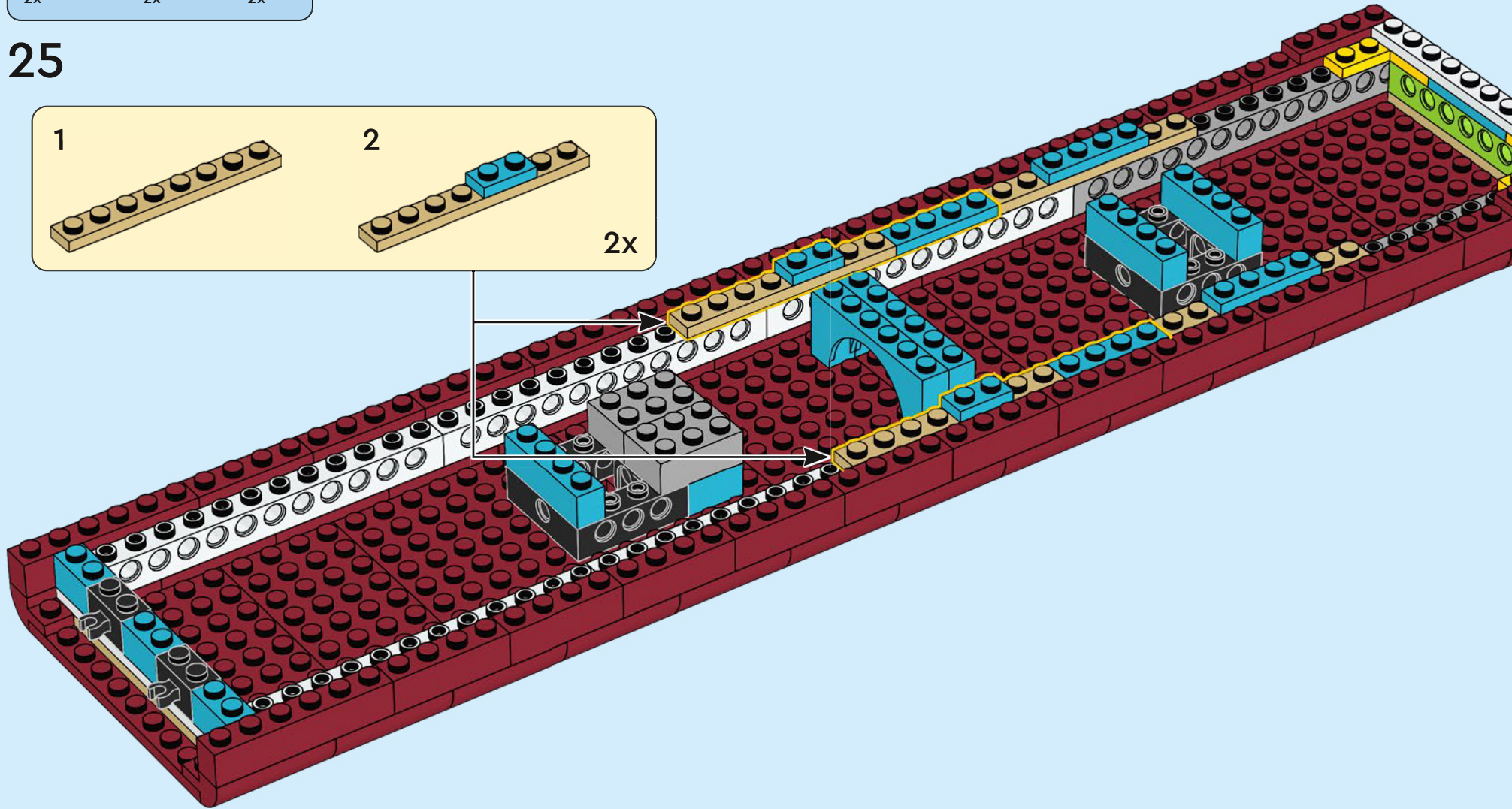
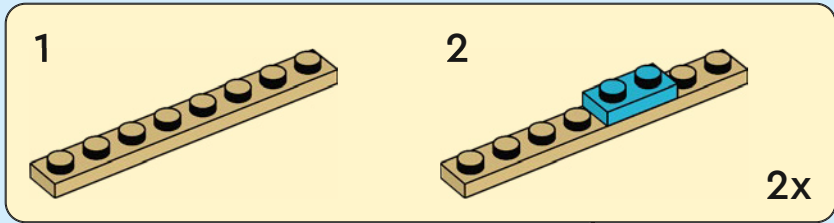

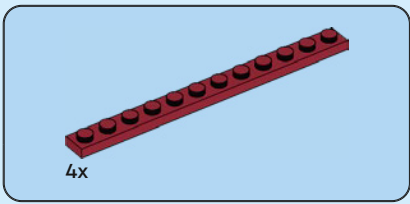

26

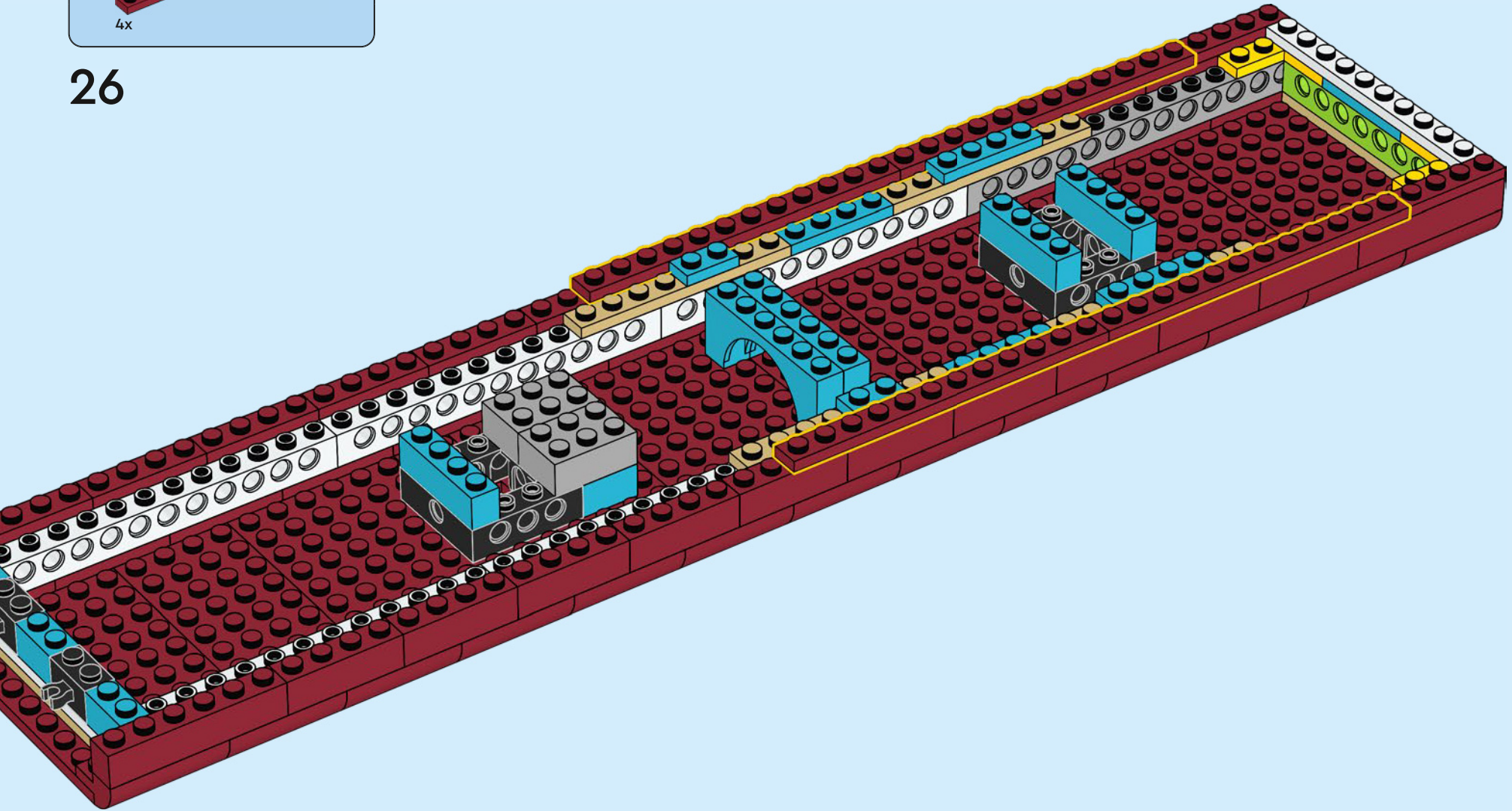

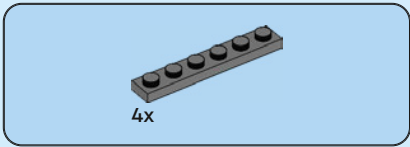

27

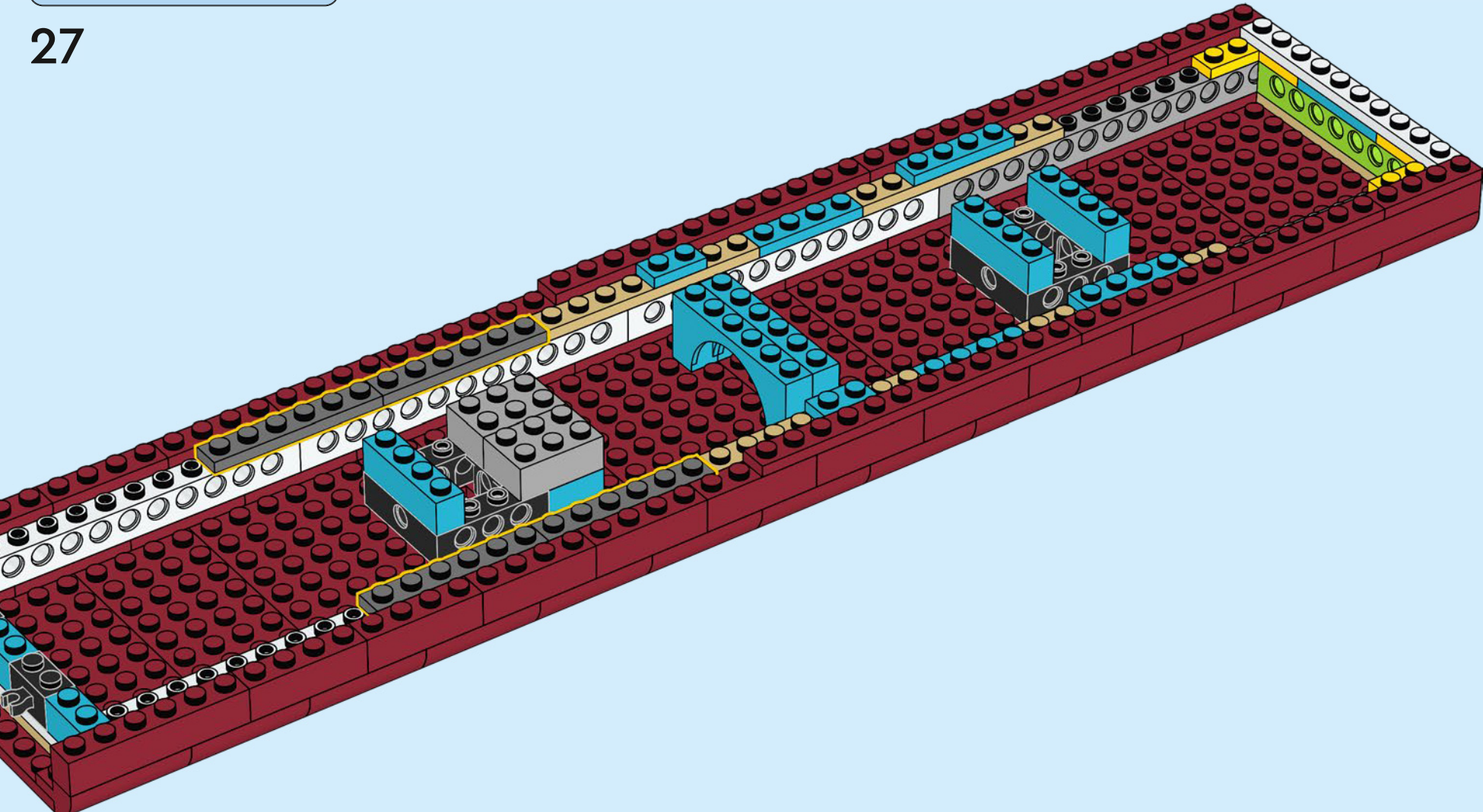

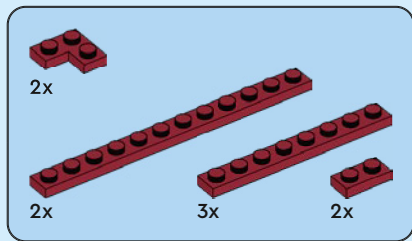

28

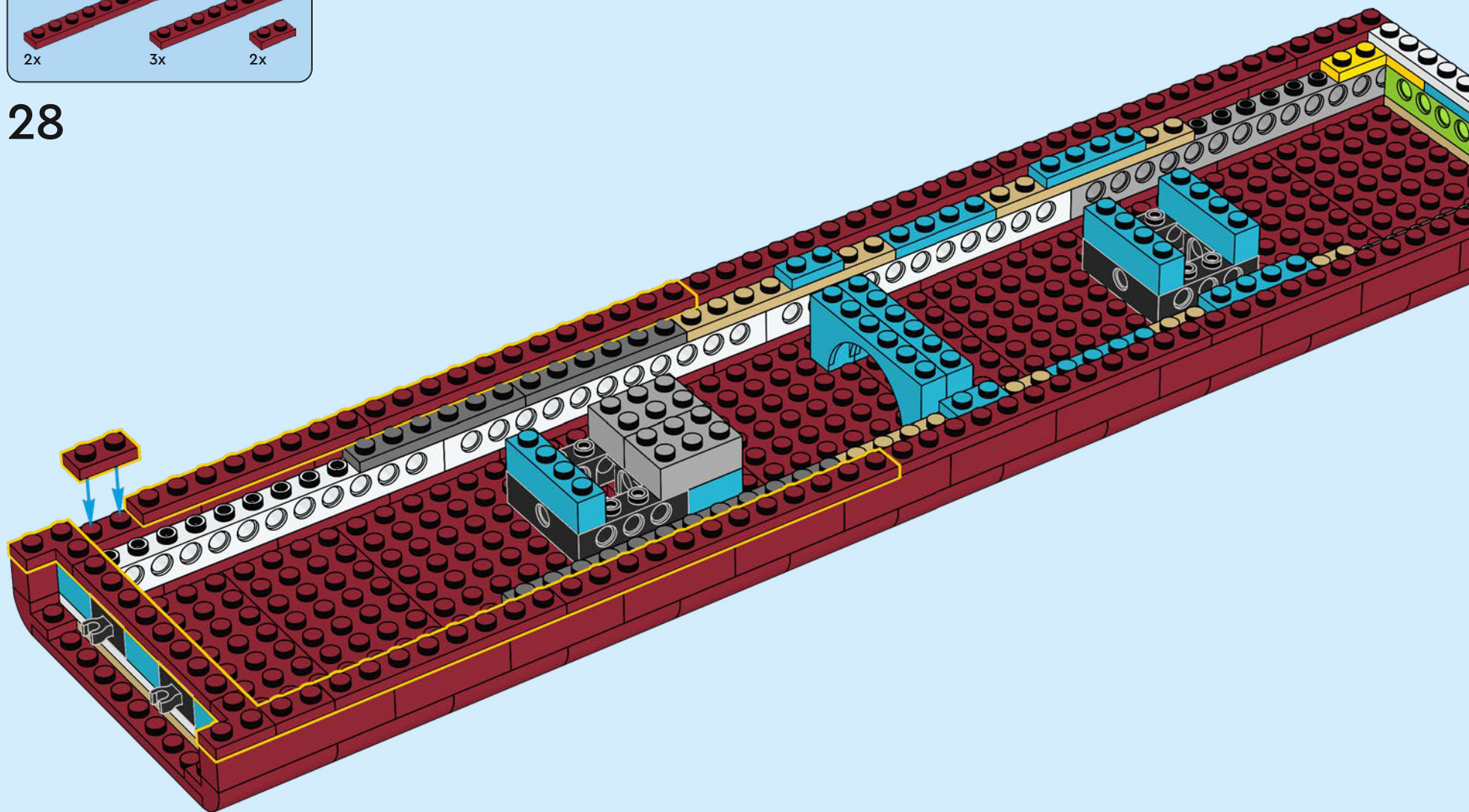

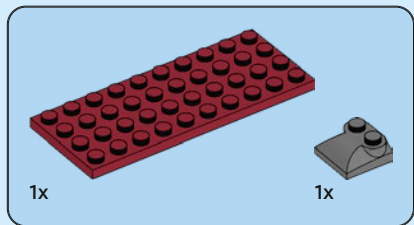
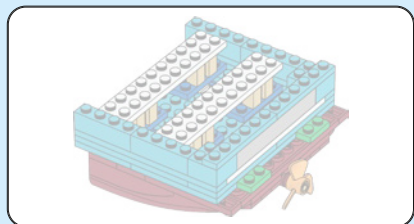

29

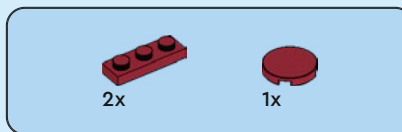
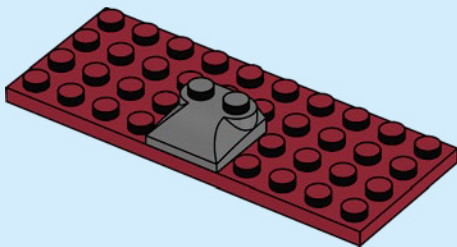

30

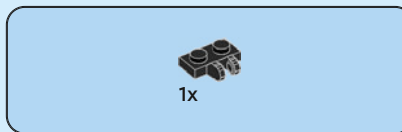
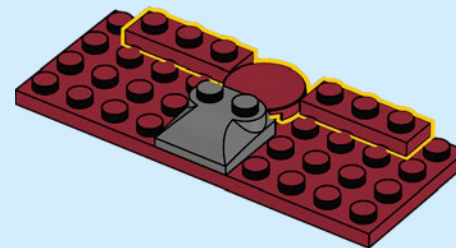

31

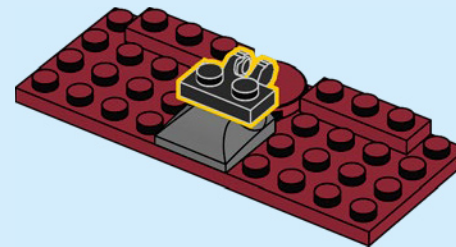

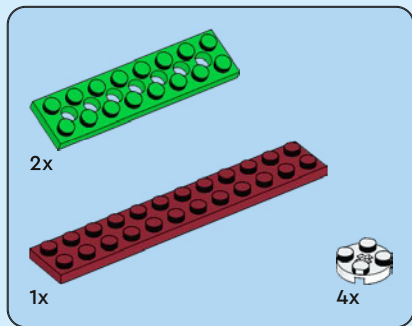

32

1

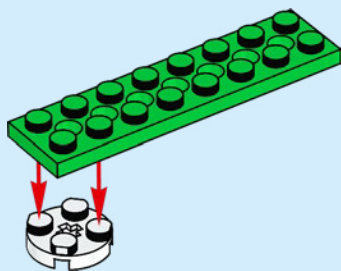

2

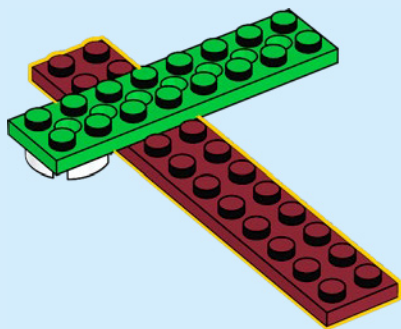

3

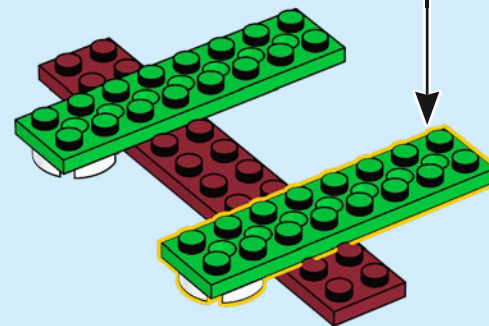
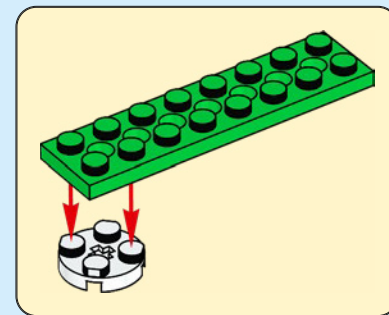

4

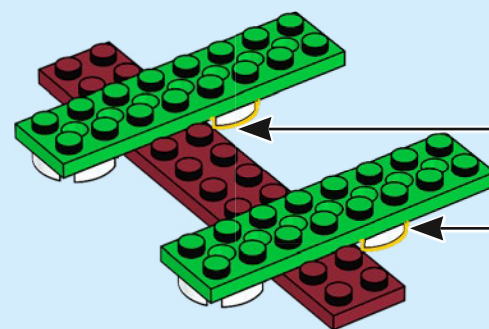

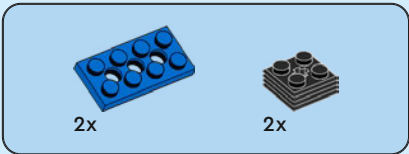

# 33

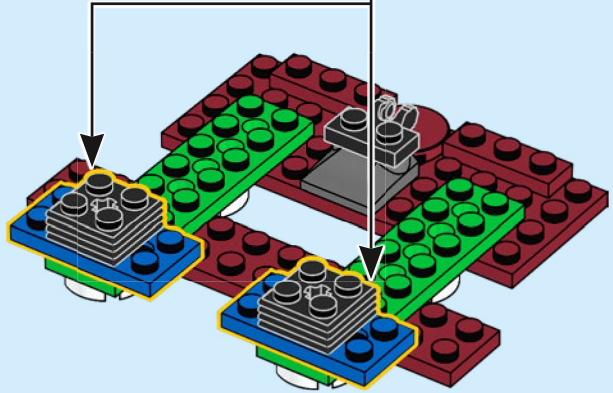
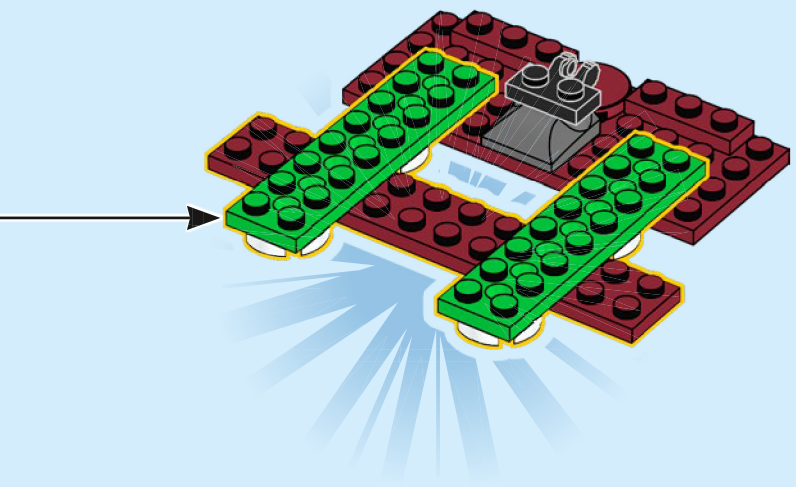
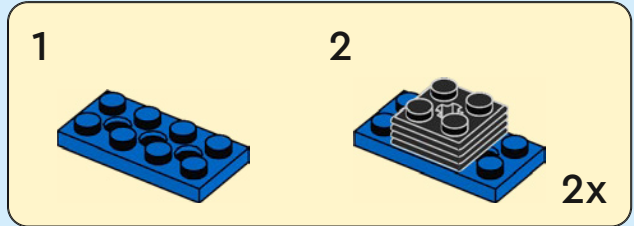

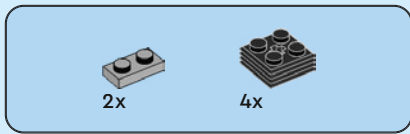

34

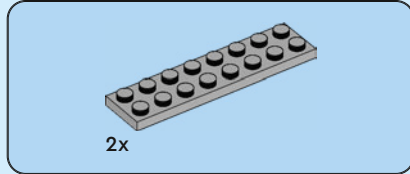
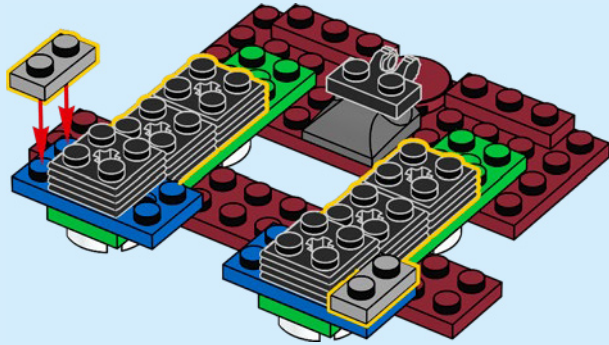

35

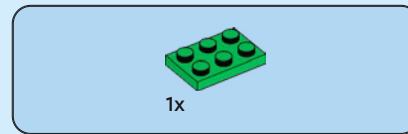
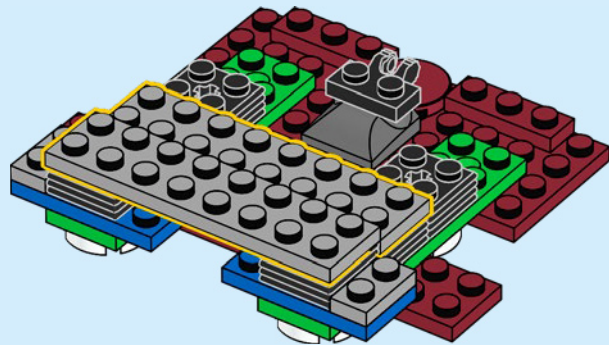

36

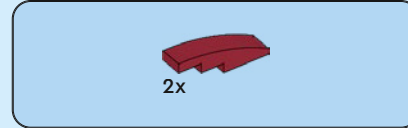
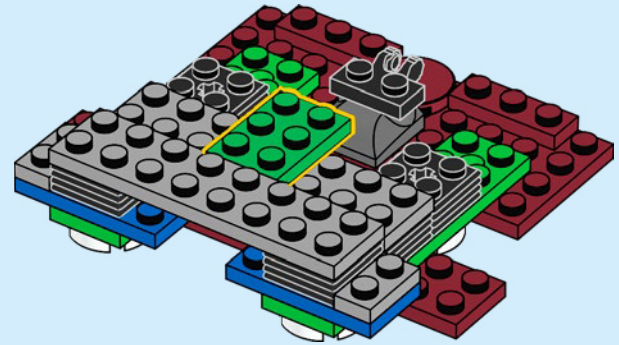

37

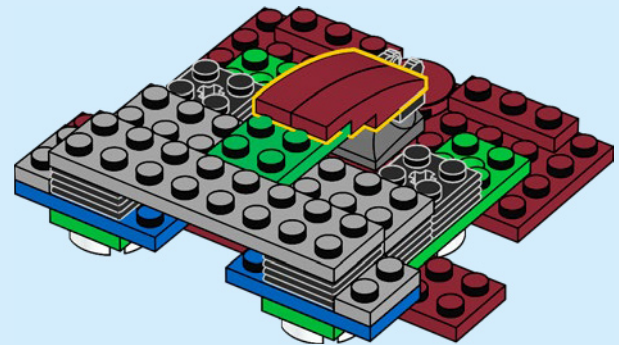

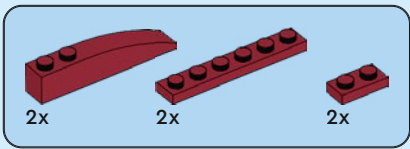

38

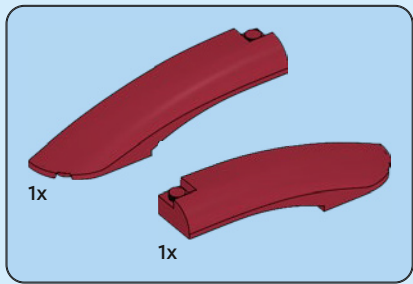
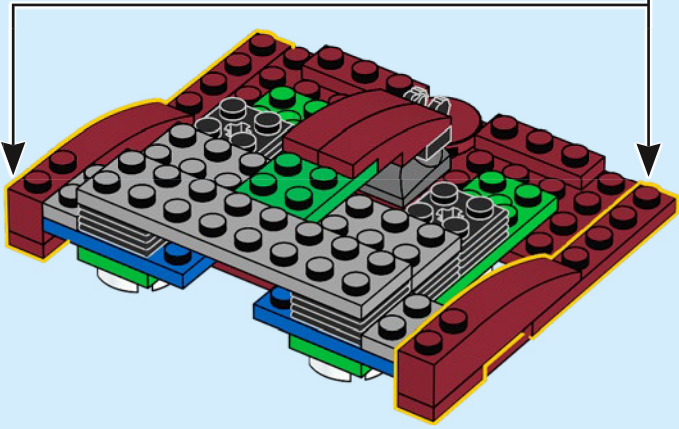
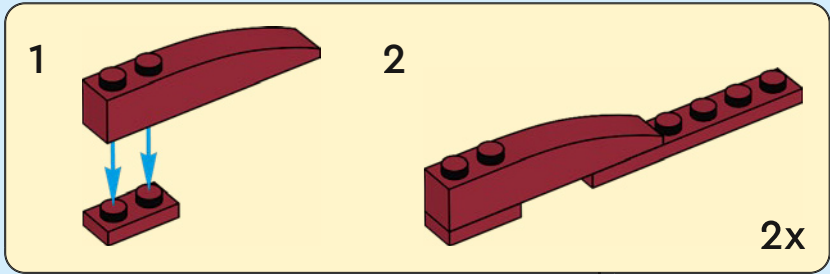

39

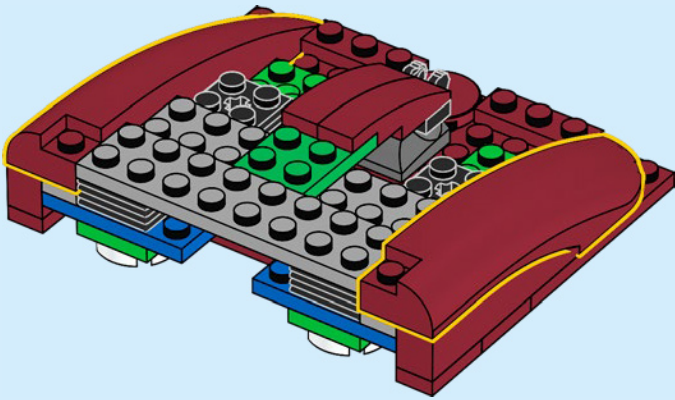

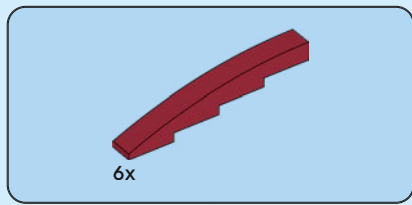

40

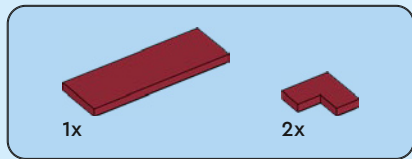
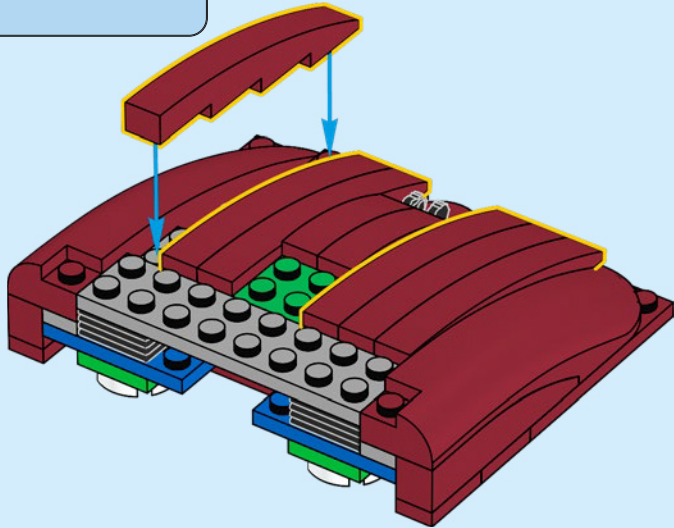

41

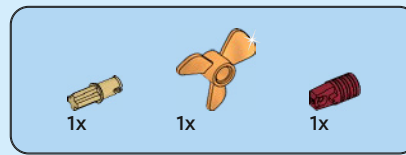
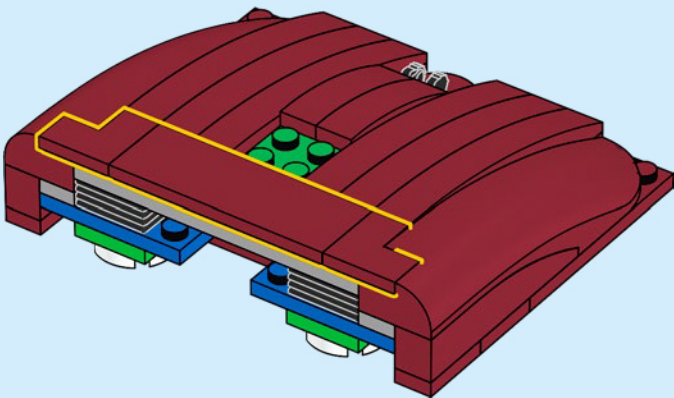

42

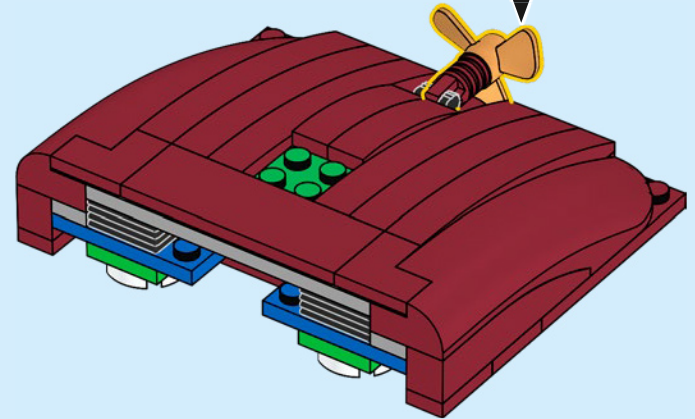
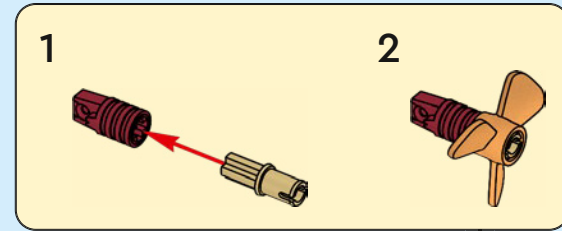

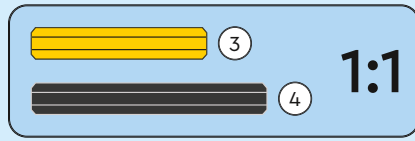
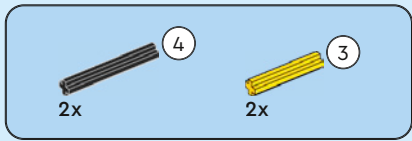

43

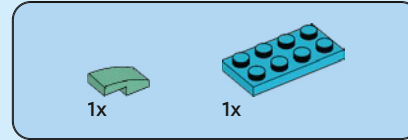
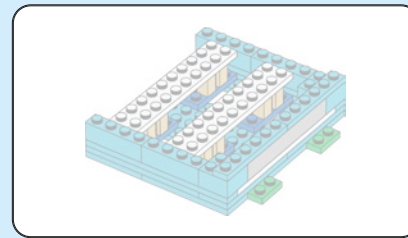
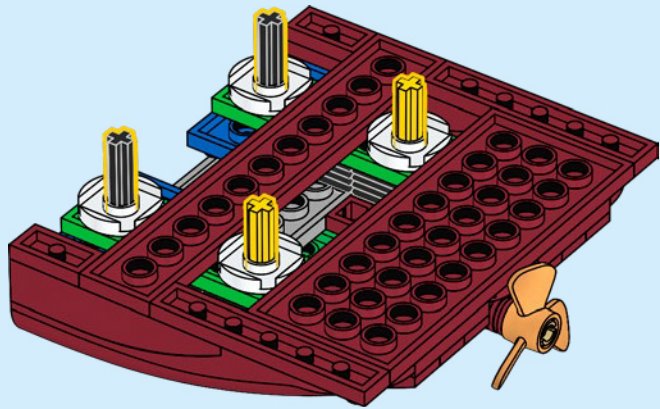

44

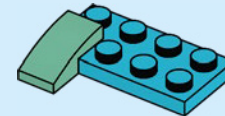

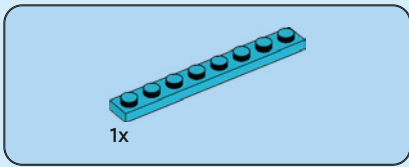

45

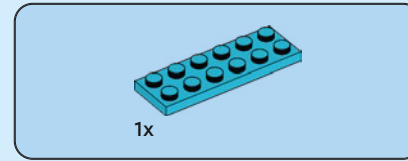
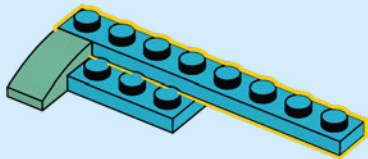
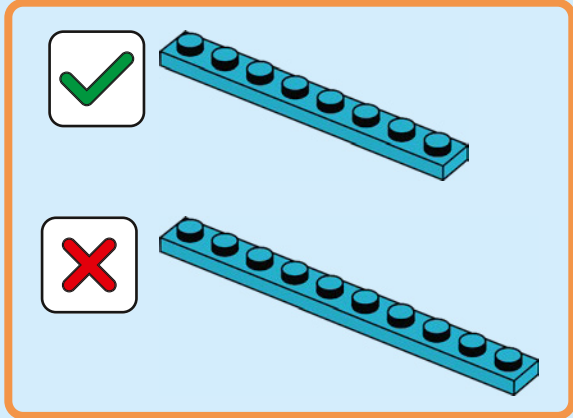

46

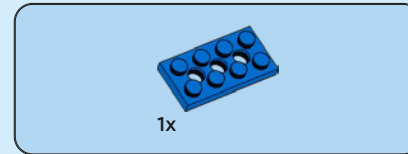
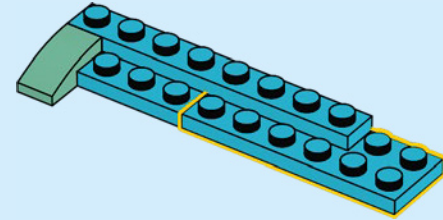

47

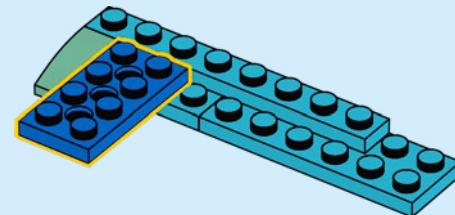

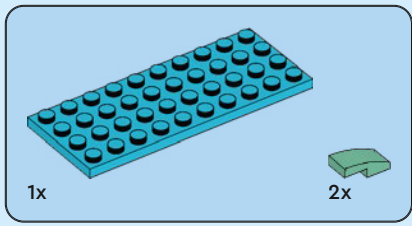

48

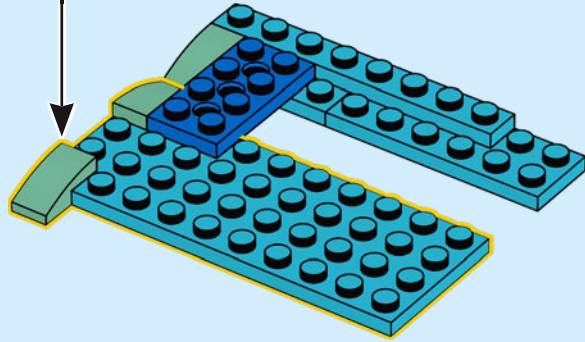
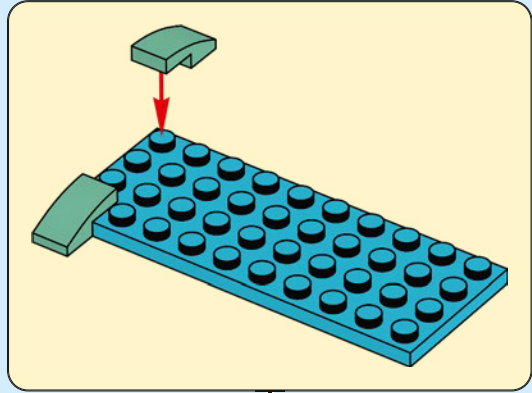

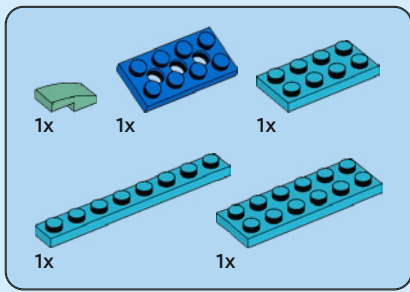

49

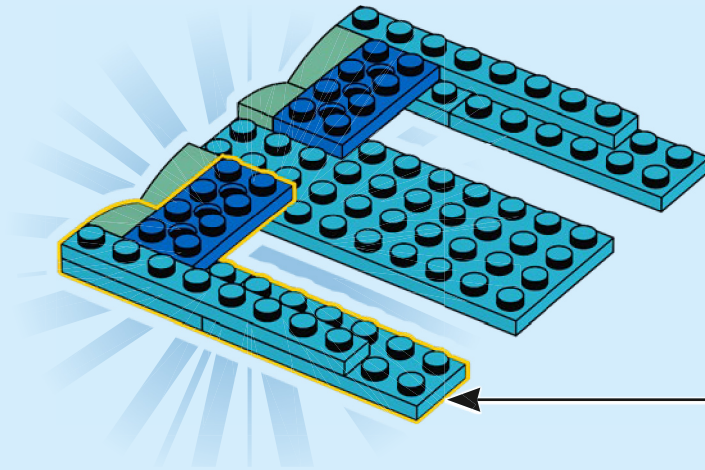
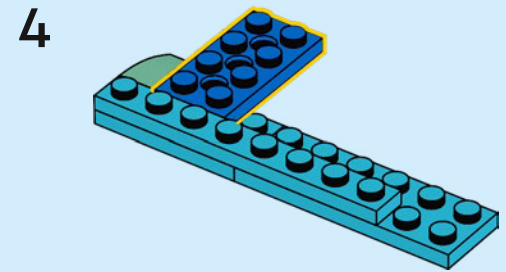
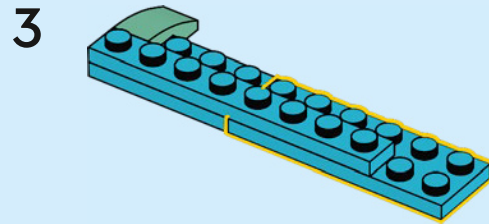
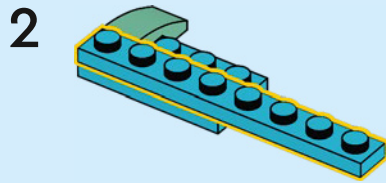
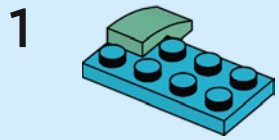
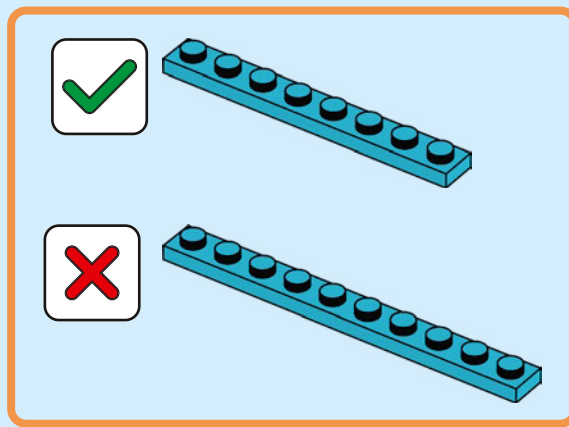



50

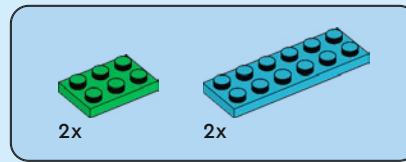
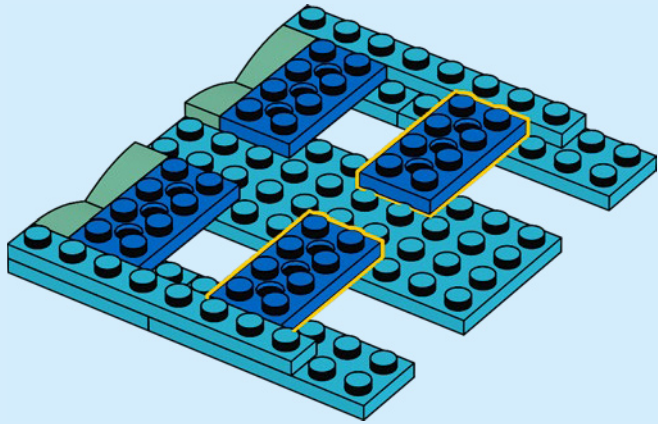

51

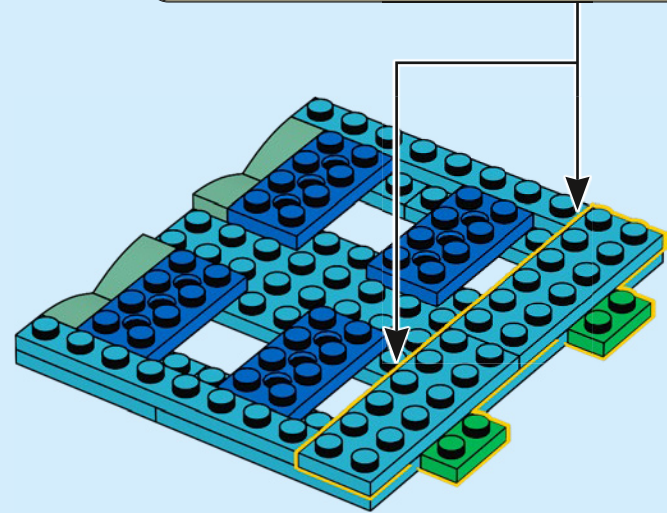
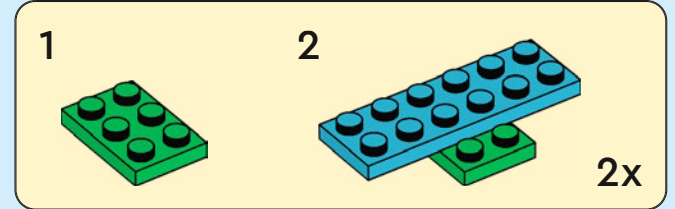

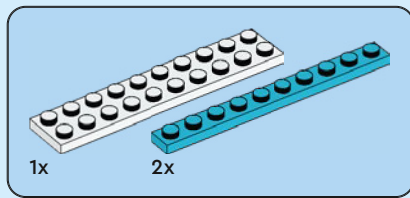

52

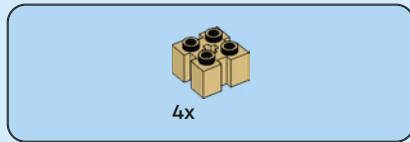
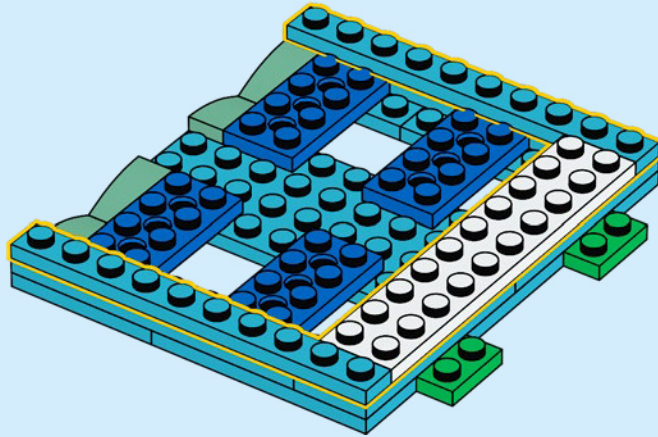

53

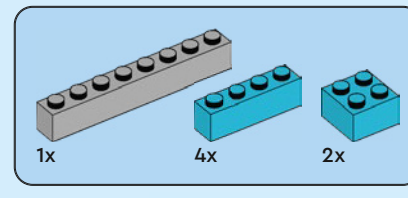
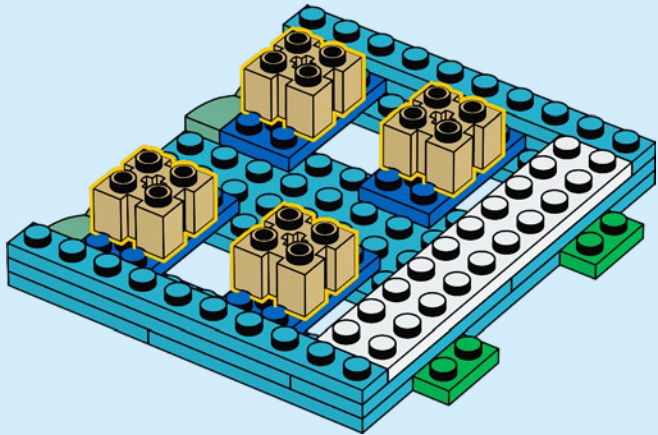

54

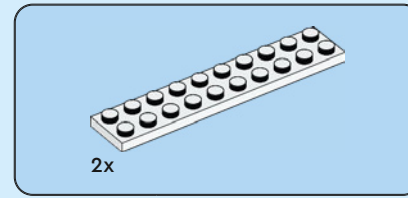
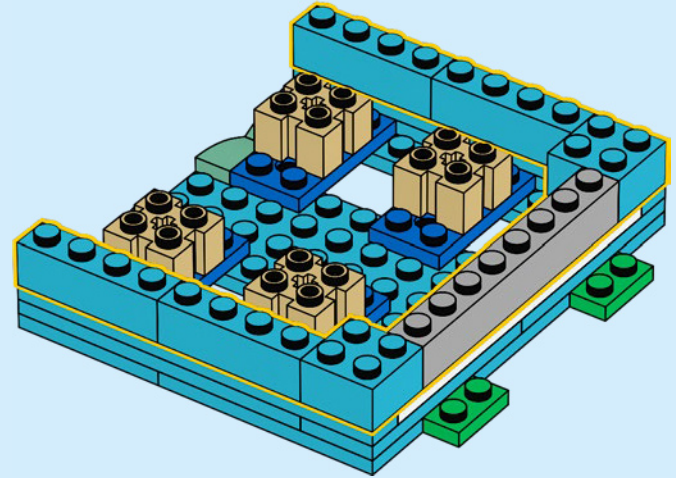

55

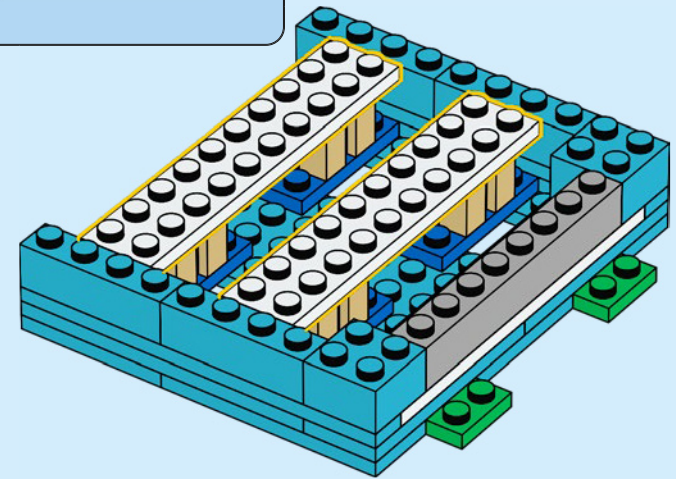

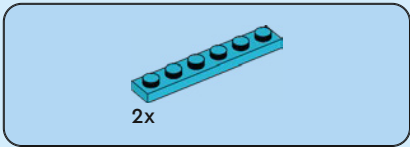

56

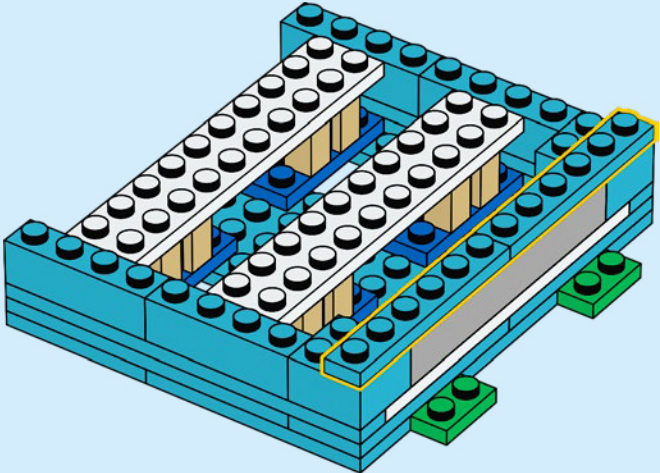

57

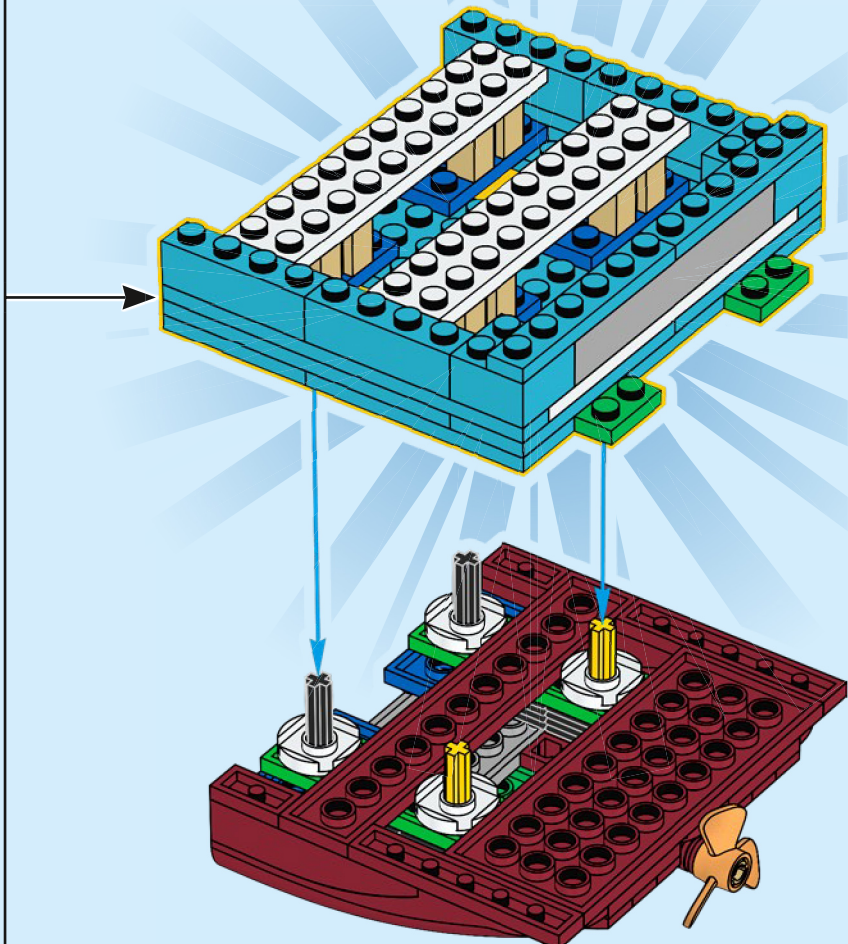

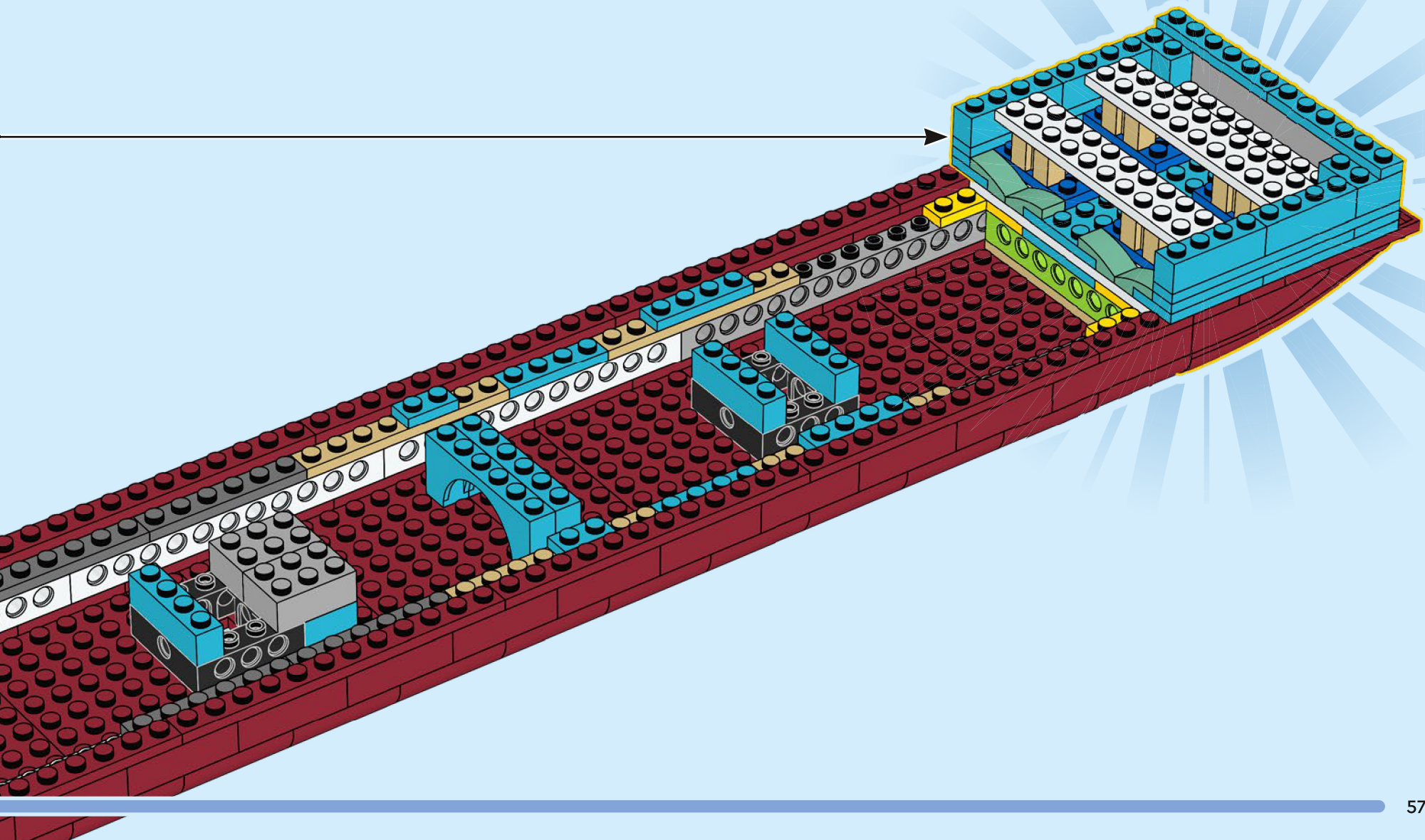

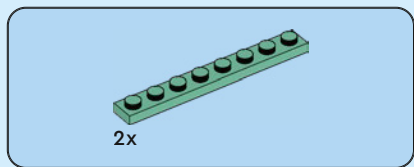
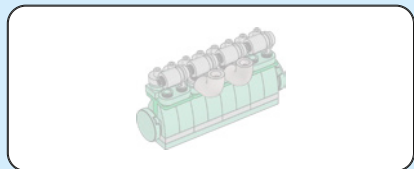

59

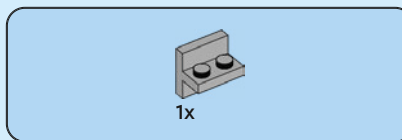
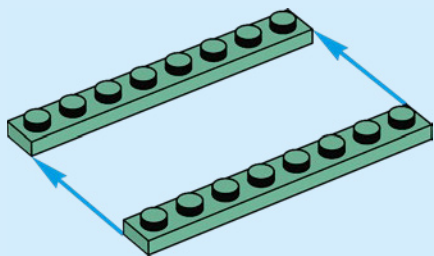

60

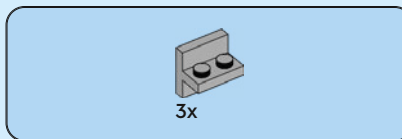
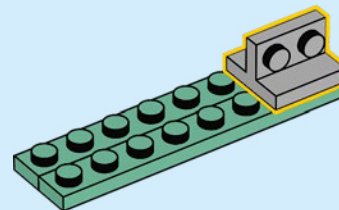

61

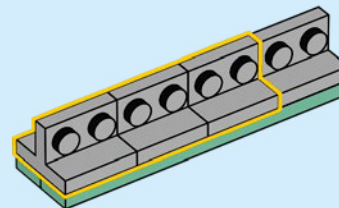



62

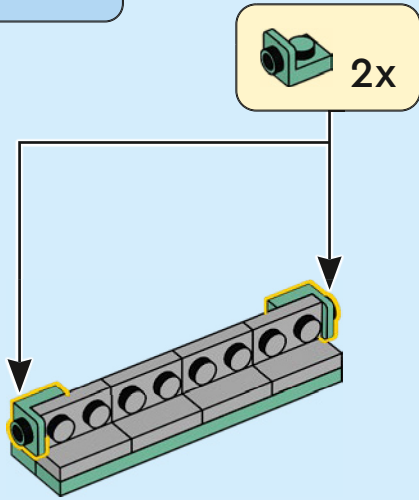

63

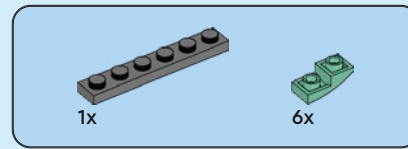
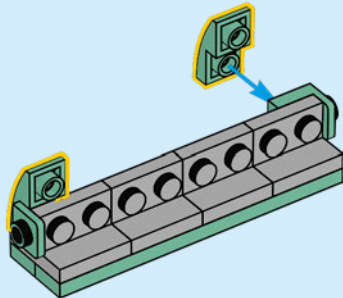

64

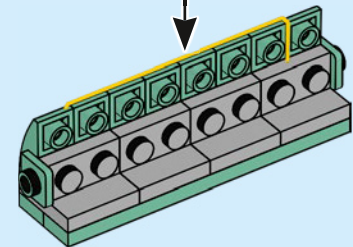
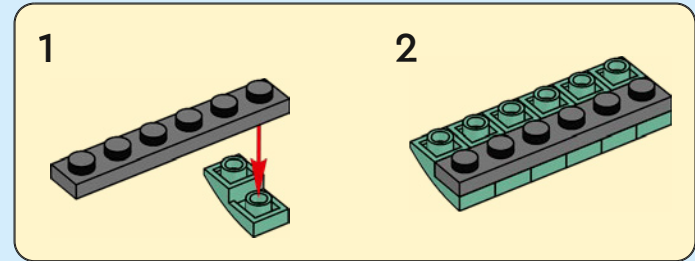

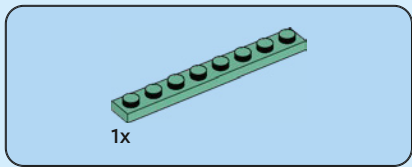

65

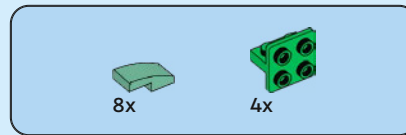
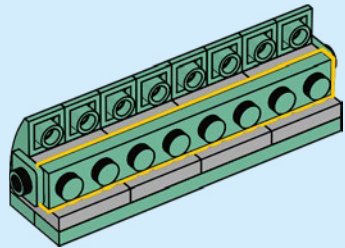

66

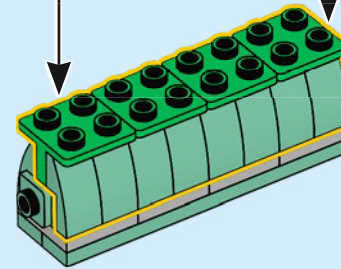
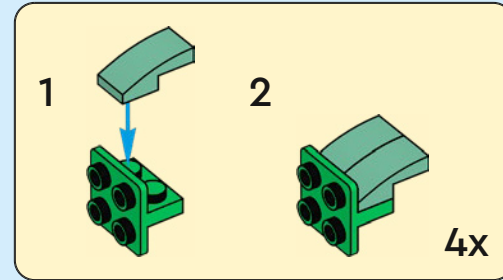

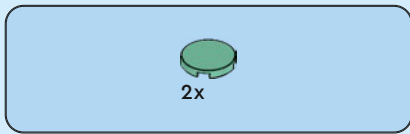

67

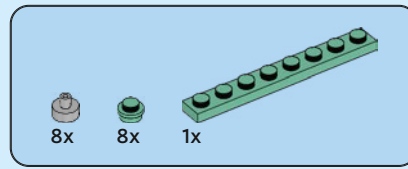
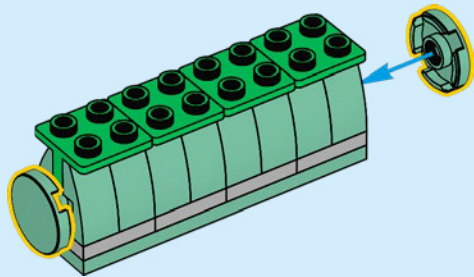

68

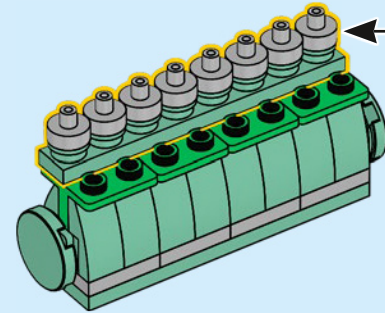
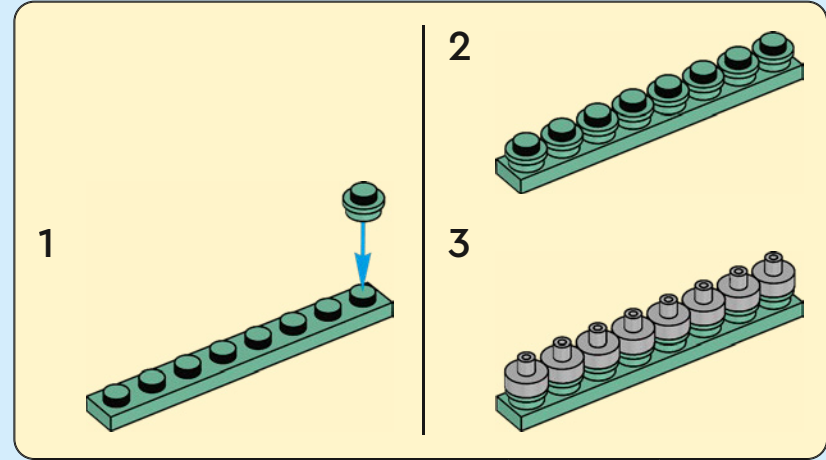



2x

69

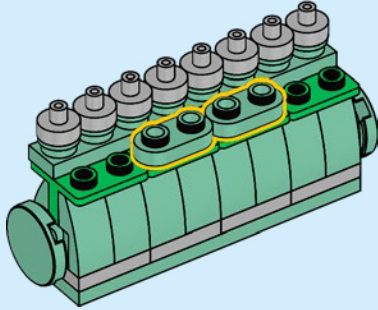

2x



2x

70

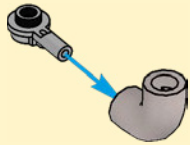
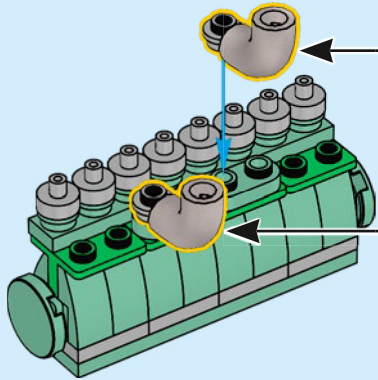

2x



2x

71

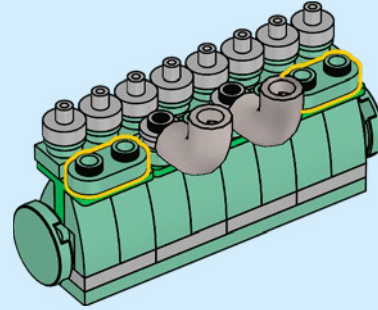

4x



4x

72

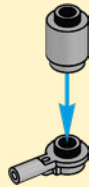
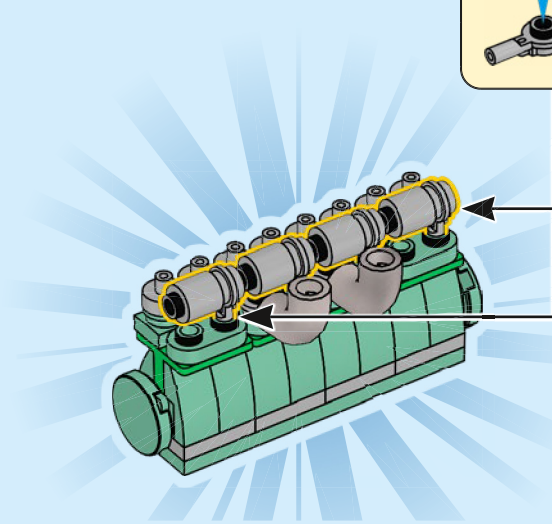

4x

73

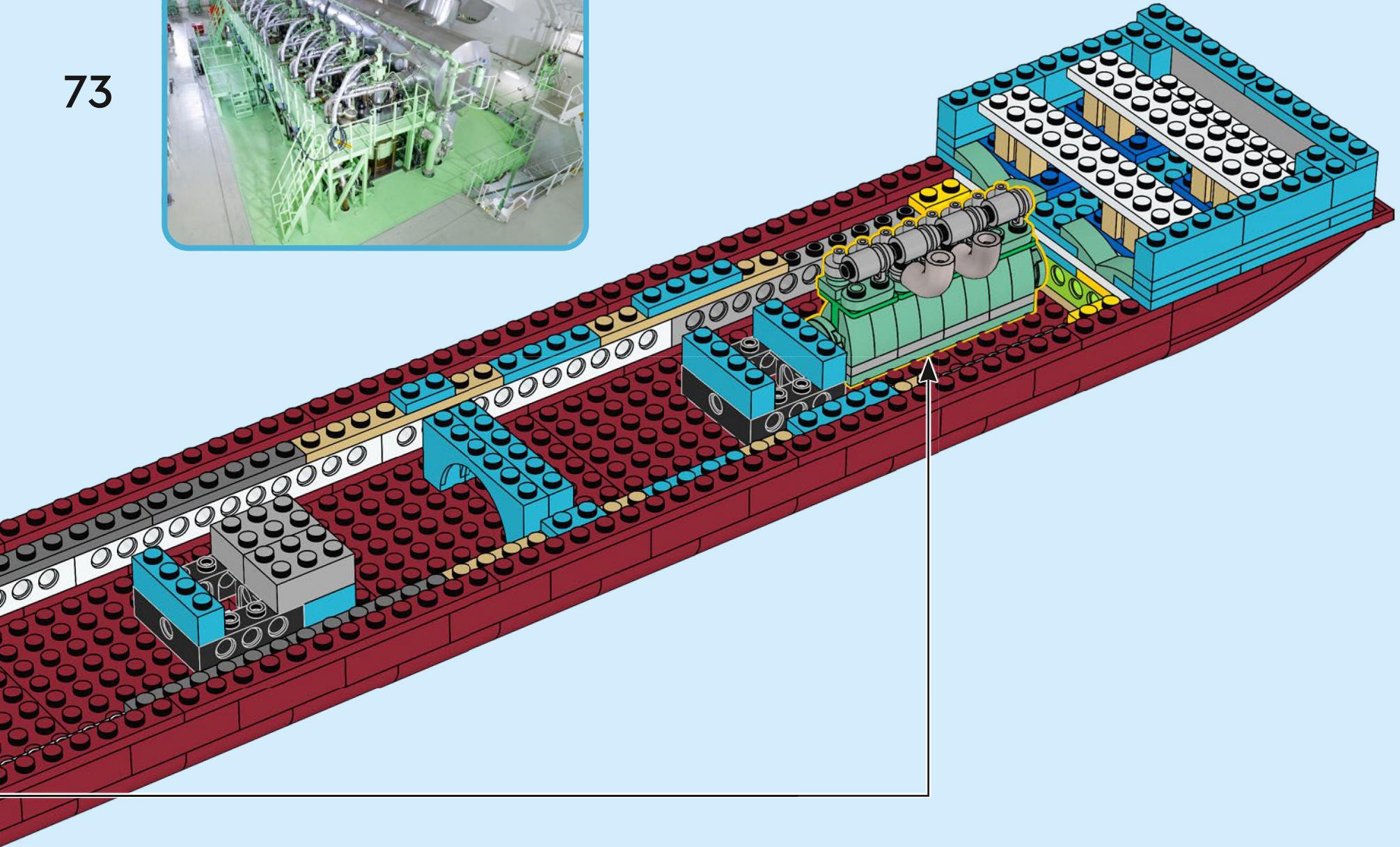
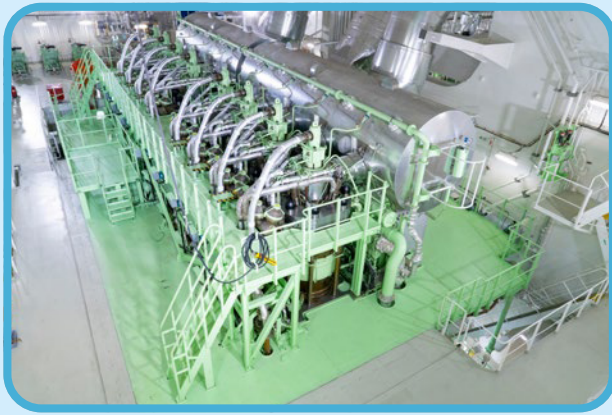

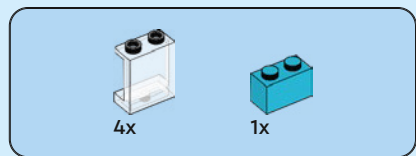

74

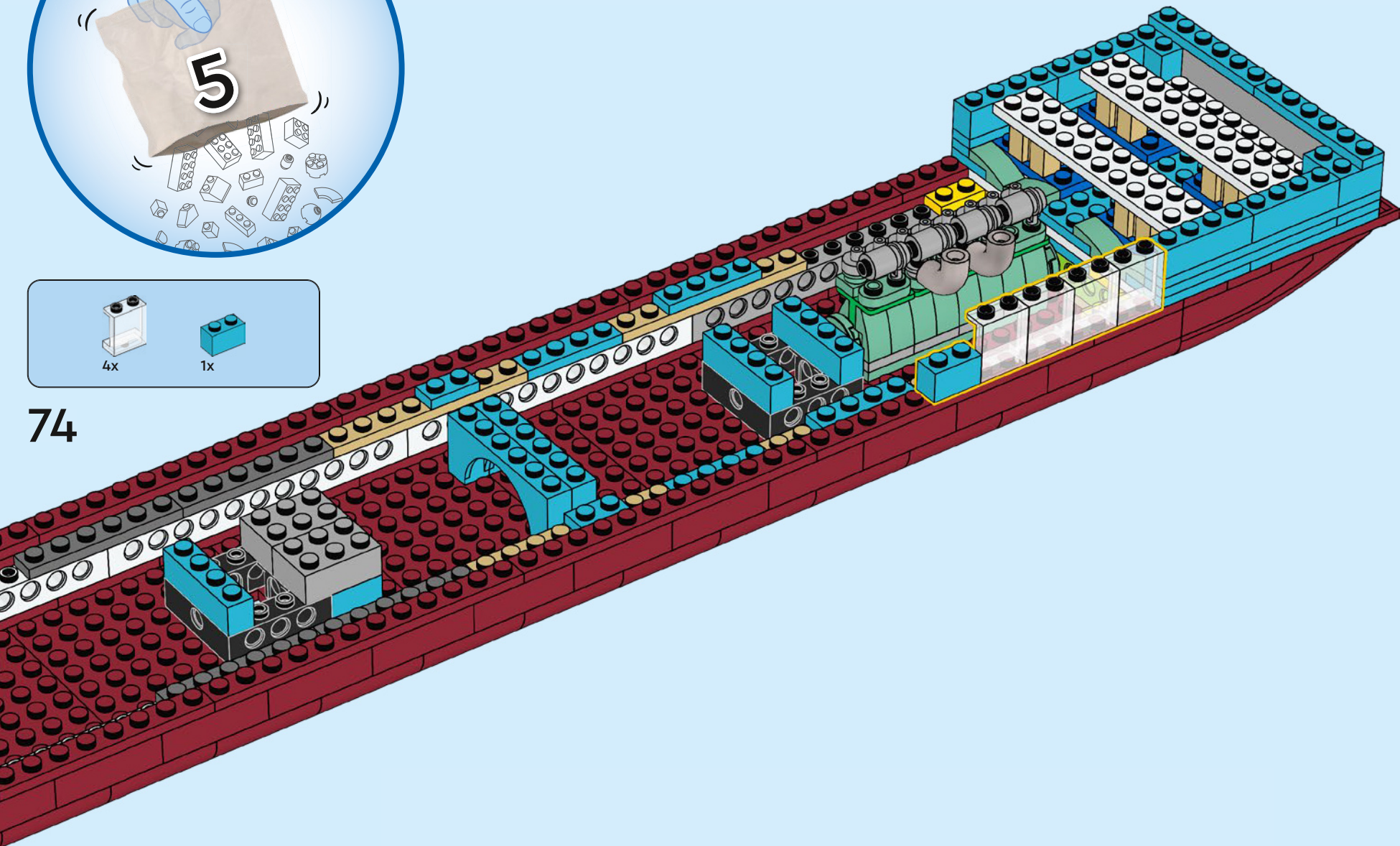

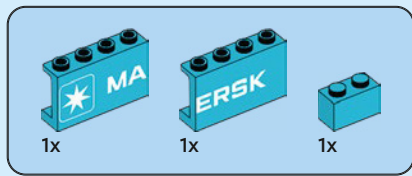

75

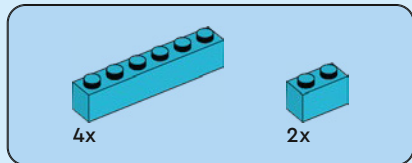
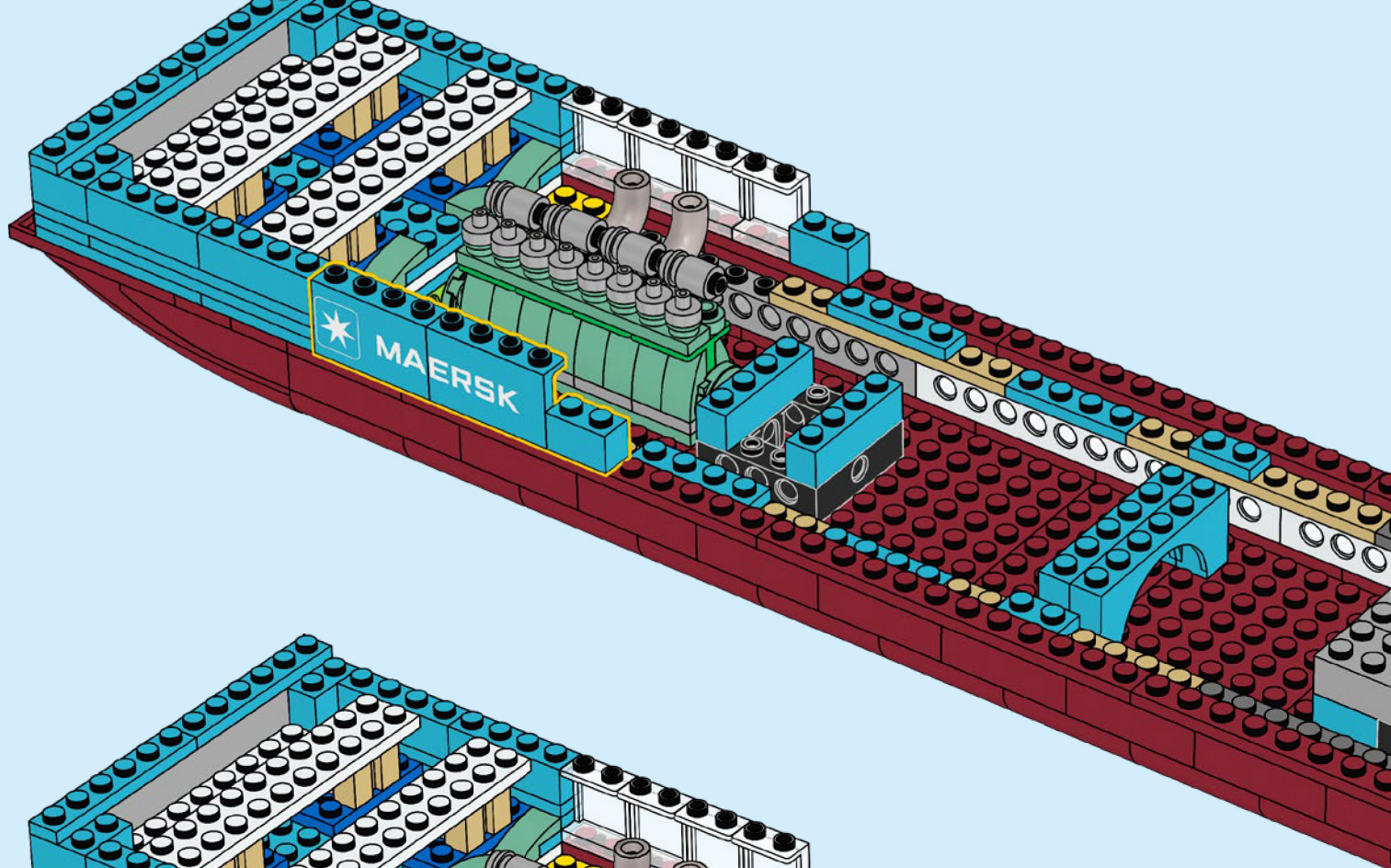

76

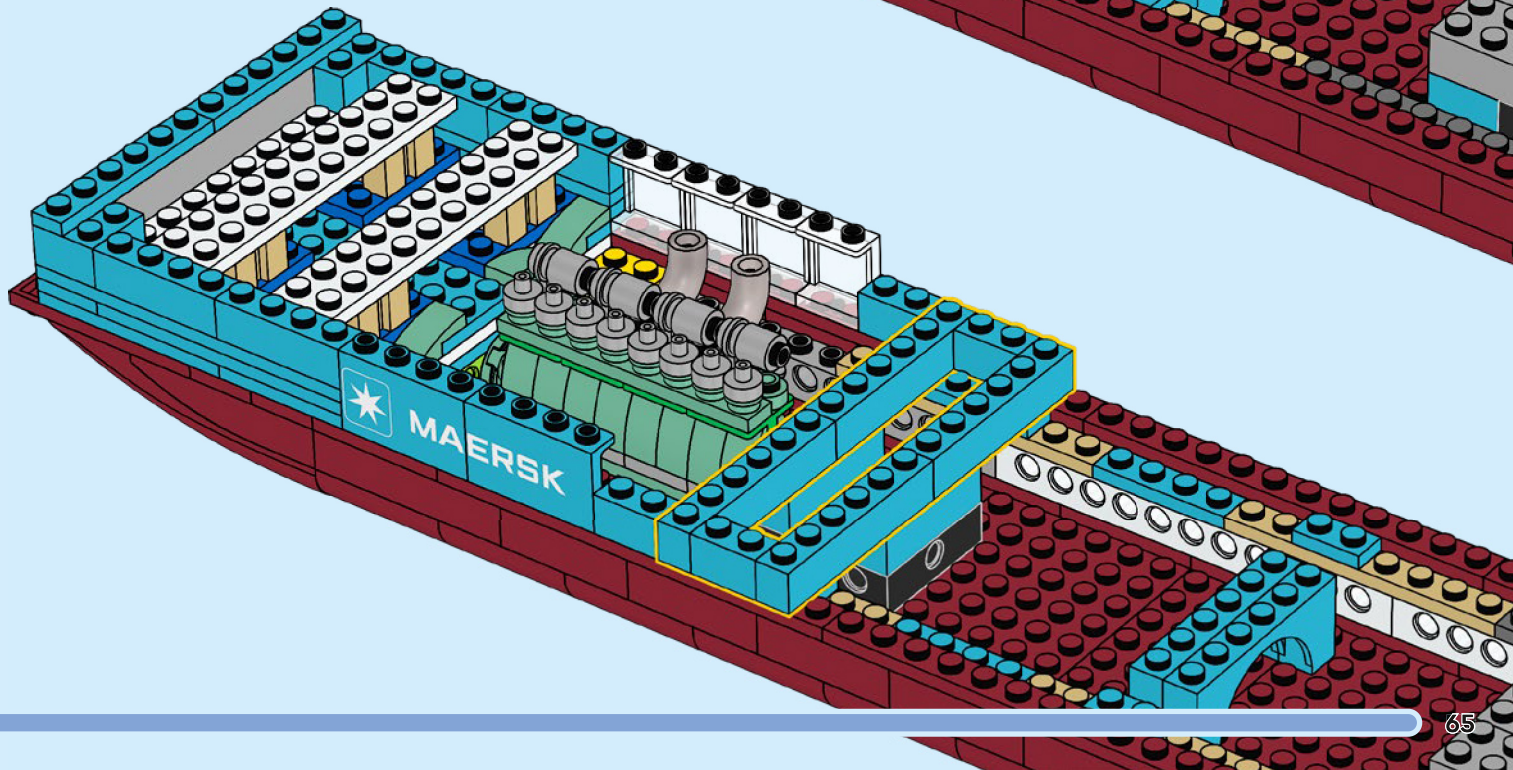

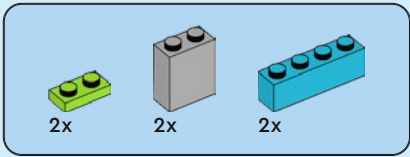

77

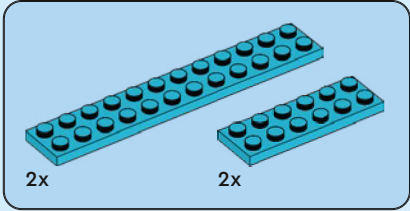
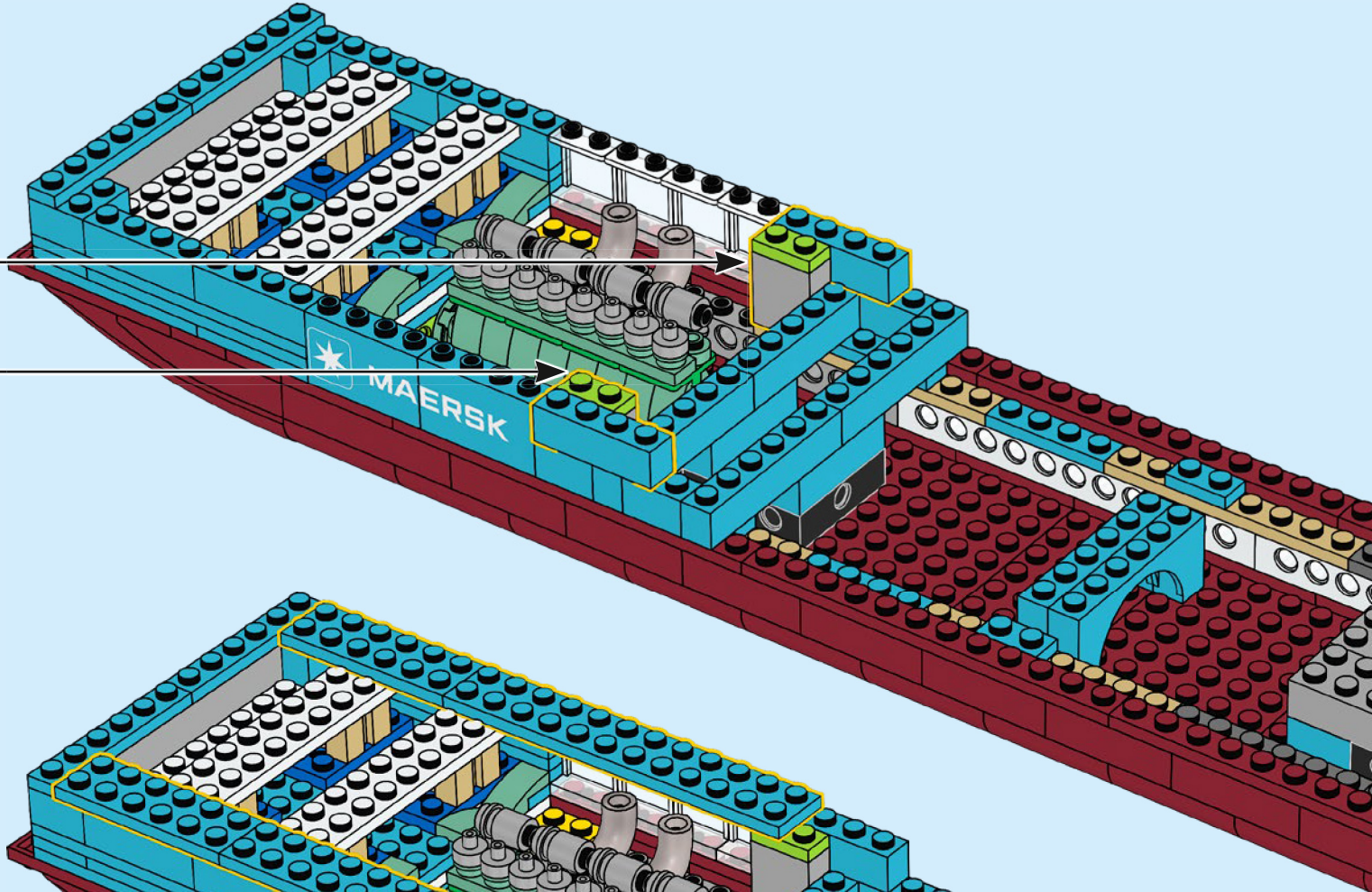
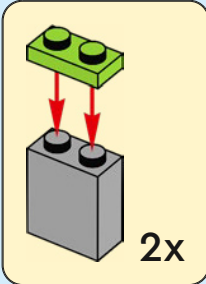

78

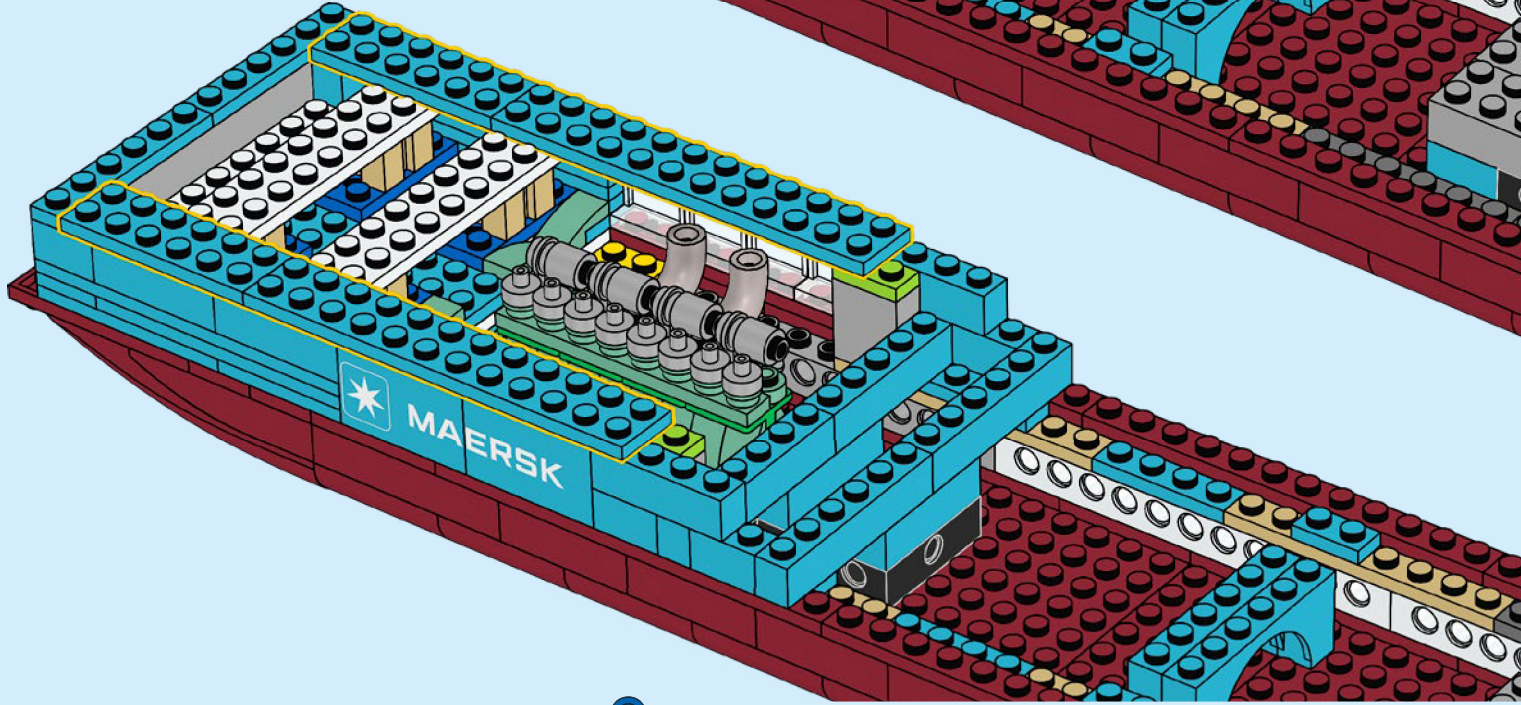

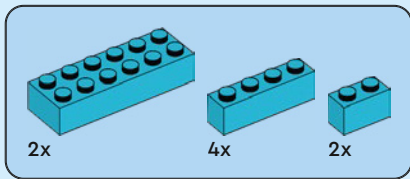

79

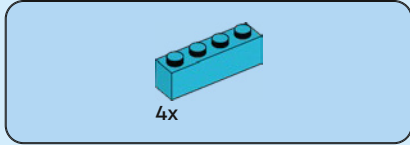
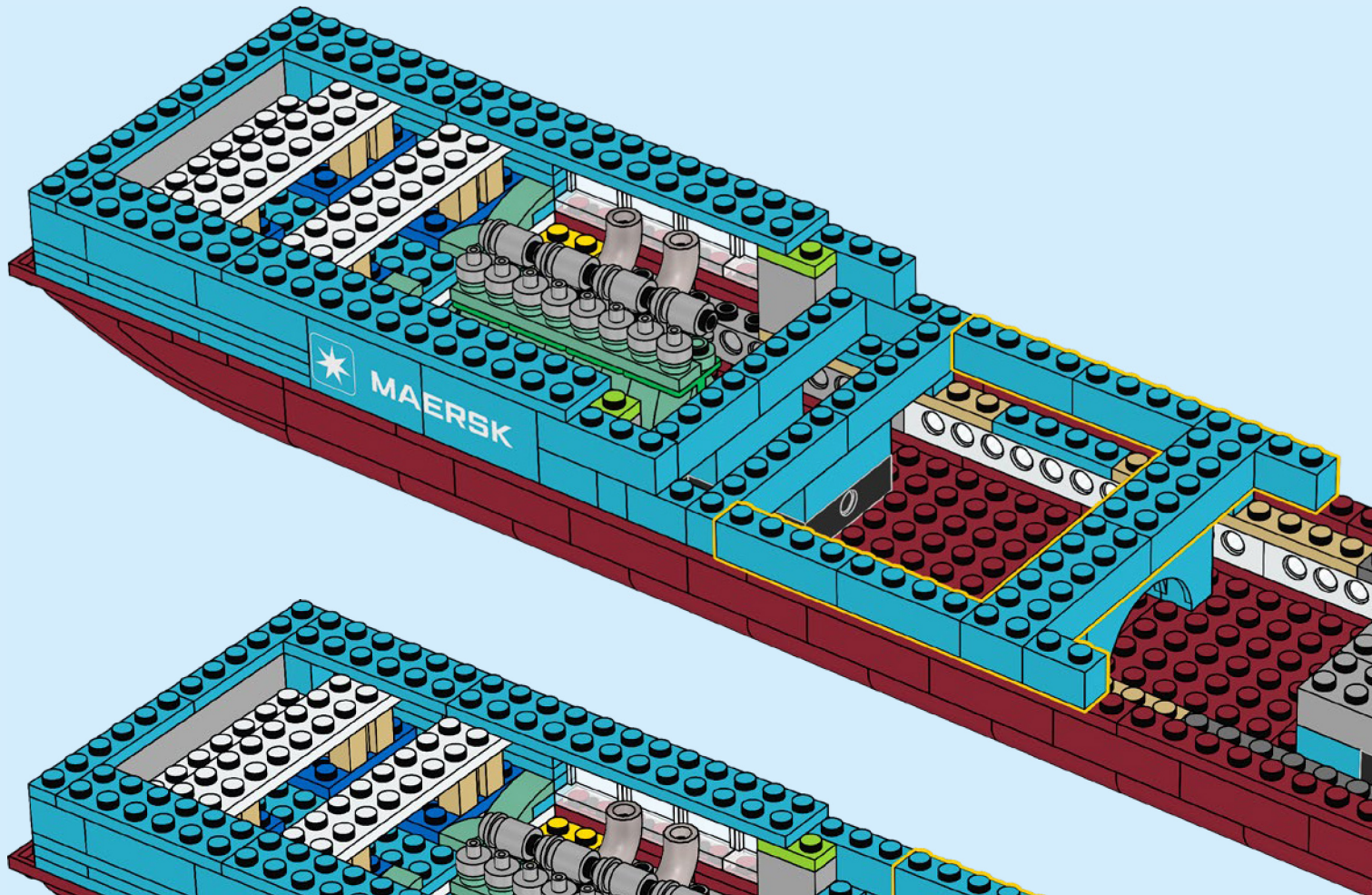

80

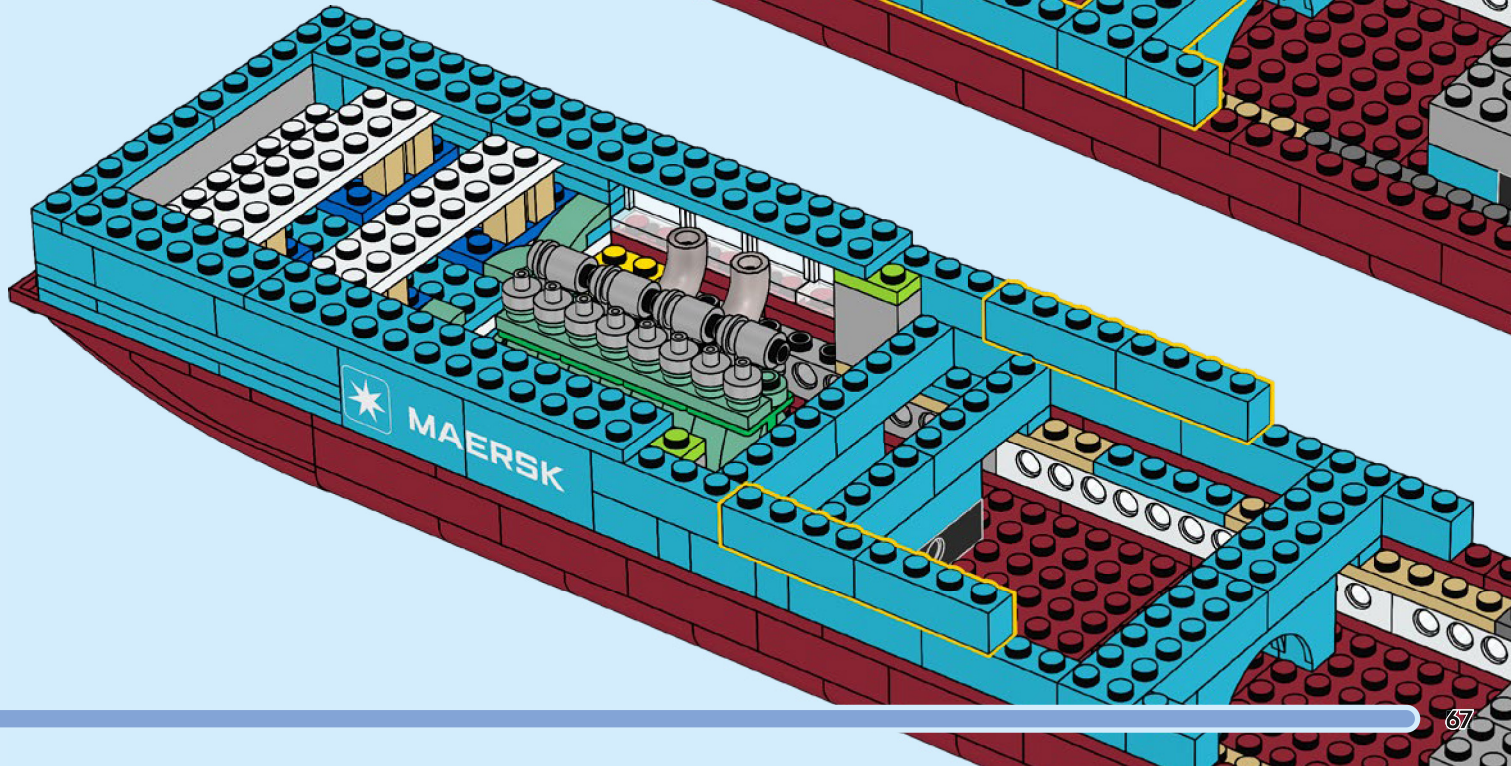

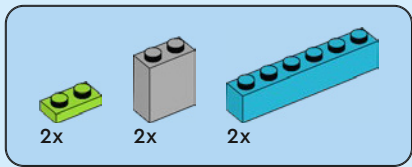

81

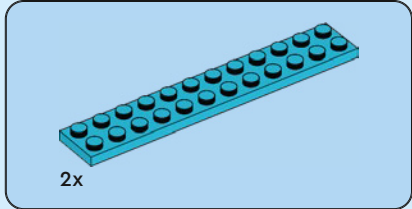
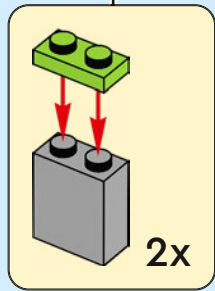
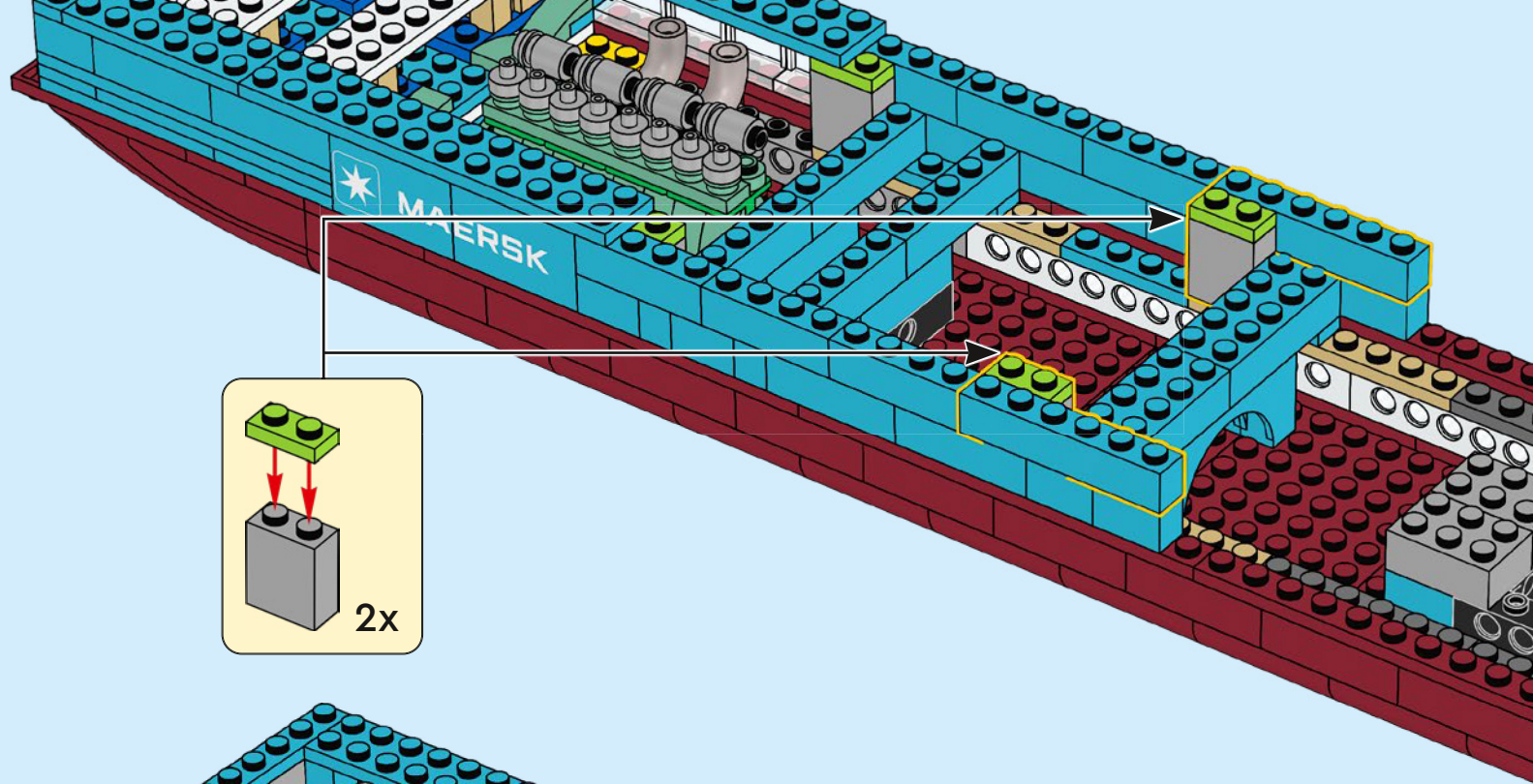

82

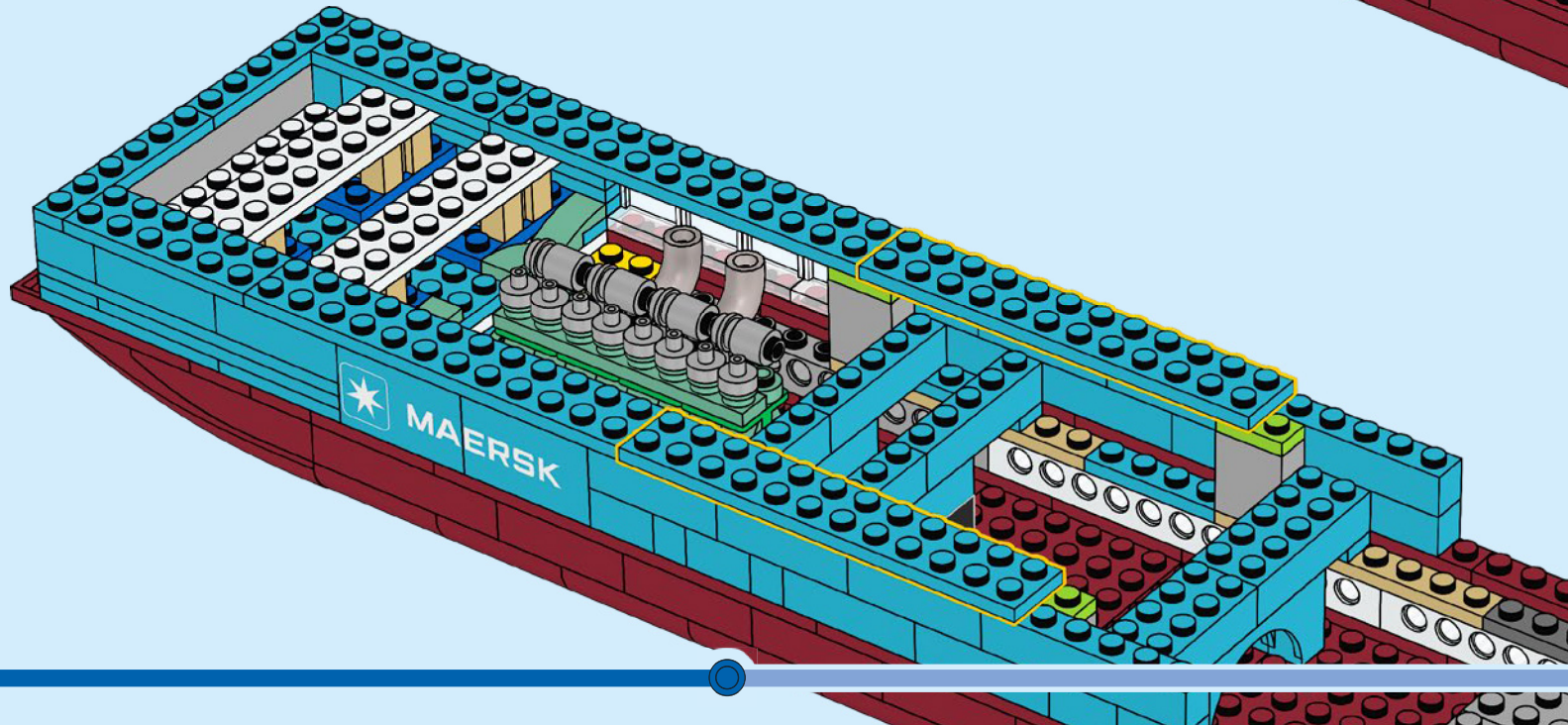

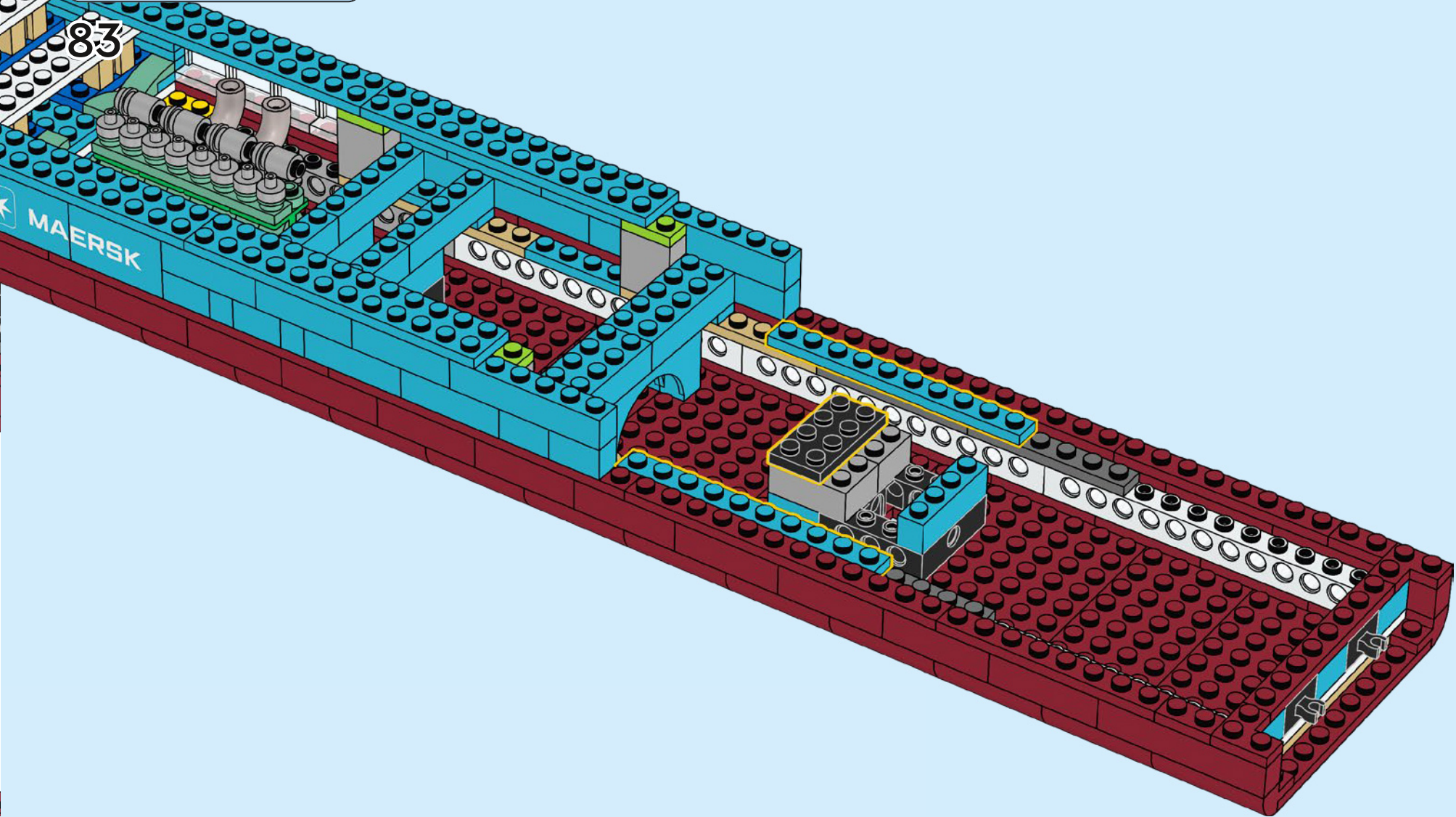
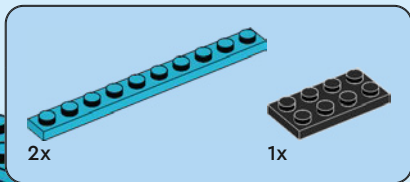

84

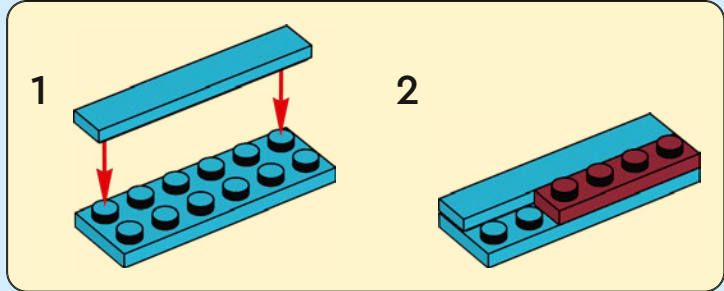
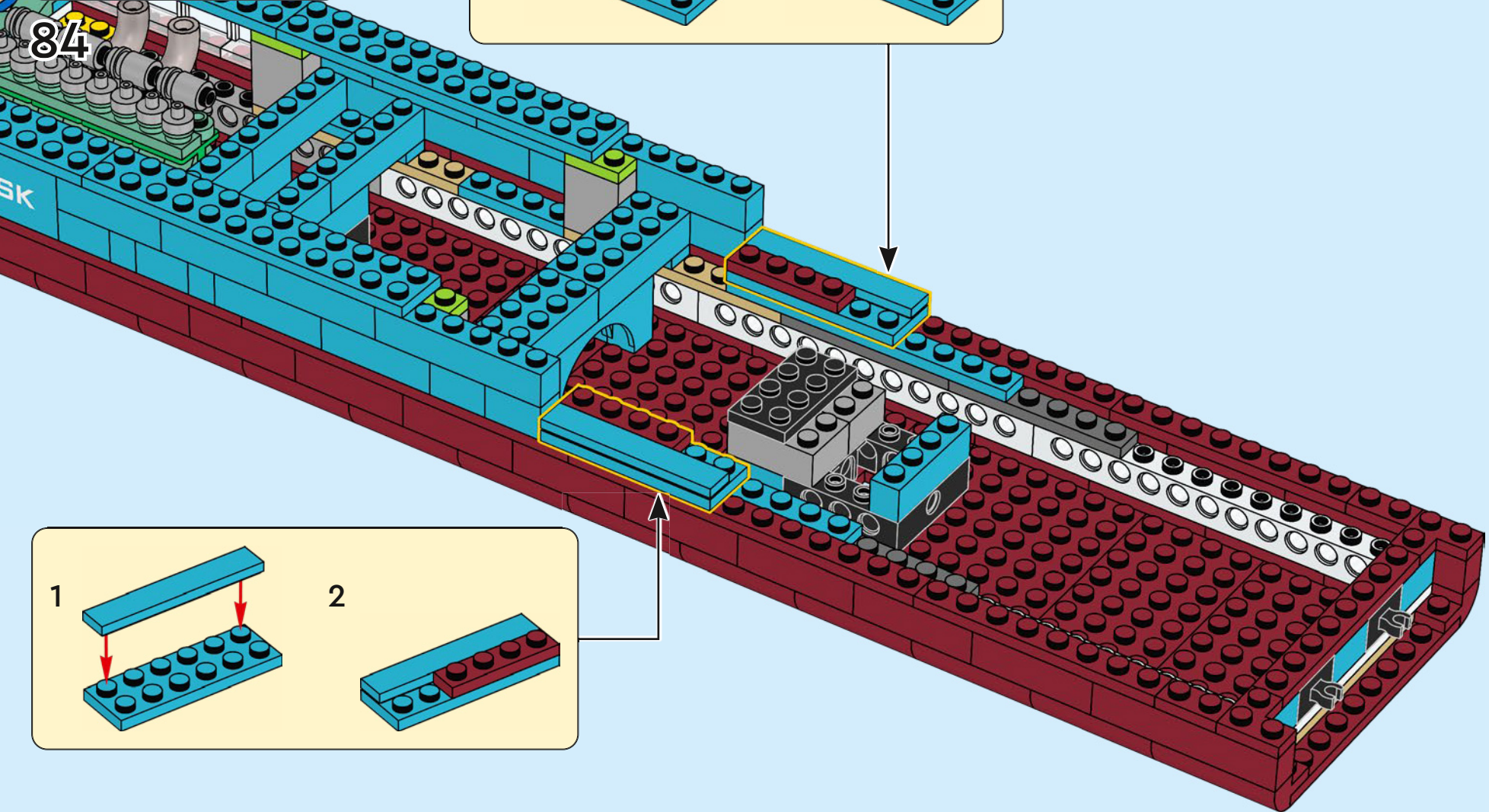
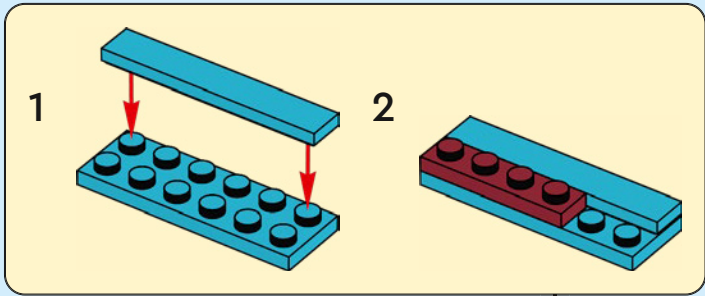
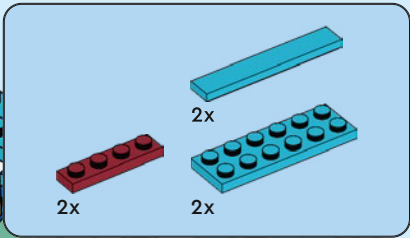

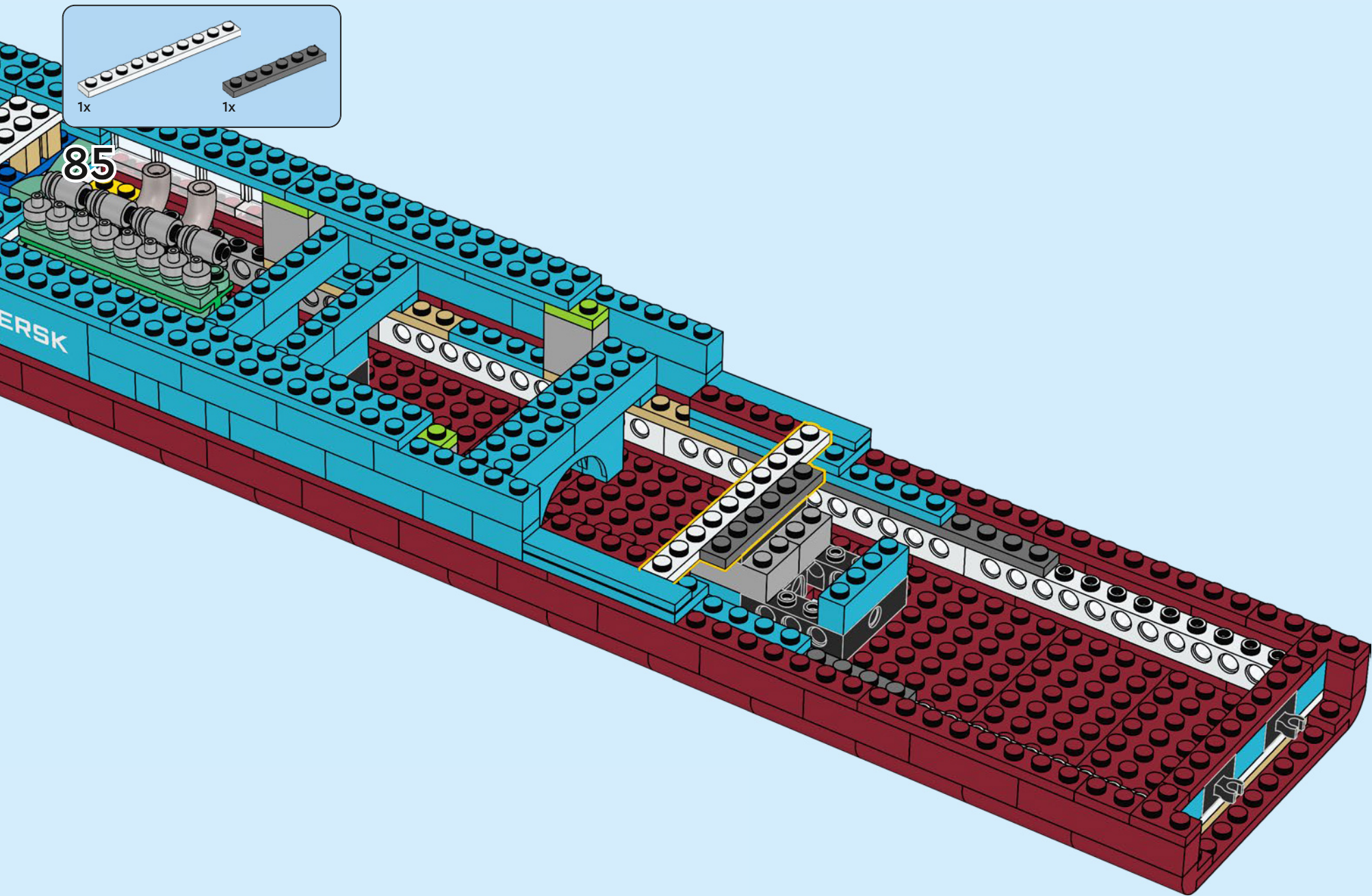

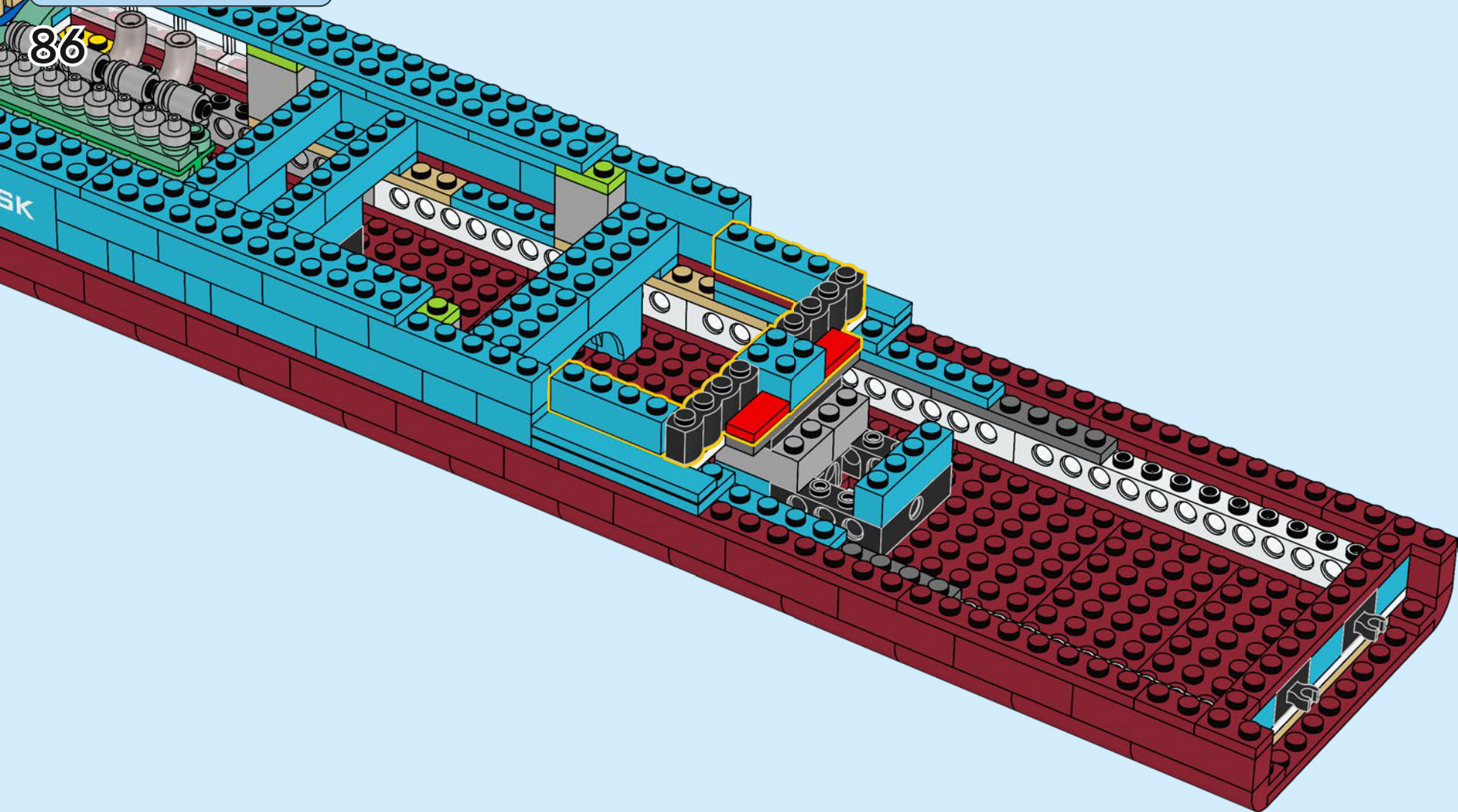
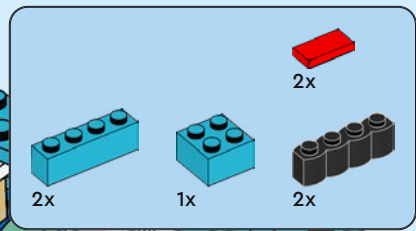

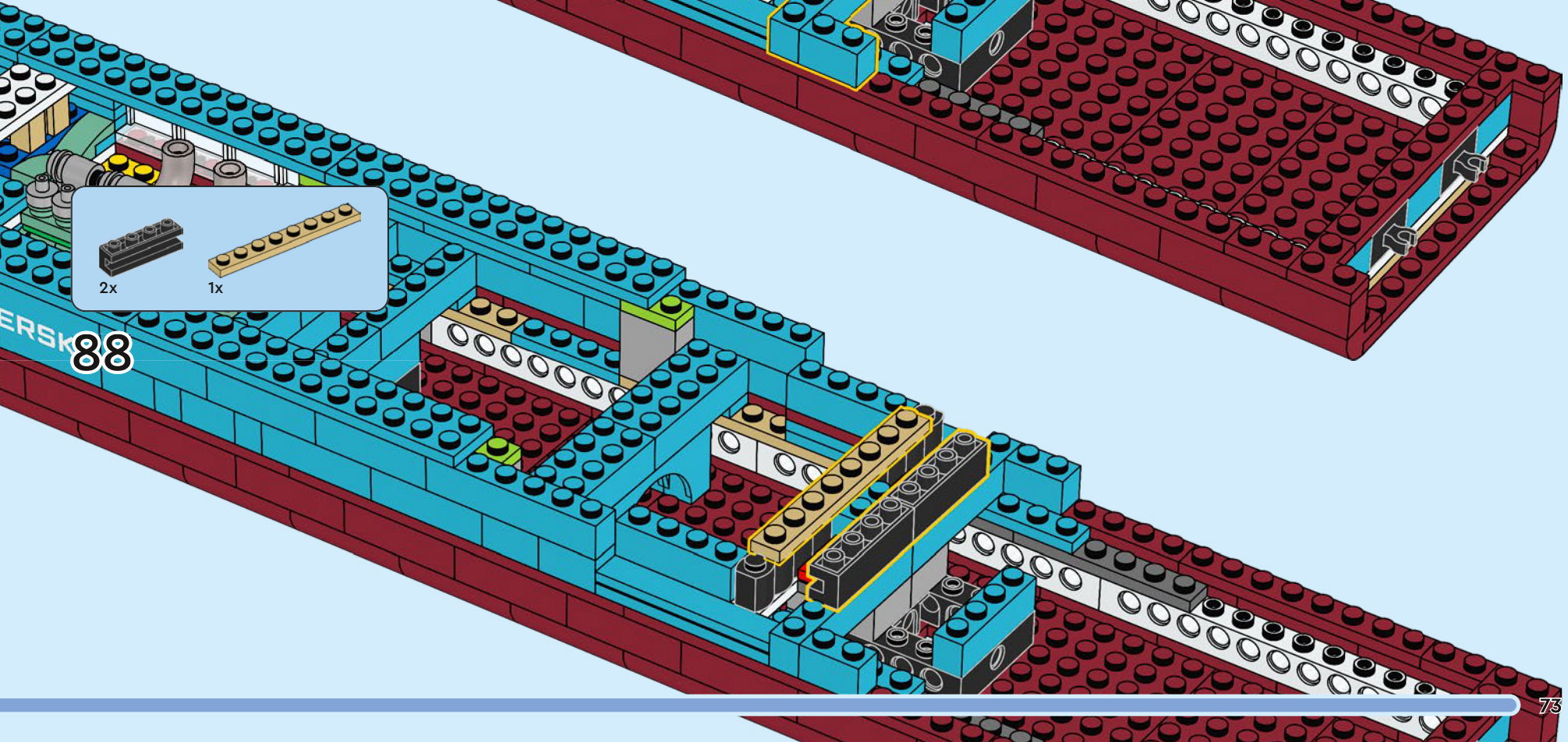
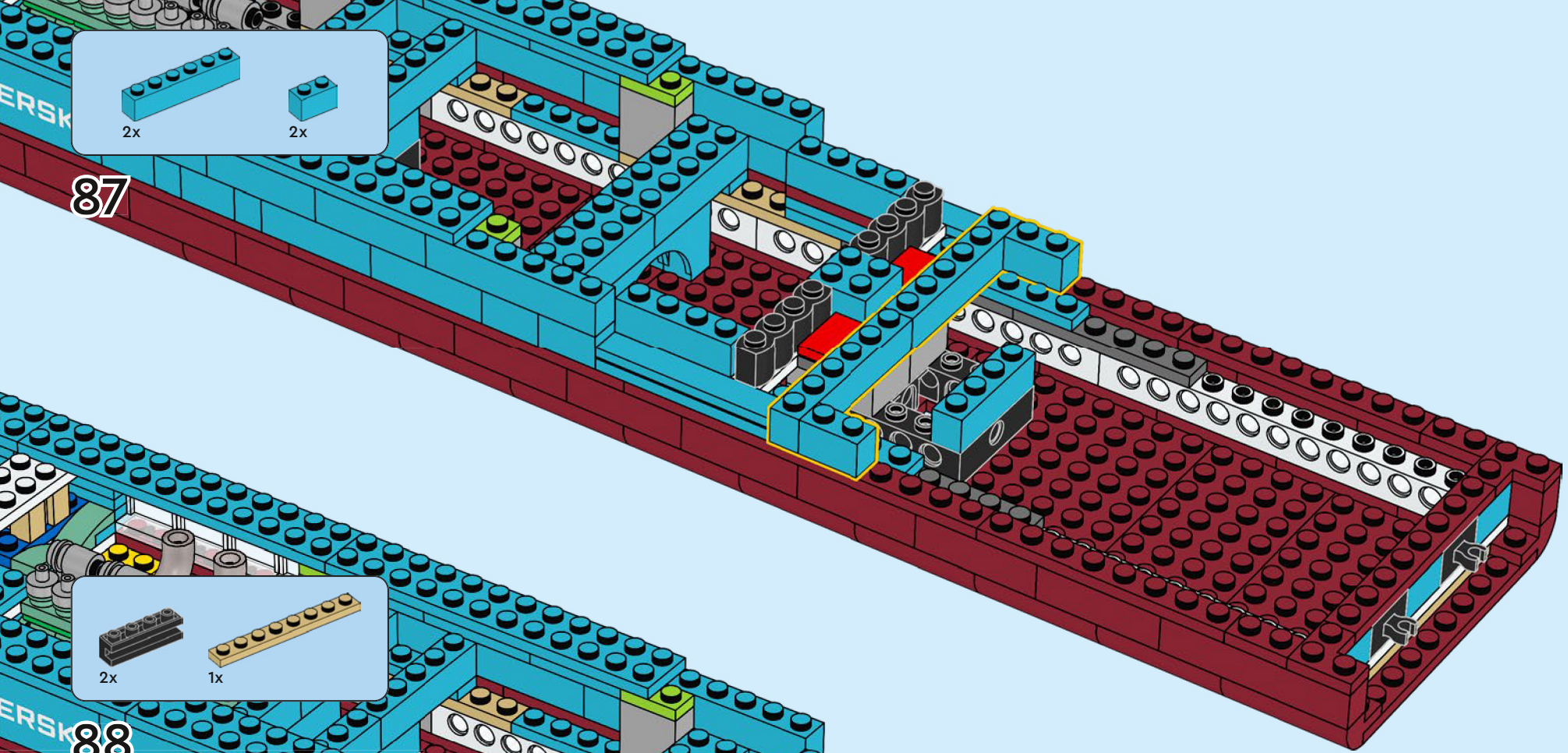

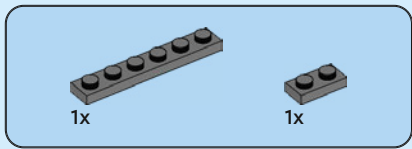

89

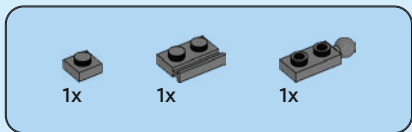
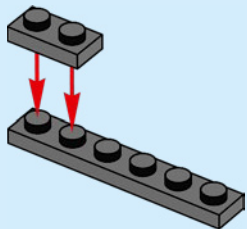

90

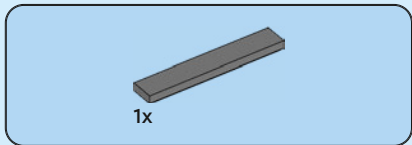
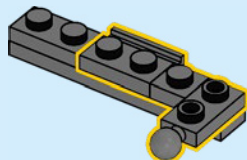

91

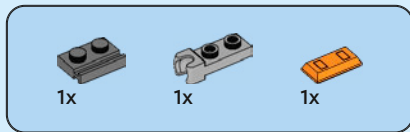
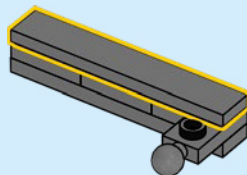

92

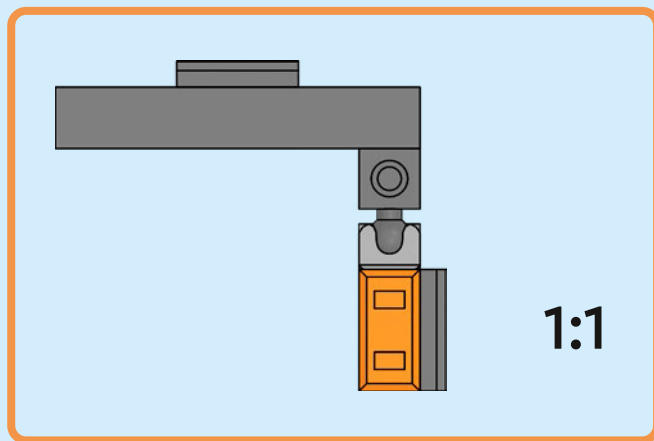
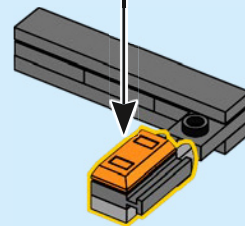
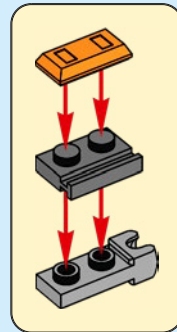

93

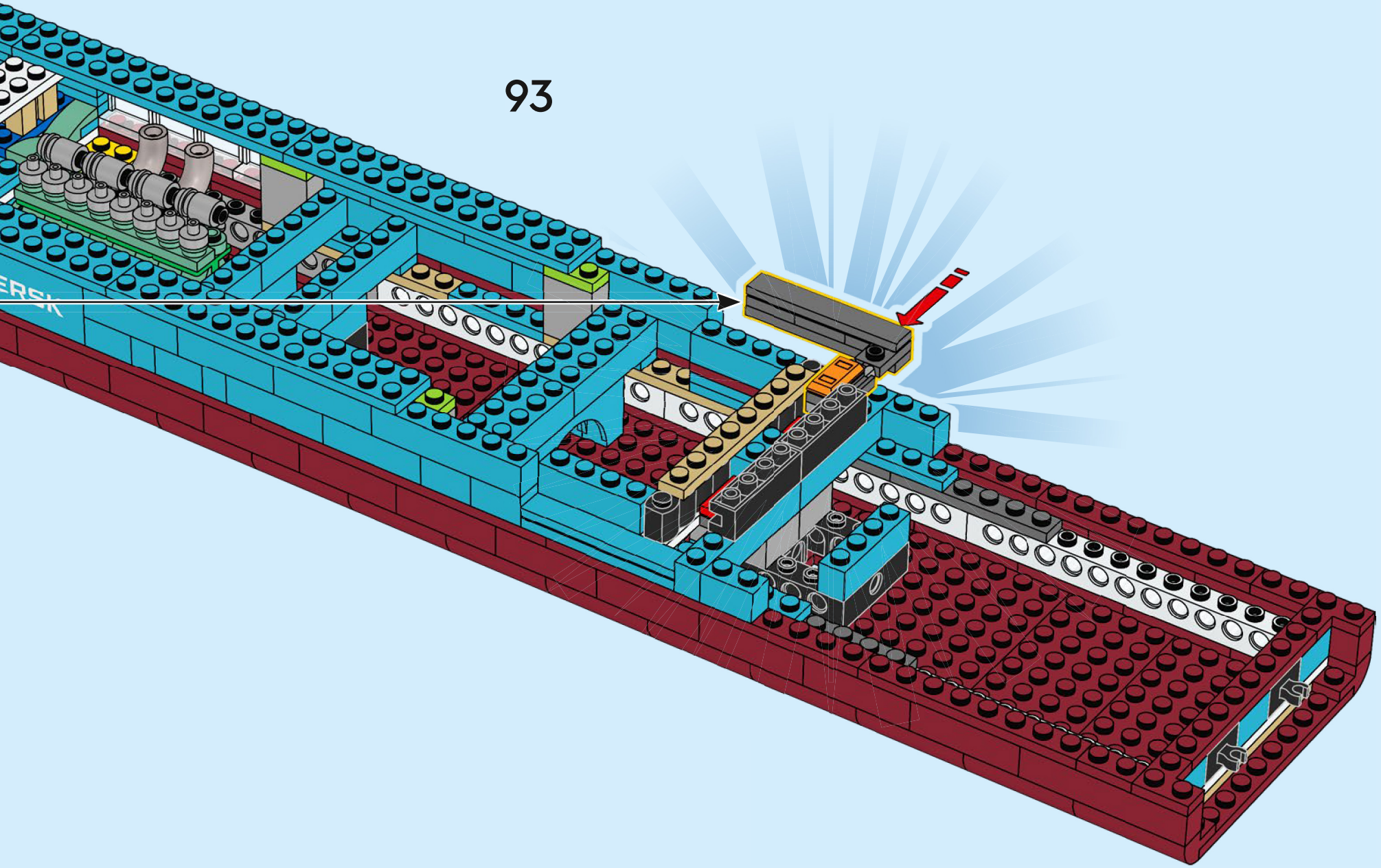

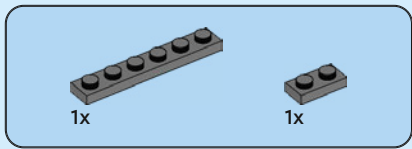

94

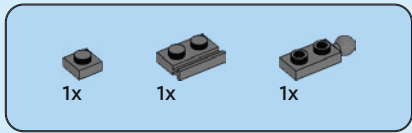
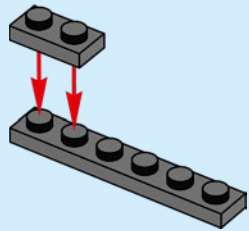

95

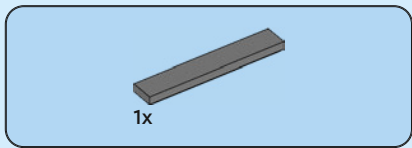
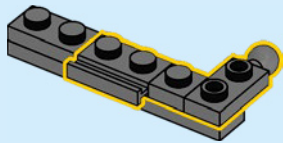

96

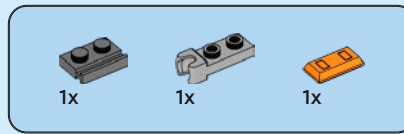
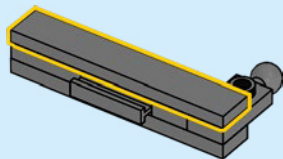

97

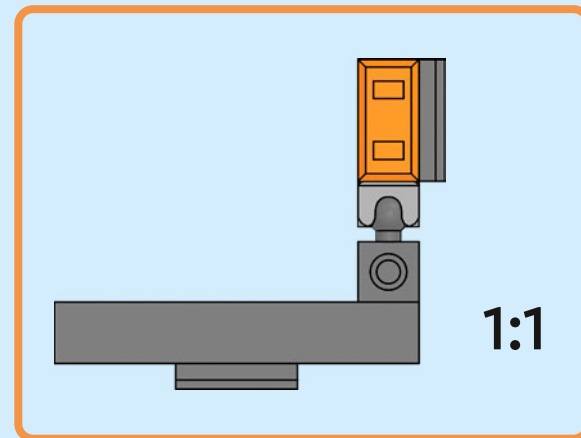
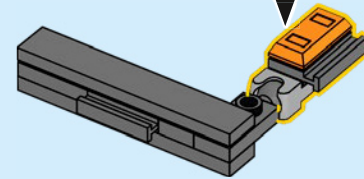
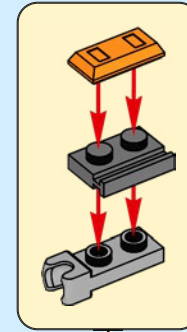

98

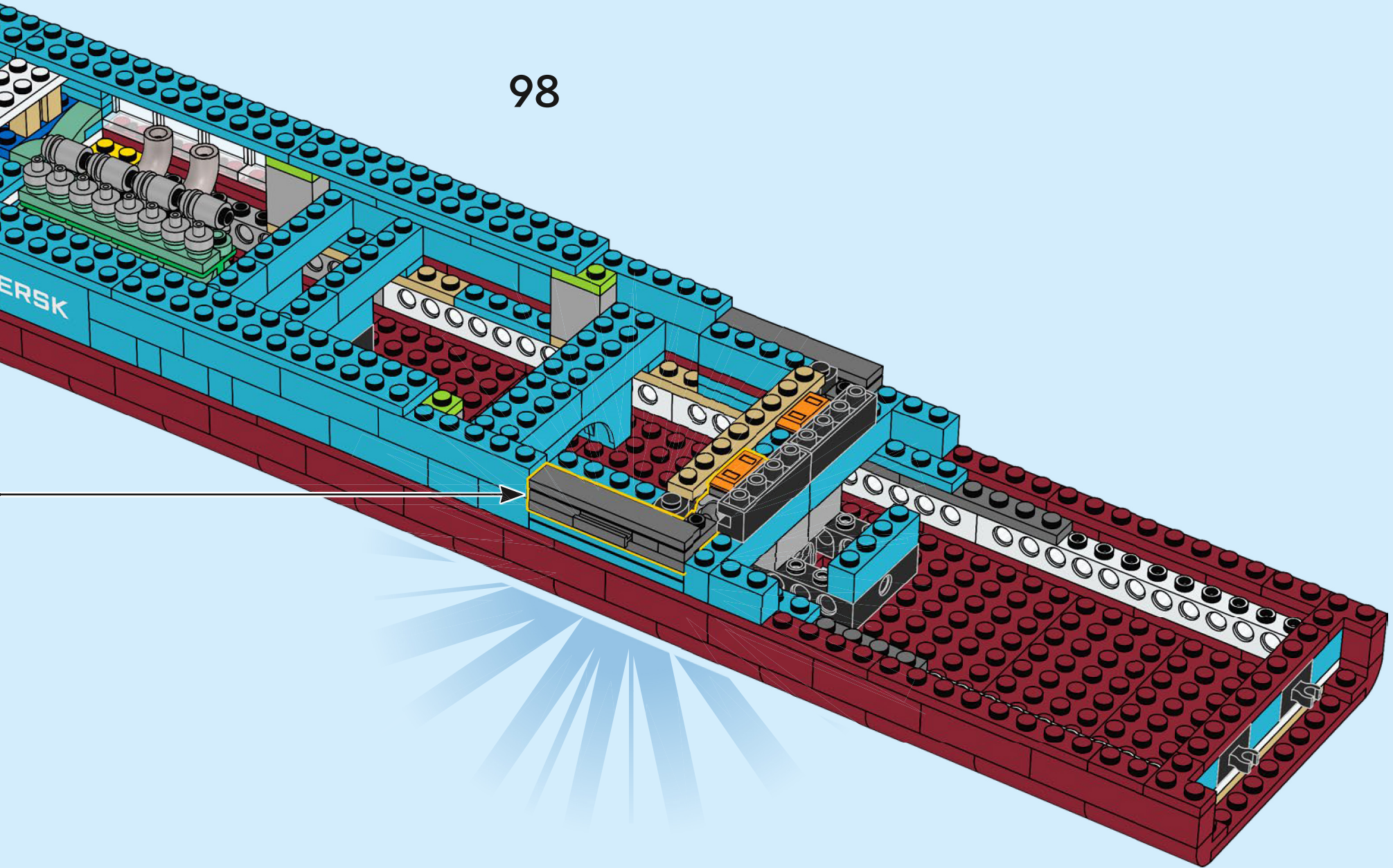

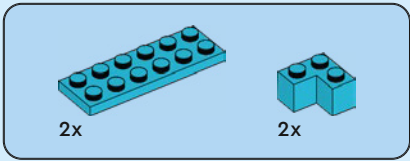

99

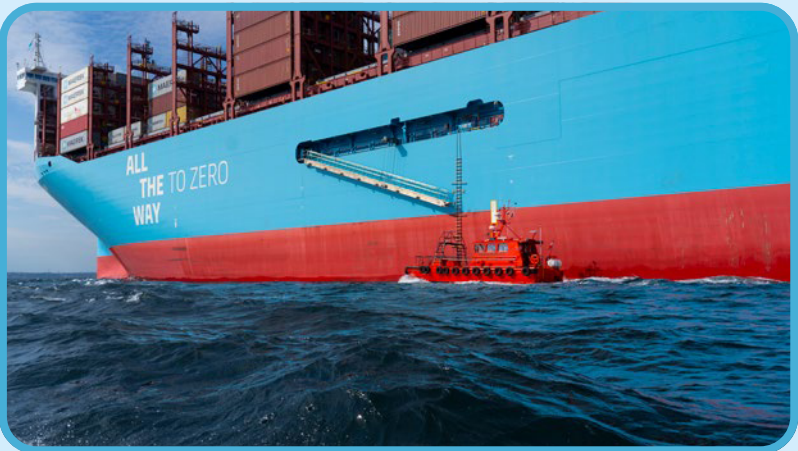
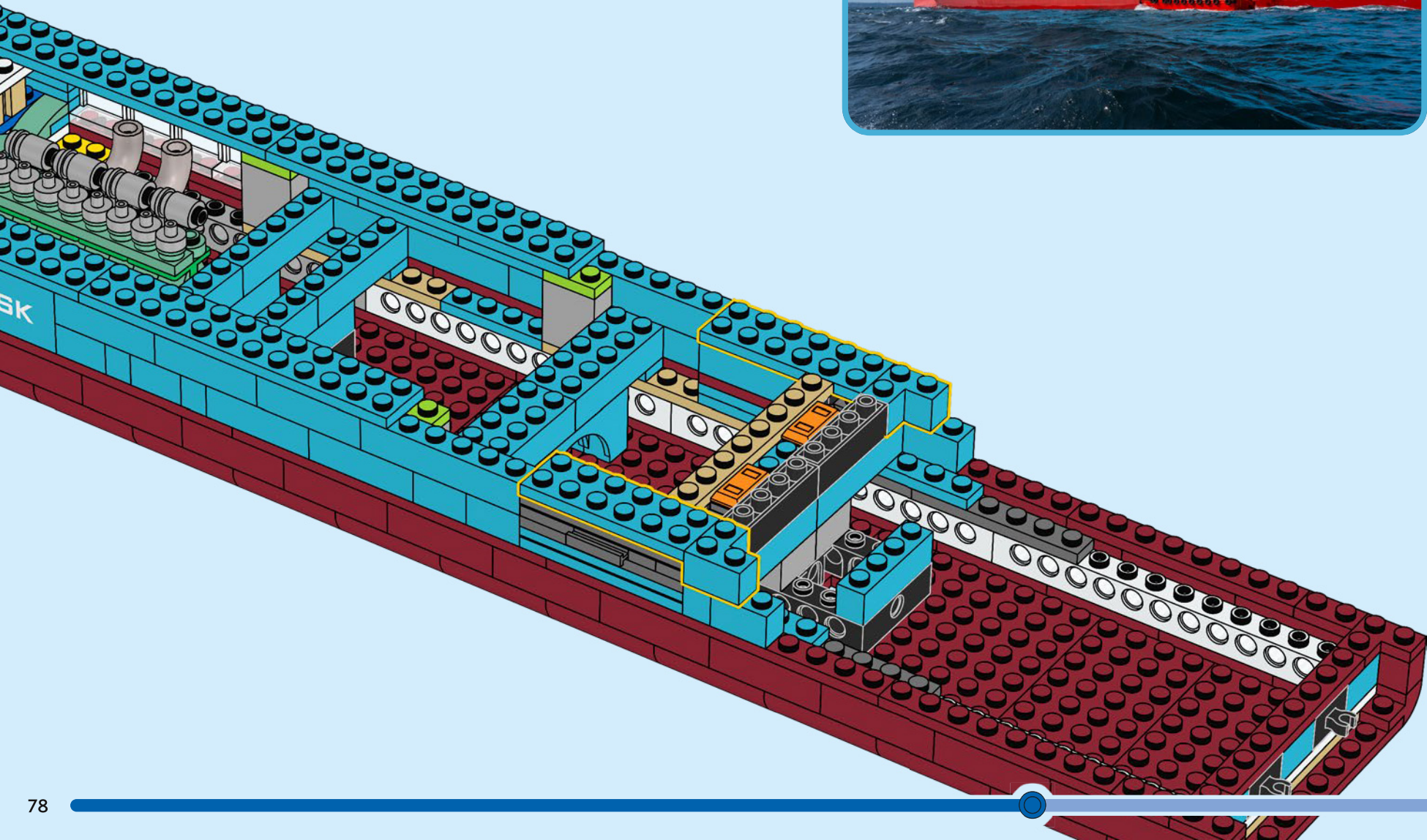

1

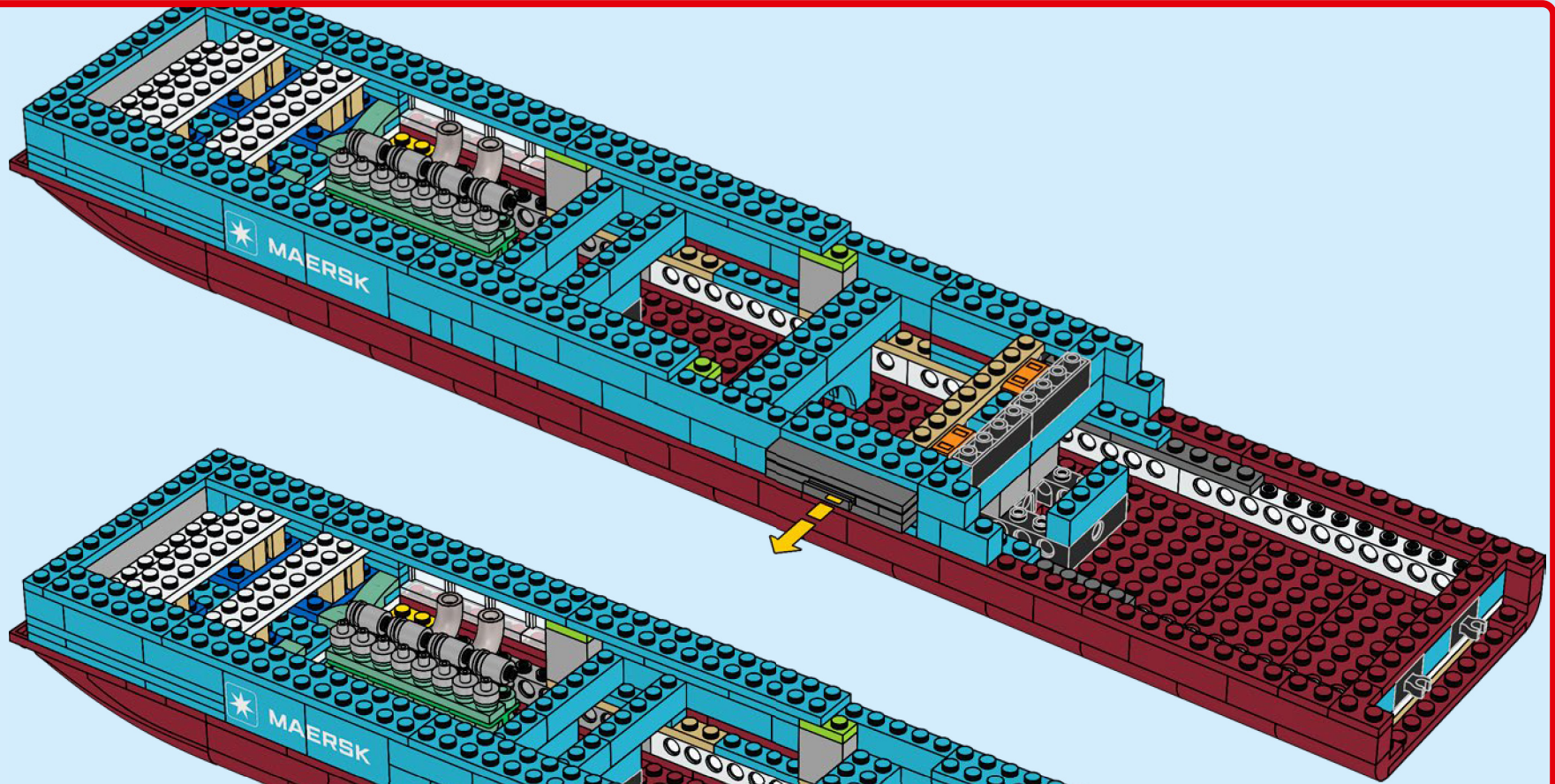

2

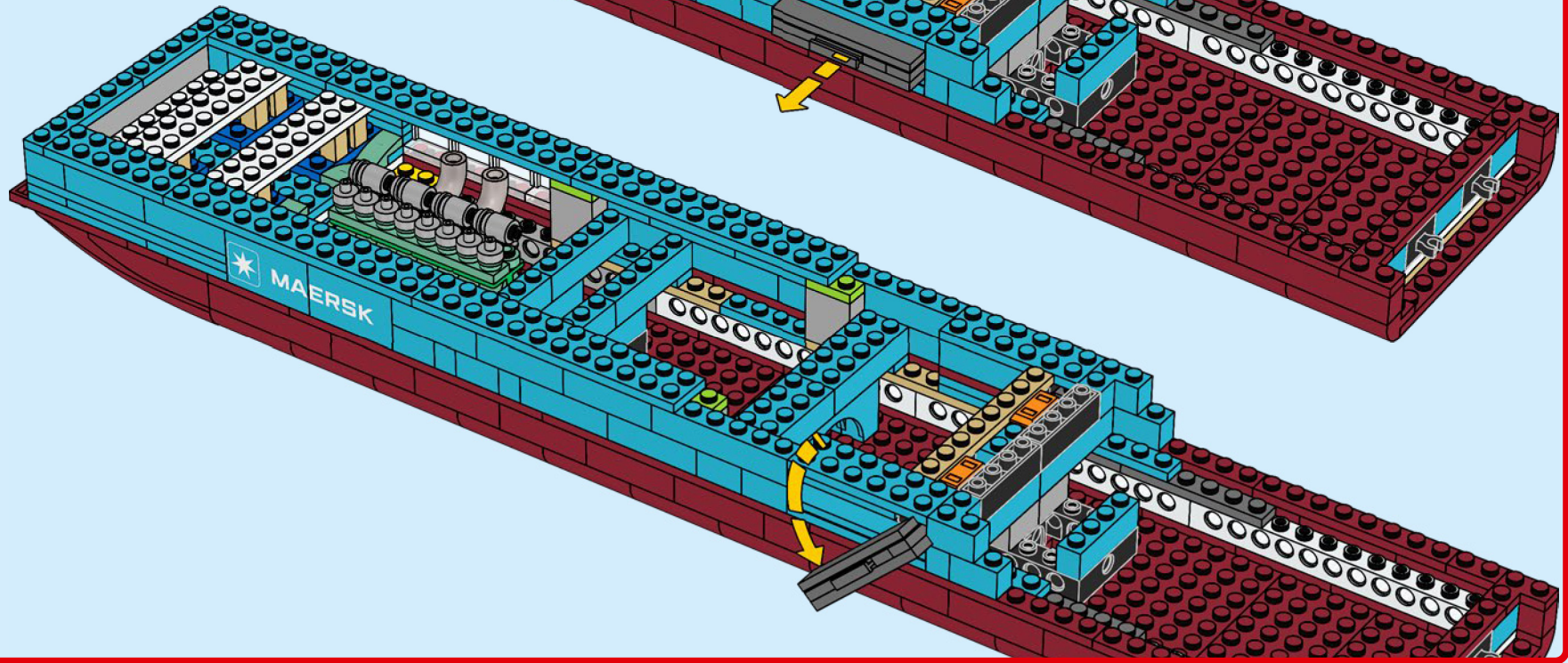

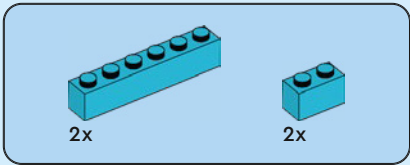

100

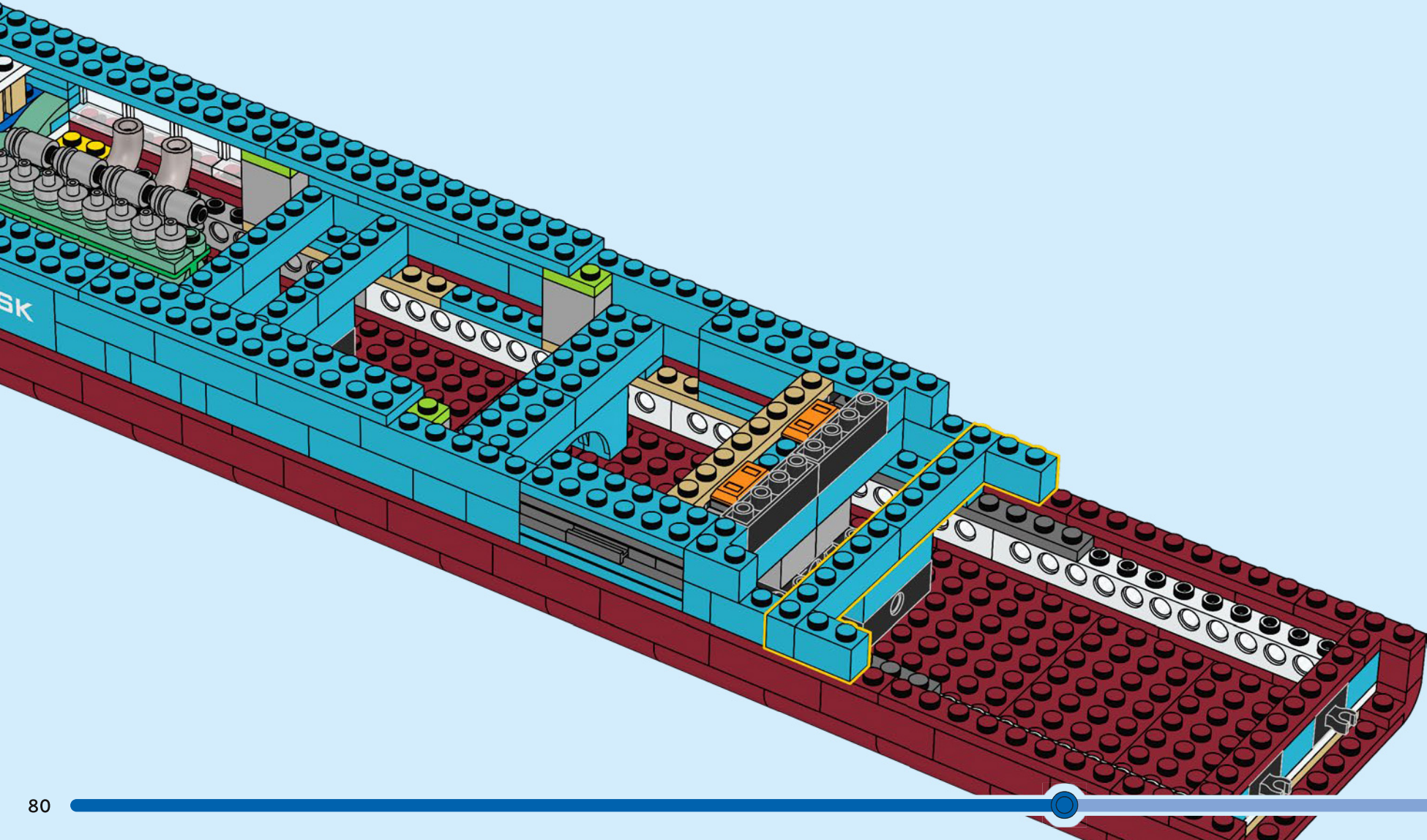

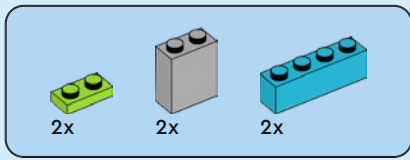

101

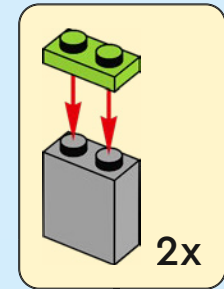
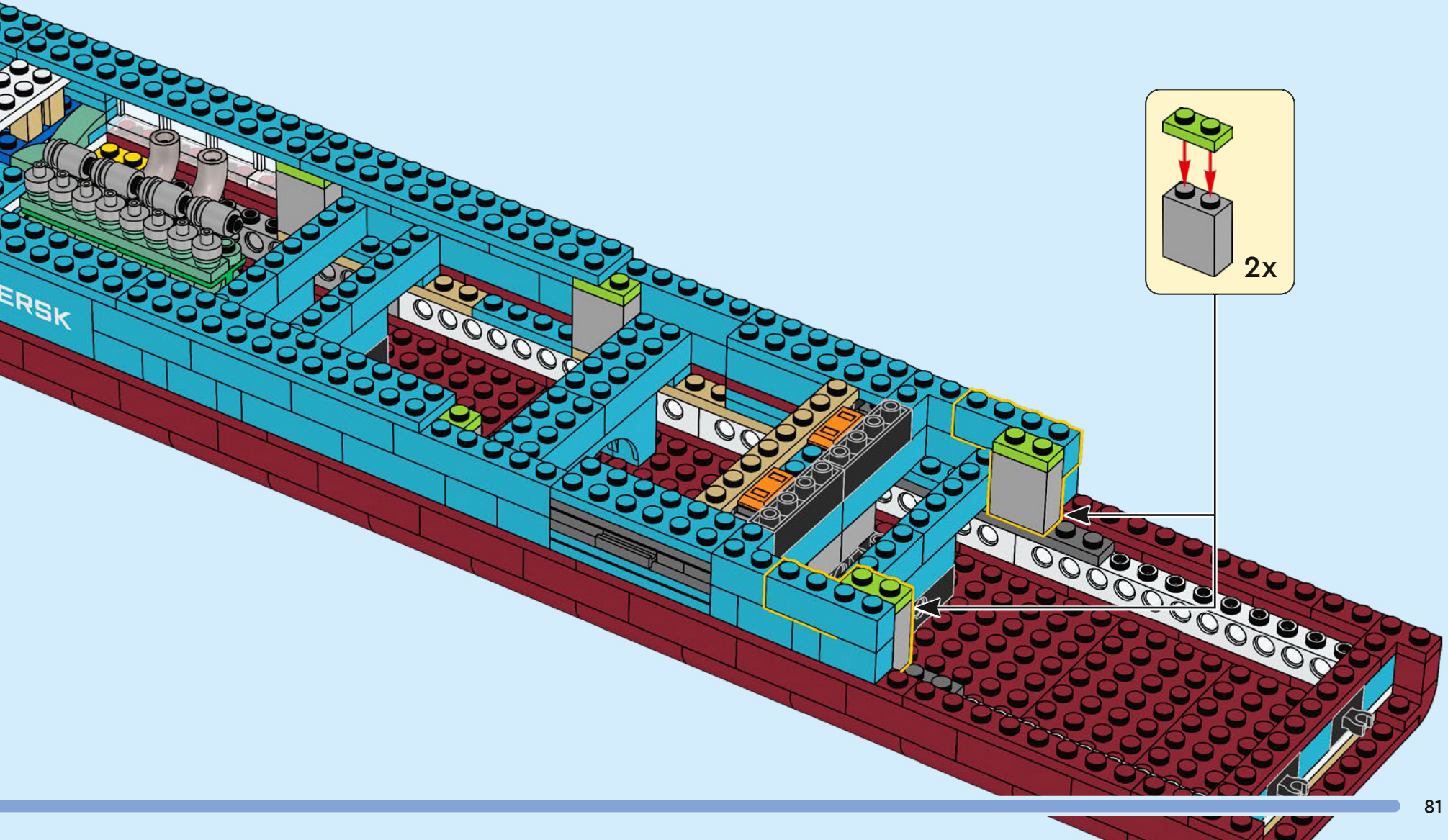

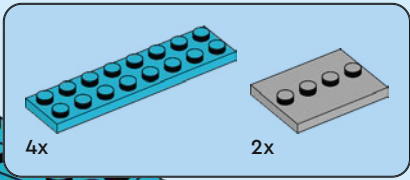

102

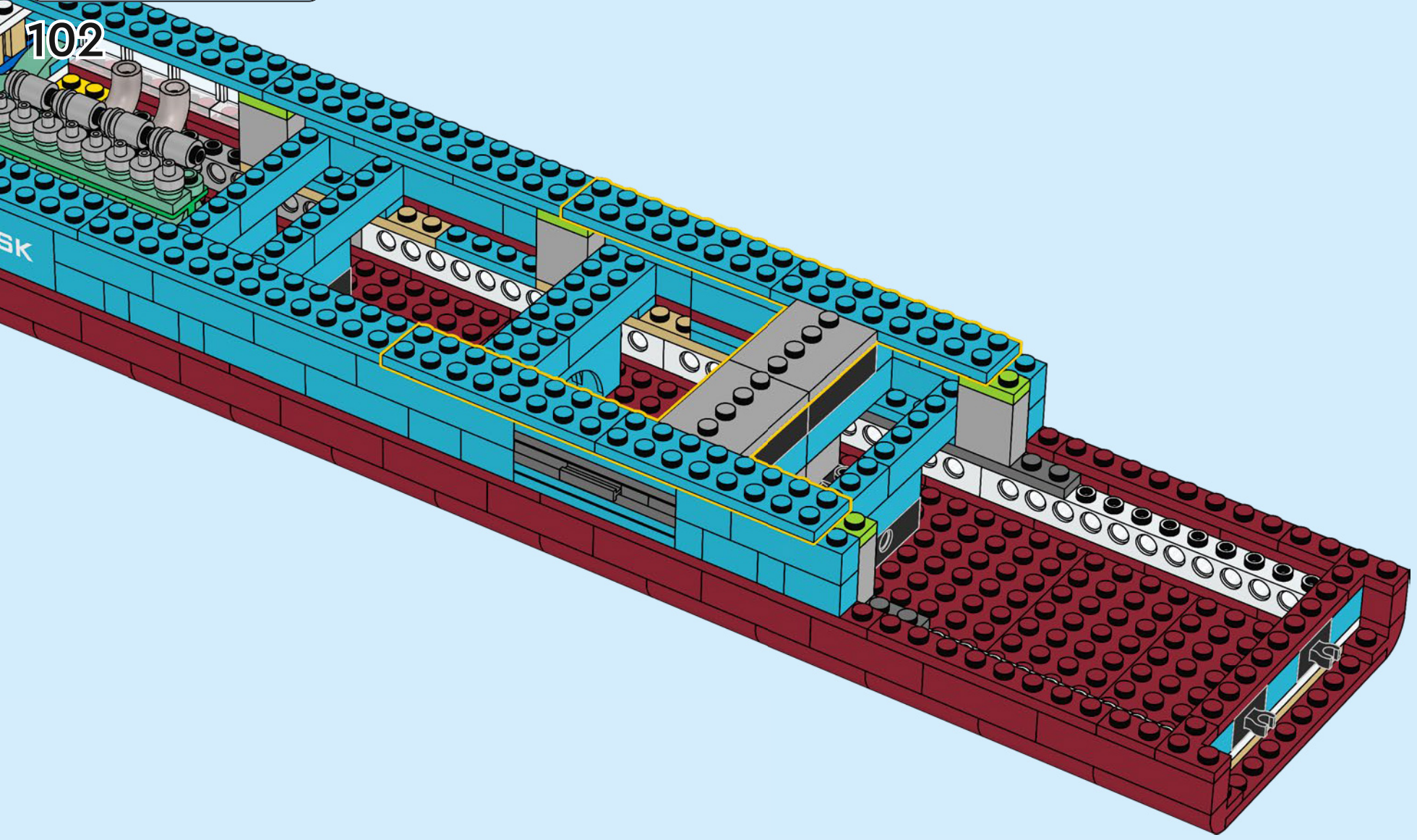

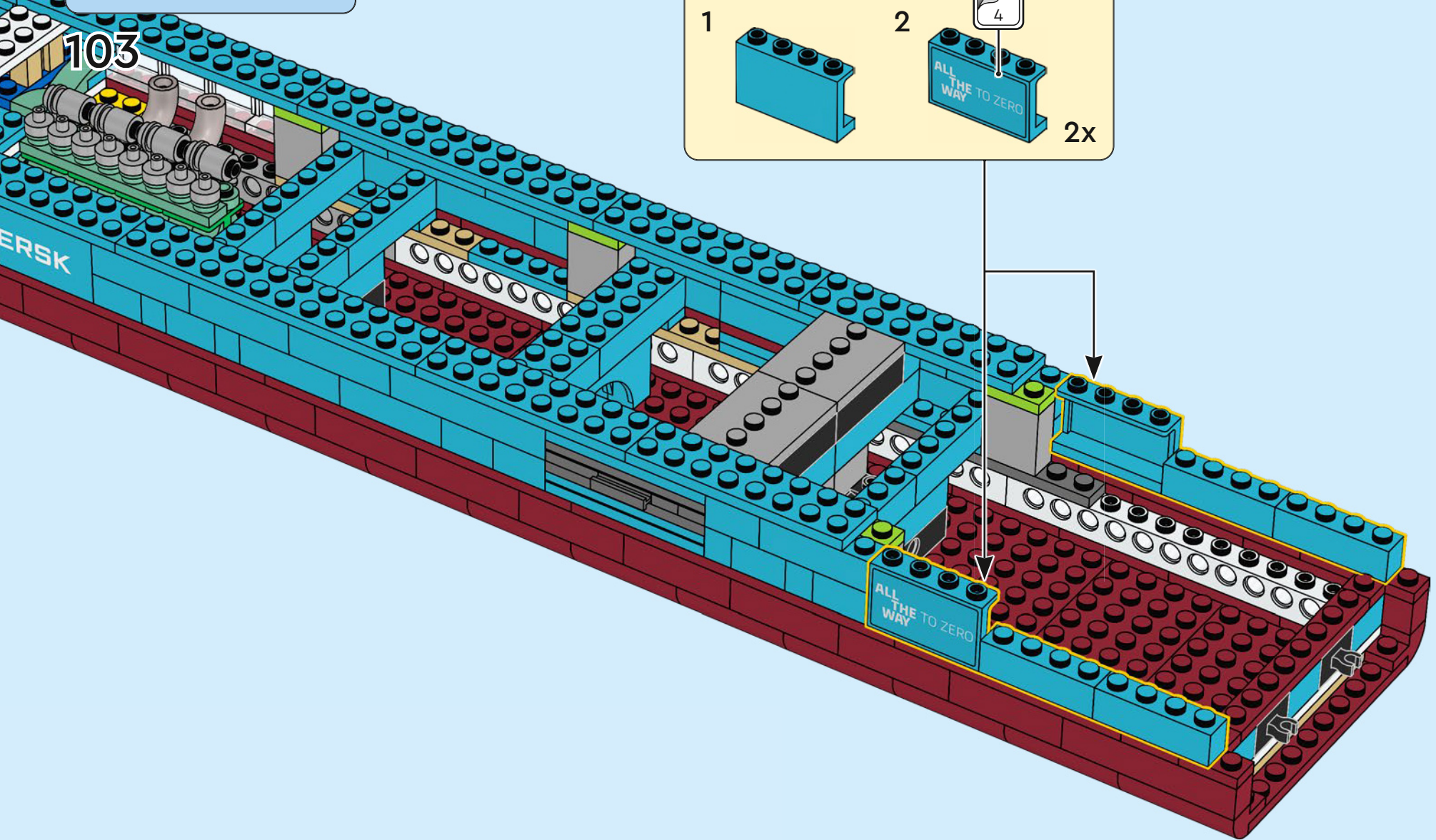
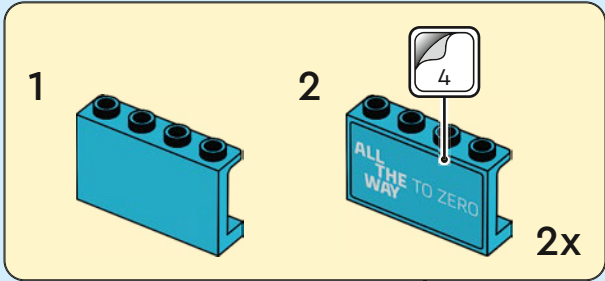
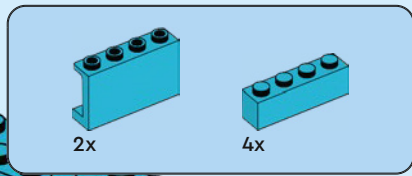



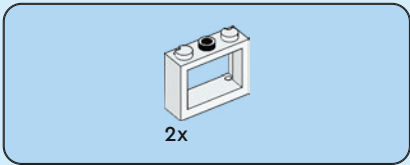

105

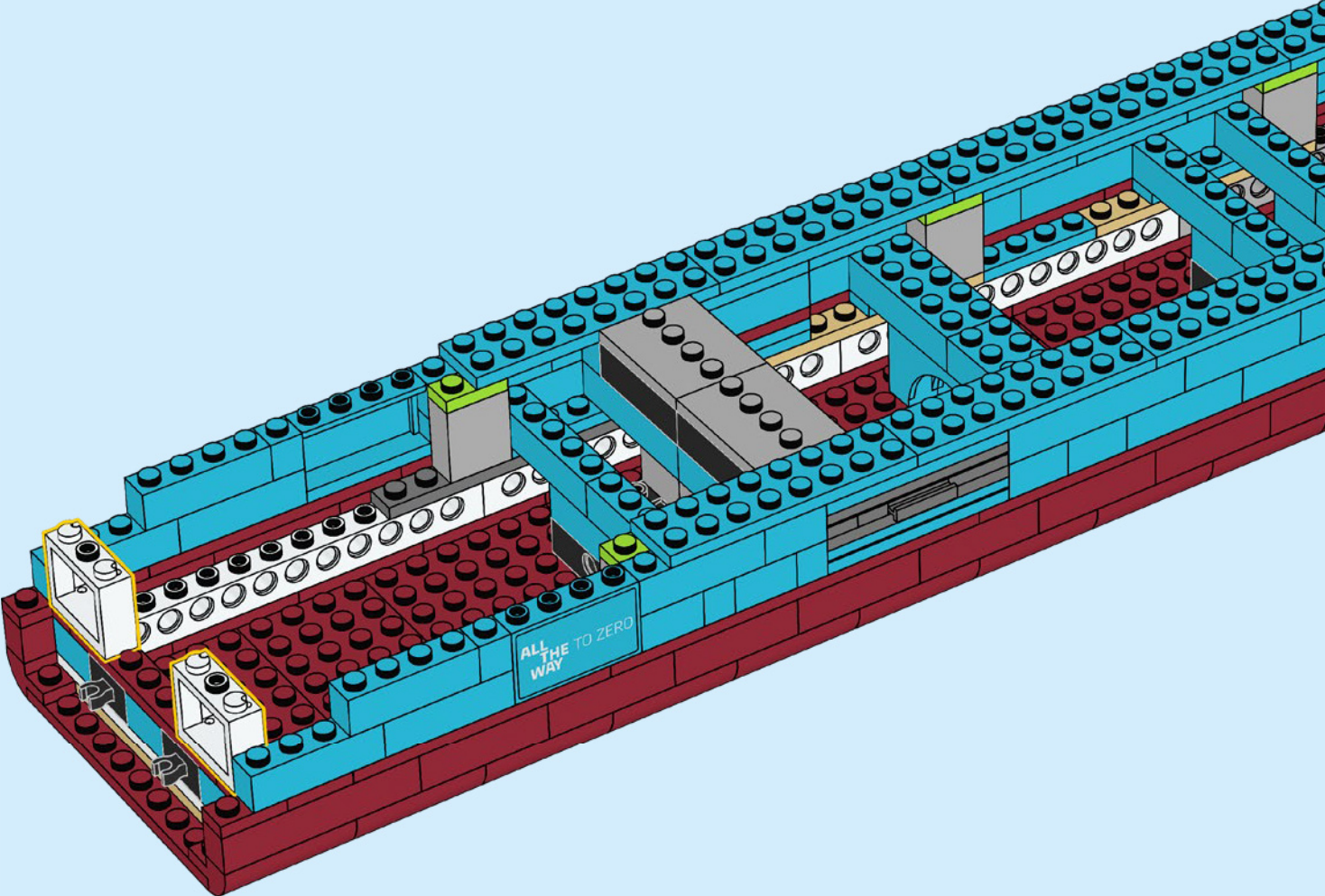

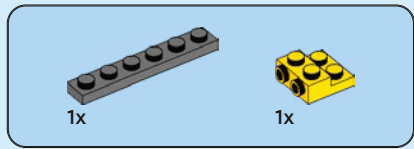
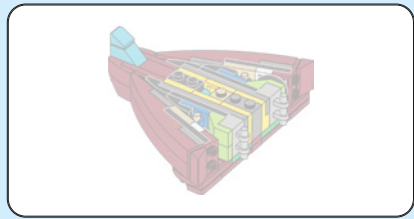
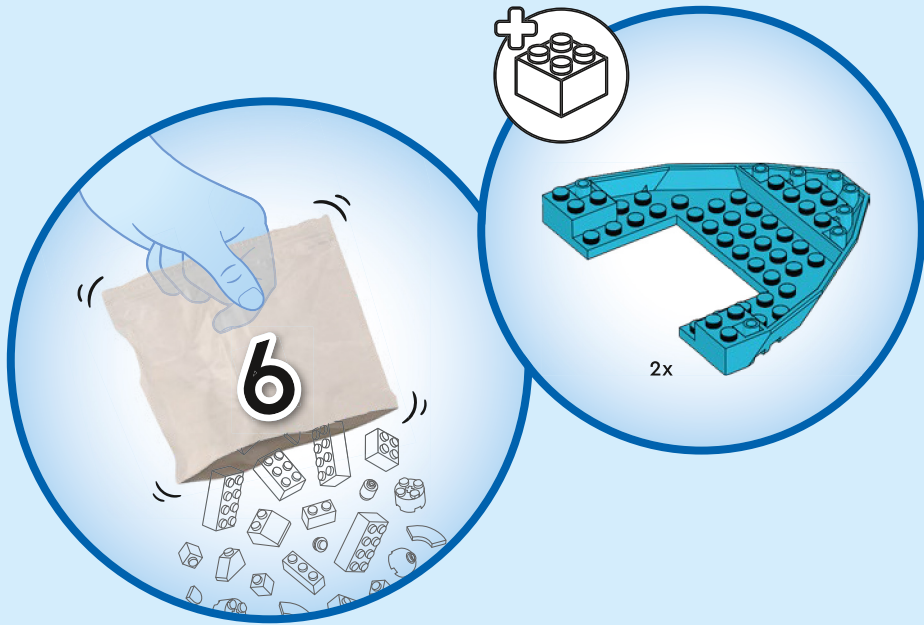

106

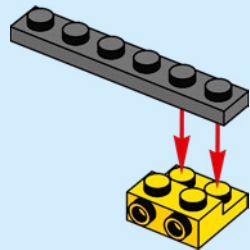

107

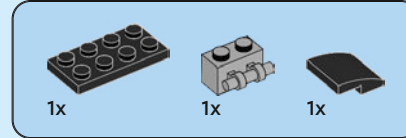
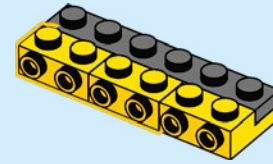

108

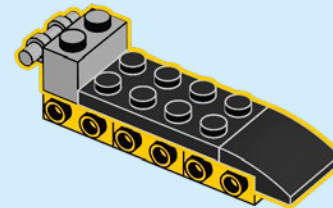

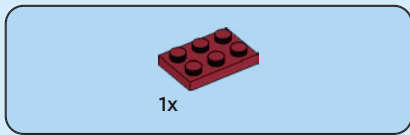

109

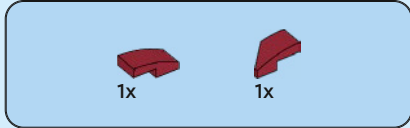
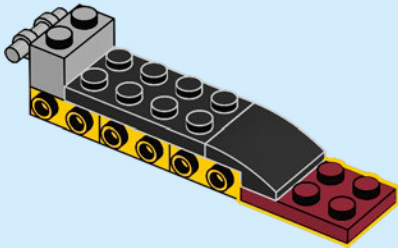

110

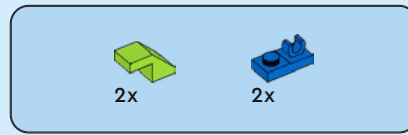
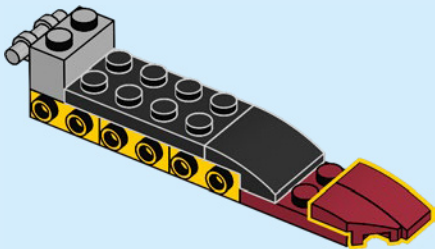

111

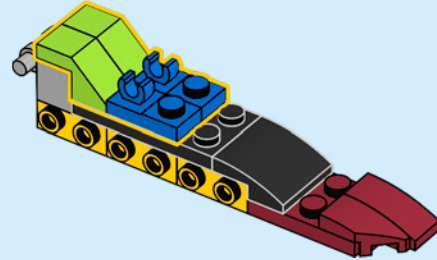

112

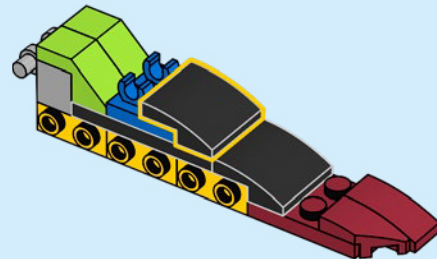

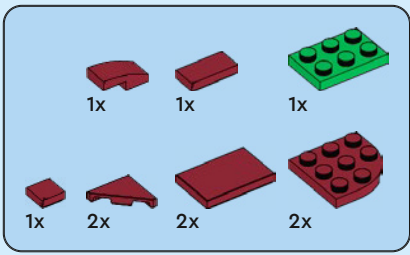

# 113

1

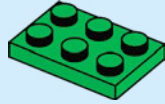

2

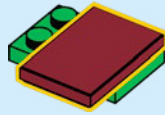

3

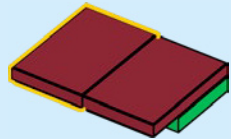

4

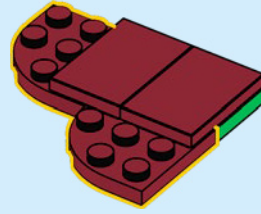

5

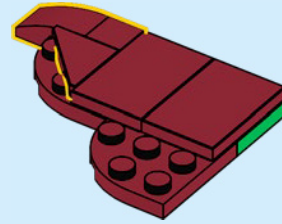

6

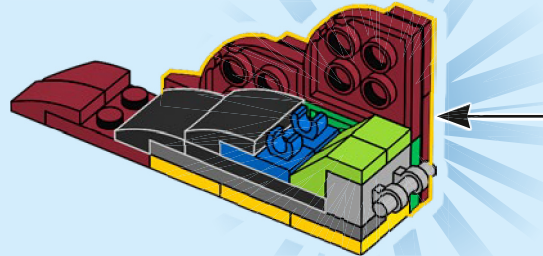
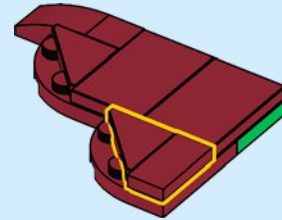

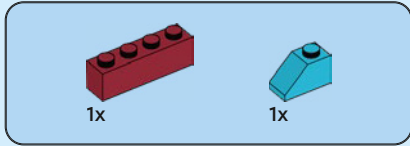
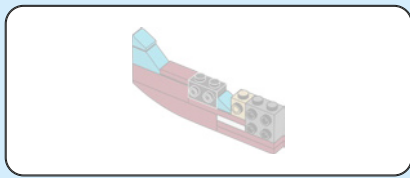

114

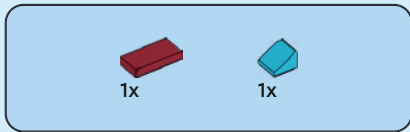
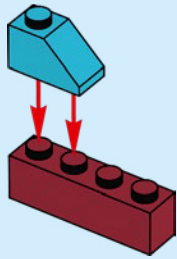

115

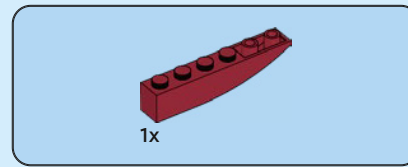
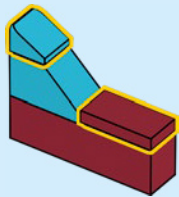

116

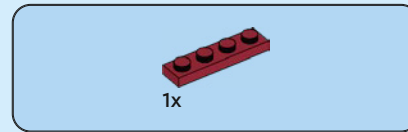
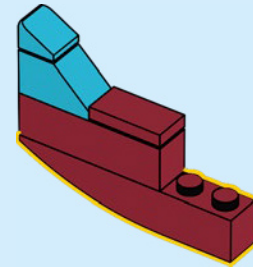

117

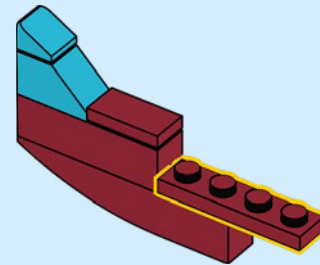

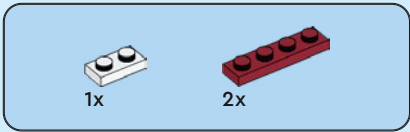

118

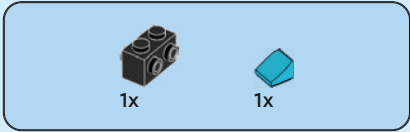
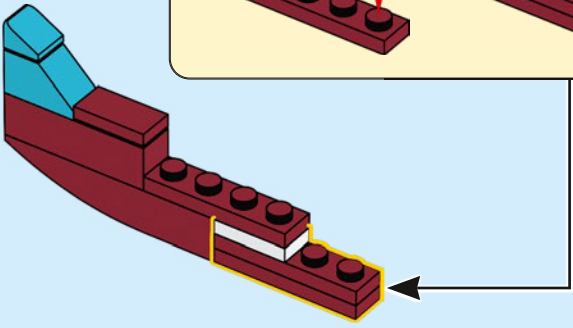
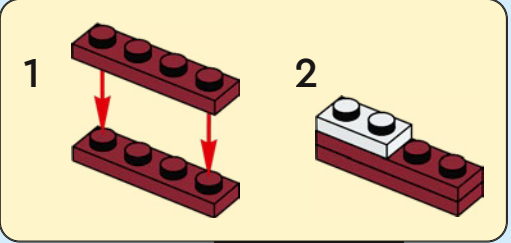

119

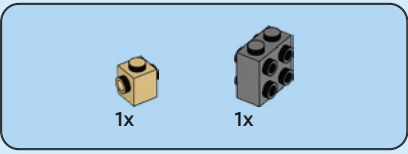
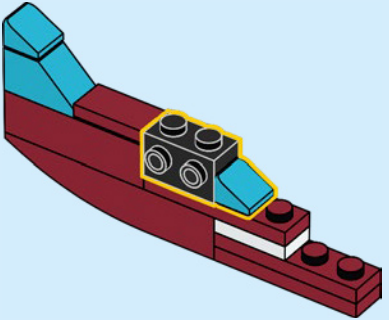

120

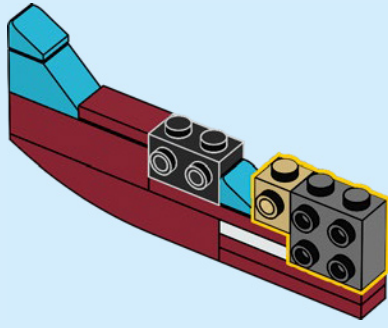

121

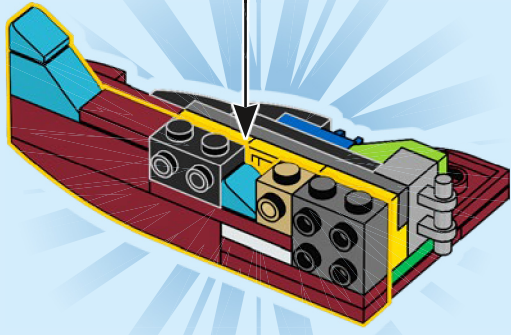

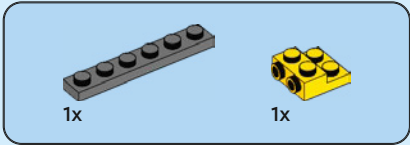
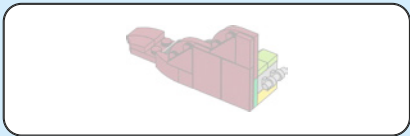

122

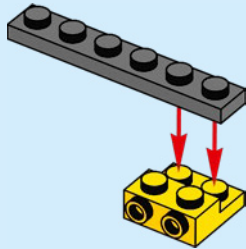

123

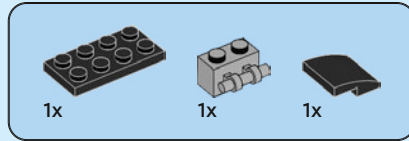
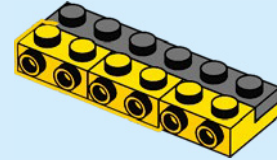

124

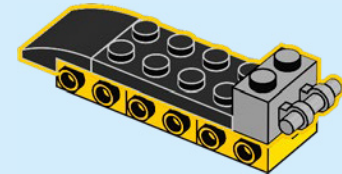

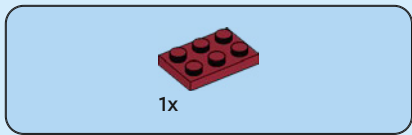

125

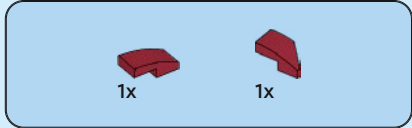
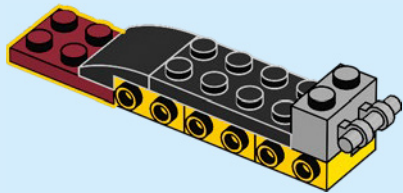

126

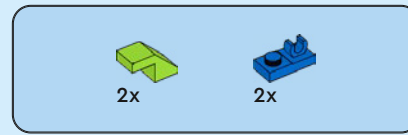
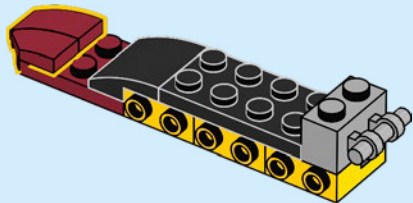

127

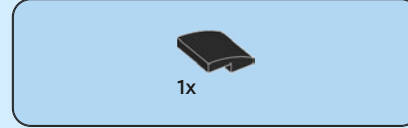
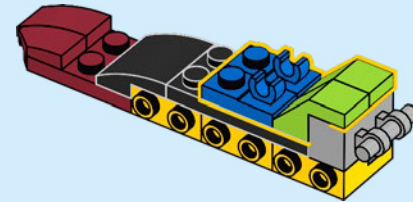

128

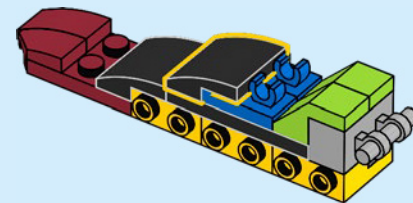

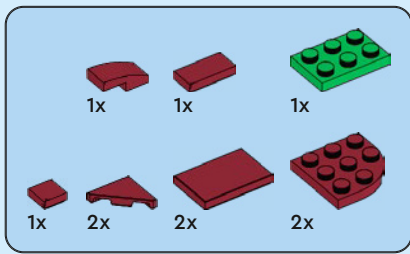

129

1

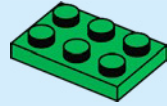

2

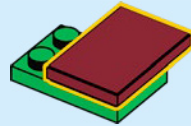

3

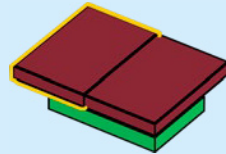

4

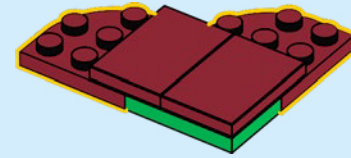

5

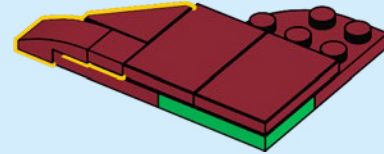

6

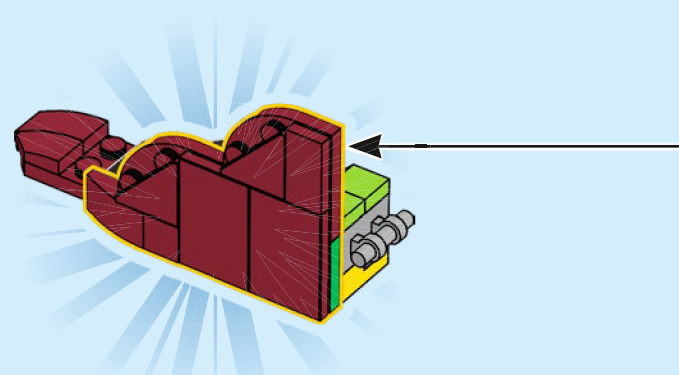
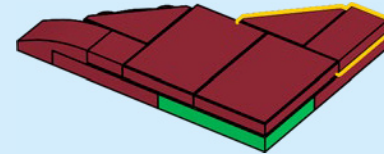

130

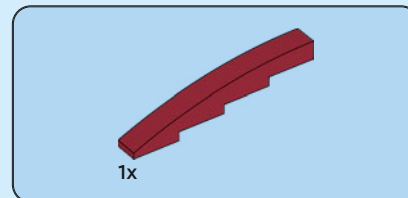
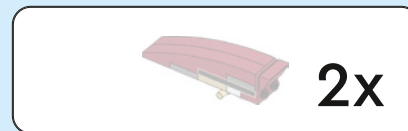
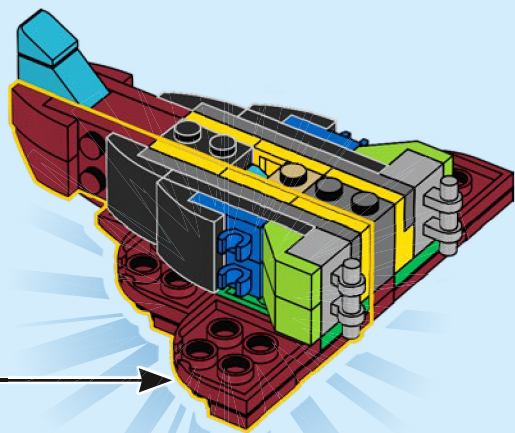

131

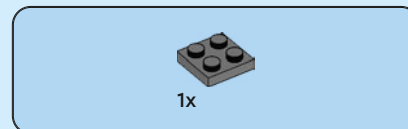
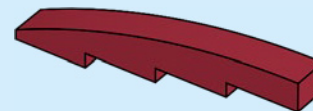

132

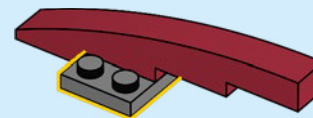

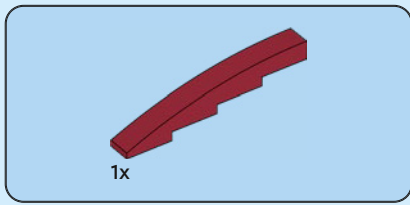

133

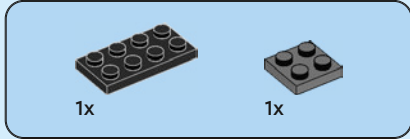
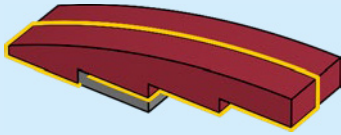

134

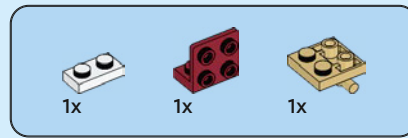
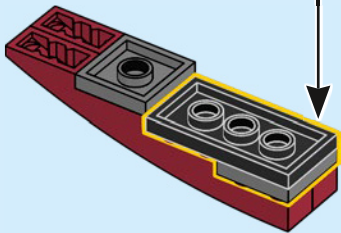
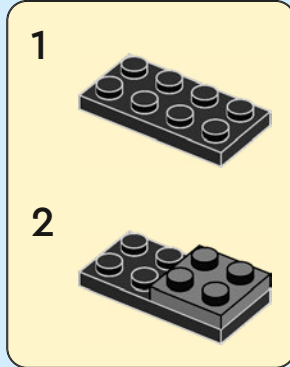

135

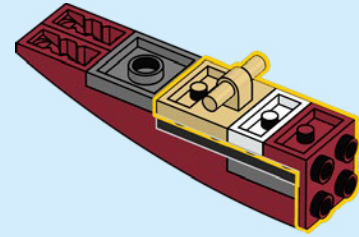

136

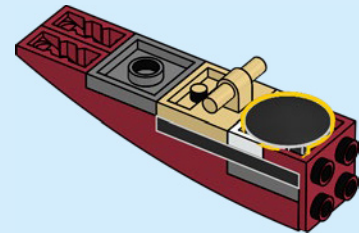



1x

137

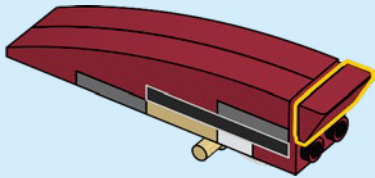

2x

138

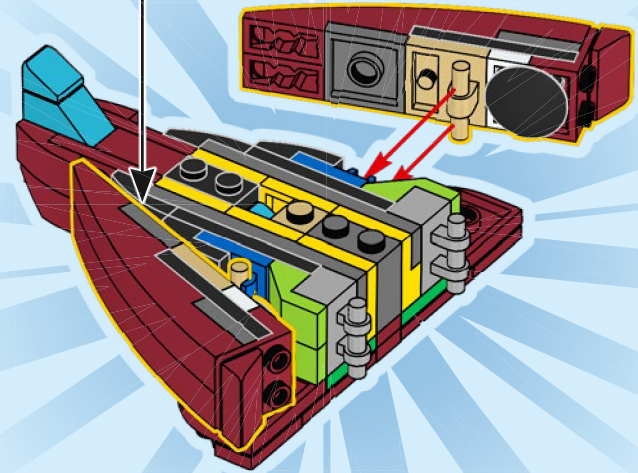

139

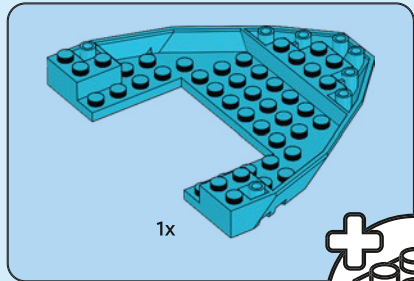
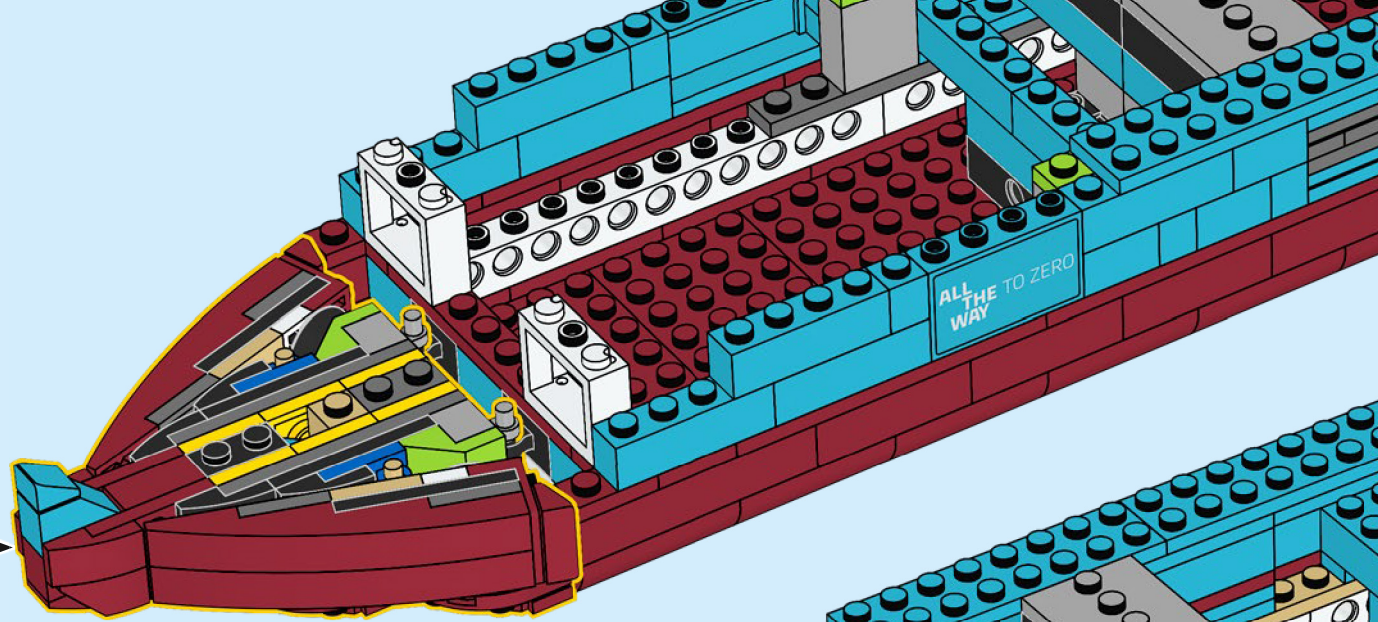

1x

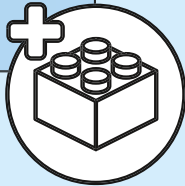

140

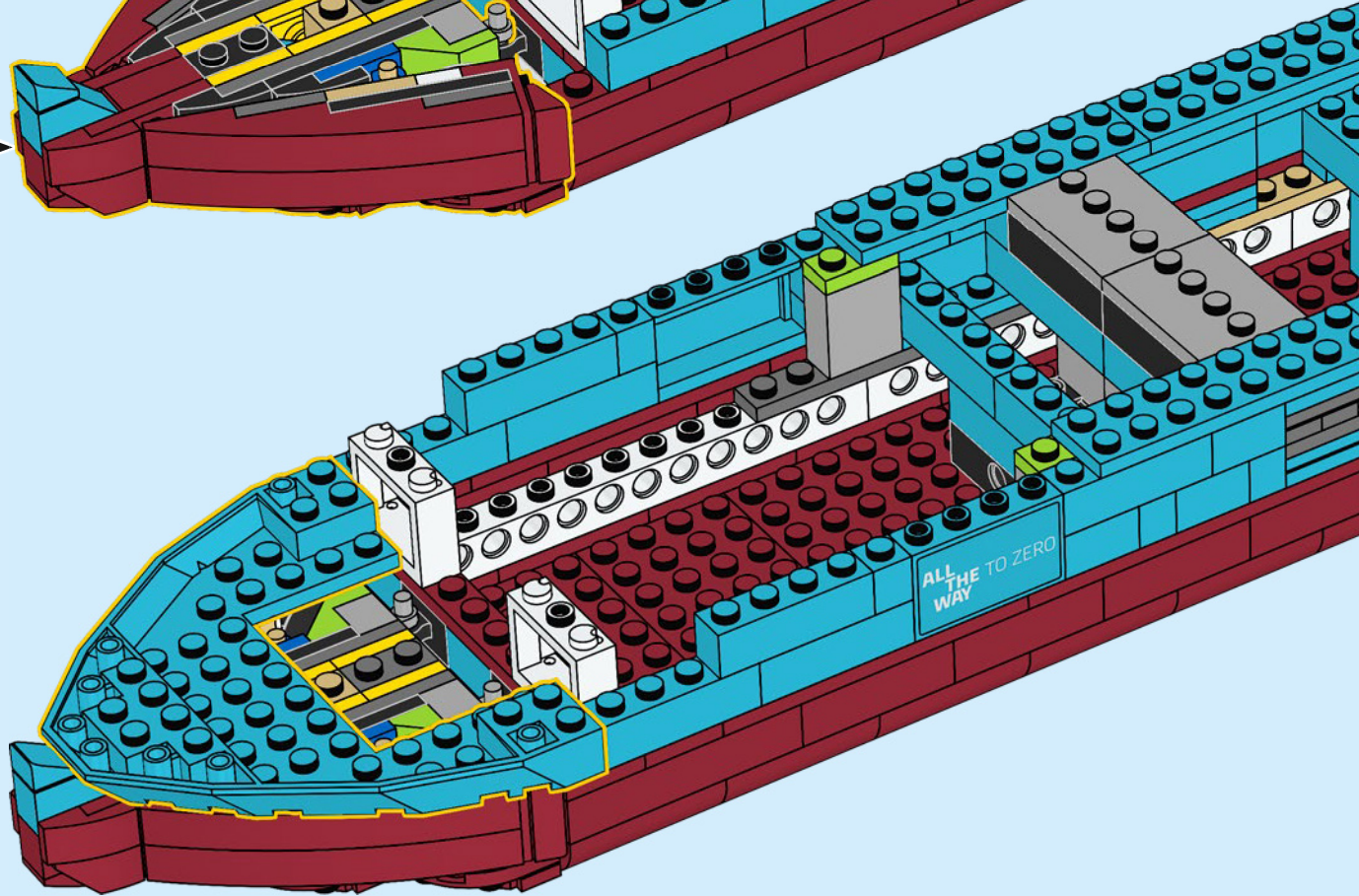

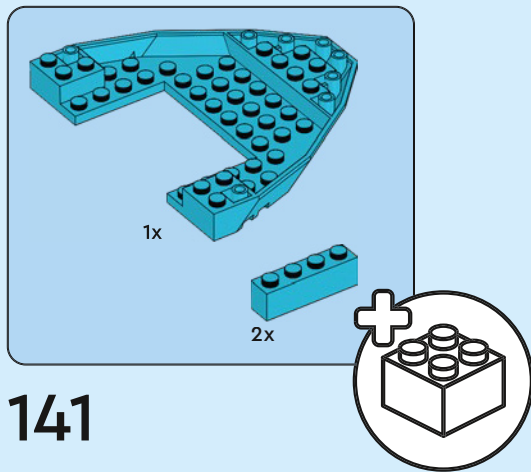

141

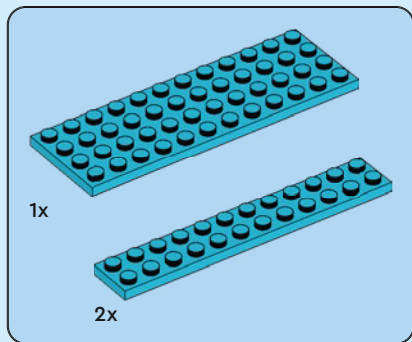
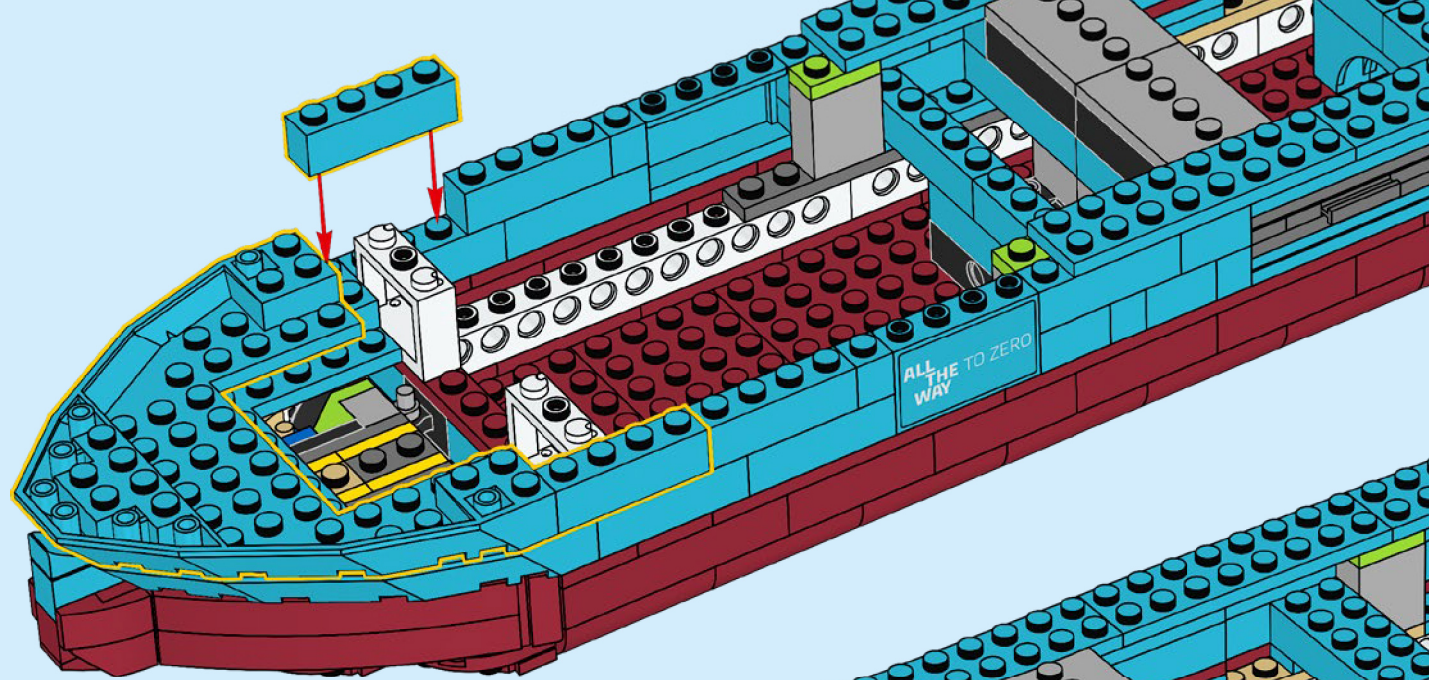

142

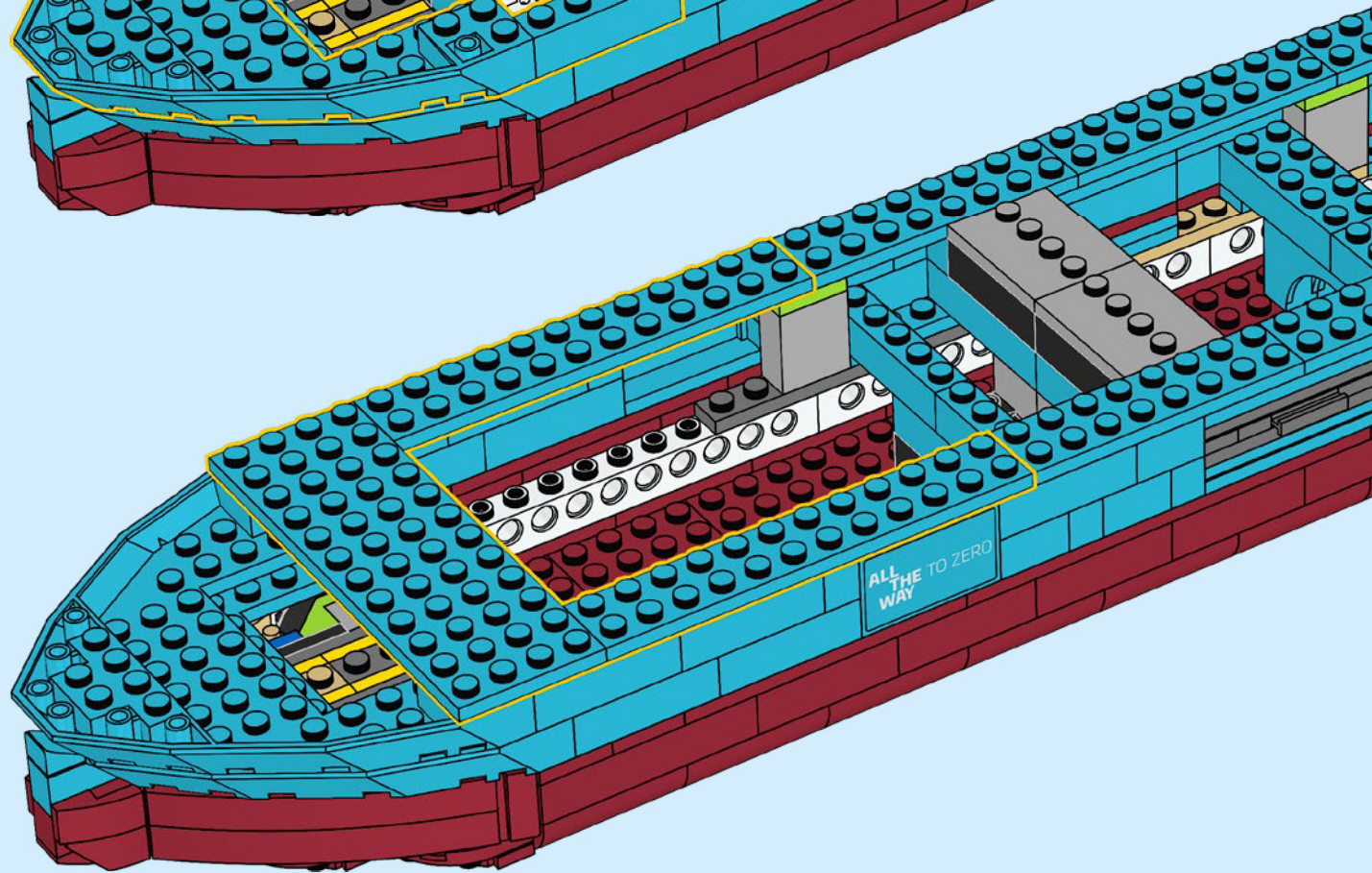

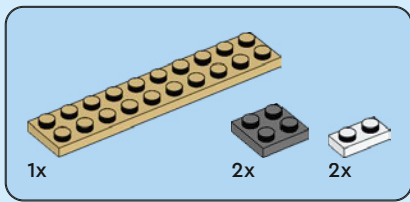

143

1

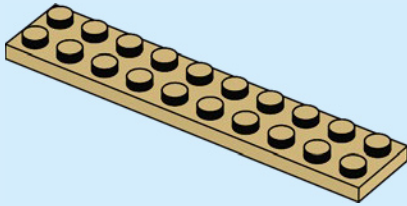

2

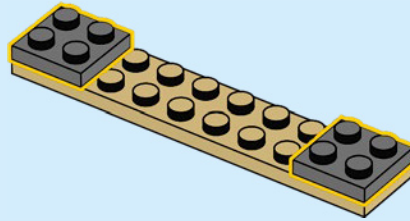

3

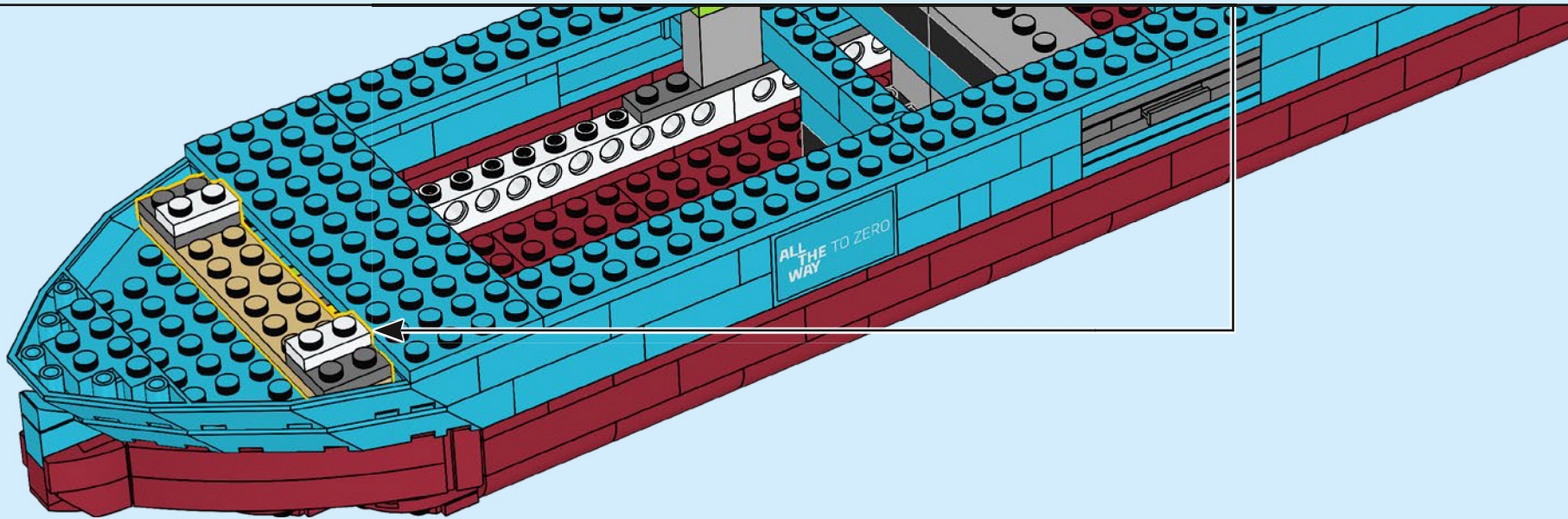
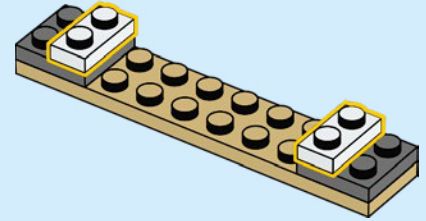

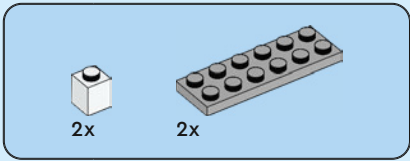

144

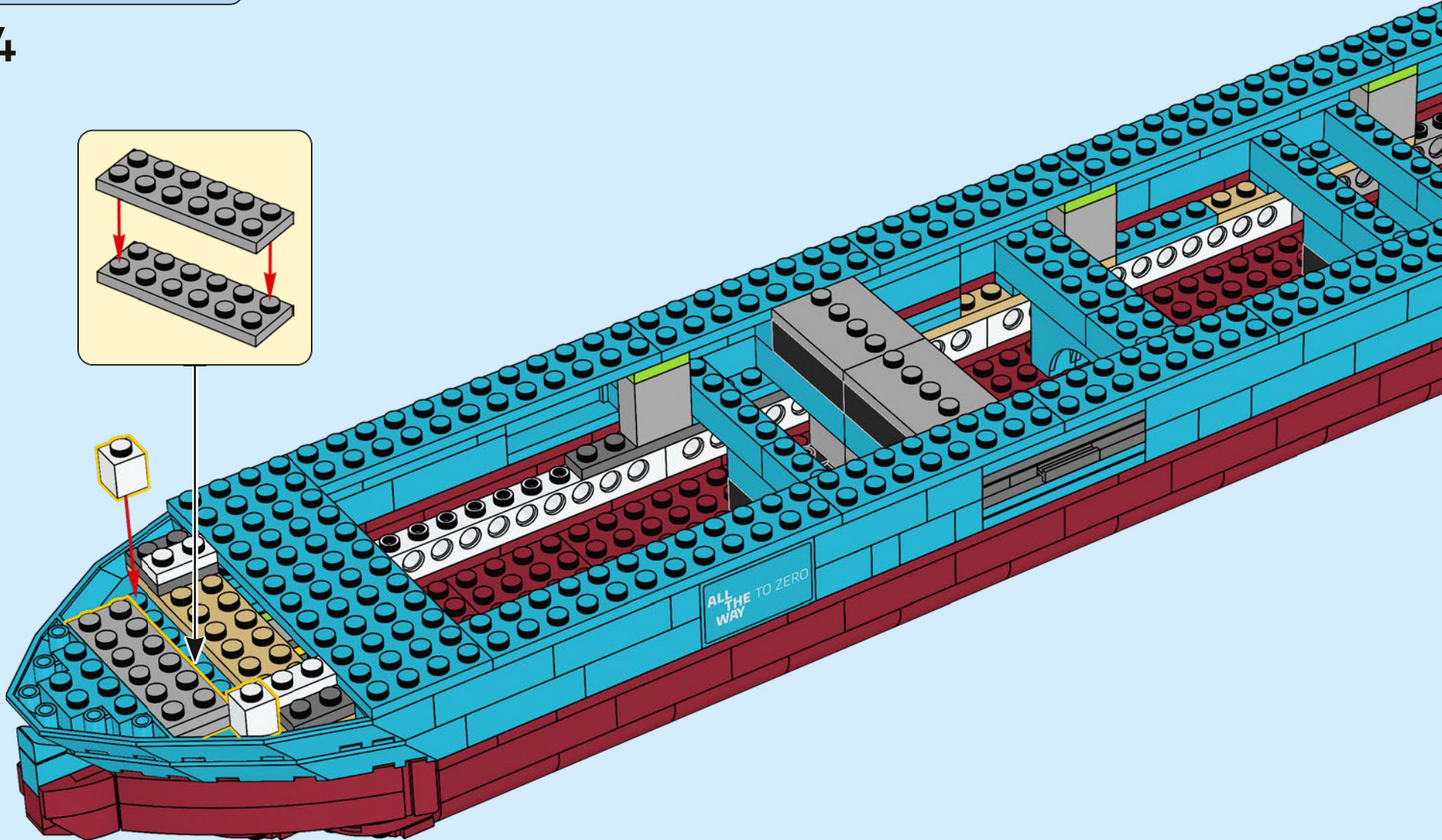
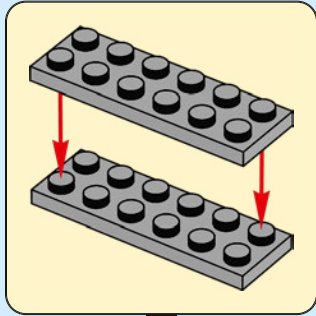

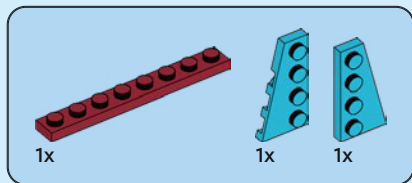

145

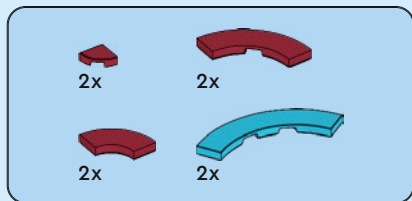
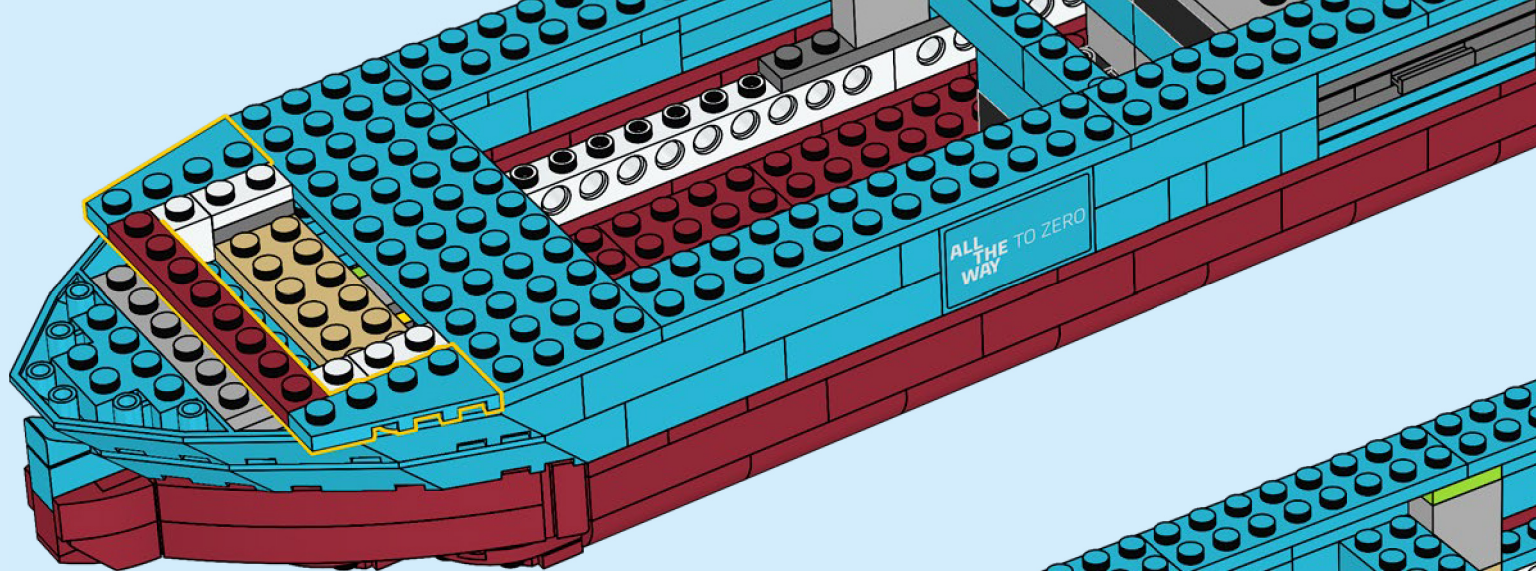

146

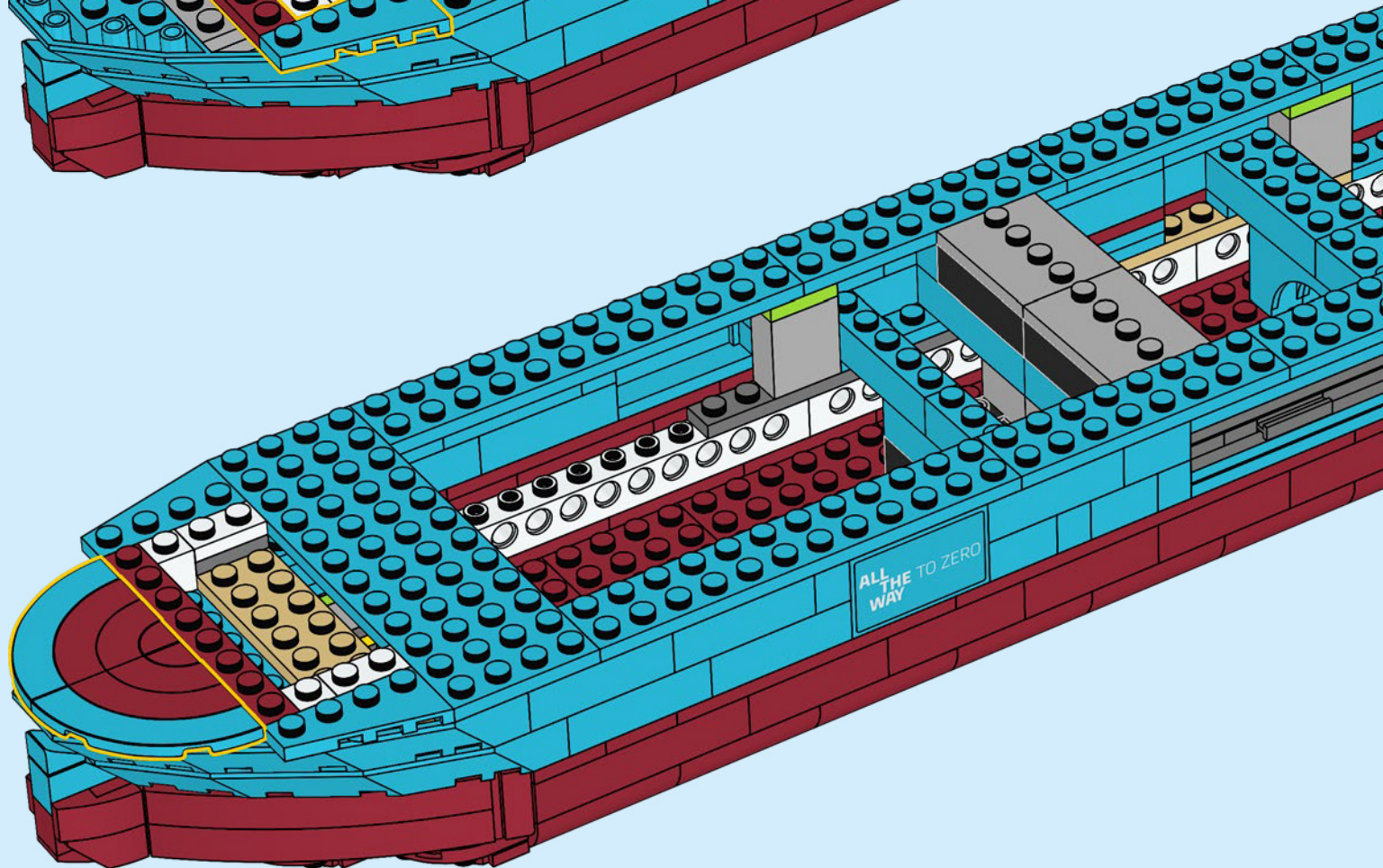

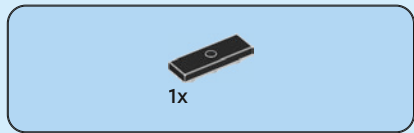

147

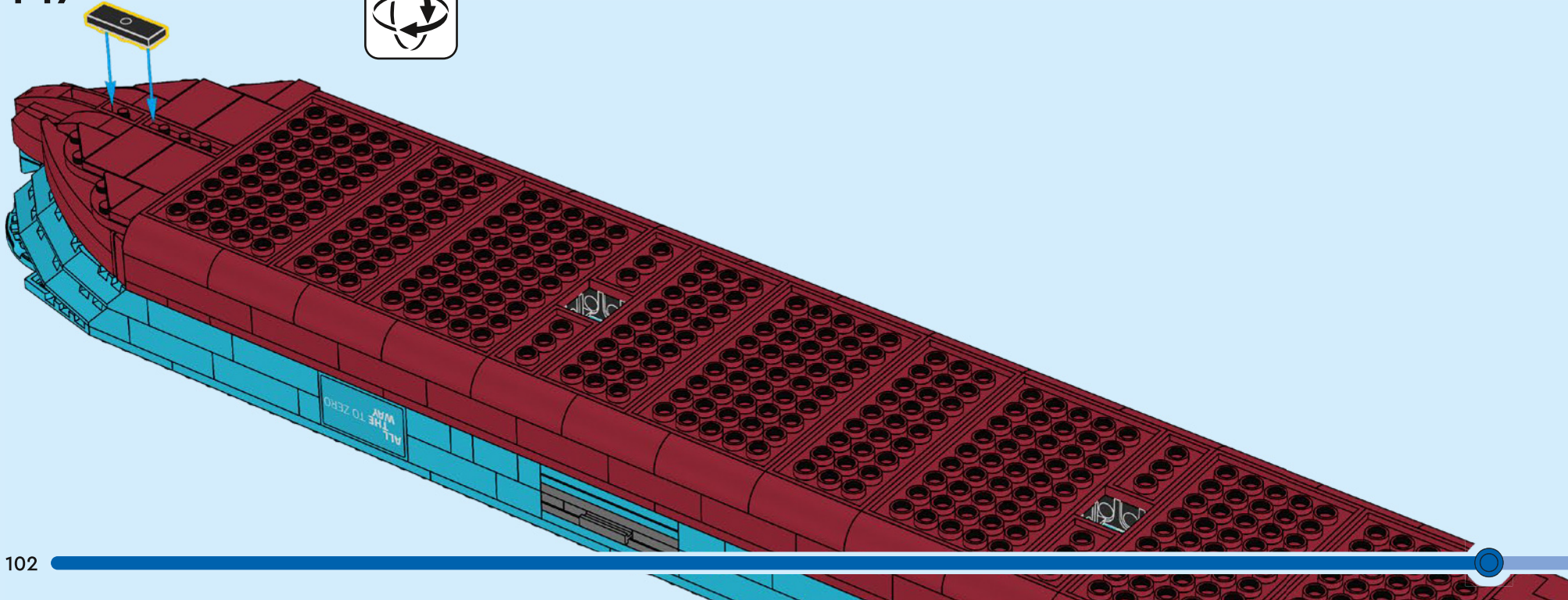



24x

148

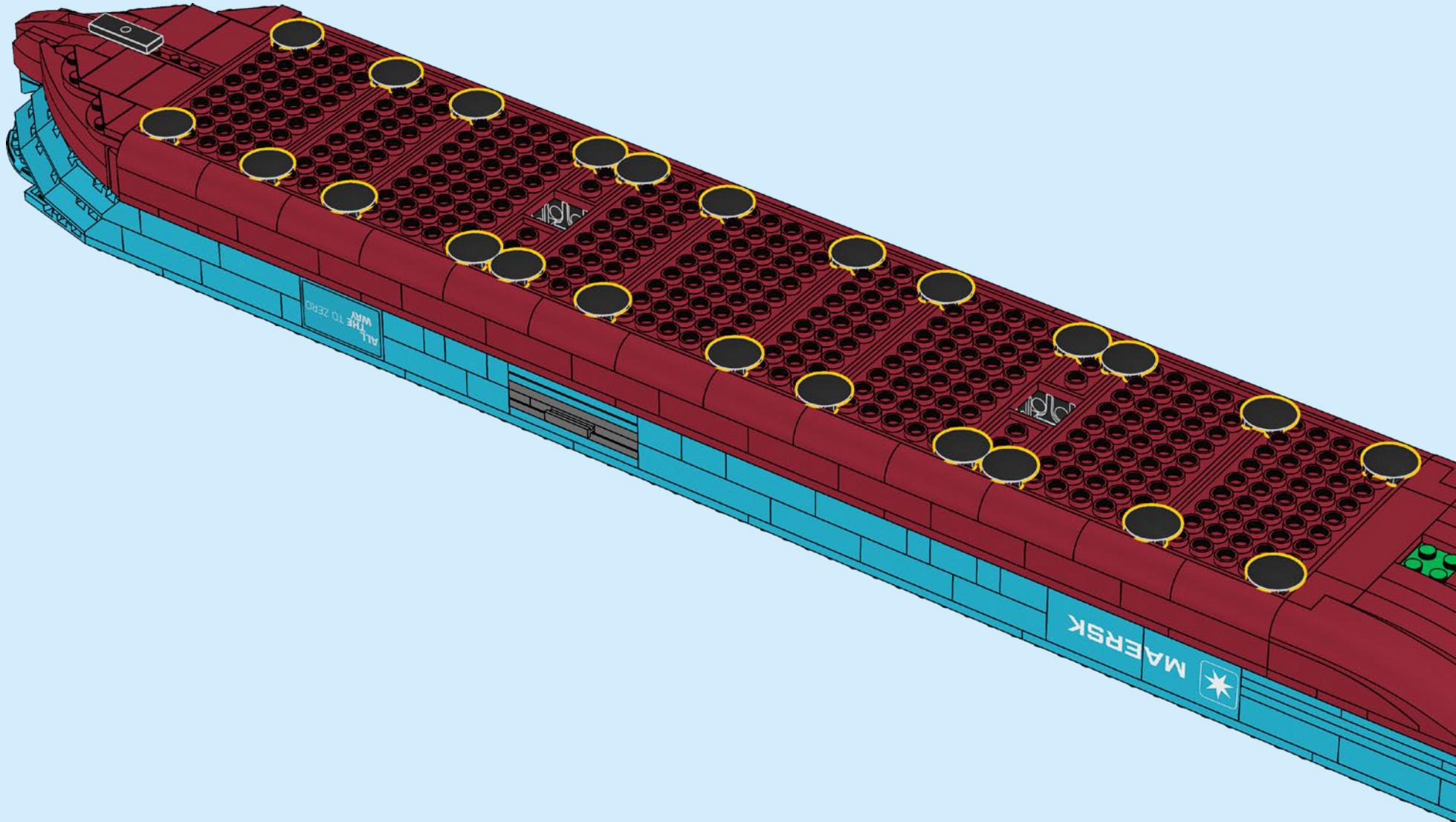

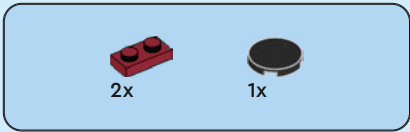

149

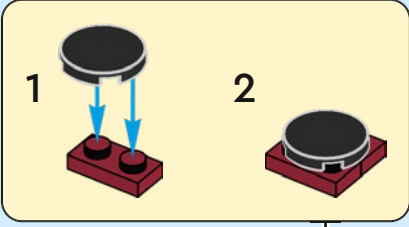
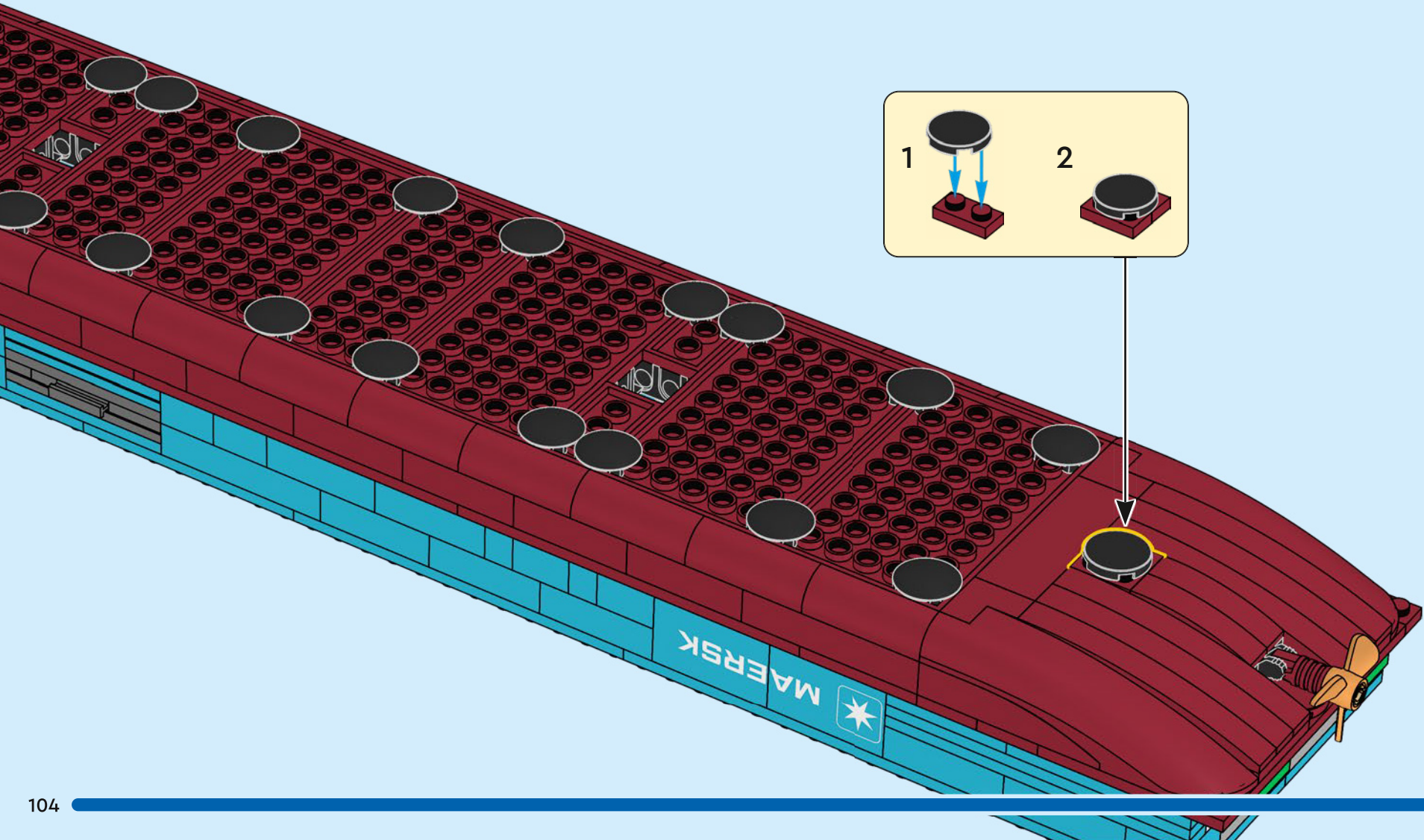

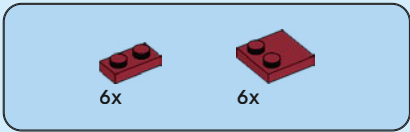

150

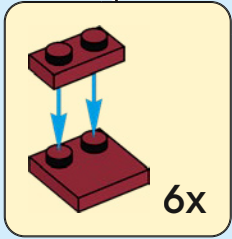
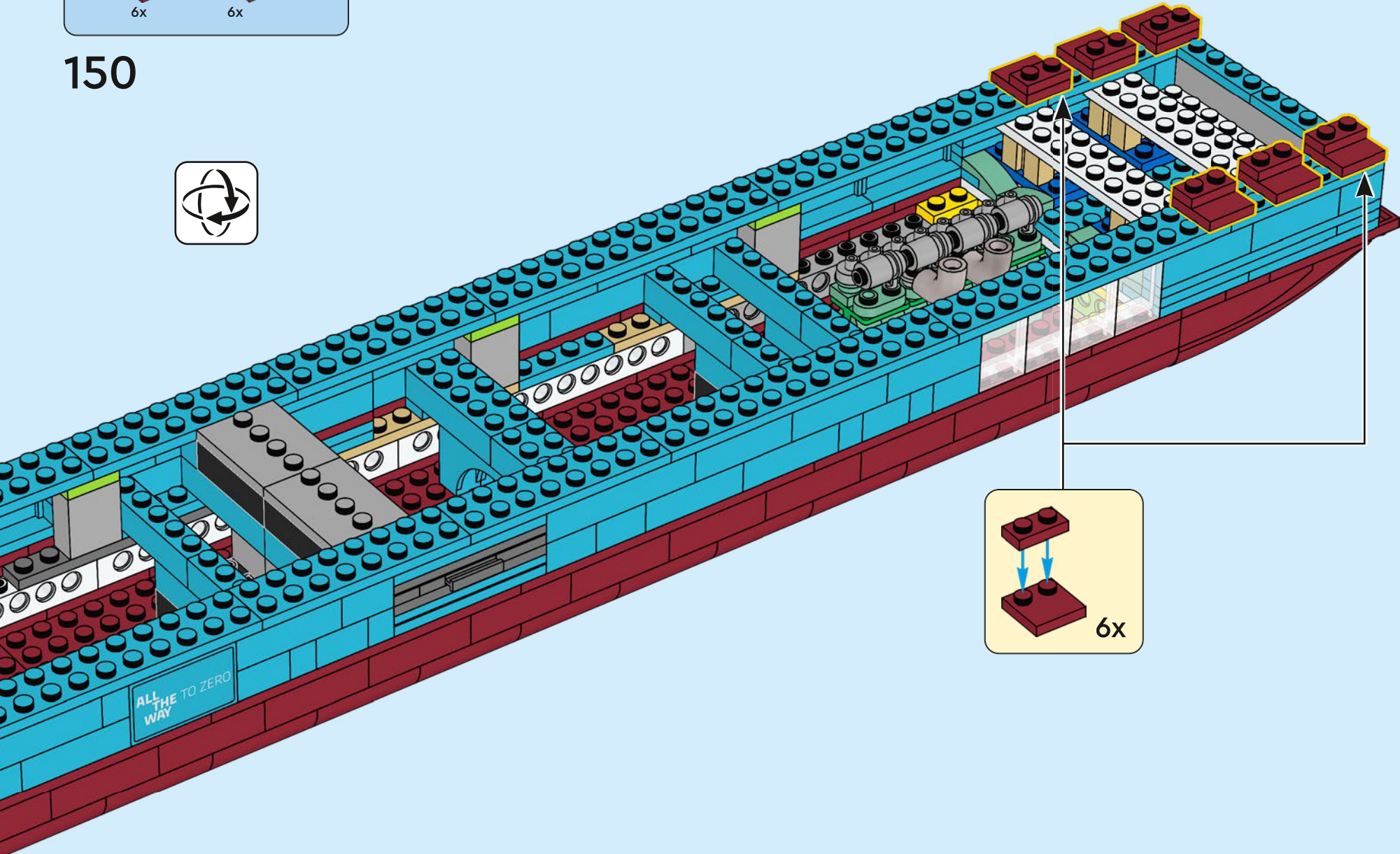

ALL  
THE  
WAY TO ZERO

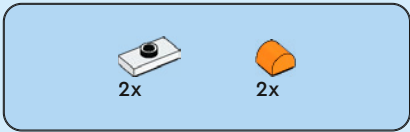

151

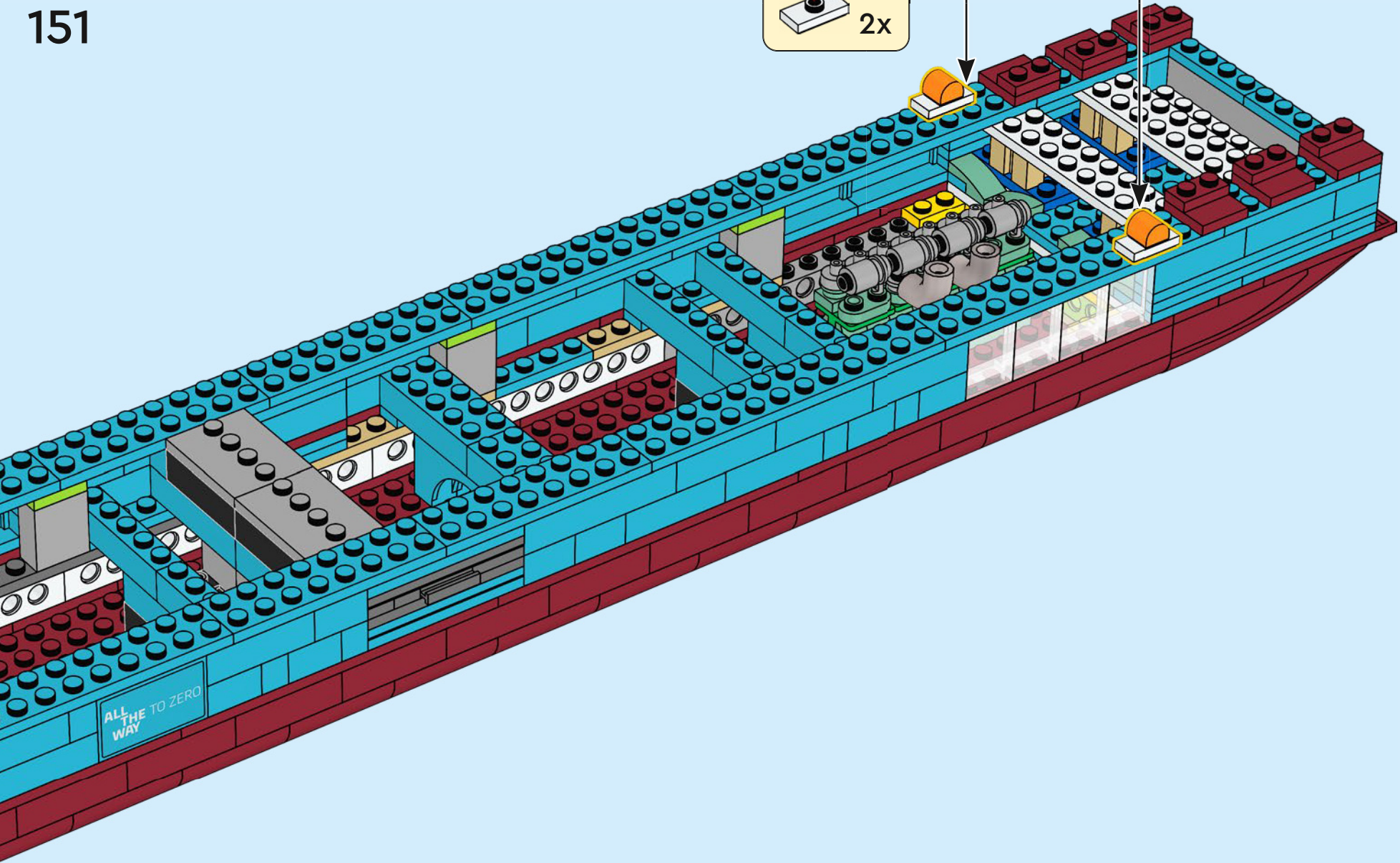
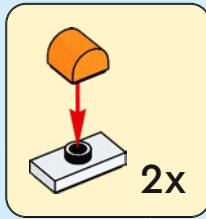

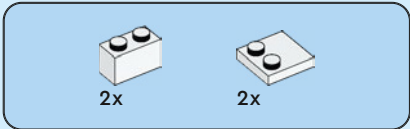

152

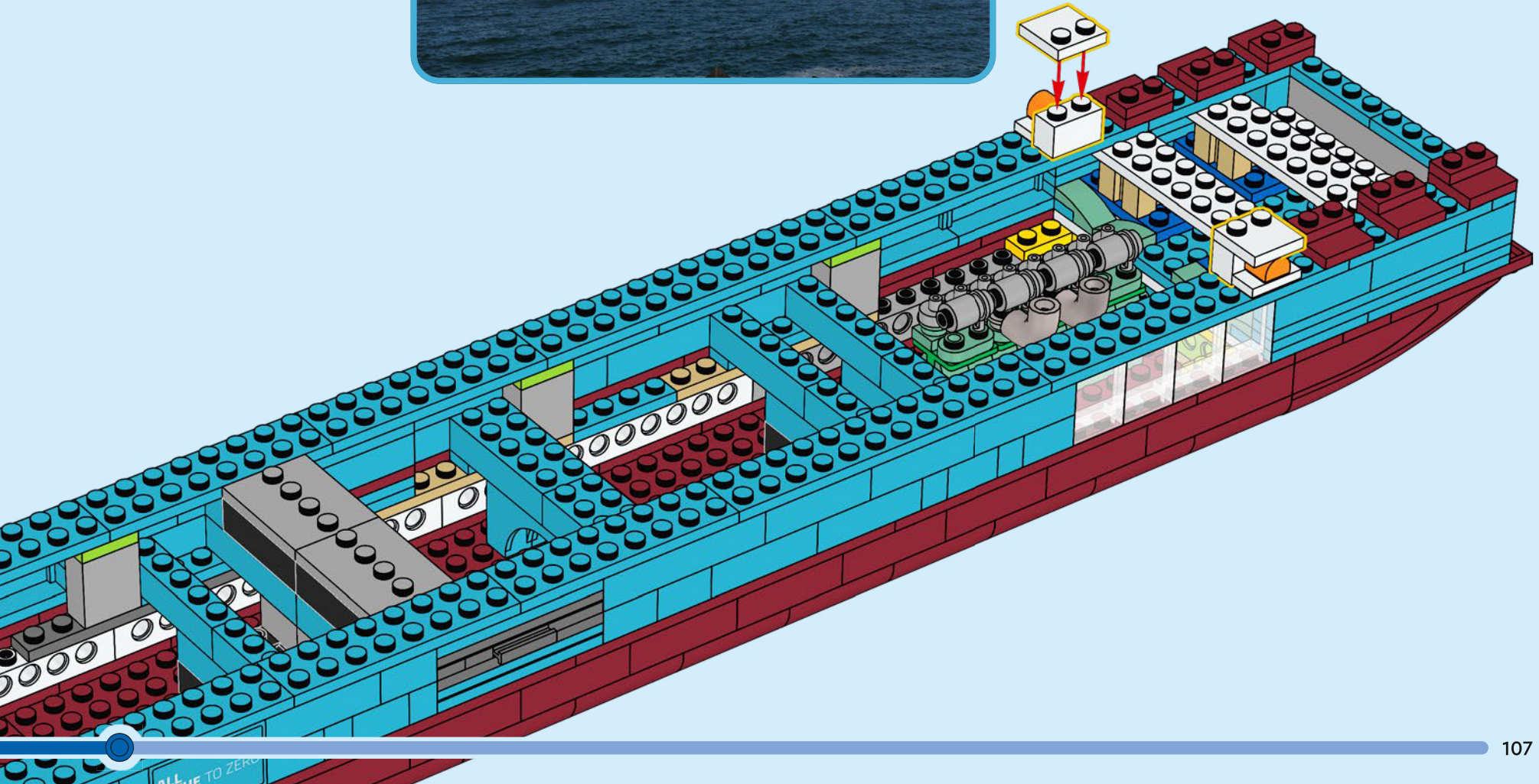
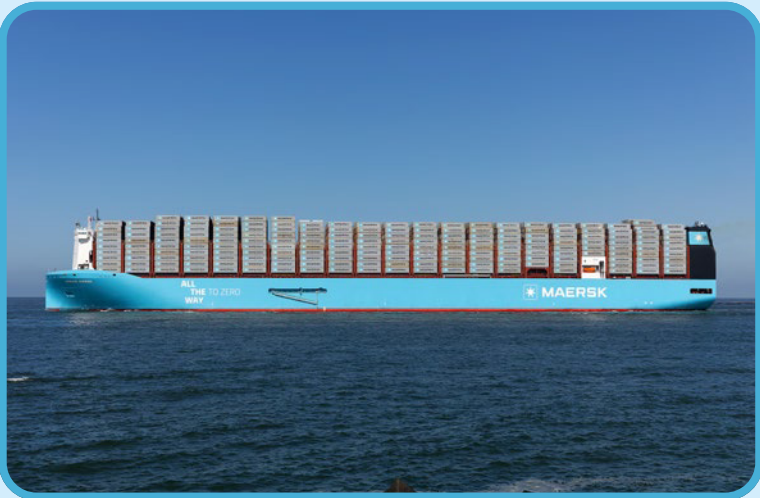

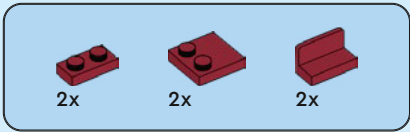

153

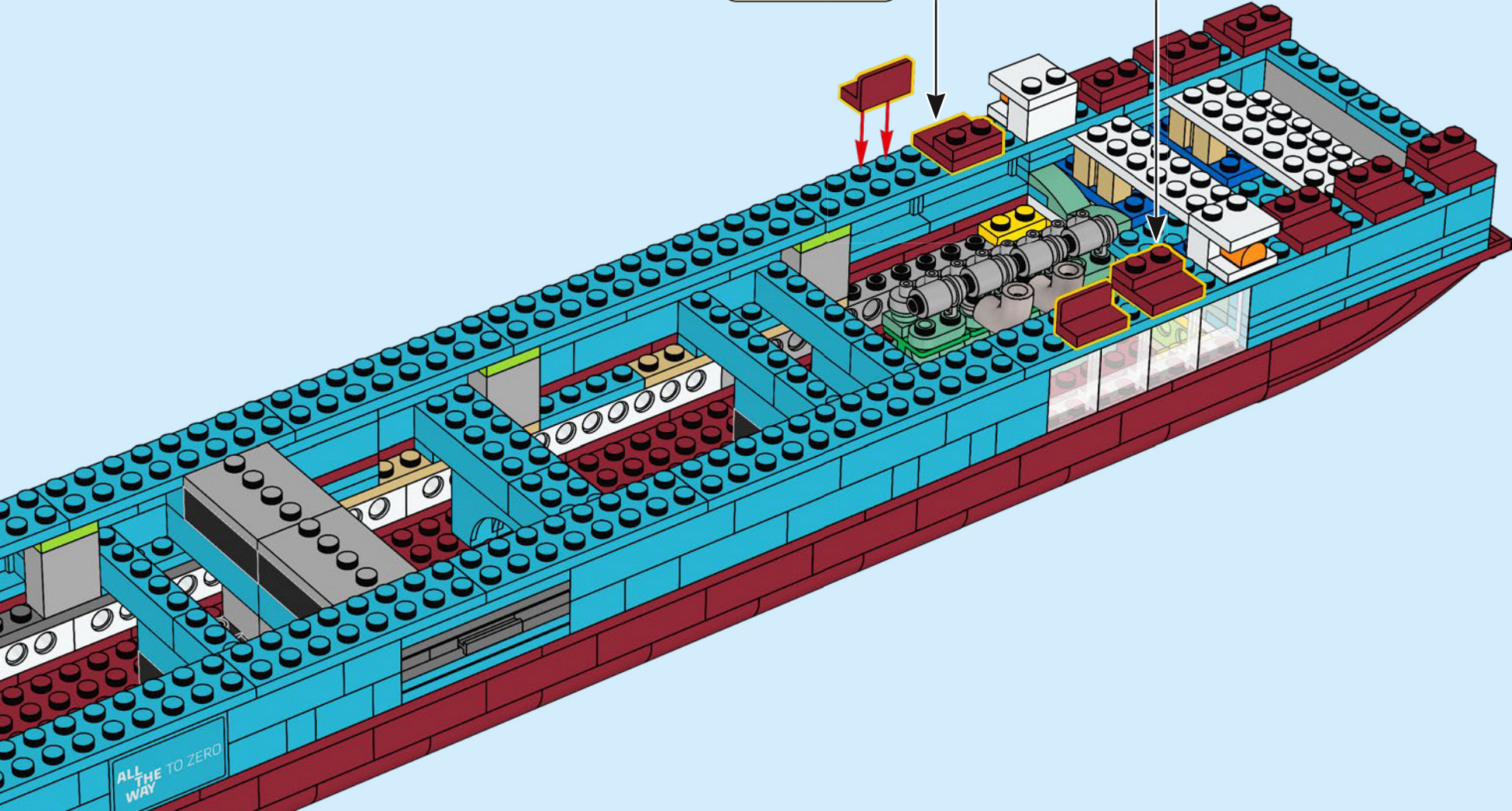
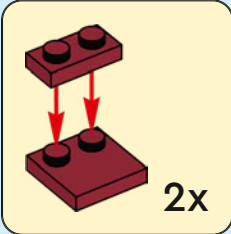

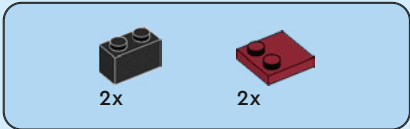

154

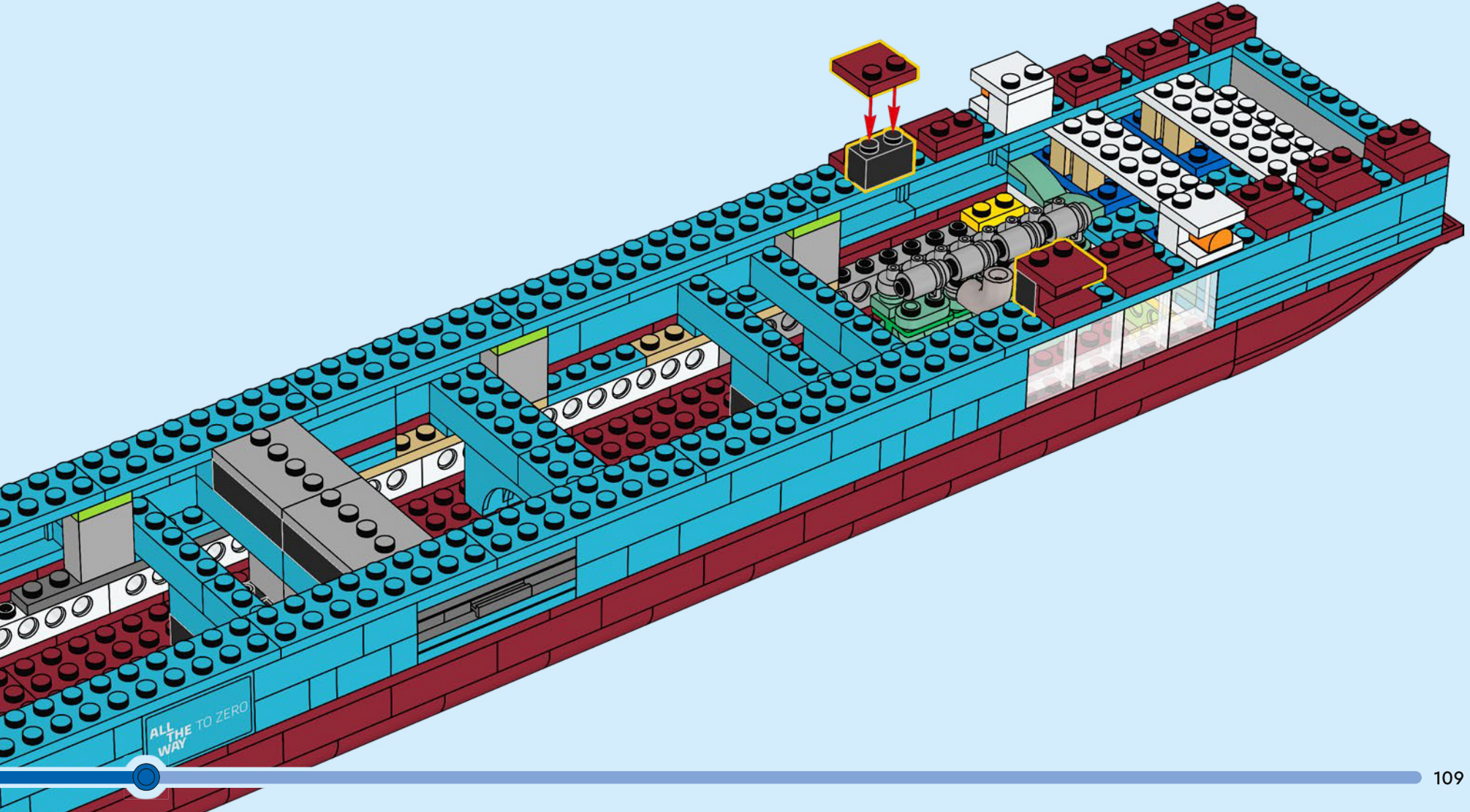

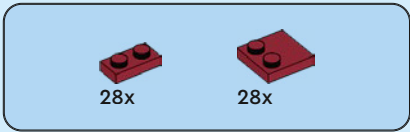

155

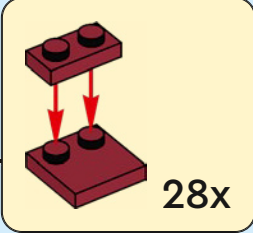
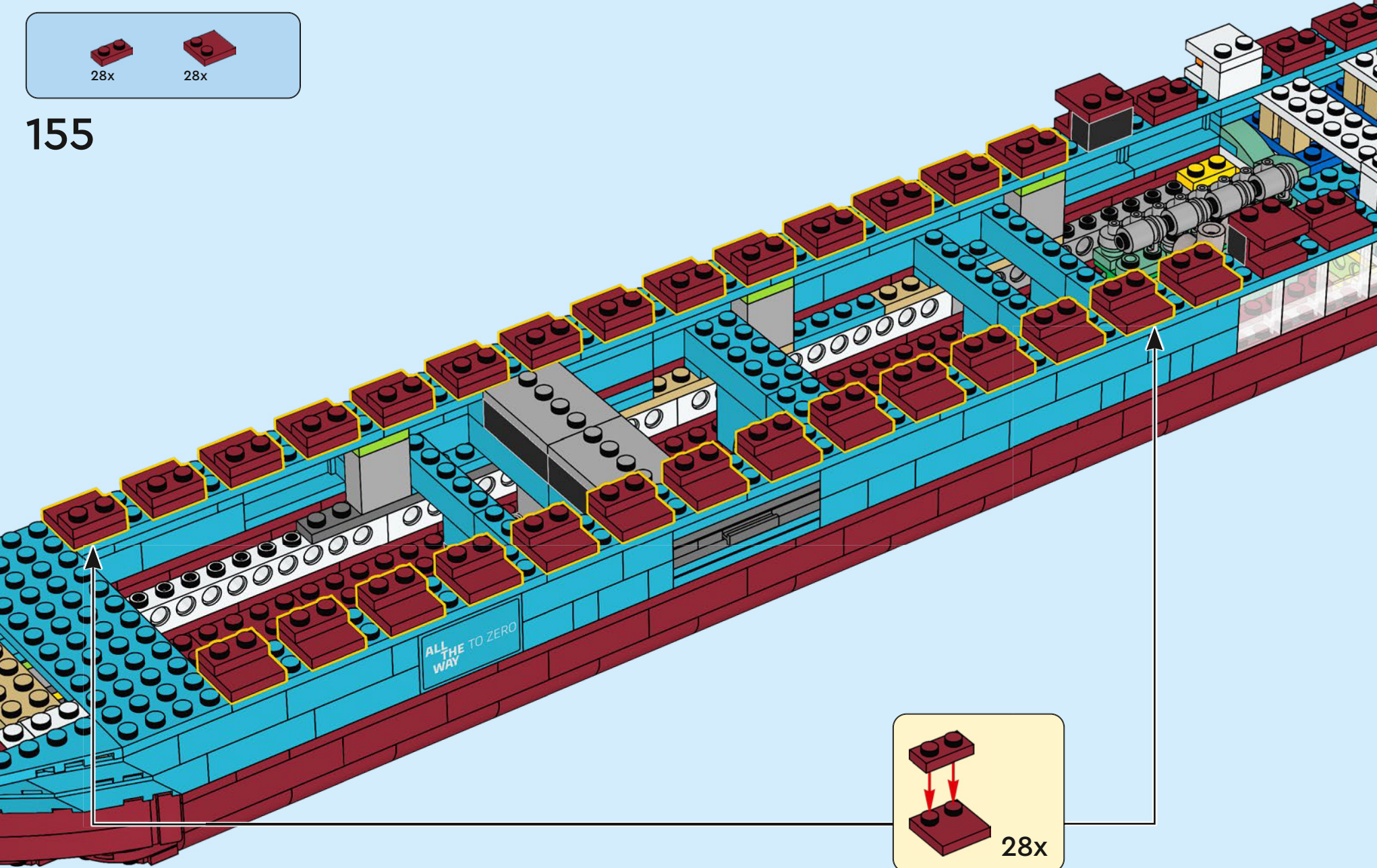

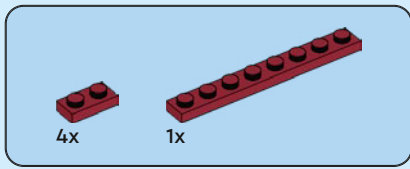

156

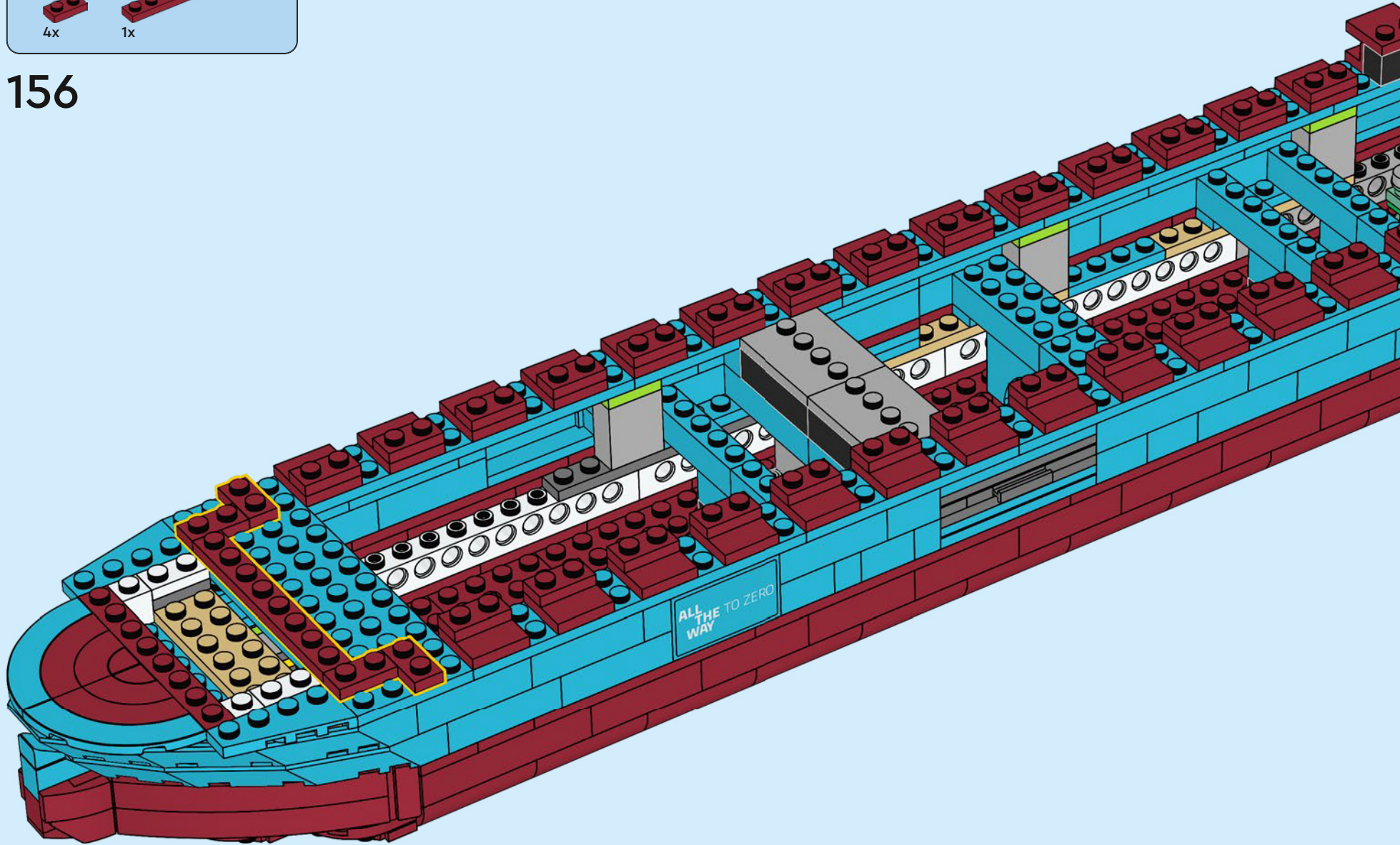

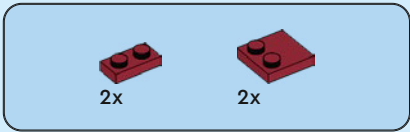

157

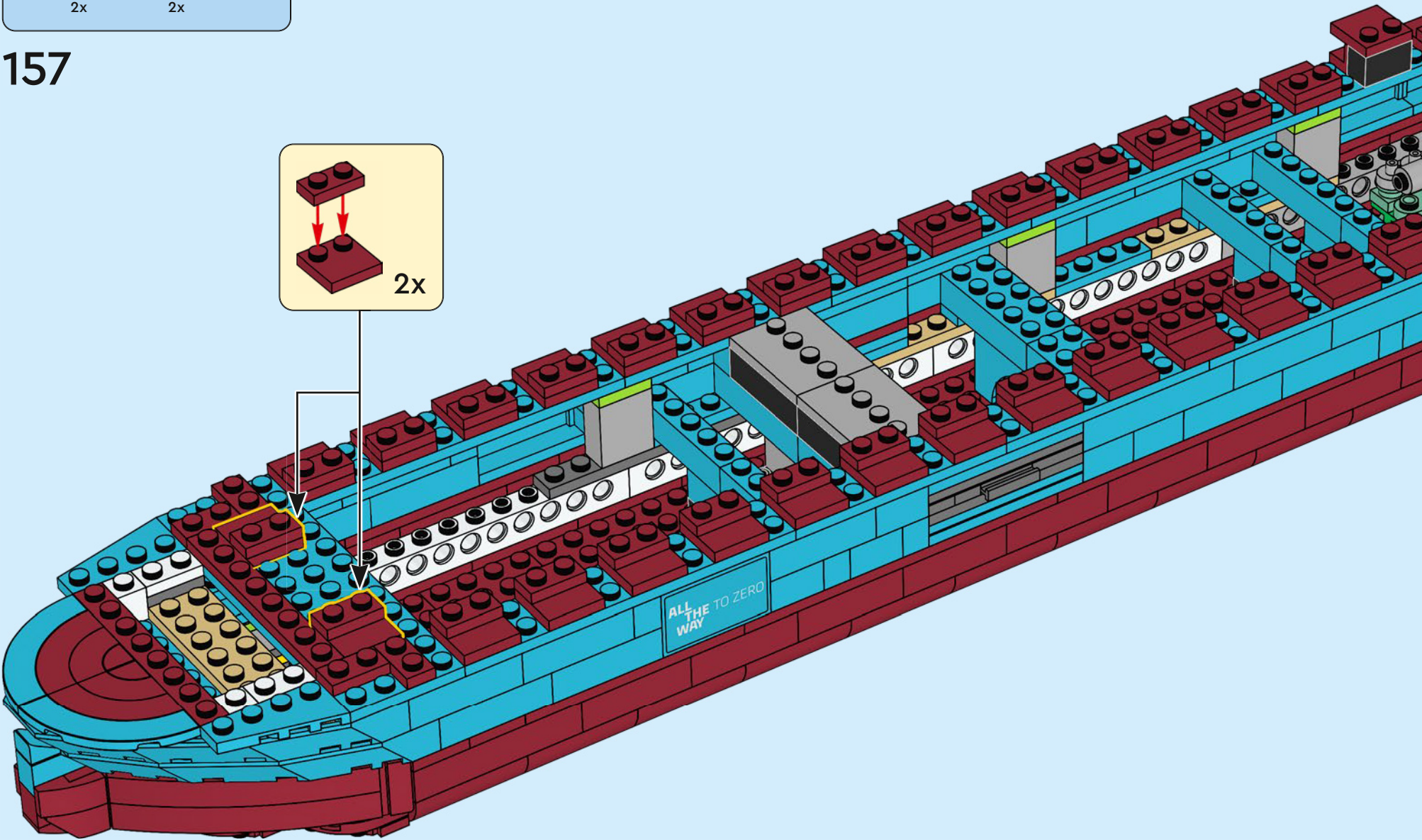
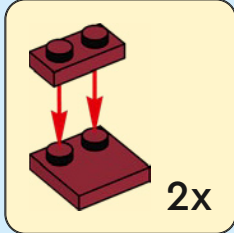

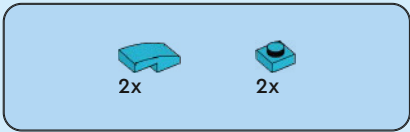

158

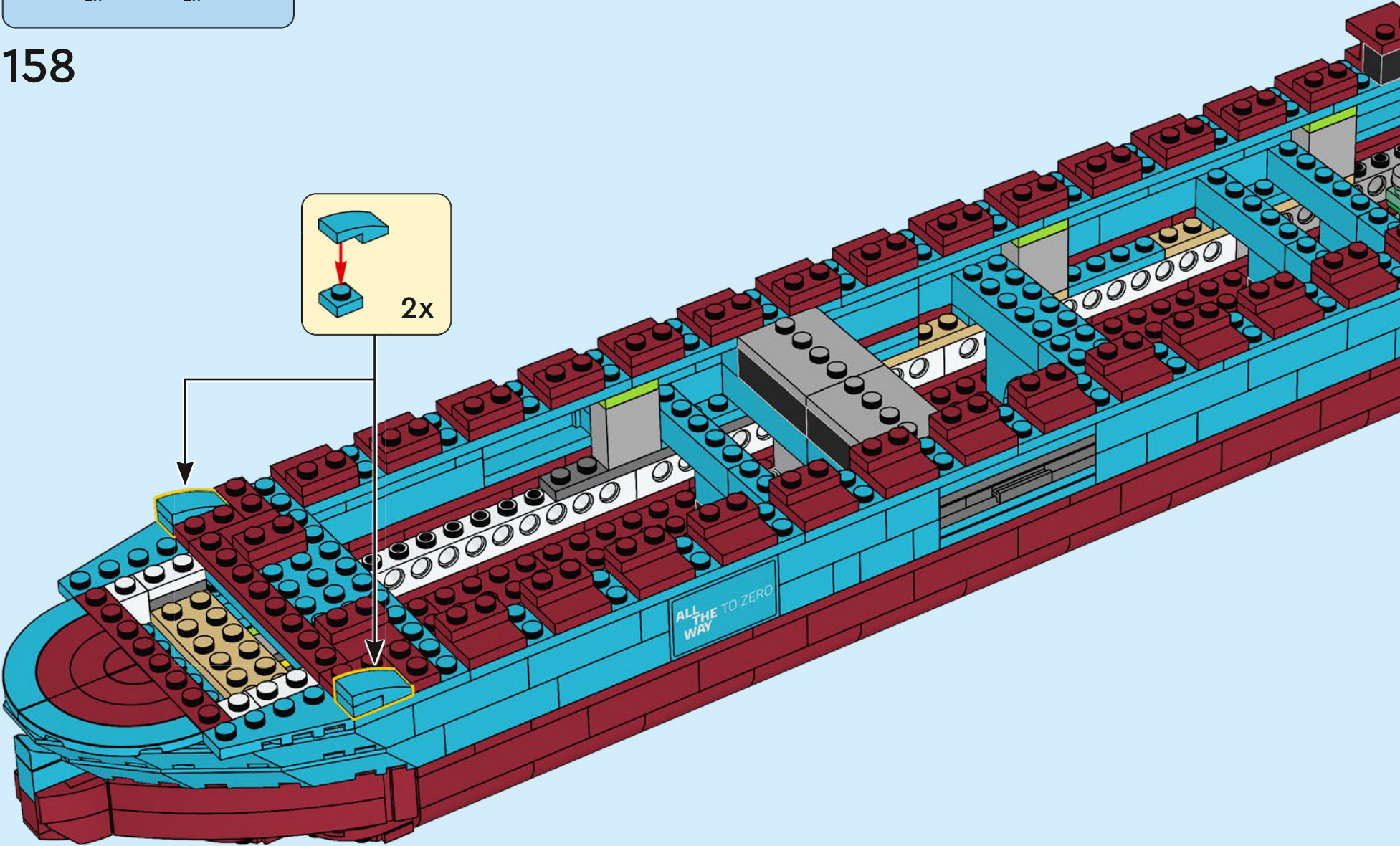
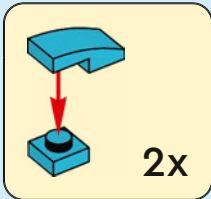

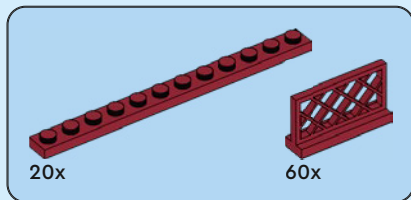
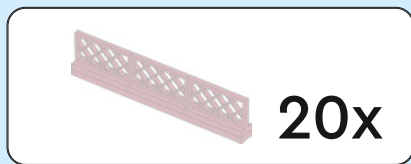

159

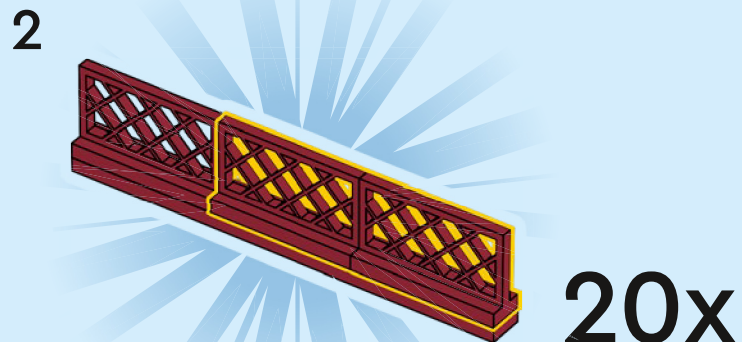
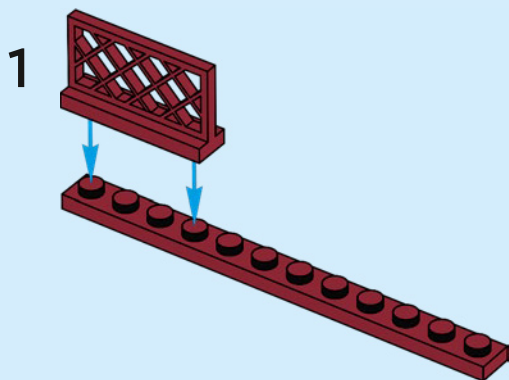
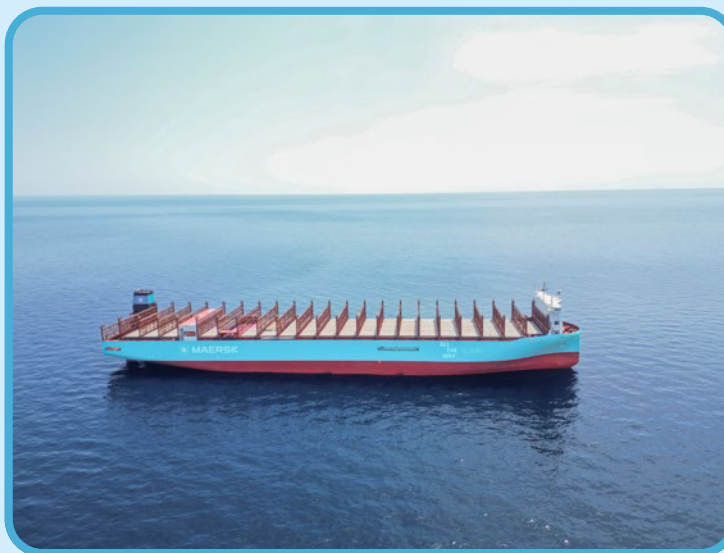

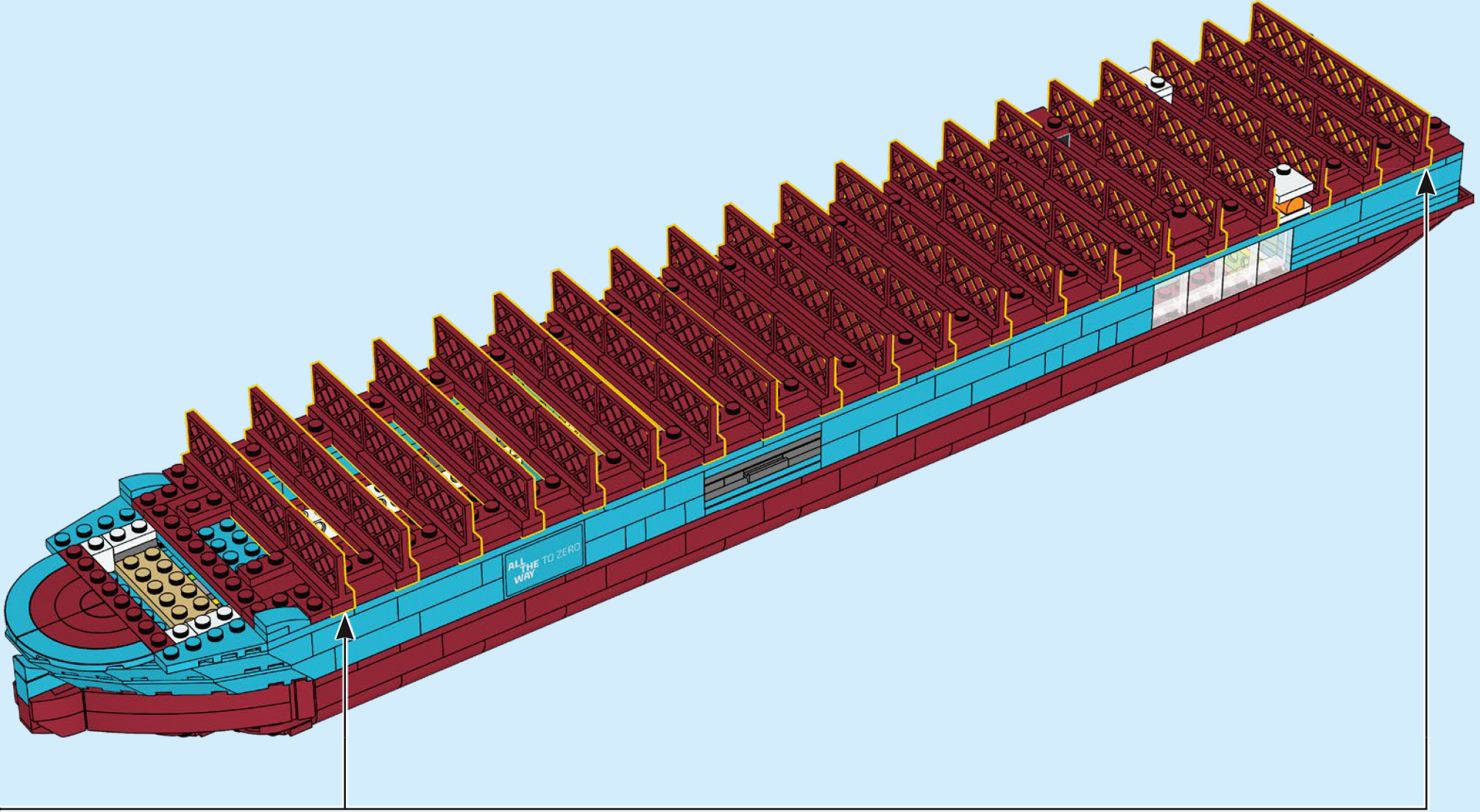

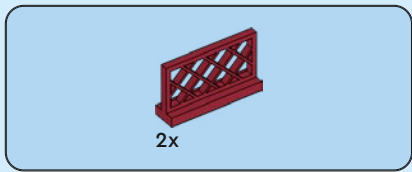

160

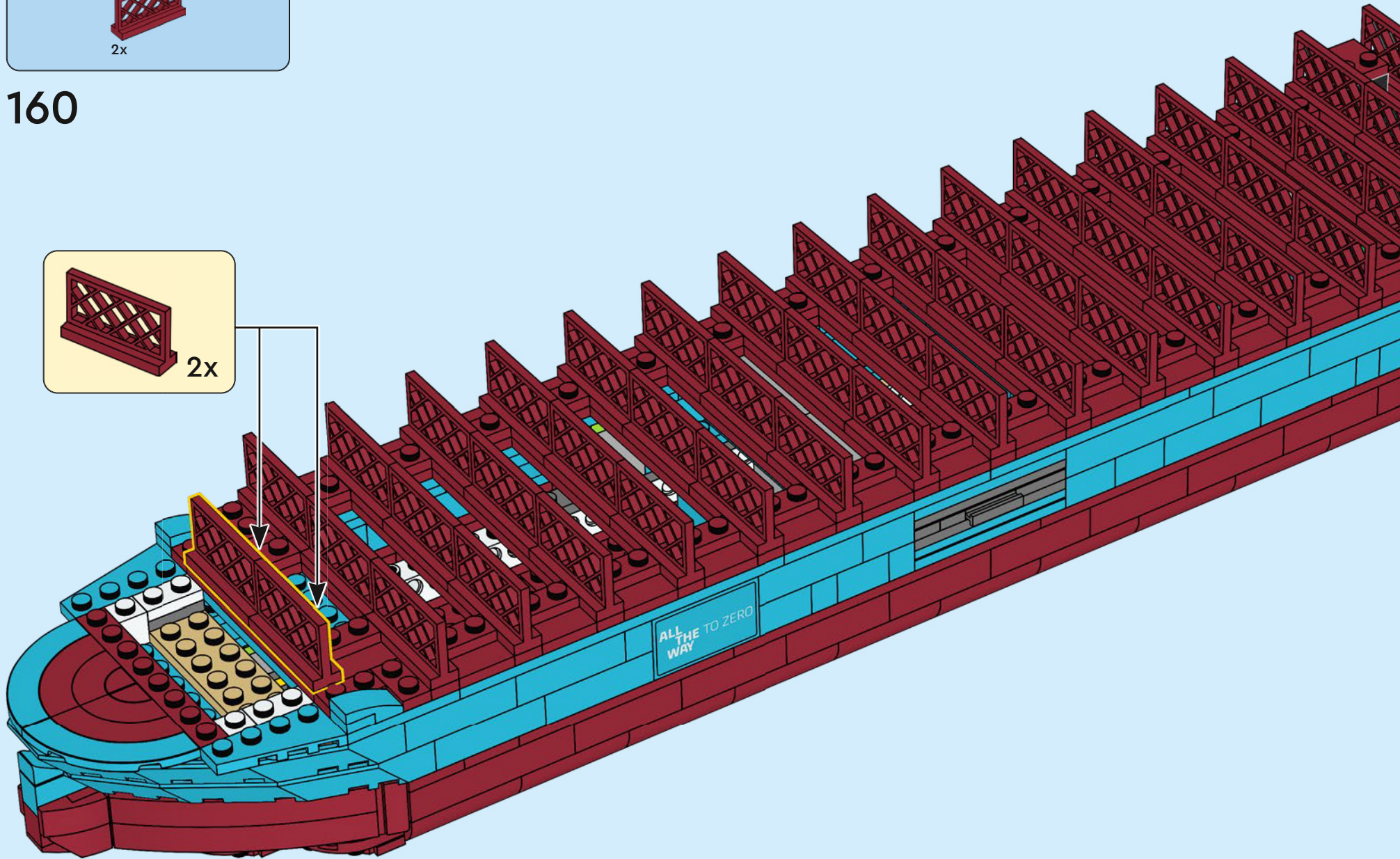
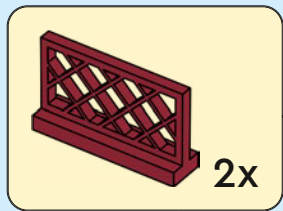

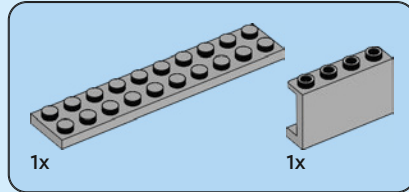
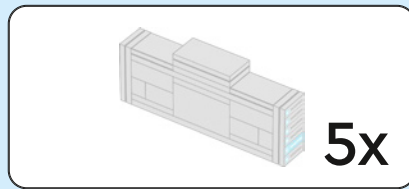

161

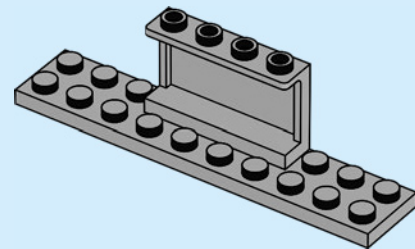
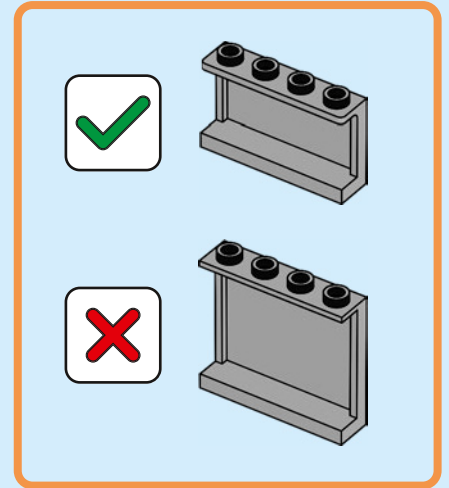

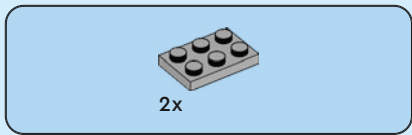

162

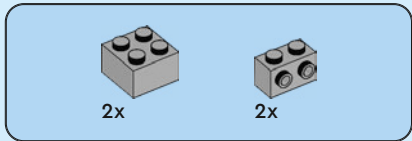
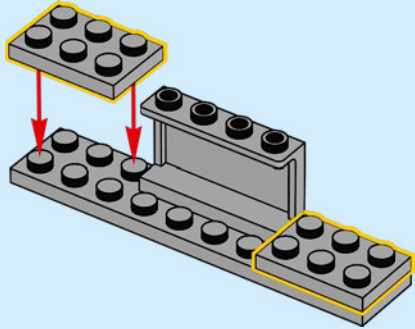

163

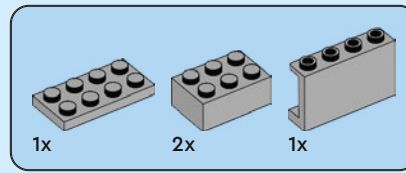
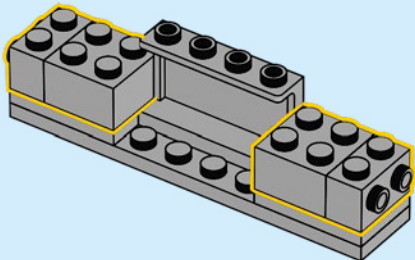

164

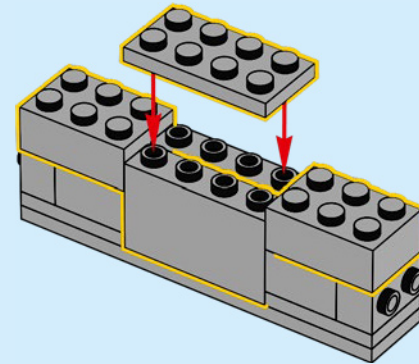

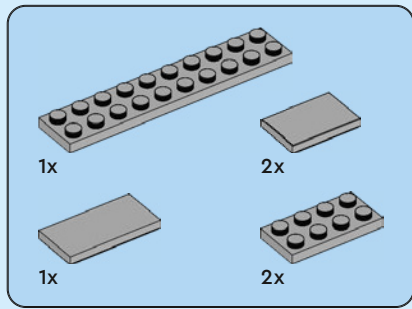

165

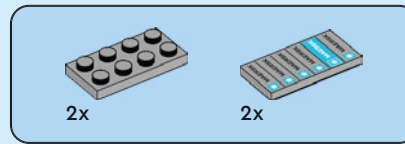
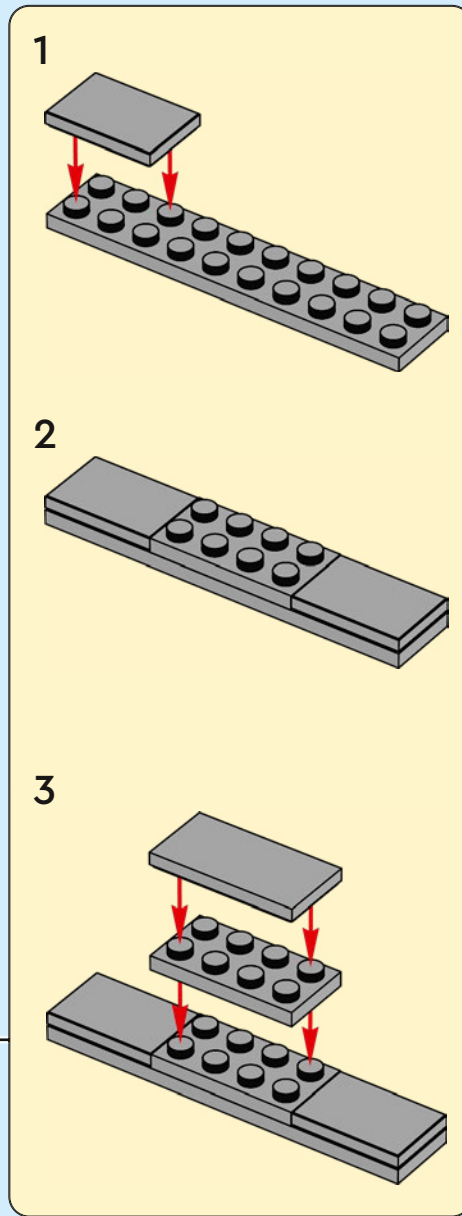
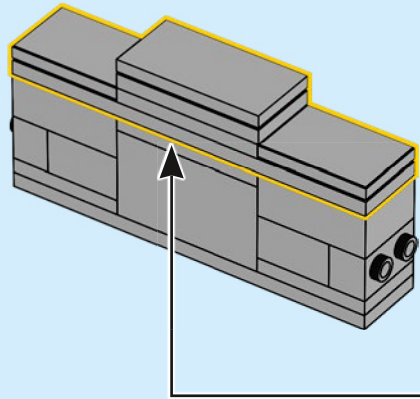

166

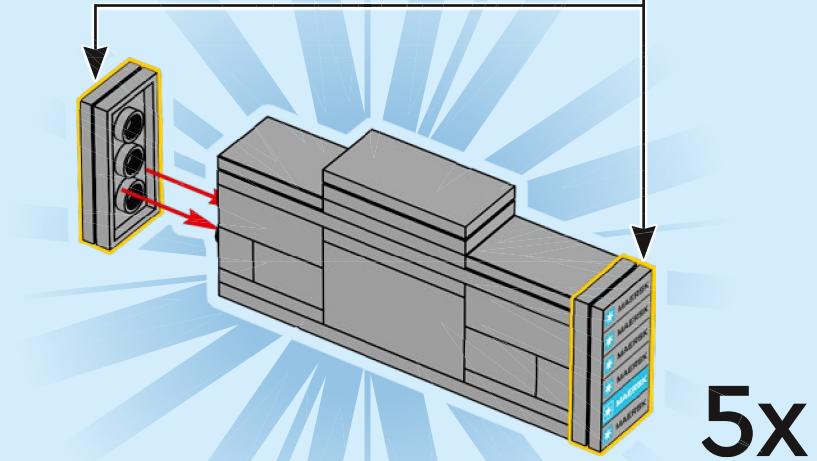
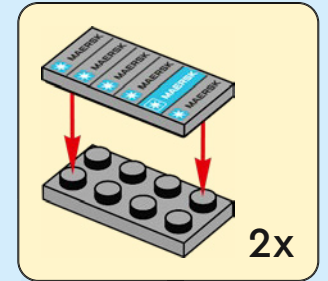

5x



167

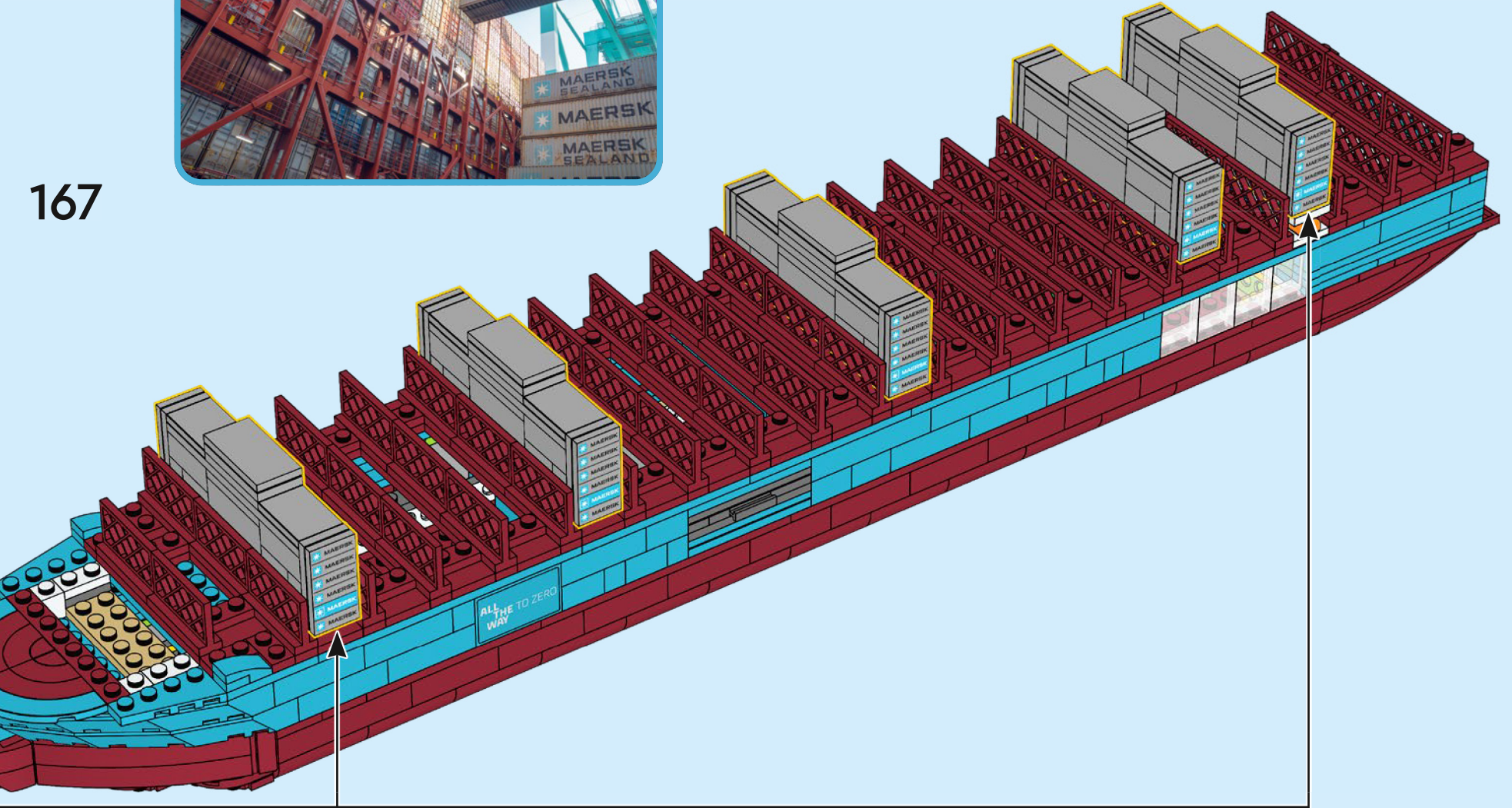

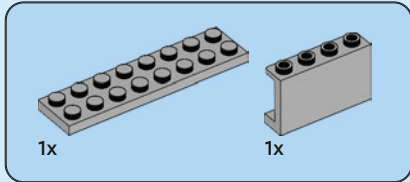
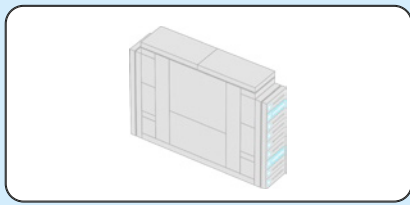

168

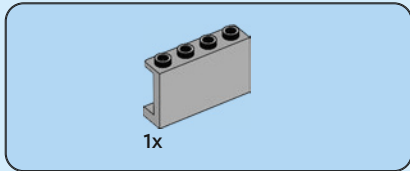
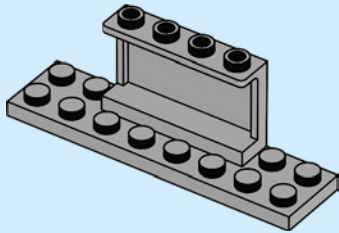

169

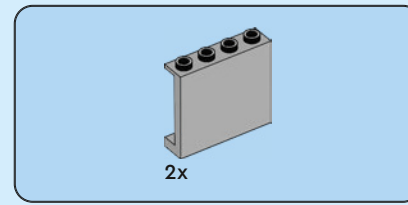
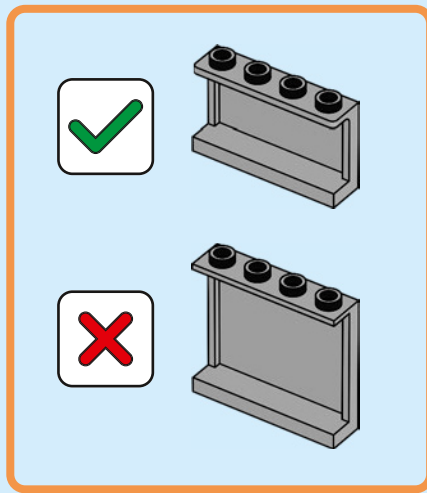
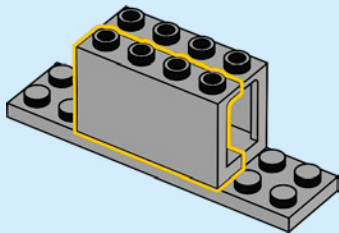

170

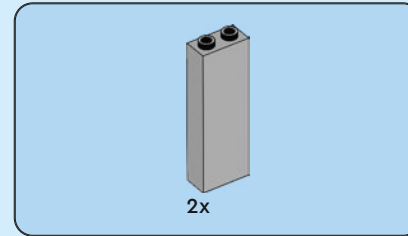
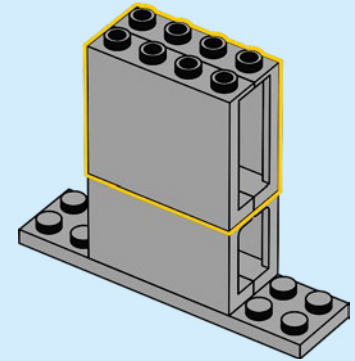

171

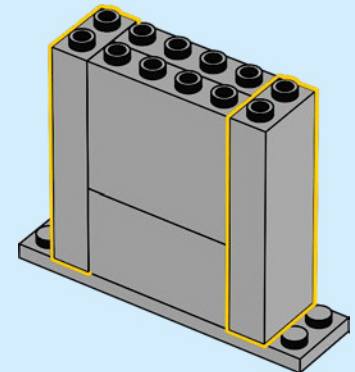



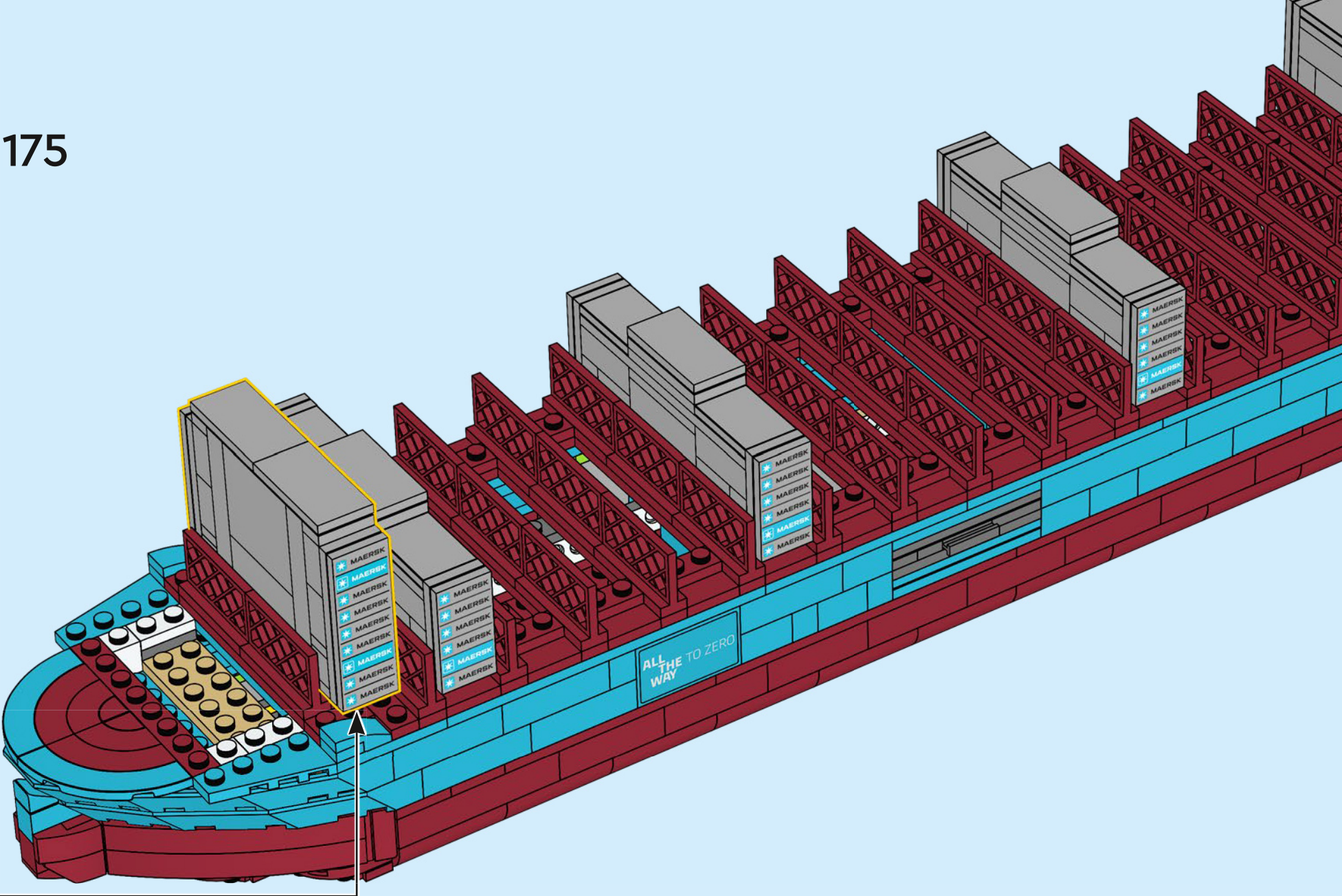

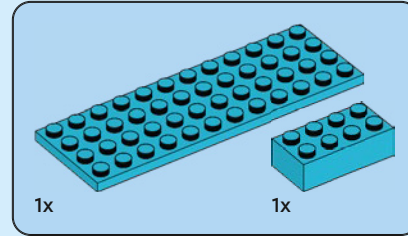
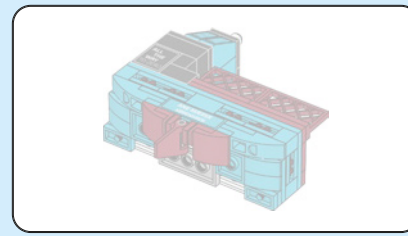

176

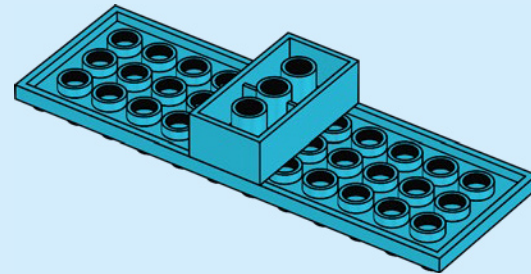

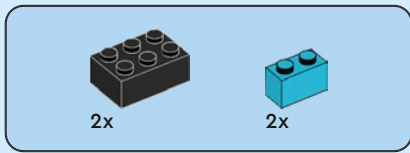

177

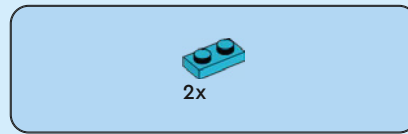
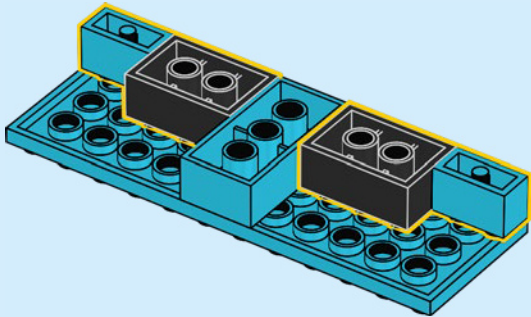

178

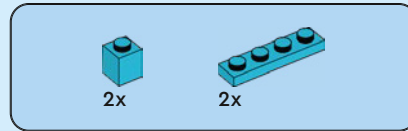
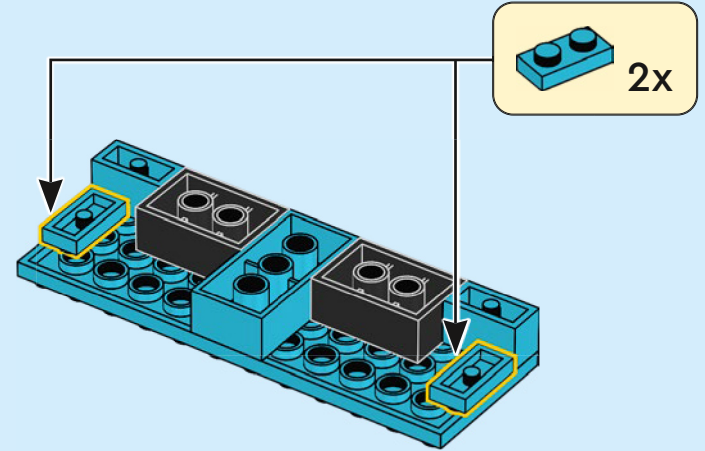

179

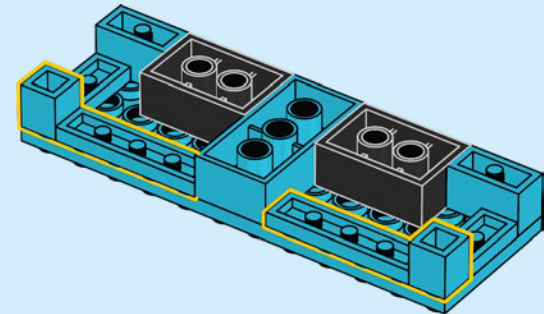

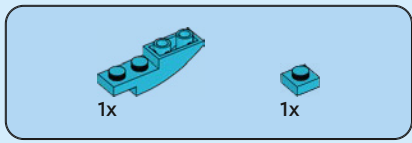

180

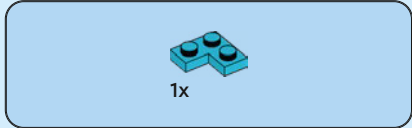
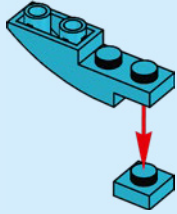

181

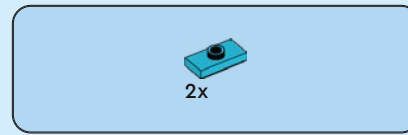
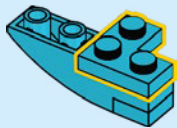

182

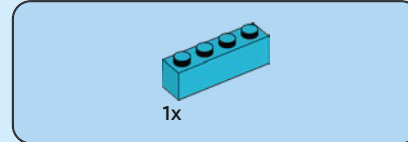
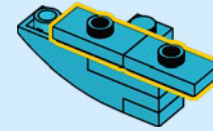

183

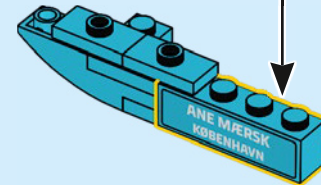
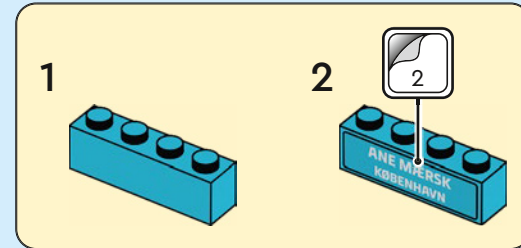

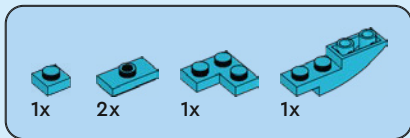

184

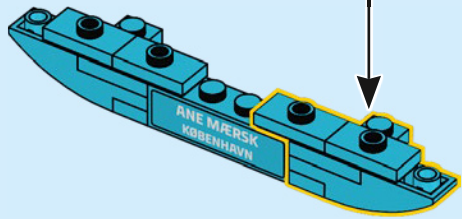
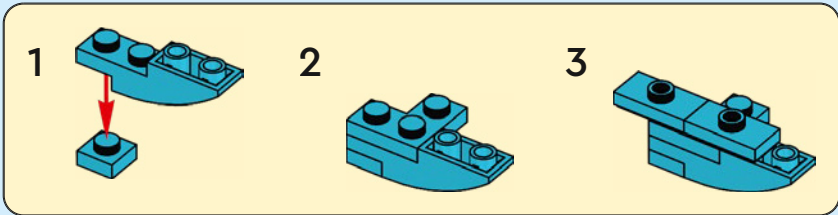

185

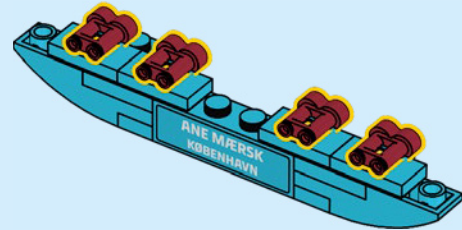

186

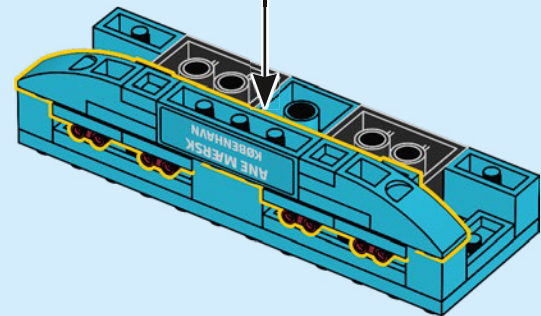

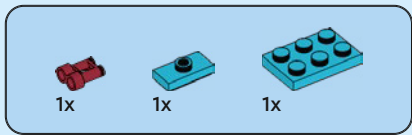

187

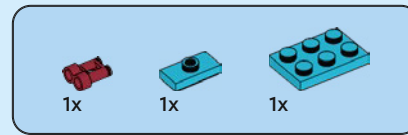
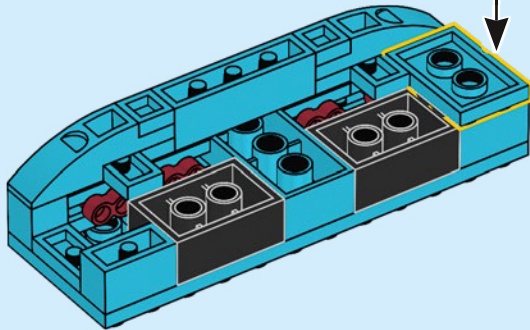
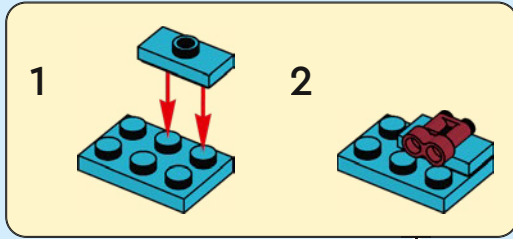

188

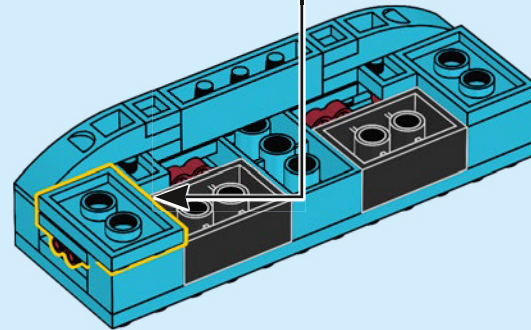
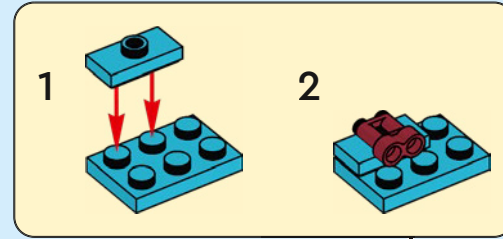

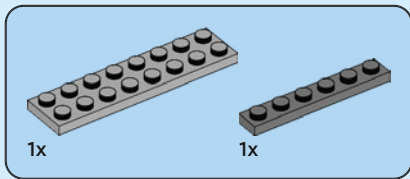

189

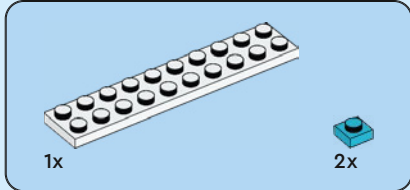
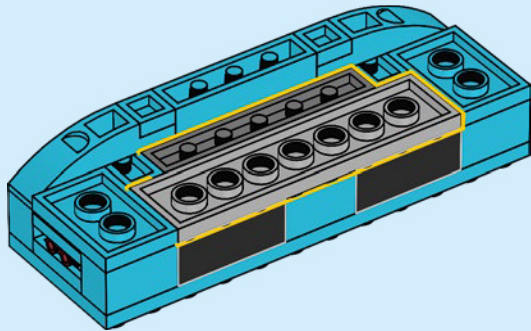

190

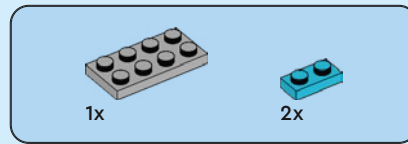
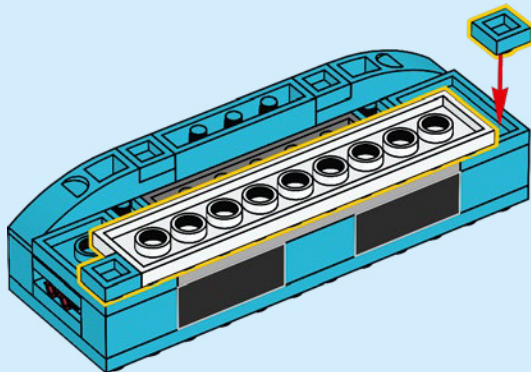

191

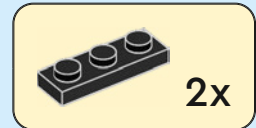
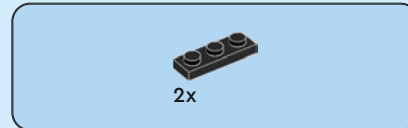
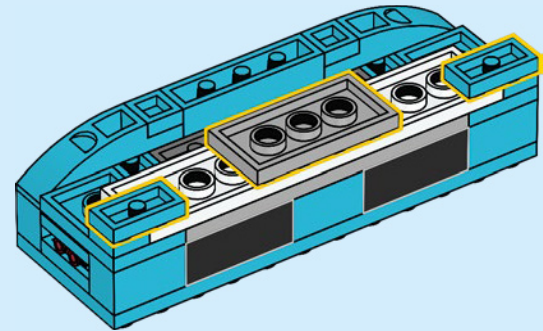

192

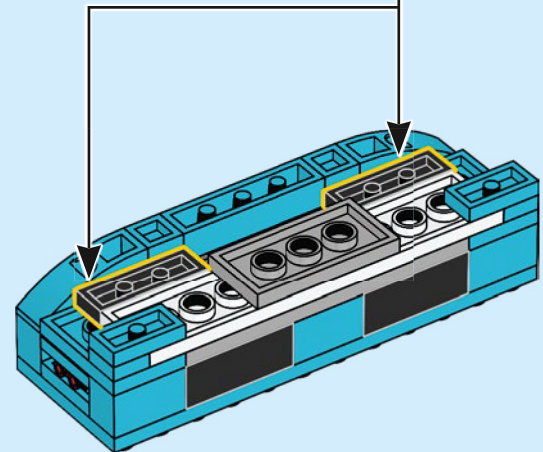



4x

# 193

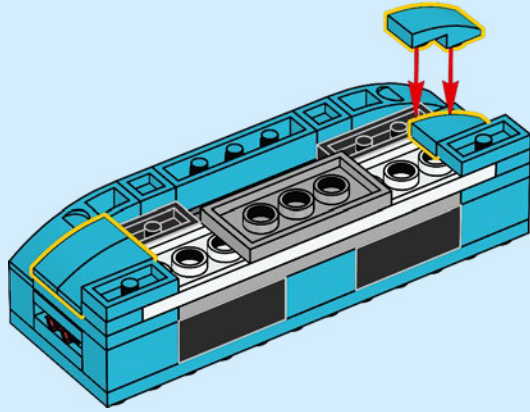

2x

# 194

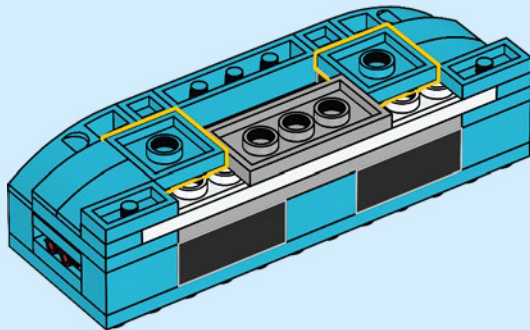

1x



1x



1x

# 195

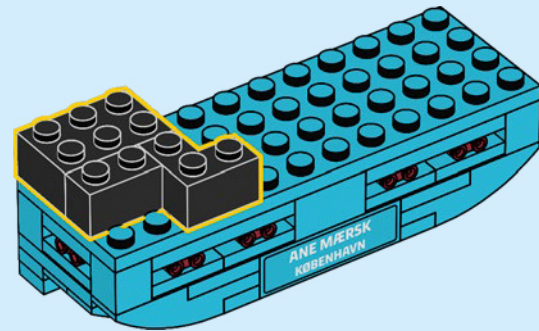



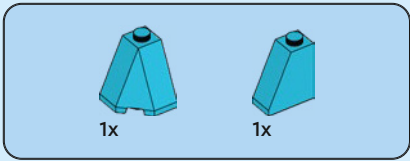

# 200

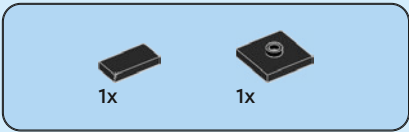
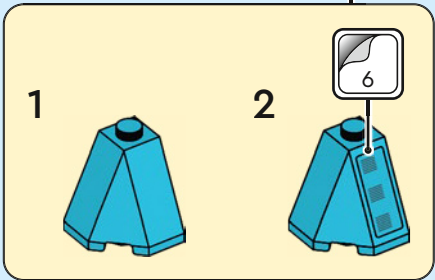
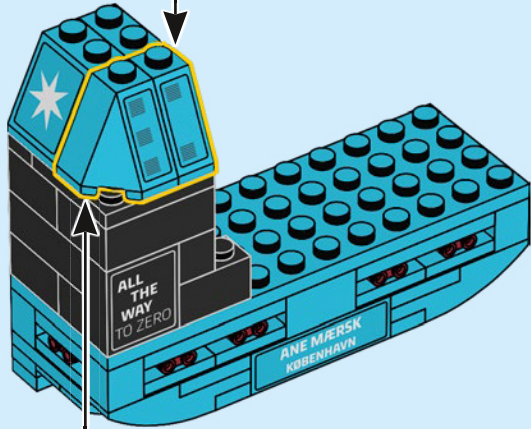
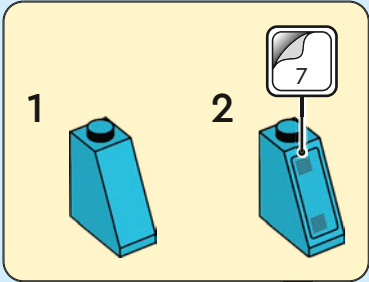

# 201

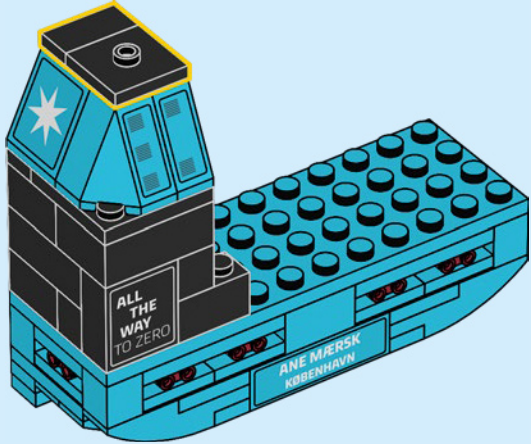



1x



1x

# 202

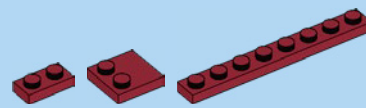
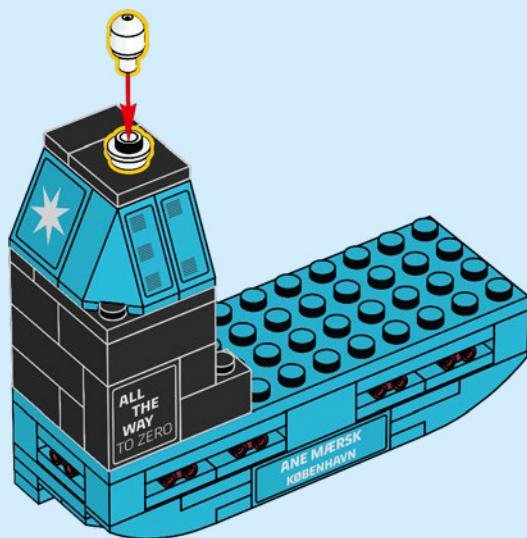

1x

2x

1x

# 203

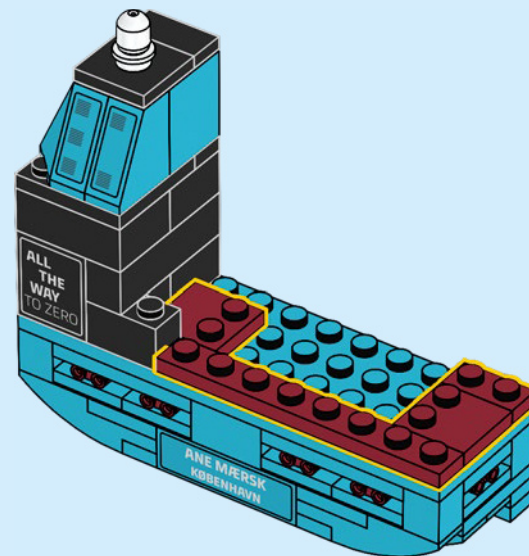



2x

204

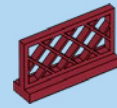
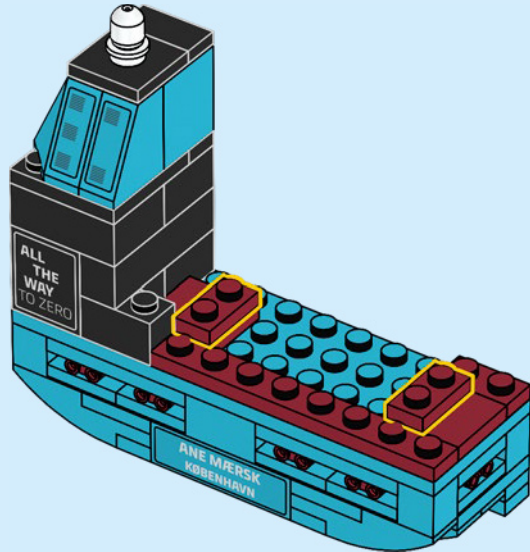

2x

205

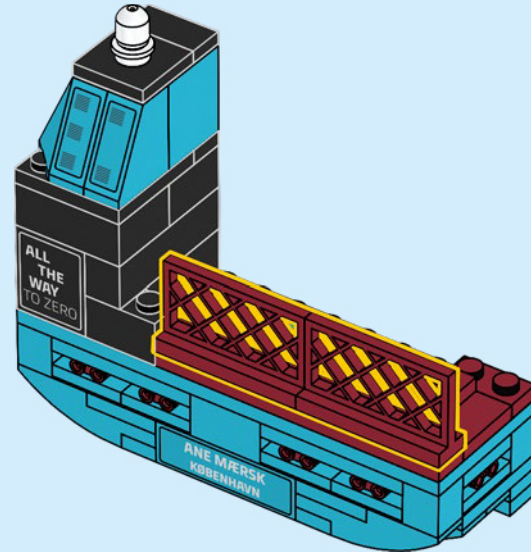

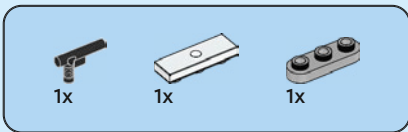

# 206

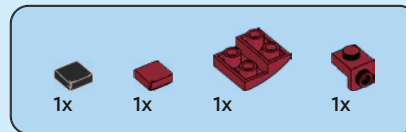
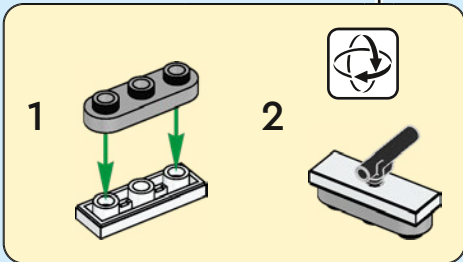
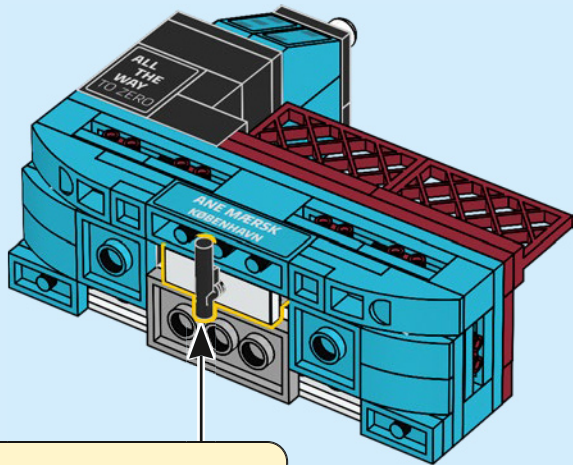

# 207

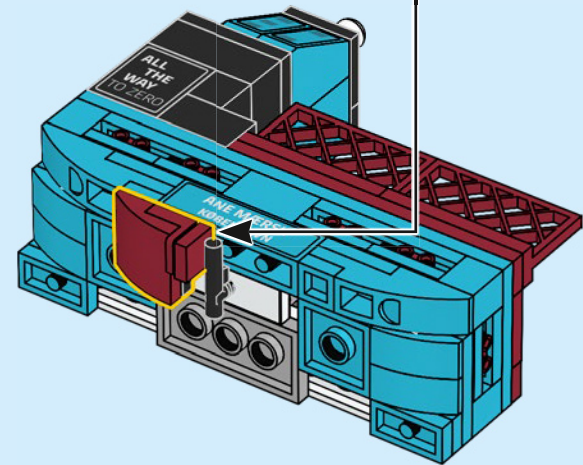
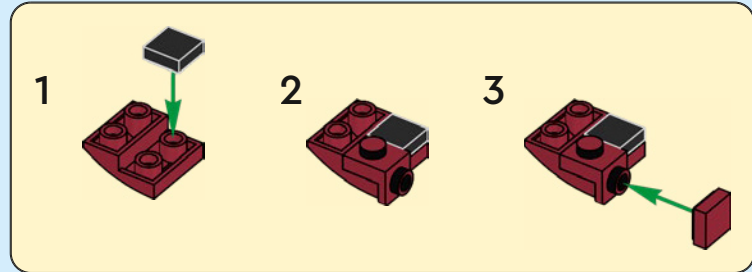

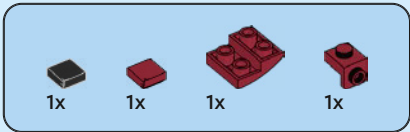

# 208

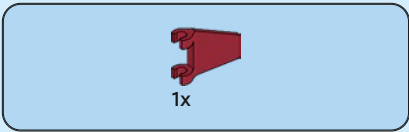
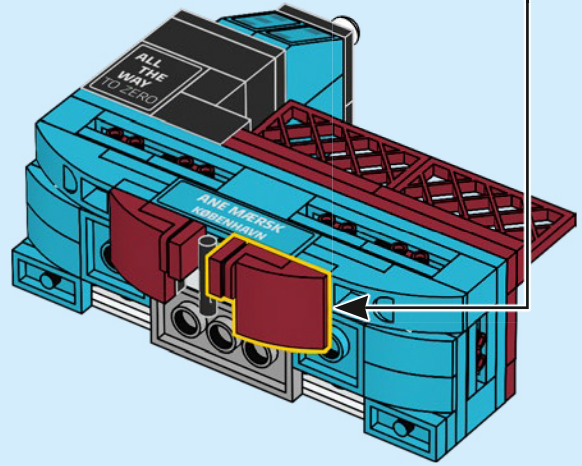

# 209

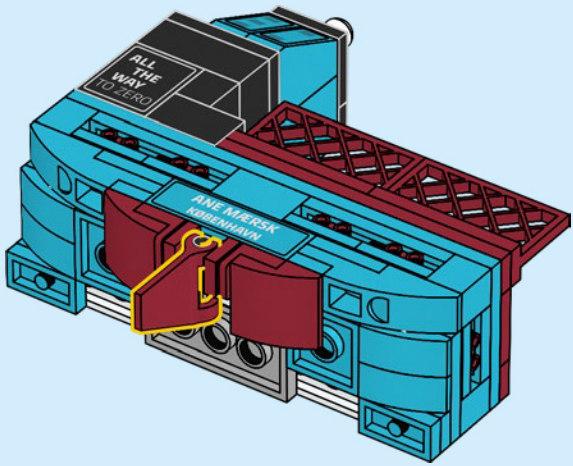

210

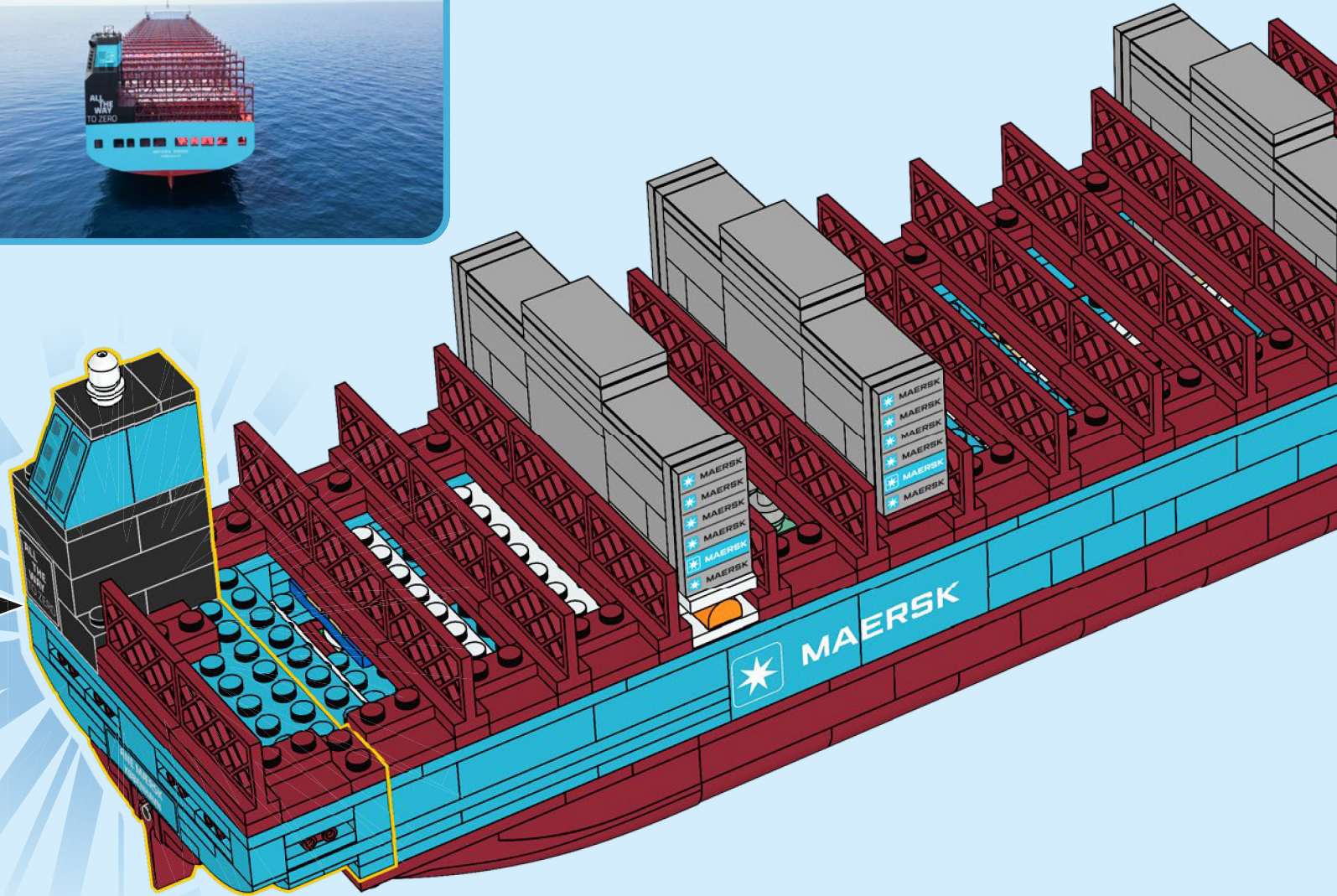
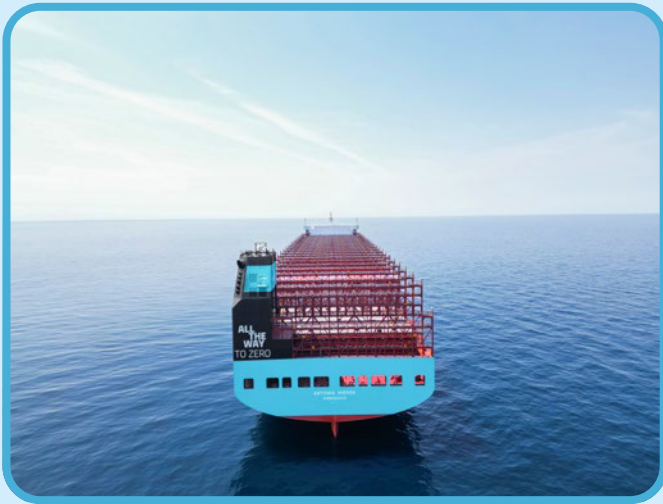

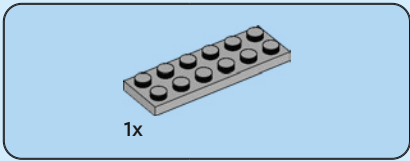

211

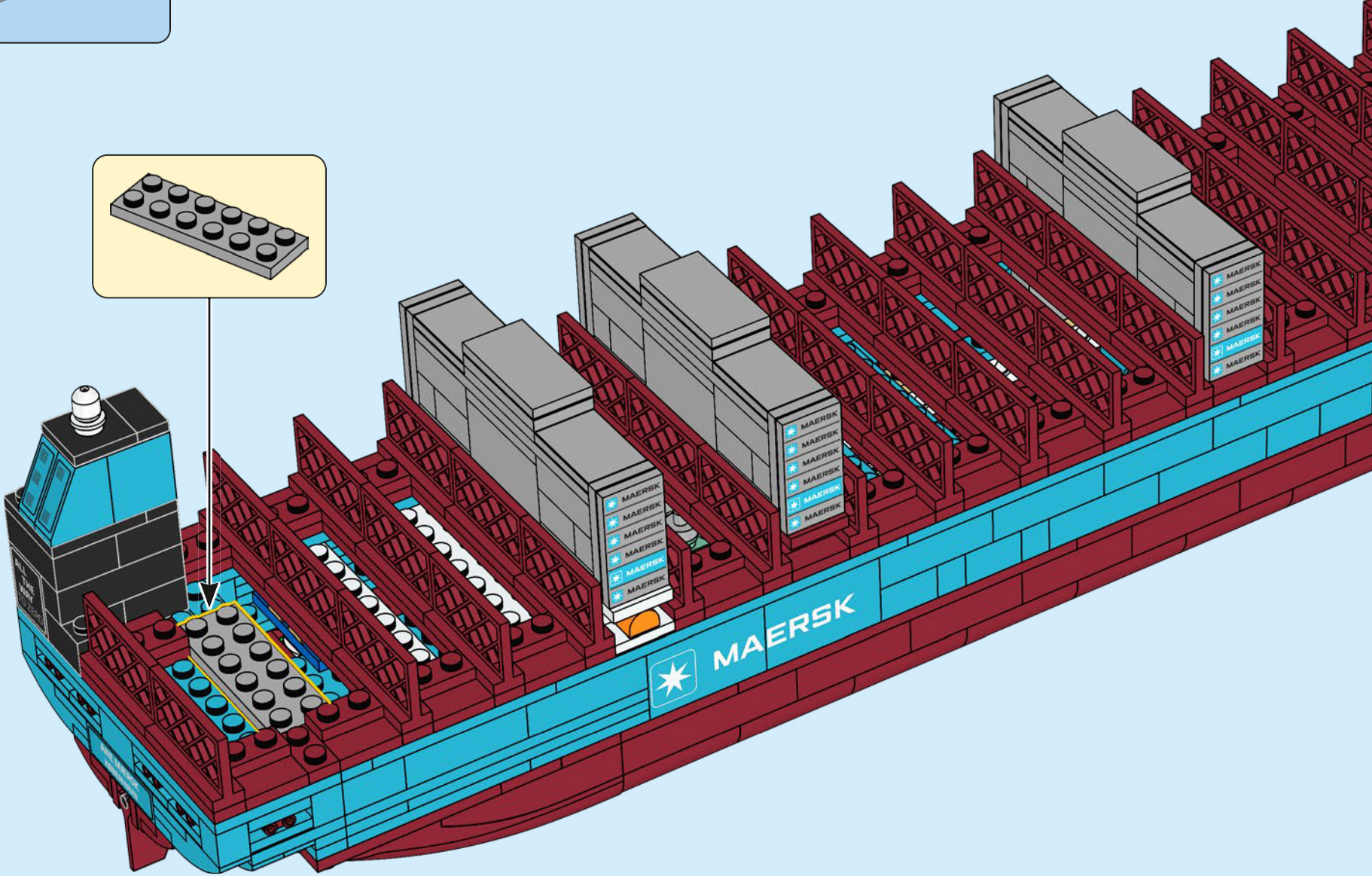
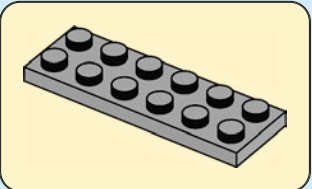

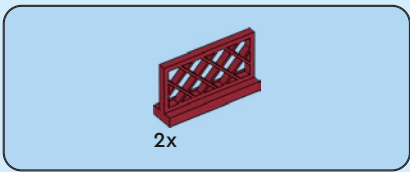

212

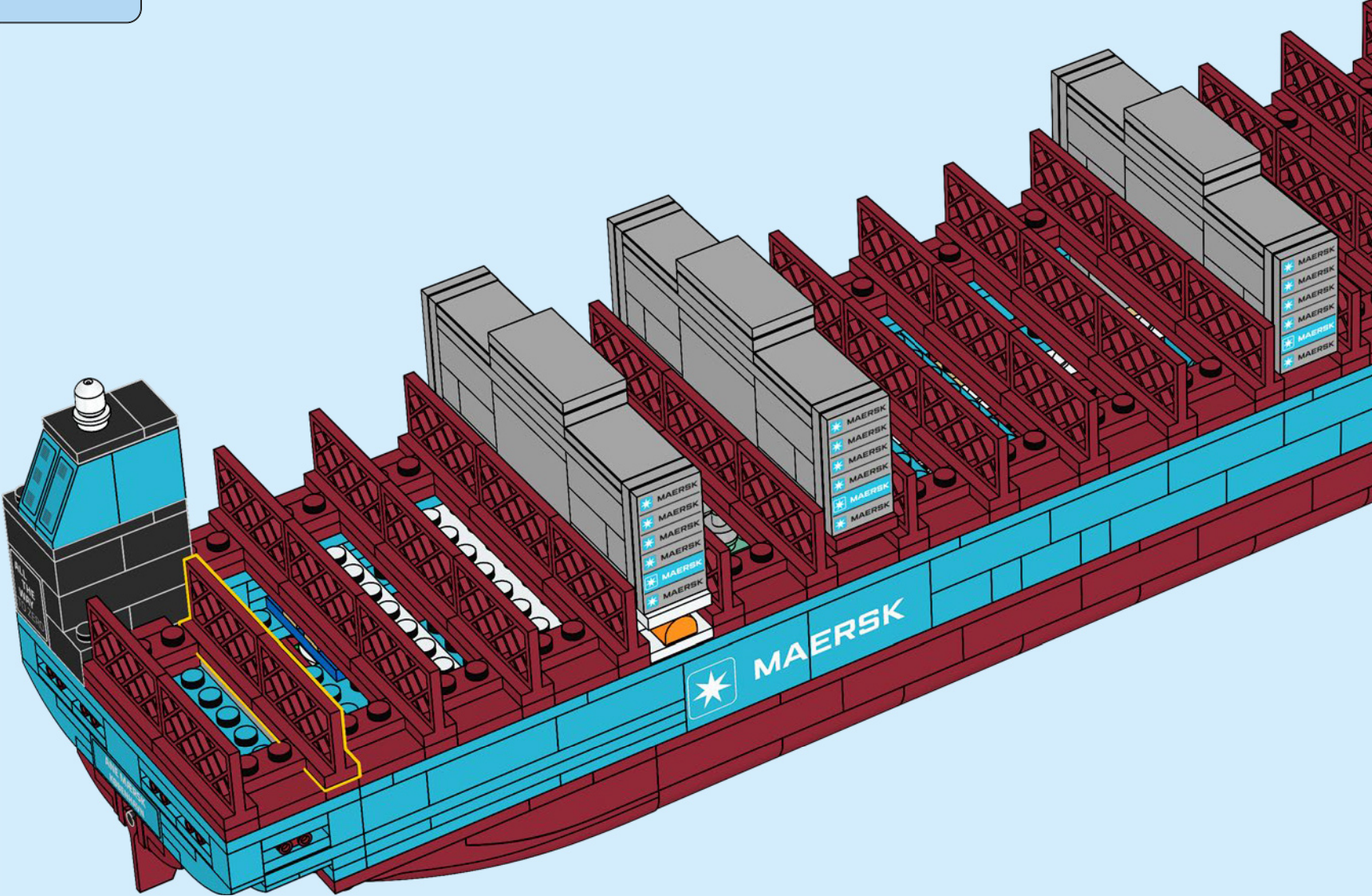

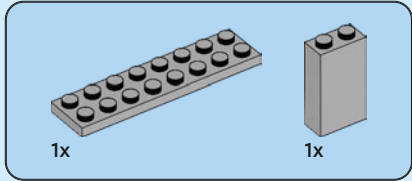
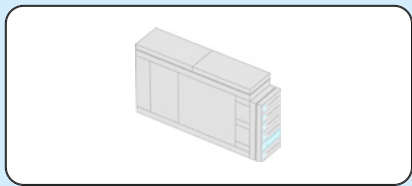

213

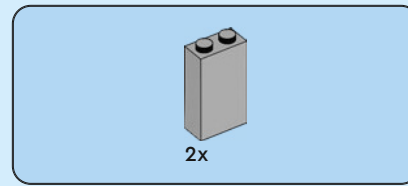
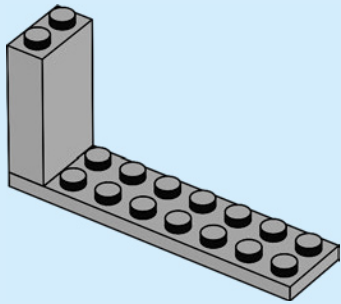

214

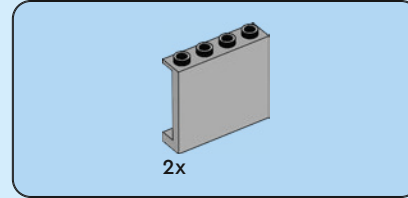
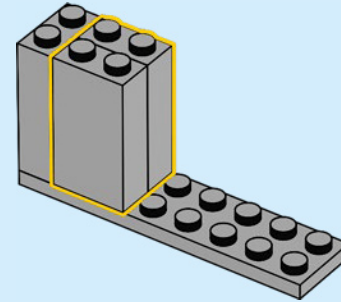

215

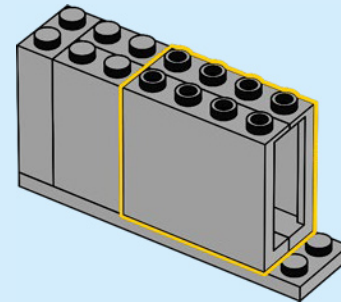

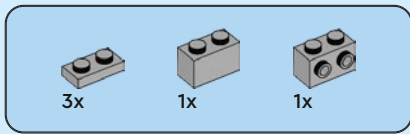

216

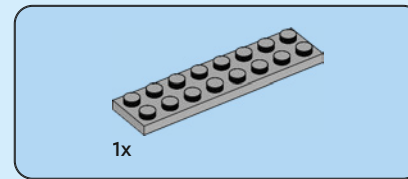
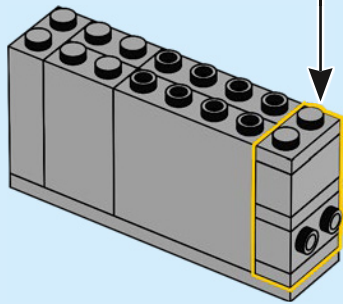
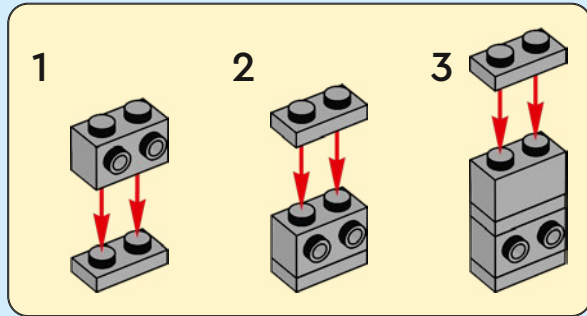

217

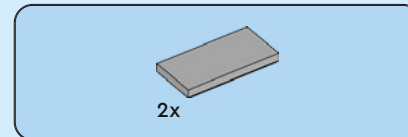
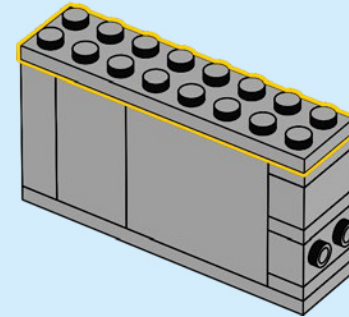

218

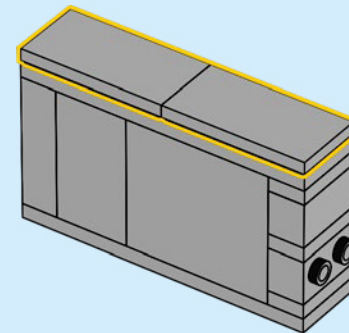

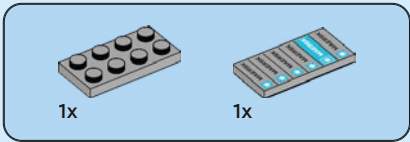

219

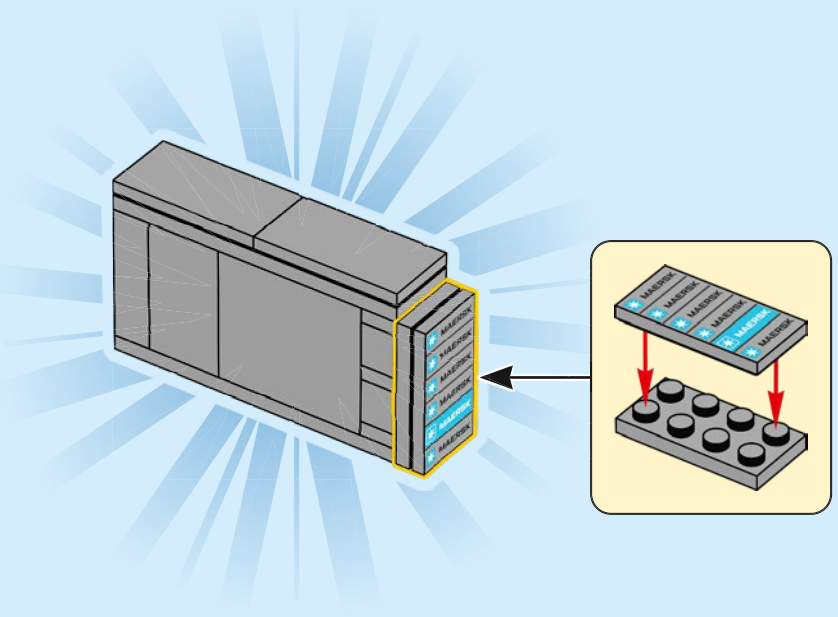

220

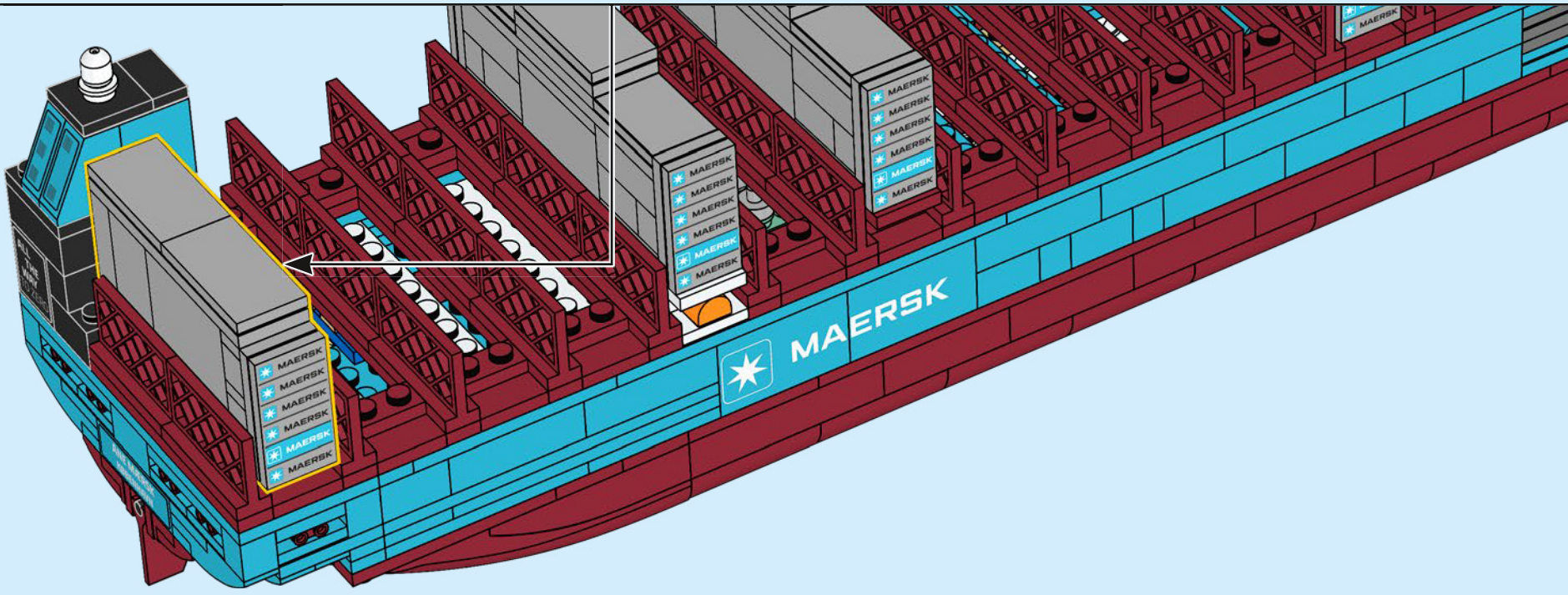

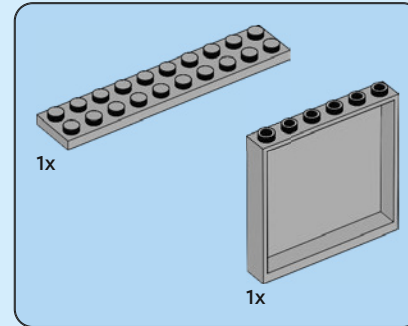
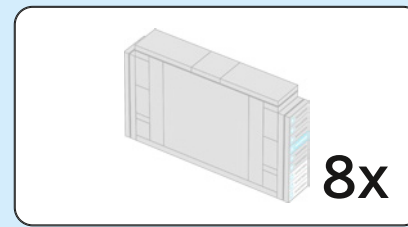

221

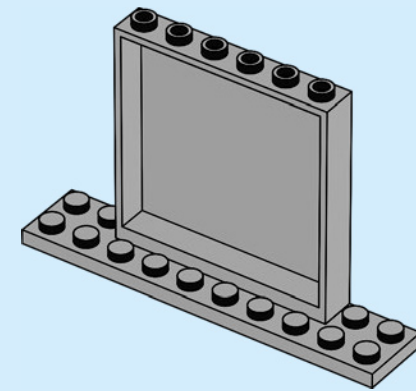

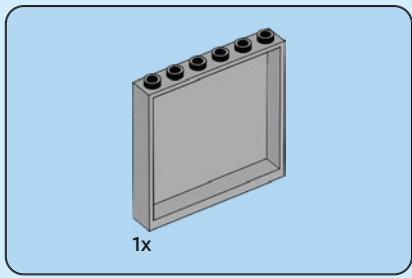

222

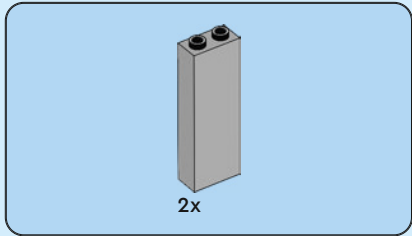
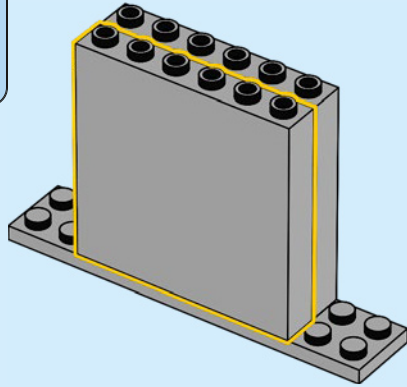

223

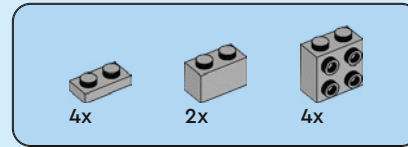
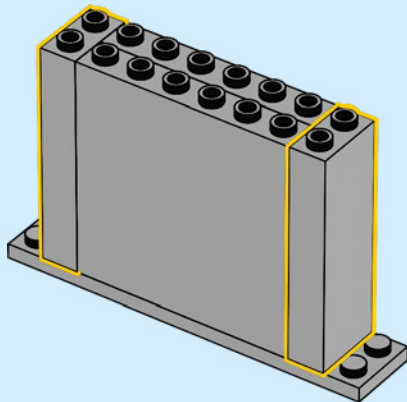

224

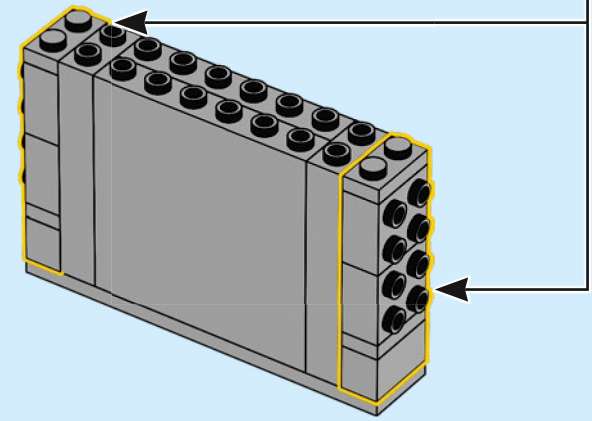
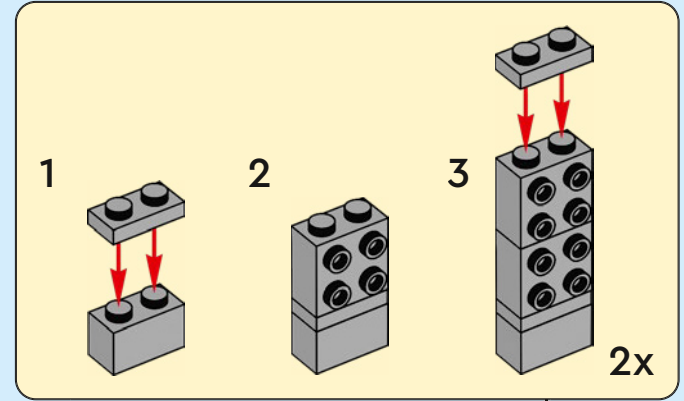

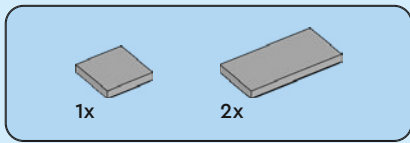

225

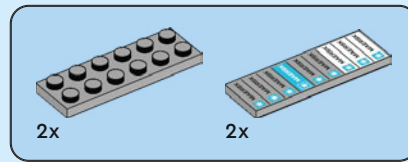
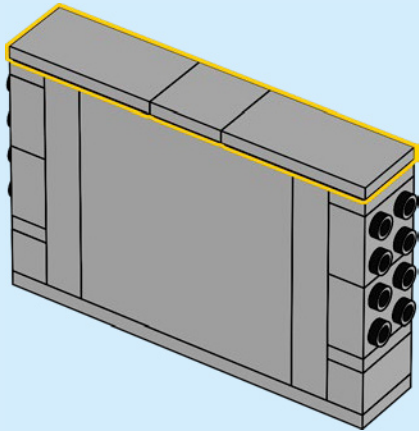

226

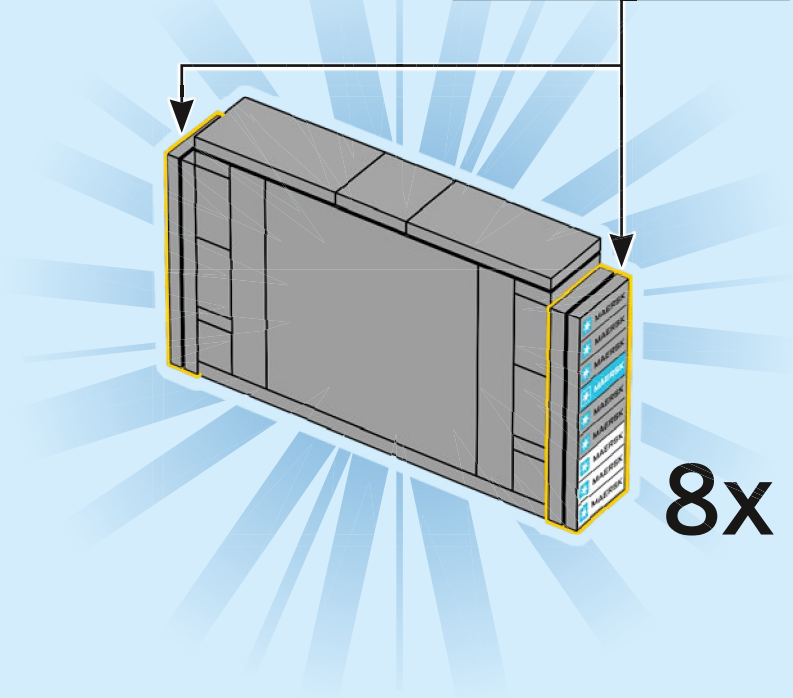
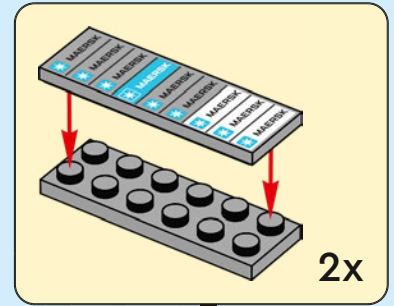

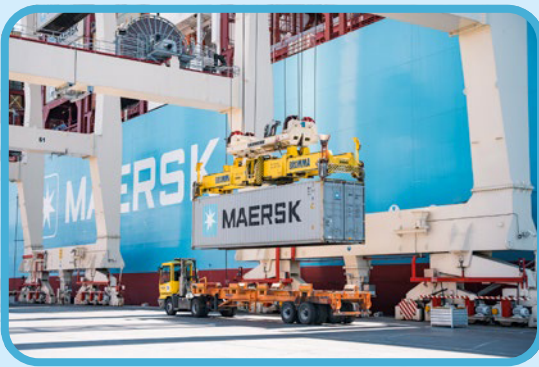

227

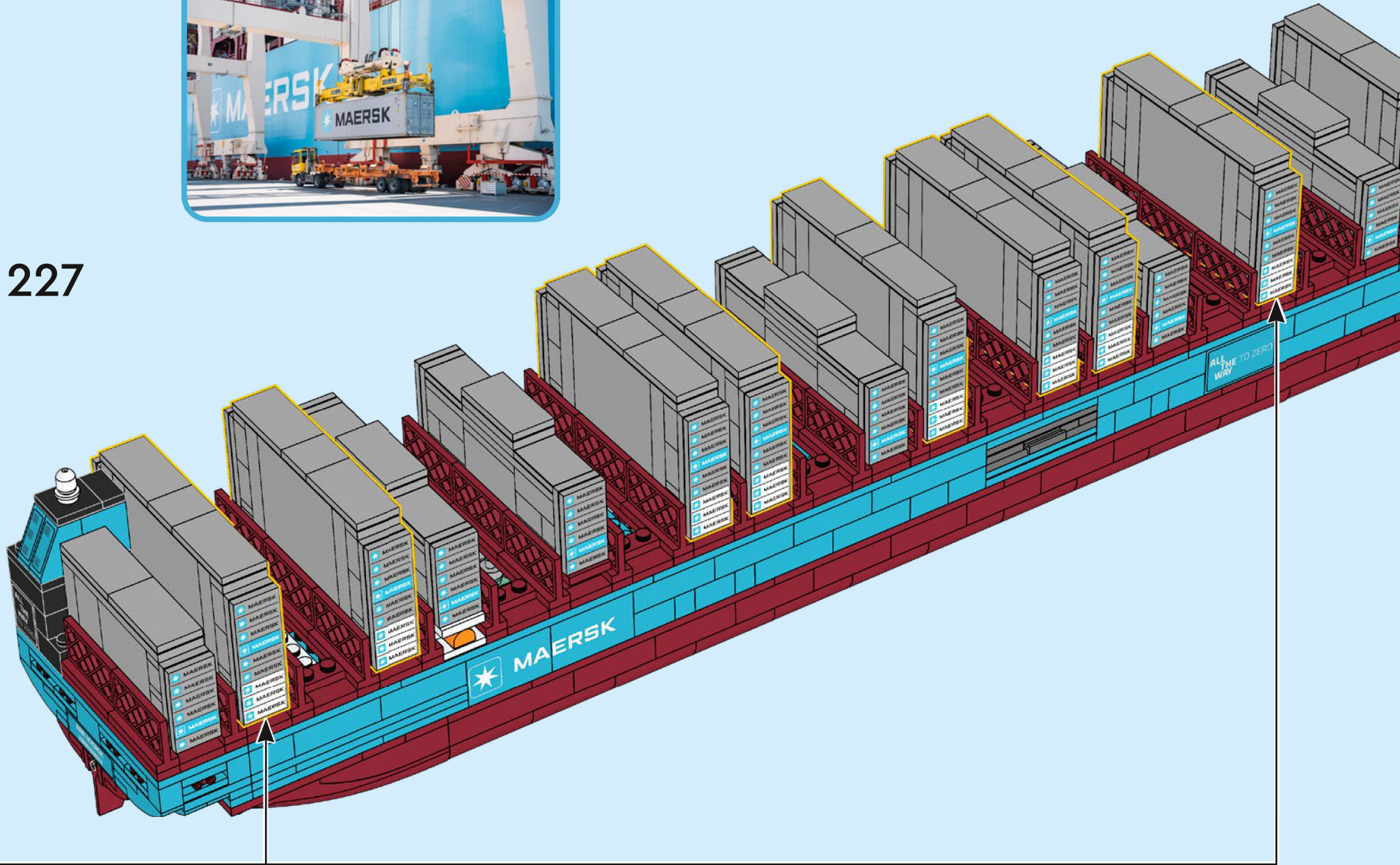





228

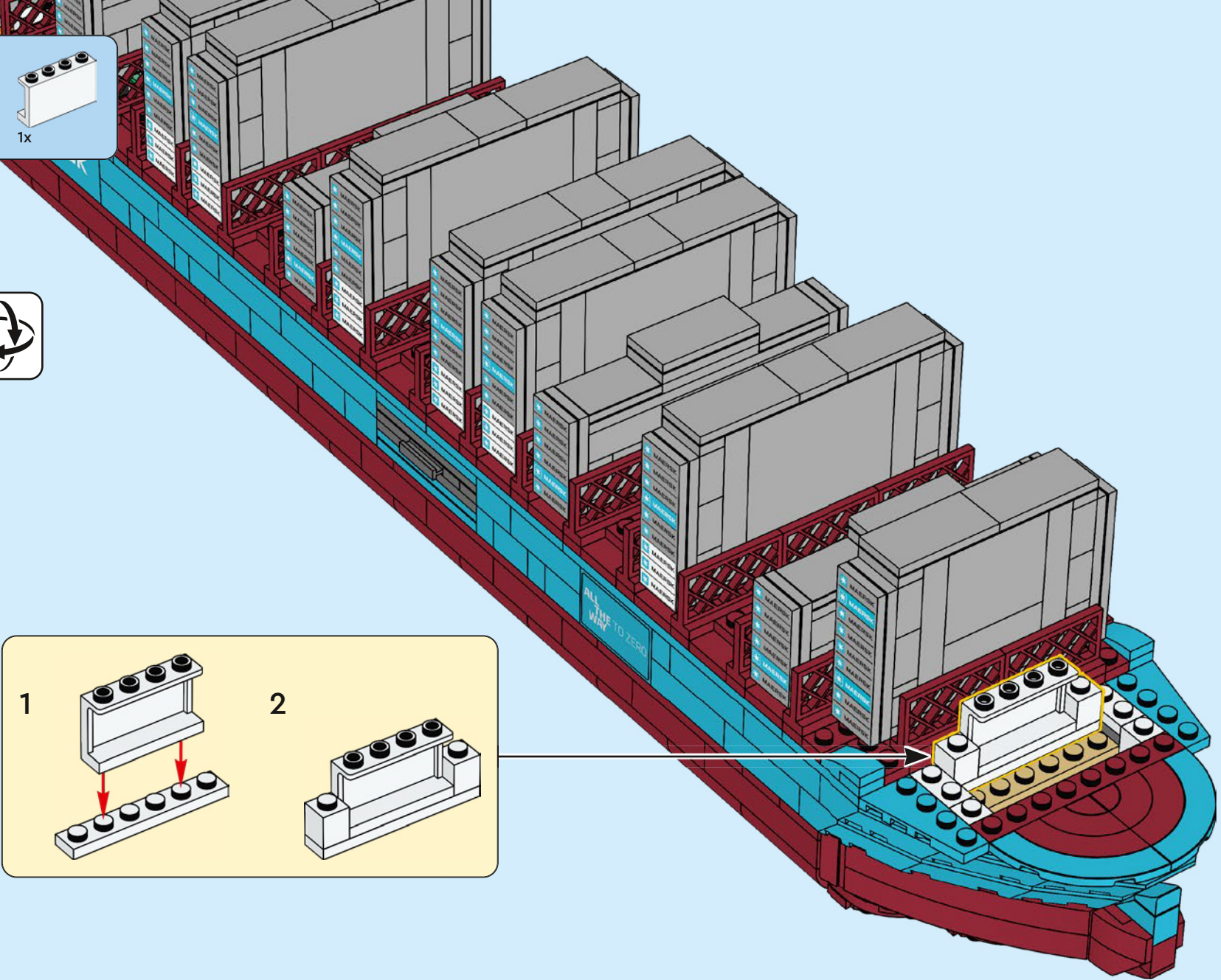
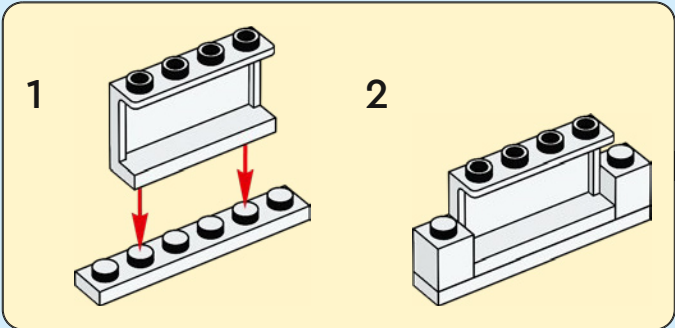

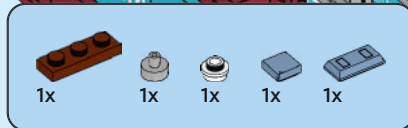

229

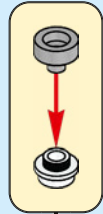
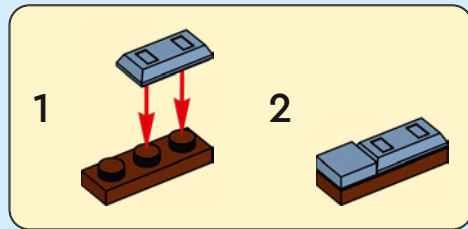



4x

230

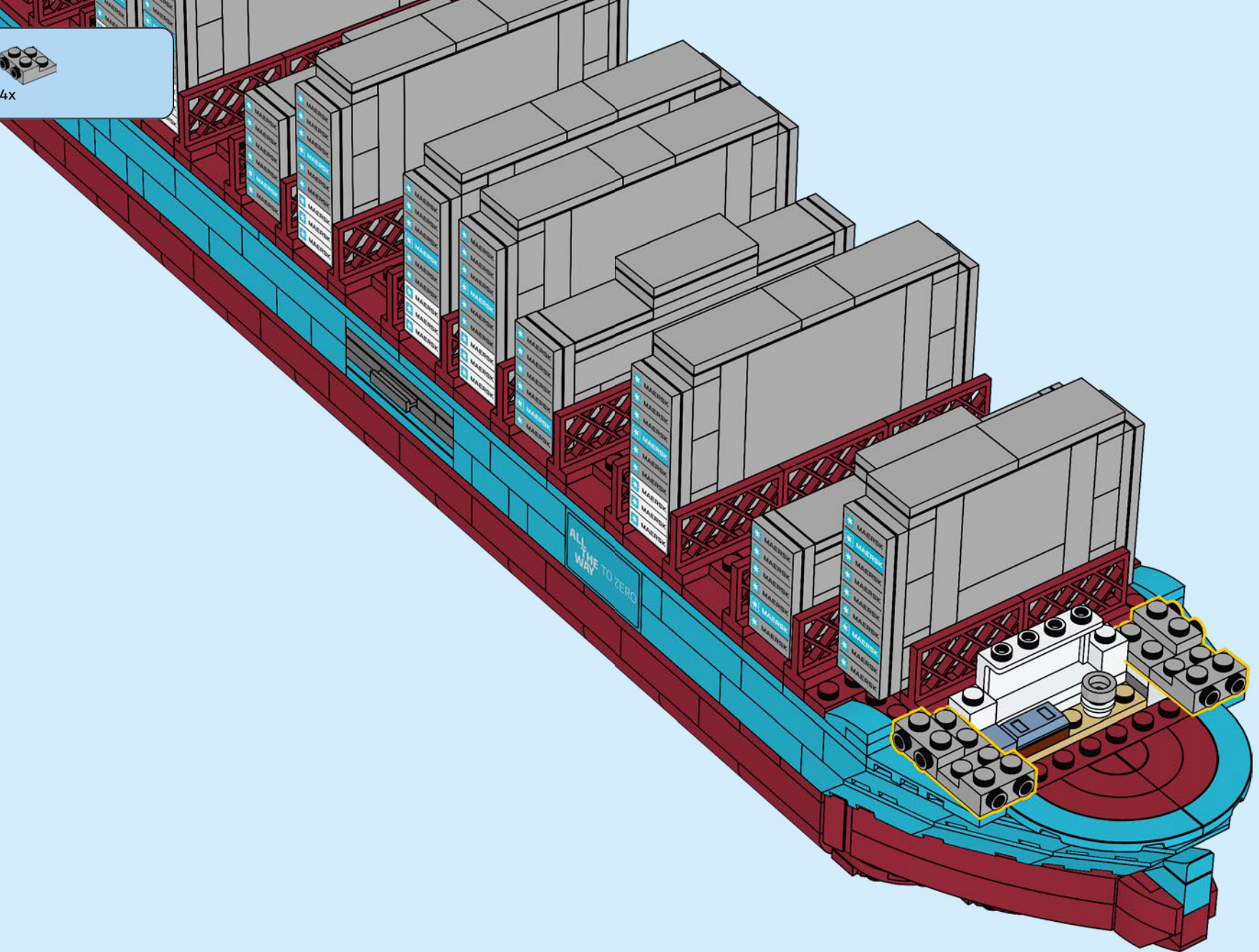

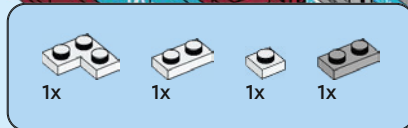

231

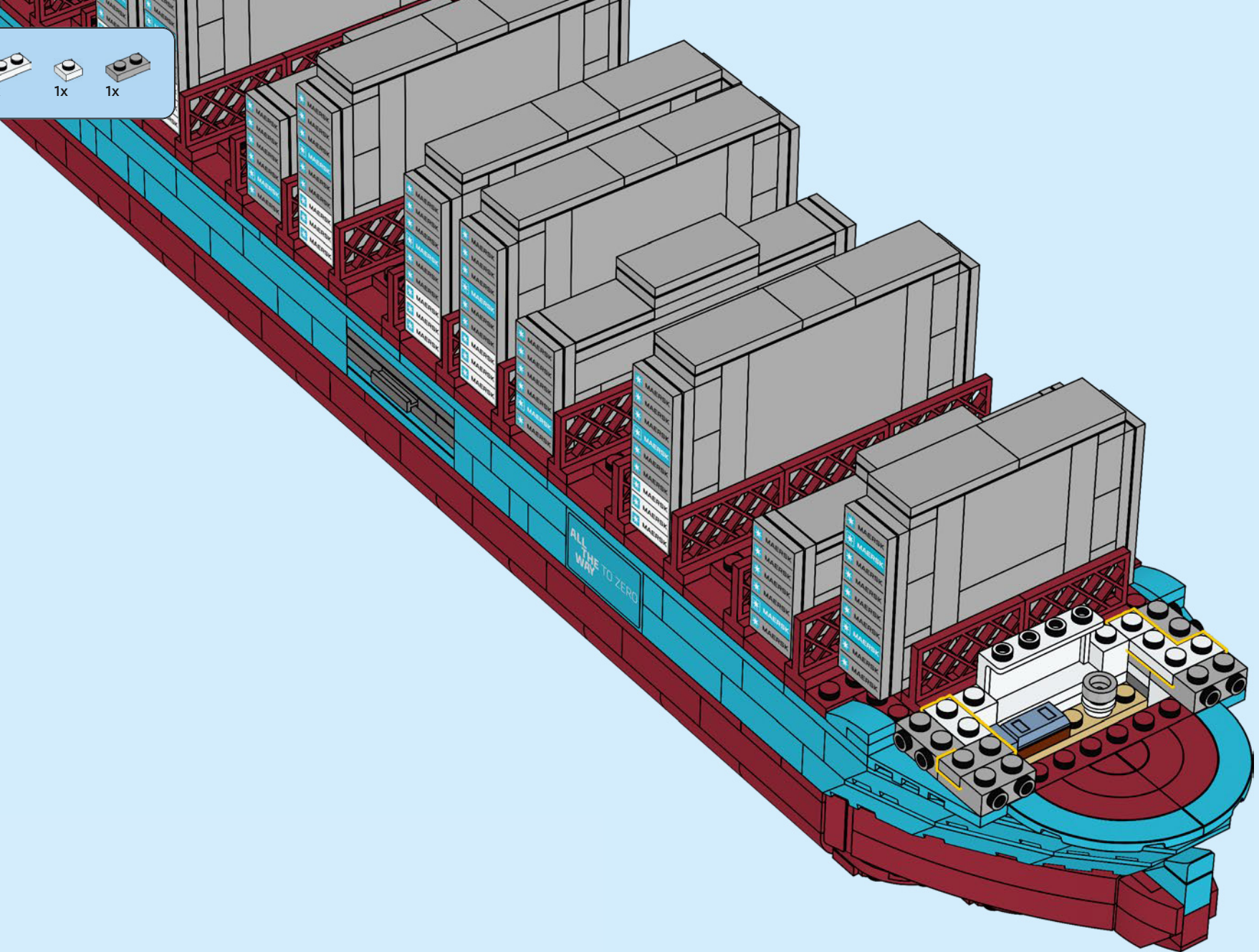

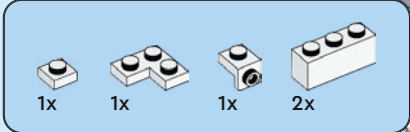

232

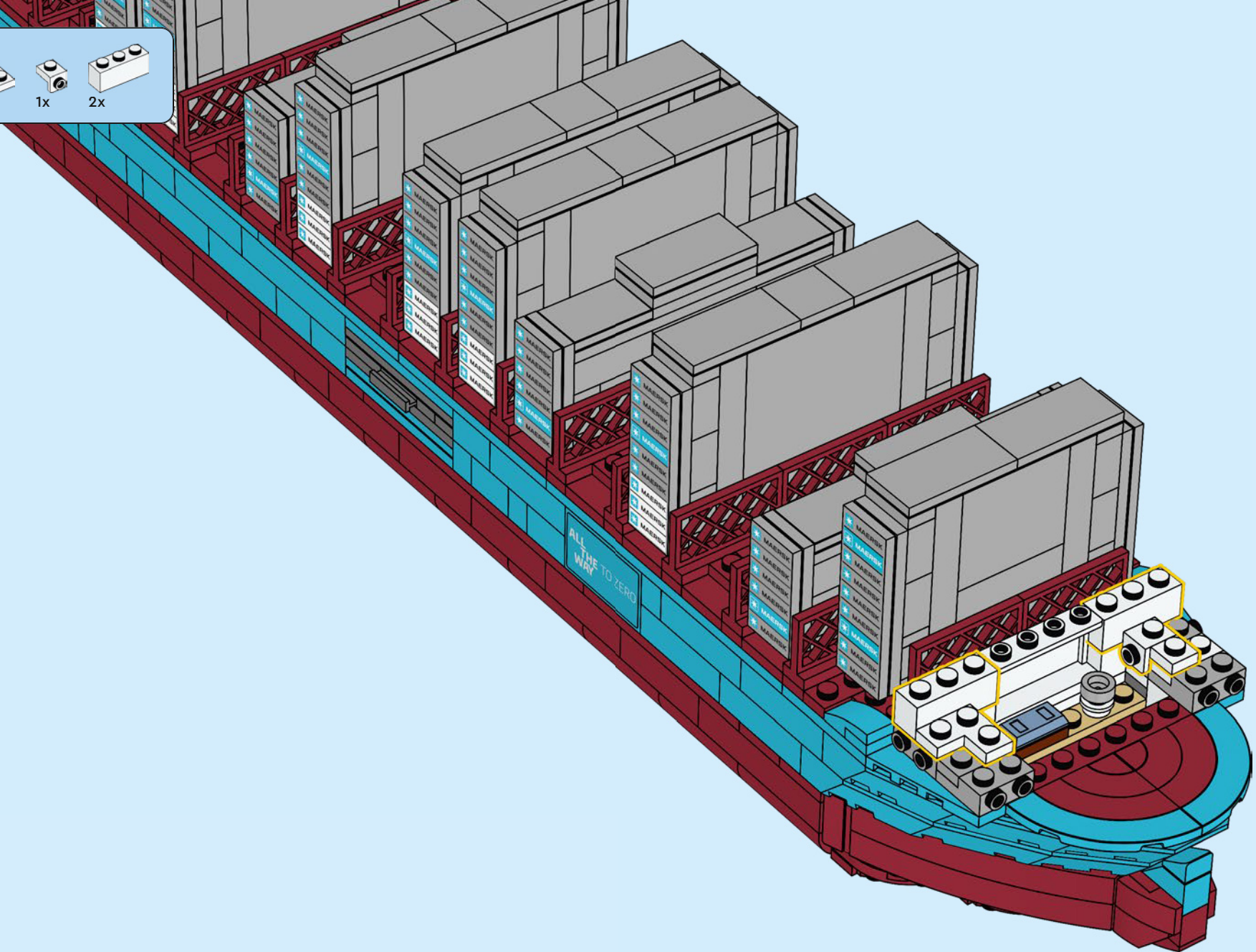

1x 1x 4x

233

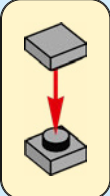
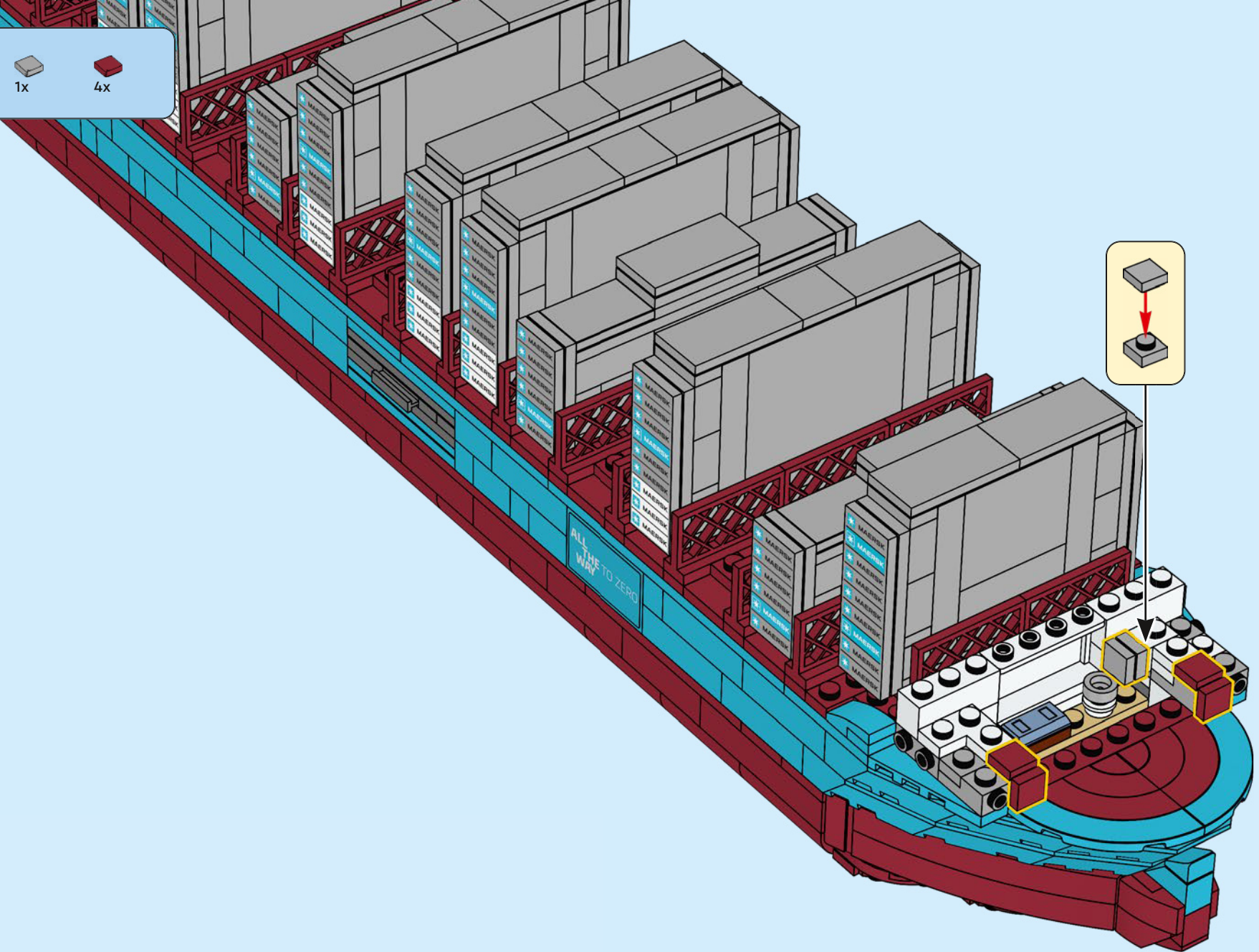

3x  
2x  
2x

234

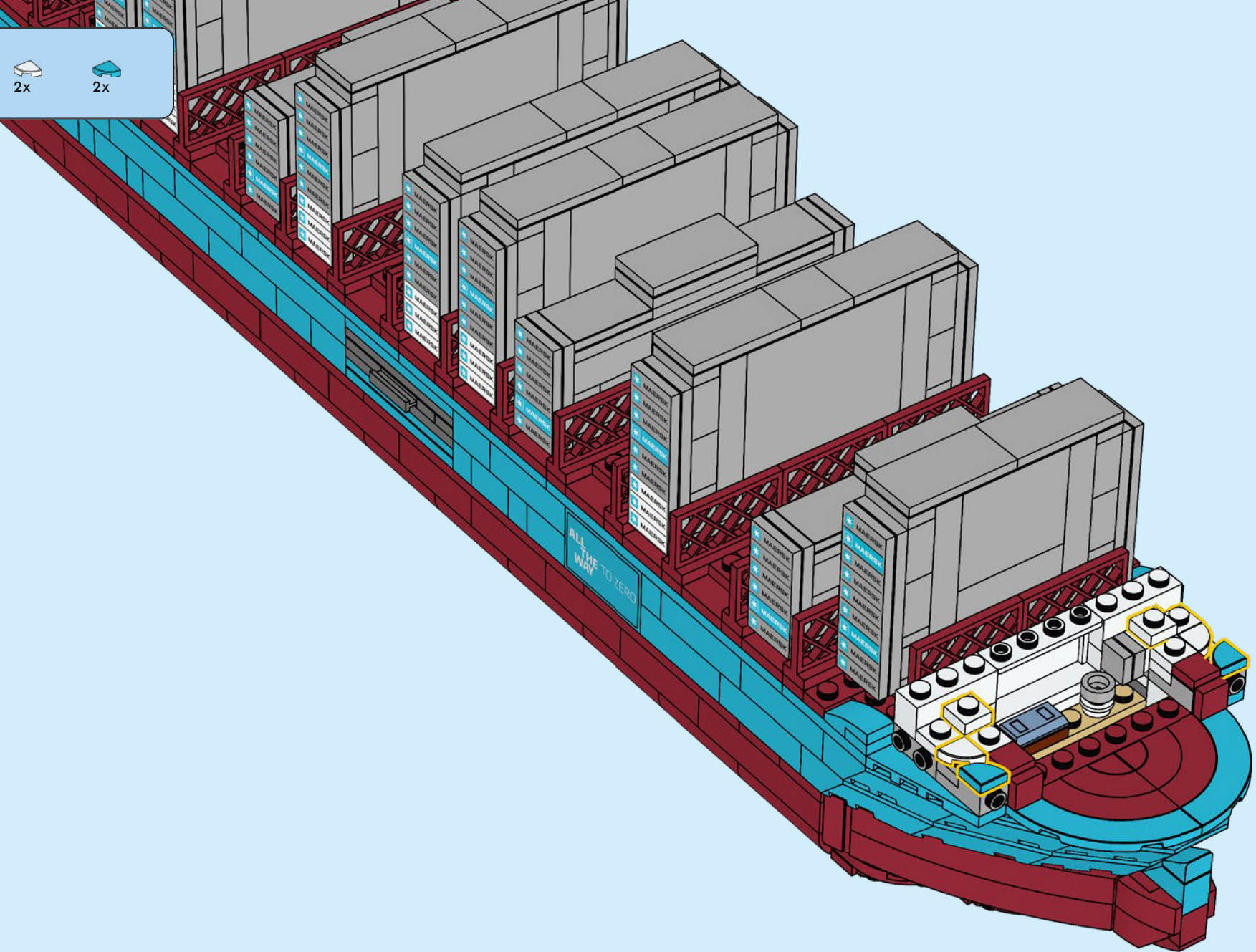

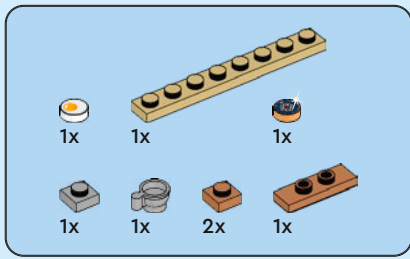

235

1

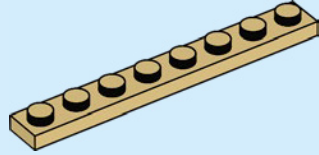

2

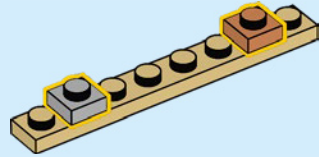

3

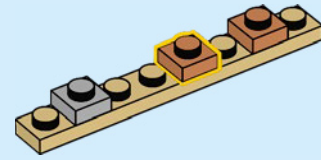

4

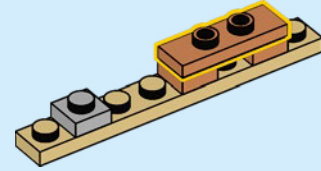

5

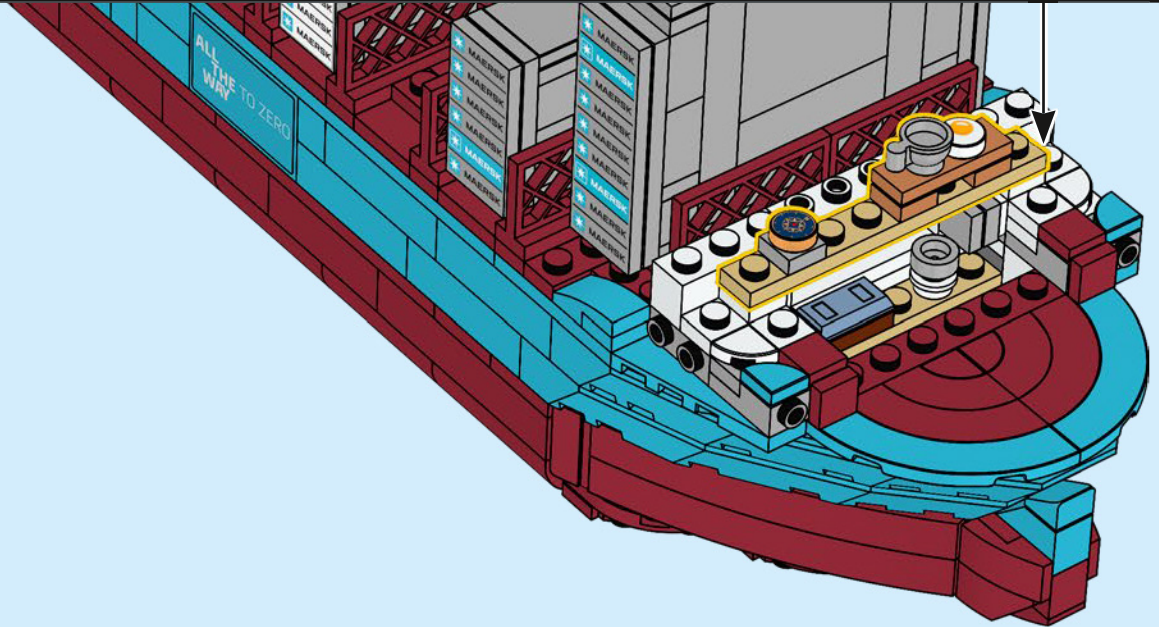

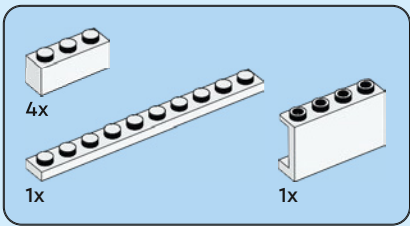

236

1

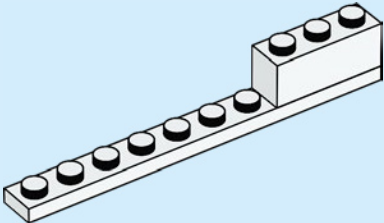

2

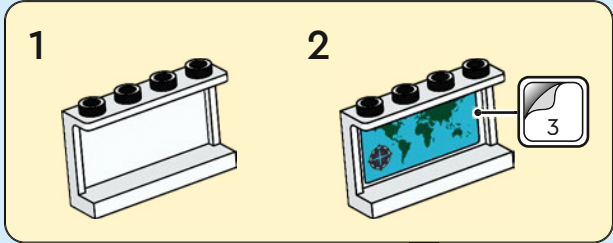
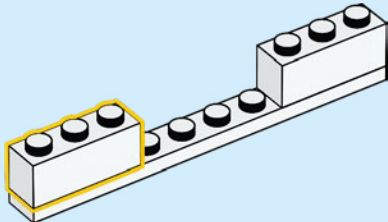

3

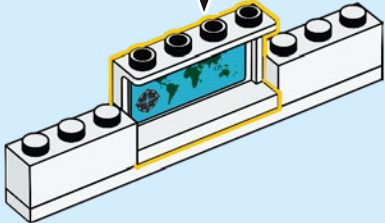

4

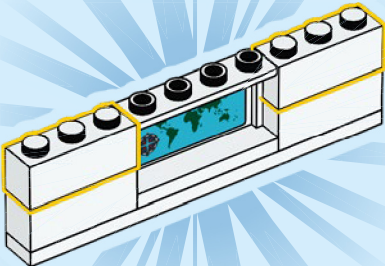

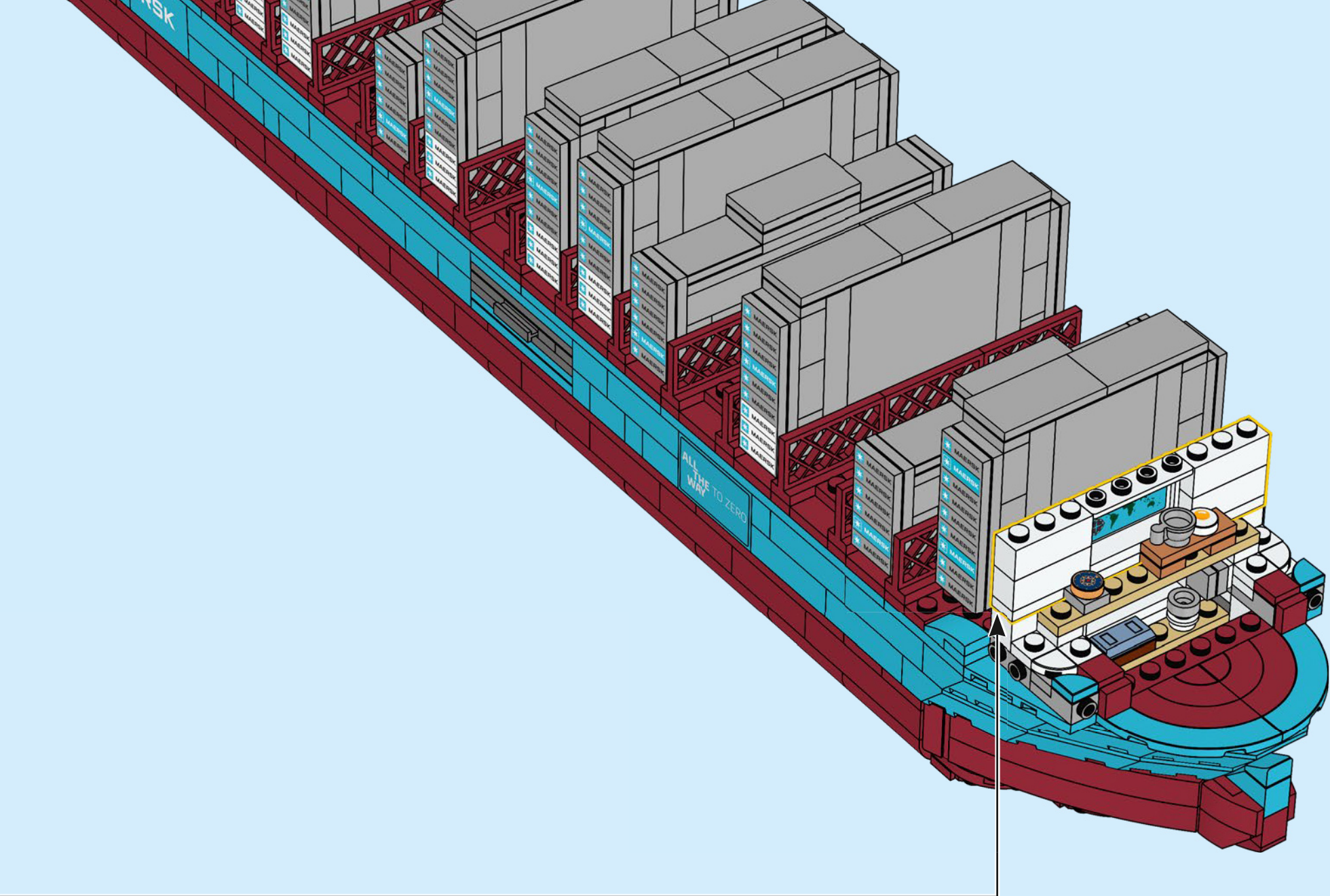

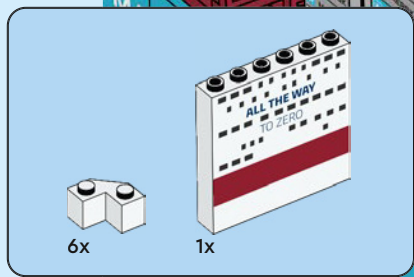

237

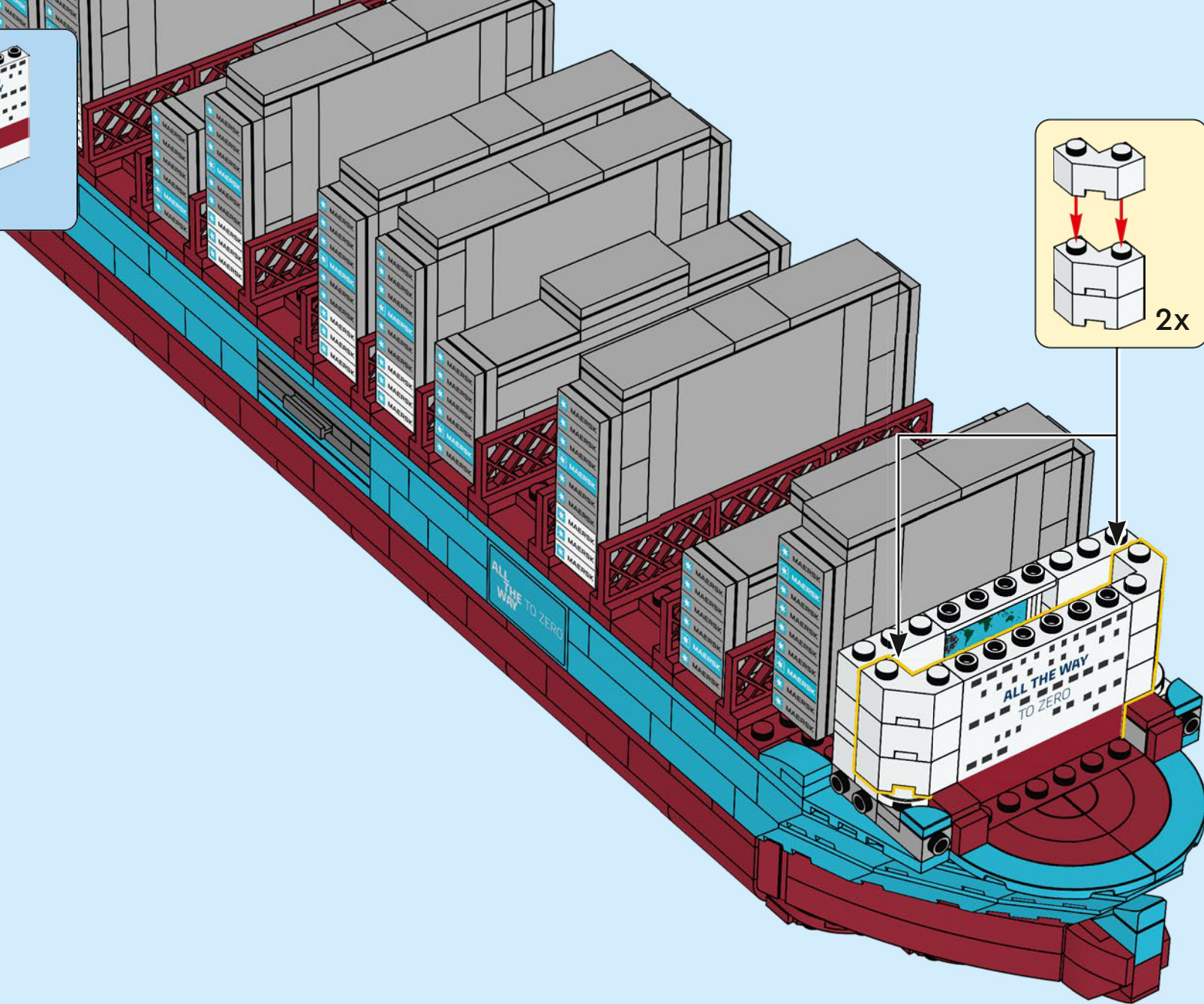



238

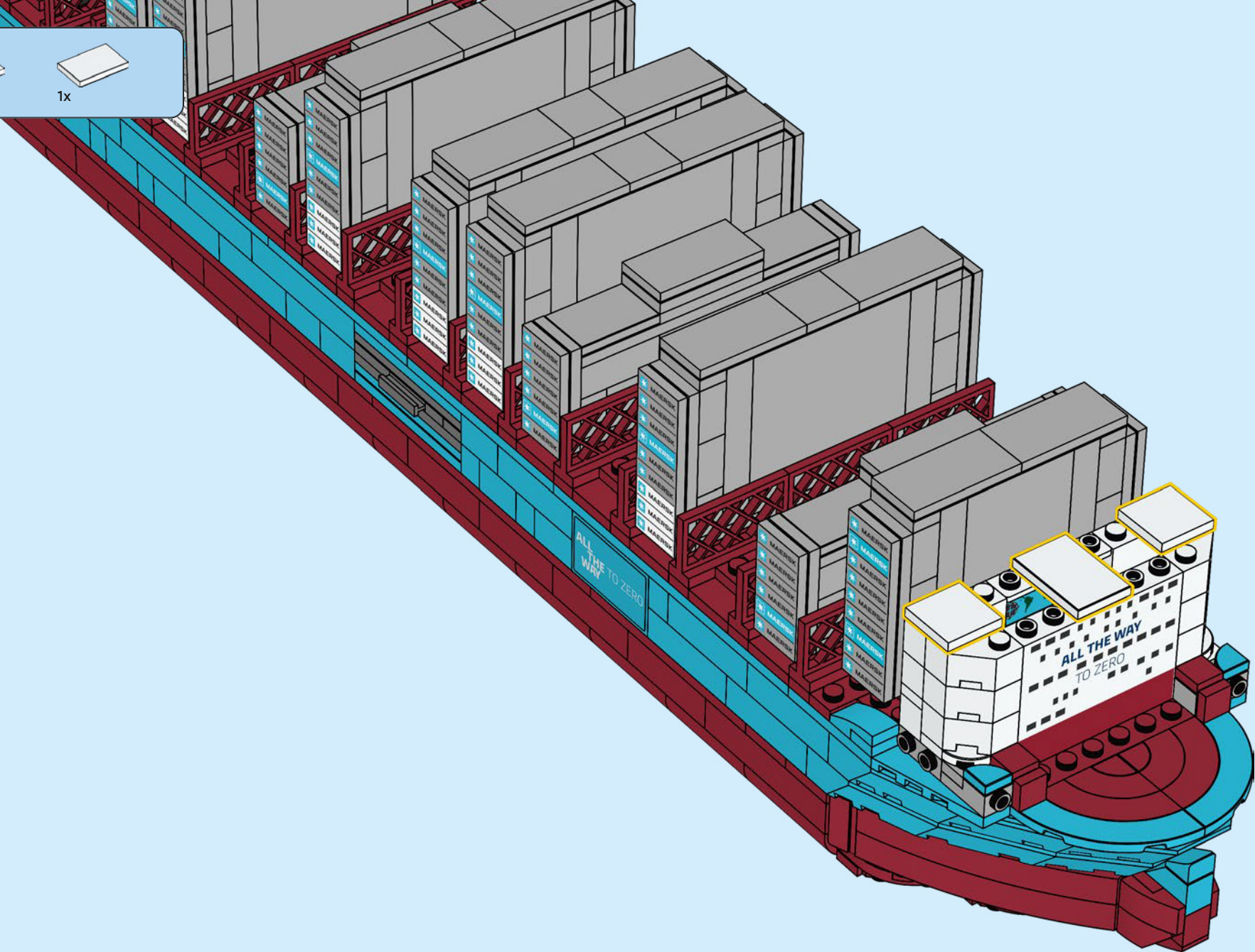

2x 1x 1x

239

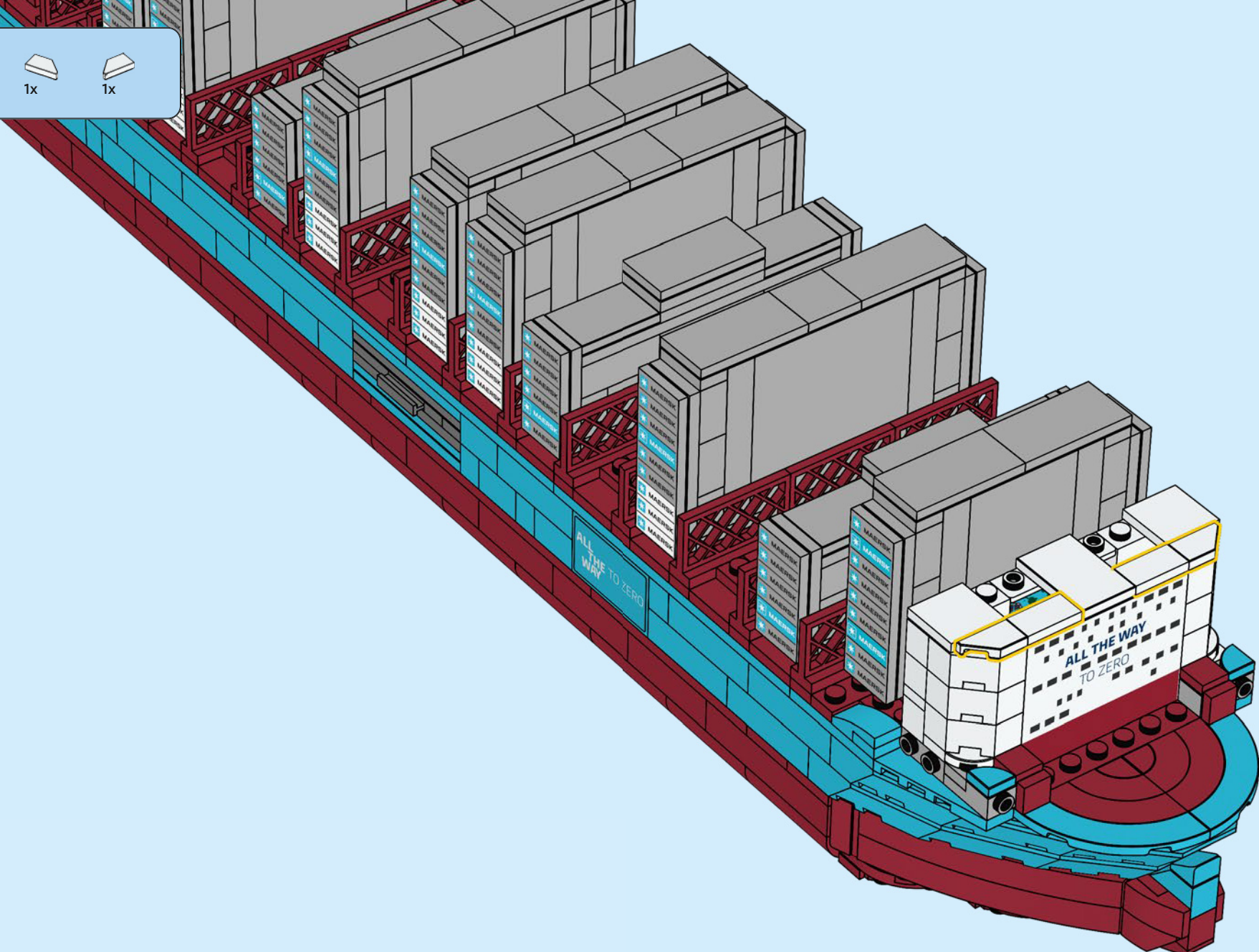

2x 2x 2x

240

1 2 2x

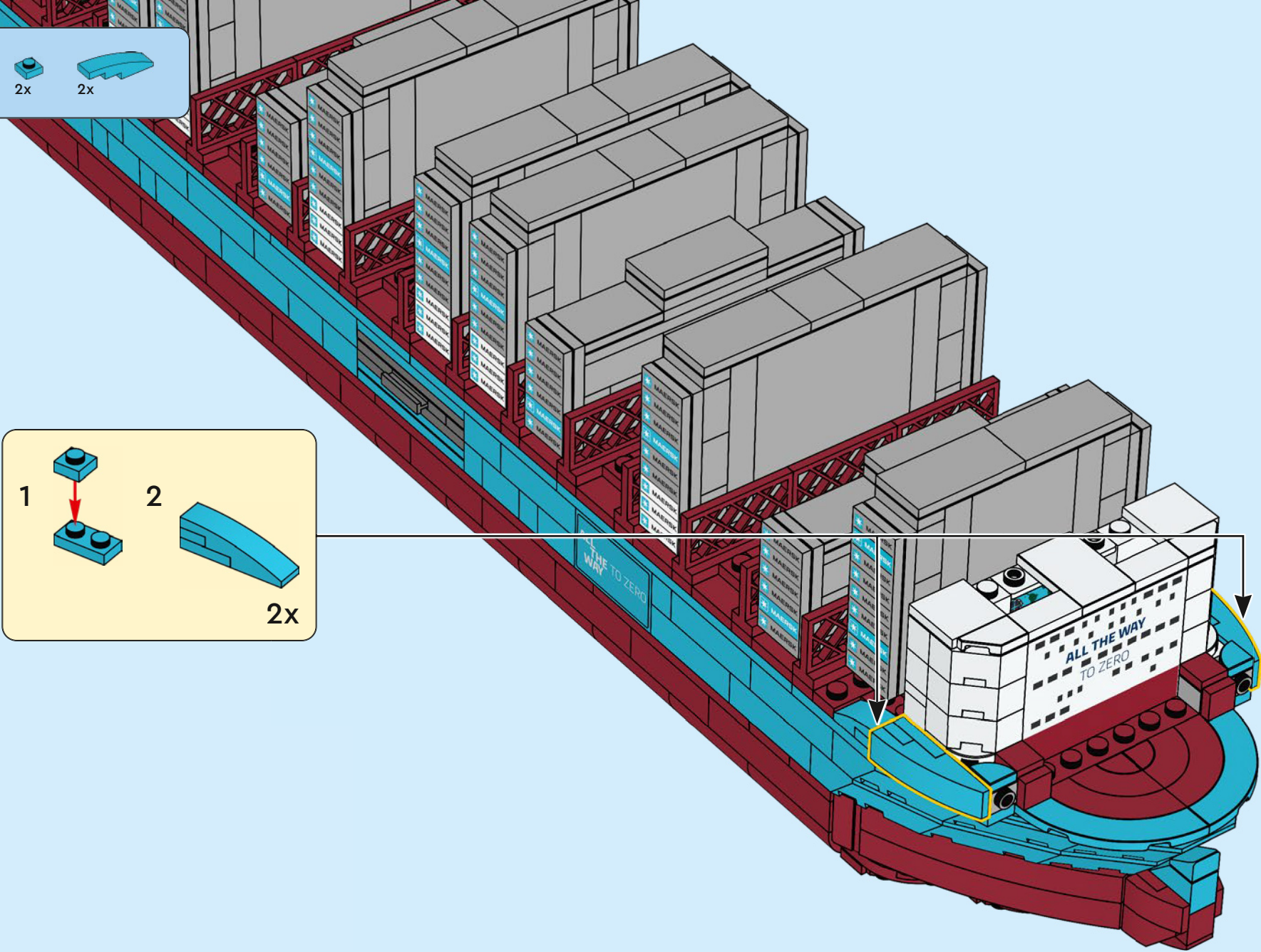

241

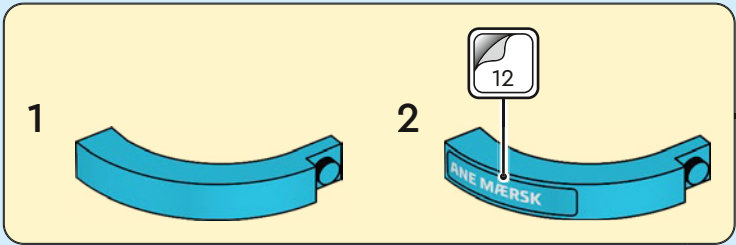
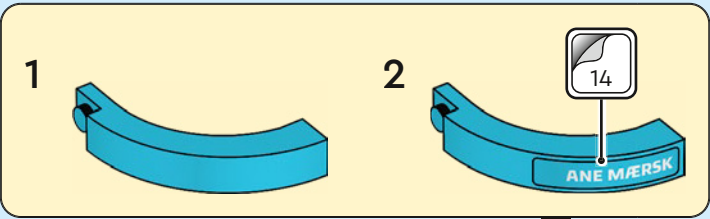
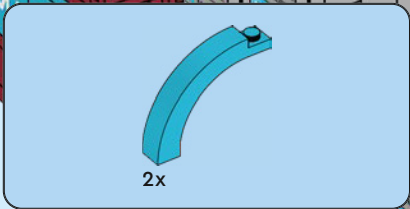

1x

242

1

2

13

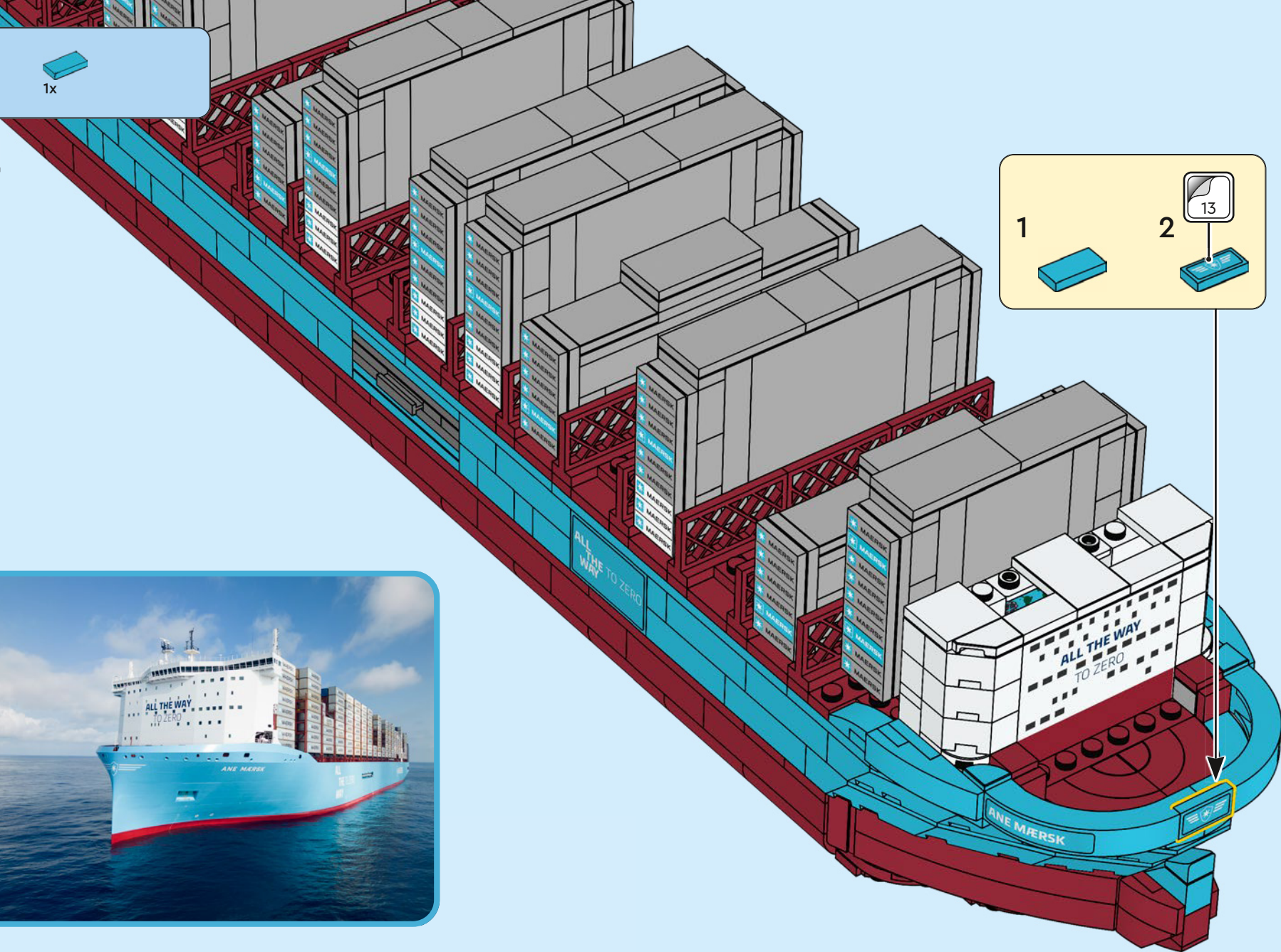

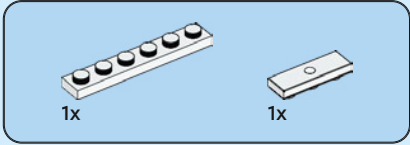
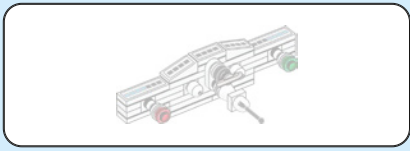

243

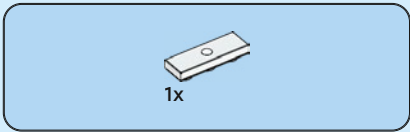
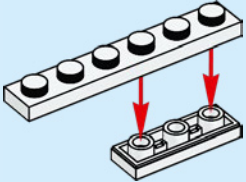

244

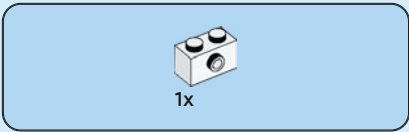
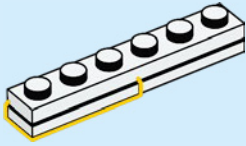

245

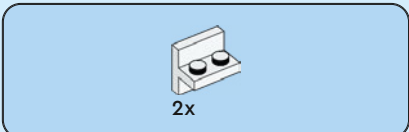
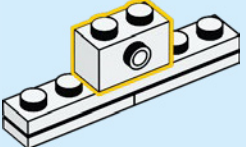

246

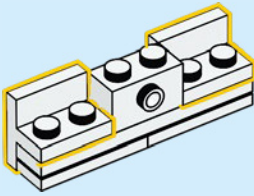



2x

# 247

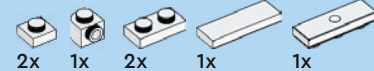
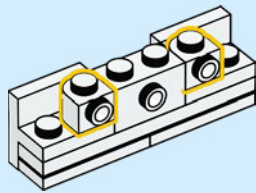

# 248

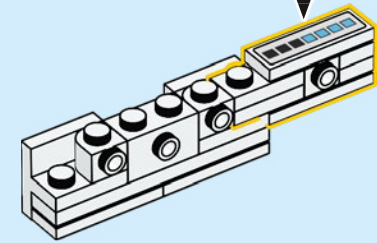
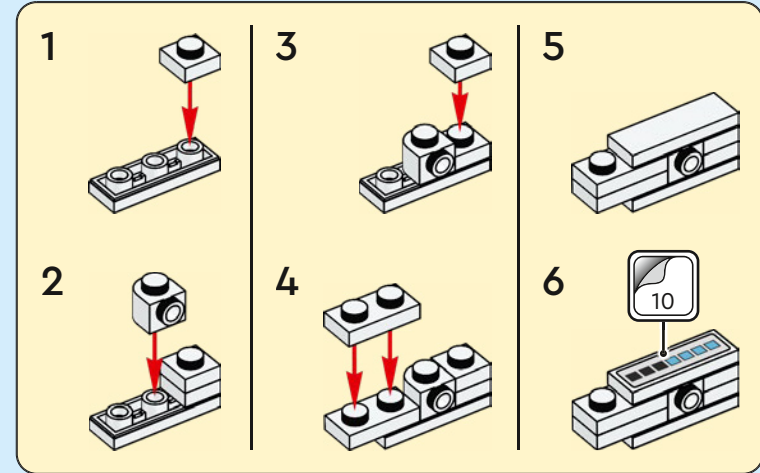

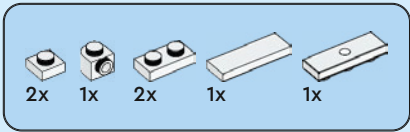

# 249

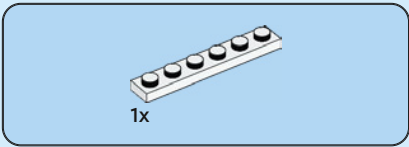
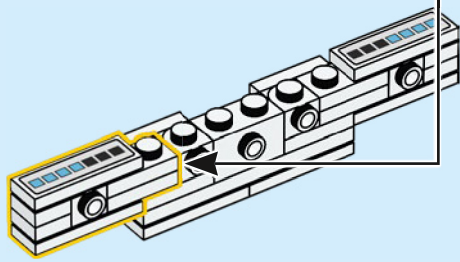
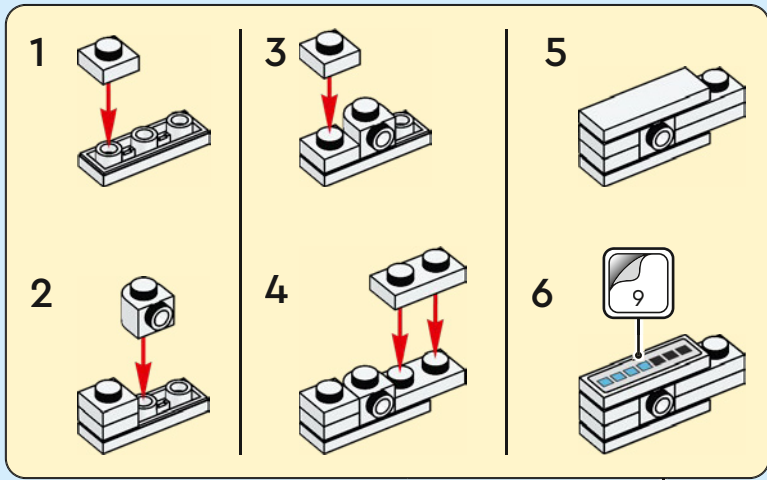

# 250

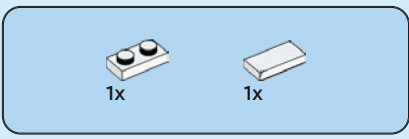
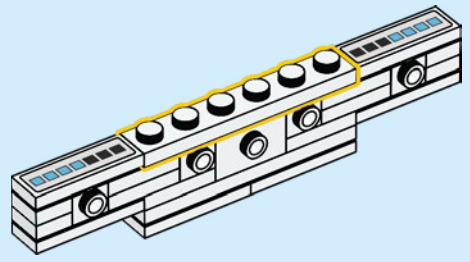

# 251

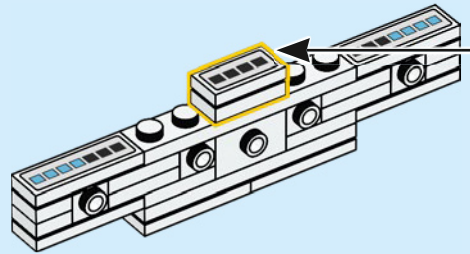
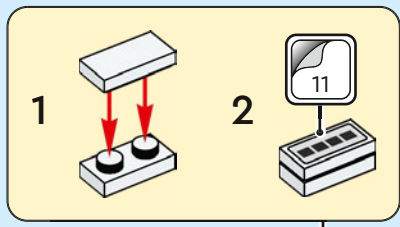

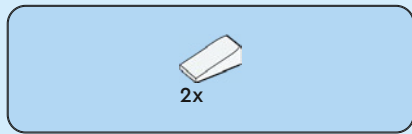

252

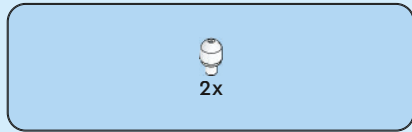
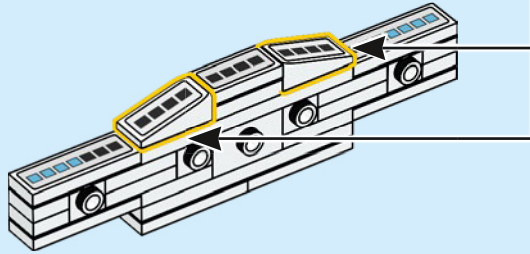
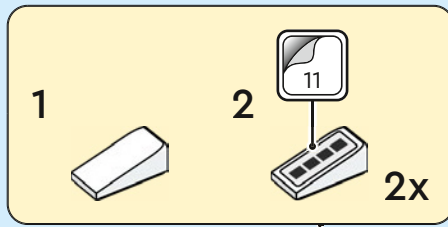

253

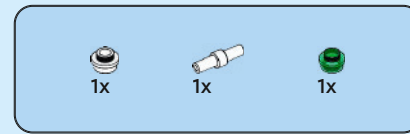
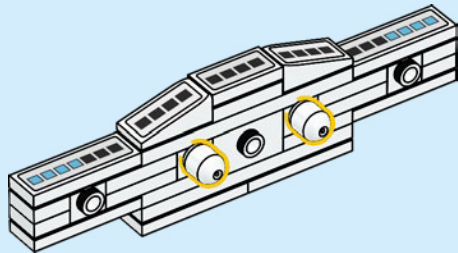

254

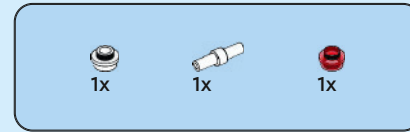
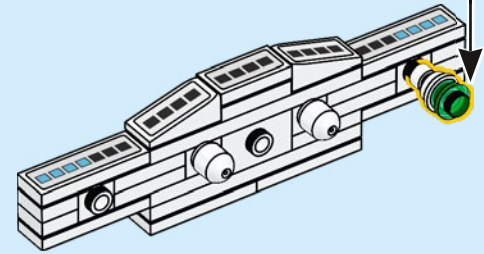
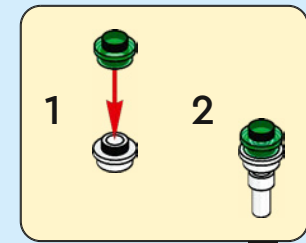

255

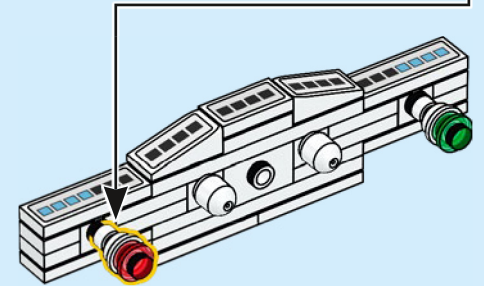
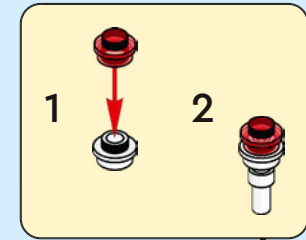

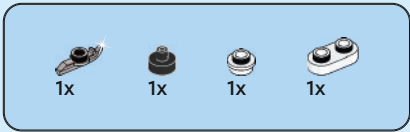

256

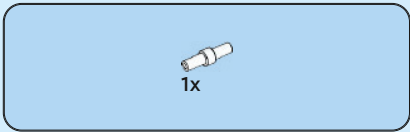
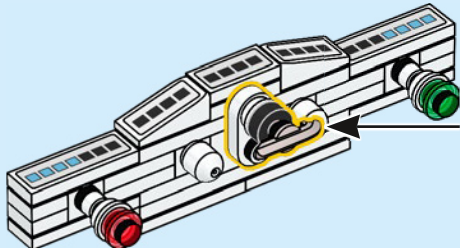
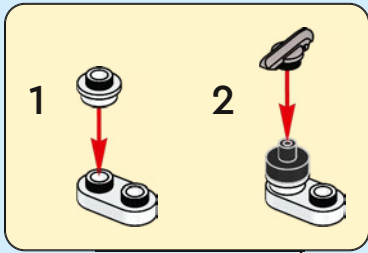

257

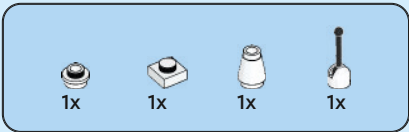
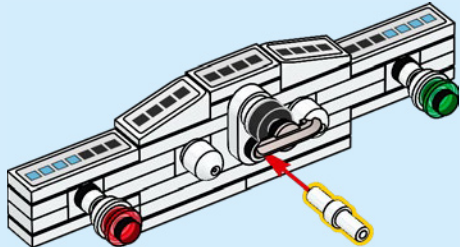

258

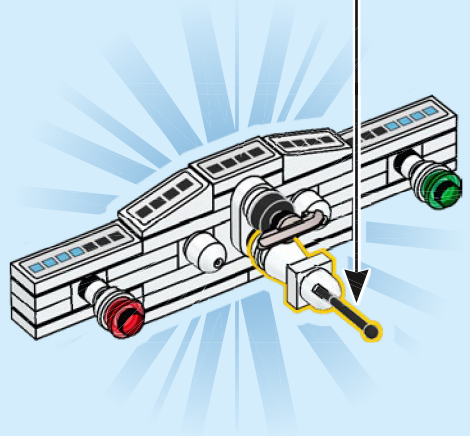
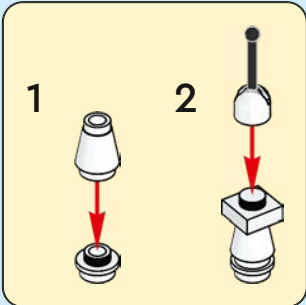

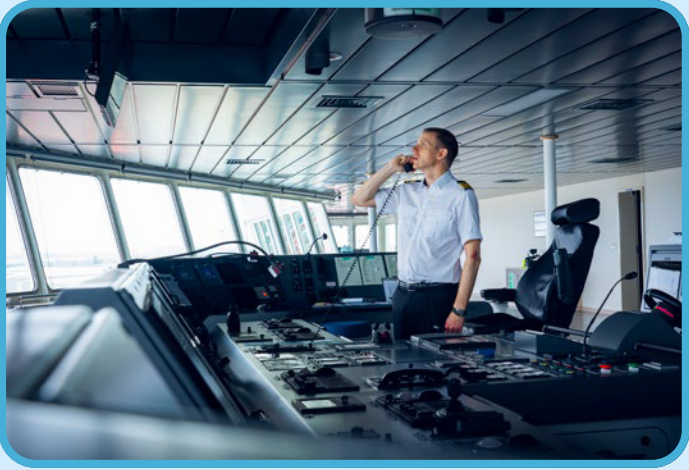
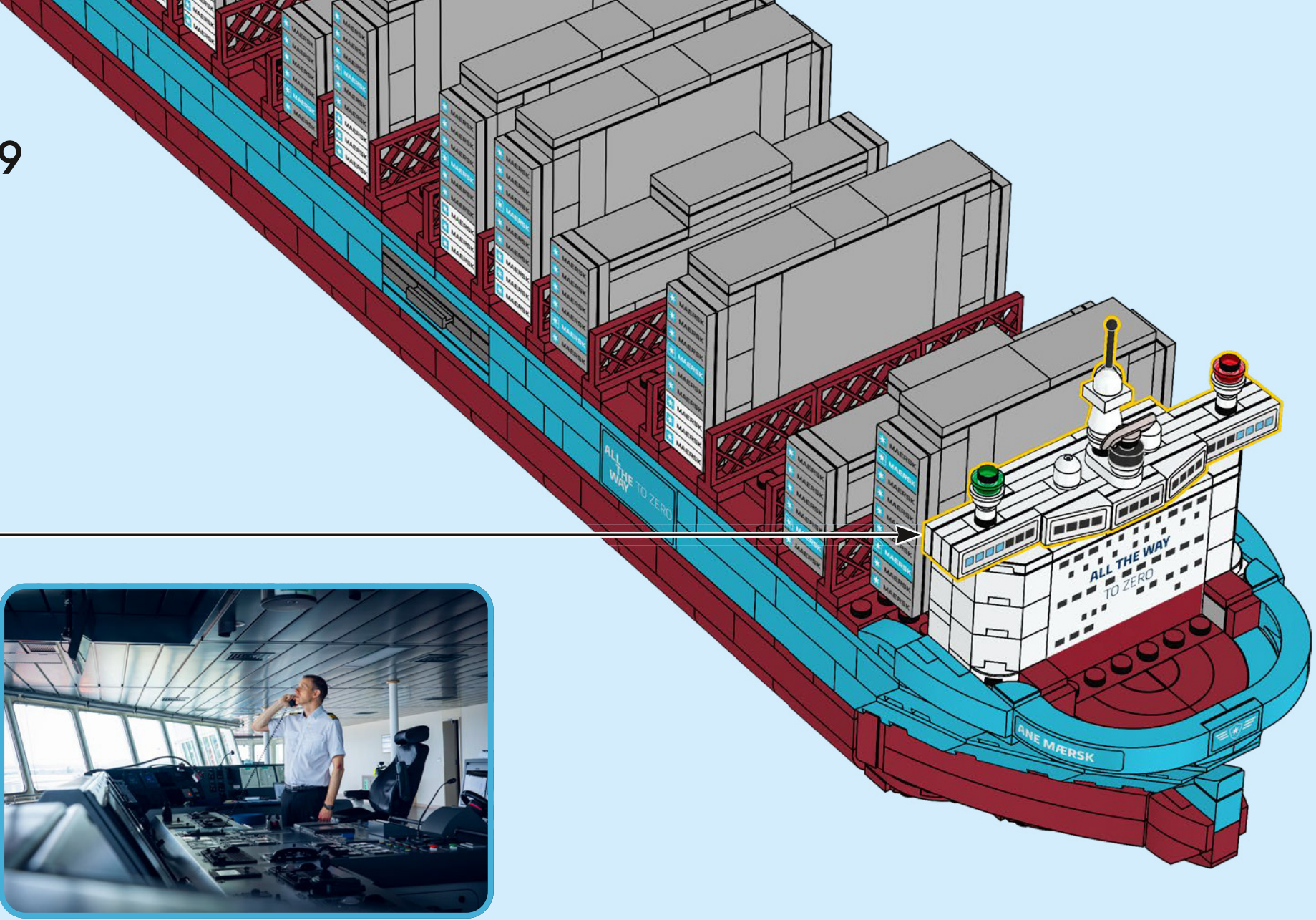

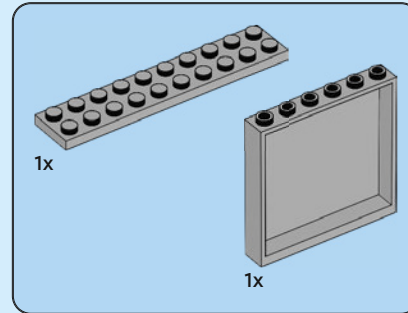
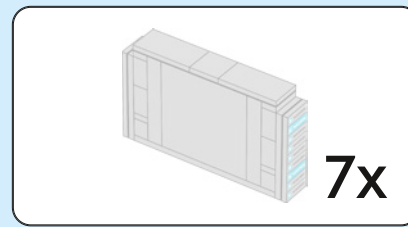

260

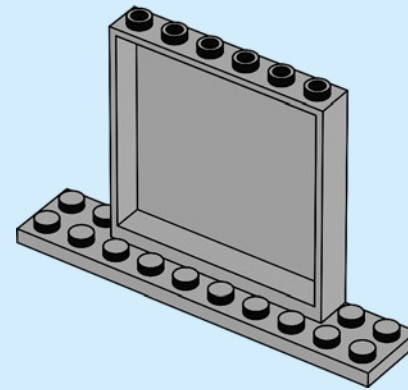

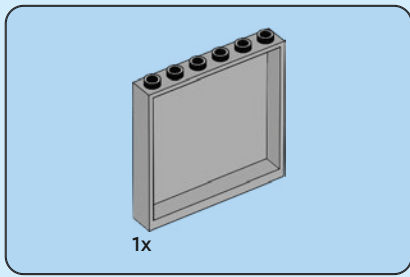

261

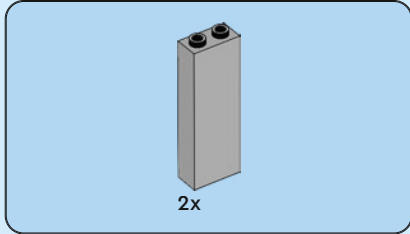
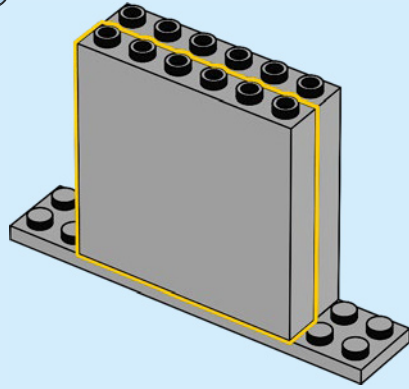

262

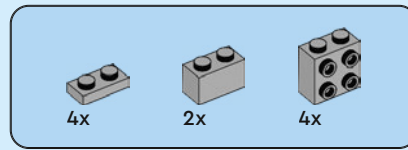
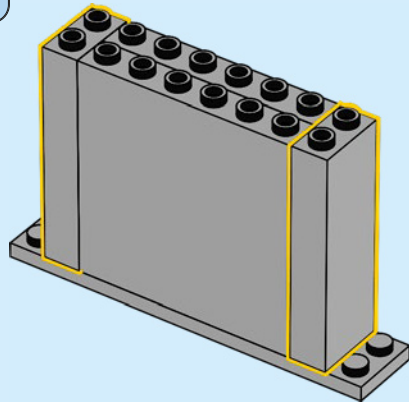

263

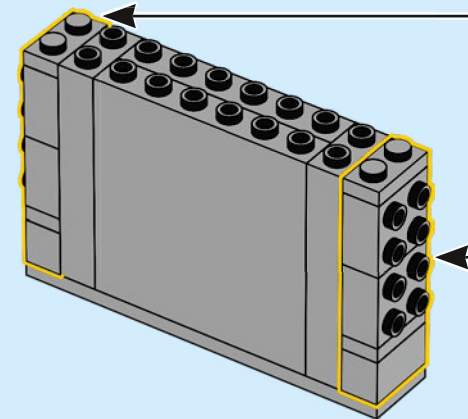
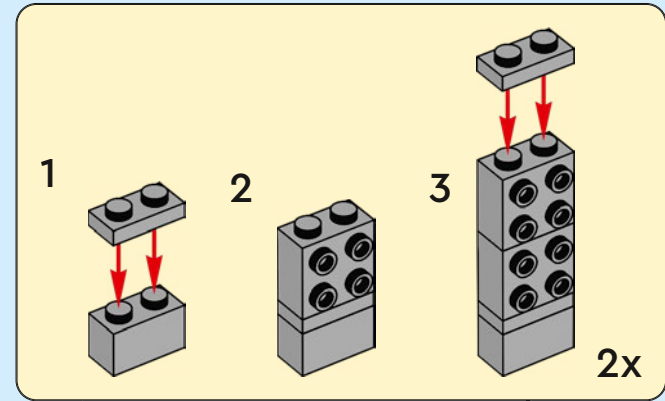

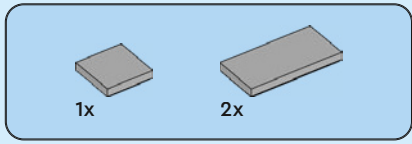

264

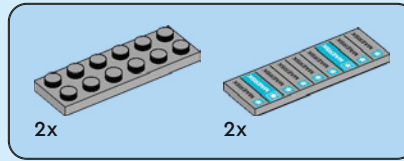
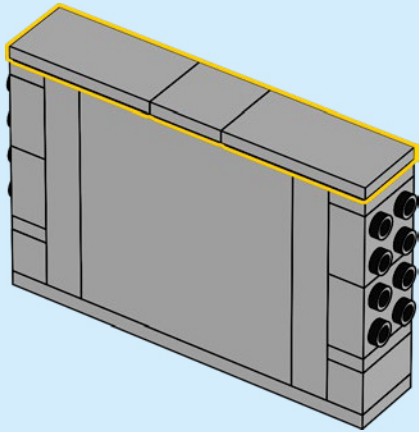

265

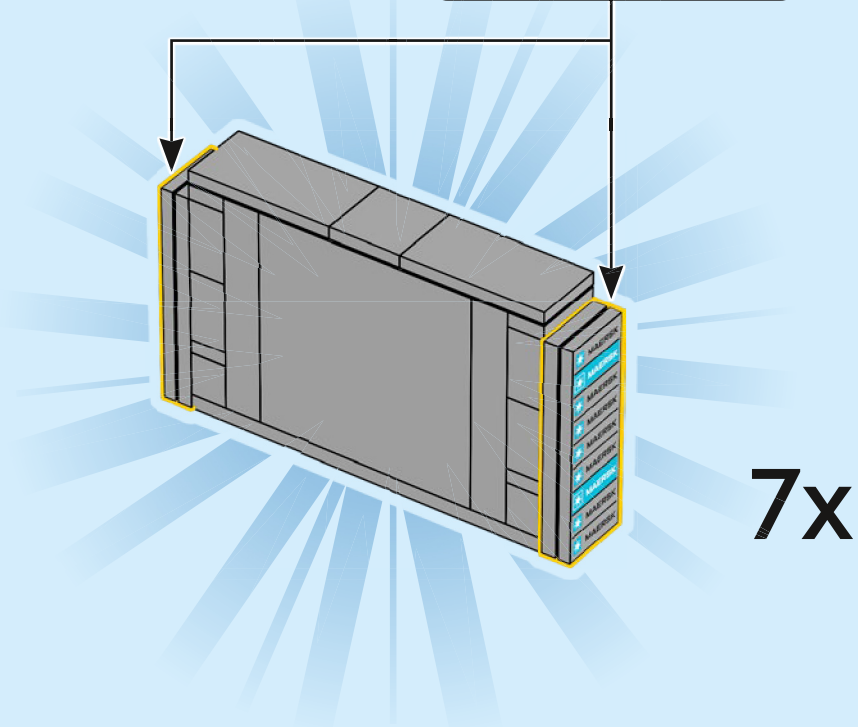
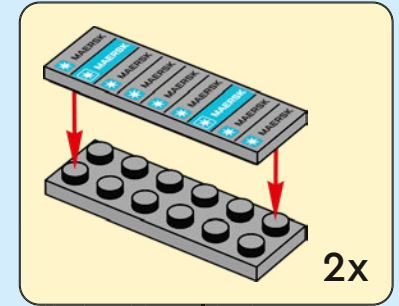

266

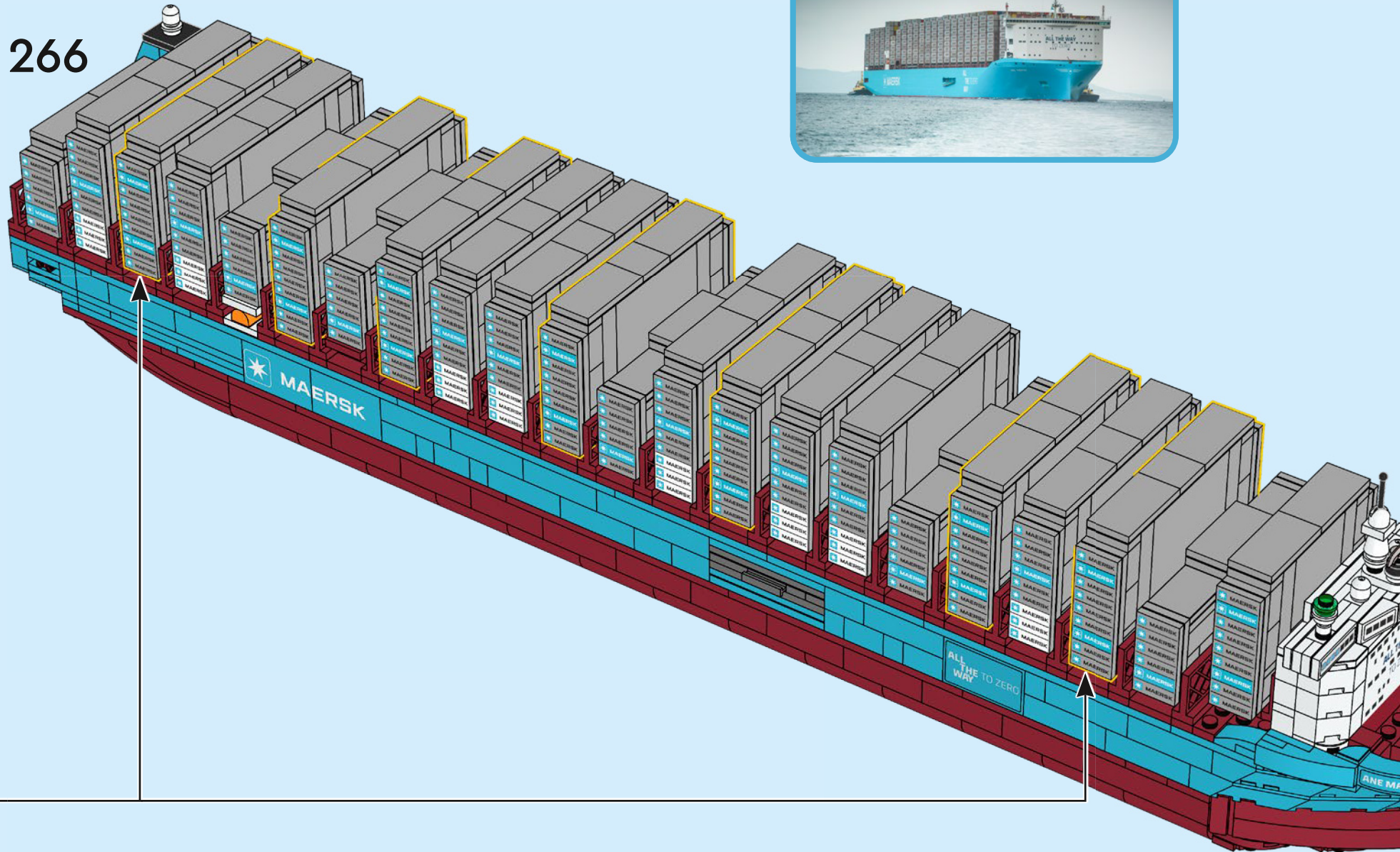

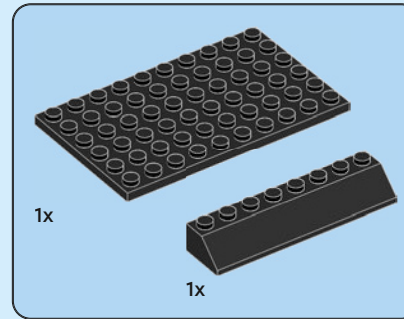
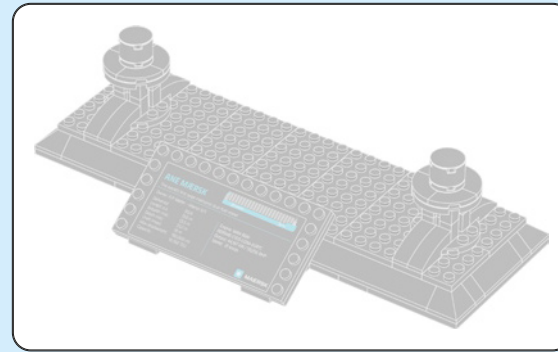

267

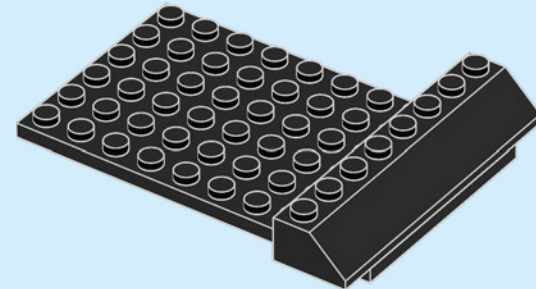

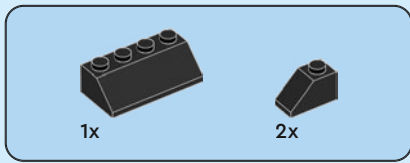

268

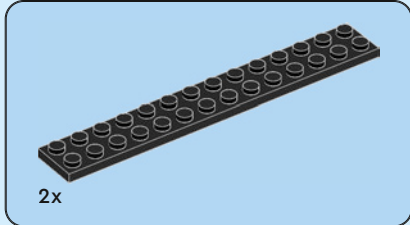
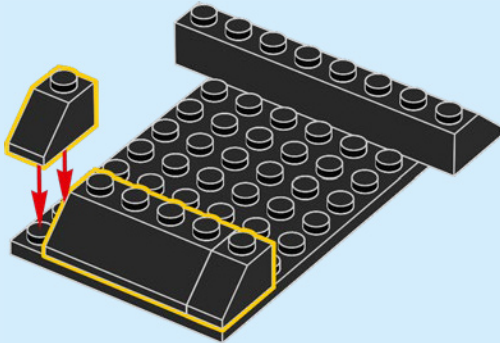

269

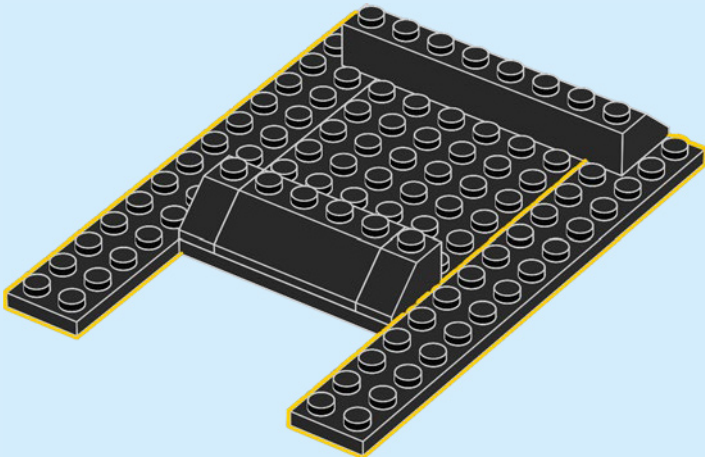

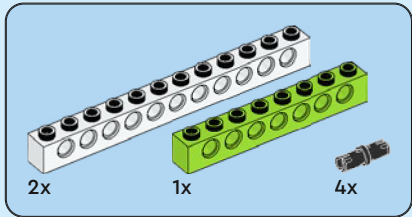
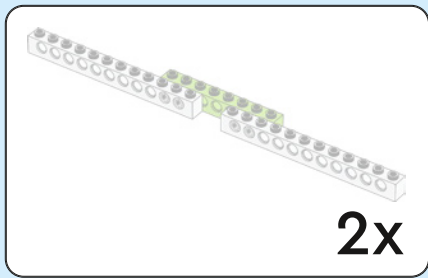

270

1

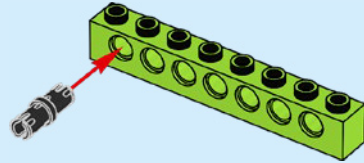

2

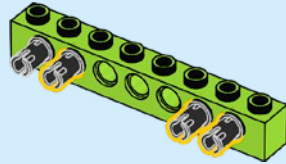

3

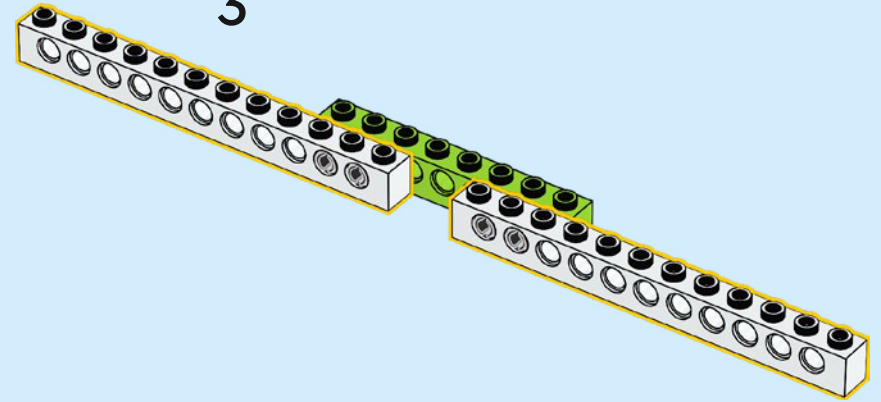

2x

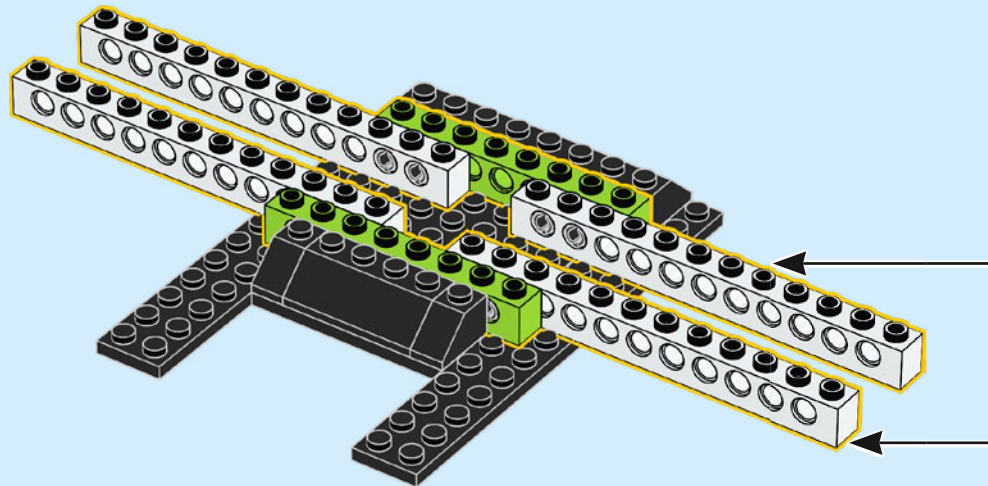

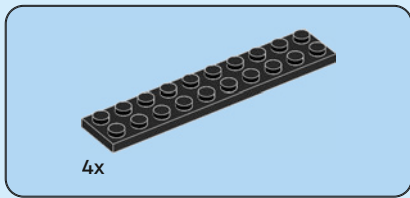

271

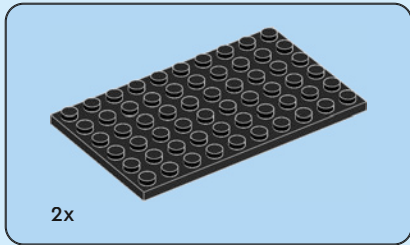
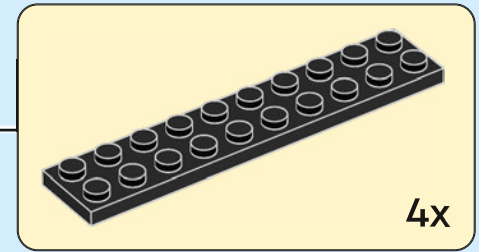
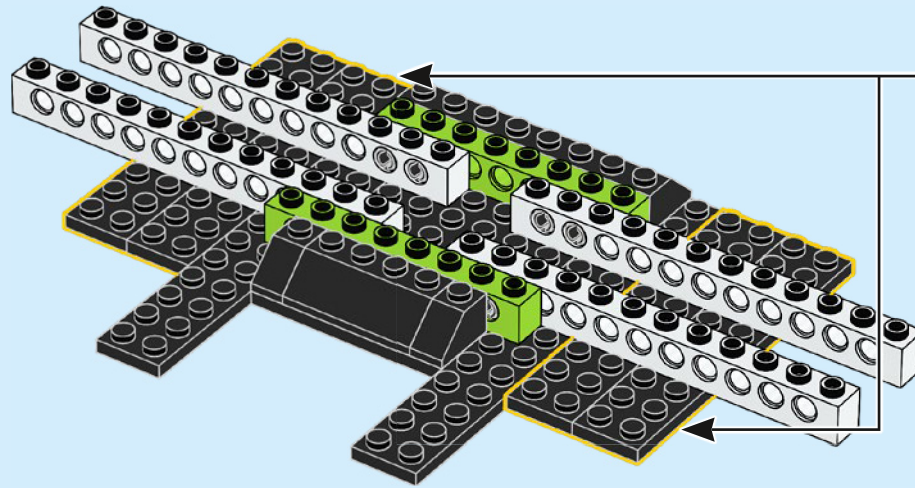

272

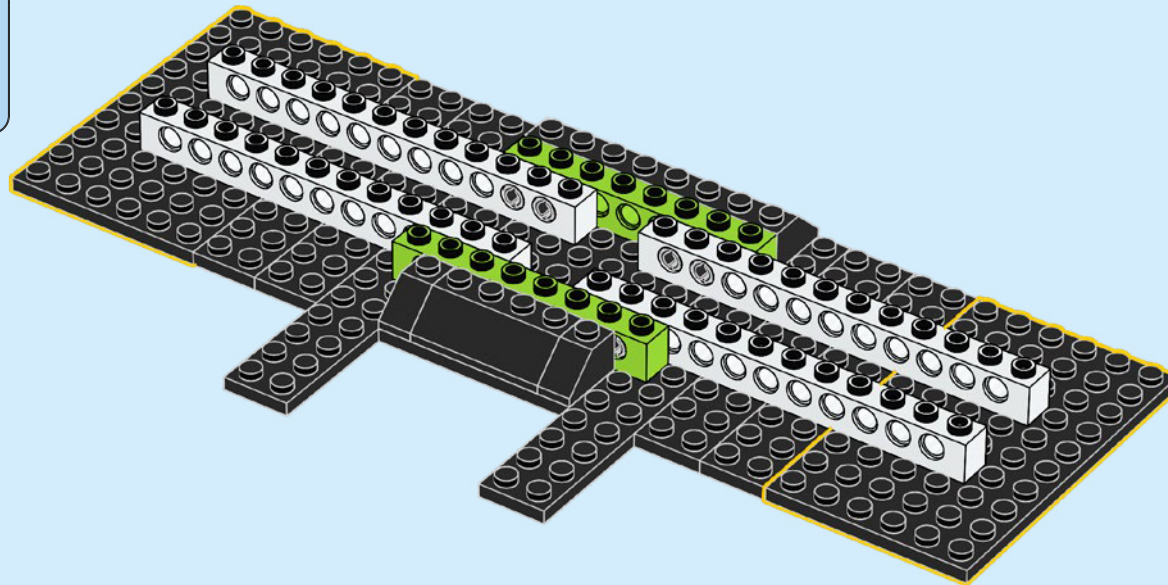

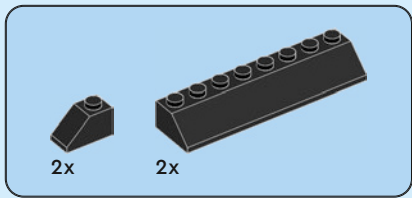

273

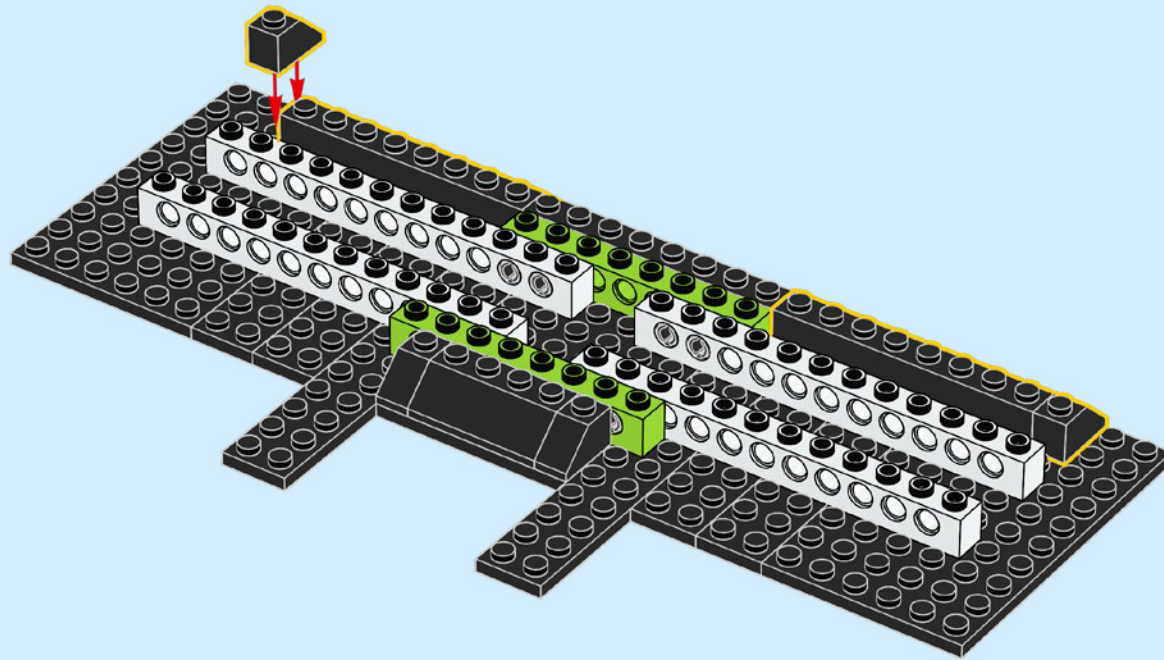

274

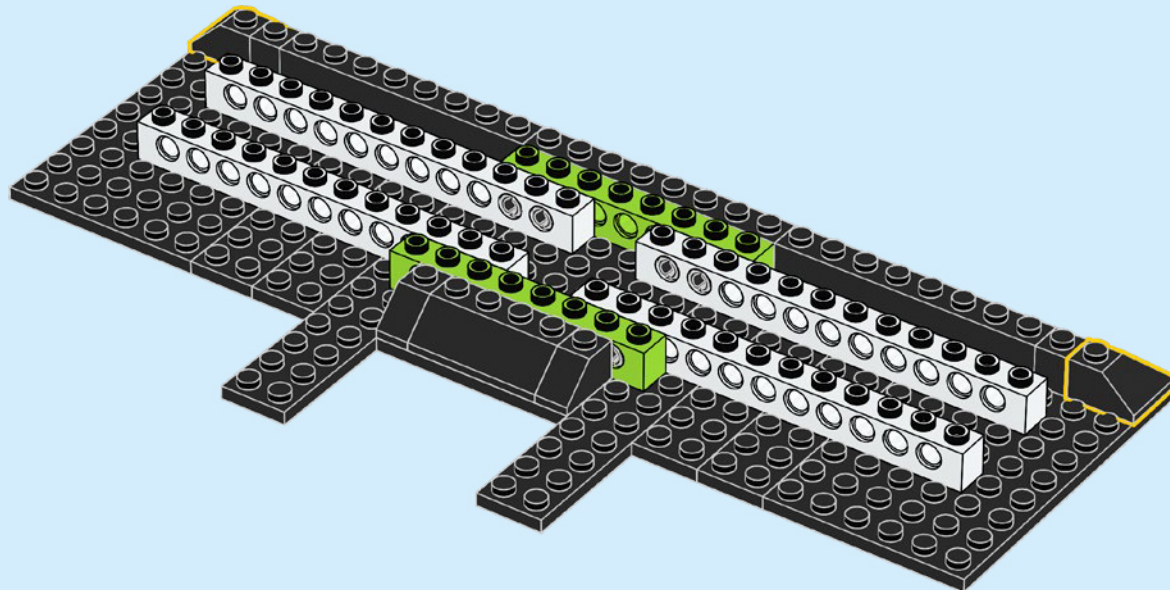

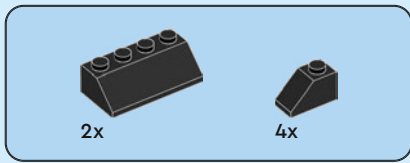

275

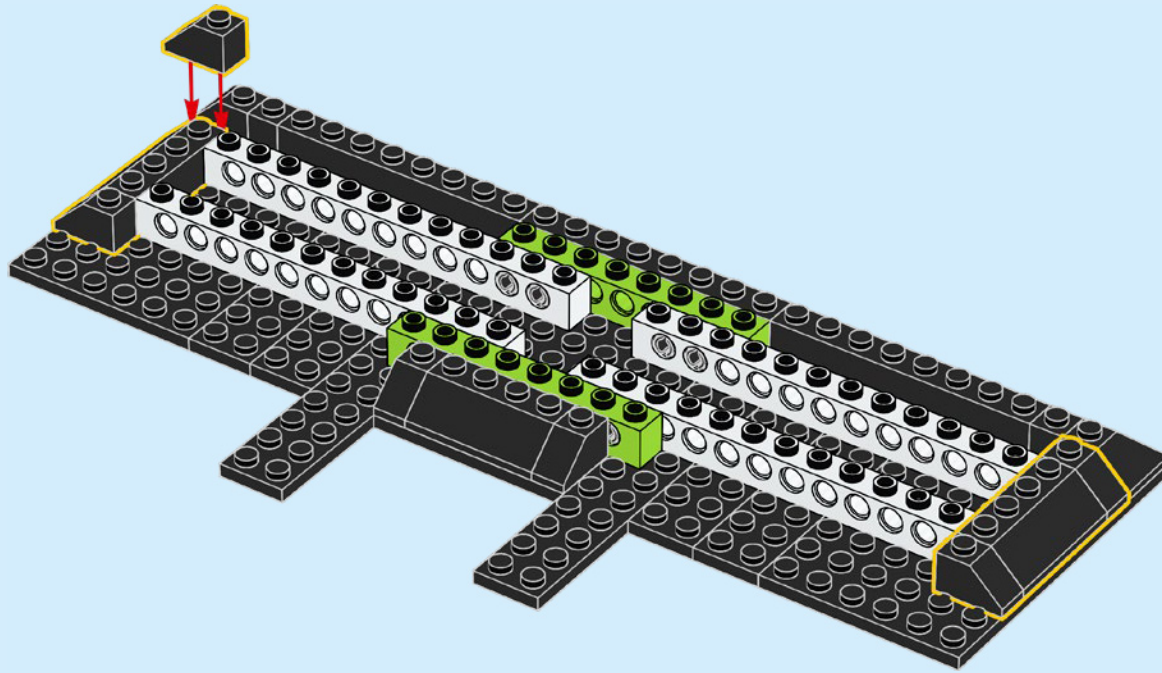

276

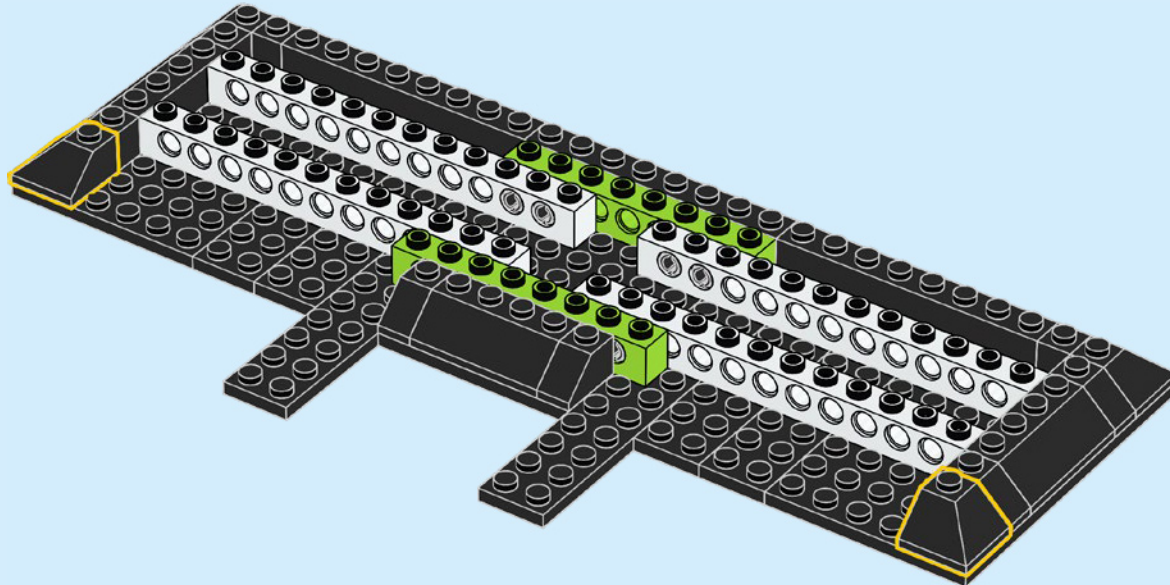



2x



2x

# 277

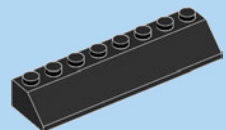
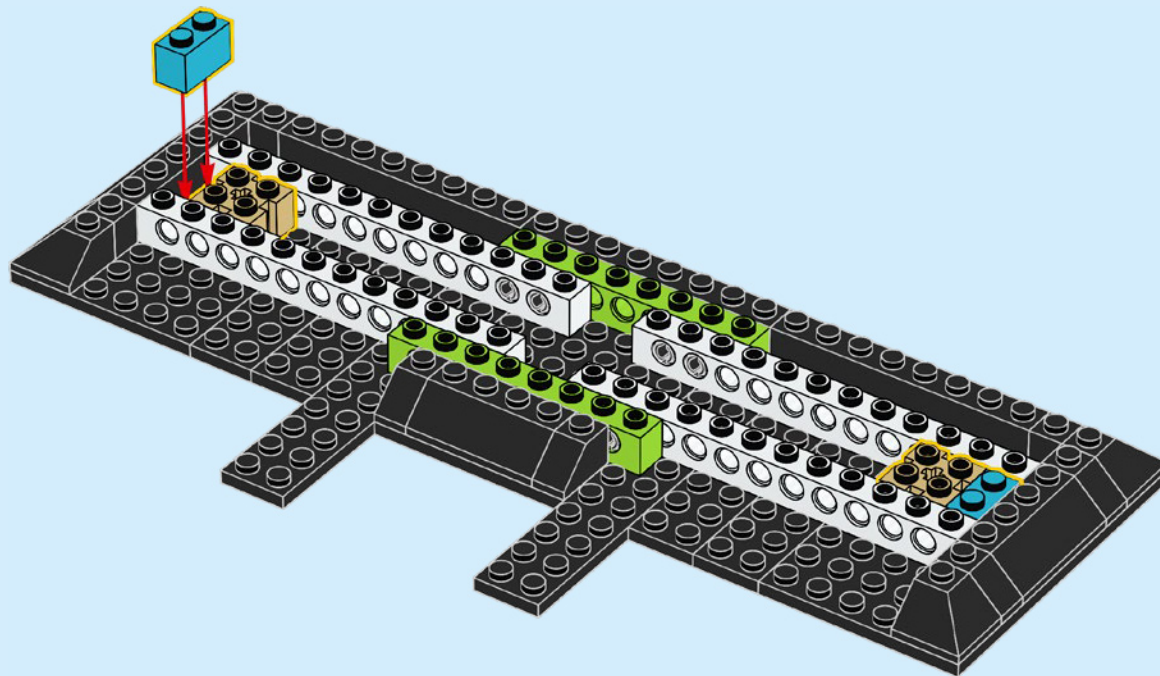

2x

# 278

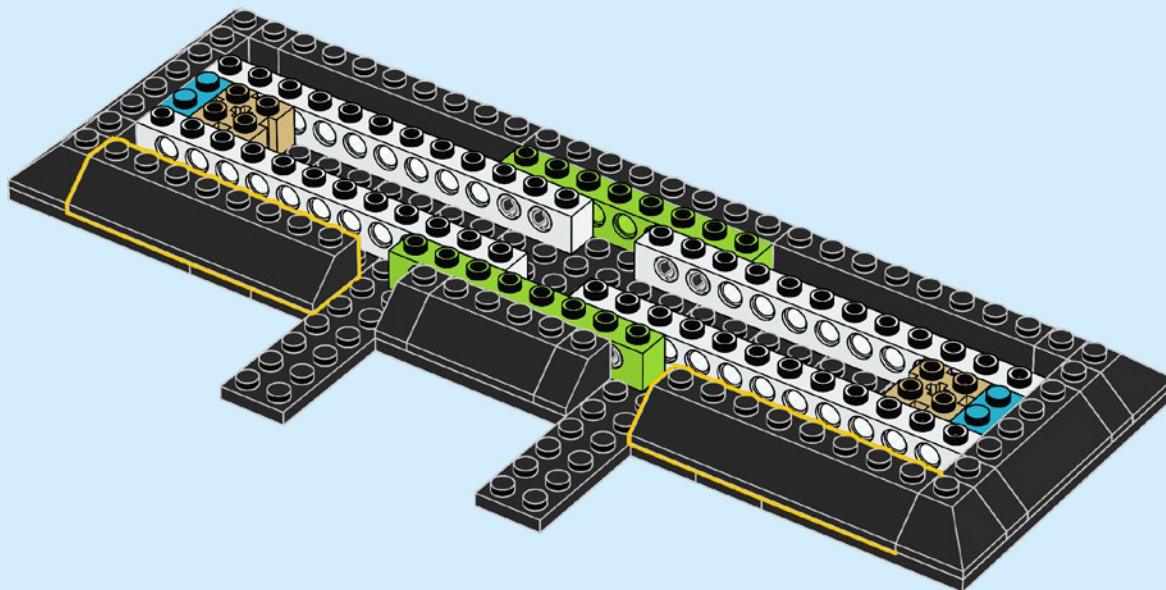

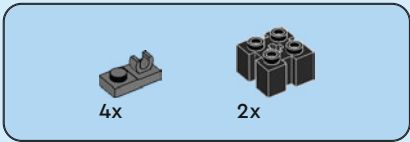

279

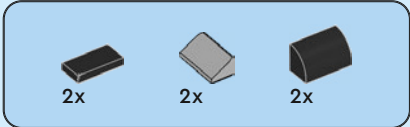
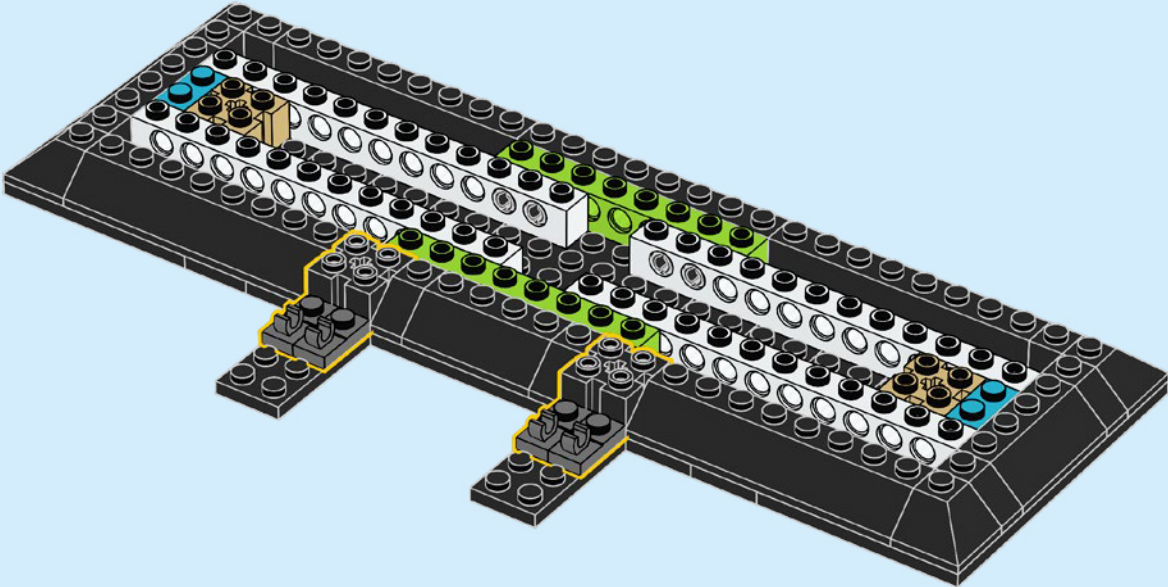

280

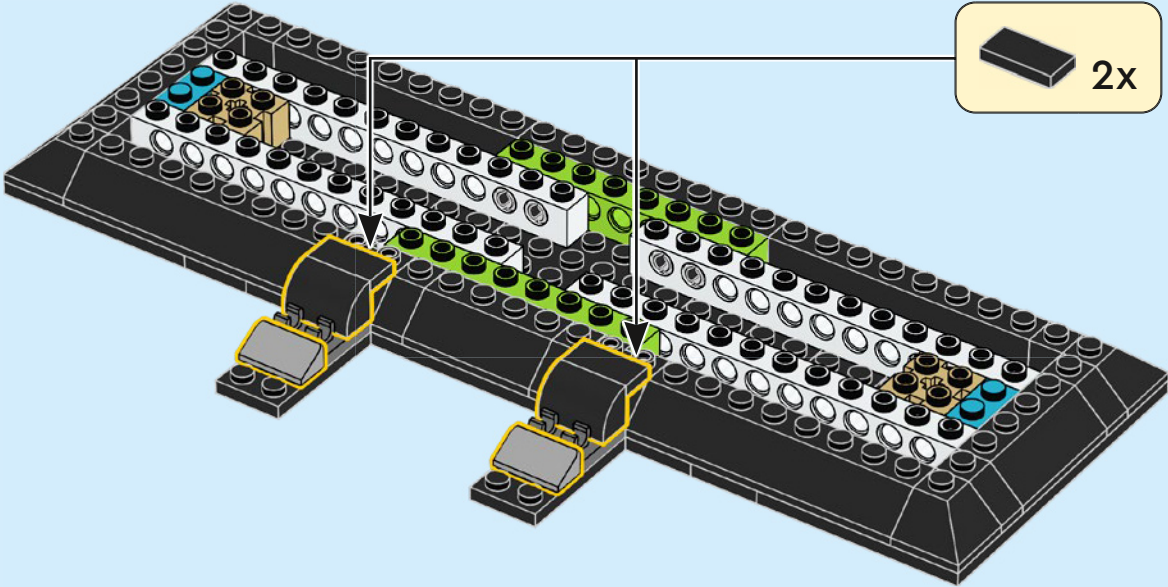

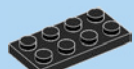

4x

# 281

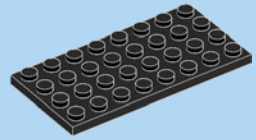
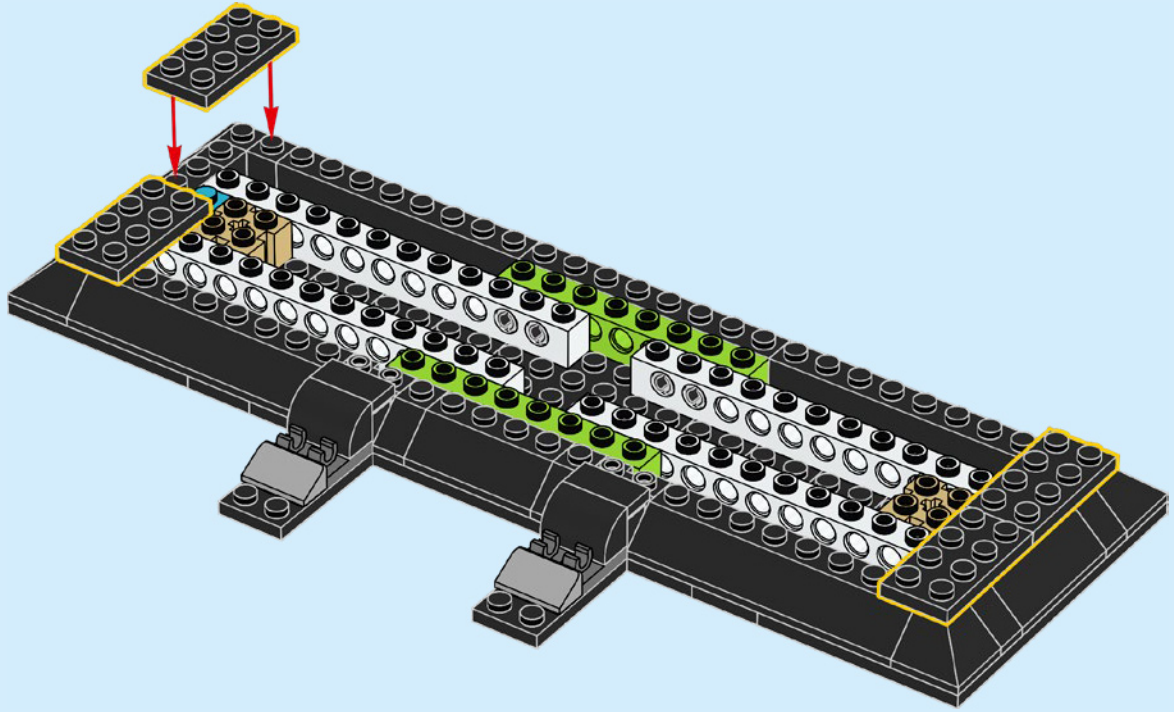

5x

# 282

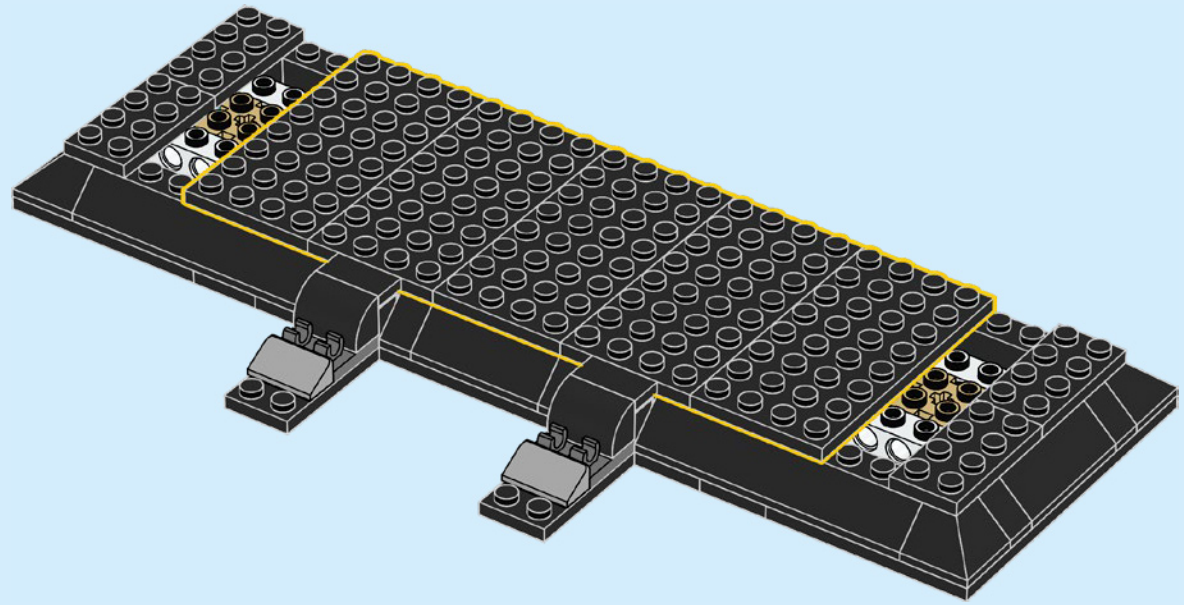

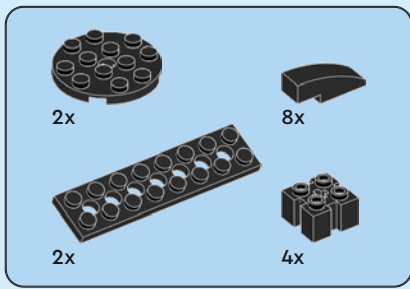

283

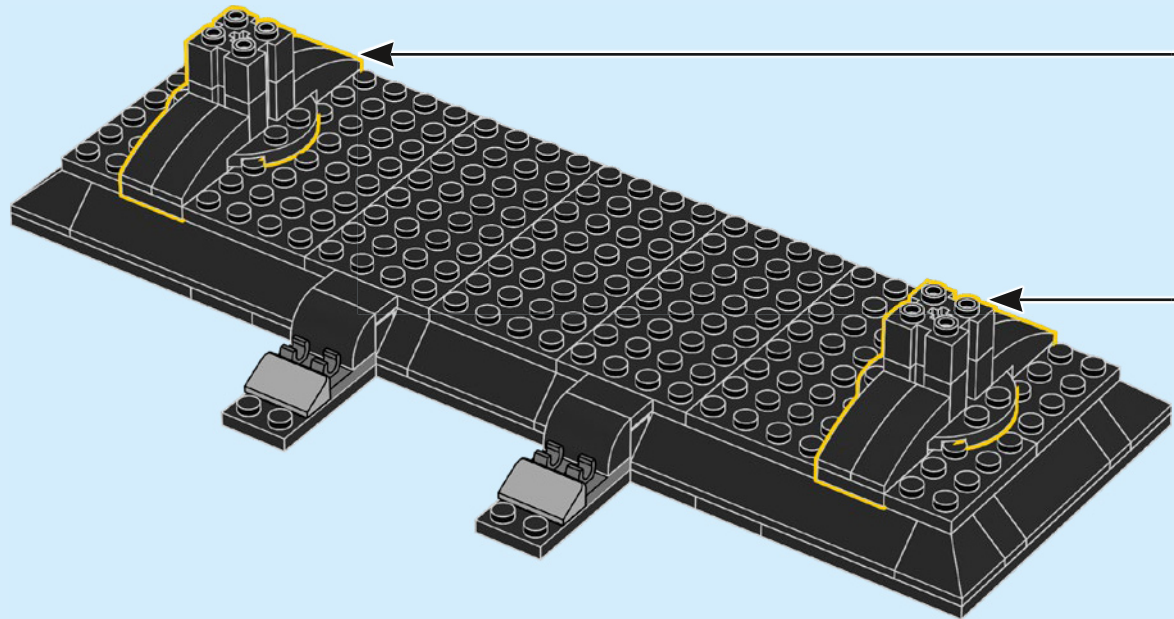
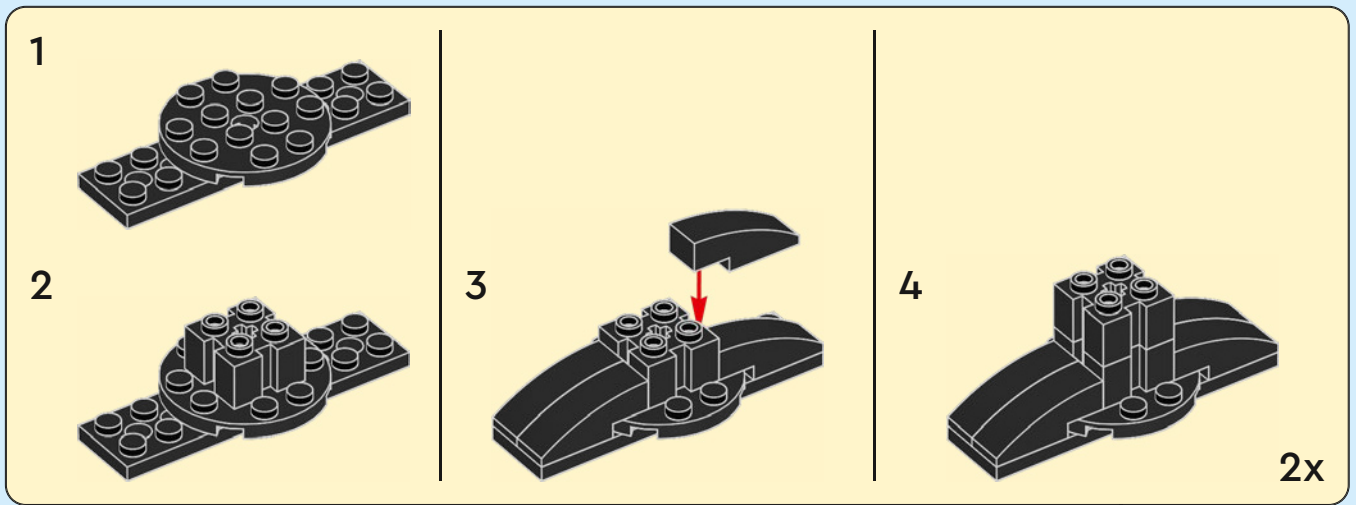

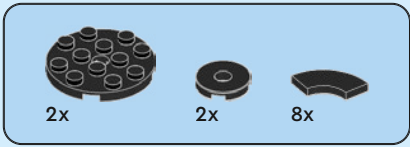

284

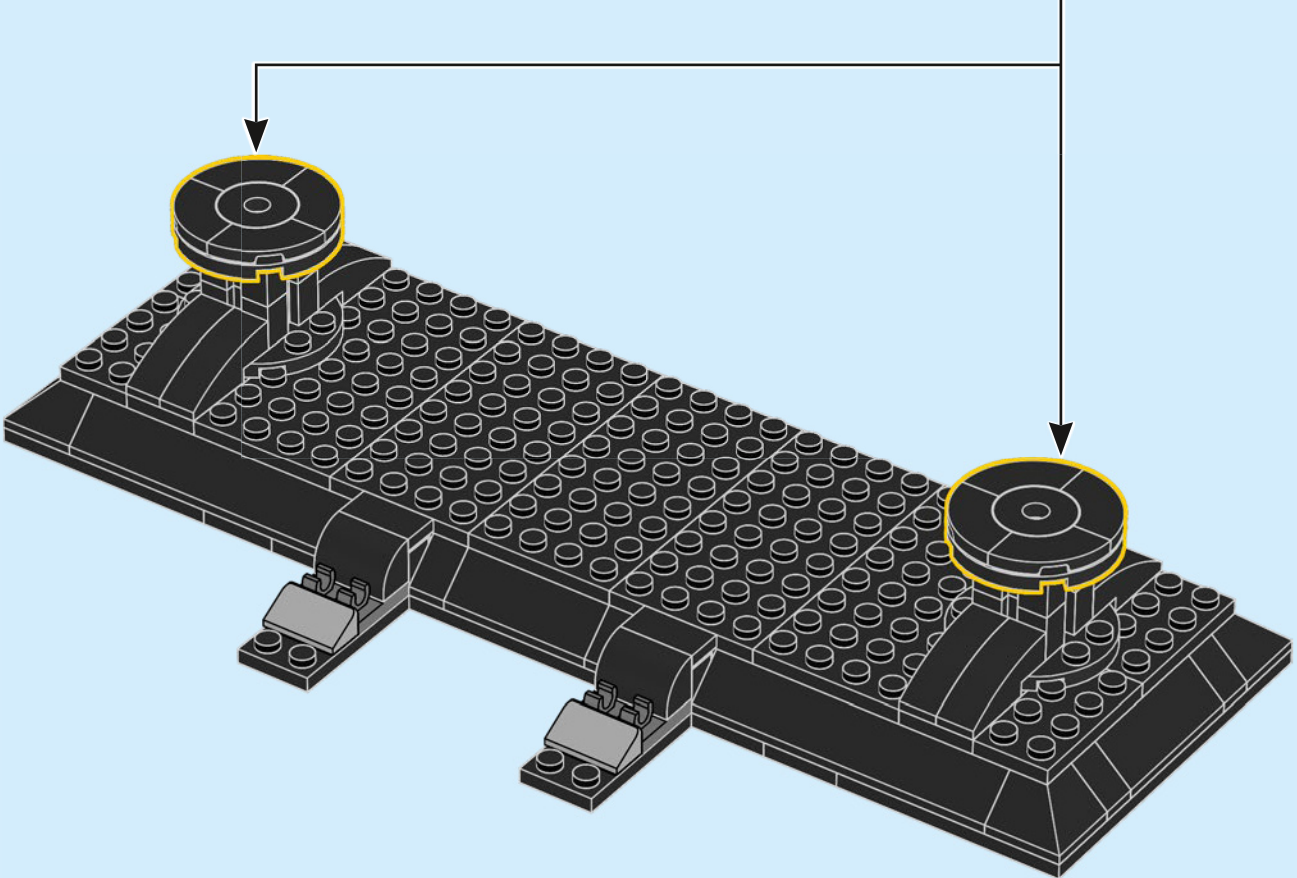
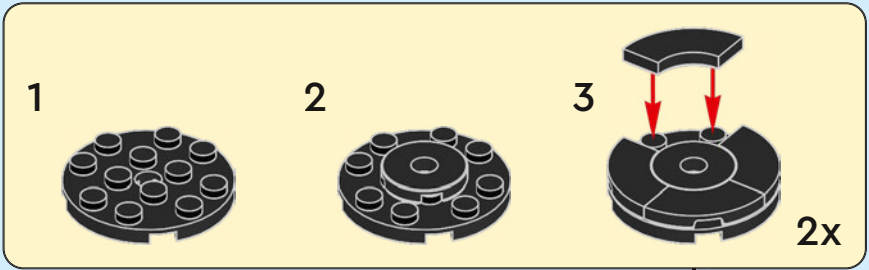

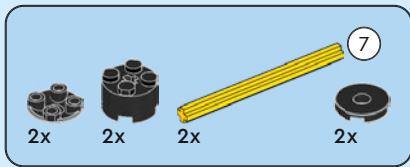

285

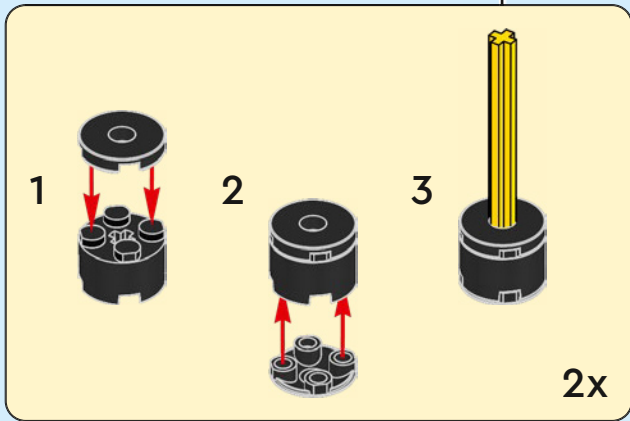
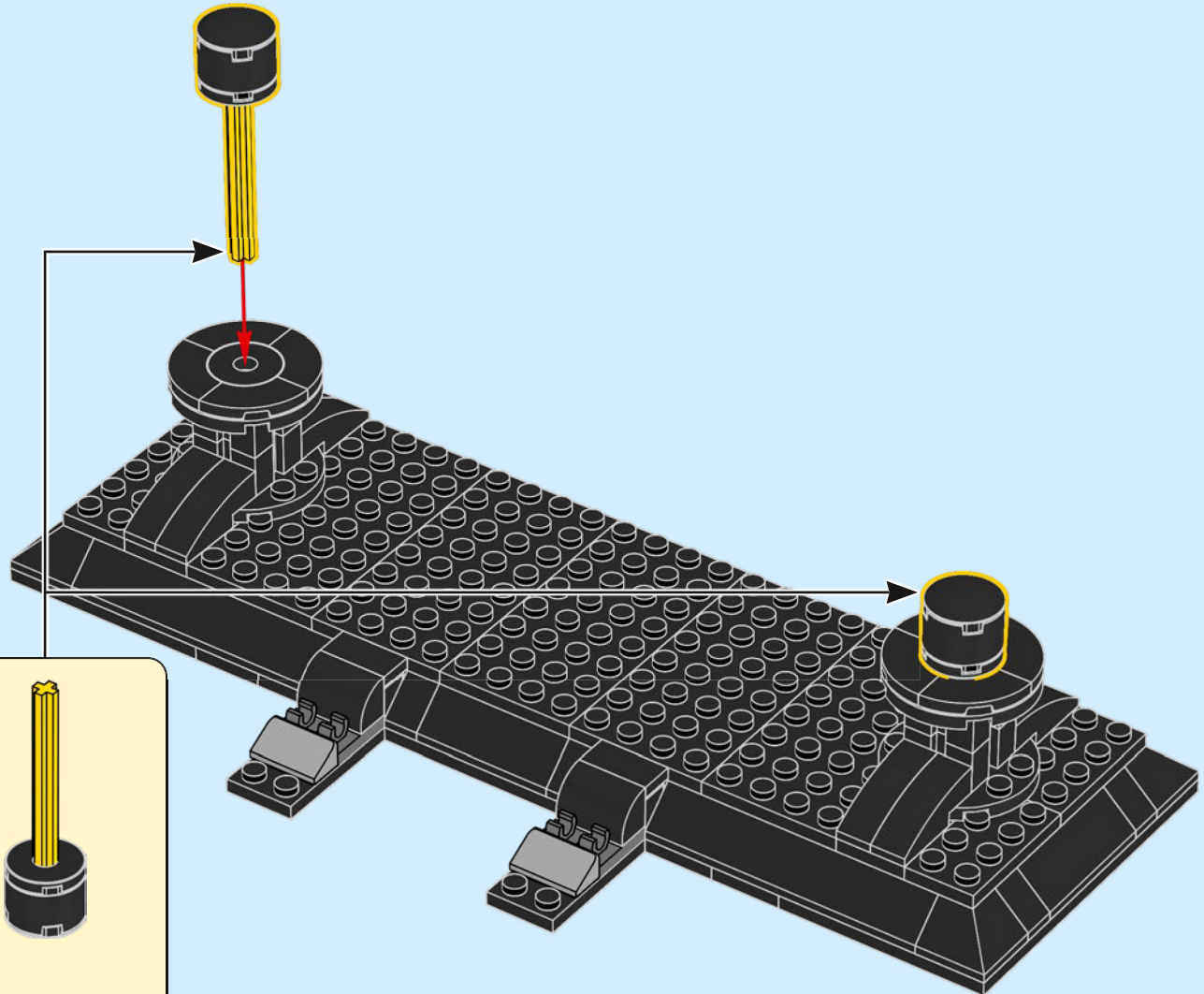

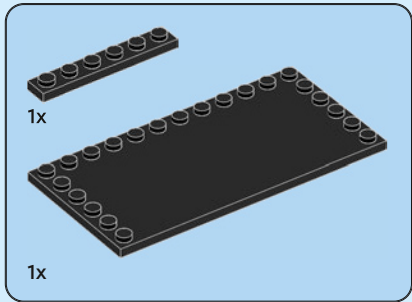

286

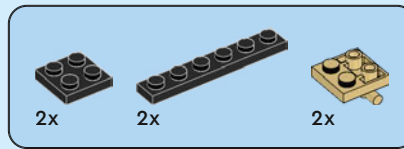
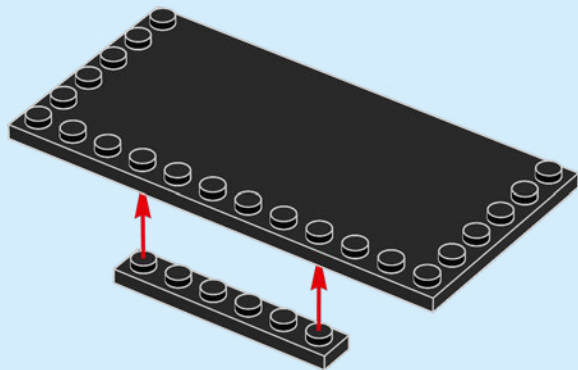

287

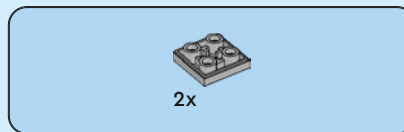
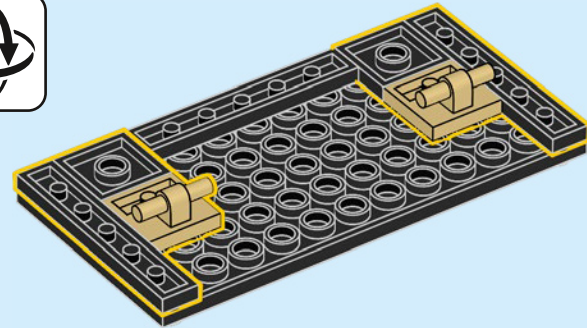

288

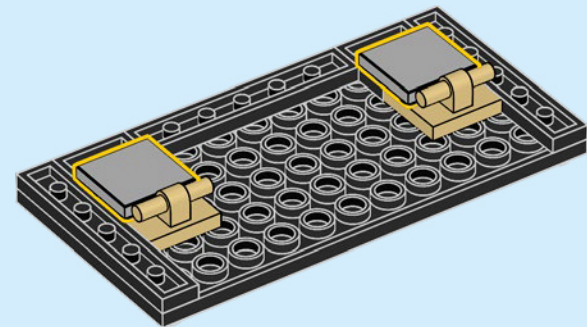

289

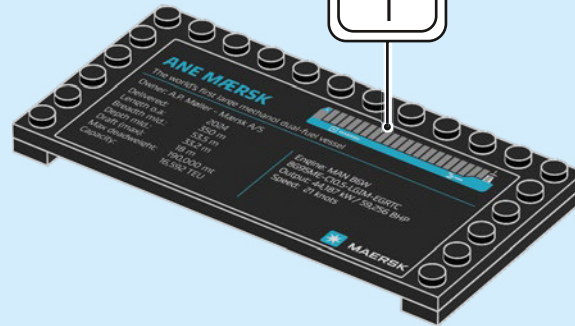

290

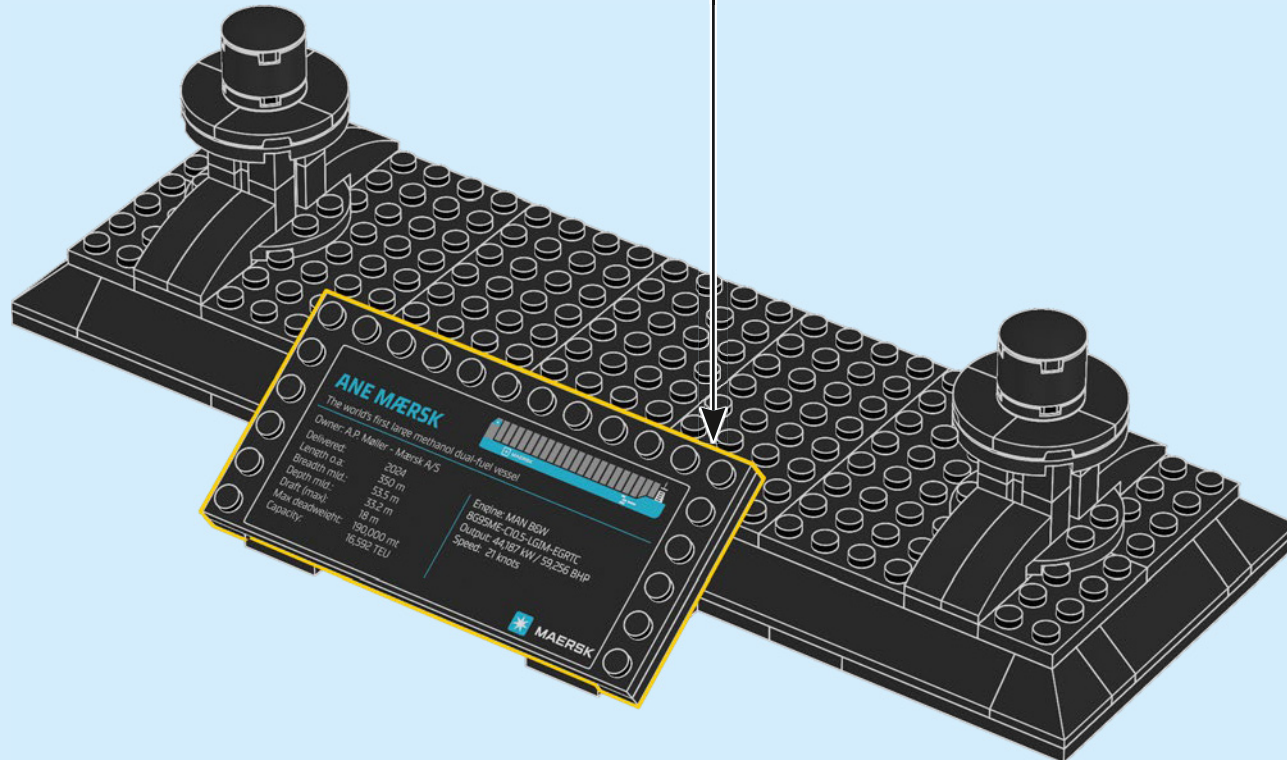



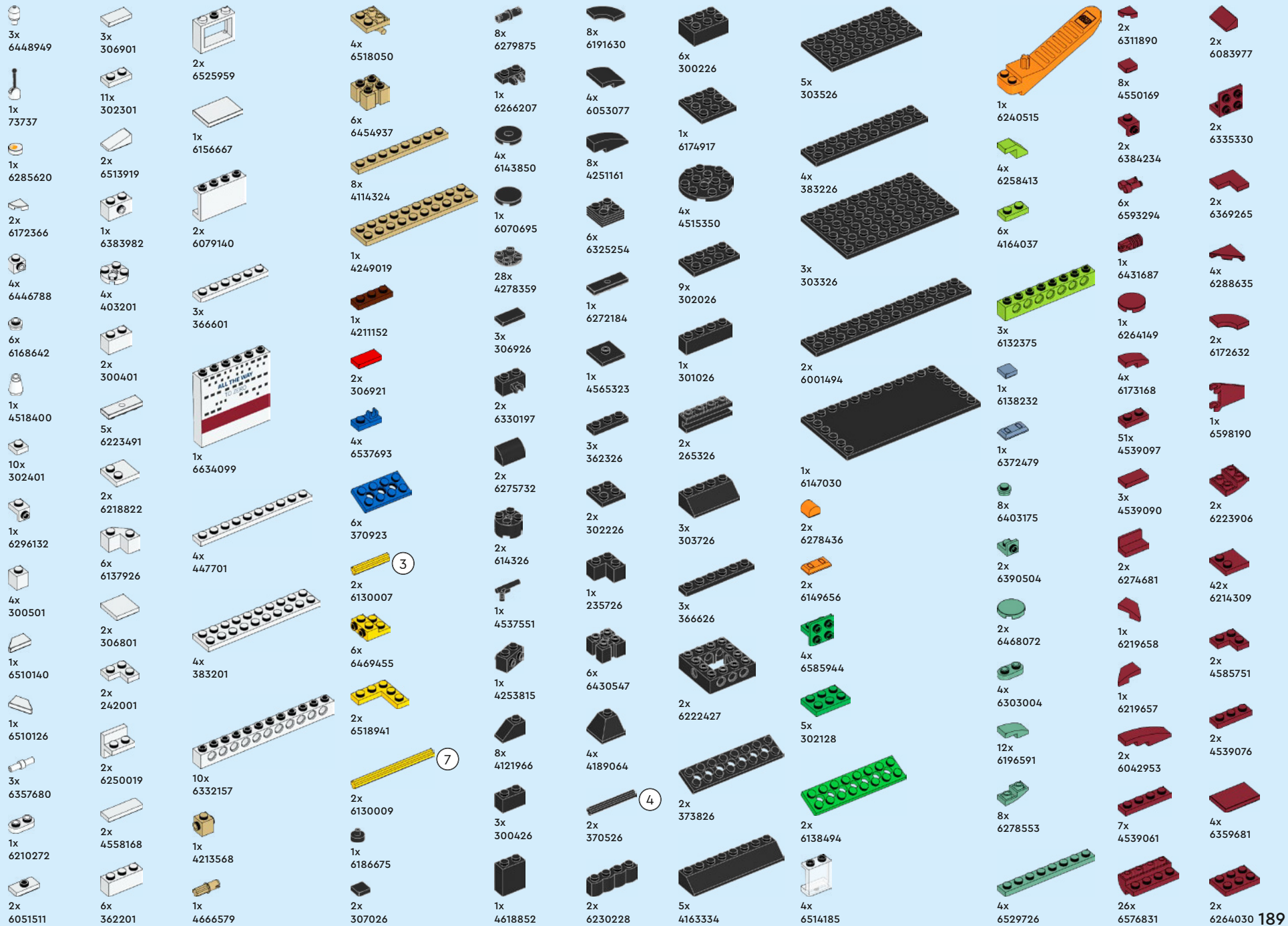

- 4x 6584062
- 4x 4541528
- 2x 6586652
- 1x 6335319
- 21x 6052777
- 6x 4541507
- 4x 4539071
- 10x 6576807
- 66x 6584063
- 1x 6465734
- 2x 6602414
- 2x 4539062
- 1x 6476042
- 1x 6350339
- 26x 6253142
- 4x 6186106
- 1x 6544174
- 6x 6440979
- 1x 4211392
- 6x 4211406
- 25x 4211462
- 2x 4211705
- 1x 6539385
- 11x 6015344
- 9x 6258831
- 2x 4568637
- 1x 4211415
- 2x 4568637
- 4x 4211412
- 33x 4211388
- 2x 4211399
- 11x 6598026
- 6x 6227897
- 70x 4211398
- 27x 4211395
- 12x 6061675
- 4x 6059033
- 2x 6079461
- 30x 4527174
- 16x 6598025
- 16x 6595947
- 35x 4211452
- 64x 6123809
- 6x 4211564
- 3x 6170387
- 32x 4211363
- 4x 6469440
- 1x 6446028
- 2x 6132886
- 2x 6043639
- 2x 4211580
- 15x 4211413
- 4x 6258820
- 10x 4211387
- 10x 6171894
- 10x 4211396
- 12x 4211386
- 1x 6514057
- 1x 6514051
- 2x 4210719
- 2x 4211063
- 4x 6344754
- 1x 6514456
- 2x 6123814
- 4x 4543086
- 1x 4218696
- 6x 4211094
- 11x 4211056
- 2x 4210651
- 1x 6287847
- 1x 6322046
- 2x 6215606
- 1x 6292145
- 1x 6088641
- 2x 6335563
- 1x 6593293
- 2x 6603341
- 8x 6603339
- 2x 6603283
- 4x 6603285
- 6x 6603587
- 8x 6603337
- 2x 6603334
- 1x 6603315
- 4x 6603598
- 17x 6603336
- 1x 6603301
- 1x 6603600
- 1x 6603591
- 1x 6603586
- 1x 6603585
- 2x 6603590
- 2x 6603344
- 2x 6603309
- 3x 6603316
- 1x 6593286
- 2x 6604733
- 2x 6603601
- 7x 6603965
- 30x 6603319
- 2x 6603317
- 2x 6576809
- 2x 6603313
- 1x 6598028
- 2x 6576810
- 1x 6598027
- 2x 6603599
- 2x 6603596
- 2x 6603342
- 2x 6603312
- 10x 6603286
- 2x 6603333
- 10x 6603340
- 2x 6603318
- 4x 6603343
- 2x 6603335
- 4x 6603595
- 1x 6603594
- 6x 6603589
- 2x 6603332
- 2x 6576813



[LEGO.com/service](https://www.LEGO.com/service)

**YOU COULD WIN**



Scan this QR code or go to **LEGO.COM/PRODUCTFEEDBACK** and give us your short feedback about this LEGO® set for a chance to win a cool LEGO prize.

Terms and Conditions apply\*

**EN: YOU COULD WIN.** Terms and Conditions apply\* **DE: Du könntest GEWINNEN.** Es gelten die Teilnahmebedingungen\* **FR: Tu pourrais GAGNER.** Des conditions s'appliquent\* **IT: Potresti VINCERE tu.** Termini e condizioni sono applicabili\* **ES: Puedes GANAR.** Aplican términos y condiciones\* **PT: PODERÁ GANHAR.** Aplicam-se Termos e Condições\* **ZH: 轻松获奖.** 条款和条件适用\* **PL: Szansa na WYGRANA.** Obowiązuje regulamin\* **CS: Máte šanci VYHRÁT.** Platí všeobecné smluvní podmínky\* **SK: Máte šancu VYHRÁT.** Platia všeobecné zmluvné podmienky\* **HU: TE IS NYERHETSZ.** Felhasználási feltételek érvényesek\* **UA: ВИ МОЖЕТЕ ВИГРАТИ.** Застосовуються загальні положення та умови\* **RO: Ai putea CÂȘTIGA.** Se aplică termenii și condiții\* **BG: Можете да СПЕЧЕЛИТЕ.** Има определени правила и условия\* **LV: Tu vari LAIMĒT.** Ir spēkā noteikumi un nosacījumi.\* **ET: Sul on võimalus VÕITA.** Kehtivad tingimused\* **LT: Jūs galite LAIMĖTI.** Taikomos sąlygos\*

\*[LEGO.com/productfeedback-terms](https://www.lego.com/productfeedback-terms)

