



40955



MAERSK





LEGO.com/sustainable-packaging



FR

DONNEZ
OU
RECYCLEZ



OU



OU



ASSOCIATION

MAGASIN

DÉCHÈTERIE

Adresses sur quefairedemesdechets.fr

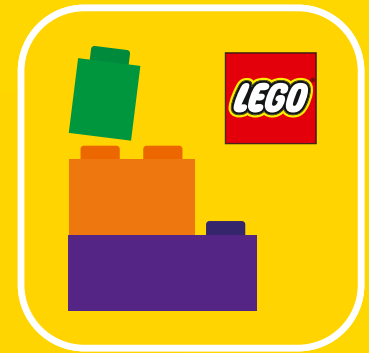

🔍 LEGO® Builder

BUILDER



Apple and the Apple logo are trademarks of Apple Inc., registered in the U.S. and other countries and regions. App Store is a service mark of Apple Inc. Google Play and the Google Play logo are trademarks of Google LLC. Tencent and the Tencent logo are trademarks of Tencent Inc.

🔍 LEGO.com/devicecheck

EN Ask parents' permission before going online | DE Eltern um Erlaubnis bitten, bevor du online gehst | FR Demande l'autorisation d'un parent avant d'aller en ligne | IT Chiedi il permesso ai tuoi genitori prima di andare online | ES Pídeles permiso a tus papás antes de conectarte a Internet | PT Peça autorização aos pais antes de acederes online | ZH 上网前应先征得父母的同意 | PL Poproś rodziców o zgodę, zanim wejdiesz do Internetu | CS Než půjdeš na internet, požádej rodiče o svolení | SK Skôr než pôjdeš na internet, vypoťaj si povolenie od rodičov | HU Kérj szülői engedélyt, mielőtt online csatlakoznál! | UA Запитуйте дозволу батьків, перш ніж користуватися інтернетом | RO Cere permisiunea părinților înainte de a te conecta online | BG Поискайте разрешение от родител, преди да влезете онлайн | LV Pirms došanās tiešsaistē palūdz atļauju vecākiem | ET Enne Interneti kasutamist küsi vanematelt luba | LT Prieš prisijungdami prie interneto, atsiklauskite tėvų



IEPAZĪSTIES AR ANE MÆRSK

ANE MÆRSK ir pirmais šāda veida lielais konteinerkuģis, kas spēj darboties ar zemu emisiju degvielu, piemēram, bio- un e-metanolu. Kopš ANE MÆRSK 2024. gada janvārī pirmo reizi devās jūrā, kuģot ir uzsākuši arī daudzi citi divkāršās degvielas tipa kuģi, iezīmējot jaunu un svarīgu posmu kuģniecībā un globālajā tirdzniecībā, un oglekļa dioksīda emisiju samazināšanā.

ANE MÆRSK ir 350 metrus (1148,2 pēdas) garš un 53,5 metrus (175,5 pēdas) plats. Kad kuģis ir tukšs, tā svars ir 47 700 tonnas (52 580,25 īsās tonnas), bet, kad kuģī ir krava, degviela un apkalpe, tas var pārvadāt arī 190 000 tonnu (209 439,1 īsās tonnas), kas atbilst 29 000 Āfrikas ziloņu svaram.

Kuģī var iekraut 16 592 TEU (divdesmit pēdu ekvivalents) konteinerus, un, ja tos visus sakārtotu rindā, to garums būtu 100,5 km (62,4 jūdzes), kas atbilst 959 futbola laukumu garumam.





 MAERSK

ALL THE 10 ZERO WAY



PĀRMAINĀNU VADĪBA — KUĢNIECĪBAS VĒSTURE

Cilvēki jau vairāk nekā 5000 gadu pārvadā preces pa jūru, bet līdz rūpnieciskajai revolūcijai un tvaika dzinēja izgudrošanai mēs bijām atkarīgi no laika apstākļiem. Bez vēja jūras šķērsošana nebija iespējama. Līdz ar tvaika enerģijas izmantošanas uzsākšanu kuģa apkalpe pirmo reizi cilvēces vēsturē vairs nebija atkarīga no laika apstākļiem vai manuālas piedziņas. Šis izgudrojums bija revolūcija jūras pārvadājumu nozarē, jo padarīja iespējamus jaunus maršrūtus un ievērojami veicināja tirdzniecību, veicot pārvadājumus pa jūru.

Lai gan tvaika dzinēji bija ievērojams uzlabojums salīdzinājumā ar burām, tie vēl joprojām bija neefektīvi, un drīz vien jūras transports vēlreiz piedzīvoja pārvērtības, pateicoties dīzeļdzinēja izgudrošanai. Tomēr revolūcijas kuģniecībā prasa laiku, un pagāja vairāki gadu desmiti, līdz dīzeļdegviela pilnībā aizstāja tvaika enerģiju. Maersk iegādājās savu pirmo kuģi ar dīzeļdzinēju, LEISE MÆRSK, 1921. gadā — tikai deviņus gadus pēc paša pirmā okeāna tirdzniecības kuģa ar dīzeļdzinēju ekspluatācijas uzsākšanas.



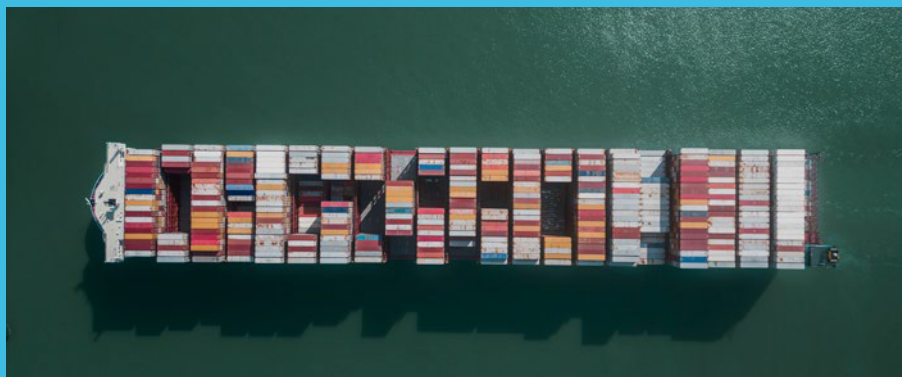

1956. gadā šī nozare atkal piedzīvoja pārmaiņas, kad tika ieviests „konteīnera kravu” efektivitātes princips, saskaņā ar kuru kravas automašīnu piekabes tika iekrautas tieši kuģos. Konteīnera ieviešana samazināja kuģu piekraušanas un izkraušanas laiku no vairākām dienām līdz dažām stundām.

Pateicoties konteīneram un svītrkodam — globālās tirdzniecības slēptajiem virzītājspēkiem — ražotājs jebkurā pasaules daļā var pārdot savas preces visos tirgos, padarot globalizāciju fiziski iespējamu. Mūdienu pasaule ir ļoti atkarīga no globālajām piegādes ķēdēm. No banānu audzētāja Kolumbijā līdz bērnam Dānijā, kurš noloba banānu savām brokastīm — piegādes ķēdes savieno pasauli un nodrošina pārtikas, zāļu, preču un materiālu plūsmu cilvēkiem visā pasaulē.





 MAER

 MAERS

 MAERSK

 MAERSK

KAS SLĒPJAS KUĢA NOSAUKUMĀ?

Kopš 1906. gada visu Maersk flotes kuģu nosaukumā ir vārds „MÆRSK”. Lielākajai daļai pirmo kuģu nosaukumi bija saistīti ar uzņēmuma dibinātāju ģimeni, bet, kad flotē esošo kuģu skaits pārsniedza ģimenes locekļu vārdu skaitu, nosaukumu piešķiršanas tradīcija bija jāmaina. Mūsdienās ir arī Maersk kuģi, kas nosaukti, piemēram, pilsētu un upju vārdos.

Lemjot par jaunās divkāršā degvielas tipa kuģu sērijas nosaukumu, Maersk atgriezās pie tradīcijas nosaukt kuģus uzņēmuma dibinātāju ģimenes locekļu vārdos — šoreiz sākot ar burtu A, lai iezīmētu jaunu ēru.

ANE MÆRSK ir nosaukts par godu Ane Mærsk Mc-Kinney Uggla, kas ir A.P. Moller – Maersk mātes uzņēmuma A.P. Moller Holding priekšsēdētāja. Arnold Peter Møller nodibināja A.P. Moller – Maersk 1904. gadā. Ane ir grupas dibinātāja Arnold Peter Møller un viņa sievas Chastine Mc-Kinney Møller mazmeita.



ANE MAERSK





WHITE STAR — CERĪBAS STARS

Ikoniskā baltā septiņstūru zvaigzne ir daļa no Maersk mantojuma jau kopš uzņēmuma dibināšanas 1904. gadā un simbolizē spēcīgās ģimenes saites, kas vēl joprojām, arī vairāk nekā 100 gadus vēlāk, ir šī uzņēmuma būtības pamatā.

Savas karjeras sākumā kapteinis Peter Mærsk Møller, A.P. Møller dibinātājs, strādāja pie angļu kuģu īpašnieka, un viņa sieva Anna dažkārt pavadīja viņu ceļojumos. Vienā no šiem ceļojumiem Anna smagi saslima. Baidoties, ka viņa neizdzīvos, Peter Mærsk Møller uzkāpa uz klāja un lūdza, lai Dievs dod zīmi, ka viņa sieva atveseļosies. Tad viņš ieraudzīja zvaigzni, kas izgaismoja citādi pelēkās debesis.

Anna atlaba, un 1886. gadā, kad Peter Mærsk Møller iegādājās savu pirmo tvaikoni LAURA, viņš kuģa skursteni izrotāja ar baltu septiņstūru zvaigzni uz gaiši zila fona kā veltījumu savai mīļajai sievai. Peter Mærsk Møller zvaigzne simbolizēja viņa sievas atveseļošanos un viņu kopīgo laimi.

Kopš tā laika baltā septiņstūru zvaigzne uz simboliskā debeszilā fona ir kļuvusi par Maersk sinonīmu, taču pats logotips gadu gaitā ir mainījies. Ir bijušas daudzas logotipa versijas, bet pašreizējais Maersk logotips ir radīts 20. gs. 70. gadu sākumā, kad tika nolemts, ka nepieciešama modernāka pieeja.



ALL THE WAY
TO ZERO



DZĪVES UZLABOŠANA IKVIENAM, APVIENOJOT PASAULI

Kā pasaules līderim loģistikas pakalpojumu jomā uzņēmumam Maersk ir vairāk nekā 100 000 klientu, tas strādā gandrīz 130 valstīs un nodarbina vairāk nekā 100 000 darbinieku. Maersk, kas uzsāka darbību kā neliels tvaikoņu uzņēmums un vēlāk kļuva par integrētu loģistikas uzņēmumu, strādā, lai savienotu un vienkāršotu savu klientu piegādes ķēdes, izmanto vairāk nekā 700 kuģus un transportē gandrīz 20 % no visa pasaules pārtikas, materiālu un preču apjoma.





MAERSK
MAERSK
MAERSK
MAERSK
MAERSK
MAERSK
MAERSK

MAERSK
MAERSK
MAERSK
MAERSK
MAERSK
MAERSK
MAERSK

ALL
THE T
WAY

ANE MAERSK

SPREADERS
TSP98
MAERSK
MAERSK

PTP T414
P423 PTP



ALL
THE WAY TO ZERO

CEĻĀ PRETĪ NULLEI — APŅEMŠANĀS SAMAZINĀT OGĻEKĻA DIOKSĪDA EMISIJAS

Tā kā pasaulei ir jātiek galā ar ārkārtas situāciju klimata jomā, piegādes ķēžu un globālās tirdzniecības nākotne ir atkarīga no spējas ieviest inovācijas un veicināt jaunu enerģijas avotu izmantošanu. Maersk ir uzņēmies nopietnas saistības līdz 2040. gadam visā uzņēmumā panākt oglekļa dioksīda emisiju apjoma samazināšanu līdz nullei. Vienlaikus ar to Maersk ir arī uzņēmies sociālas saistības rādīt piemēru klimata krīzes risināšanā, samazinot emisiju apjomu globālajās piegādes ķēdēs un veicinot taisnīgu pāreju uz neto nulles emisiju ekonomiku.

Maersk ir izvirzījis ambiciozus mērķus laikā līdz 2040. gadam, lai nodrošinātu ievērojamu progresu šajā desmitgadē: okeānā, uz sauszemes, gaisā un mūsu termināļos. Un, ņemot vērā daudzu tādu divkāršā degvielas tipa kuģu pasūtīšanu un piegādi, kas spēj pārvietoties ar zemu emisiju degvielu, piemēram, bio- un e-metanolu, kā arī biometānu, līdz šim šī misija samazināt oglekļa dioksīda emisiju apjomu ir bijusi sekmīga.



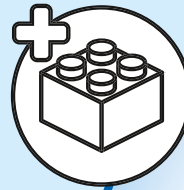
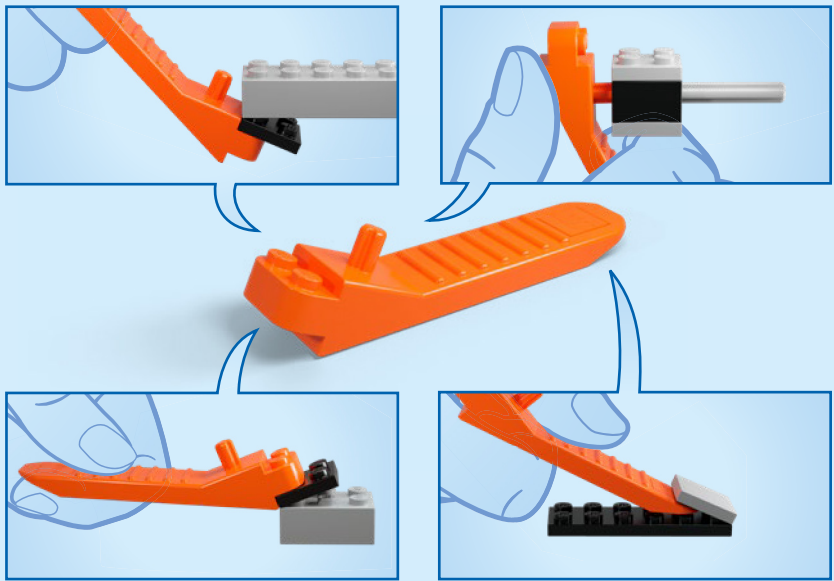

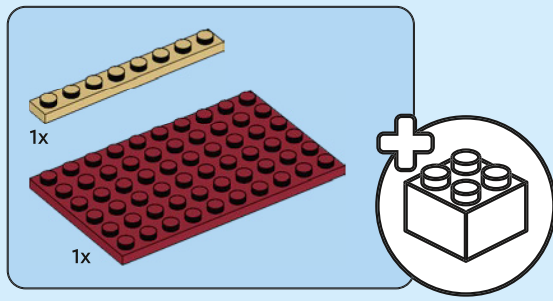

1

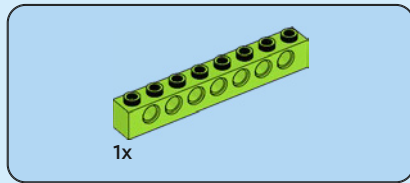
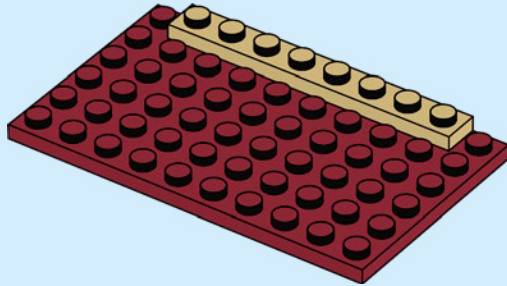

2

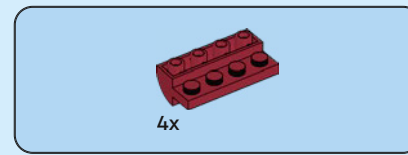
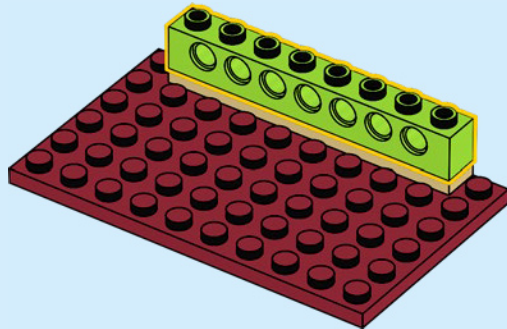

3

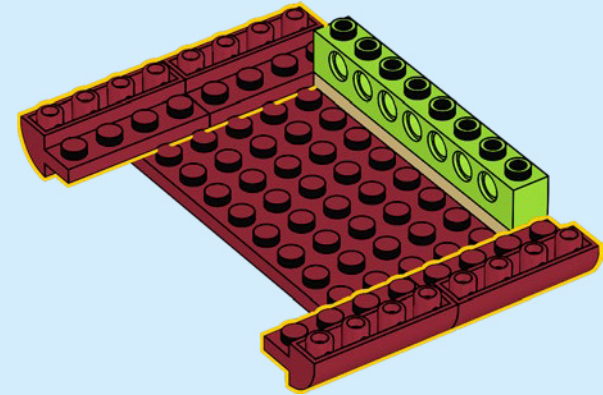

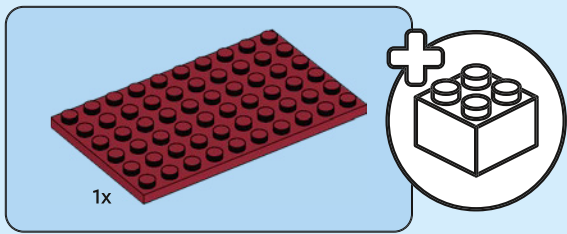

4

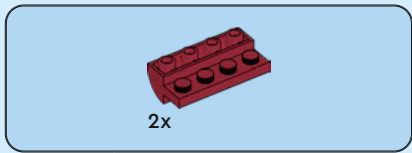
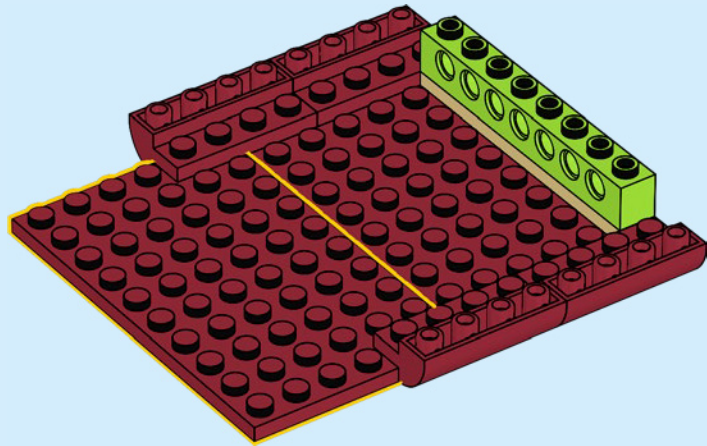

5

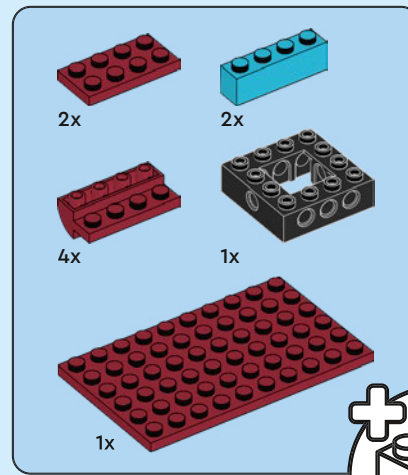
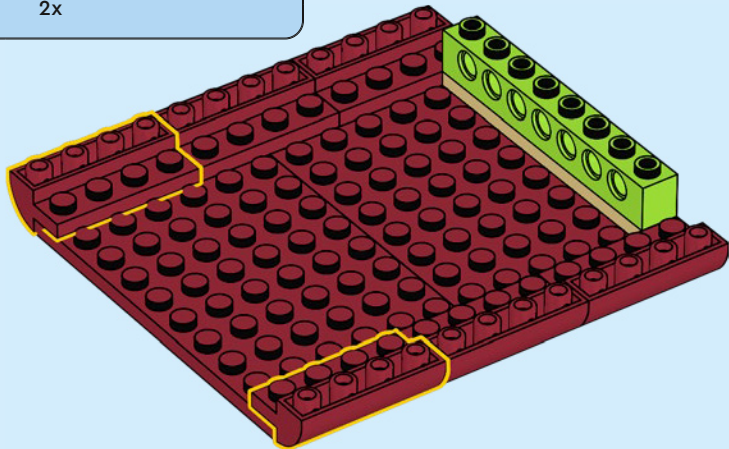

6

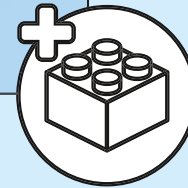

1

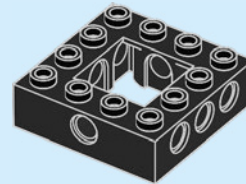

2

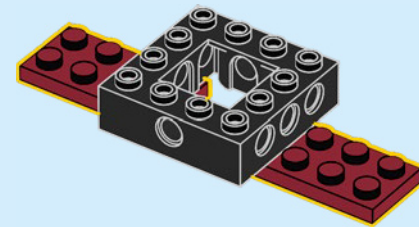

3

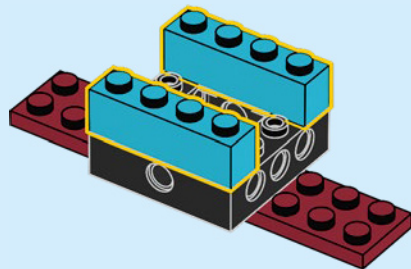

4

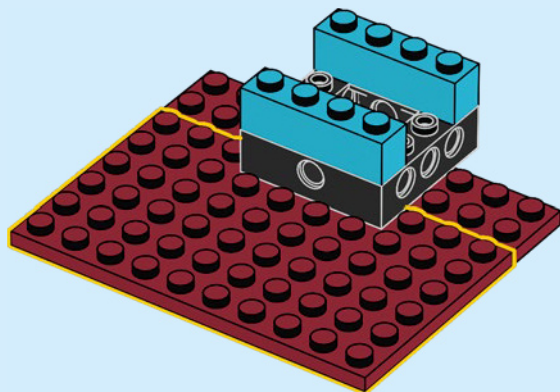

5

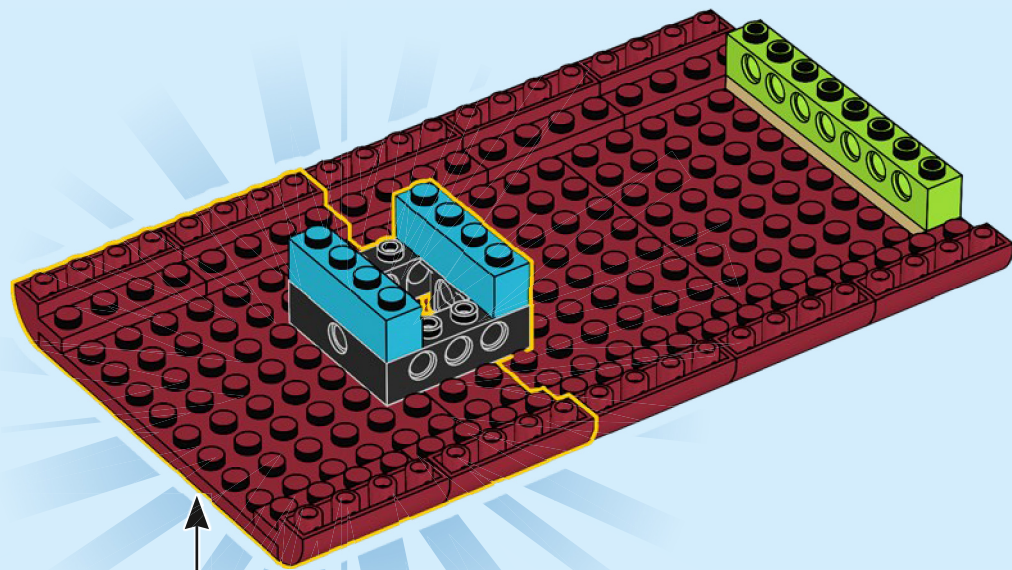
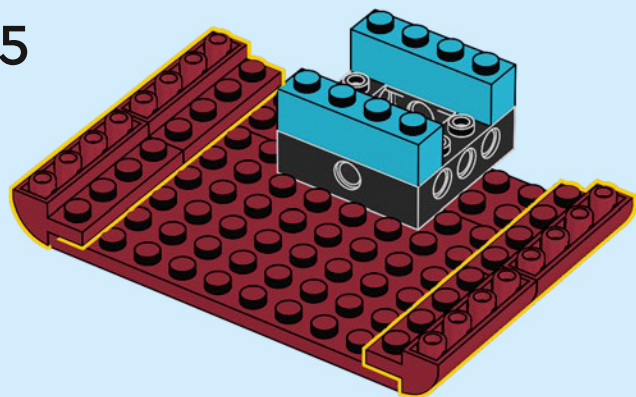

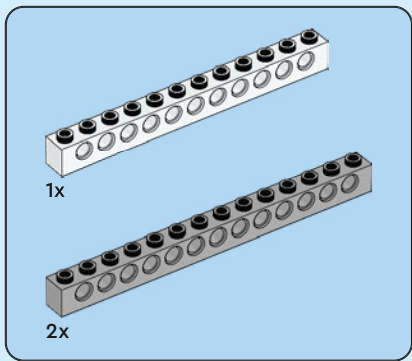

7

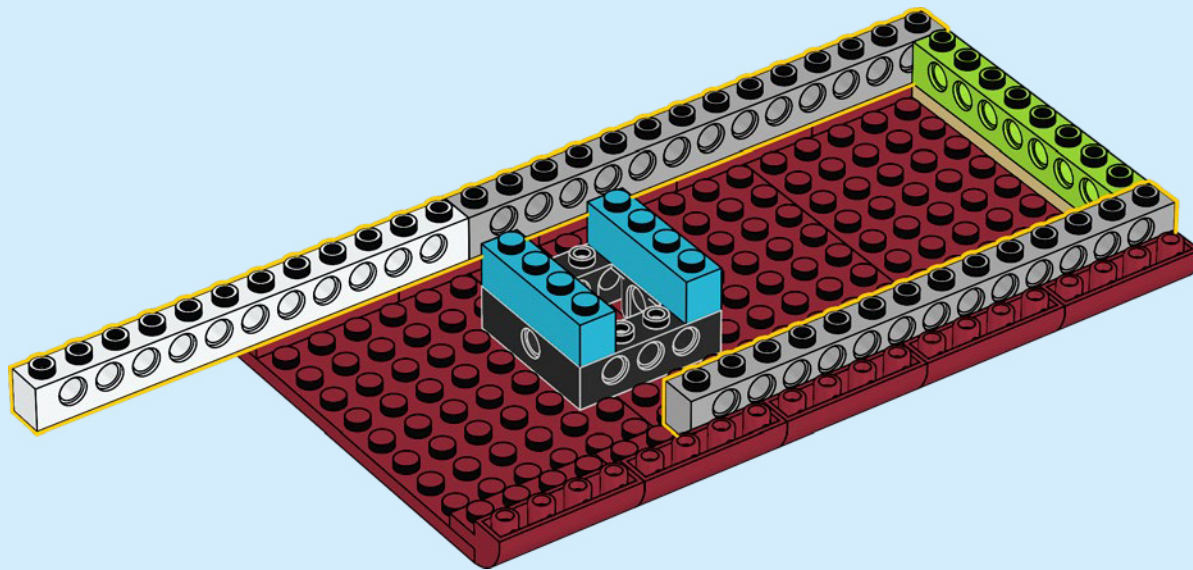

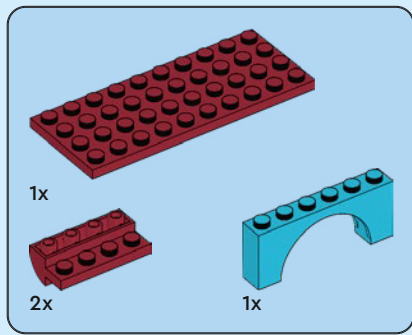

8

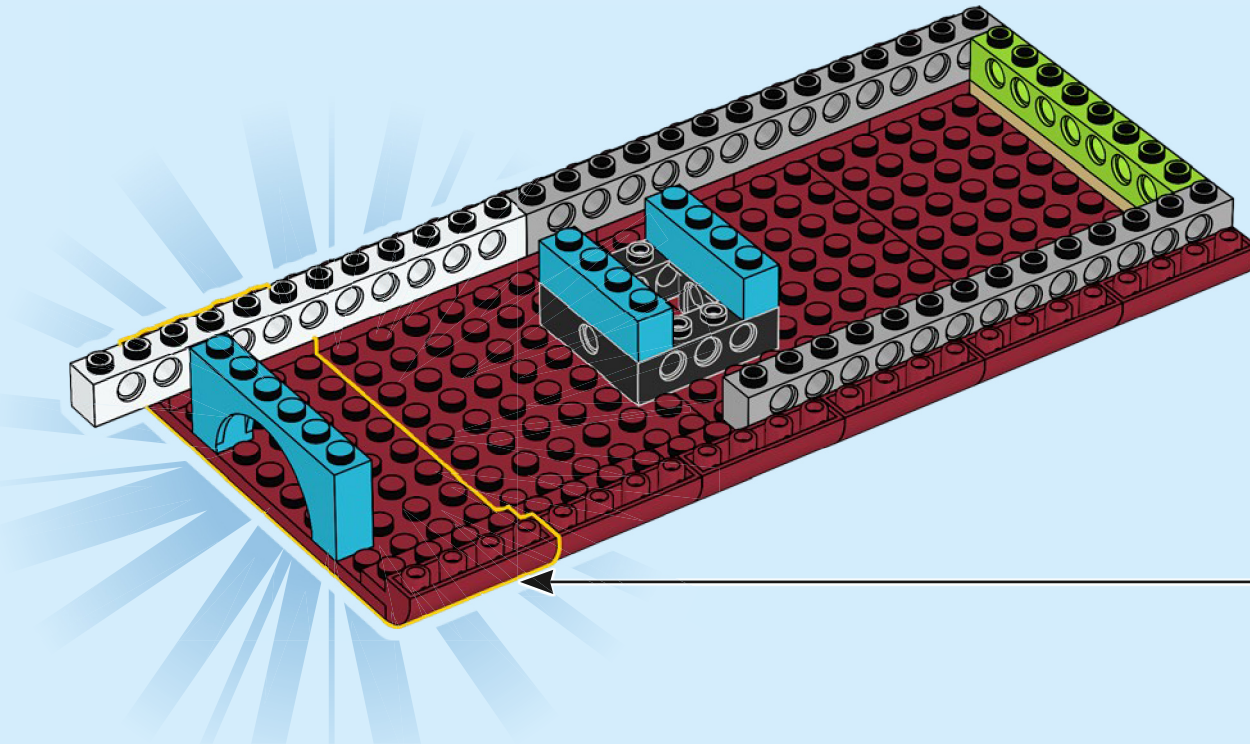
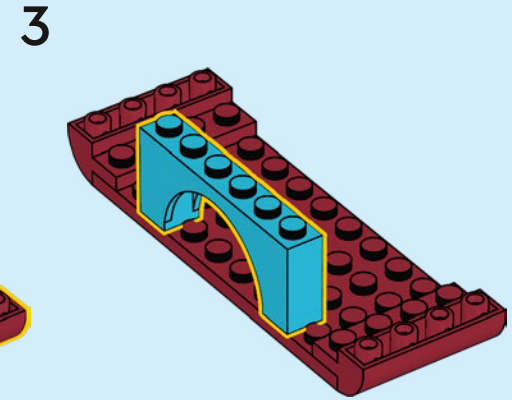
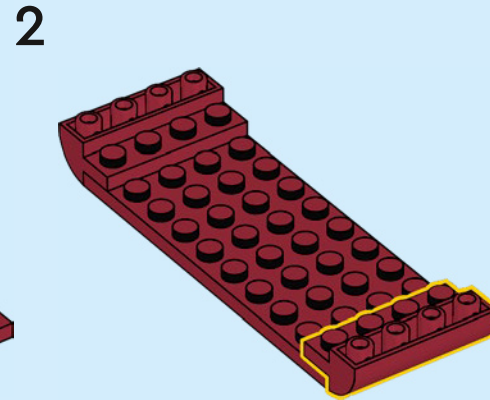
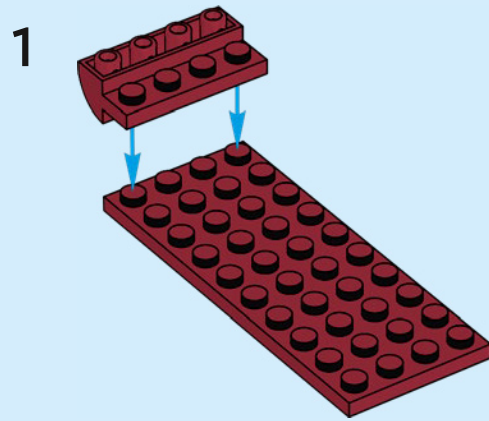

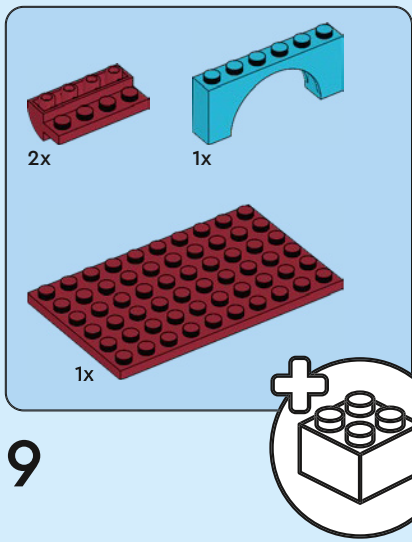

9

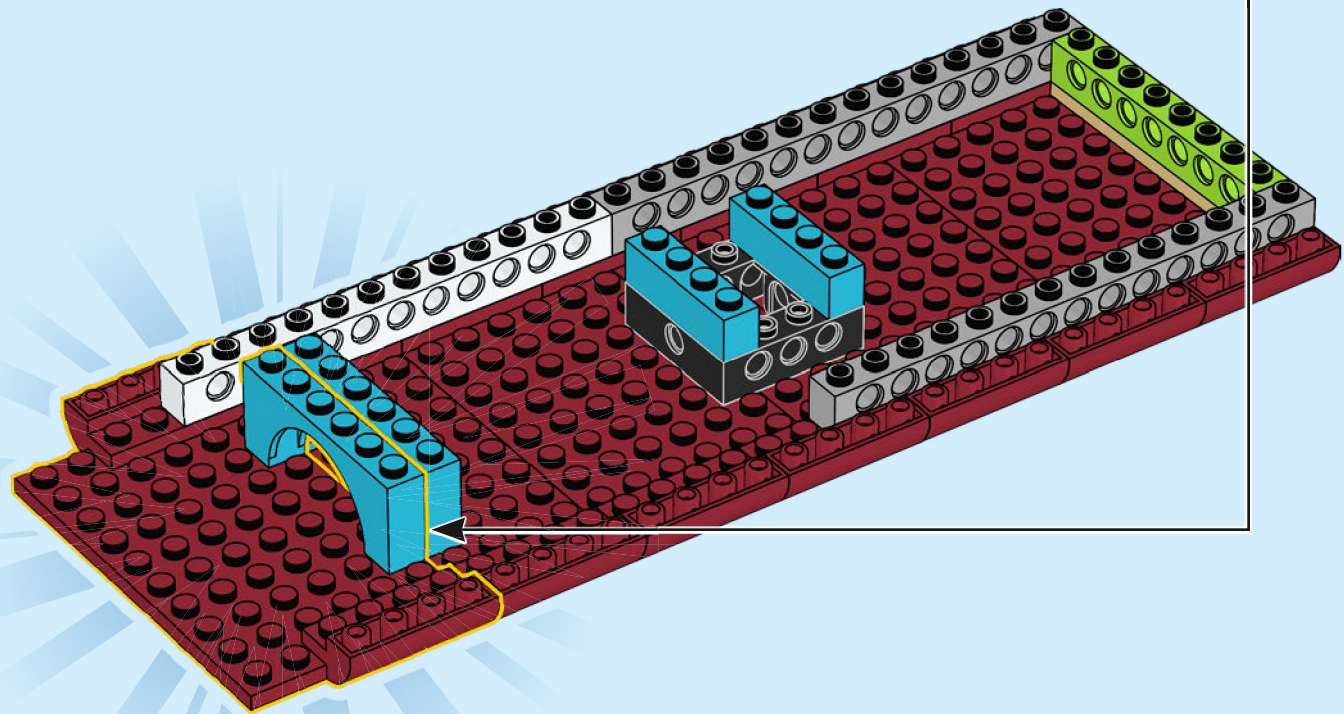
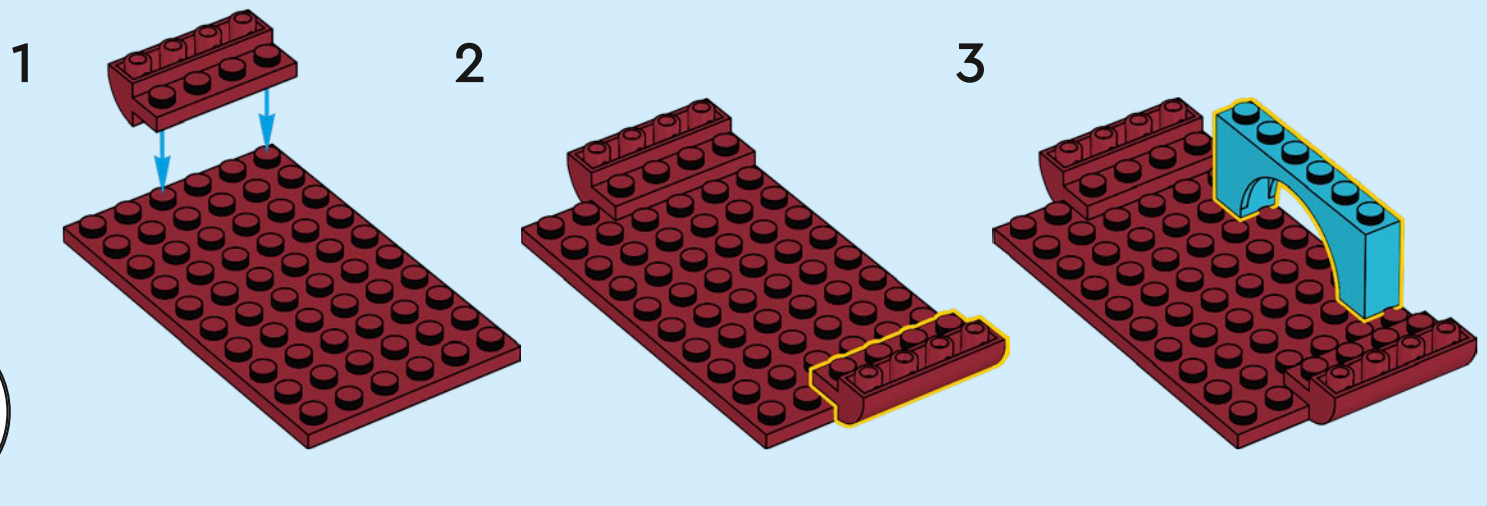

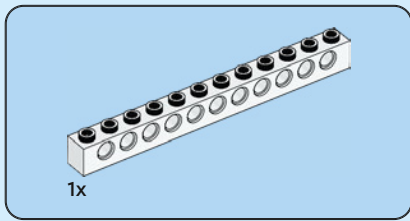

10

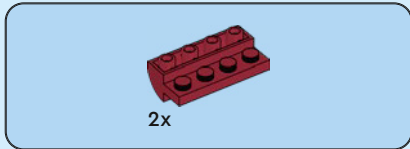
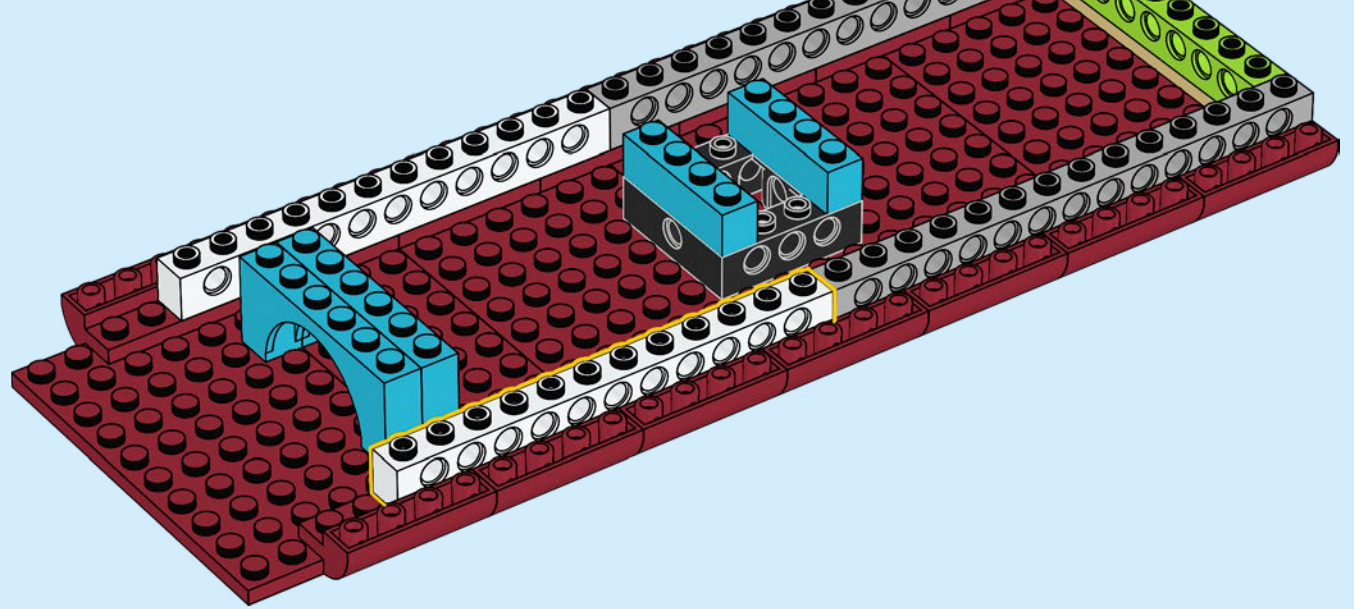

11

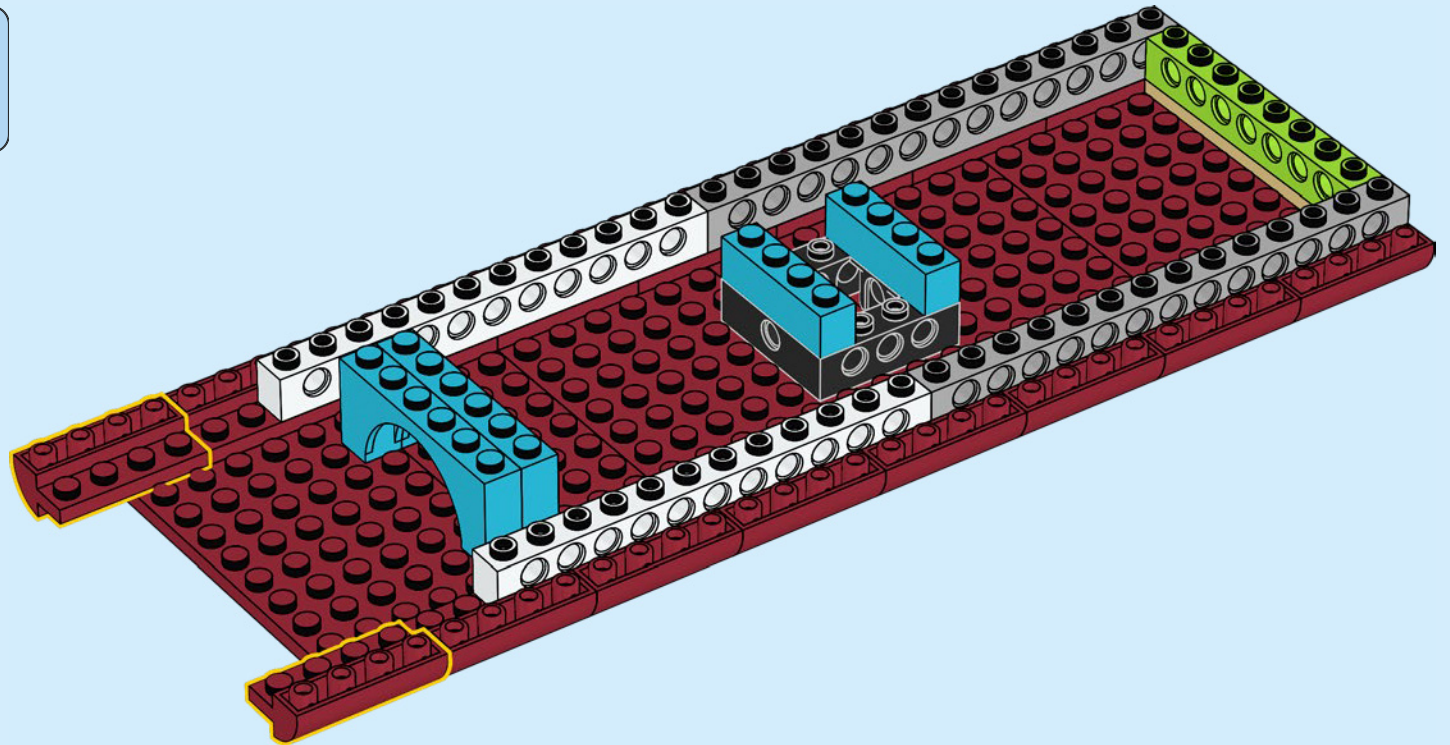

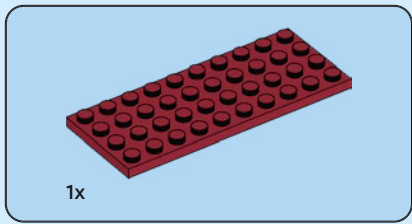

12

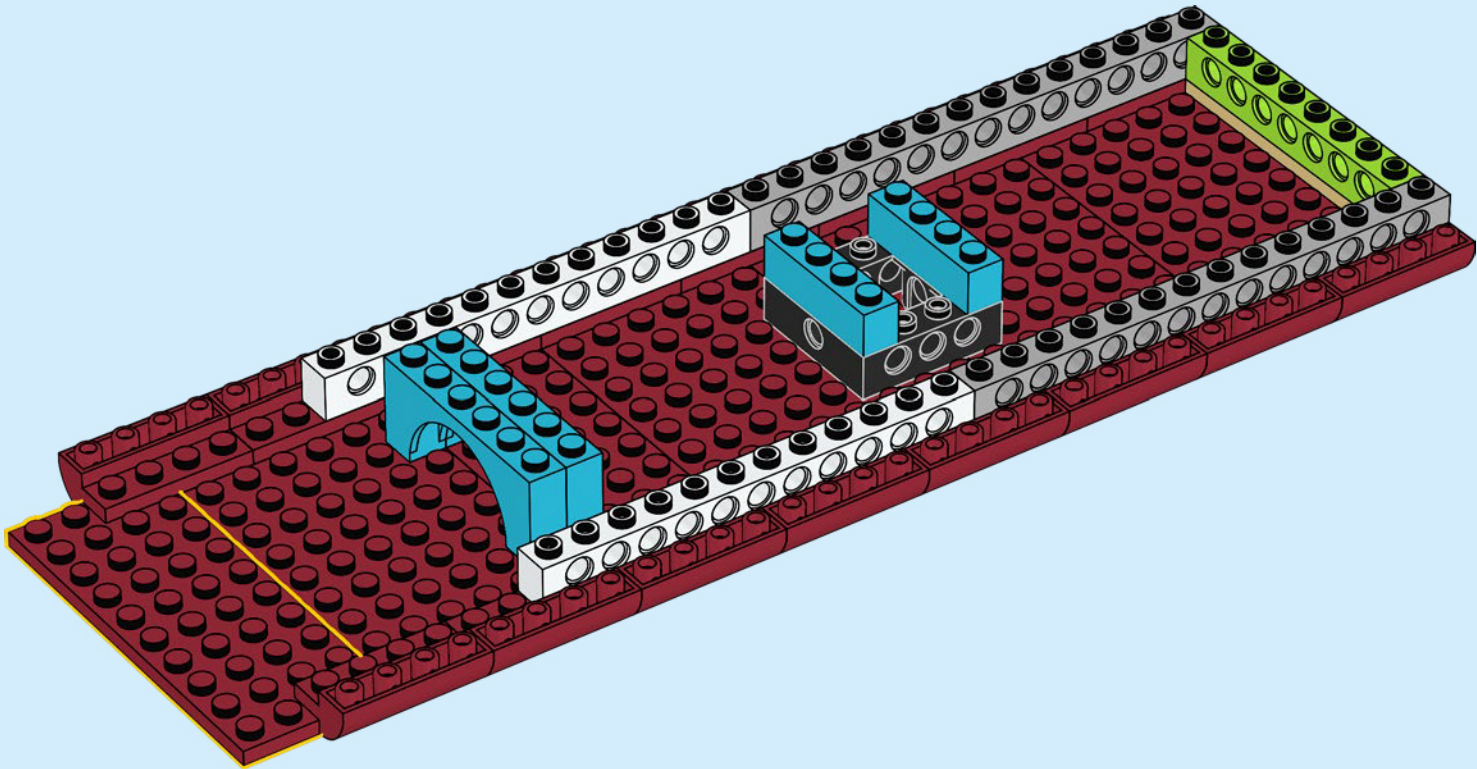

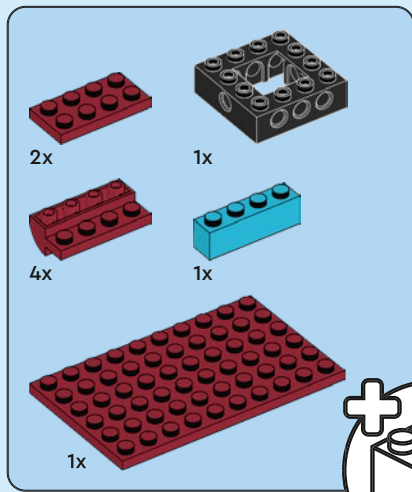

13

1

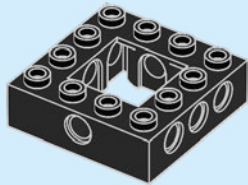

2

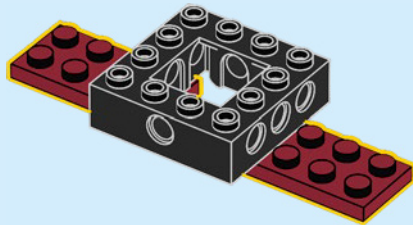

3

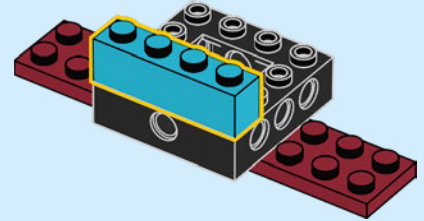

4

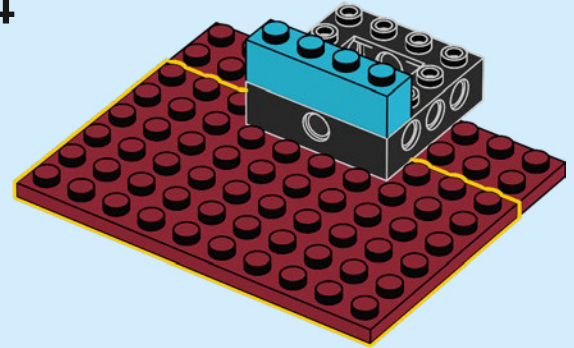

5

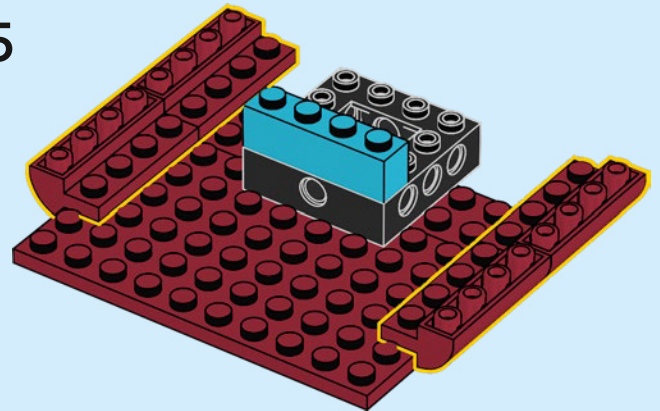

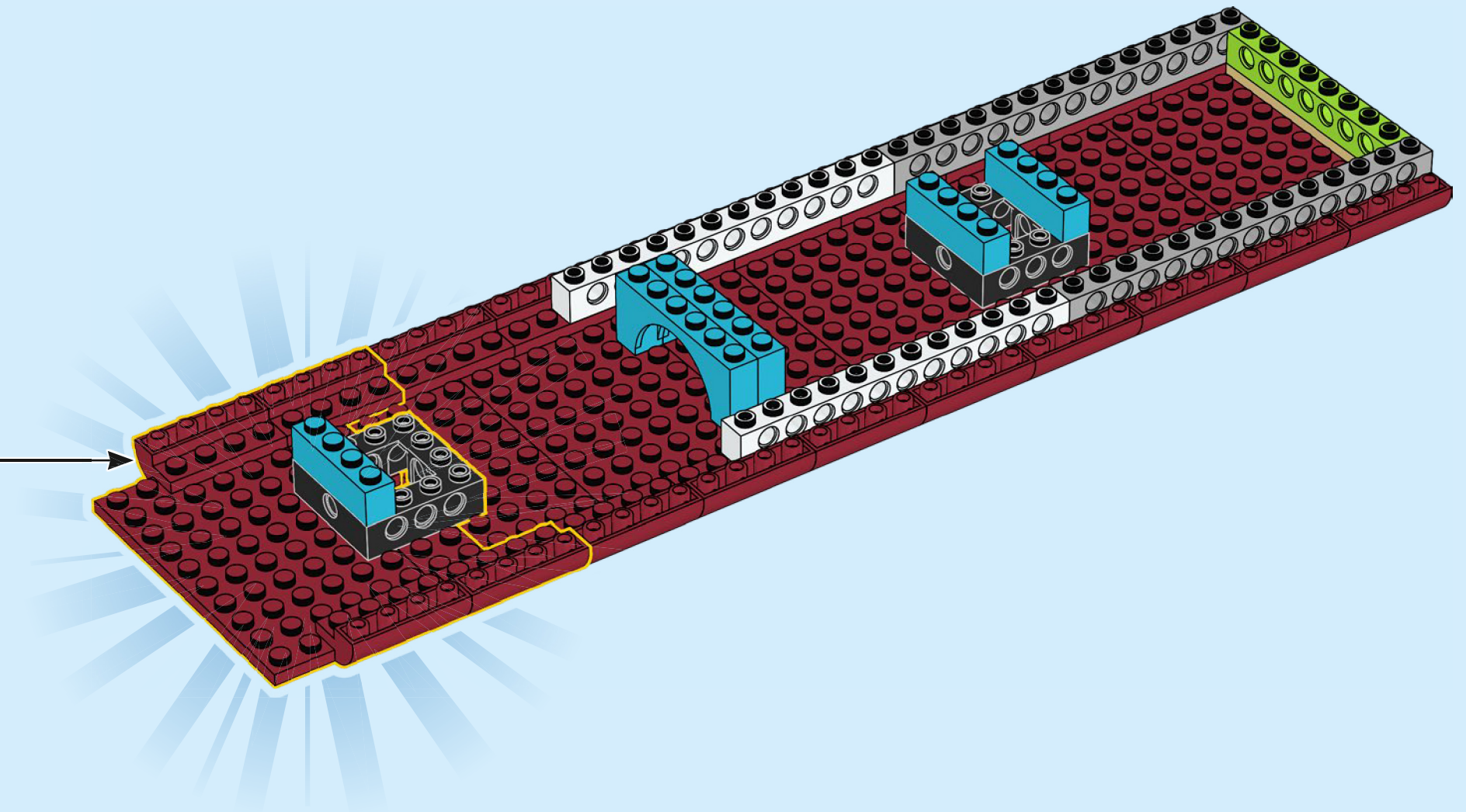

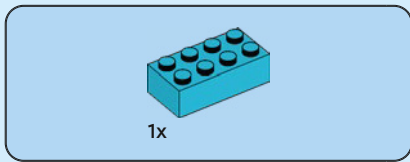

14

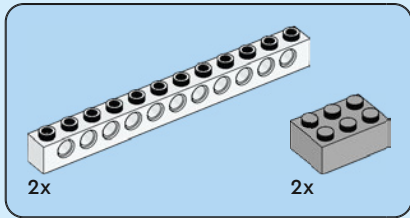
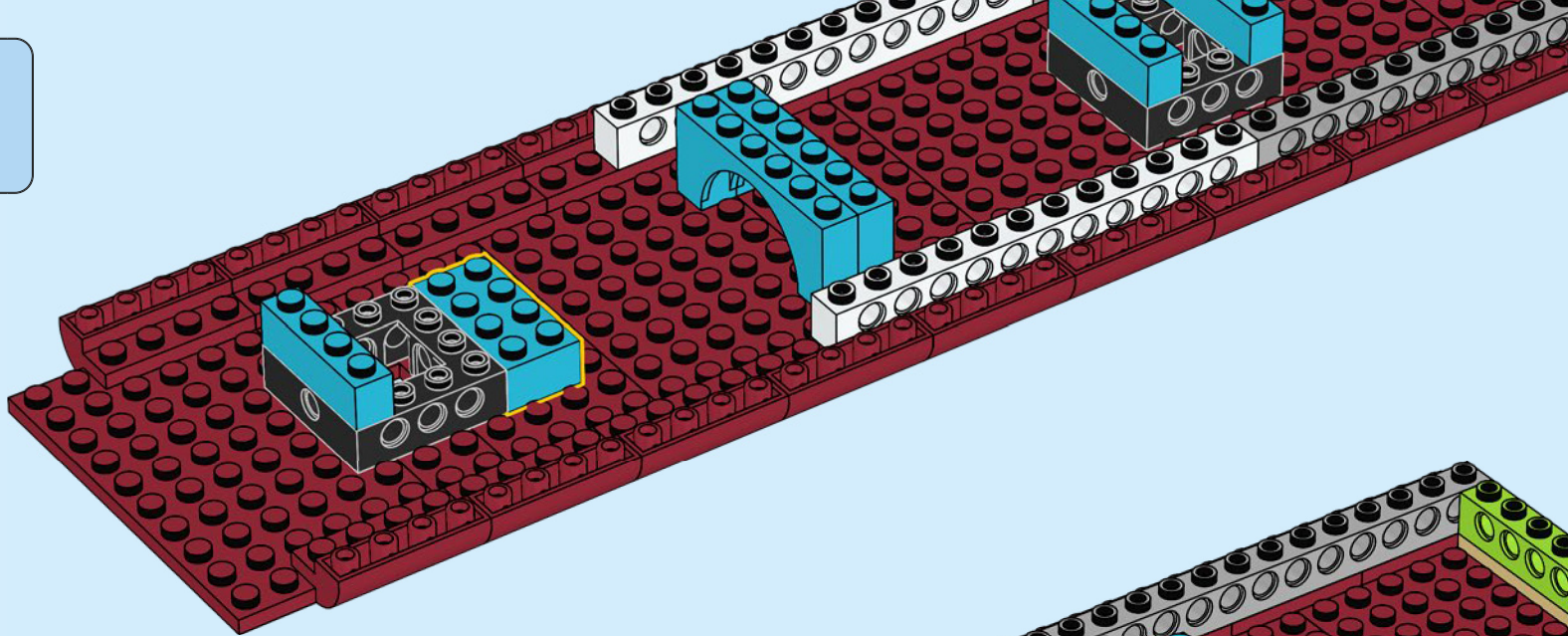

15

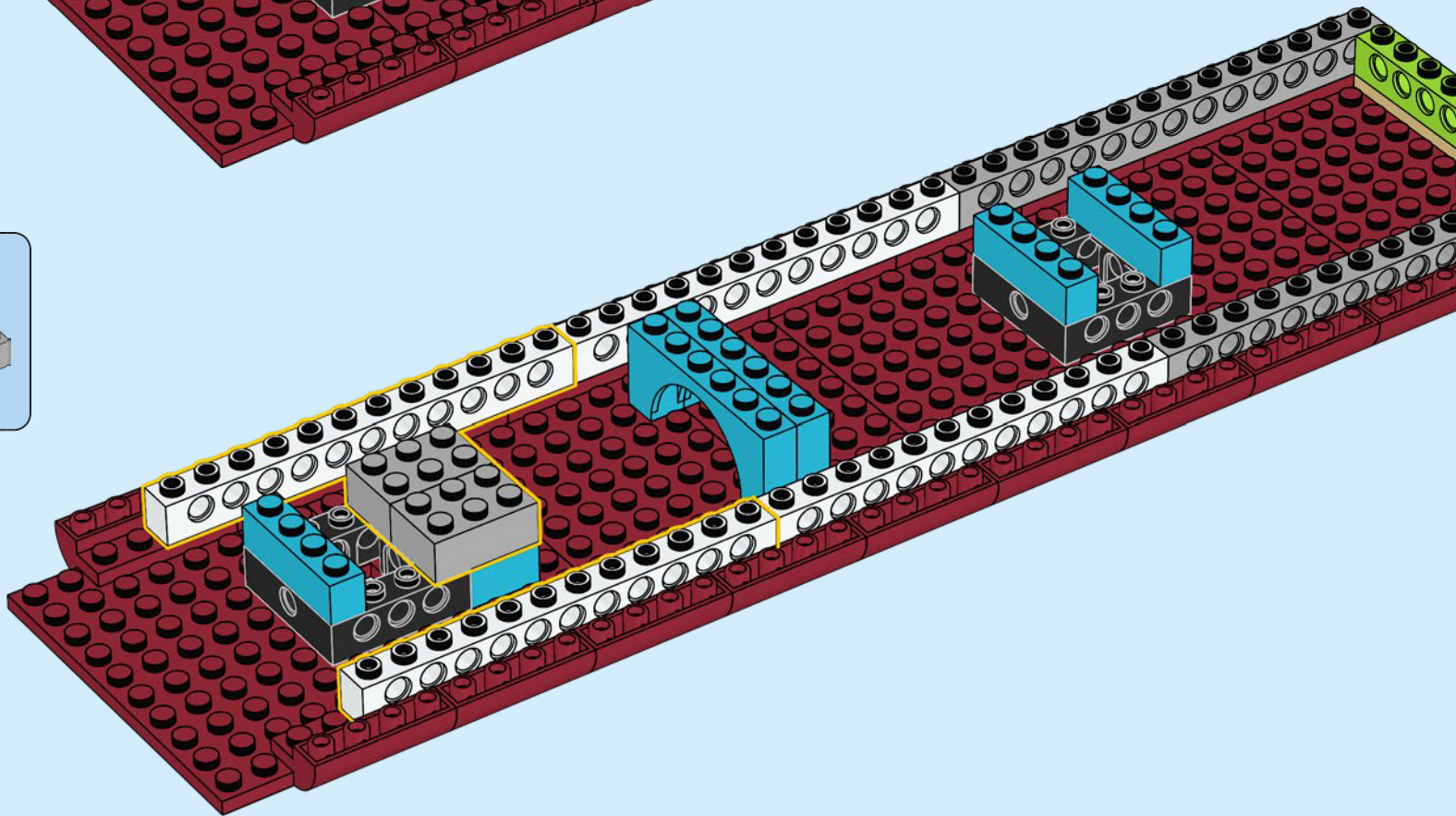

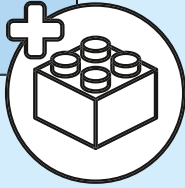
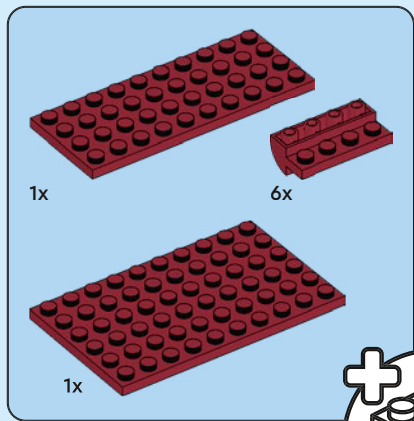

16

1

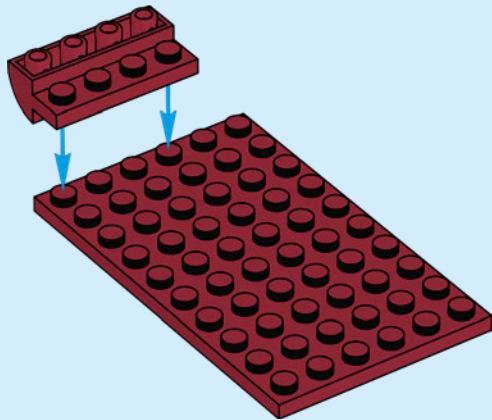

2

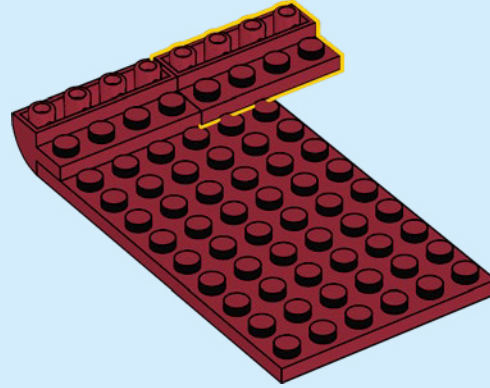

3

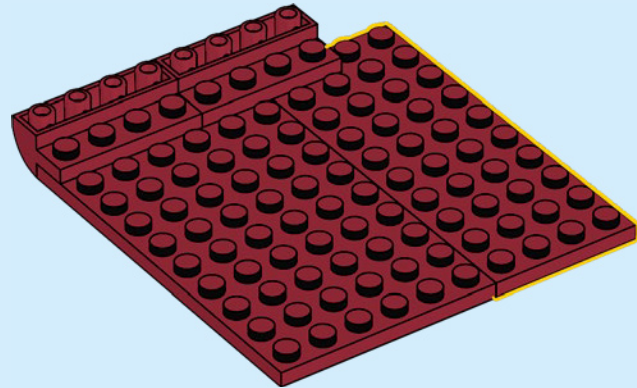

4

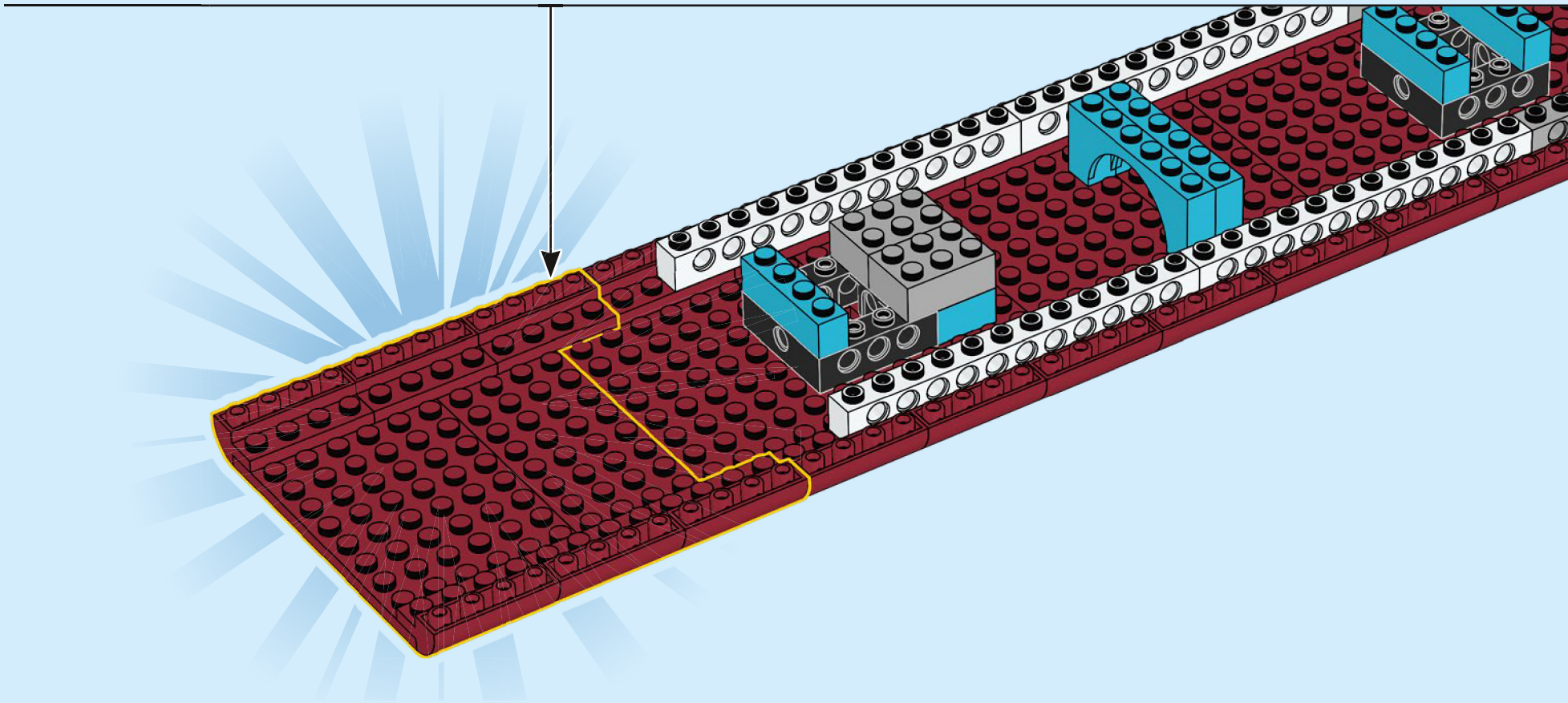
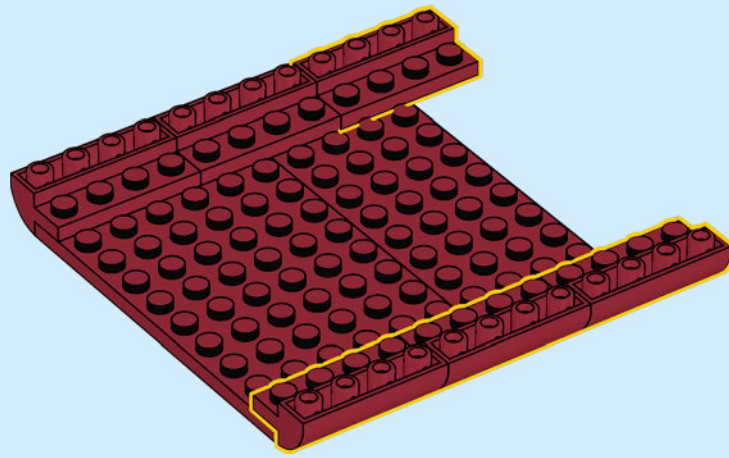

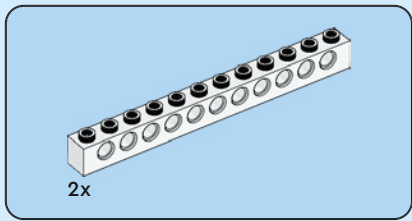

17

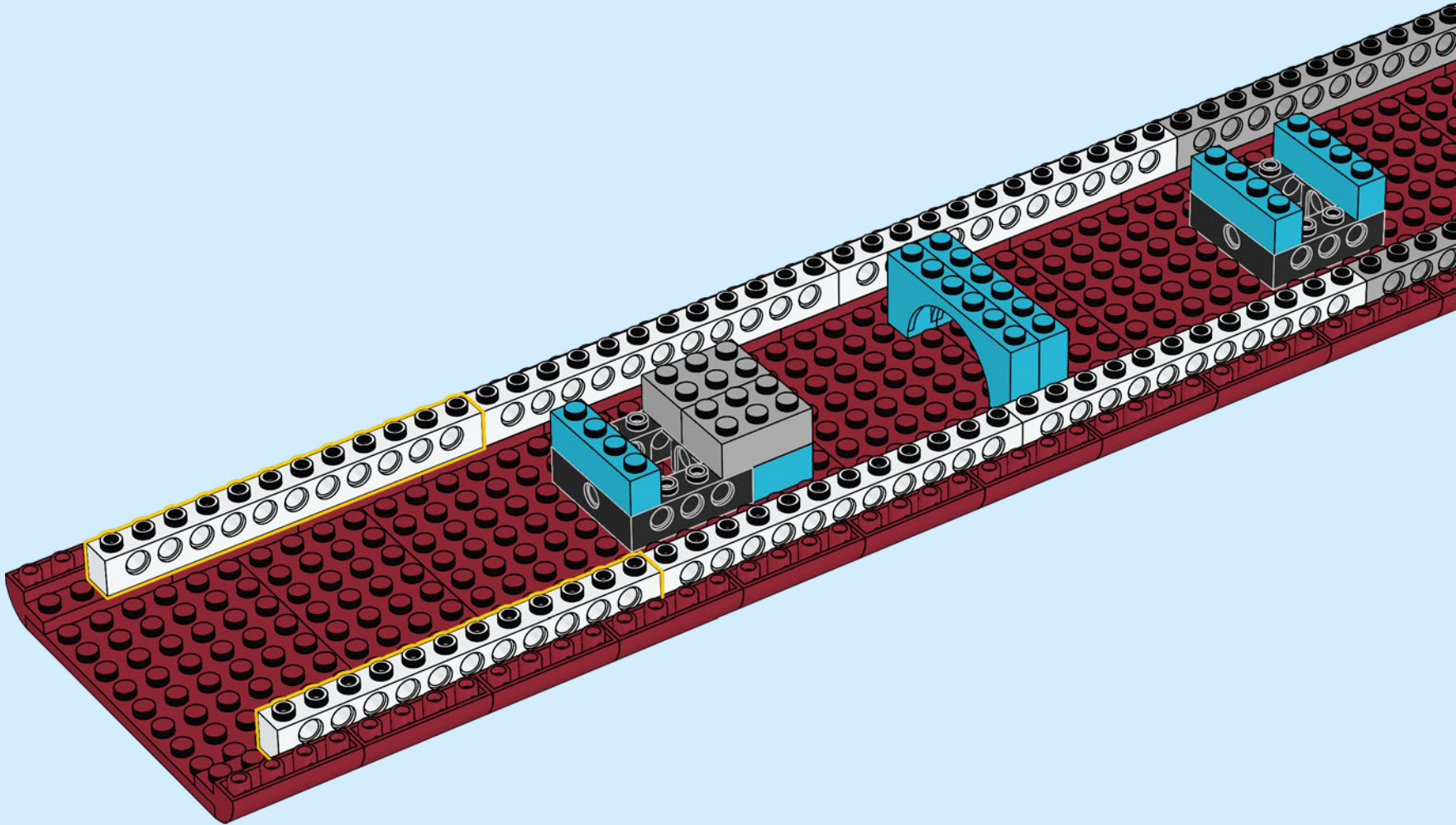

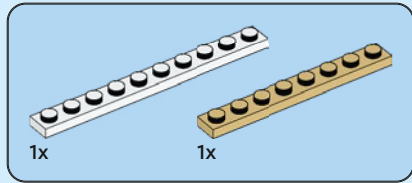

18

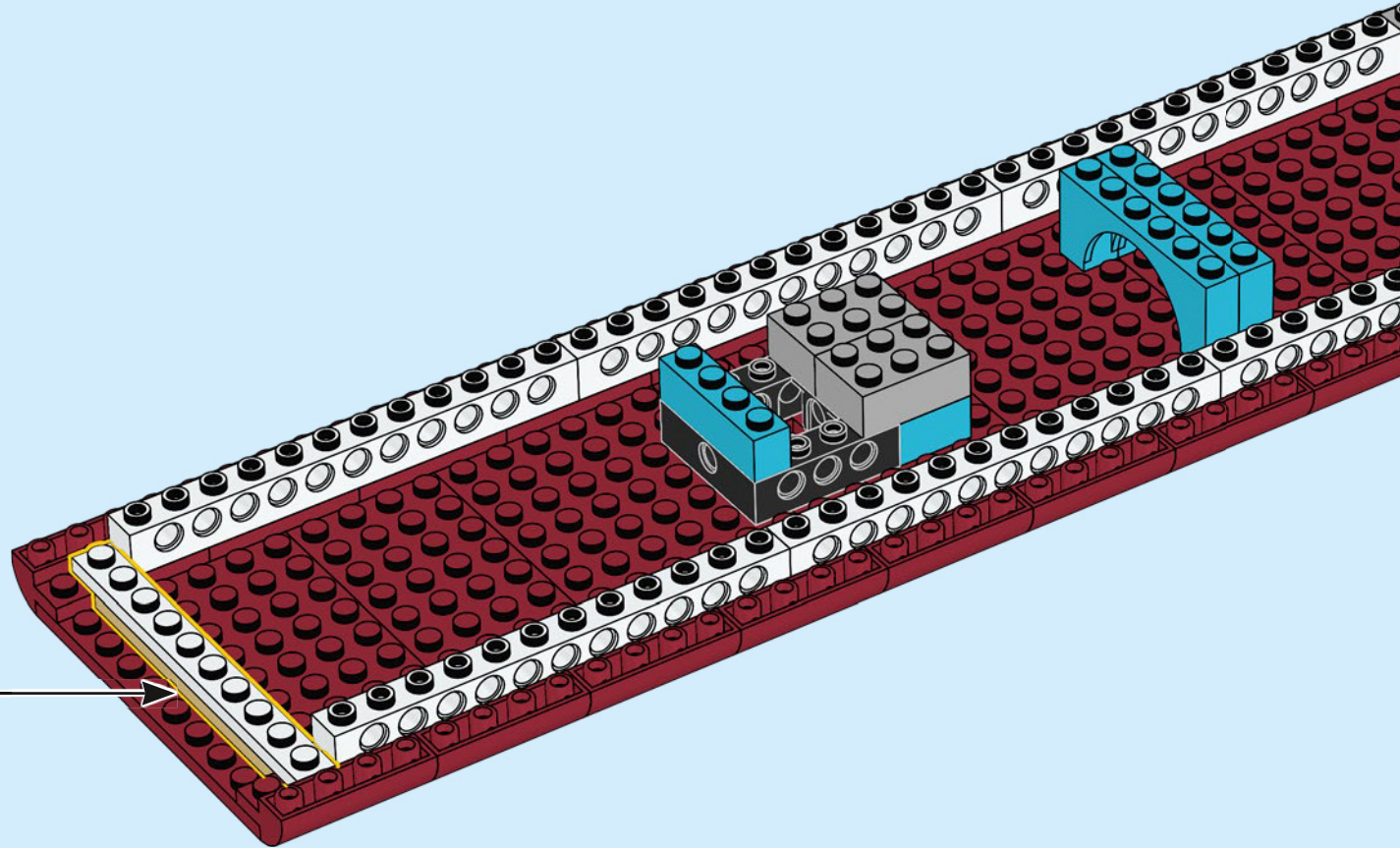
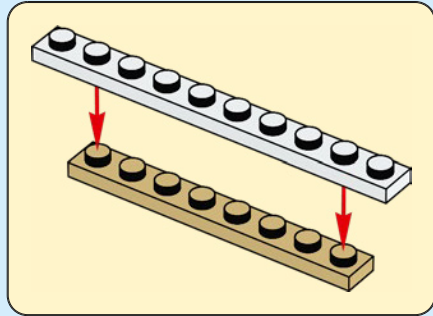

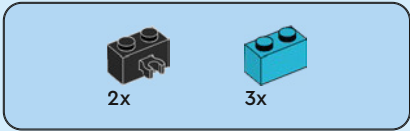

19

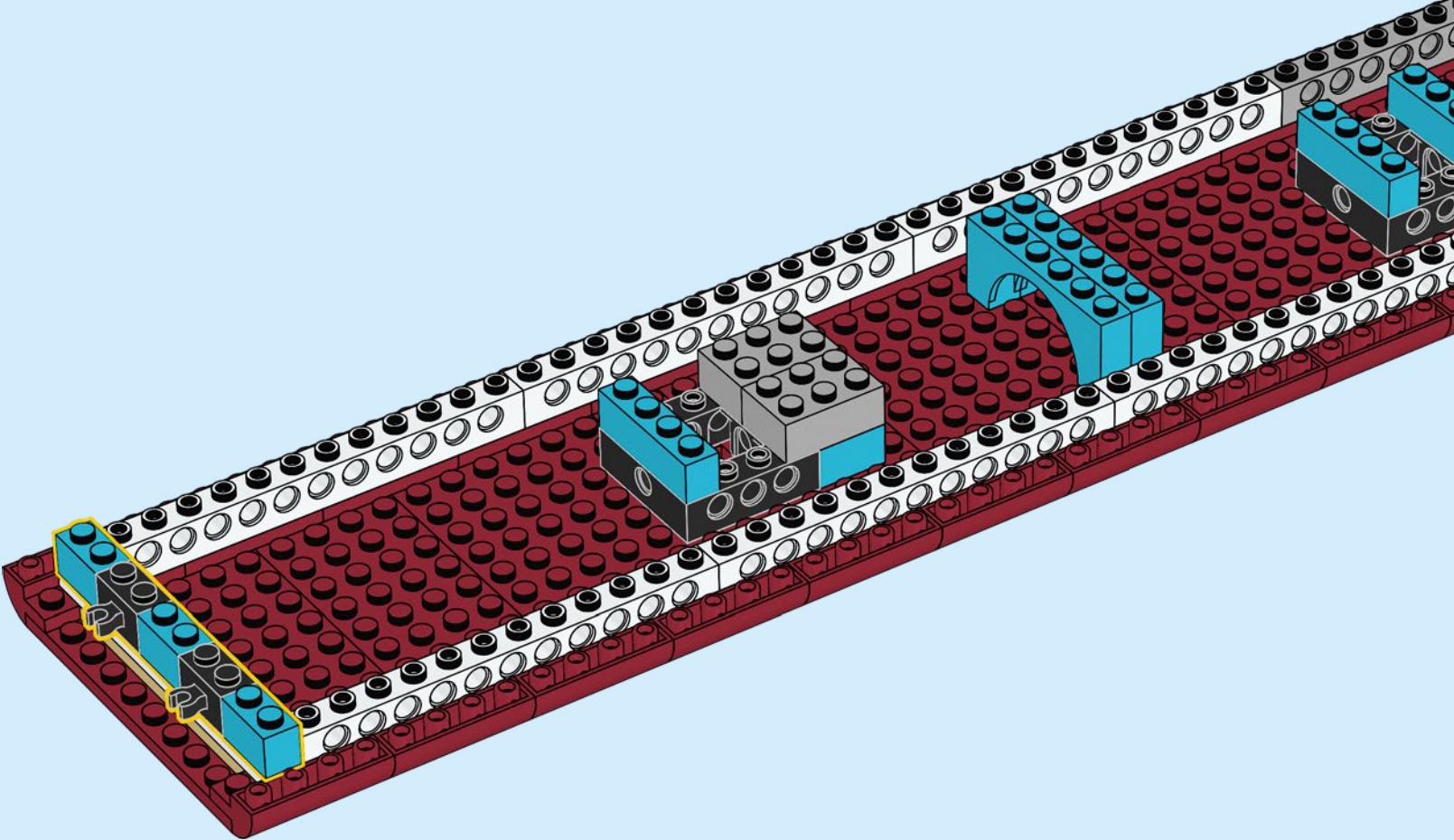

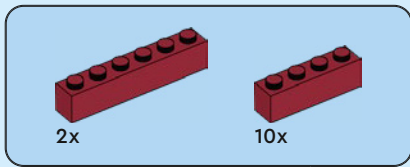

20

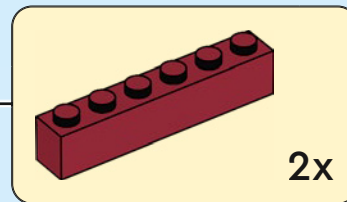
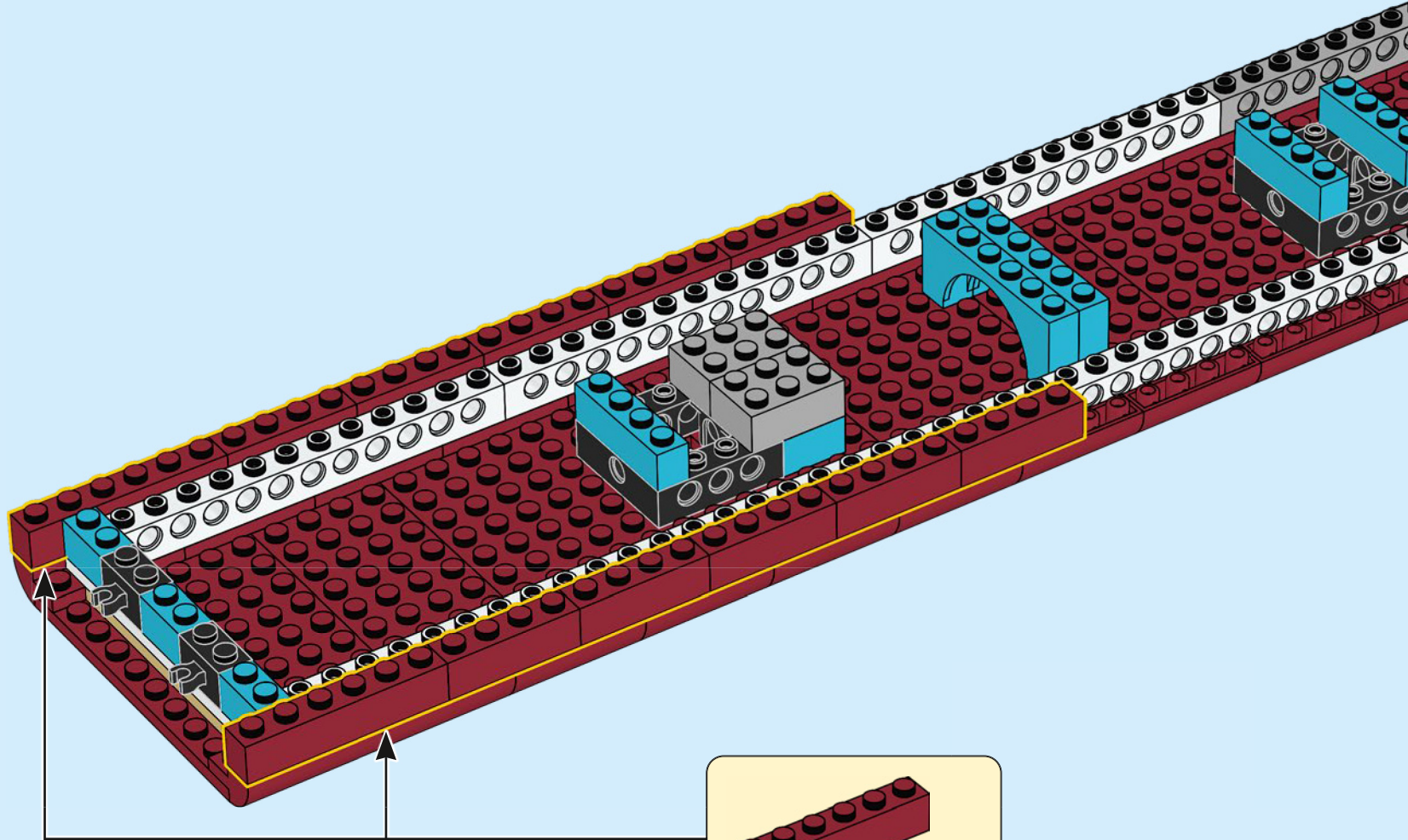

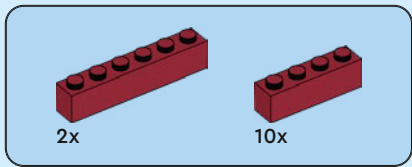

21

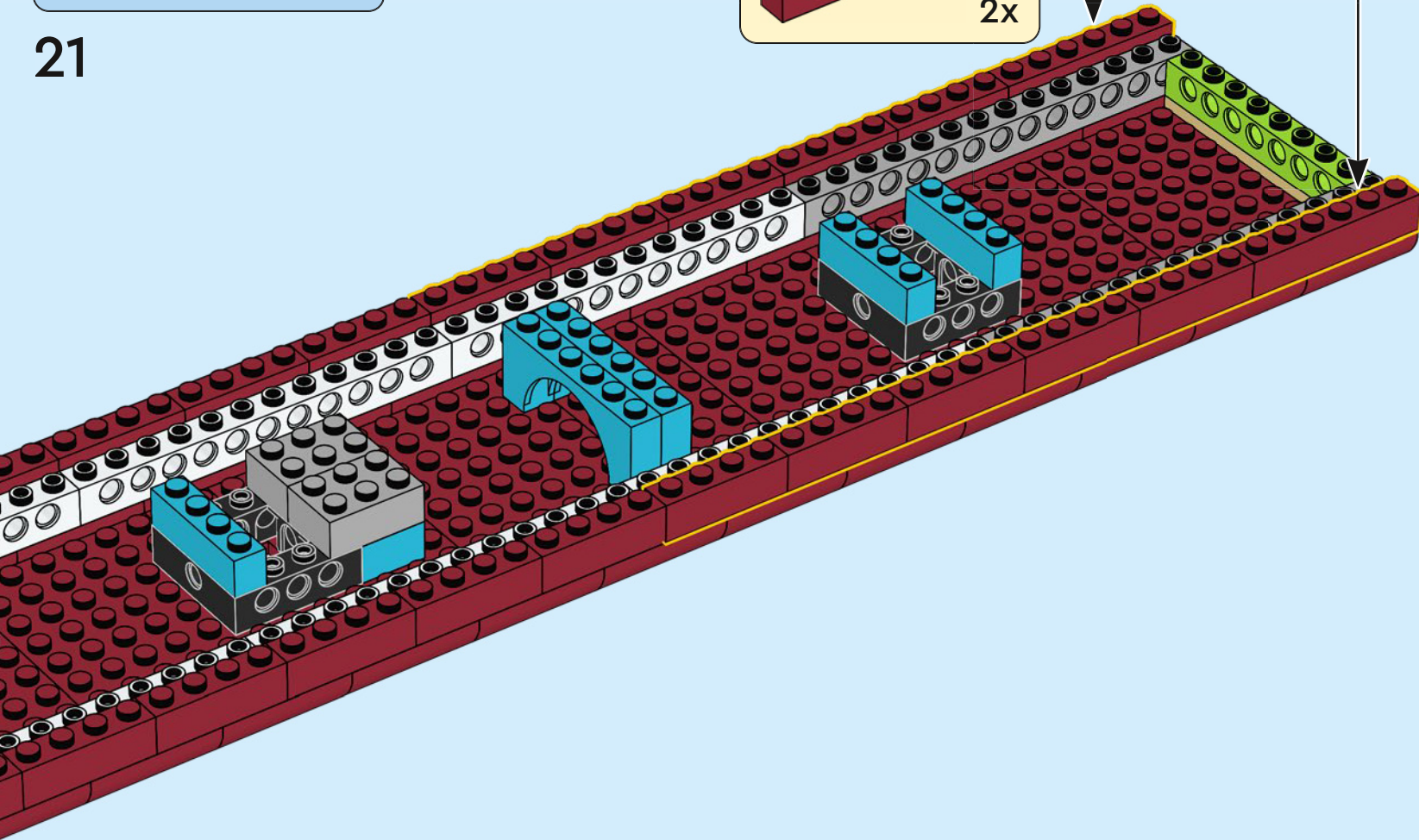
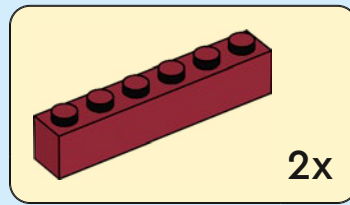

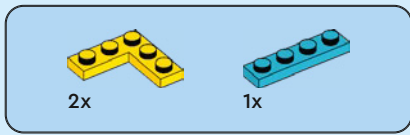

22

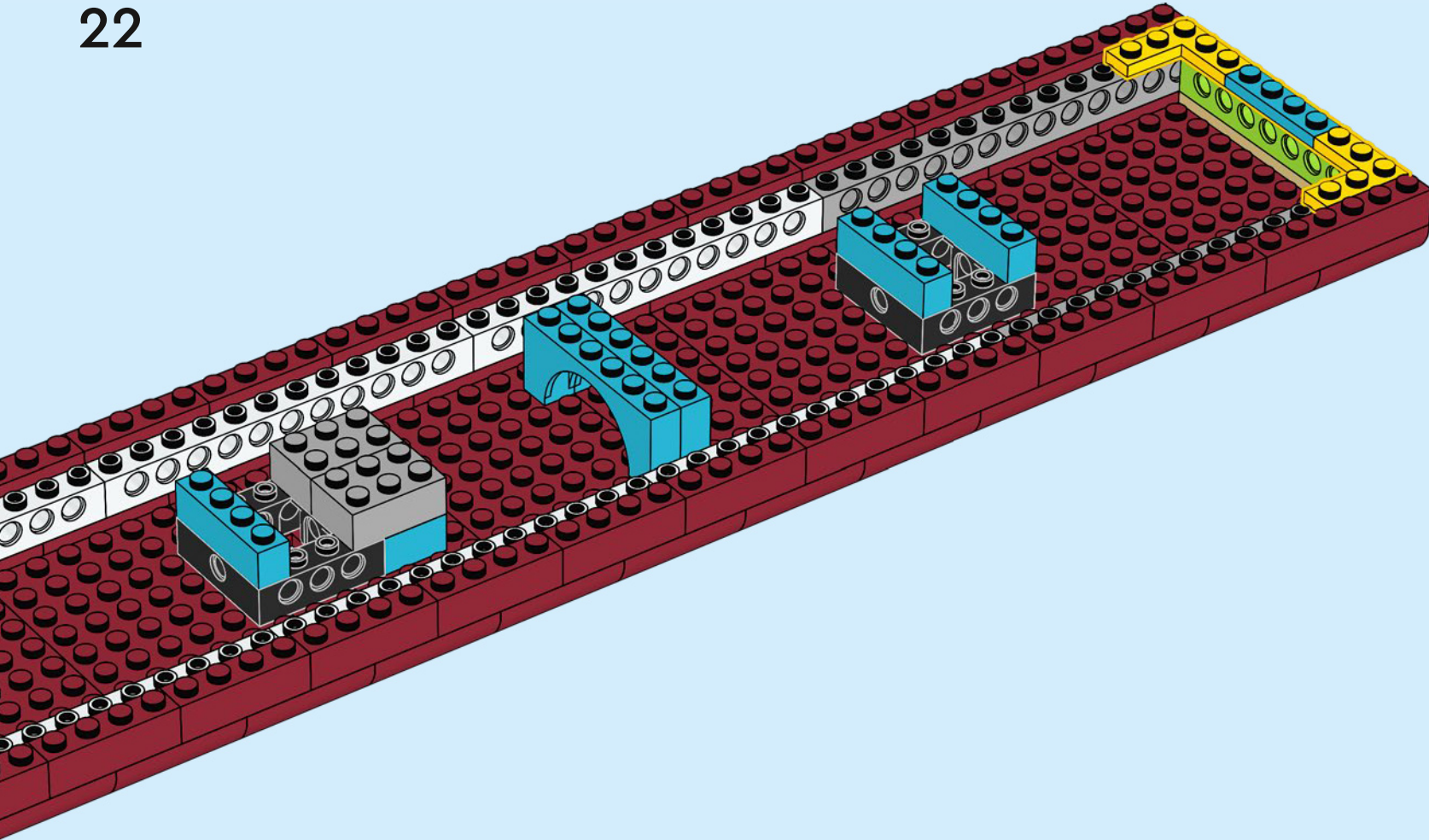

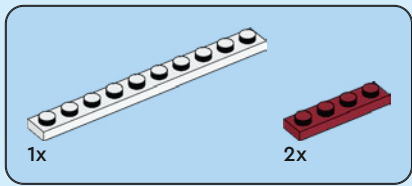

23

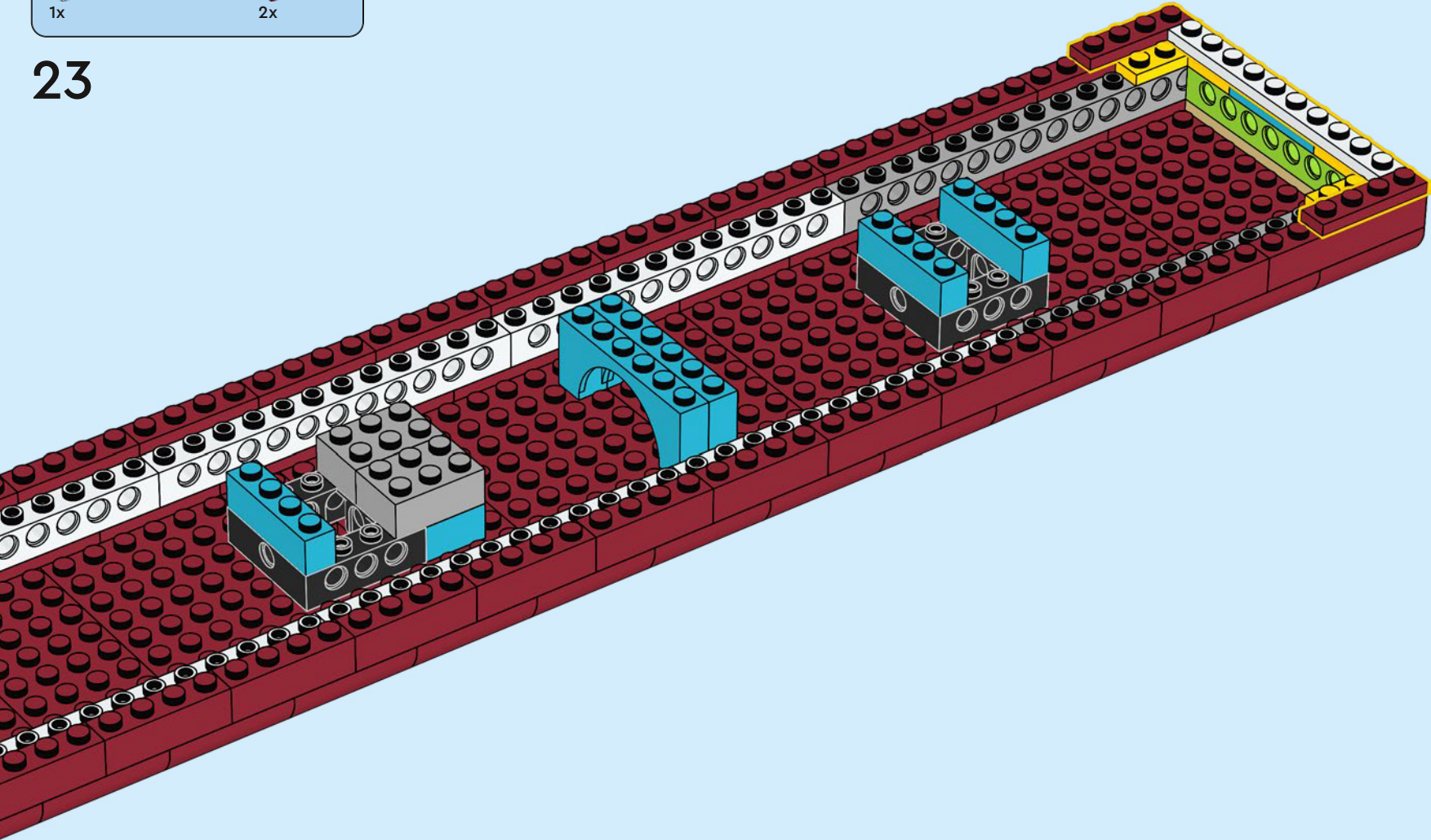

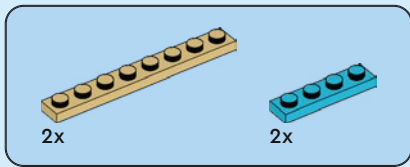

24

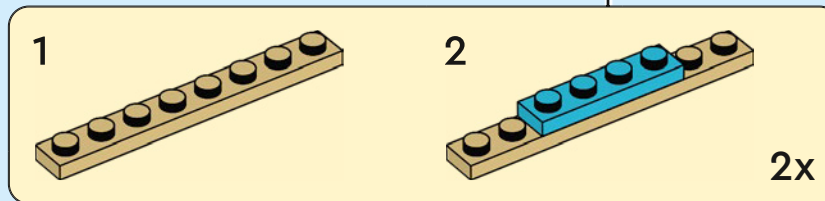
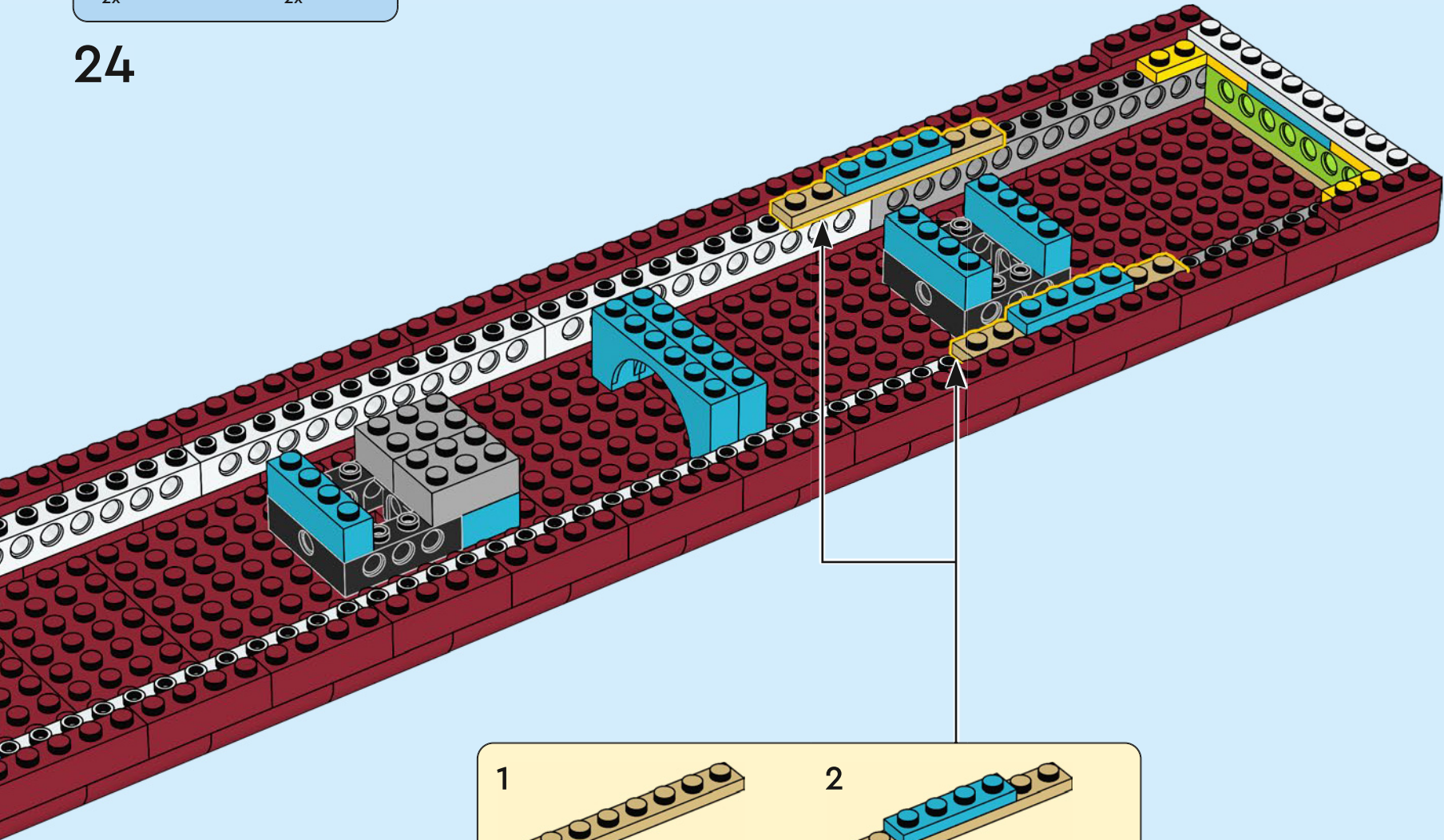

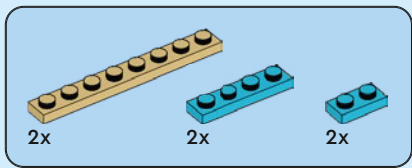

25

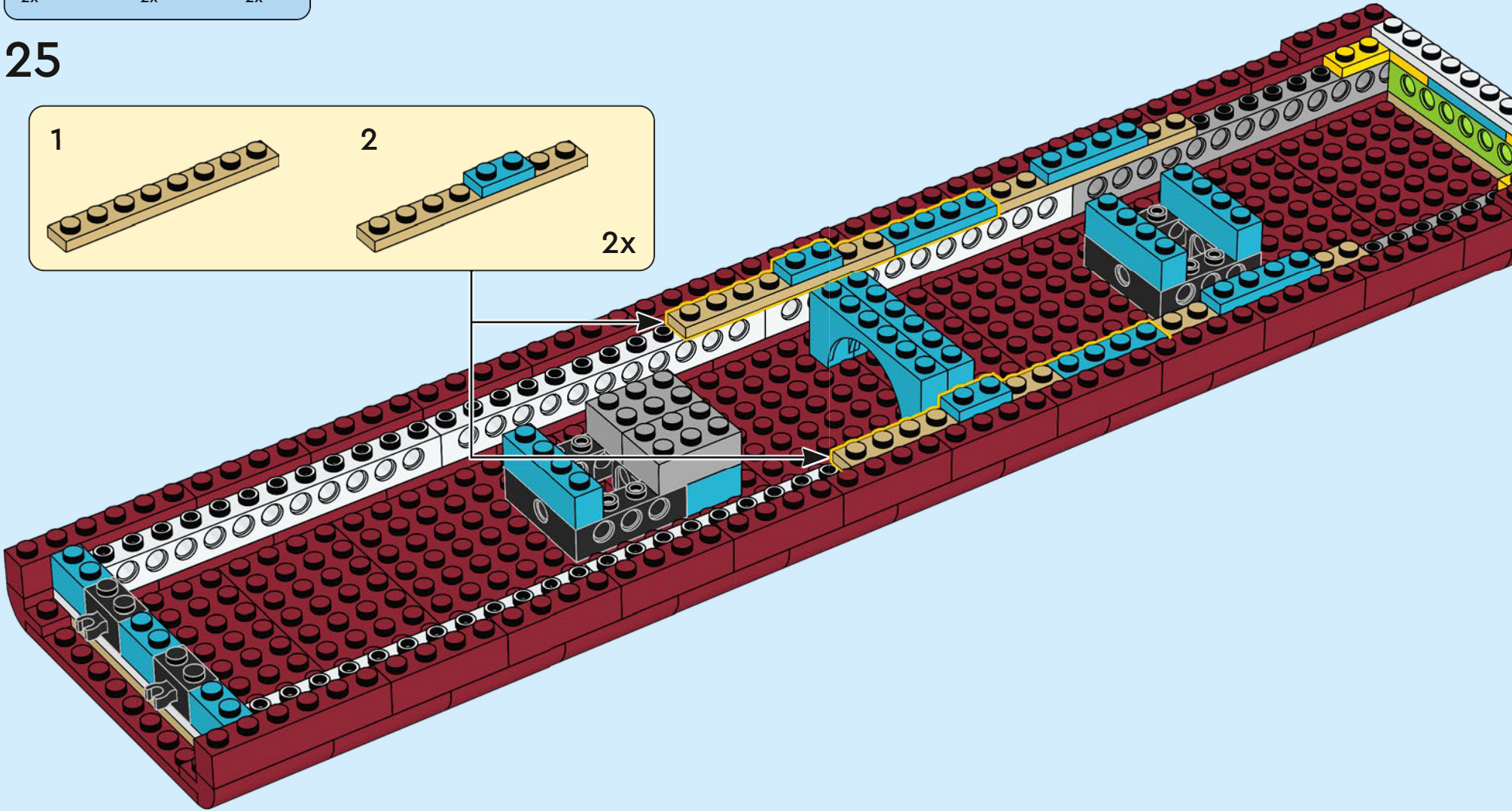
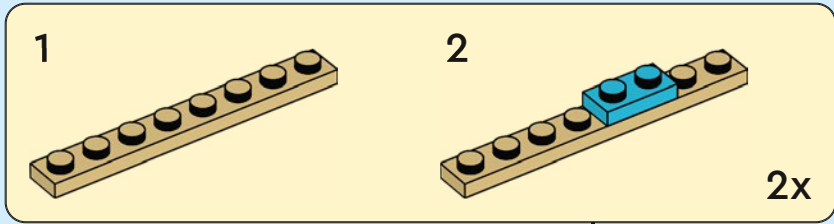

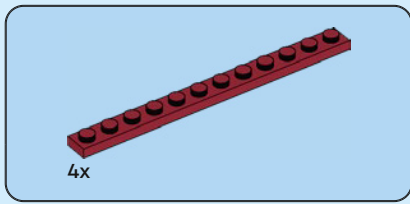

26

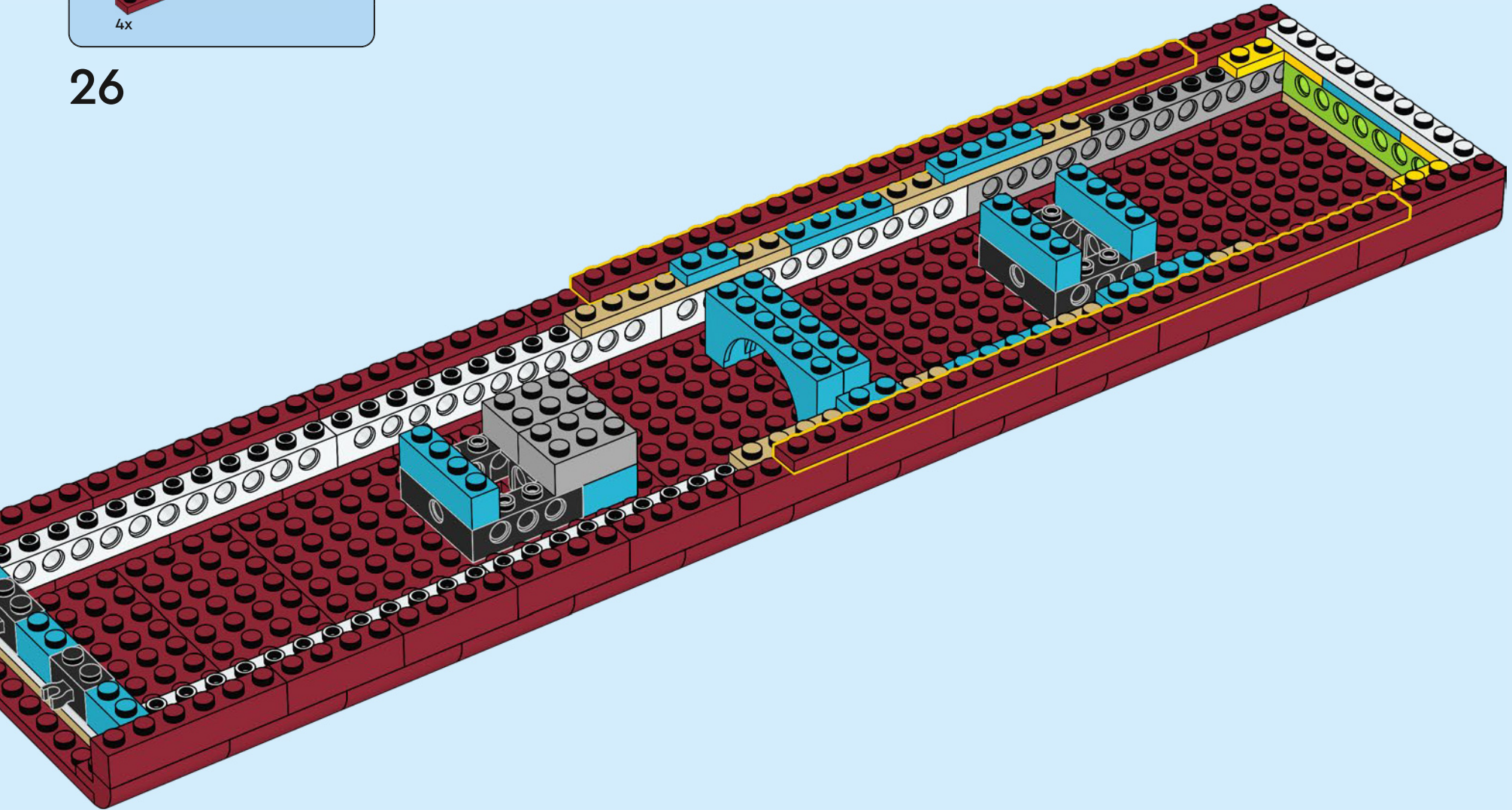

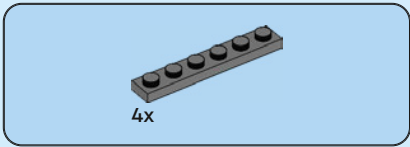

27

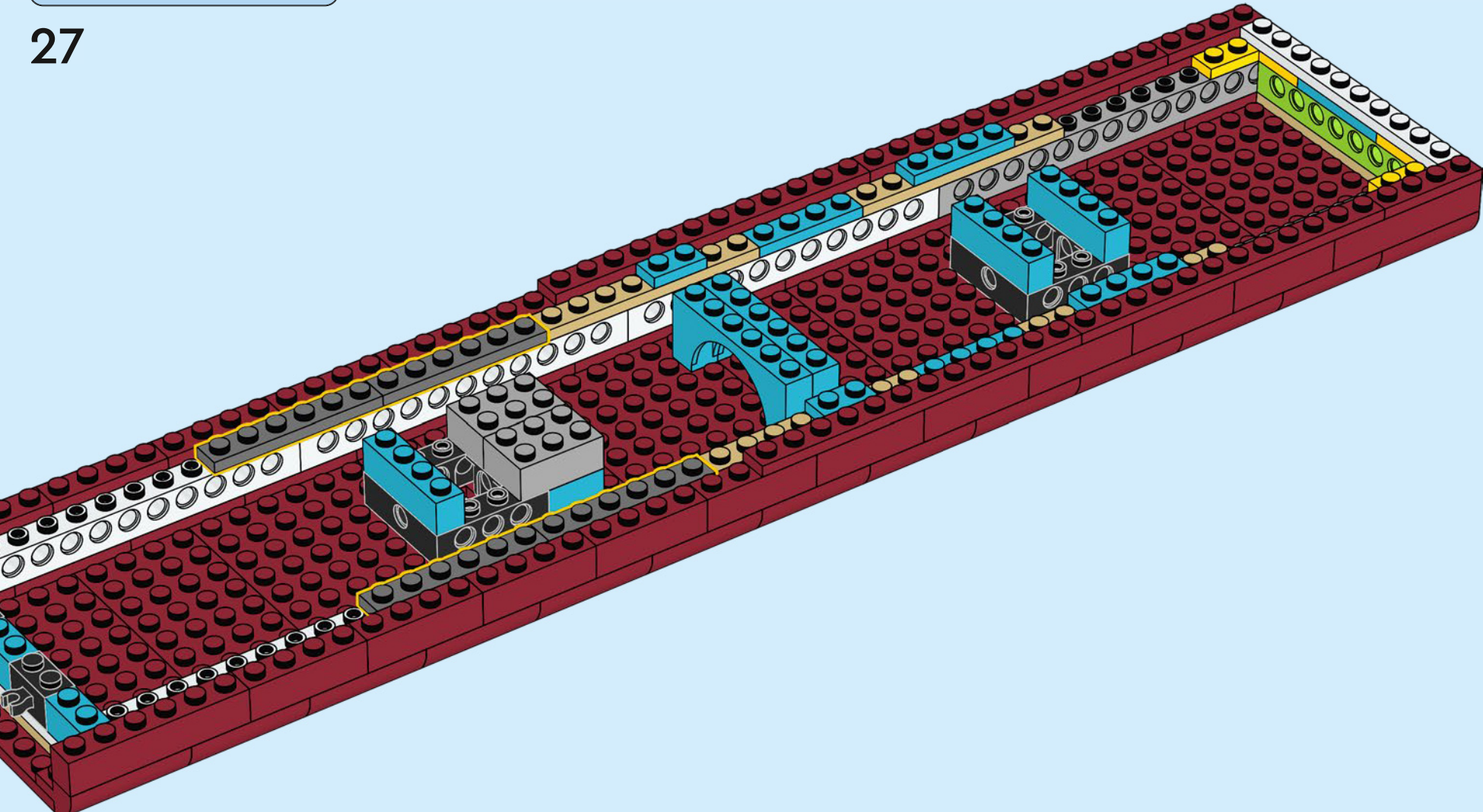

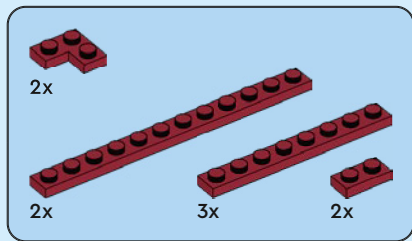

28

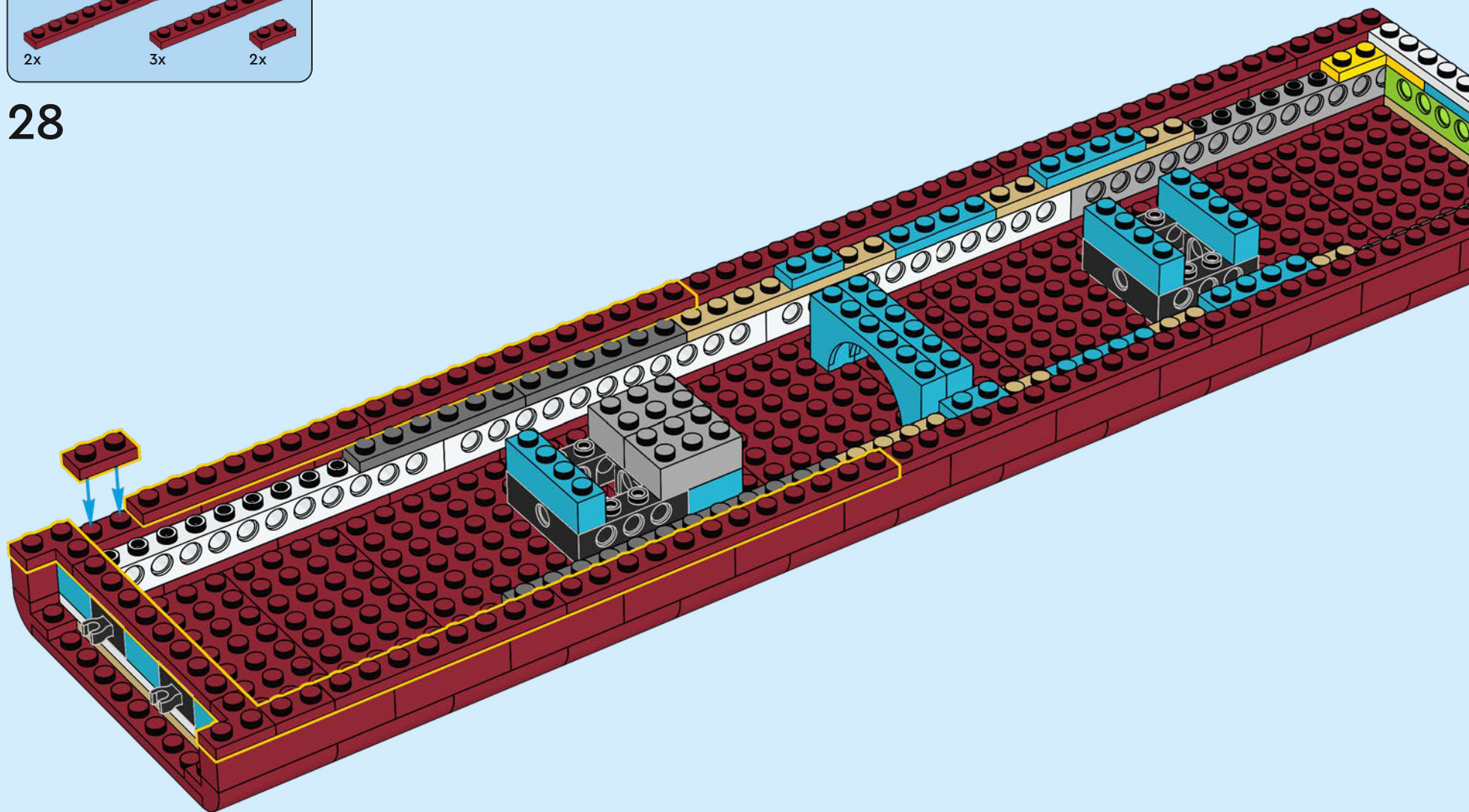

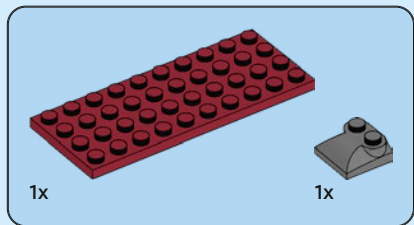
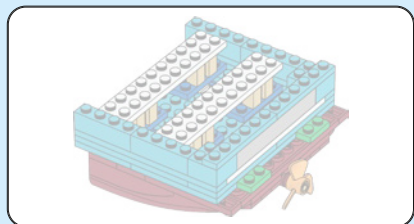

29

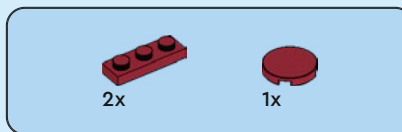
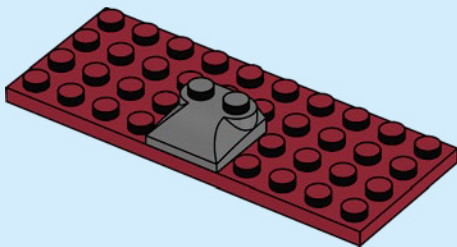

30

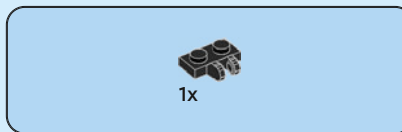
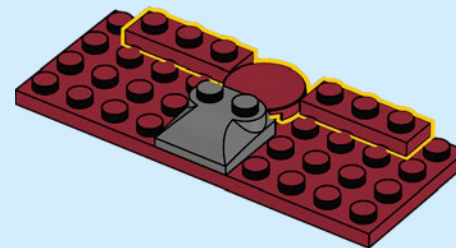

31

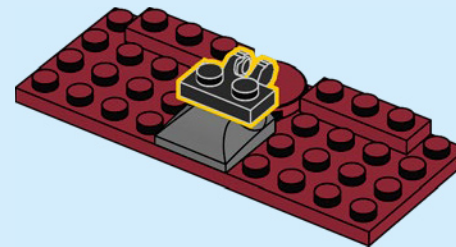

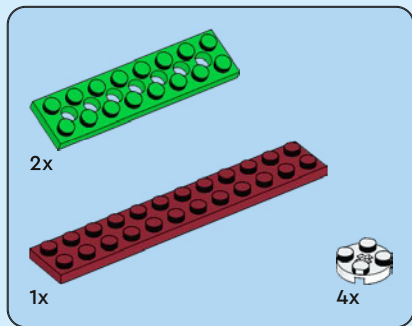

32

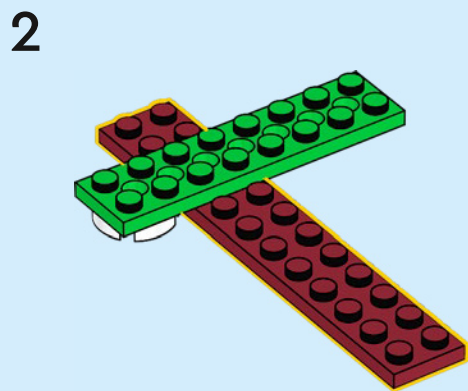
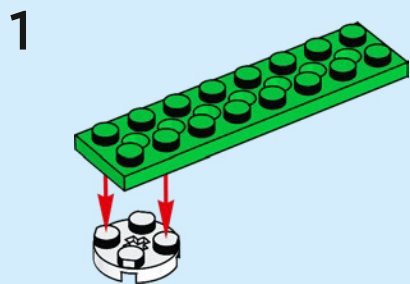

3

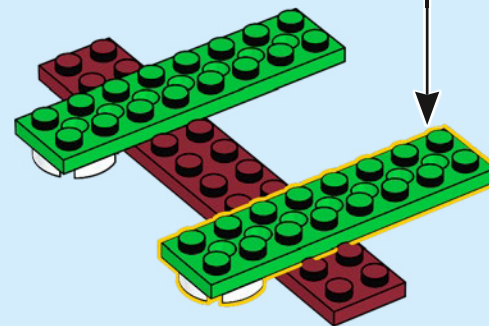
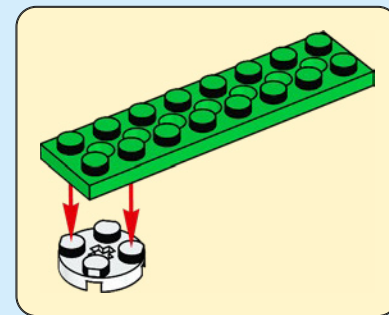

4

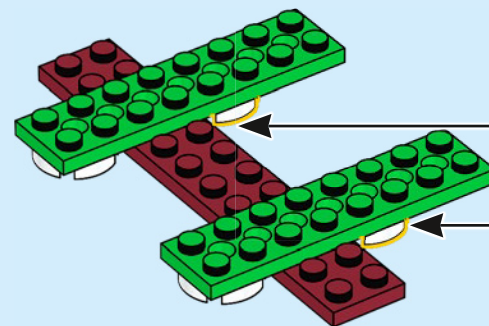

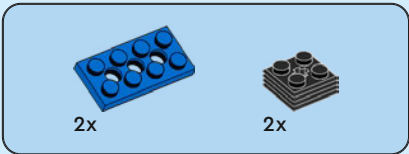

33

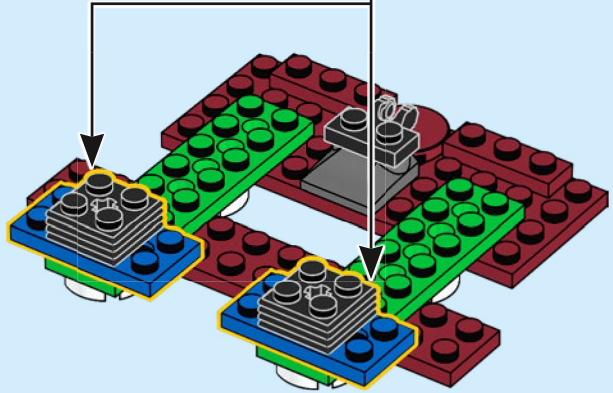
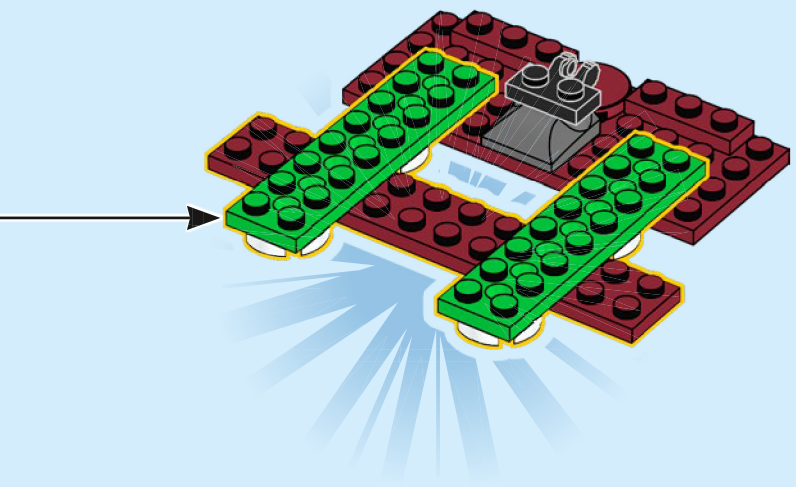
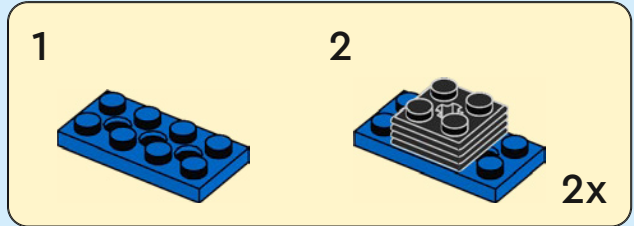

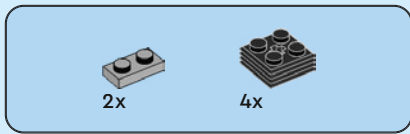

34

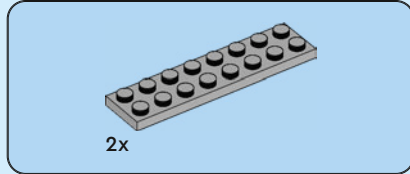
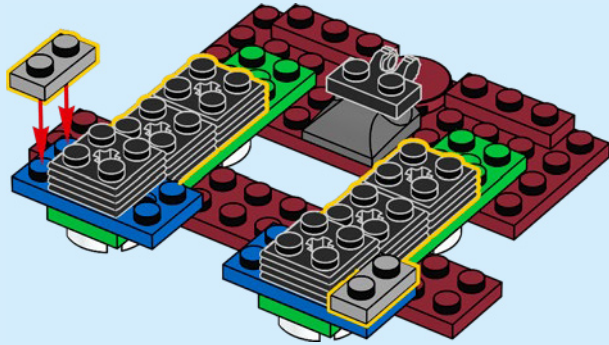

35

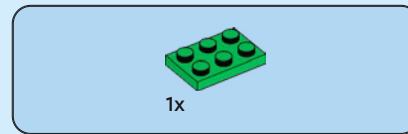
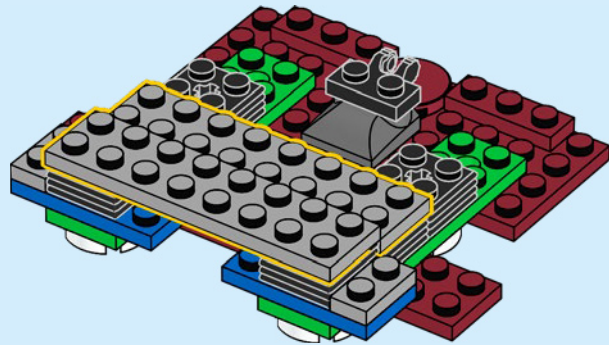

36

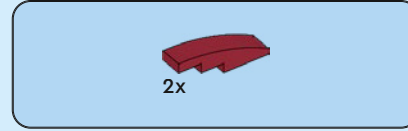
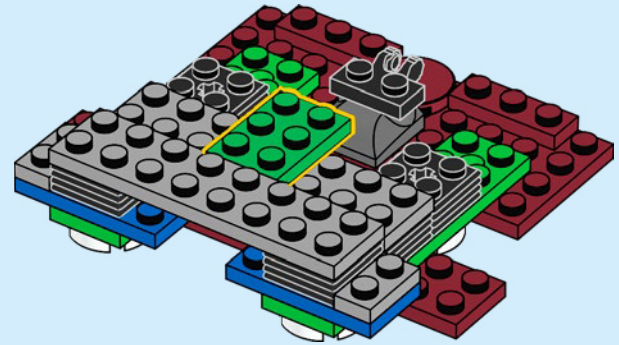

37

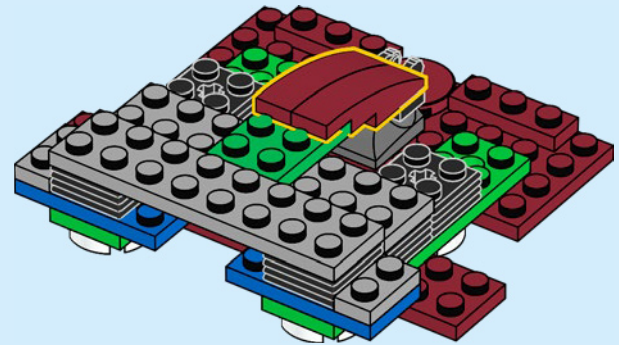

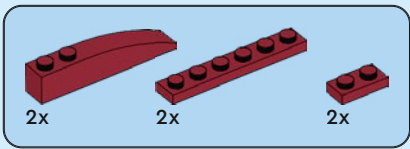

38

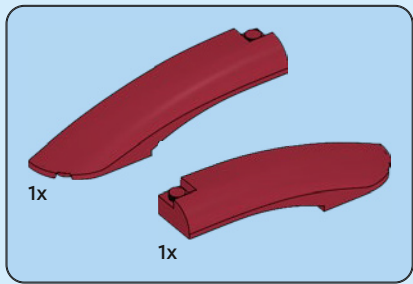
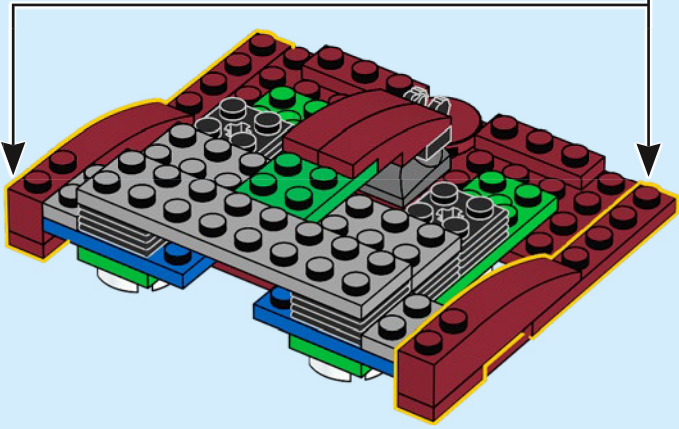
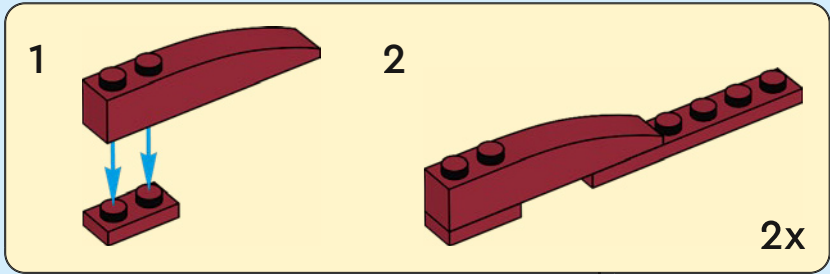

39

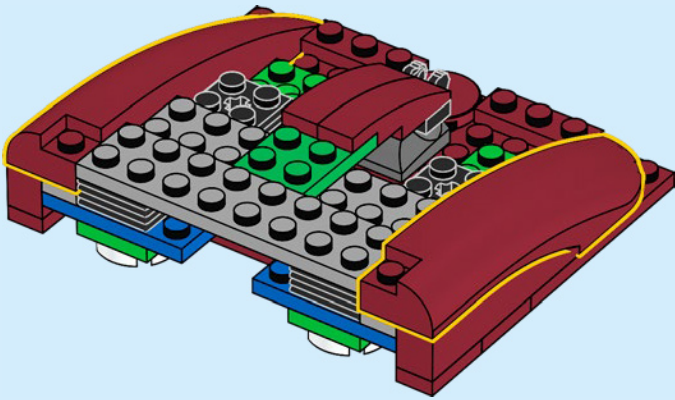

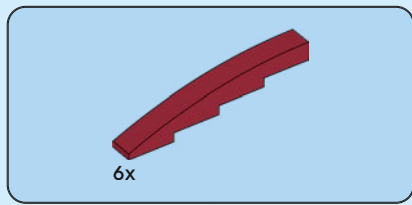

40

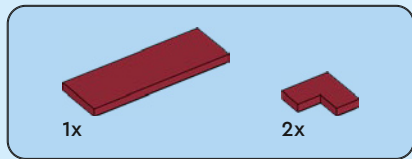
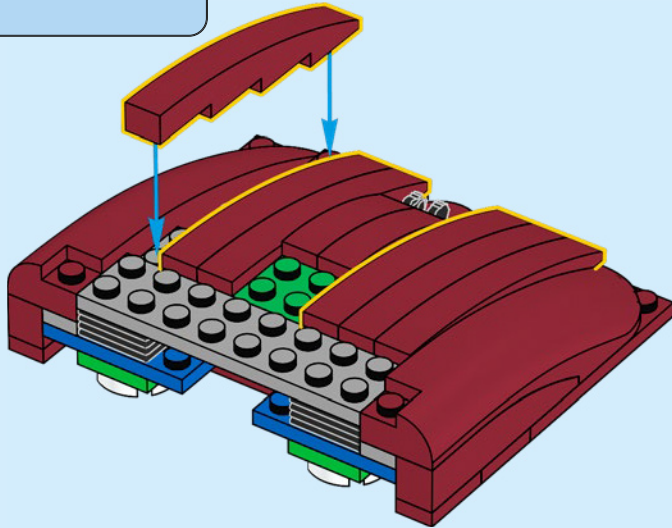

41

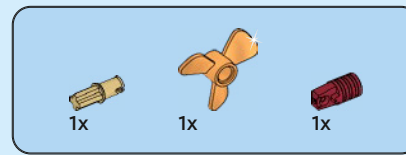
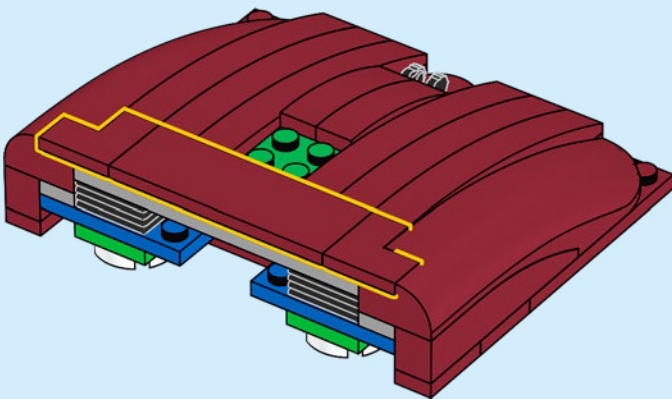

42

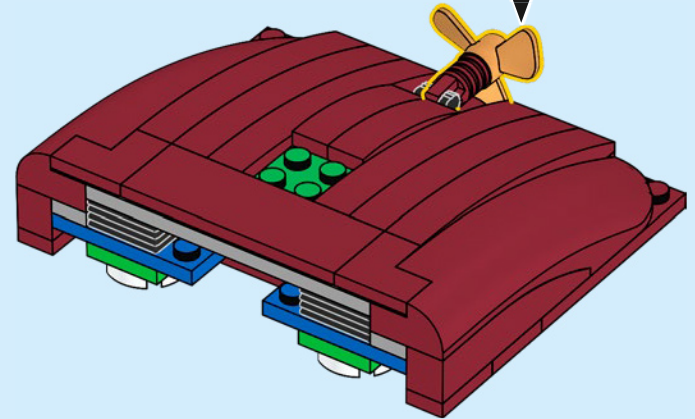
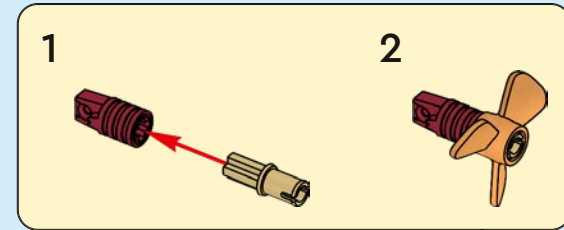

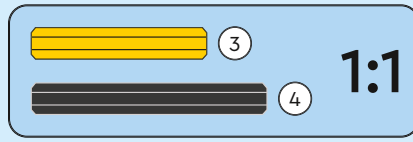
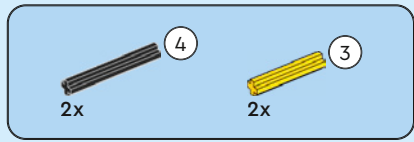

43

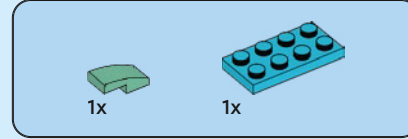
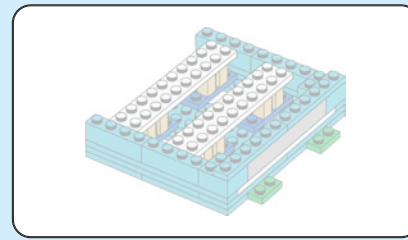
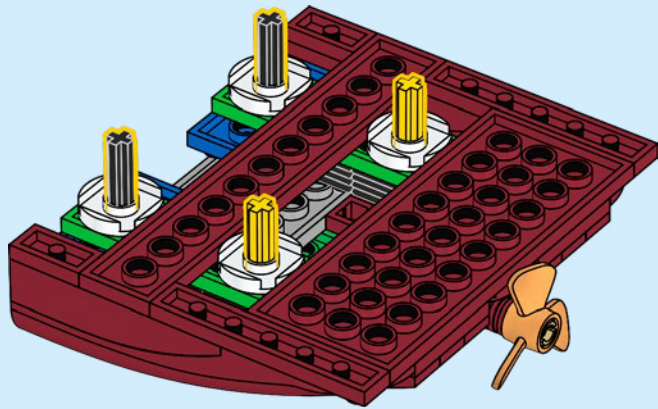

44

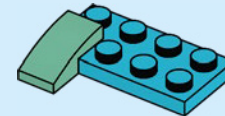

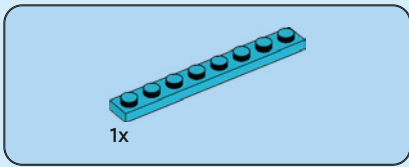

45

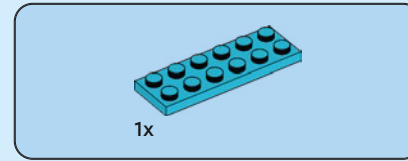
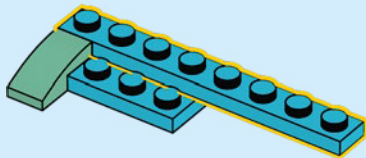
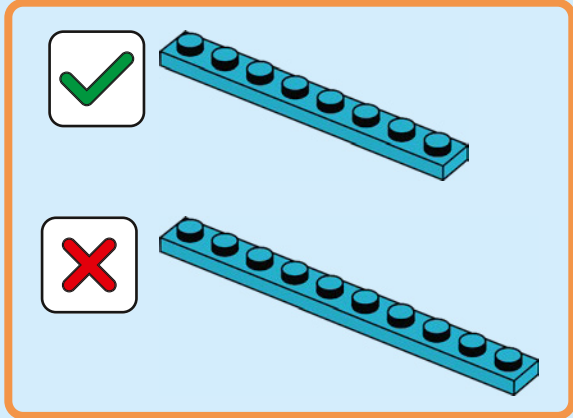

46

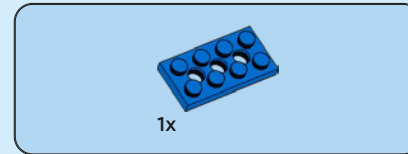
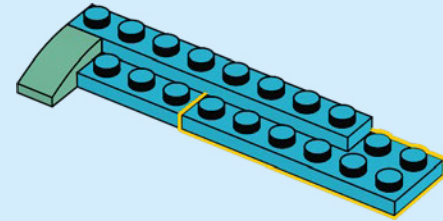

47

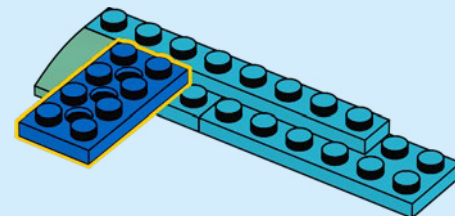

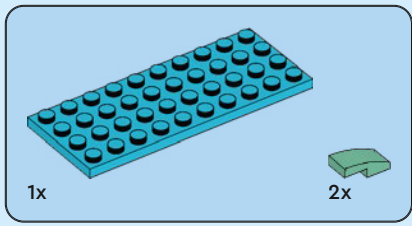

48

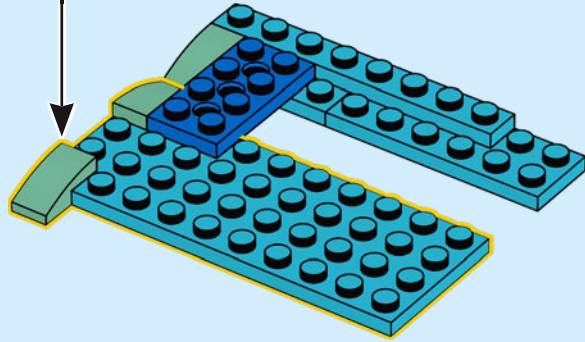
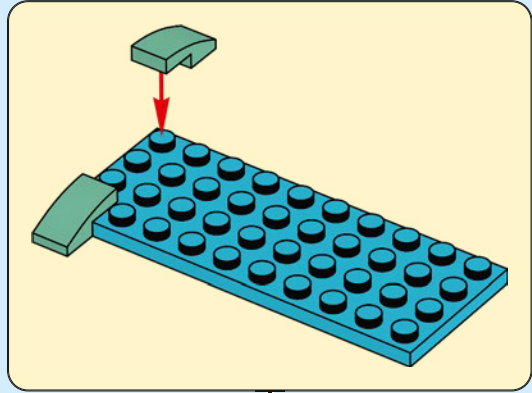

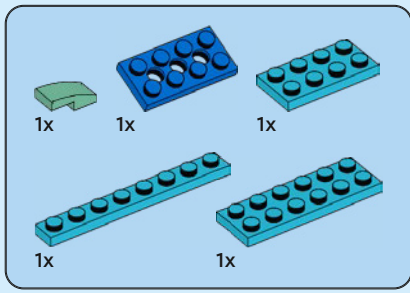

49

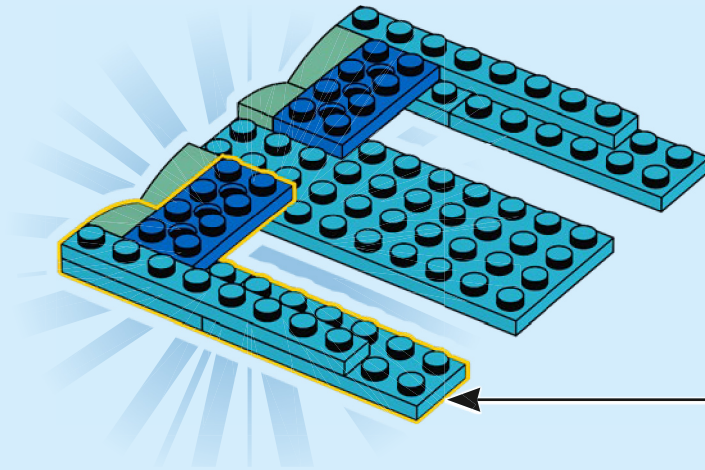
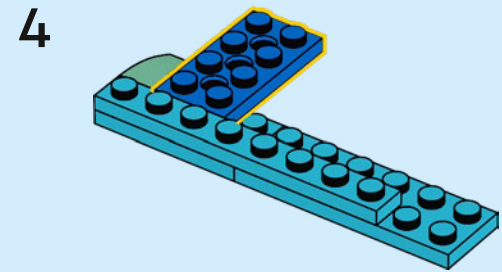
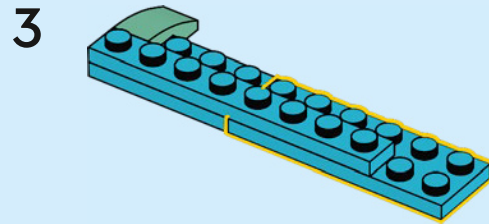
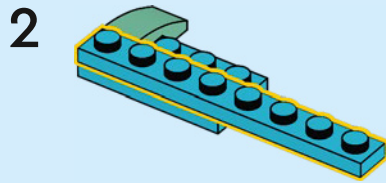
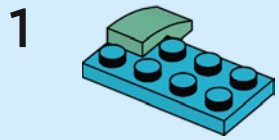
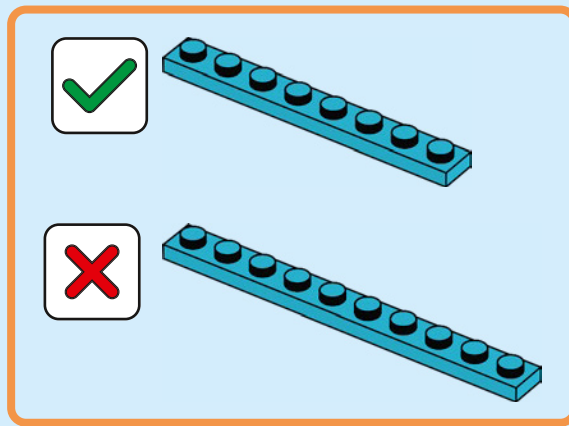



50

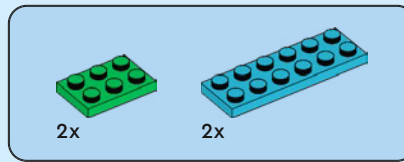
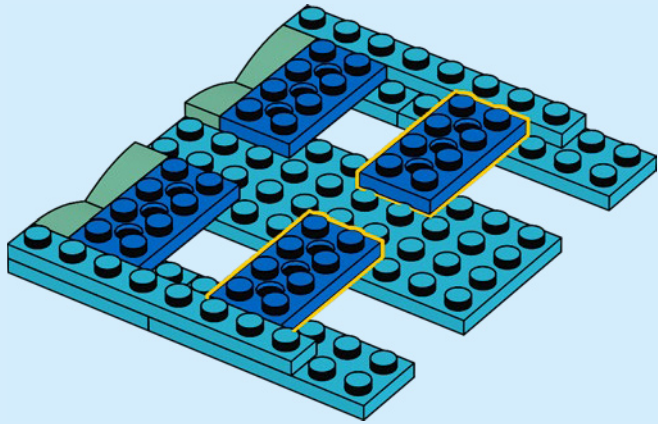

51

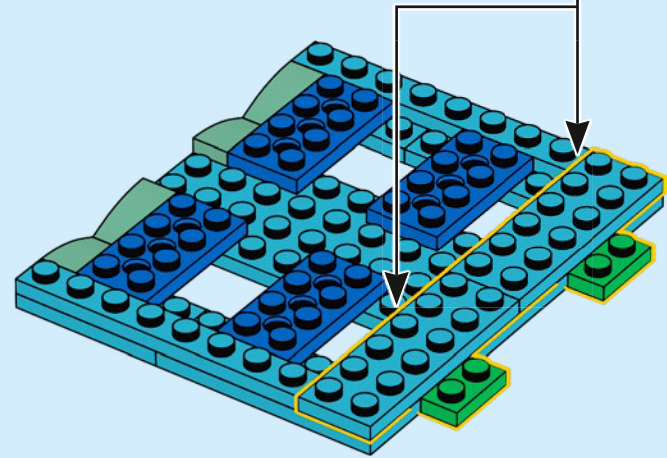
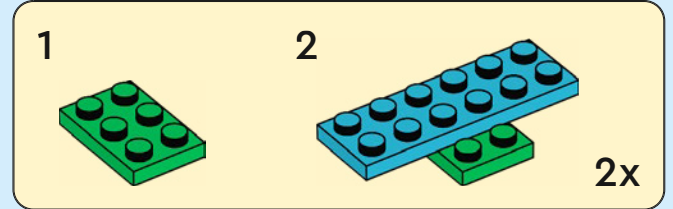

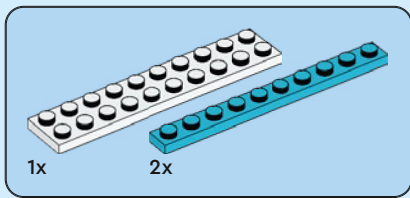

52

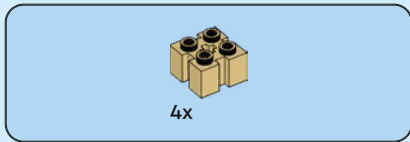
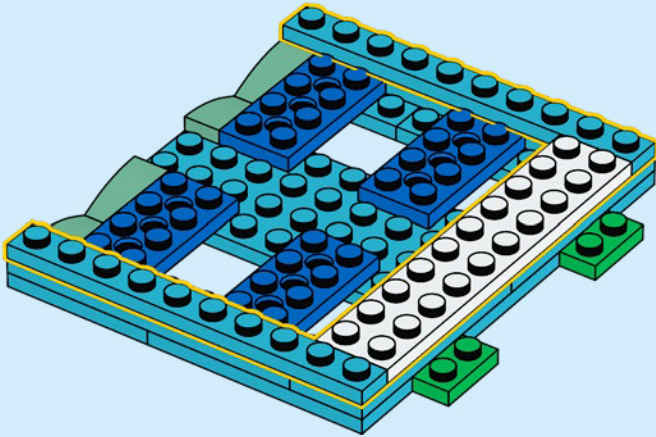

53

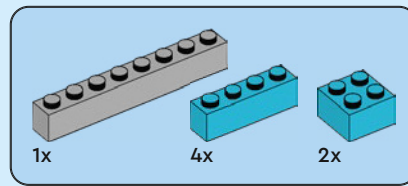
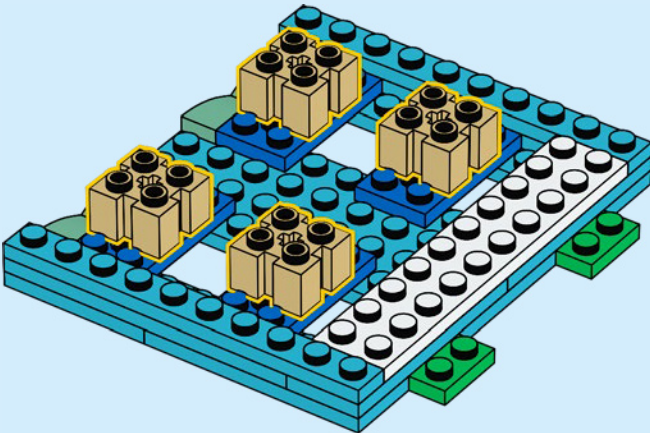

54

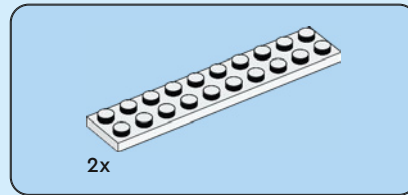
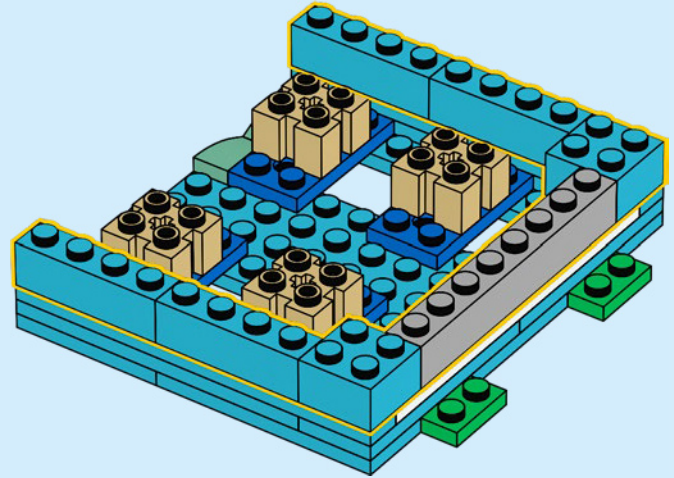

55

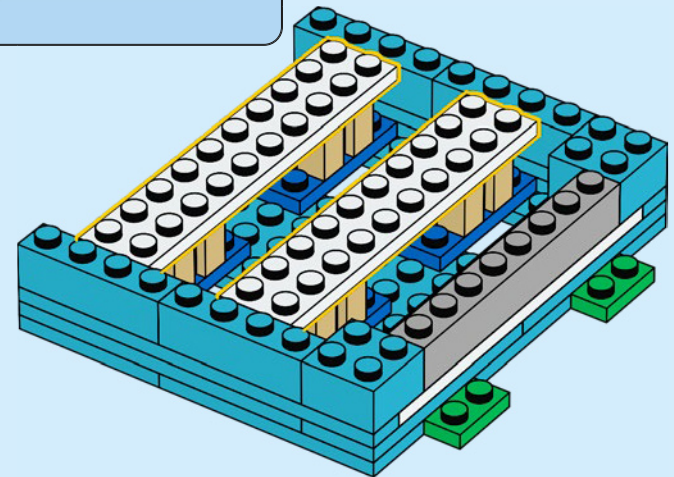

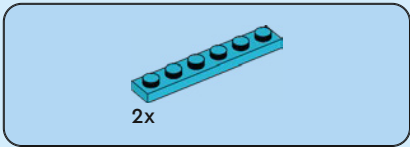

56

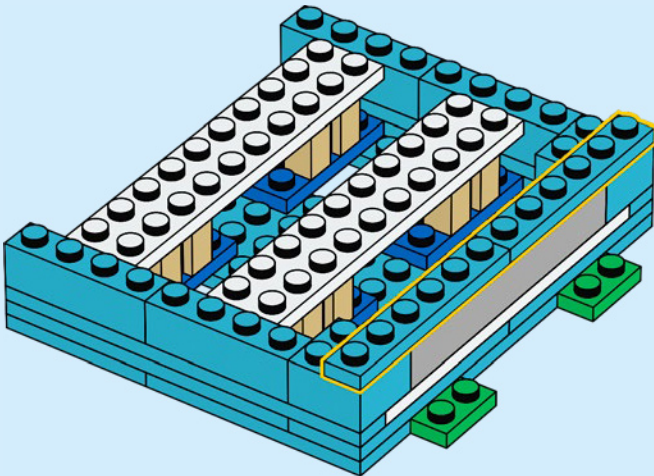

57

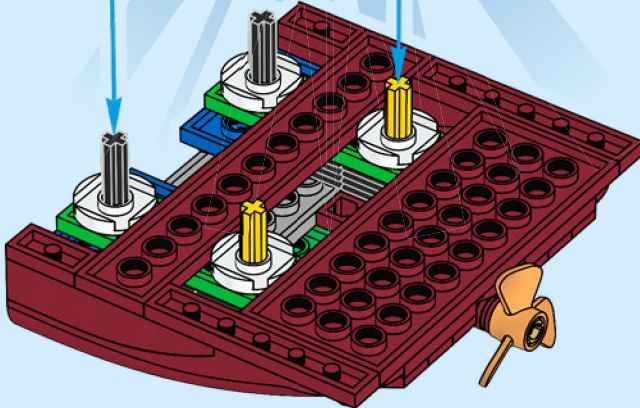
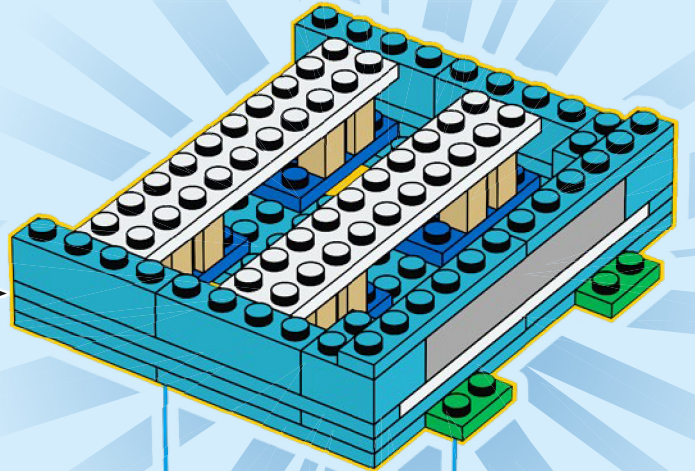

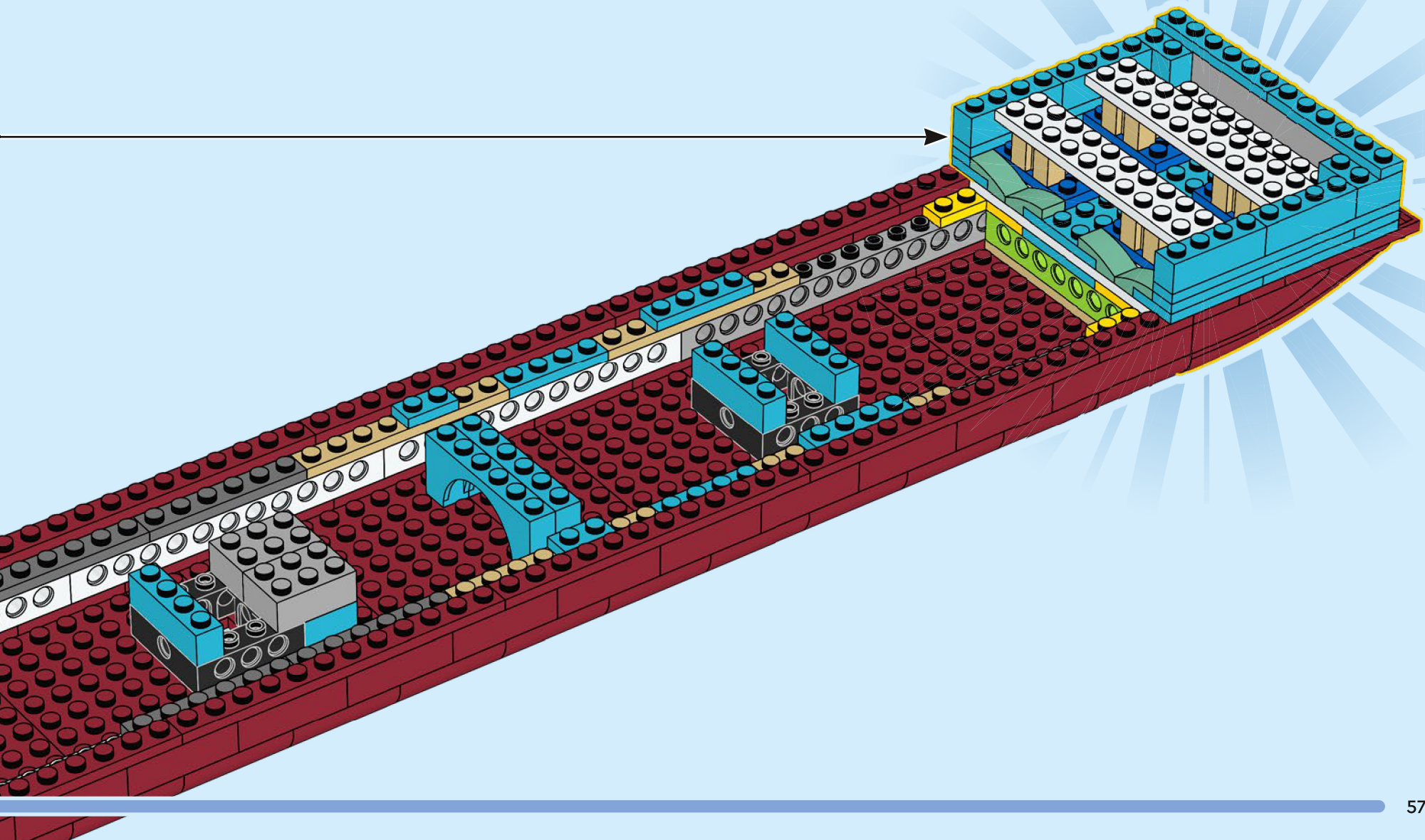

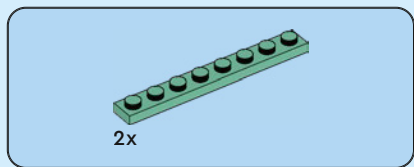
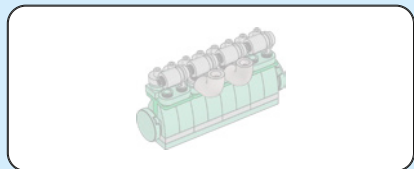

2x

59

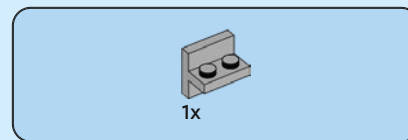
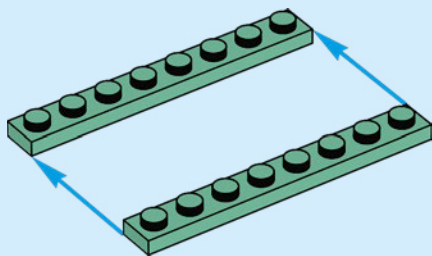

1x

60

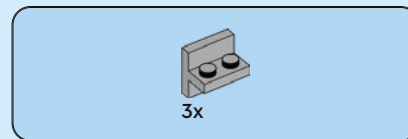
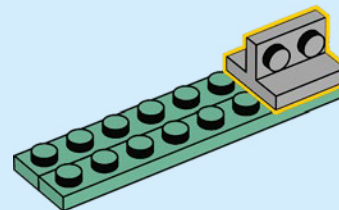

3x

61

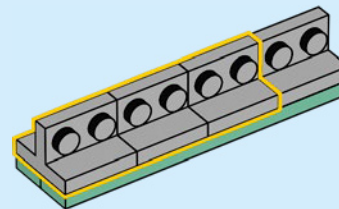



62

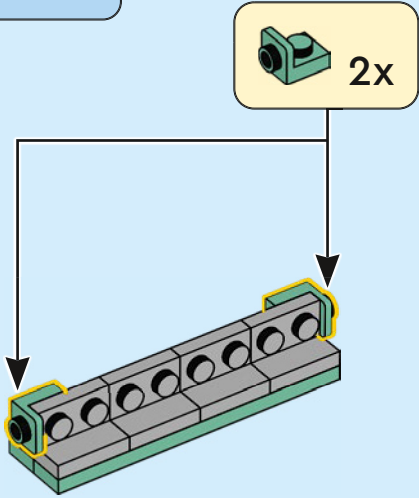

63

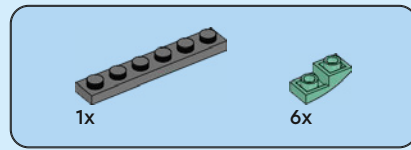
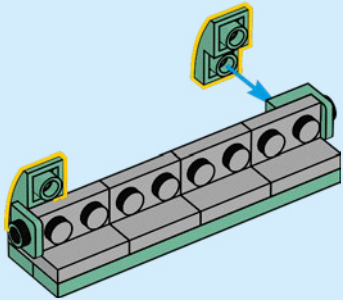

64

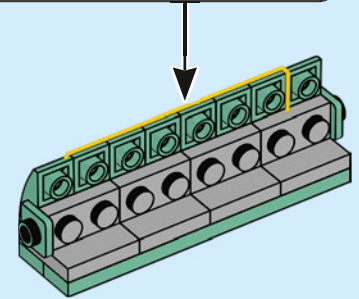
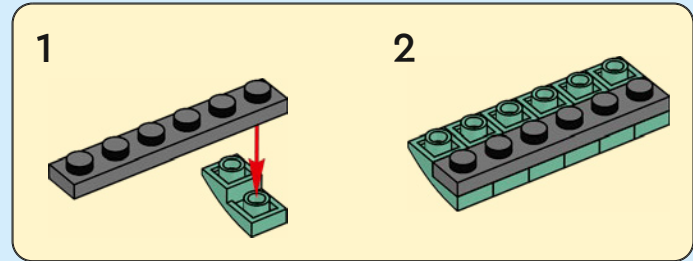

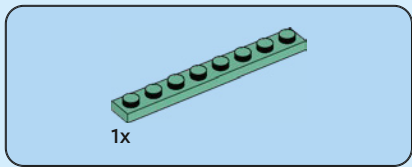

65

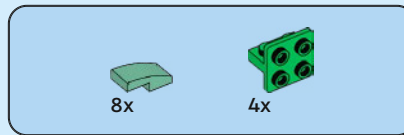
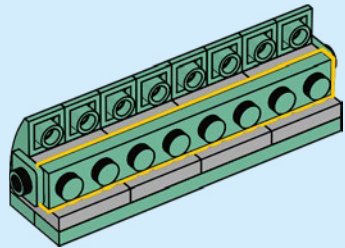

66

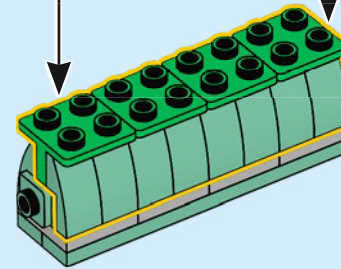
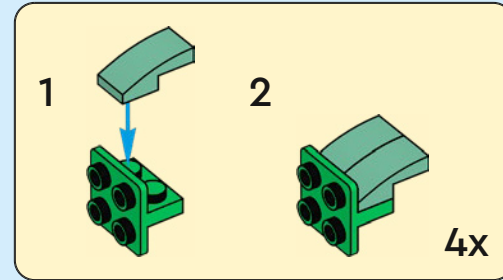

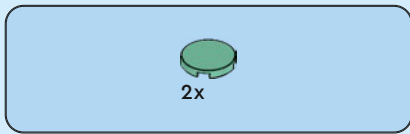

67

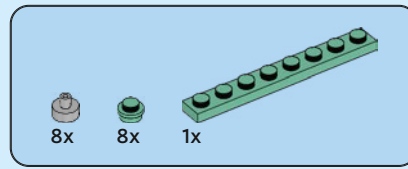
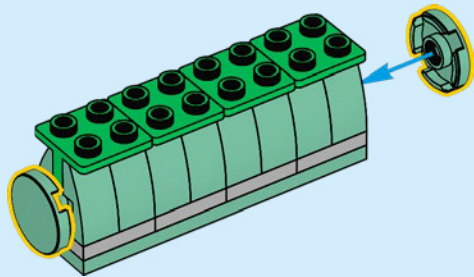

68

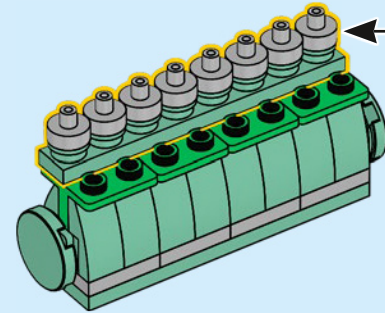
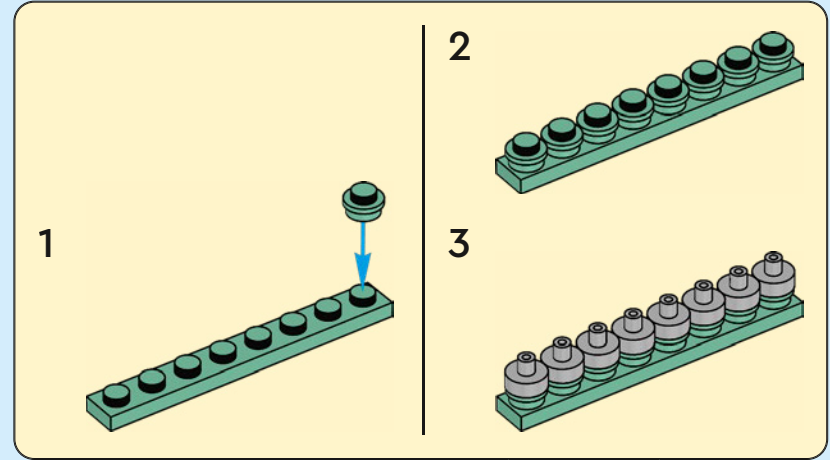



2x

69

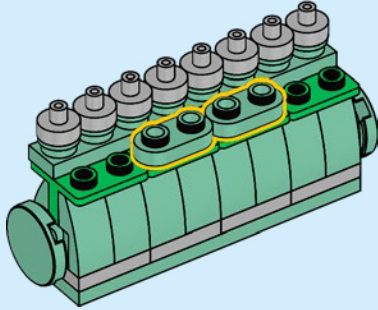

2x



2x

70

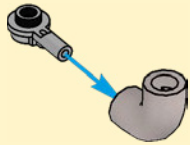
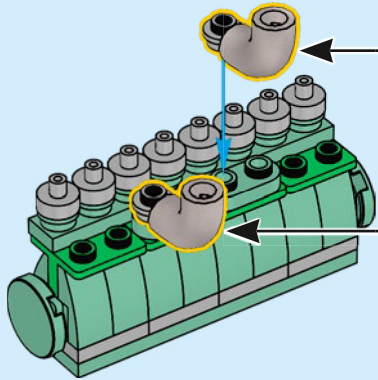

2x



2x

71

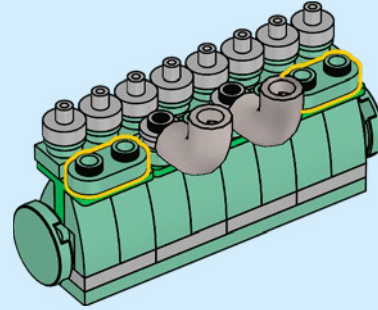

4x



4x

72

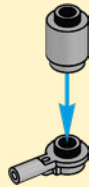
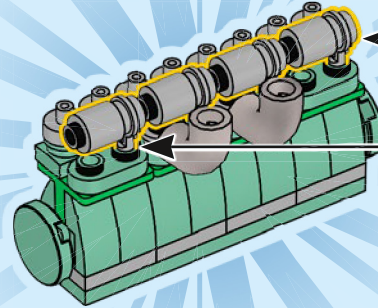

4x

73

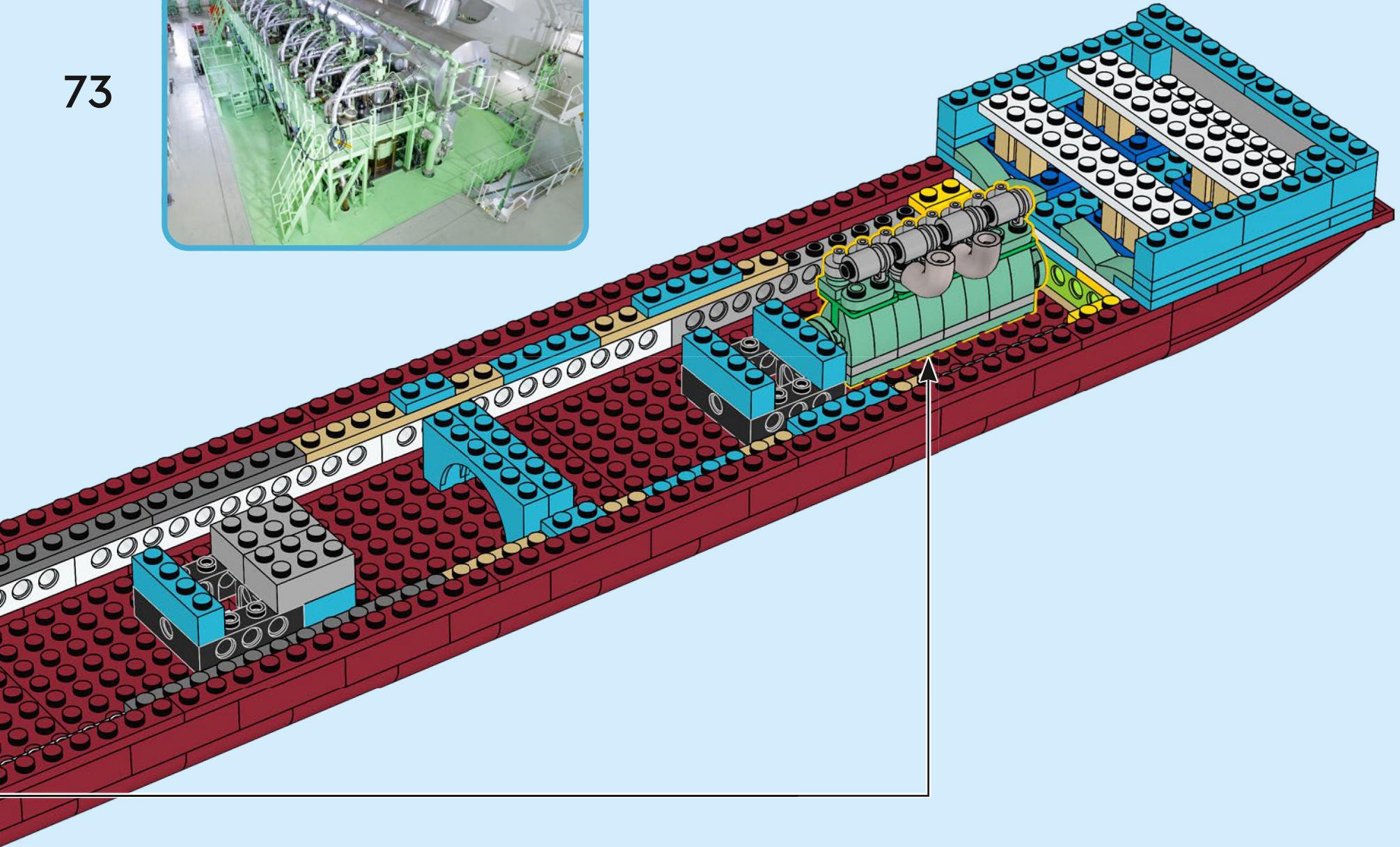

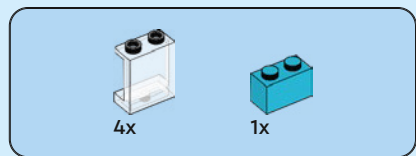

74

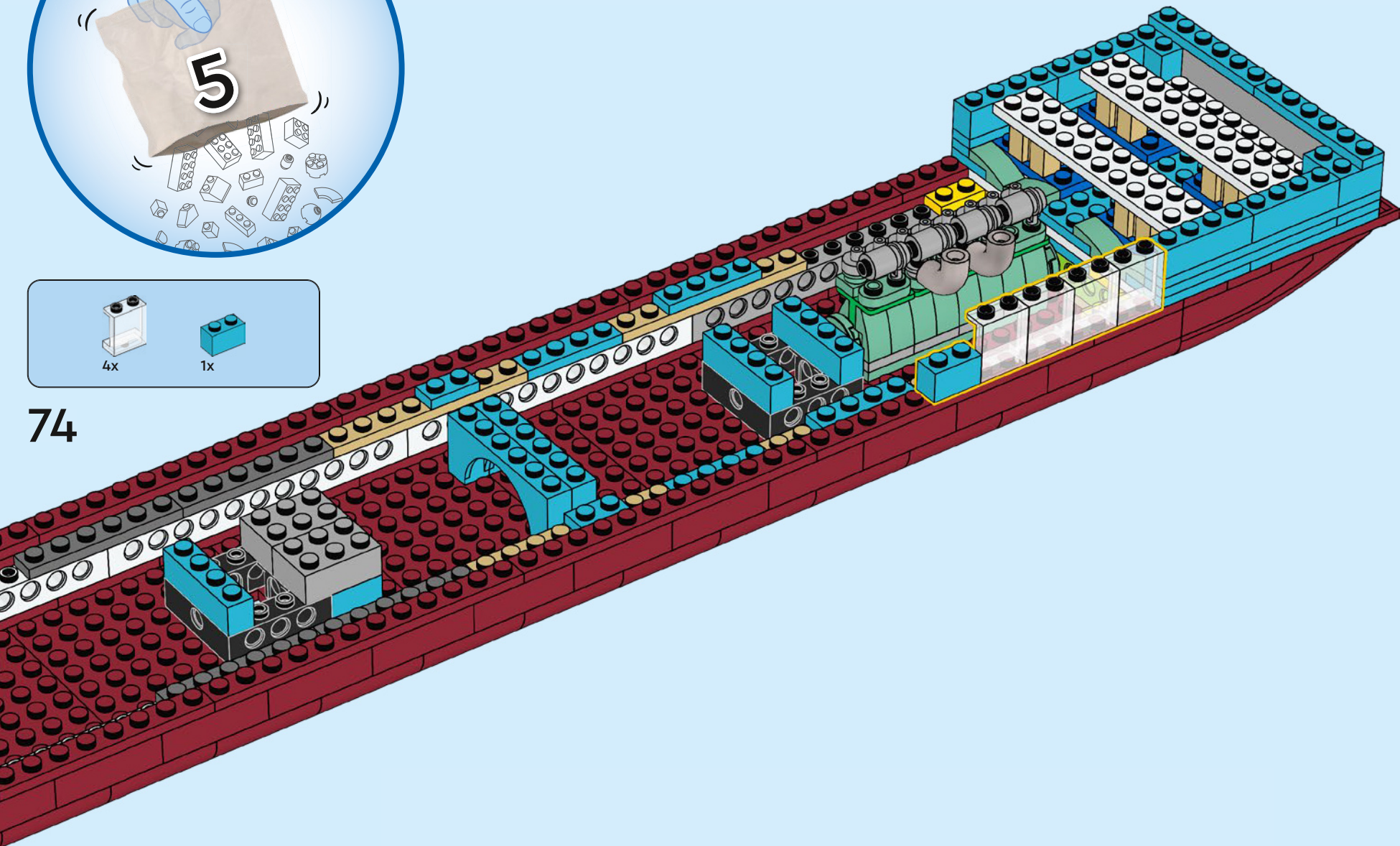

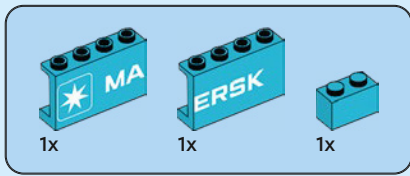

75

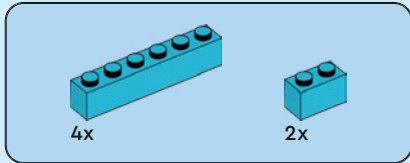
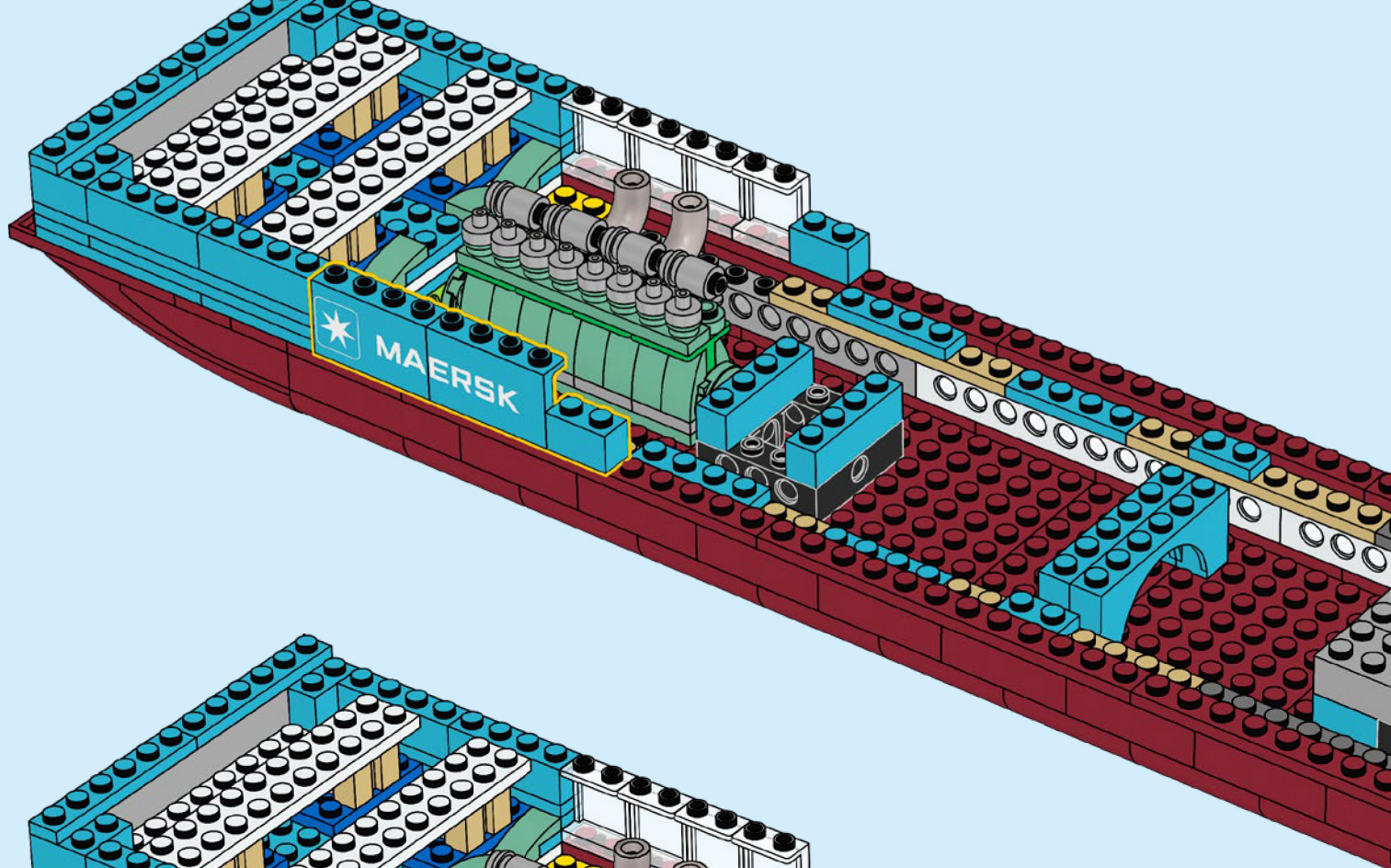

76

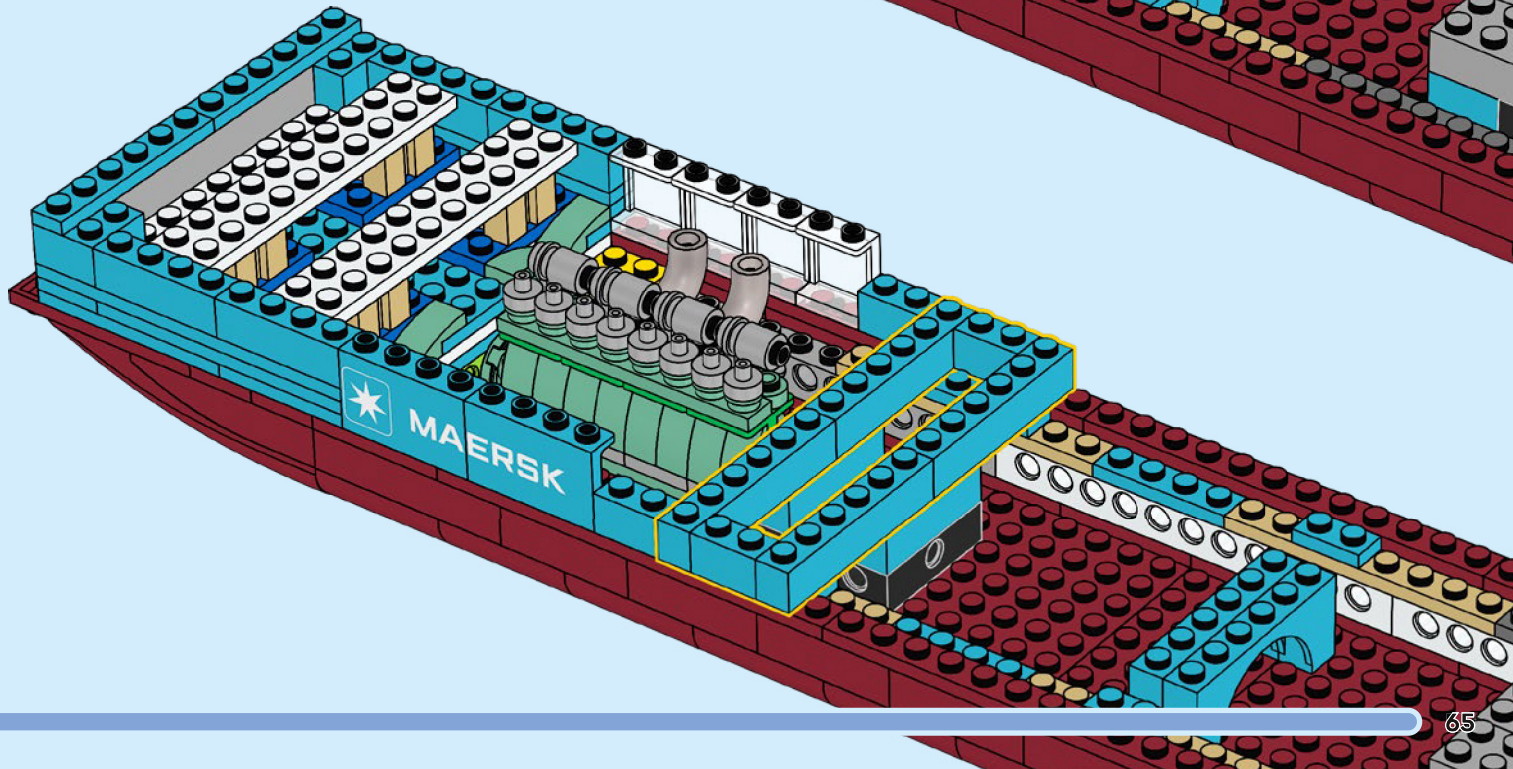

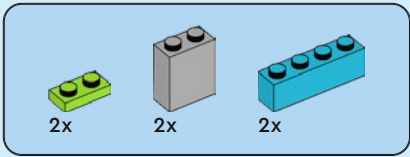

77

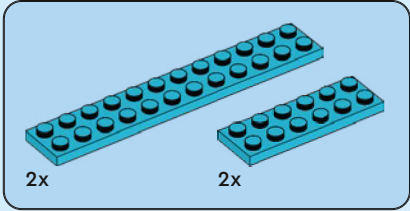
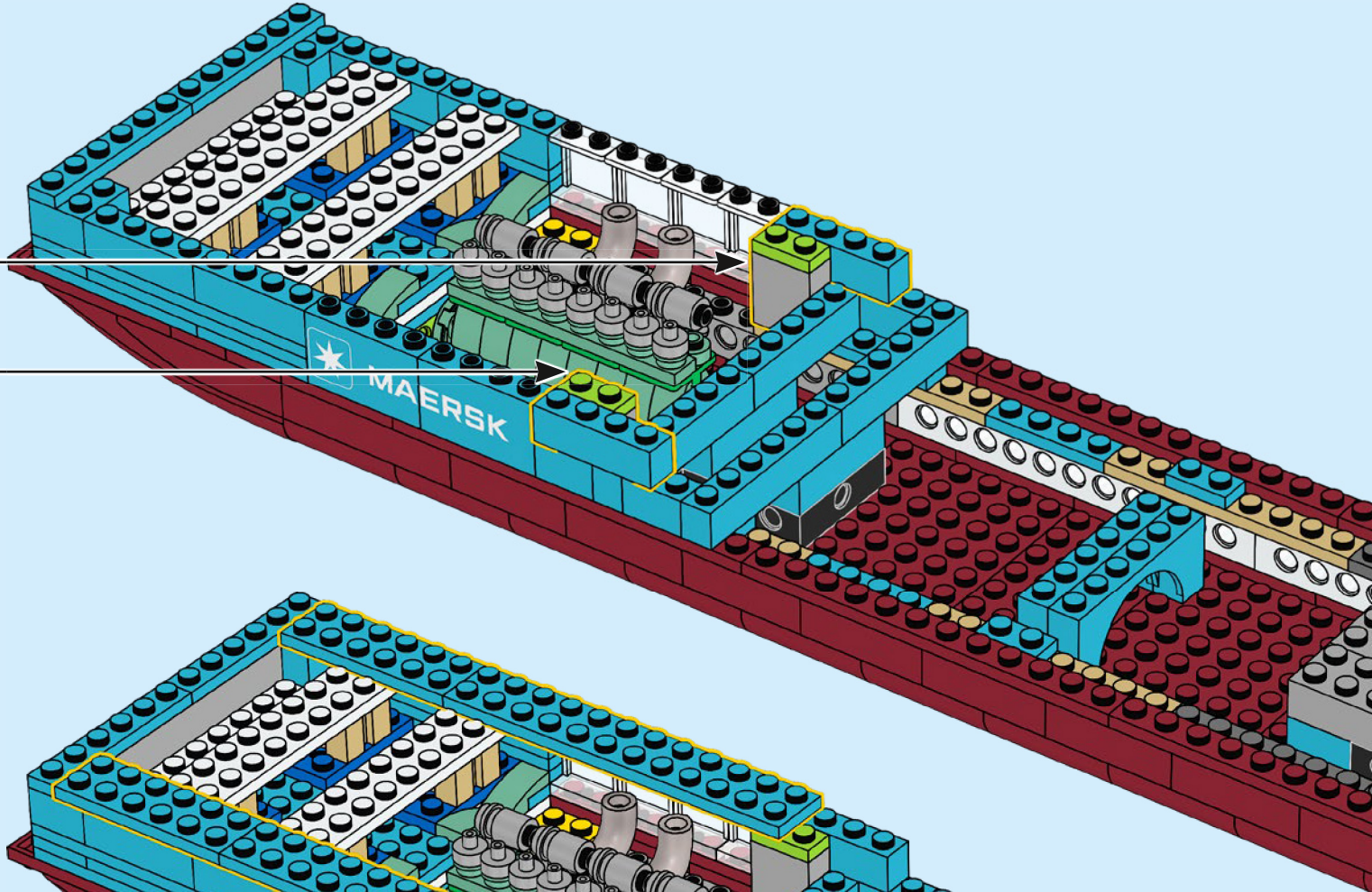
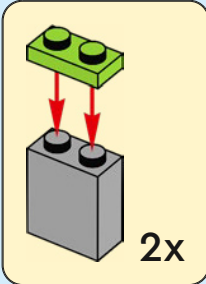

78

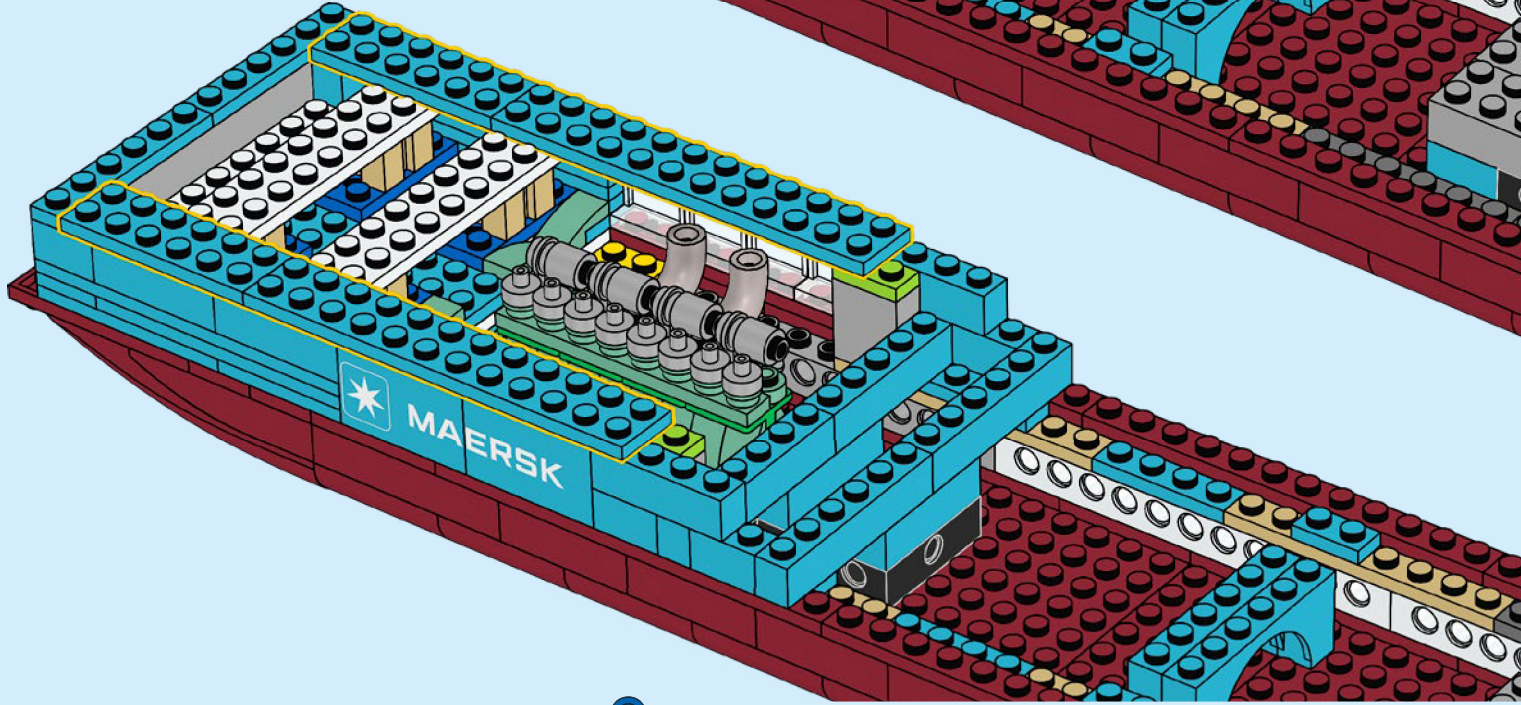

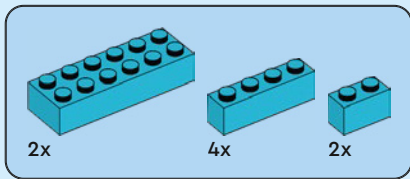

79

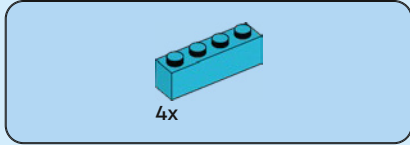
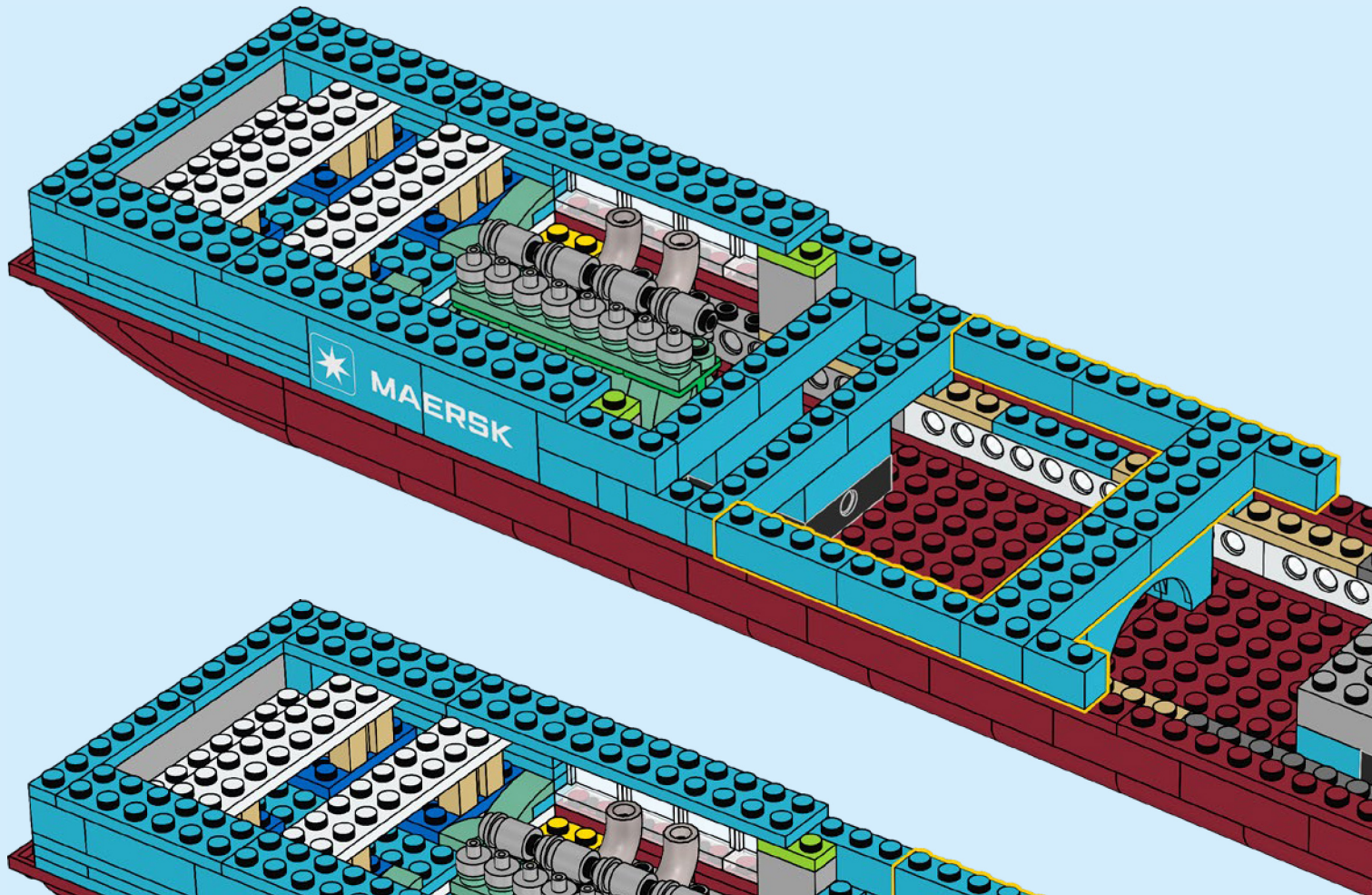

80

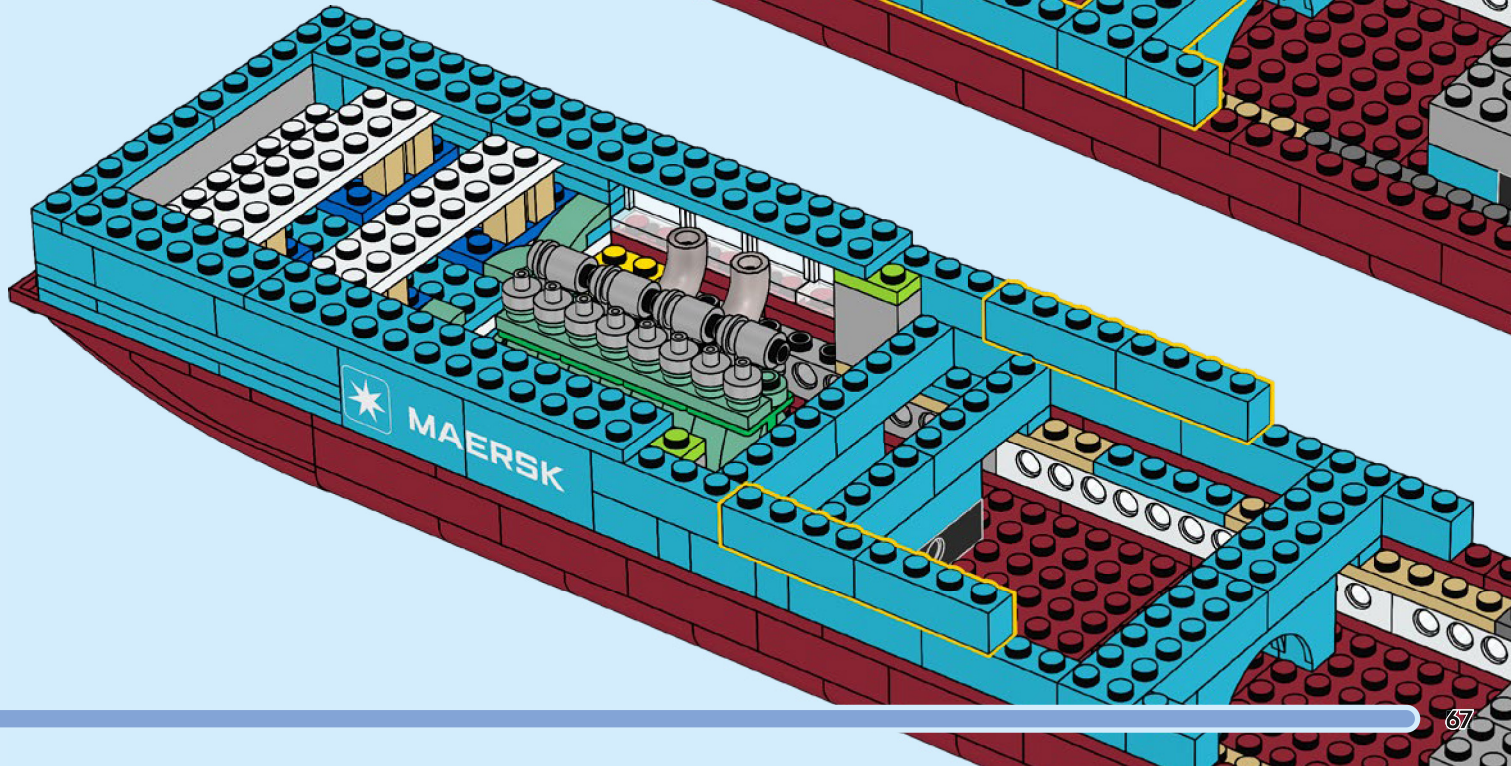

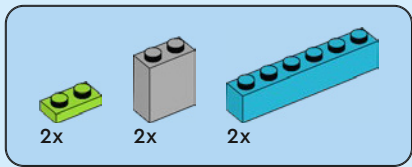

81

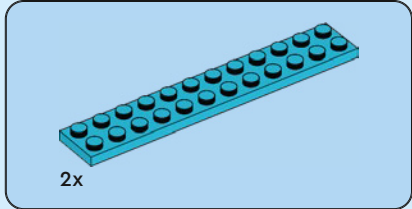
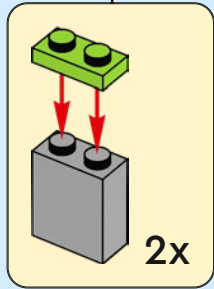
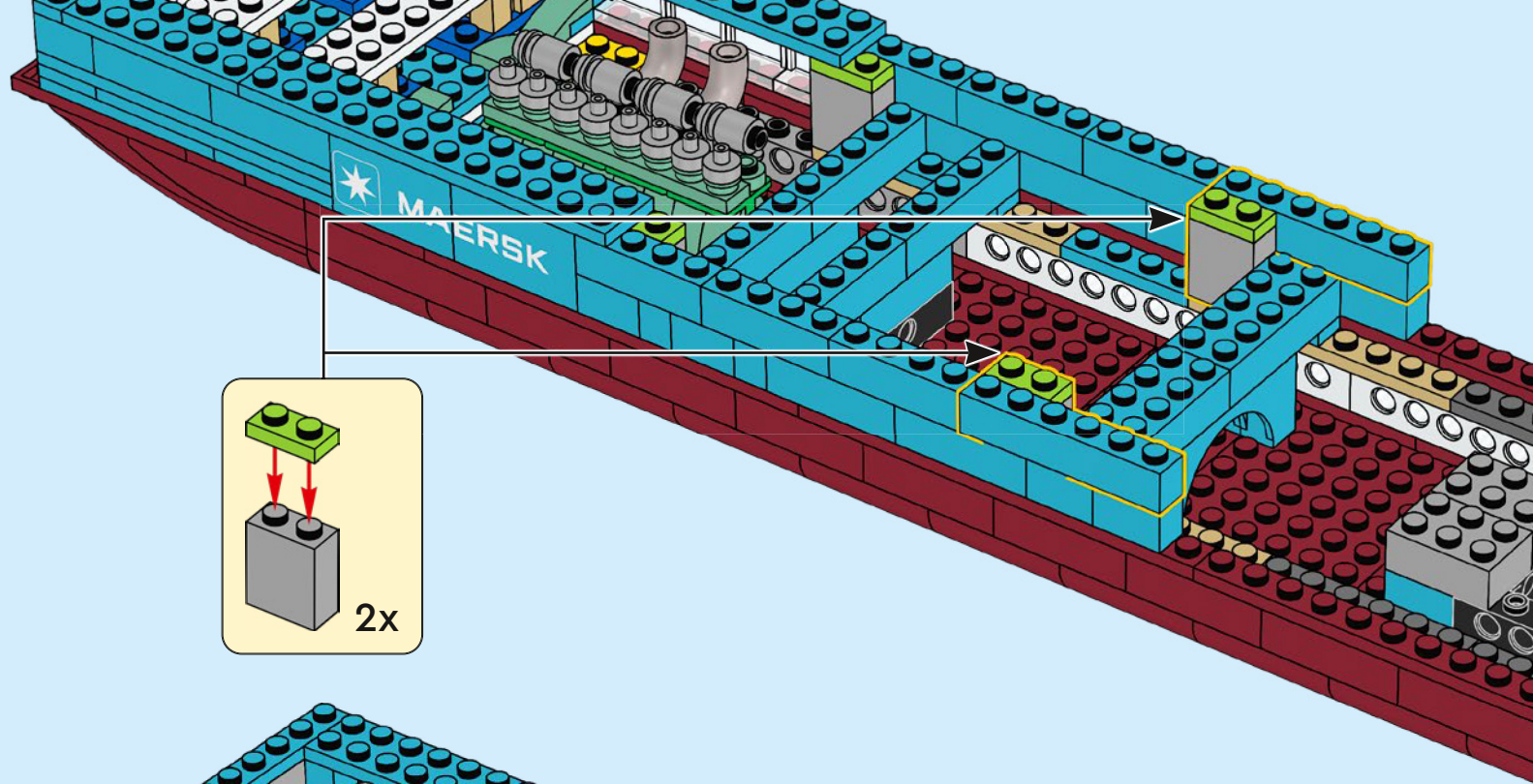

82

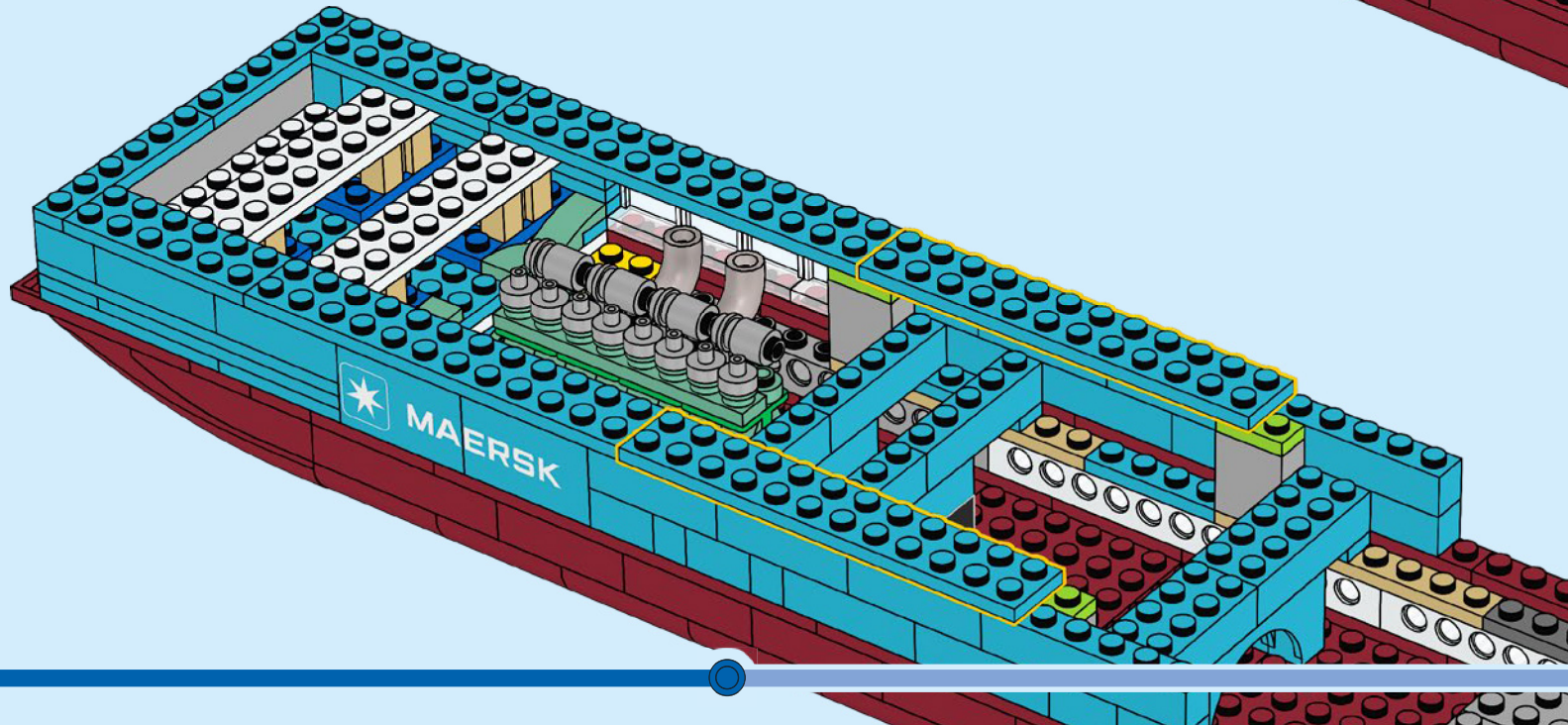

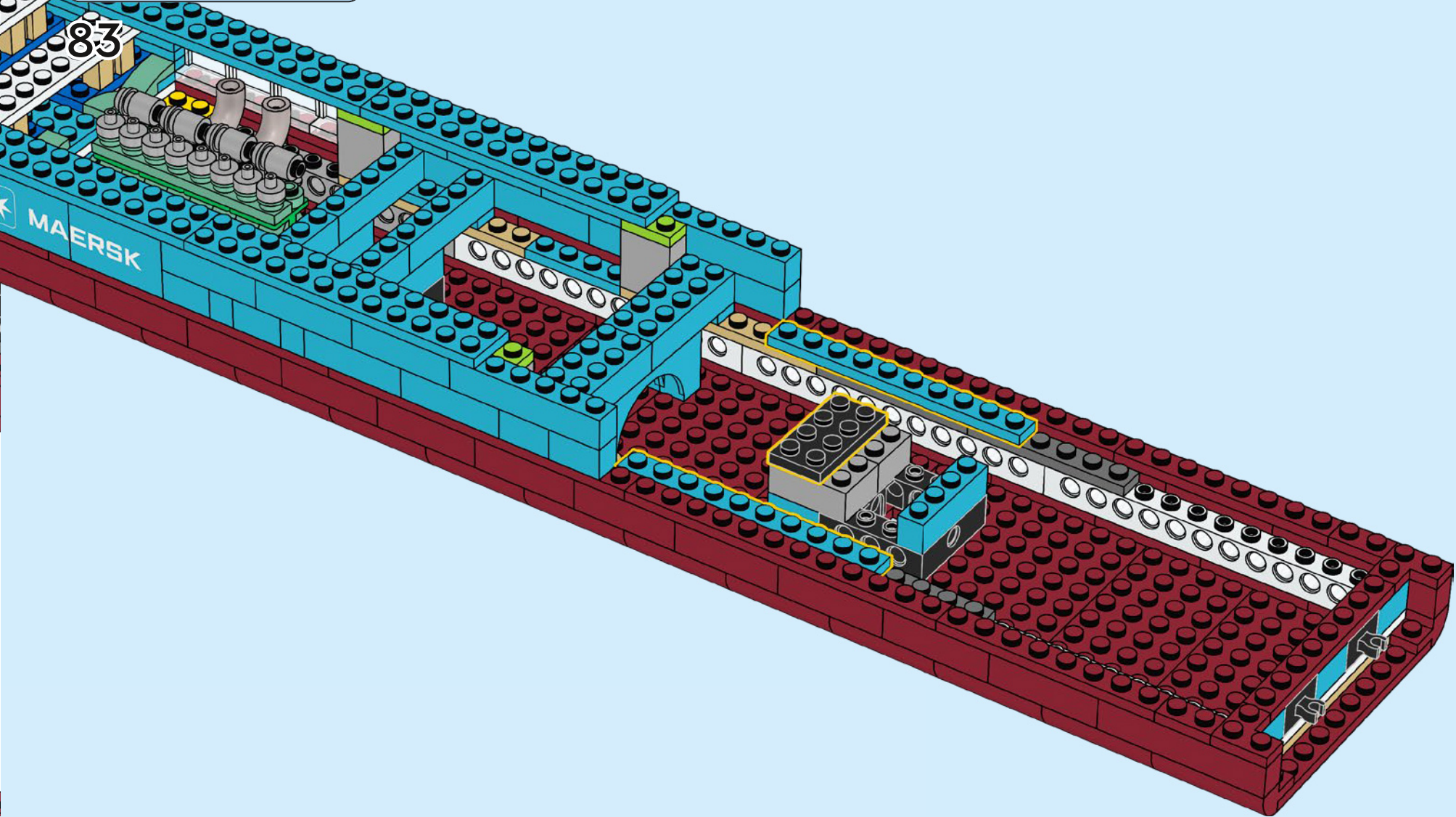
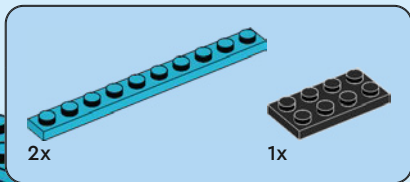

84

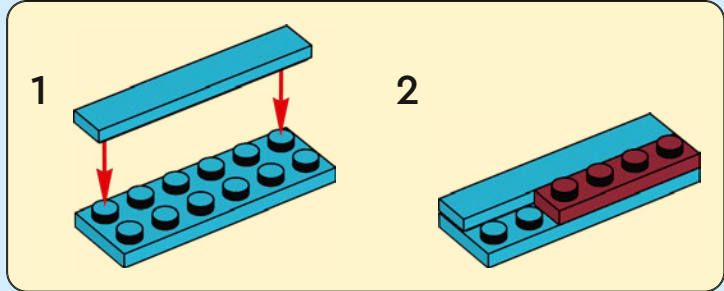
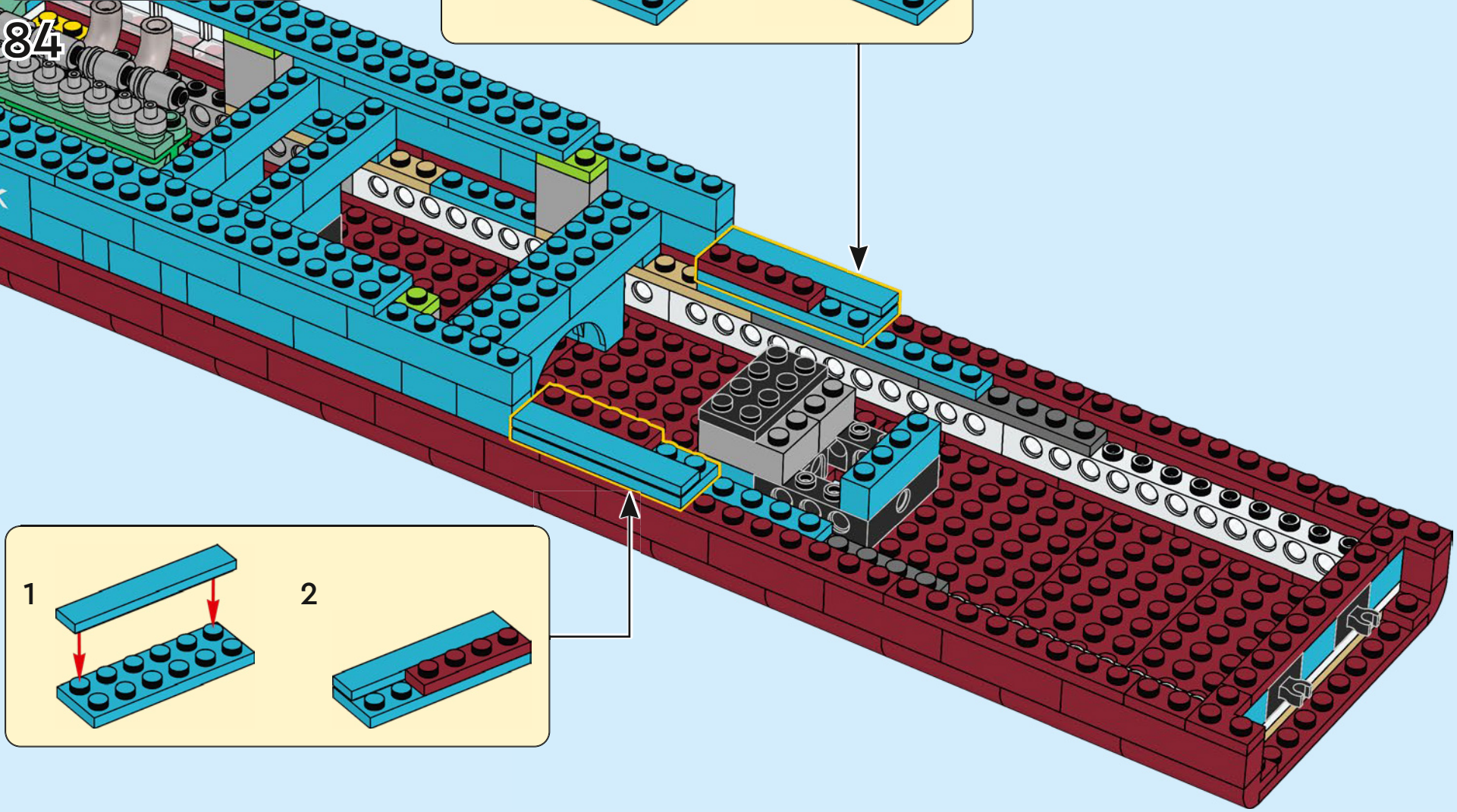
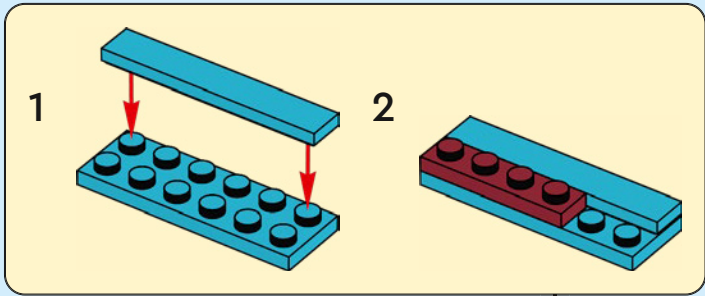
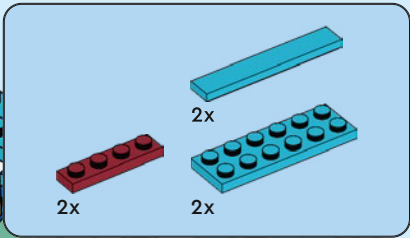

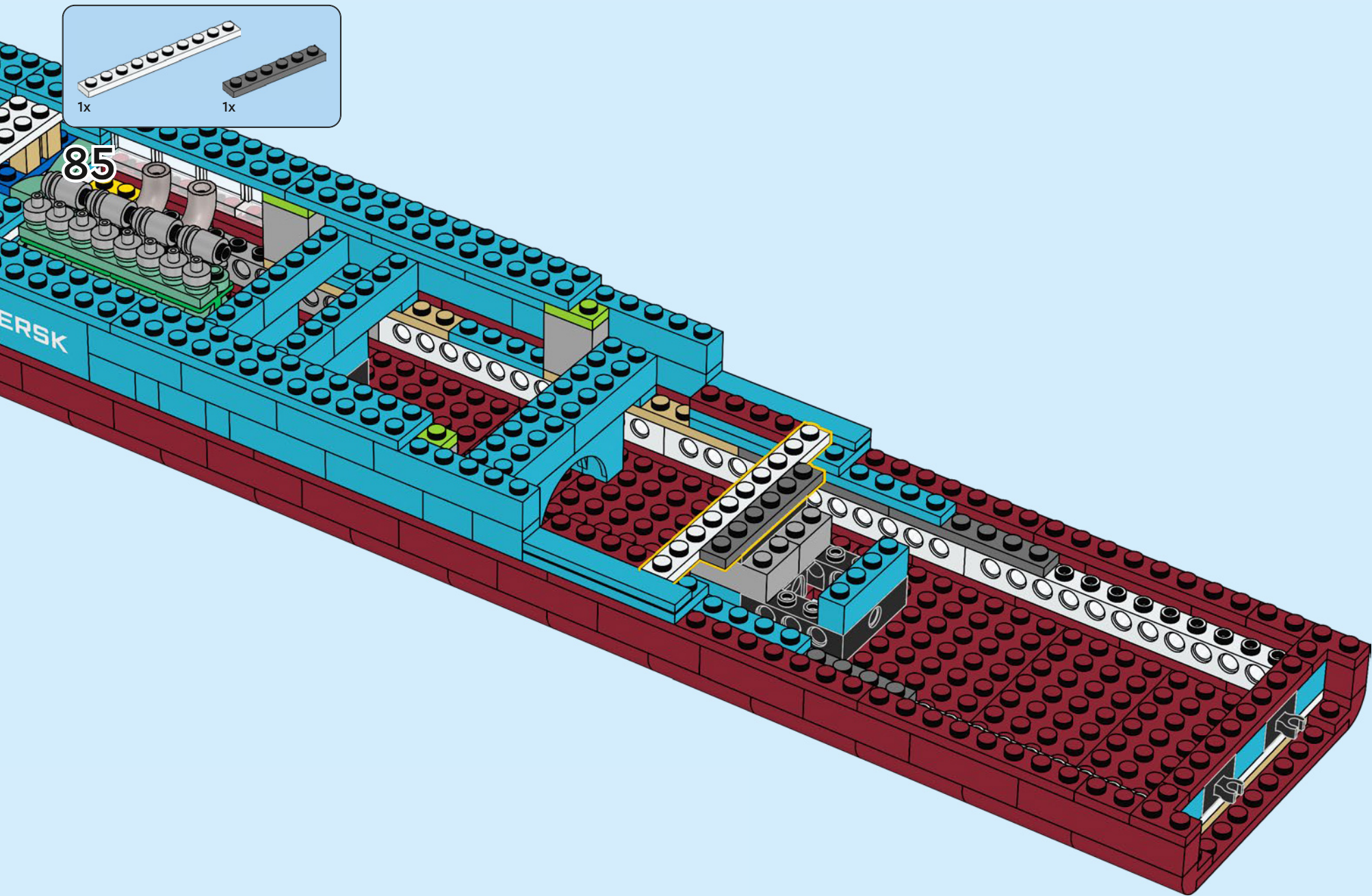

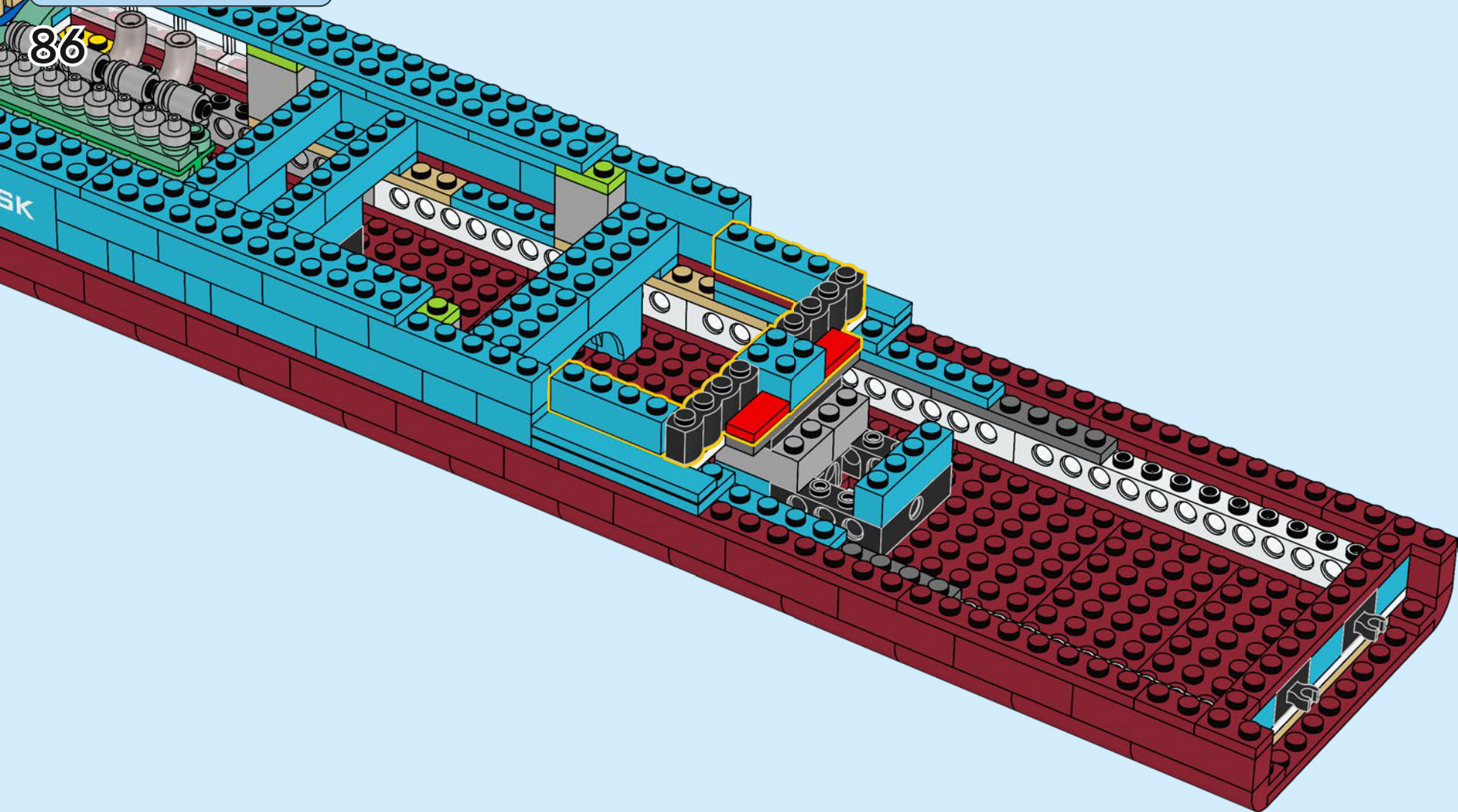
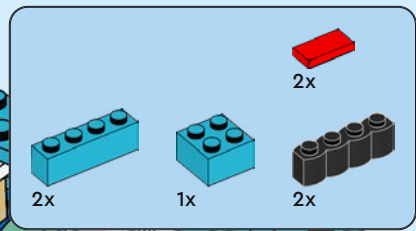

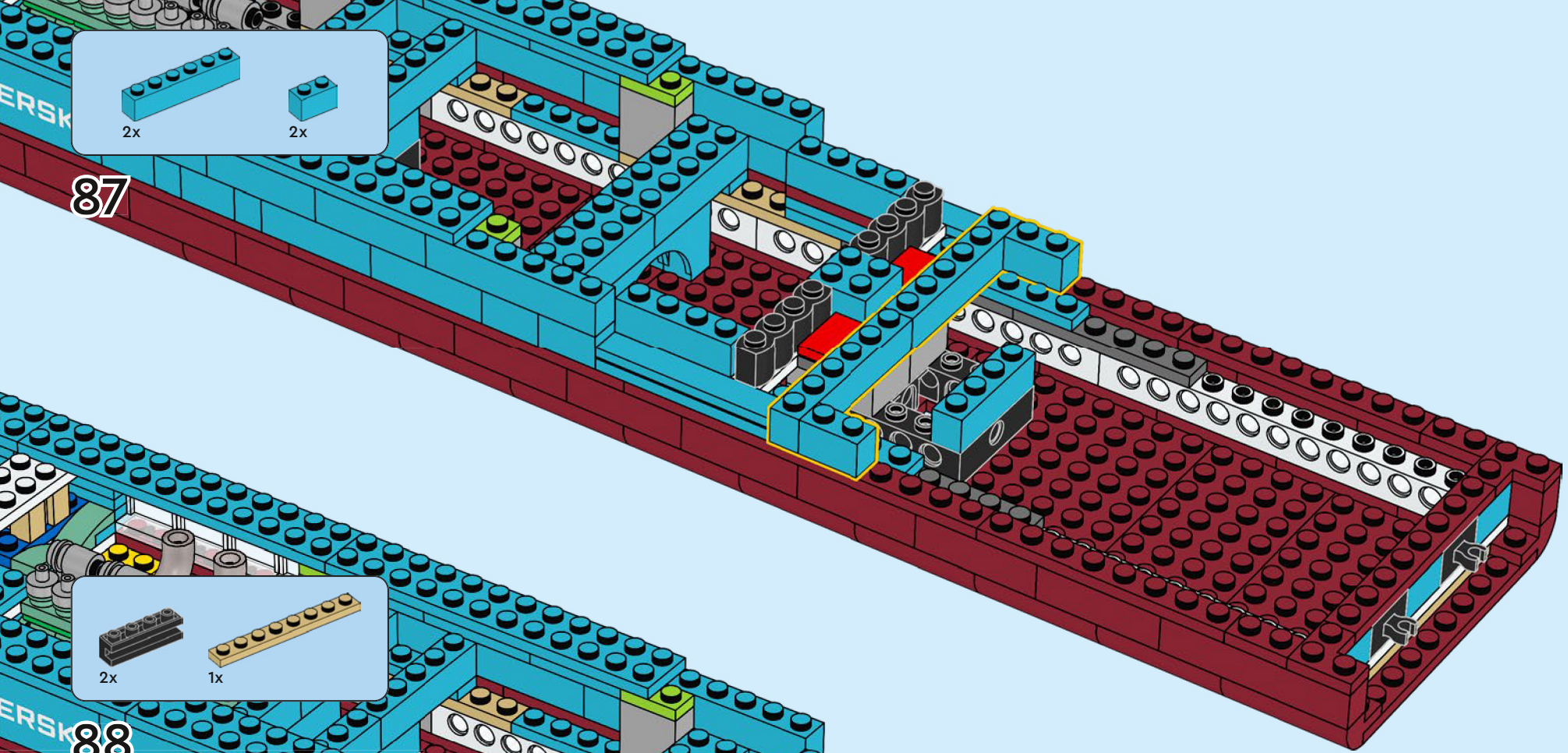

87



88

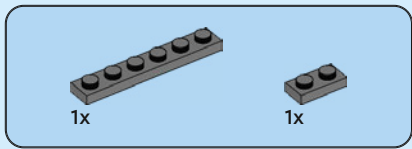

89

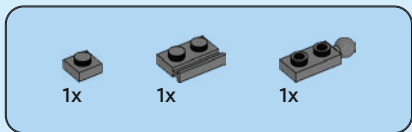
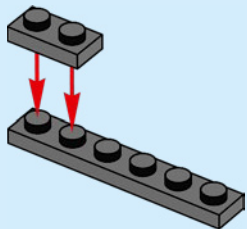

90

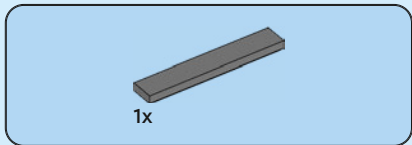
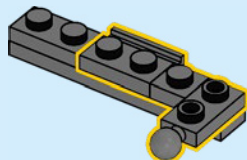

91

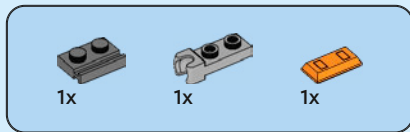
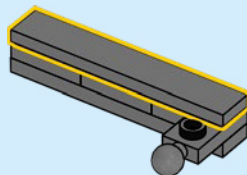

92

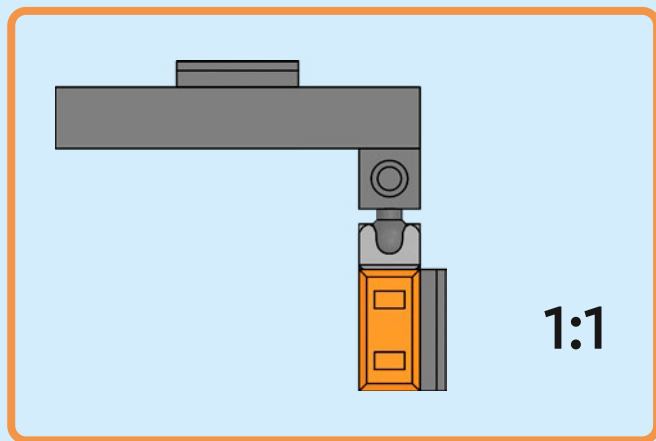
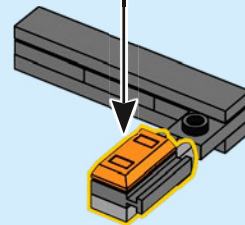
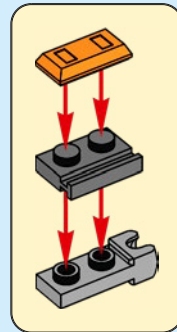

93

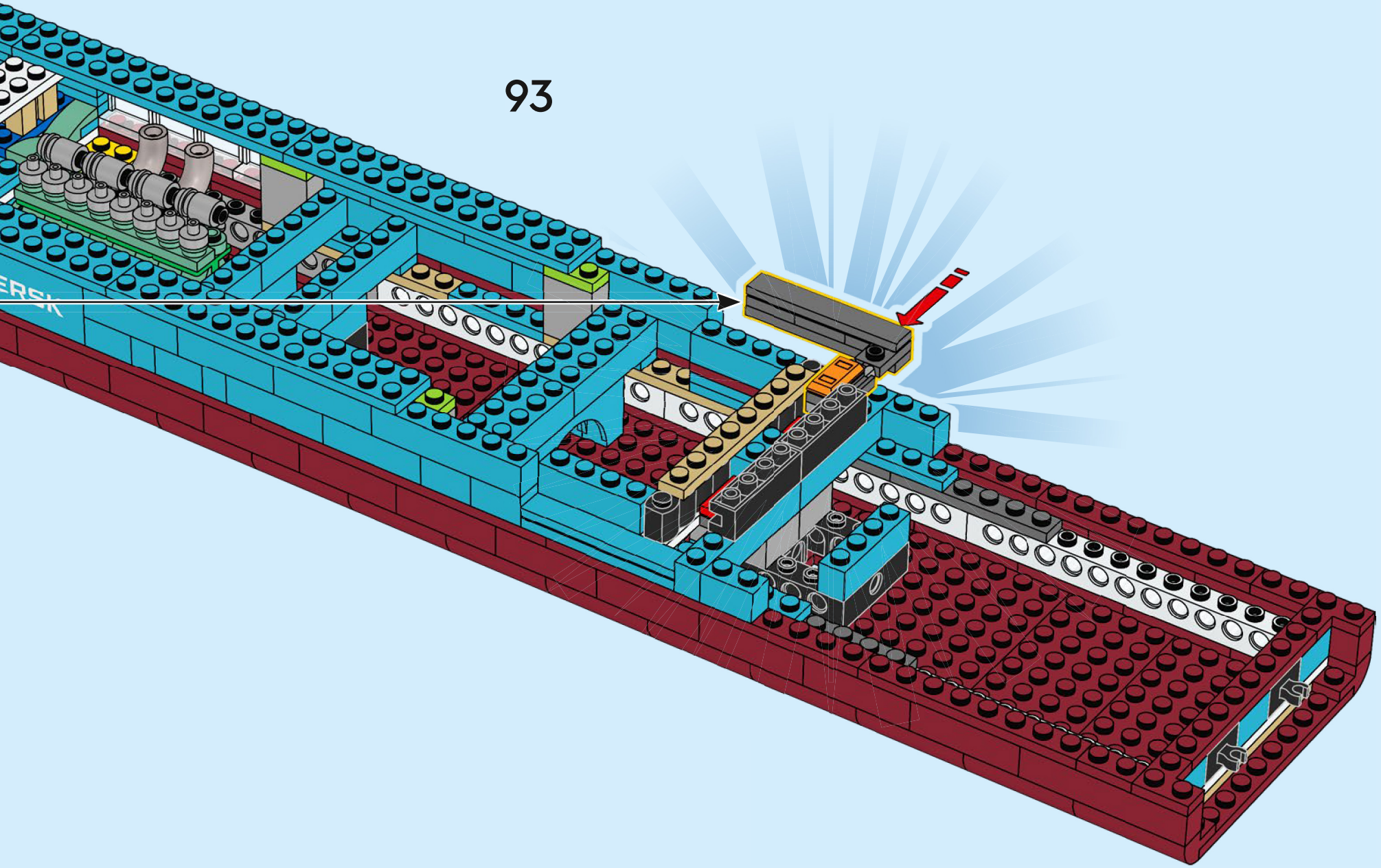

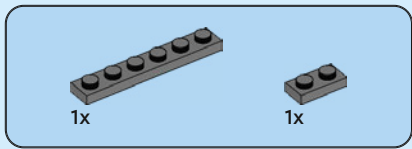

94

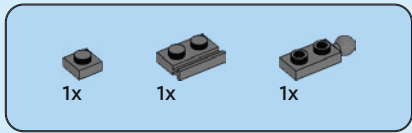
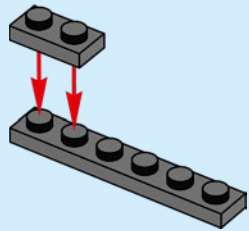

95

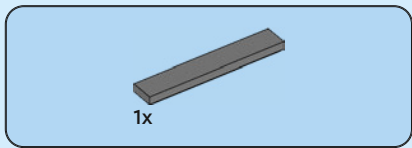
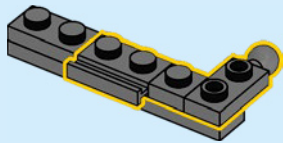

96

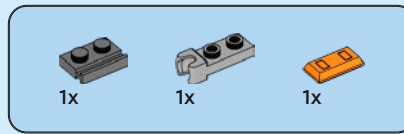
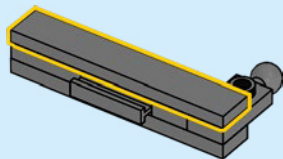

97

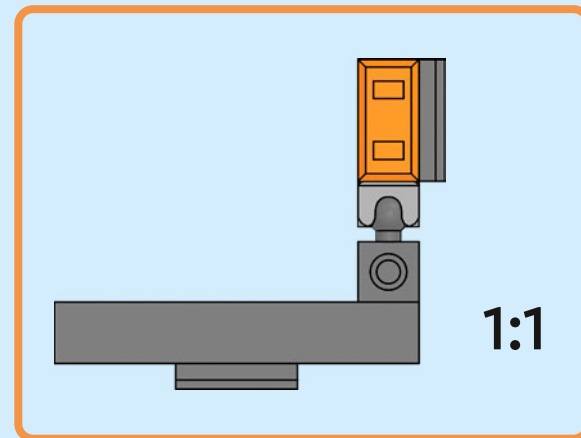
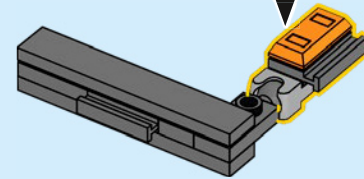
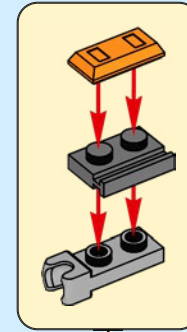

98

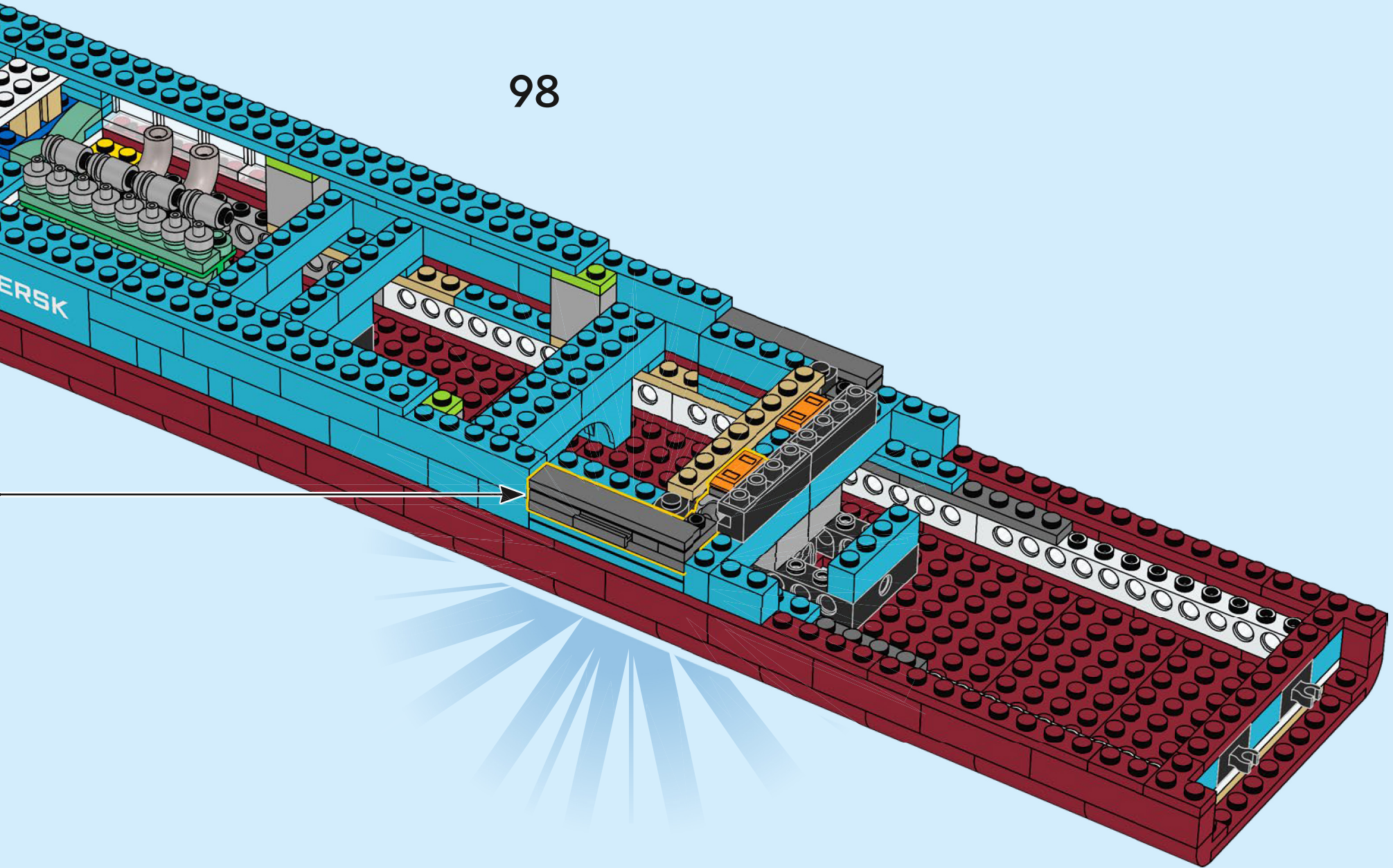

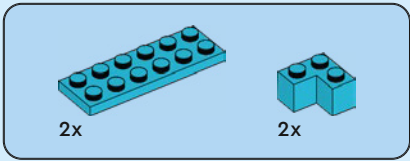

99

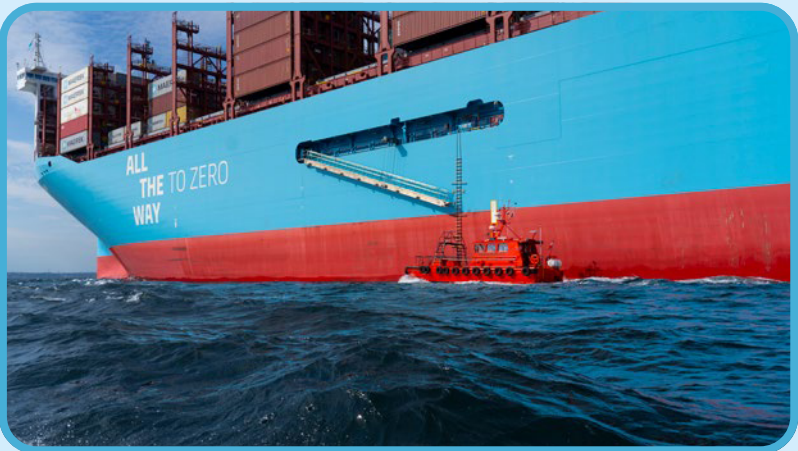
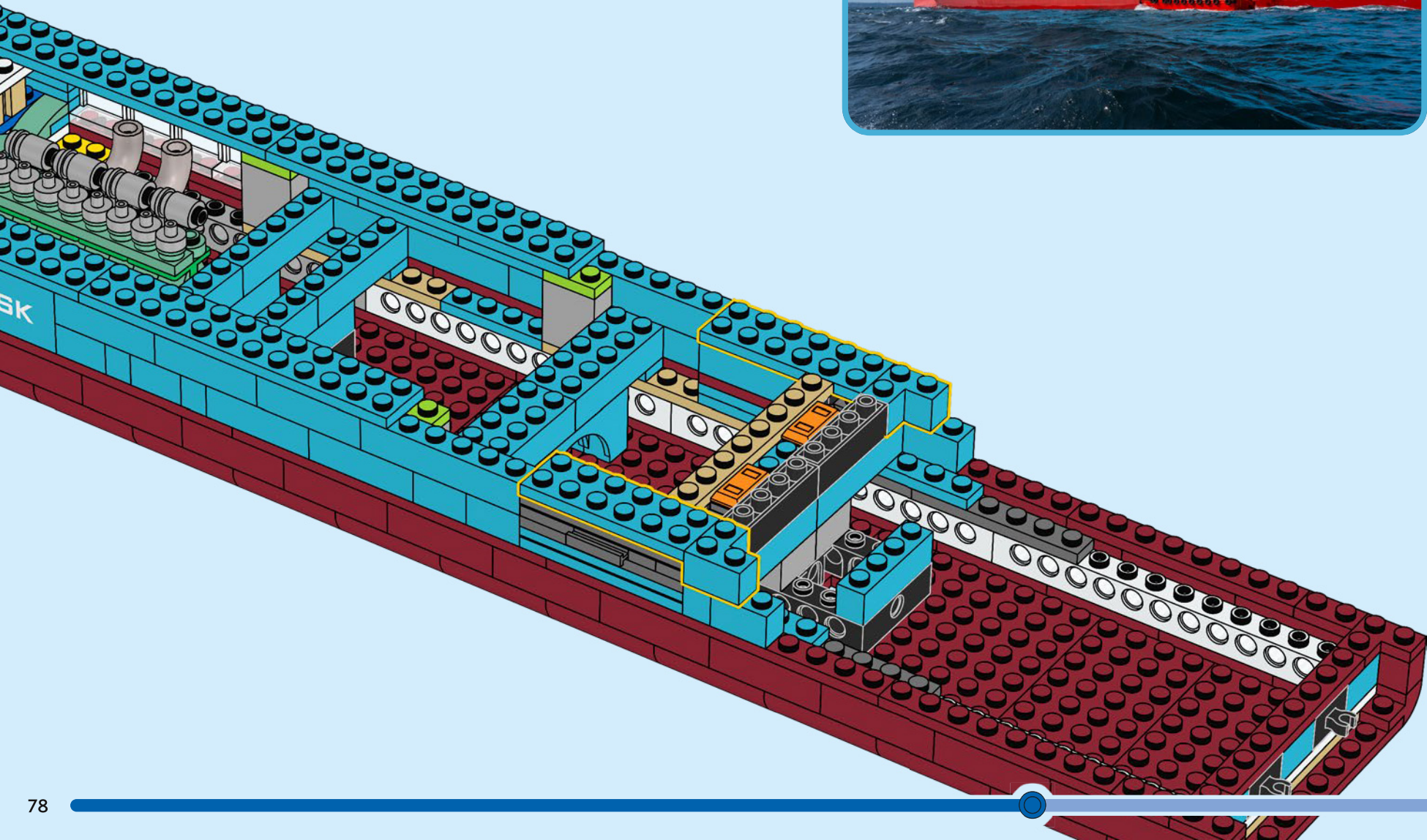

1

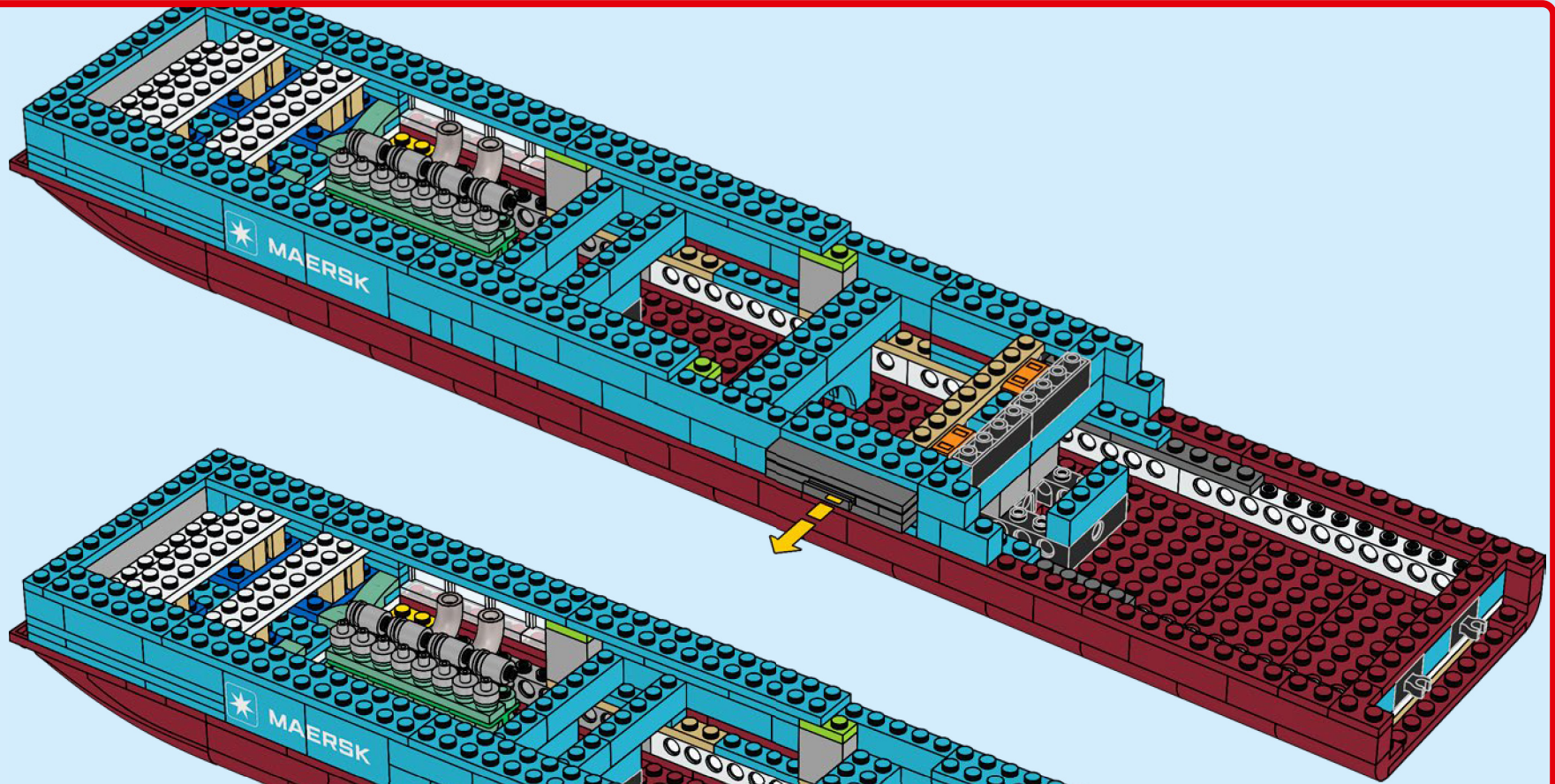

2

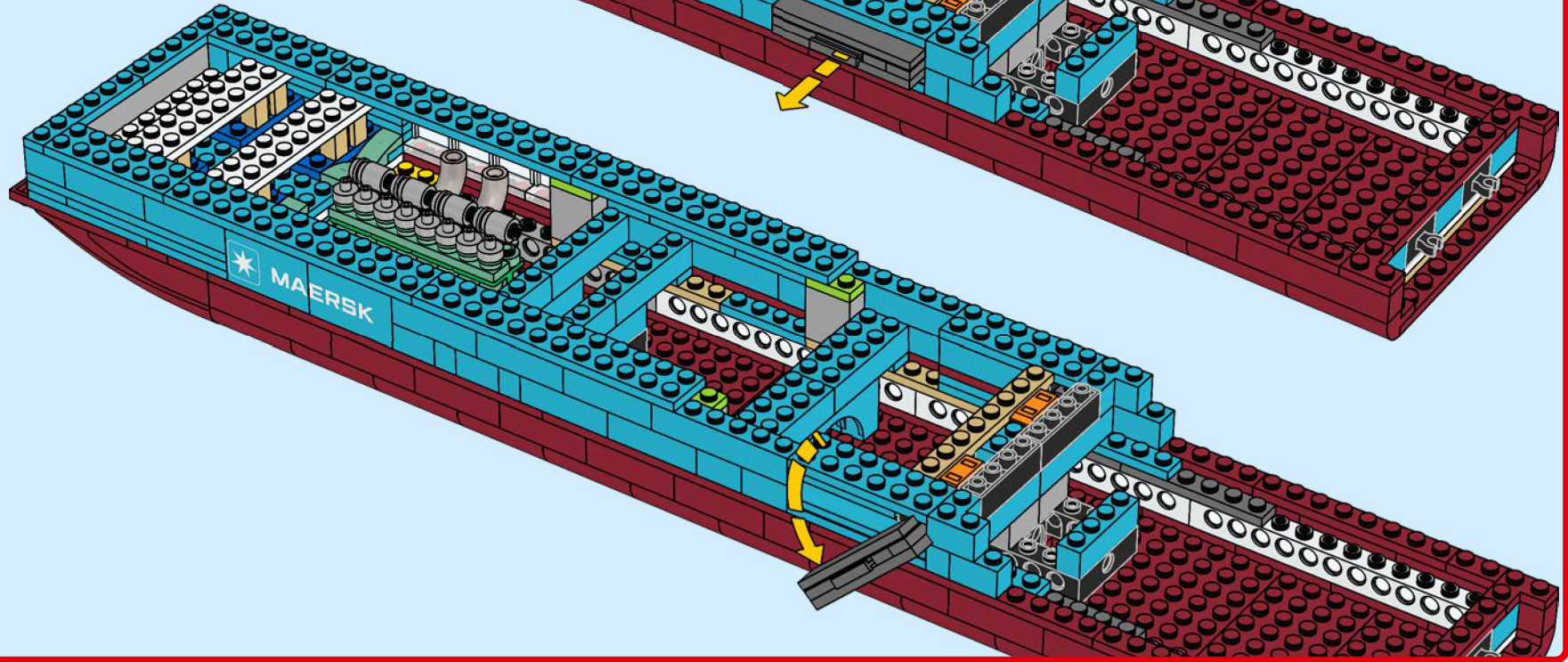

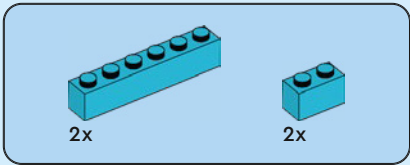

100

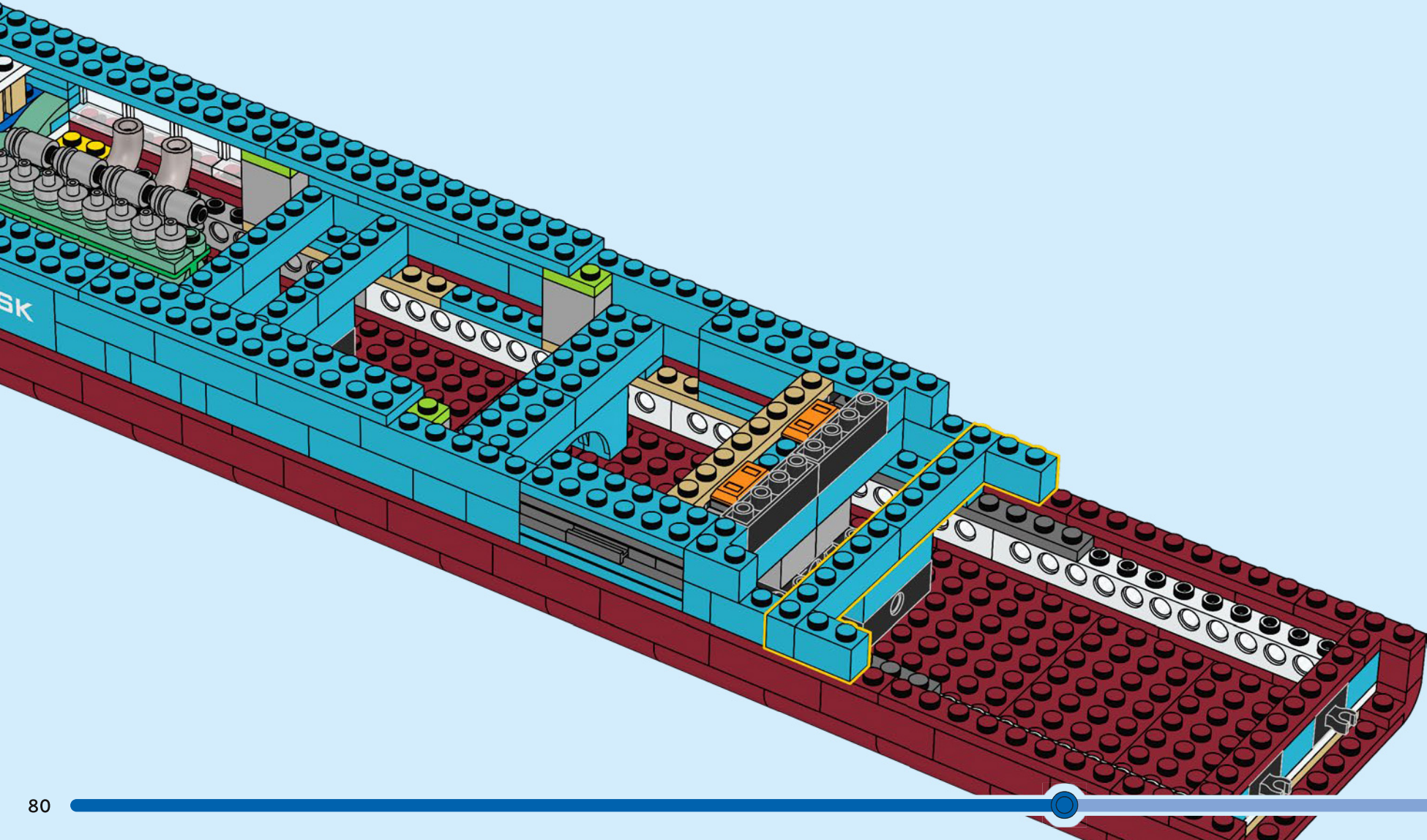

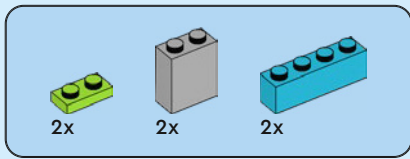

101

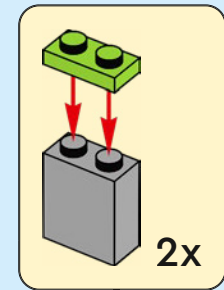
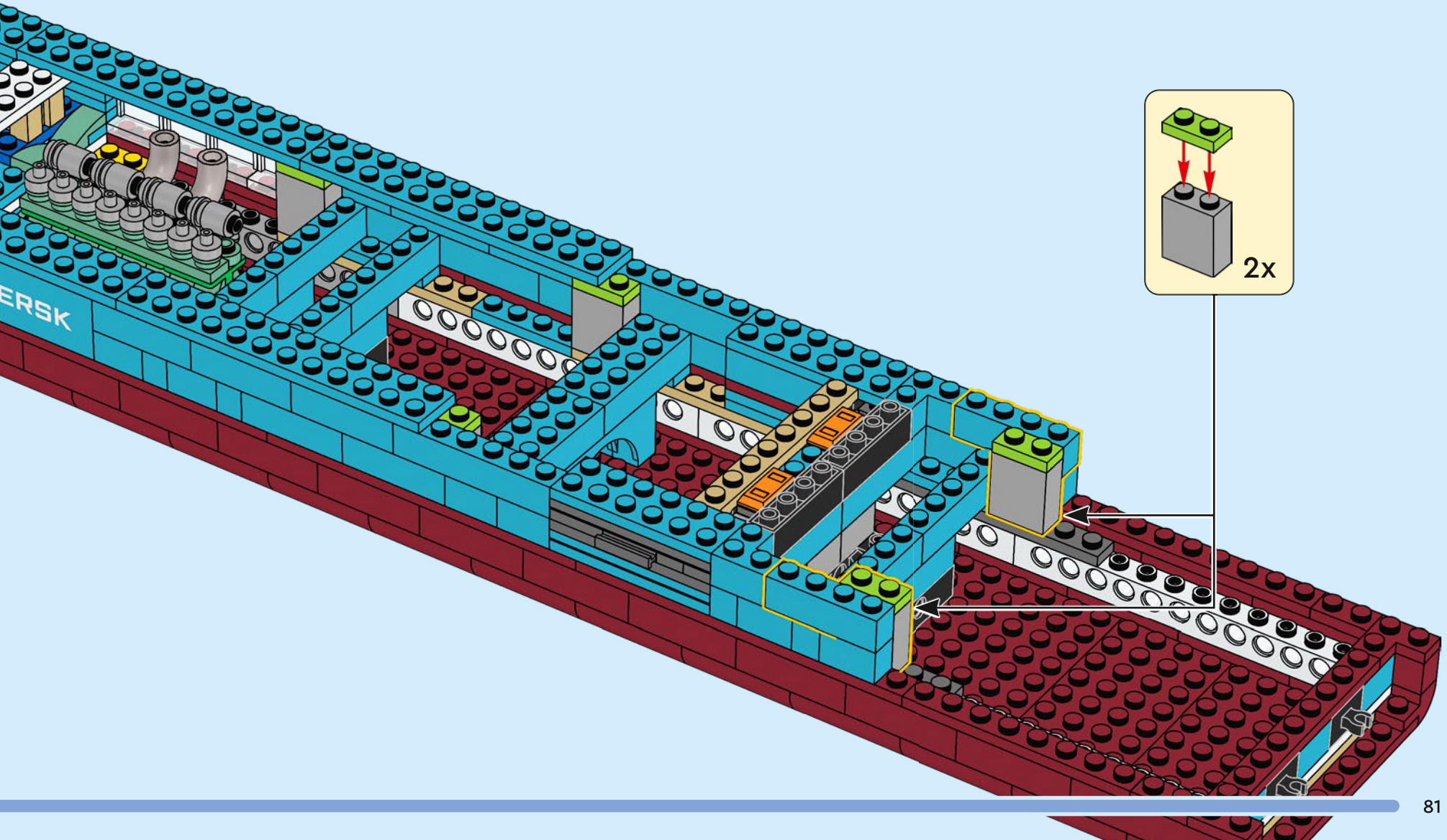

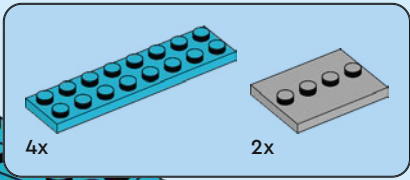

102

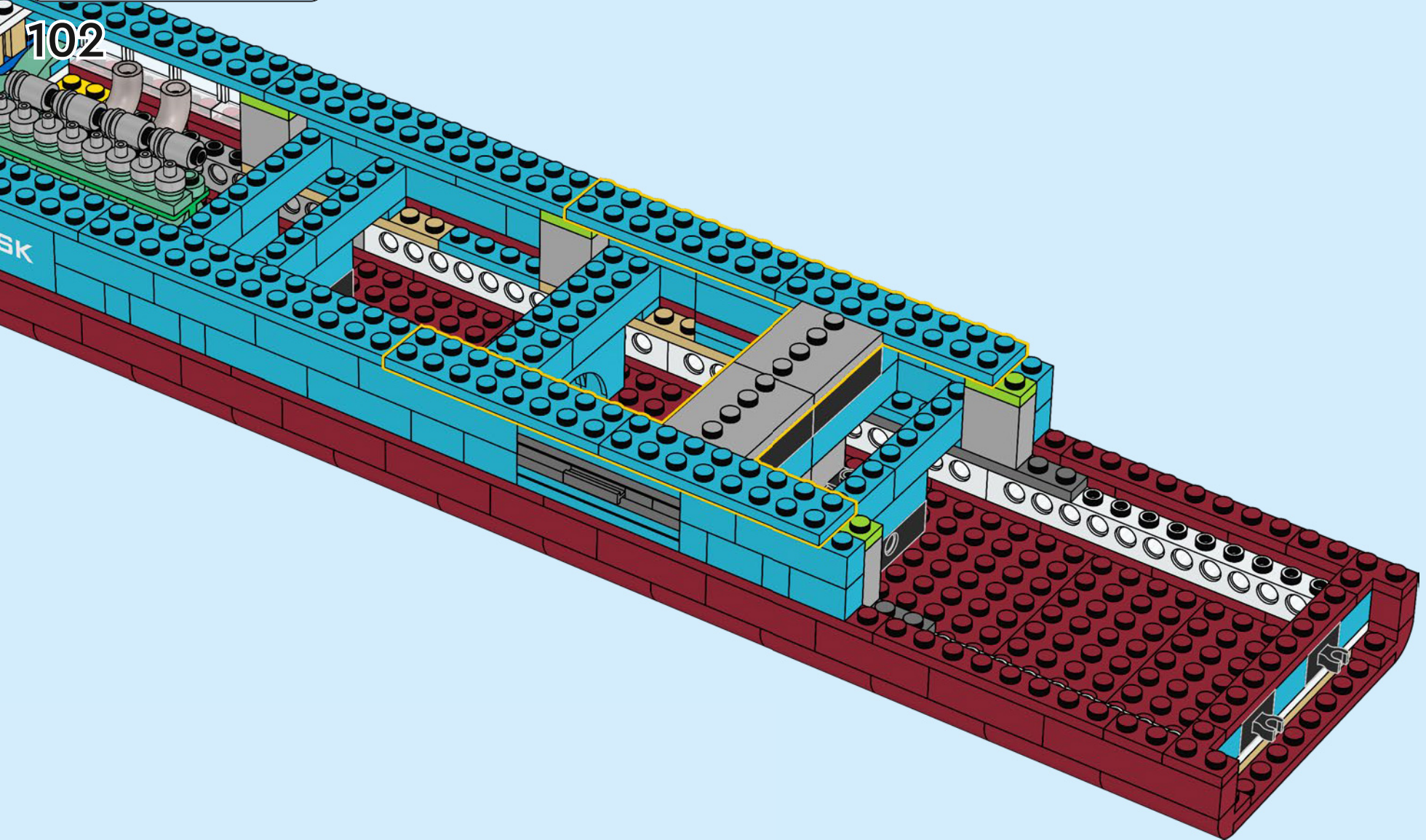

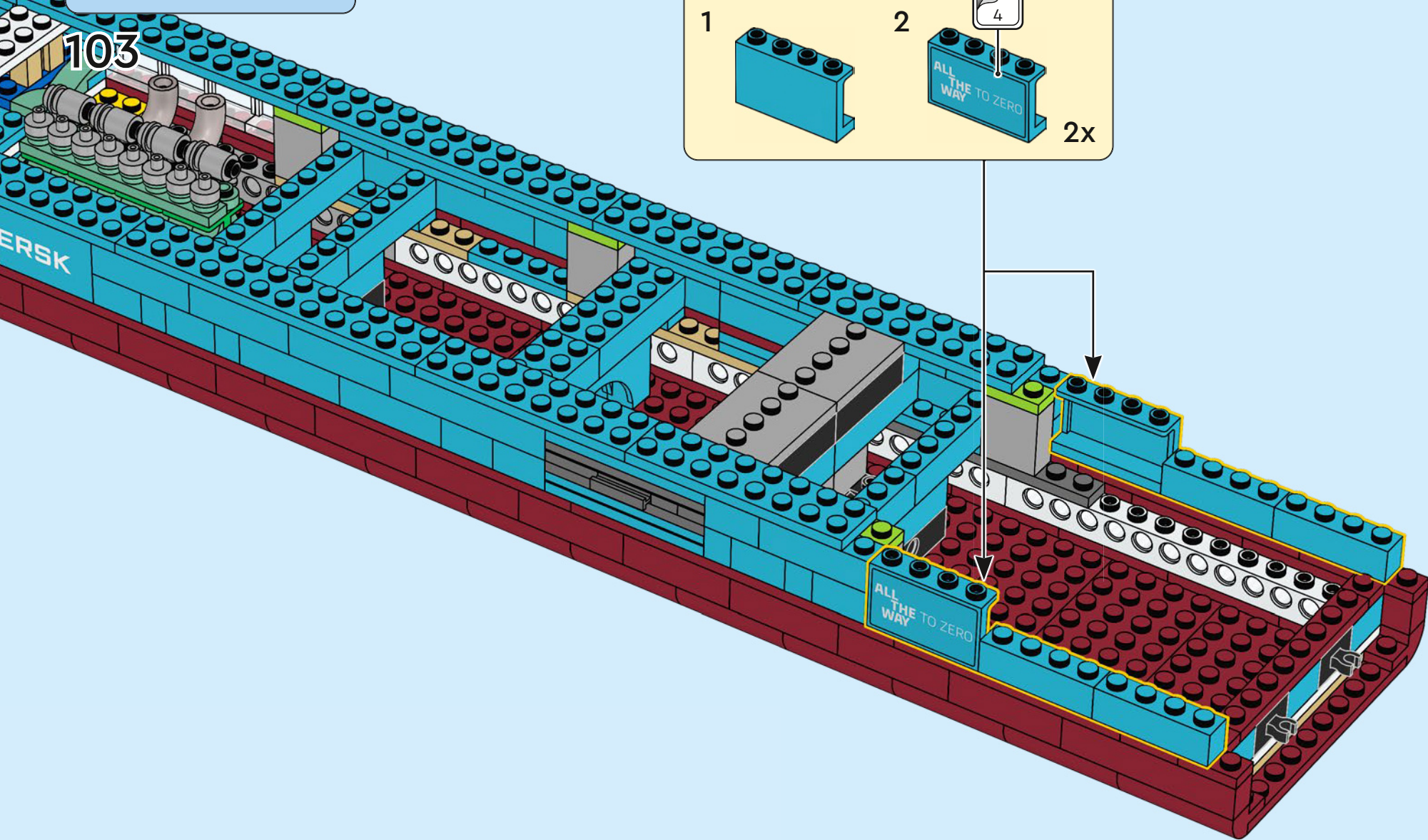
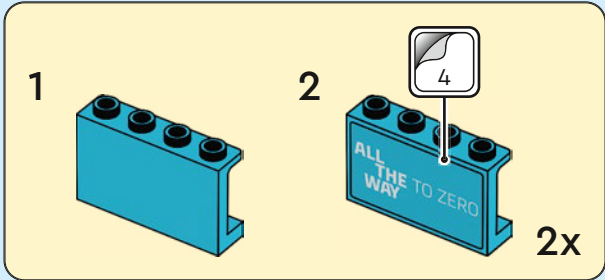
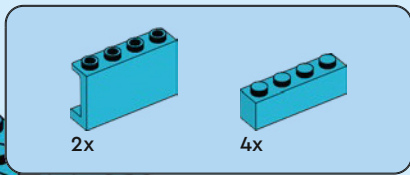

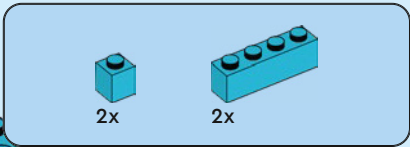

104

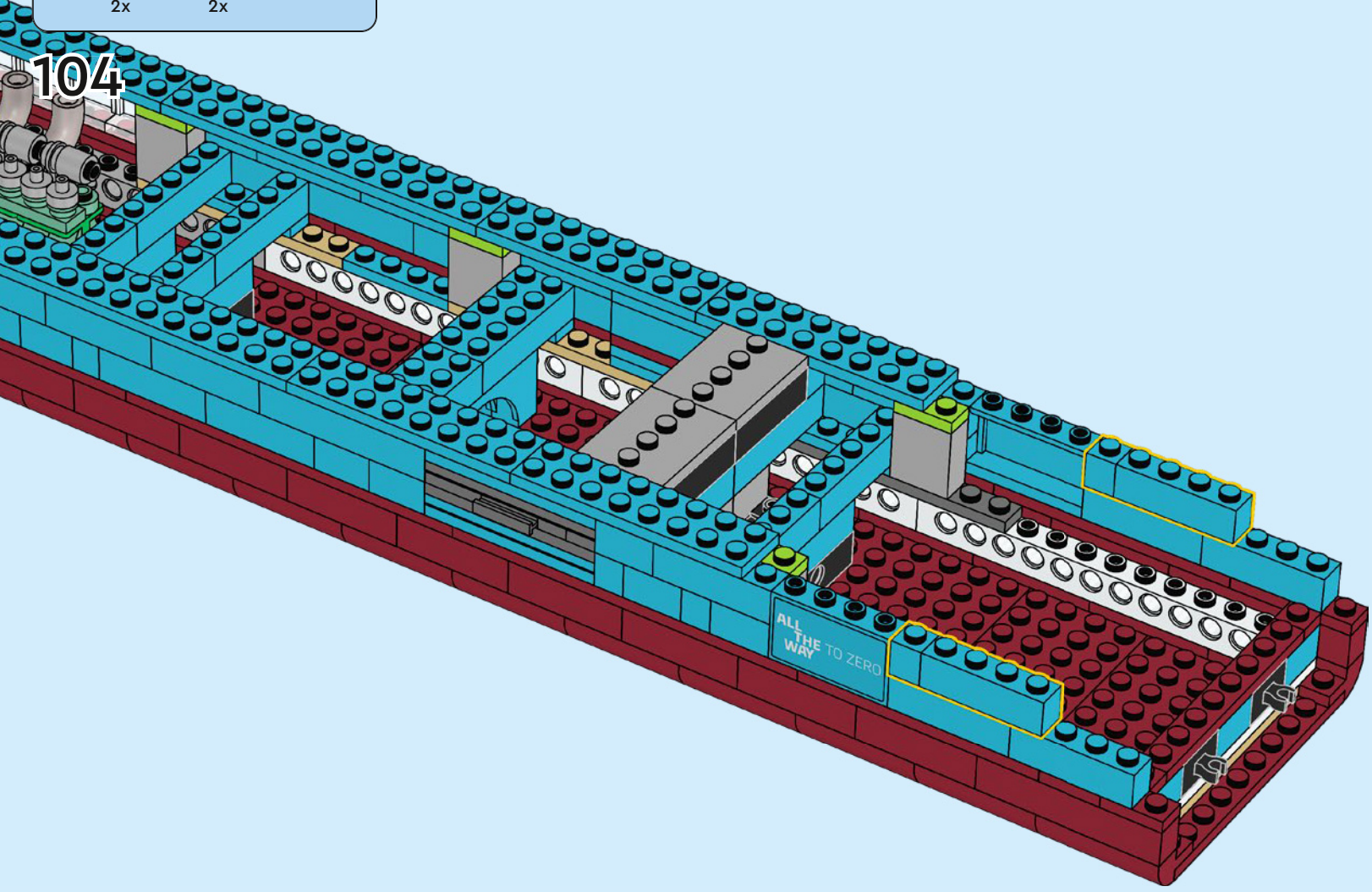

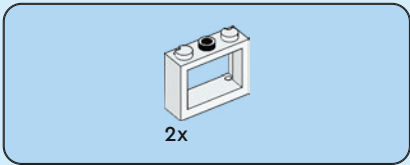

105

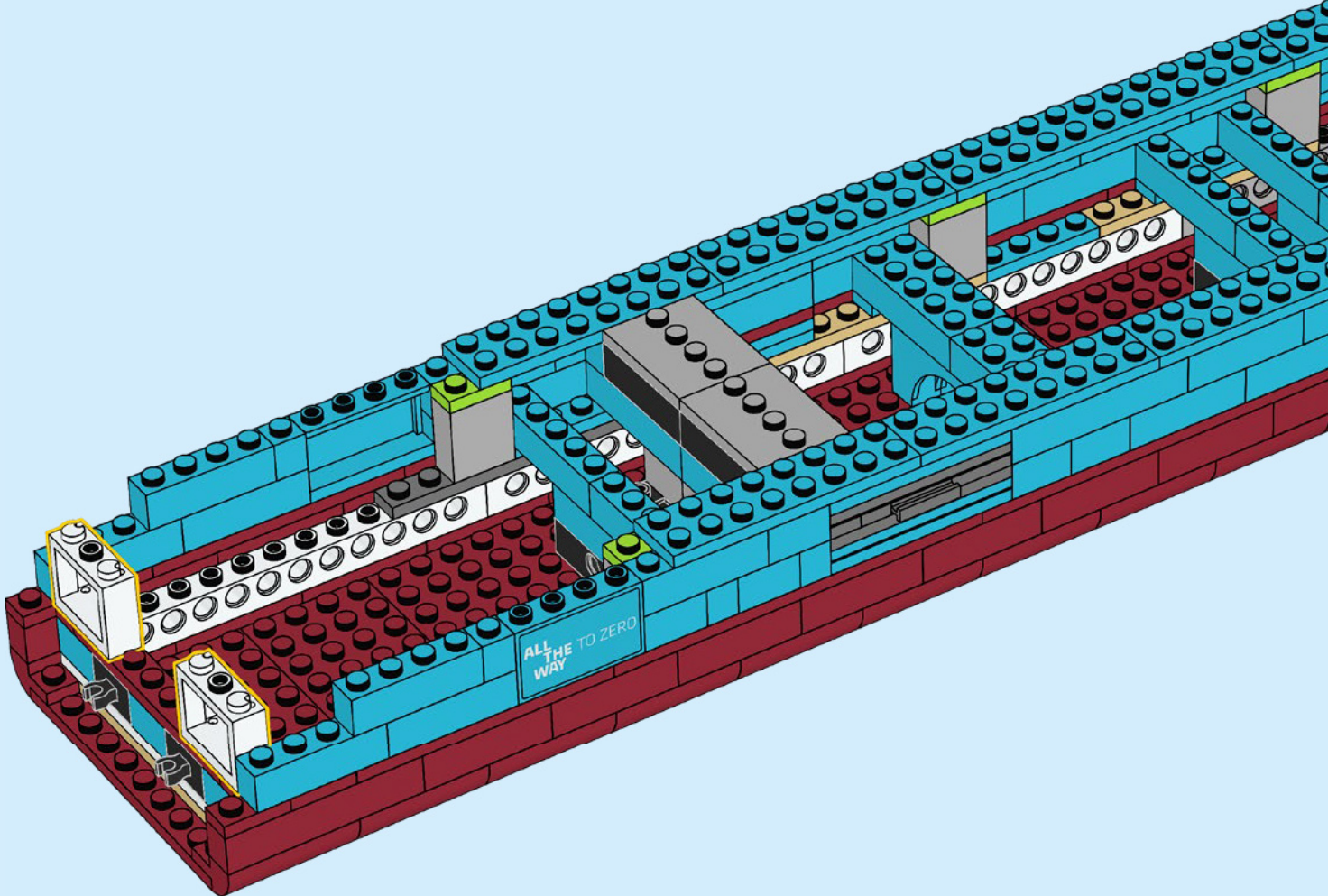

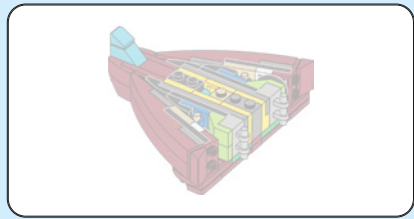
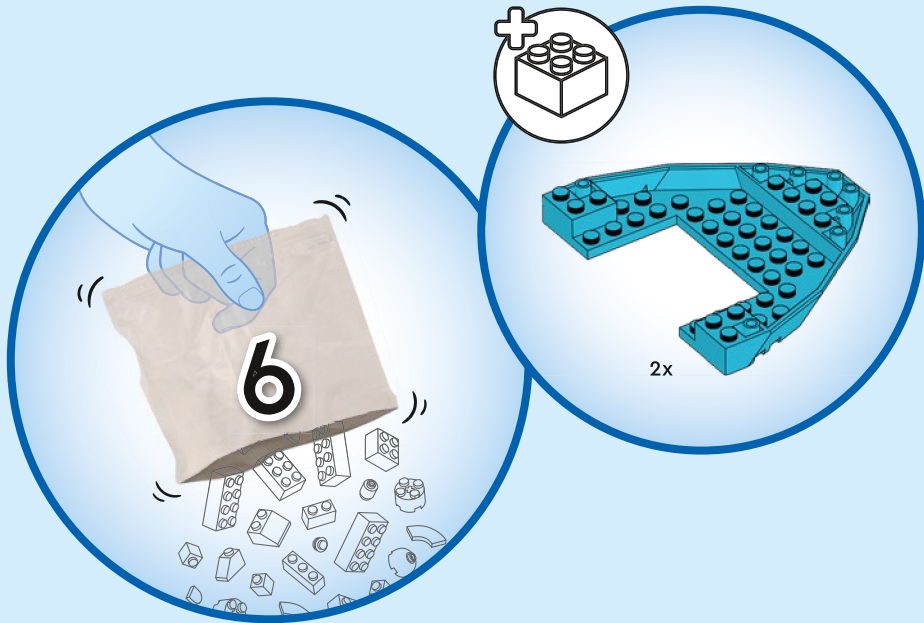

106

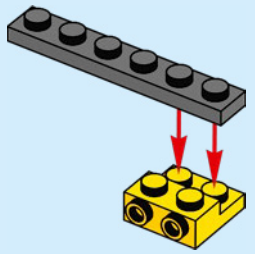

107

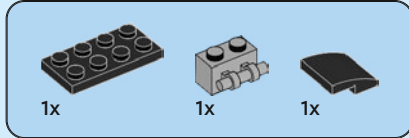
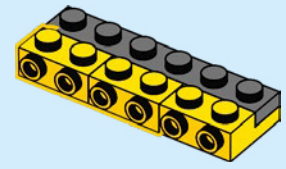

108

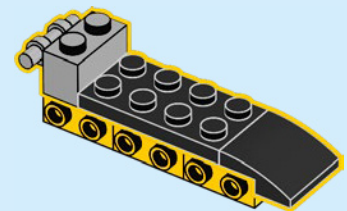

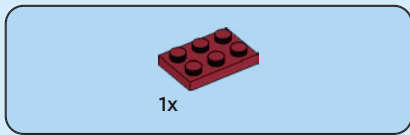

109

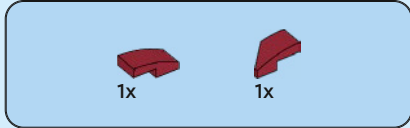
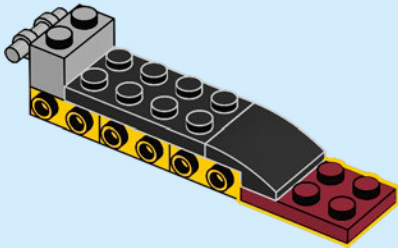

110

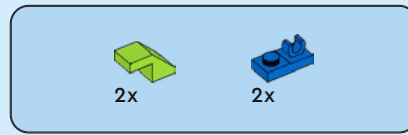
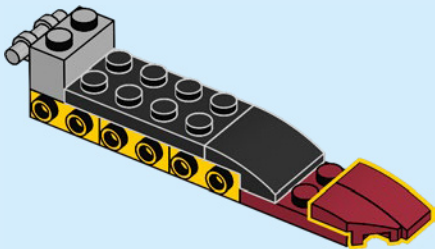

111

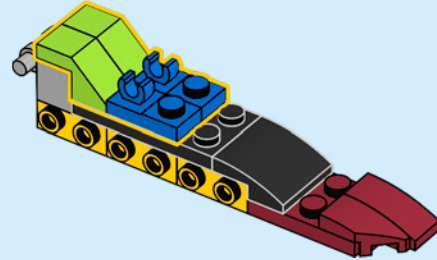

112

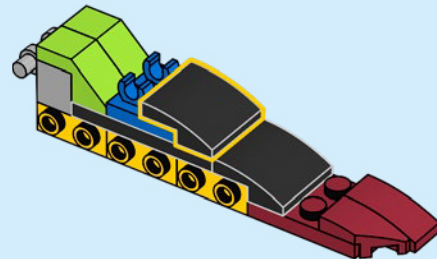

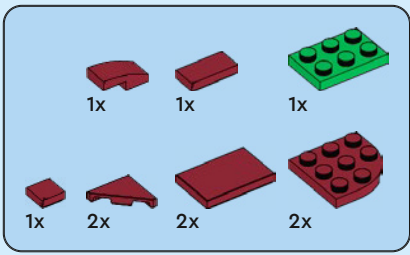

113

1

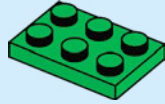

2

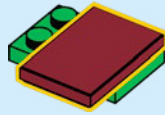

3

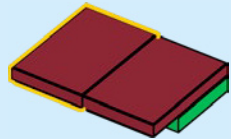

4

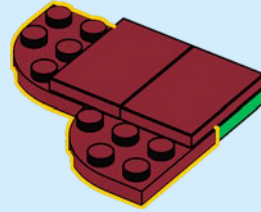

5

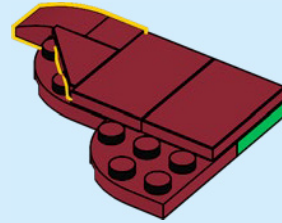

6

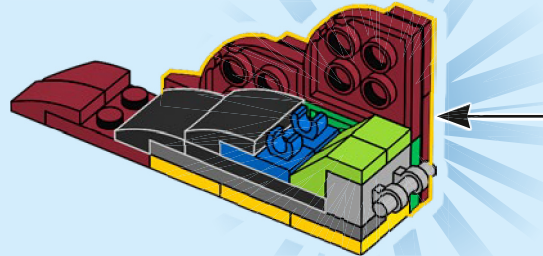
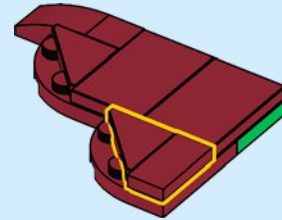

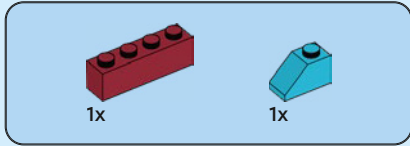
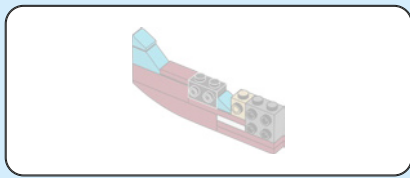

114

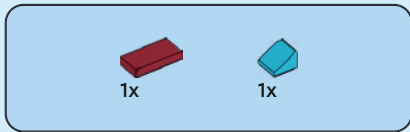
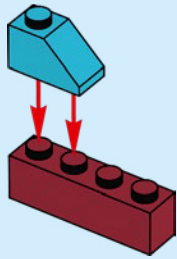

115

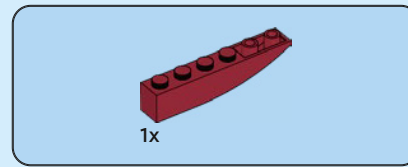
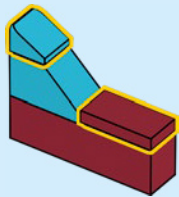

116

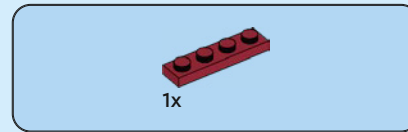
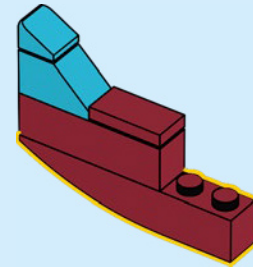

117

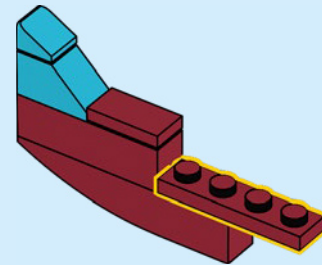

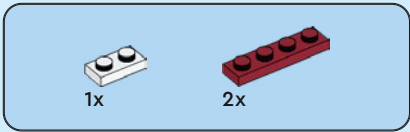

118

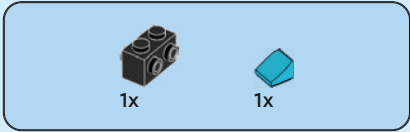
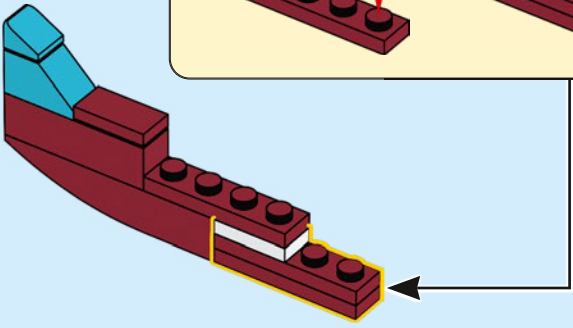
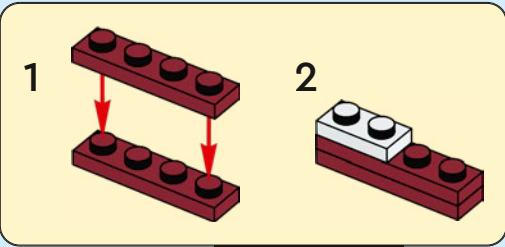

119

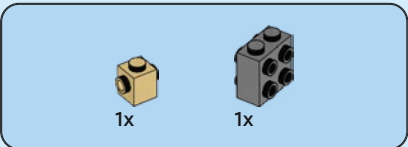
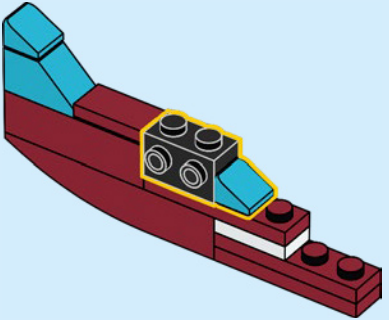

120

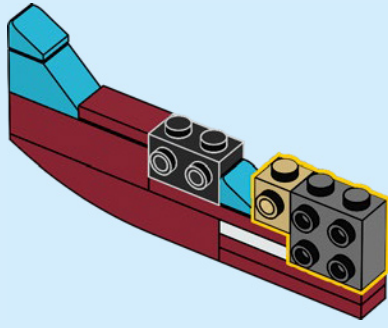

121

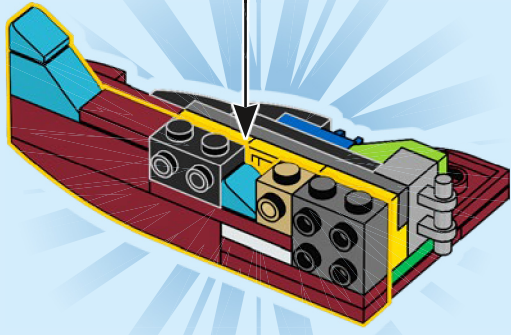

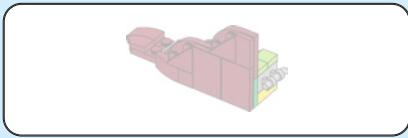

122

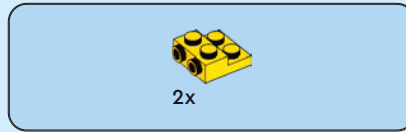
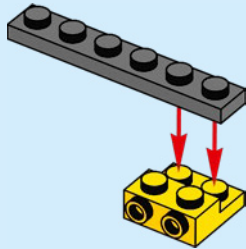

123

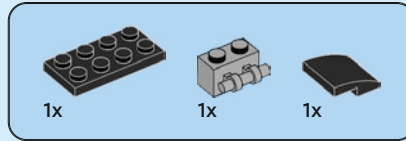
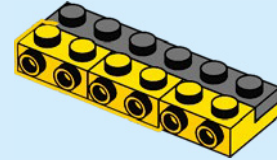

124

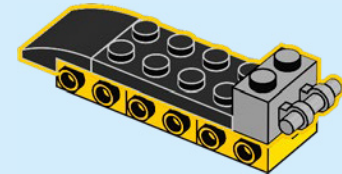

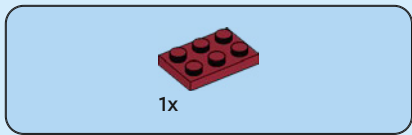

125

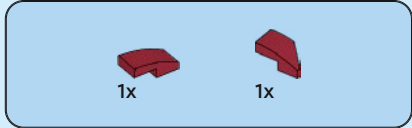
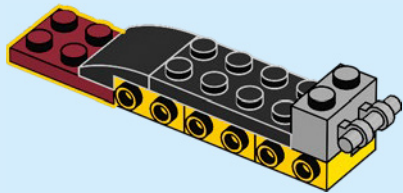

126

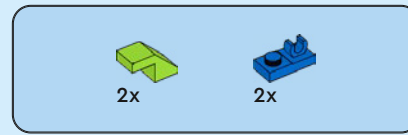
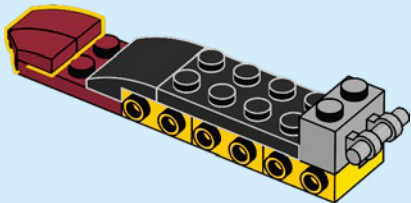

127

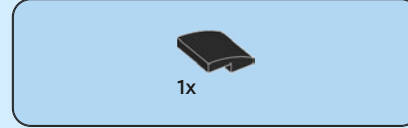
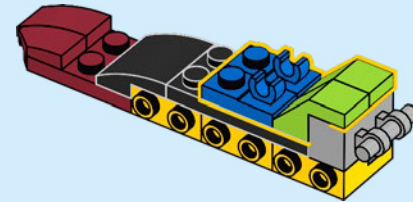

128

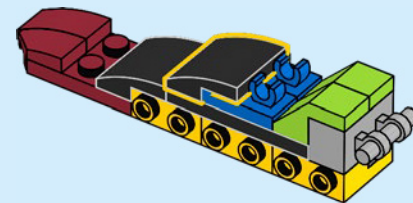

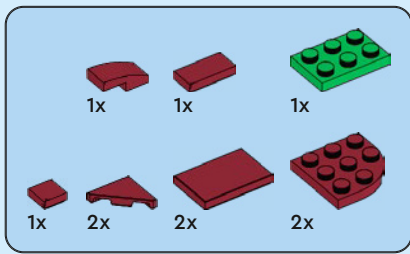

129

1

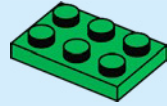

2

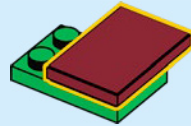

3

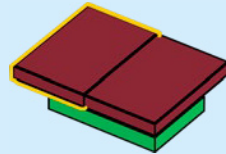

4

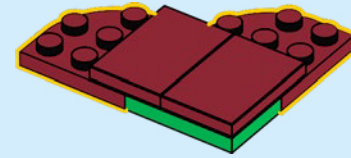

5

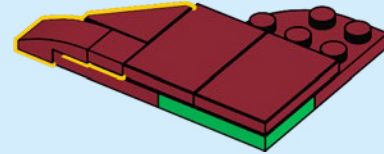

6

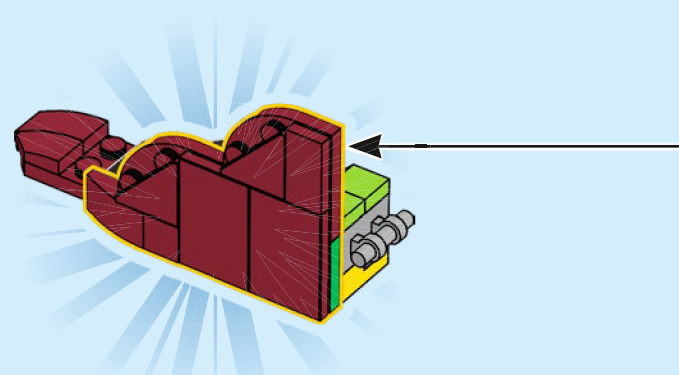
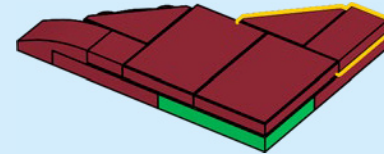

130

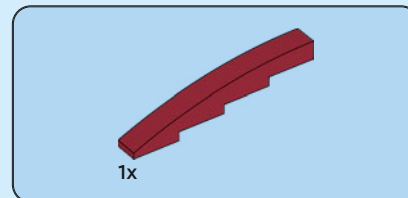
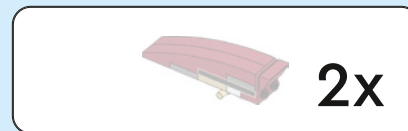
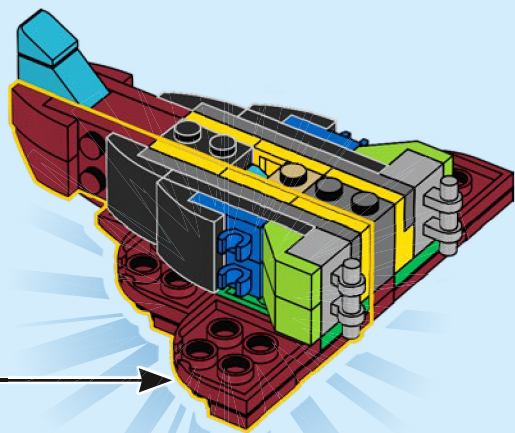

131

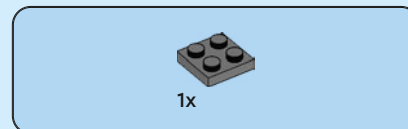
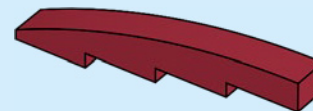

132

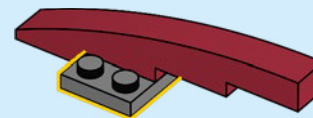

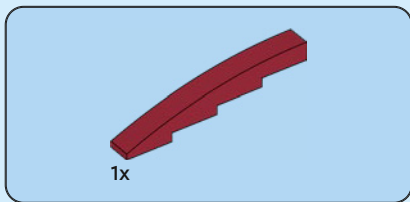

133

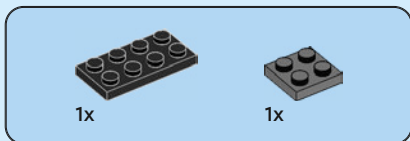
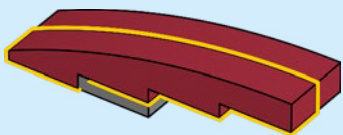

134

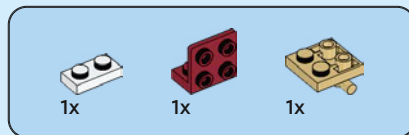
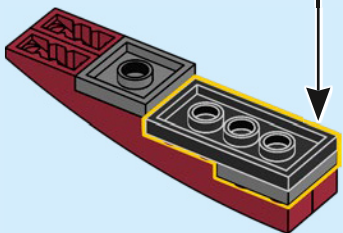
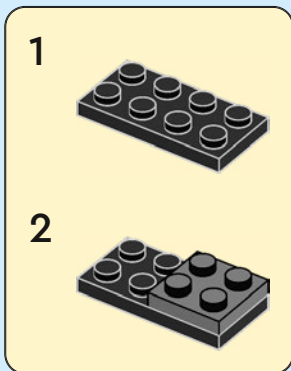

135

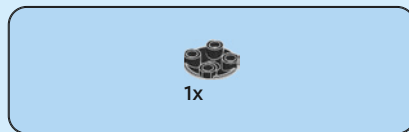
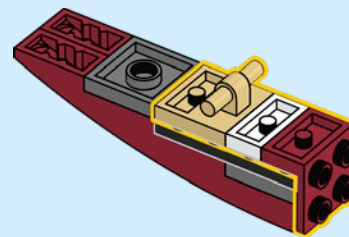

136

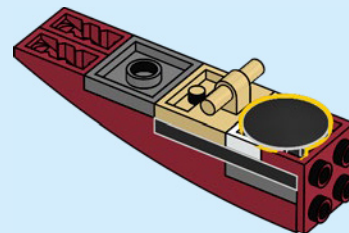



1x

137

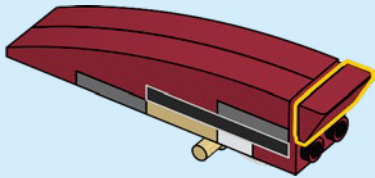

2x

138

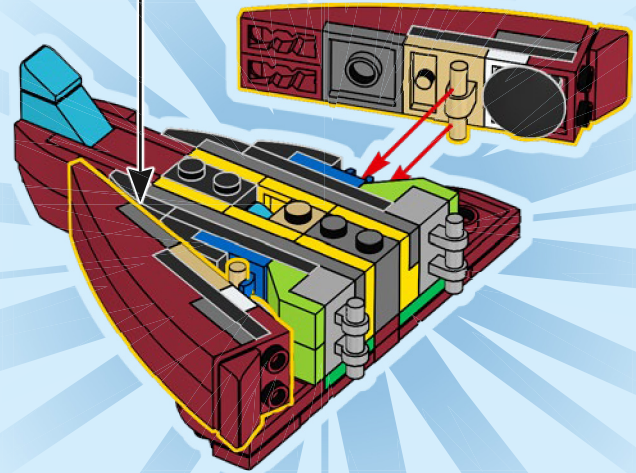

139

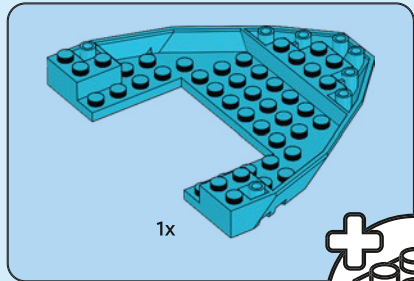
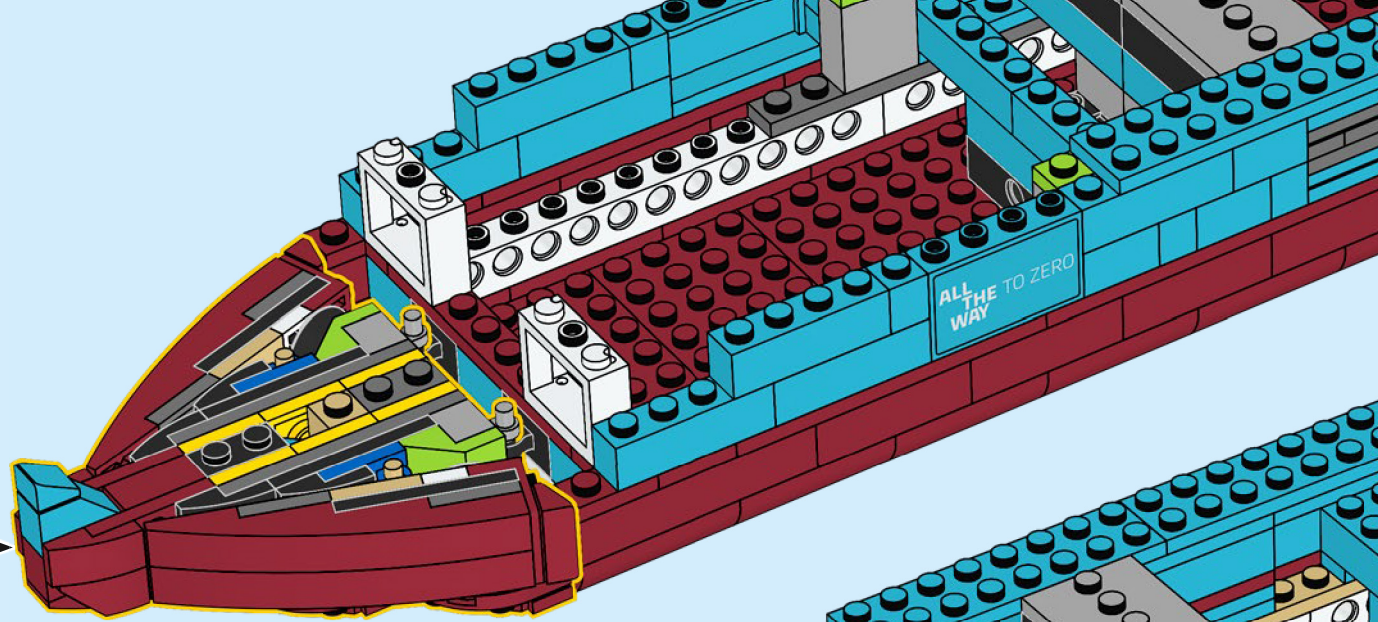

1x

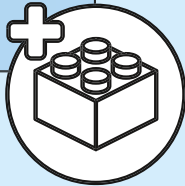

140

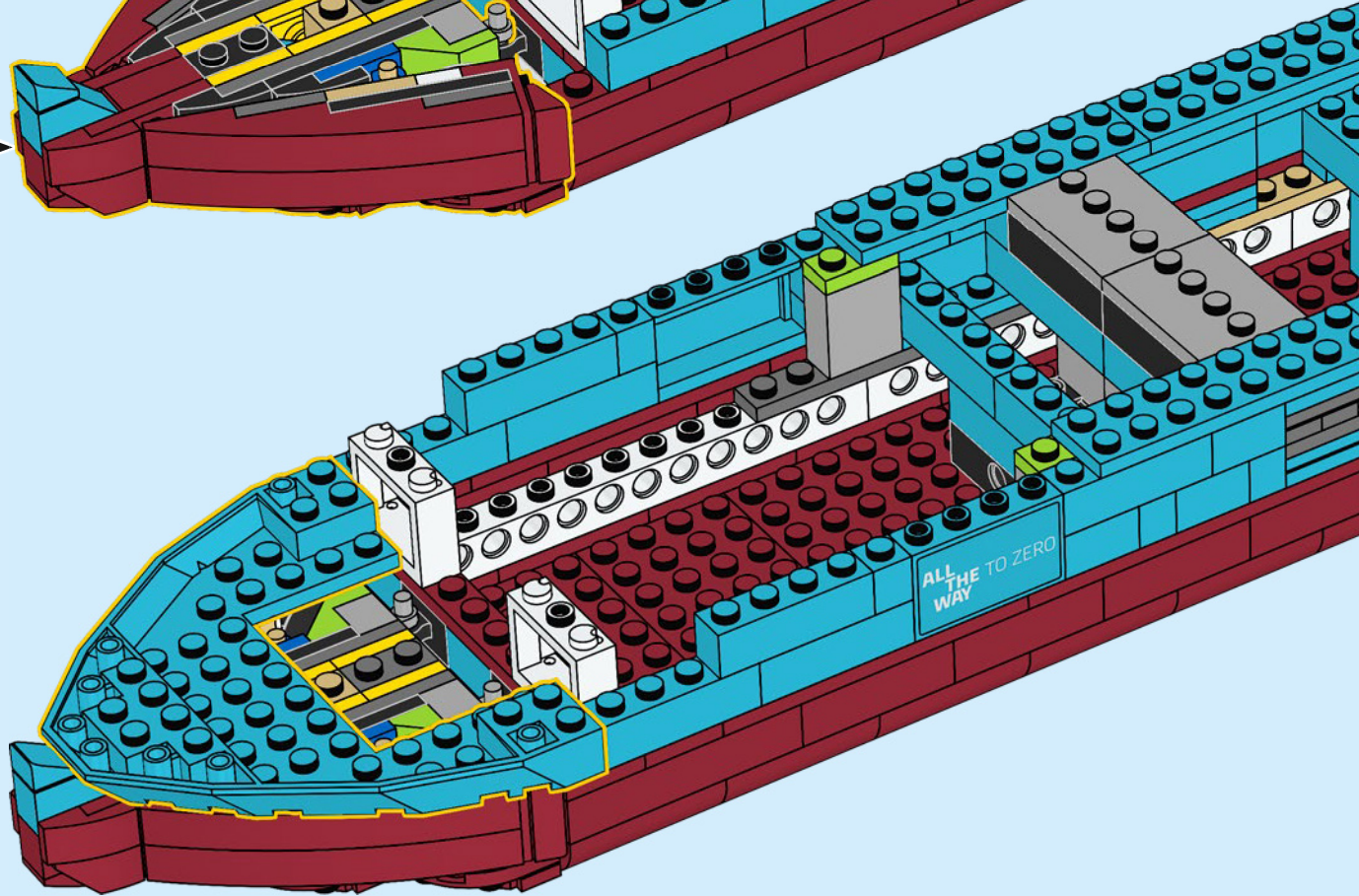

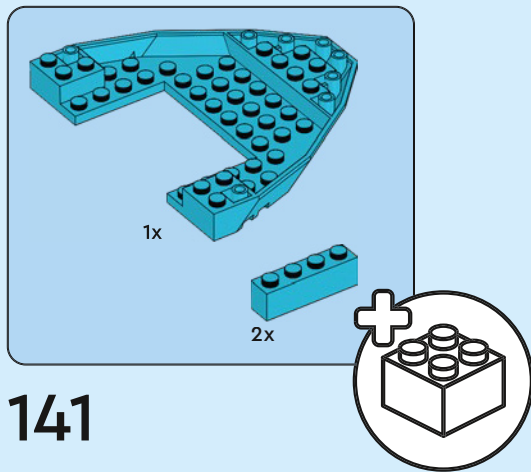

141

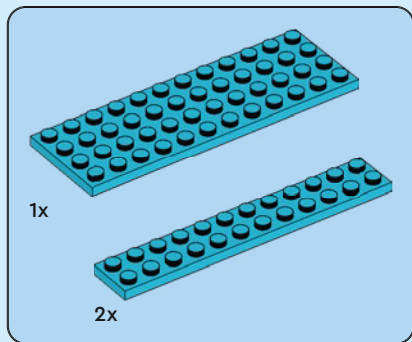
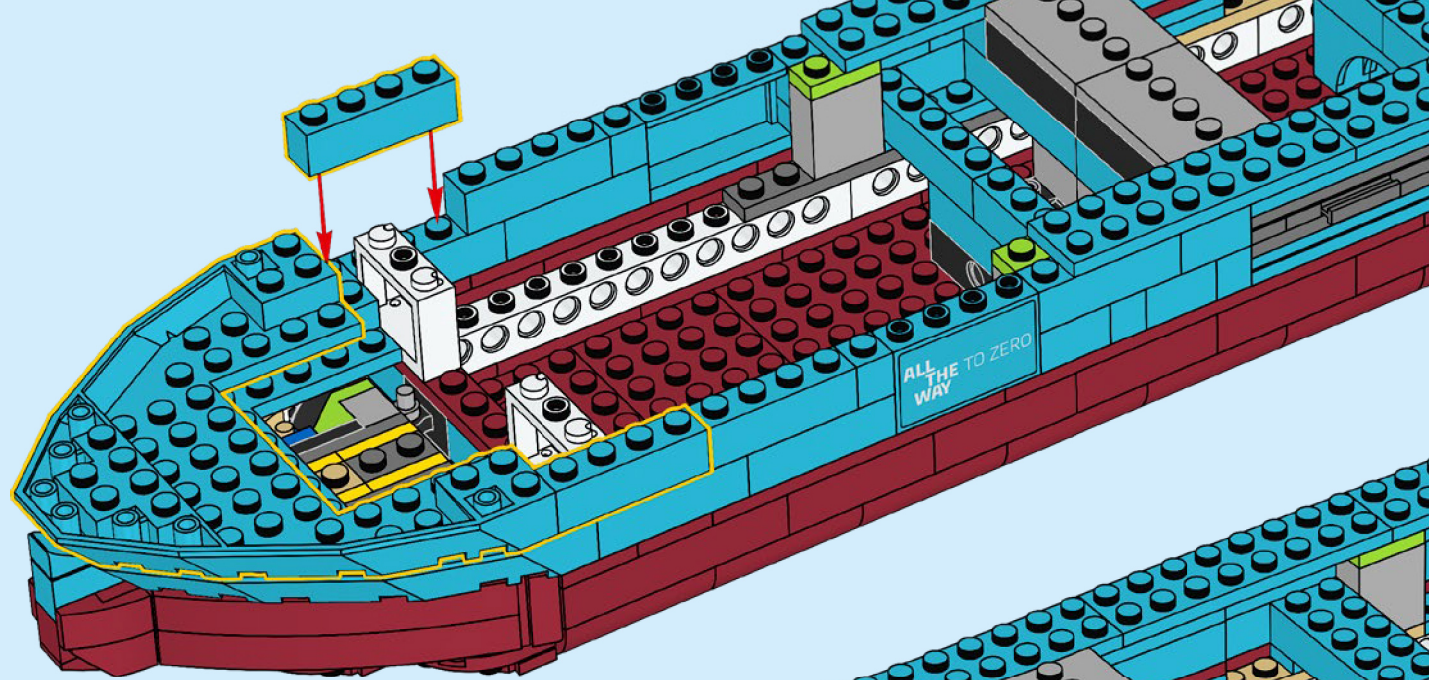

142

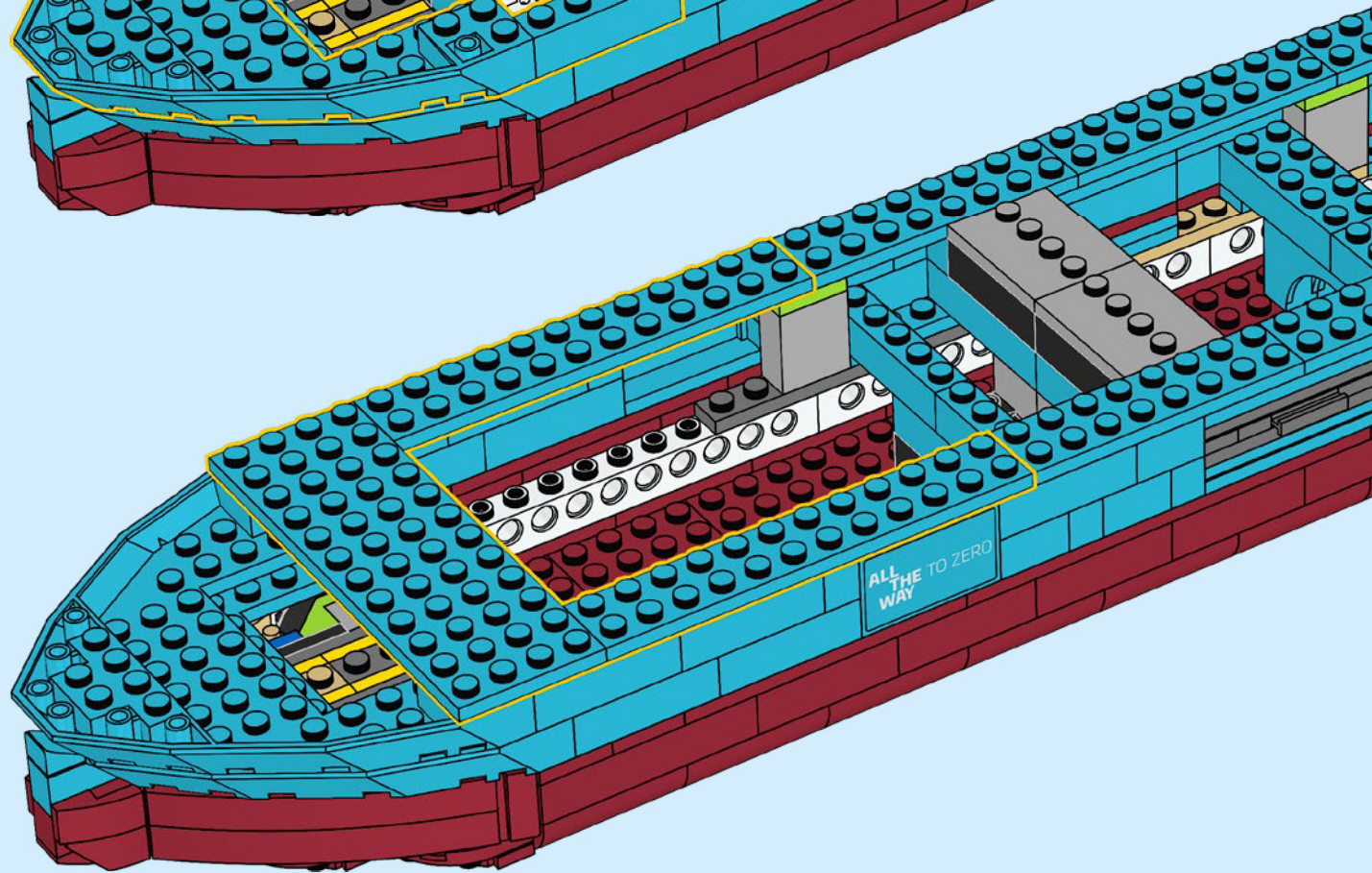

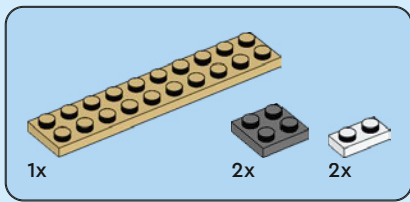

143

1

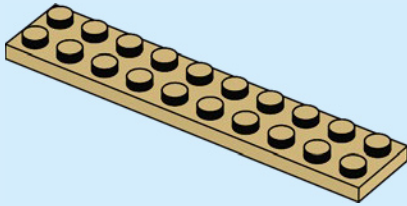

2

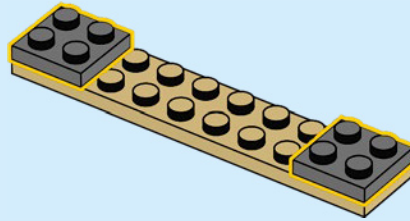

3

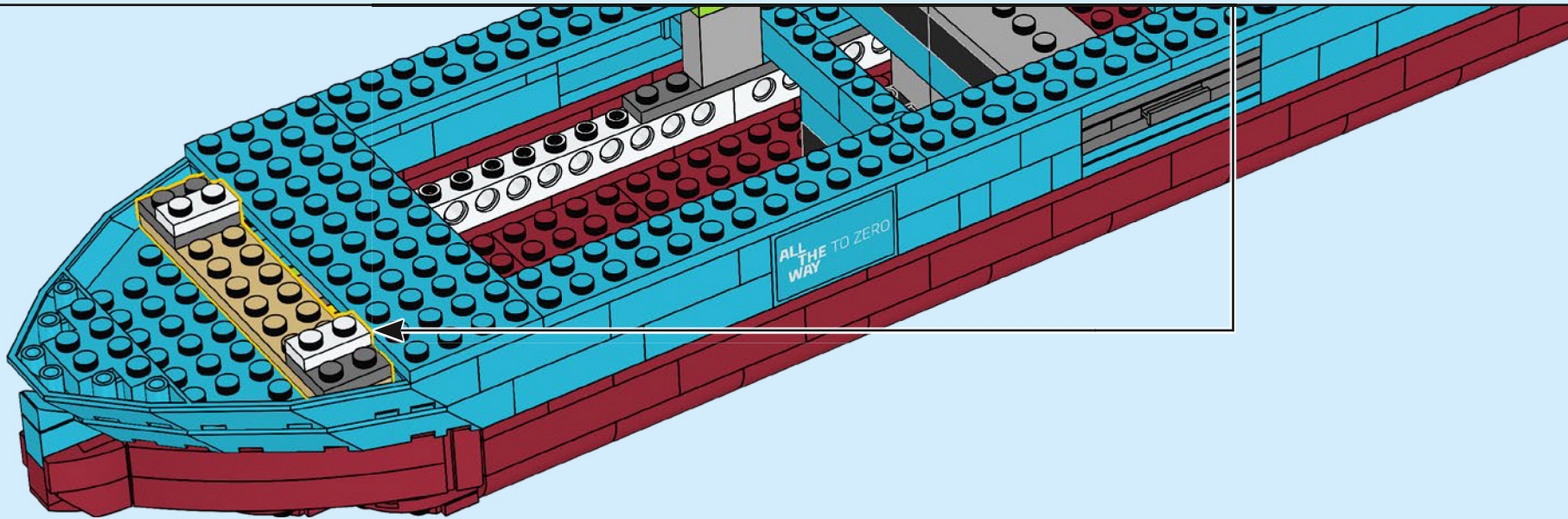
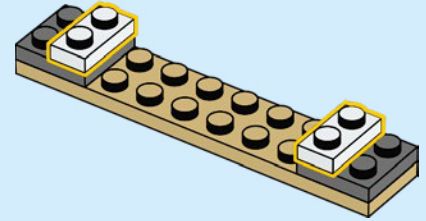

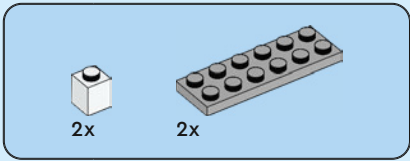

144

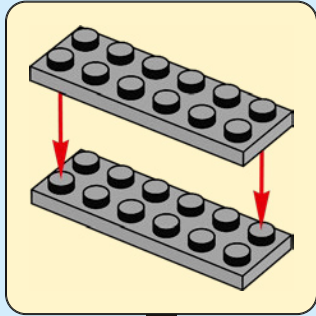
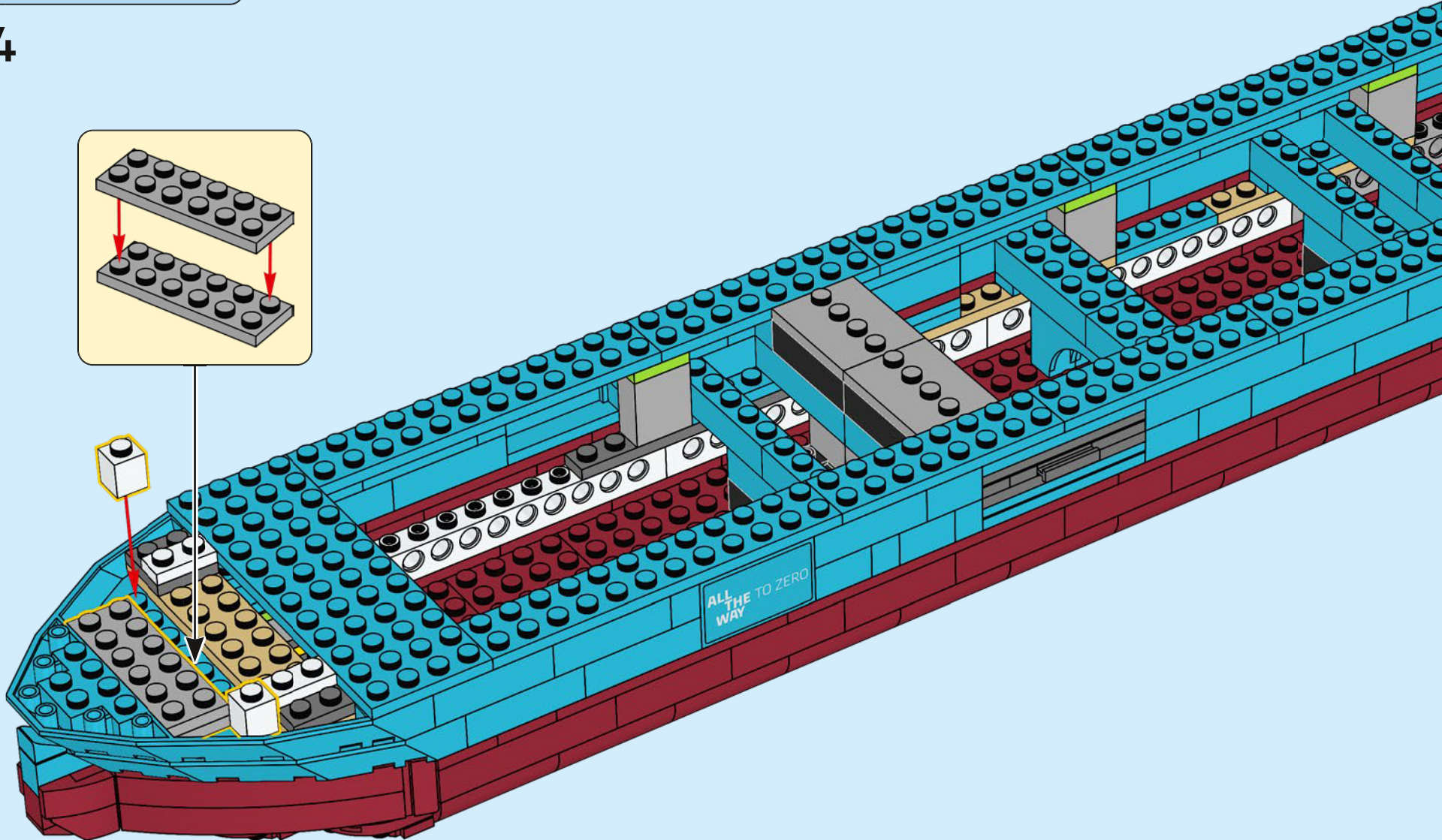

ALL THE WAY TO ZERO



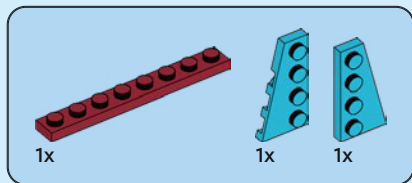

145

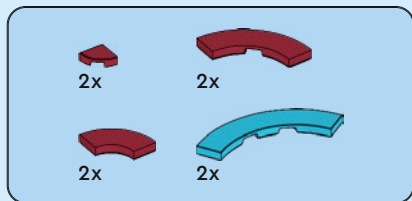
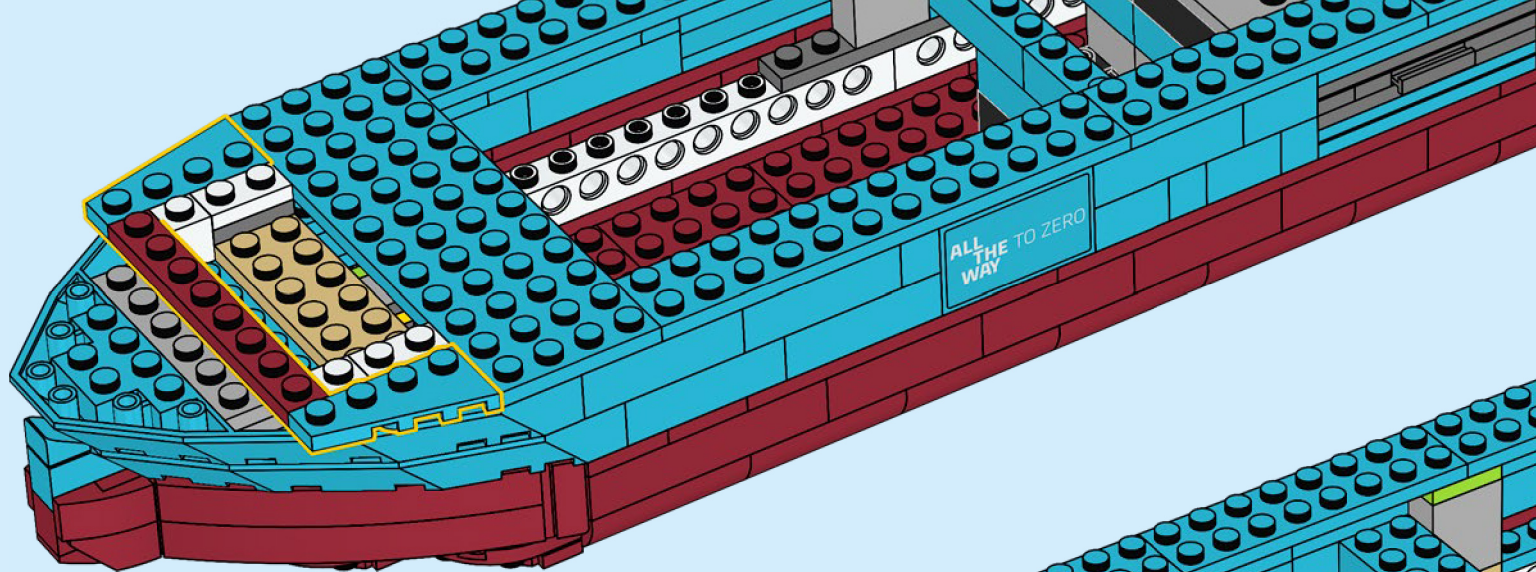

146

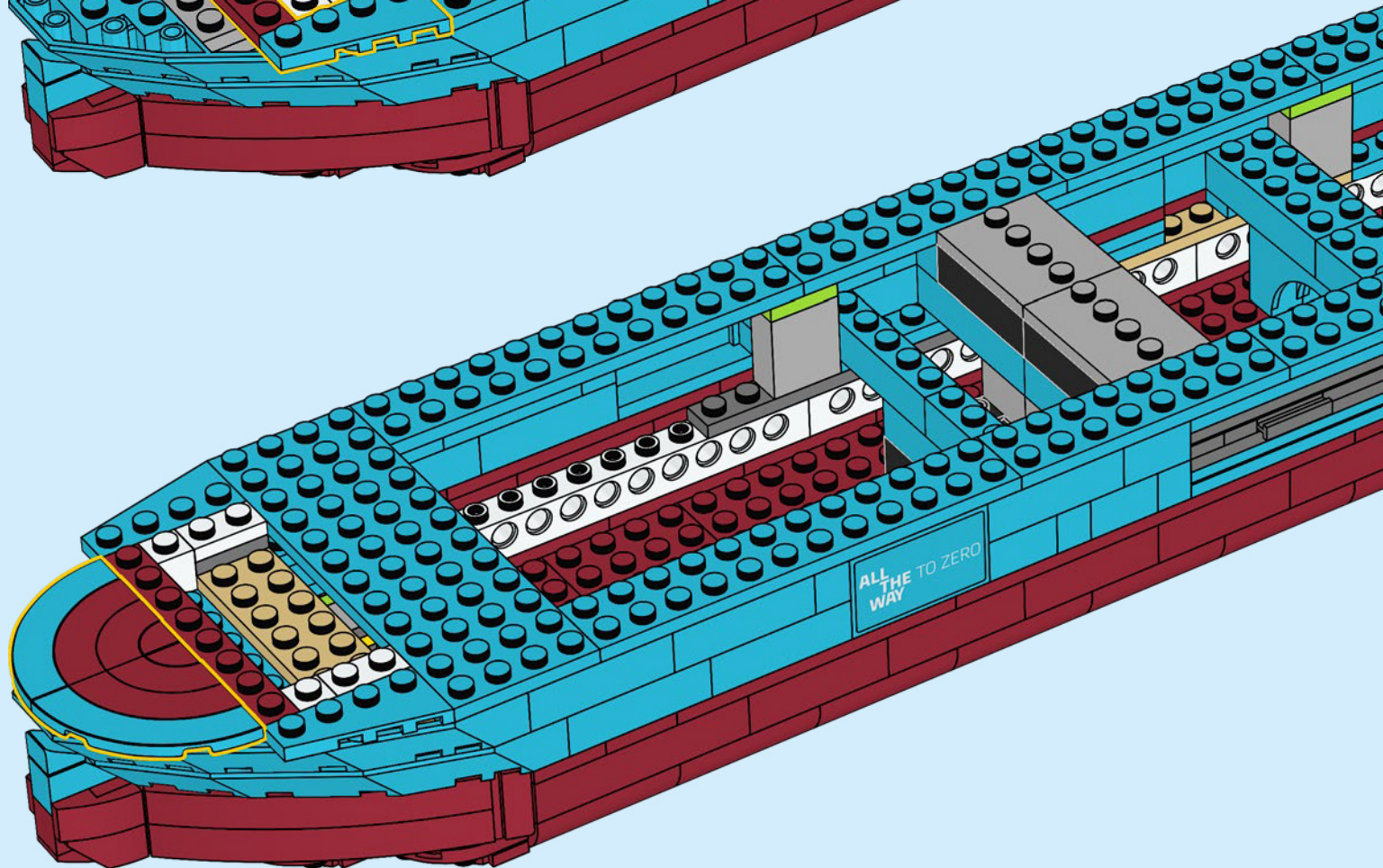

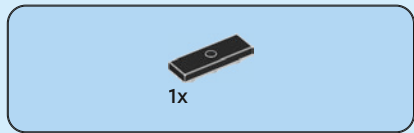

147

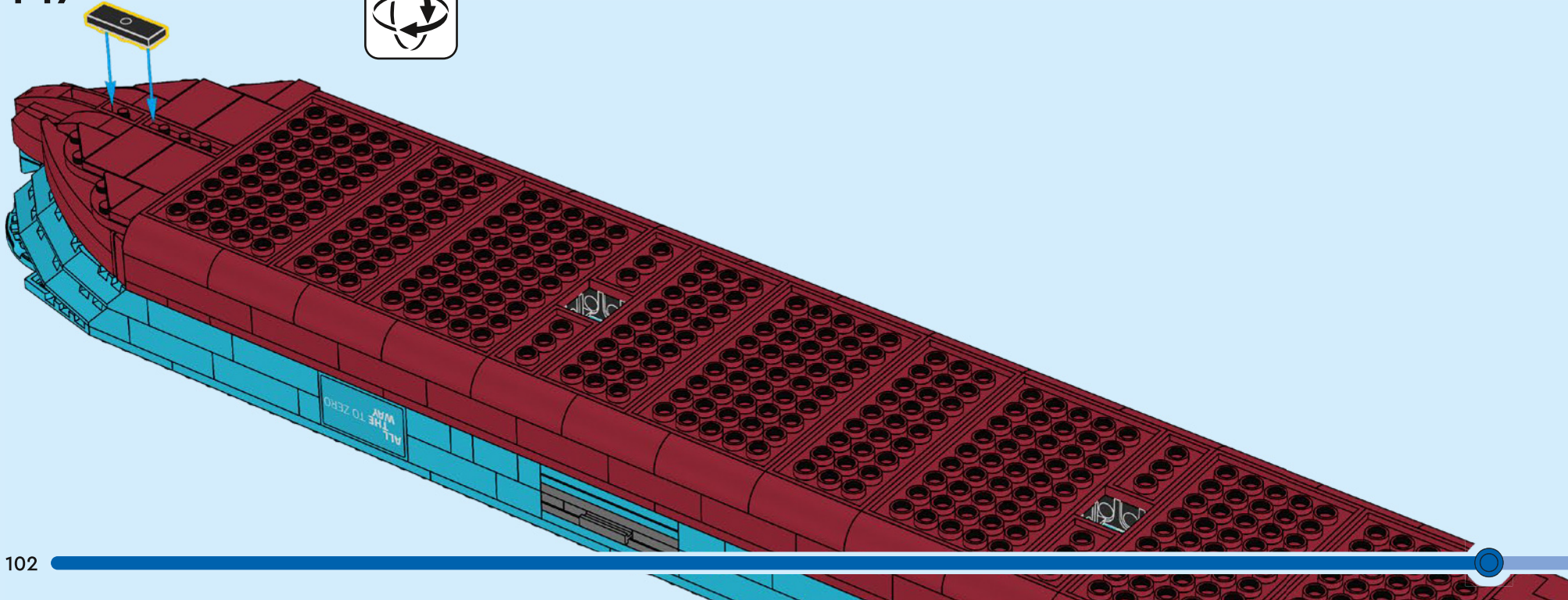



24x

148

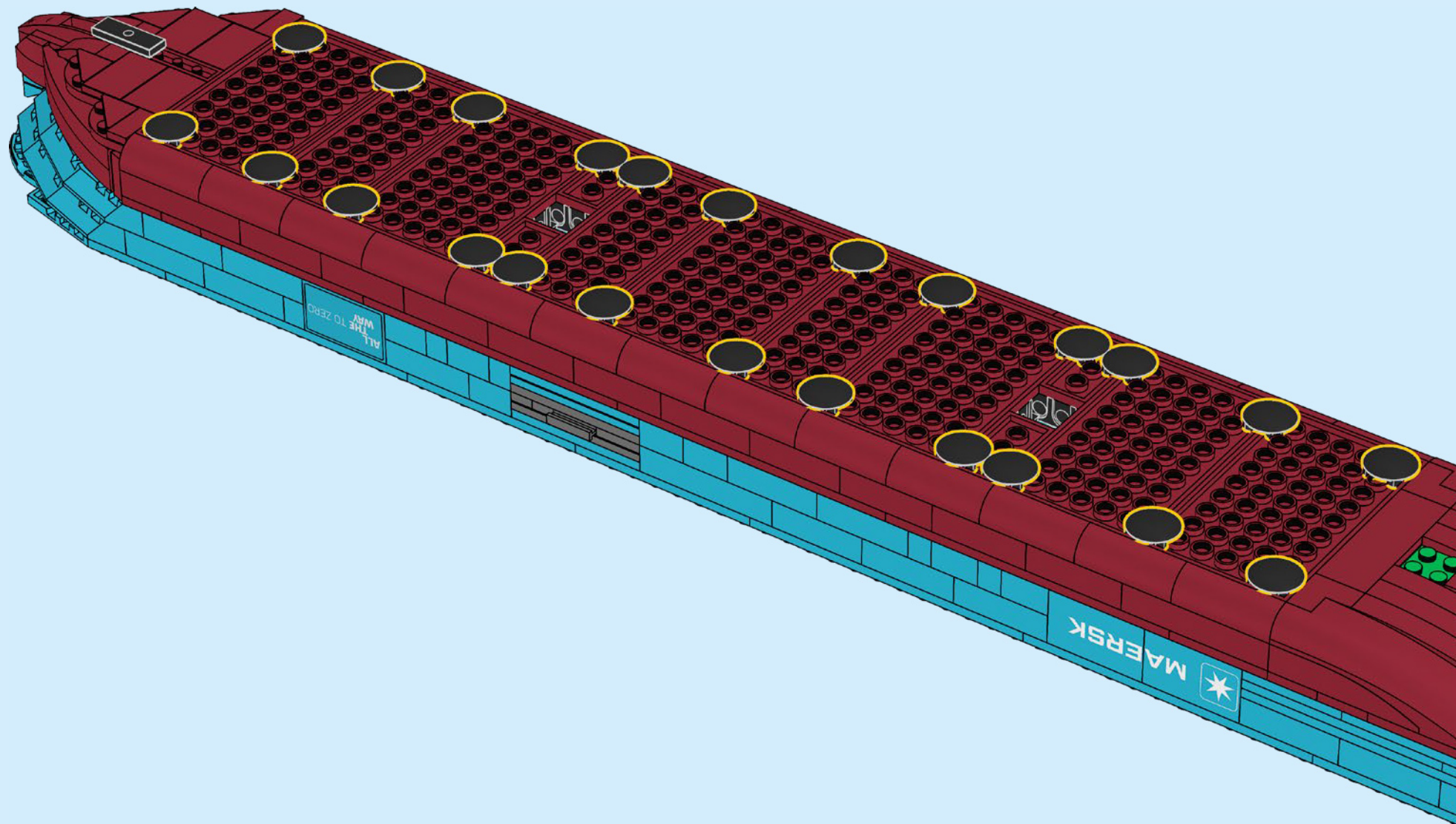

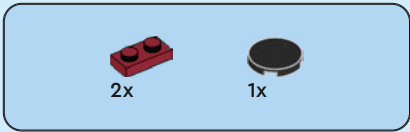

149

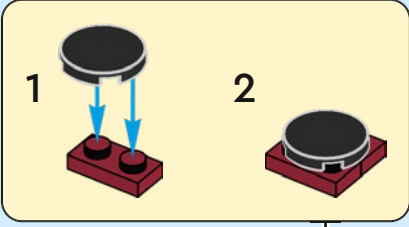
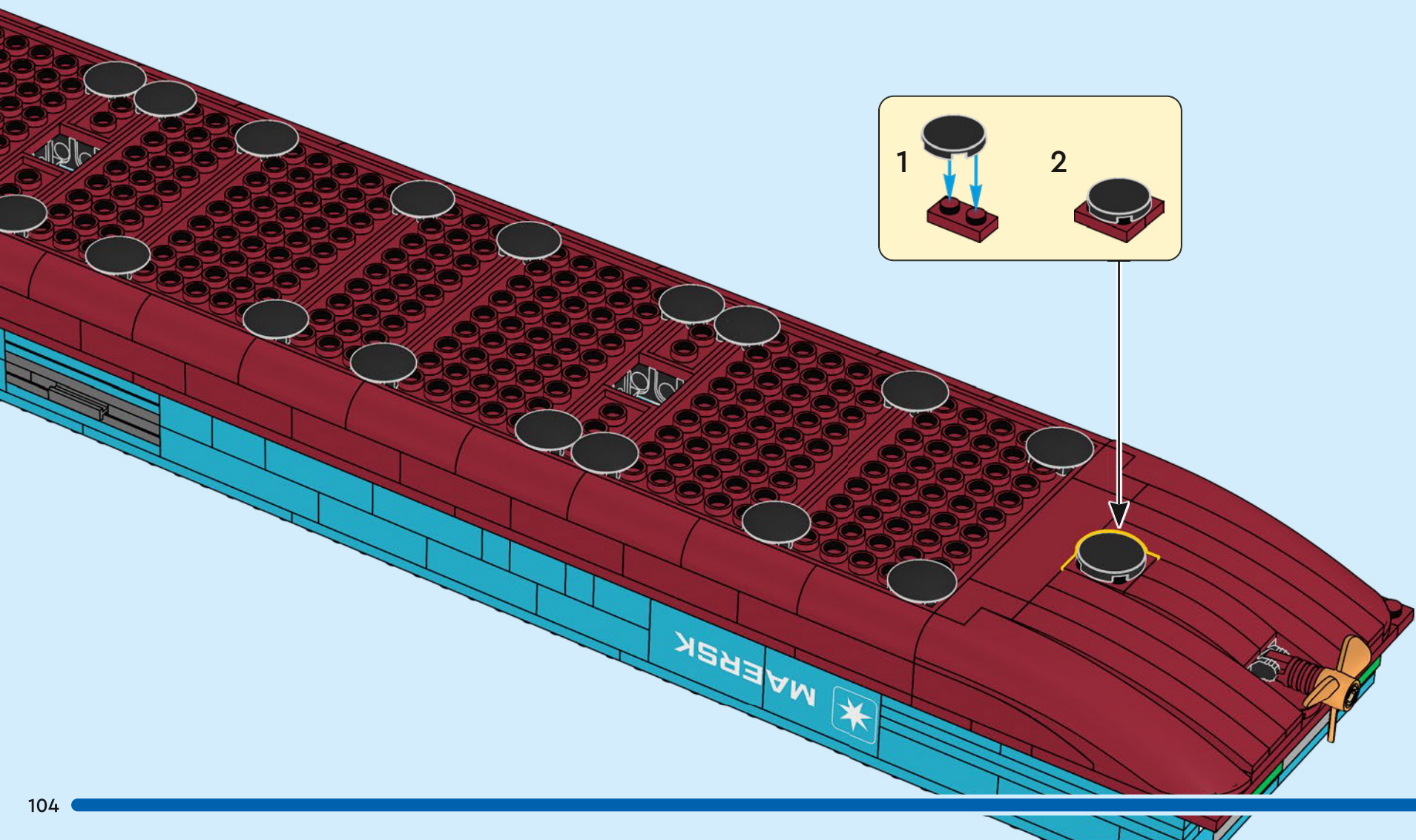

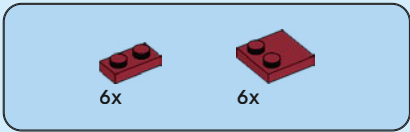

150

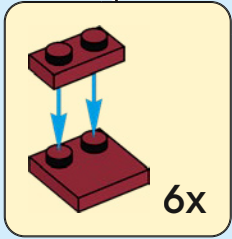
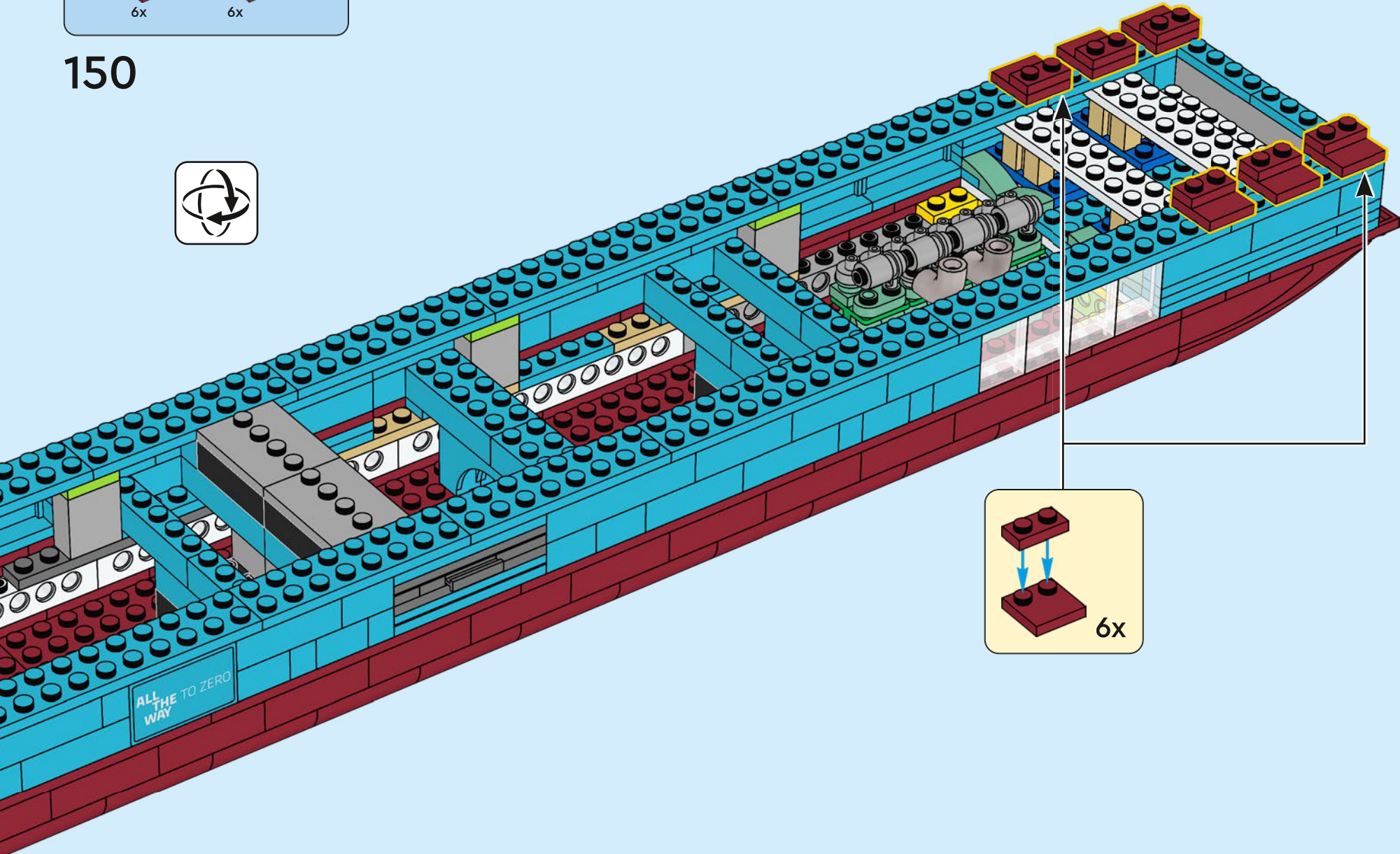

ALL
THE
WAY TO ZERO

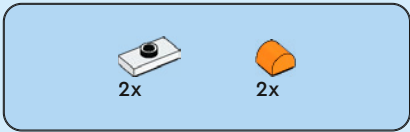

151

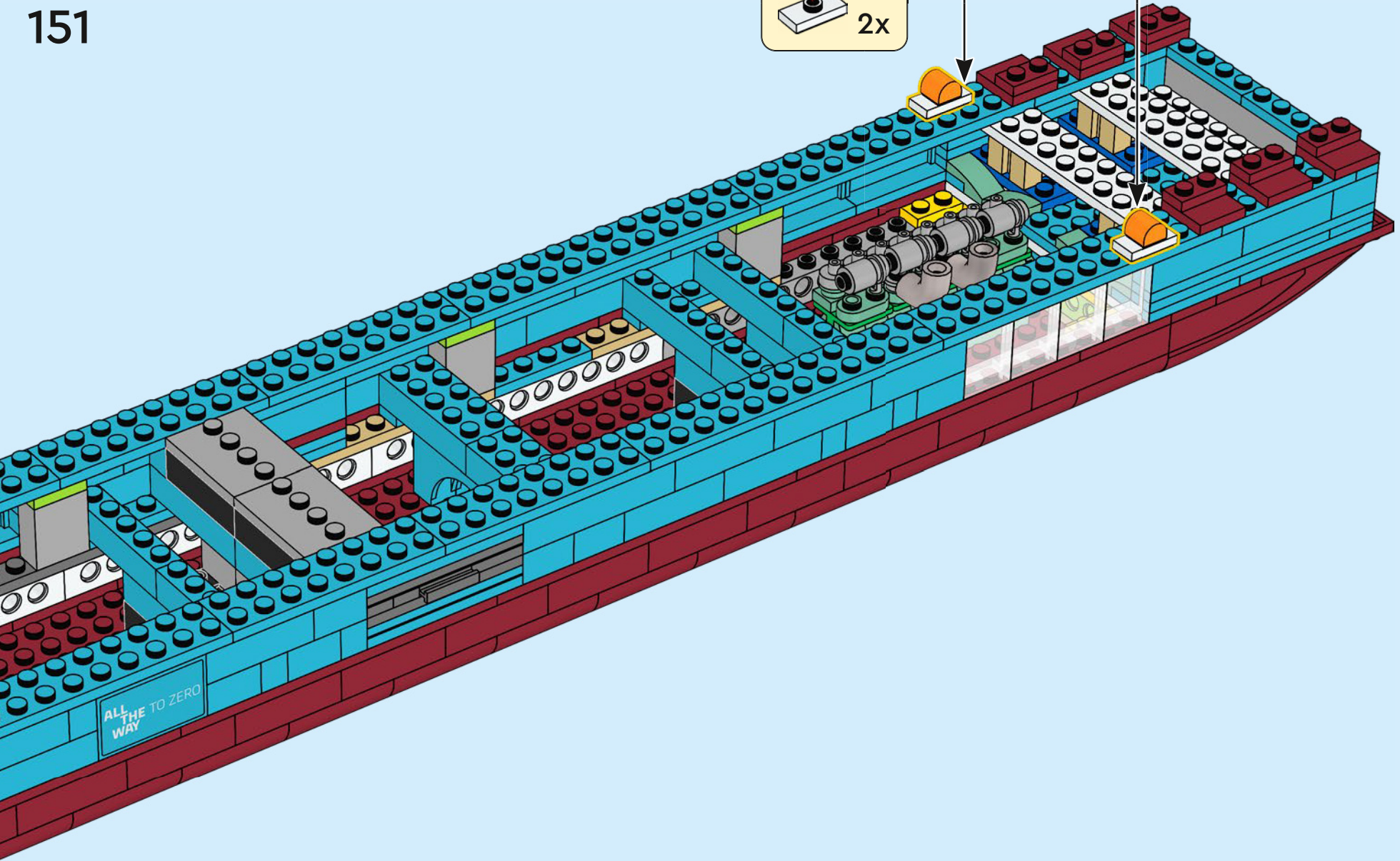
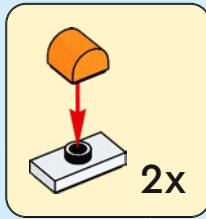

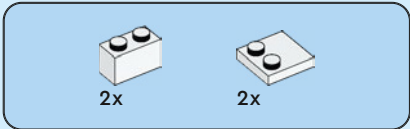

152

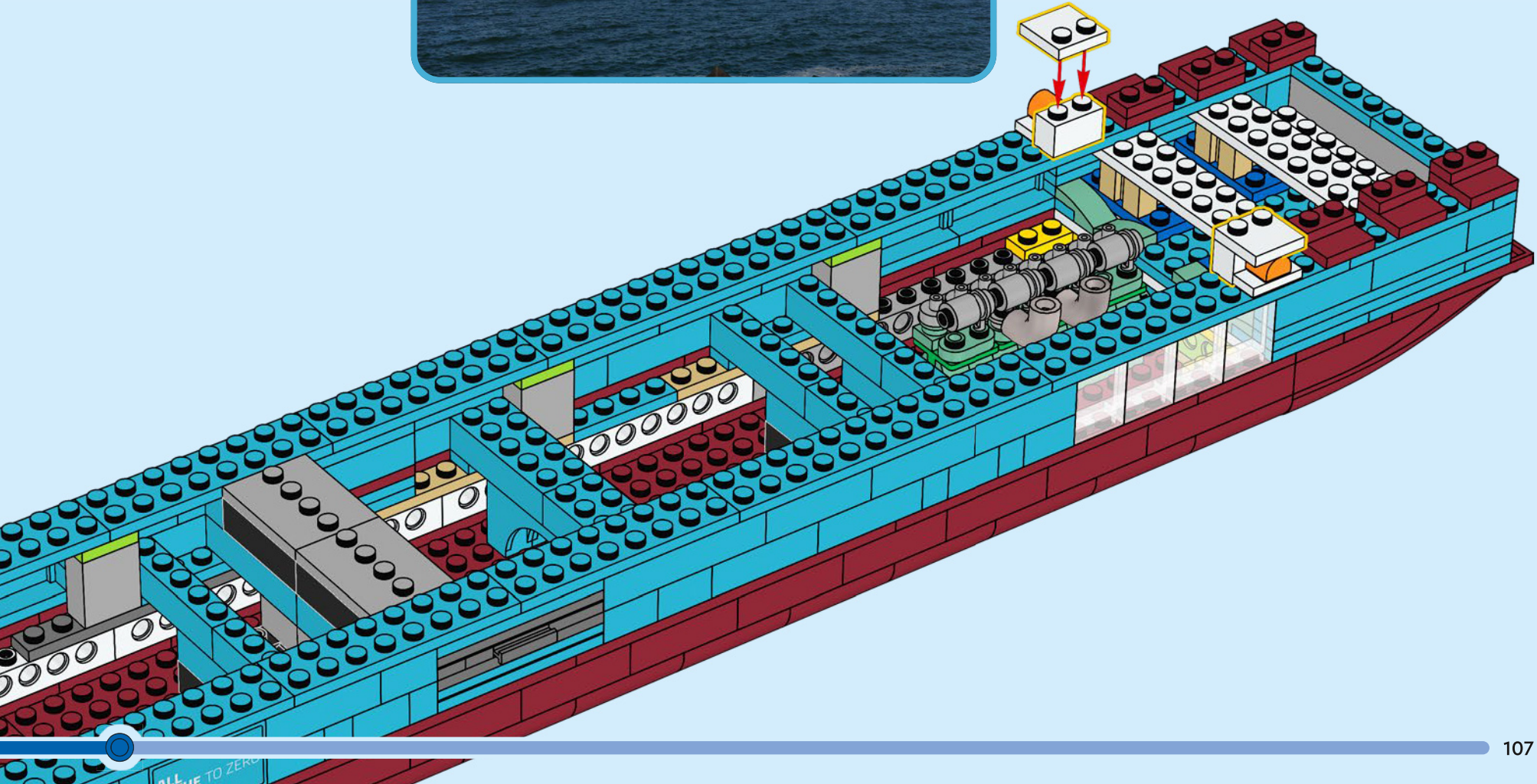
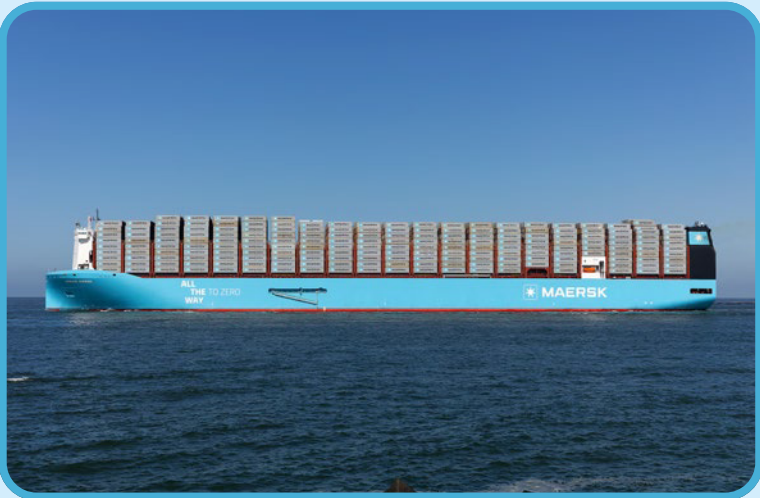

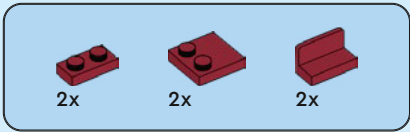

153

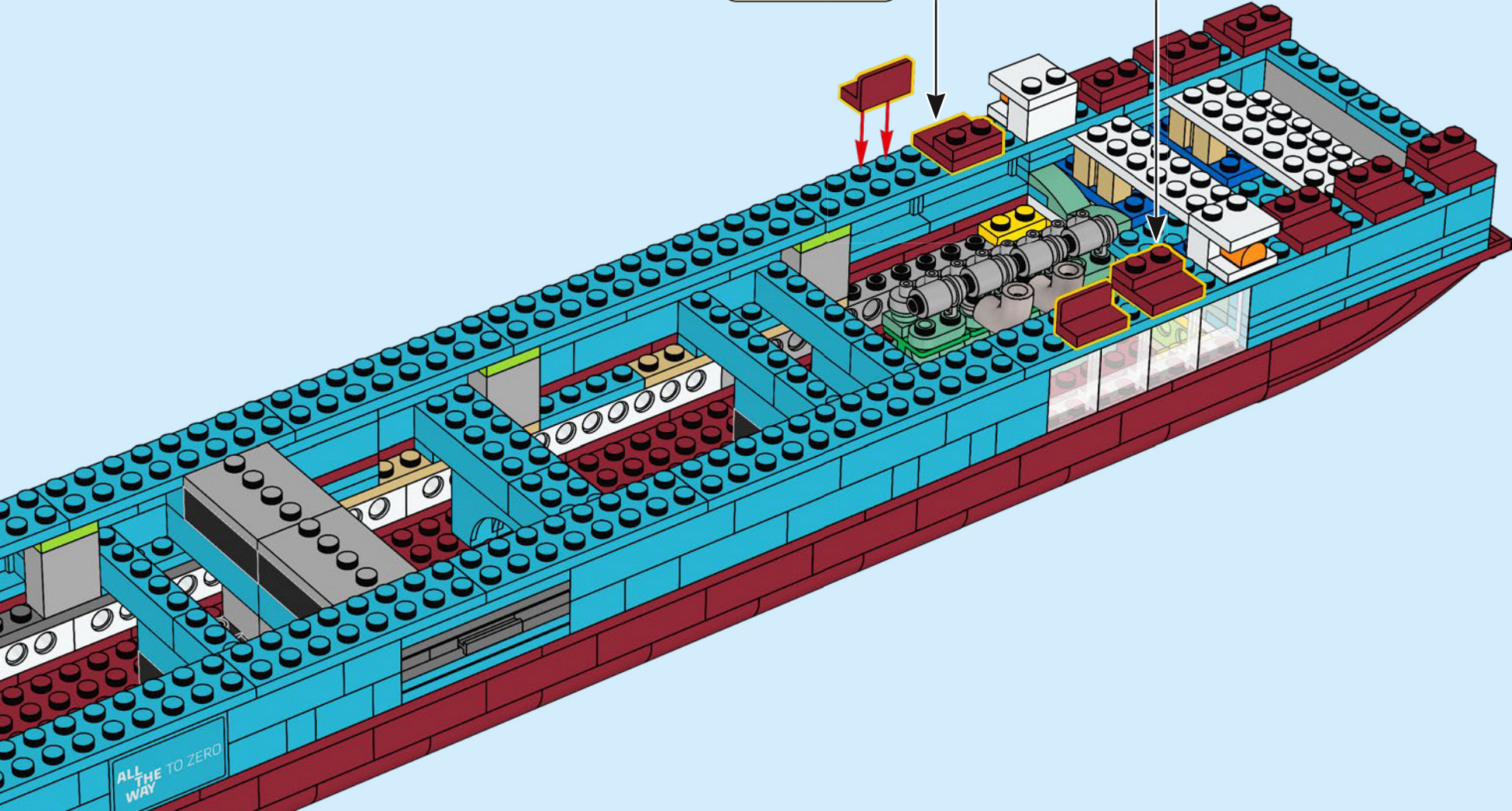
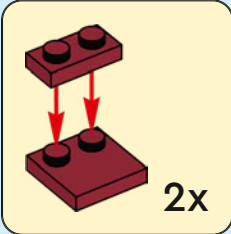

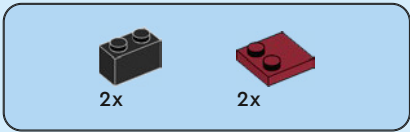

154

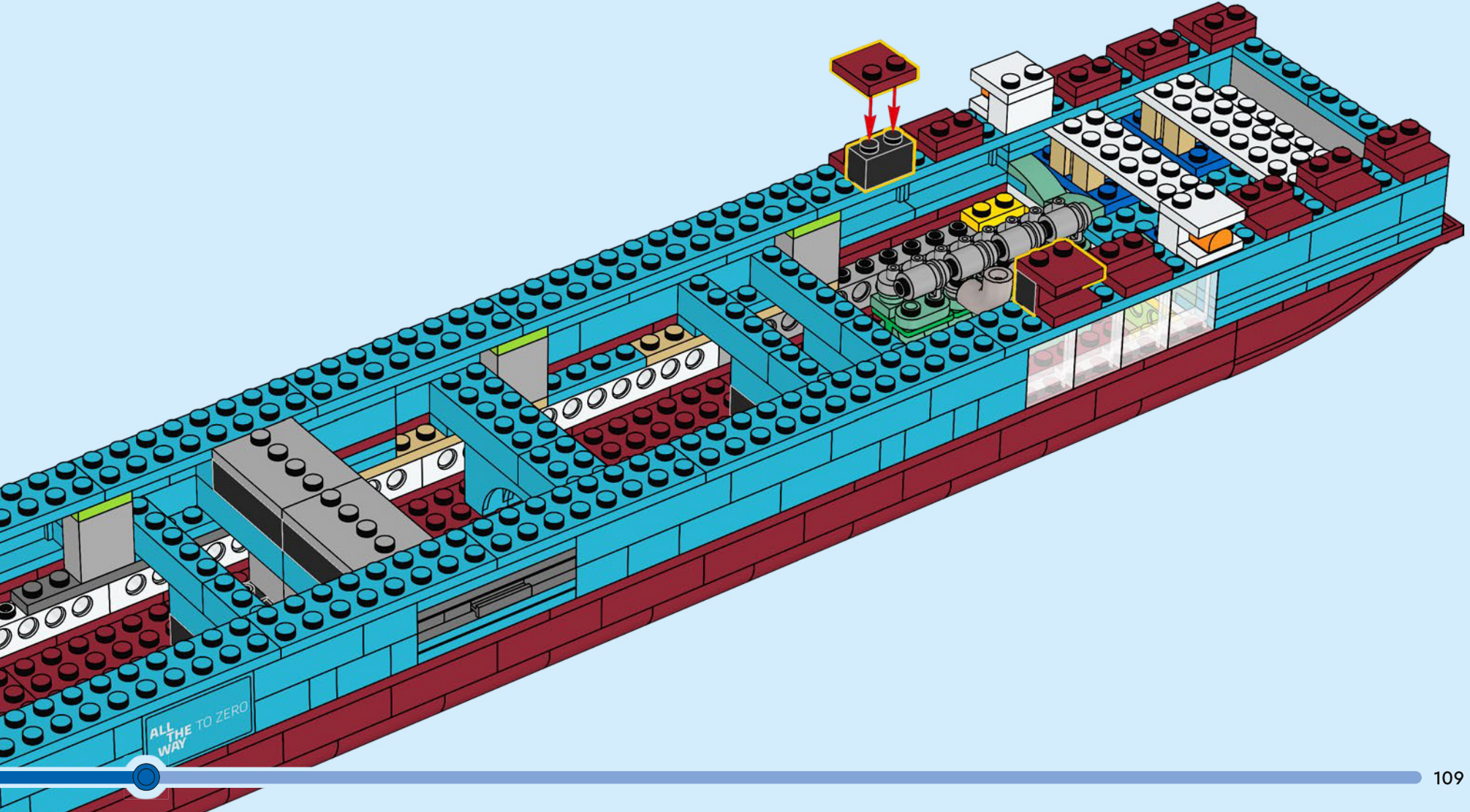

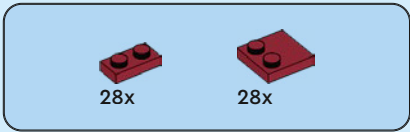

155

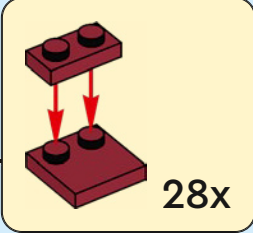
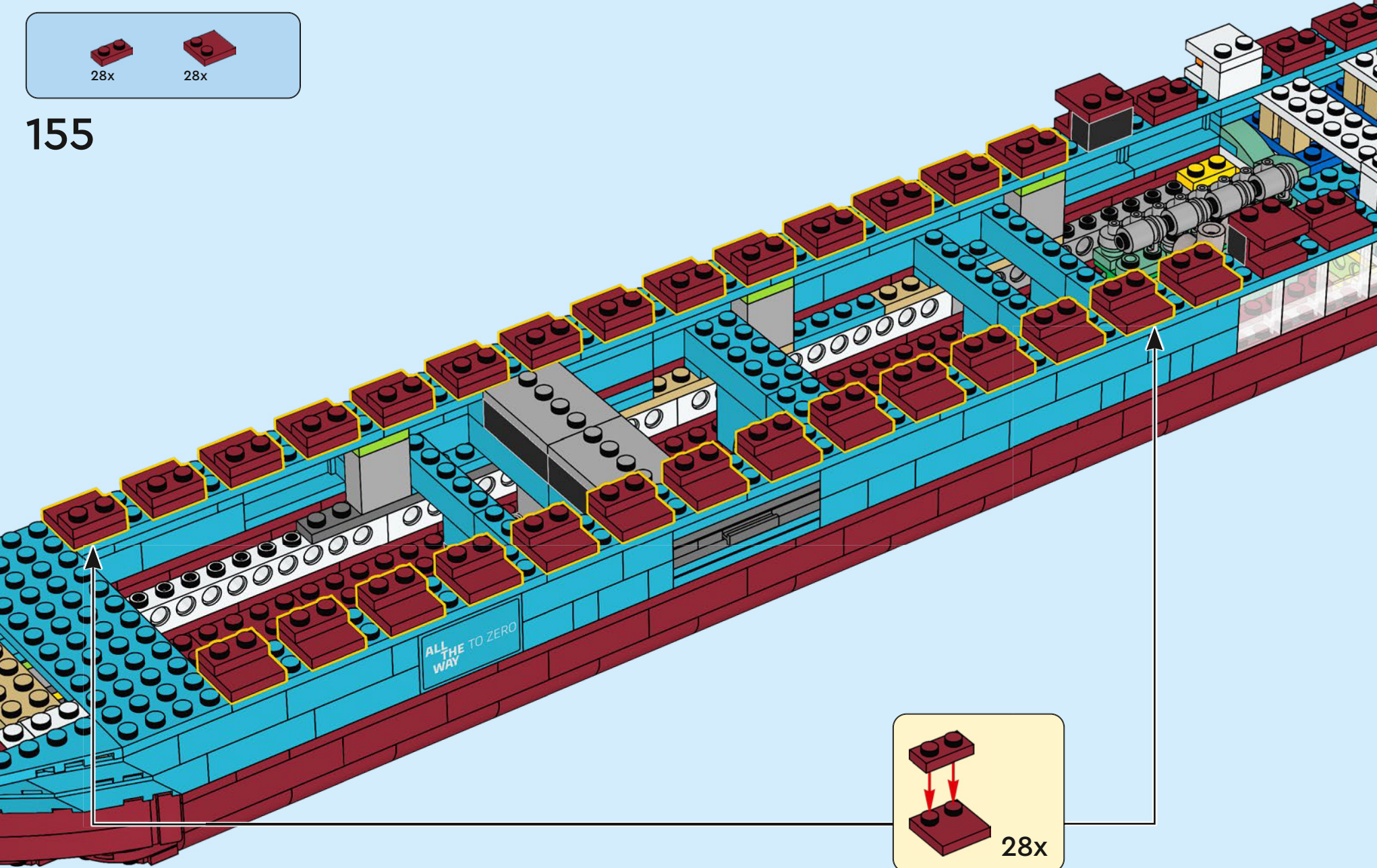

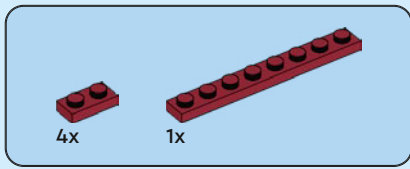

156

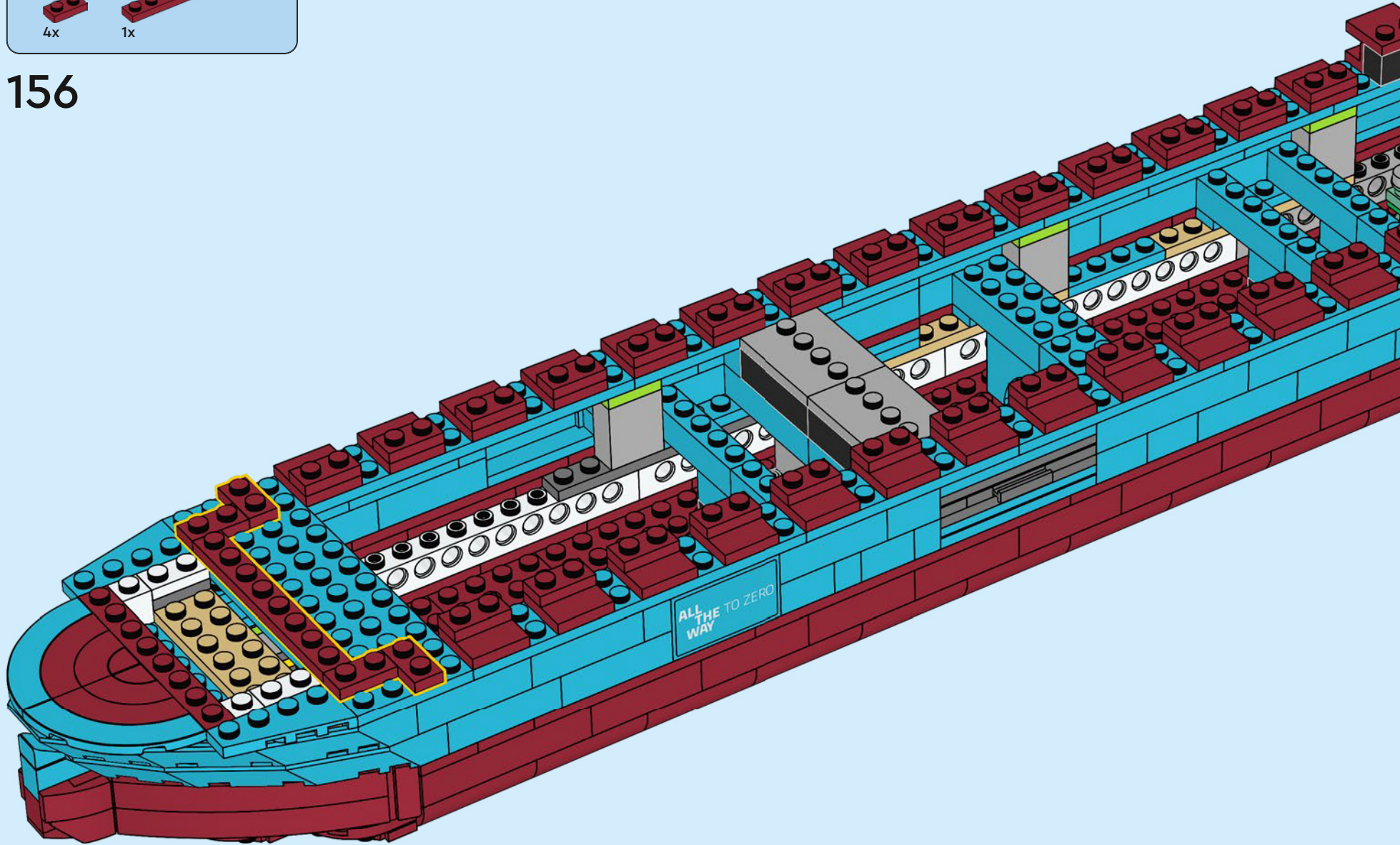

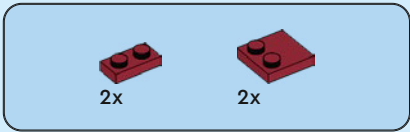

157

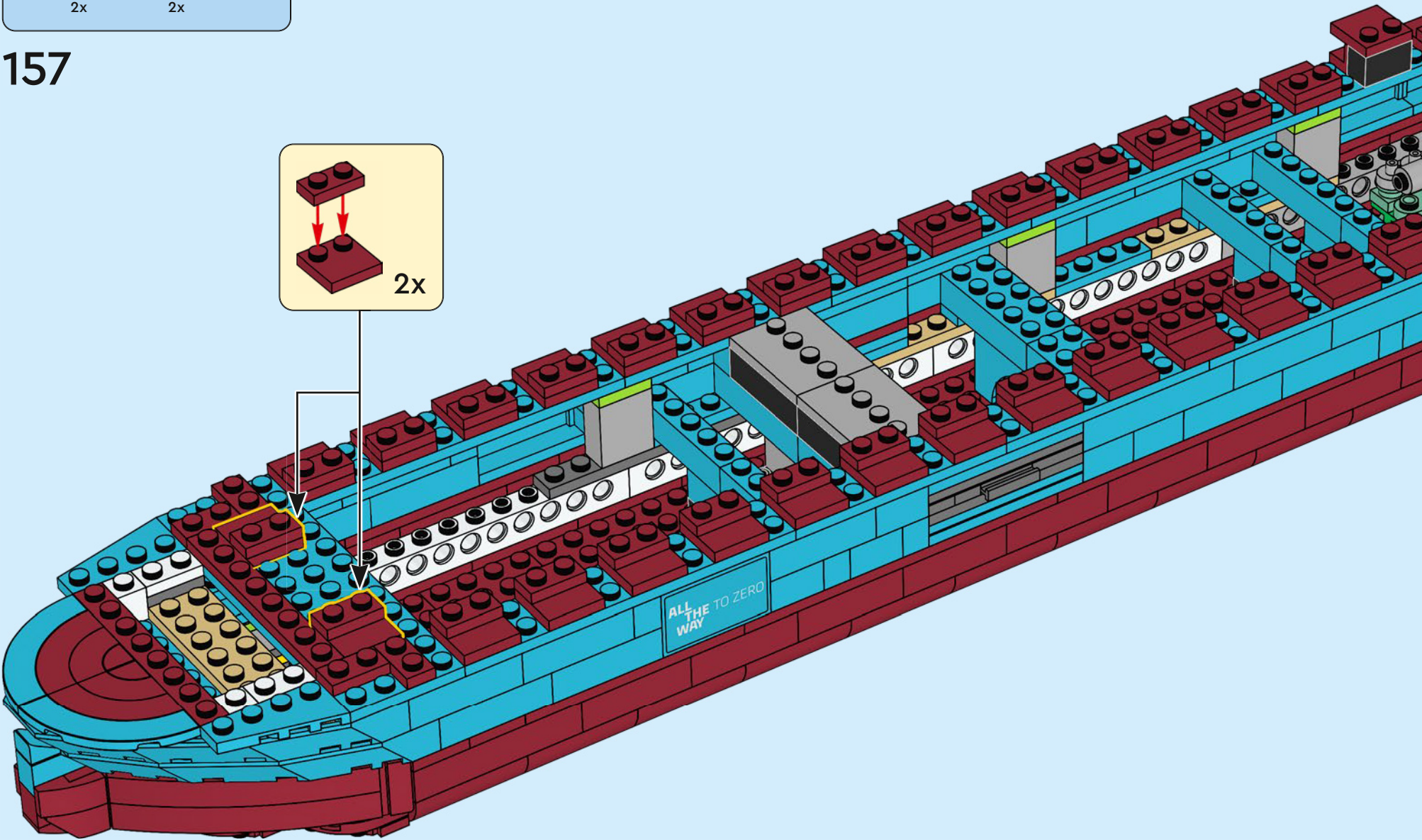
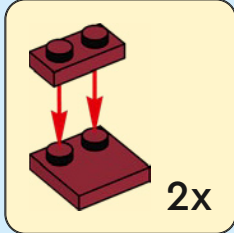

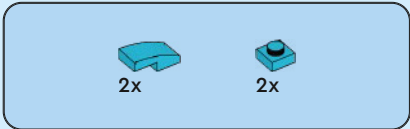

158

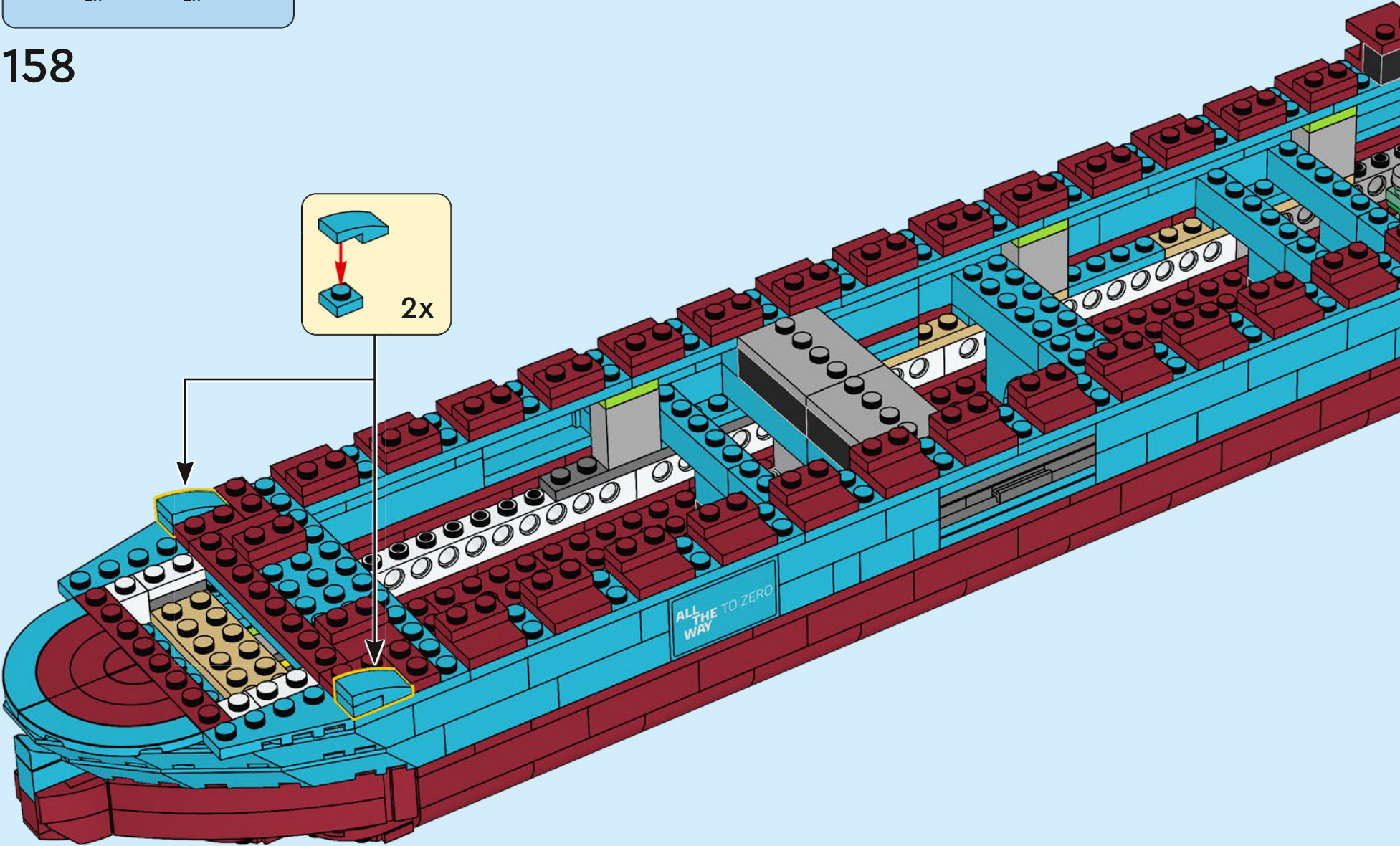
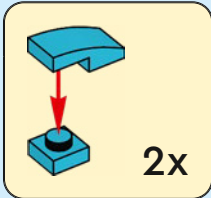

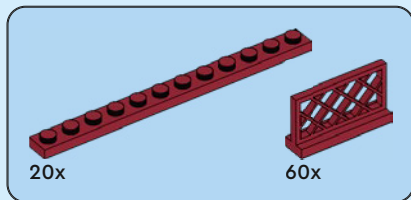
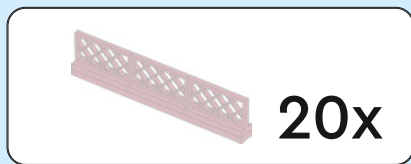

159

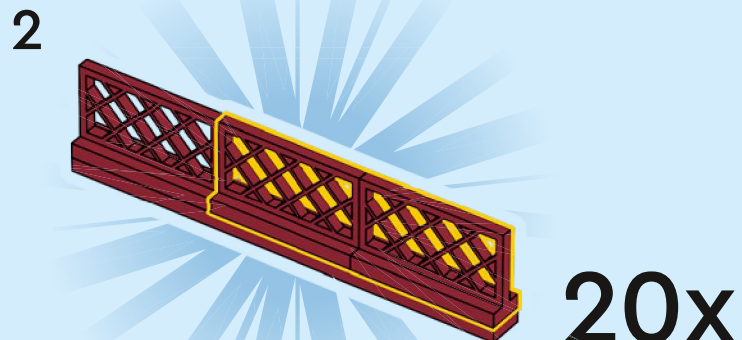
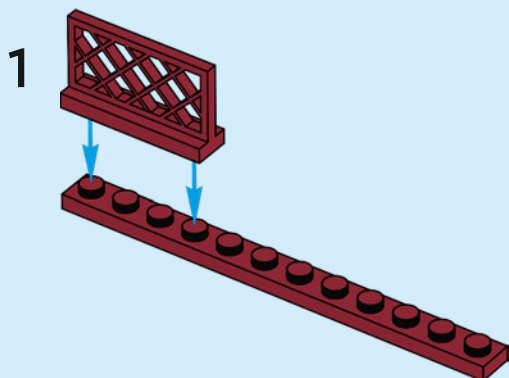
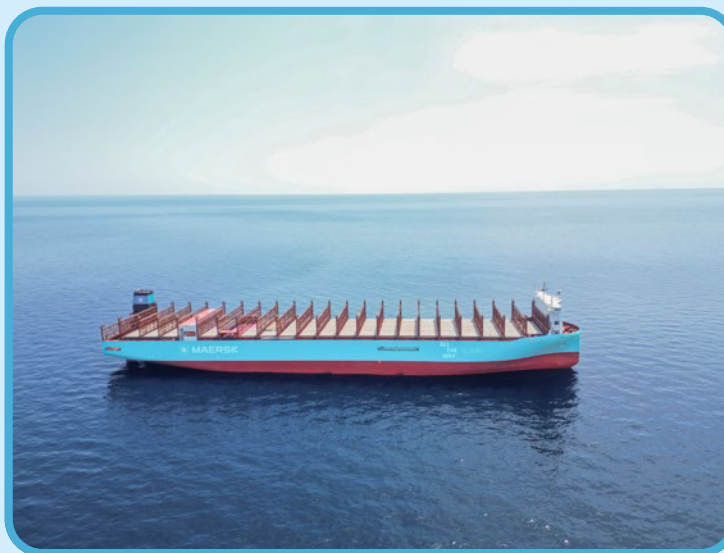

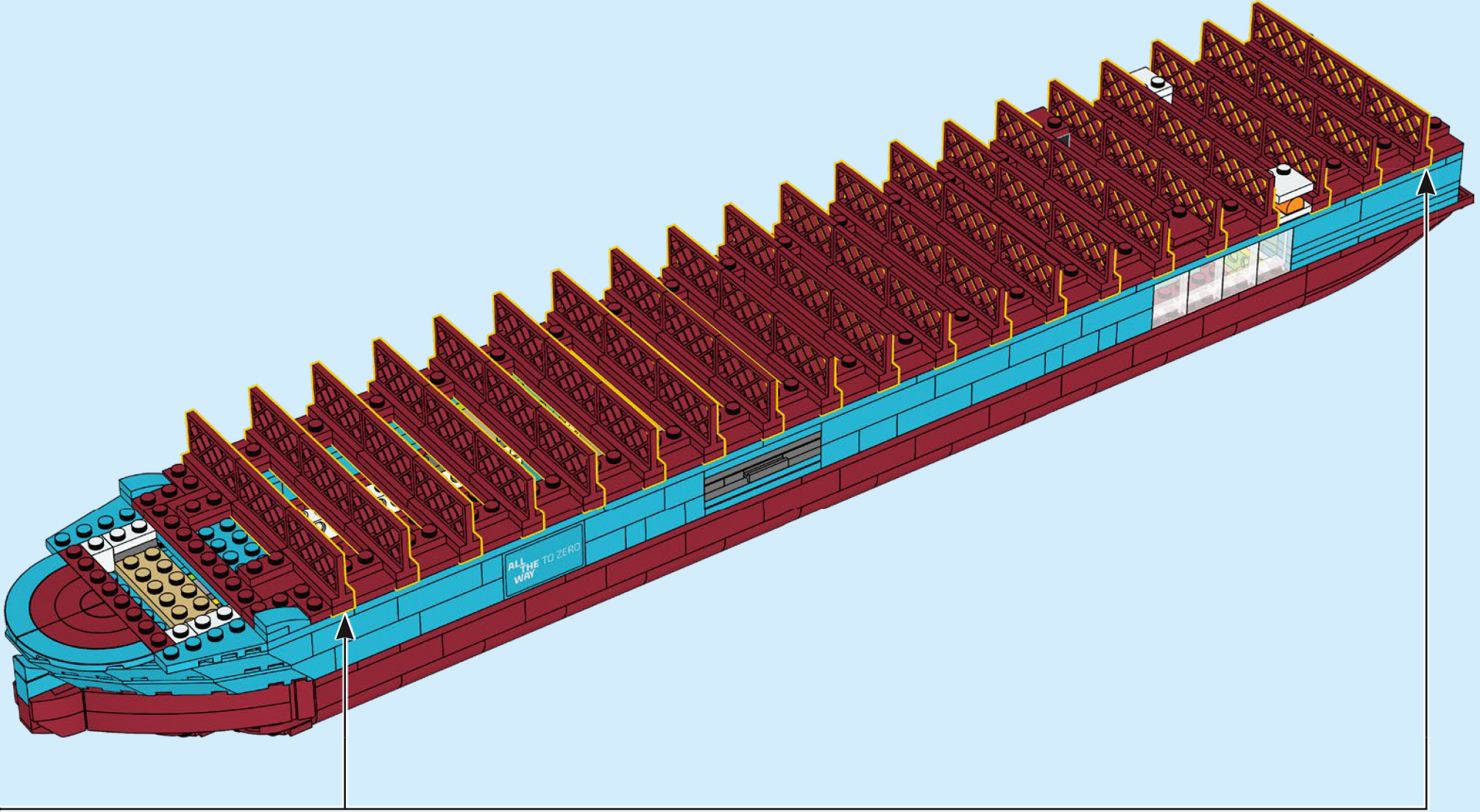

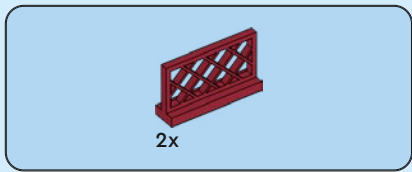

160

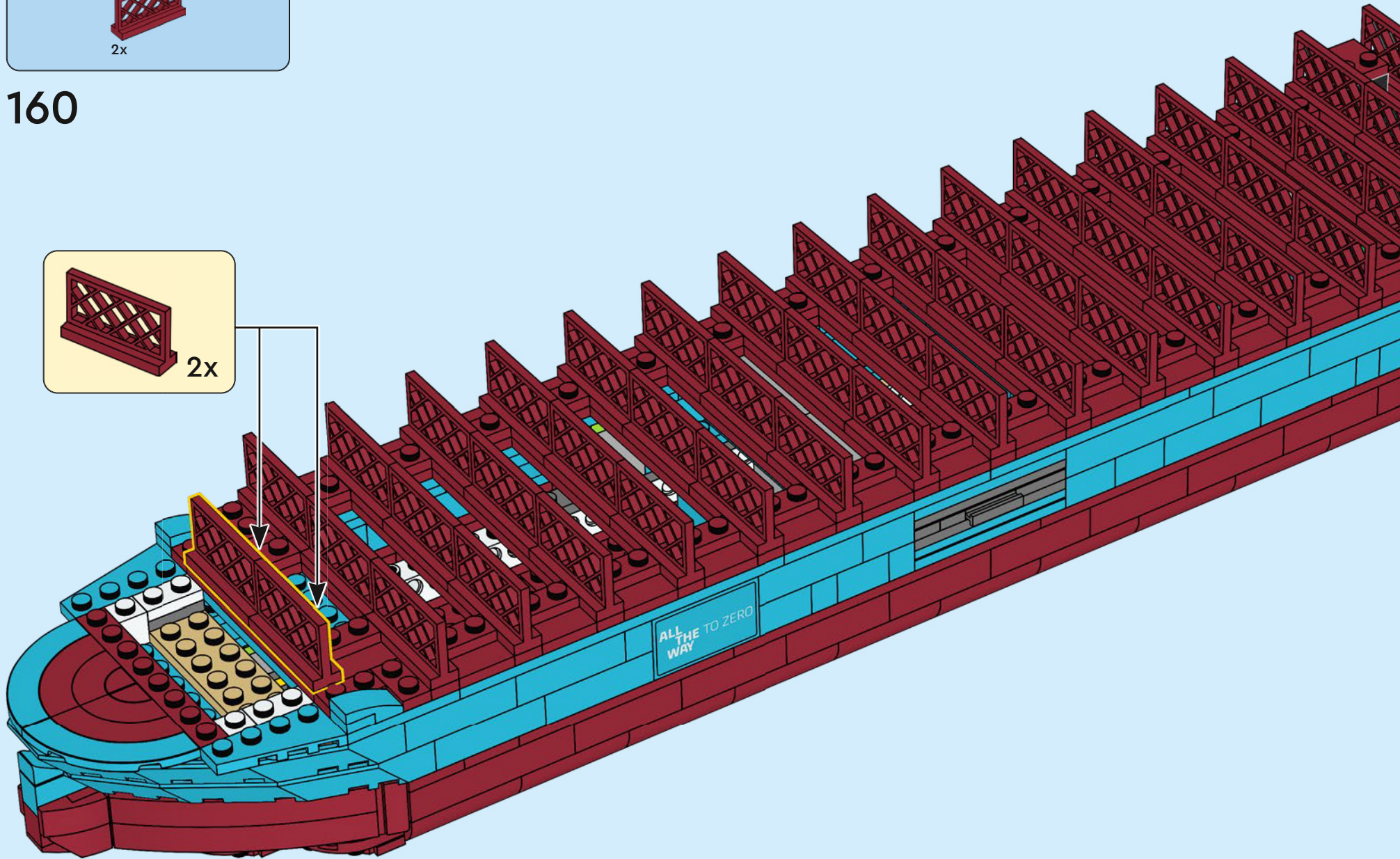
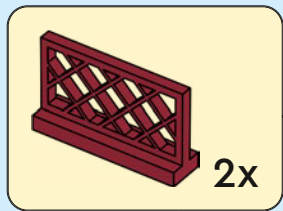

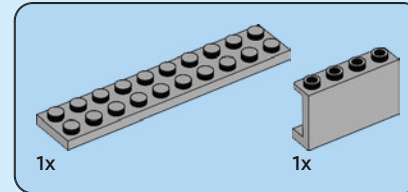
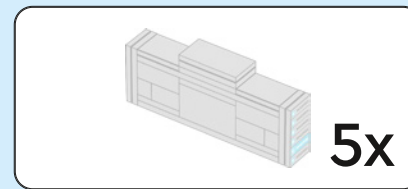

161

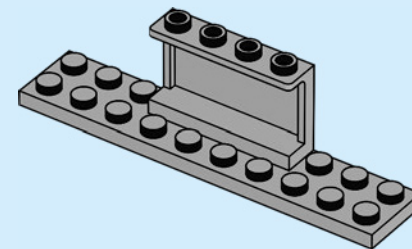
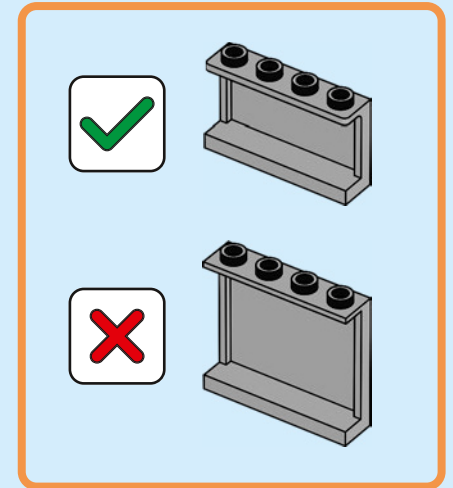

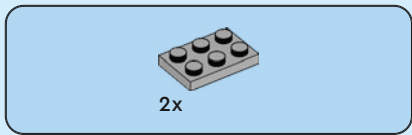

162

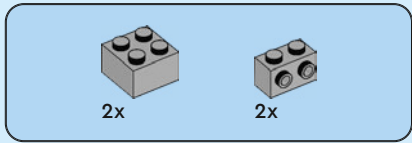
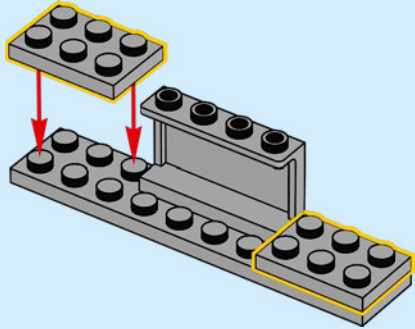

163

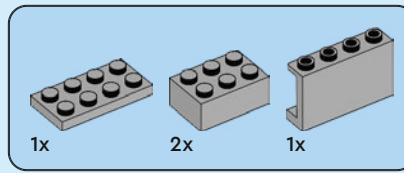
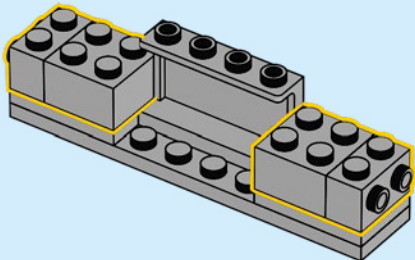

164

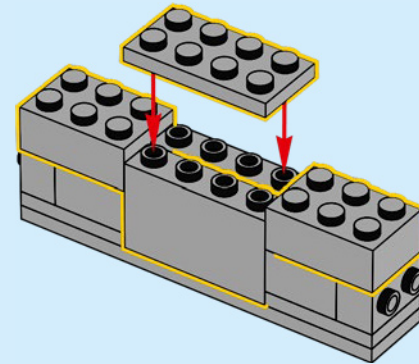

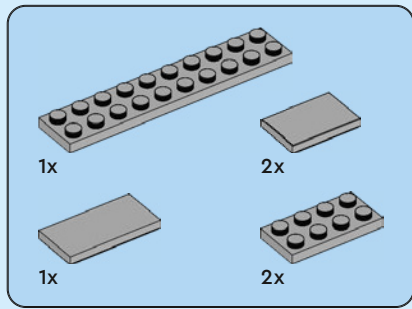

165

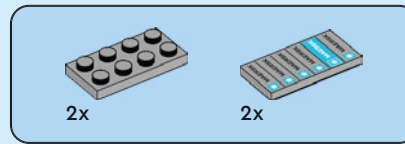
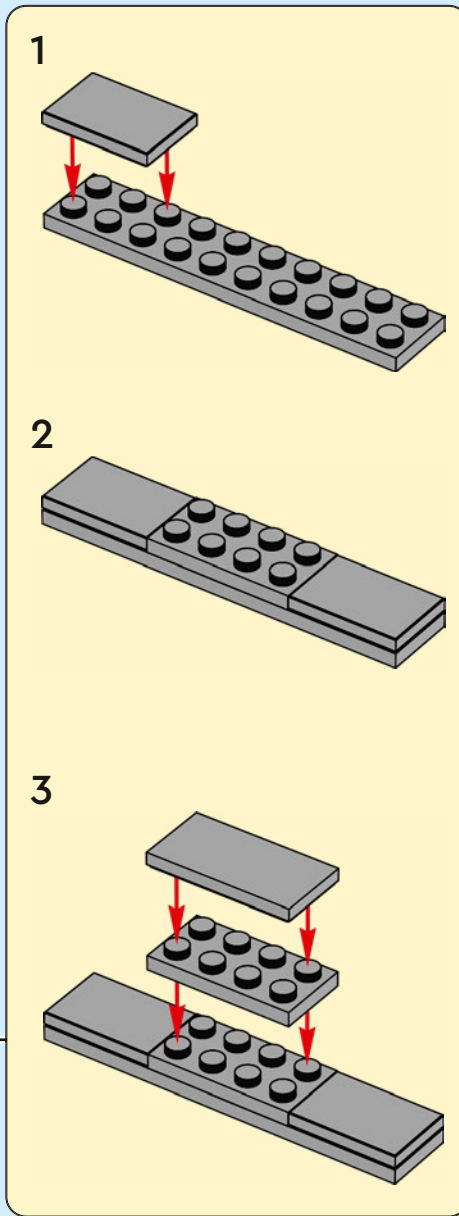
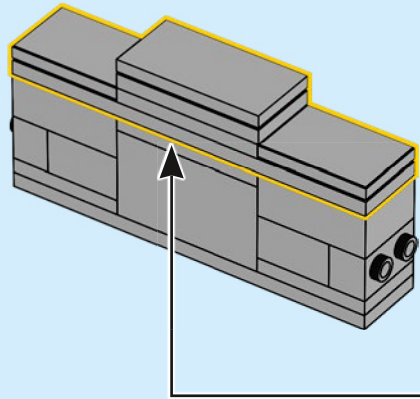

166

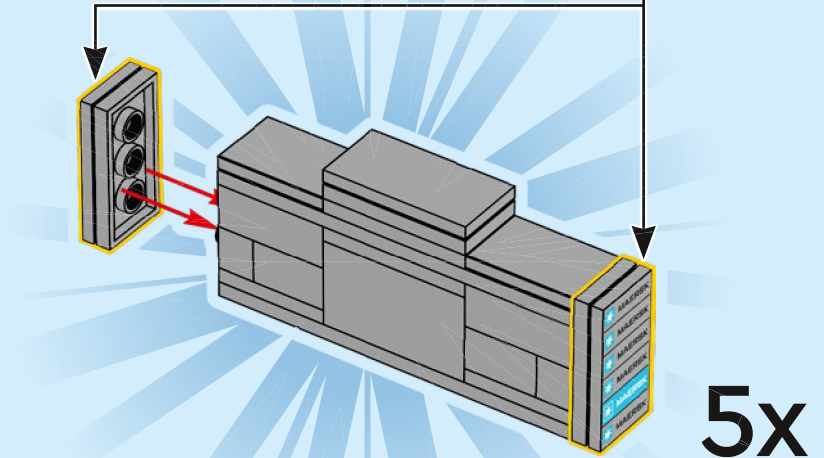
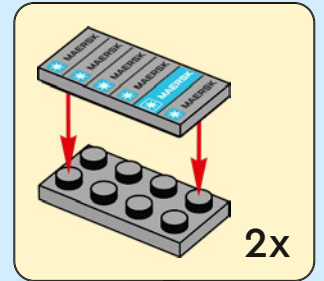

5x



167

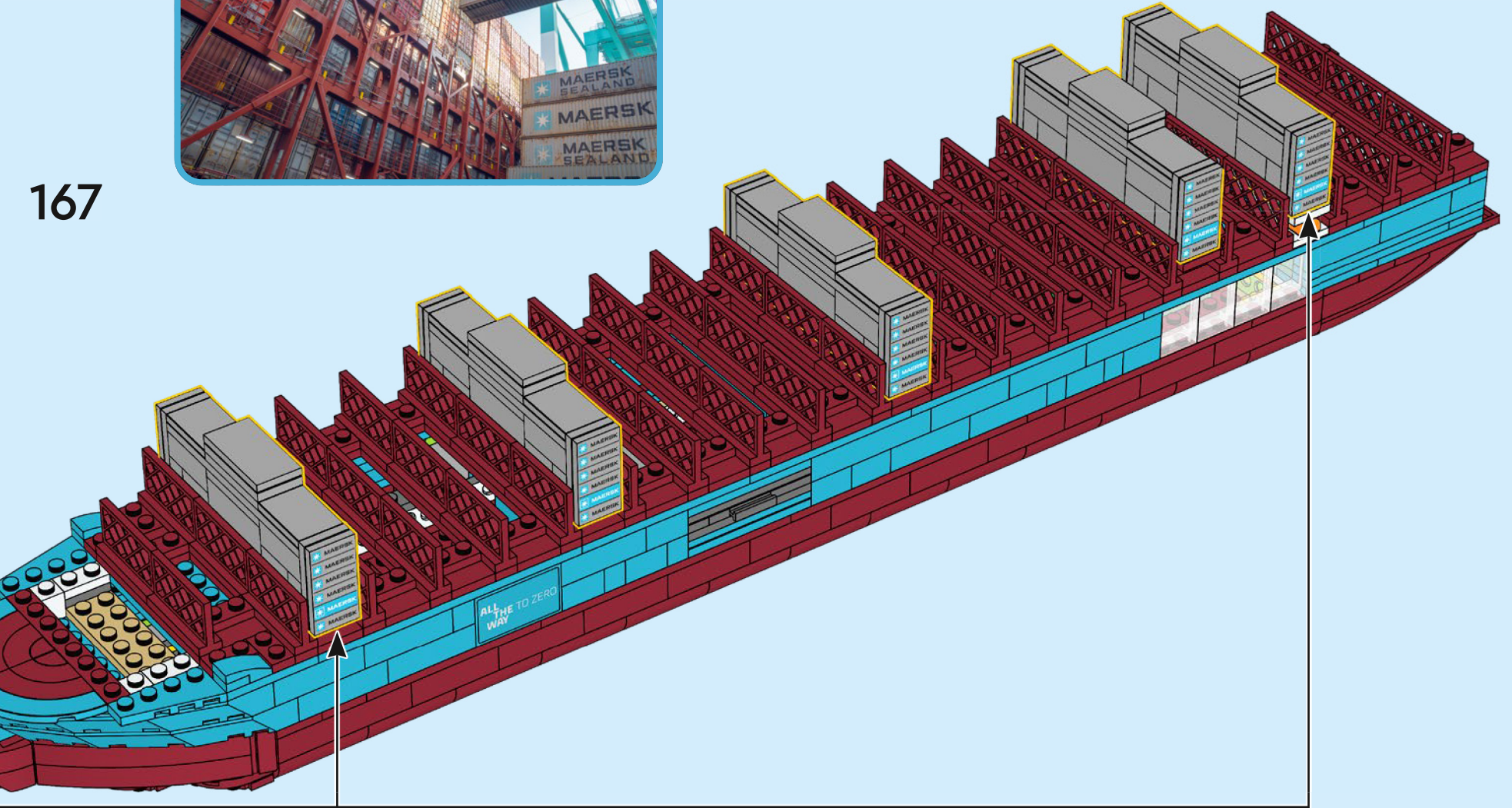

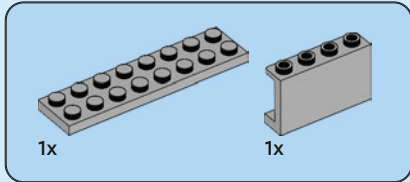
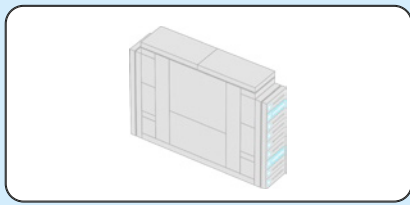

168

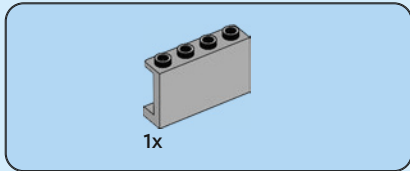
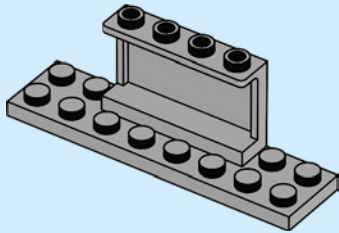

169

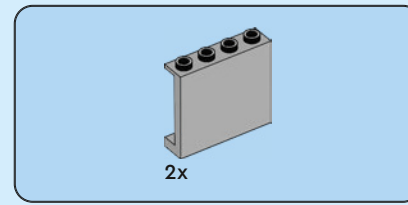
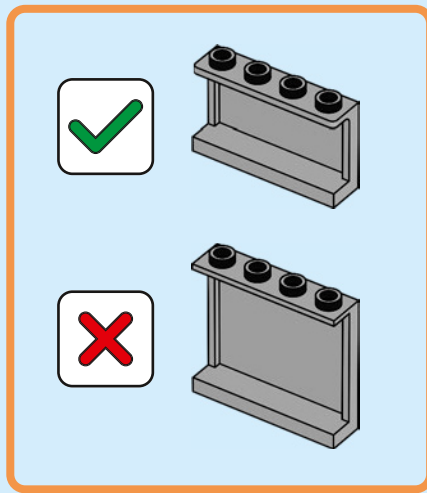
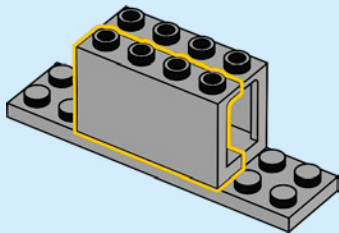

170

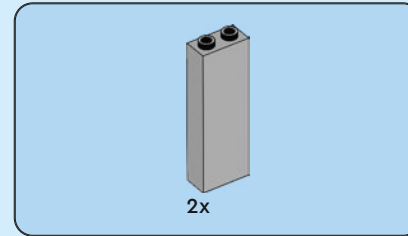
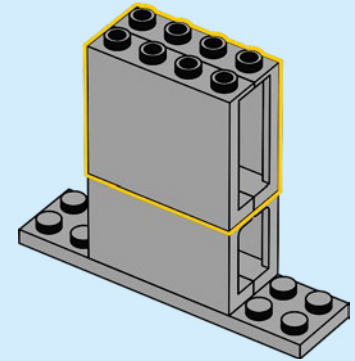

171

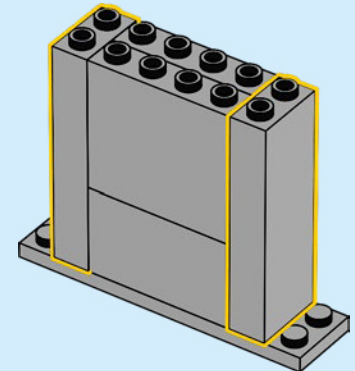

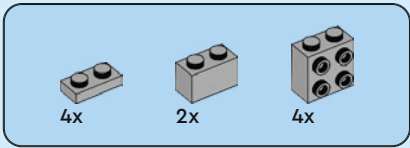

172

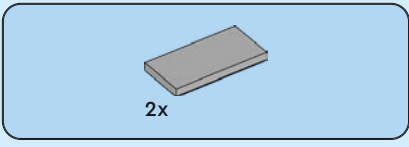
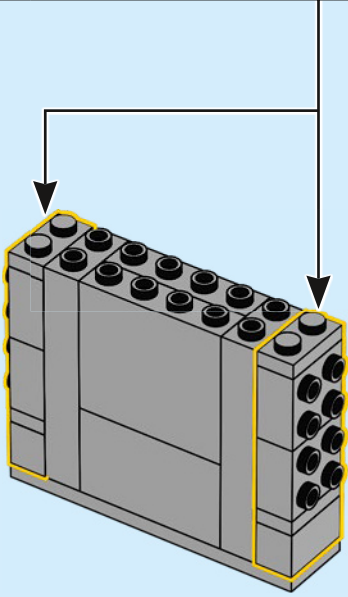
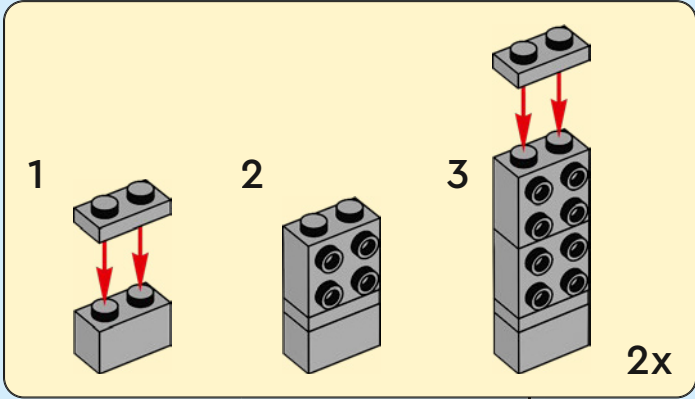

173

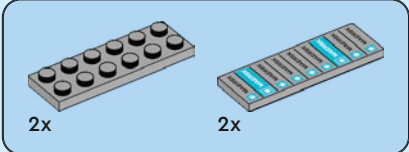
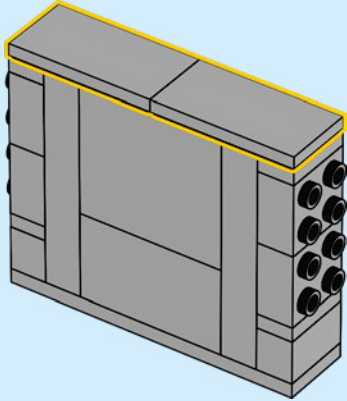

174

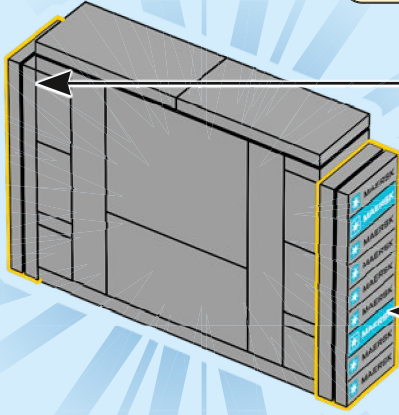
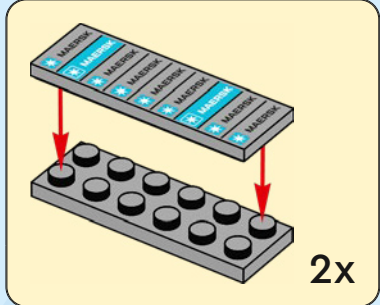

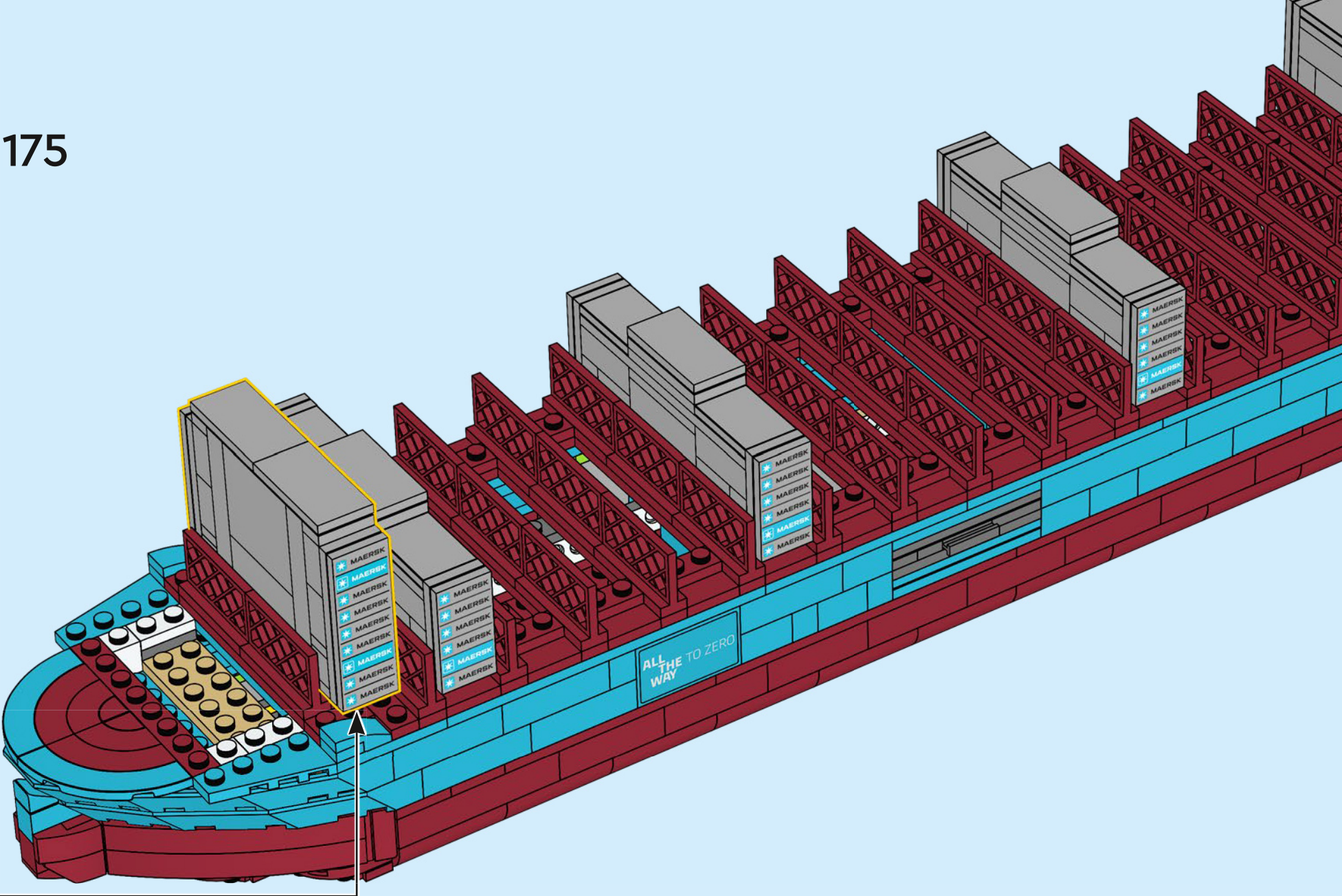

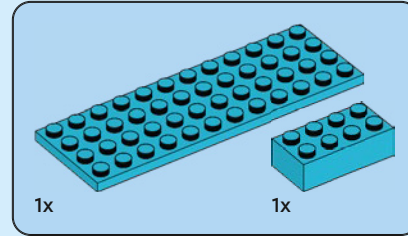
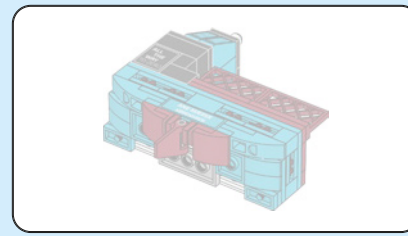

176

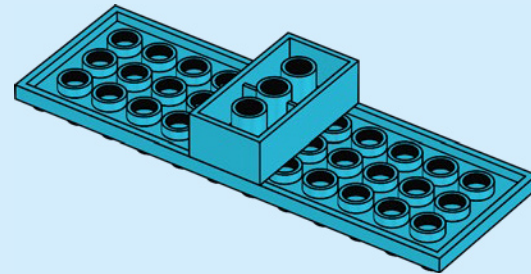

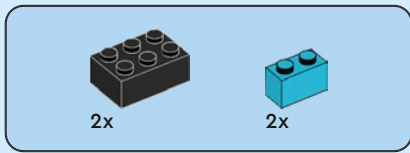

177

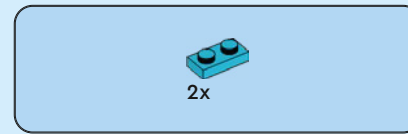
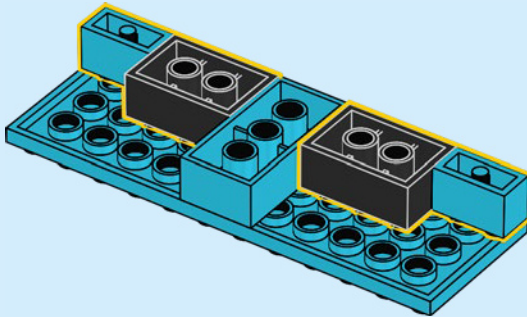

178

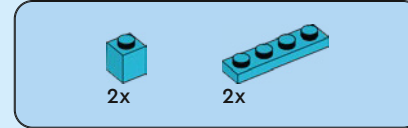
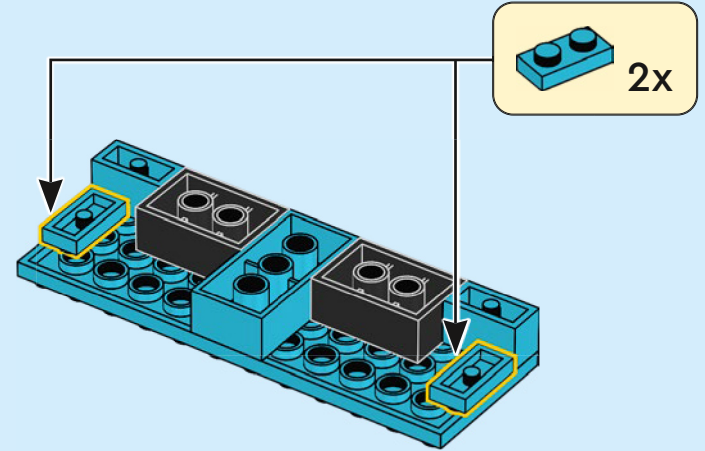

179

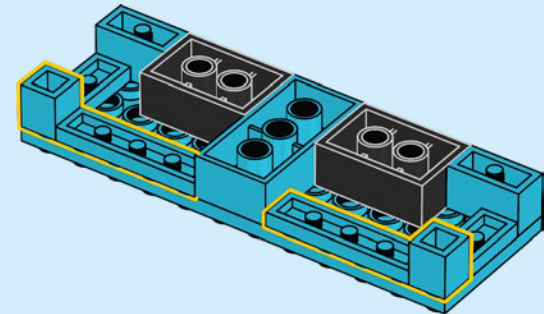

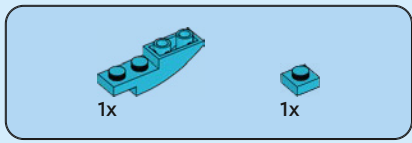

180

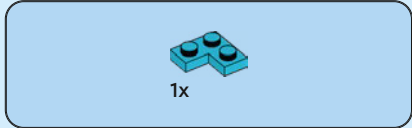
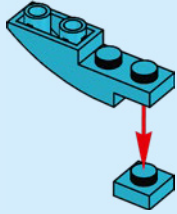

181

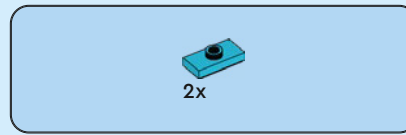
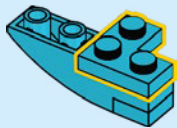

182

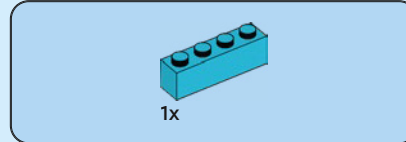
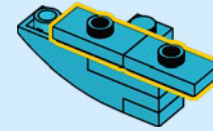

183

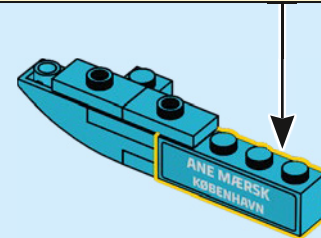
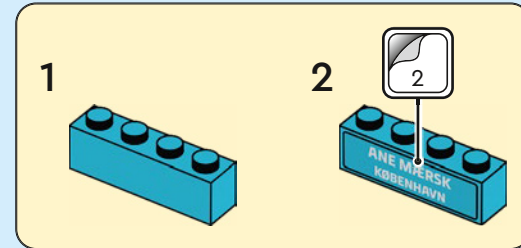

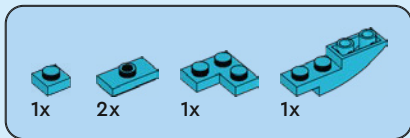

184

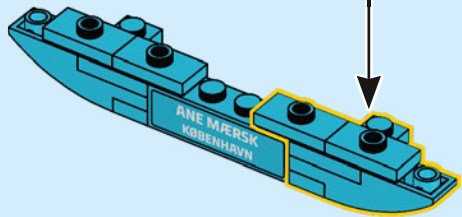
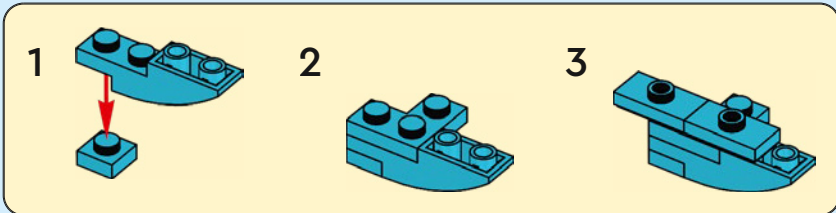

185

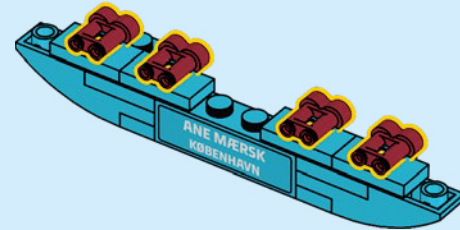

186

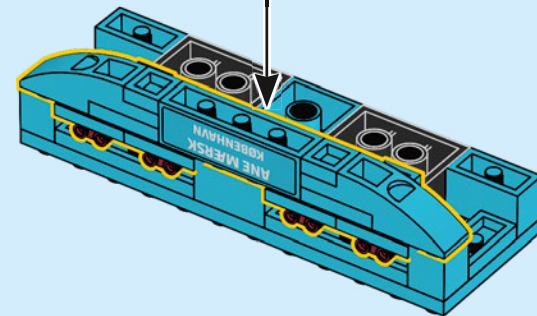

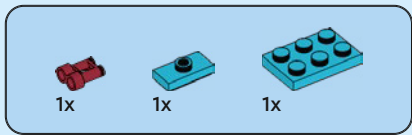

187

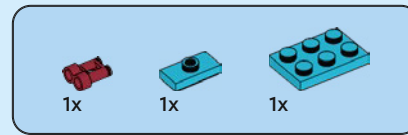
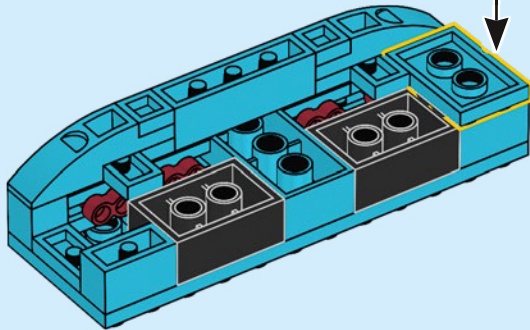
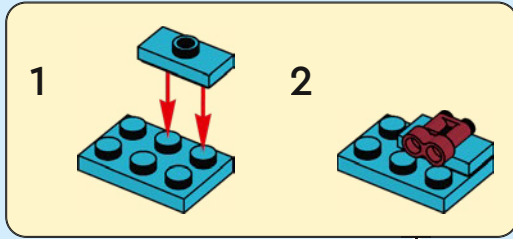

188

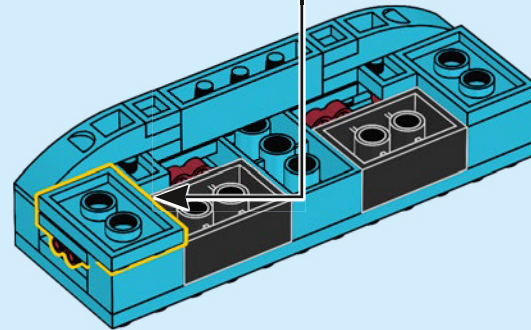
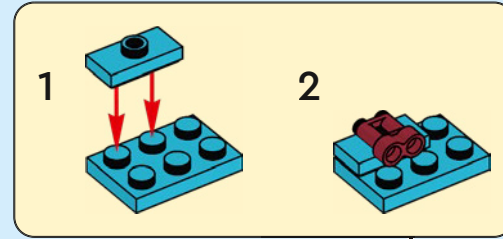

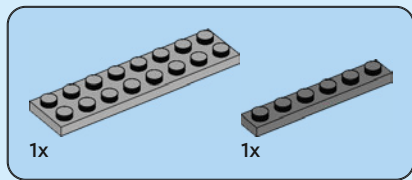

189

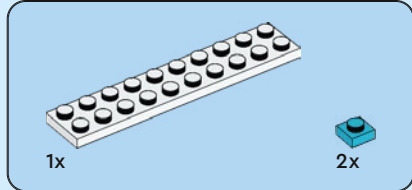
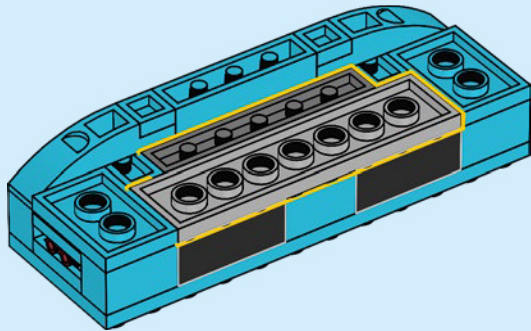

190

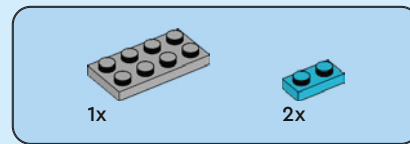
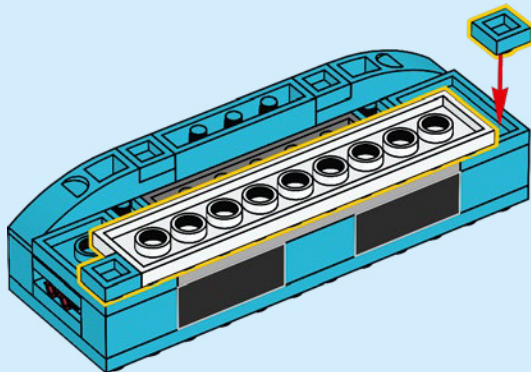

191

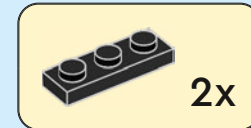
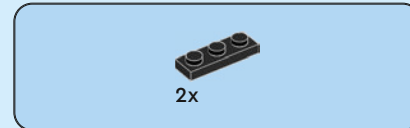
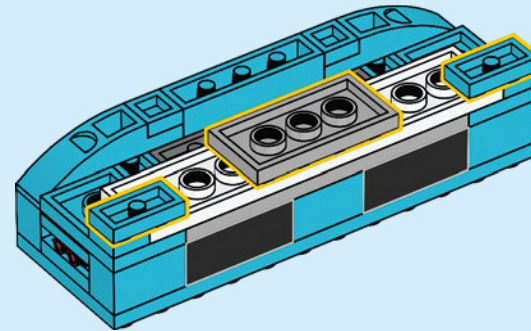

192

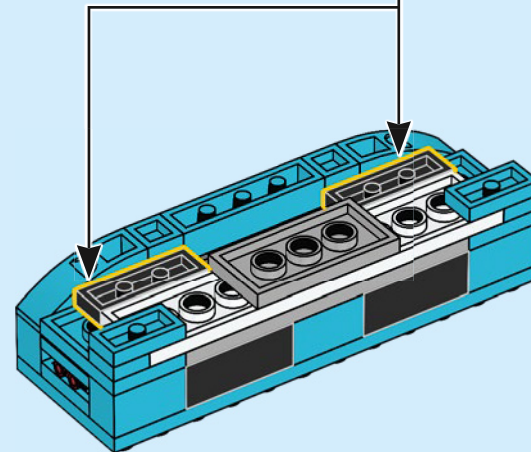



4x

193

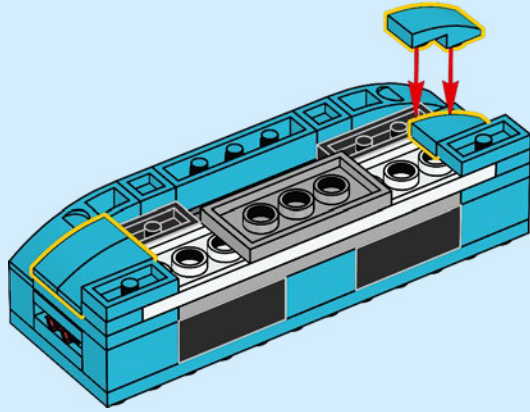

2x

194

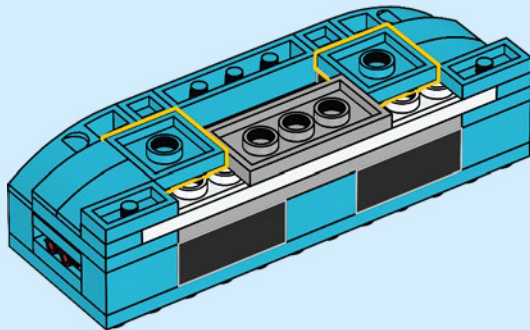

1x

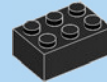

1x



1x

195

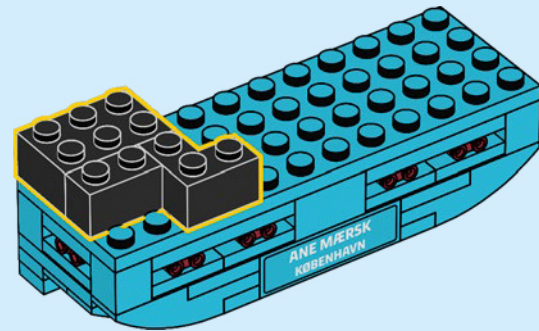

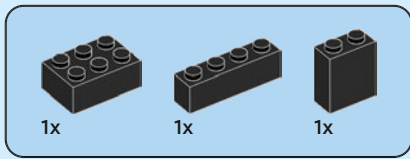

196

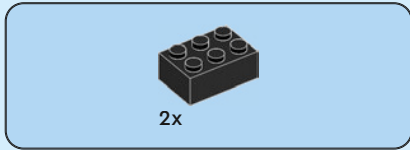
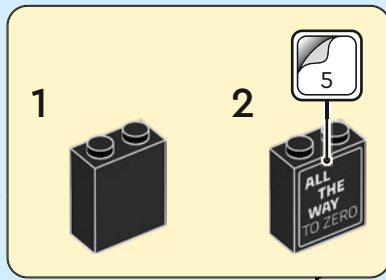
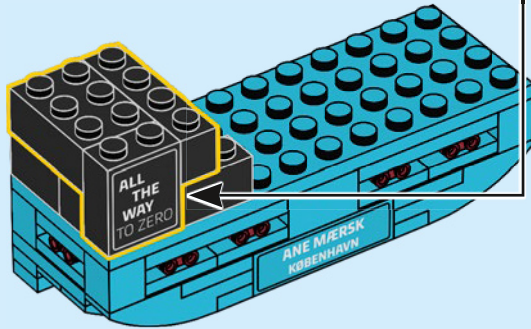

197

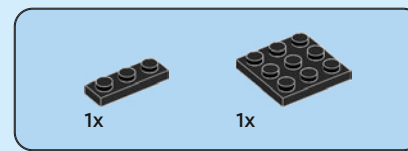
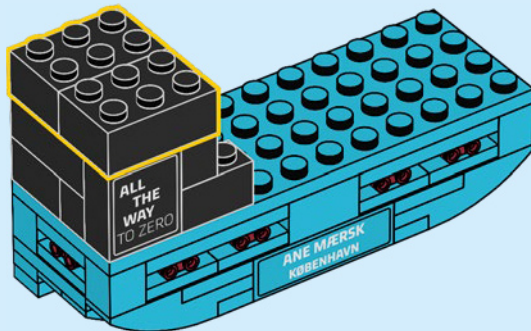

198

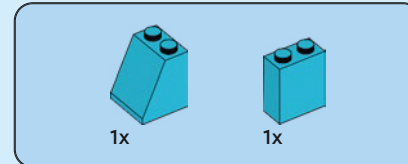
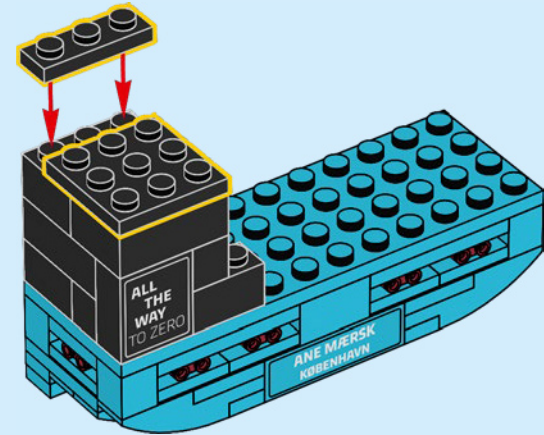

199

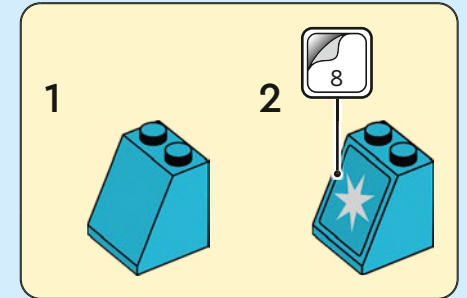
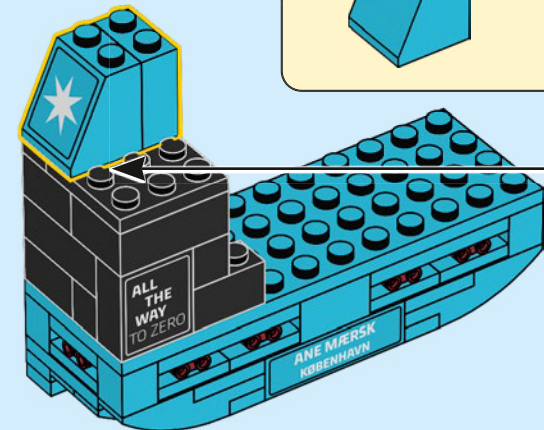

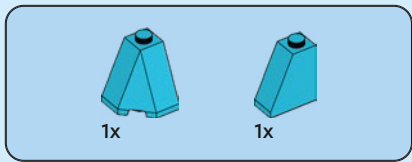

200

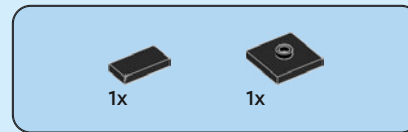
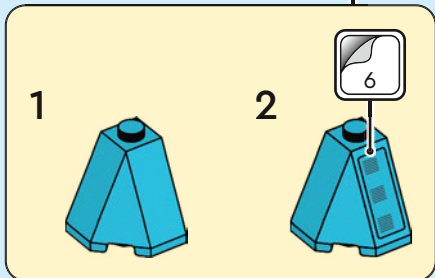
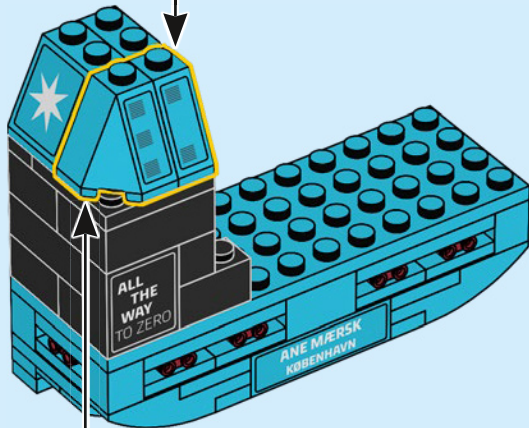
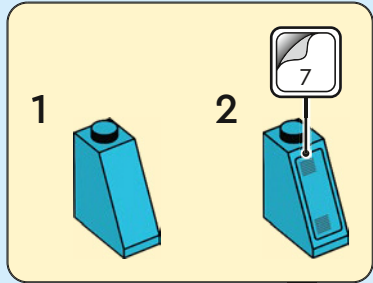

201

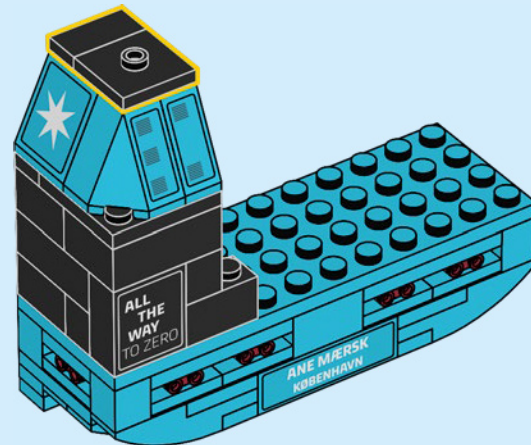



1x



1x

202

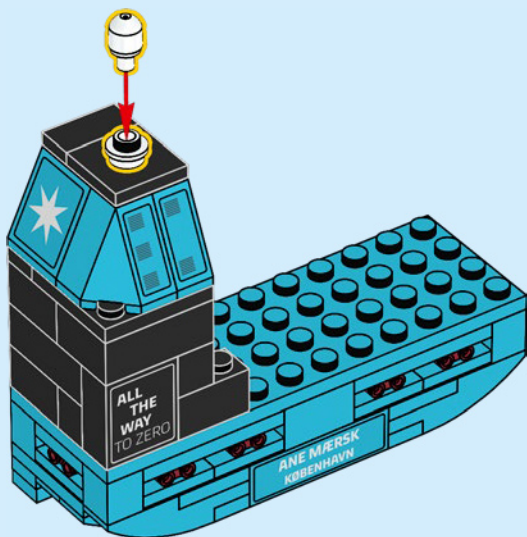

1x

2x

1x

203

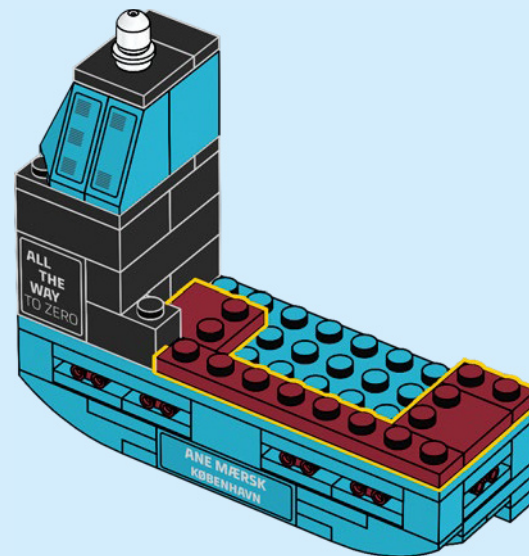



2x

204

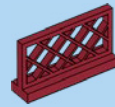
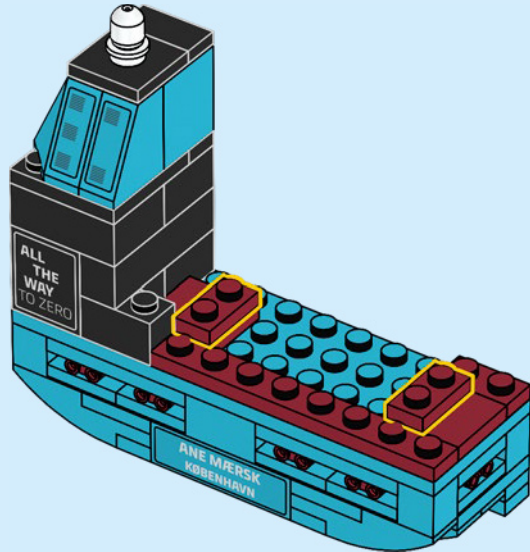

2x

205

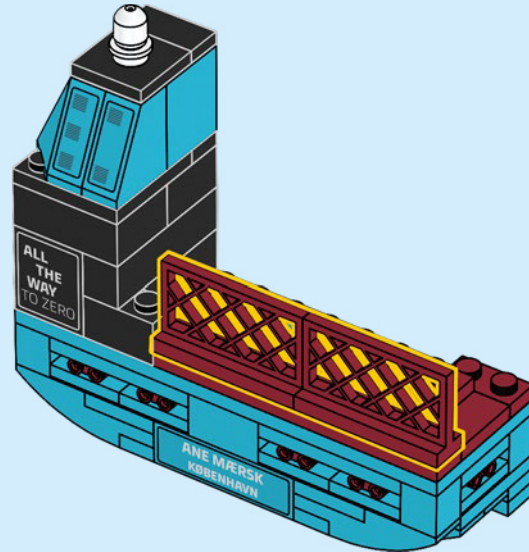

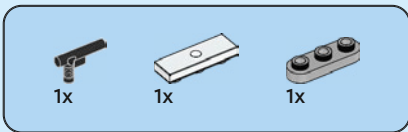

206

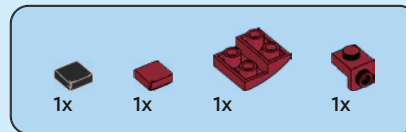
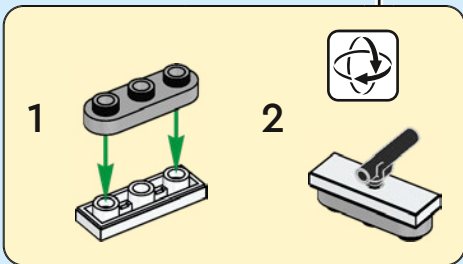
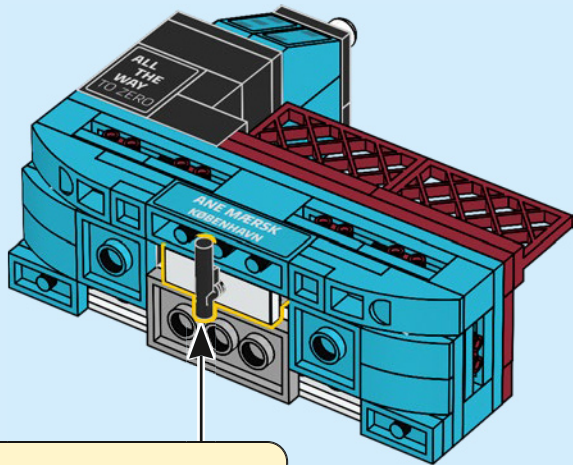

207

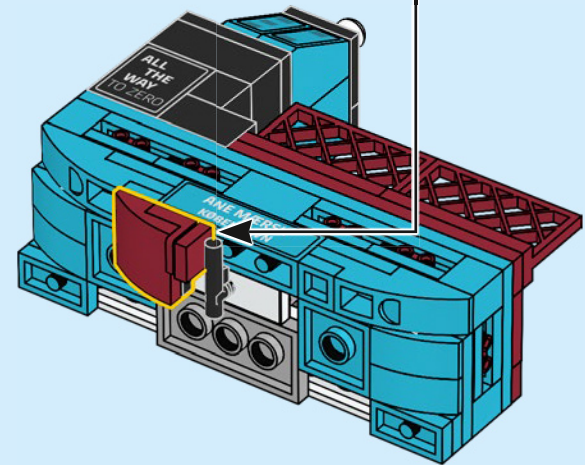
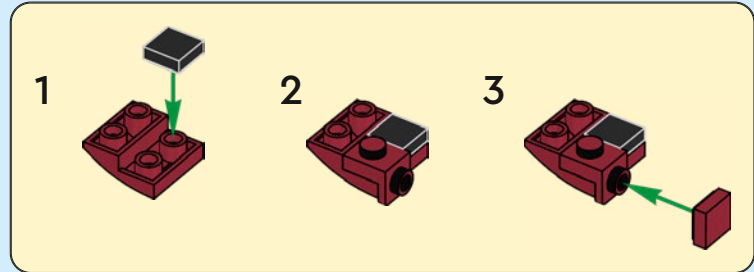

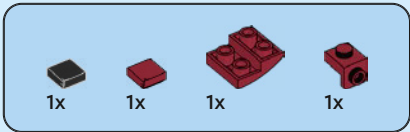

208

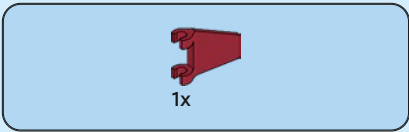
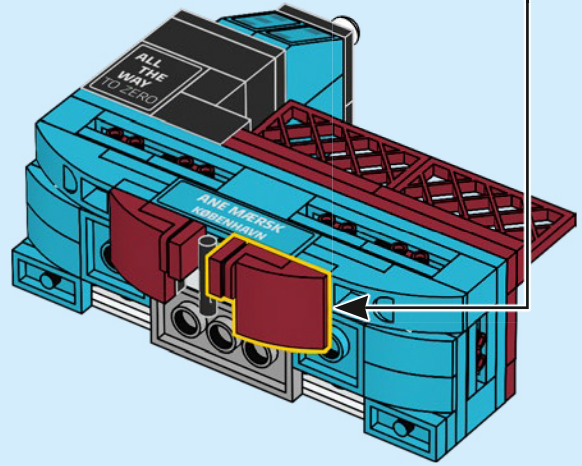

209

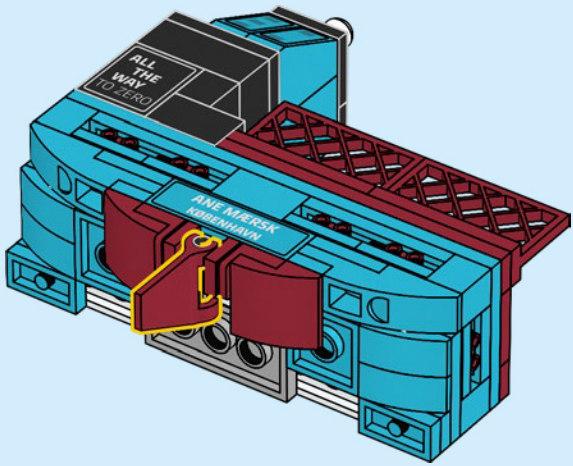

210

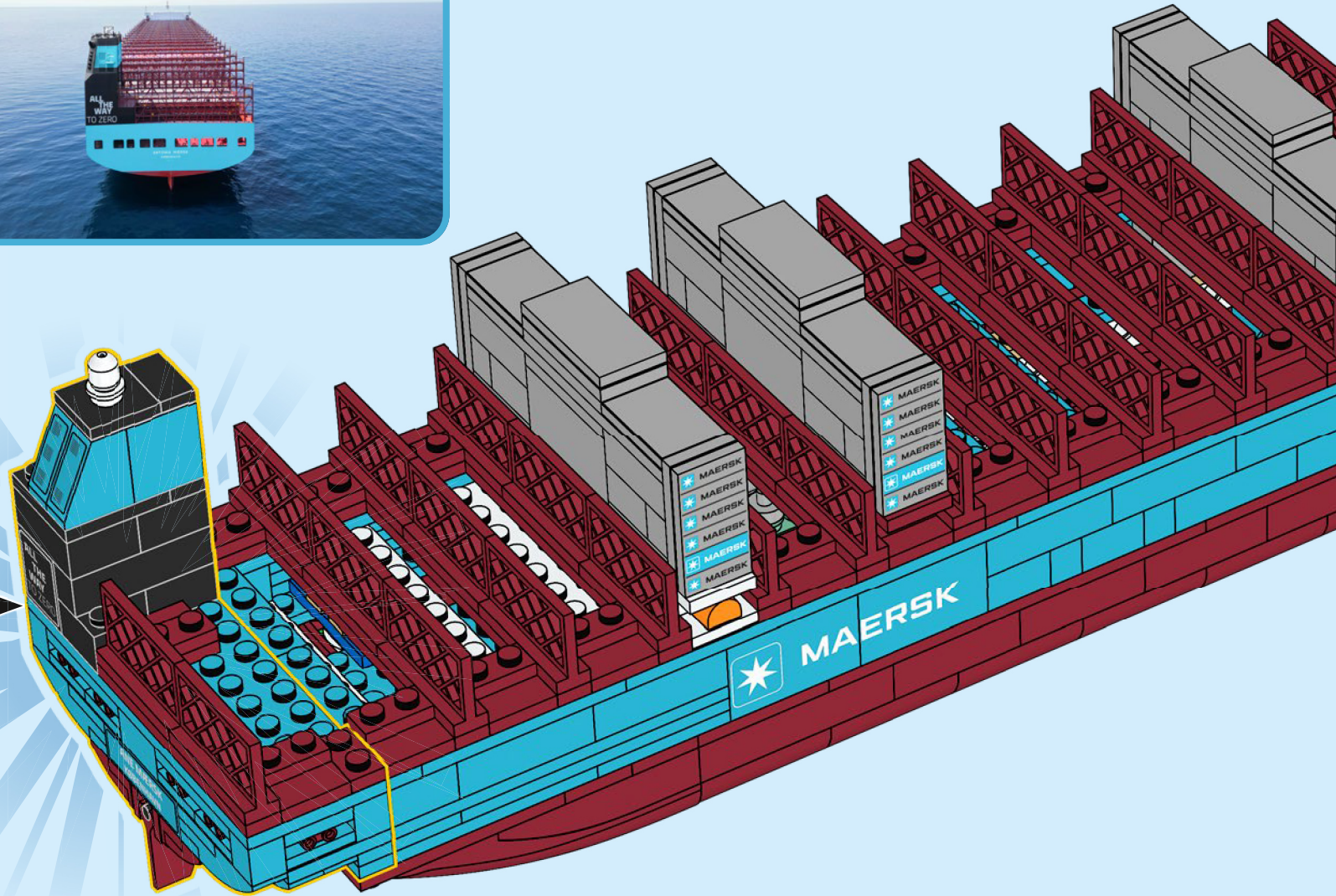
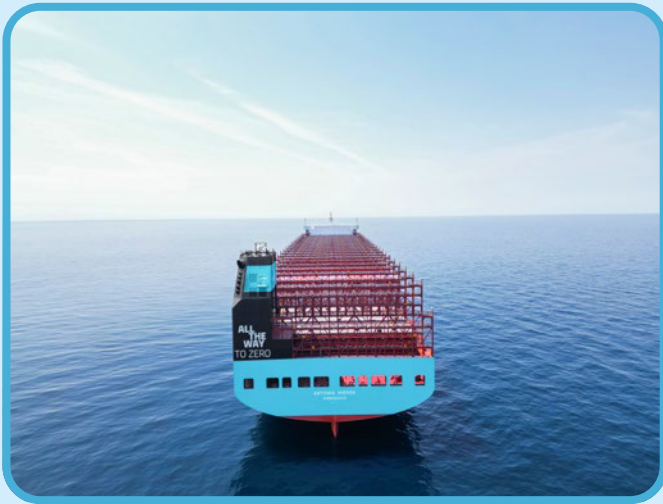

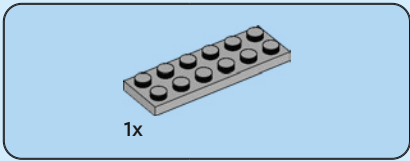

211

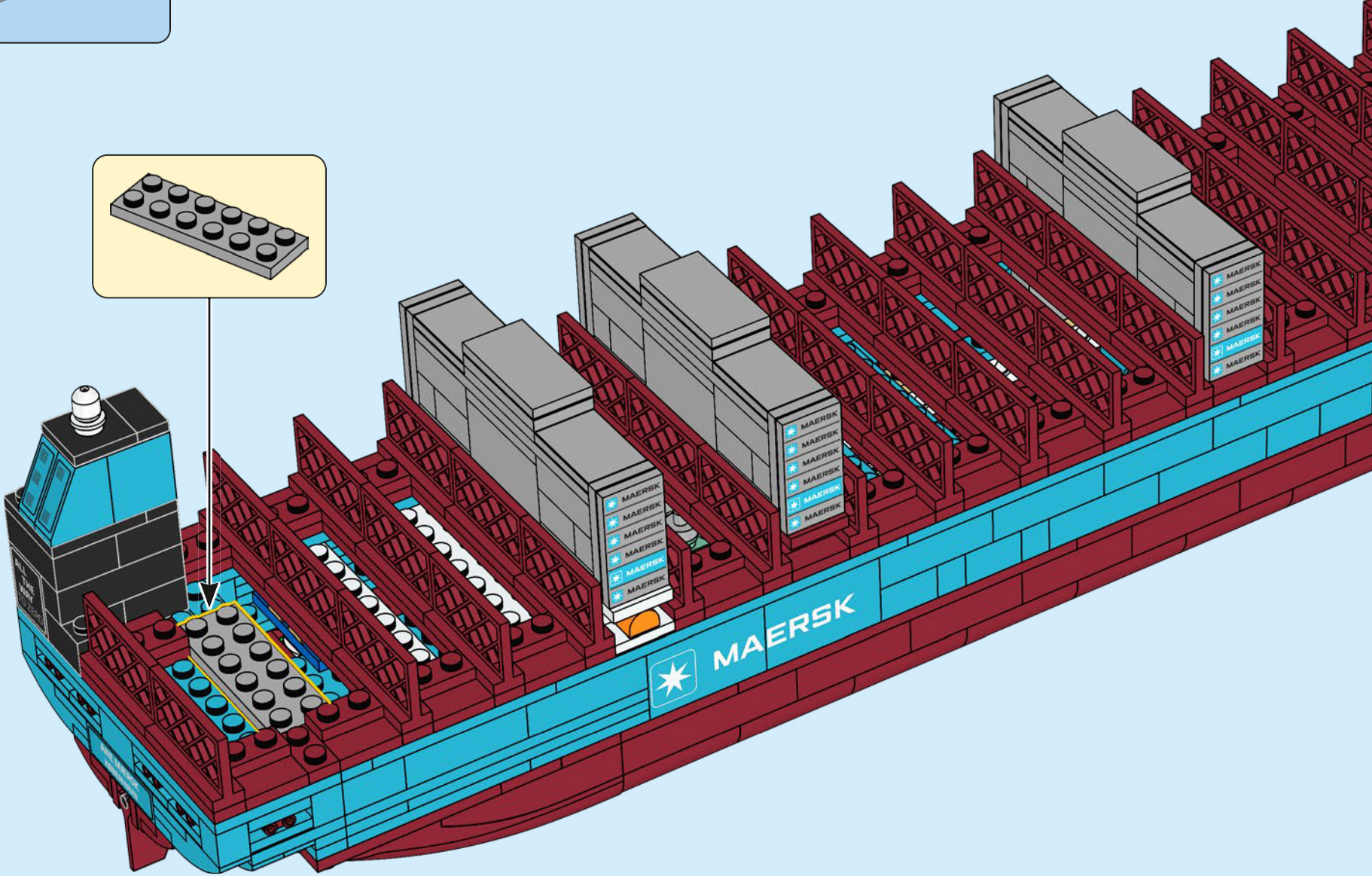
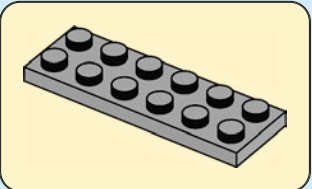

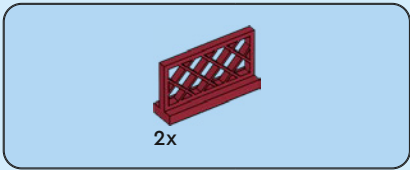

212

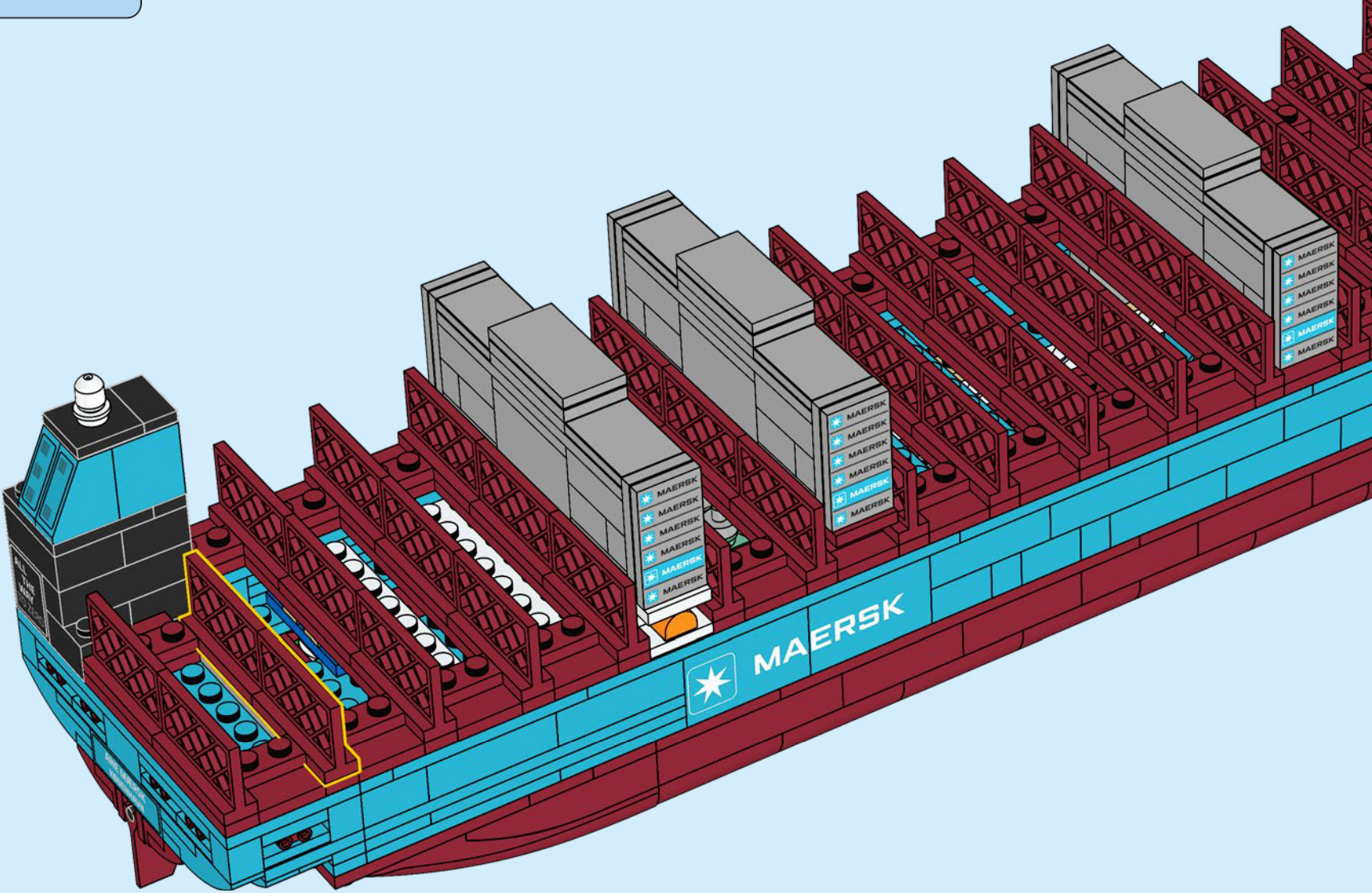

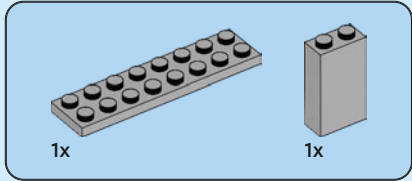
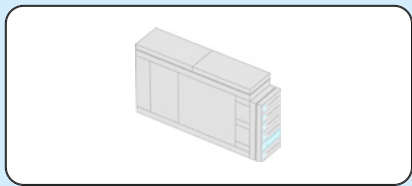

213

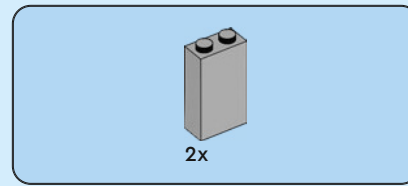
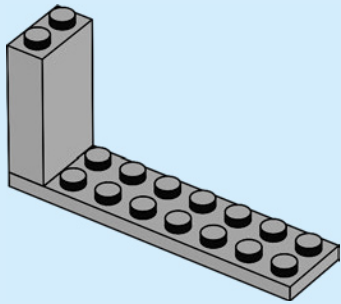

214

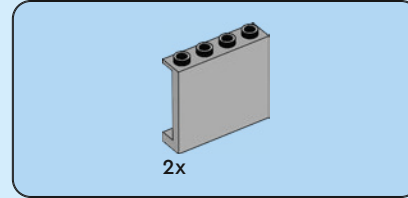
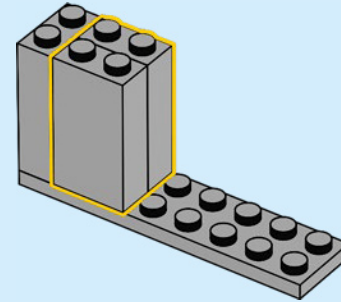

215

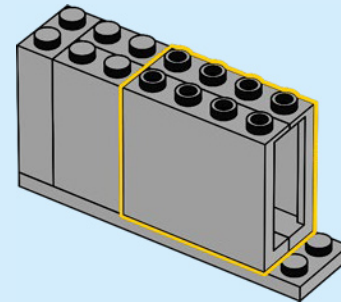

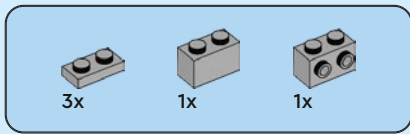

216

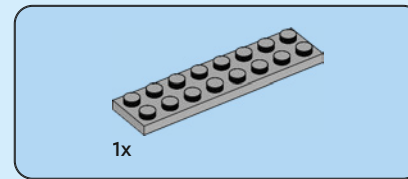
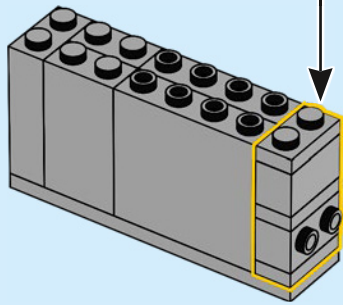
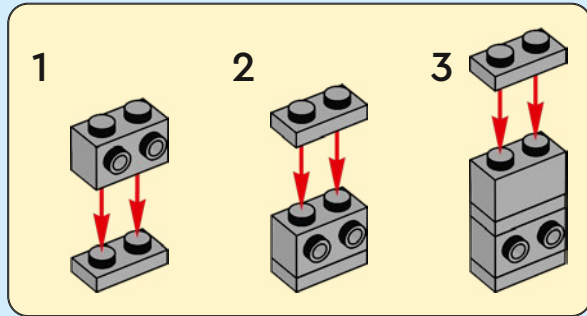

217

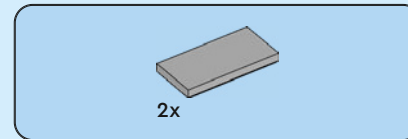
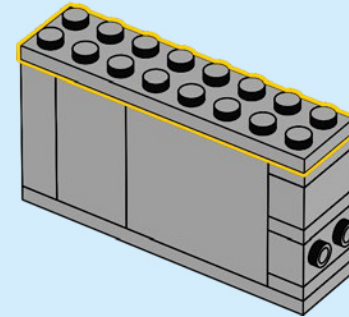

218

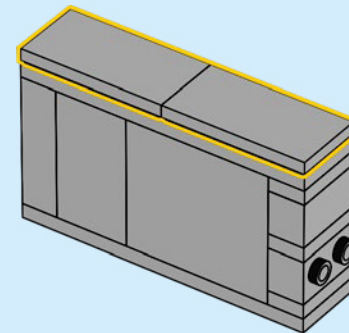

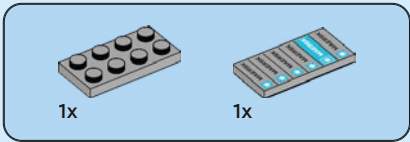

219

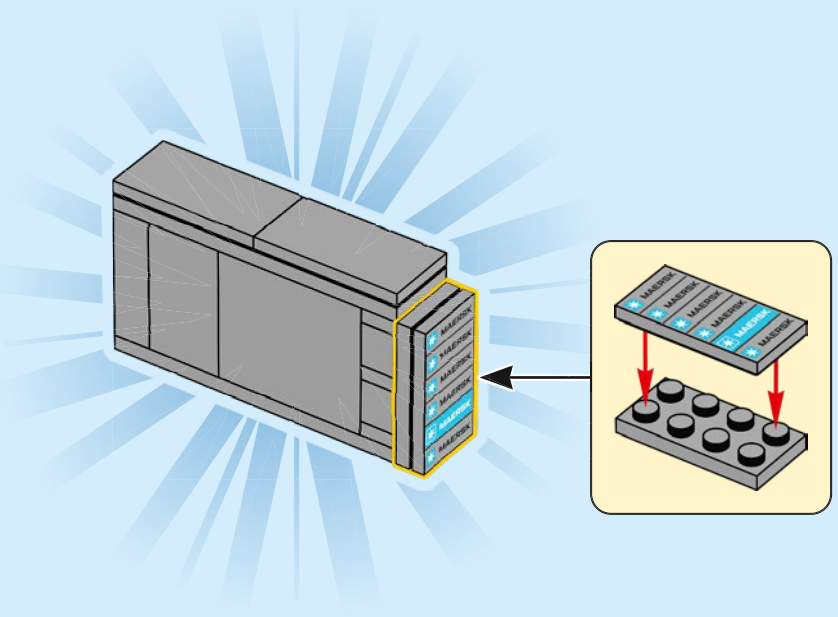

220

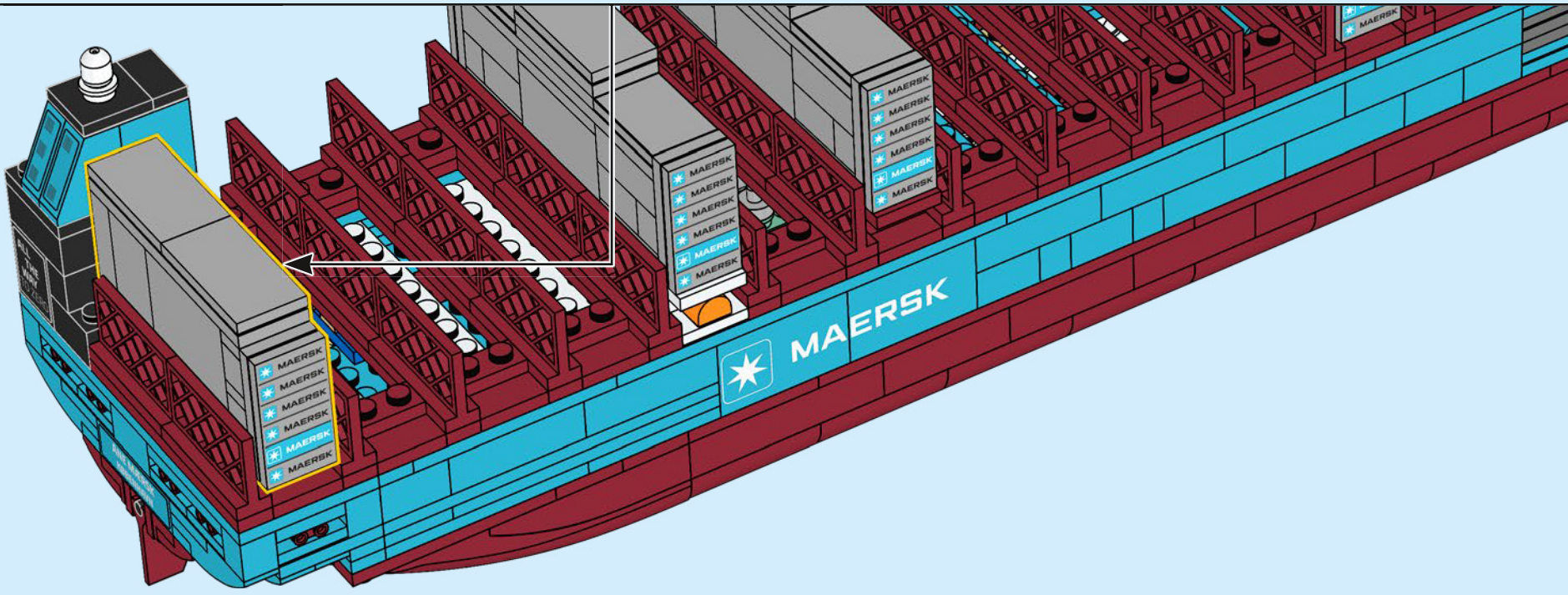

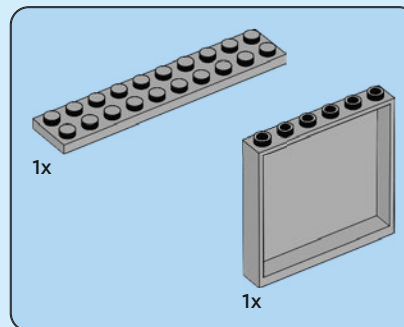
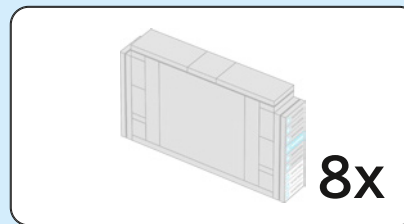

221

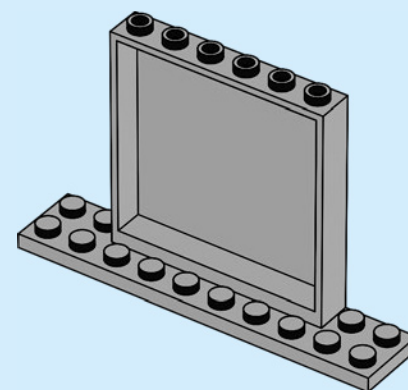

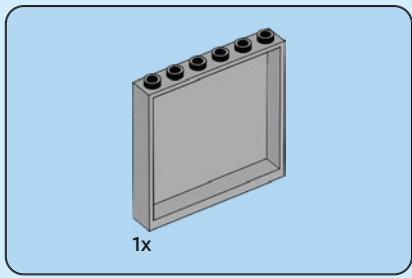

222

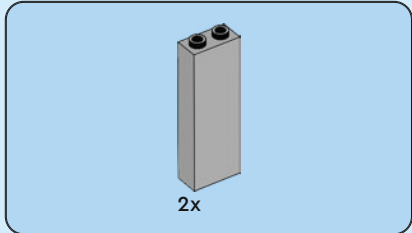
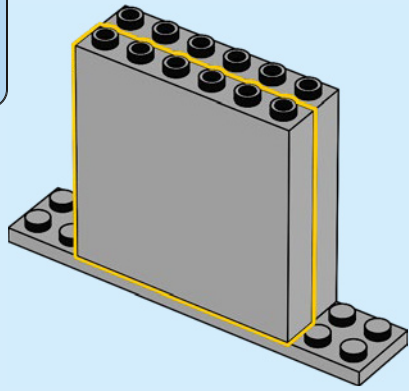

223

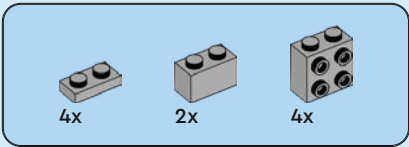
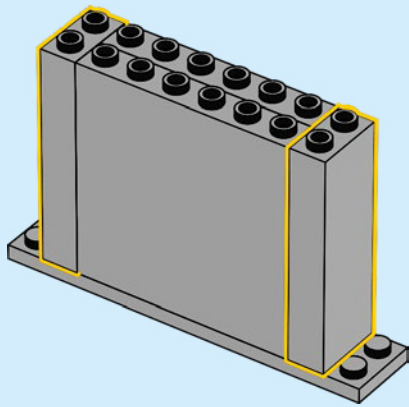

224

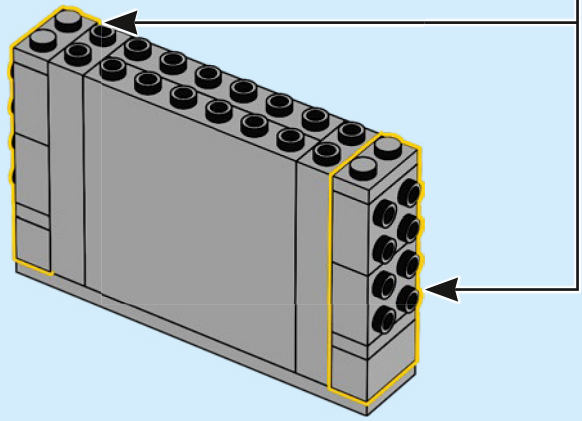
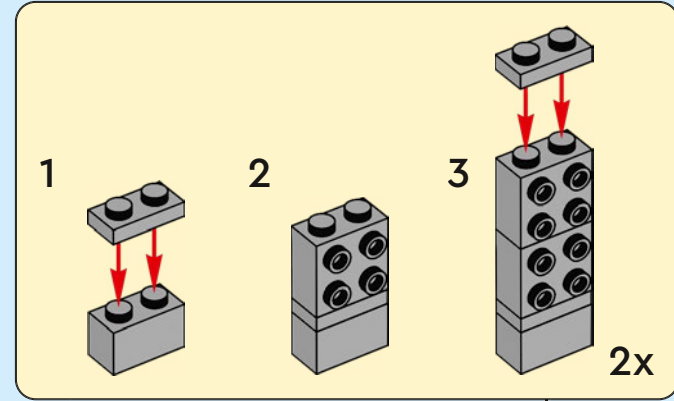

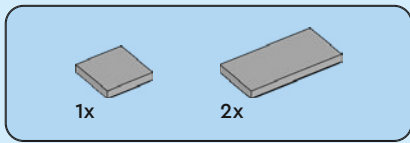

225

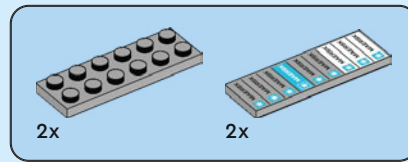
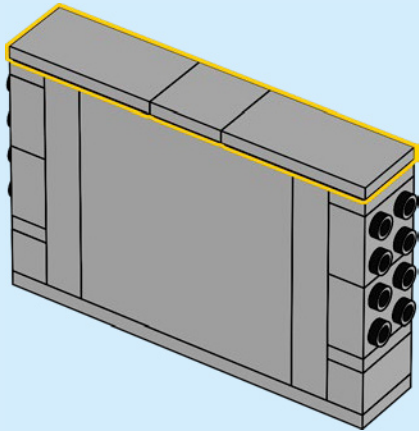

226

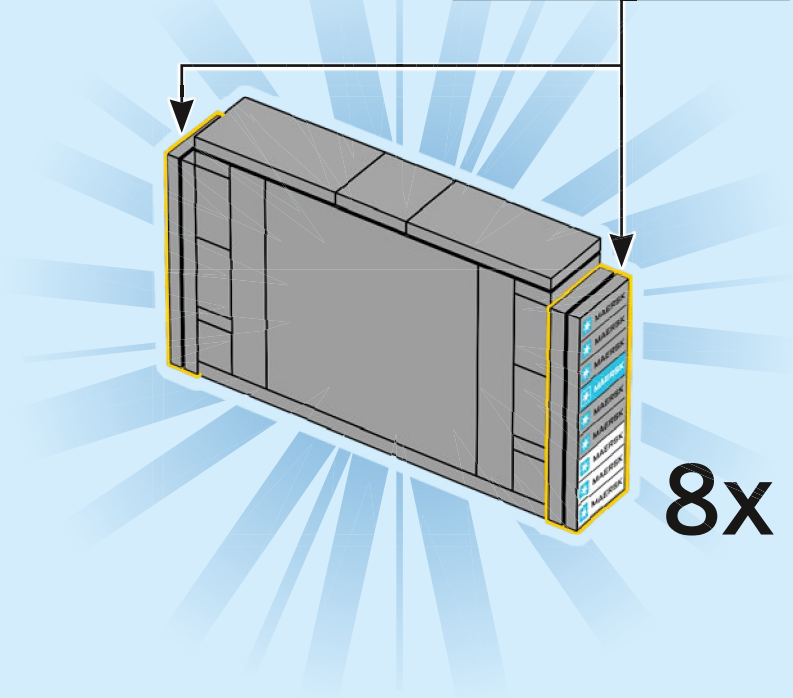
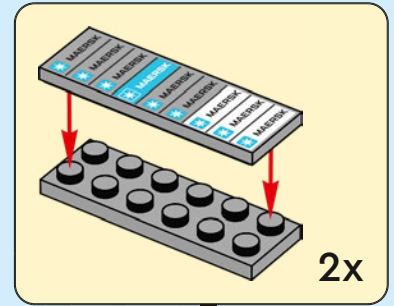

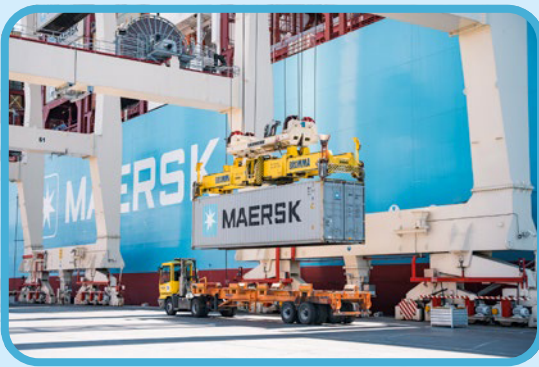

227

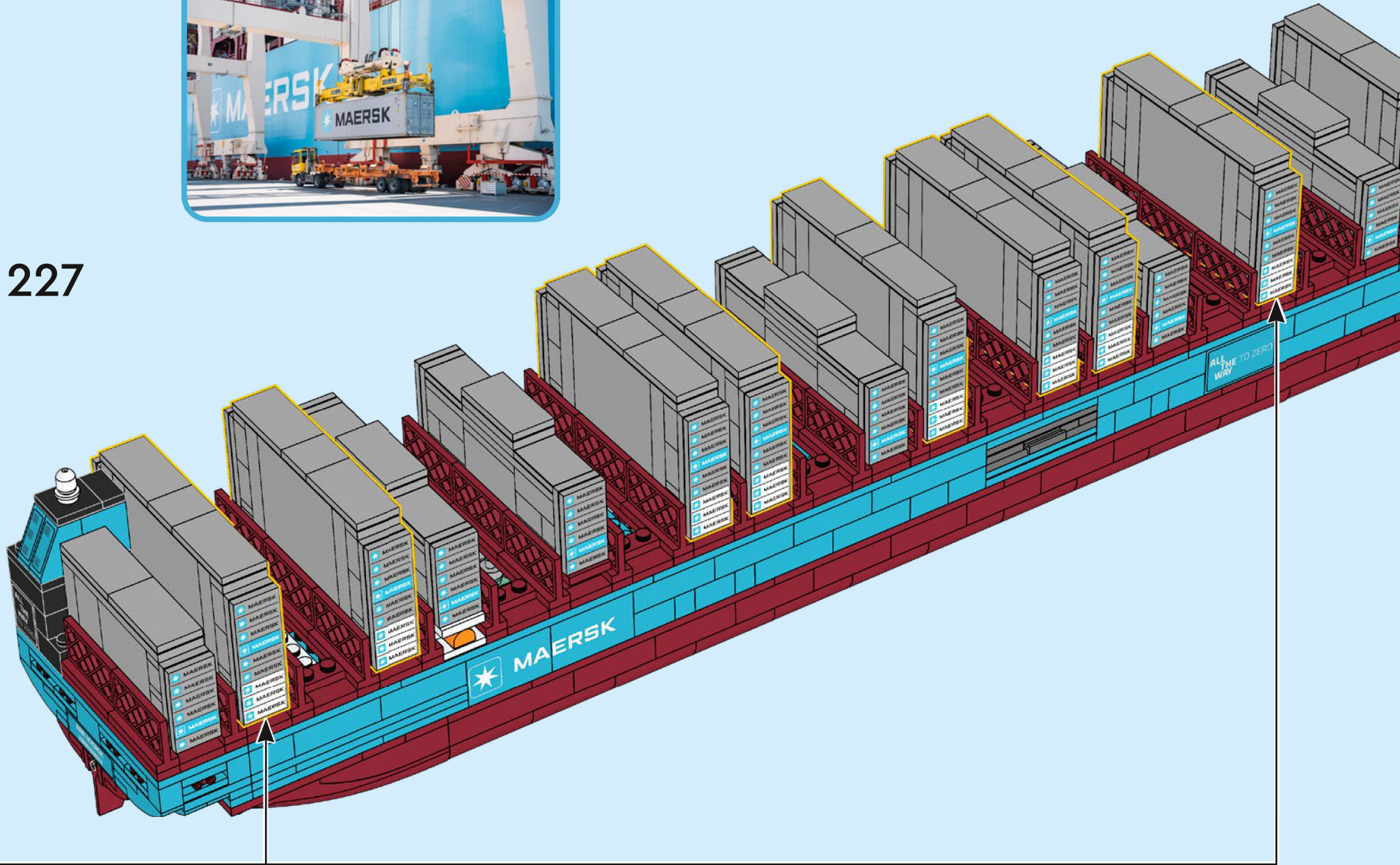





228

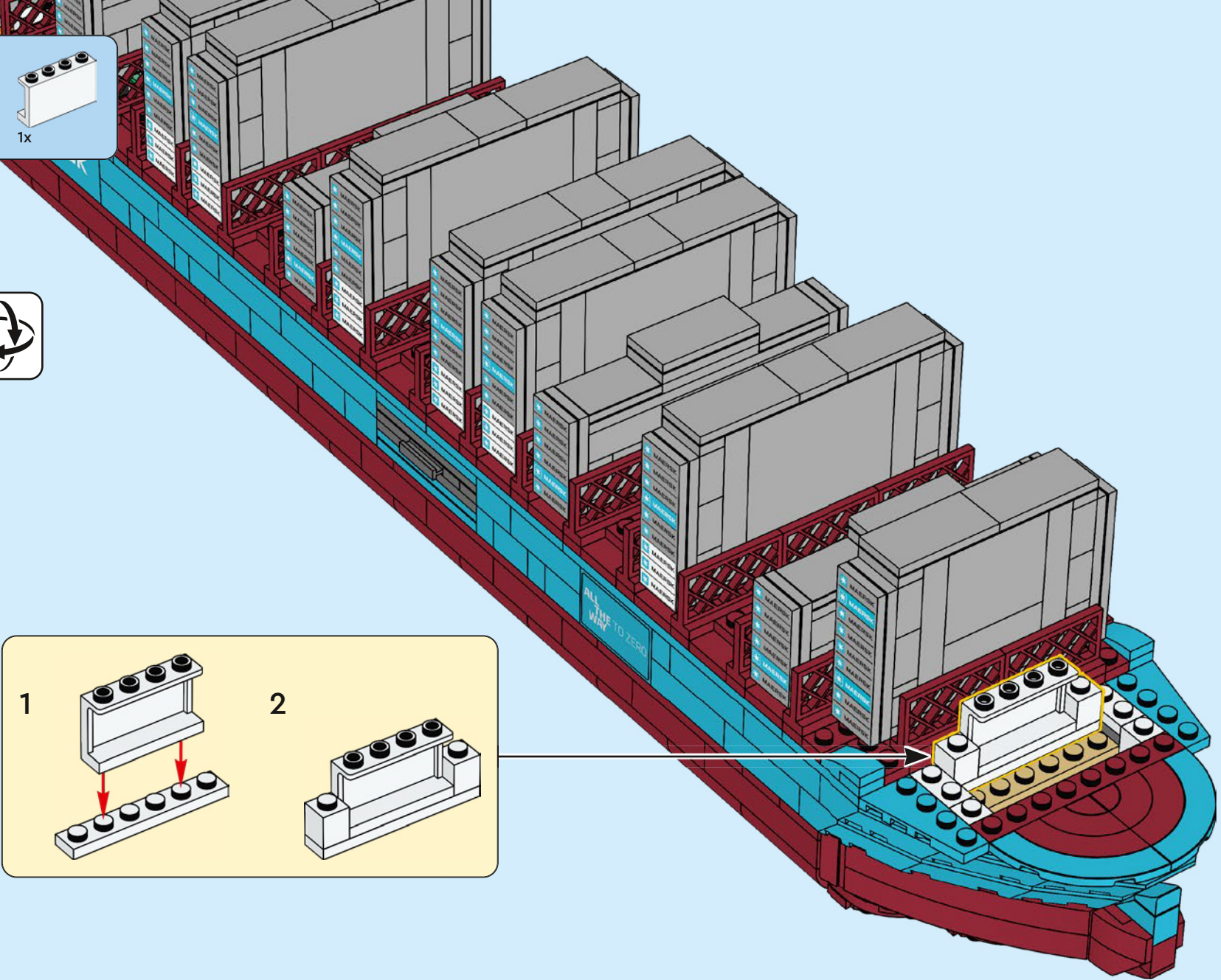
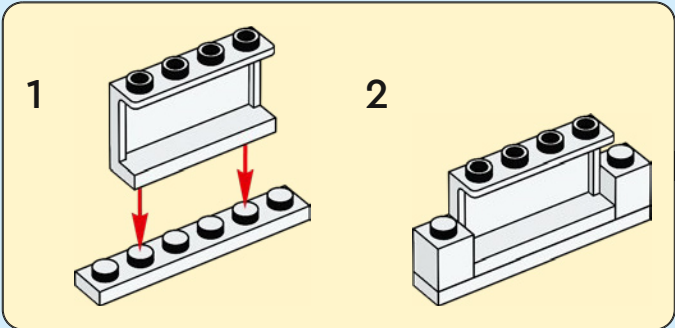

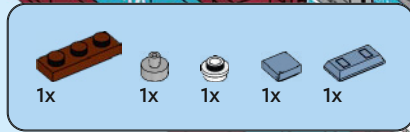

229

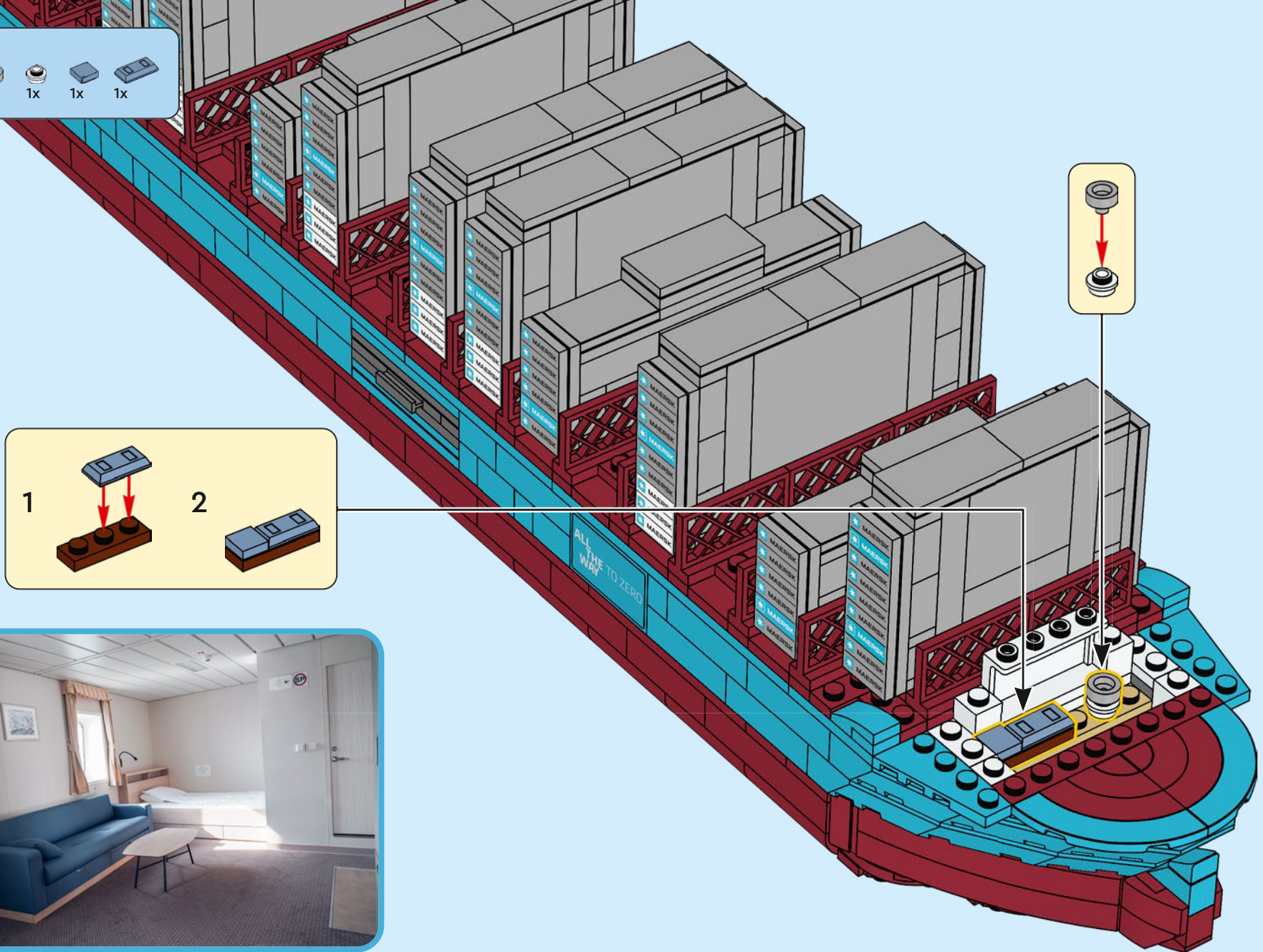
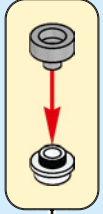
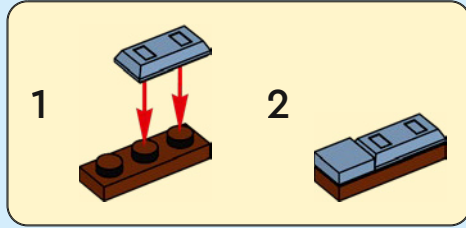



4x

230

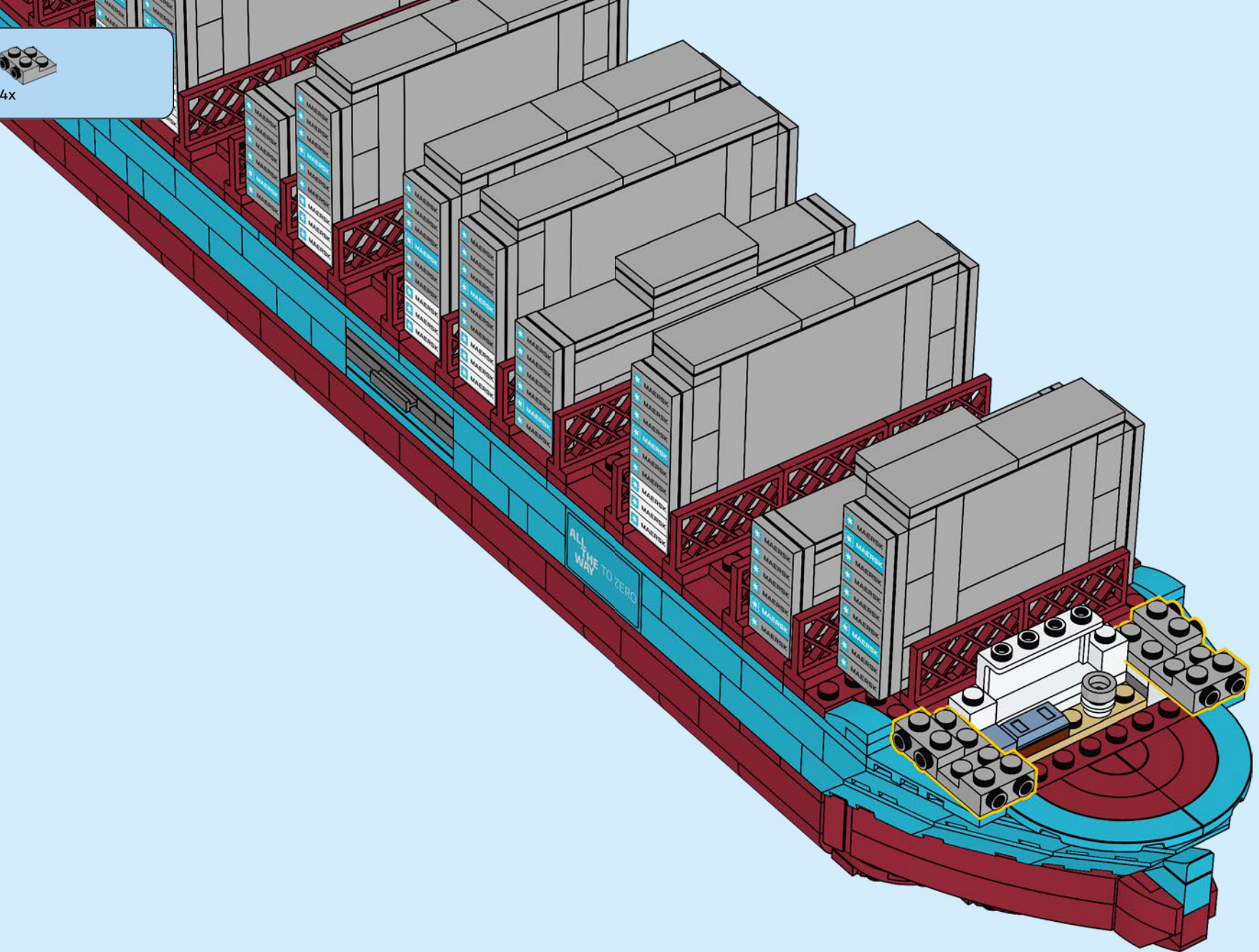

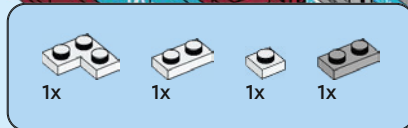

231

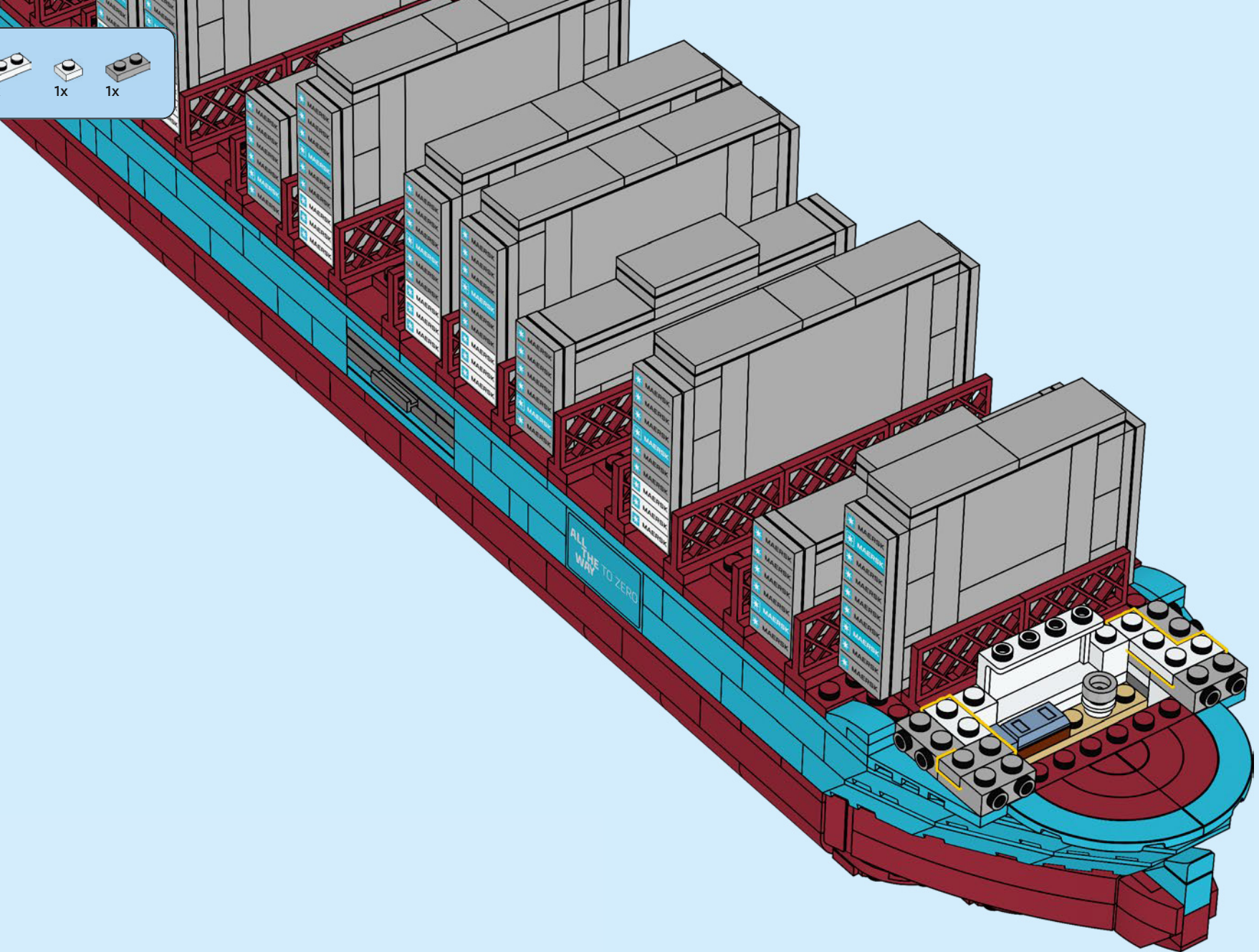

1x 1x 1x 2x

232

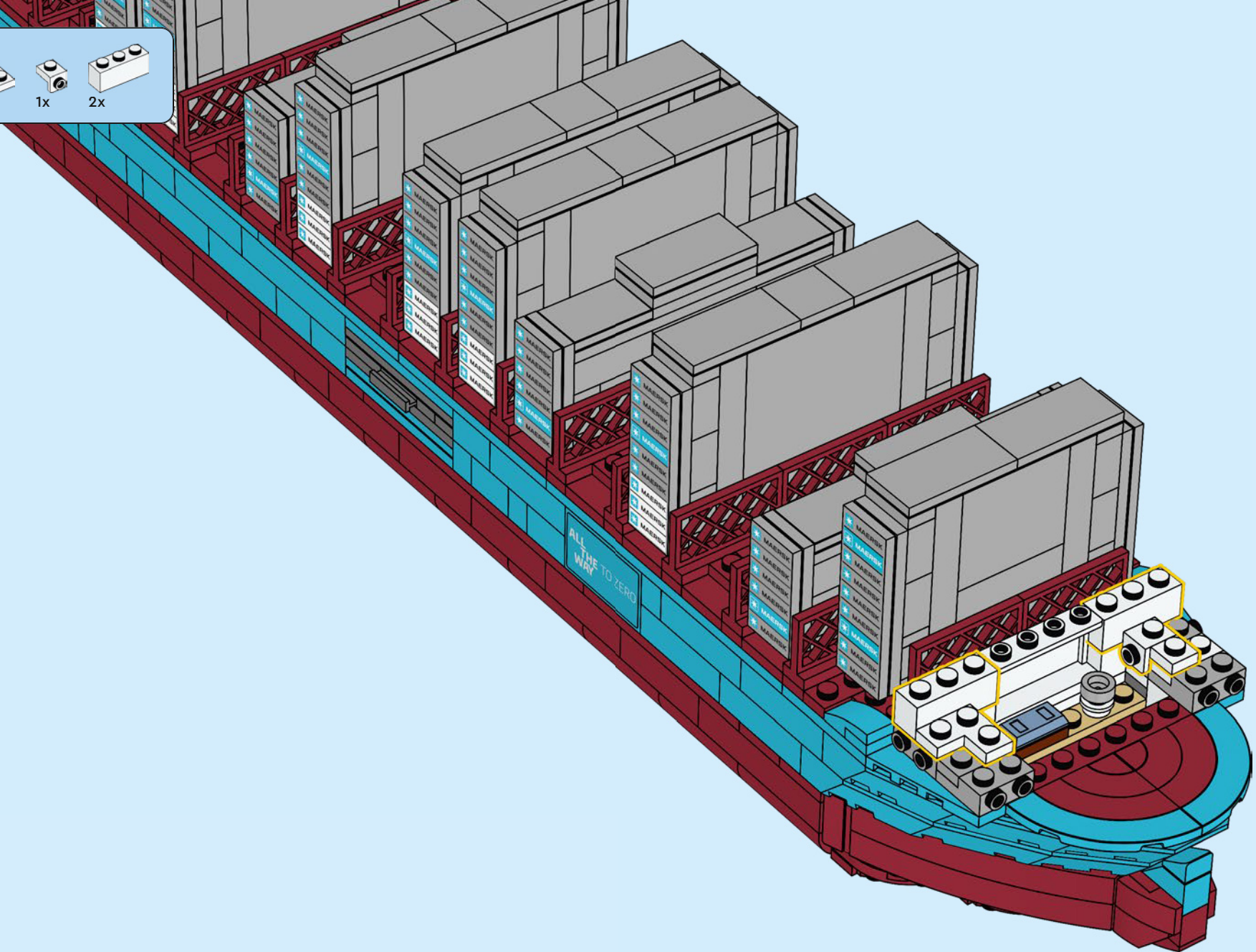

1x 1x 4x

233

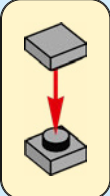
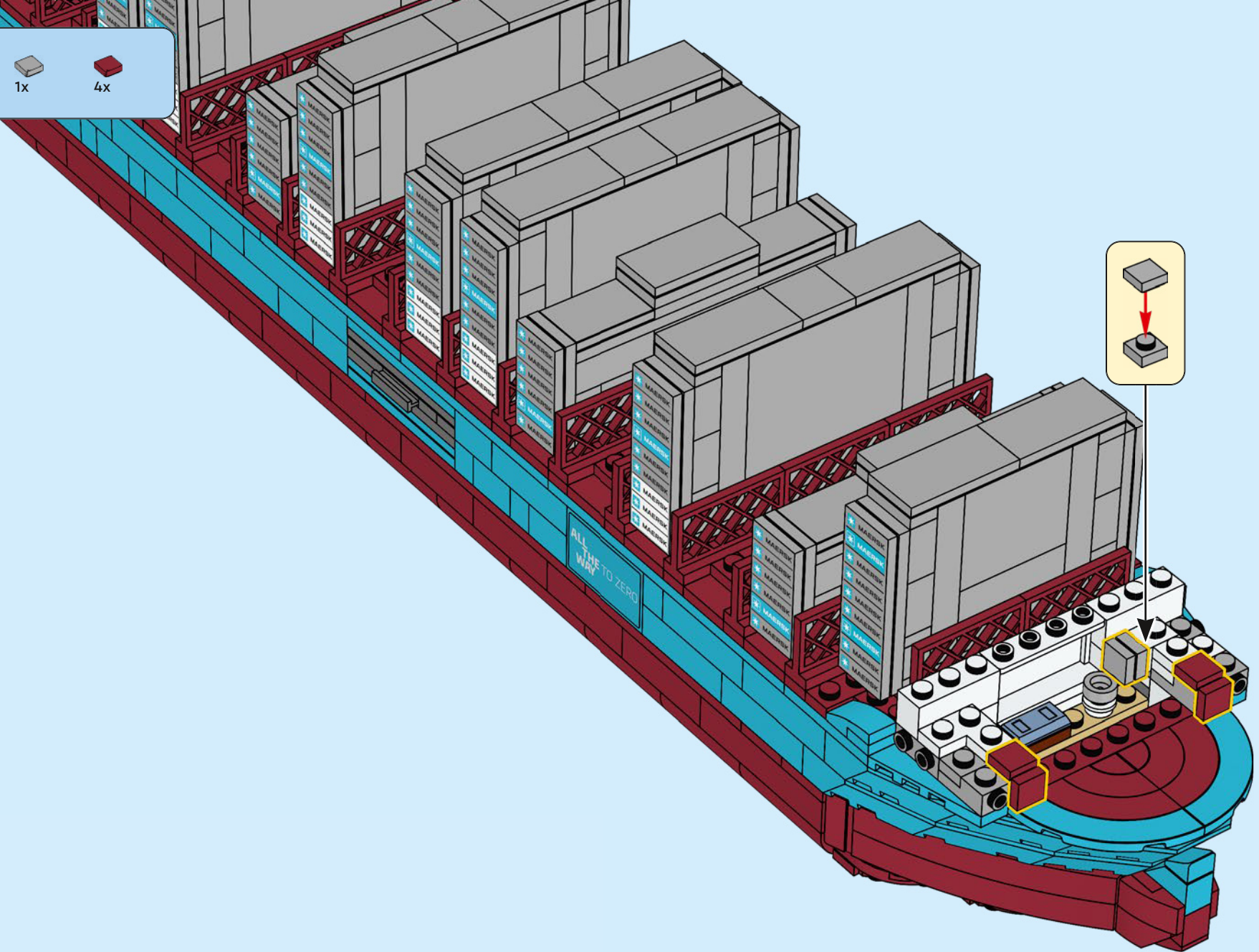

3x 2x 2x

234

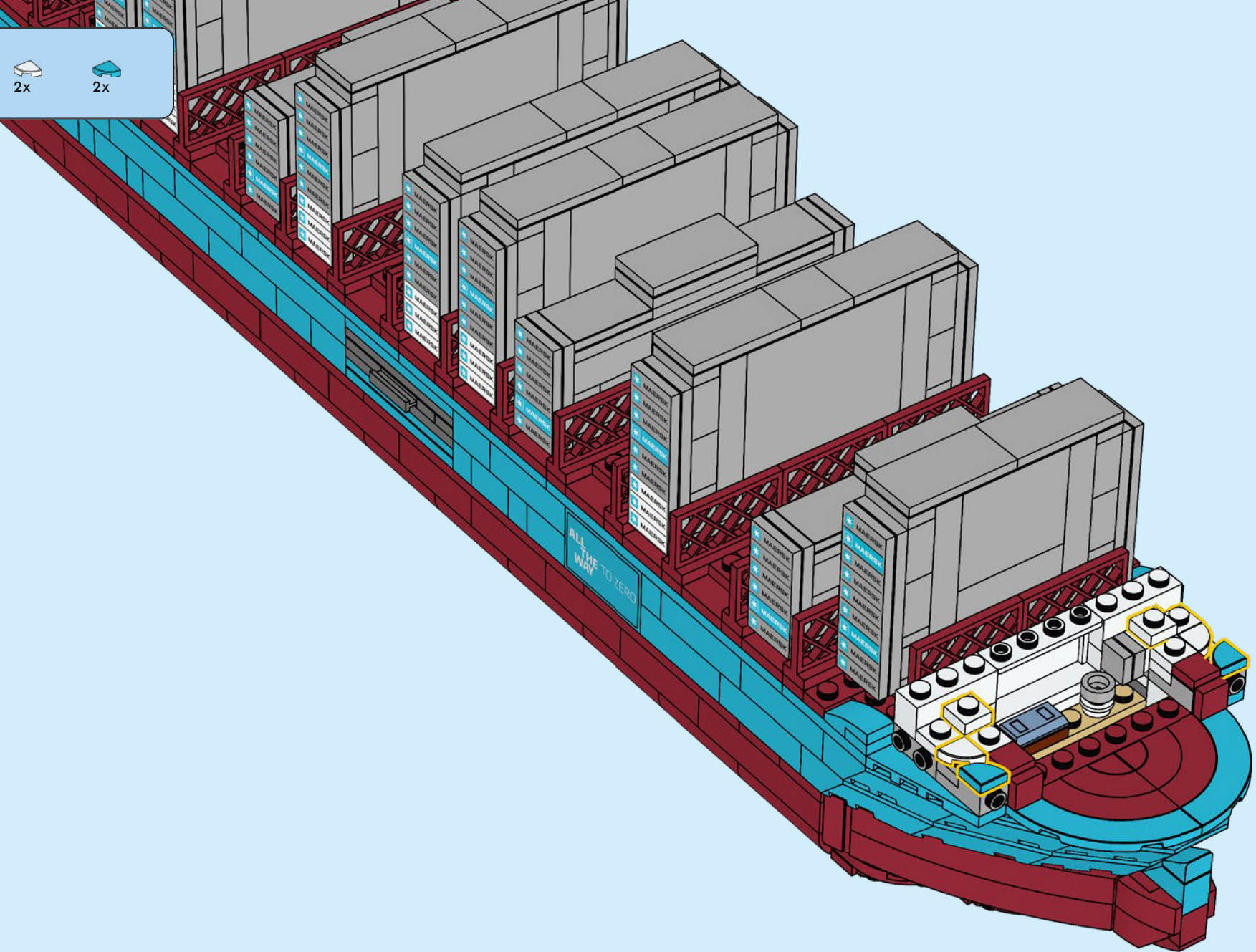

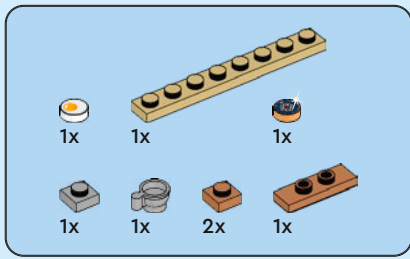

235

1

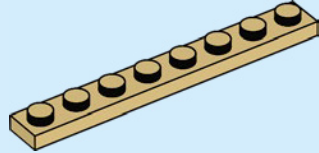

2

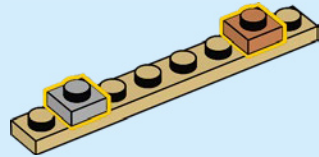

3

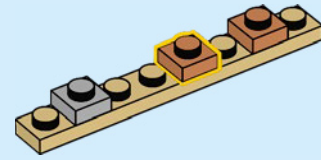

4

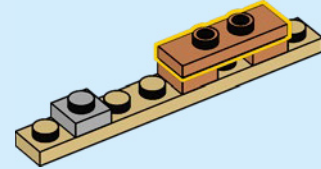

5

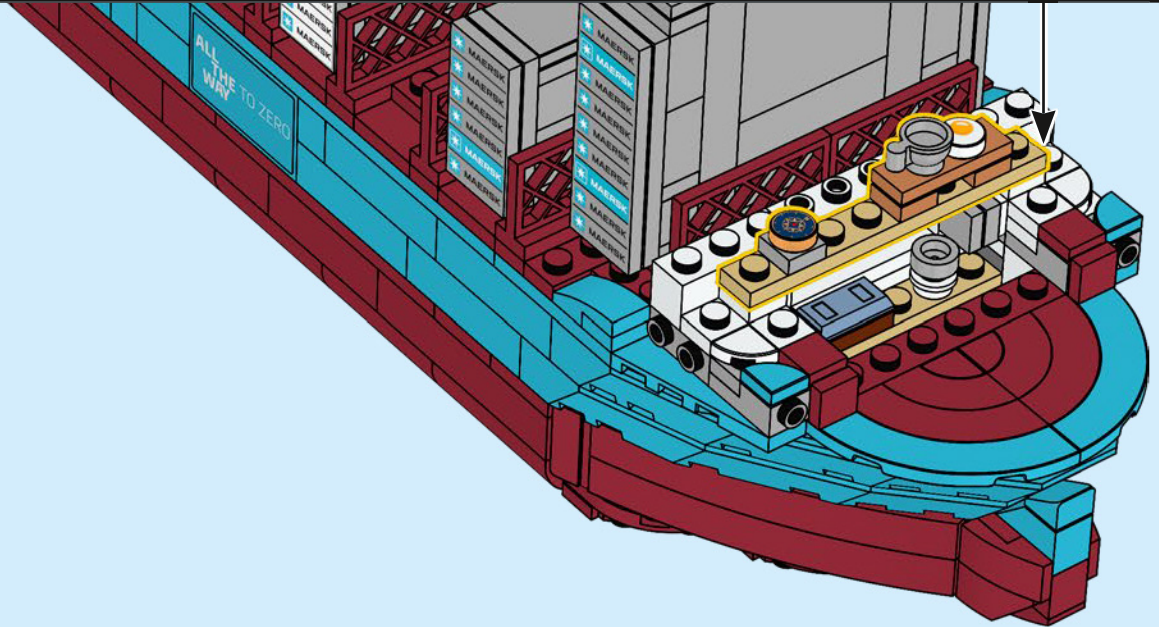
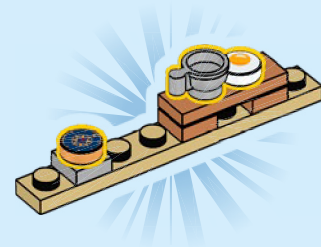

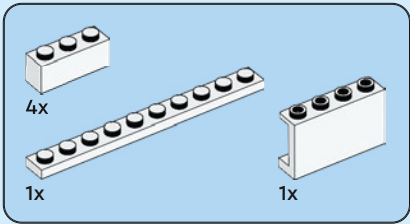

236

1

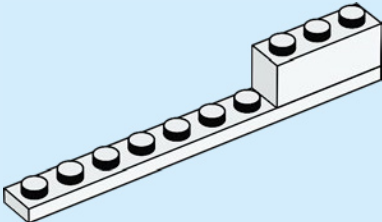

2

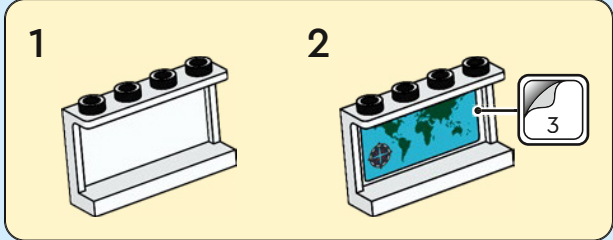
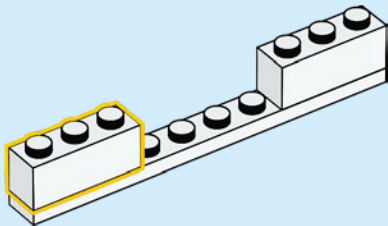

3

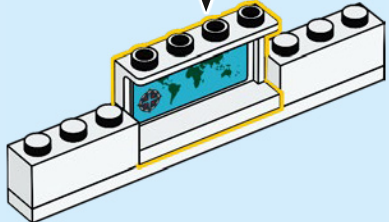

4

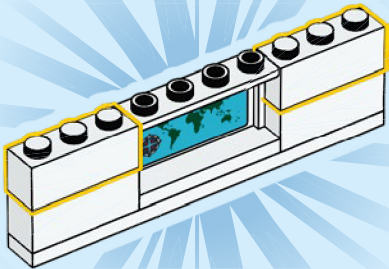

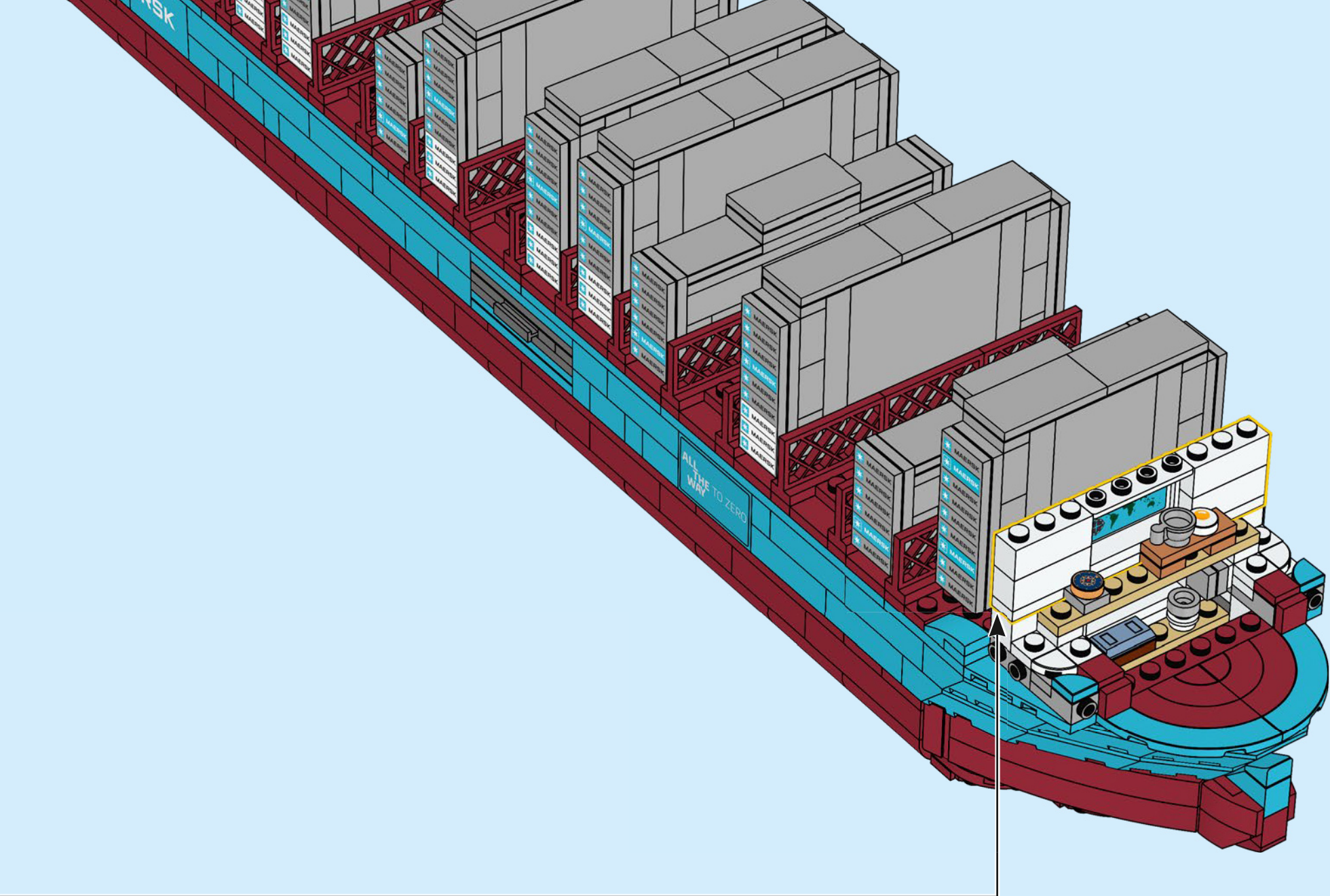

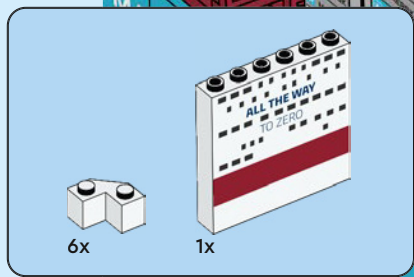

237

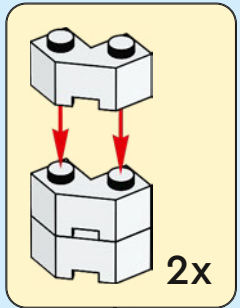
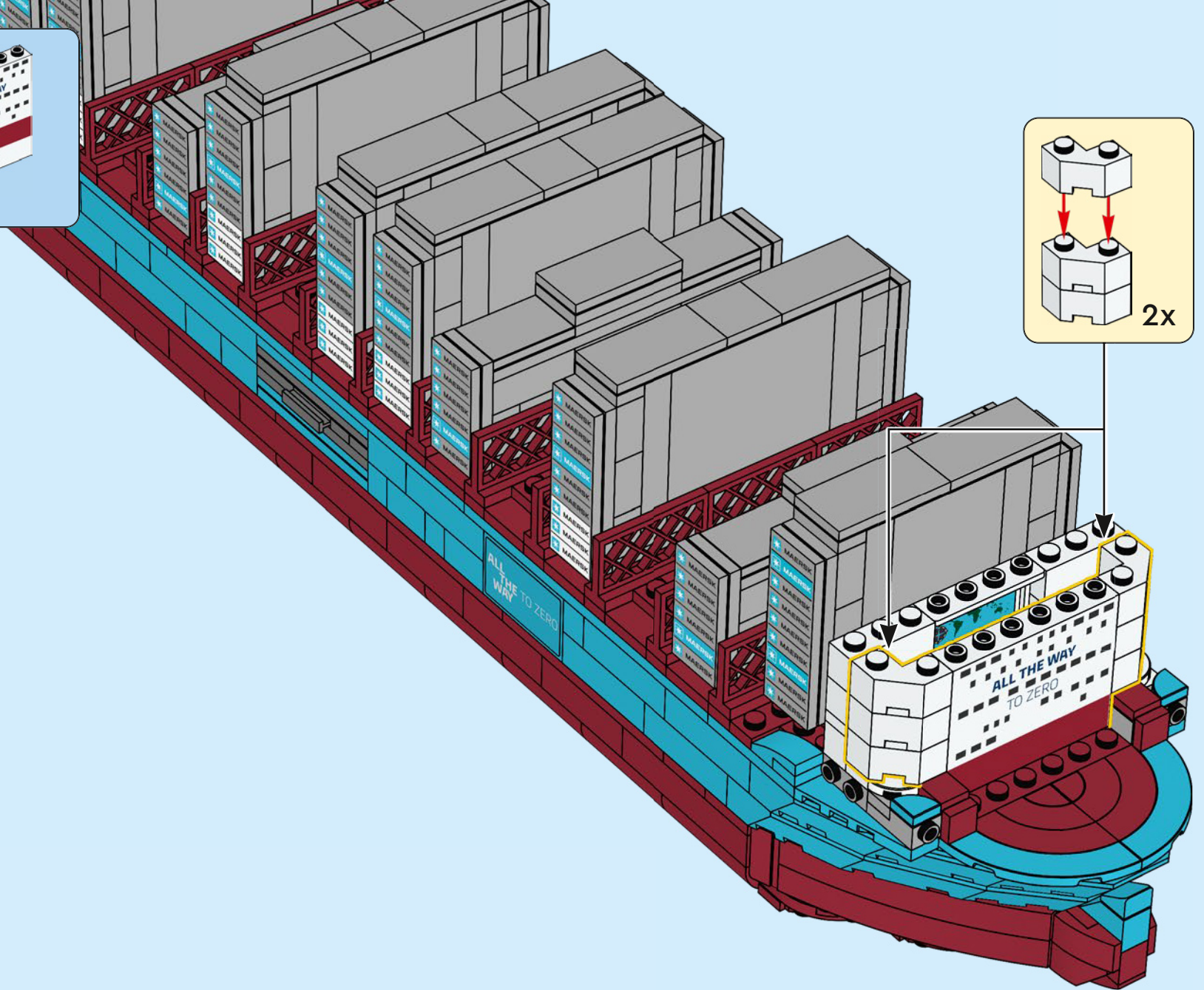



238

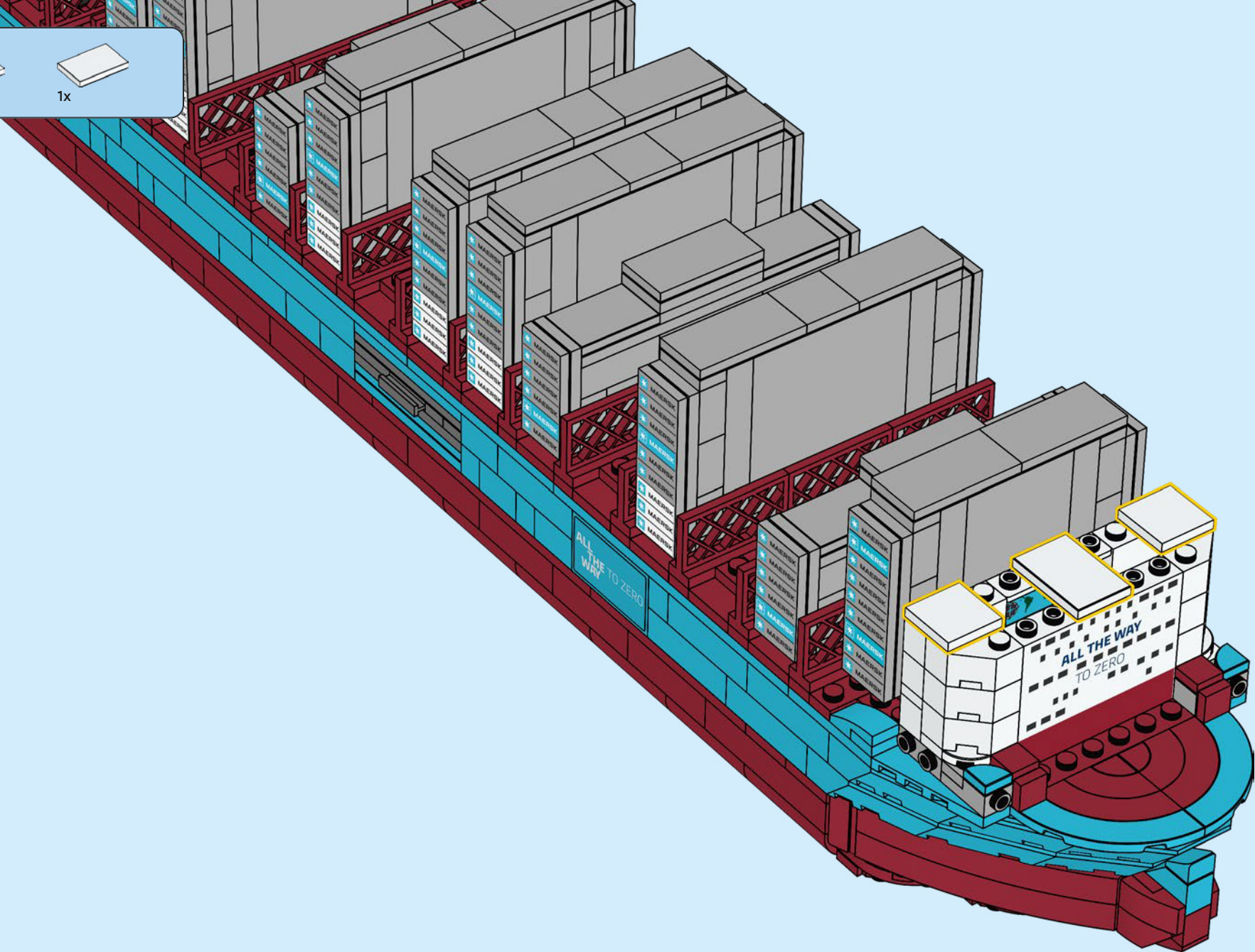

2x 1x 1x

239

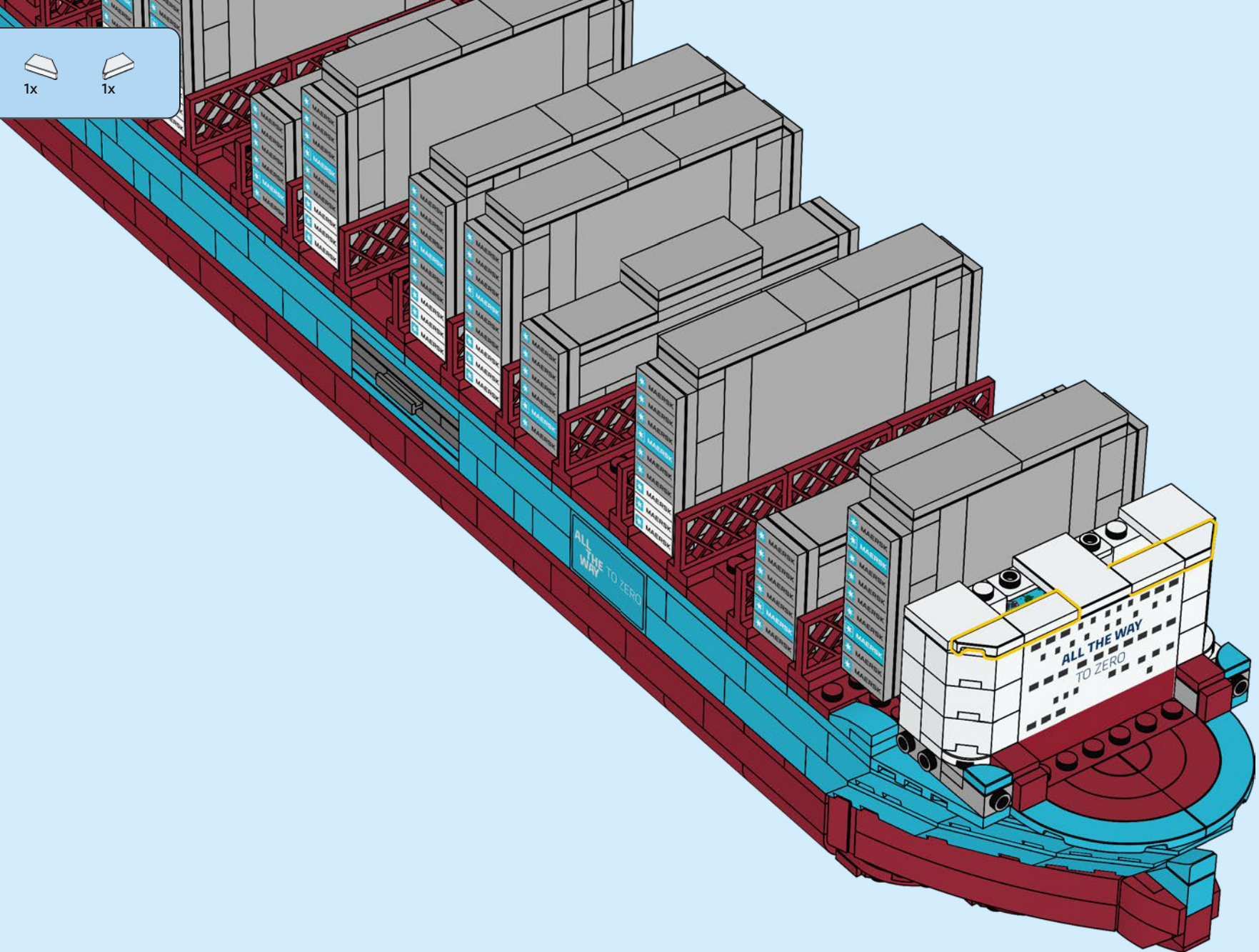

2x 2x 2x

240

1 2 2x

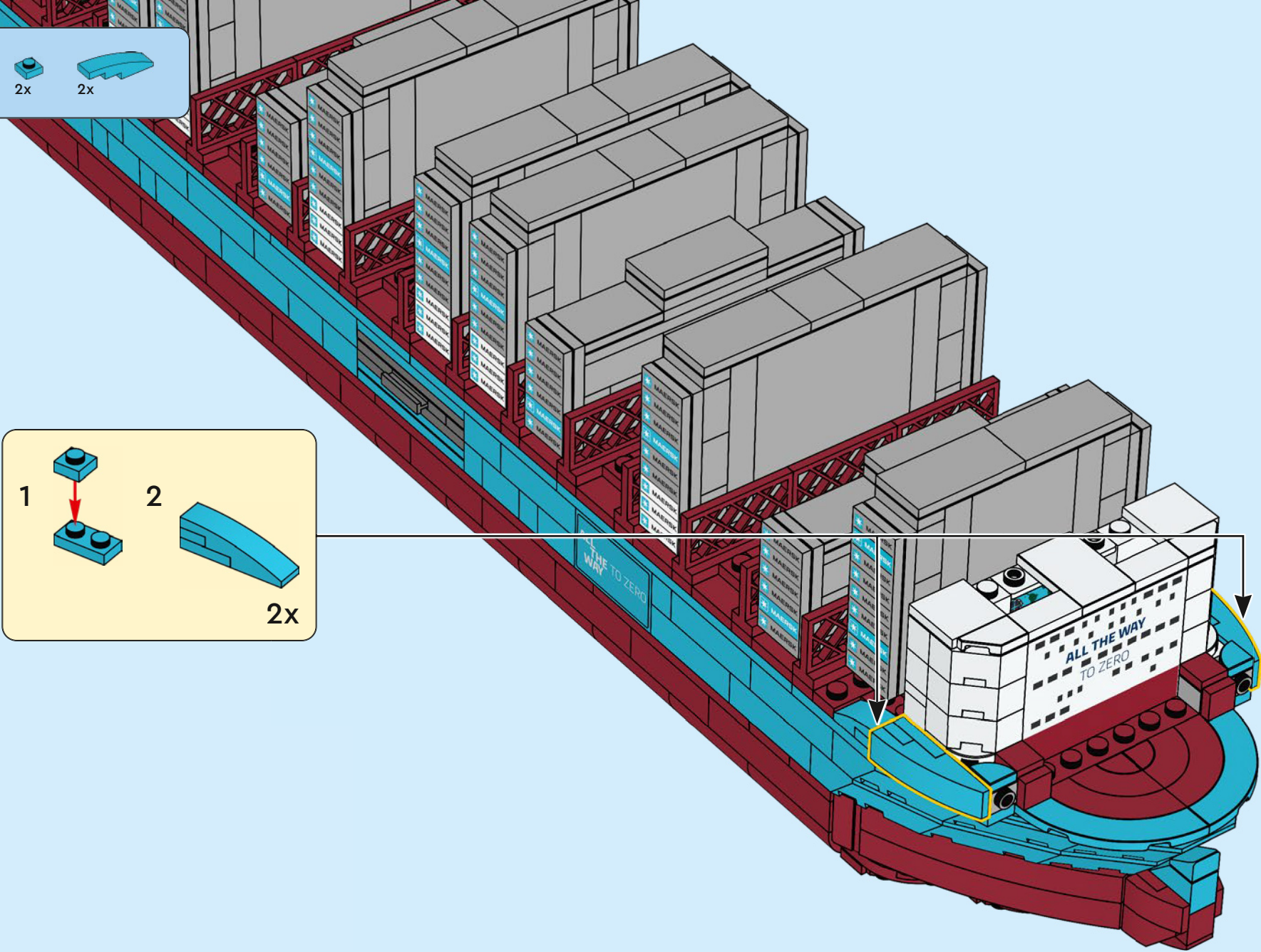

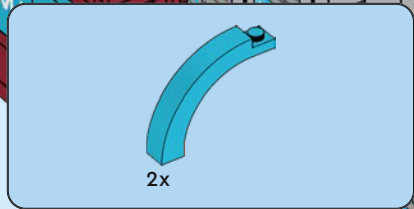

241

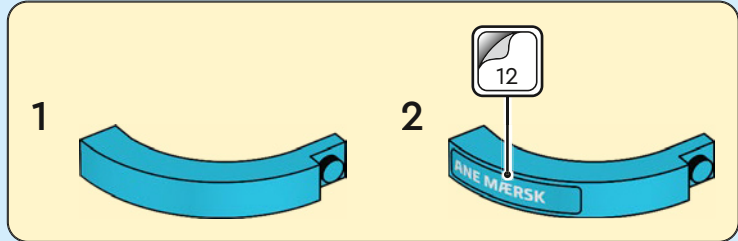
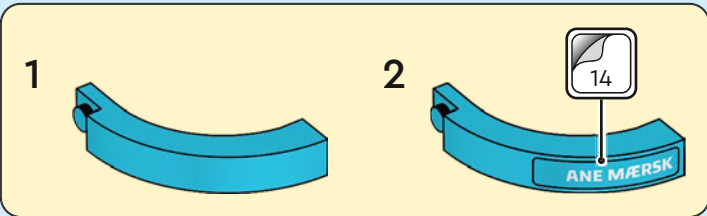

1x

242

1

2

13

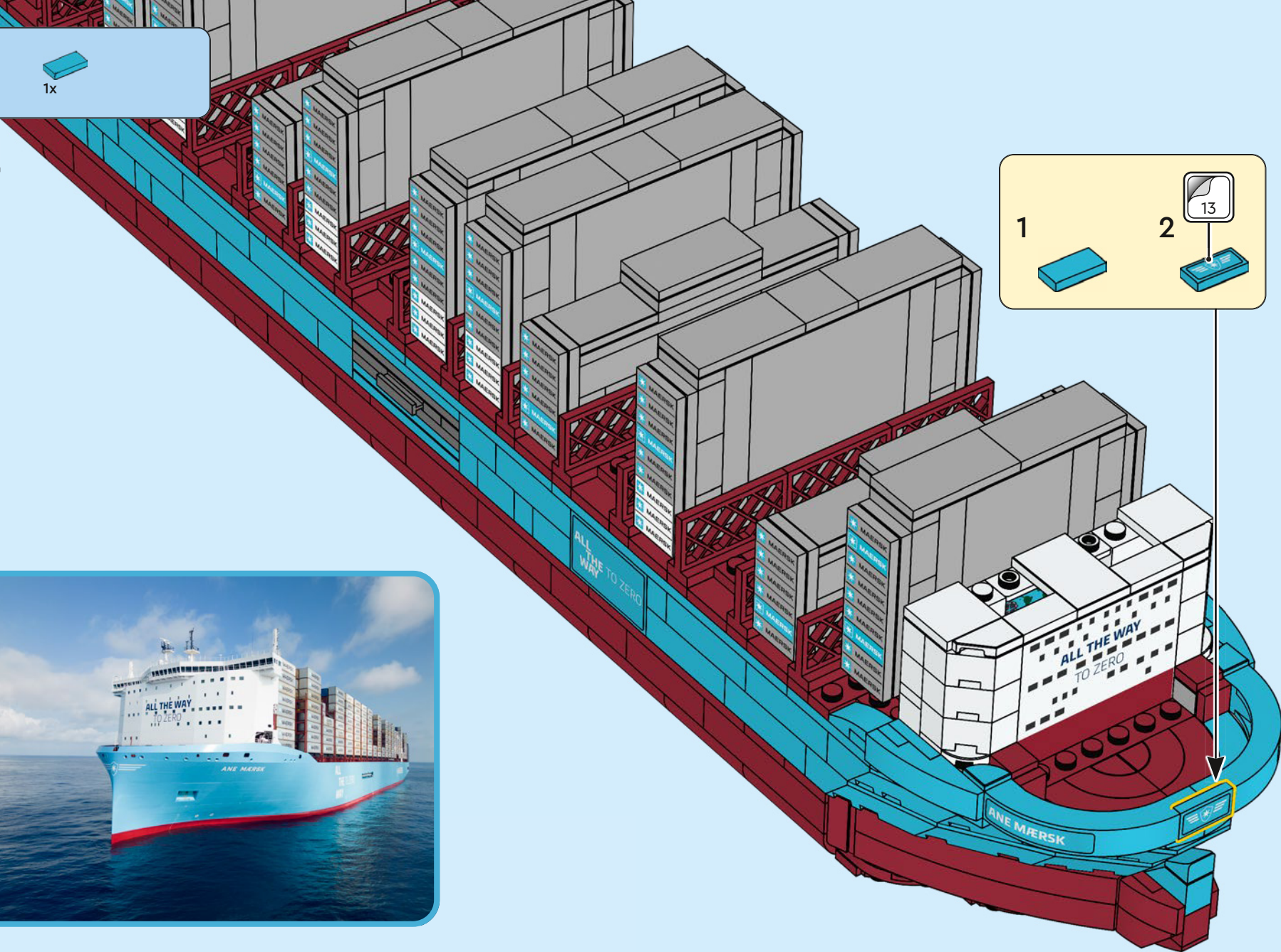

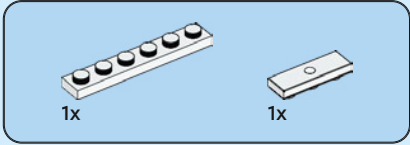
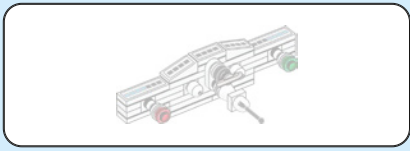

243

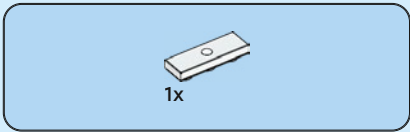
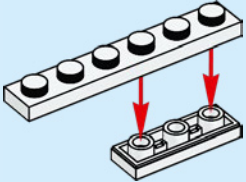

244

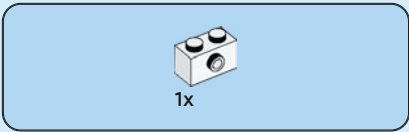
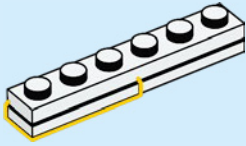

245

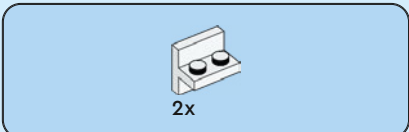
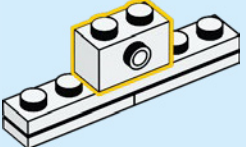

246

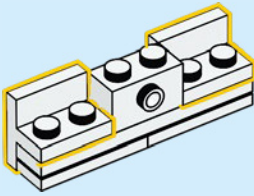



2x

247

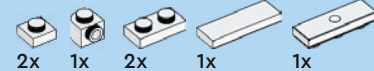
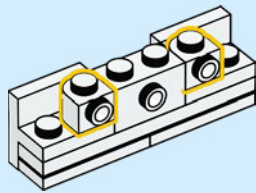

248

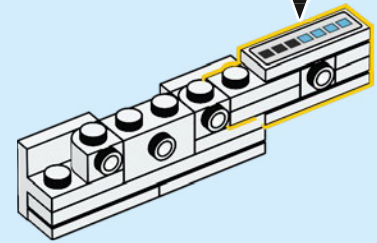
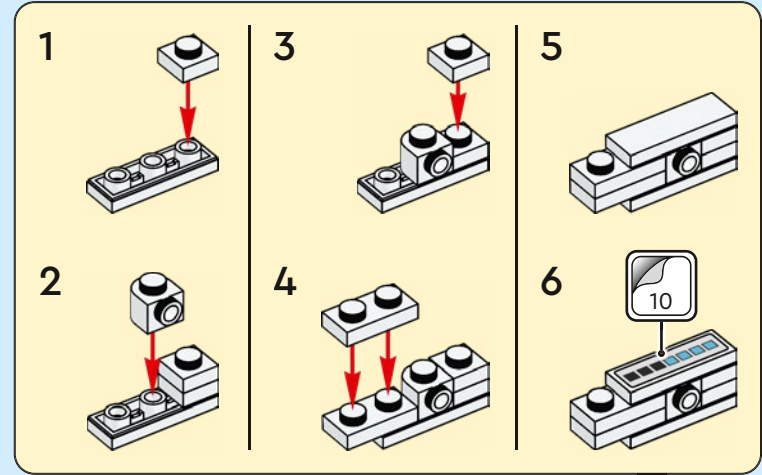

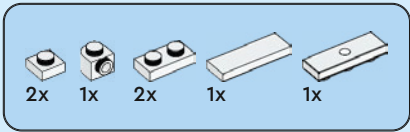

249

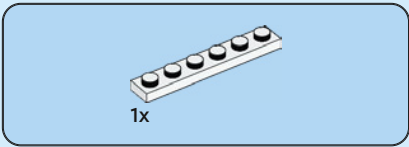
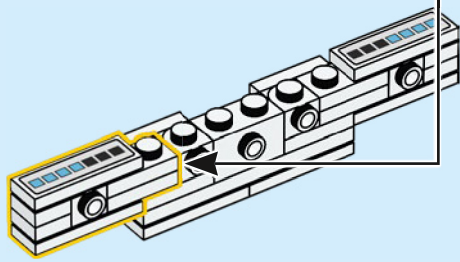
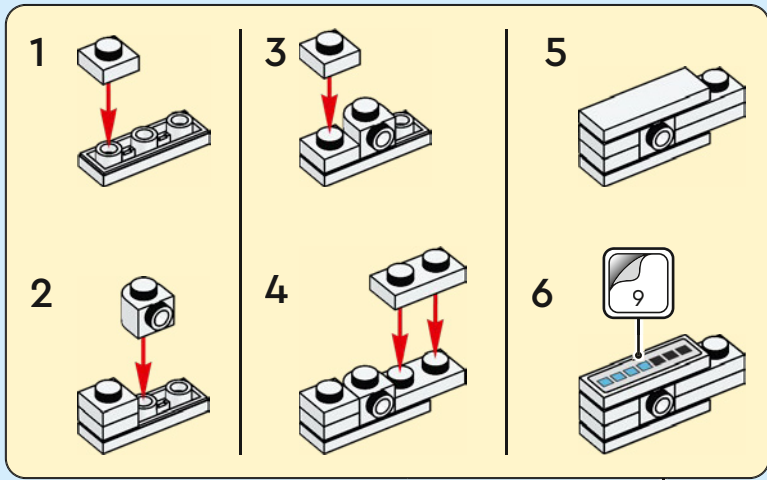

250

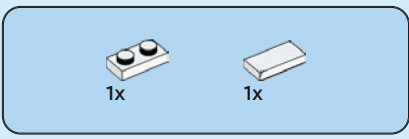
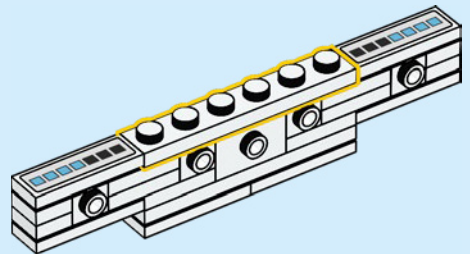

251

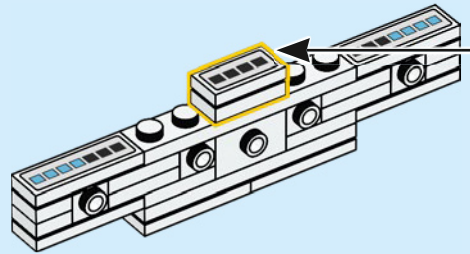
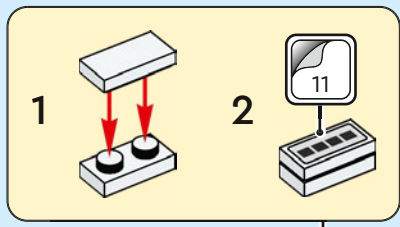

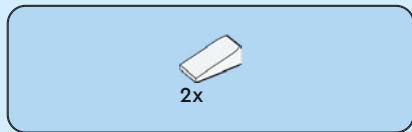

252

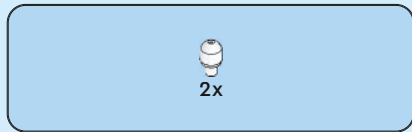
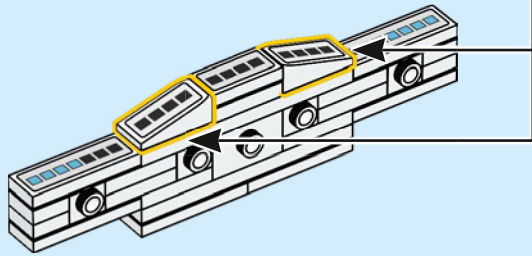
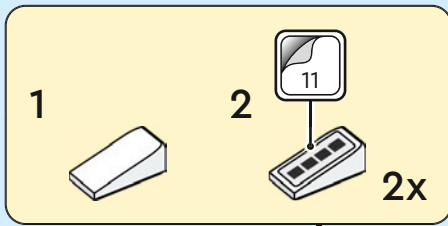

253

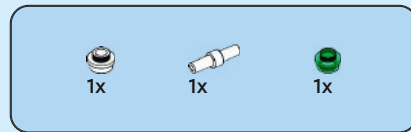
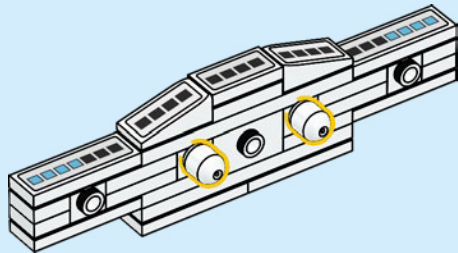

254

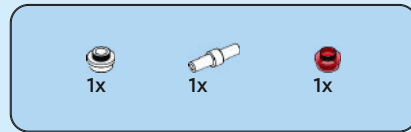
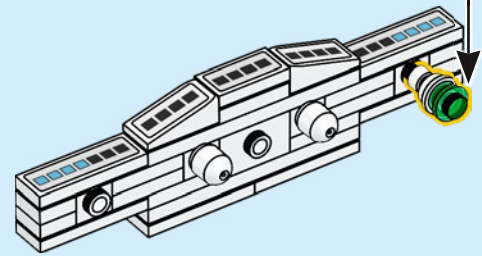
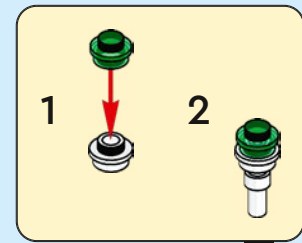

255

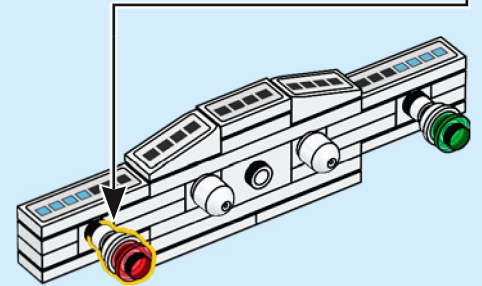
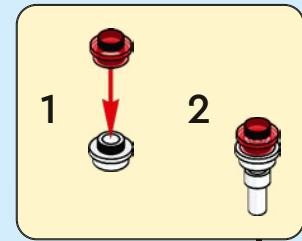

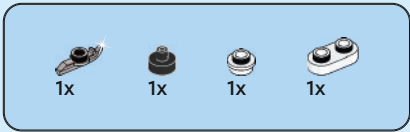

256

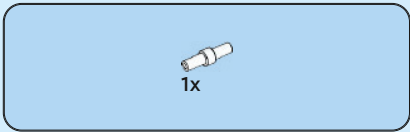
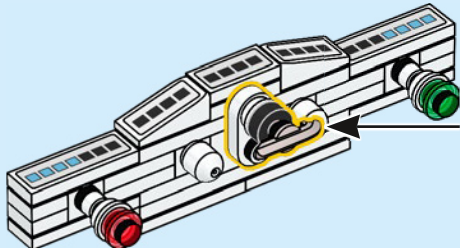
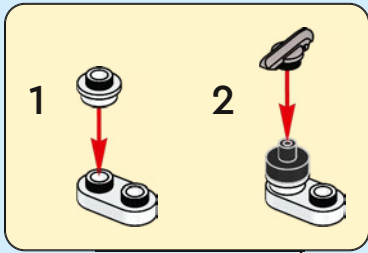

257

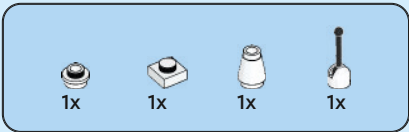
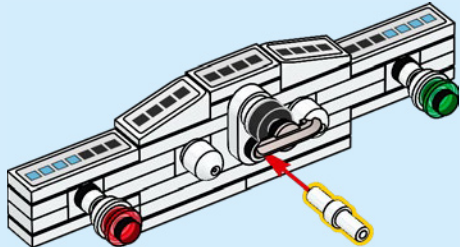

258

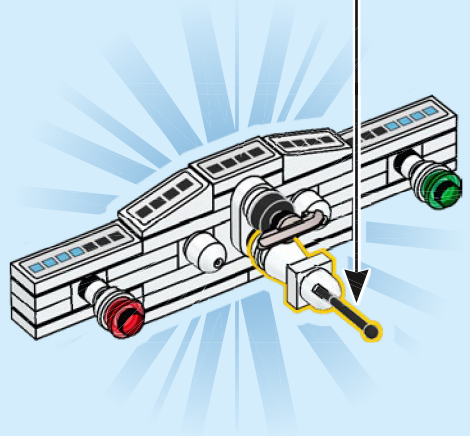
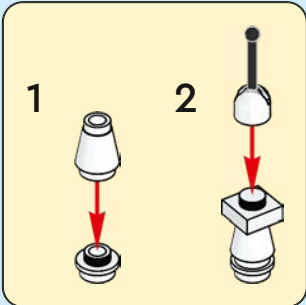

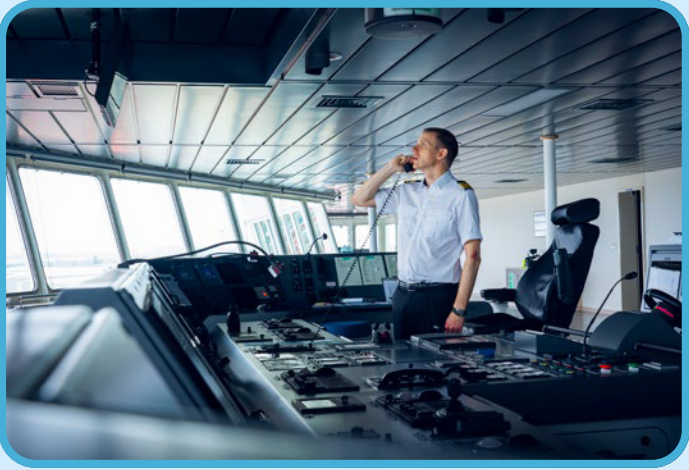
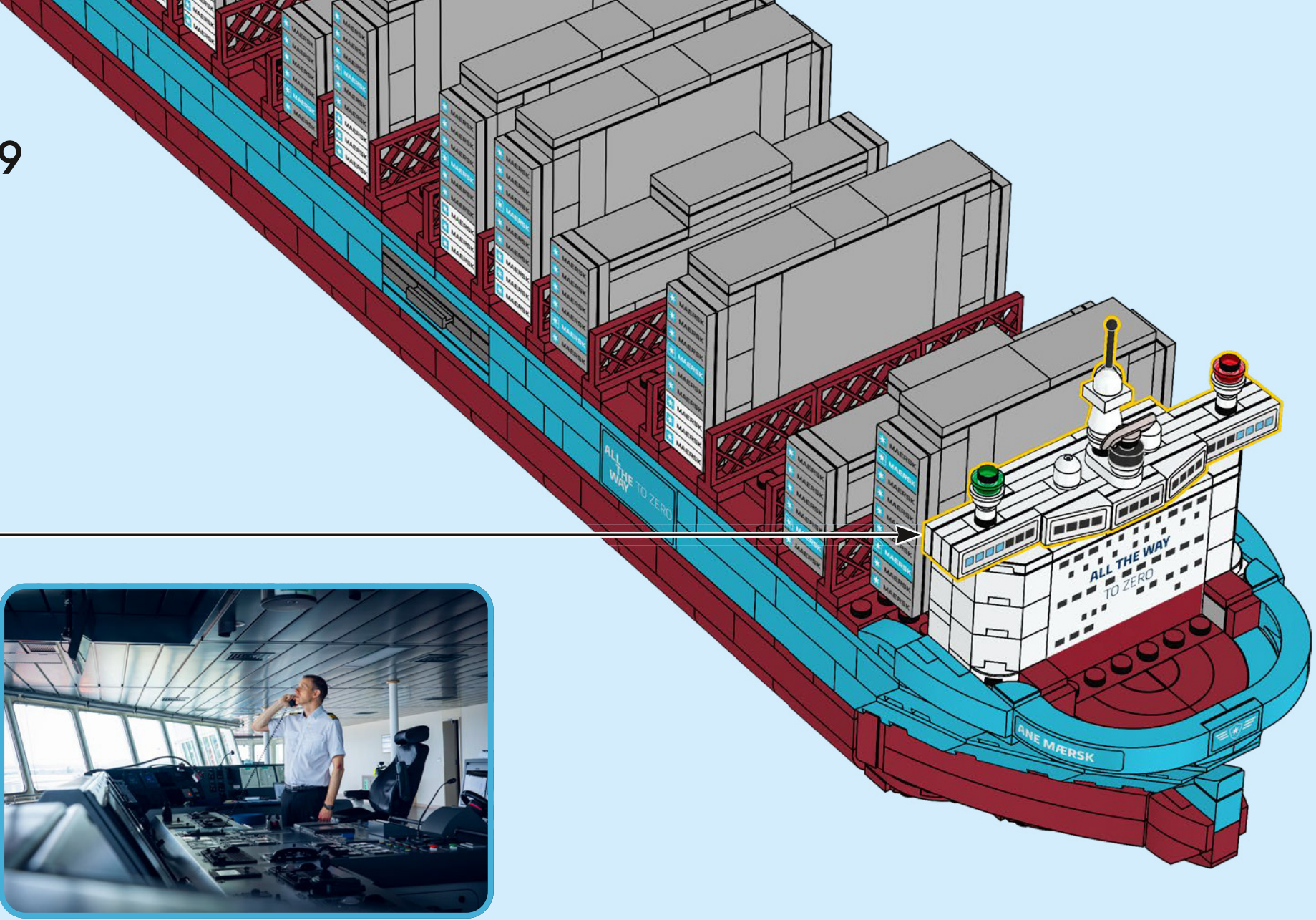

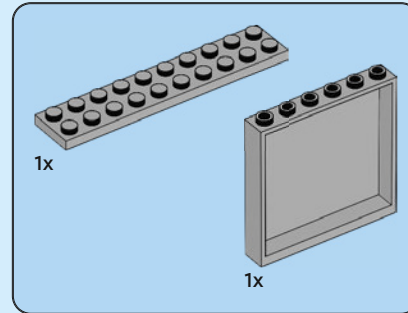
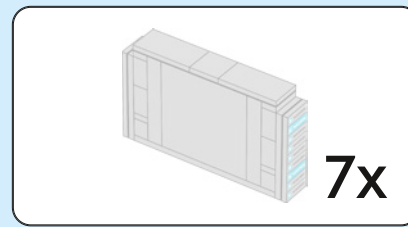

260

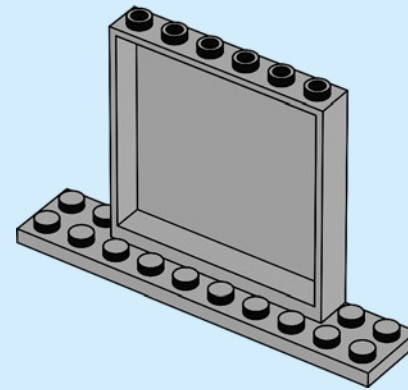

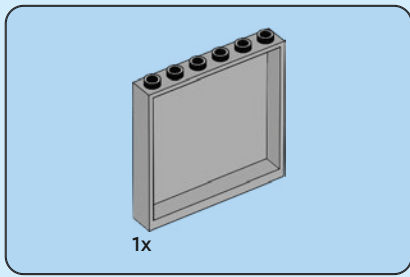

261

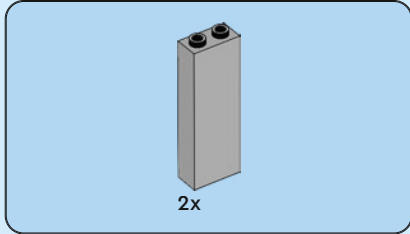
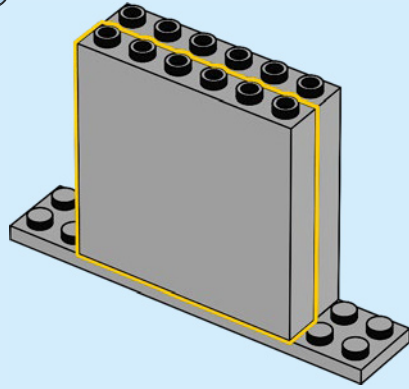

262

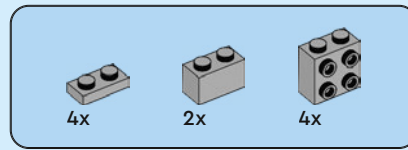
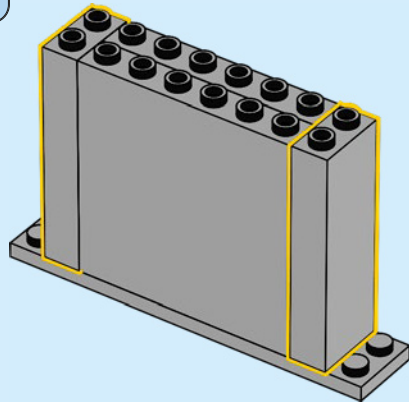

263

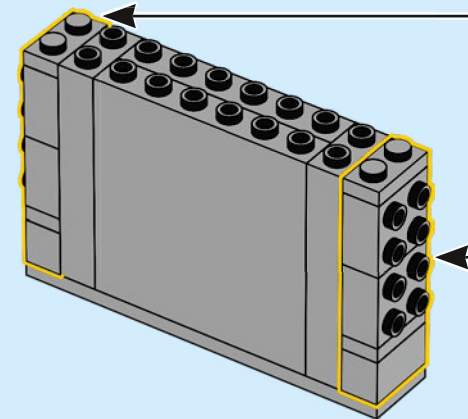
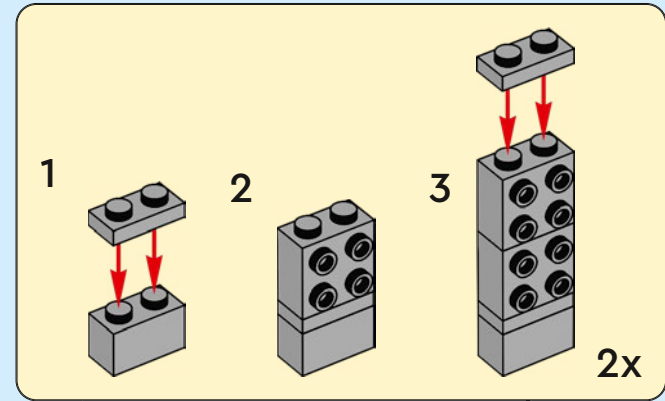

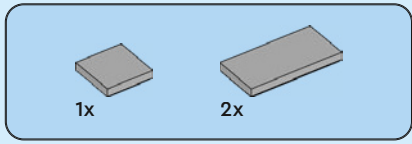

264

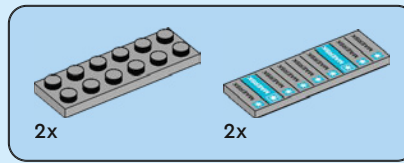
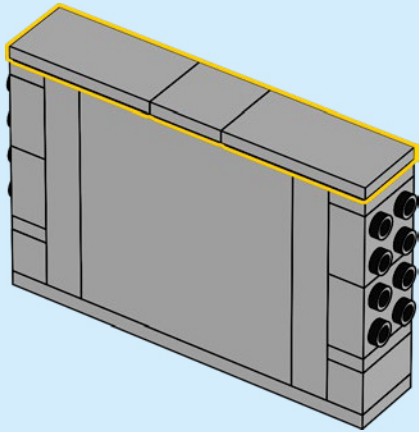

265

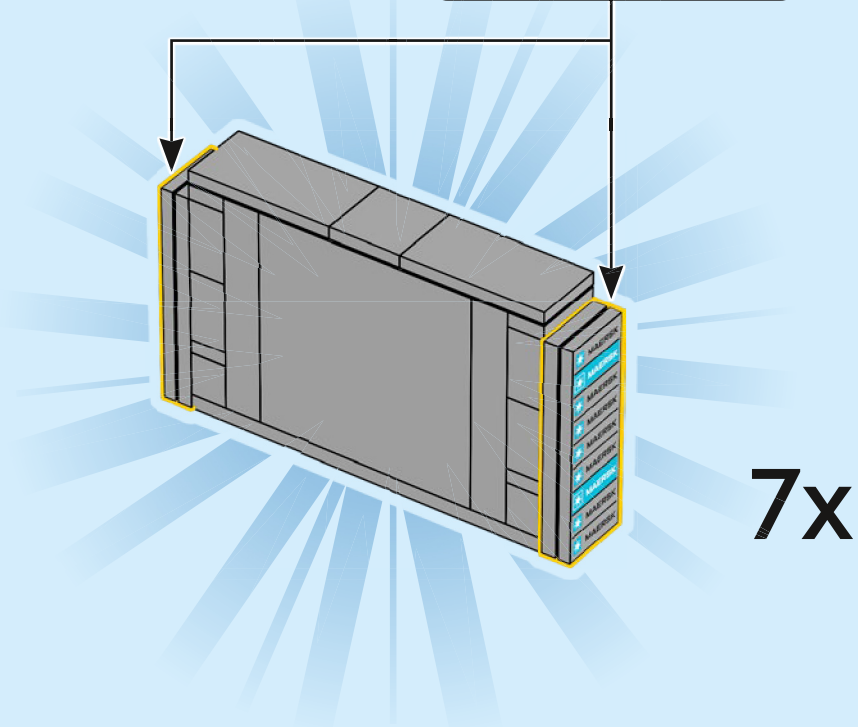
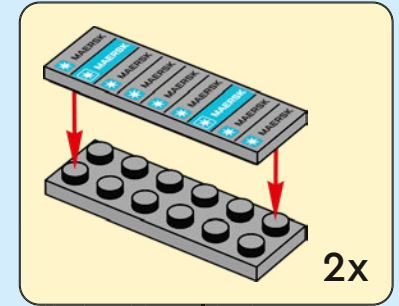

266

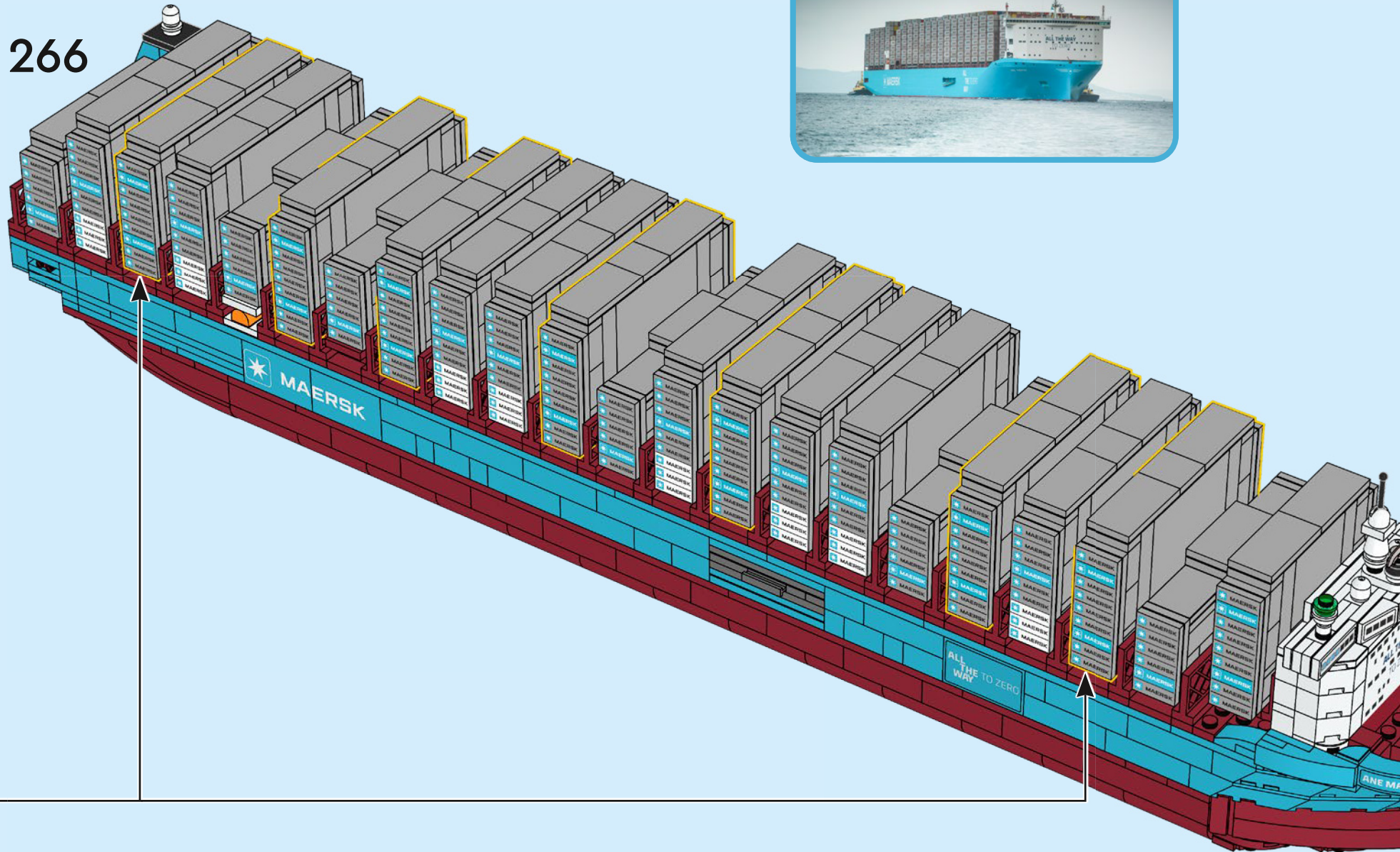

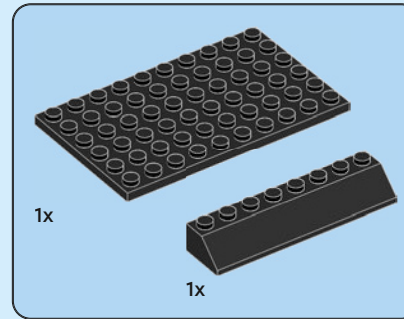
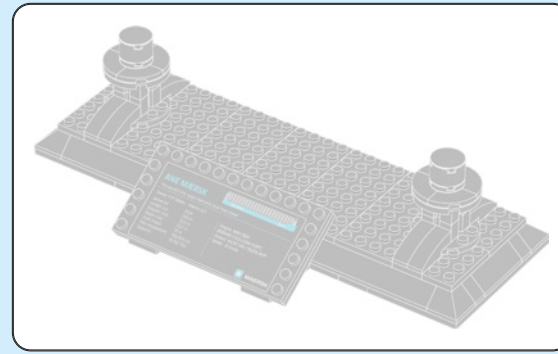

267

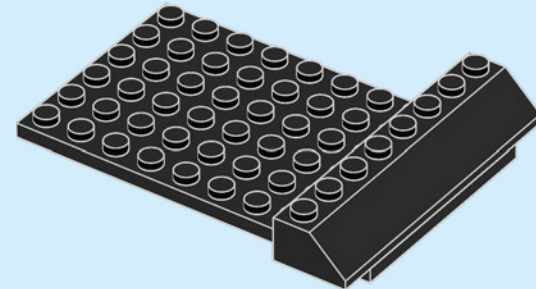

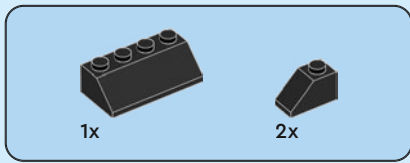

268

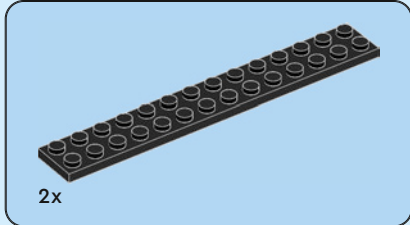
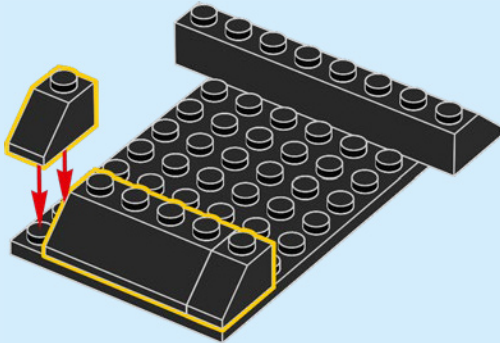

269

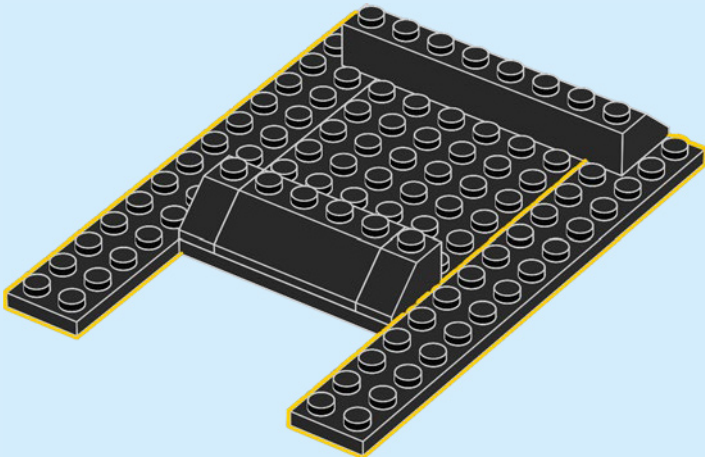

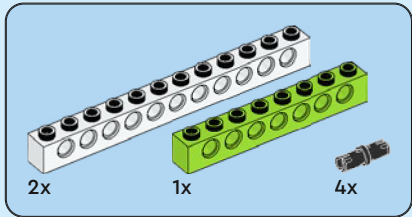
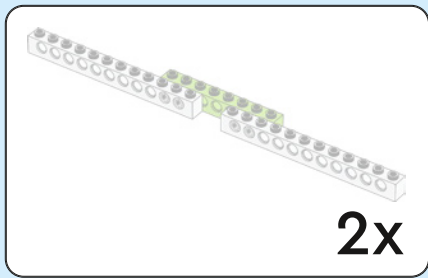

270

1

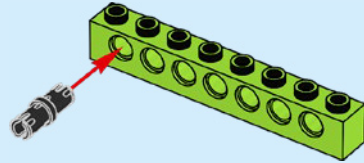

2

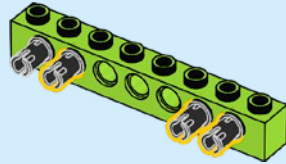

3

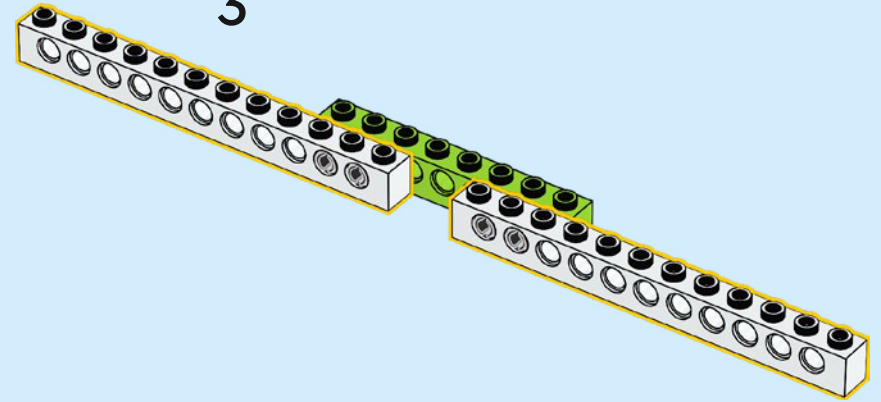

2x

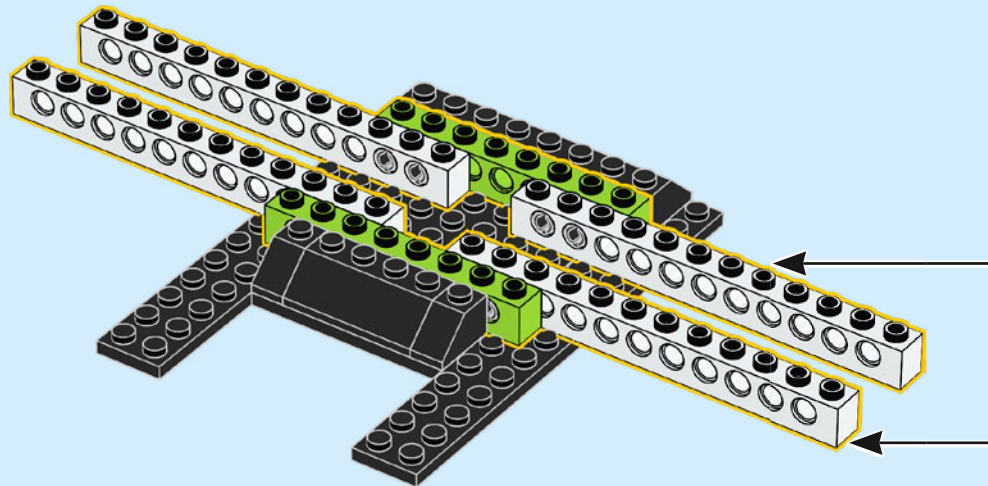

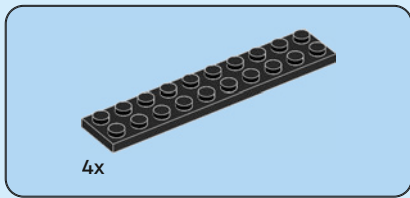

271

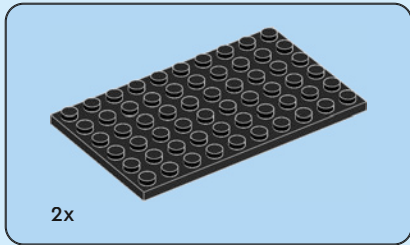
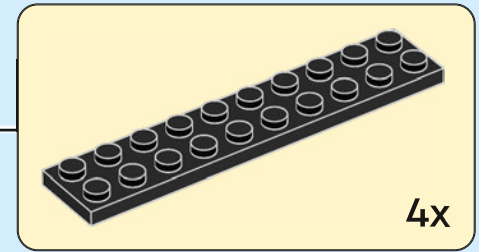
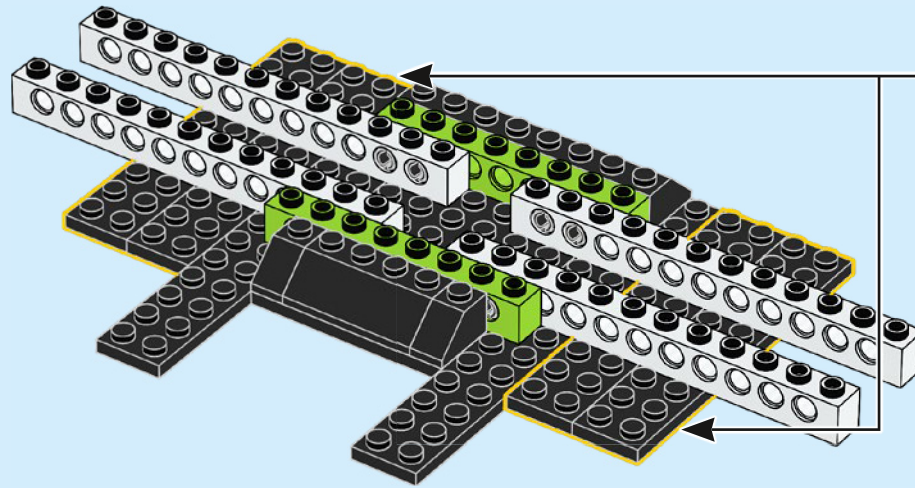

272

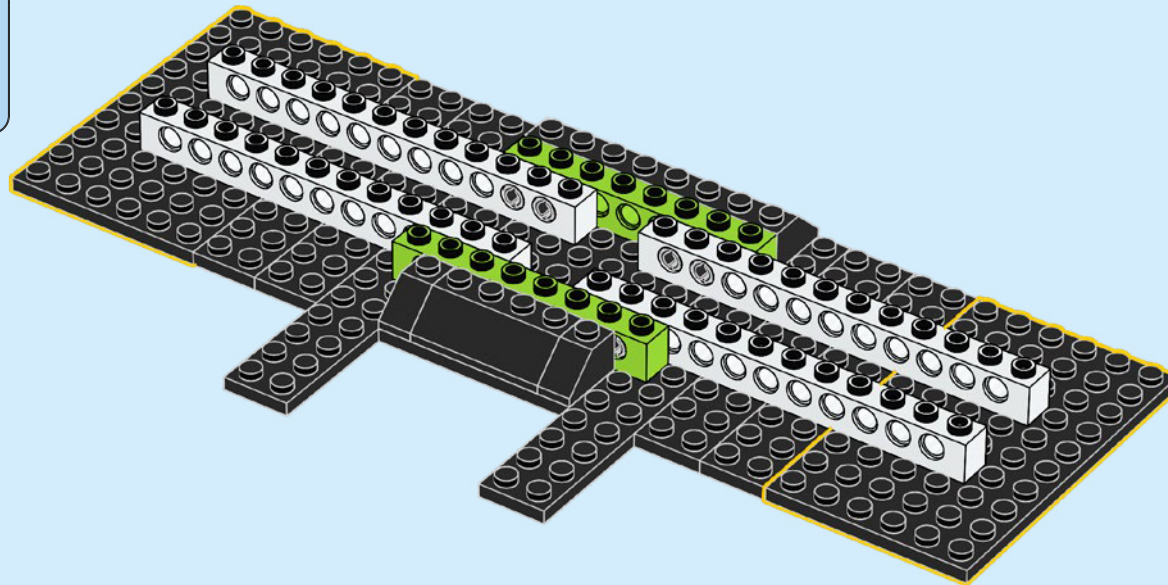

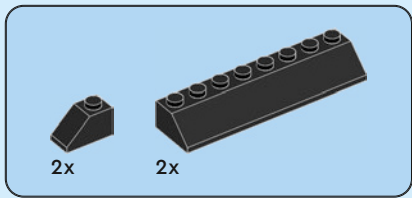

273

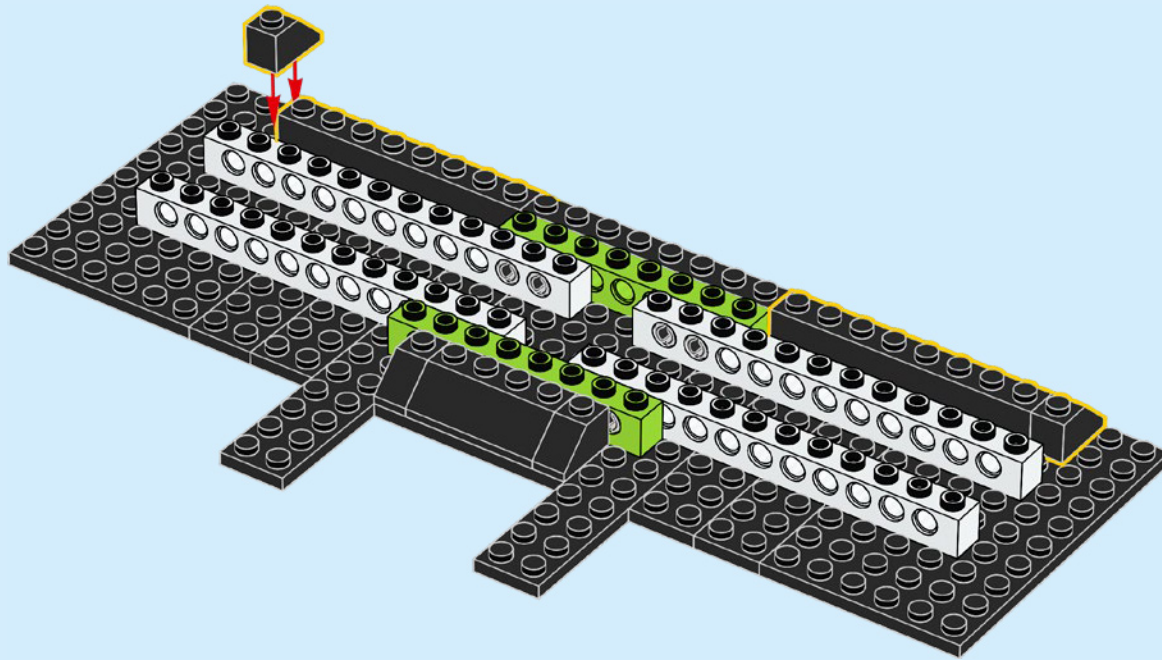

274

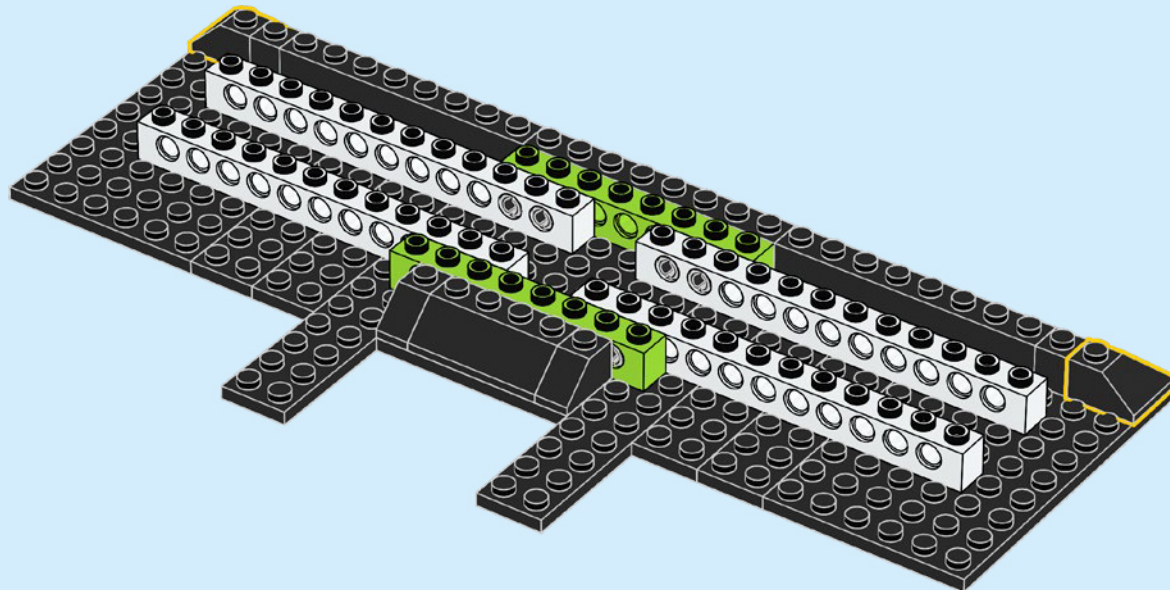

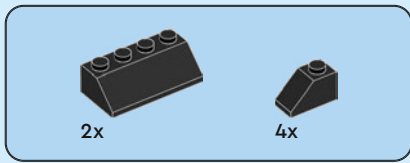

275

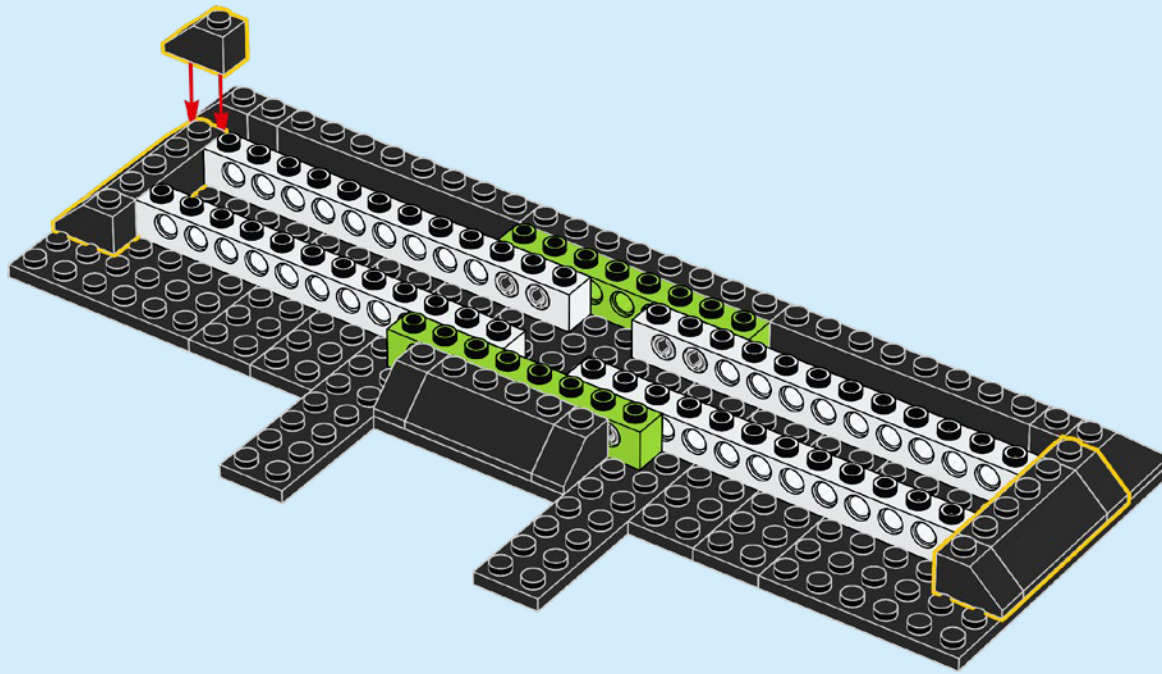

276

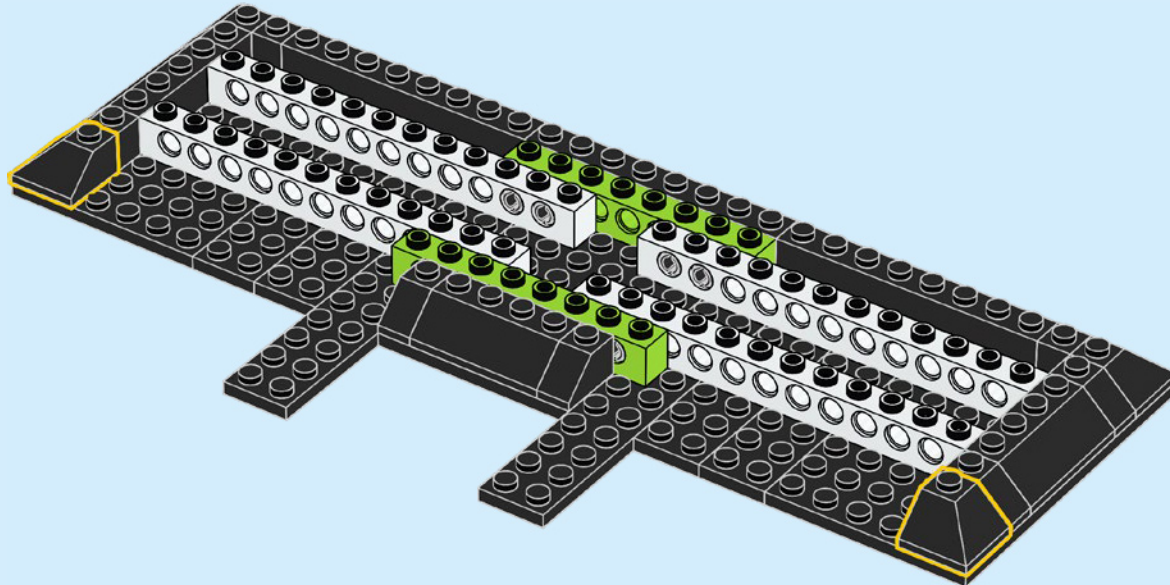



2x



2x

277

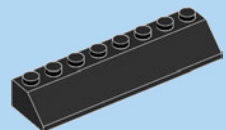
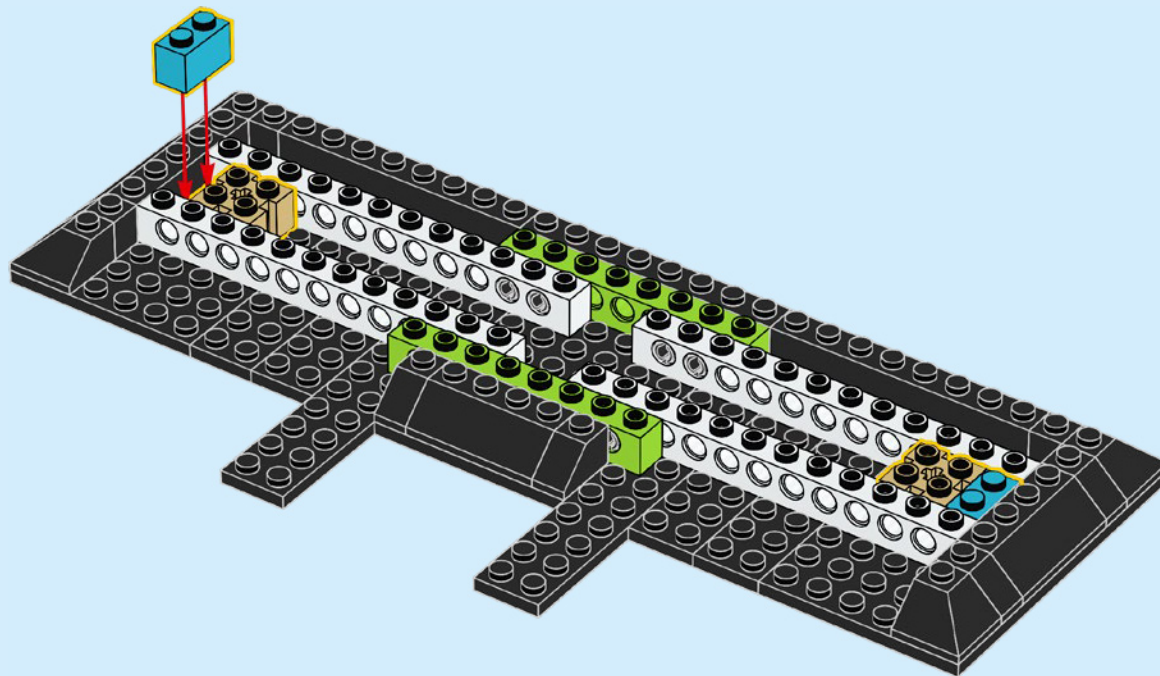

2x

278

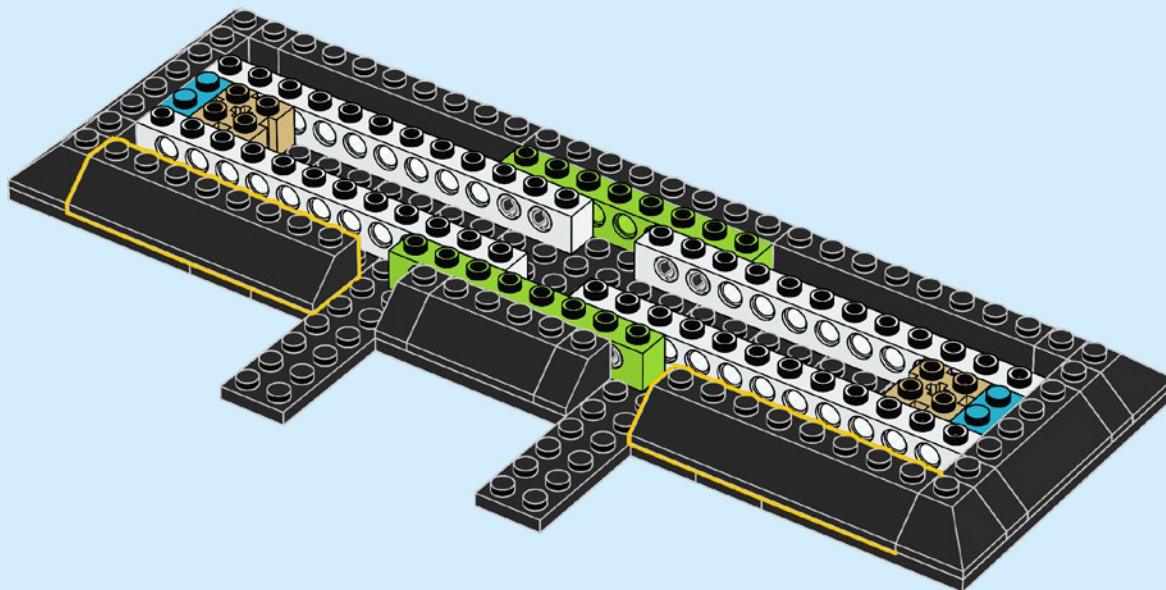

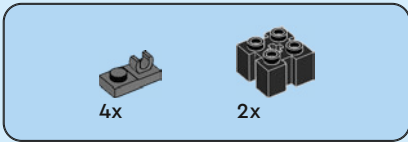

279

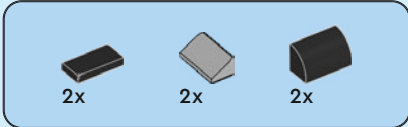
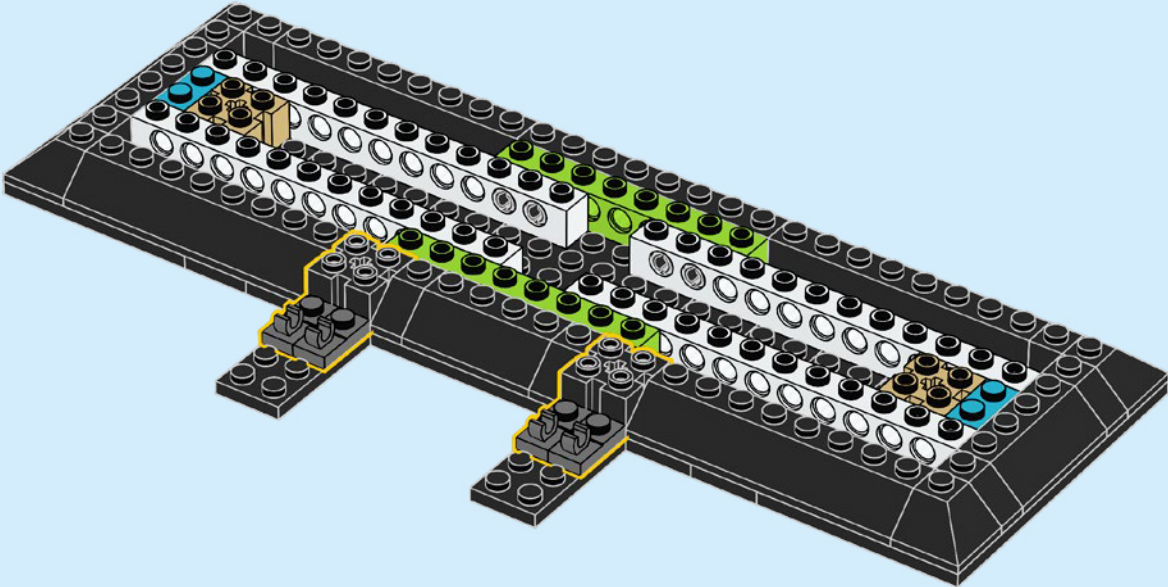

280

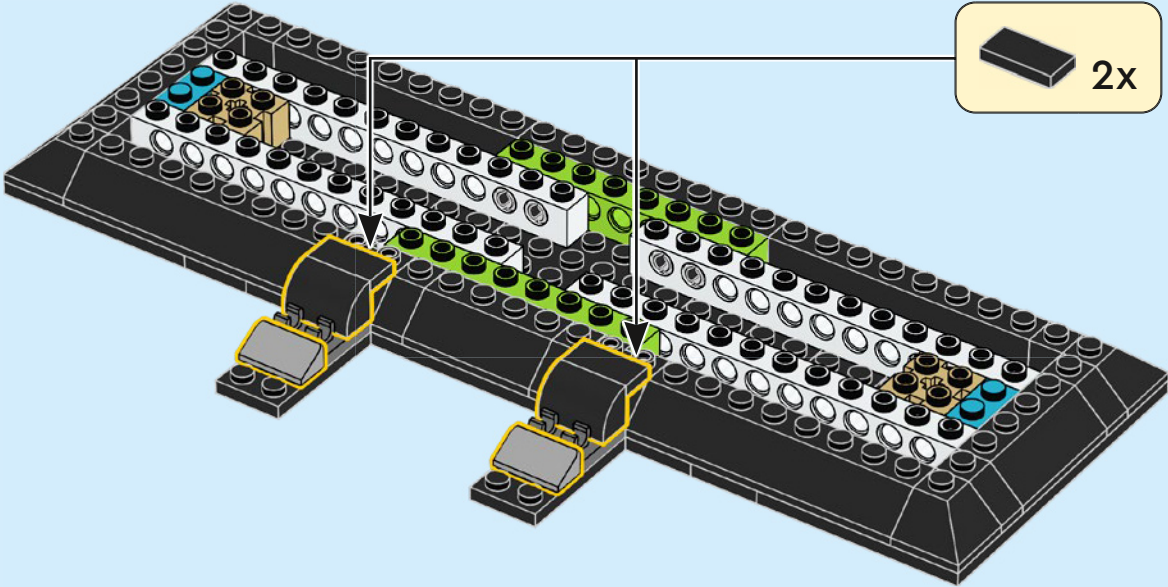

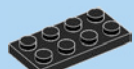

4x

281

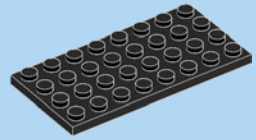
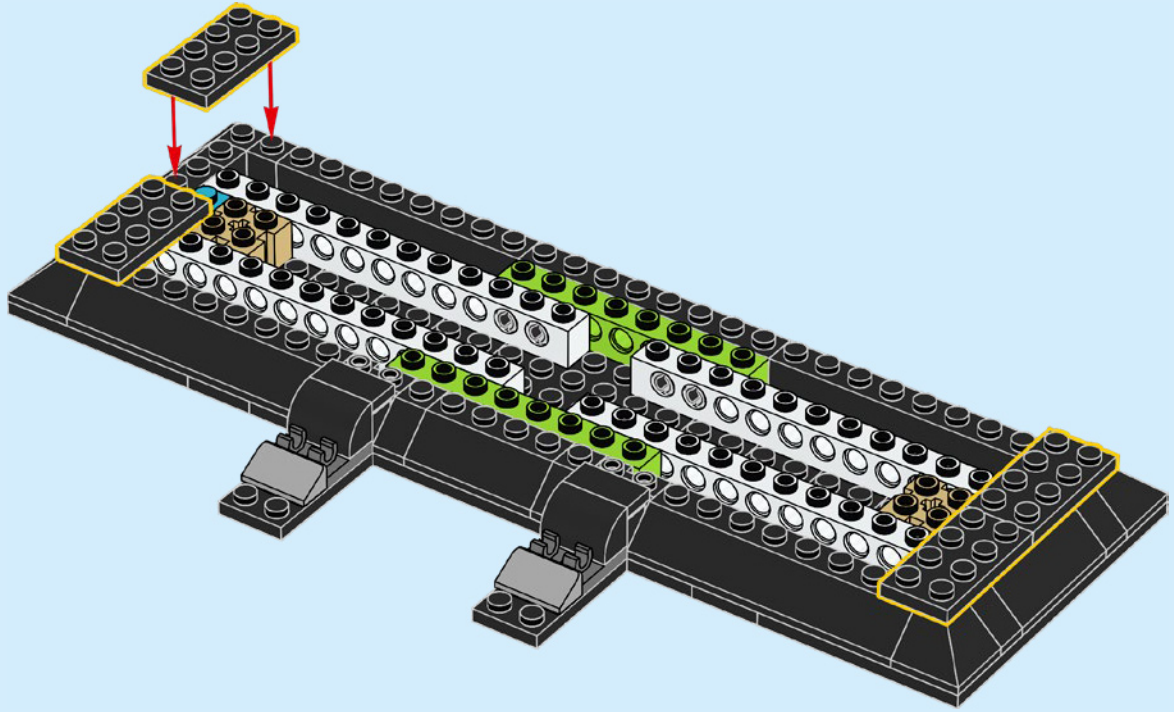

5x

282

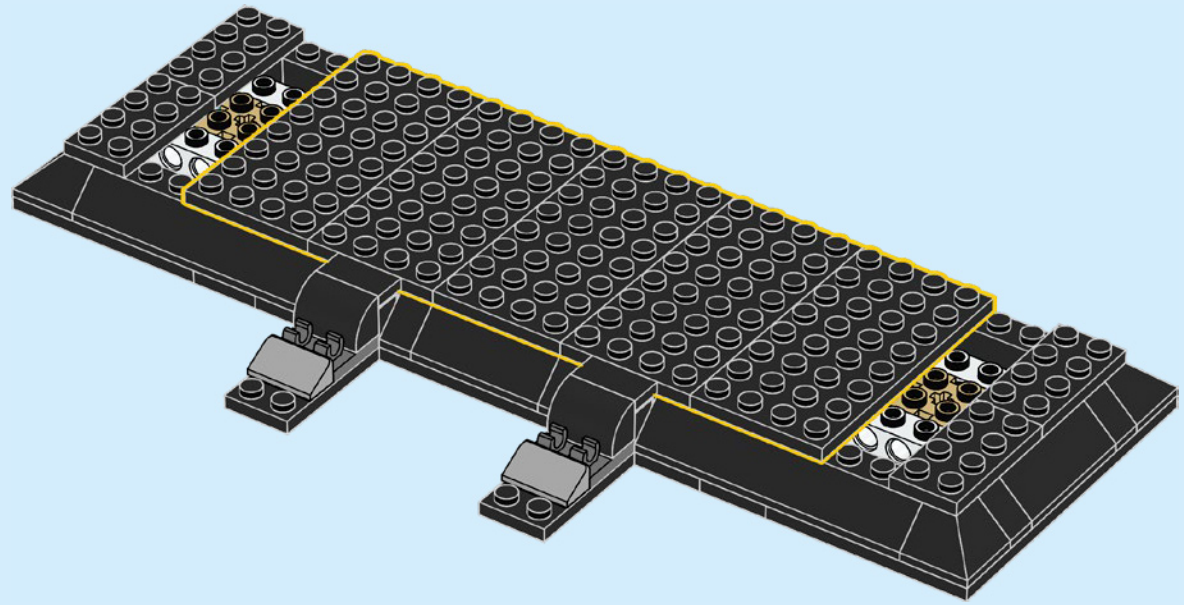

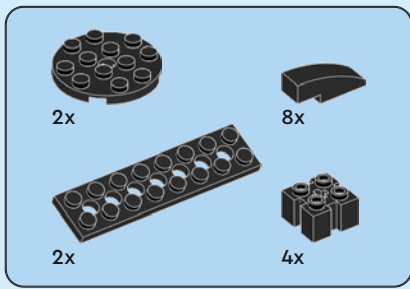

283

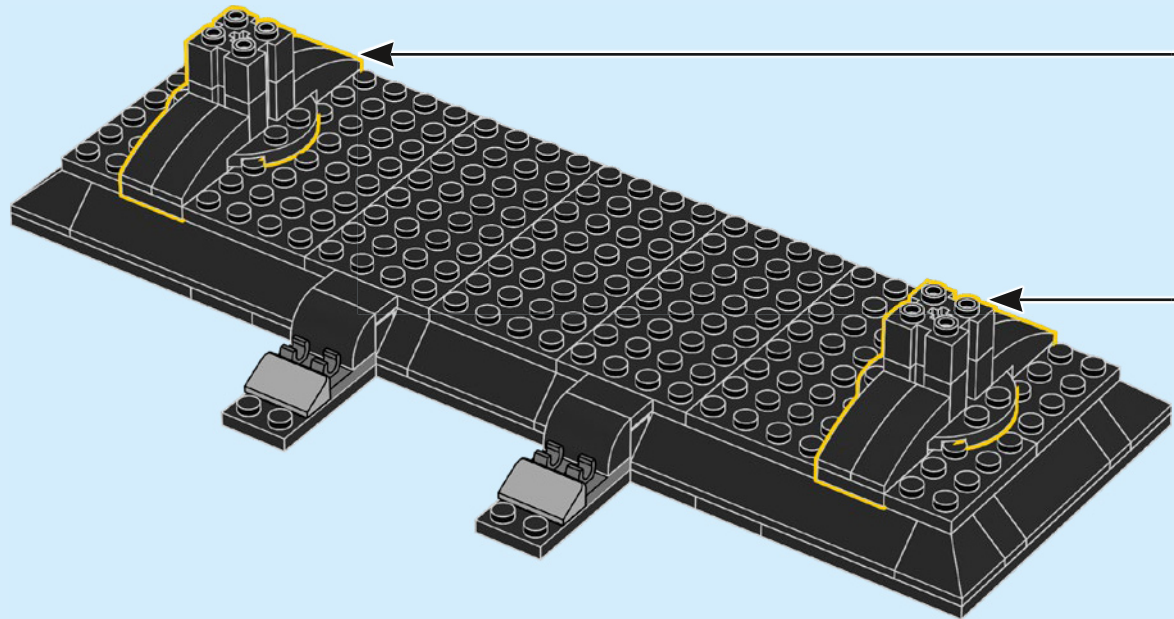
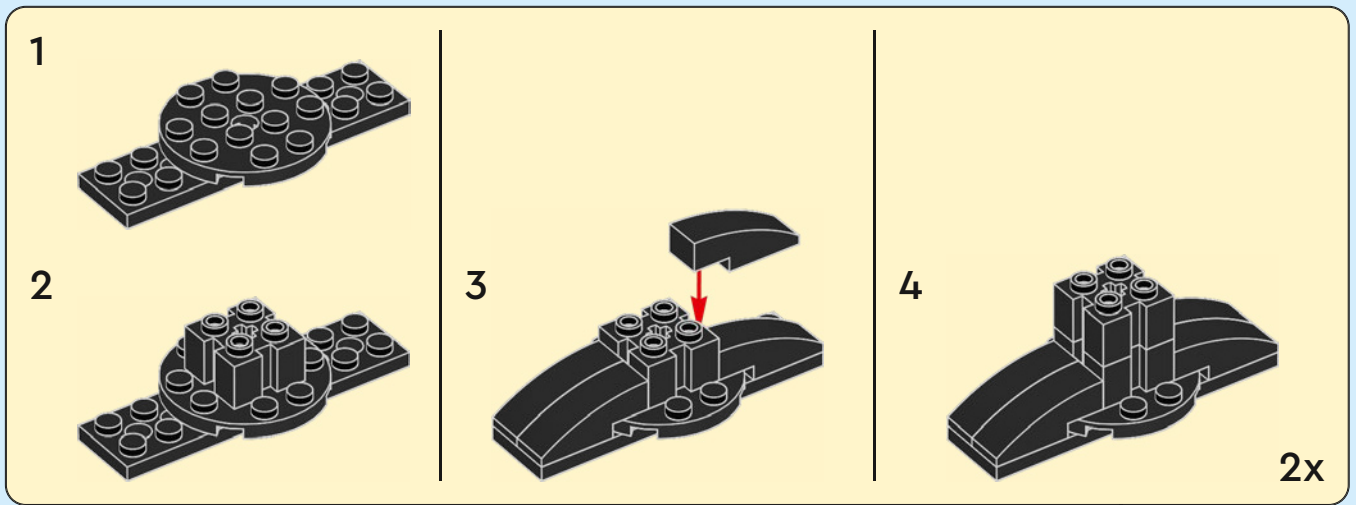

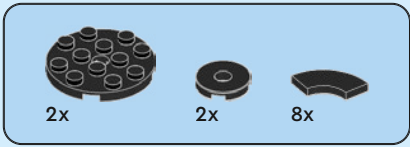

284

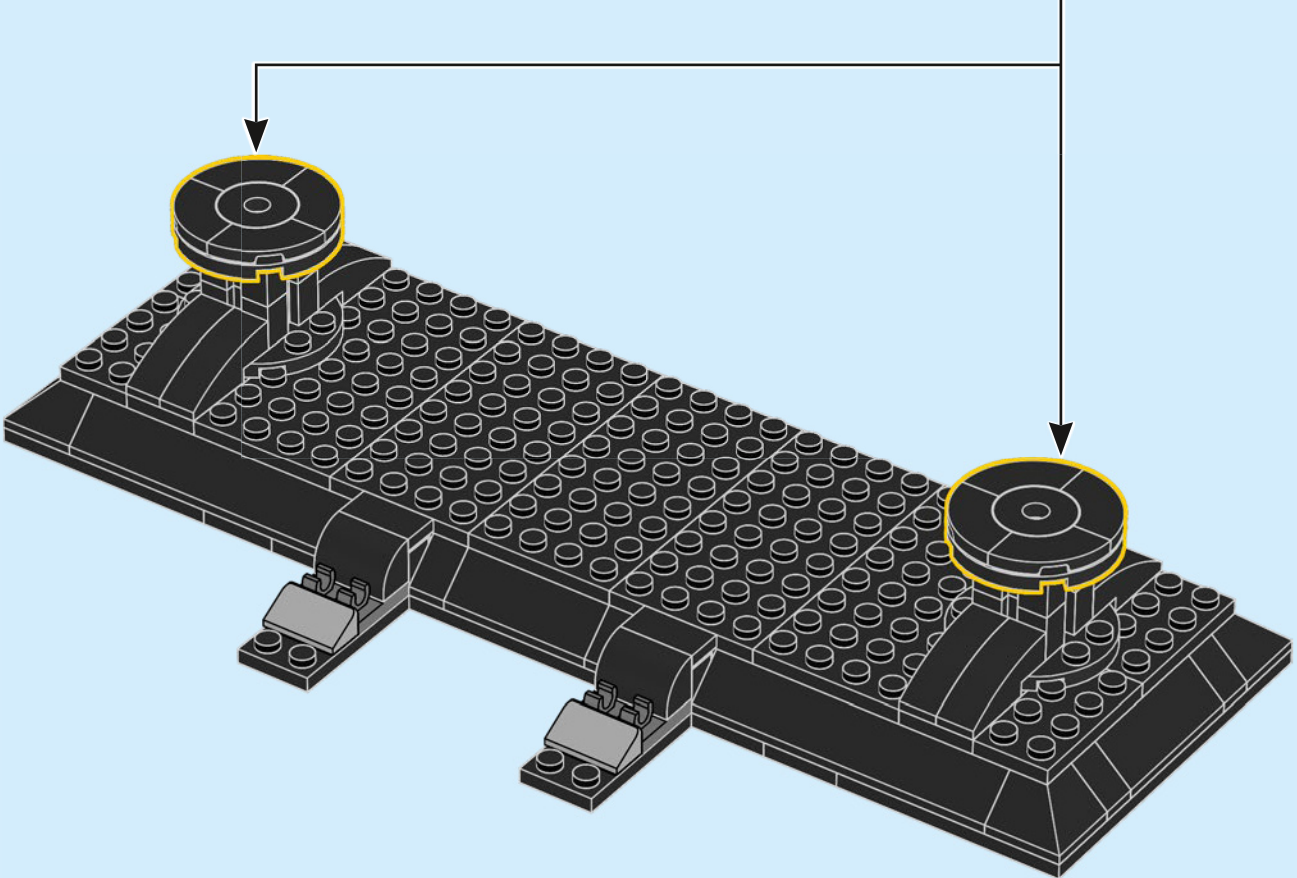
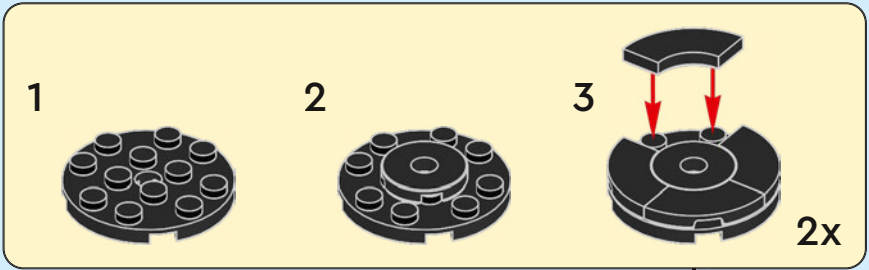

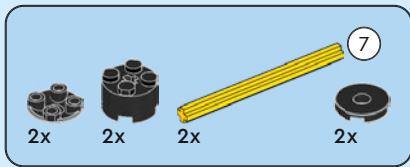

285

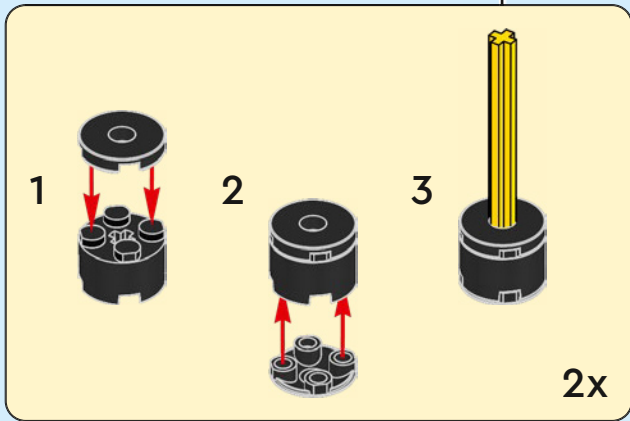
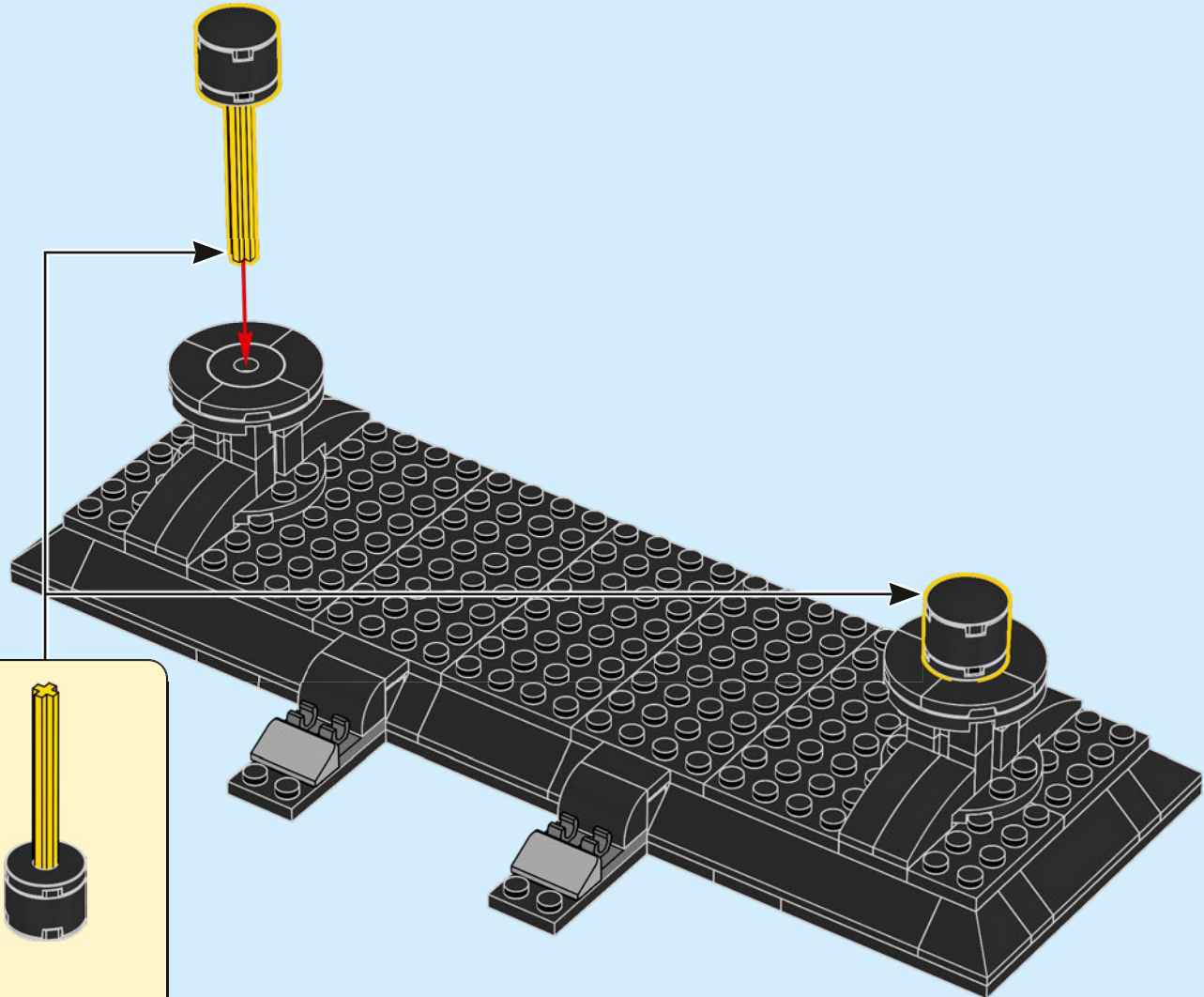

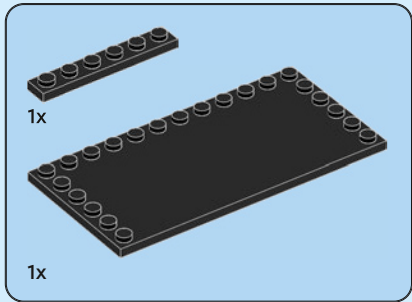

286

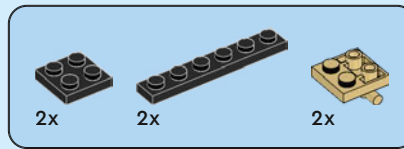
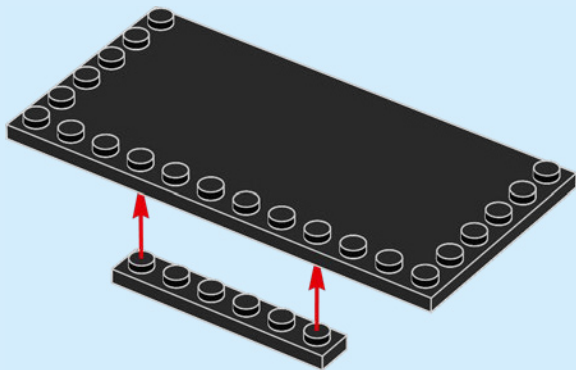

287

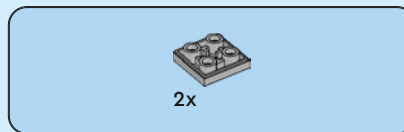
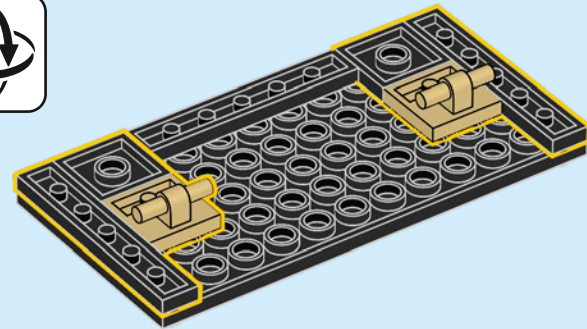

288

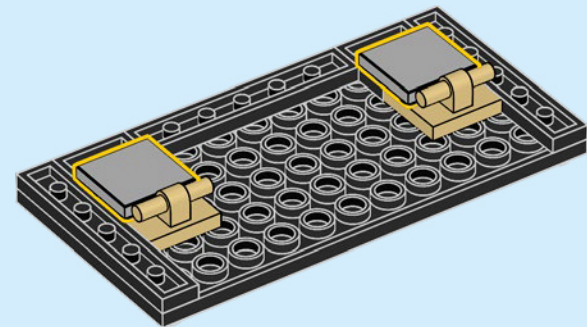

289

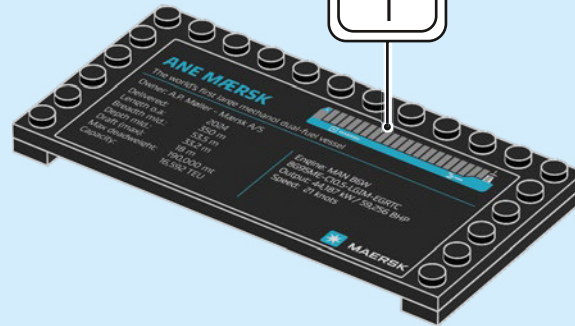

290

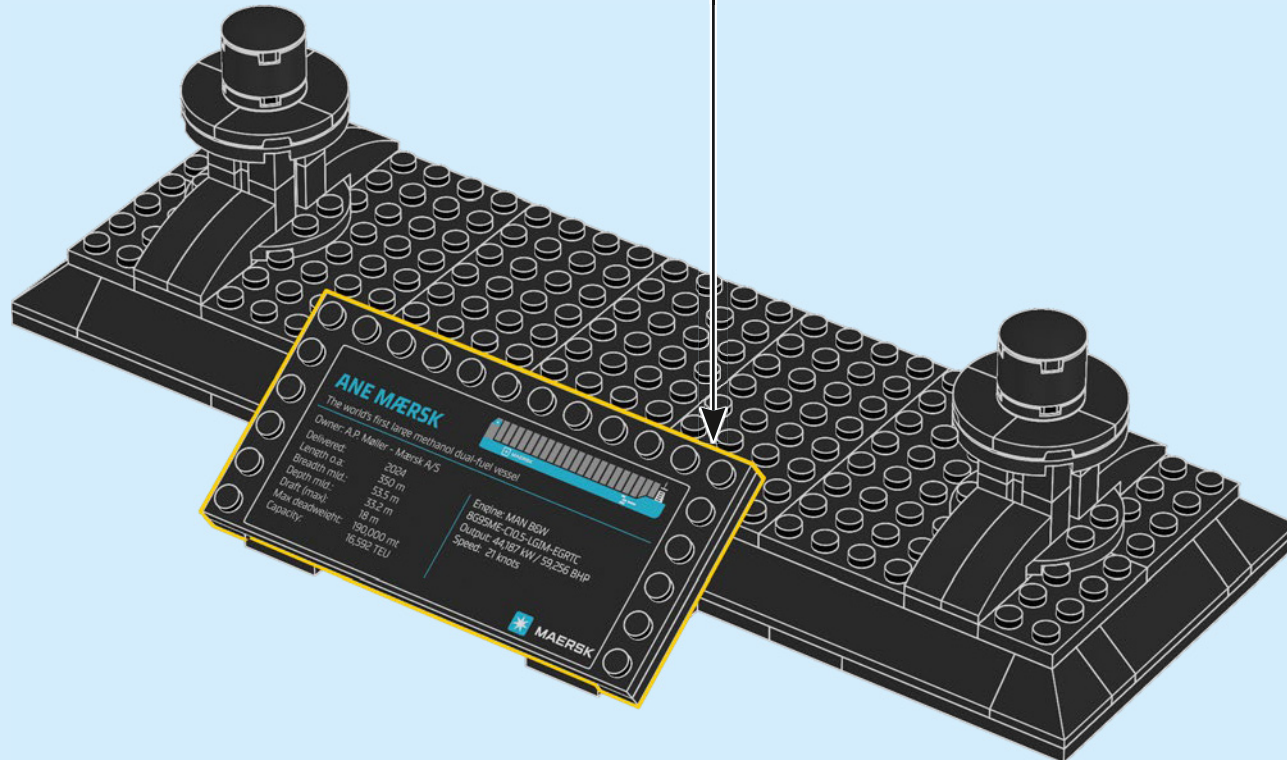

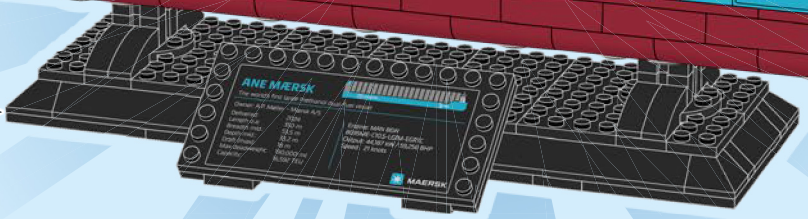
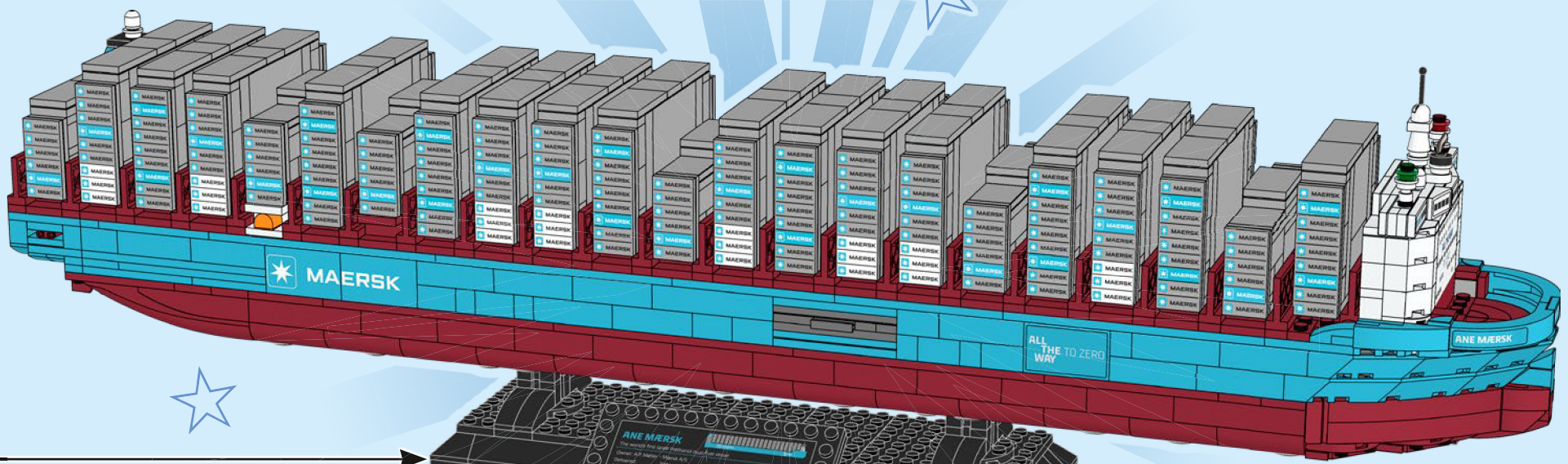
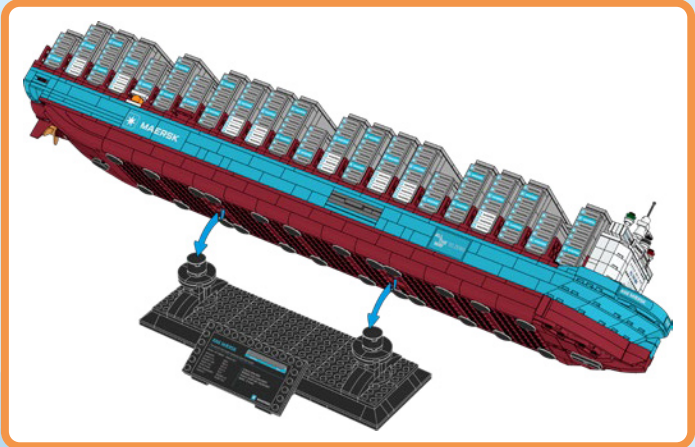

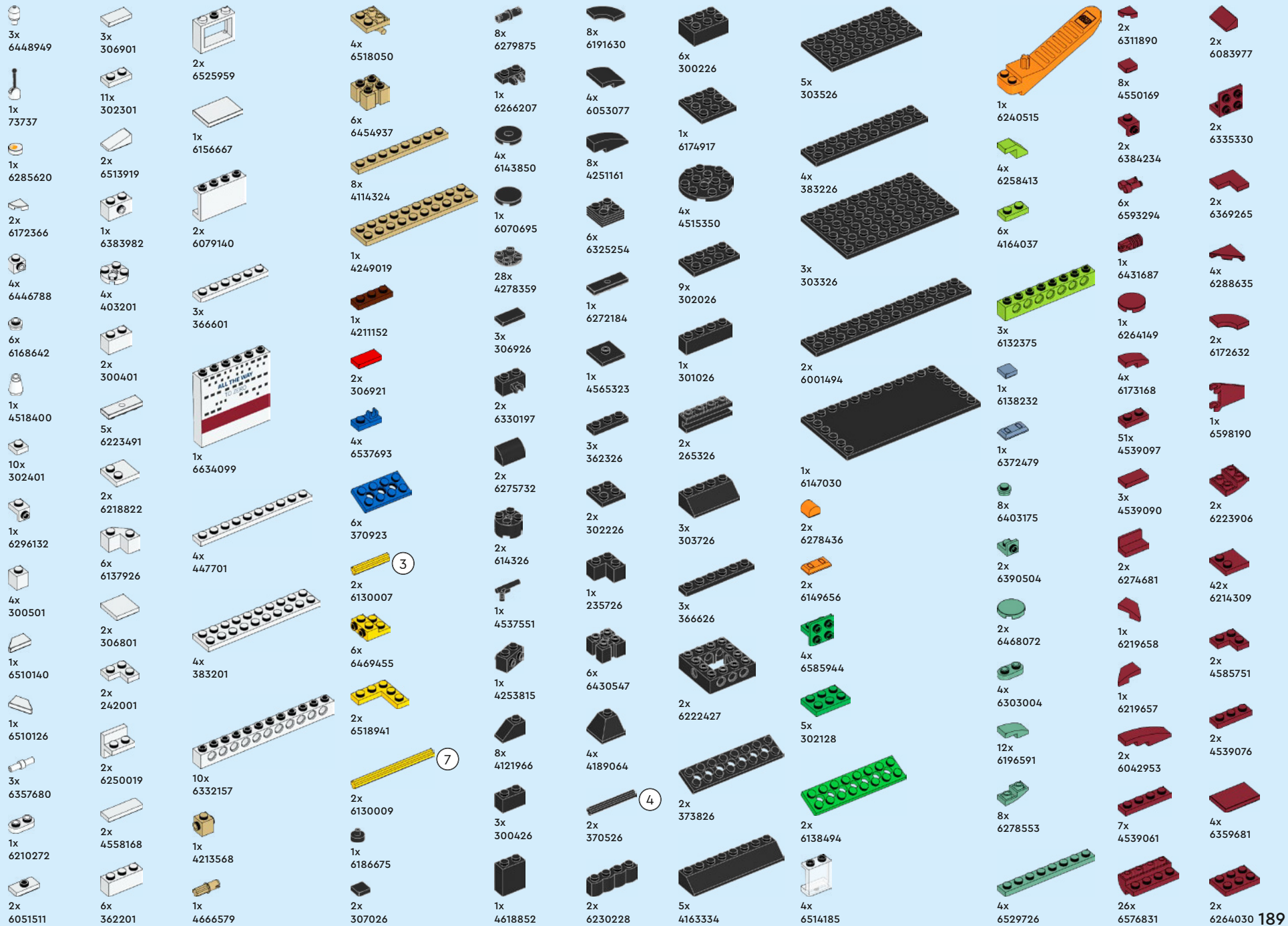

- 4x 6584062
- 4x 4541528
- 2x 6586652
- 1x 6335319
- 21x 6052777
- 6x 4541507
- 4x 4539071
- 10x 6576807
- 66x 6584063
- 1x 6465734
- 2x 6602414
- 2x 4539062
- 1x 6476042
- 1x 6350339
- 26x 6253142
- 4x 6186106
- 1x 6544174
- 6x 6440979
- 1x 4211392
- 6x 4211406
- 25x 4211462
- 2x 4211705
- 1x 6539385
- 11x 6015344
- 9x 6258831
- 2x 4568637
- 1x 4211415
- 2x 4568637
- 4x 4211412
- 33x 4211388
- 2x 4211399
- 11x 6598026
- 6x 6227897
- 70x 4211398
- 27x 4211395
- 12x 6061675
- 4x 6059033
- 2x 6079461
- 30x 4527174
- 16x 6598025
- 16x 6595947
- 35x 4211452
- 64x 6123809
- 6x 4211564
- 3x 6170387
- 32x 4211363
- 4x 6469440
- 1x 6446028
- 2x 6132886
- 2x 6043639
- 2x 4211580
- 15x 4211413
- 4x 6258820
- 10x 4211387
- 10x 6171894
- 10x 4211396
- 12x 4211386
- 1x 6514057
- 1x 6514051
- 2x 4210719
- 2x 4211063
- 4x 6344754
- 1x 6514456
- 2x 6123814
- 4x 4543086
- 1x 4218696
- 6x 4211094
- 11x 4211056
- 2x 4210651
- 1x 6287847
- 1x 6322046
- 2x 6215606
- 1x 6292145
- 1x 6088641
- 2x 6335563
- 1x 6593293
- 2x 6603341
- 8x 6603339
- 2x 6603283
- 4x 6603285
- 6x 6603587
- 8x 6603337
- 2x 6603334
- 1x 6603315
- 4x 6603598
- 17x 6603336
- 1x 6603301
- 1x 6603600
- 1x 6603591
- 1x 6603586
- 1x 6603585
- 2x 6603590
- 2x 6603344
- 2x 6603309
- 3x 6603316
- 1x 6593286
- 2x 6604733
- 2x 6603601
- 7x 6603965
- 30x 6603319
- 2x 6603317
- 2x 6576809
- 2x 6603313
- 1x 6598028
- 2x 6576810
- 1x 6598027
- 2x 6603599
- 2x 6603596
- 2x 6603342
- 2x 6603312
- 10x 6603286
- 2x 6603333
- 10x 6603340
- 2x 6603318
- 4x 6603343
- 2x 6603335
- 4x 6603595
- 1x 6603594
- 6x 6603589
- 2x 6603332
- 2x 6576813



[LEGO.com/service](https://www.LEGO.com/service)

YOU COULD WIN



Scan this QR code or go to
LEGO.COM/PRODUCTFEEDBACK and give us
your short feedback about this LEGO® set
for a chance to win a cool LEGO prize.

Terms and Conditions apply*

EN: YOU COULD WIN. Terms and Conditions apply* **DE: Du könntest GEWINNEN.** Es gelten die Teilnahmebedingungen* **FR: Tu pourrais GAGNER.** Des conditions s'appliquent* **IT: Potresti VINCERE tu.** Termini e condizioni sono applicabili* **ES: Puedes GANAR.** Aplican términos y condiciones* **PT: PODERÁ GANHAR.** Aplicam-se Termos e Condições* **ZH: 轻松获奖.** 条款和条件适用* **PL: Szansa na WYGRANĄ.** Obowiązuje regulamin* **CS: Máte šanci VYHRÁT.** Platí všeobecné smluvní podmínky* **SK: Máte šancu VYHRÁT.** Platia všeobecné zmluvné podmienky* **HU: TE IS NYERHETSZ.** Felhasználási feltételek érvényesek* **UA: ВИ МОЖЕТЕ ВИГРАТИ.** Застосовуються загальні положення та умови* **RO: Ai putea CÂȘTIGA.** Se aplică termenii și condiții* **BG: Можете да СПЕЧЕЛИТЕ.** Има определени правила и условия* **LV: Tu vari LAIMĒT.** Ir spēkā noteikumi un nosacījumi.* **ET: Sul on võimalus VÕITA.** Kehtivad tingimused* **LT: Jūs galite LAIMĖTI.** Taikomos sąlygos*

*[LEGO.com/productfeedback-terms](https://www.lego.com/productfeedback-terms)

