



40955



MAERSK





LEGO.com/sustainable-packaging



FR

DONNEZ
OU
RECYCLEZ



OU



OU



ASSOCIATION

MAGASIN

DÉCHÈTERIE

Adresses sur quefairedemesdechets.fr

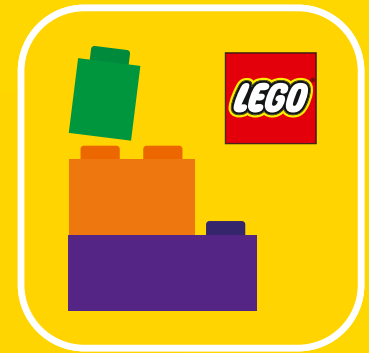

🔍 LEGO® Builder

BUILDER



Apple and the Apple logo are trademarks of Apple Inc., registered in the U.S. and other countries and regions. App Store is a service mark of Apple Inc. Google Play and the Google Play logo are trademarks of Google LLC. Tencent and the Tencent logo are trademarks of Tencent Inc.

🔍 LEGO.com/devicecheck

EN Ask parents' permission before going online | DE Eltern um Erlaubnis bitten, bevor du online gehst | FR Demande l'autorisation d'un parent avant d'aller en ligne | IT Chiedi il permesso ai tuoi genitori prima di andare online | ES Pídeles permiso a tus papás antes de conectarte a Internet | PT Peça autorização aos pais antes de acederes online | ZH 上网前应先征得父母的同意 | PL Poproś rodziców o zgodę, zanim wejdiesz do Internetu | CS Než půjdeš na internet, požádej rodiče o svolení | SK Skôr než pôjdeš na internet, vypoťaj si povolenie od rodičov | HU Kérj szülői engedélyt, mielőtt online csatlakoznál! | UA Запитуйте дозволу батьків, перш ніж користуватися інтернетом | RO Cere permisiunea părinților înainte de a te conecta online | BG Поискайте разрешение от родител, преди да влезете онлайн | LV Pirms došanās tiešsaistē palūdz atļauju vecākiem | ET Enne Interneti kasutamist küsi vanematelt lüba | LT Prieš prisijungdami prie interneto, atsiklauskite tėvų



PRISTATOME „ANE MÆRSK“

ANE MÆRSK – pirmasis didelis konteinerių laivas, varomas mažataršių degalų, tokių kaip biometanolis ir e. metanolis. Nuo 2024 m. sausio mėnesio, kai pirmą sykį išplaukė ANE MÆRSK, pradėjo plaukioti ir daugiau dvi degalų rūšis naudojančių laivų, žyminčių naują ir svarbų išmetamo anglies dioksido kiekio mažinimo laivininkystėje ir pasaulinėje prekyboje etapą.

ANE MÆRSK yra 350 metrų (1 148,2 pėdų) ilgio ir 53,5 metrų (175,5 pėdų) pločio. Tuščias laivas sveria 47 700 metrinių tonų (52 580,25 tonų), o visiškai pakrautas – su kroviniu, degalais ir įgula – gali gabenti stulbinamą 190 000 metrinių tonų (209 439,1 tonų) svorį, prilygstantį 29 000 Afrikos dramblių svoriui.

Į laivą galima pakrauti 16 592 TEU (dvidešimties pėdų ekvivalento) konteinerius, o jei juos visus išrikiuotume į eilę, jų ilgis būtų 100,5 km (62,4 mylios) – kaip 959 futbolo aikščių.





 MAERSK

ALL THE 10 ZERO WAY



KELIONĖ PER POKYČIUS – LAIVYBOS ISTORIJA

Žmonės prekes jūra gabena jau daugiau kaip 5 000 metų, tačiau iki pramonės revoliucijos ir garo variklio išradimo buvome priklausomi nuo oro sąlygų. Nėra vėjo, nėra kelionės. Pradėjus naudoti garo energiją, pirmą kartą žmonijos istorijoje laivo įgula nebe priklausė nuo oro sąlygų ar rankomis varomo mechanizmo. Šis išradimas visiškai pakeitė jūrų transportą – atsirado naujų maršrutų, o prekyba jūra įgavo didelį pagreitį.

Nors garo varikliai gerokai patobulino keliavimą laivais, jie vis dar buvo neefektyvūs, todėl netrukus buvo išrastas dyzelinis variklis, ir jūrų transportas vėl pasikeitė. Vis dėlto revoliucijai laivyboje reikia laiko. Prireikė kelių dešimtmečių, kol dyzelinas visiškai pakeitė garo energiją. Pirmą dyzelinį laivą „Maersk“ įsigijo 1921 metais, praėjus vos devyneriems metams nuo pirmojo dyzeline varomo prekybinio jūrų laivo nuleidimo į vandenį.



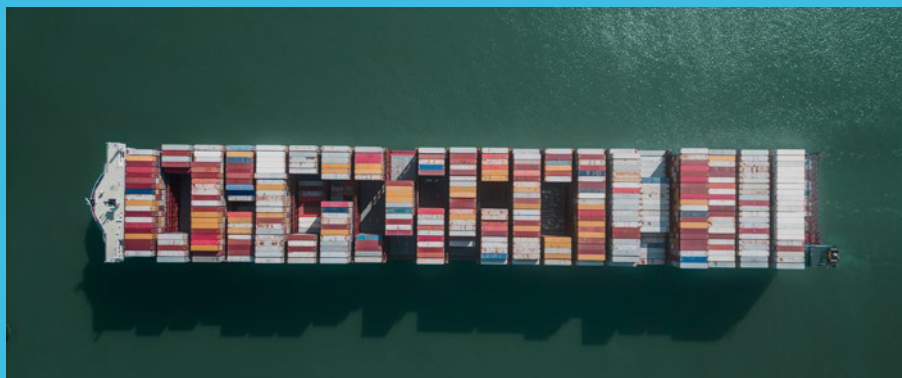

1956 metais laivininkystė vėl pasikeitė: pradėta naudoti efektyvi „krovinių konteineriuose“ sistema, kuomet sunkvežimio priekabos kraunamos tiesiai į laivus. Atsiradus konteineriams, laivų pakrovimo ir iškrovimo laikas sutrumpėjo nuo kelių dienų iki kelių valandų.

Dėl konteinerių ir brūkšninių kodų – nepastebimų pasaulinės prekybos variklių – bet kurios pasaulio dalies gamintojas gali parduoti savo prekes visose rinkose, todėl globalizacija tapo fiziškai įmanoma. Pasaulis, kokį jį pažįstame šiandien, labai priklauso nuo pasaulinių tiekimo grandinių. Nuo Kolumbijos bananų augintojo iki danų vaiko, lupančio bananą priešpiečiams – tiekimo grandinės sujungia pasaulį ir užtikrina viso pasaulio žmonių aprūpinimą maisto produktais, vaistais, prekėmis ir medžiagomis.





 MAER

 MAERS

 MAERSK

 MAERSK

KAS SLYPI PAVADINIME?

Nuo 1906 metų visų „Maersk“ laivyno laivų pavadinimuose yra žodis „MÆRSK“. Daugumos pirmųjų laivų vardai susiję su laivyno įkūrėjų šeima, tačiau, laivynui išaugus, pavadinimo tradiciją teko keisti. Šiandien „Maersk“ laivai taip pat turi, pavyzdžiui, miestų ar upių vardus.

Spręsdama, kaip pavadinti naująją dviejų rūšių degalais varomų laivų seriją, „Maersk“ grįžo prie tradicijos laivams suteikti bendrovę įsteigusios šeimos narių vardus – šįkart prasidedančius raide A, taip pažymint naujos eros pradžią.

Laivas ANE MÆRSK pavadintas bendrovės „A.P. Moller Holding“, patronuojančios „A.P. Moller – Maersk“, pirmininkės Ane Mærsk Mc-Kinney Ugglā vardu. „A.P. Moller – Maersk“ 1904 metais įkūrė Arnold Peter Møller. Ane yra grupės įsteigėjo Arnold Peter Møller ir jo žmonos Chastine Mc-Kinney Møller vaikaitė.



ANE MAERSK





BALTOJI ŽVAIGŽDĖ – VILTIES ŠVYTURYS

Garsioji baltoji septyniakampė žvaigždė, „Maersk“ paveldo dalis nuo pat bendrovės įkūrimo 1904 metais, yra nemarus stiprių šeimos ryšių, kurie net ir po 100 metų yra kertinė bendrovės vertybė, simbolis.

Kapitonas Peter Mærsk Møller, A. P. Møller tėvas, karjeros pradžioje dirbo pas vieną anglų laivo savininką, o jo žmona Anna kartais lydėdavo jį kelionėse. Per vieną iš šių kelionių Anna sunkiai susirgo. Baimindamasis, kad ji neišgyvens, Peter Mærsk Møller užlipo ant denio ir meldė Dievą ženkle, kad jo žmona pasveiktų. Tuomet jis išvydo žvaigždę, nušvietusią pilką dangų.

Anna pasveiko, ir 1886 metais, kai įsigijo pirmąjį laivą – garlaivį LAURA, Peter Mærsk Møller papuošė jo kaminą balta septyniakampe žvaigžde žydrame fone, taip pagerbdamas savo mylimą žmoną. Peter Maersk Møller ši žvaigždė reiškė jos išgijimą ir jų sėkmę.

Nuo to laiko balta septyniakampė žvaigždė simboliniame dangaus mėlynumo fone tapo „Maersk“ sinonimu, tačiau pats logotipas bėgant metams keitėsi. Būta daug logotipo versijų, tačiau dabartinis „Maersk“ logotipas sukurtas XX a. aštuntojo dešimtmečio pradžioje, nusprendus, kad reikia modernesnio požiūrio.



ALL THE WAY
TO ZERO



GERESNIS GYVENIMAS VISIEMS, SUJUNGIANT PASAULĮ

Būdamą pasaulio logistikos paslaugų lydere „Maersk“ turi per 100 000 klientų, veikia beveik 130 šalių ir samdo per 100 000 darbuotojų. Nuo kuklios garlaivių bendrovės iki integruotos logistikos bendrovės, siekiančios sujungti ir supaprastinti savo klientų tiekimo grandines – šiandien „Maersk“ turi per 700 laivų ir gabena beveik 20 proc. pasaulio maisto produktų, medžiagų ir prekių.





MAERSK
MAERSK
MAERSK
MAERSK
MAERSK
MAERSK
MAERSK

MAERSK
MAERSK
MAERSK
MAERSK
MAERSK
MAERSK
MAERSK

ALL
THE T
WAY

ANE MAERSK

SPREADERS
TSP98
MAERSK
MAERSK

PTP
T414
P423 PTP

KELIAS IKI NULINĖS TARŠOS – ĮSIPAREIGOJIMAS SIEKTI ATEITIES BE ANGLIES DIOKSIDO

Pasauliui bandant išspręsti klimato kaitos problemas, tiekimo grandinių ir pasaulinės prekybos ateitis priklauso nuo gebėjimo diegti naujoves ir skatinti naujus energijos šaltinius. Bendrovė „Maersk“ prisiėmė rimtą įsipareigojimą iki 2040 metų visuose įmonės procesuose pasiekti grynąjį nulinį išmetamų šiltnamio efektą sukeliančių dujų kiekį. Mažindama įmonės procesų metu išmetamo anglies dioksido kiekį „Maersk“ taip pat prisiėmė socialinį pasižadėjimą rodyti pavyzdį sprendžiant klimato krizę, mažinant pasaulinių tiekimo grandinių anglies dioksido išmetimą ir sudarant sąlygas teisingam perėjimui prie grynojo nulinio išmetimo ekonomikos.

„Maersk“ užsibrėžė iki 2040 metų pasiekti ambicingus tikslus, kad per šį dešimtmetį užtikrintų didelę pažangą jūroje, sausumoje, ore ir mūsų terminaluose. Bendrovė užsako ir tiekia daug dviejų degalų rūšių laivų, kurie gali plaukioti naudodami mažataršius degalus, pavyzdžiui, biometanolį ir e. metanolį, taip pat biometaną, todėl iki šiol laivyno išmetamo anglies dioksido kiekio mažinimo misija vykdoma sėkmingai.



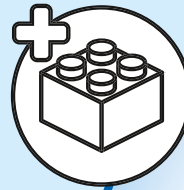
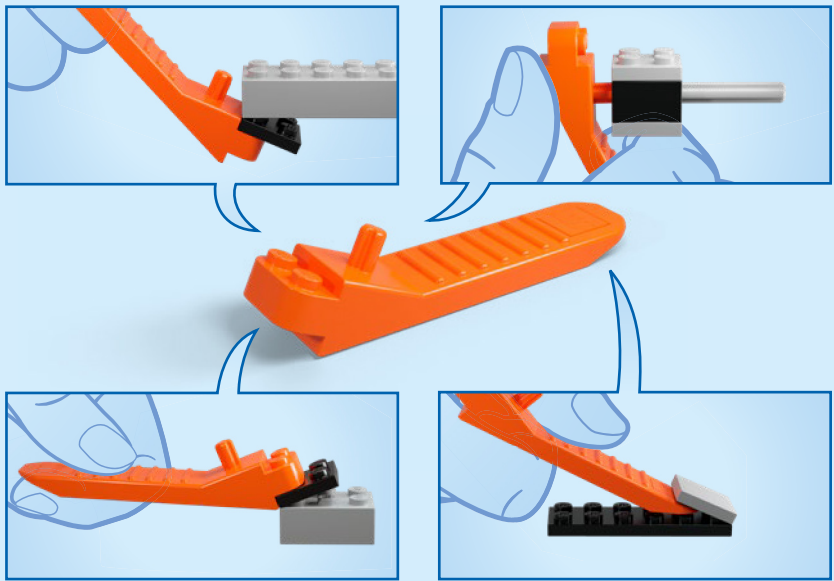

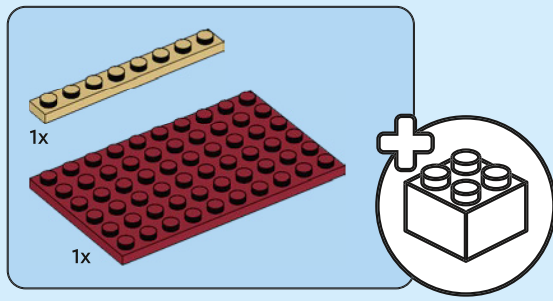

1

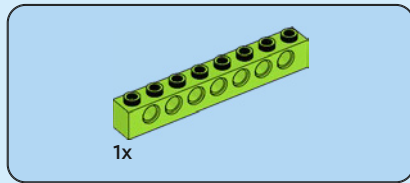
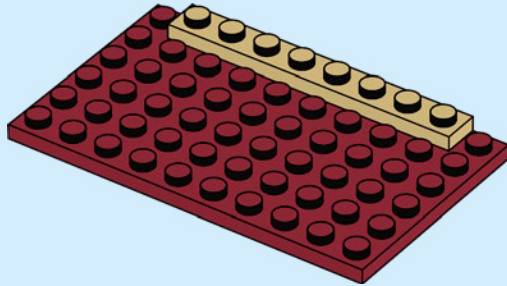

2

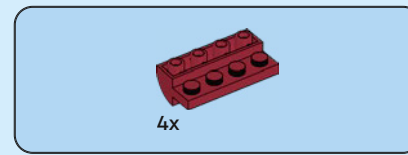
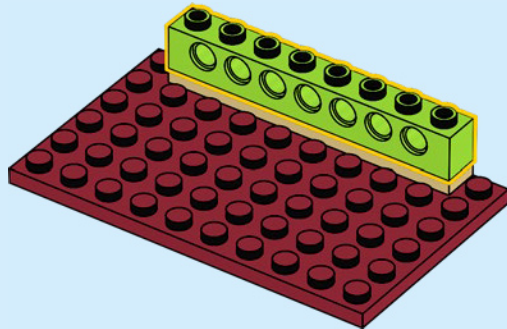

3

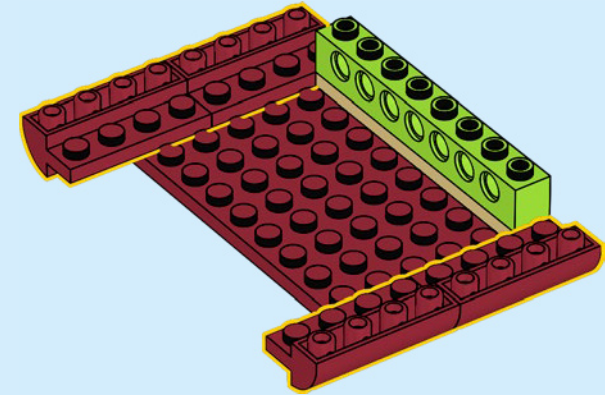

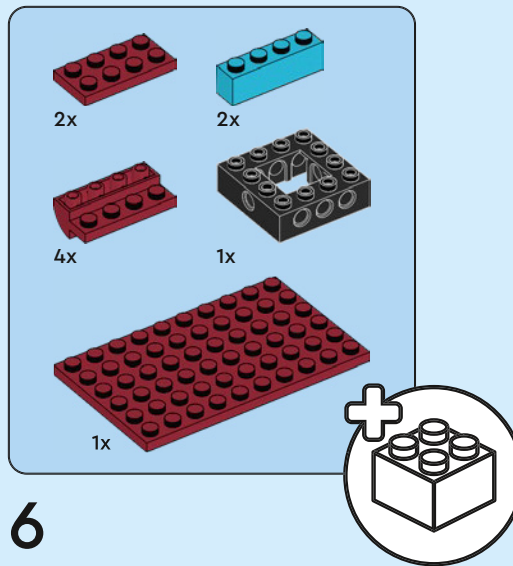
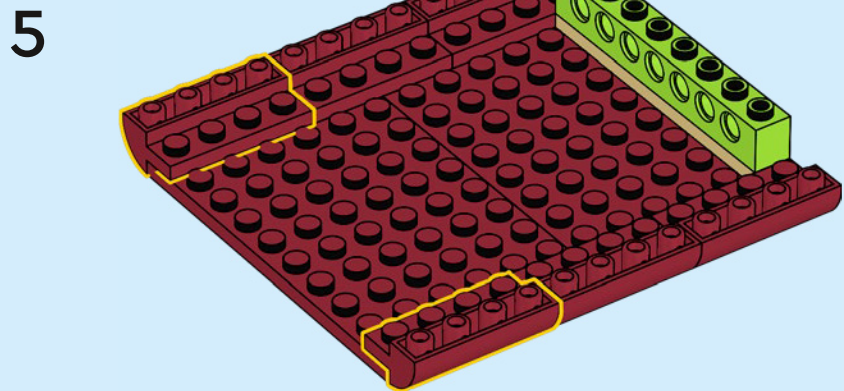
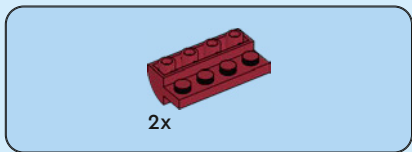
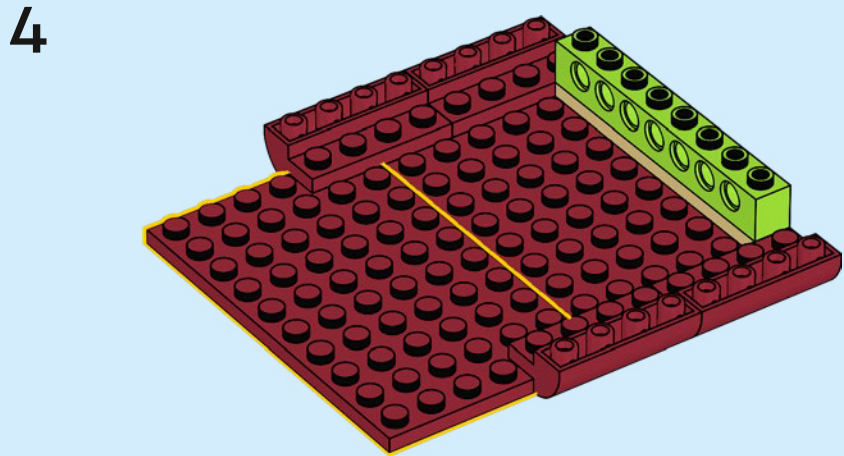
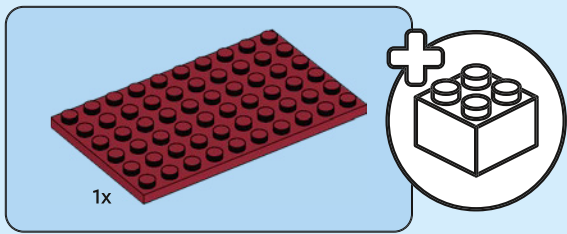

6

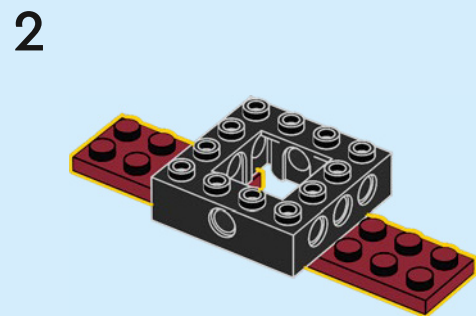
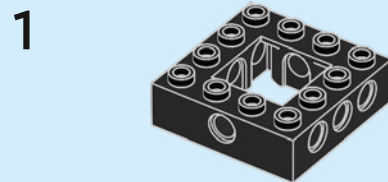

3

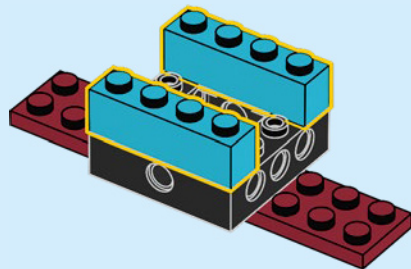

4

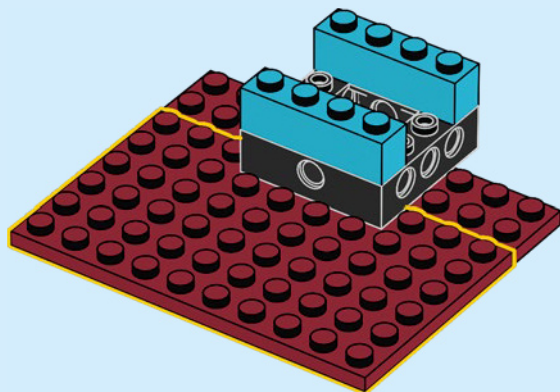

5

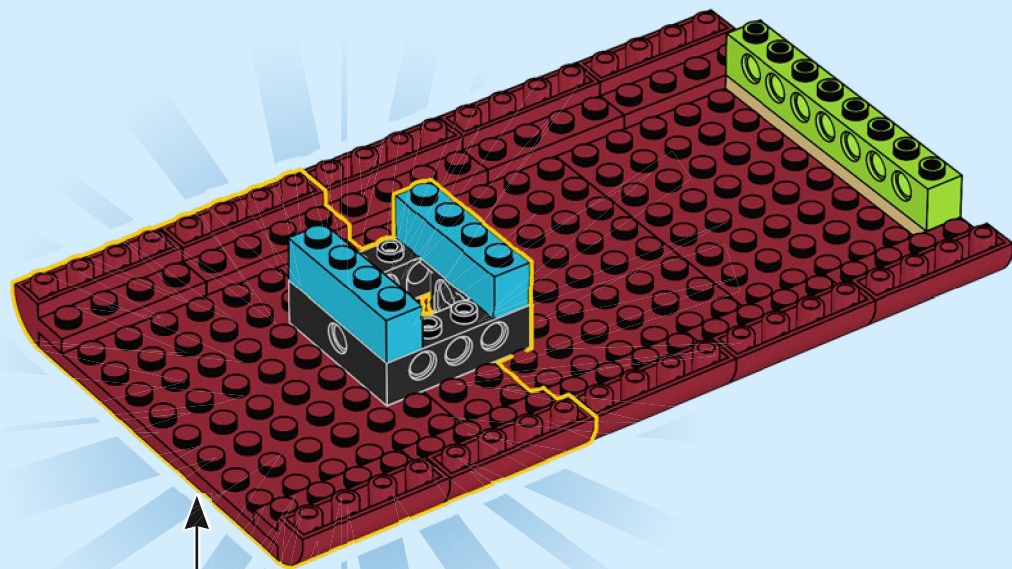
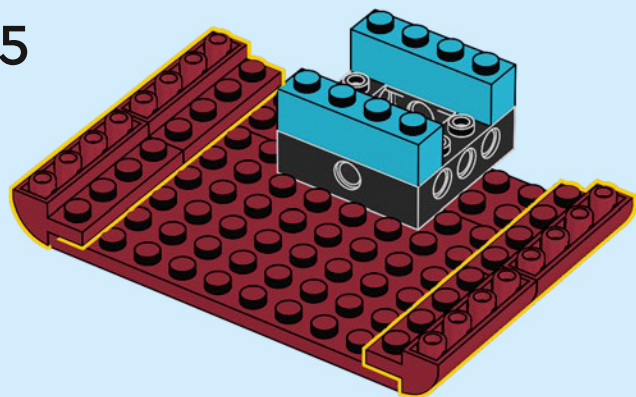

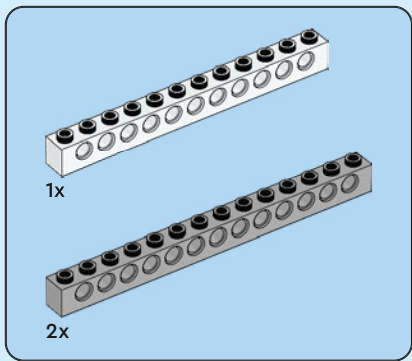

7

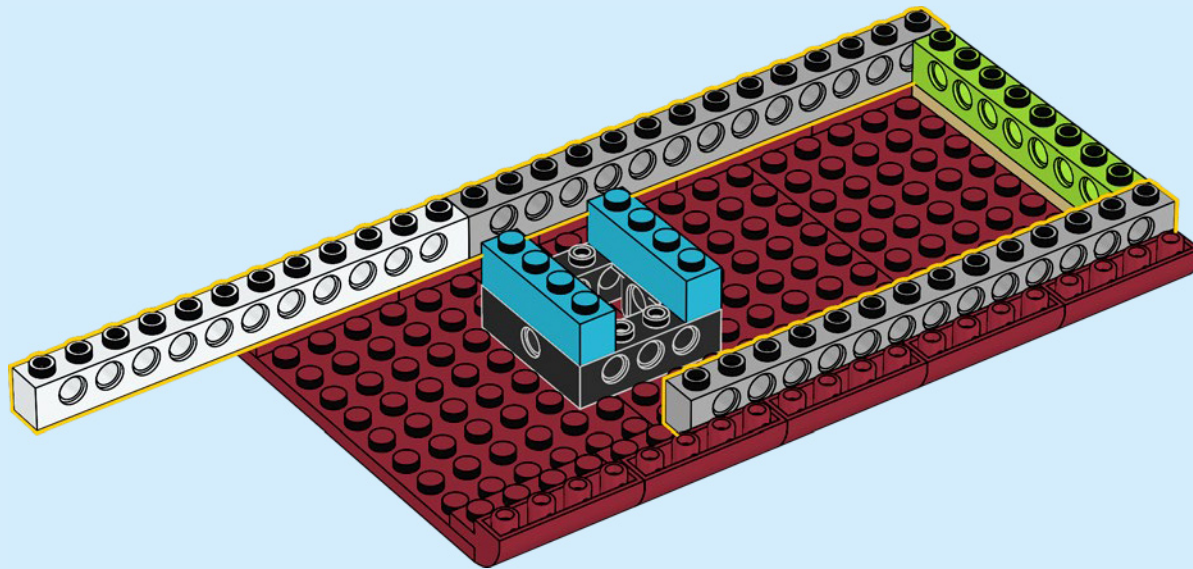

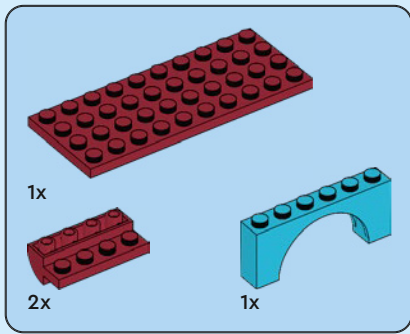

8

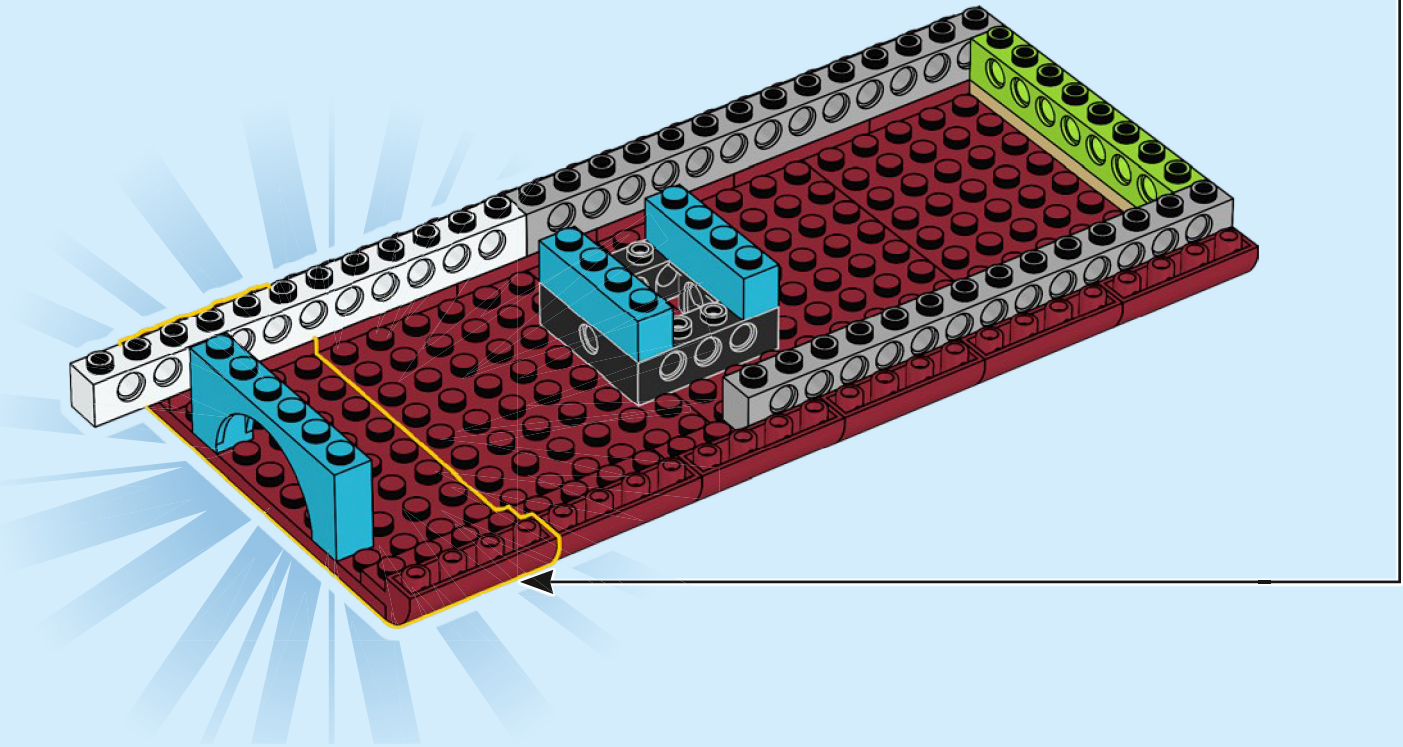
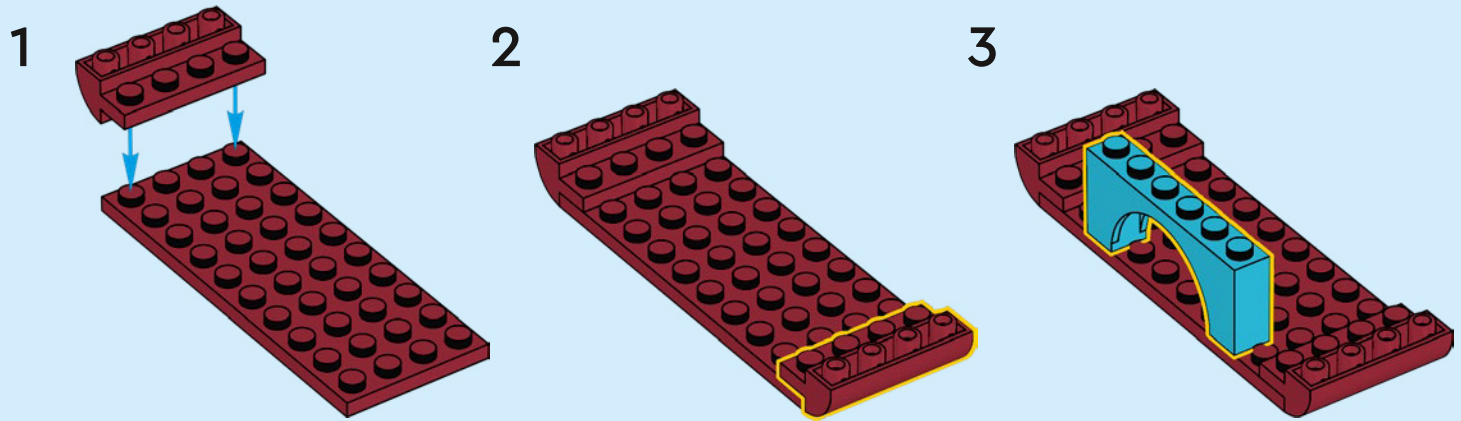

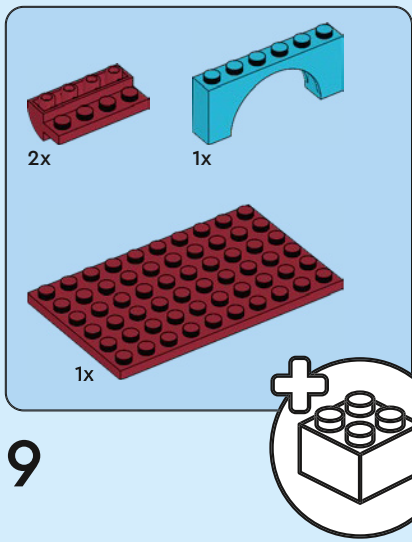

9

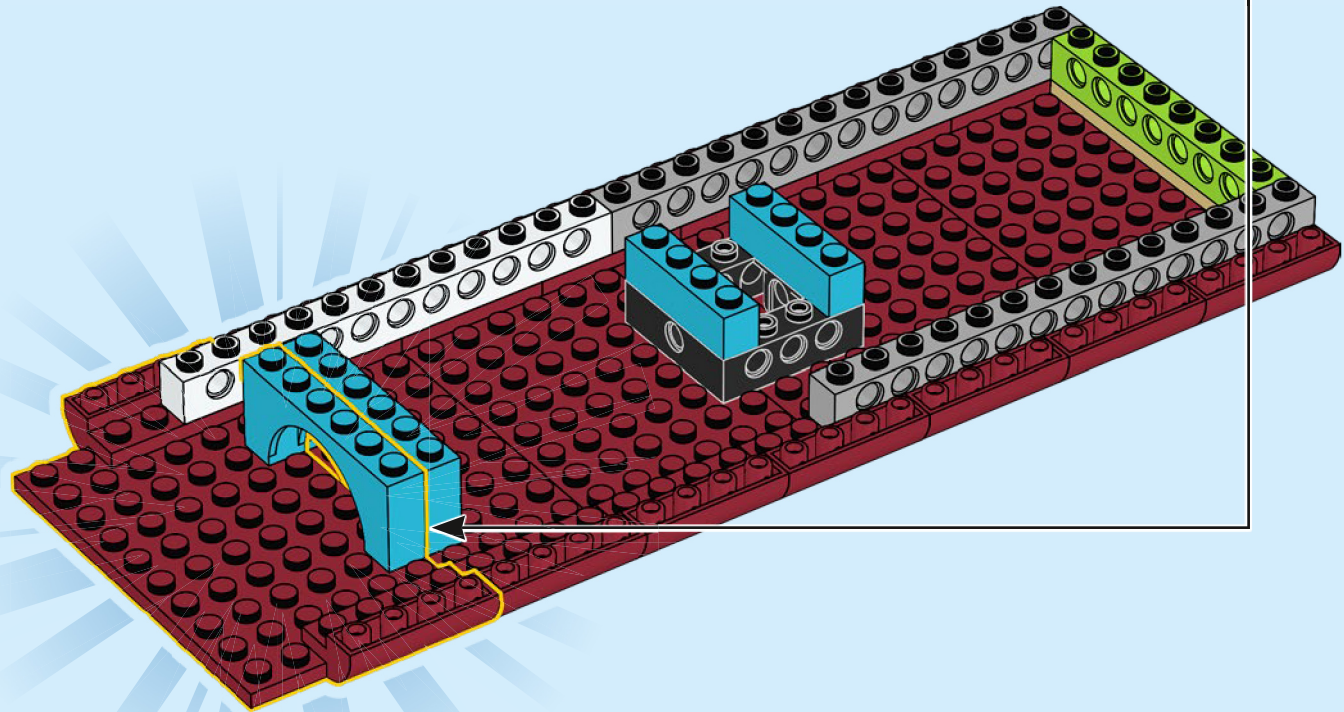
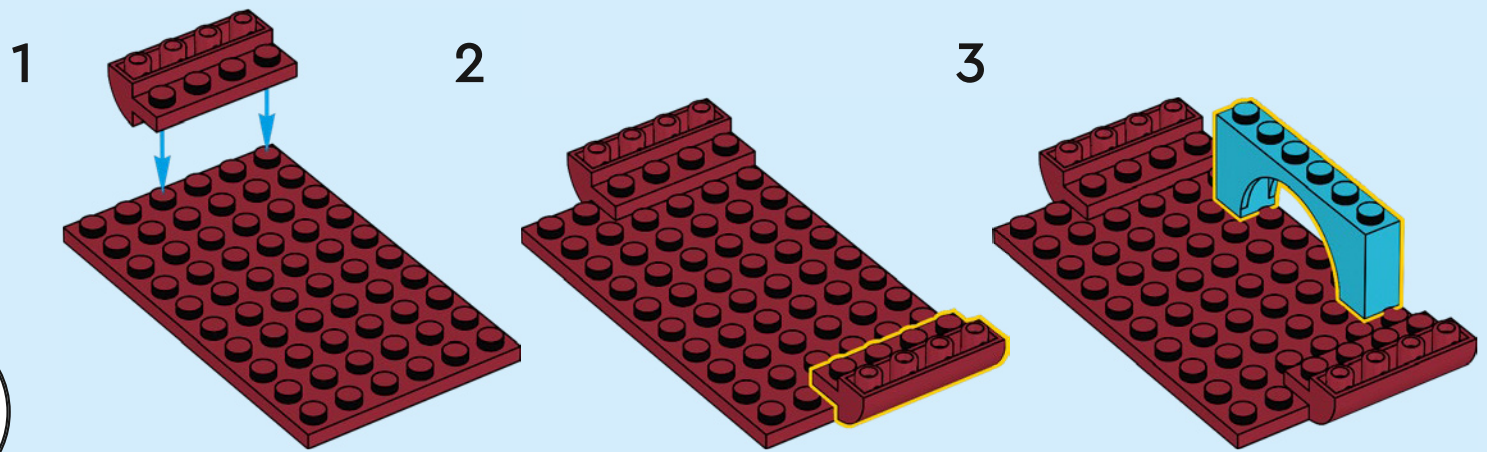

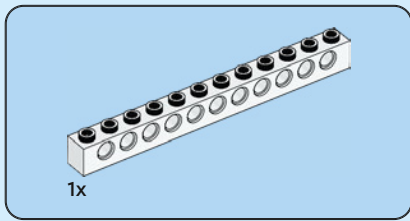

10

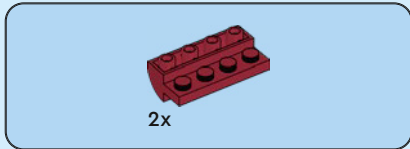
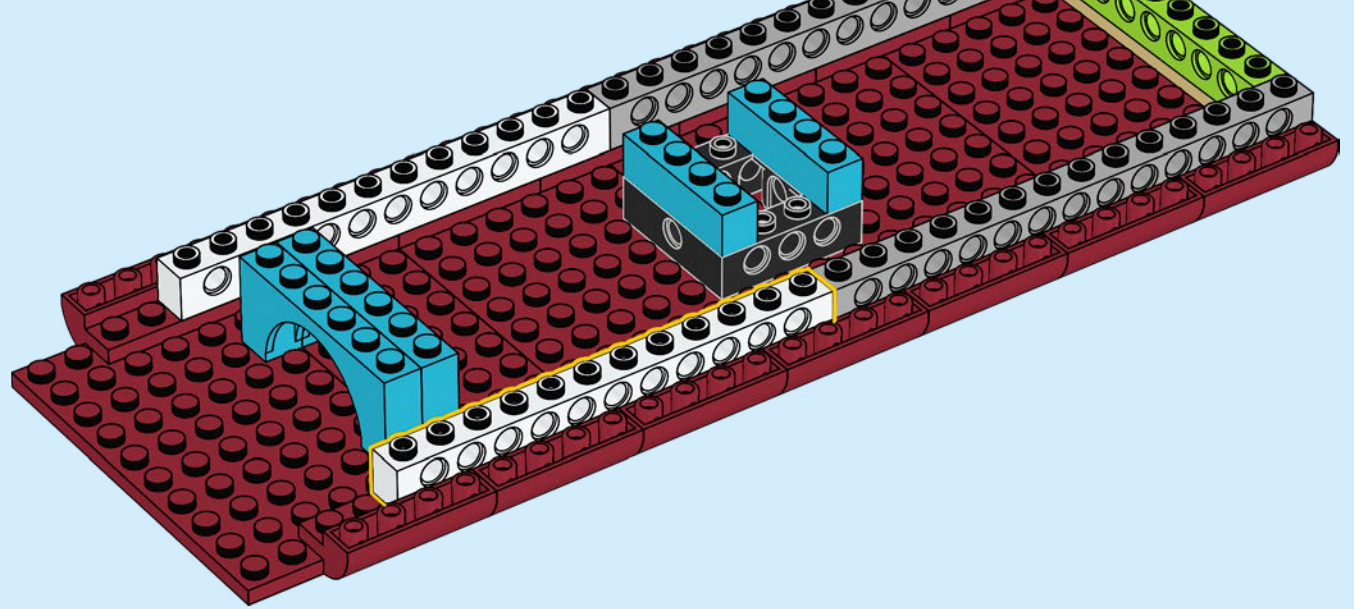

11

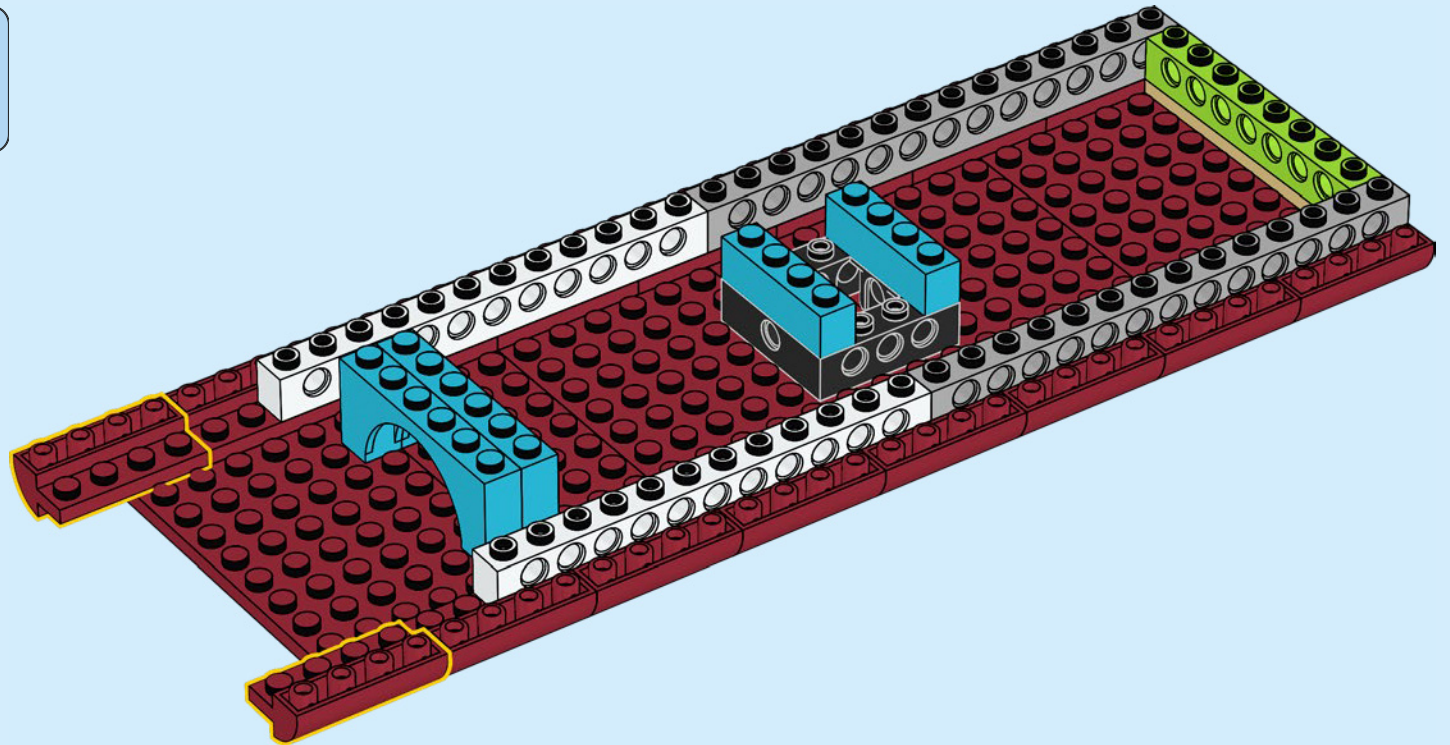

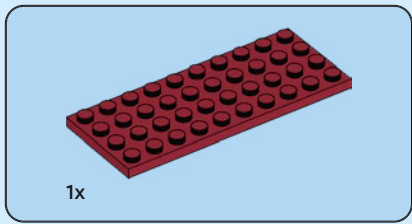

12

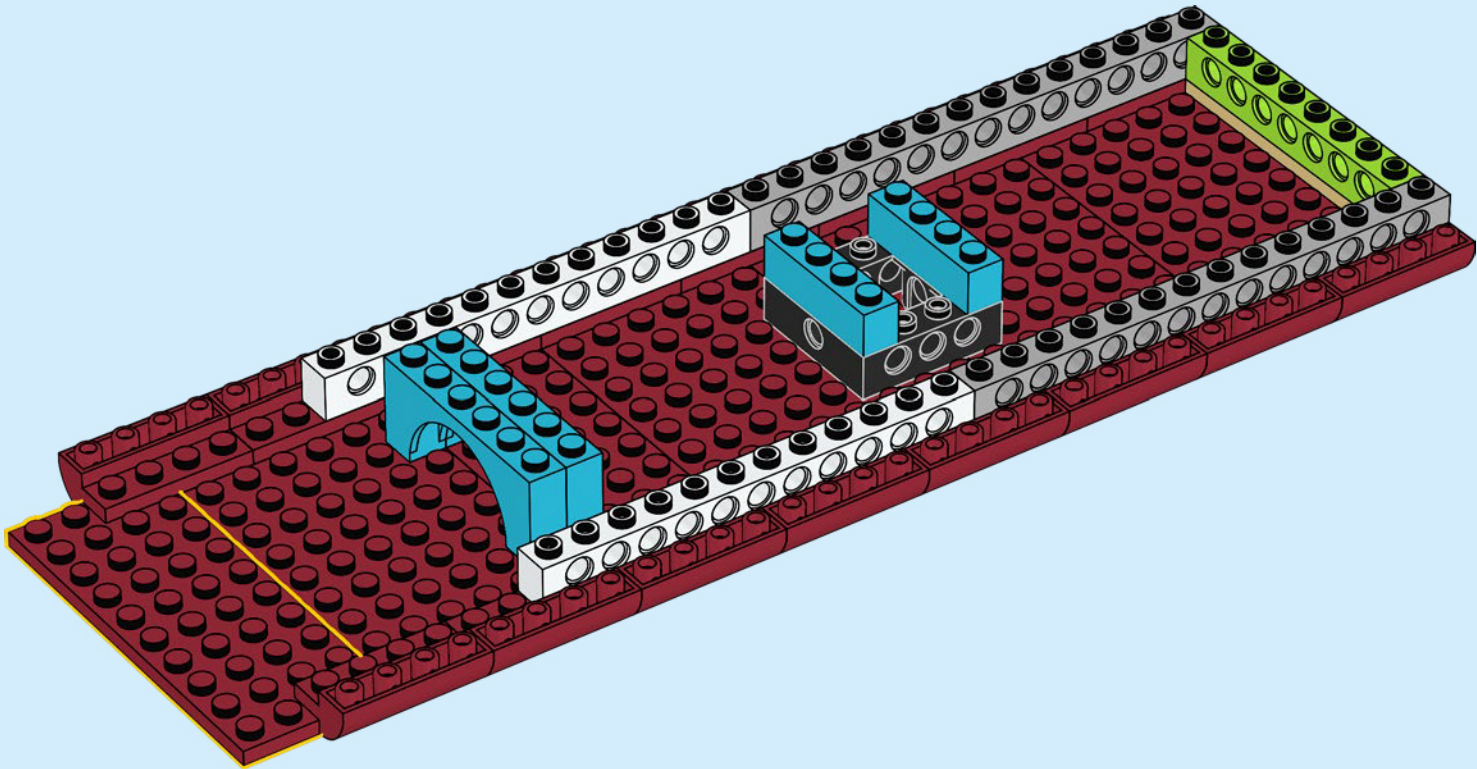

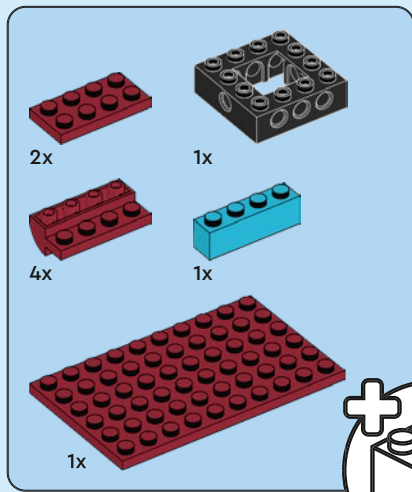

13

1

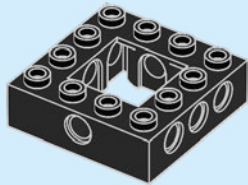

2

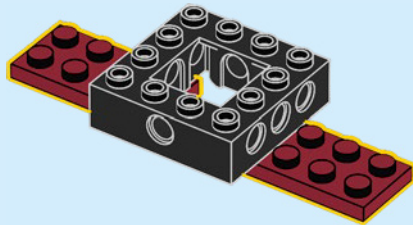

3

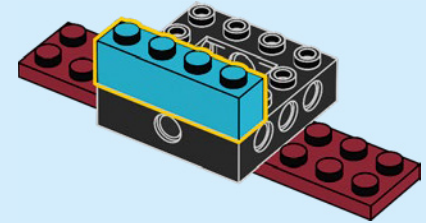

4

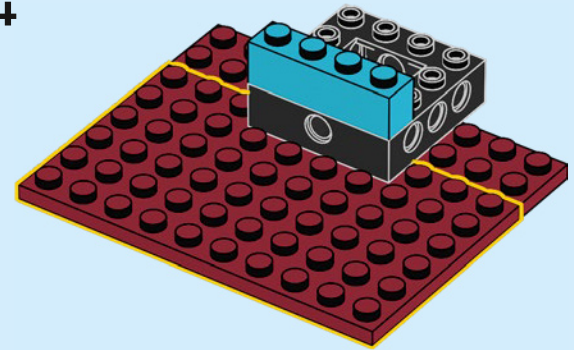

5



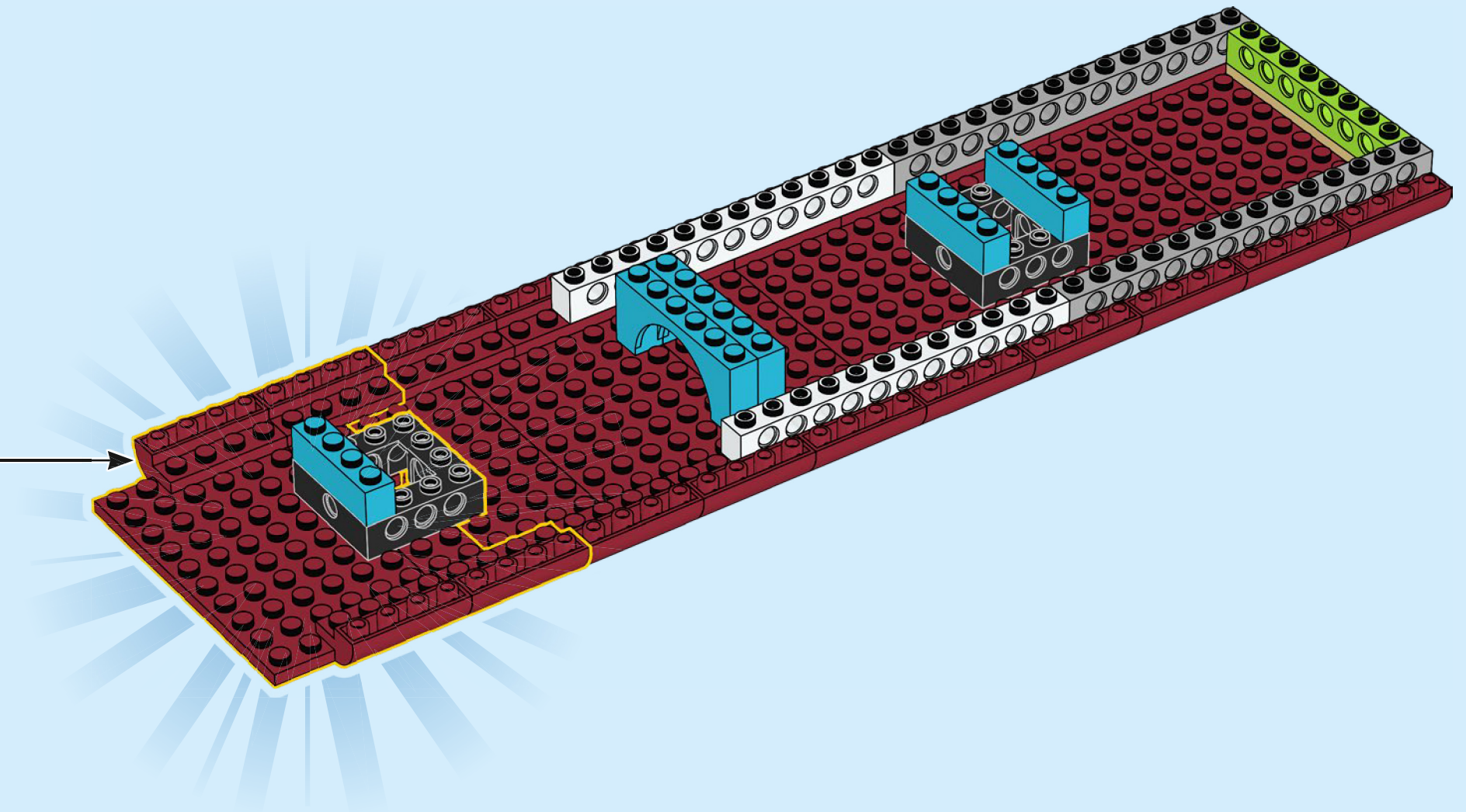

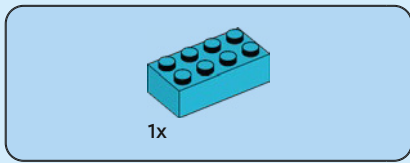

14

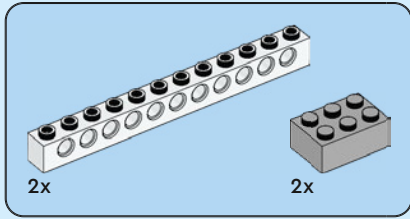
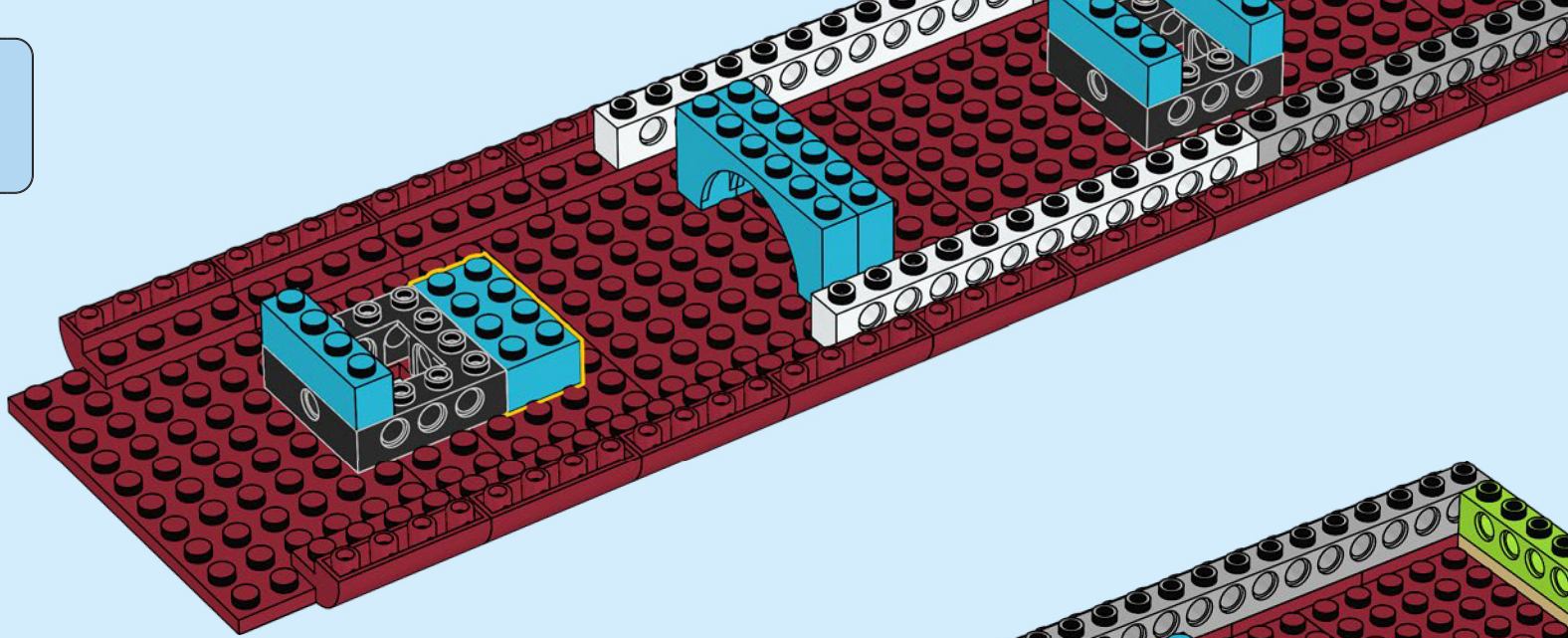

15

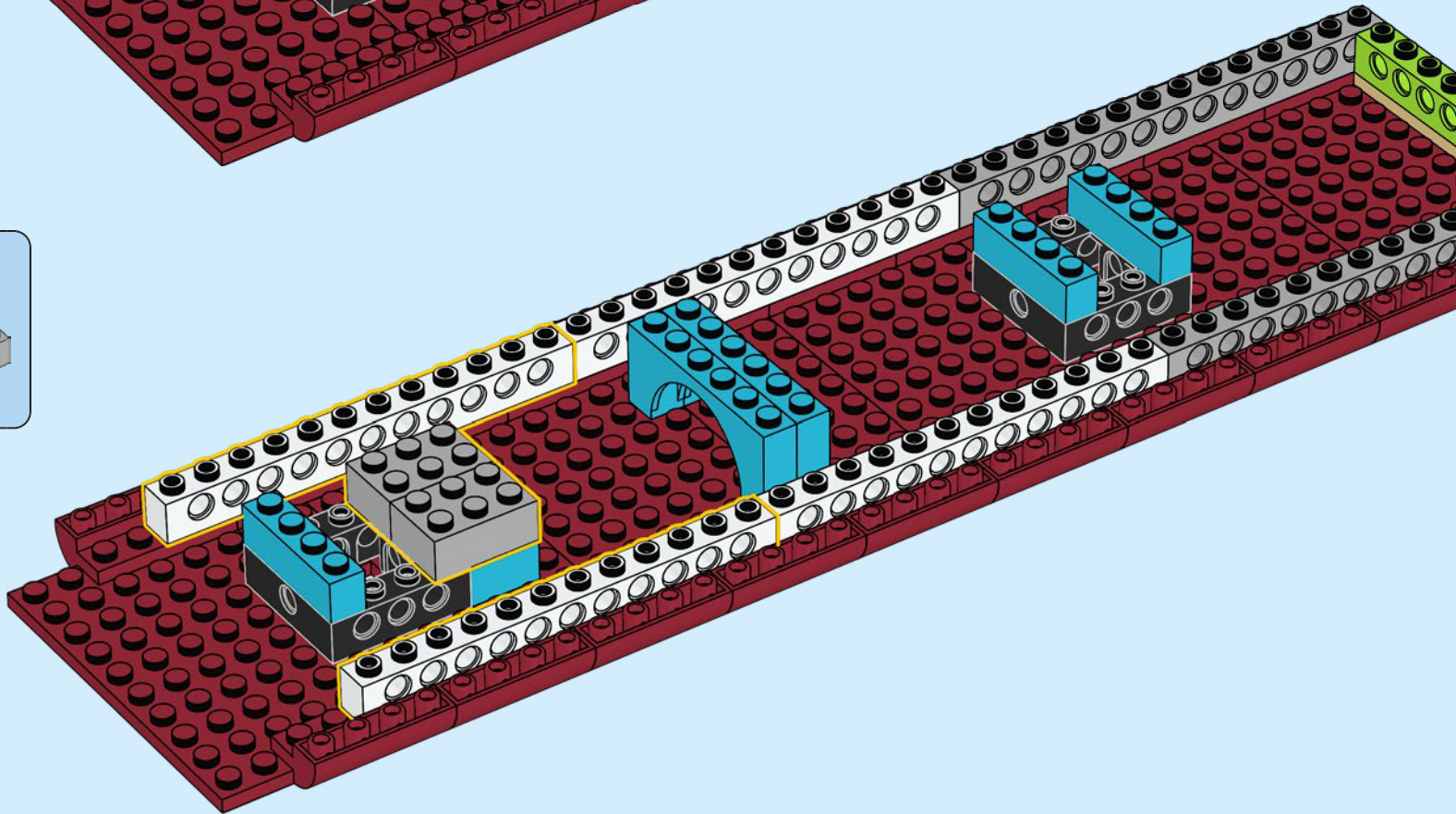

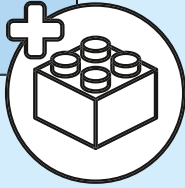
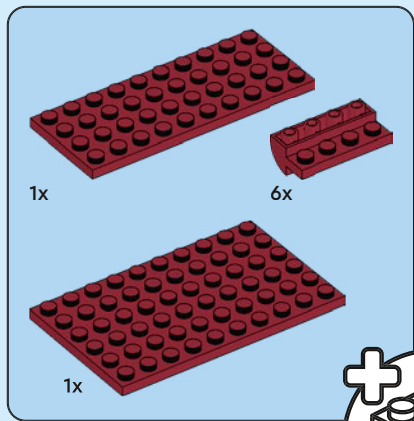

16

1

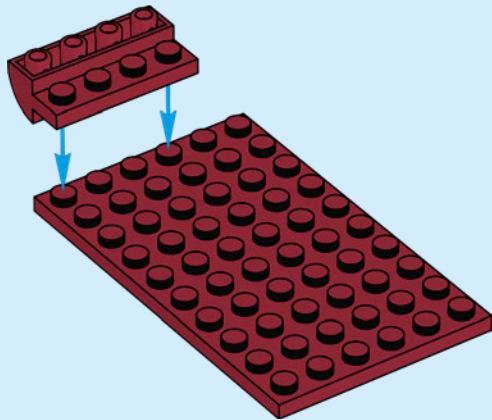

2

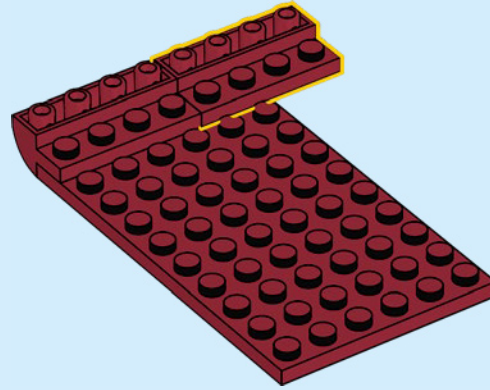

3

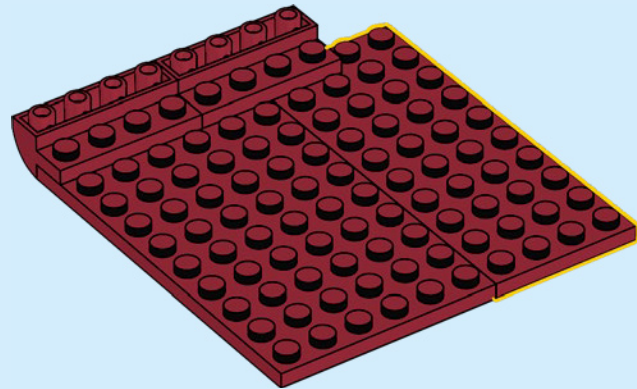

4

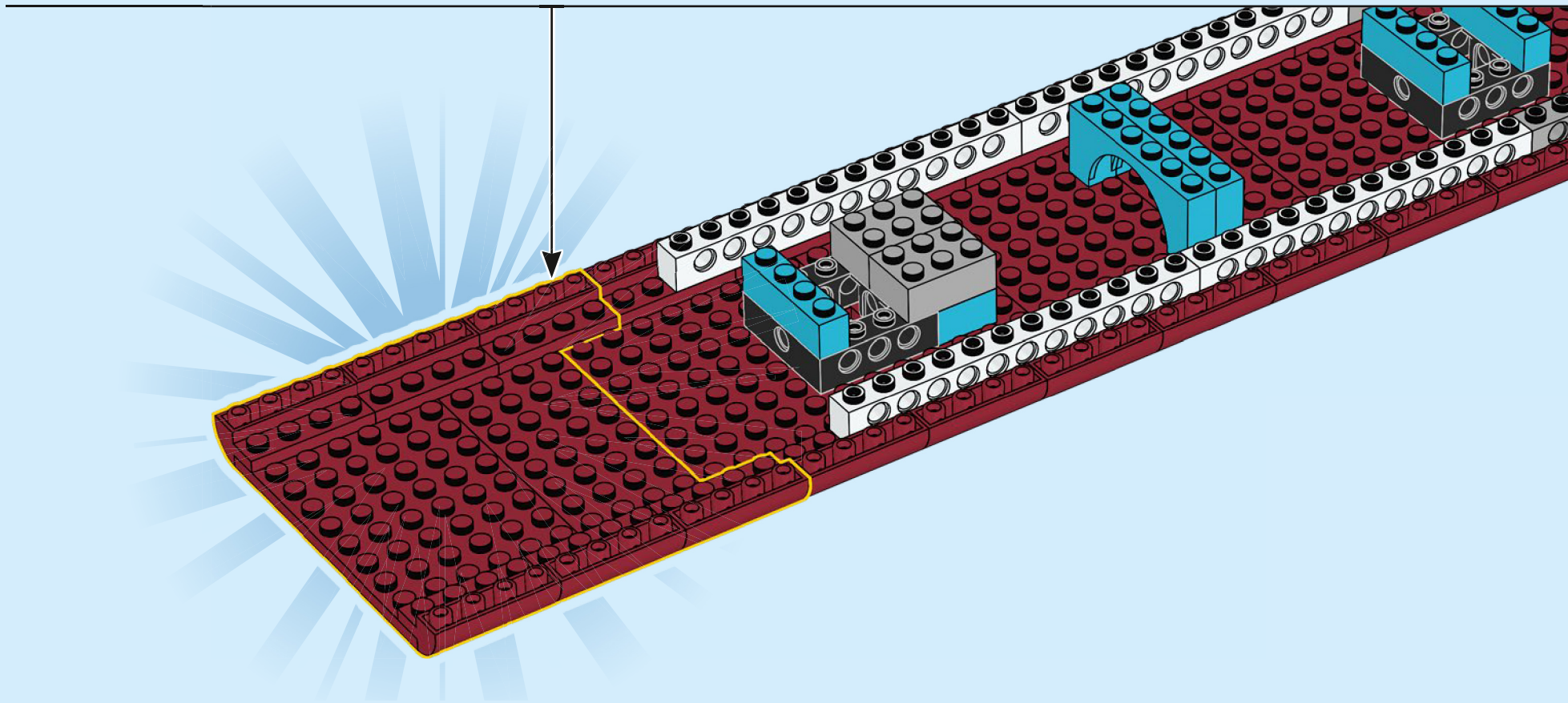
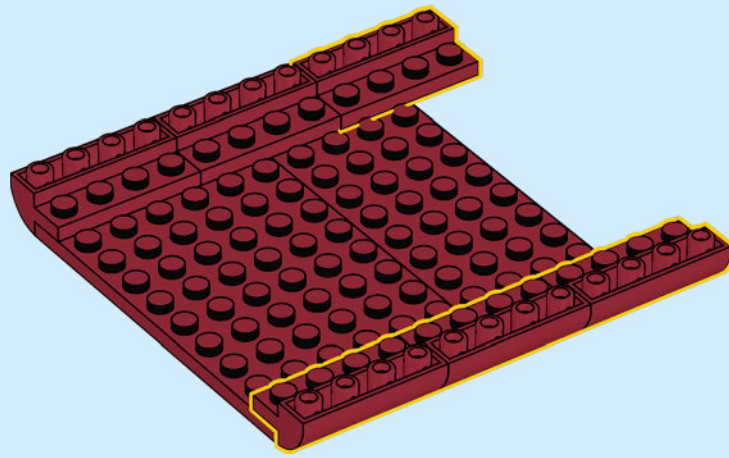

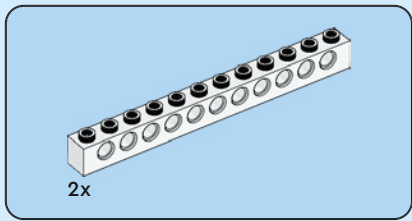

17

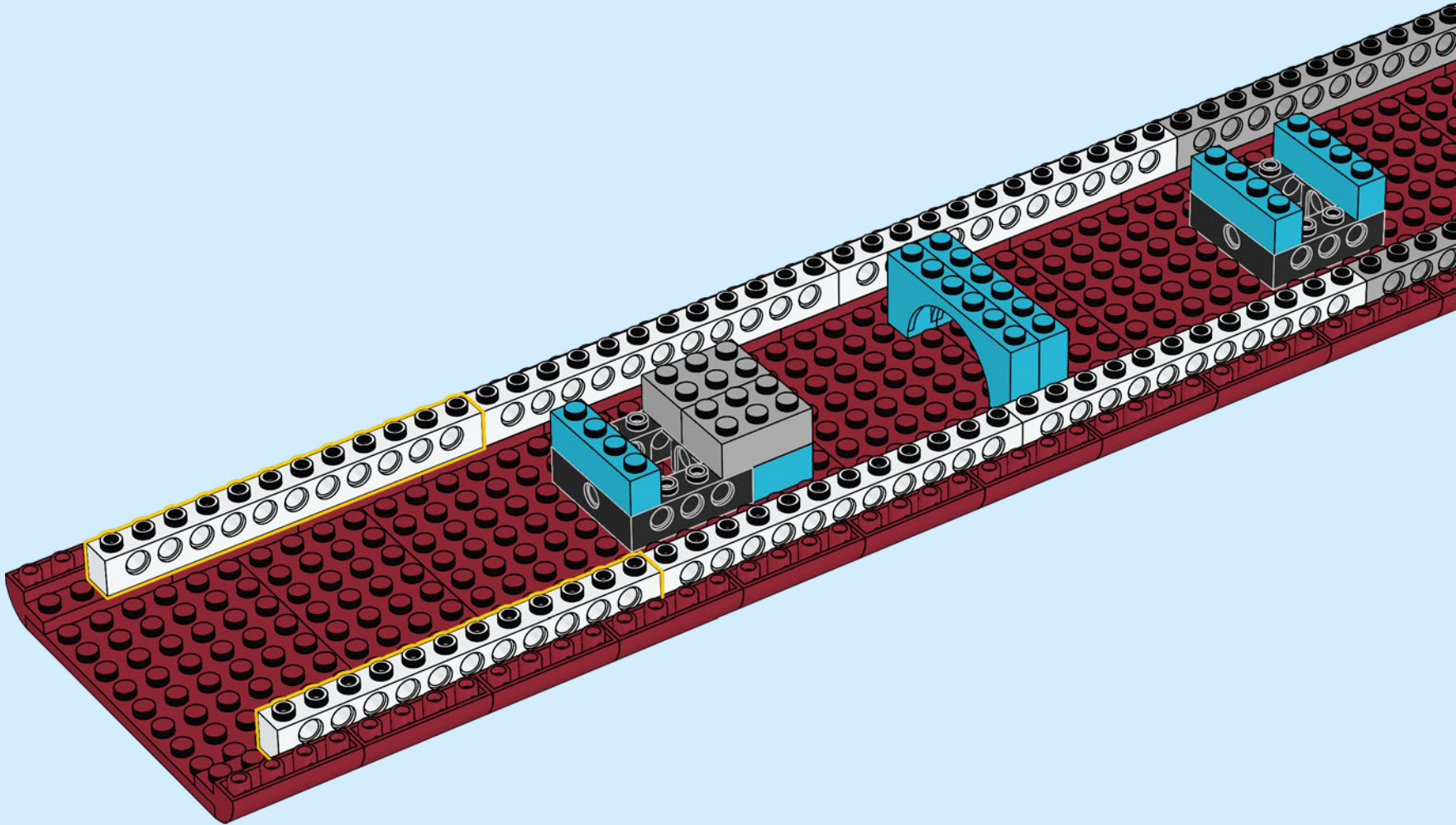

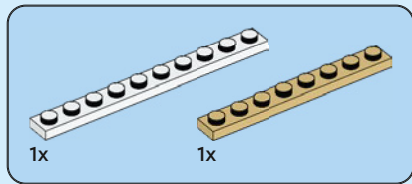

18

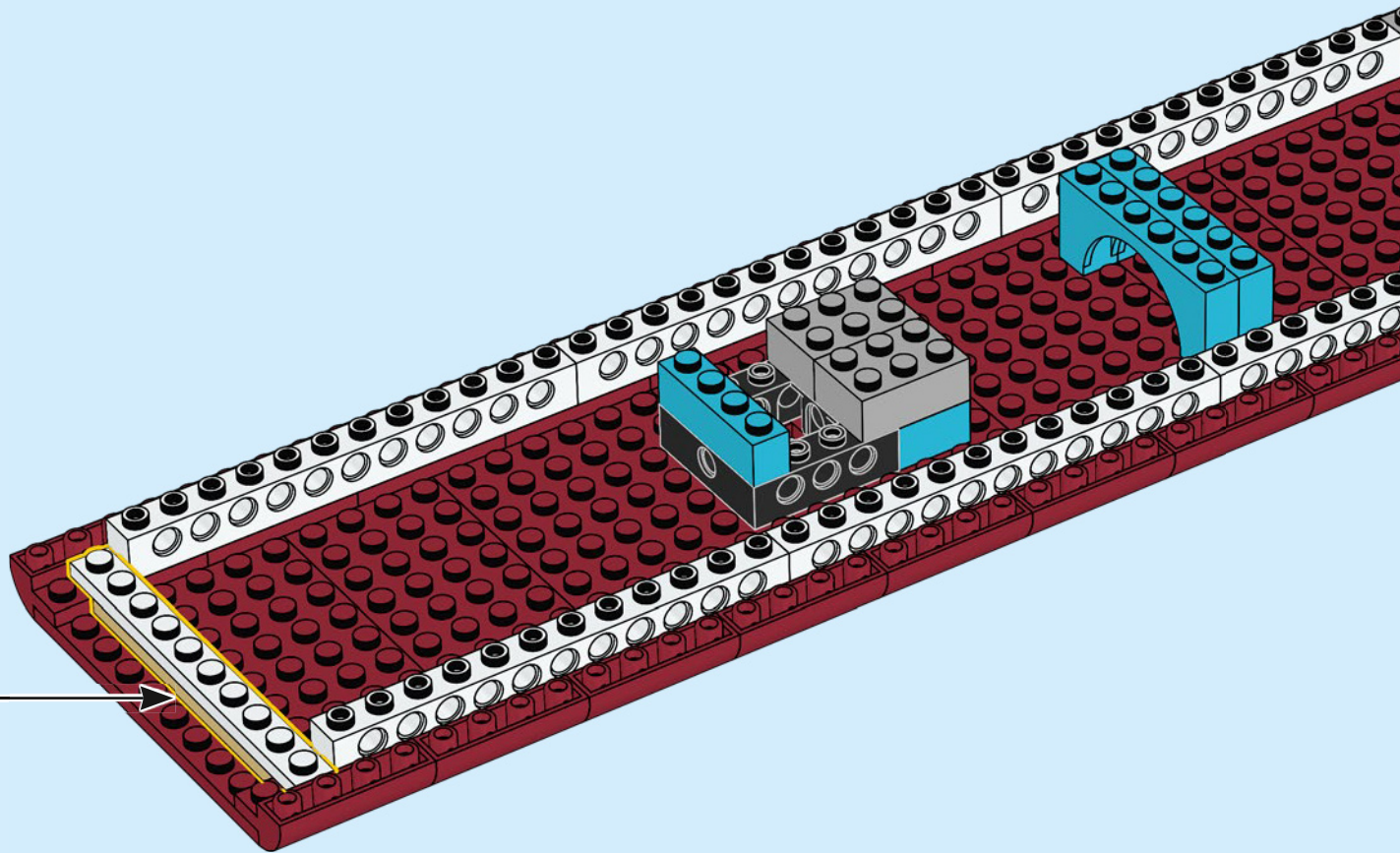
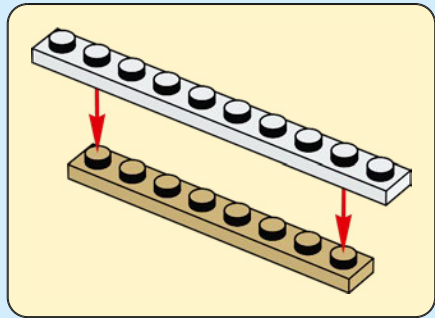

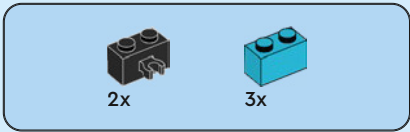

19

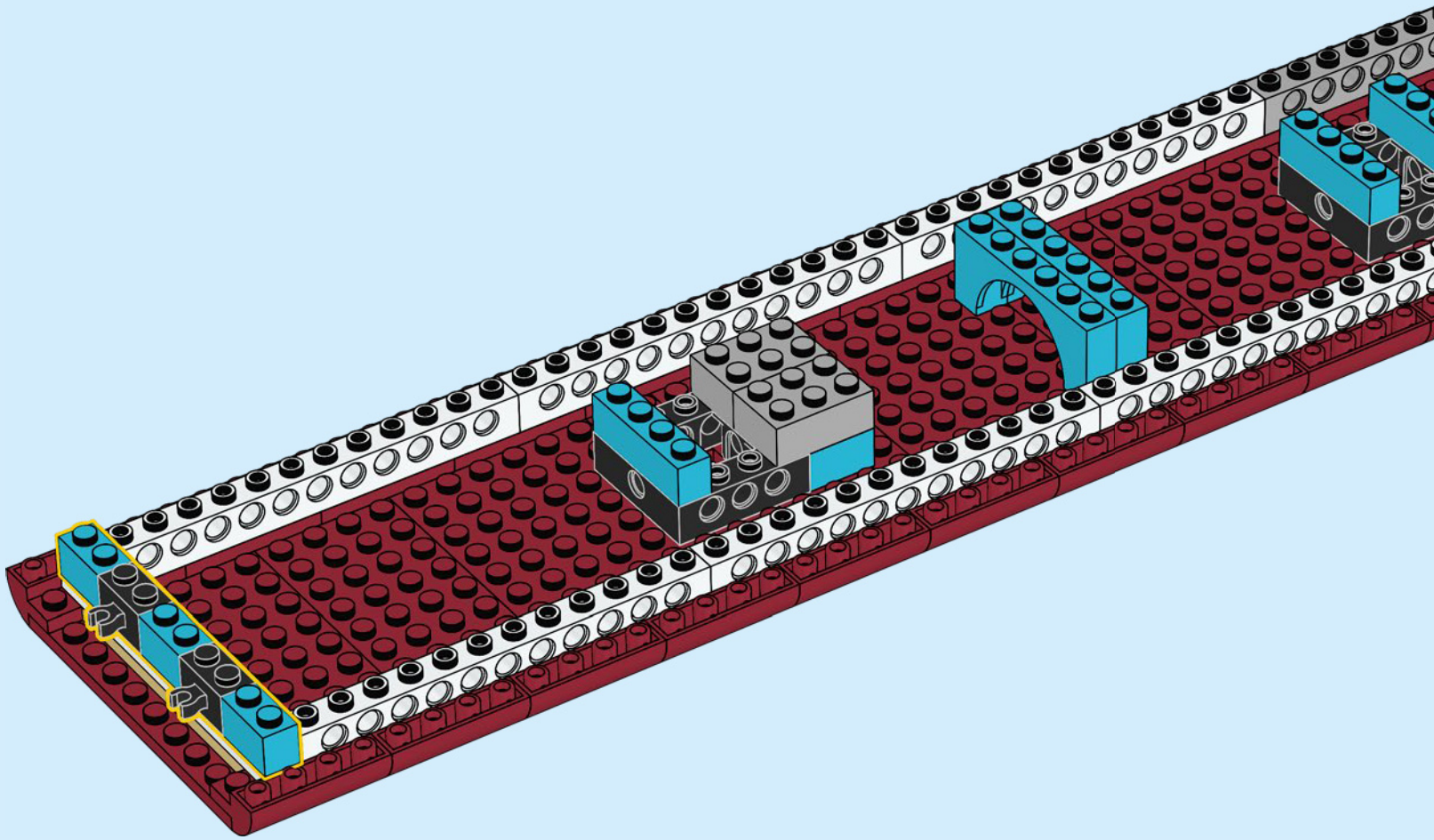

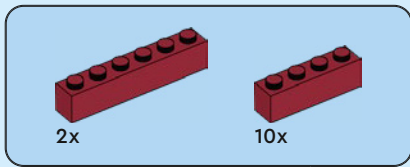

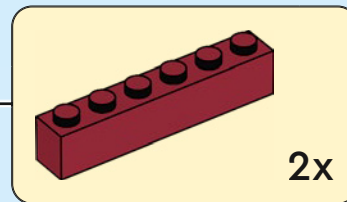
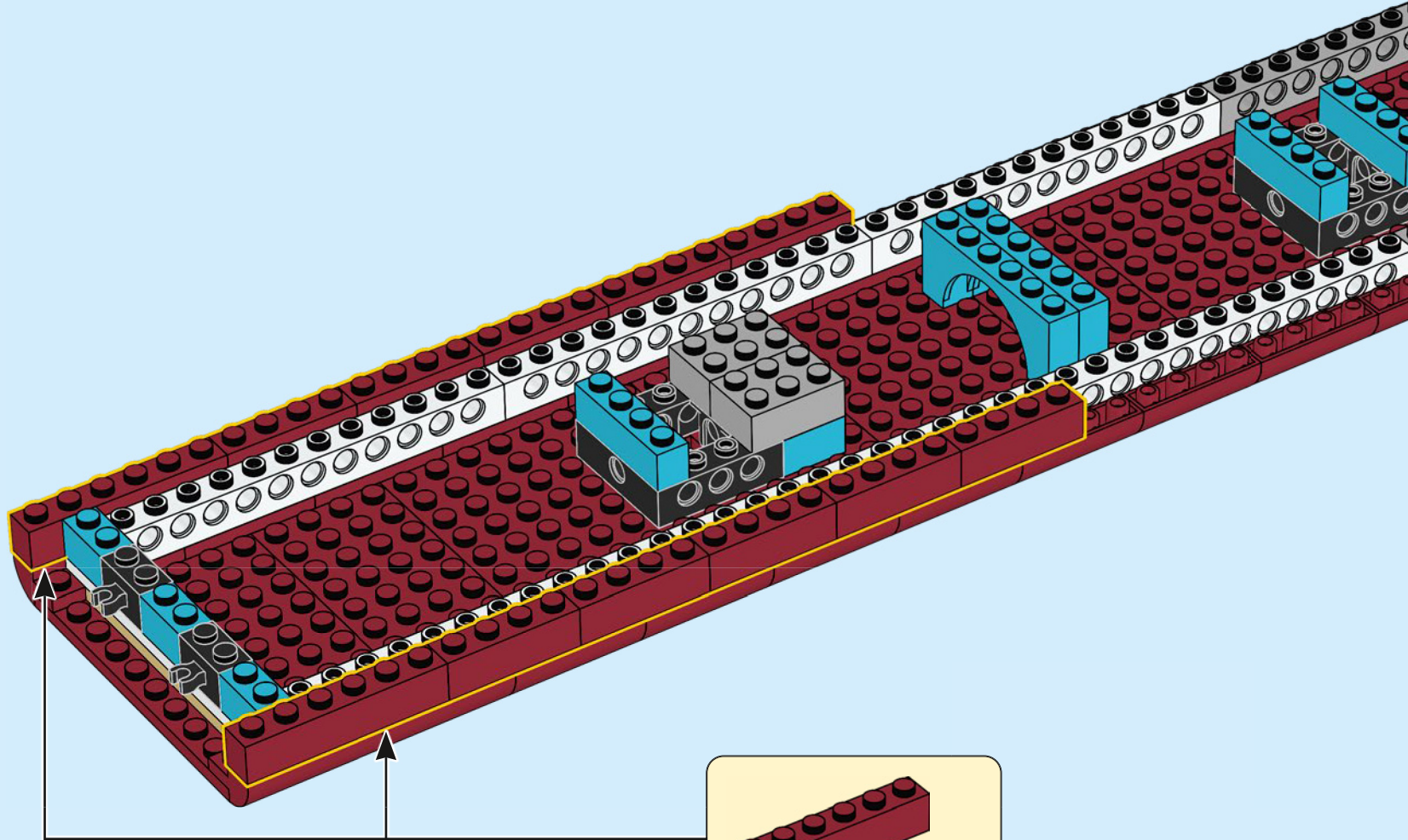

20

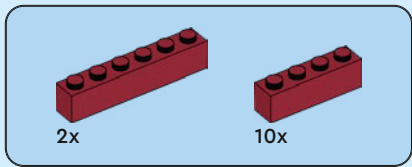

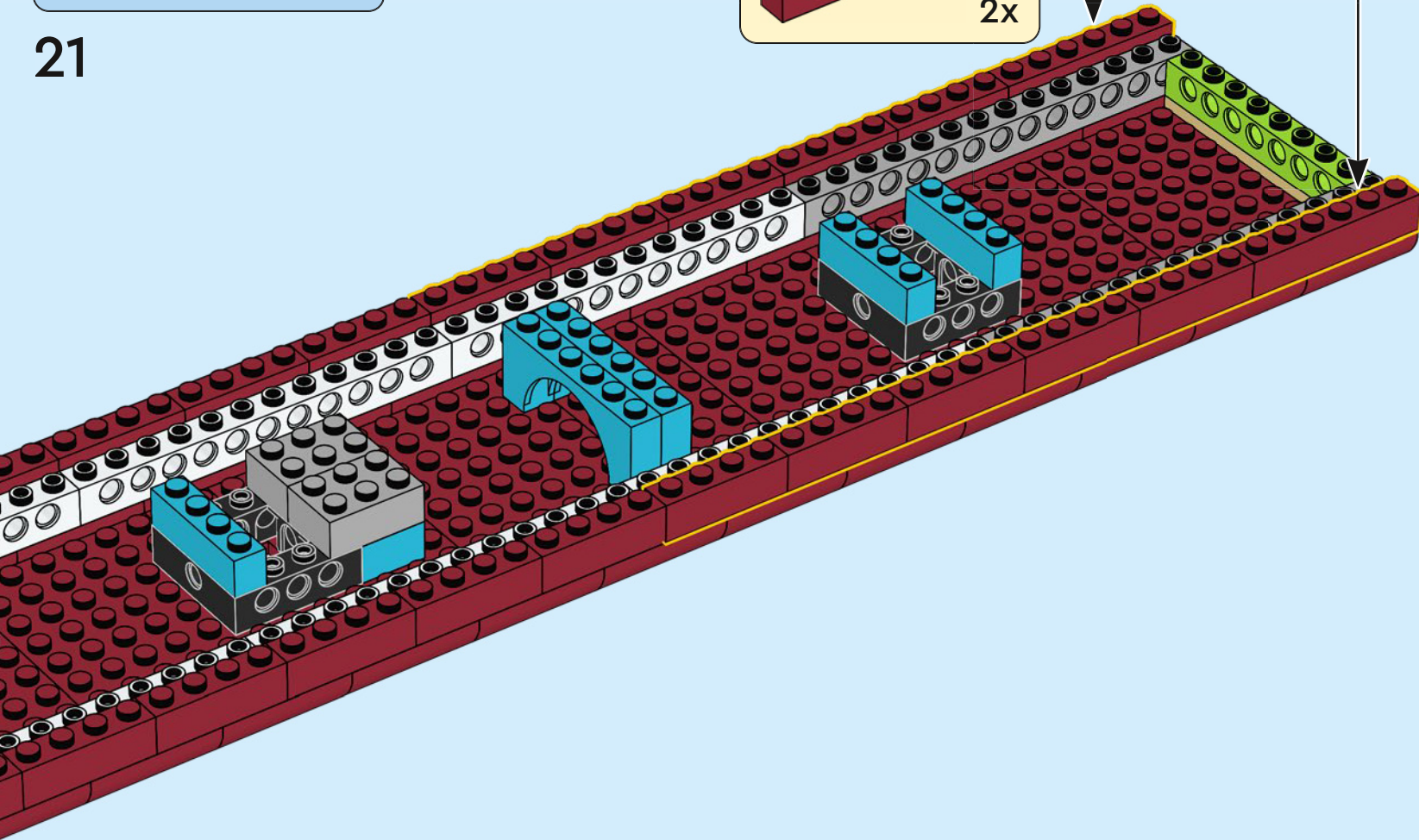
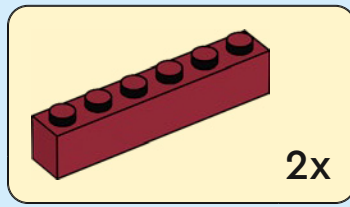

21



2x  1x 

22

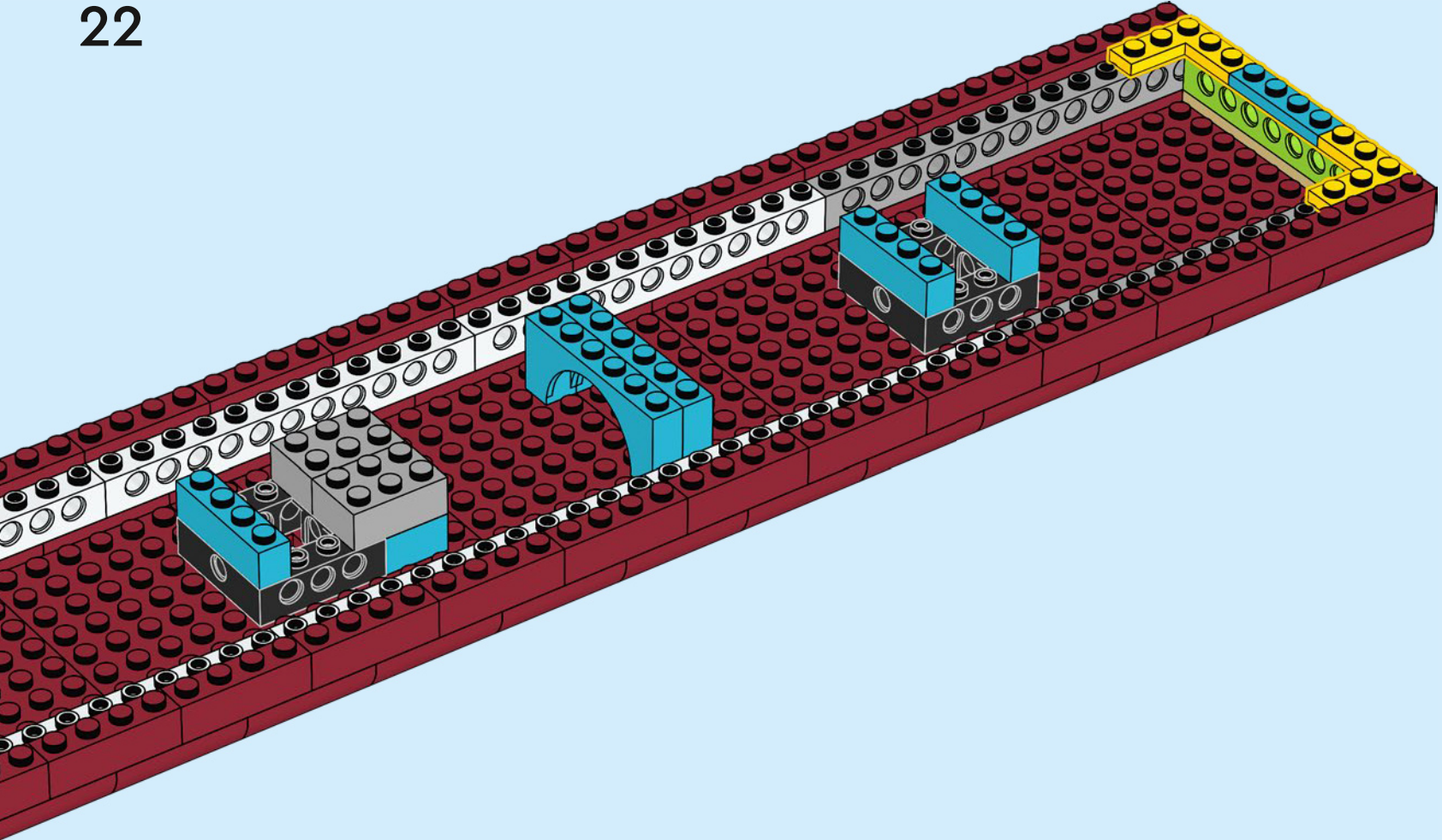

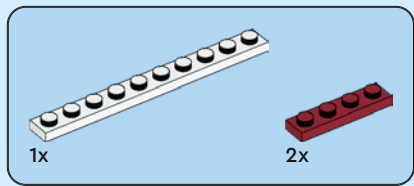

23

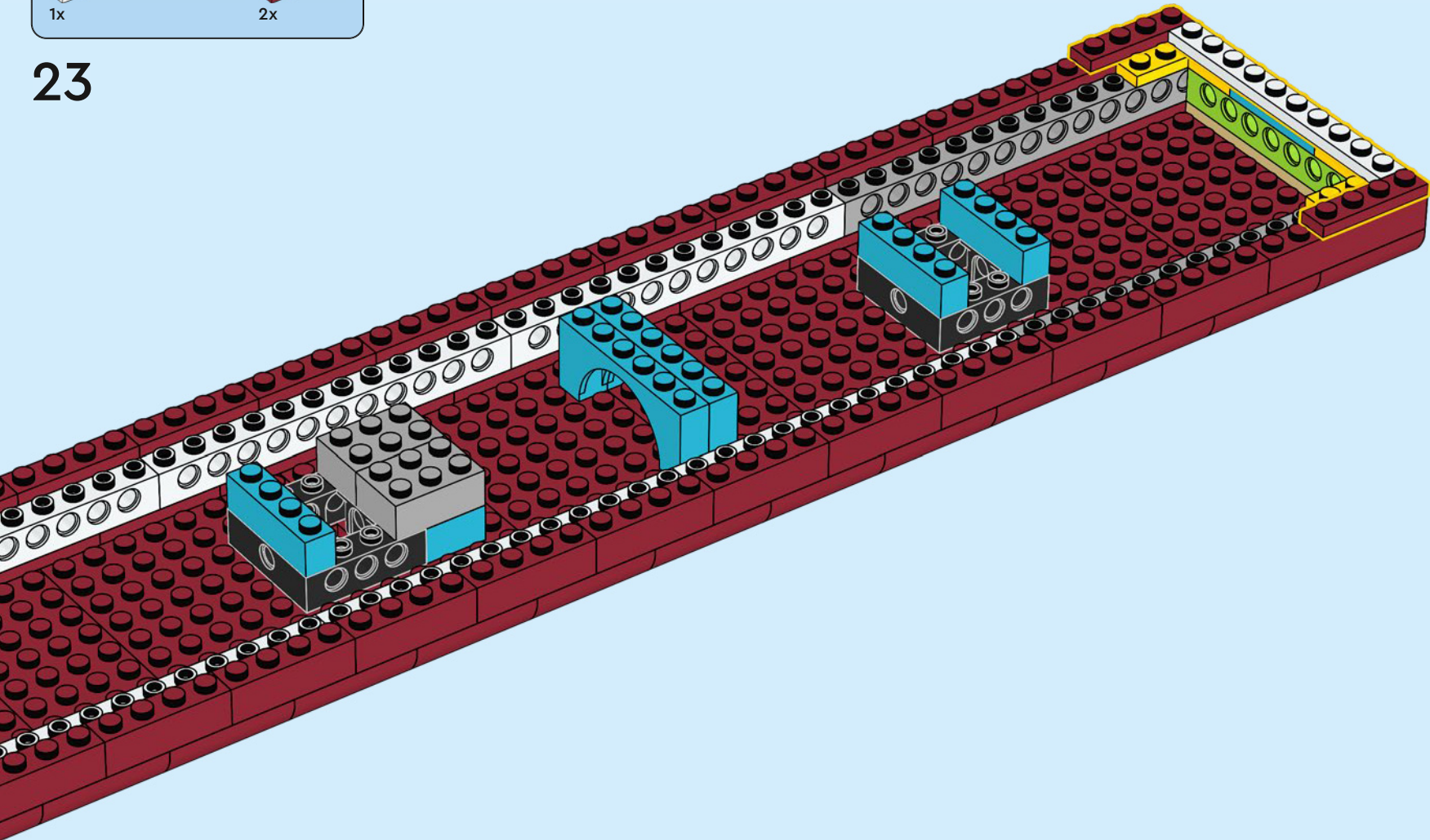

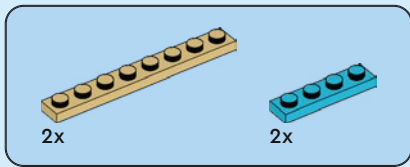

24

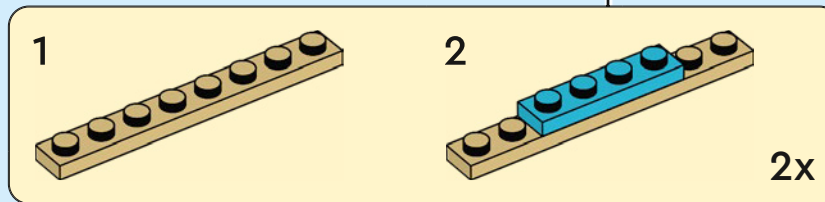
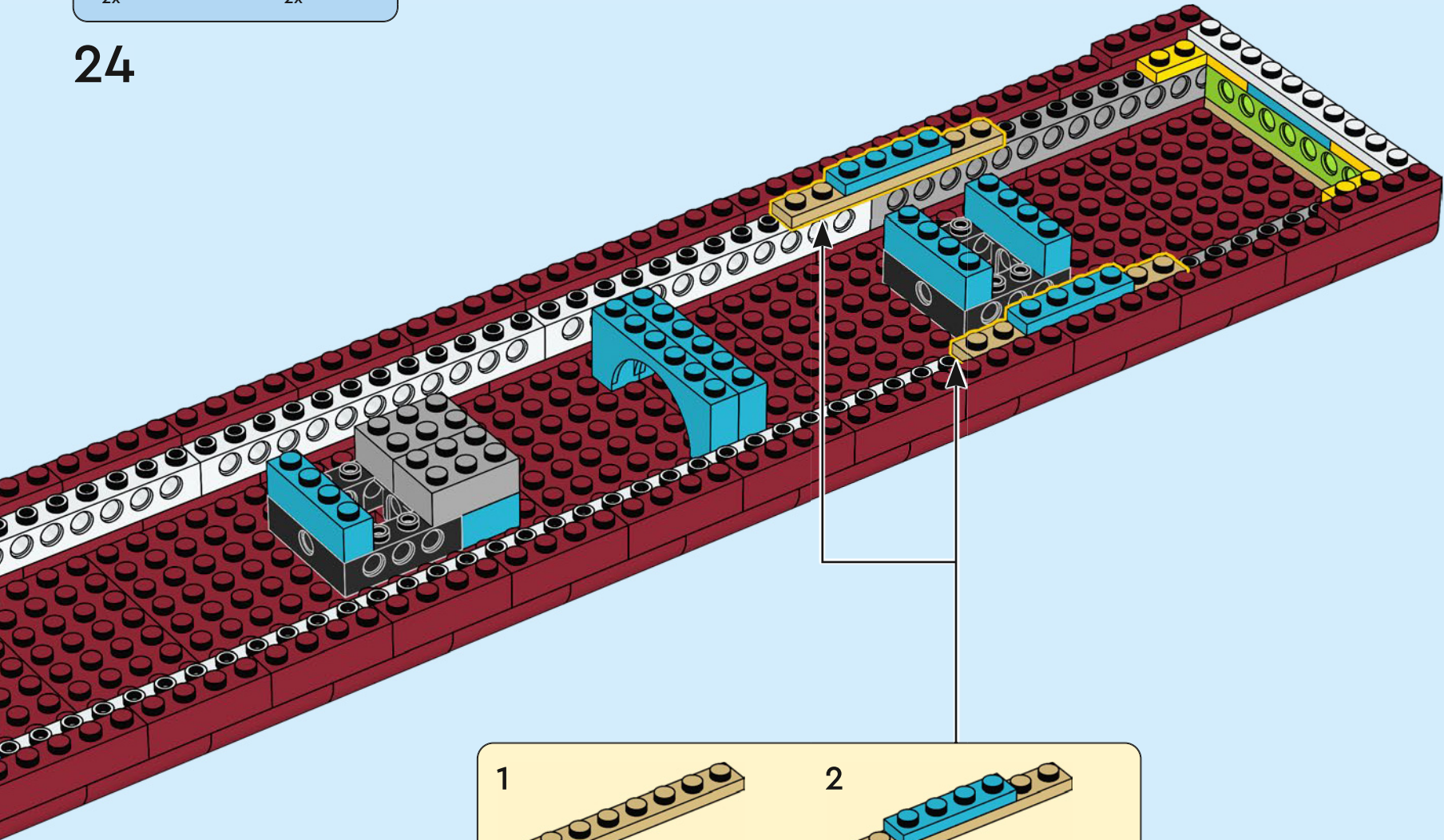

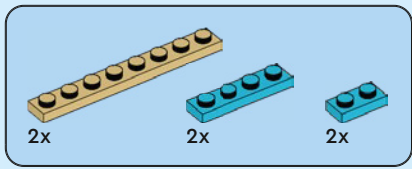

25

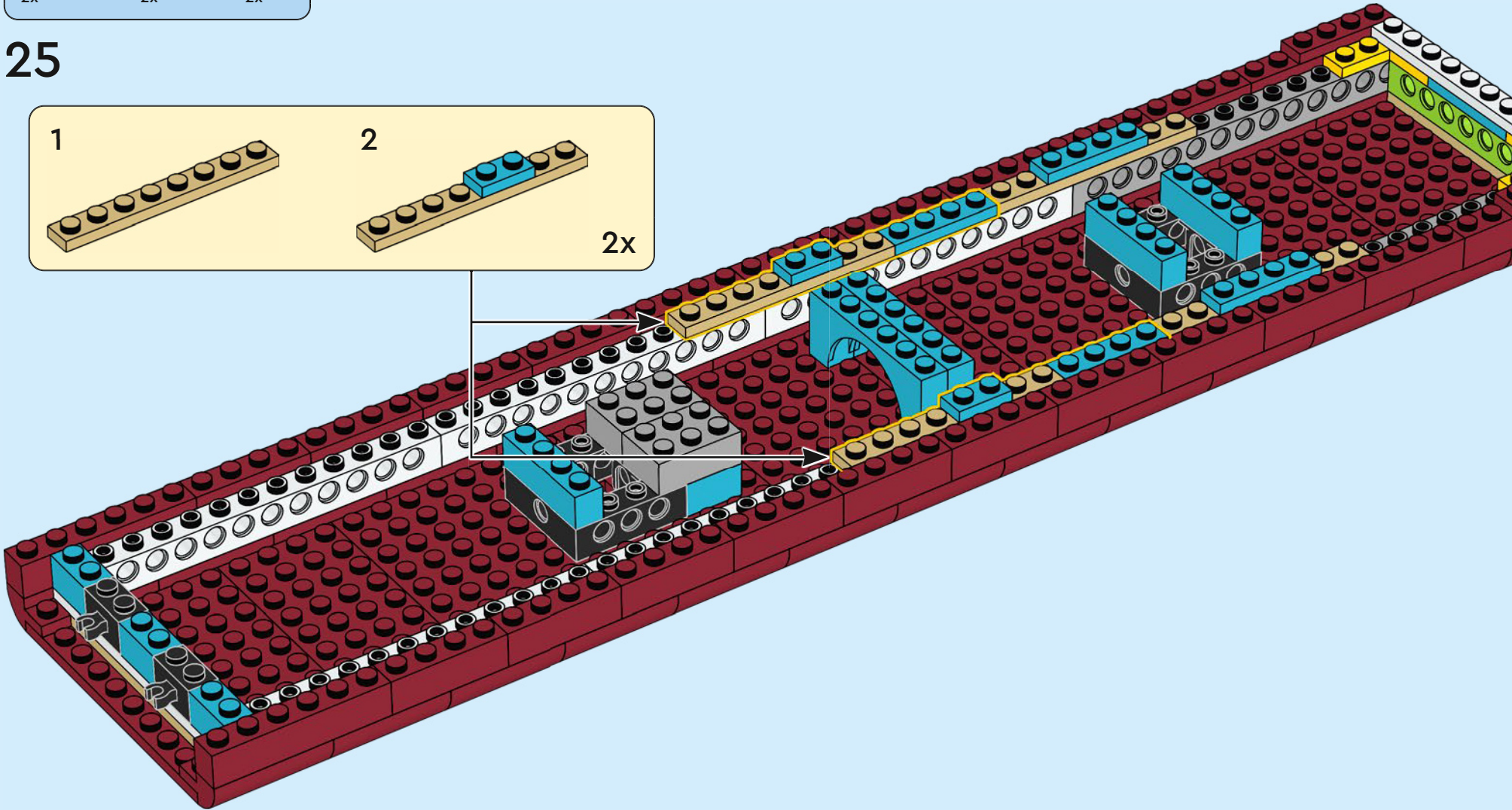
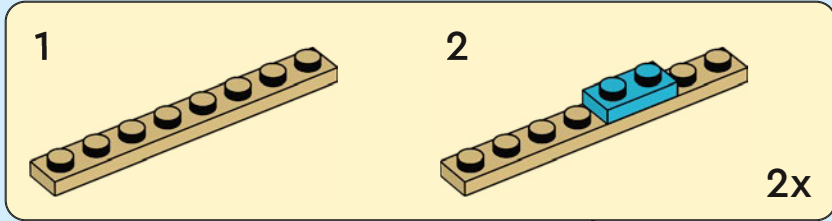

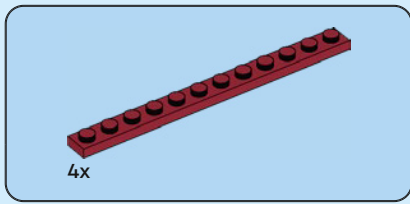

26

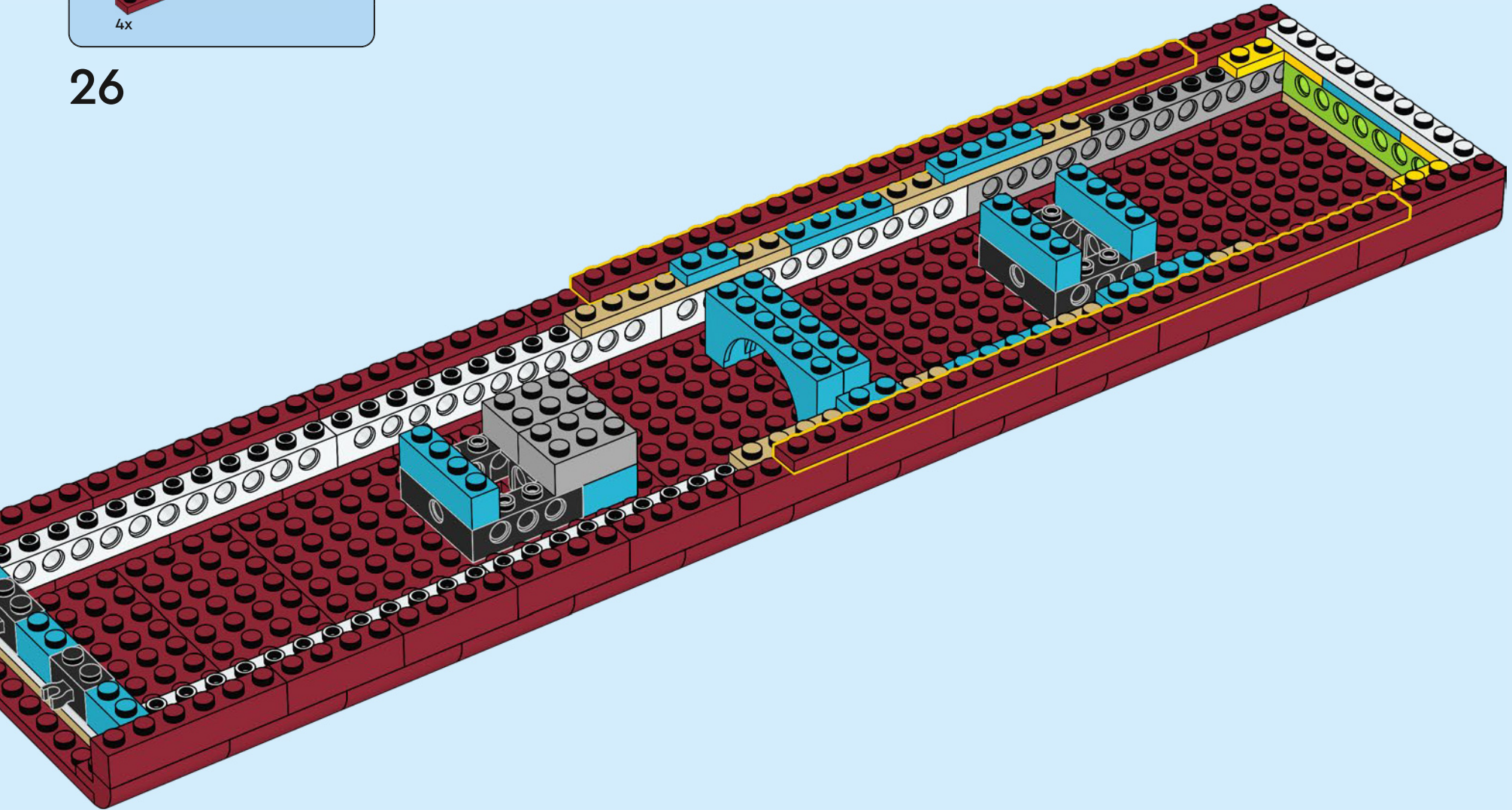

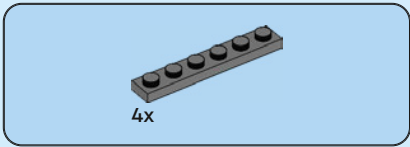

27

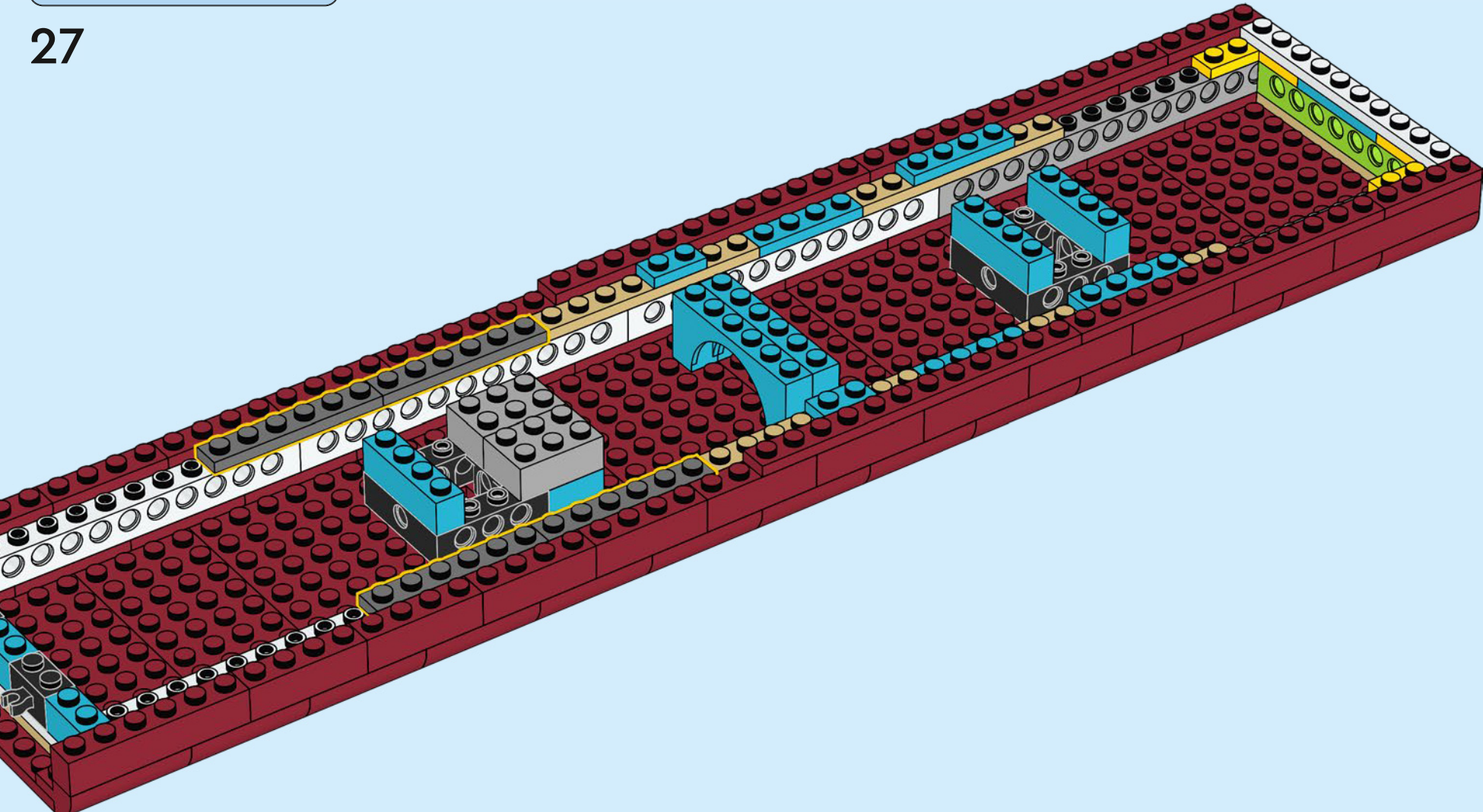

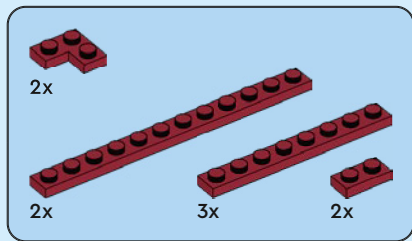

28

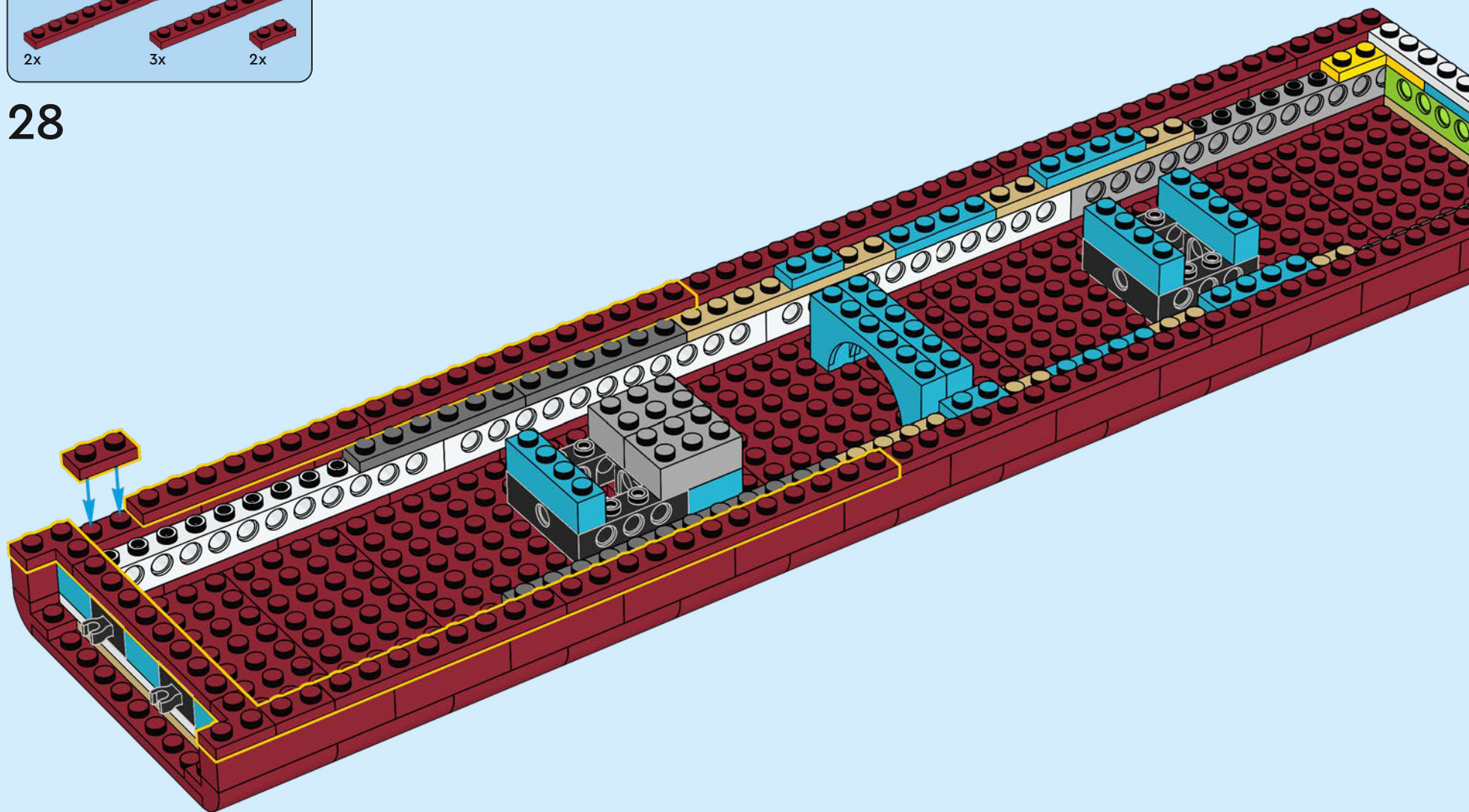

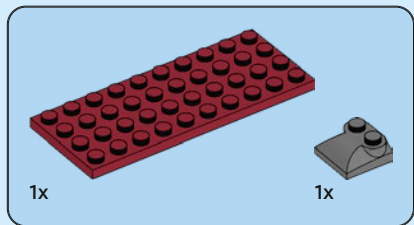
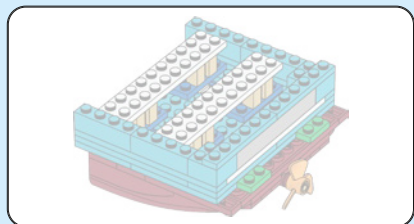

29

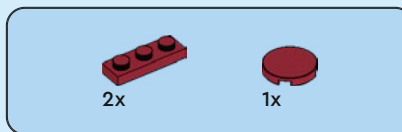
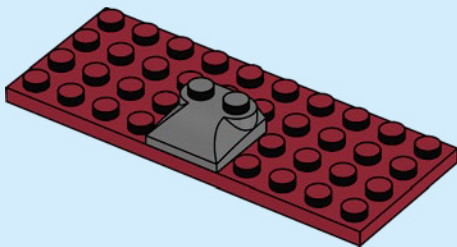

30

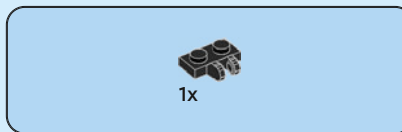
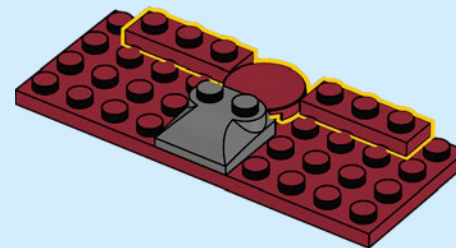

31

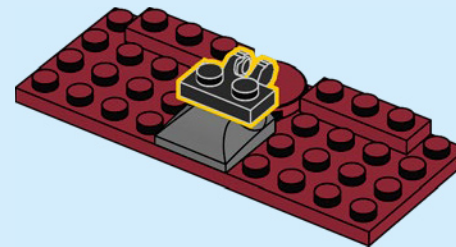

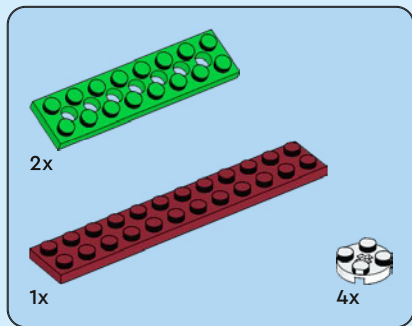

32

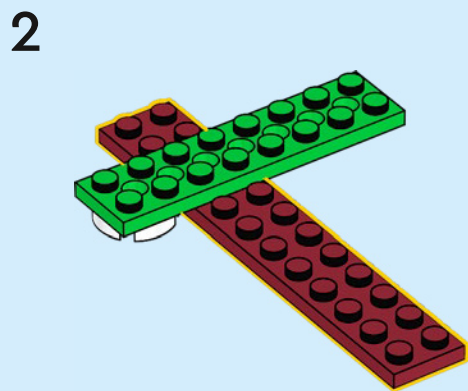
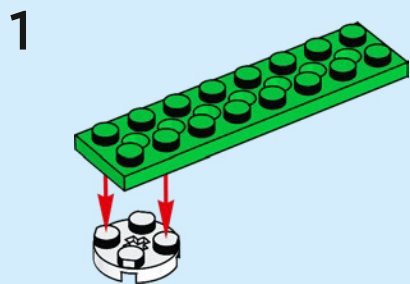

3

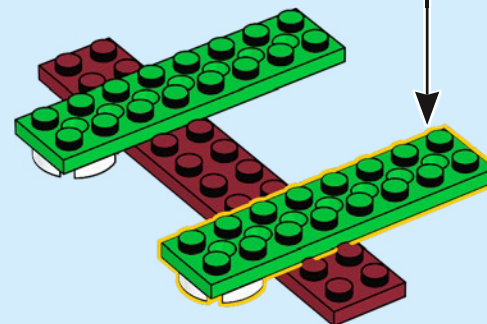
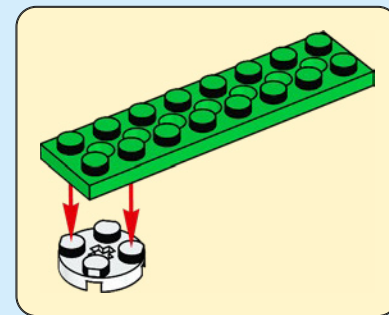

4

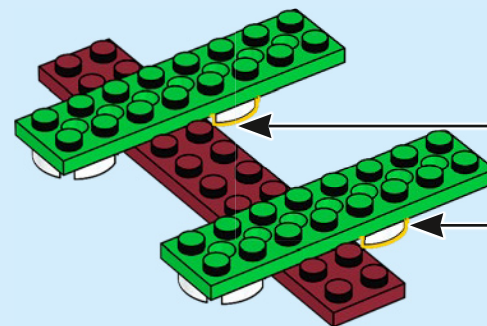

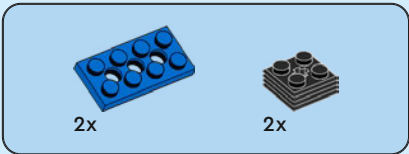

33

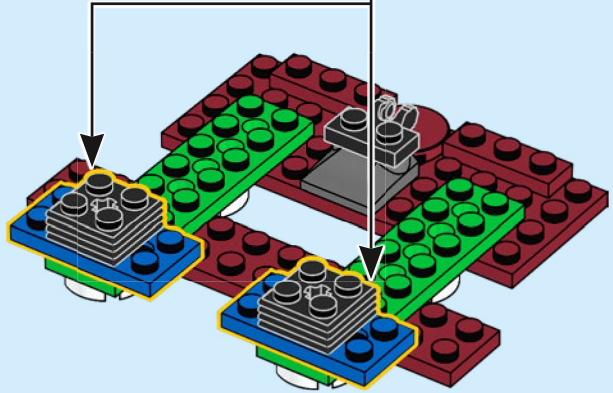
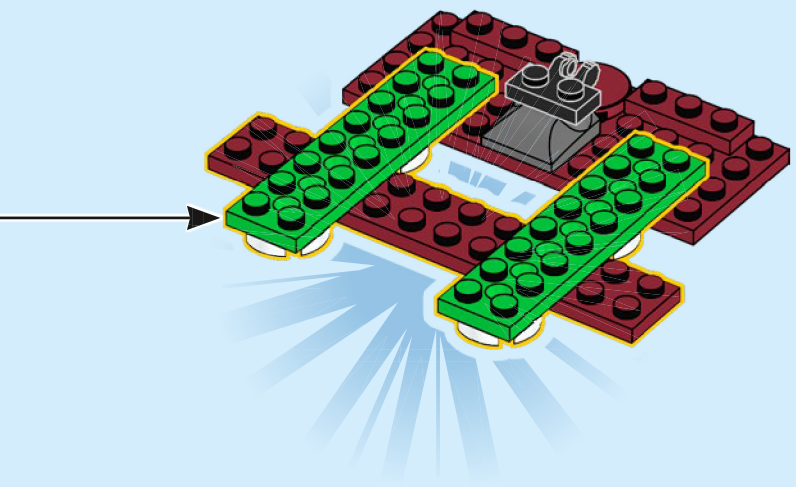
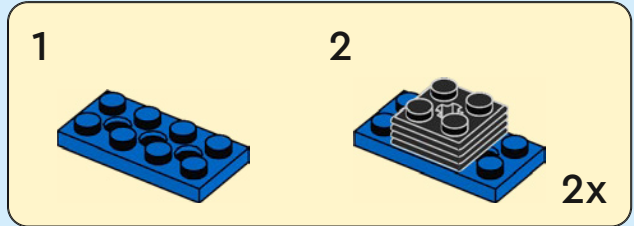

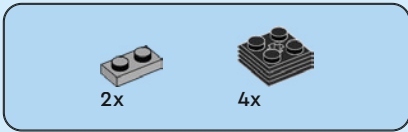

34

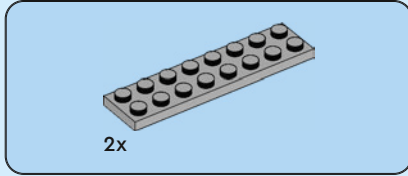
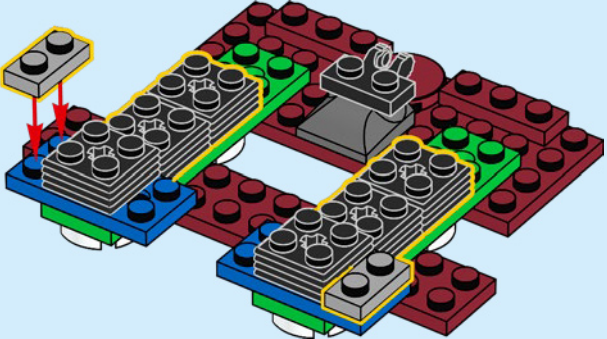

35

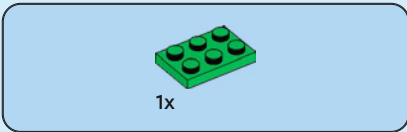
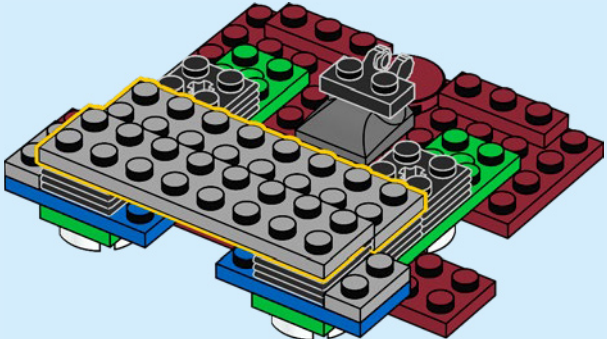

36

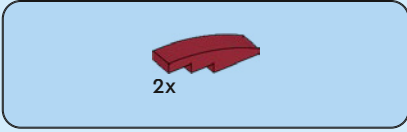
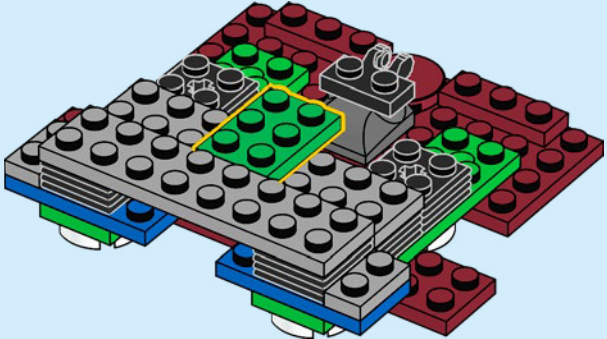

37

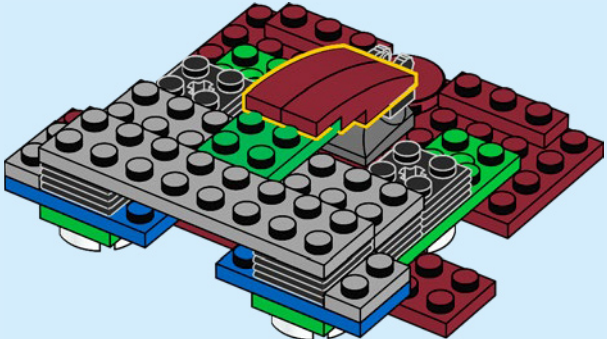

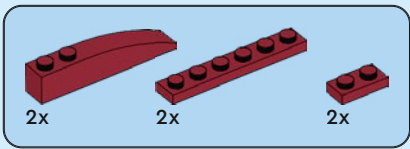

38

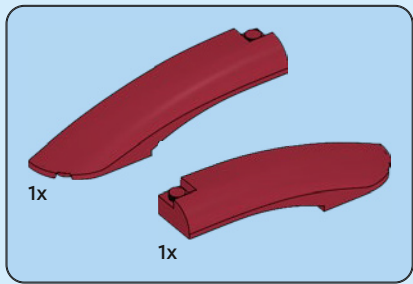
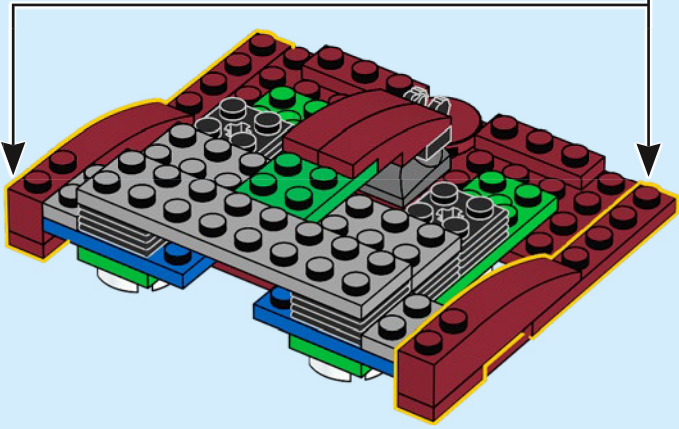
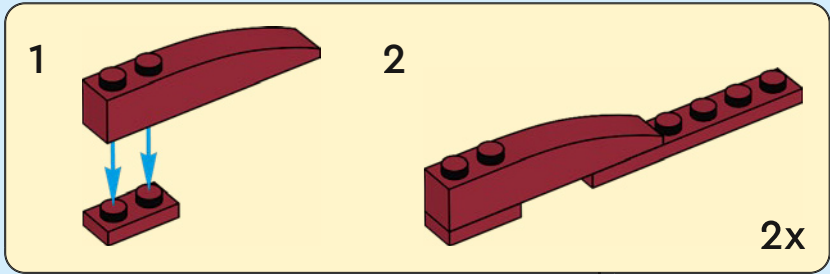

39

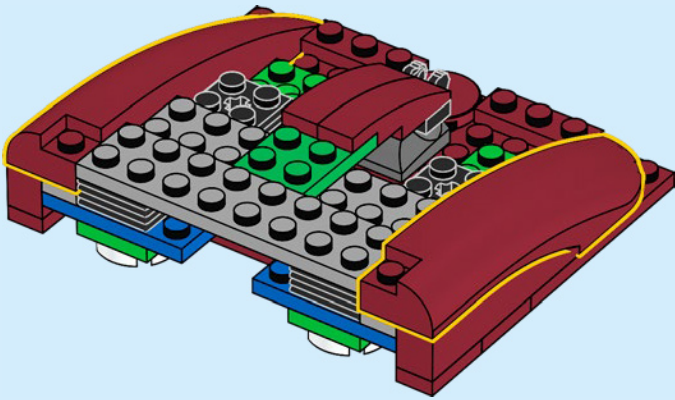

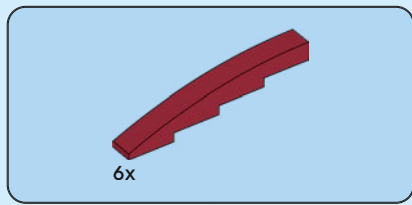

40

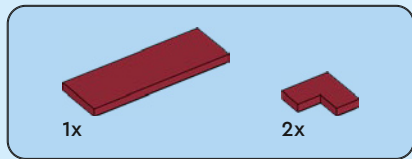
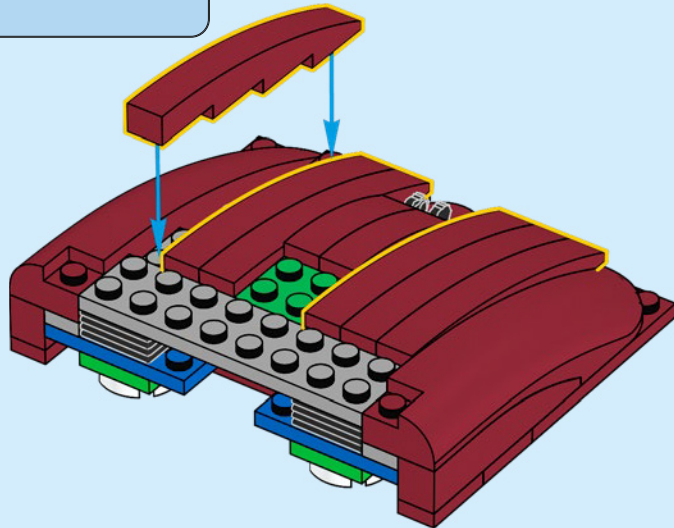

41

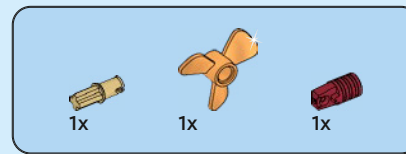
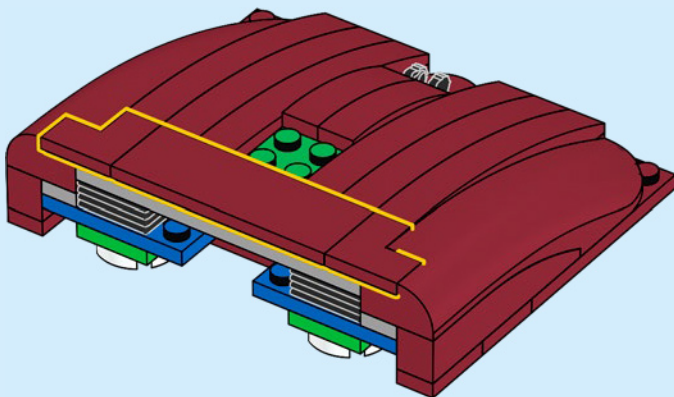

42

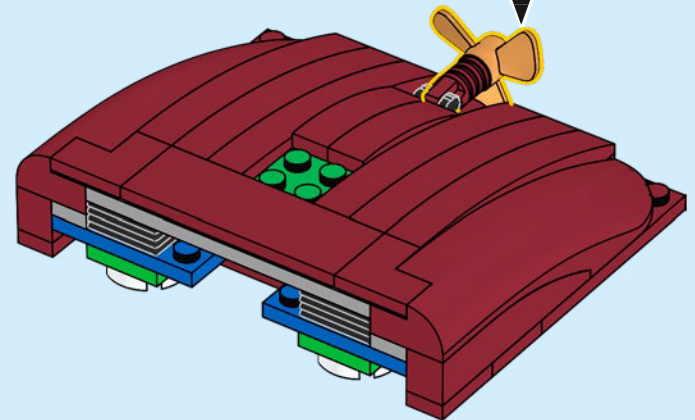
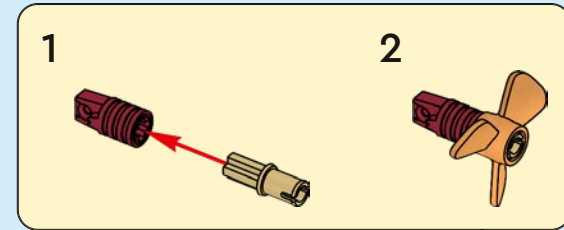

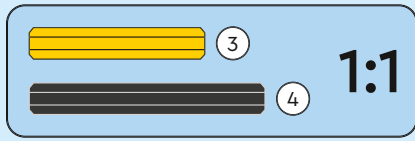
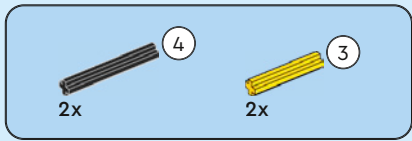

43

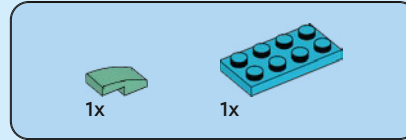
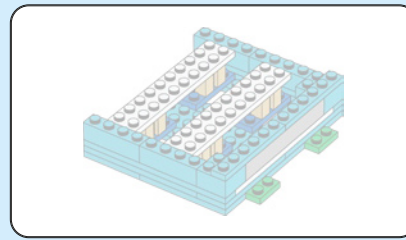
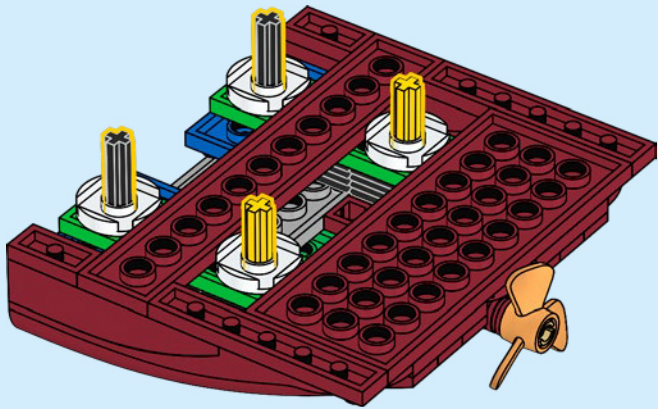

44

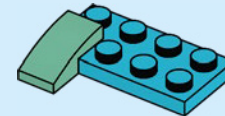

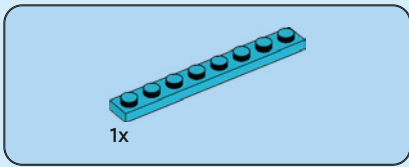

45

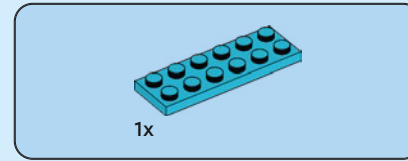
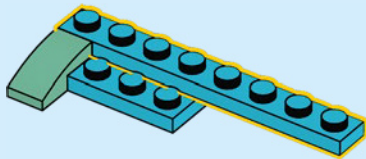
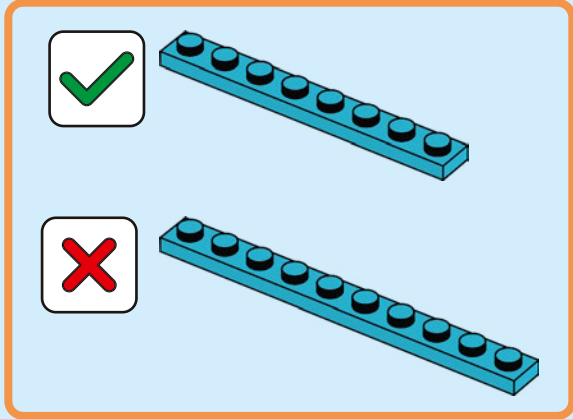

46

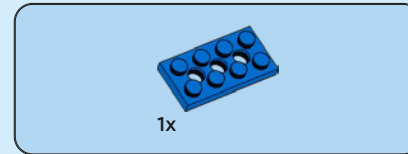
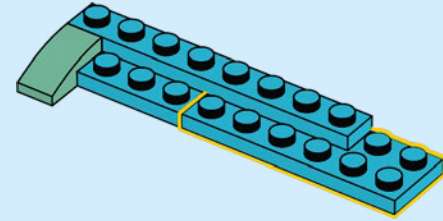

47

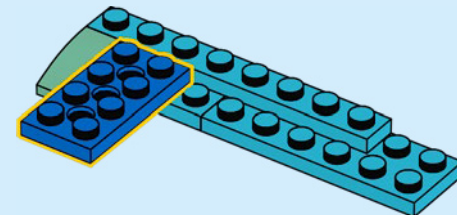

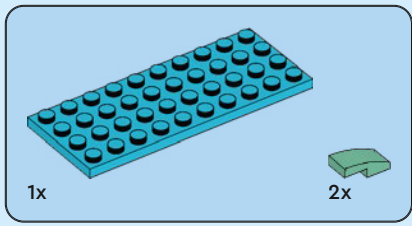

48

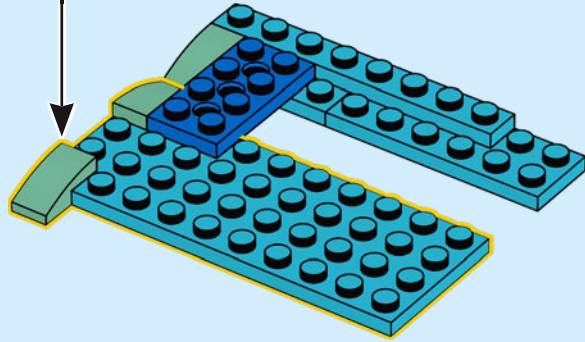
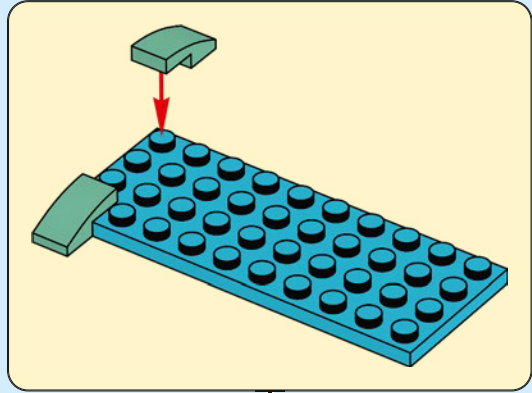

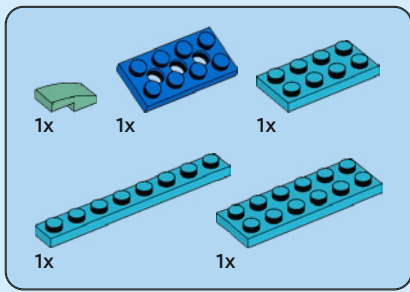

49

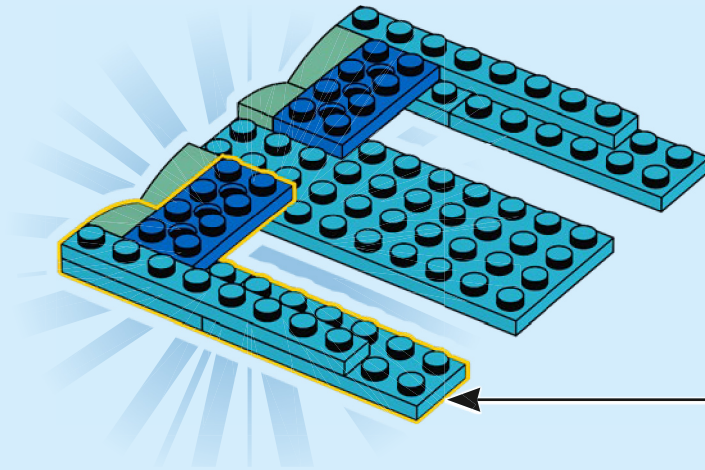
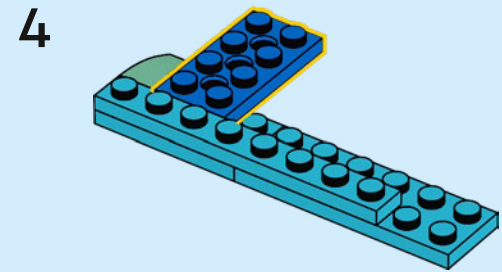
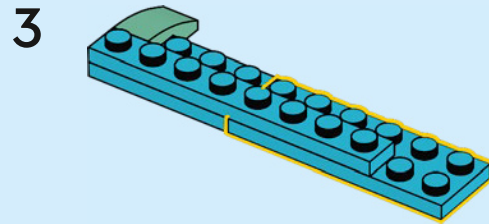
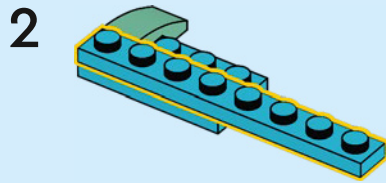
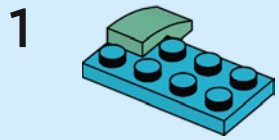
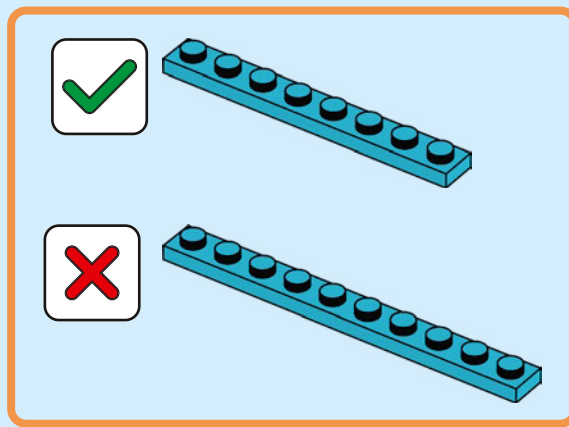



50

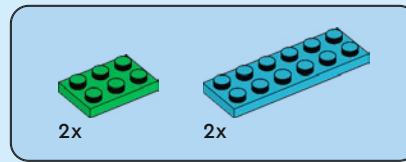
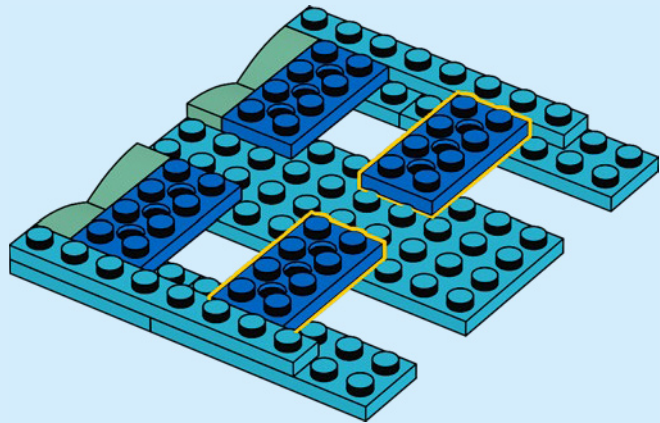

51

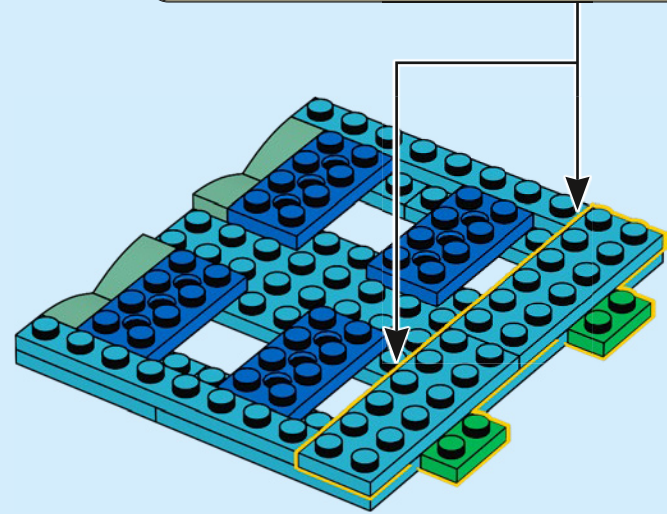
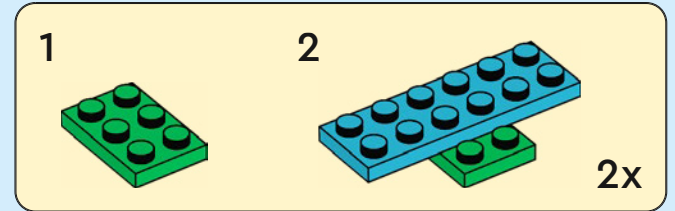

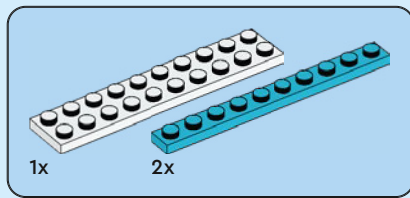

52

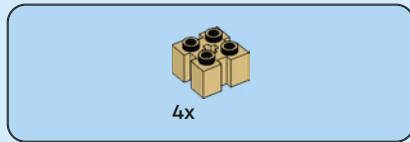
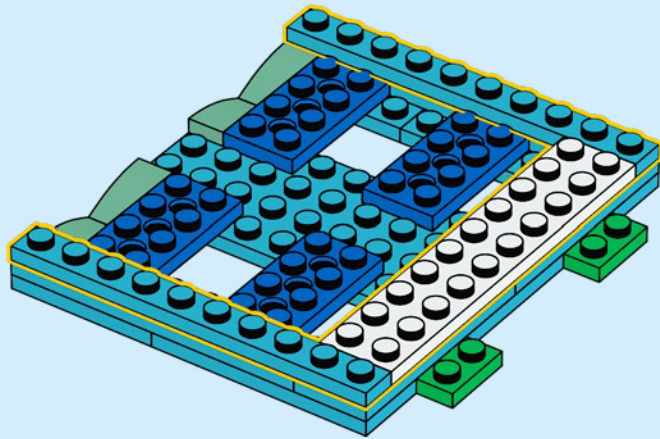

53

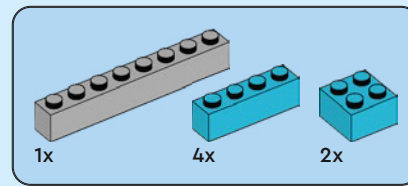
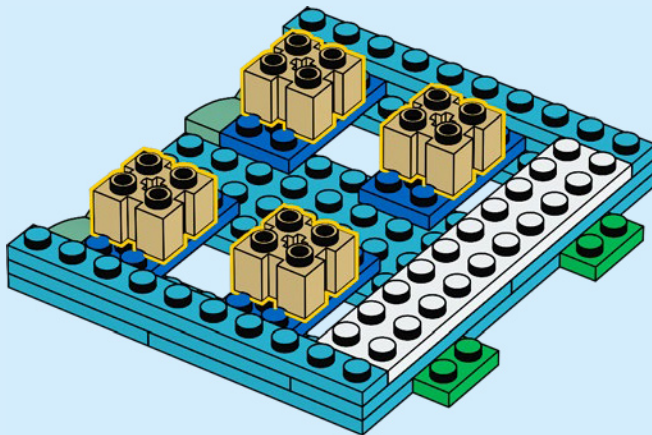

54

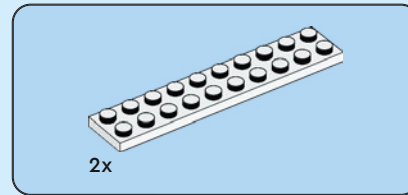
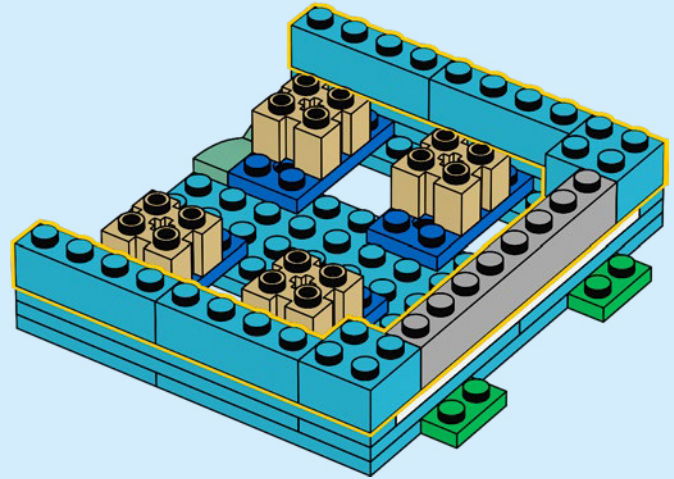

55

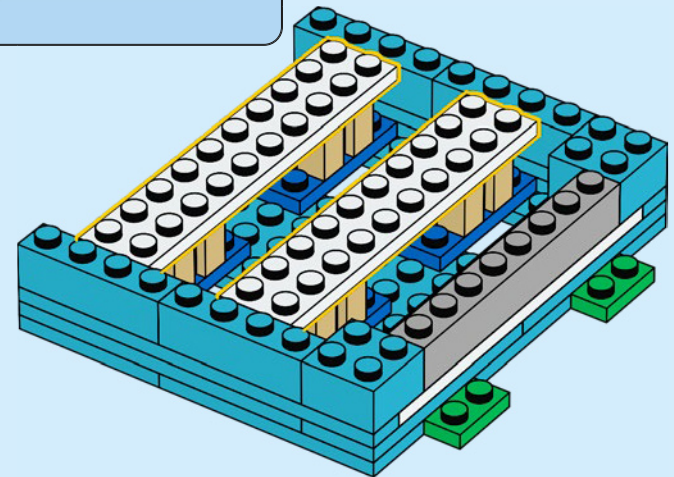

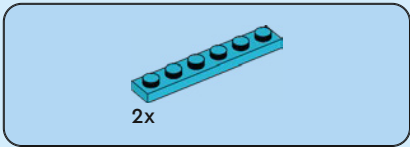

56

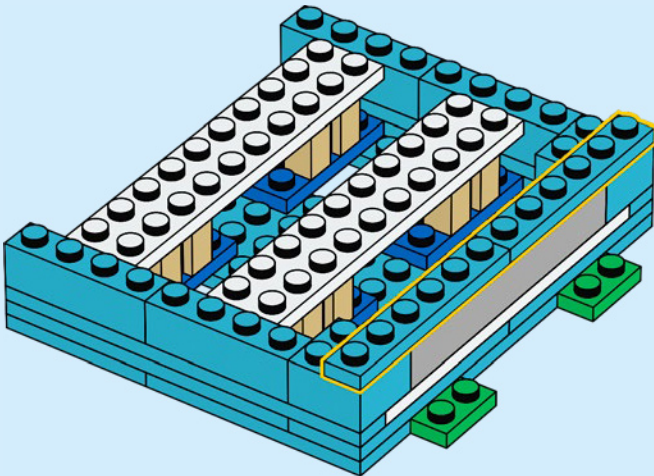

57

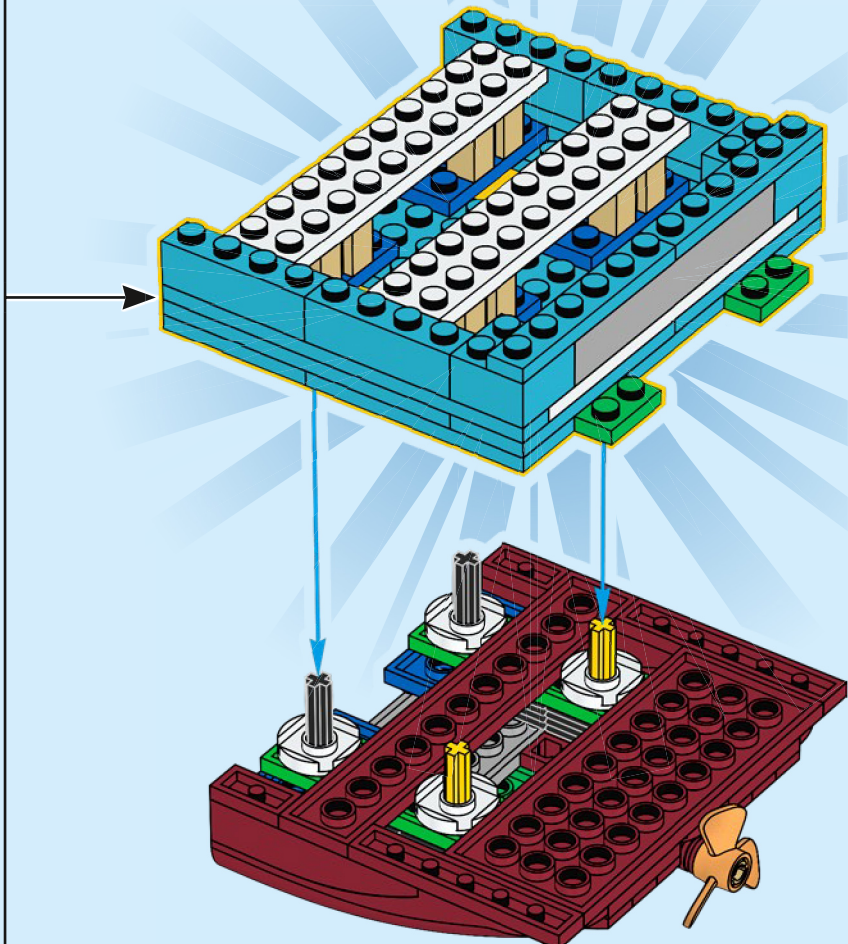

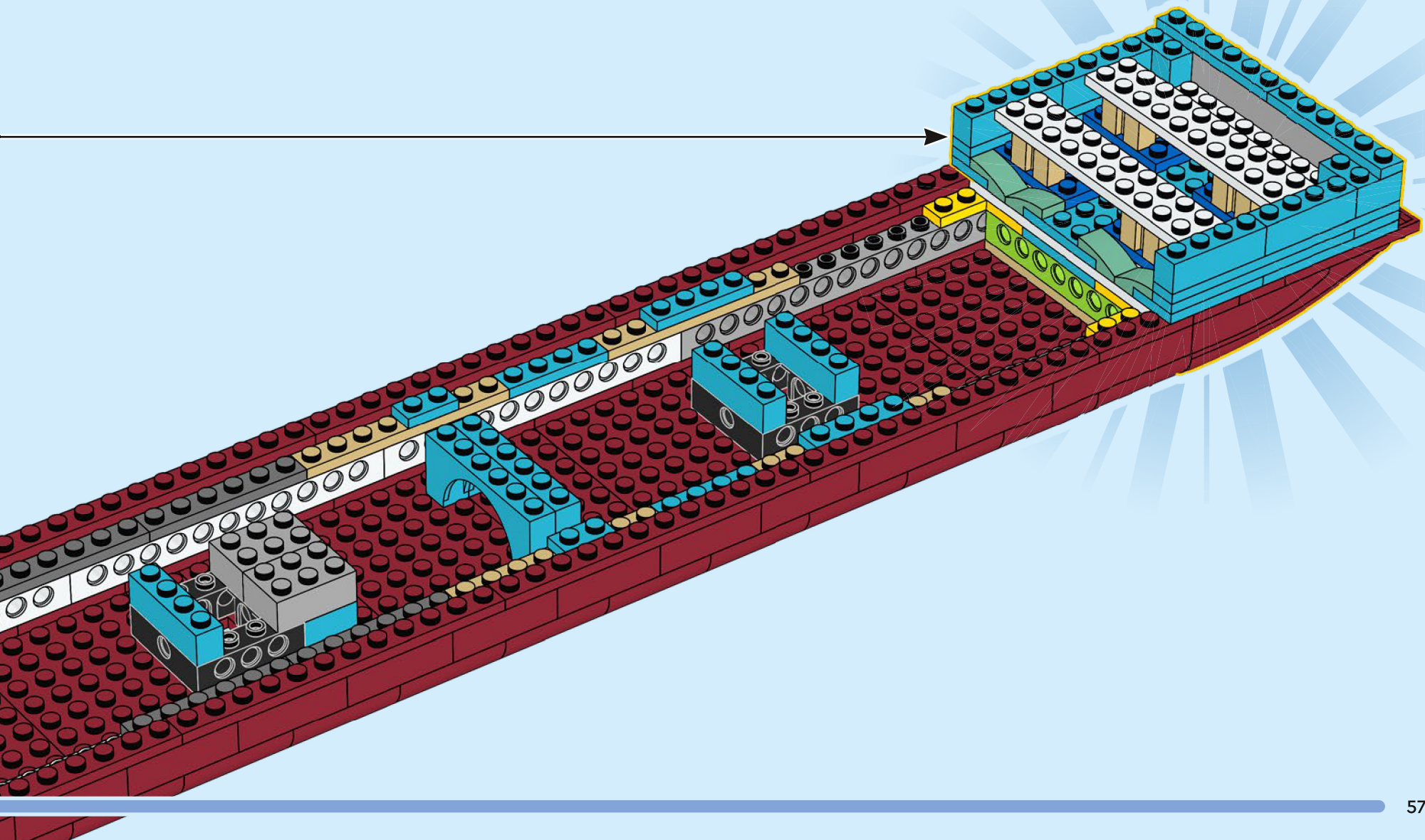

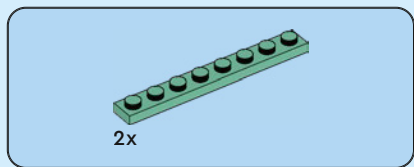
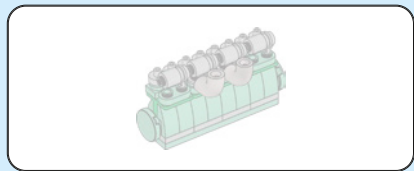

59

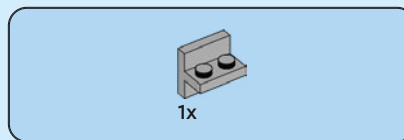
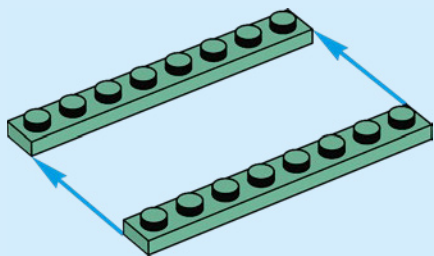

60

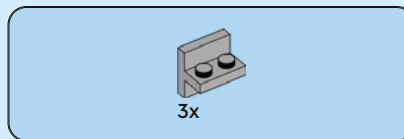
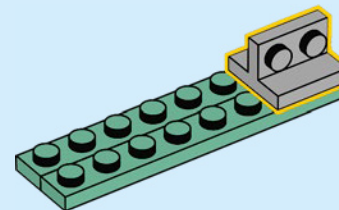

61

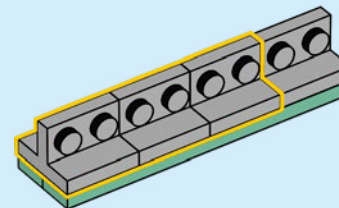



62

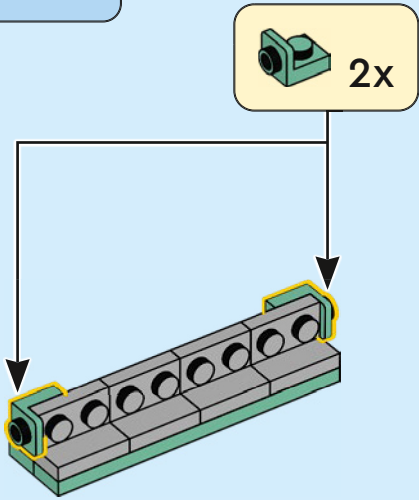

63

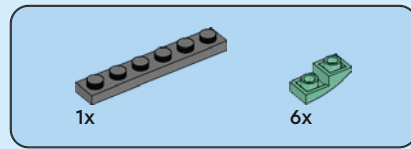
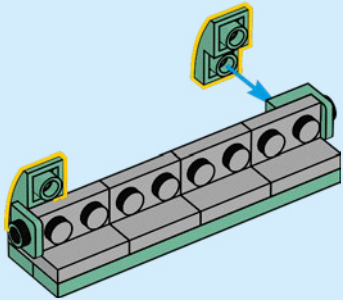

64

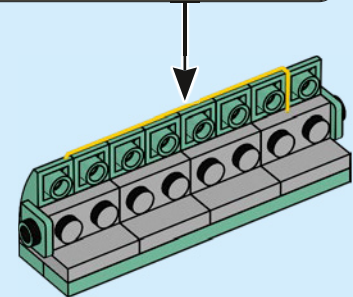
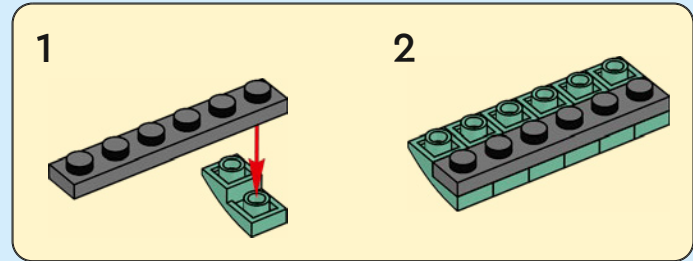

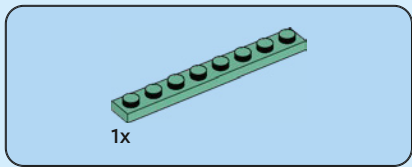

65

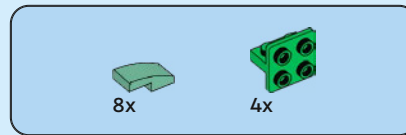
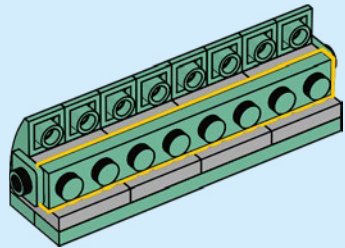

66

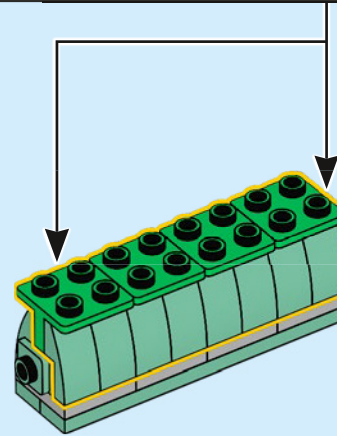
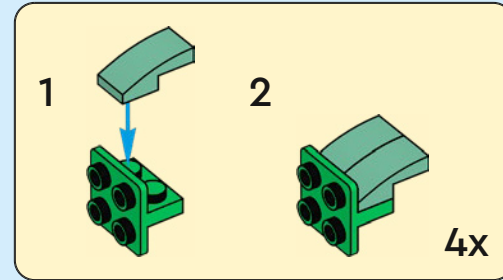

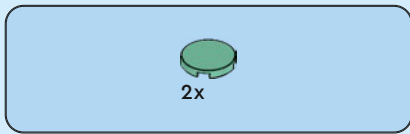

67

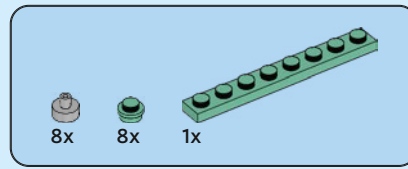
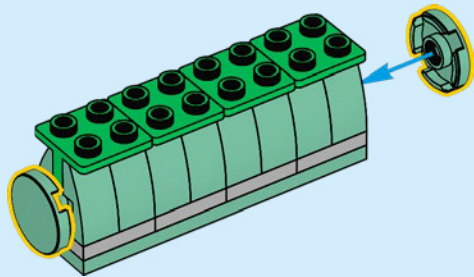

68

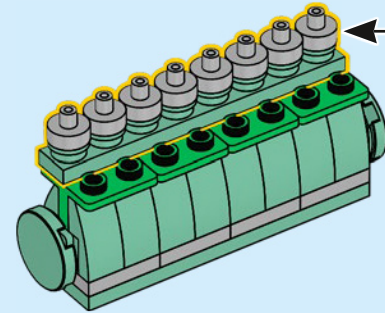
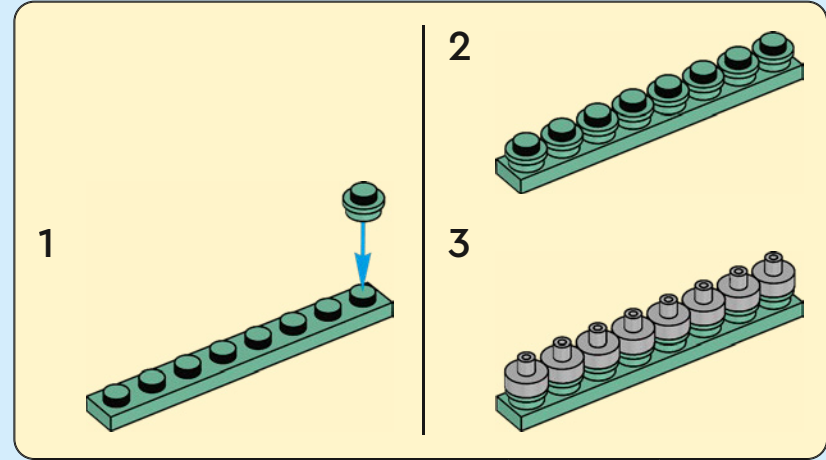



2x

69

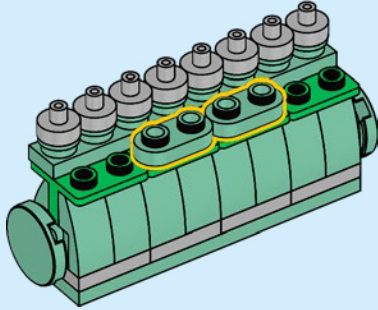

2x



2x

70

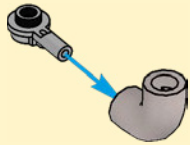
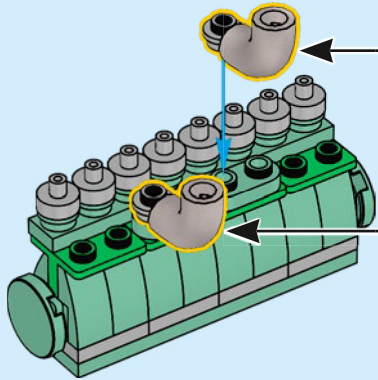

2x



2x

71

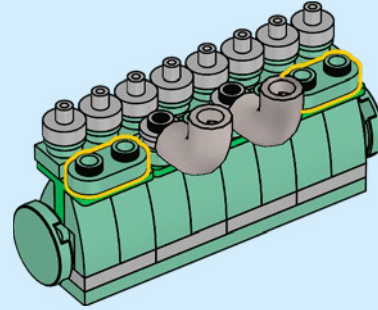

4x



4x

72

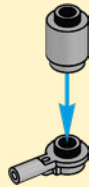
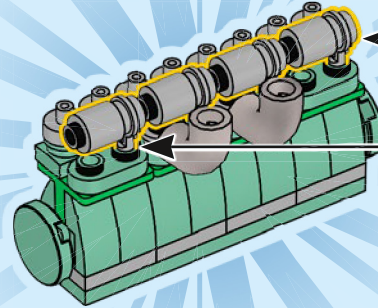

4x

73

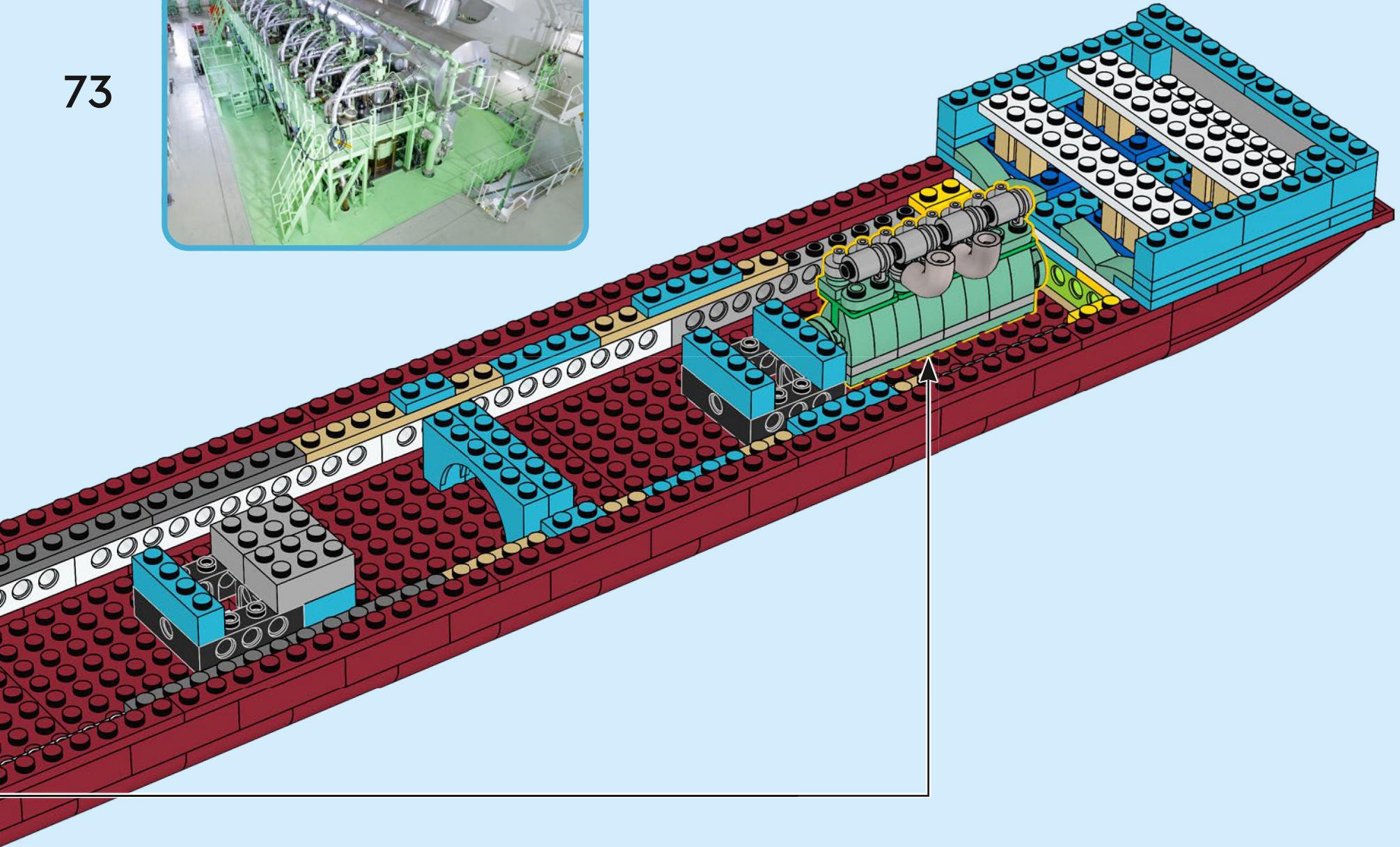

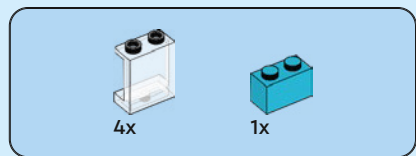

74

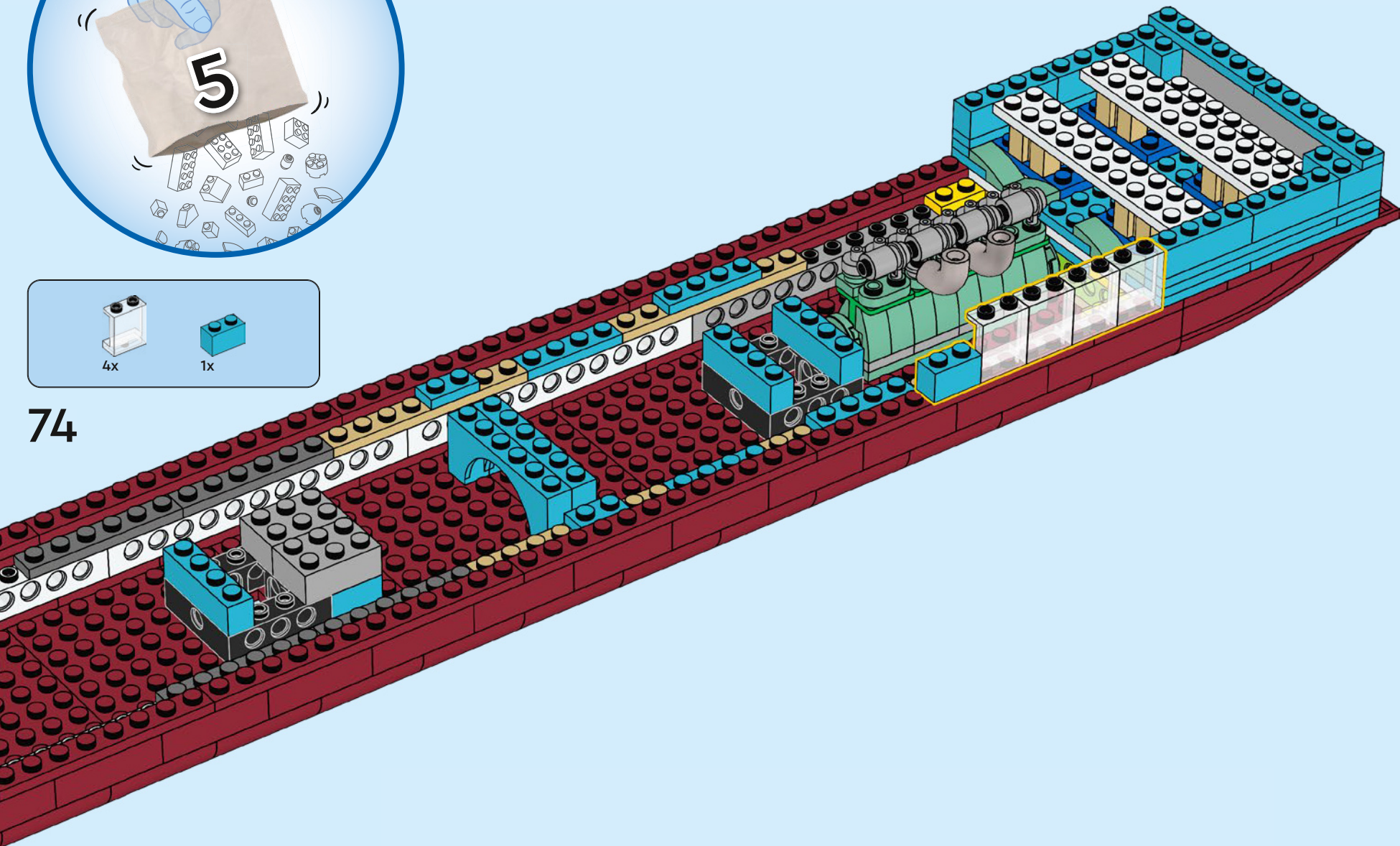

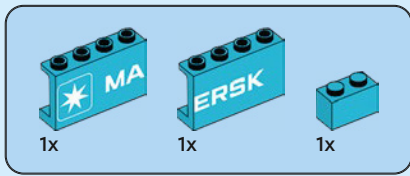

75

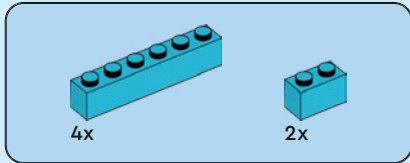
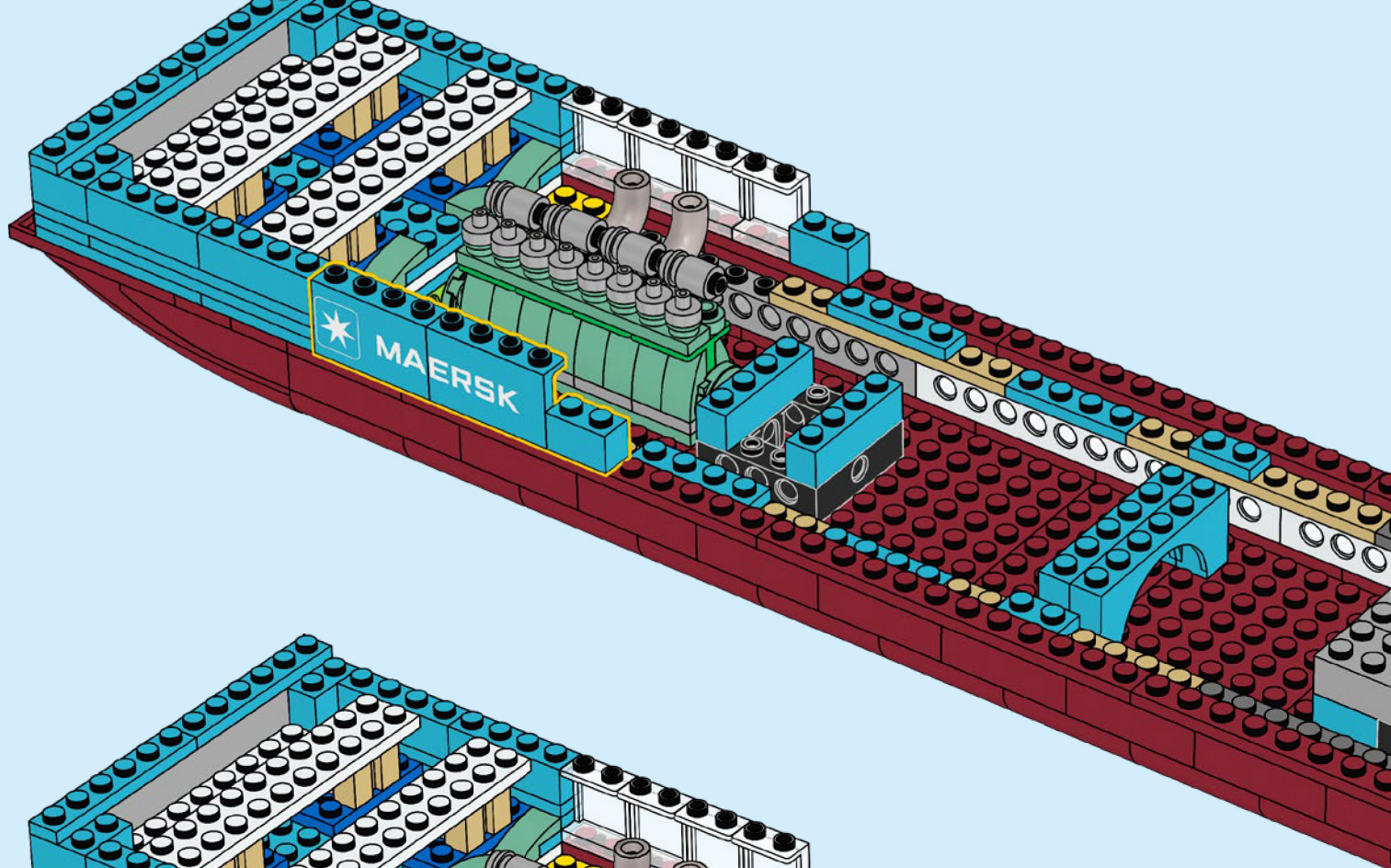

76

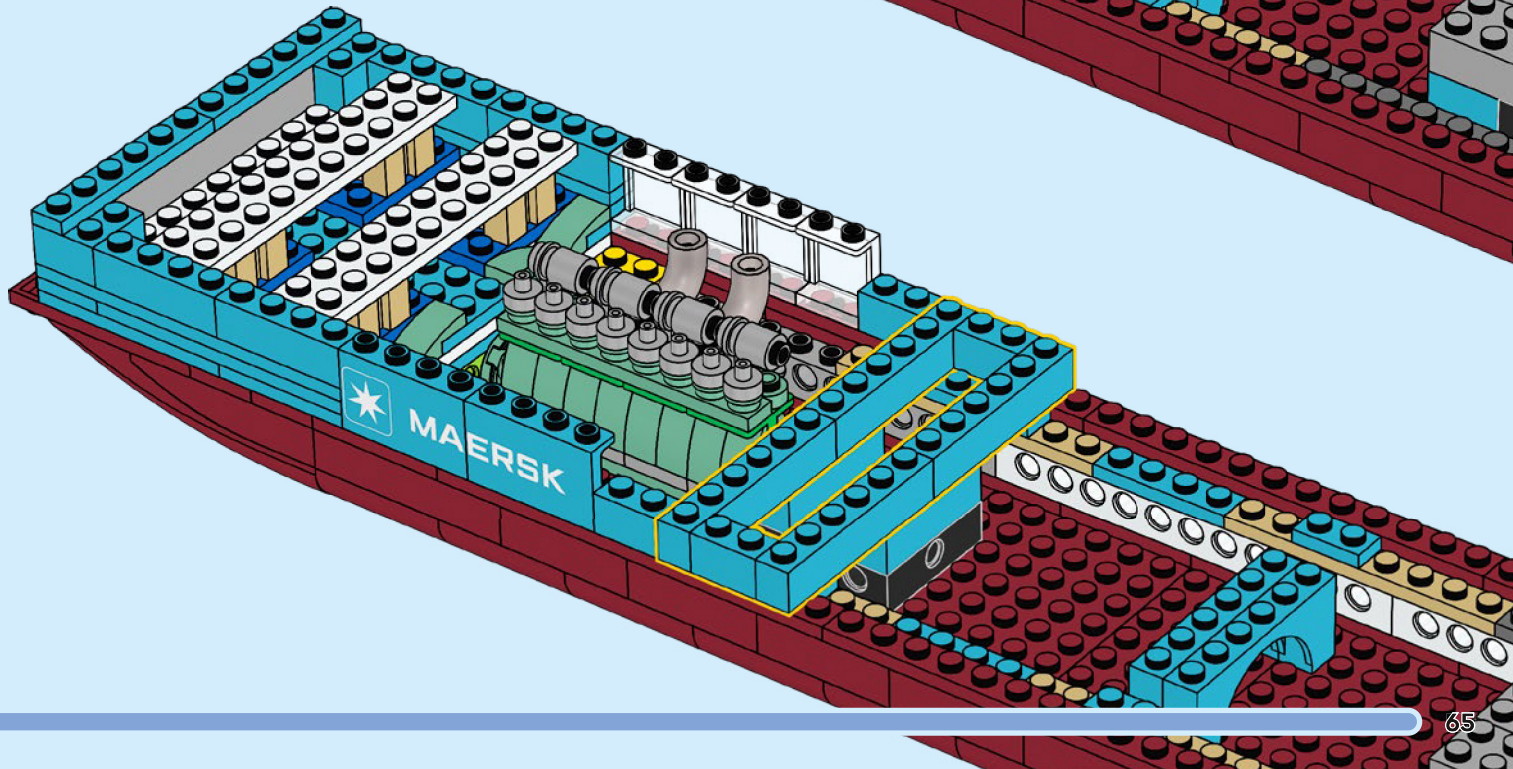

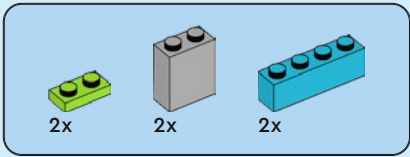

77

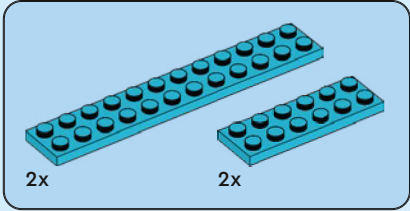
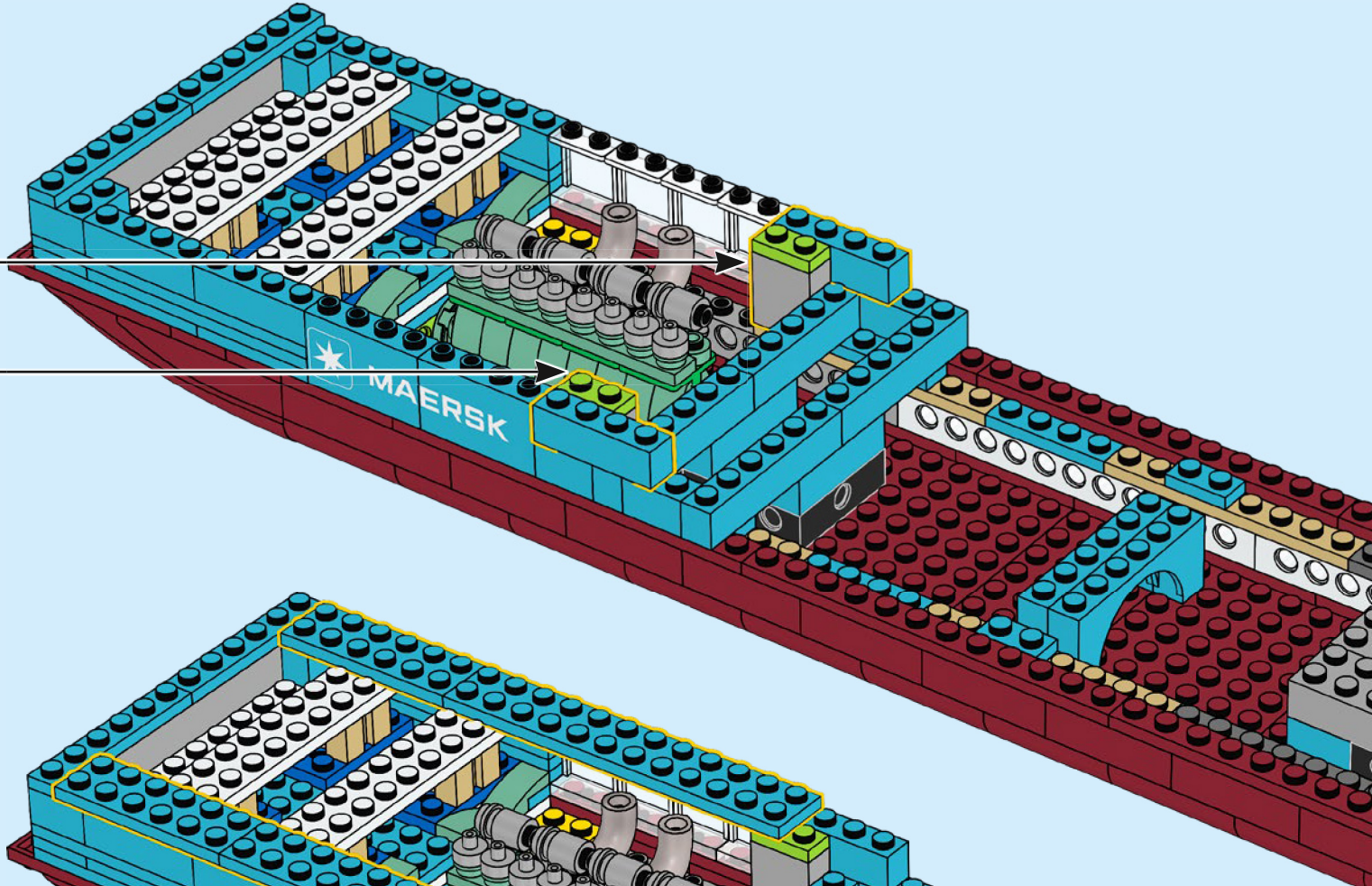
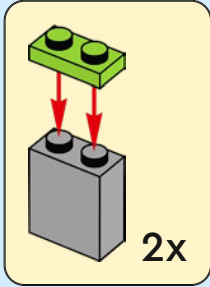

78

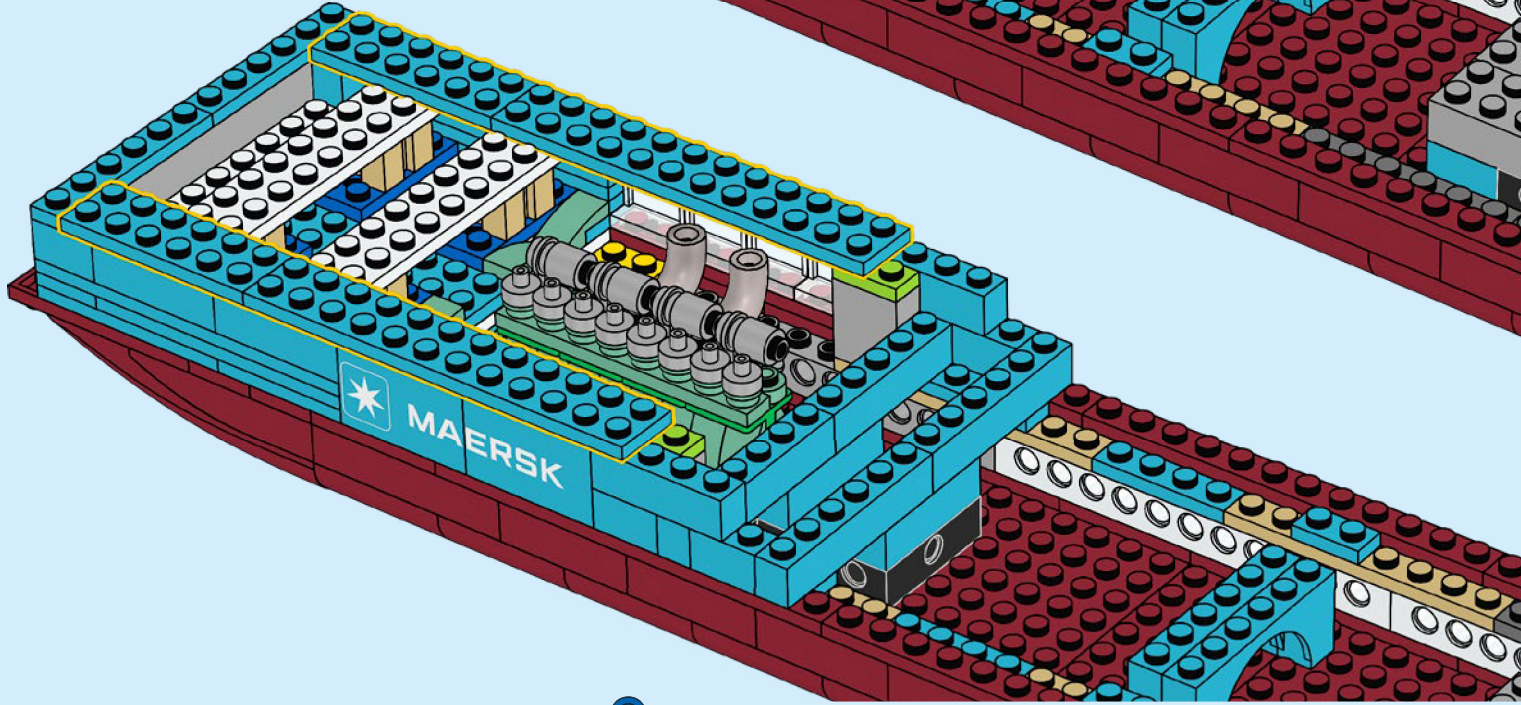

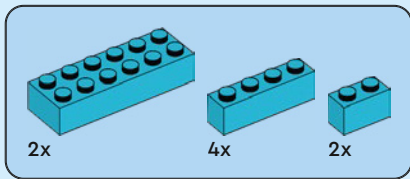

79

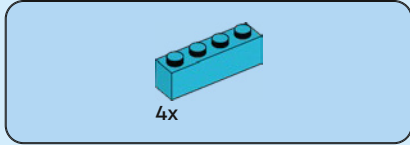
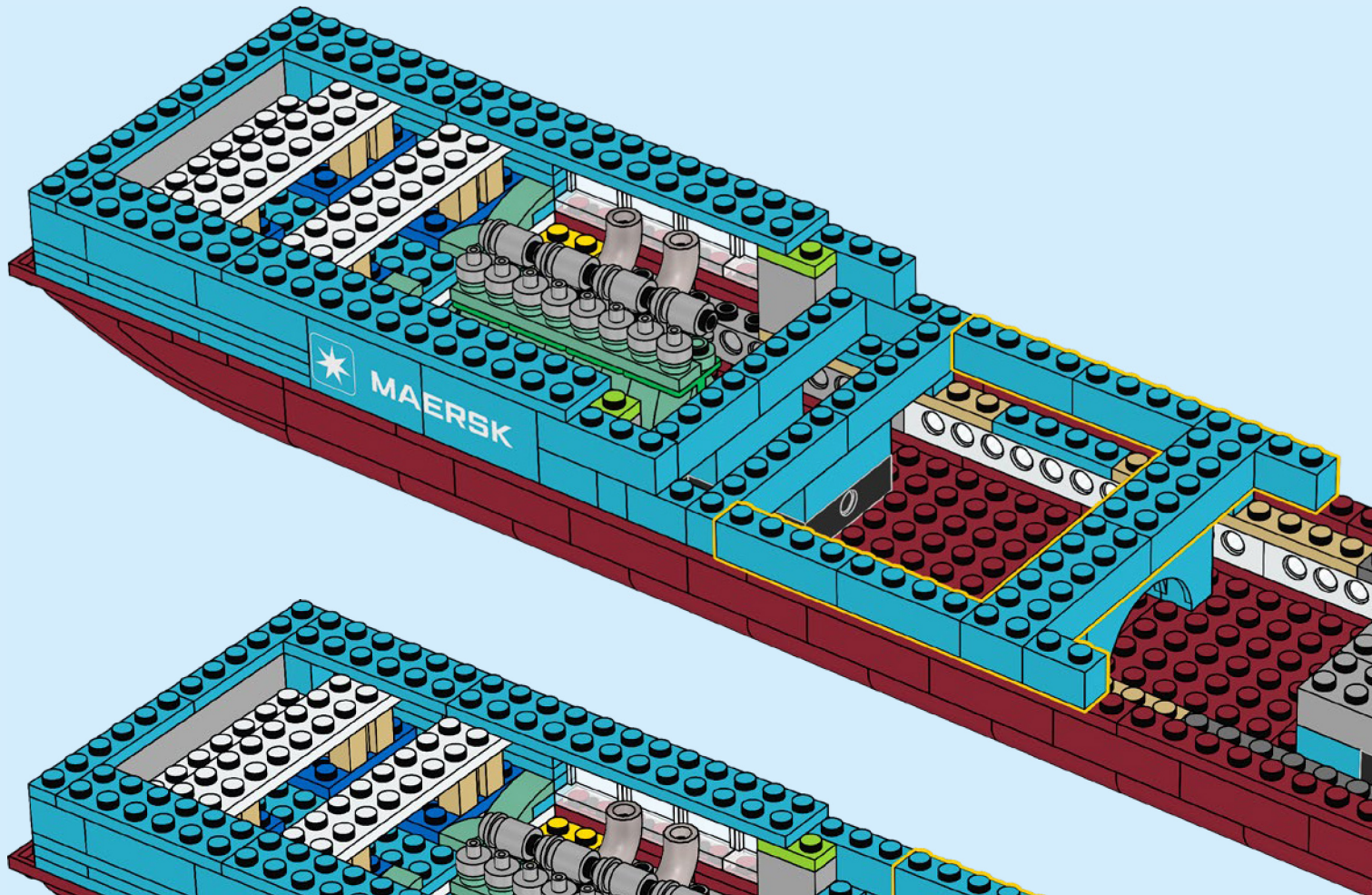

80

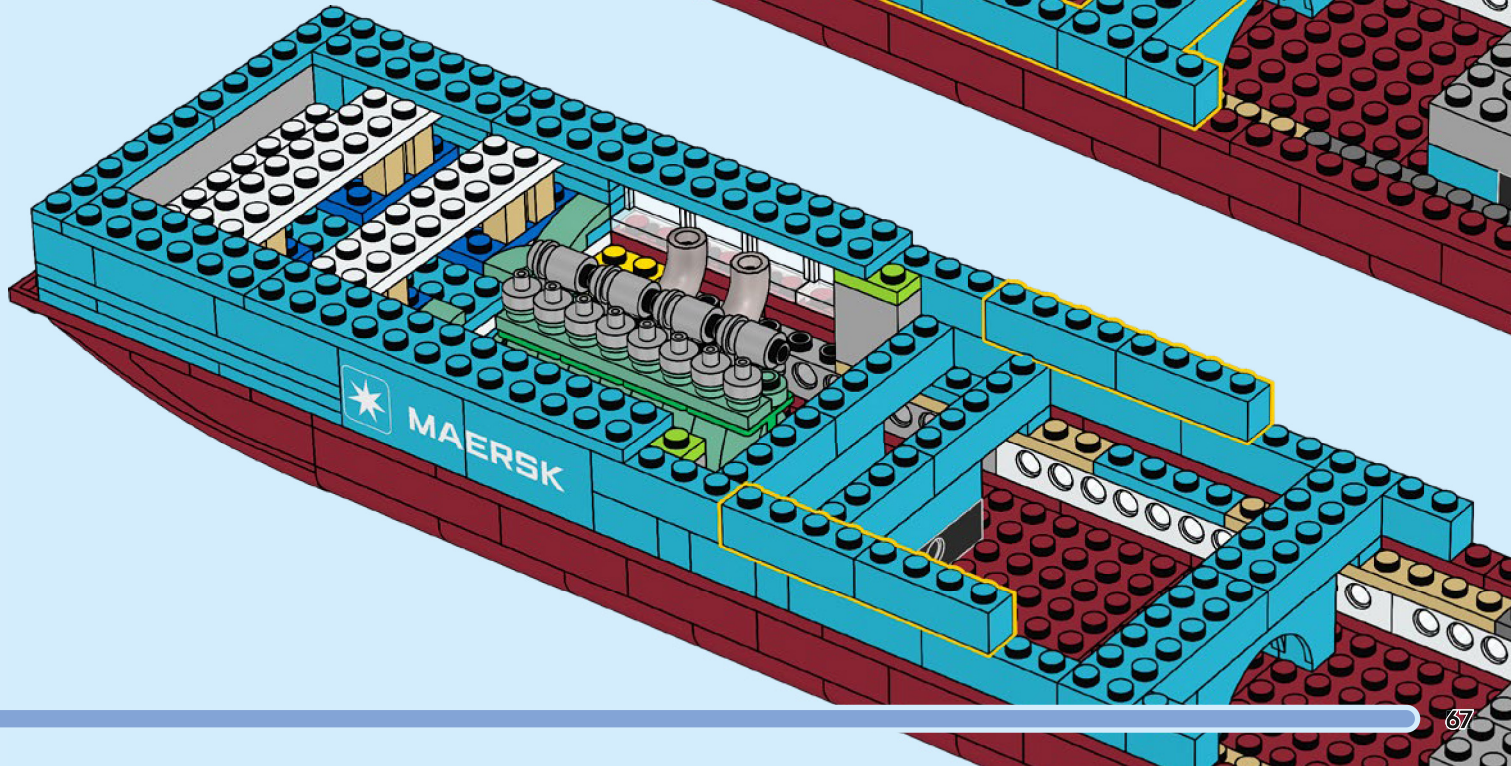

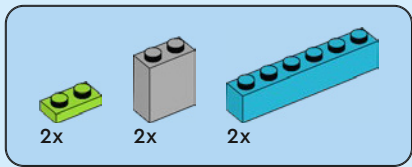

81

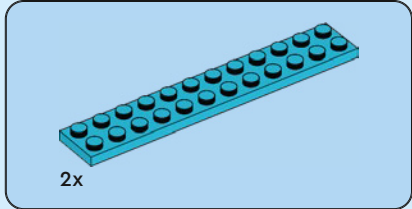
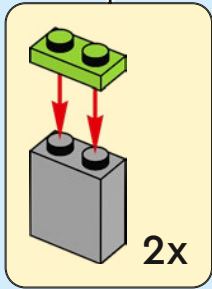
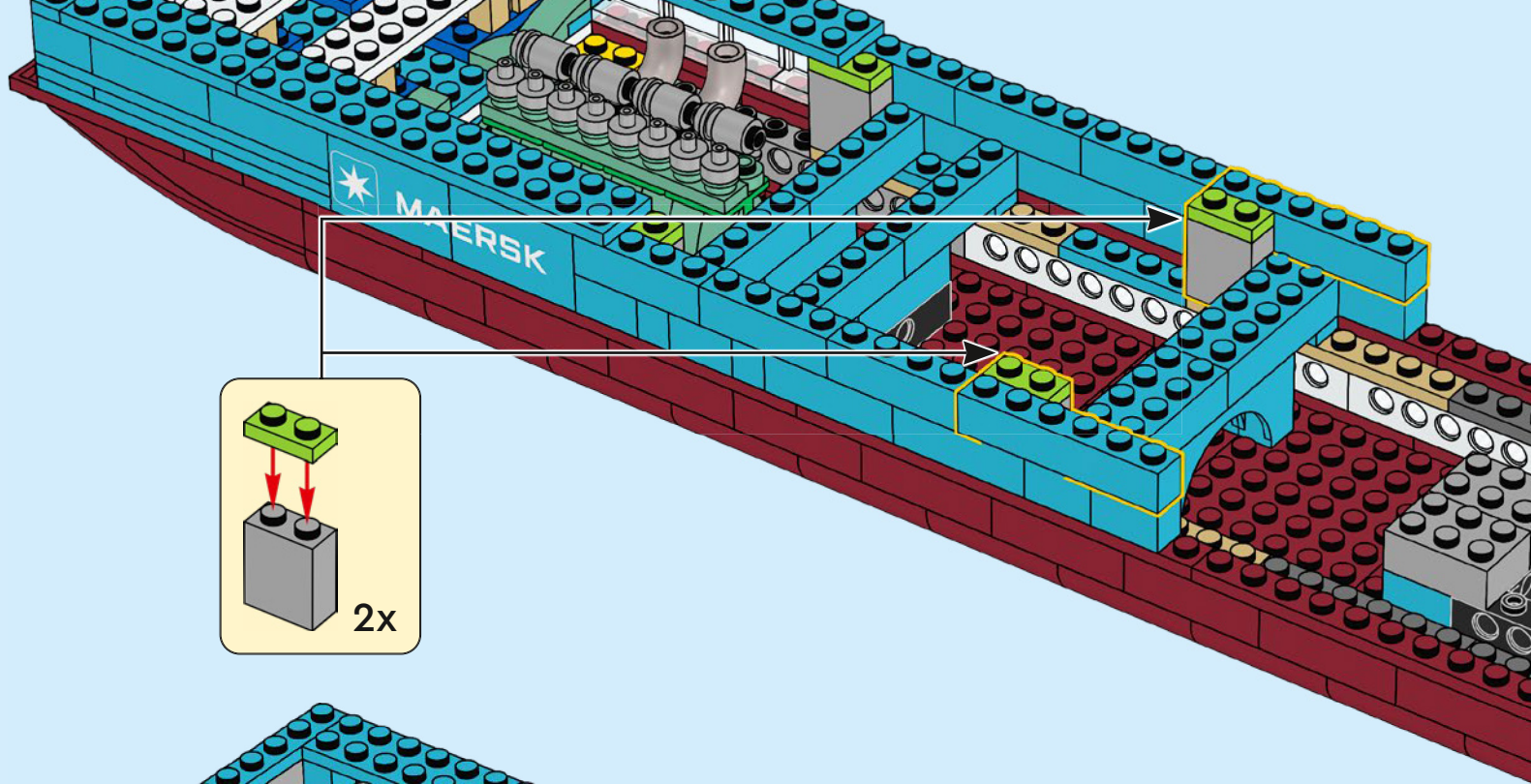

82

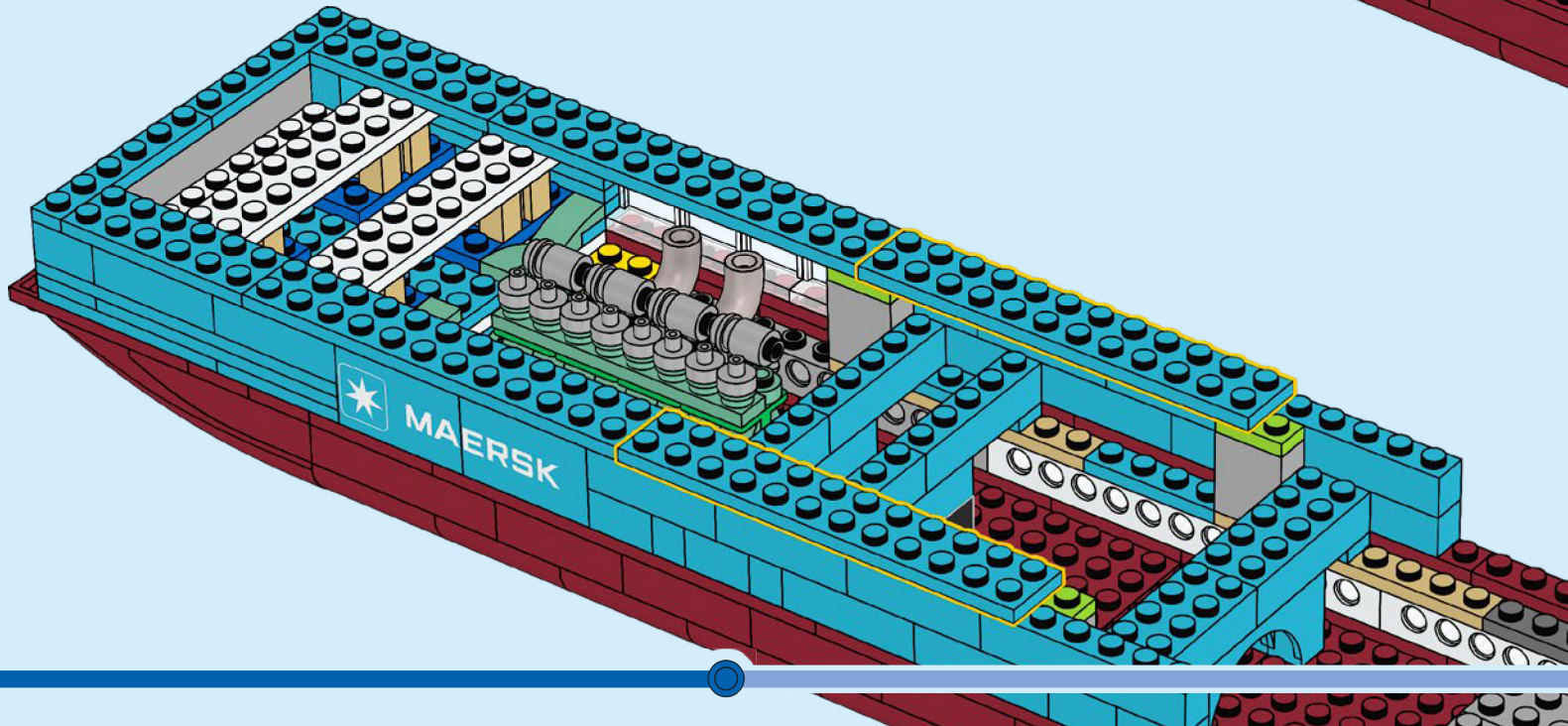

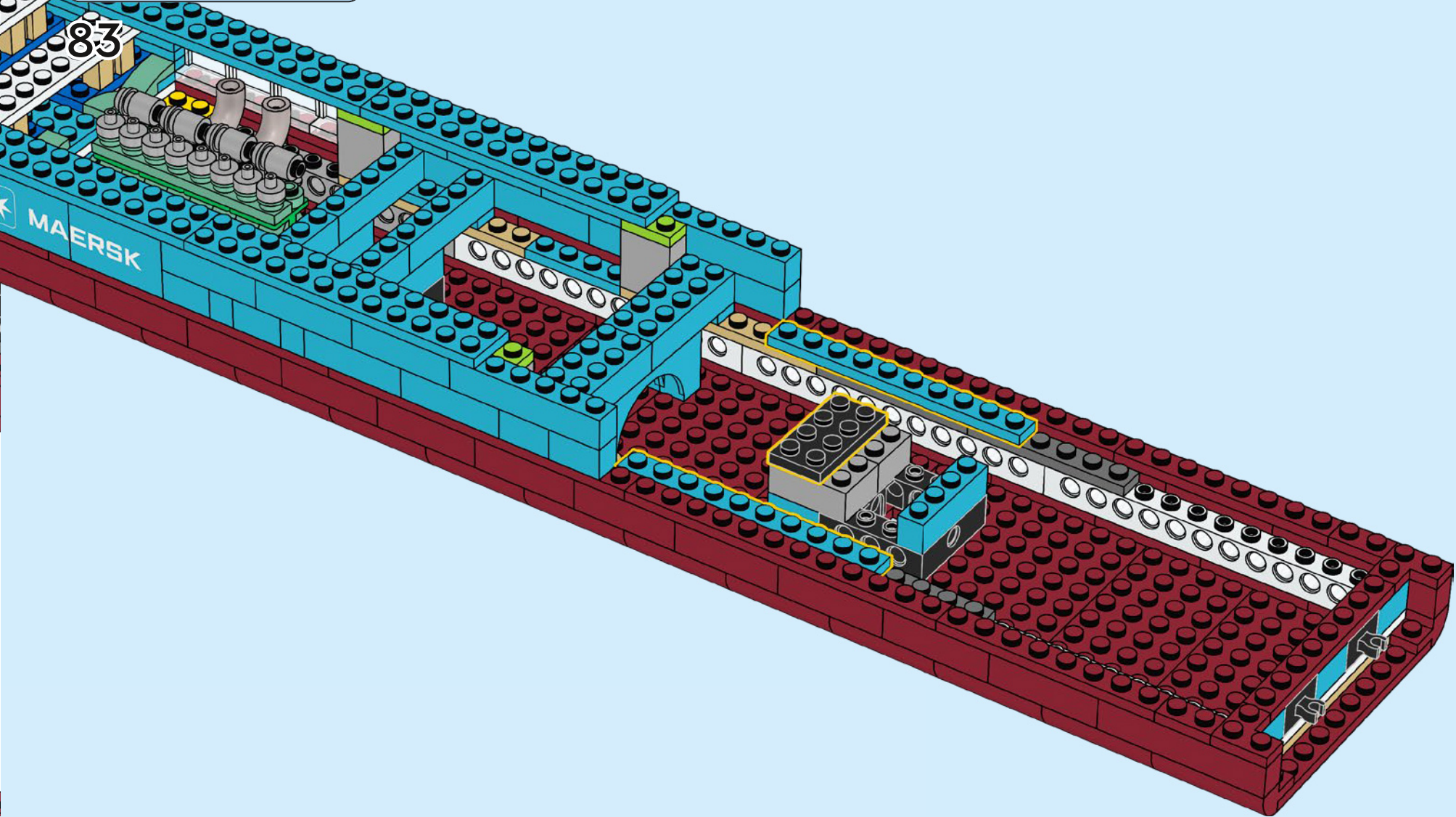
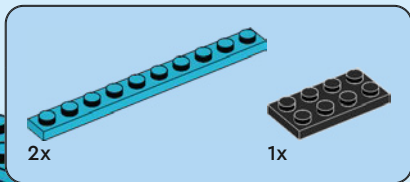

84

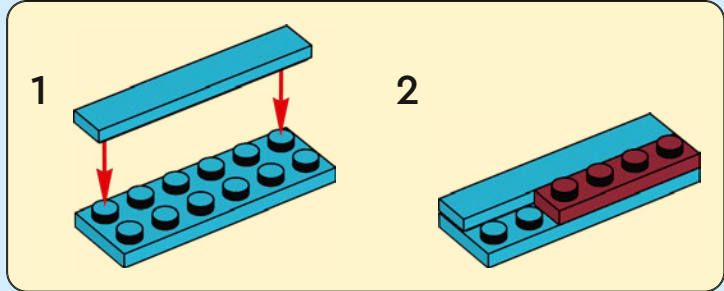
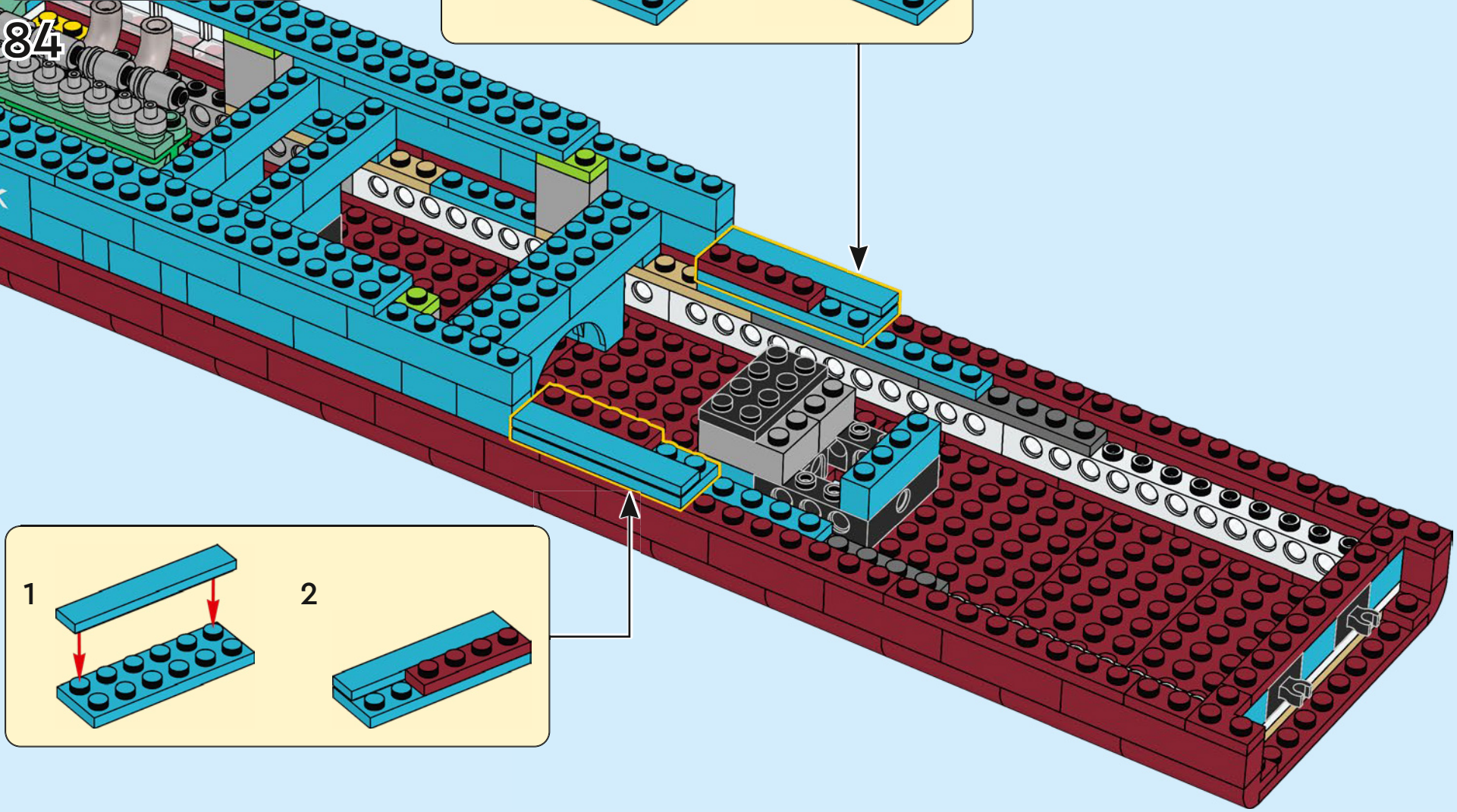
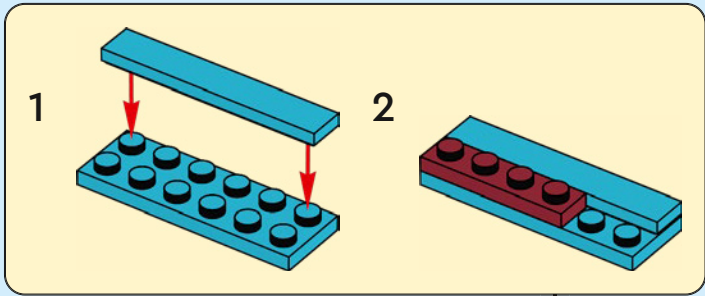
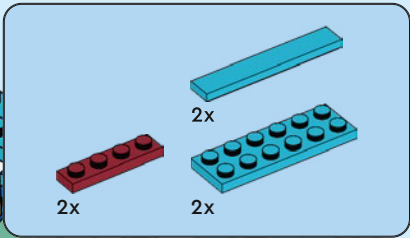

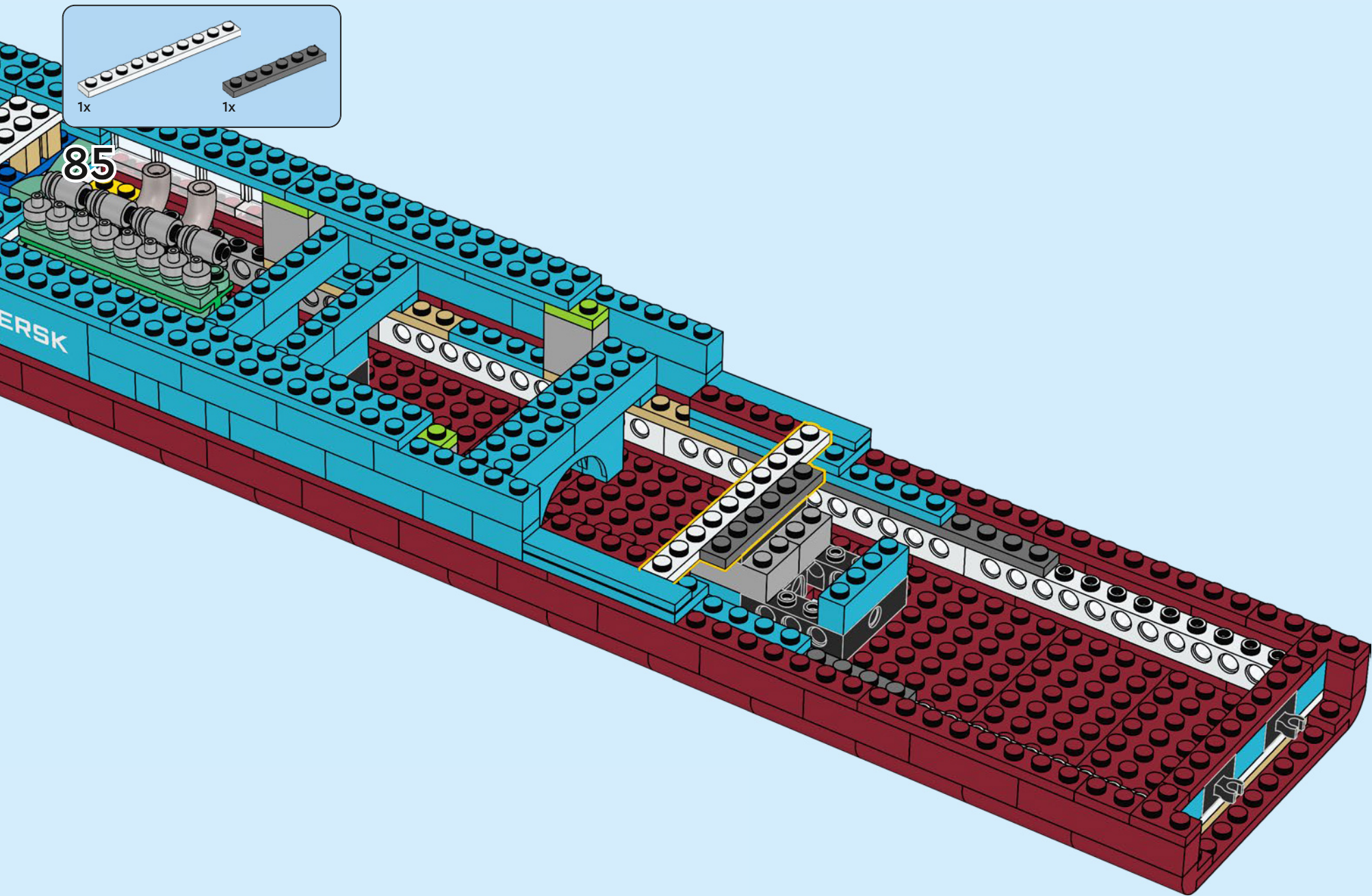

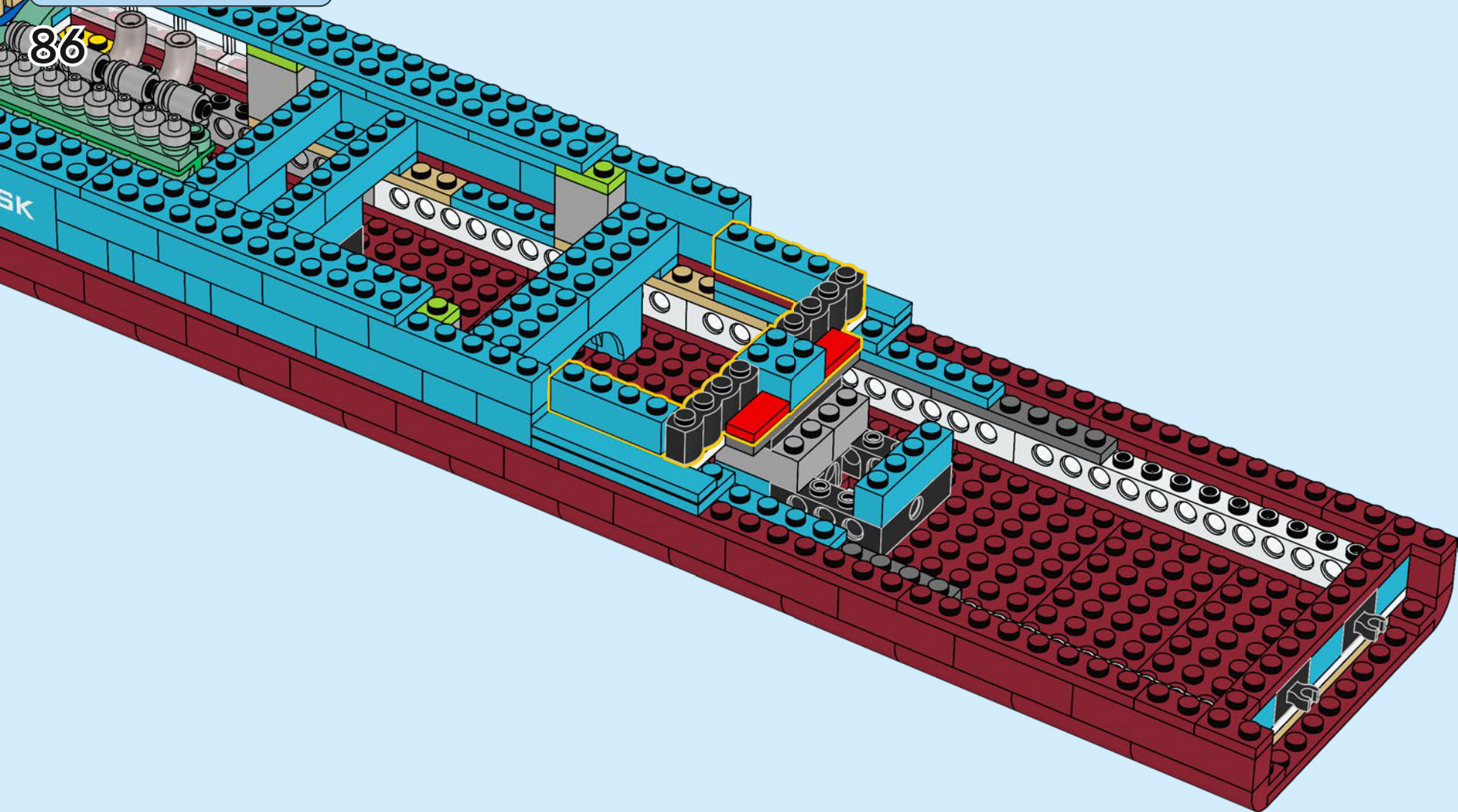
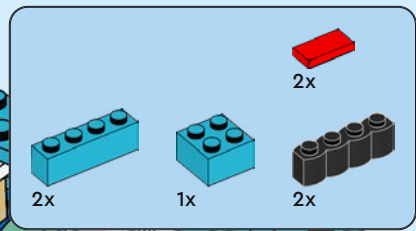

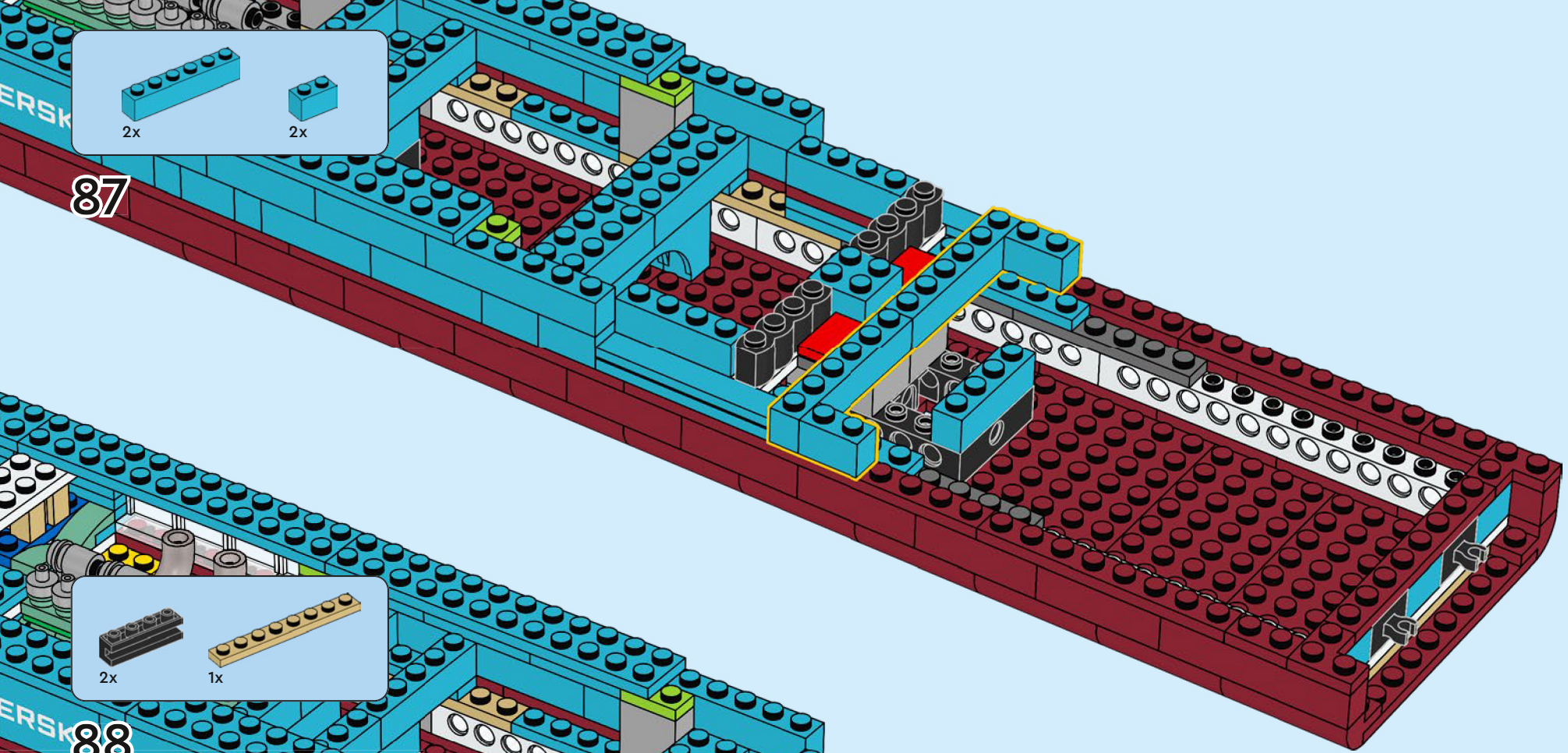

2x

2x

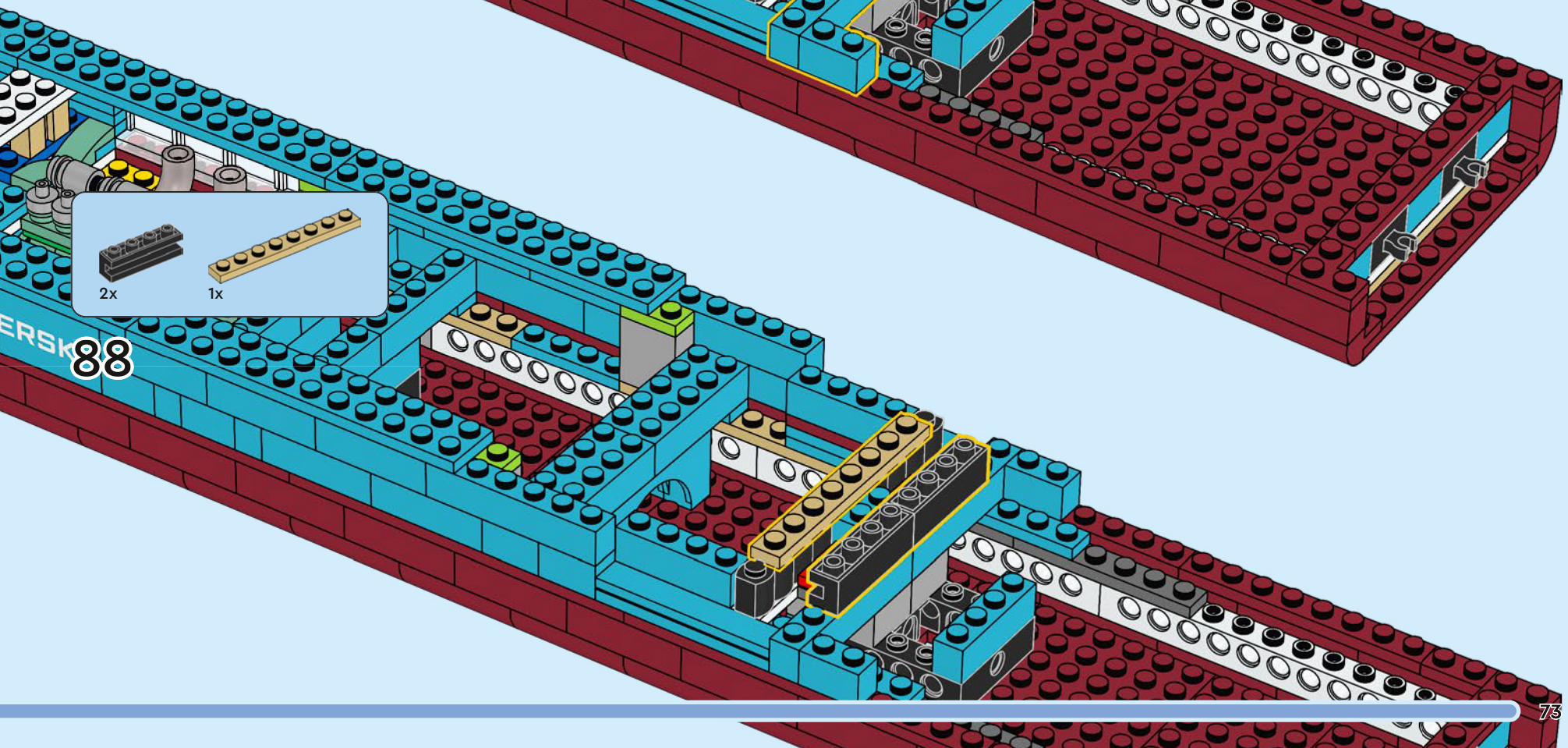

2x

1x

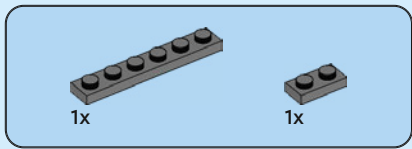

89

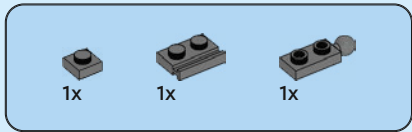
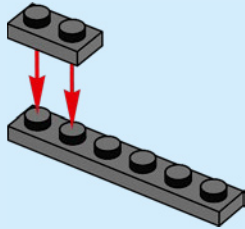

90

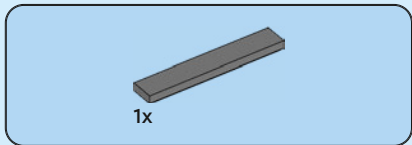
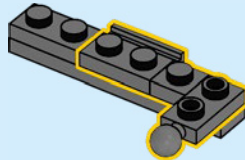

91

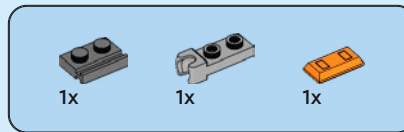
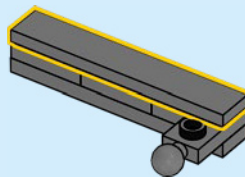

92

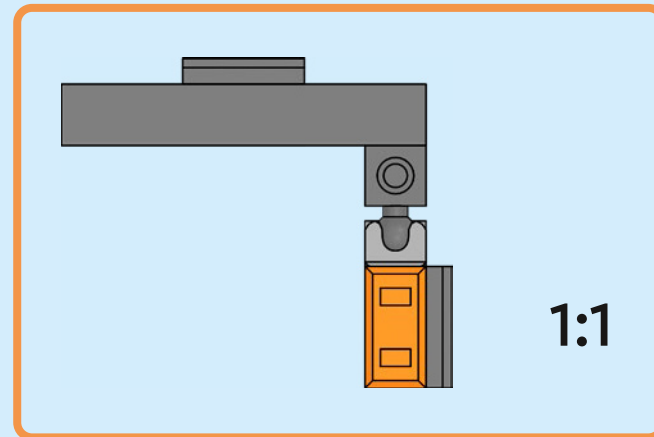
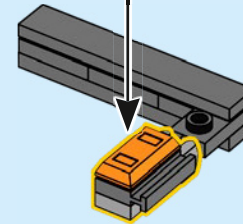
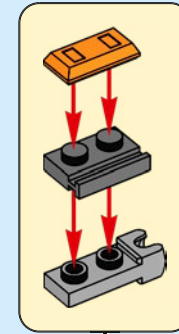

93

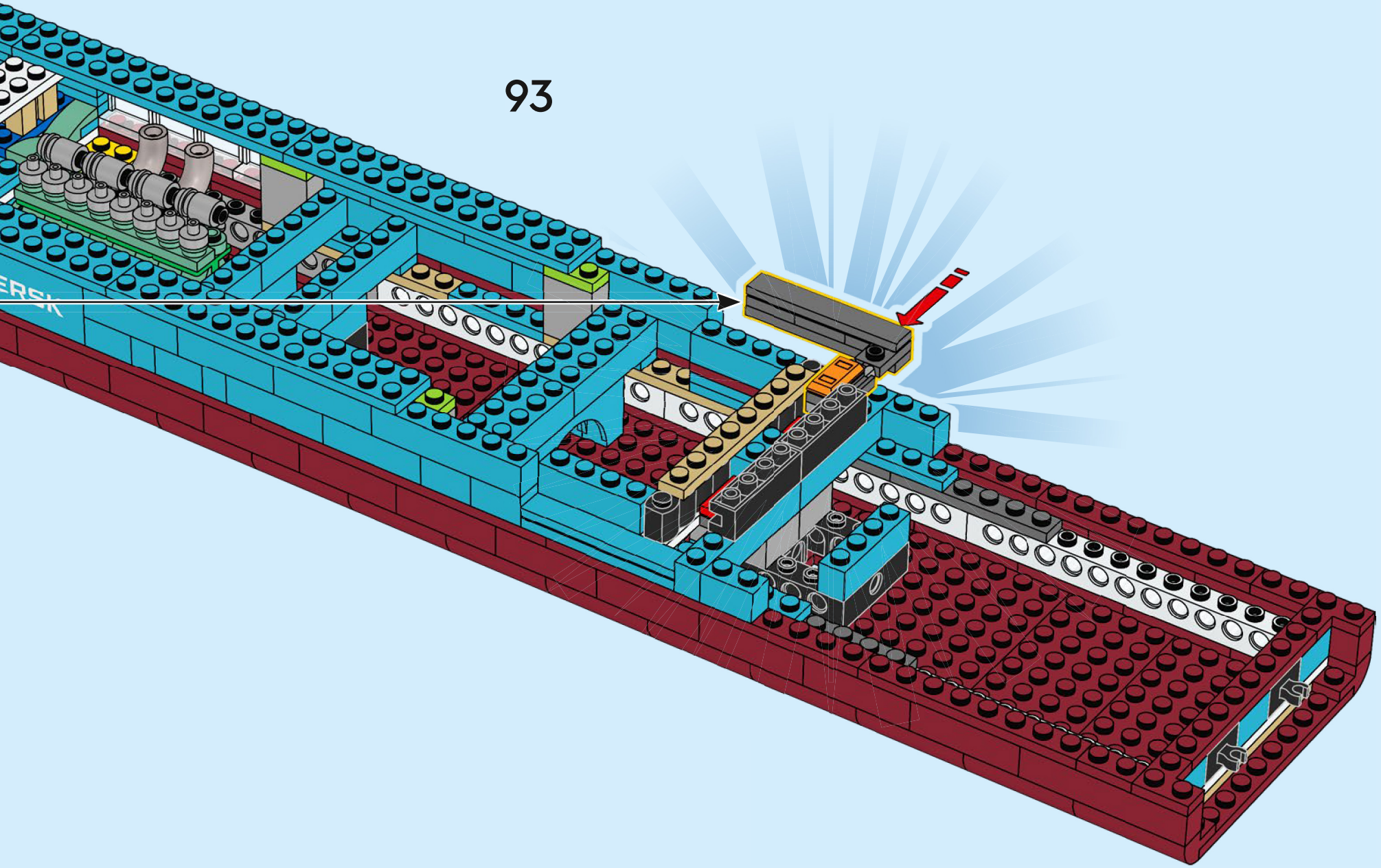

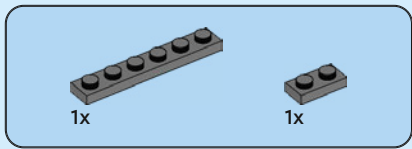

94

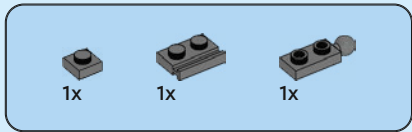
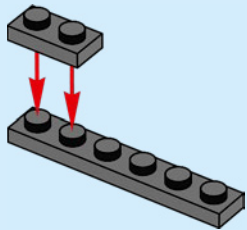

95

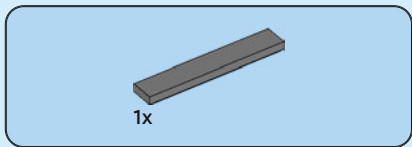
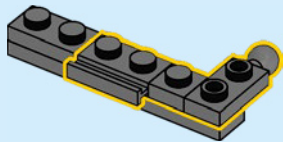

96

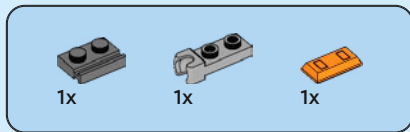
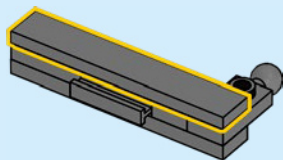

97

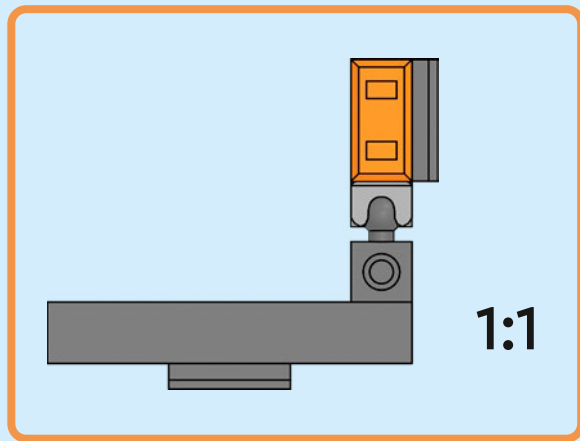
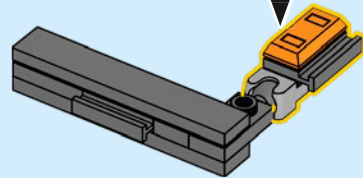
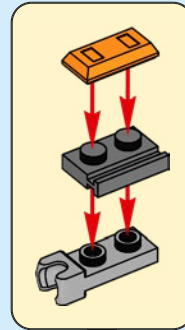

98

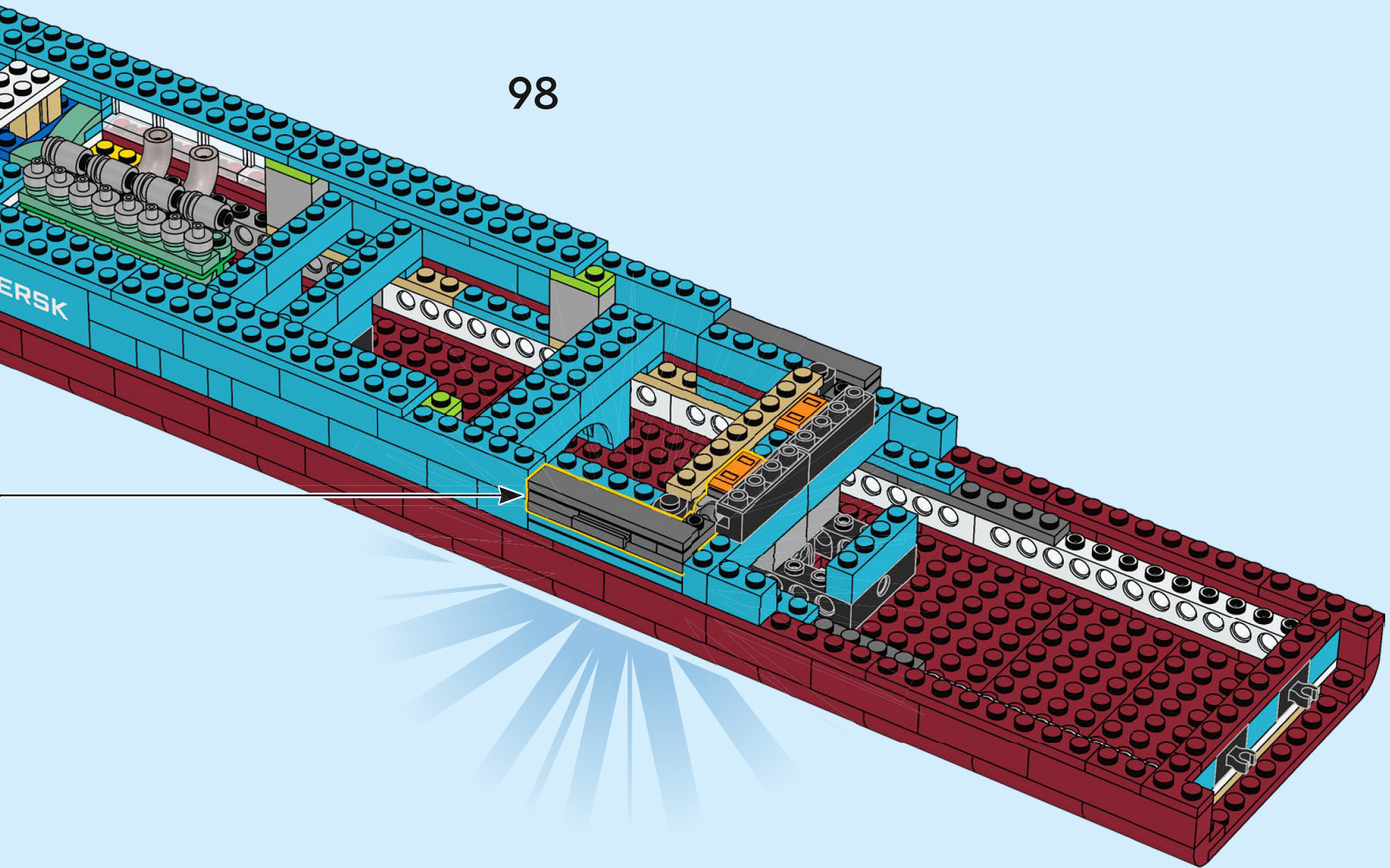

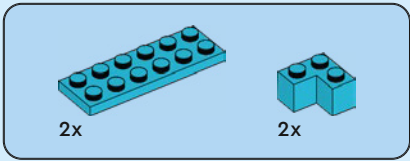

99

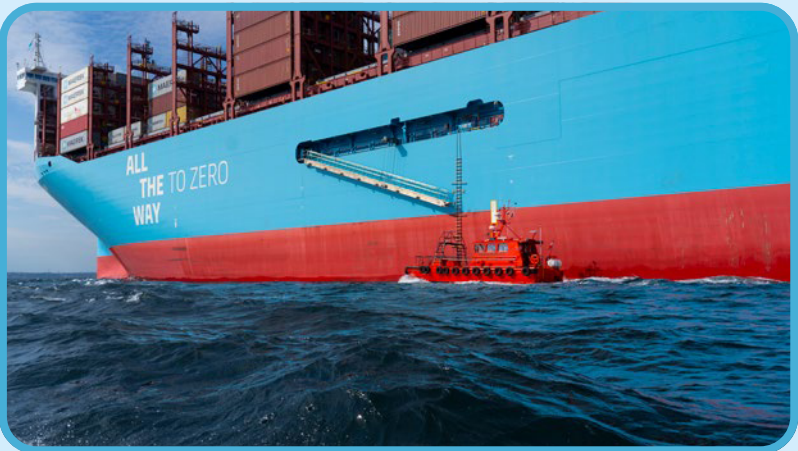
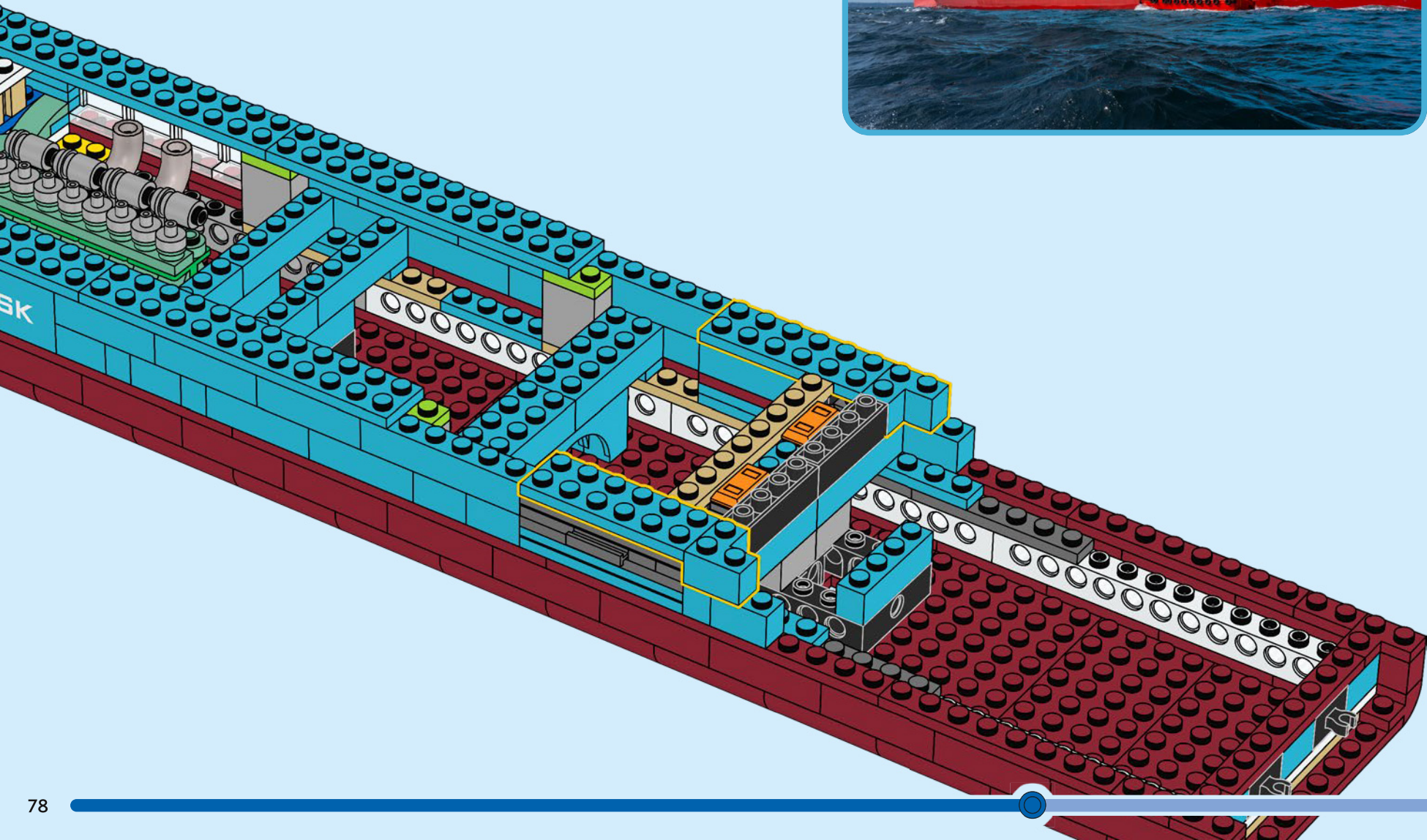

1

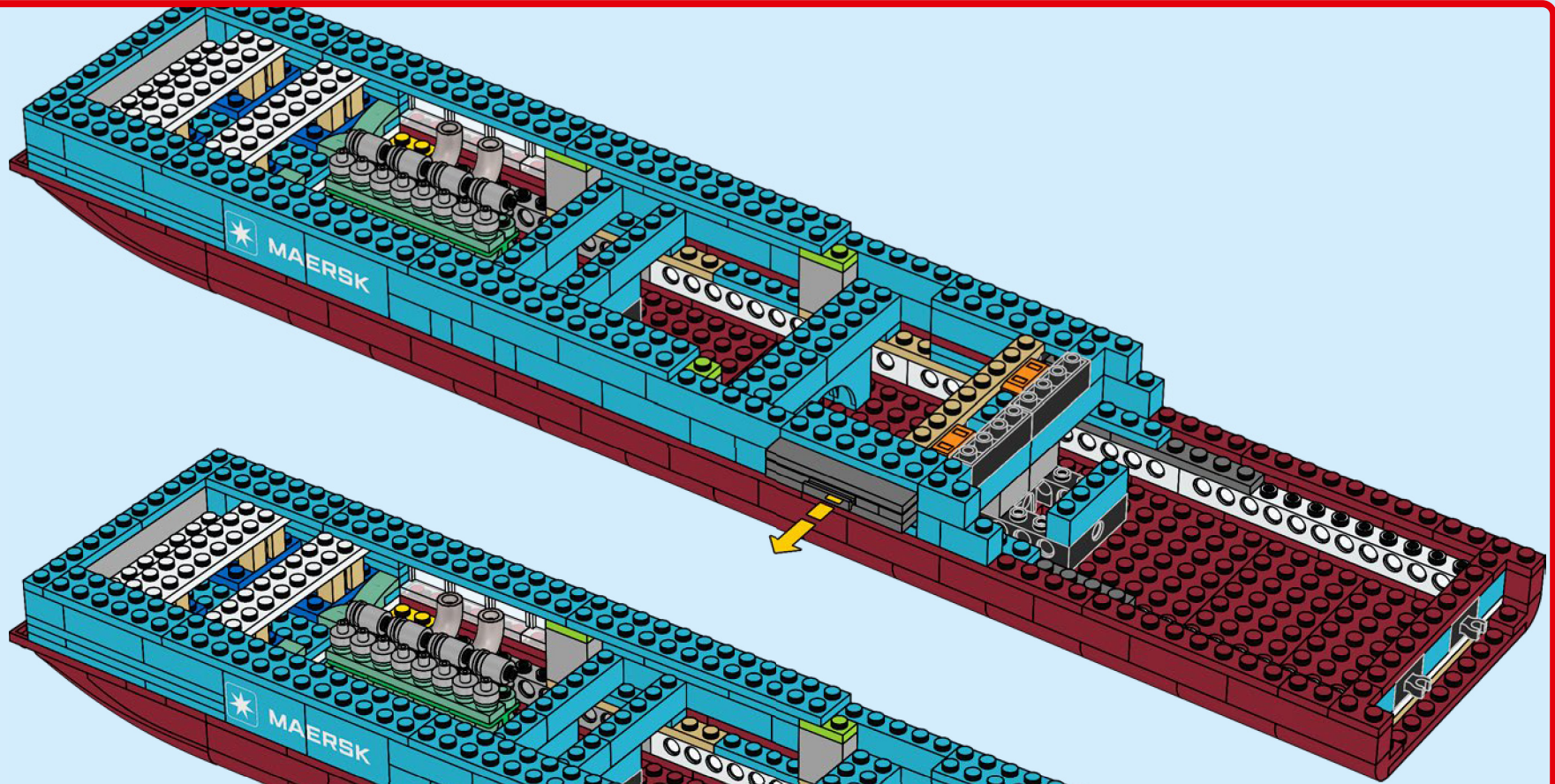

2

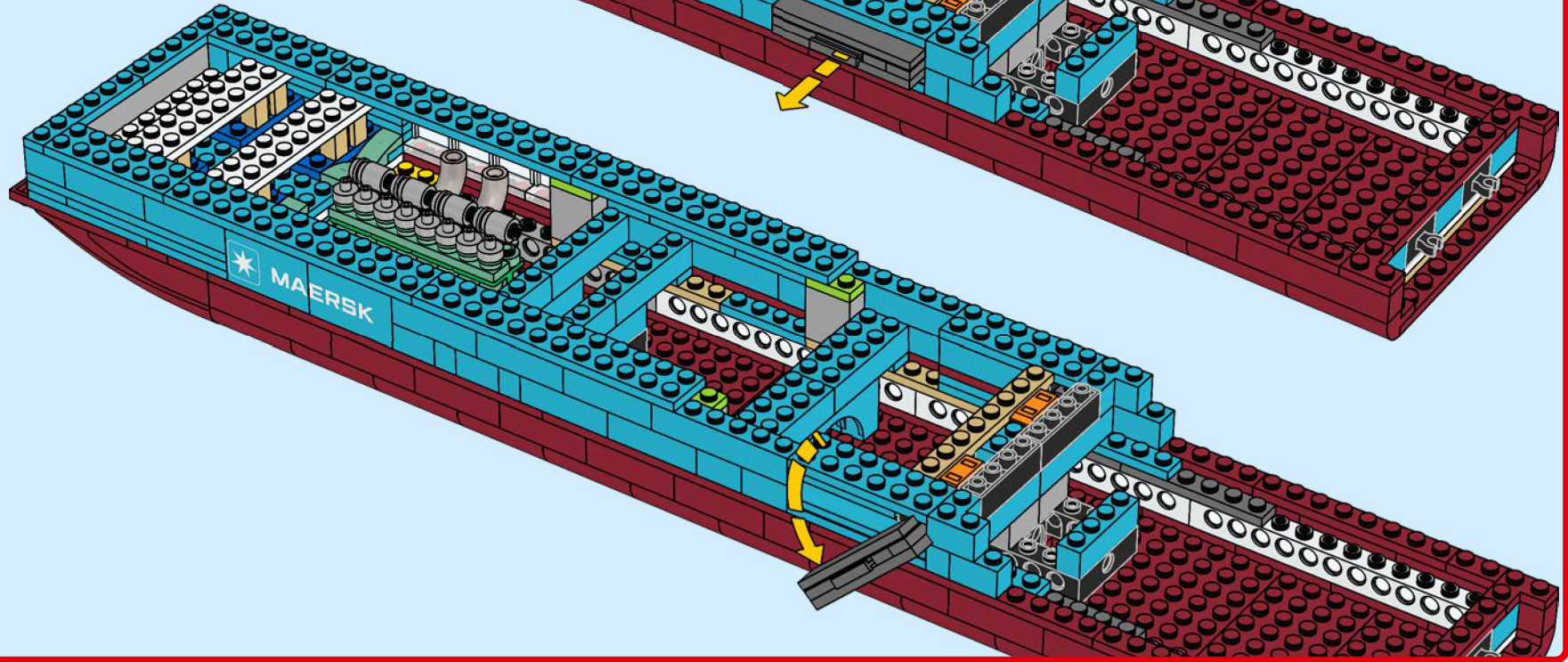

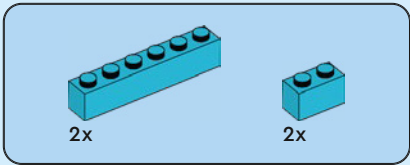

100

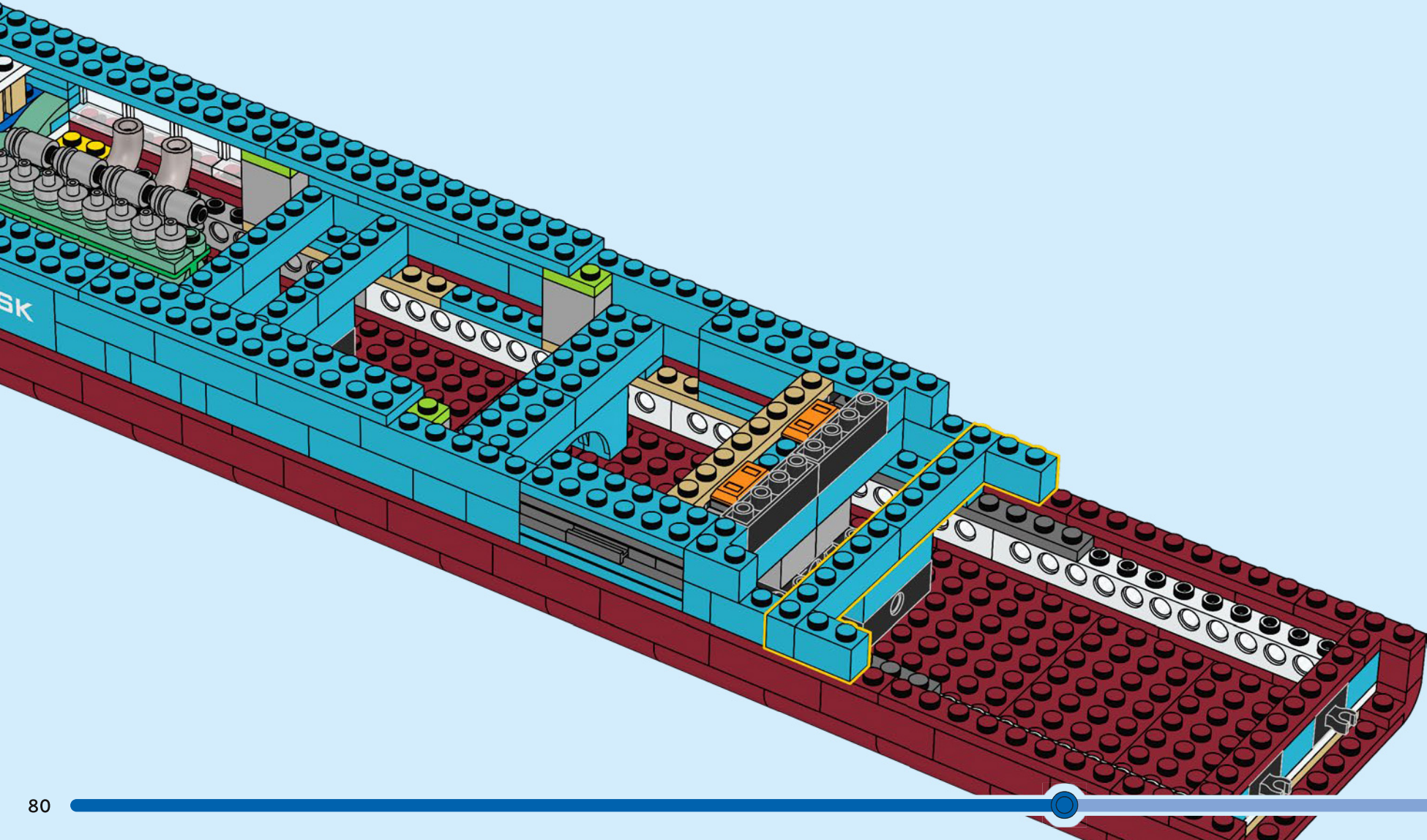

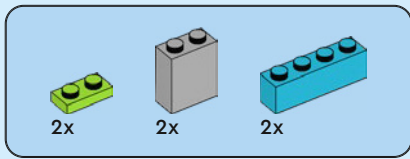

101

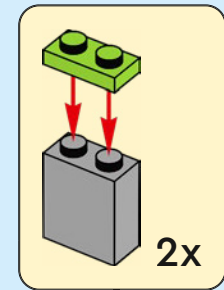
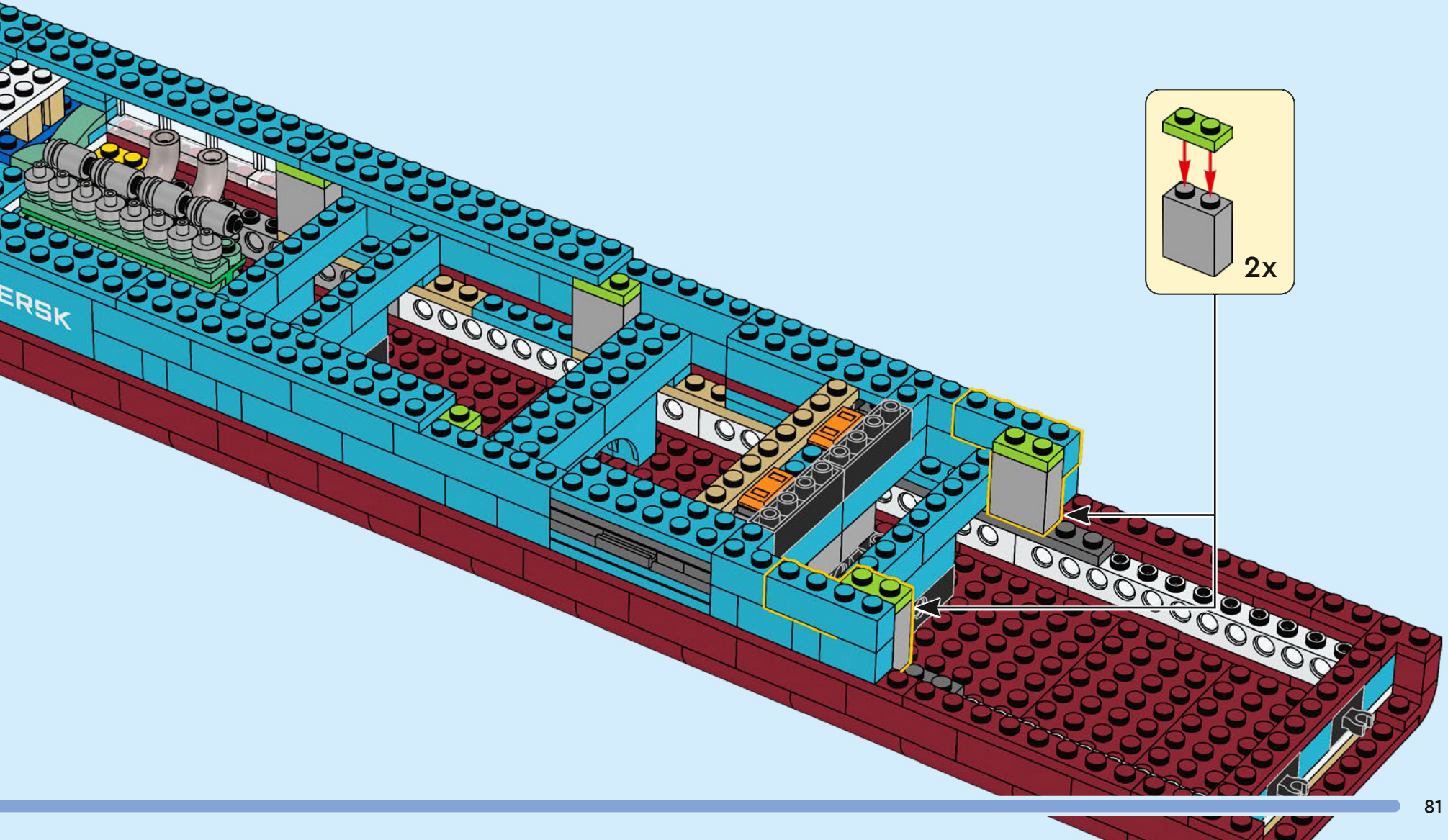

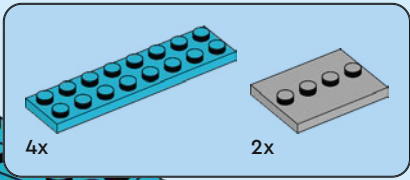

102

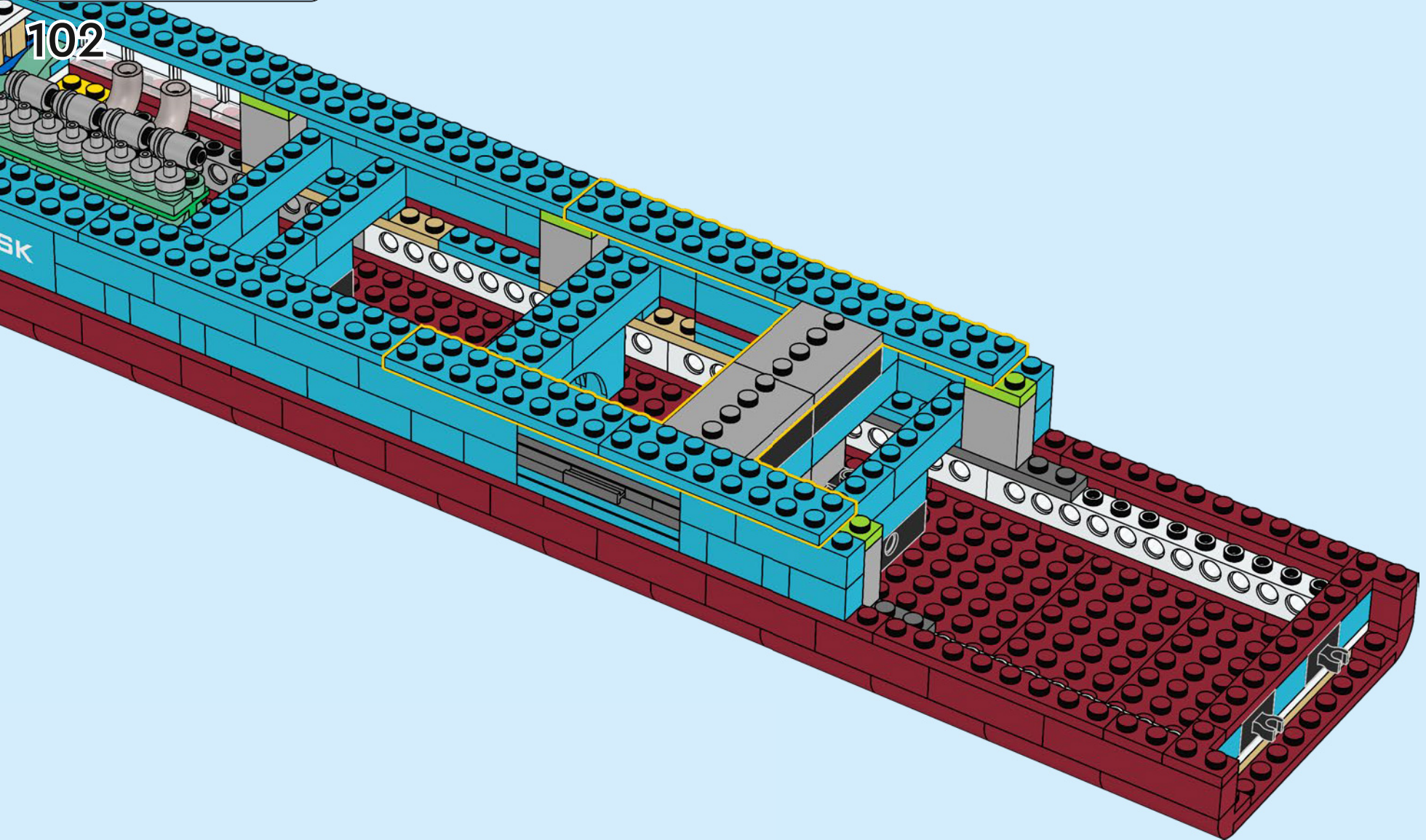

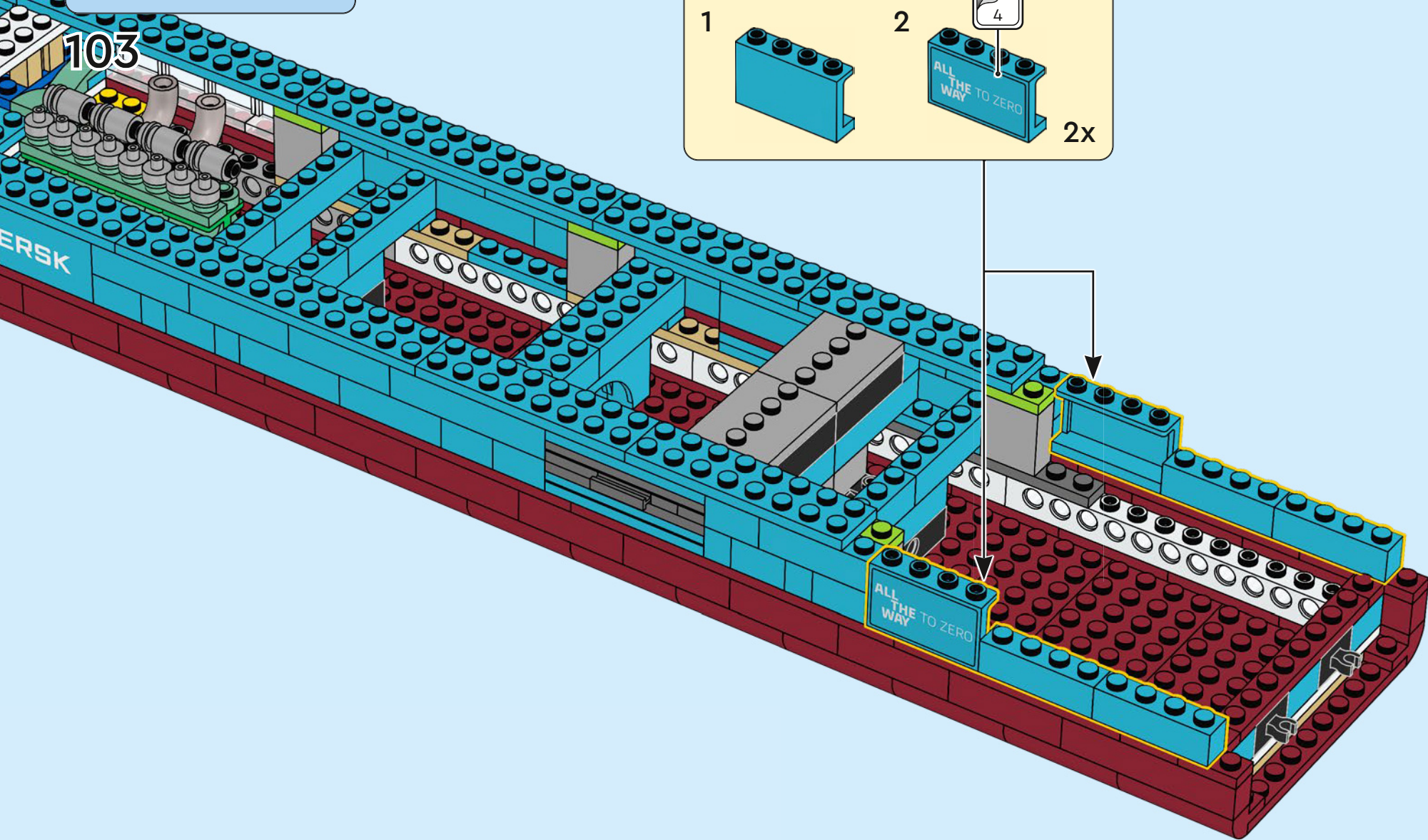
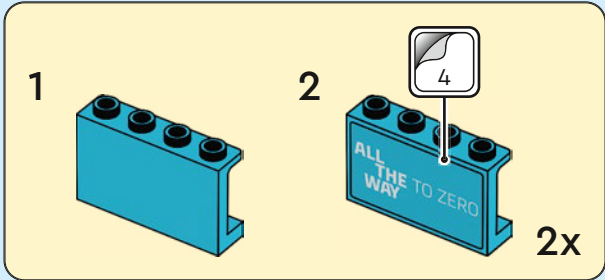
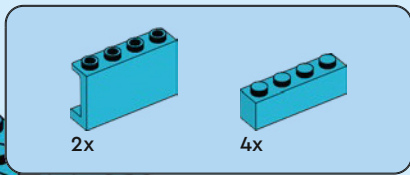

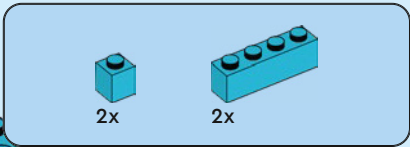

104

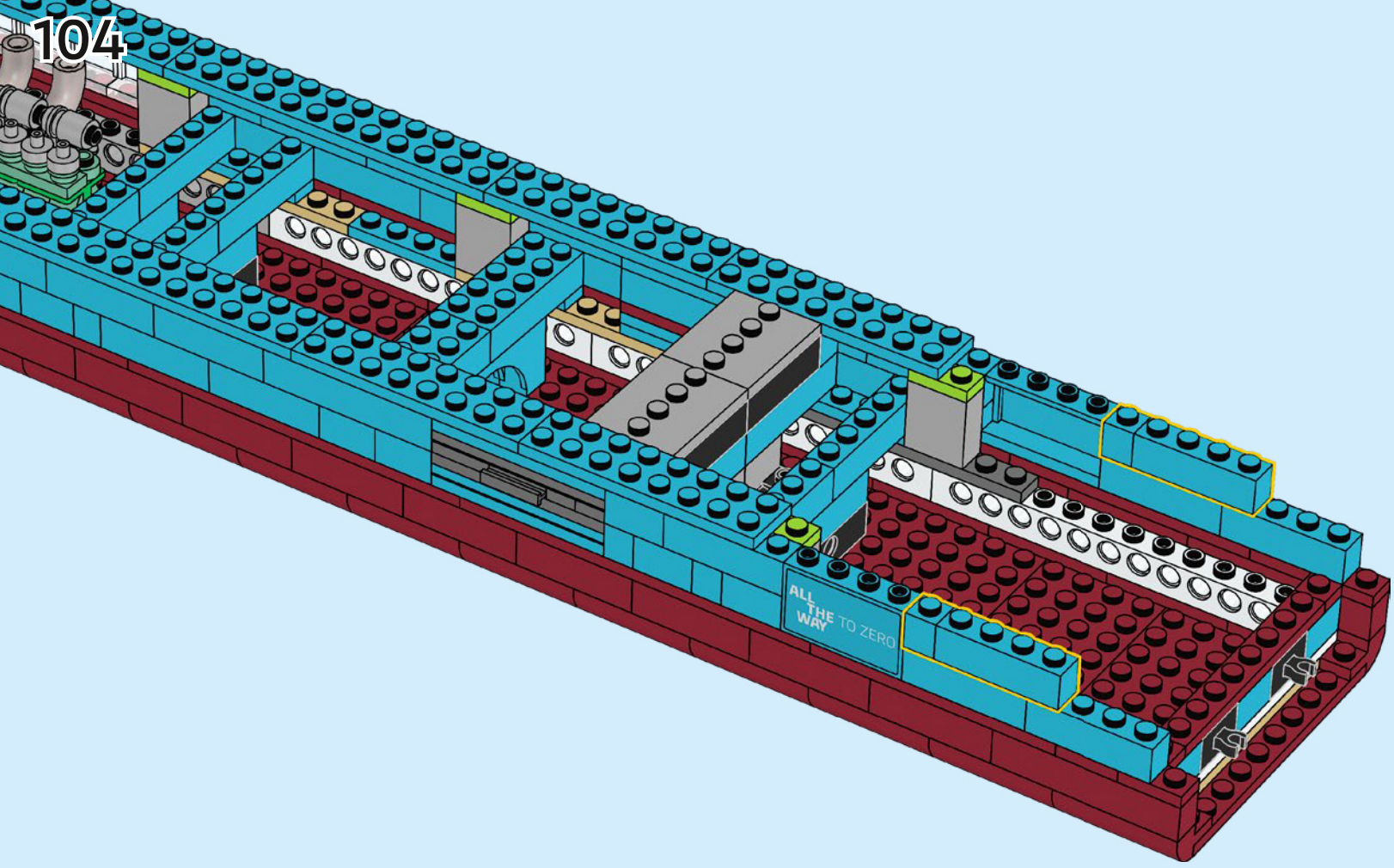

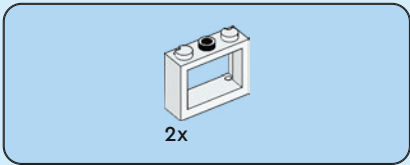

105

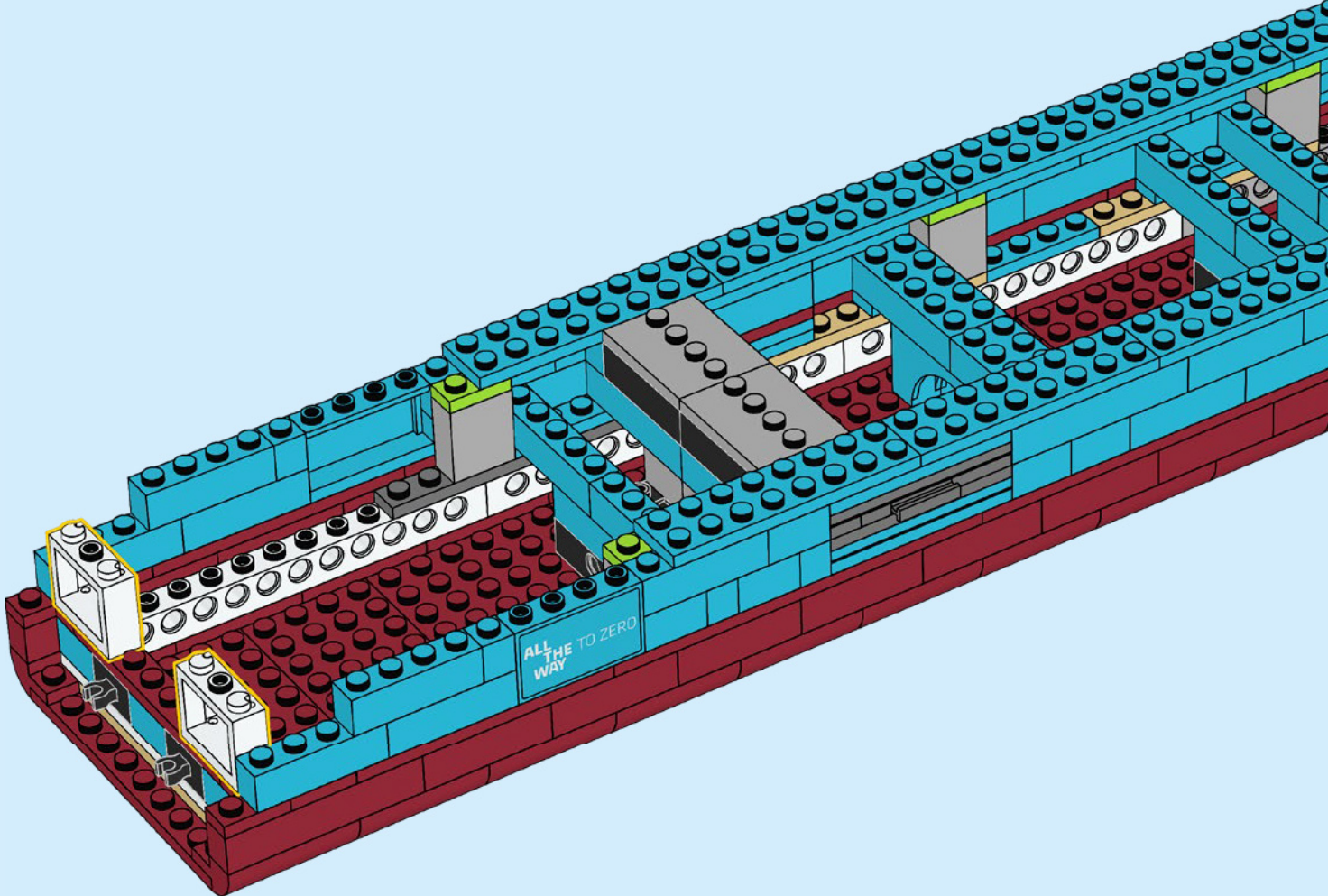

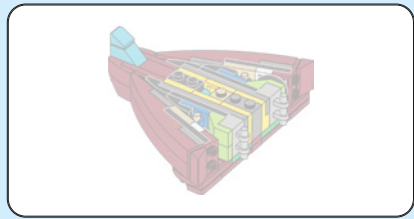
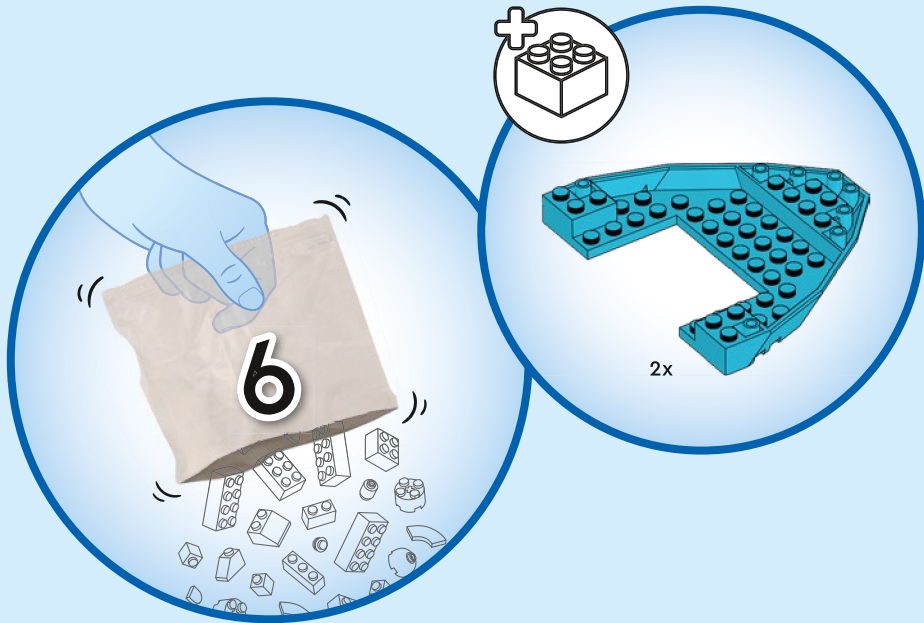

106

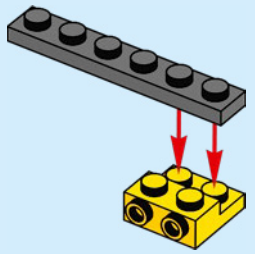

107

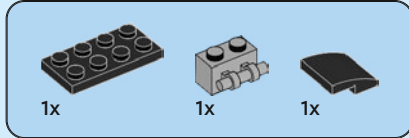
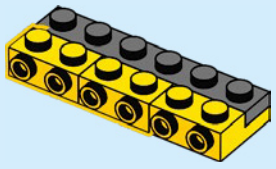

108

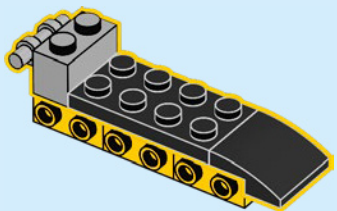

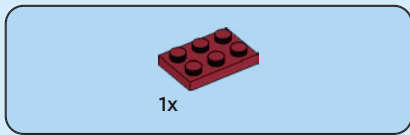

109

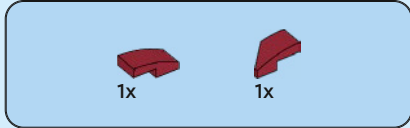
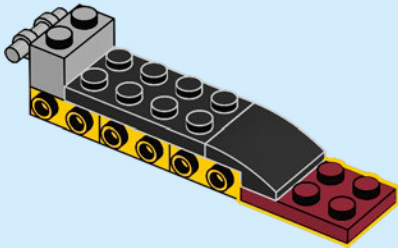

110

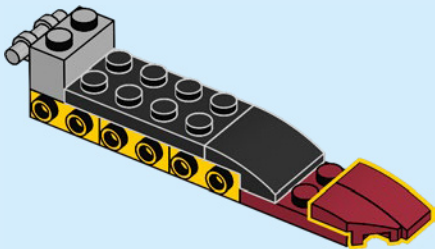

111

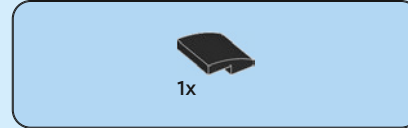
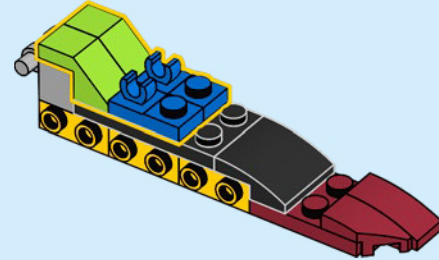

112

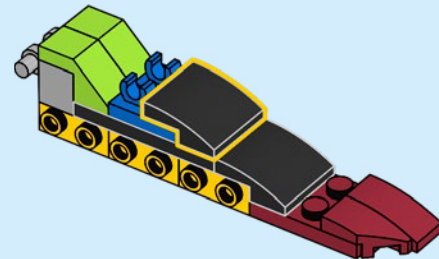

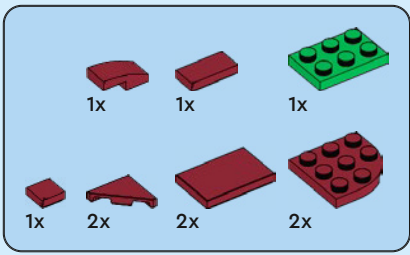

113

1

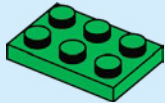

2

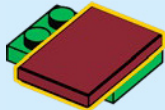

3

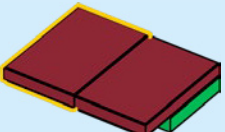

4

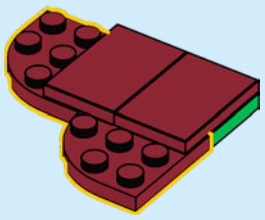

5

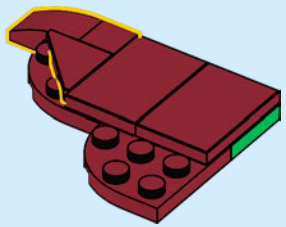

6

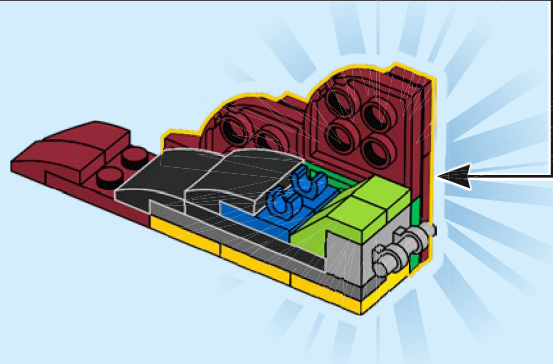
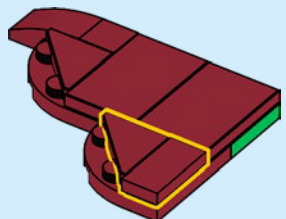

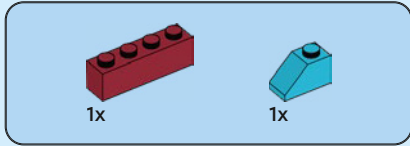
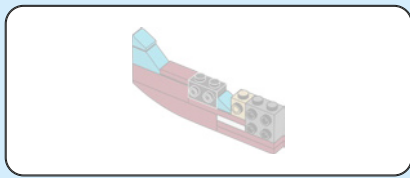

114

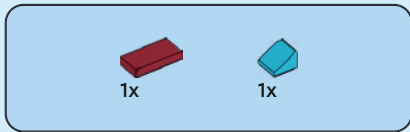
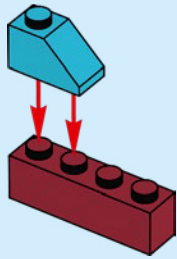

115

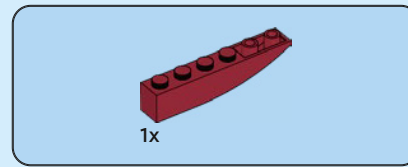
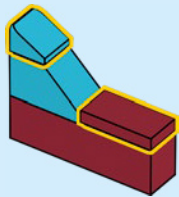

116

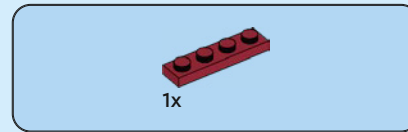
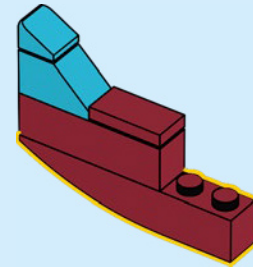

117

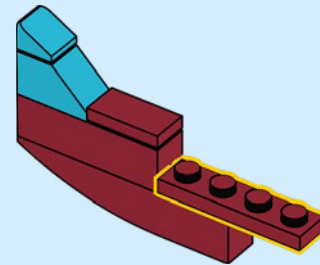

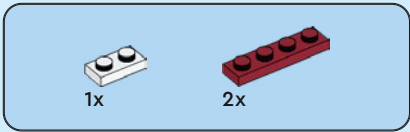

118

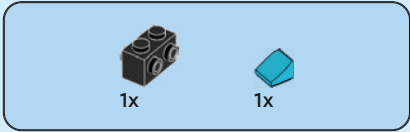
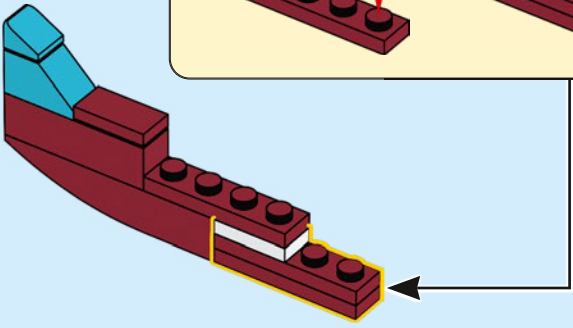
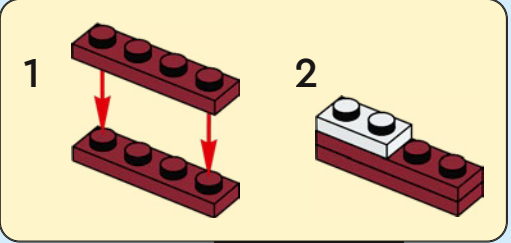

119

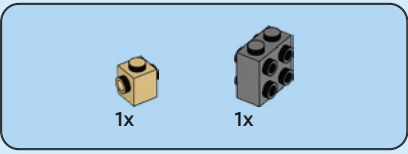
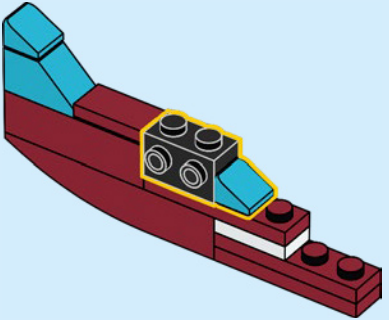

120

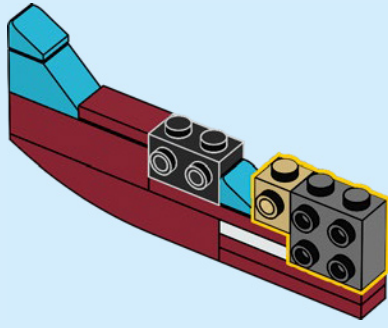

121

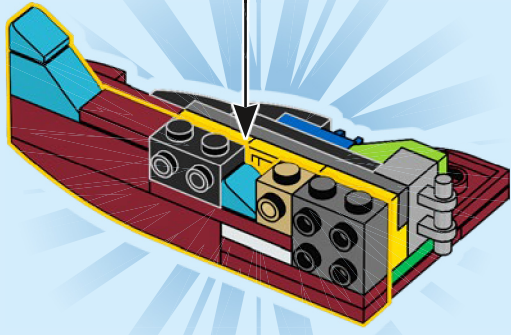

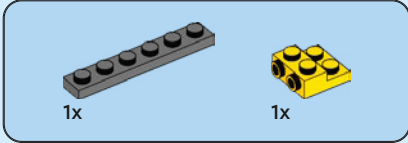
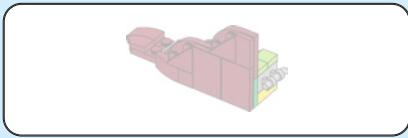

122

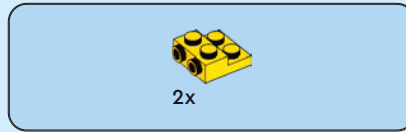
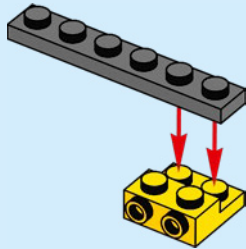

123

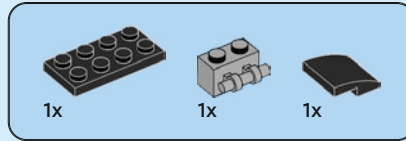
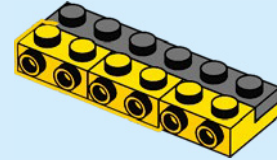

124

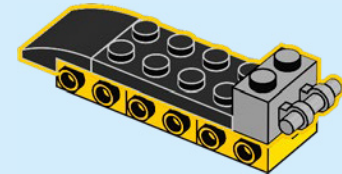

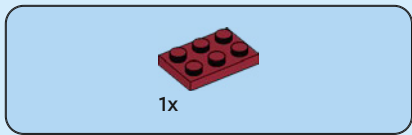

125

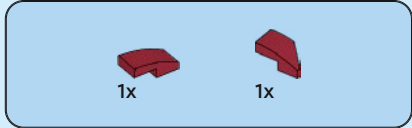
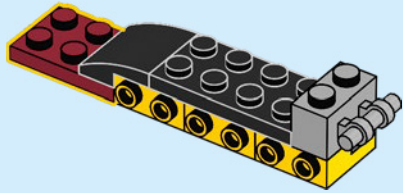

126

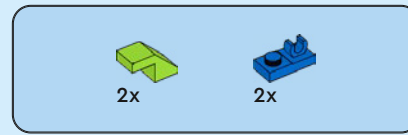
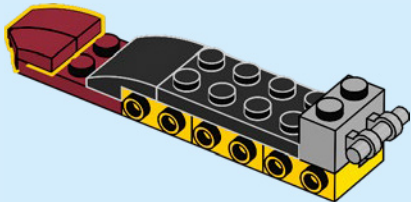

127

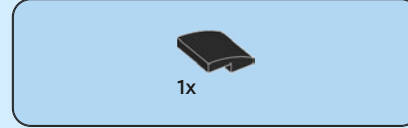
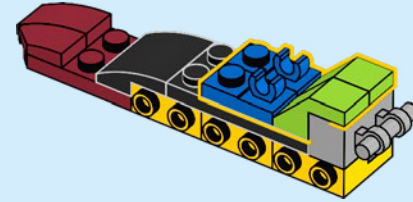

128

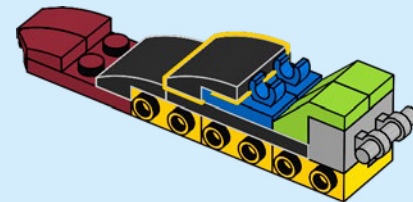

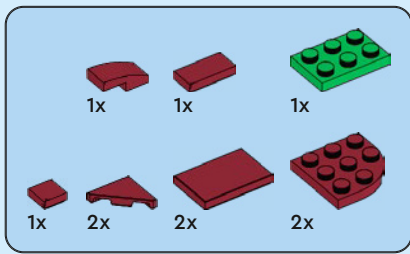

129

1

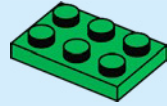

2

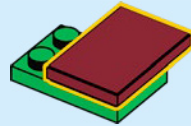

3

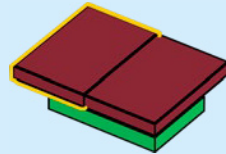

4

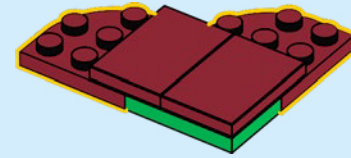

5

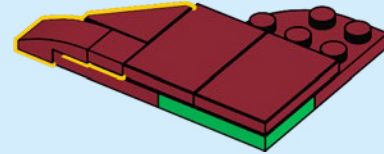

6

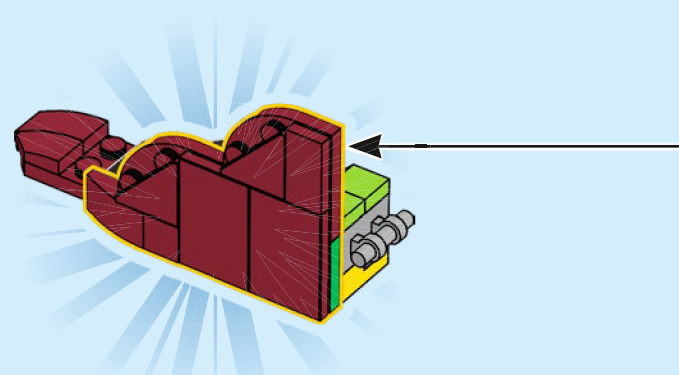
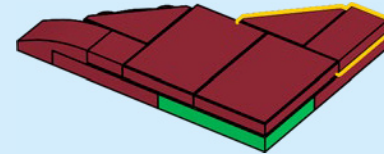

130

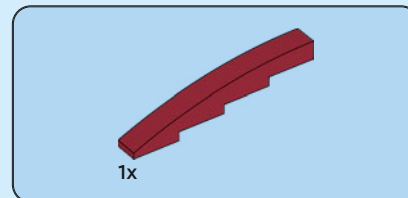
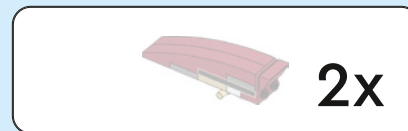
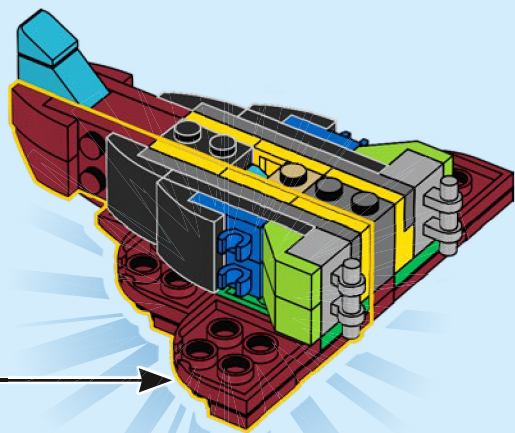

131

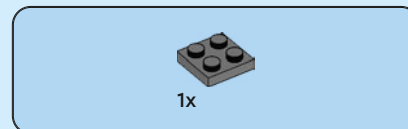
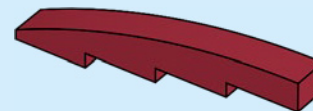

132

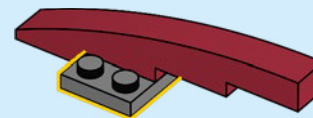

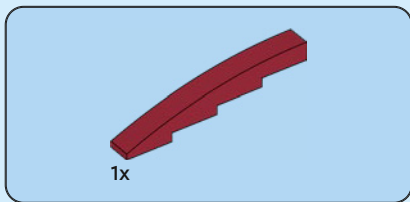

133

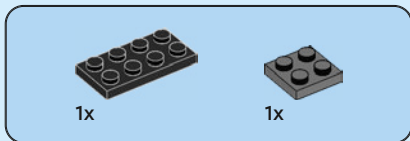
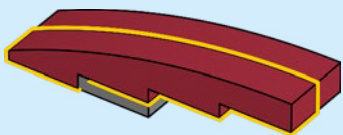

134

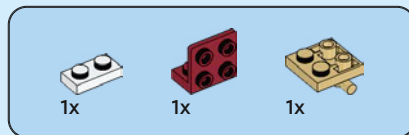
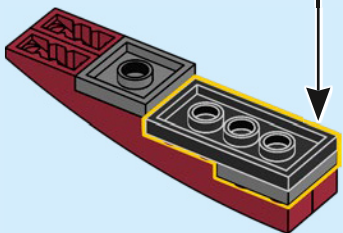
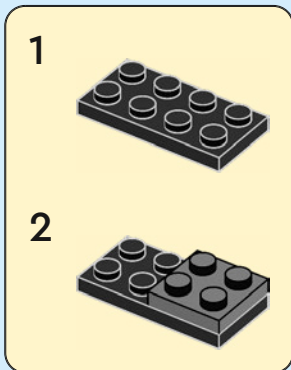

135

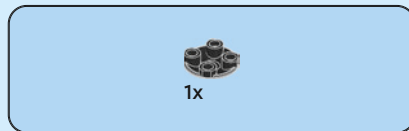
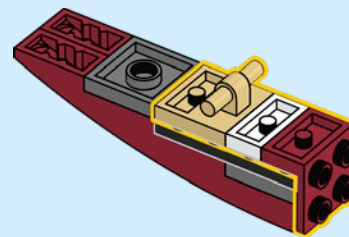

136

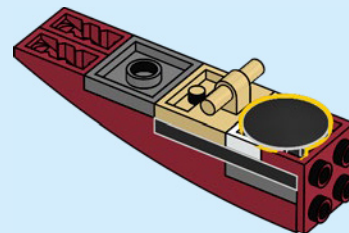



1x

137

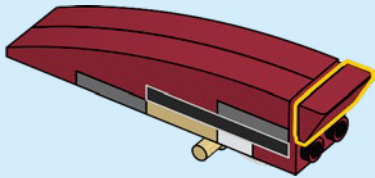

2x

138

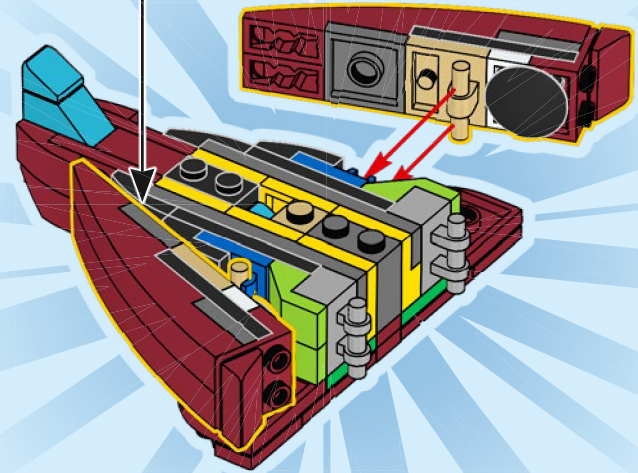

139

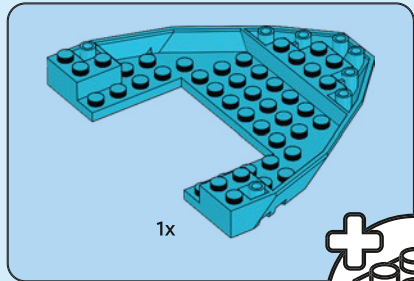
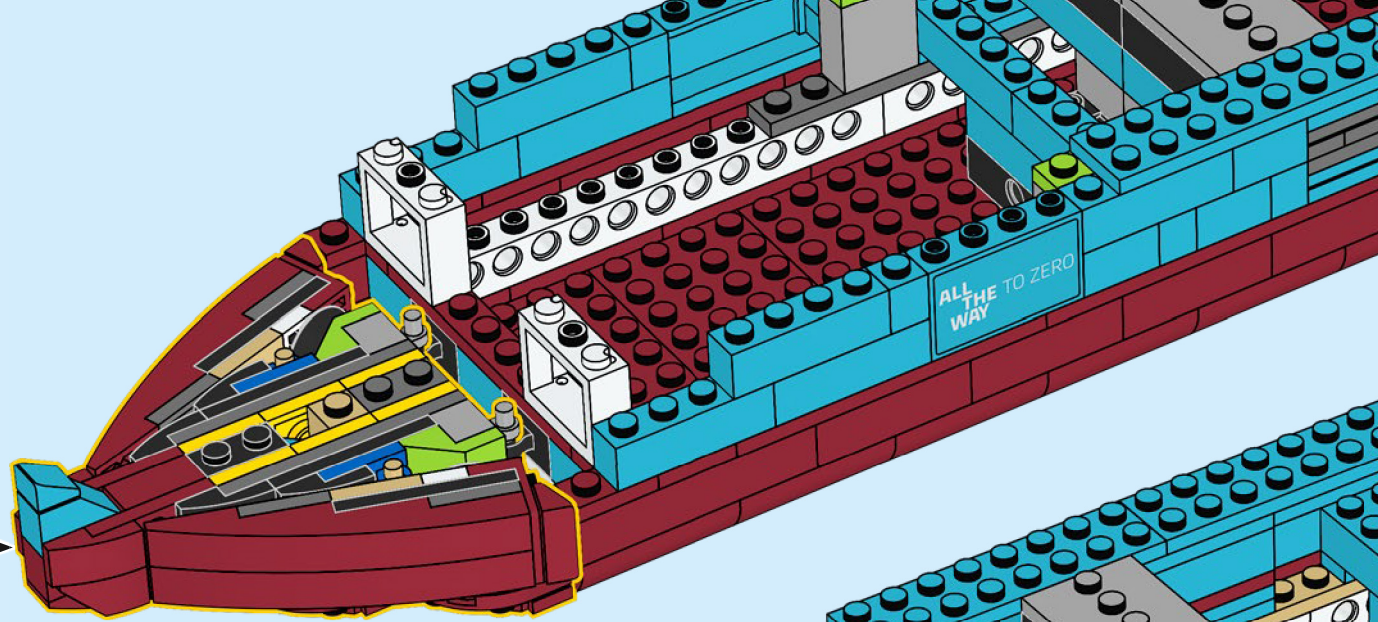

140

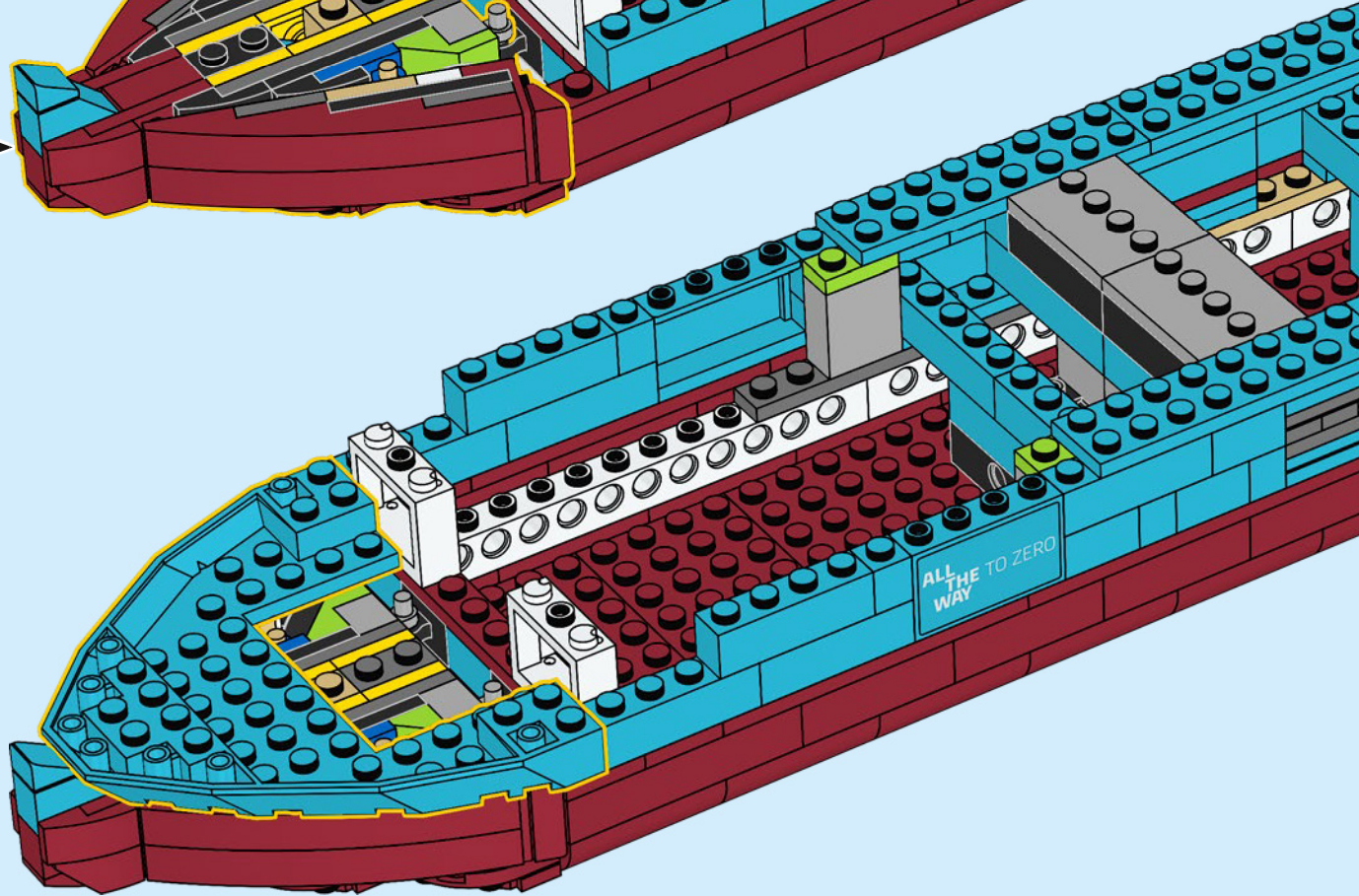
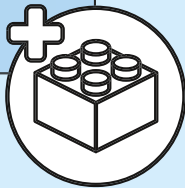

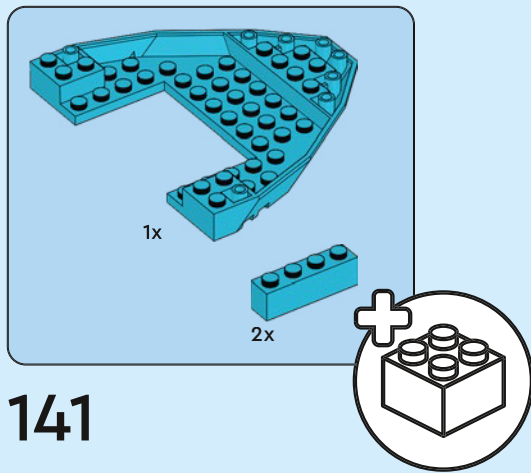

141

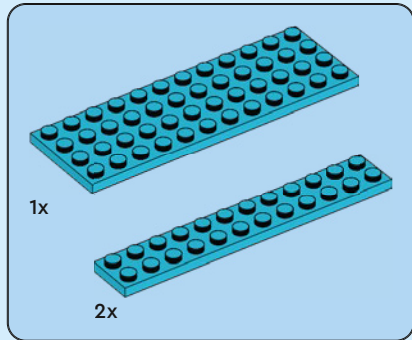
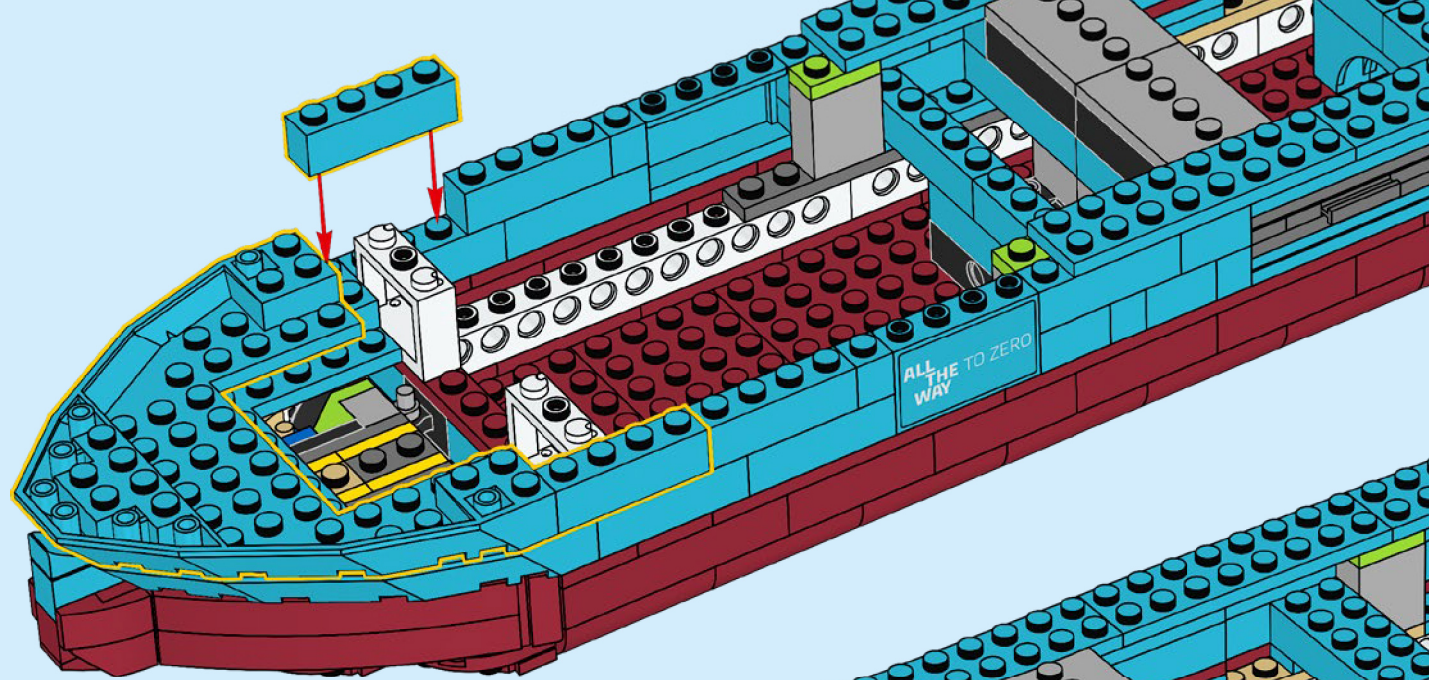

142

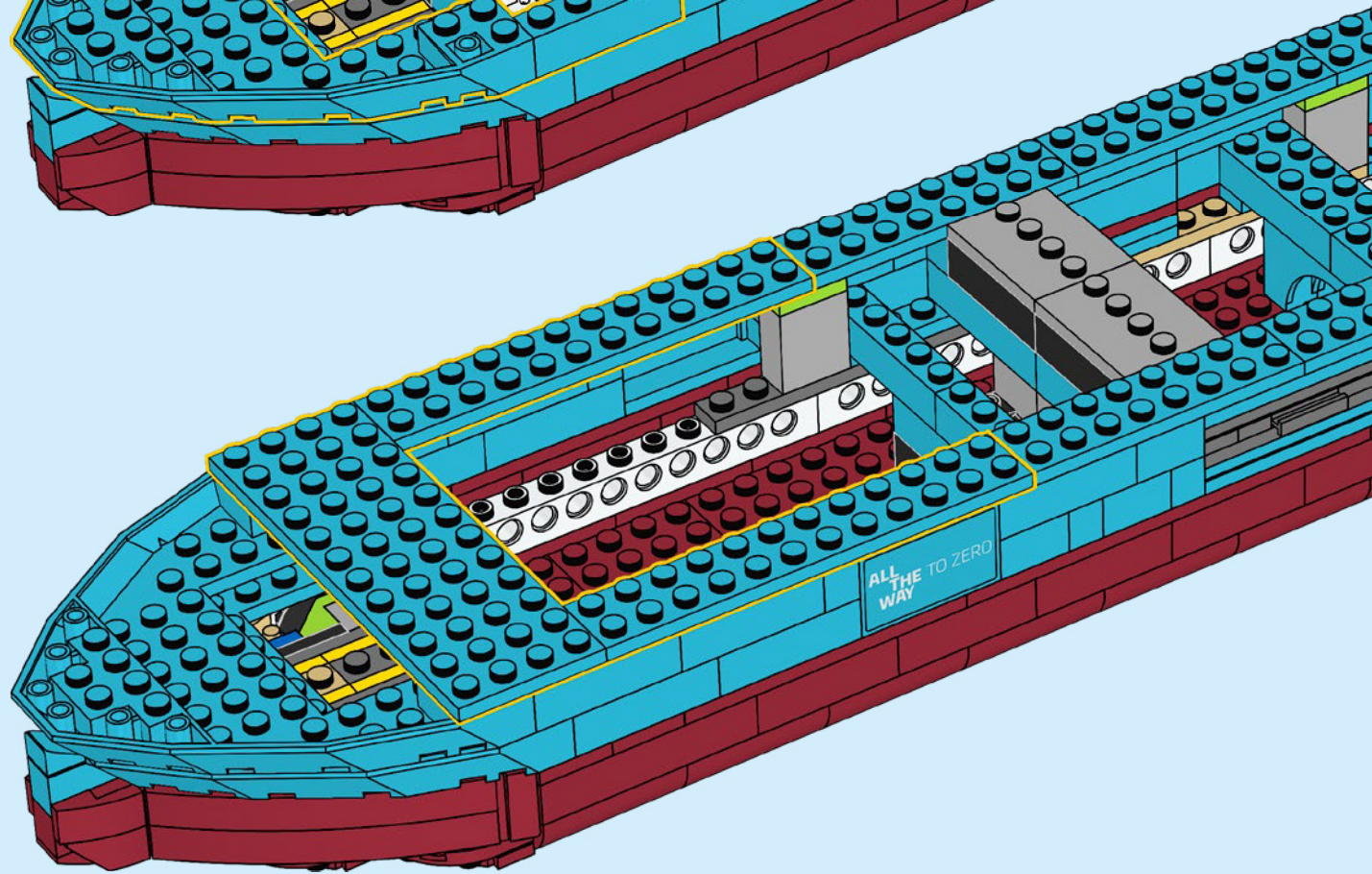

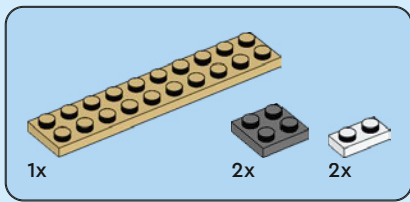

143

1

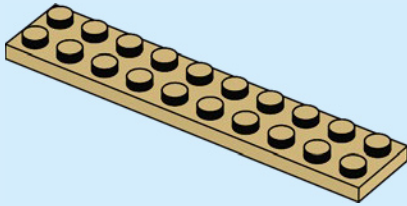

2

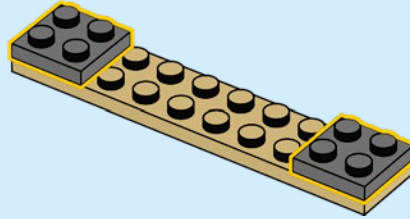

3

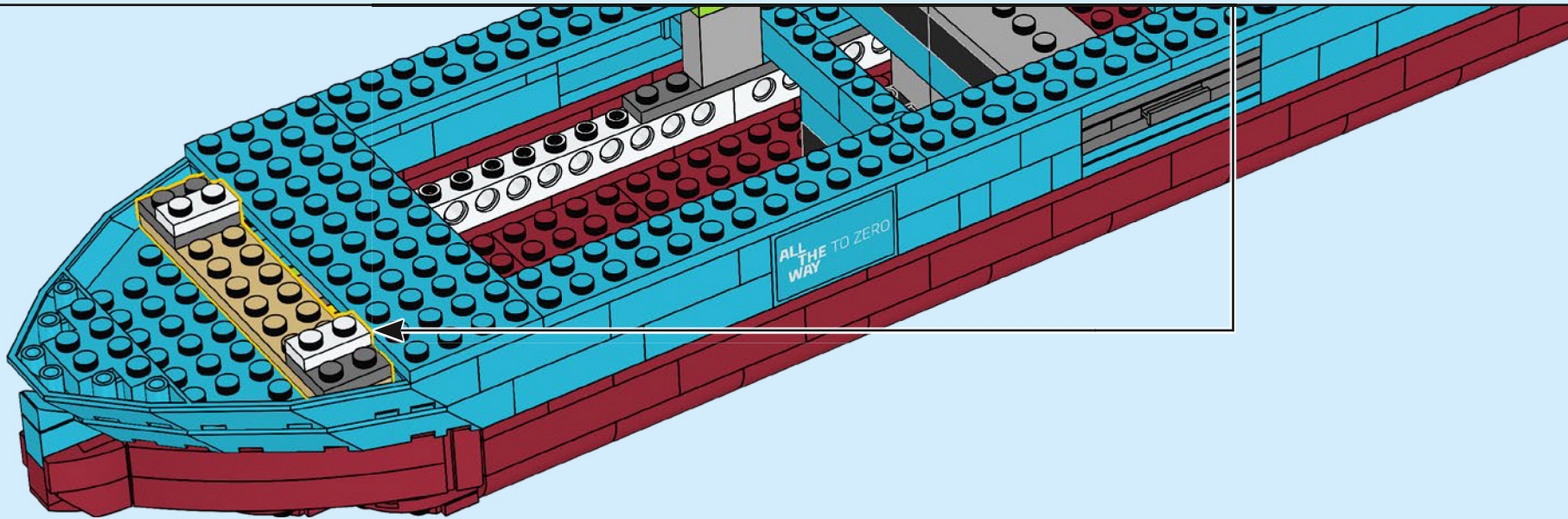
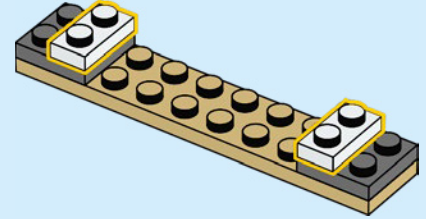

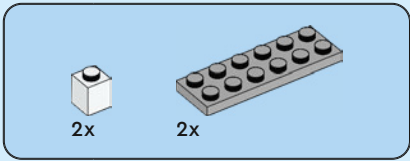

144

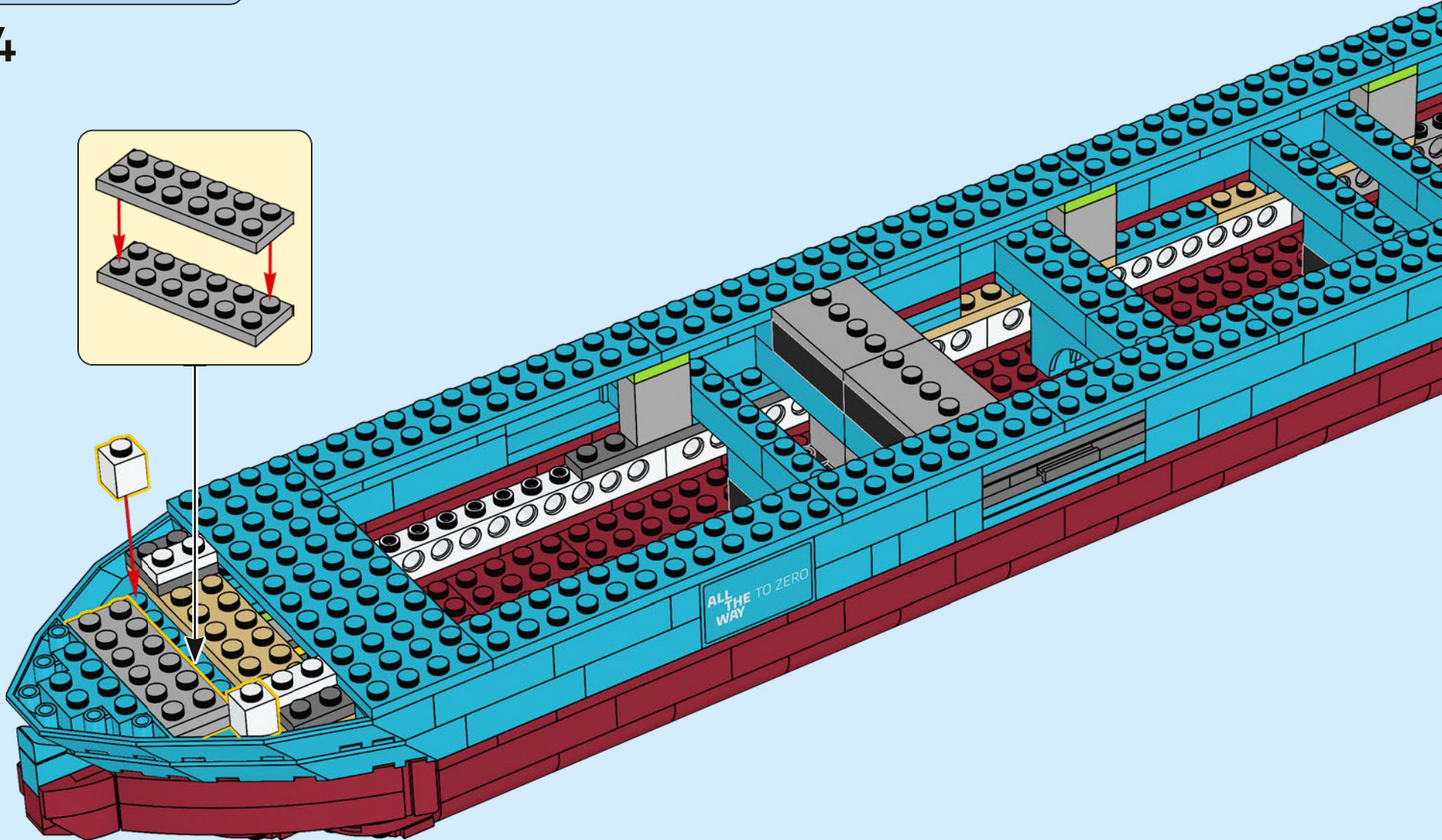
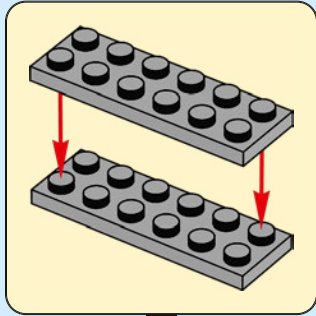

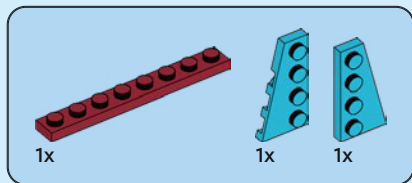

145

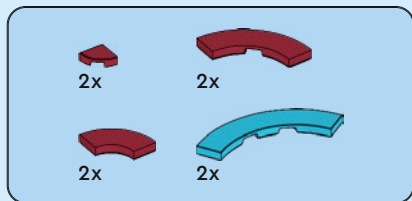
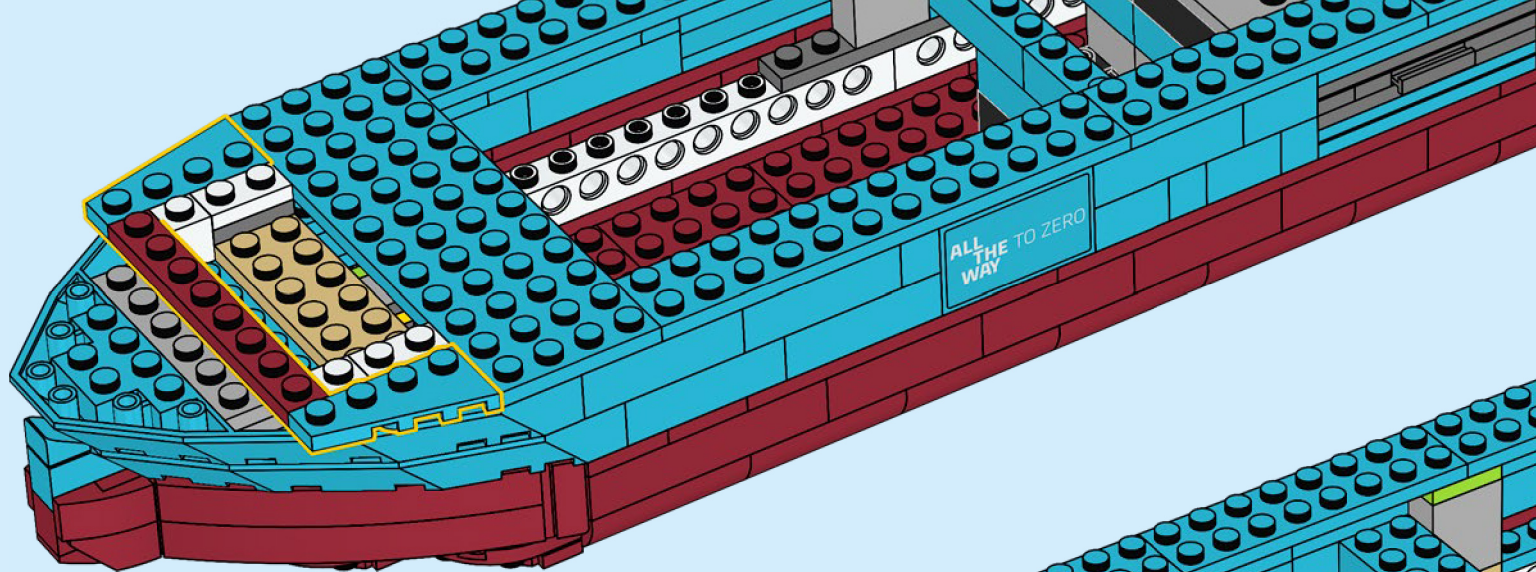

146

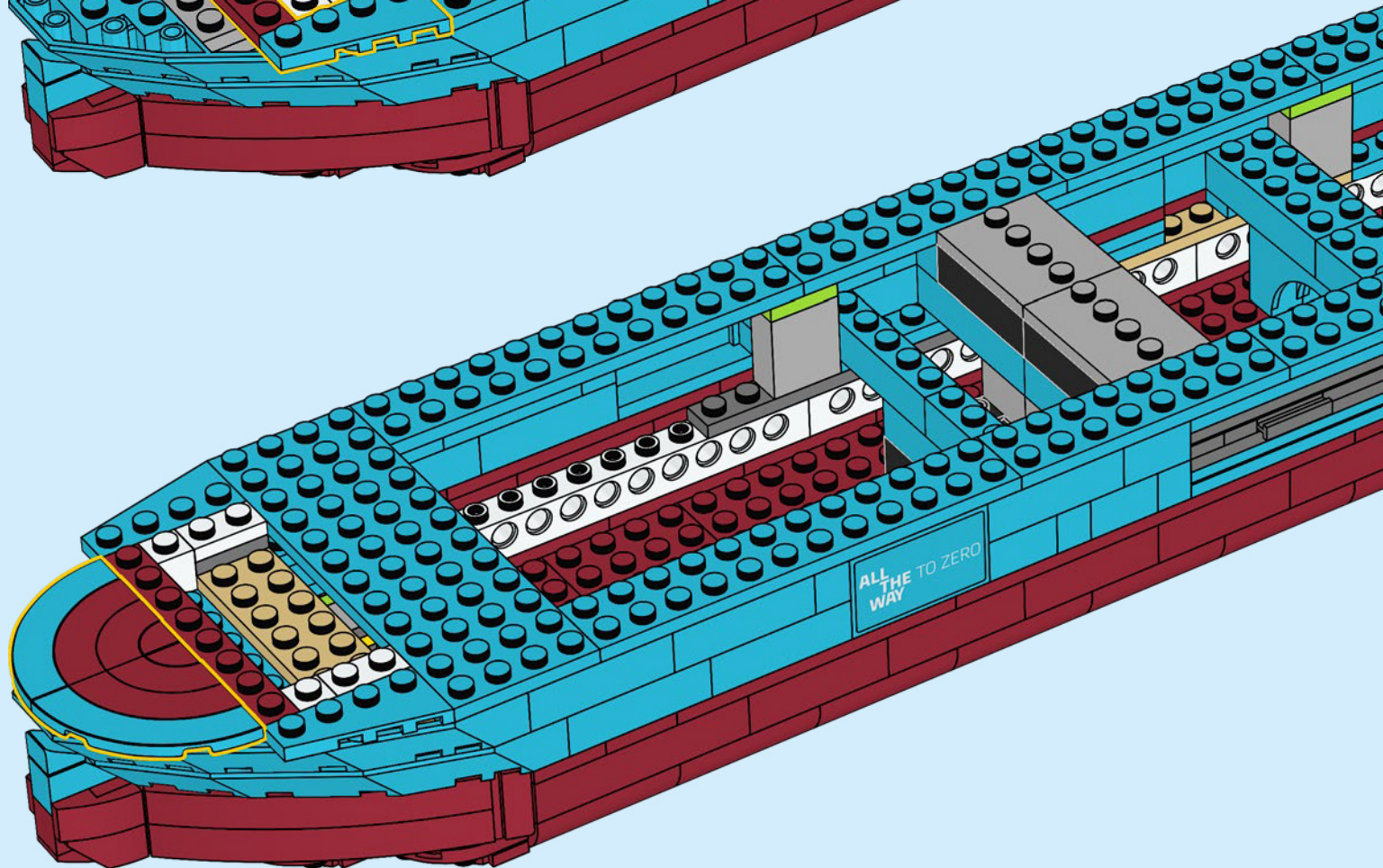

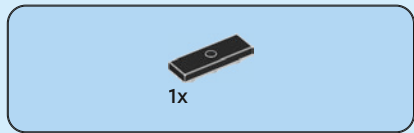

147

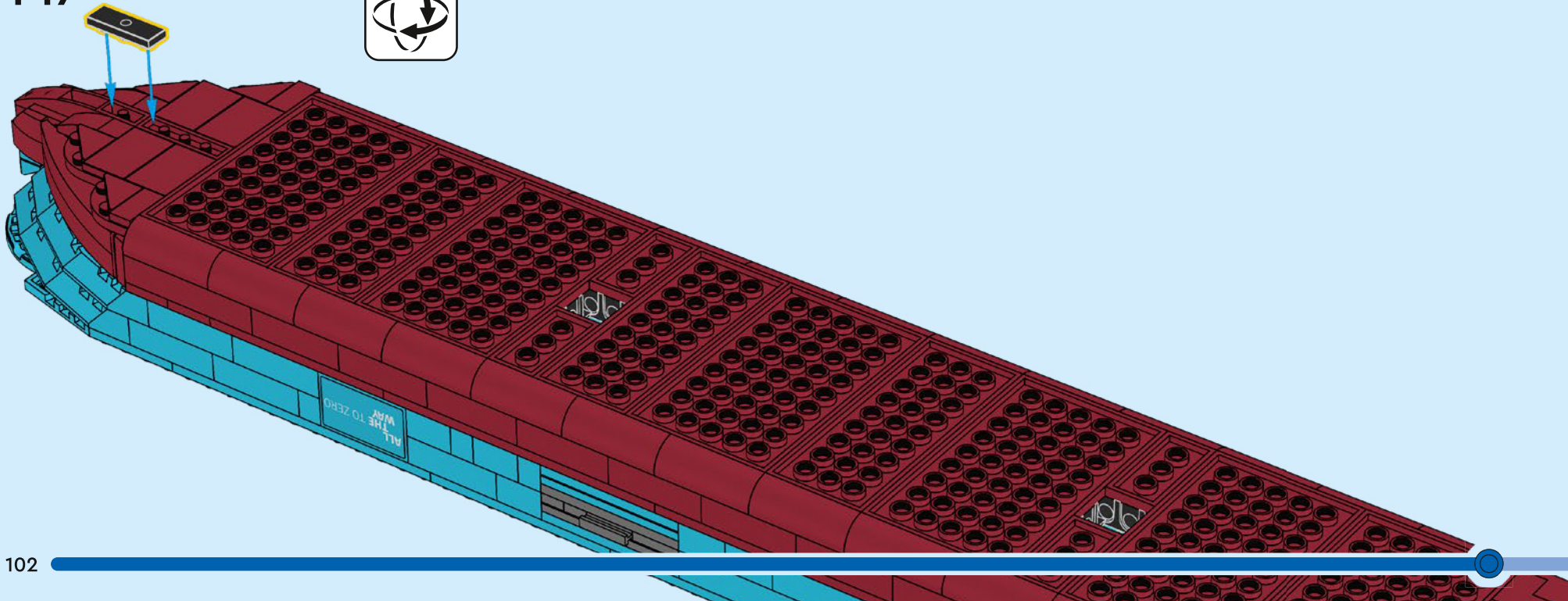



24x

148

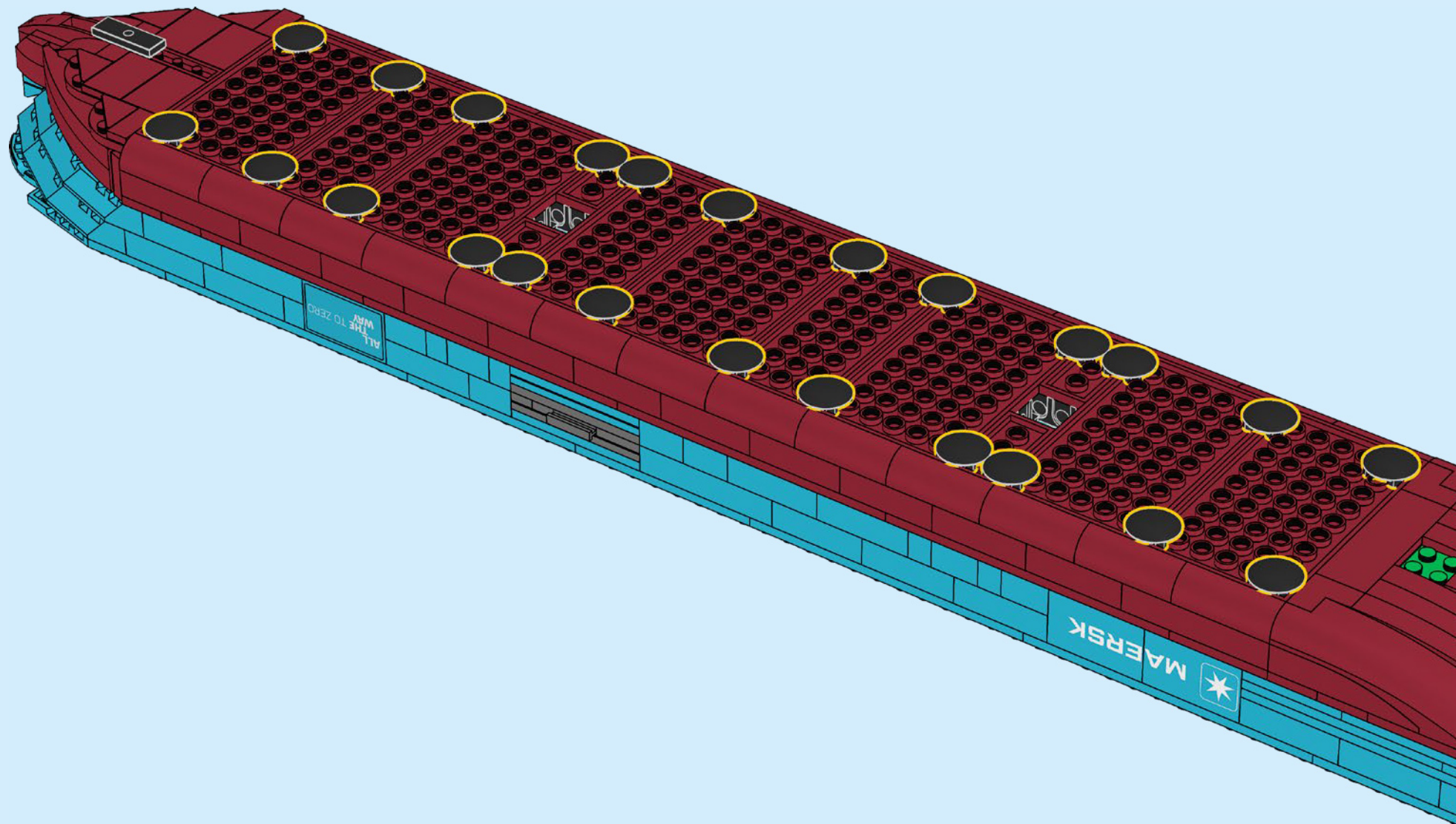

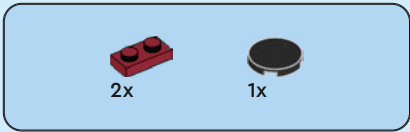

149

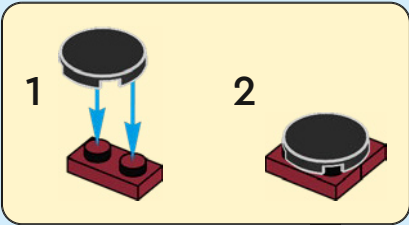
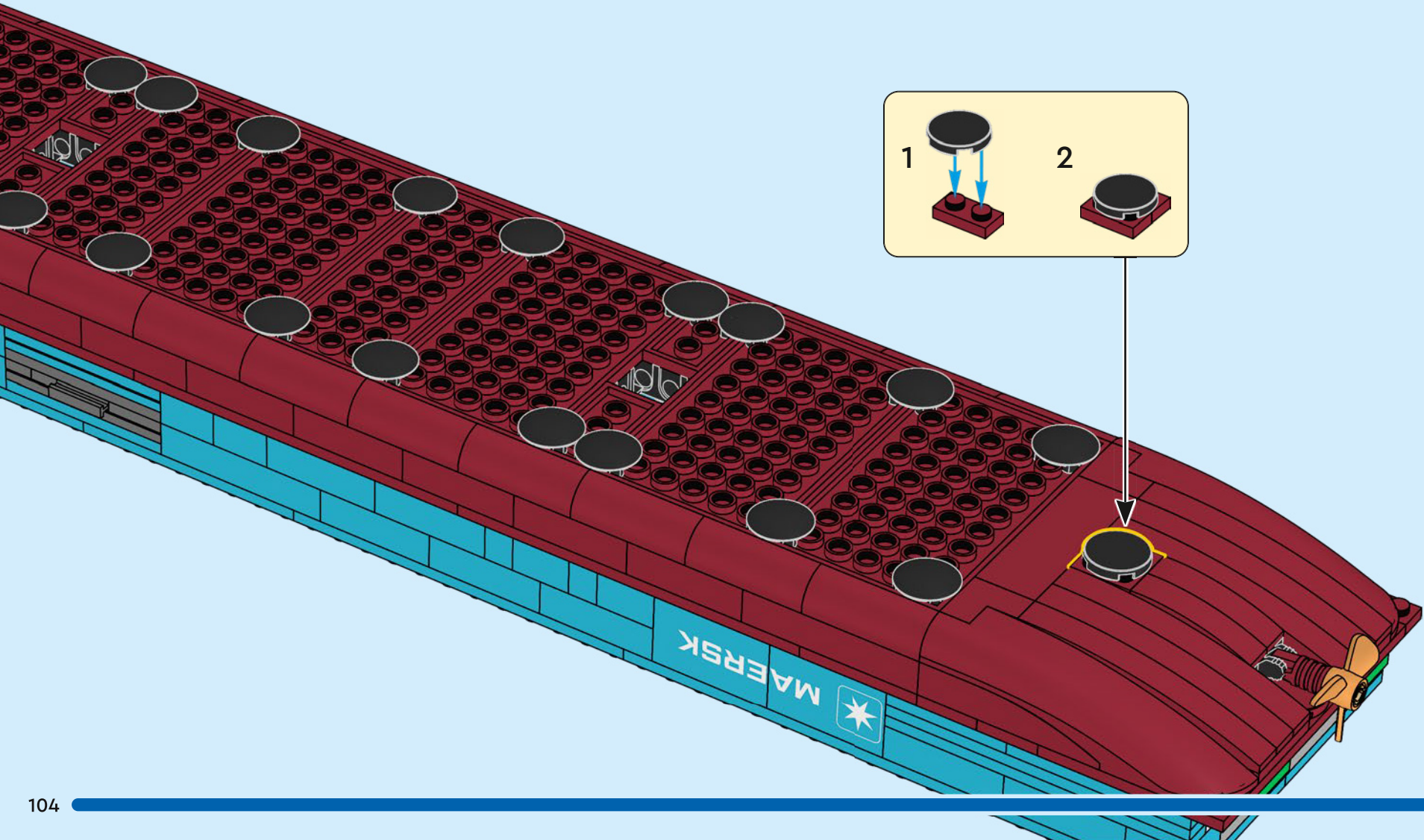

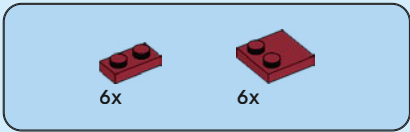

150

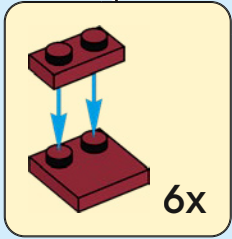
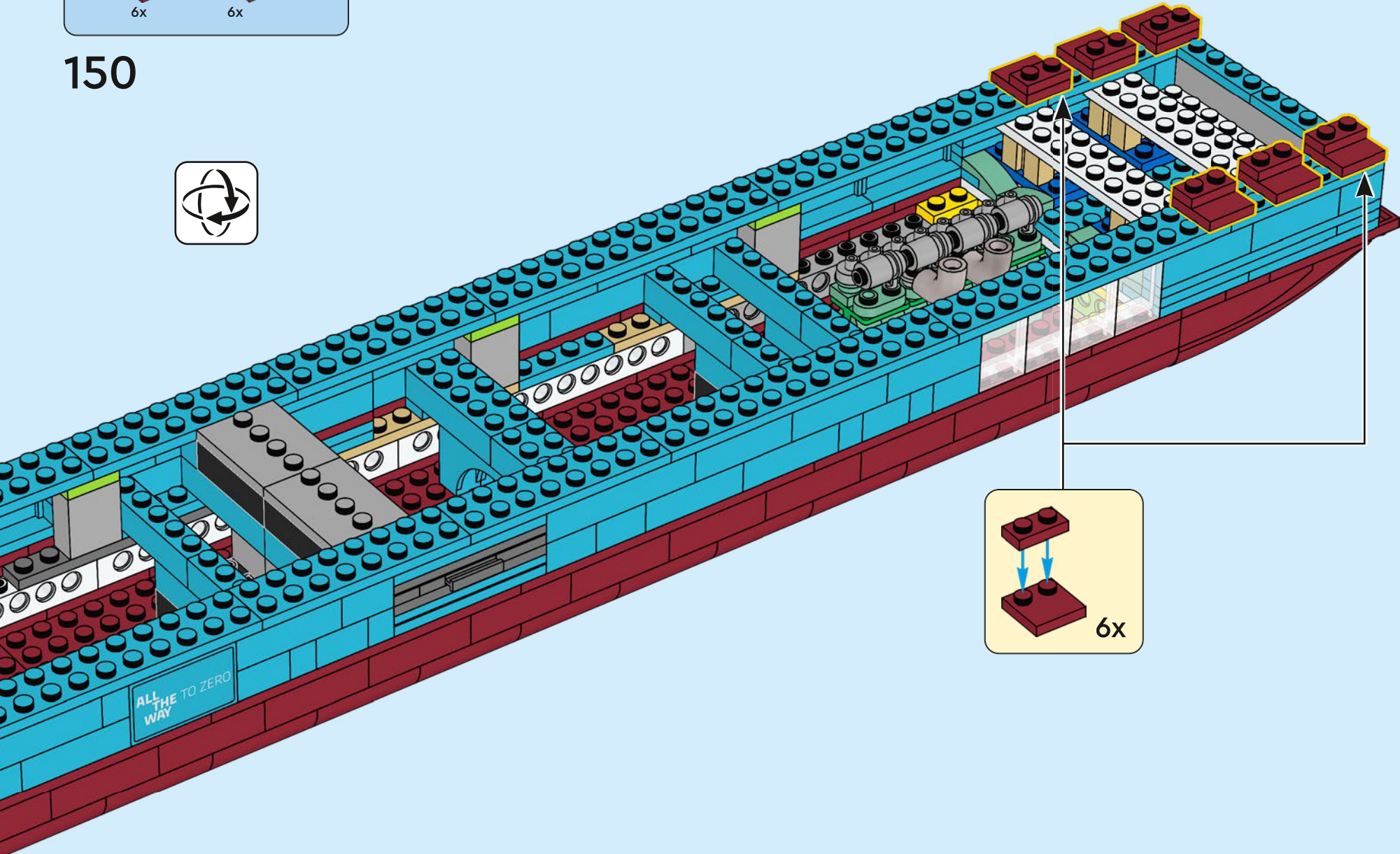

ALL
THE
WAY TO ZERO

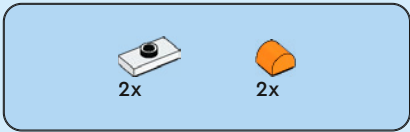

151

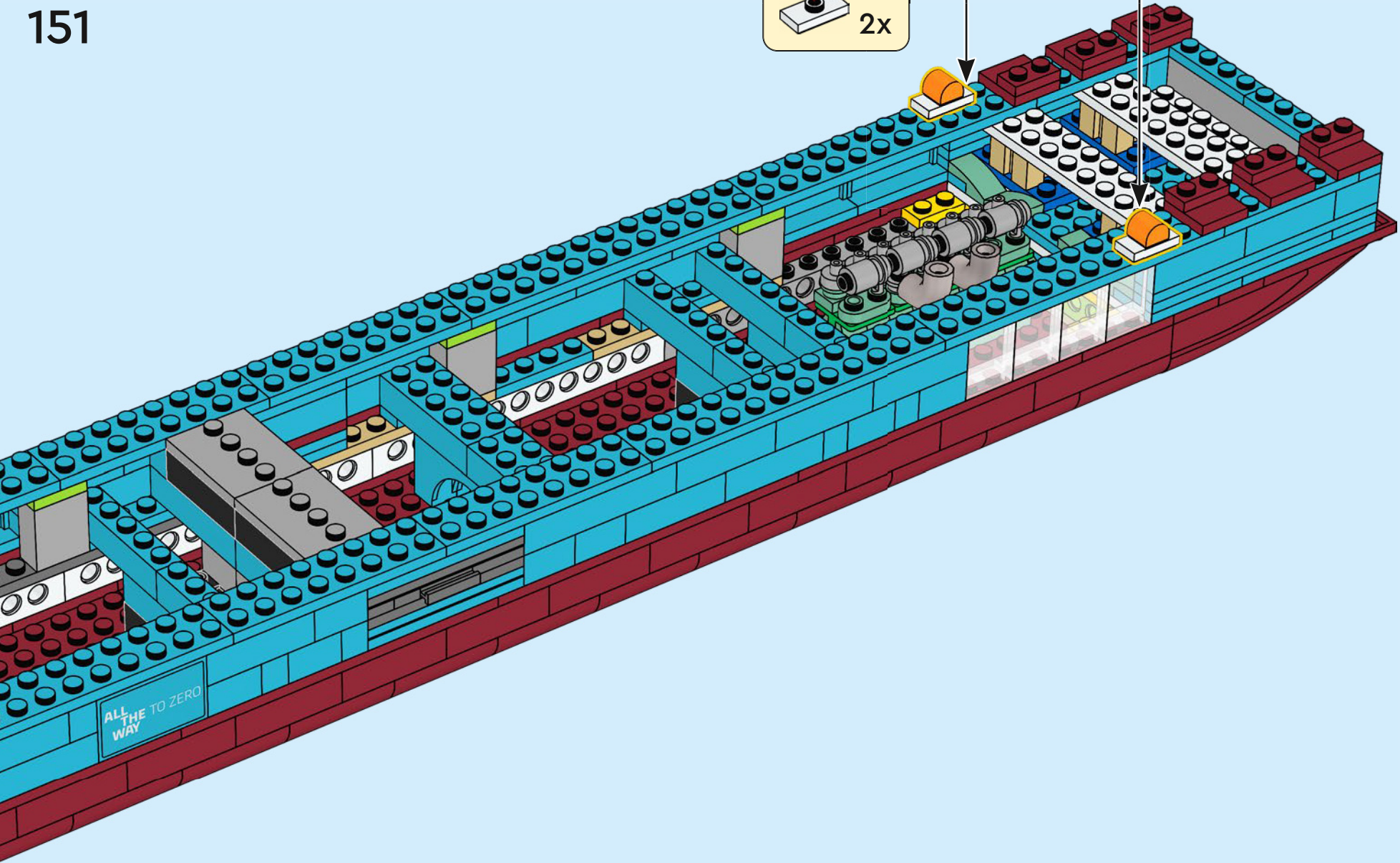
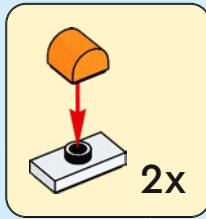

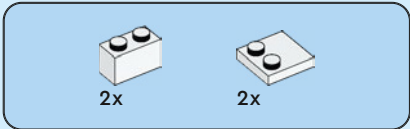

152

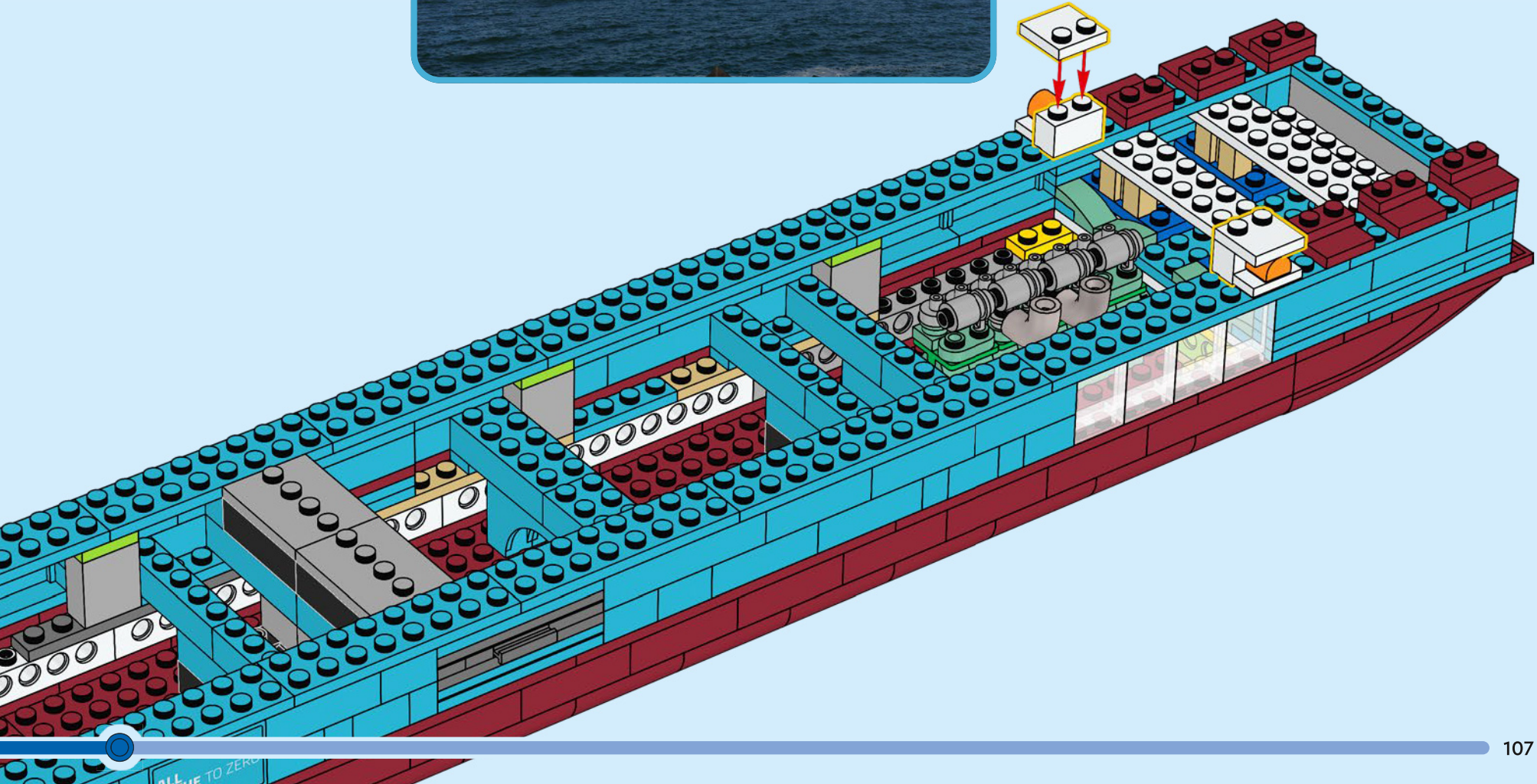
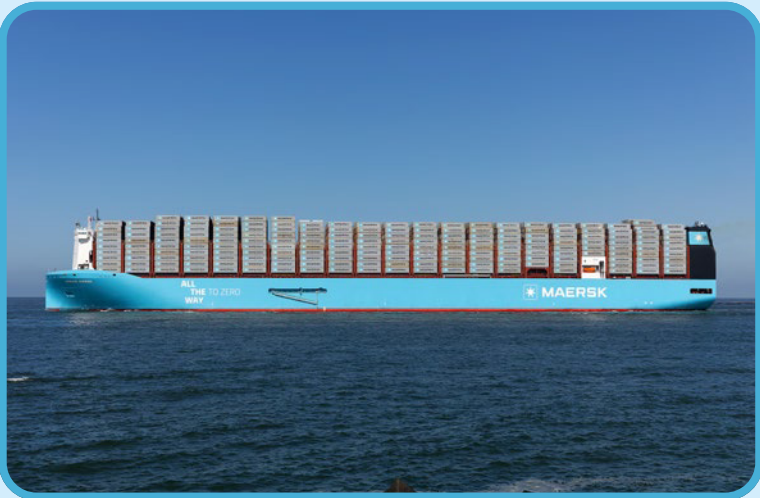

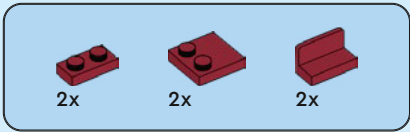

153

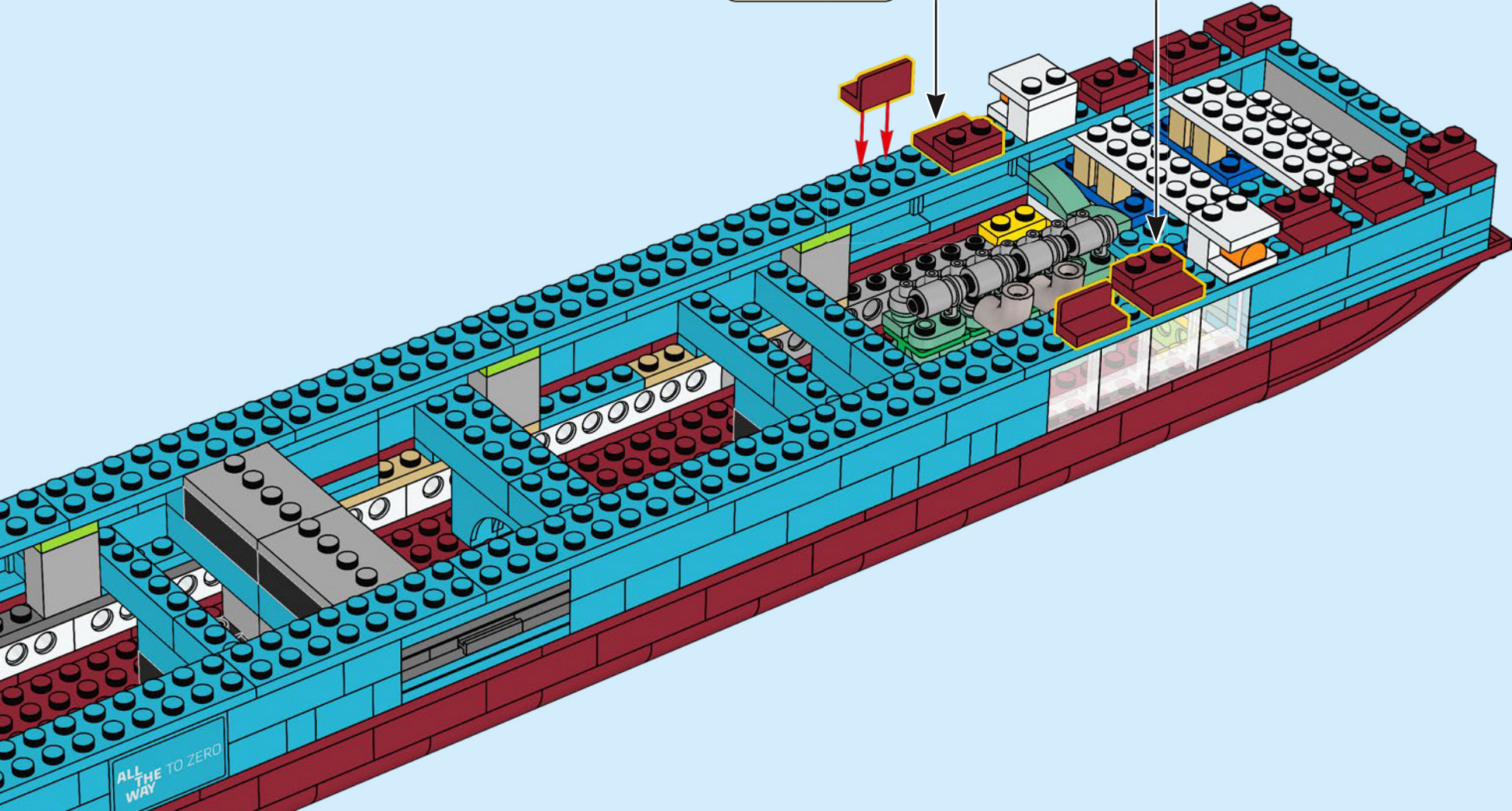
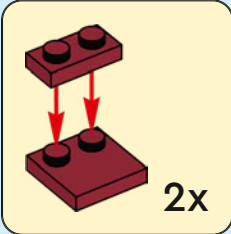

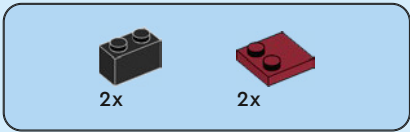

154

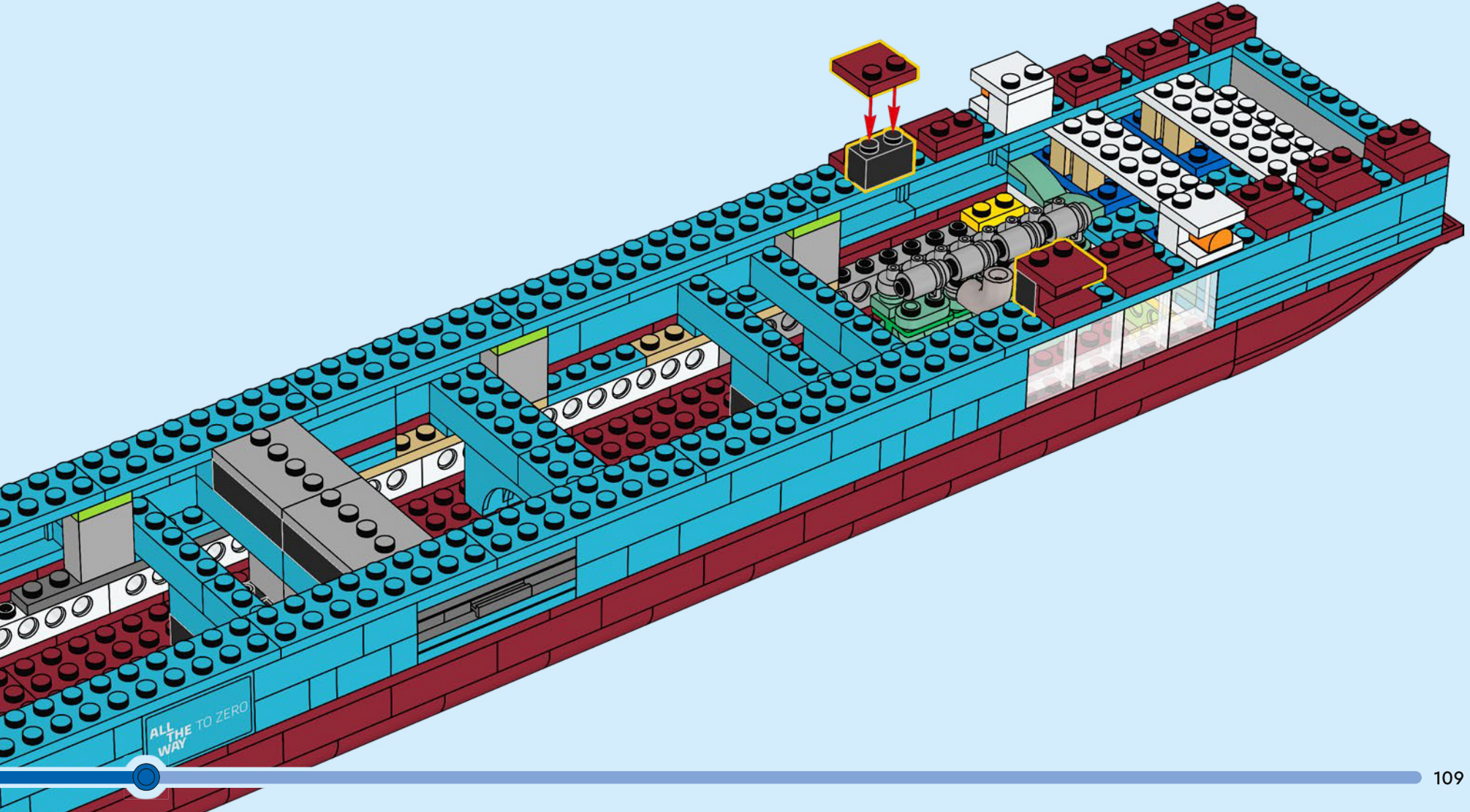

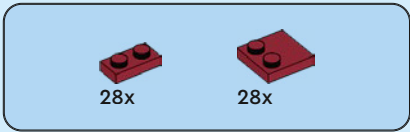

155

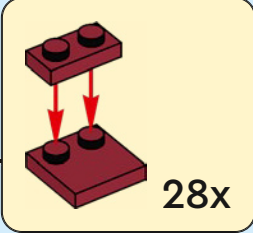
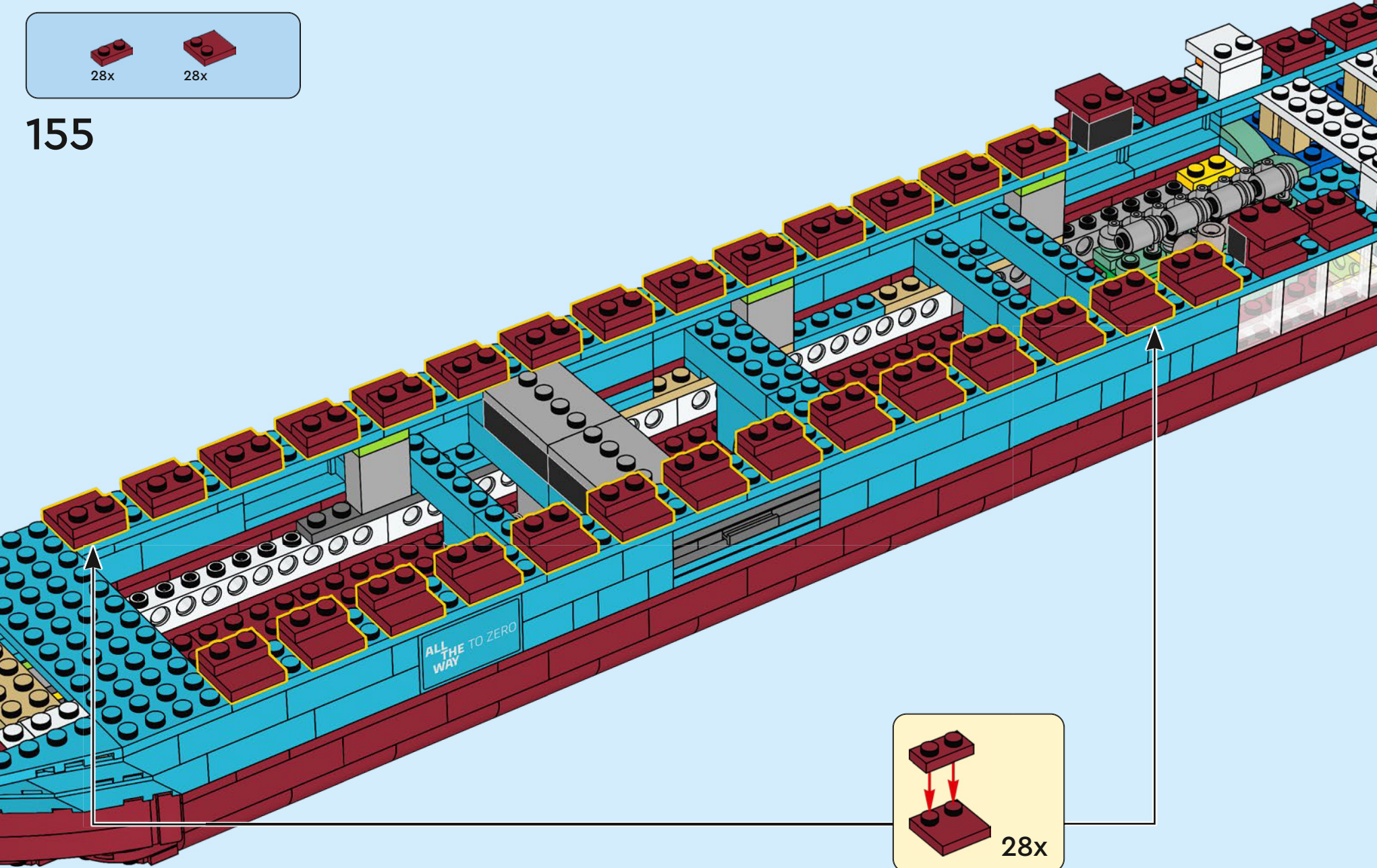

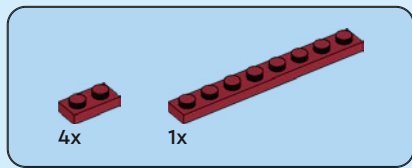

156

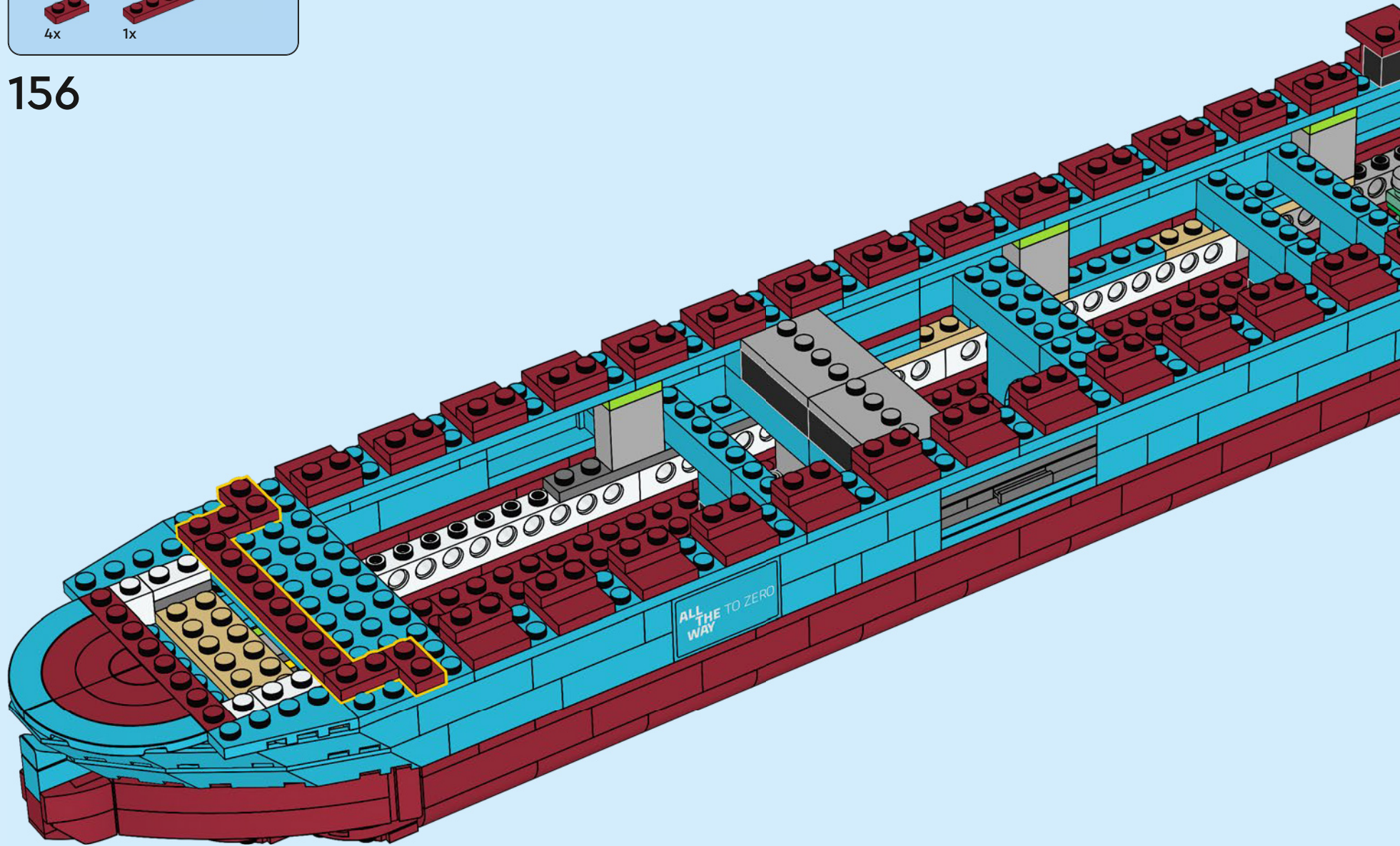

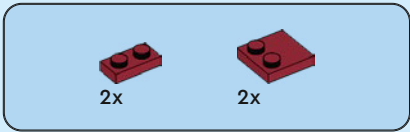

157

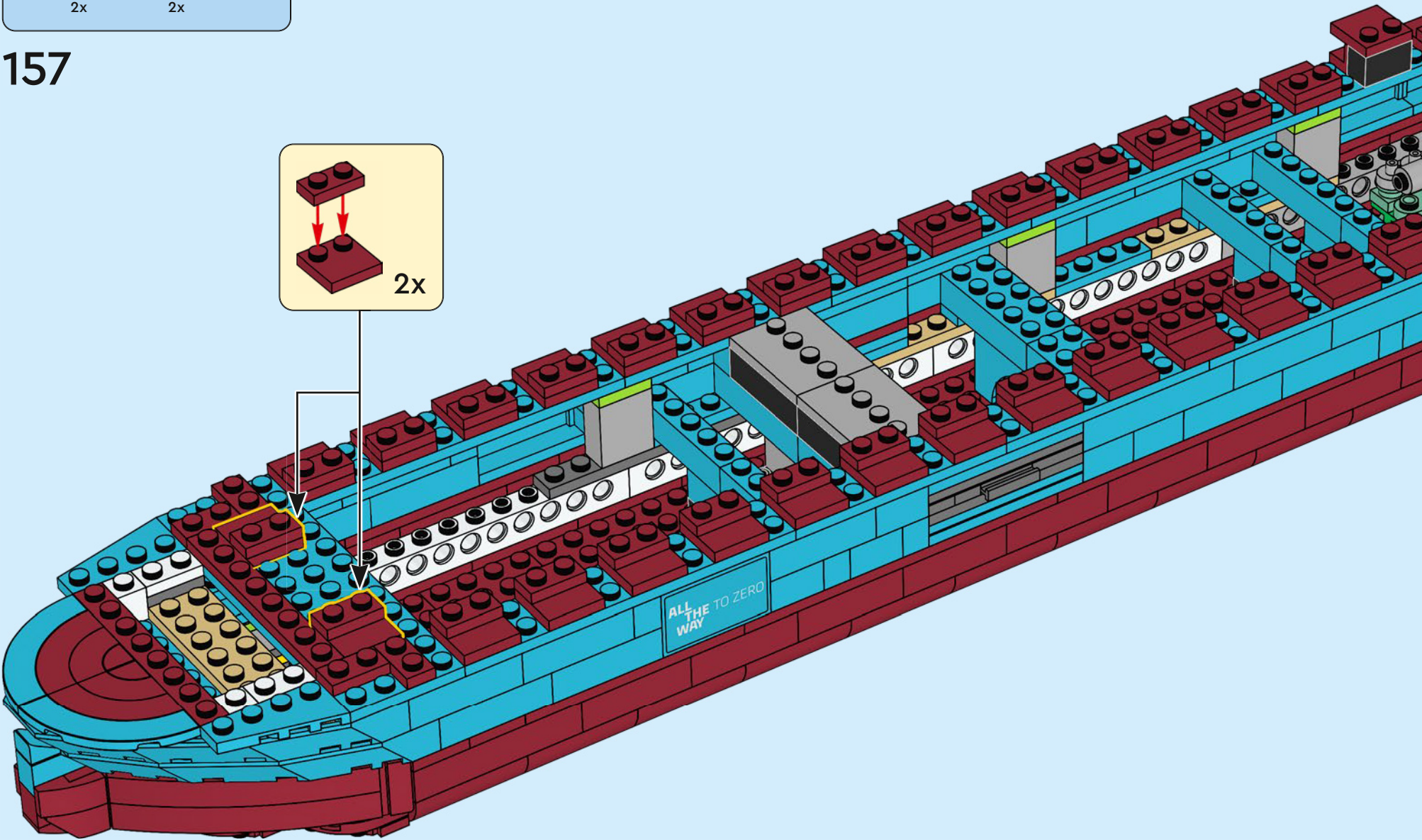
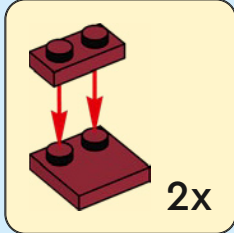

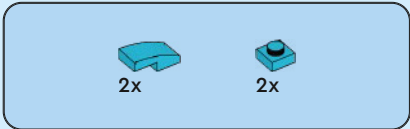

158

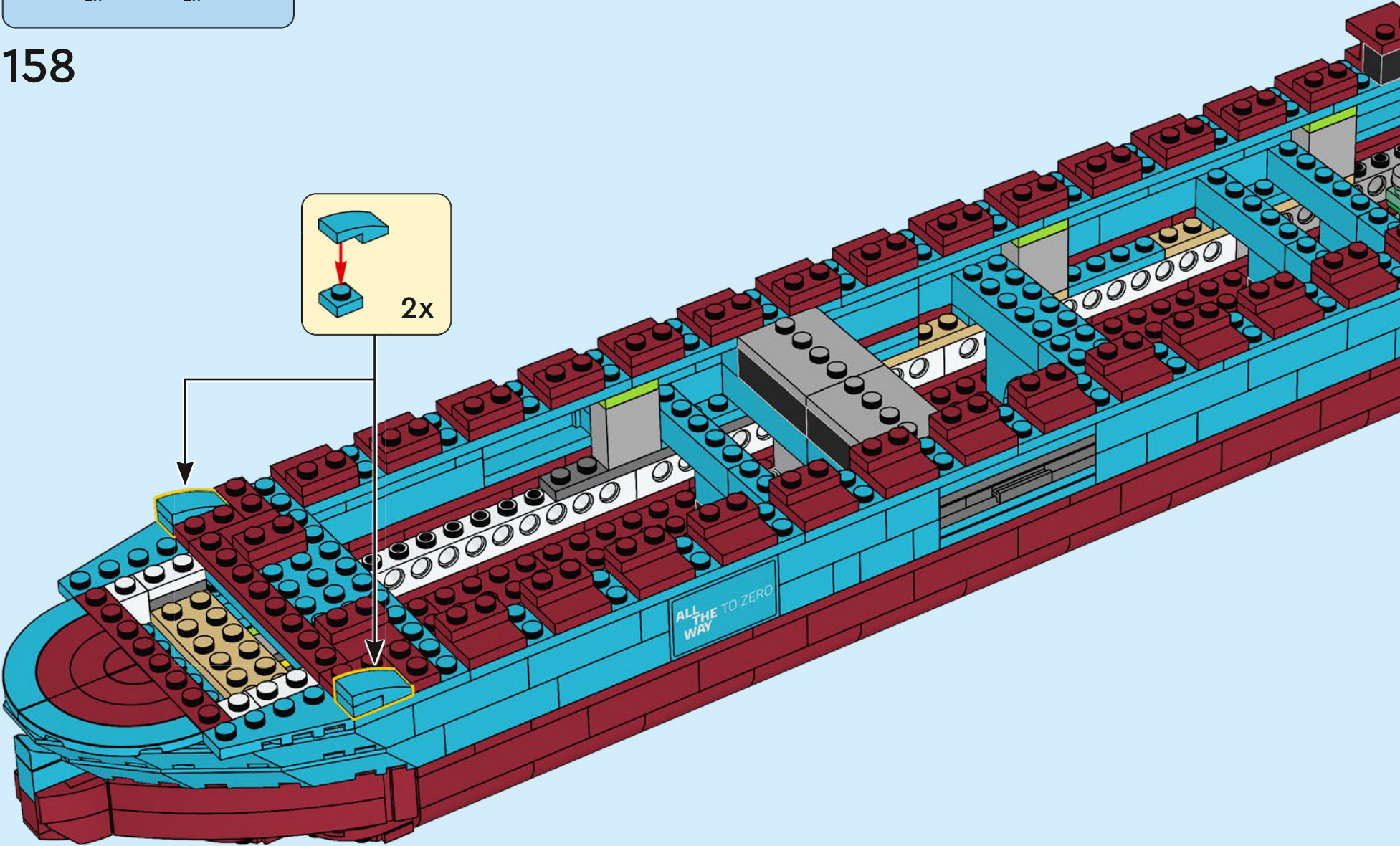
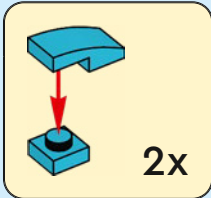

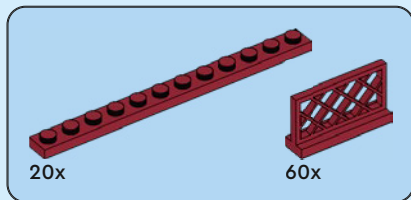
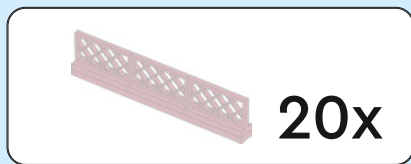

159

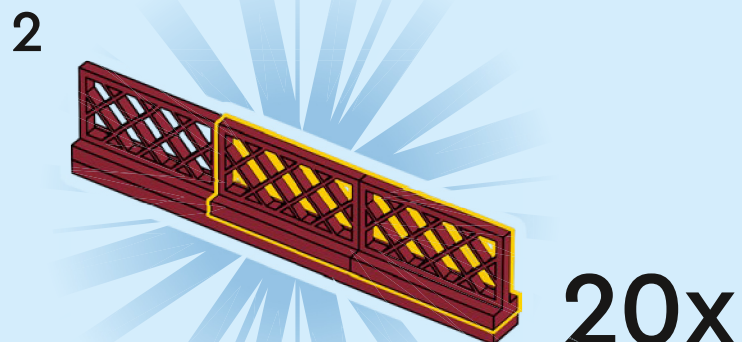
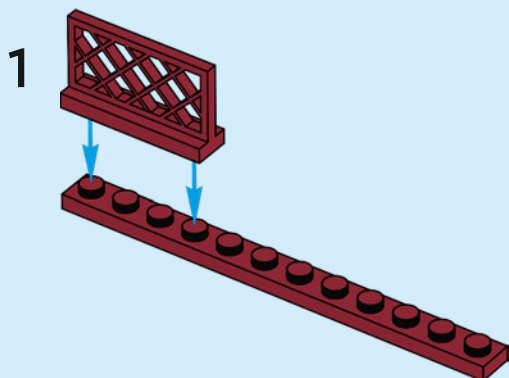
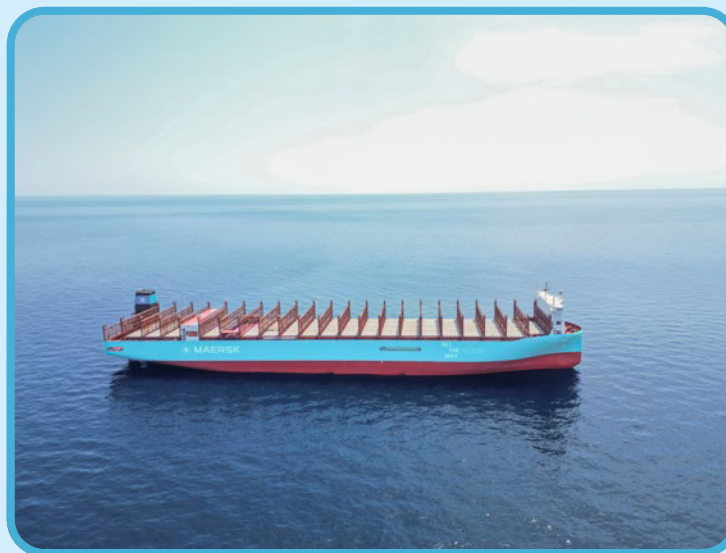

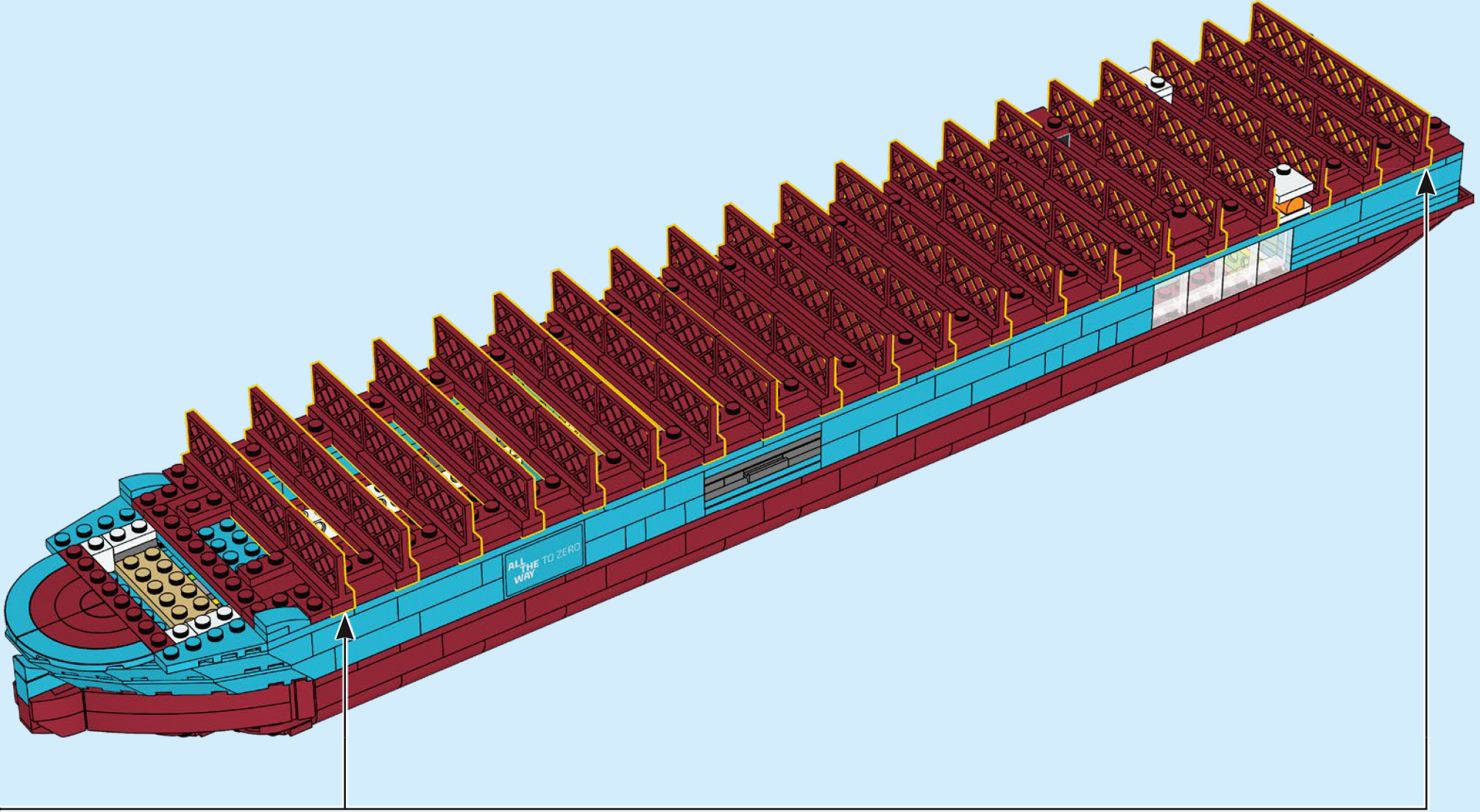

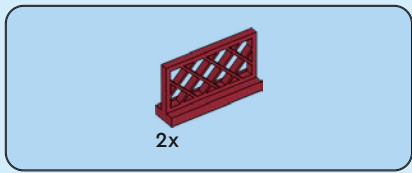

160

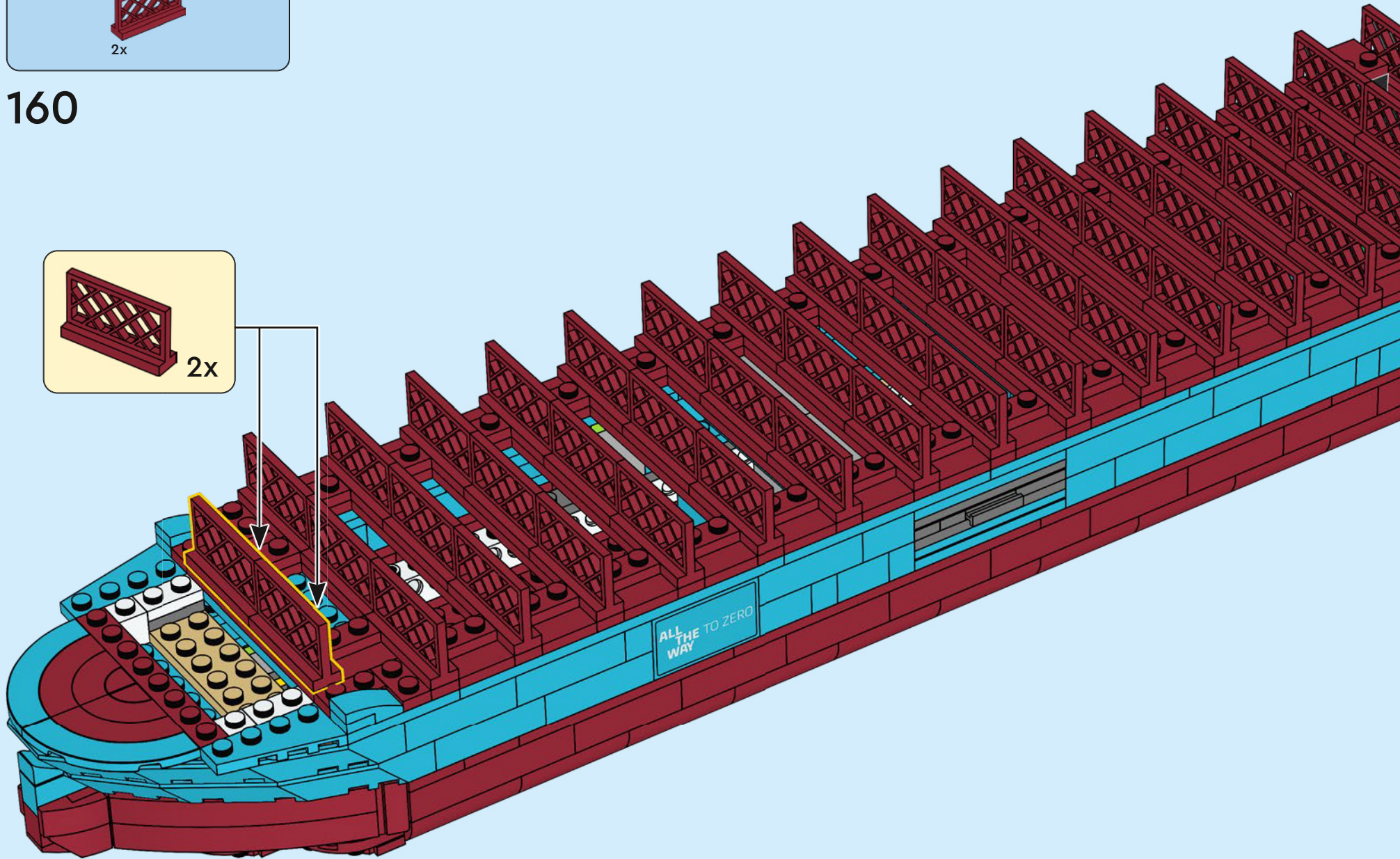
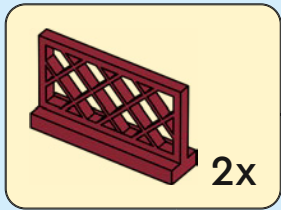

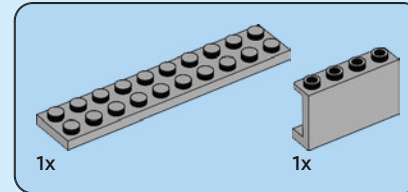
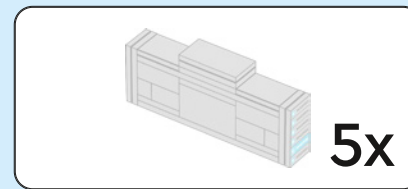

161

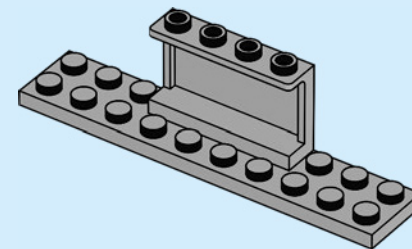
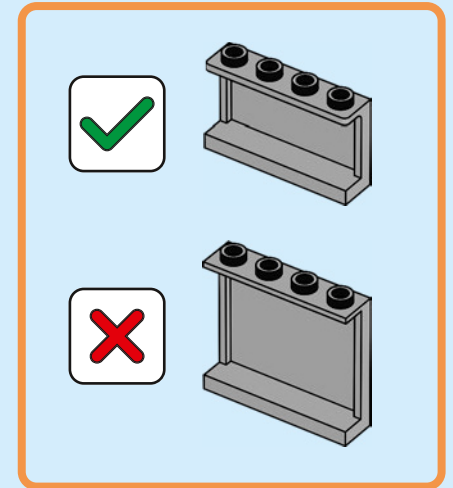

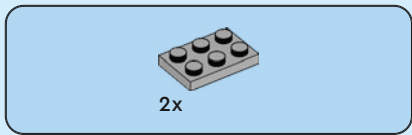

162

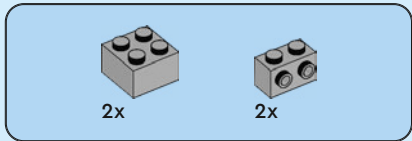
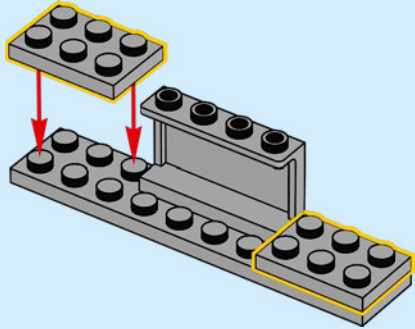

163

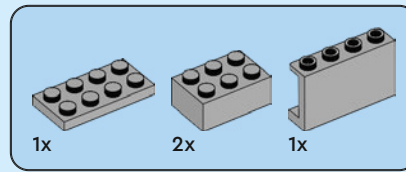
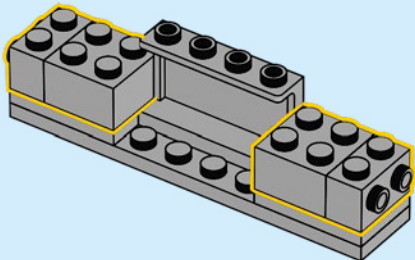

164

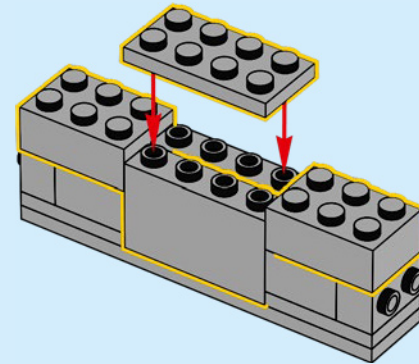

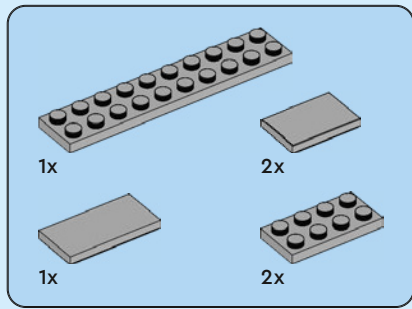

165

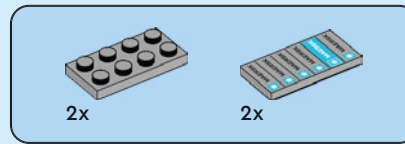
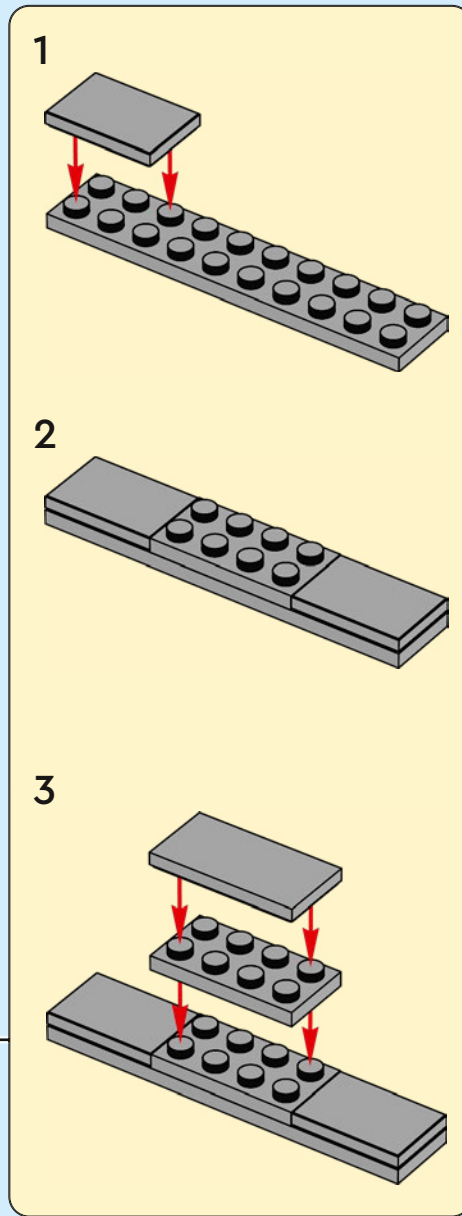
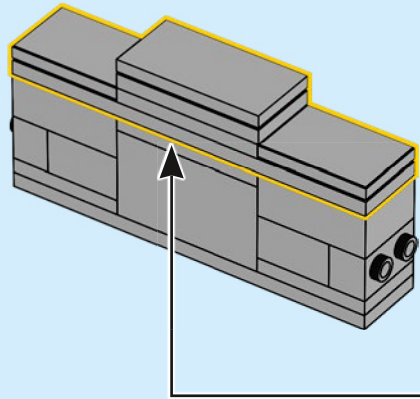

166

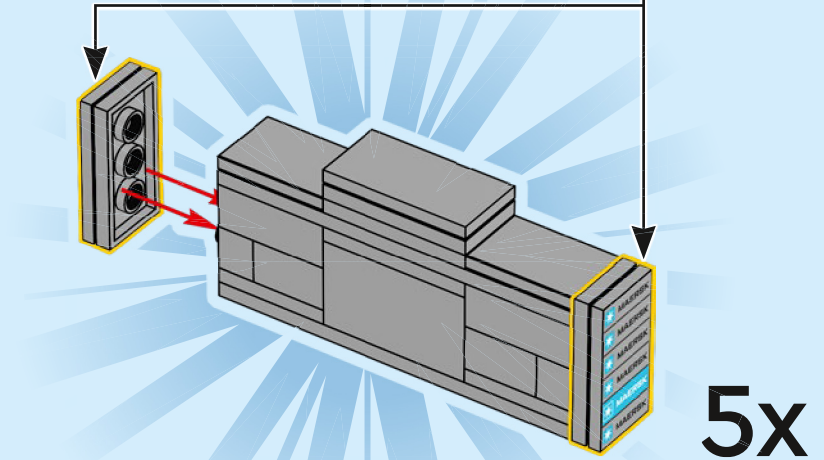
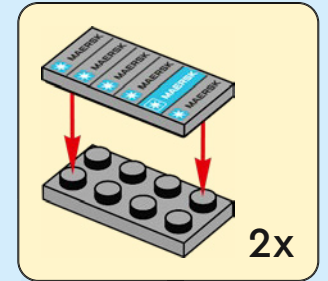



167

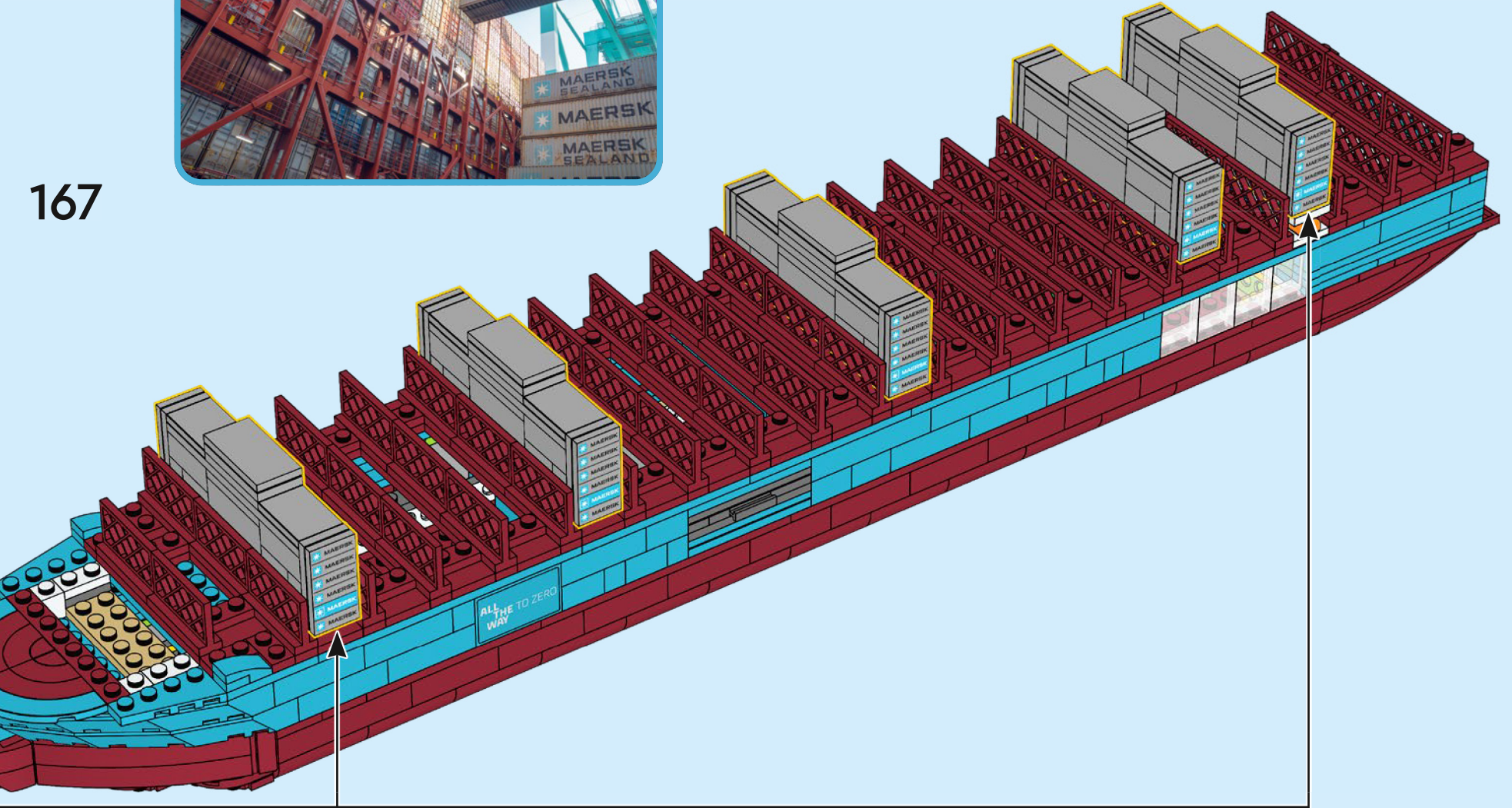

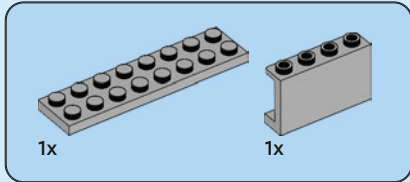
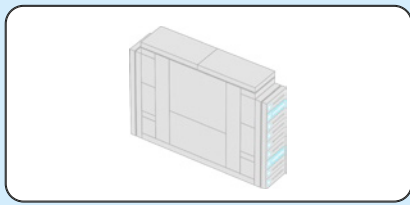

168

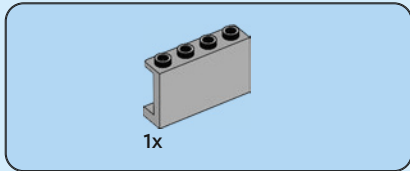
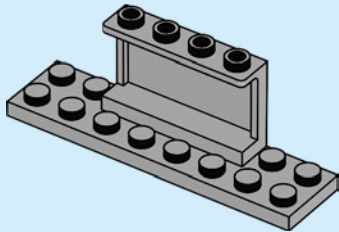

169

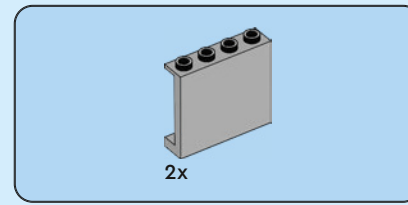
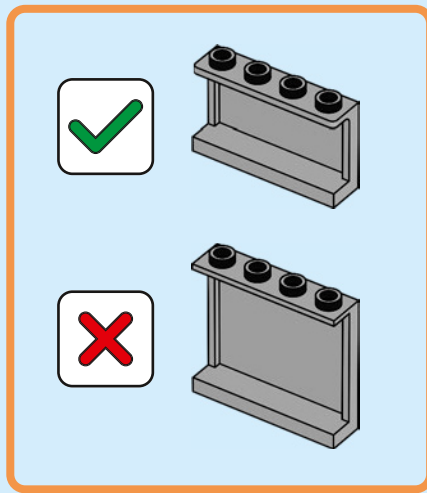
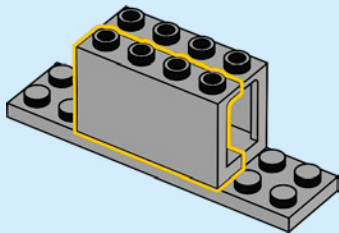

170

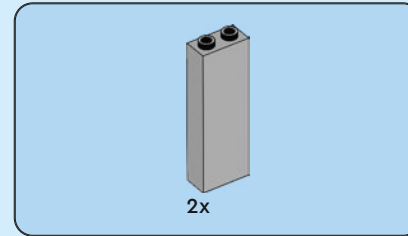
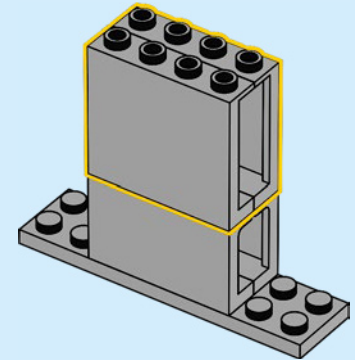

171

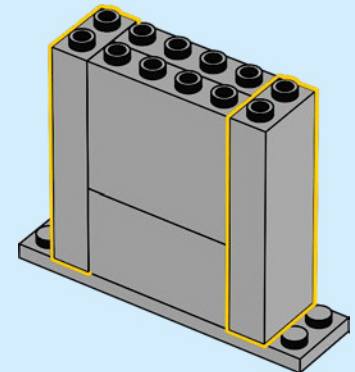

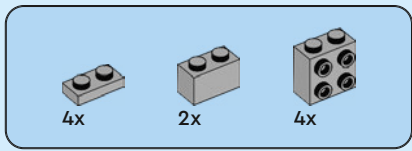

172

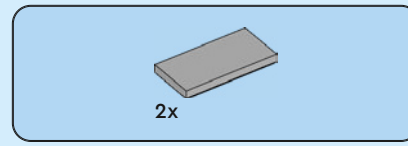
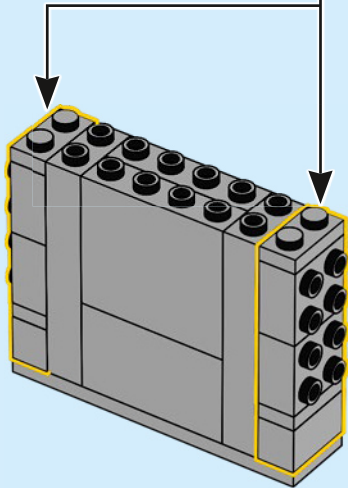
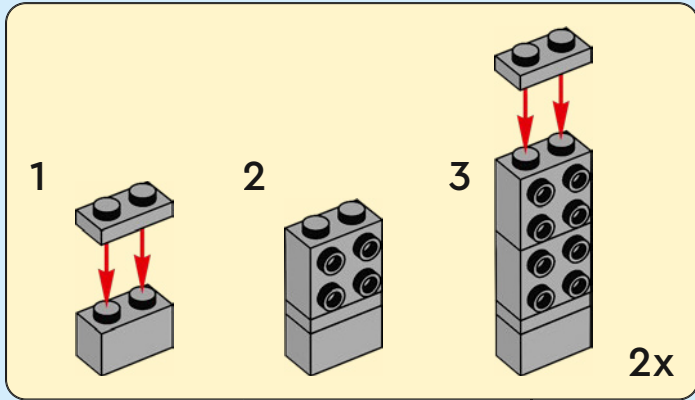

173

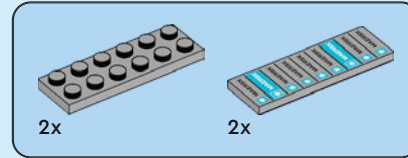
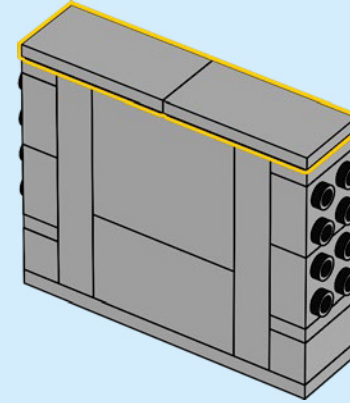

174

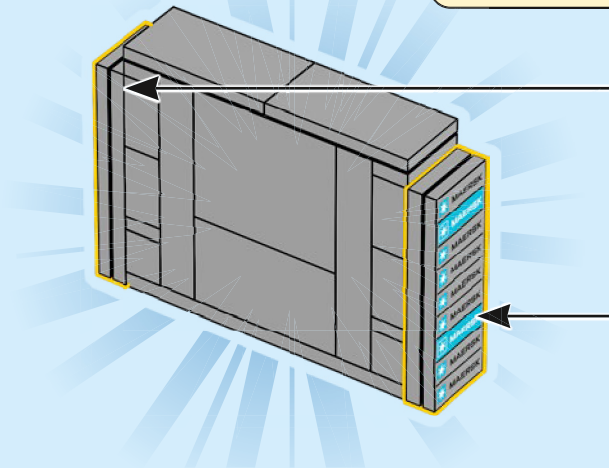
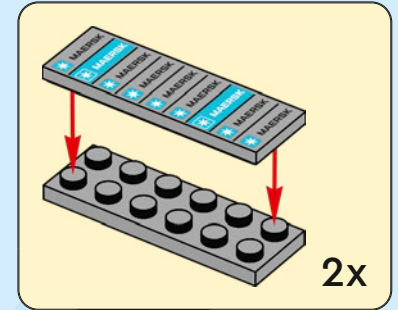

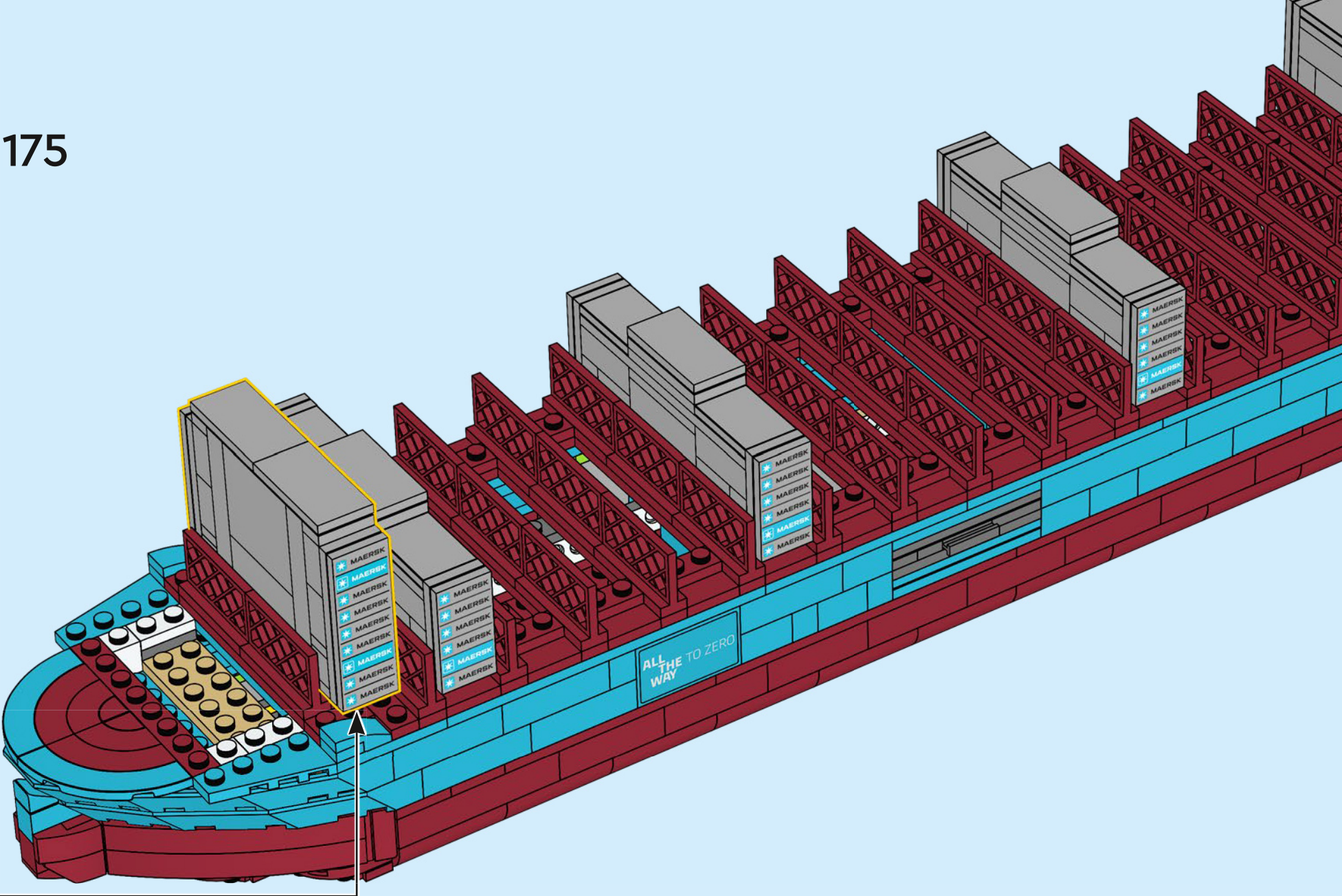

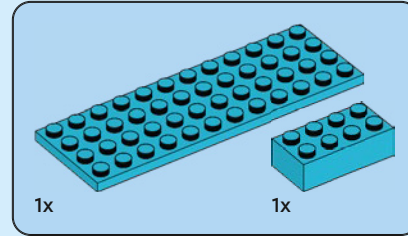
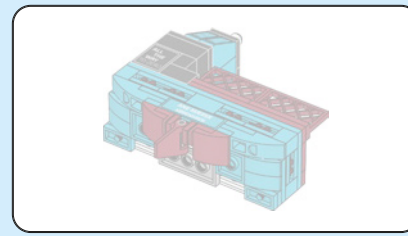

176

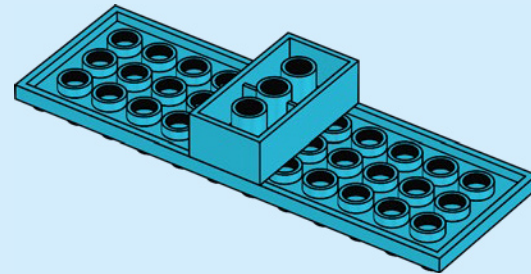

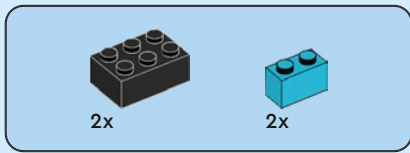

177

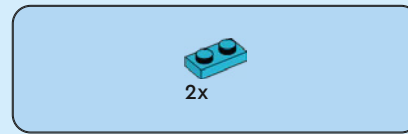
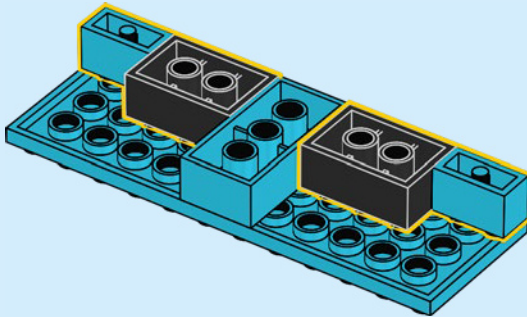

178

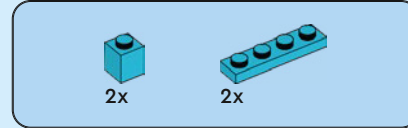
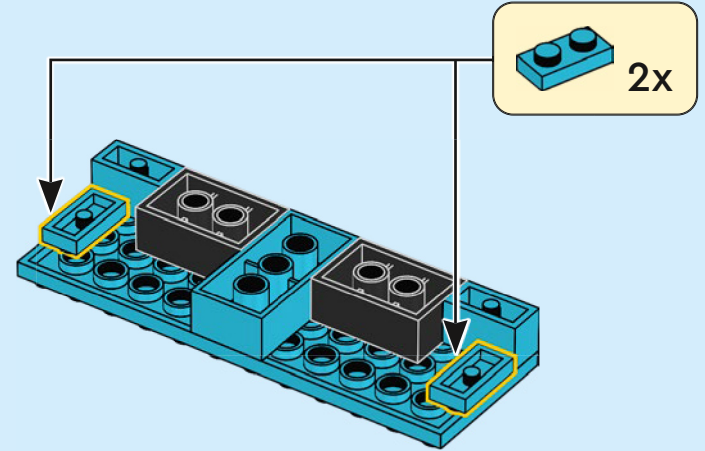

179

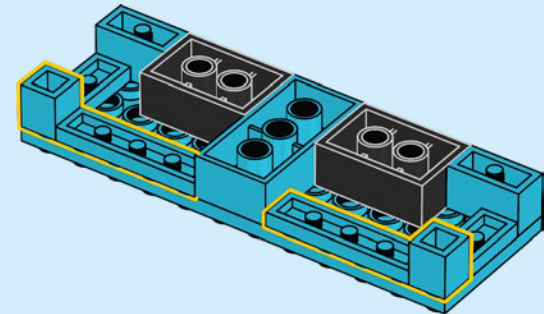

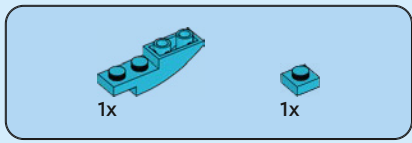

180

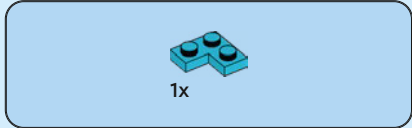
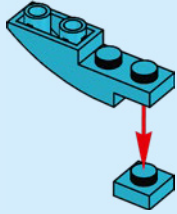

181

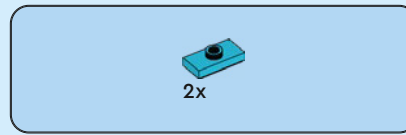
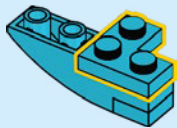

182

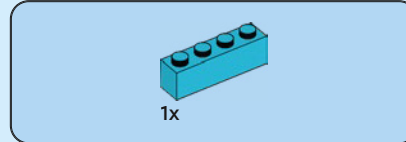
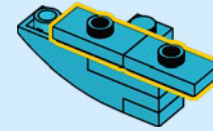

183

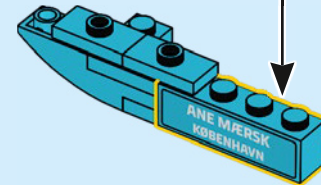
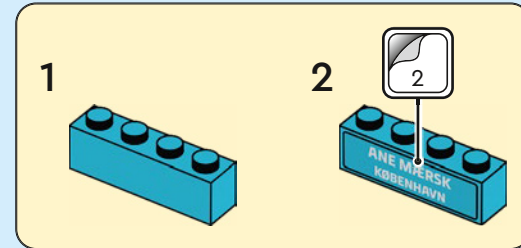

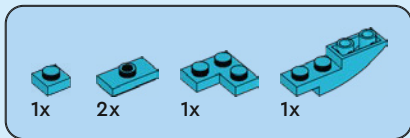

184

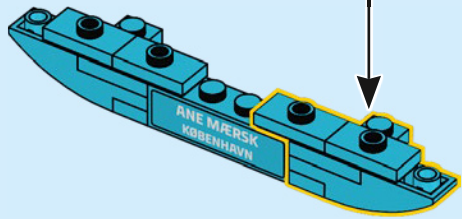
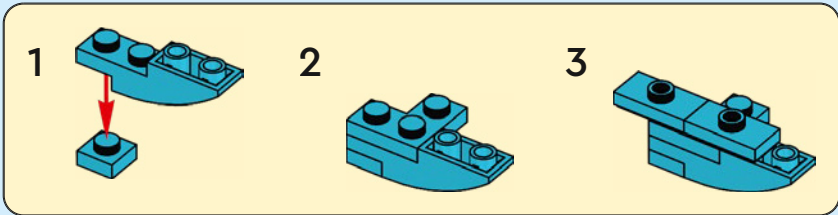

185

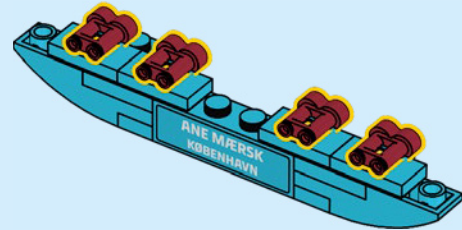

186

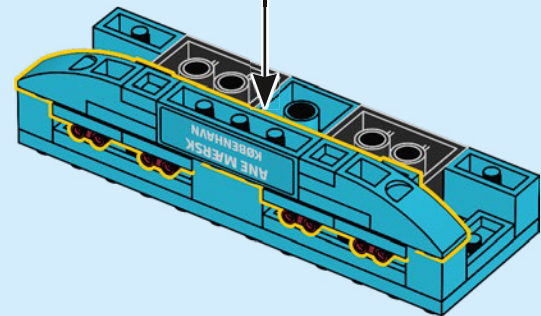

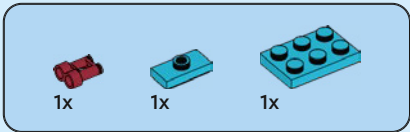

187

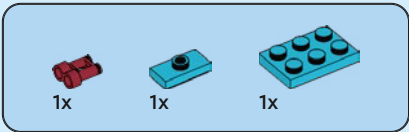
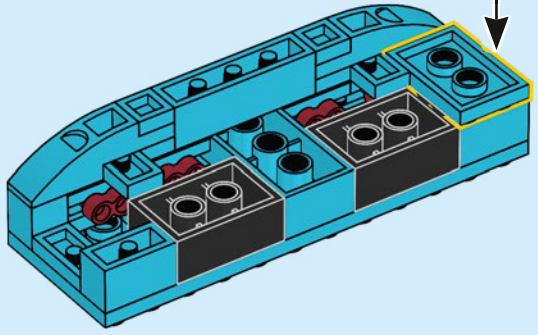
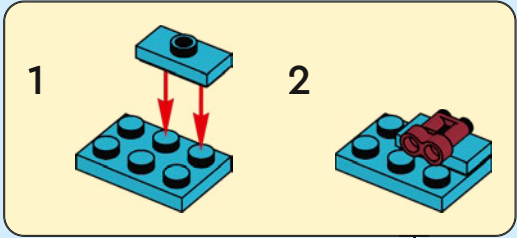

188

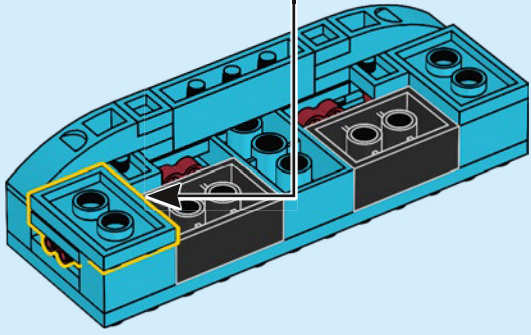
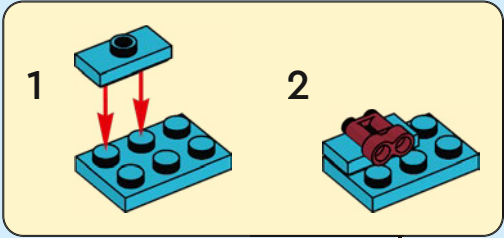

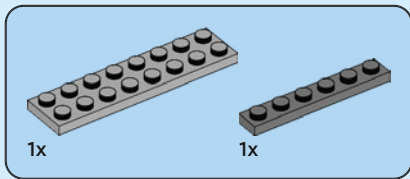

189

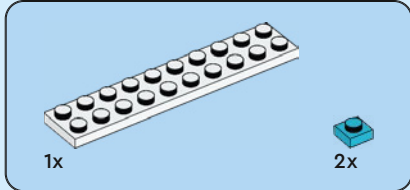
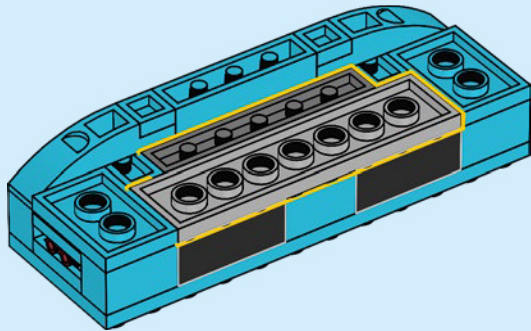

190

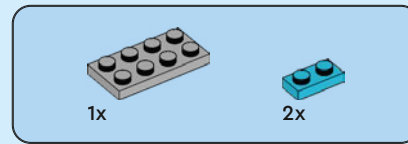
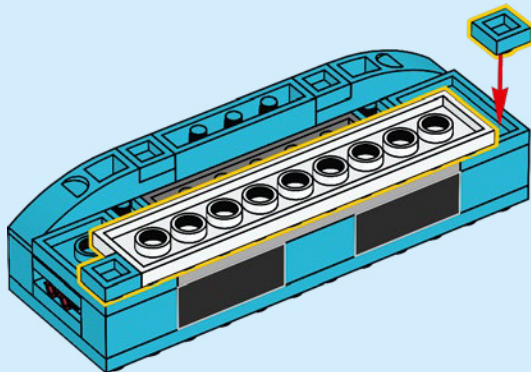

191

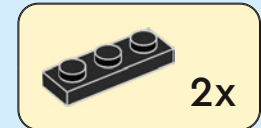
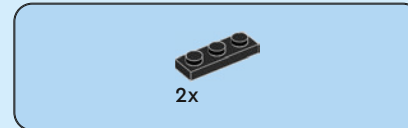
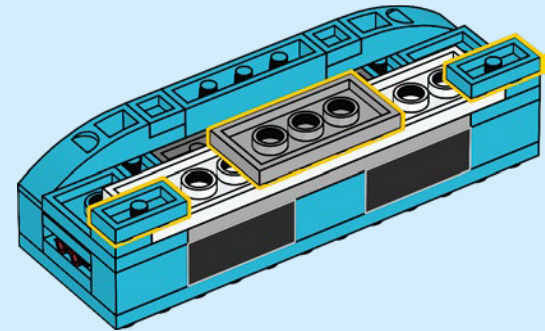

192

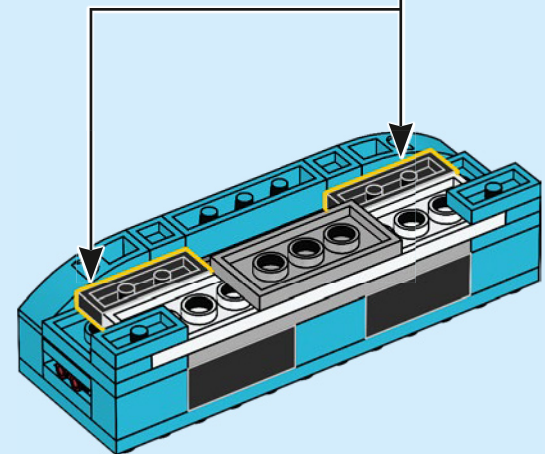



4x

193

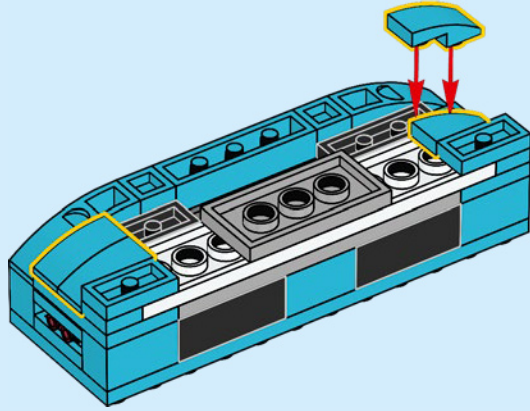

2x

194

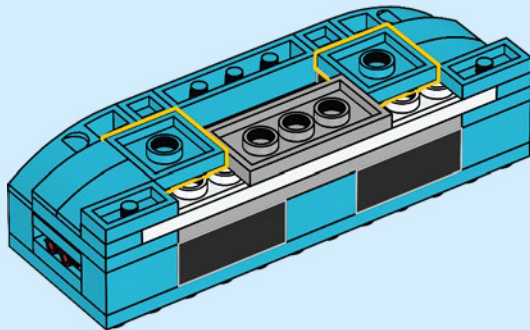

1x



1x



1x

195

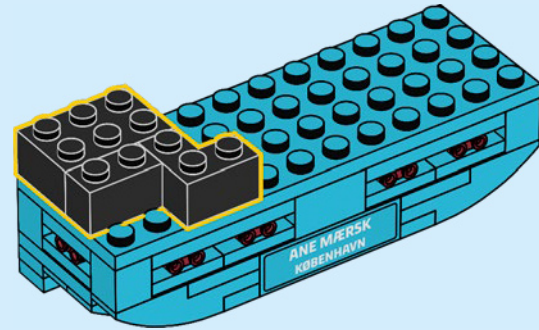

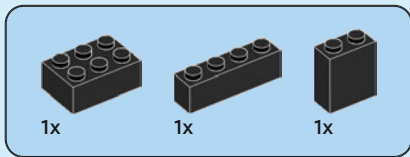

196

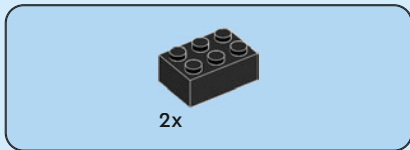
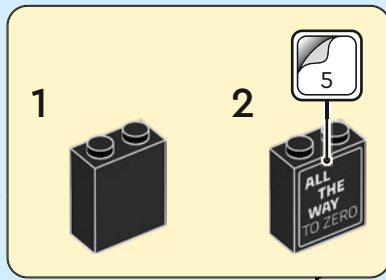
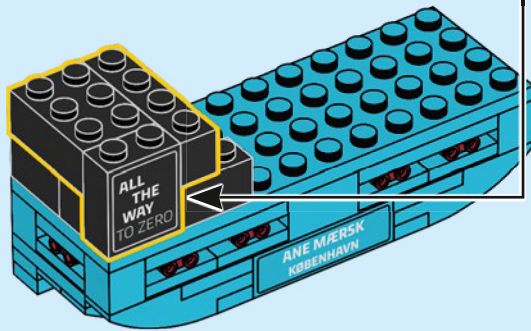

197

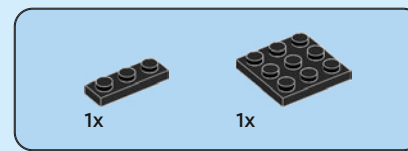
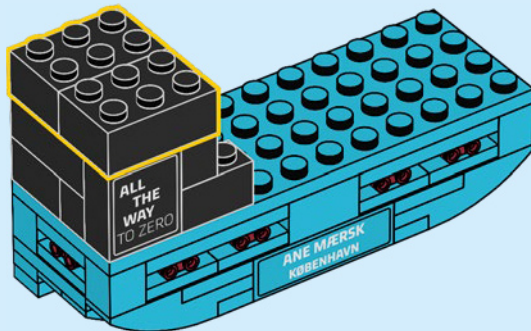

198

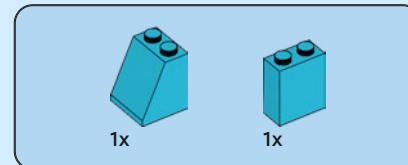
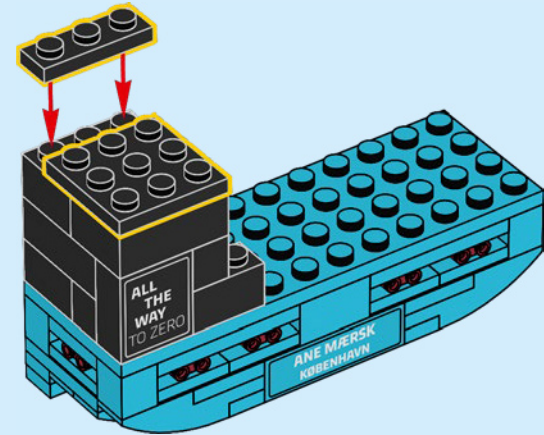

199

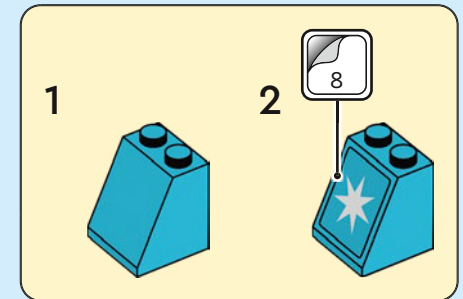
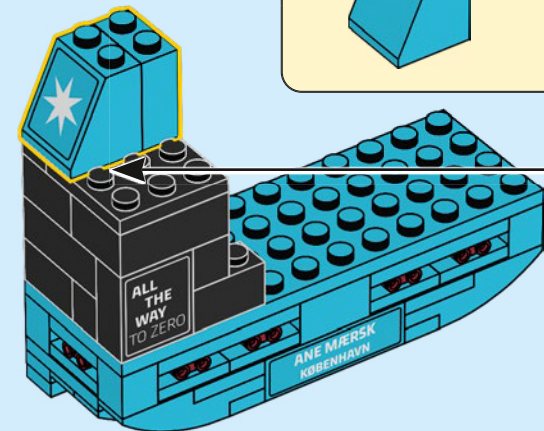

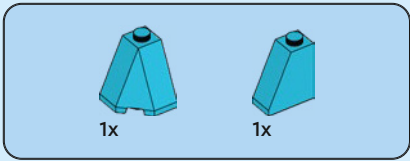

200

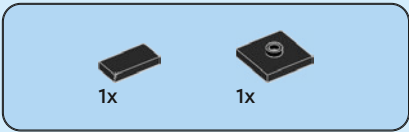
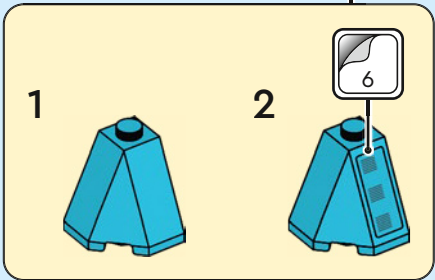
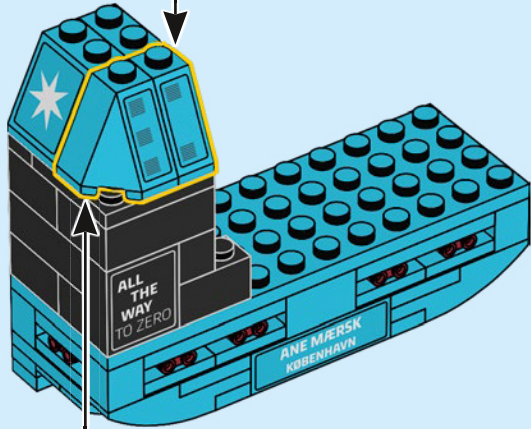
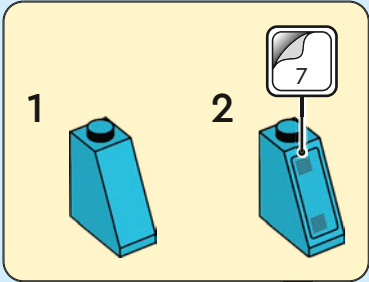

201

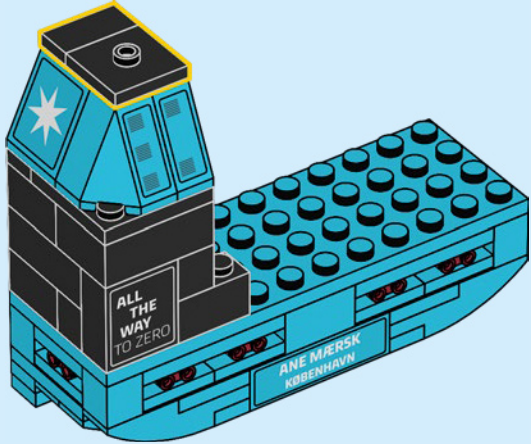



1x



1x

202

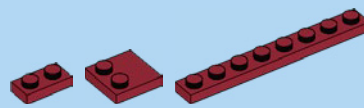
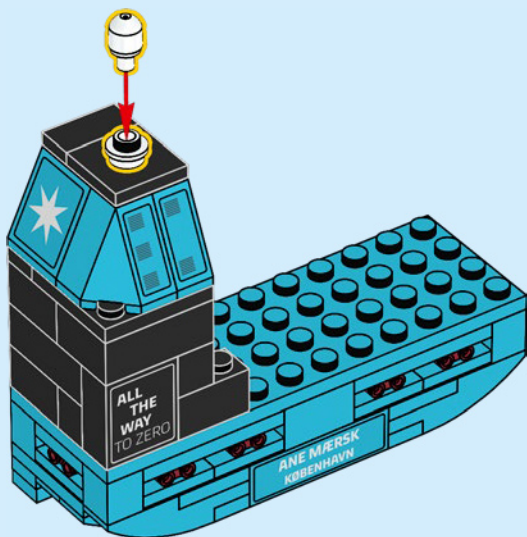

1x

2x

1x

203

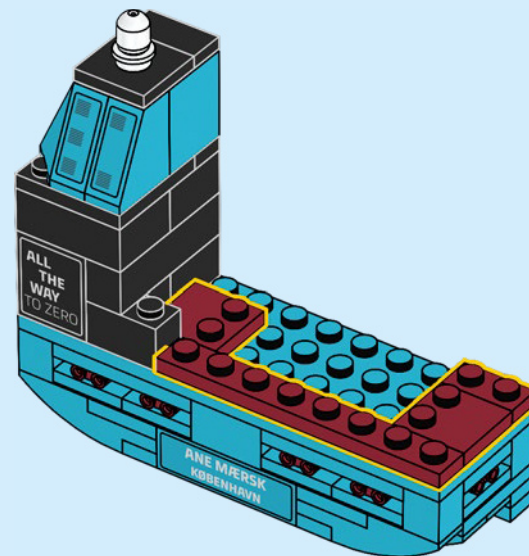



2x

204

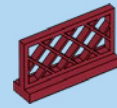
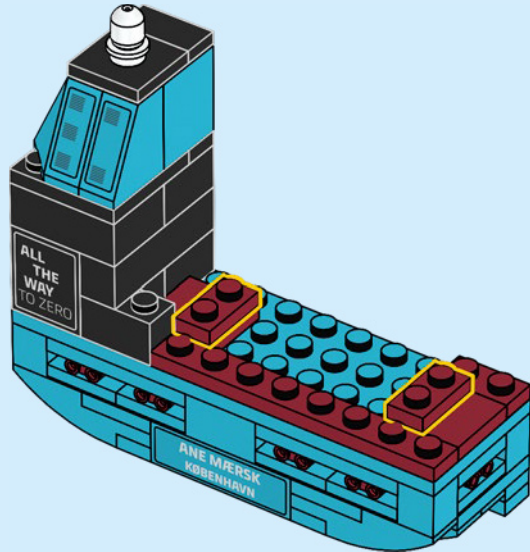

2x

205

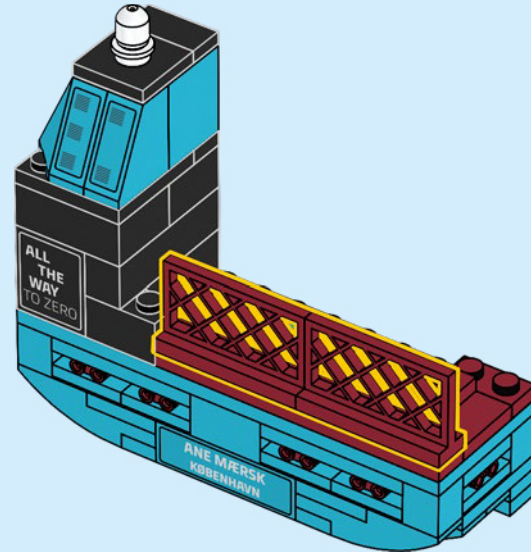

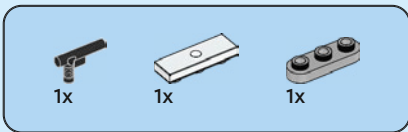

206

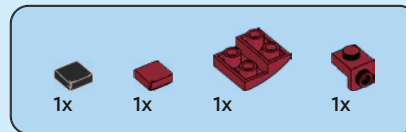
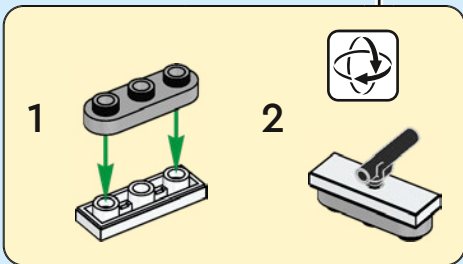
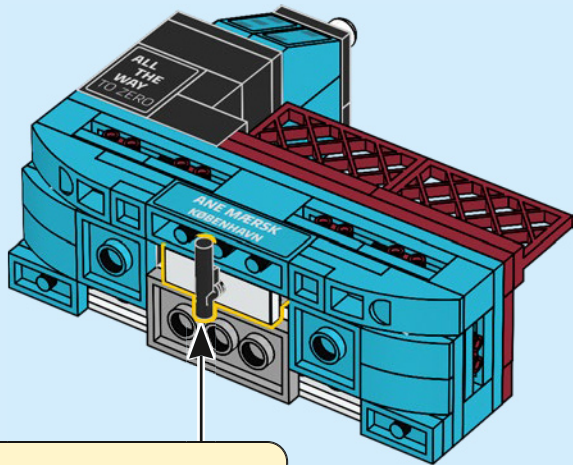

207

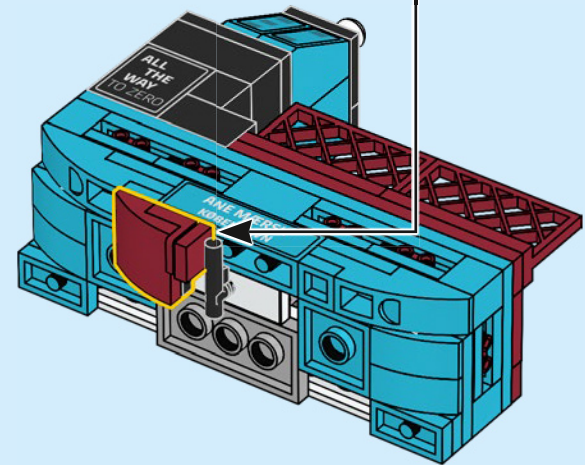
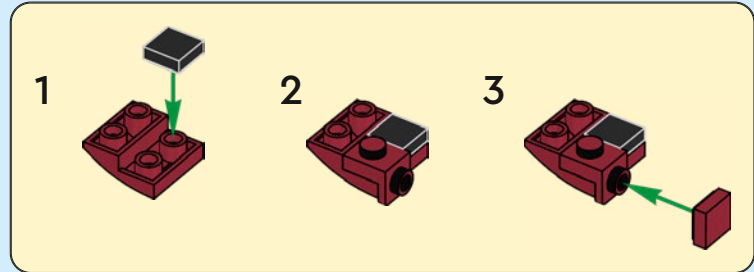

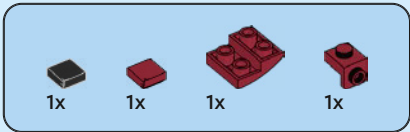

208

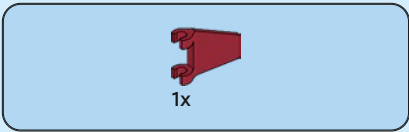
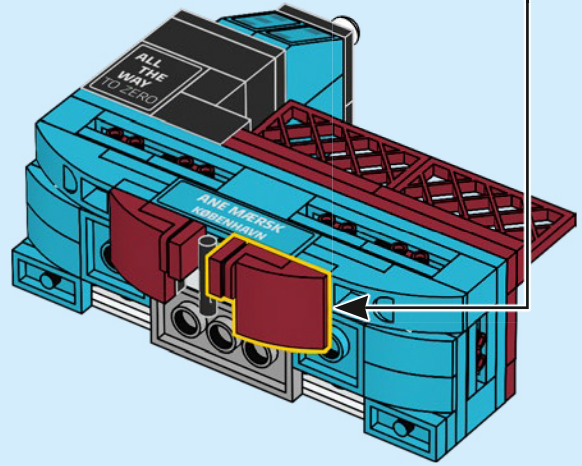

209

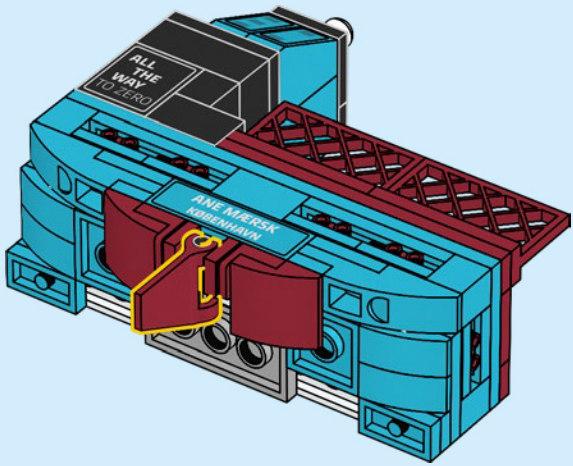

210

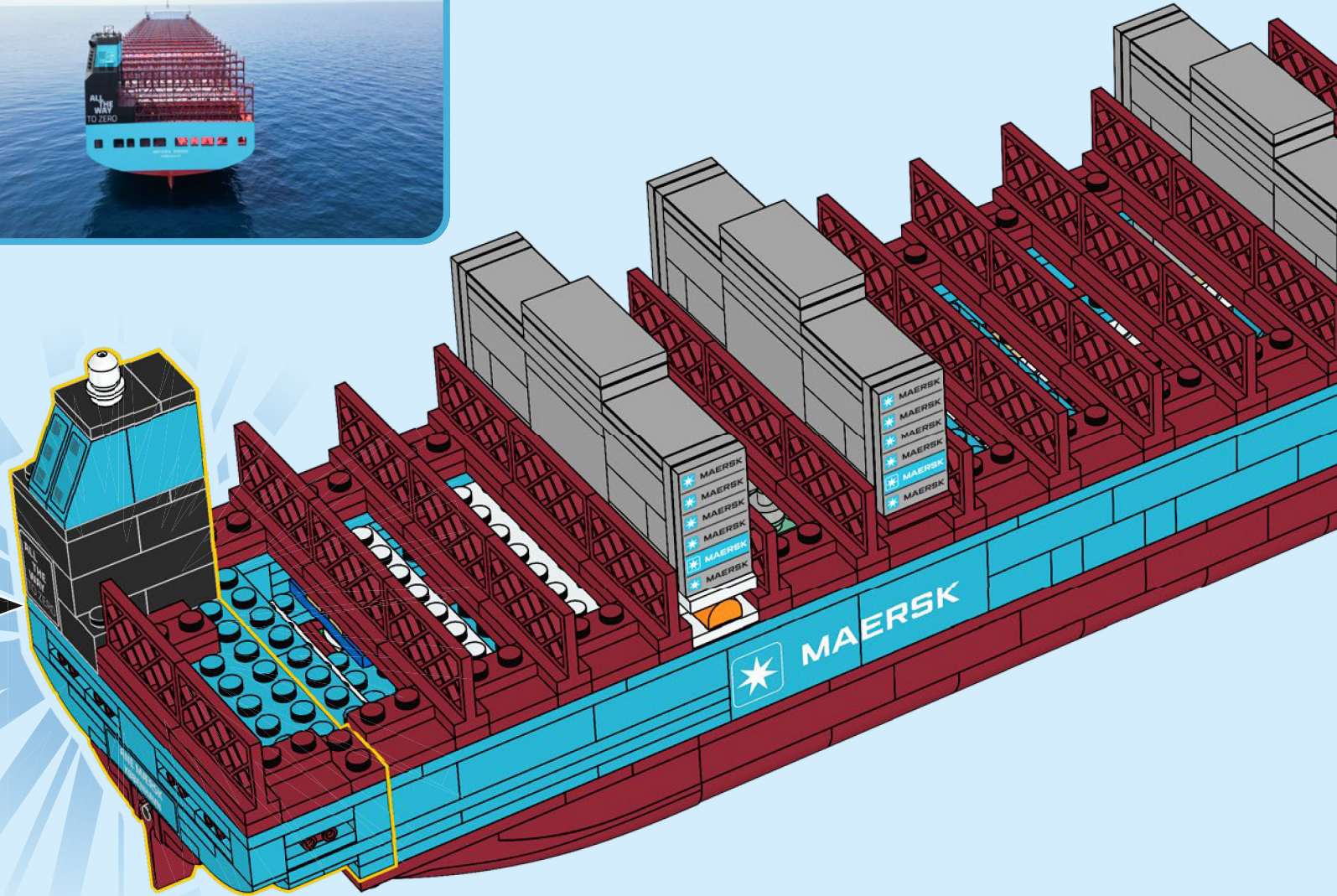
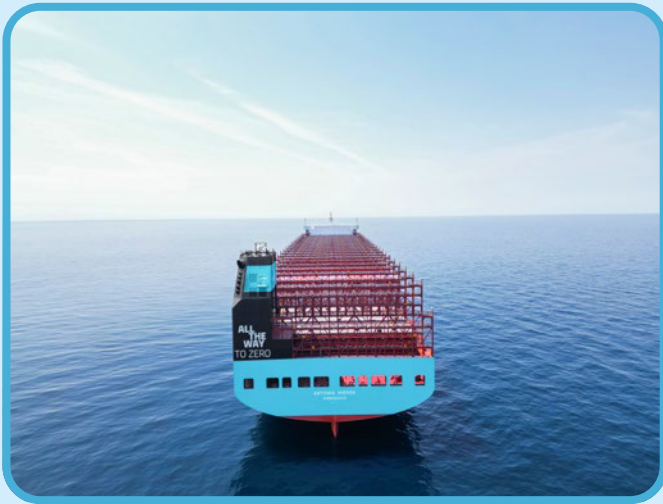

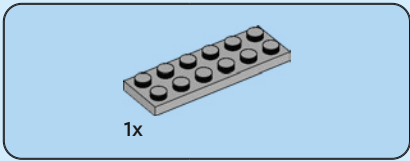

211

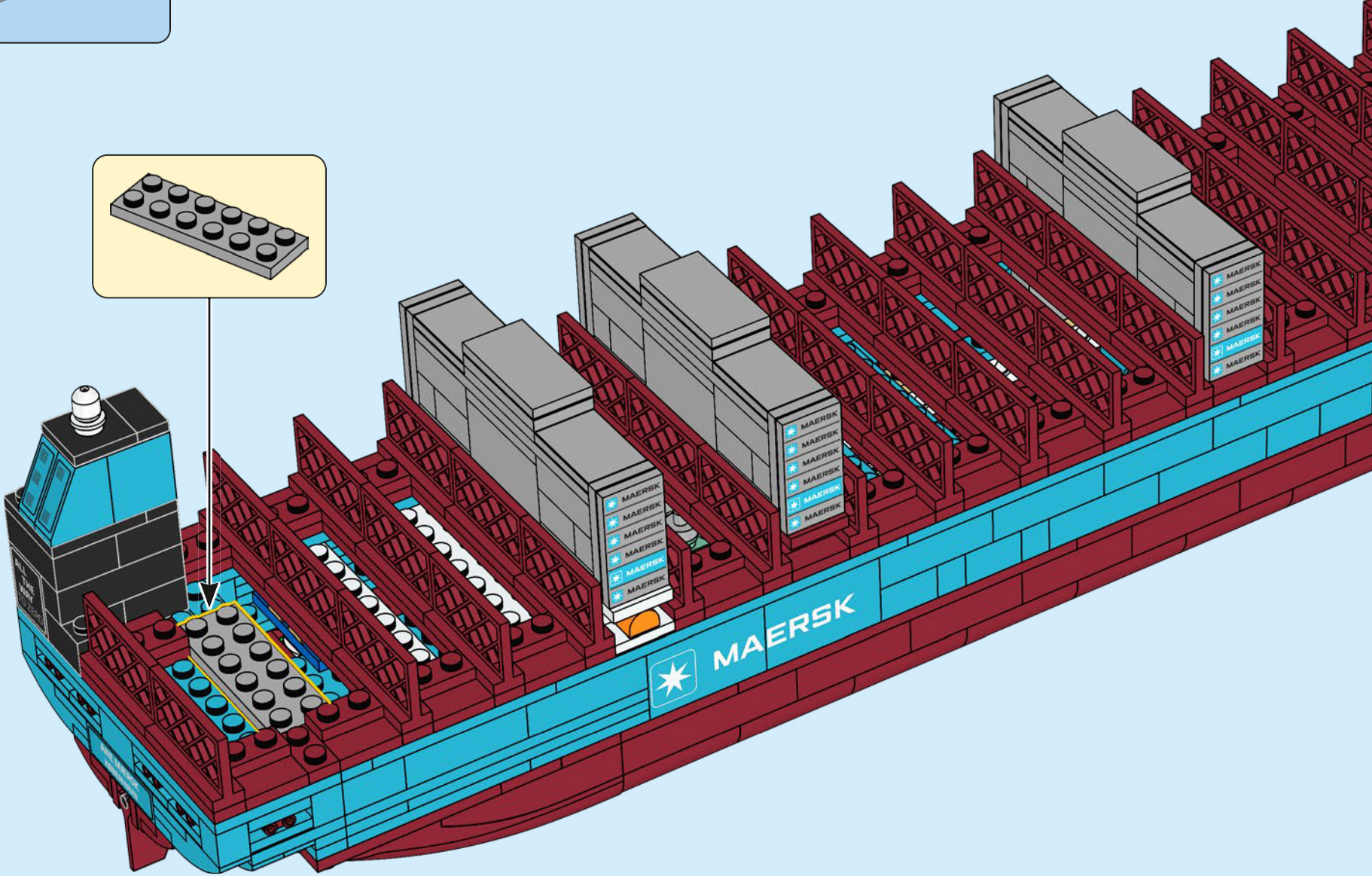
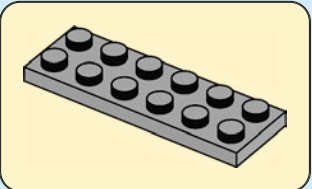

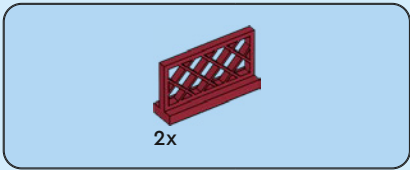

212

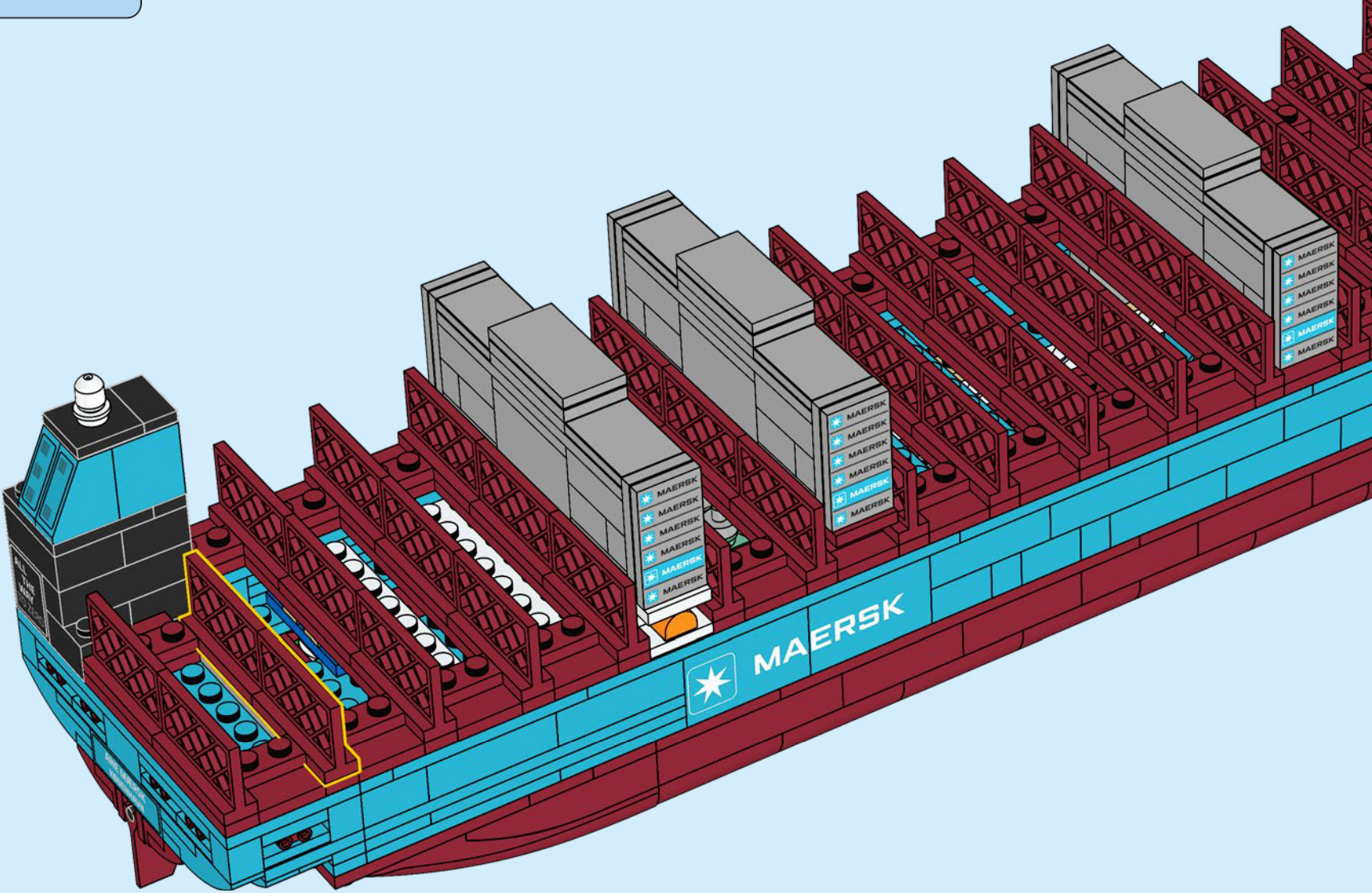

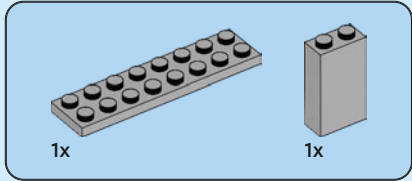
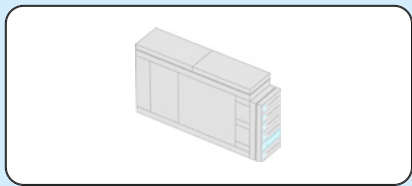

213

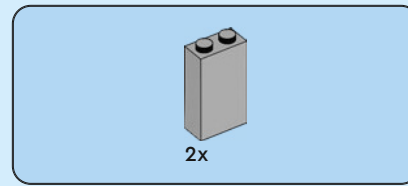
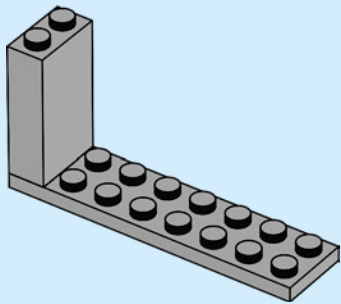

214

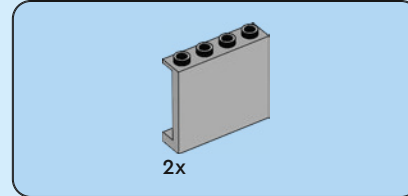
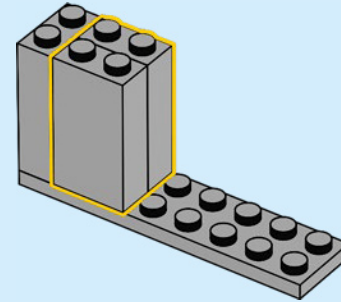

215

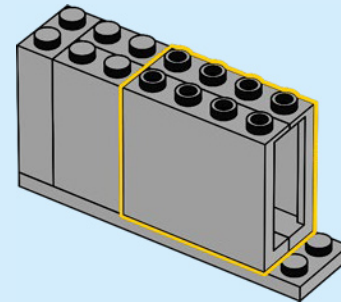

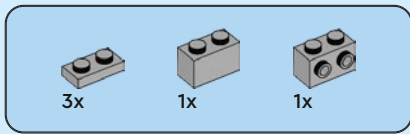

216

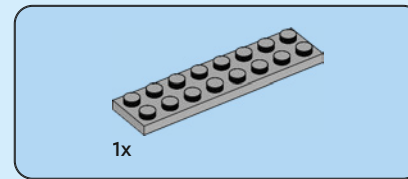
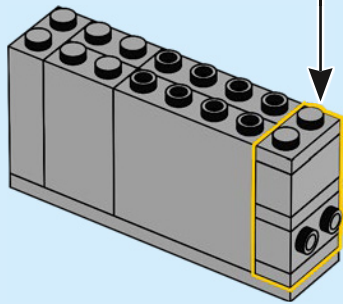
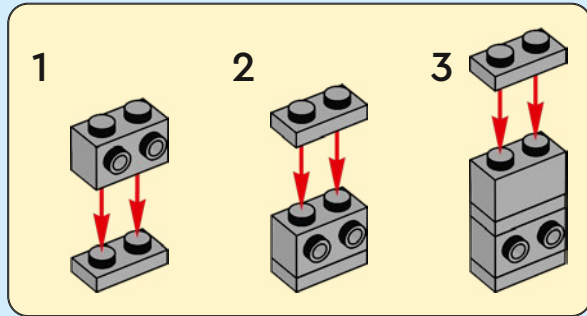

217

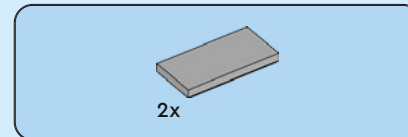
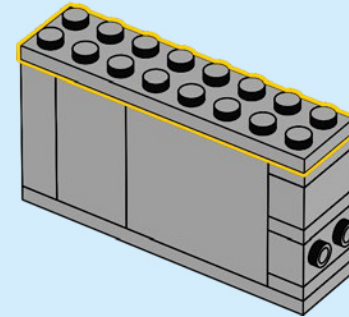

218

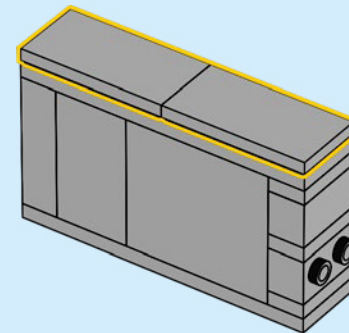

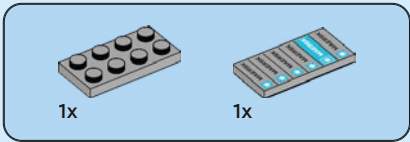

219

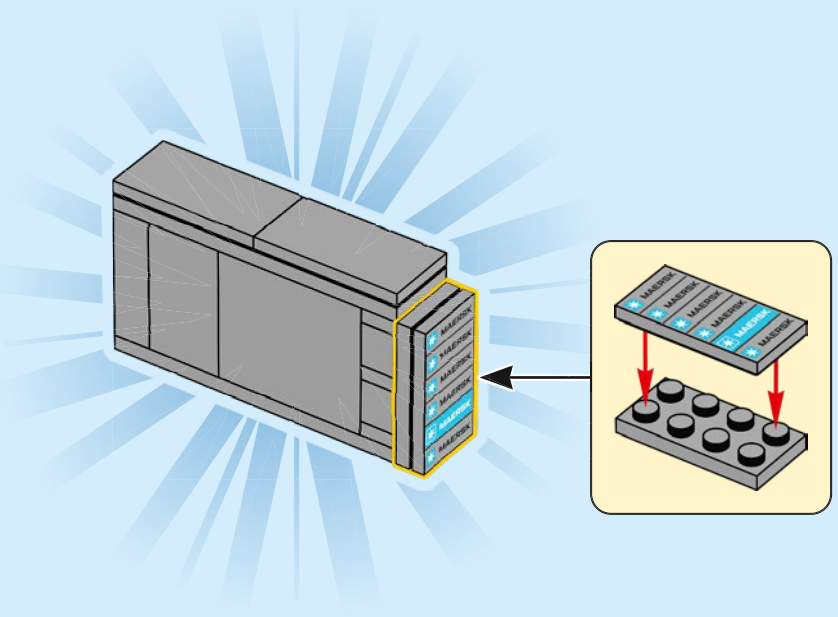

220

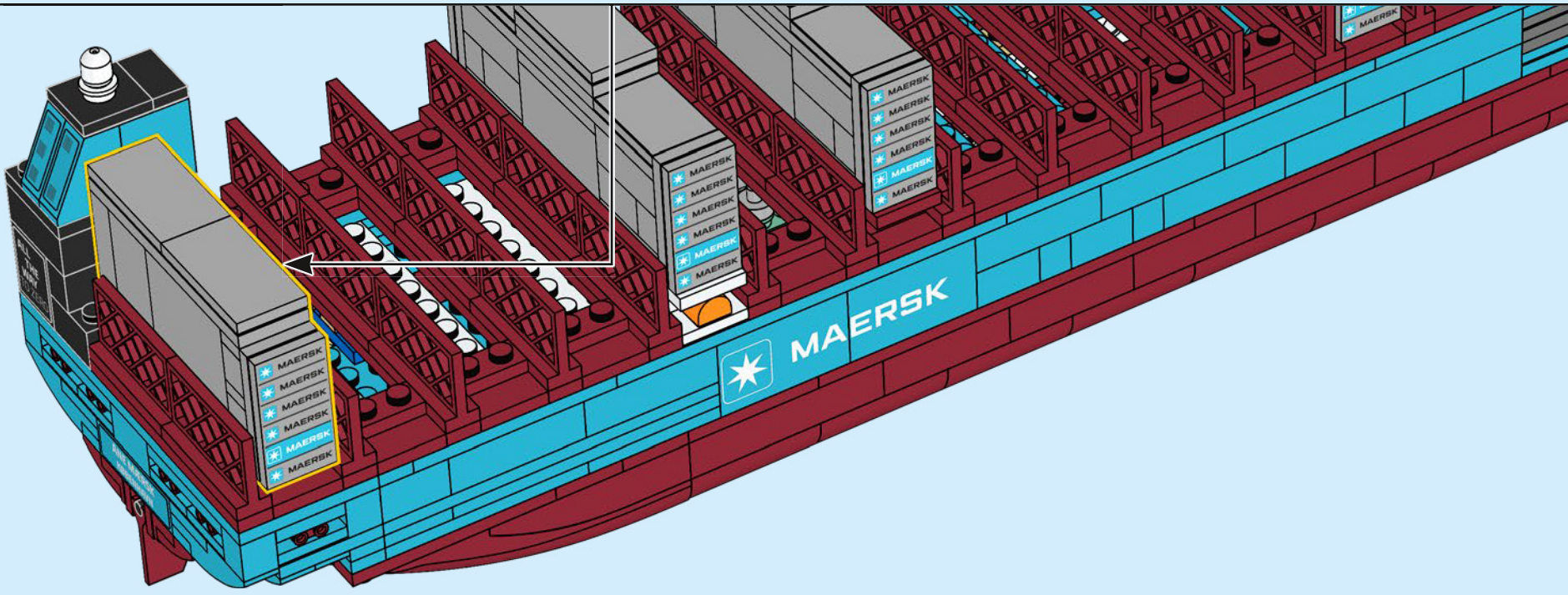

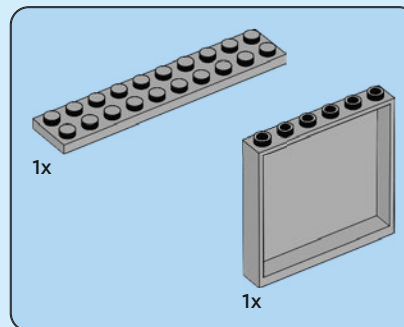
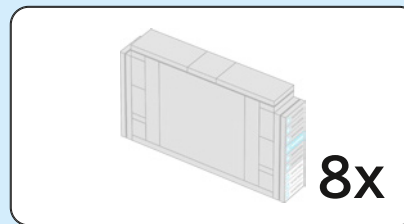

221

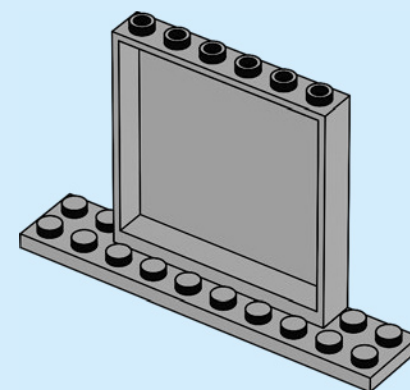

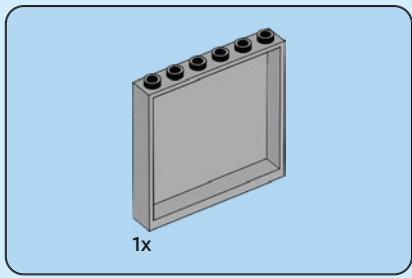

222

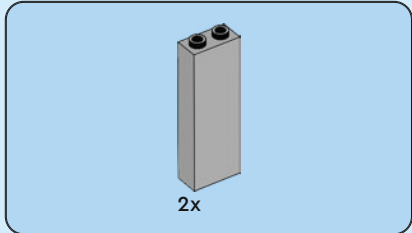
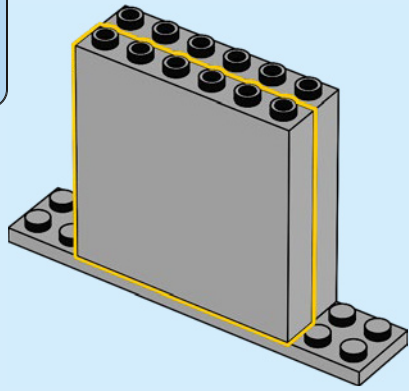

223

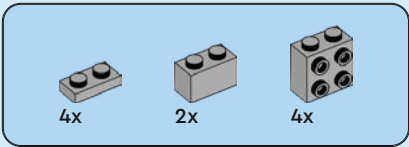
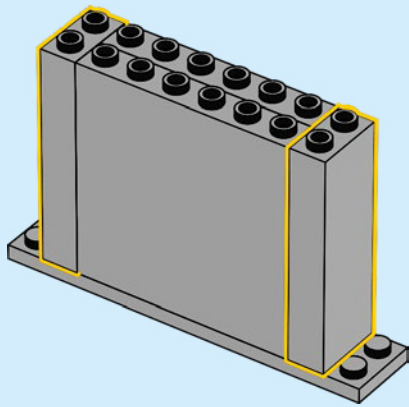

224

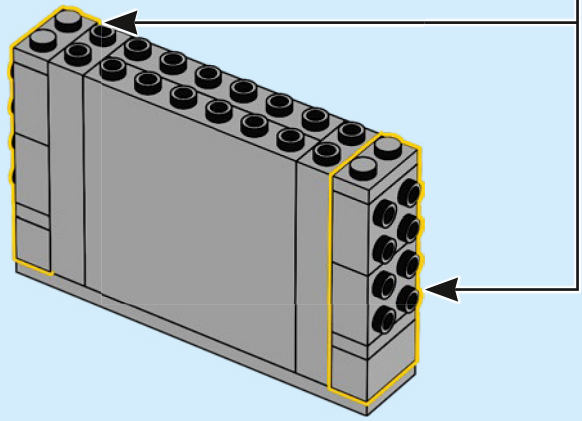
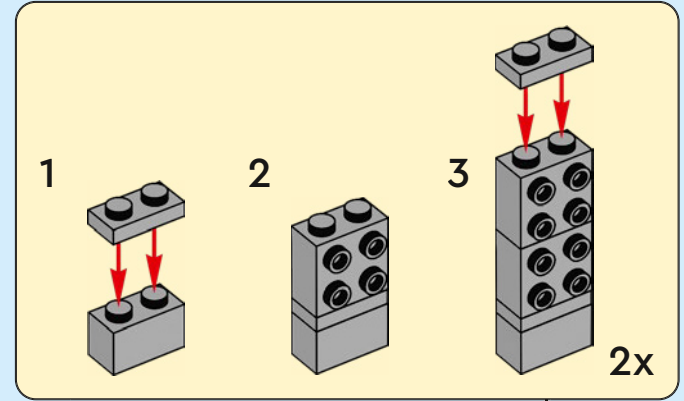

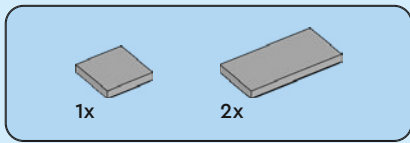

225

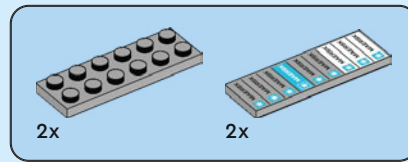
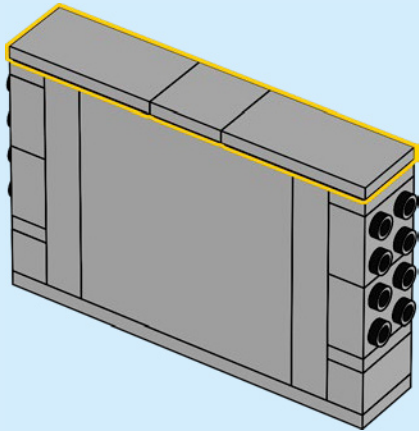

226

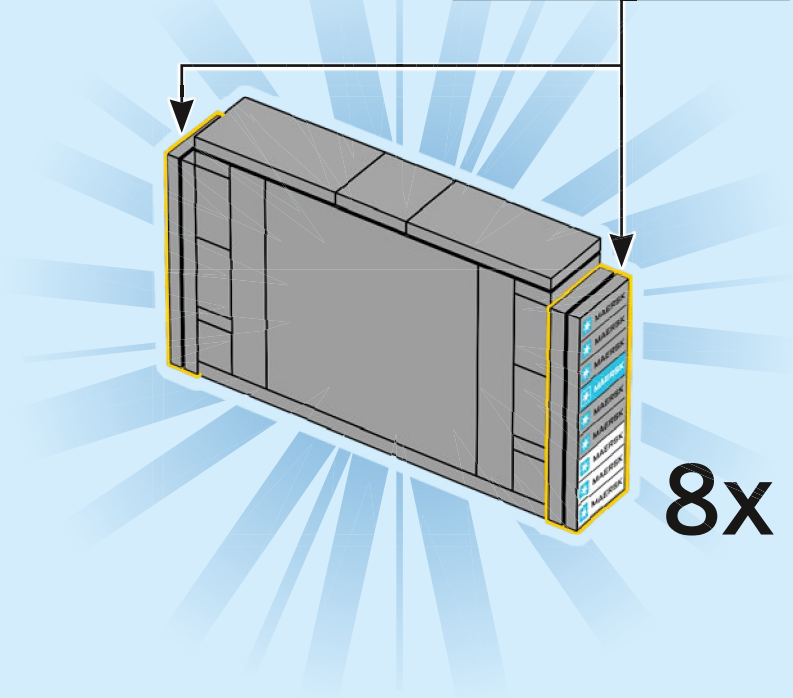
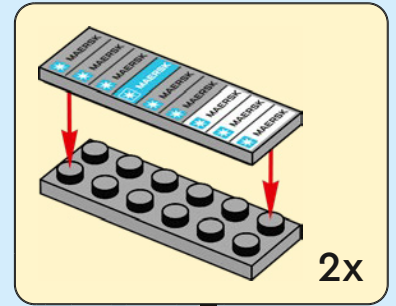

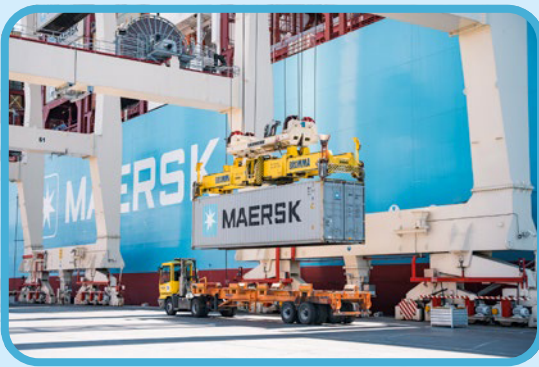

227

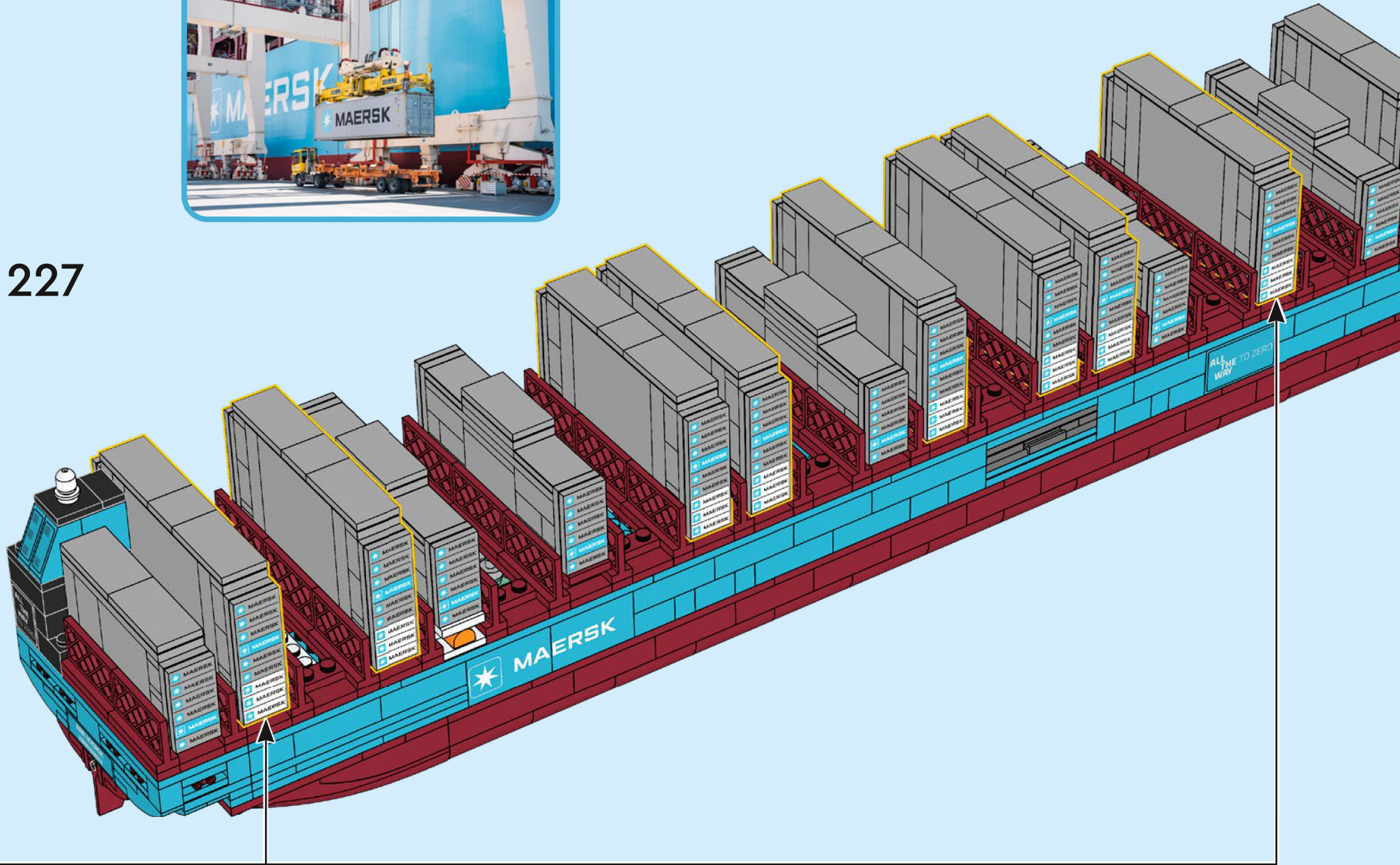





228

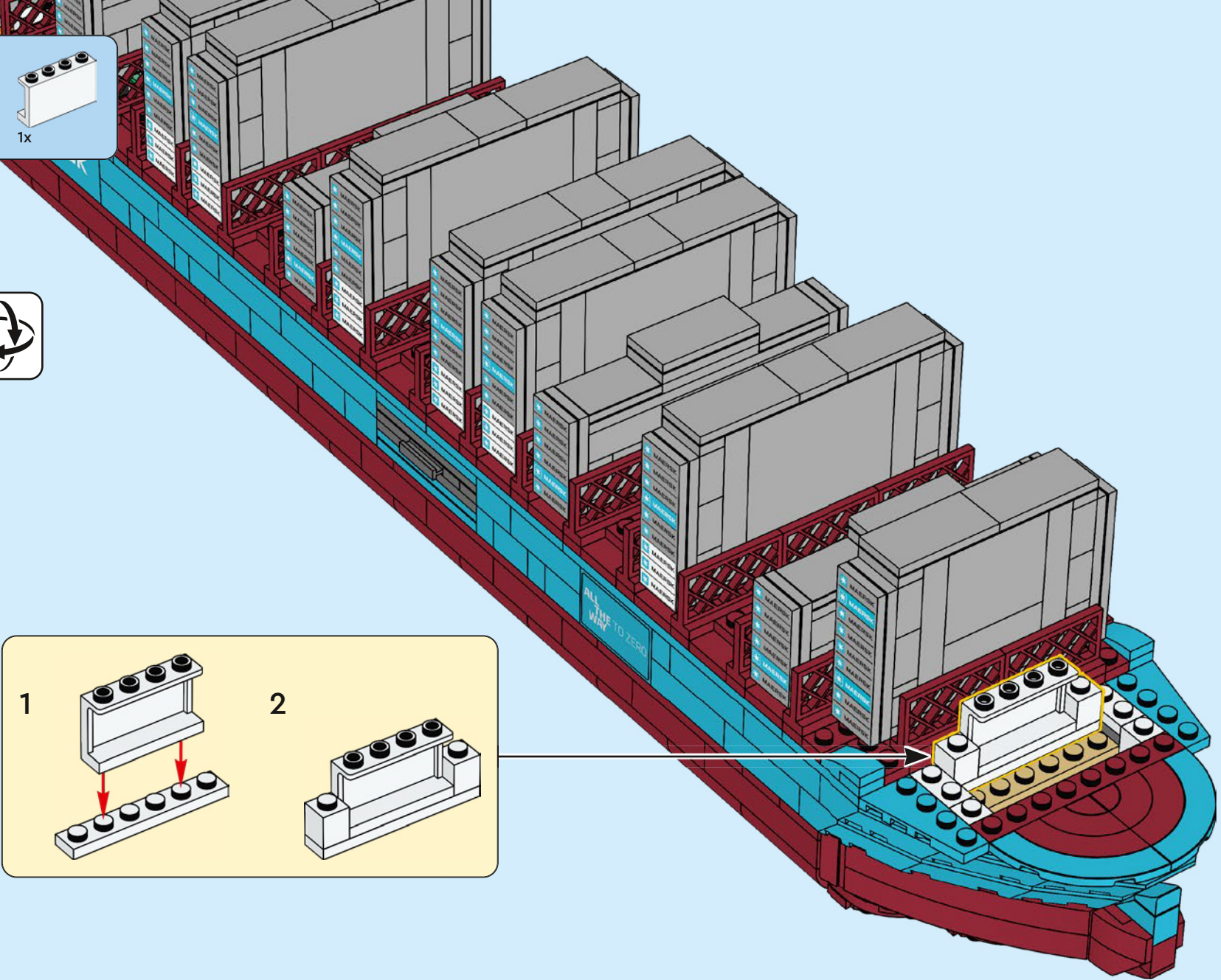
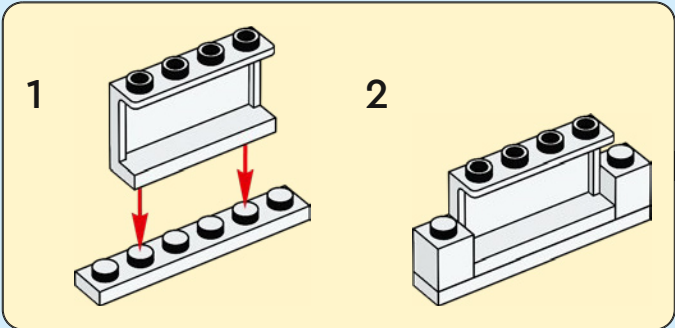

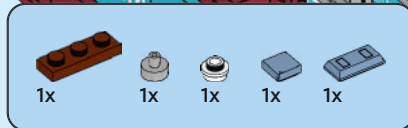

229

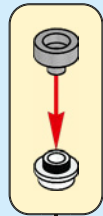
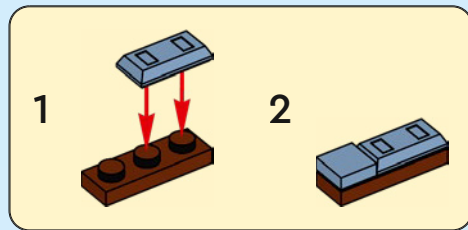



4x

230

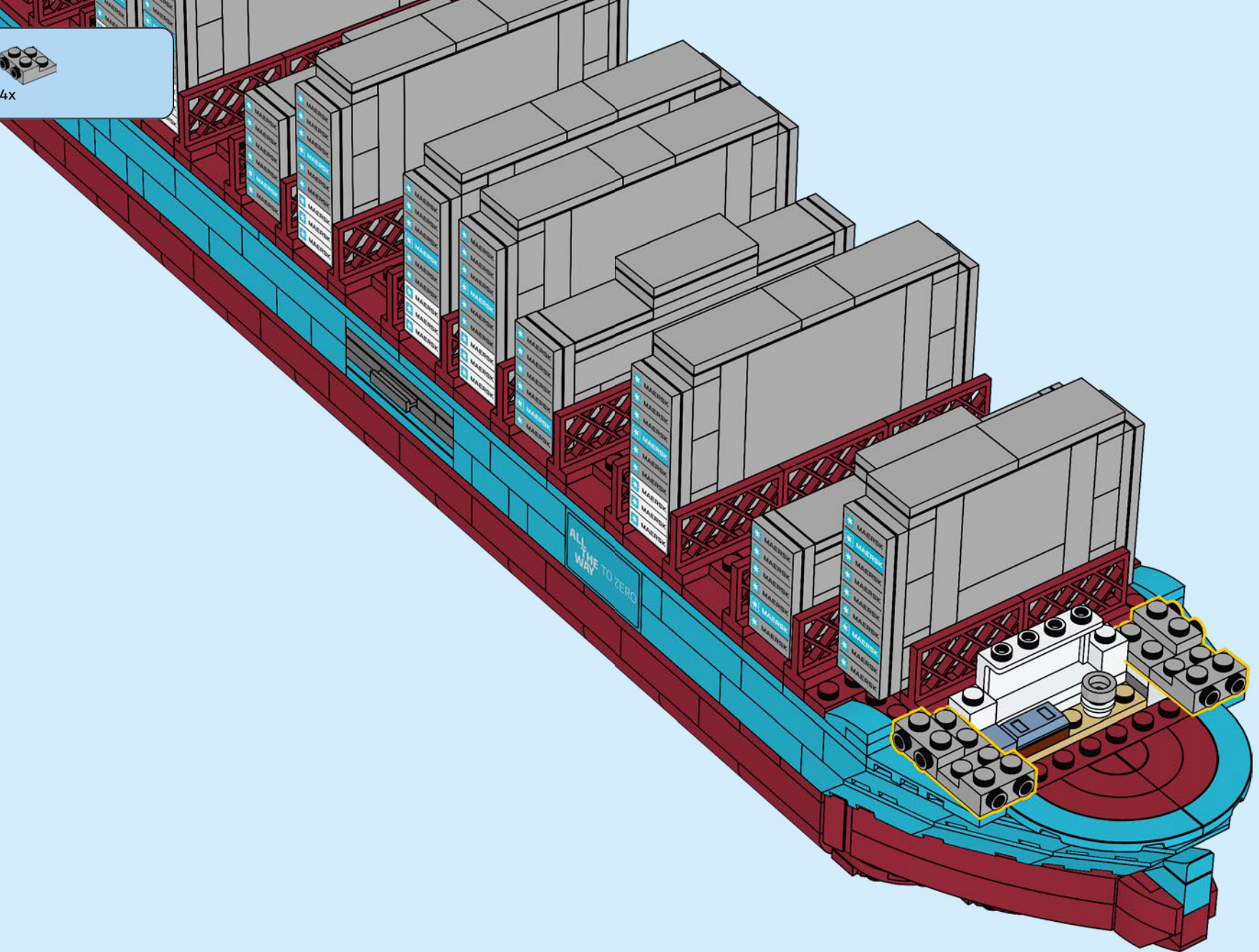

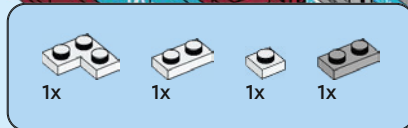

231

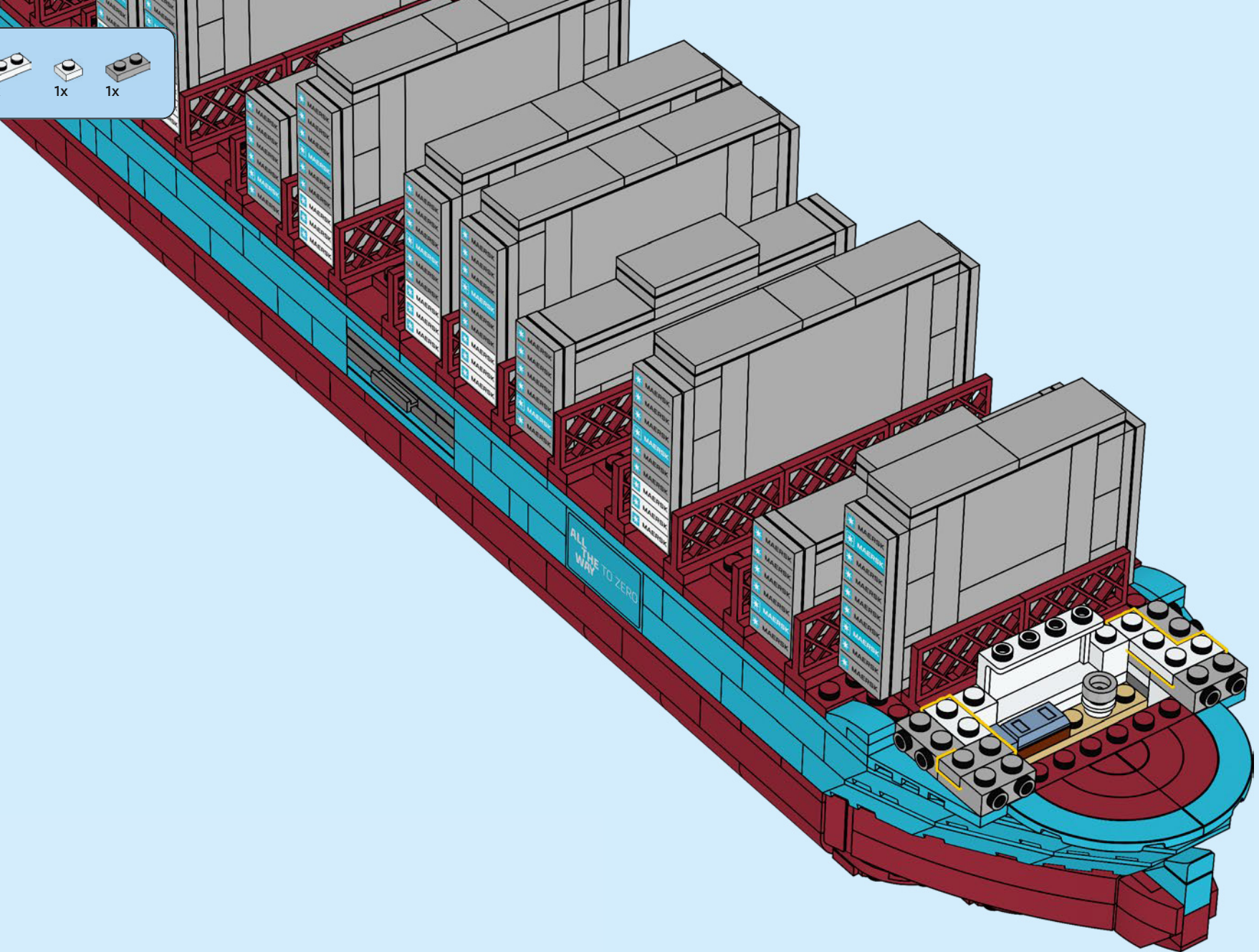

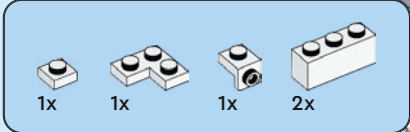

232

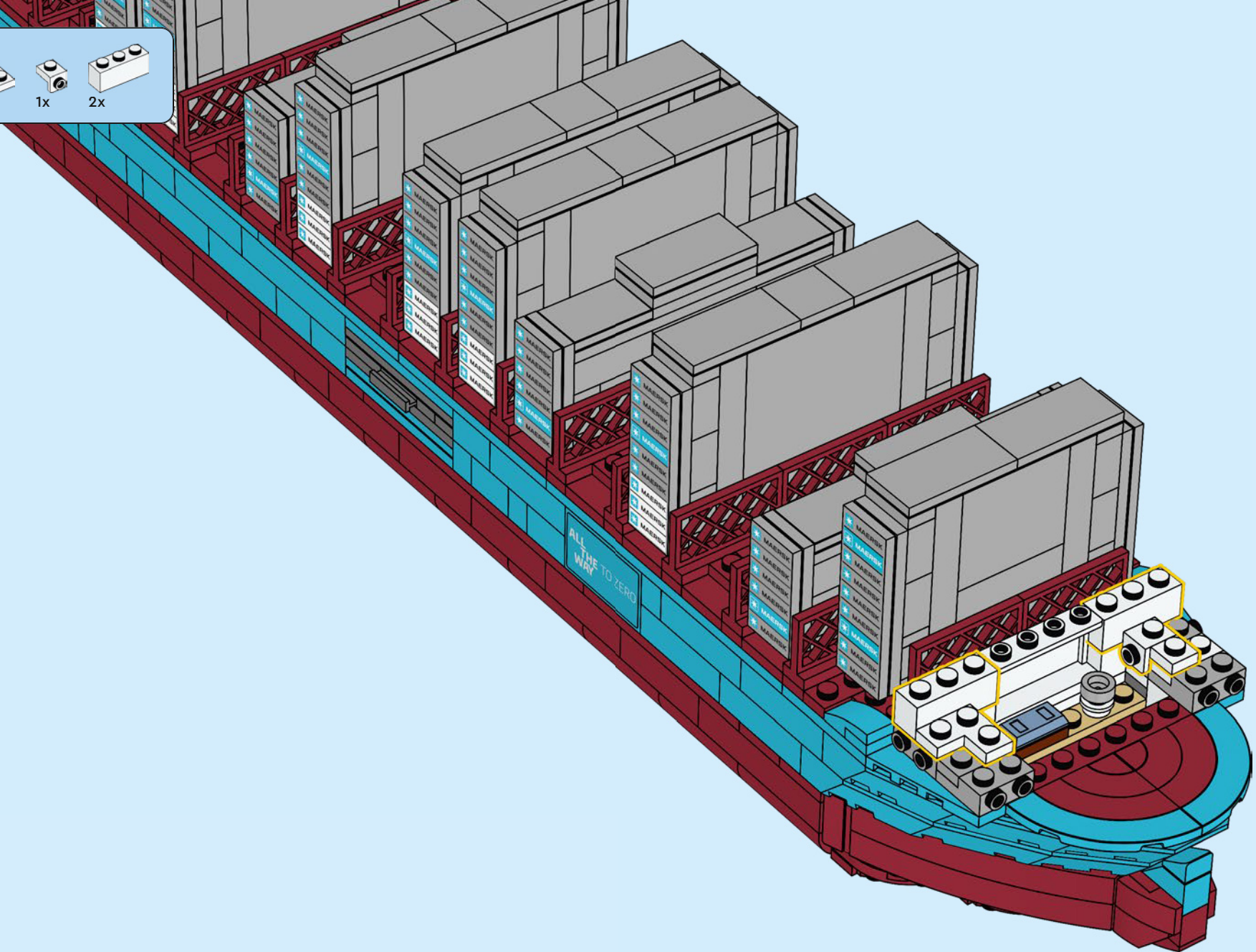

1x 1x 4x

233

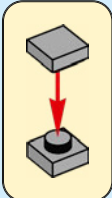
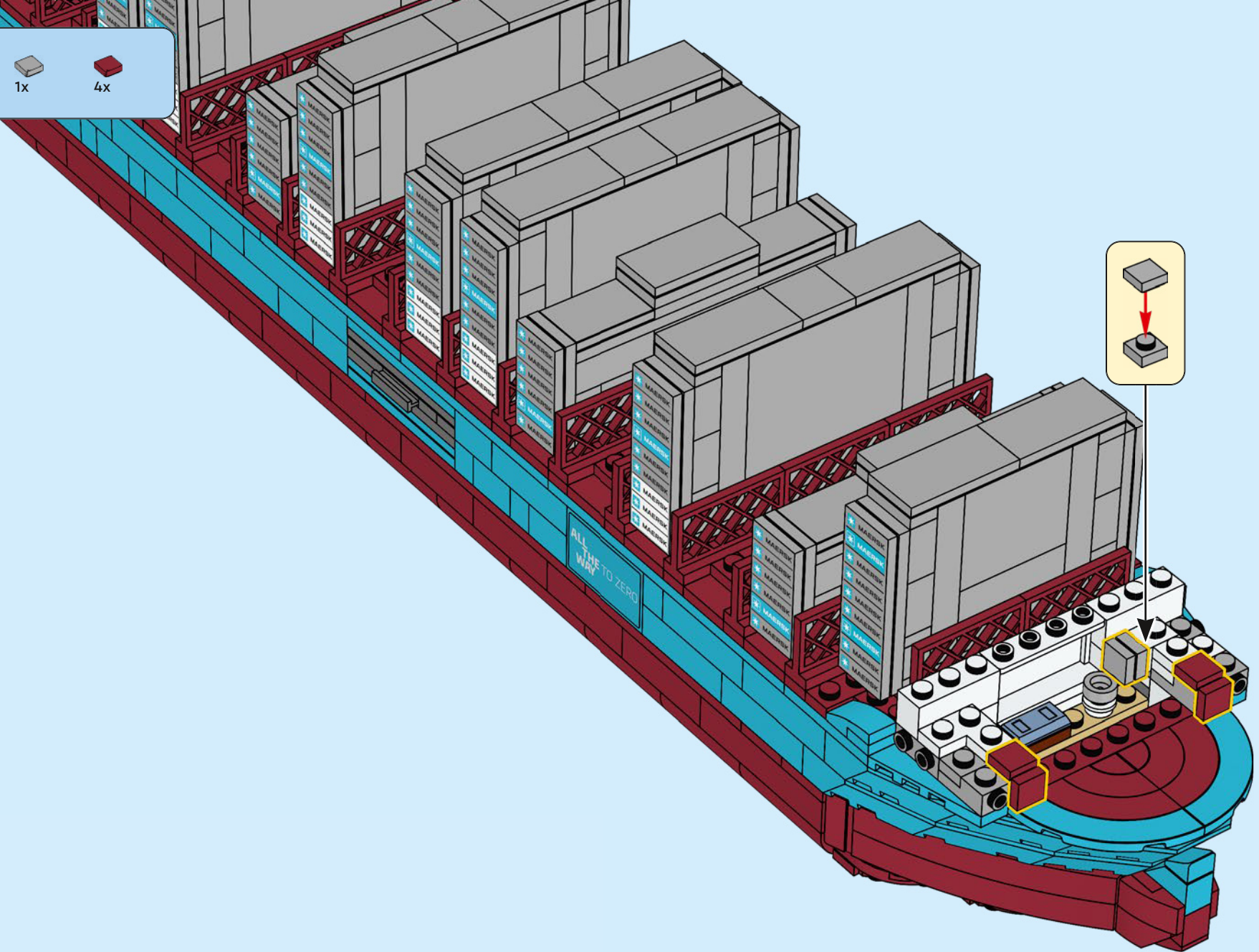

3x 2x 2x

234

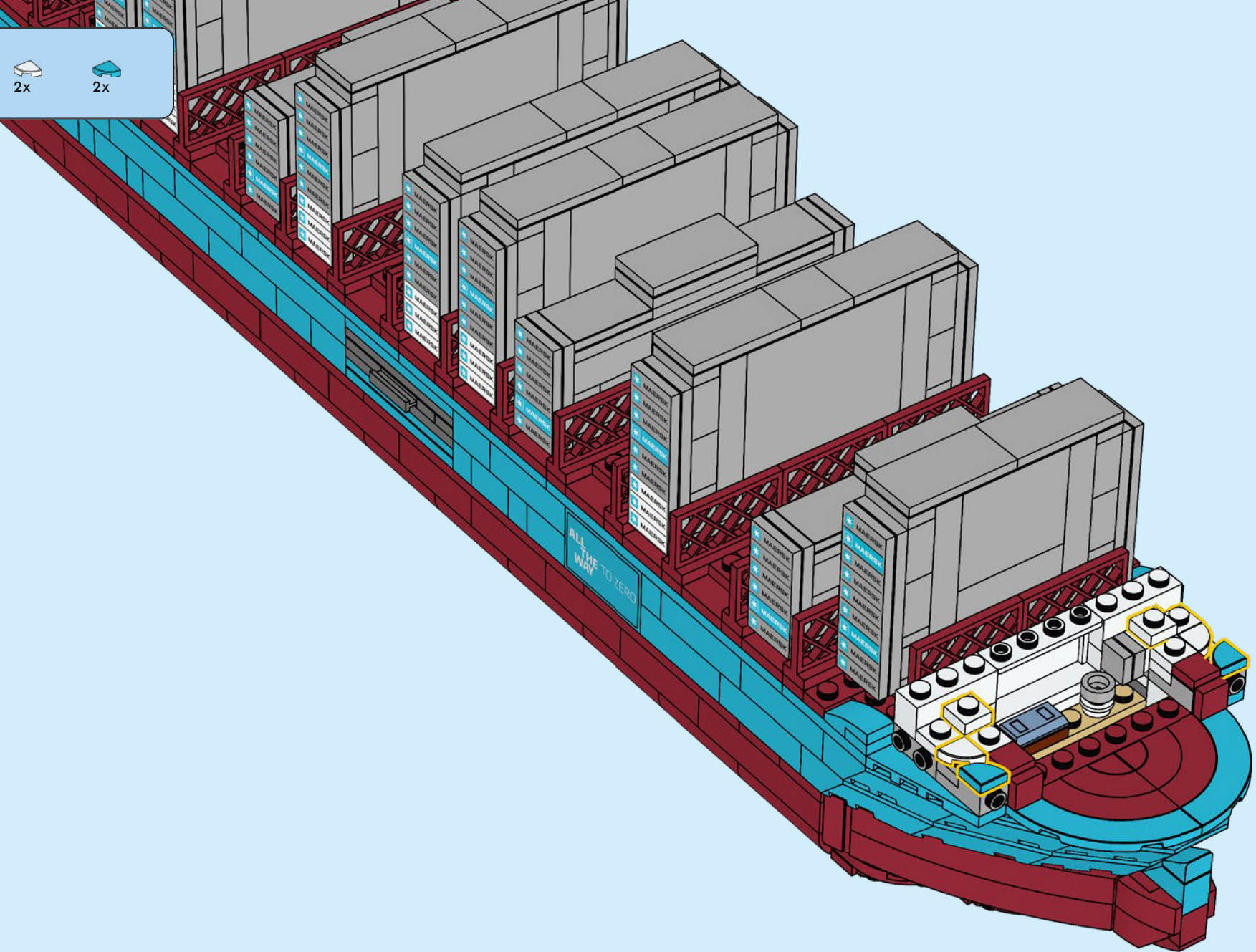

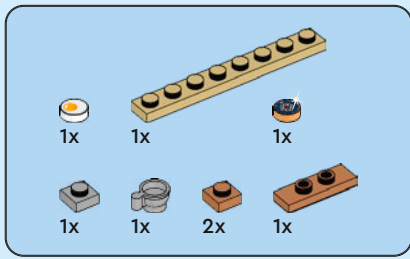

235

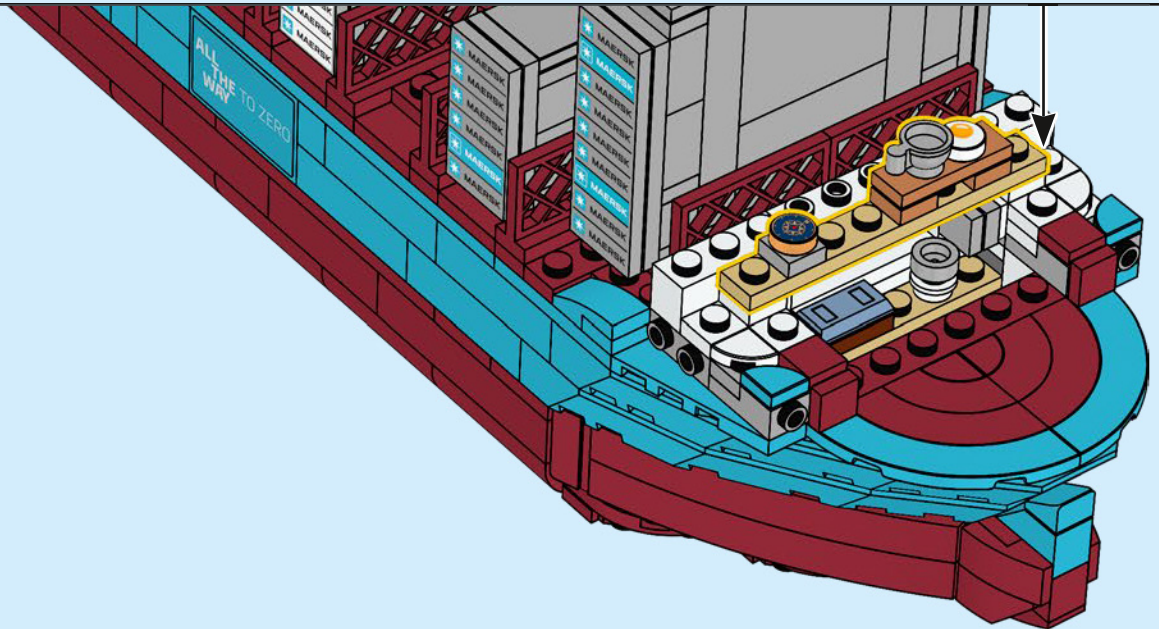
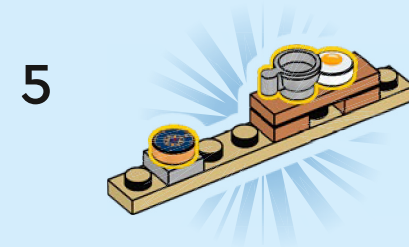
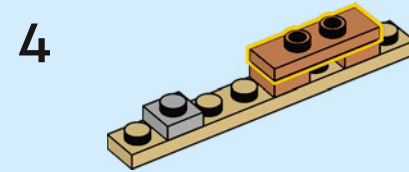
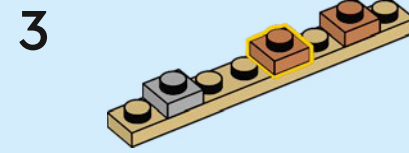
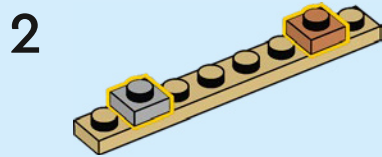
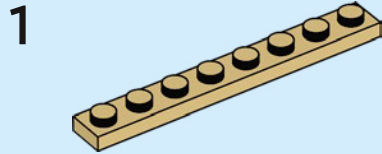

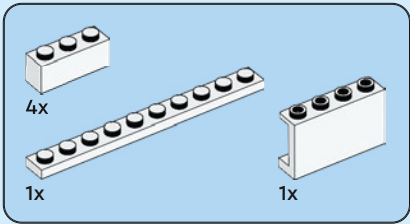

236

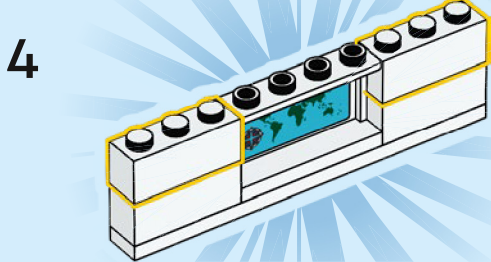
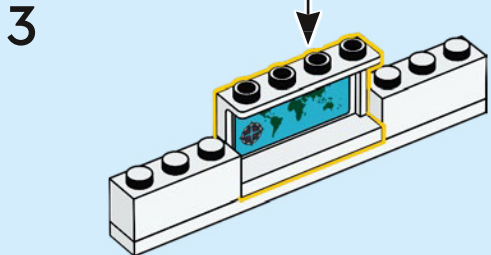
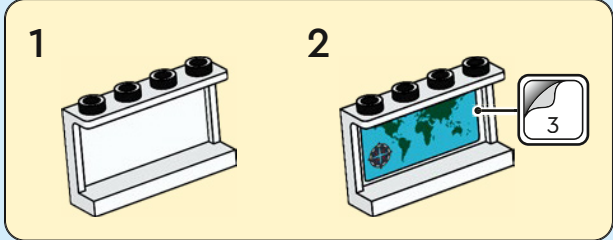
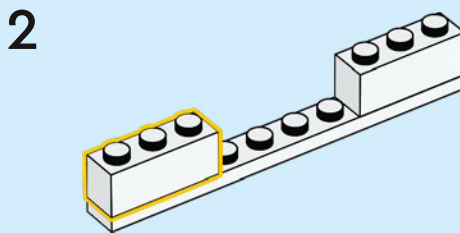
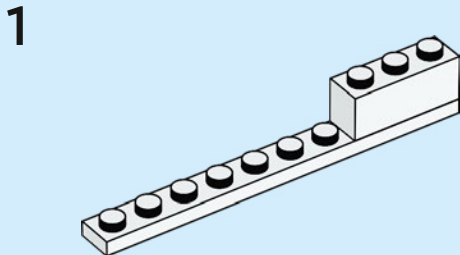

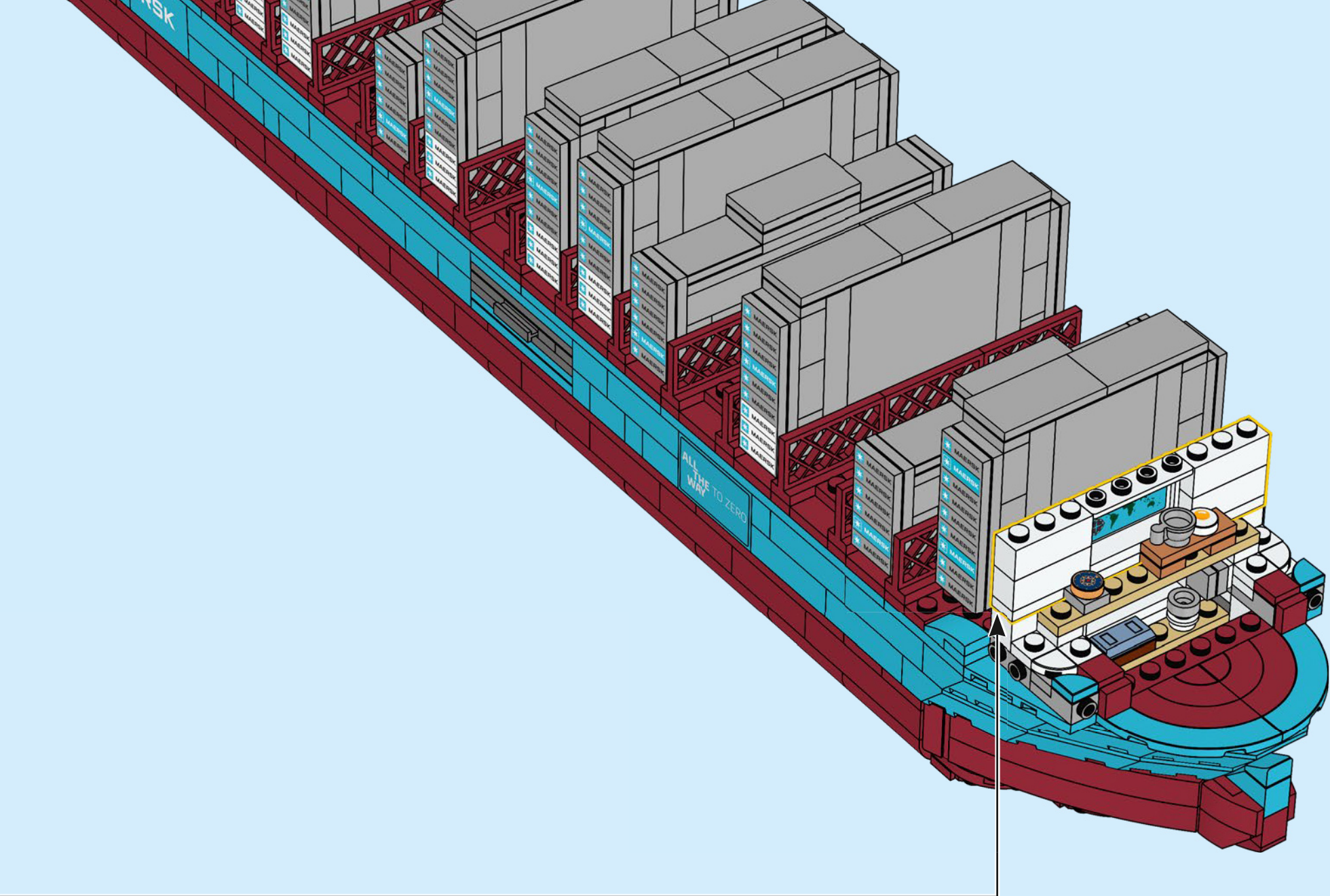

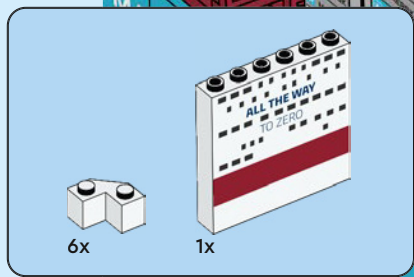

237

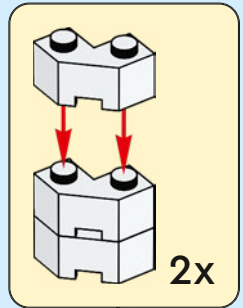
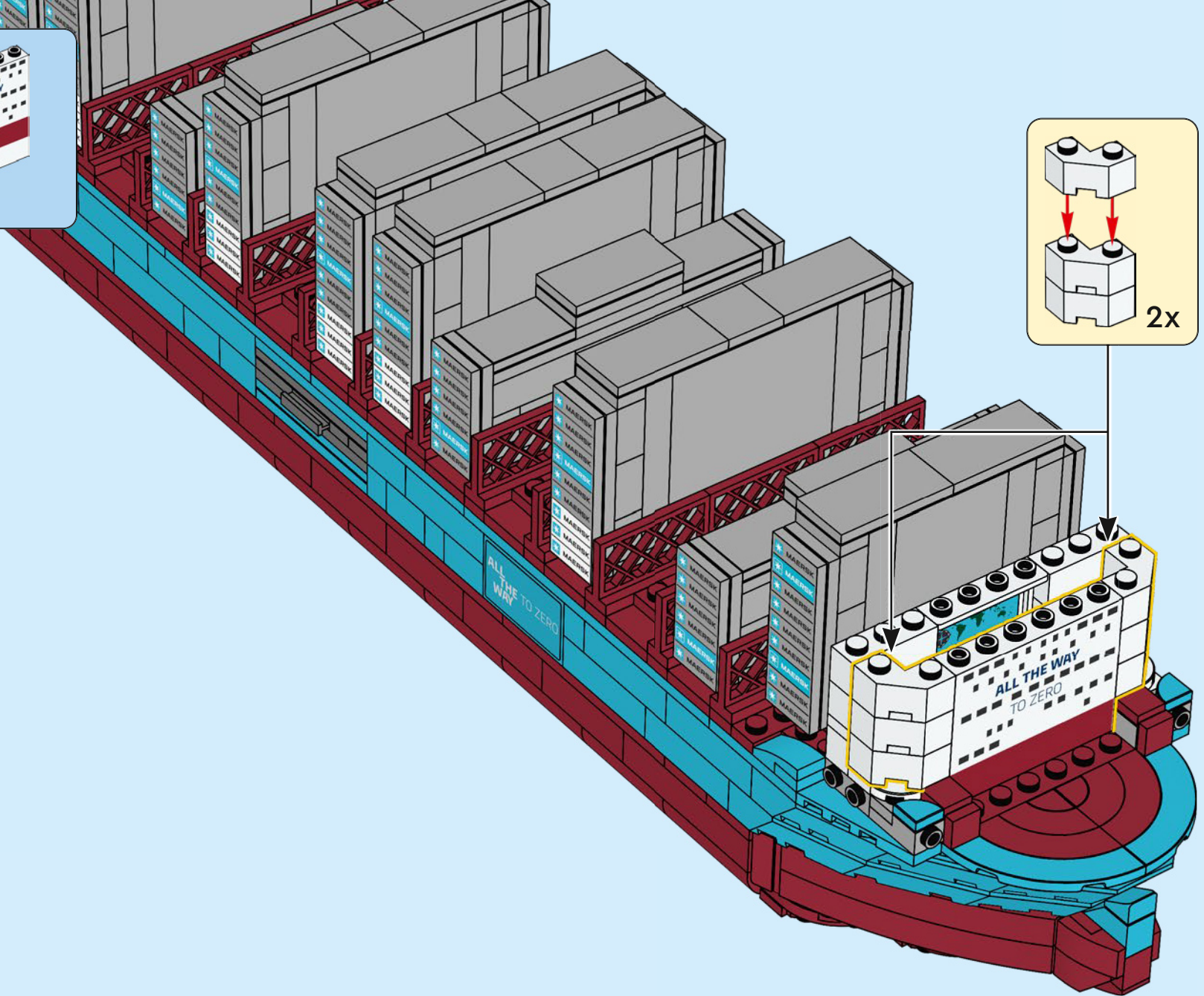



238

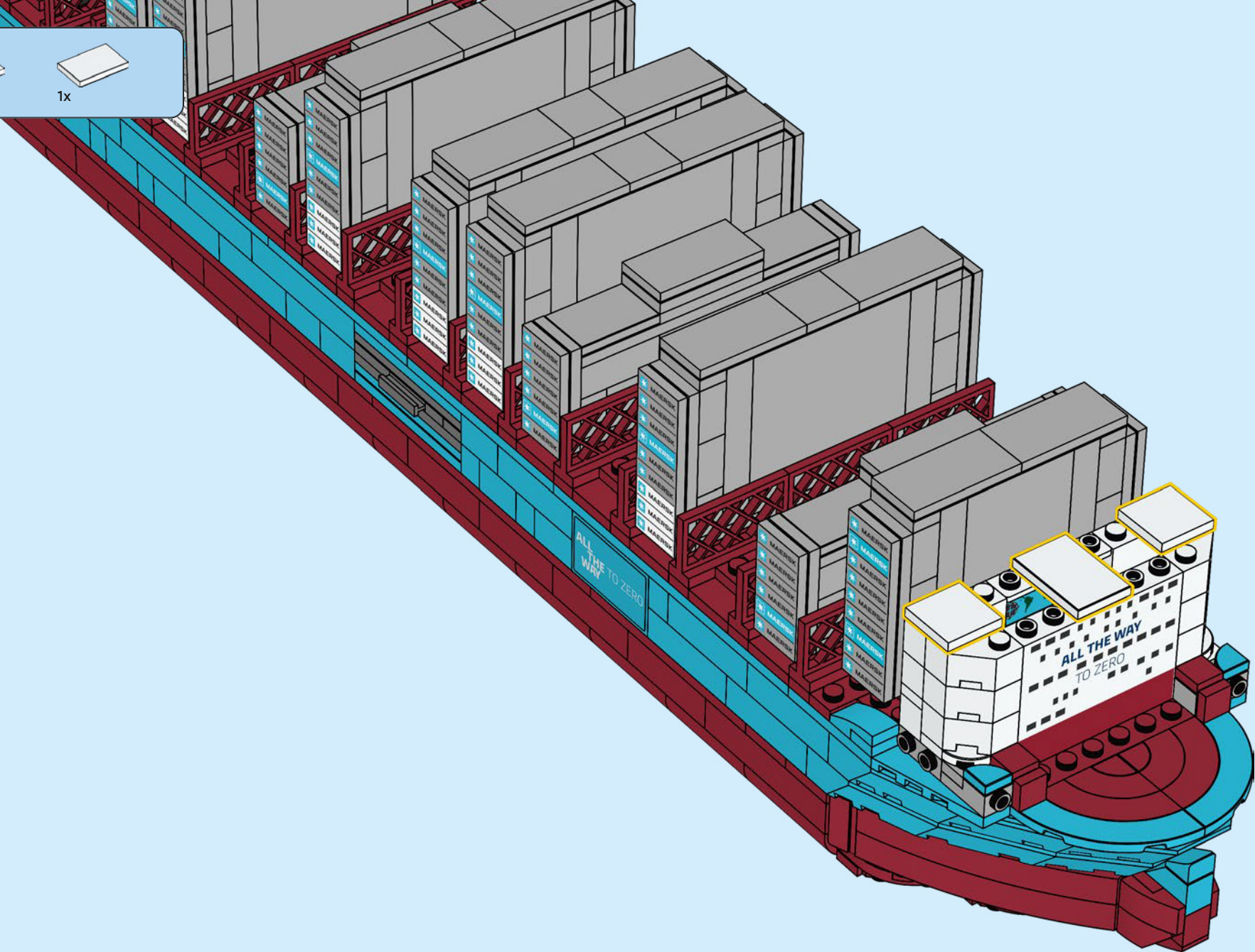

2x 1x 1x

239

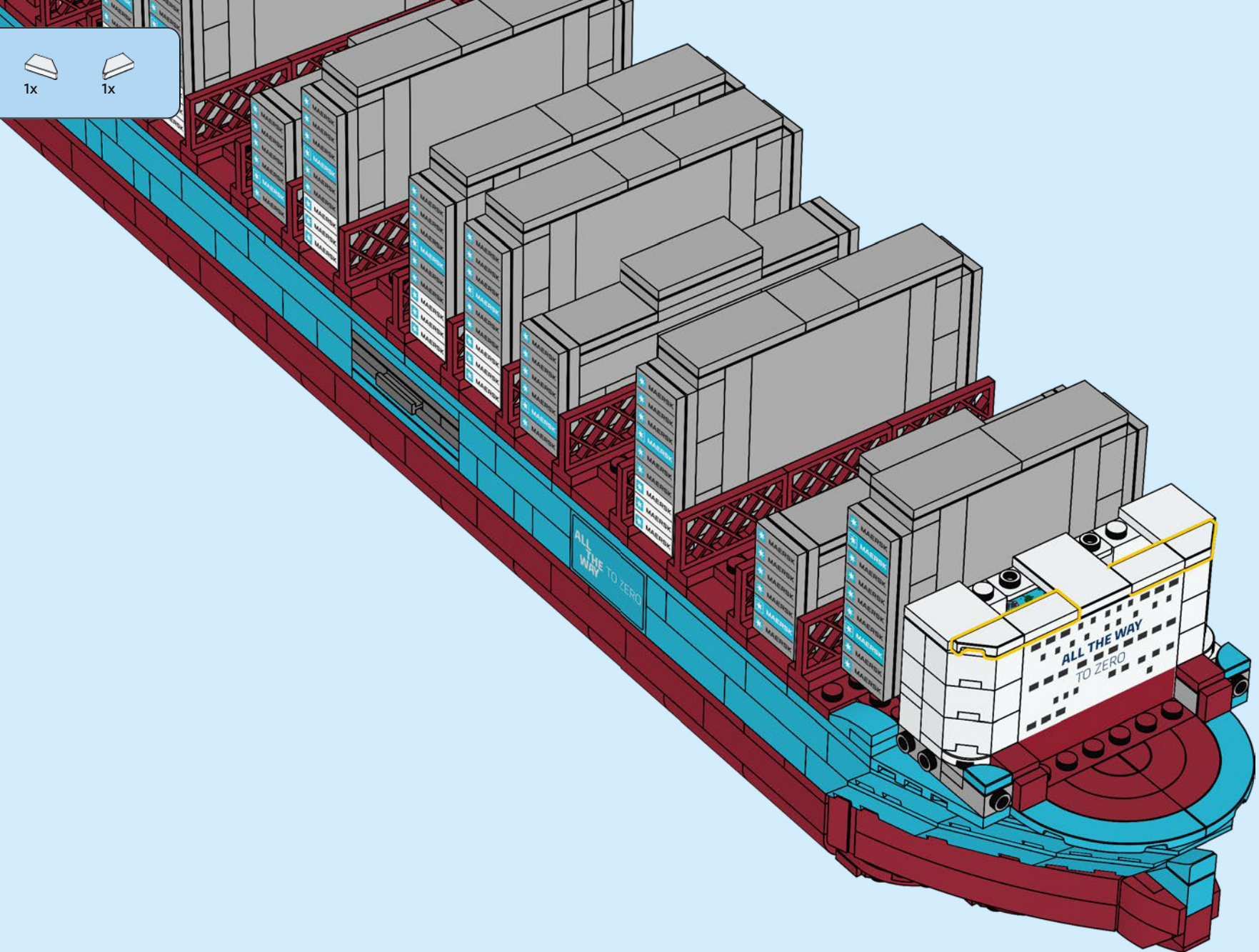

2x 2x 2x

240

1 2 2x

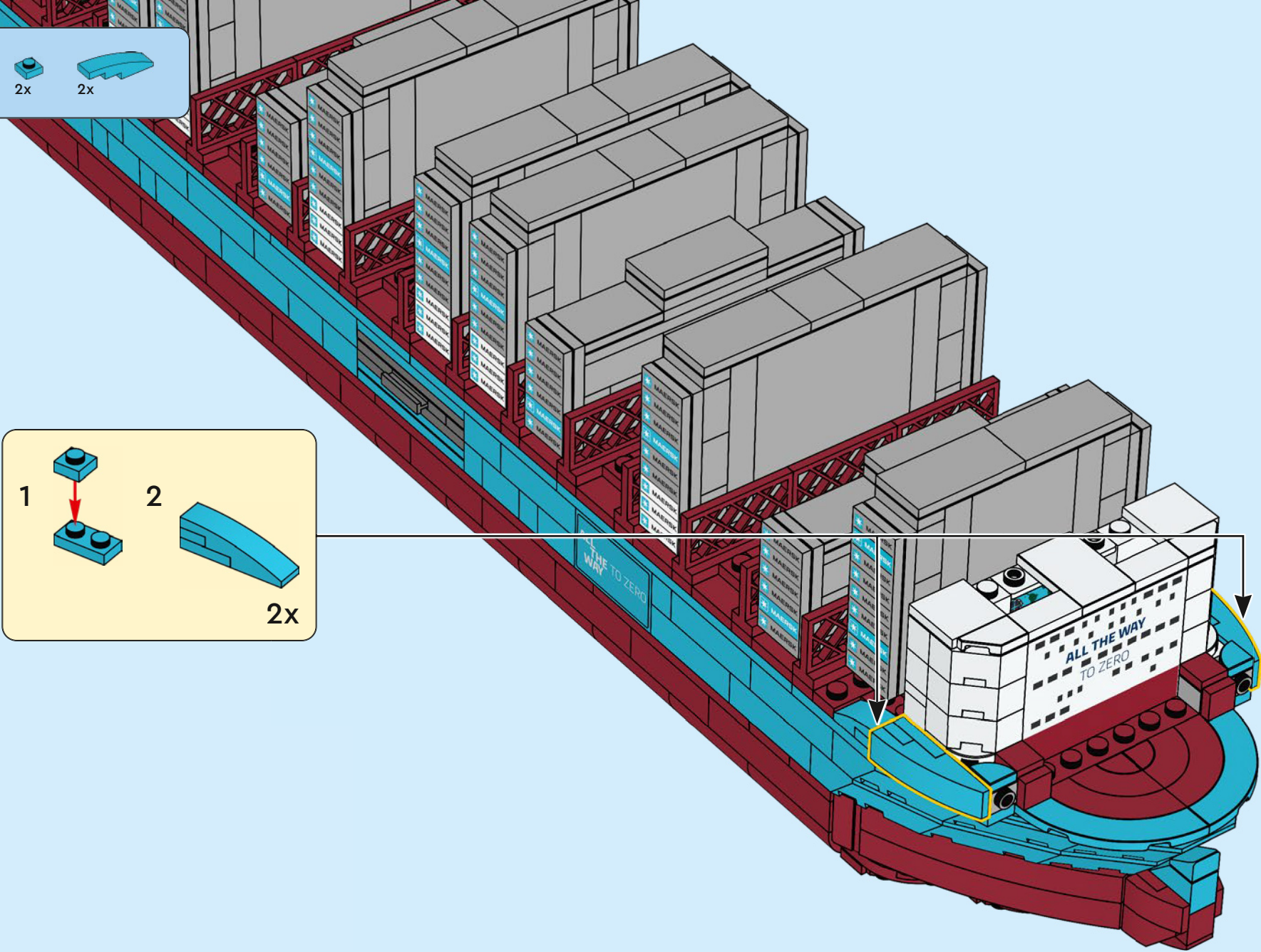

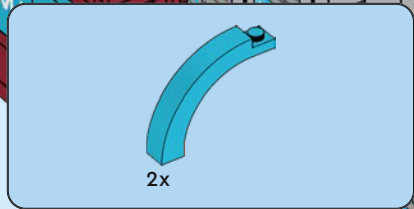

241

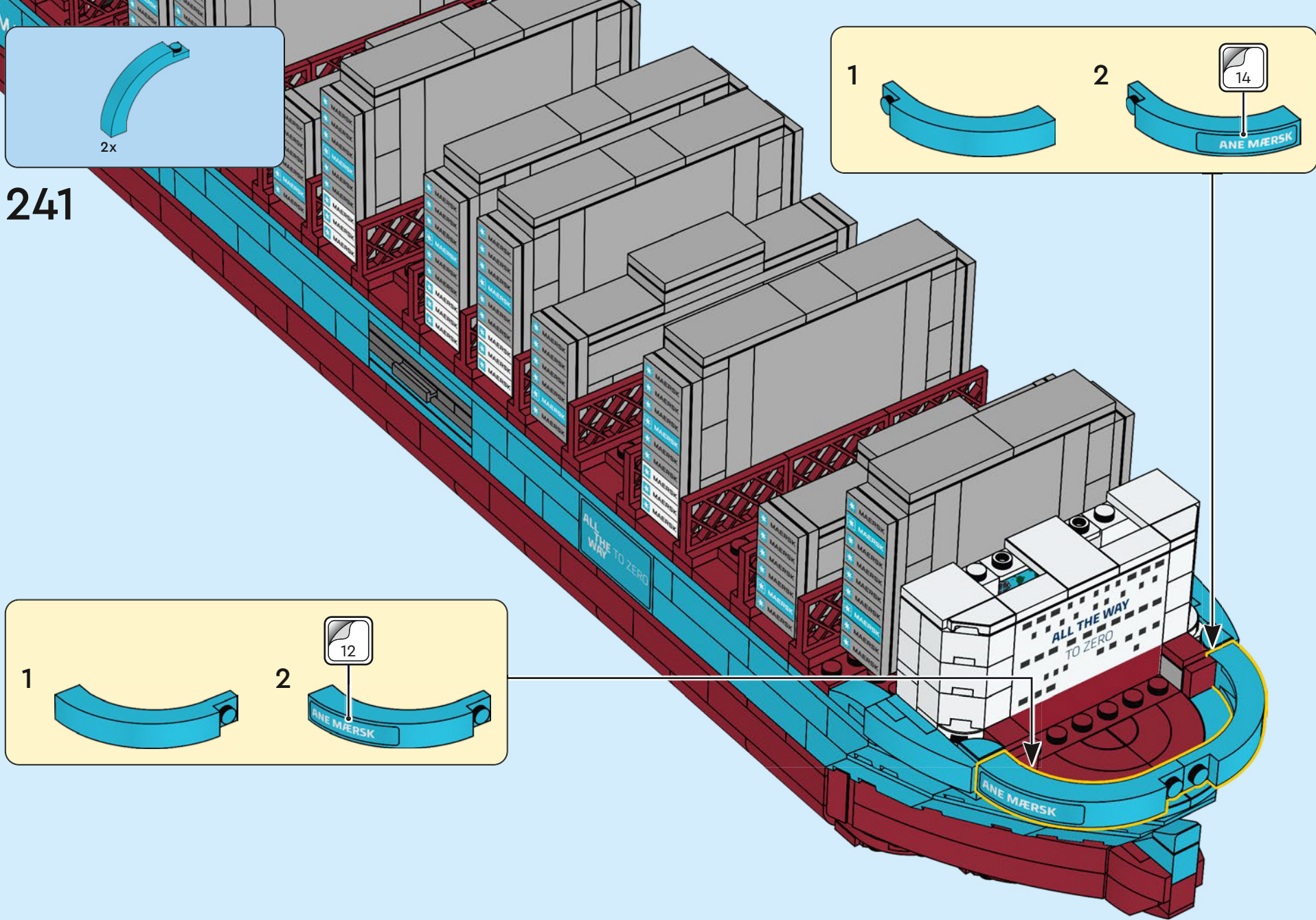
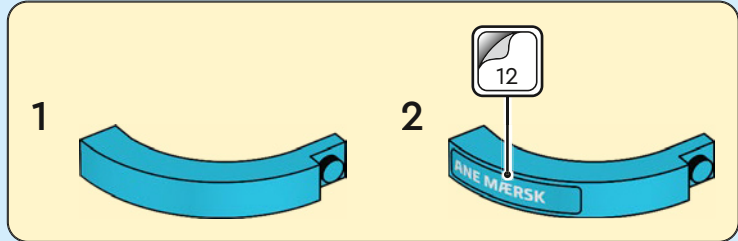
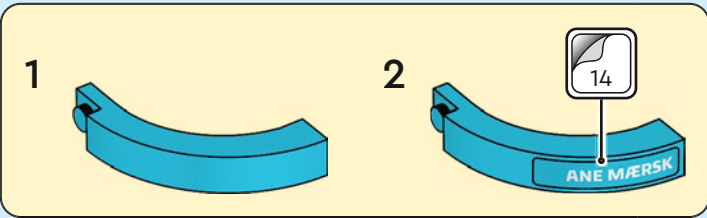

1x

242

1

2

13

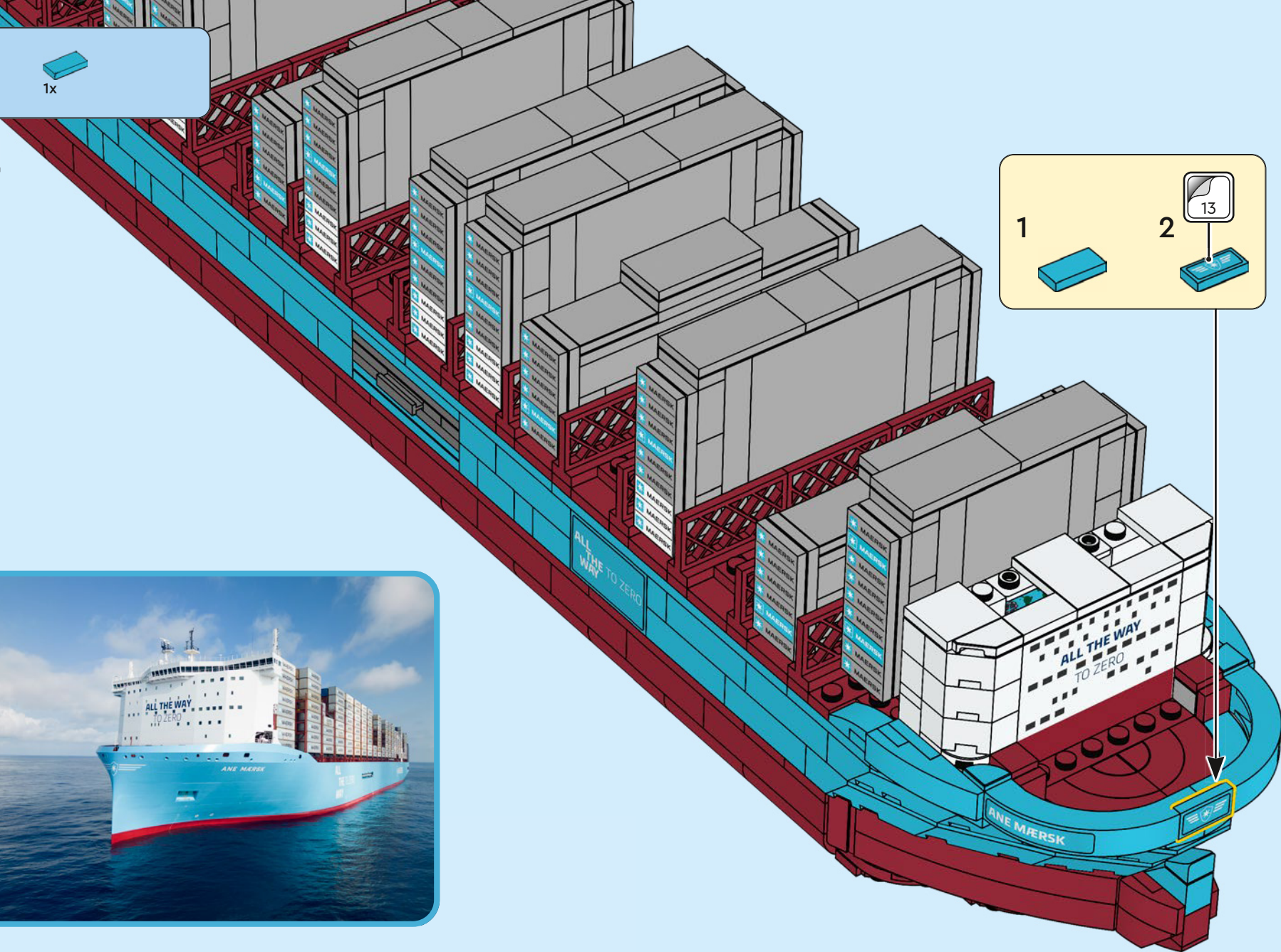

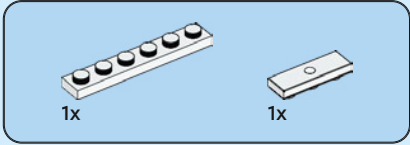
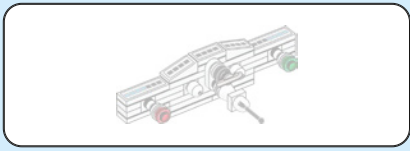

243

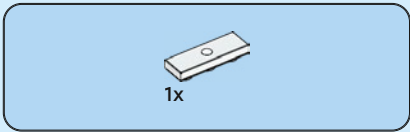
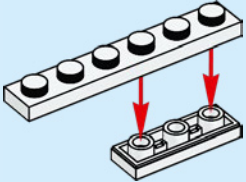

244

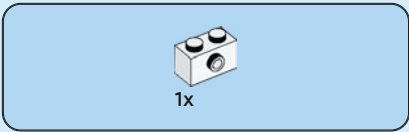
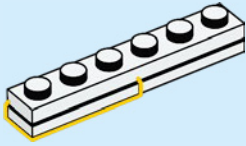

245

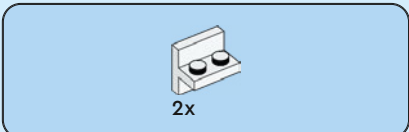
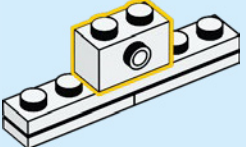

246

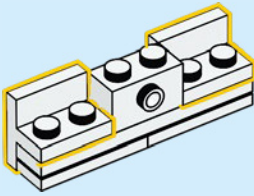



2x

247

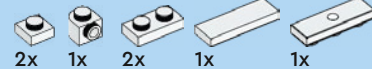
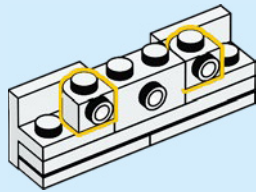

248

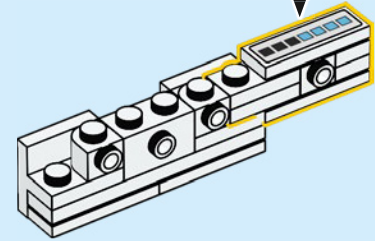
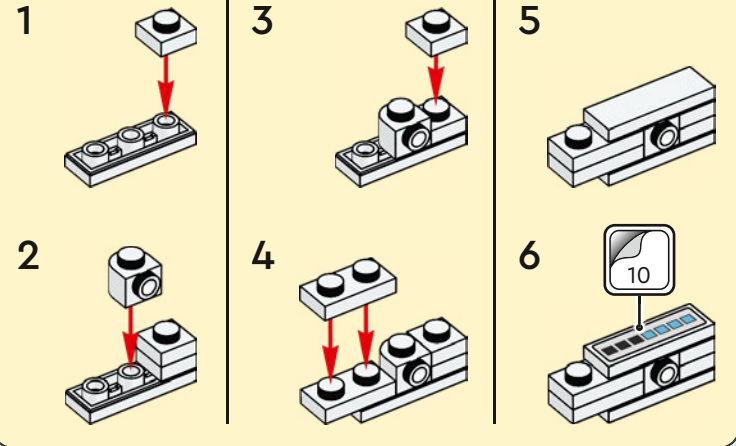

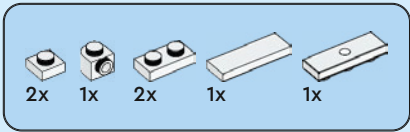

249

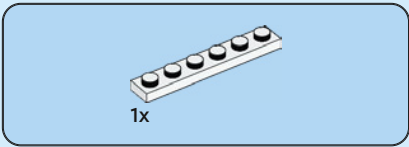
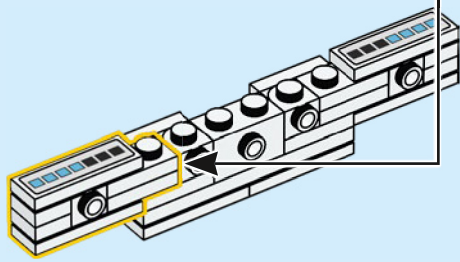
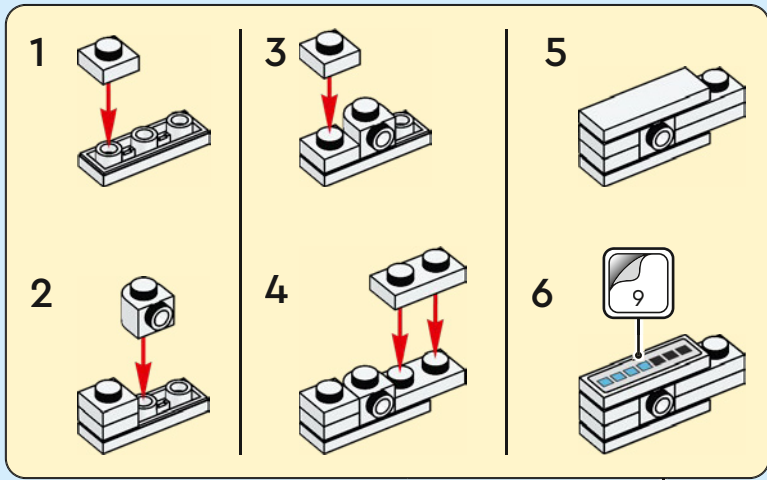

250

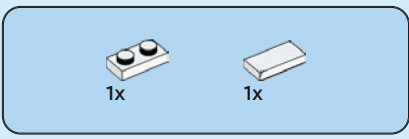
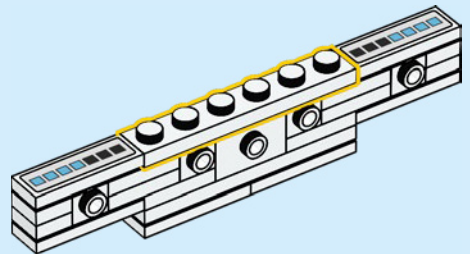

251

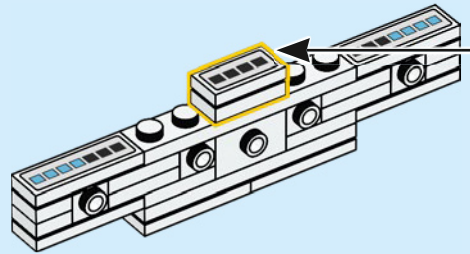
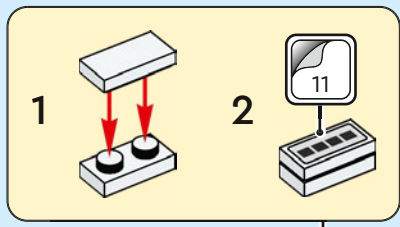

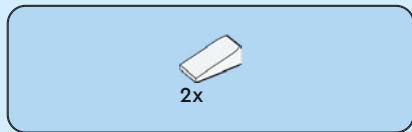

252

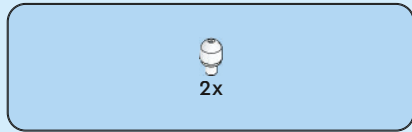
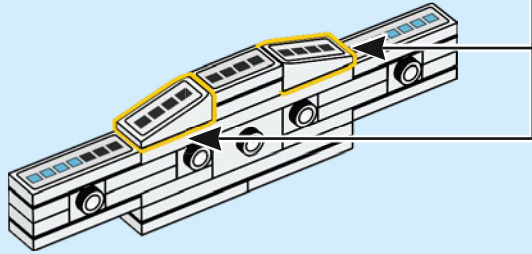
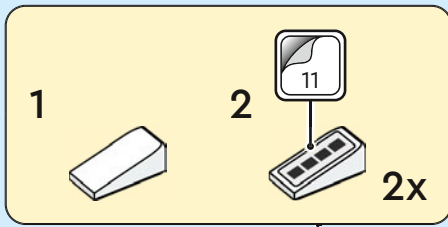

253

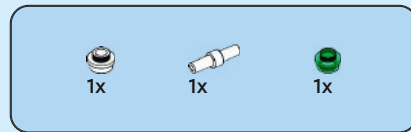
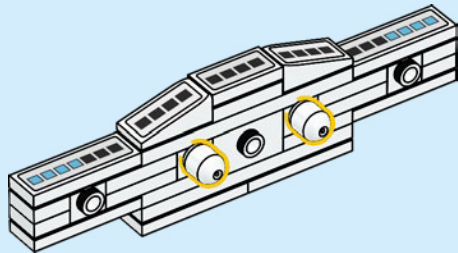

254

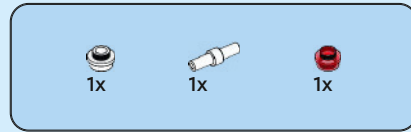
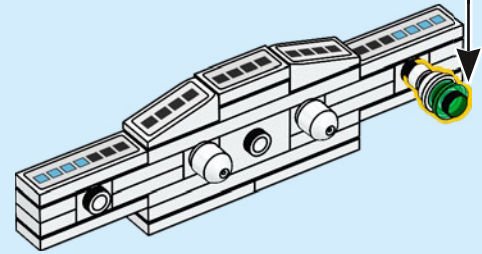
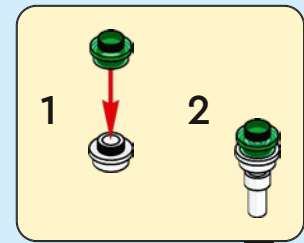

255

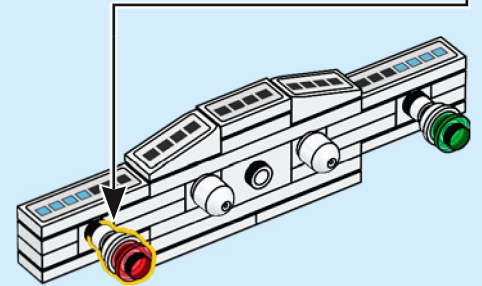
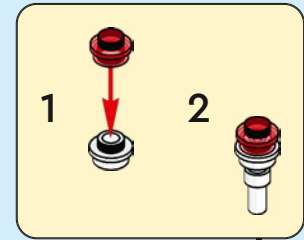

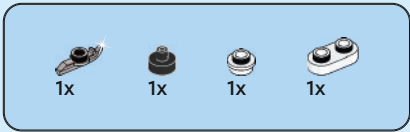

256

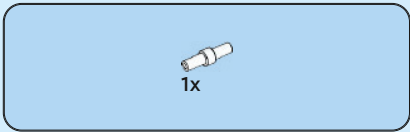
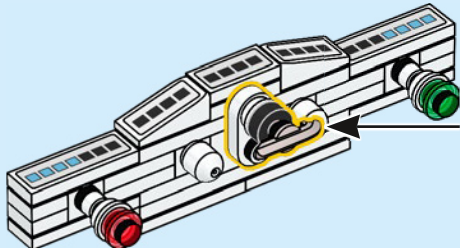
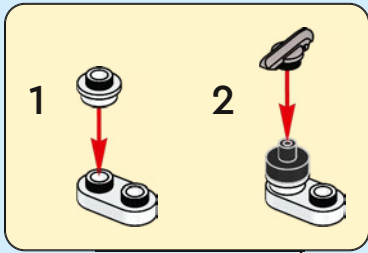

257

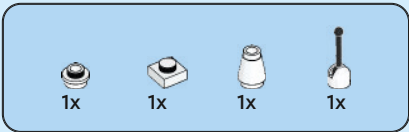
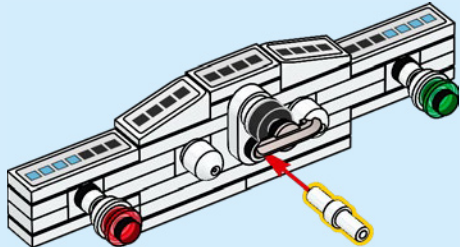

258

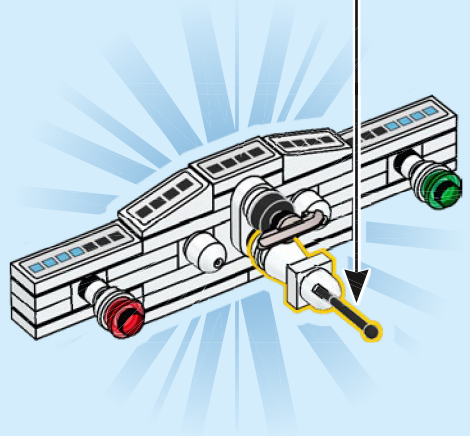
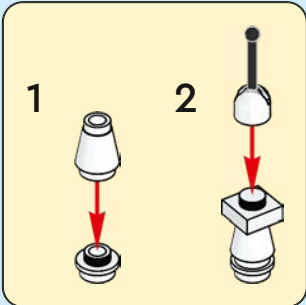

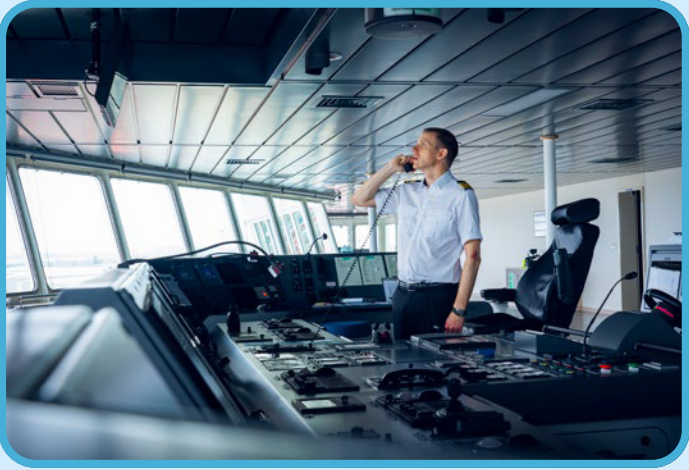
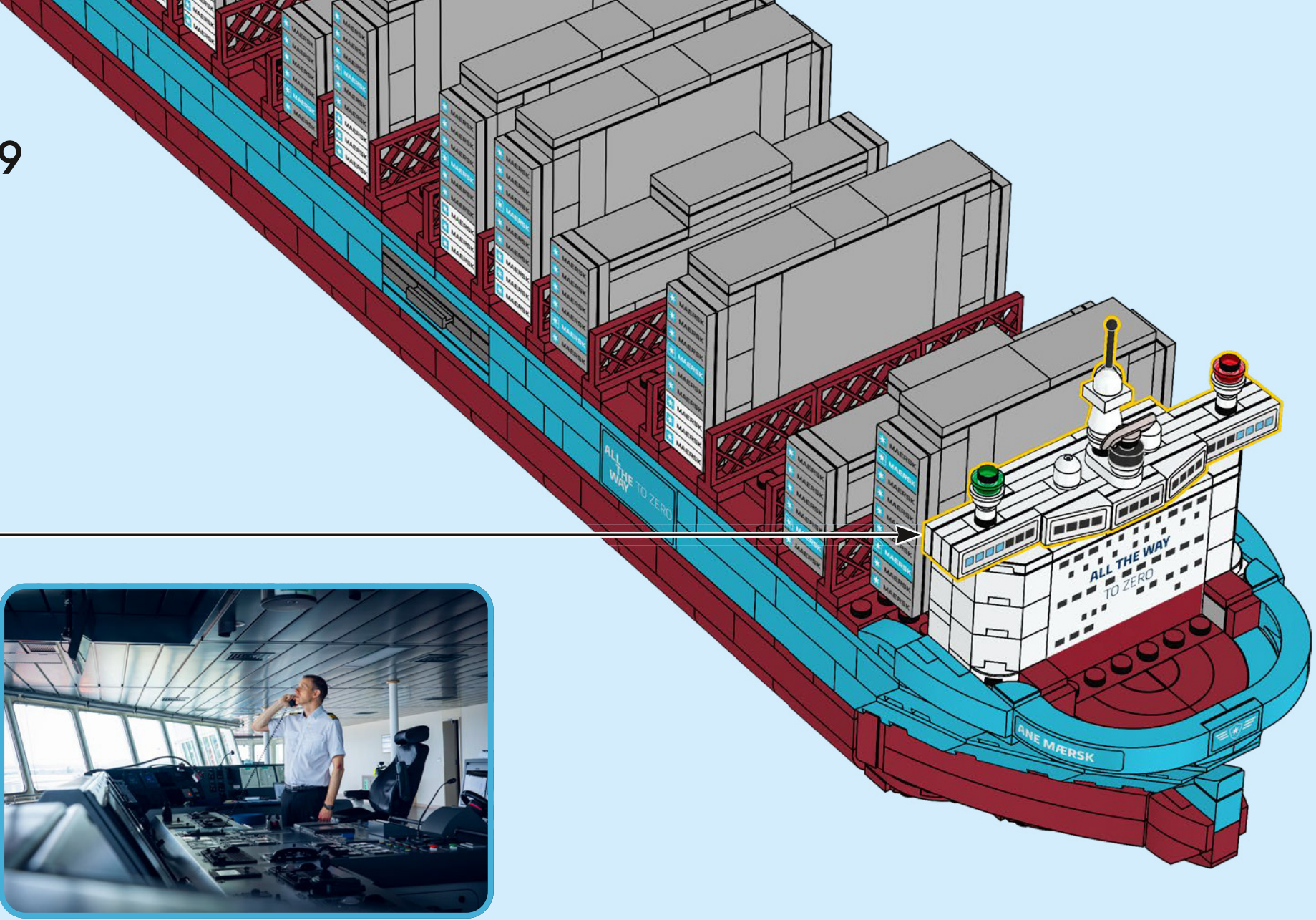

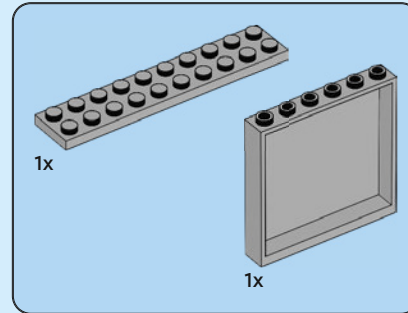
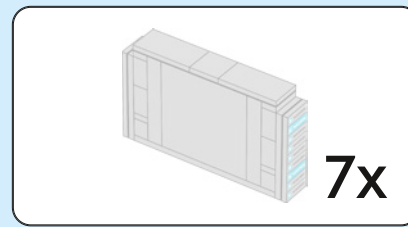

260

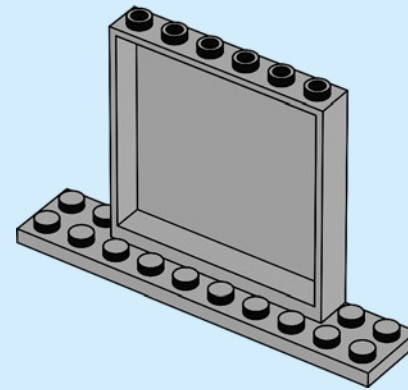

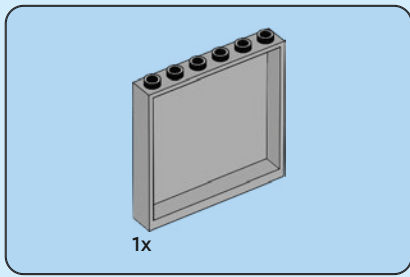

261

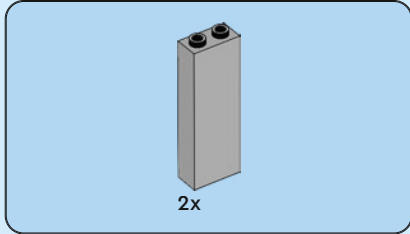
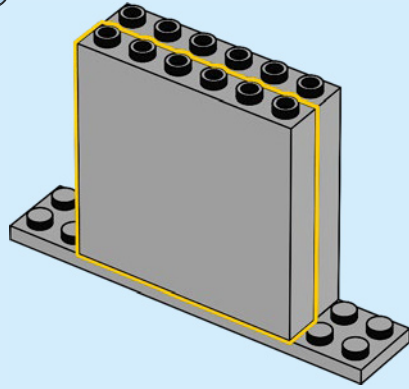

262

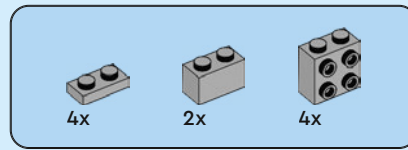
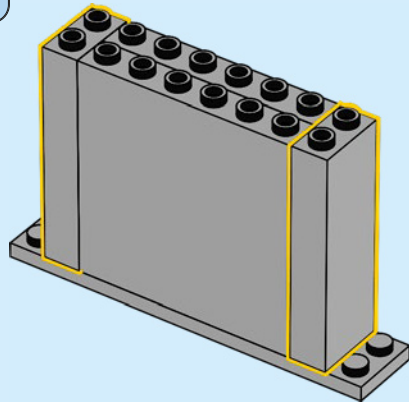

263

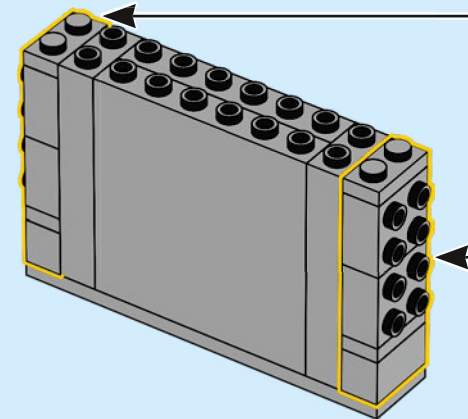
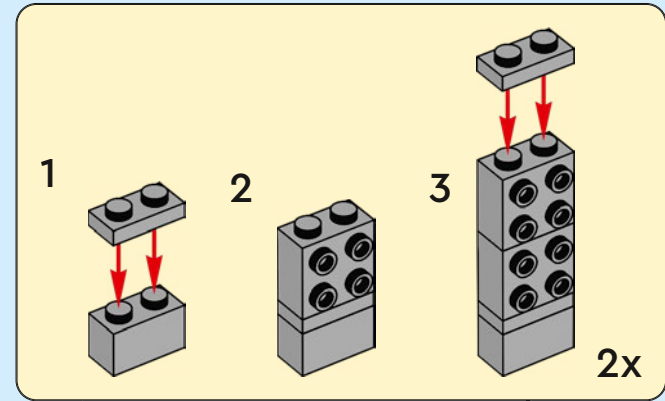

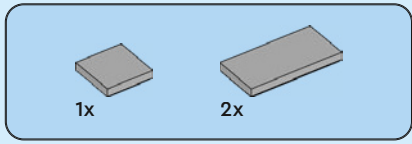

264

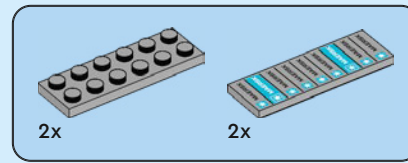
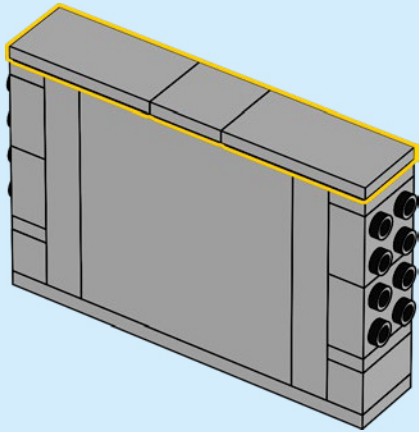

265

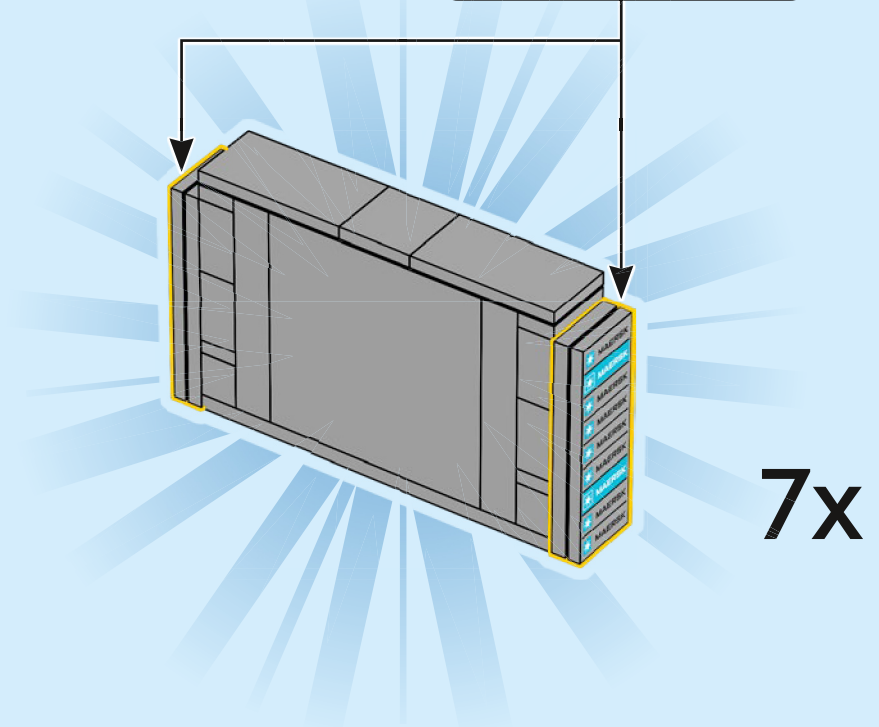
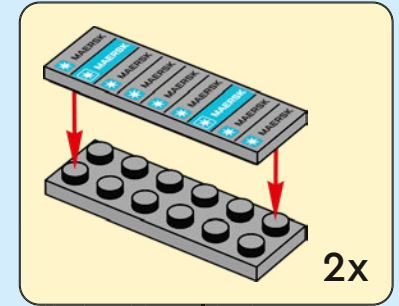

266

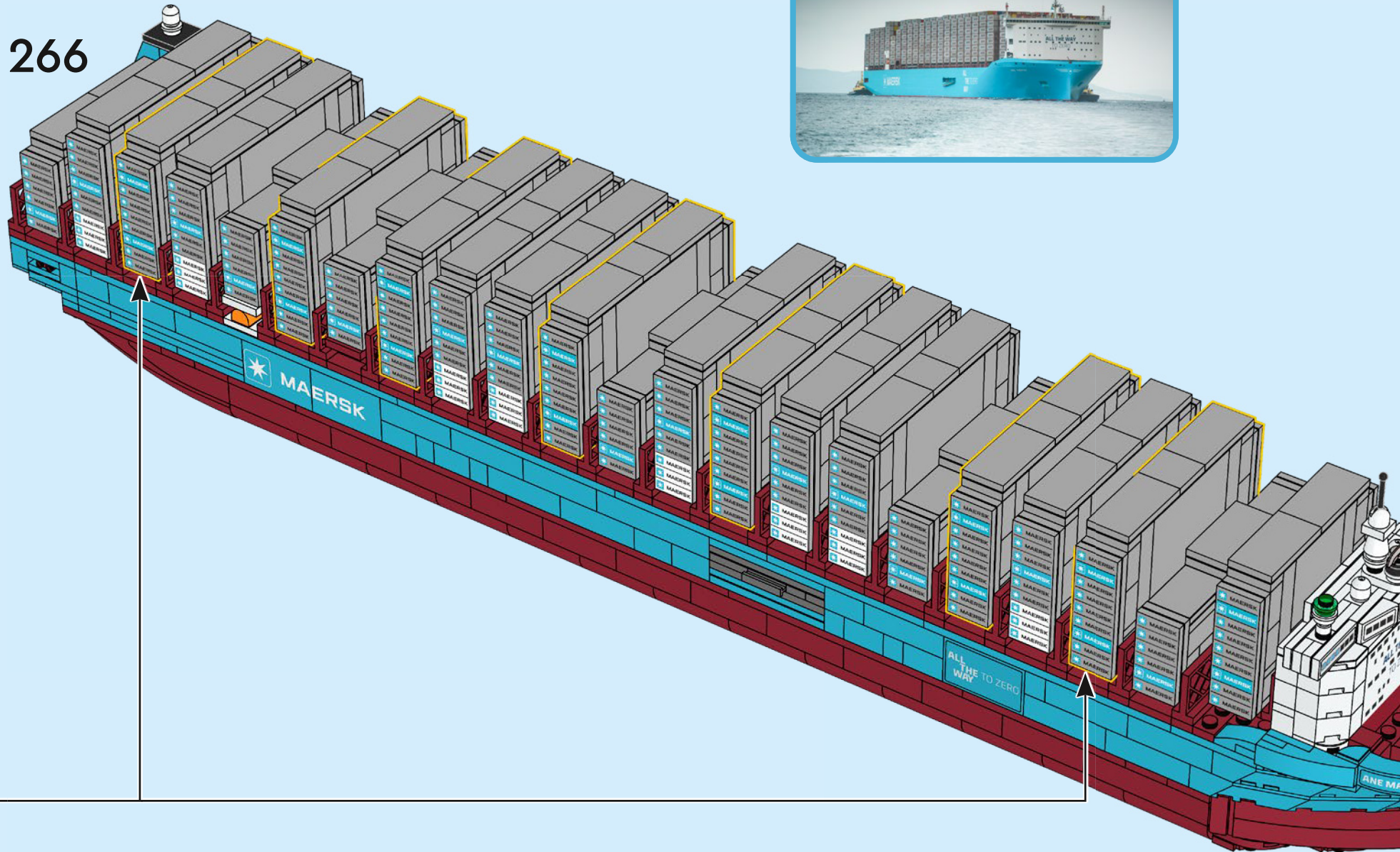

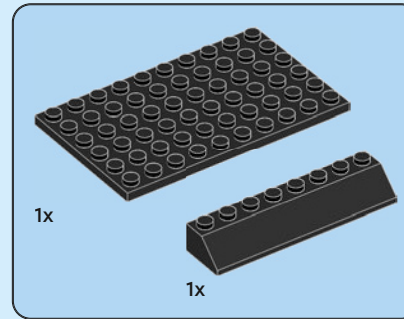
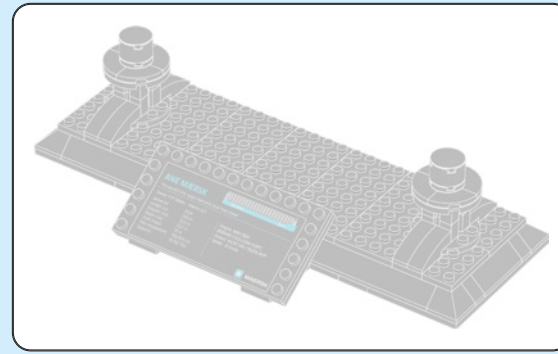

267

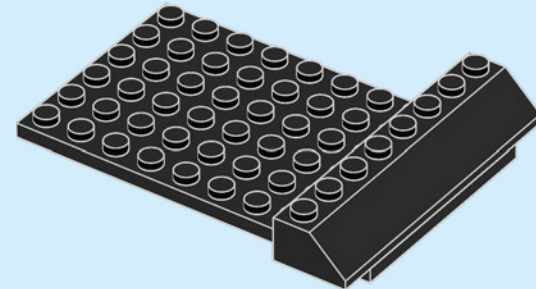

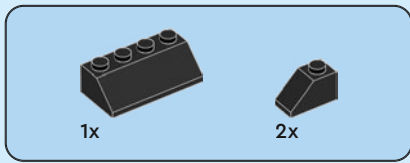

268

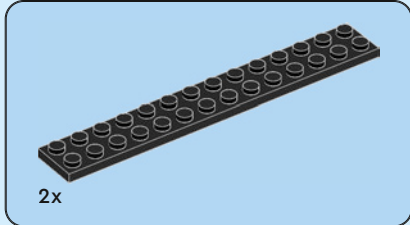
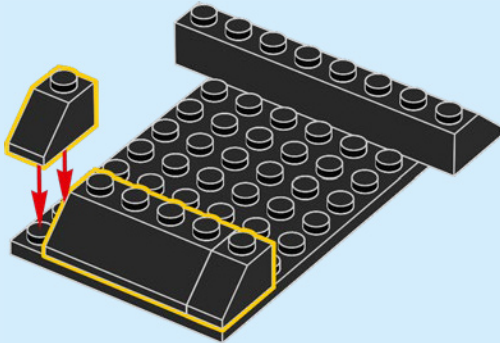

269

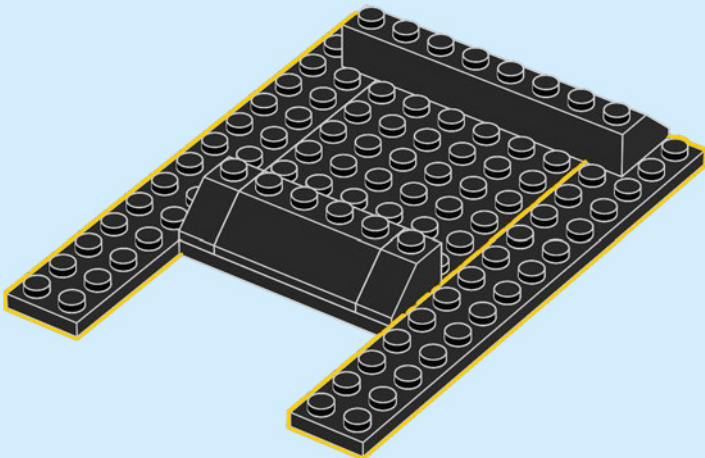

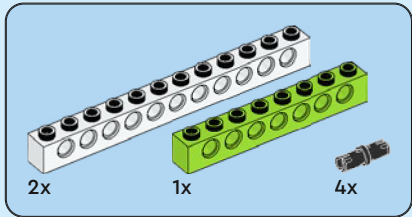
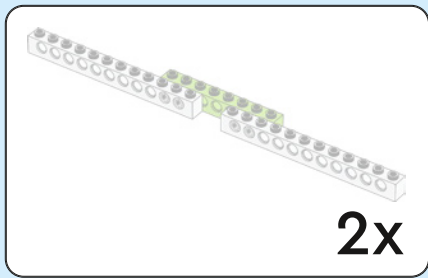

270

1

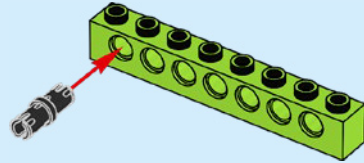

2

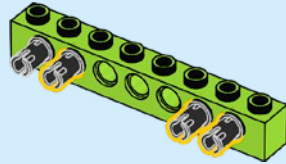

3

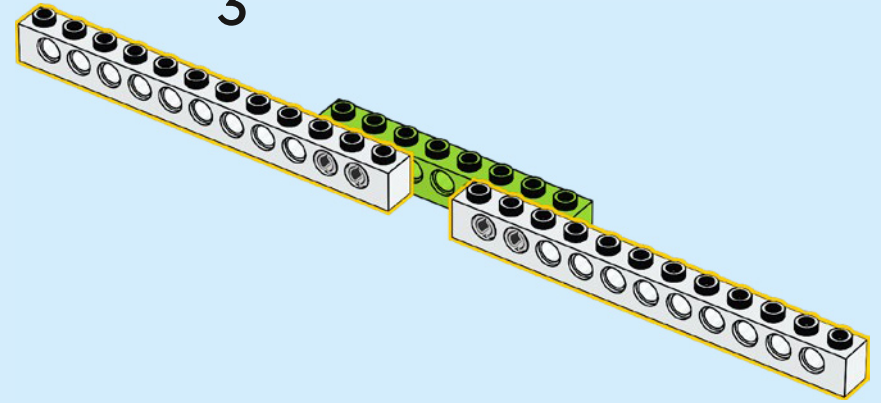

2x

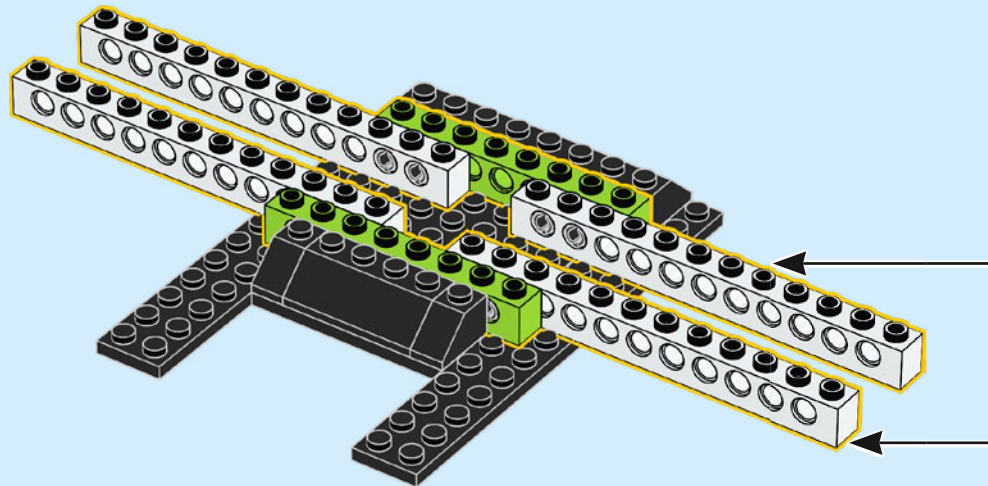

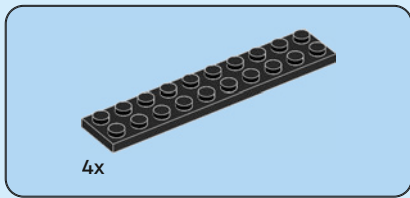

271

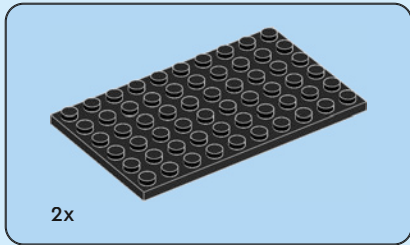
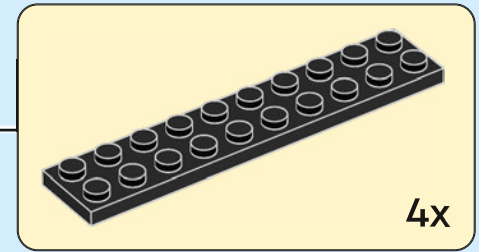
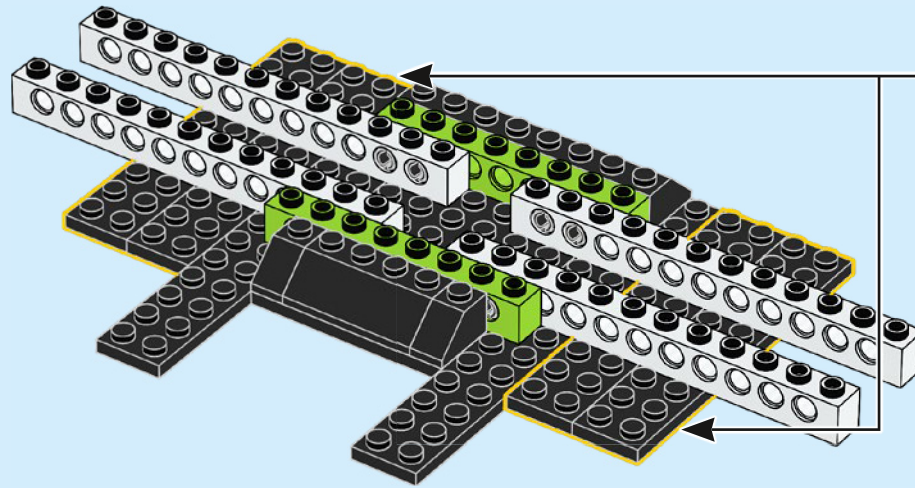

272

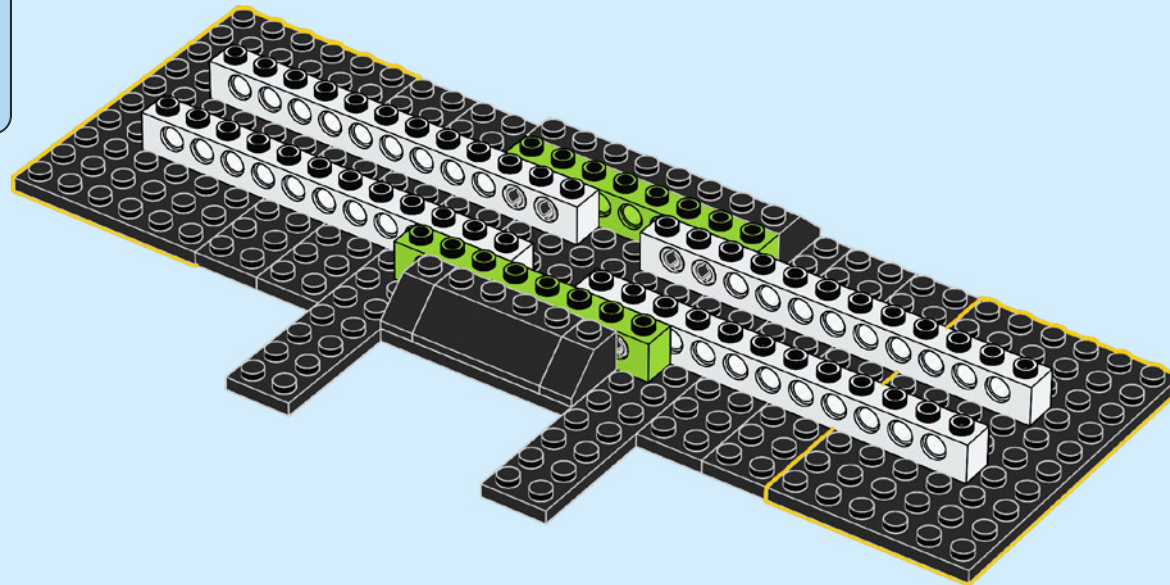

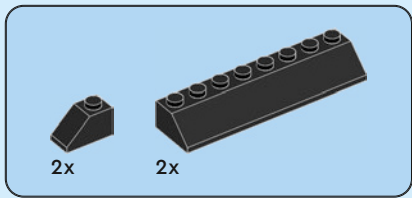

273

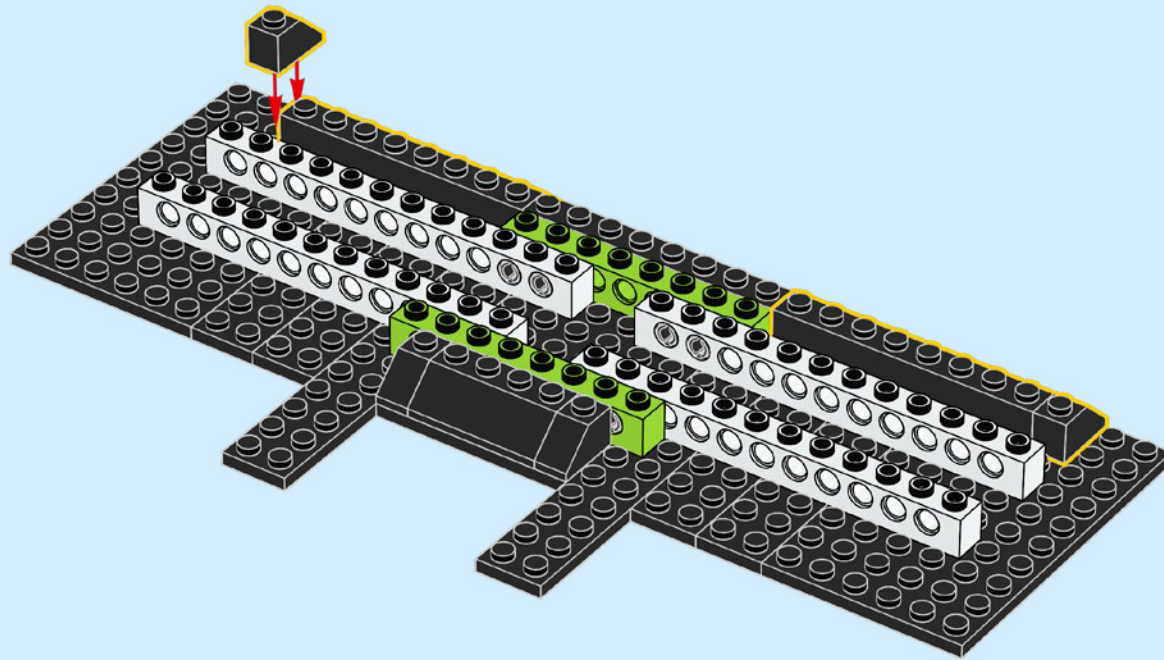

274

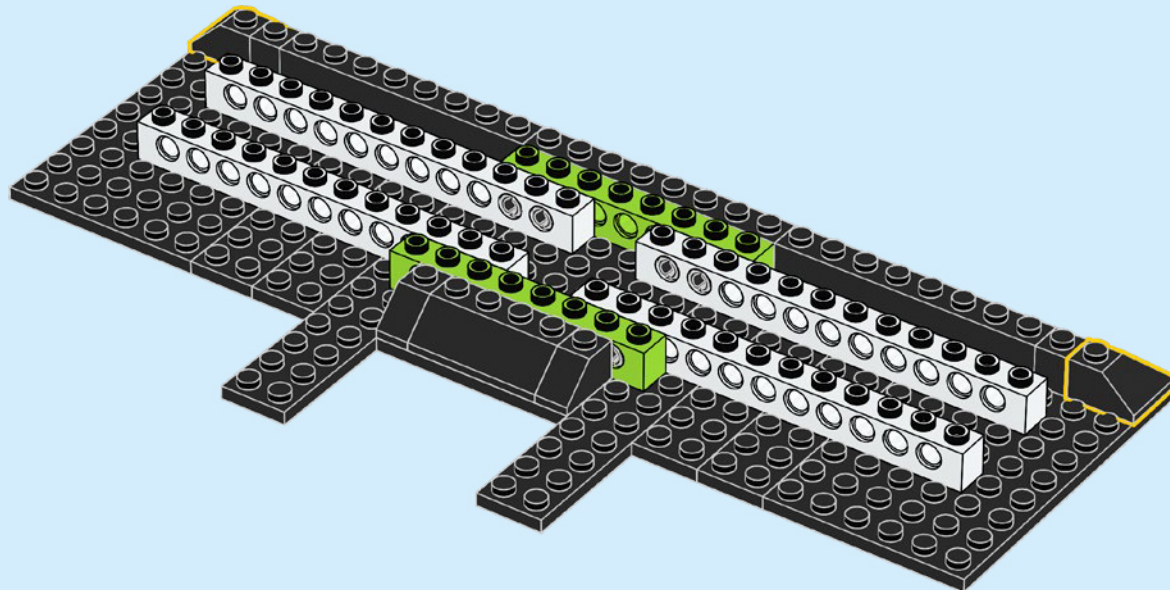

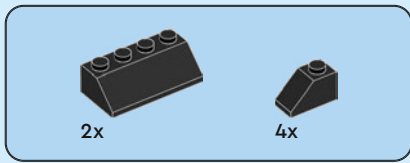

275

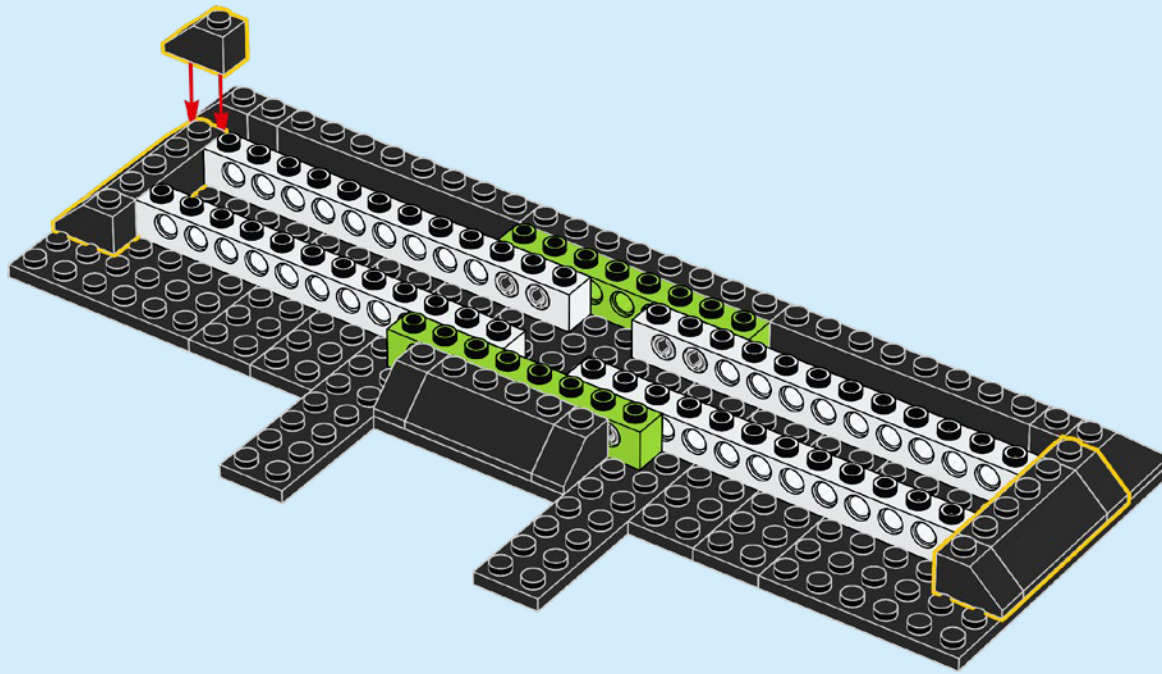

276

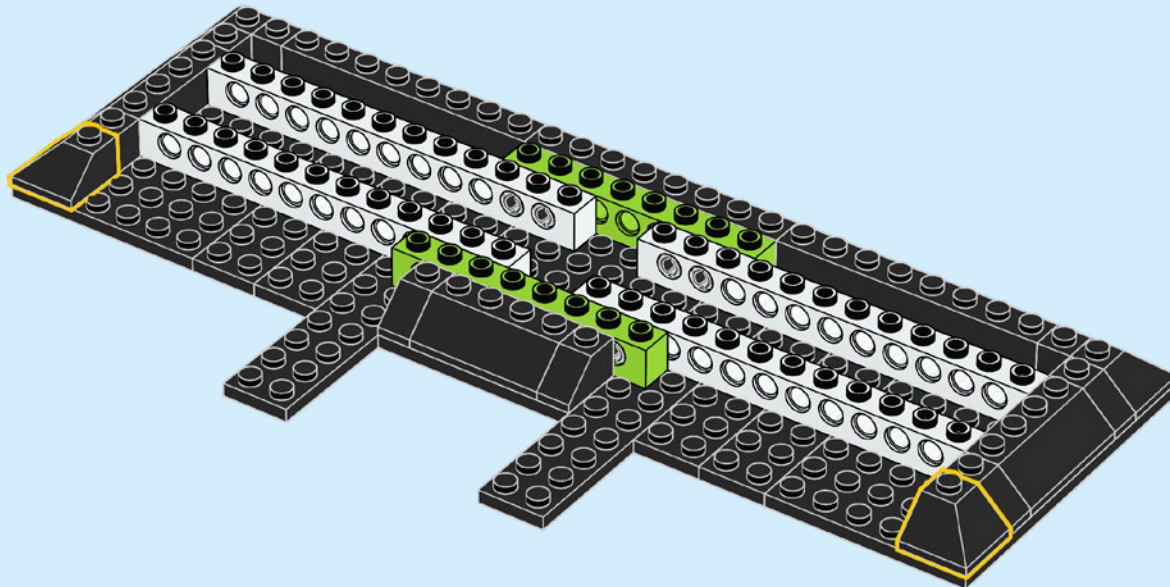



2x



2x

277

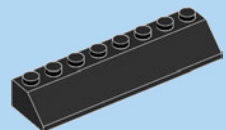
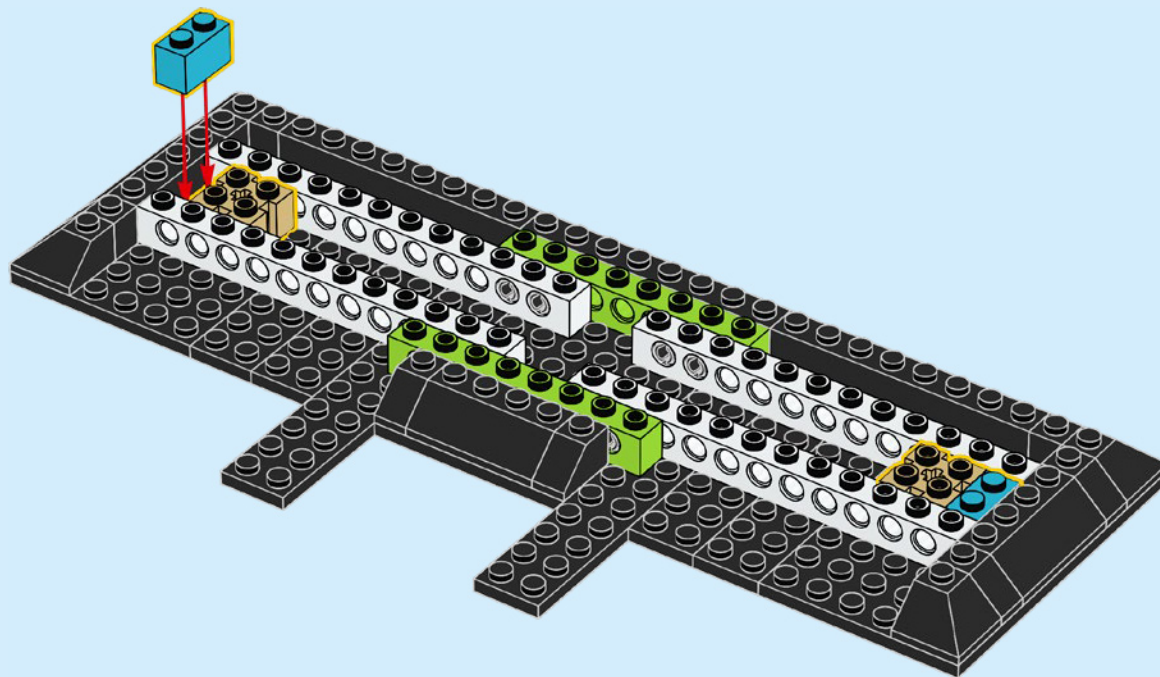

2x

278

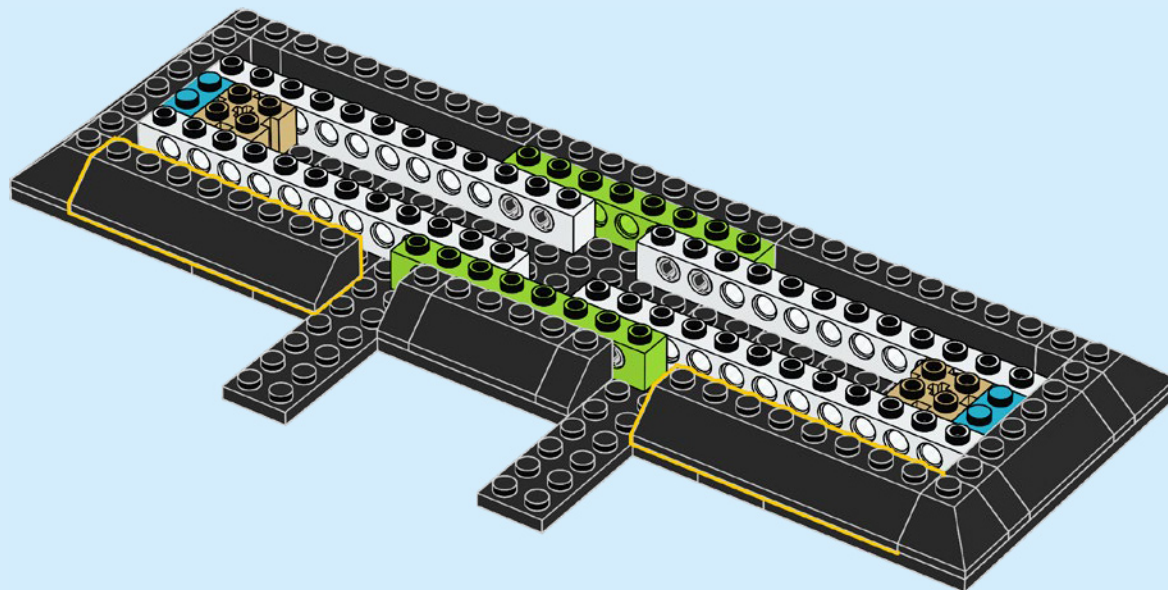

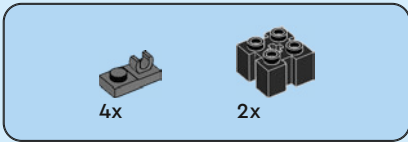

279

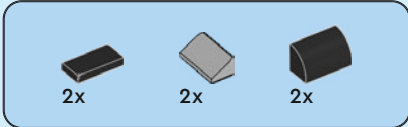
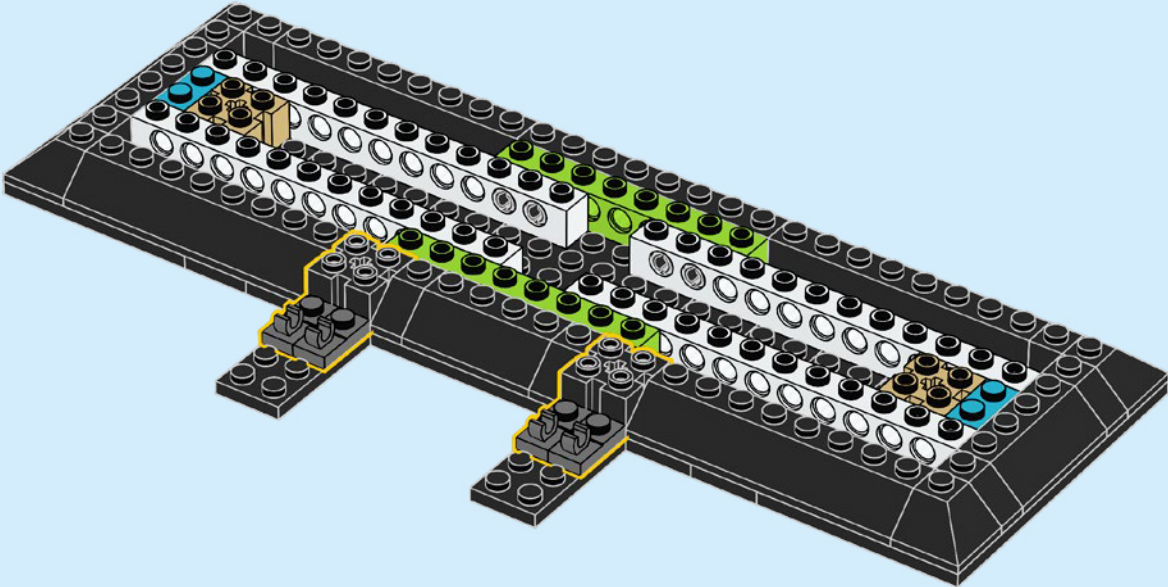

280

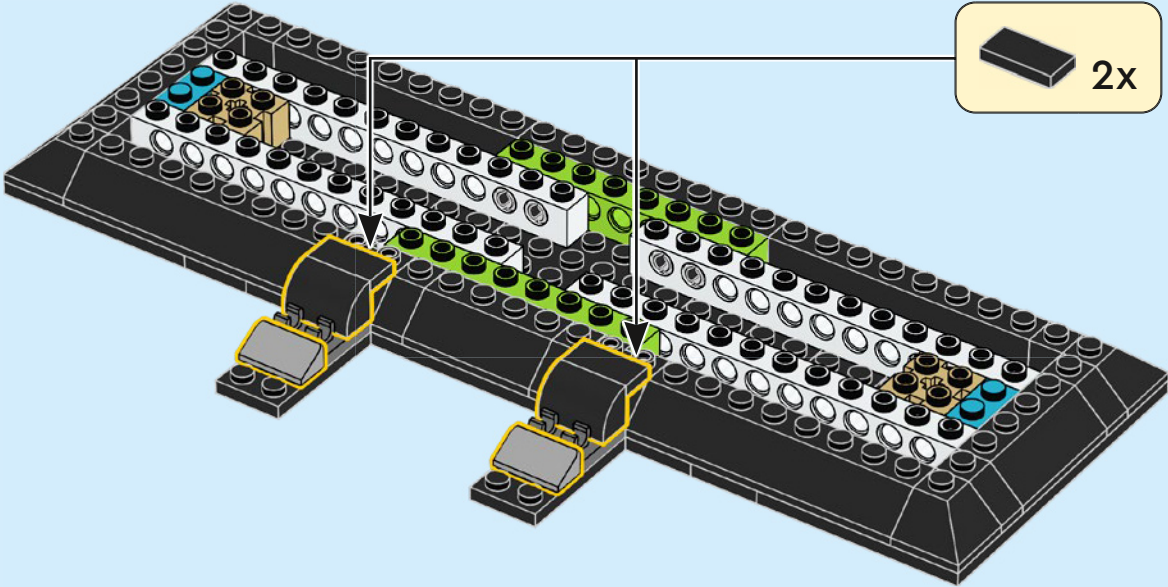

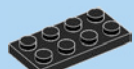

4x

281

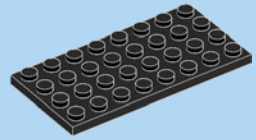
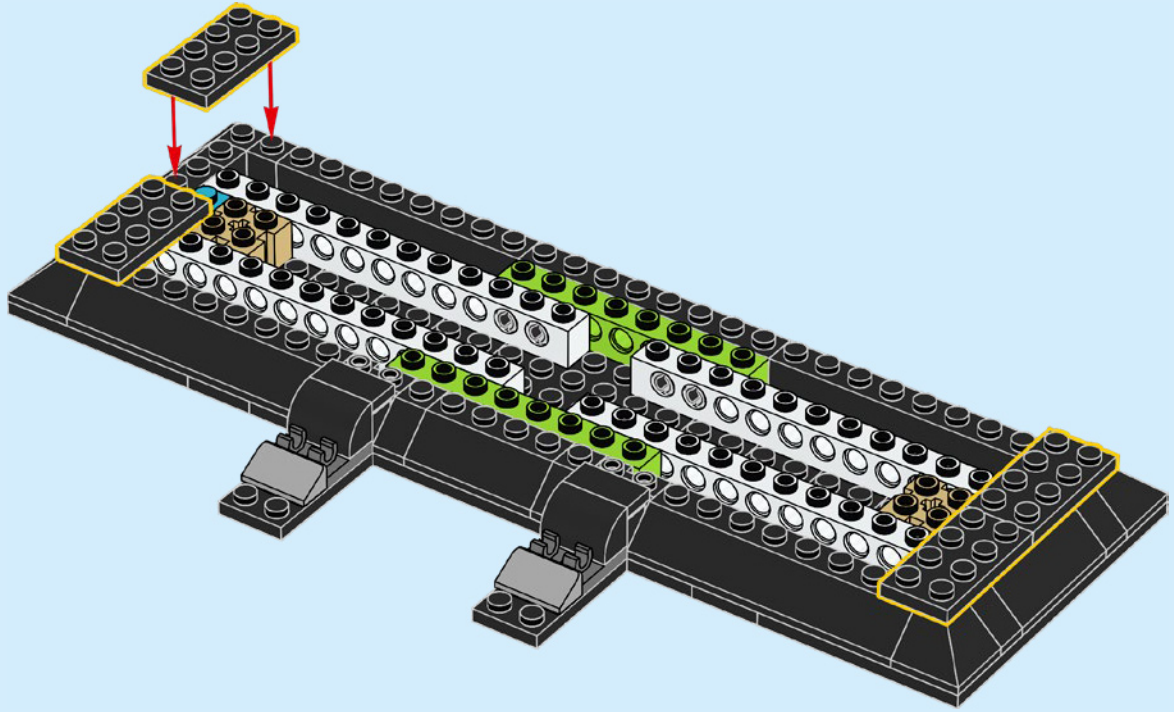

5x

282

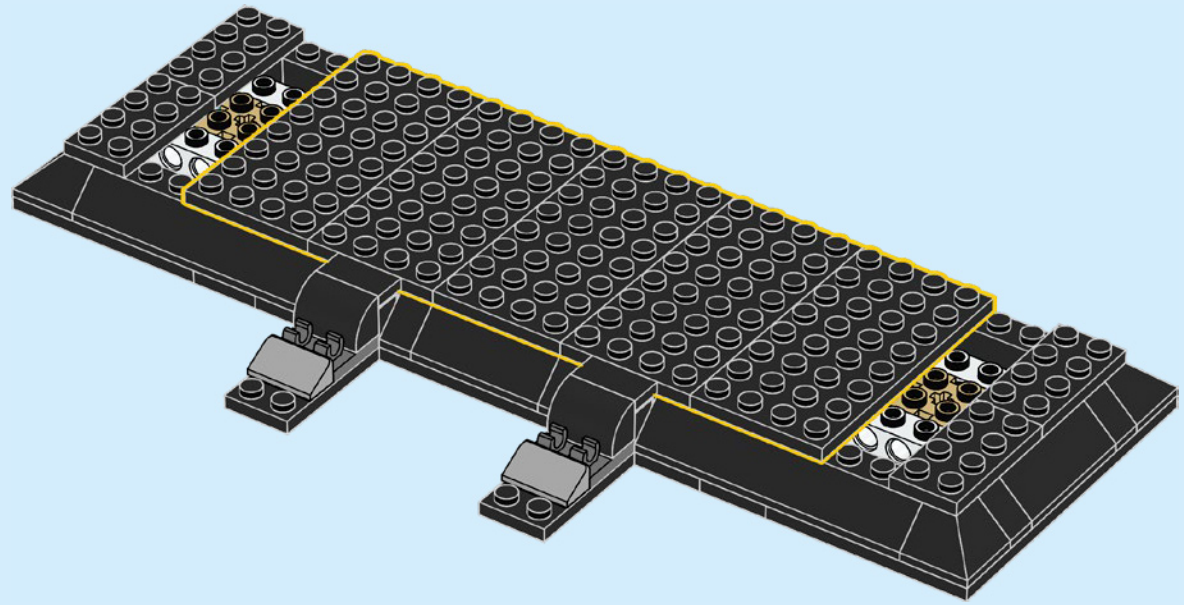

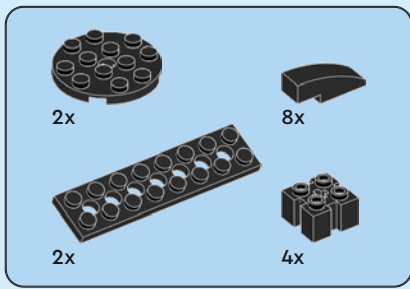

283

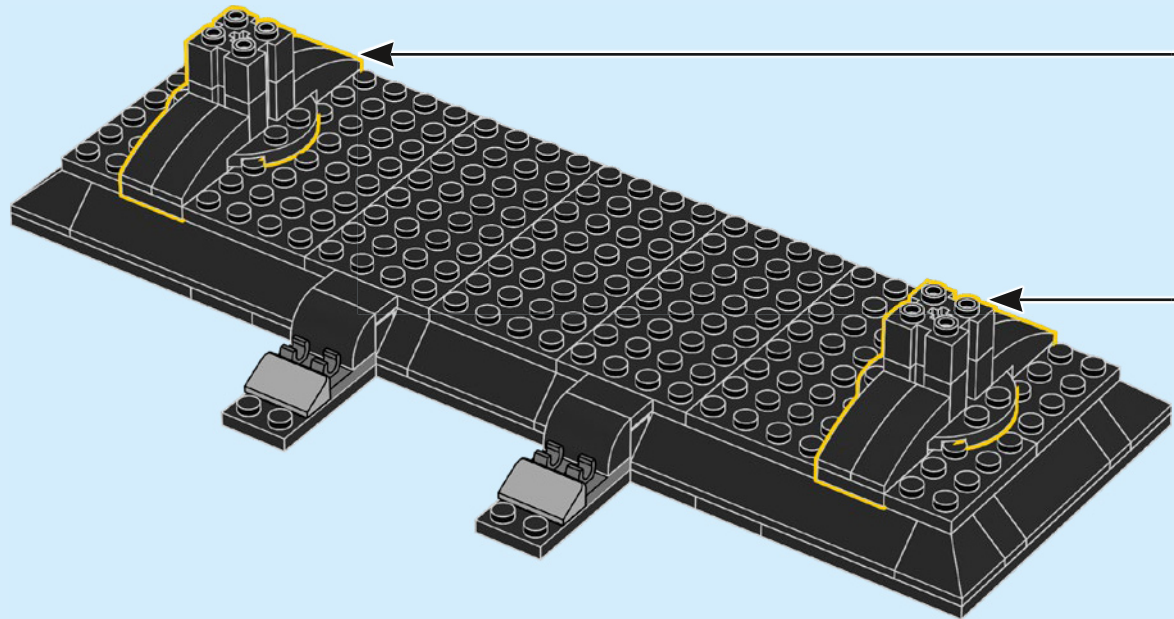
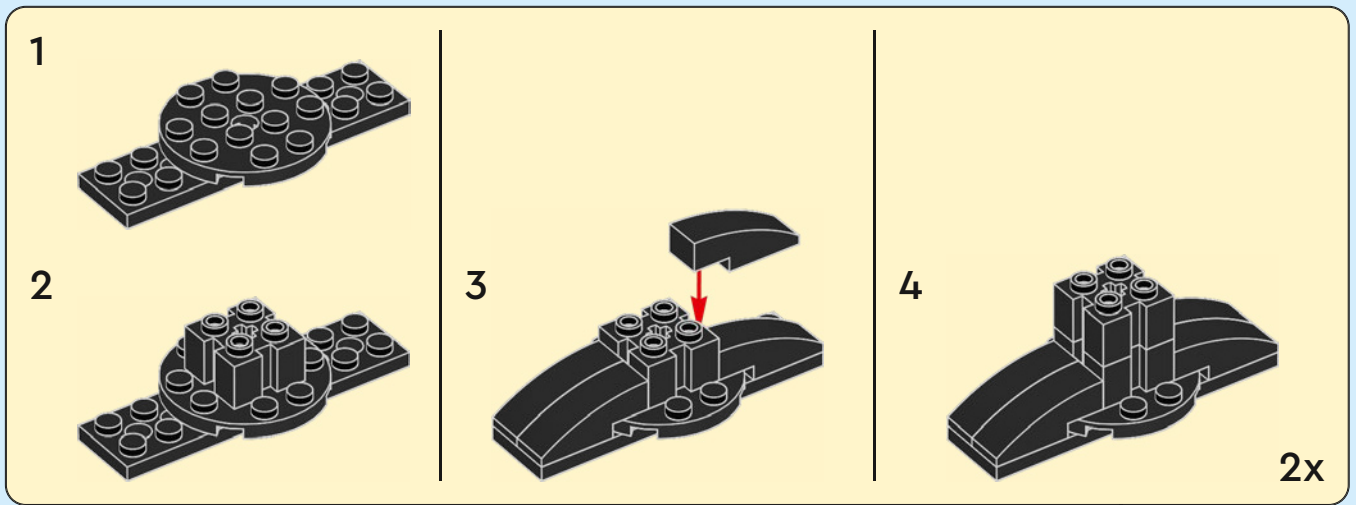

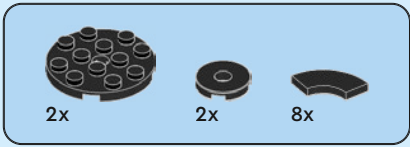

284

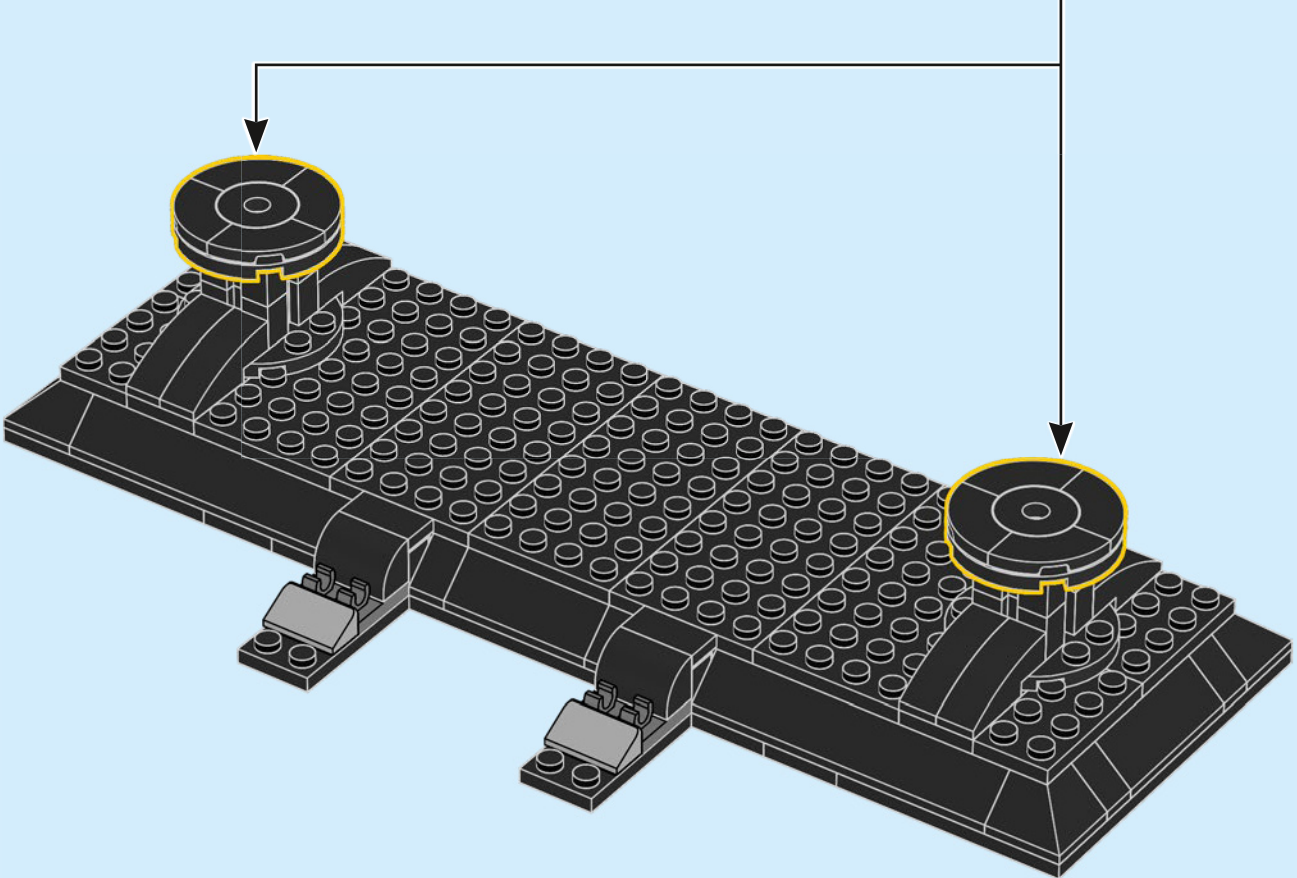
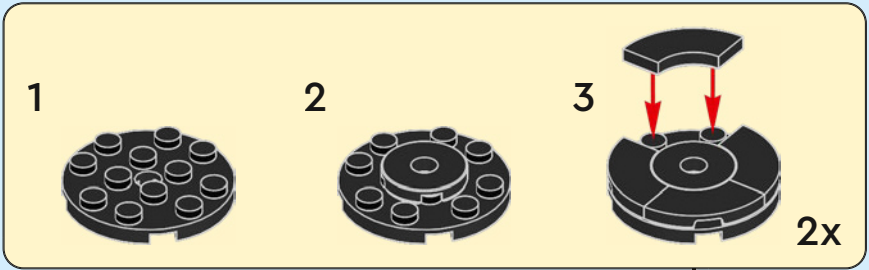

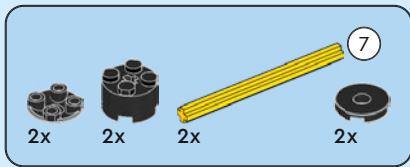

285

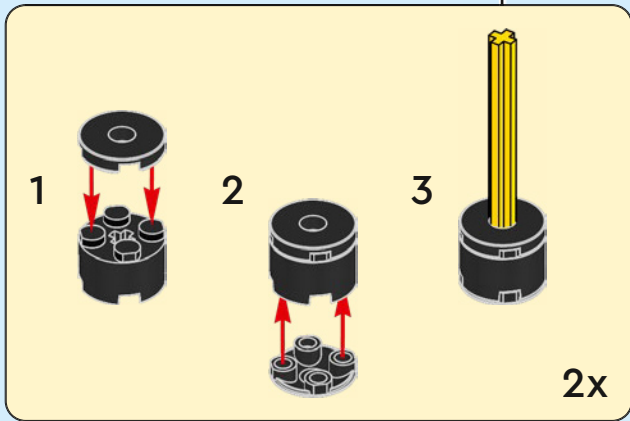
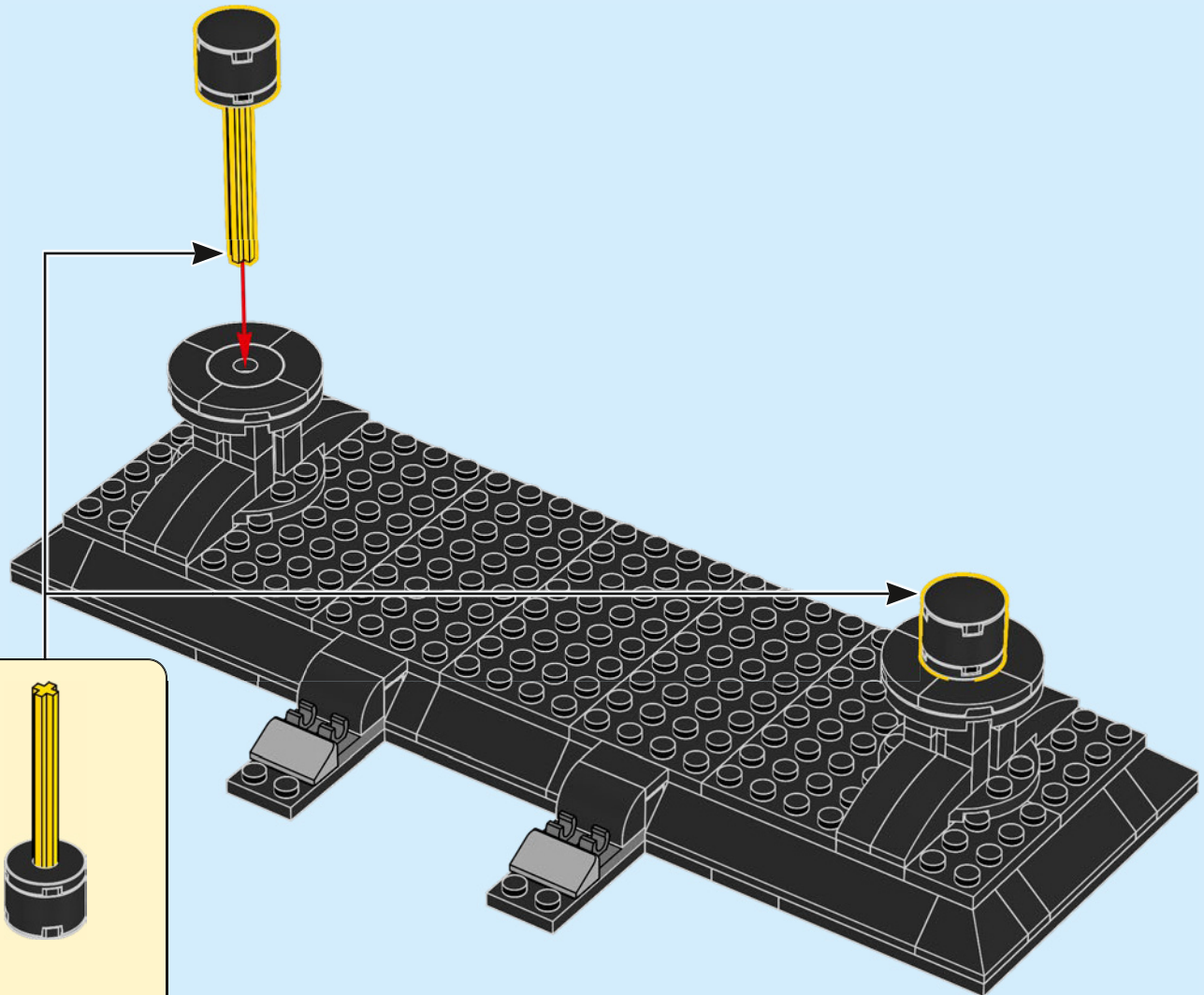

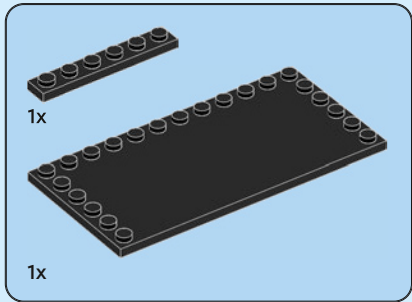

286

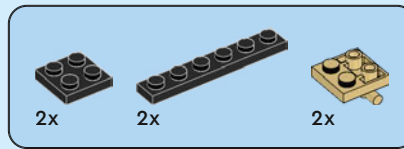
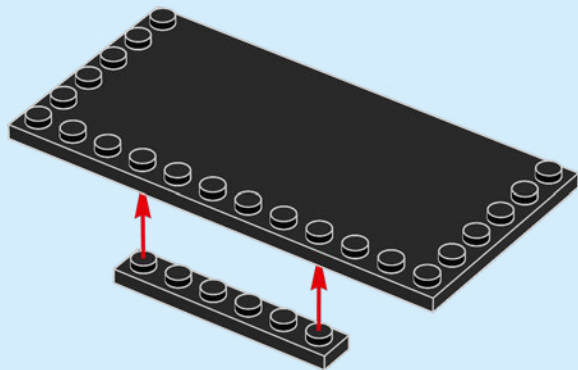

287

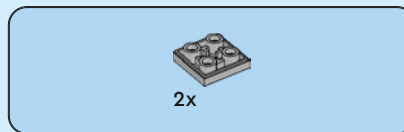
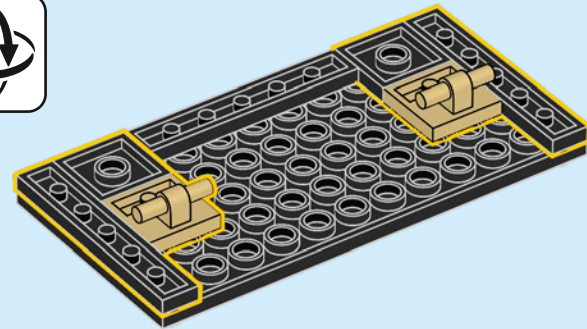

288

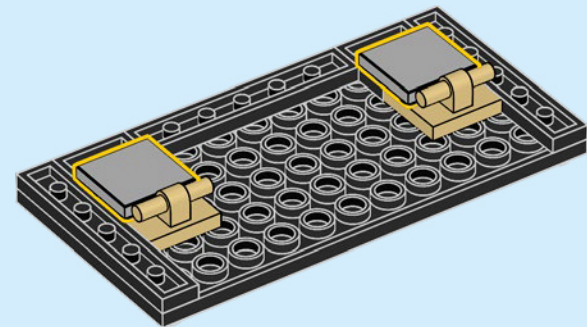

289

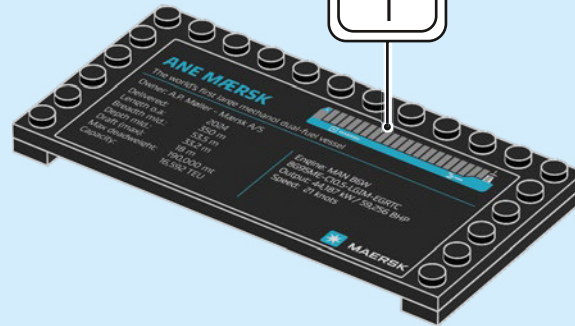

290

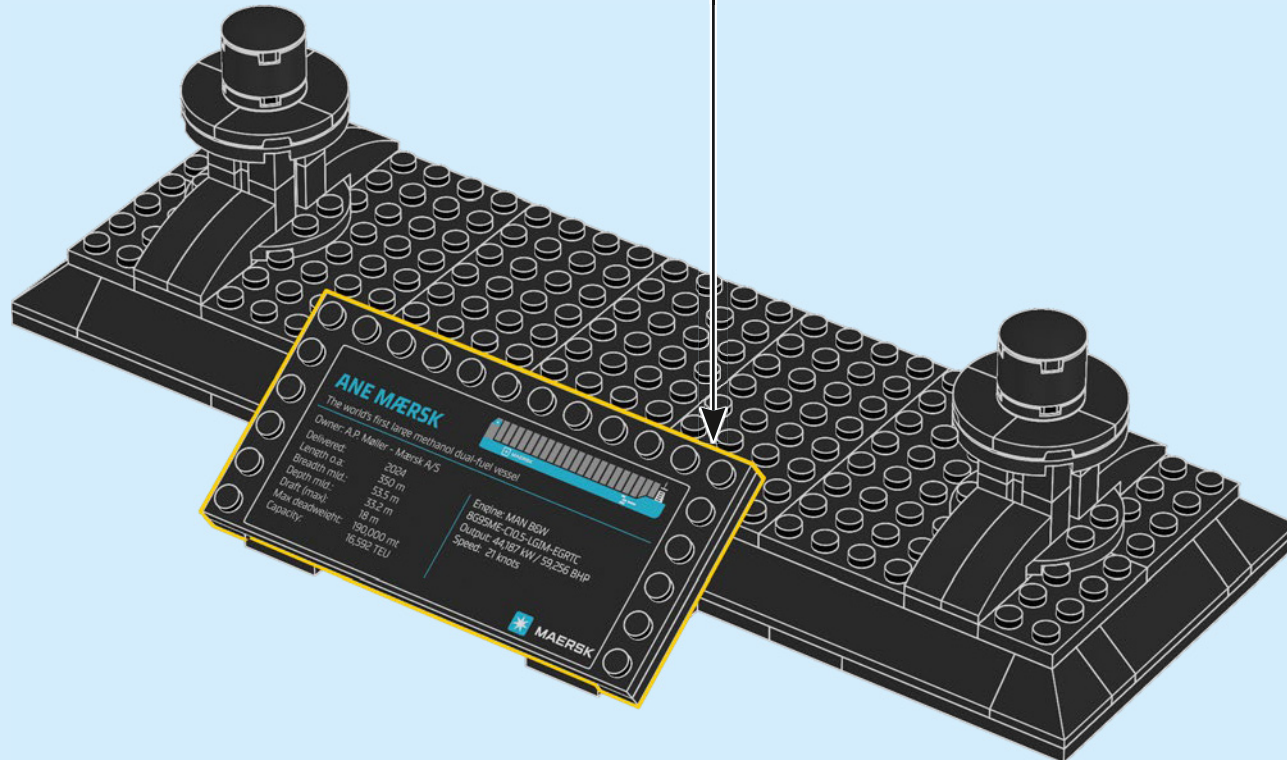

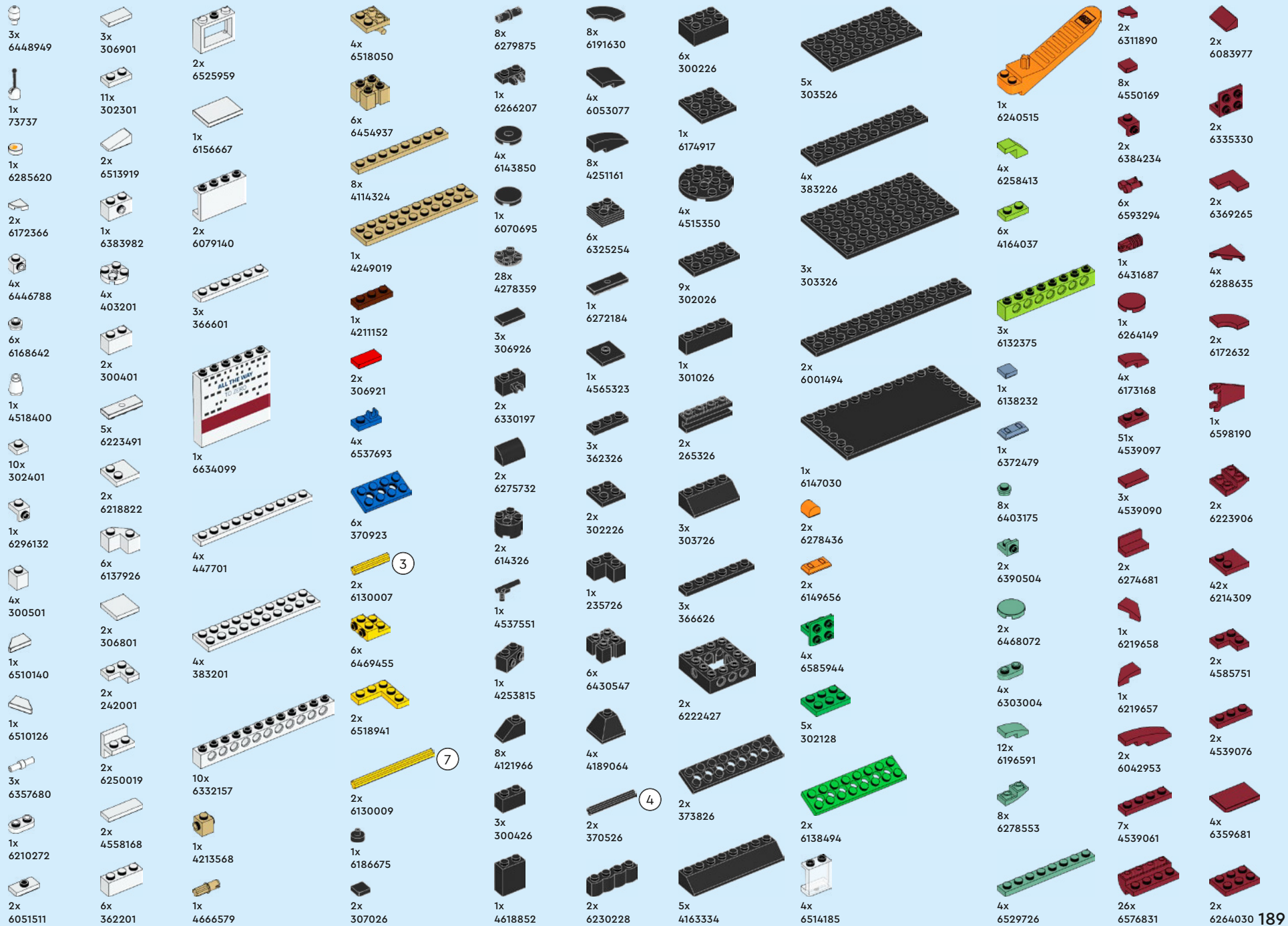

- 4x 6584062
- 4x 4541528
- 2x 6586652
- 1x 6335319
- 21x 6052777
- 6x 4541507
- 4x 4539071
- 10x 6576807
- 66x 6584063
- 1x 6465734
- 2x 6602414
- 2x 4539062
- 1x 6476042
- 1x 6350339
- 26x 6253142
- 4x 6186106
- 1x 6544174
- 6x 6440979
- 1x 4211392
- 6x 4211406
- 25x 4211462
- 2x 4211705
- 1x 6539385
- 11x 6015344
- 9x 6258831
- 2x 4568637
- 1x 4211415
- 2x 4568637
- 4x 4211412
- 33x 4211388
- 2x 4211399
- 11x 6598026
- 6x 6227897
- 70x 4211398
- 27x 4211395
- 12x 6061675
- 4x 6059033
- 2x 6079461
- 30x 4527174
- 16x 6598025
- 16x 6595947
- 35x 4211452
- 64x 6123809
- 6x 4211564
- 3x 6170387
- 32x 4211363
- 4x 6469440
- 1x 6446028
- 2x 6132886
- 2x 6043639
- 2x 4211580
- 15x 4211413
- 4x 6258820
- 10x 4211387
- 10x 6171894
- 10x 4211396
- 12x 4211386
- 1x 6514057
- 1x 6514051
- 2x 4210719
- 2x 4211063
- 4x 6344754
- 1x 6514456
- 2x 6123814
- 4x 4543086
- 1x 4218696
- 6x 4211094
- 11x 4211056
- 2x 4210651
- 1x 6287847
- 1x 6322046
- 2x 6215606
- 1x 6292145
- 1x 6088641
- 2x 6335563
- 1x 6593293
- 2x 6603341
- 8x 6603339
- 2x 6603283
- 4x 6603285
- 6x 6603587
- 8x 6603337
- 2x 6603334
- 1x 6603315
- 4x 6603598
- 17x 6603336
- 1x 6603301
- 1x 6603600
- 1x 6603591
- 1x 6603586
- 1x 6603585
- 2x 6603590
- 2x 6603344
- 2x 6603309
- 3x 6603316
- 1x 6593286
- 2x 6604733
- 2x 6603601
- 7x 6603965
- 30x 6603319
- 2x 6603317
- 2x 6576809
- 2x 6603313
- 1x 6598028
- 2x 6576810
- 1x 6598027
- 2x 6603599
- 2x 6603596
- 2x 6603342
- 2x 6603312
- 10x 6603286
- 2x 6603333
- 10x 6603340
- 2x 6603318
- 4x 6603343
- 2x 6603335
- 4x 6603595
- 1x 6603594
- 6x 6603589
- 2x 6603332
- 2x 6576813



[LEGO.com/service](https://www.LEGO.com/service)

YOU COULD WIN



Scan this QR code or go to
LEGO.COM/PRODUCTFEEDBACK and give us
your short feedback about this LEGO® set
for a chance to win a cool LEGO prize.

Terms and Conditions apply*

EN: YOU COULD WIN. Terms and Conditions apply* **DE: Du könntest GEWINNEN.** Es gelten die Teilnahmebedingungen* **FR: Tu pourrais GAGNER.** Des conditions s'appliquent* **IT: Potresti VINCERE tu.** Termini e condizioni sono applicabili* **ES: Puedes GANAR.** Aplican términos y condiciones* **PT: PODERÁ GANHAR.** Aplicam-se Termos e Condições* **ZH: 轻松获奖.** 条款和条件适用* **PL: Szansa na WYGRANA.** Obowiązuje regulamin* **CS: Máte šanci VYHRÁT.** Platí všeobecné smluvní podmínky* **SK: Máte šancu VYHRÁT.** Platia všeobecné zmluvné podmienky* **HU: TE IS NYERHETSZ.** Felhasználási feltételek érvényesek* **UA: ВИ МОЖЕТЕ ВИГРАТИ.** Застосовуються загальні положення та умови* **RO: Ai putea CÂȘTIGA.** Se aplică termenii și condiții* **BG: Можете да СПЕЧЕЛИТЕ.** Има определени правила и условия* **LV: Tu vari LAIMĒT.** Ir spēkā noteikumi un nosacījumi.* **ET: Sul on võimalus VÕITA.** Kehtivad tingimused* **LT: Jūs galite LAIMĖTI.** Taikomos sąlygos*

*[LEGO.com/productfeedback-terms](https://www.lego.com/productfeedback-terms)

