



LEGO.com/sustainable-packaging



FR

DONNEZ
OU
RECYCLEZ



OU



OU



ASSOCIATION

MAGASIN

DÉCHÈTERIE

Adresses sur quefairedemesdechets.fr

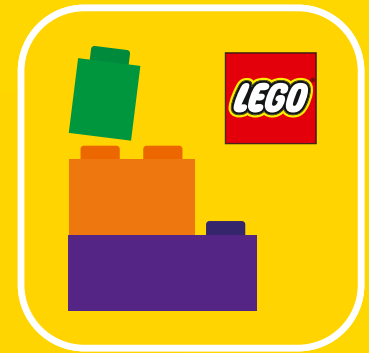

🔍 LEGO® Builder

BUILDER



Apple and the Apple logo are trademarks of Apple Inc., registered in the U.S. and other countries and regions. App Store is a service mark of Apple Inc. Google Play and the Google Play logo are trademarks of Google LLC. Tencent and the Tencent logo are trademarks of Tencent Inc.

🔍 LEGO.com/devicecheck

EN Ask parents' permission before going online | DE Eltern um Erlaubnis bitten, bevor du online gehst | FR Demande l'autorisation d'un parent avant d'aller en ligne | IT Chiedi il permesso ai tuoi genitori prima di andare online | ES Pídeles permiso a tus papás antes de conectarte a Internet | PT Peça autorização aos pais antes de acederes online | ZH 上网前应先征得父母的同意 | PL Poproś rodziców o zgodę, zanim wejdiesz do Internetu | CS Než půjdeš na internet, požádej rodiče o svolení | SK Skôr než pôjdeš na internet, vypoťaj si povolenie od rodičov | HU Kérj szülői engedélyt, mielőtt online csatlakoznál! | UA Запитуйте дозволу батьків, перш ніж користуватися інтернетом | RO Cere permisiunea părinților înainte de a te conecta online | BG Поискайте разрешение от родител, преди да влезете онлайн | LV Pirms došanās tiešsaistē palūdz atļauju vecākiem | ET Enne Interneti kasutamist küsi vanematelt luba | LT Prieš prisijungdami prie interneto, atsiklauskite tėvų



VI PRESENTIAMO L'ANE MÆRSK

L'ANE MÆRSK è una nave davvero unica nel suo genere: la prima grande nave portacontainer alimentata a carburante a basse emissioni come bio-metanolo ed e-metanolo. Da quando l'ANE MÆRSK ha solcato le onde per la prima volta nel gennaio 2024, numerose navi dual-fuel hanno preso il largo, segnando un capitolo nuovo e cruciale nella decarbonizzazione dei trasporti marittimi e del commercio globale.

L'ANE MÆRSK è lunga 350 metri e larga 53,5 metri. Senza carico, il natante pesa 47.700 tonnellate, e ha una capacità di carico complessiva di 190.000 tonnellate, l'equivalente di 29.000 elefanti africani, più che sufficiente per trasportare merci, carburante ed equipaggio.

La nave può trasportare 16.592 TEU (equivalente a 6 m), e se li disponessimo in fila, si estenderebbero per 100,5 km, ovvero la lunghezza di 959 campi da calcio.





 MAERSK

ALL THE 10 ZERO WAY



NAVIGARE IL CAMBIAMENTO – LA STORIA DELLE SPEDIZIONI MARITTIME

Da migliaia di anni, gli esseri umani trasportano merci per mare, ma fino alla Rivoluzione Industriale e all'invenzione del motore a vapore, eravamo completamente alla mercé delle condizioni meteorologiche. Niente vento, niente traversata. Con l'avvento del motore a vapore, per la prima volta nella storia dell'umanità, l'equipaggio di una nave non dipendeva più dalle condizioni meteo o dalla propulsione manuale. L'invenzione ha completamente rivoluzionato il trasporto marittimo, rendendo possibili nuove rotte e dando al commercio marittimo una grande spinta.

Sebbene i motori a vapore rappresentassero un notevole progresso rispetto alle vele, erano ancora poco efficienti, e non sarebbe passato molto tempo prima che la navigazione venisse rivoluzionata dall'invenzione del motore diesel. Tuttavia, le rivoluzioni nel settore marittimo richiedono tempo, e sarebbero trascorsi diversi decenni prima che il diesel sostituisse completamente la propulsione a vapore. Maersk acquistò la sua prima nave diesel, la LEISE MÆRSK, nel 1921, appena nove anni dopo il lancio della prima nave mercantile oceanica diesel.



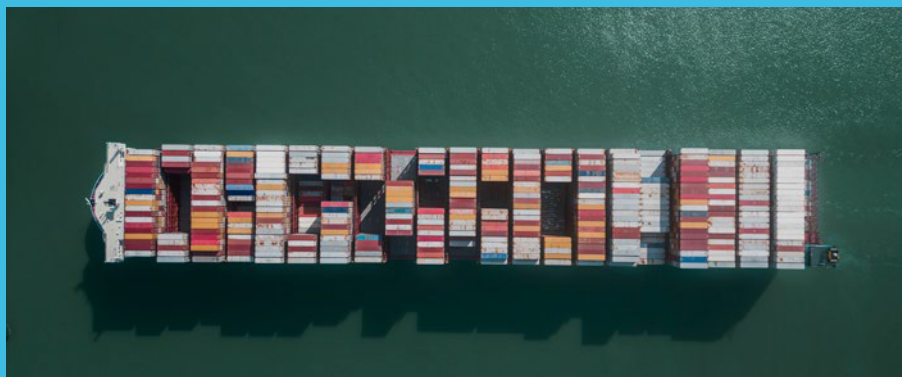

Nel 1956, l'industria subì un'altra rivoluzione con l'introduzione della "movimentazione dei container", un sistema che permetteva di caricare direttamente i rimorchi dei camion sulle navi, aumentando significativamente l'efficienza delle operazioni di trasporto marittimo. L'introduzione del container ridusse il tempo necessario per caricare e scaricare le navi da diversi giorni a poche ore.

Grazie al container e al codice a barre – l'eroe "invisibile" del commercio mondiale – un produttore in una qualsiasi parte del mondo può vendere i propri prodotti su tutti i mercati, rendendo la globalizzazione fisicamente attuabile. Il mondo che conosciamo oggi dipende profondamente dalle catene di approvvigionamento globali. Dal produttore di banane in Colombia, fino al bambino danese che consuma una banana per il suo pranzo, le supply chain mantengono il mondo connesso e garantiscono il flusso di cibi, medicine, merci e materiali per le persone di tutto il mondo.





 MAER

 MAERS

 MAERSK

 MAERSK

IL SIGNIFICATO DI UN NOME

Dal 1906, tutte le navi della flotta Maersk includono "MÆRSK" nel loro nome. La maggior parte delle prime imbarcazioni portava nomi legati alla famiglia fondatrice ma, man mano che la flotta cresceva, i nomi disponibili si esaurirono e la tradizione di denominare le navi in questo modo fu interrotta. Oggi, le navi Maersk portano anche i nomi di città e fiumi.

Quando Maersk si trovò a denominare la nuova serie di navi dual-fuel, ritornò alla tradizione familiare di assegnare i nomi dei membri della famiglia fondatrice, scegliendo questa volta nomi che iniziavano con la lettera A, per simboleggiare l'inizio di una nuova era.

ANE MÆRSK prende il nome da Ane Mærsk Mc-Kinney Uggla, presidente di A.P. Moller Holding, la società madre di A.P. Moller - Maersk. A.P. Moller - Maersk fu fondata nel 1904 da Arnold Peter Møller. Ane è la nipote del fondatore del Gruppo, Arnold Peter Møller, e sua moglie, Chastine Mc-Kinney Møller.



ANE MAERSK





LA WHITE STAR – UN FARO DI SPERANZA

L'iconica stella bianca a sette punte fa parte del retaggio di Maersk da prima della fondazione dell'azienda nel 1904 ed è un simbolo duraturo dei forti legami familiari che ancora supportano la società, oltre 100 anni dopo.

Agli inizi della sua carriera, il Capitano Peter Mærsk Møller, padre di A.P. Møller, lavorava per un armatore inglese, e sua moglie Anna talvolta lo accompagnava nei suoi viaggi in mare. Fu proprio durante uno di questi viaggi che Anna si ammalò gravemente. Temendo che non ce l'avrebbe fatta, Peter Mærsk Møller salì sul ponte e implorò Dio di dargli un segno che sua moglie si sarebbe ripresa. Fu in quel momento che scorse una stella solitaria illuminare il cielo altrimenti grigio.

Anna si riprese, e nel 1886, quando Peter Mærsk Møller acquistò la sua prima nave a vapore – la LAURA – decorò il fumaiolo con una stella bianca a sette punte su sfondo azzurro chiaro, come omaggio alla sua amatissima moglie. Per Peter Maersk Møller, la stella divenne il simbolo della sua guarigione e della loro buona sorte.

Da allora, la stella bianca a sette punte su uno sfondo azzurro rappresenta l'identità di Maersk, e nel corso degli anni ha subito alcune trasformazioni grafiche che ne hanno arricchito il significato e l'impatto visivo. Ci sono state molte versioni del logo, ma l'attuale logo Maersk risale all'inizio degli anni Settanta, quando si decise di adottare un approccio più moderno.



ALL THE WAY
TO ZERO



MIGLIORARE LA VITA DI TUTTI CONNETTENDO IL MONDO

In qualità di leader globale di servizi logistici, Maersk vanta oltre 100.000 clienti, opera in quasi 130 paesi e dà lavoro a più di 100.000 dipendenti. Dalle sue umili origini come compagnia di navi a vapore fino a diventare un'azienda logistica integrata che lavora per connettere e semplificare le catene di approvvigionamento dei suoi clienti, Maersk schiera oltre 700 navi e trasporta quasi il 20% dei cibi, materiali e merci del mondo.





MAERSK
MAERSK
MAERSK
MAERSK
MAERSK
MAERSK

MAERSK
MAERSK
MAERSK
MAERSK
MAERSK
MAERSK

ALL
THE TIME
THE WAY

SPREADERS
TSP98
MAERSK
MAERSK

ANE MAERSK
P423 PTP

PTP T414
65 TOP'S SWL



ALL
THE WAY
TO ZERO

VERSO IL NET ZERO – UN IMPEGNO PER UN FUTURO SENZA EMISSIONI

Di fronte all'emergenza climatica globale, il futuro delle supply chain e del commercio internazionale dipende dalla capacità di innovare e promuovere nuove fonti energetiche. Maersk ha assunto un impegno cruciale: raggiungere zero emissioni nette di gas serra entro il 2040 in tutti i settori aziendali. Mentre Maersk riduce le proprie emissioni di carbonio, l'azienda si è anche impegnata socialmente nella lotta alla crisi climatica, promuovendo la decarbonizzazione delle catene di approvvigionamento globali e favorendo una transizione equa verso un'economia net-zero.

Maersk ha stabilito obiettivi ambiziosi per il 2040, mirando a conseguire progressi significativi in questo decennio: via mare, terra, aria e nei suoi terminal. Con l'ordinazione e la consegna di numerose navi dual-fuel, alimentate da combustibili a basso impatto ambientale come il bio-metanolo, l'e-metanolo e il biometano, la missione di decarbonizzazione della flotta sta procedendo a gonfie vele.



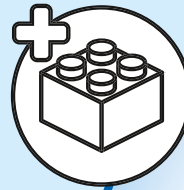
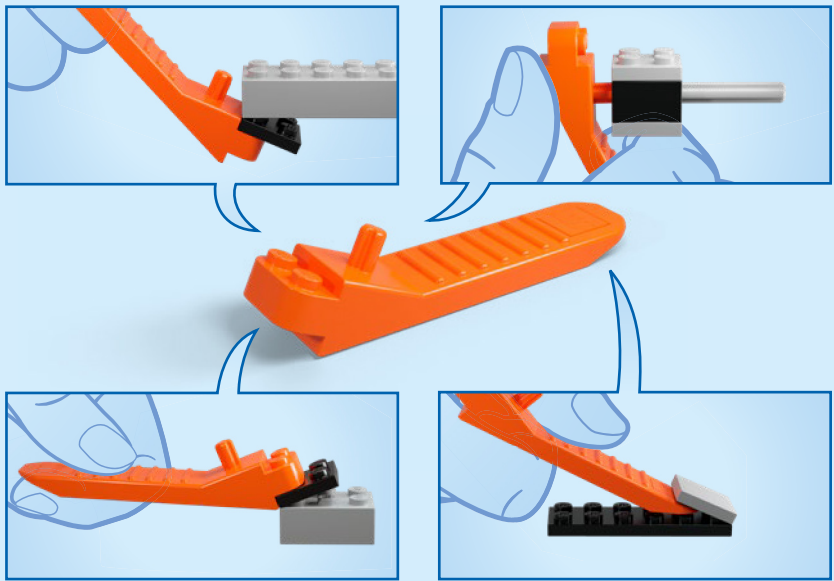

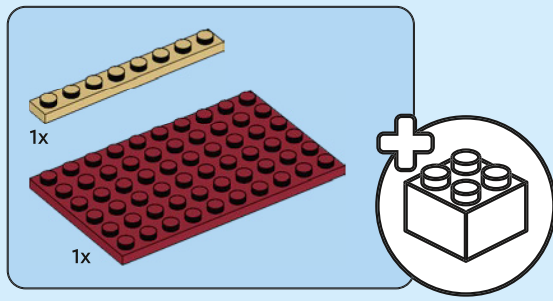

1

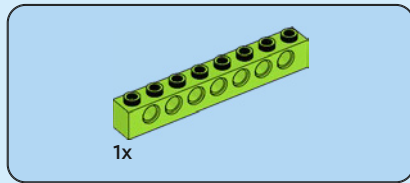
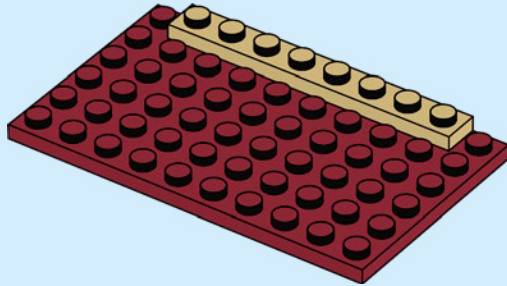

2

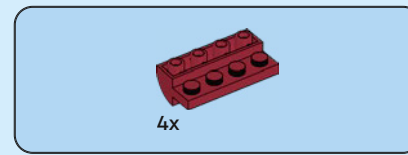
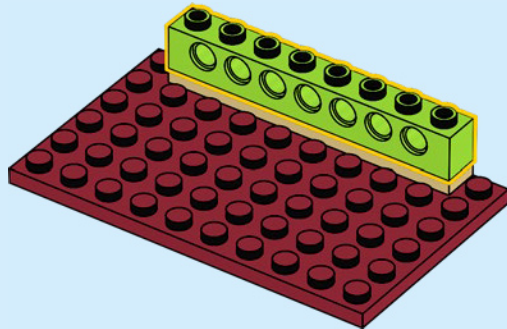

3

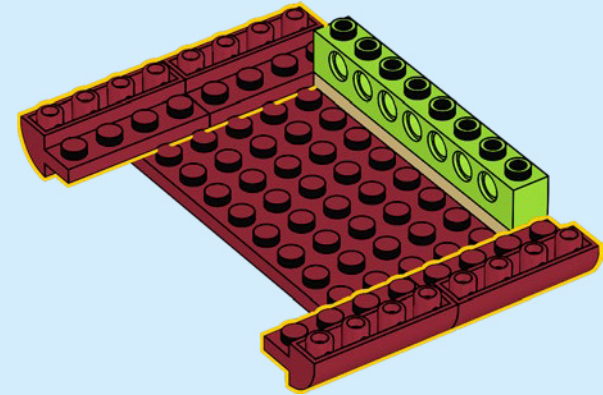

3

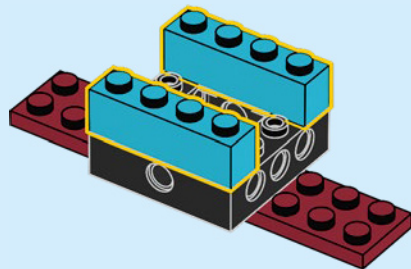

4

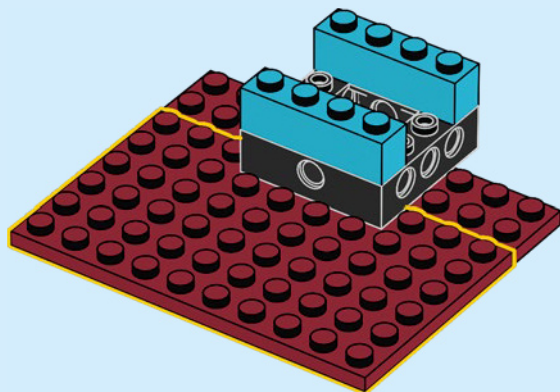

5

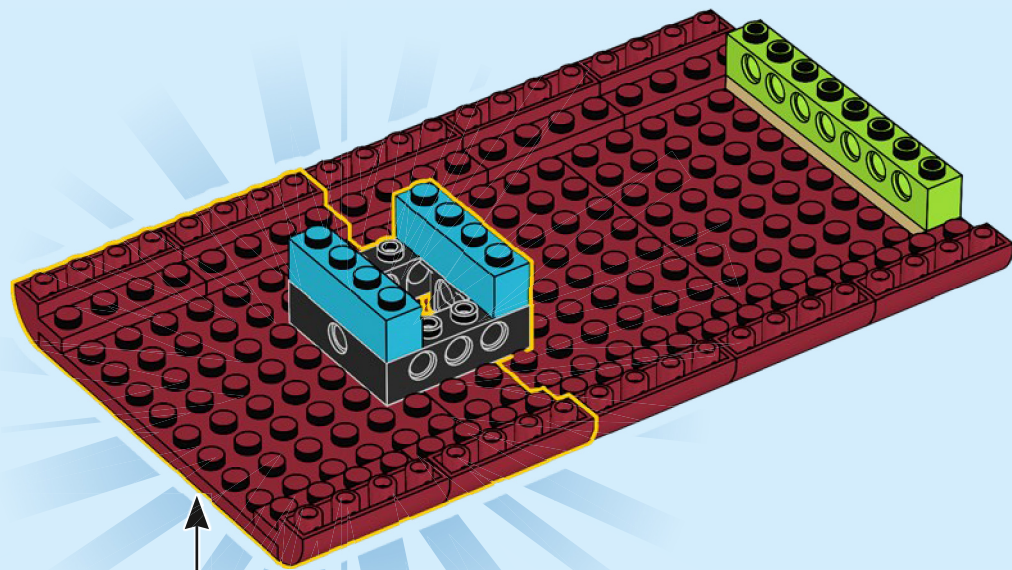
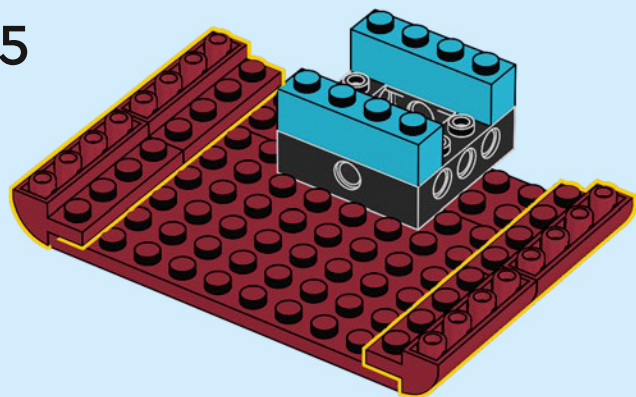

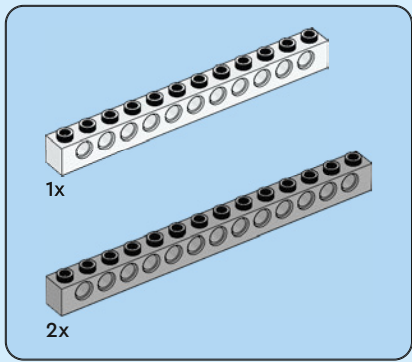

7

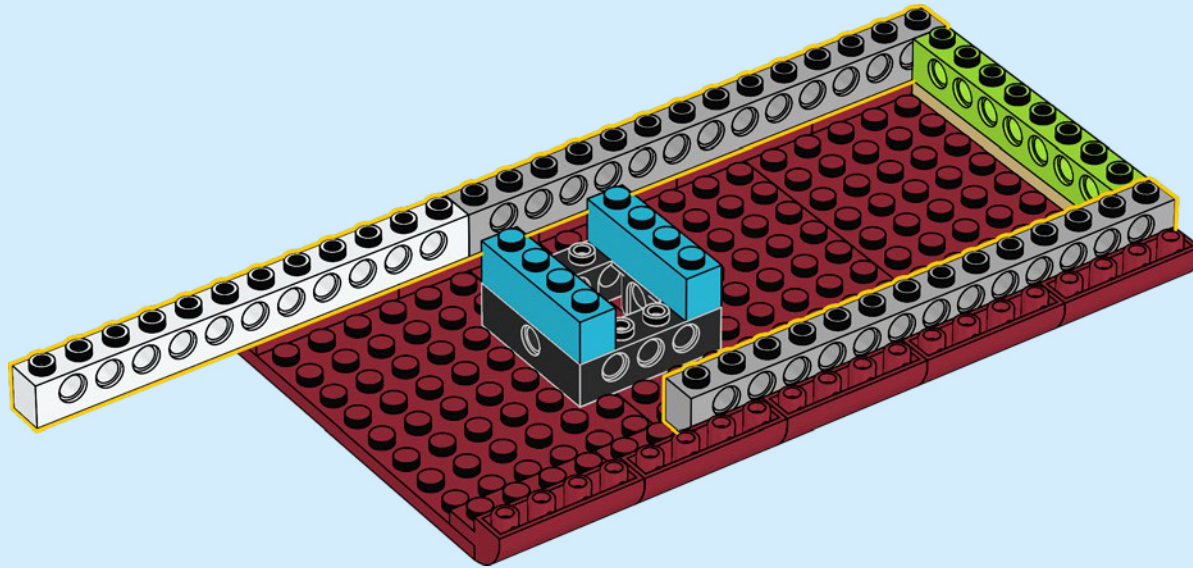

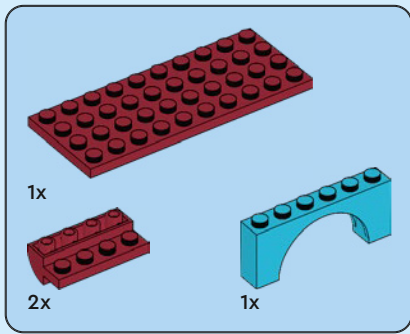

8

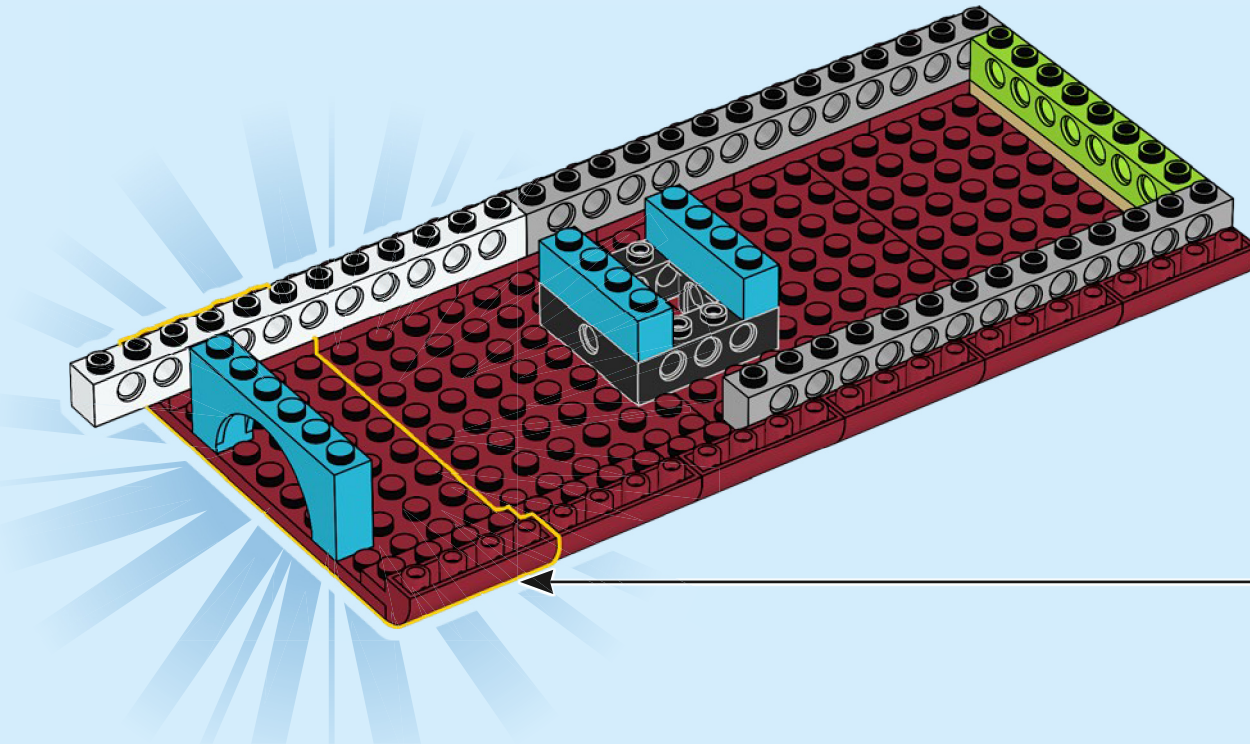
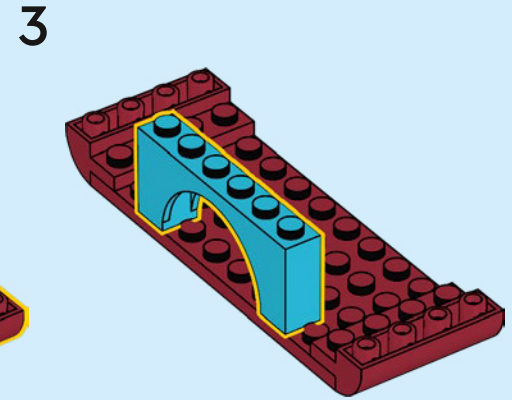
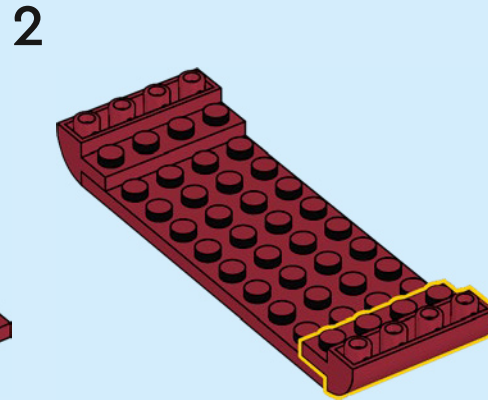
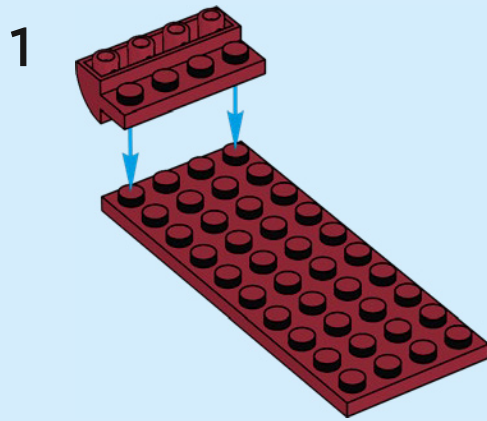

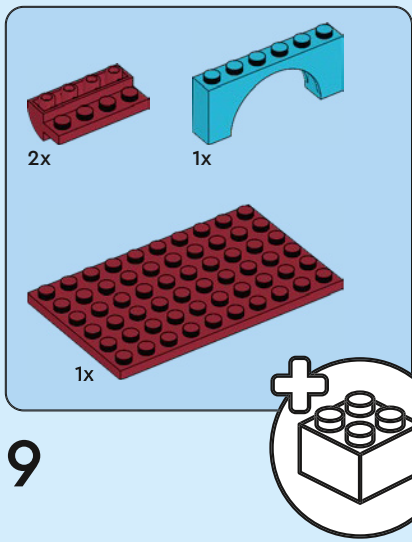

9

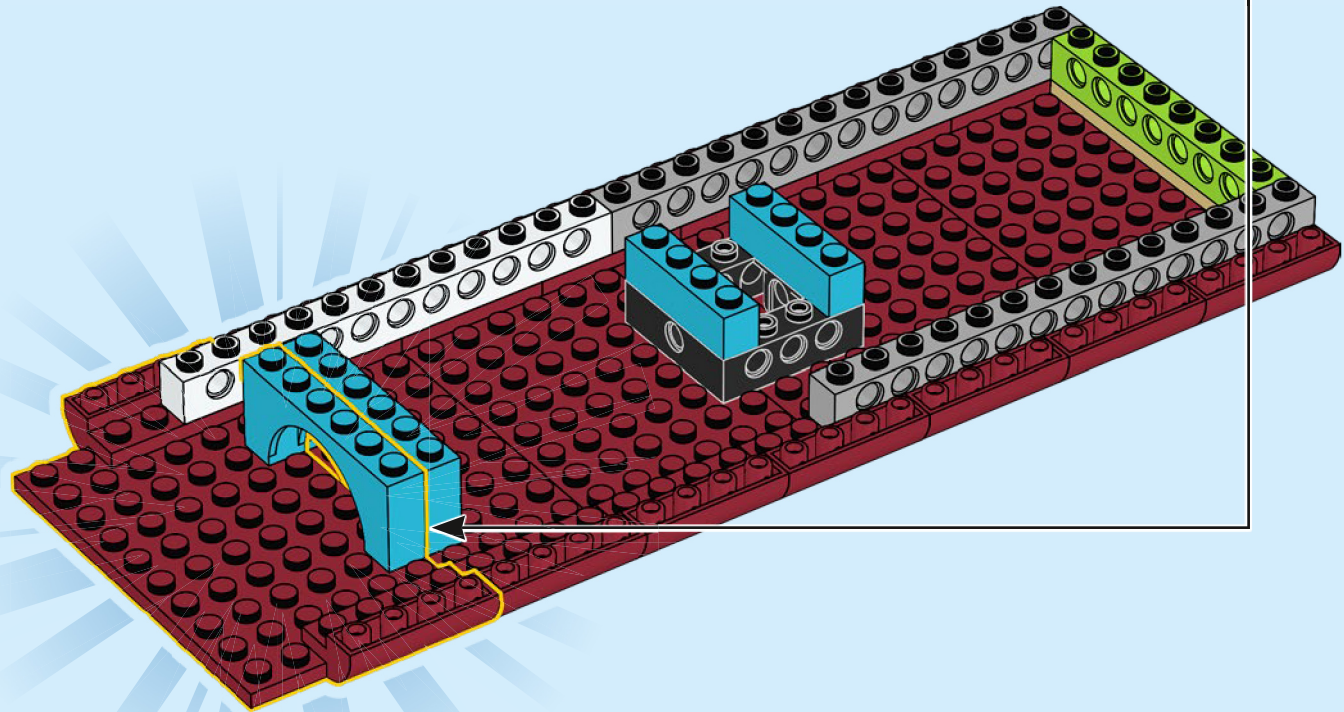
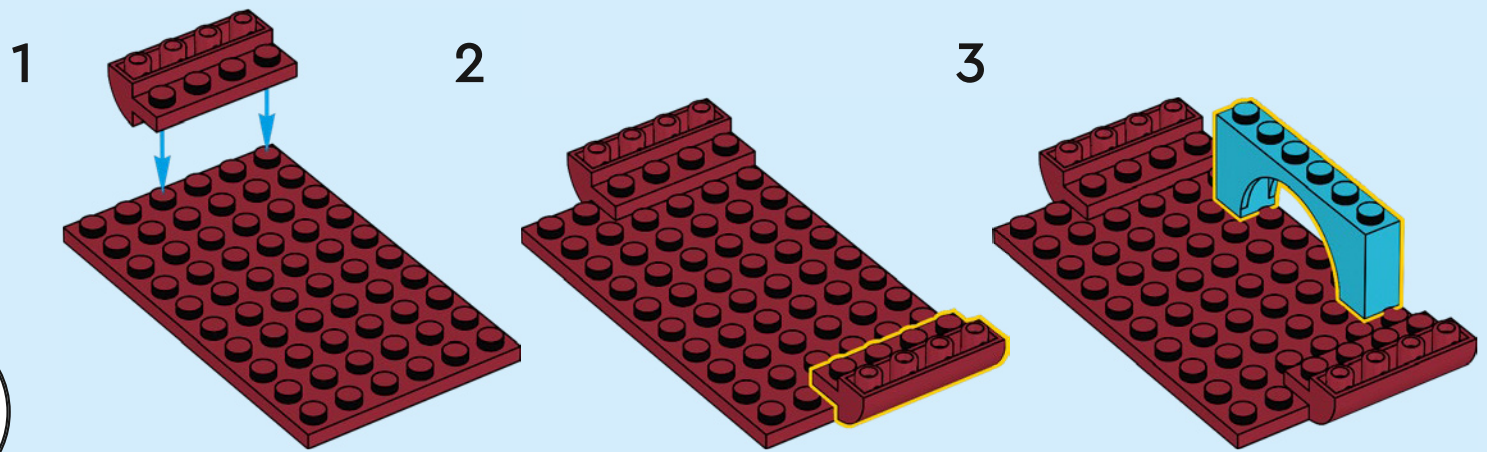

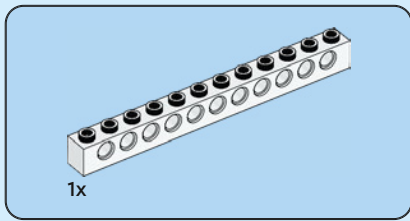

10

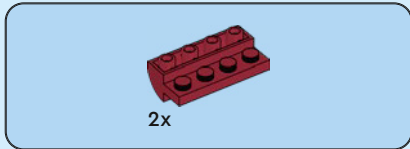
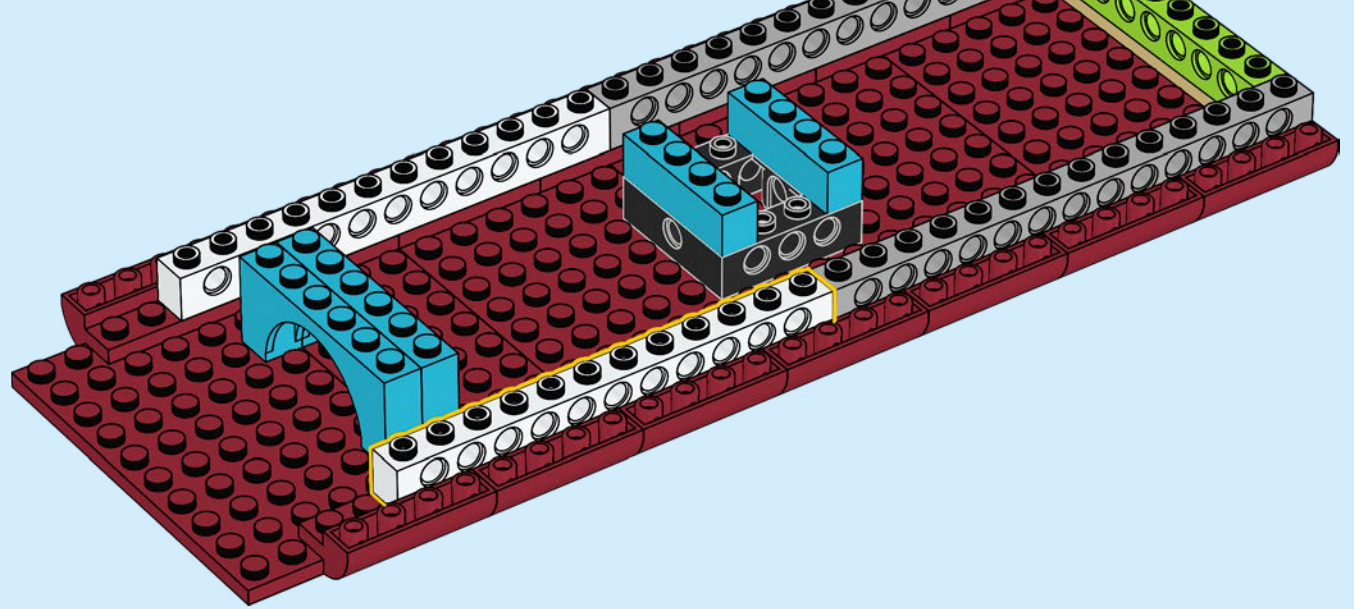

11

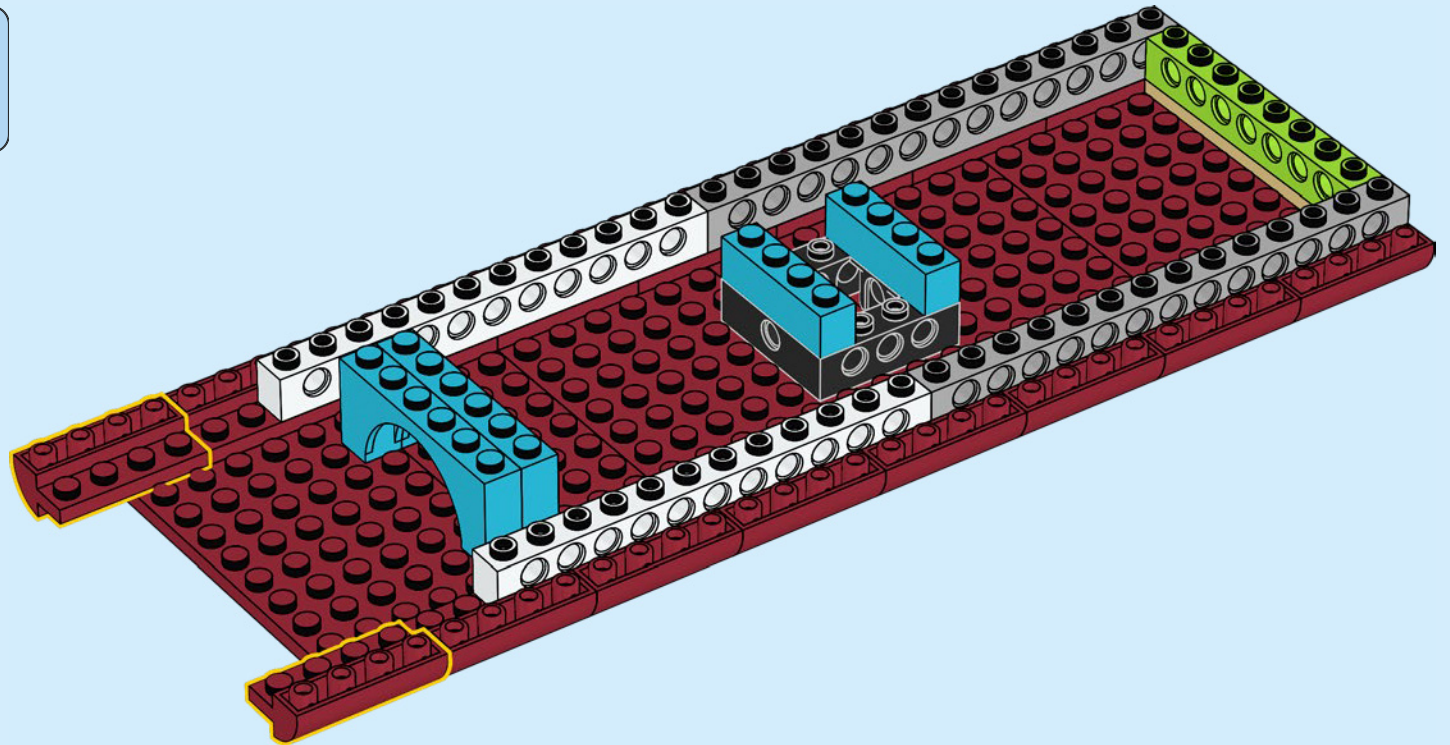

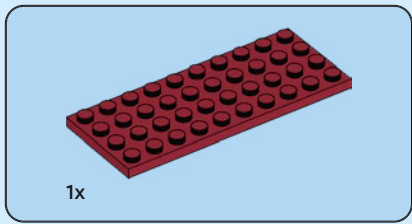

12

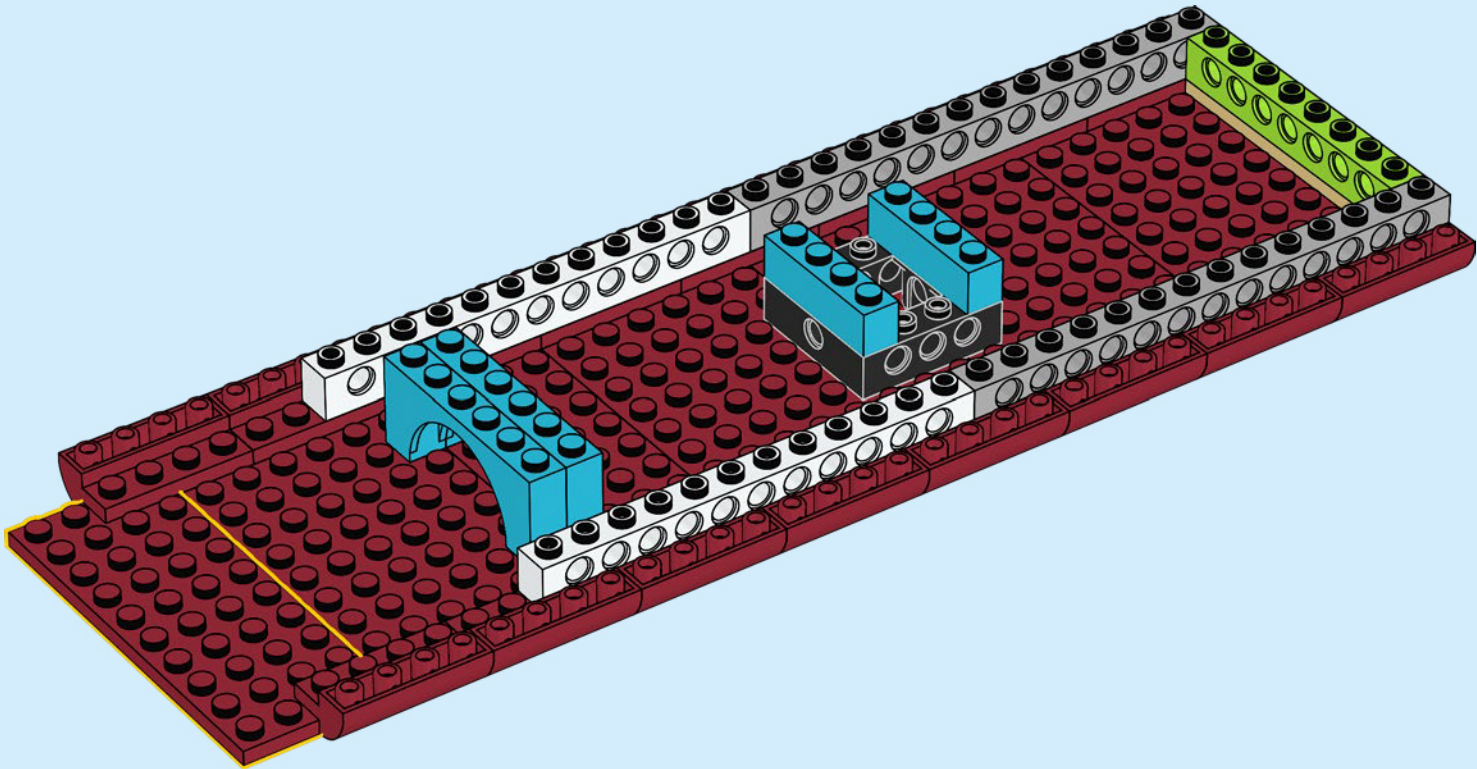

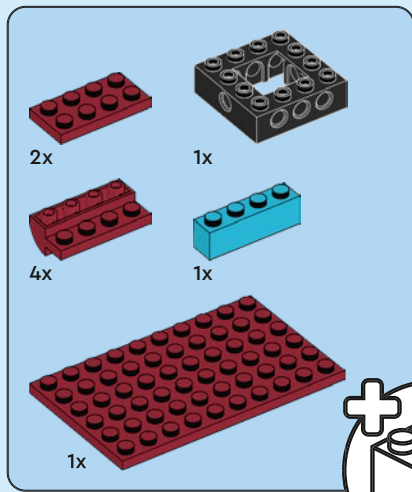

13

1

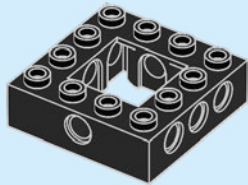

2

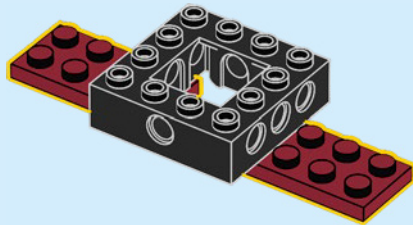

3

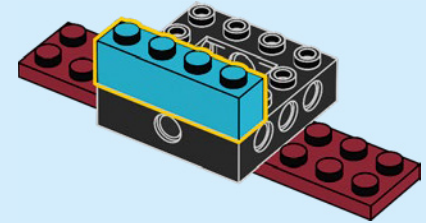

4

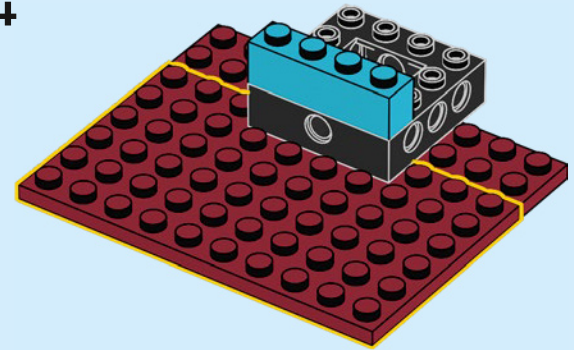

5



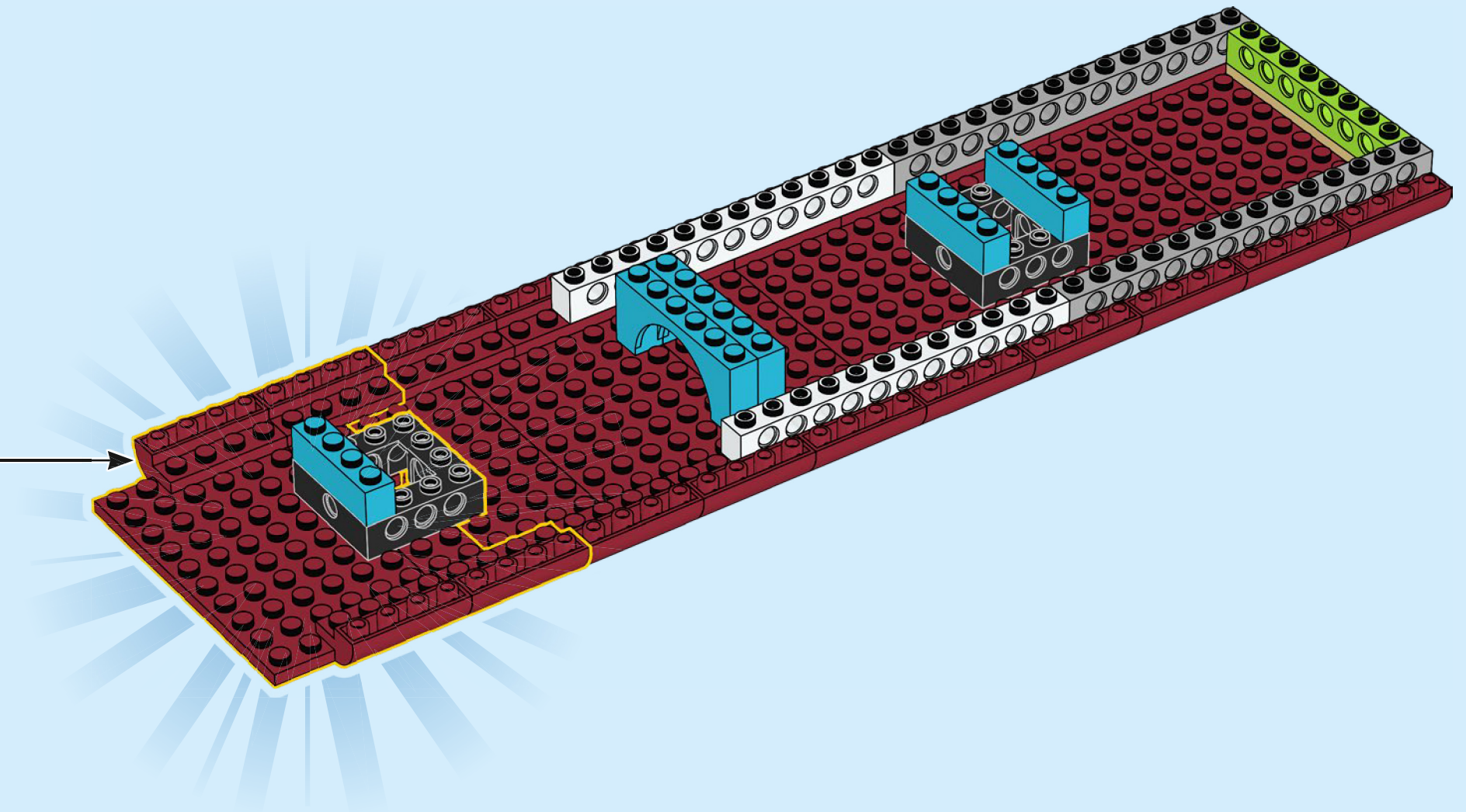

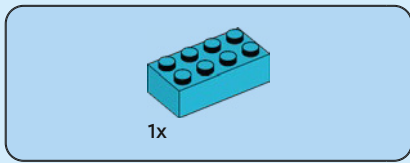

14

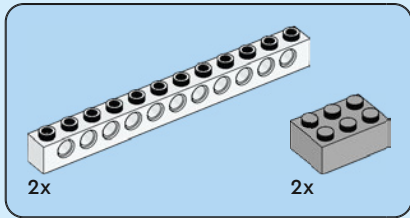
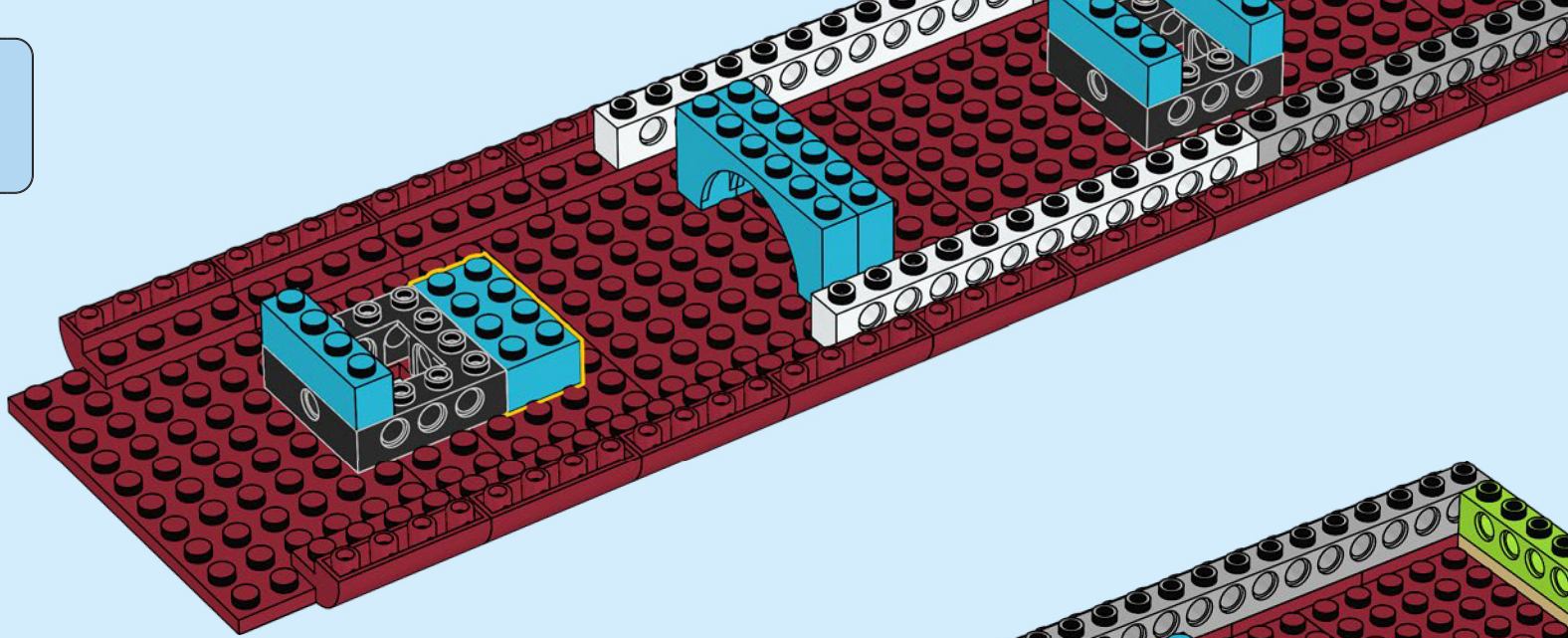

15

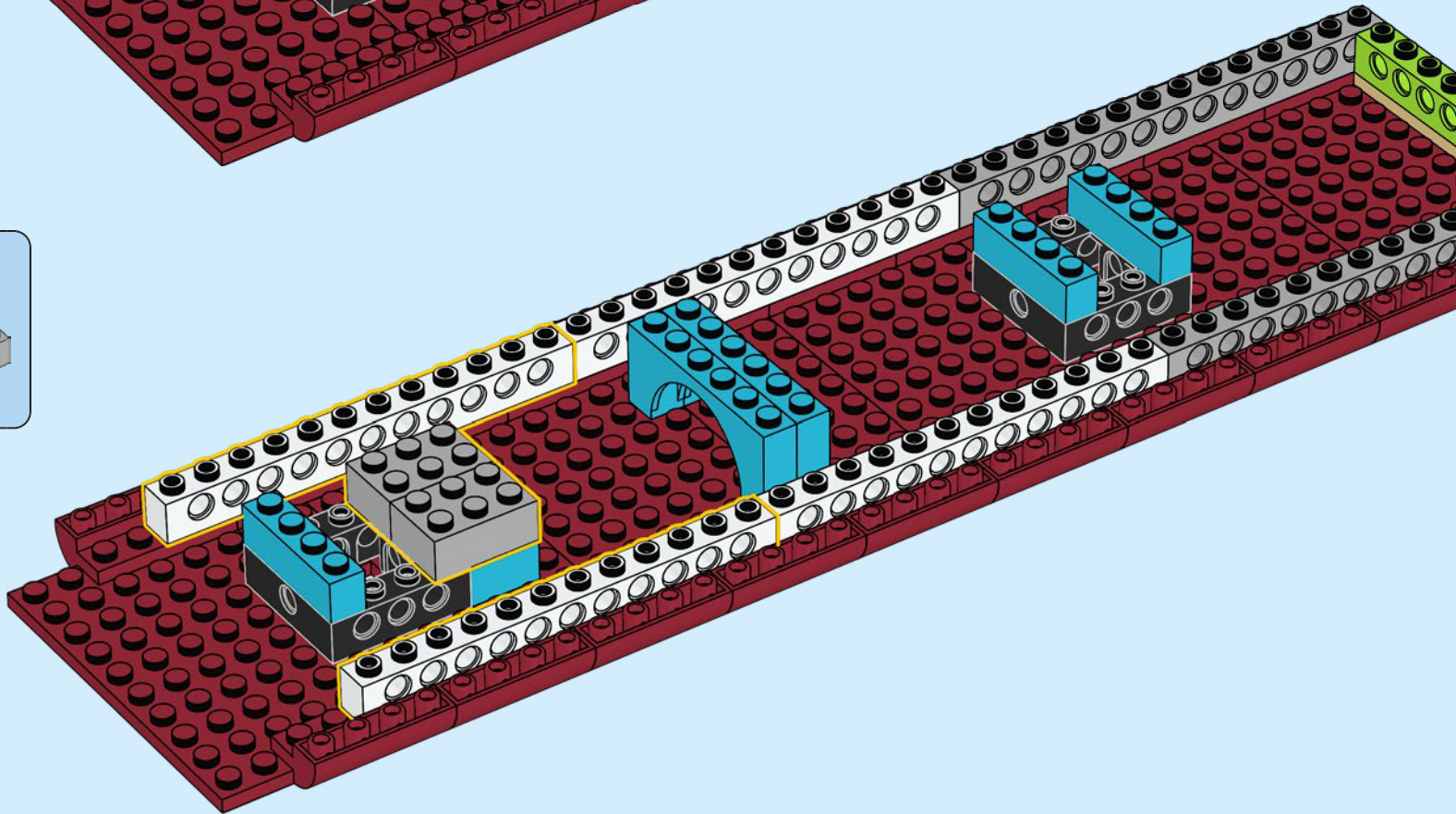

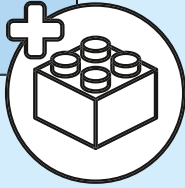
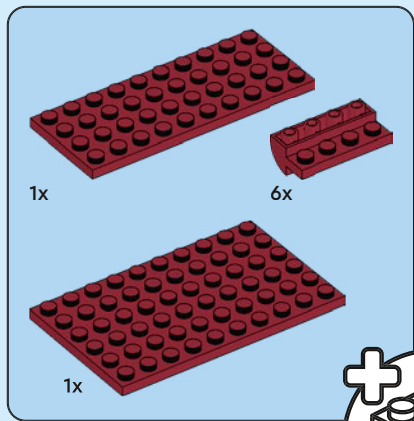

16

1

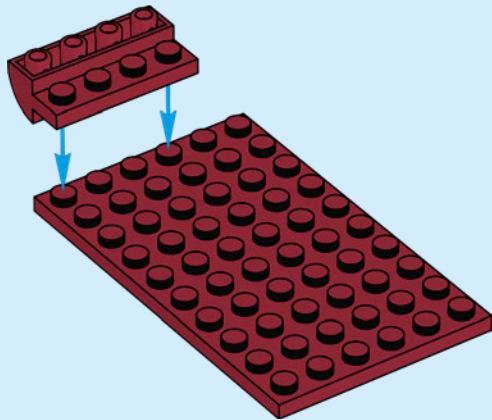

2

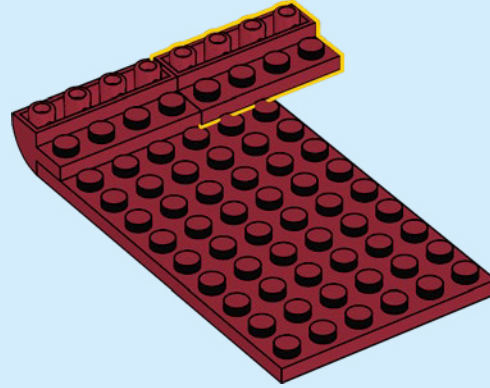

3

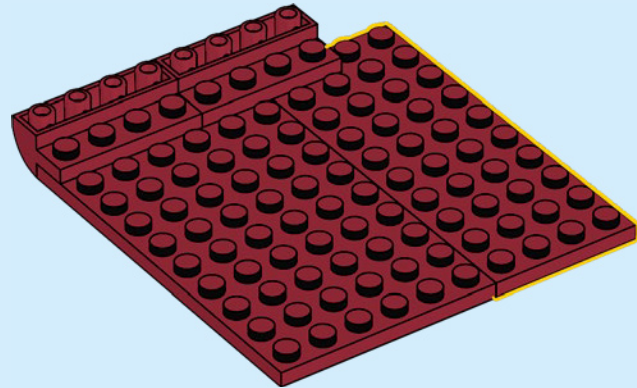

4

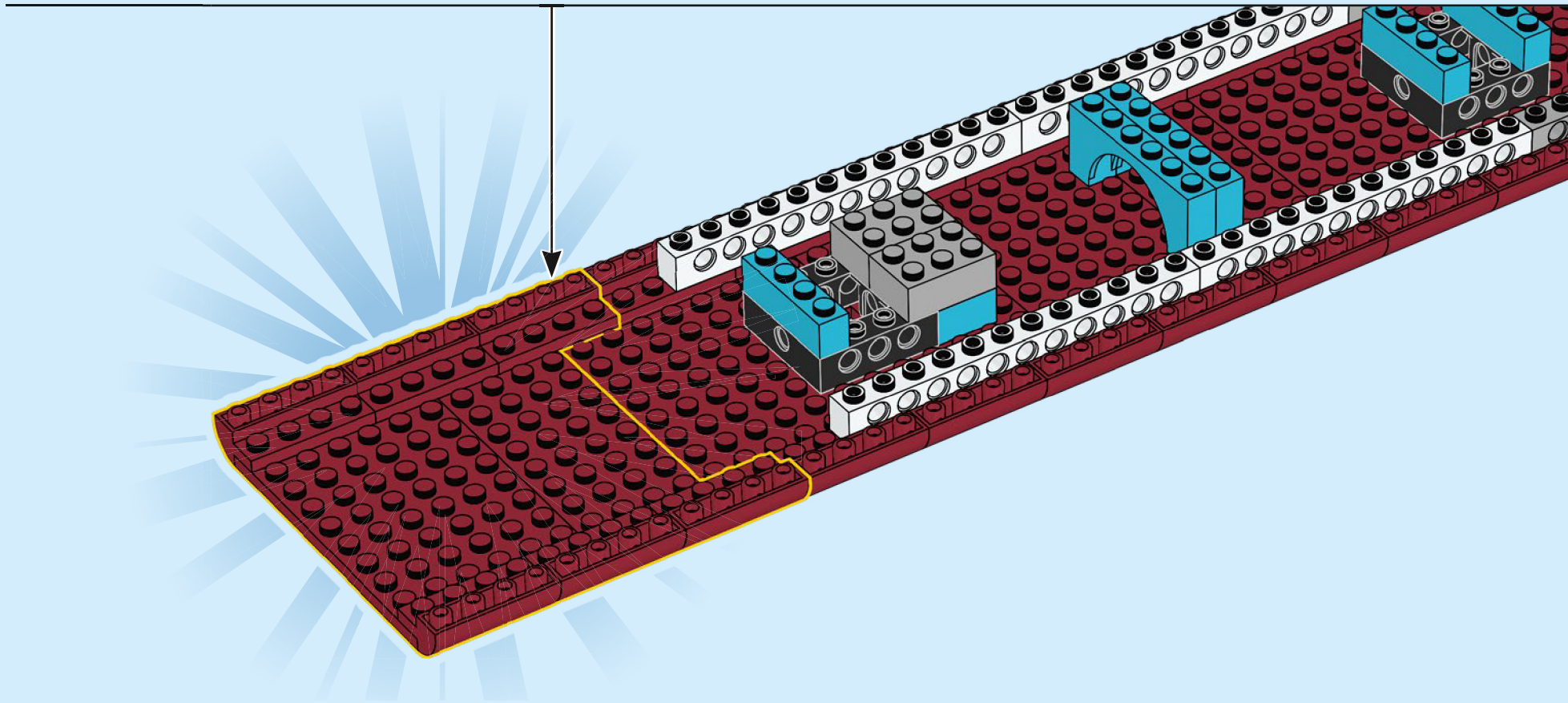
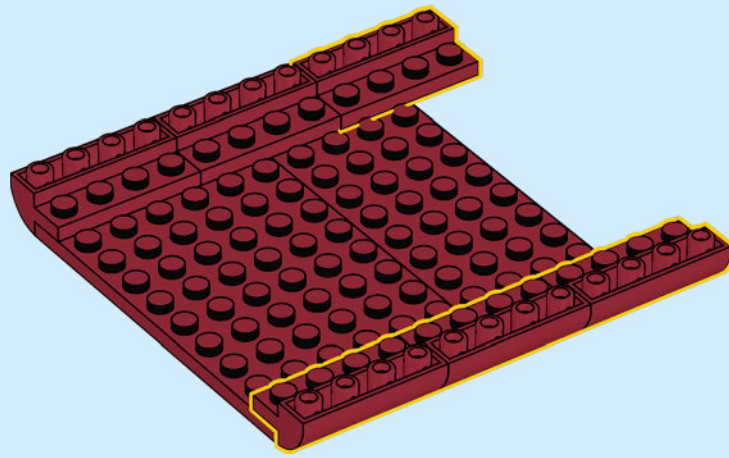

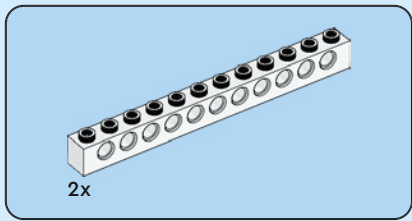

17

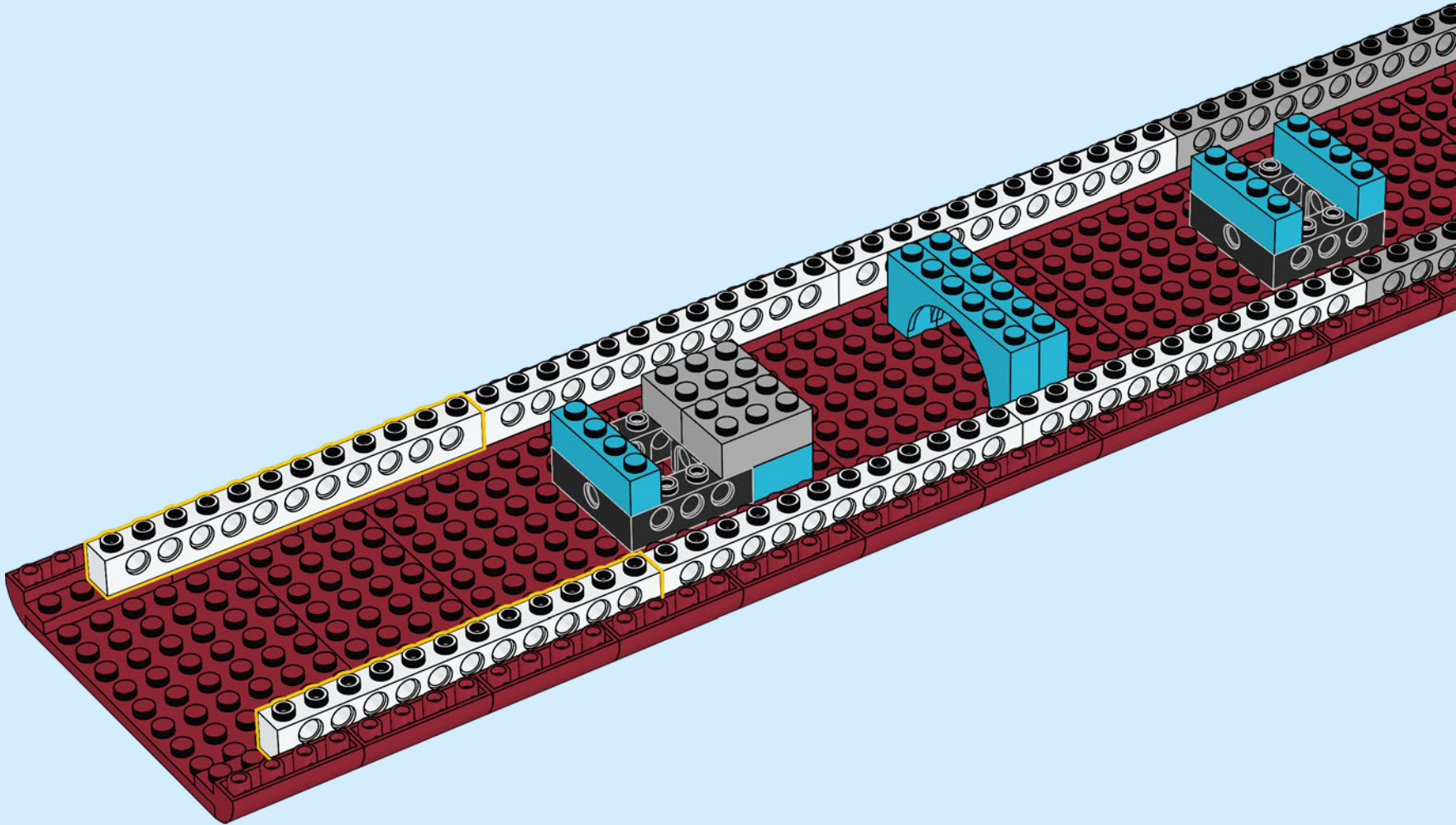

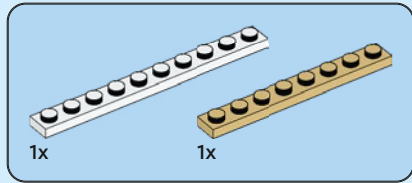

18

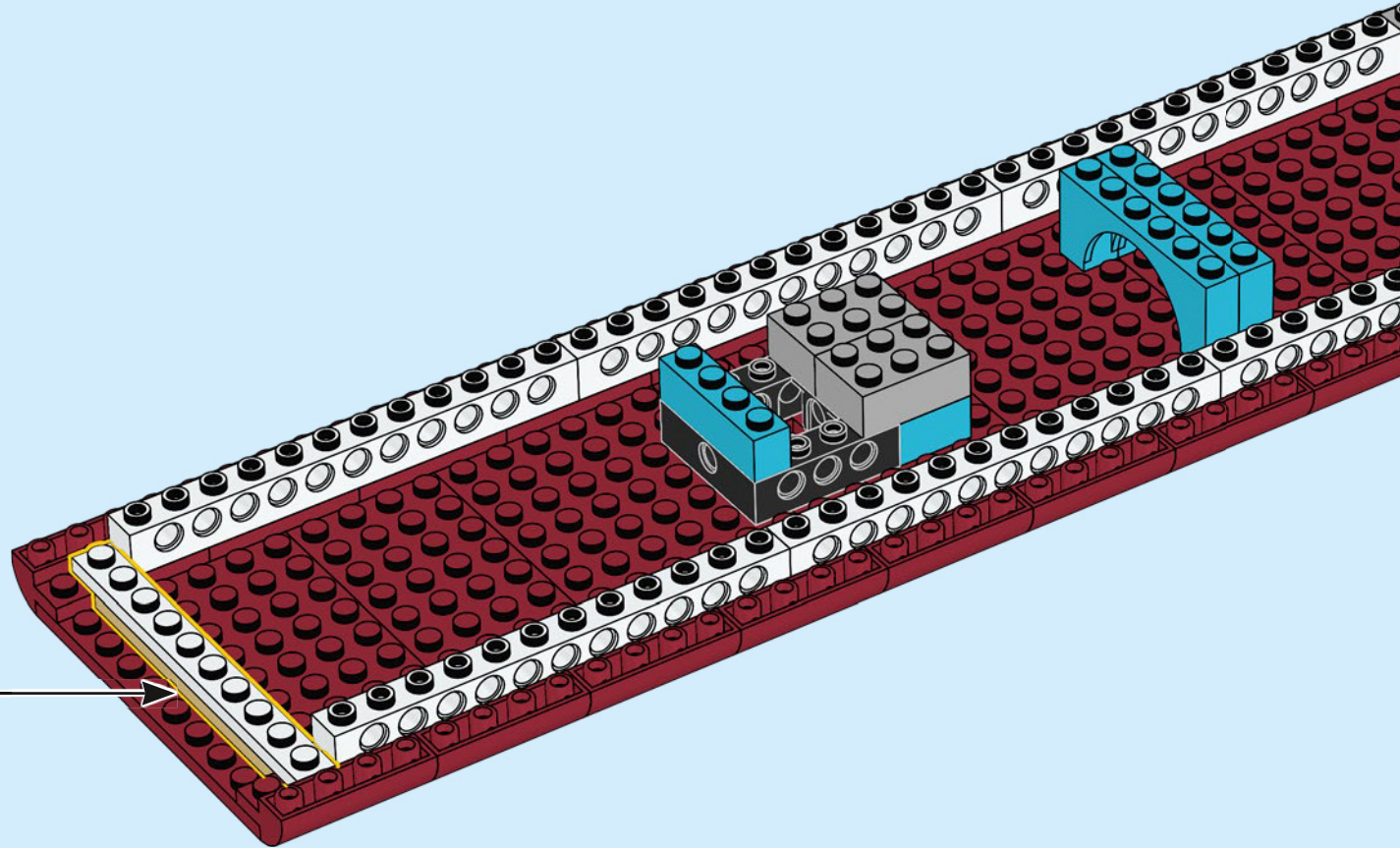
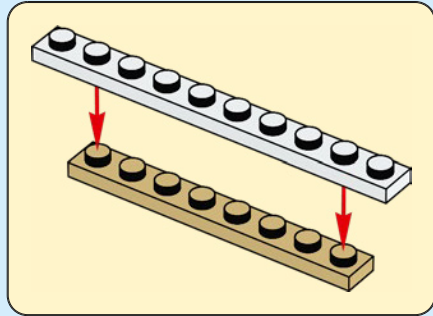

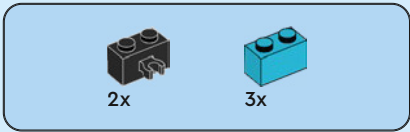

19

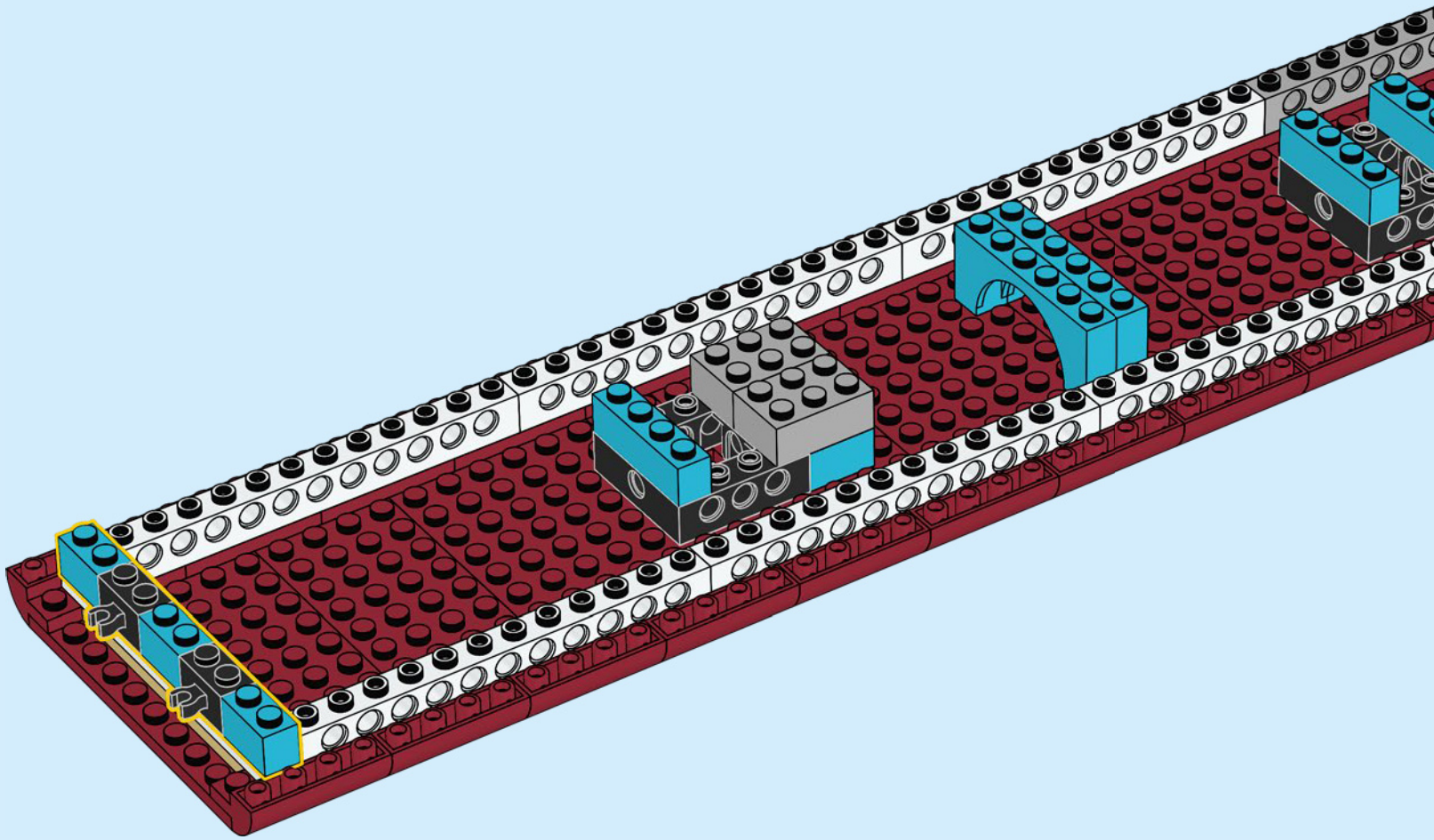

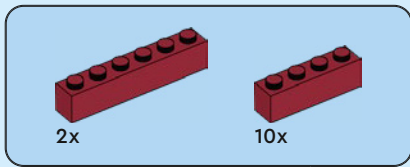

20

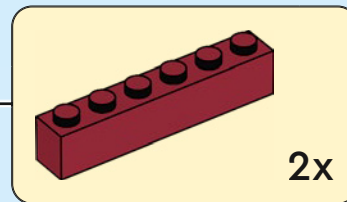
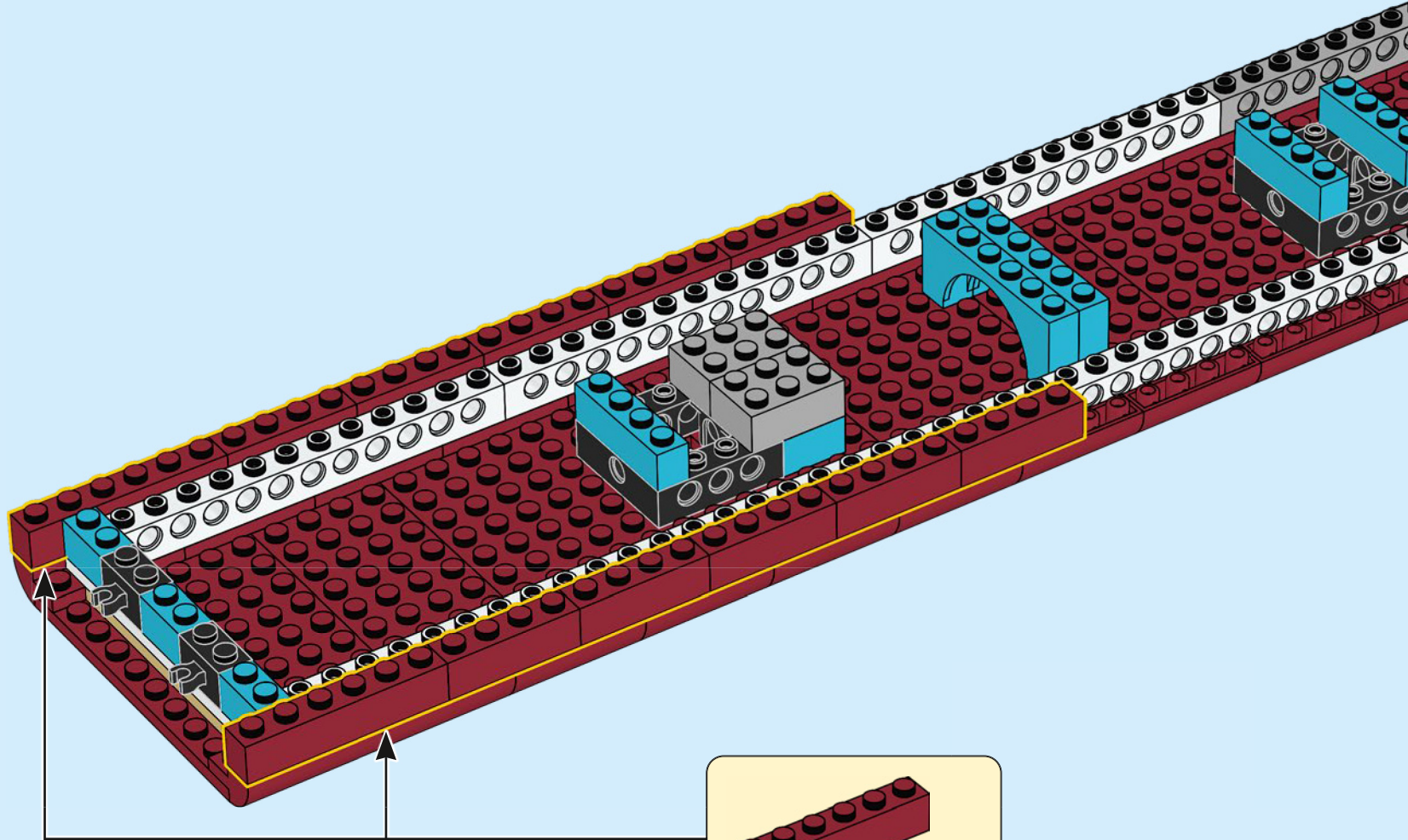

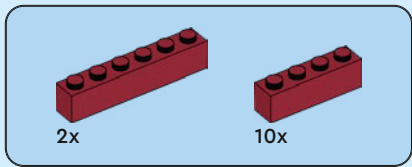

21

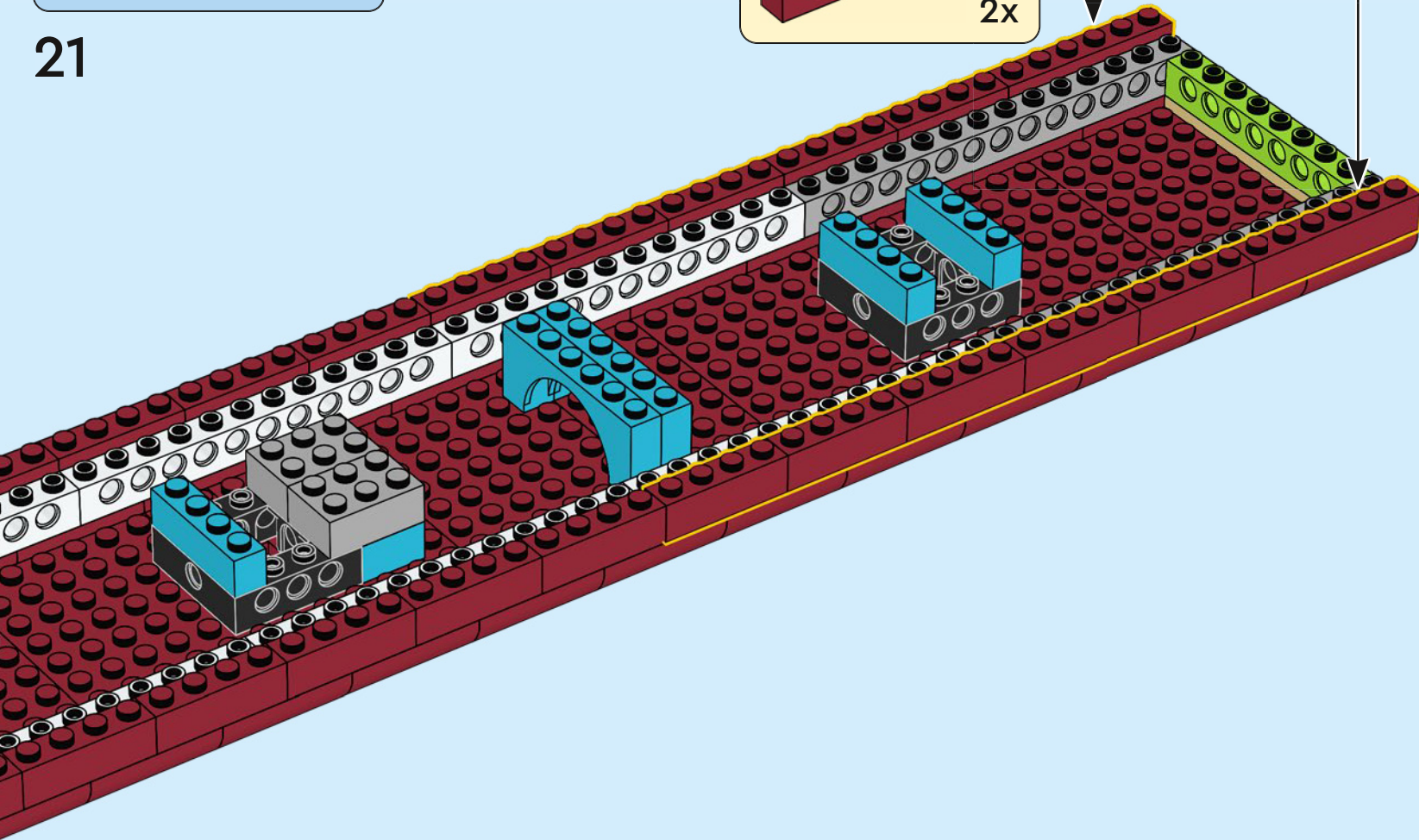
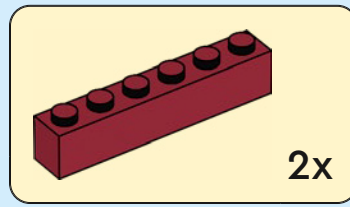

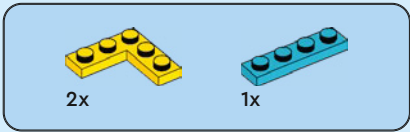

22

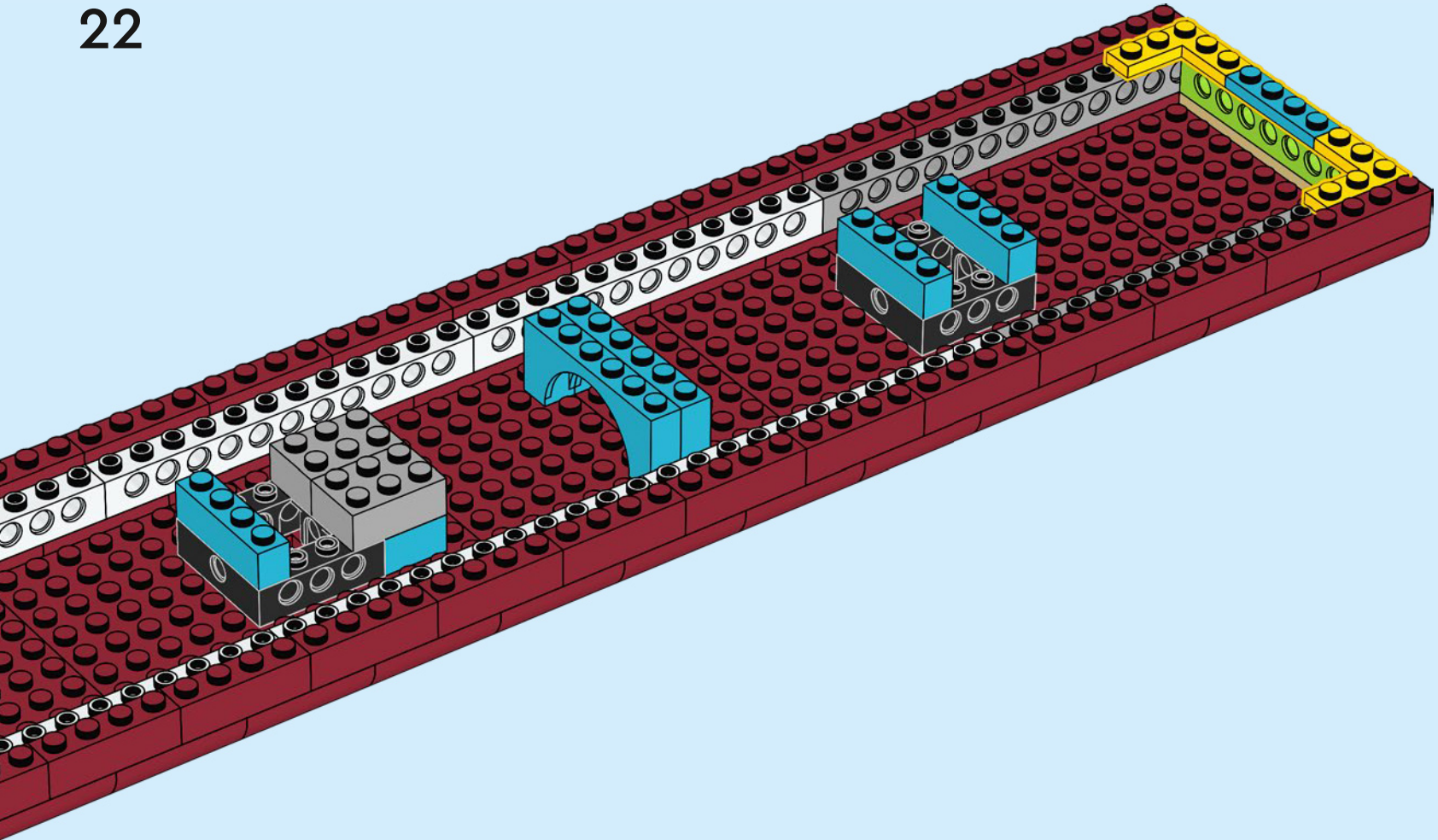

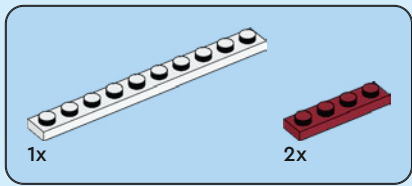

23

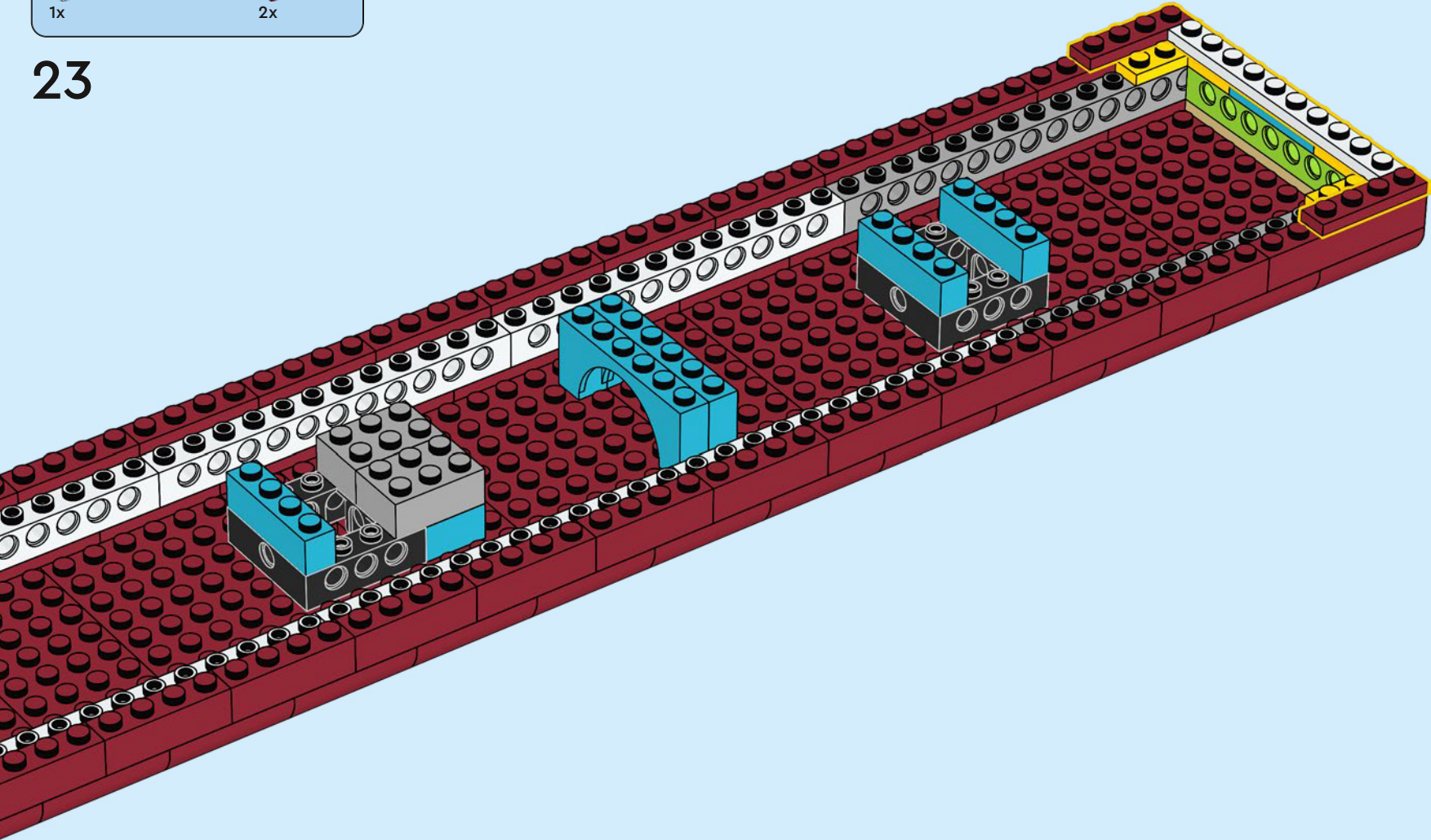

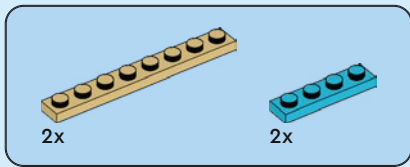

24

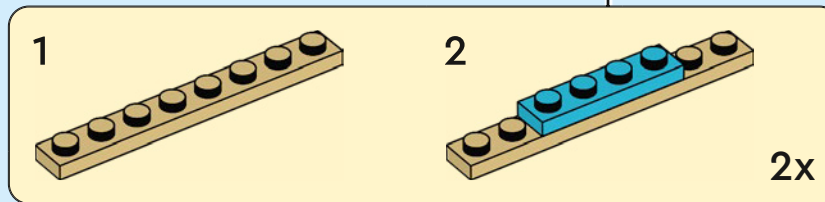
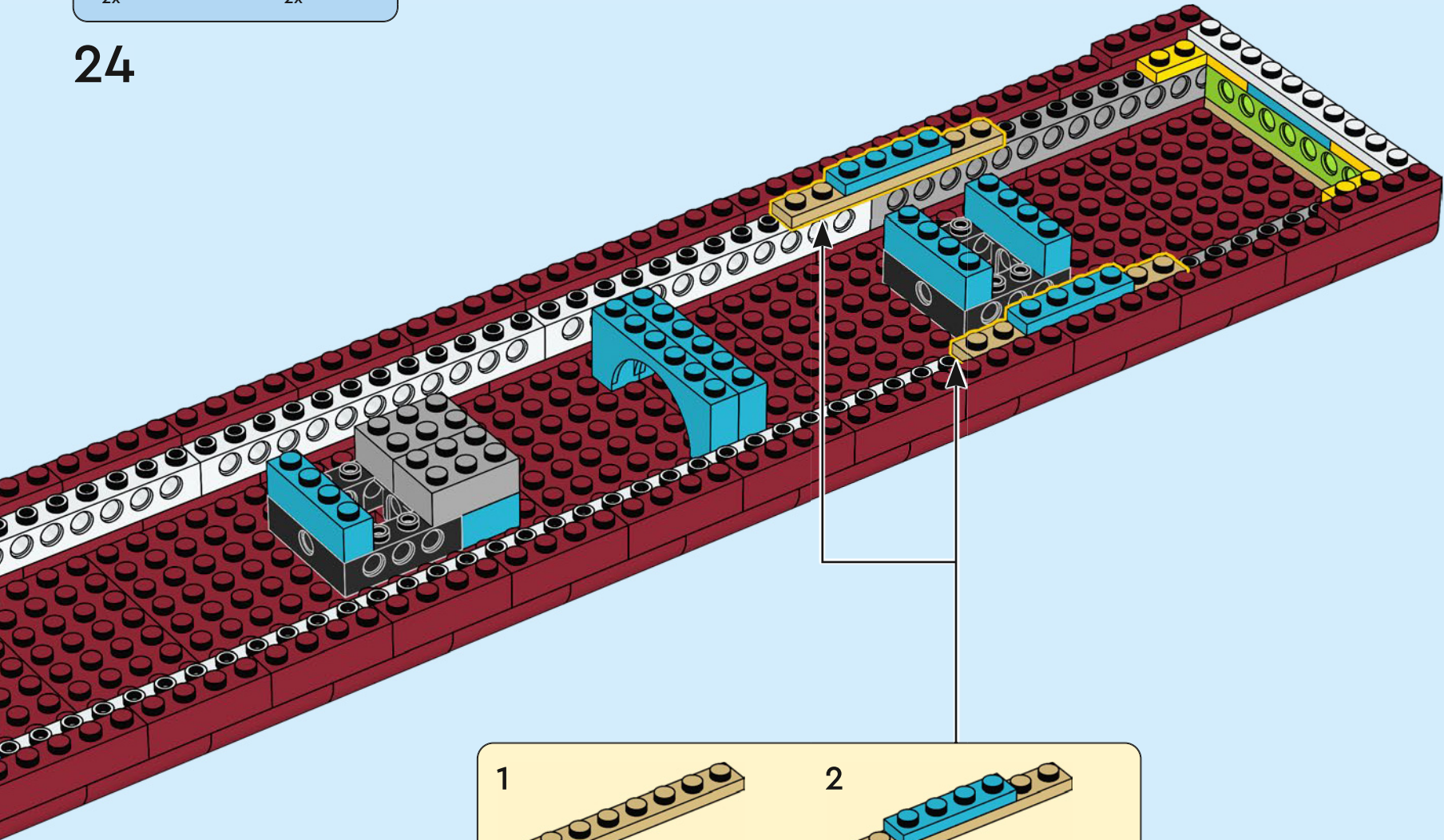

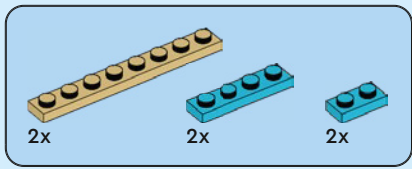

25

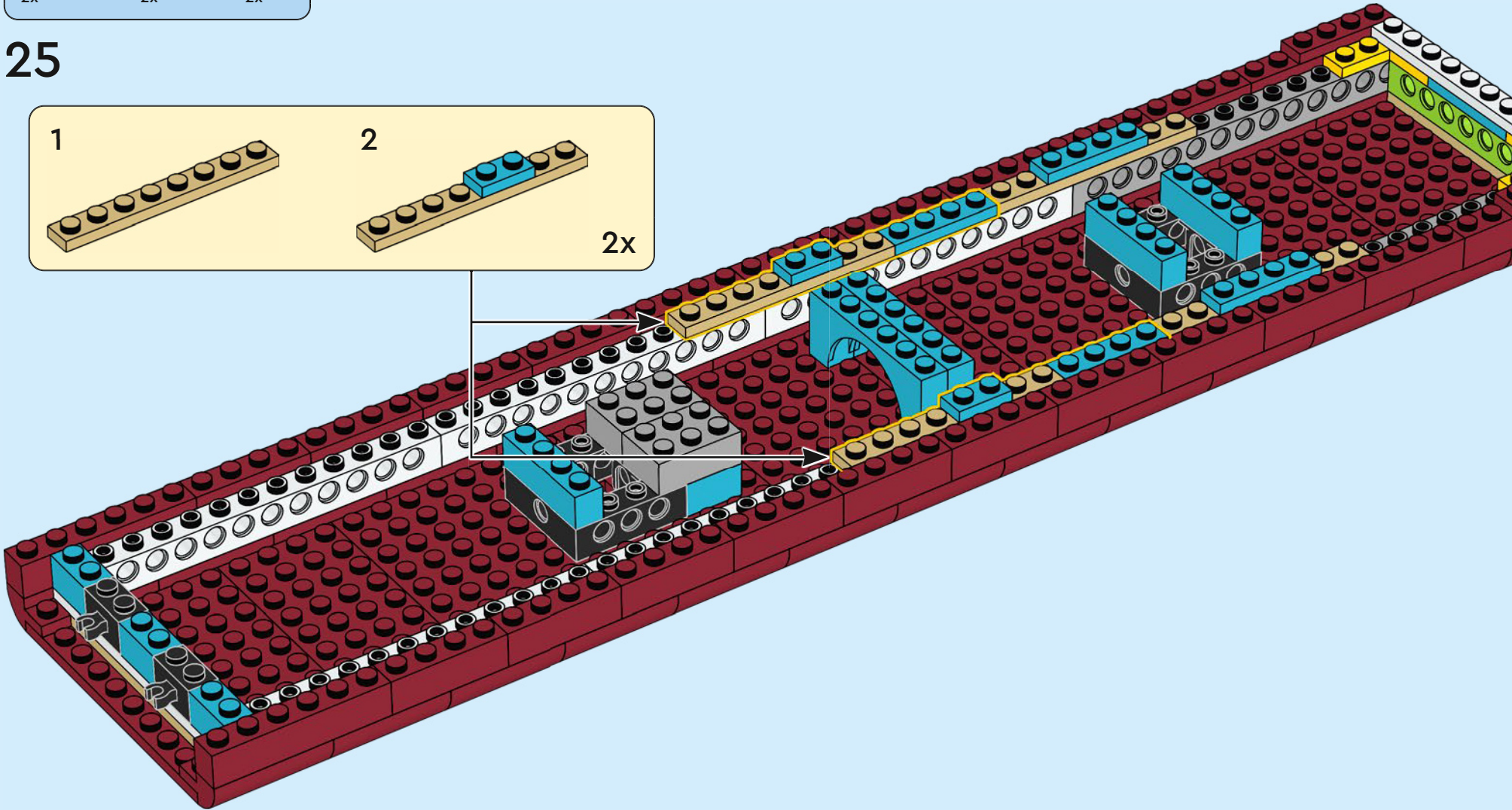
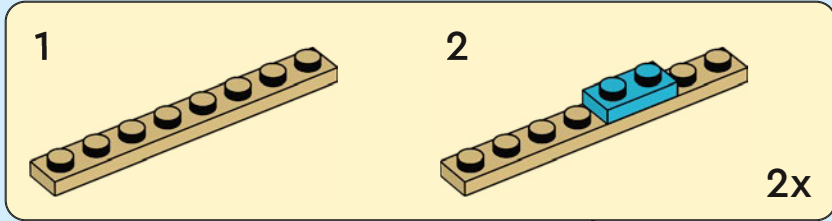

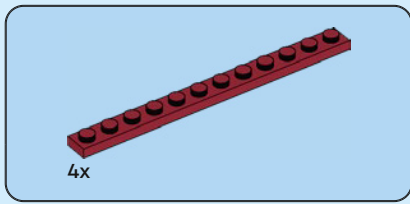

26

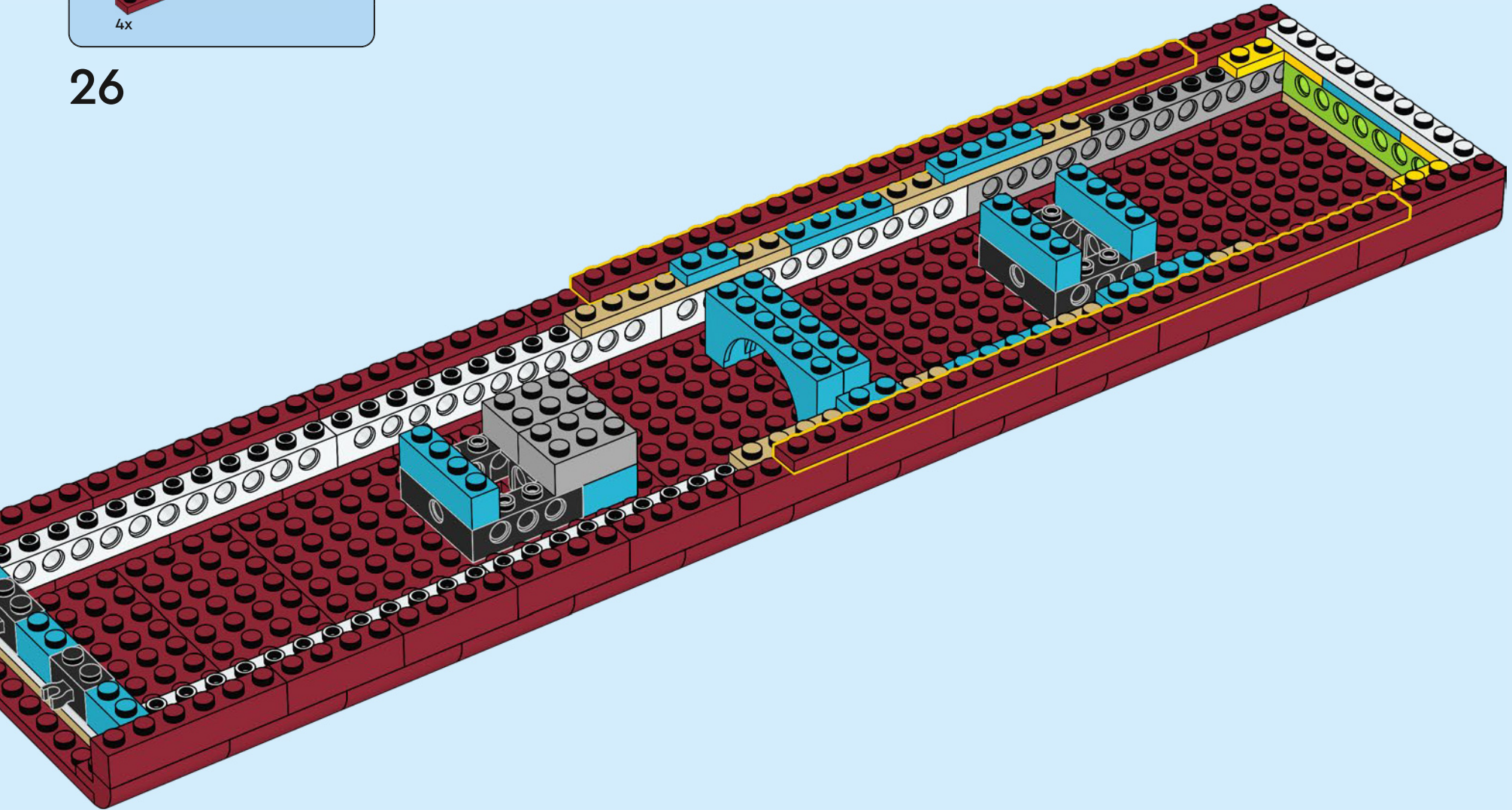

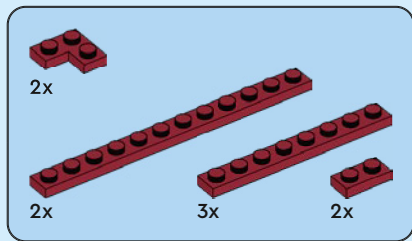

28

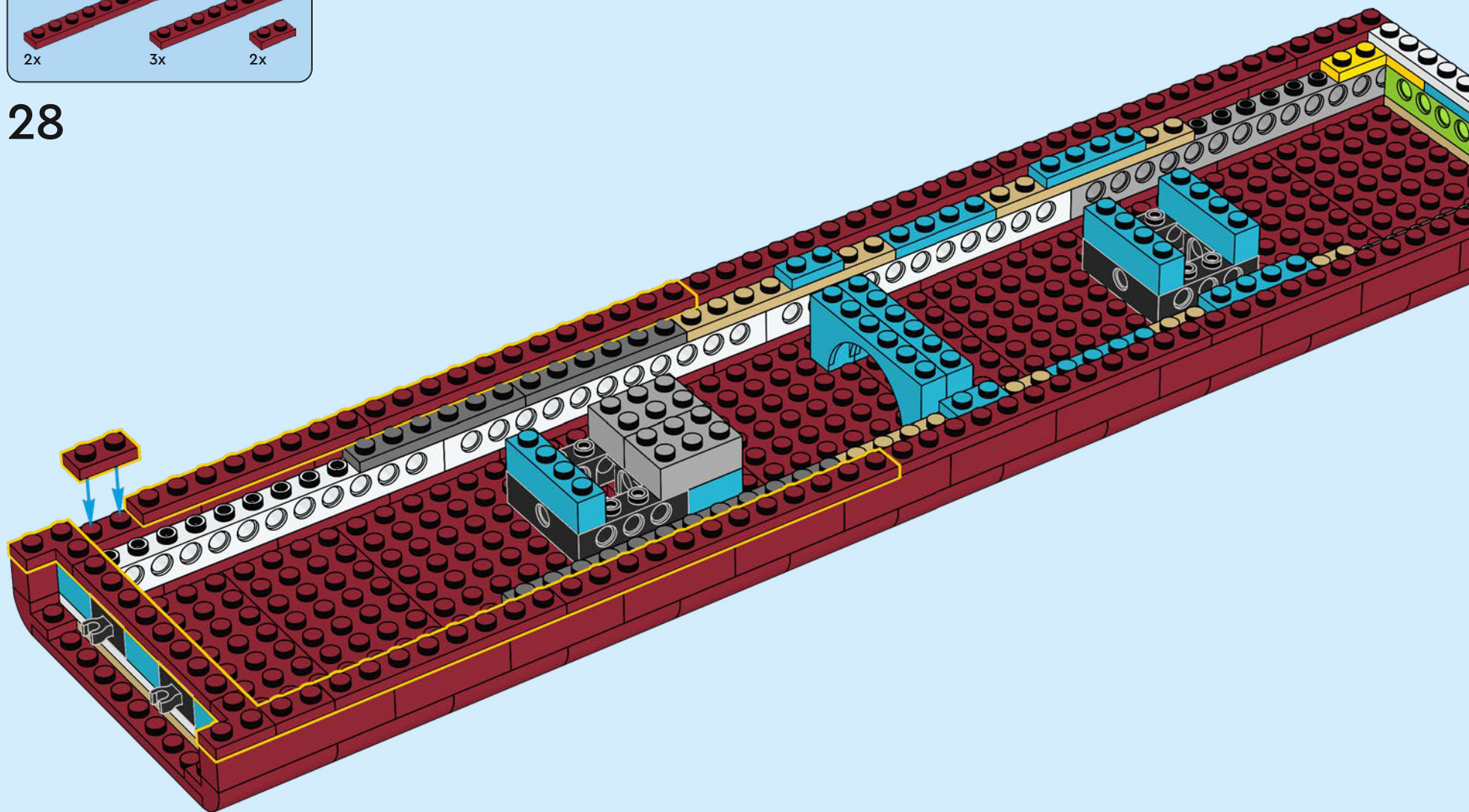

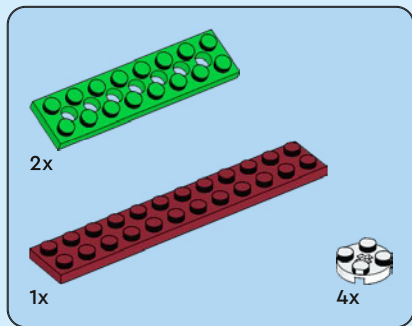

32

1

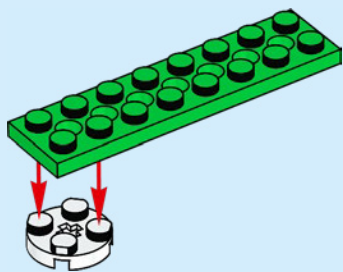

2

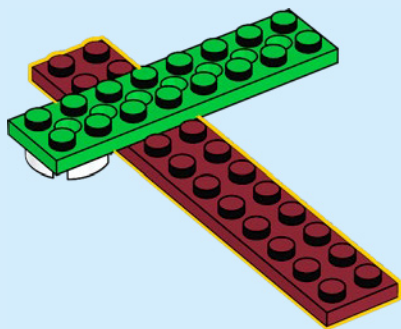

3

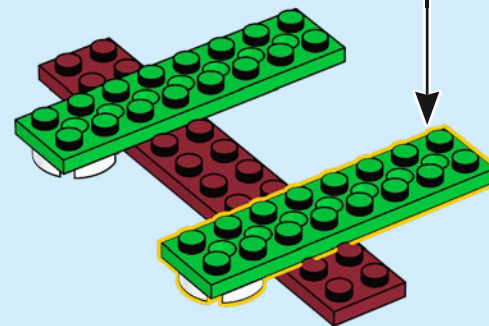
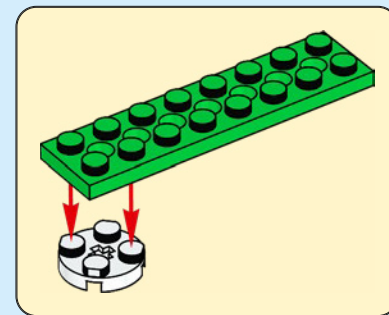

4

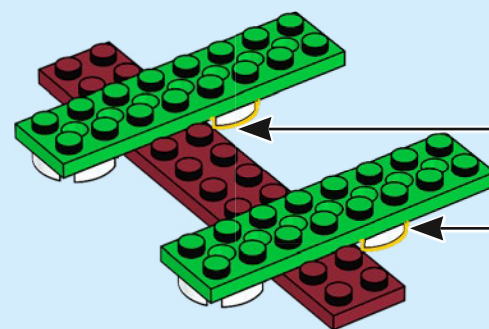

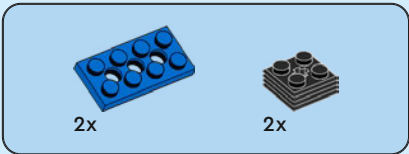

33

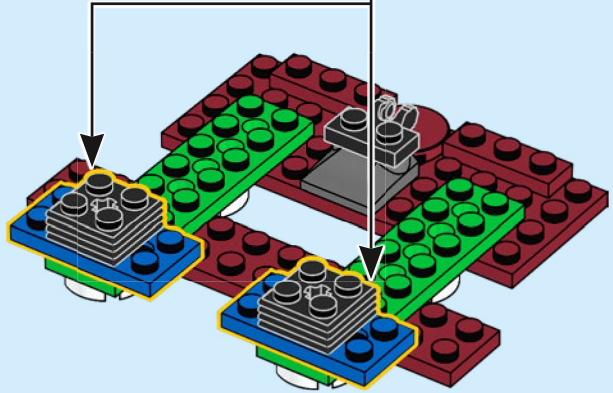
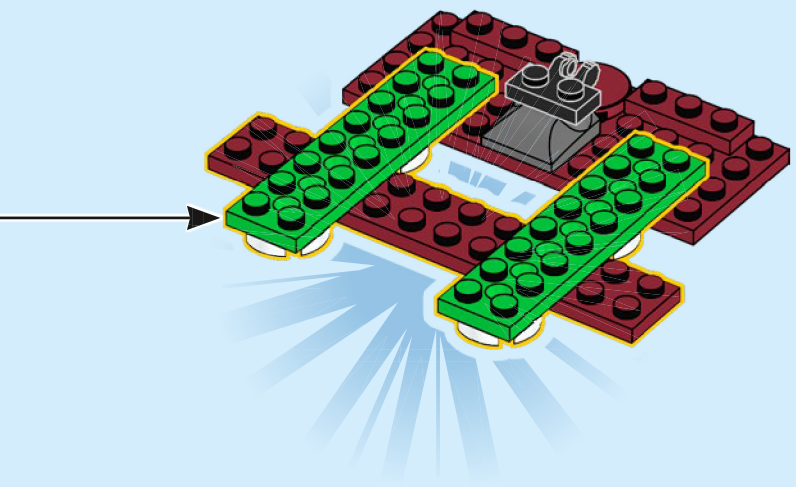
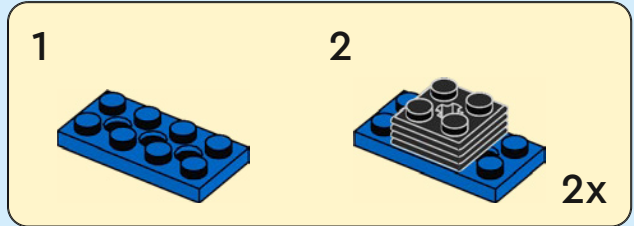

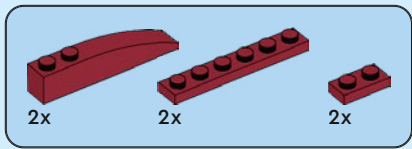

38

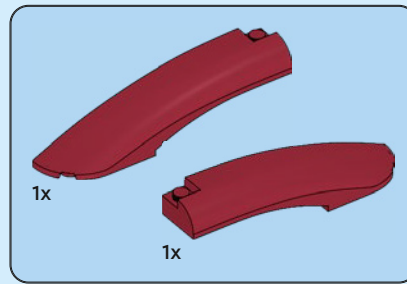
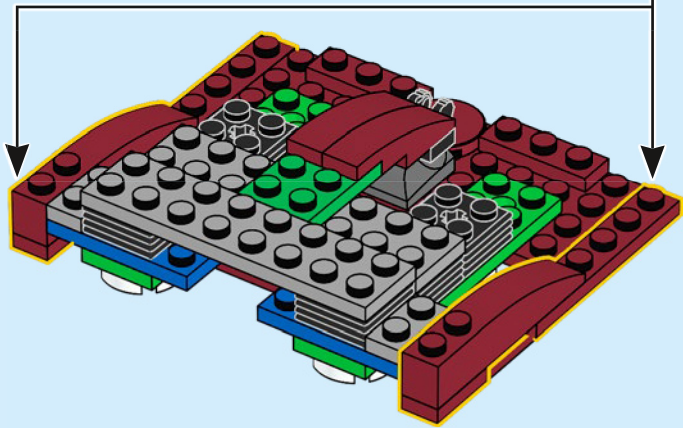
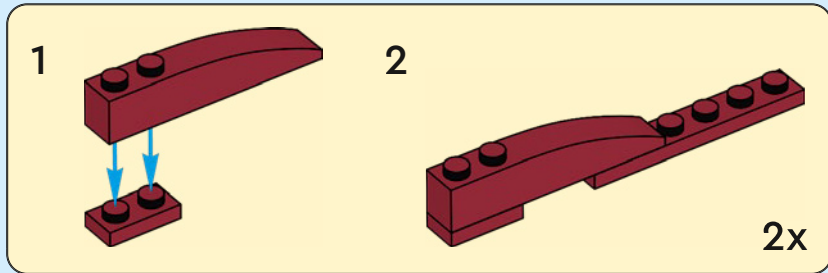

39

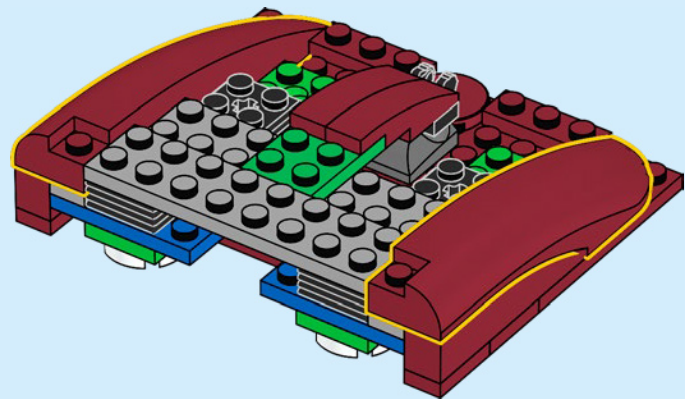

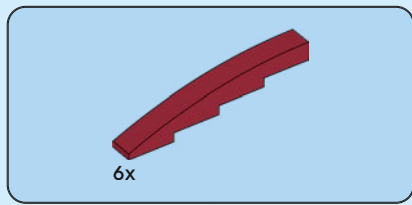

40

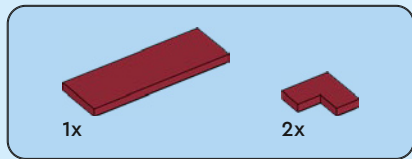
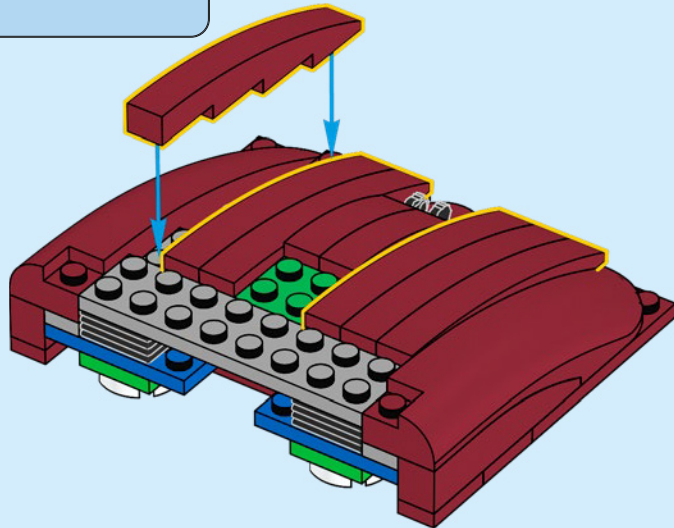

41

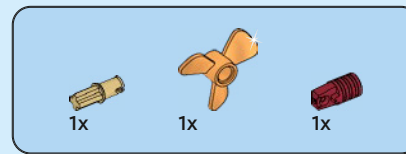
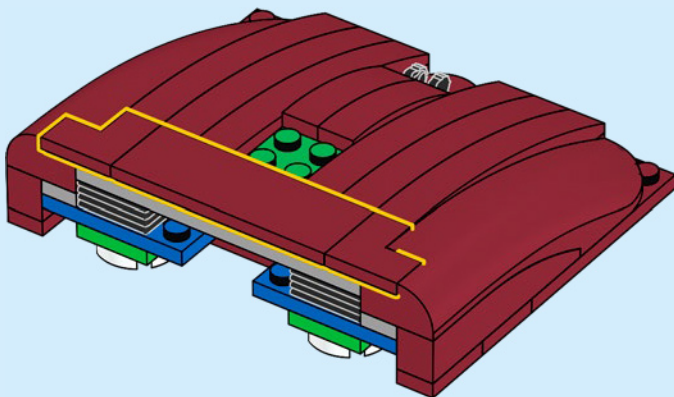

42

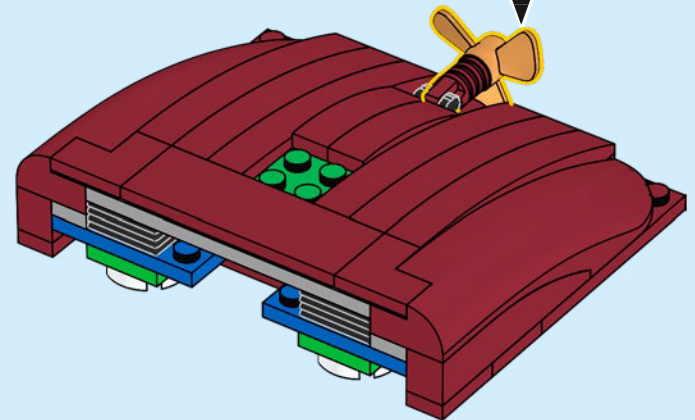
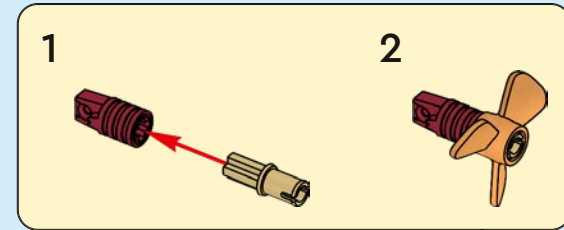

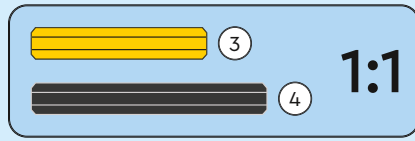
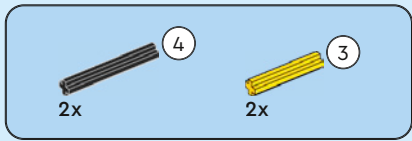

43

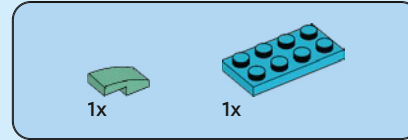
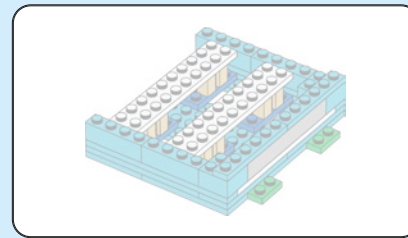
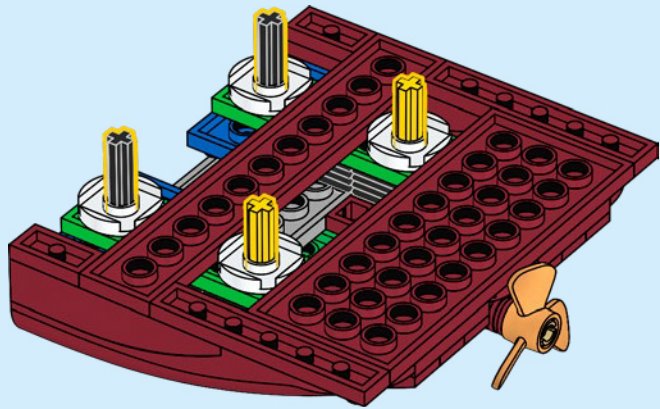

44

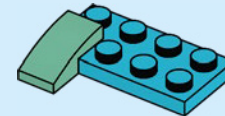

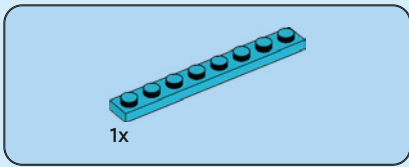

45

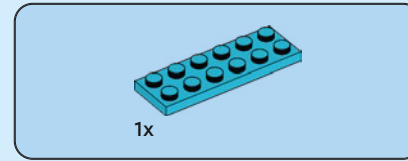
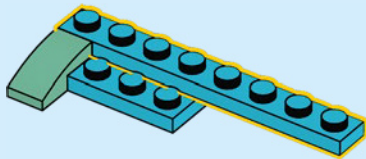
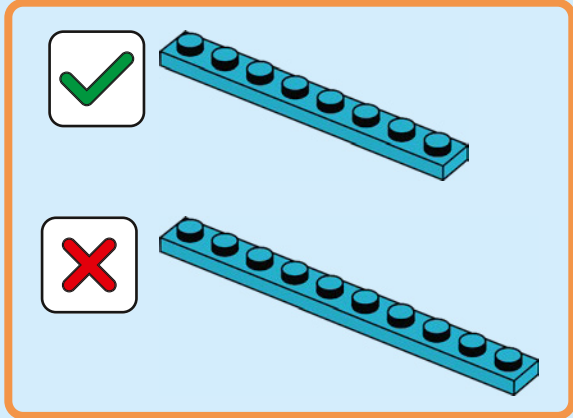

46

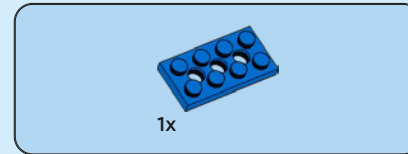
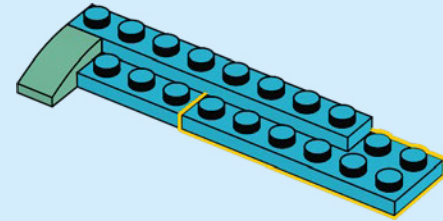

47

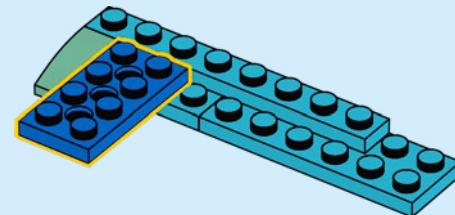

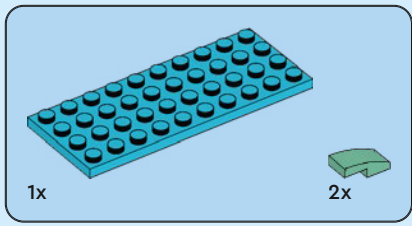

48

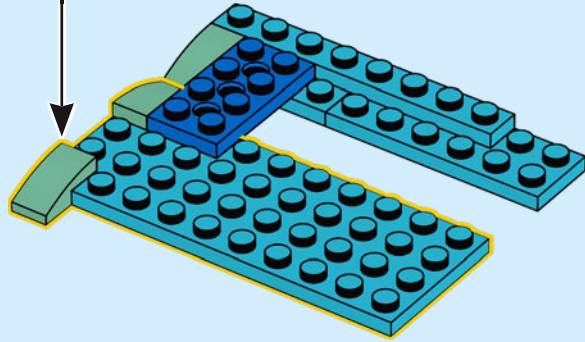
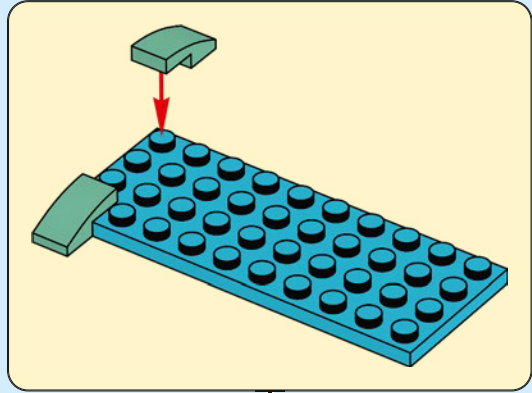

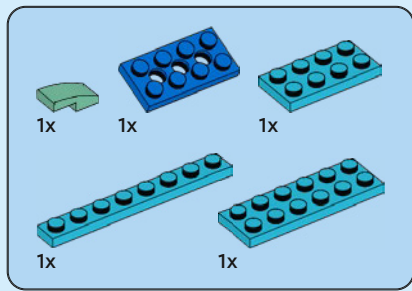

49

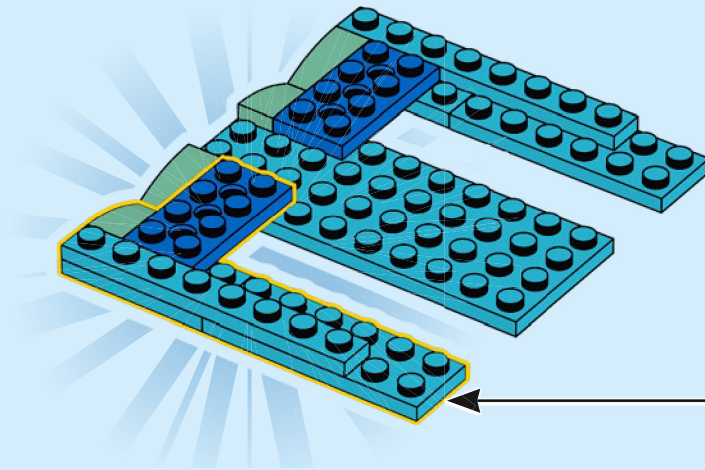
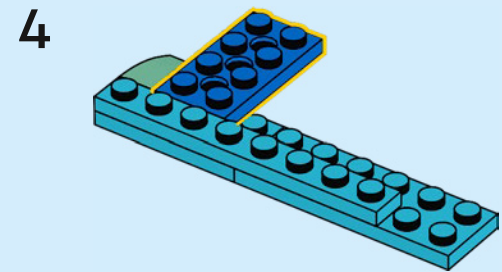
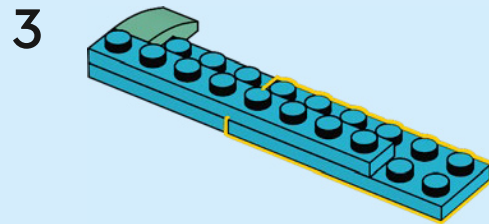
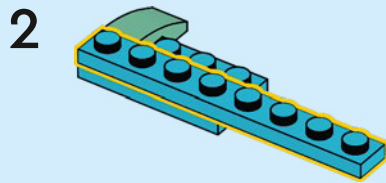
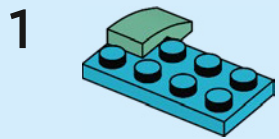
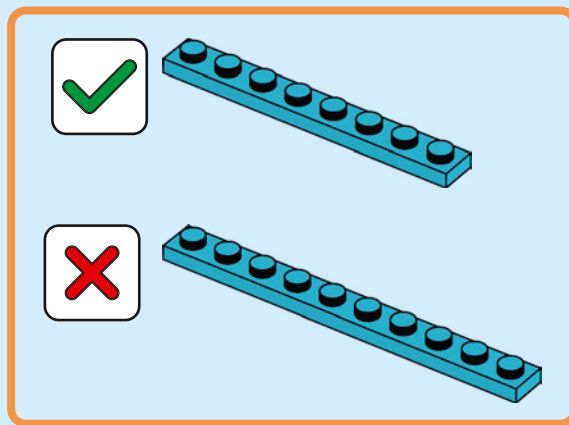



50

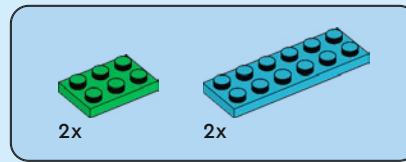
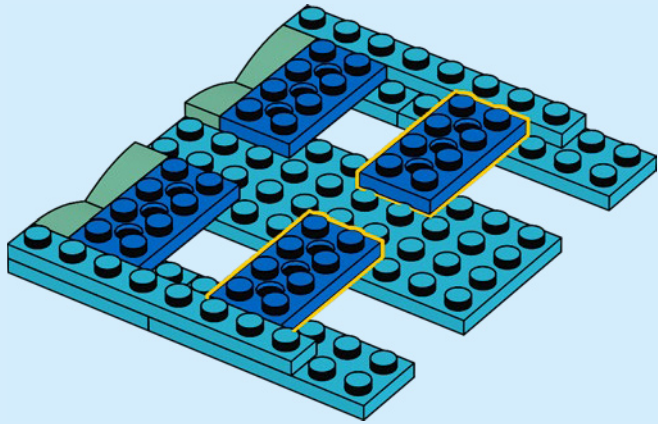

51

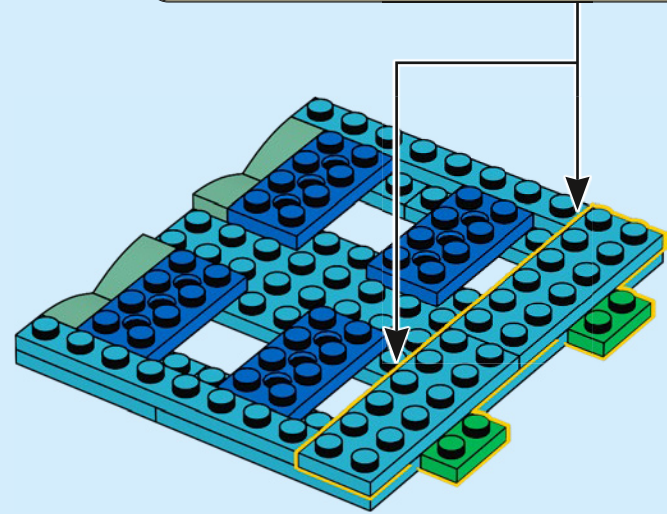
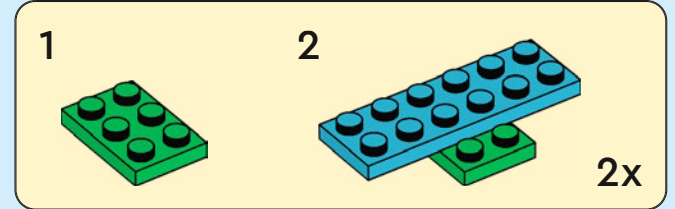

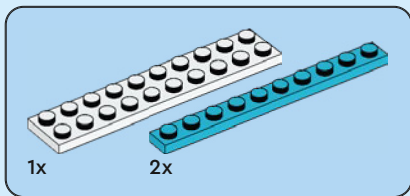

52

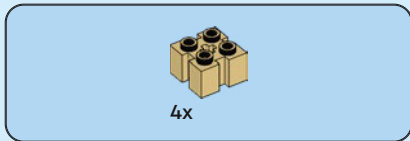
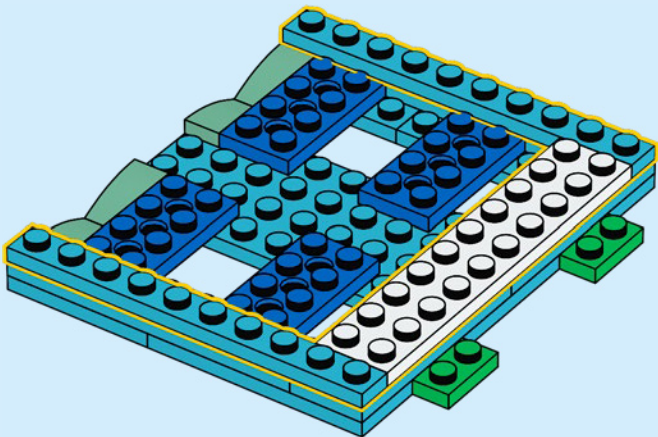

53

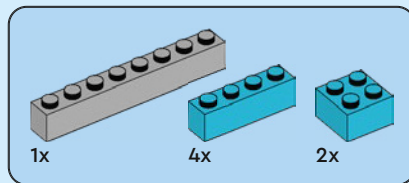
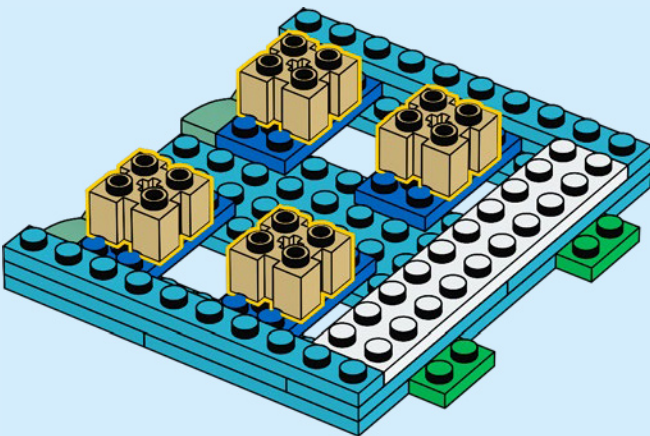

54

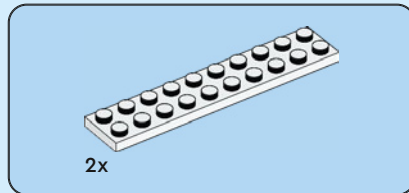
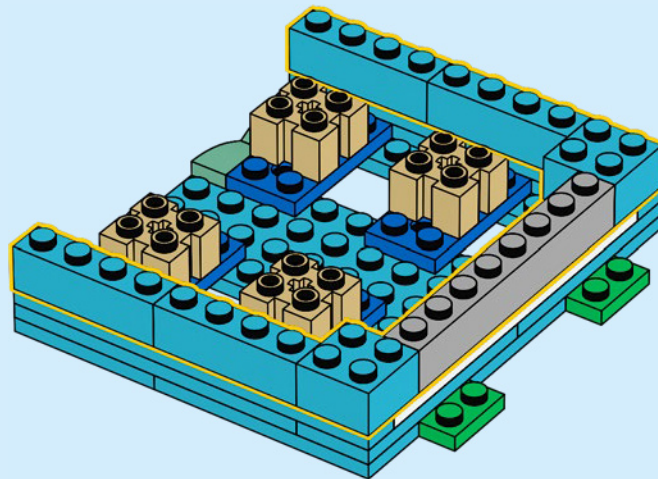

55

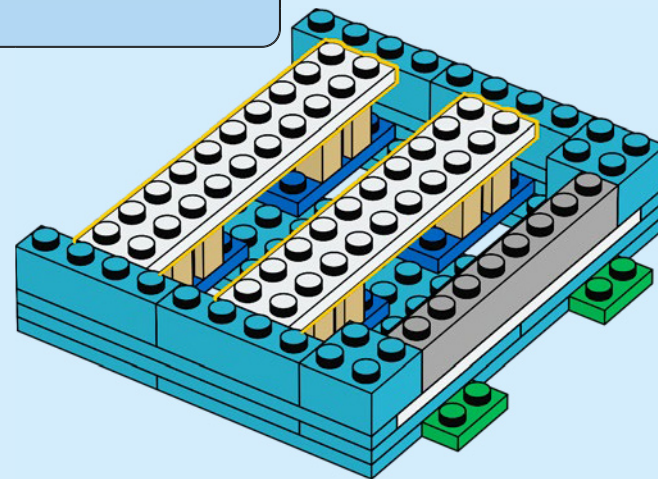

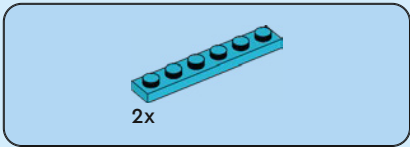

56

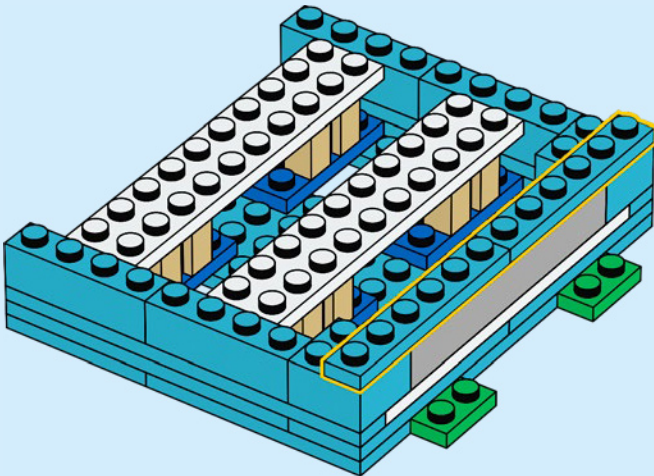

57

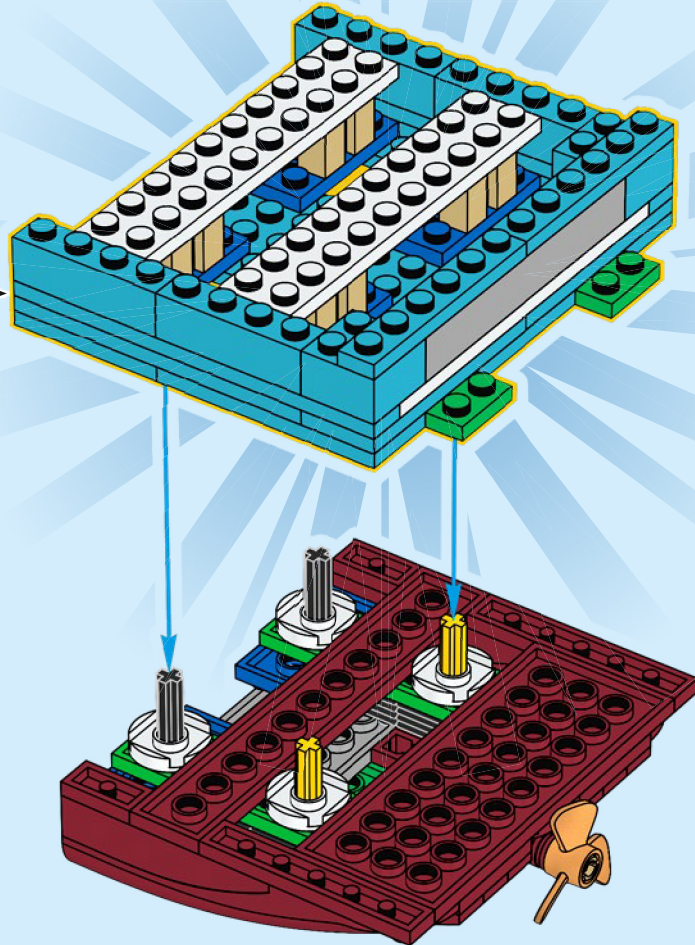

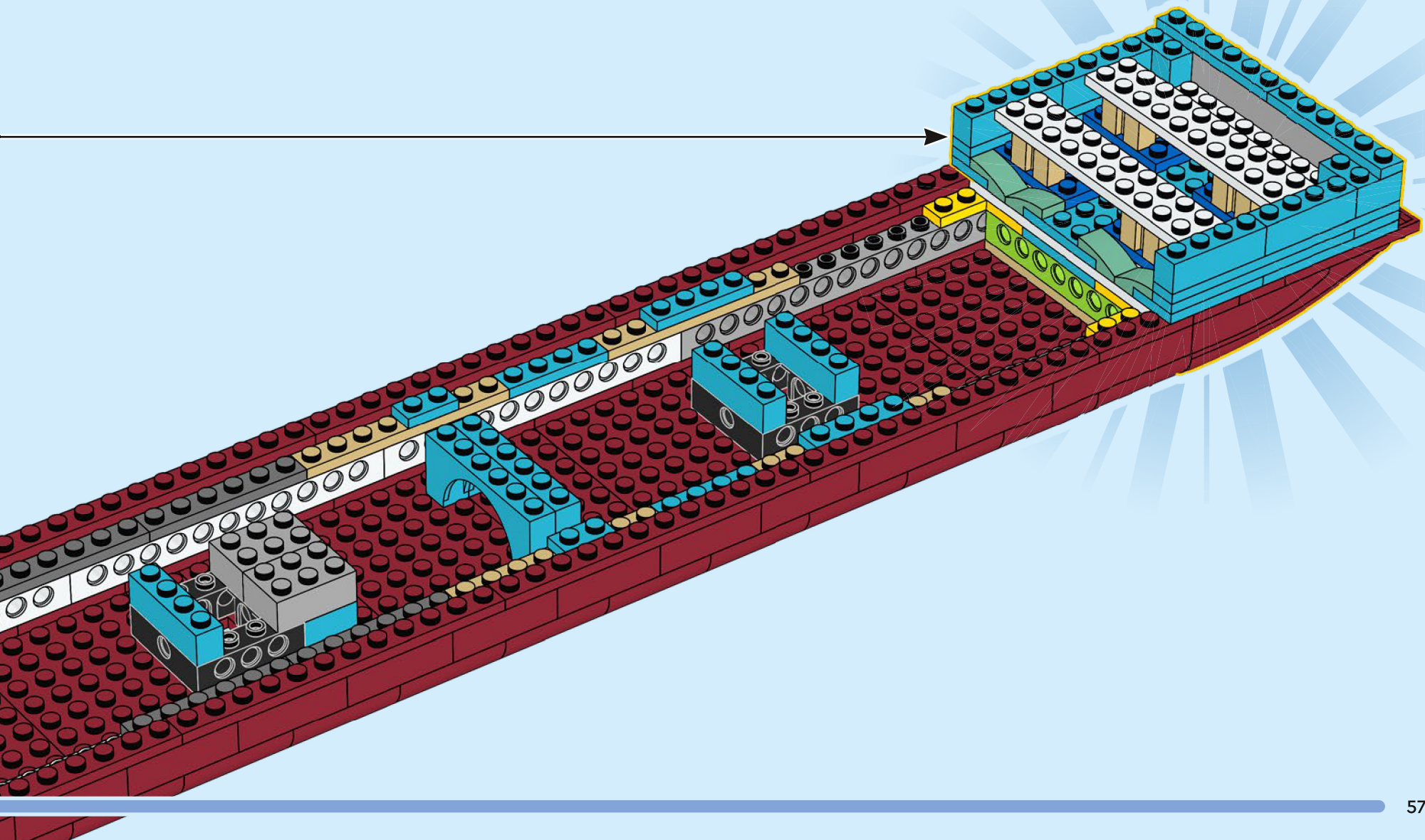

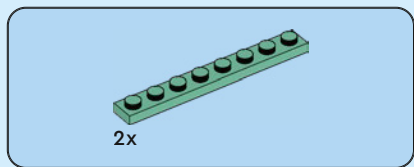
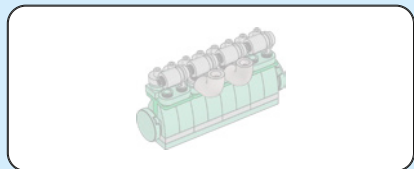

59

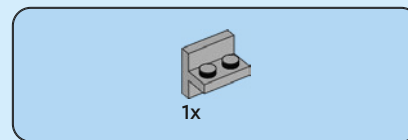
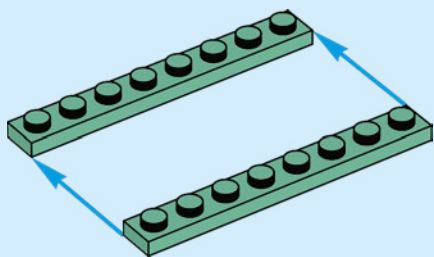

60

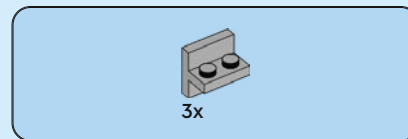
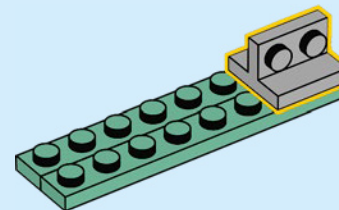

61

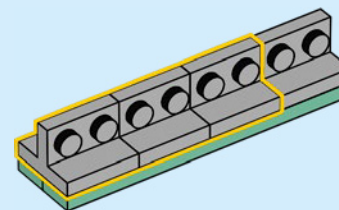



62

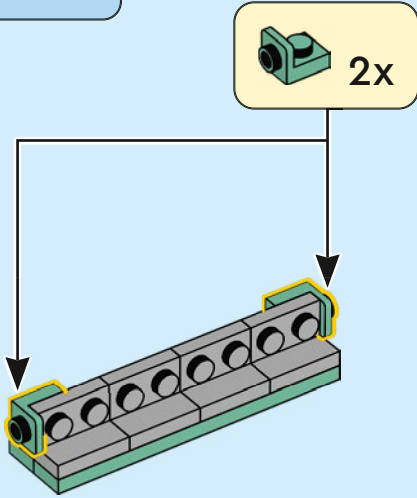

63

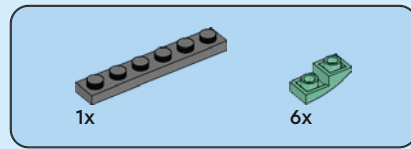
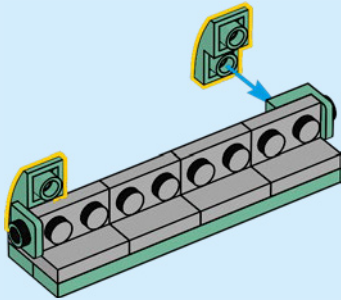

64

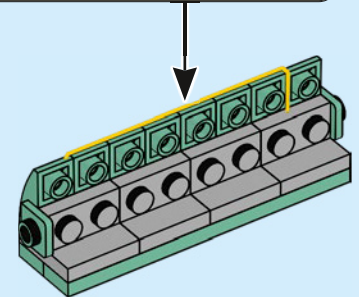
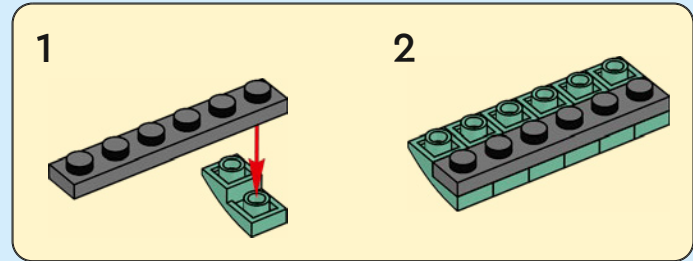

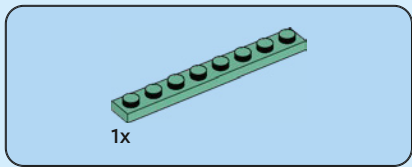

65

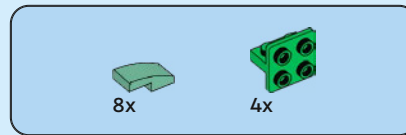
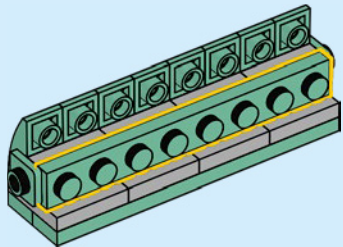

66

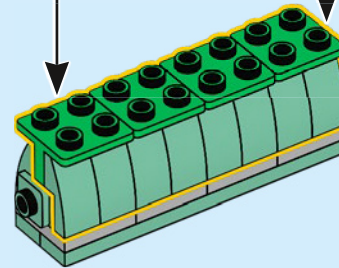
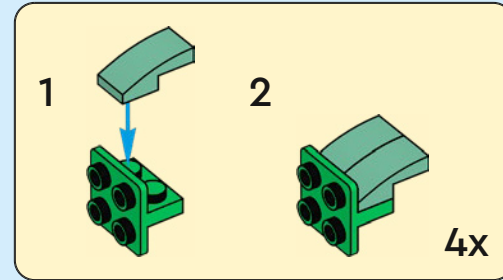

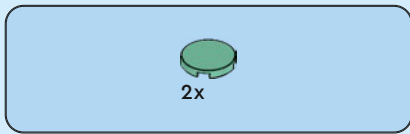

67

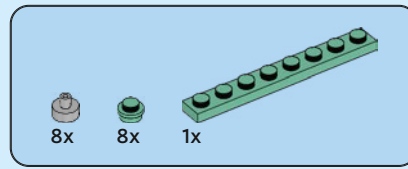
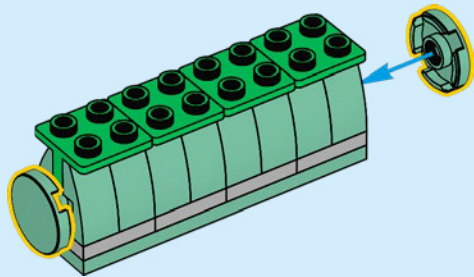

68

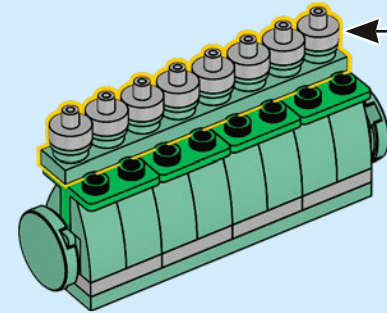
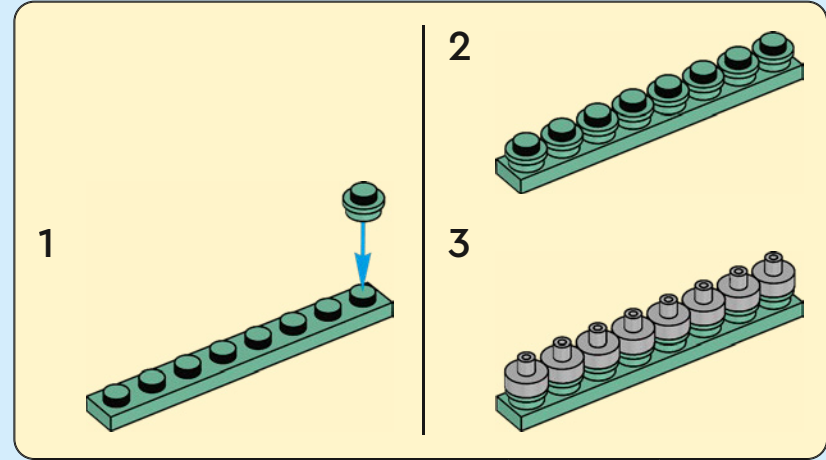



2x

69

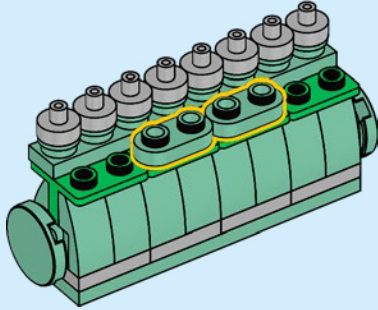

2x



2x

70

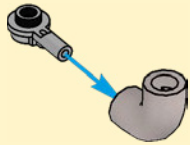
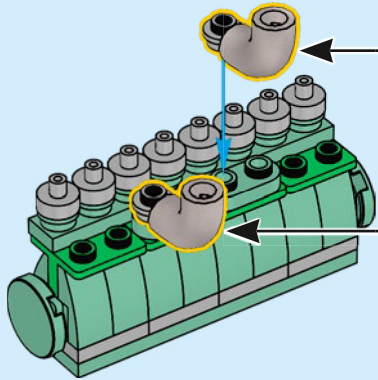

2x



2x

71

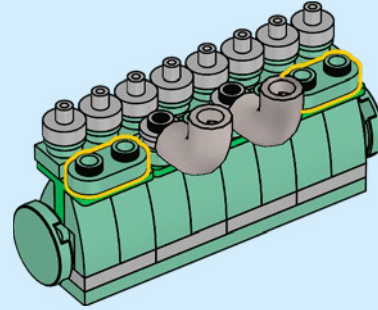

4x



4x

72

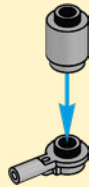
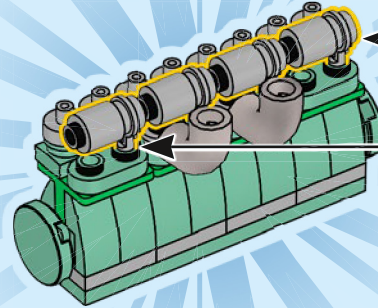

4x

73

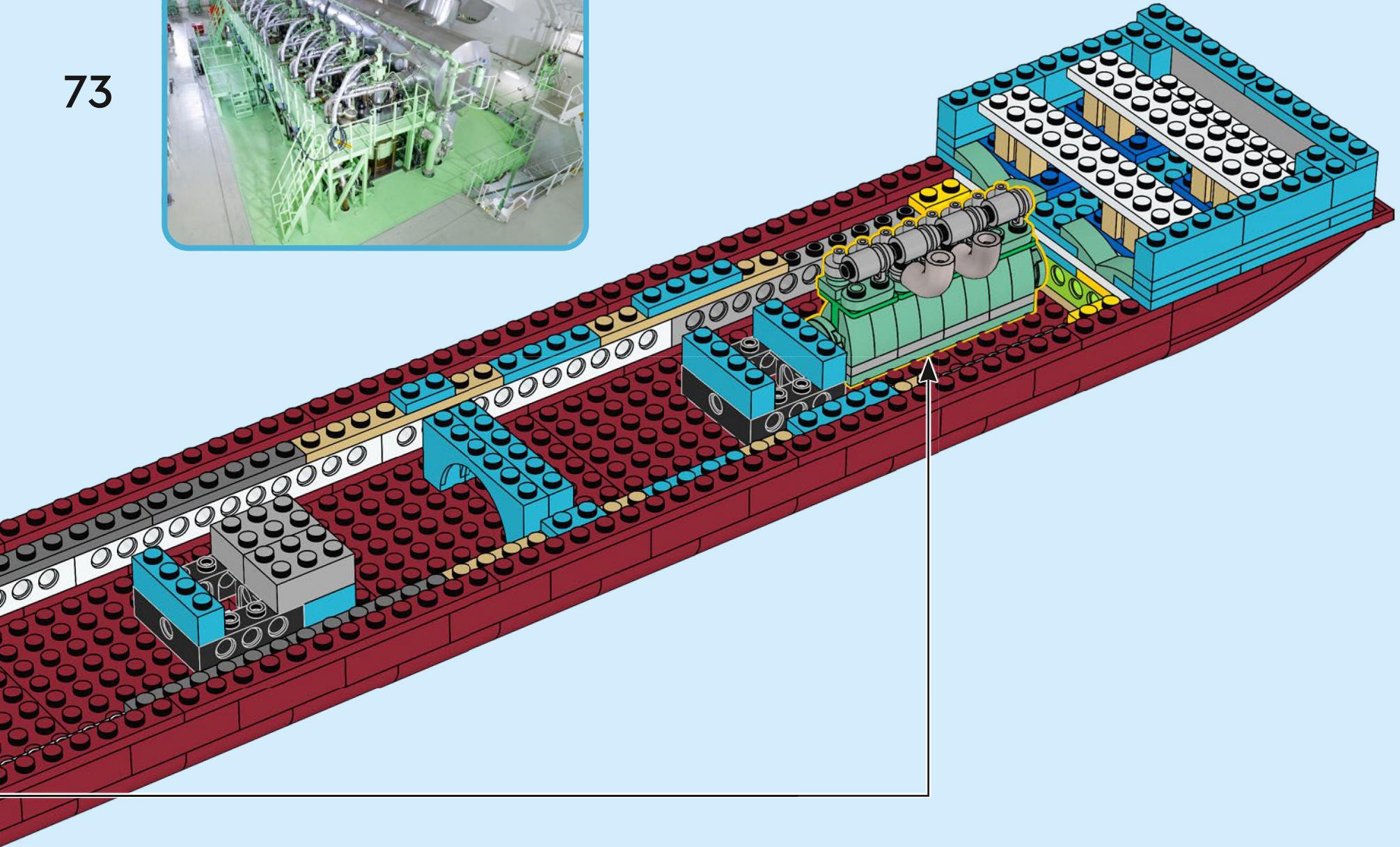

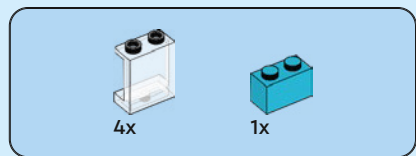

74

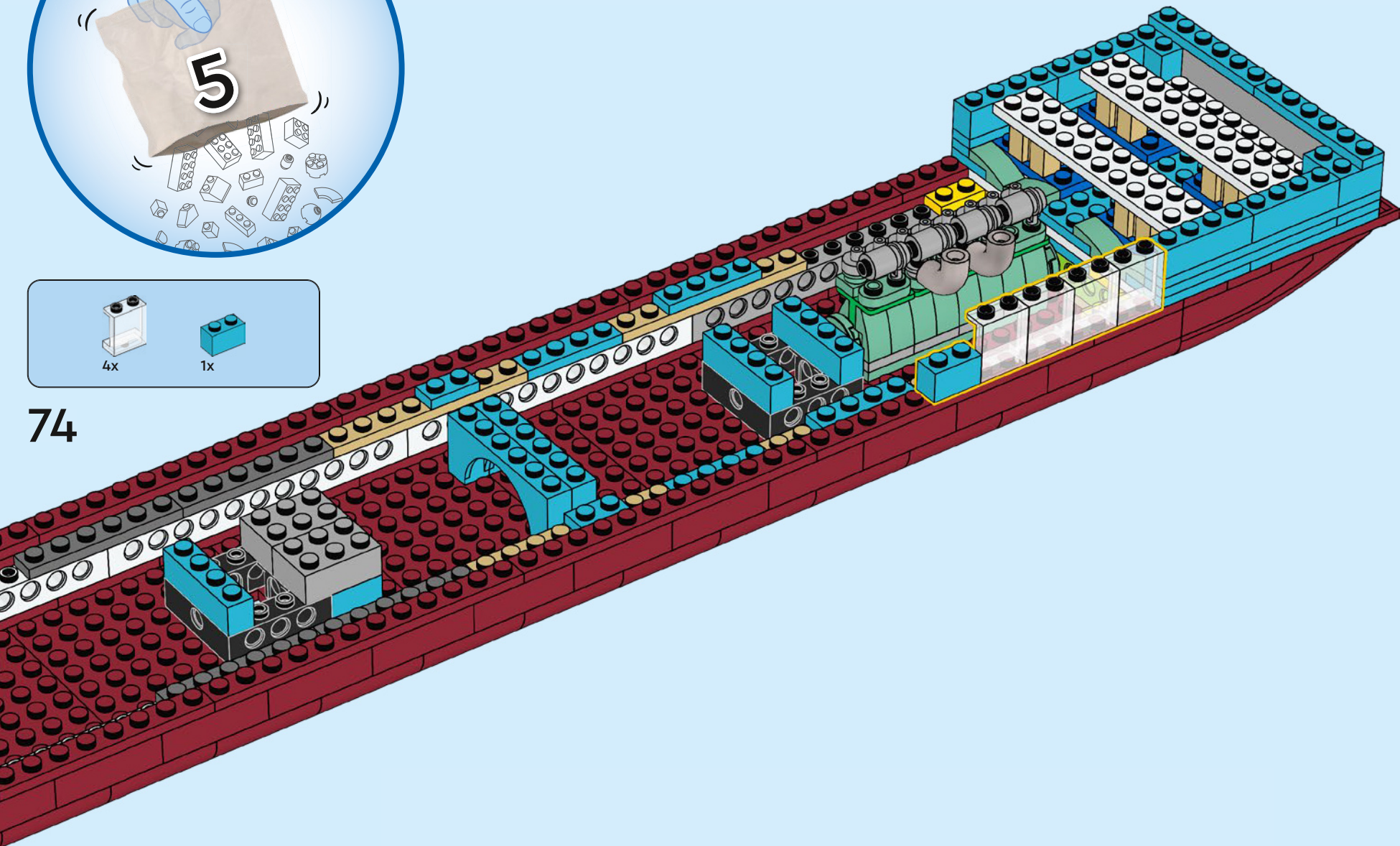

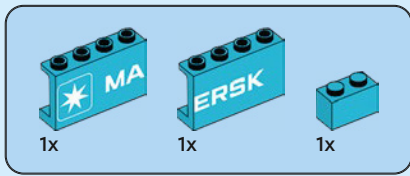

75

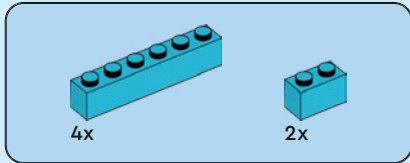
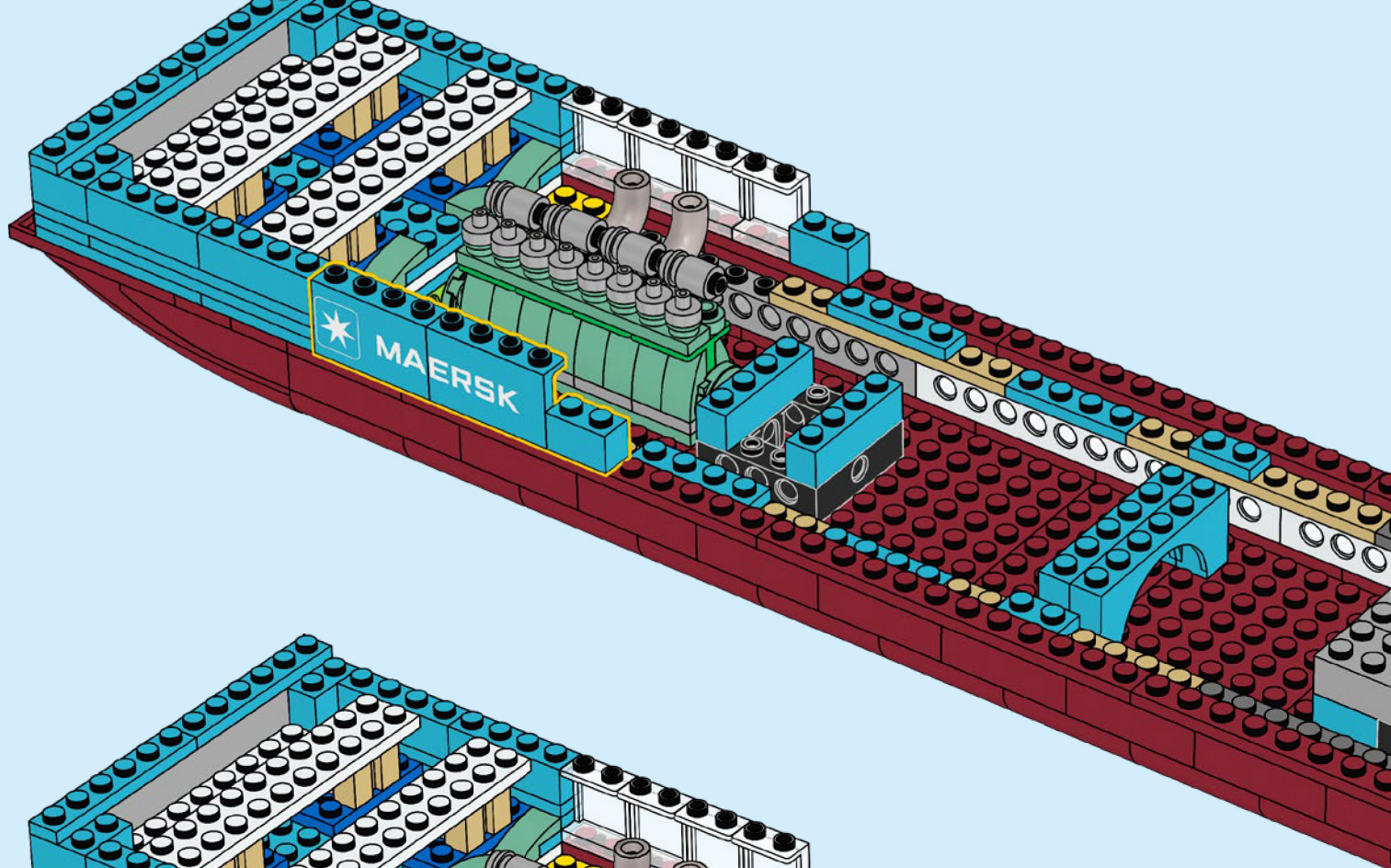

76

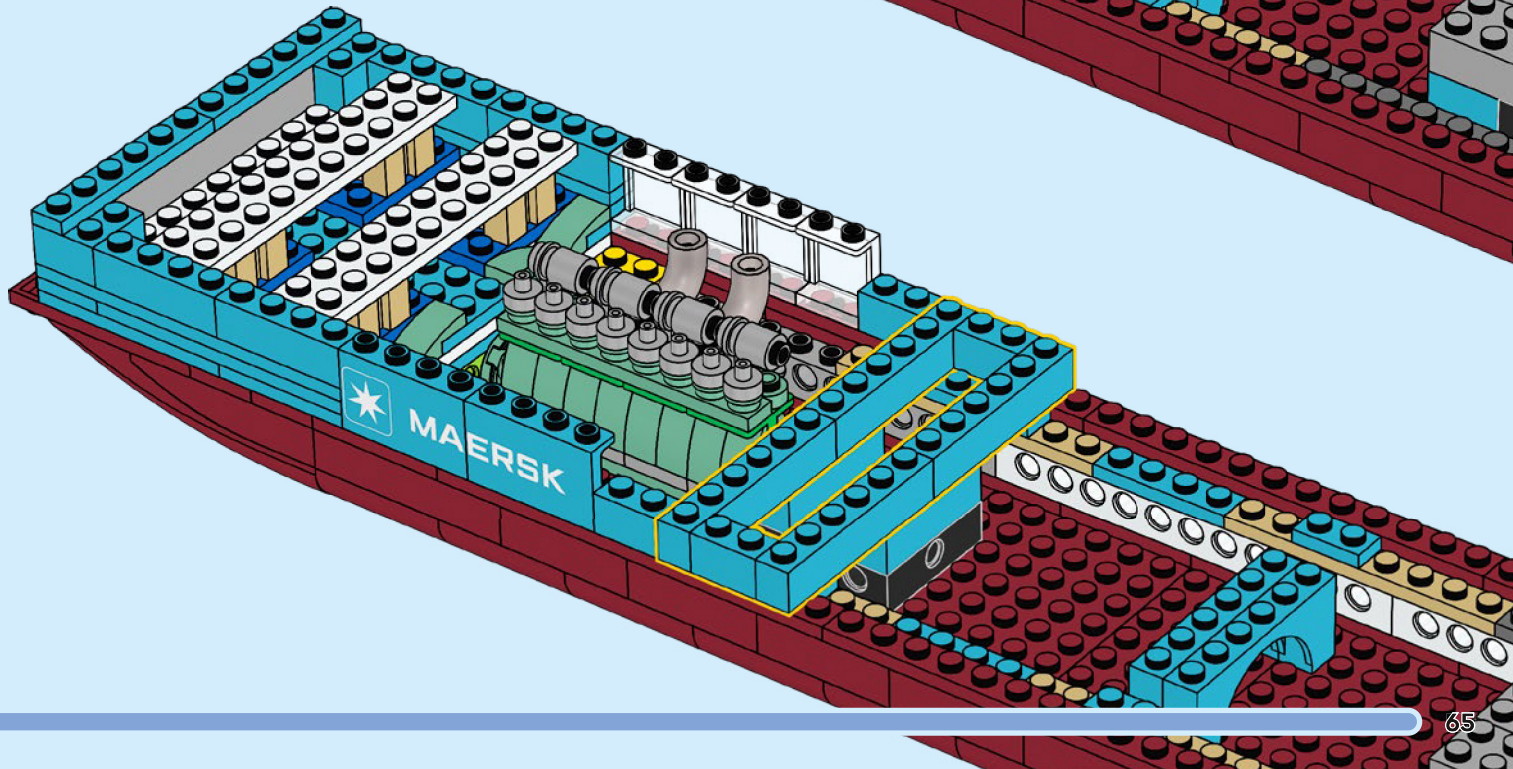

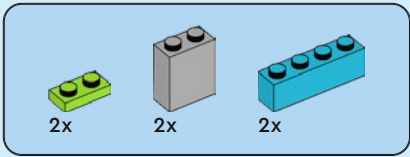

77

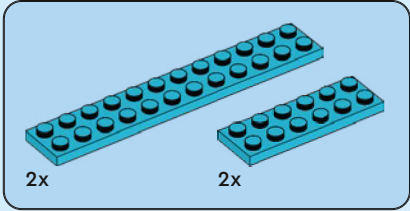
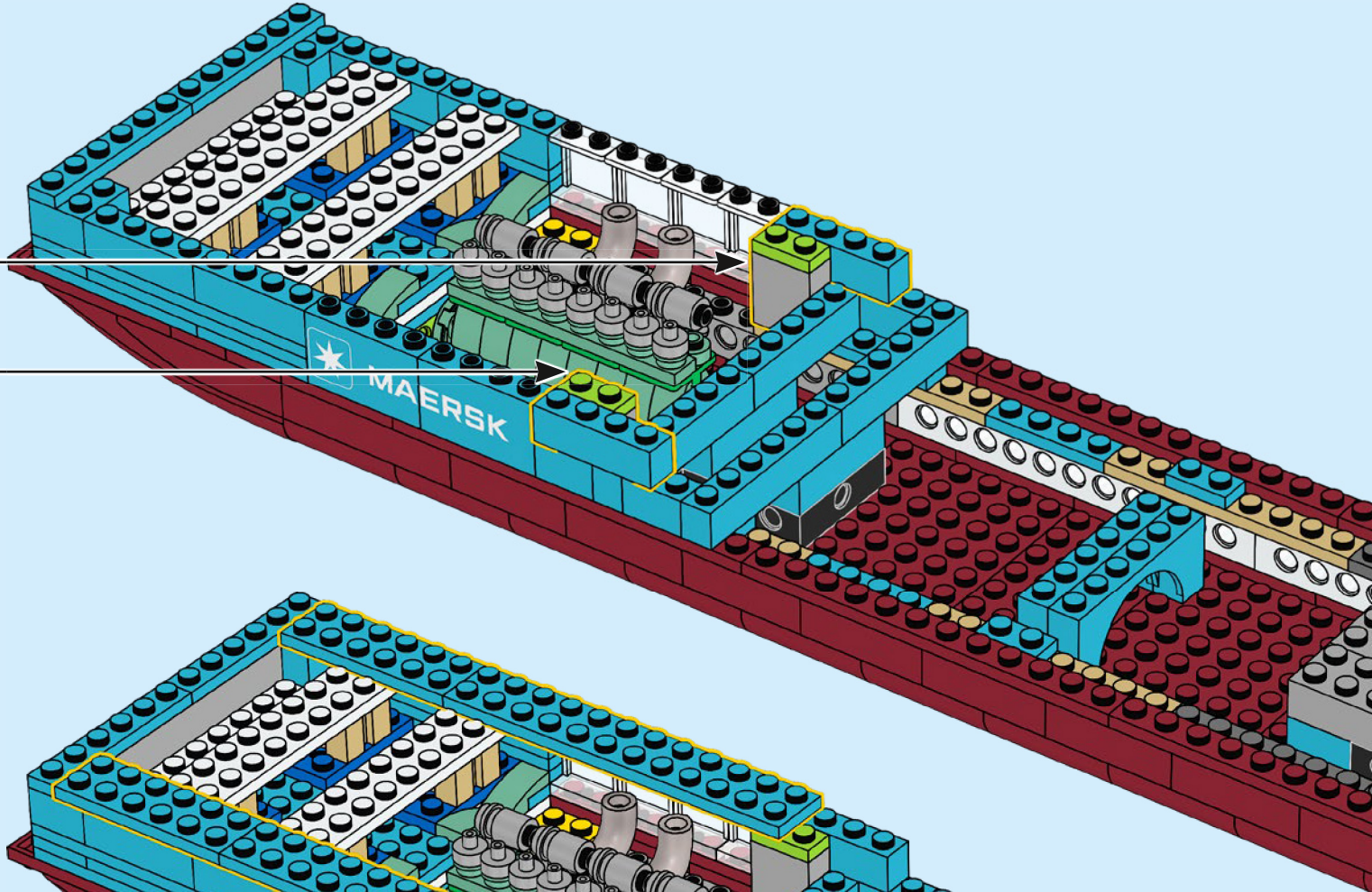
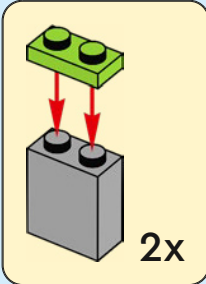

78

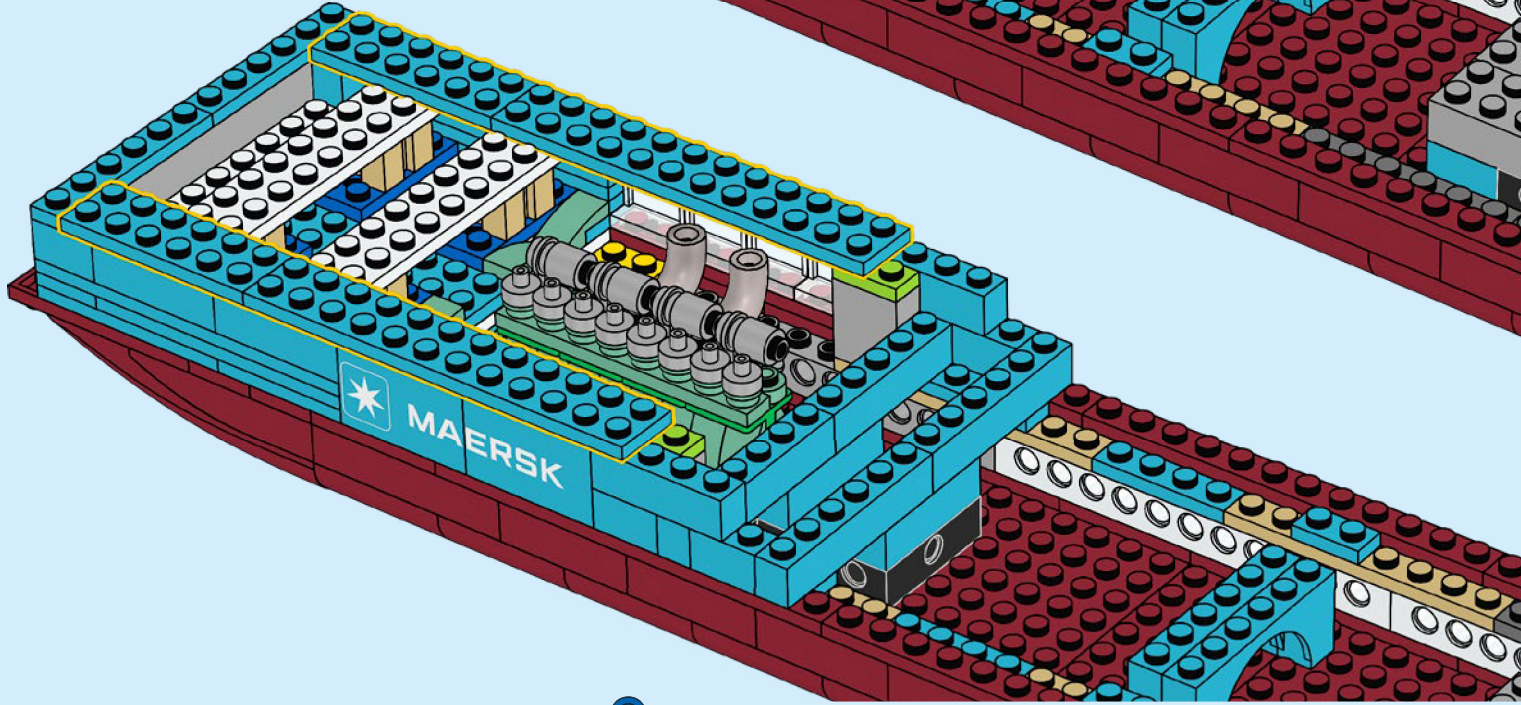

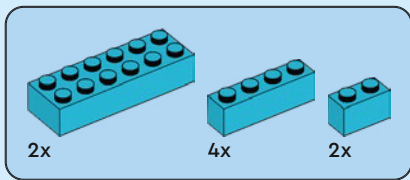

79

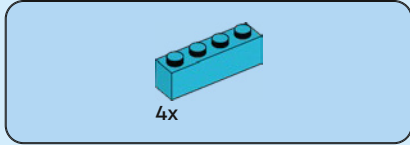
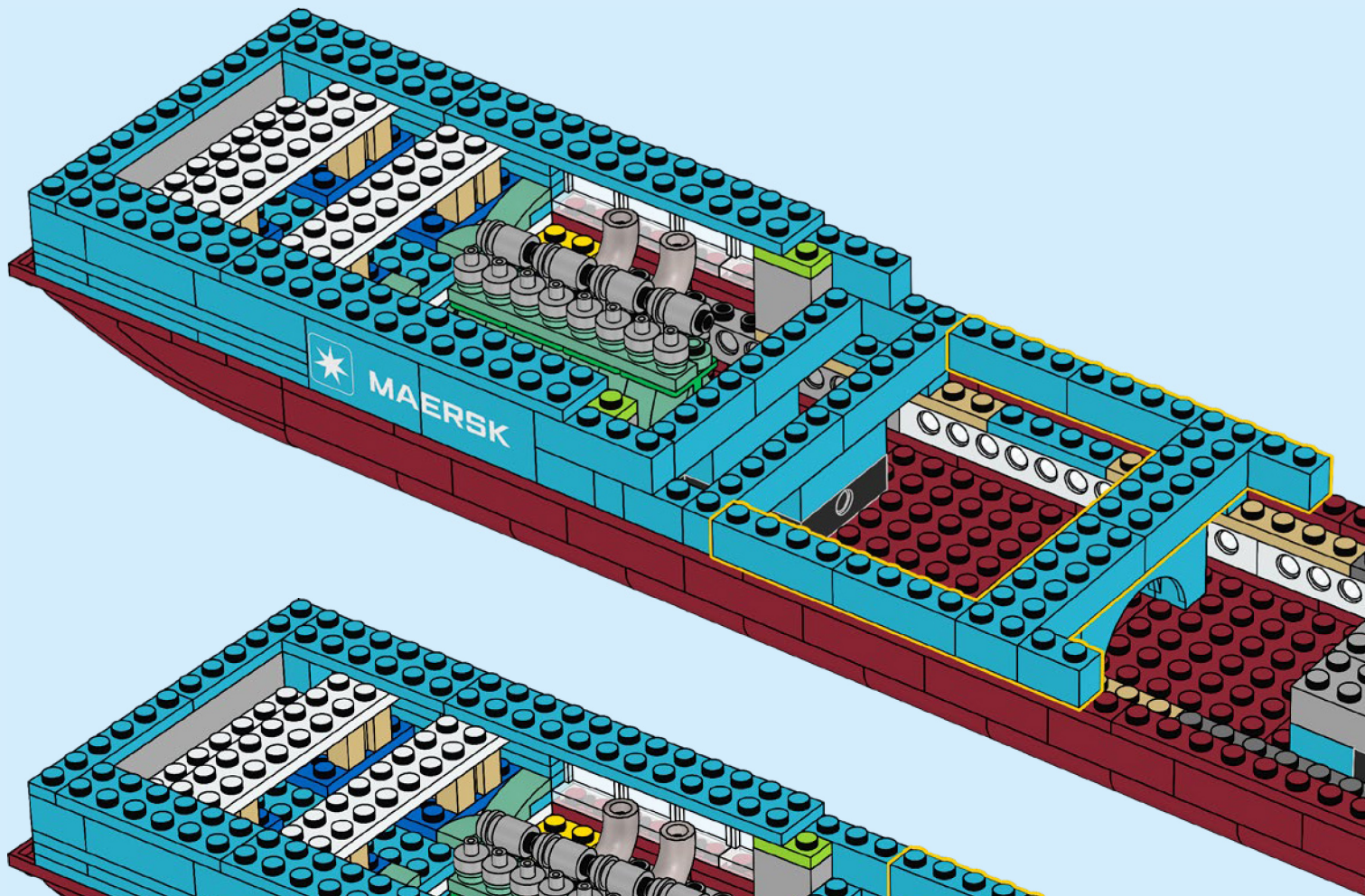

80

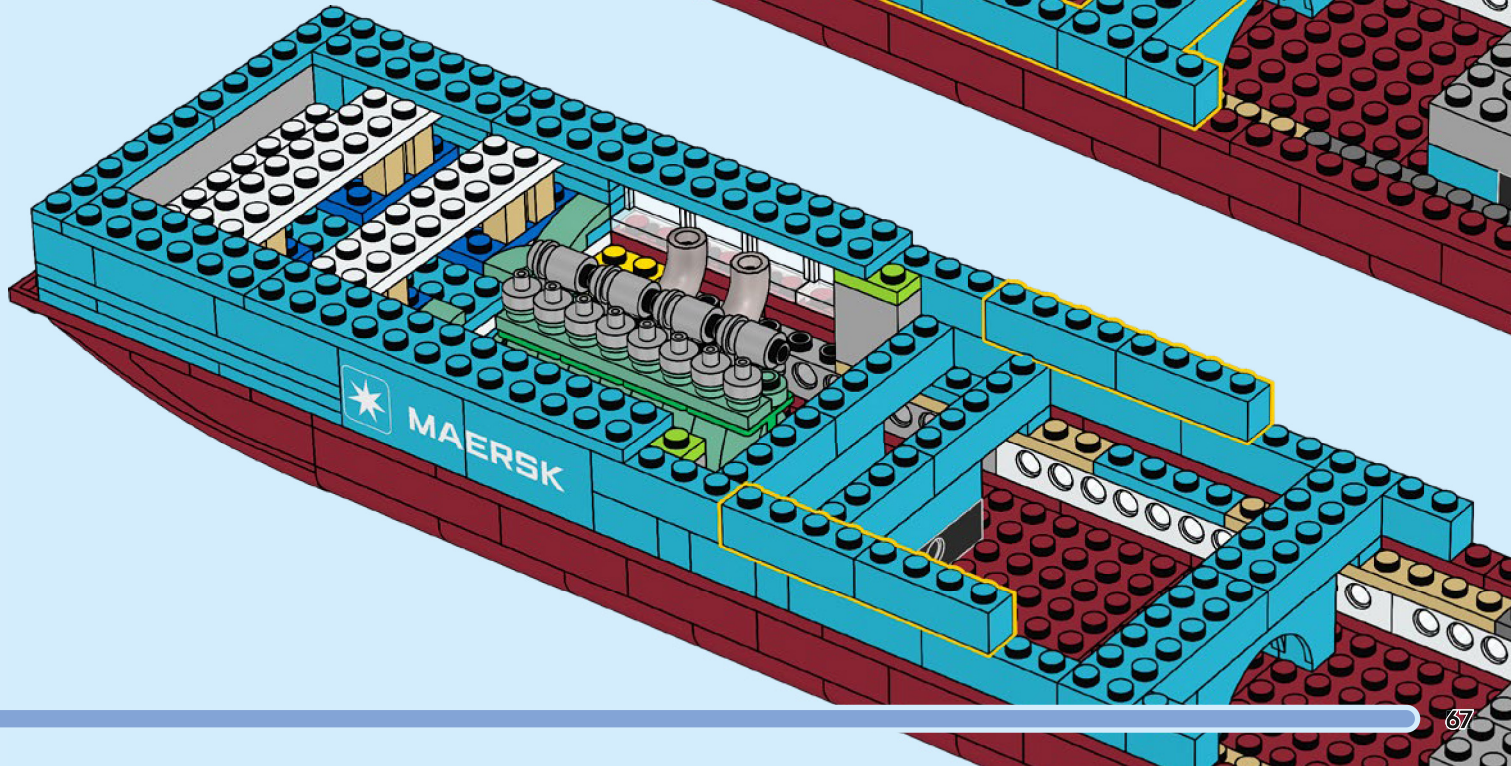

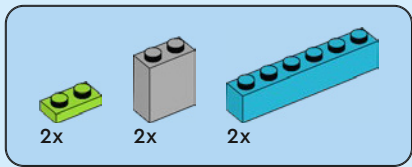

81

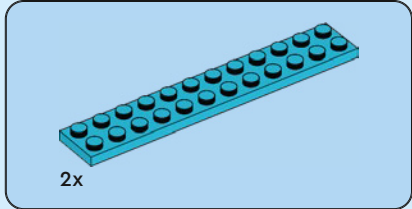
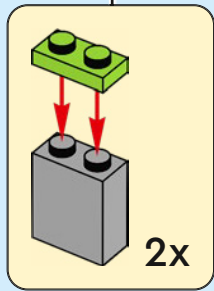
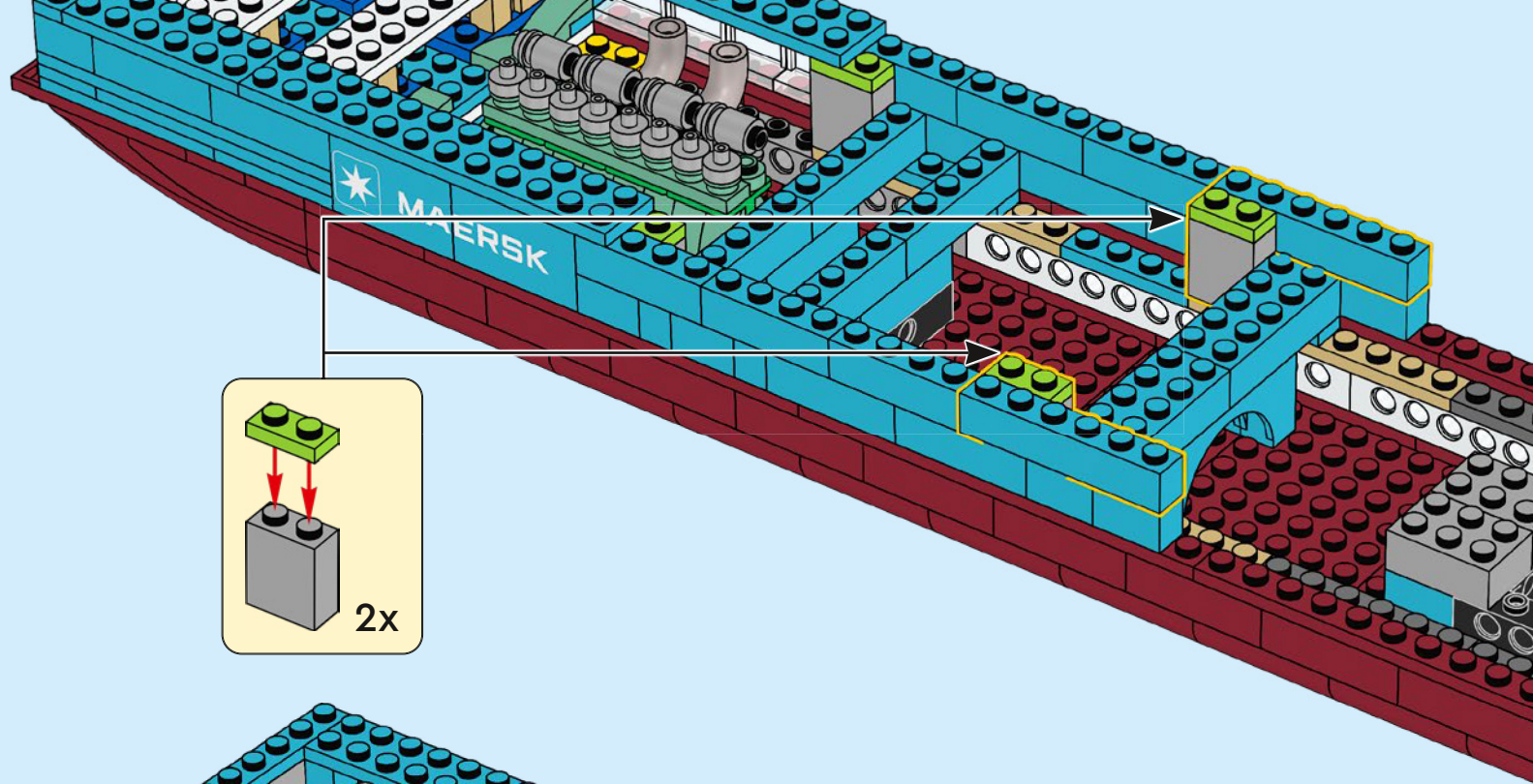

82

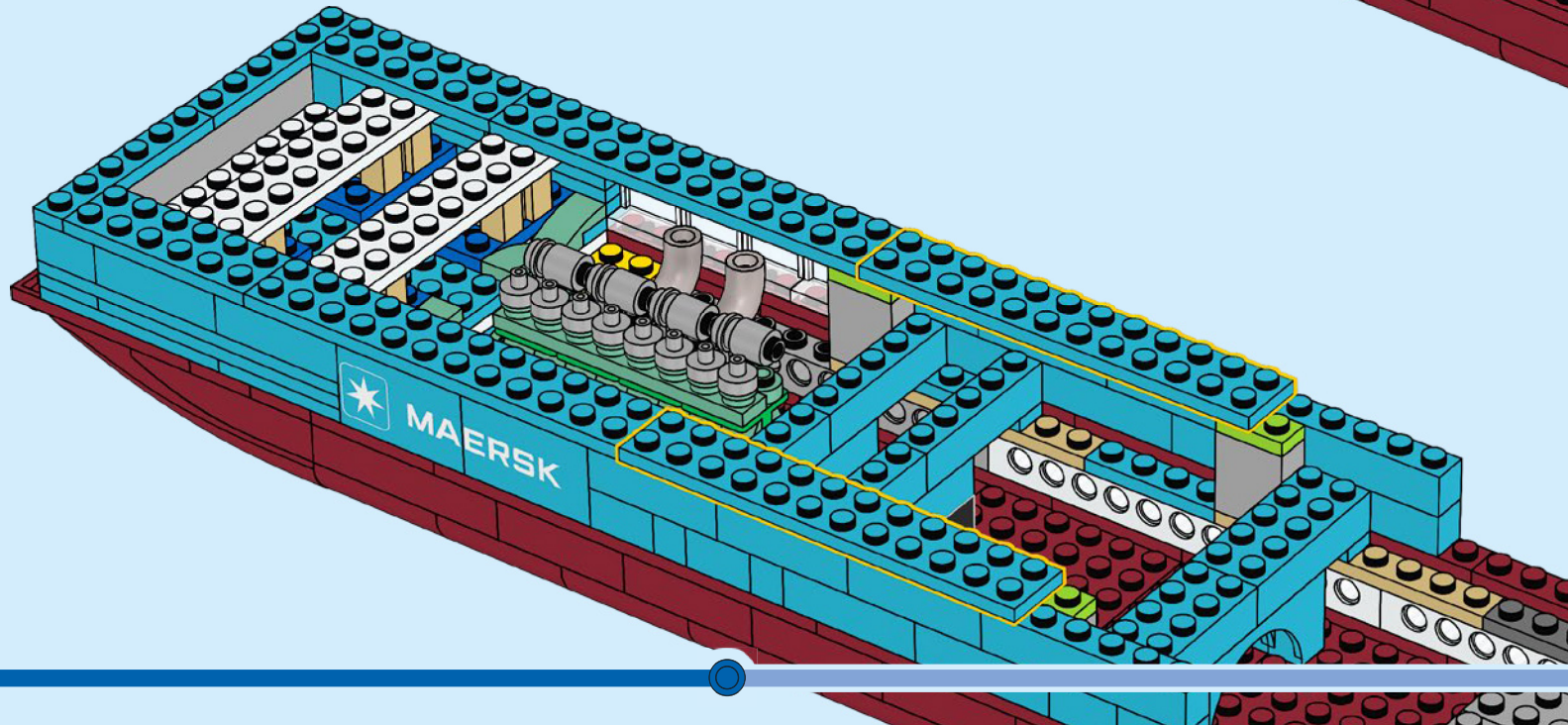

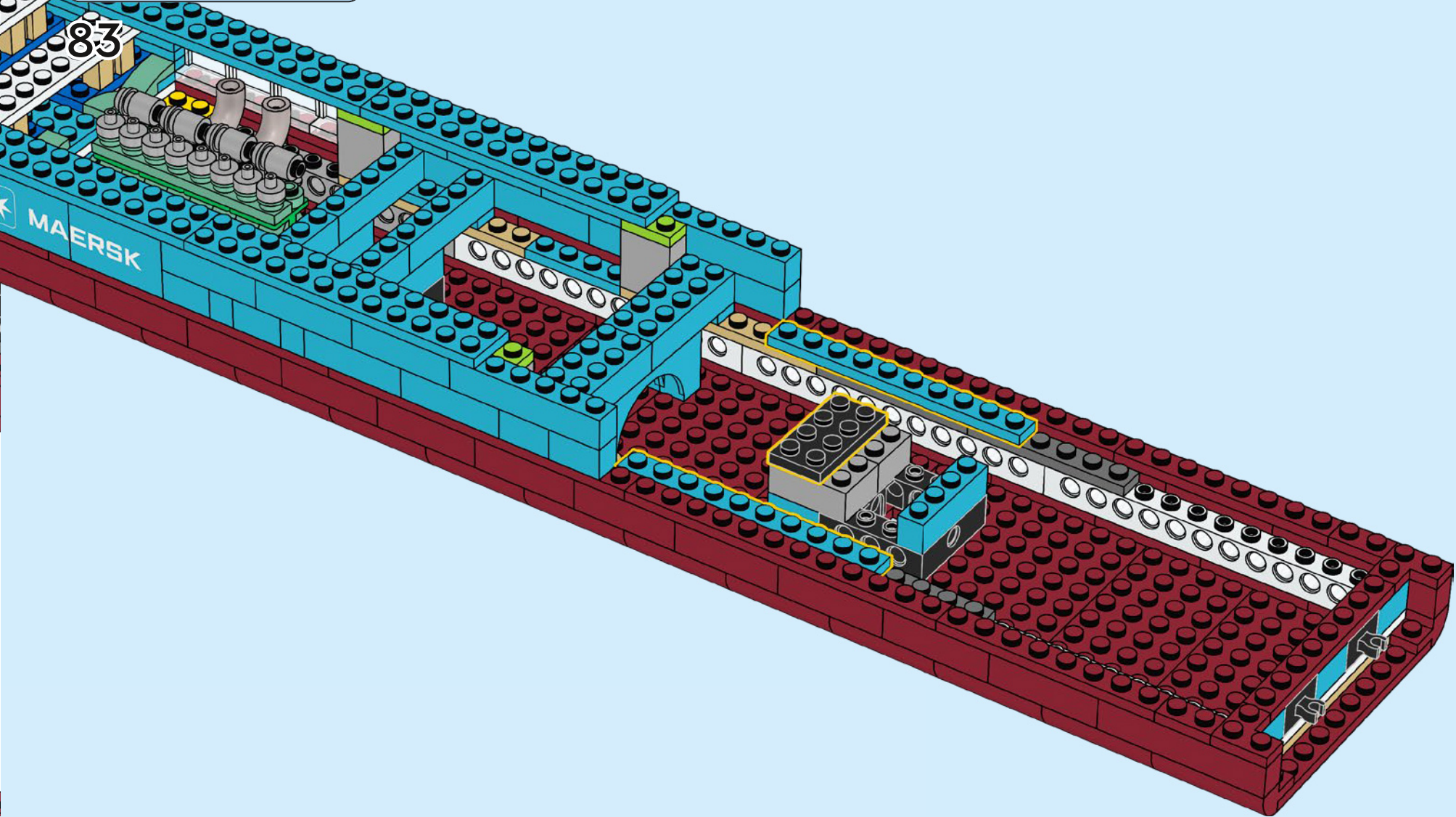
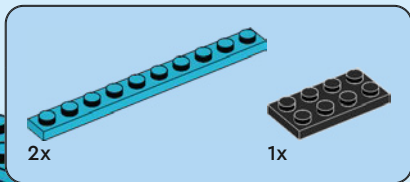

84

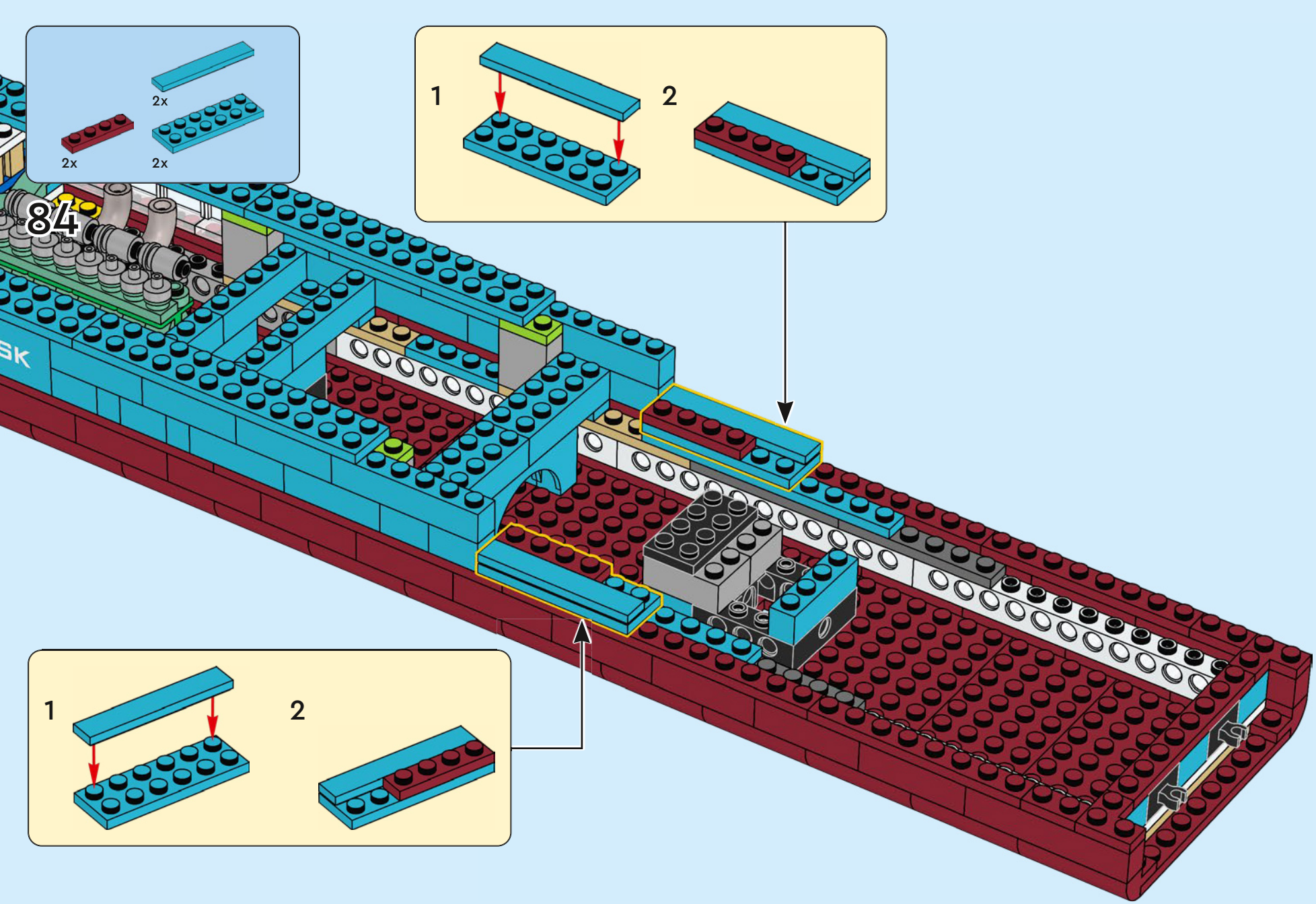
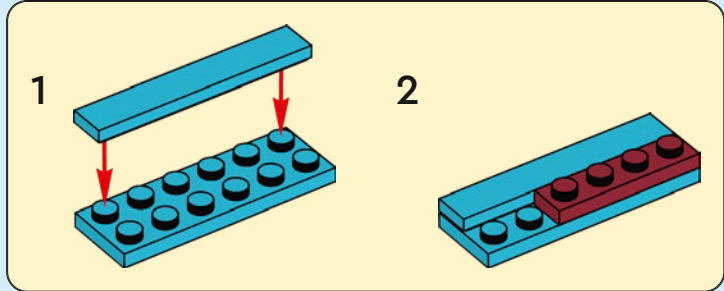
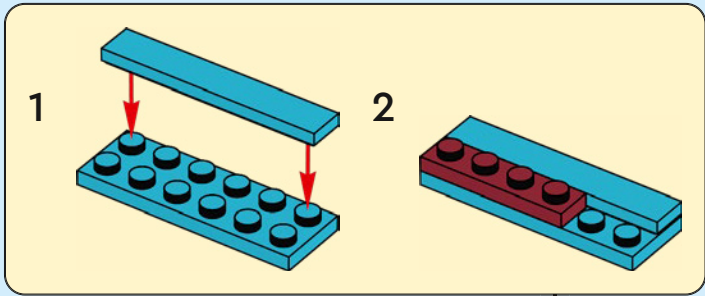
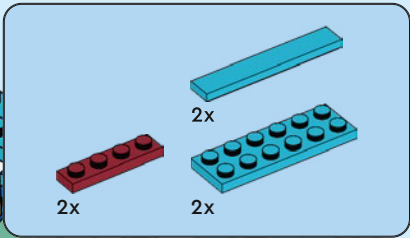

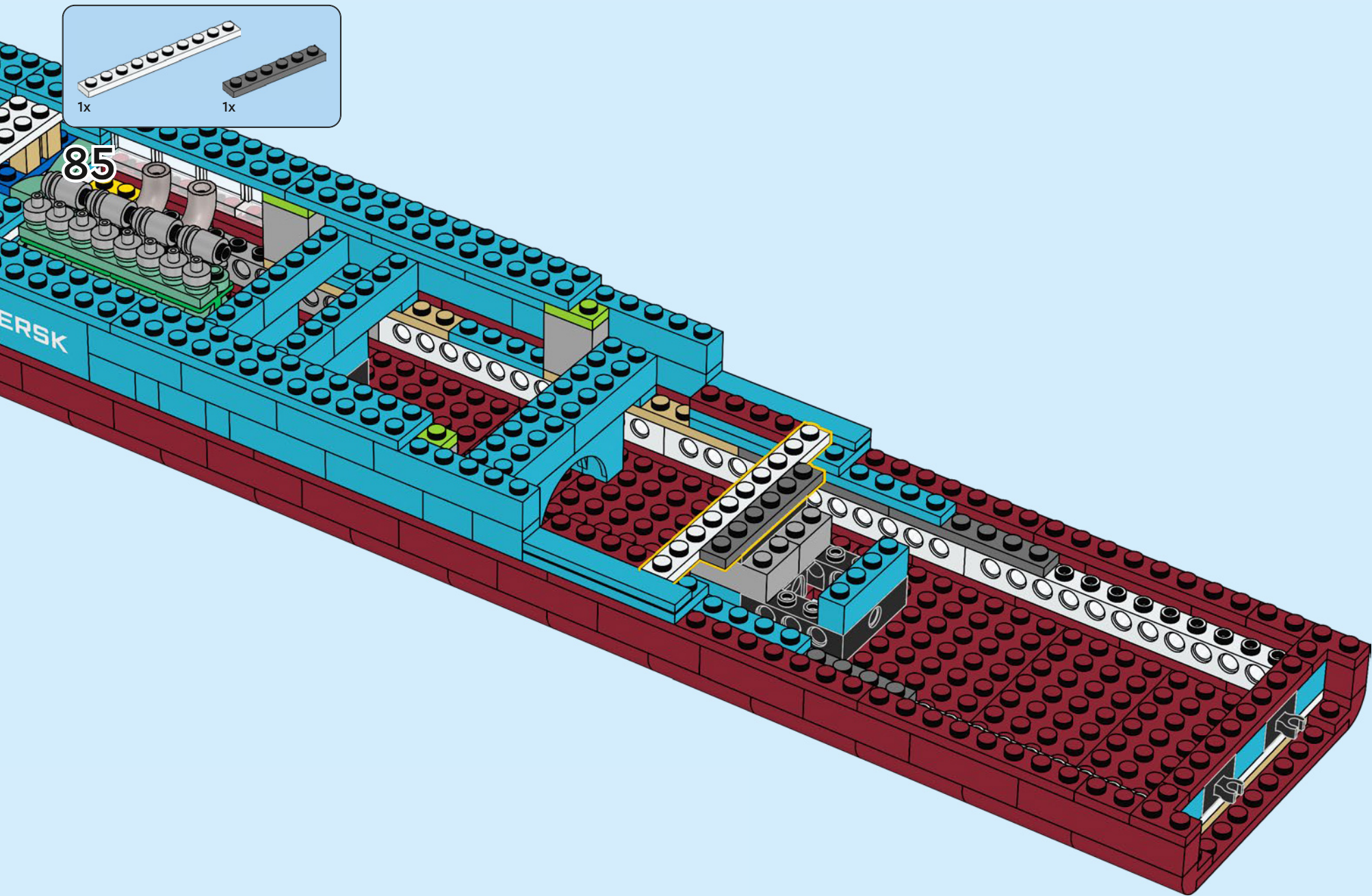

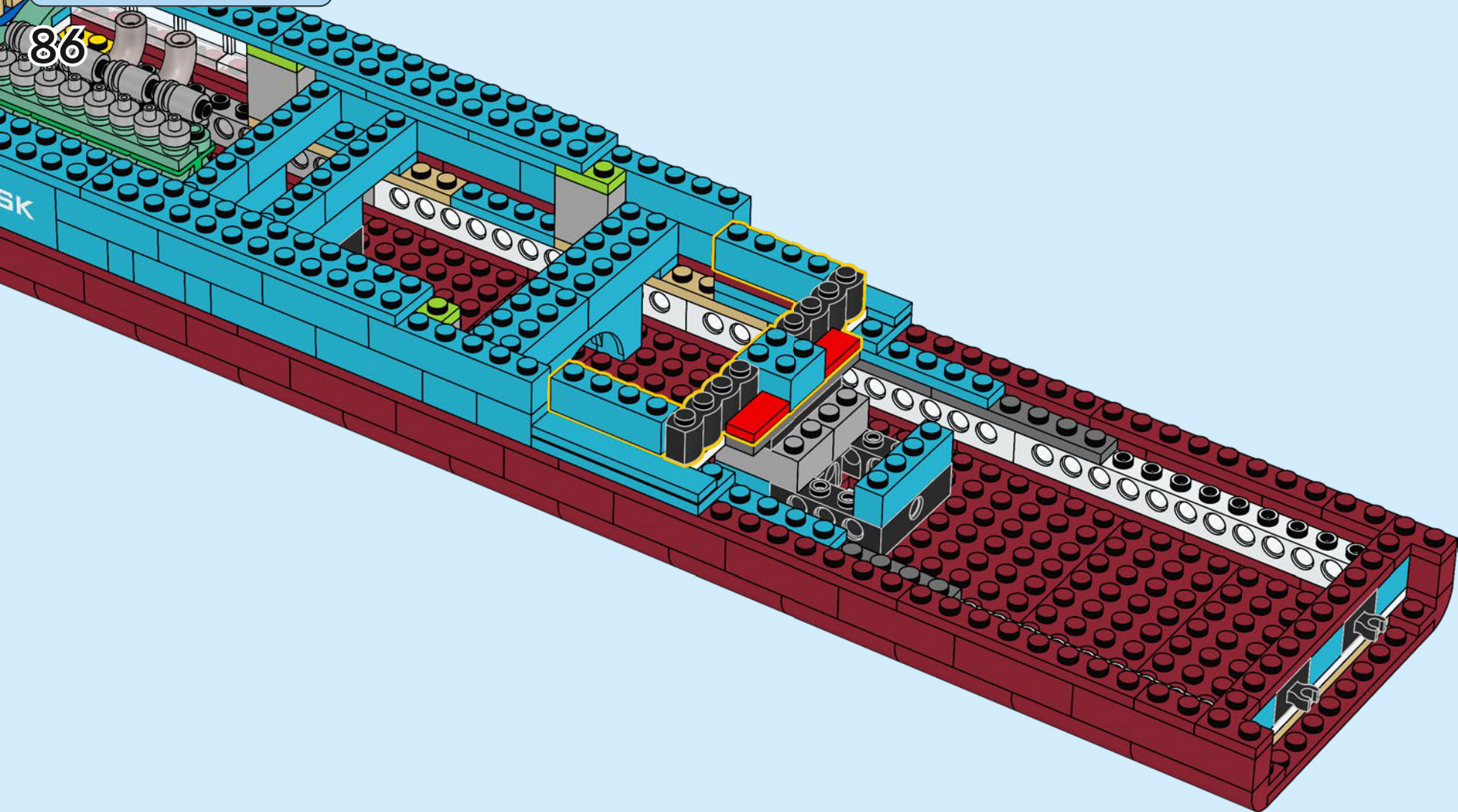
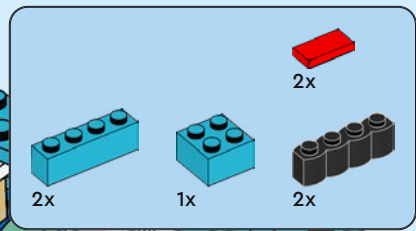

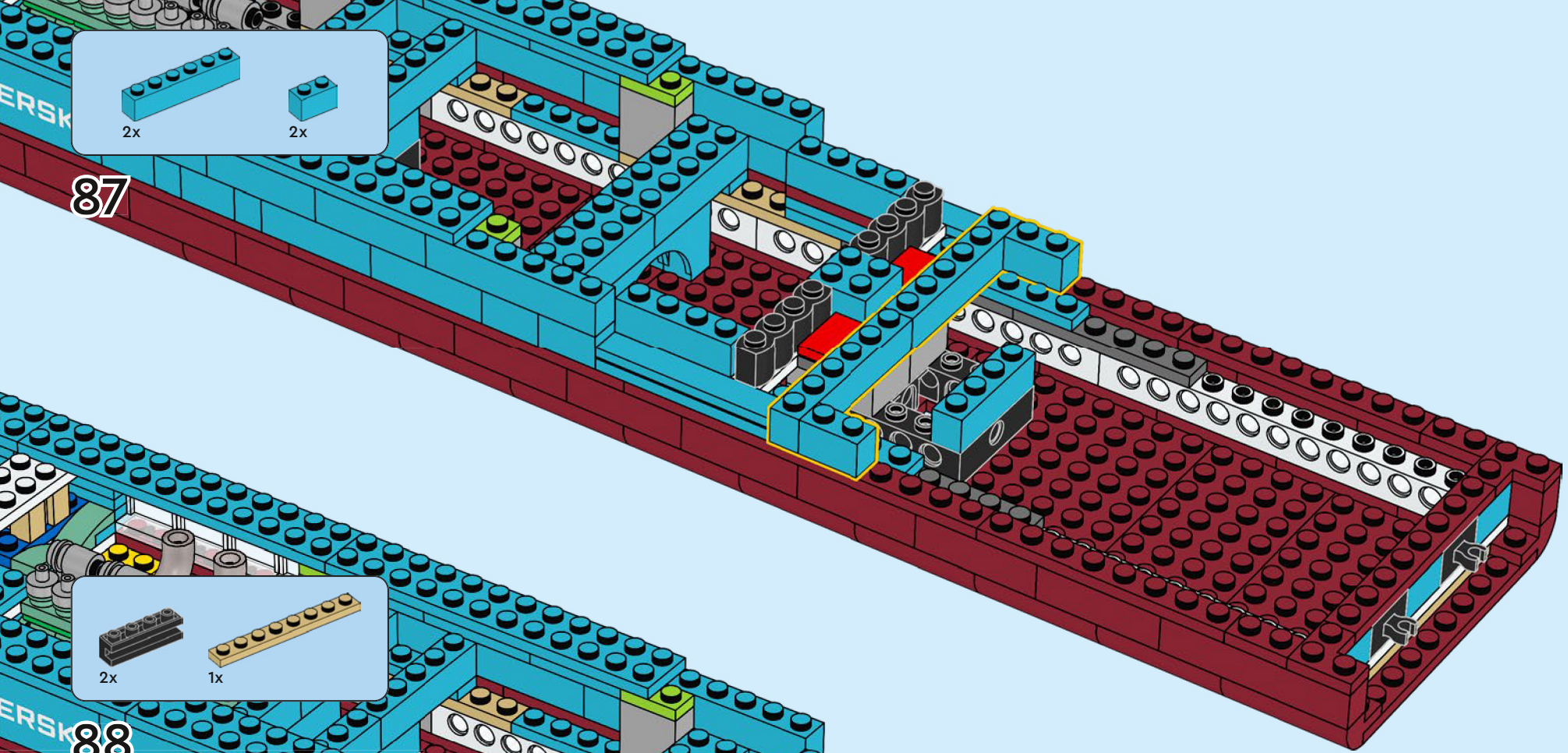

87



88

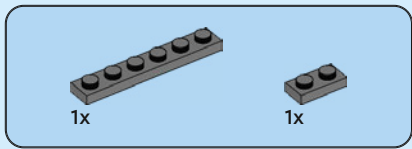

89

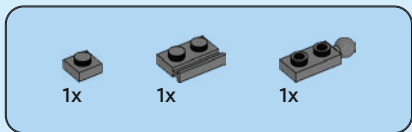
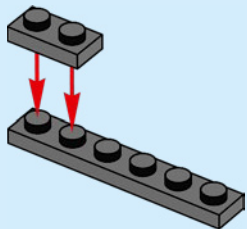

90

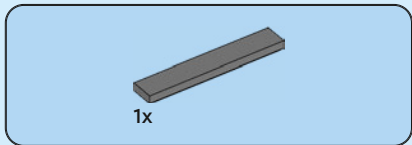
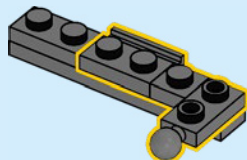

91

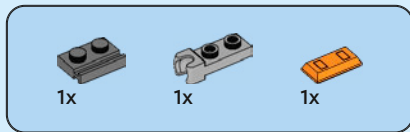
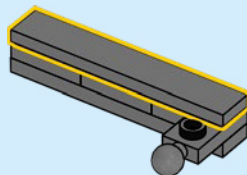

92

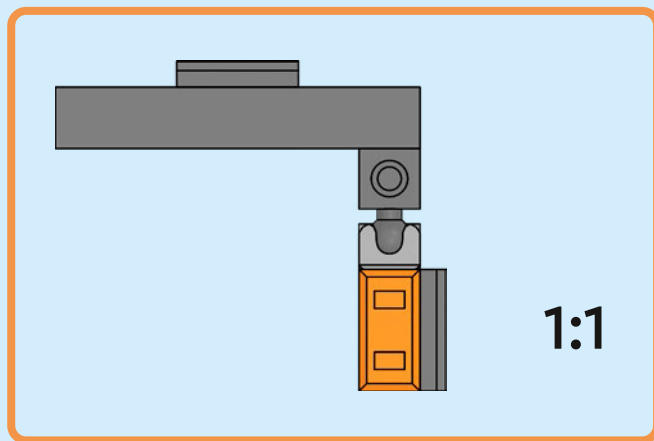
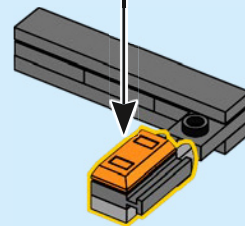
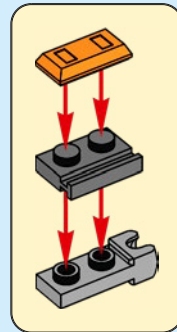

1:1

93

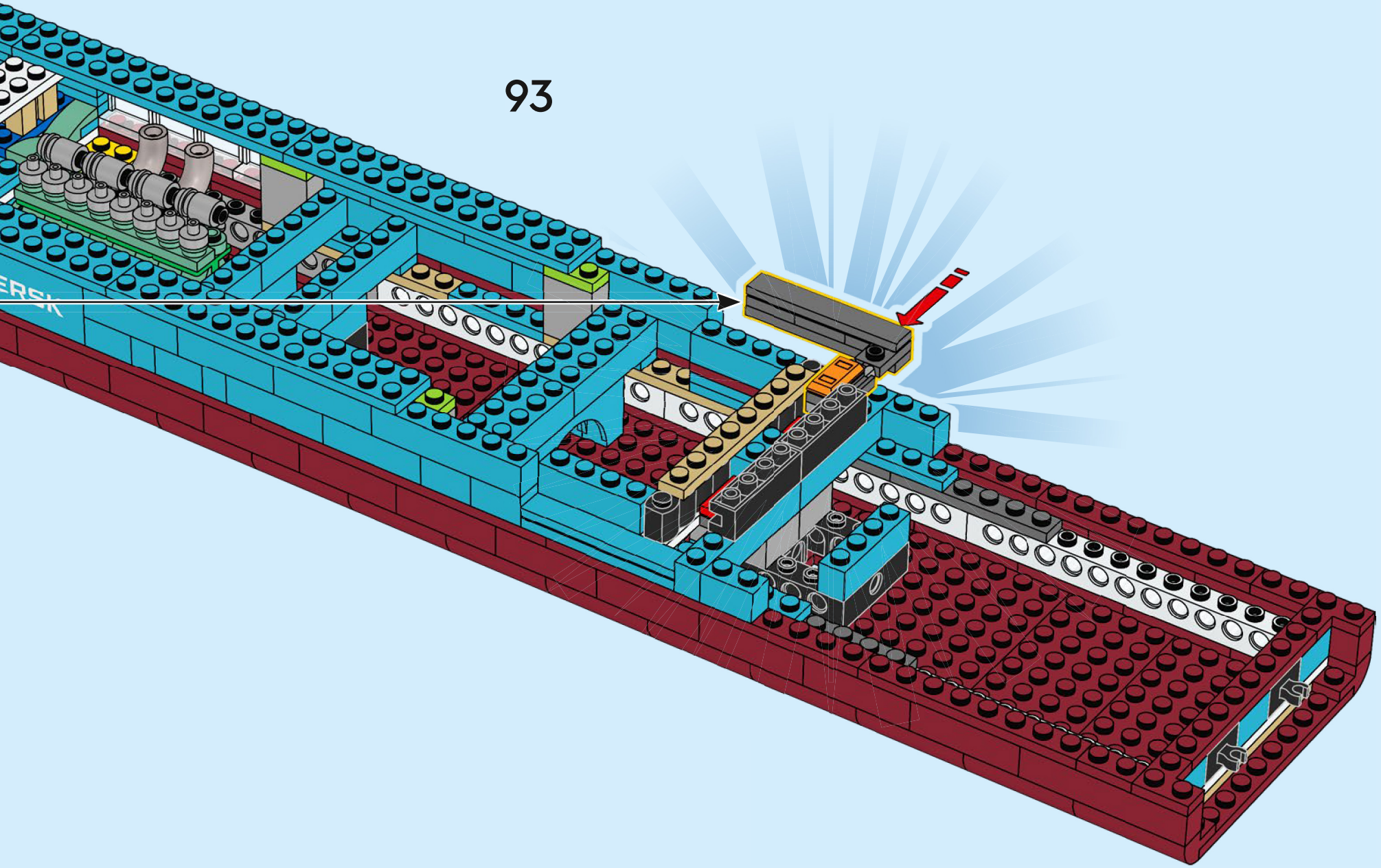

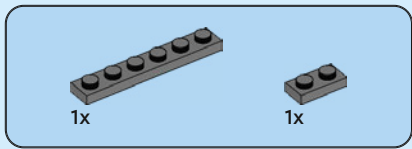

94

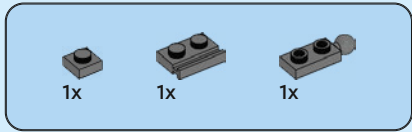
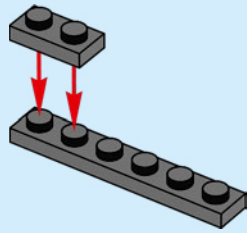

95

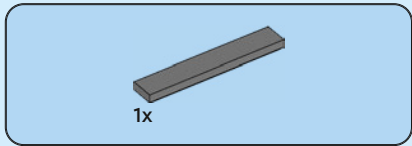
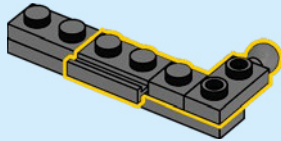

96

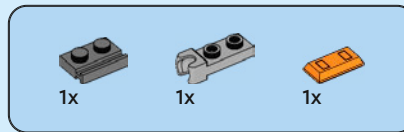
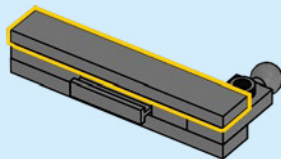

97

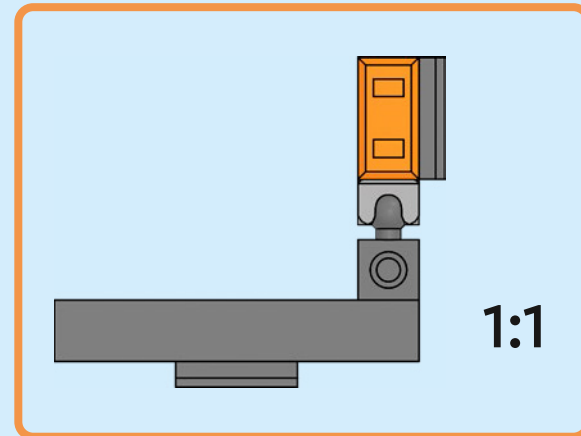
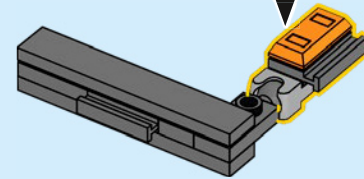
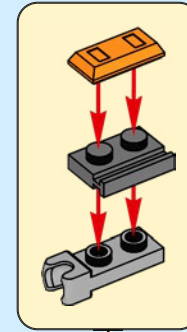

98

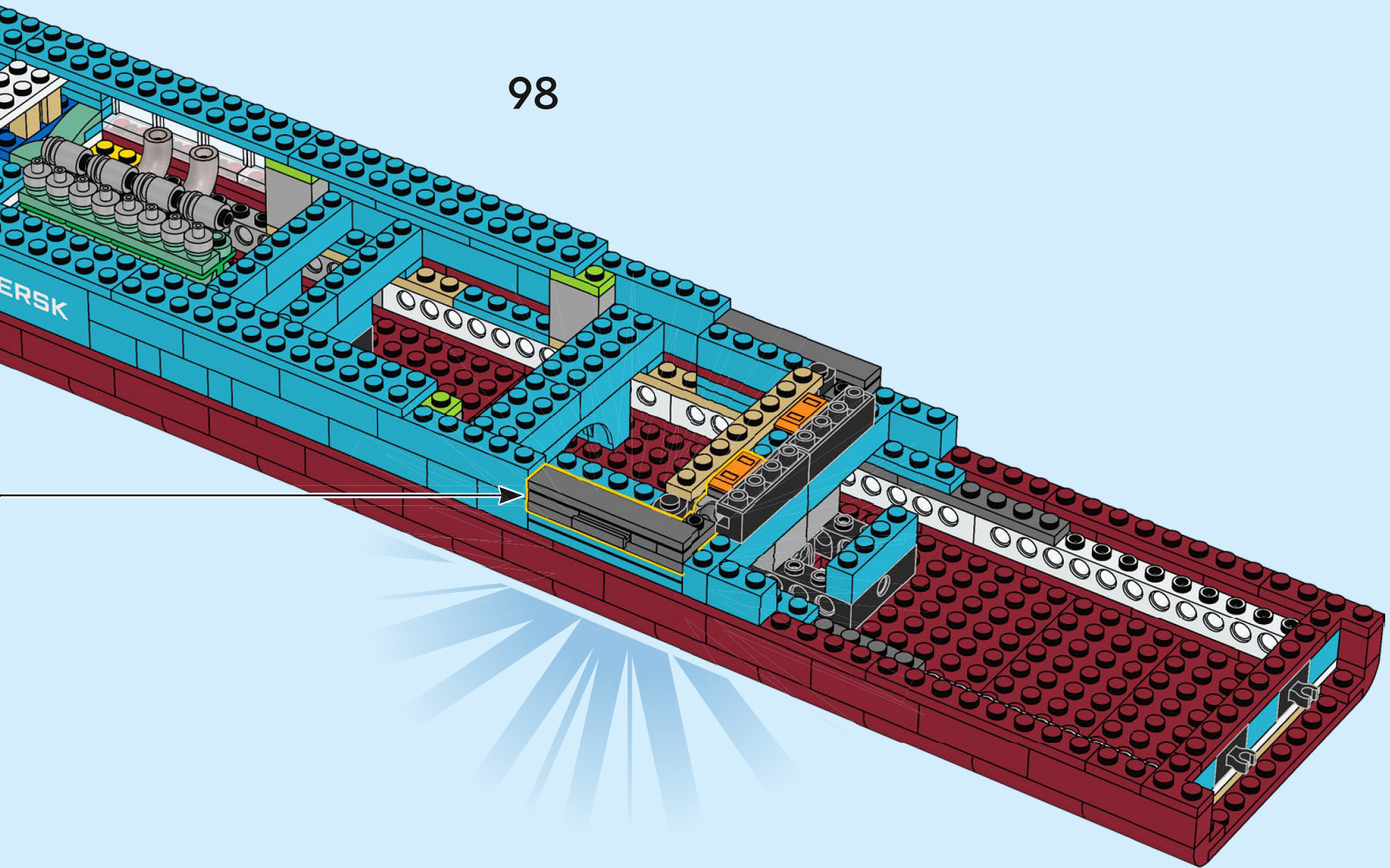

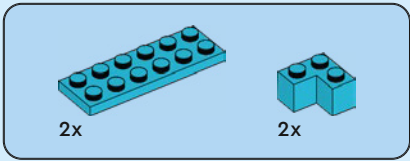

99

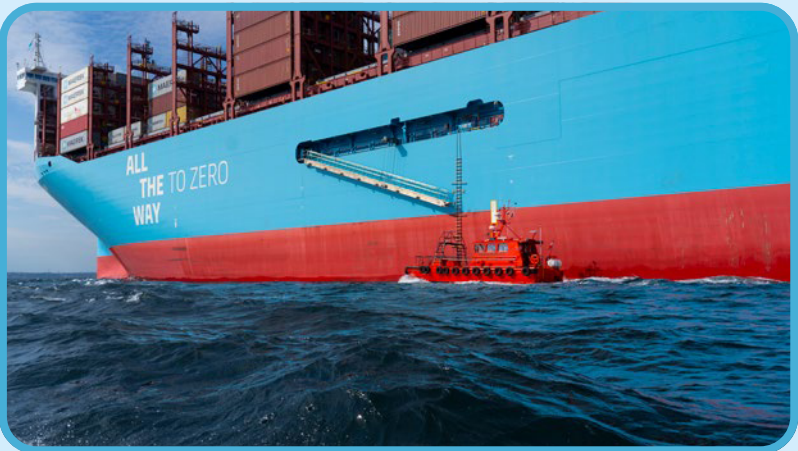
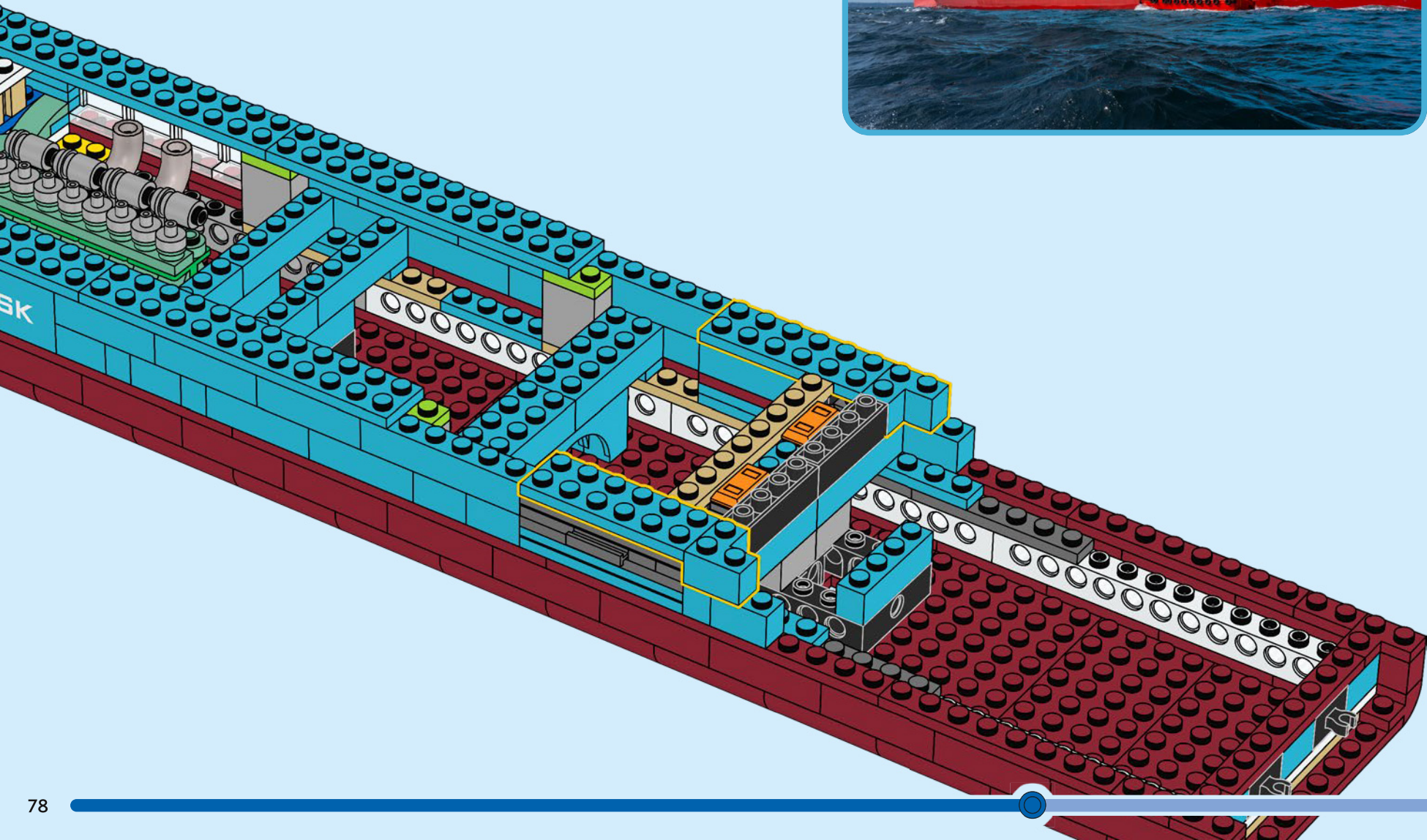

1

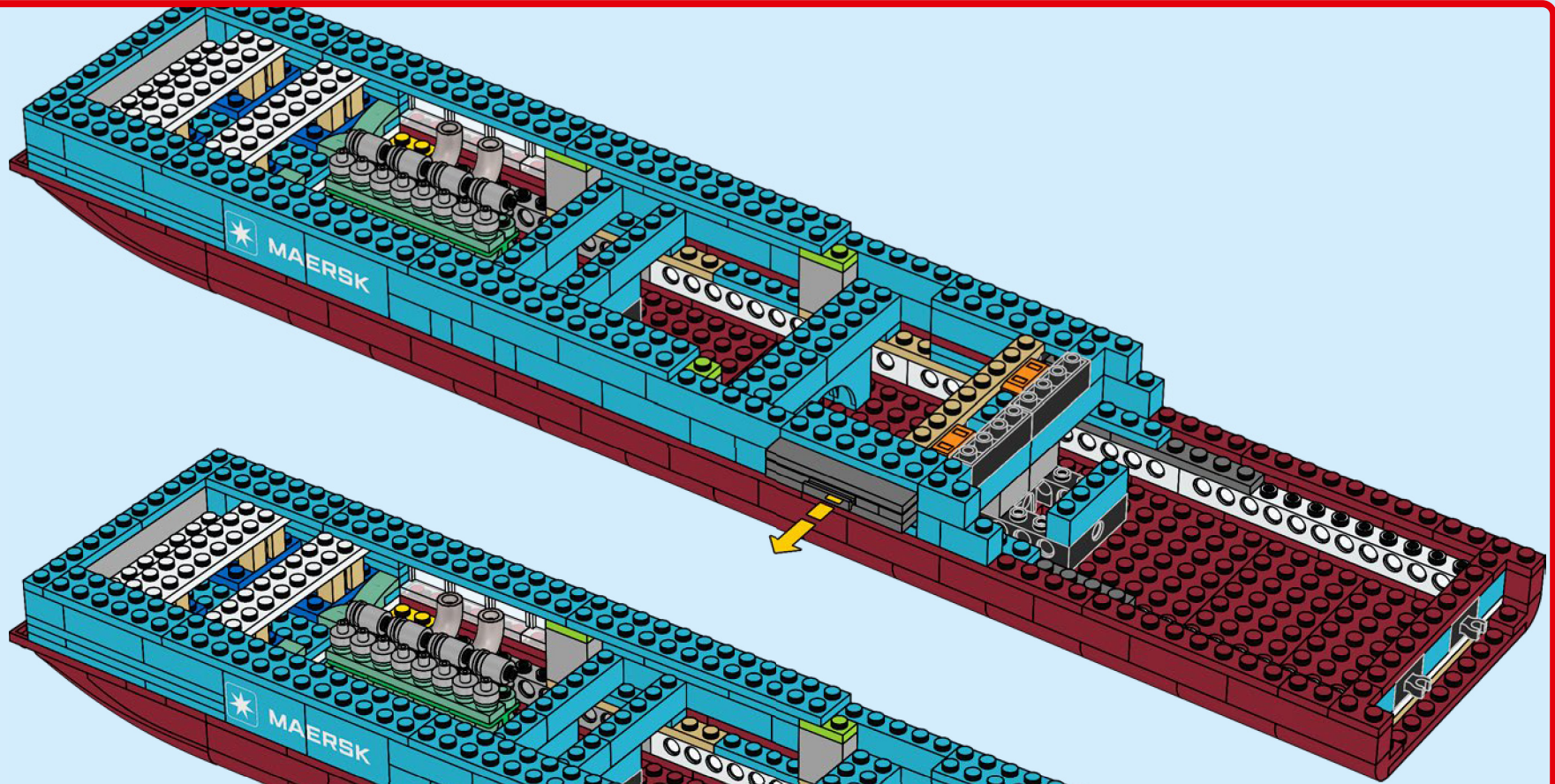

2

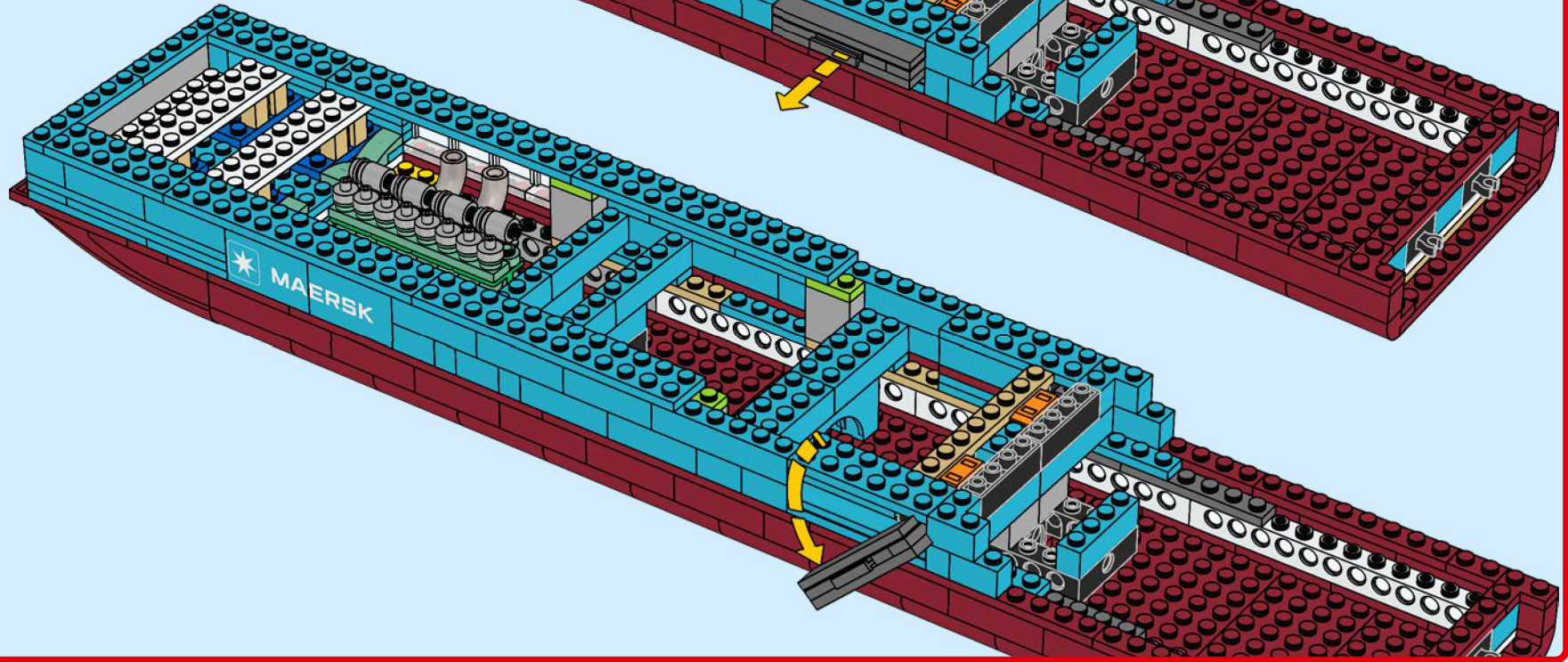

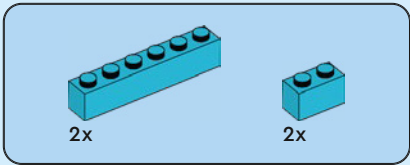

100

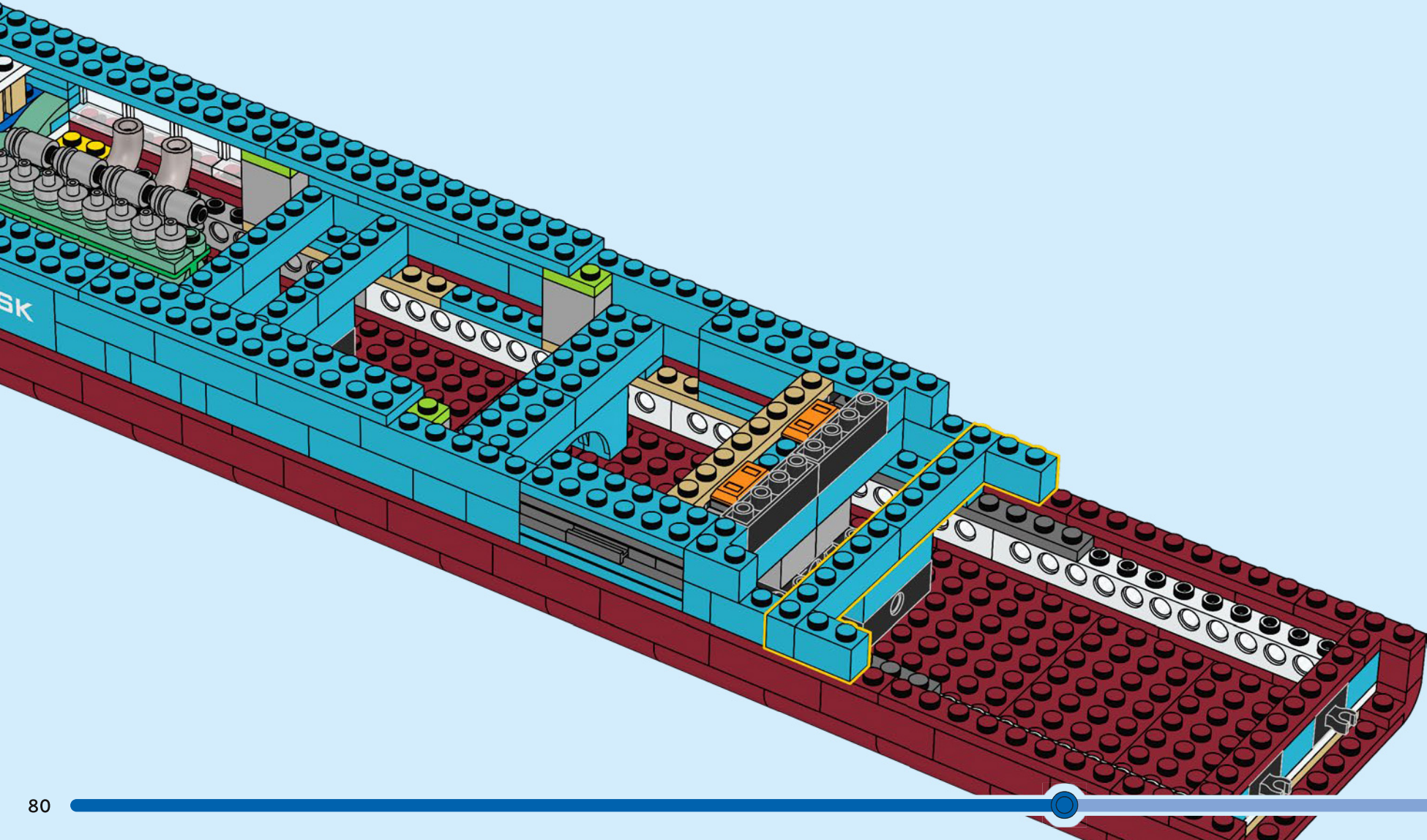

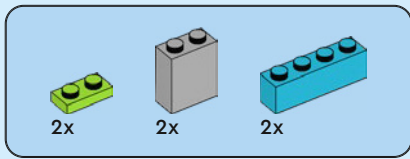

101

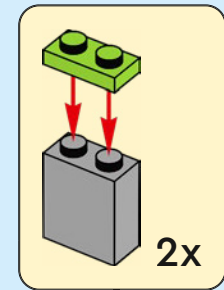
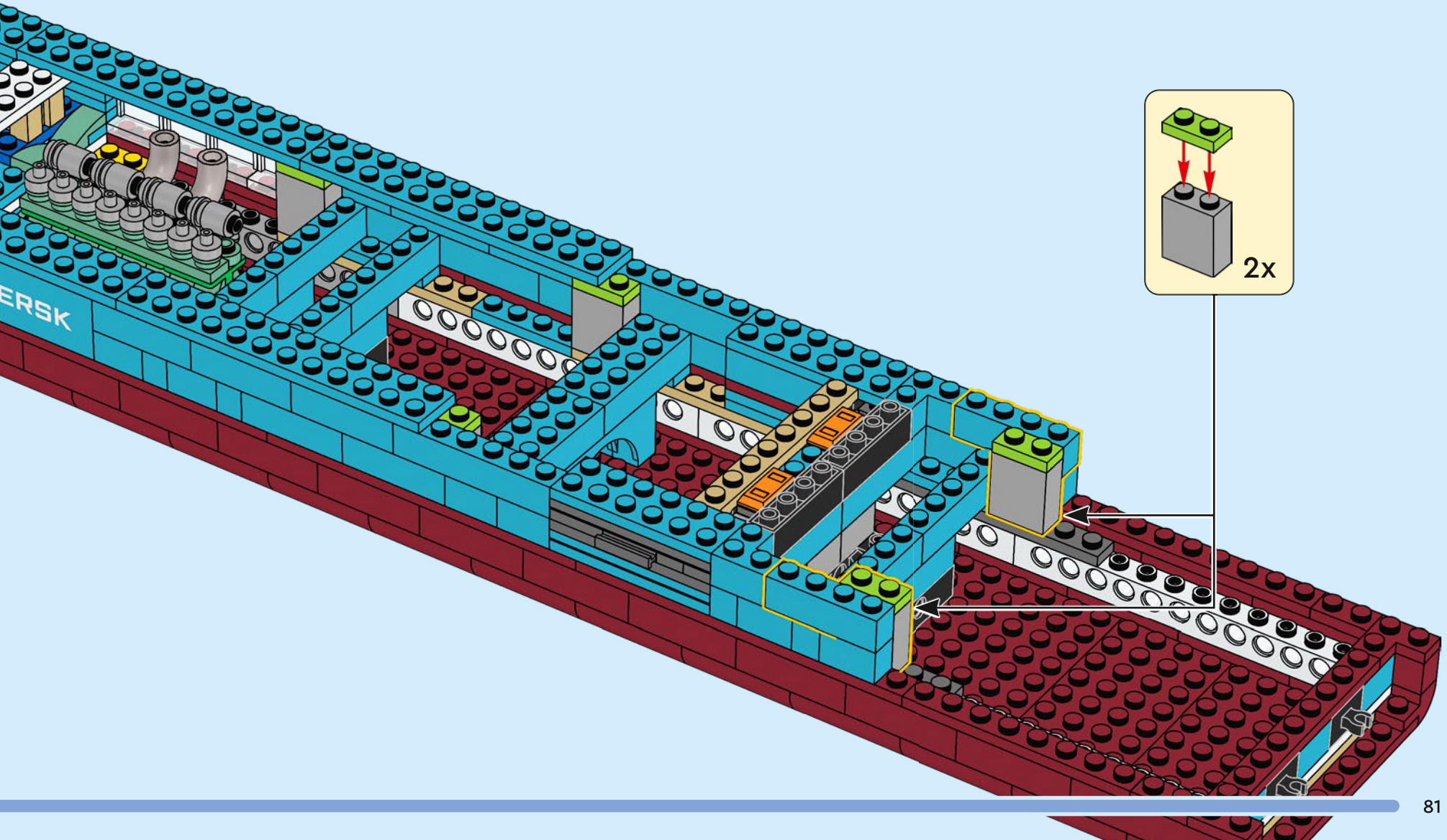

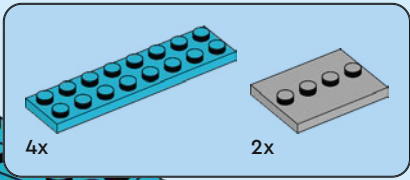

102

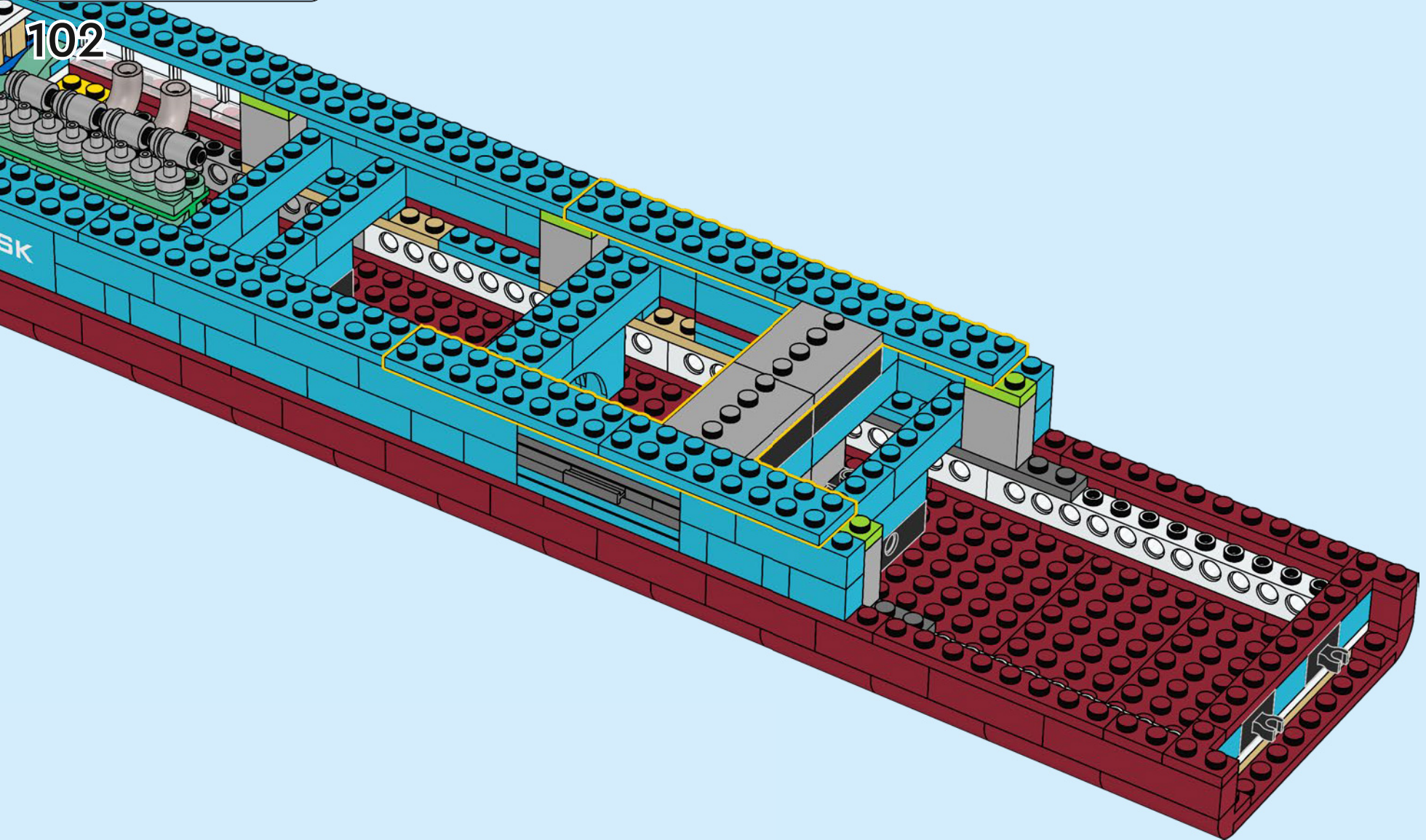

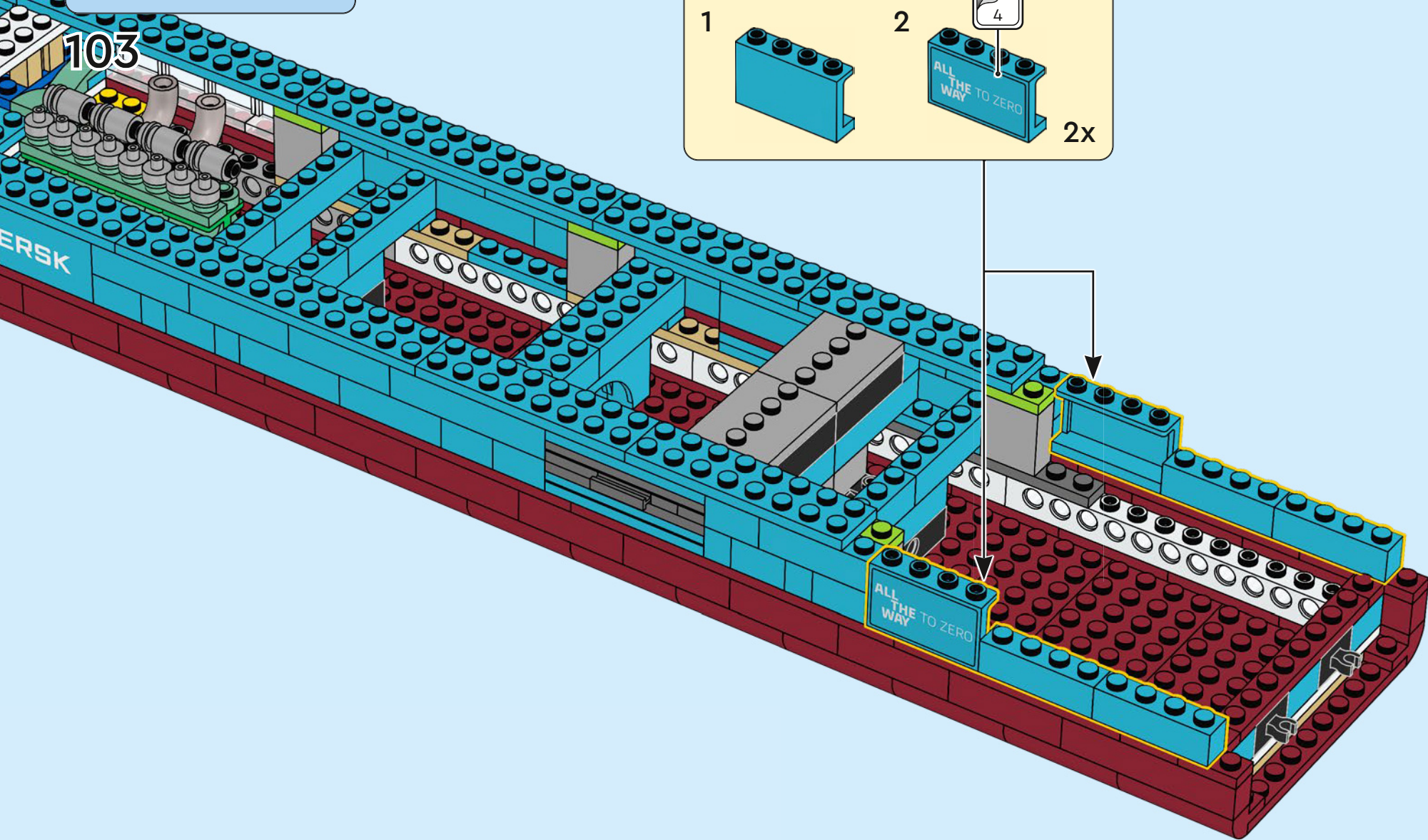
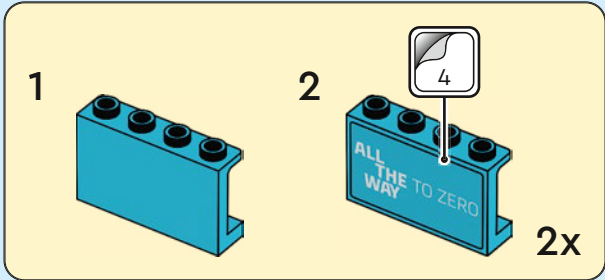
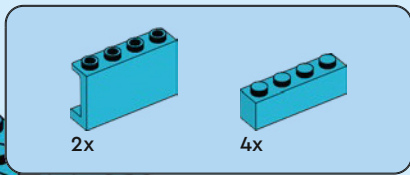

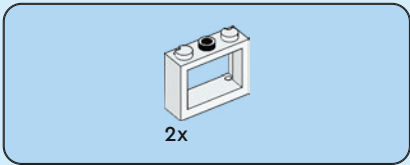

105

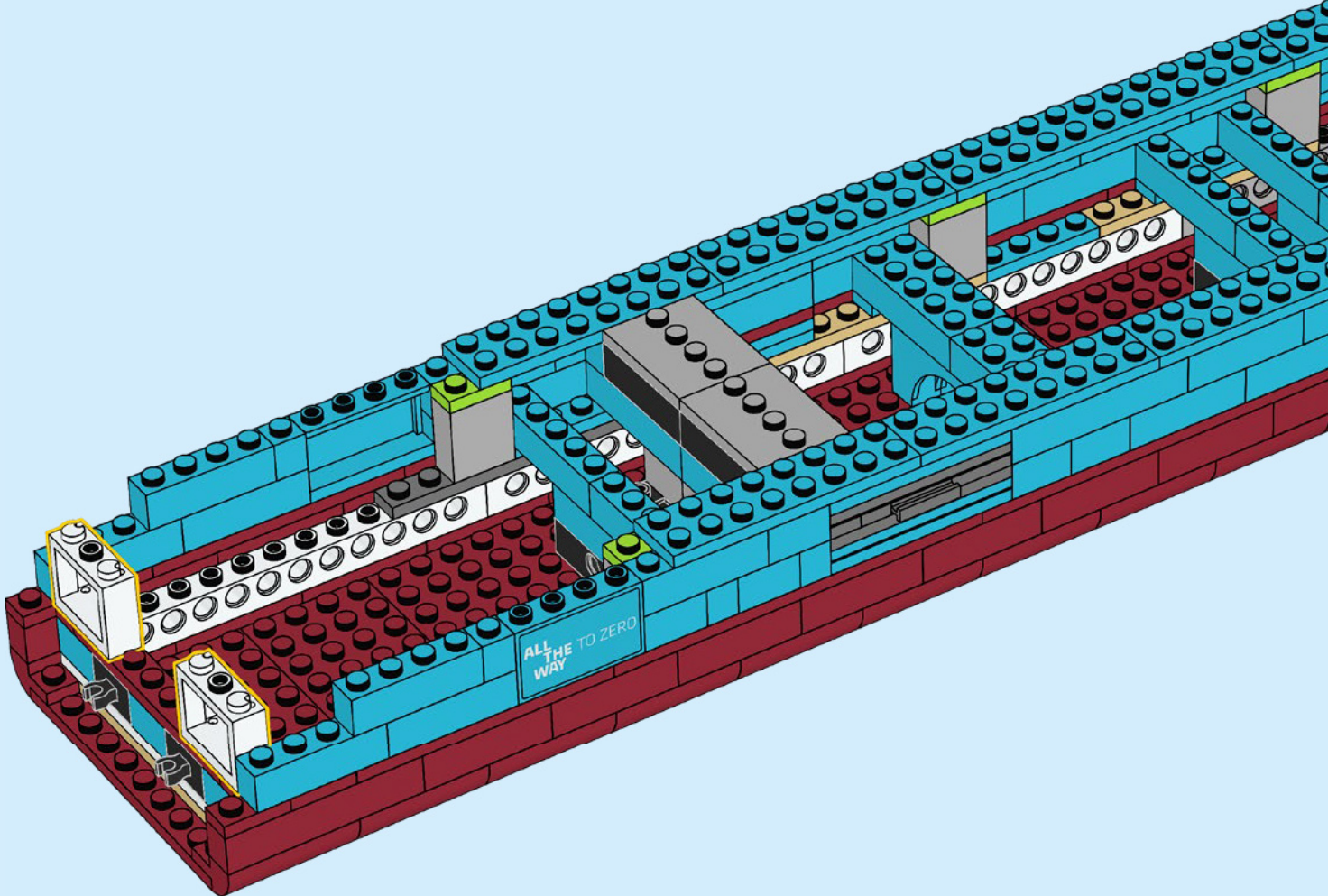

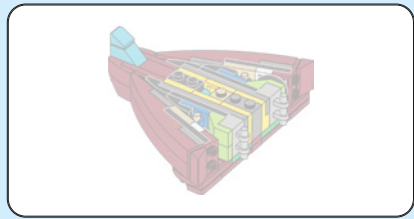
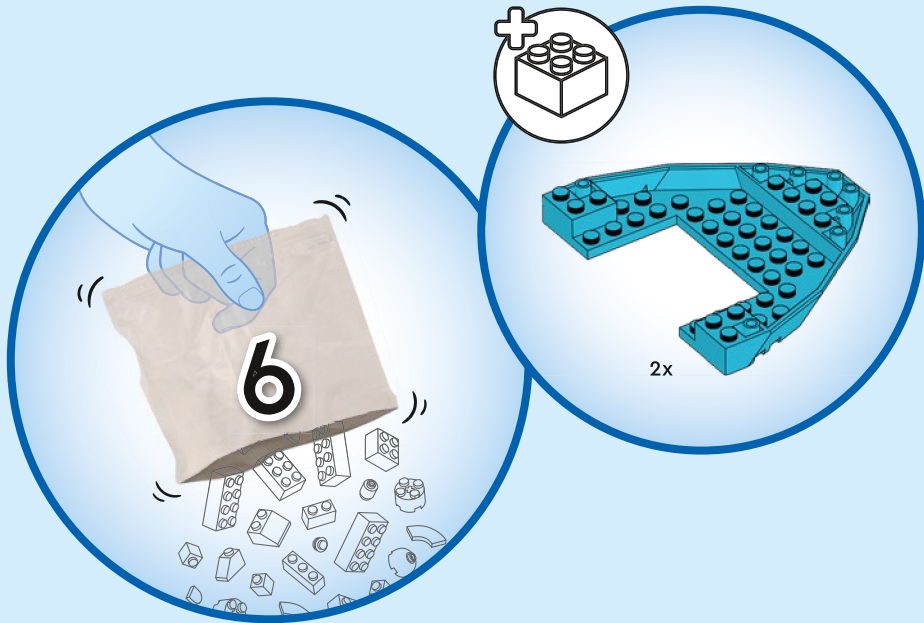

106

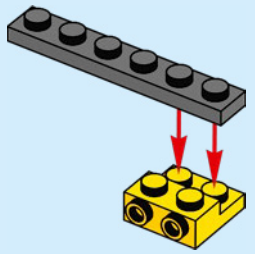

107

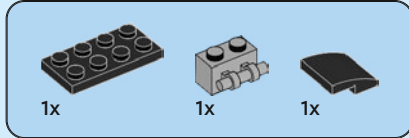
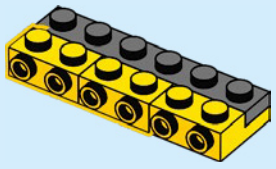

108

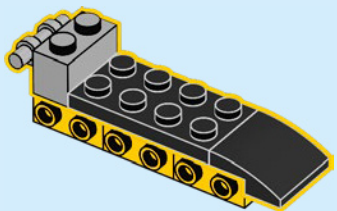

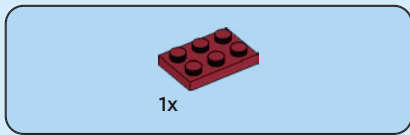

109

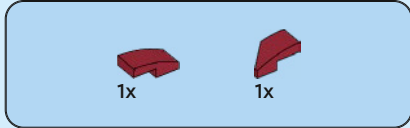
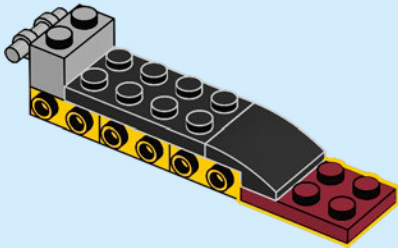

110

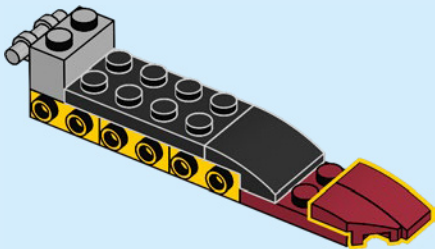

111

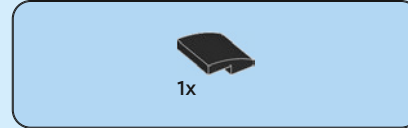
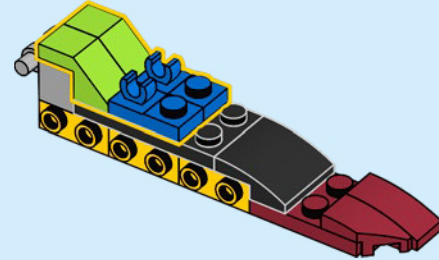

112

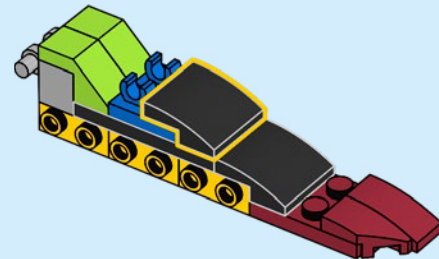

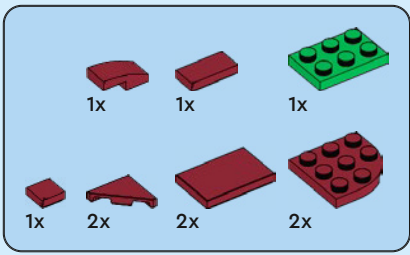

113

1

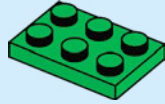

2

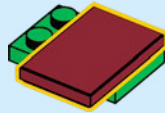

3

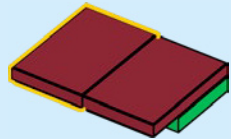

4

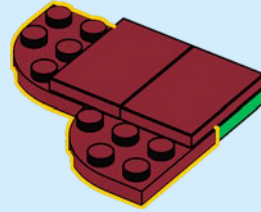

5

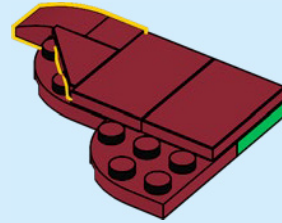

6

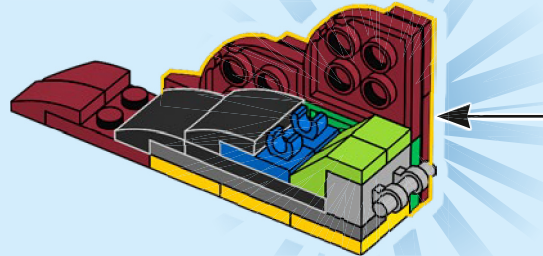
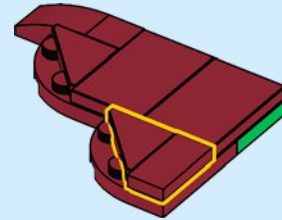

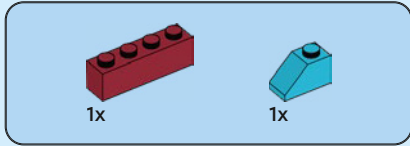
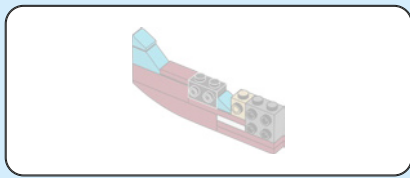

114

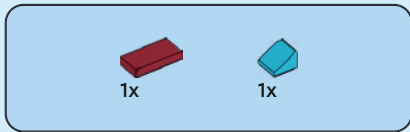
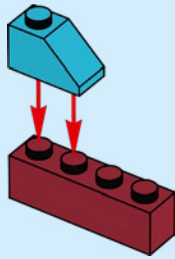

115

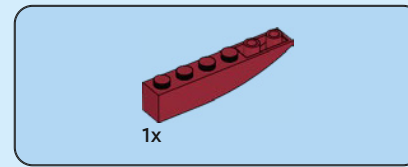
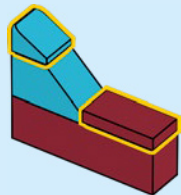

116

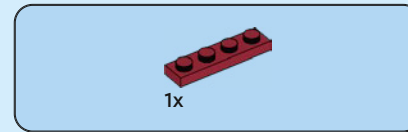
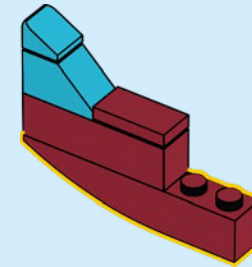

117

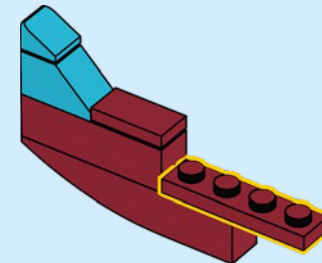

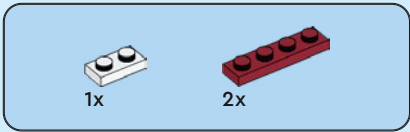

118

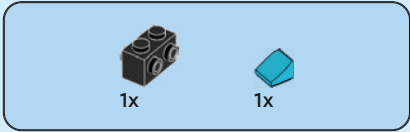
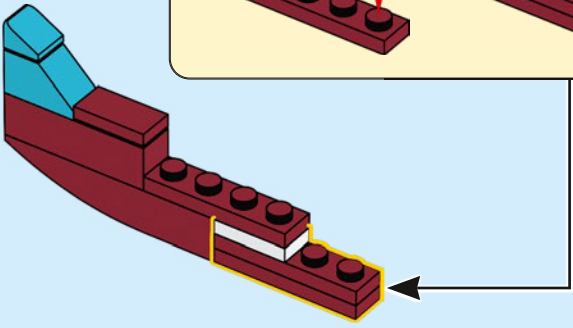
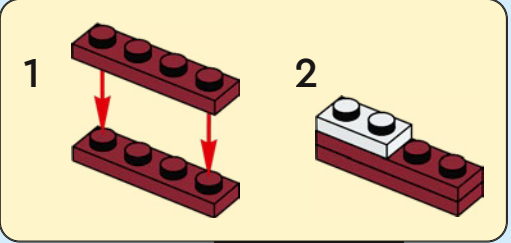

119

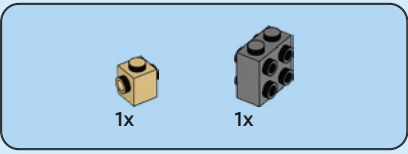
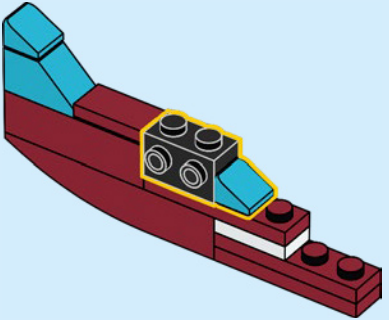

120

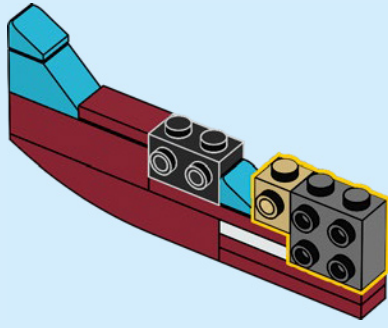

121

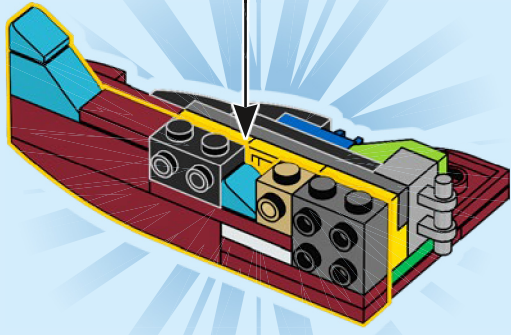

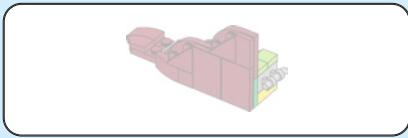

122

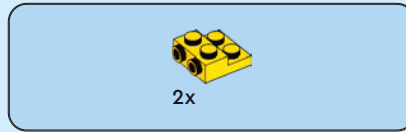
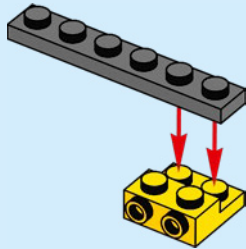

123

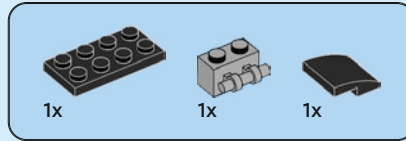
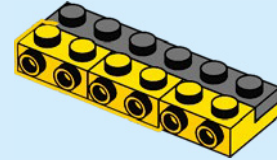

124

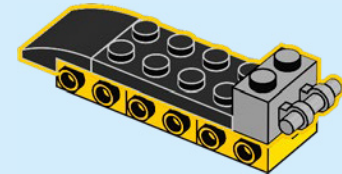

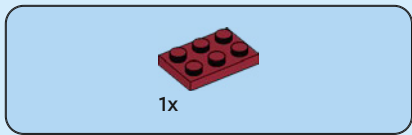

125

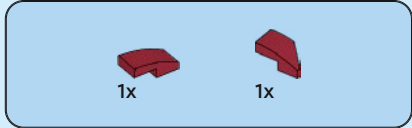
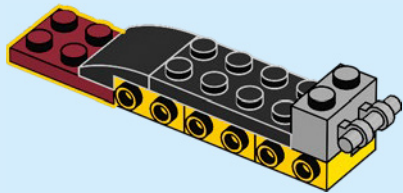

126

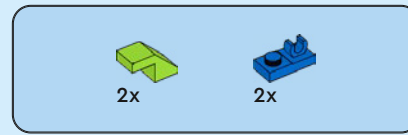
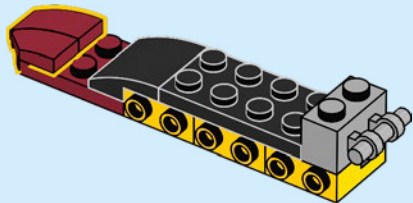

127

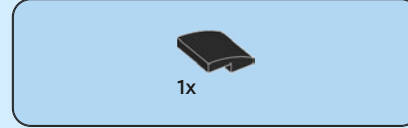
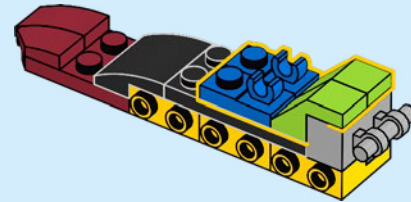

128

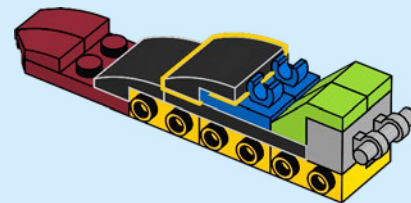

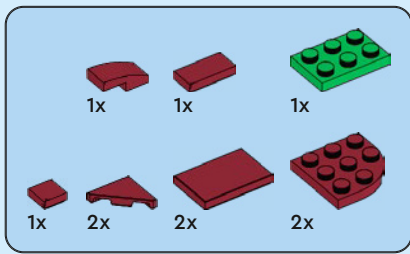

129

1

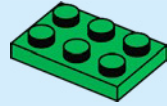

2

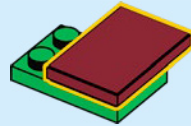

3

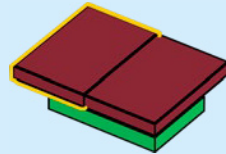

4

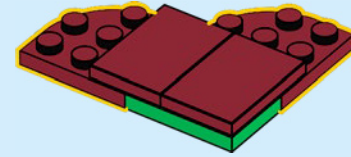

5

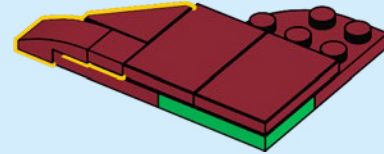

6

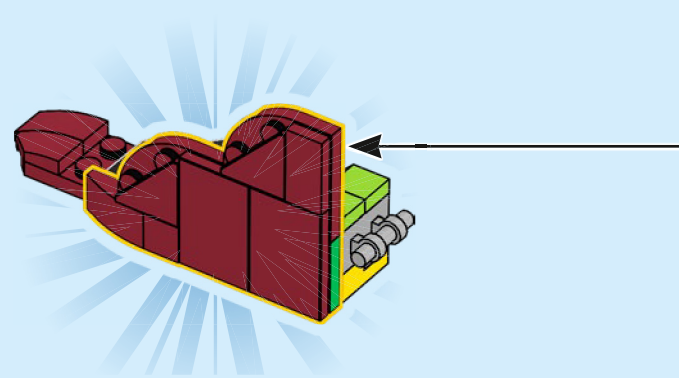
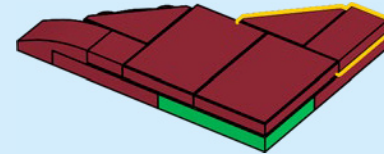

130

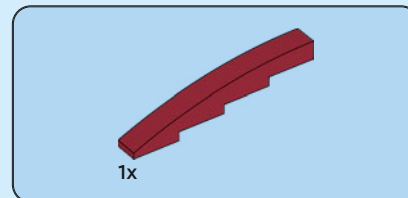
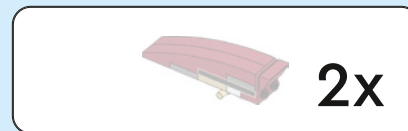
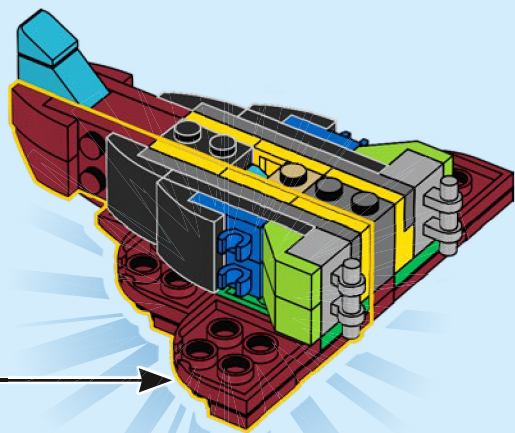

131

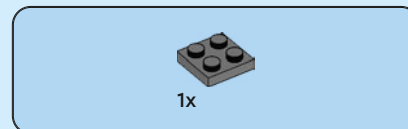
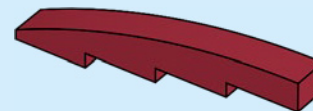

132

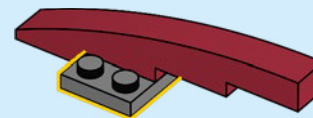

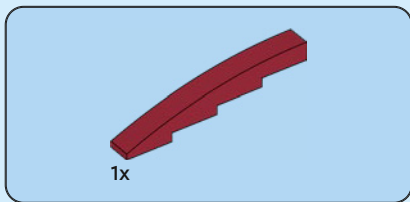

133

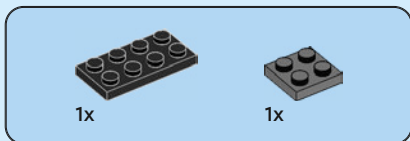
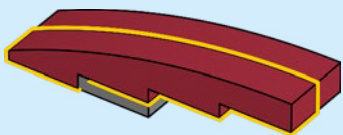

134

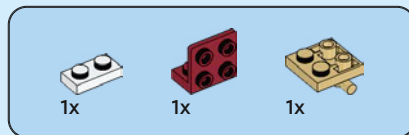
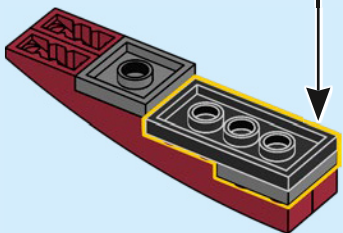
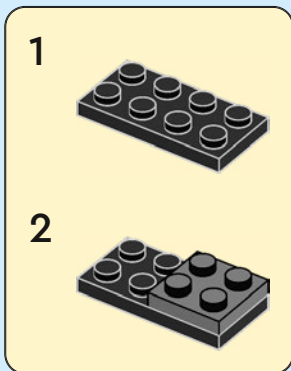

135

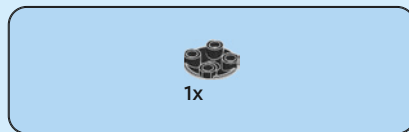
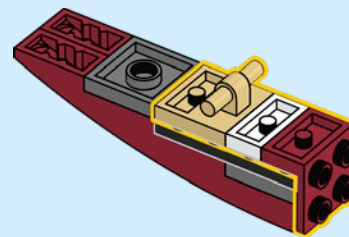

136

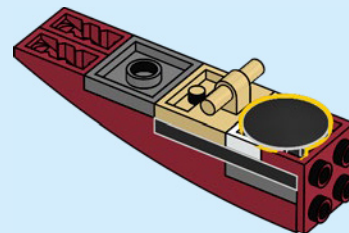



1x

137

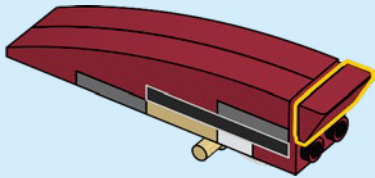

2x

138

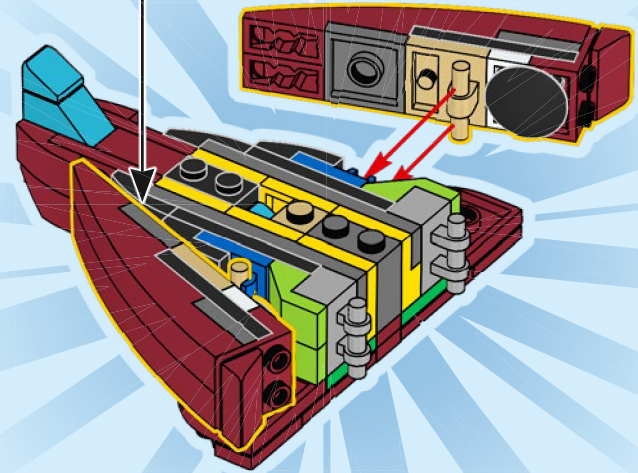

139

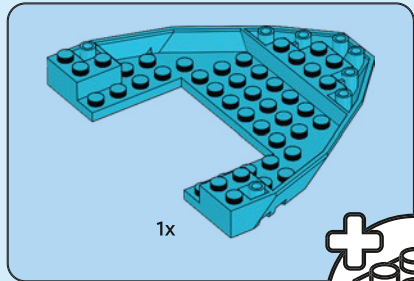
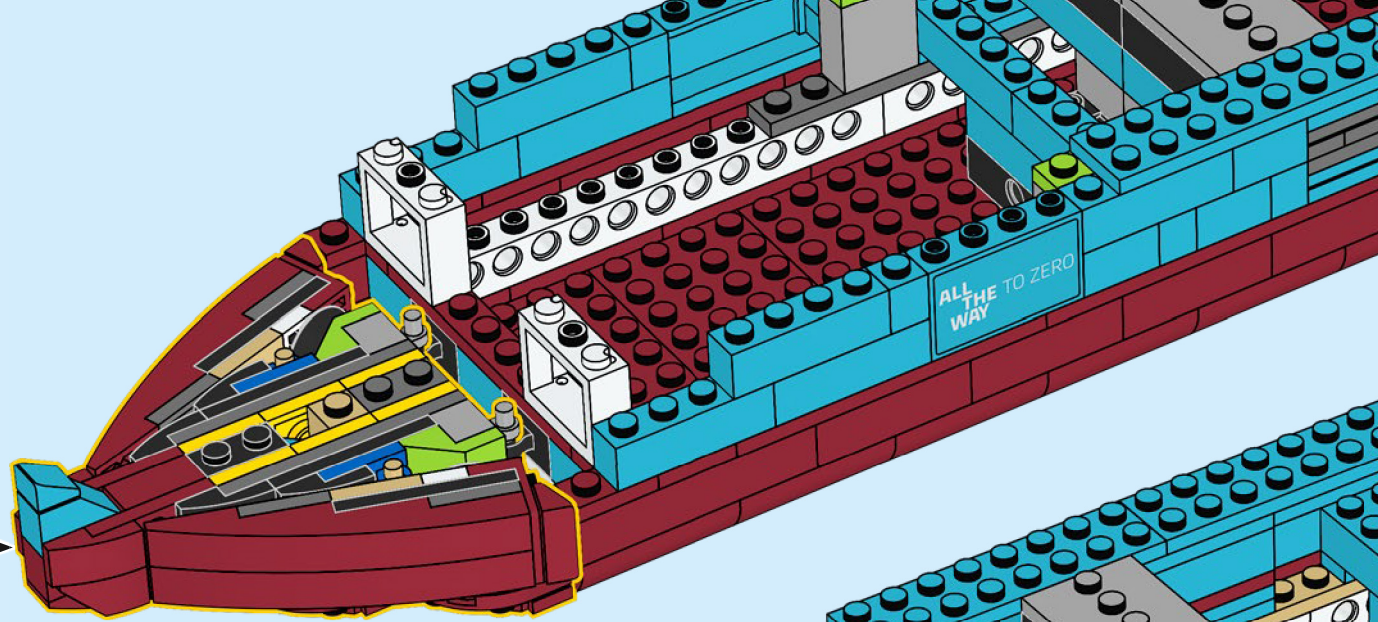

1x

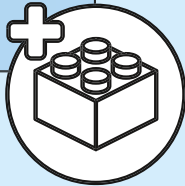

140

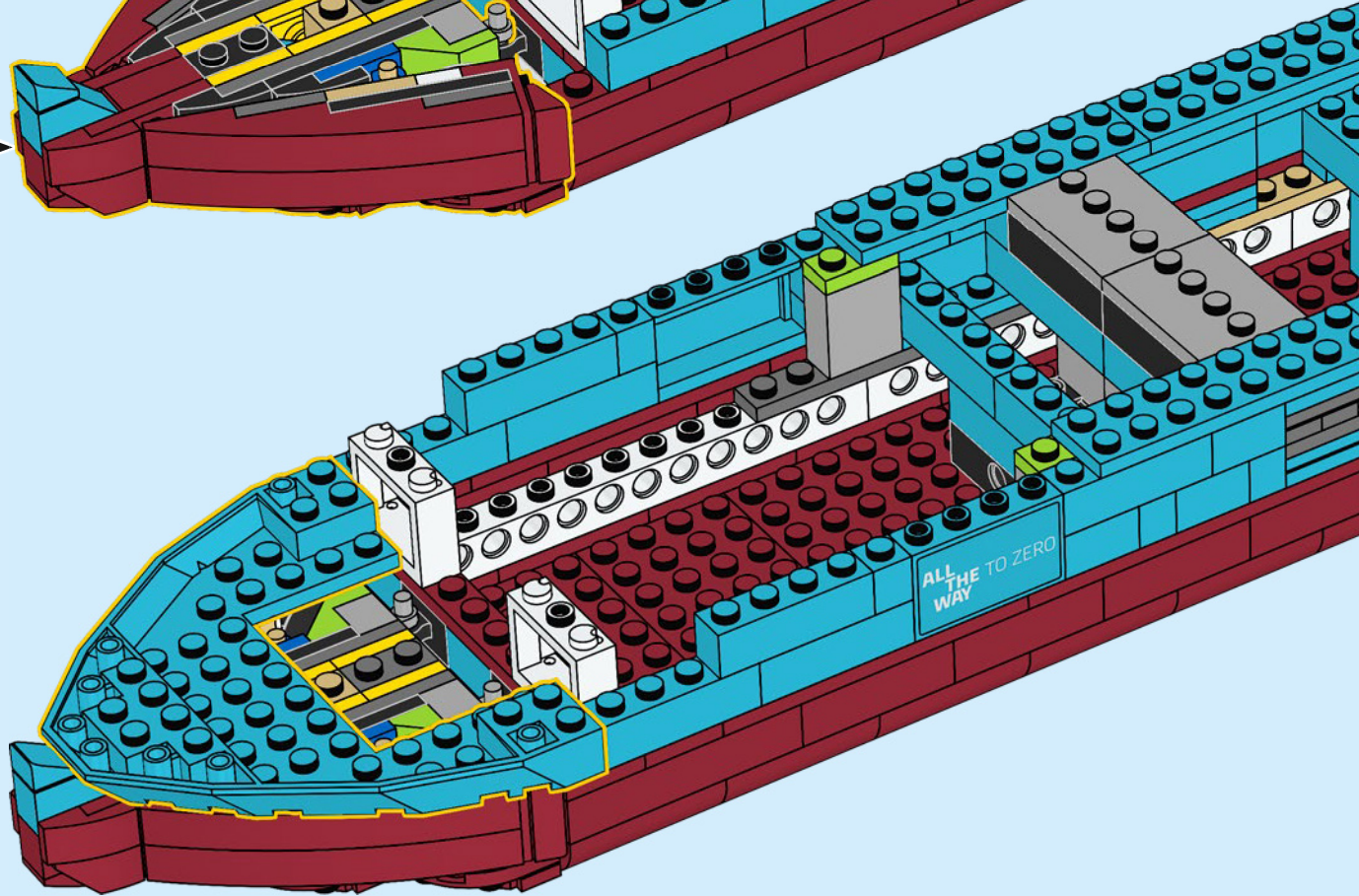

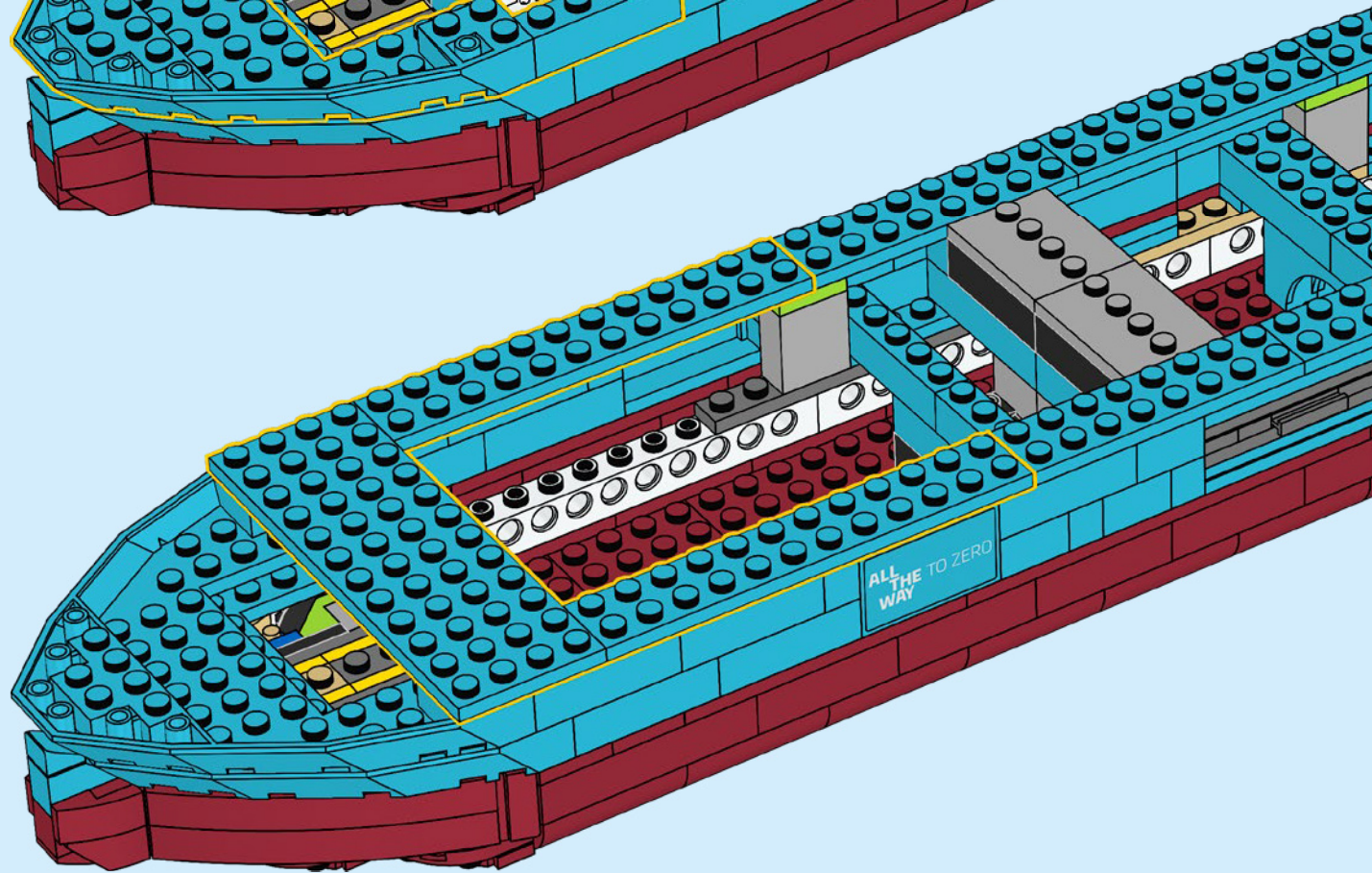
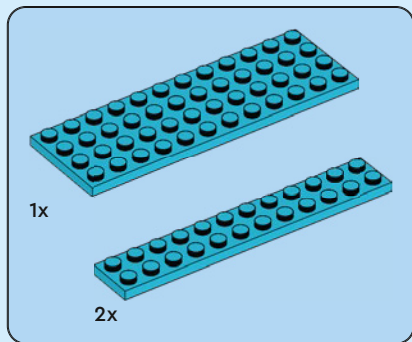
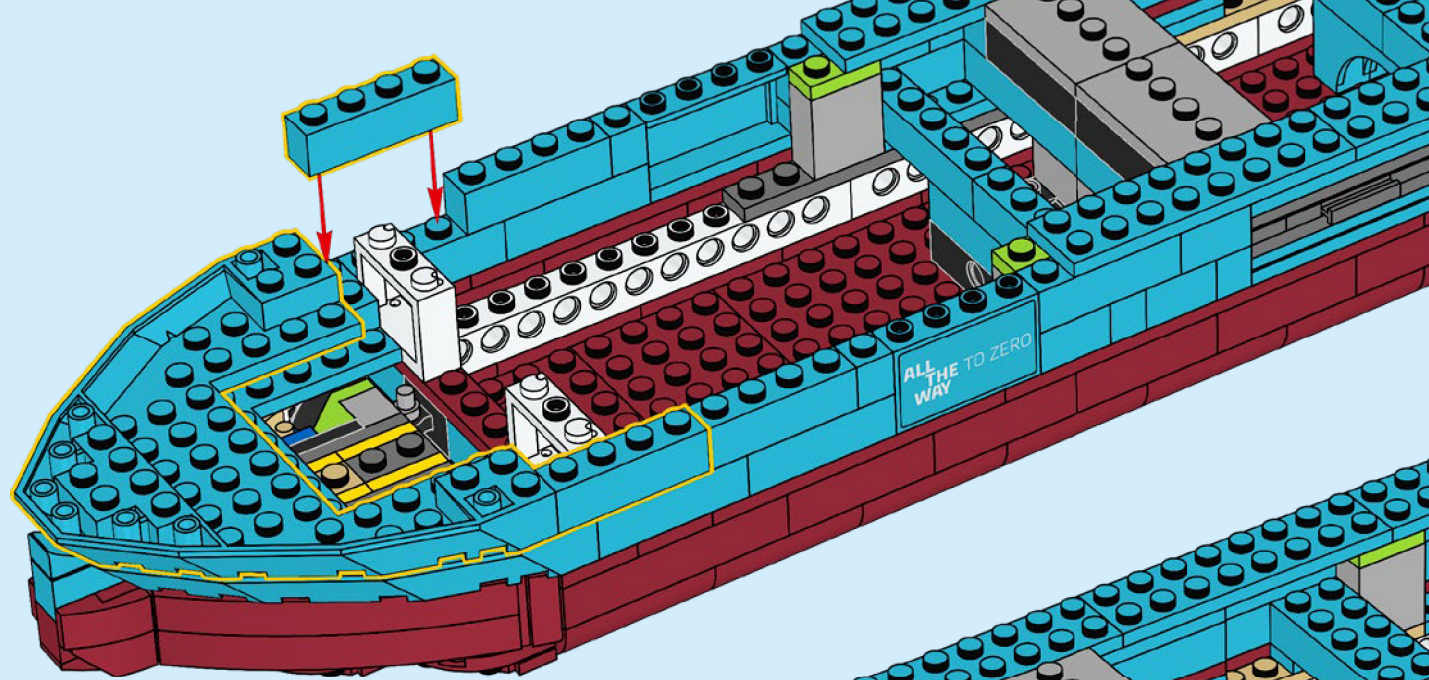
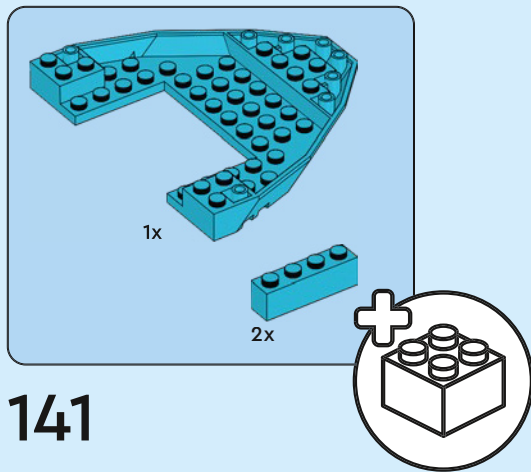

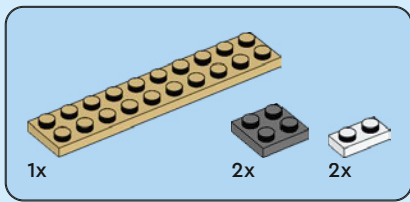

143

1

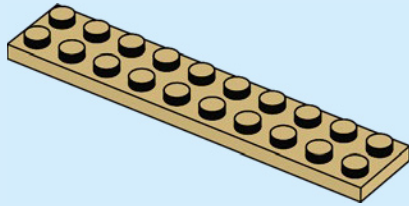

2

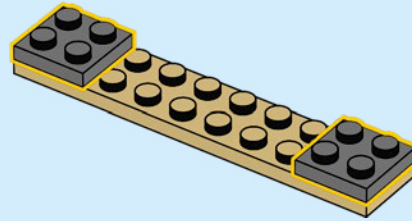

3

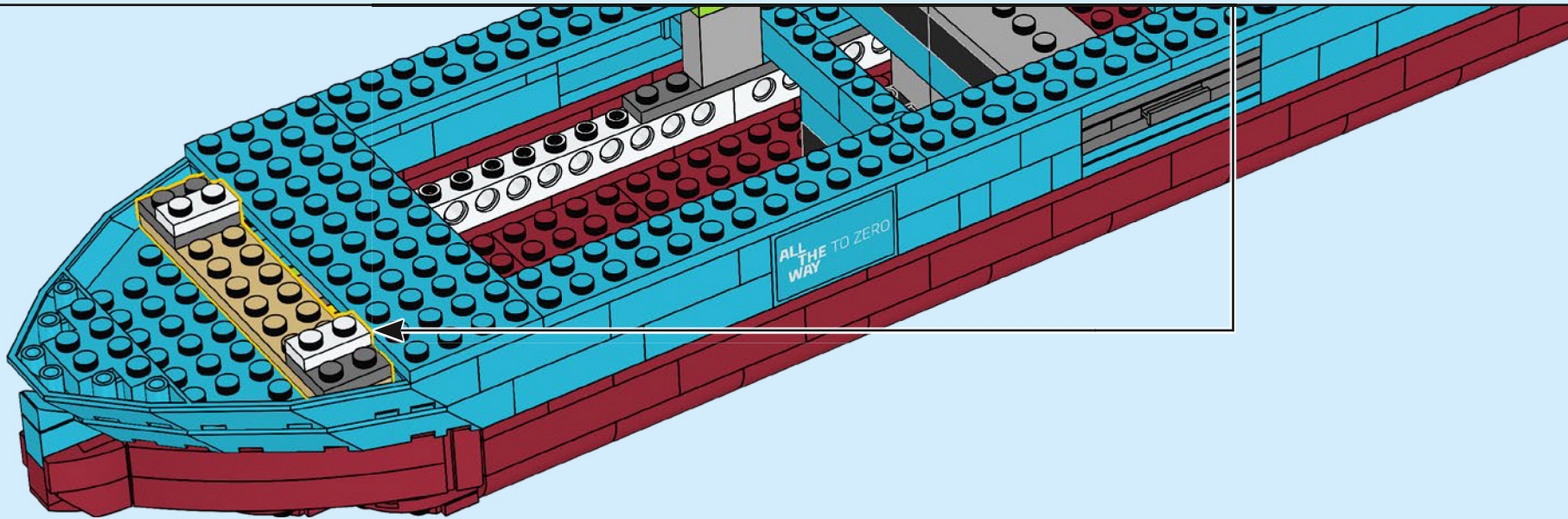
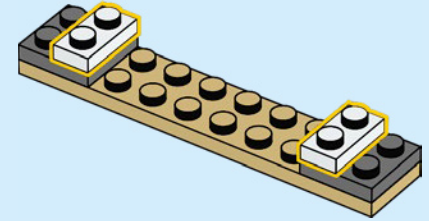

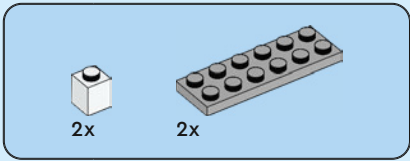

144

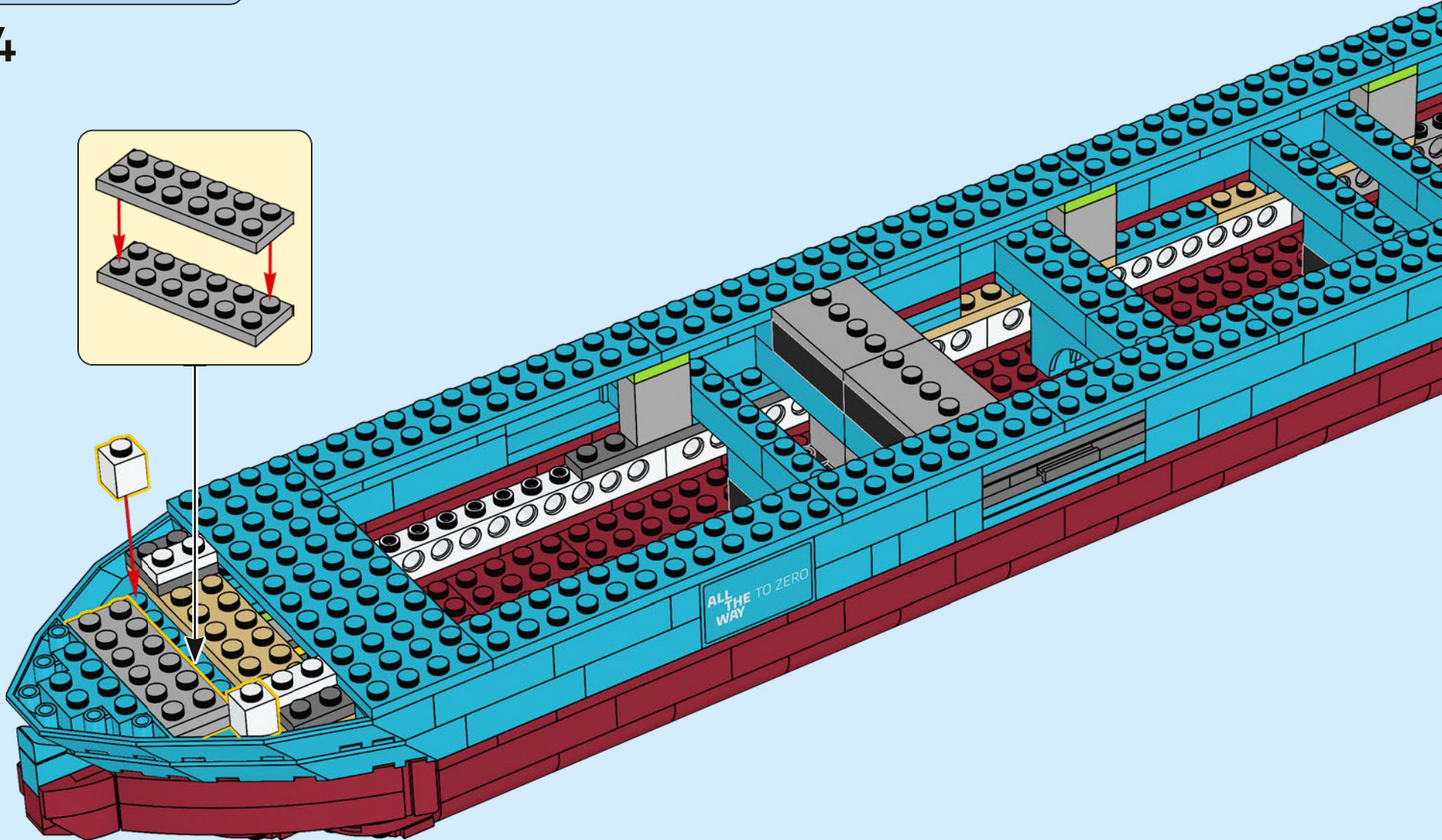
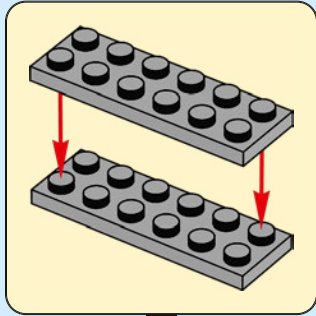

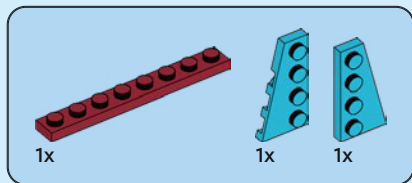

145

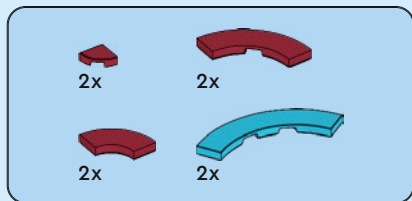
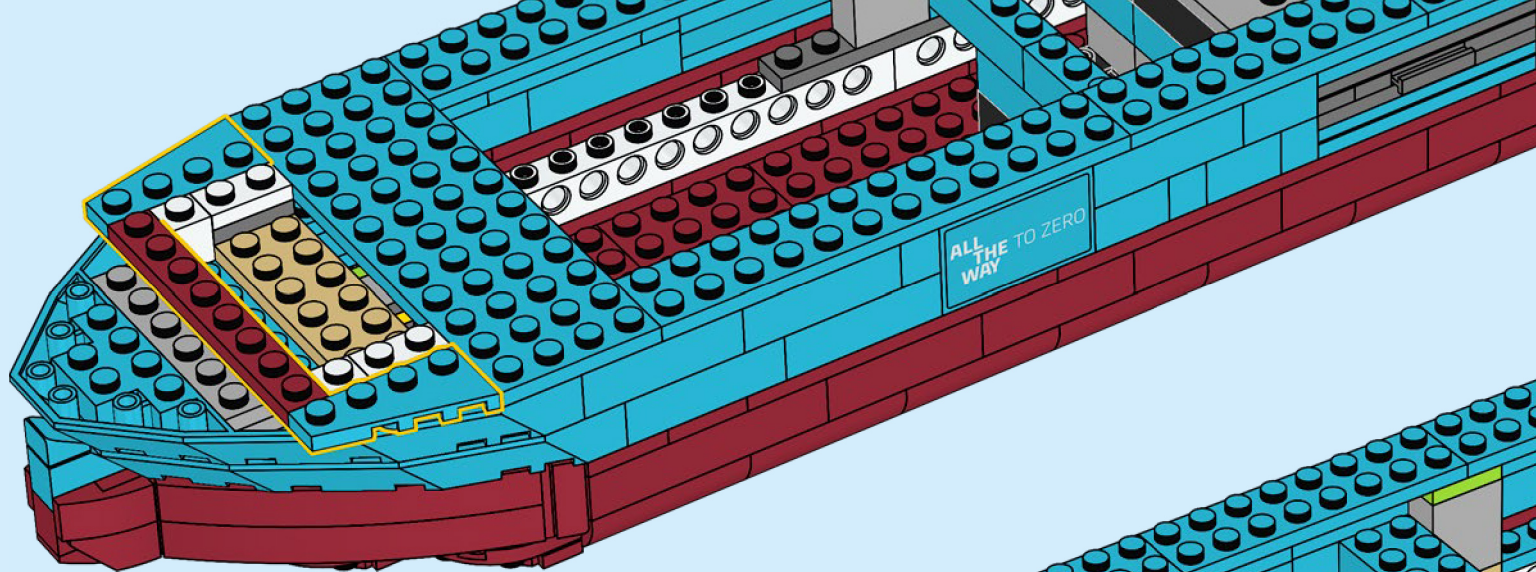

146

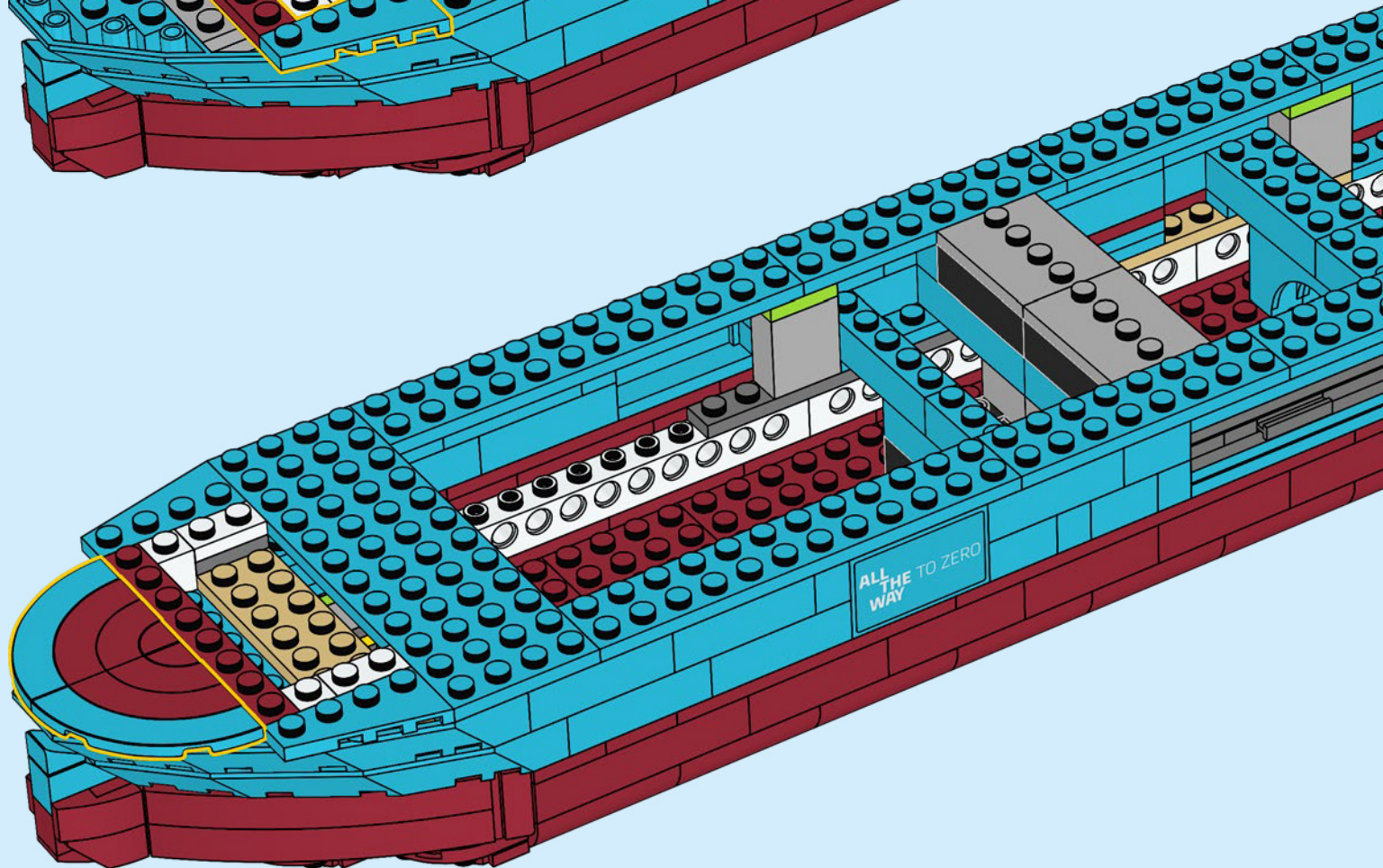

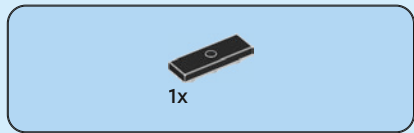

147

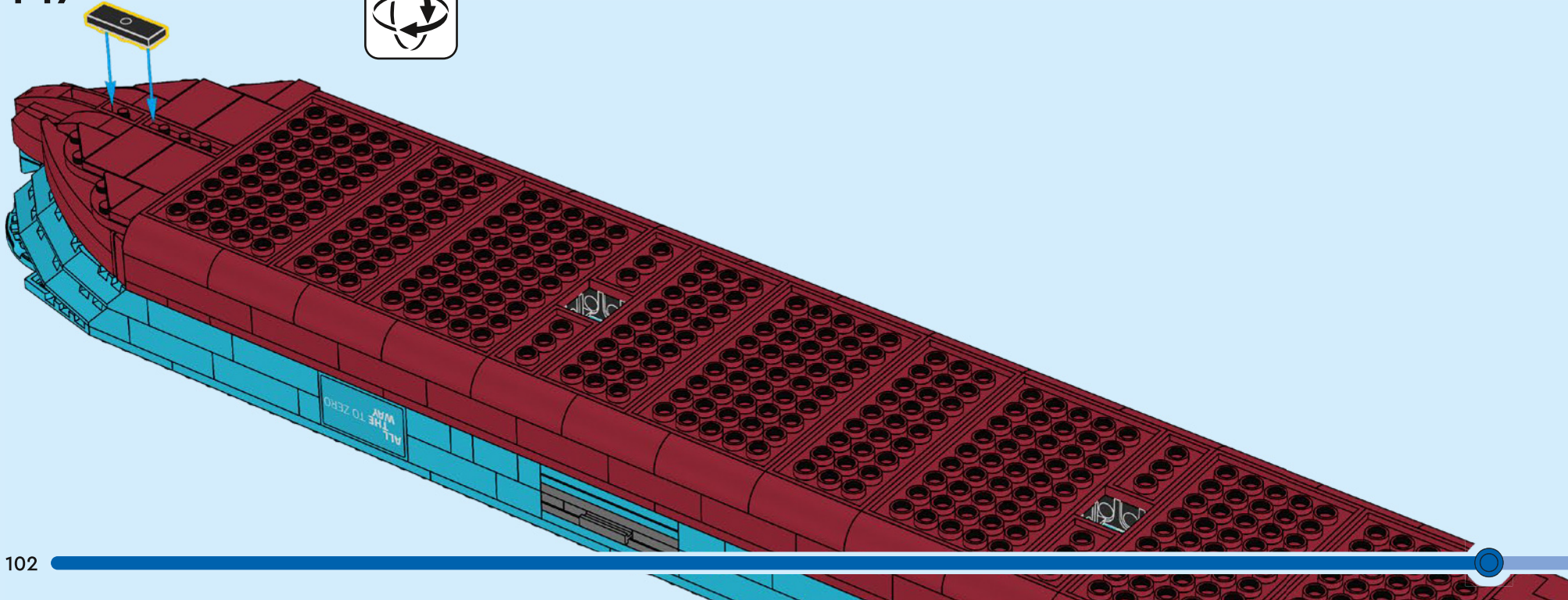



24x

148

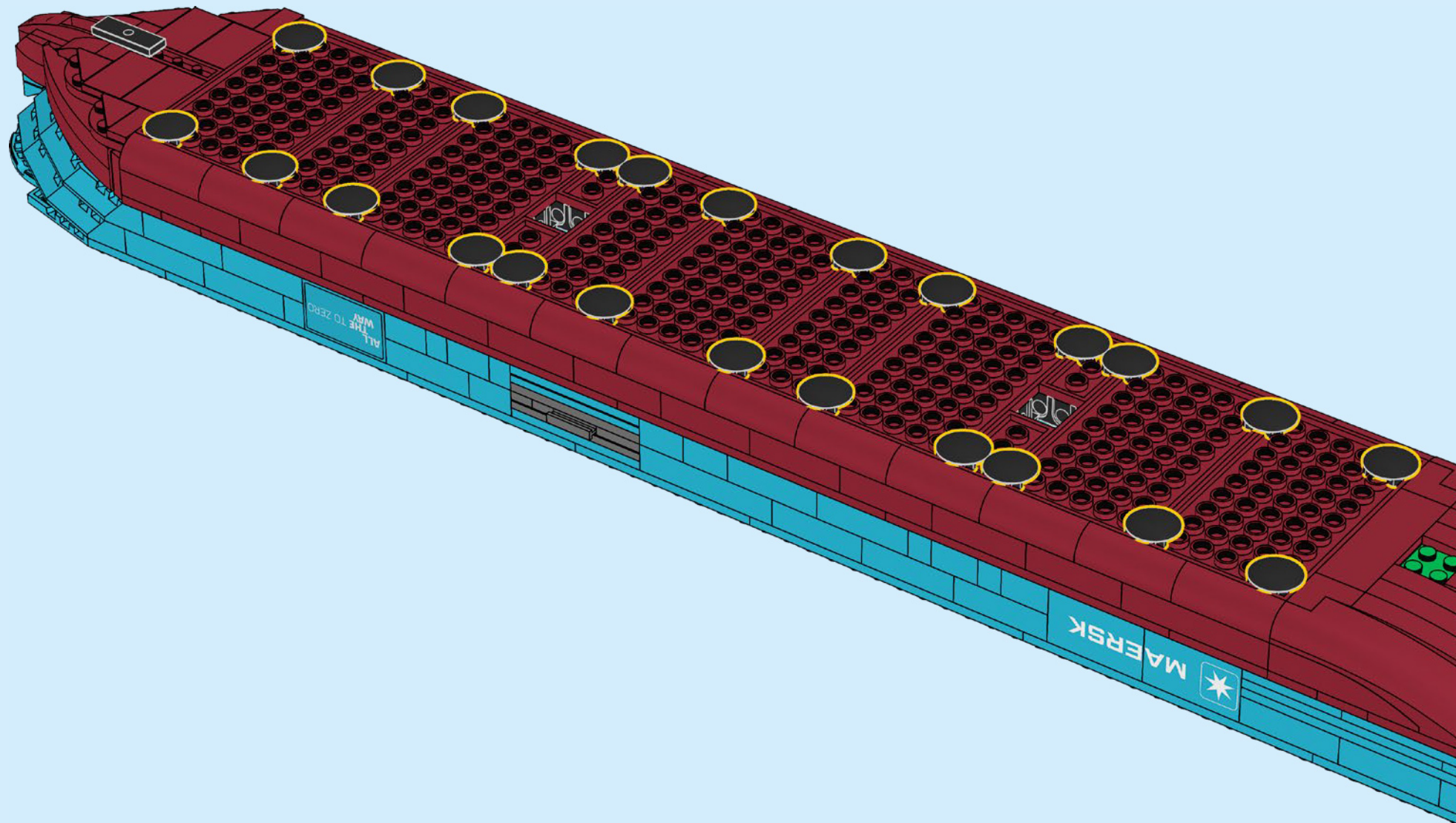

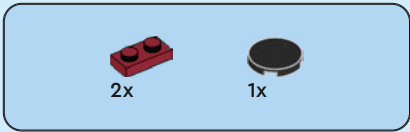

149

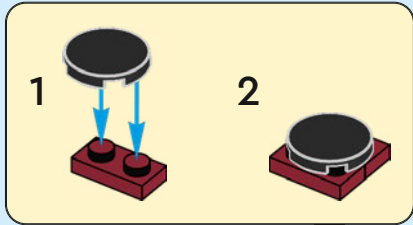
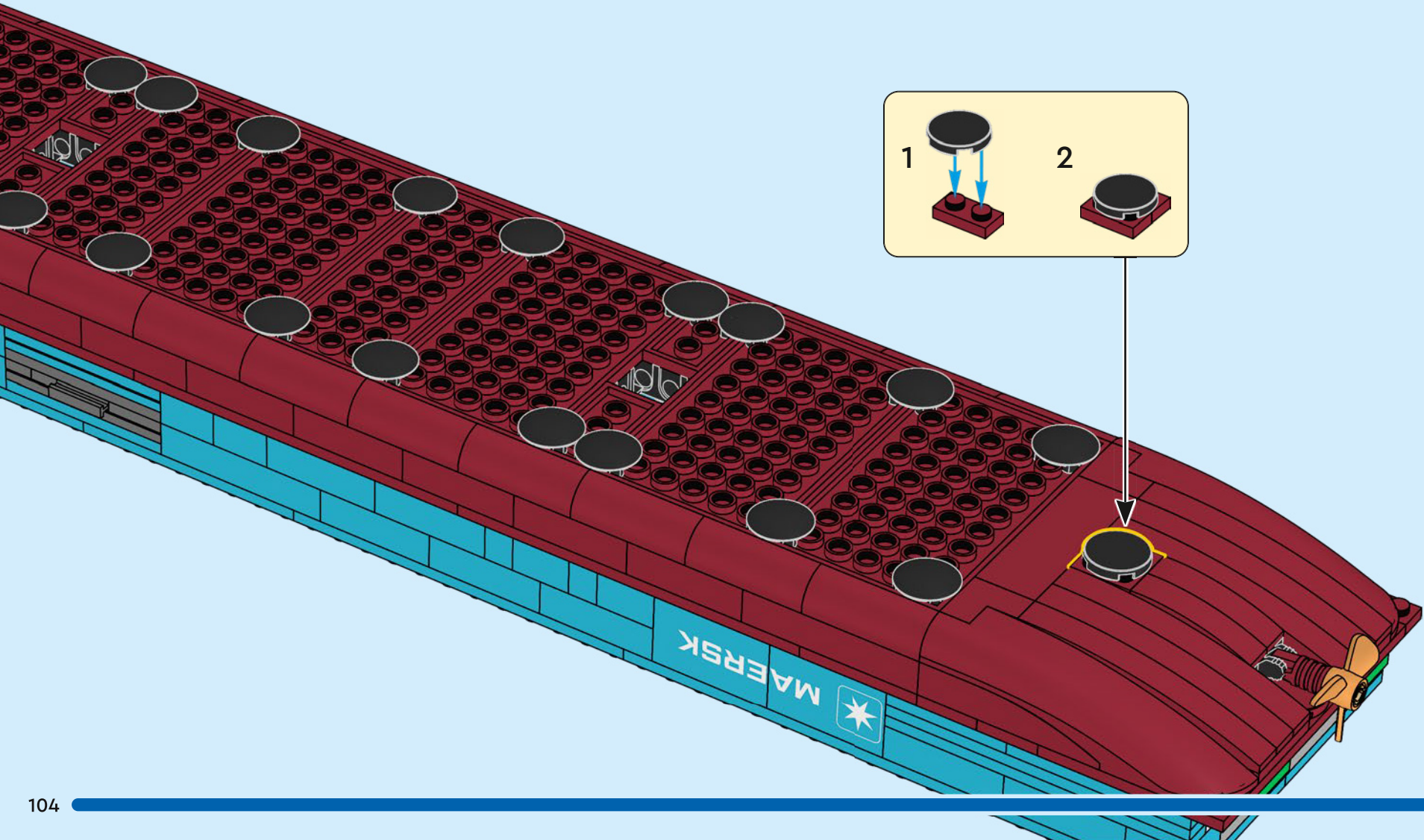

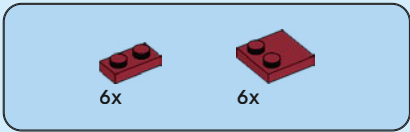

150

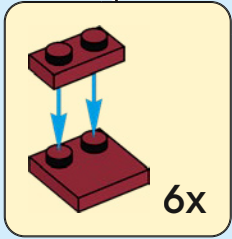
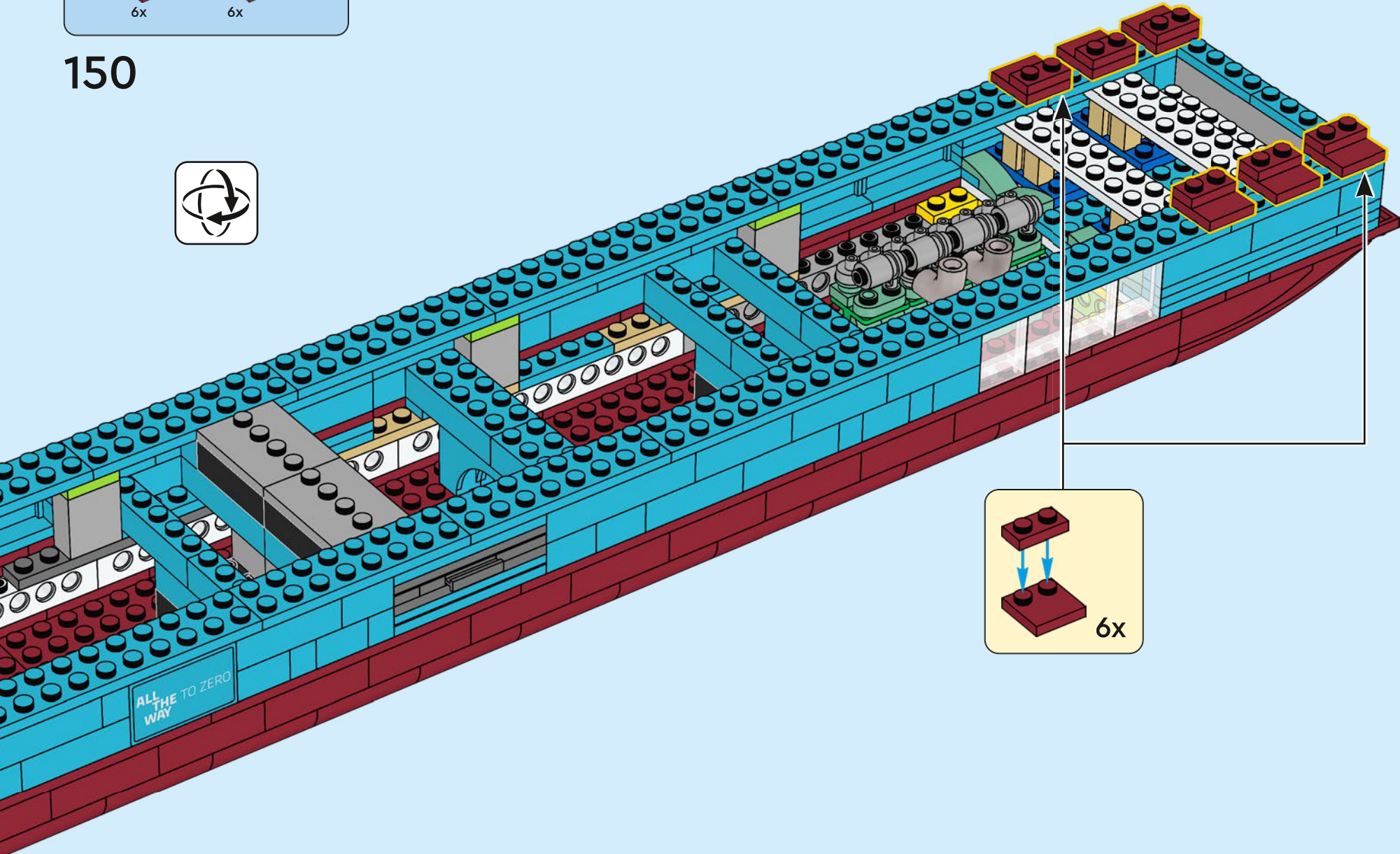

ALL
THE
WAY TO ZERO

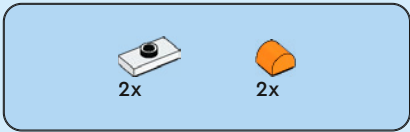

151

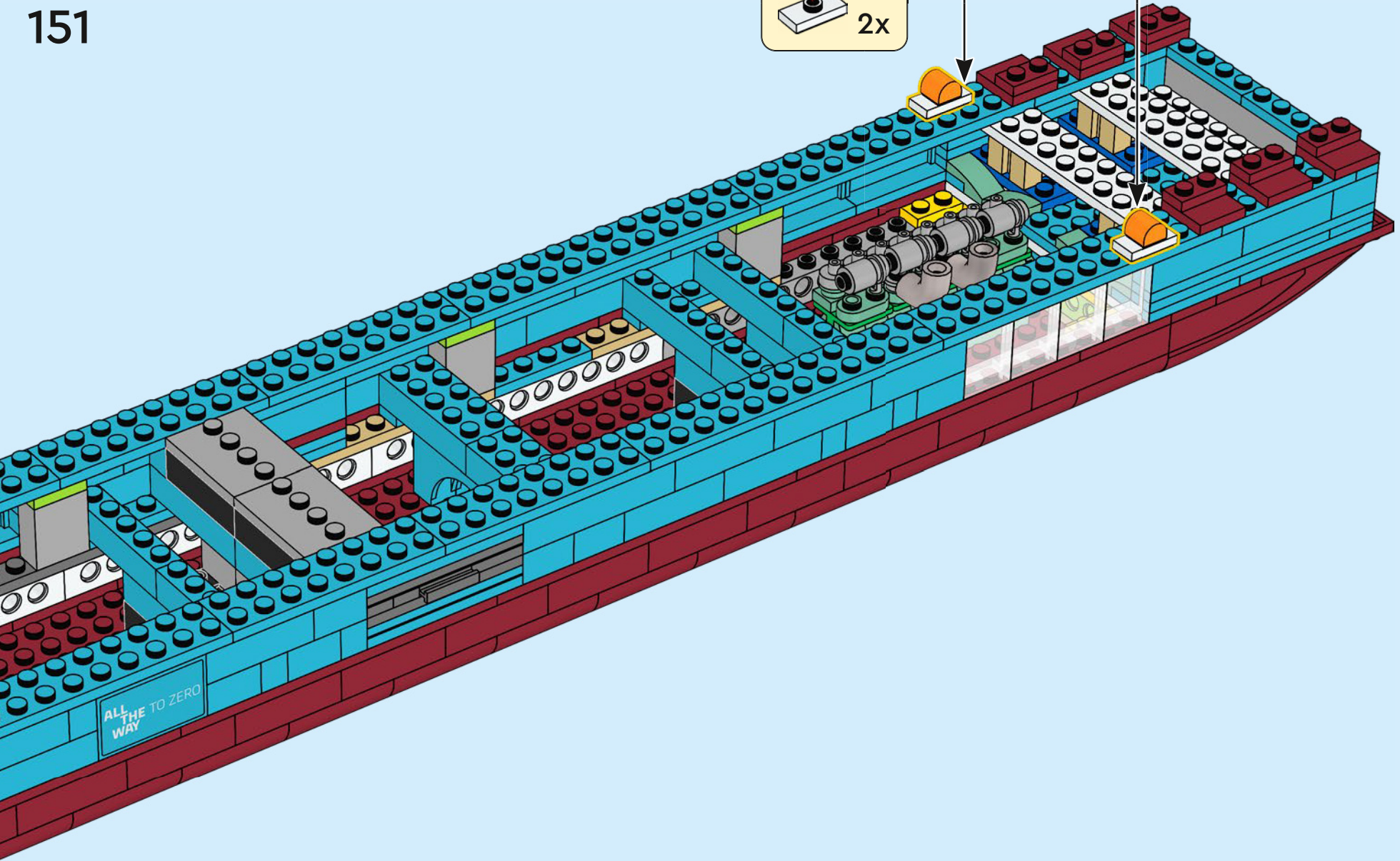
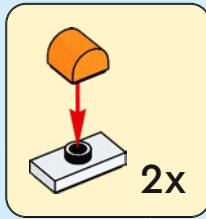

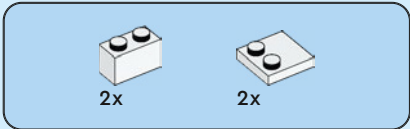

152

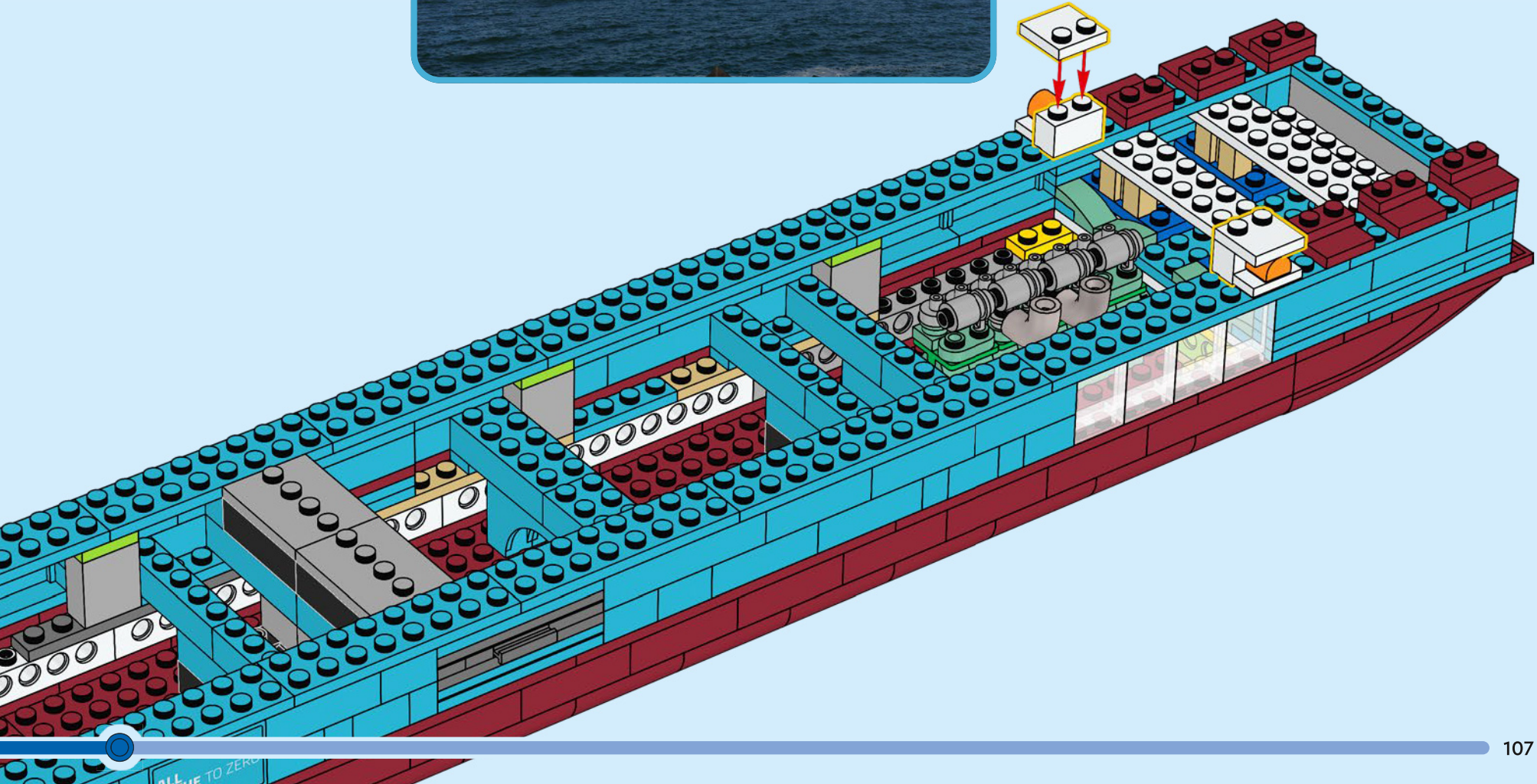
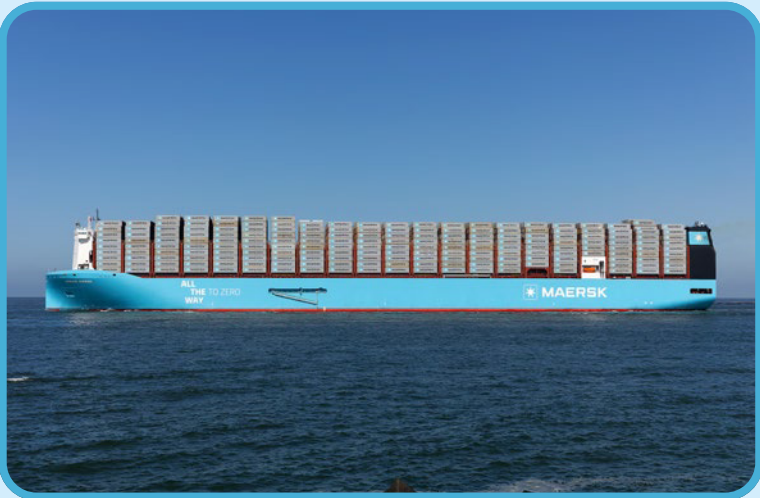

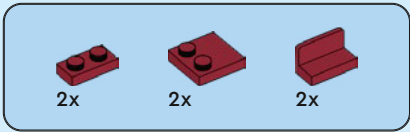

153

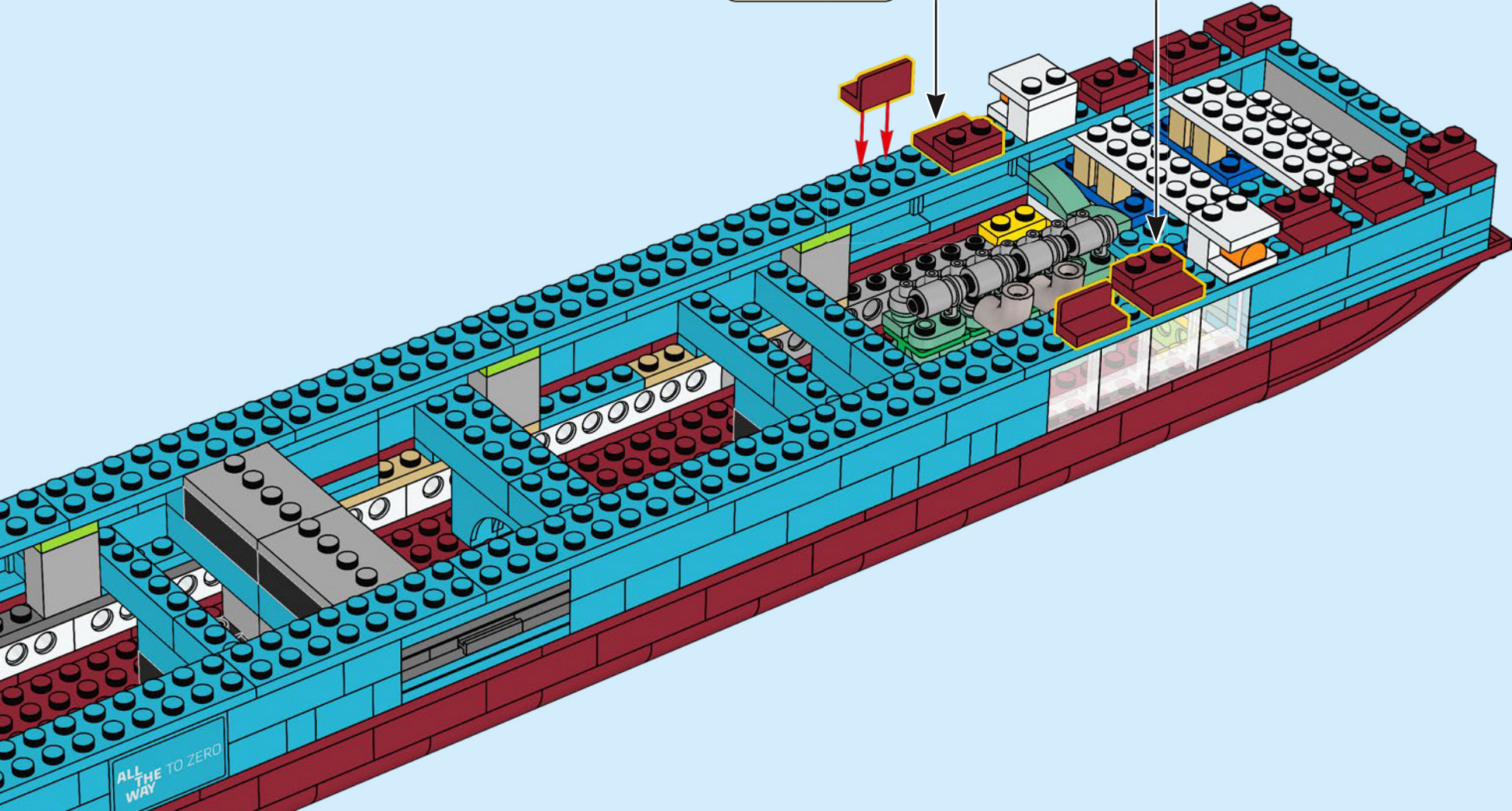
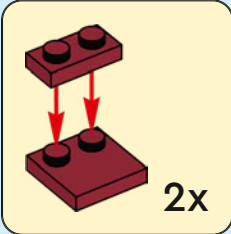

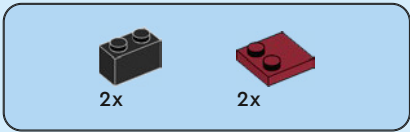

154

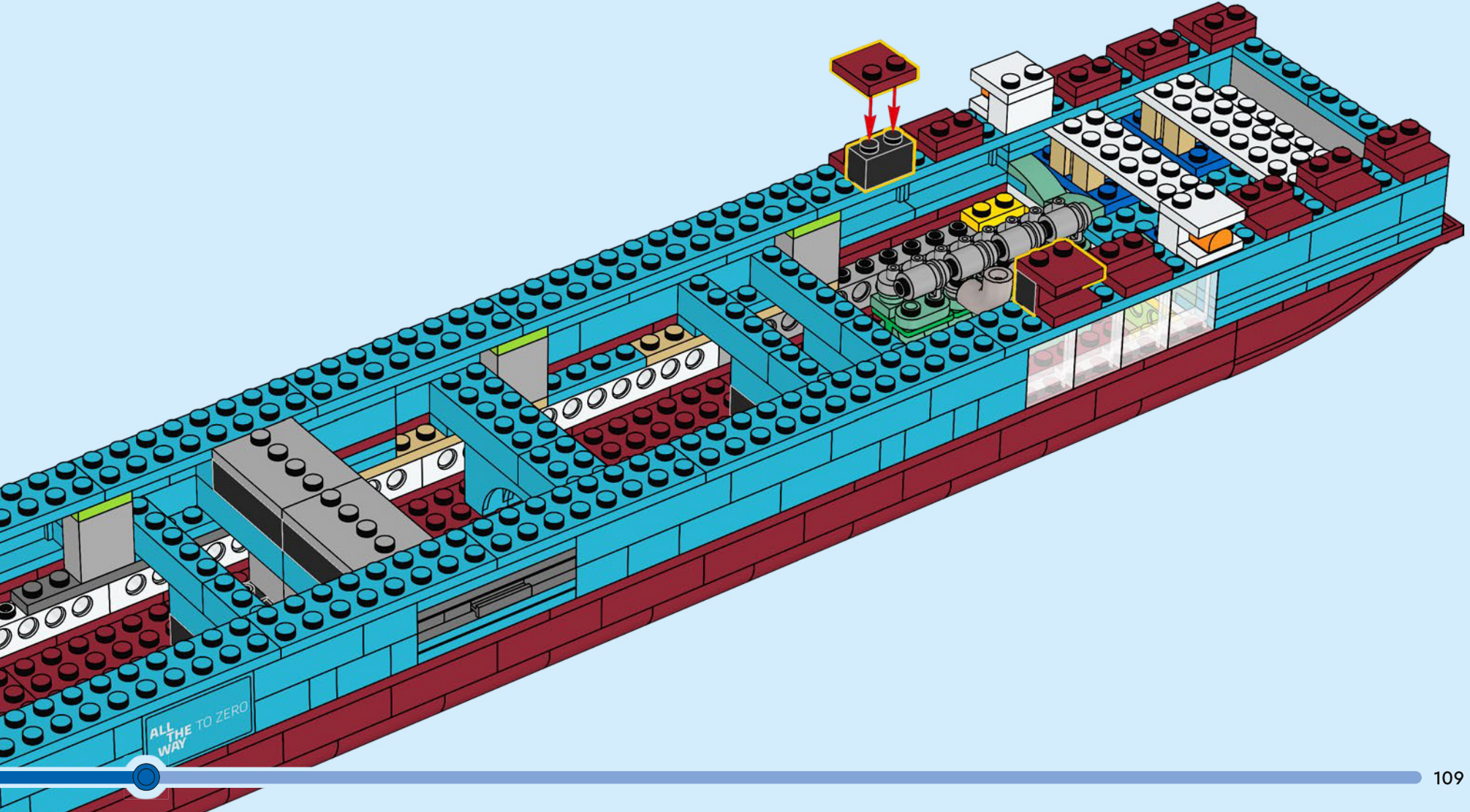

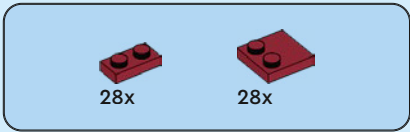

155

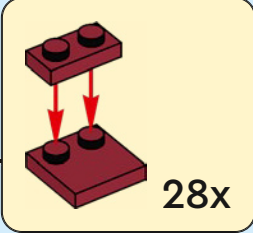
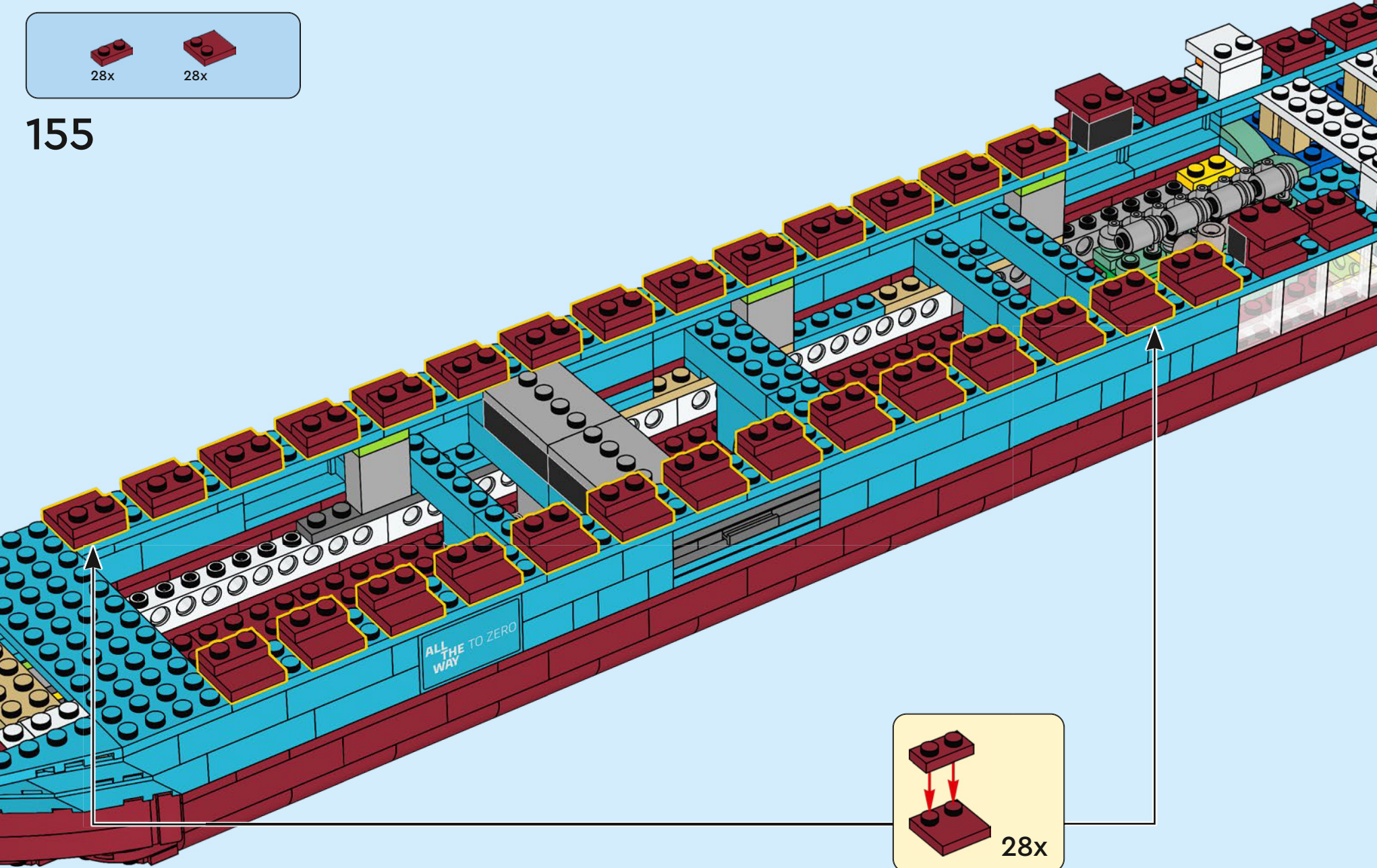

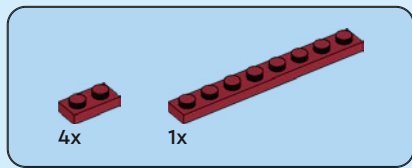

156

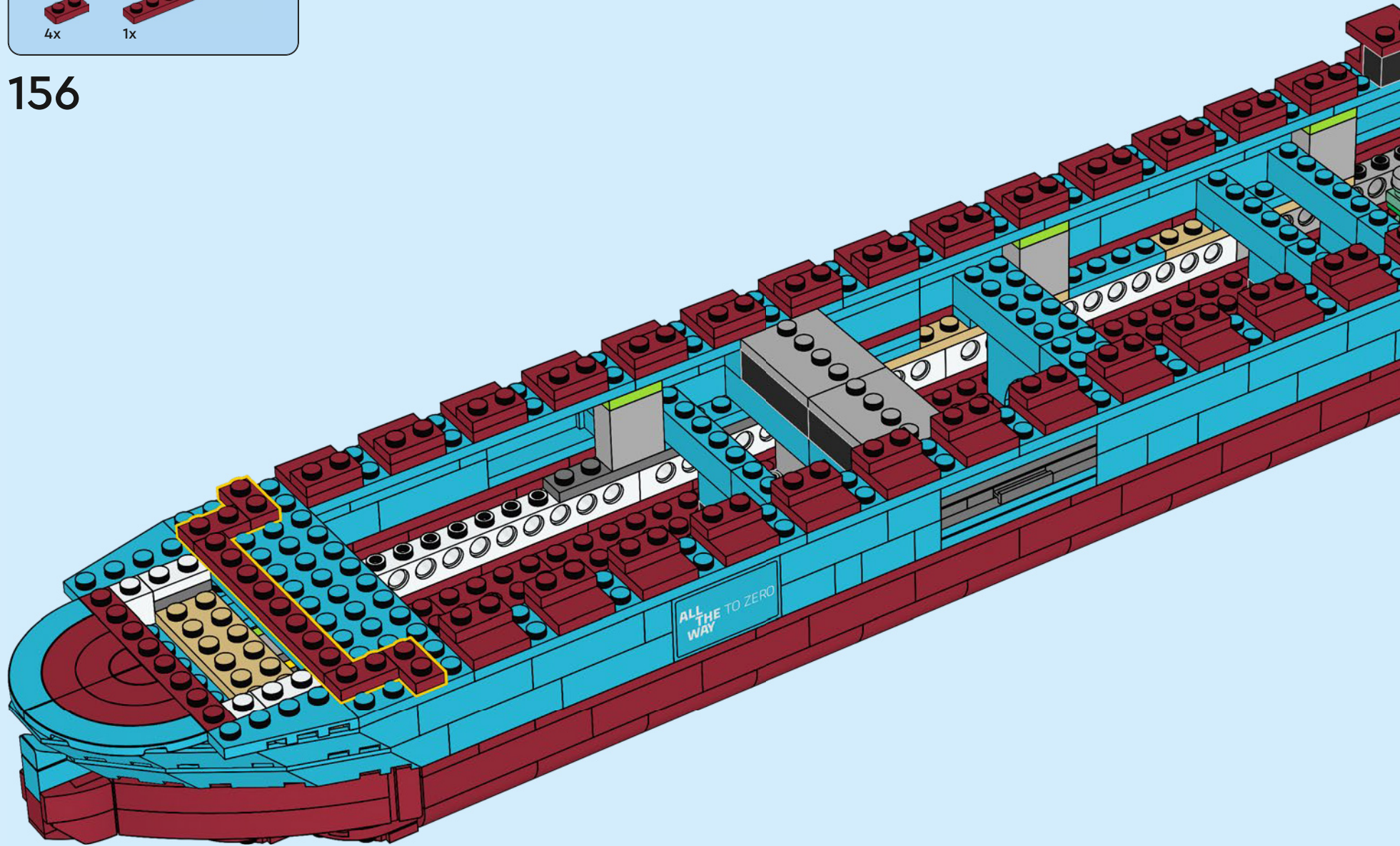

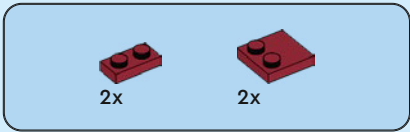

157

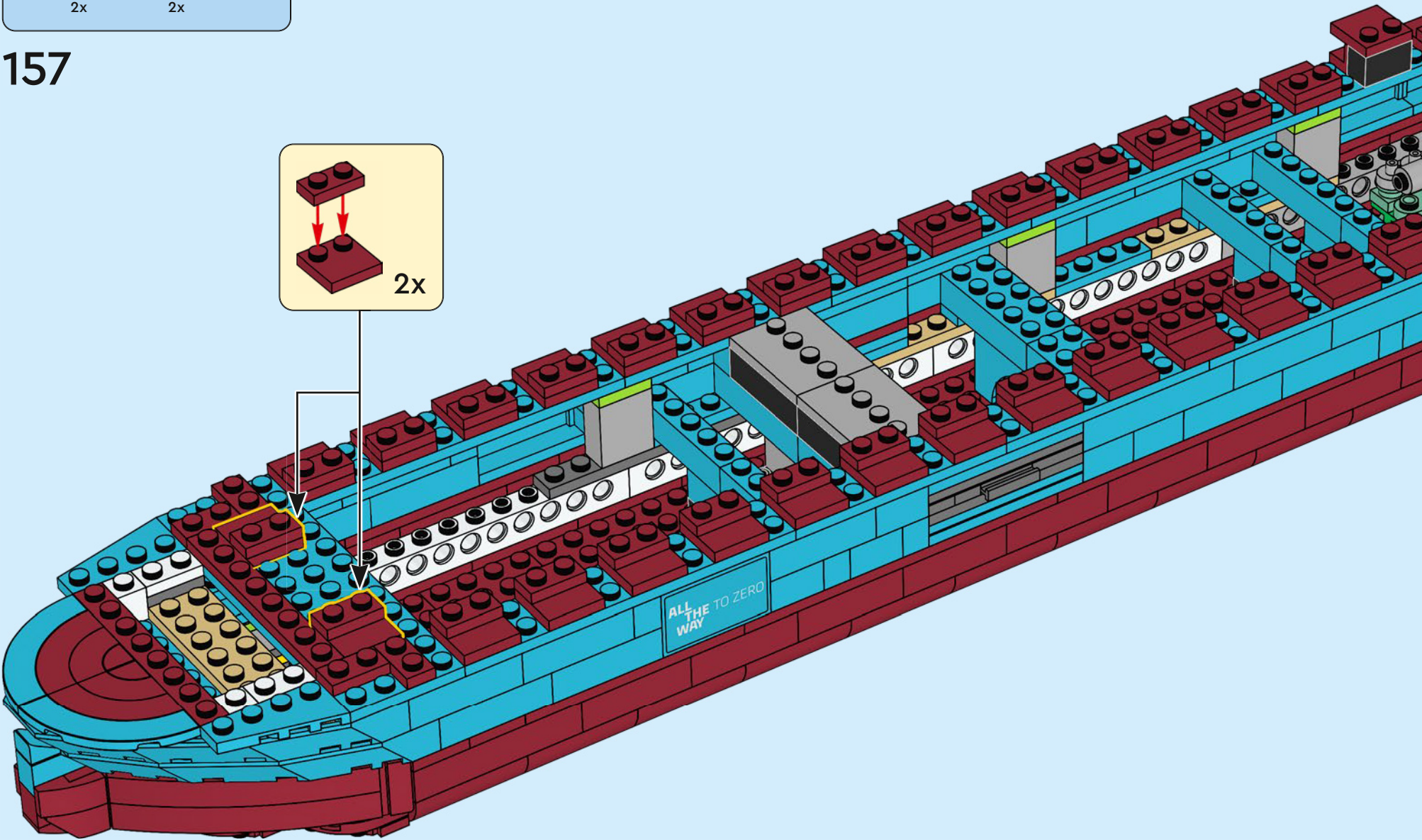
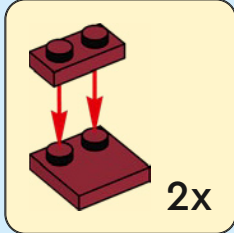

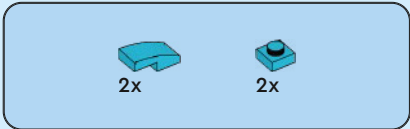

158

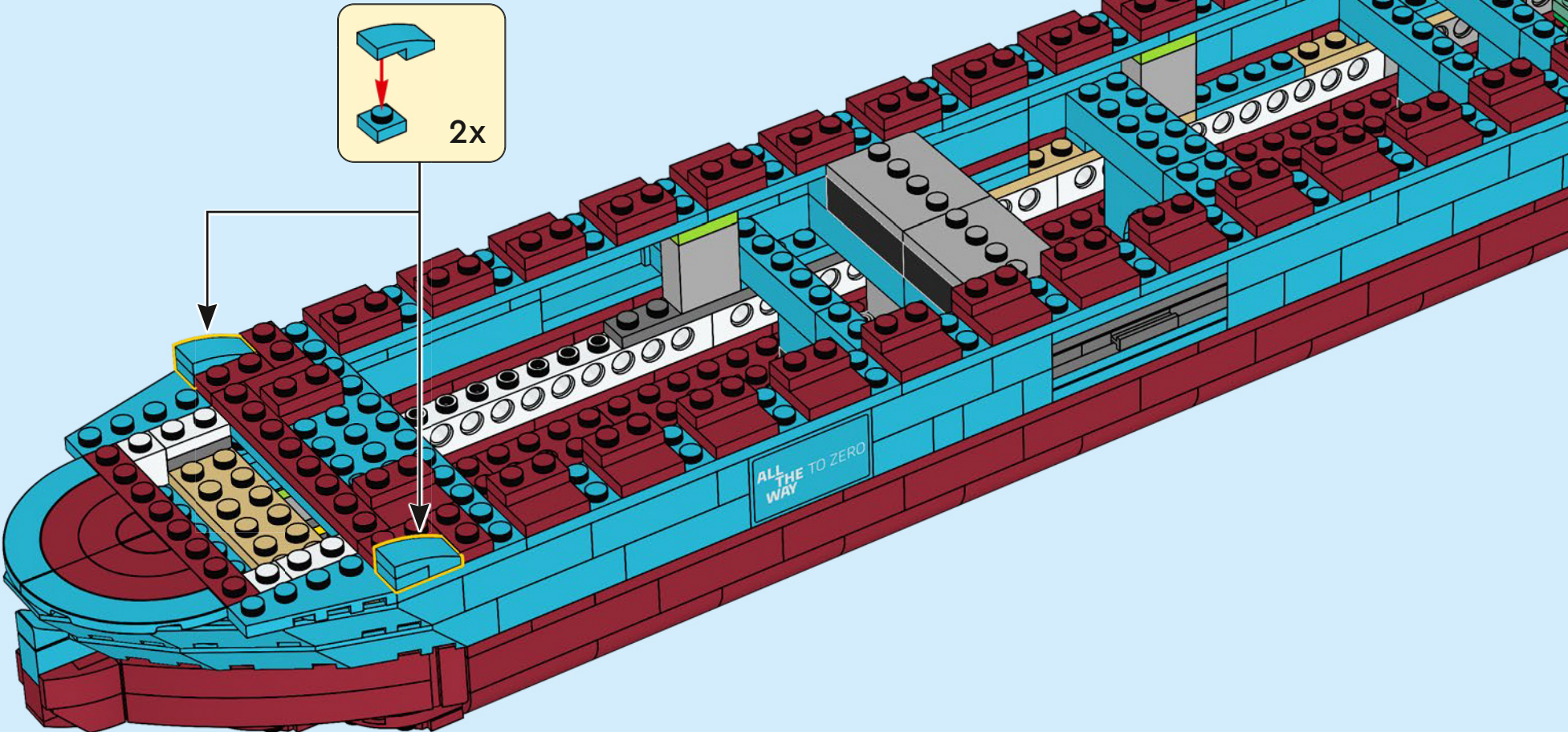

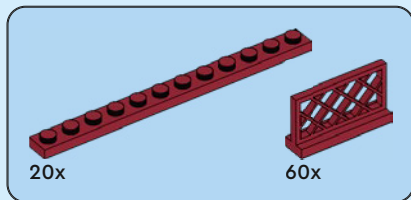
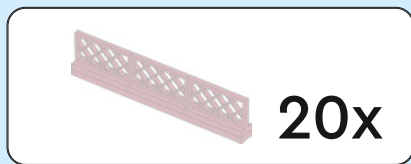

159

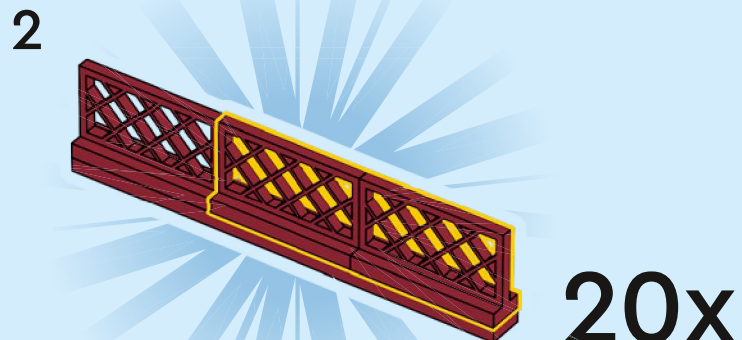
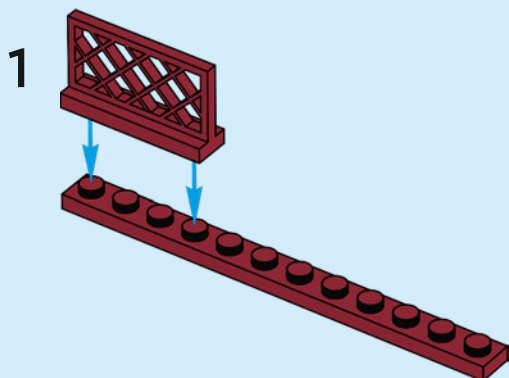
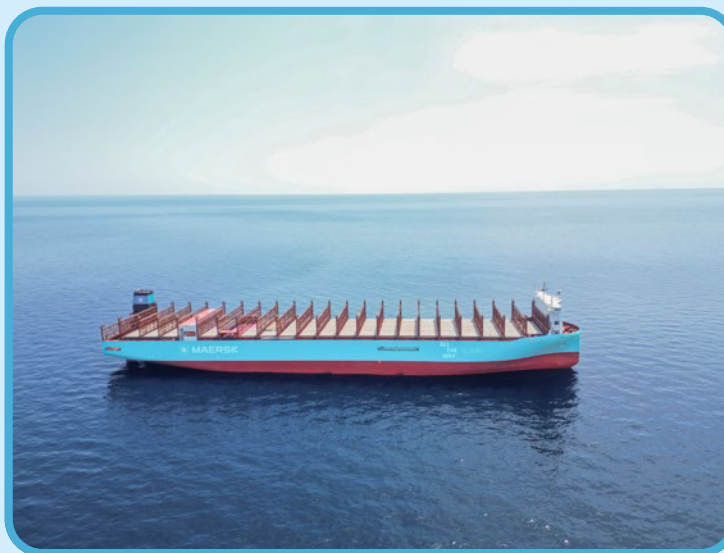

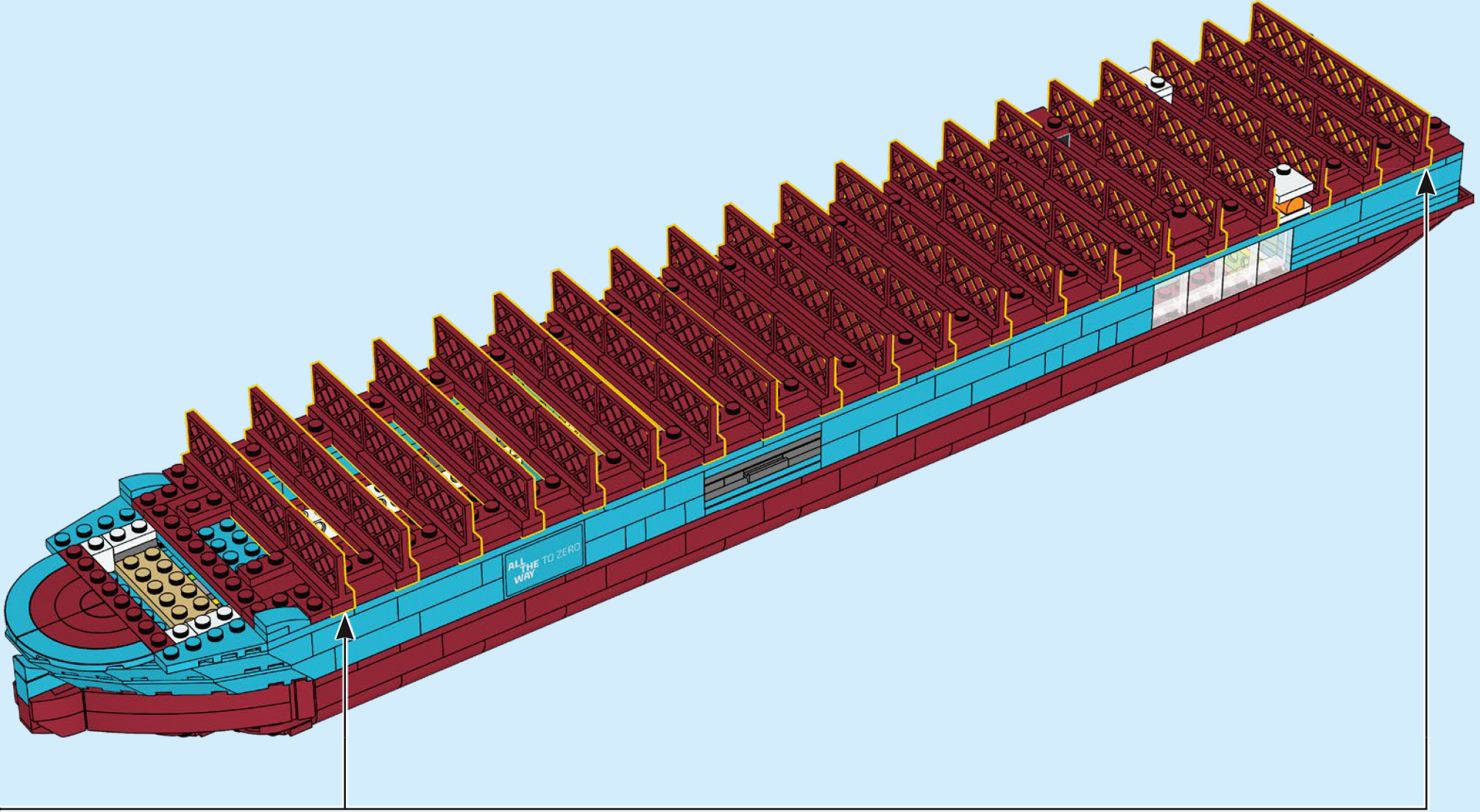

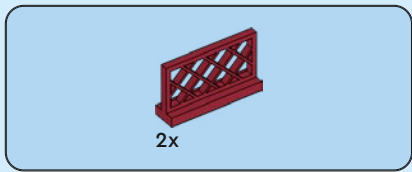

160

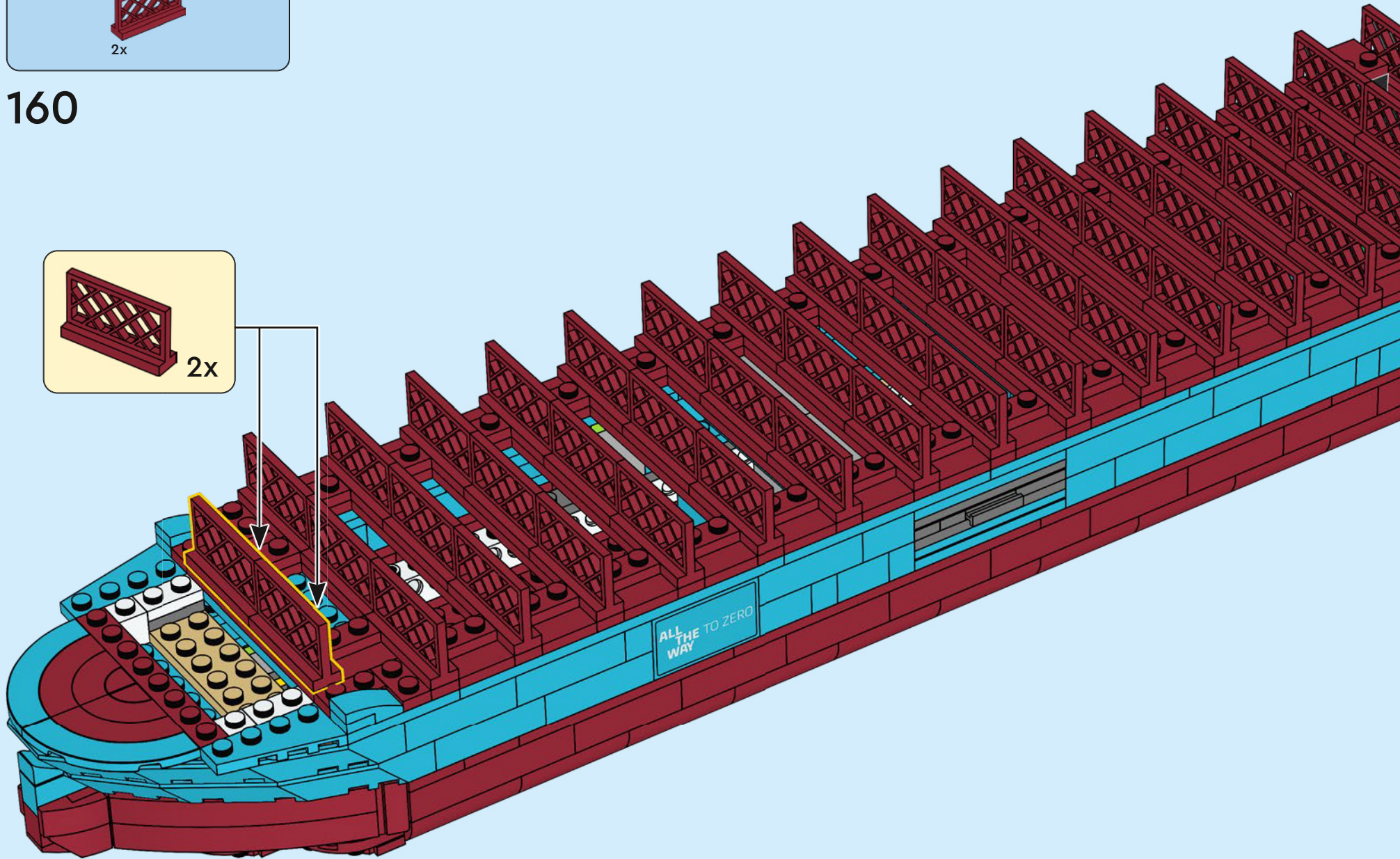
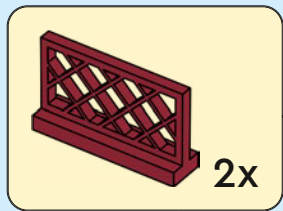

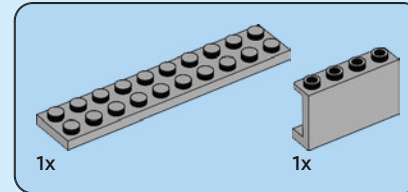
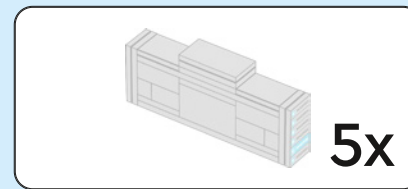

161

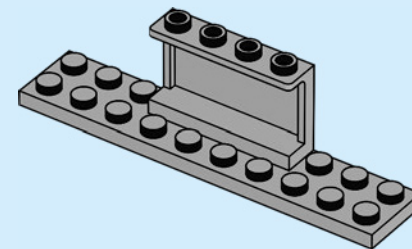
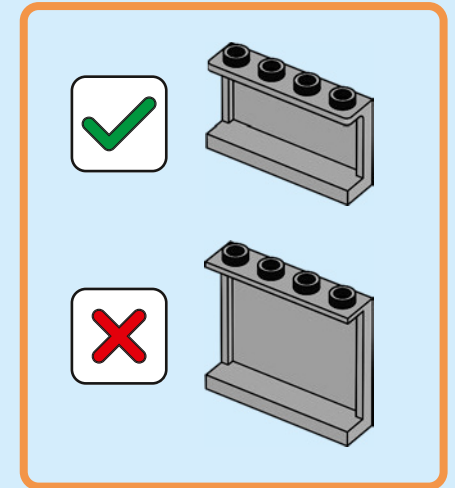

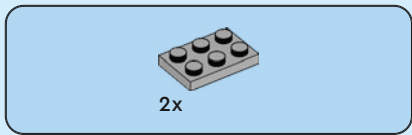

162

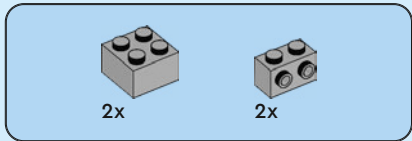
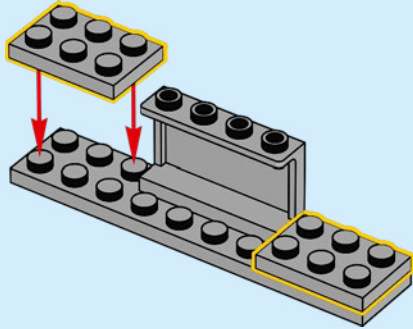

163

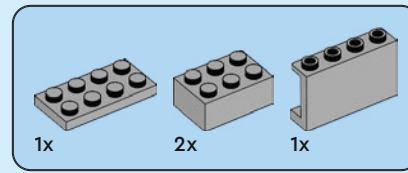
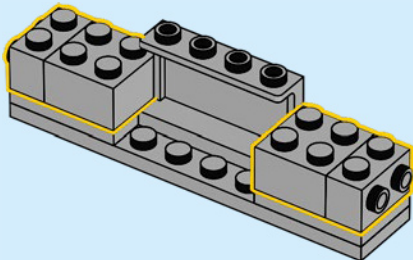

164

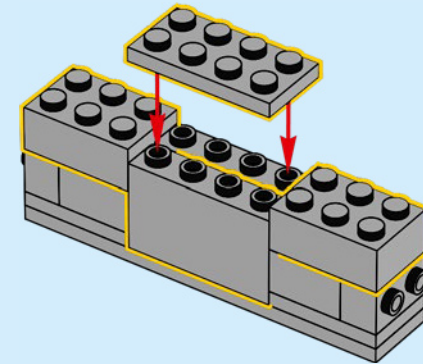

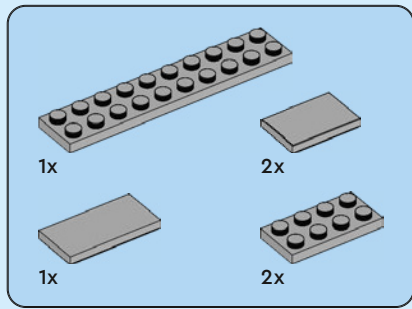

165

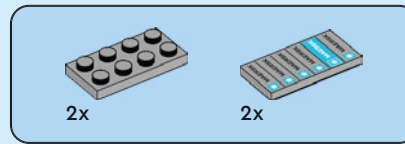
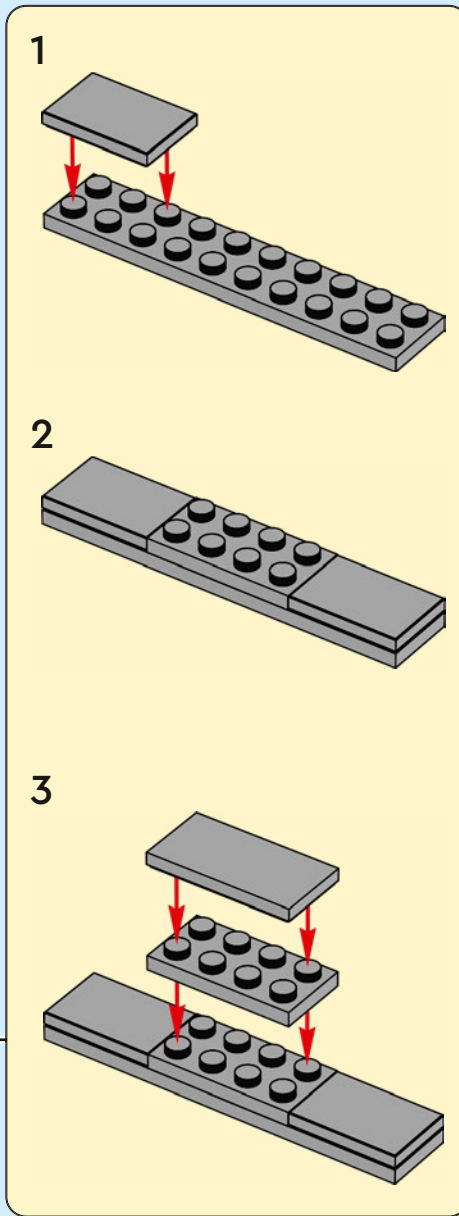
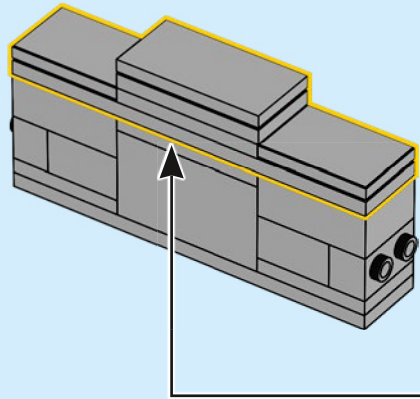

166

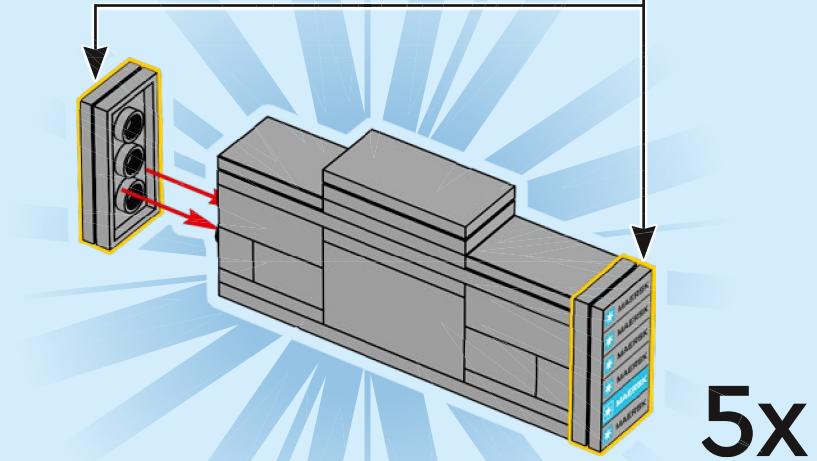
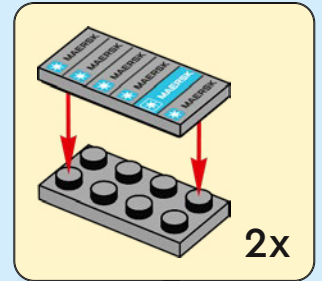

5x



167

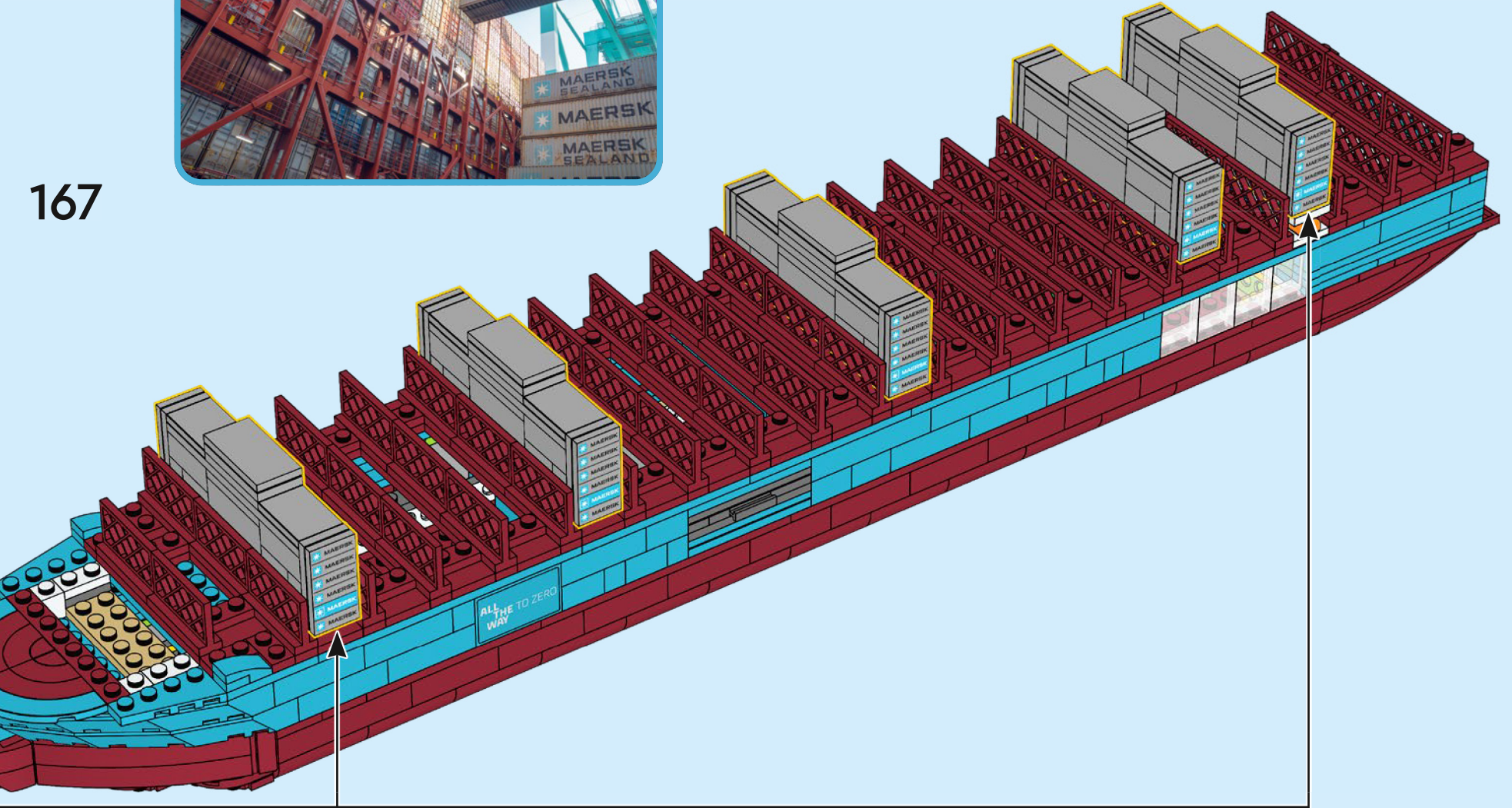

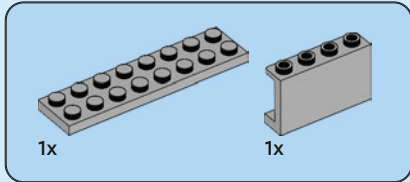
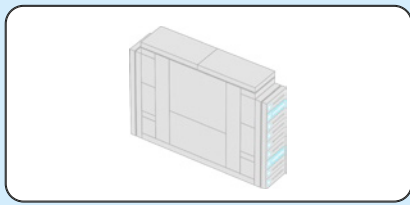

168

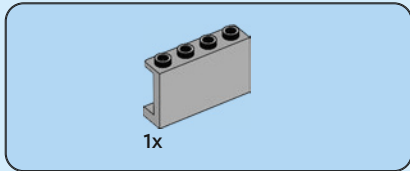
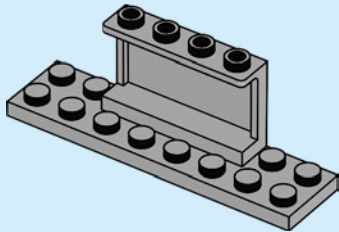

169

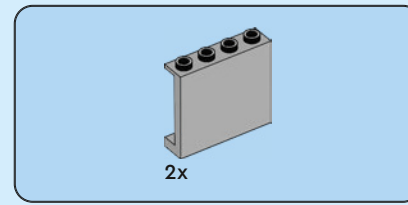
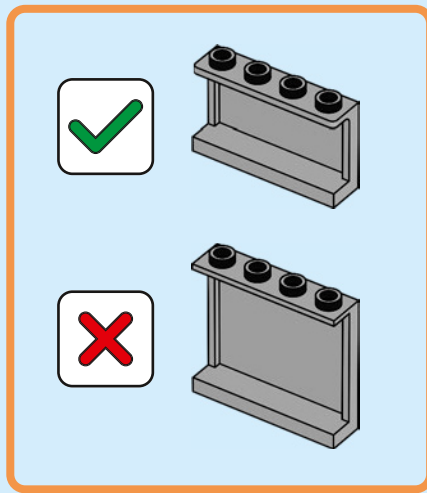
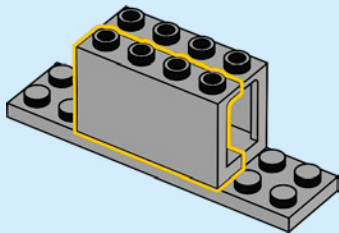

170

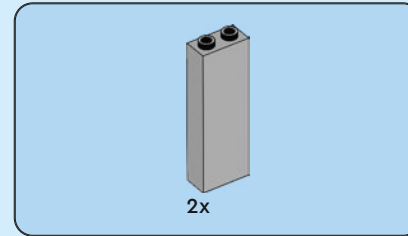
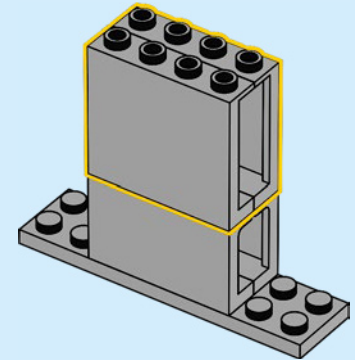

171

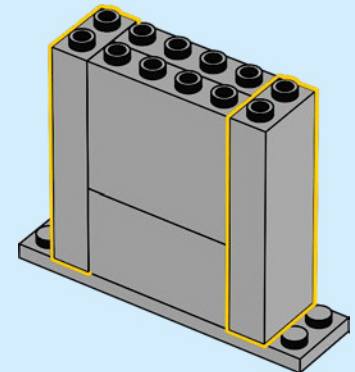

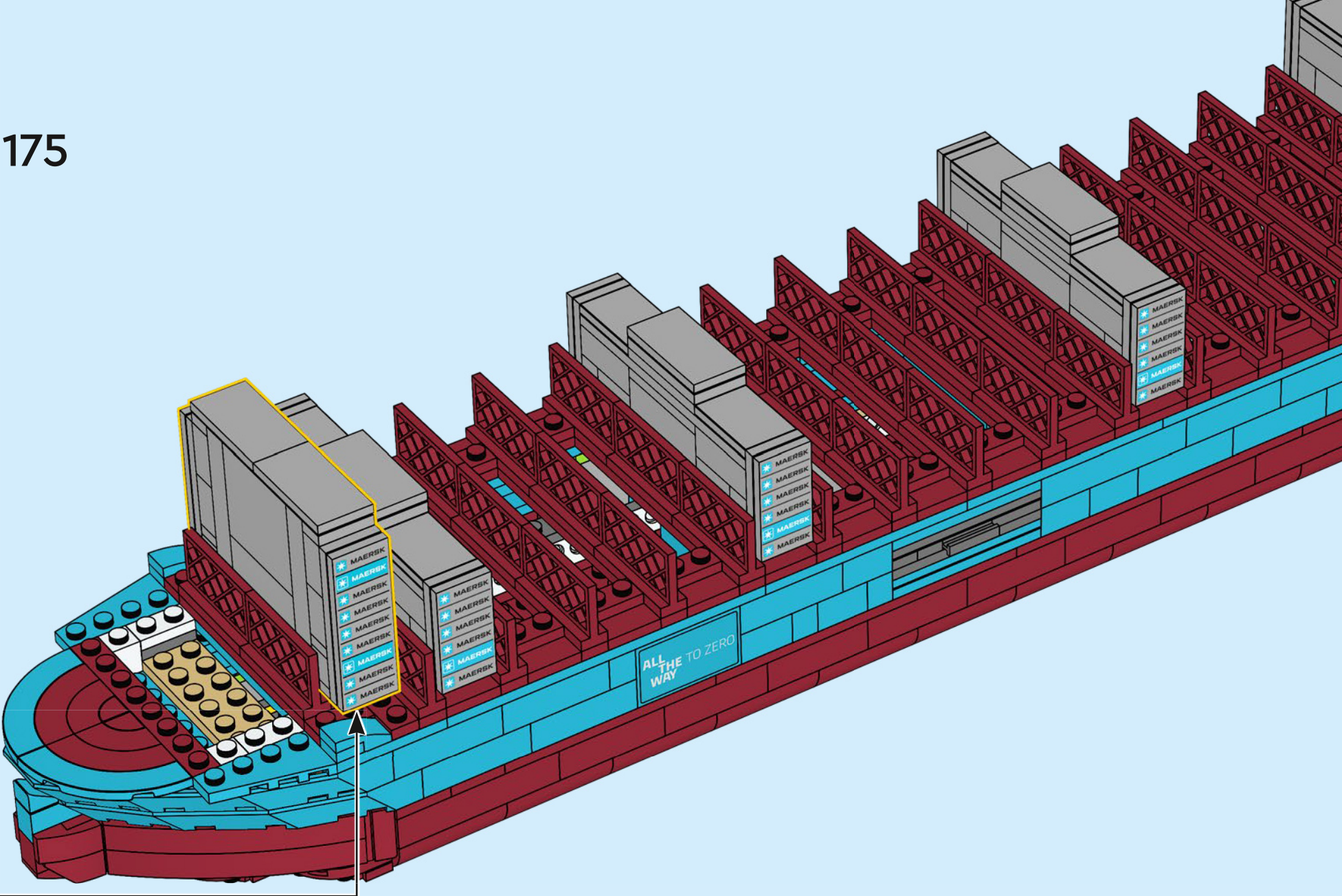

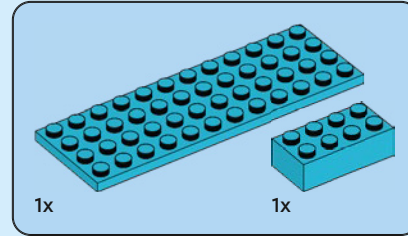
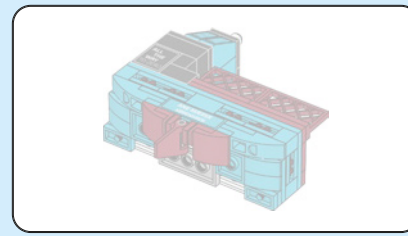

176

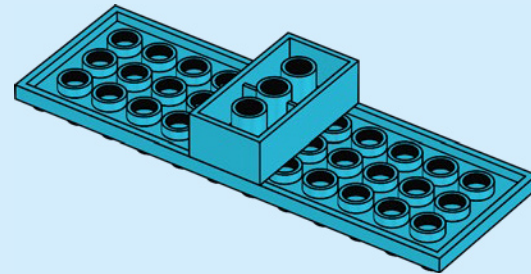

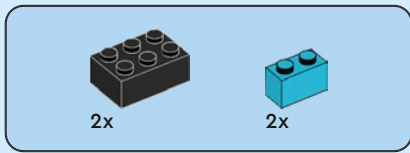

177

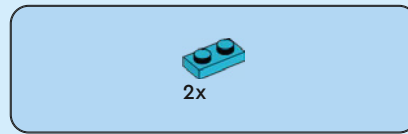
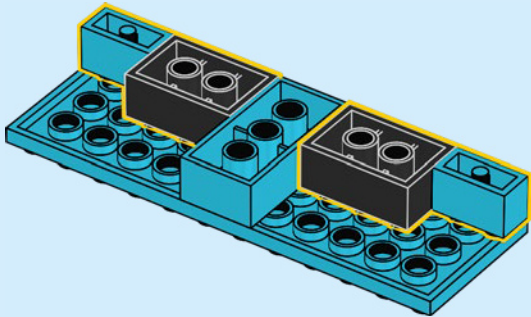

178

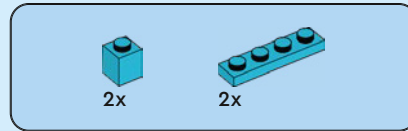
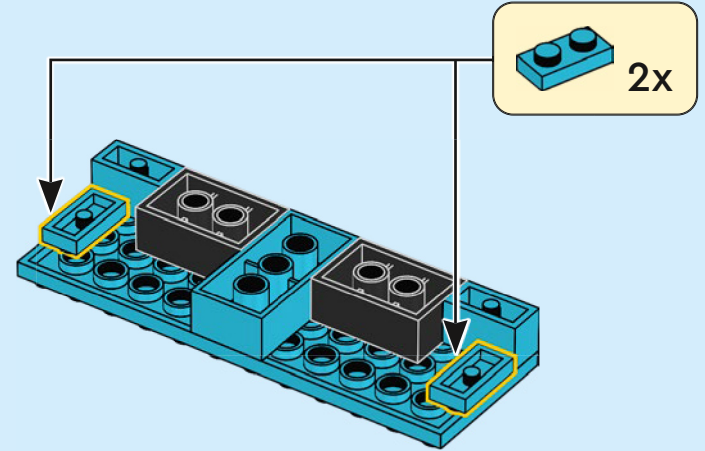

179

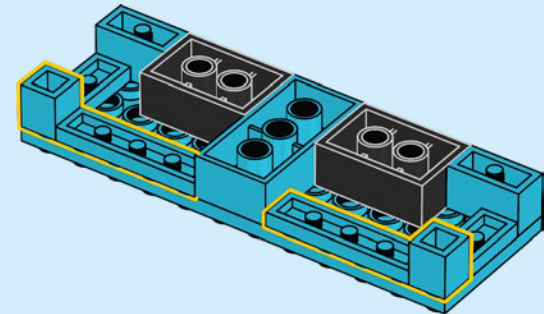

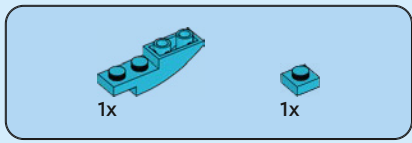

180

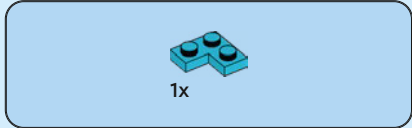
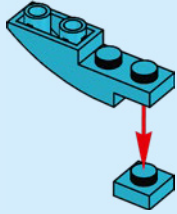

181

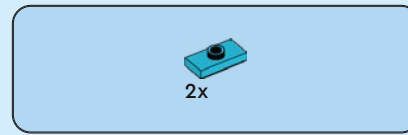
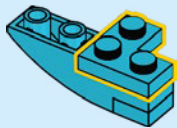

182

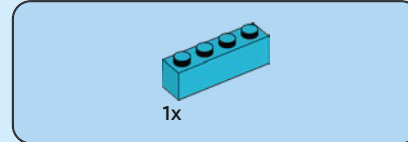
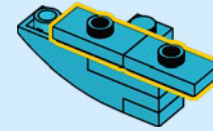

183

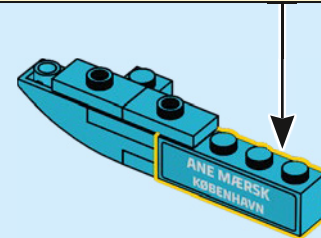
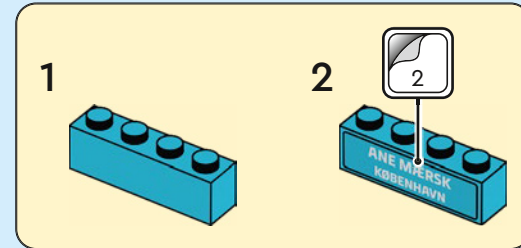

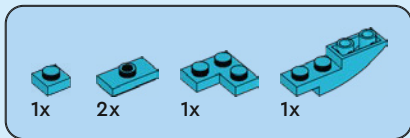

184

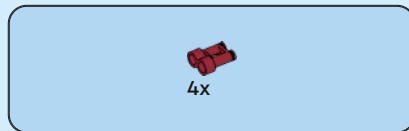
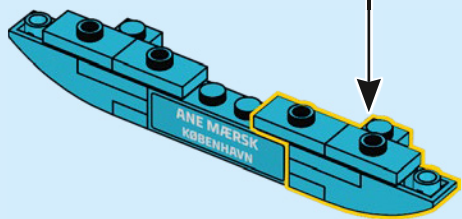
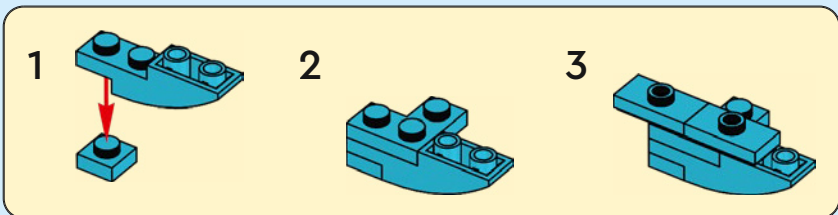

185

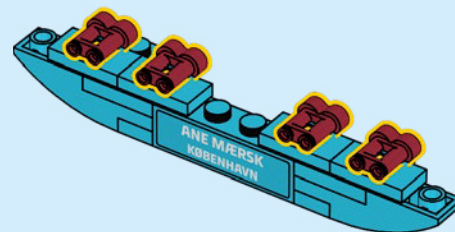

186

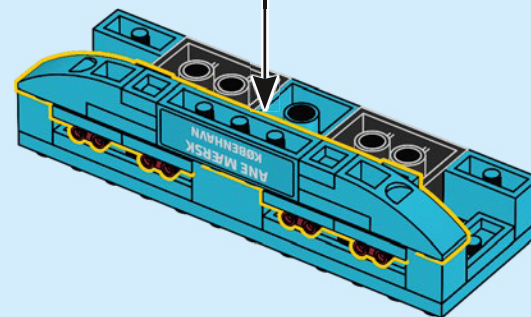

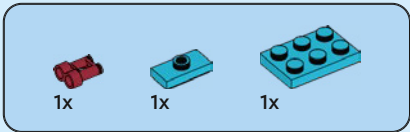

187

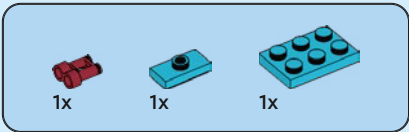
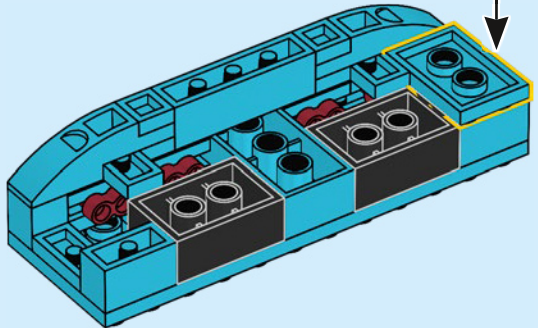
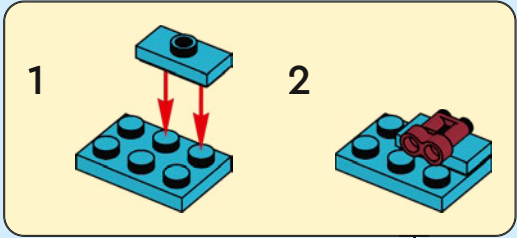

188

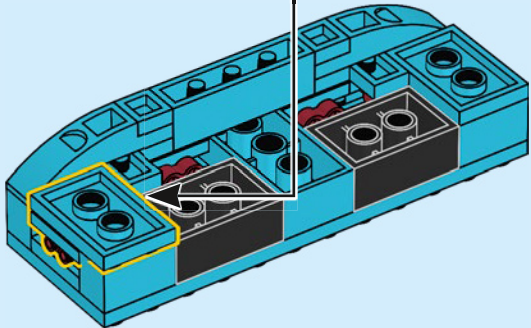
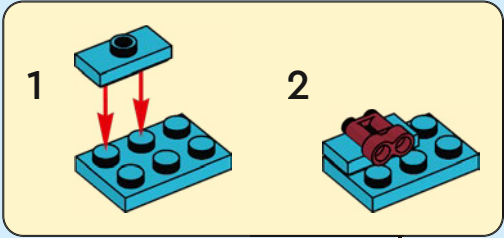

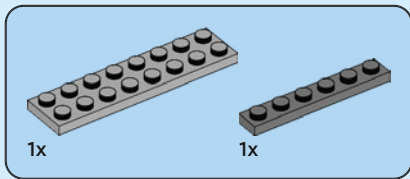

189

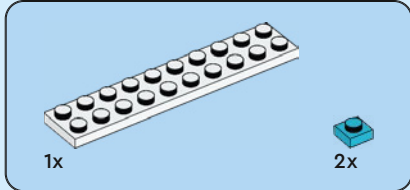
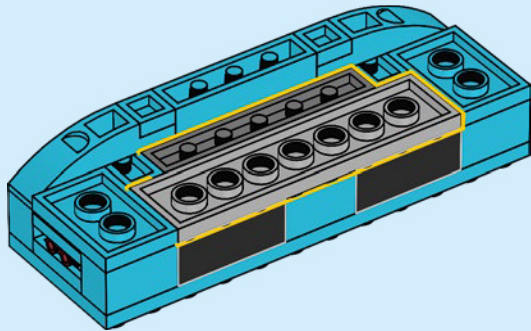

190

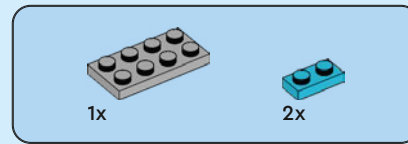
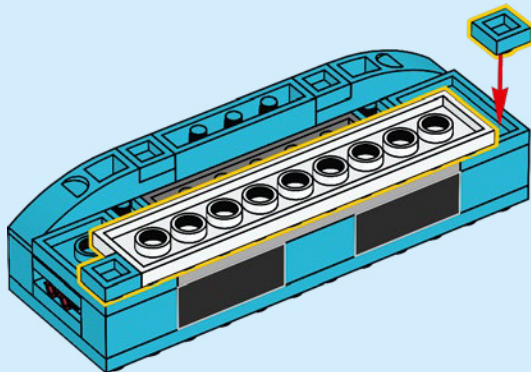

191

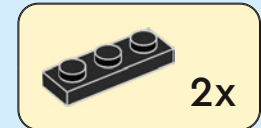
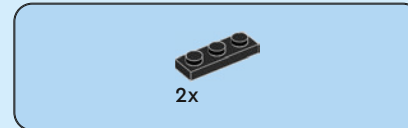
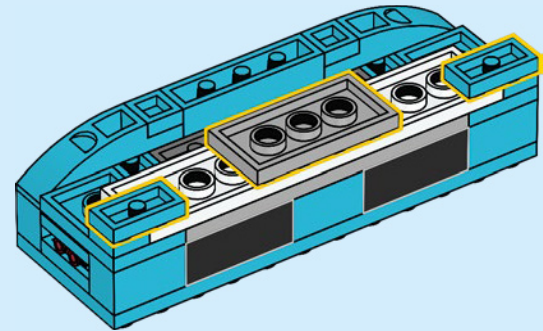

192

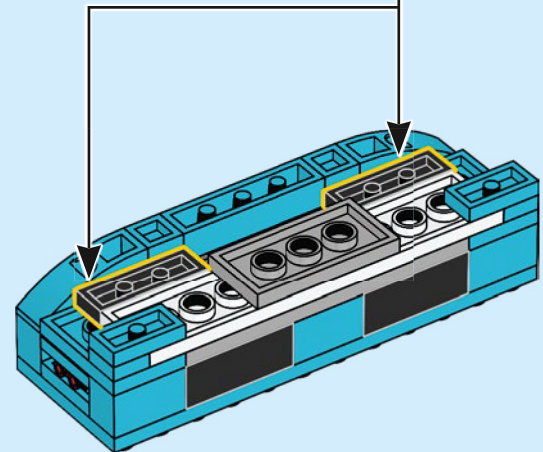



4x

193

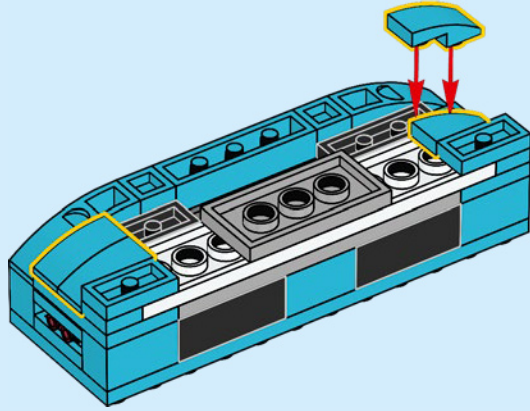

2x

194

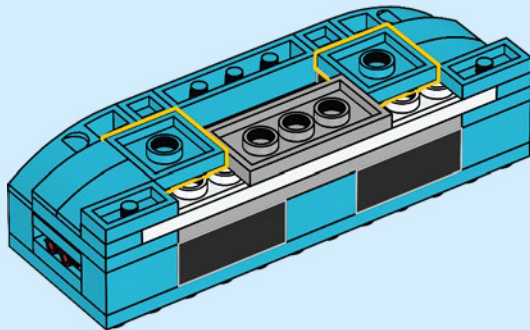

1x

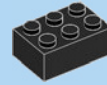

1x



1x

195

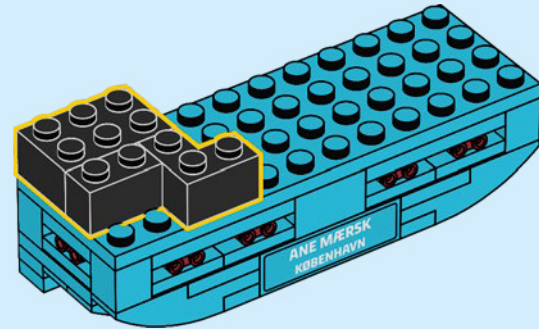

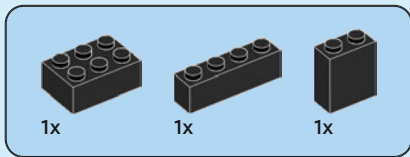

196

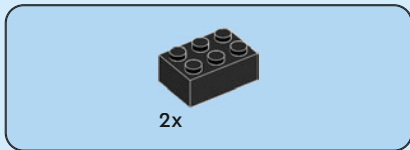
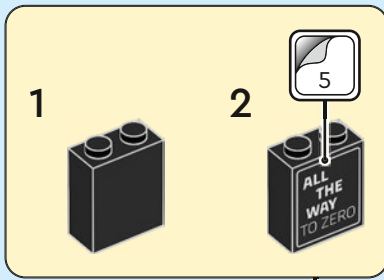
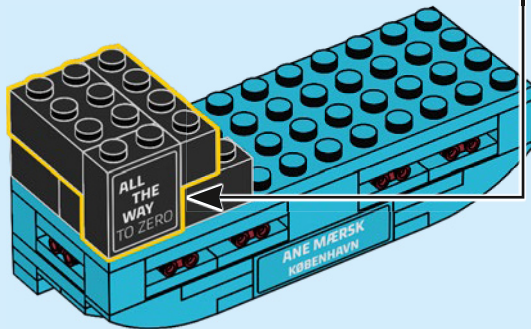

197

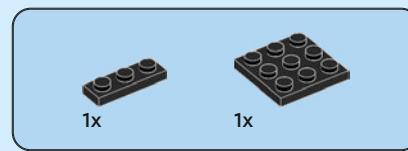
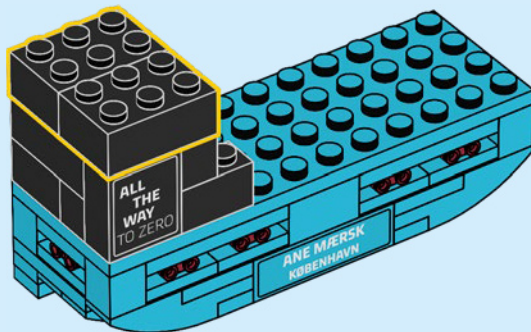

198

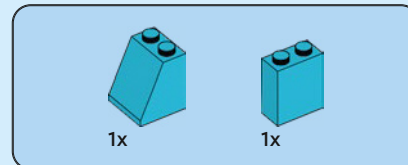
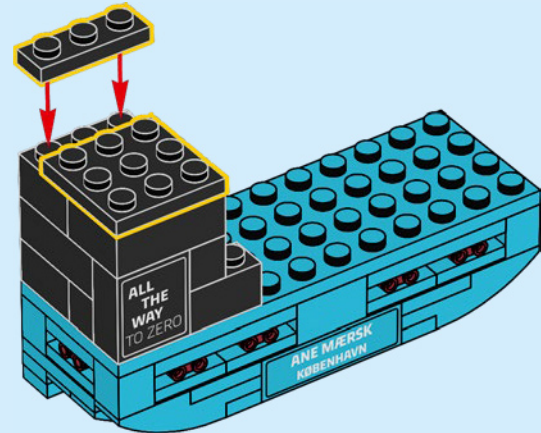

199

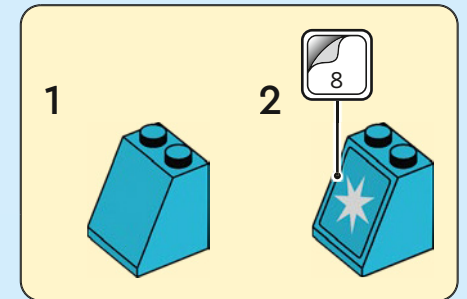
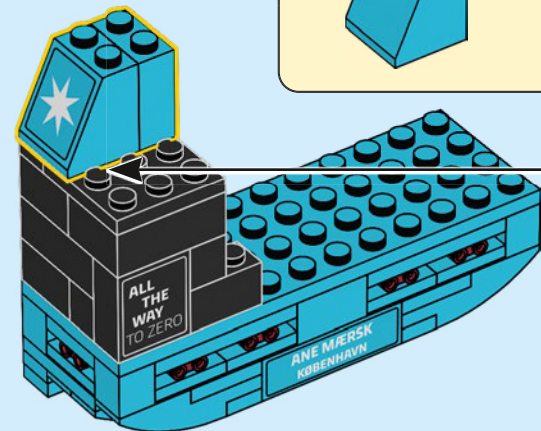

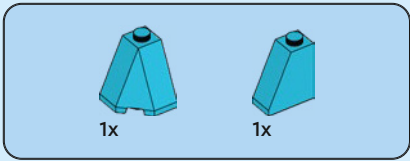

200

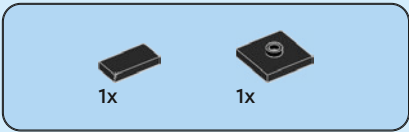
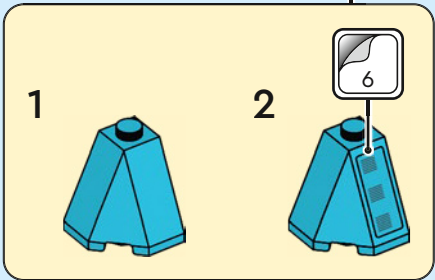
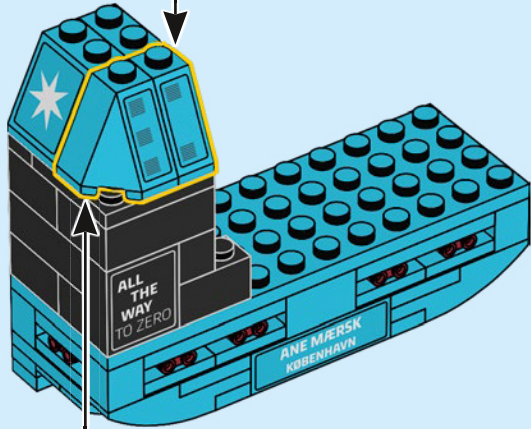
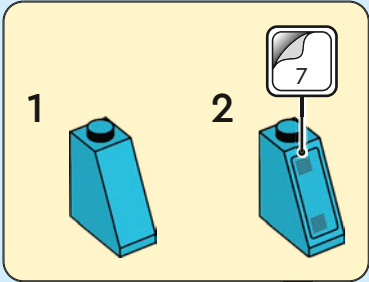

201

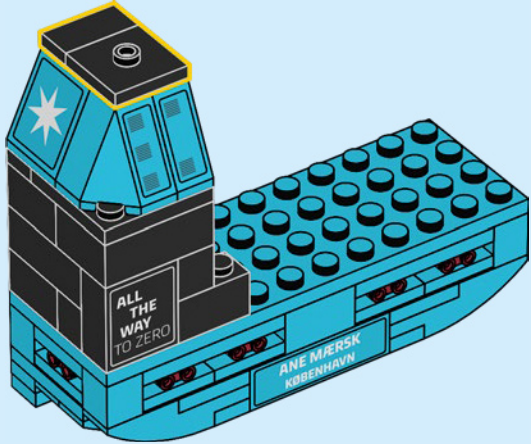



1x



1x

202

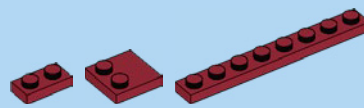
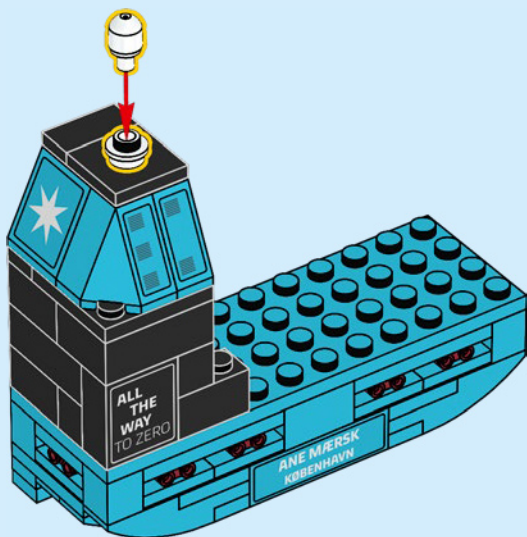

1x

2x

1x

203

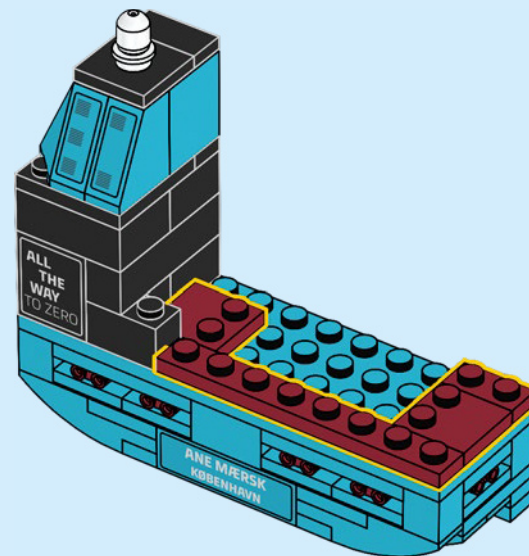



2x

204

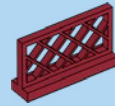
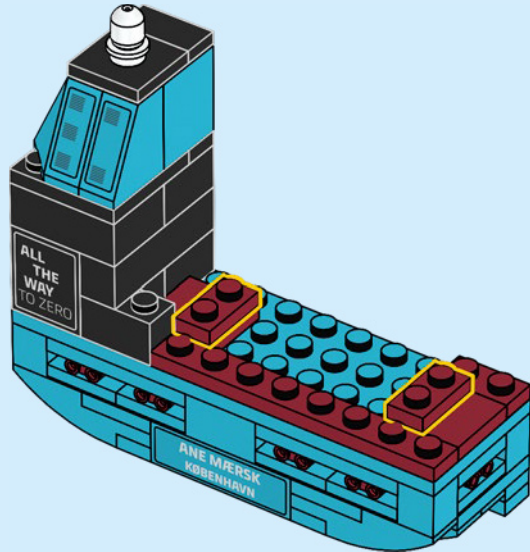

2x

205

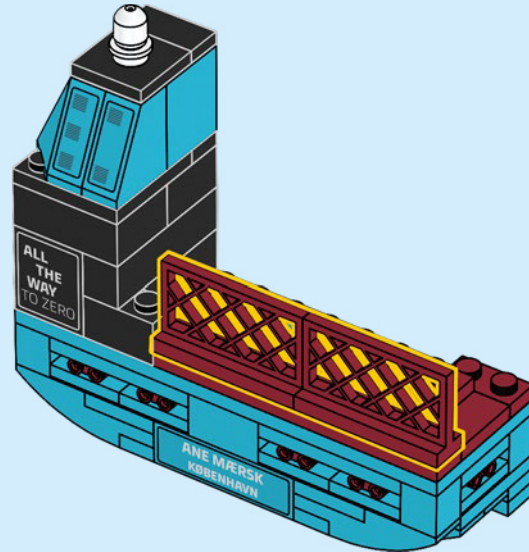

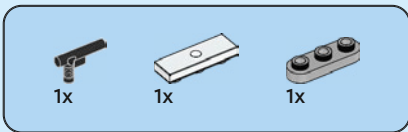

206

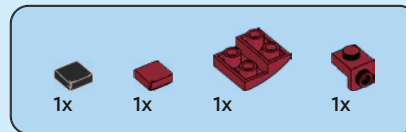
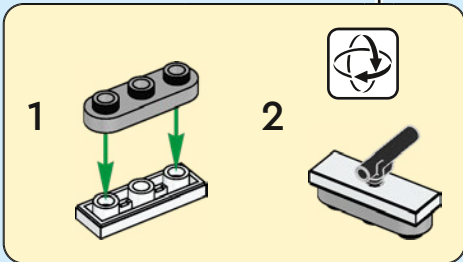
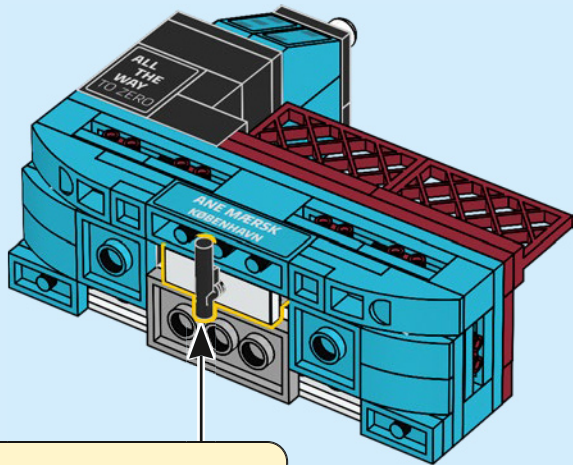

207

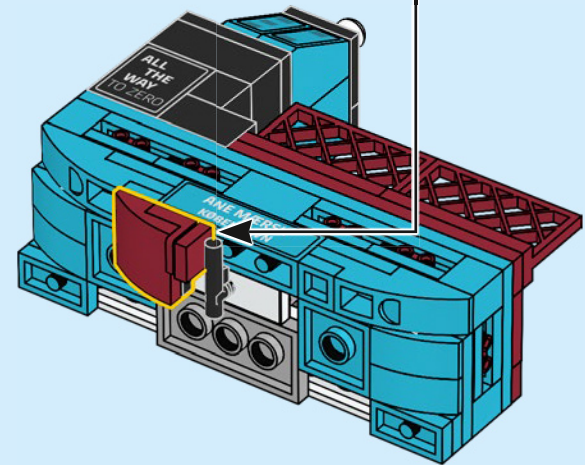
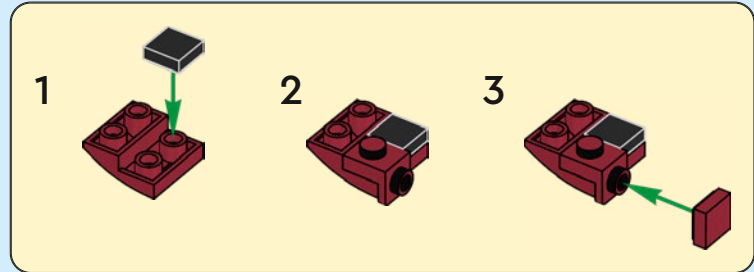

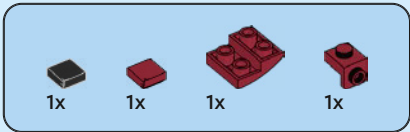

208

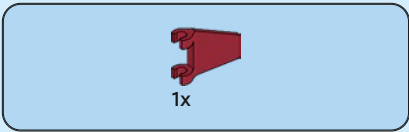
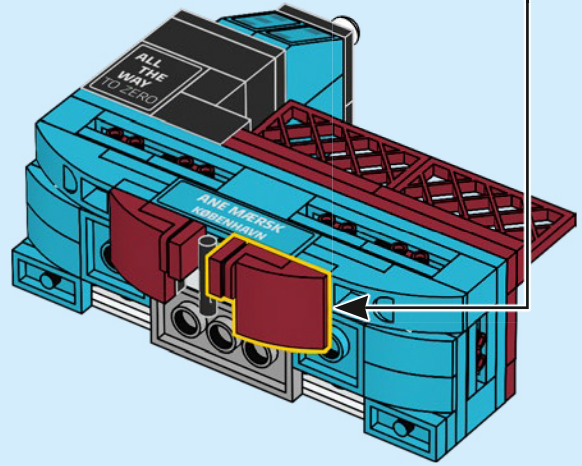

209

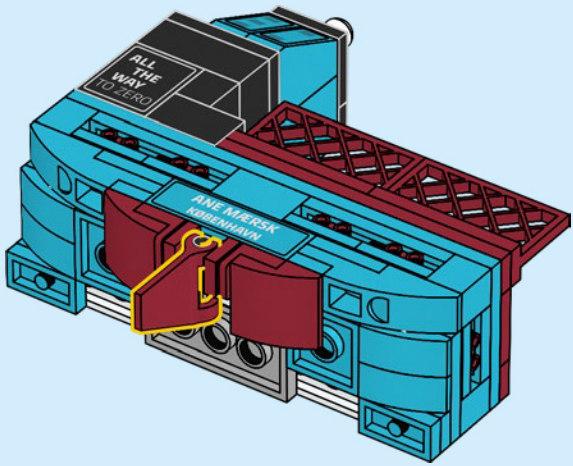

210

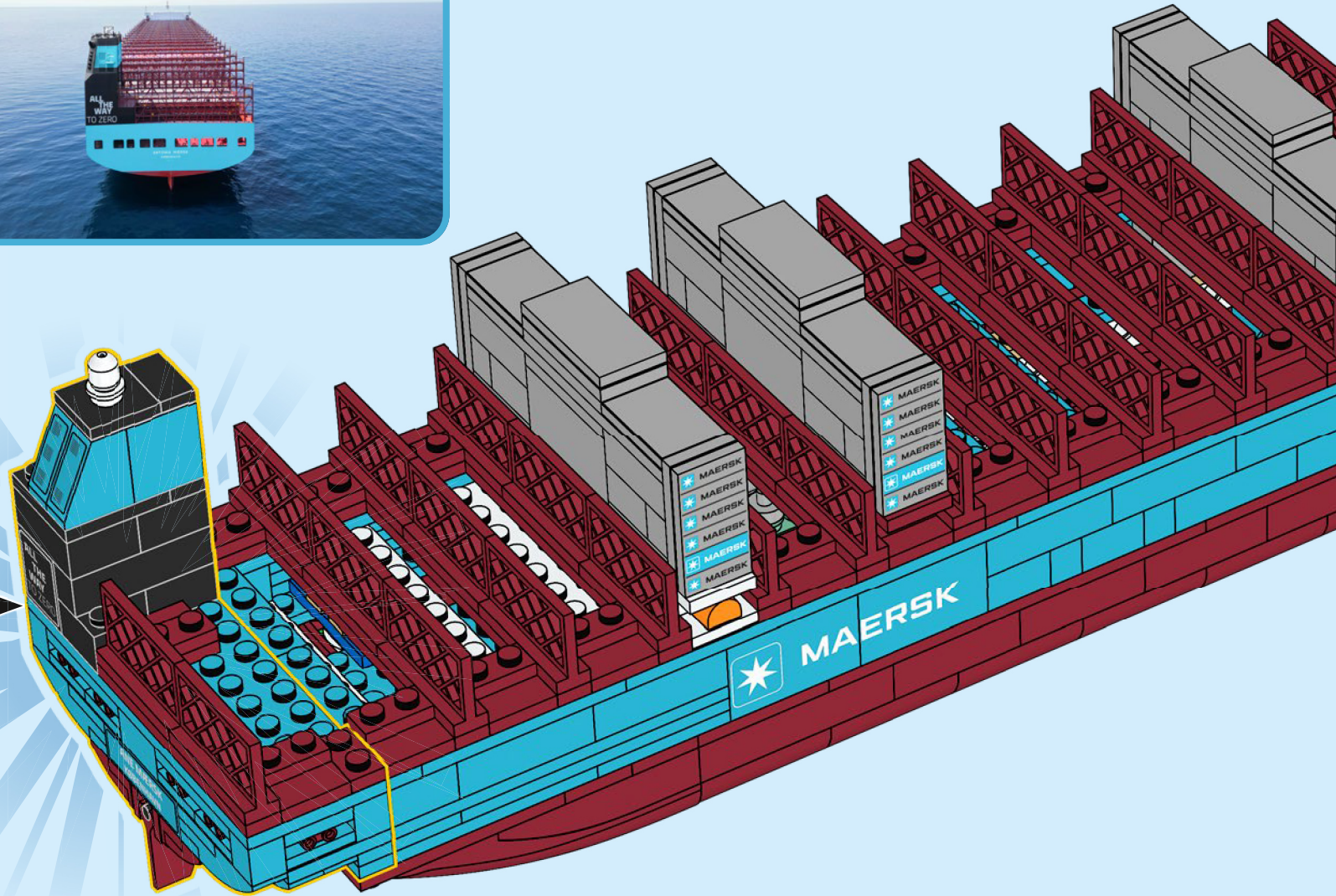
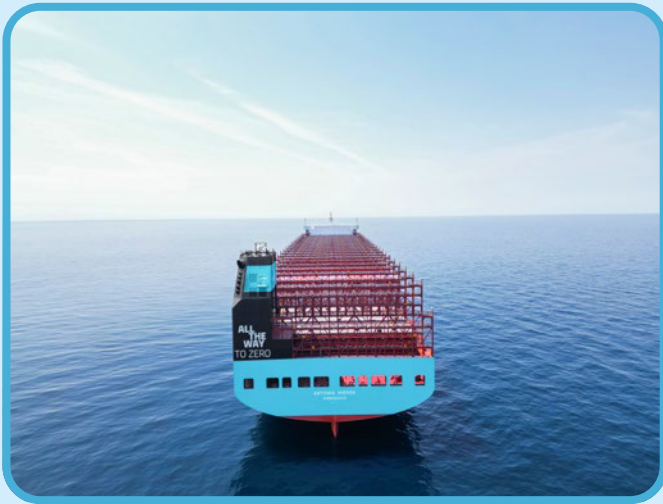

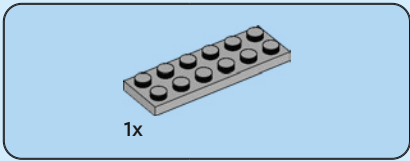

211

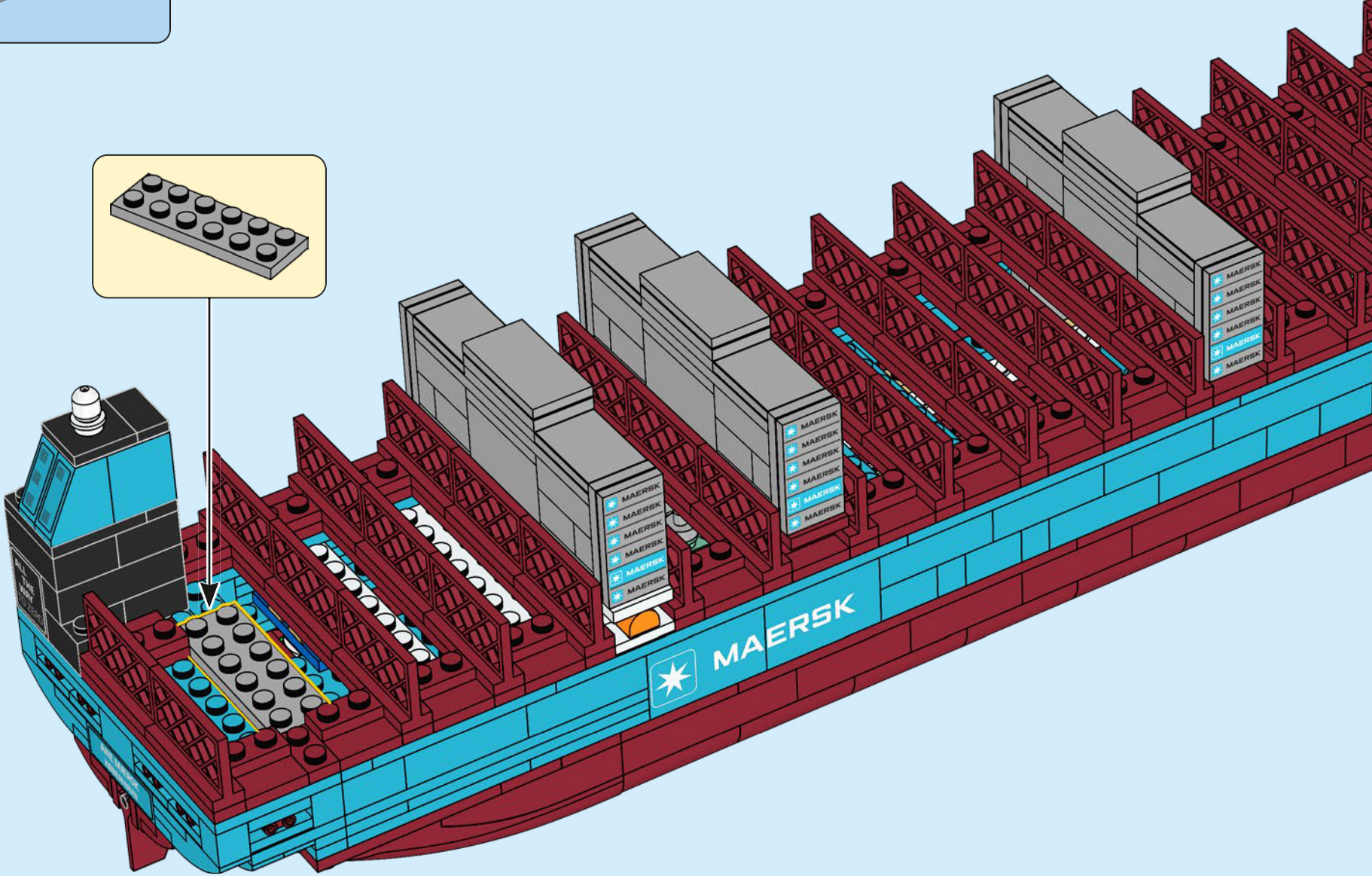
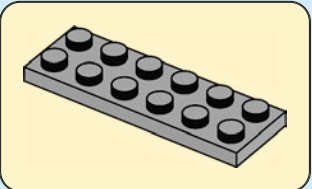

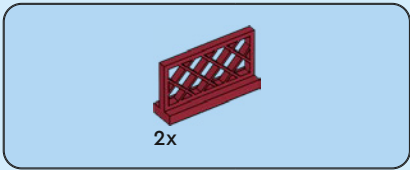

212

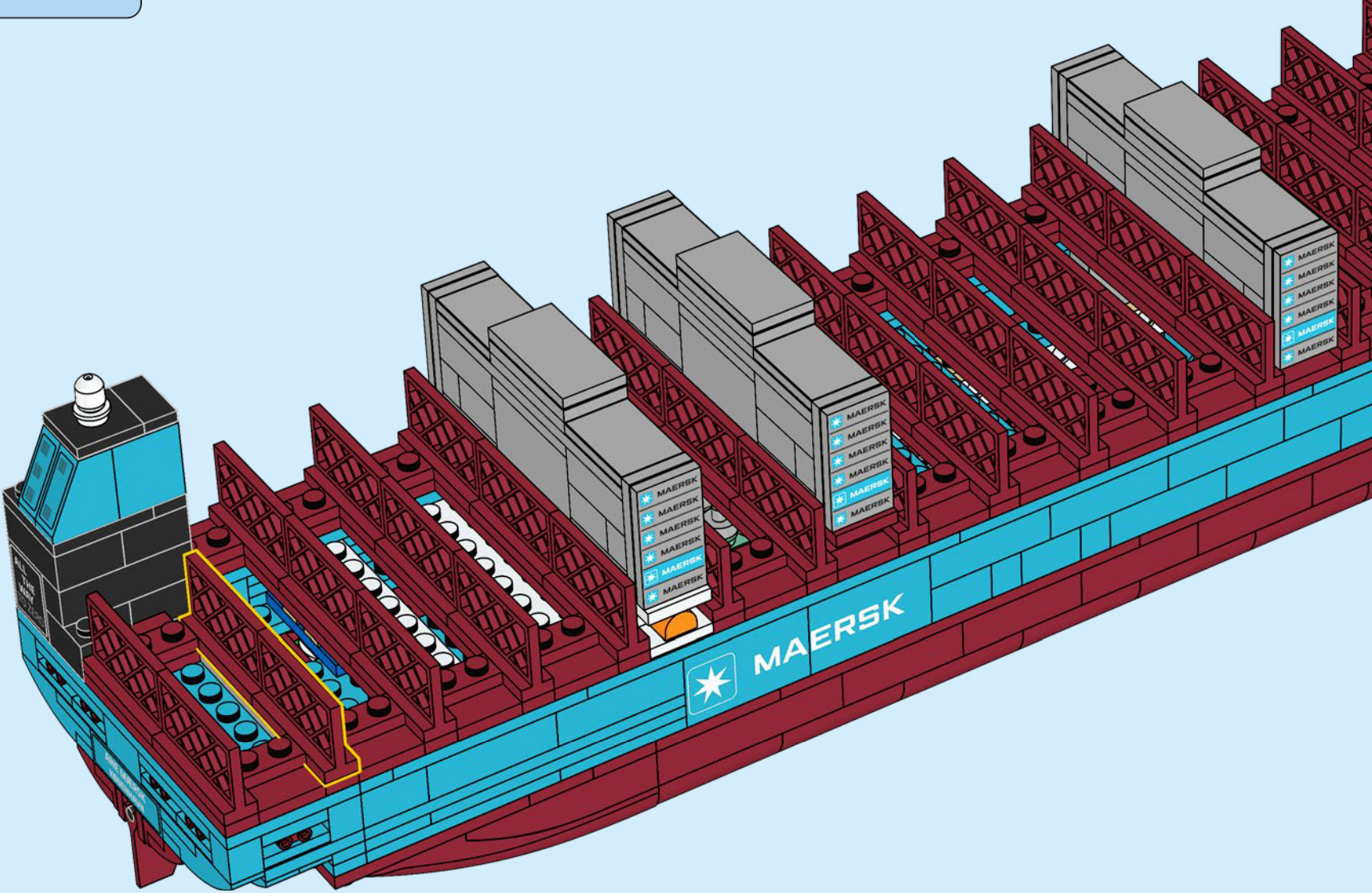

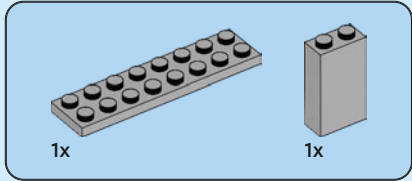
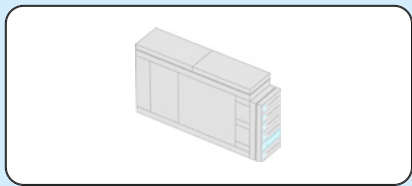

213

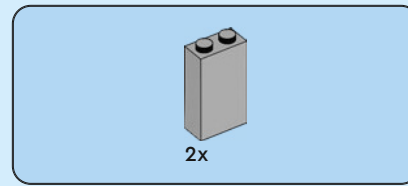
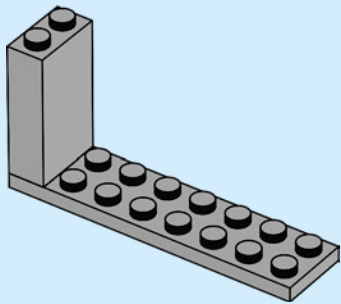

214

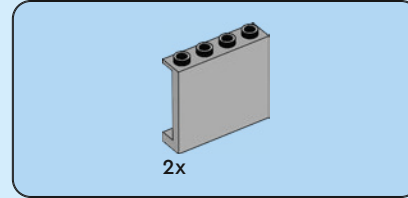
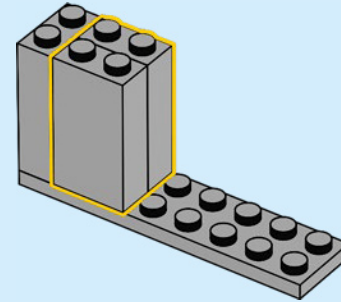

215

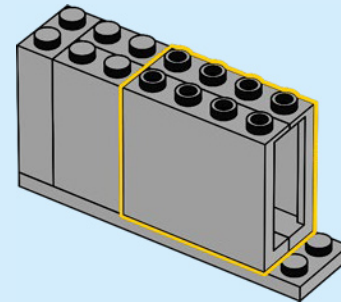

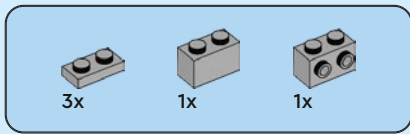

216

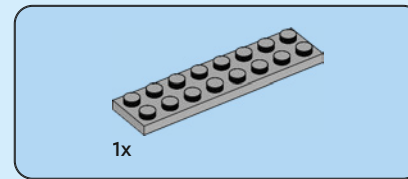
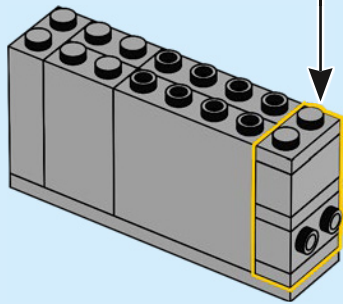
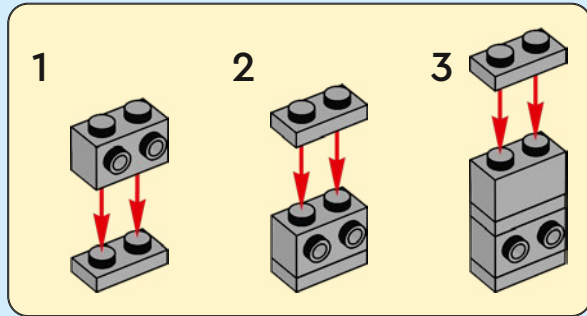

217

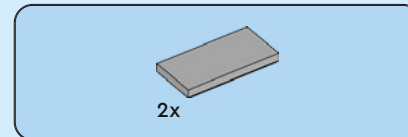
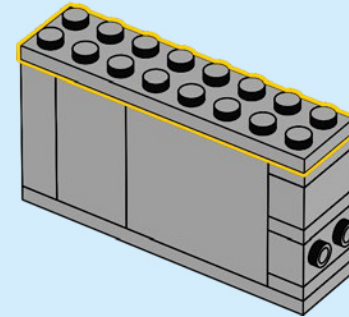

218

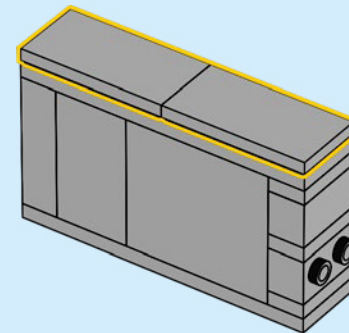

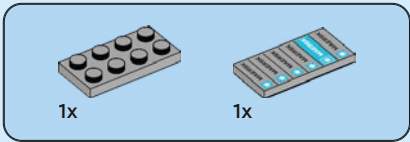

219

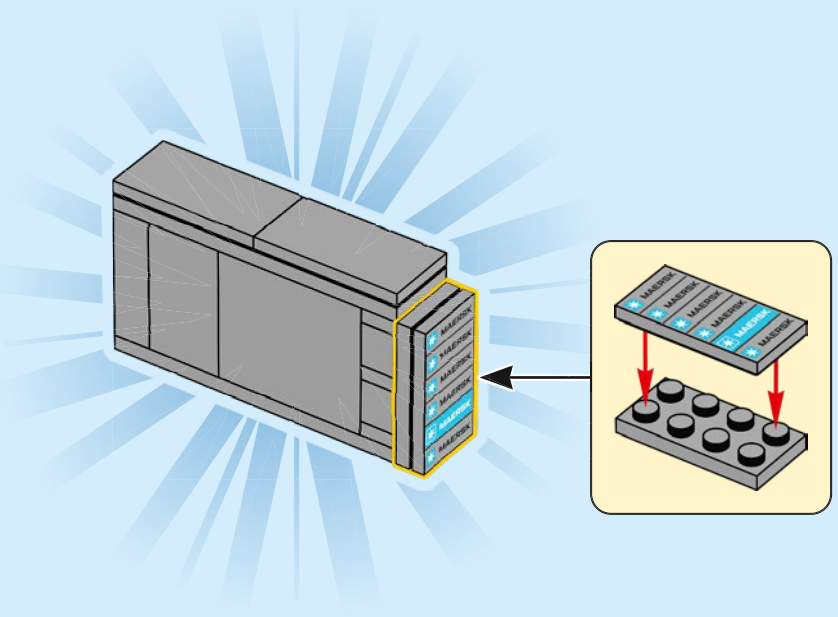

220

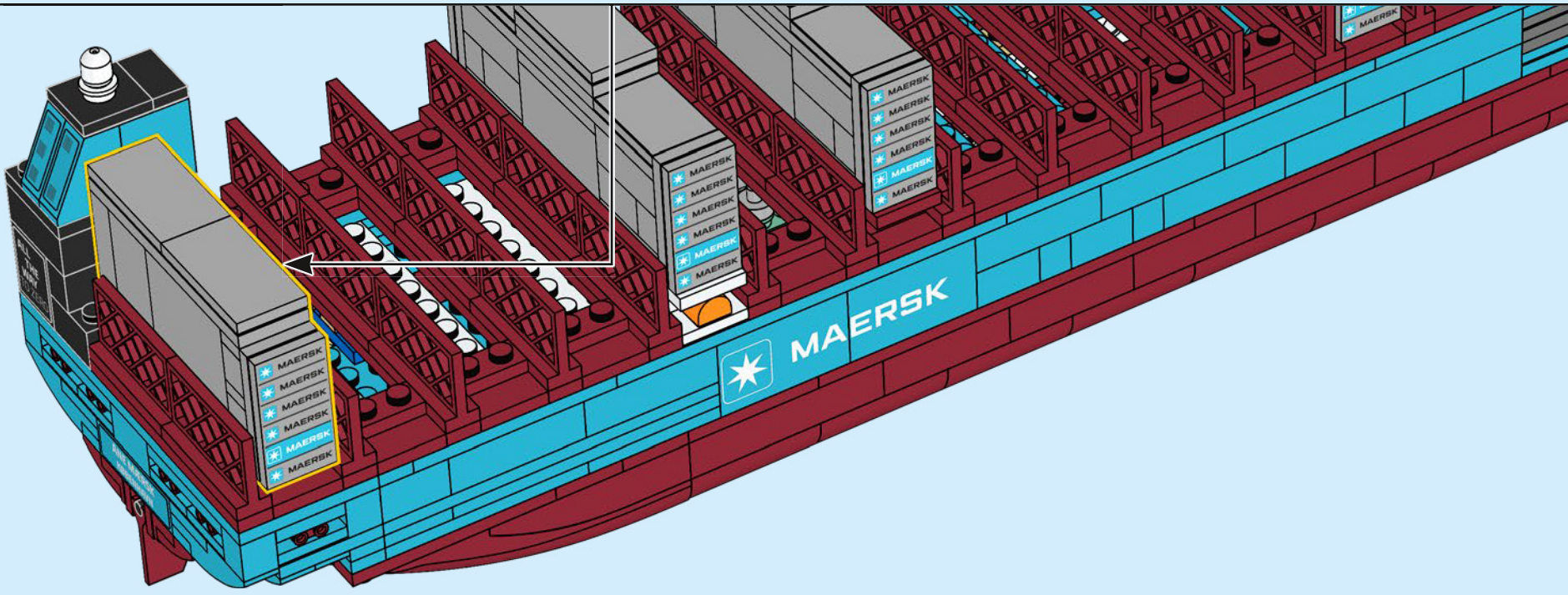

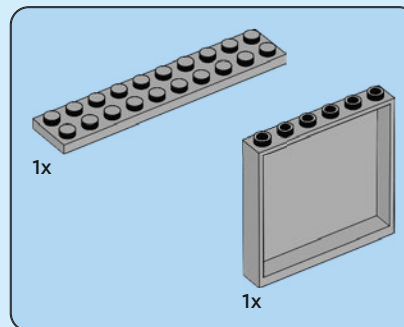
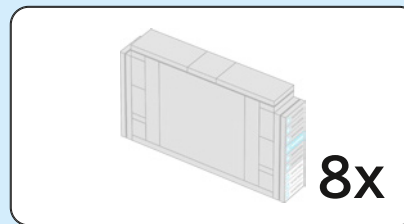

221

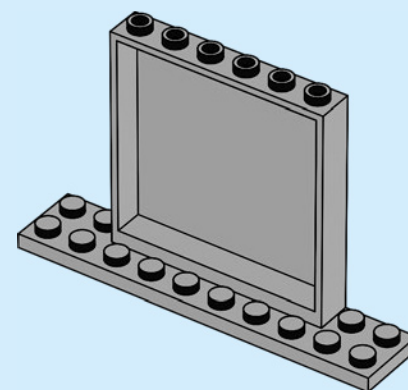

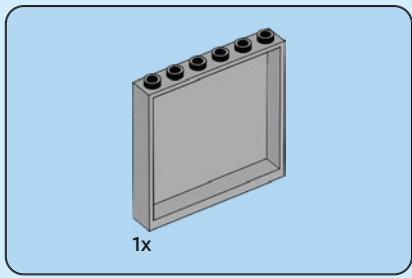

222

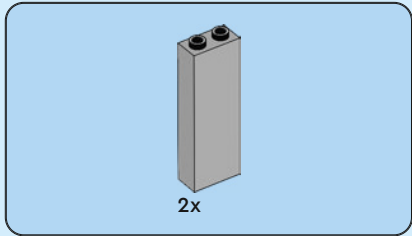
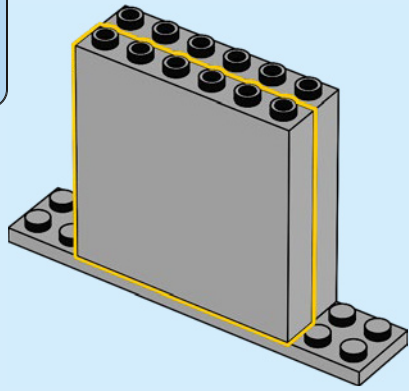

223

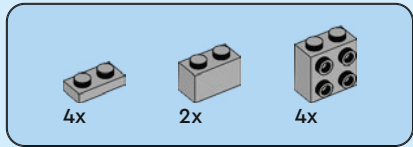
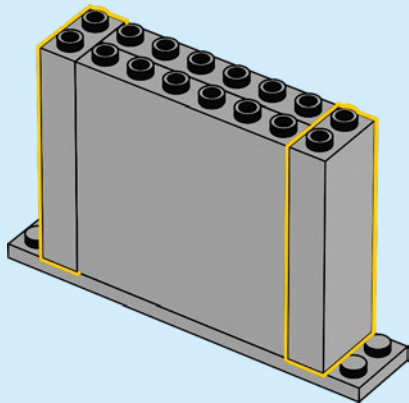

224

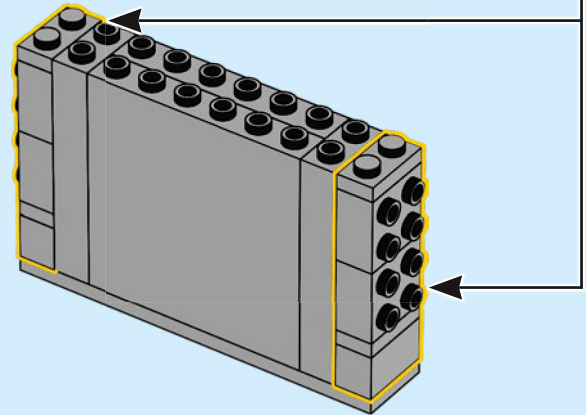
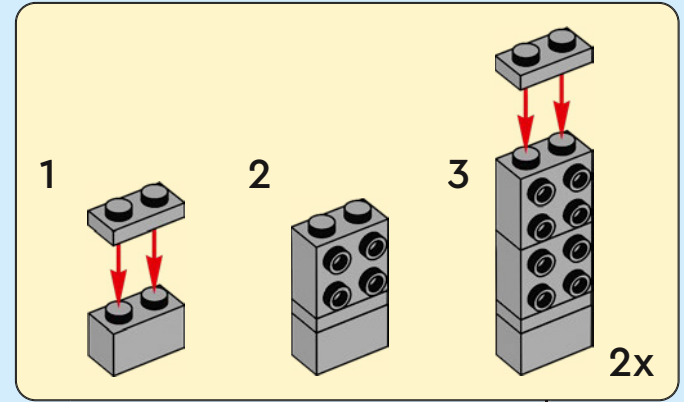

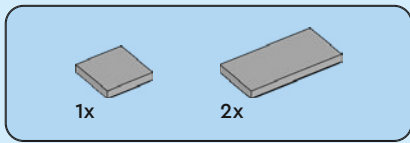

225

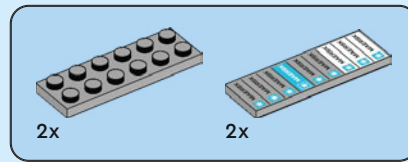
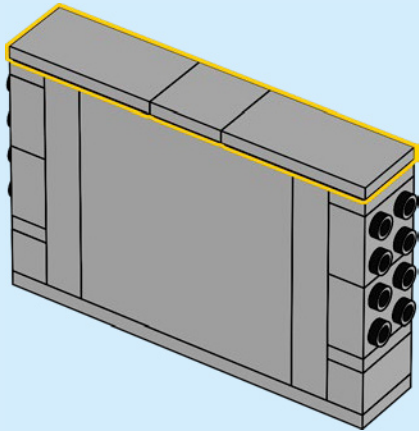

226

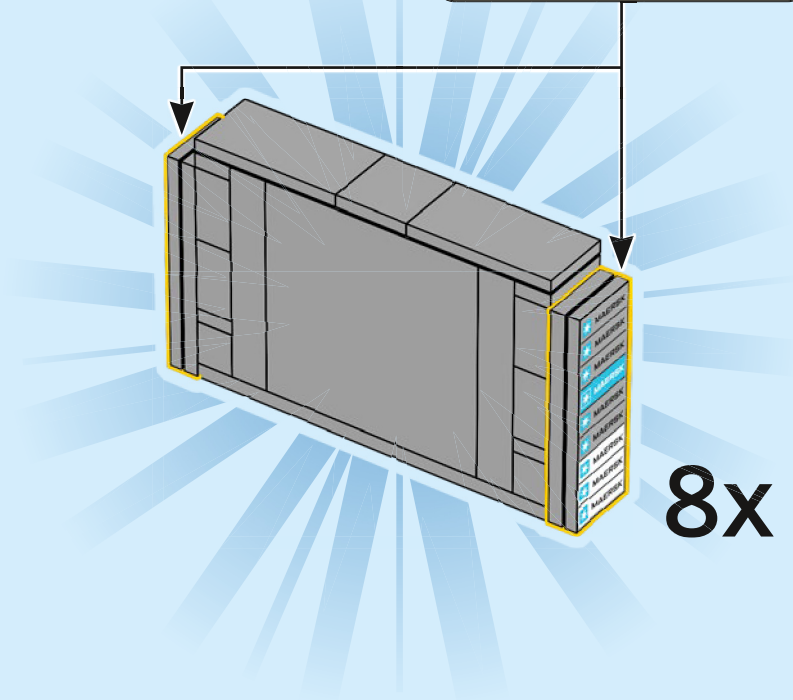
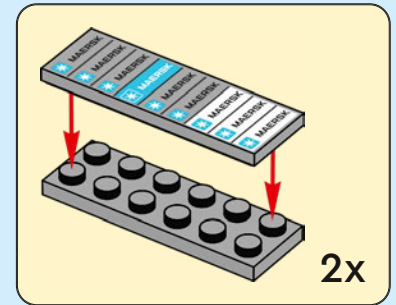

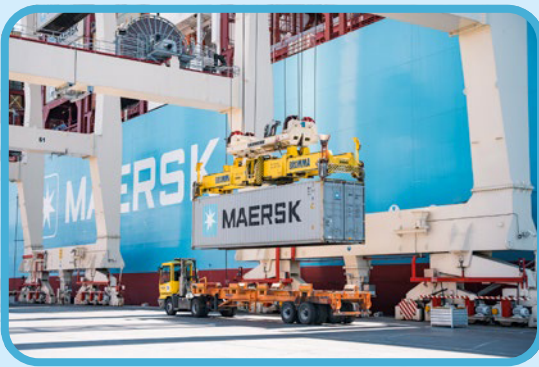

227

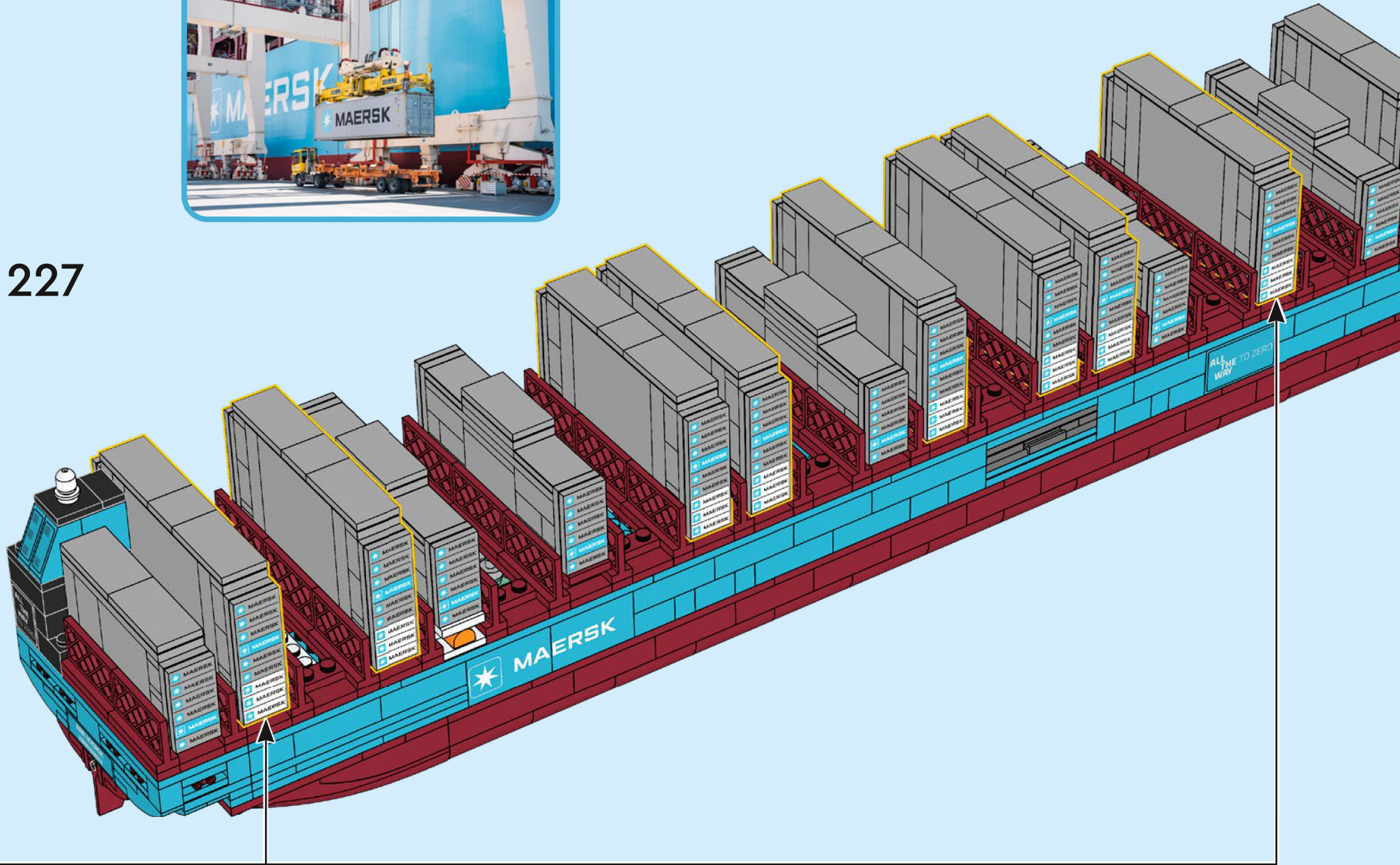





228

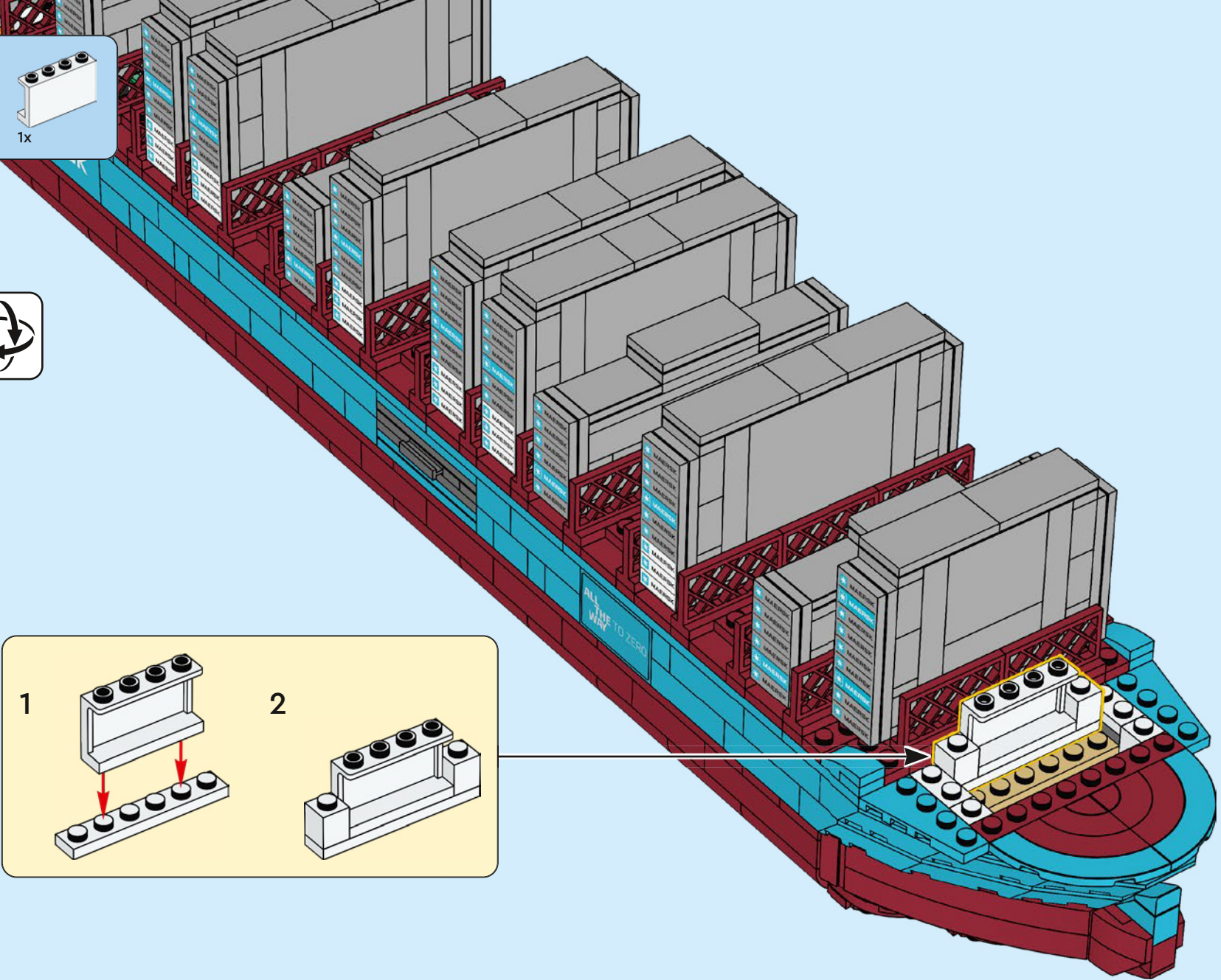
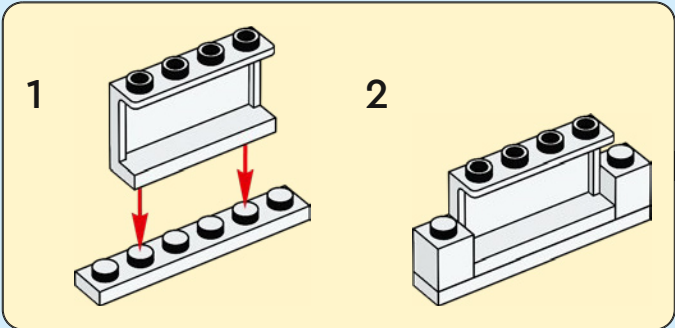

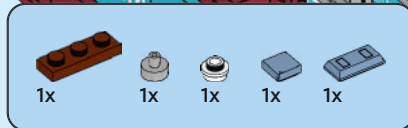

229

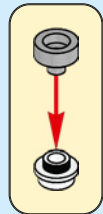
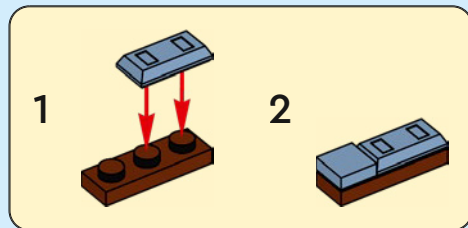



4x

230

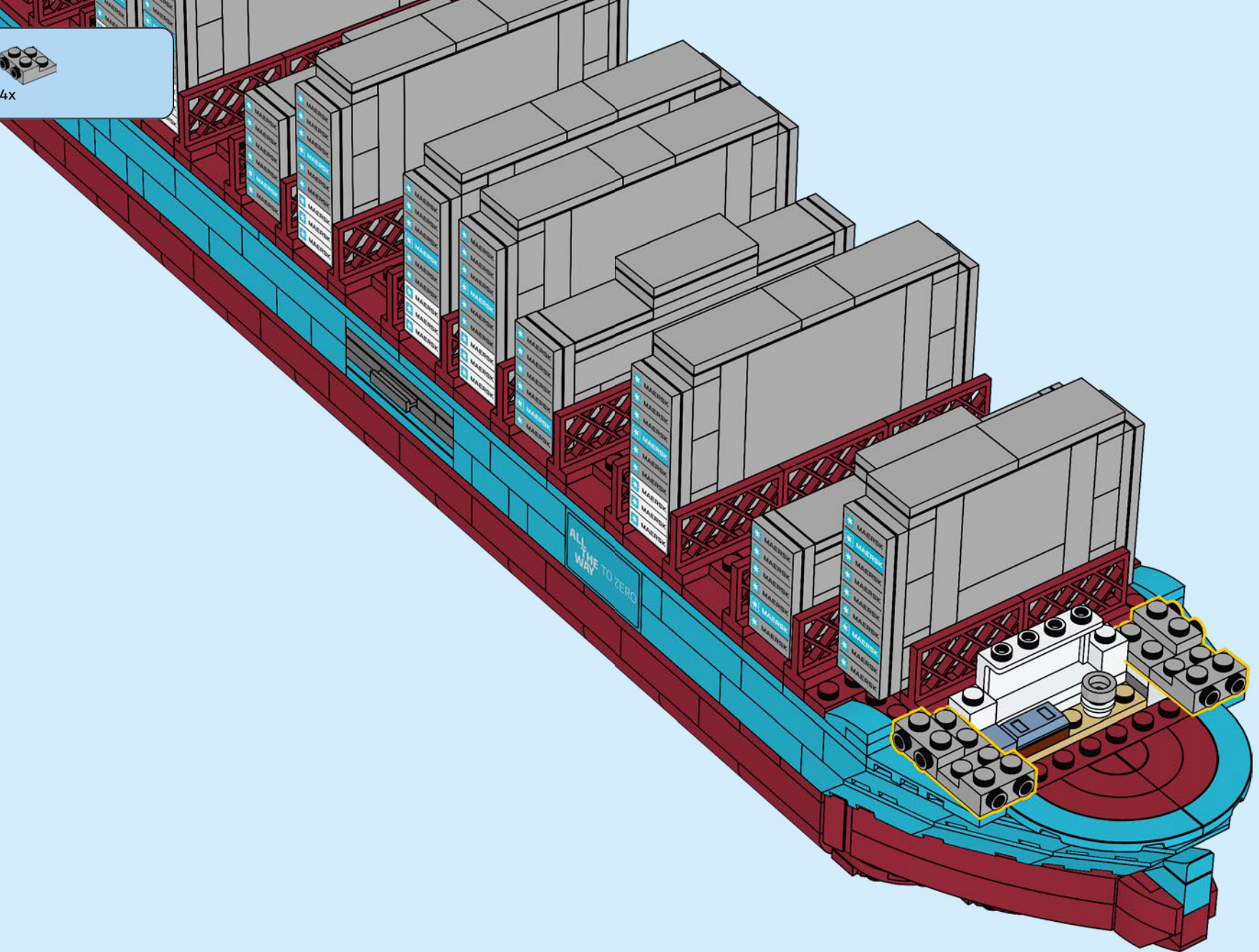

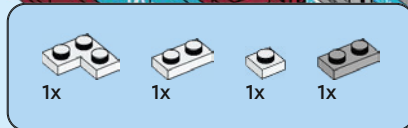

231

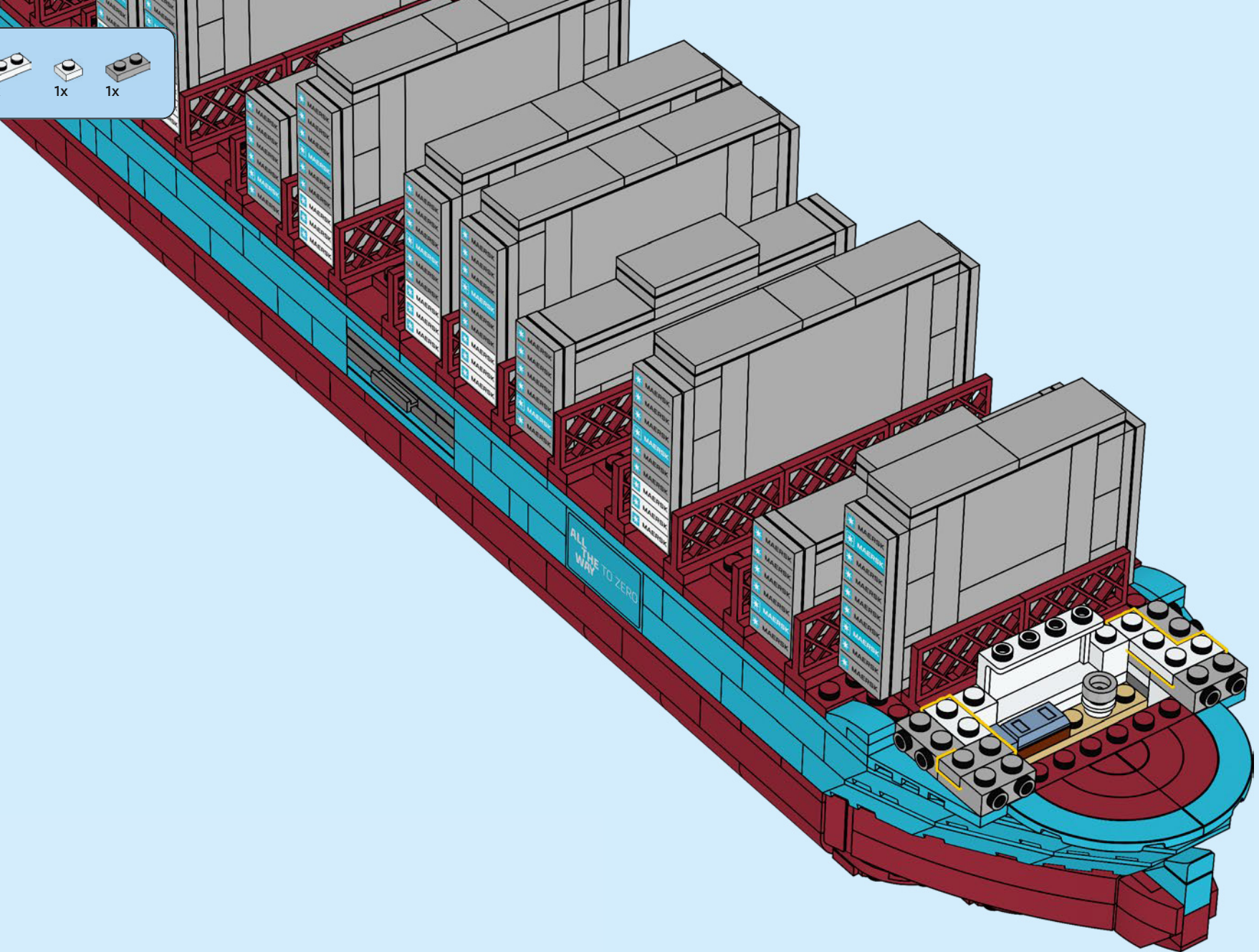

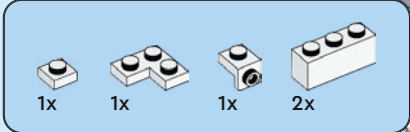

232

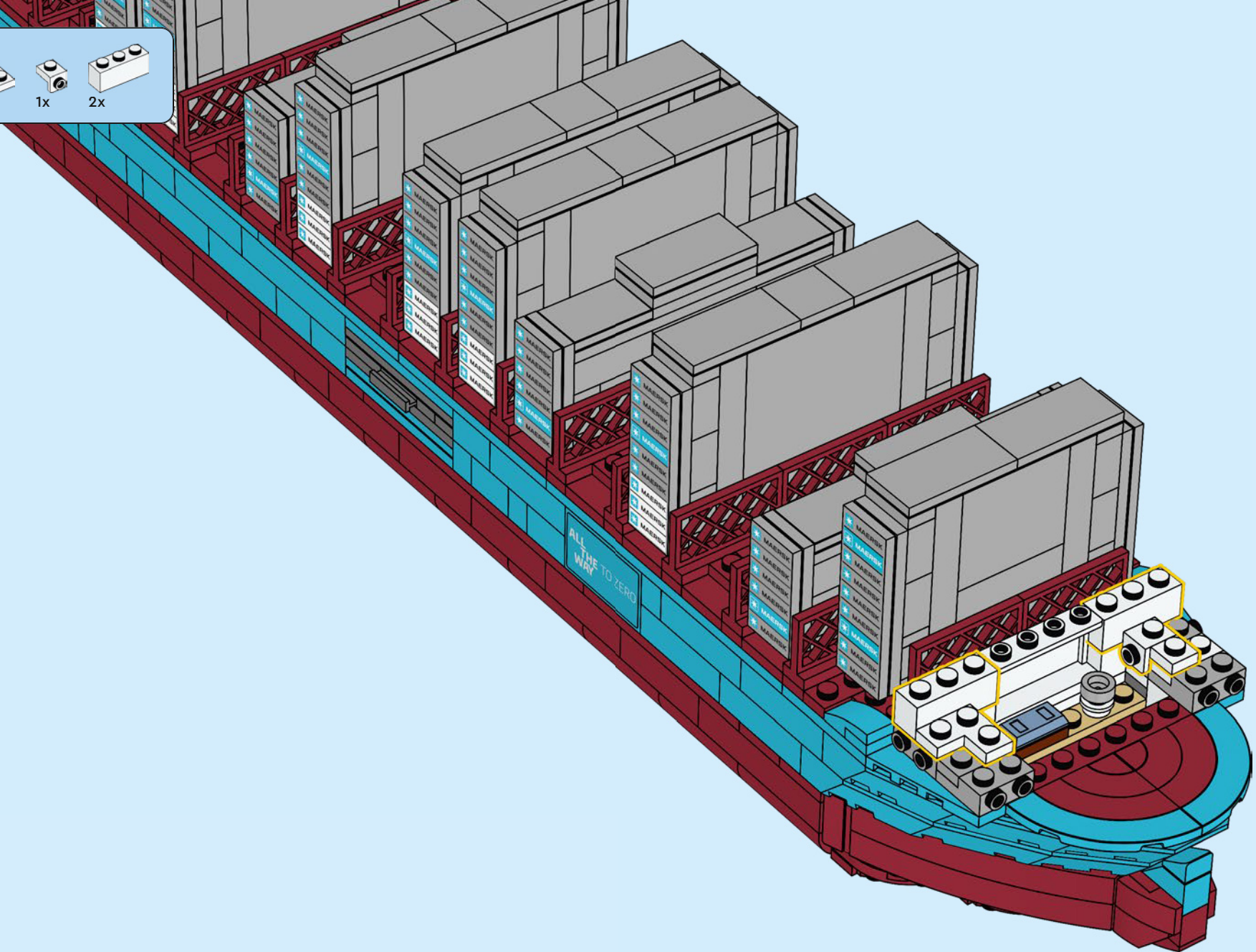

1x 1x 4x

233

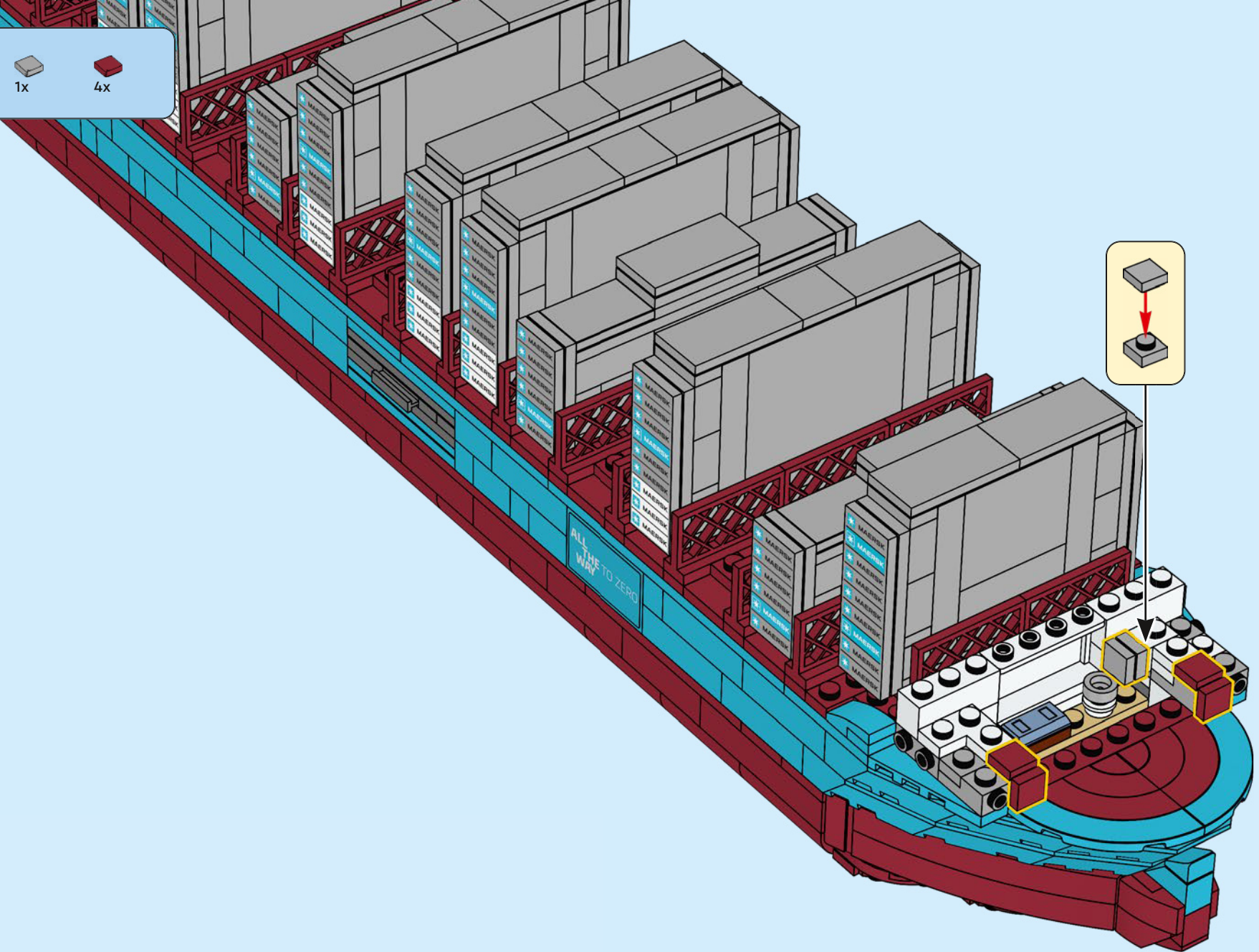

3x 2x 2x

234

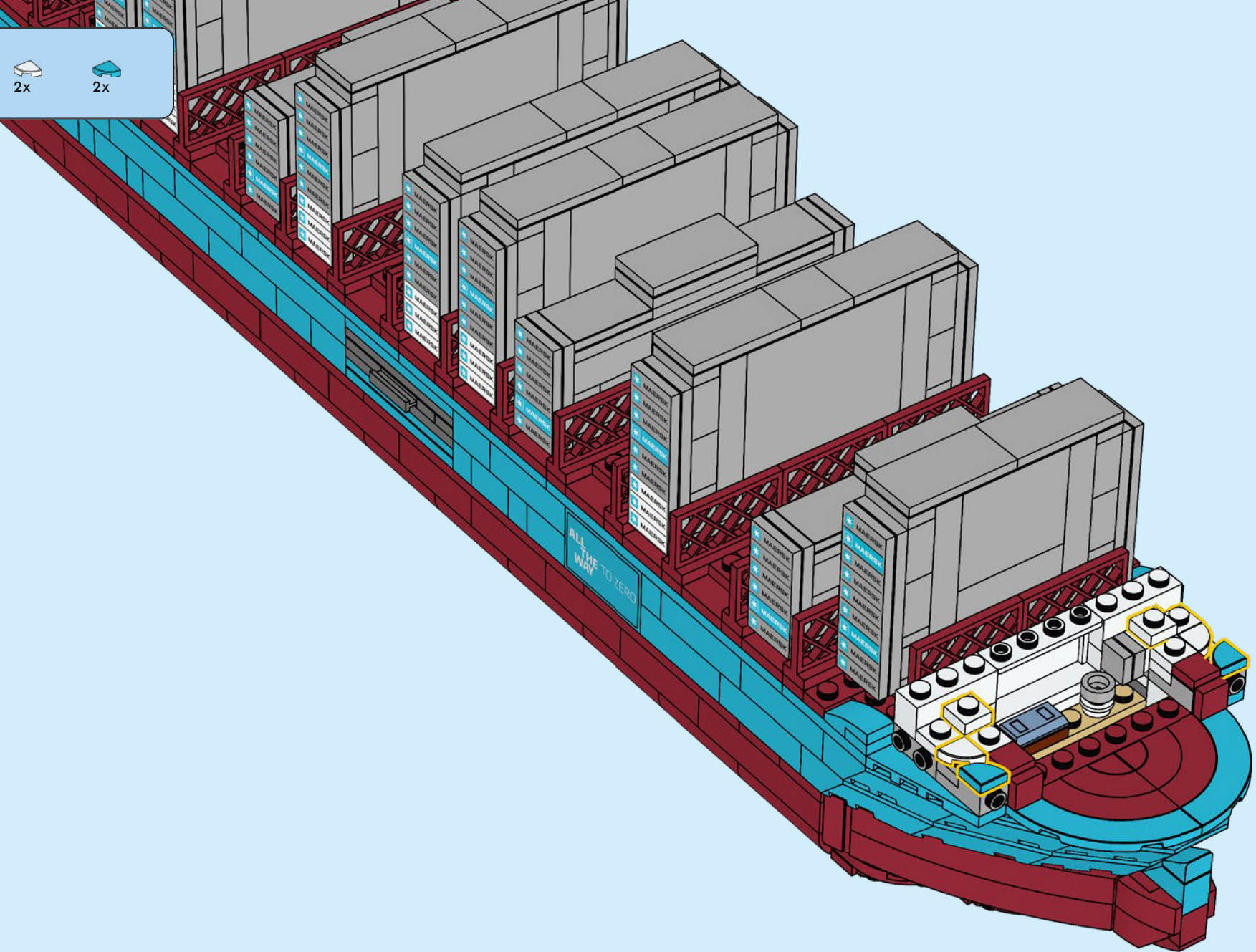

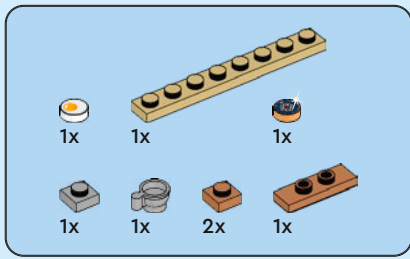

235

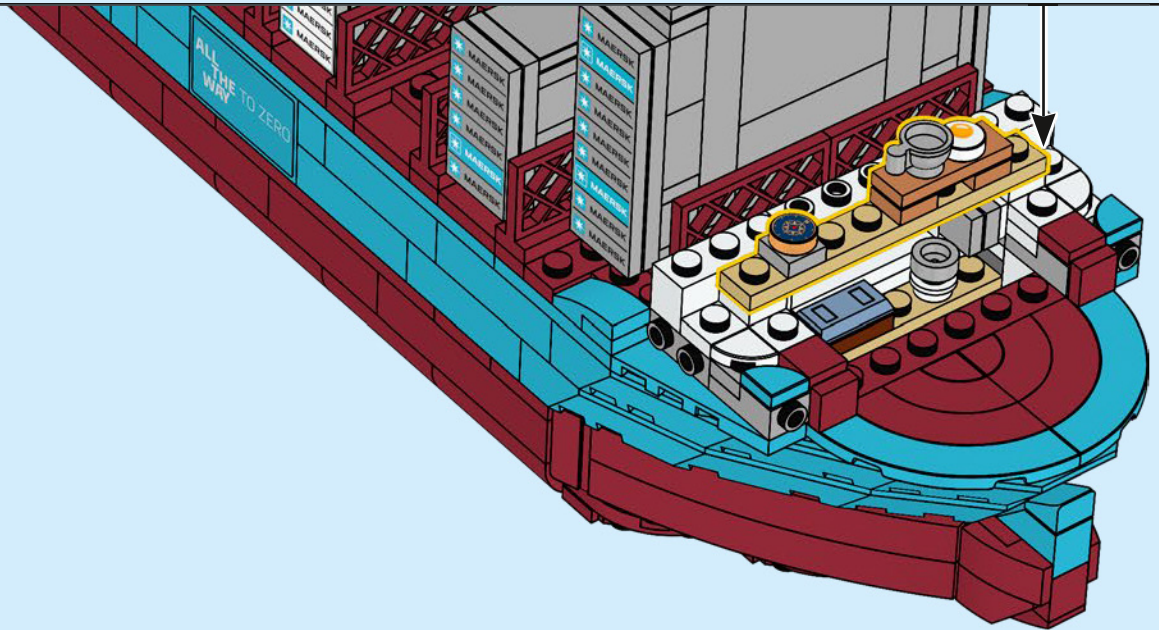
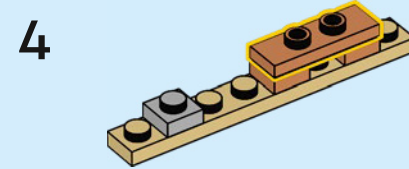
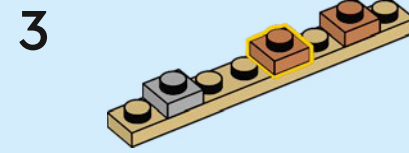
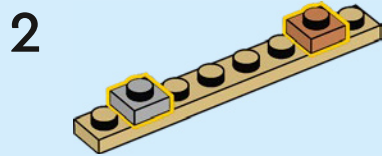
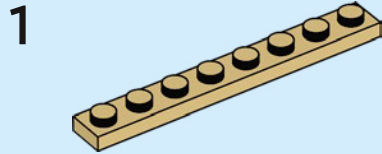

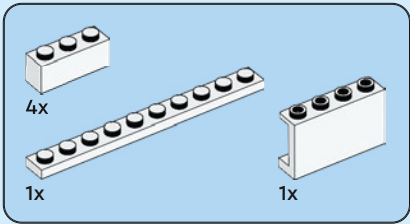

236

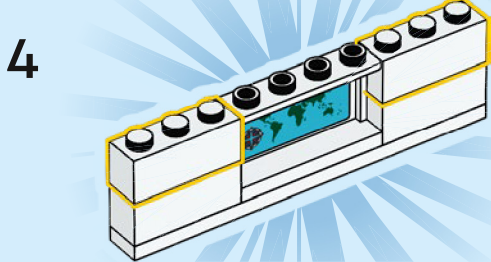
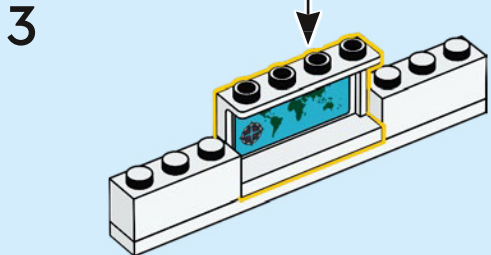
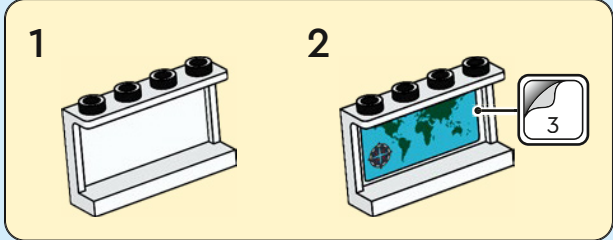
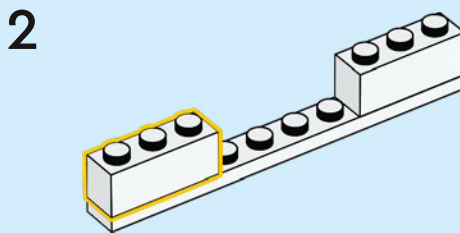
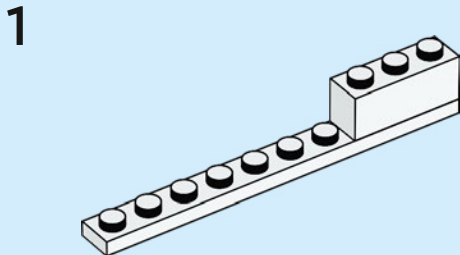

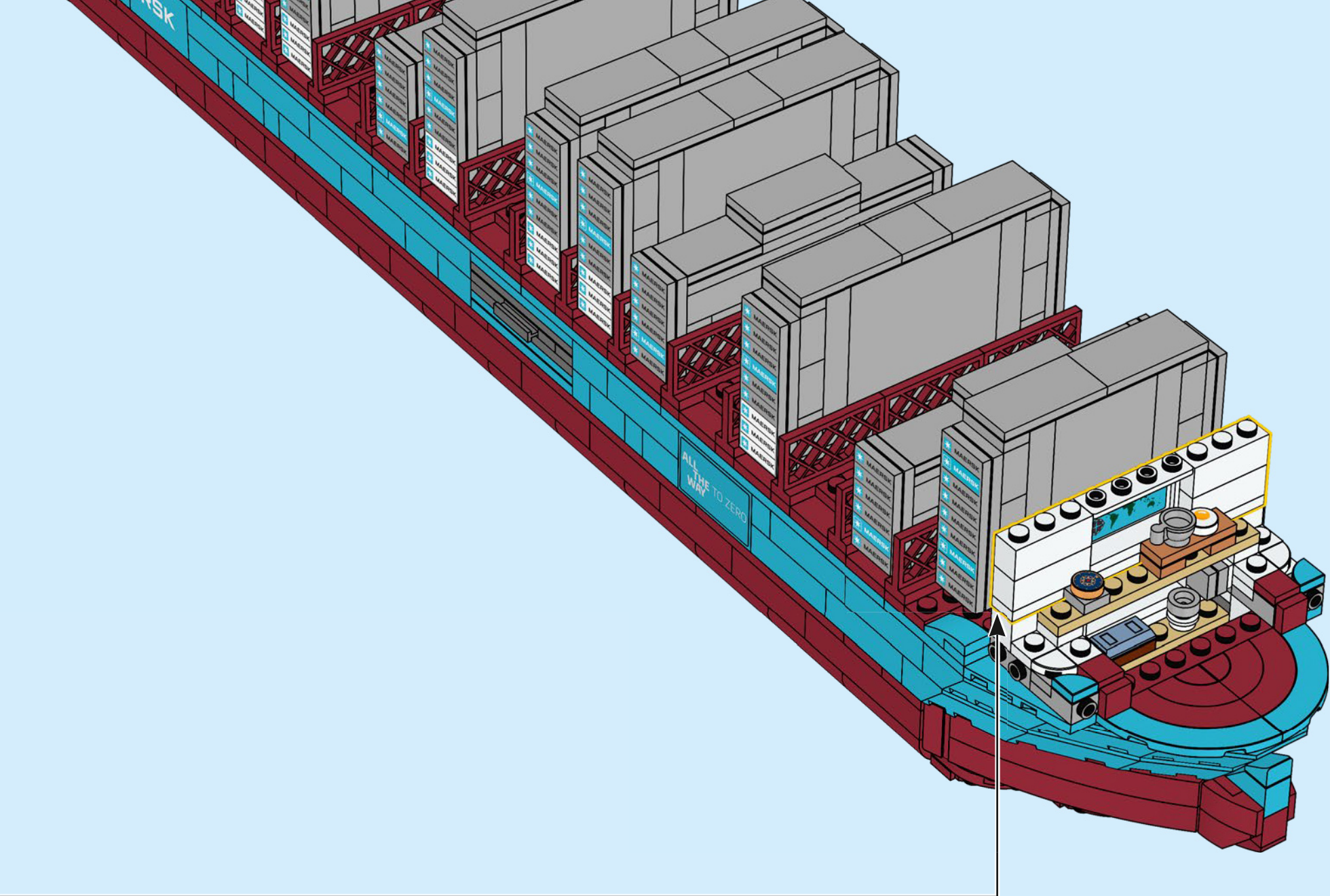

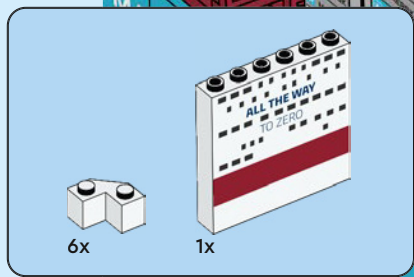

237

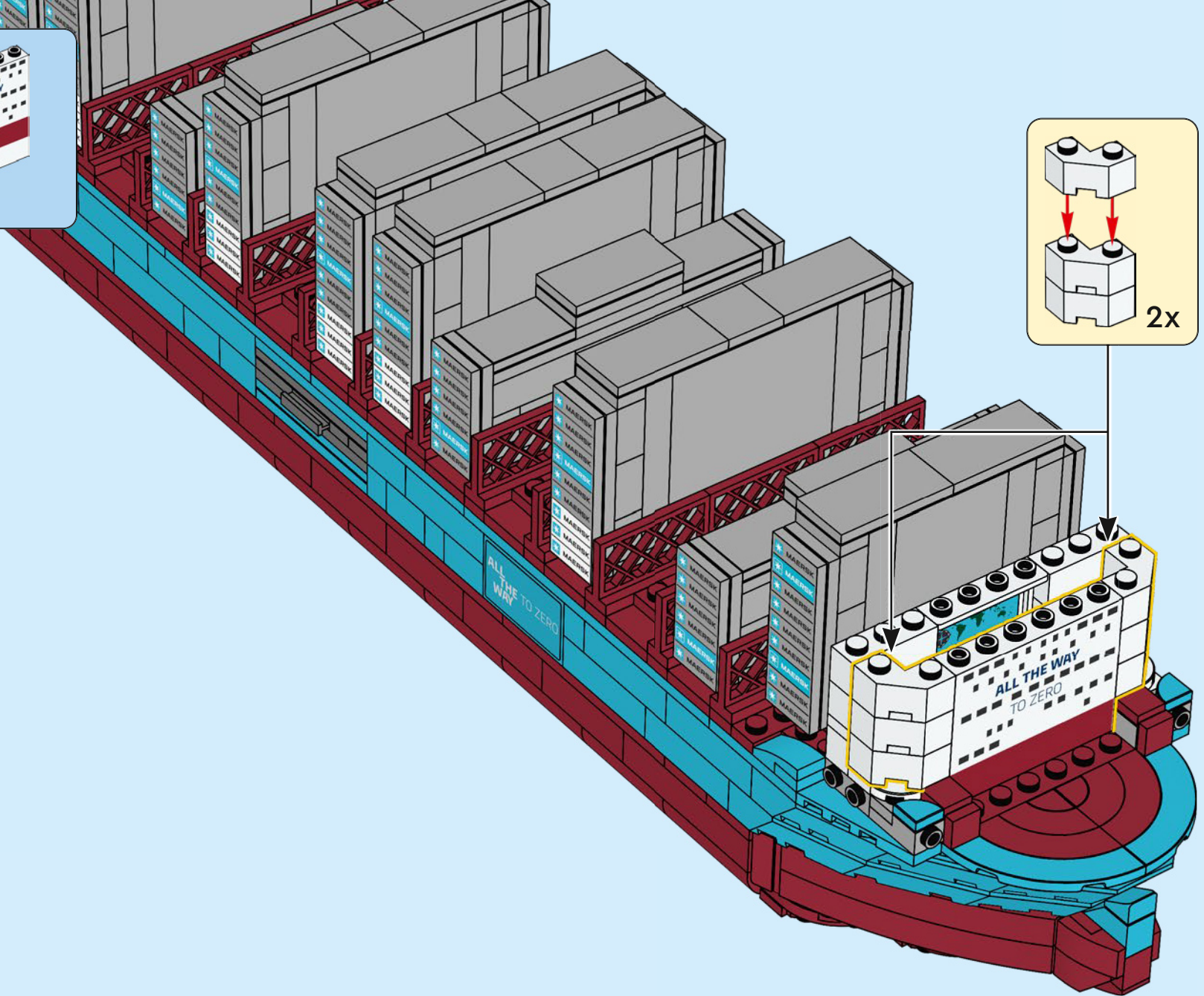



238

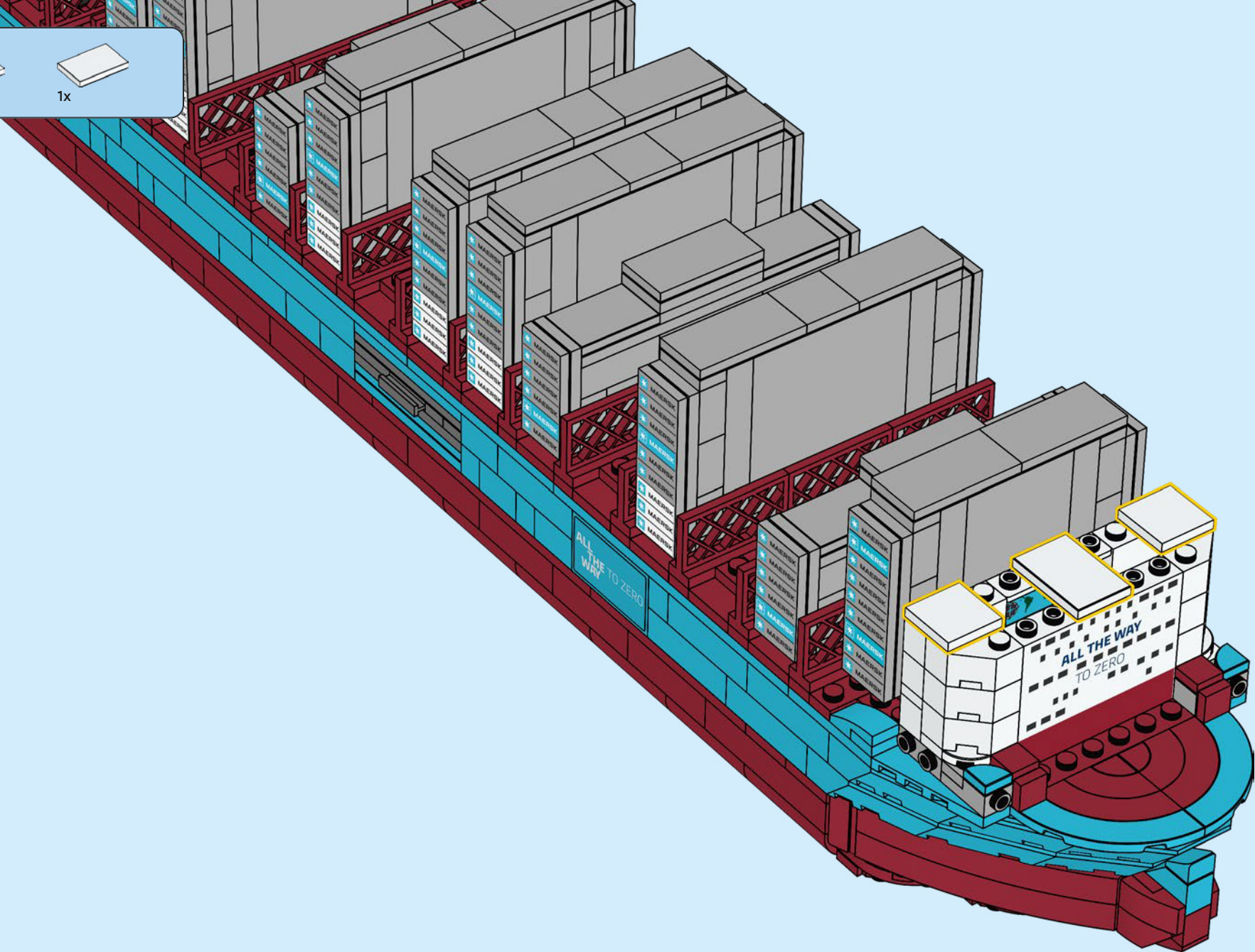

2x 1x 1x

239

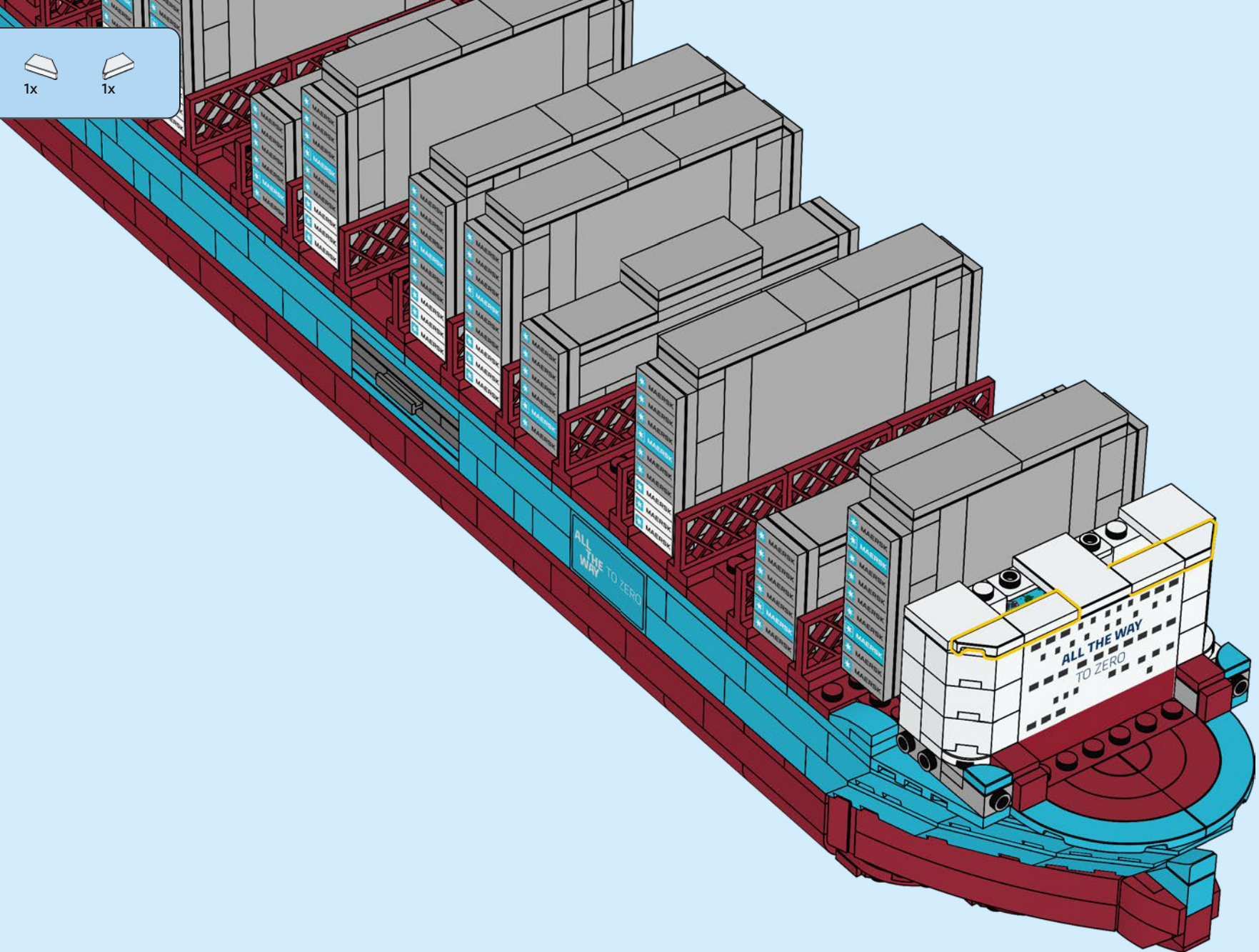

2x 2x 2x

240

1 2 2x

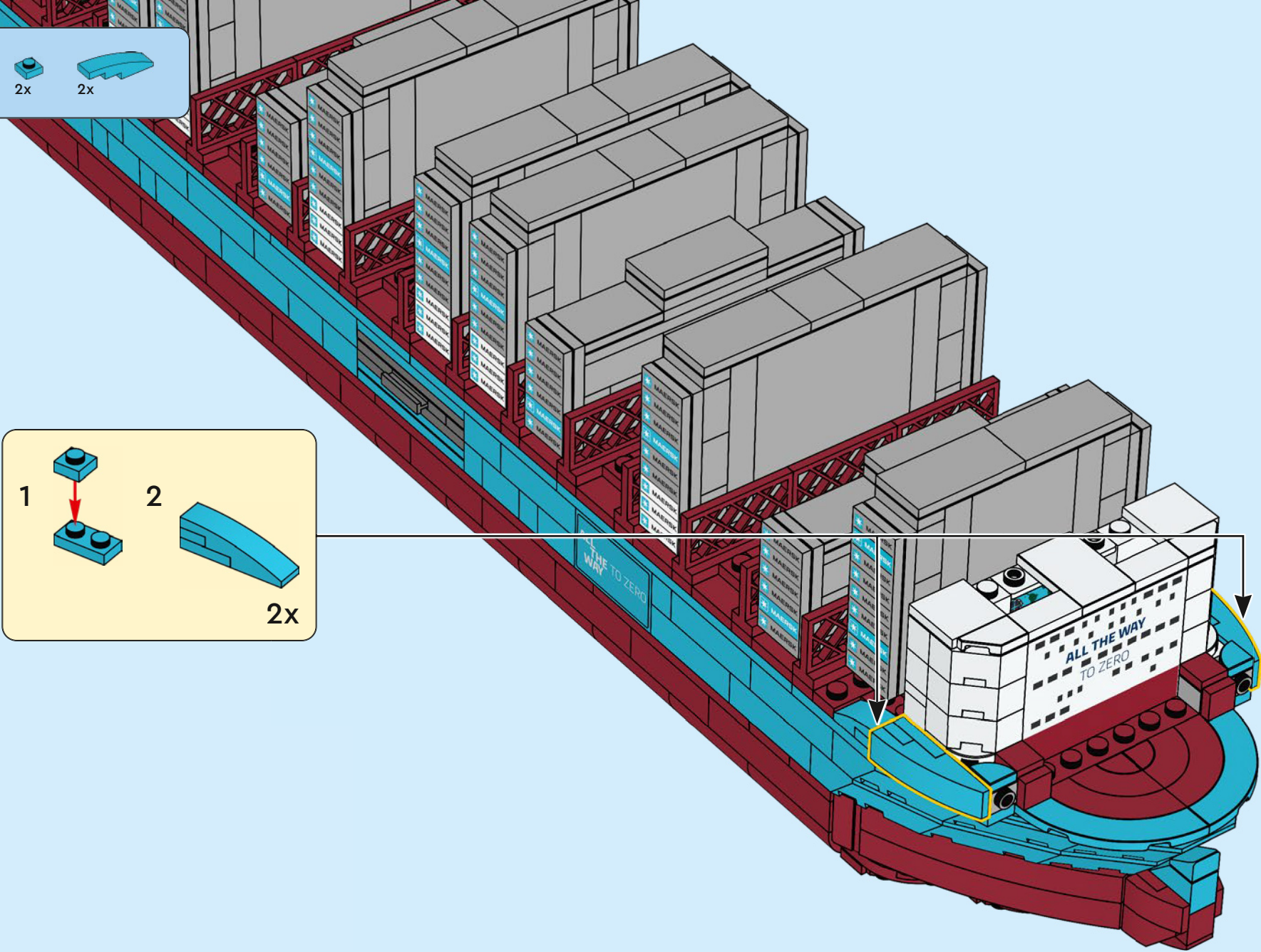

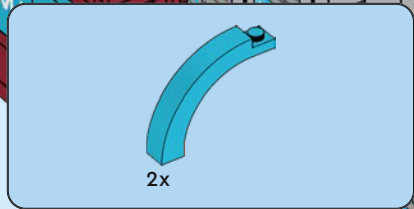

241

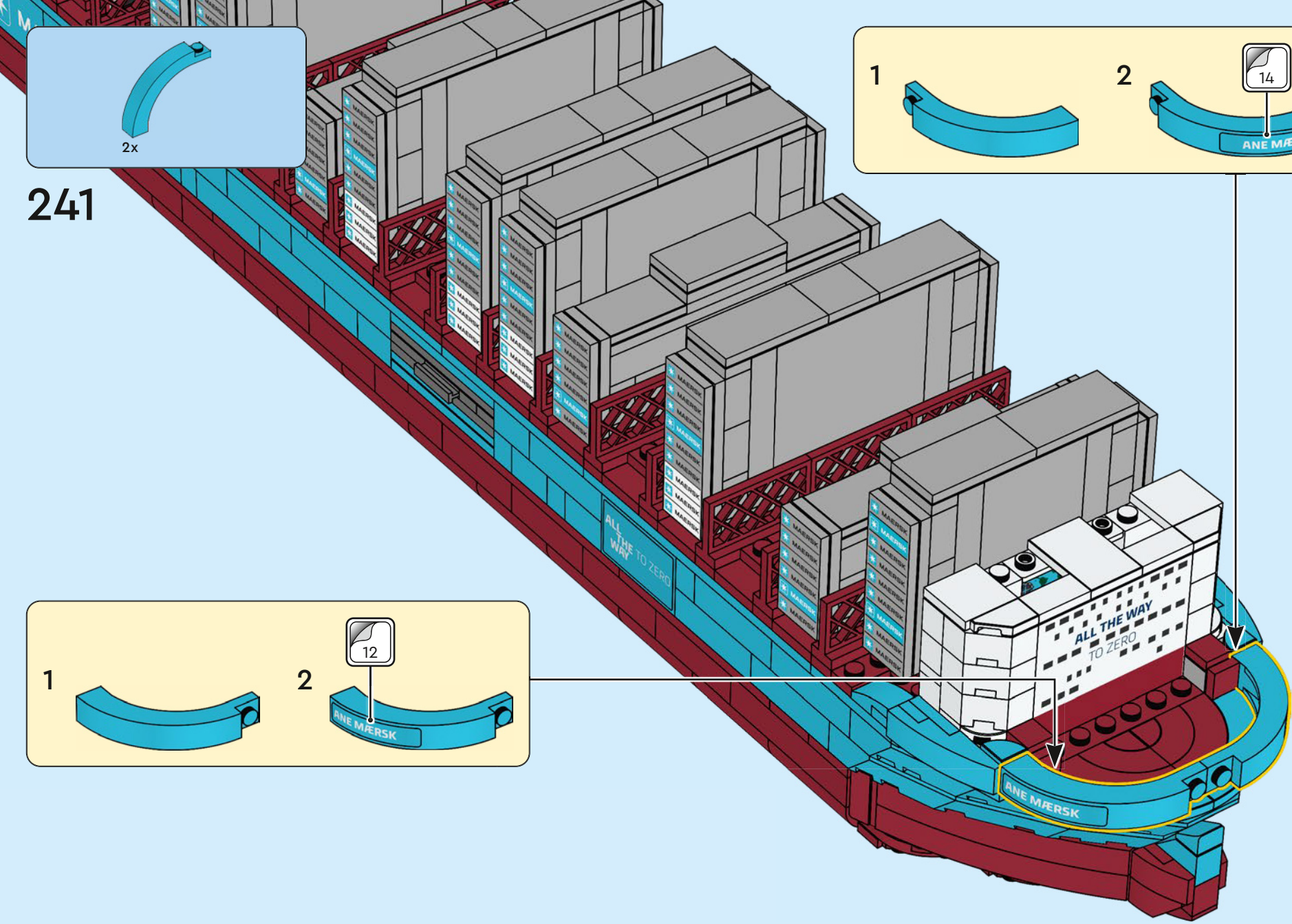
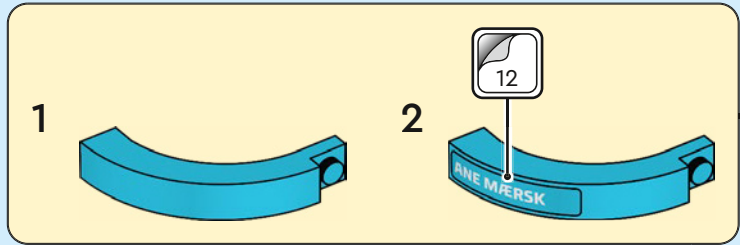
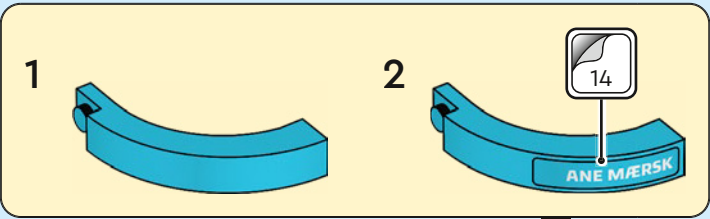

1x

242

1

2

13

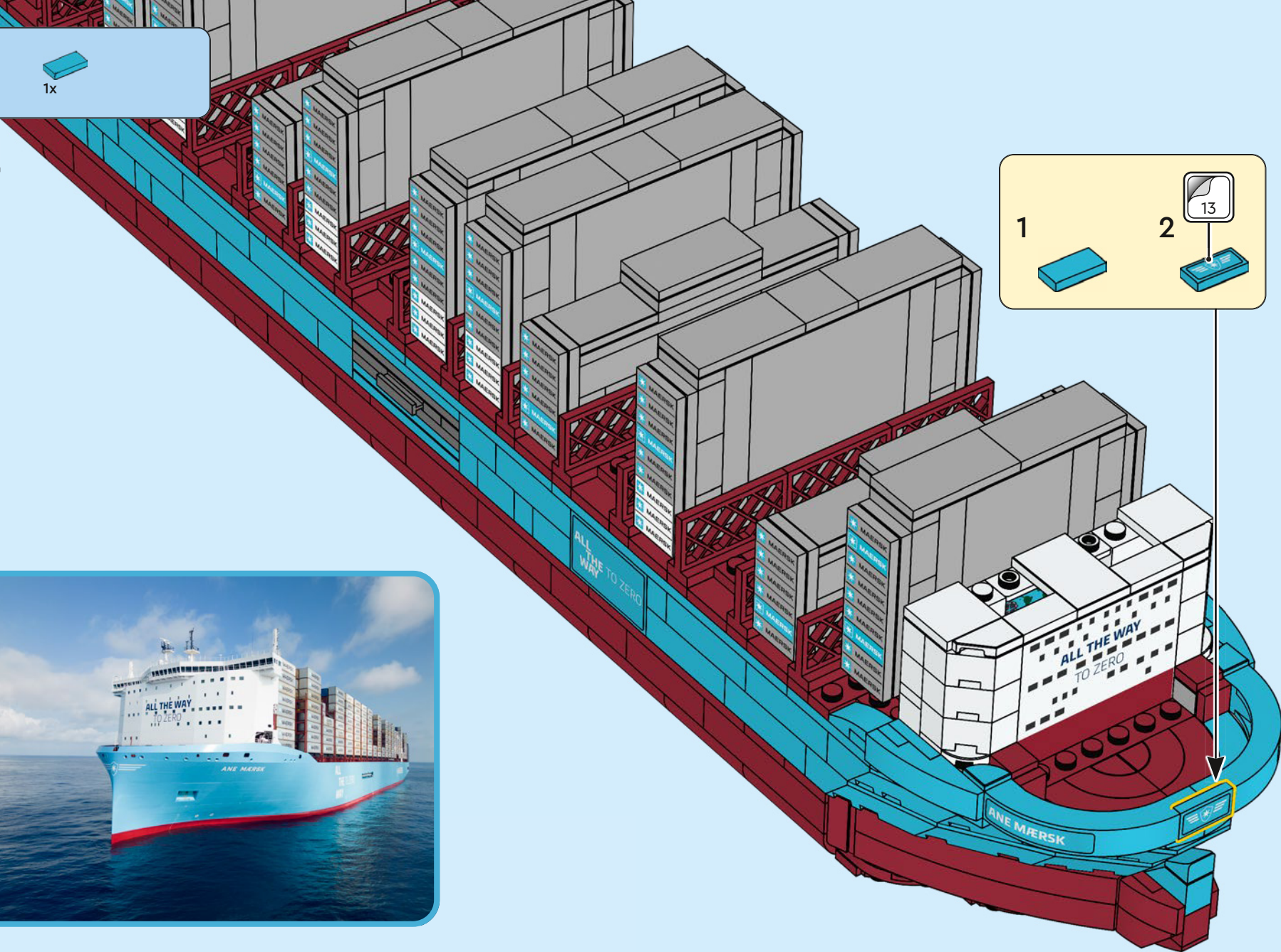

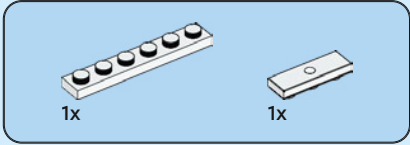
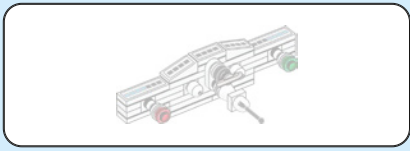

243

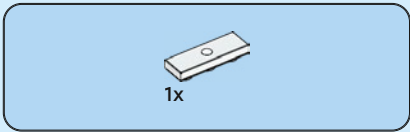
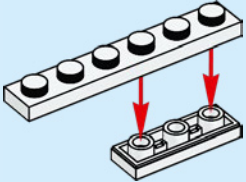

244

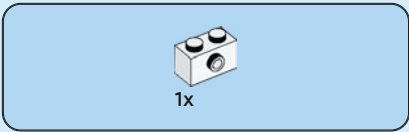
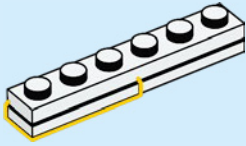

245

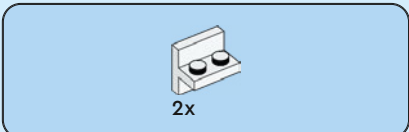
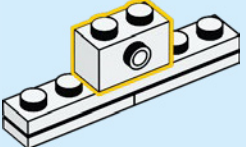

246

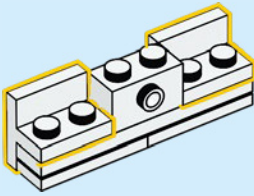



2x

247

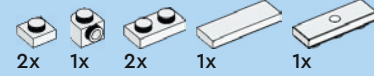
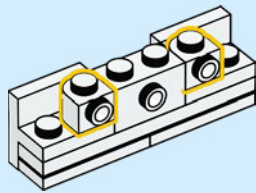

248

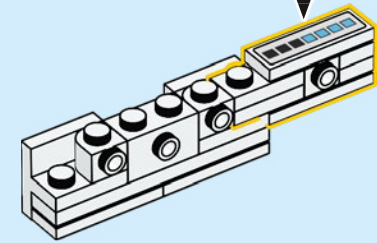
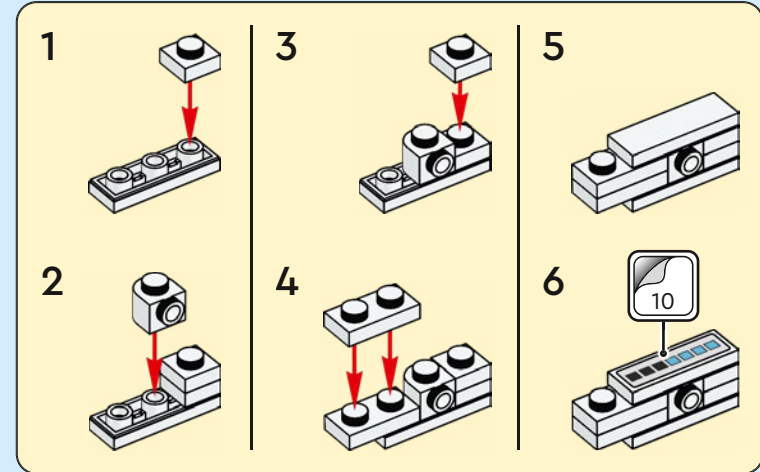

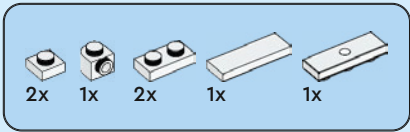

249

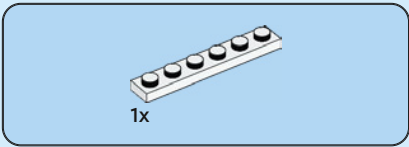
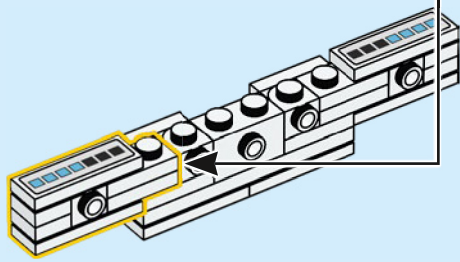
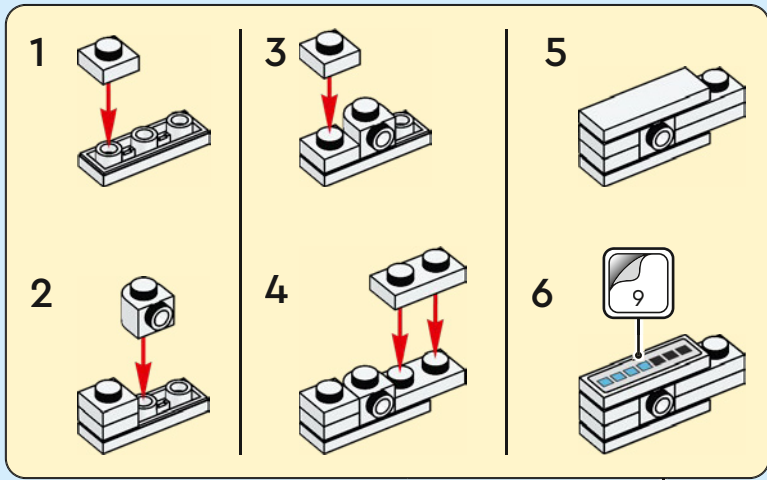

250

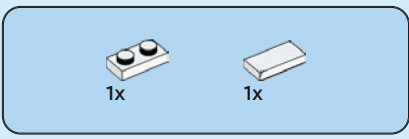
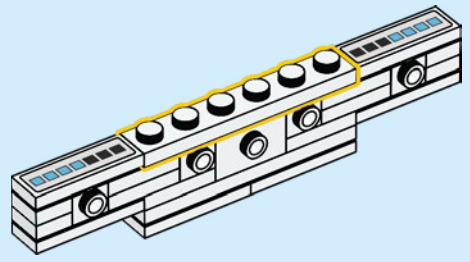

251

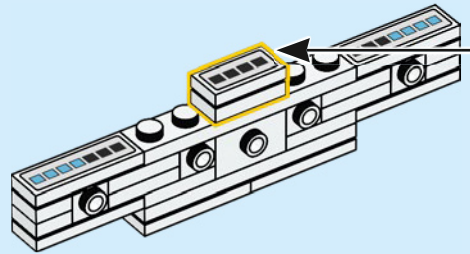
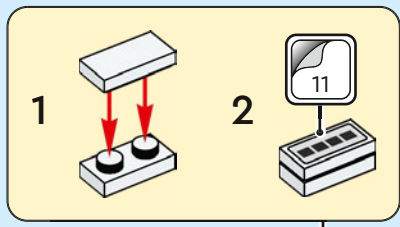

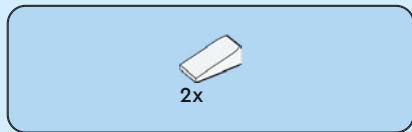

252

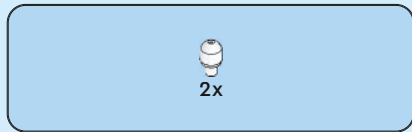
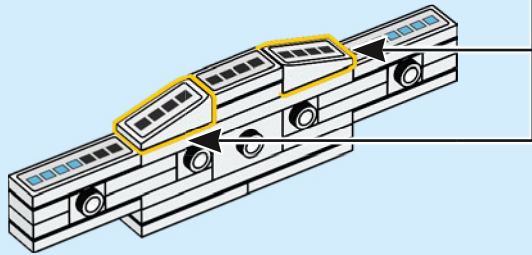
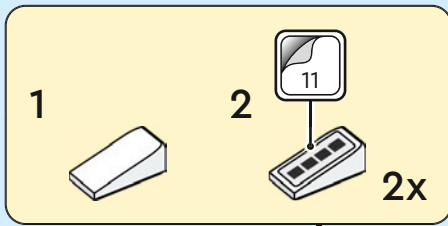

253

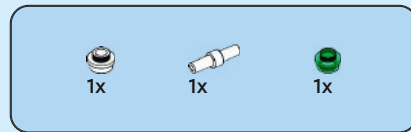
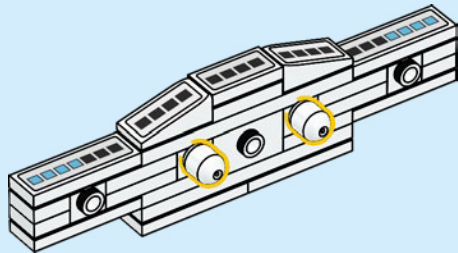

254

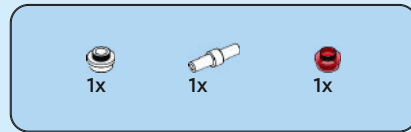
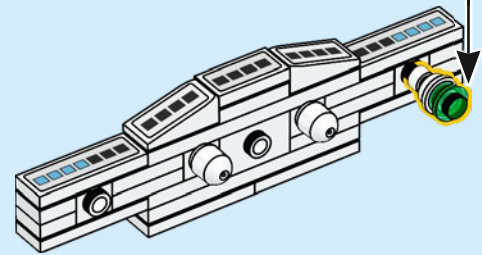
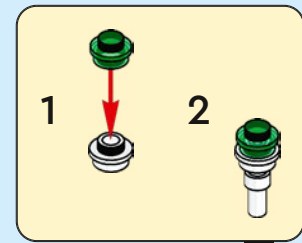

255

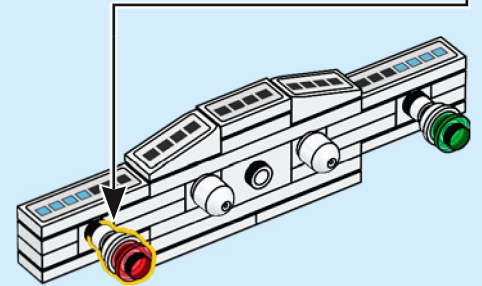
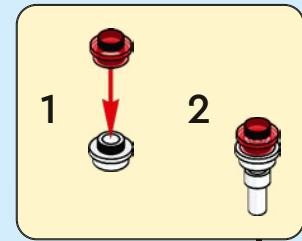

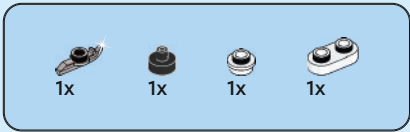

256

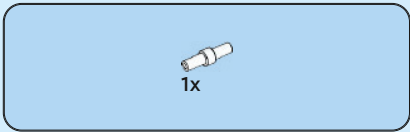
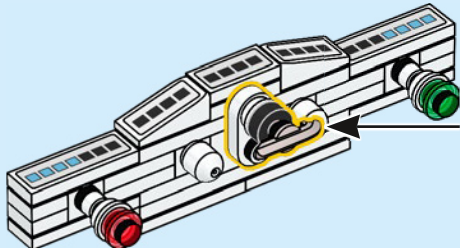
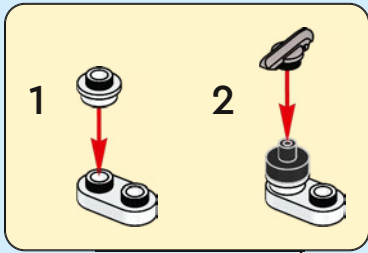

257

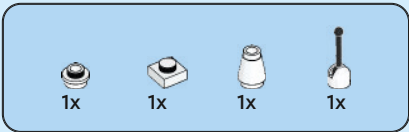
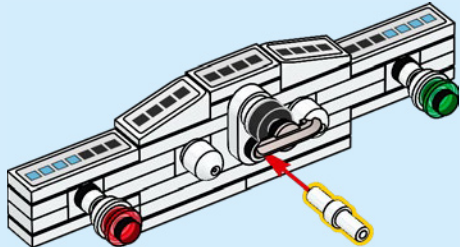

258

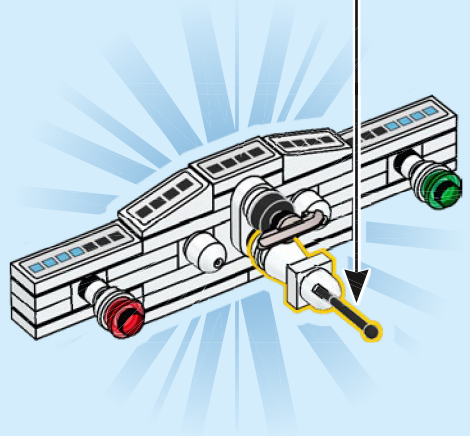
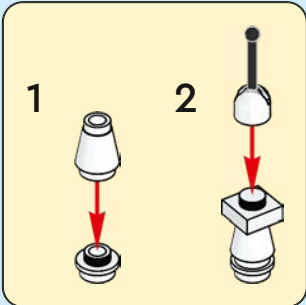

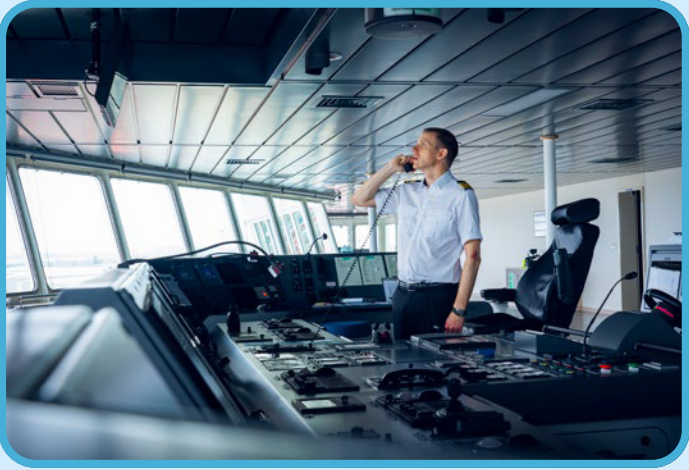
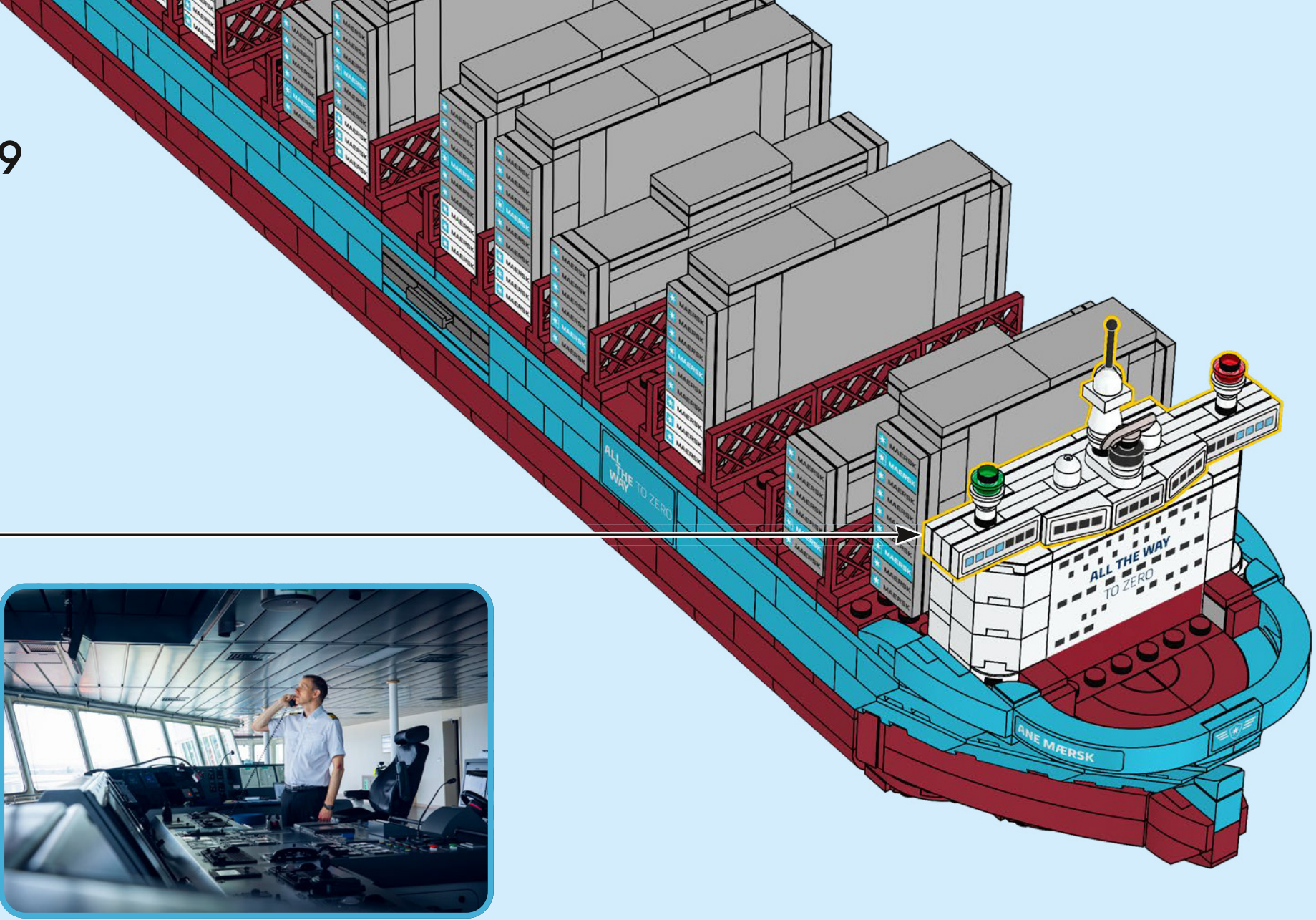

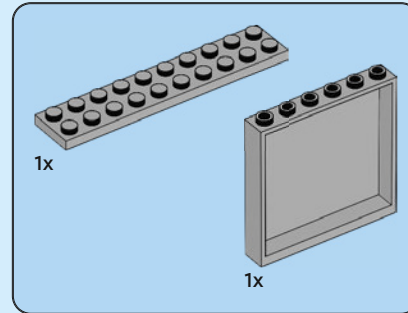
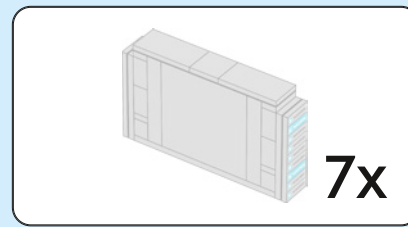

260

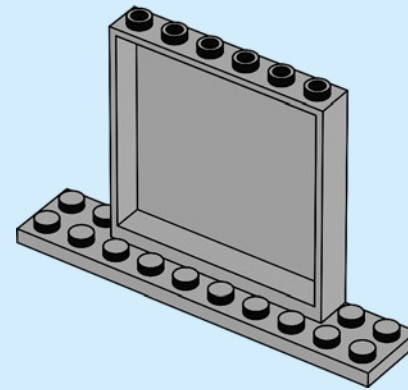

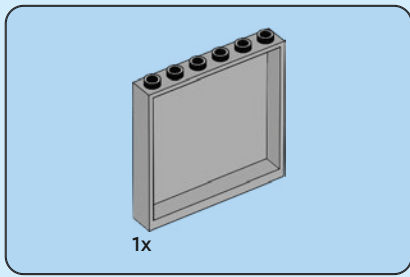

261

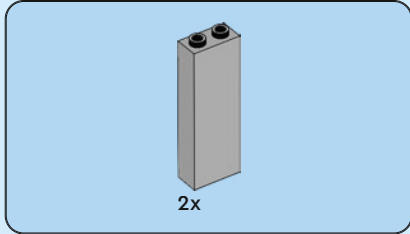
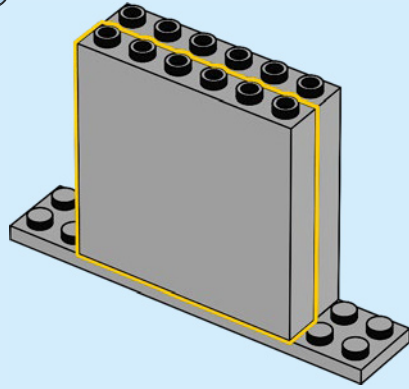

262

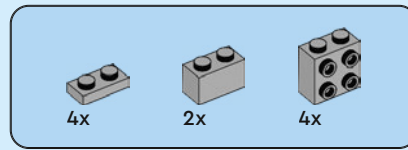
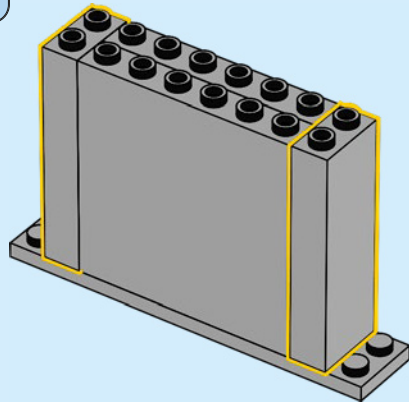

263

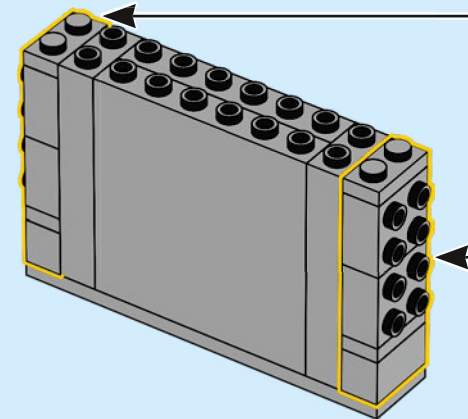
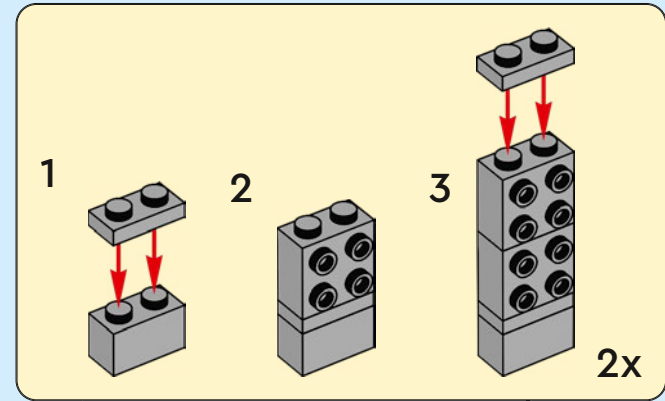

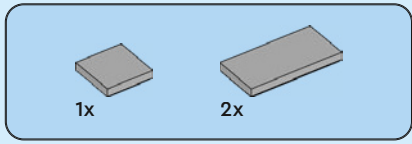

264

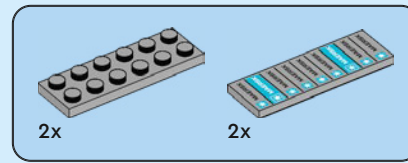
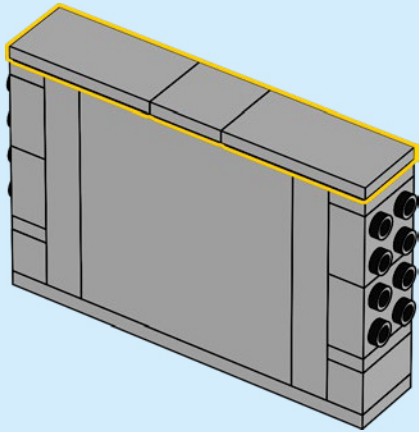

265

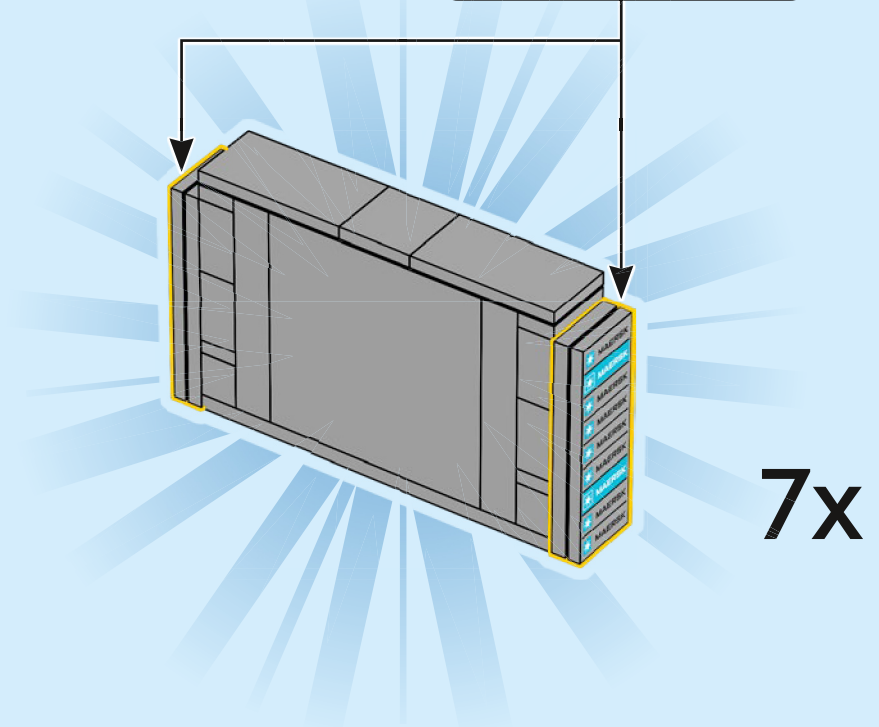
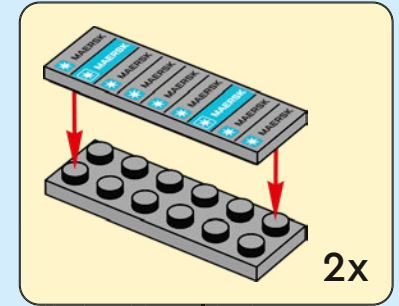

266

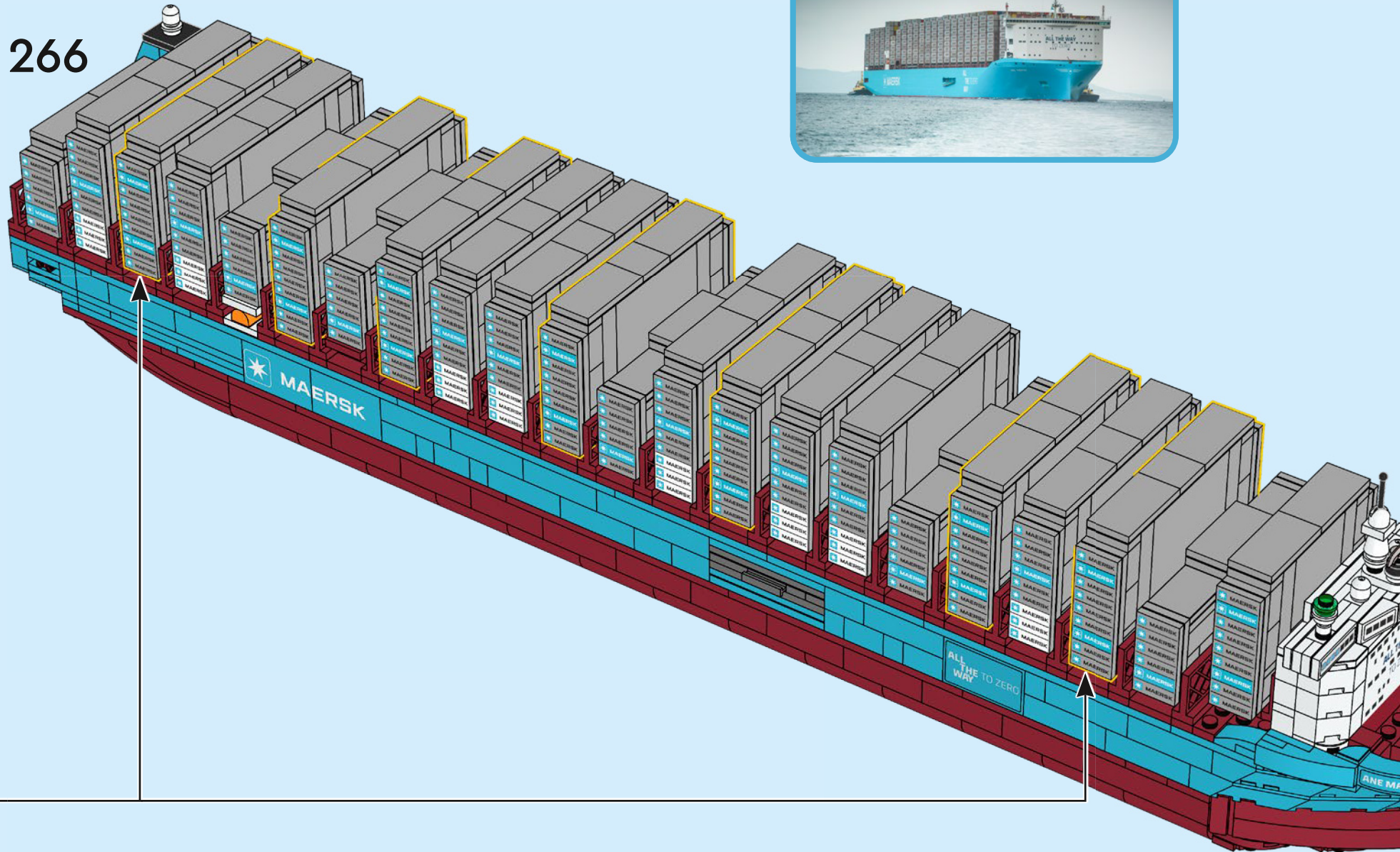

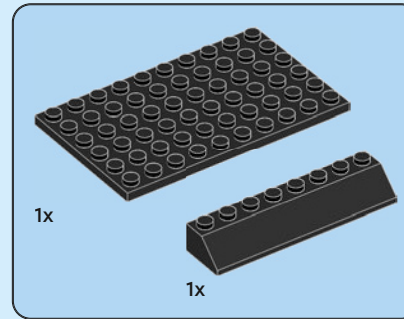
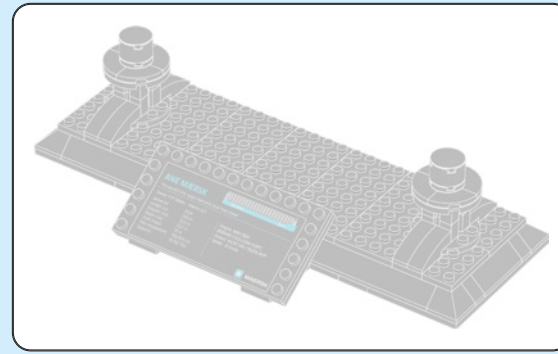

267

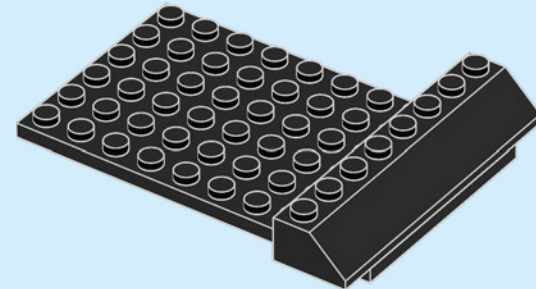

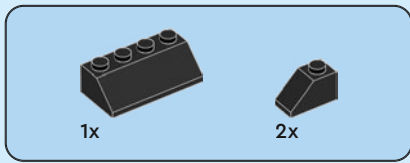

268

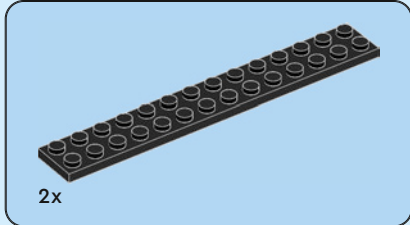
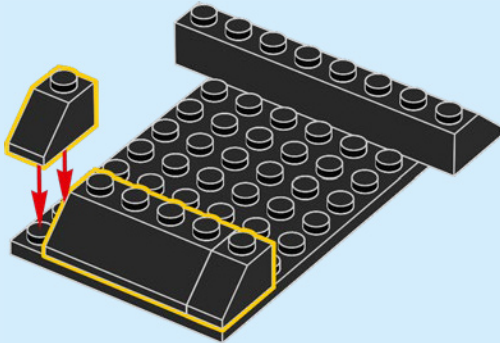

269

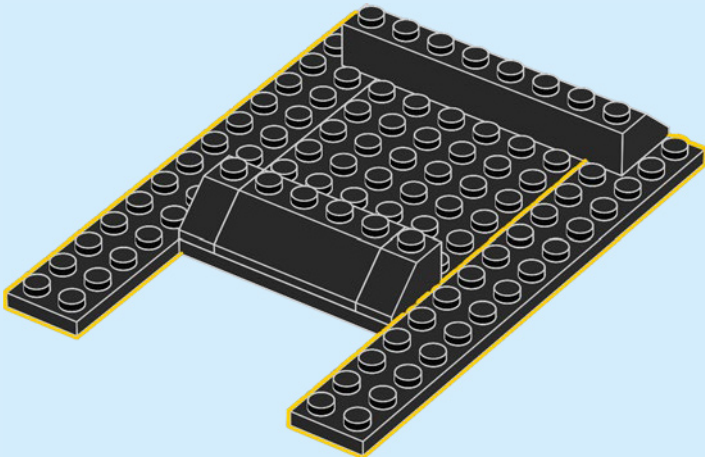

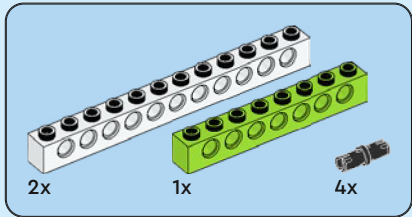
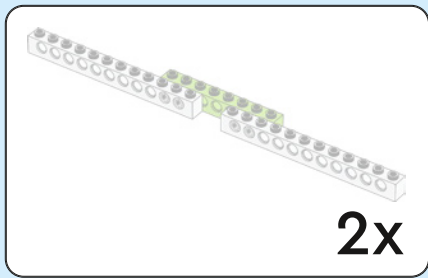

270

1

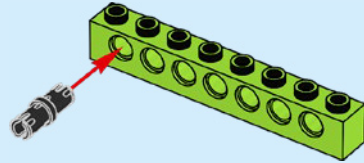

2

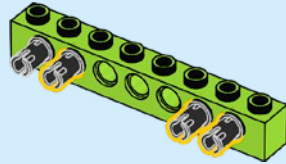

3

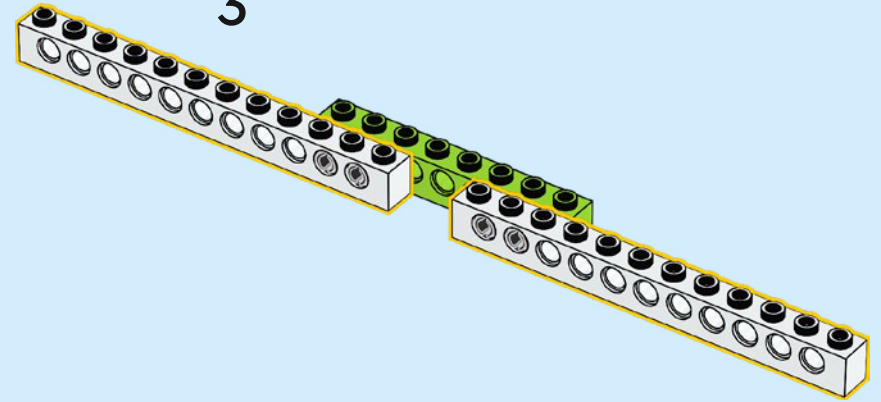

2x

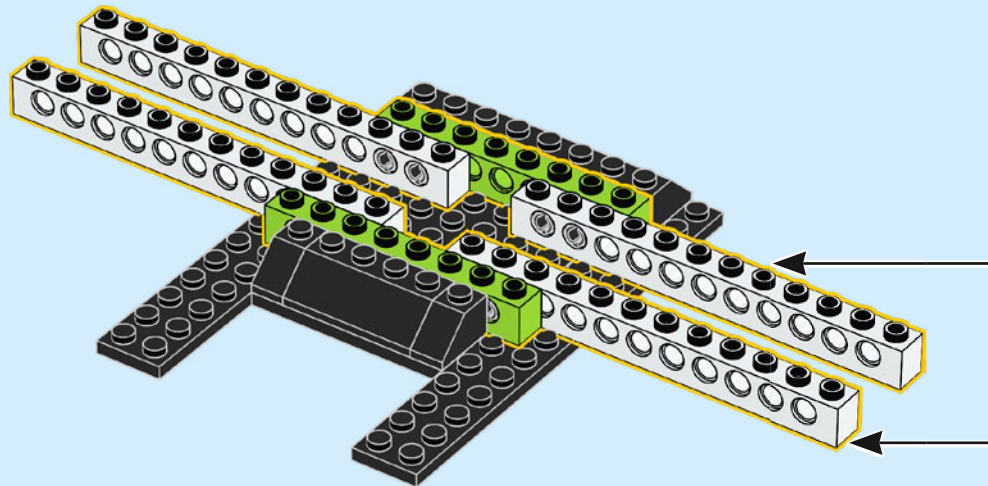

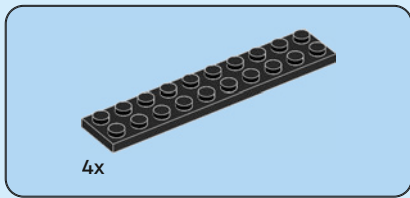

271

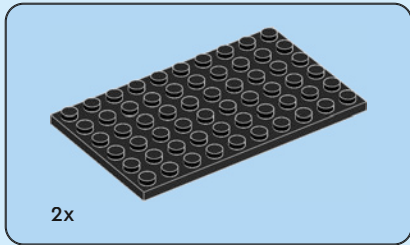
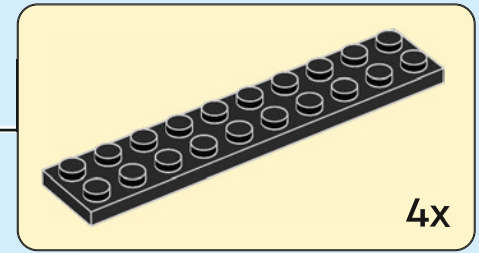
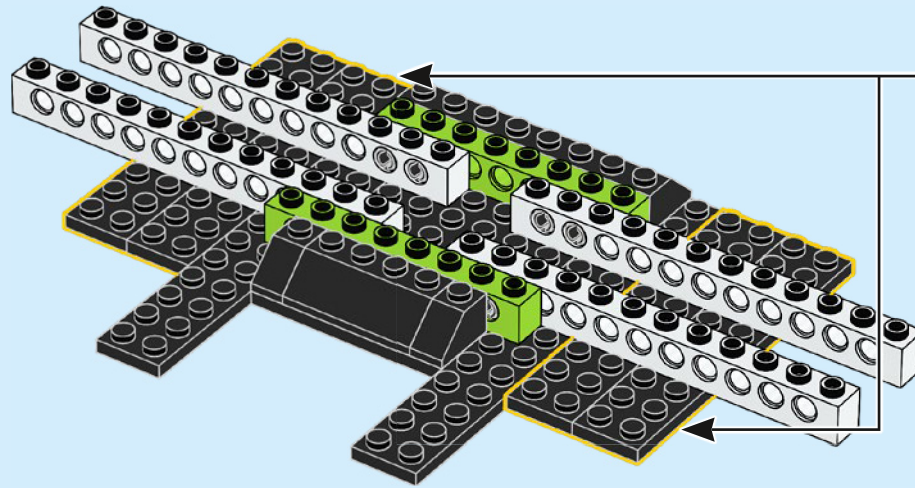

272

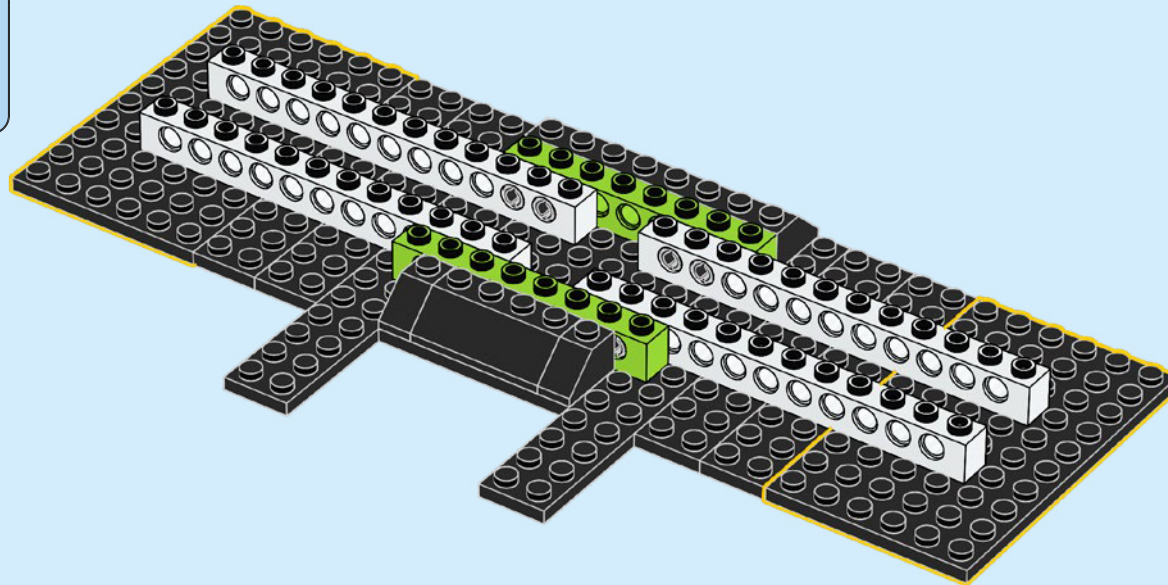

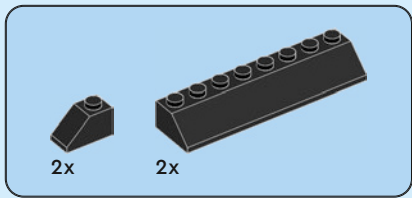

273

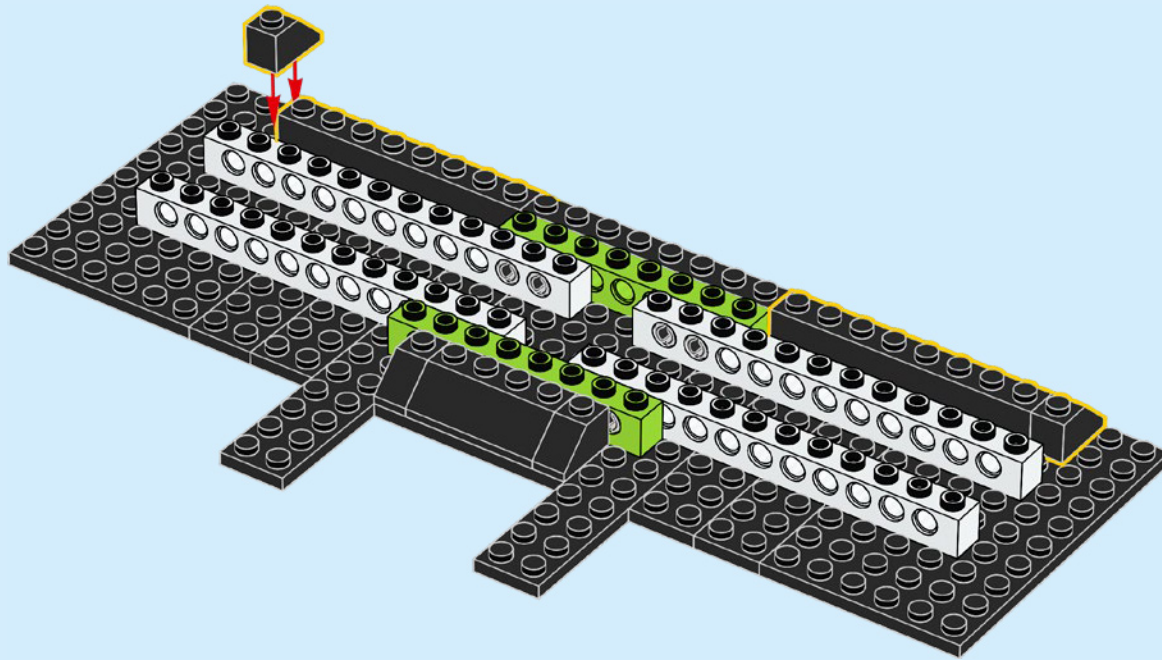

274

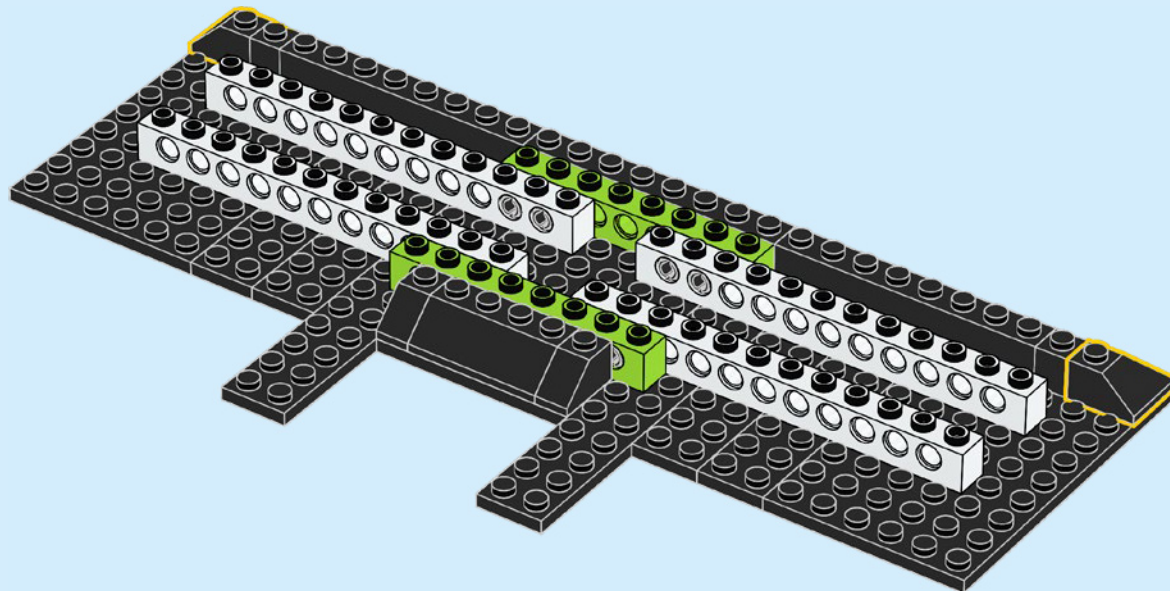

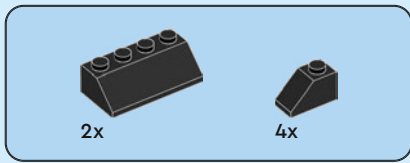

275

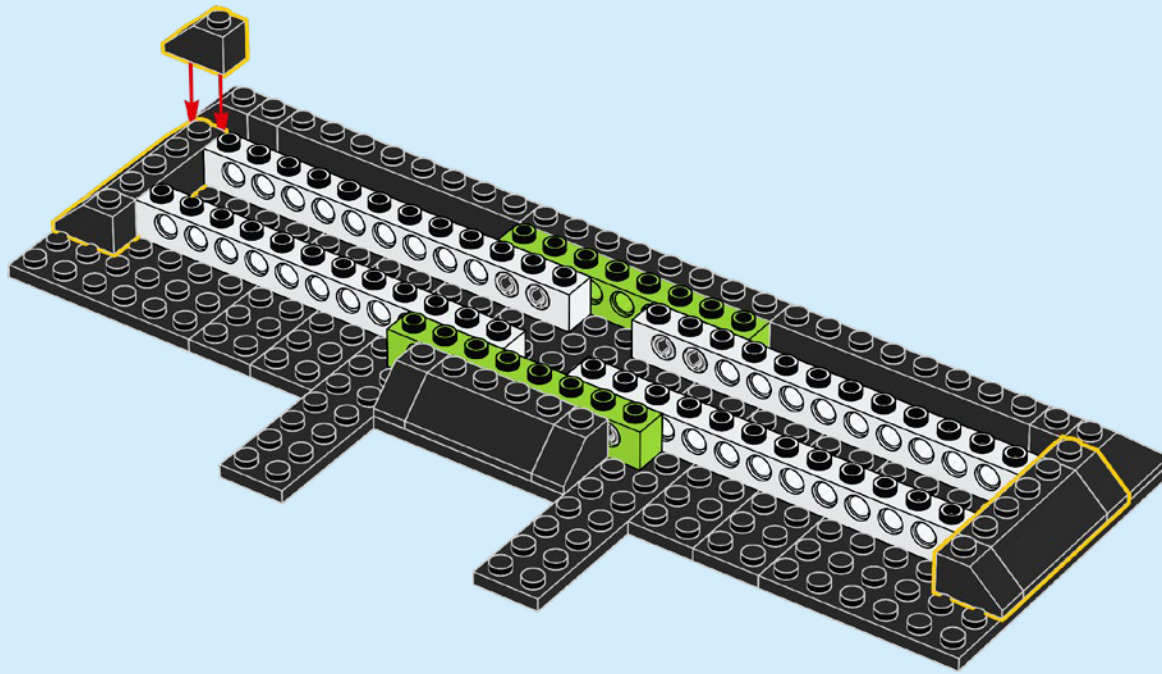

276

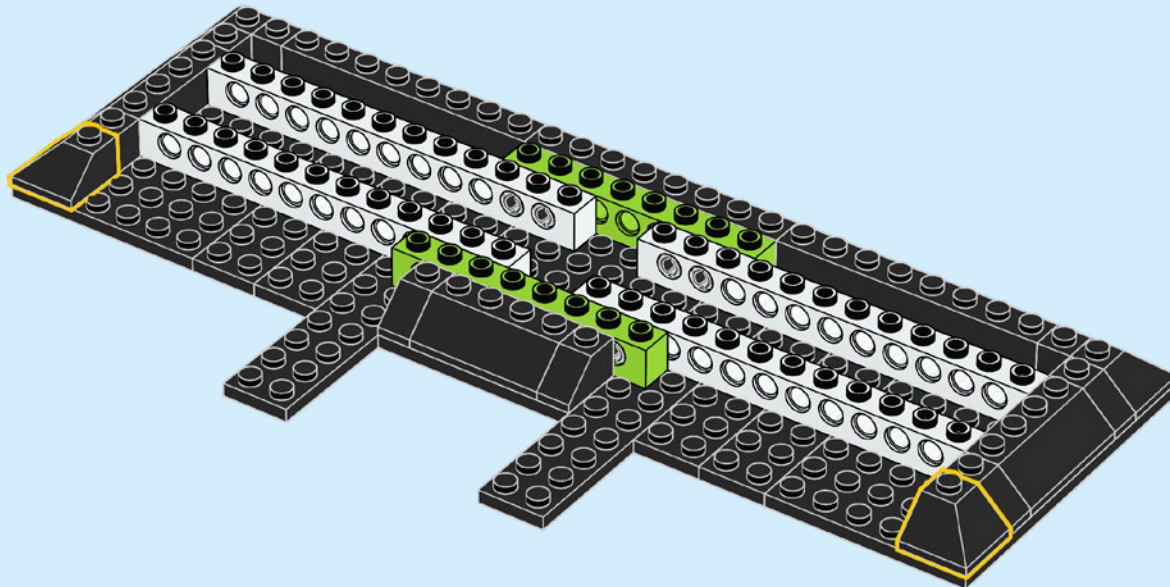



2x



2x

277

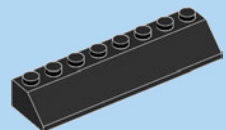
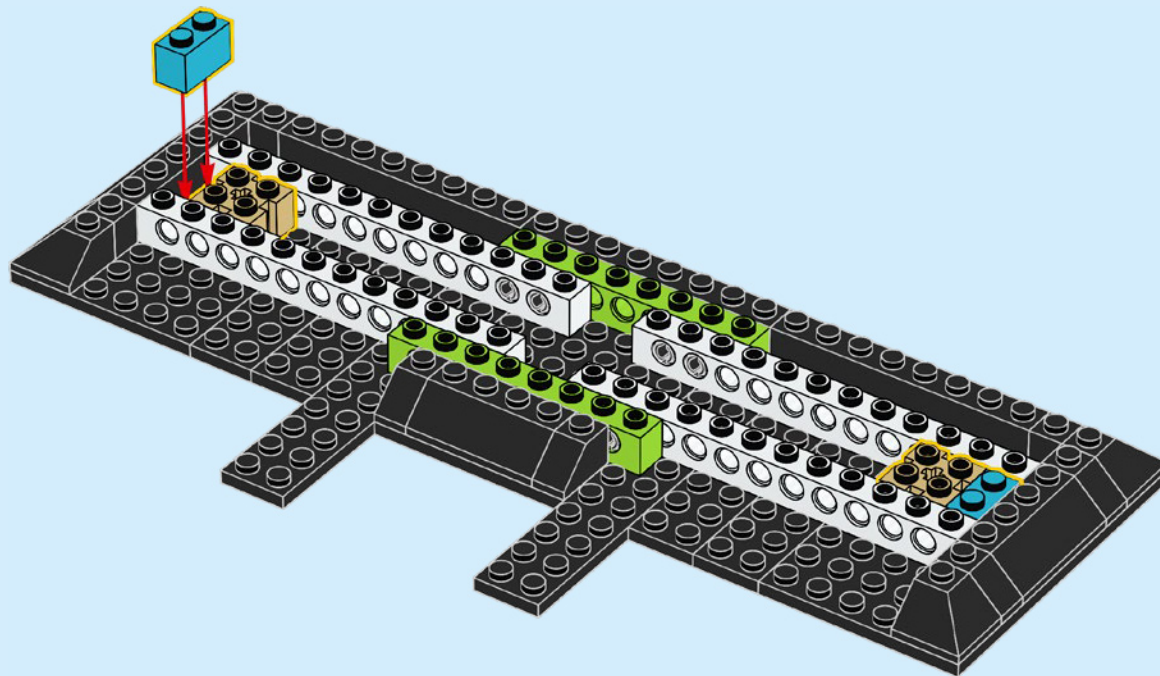

2x

278

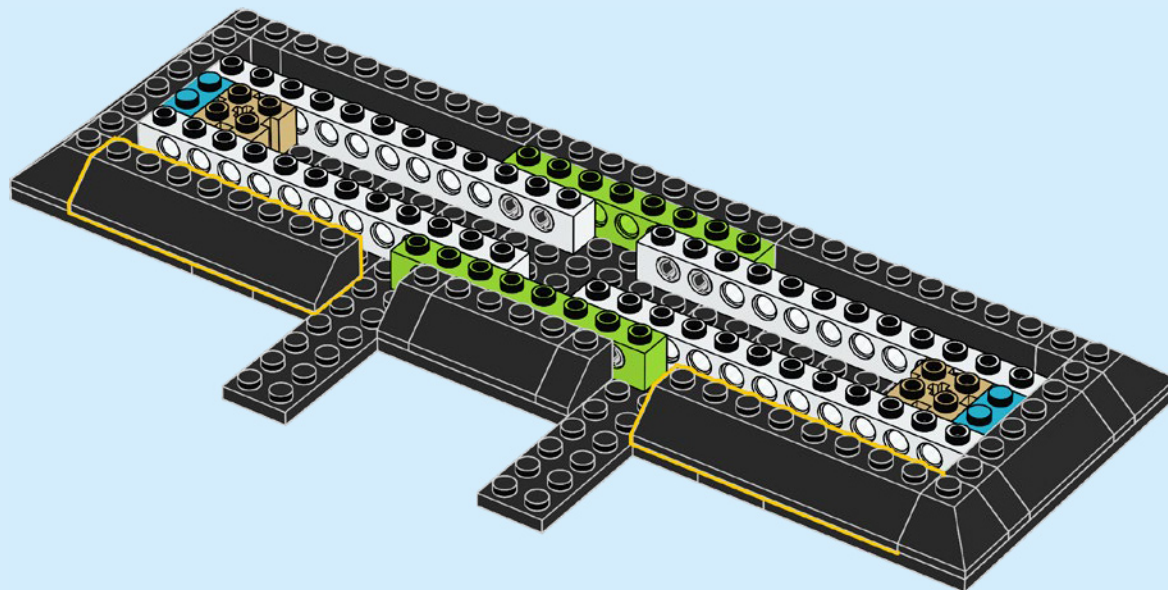

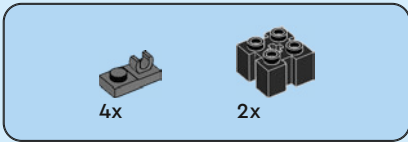

279

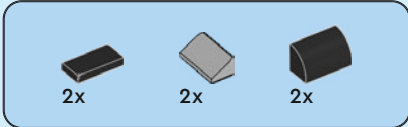
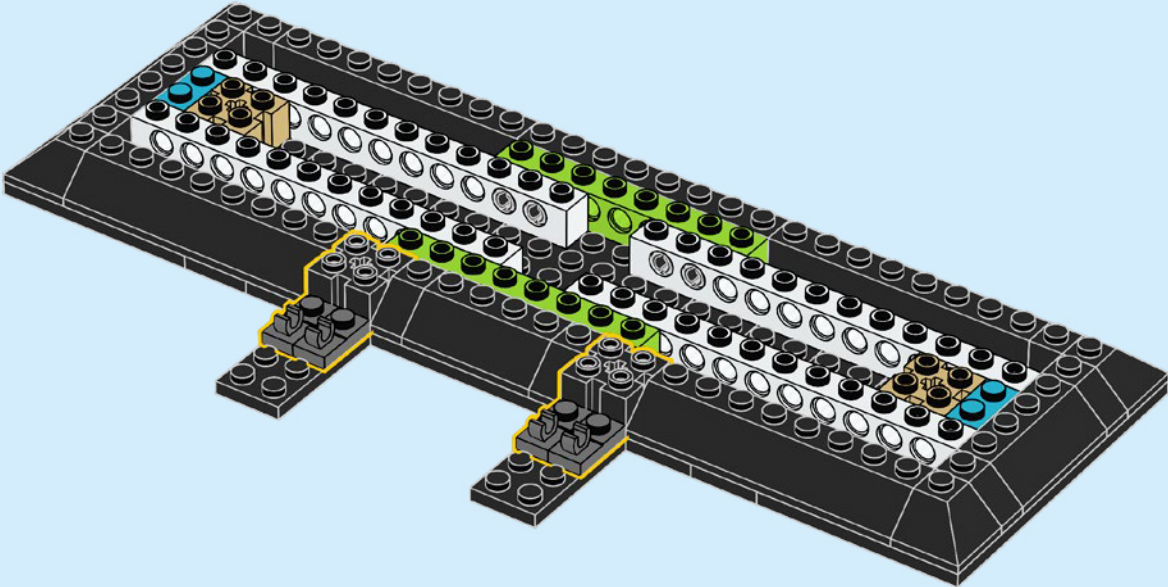

280

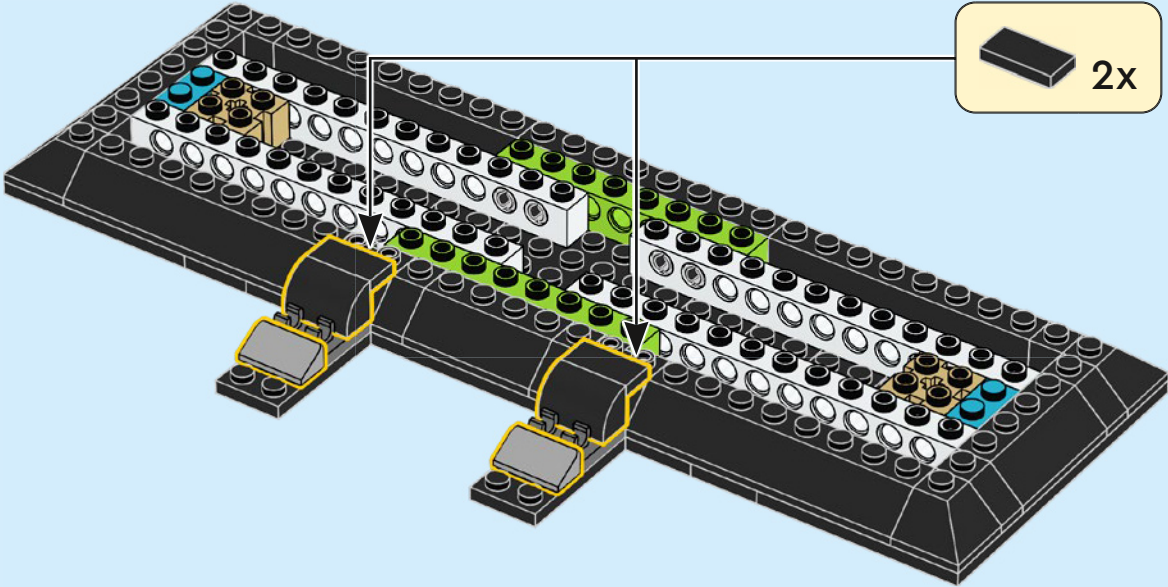

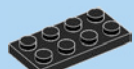

4x

281

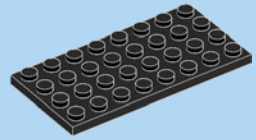
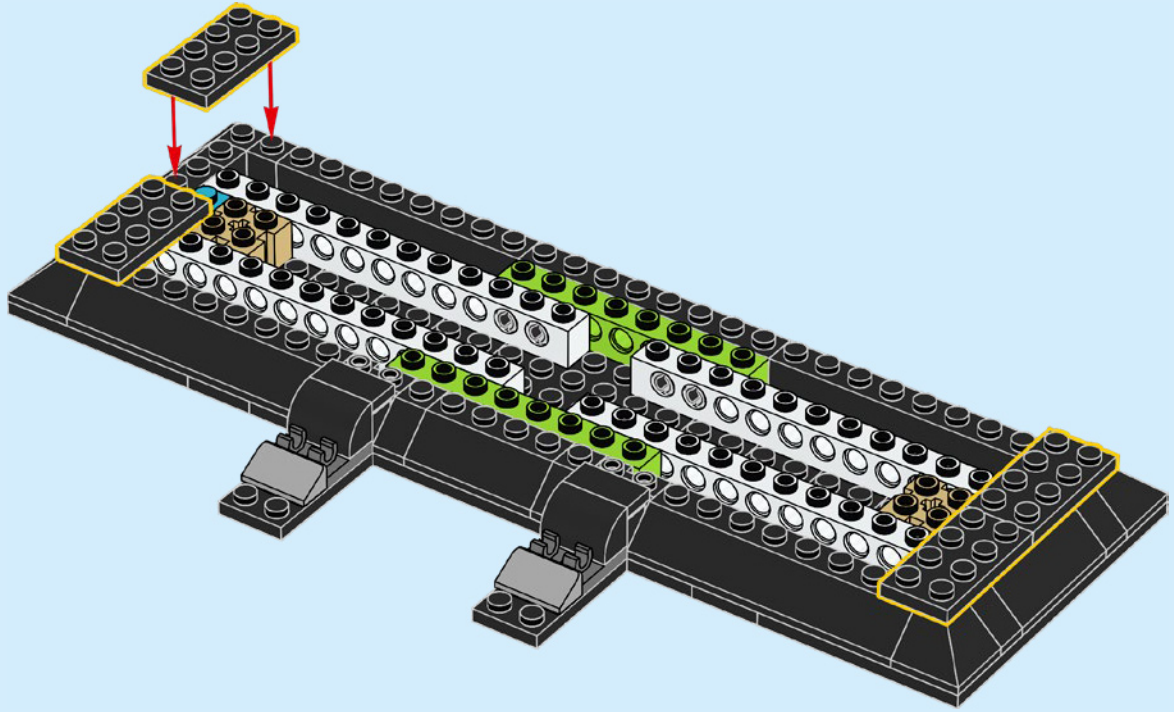

5x

282

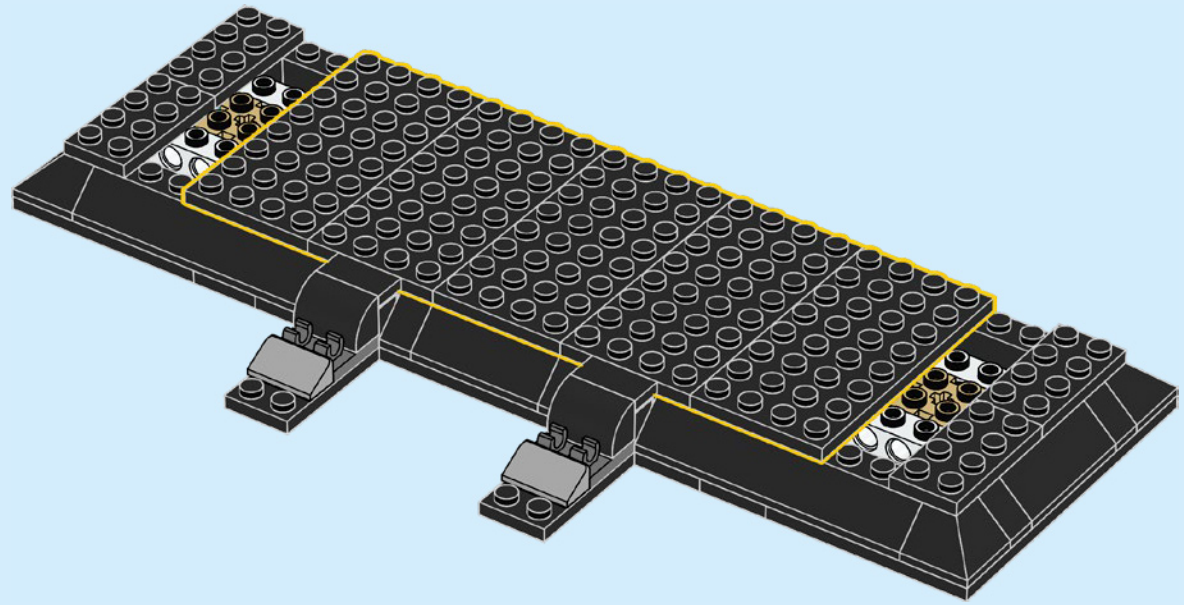

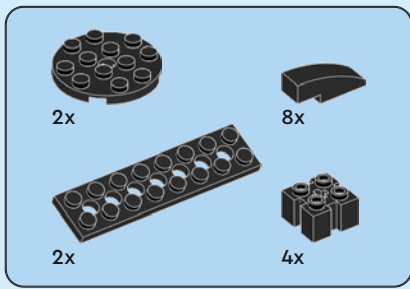

283

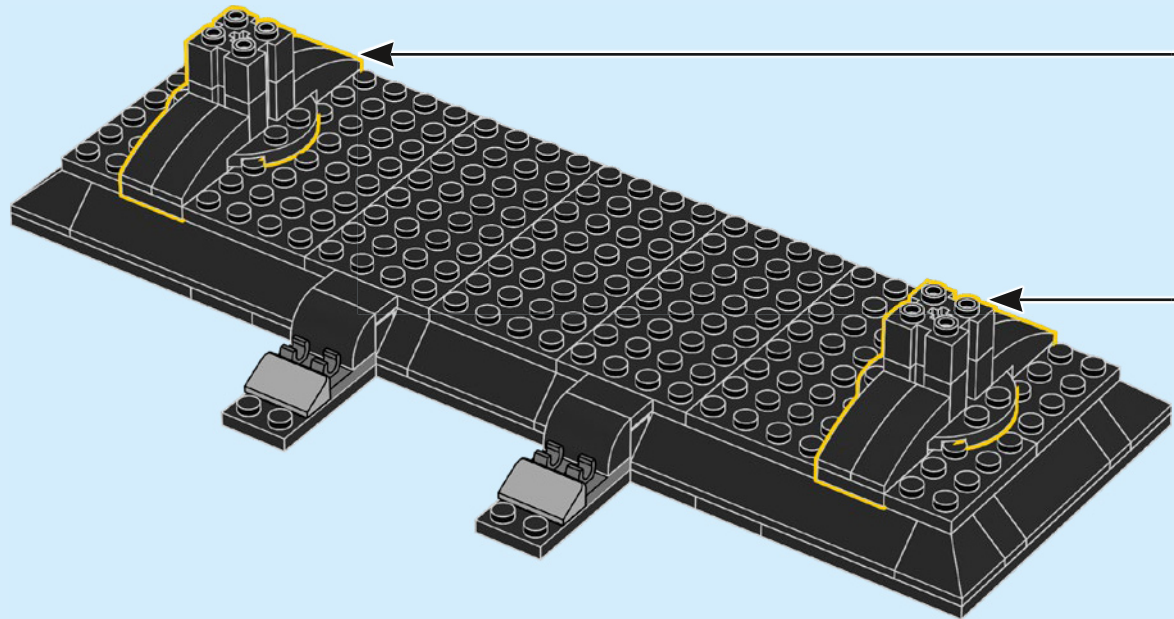
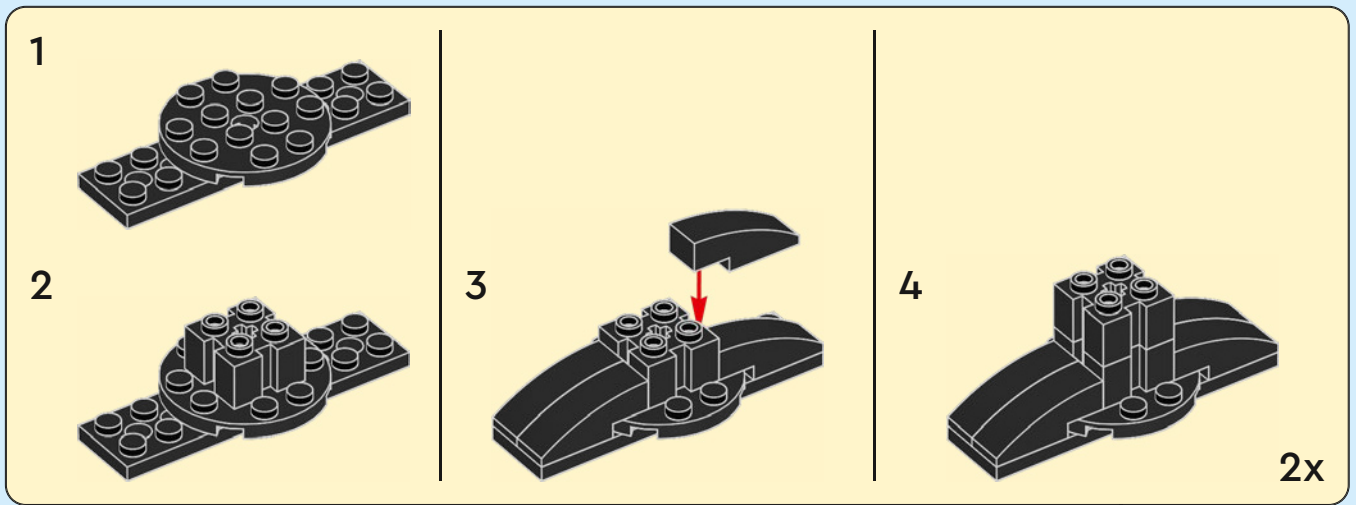

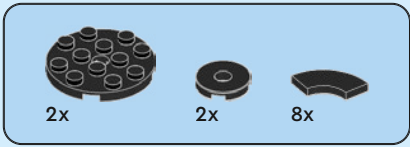

284

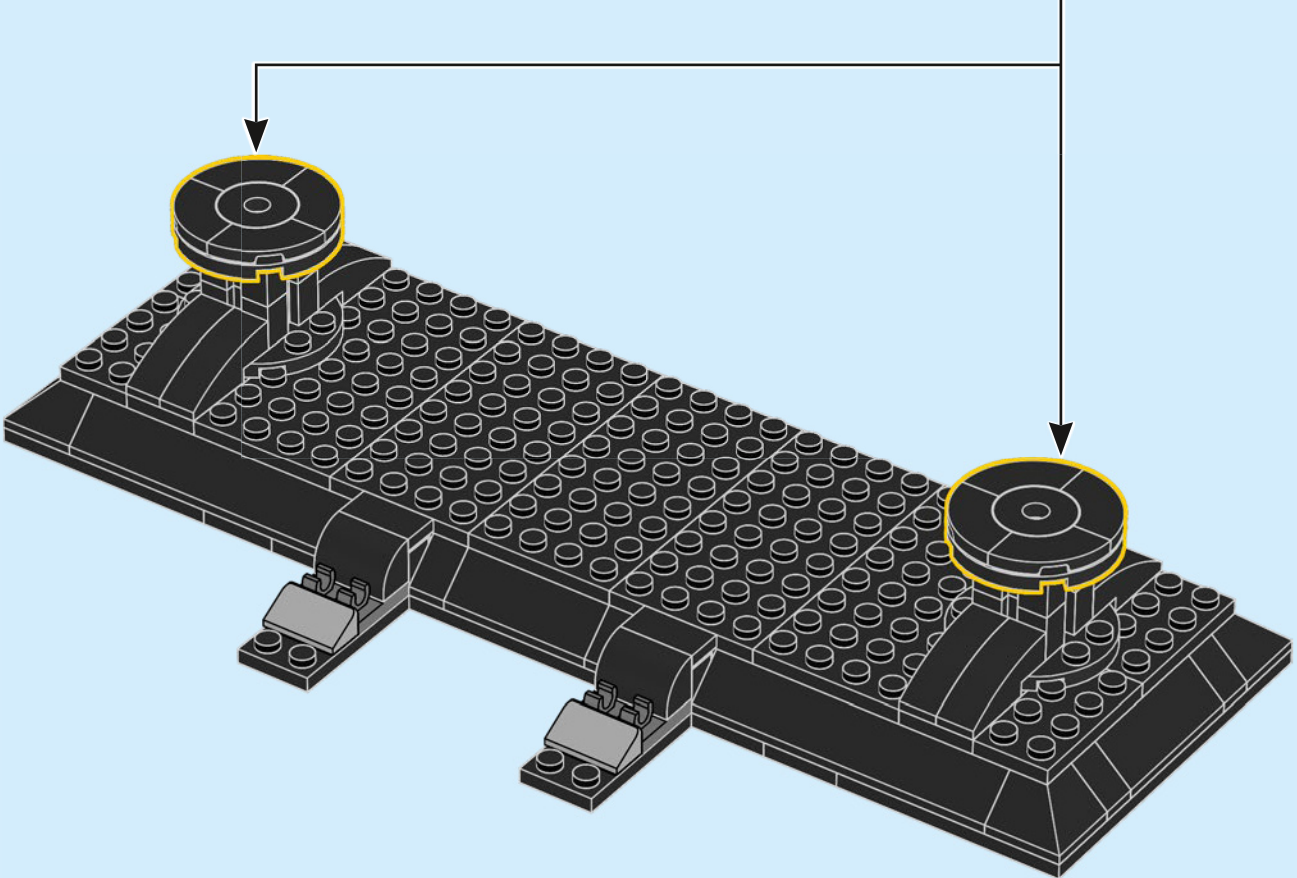
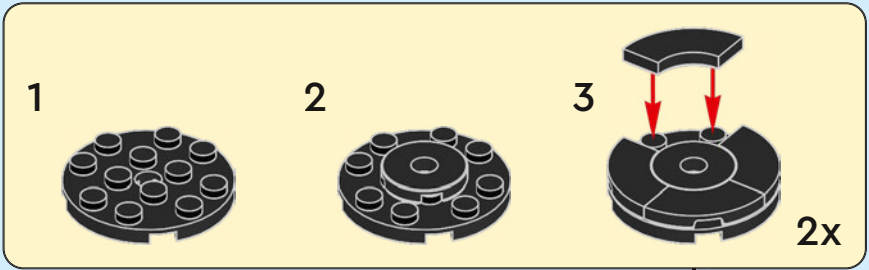

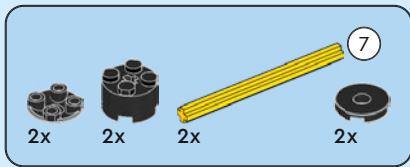

285

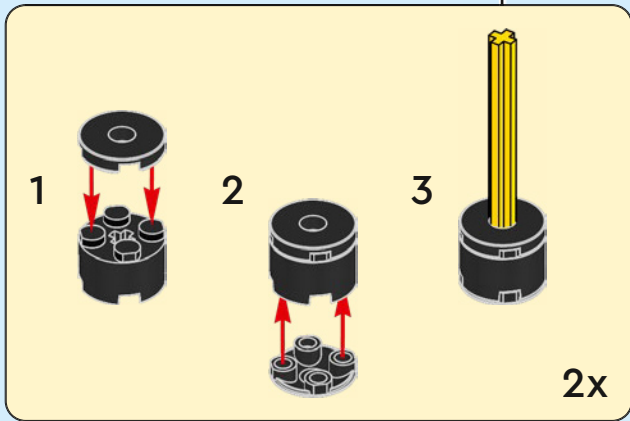
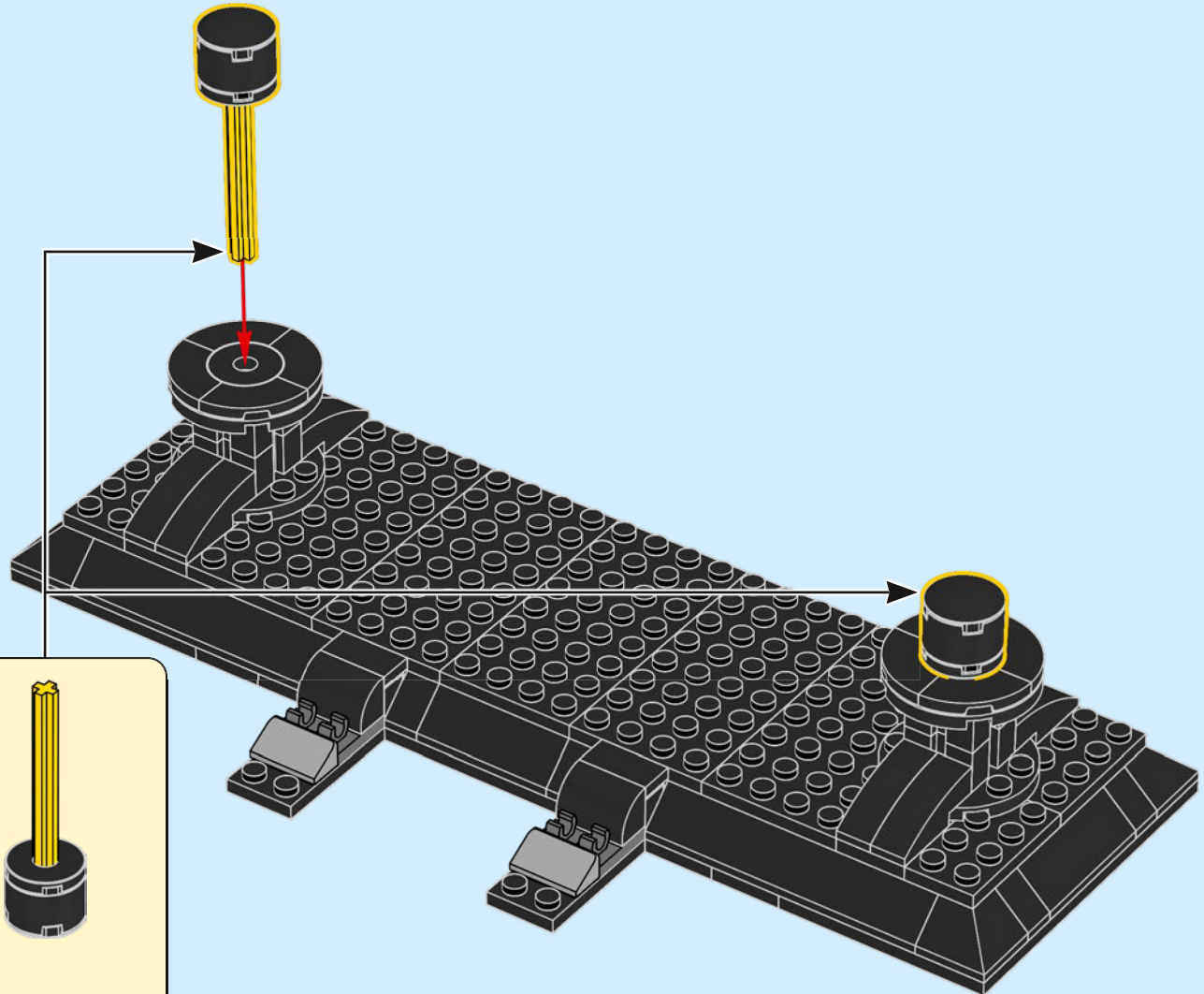

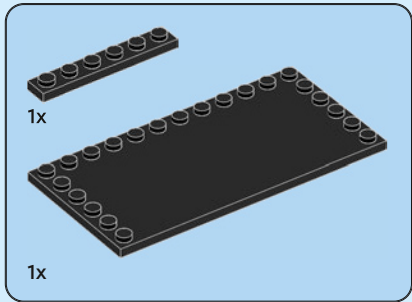

286

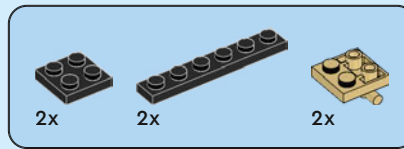
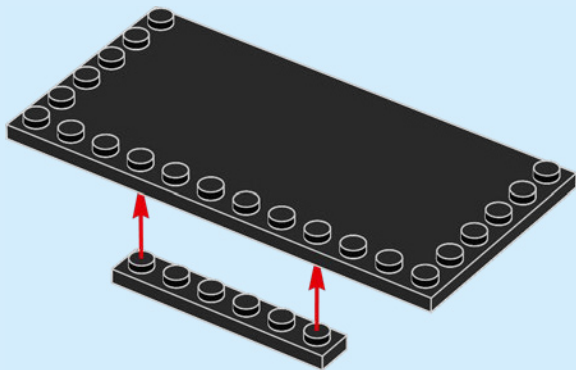

287

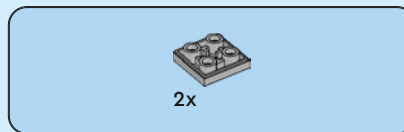
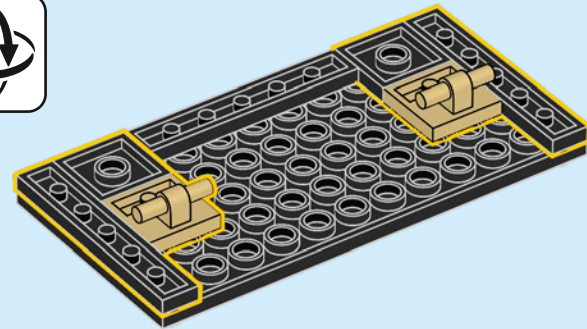

288

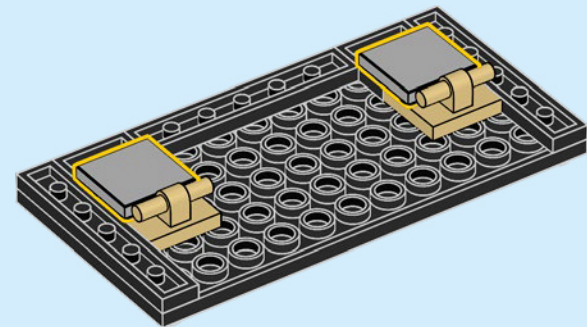

289

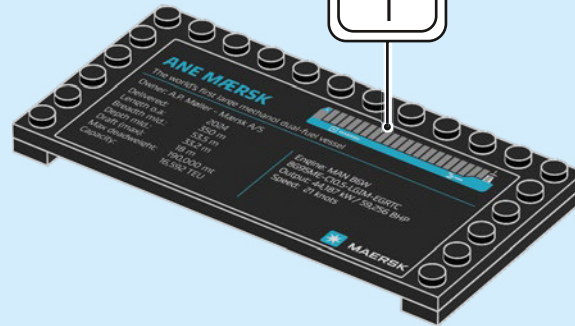

290

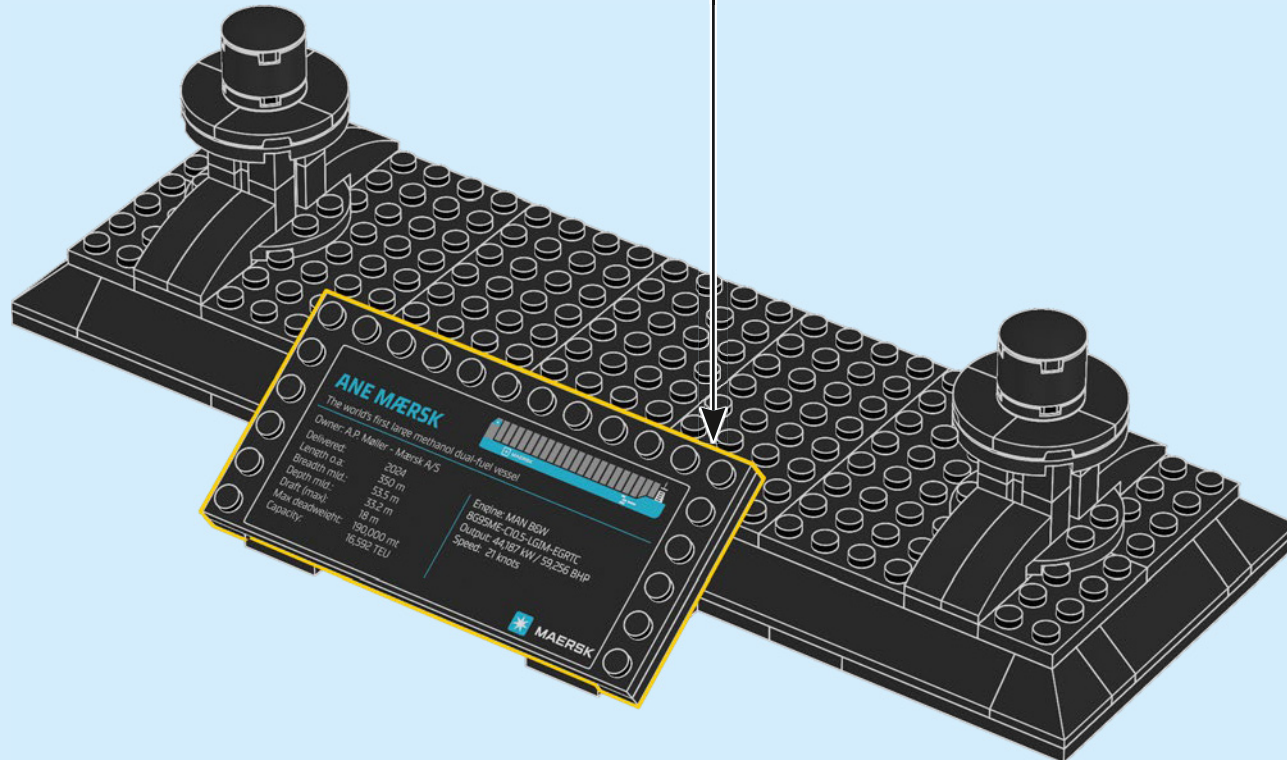

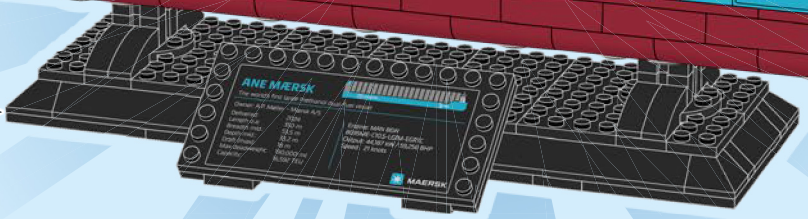
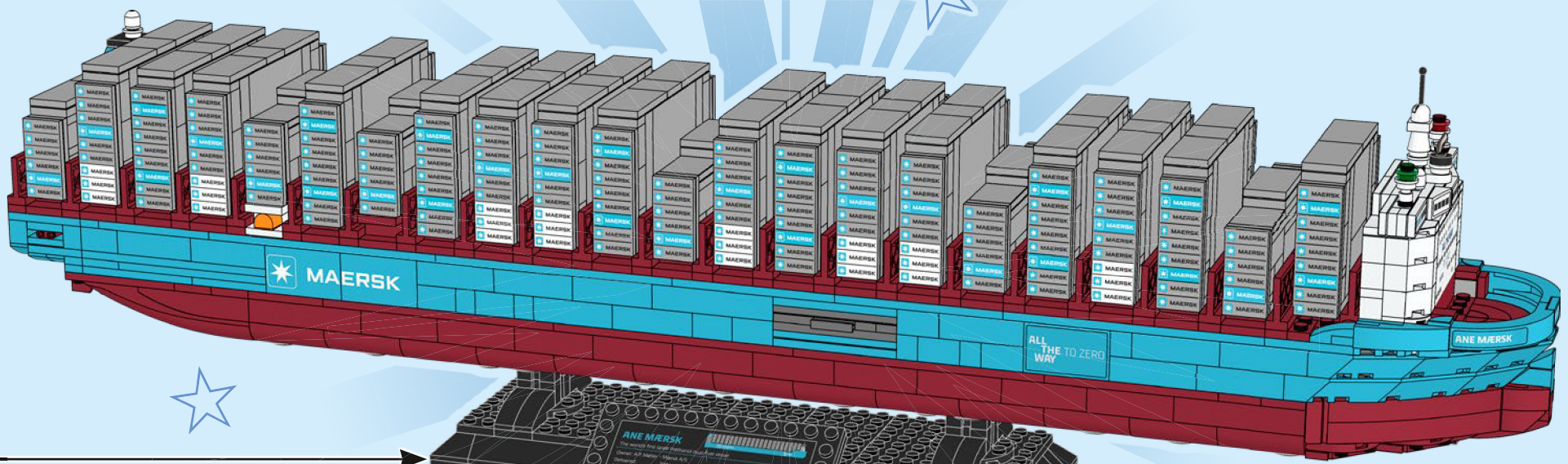
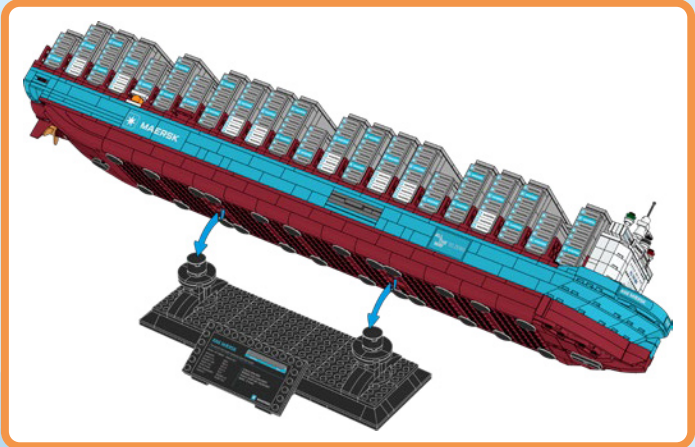

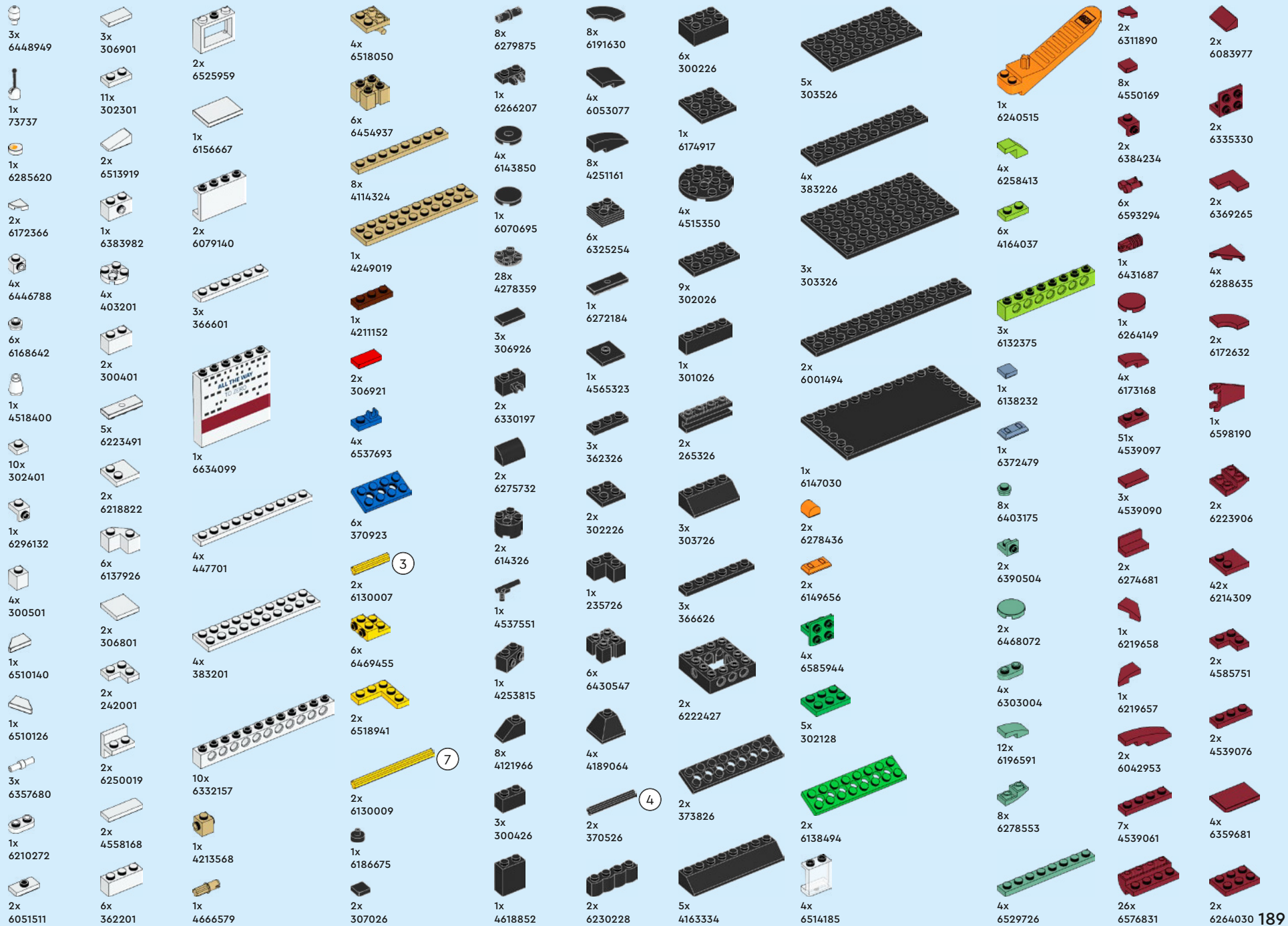

- 4x 6584062
- 4x 4541528
- 2x 6586652
- 1x 6335319
- 21x 6052777
- 6x 4541507
- 4x 4539071
- 10x 6576807
- 66x 6584063
- 1x 6465734
- 2x 6602414
- 2x 4539062
- 1x 6476042
- 1x 6350339
- 26x 6253142
- 4x 6186106
- 1x 6544174
- 6x 6440979
- 1x 4211392
- 6x 4211406
- 25x 4211462
- 2x 4211705
- 1x 6539385
- 11x 6015344
- 9x 6258831
- 2x 4568637
- 1x 4211415
- 2x 4568637
- 4x 4211412
- 33x 4211388
- 2x 4211399
- 11x 6598026
- 6x 6227897
- 70x 4211398
- 27x 4211395
- 12x 6061675
- 4x 6059033
- 2x 6079461
- 30x 4527174
- 16x 6598025
- 16x 6595947
- 35x 4211452
- 64x 6123809
- 6x 4211564
- 3x 6170387
- 32x 4211363
- 4x 6469440
- 1x 6446028
- 2x 6132886
- 2x 6043639
- 2x 4211580
- 15x 4211413
- 4x 6258820
- 10x 4211387
- 10x 6171894
- 10x 4211396
- 12x 4211386
- 1x 6514057
- 1x 6514051
- 2x 4210719
- 2x 4211063
- 4x 6344754
- 1x 6514456
- 2x 6123814
- 4x 4543086
- 1x 4218696
- 6x 4211094
- 11x 4211056
- 2x 4210651
- 1x 6287847
- 1x 6322046
- 2x 6215606
- 1x 6292145
- 1x 6088641
- 2x 6335563
- 1x 6593293
- 2x 6603341
- 8x 6603339
- 2x 6603283
- 4x 6603285
- 6x 6603587
- 8x 6603337
- 2x 6603334
- 1x 6603315
- 4x 6603598
- 17x 6603336
- 1x 6603301
- 1x 6603600
- 1x 6603591
- 1x 6603586
- 1x 6603585
- 2x 6603590
- 2x 6603344
- 2x 6603309
- 3x 6603316
- 1x 6593286
- 2x 6604733
- 2x 6603601
- 7x 6603965
- 30x 6603319
- 2x 6603317
- 2x 6576809
- 2x 6603313
- 1x 6598028
- 2x 6576810
- 1x 6598027
- 2x 6603599
- 2x 6603596
- 2x 6603342
- 2x 6603312
- 10x 6603286
- 2x 6603333
- 10x 6603340
- 2x 6603318
- 4x 6603343
- 2x 6603335
- 4x 6603595
- 1x 6603594
- 6x 6603589
- 2x 6603332
- 2x 6576813



[LEGO.com/service](https://www.LEGO.com/service)

YOU COULD WIN



Scan this QR code or go to
LEGO.COM/PRODUCTFEEDBACK and give us
your short feedback about this LEGO® set
for a chance to win a cool LEGO prize.

Terms and Conditions apply*

EN: YOU COULD WIN. Terms and Conditions apply* **DE: Du könntest GEWINNEN.** Es gelten die Teilnahmebedingungen* **FR: Tu pourrais GAGNER.** Des conditions s'appliquent* **IT: Potresti VINCERE tu.** Termini e condizioni sono applicabili* **ES: Puedes GANAR.** Aplican términos y condiciones* **PT: PODERÁ GANHAR.** Aplicam-se Termos e Condições* **ZH: 轻松获奖.** 条款和条件适用* **PL: Szansa na WYGRANĄ.** Obowiązuje regulamin* **CS: Máte šanci VYHRÁT.** Platí všeobecné smluvní podmínky* **SK: Máte šancu VYHRÁT.** Platia všeobecné zmluvné podmienky* **HU: TE IS NYERHETSZ.** Felhasználási feltételek érvényesek* **UA: ВИ МОЖЕТЕ ВИГРАТИ.** Застосовуються загальні положення та умови* **RO: Ai putea CÂȘTIGA.** Se aplică termenii și condiții* **BG: Можете да СПЕЧЕЛИТЕ.** Има определени правила и условия* **LV: Tu vari LAIMĒT.** Ir spēkā noteikumi un nosacījumi.* **ET: Sul on võimalus VÕITA.** Kehtivad tingimused* **LT: Jūs galite LAIMĖTI.** Taikomos sąlygos*

*[LEGO.com/productfeedback-terms](https://www.lego.com/productfeedback-terms)

