



40955



MAERSK





LEGO.com/sustainable-packaging



FR

**DONNEZ
OU
RECYCLEZ**



OU



OU



ASSOCIATION

MAGASIN

DÉCHÈTERIE

Adresses sur quefairedemesdechets.fr

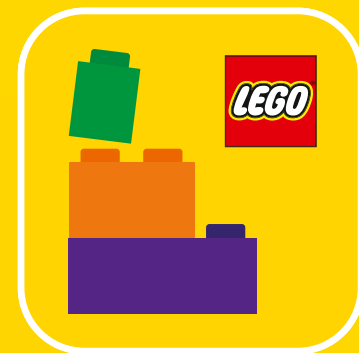

🔍 LEGO® Builder

BUILDER



Apple and the Apple logo are trademarks of Apple Inc., registered in the U.S. and other countries and regions. App Store is a service mark of Apple Inc. Google Play and the Google Play logo are trademarks of Google LLC. Tencent and the Tencent logo are trademarks of Tencent Inc.

🔍 LEGO.com/devicecheck

EN Ask parents' permission before going online | DE Eltern um Erlaubnis bitten, bevor du online gehst | FR Demande l'autorisation d'un parent avant d'aller en ligne | IT Chiedi il permesso ai tuoi genitori prima di andare online | ES Pídeles permiso a tus papás antes de conectarte a Internet | PT Peça autorização aos pais antes de acederes online | ZH 上网前应先征得父母的同意 | PL Poproś rodziców o zgodę, zanim wejdiesz do Internetu | CS Než půjdeš na internet, požádej rodiče o svolení | SK Skôr než pôjdeš na internet, vypoťaj si povolenie od rodičov | HU Kérj szülői engedélyt, mielőtt online csatlakoznál! | UA Запитуйте дозволу батьків, перш ніж користуватися інтернетом | RO Cere permisiunea părinților înainte de a te conecta online | BG Поискайте разрешение от родител, преди да влезете онлайн | LV Pirms došanās tiešsaistē palūdz atļauju vecākiem | ET Enne Interneti kasutamist küsi vanematelt luba | LT Prieš prisijungdami prie interneto, atsiklauskite tėvų



TUTVUSTAME ANE MÆRSKI

ANE MÆRSK on esimene omataoline – esimene suur konteinerlaev, mis suudab sõita madala heitega kütusega, nagu bio- ja e-metanool. Alates ANE MÆRSKi esimese meresõidu algusest 2024. aasta jaanuaris on merele läinud veel palju kahe kütusega laevu, mis tähistab uut ja olulist peatükki laevanduse ja maailmakaubanduse süsinikdioksiidiheitmete vähendamises.

ANE MÆRSK on 350 meetrit pikk ja 53,5 meetrit lai. Tühi laev kaalub 47 700 tonni ja täislaadituna kaubaga, kütuse ja meeskonnaga võib laev transportida hämmastavat 190 000 tonni, mis vastab 29 000 Aafrika elevantile.

Laev mahutab 16 592 TEU konteinerit, mis üksteise järel rivistatuna moodustaksid 100,5 km pikkuse rea, mis võrdub 959 jalgpalliväljaku pikkusega.





 MAERSK

ALL THE 10 ZERO WAY



MUUTUSTEGA TOIMETULEK – LAEVANDUSE AJALUGU

Inimesed on transportinud kaupu meritsi juba üle 5000 aasta, kuid kuni tööstusrevolutsioonini ja aurumasina leiutamiseni olime ilmast sõltuvad. Ilma tuuleta puudus võimalus merd ületada. Aurujõu kasutuselevõtuga ei olnud laeva meeskond inimkonna ajaloos esimest korda enam sõltuv ilmast ega käsitsi liikumisest. Leiutis muutis meretransporti täielikult, võimaldades uusi marsruute ja andes meretranspordile suure tõuke.

Kuigi aurumasinad olid seilamises suur edasimineku, olid need ikkagi ebatõhusad ja varsti muutis diiselmootori leiutamine meretransporti taaskord põhjalikult. Kuid revolutsioonid laevanduses võtavad aega ja kulus mitukümmend aastat enne, kui diiseli täielikult aurujõu asendas. Maersk ostis oma esimese diiselmootoriga laeva LEISE MÆRSKI 1921. aastal, vaid üheksa aastat pärast esimese diiselmootoriga ookeanilaeva vettelaskmist.



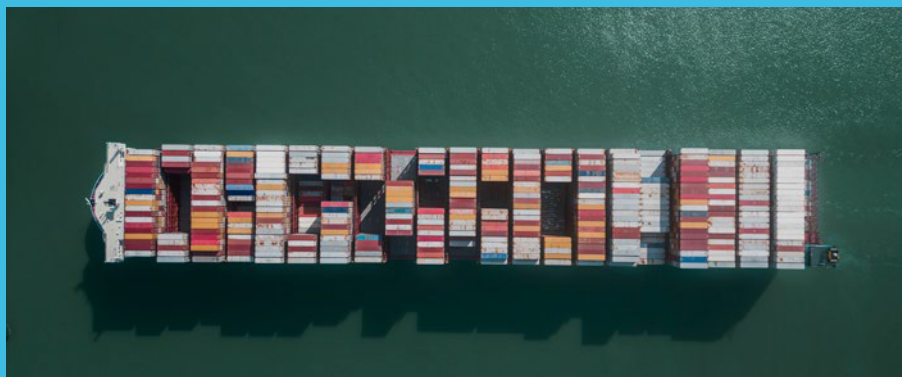

1956. aastal muutus tööstusharu taas, kui võeti kasutusele tõhus konteinervedu, mille puhul veoautode haagised laaditakse otse laevadele. Konteineri kasutuselevõtt vähendas laevadele peale- ja mahalaadimiseks kuluvat aega mitmelt päevalt mõnele tunnile.

Tänu konteinerile ja vöotkoodile – maailmakaubanduse varjatud võimaldajatele – saab tootja mis tahes maailma osas oma kaupu müüa kõigil turgudel, muutes globaliseerumise füüsiliselt võimalikuks. Maailm, nagu me seda täna tunneme, sõltub sügavalt ülemaailmsetest tarneahelatest. Alates Colombia banaanikasvatajast kuni Taani lapseni, kes koorib lõunaks banaani, hoiavad tarneahelad maailma ühenduses ja tagavad toidu, ravimite, kaupade ja materjalide voo inimestele üle kogu maailma.





 MAER

 MAERS

 MAERSK

 MAERSK

LUGU NIME TAGA

Alates 1906. aastast on kõik Maerski laevastiku laevad kandnud nimes sõna MÆRSK. Enamikul varajastel laevadel olid eesnimed, mis olid seotud asutajaperekonnaga, kuid kuna laevastik kasvas saadaolevatest perekonnanimedest suuremaks, tuli nimetamise traditsiooni kohandada. Tänapäeval näeb ka Maerski laevu, mis on nimetatud näiteks linnade ja jõgede järgi.

Uue kahekütuseliste laevade seeria nimetamise otsustamisel naasis Maersk traditsiooni juurde nimetada laevu asutajapere liikmete järgi – seekord alustades uue ajastu tähistamiseks tähega A.

ANE MÆRSK on nime saanud Ane Mærsk Mc-Kinney Ugbla järgi, kes on A.P. Moller Holdingu juhatuse esimees, mis on A.P. Moller – Maerski emaettevõtte. A.P. Moller – Maerski asutas 1904. aastal Arnold Peter Møller. Ane on kontserni asutaja Arnold Peter Mølleri ja tema abikaasa Chastine Mc-Kinney Mølleri lapselaps.



ANE MAERSK





WHITE STAR – LOOTUSE MAJAKAS

Ikooniline valge seitsmeharuline täht on olnud osa Maerski pärandist juba enne ettevõtte asutamist 1904. aastal ning on kestev sümbol tugevatest perekondlikest sidemetest, mis läbivad ettevõtte südant ka üle 100 aasta hiljem.

Oma karjääri alguses töötas kapten Peter Mærsk Møller, A.P. Mølleri isa, Inglise laevaomaniku heaks ja tema naine Anna saatis teda vahel reisidel. Just ühel neist reisidest jäi Anna raskelt haigeks. Kartes, et ta ei ela seda üle, läks Peter Mærsk Møller tekile ja palus Jumalalt märki, et tema naine paraneks. Just siis nägi ta üht tähte säramas muidu hallis taevas.

Anna toibuski ja kui Peter Mærsk Møller 1886. aastal oma esimese aurulaeva – LAURA – ostis, kaunistas ta laeva korstna helesinisel taustal valge seitsmeharulise tähega, austusavaldusena oma armastatud naisele. Peter Maersk Møllerile tähendas täht tema paranemist ja nende õnne.

Sellest ajast peale on valge seitsmeharuline täht taevasinisel taustal olnud Maerski sümboliks, kuid logo ise on aastate jooksul mõnevõrra muutunud. Logo on olnud mitmes versioonis, kuid tänapäevane Maerski logo pärineb 1970. aastate algusest, kui otsustati, et vaja on moodsamat lähenemisviisi.



ALL THE WAY
TO ZERO



KÕIGI ELU PARANDAMINE MAAILMA INTEGREERIMISE KAUDU

Logistikateenuste globaalse liidrina on Maerskil üle 100 000 kliendi, see tegutseb peaaegu 130 riigis ja annab tööd enam kui 100 000 inimesele. Alates tagasihoidlikest algustest aurulaevafirmana kuni integreeritud logistikaettevõtteni, mis ühendab ja lihtsustab oma klientide tarneahelaid, kasutab Maersk üle 700 laeva ja transpordib ligi 20% maailma toidust, materjalidest ja kaupadest.





MAERSK
MAERSK
MAERSK
MAERSK
MAERSK
MAERSK
MAERSK

MAERSK
MAERSK
MAERSK
MAERSK
MAERSK
MAERSK
MAERSK

ALL
THE T
WAY

ANE MAERSK

SPREADERS
TSP98
MAERSK
MAERSK

PTP T414
65 TOP'S SWL
P423 PTP



ALL
THE WAY TO ZERO

NULLINI VÄLJA – PÜHENDUMUS SÜSINIKUVABALE TULEVIKULE

Kuna maailm maadleb kliimakriisidega, sõltub tarneahelate ja globaalse kaubanduse tulevik võimest uuendusi teha ja uusi energiaallikaid edendada. Maersk on võtnud endale tõsise kohustuse saavutada 2040. aastaks kogu äritegevuses kasvuhoonegaaside netoheitete nulltase. Oma tegevuse süsinikdioksiidiheitmete vähendamise kõrval on Maersk võtnud ka sotsiaalse kohustuse olla kliimakriisi lahendamisel eesrinnas, vähendades süsinikdioksiidiheitmeid globaalsetes tarneahelates ja võimaldades õiglast üleminekut nullkoguse heitmetega majandusele.

Maersk on seadnud ambitsioonikad eesmärgid aastaks 2040, et tagada märkimisväärne edasimineku käesoleval kümnendil: merel, maal, õhus ja meie terminalides. Paljude kahe kütuseliigiga laevade tellimise ja tarnimisega, mis suudavad sõita madala heitega kütustel, nagu bio- ja e-metanool ning biometaan, on laevastiku süsinikdioksiidiheitmete vähendamise missioon seni hästi edenenud.



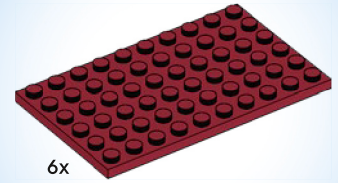
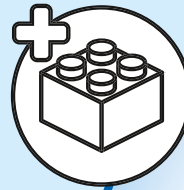
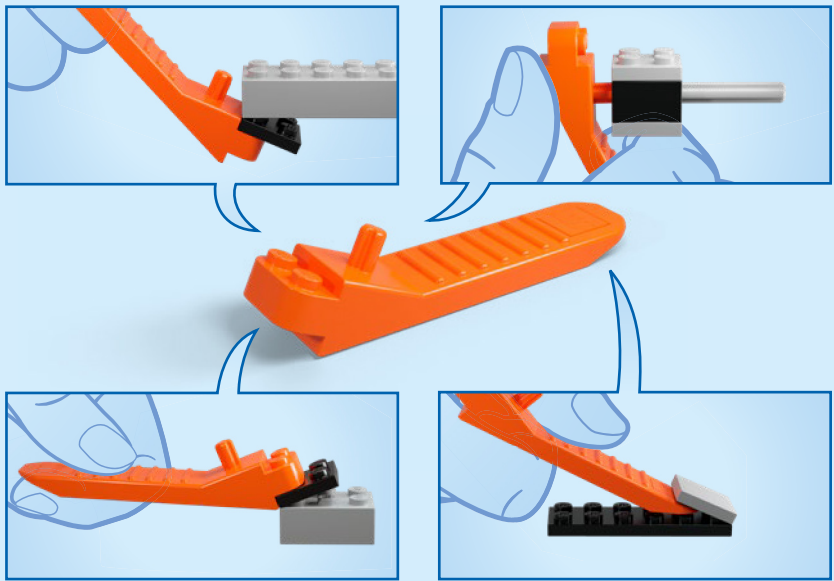

6x



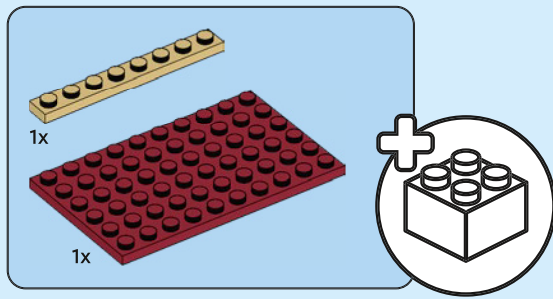

1

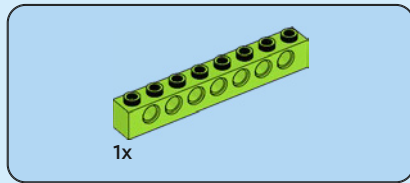
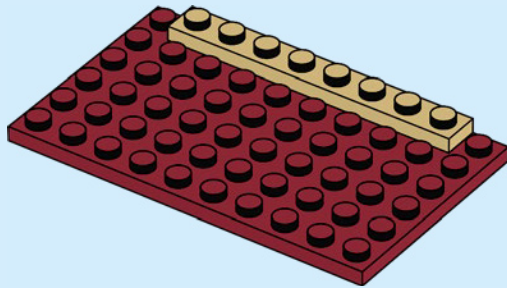

2

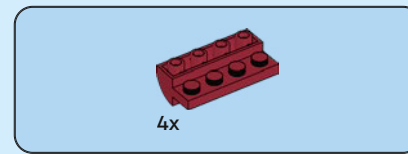
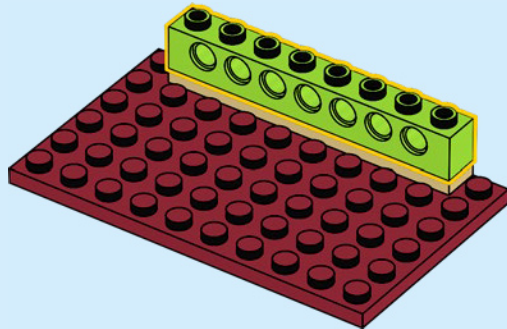

3

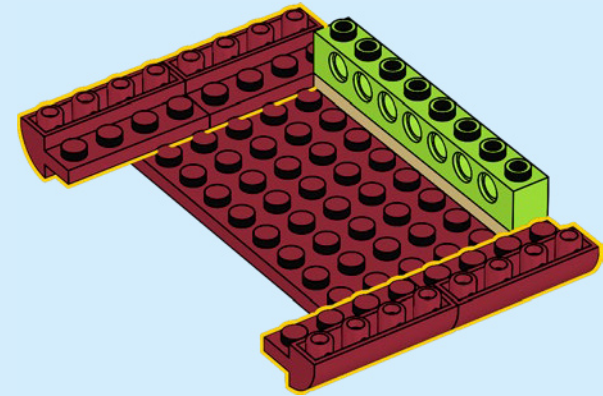

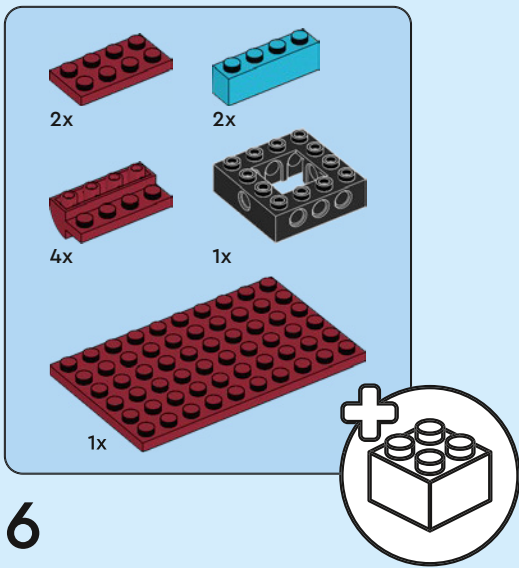
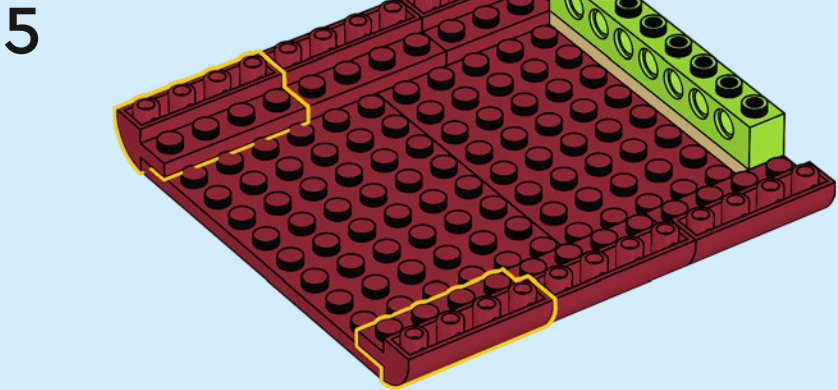
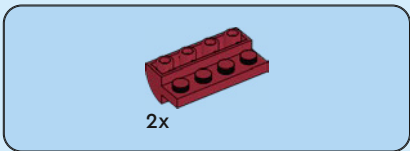
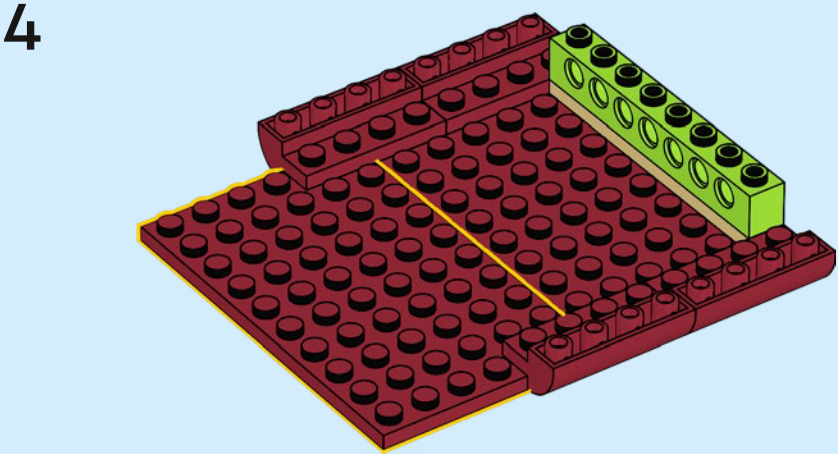
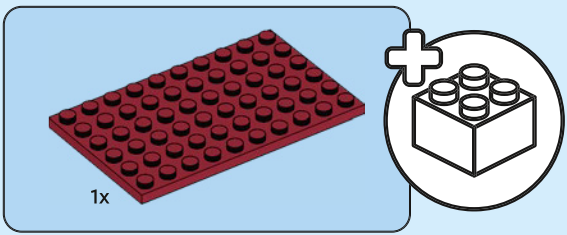

6

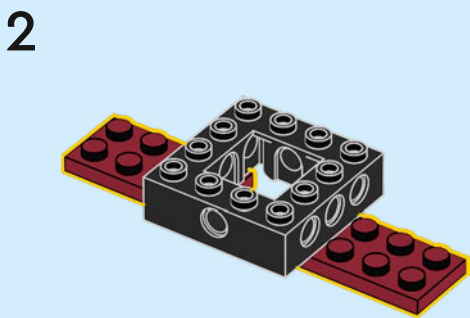
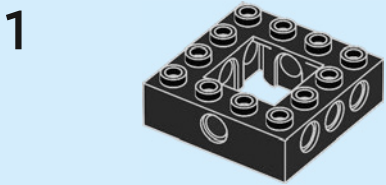

3

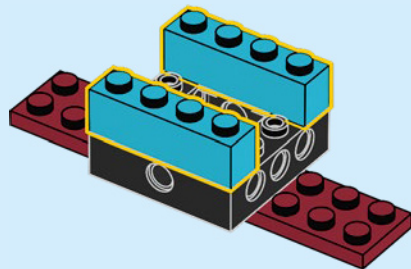

4

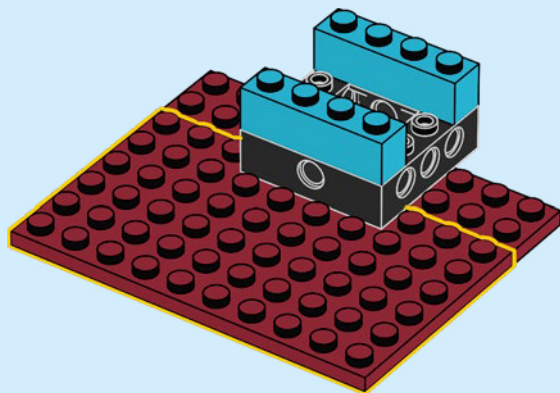

5

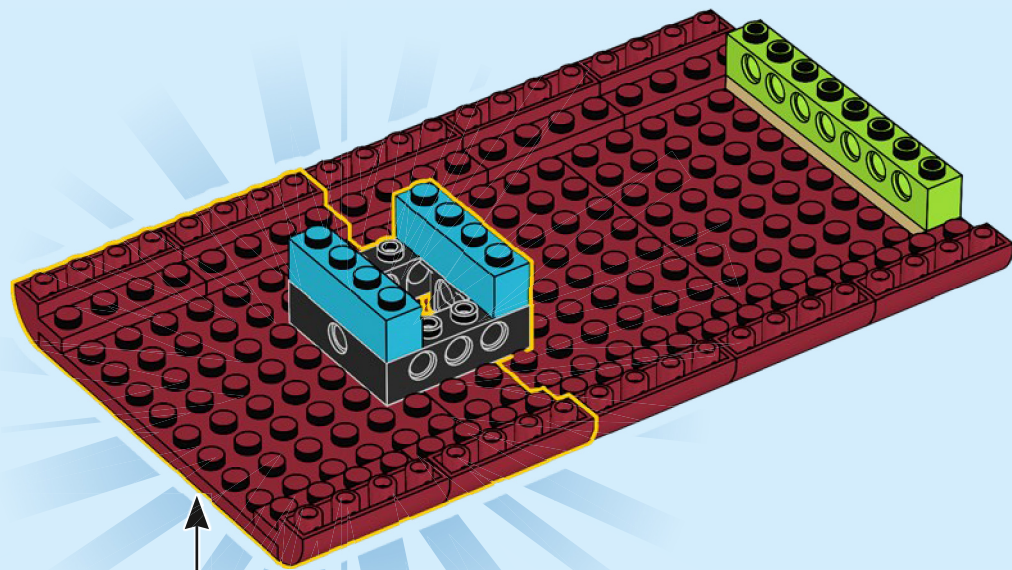
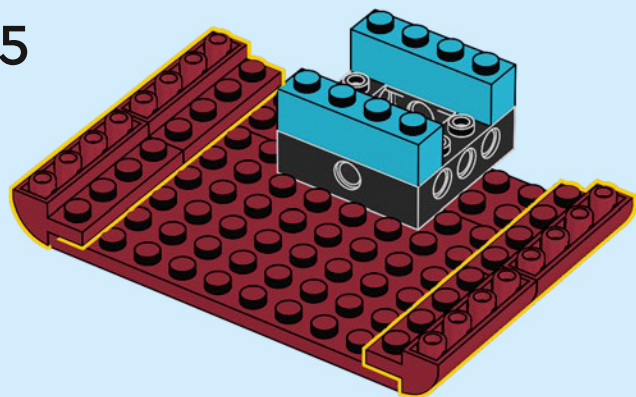

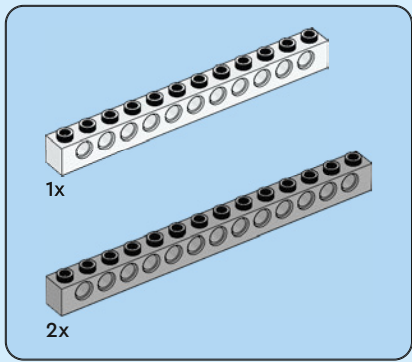

7

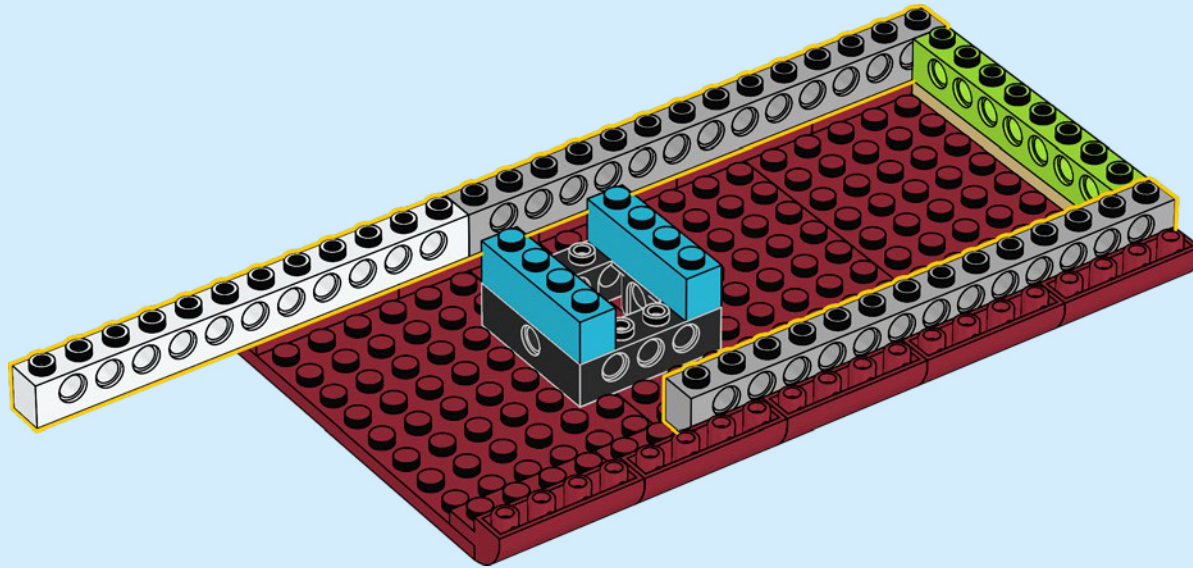

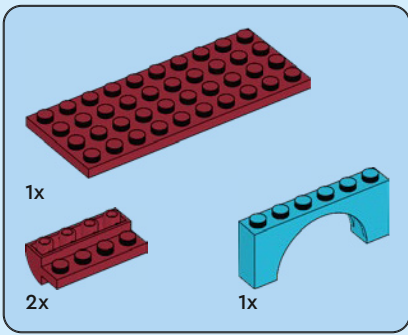

8

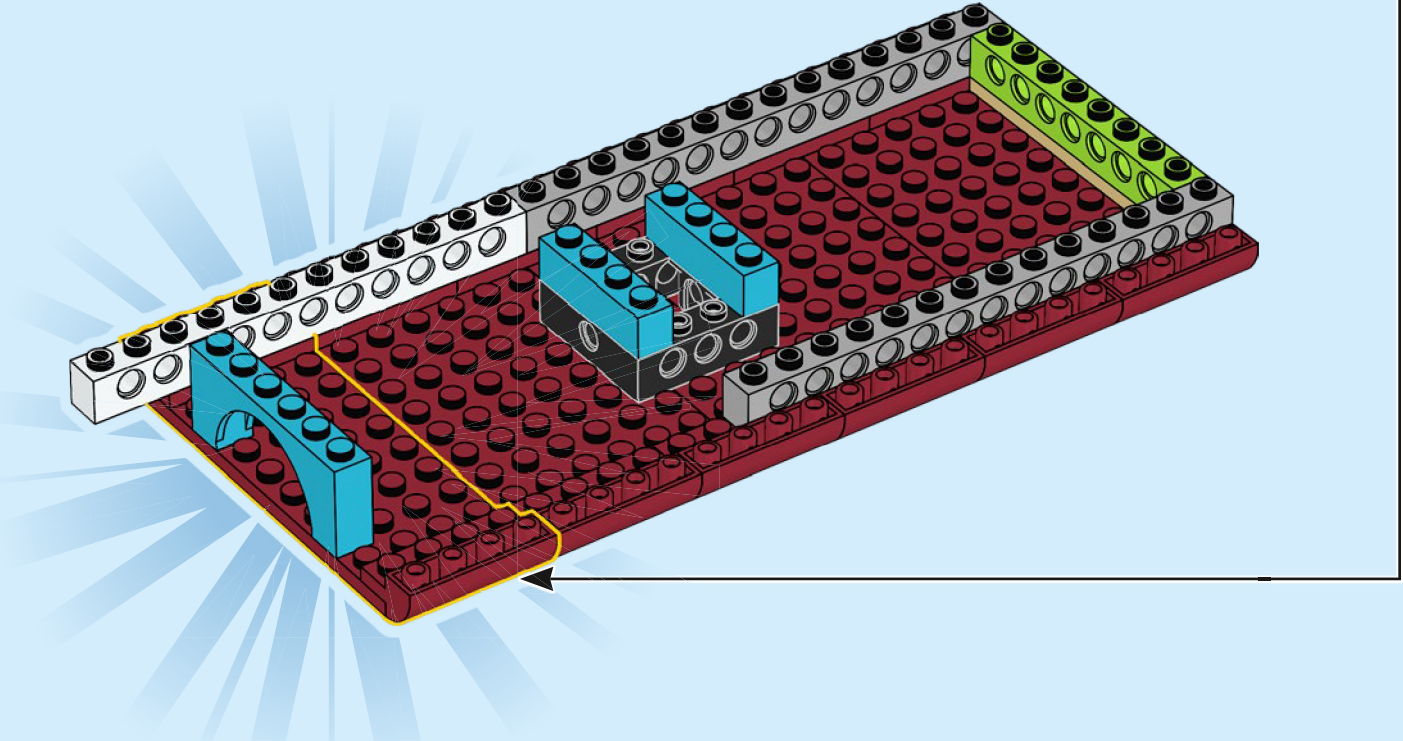
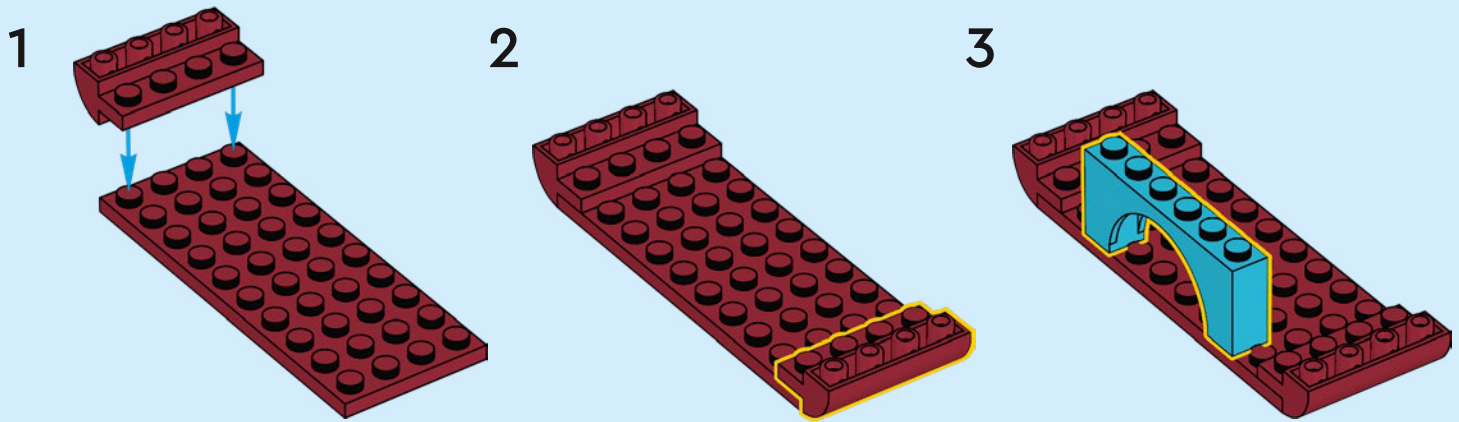

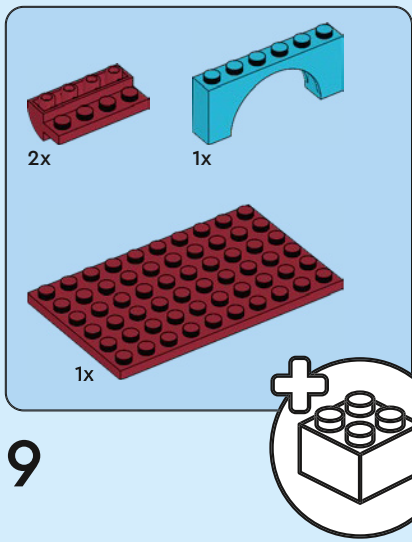

9

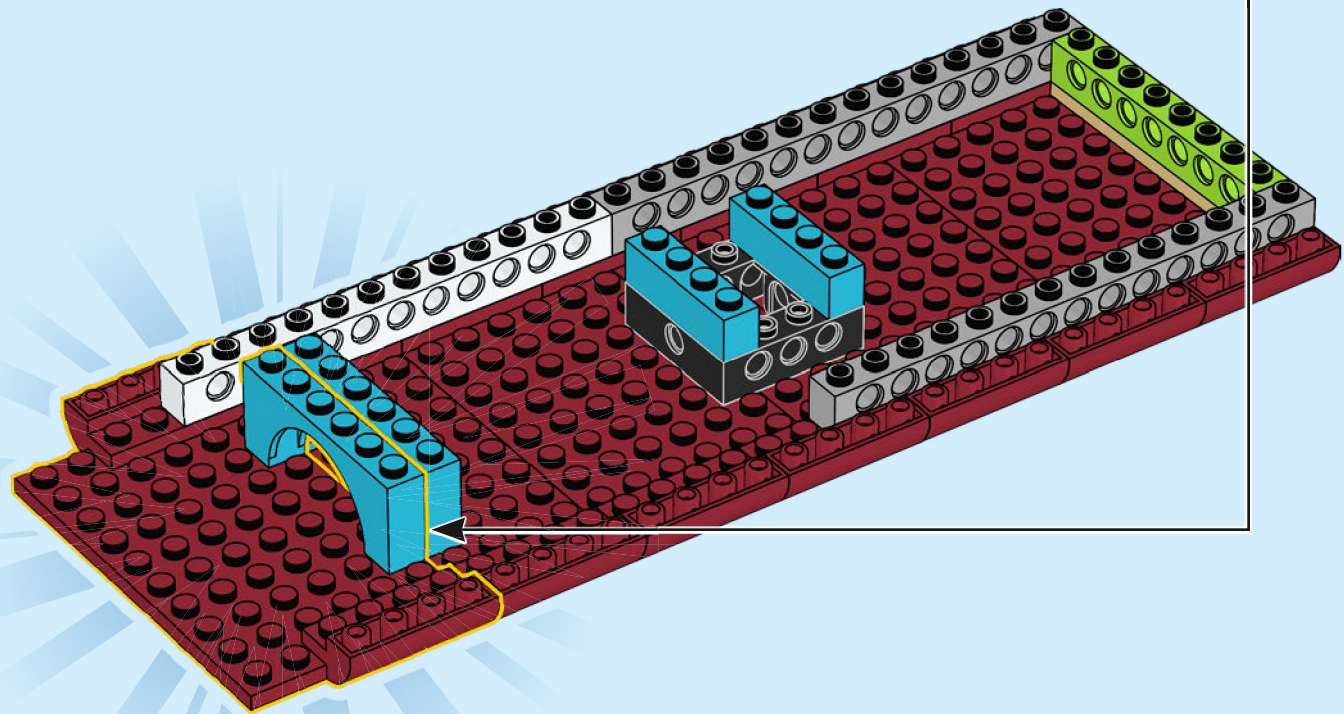
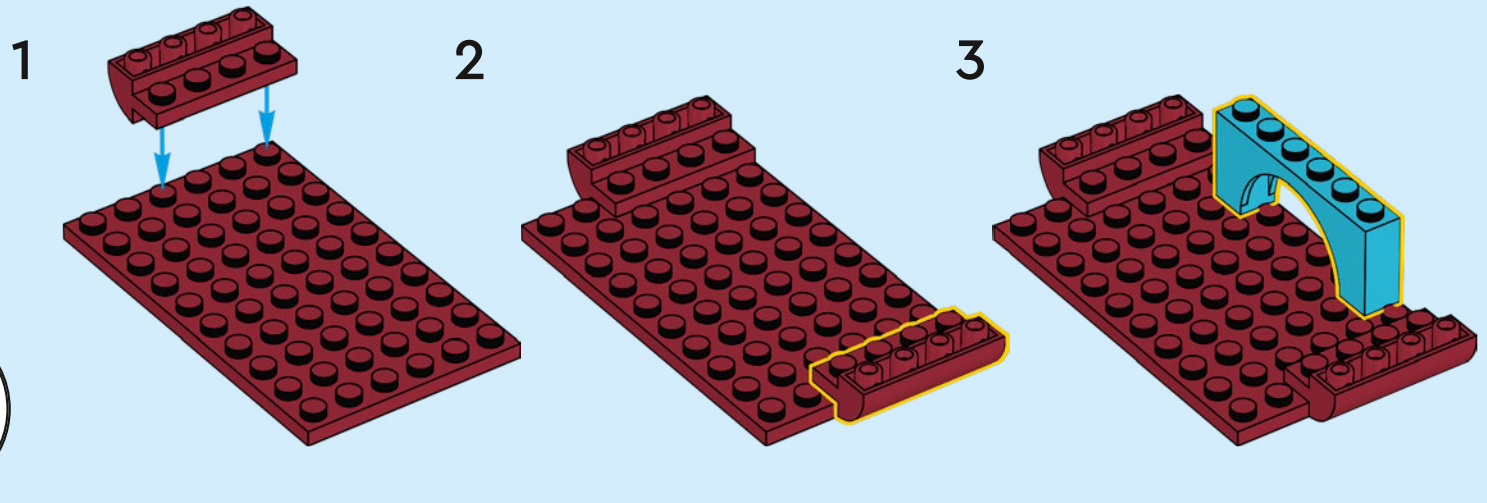

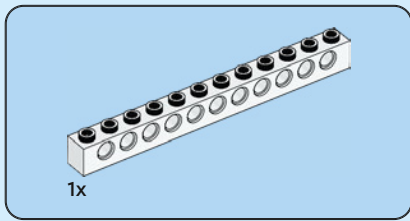

10

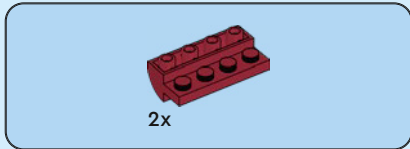
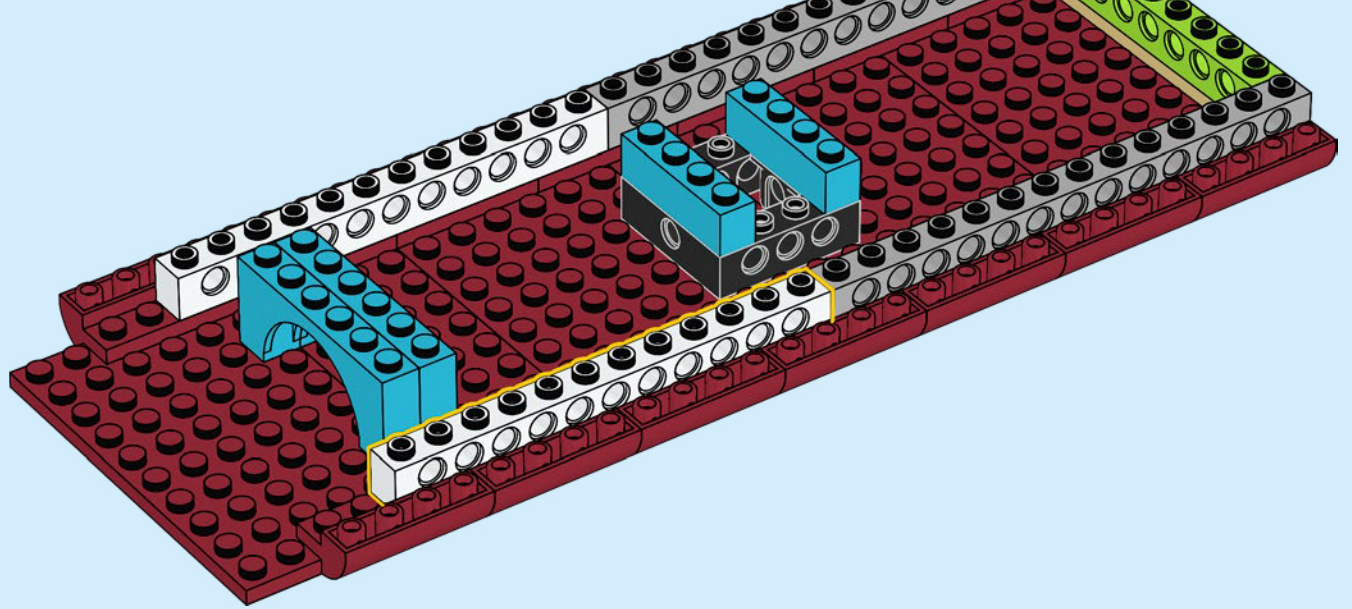

11

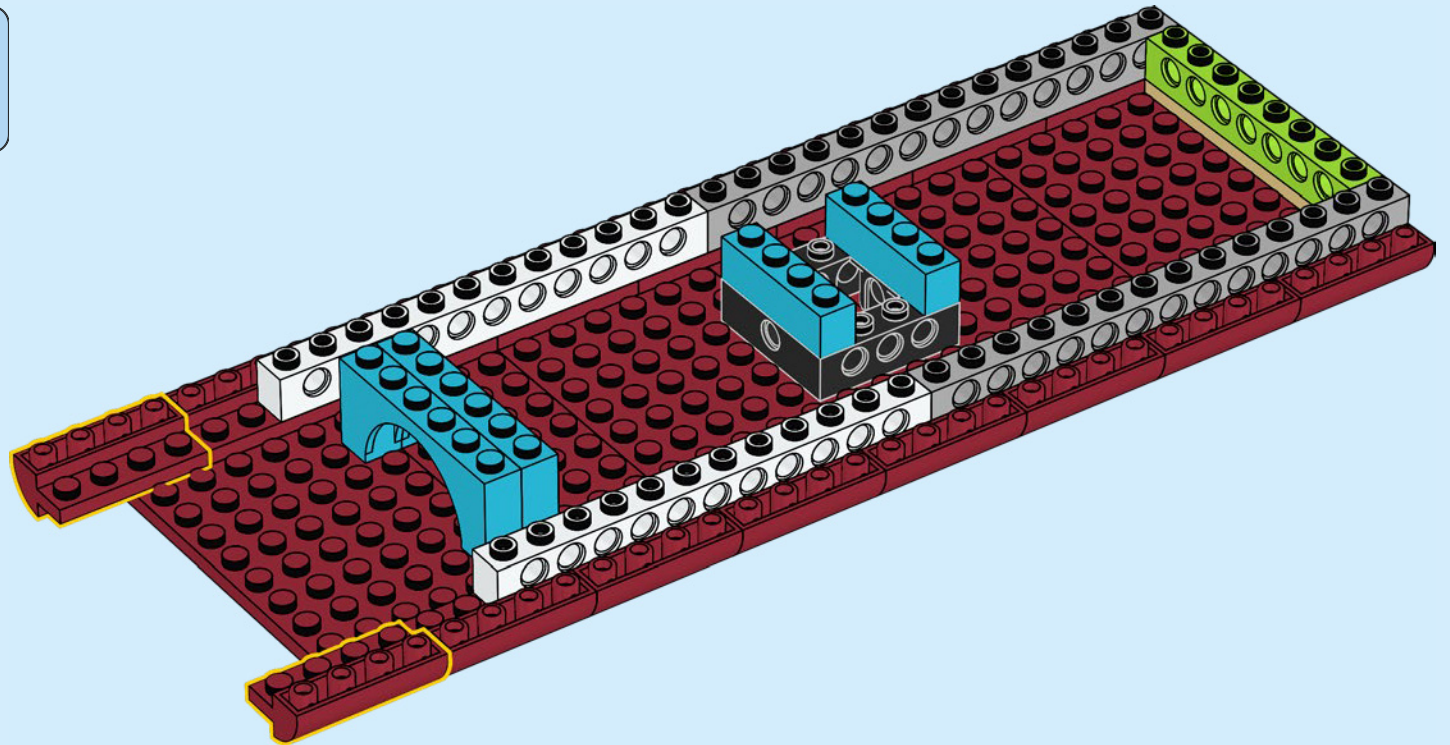

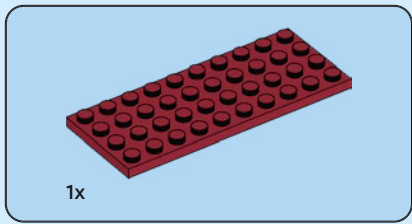

12

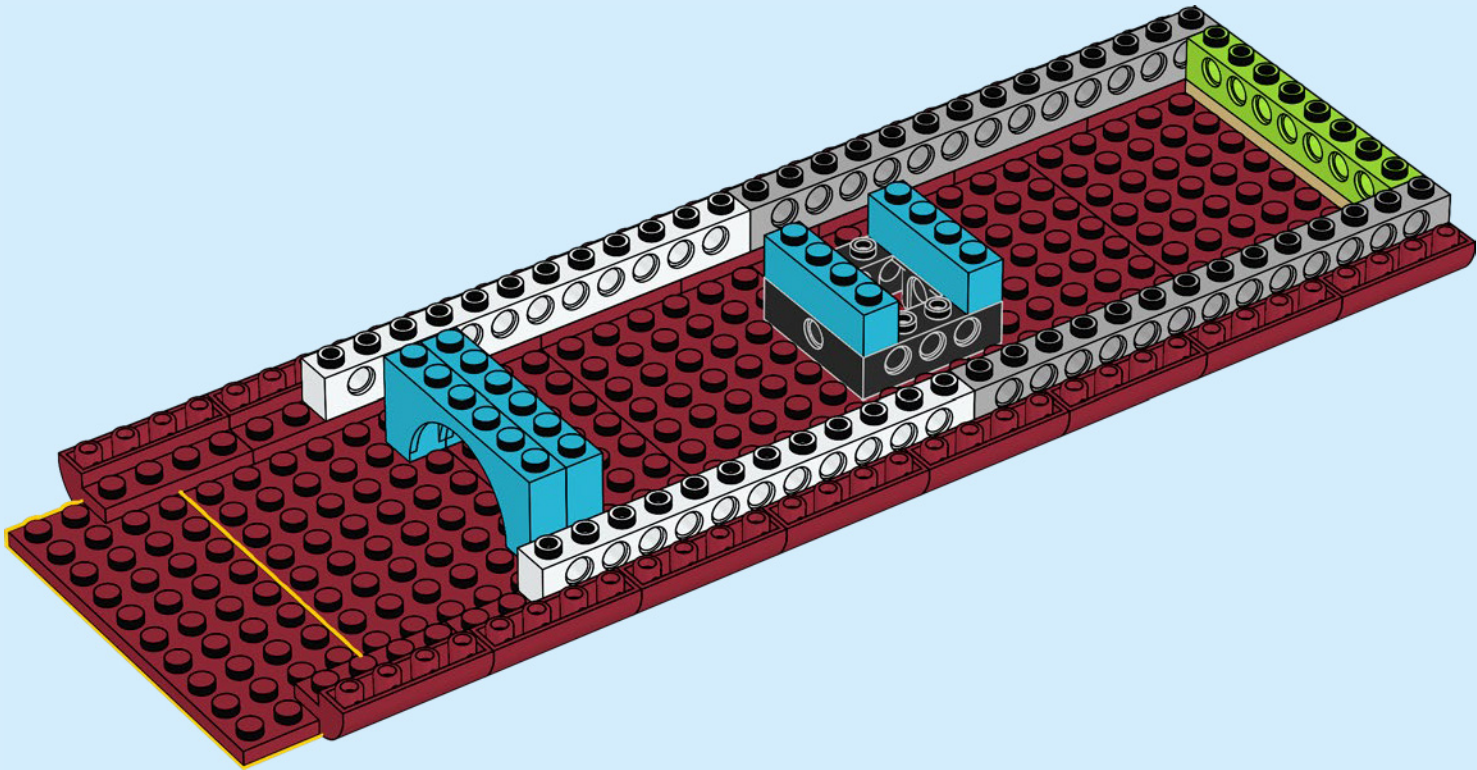

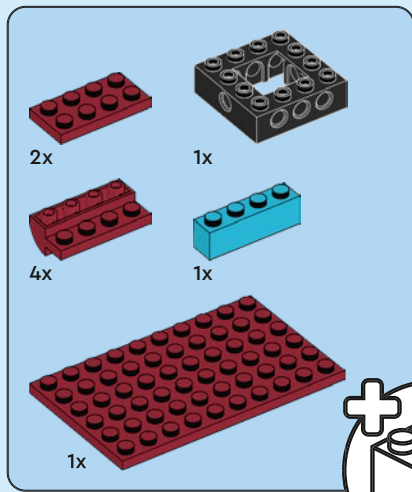

13

1

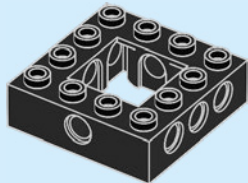

2

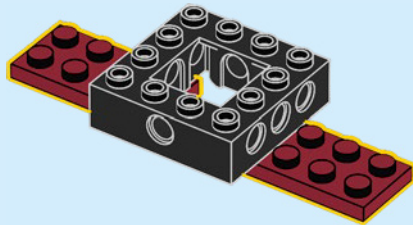

3

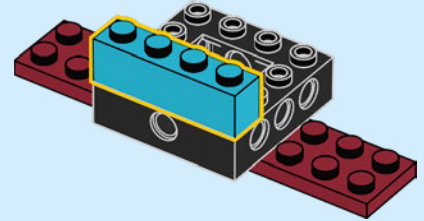

4

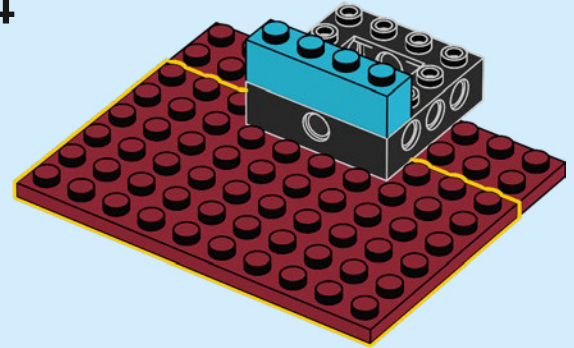

5

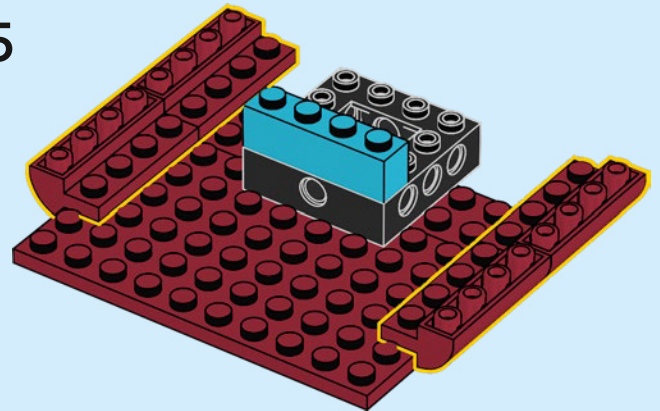

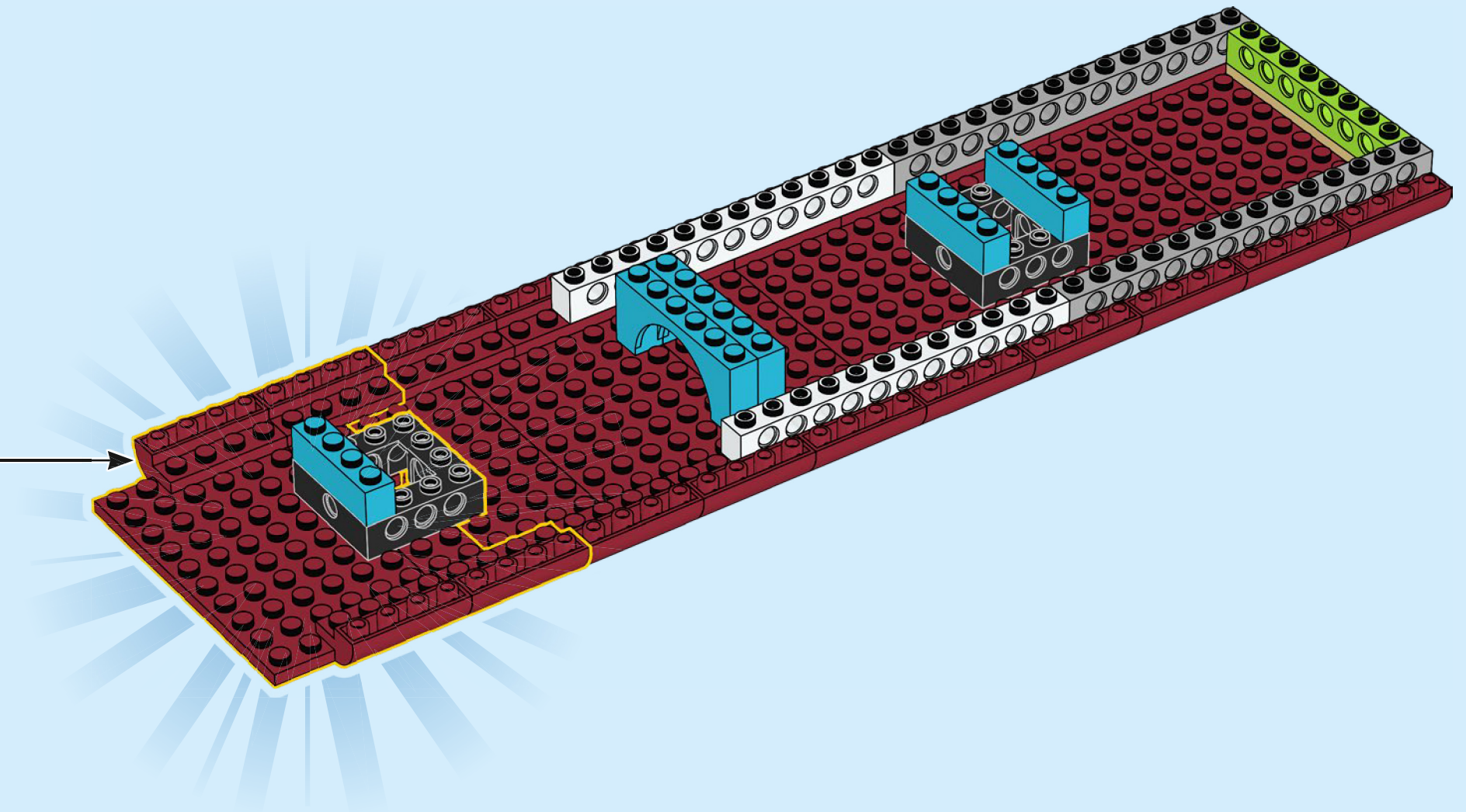

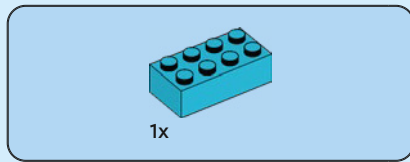

14

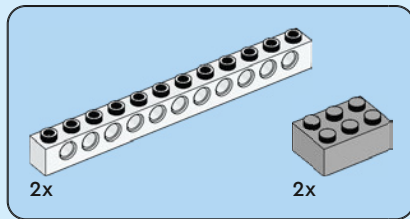
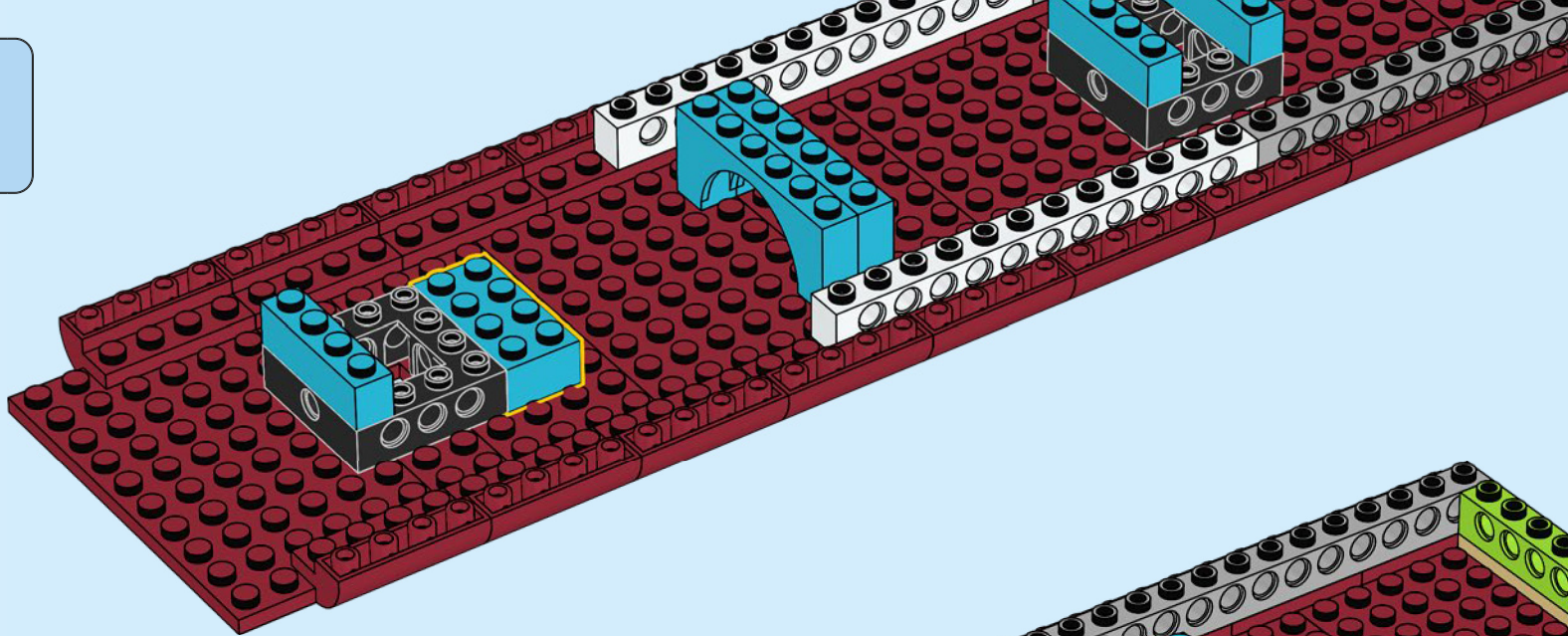

15

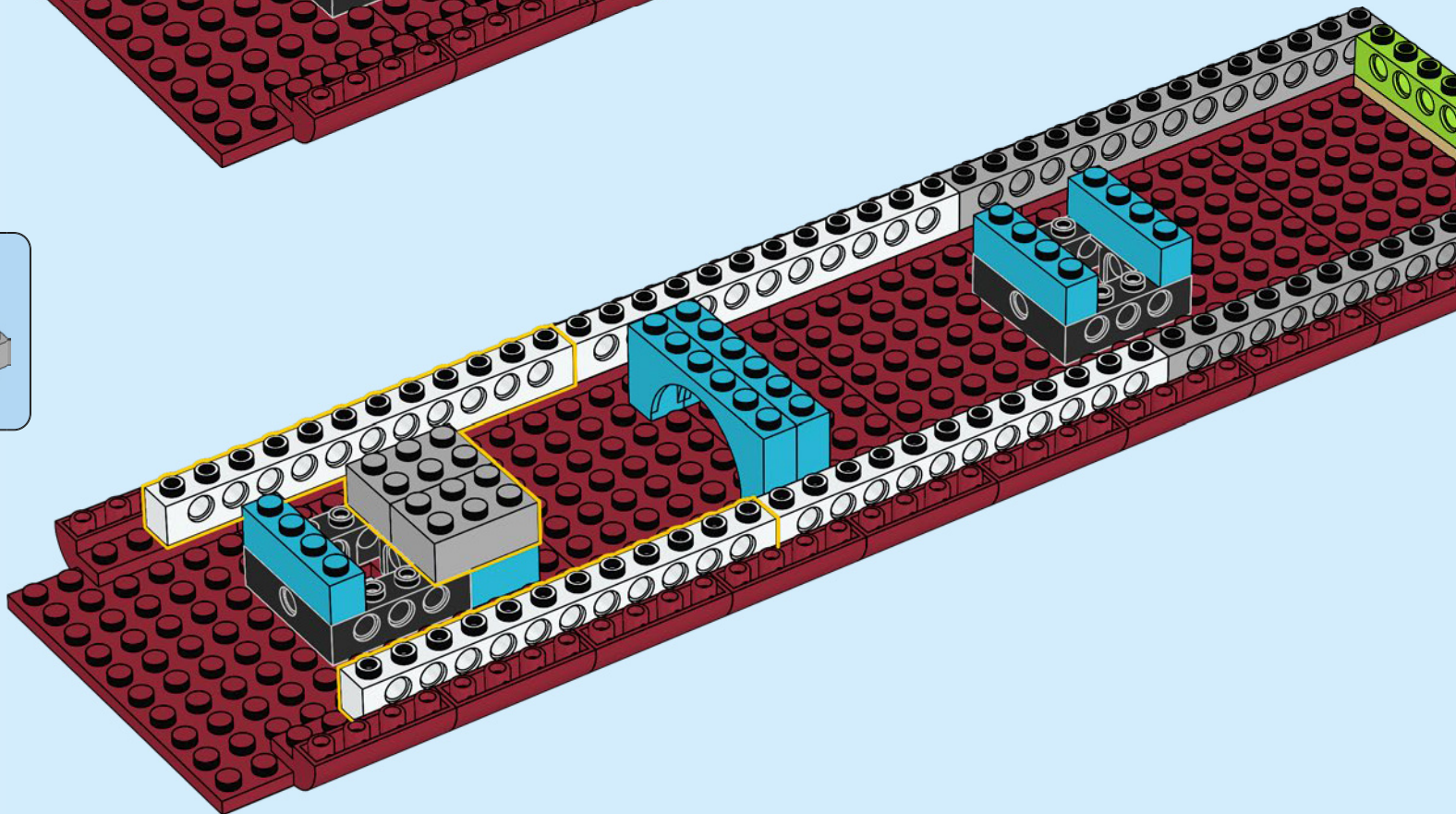

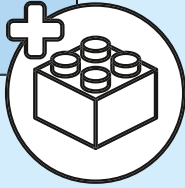
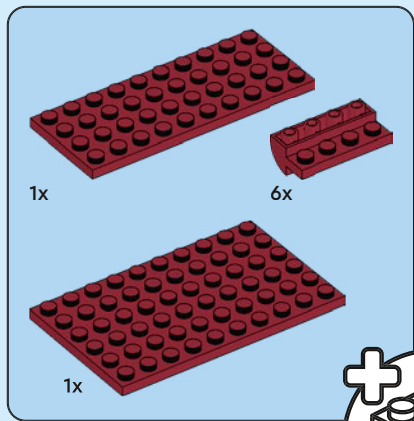

16

1

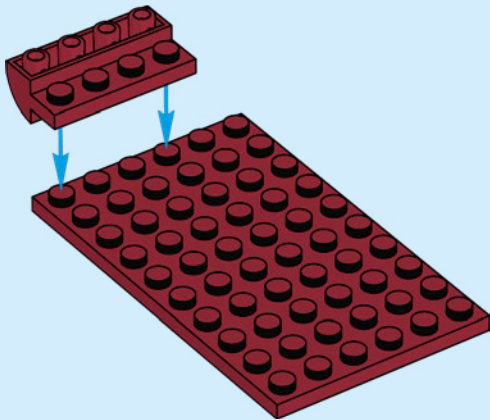

2

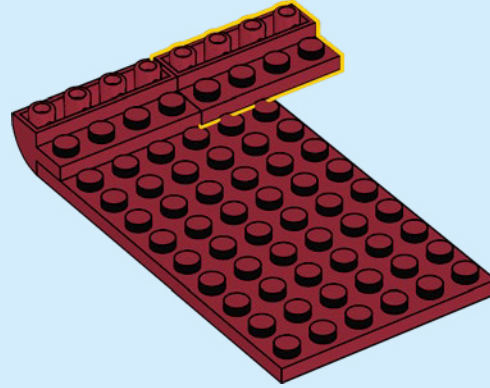

3

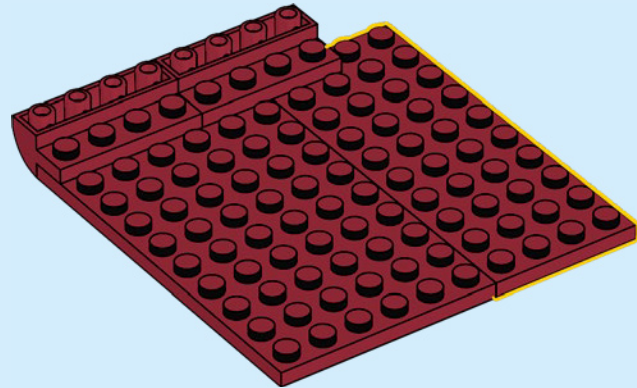

4

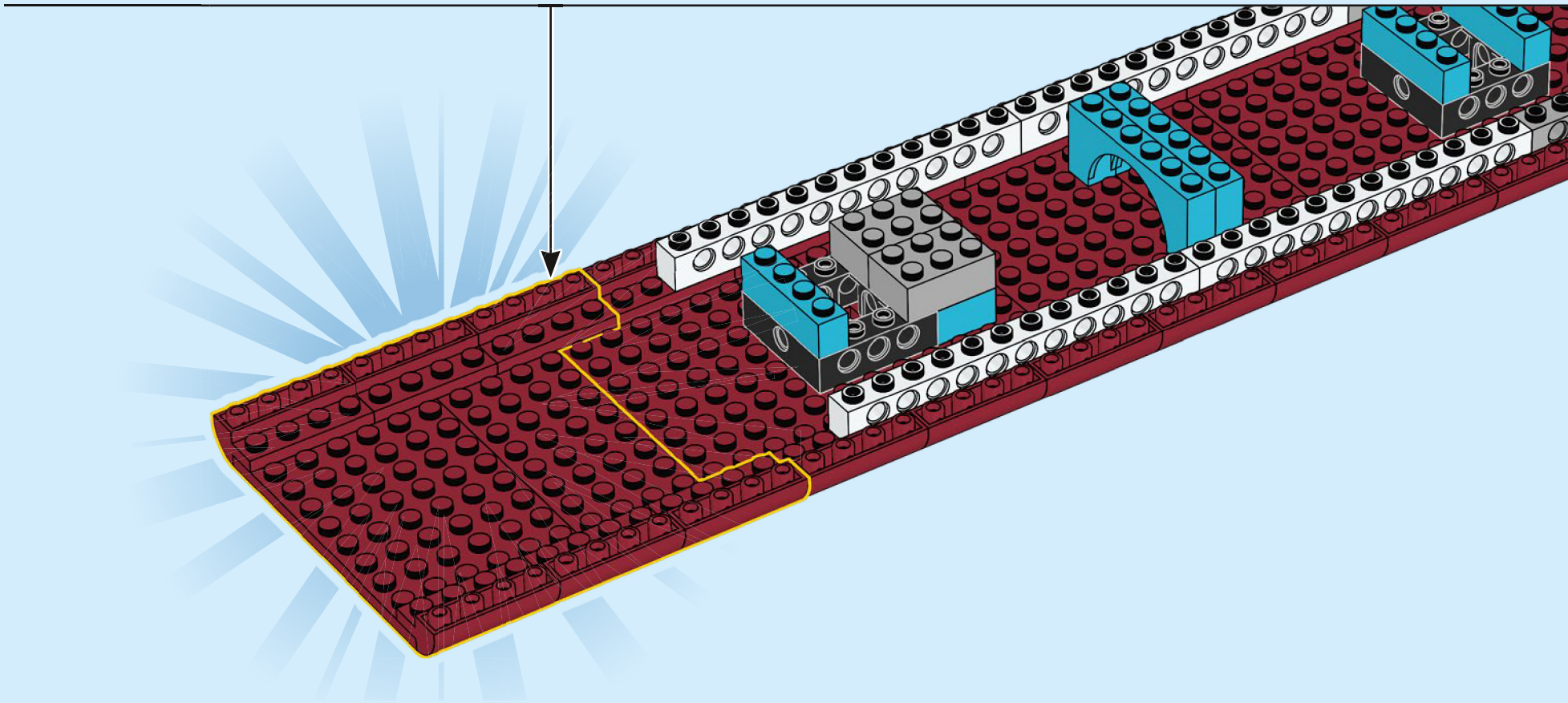
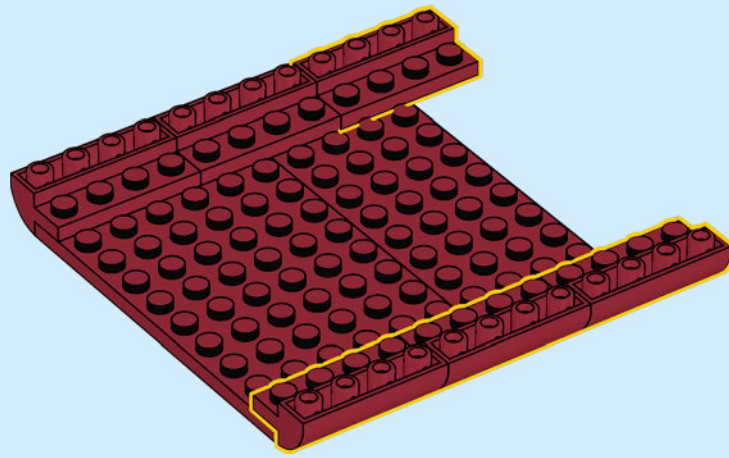

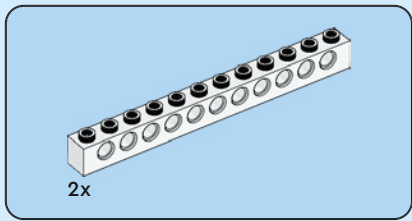

17

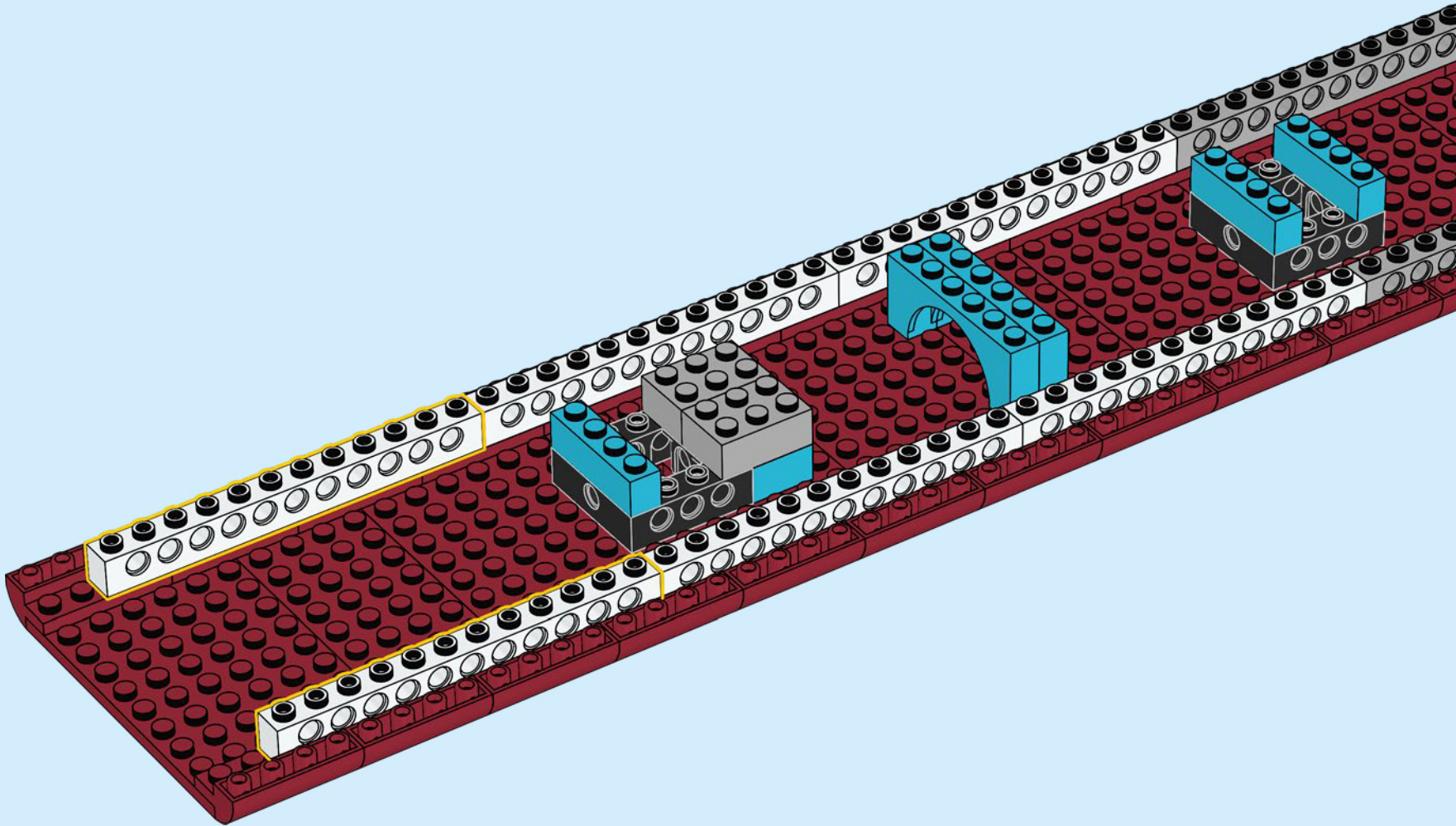

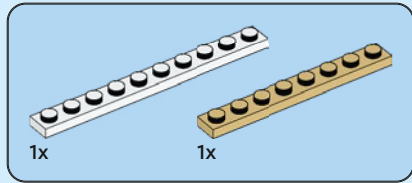

18

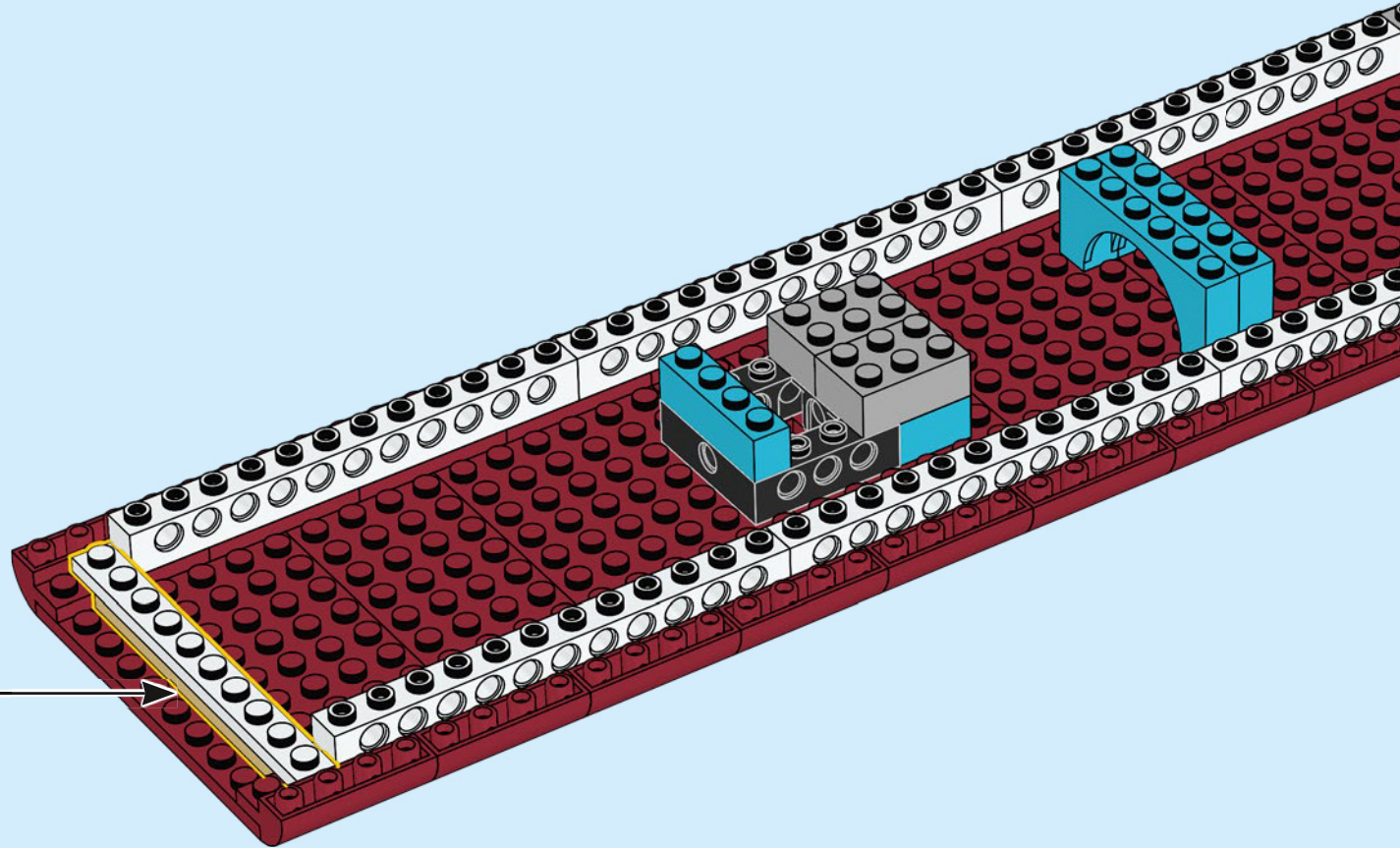
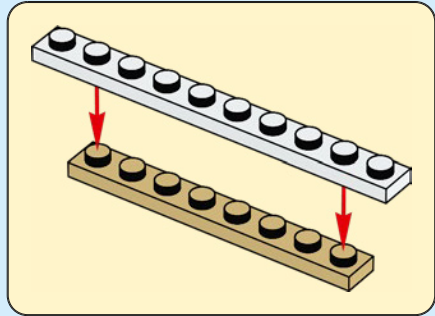

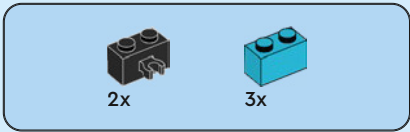

19

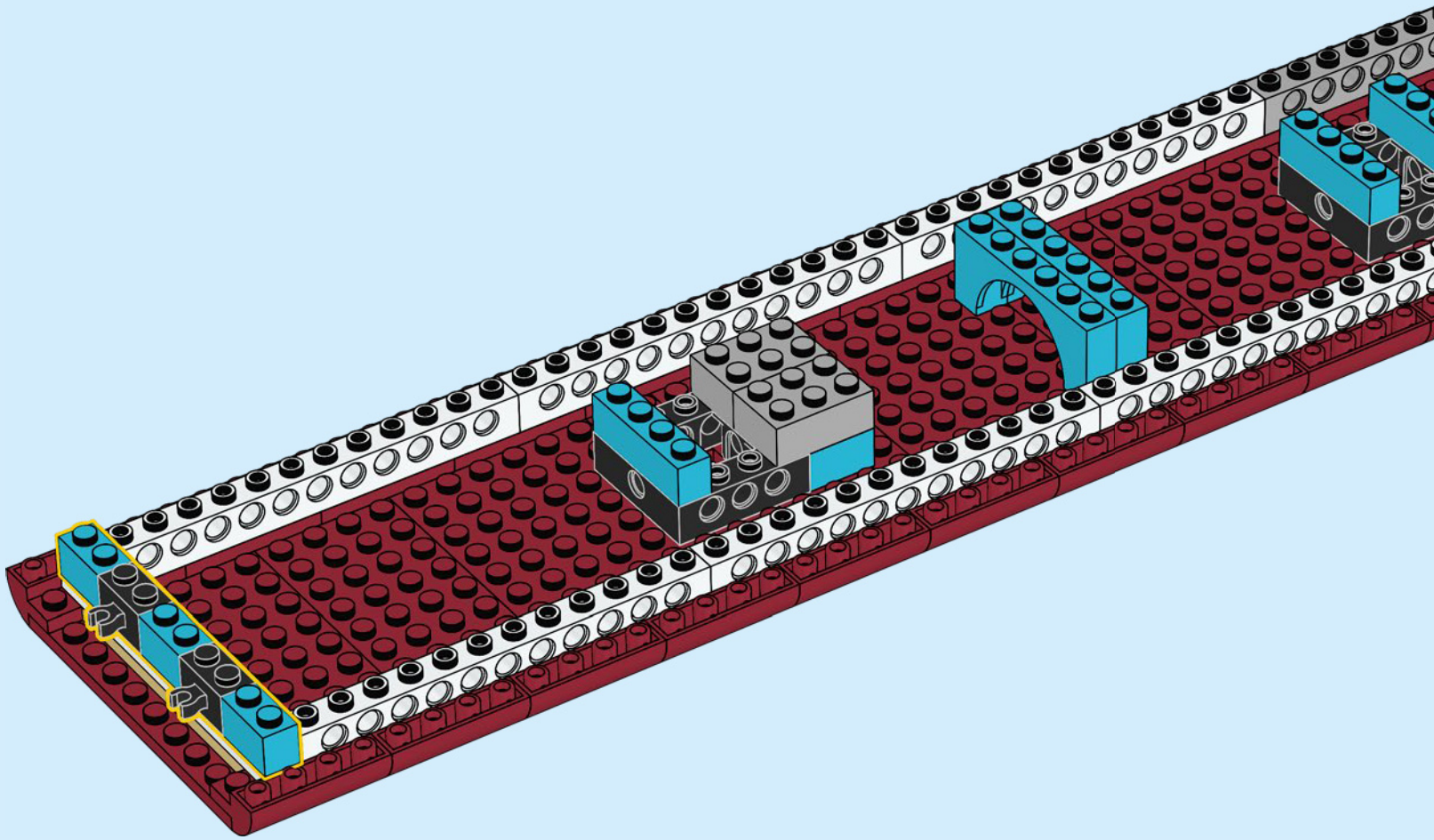

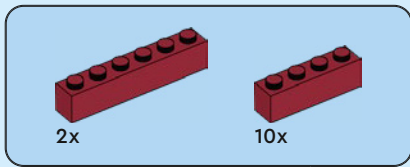

20

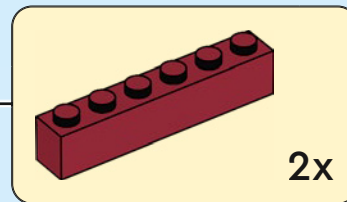
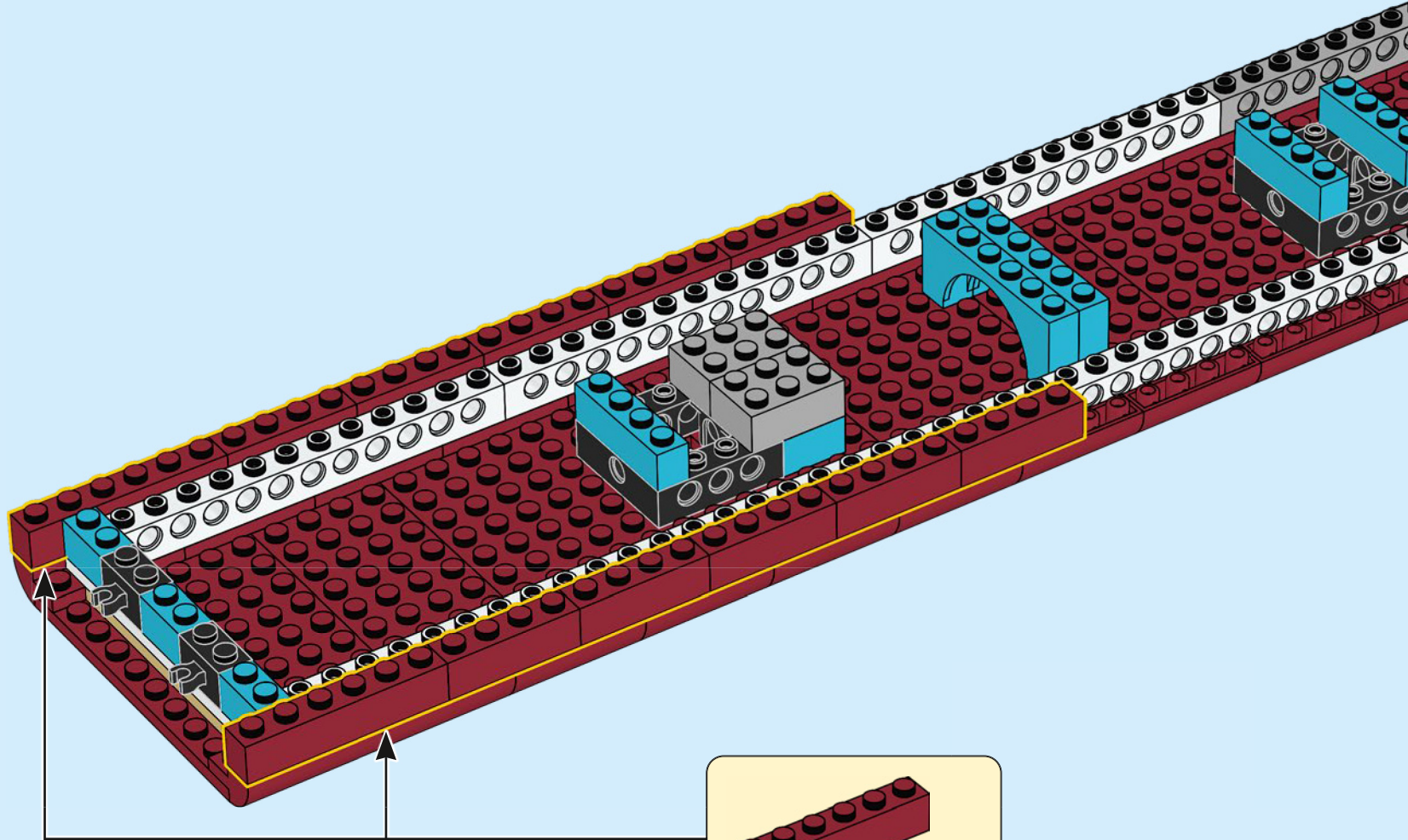

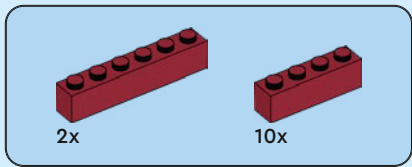

21

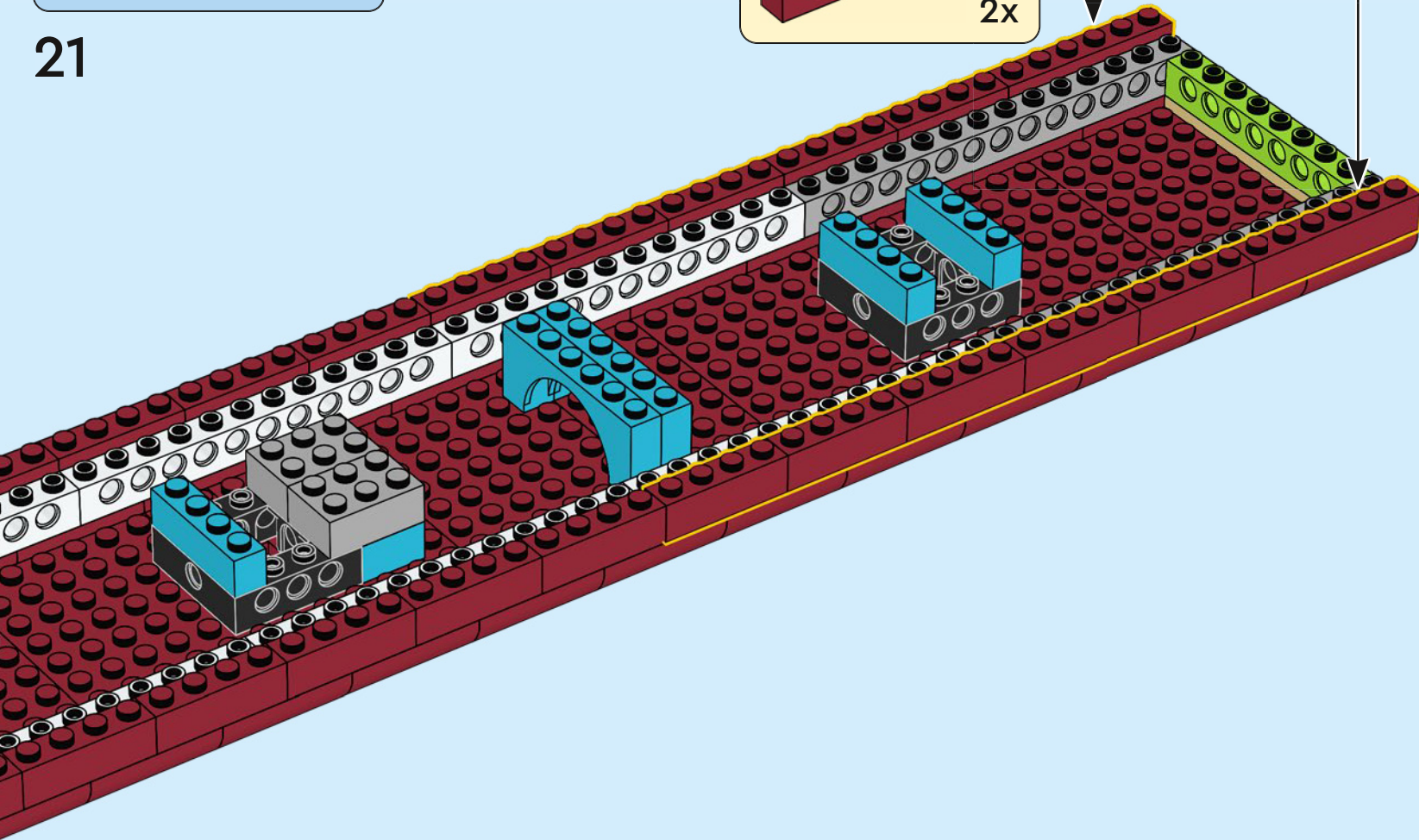
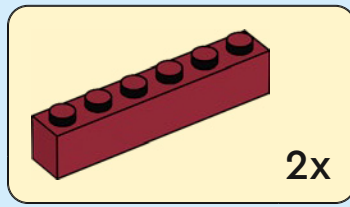

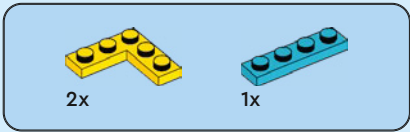

22

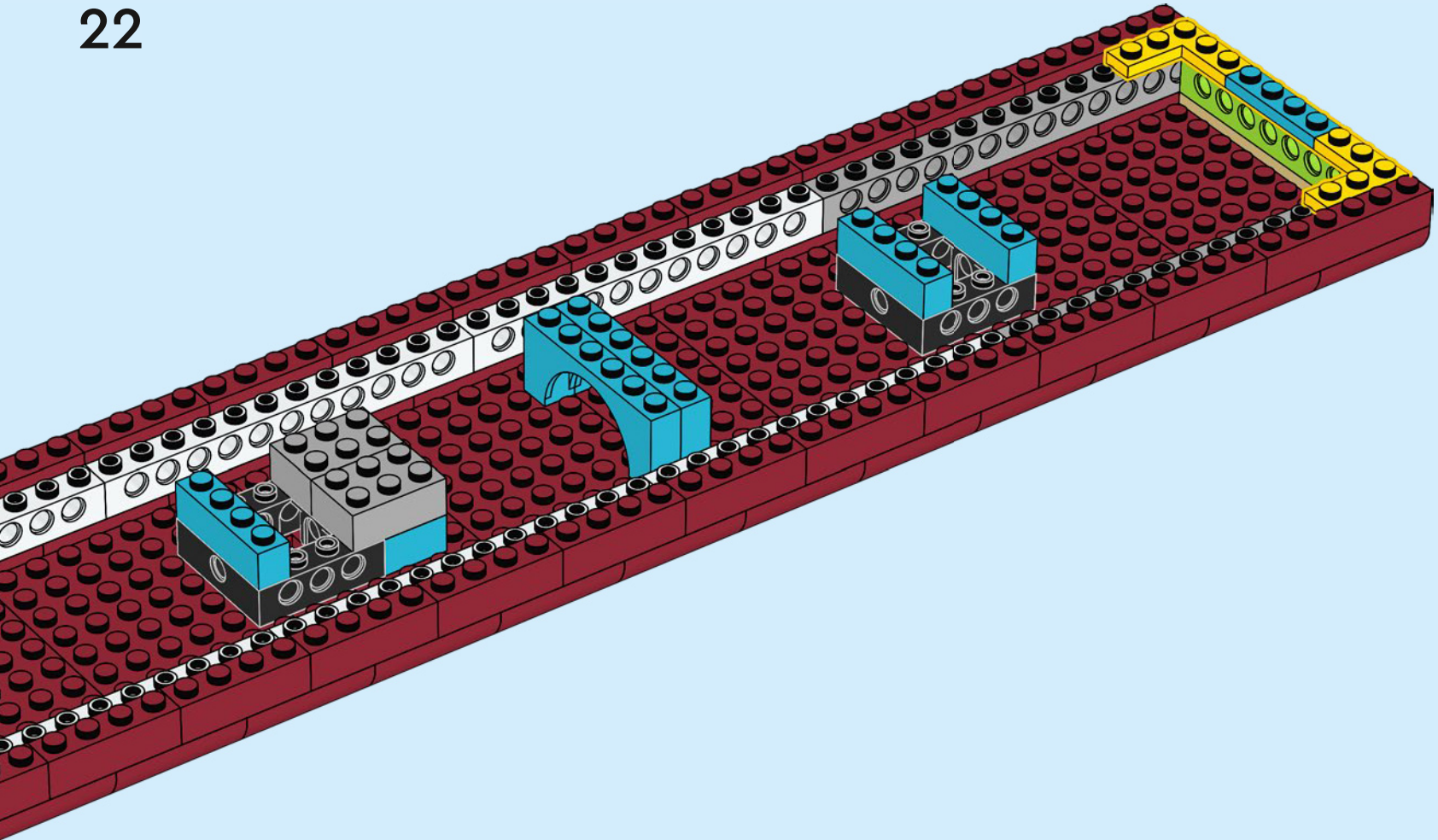

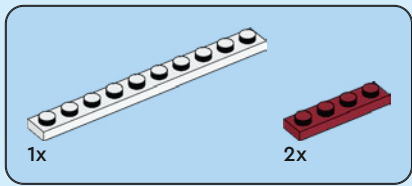

23

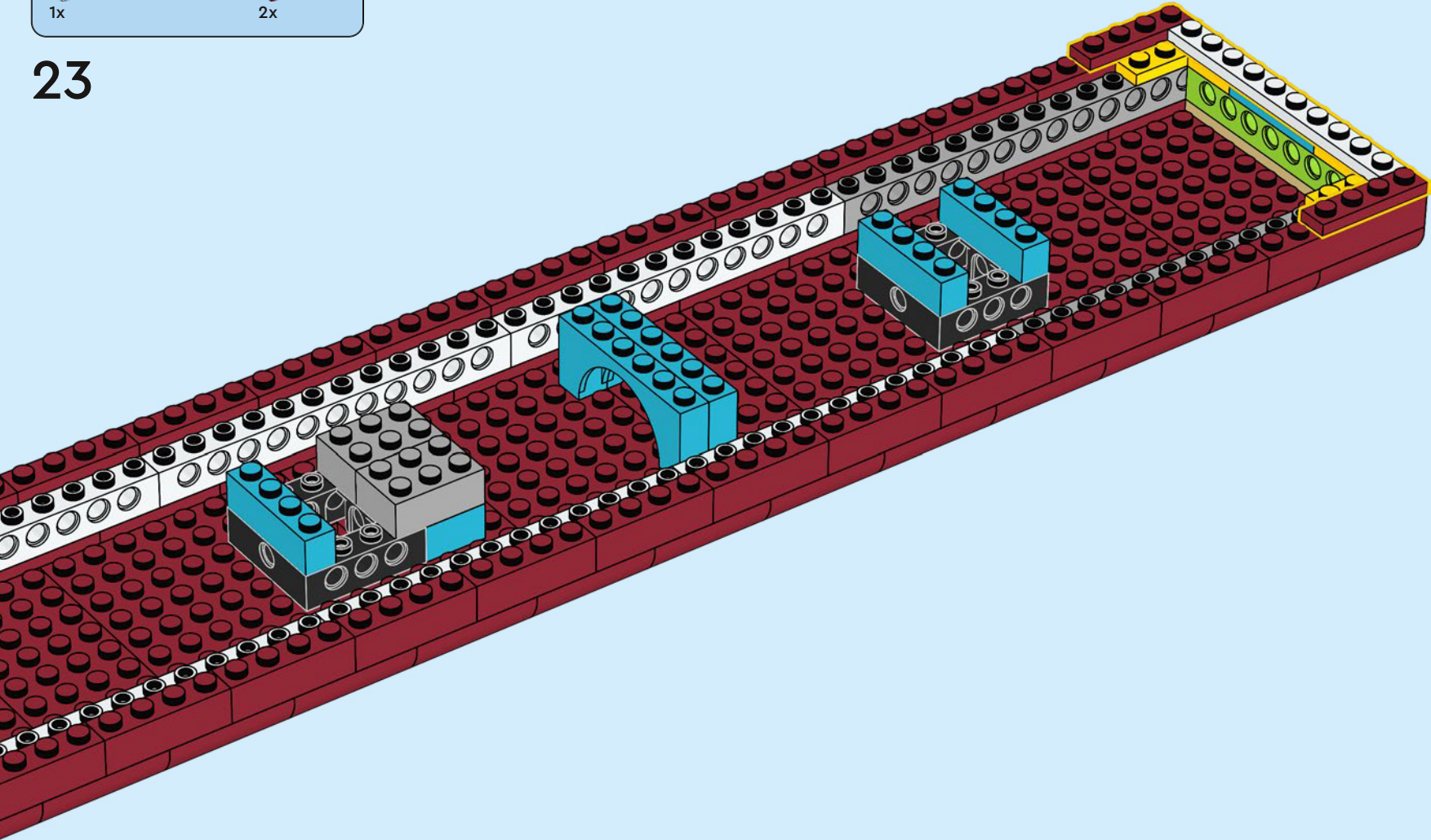

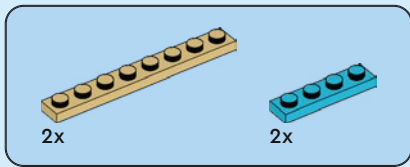

24

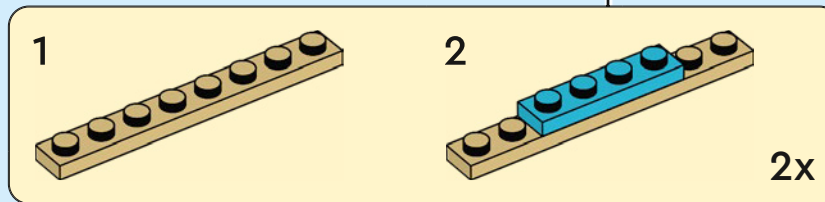
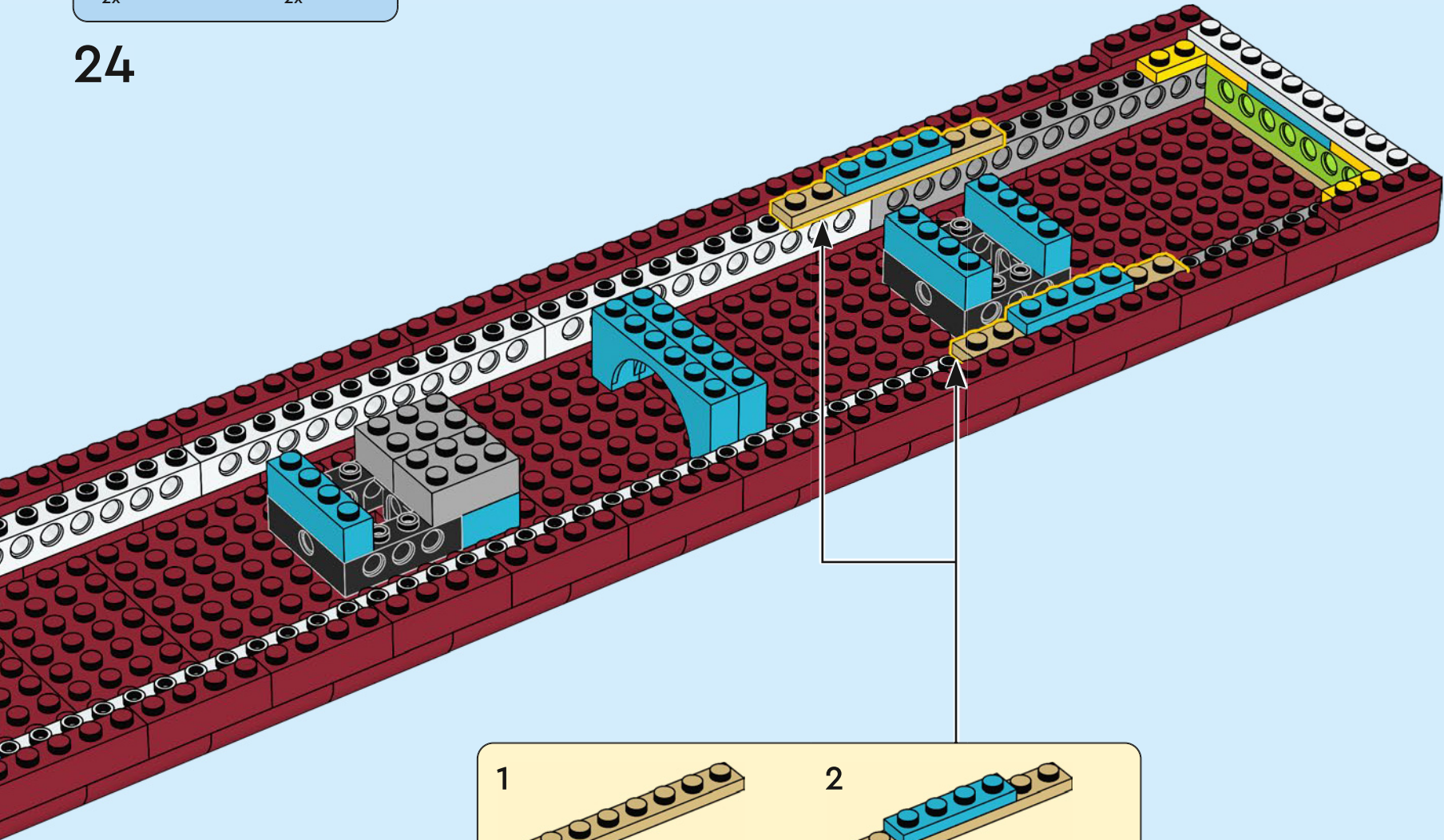

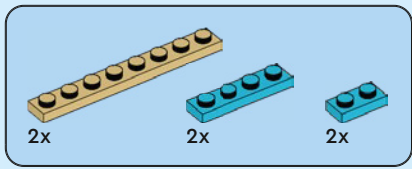

25

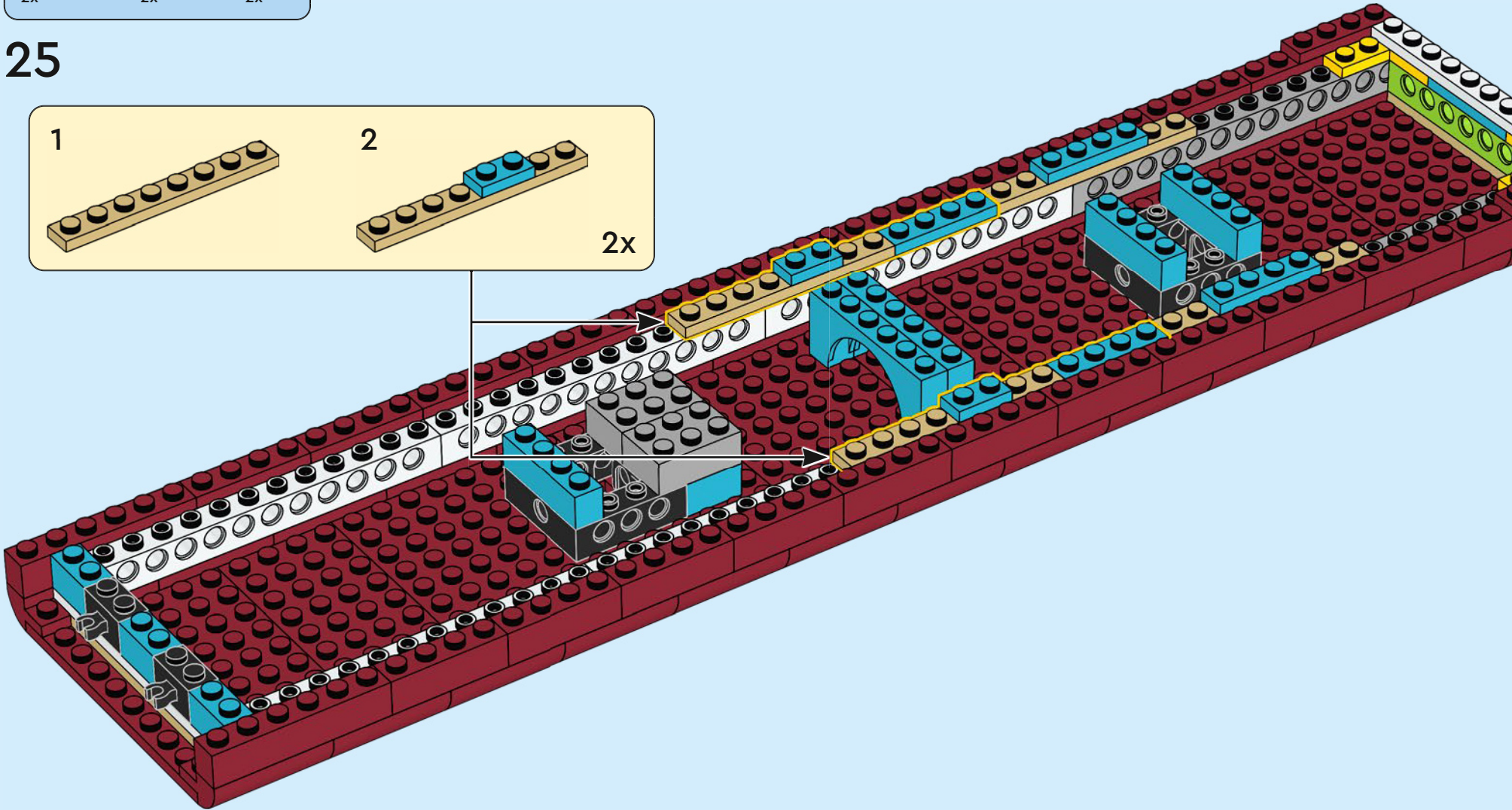
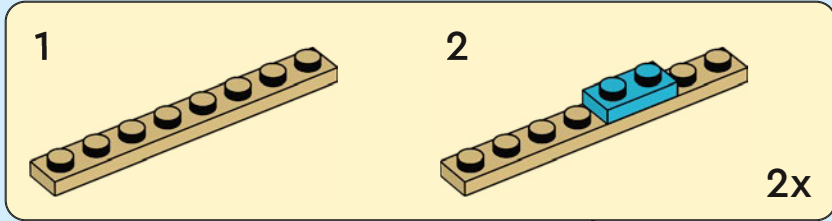

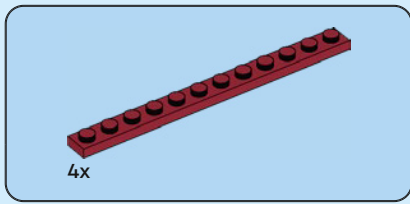

26

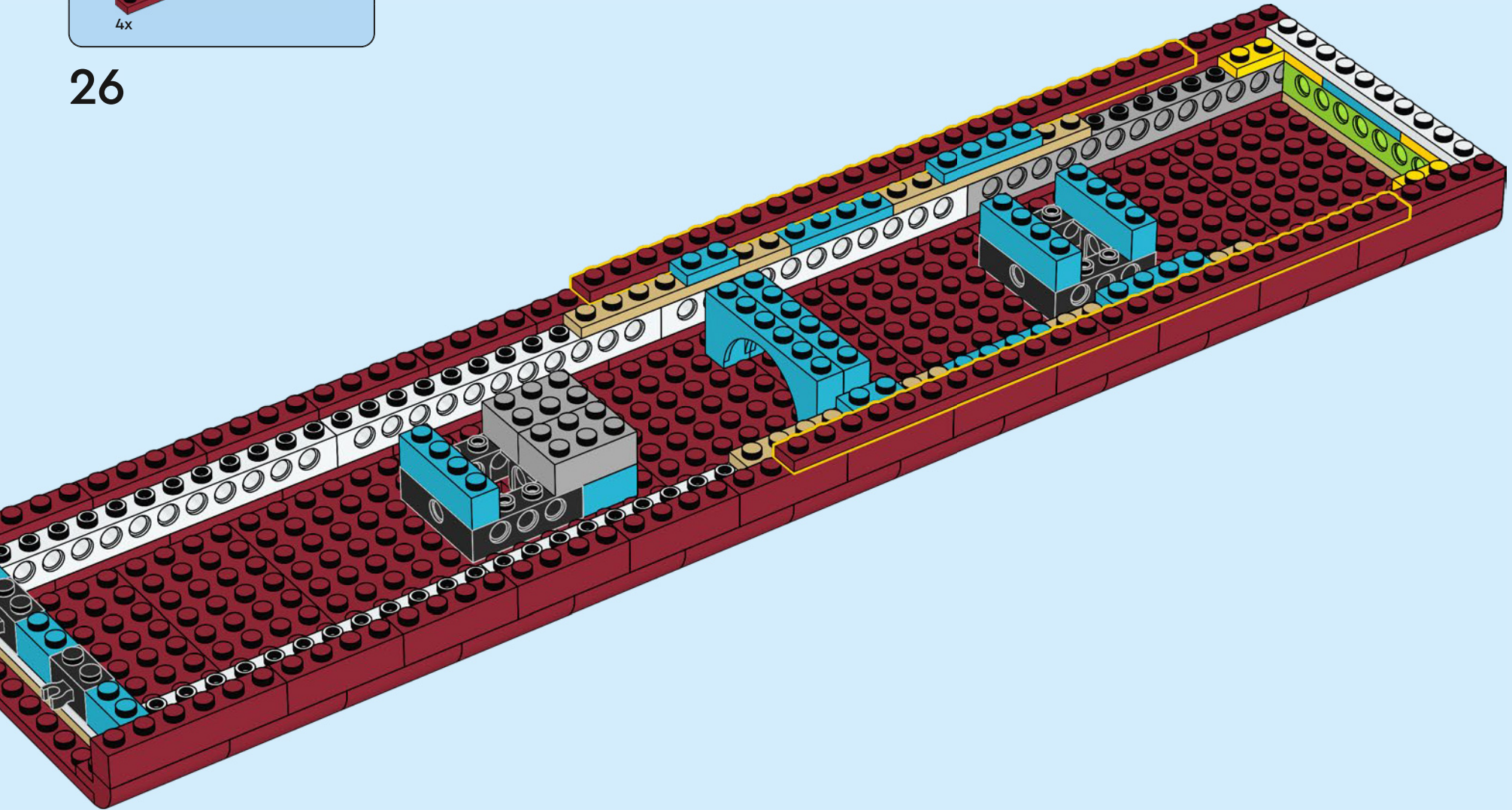

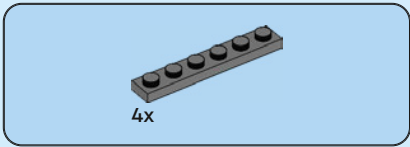

27

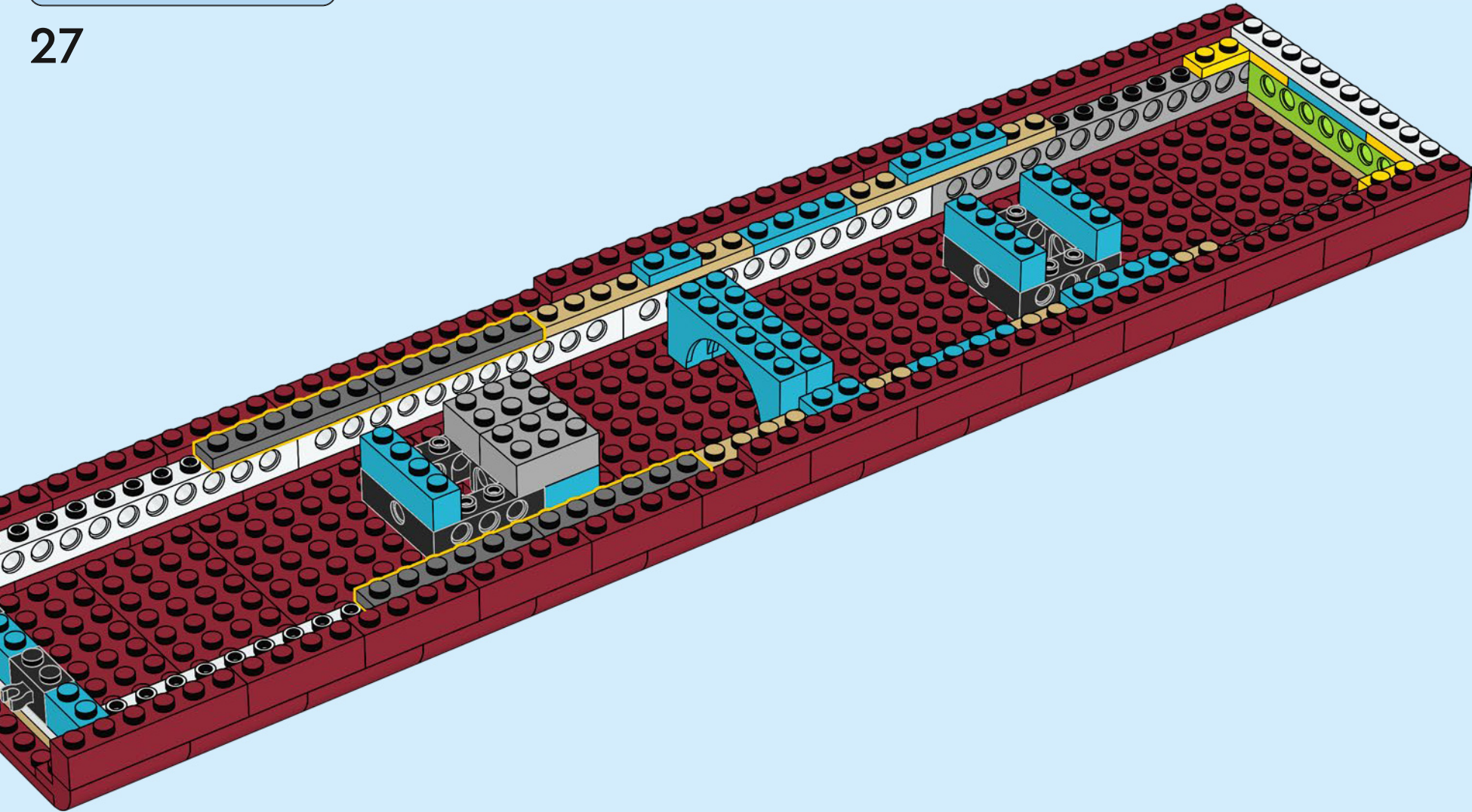

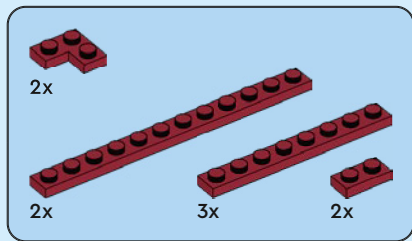

28

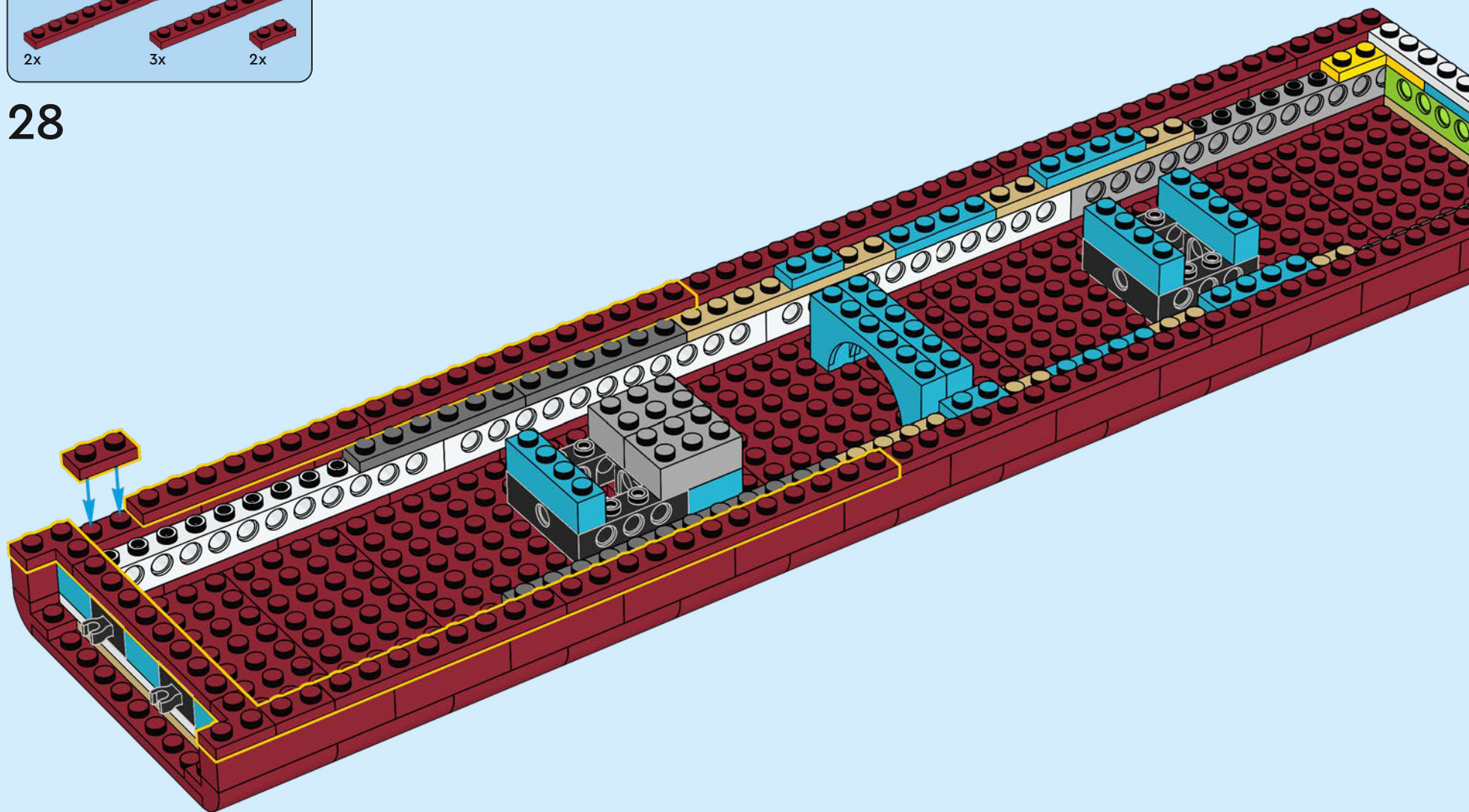

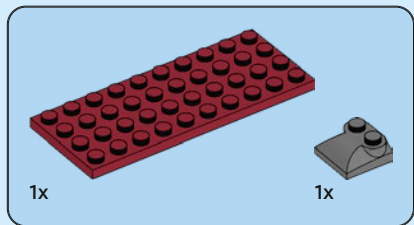
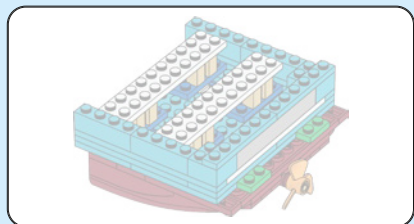

29

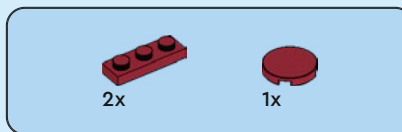
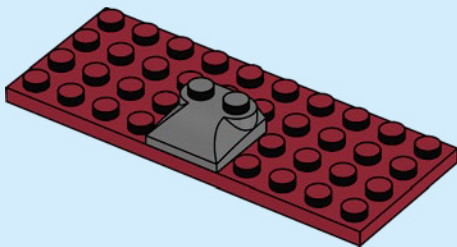

30

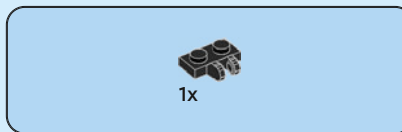
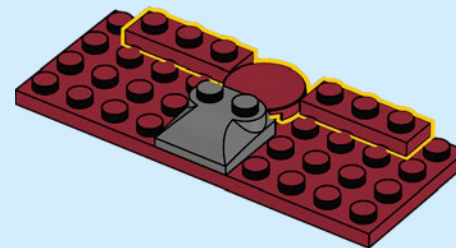

31

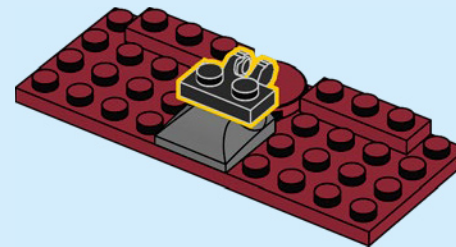

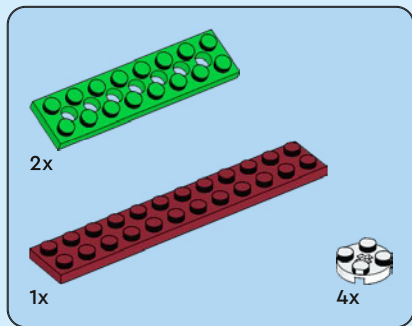

32

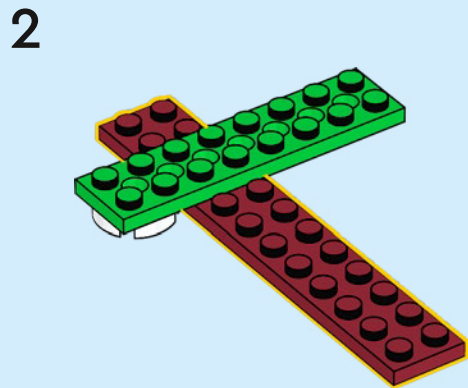
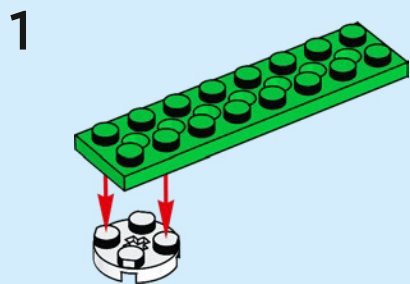

3

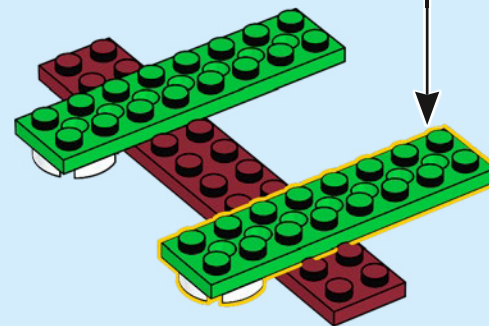
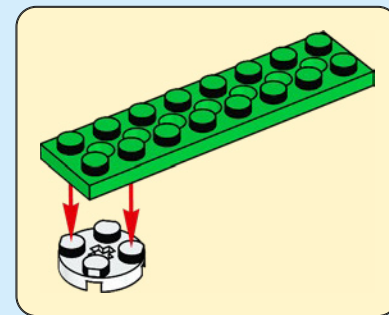

4

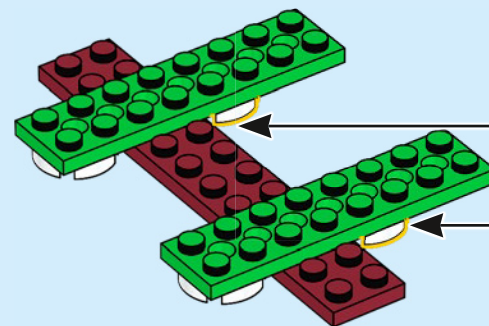

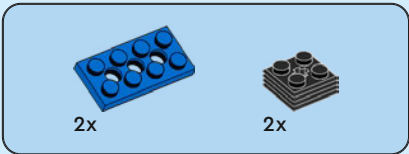

33

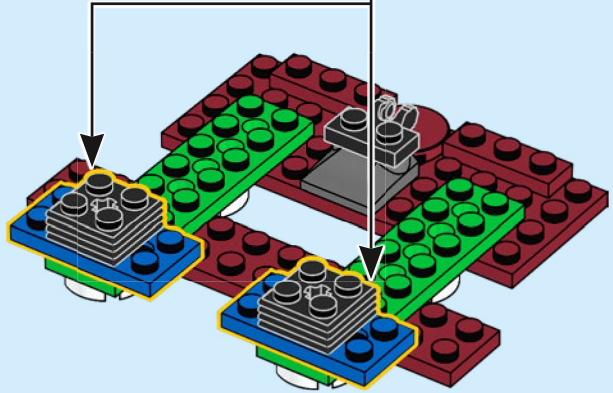
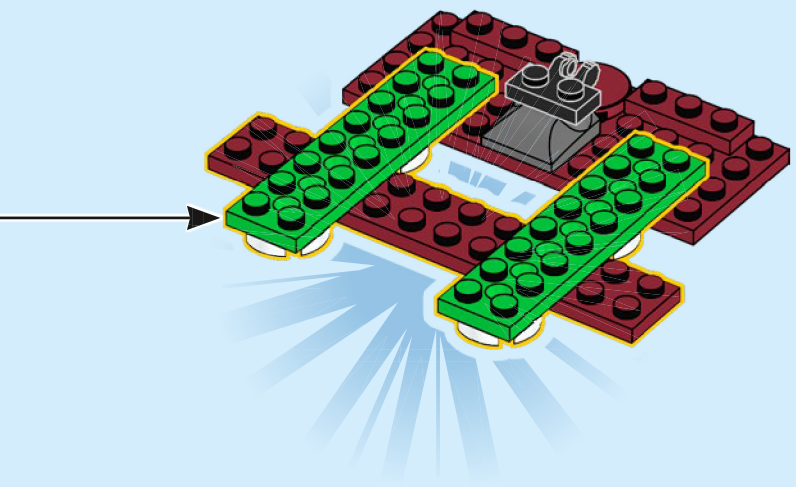
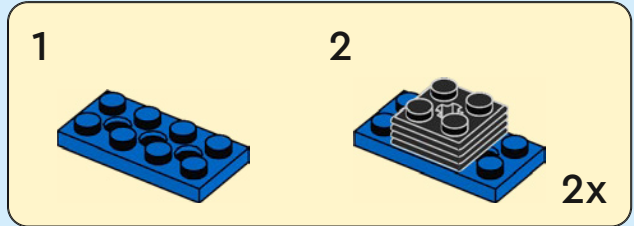

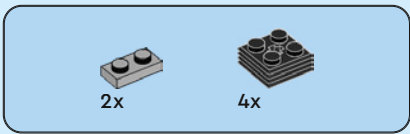

34

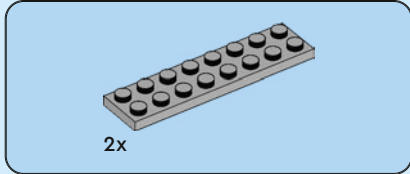
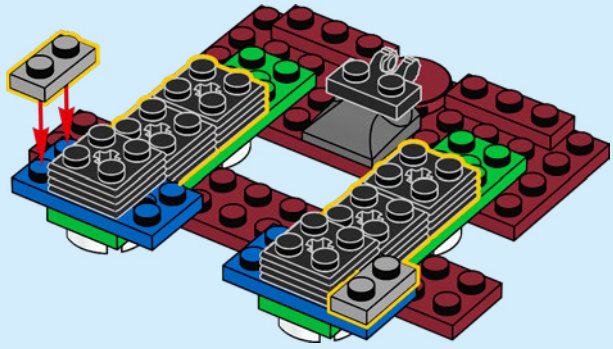

35

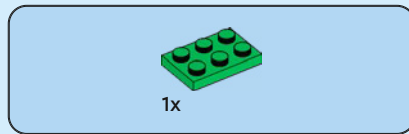
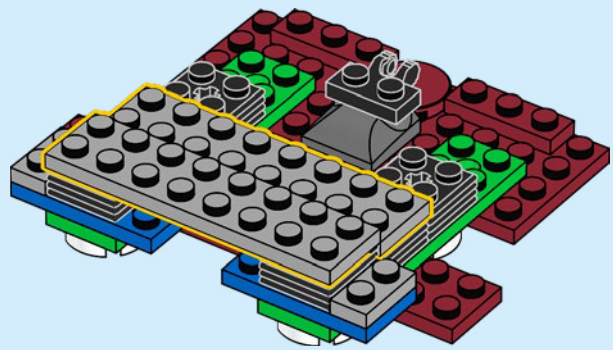

36

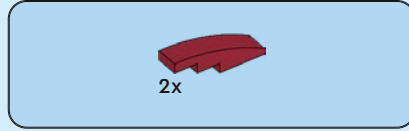
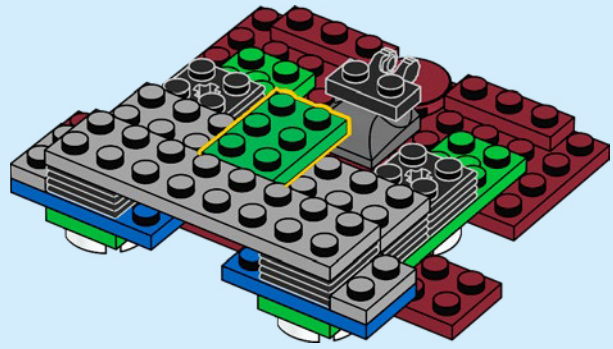

37

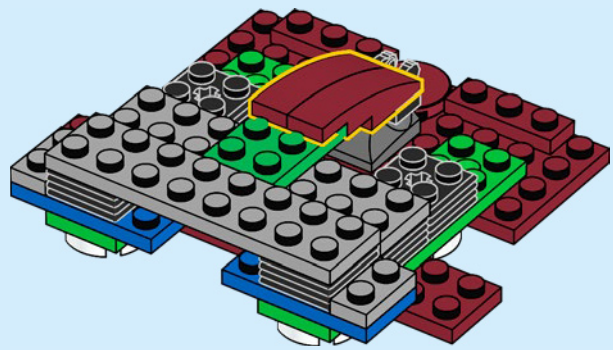

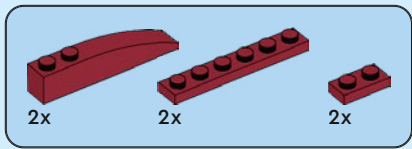

38

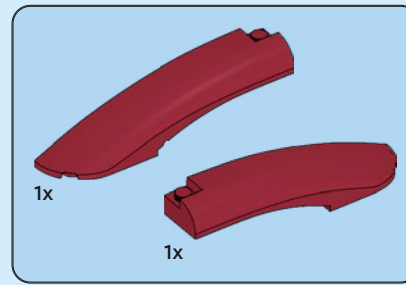
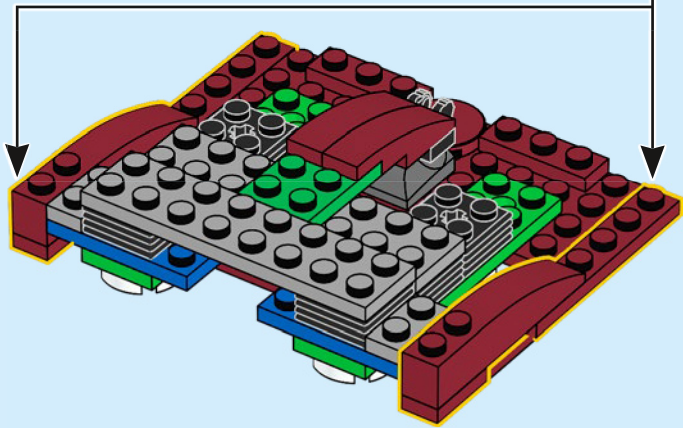
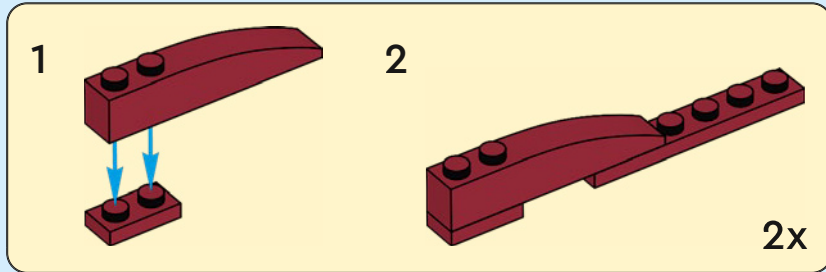

39

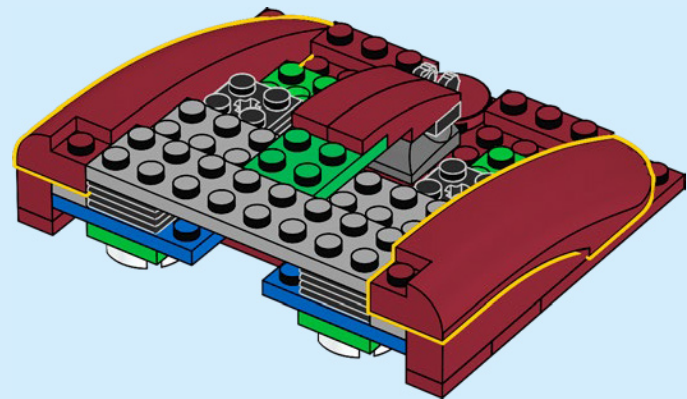

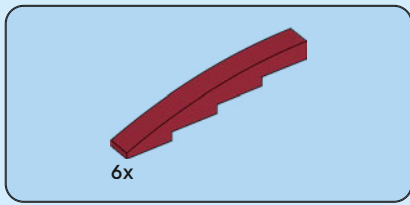

40

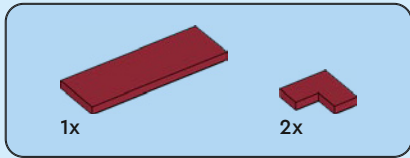
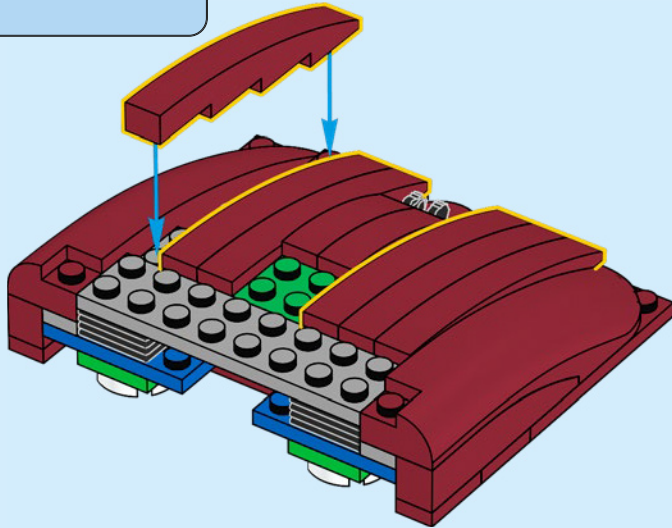

41

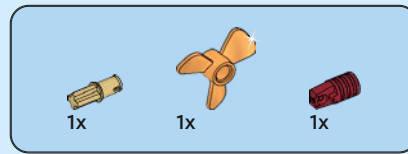
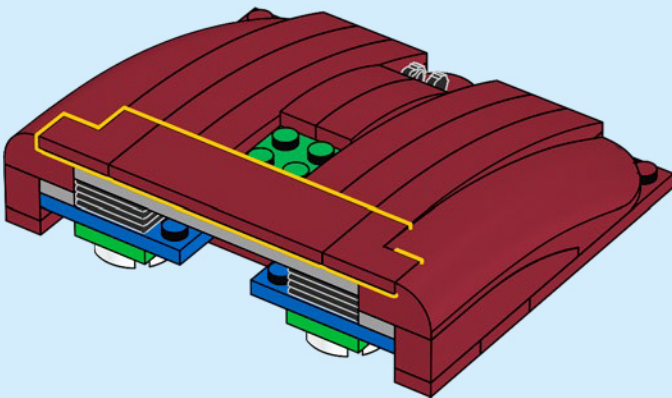

42

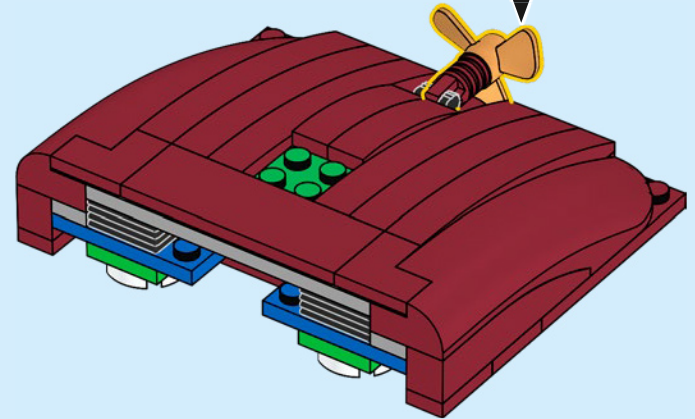
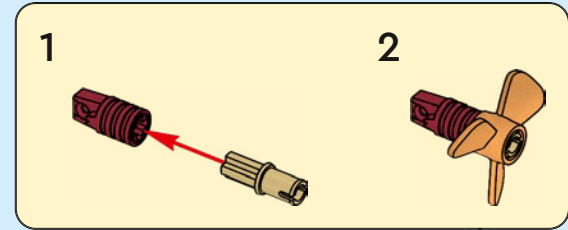

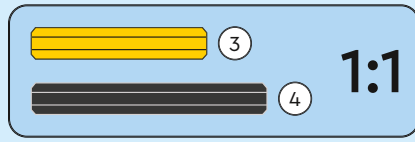
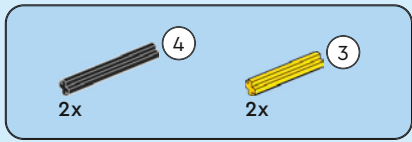

43

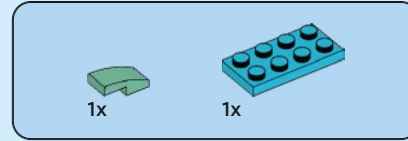
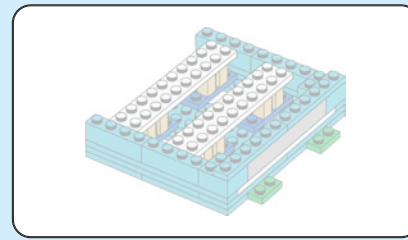
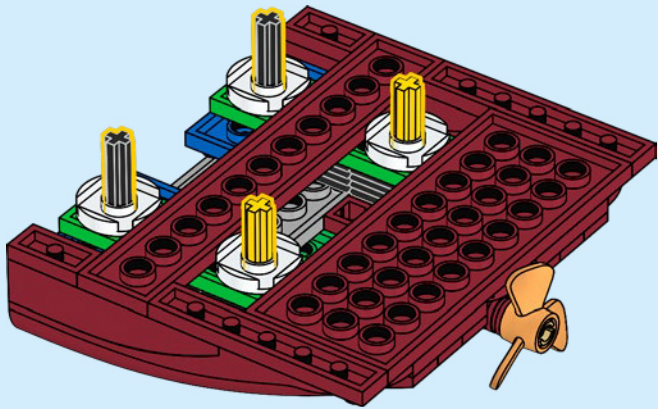

44

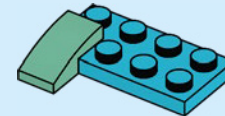

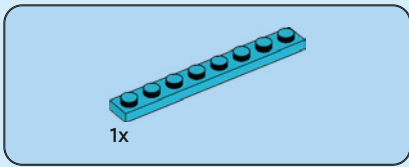

45

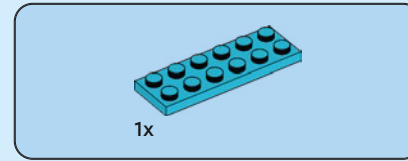
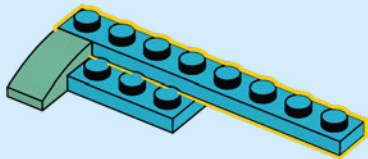
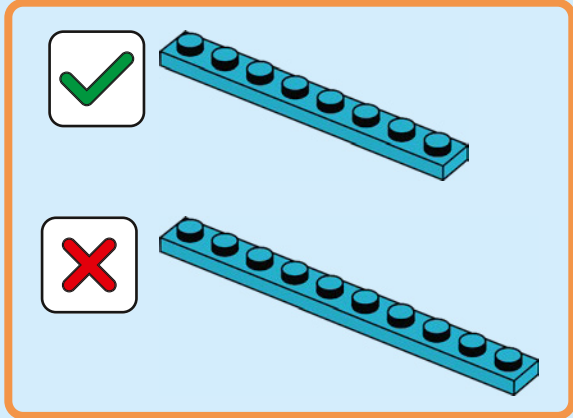

46

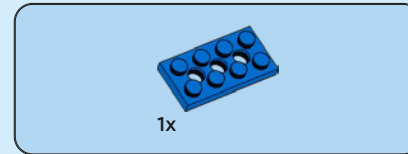
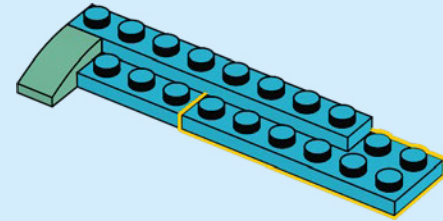

47

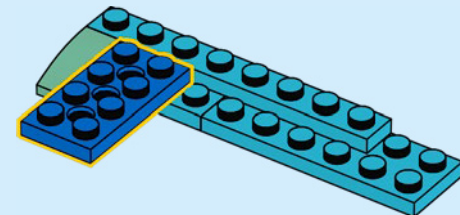

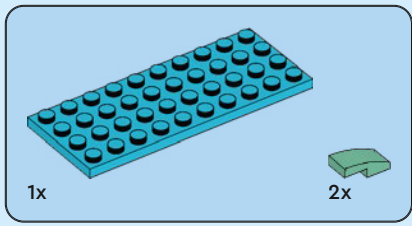

48

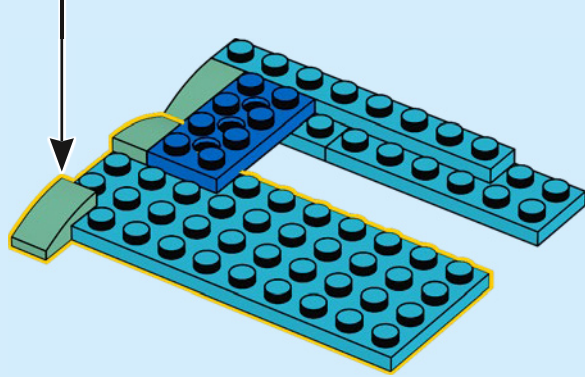
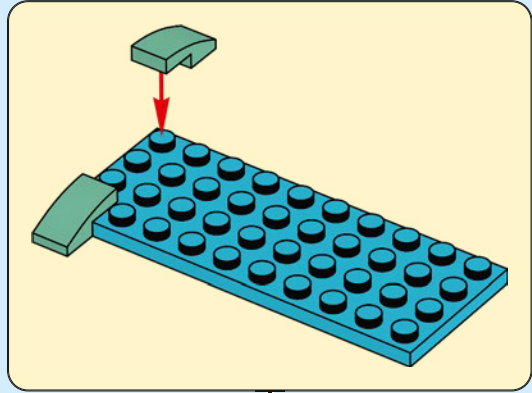

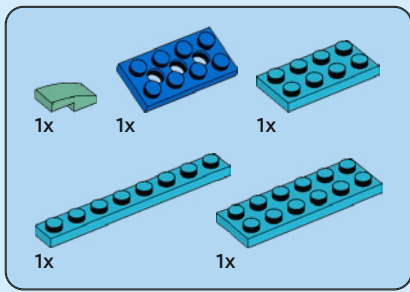

49

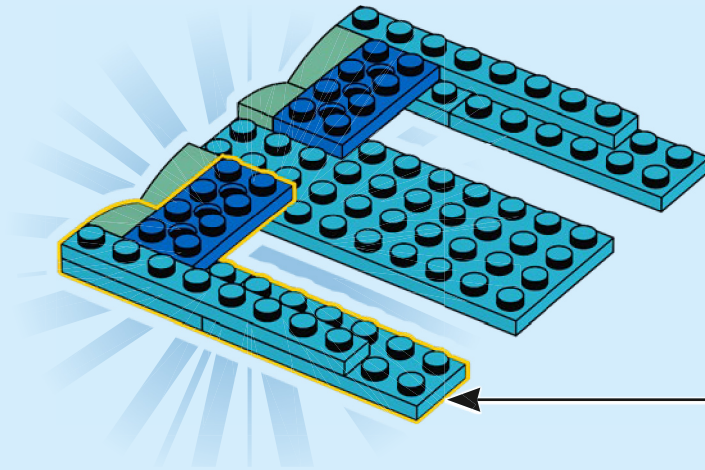
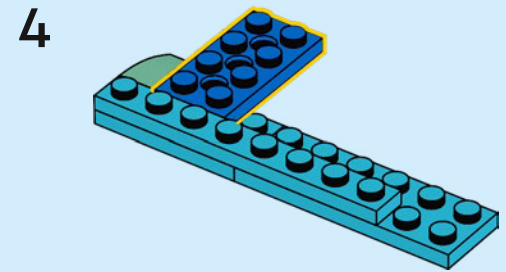
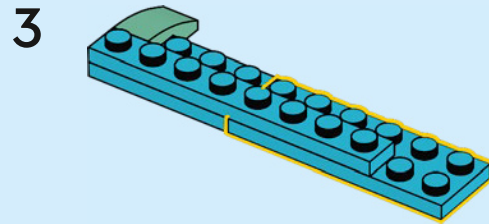
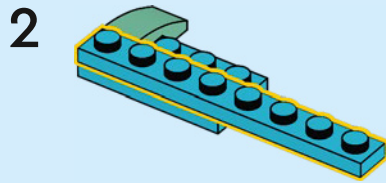
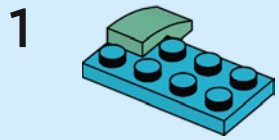
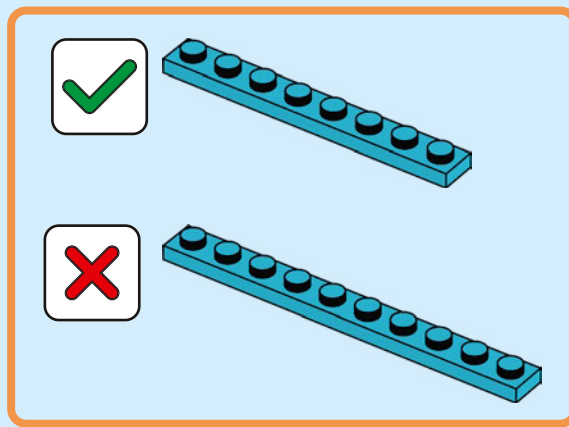



50

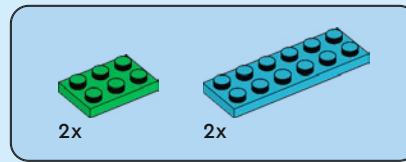
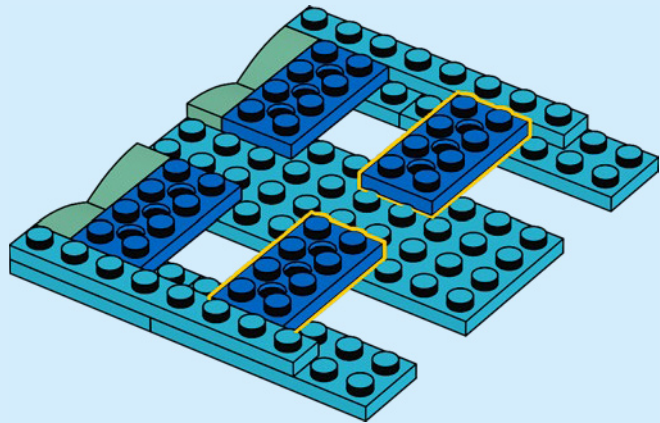

51

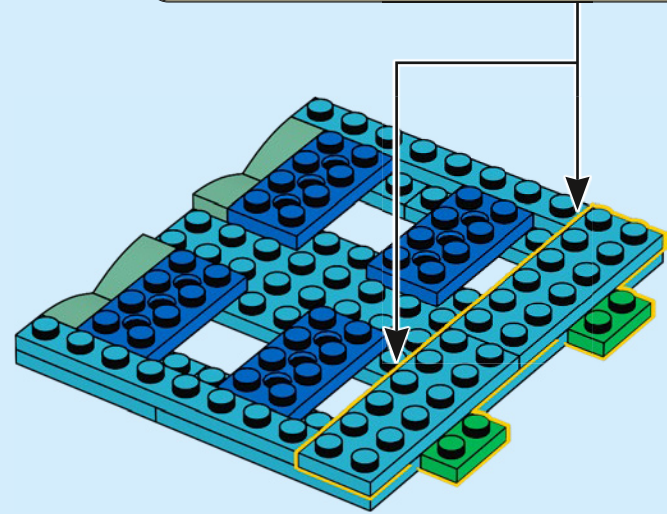
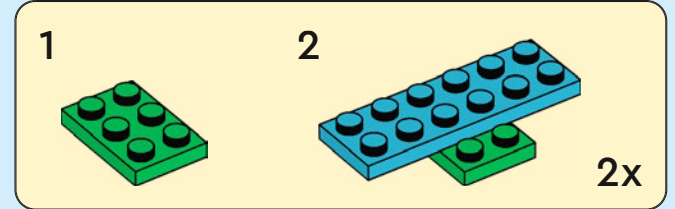

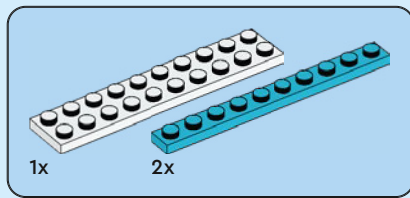

52

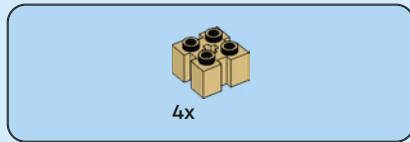
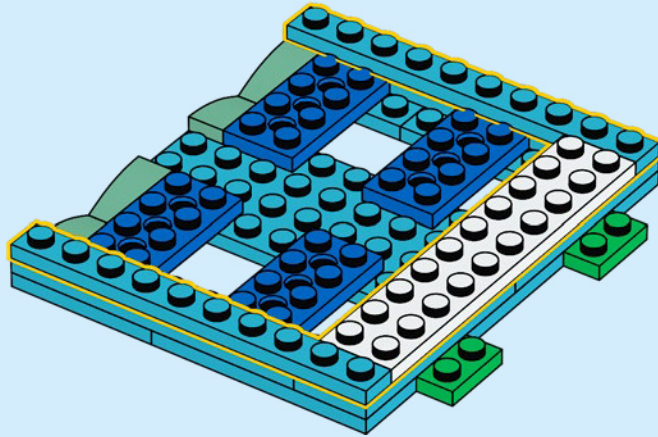

53

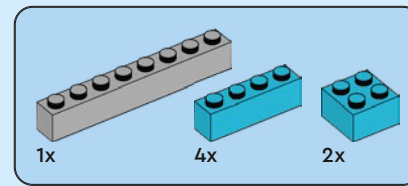
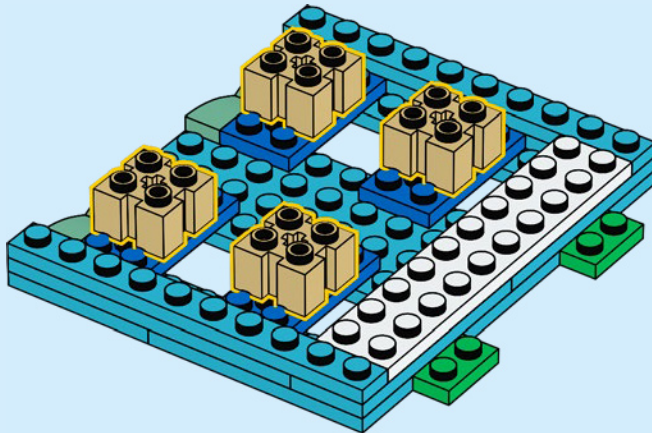

54

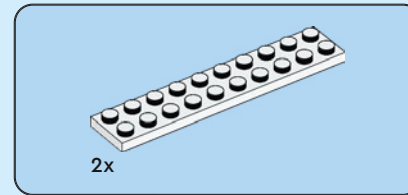
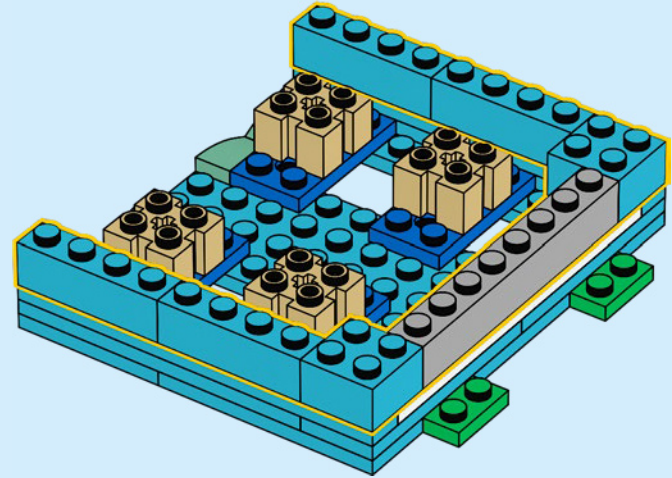

55

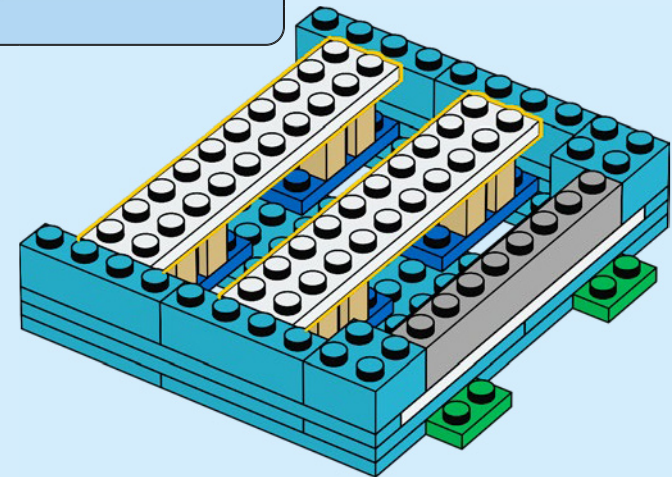

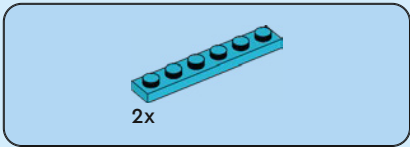

56

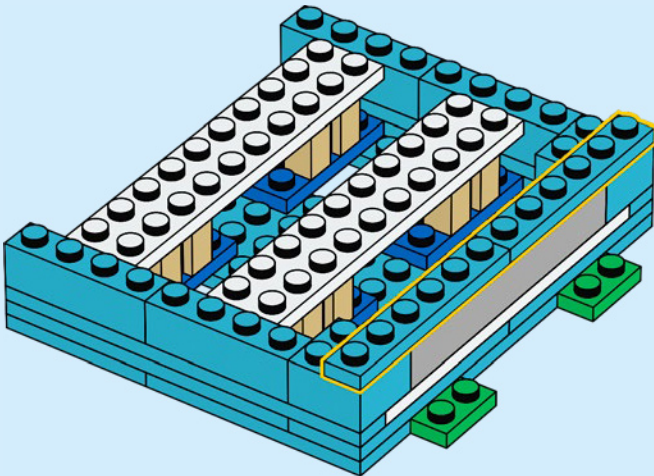

57

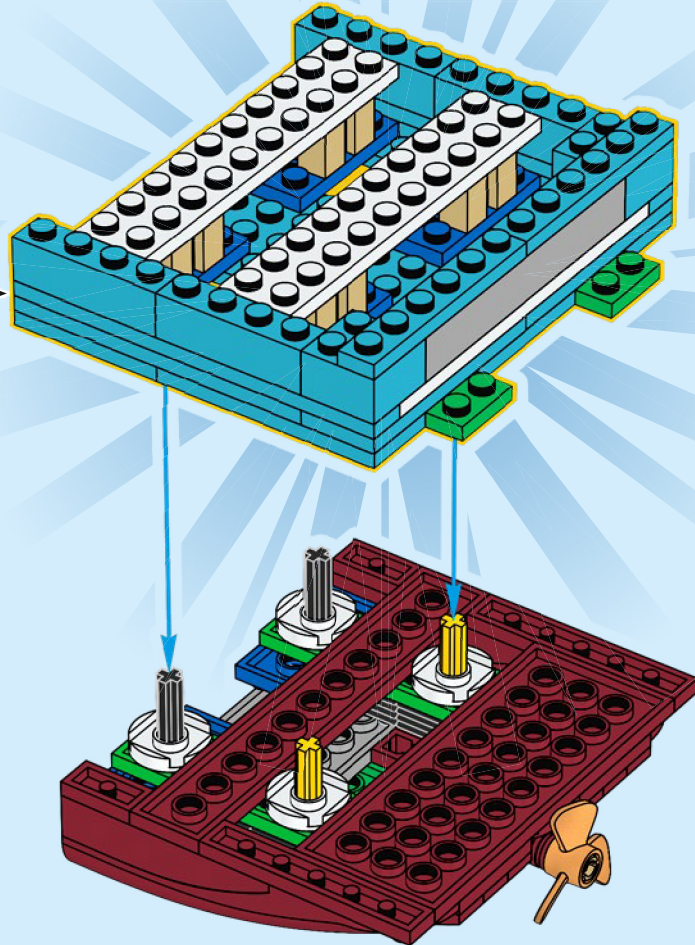

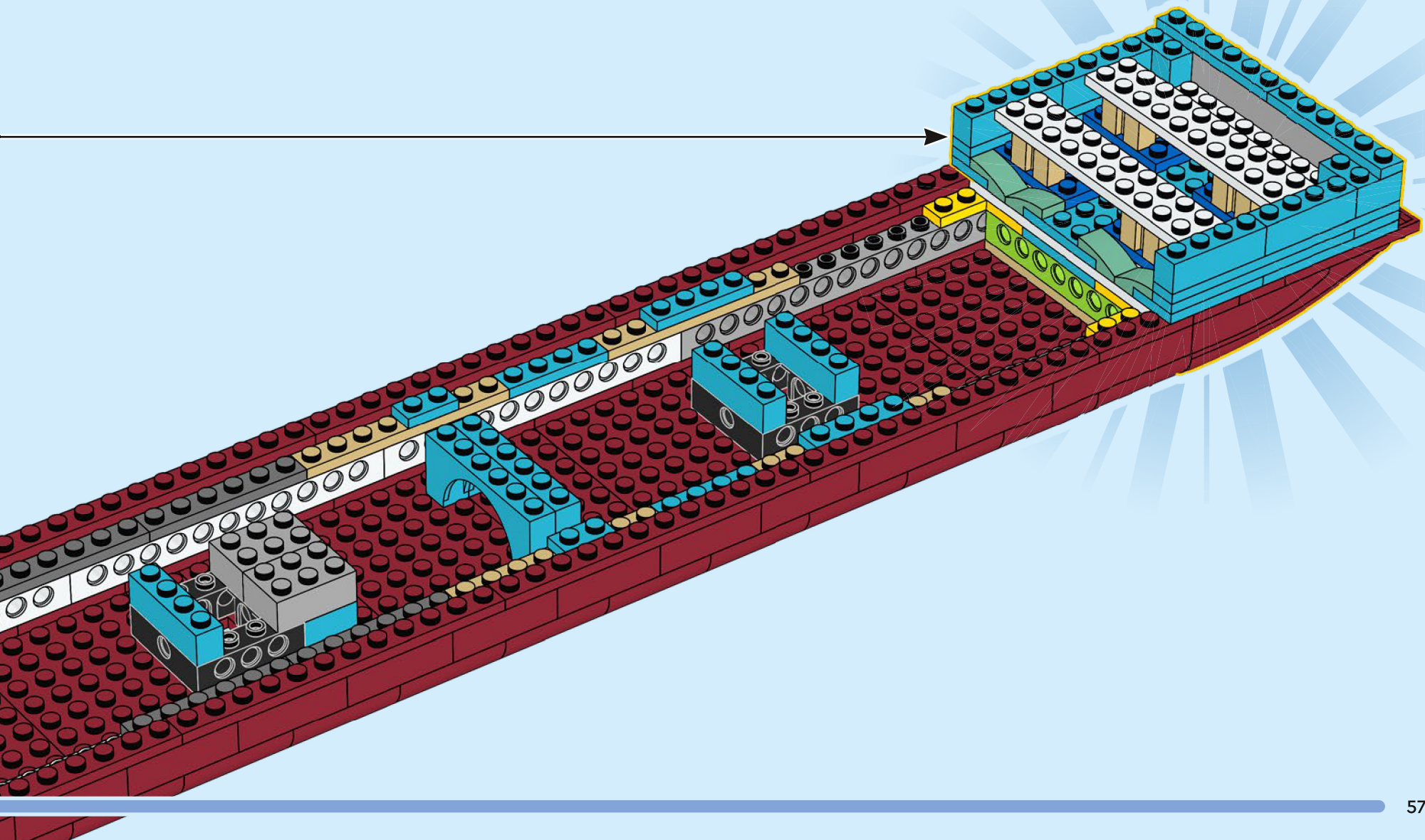

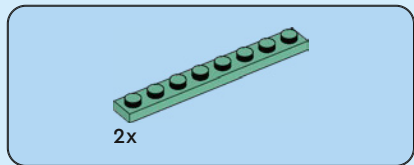
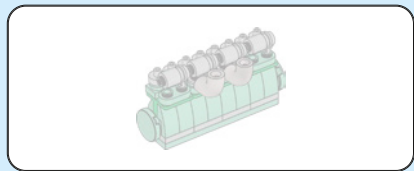

59

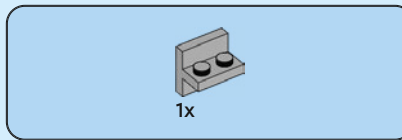
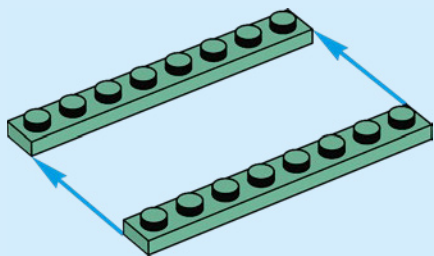

60

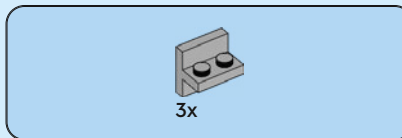
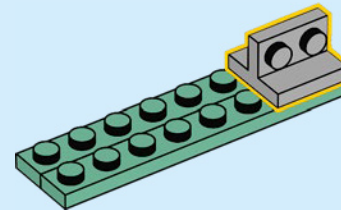

61

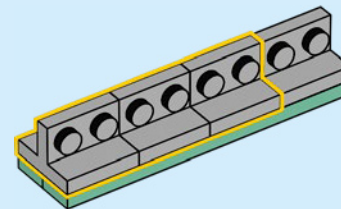



62

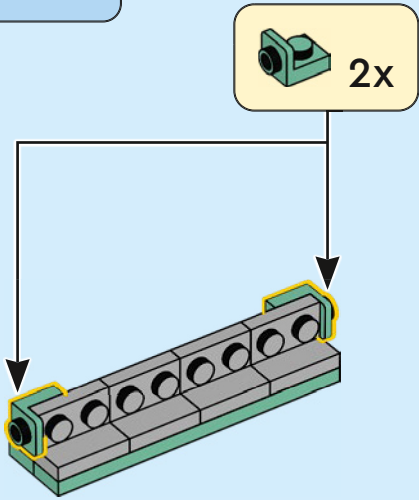

63

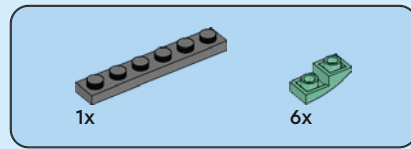
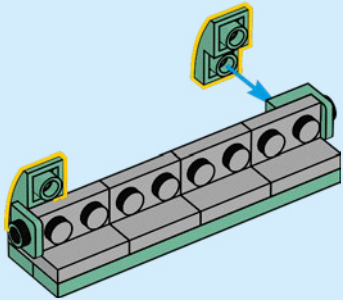

64

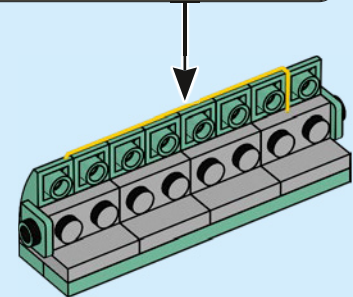
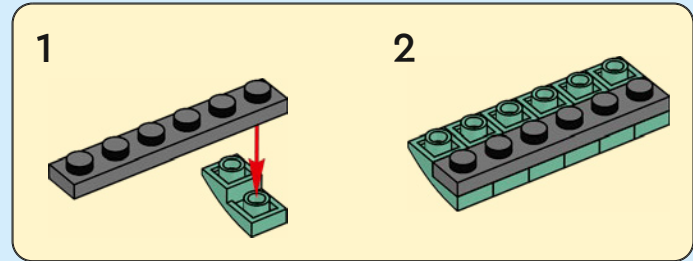

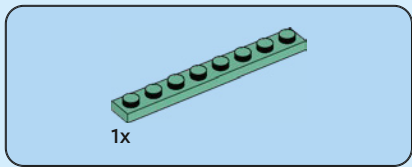

65

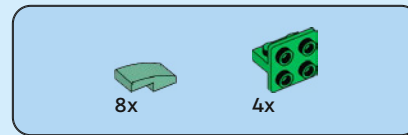
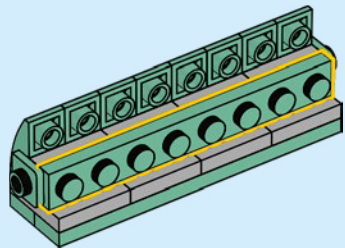

66

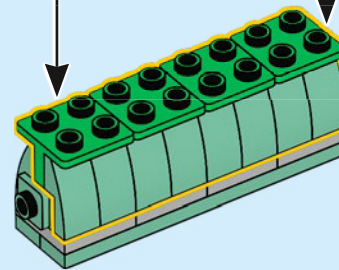
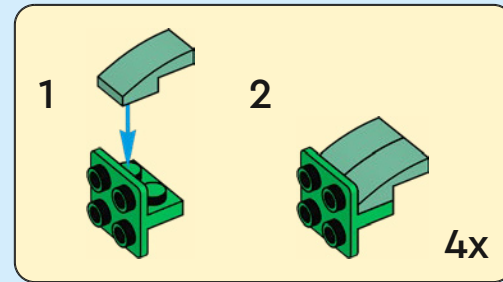

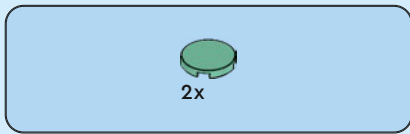

67

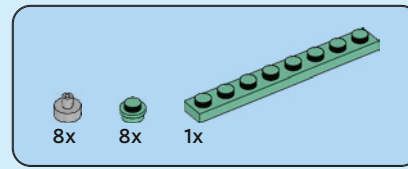
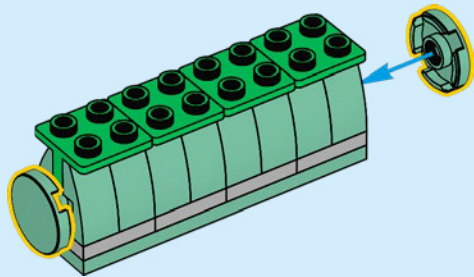

68

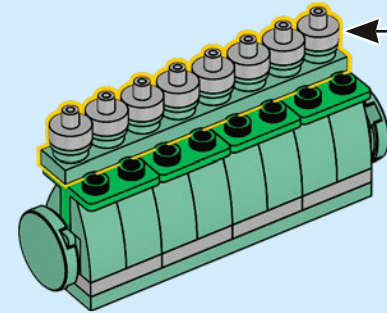
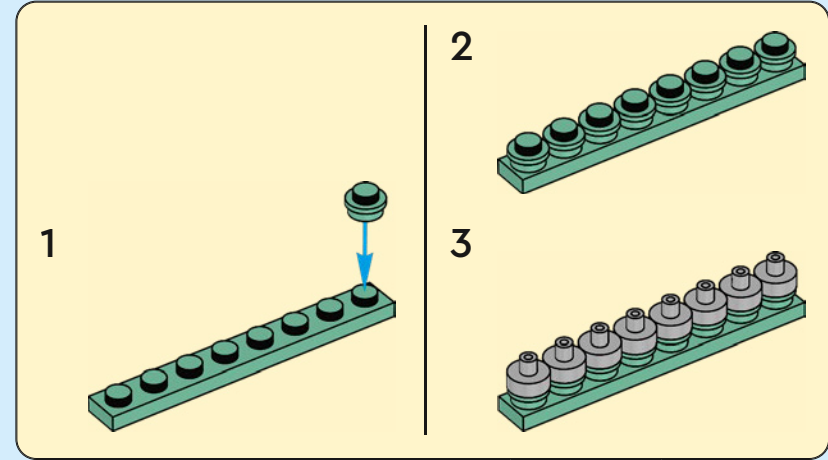



2x

69

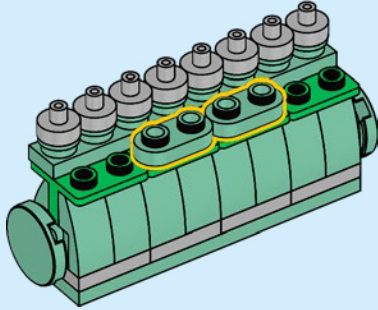

2x



2x

70

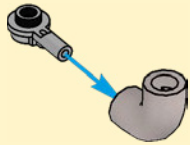
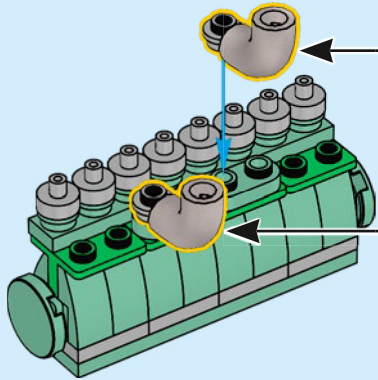

2x



2x

71

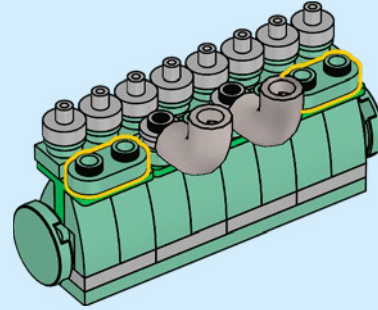

4x



4x

72

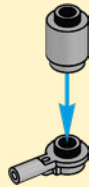
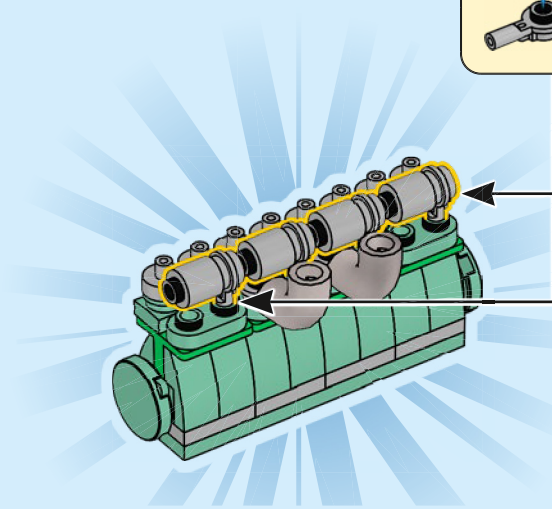

4x

73

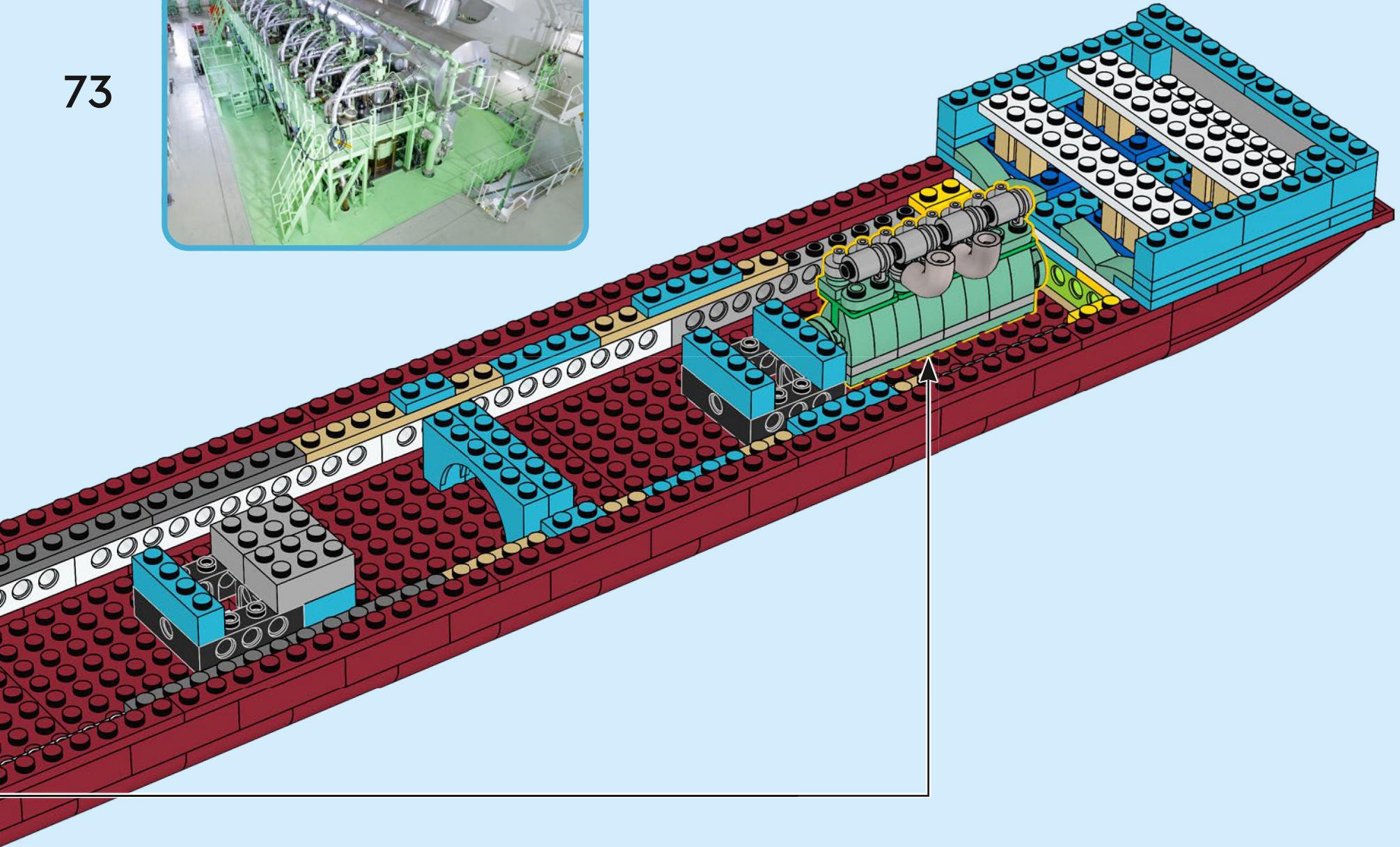

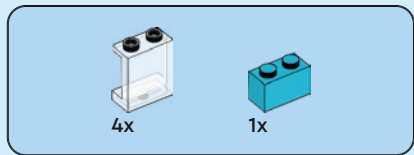

74

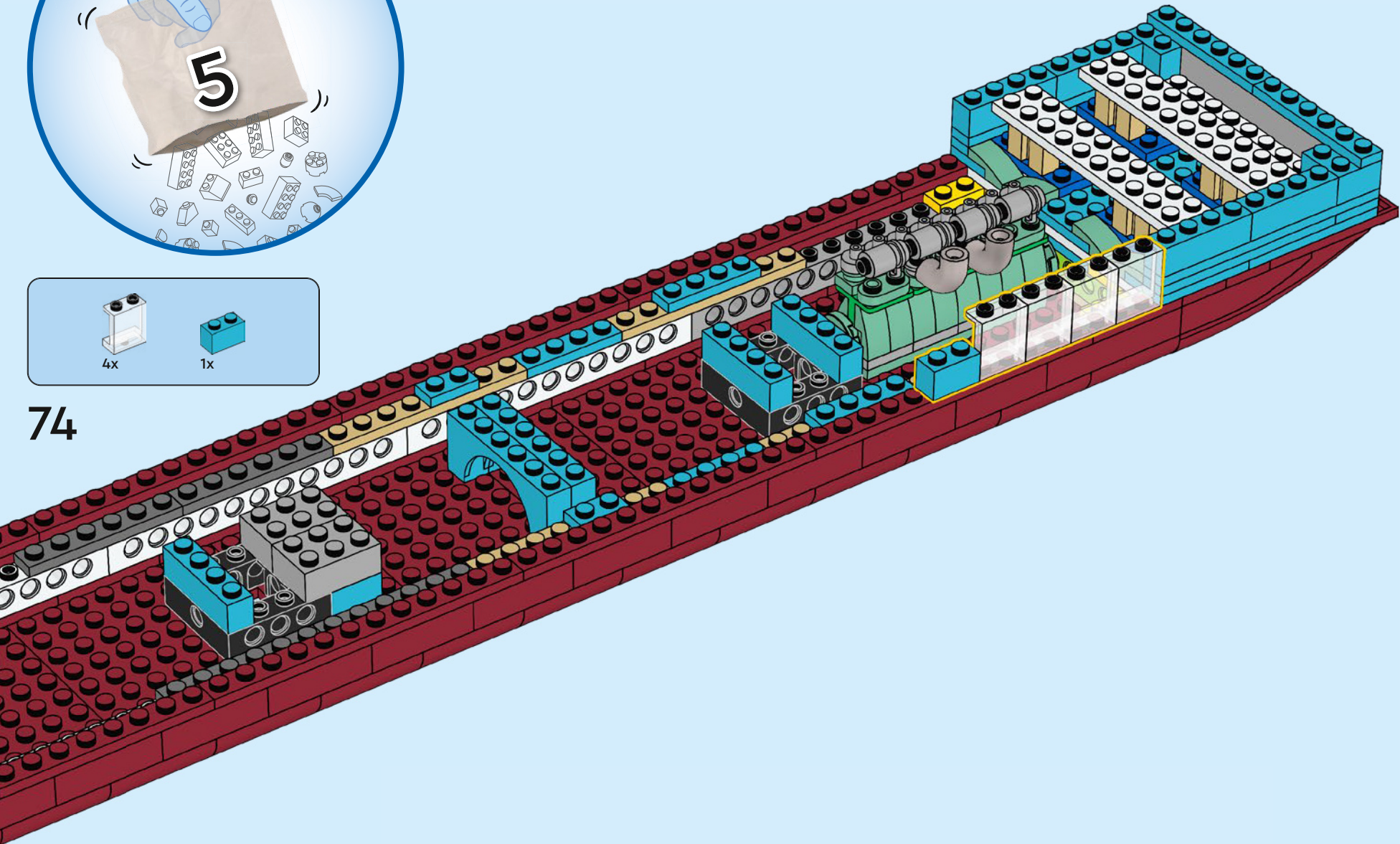

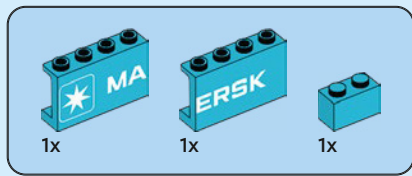

75

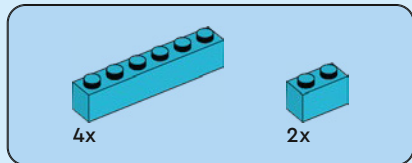
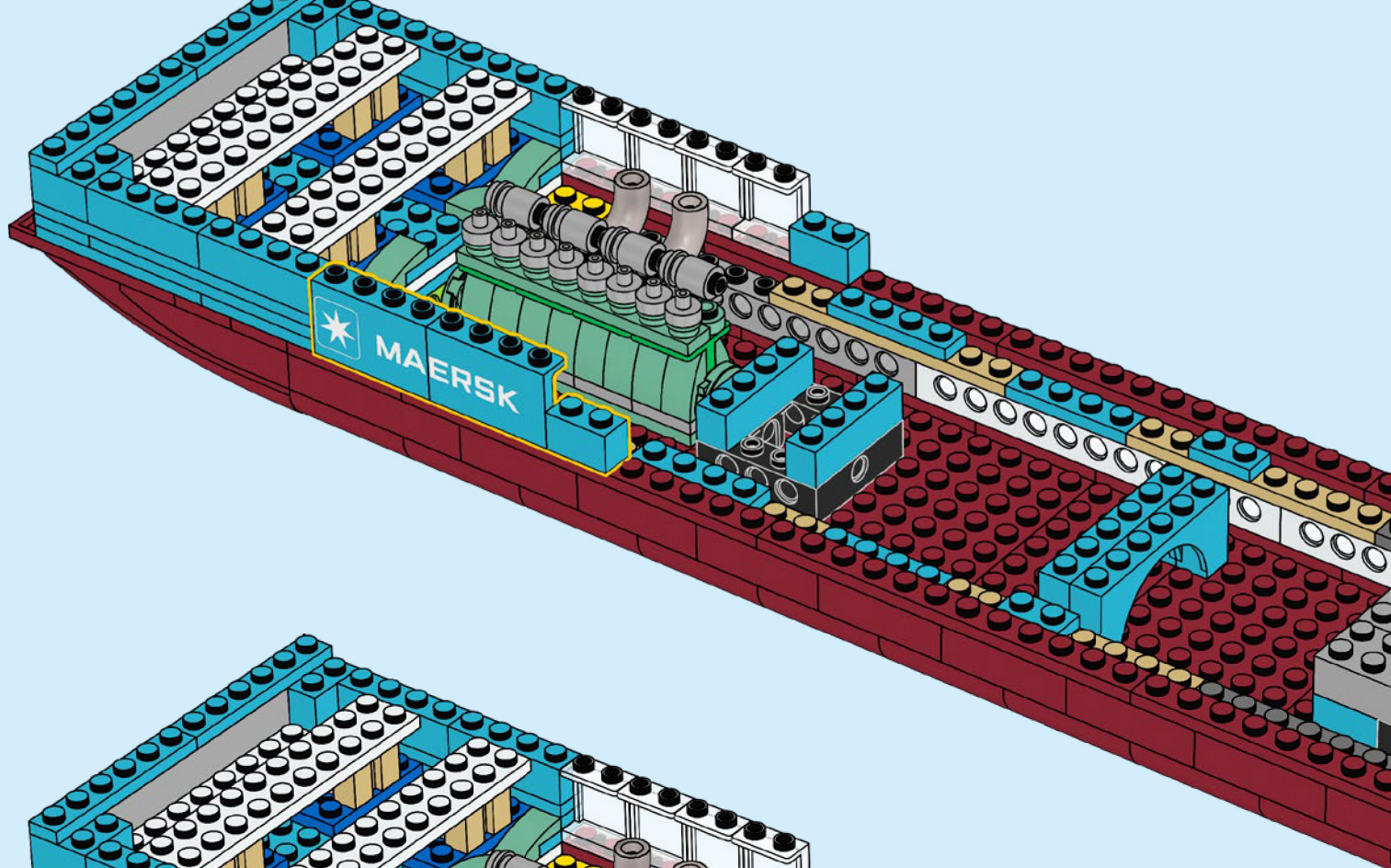

76

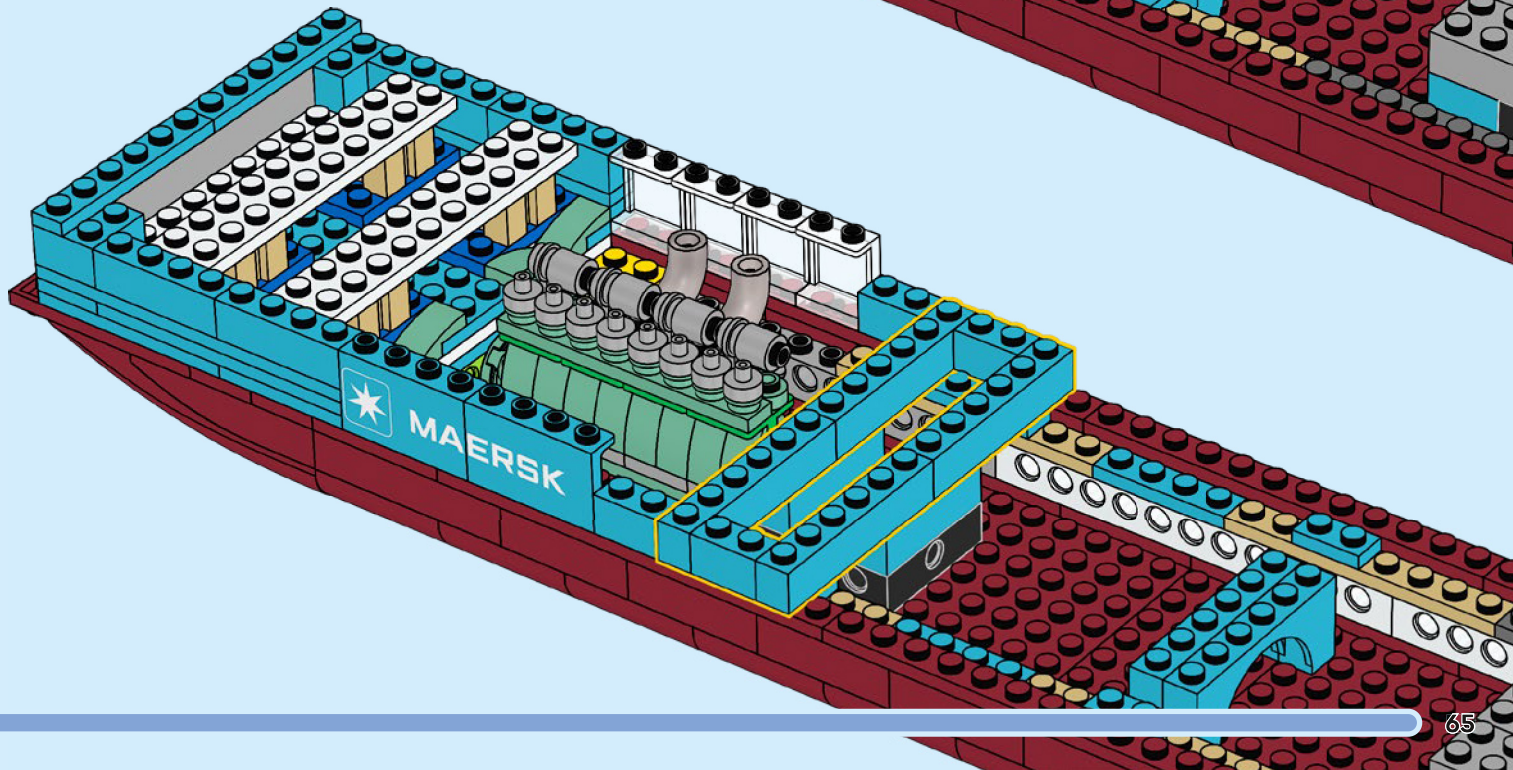

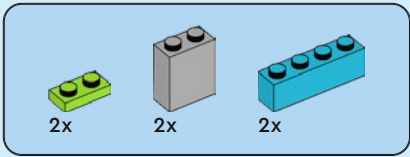

77

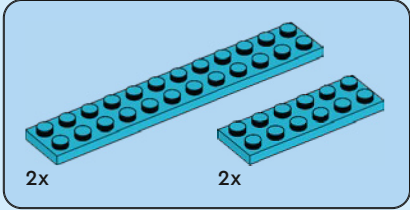
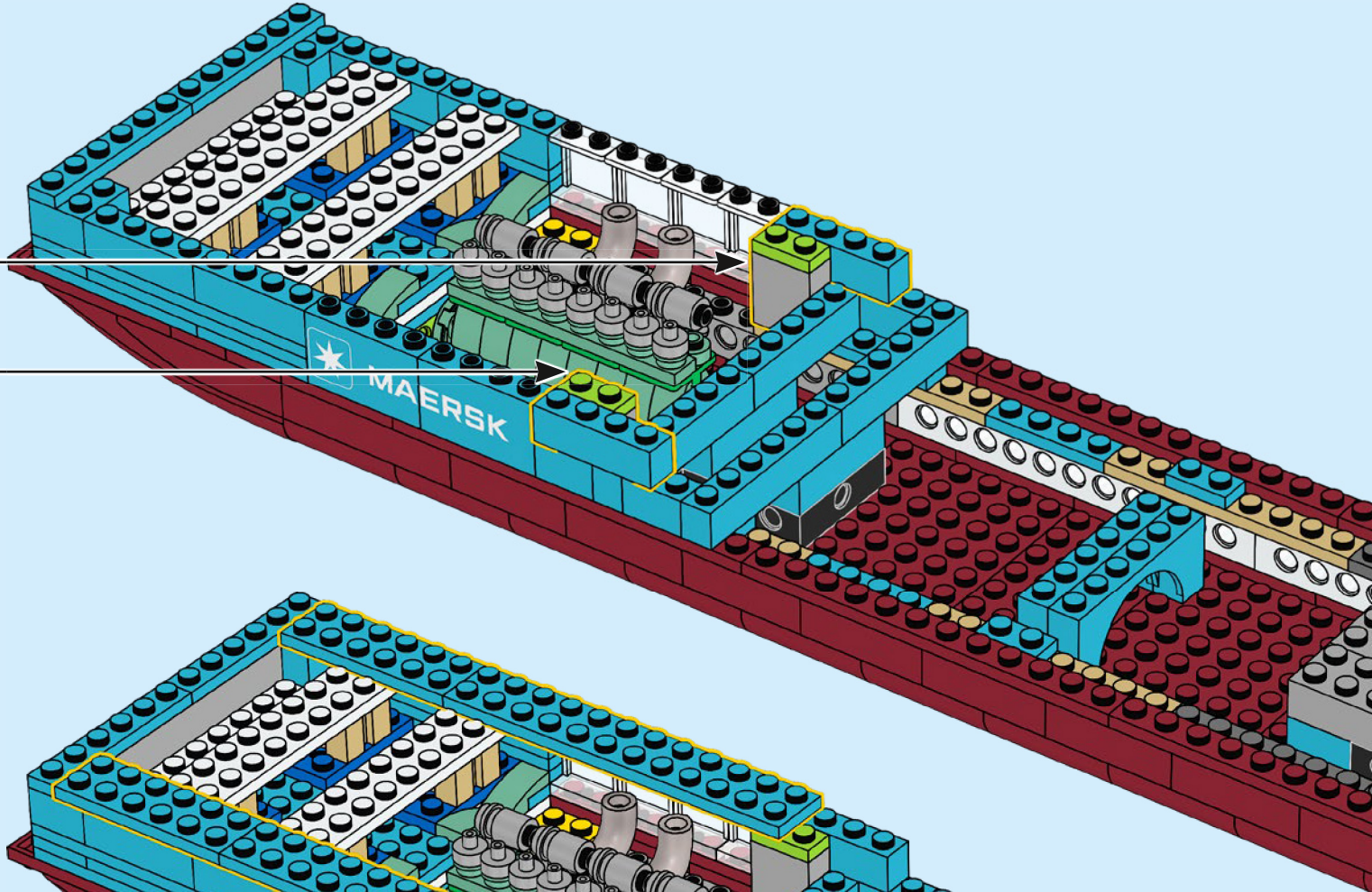
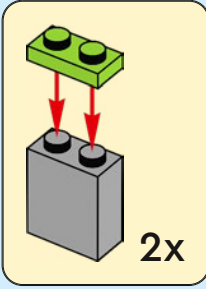

78

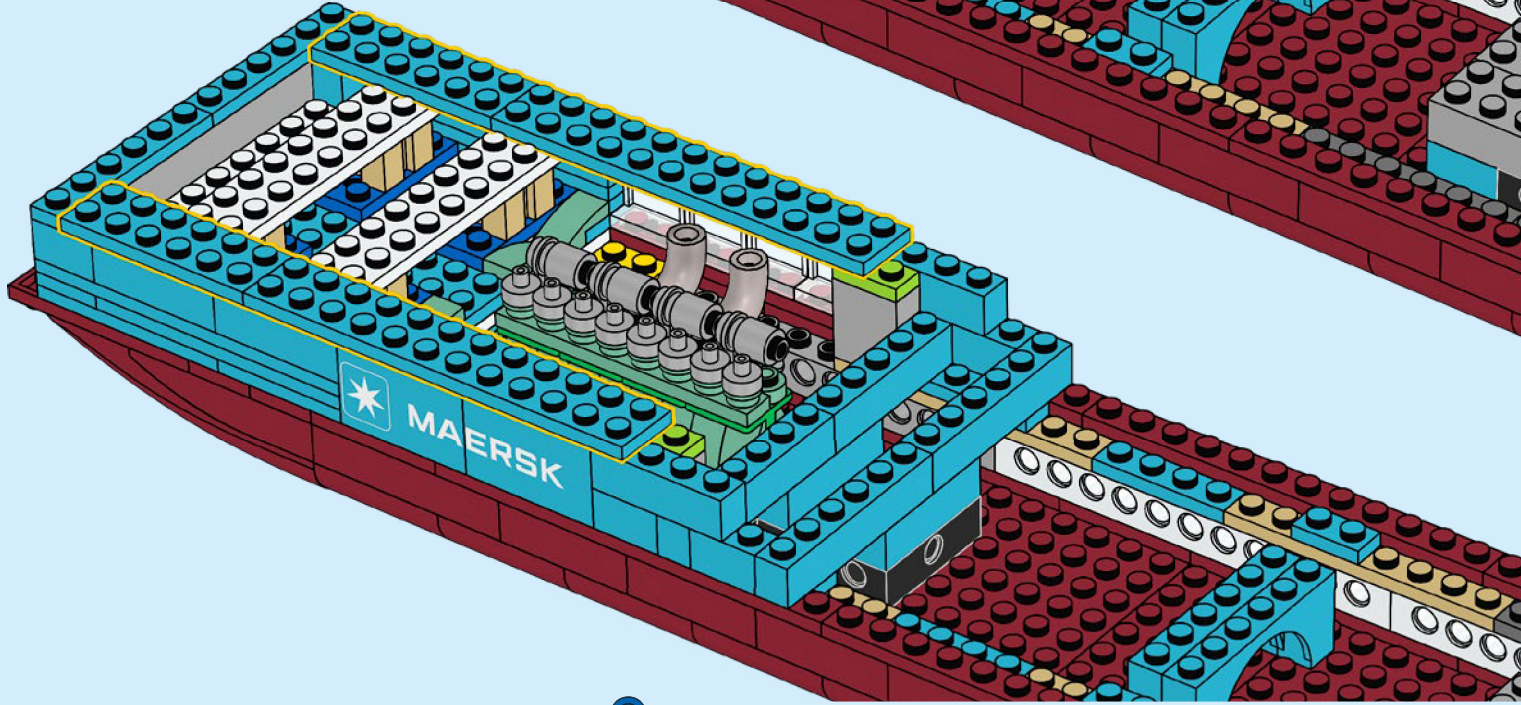

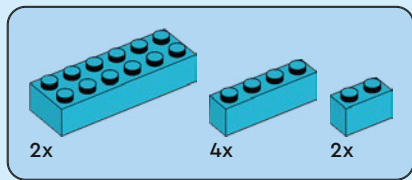

79

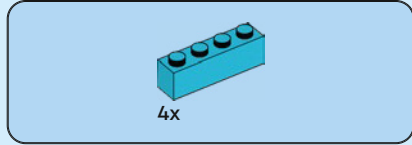
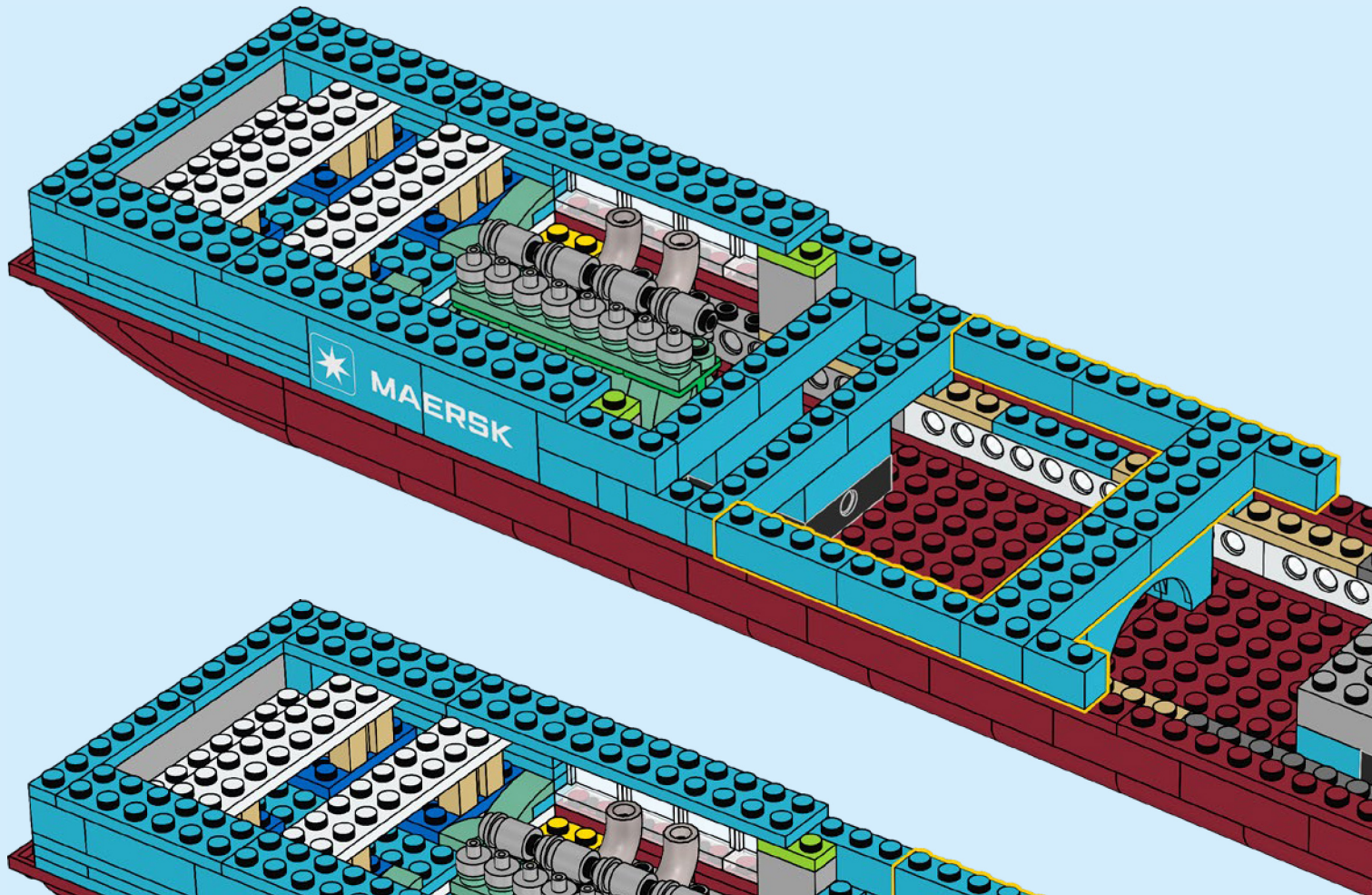

80

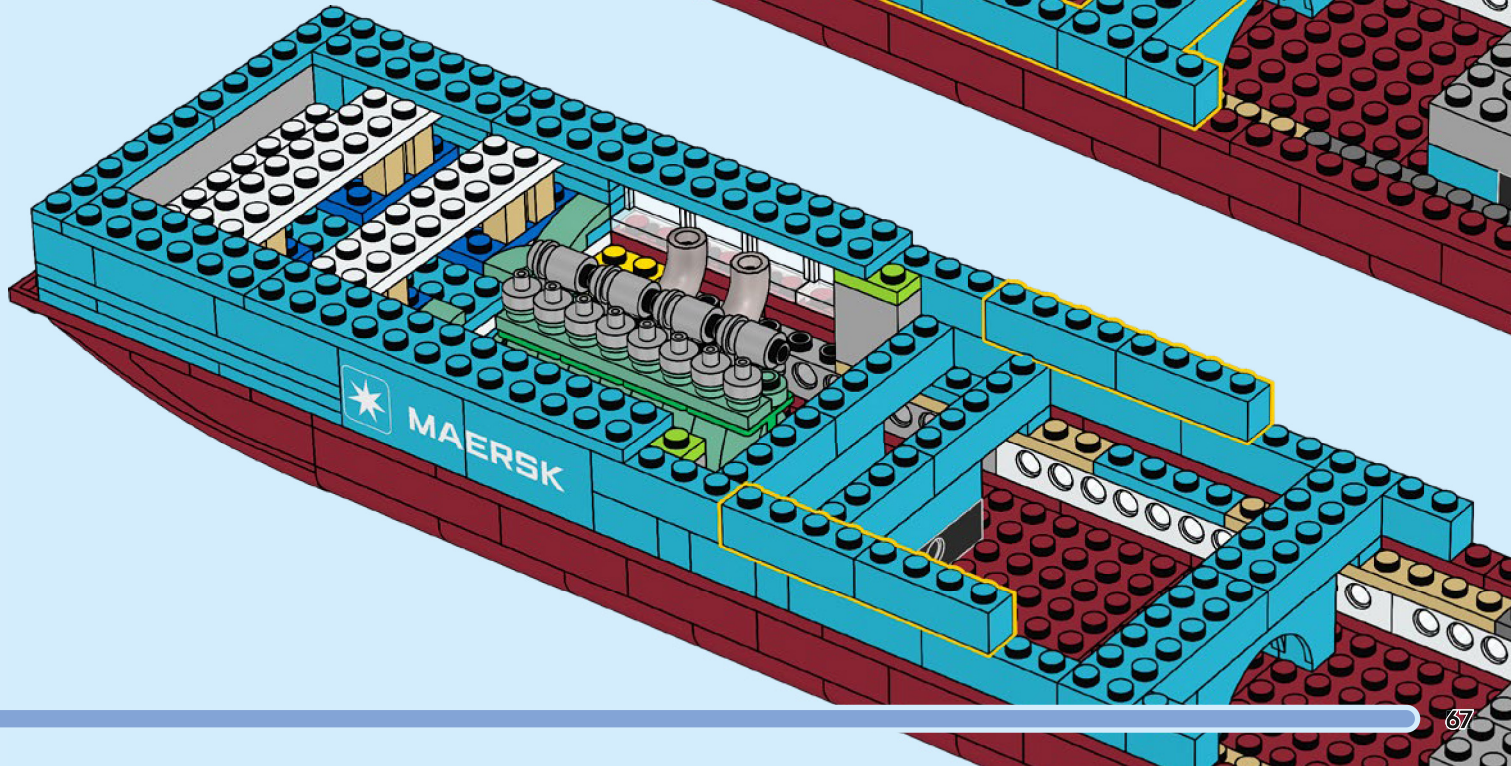

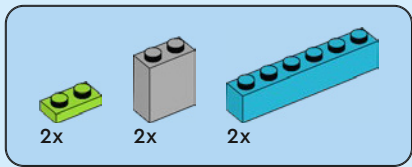

81

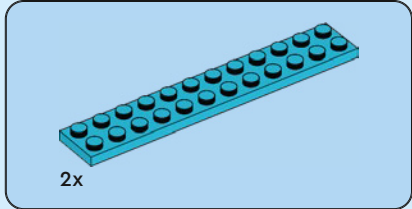
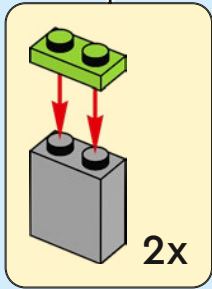
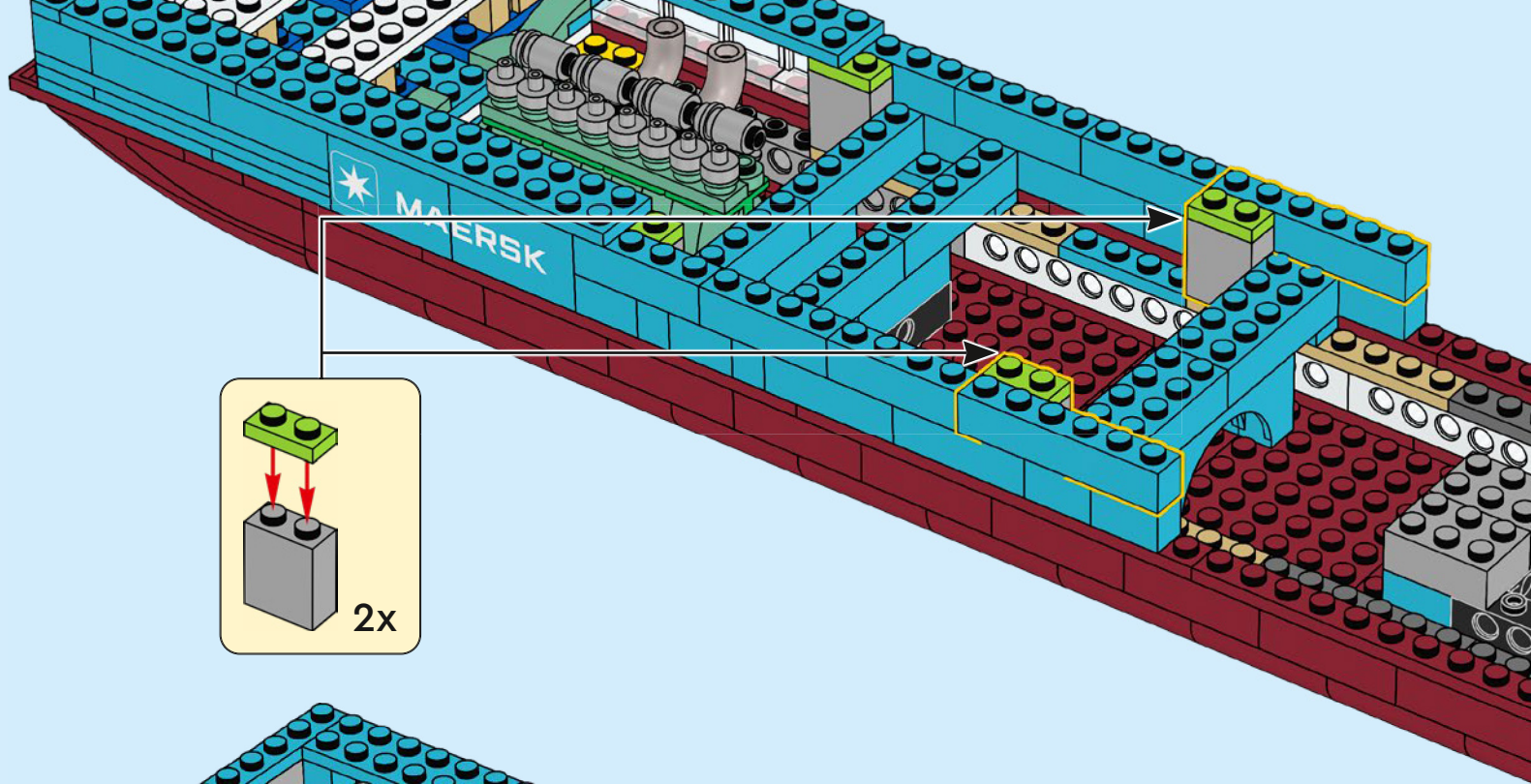

82

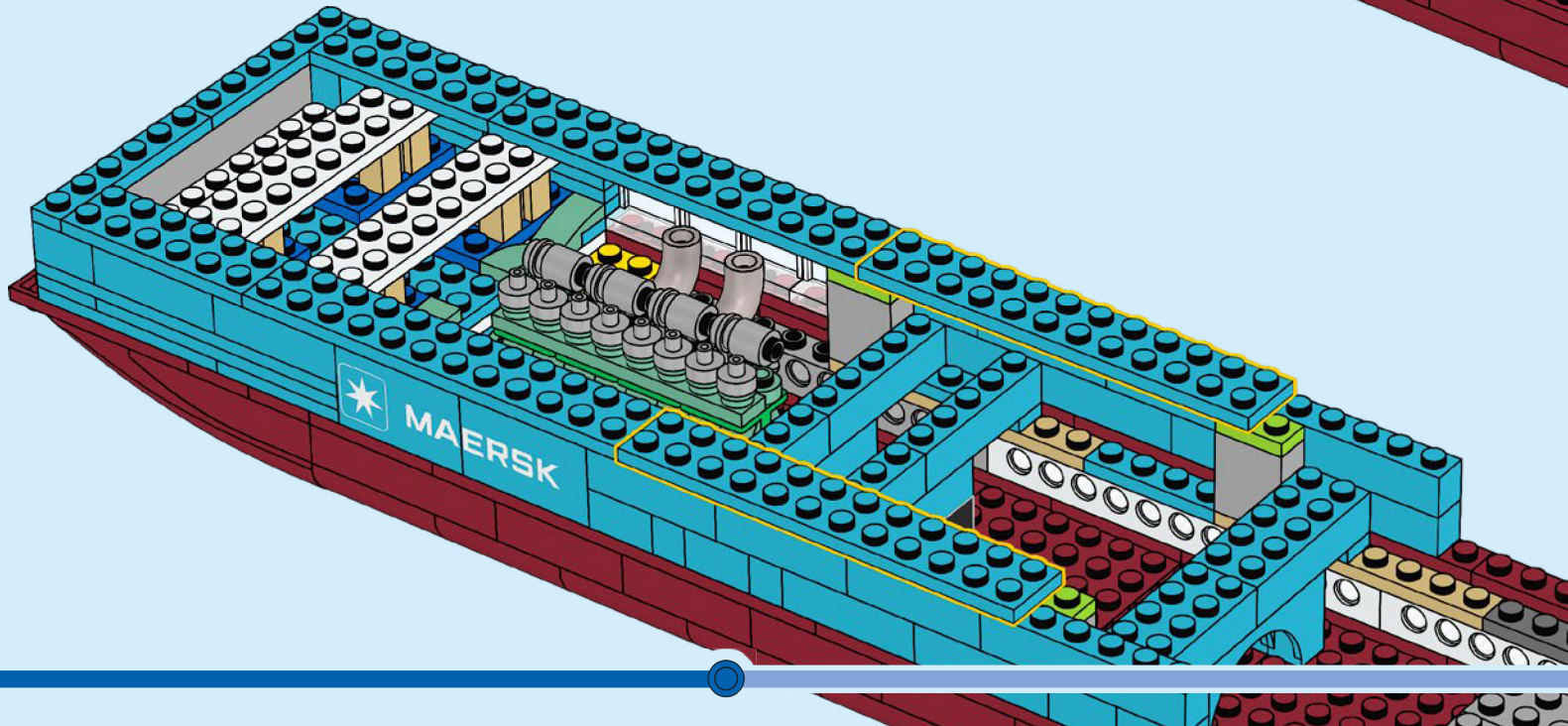

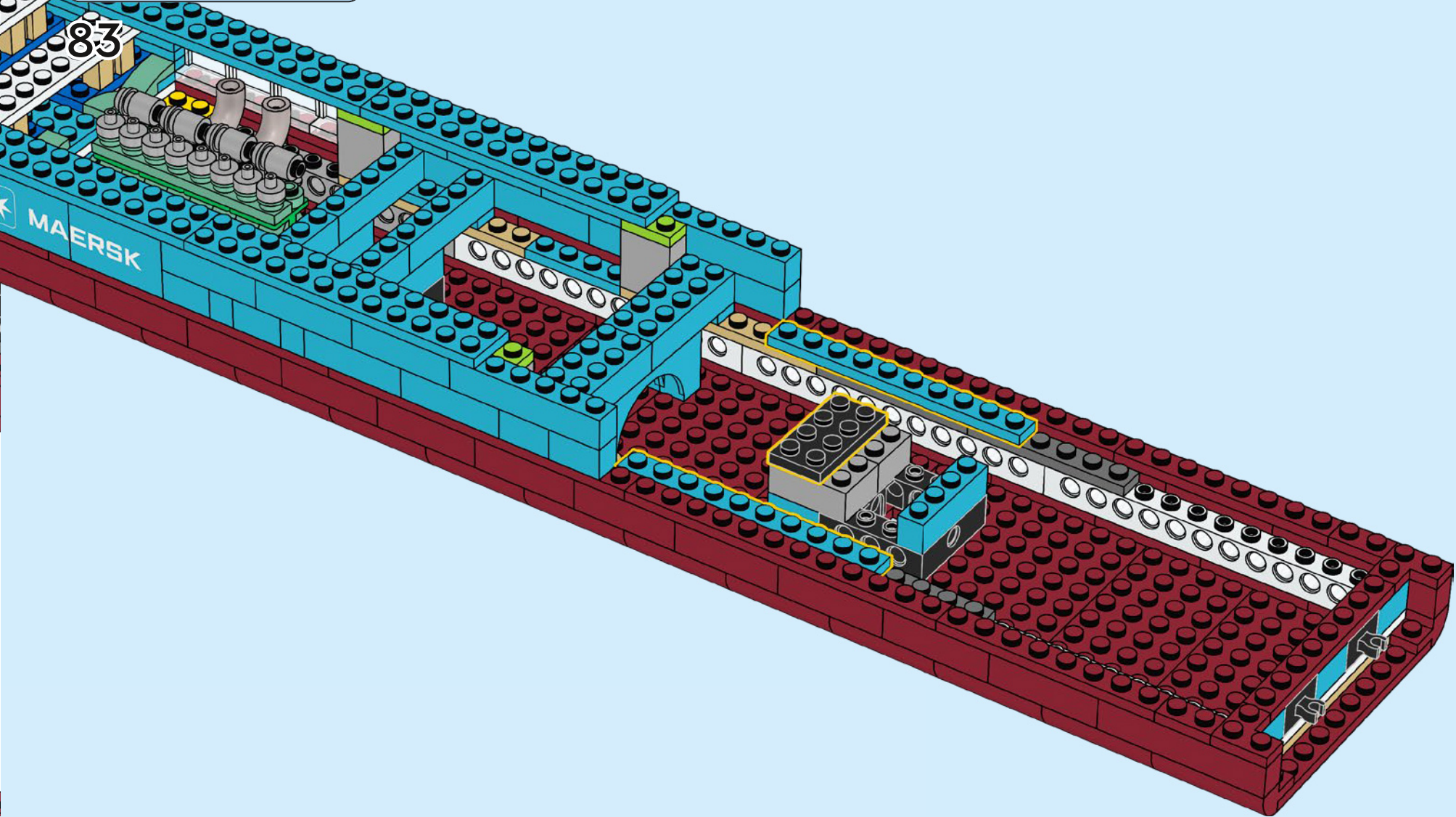
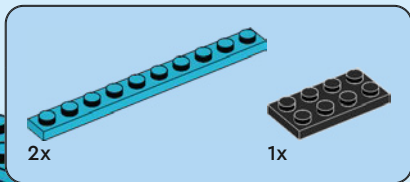

84

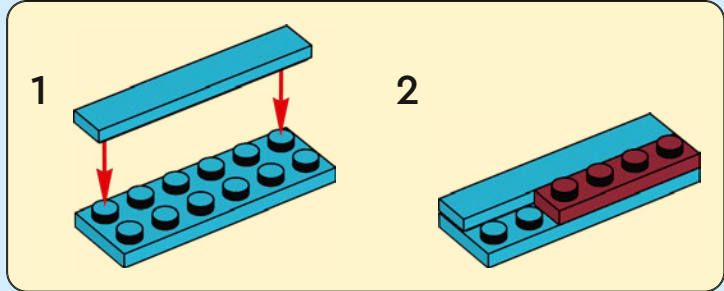
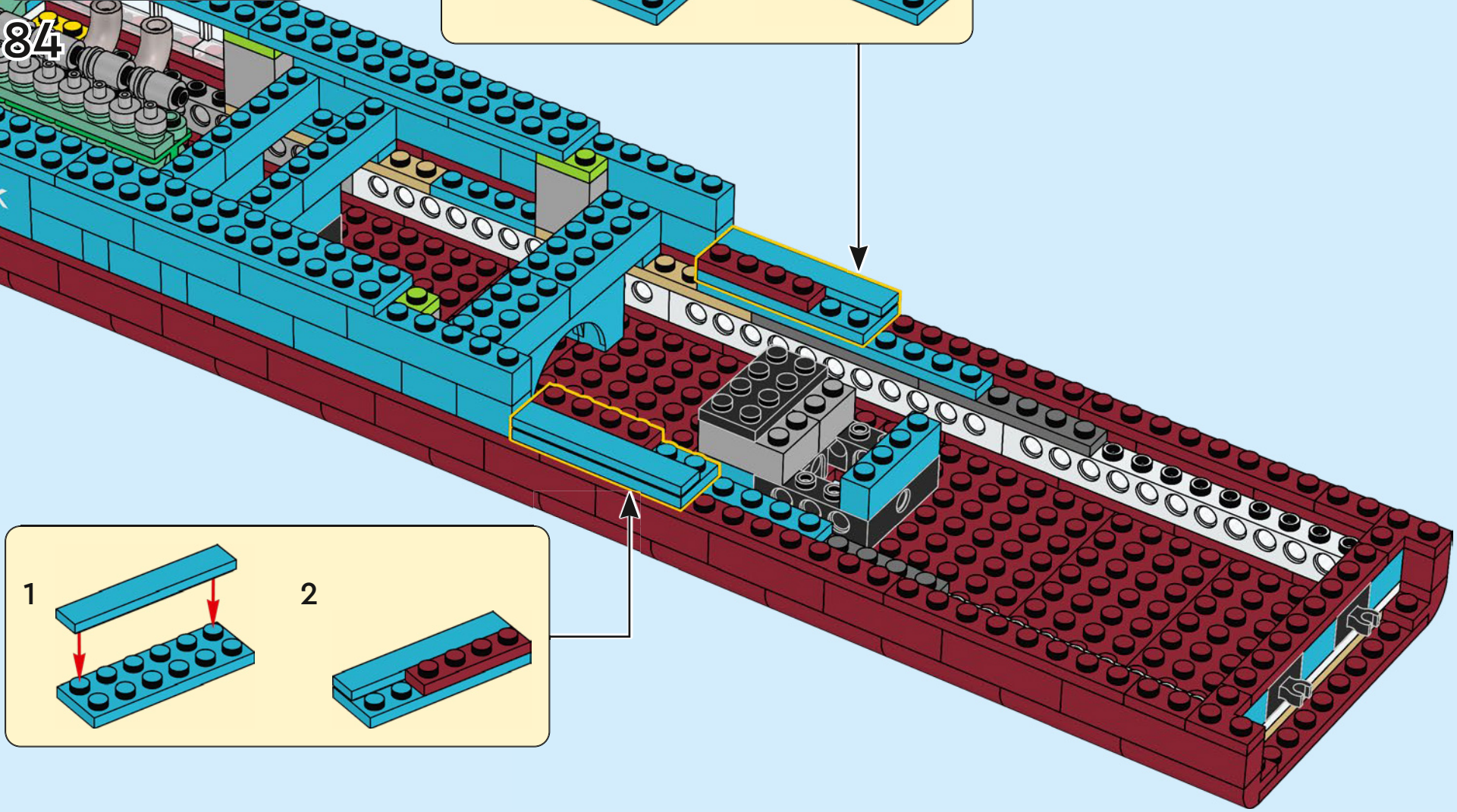
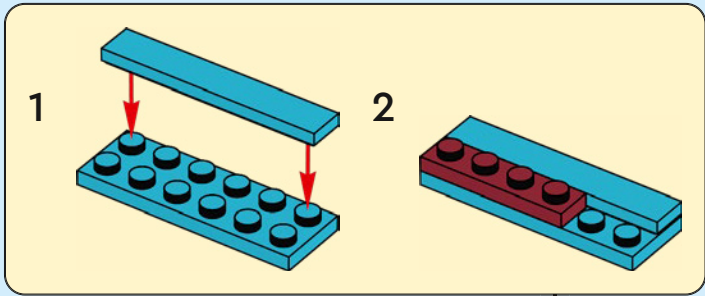
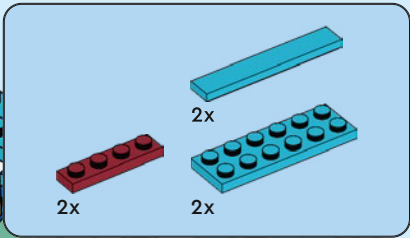

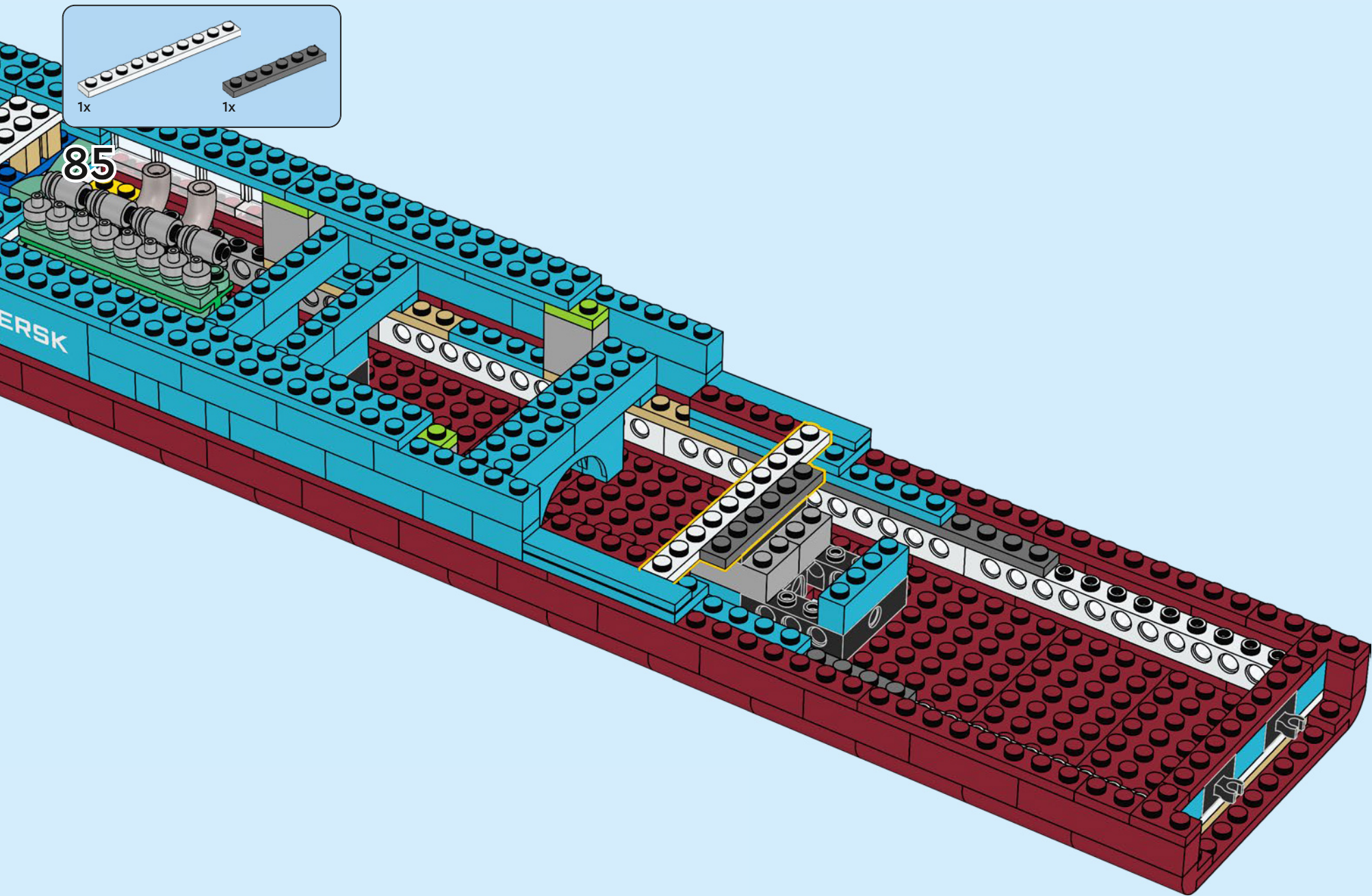

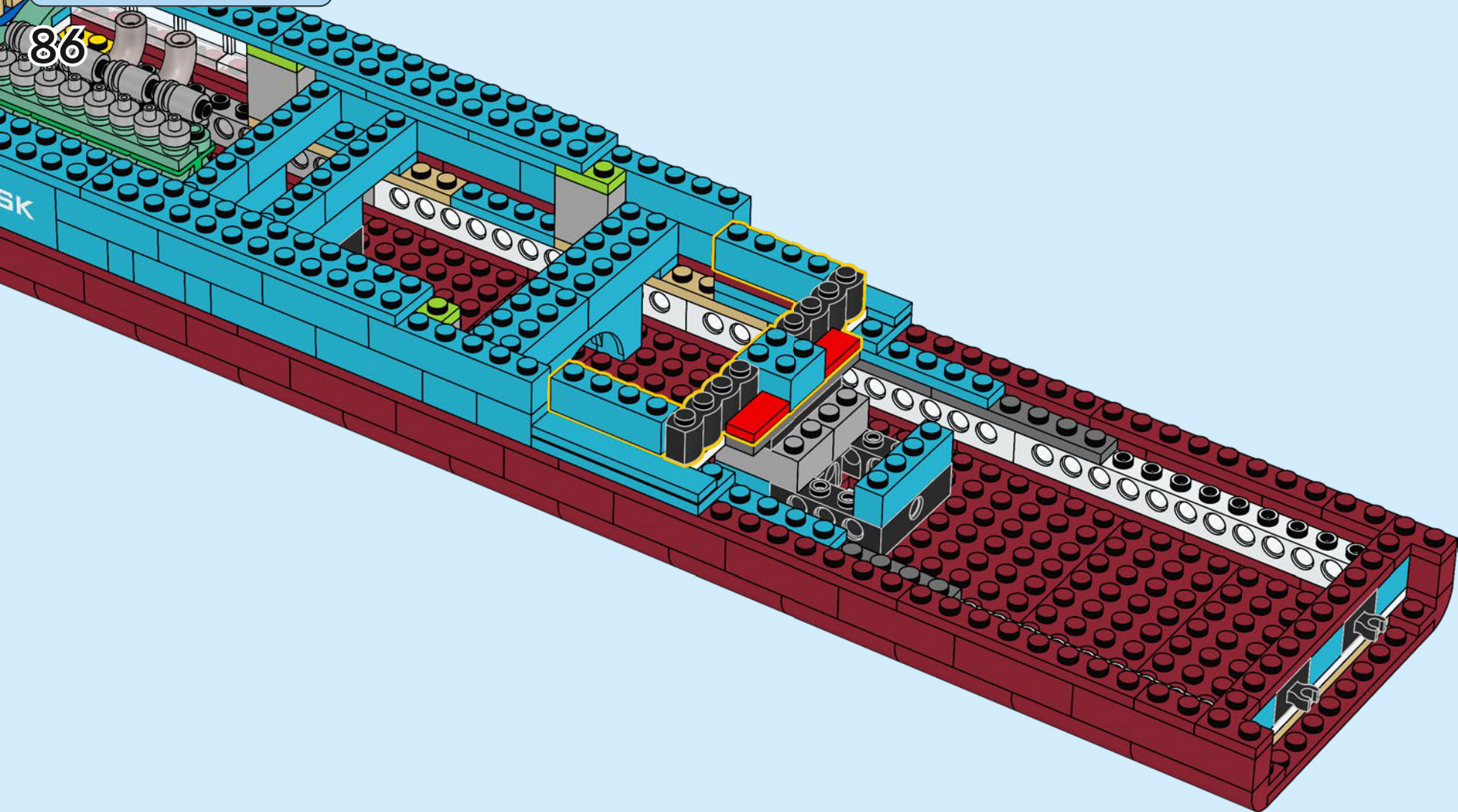
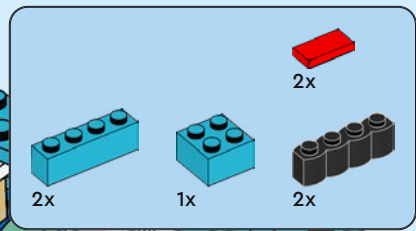

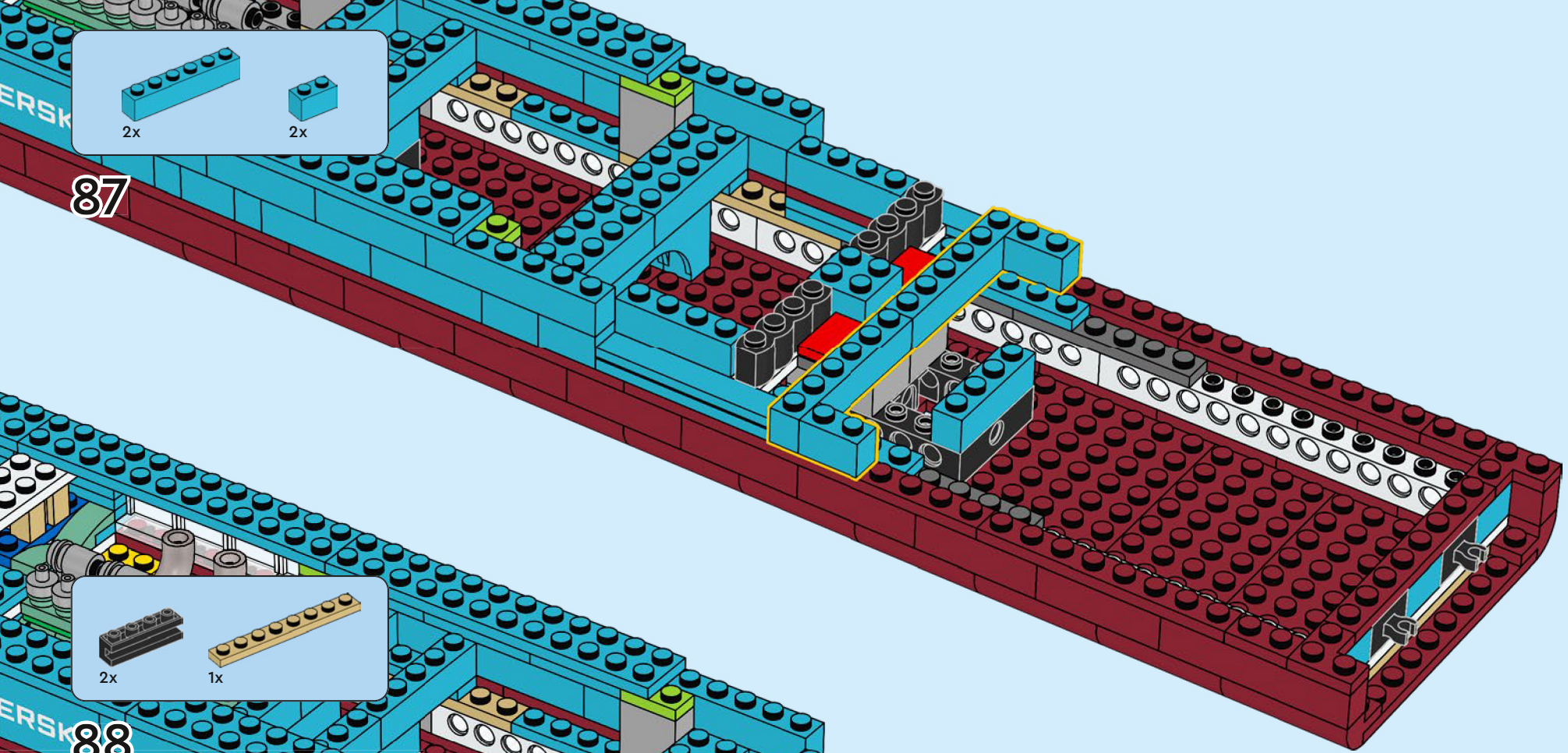

87



88

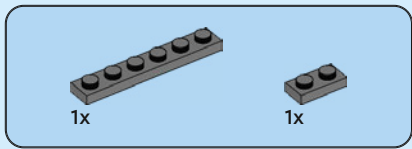

89

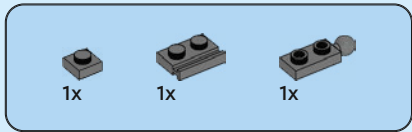
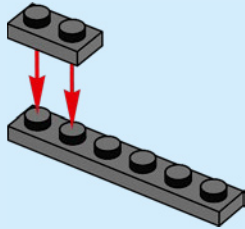

90

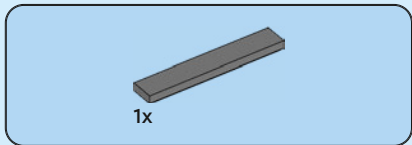
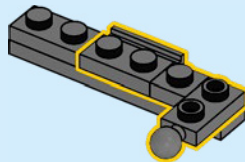

91

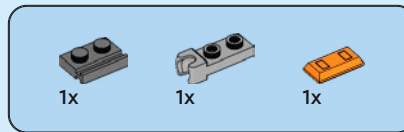
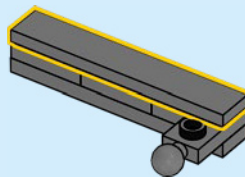

92

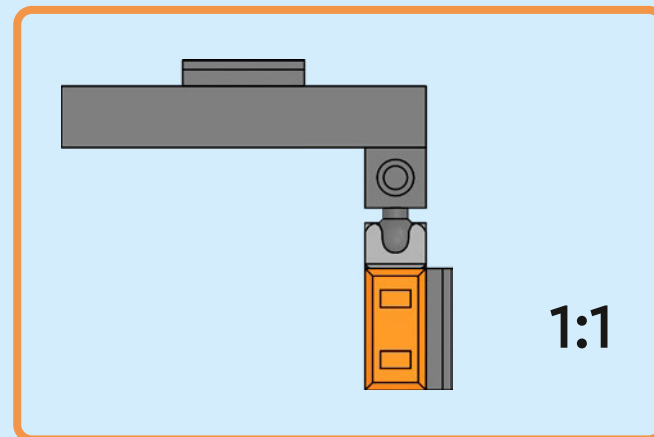
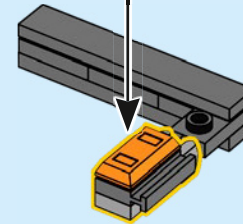
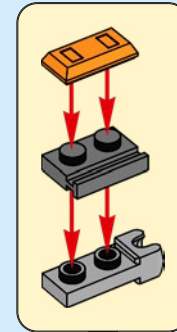

1:1

93

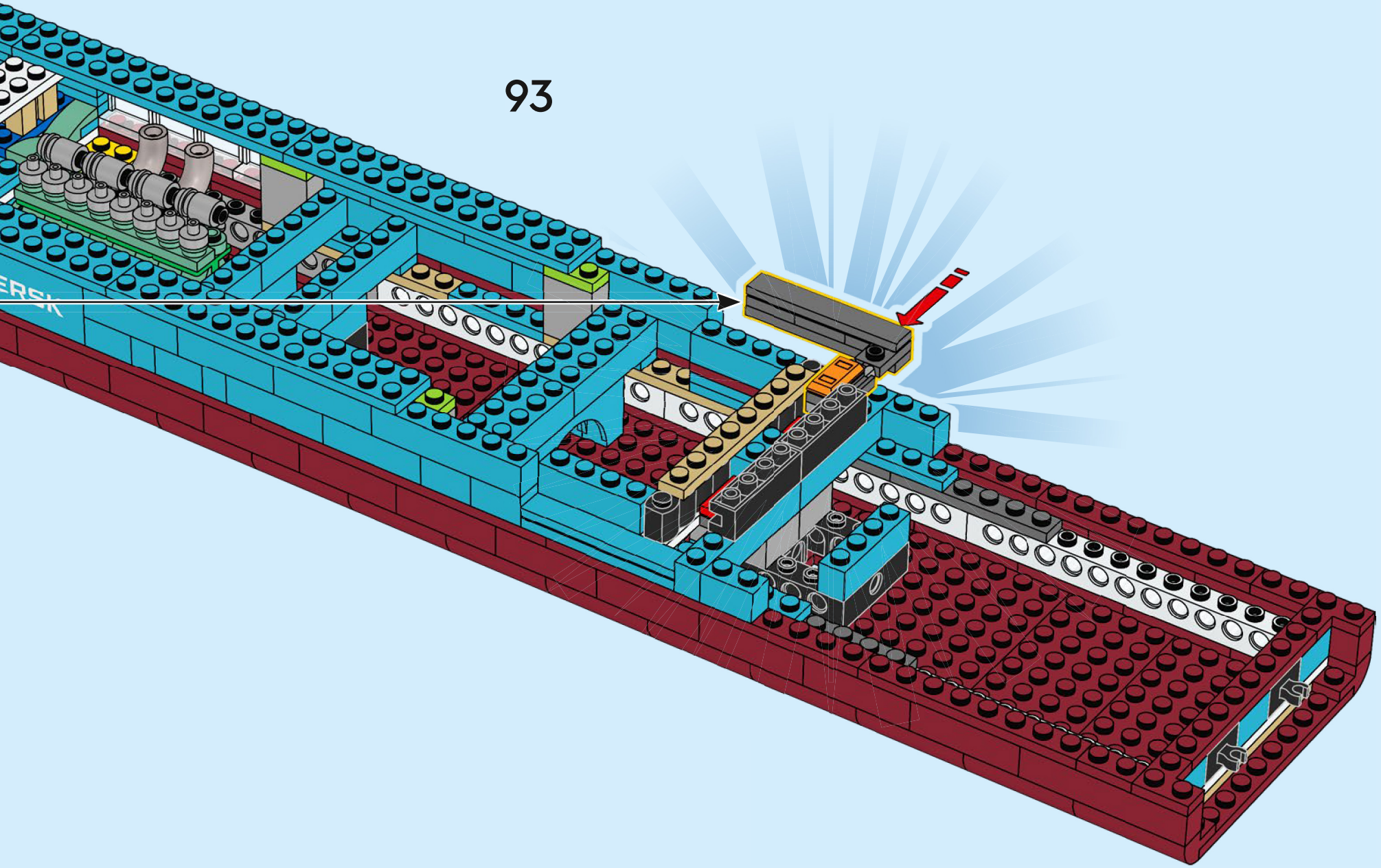

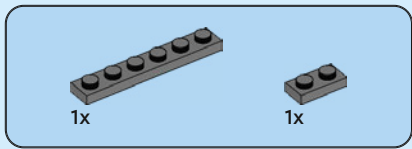

94

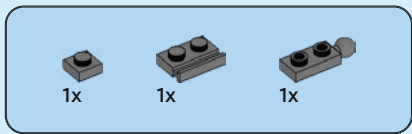
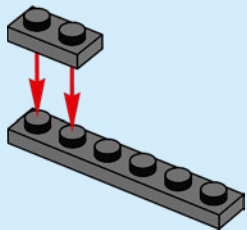

95

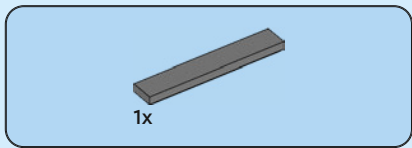
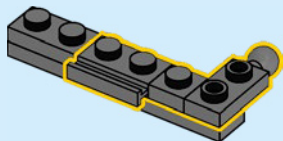

96

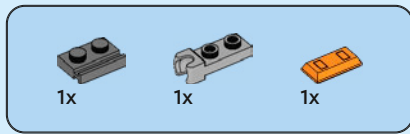
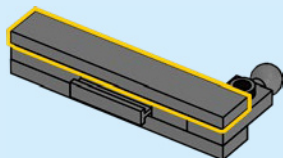

97

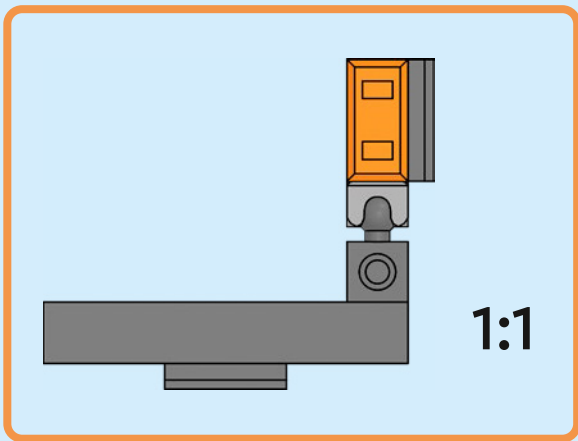
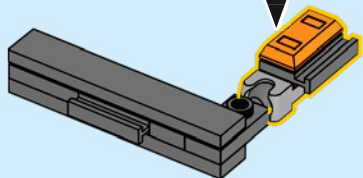
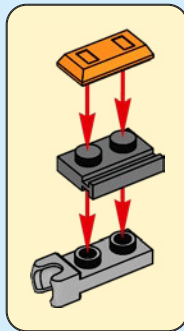

98

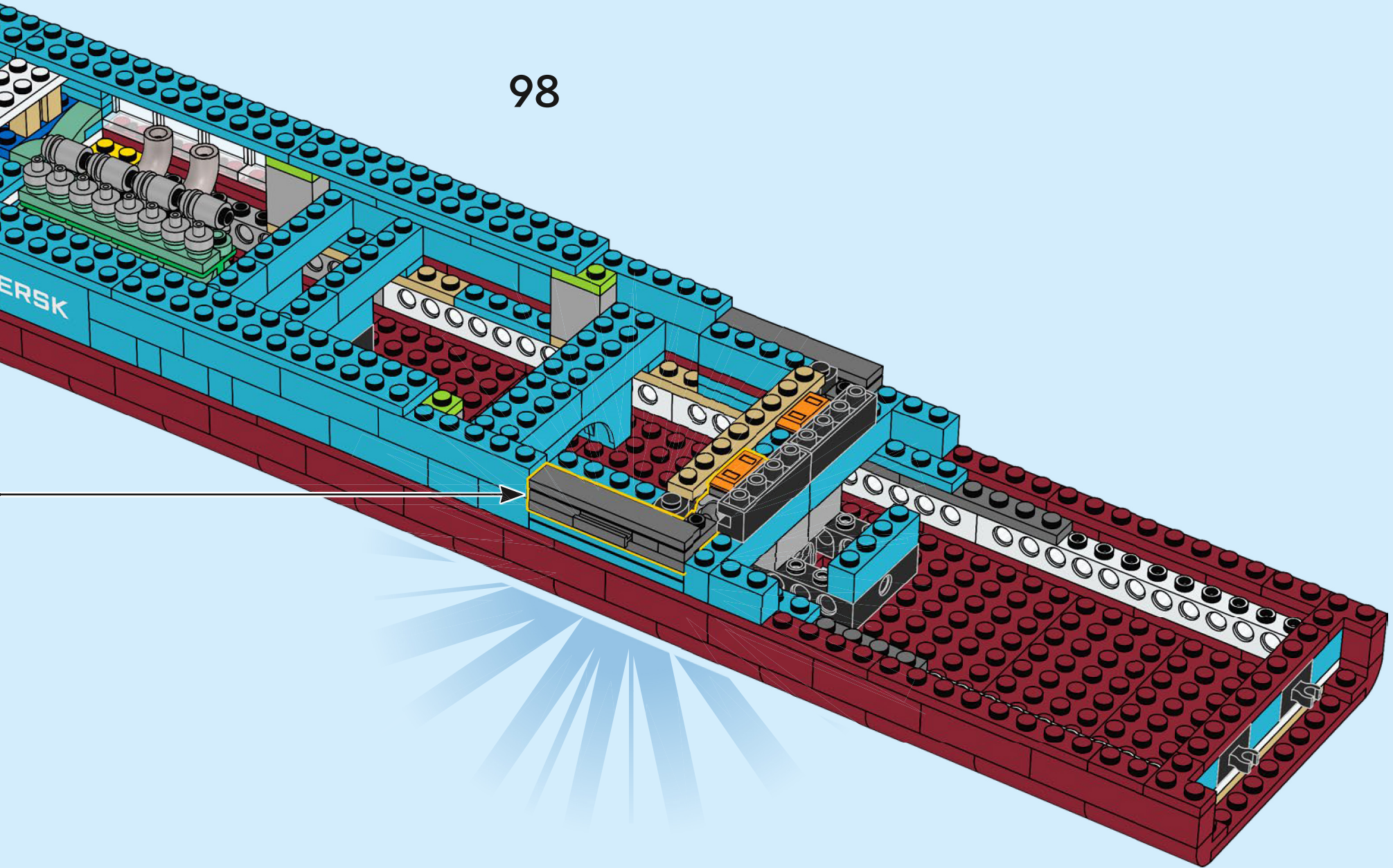

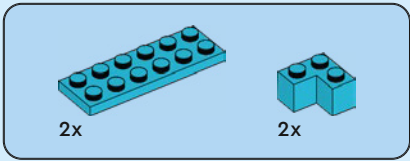

99

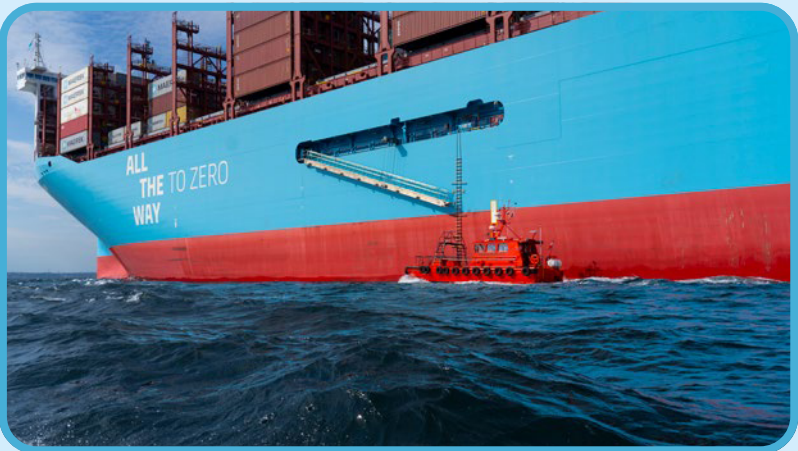
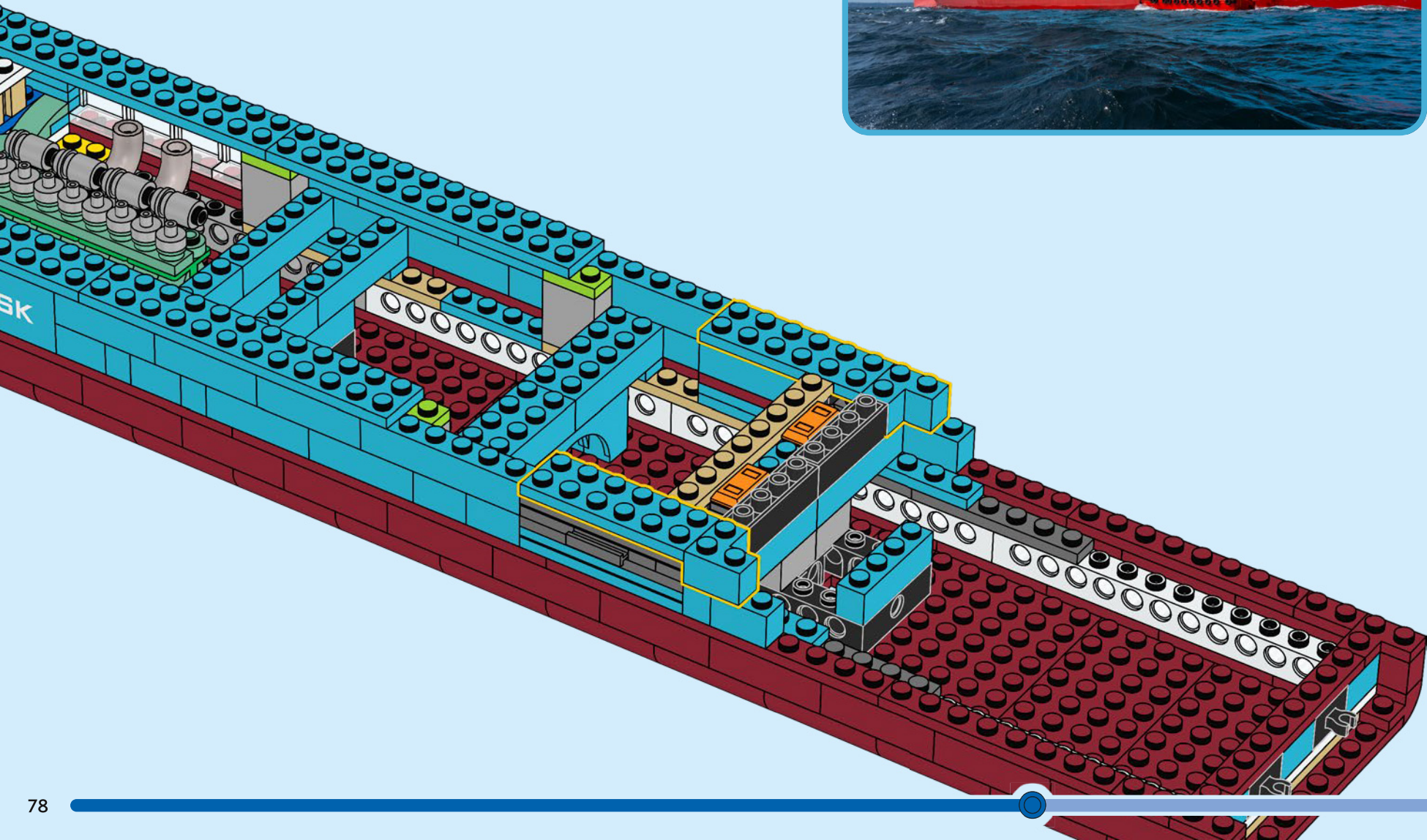

1

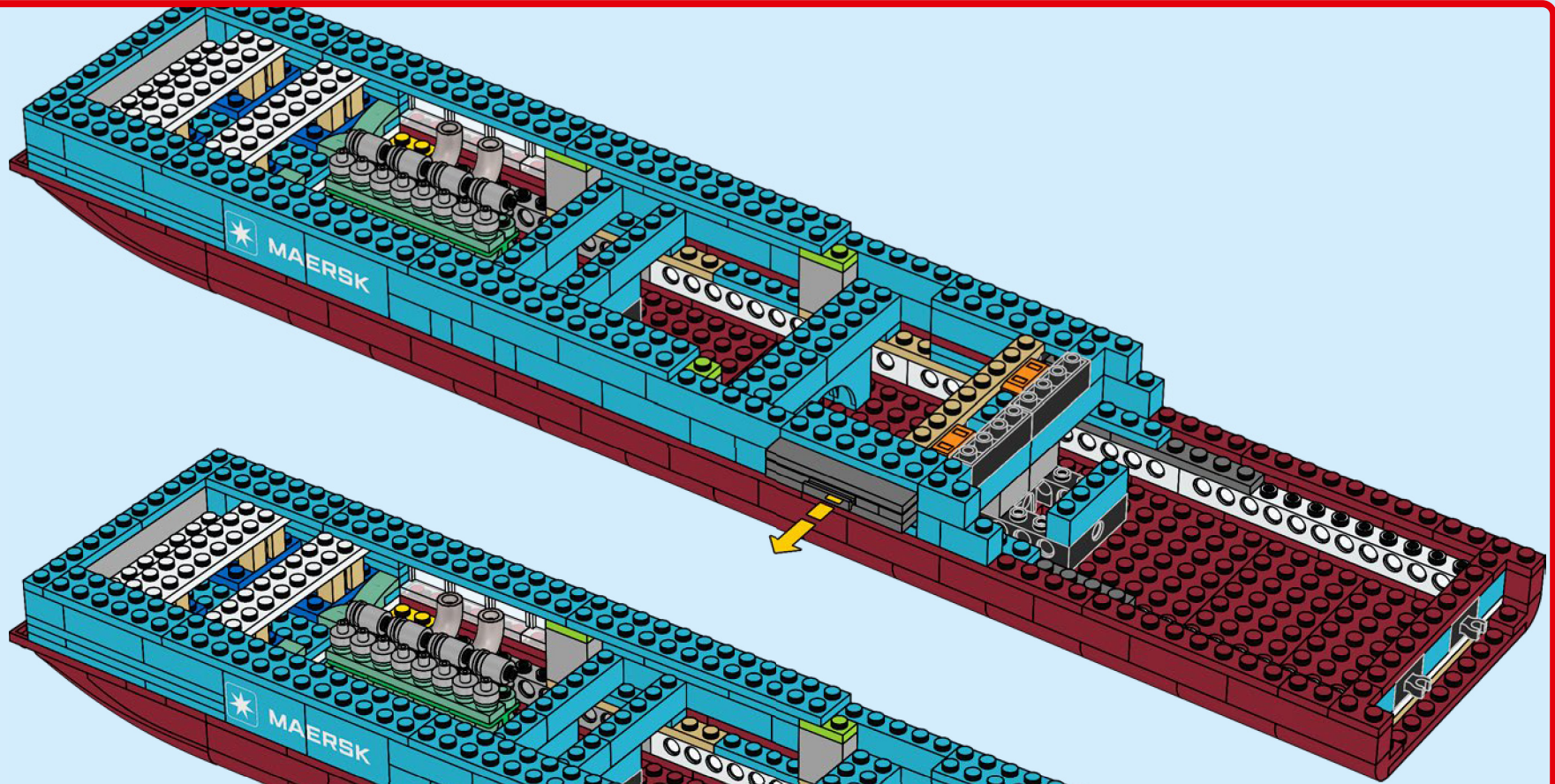

2

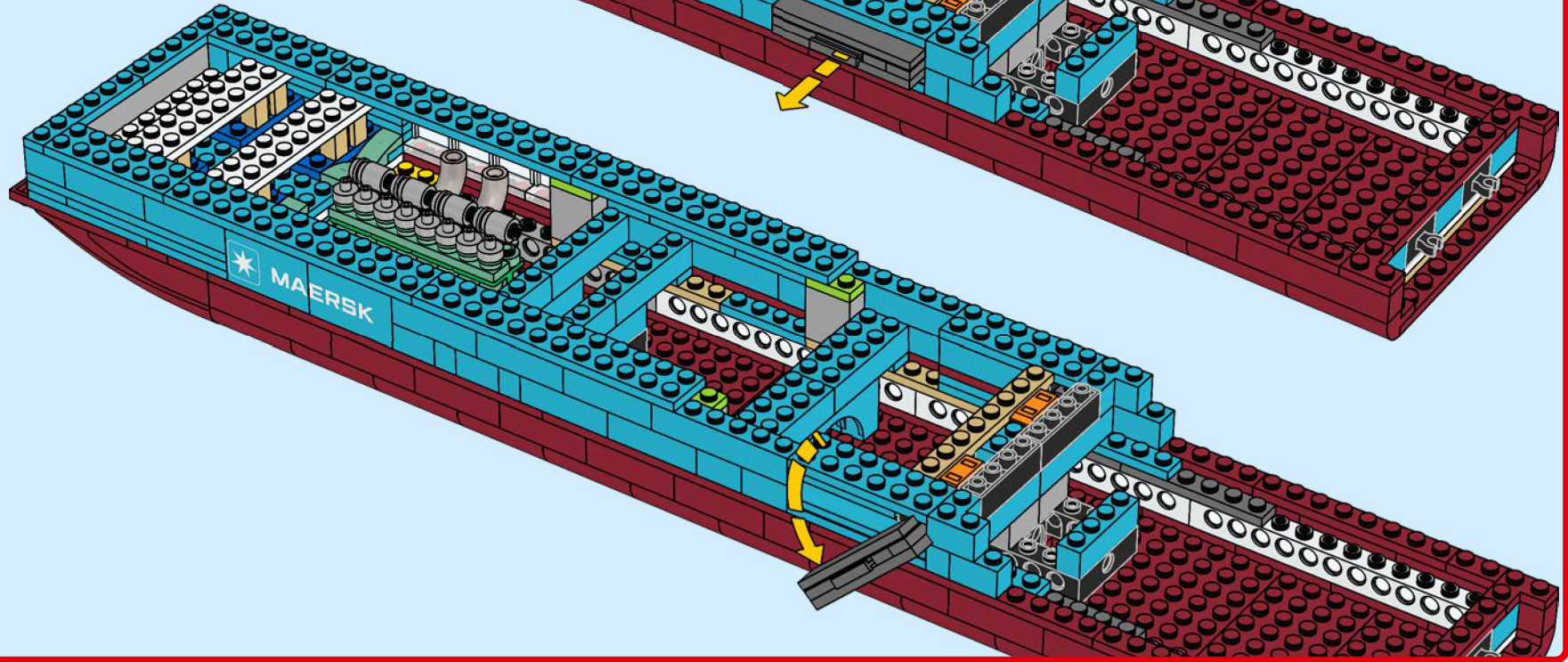

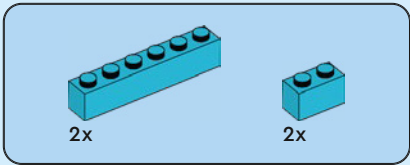

100

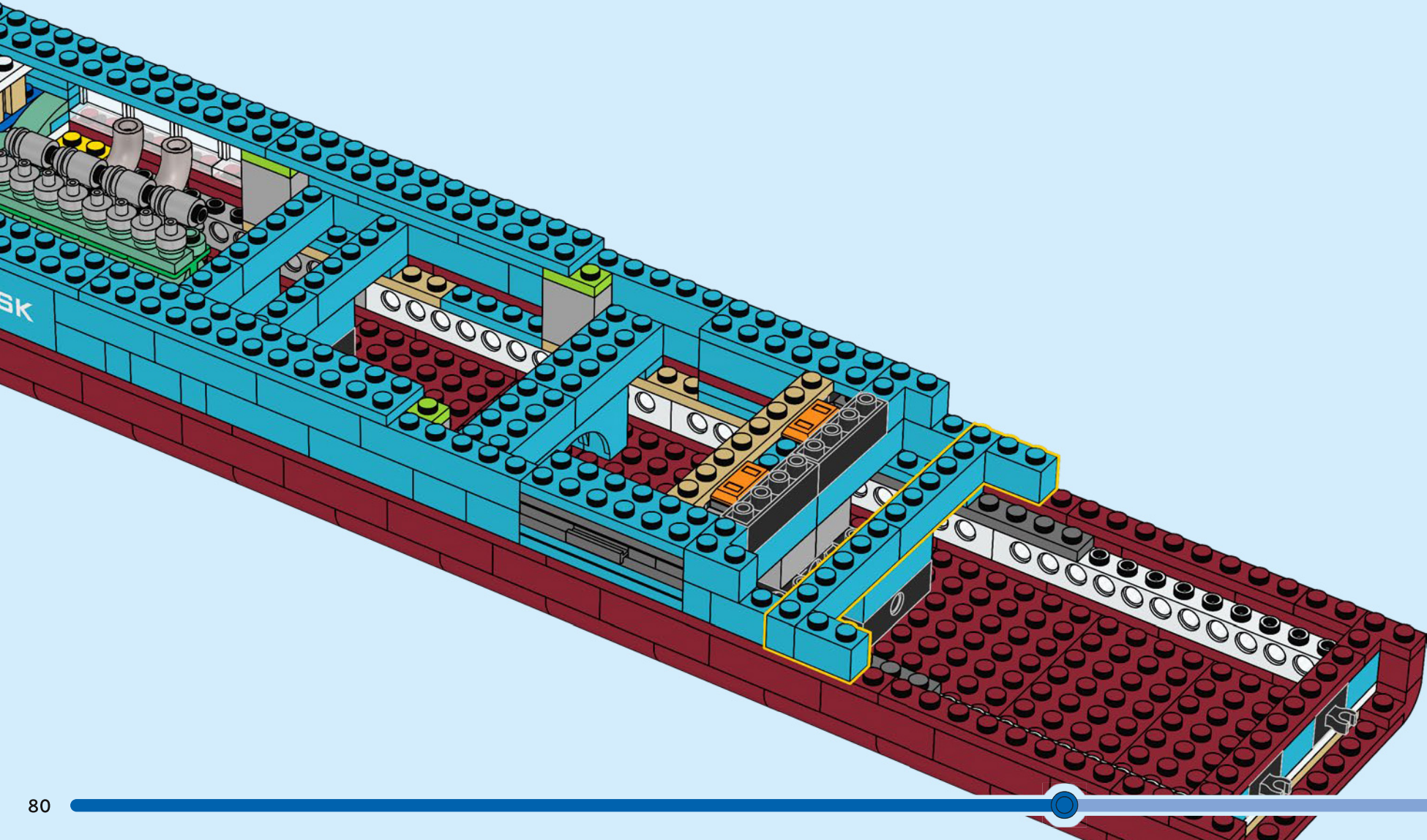

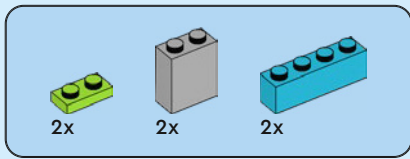

101

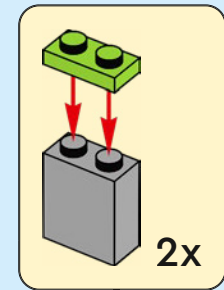
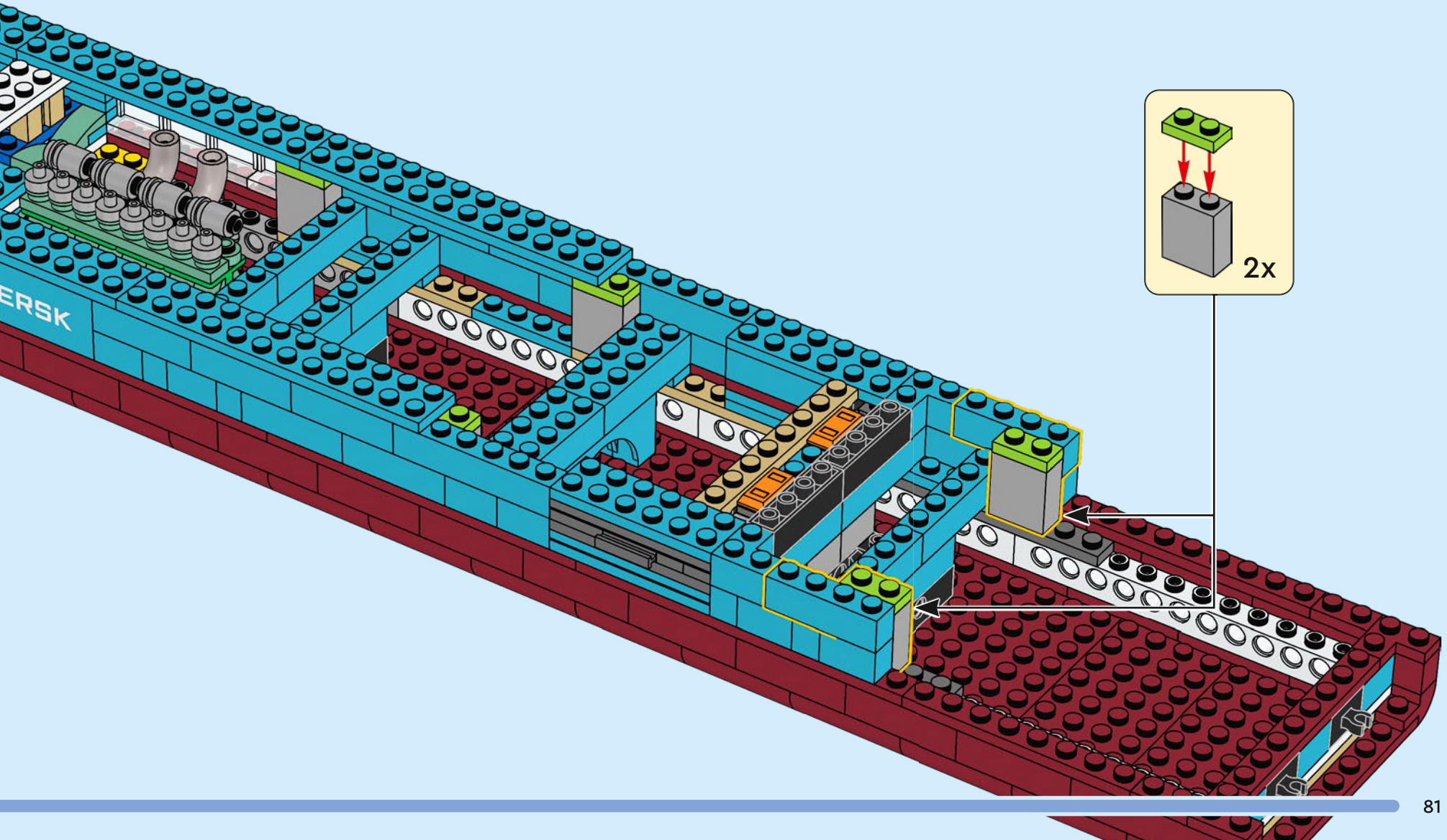

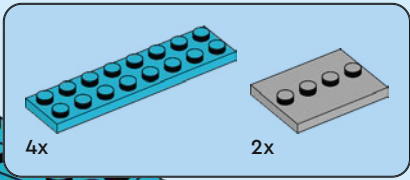

102

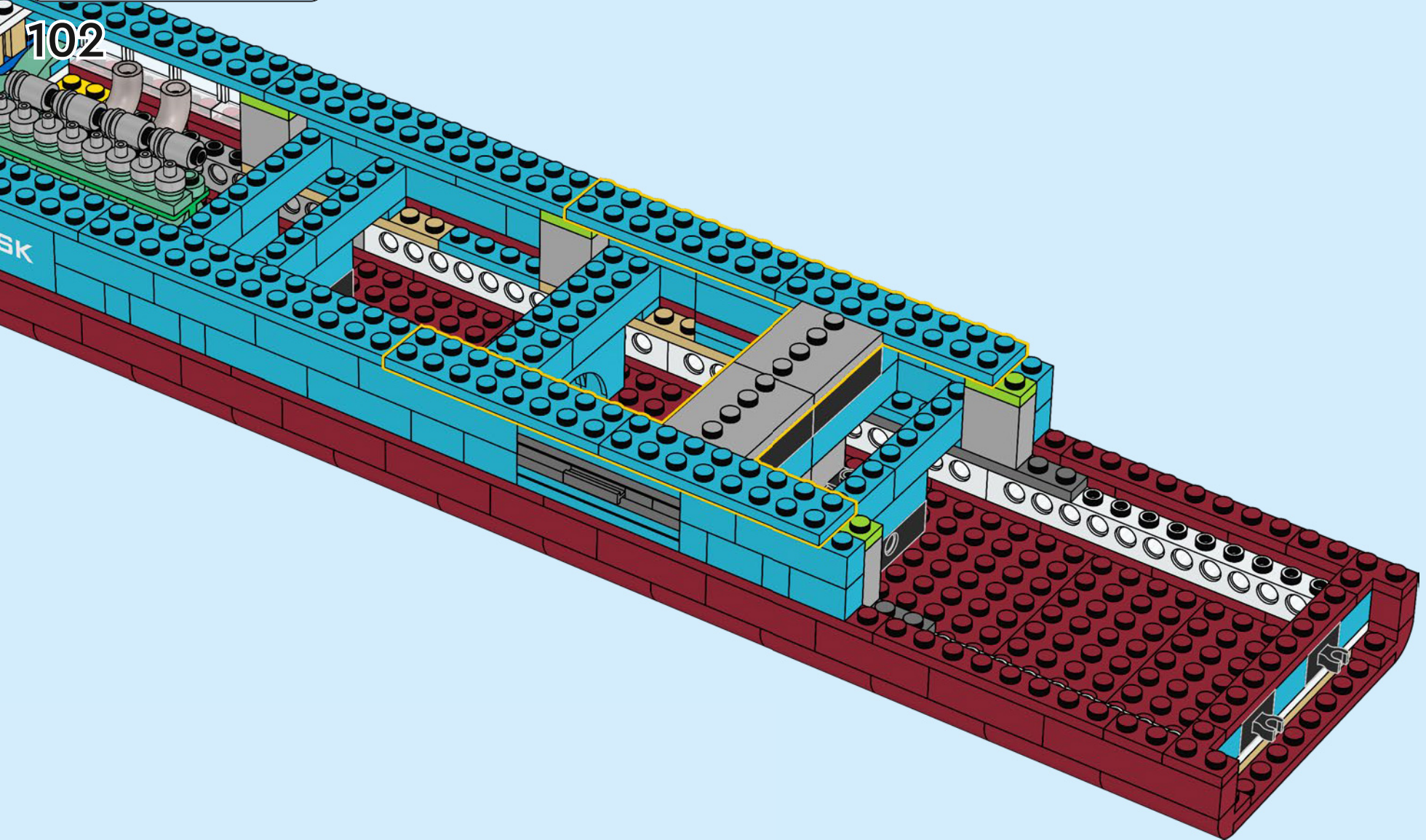

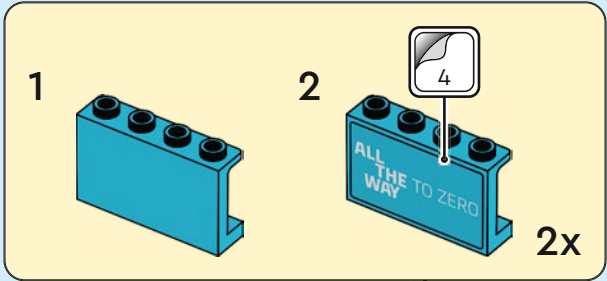
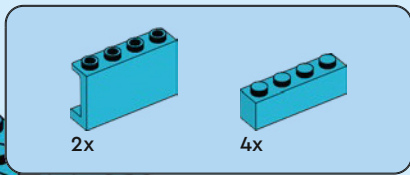

103
ERSK

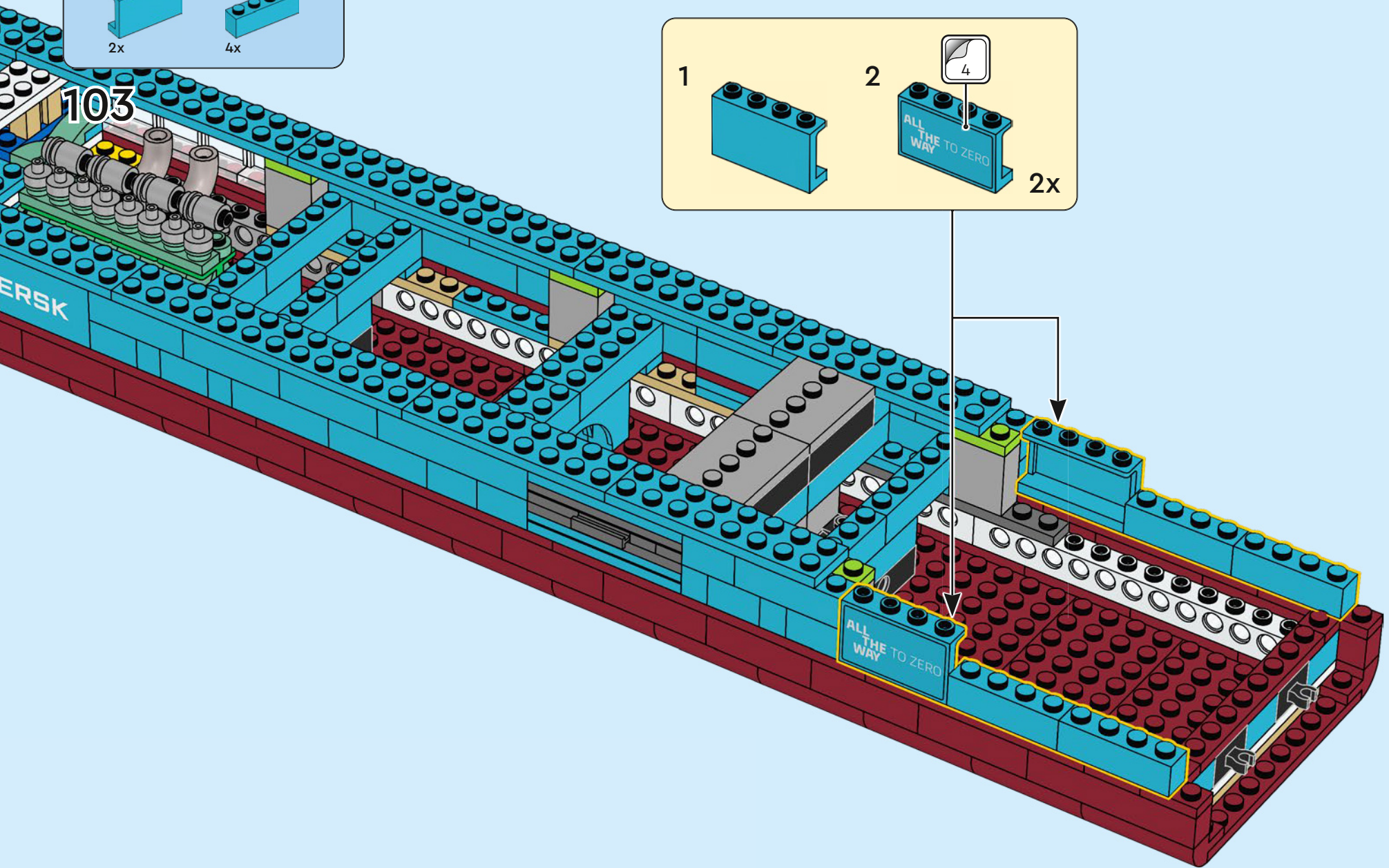

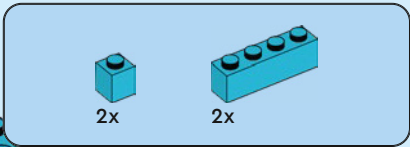

104

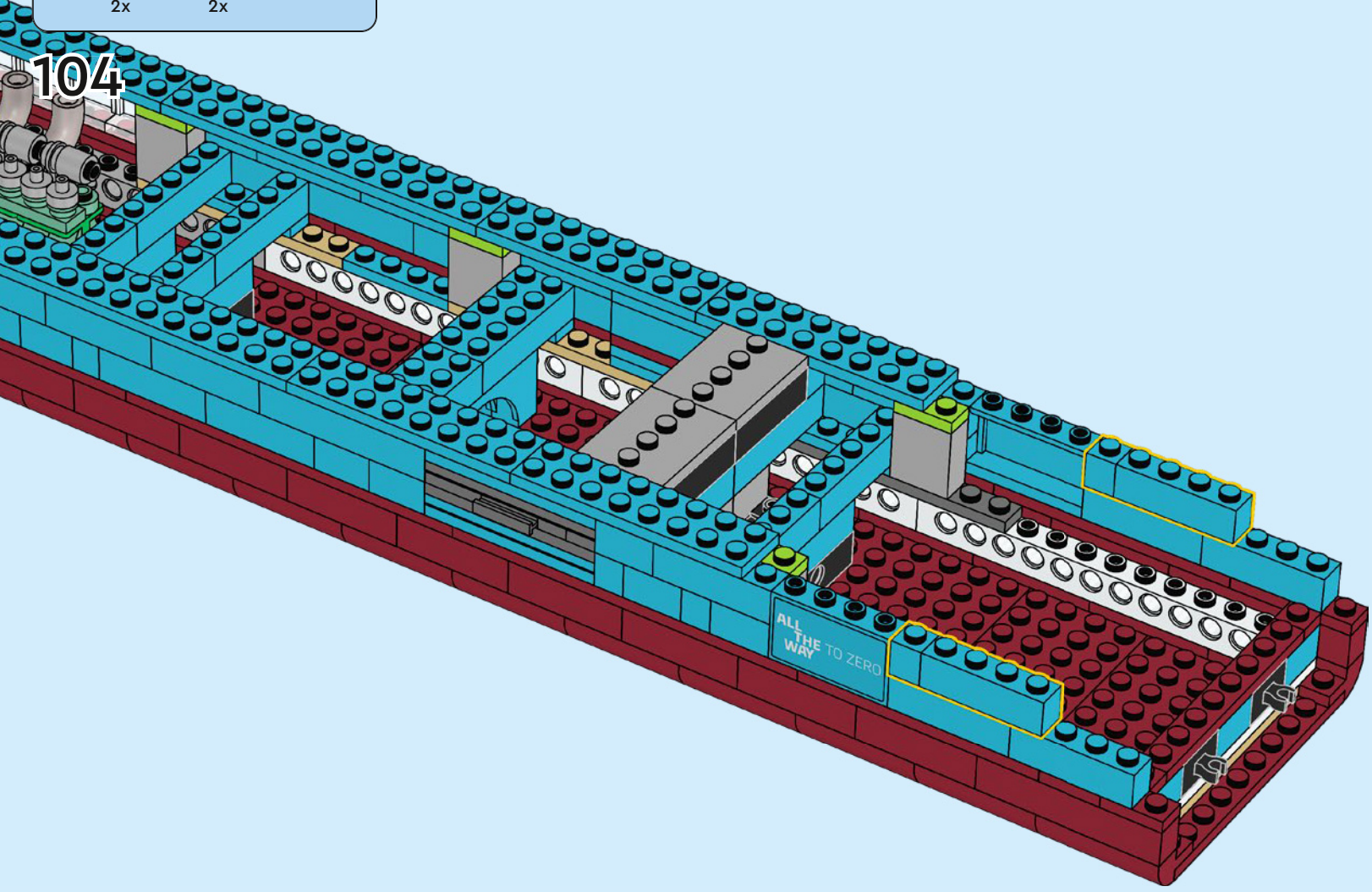

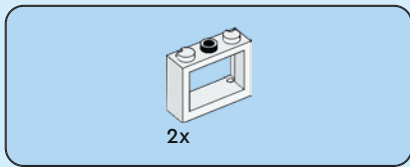

105

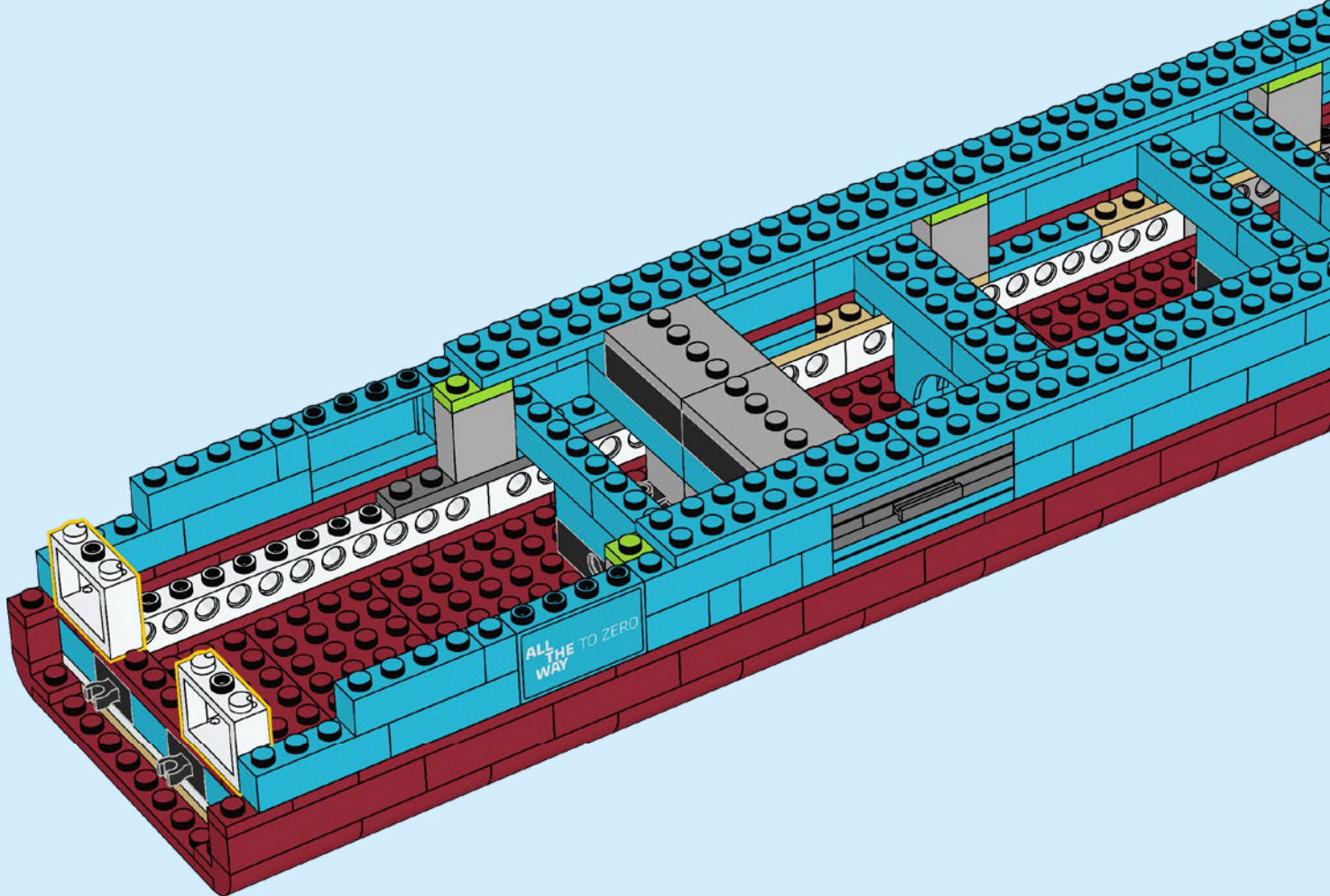

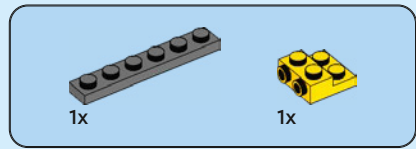
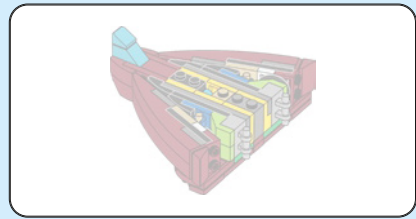
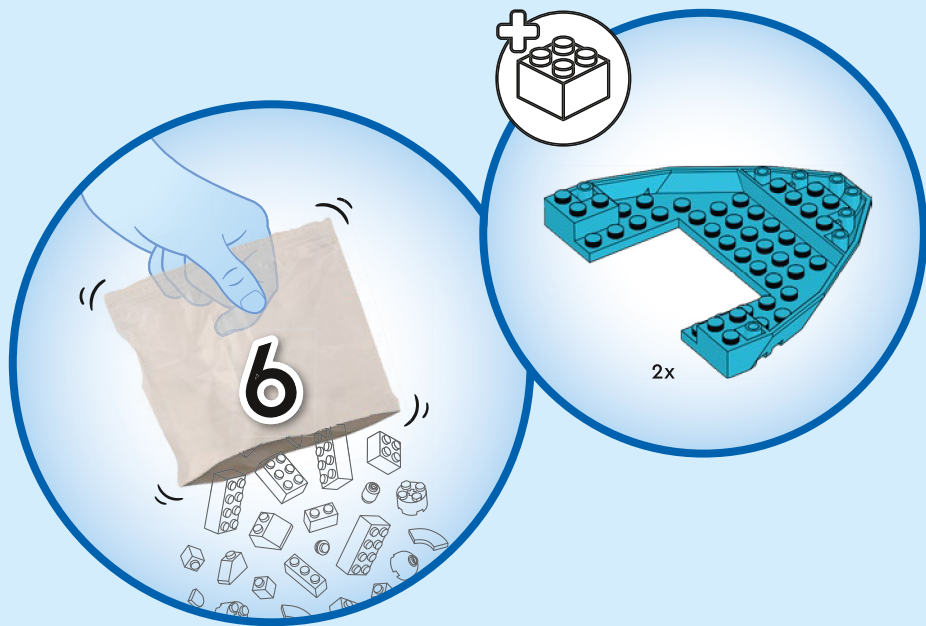

106

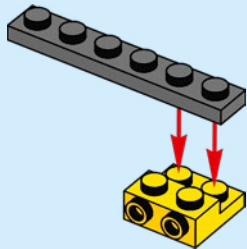

107

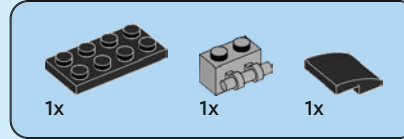
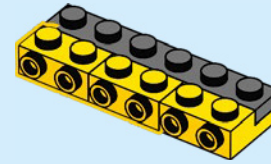

108

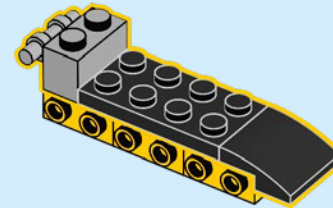

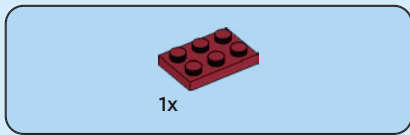

109

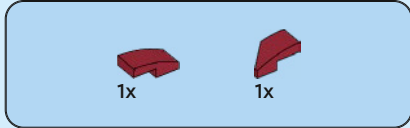
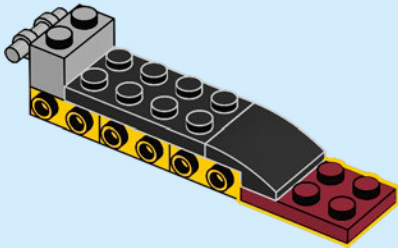

110

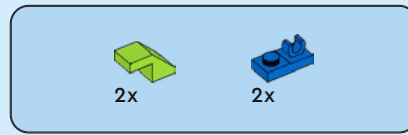
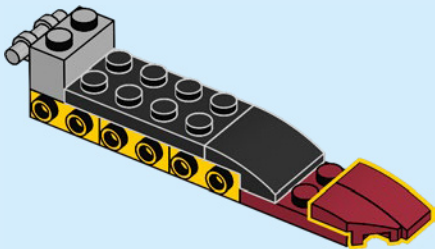

111

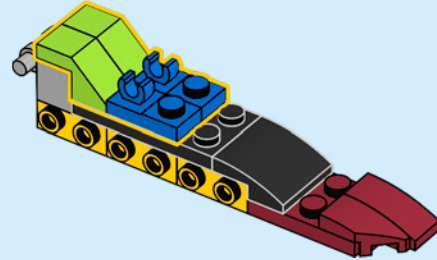

112

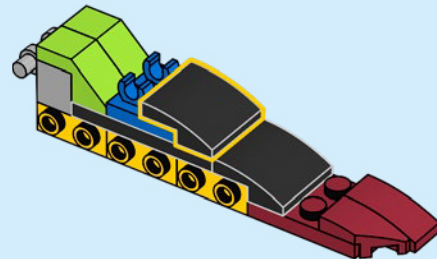

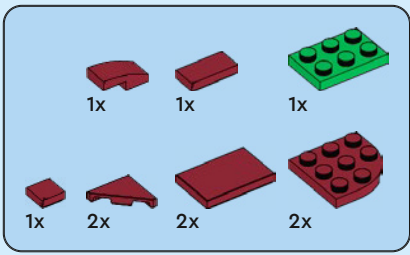

113

1

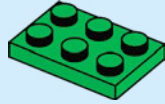

2

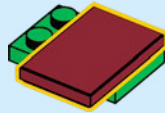

3

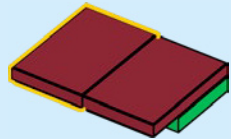

4

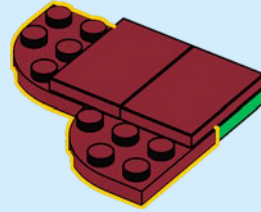

5

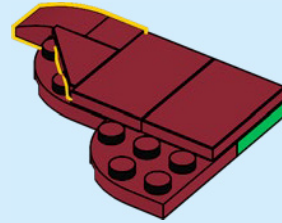

6

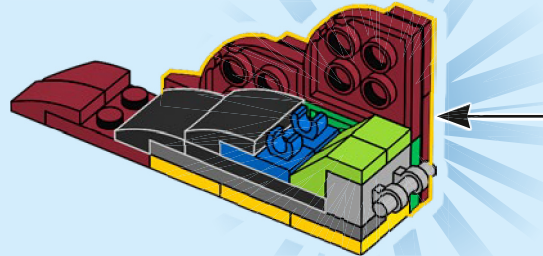
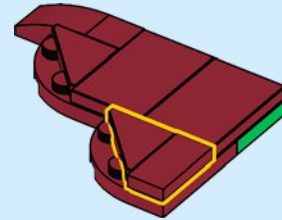

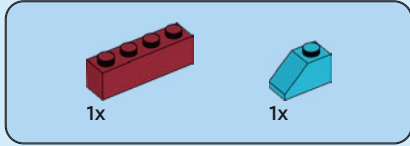
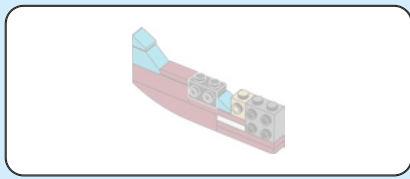

114

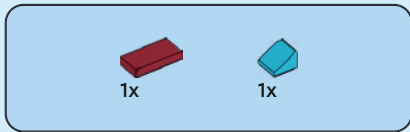
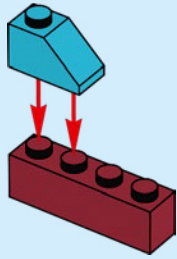

115

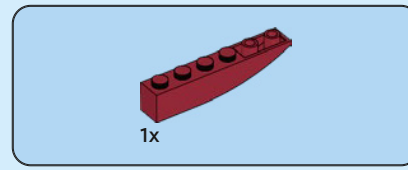
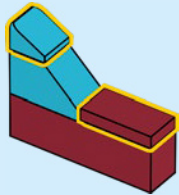

116

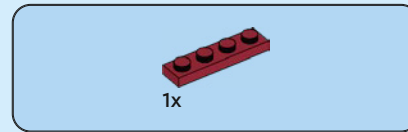
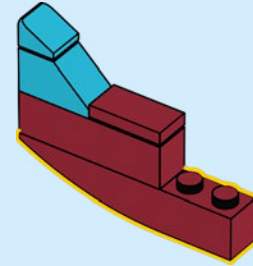

117

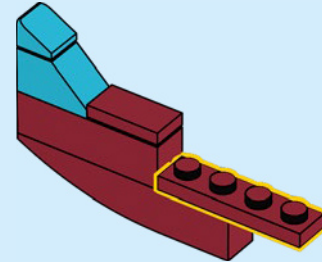

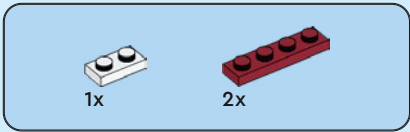

118

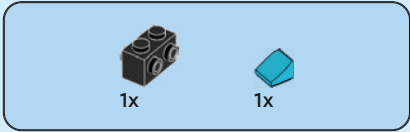
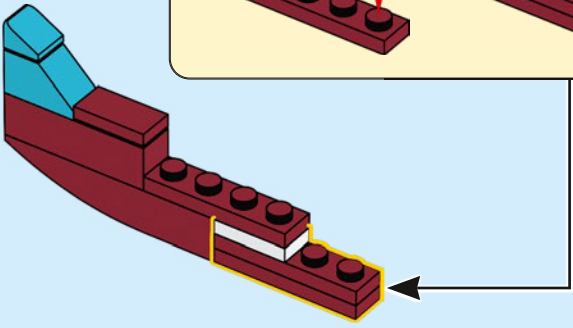
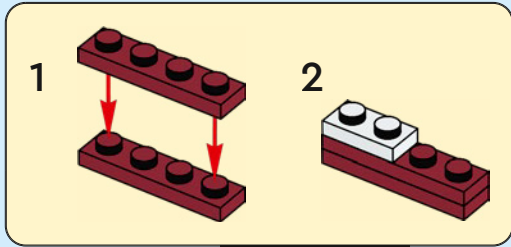

119

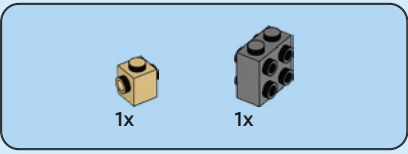
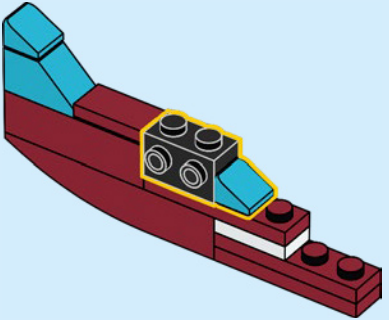

120

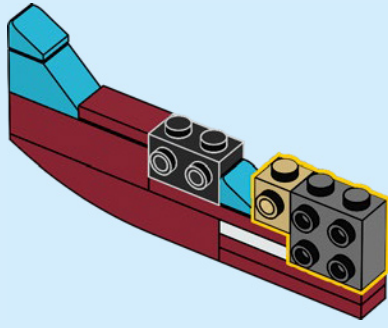

121

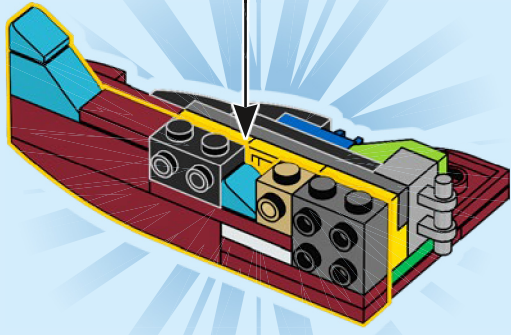

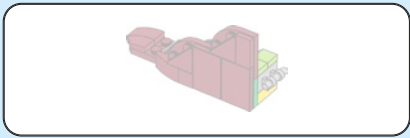

122

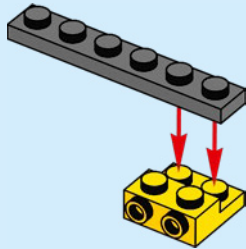

123

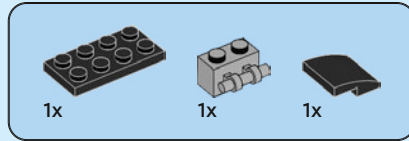
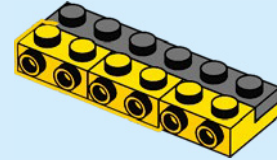

124

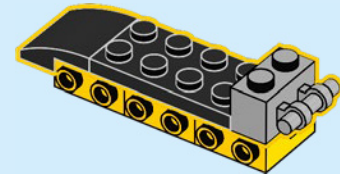

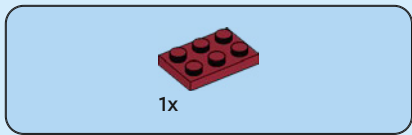

125

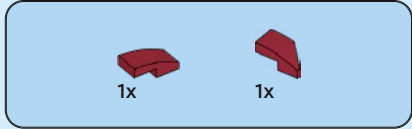
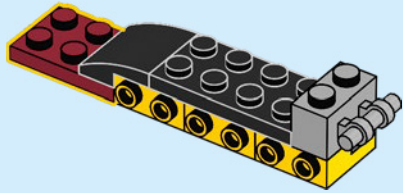

126

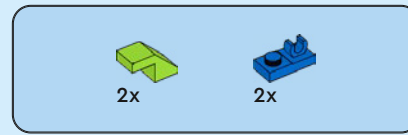
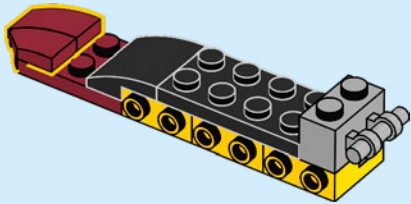

127

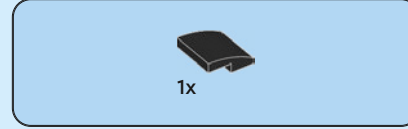
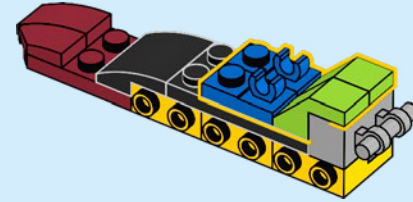

128

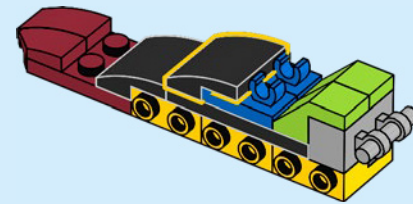

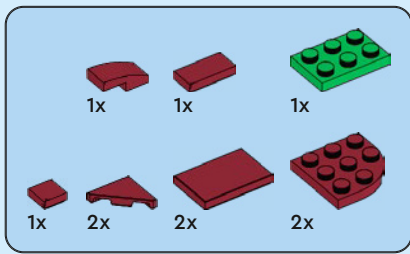

129

1

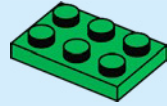

2

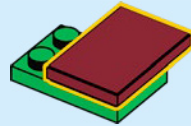

3

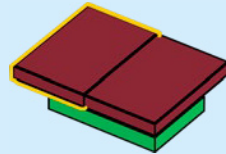

4

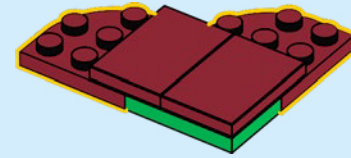

5

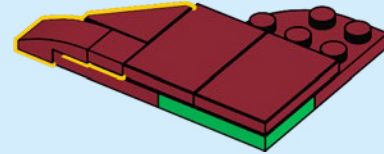

6

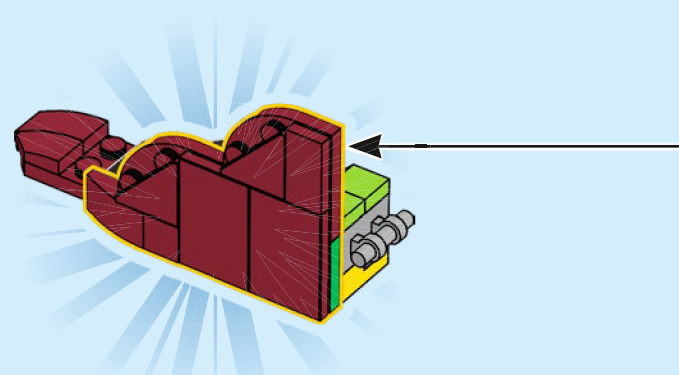
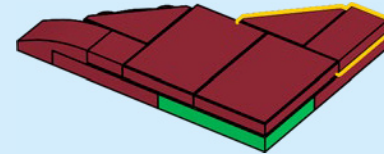

130

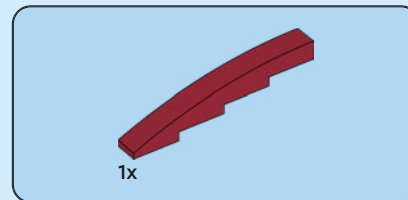
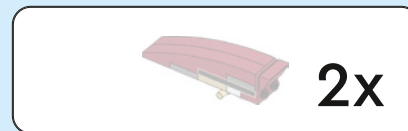
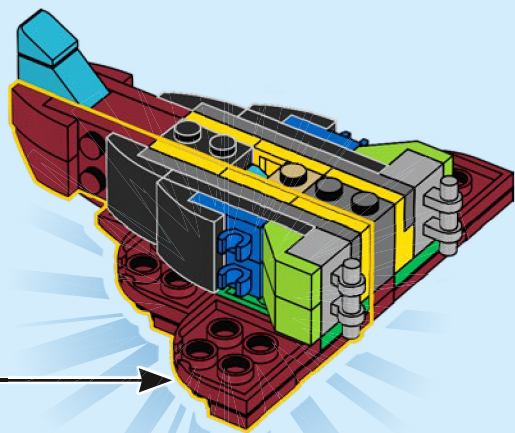

131

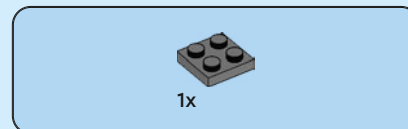
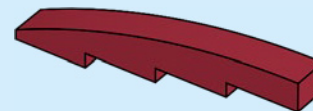

132

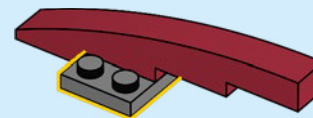

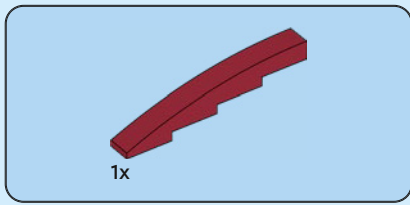

133

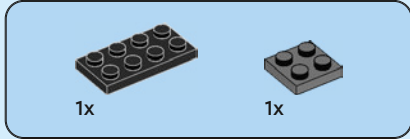
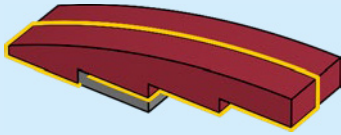

134

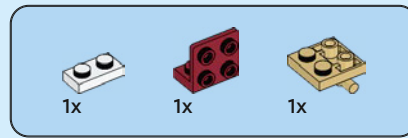
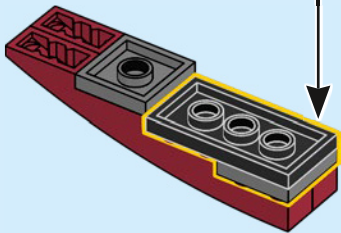
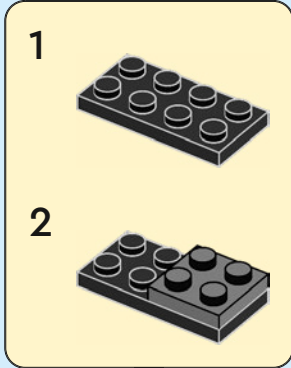

135

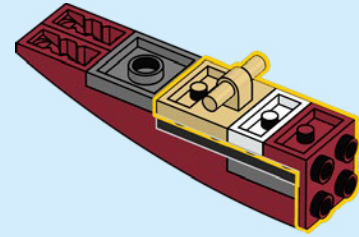

136

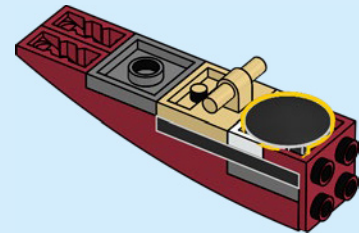



1x

137

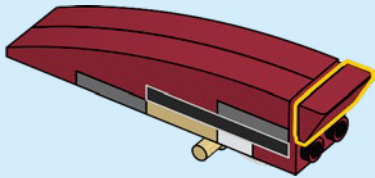

2x

138

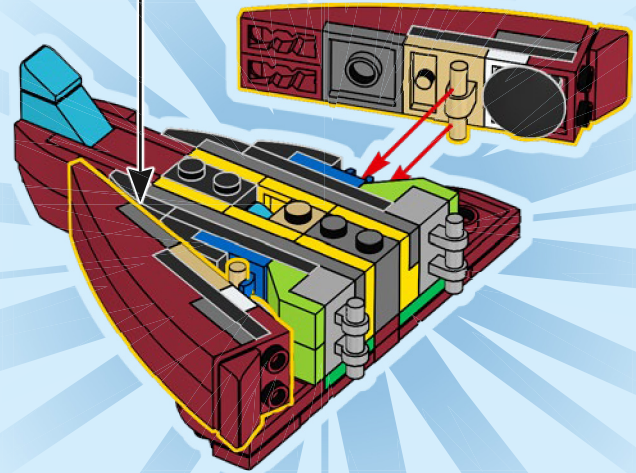

139

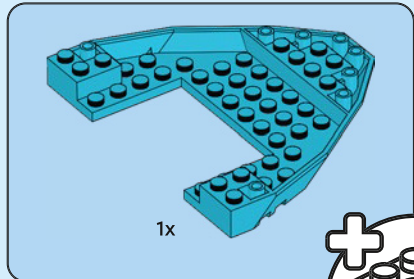
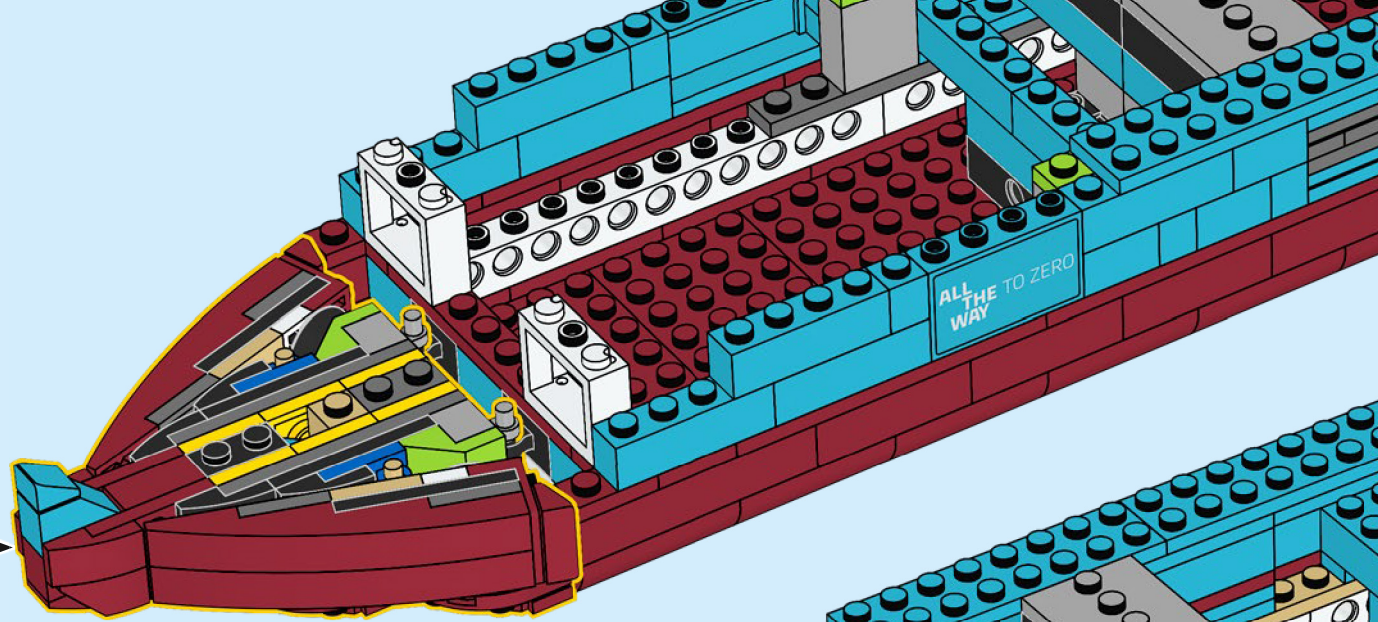

1x

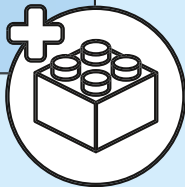

140

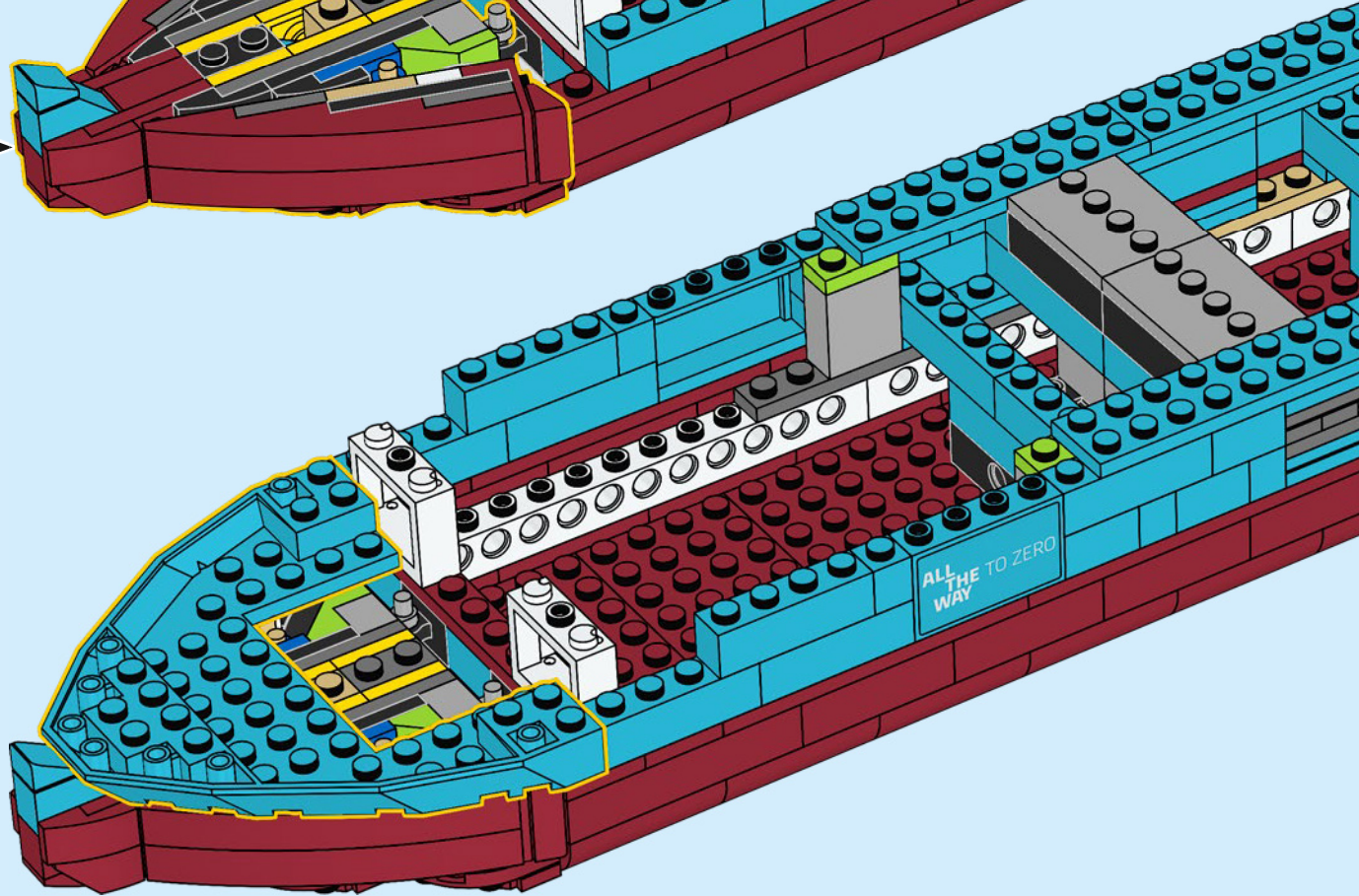

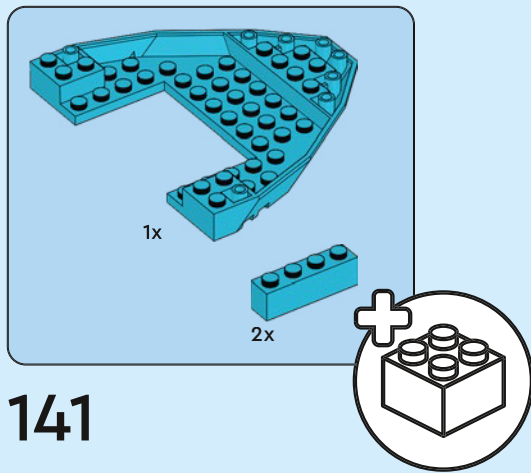

141

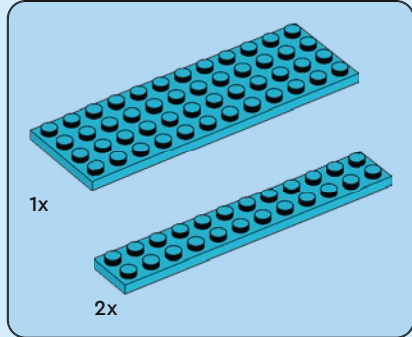
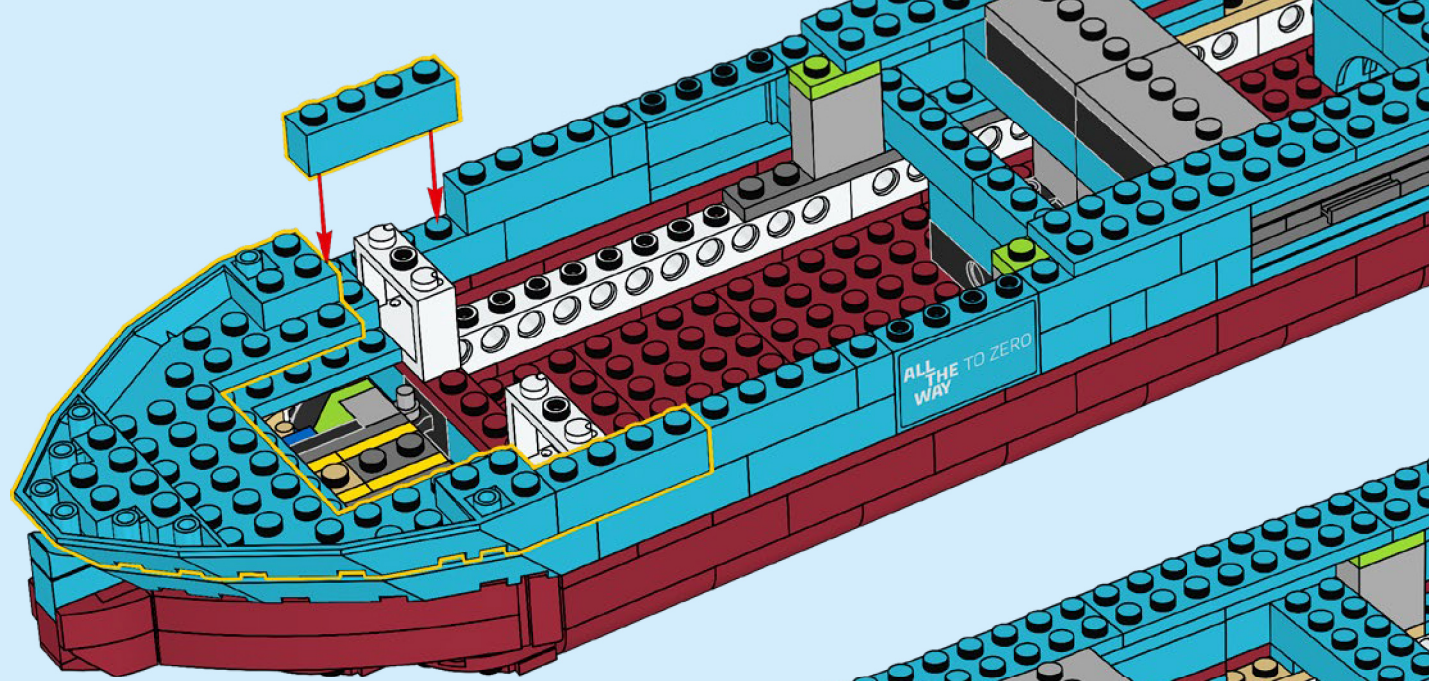

142

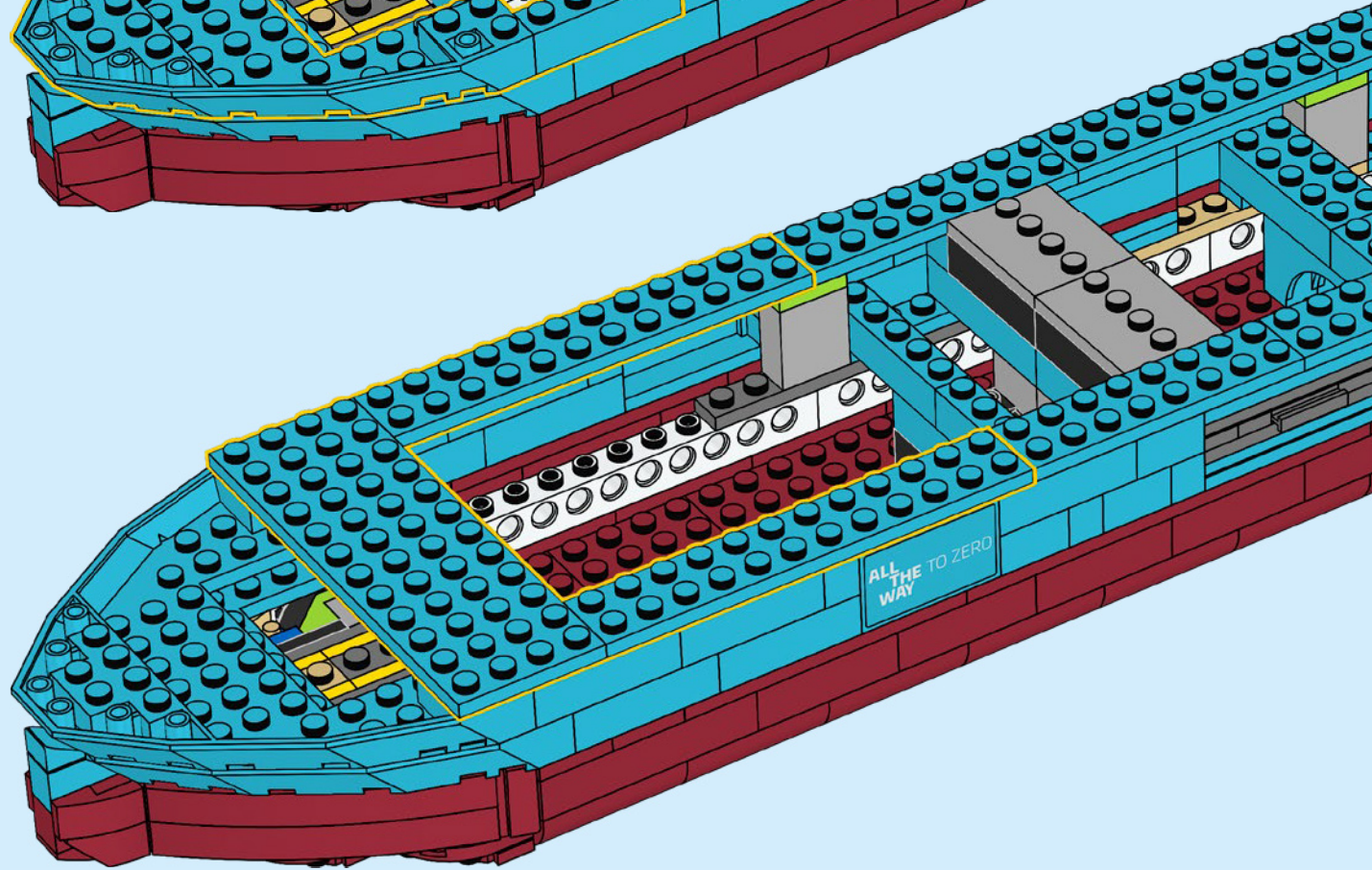

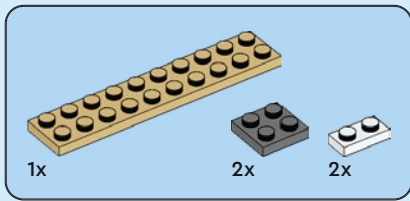

143

1

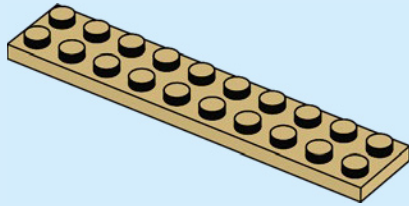

2

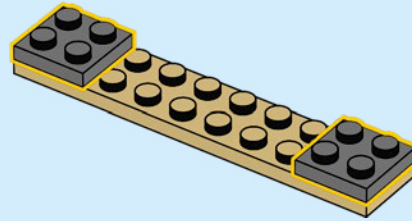

3

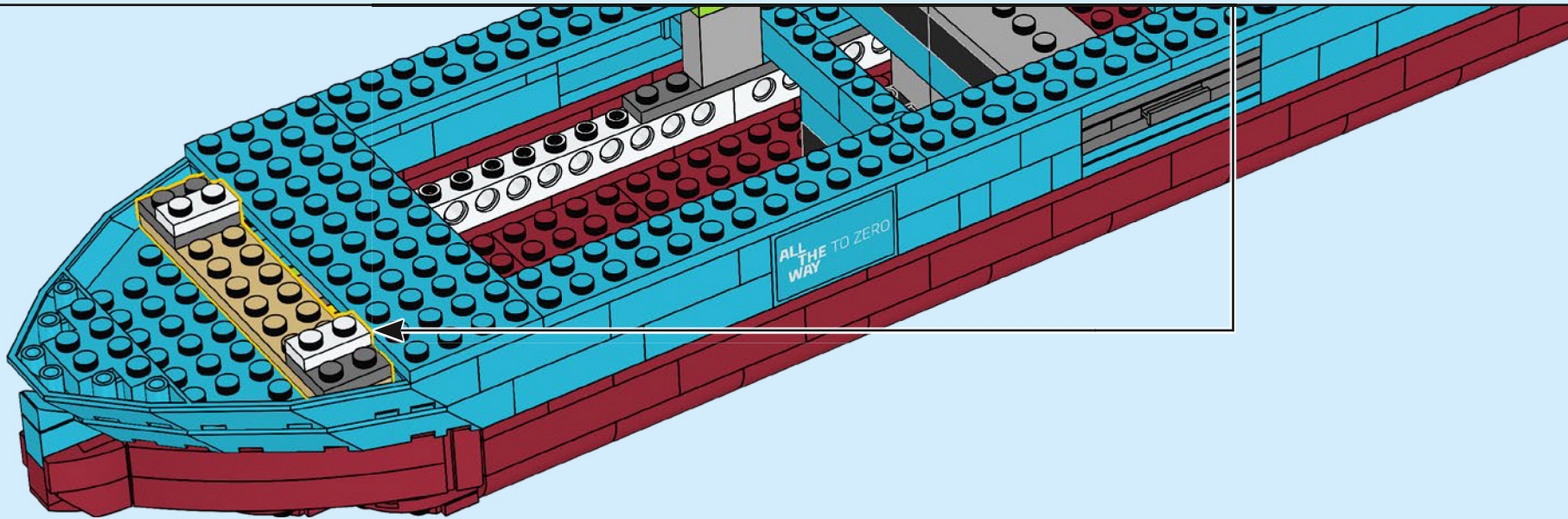
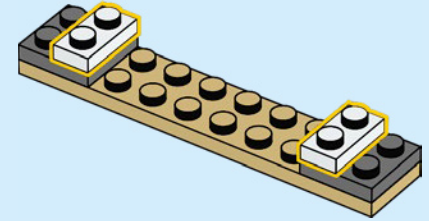

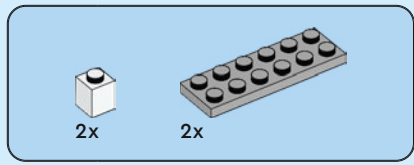

144

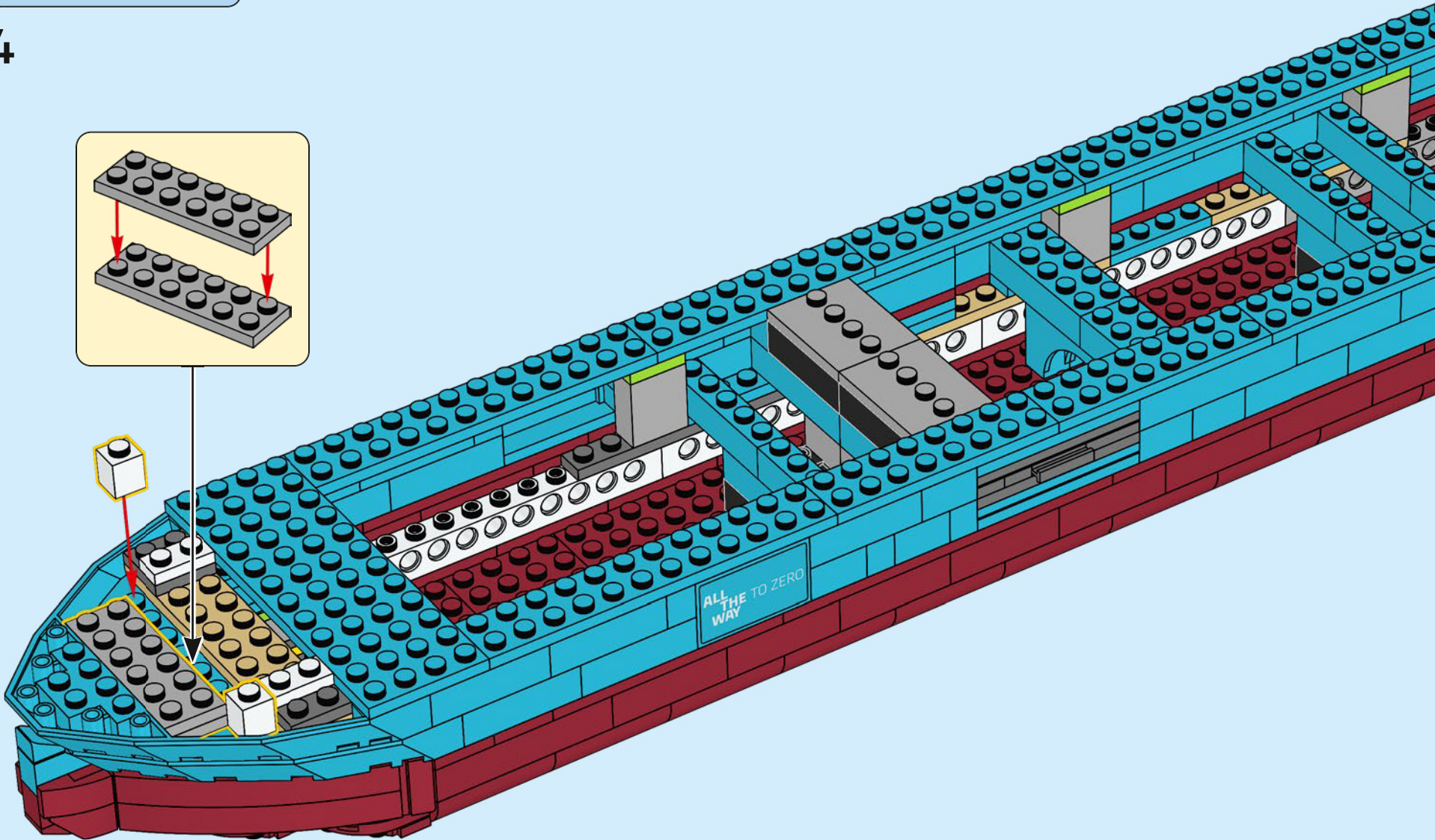
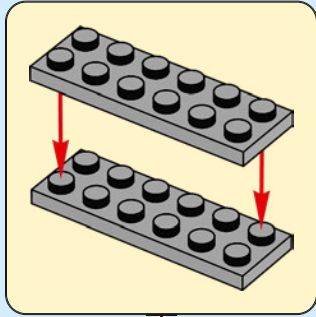

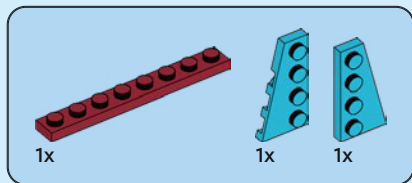

145

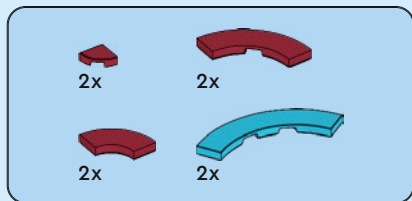
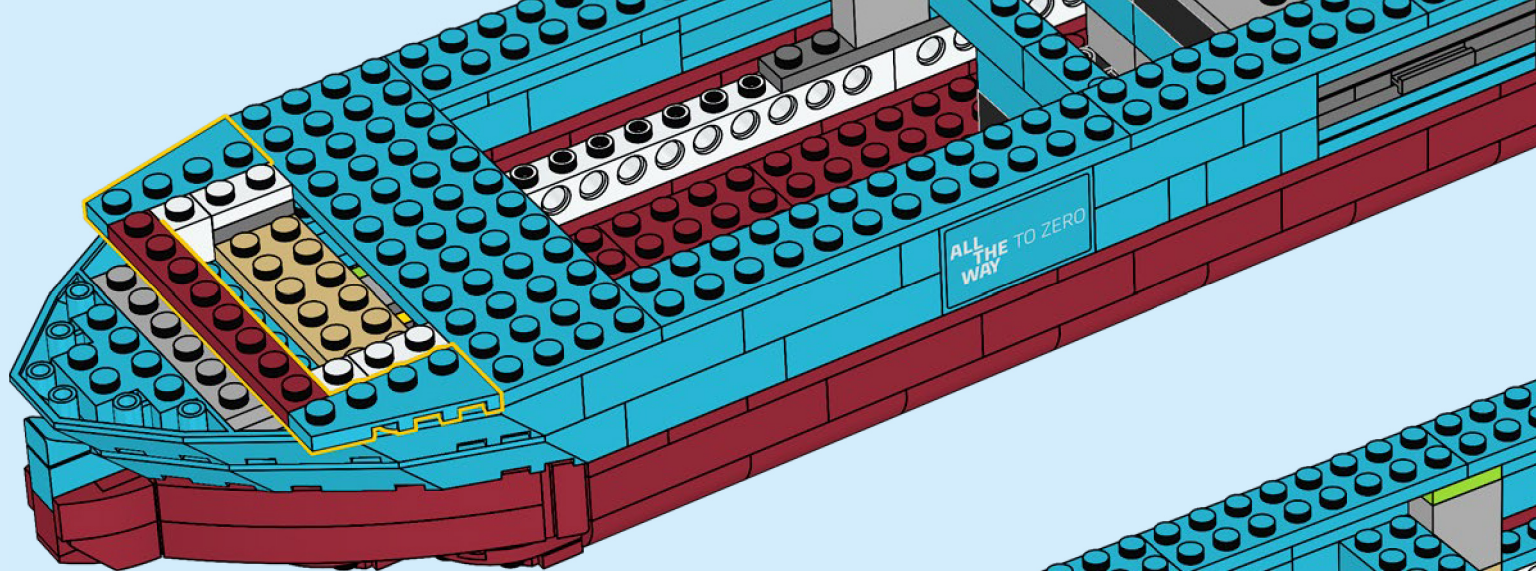

146

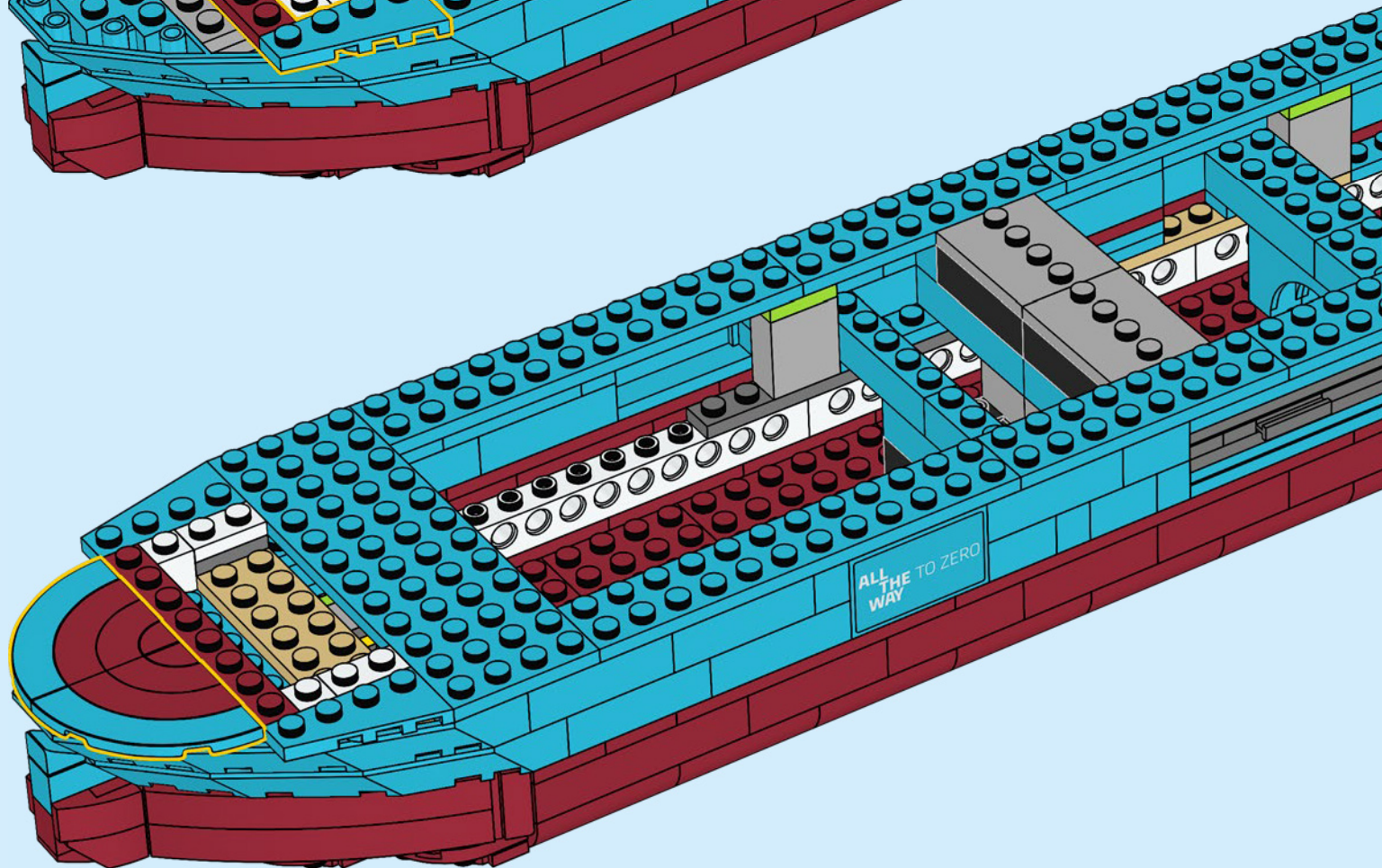

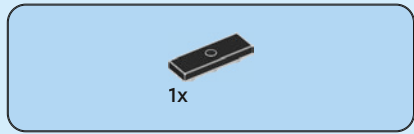

147

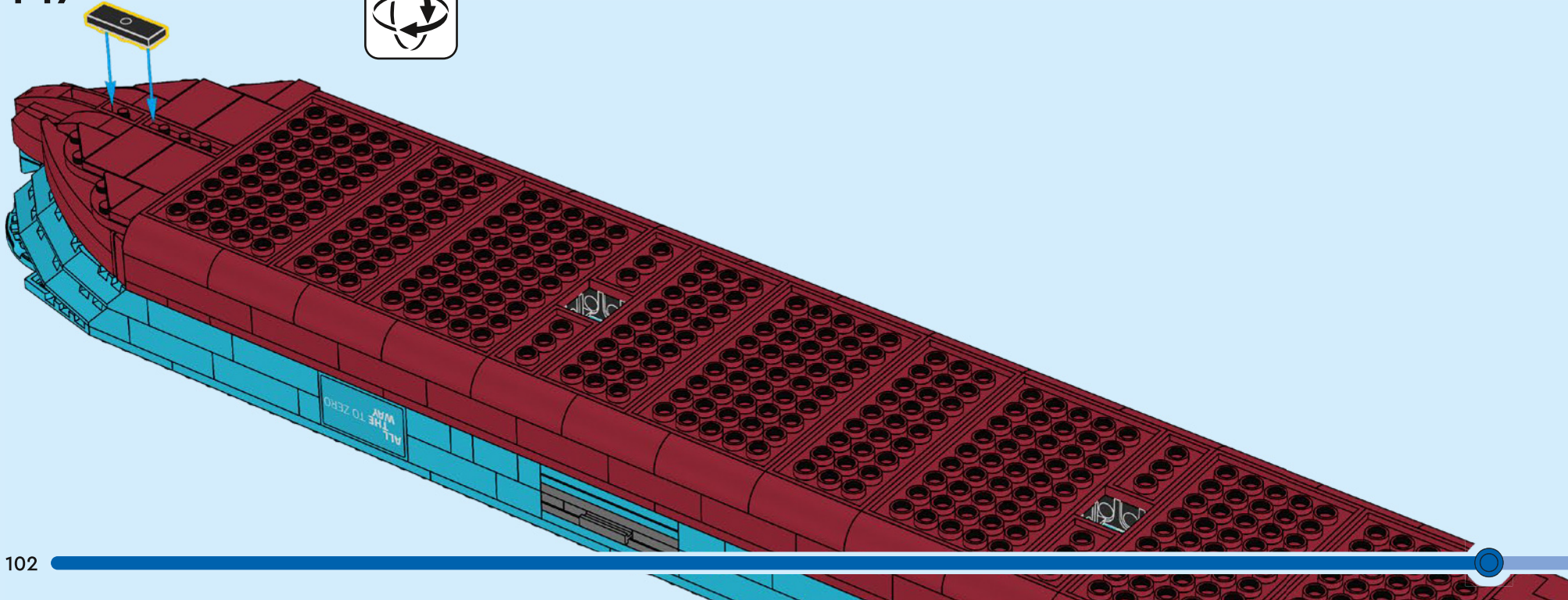



24x

148

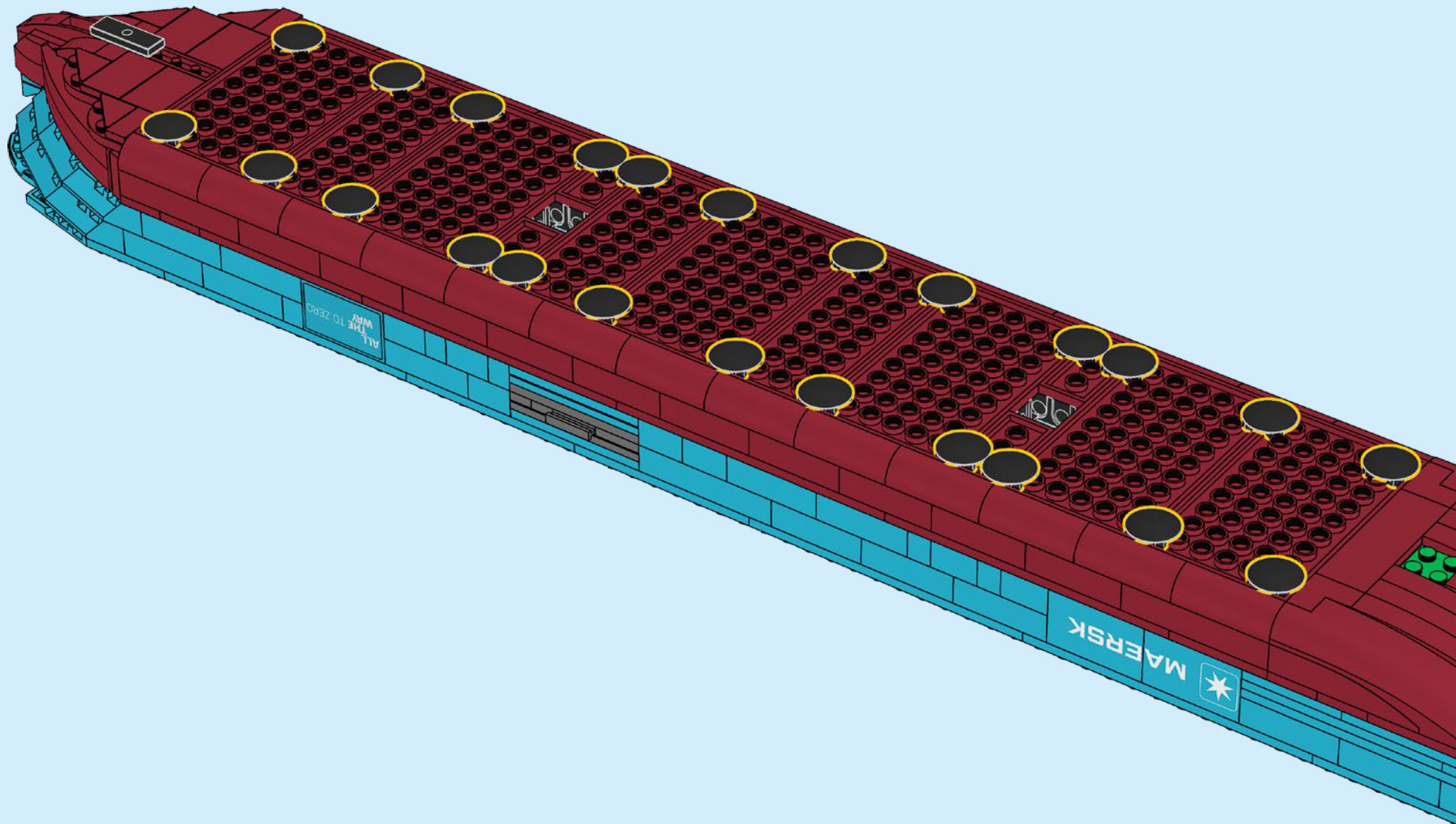

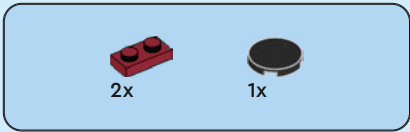

149

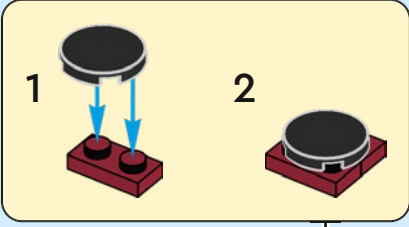
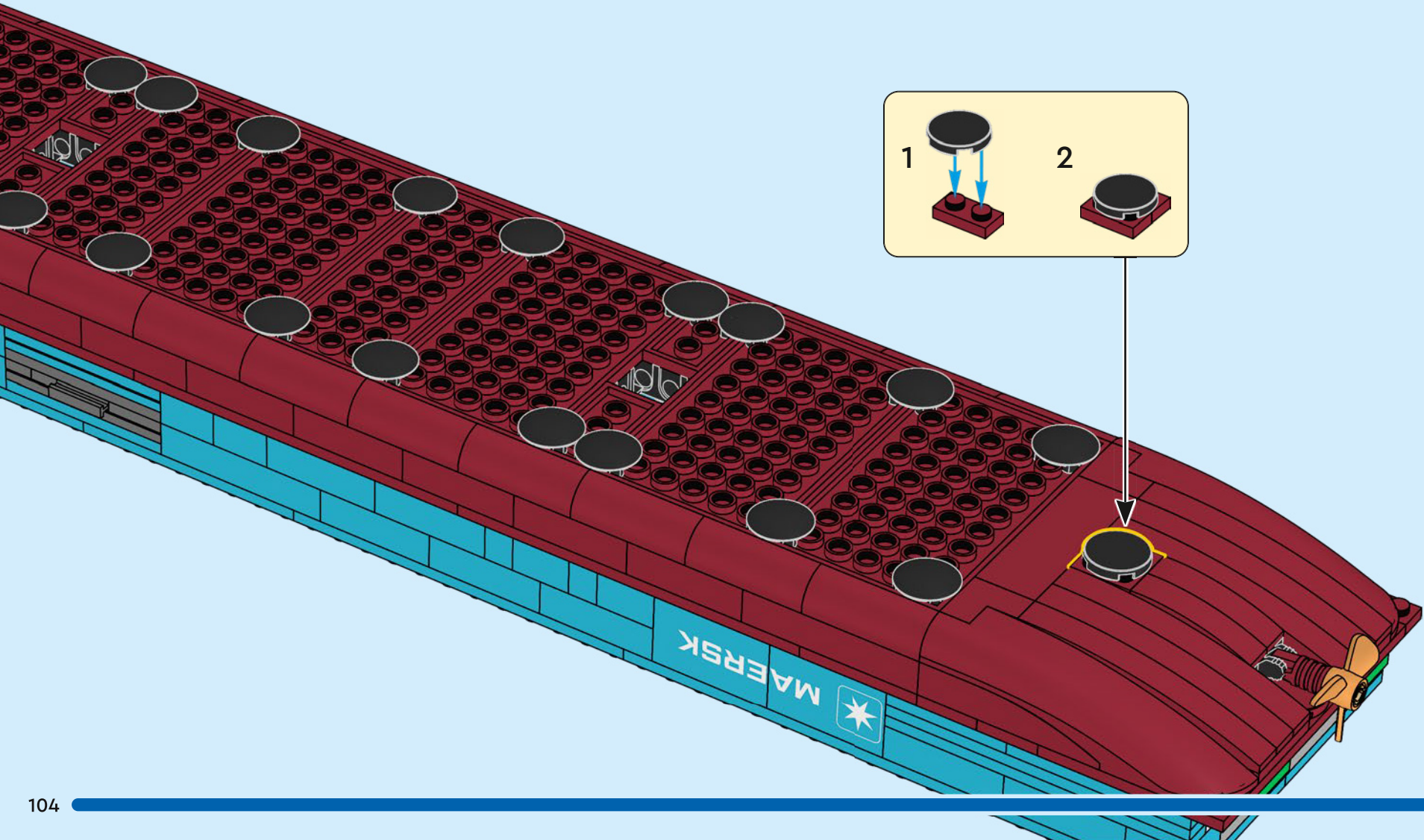

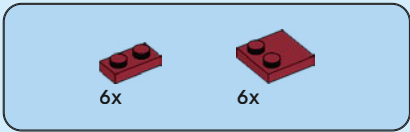

150

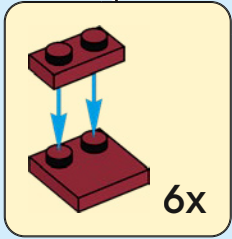
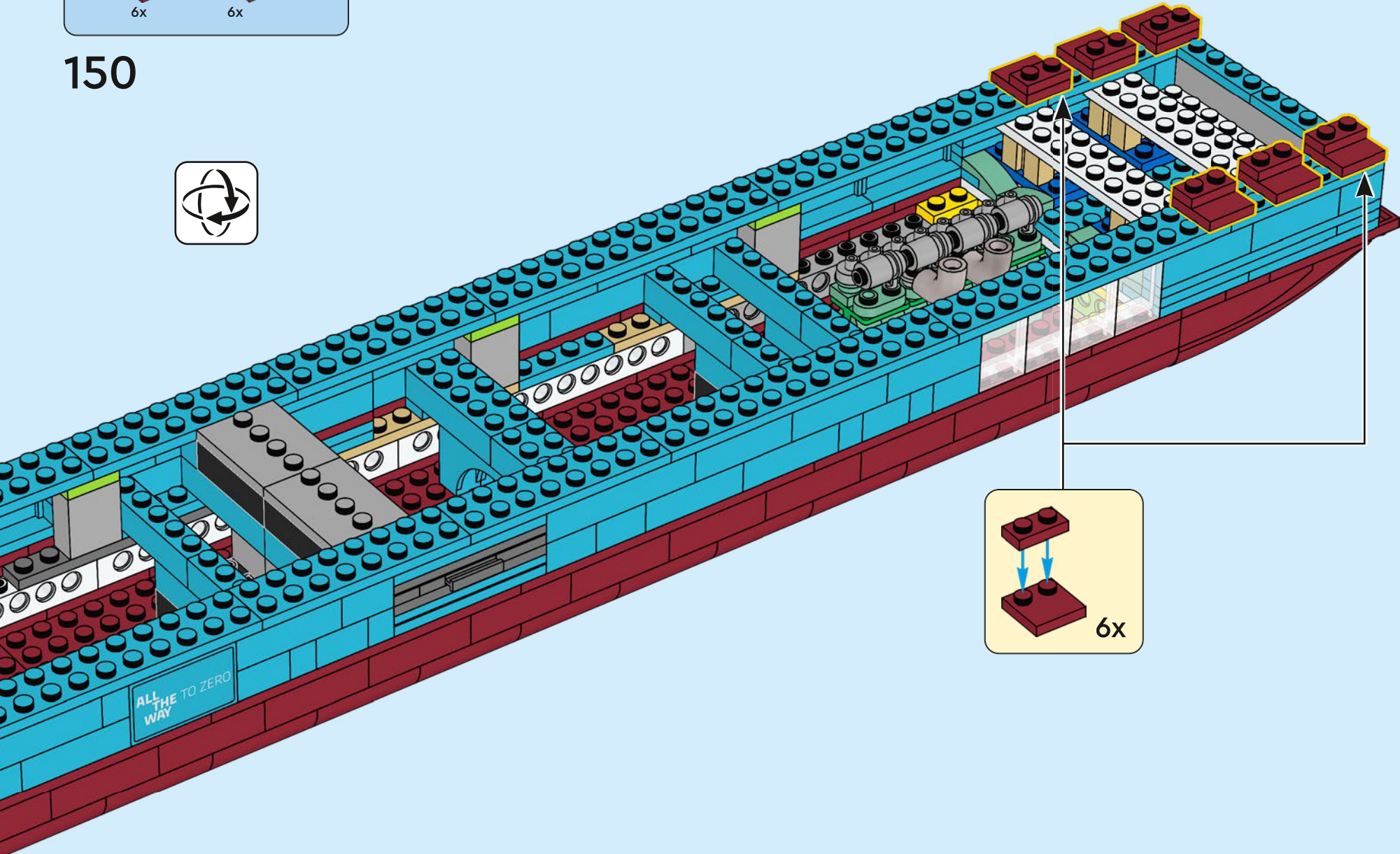

ALL
THE
WAY TO ZERO

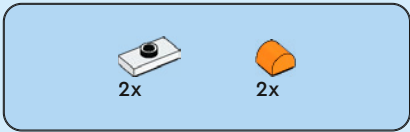

151

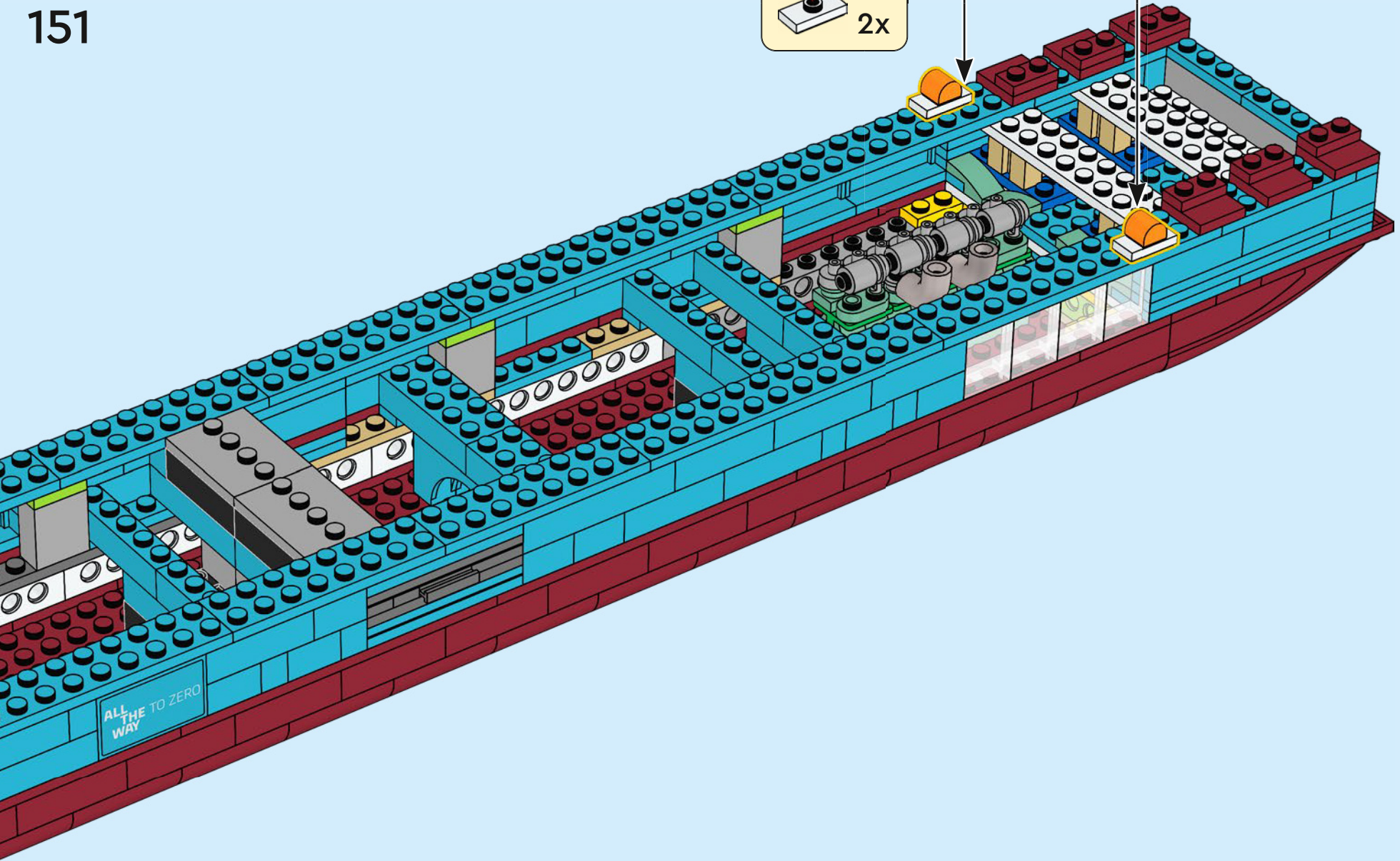
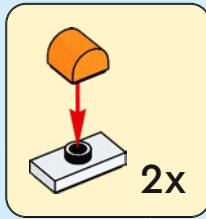

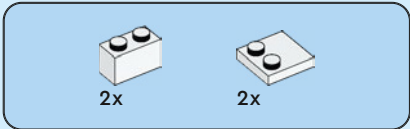

152

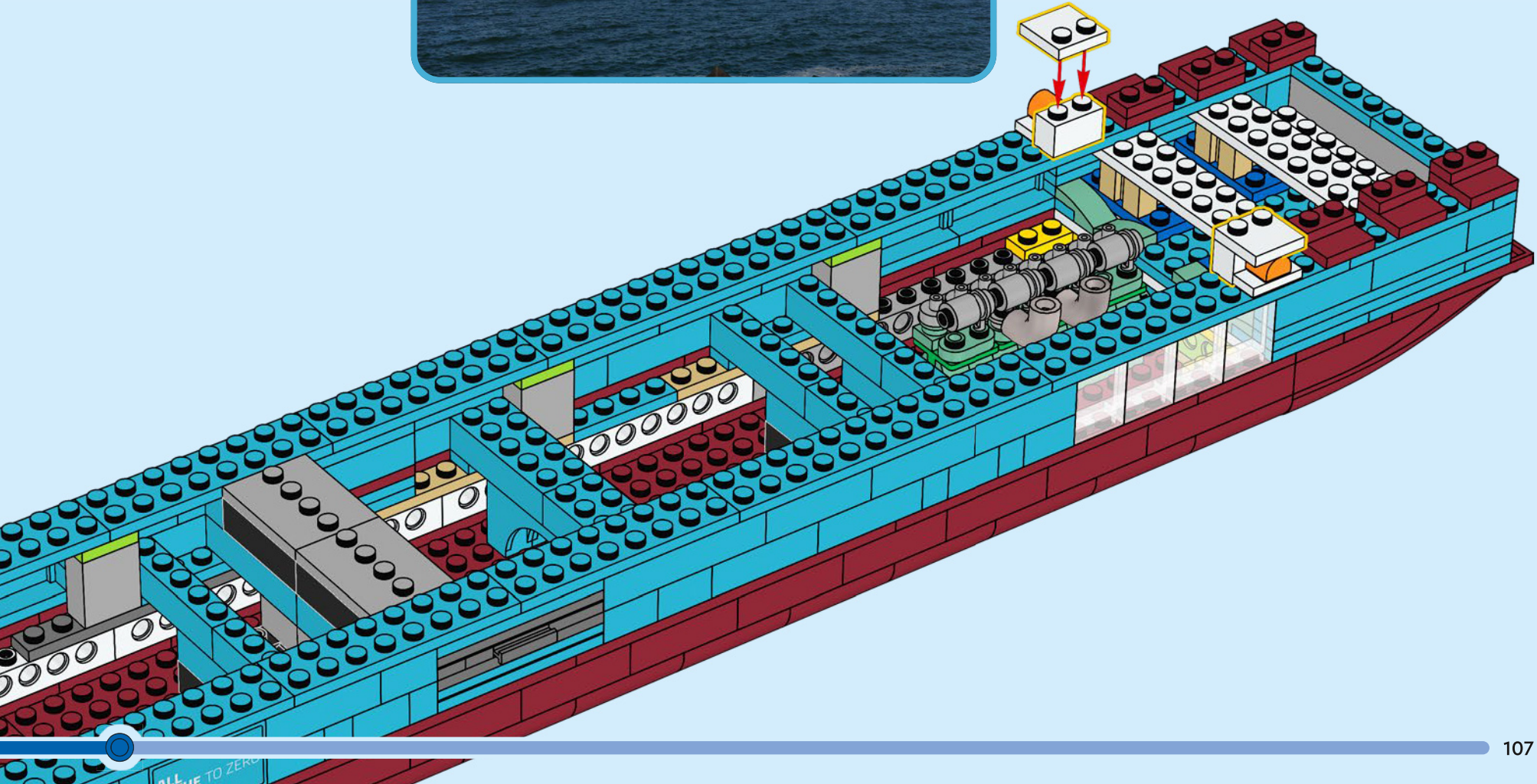
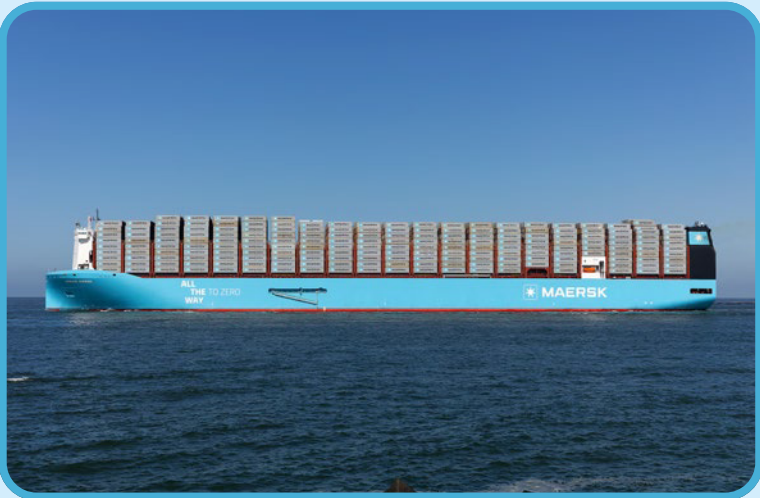

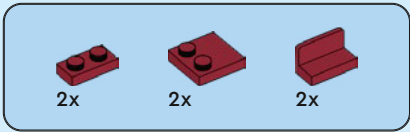

153

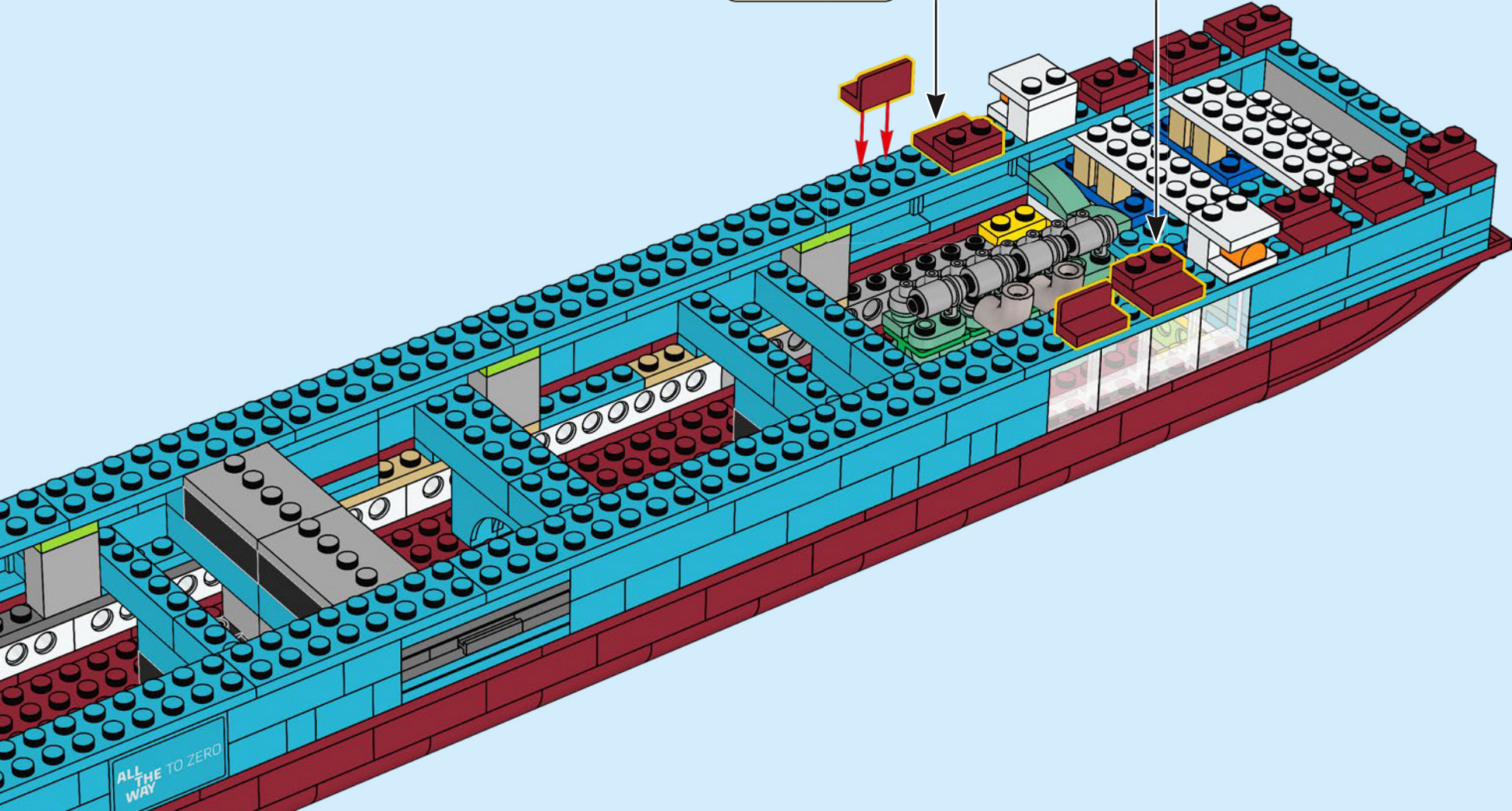
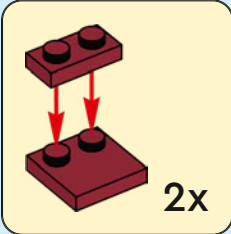

ALL THE WAY TO ZERO

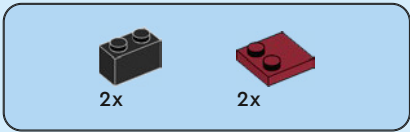

154

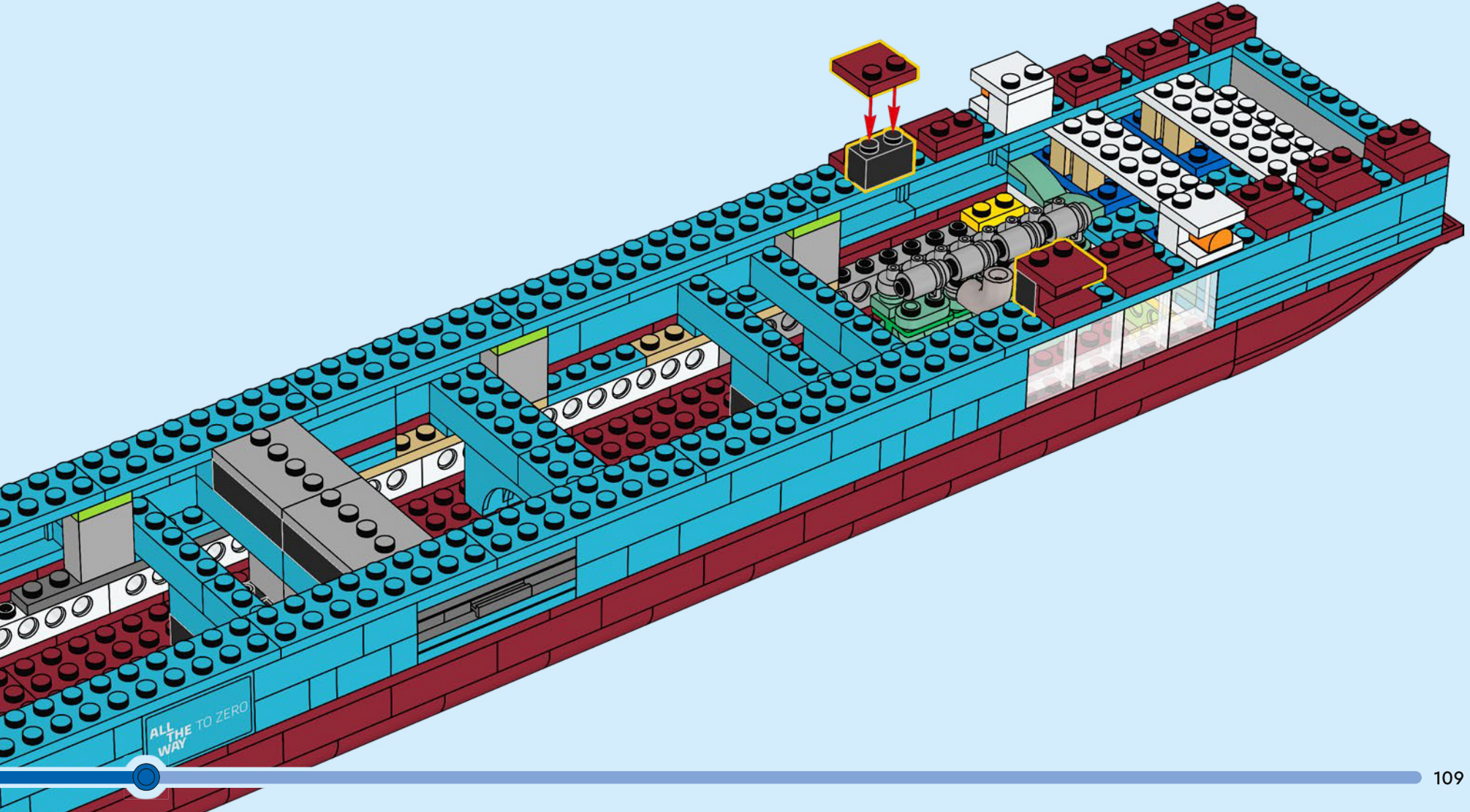

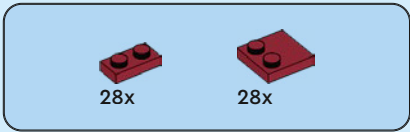

155

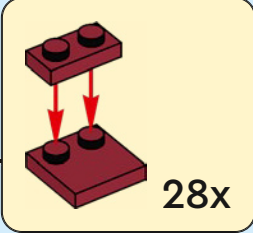
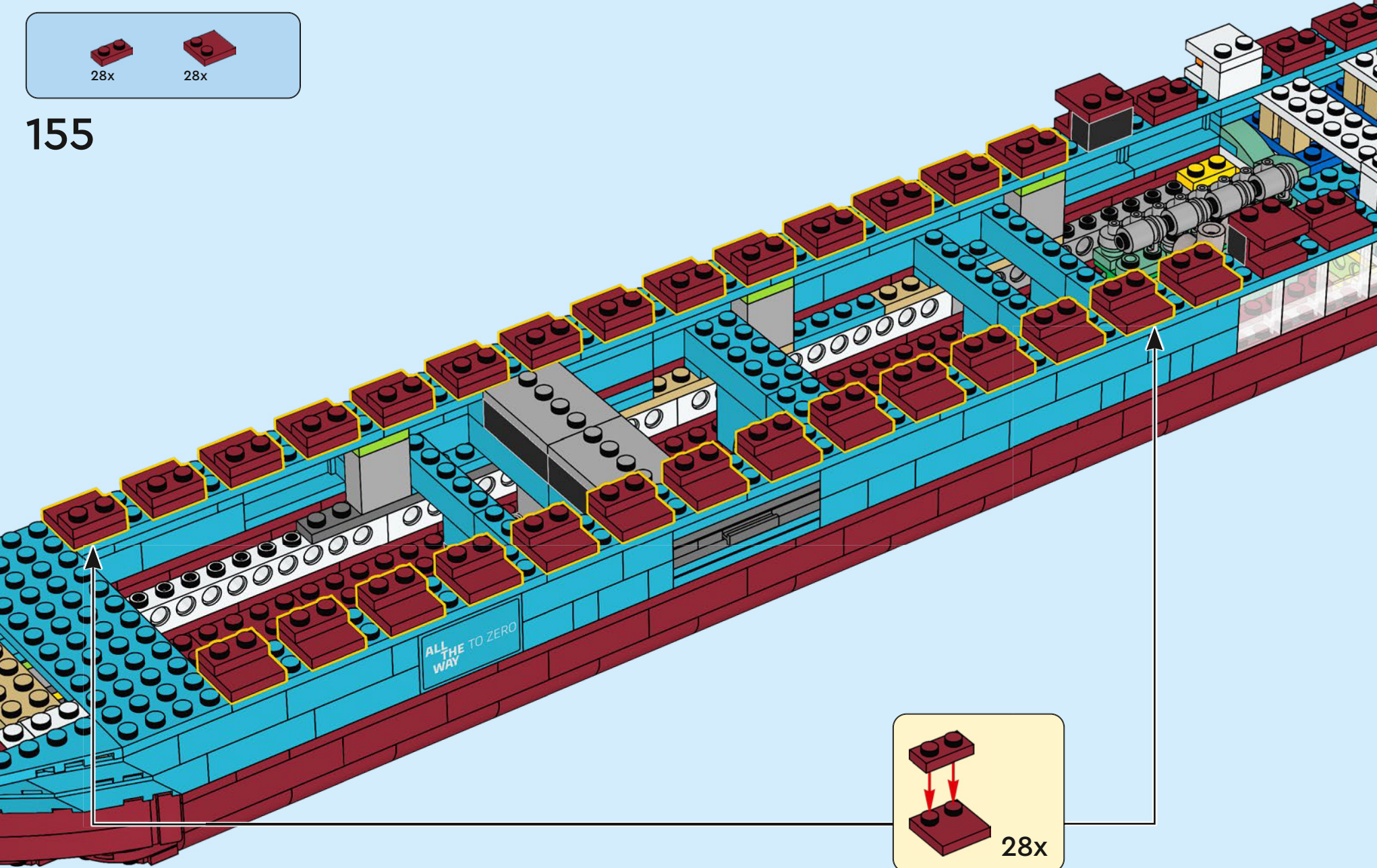

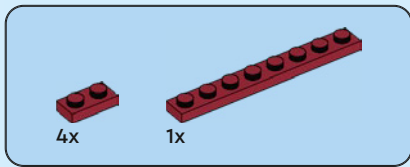

156

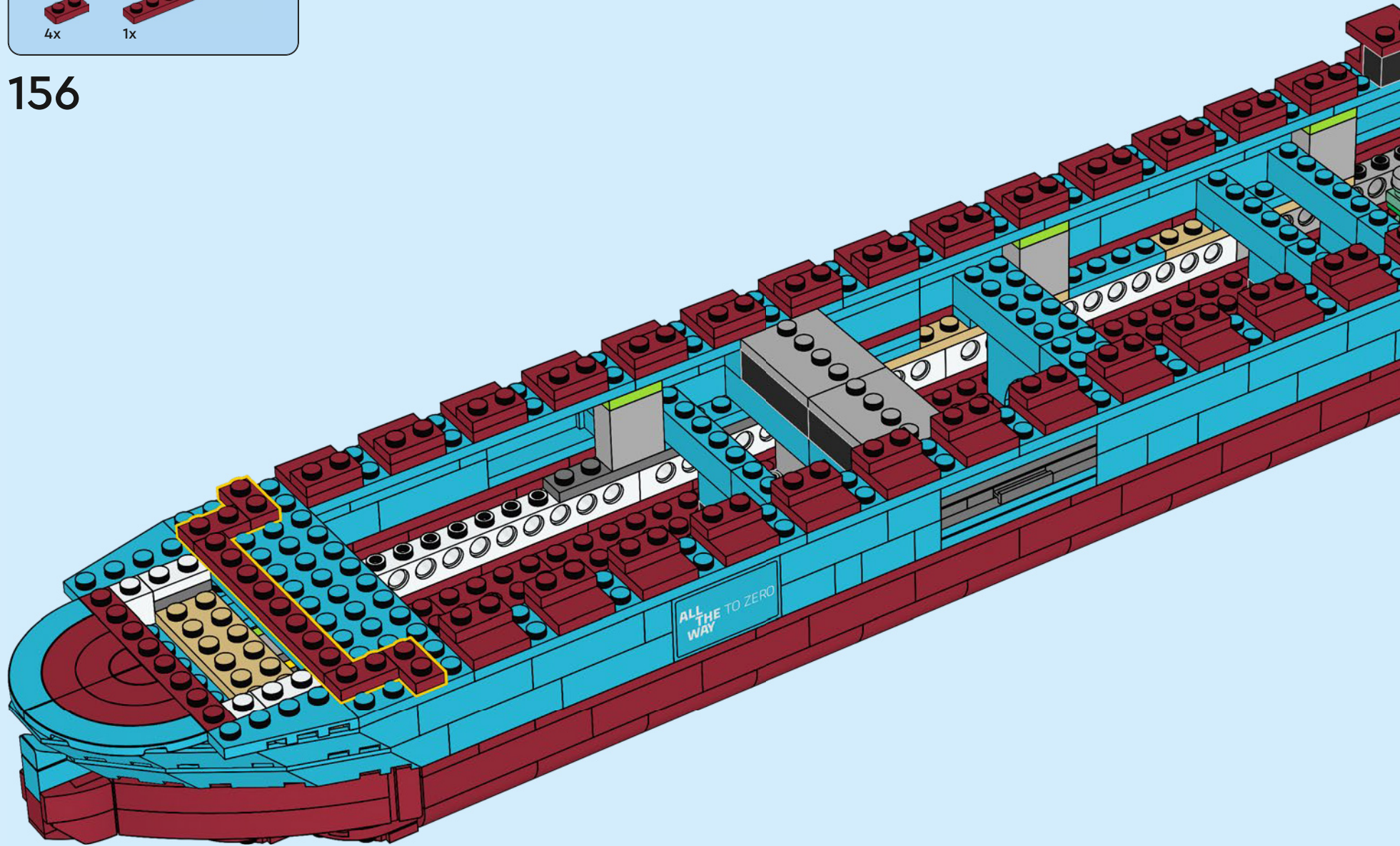

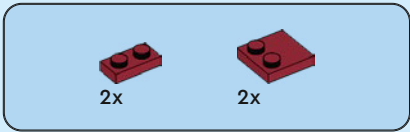

157

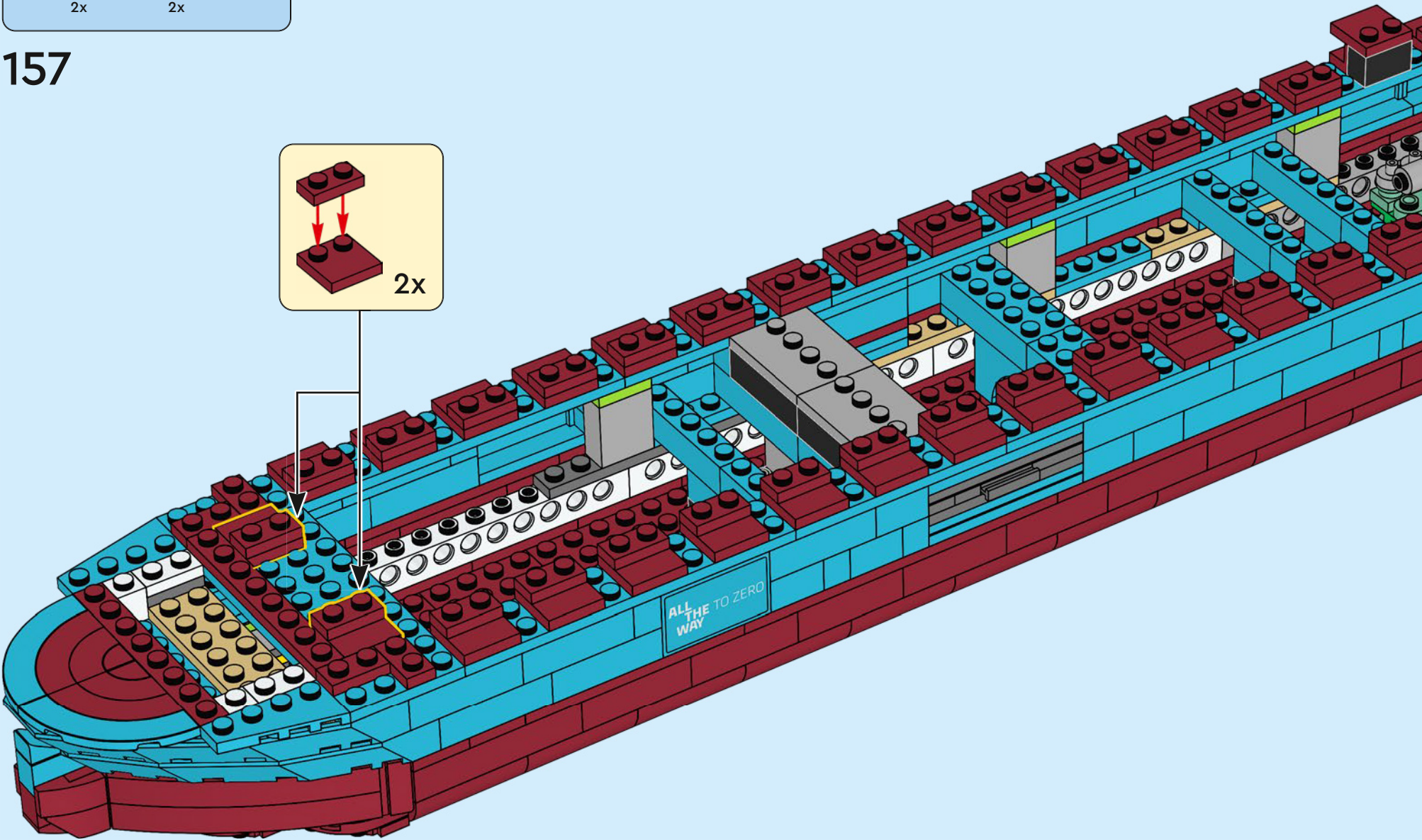
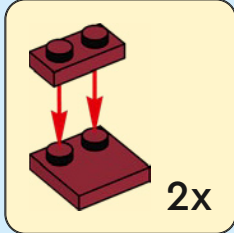

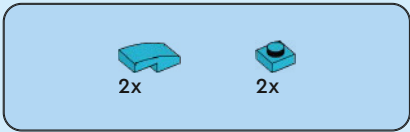

158

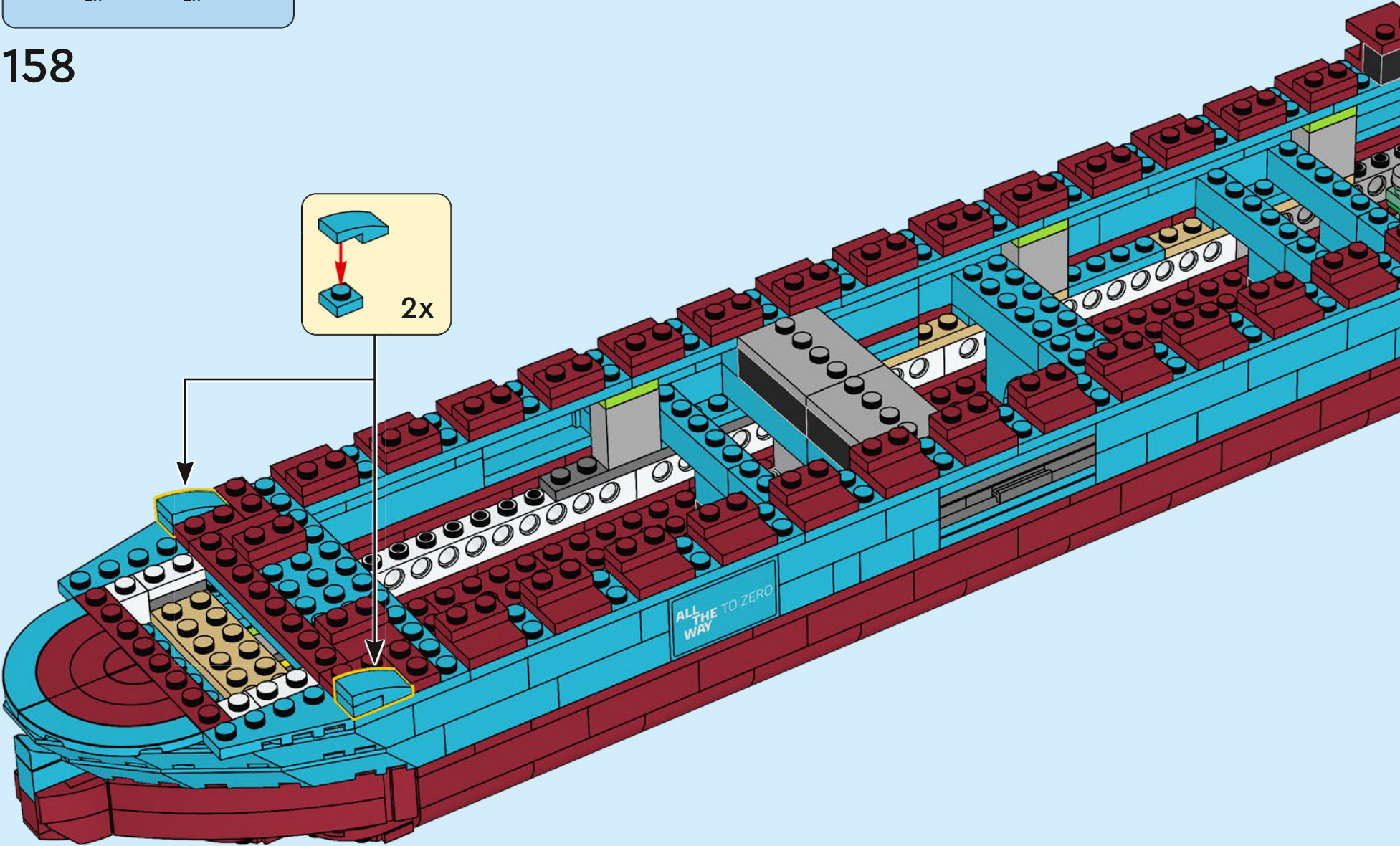
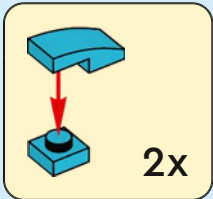

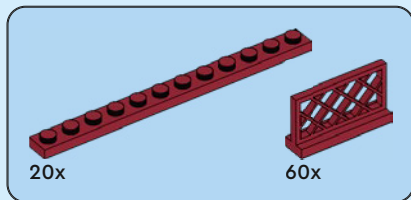
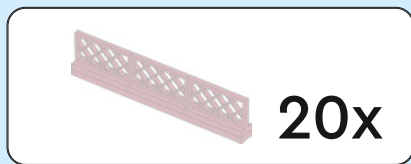

159

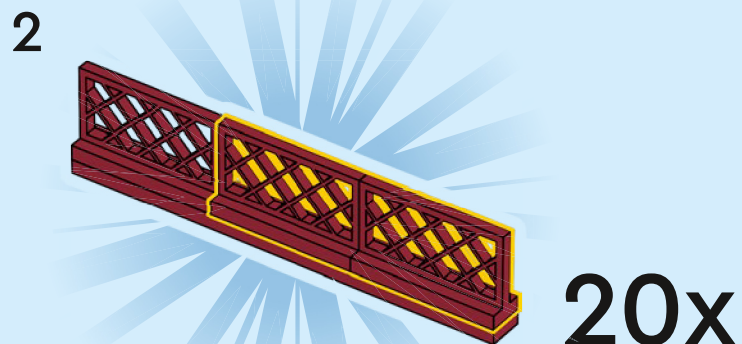
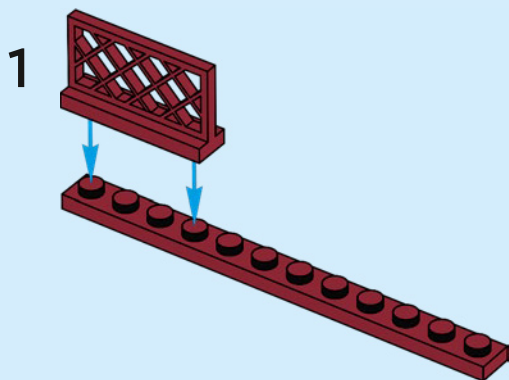
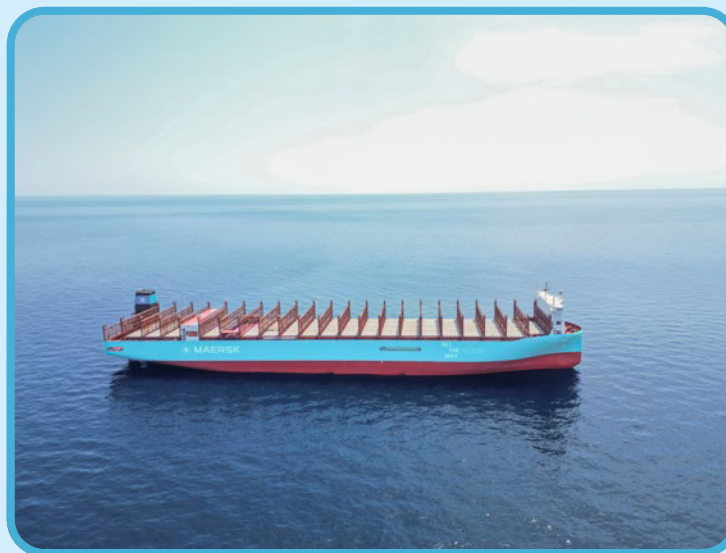

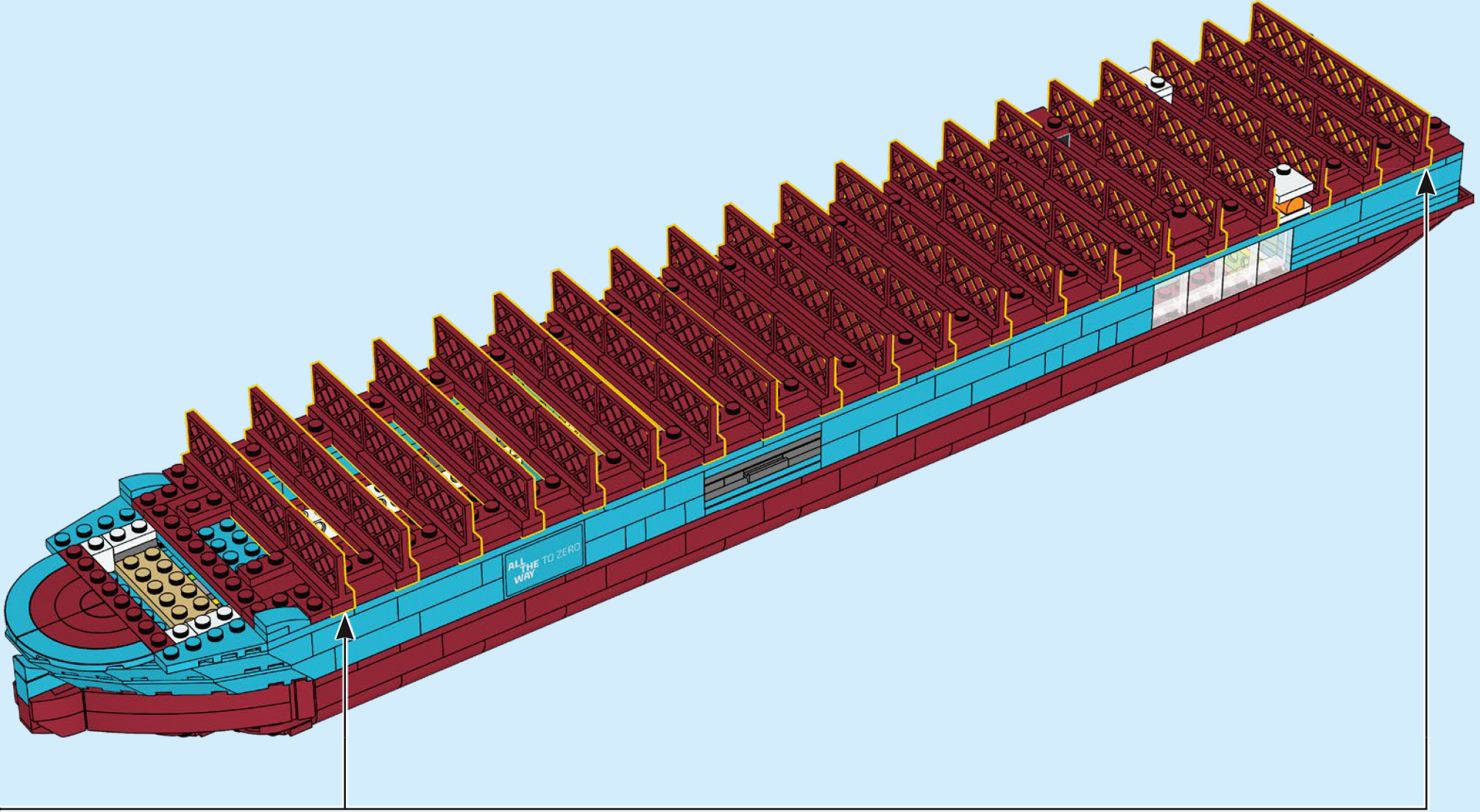

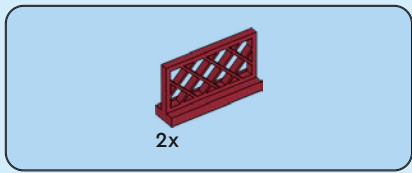

160

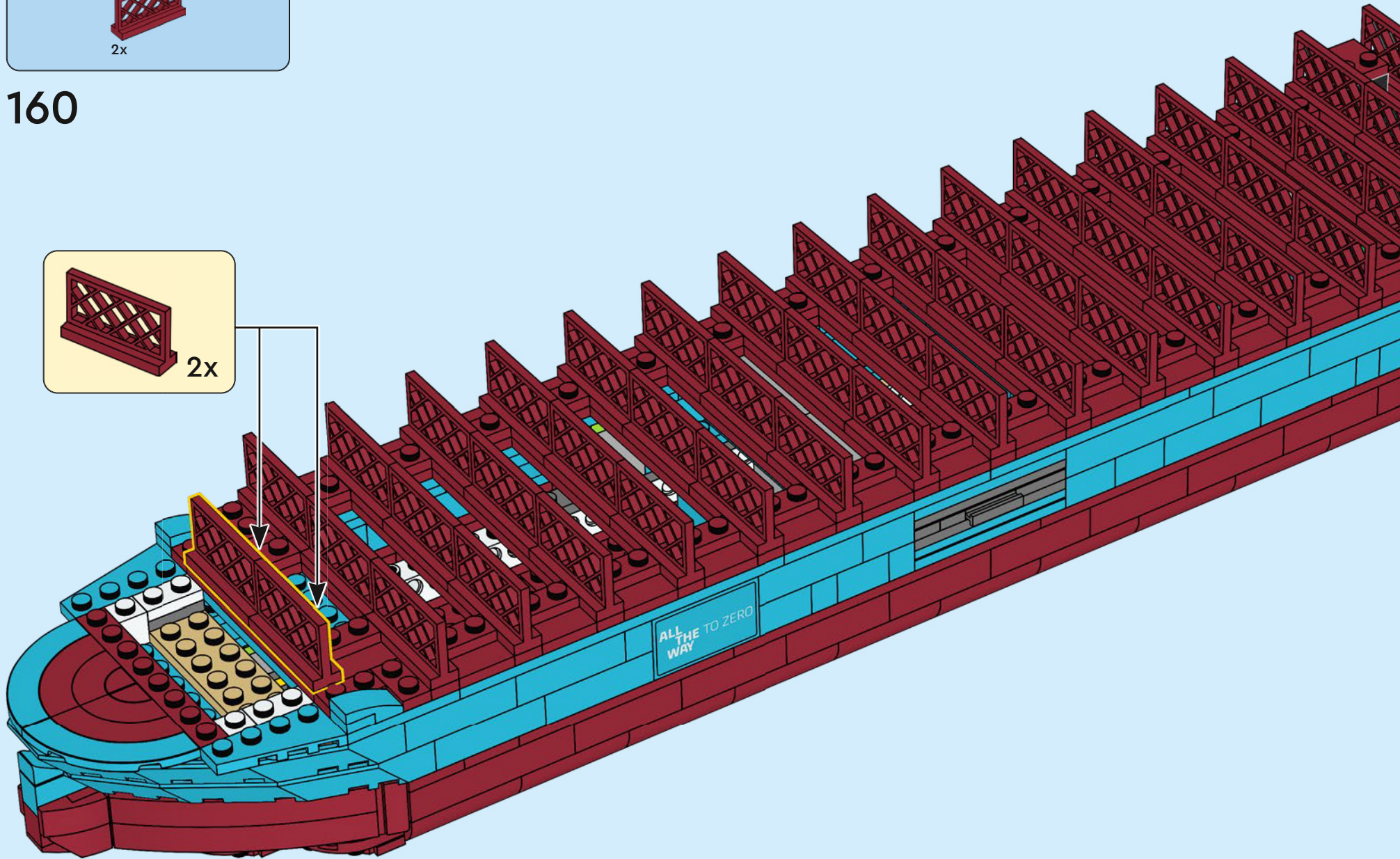
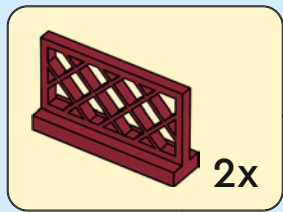

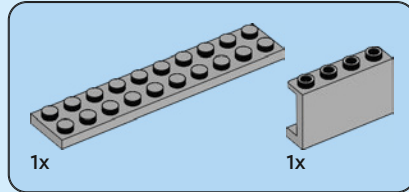
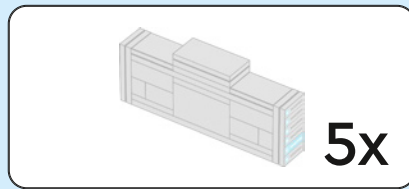

161

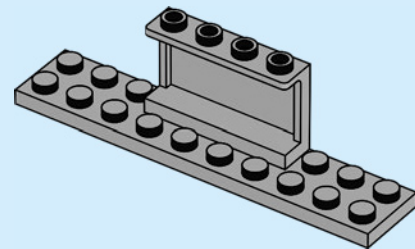
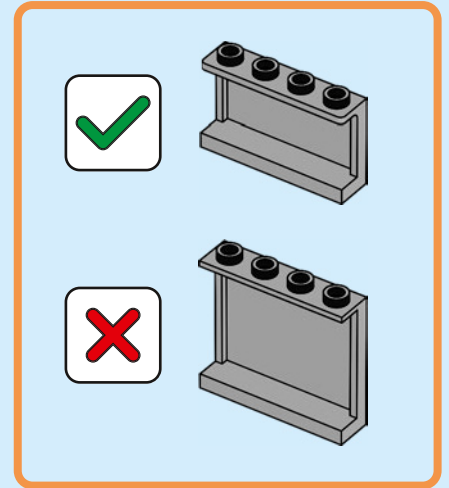

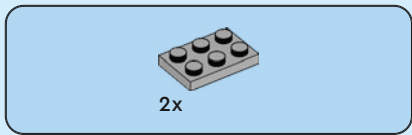

162

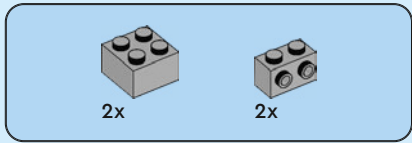
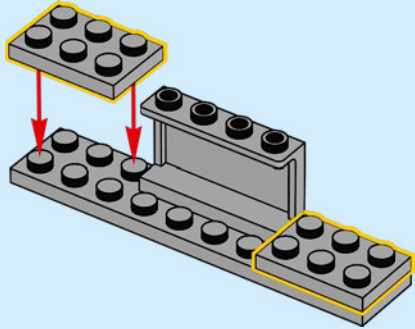

163

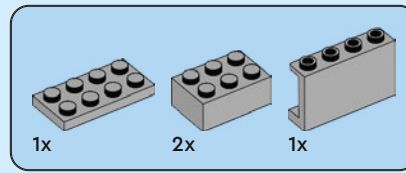
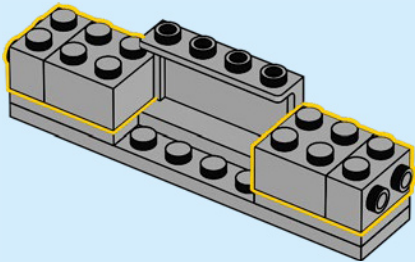

164

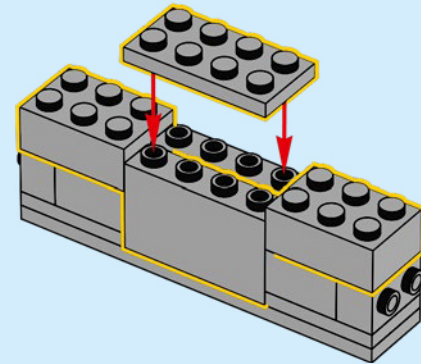

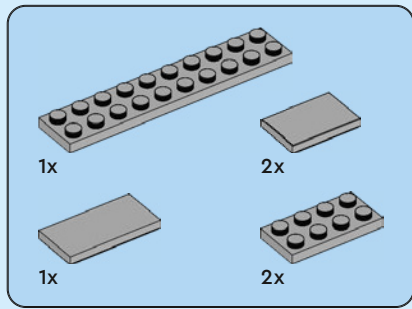

165

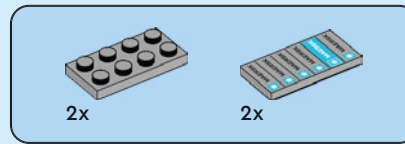
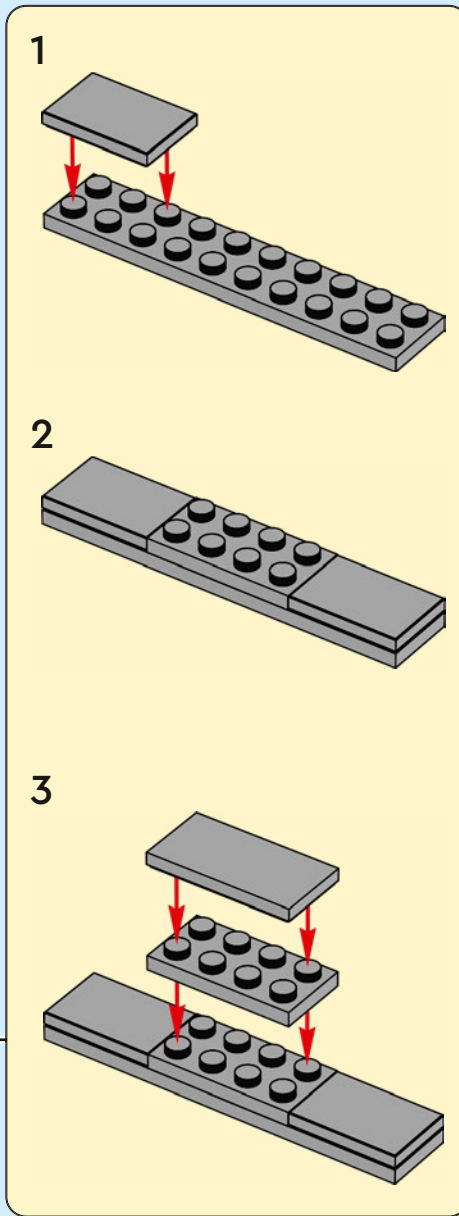
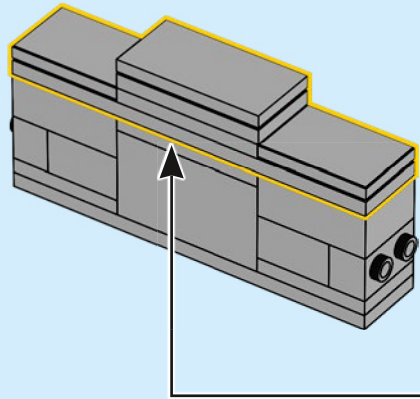

166

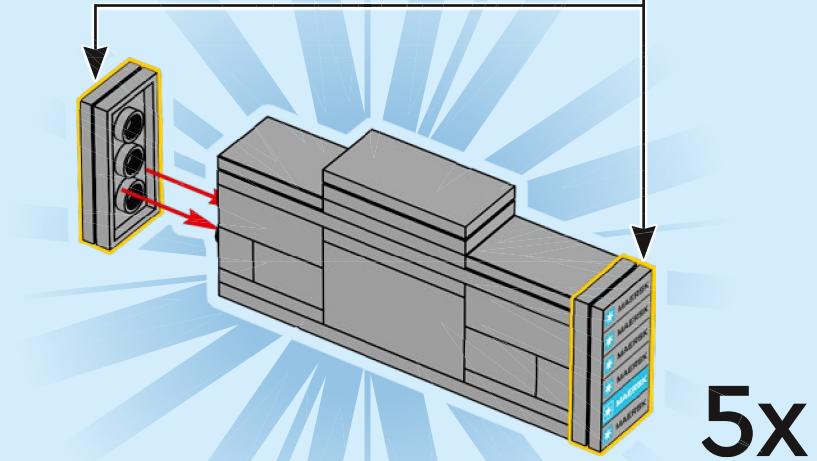
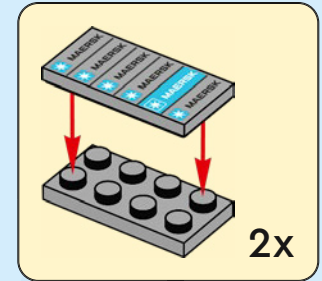

5x



167

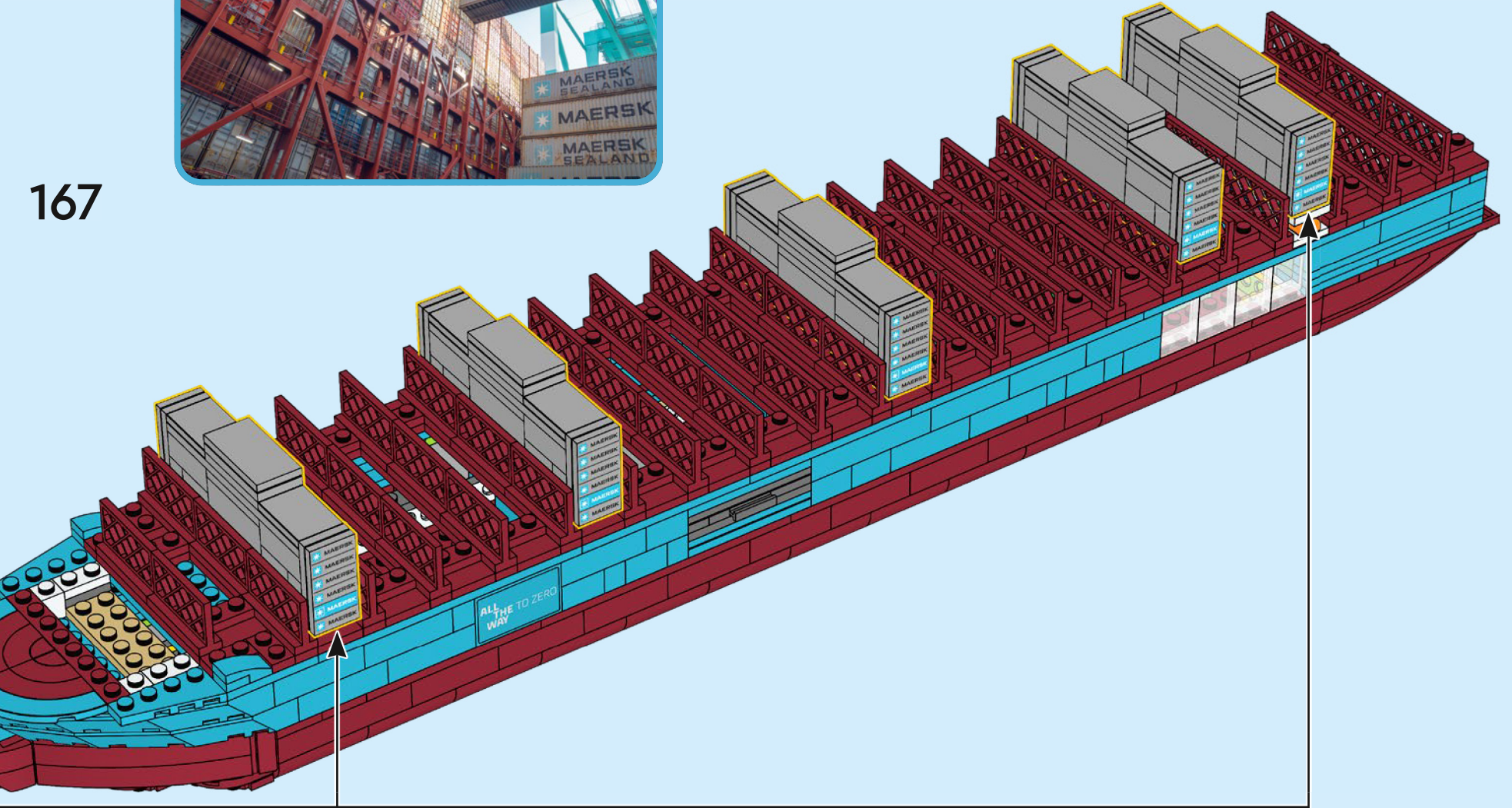

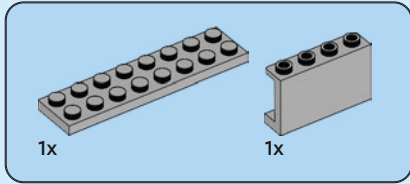
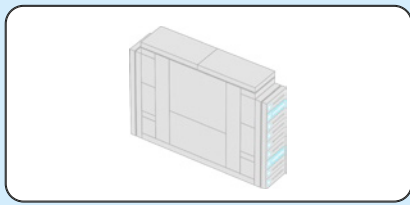

168

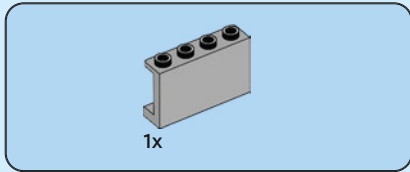
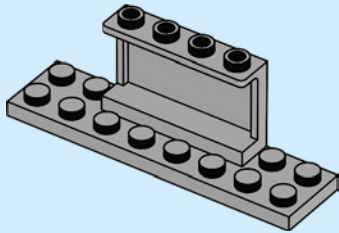

169

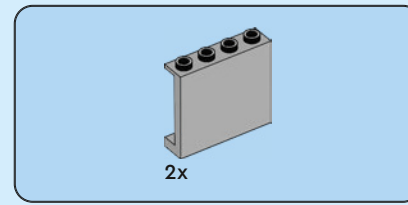
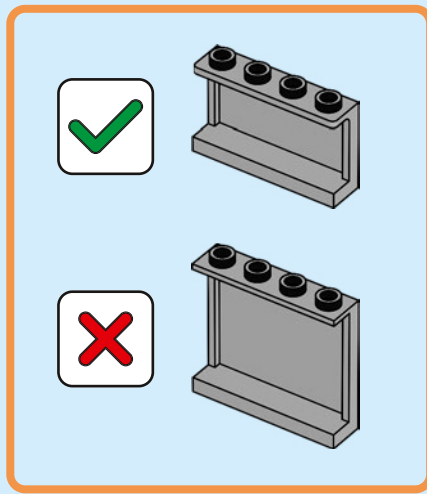
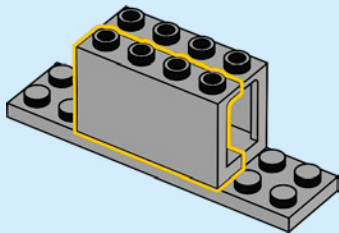

170

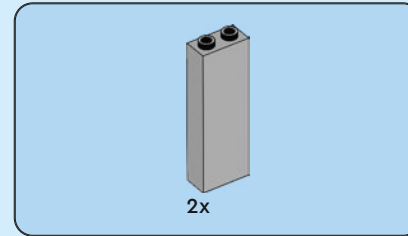
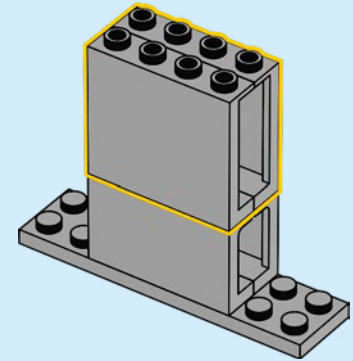

171

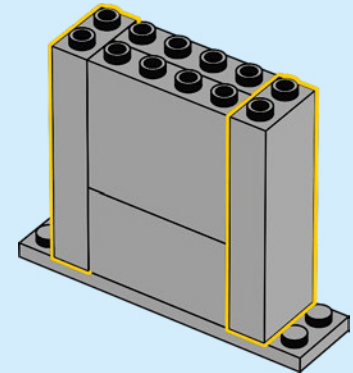

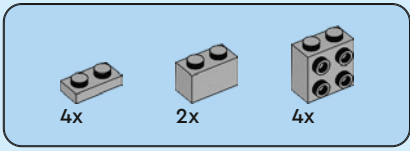

172

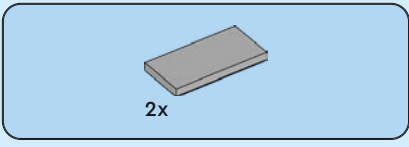
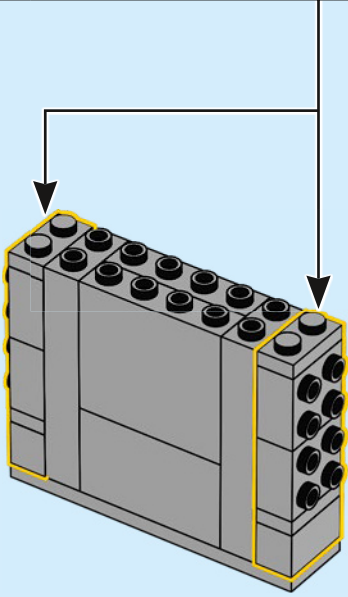
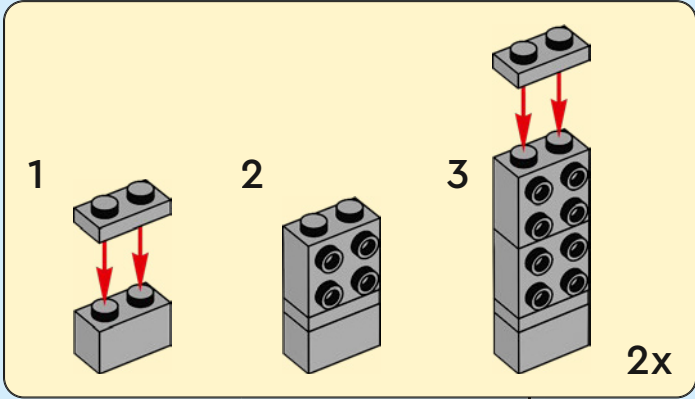

173

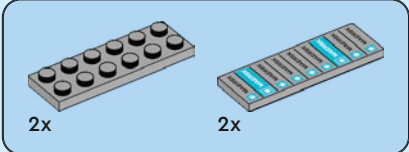
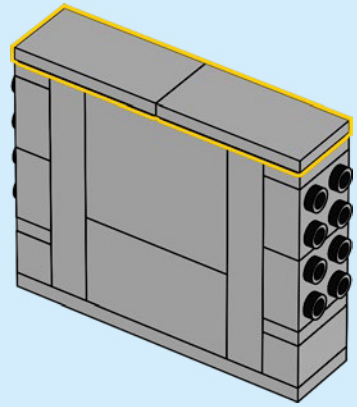

174

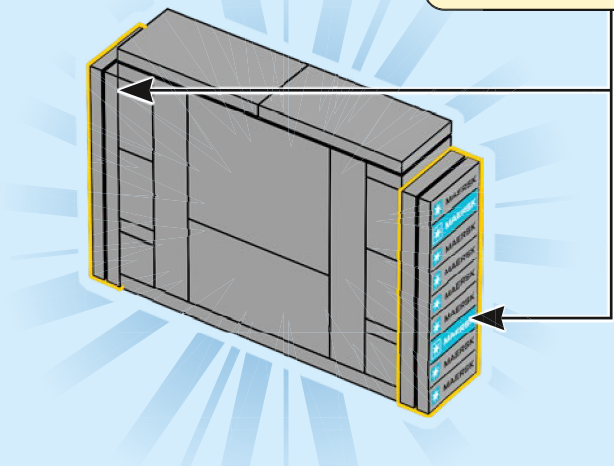
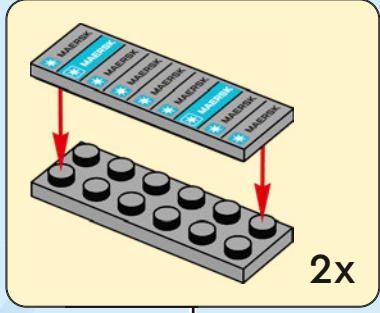

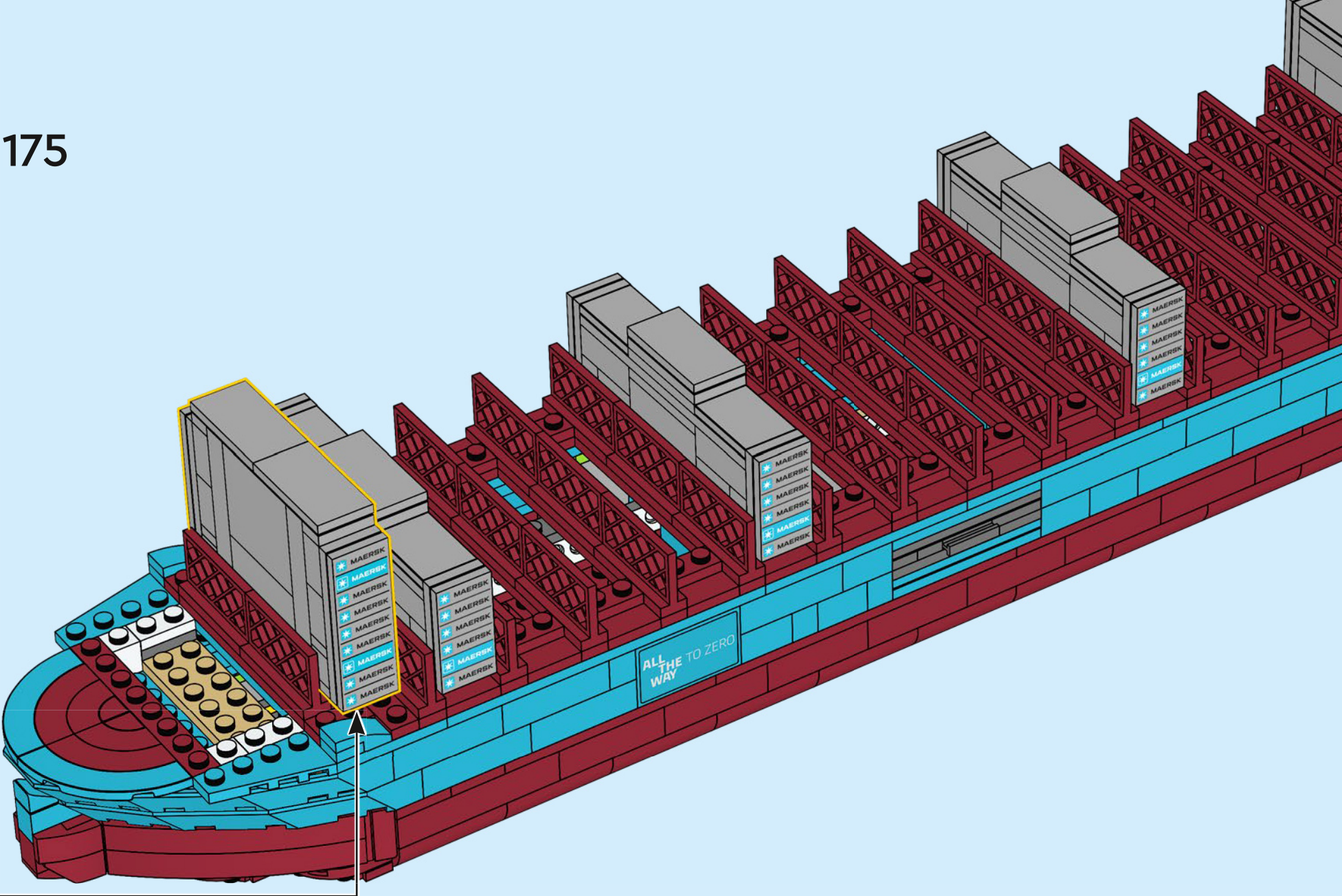

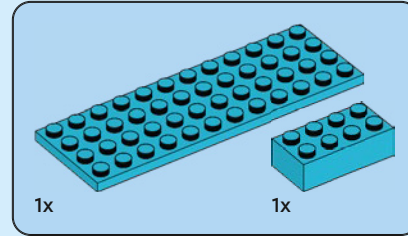
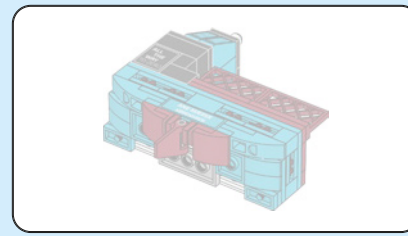

176

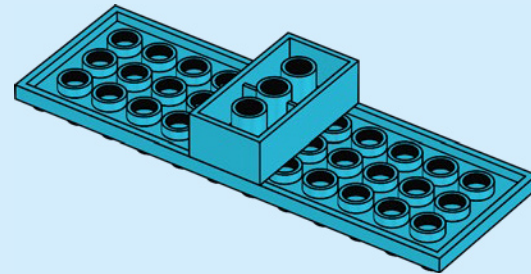

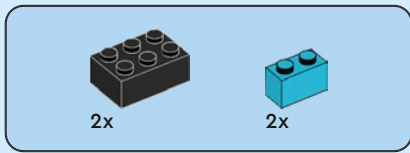

177

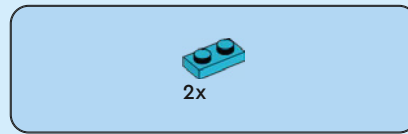
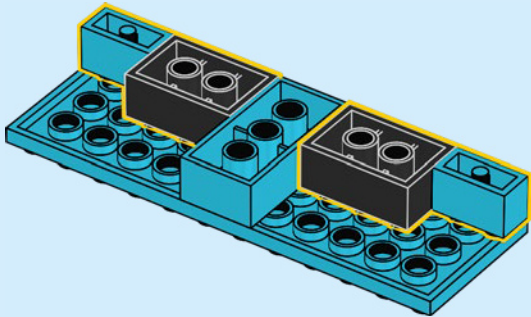

178

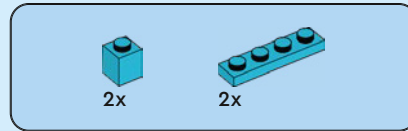
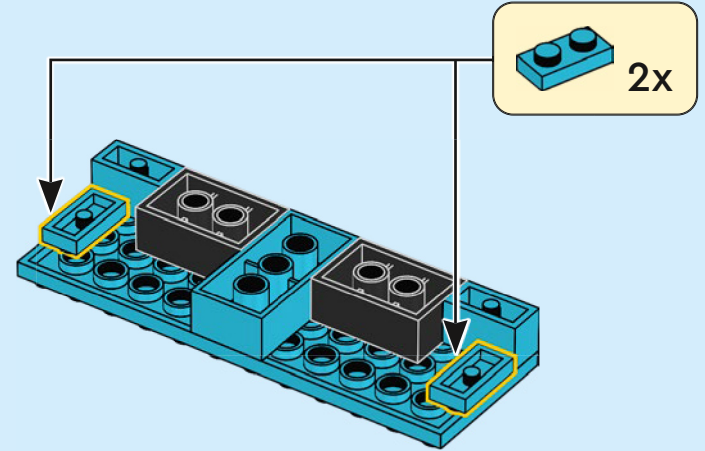

179

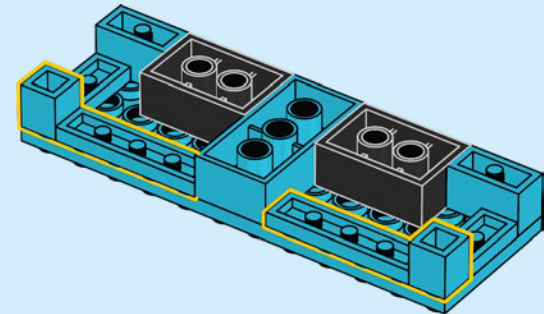

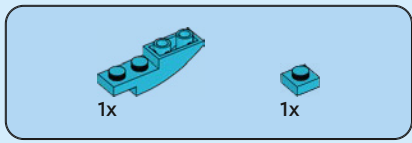

180

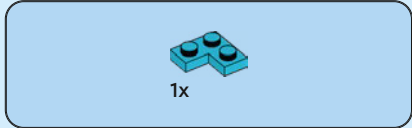
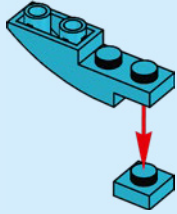

181

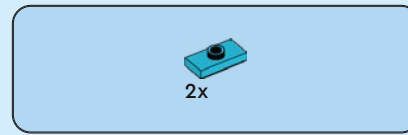
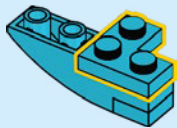

182

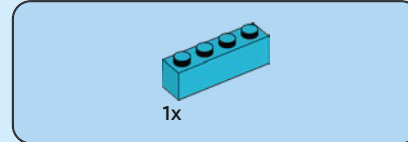
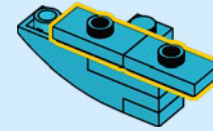

183

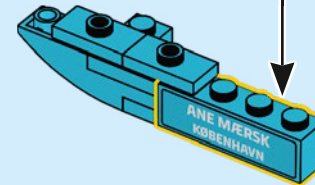
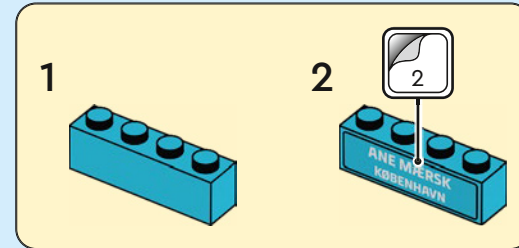

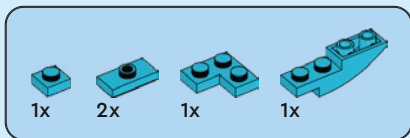

184

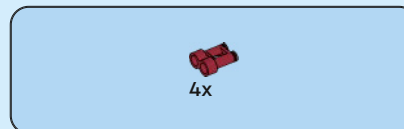
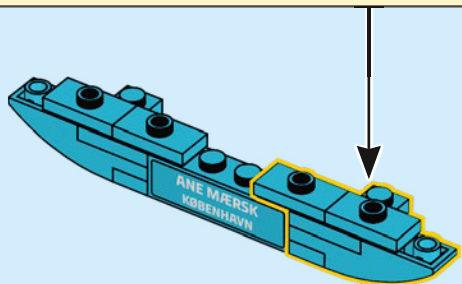
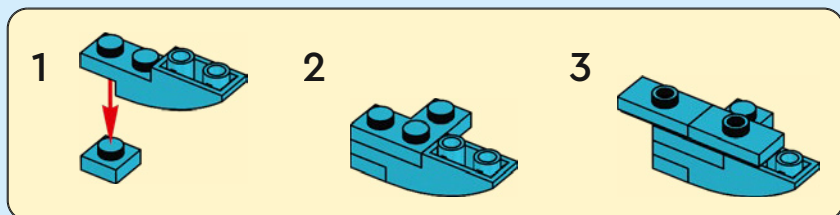

185

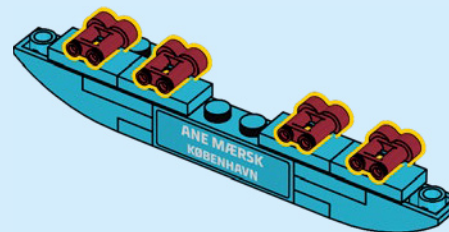

186

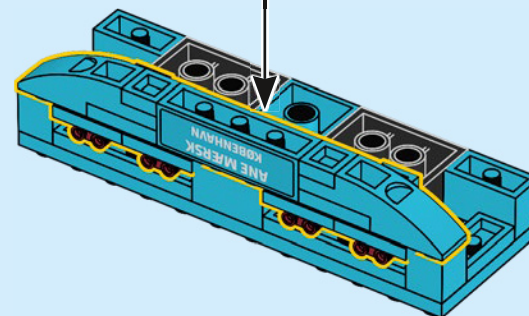

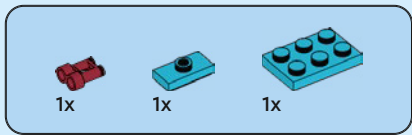

187

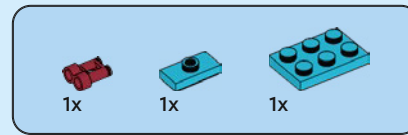
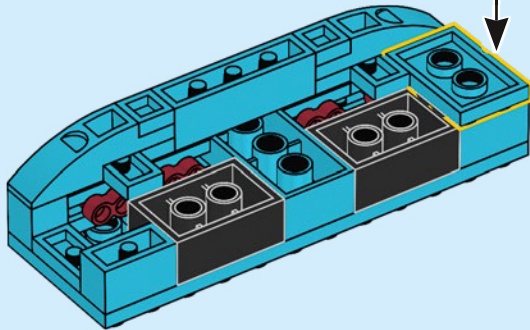
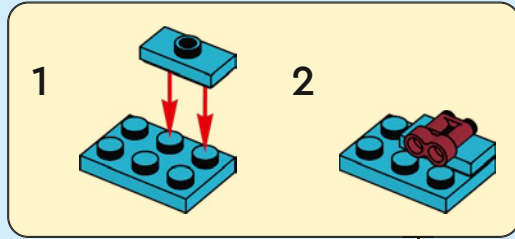

188

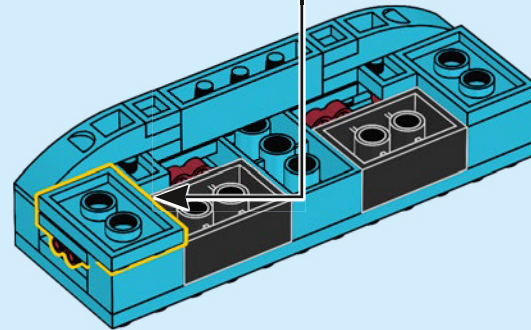
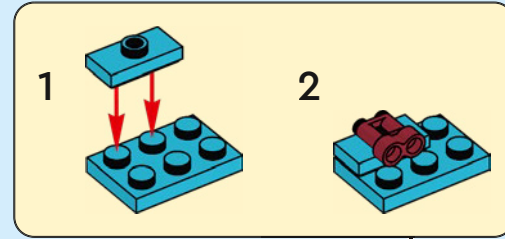

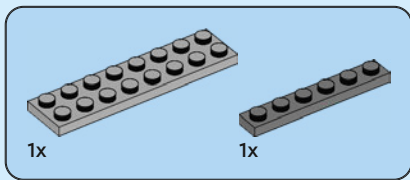

189

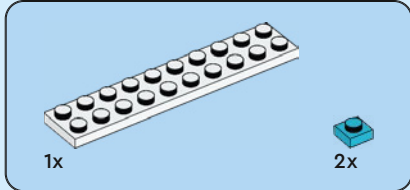
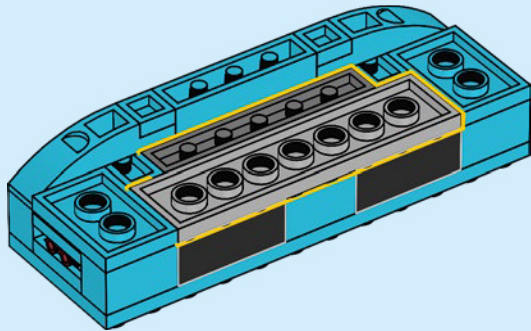

190

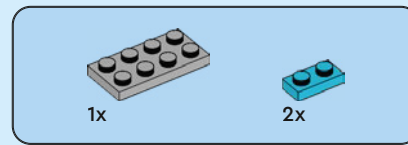
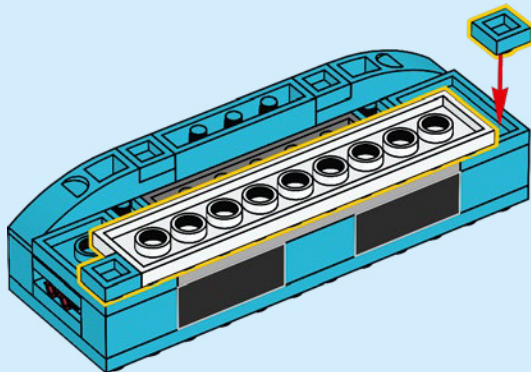

191

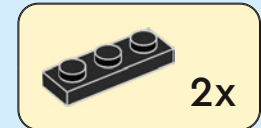
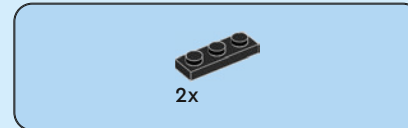
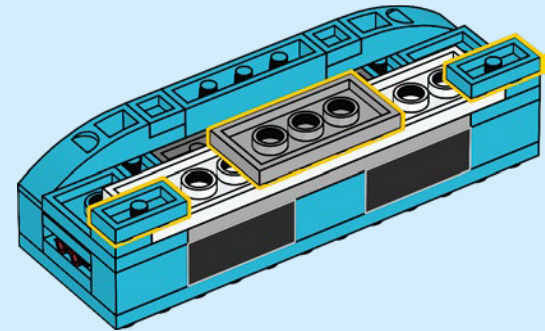

192

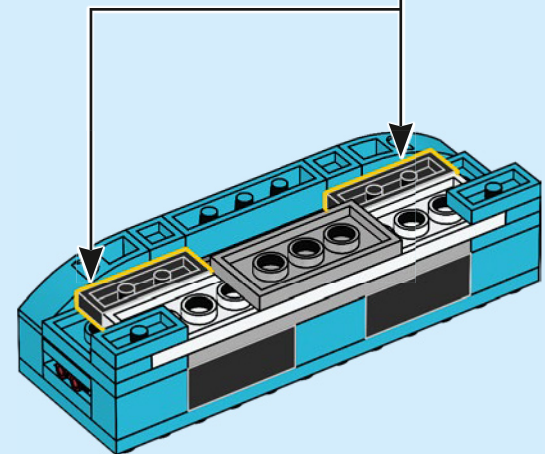



4x

193

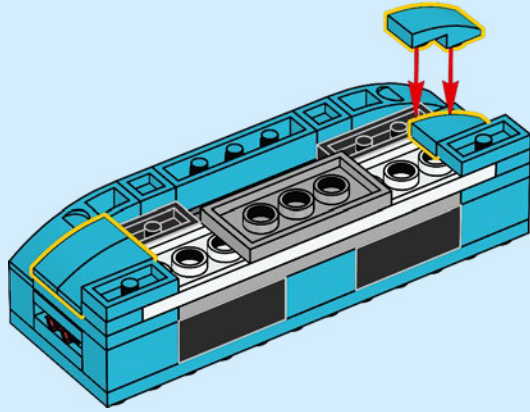

2x

194

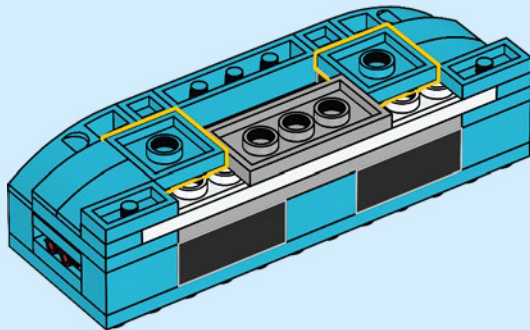

1x



1x



1x

195

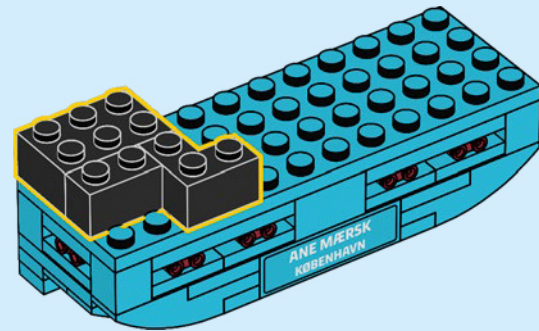

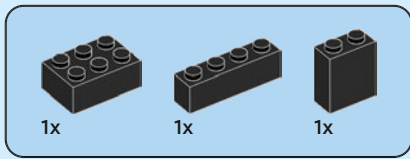

196

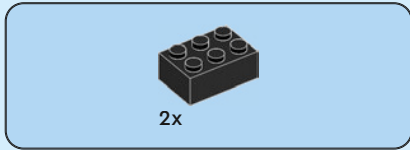
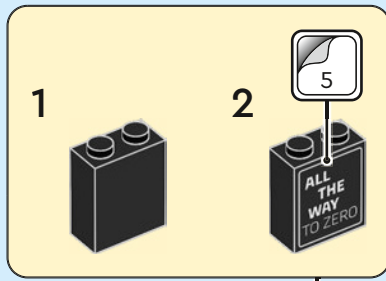
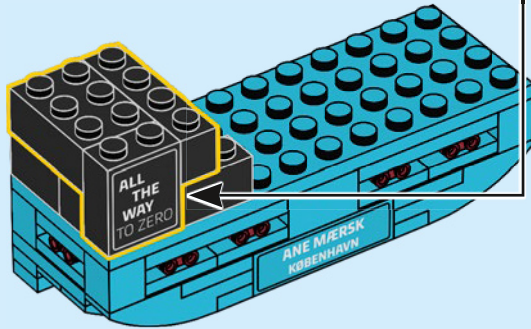

197

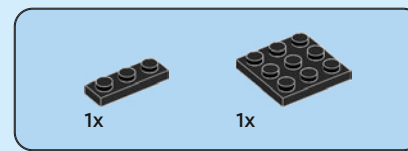
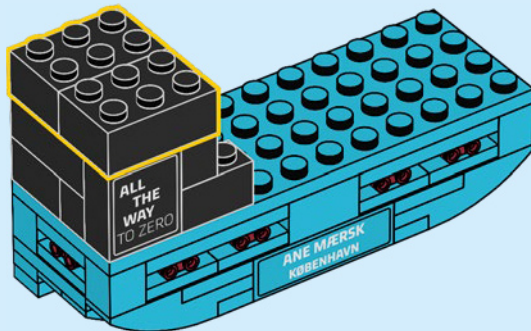

198

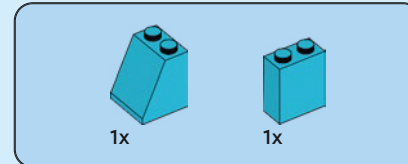
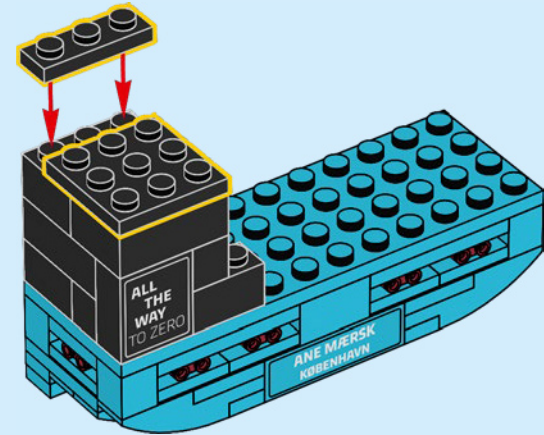

199

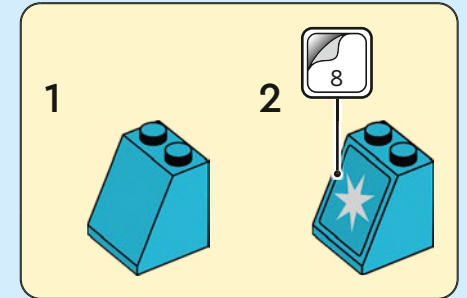
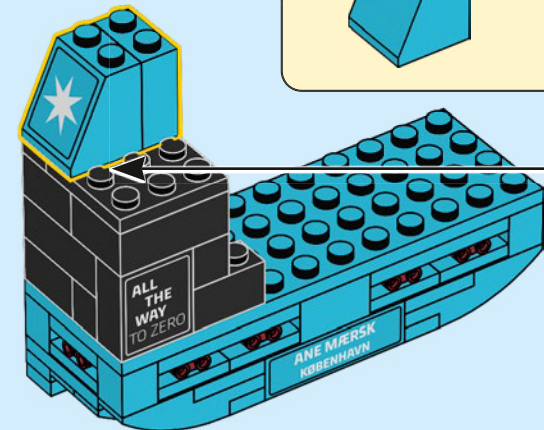

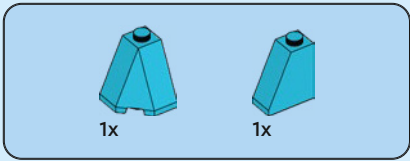

200

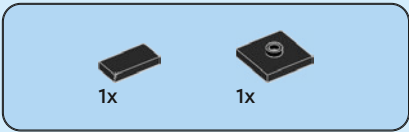
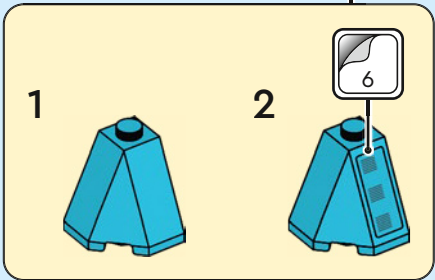
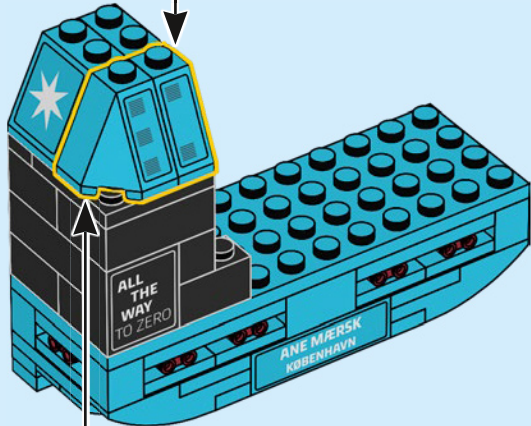
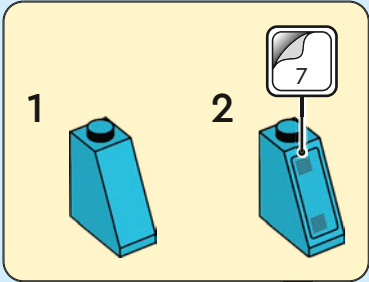

201

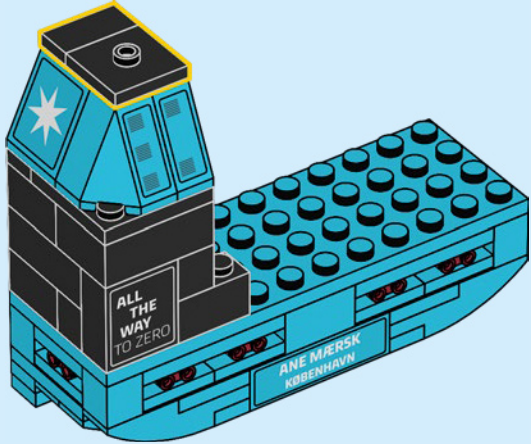



1x



1x

202

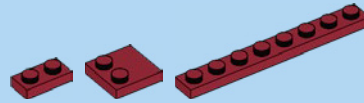
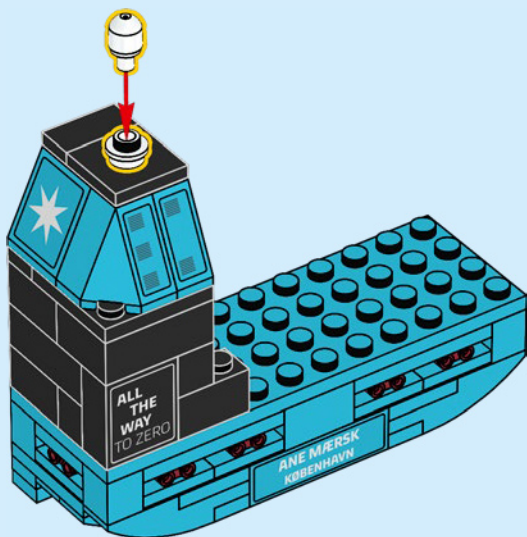

1x

2x

1x

203

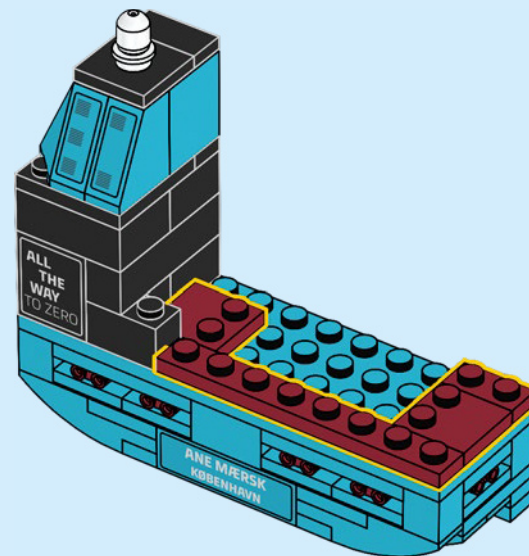



2x

204

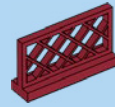
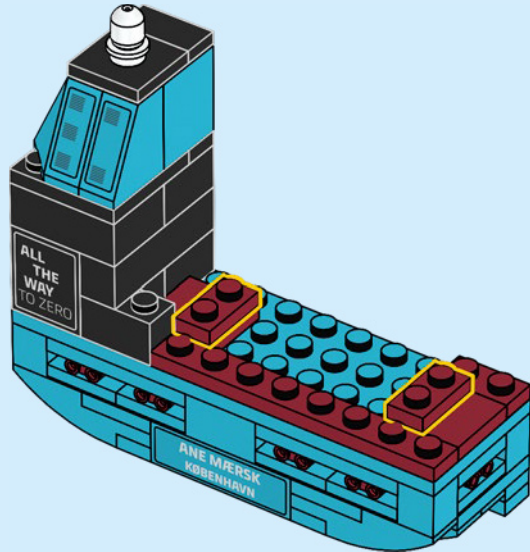

2x

205

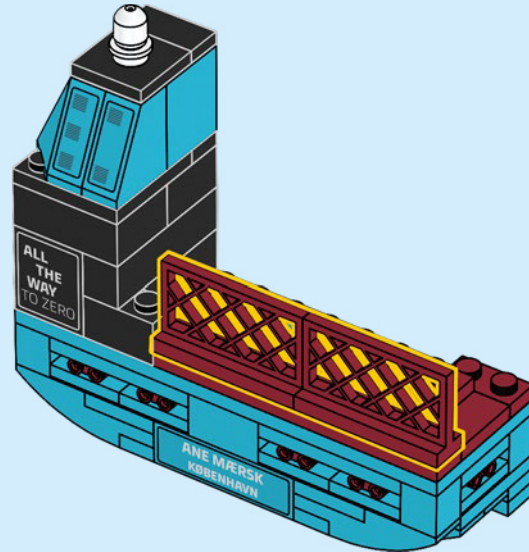

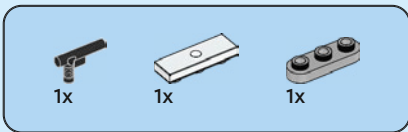

206

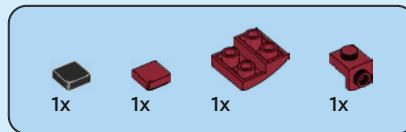
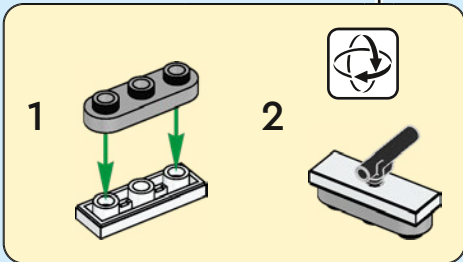
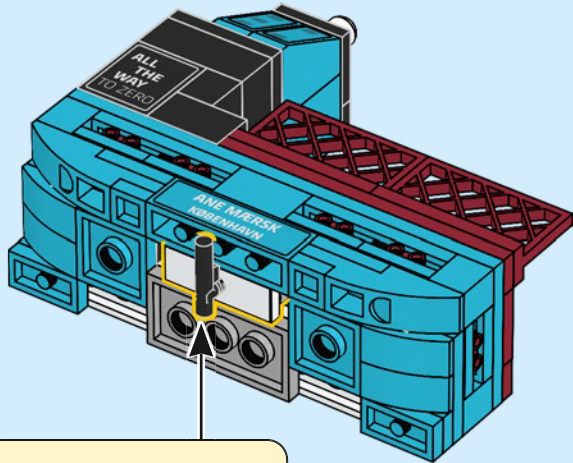

207

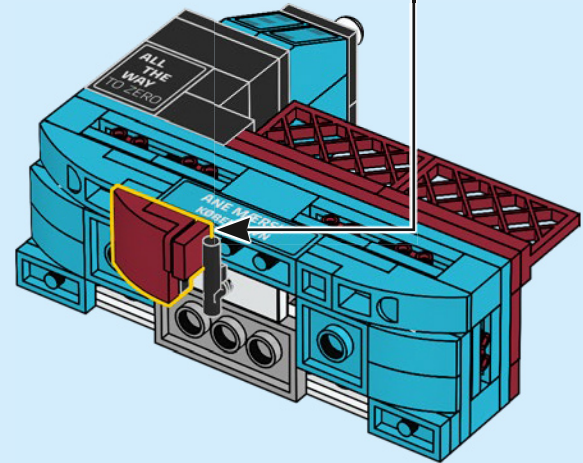
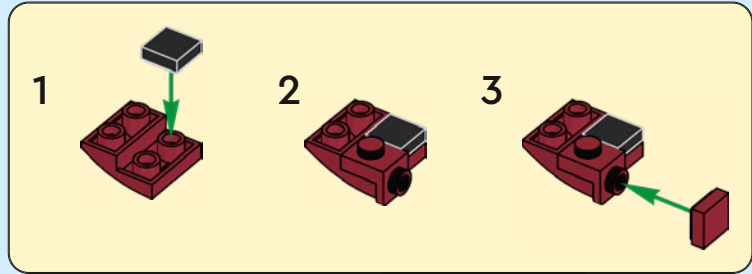

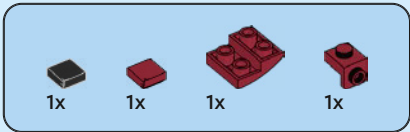

208

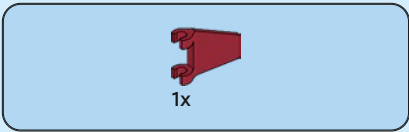
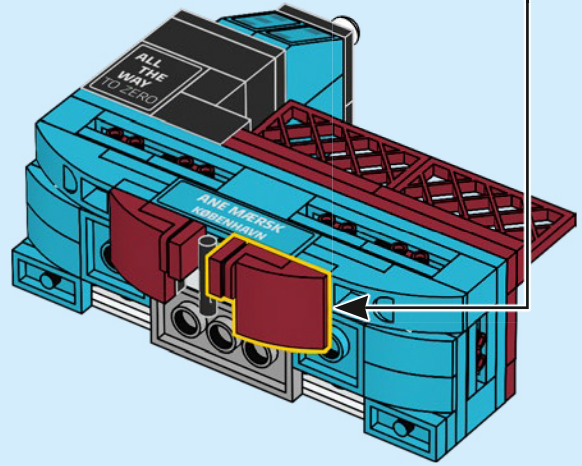

209

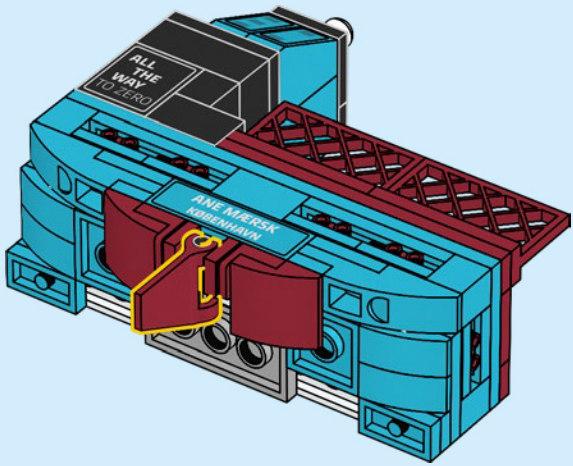

210

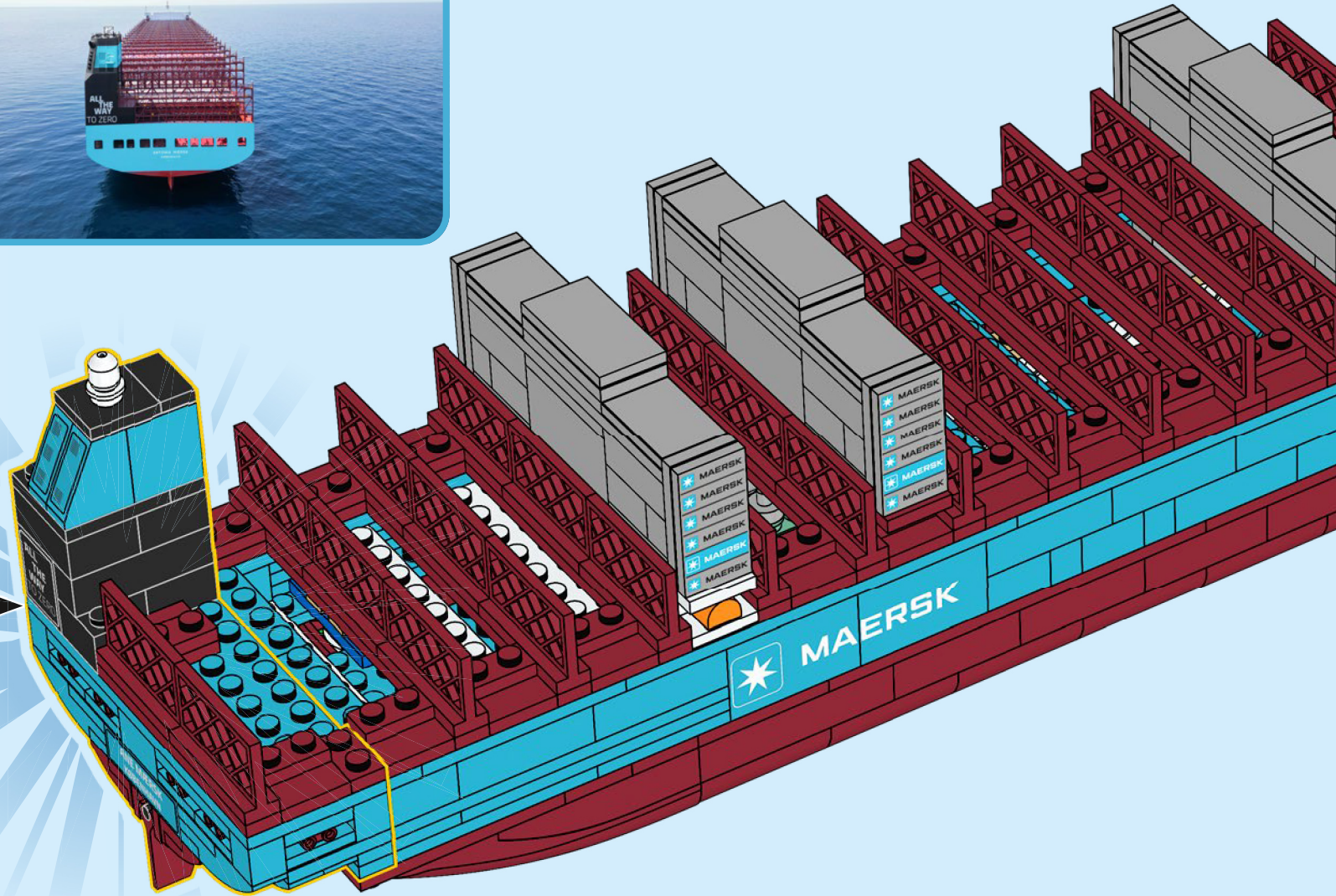
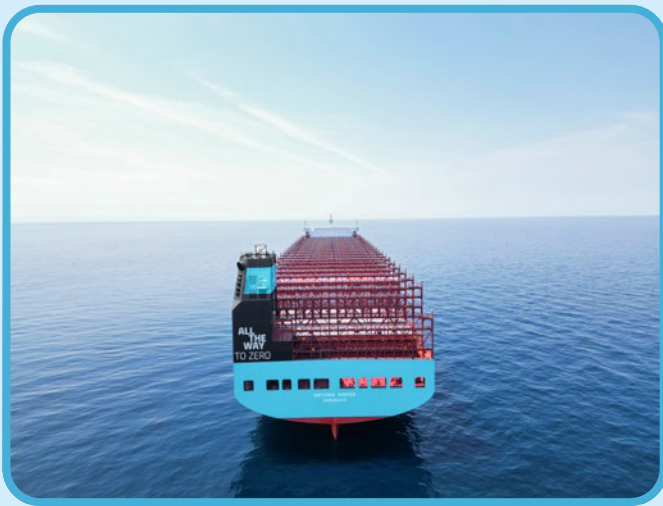

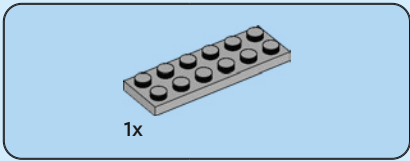

211

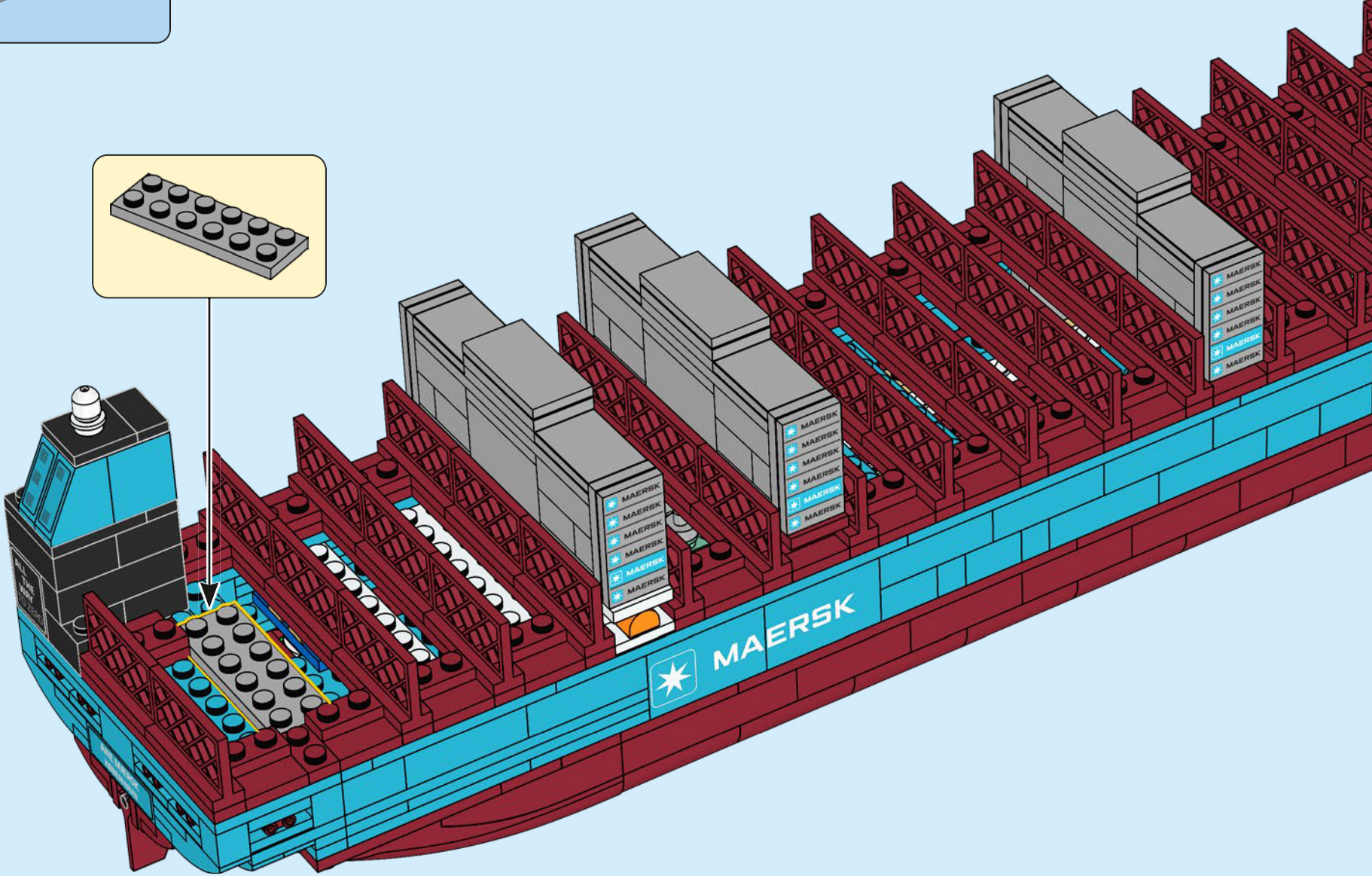
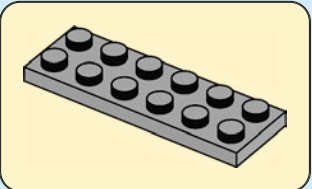

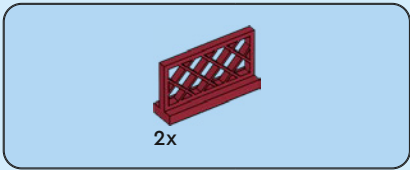

212

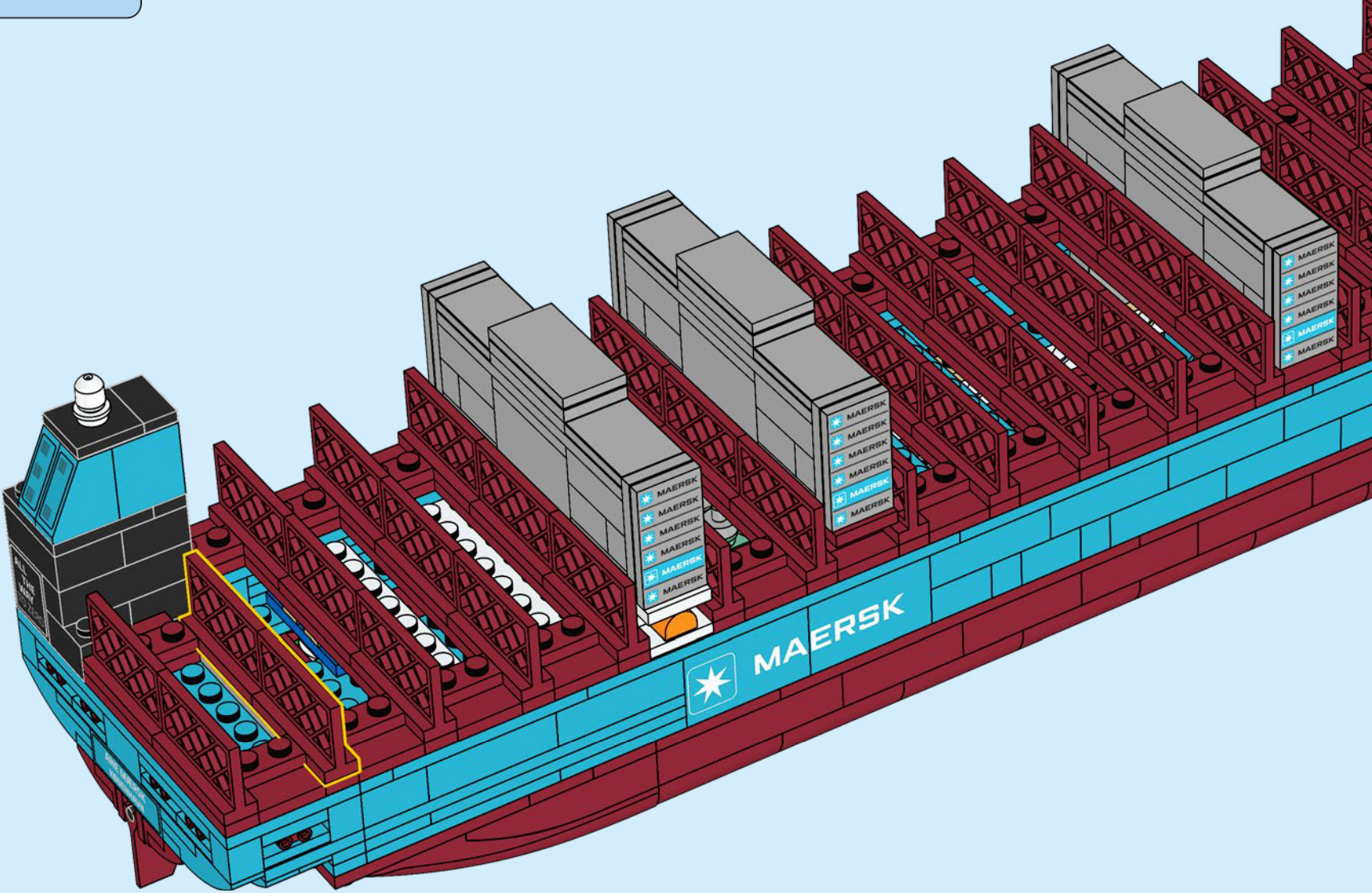

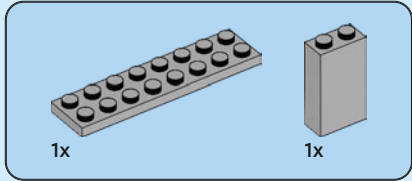
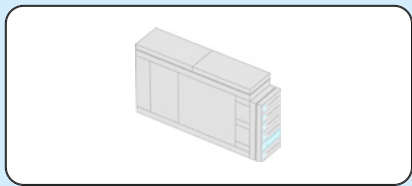

213

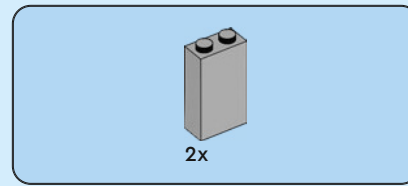
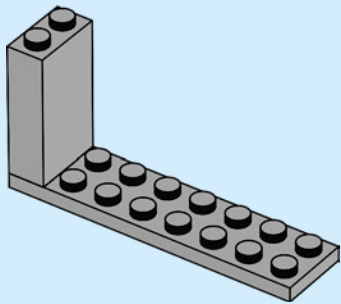

214

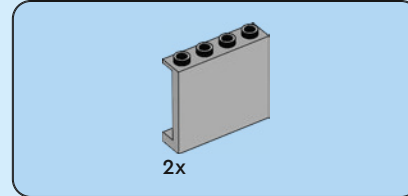
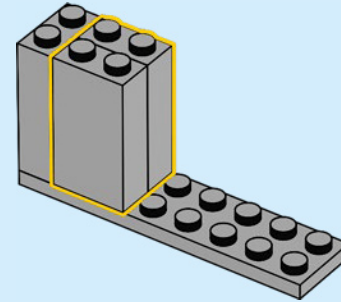

215

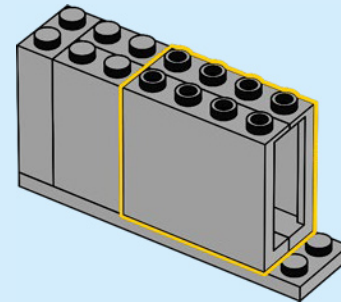

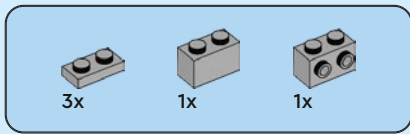

216

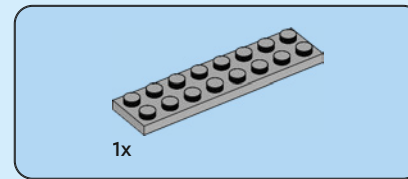
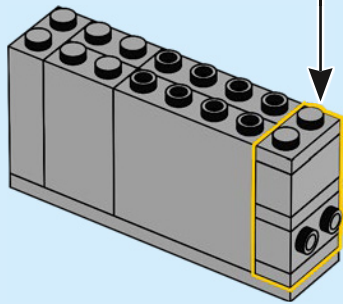
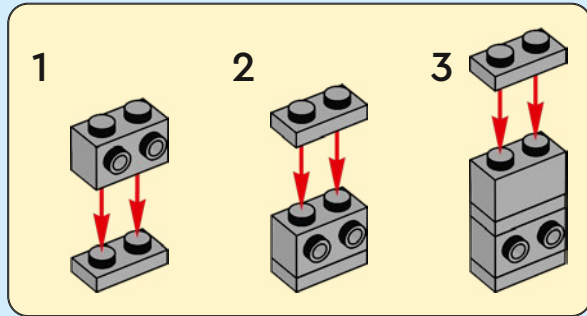

217

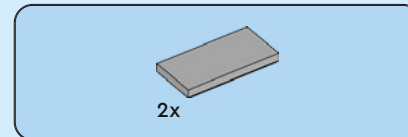
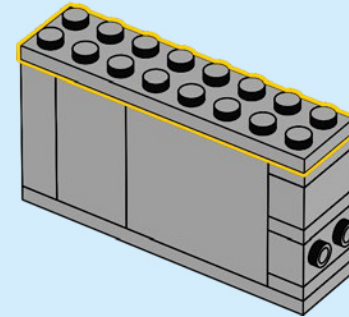

218

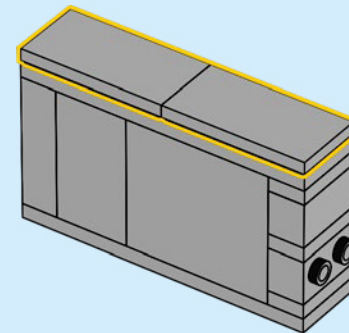

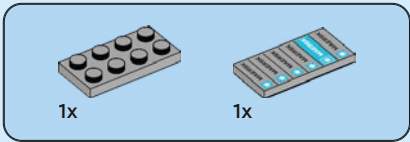

219

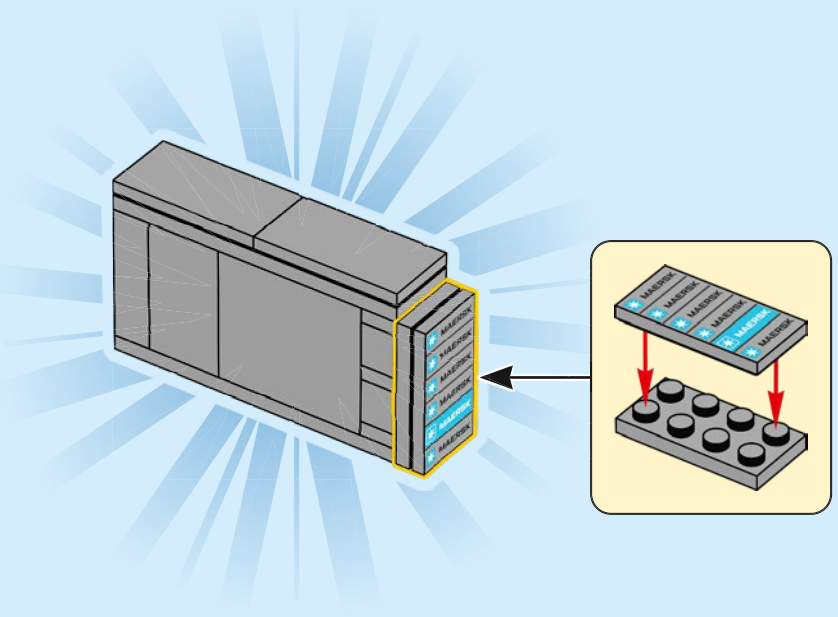

220

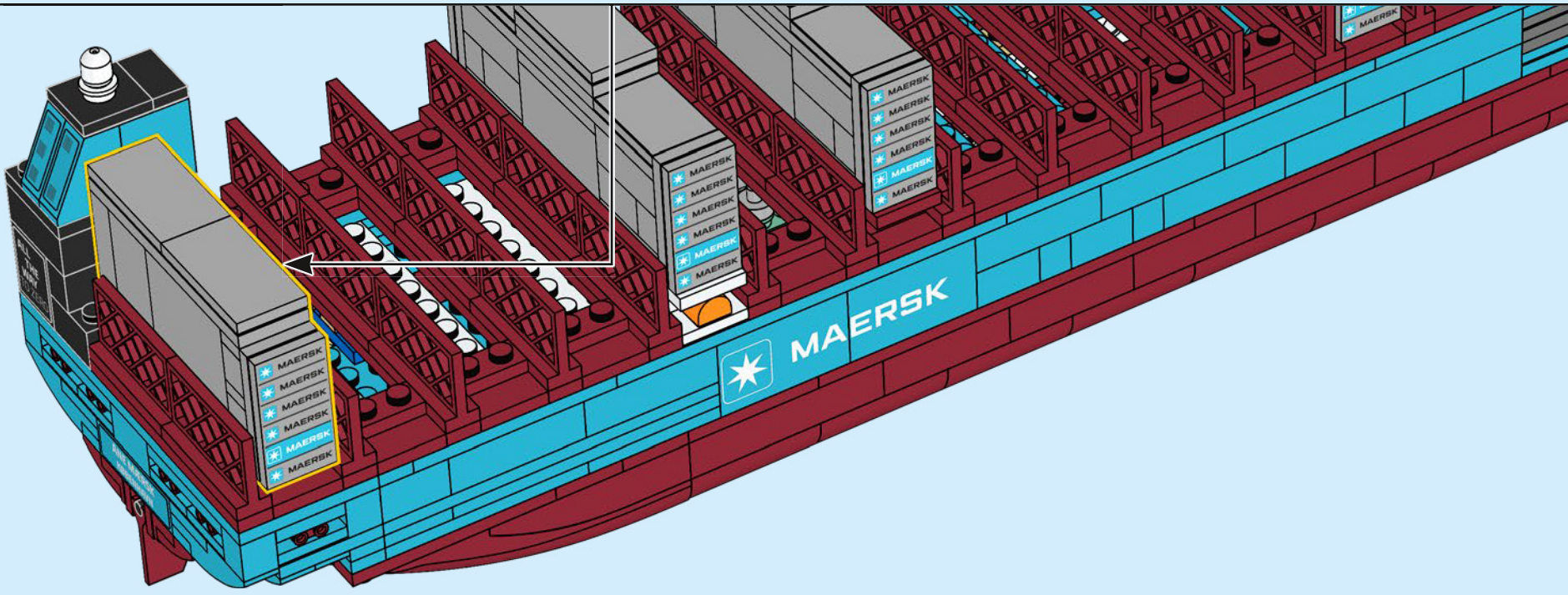

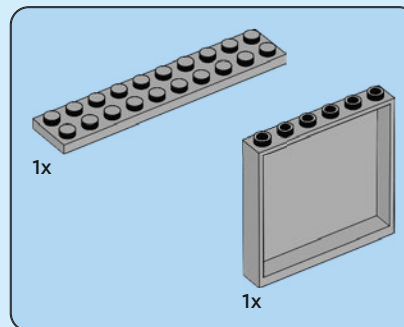
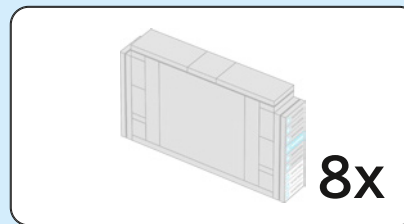

221

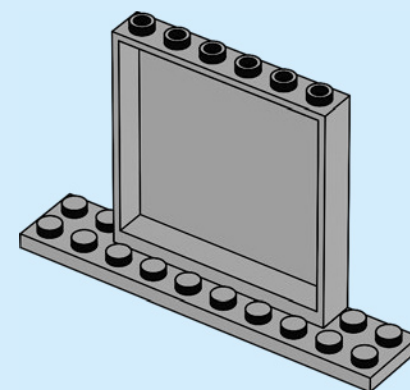

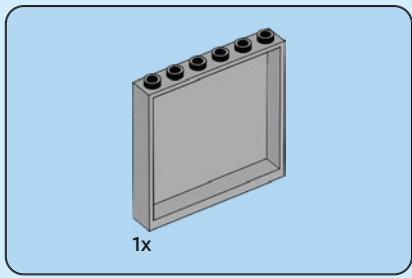

222

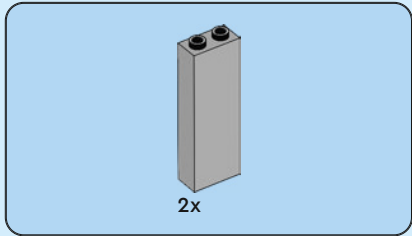
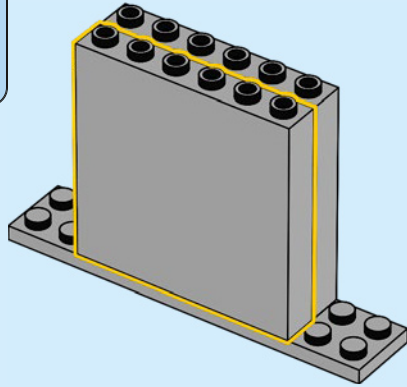

223

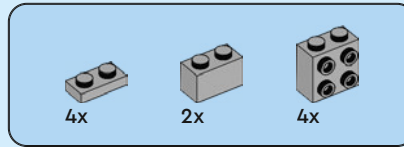
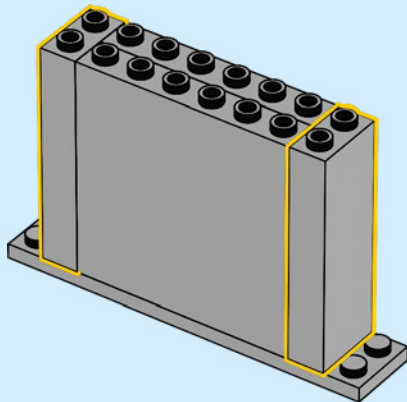

224

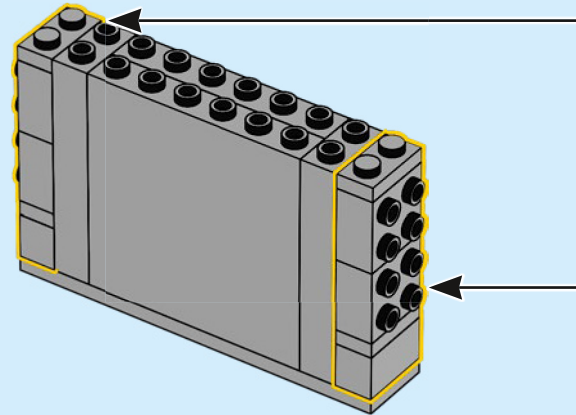
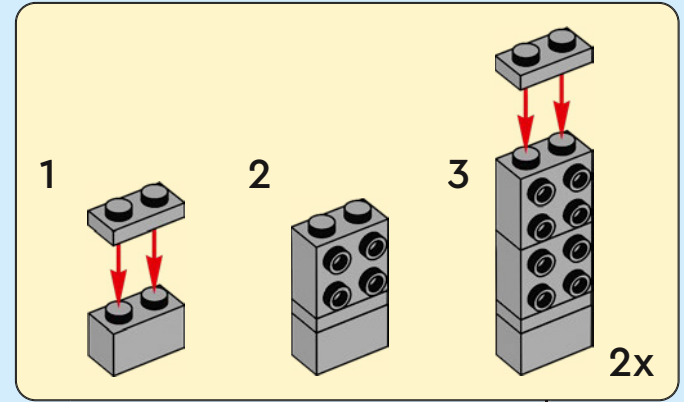

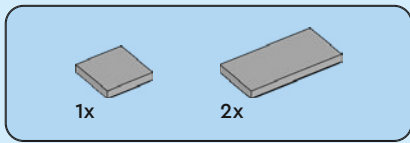

225

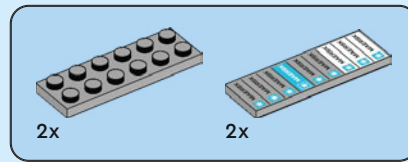
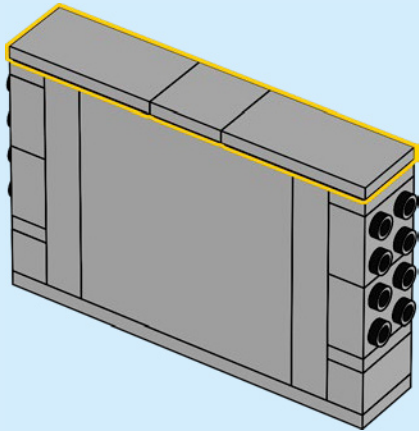

226

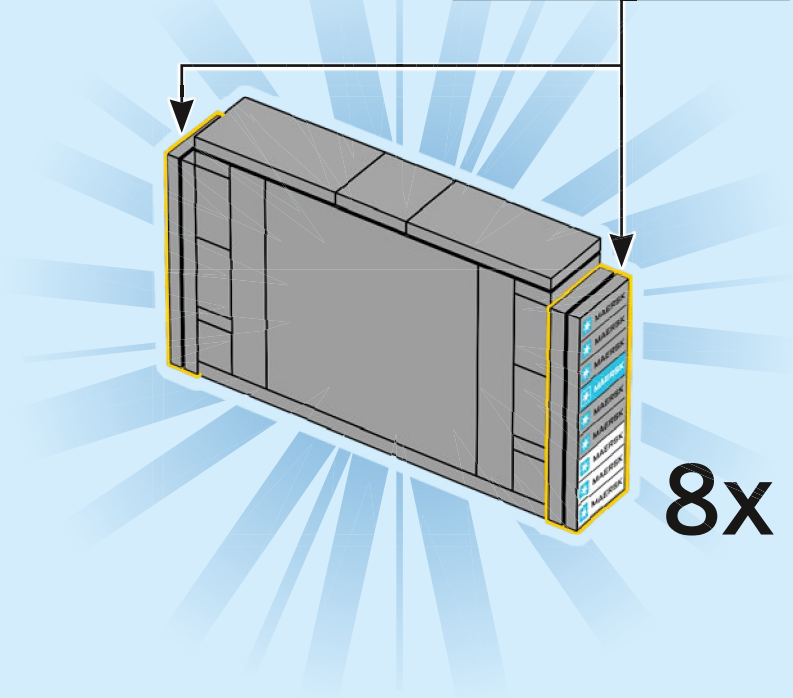
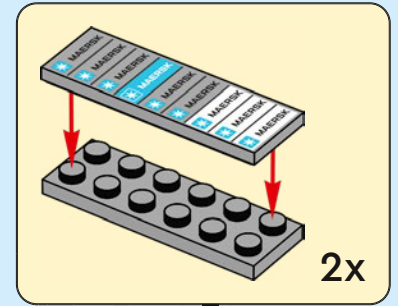

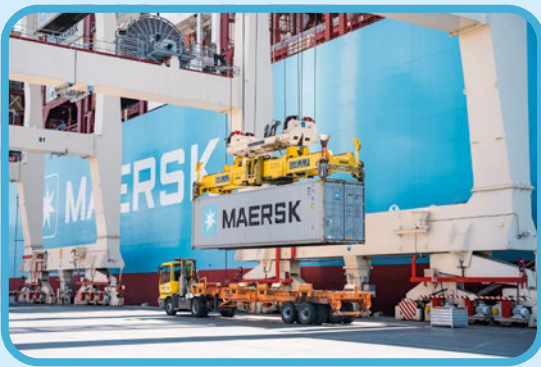

227

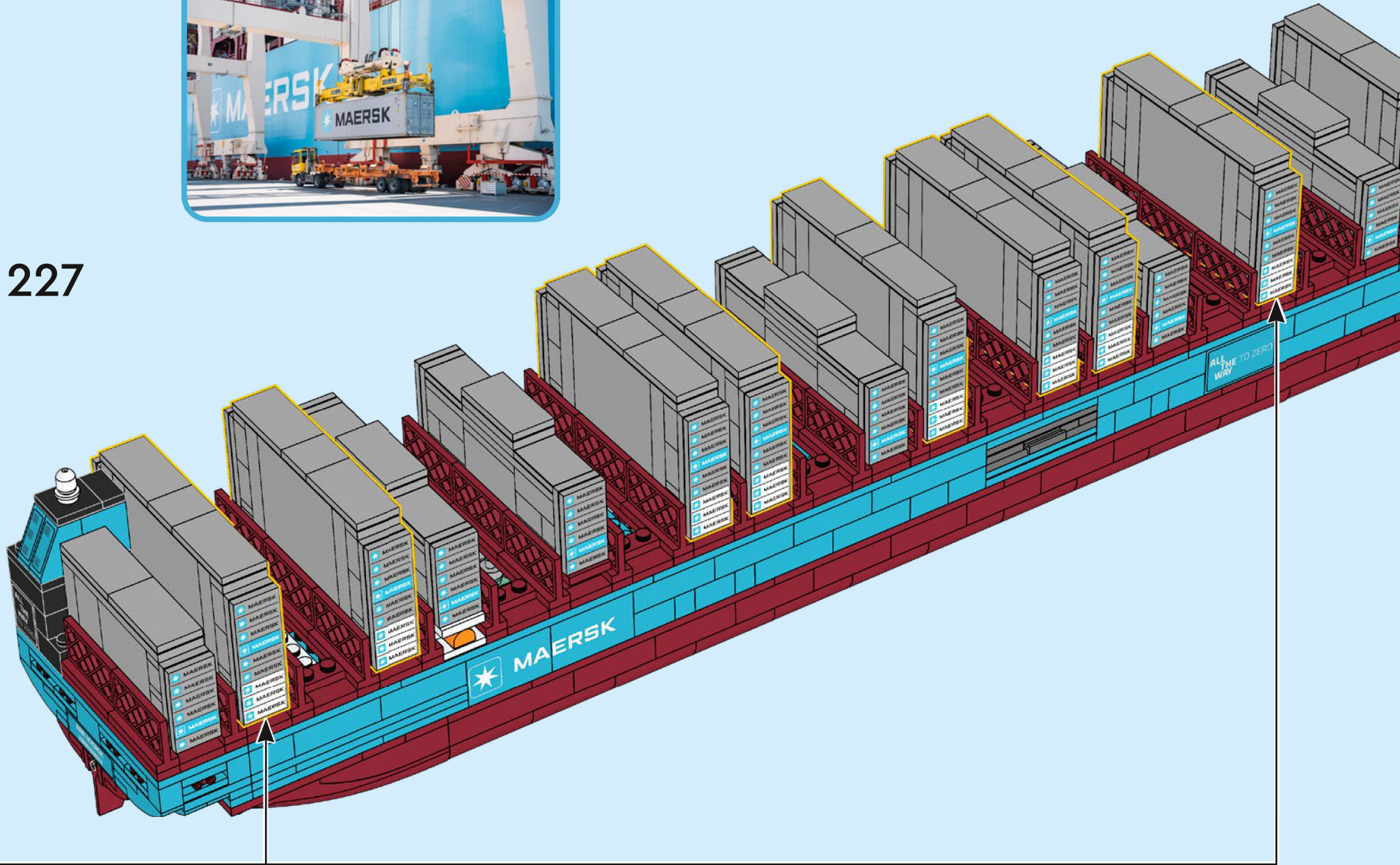





228

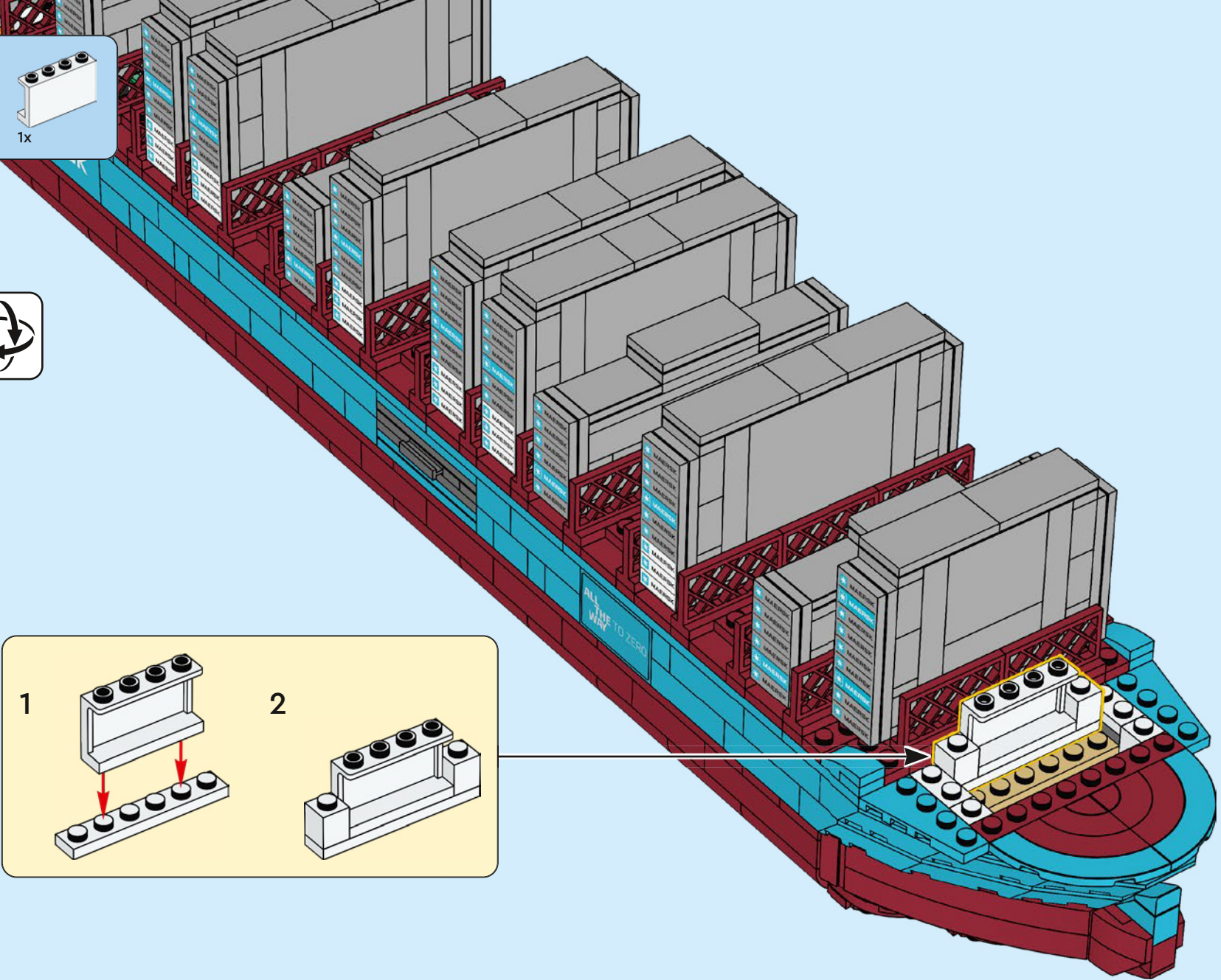
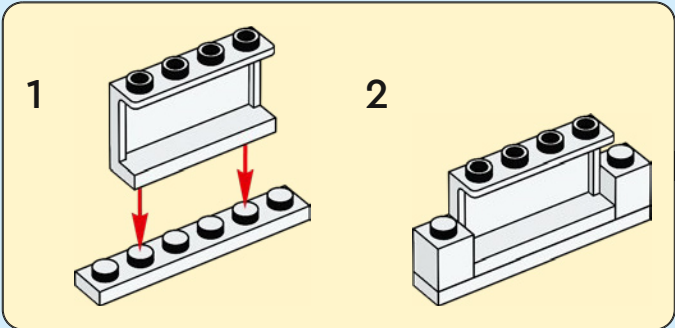

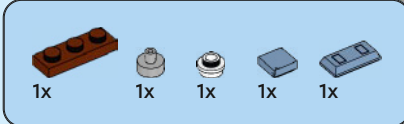

229

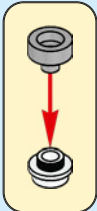
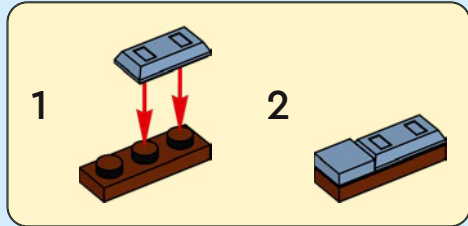

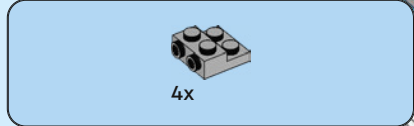

230

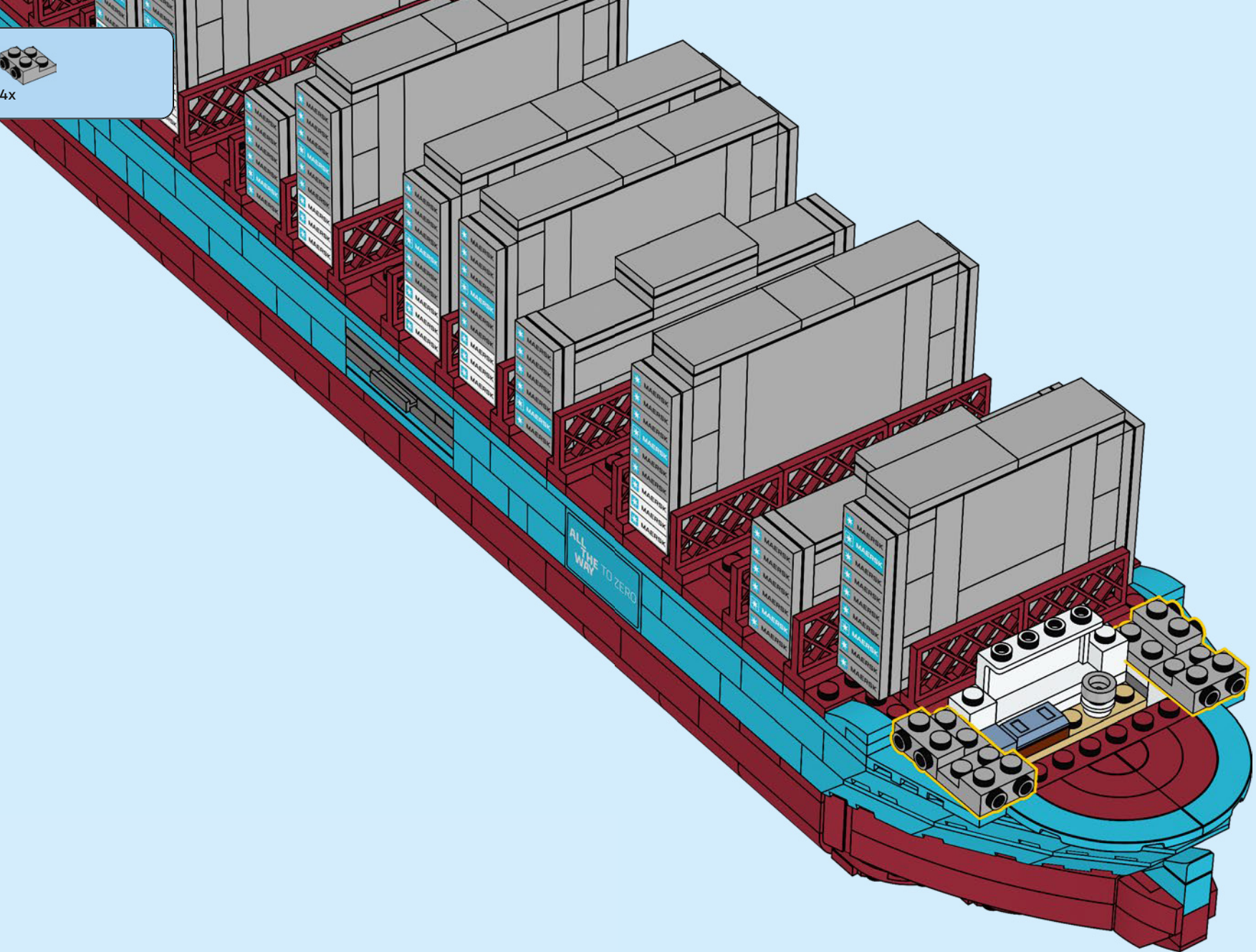

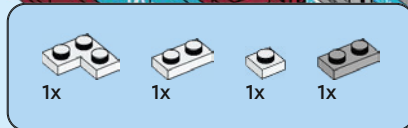

231

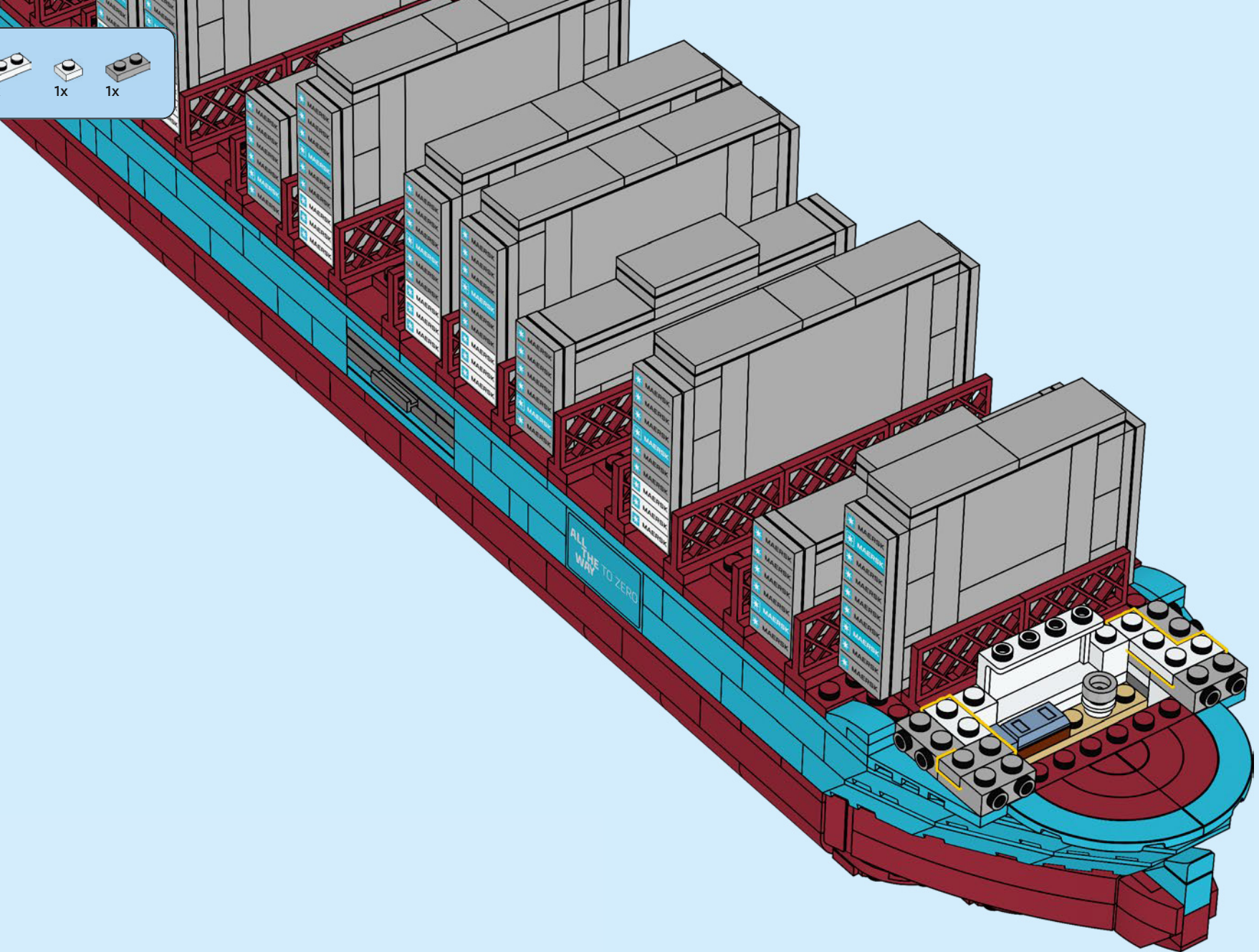

1x 1x 1x 2x

232

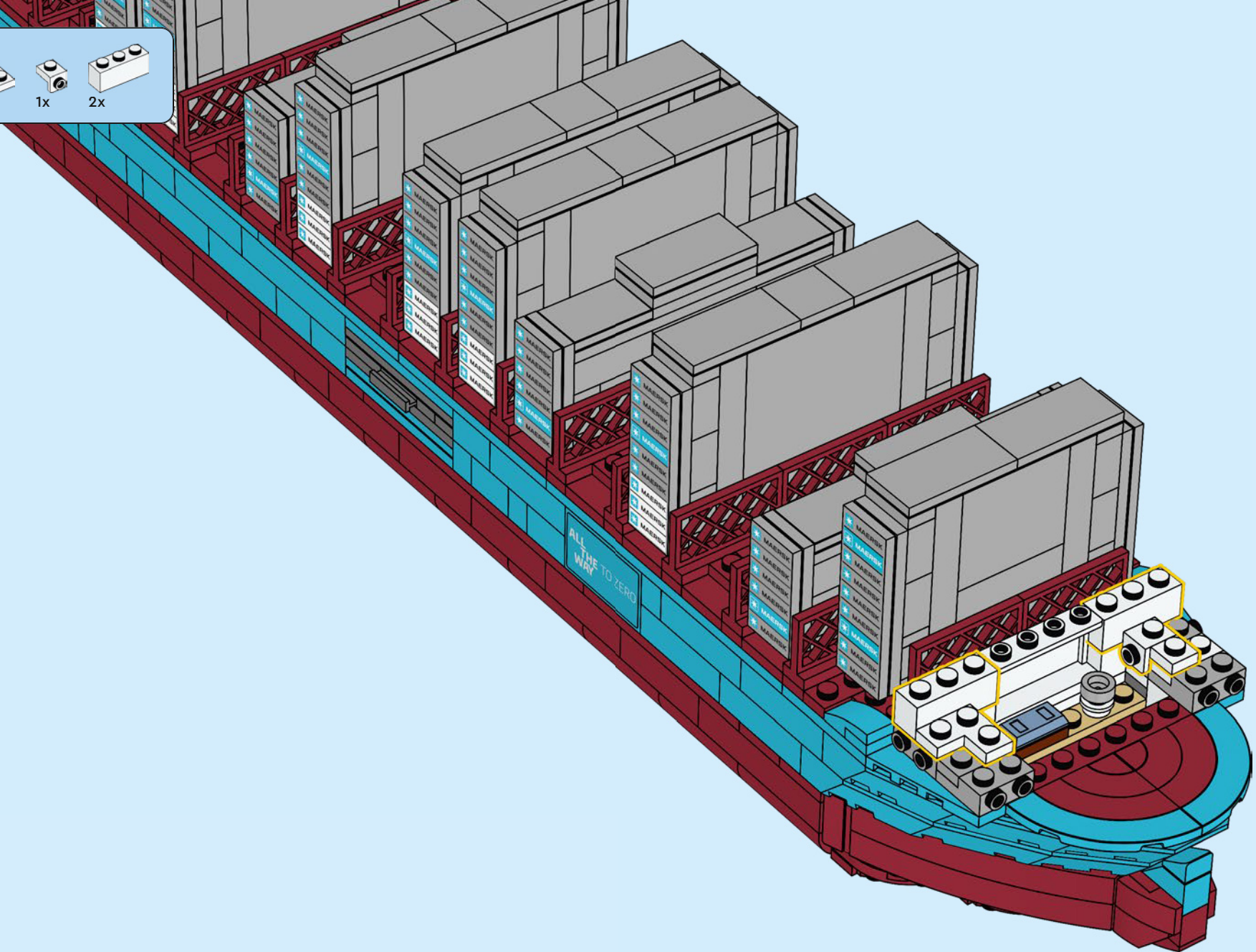

1x 1x 4x

233

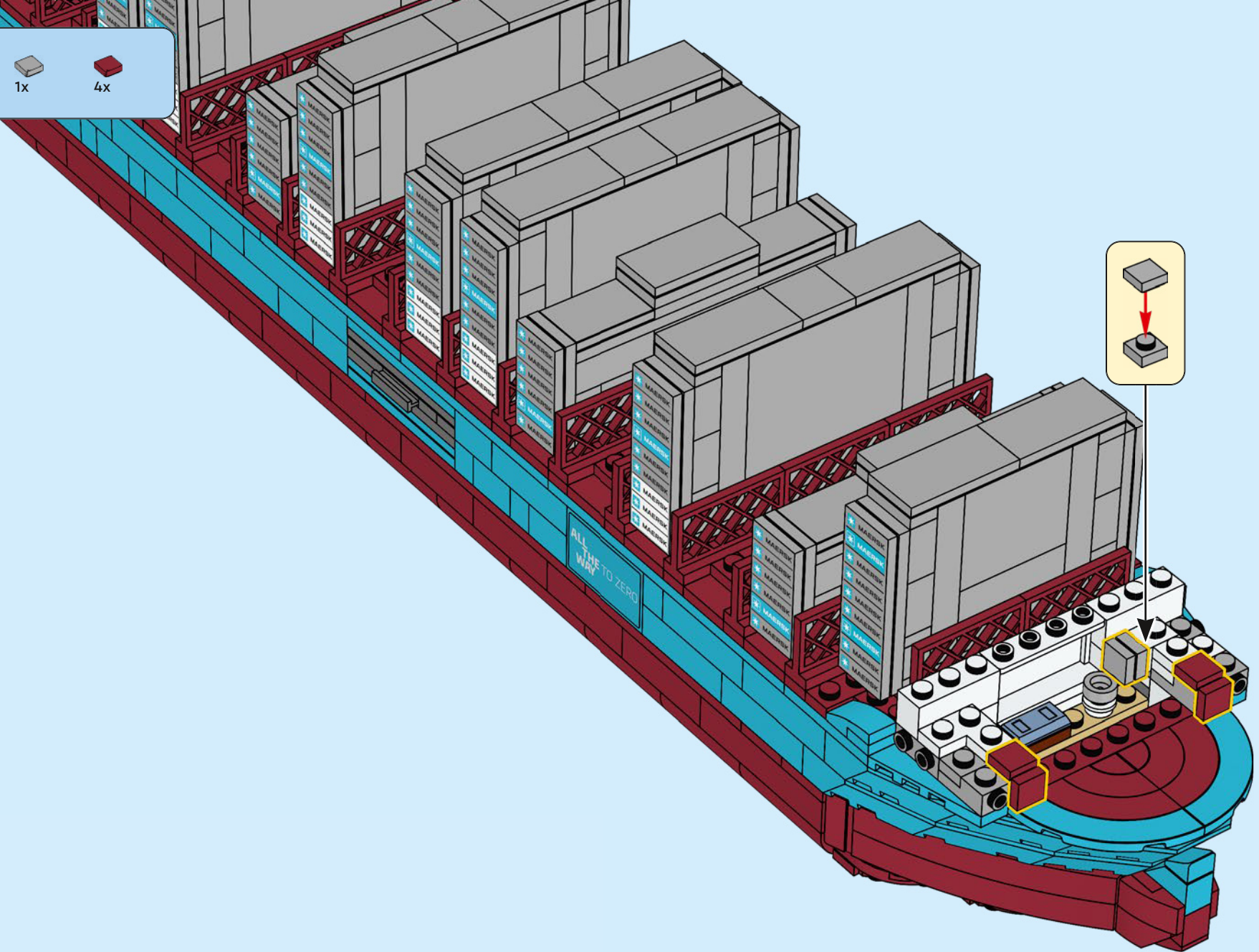

3x 2x 2x

234

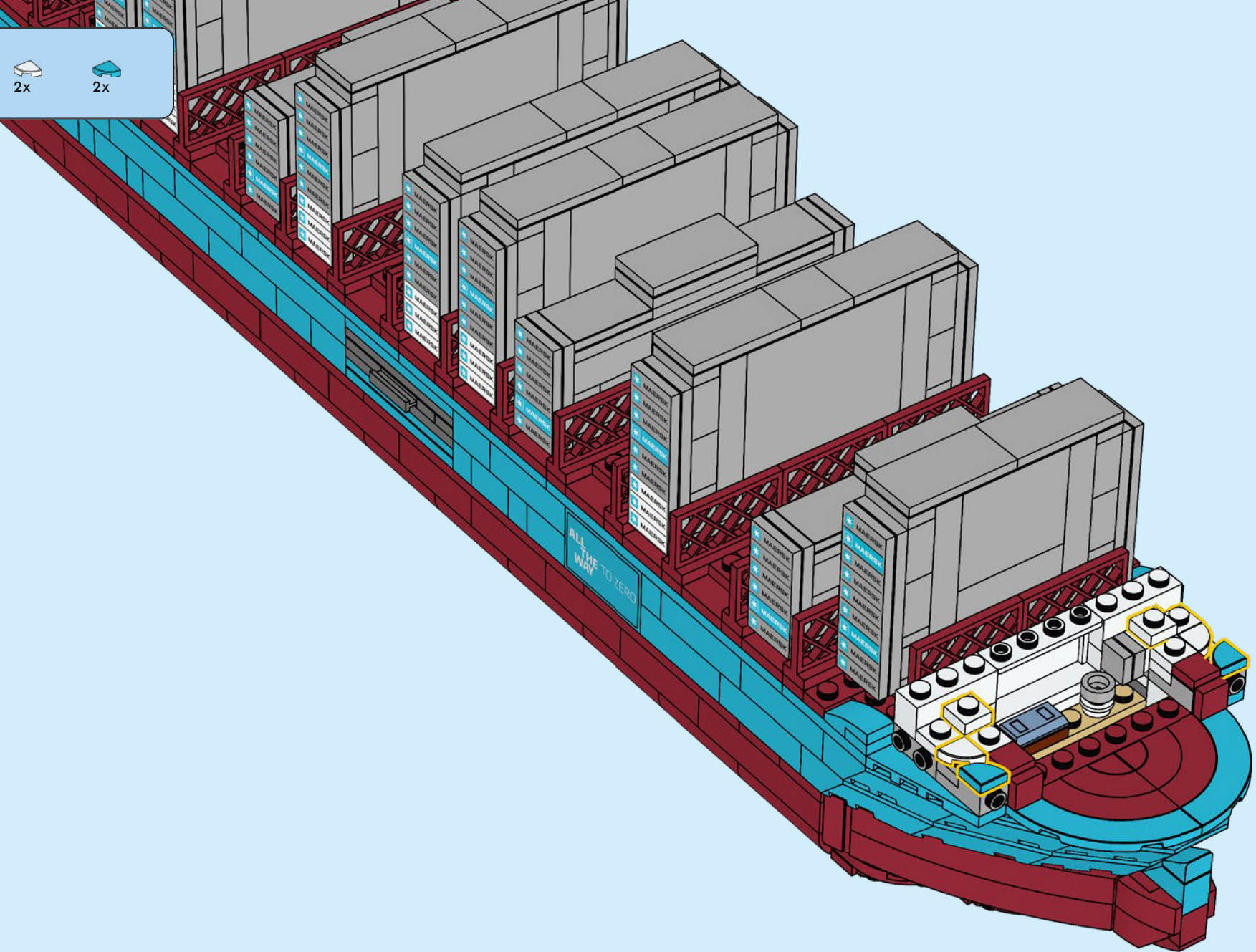

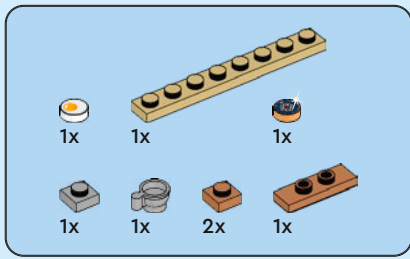

235

1

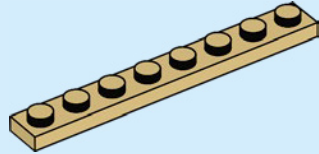

2

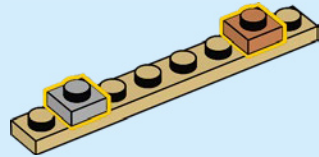

3

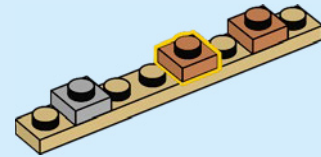

4

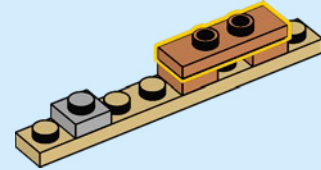

5

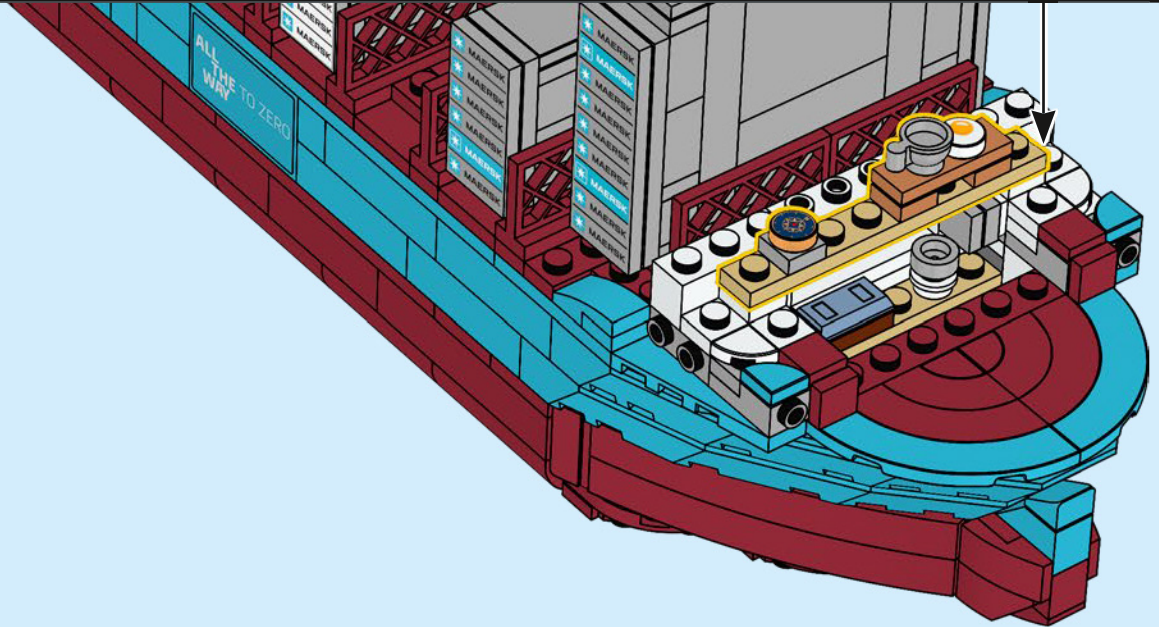
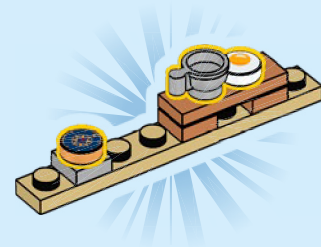

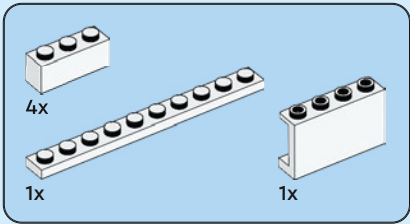

236

1

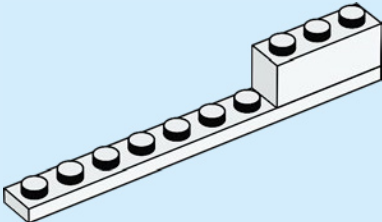

2

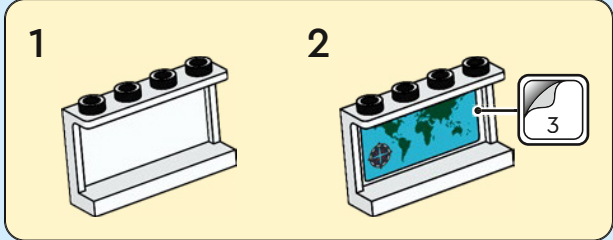
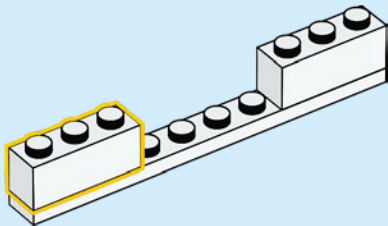

3

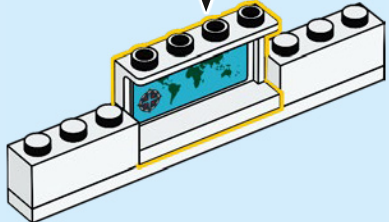

4

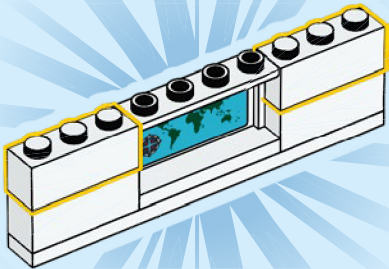

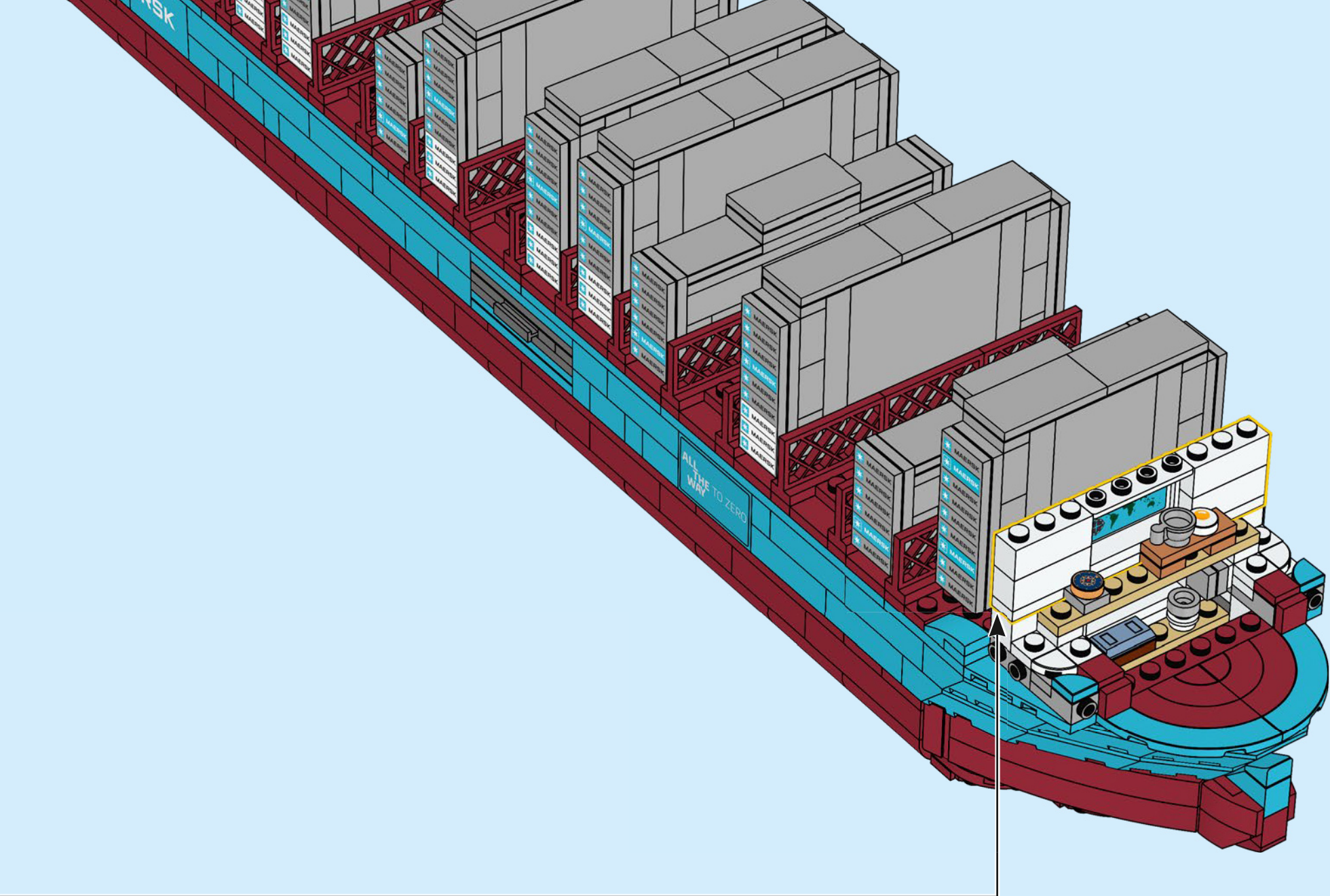

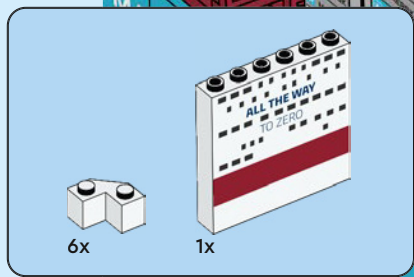

237

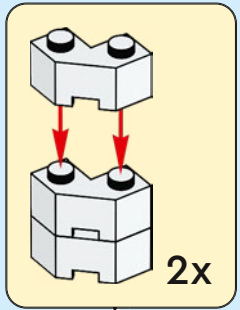
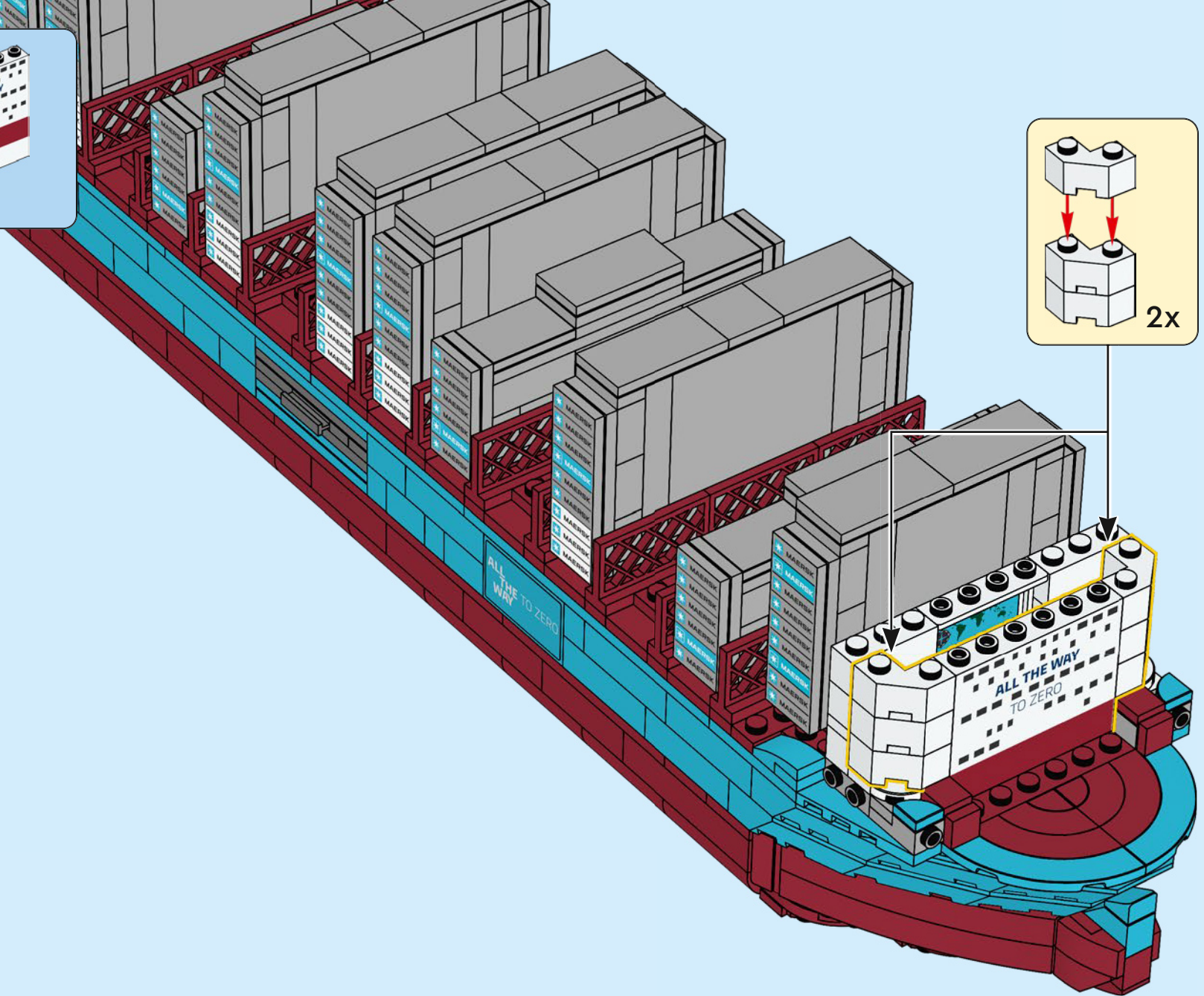

238

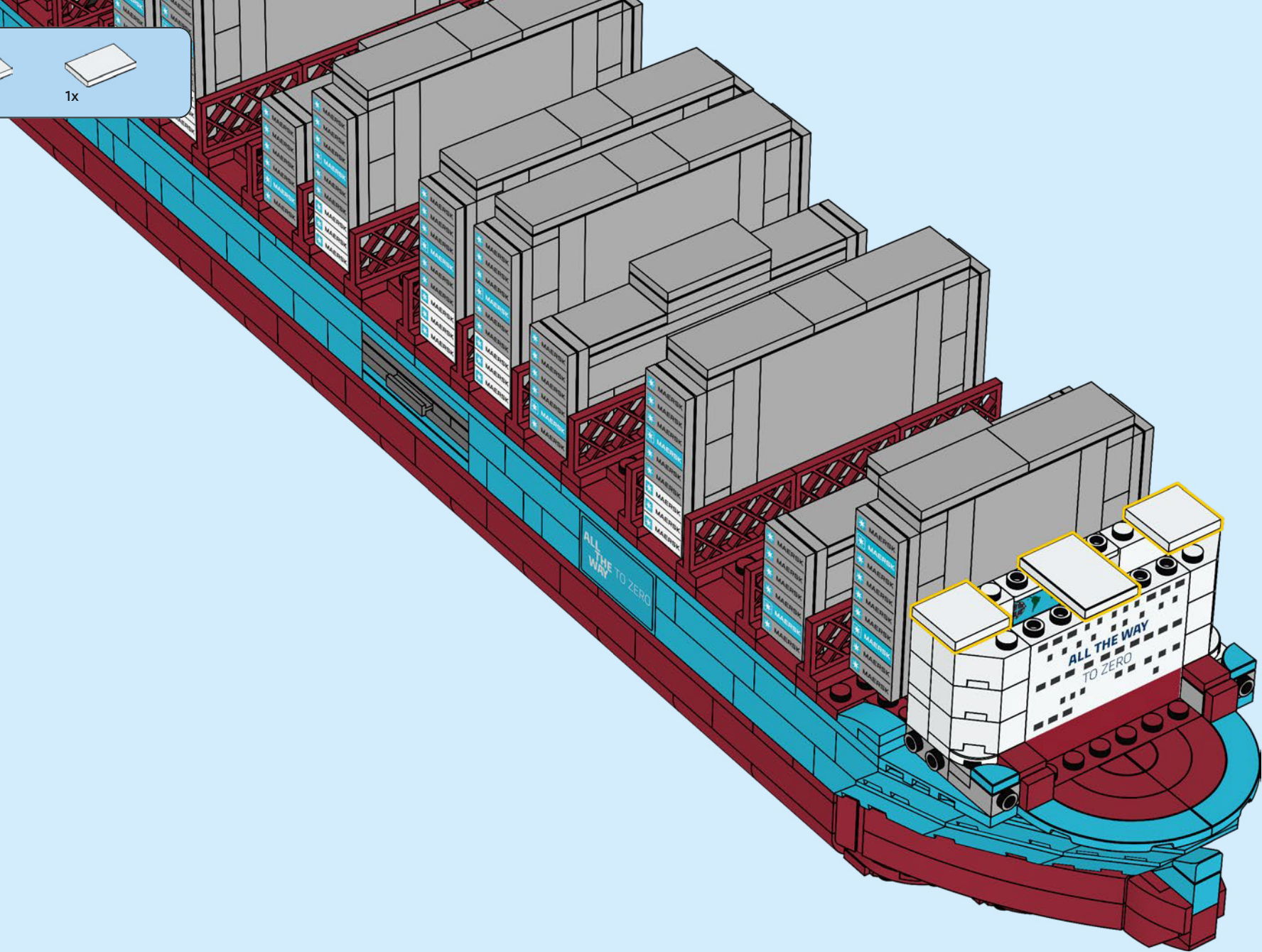

2x 1x 1x

239

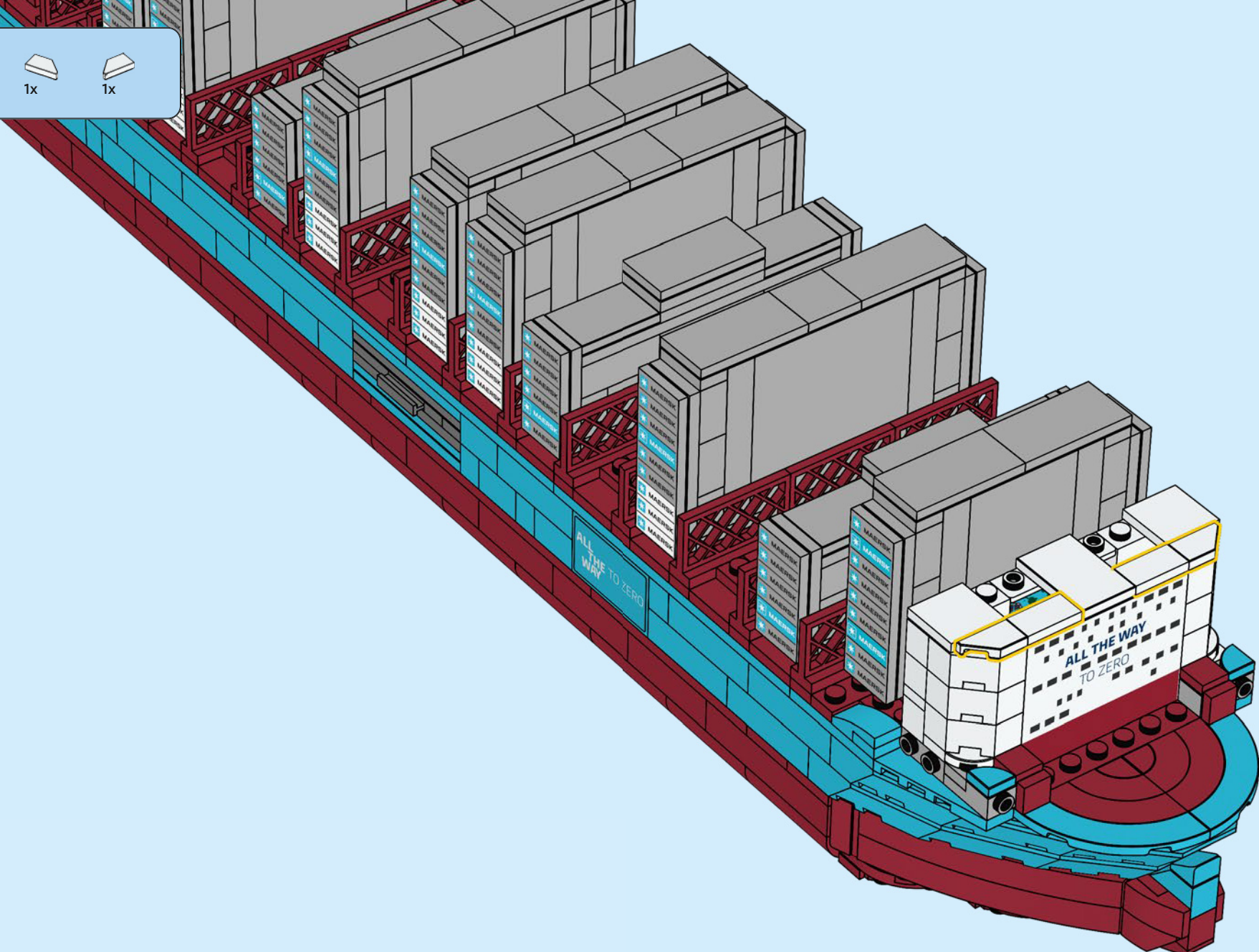

2x 2x 2x

240

1 2 2x

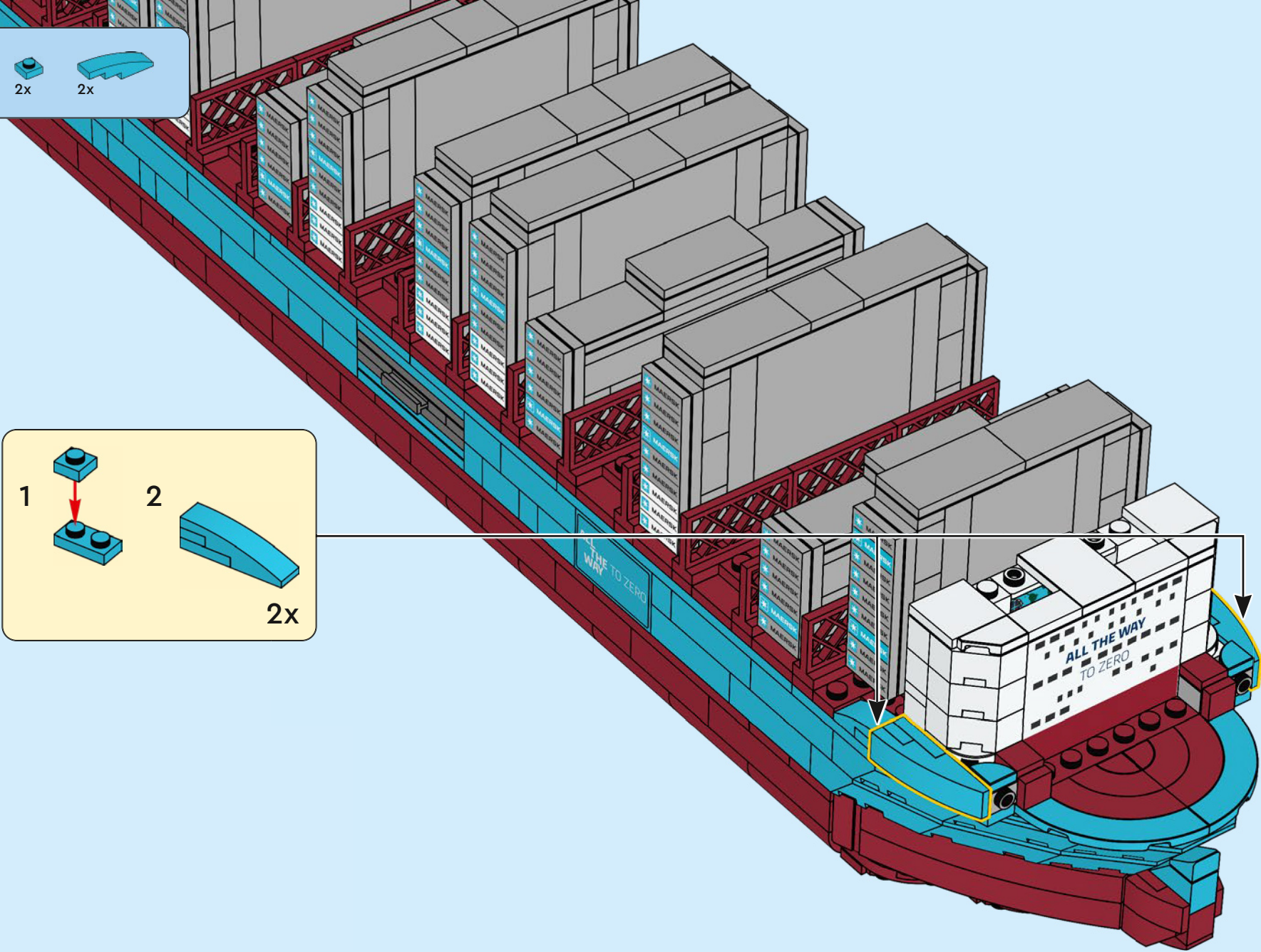

241

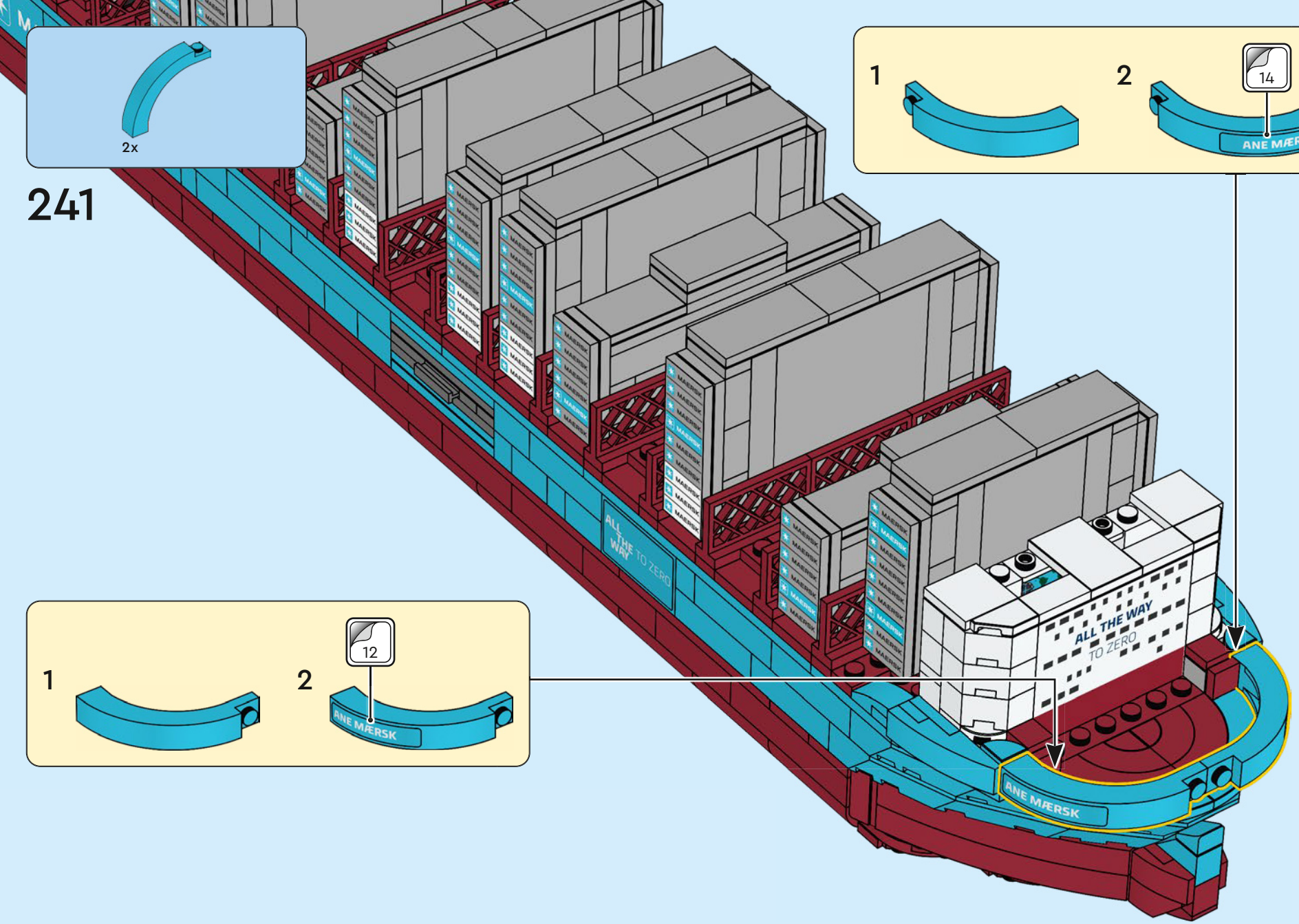
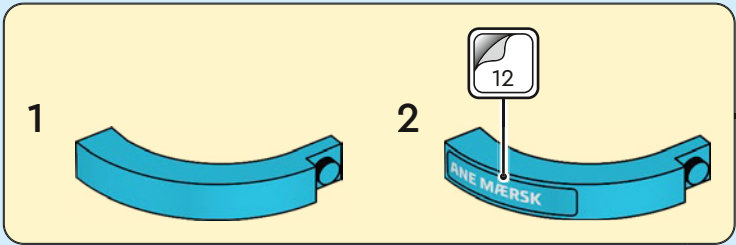
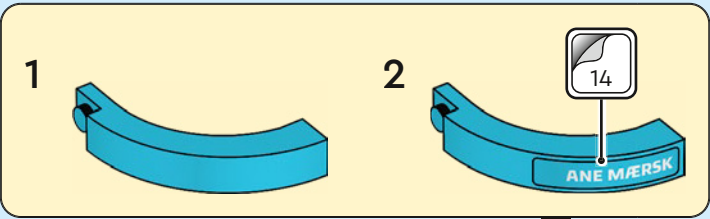
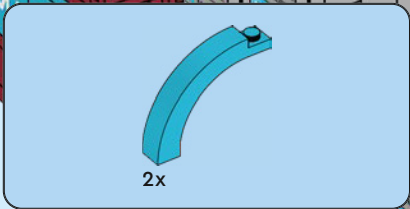

1x

242

1

2

13

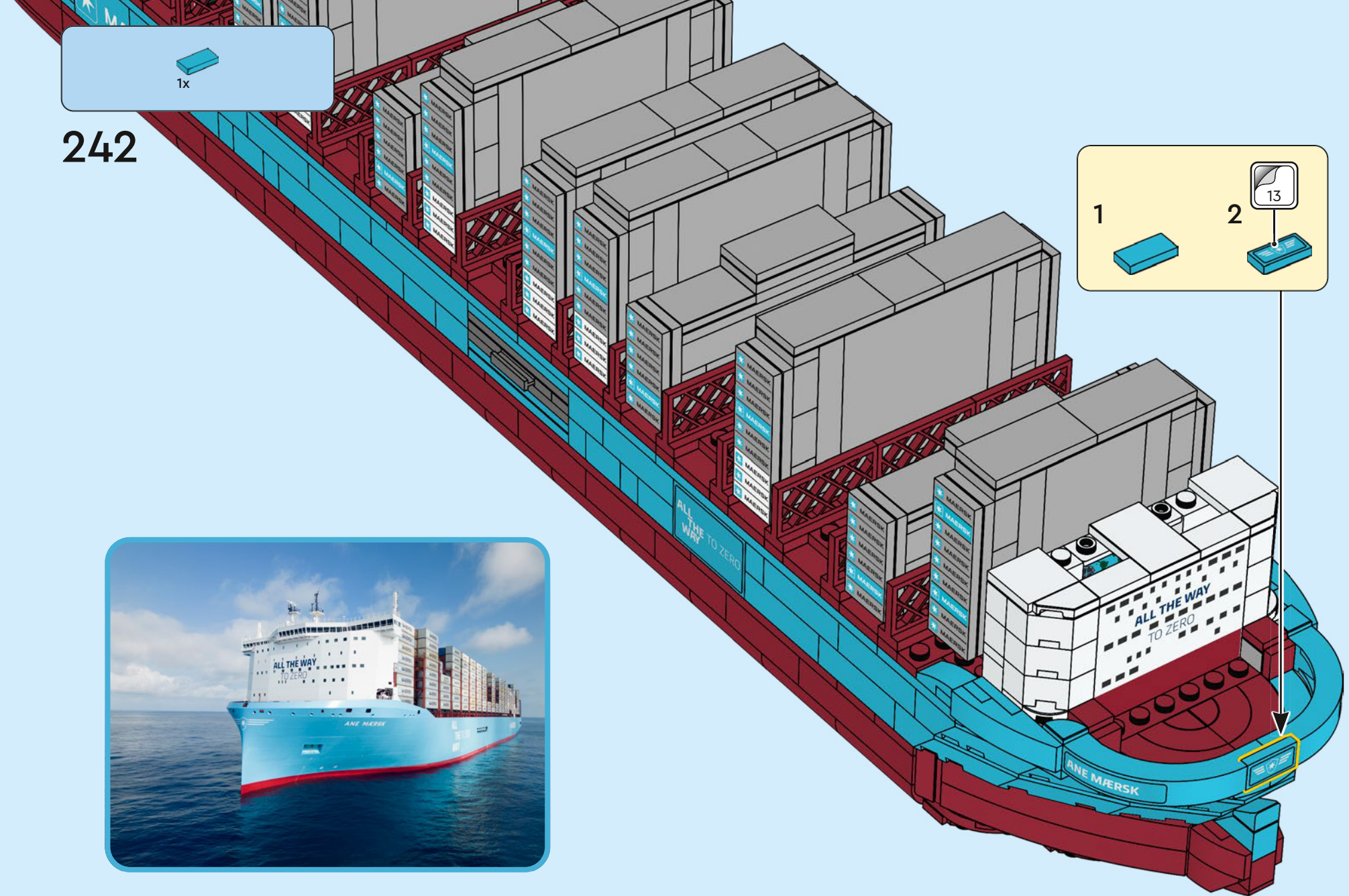

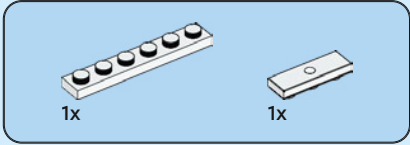
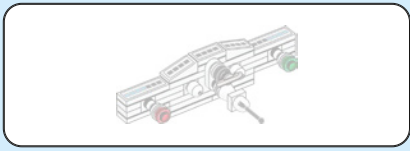

243

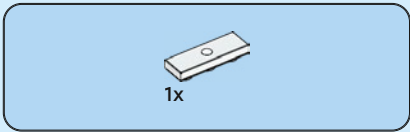
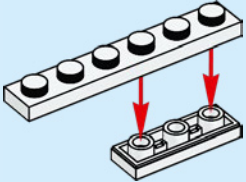

244

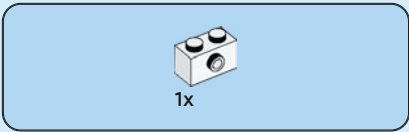
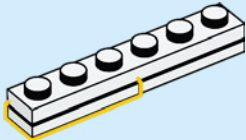

245

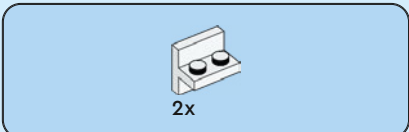
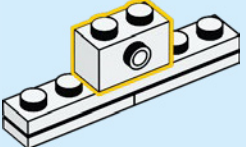

246

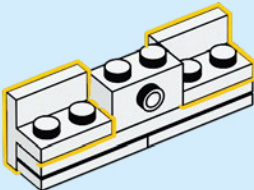



2x

247

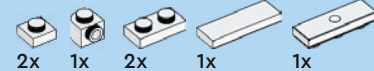
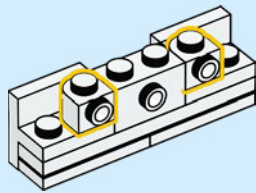

248

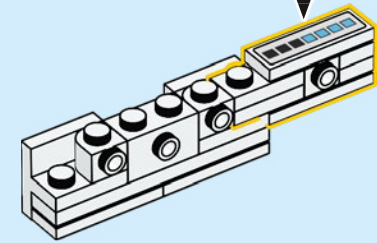
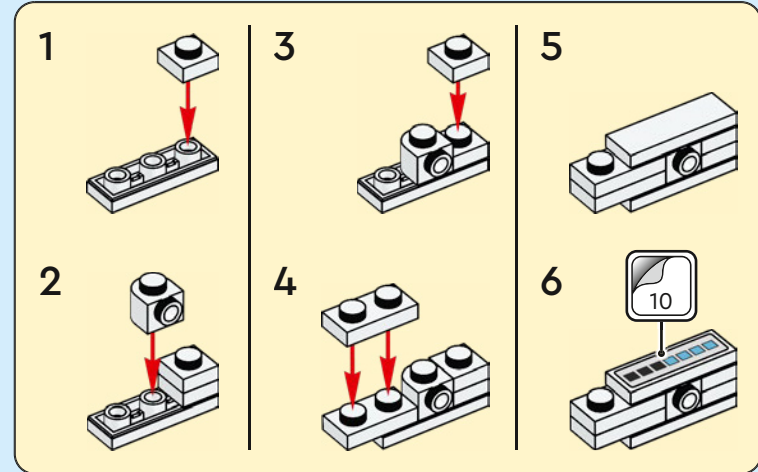

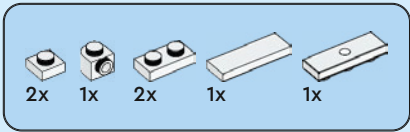

249

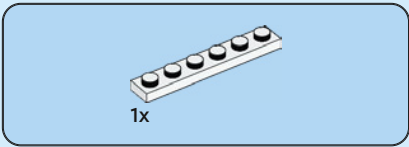
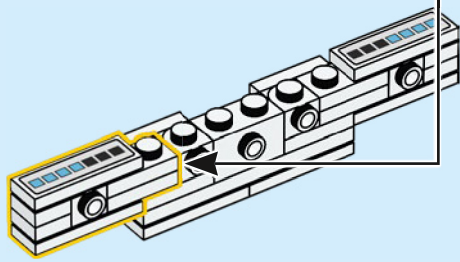
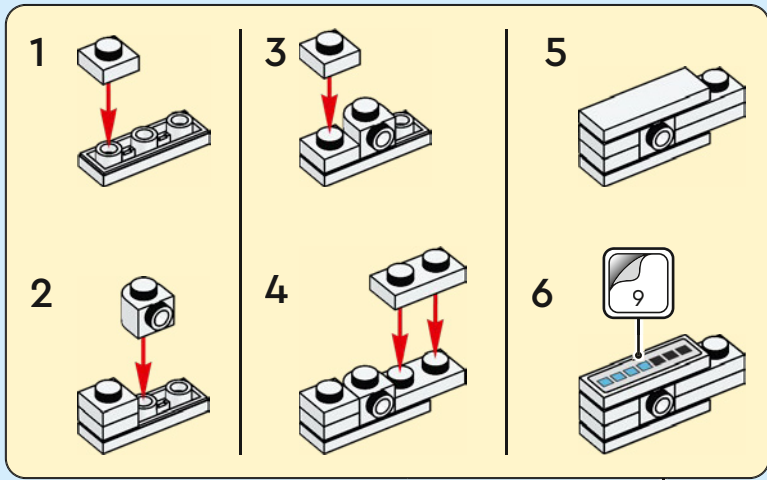

250

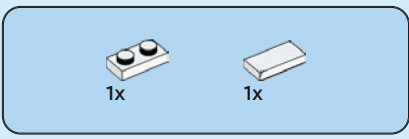
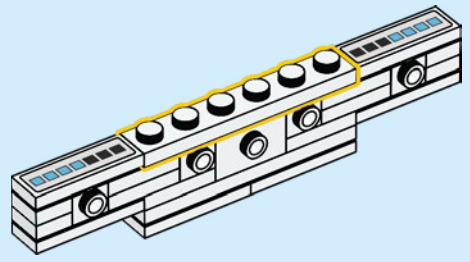

251

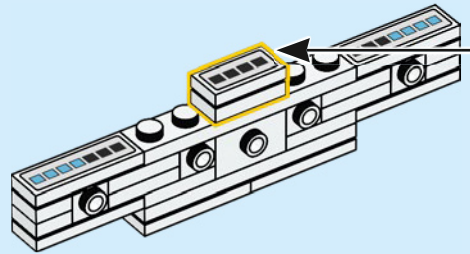
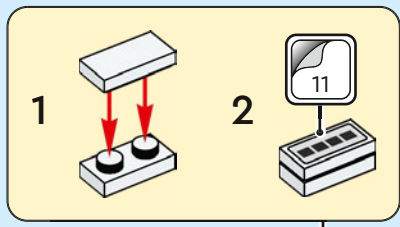

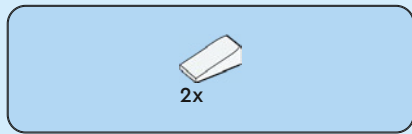

252

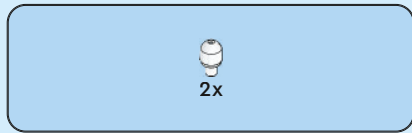
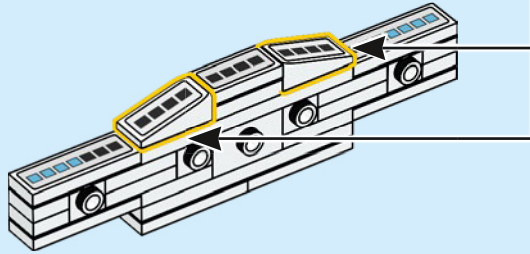
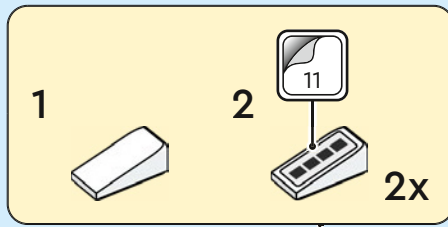

253

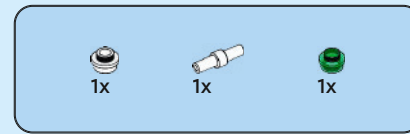
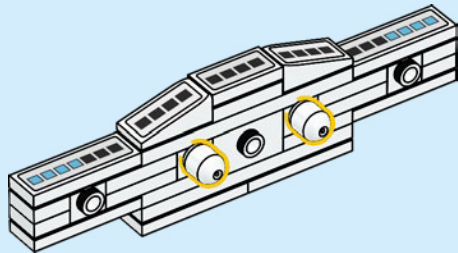

254

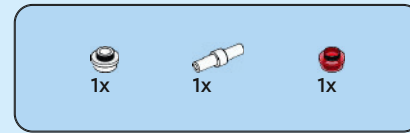
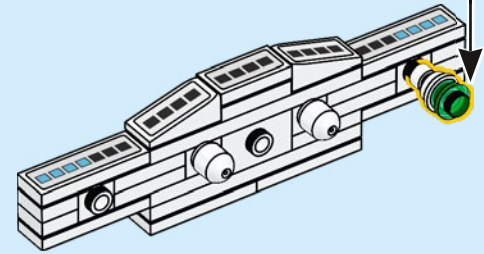
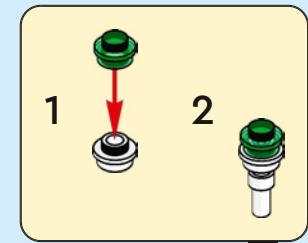

255

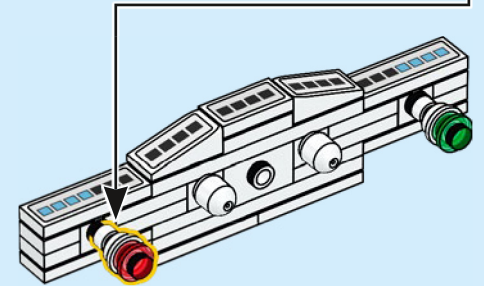
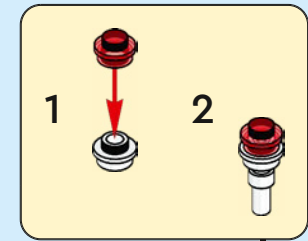

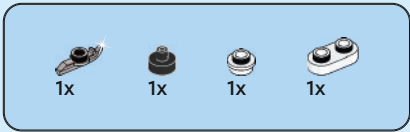

256

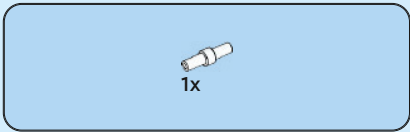
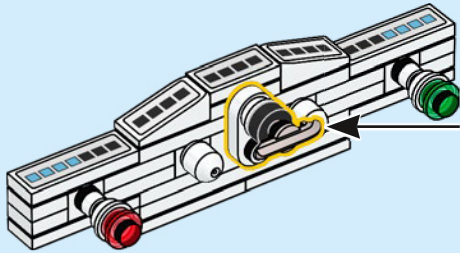
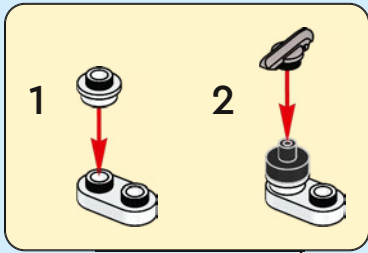

257

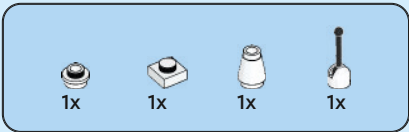
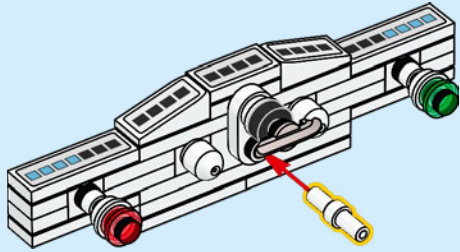

258

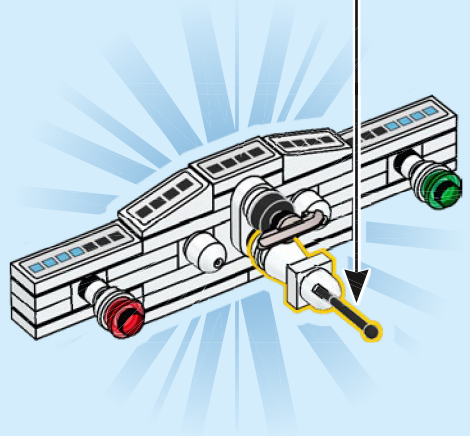
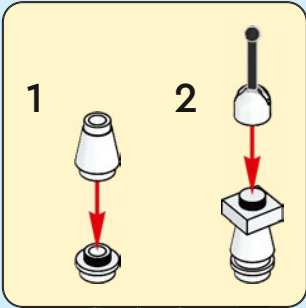

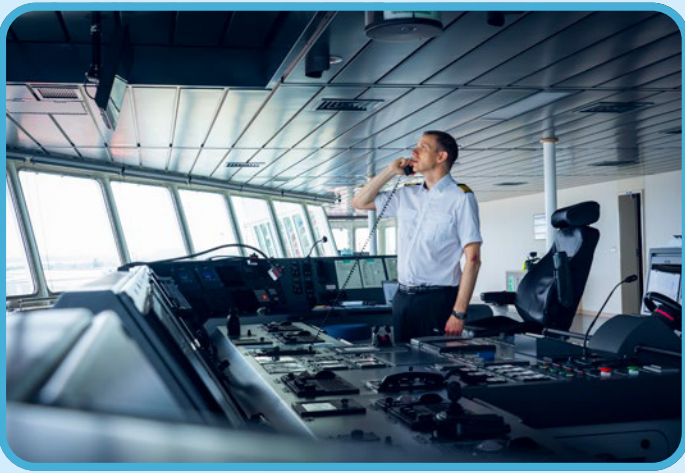
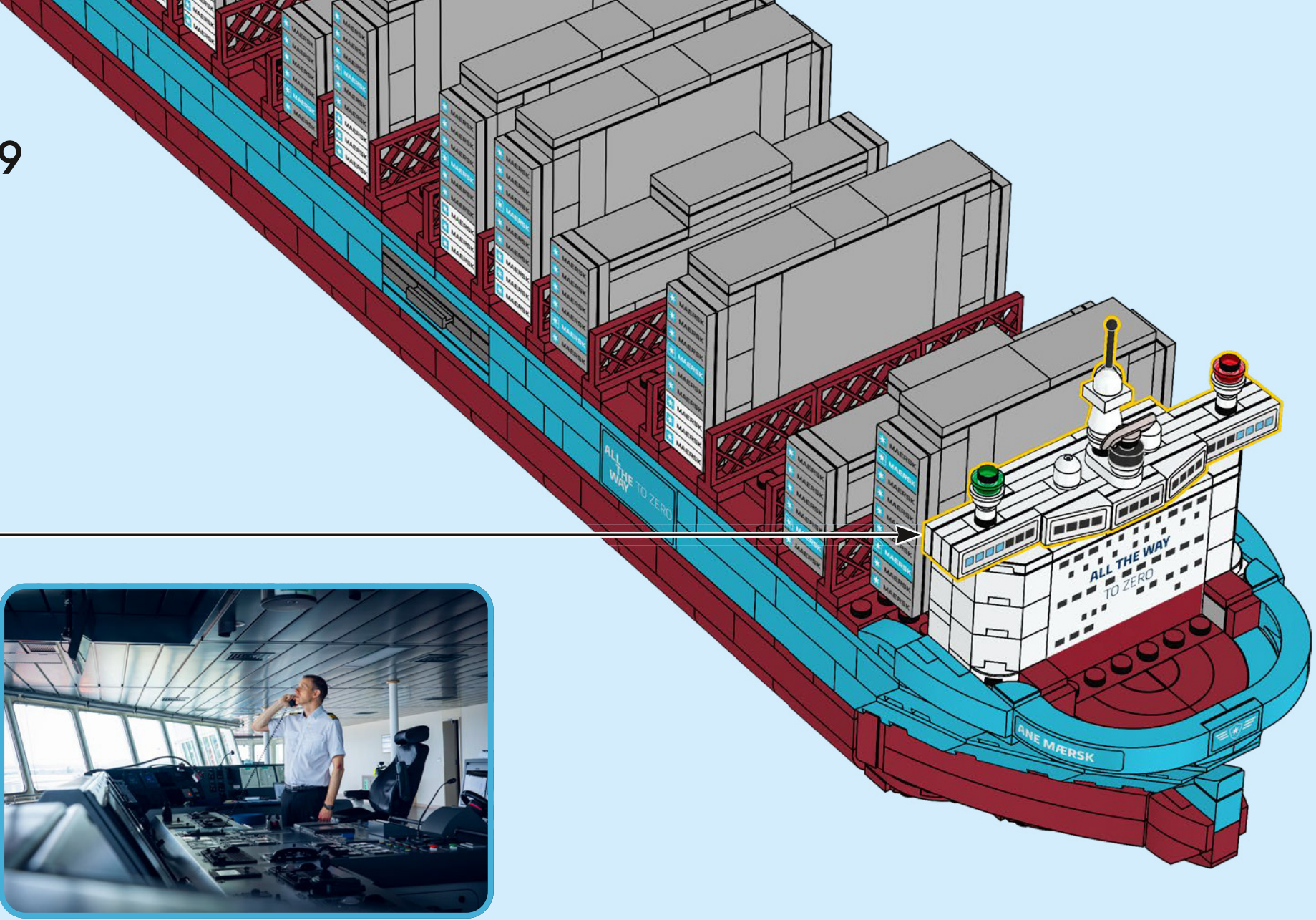

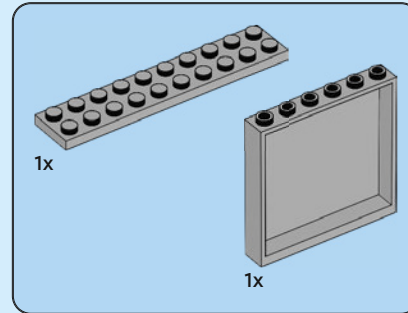
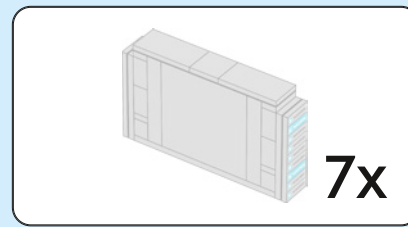

260

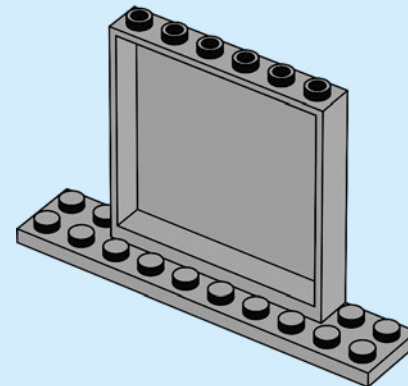

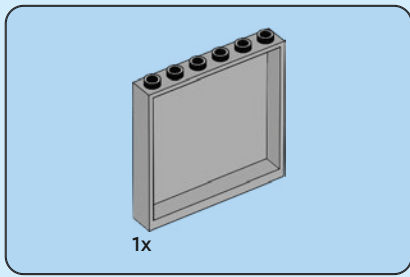

261

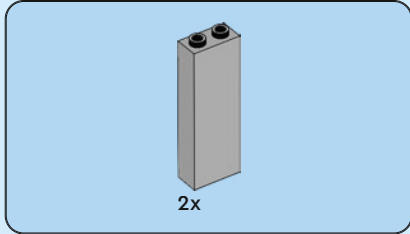
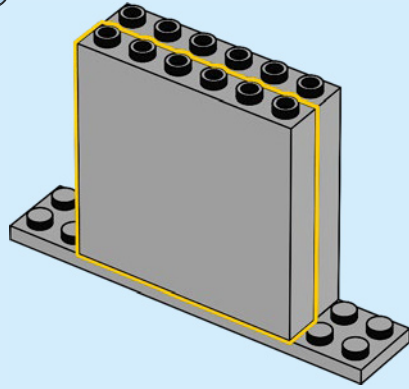

262

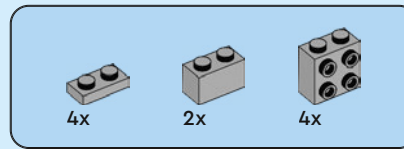
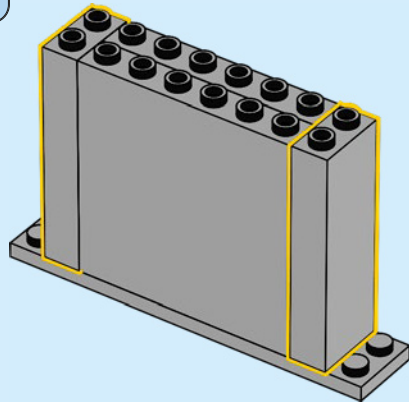

263

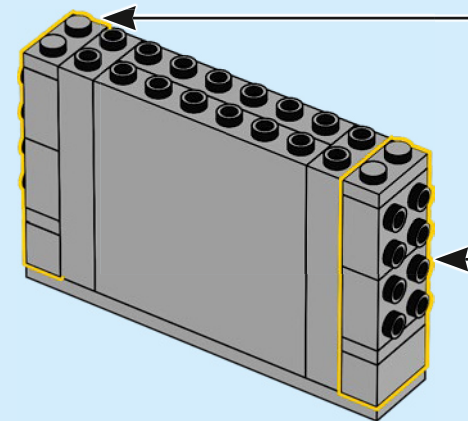
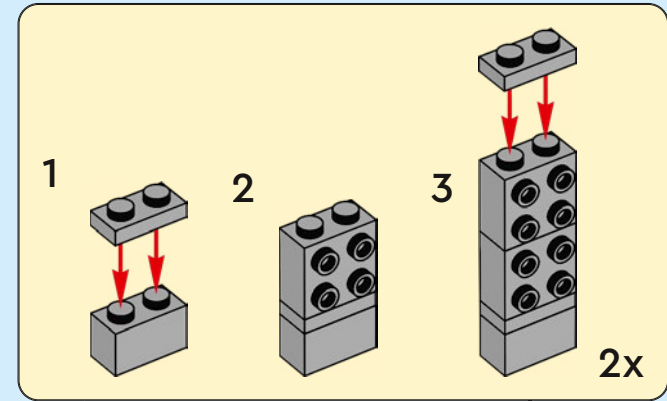

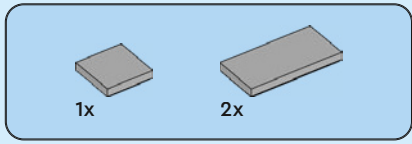

264

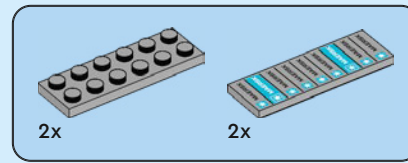
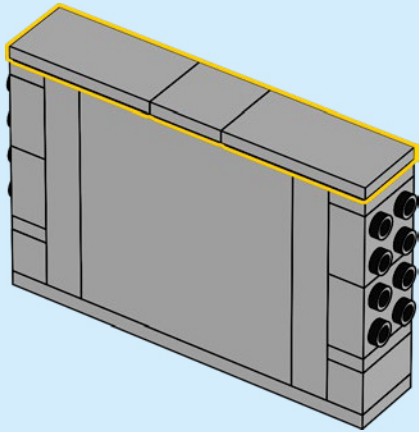

265

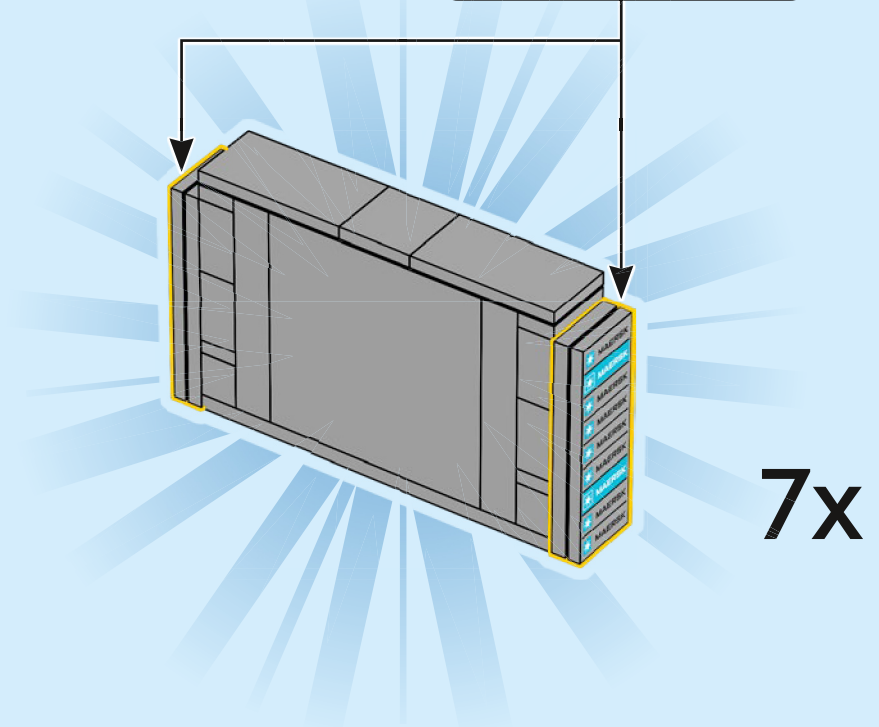
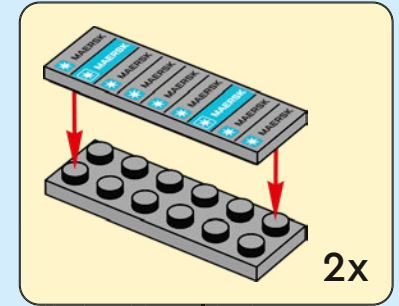

266

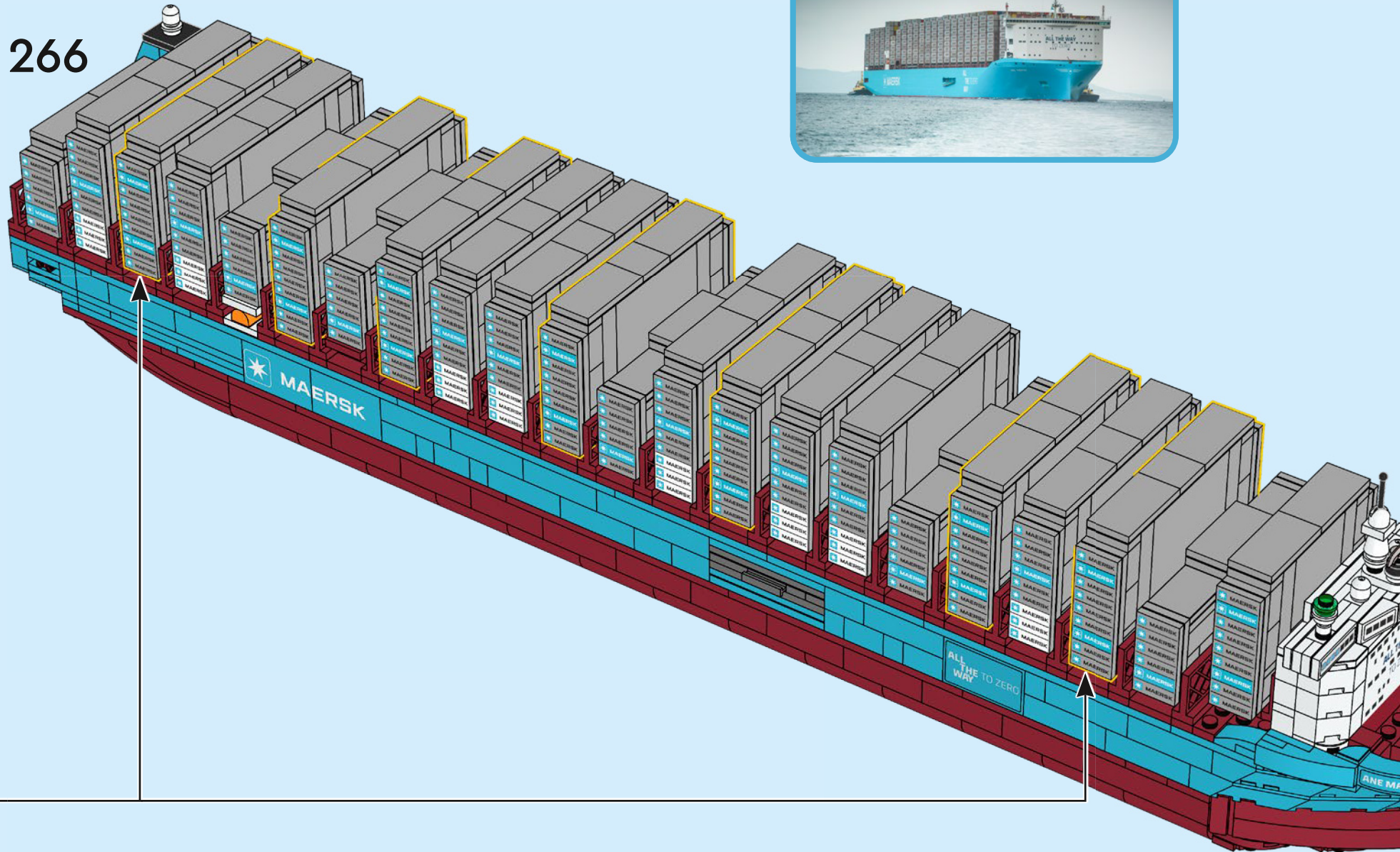

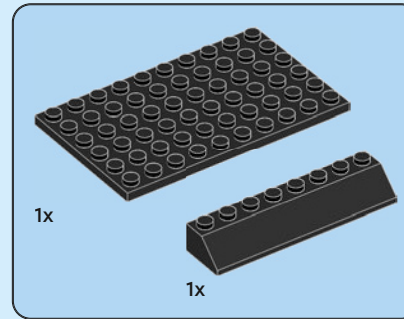
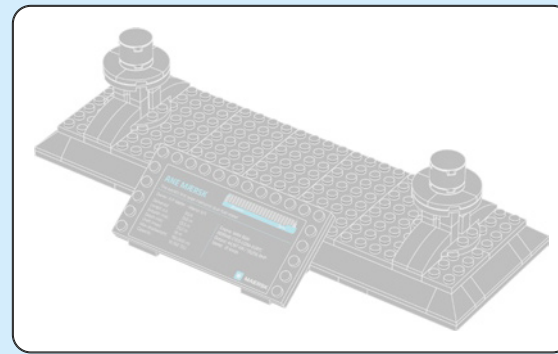

267

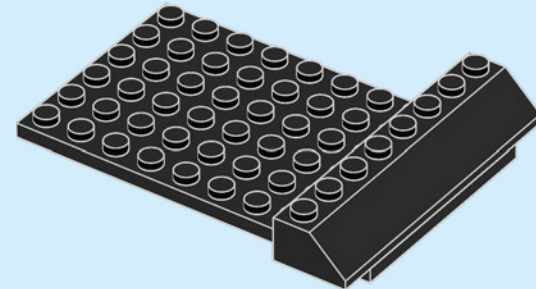

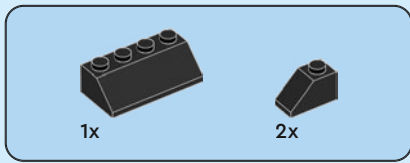

268

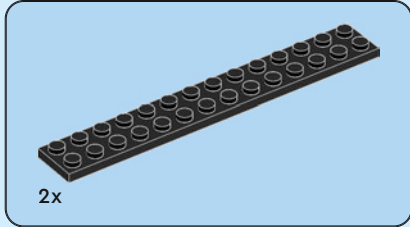
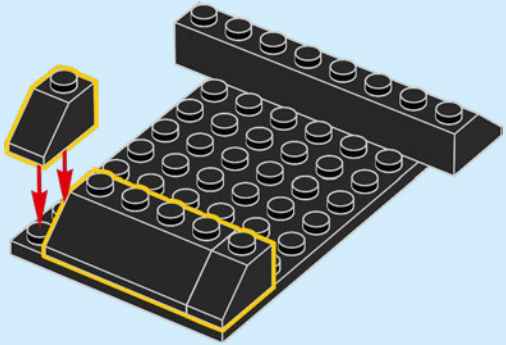

269

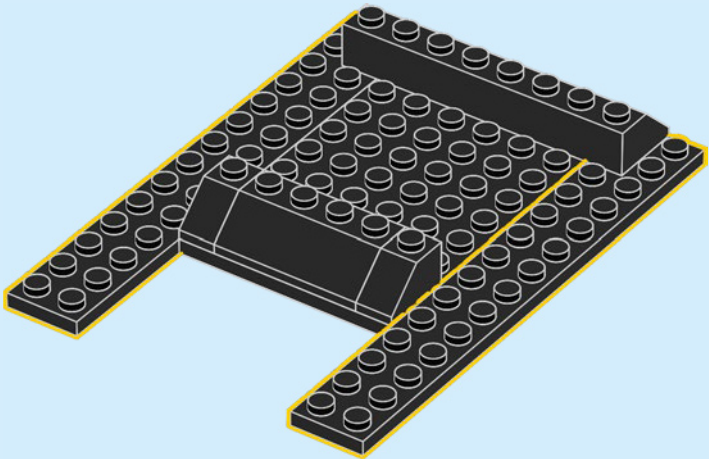

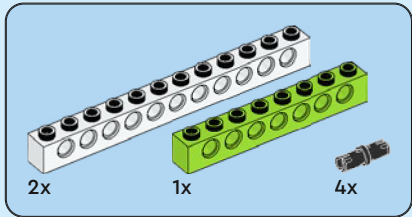
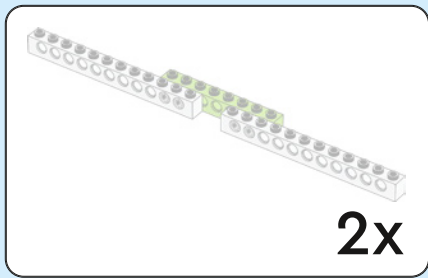

270

1

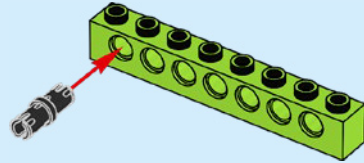

2

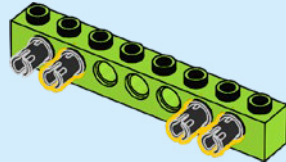

3

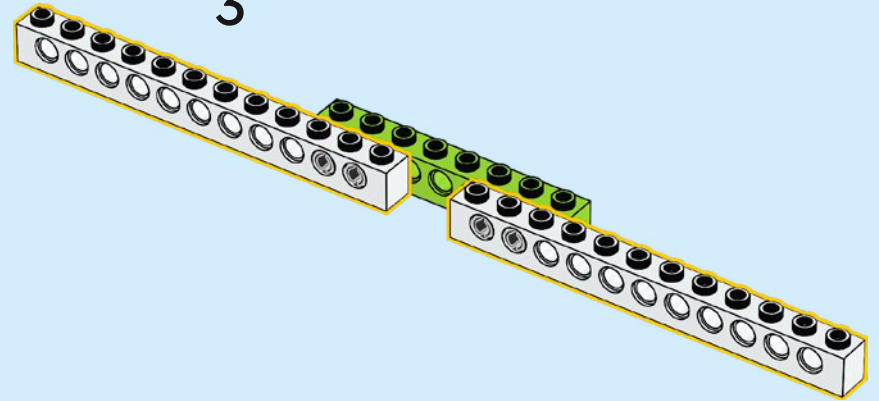

2x

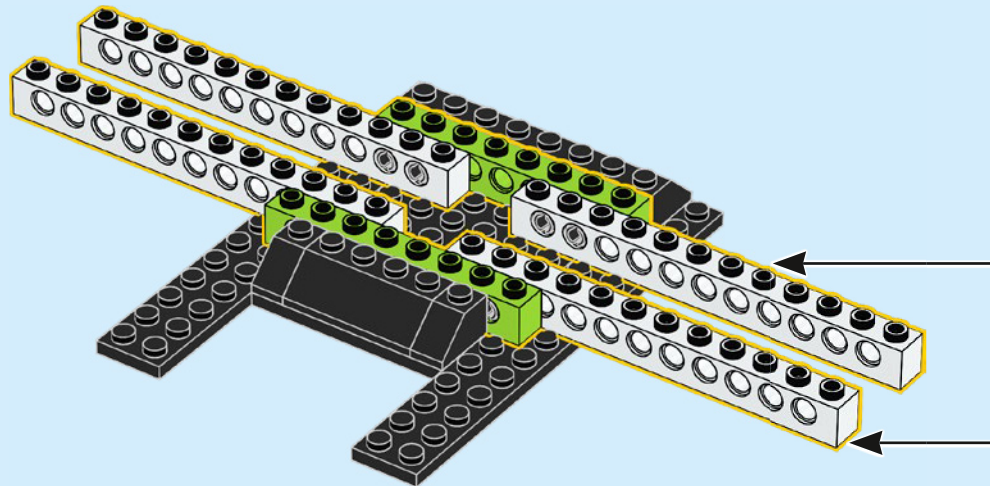

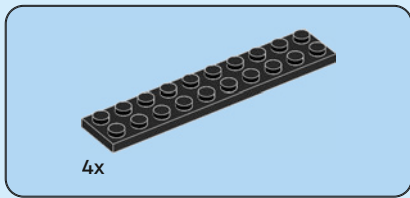

271

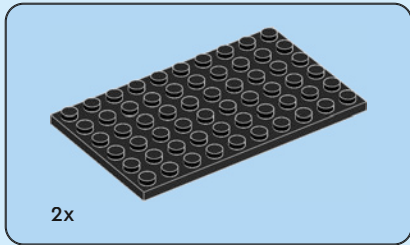
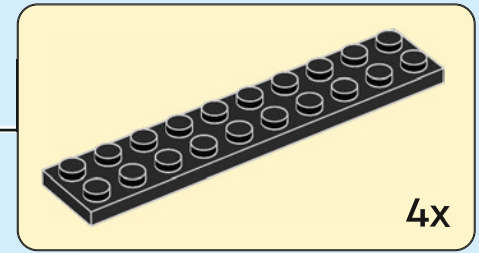
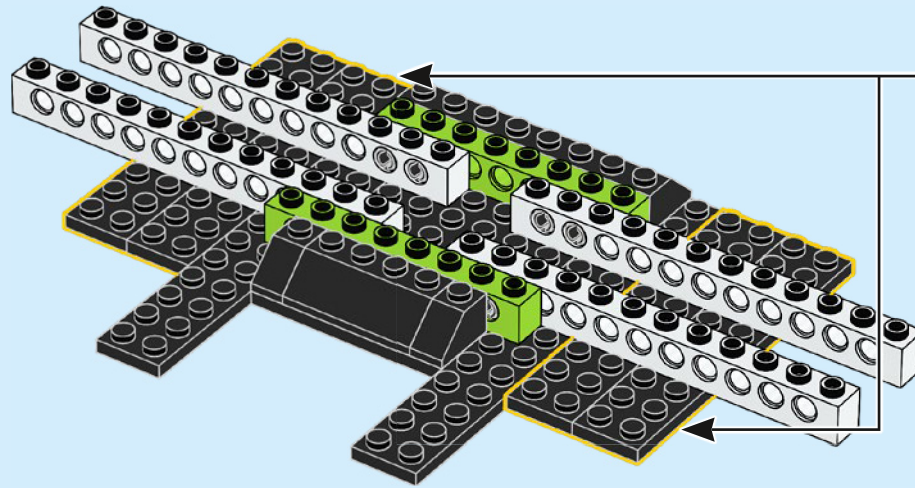

272

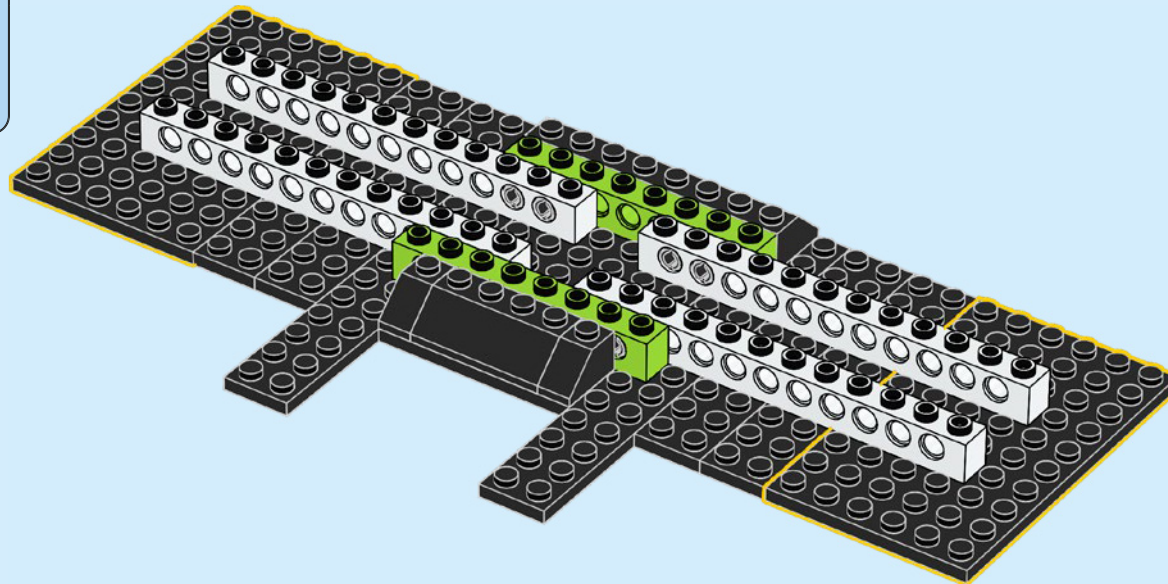

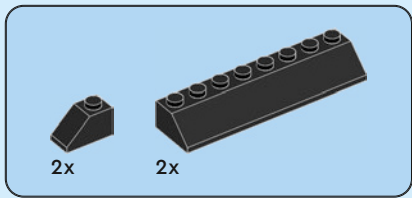

273

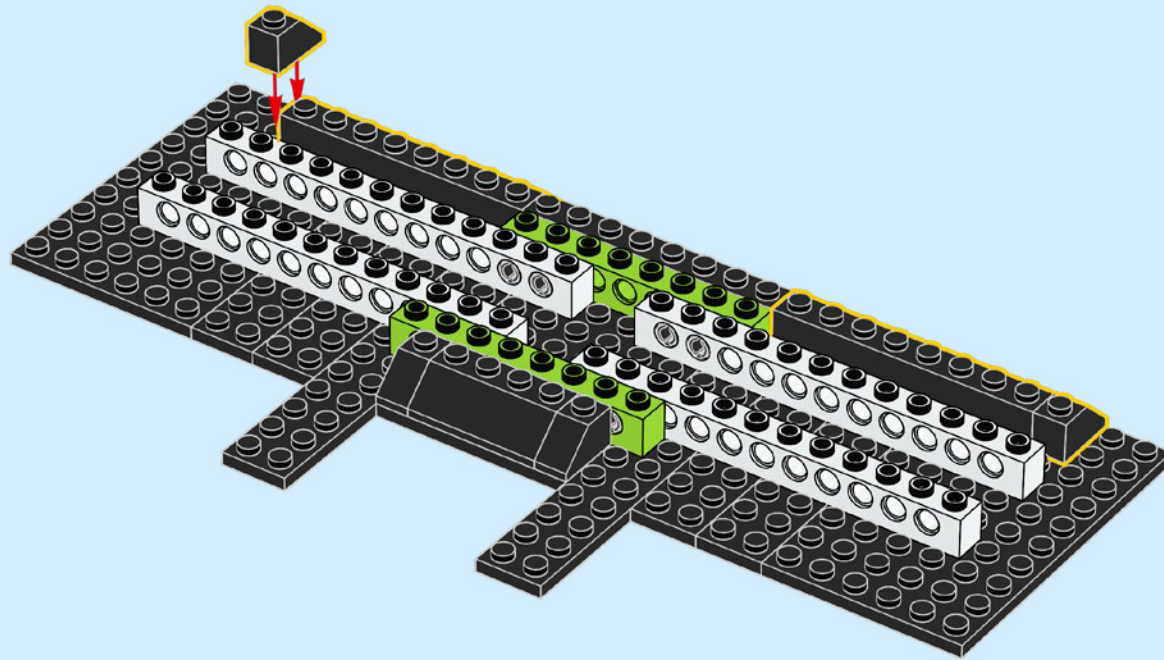

274

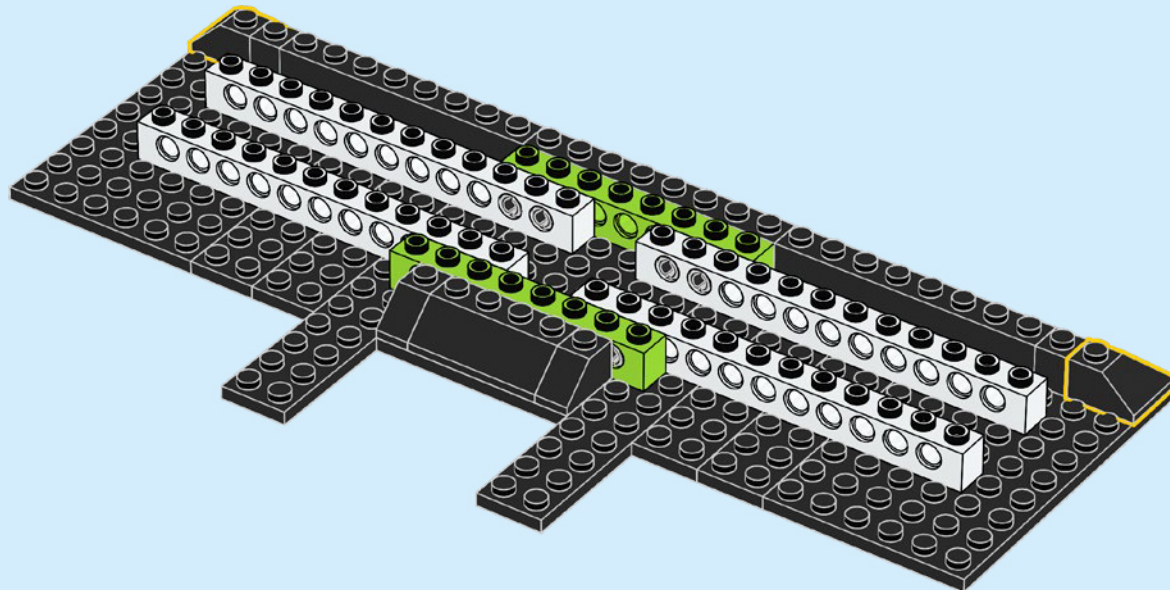

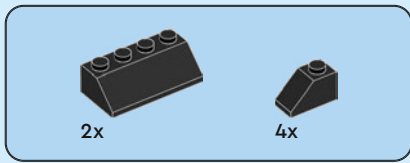

275

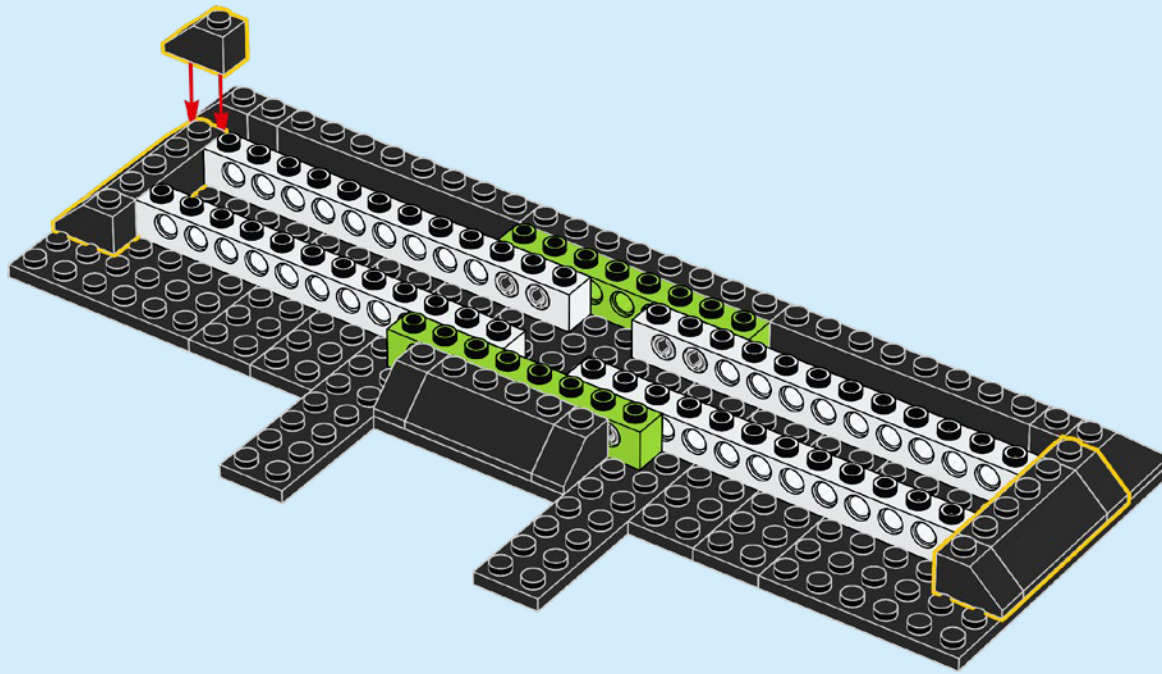

276

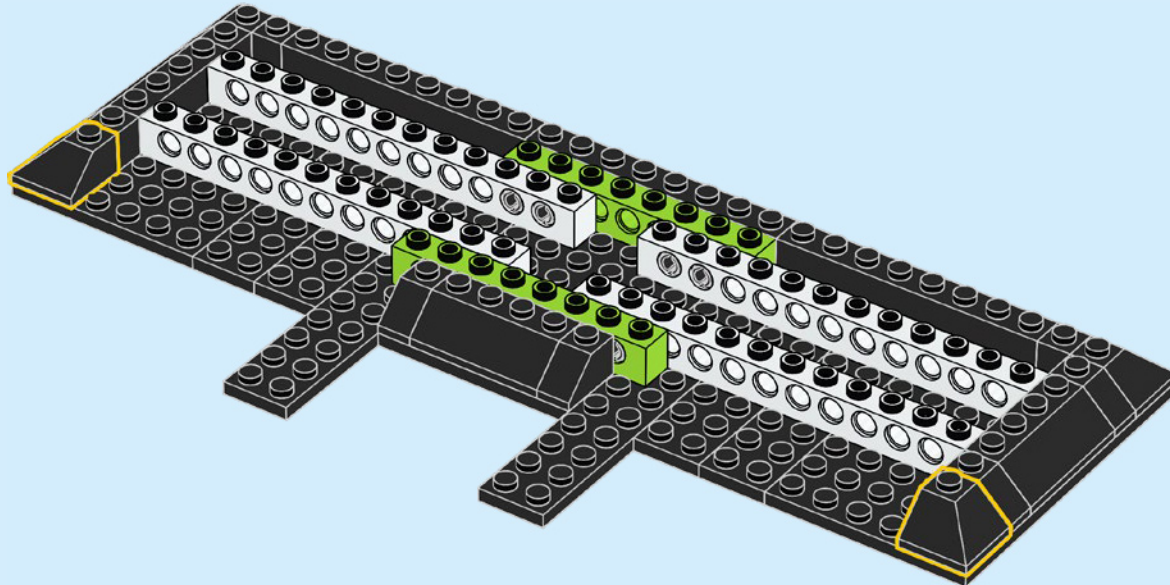



2x



2x

277

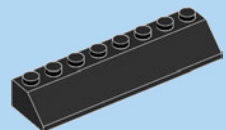
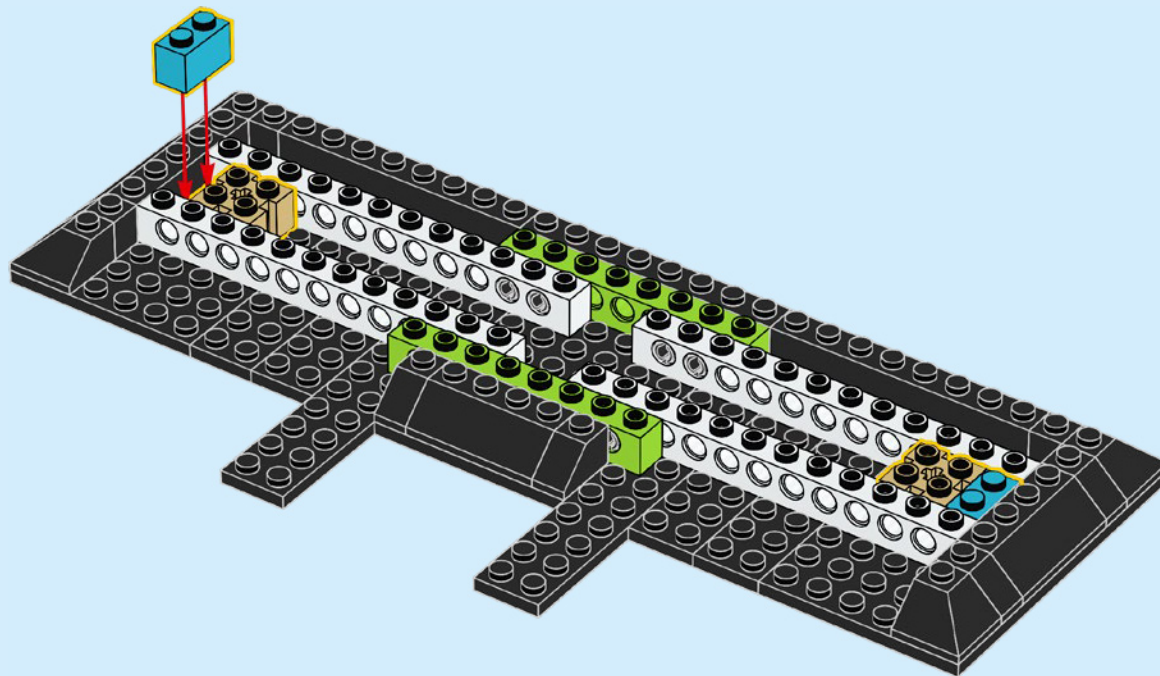

2x

278

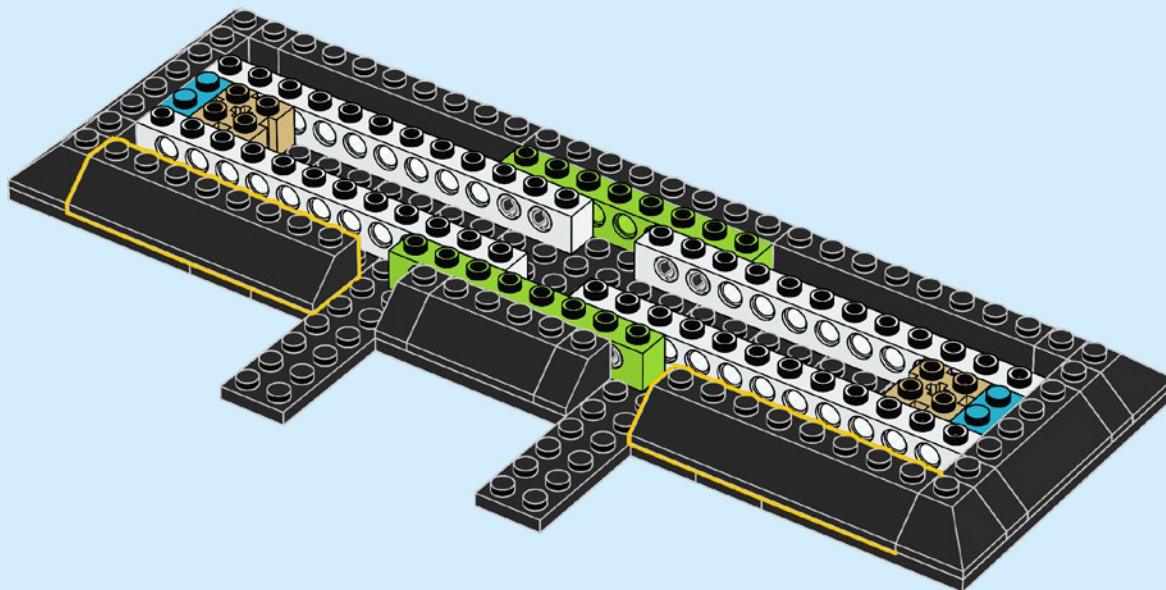

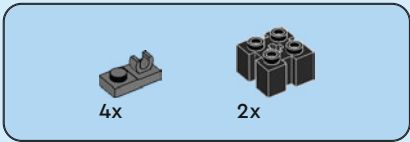

279

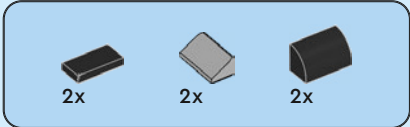
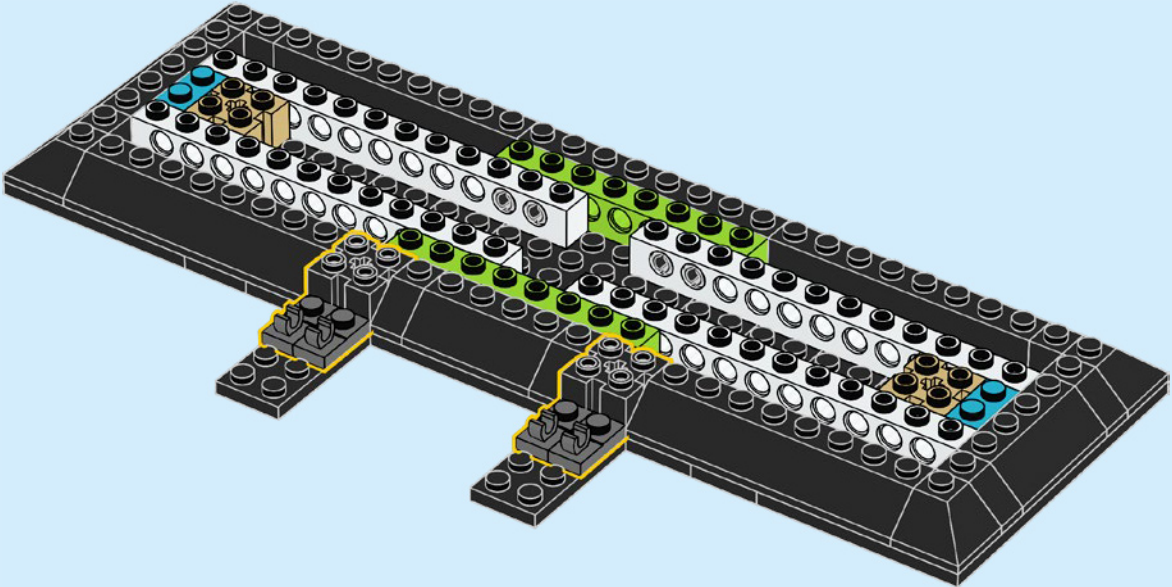

280

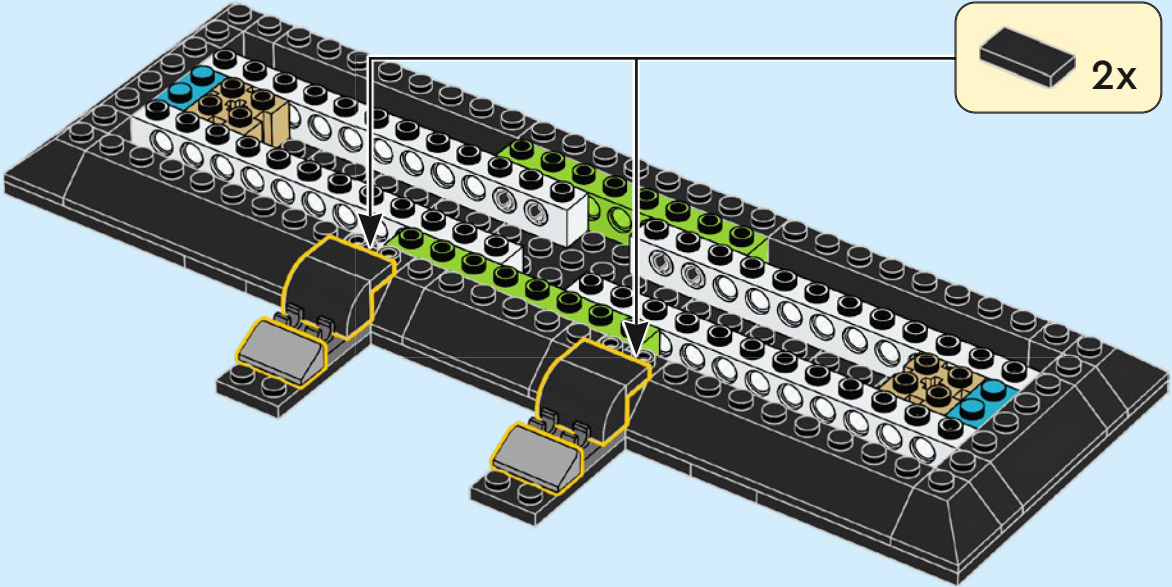

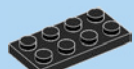

4x

281

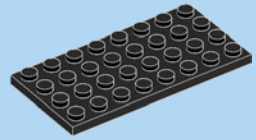
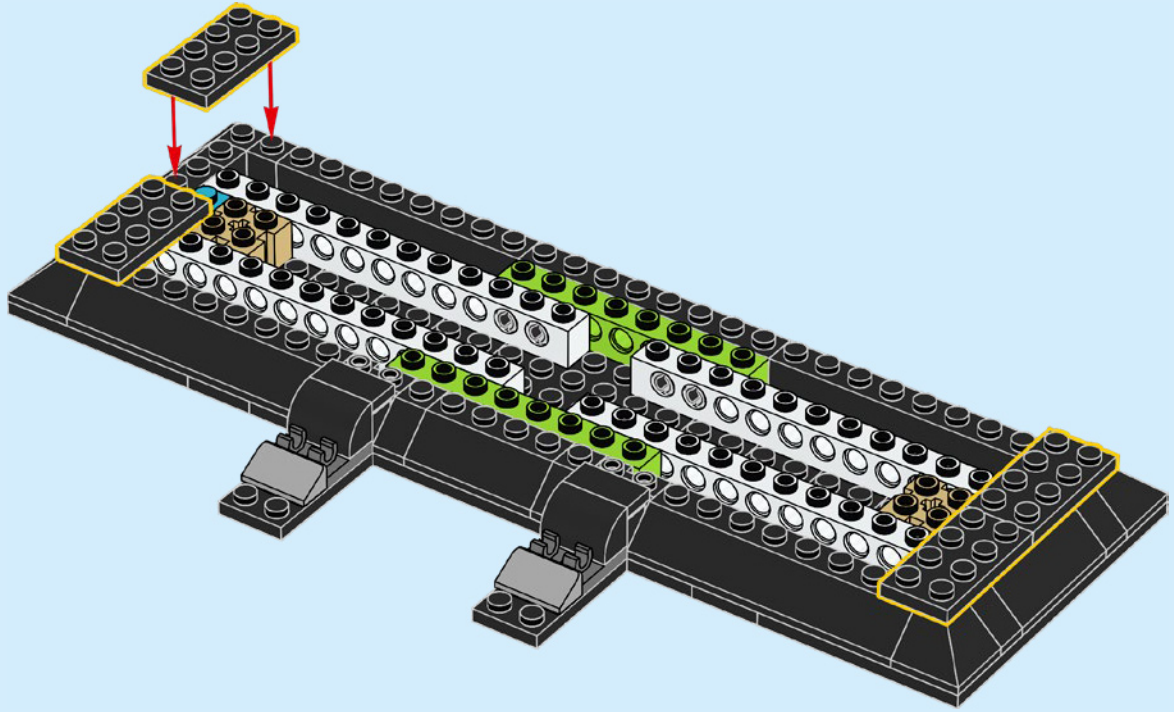

5x

282

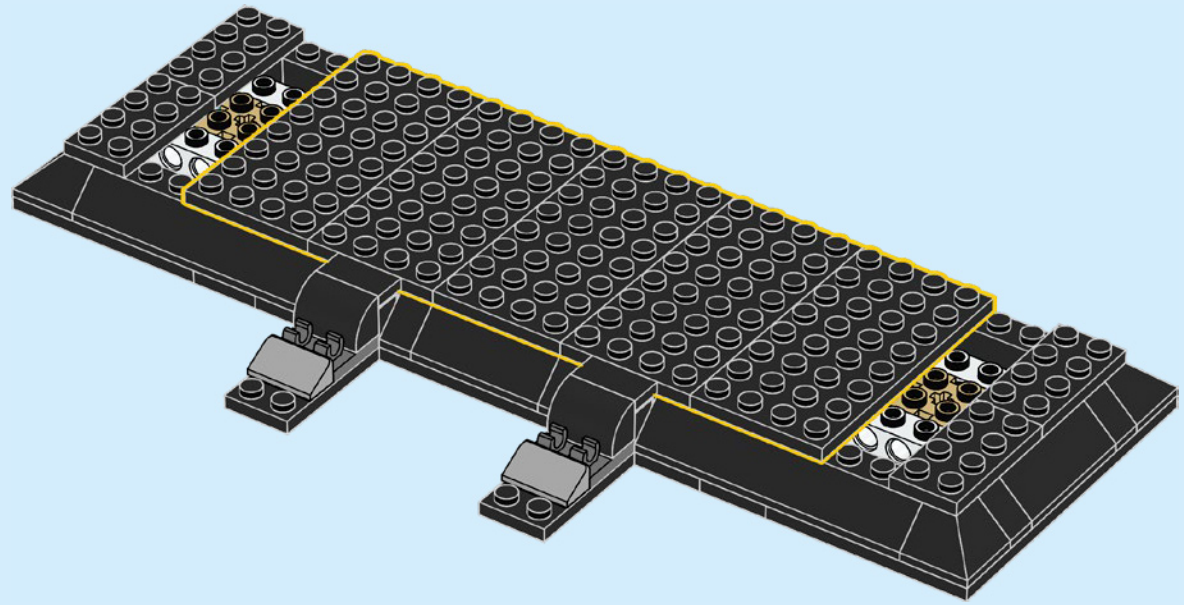

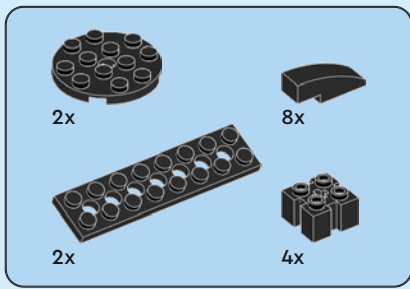

283

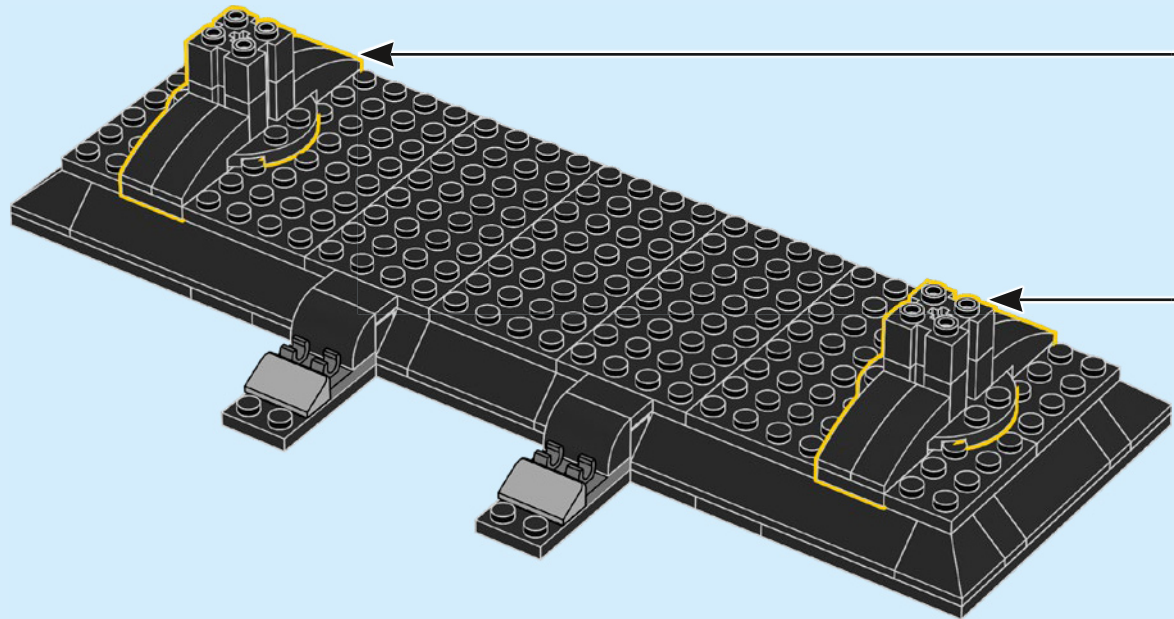
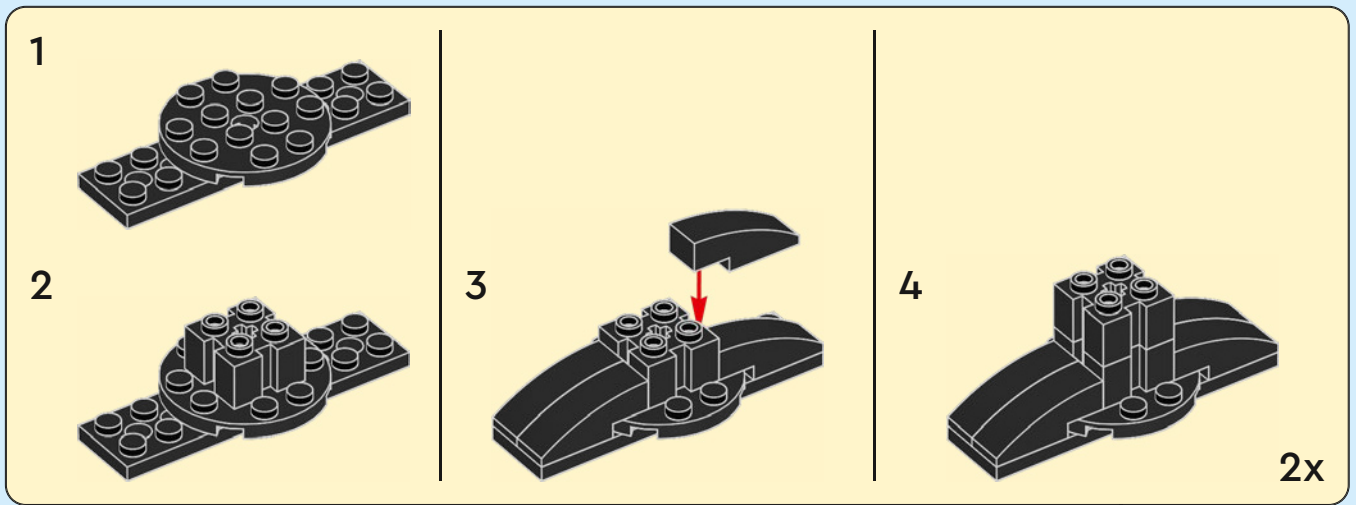

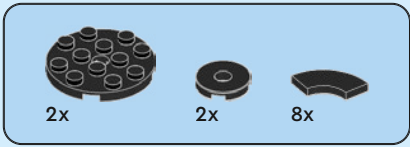

284

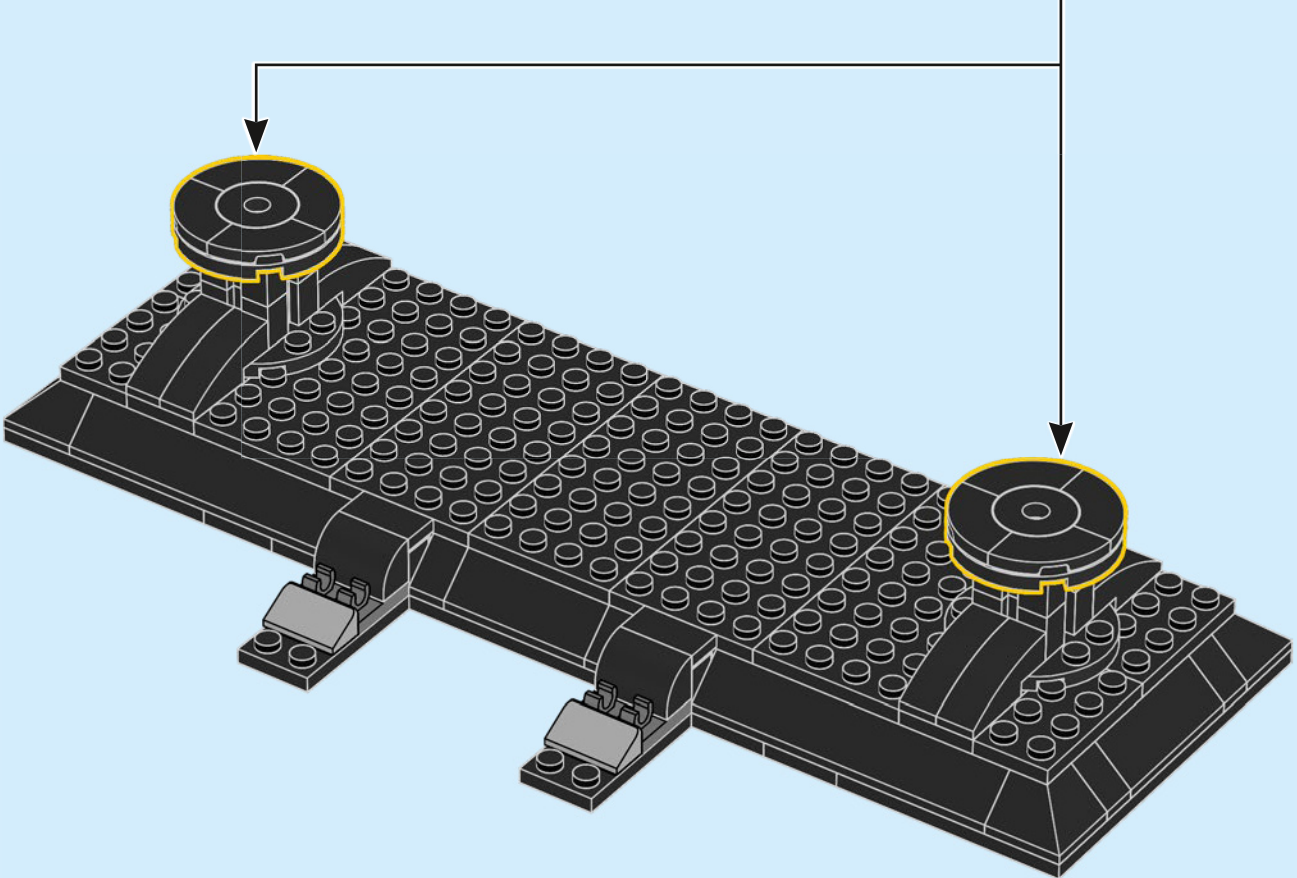
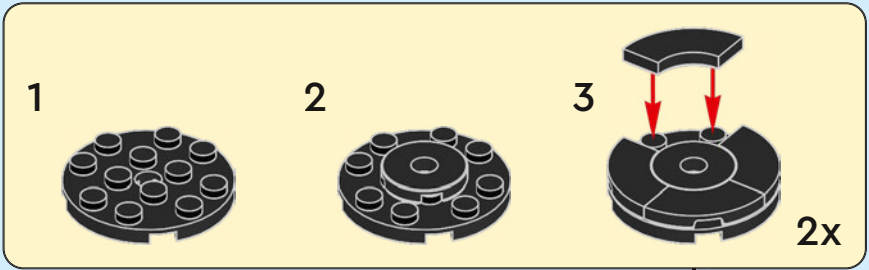

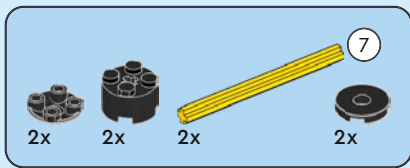

285

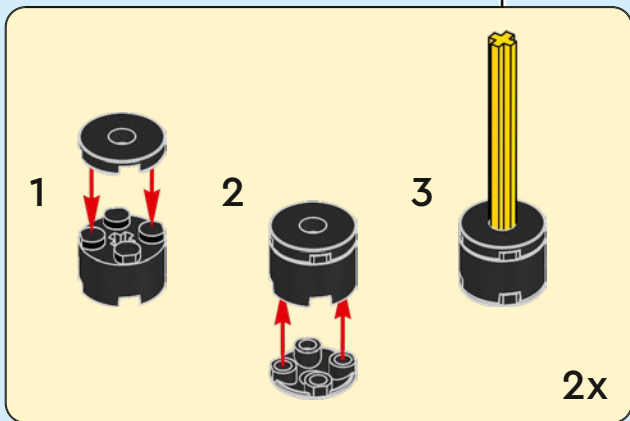
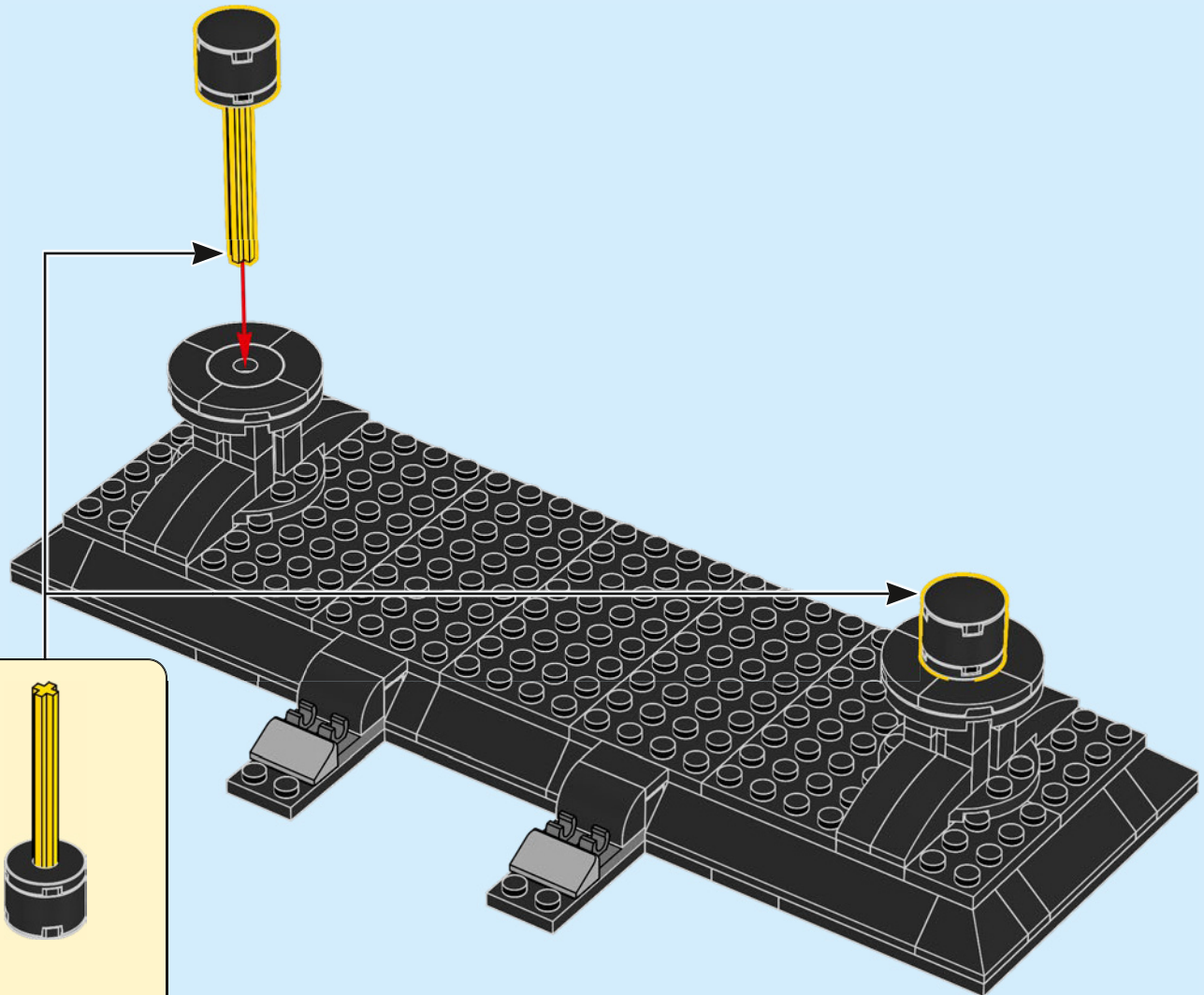

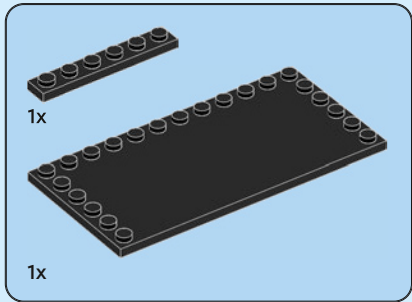

286

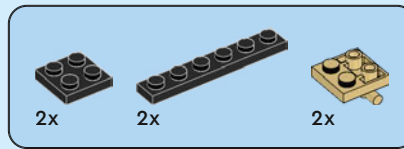
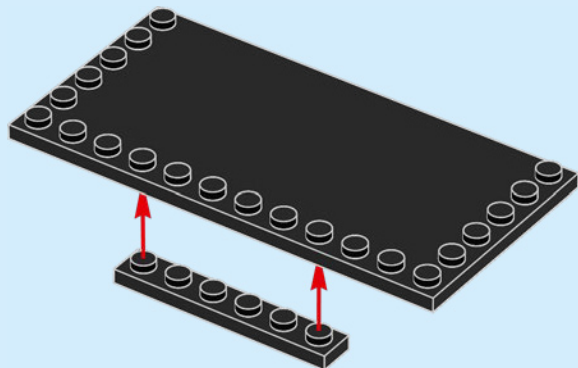

287

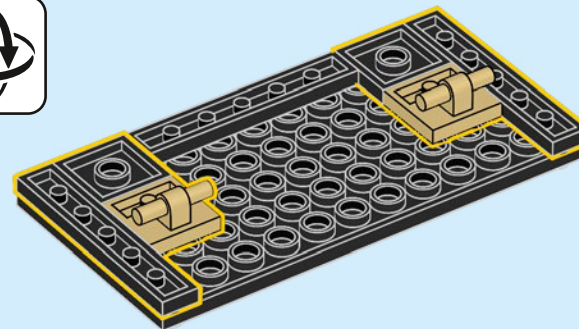

288

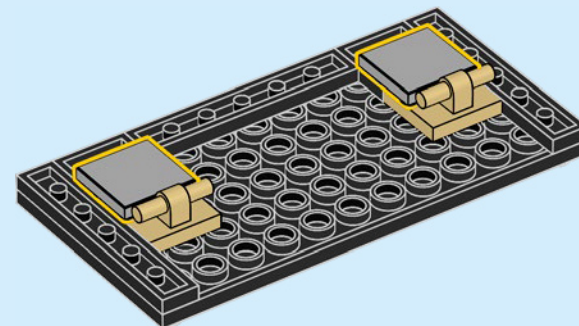

289

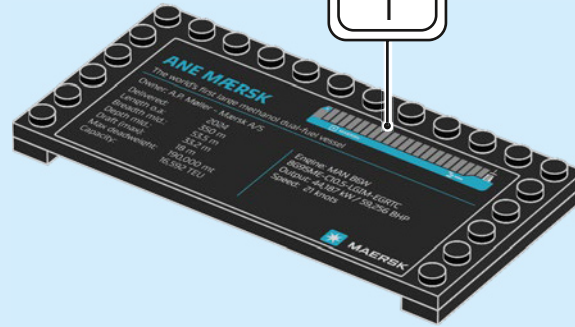

290

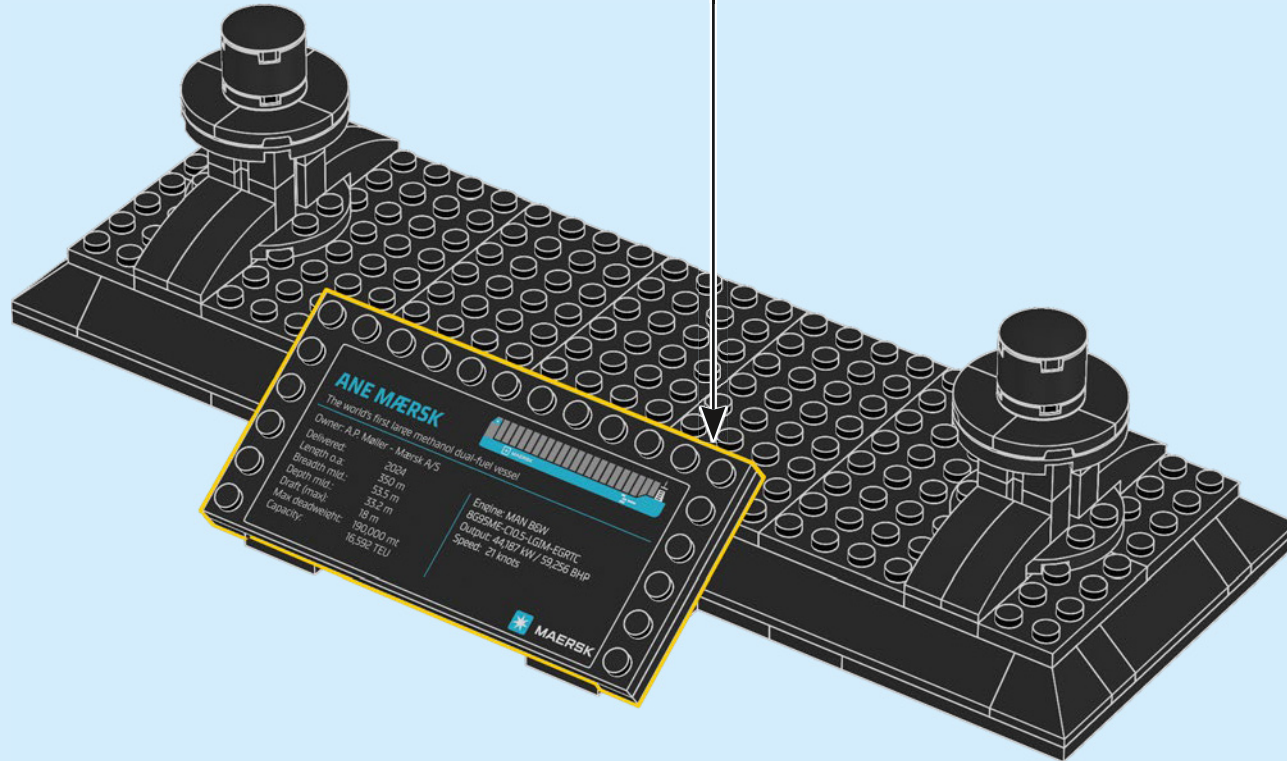

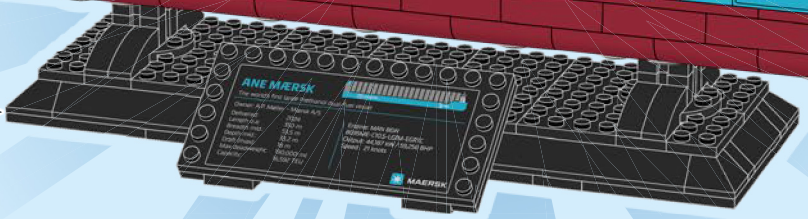
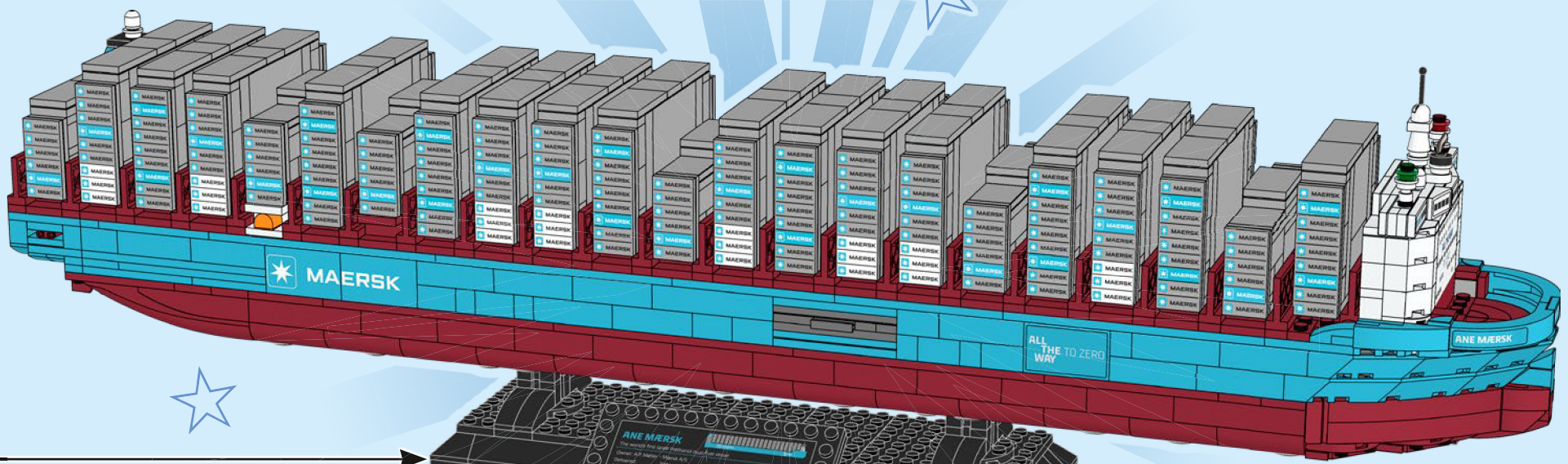
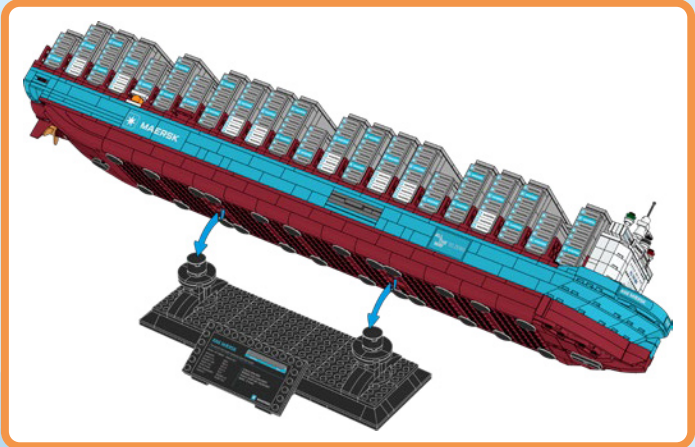

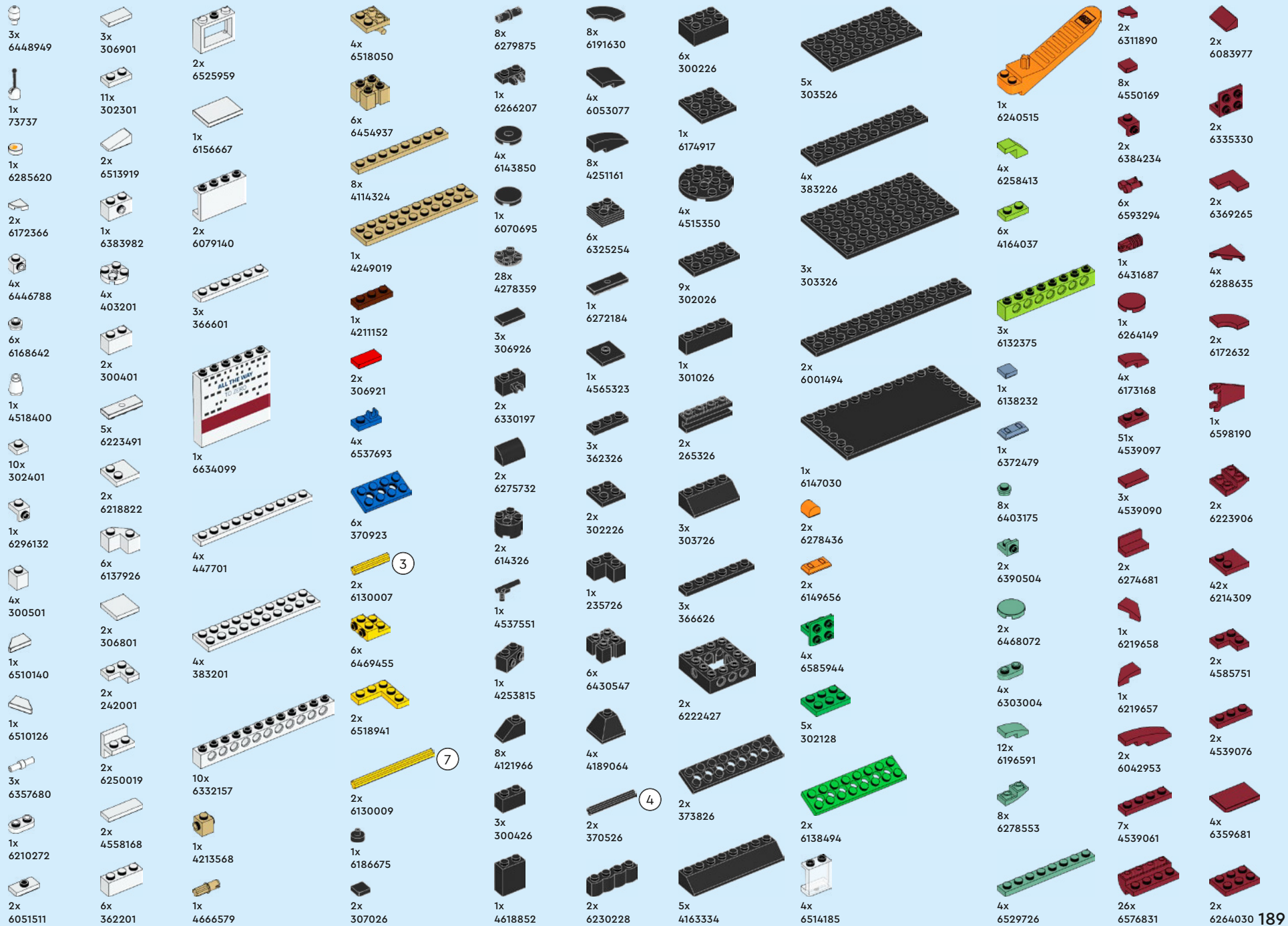

- 4x 6584062
- 4x 4541528
- 2x 6586652
- 1x 6335319
- 21x 6052777
- 6x 4541507
- 4x 4539071
- 10x 6576807
- 66x 6584063
- 1x 6465734
- 2x 6602414
- 2x 4539062
- 1x 6476042
- 1x 6350339
- 26x 6253142

- 4x 6186106
- 1x 6544174
- 6x 6440979
- 1x 4211392
- 6x 4211406
- 25x 4211462
- 2x 4211705
- 1x 6539385
- 9x 6258831
- 1x 4211415
- 4x 4211412
- 2x 4211399
- 6x 6227897
- 70x 4211398

- 27x 4211395
- 12x 6061675
- 4x 6059033
- 2x 6079461
- 30x 4527174
- 16x 6598025
- 16x 6595947
- 35x 4211452
- 64x 6123809
- 6x 4211564

- 3x 6170387
- 32x 4211363
- 4x 6469440
- 1x 6446028
- 2x 6132886
- 2x 6043639
- 2x 4211580
- 15x 4211413
- 4x 6258820
- 10x 4211387
- 10x 6171894
- 10x 4211396
- 12x 4211386

- 1x 6514057
- 1x 6514051
- 2x 4210719
- 2x 4211063
- 4x 6344754
- 1x 6514456
- 2x 6123814
- 4x 4543086
- 1x 4218696
- 6x 4211094
- 11x 4211056
- 2x 4210651
- 1x 6287847
- 1x 6322046

- 2x 6215606
- 1x 6292145
- 1x 6088641
- 2x 6335563
- 1x 6593293
- 2x 6603341
- 8x 6603339
- 2x 6603283
- 4x 6603285
- 6x 6603587
- 8x 6603337
- 2x 6603334
- 1x 6603315
- 4x 6603598
- 17x 6603336

- 1x 6603301
- 1x 6603600
- 1x 6603591
- 1x 6603586
- 1x 6603585
- 2x 6603590
- 2x 6603344
- 2x 6603309
- 3x 6603316
- 1x 6593286
- 2x 6604733
- 2x 6603601
- 7x 6603965

- 30x 6603319
- 2x 6603317
- 2x 6576809
- 2x 6603313
- 1x 6598028
- 2x 6576810
- 1x 6598027
- 2x 6603599
- 2x 6603596
- 2x 6603342
- 2x 6603312
- 10x 6603286

- 2x 6603333
- 10x 6603340
- 2x 6603318
- 4x 6603343
- 2x 6603335
- 4x 6603595
- 1x 6603594
- 6x 6603589
- 2x 6603332
- 2x 6576813



LEGO.com/service

YOU COULD WIN



Scan this QR code or go to
LEGO.COM/PRODUCTFEEDBACK and give us
your short feedback about this LEGO® set
for a chance to win a cool LEGO prize.

Terms and Conditions apply*

EN: YOU COULD WIN. Terms and Conditions apply* **DE: Du könntest GEWINNEN.** Es gelten die Teilnahmebedingungen* **FR: Tu pourrais GAGNER.** Des conditions s'appliquent* **IT: Potresti VINCERE tu.** Termini e condizioni sono applicabili* **ES: Puedes GANAR.** Aplican términos y condiciones* **PT: PODERÁ GANHAR.** Aplicam-se Termos e Condições* **ZH: 轻松获奖.** 条款和条件适用* **PL: Szansa na WYGRANĄ.** Obowiązuje regulamin* **CS: Máte šanci VYHRÁT.** Platí všeobecné smluvní podmínky* **SK: Máte šancu VYHRÁT.** Platia všeobecné zmluvné podmienky* **HU: TE IS NYERHETSZ.** Felhasználási feltételek érvényesek* **UA: ВИ МОЖЕТЕ ВИГРАТИ.** Застосовуються загальні положення та умови* **RO: Ai putea CÂȘTIGA.** Se aplică termenii și condiții* **BG: Можете да СПЕЧЕЛИТЕ.** Има определени правила и условия* **LV: Tu vari LAIMĒT.** Ir spēkā noteikumi un nosacījumi.* **ET: Sul on võimalus VÕITA.** Kehtivad tingimused* **LT: Jūs galite LAIMĖTI.** Taikomos sąlygos*

*[LEGO.com/productfeedback-terms](https://www.lego.com/productfeedback-terms)

