



40955



MAERSK





LEGO.com/sustainable-packaging



FR

DONNEZ
OU
RECYCLEZ



OU



OU



ASSOCIATION

MAGASIN

DÉCHÈTERIE

Adresses sur quefairedemesdechets.fr

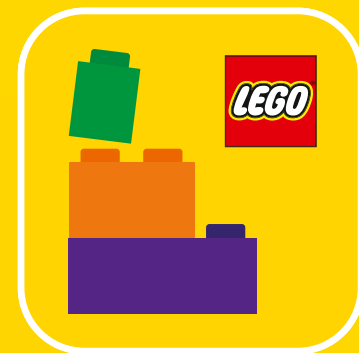

BUILDER



Apple and the Apple logo are trademarks of Apple Inc., registered in the U.S. and other countries and regions. App Store is a service mark of Apple Inc. Google Play and the Google Play logo are trademarks of Google LLC. Tencent and the Tencent logo are trademarks of Tencent Inc.

Q LEGO.com/devicecheck

EN Ask parents' permission before going online | DE Eltern um Erlaubnis bitten, bevor du online gehst | FR Demande l'autorisation d'un parent avant d'aller en ligne | IT Chiedi il permesso ai tuoi genitori prima di andare online | ES Pídeles permiso a tus papás antes de conectarte a Internet | PT Peça autorização aos pais antes de acederes online | ZH 上网前应先征得父母的同意 | PL Poproś rodziców o zgodę, zanim wejdiesz do Internetu | CS Než půjdeš na internet, požádej rodiče o svolení | SK Skôr než pôjdeš na internet, vypoťaj si povolenie od rodičov | HU Kérj szülői engedélyt, mielőtt online csatlakoznál! | UA Запитуйте дозволу батьків, перш ніж користуватися інтернетом | RO Cere permisiunea părinților înainte de a te conecta online | BG Поискайте разрешение от родител, преди да влезете онлайн | LV Pirms došanās tiešsaistē palūdz atļauju vecākiem | ET Enne Interneti kasutamist küsi vanematelt luba | LT Prieš prisijungdami prie interneto, atsiklauskite tėvų



PŘEDSTAVUJEME ANE MÆRSK

ANE MÆRSK je první lodí svého druhu – první velká nákladní loď, která může být poháněna palivem s nízkými emisemi, jako je biometanol a e-metanol. Od chvíle, kdy loď ANE MÆRSK poprvé vyplula na moře v lednu roku 2024, se na vodu vydalo i mnoho dalších plavidel s duálním pohonem, což předznamenalo začátek nové důležité kapitoly v oblasti dekarbonizace lodní dopravy a globálního obchodu.

ANE MÆRSK měří 350 metrů na délku a 53,5 metru na šířku. Prázdná loď váží 47 700 tun a při plném naložení nákladem, palivem a posádkou může přepravit úctyhodných 190 000 tun, což odpovídá zhruba váze 29 tisíc slonů.

Lodí může pojmout kontejnery o objemu až 16 592 TEU (z anglického *Twenty-foot Equivalent Unit*) a pokud byste je všechny naskládali za sebe, měřily by na délku 100,5 km, což odpovídá délce asi 959 fotbalových hřišť.





 MAERSK

ALL THE 10 ZERO WAY



VSTŘÍC ZMĚNÁM – HISTORIE LODNÍ DOPRAVY

Po moři se zboží přepravuje již více než 5 000 let, ale až do průmyslové revoluce a vynálezu parního stroje bylo lidstvo závislé na počasí. Bez větru se nikam neplulo. S objevem parní energie se posádka lodi poprvé v historii lidstva mohla přestat spoléhat na počasí a ruční pohon. Tento vynález způsobil v námořní dopravě skutečnou revoluci, kdy mohly vznikat nové trasy a námořní obchod mohl vzkvétat.

Ačkoli parní stroje představovaly na moři obrovský pokrok, jejich efektivita nebyla nijak výrazná a netrvalo dlouho, než se námořní doprava dočkala další transformace díky vynálezu dieselového motoru. Revoluce v lodní dopravě však vyžadují čas, a tak trvalo několik desetiletí, než dieselové motory zcela nahradily parní pohon. Společnost Maersk zakoupila své první plavidlo s dieselovým pohonem, LEISE MÆRSK, v roce 1921, tedy pouhých devět let po uvedení vůbec prvního oceánského obchodního plavidla s dieselovým pohonem.



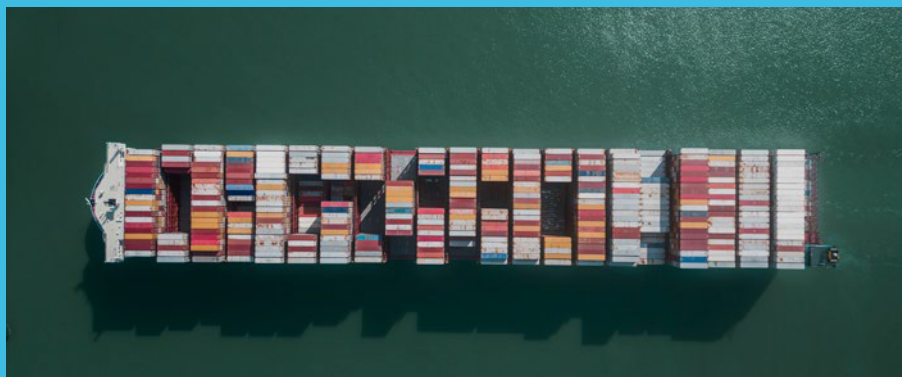

V roce 1956 došlo k další proměně tohoto odvětví, kdy byla zavedena efektivní „kontejnerová přeprava“, při které se návěsy nákladních vozidel nakládaly přímo na loď. Využívání kontejnerů zkrátilo dobu nakládky a vykládky lodí z několika dnů na pouhé hodiny.

Díky kontejnerům a čárovým kódům – skrytým hybatelům světového obchodu – může výrobce z jakékoli části světa prodávat své zboží na všech trzích, a tak globalizace nabrala reálné obrysy. Svět, jak ho dnes známe, je silně závislý na globálních dodavatelských řetězcích. Dodavatelské řetězce propojují svět a zajišťují přísun potravin, léků, zboží a materiálů k lidem po celém světě – od pěstitele banánů v Kolumbii až po dánské dítě, které si dá banán na svačinu.





 MAER

 MAERS

 MAERSK

 MAERSK

CO SE VE JMÉNU UKRÝVÁ?

Od roku 1906 nesou všechna plavidla flotily Maersk v názvu slovo „MÆRSK“. Většina prvních plavidel nesla jména zakládající rodiny, ale jakmile se flotila rozrostla a rodinná jména došla, musela být tradice pojmenovávání poněkud upravena. V dnešní době můžete spatřit také lodě společnosti Maersk pojmenované například podle měst a řek.

Při rozhodování o názvu nové řady lodí s duálním pohonem se společnost Maersk vrátila k tradici pojmenovávání lodí po členech zakládající rodiny – tentokrát však začala písmenem A, aby symbolicky zahájila novou éru.

ANE MÆRSK je pojmenována po Ane Mærsk Mc-Kinney Uggla, předsedkyni společnosti A.P. Moller Holding, která je mateřskou společností A.P. Moller – Maersk. Společnost A.P. Moller – Maersk byla založena v roce 1904 Arnoldem Peterem Møllerem. Ane je vnučkou zakladatele skupiny Arnolda Petera Møllera a jeho manželky Chastine Mc-Kinney Møllerové.



ANE MAERSK





BÍLÁ HVĚZDA – MAJÁK NADĚJE

Kultovní bílá sedmicípá hvězda je symbolem společnosti Maersk již od doby před jejím založením v roce 1904 a je trvalou připomínkou silných rodinných vazeb, které i po více než 100 letech stále prostupují srdcem společnosti.

Na počátku své kariéry pracoval kapitán Peter Mærsk Møller, otec A.P. Møllera, pro anglického majitele lodí a jeho manželka Anna ho někdy doprovázela na plavbách. Právě během jedné z těchto cest Anna vážně onemocněla. Peter Mærsk Møller se obával, že zemře, a tak se na palubě lodi modlil k Bohu, aby mu dal znamení, že se jeho žena uzdraví. V tu chvíli spatřil jedinou hvězdu, která osvětlovala jinak šedou oblohu.

Anna se uzdravila a v roce 1886, když Peter Mærsk Møller koupil svou první parní loď – parník LAURA – nechal na komín lodi namalovat bílou sedmicípou hvězdu na světle modrém pozadí jako poctu své milované ženě. Pro Petera Maerska Møllera se hvězda stala symbolem jejího uzdravení a jejich štěstí.

Od té doby se bílá sedmicípá hvězda na charakteristickém nebesky modrém pozadí stala synonymem pro společnost Maersk, i když samotné logo prošlo v průběhu let určitým vývojem. Existovalo mnoho verzí, ale dnešní logo Maersk pochází z počátku 70. let, kdy bylo rozhodnuto, že je třeba modernější přístup.



ALL THE WAY
TO ZERO



LEPŠÍ ŽIVOT PRO VŠECHNY SKRZE INTEGRACI SVĚTA

Jako světový lídr v oblasti logistických služeb má společnost Maersk více než 100 000 zákazníků, působí v téměř 130 zemích a zaměstnává více než 100 000 lidí. Od skromných začátků jako paroplavební společnost až po integrovanou logistickou společnost, která se snaží propojit a zjednodušit dodavatelské řetězce svých zákazníků, Maersk provozuje více než 700 plavidel a přepravuje téměř 20 % světových potravin, materiálů a zboží.





MAERSK
MAERSK
MAERSK
MAERSK
MAERSK
MAERSK
MAERSK

MAERSK
MAERSK
MAERSK
MAERSK
MAERSK
MAERSK
MAERSK

ALL
THE T
WAY

SPREADERS
TSP98
MAERSK
MAERSK

ANE MAERSK
P423 PTP

PTP T414
65 TOP'S SWL



ALL
THE WAY TO ZERO

AŽ NA NULU – ZÁVAZEK K DEKARBONIZOVANÉ BUDOUCNOSTI

V době, kdy se svět potýká s klimatickými krizemi, závisí budoucnost dodavatelských řetězců a globálního obchodu na schopnosti inovovat a podporovat nové zdroje energie. Společnost Maersk přijala závazek dosáhnout do roku 2040 nulových emisí skleníkových plynů ve všech odvětvích své činnosti. Zatímco společnost Maersk dekarbonizuje své vlastní procesy, přijala také sociální závazek, že bude hrát vedoucí roli v řešení klimatické krize tím, že dekarbonizuje globální dodavatelské řetězce a umožní spravedlivý přechod k ekonomice s nulovými emisemi.

Společnost Maersk si navíc stanovila ambiciózní cíle do roku 2040, aby zajistila významný pokrok v tomto desetiletí – na moři, na souši, ve vzduchu i v našich terminálech. A díky objednávkám a dodávkám řady plavidel s duálním pohonem, která jsou schopna využívat paliva s nízkými emisemi, jako je biometanol, e-metanol a biometan, je mise dekarbonizovat flotilu v plném proudu.



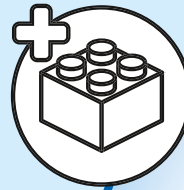
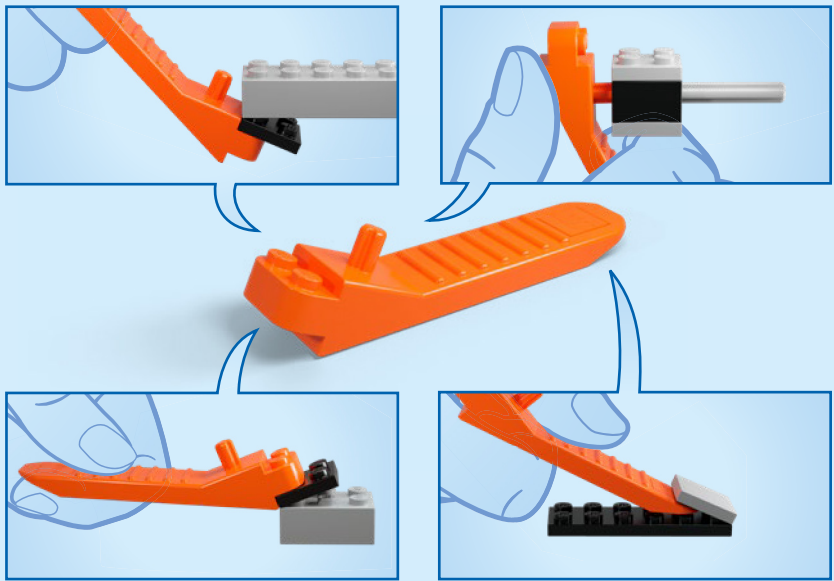

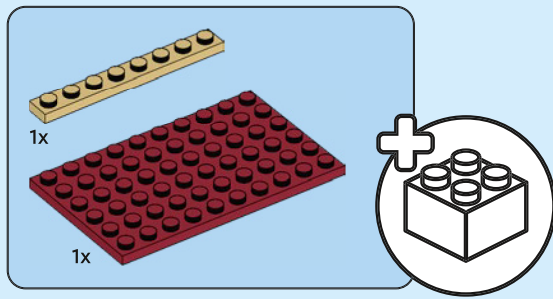

1

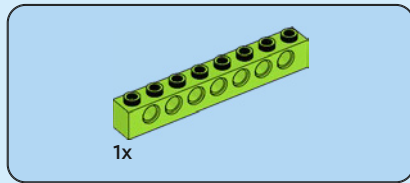
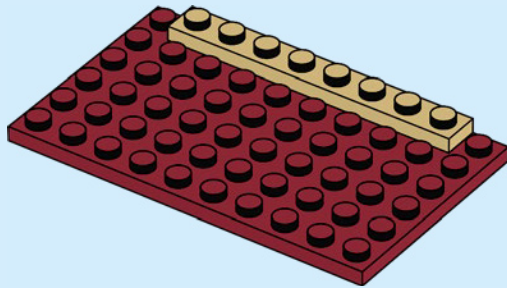

2

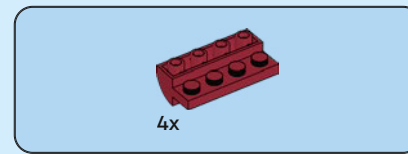
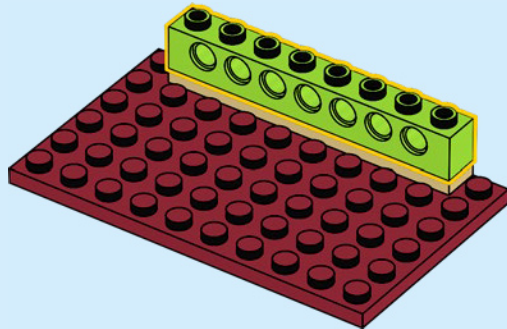

3

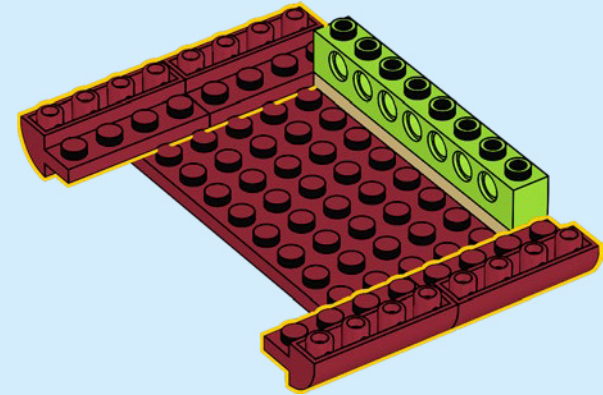

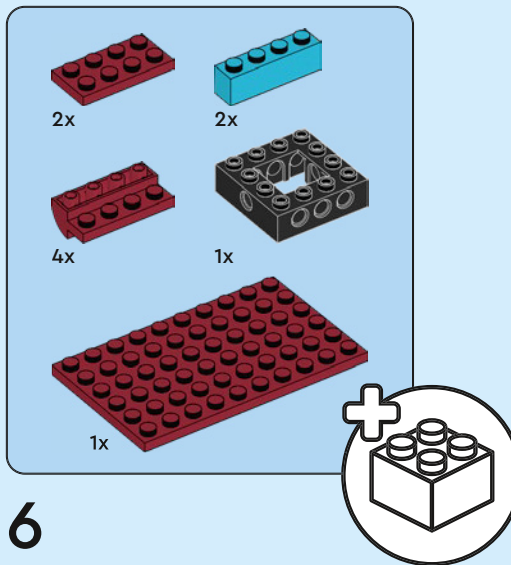
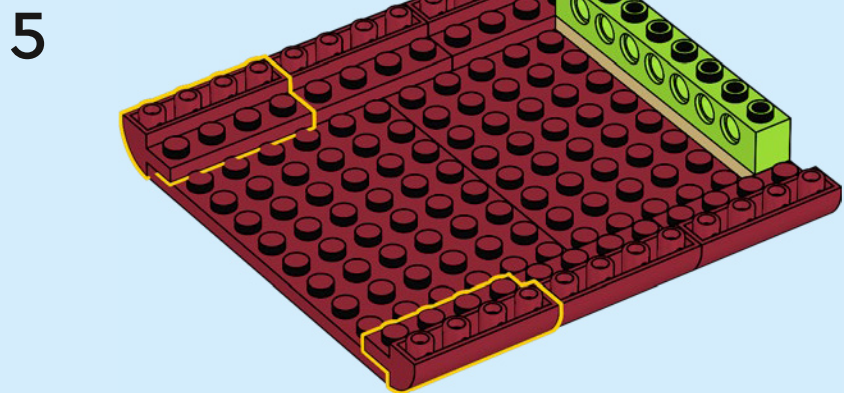
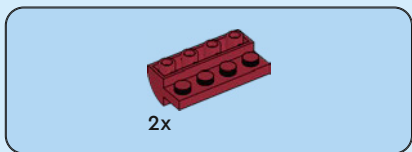
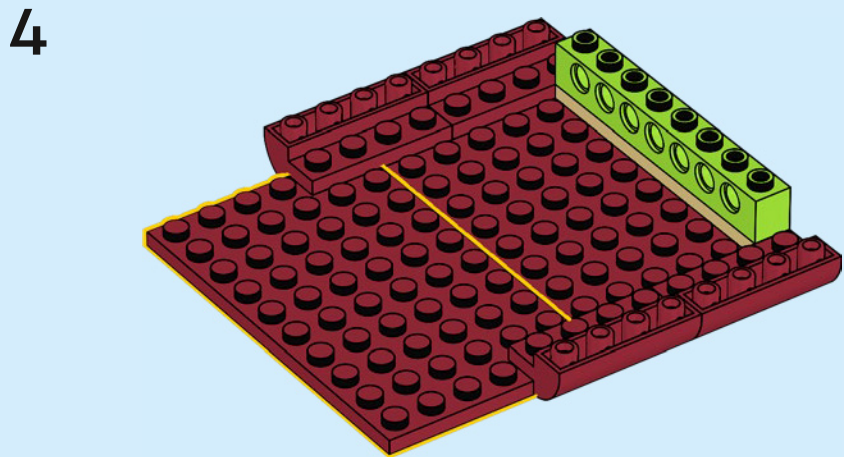
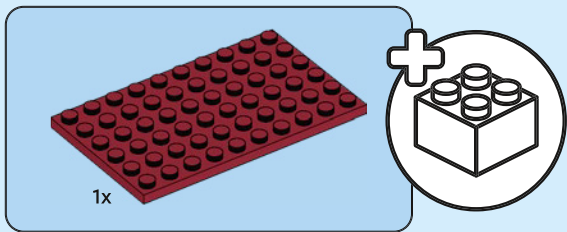

6

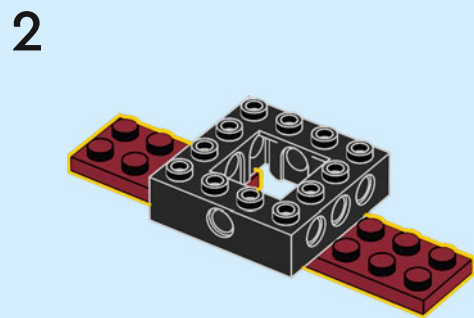
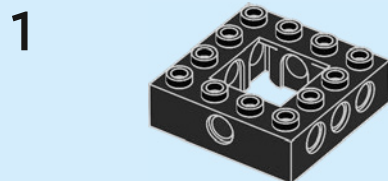

3

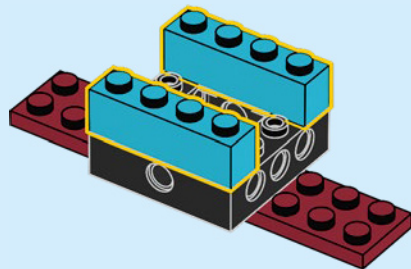

4

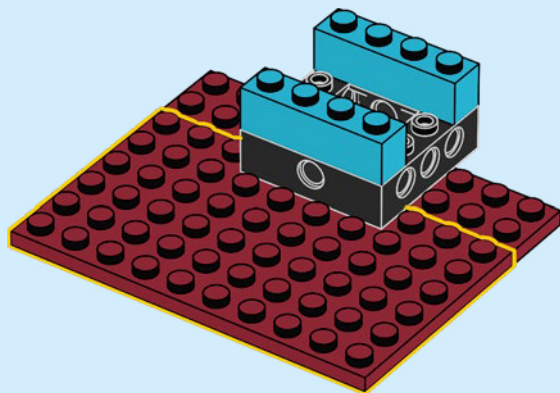

5

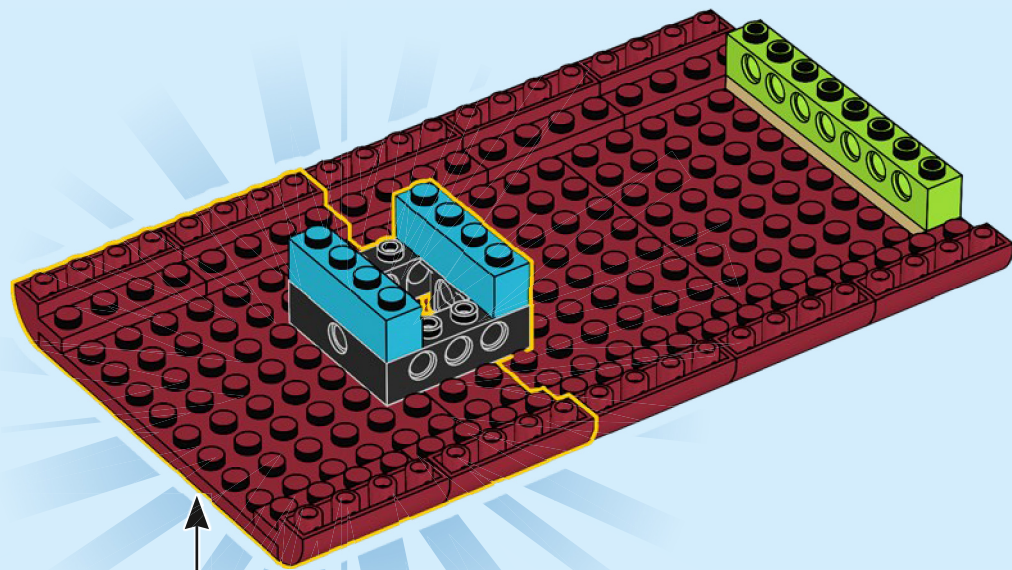
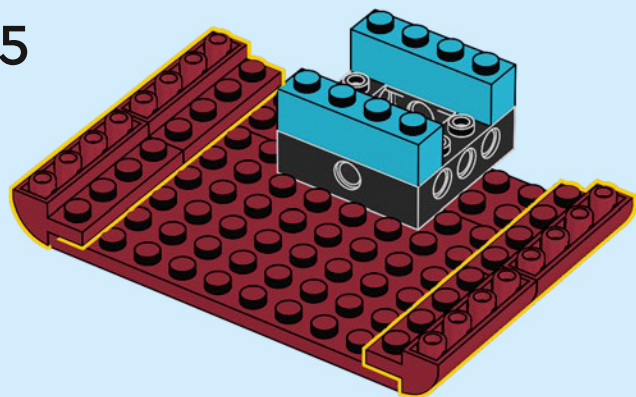

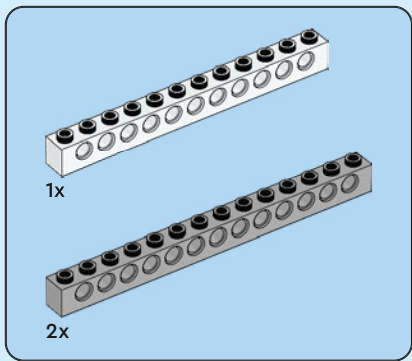

7

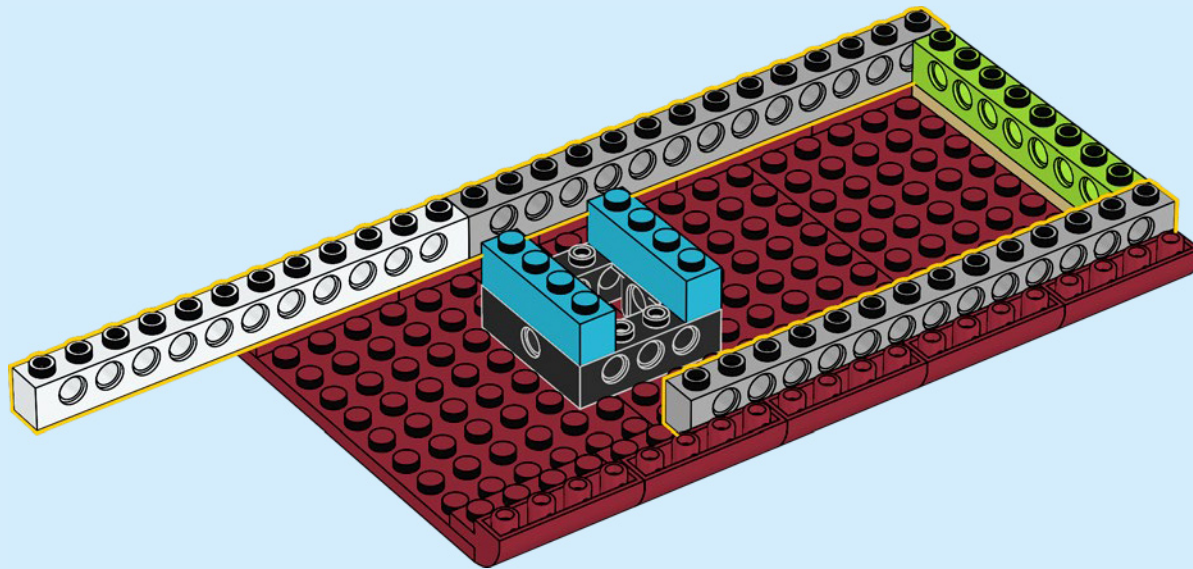

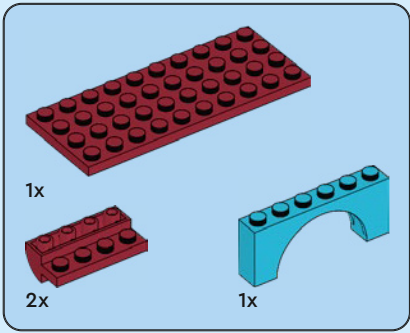

8

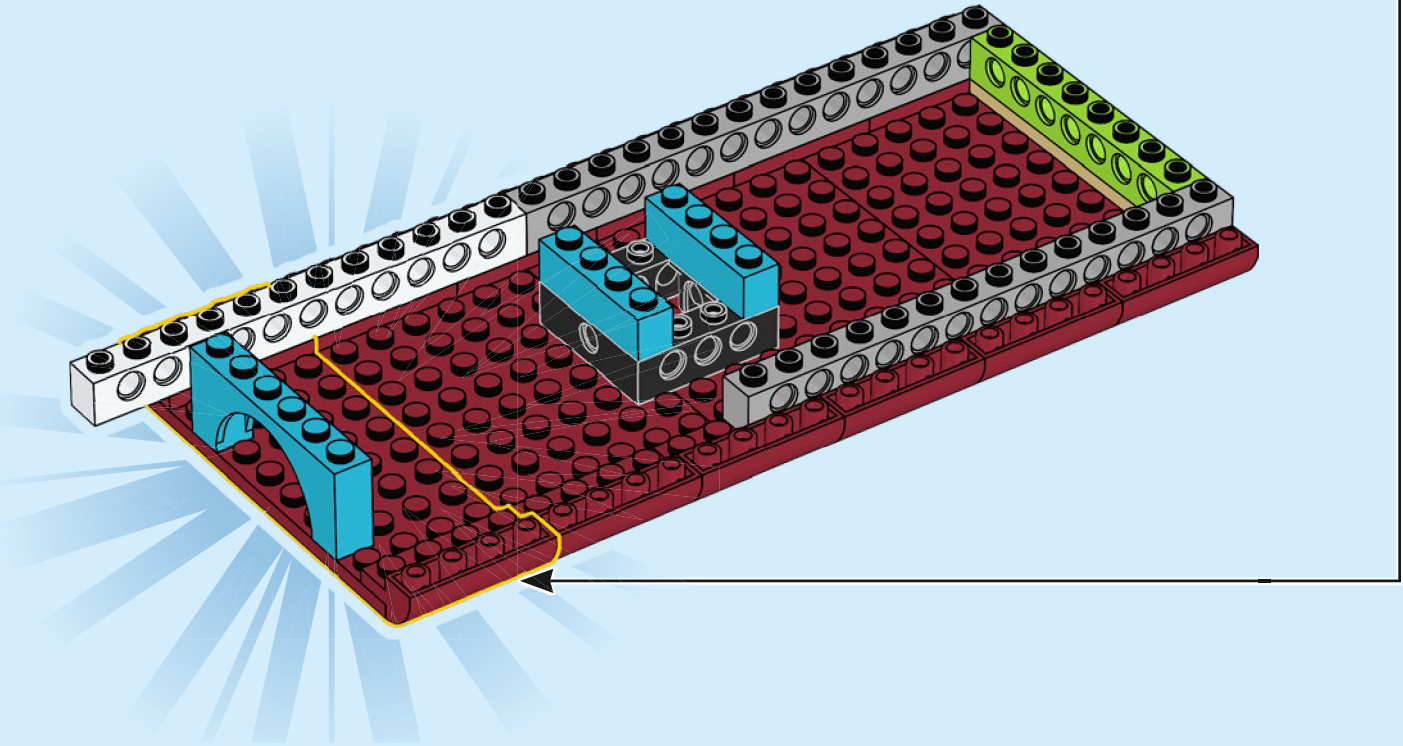
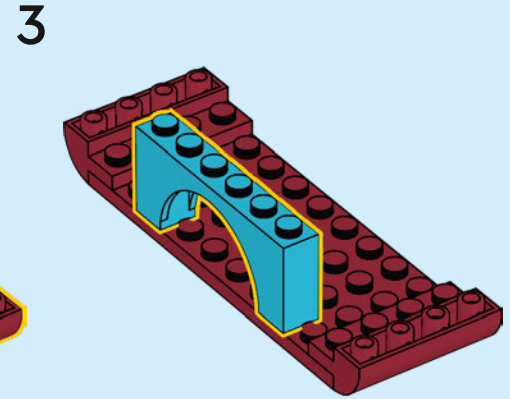
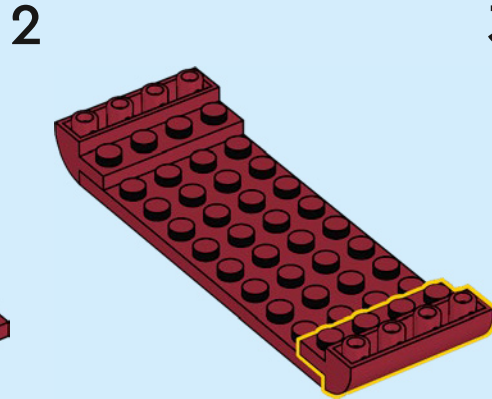
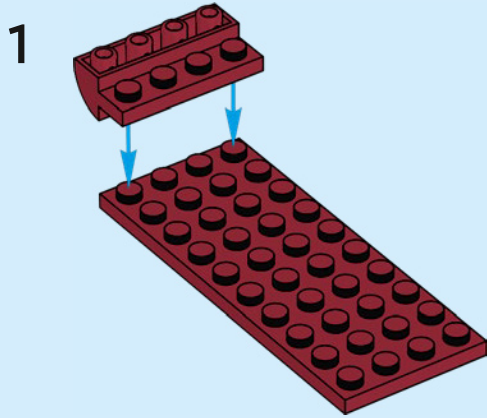

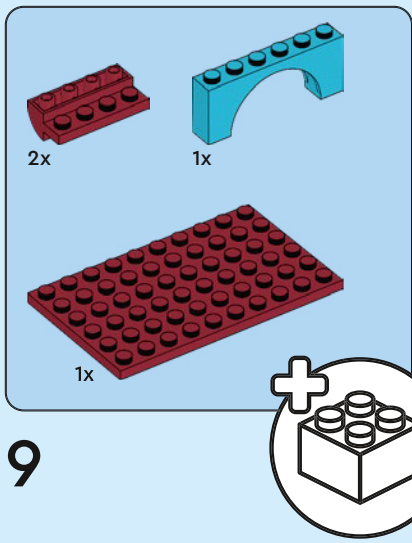

9

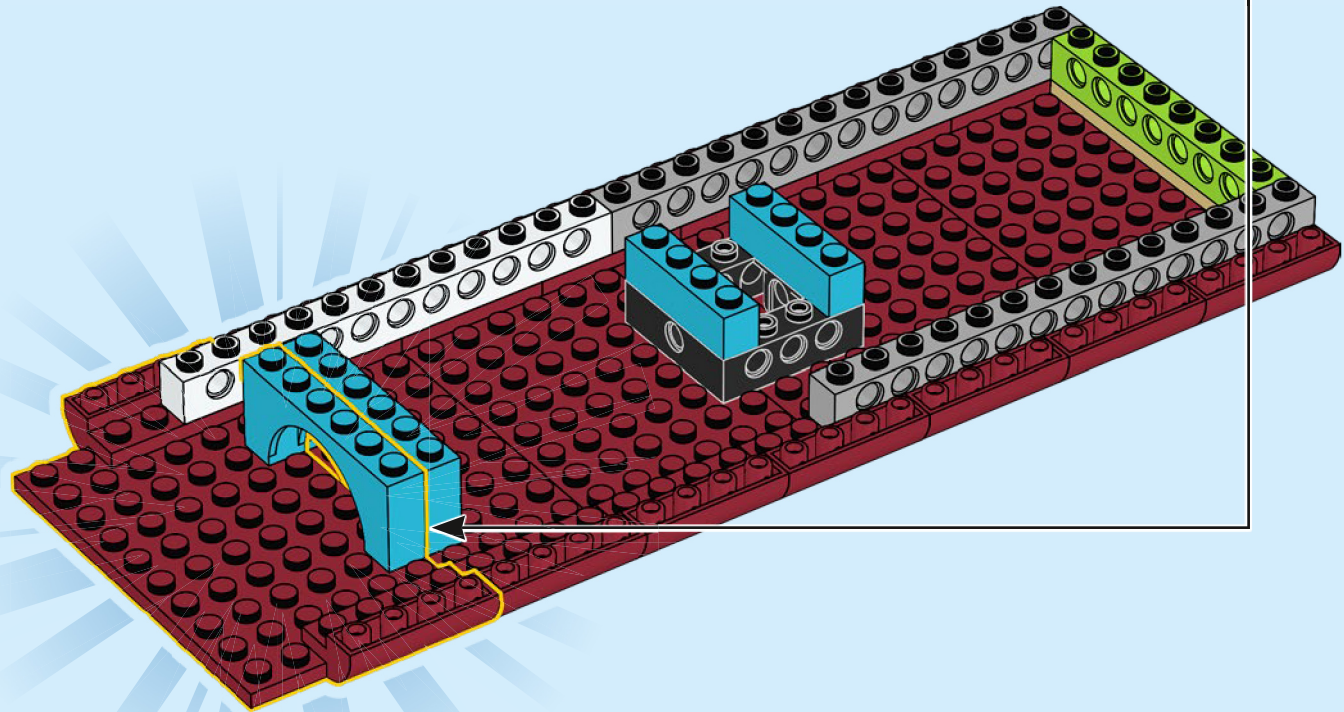
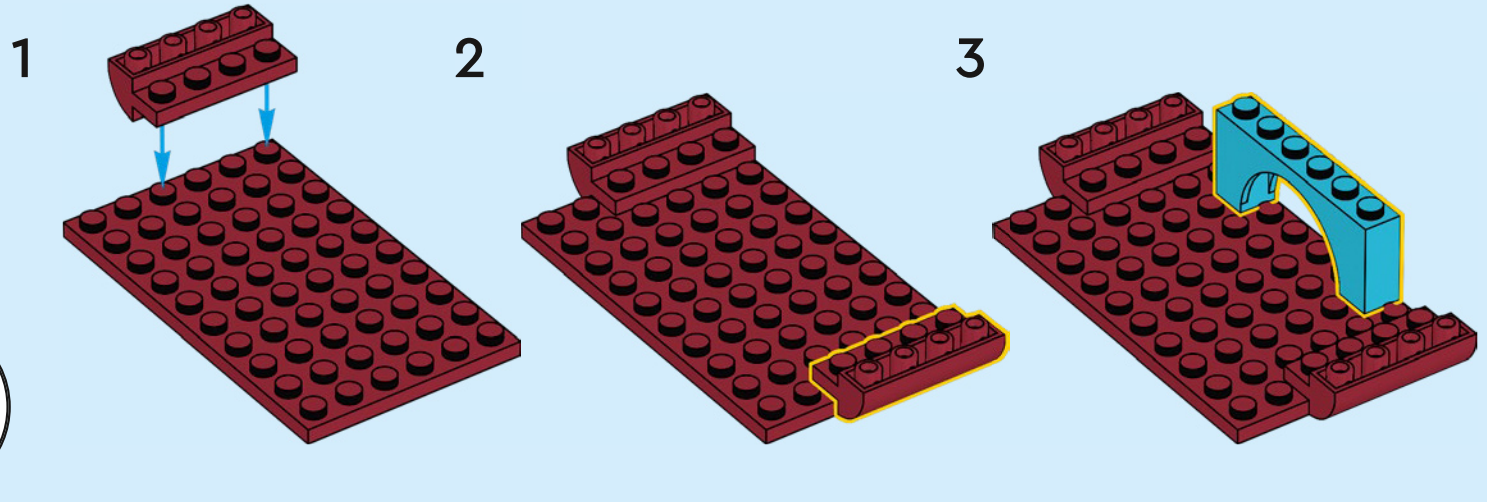

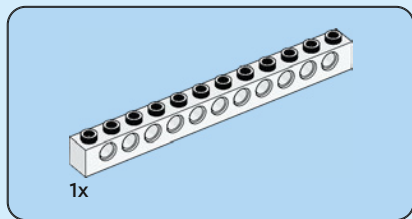

10

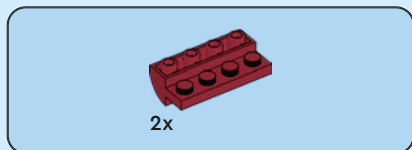
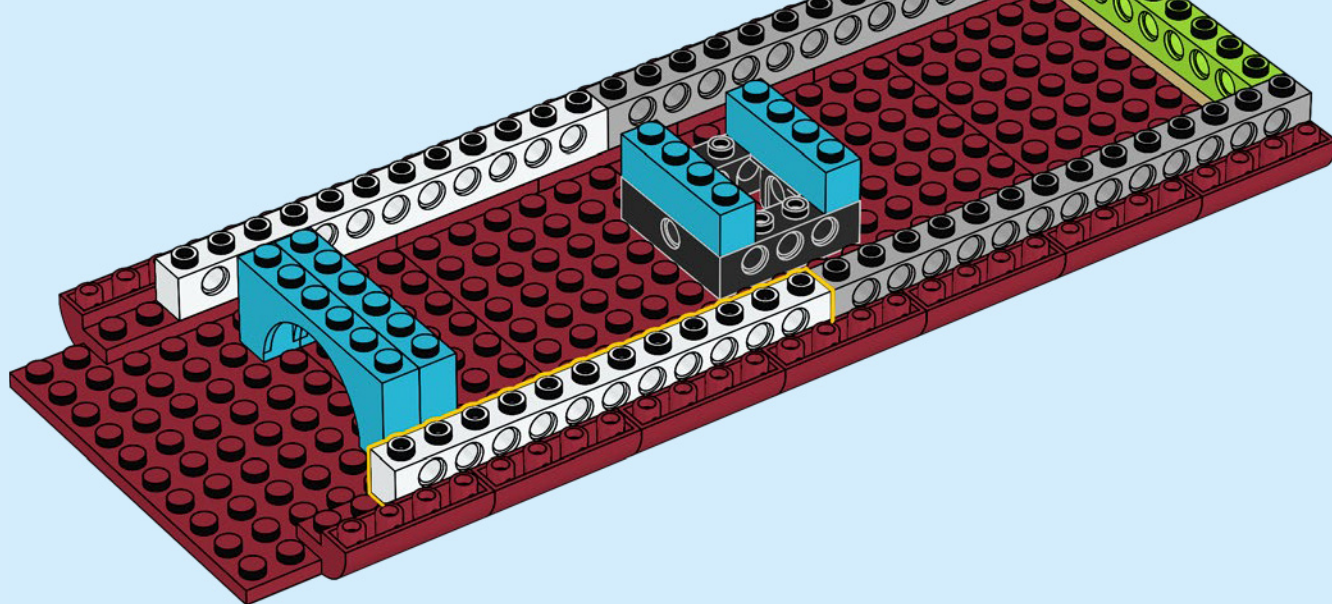

11

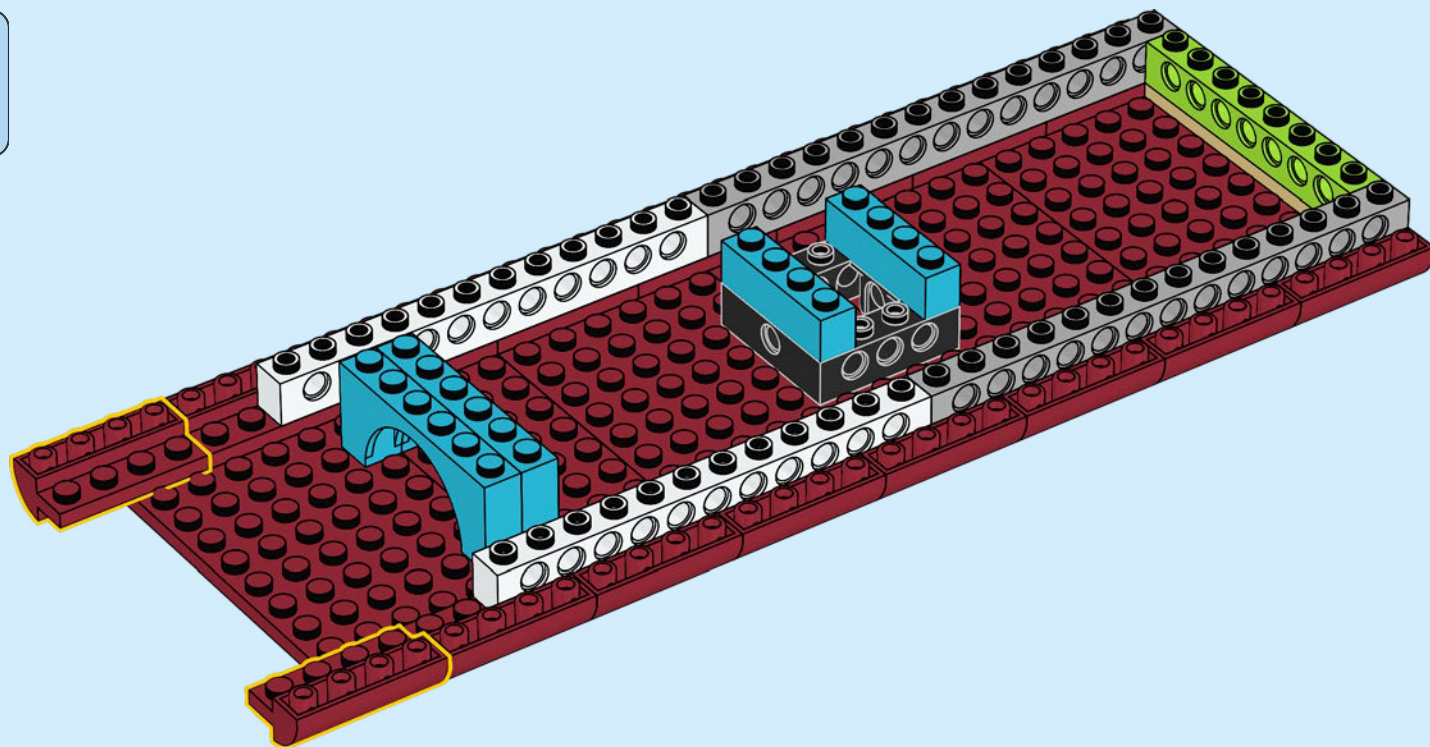

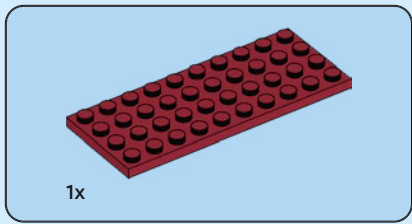

12

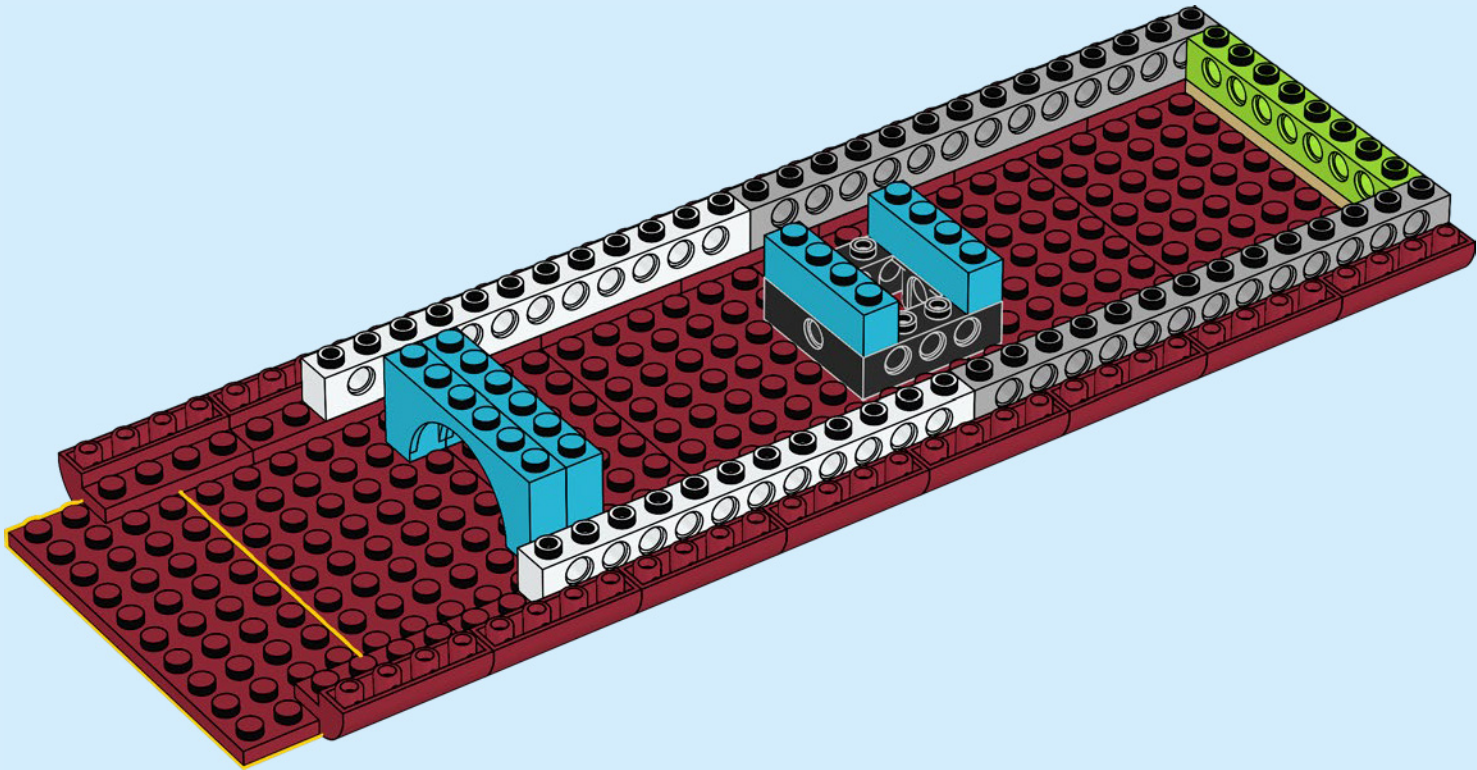

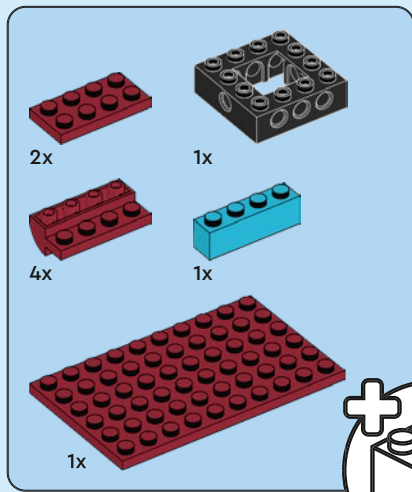

13

1

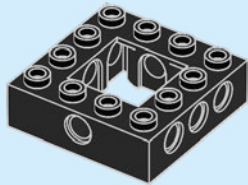

2

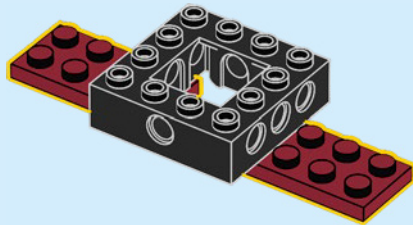

3

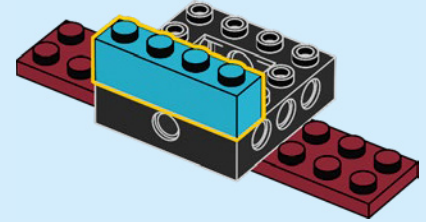

4

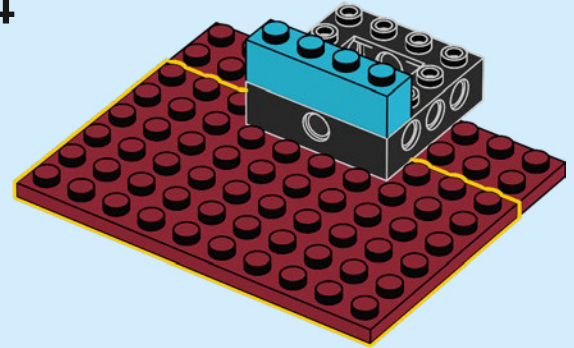

5

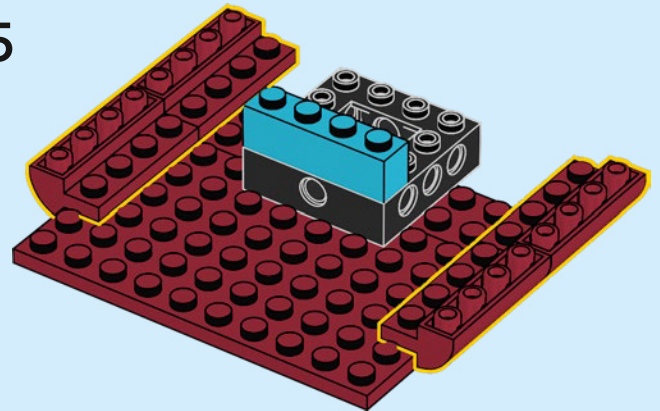

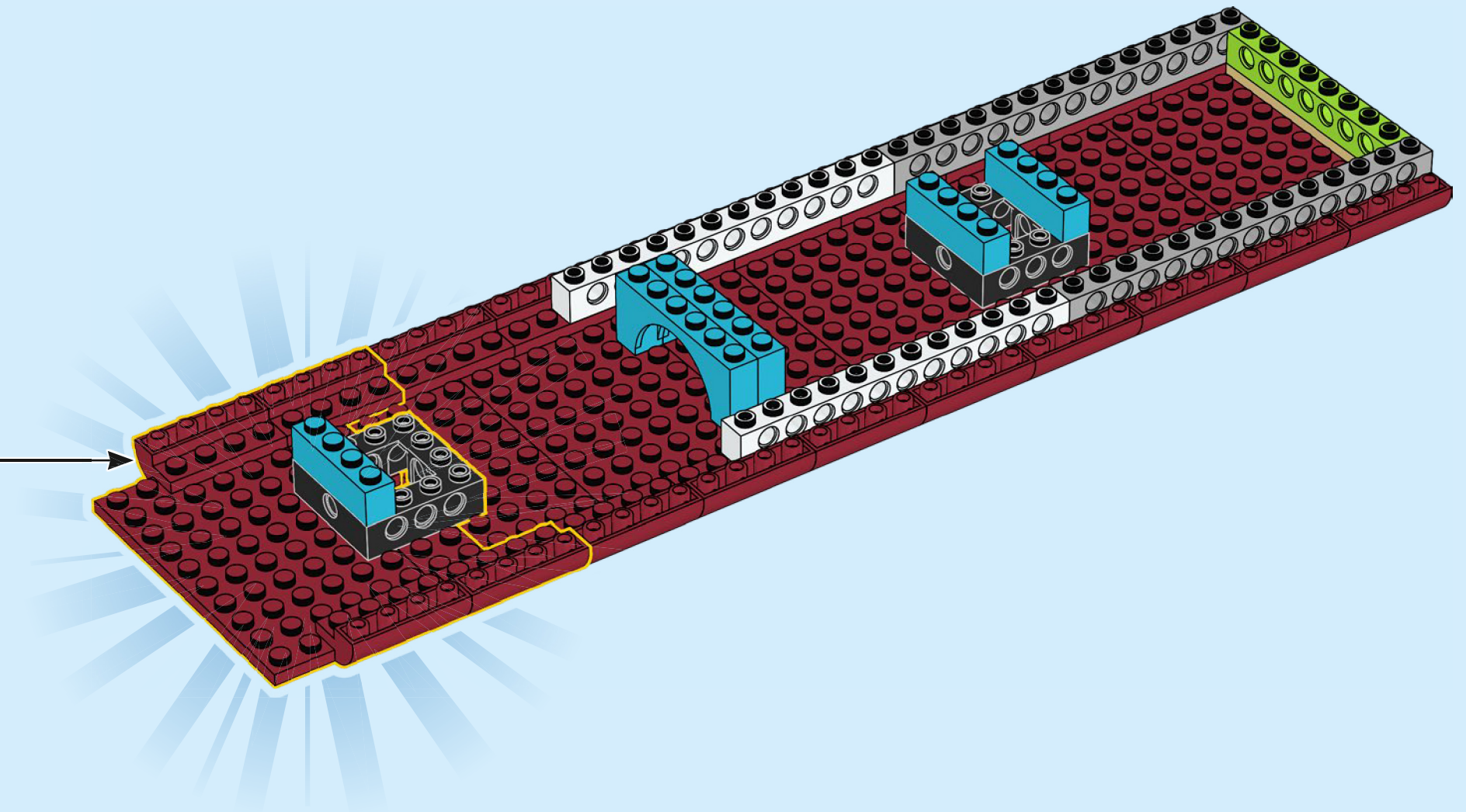

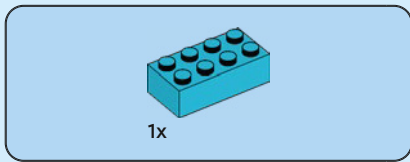

14

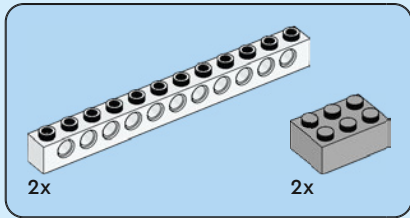
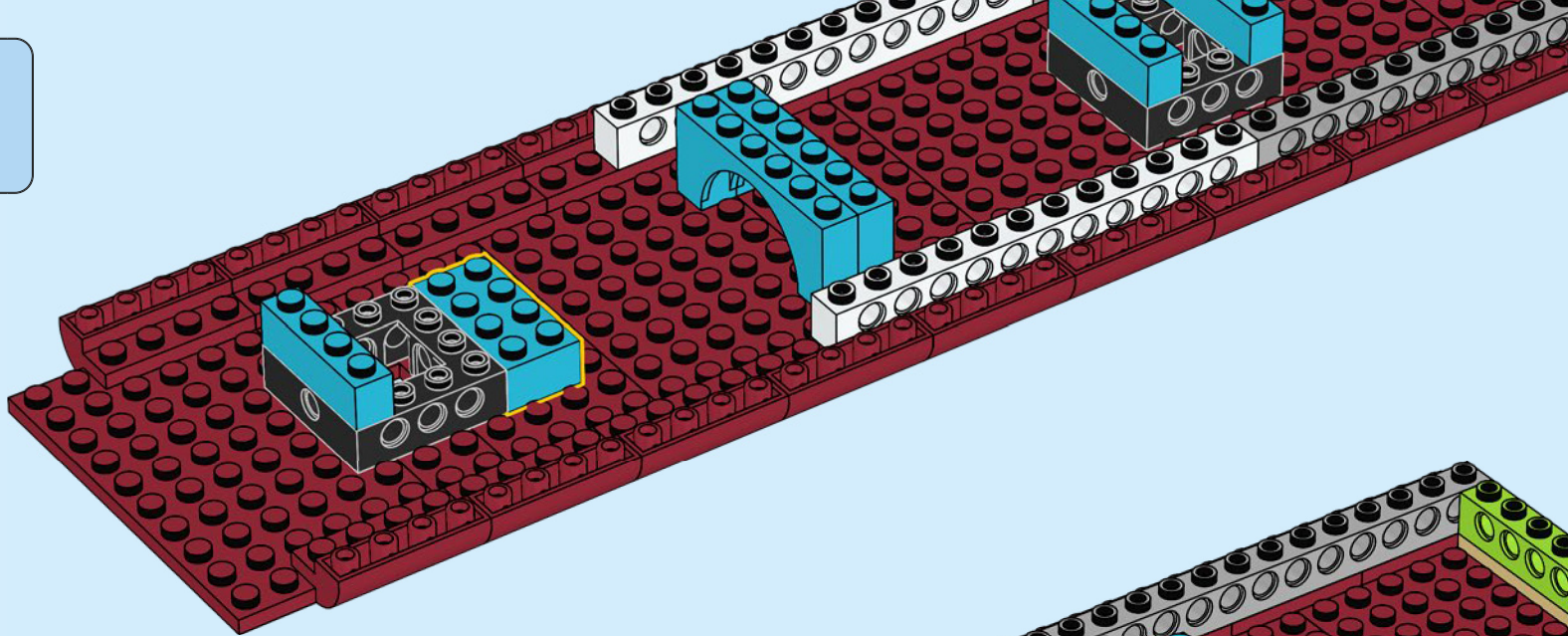

15

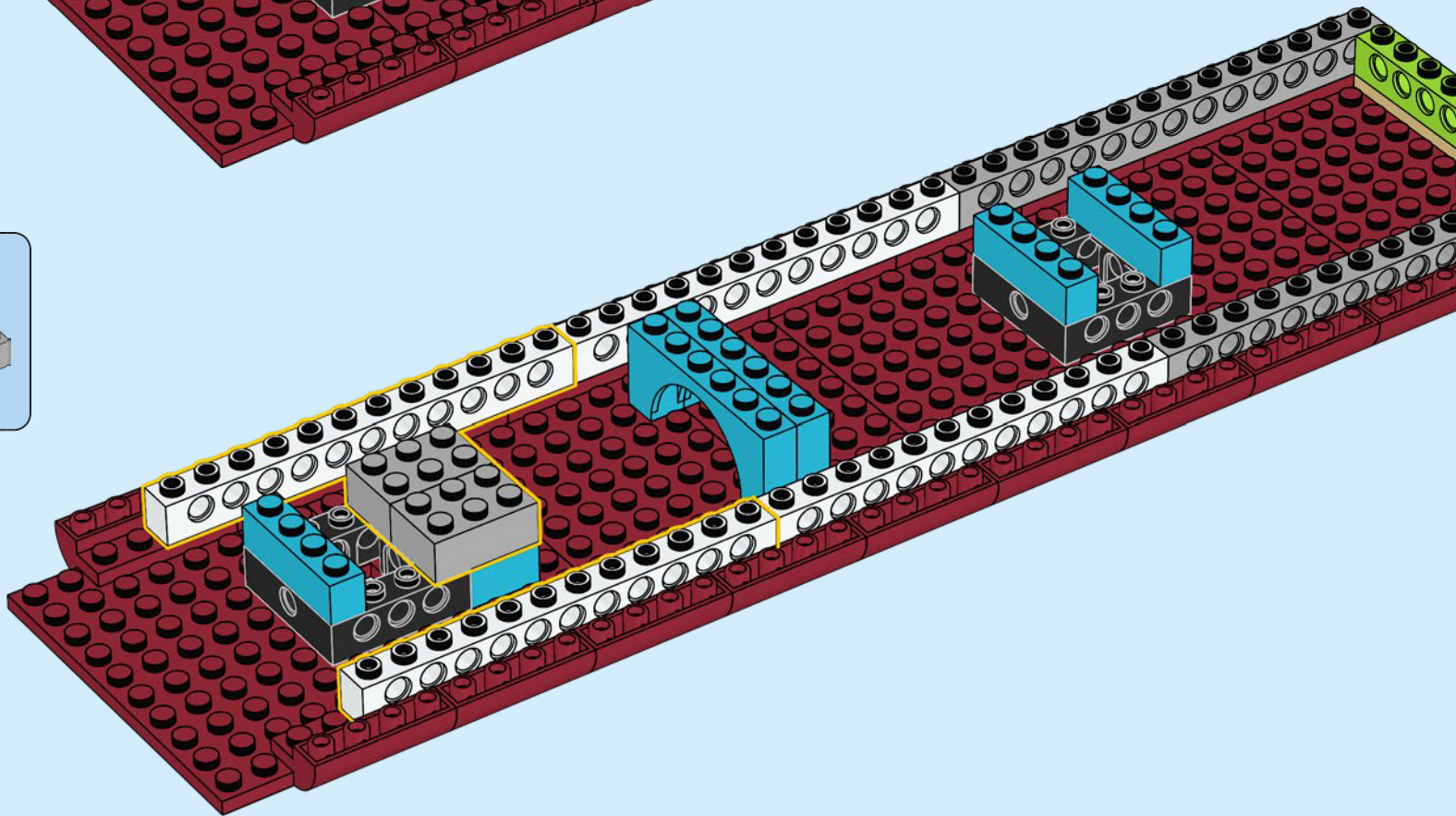

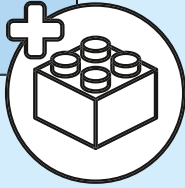
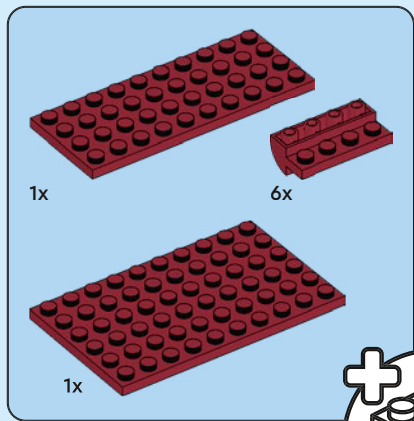

16

1

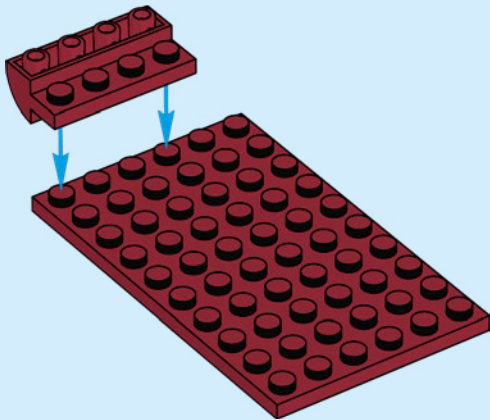

2

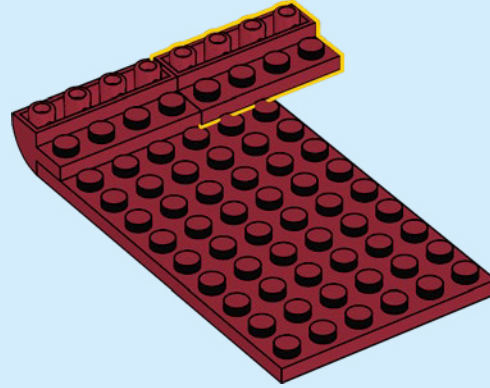

3

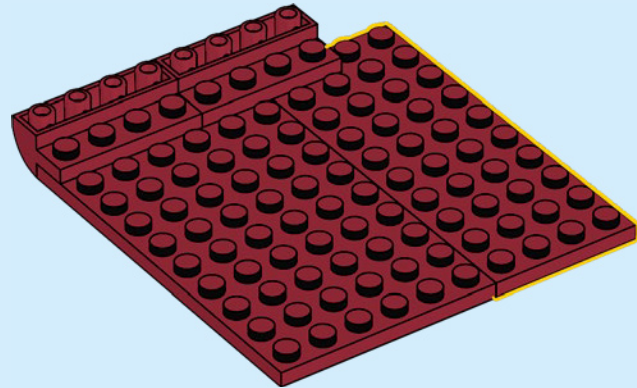

4

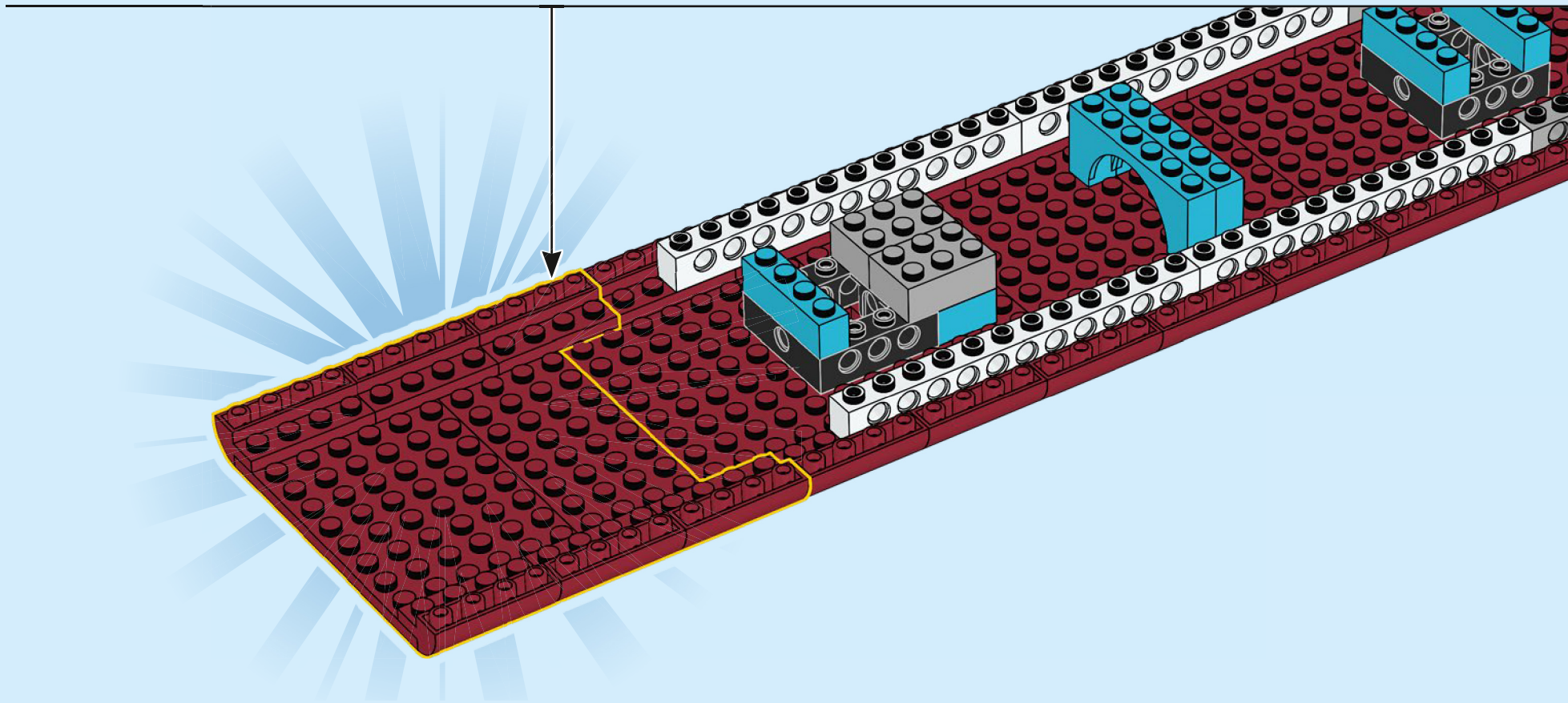
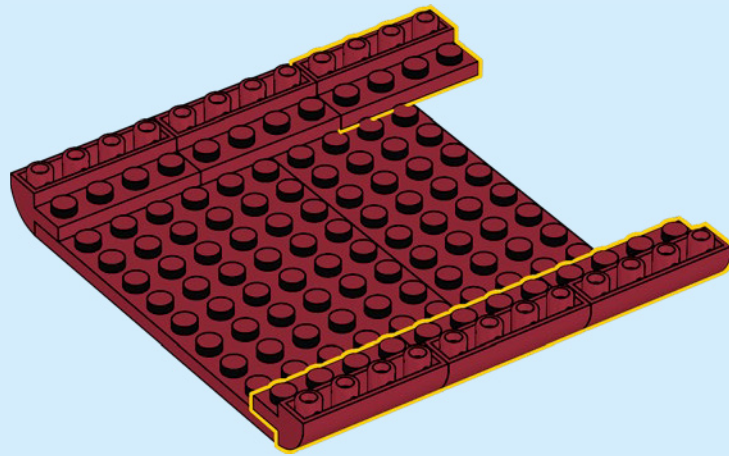

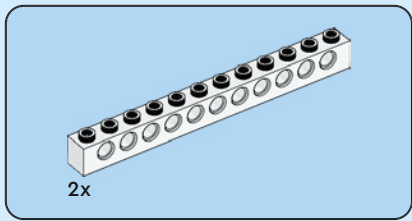

17

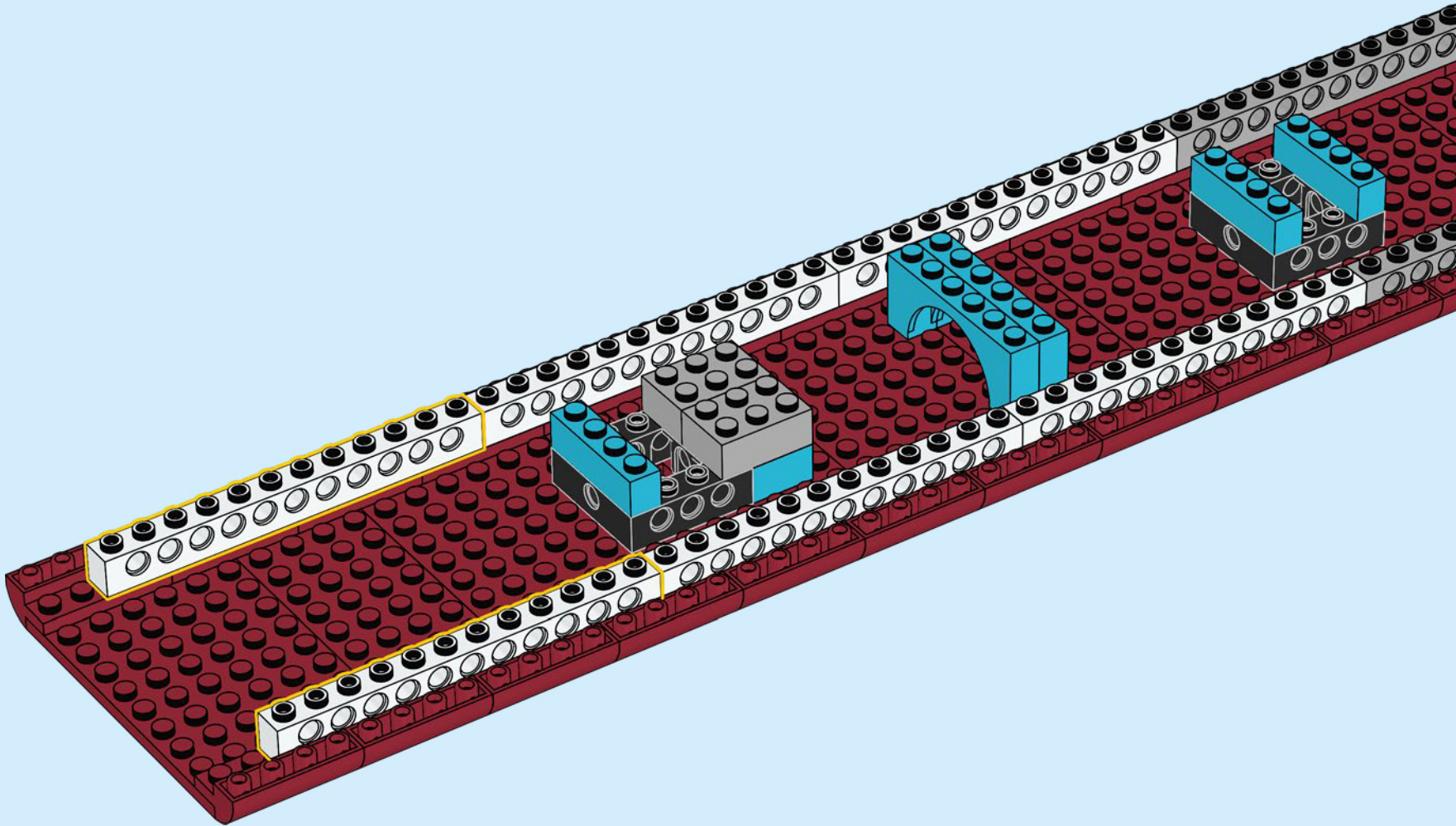

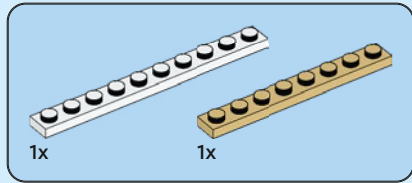

18

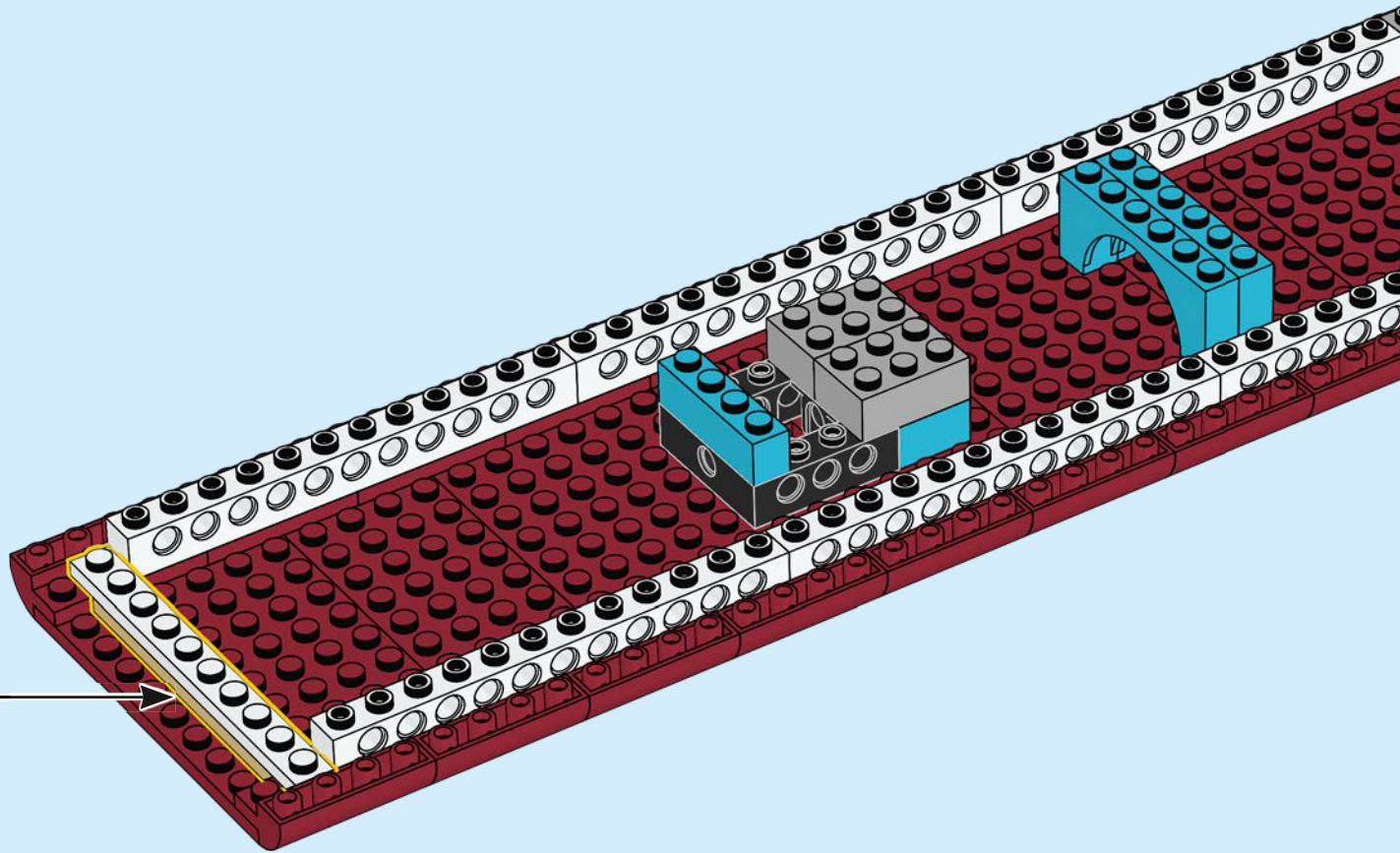
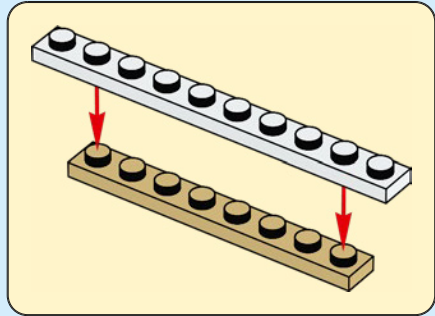

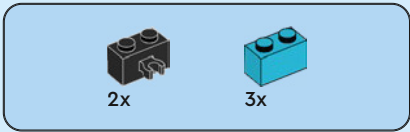

19

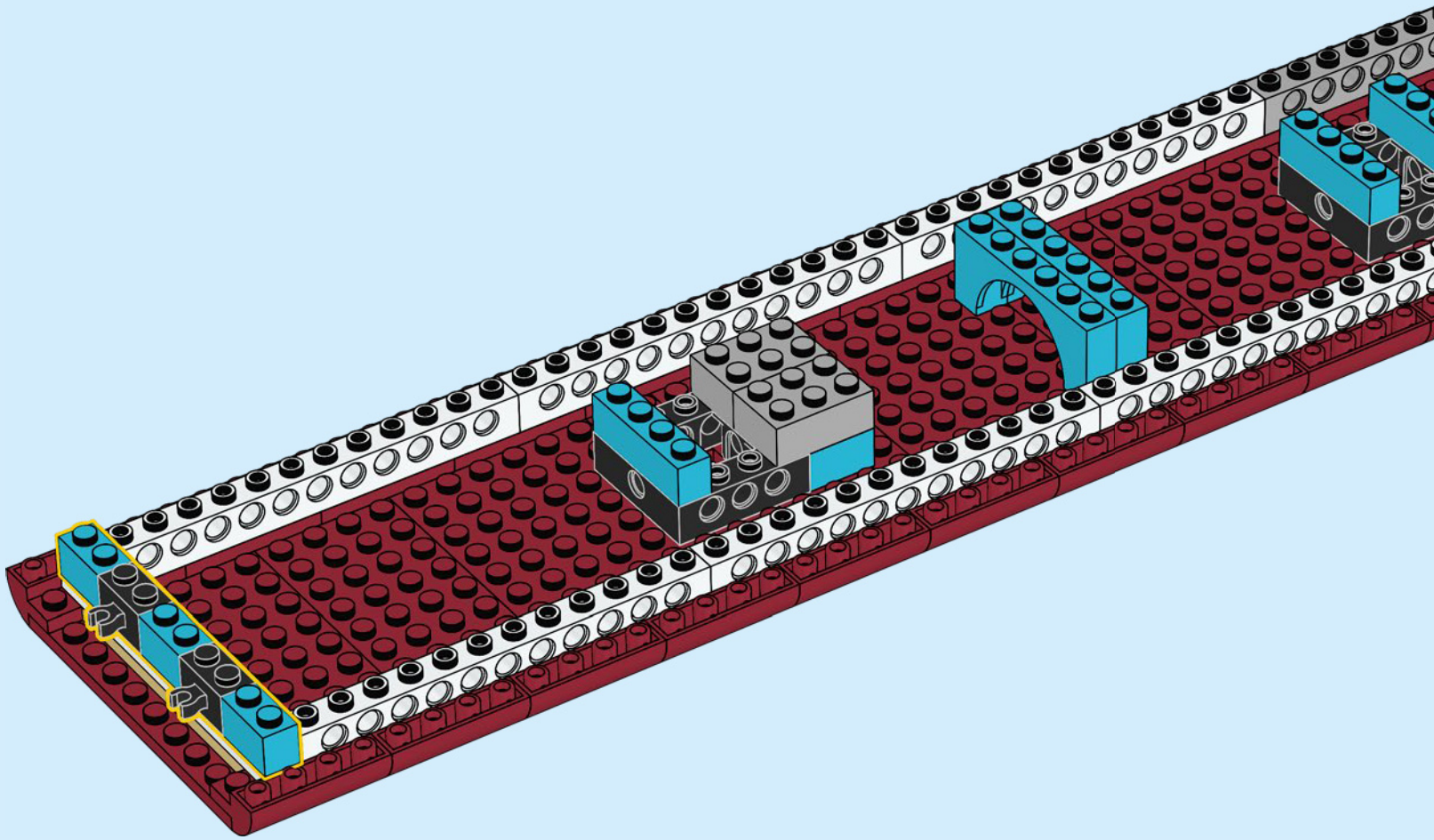

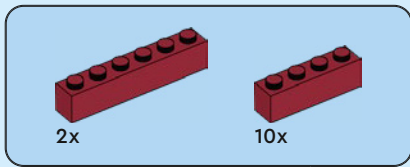

20

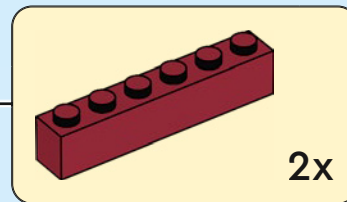
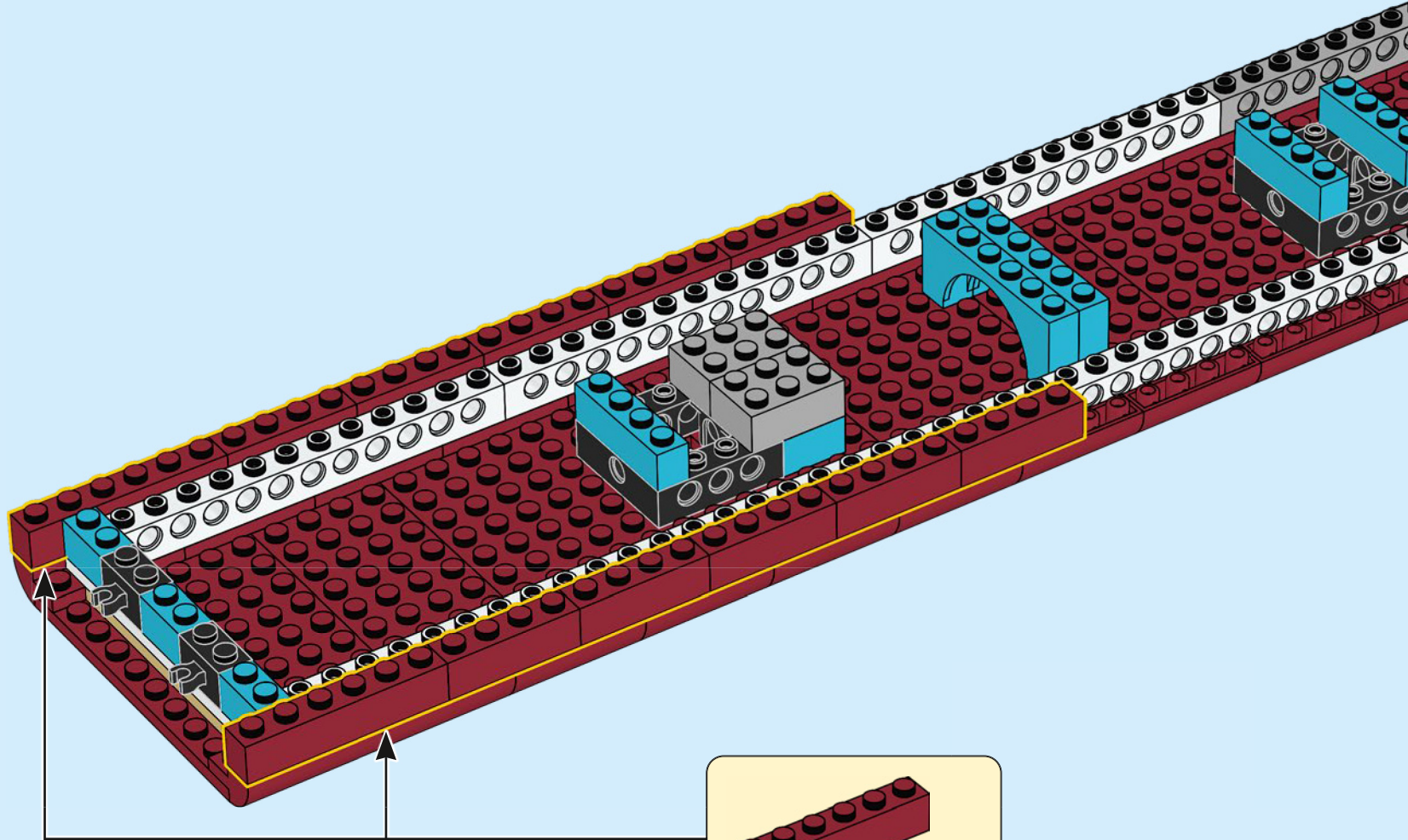

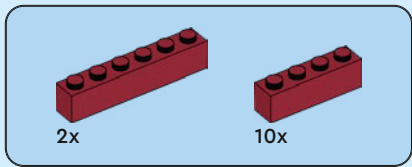

21

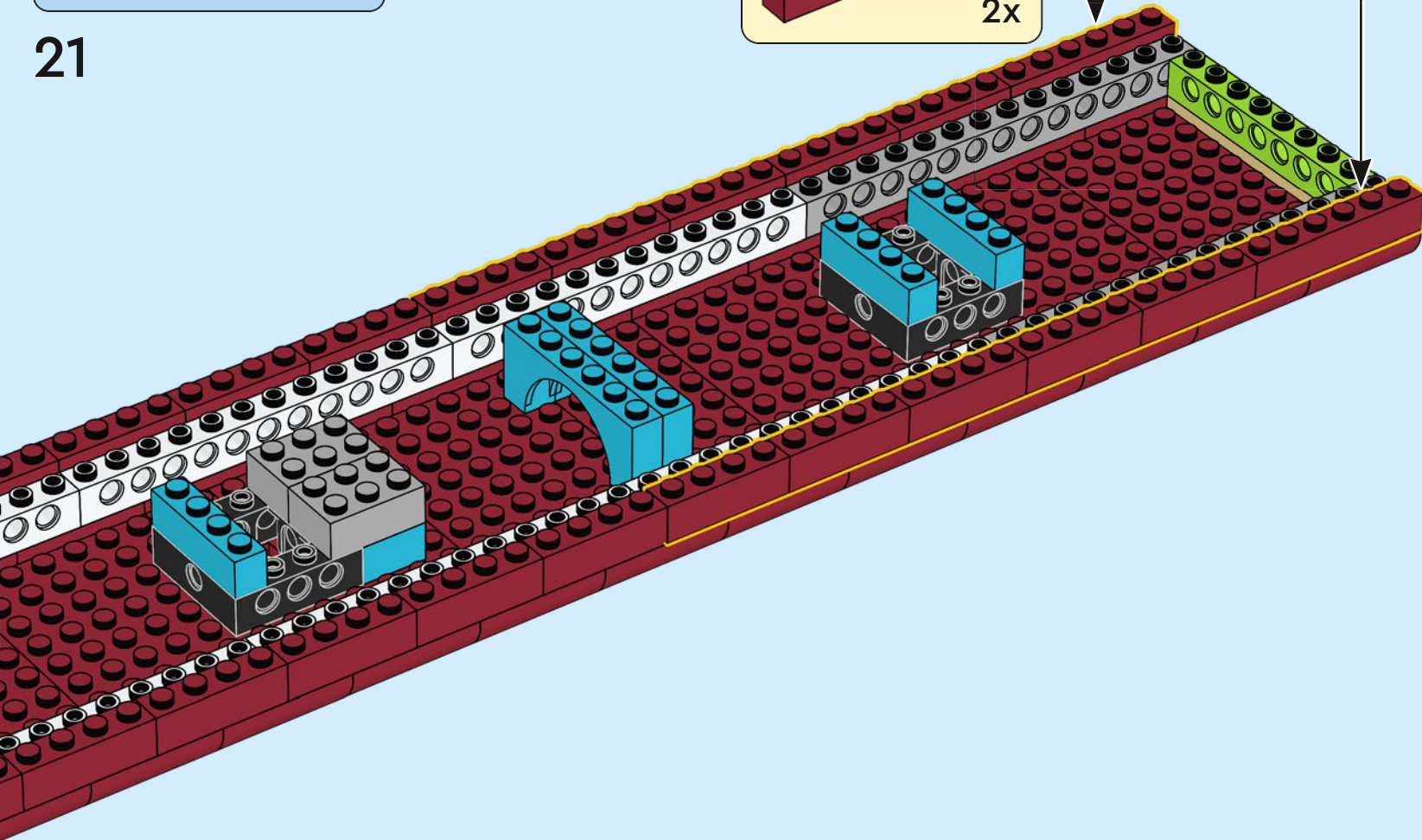
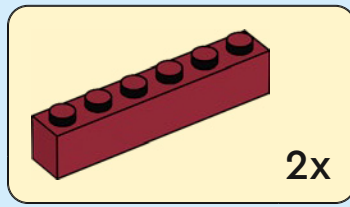

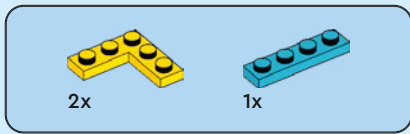

22

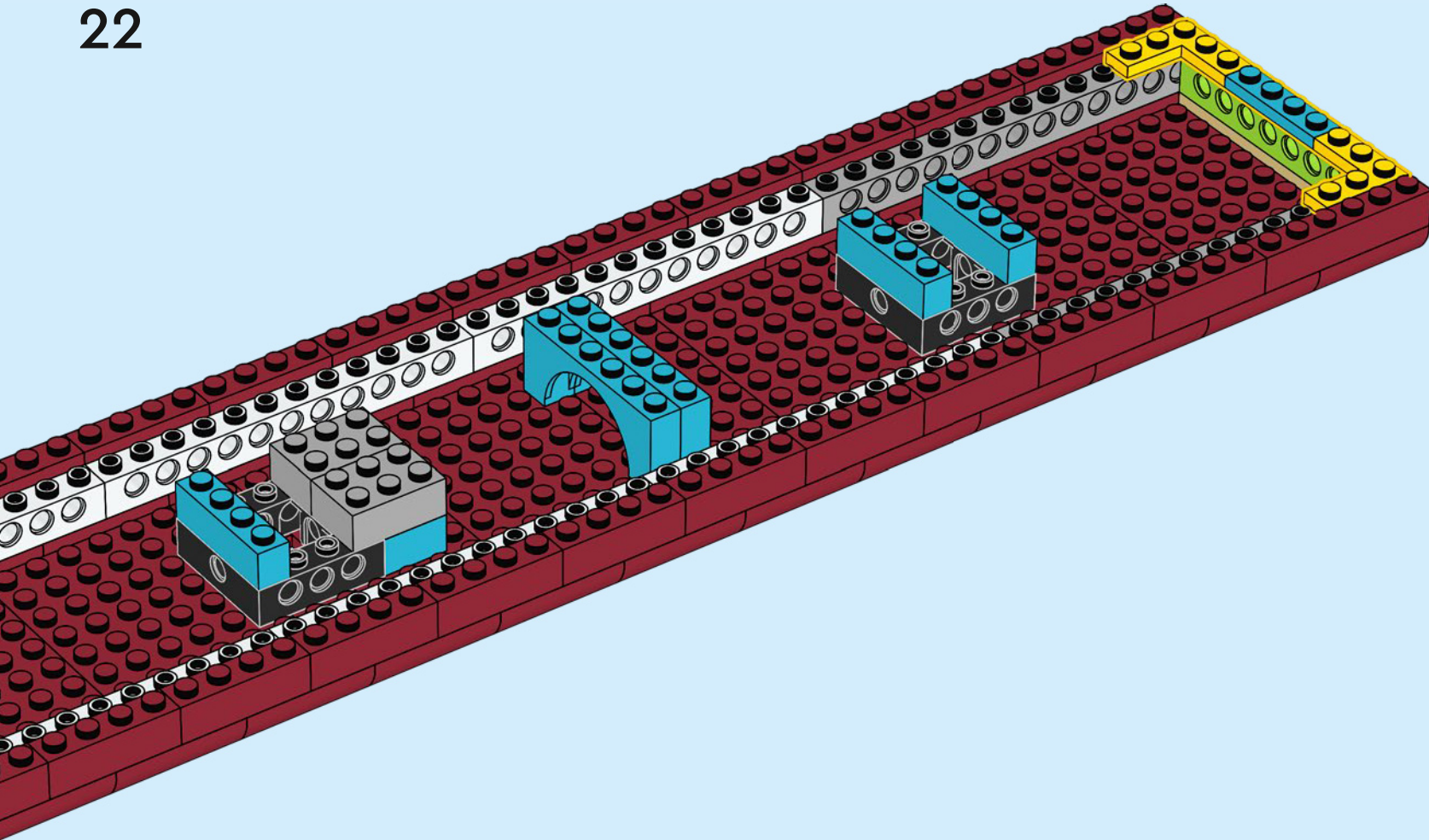

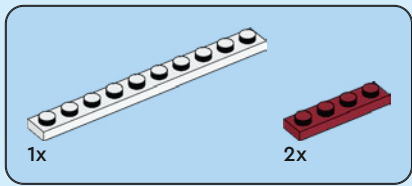

23

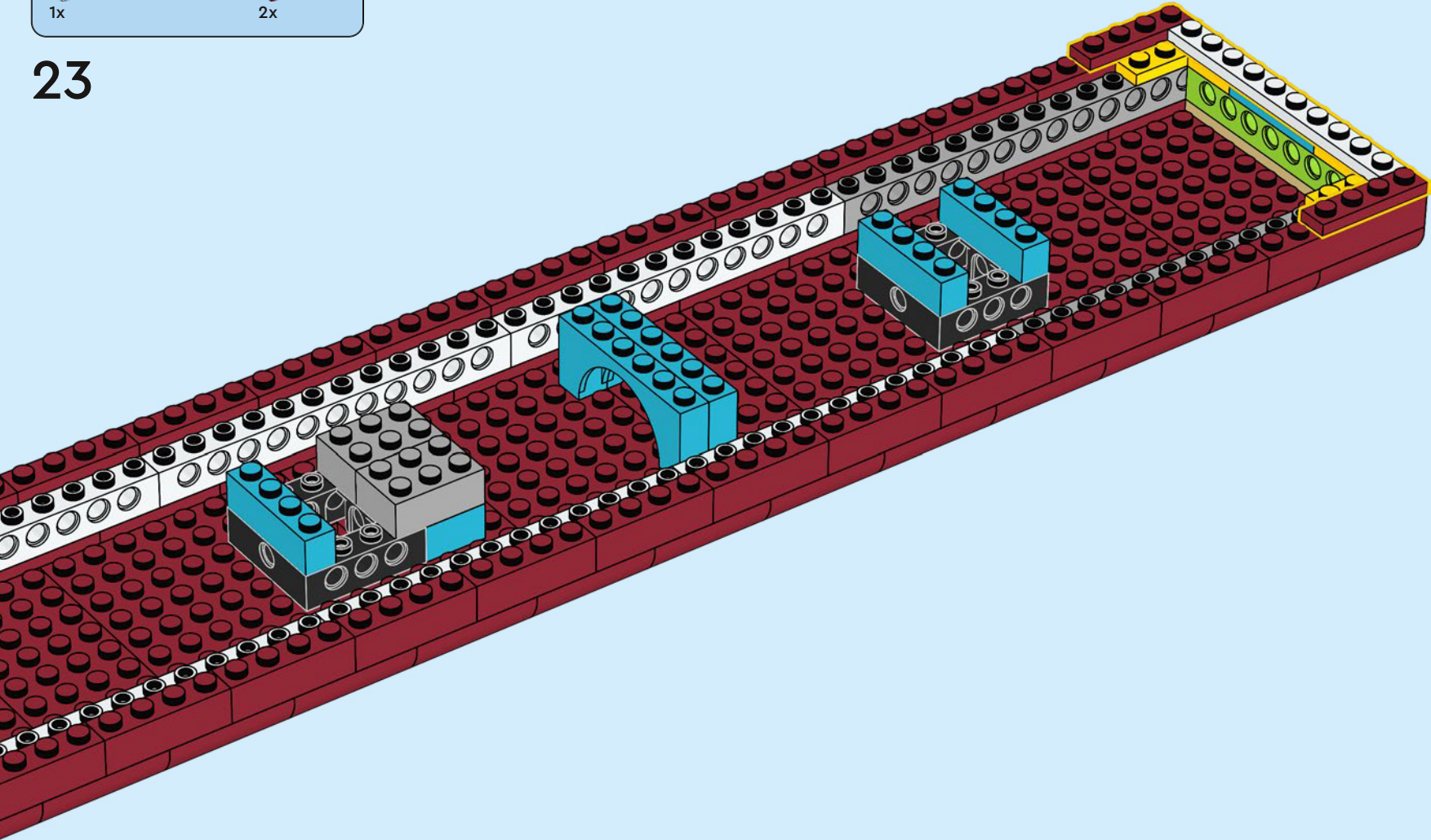

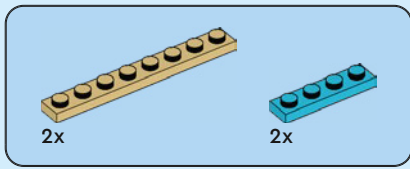

24

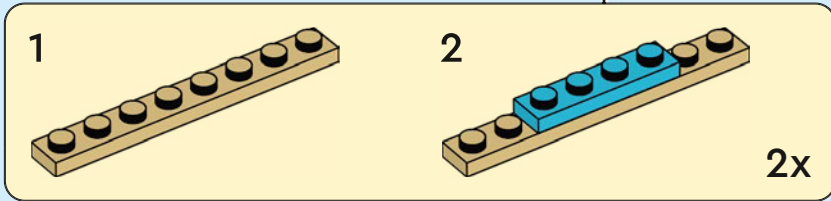
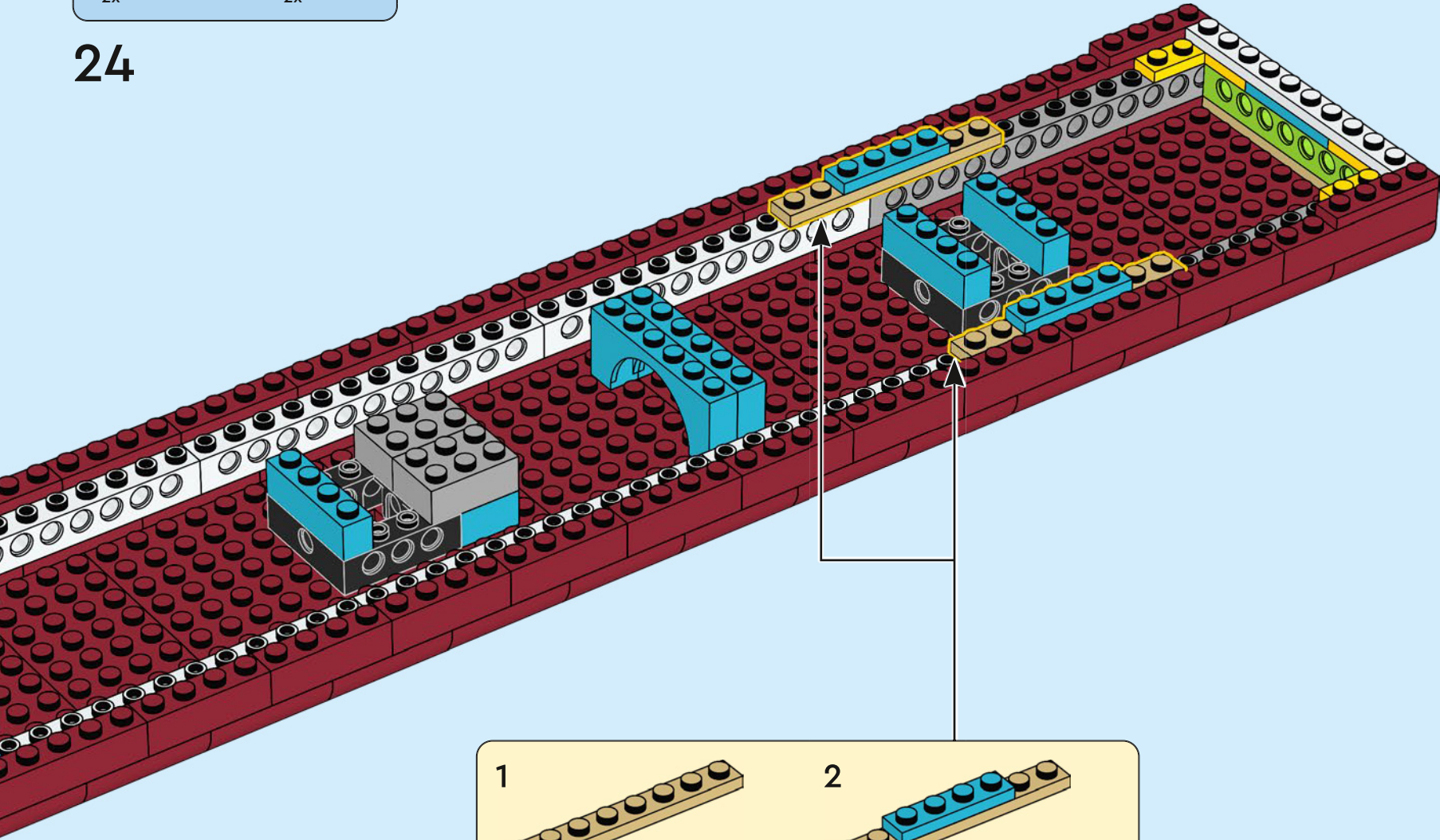

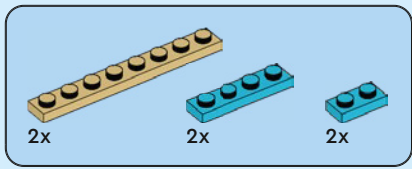

25

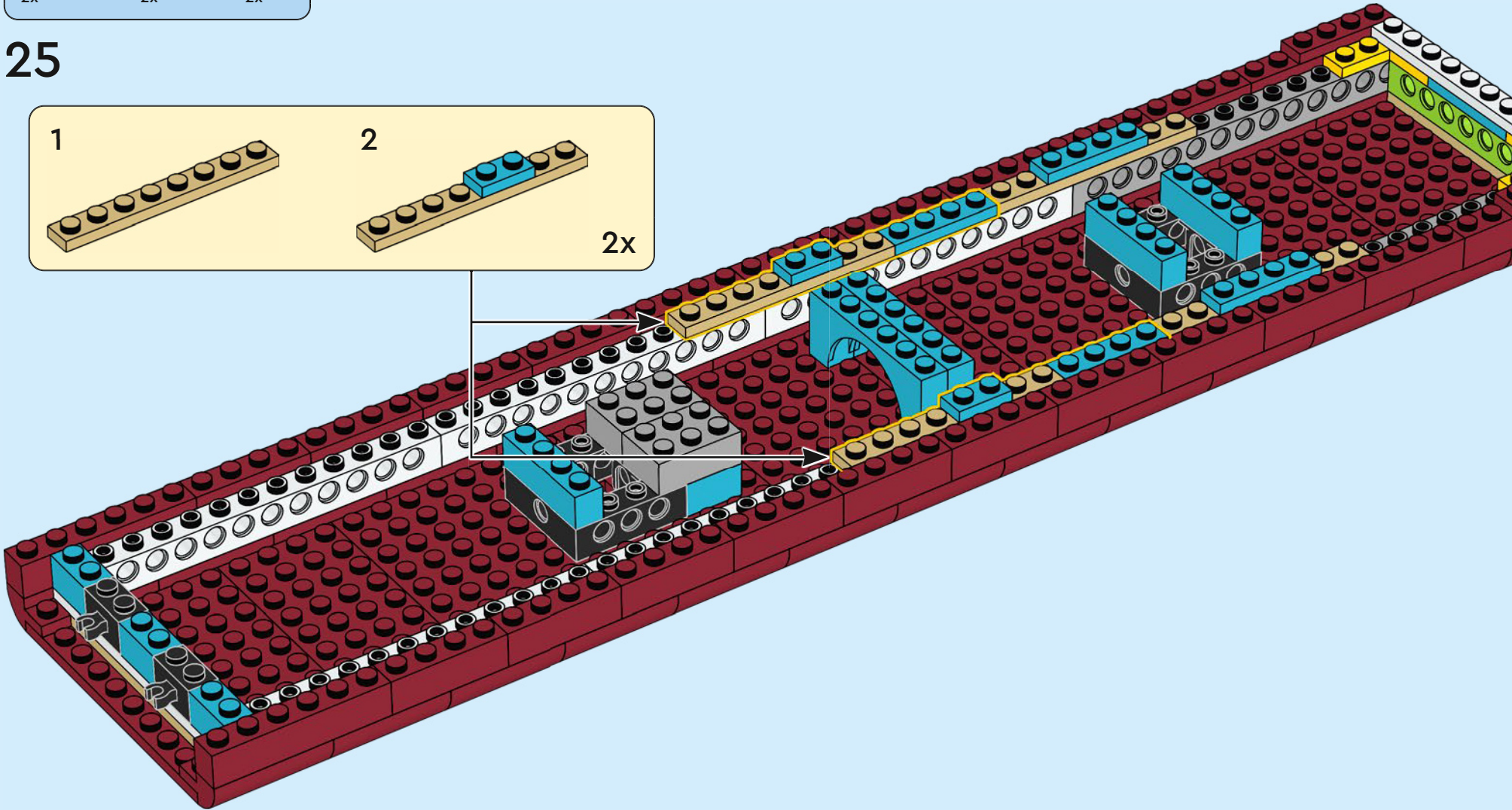
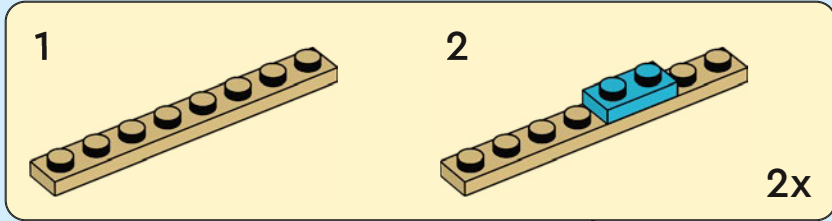

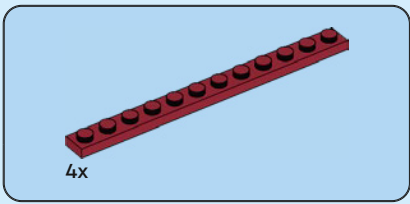

26

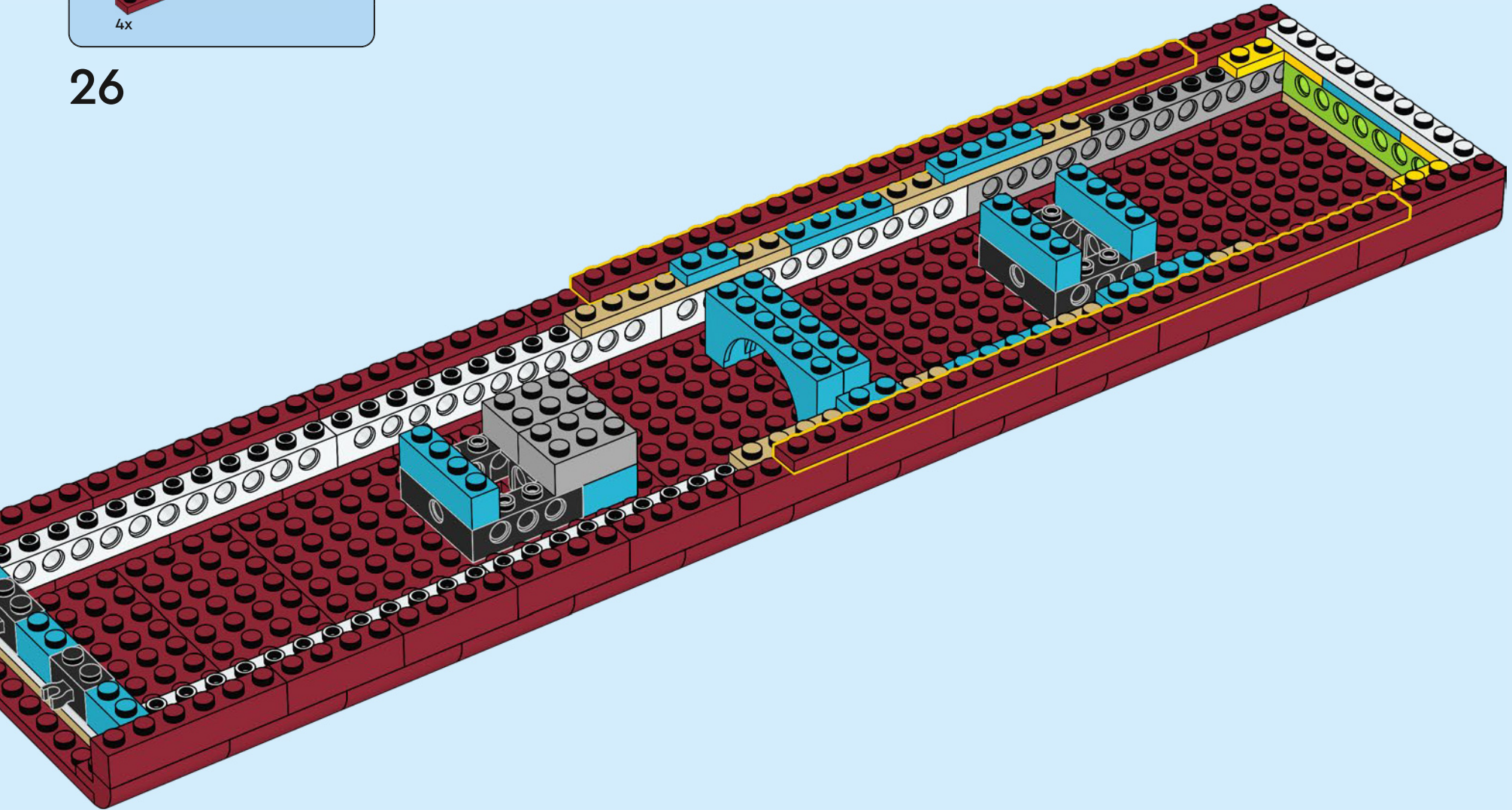

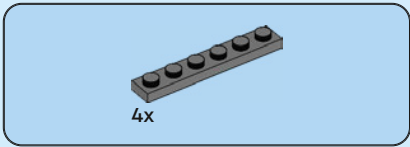

27

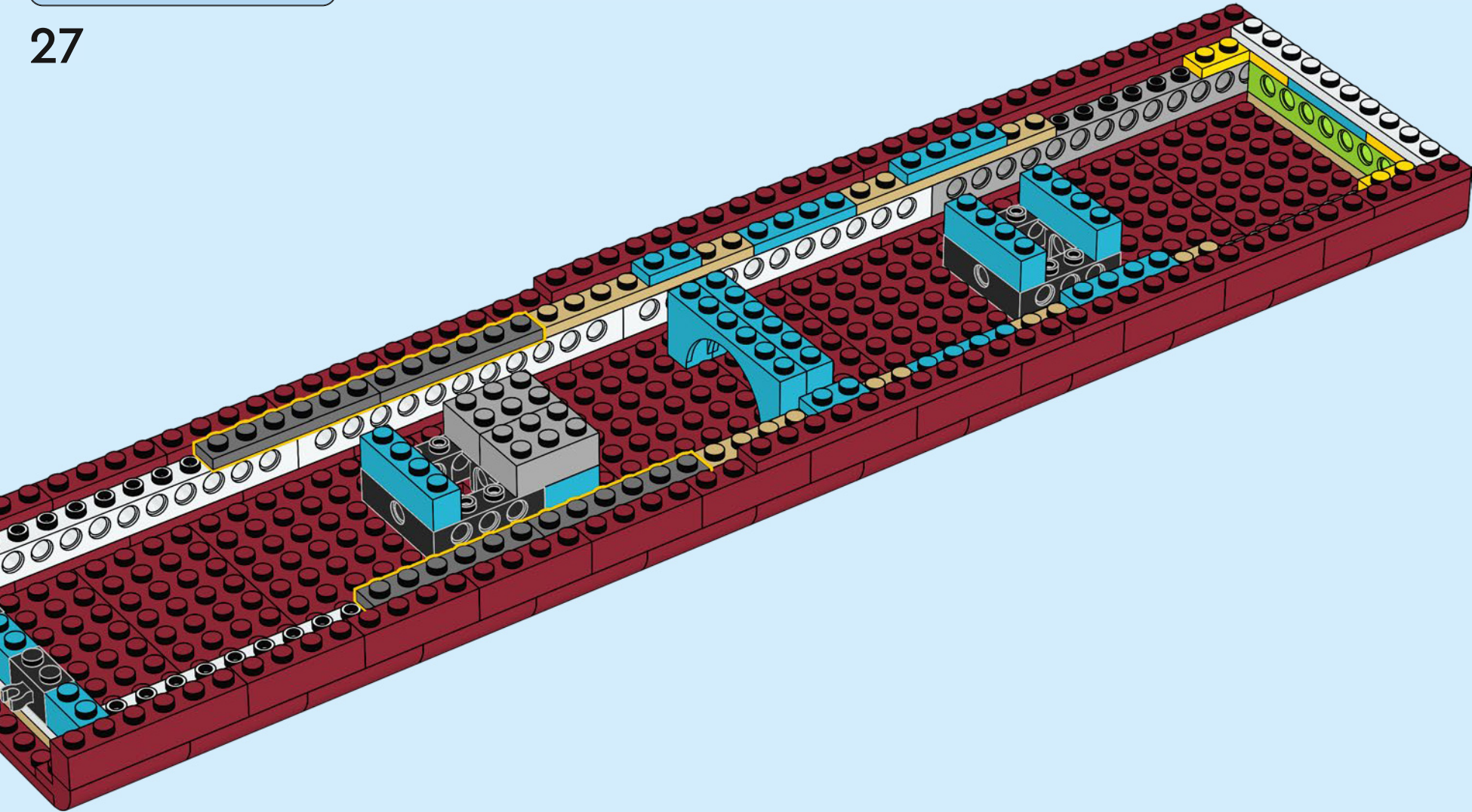

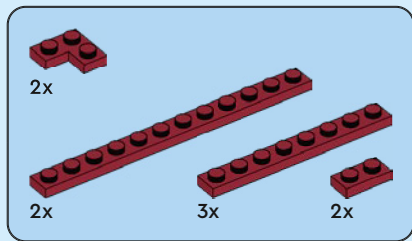

28

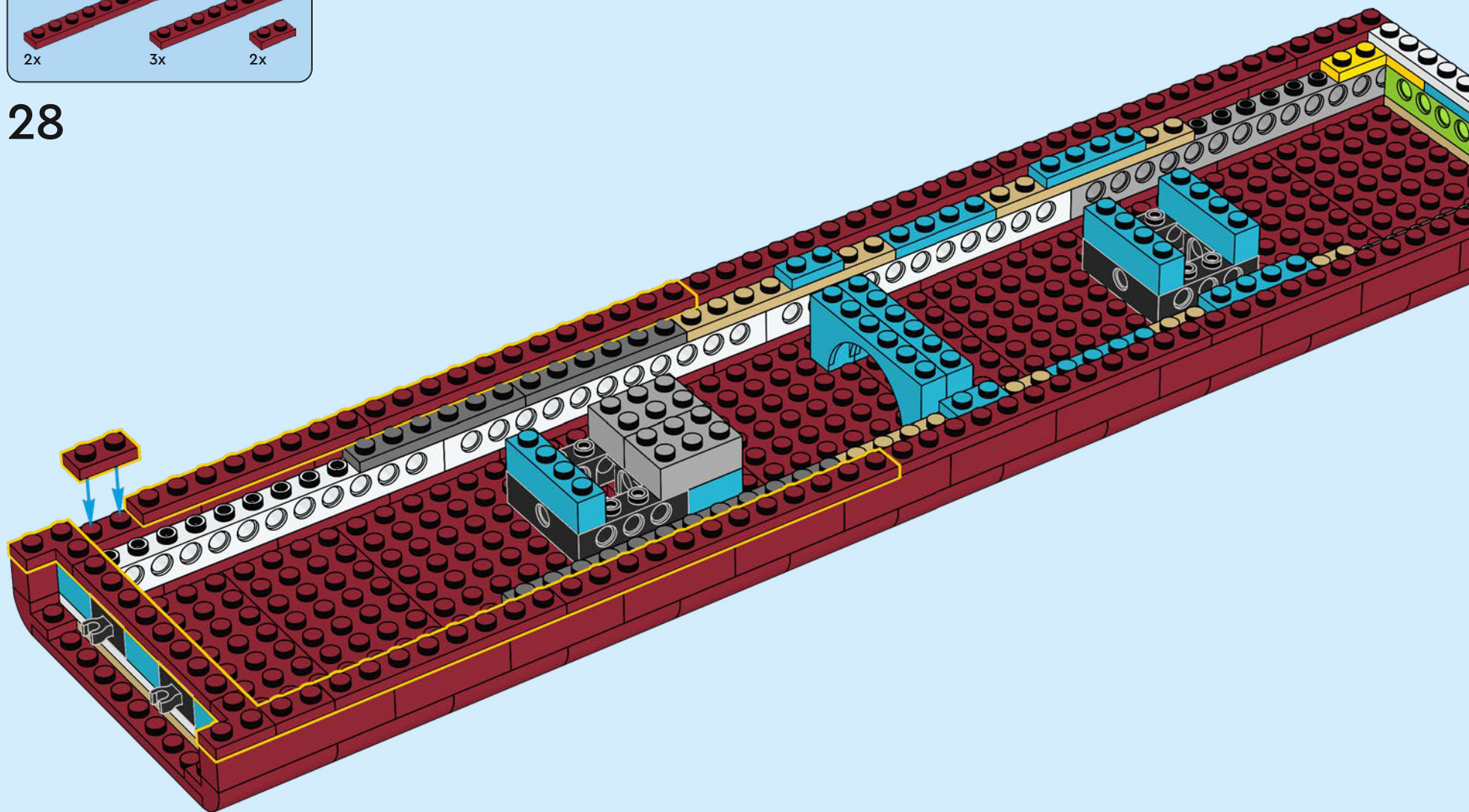

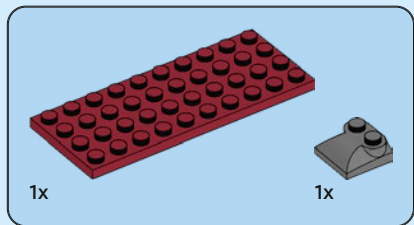
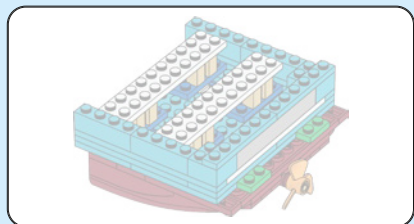

29

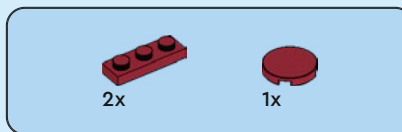
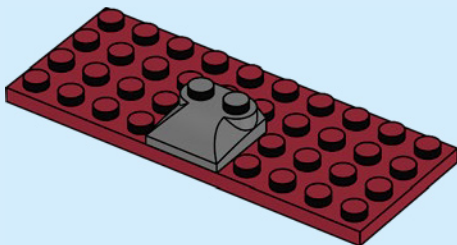

30

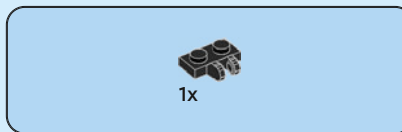
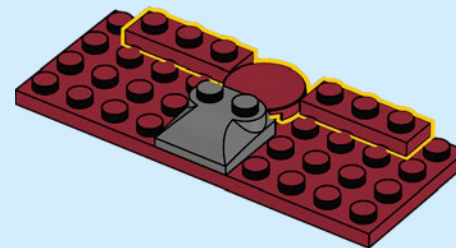

31

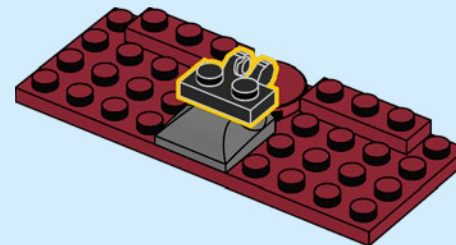

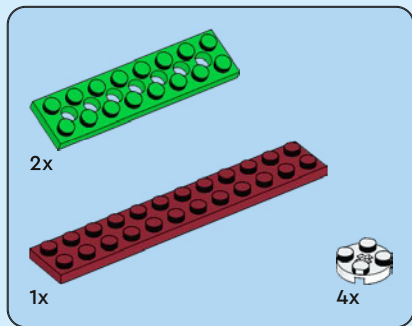

32

1

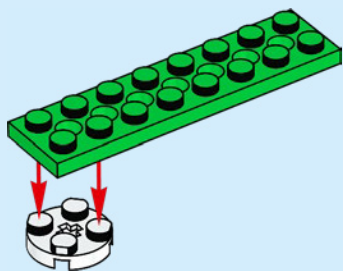

2

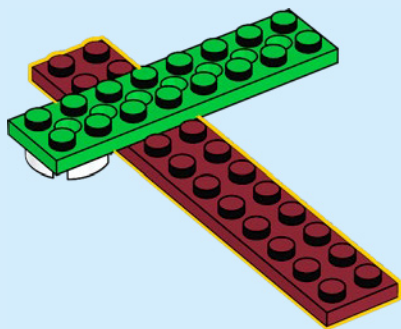

3

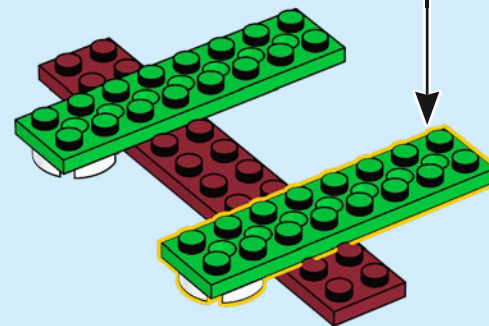
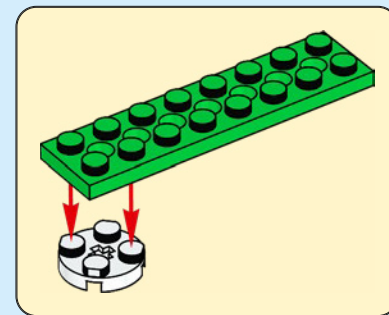

4

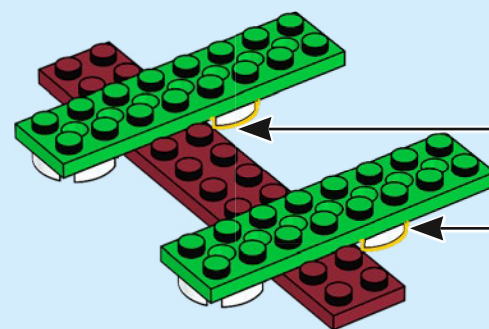

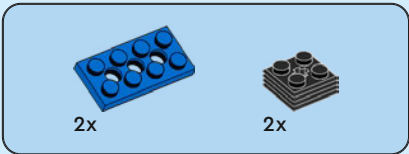

33

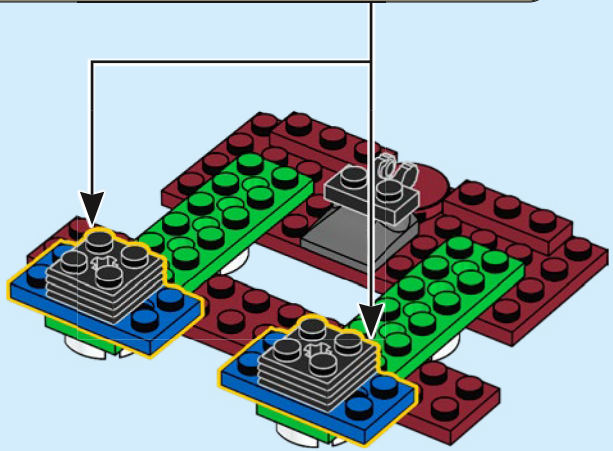
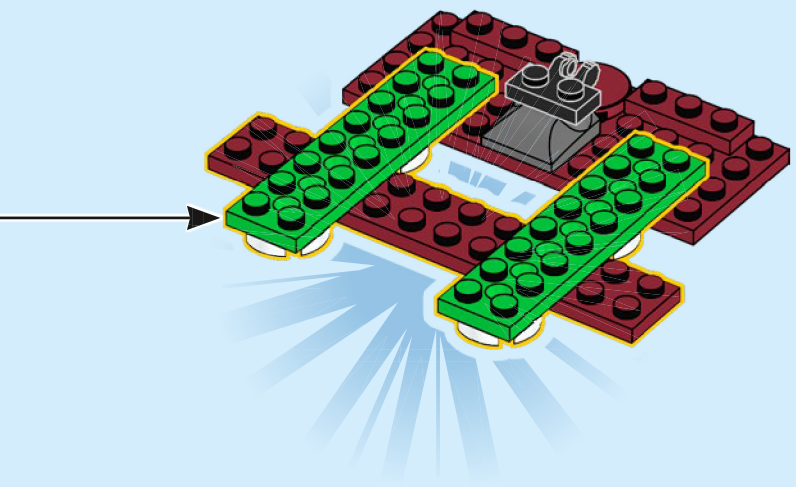
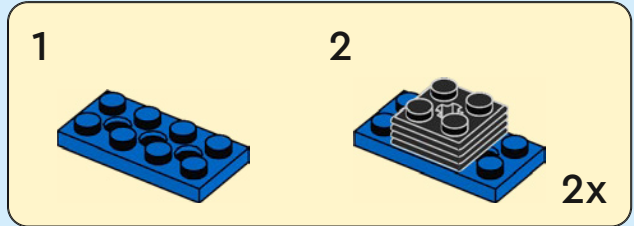

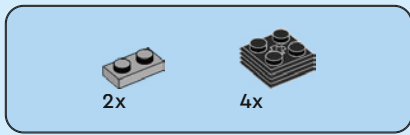

34

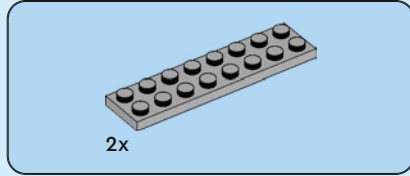
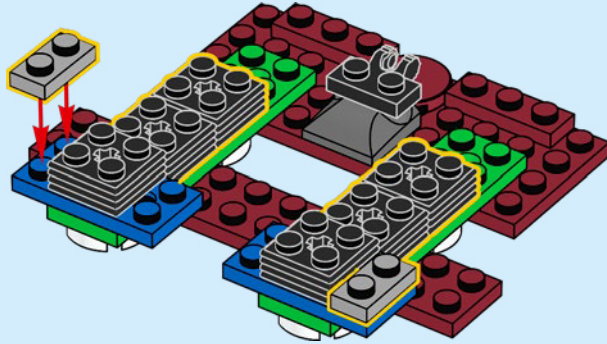

35

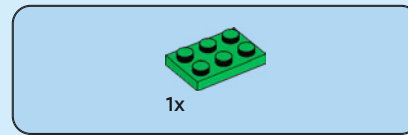
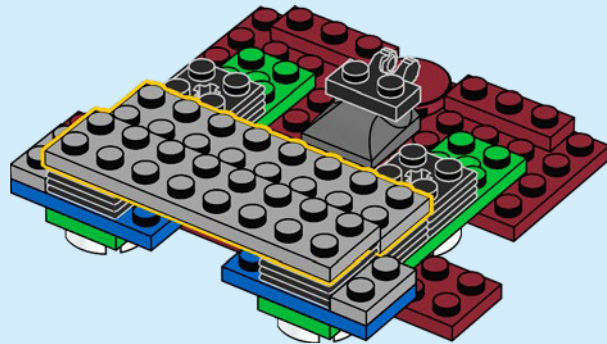

36

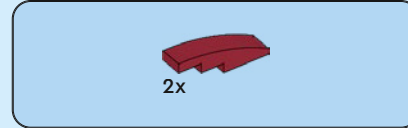
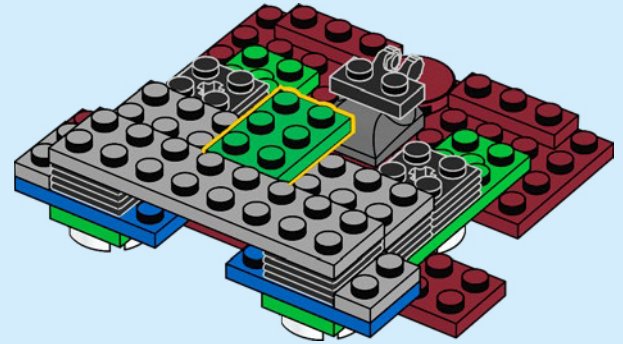

37

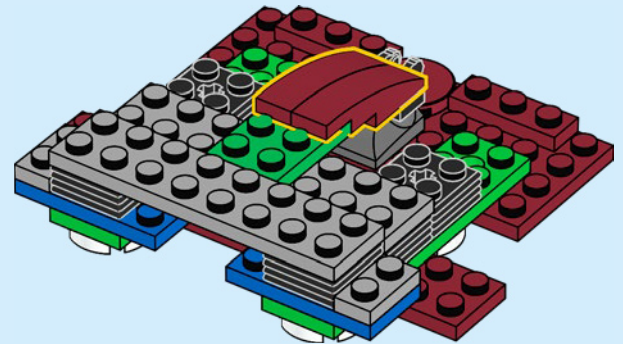

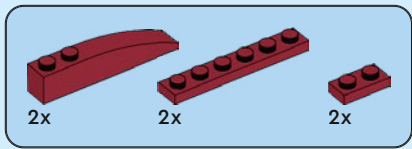

38

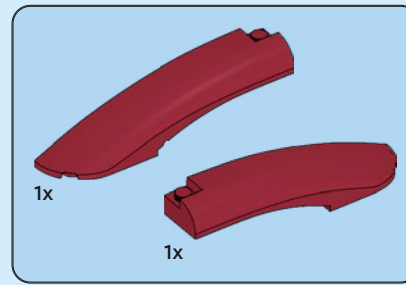
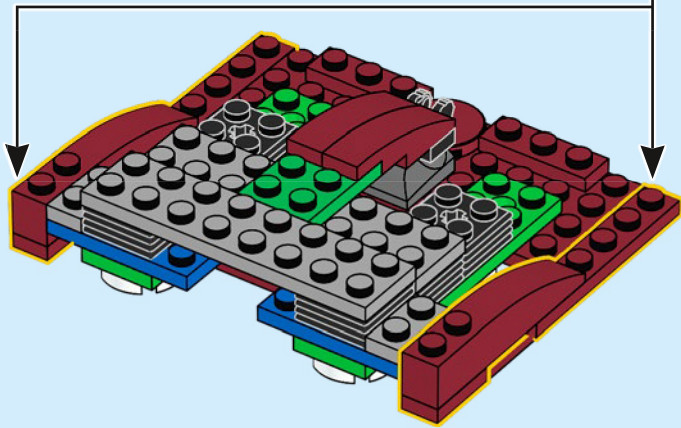
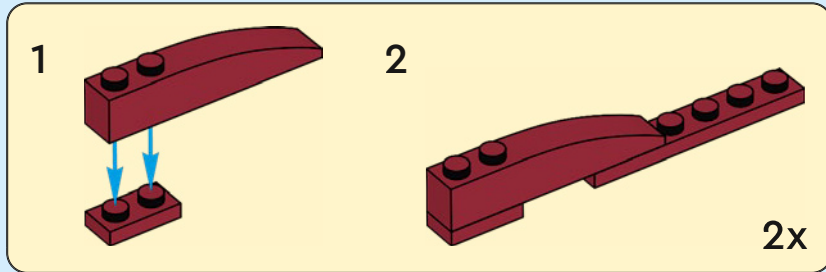

39

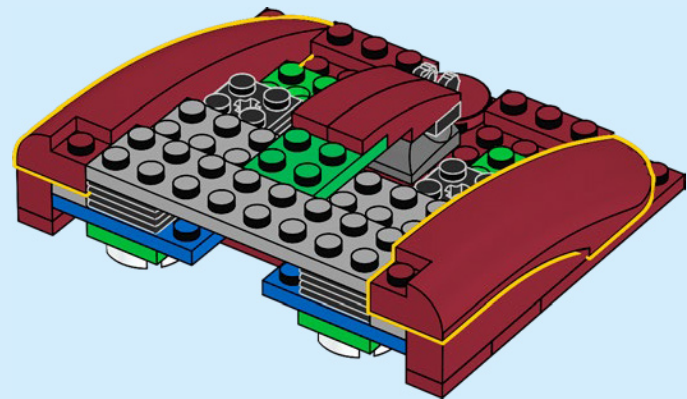

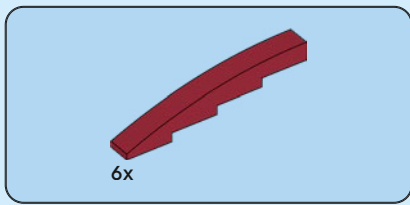

40

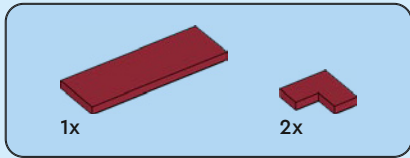
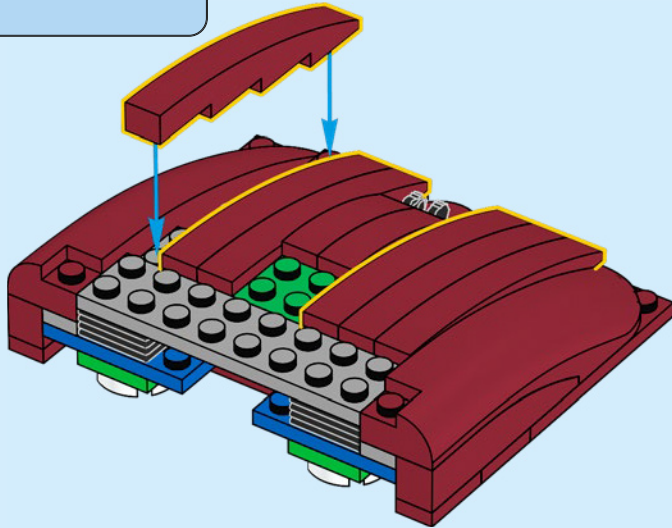

41

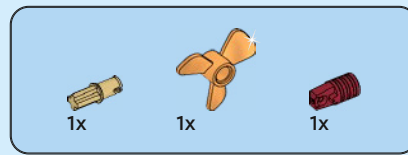
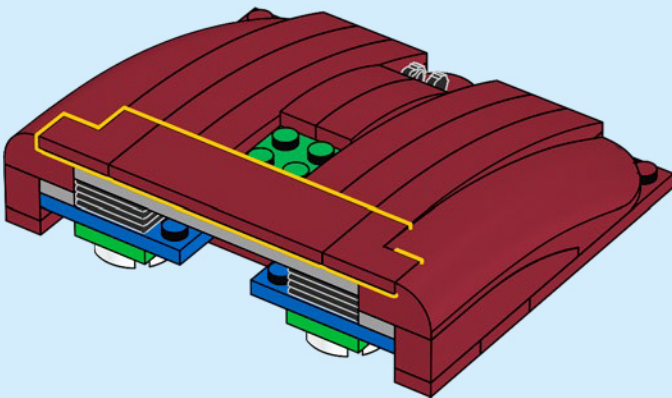

42

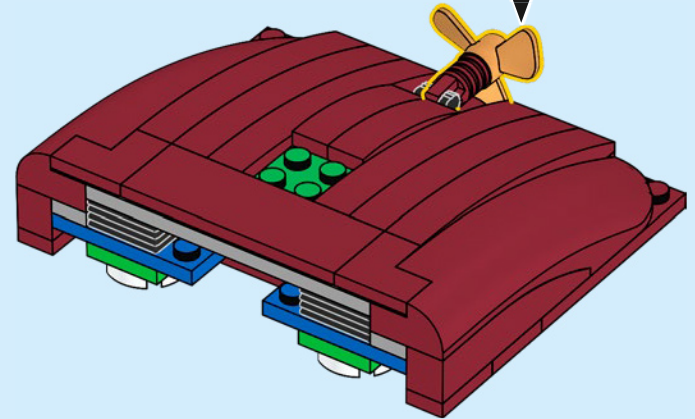
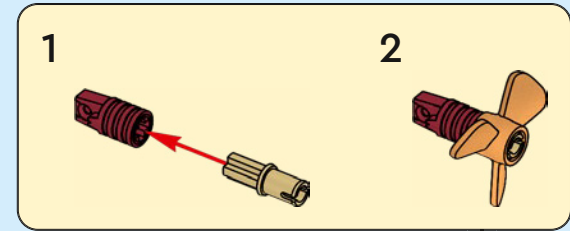

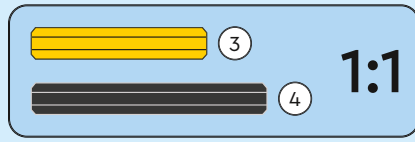
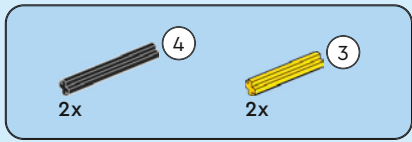

43

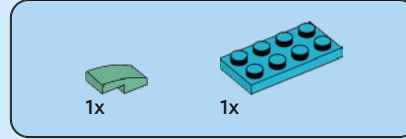
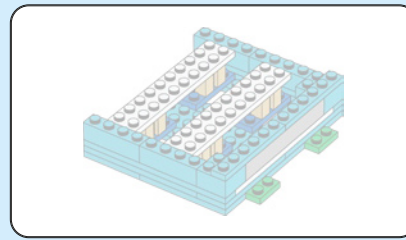
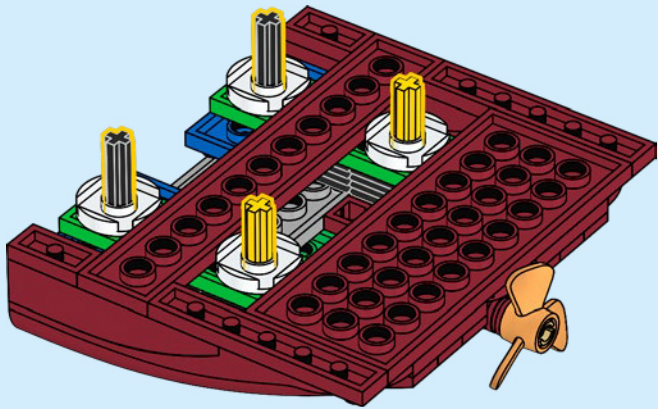

44

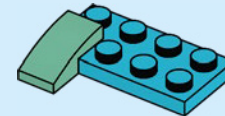

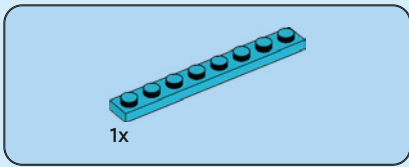

45

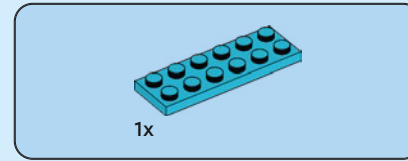
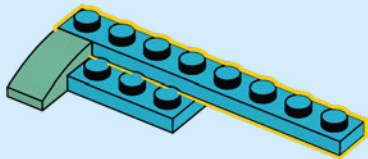
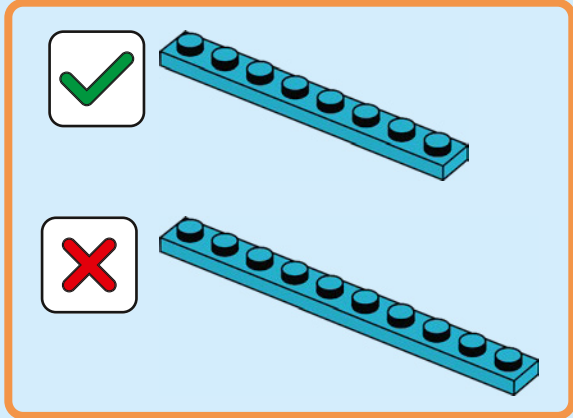

46

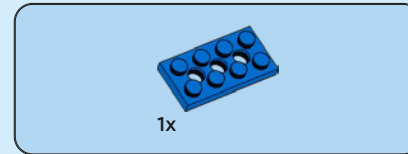
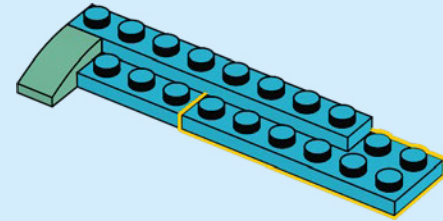

47

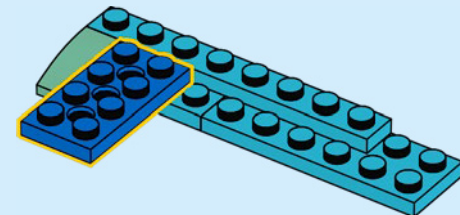

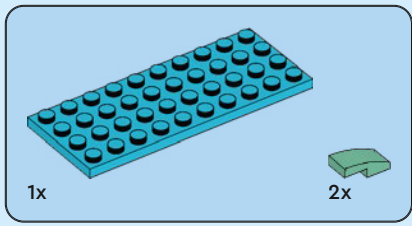

48

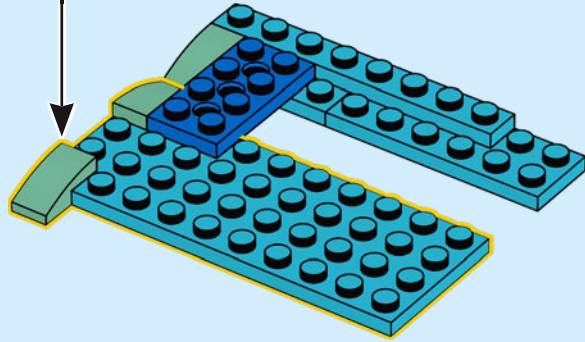
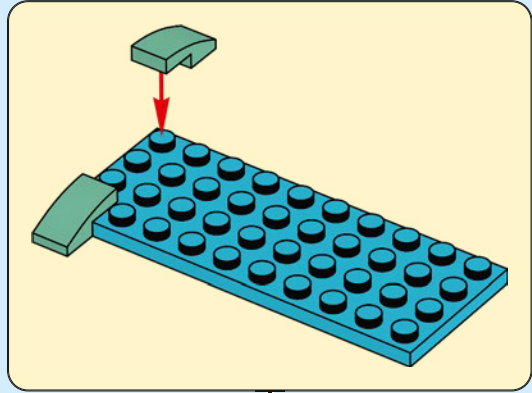

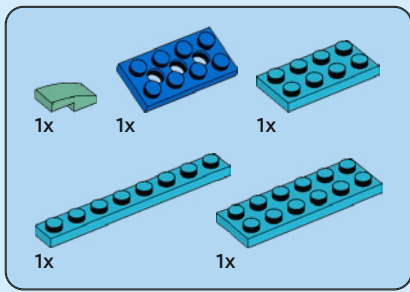

49

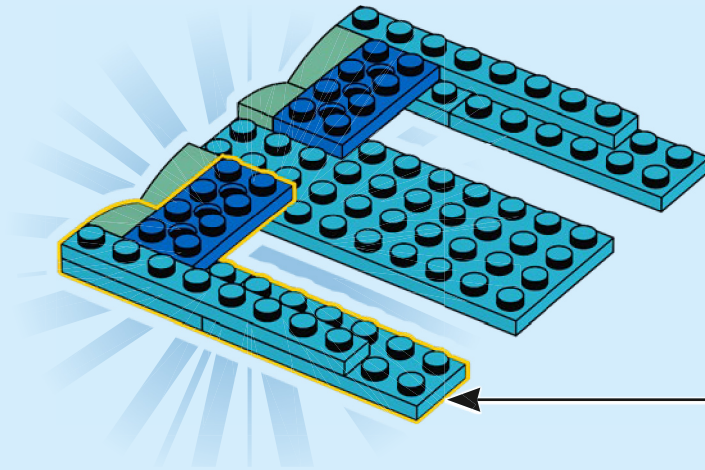
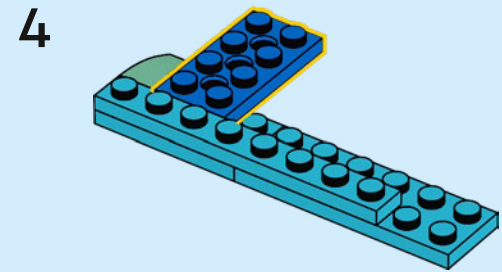
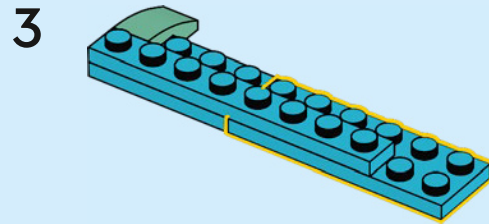
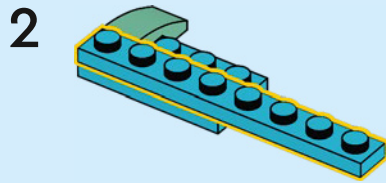
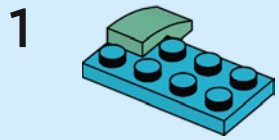
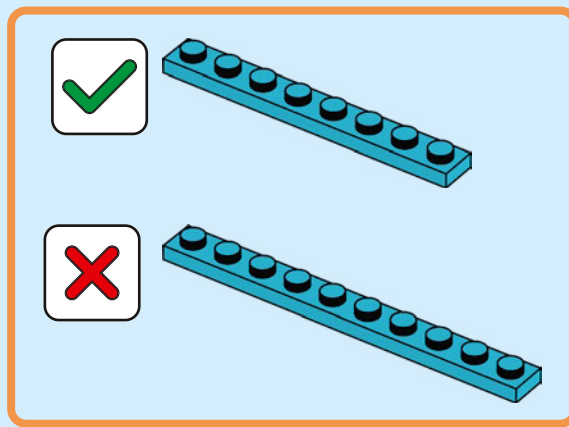



50

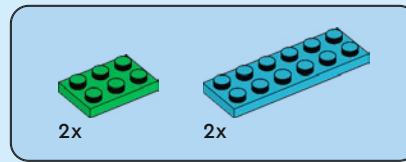
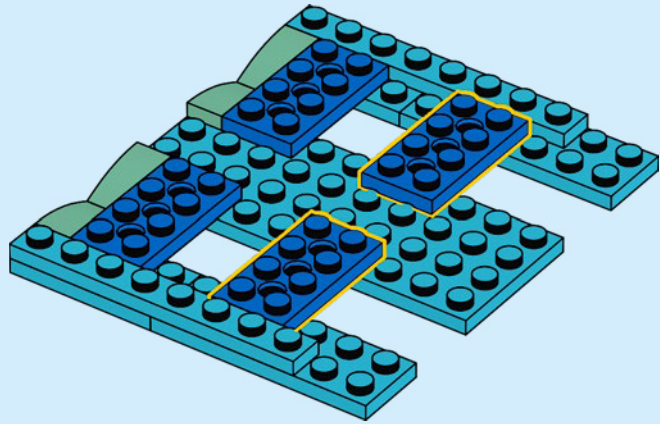

51

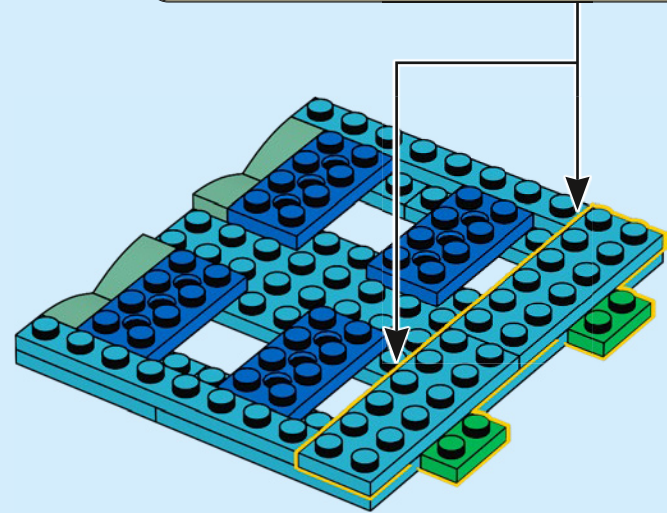
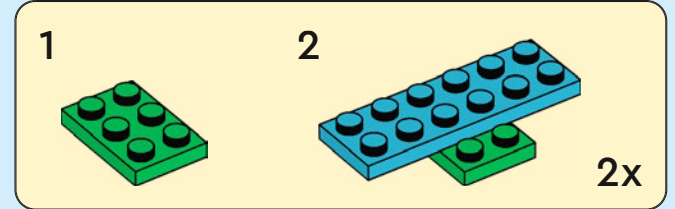

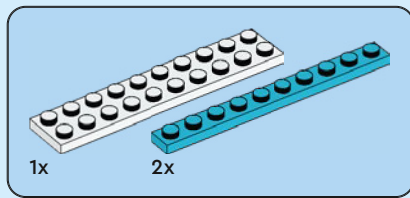

52

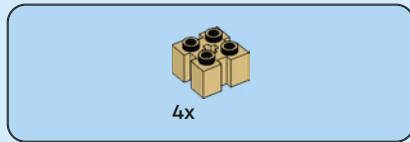
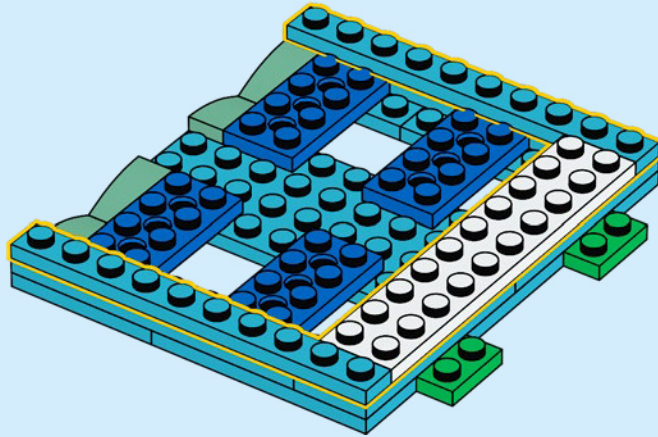

53

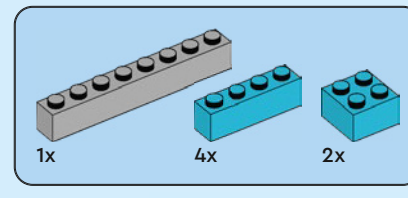
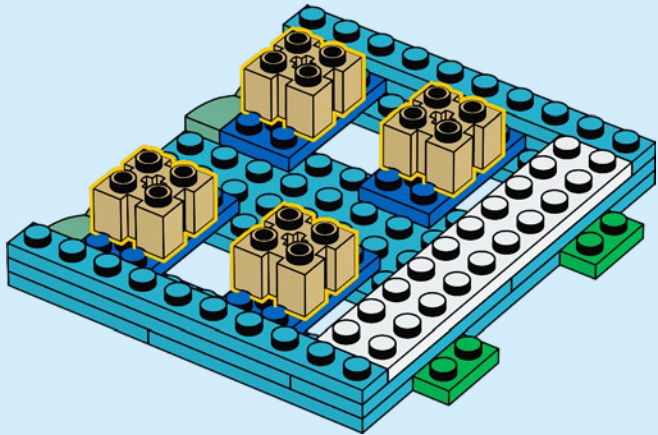

54

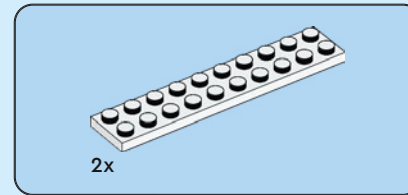
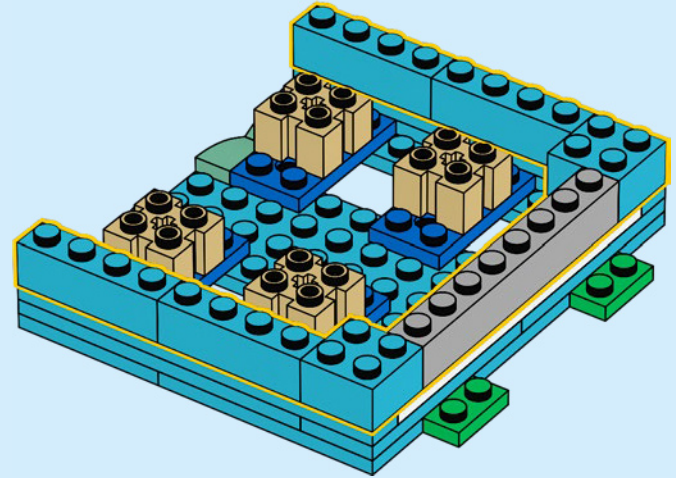

55

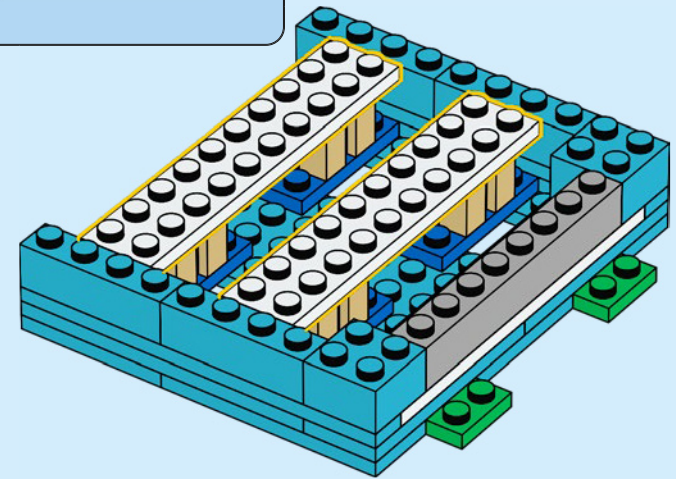

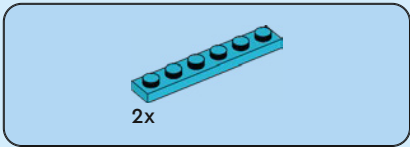

56

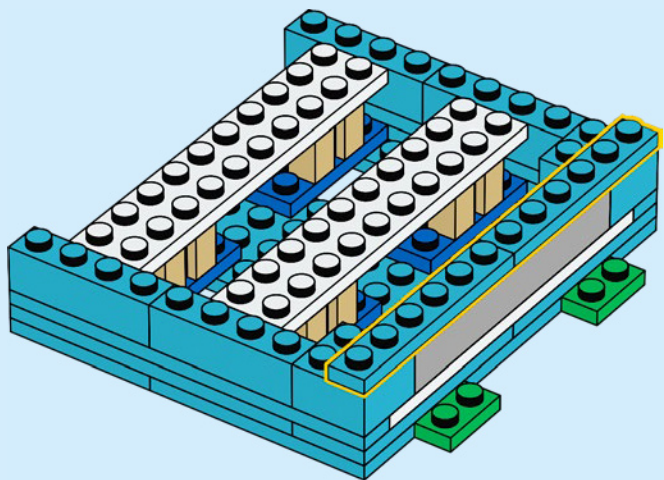

57

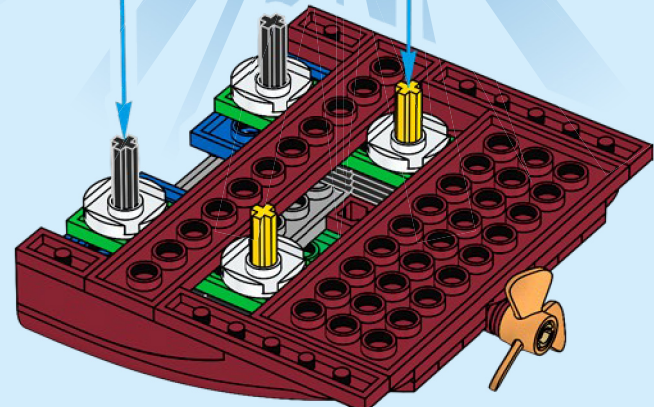
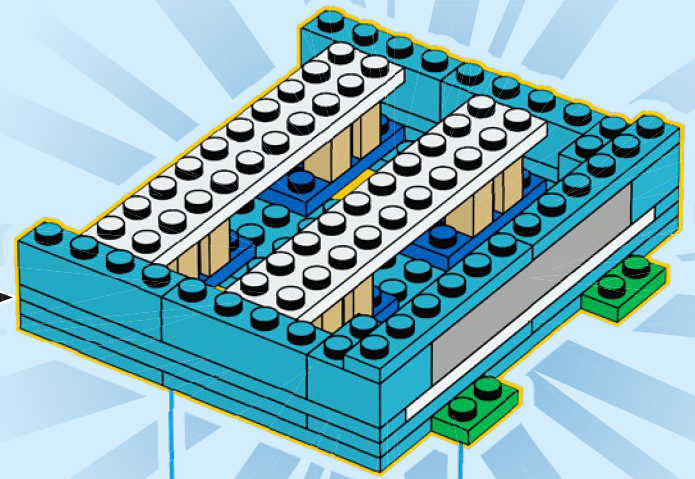

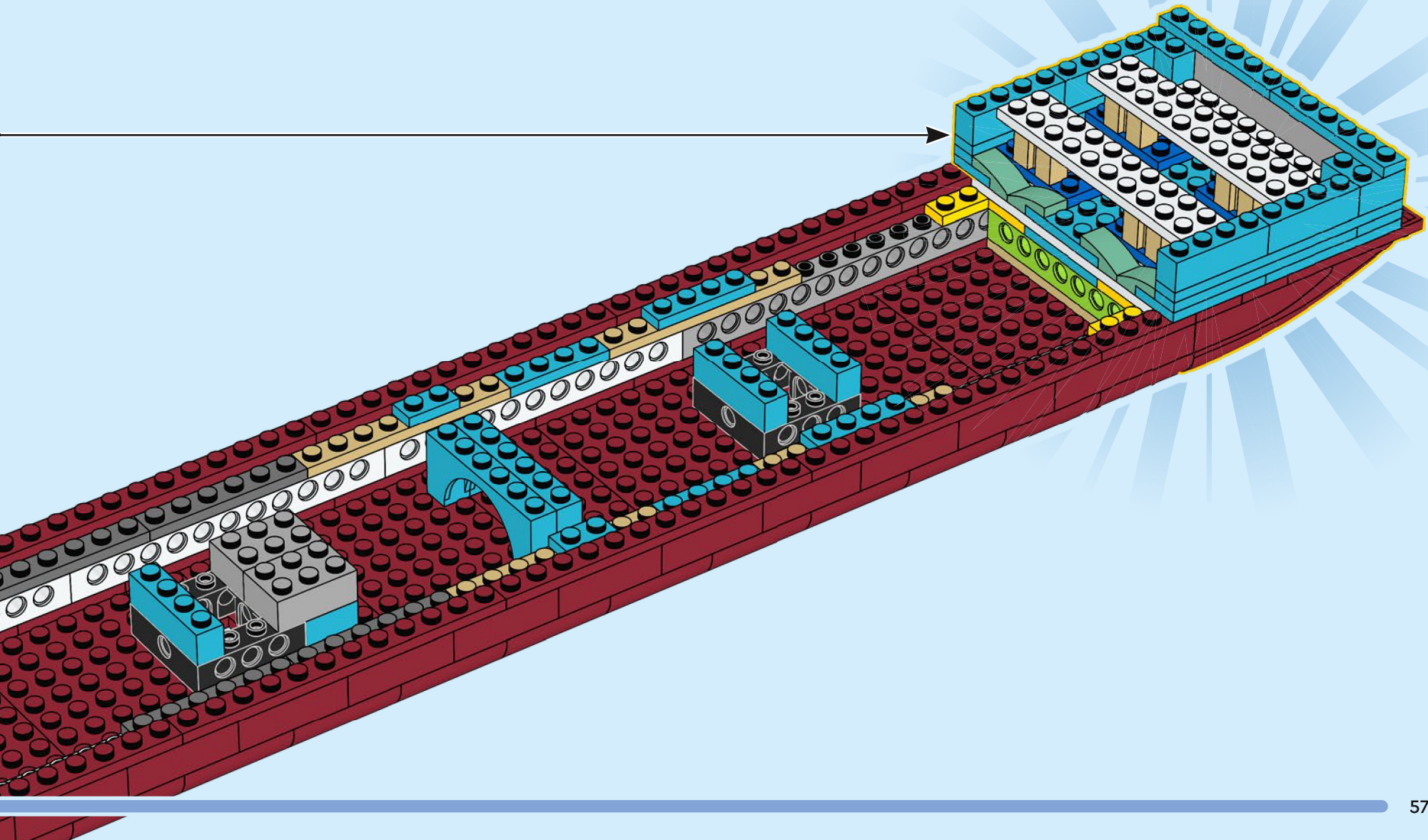

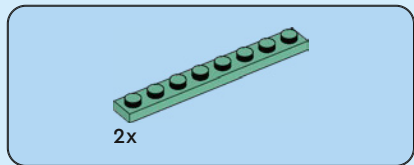
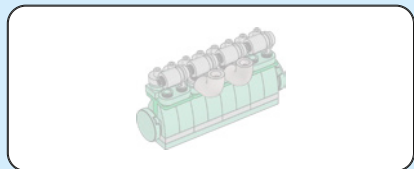

59

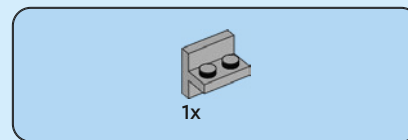
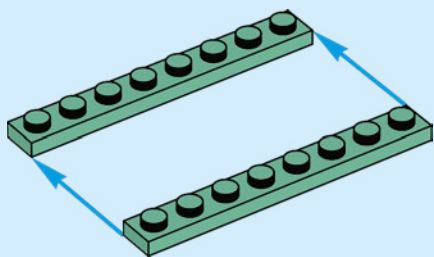

60

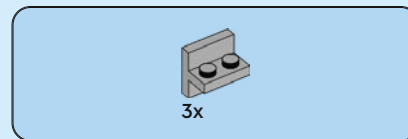
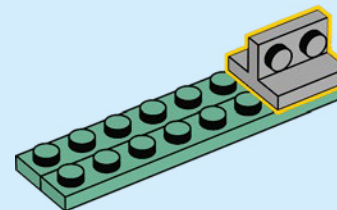

61

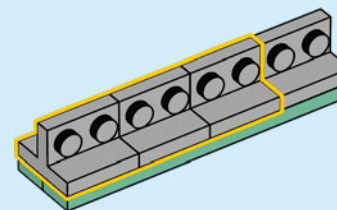



62

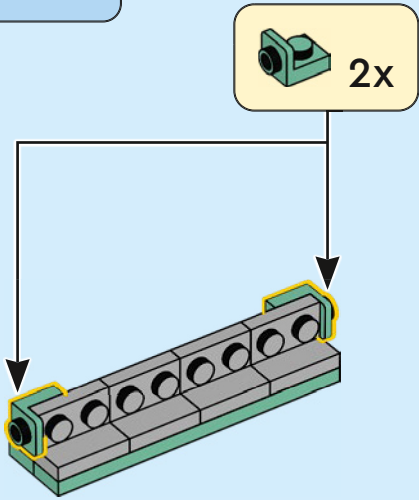

63

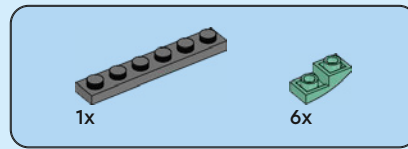
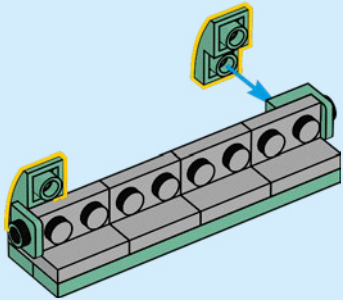

64

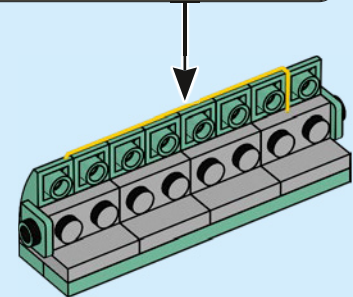
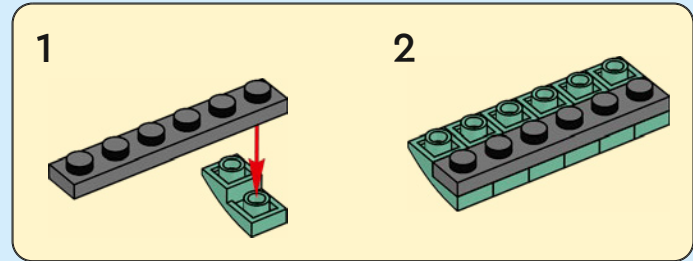

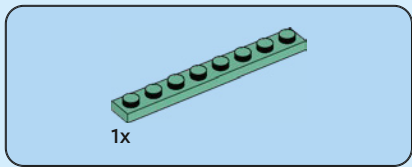

65

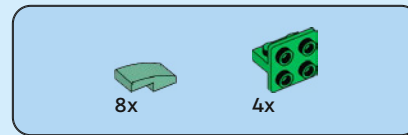
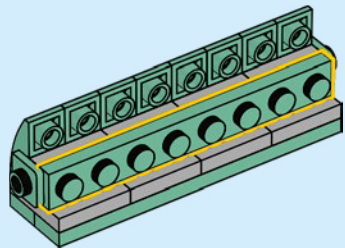

66

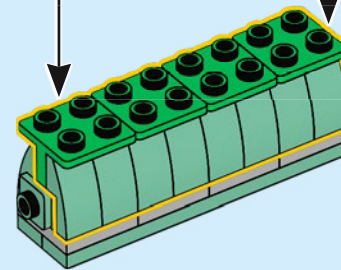
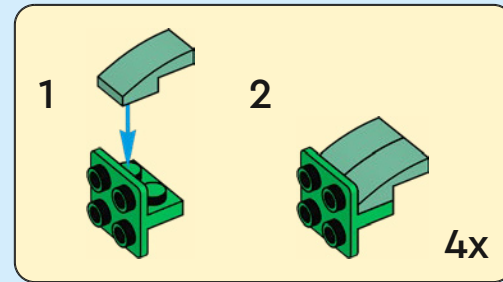

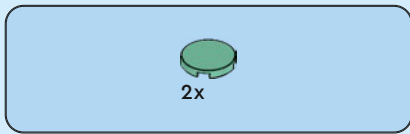

67

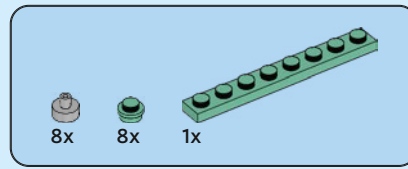
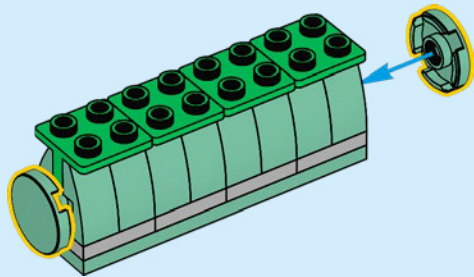

68

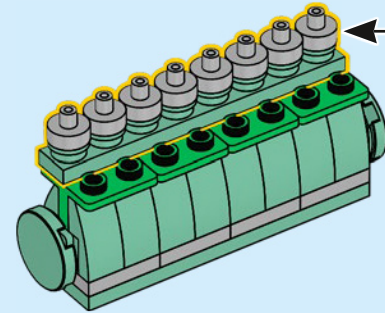
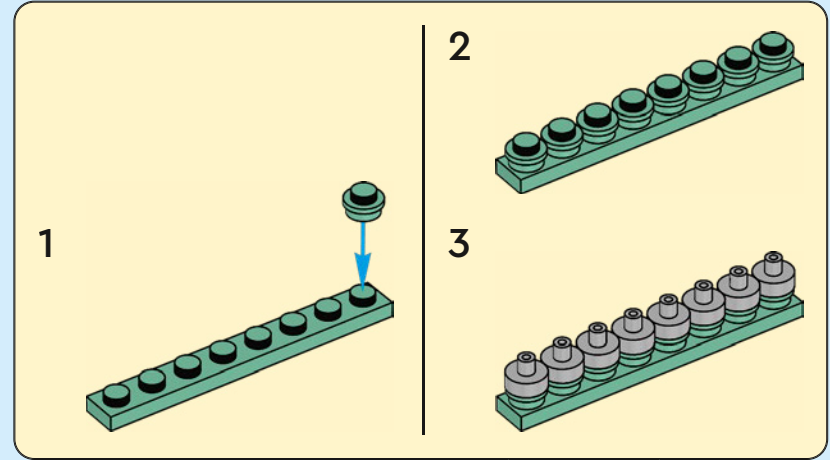



2x

69

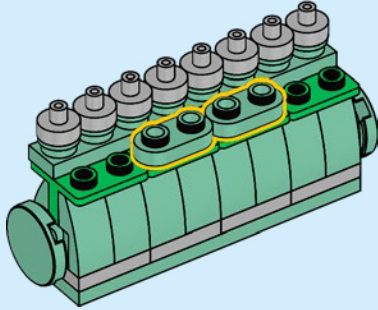

2x



2x

70

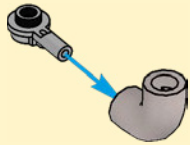
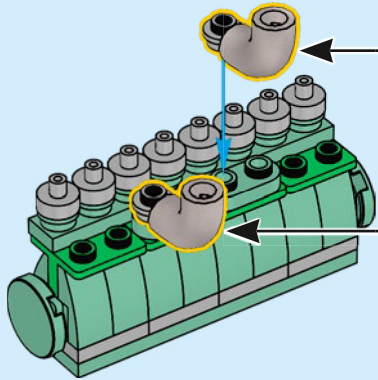

2x



2x

71

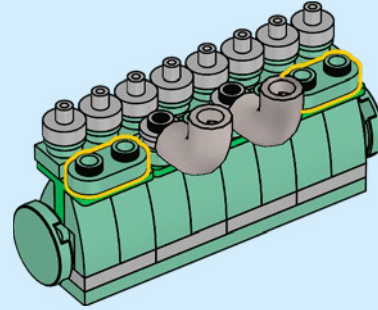

4x



4x

72

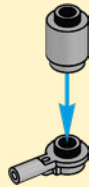
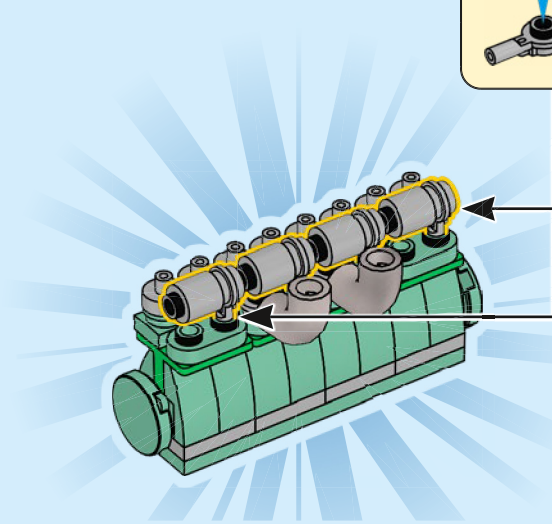

4x

73

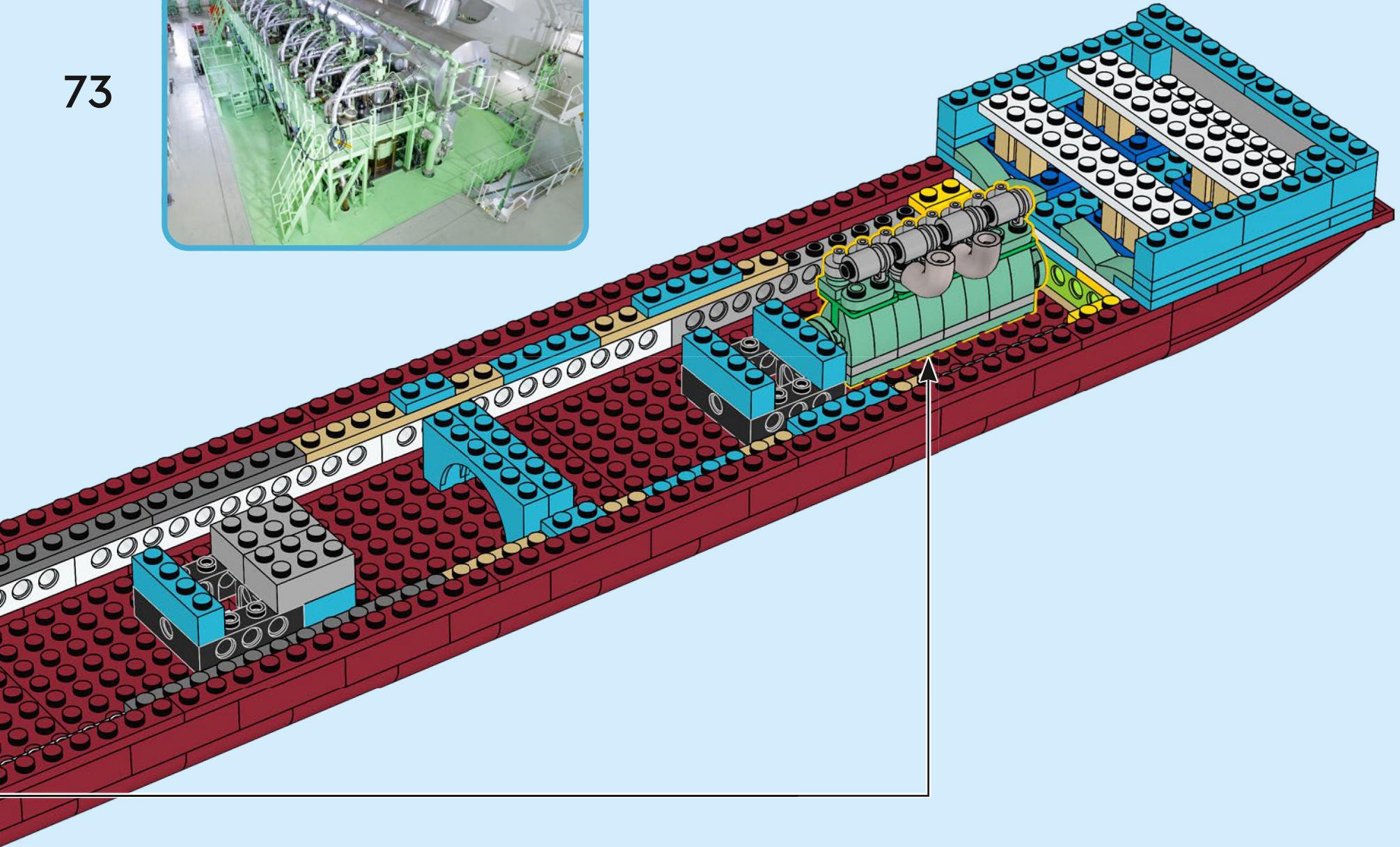
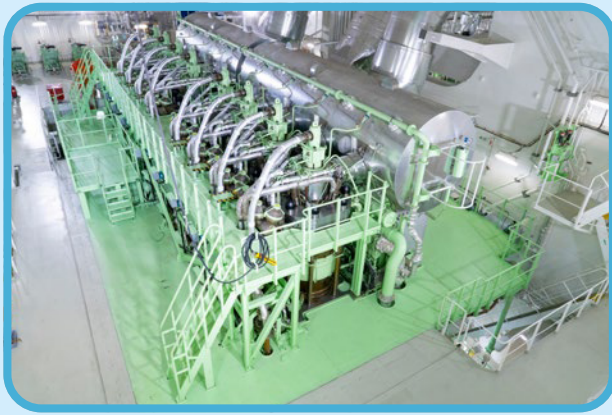

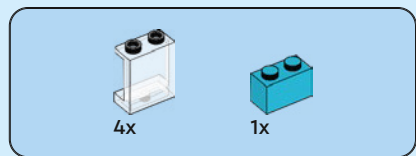

74

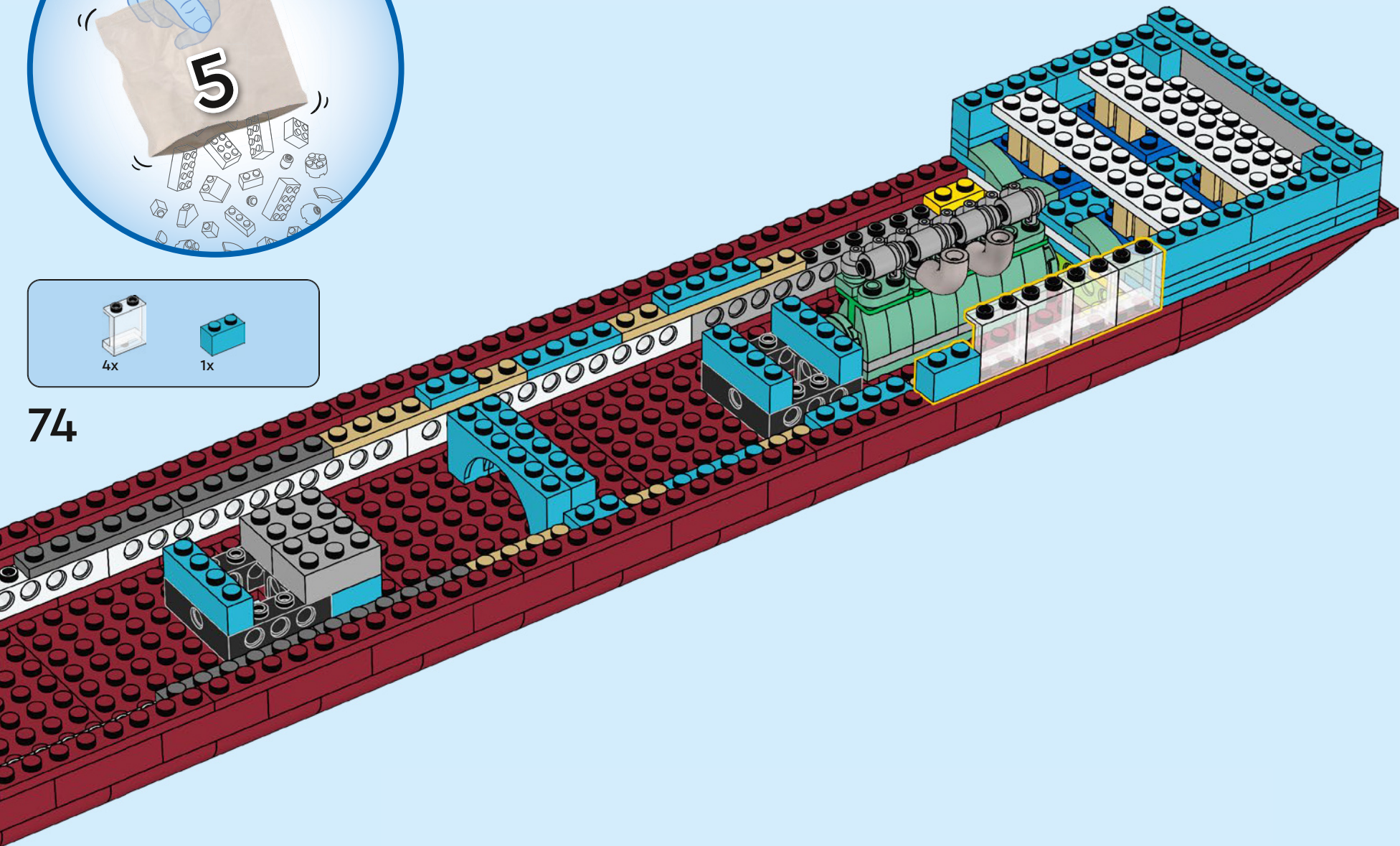

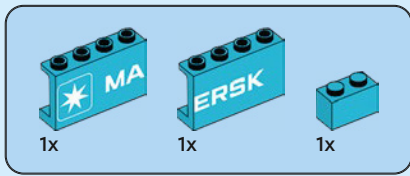

75

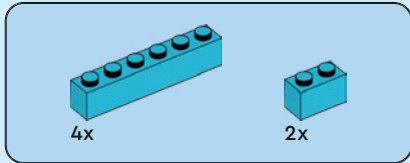
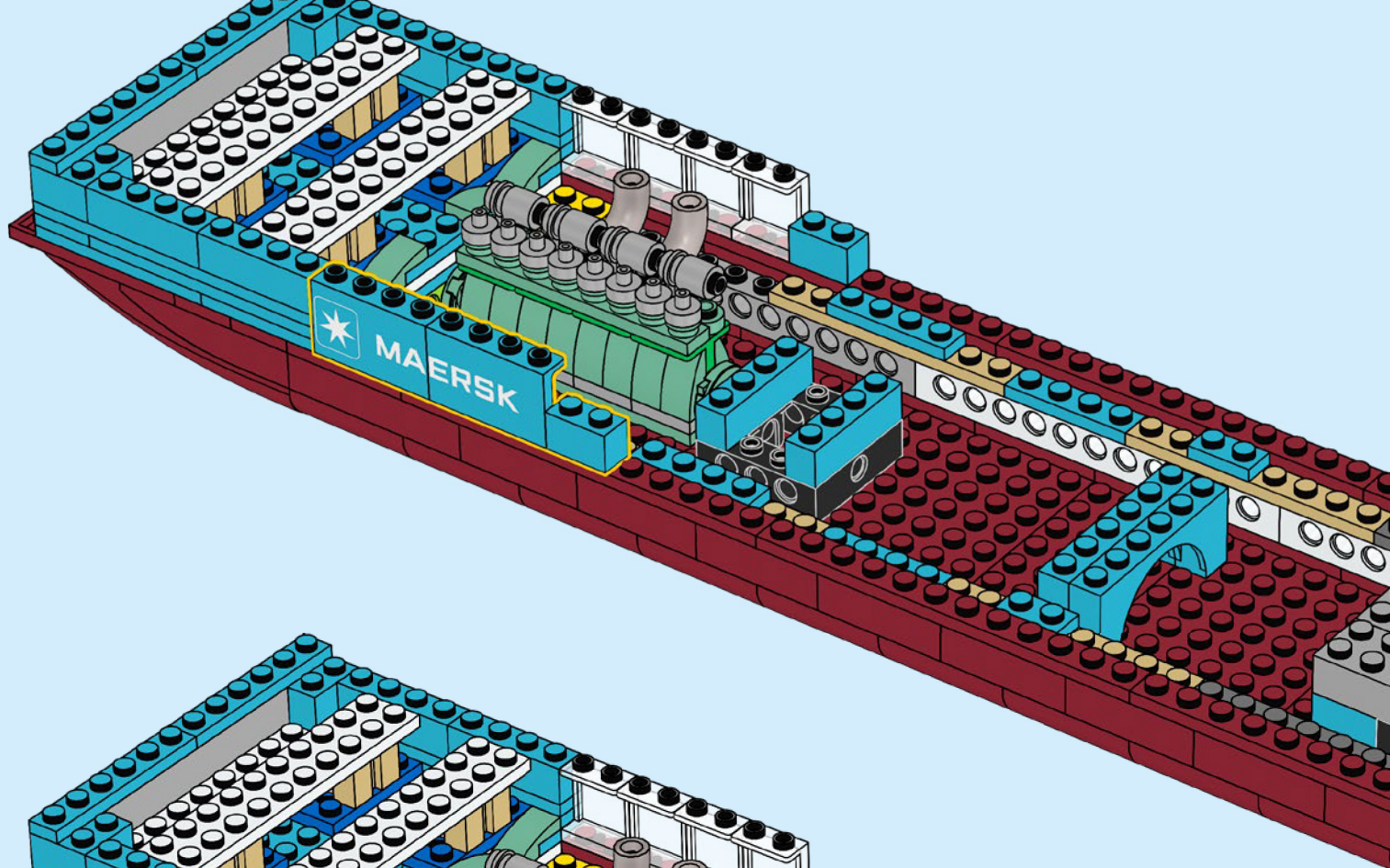

76

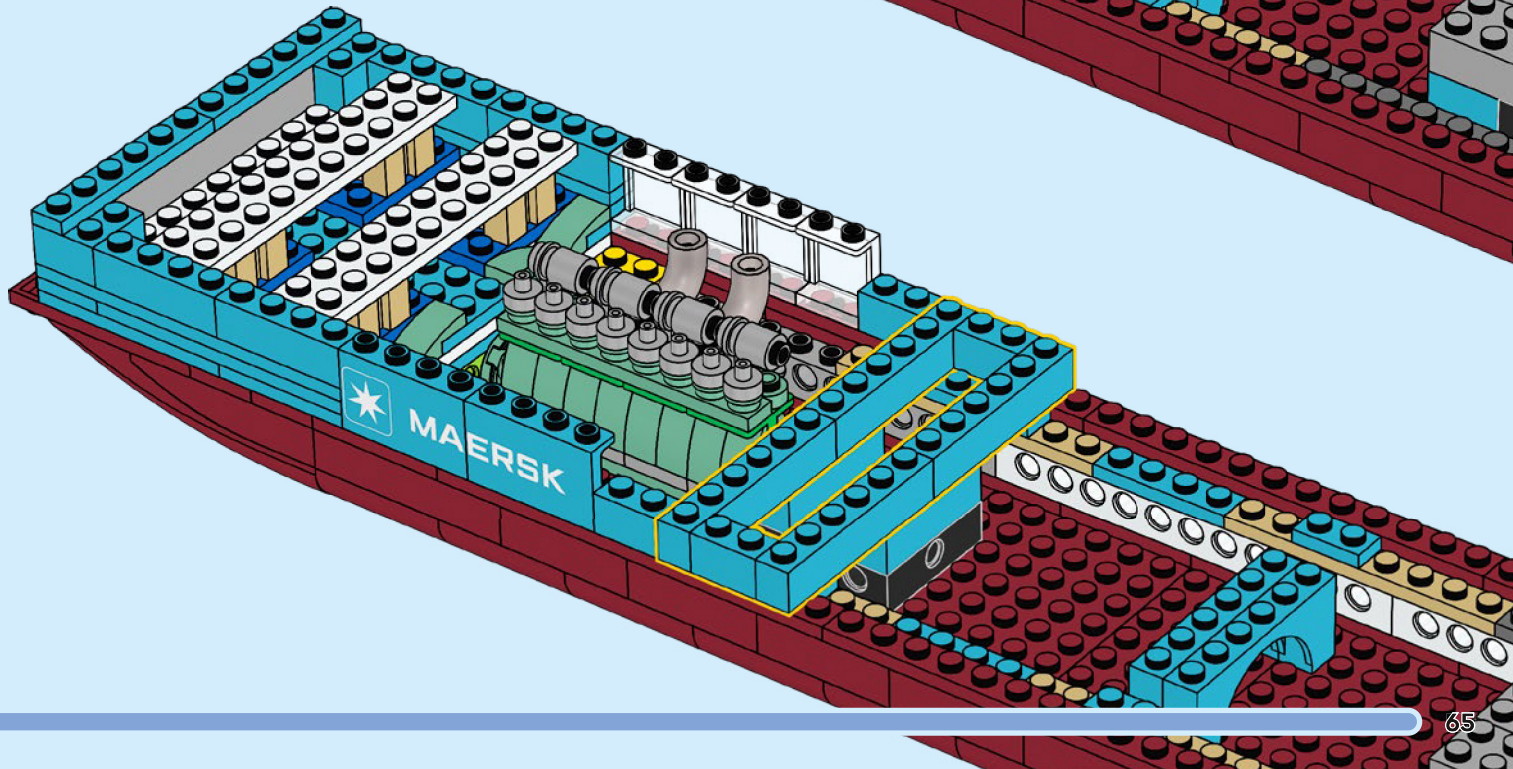

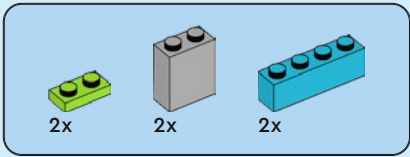

77

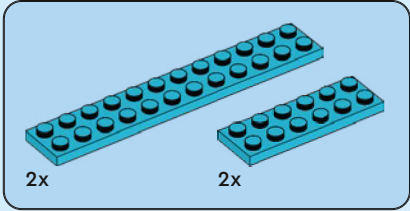
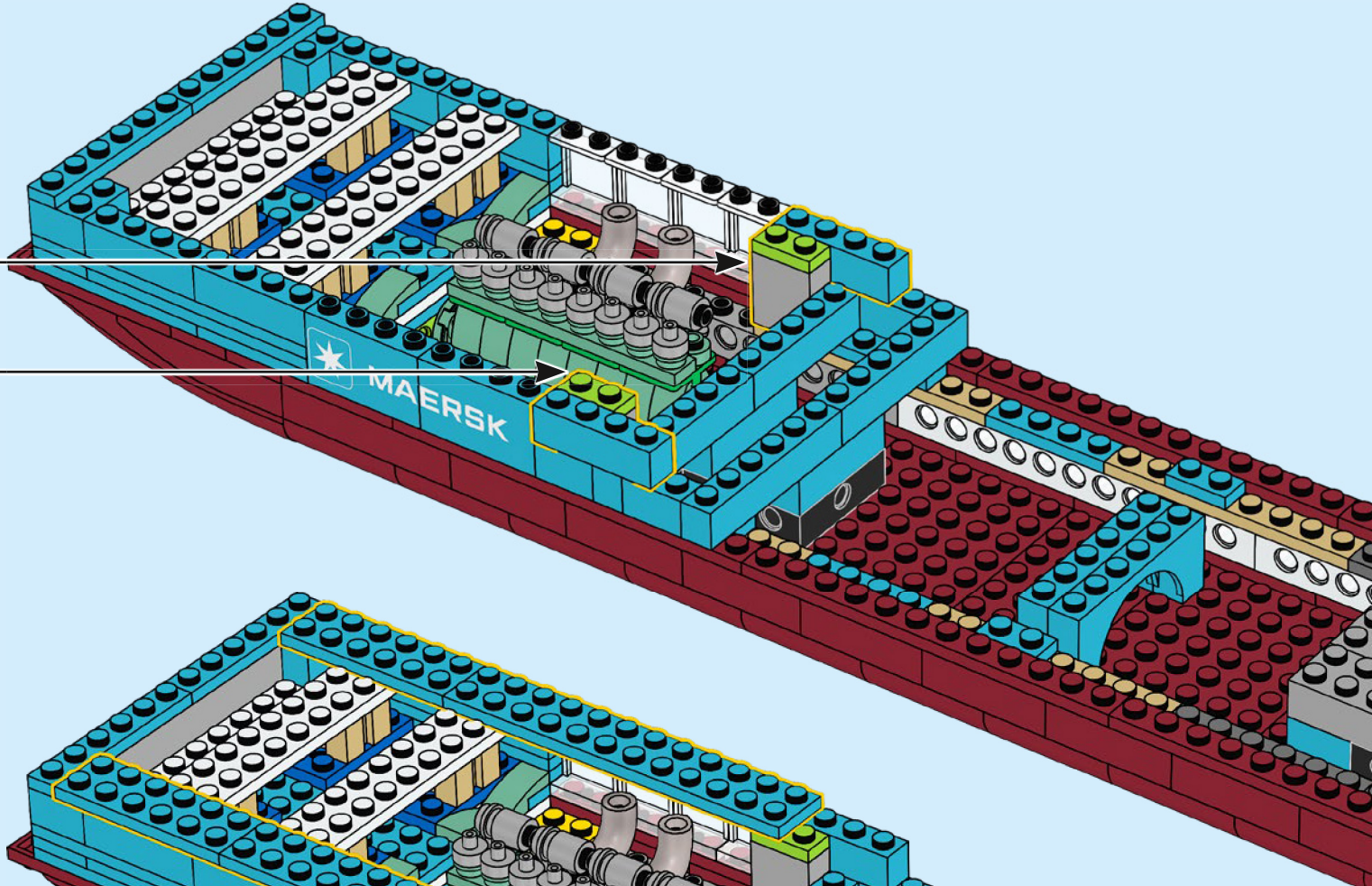
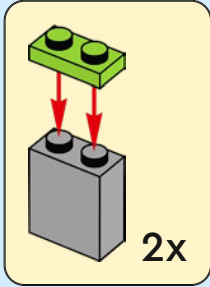

78

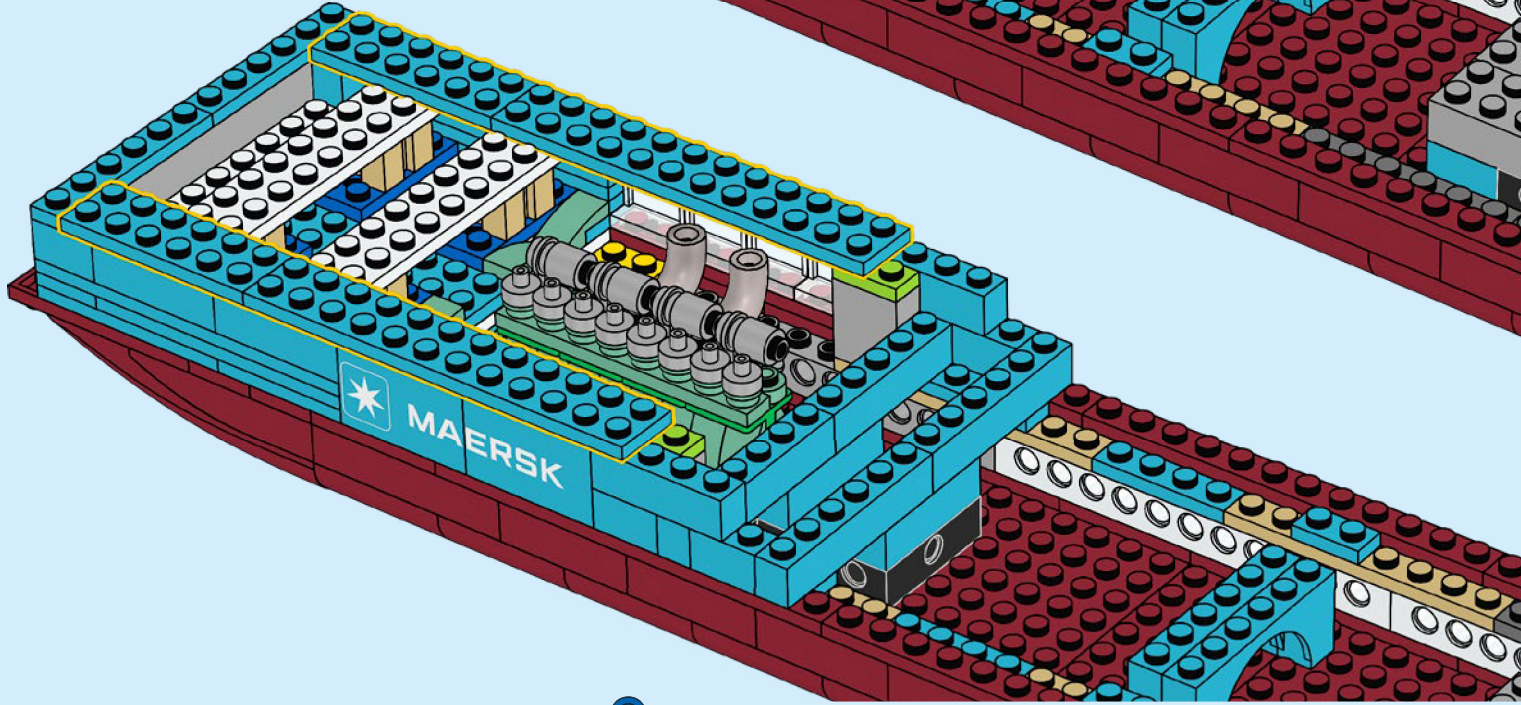

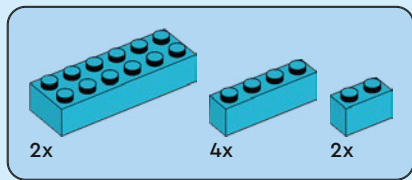

79

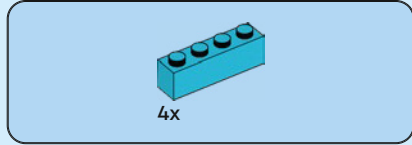
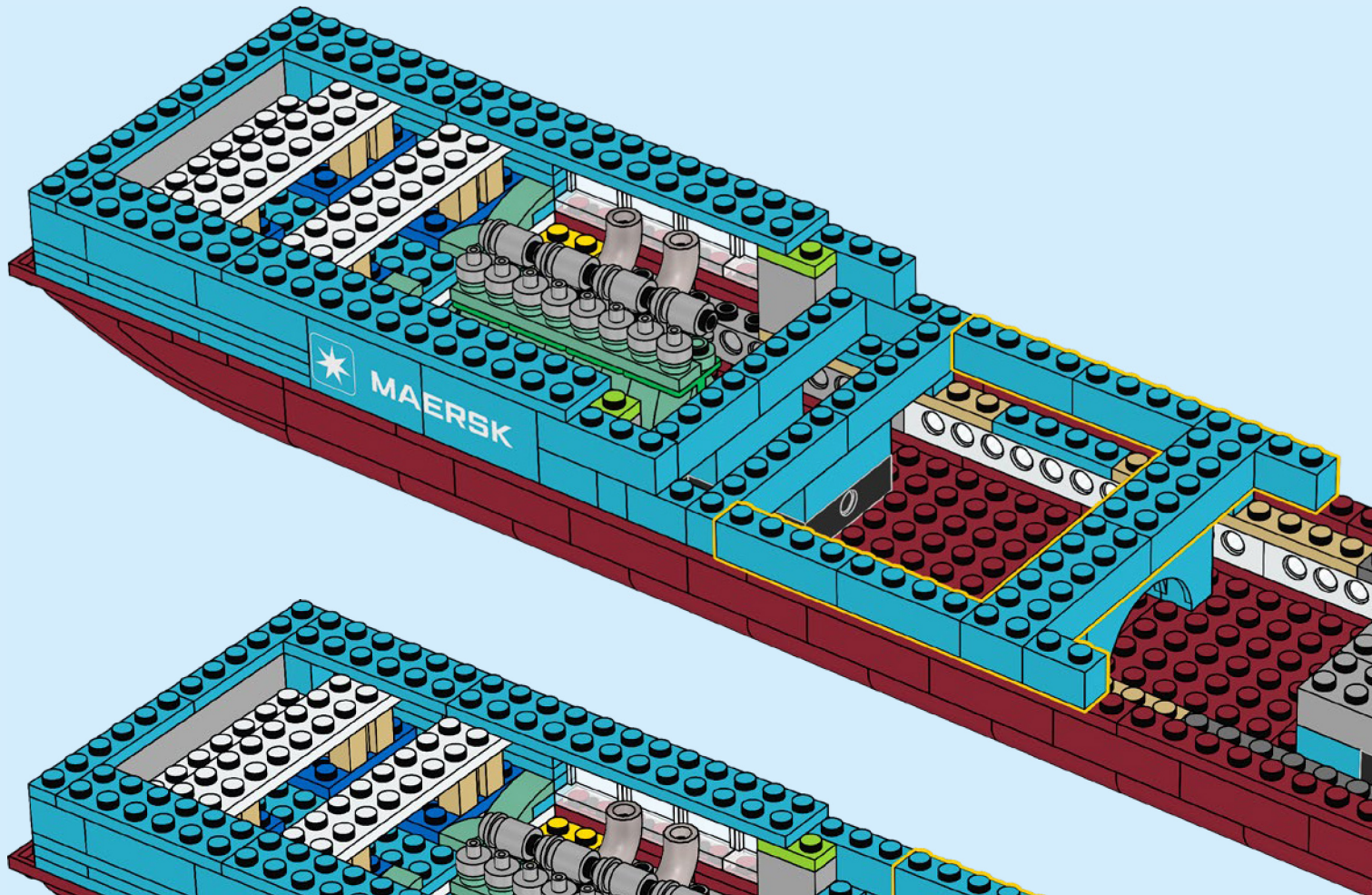

80

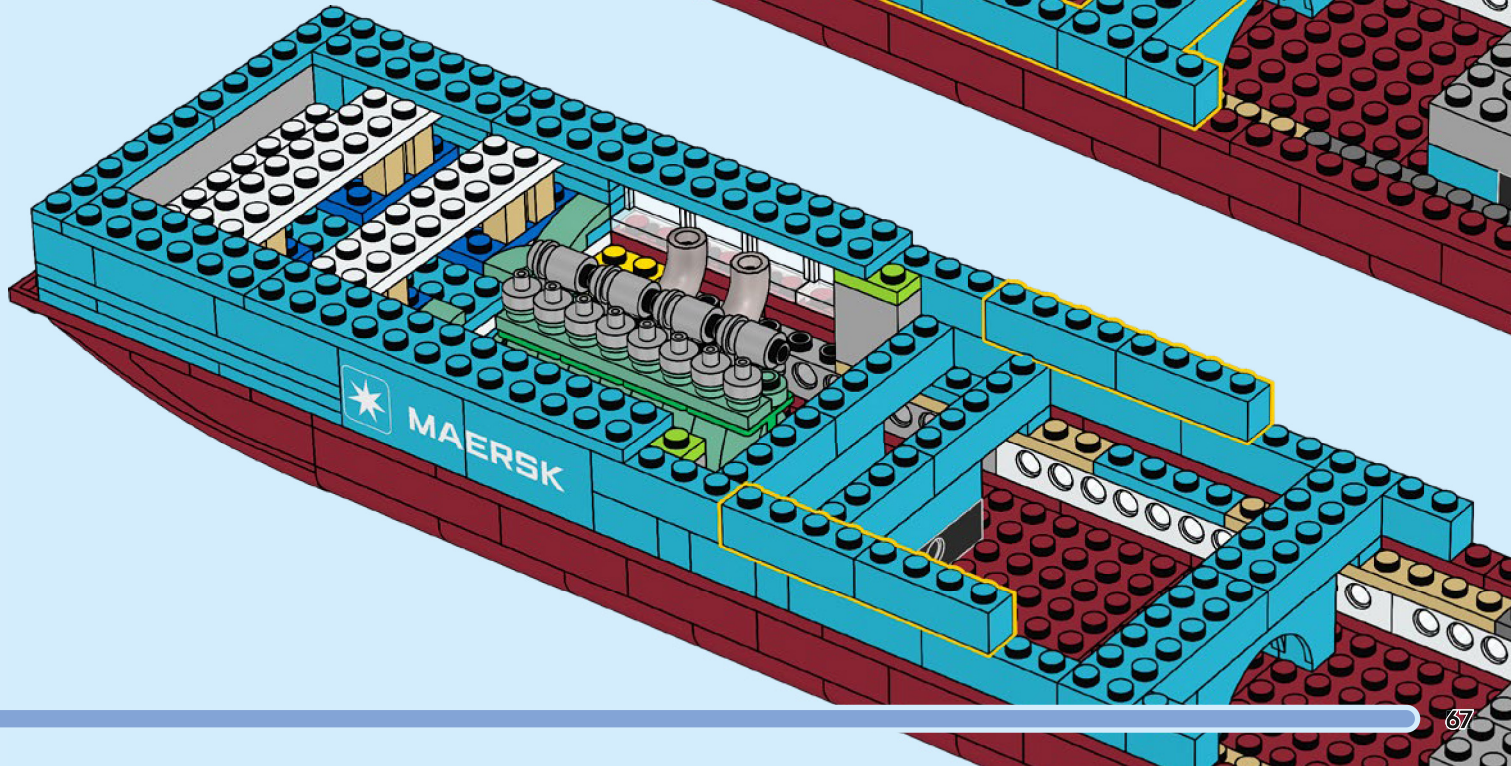

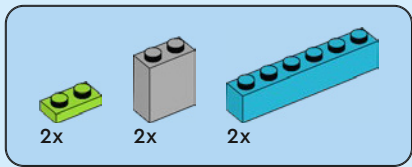

81

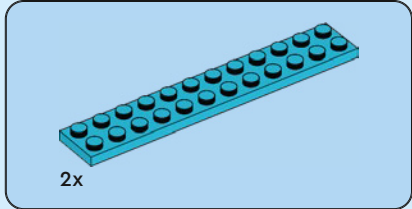
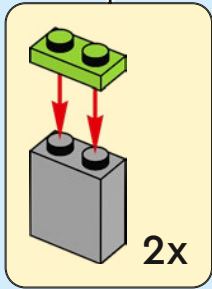
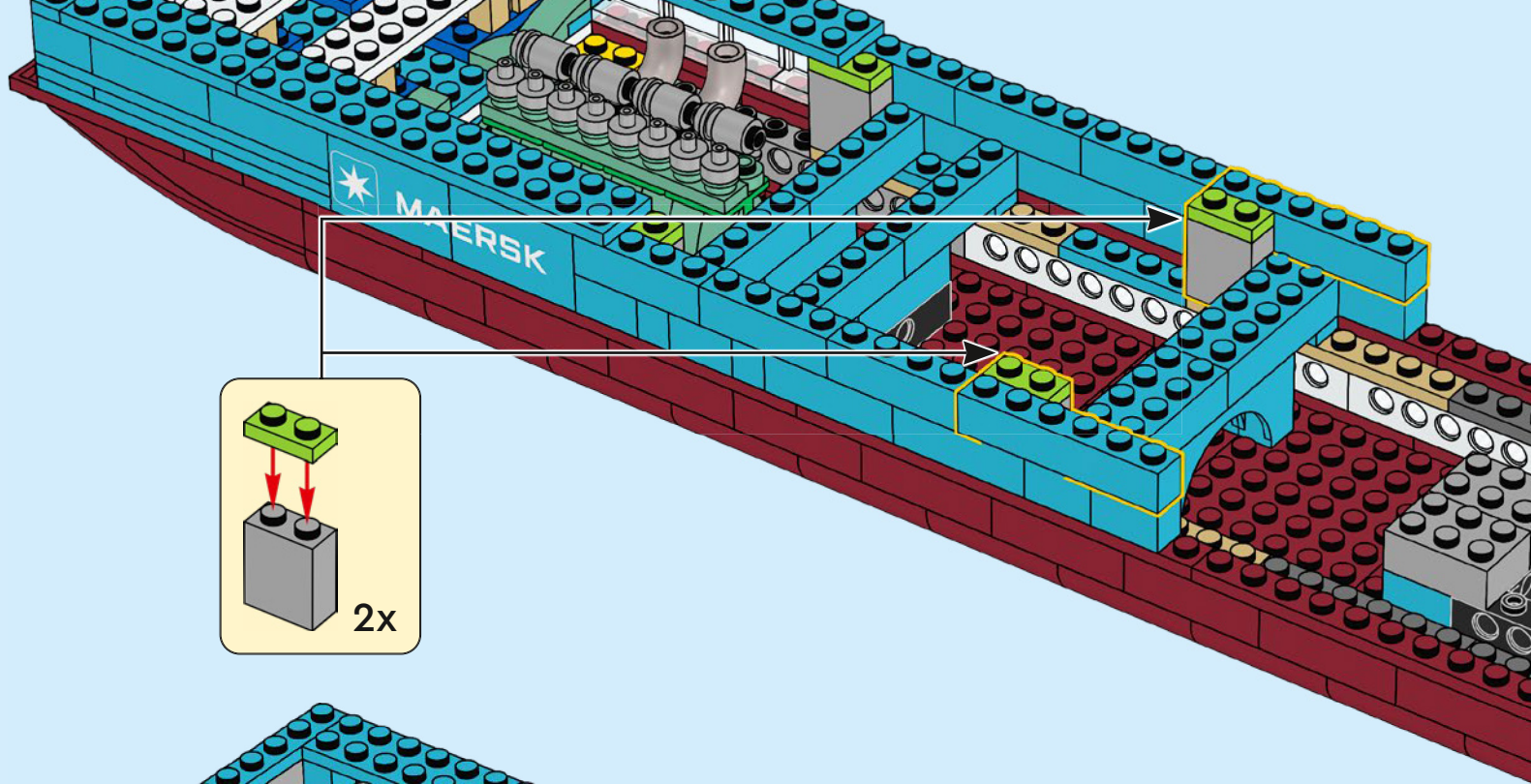

82

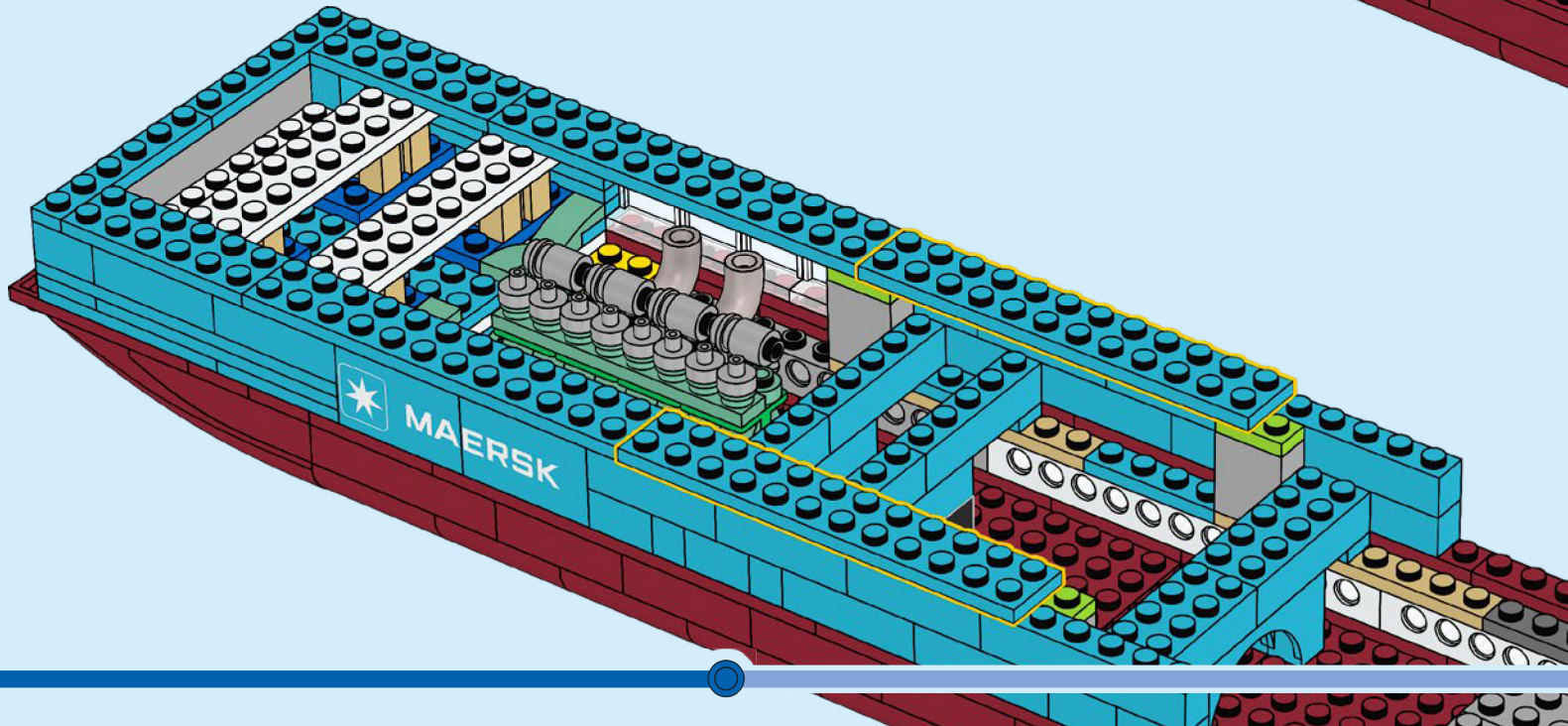

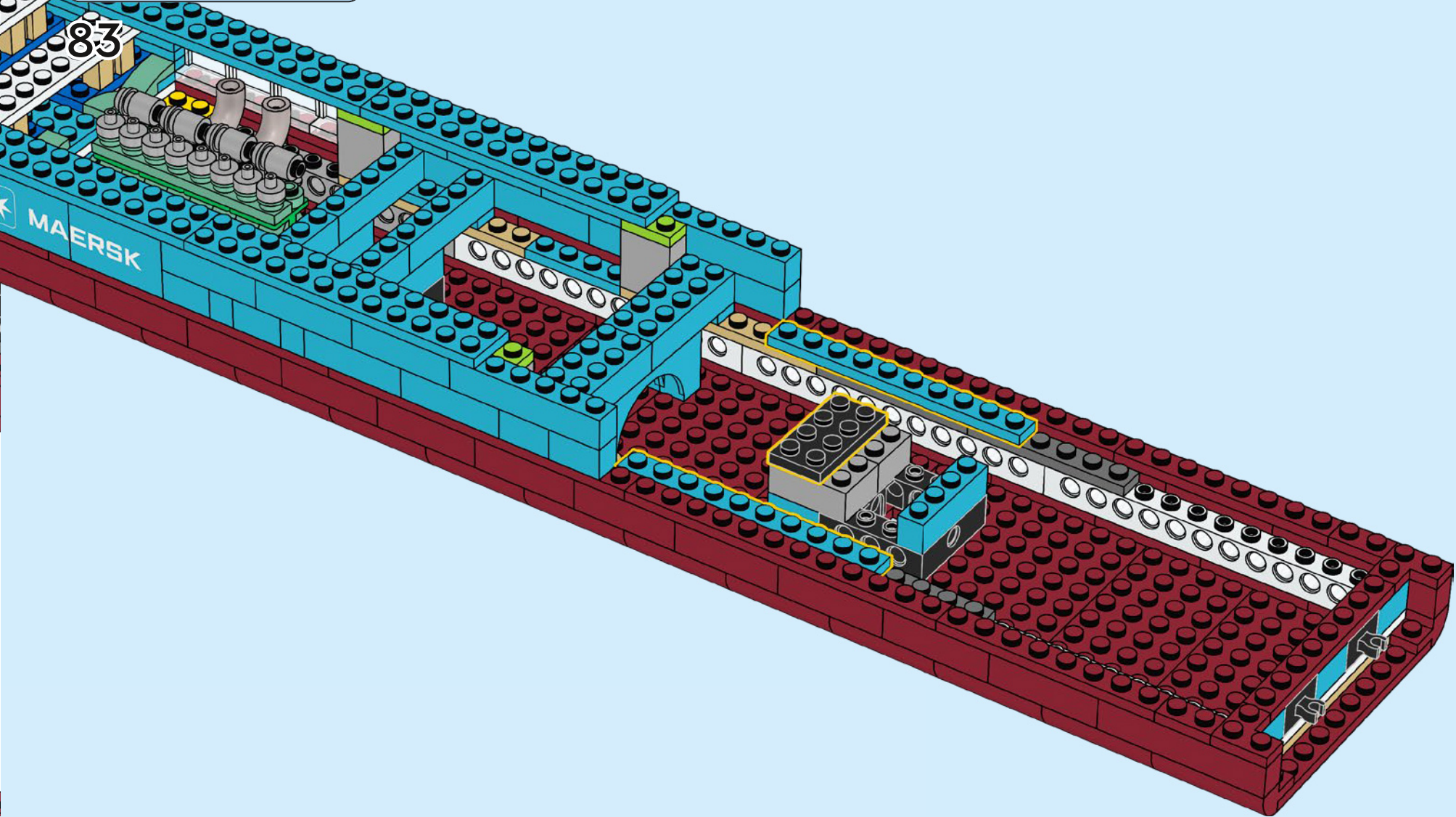
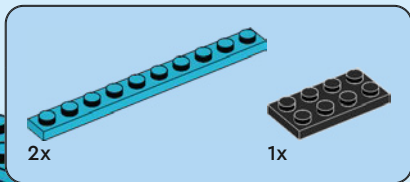

84

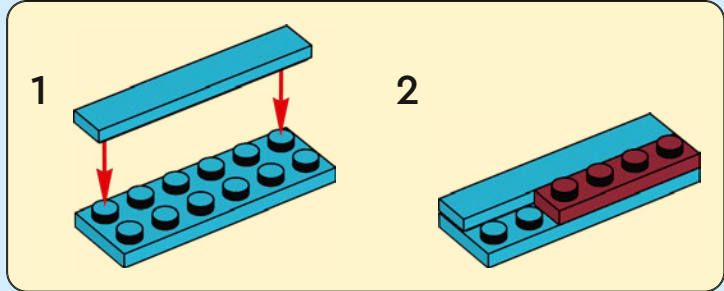
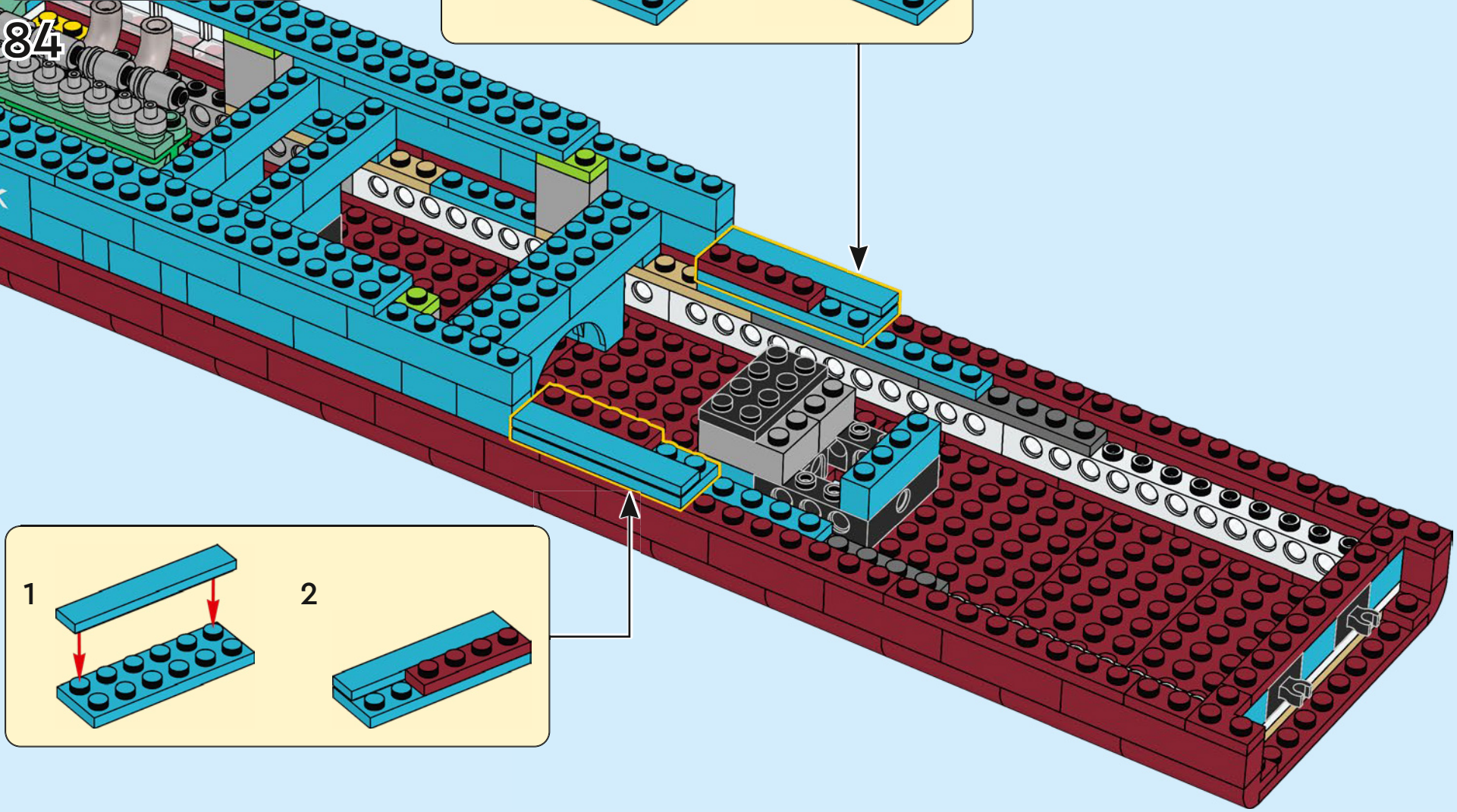
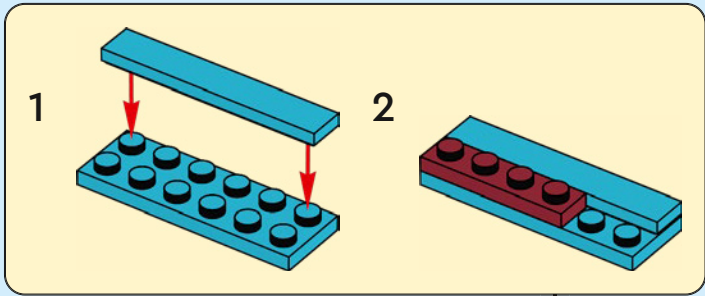
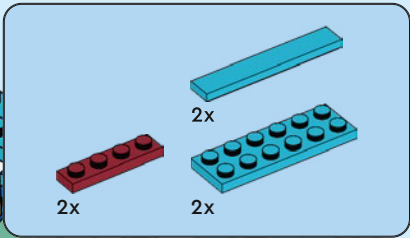

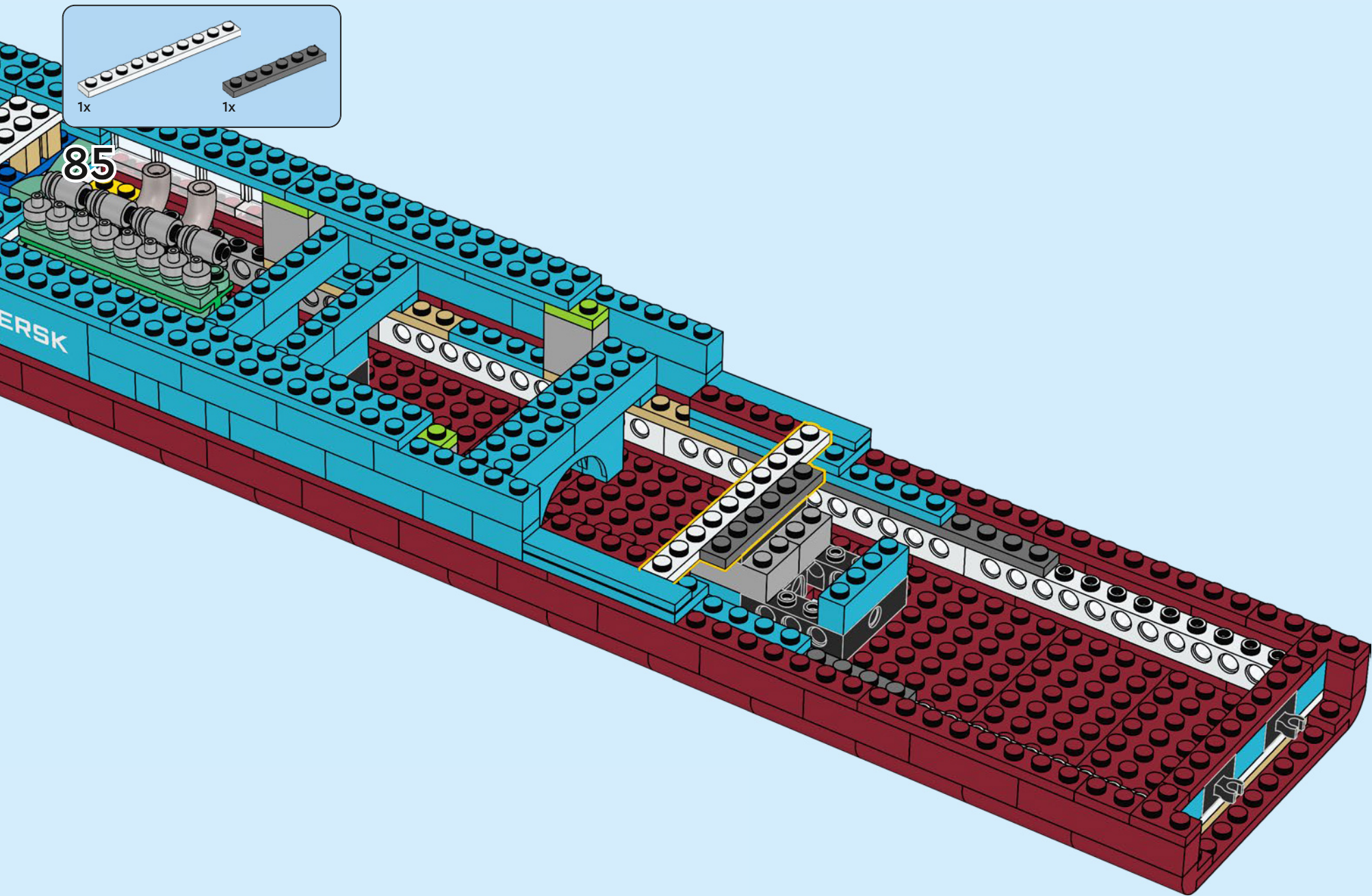

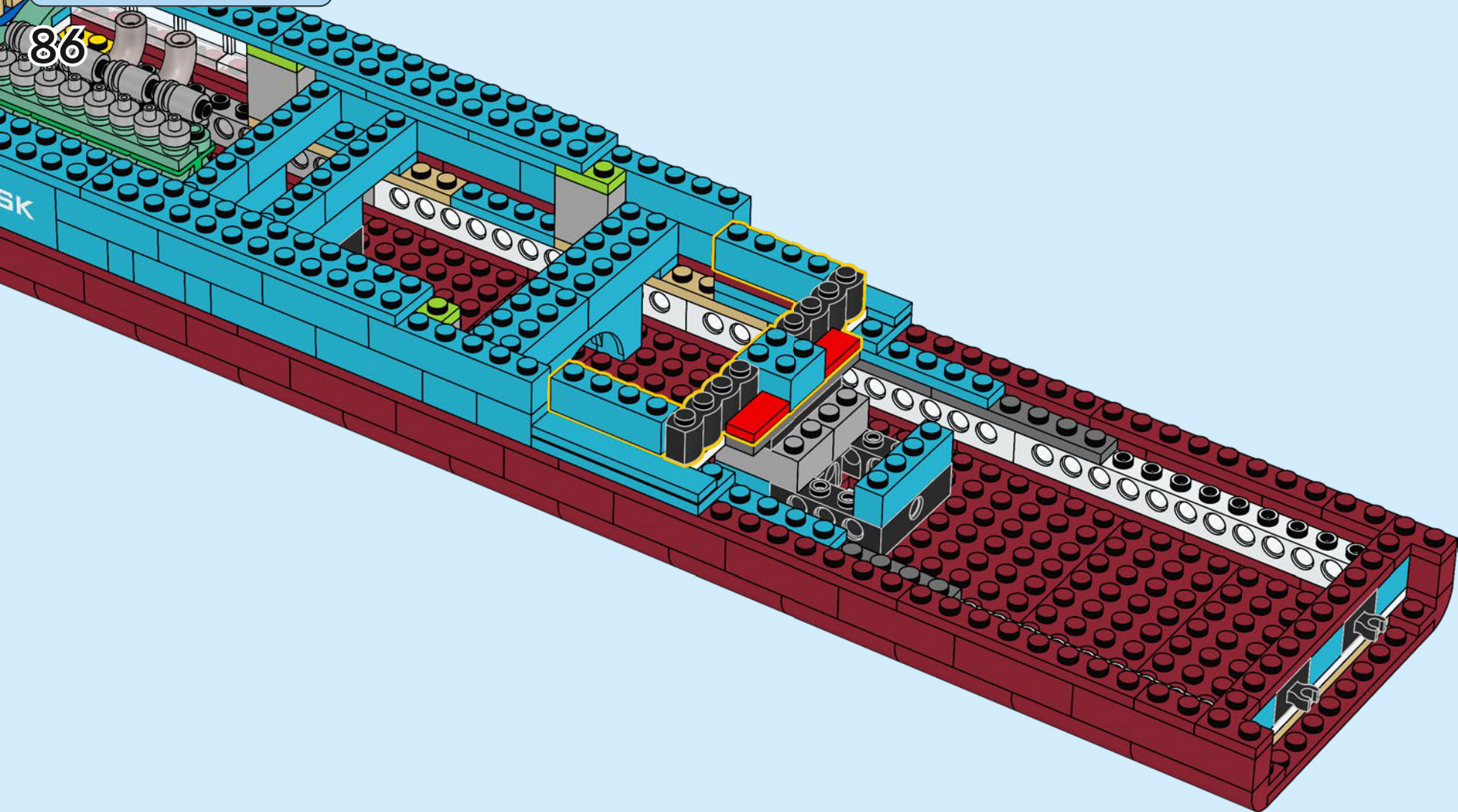
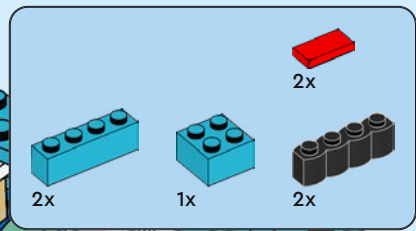

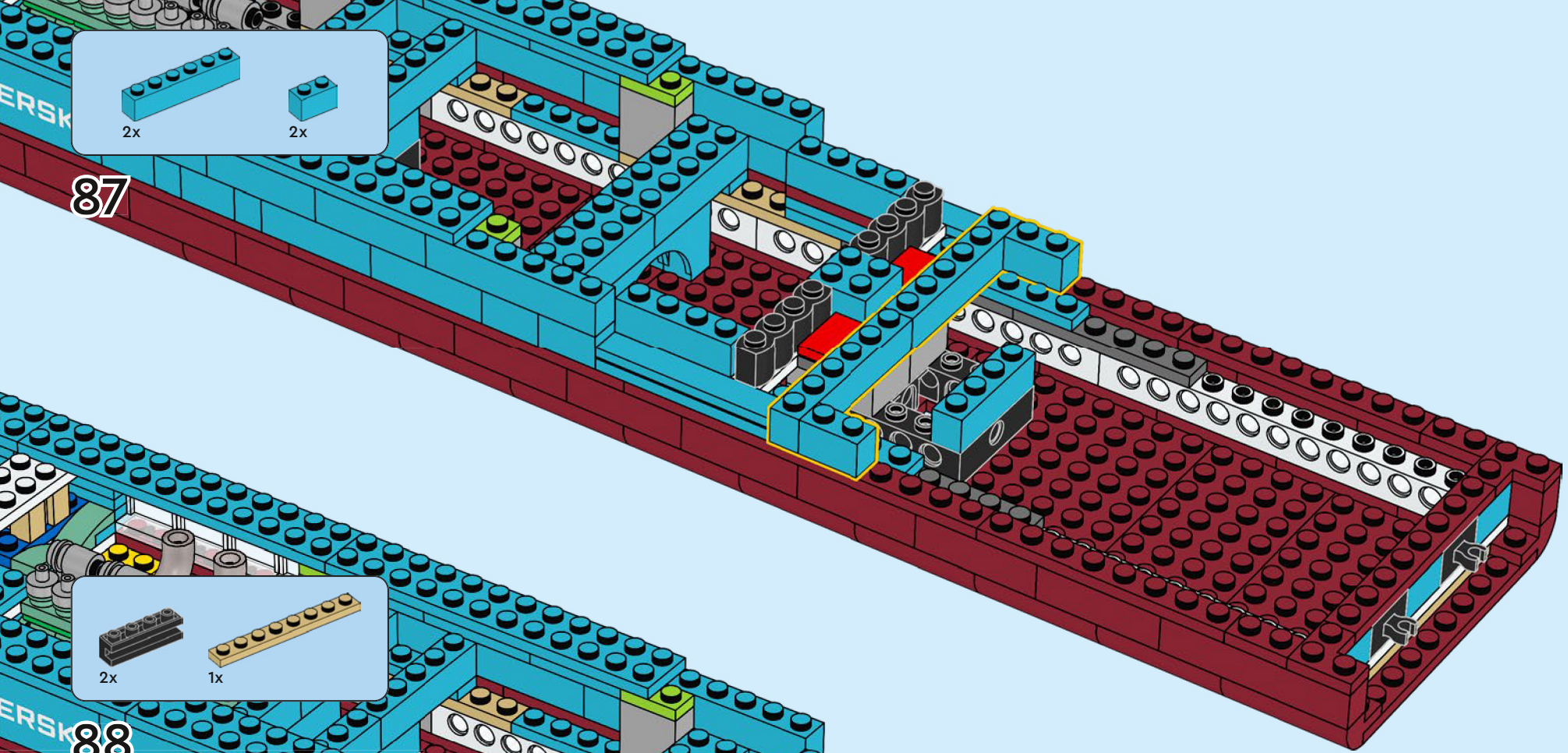

87

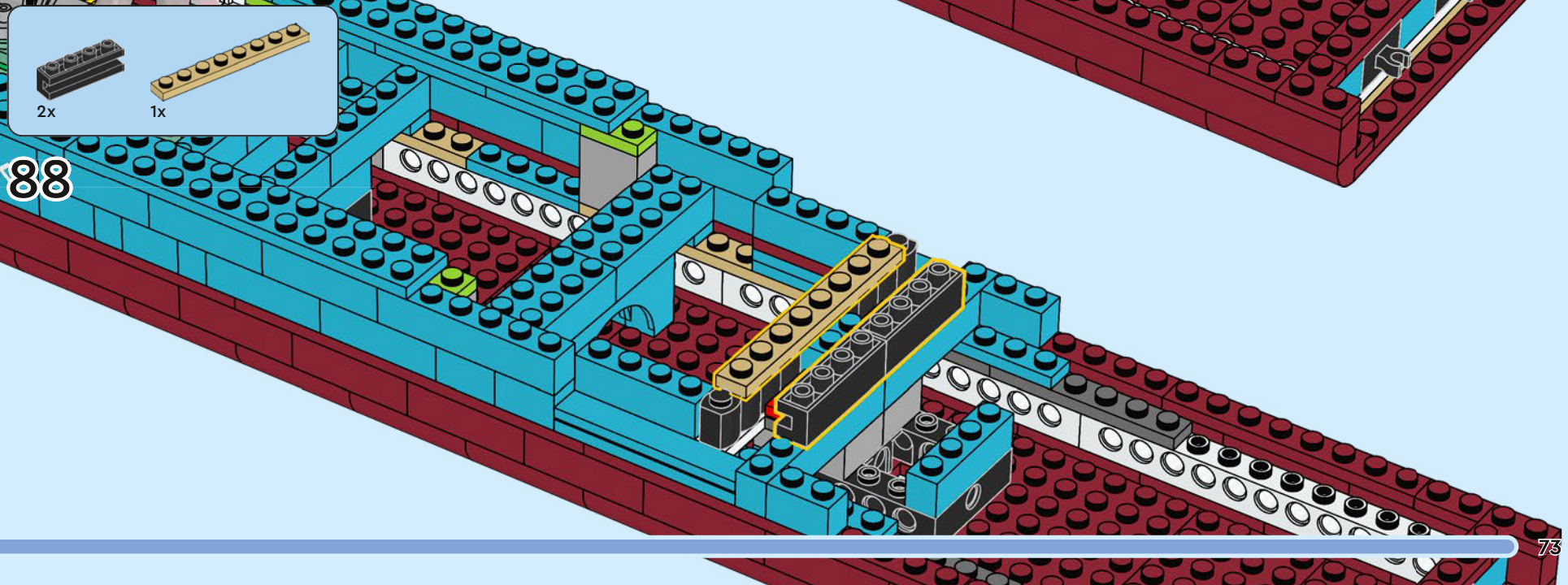

88

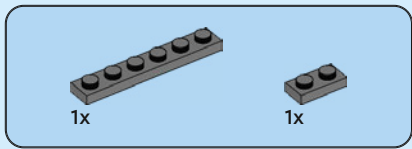

89

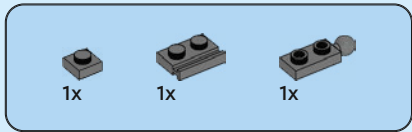
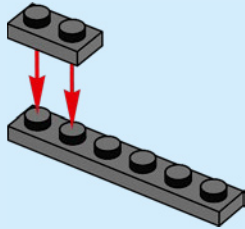

90

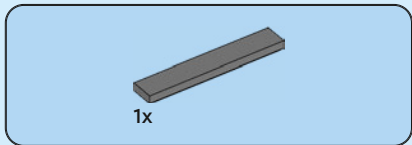
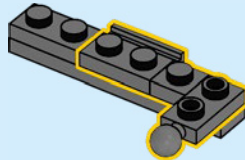

91

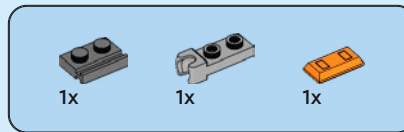
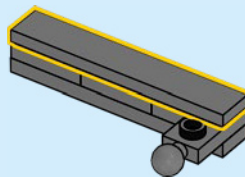

92

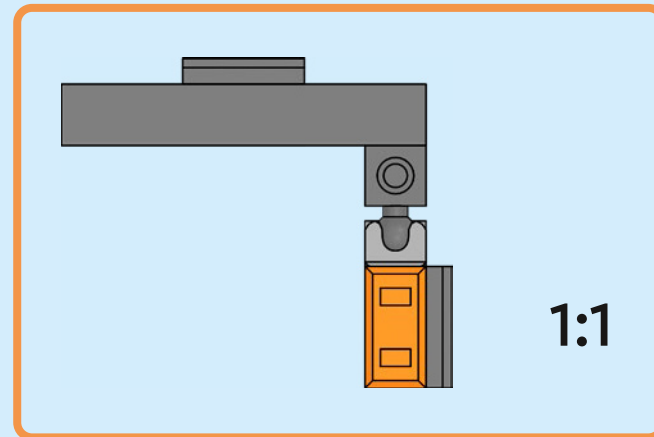
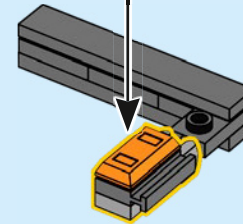
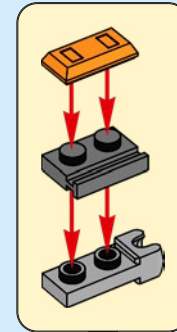

93

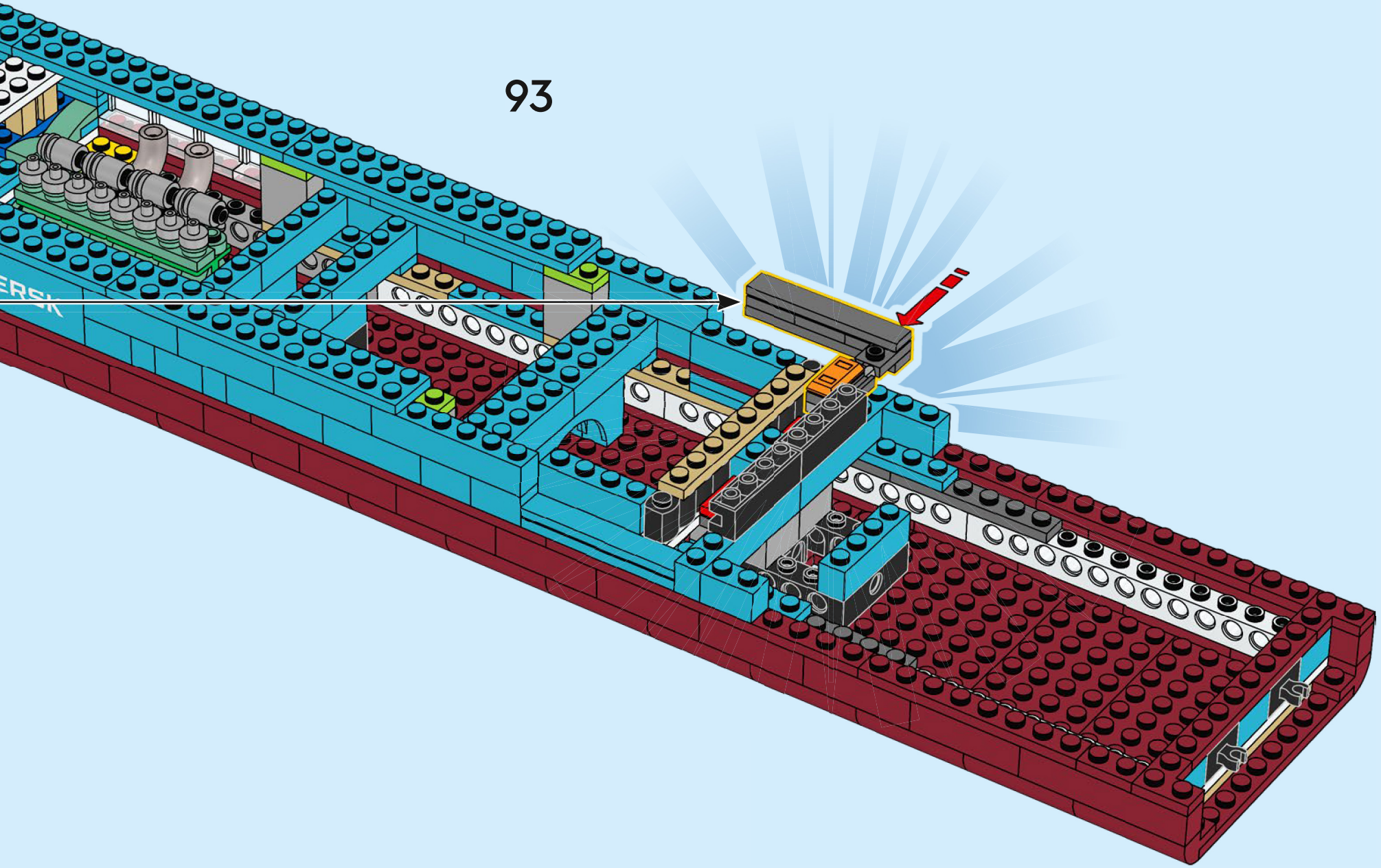

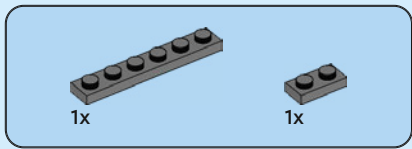

94

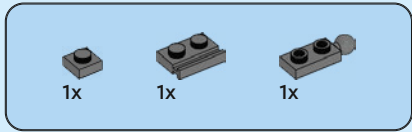
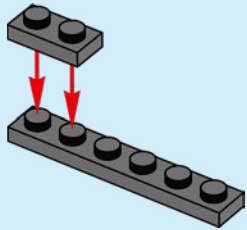

95

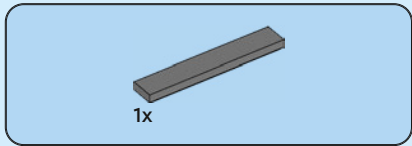
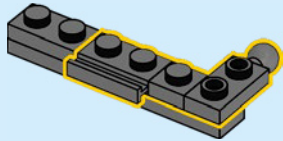

96

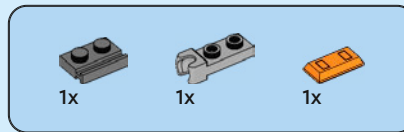
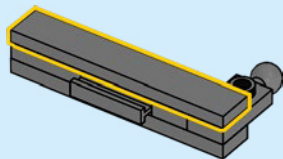

97

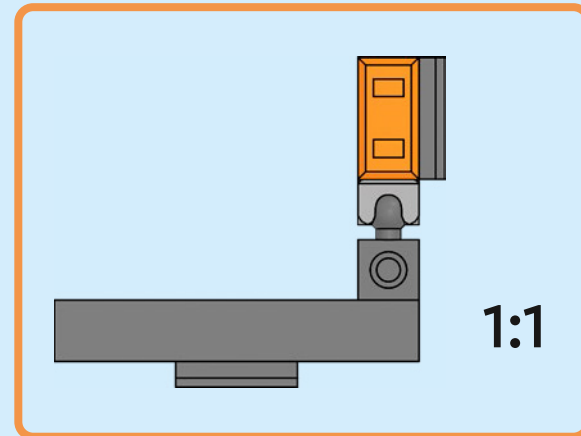
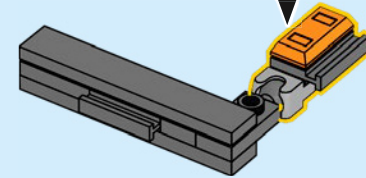
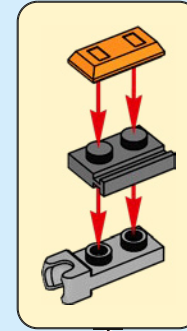

98

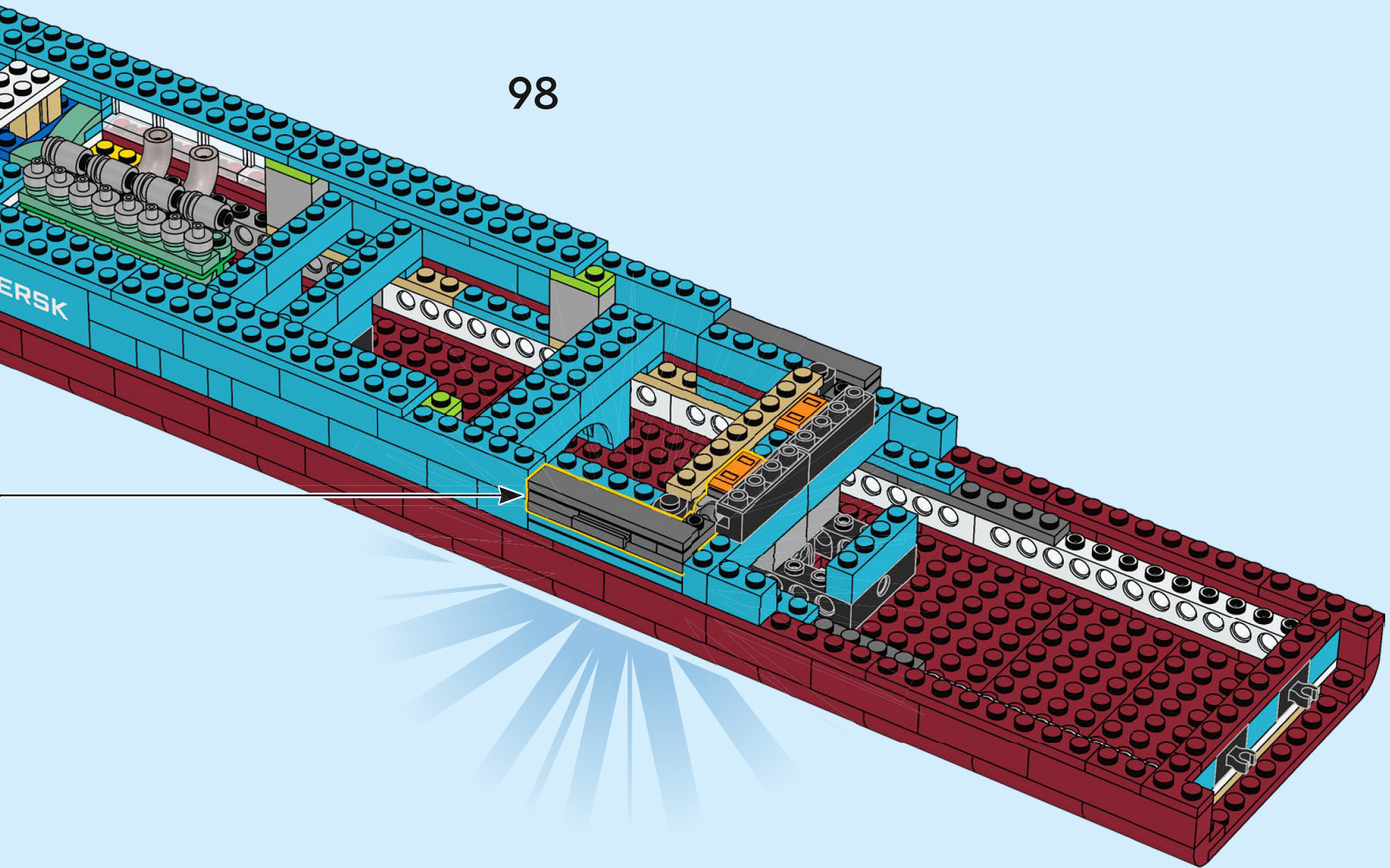

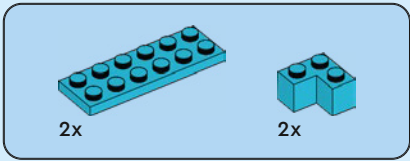

99

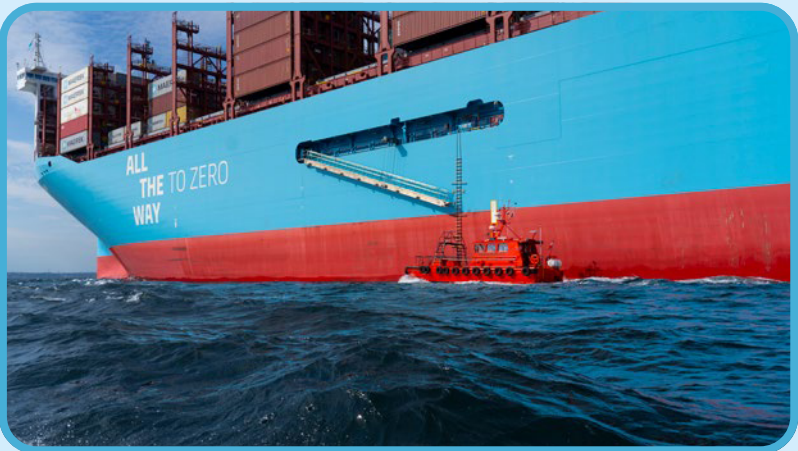
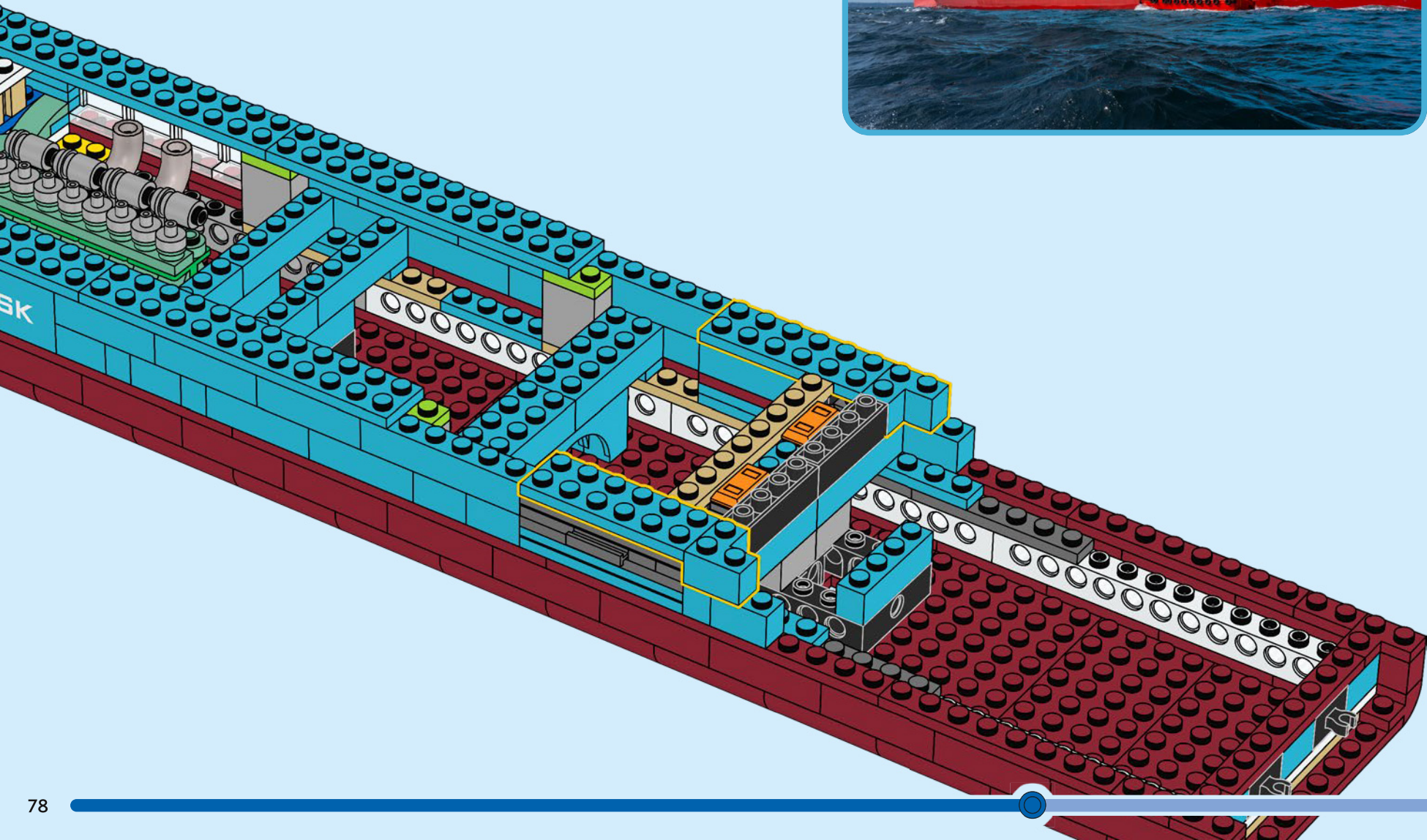

1

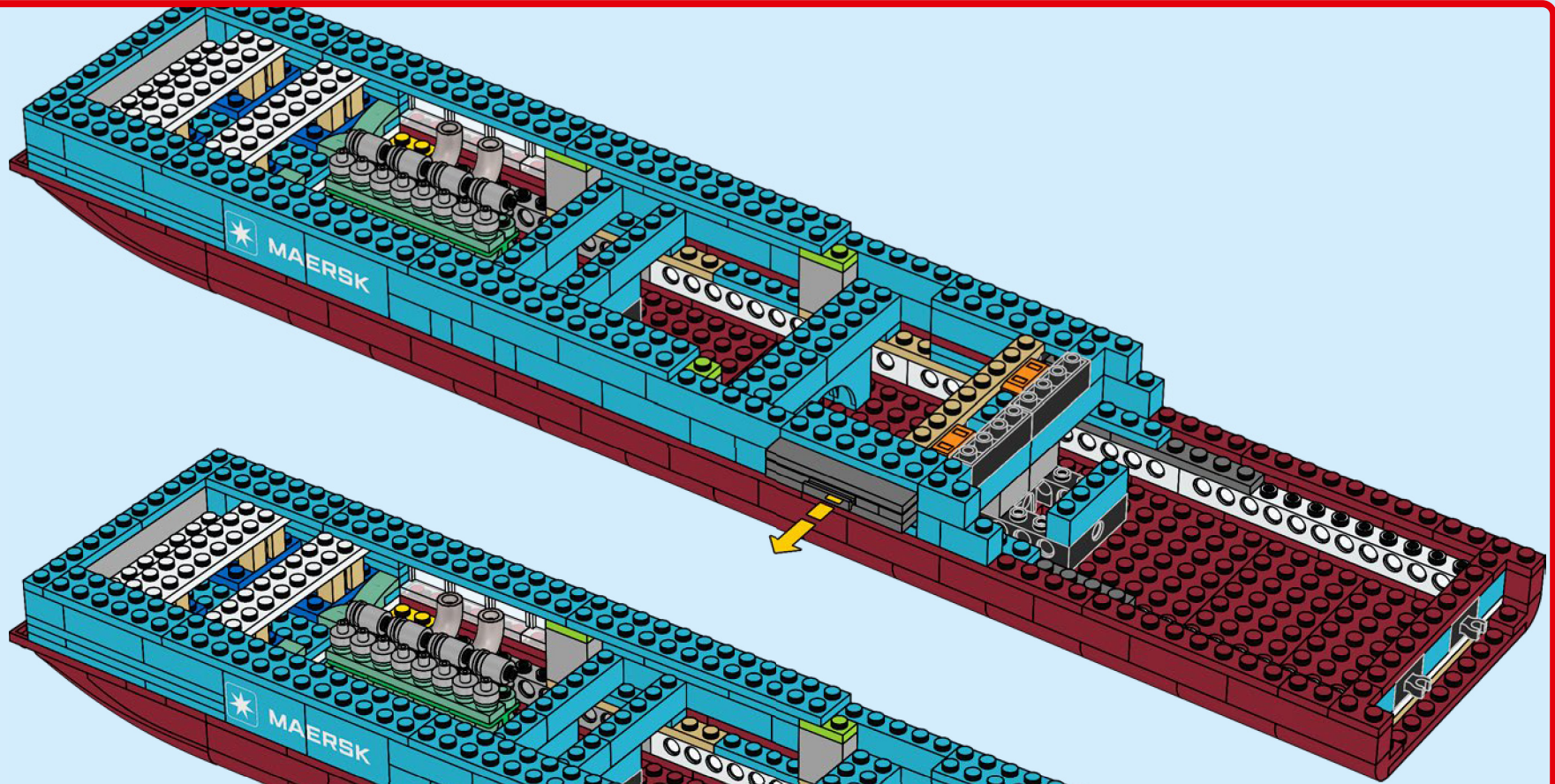

2

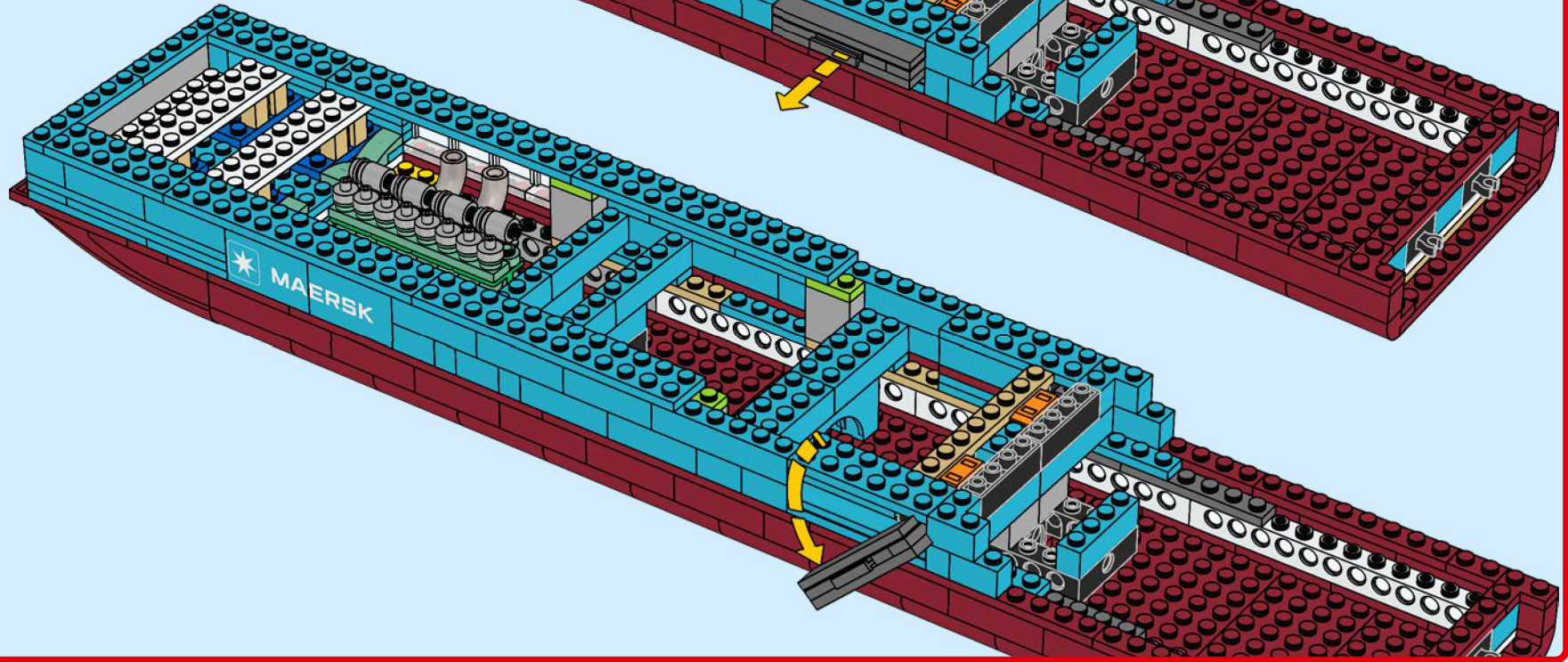

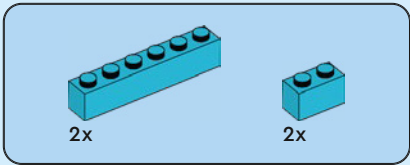

100

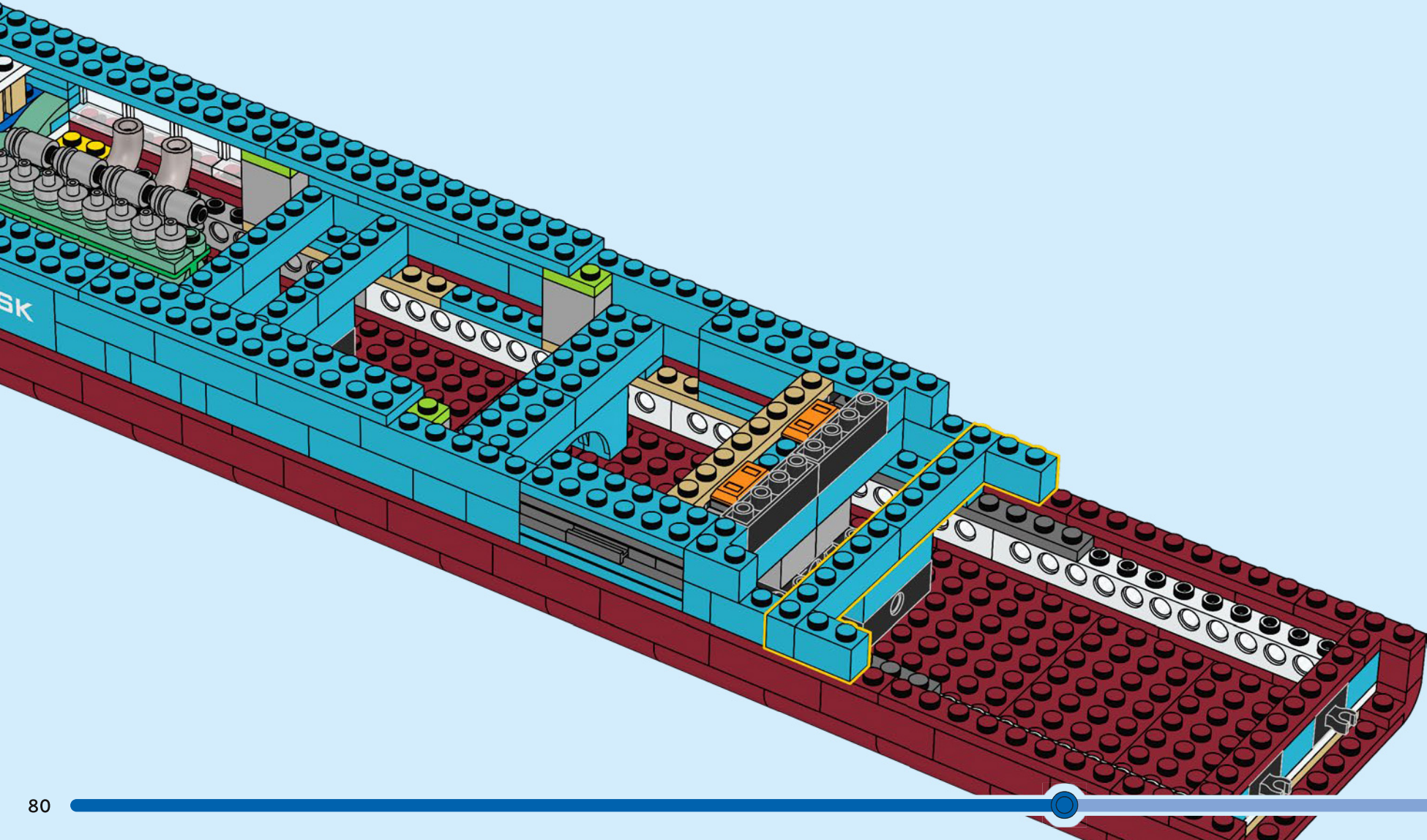

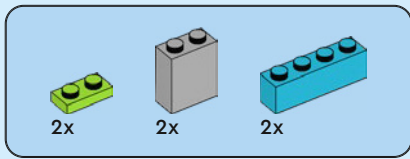

101

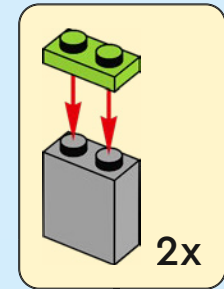
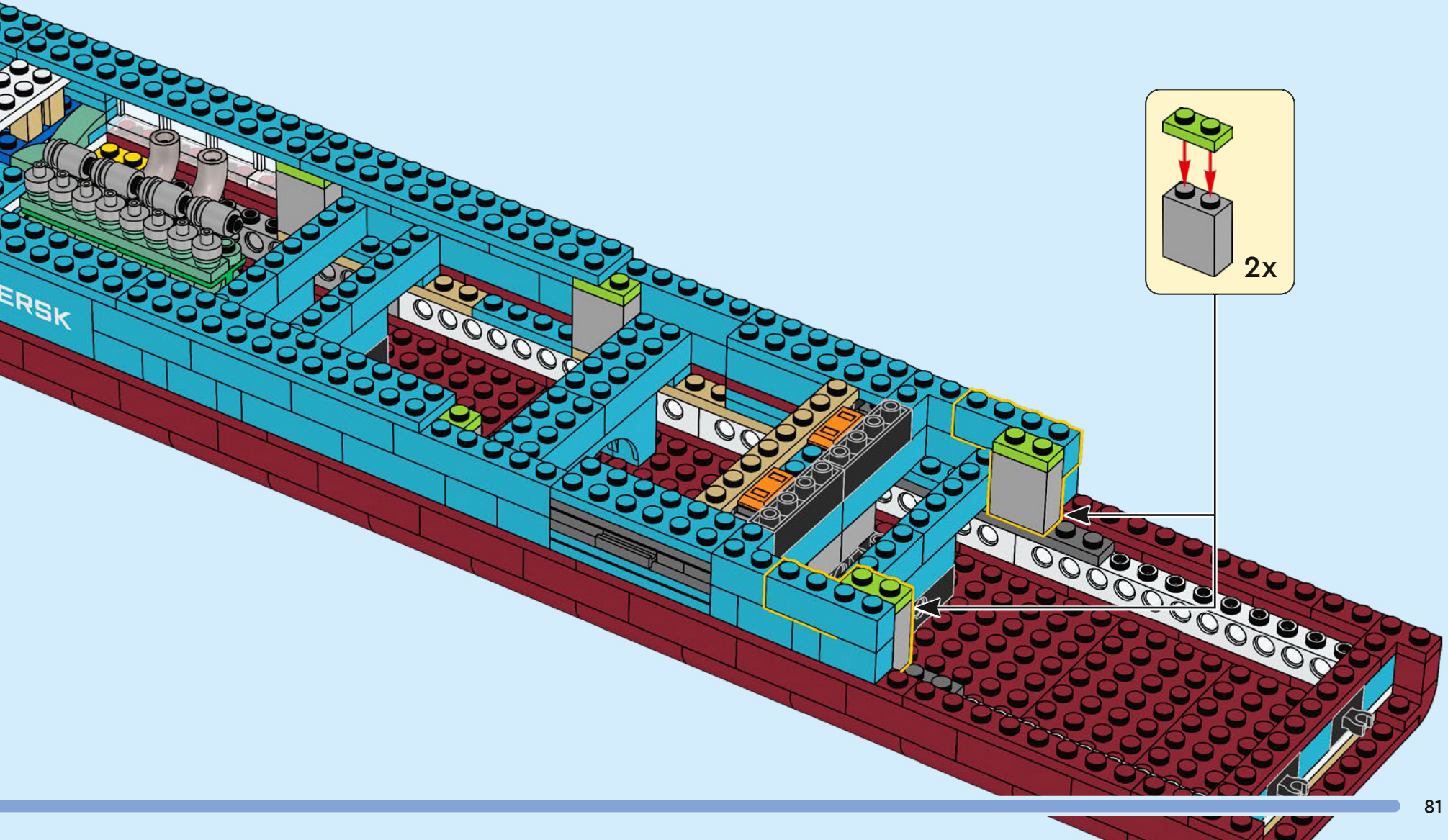

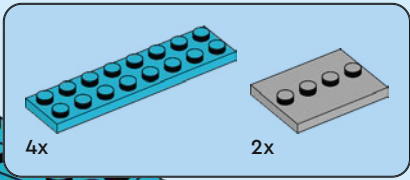

102

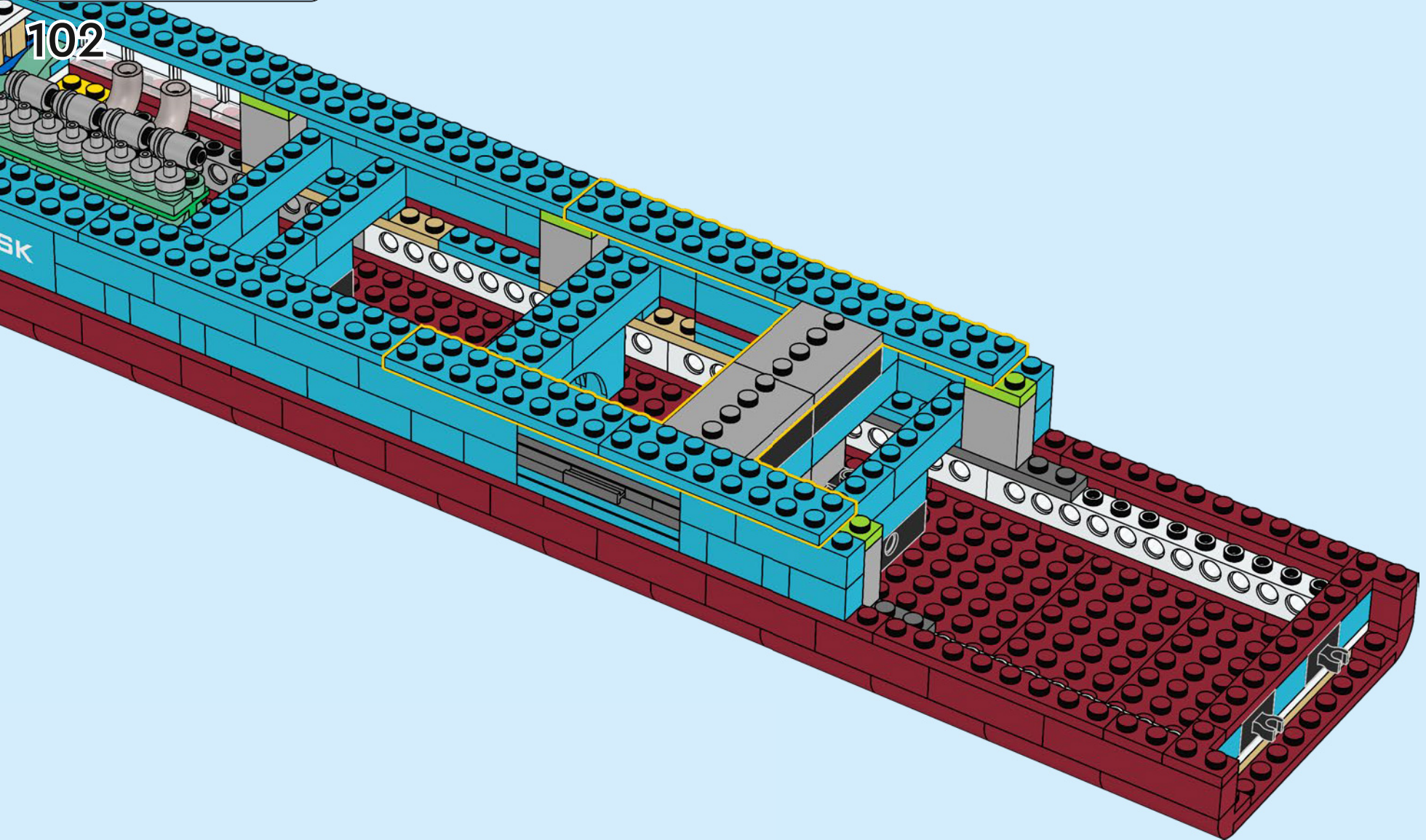

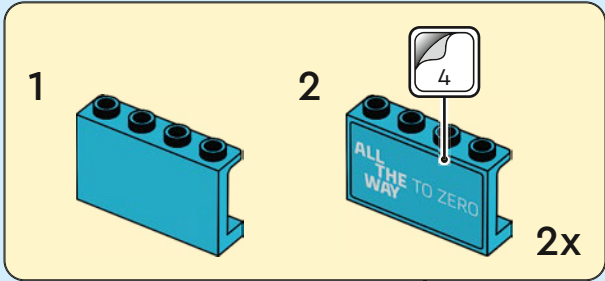
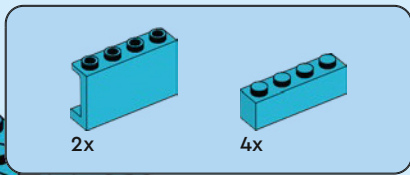

103
ERSK

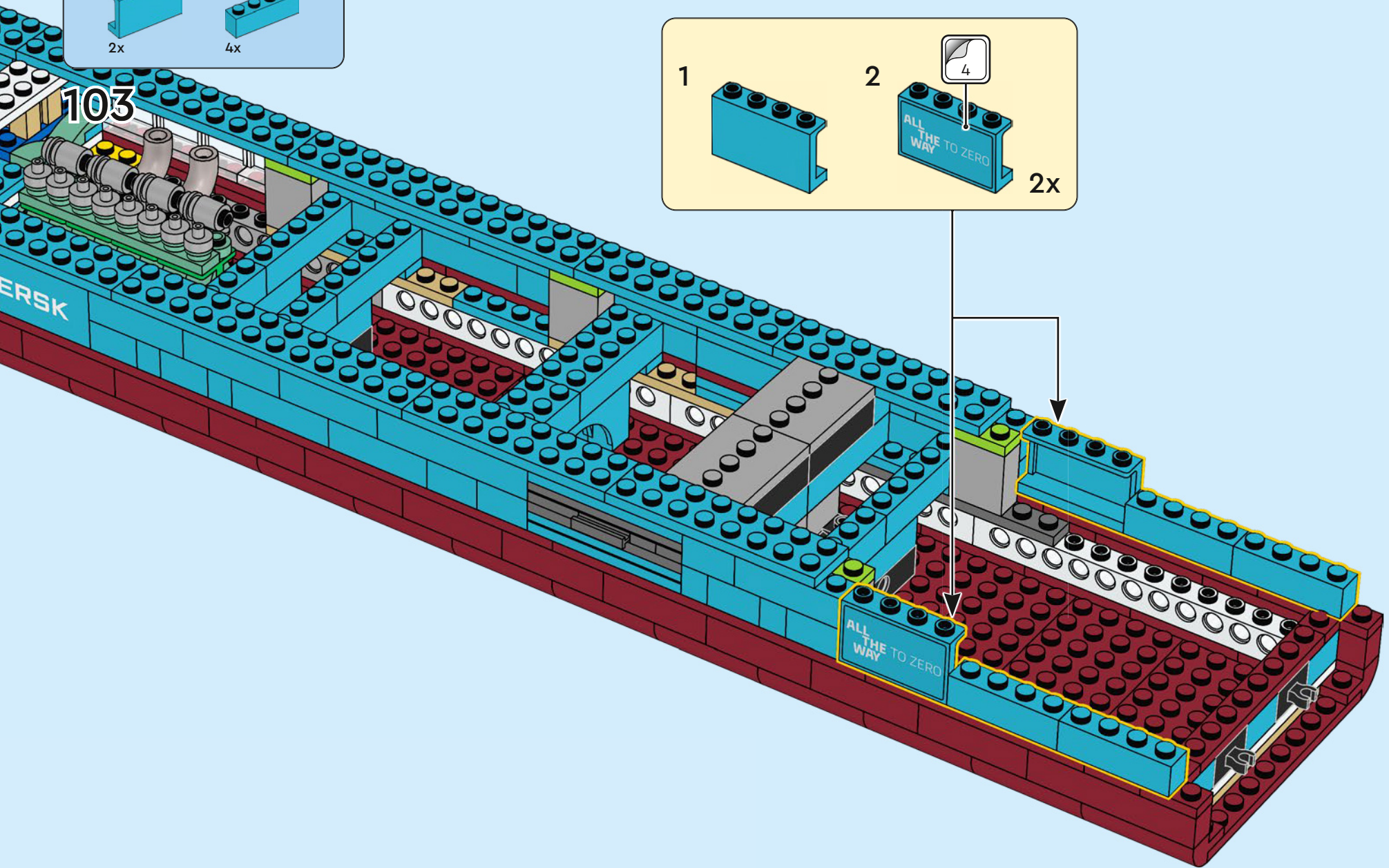

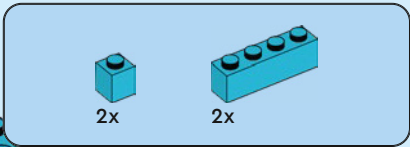

104

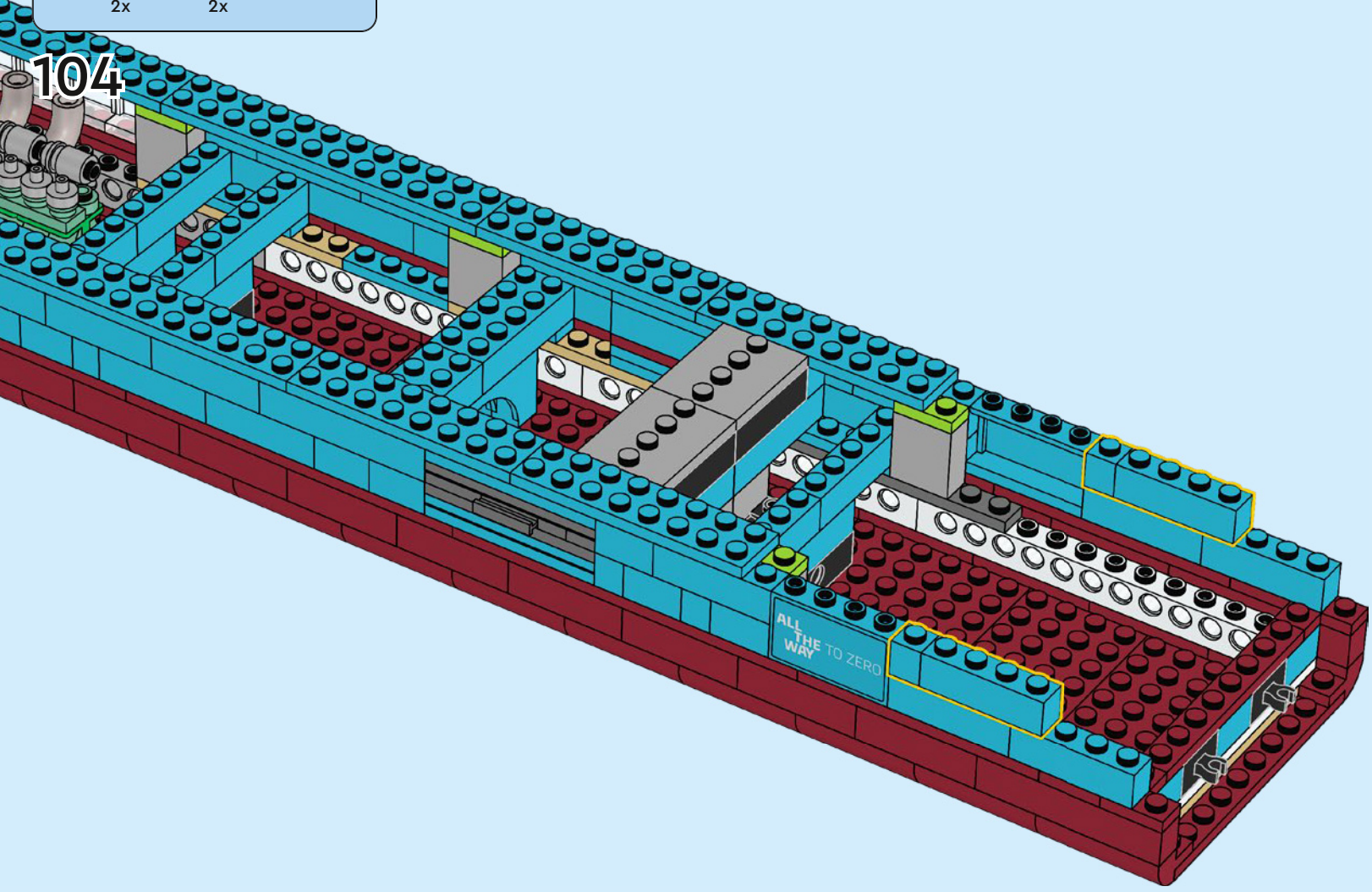

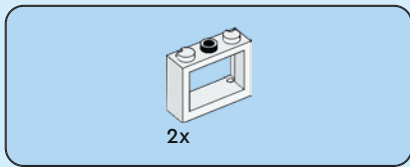

105

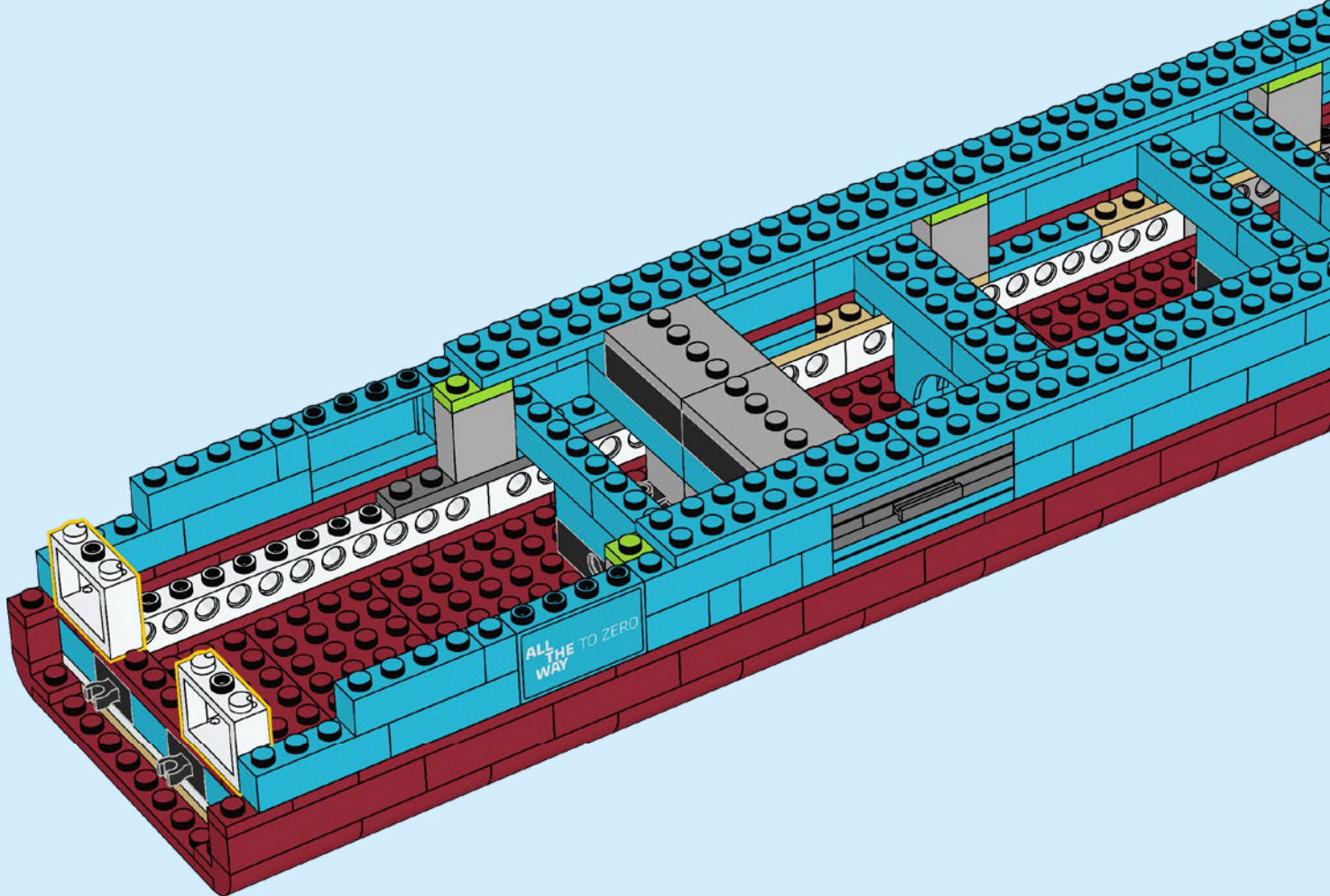

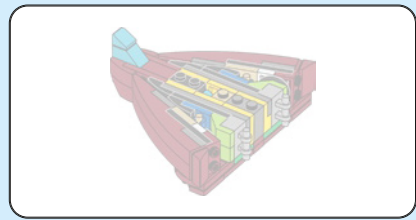
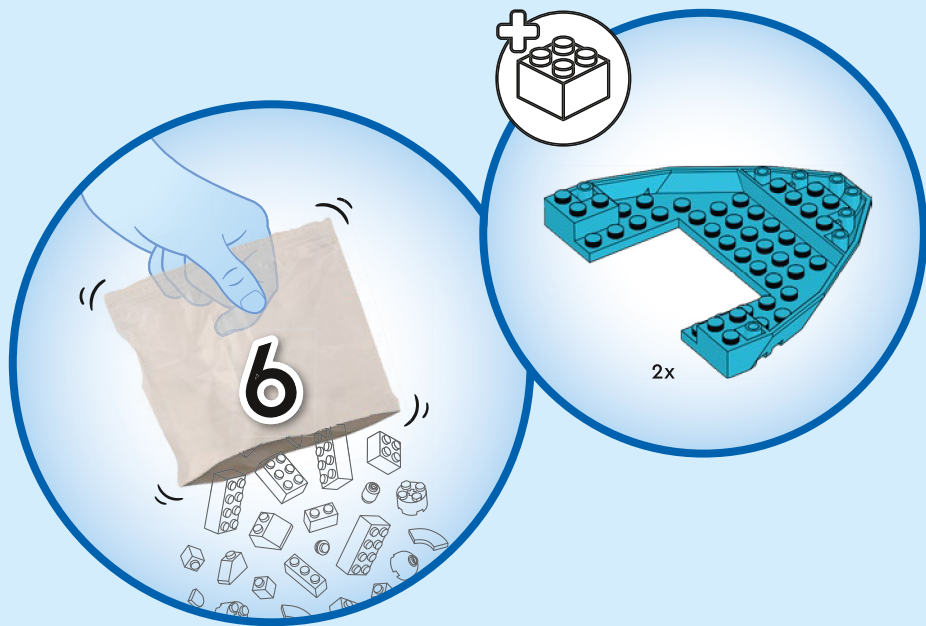

106

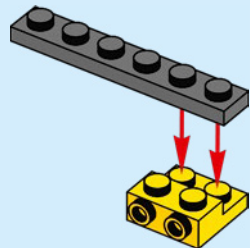

107

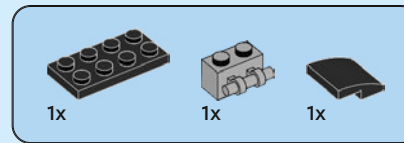
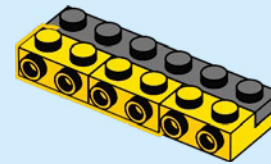

108

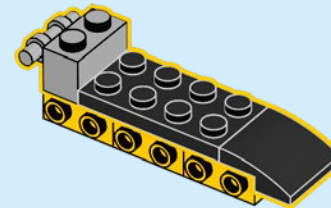

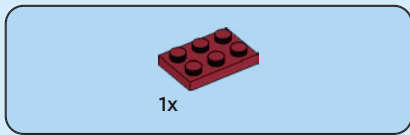

109

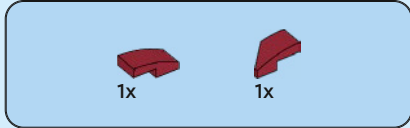
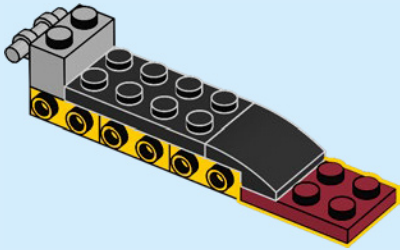

110

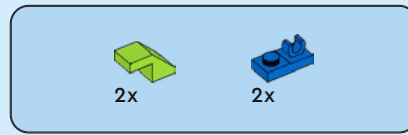
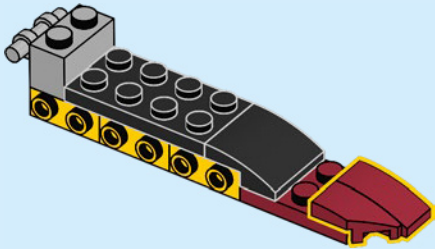

111

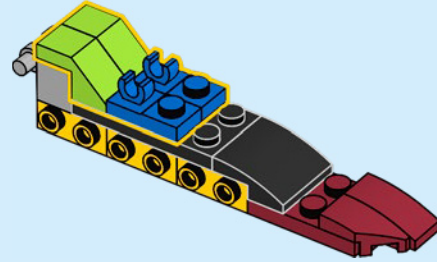

112

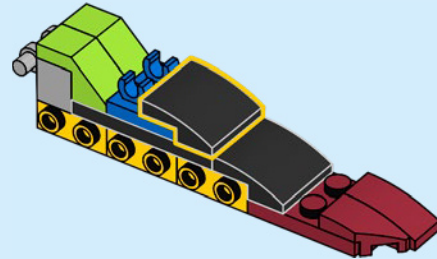

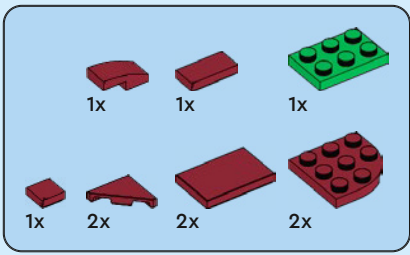

113

1

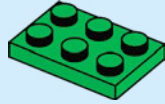

2

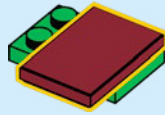

3

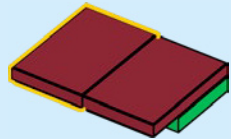

4

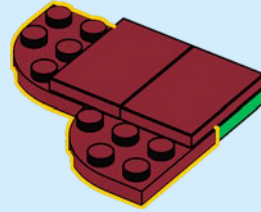

5

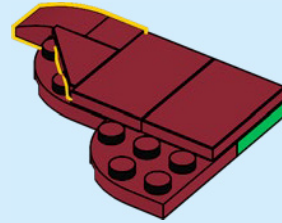

6

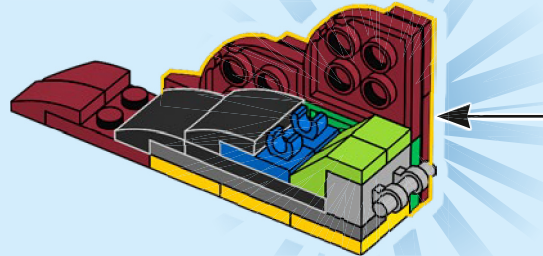
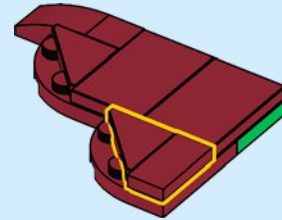

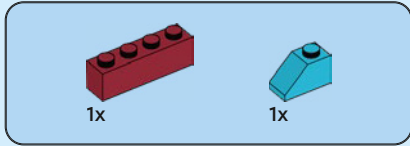
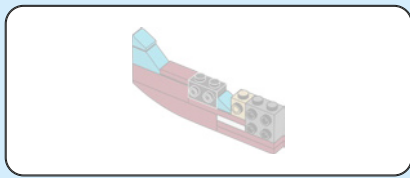

114

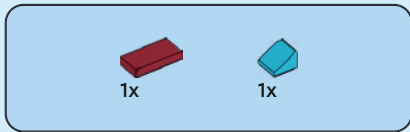
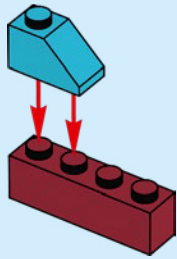

115

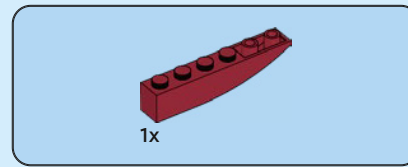
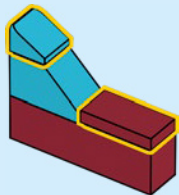

116

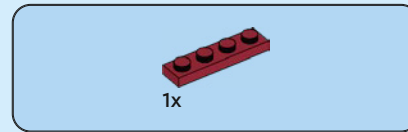
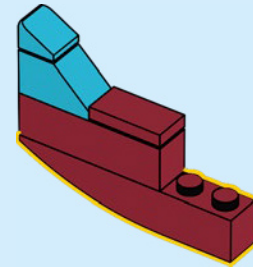

117

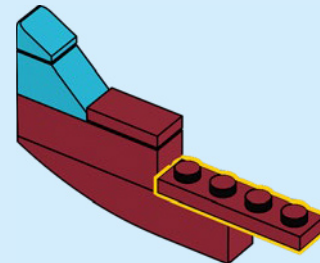

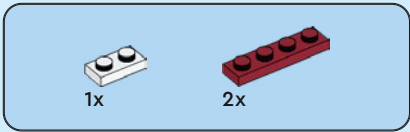

118

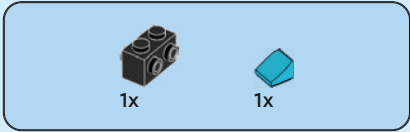
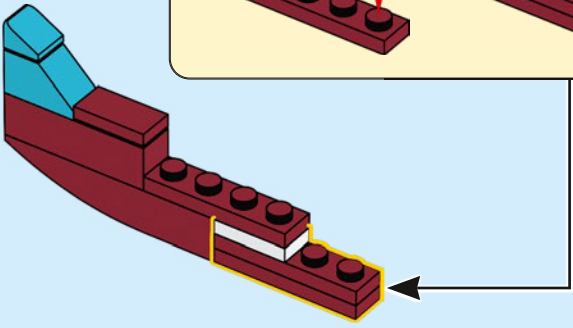
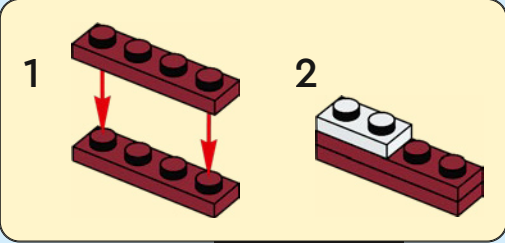

119

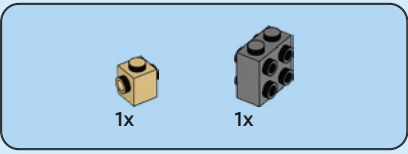
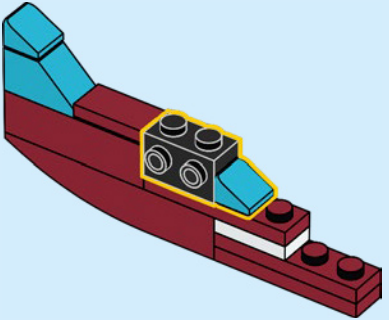

120

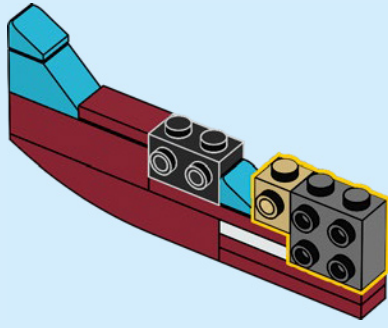

121

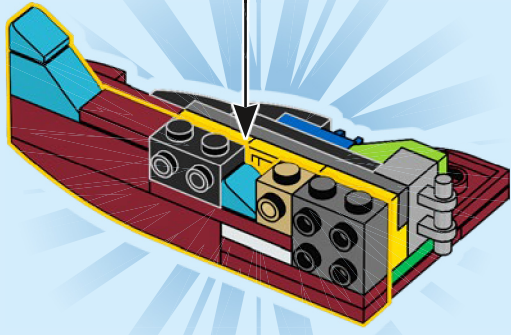

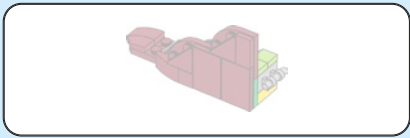

122

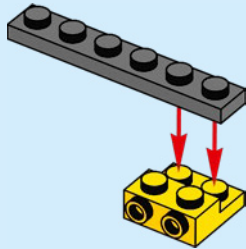

123

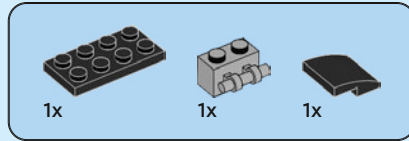
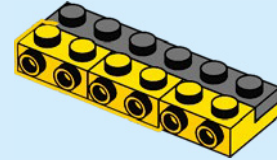

124

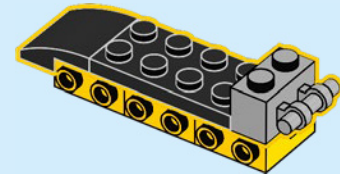

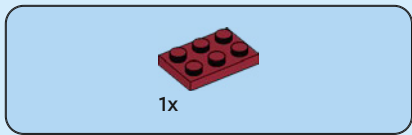

125

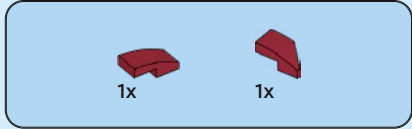
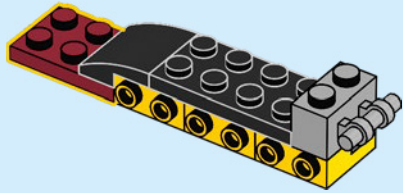

126

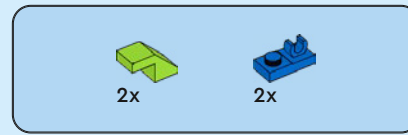
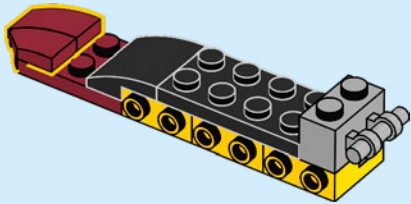

127

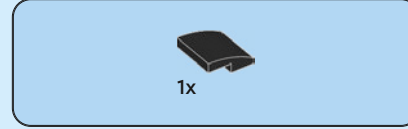
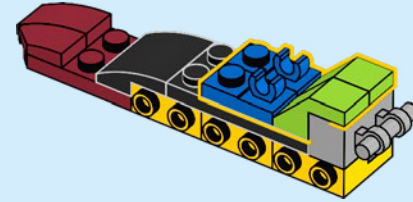

128

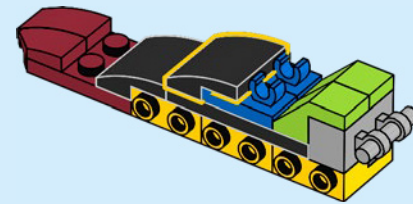

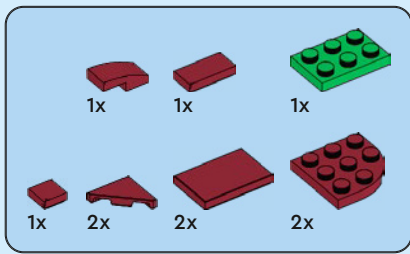

129

1

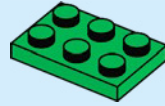

2

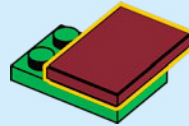

3

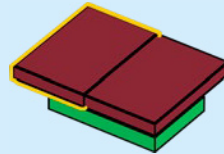

4

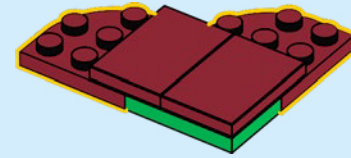

5

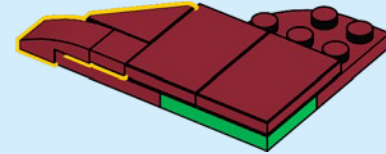

6

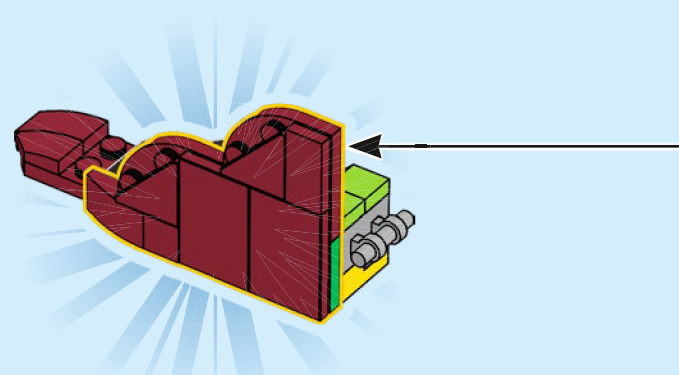
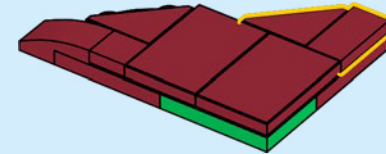

130

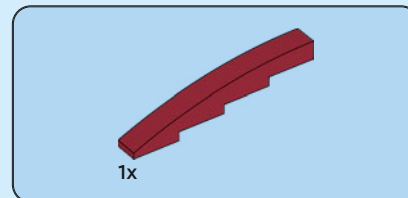
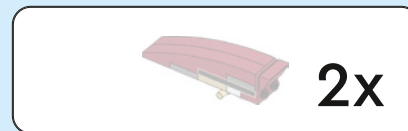
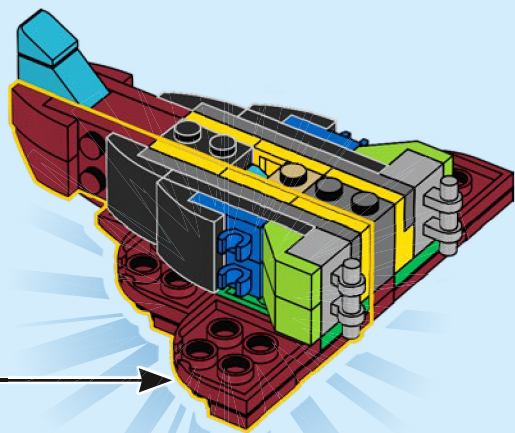

131

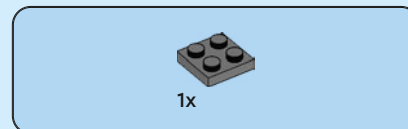
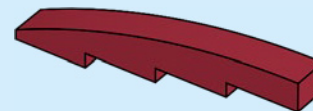

132

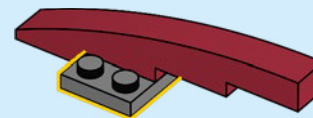

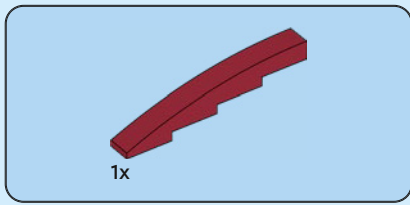

133

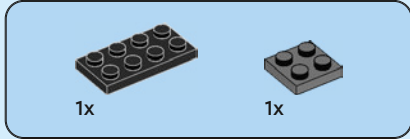
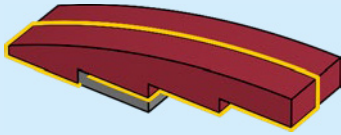

134

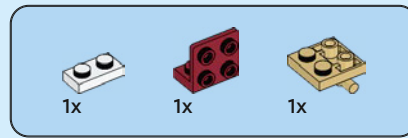
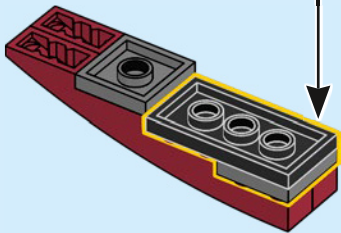
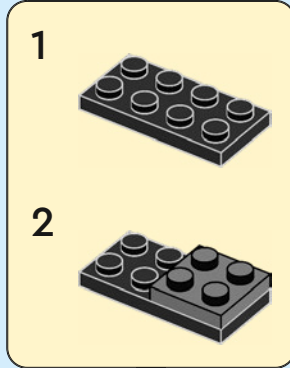

135

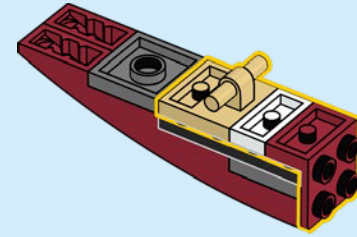

136

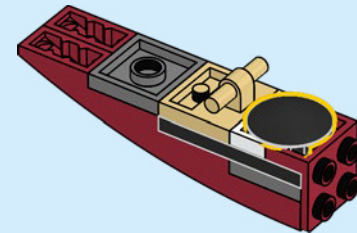



1x

137

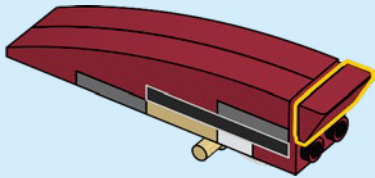

2x

138

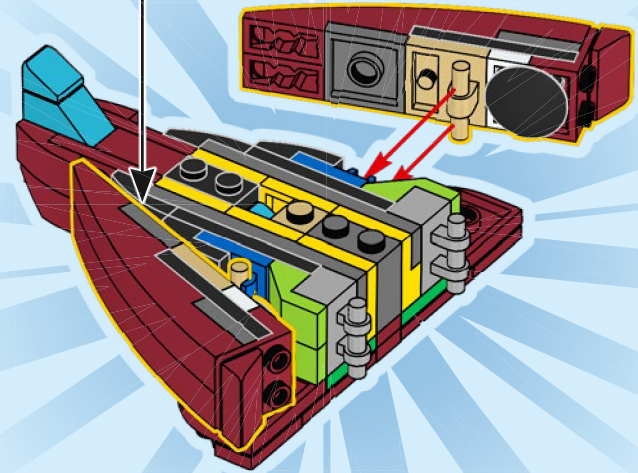

139

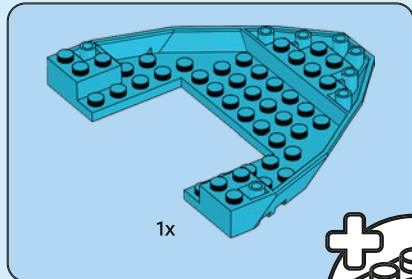
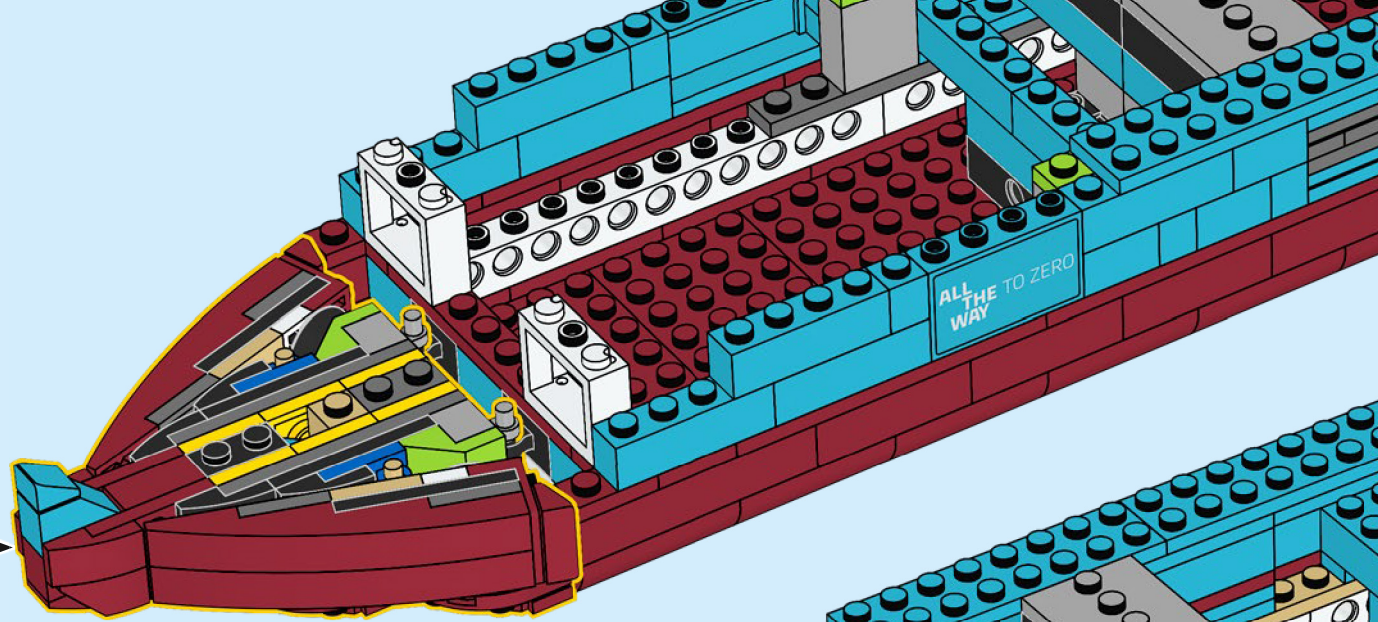

1x

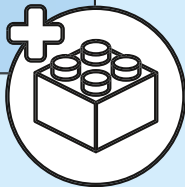

140

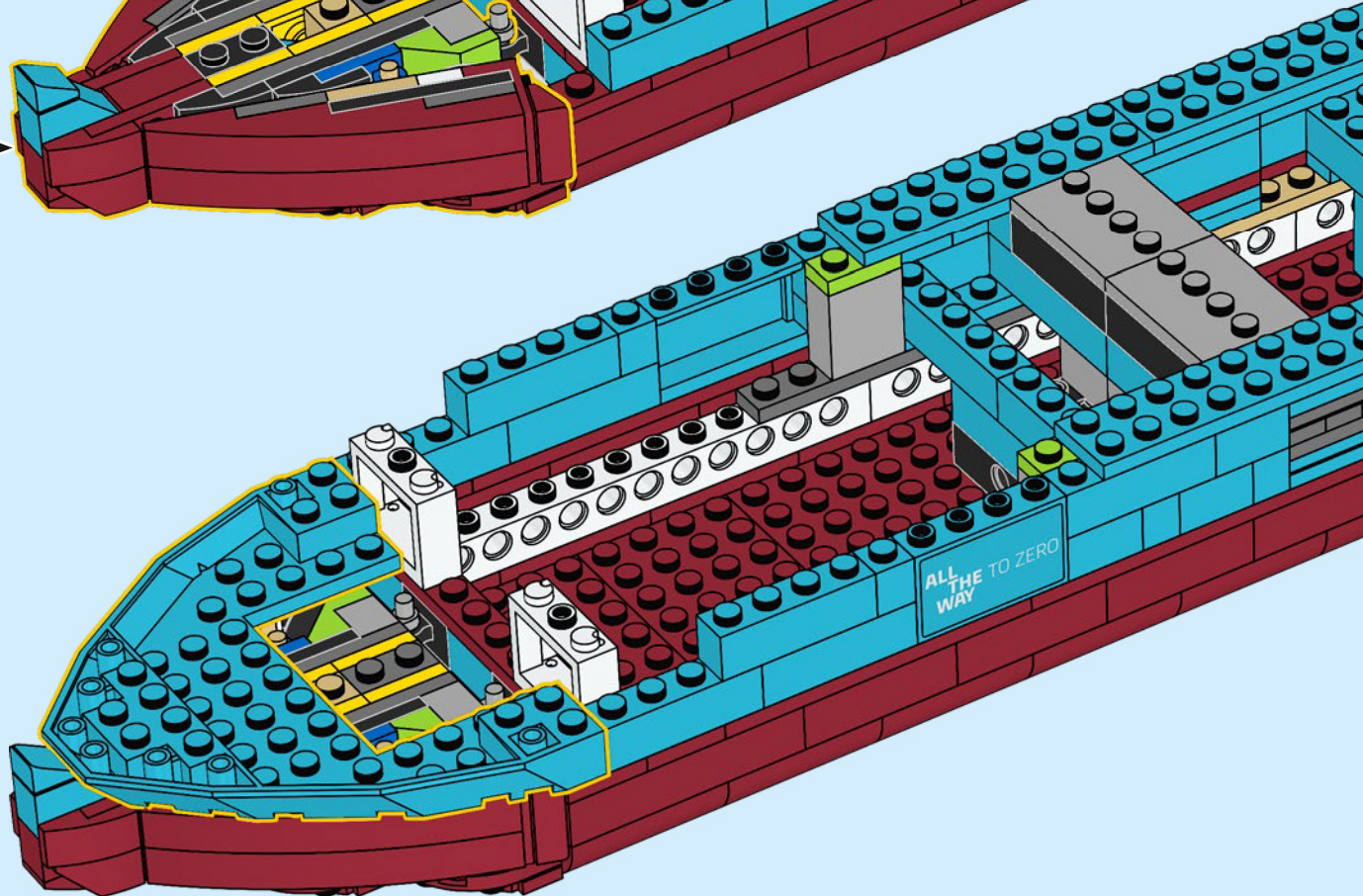

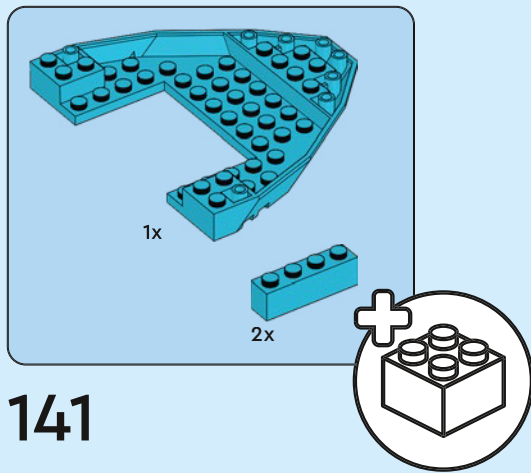

141

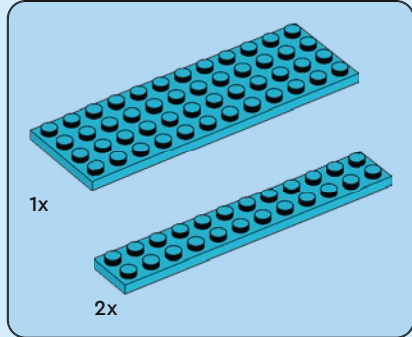
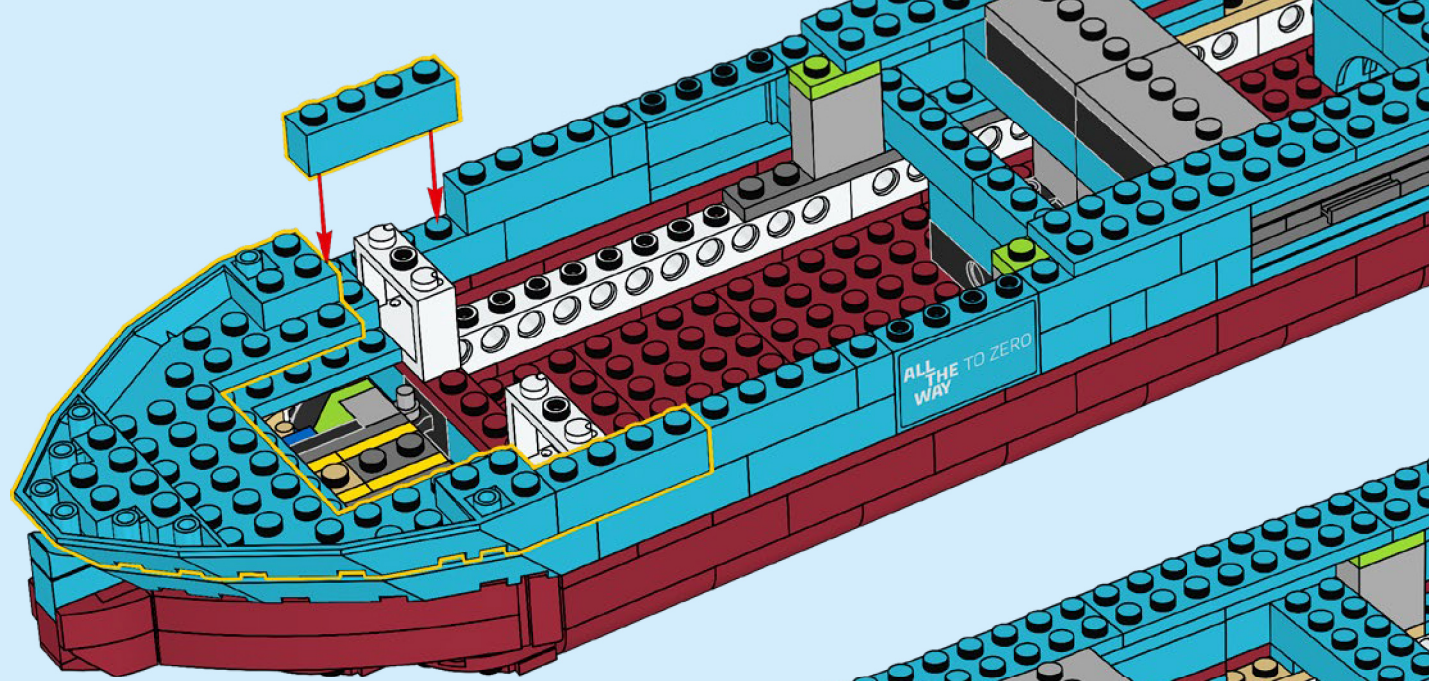

142

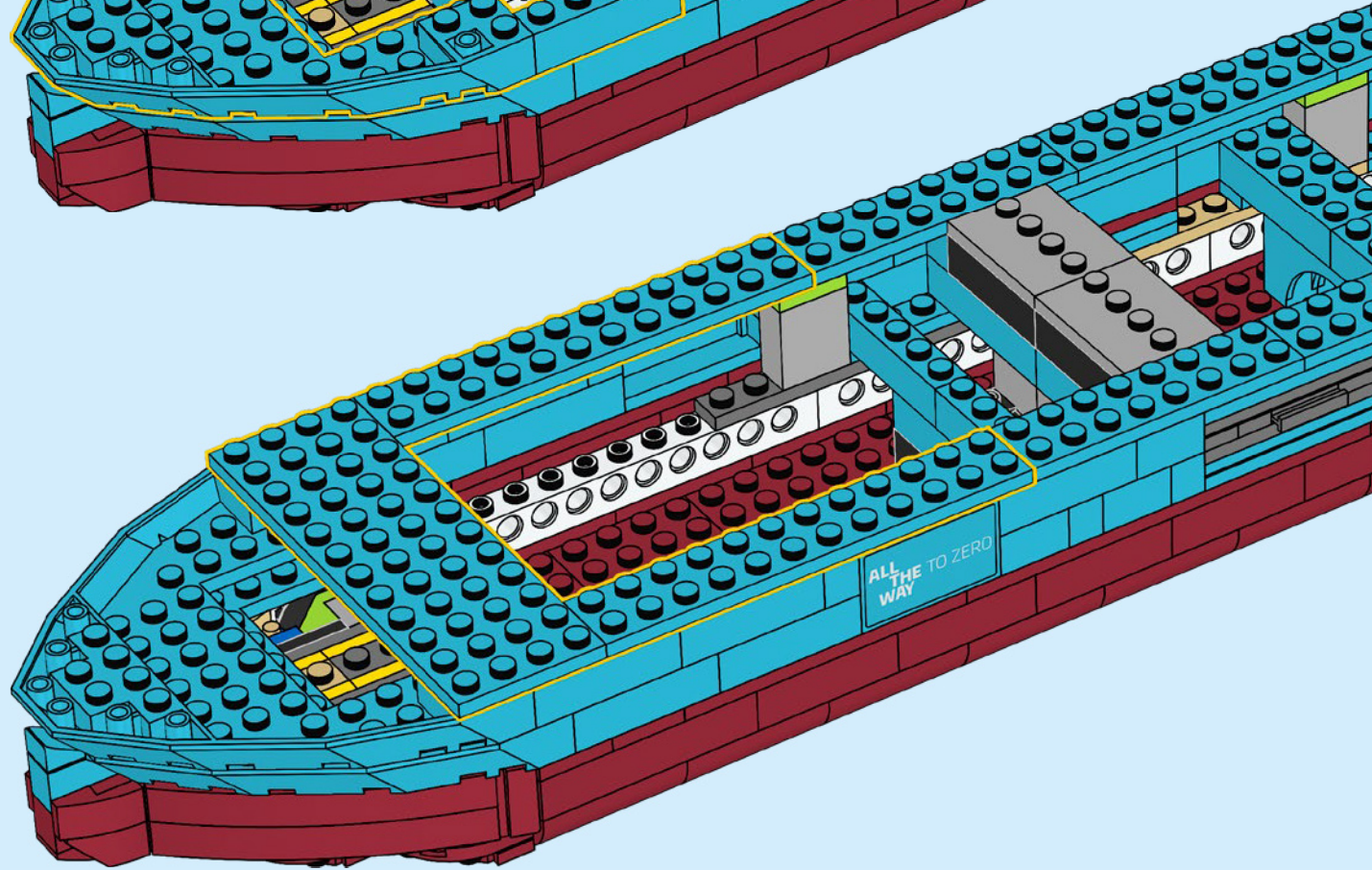

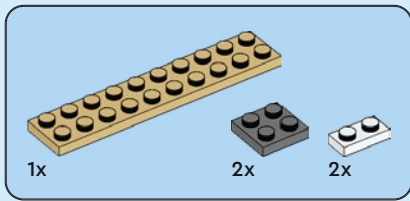

143

1

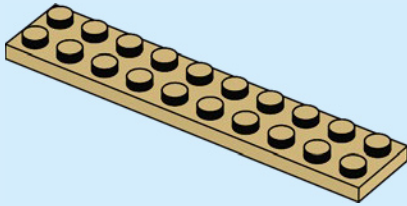

2

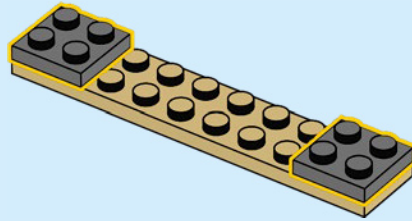

3

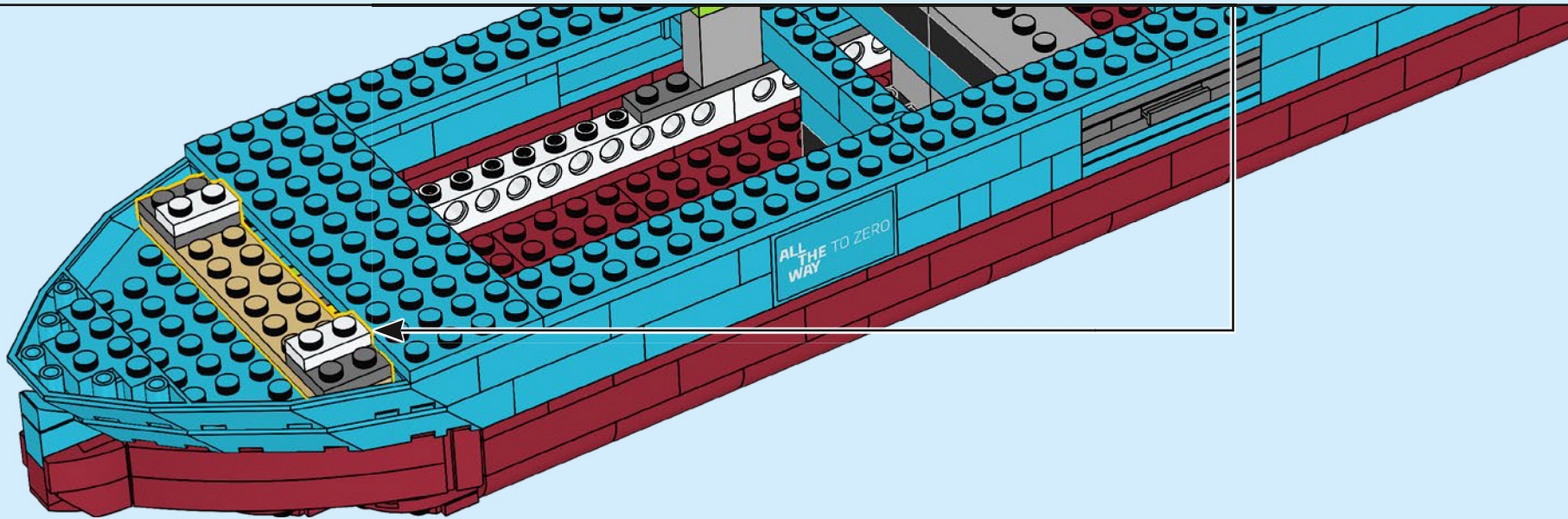
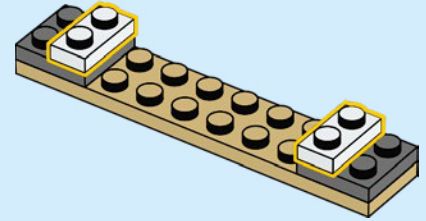

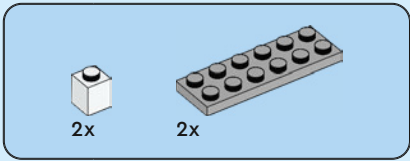

144

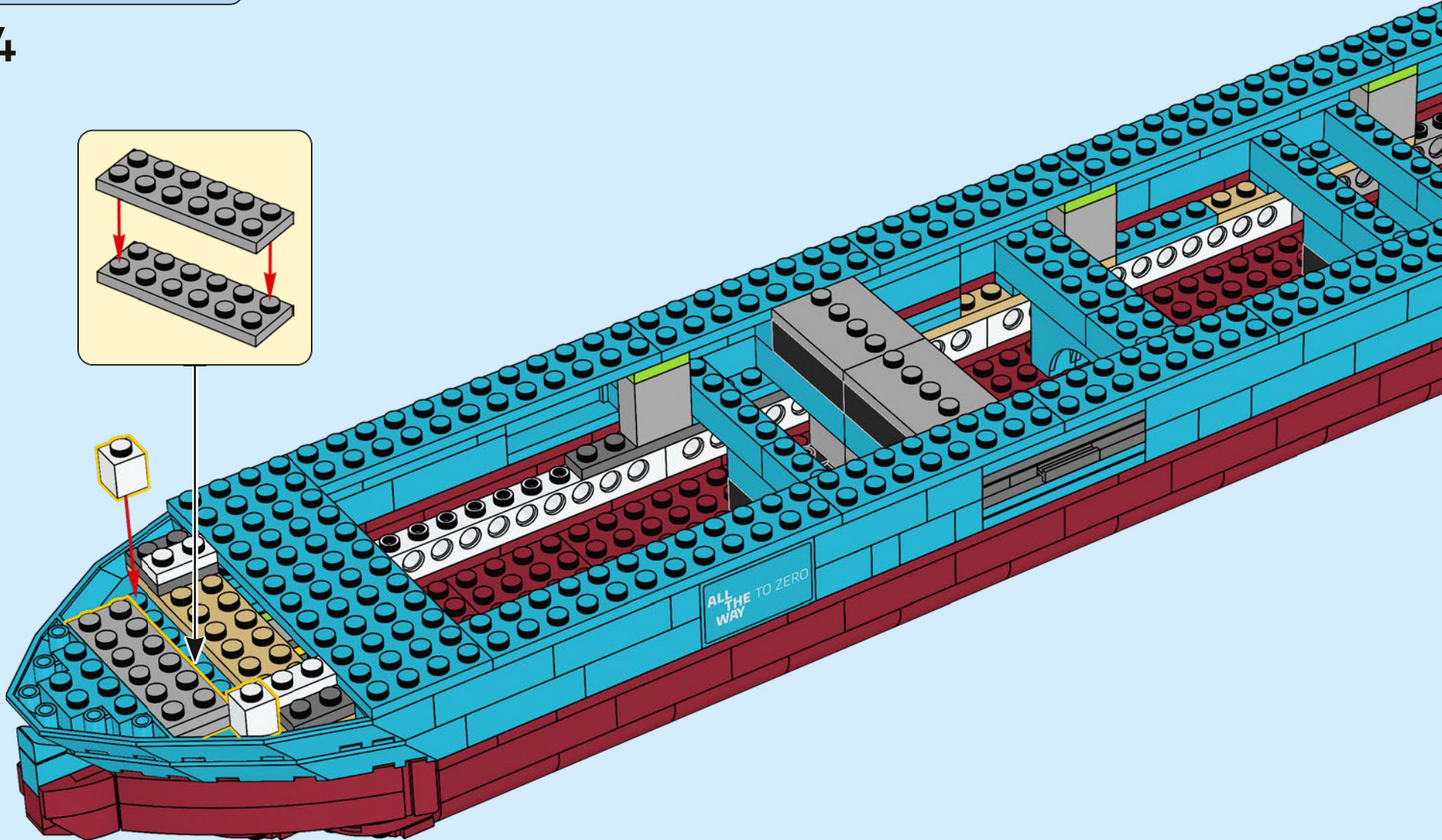
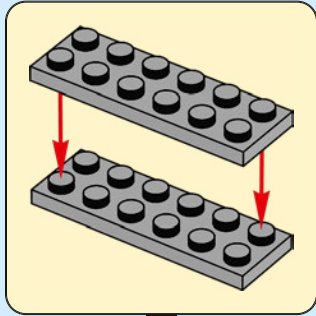

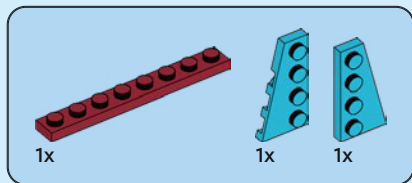

145

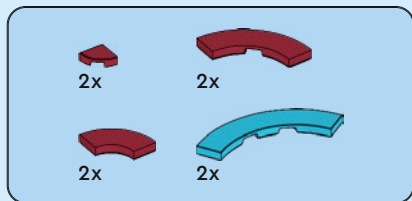
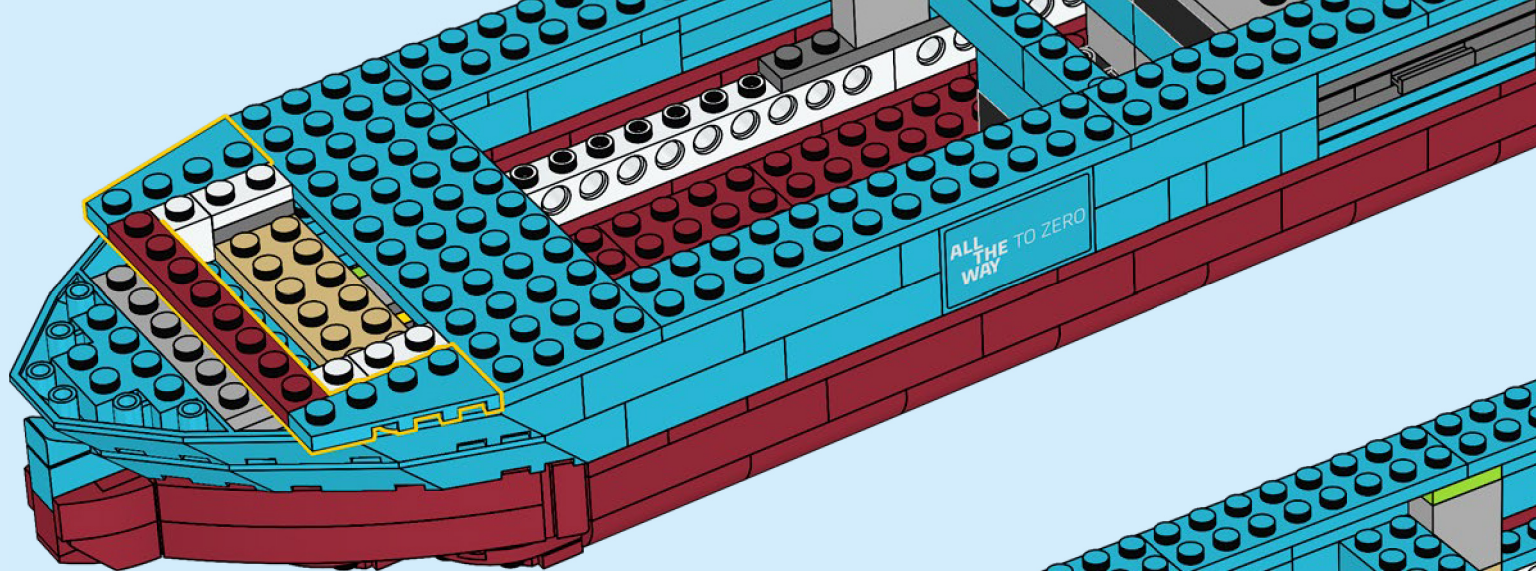

146

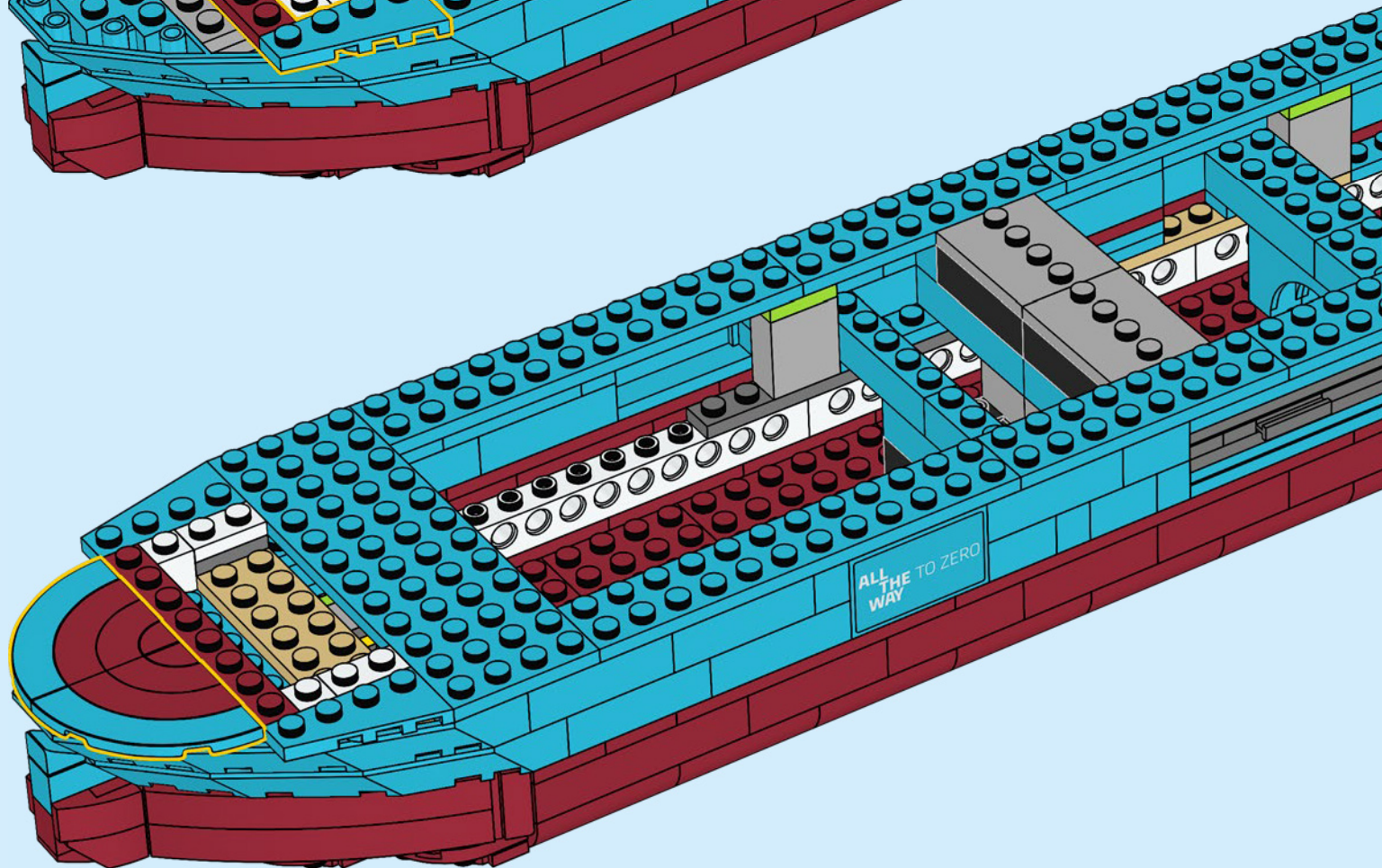

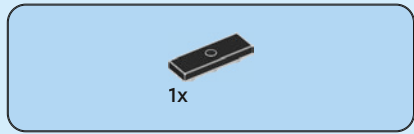

147

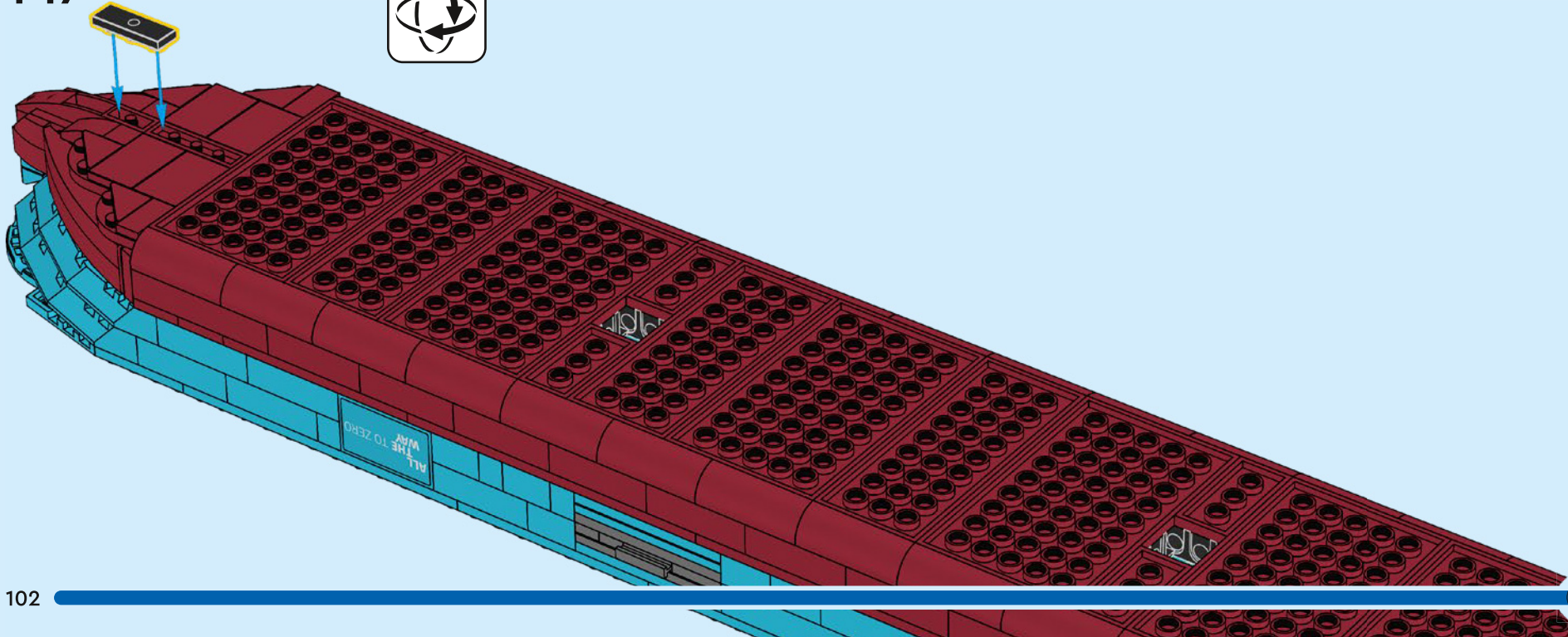



24x

148

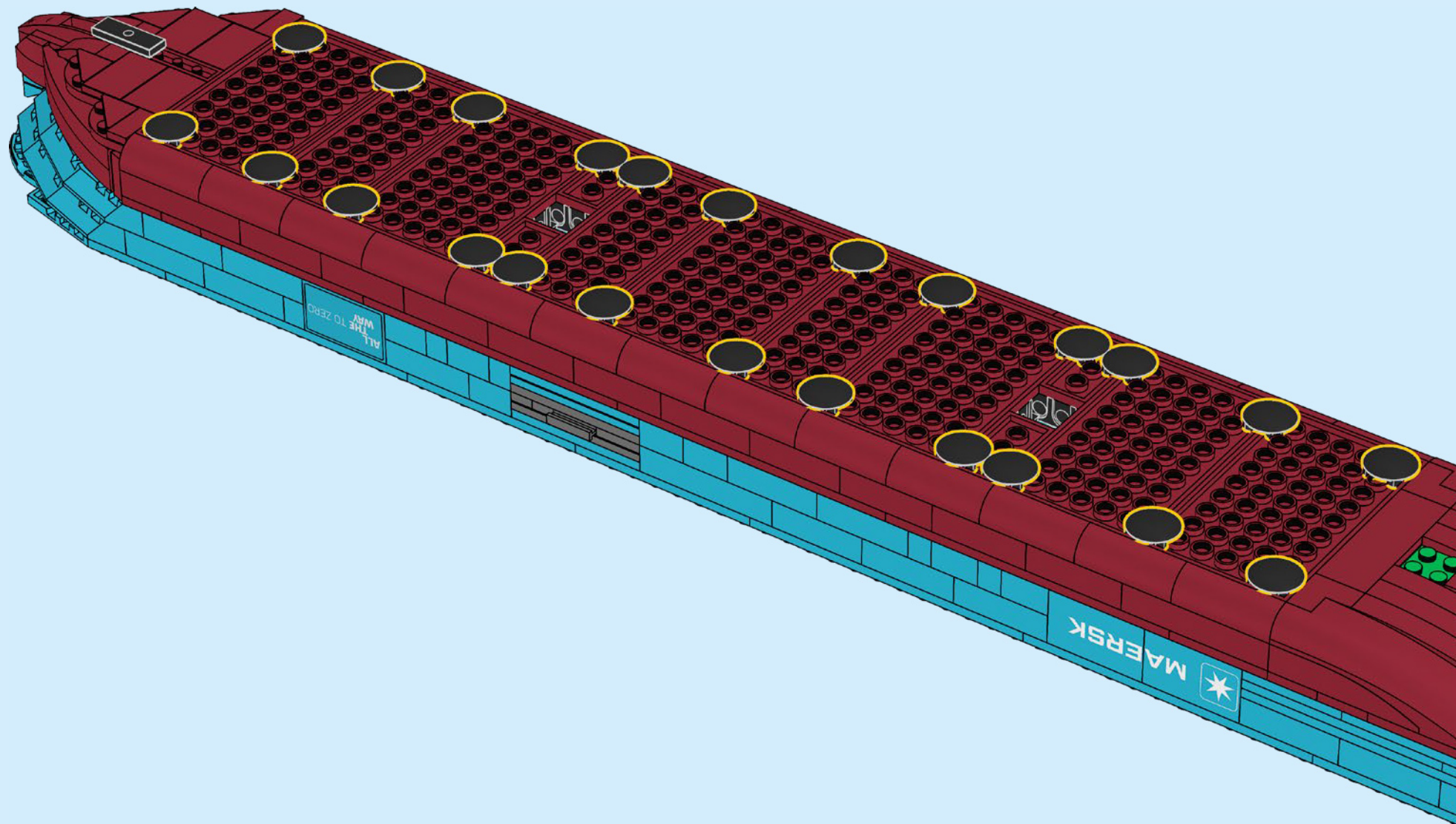

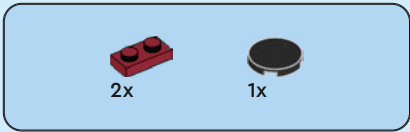

149

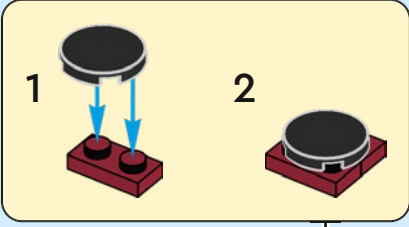
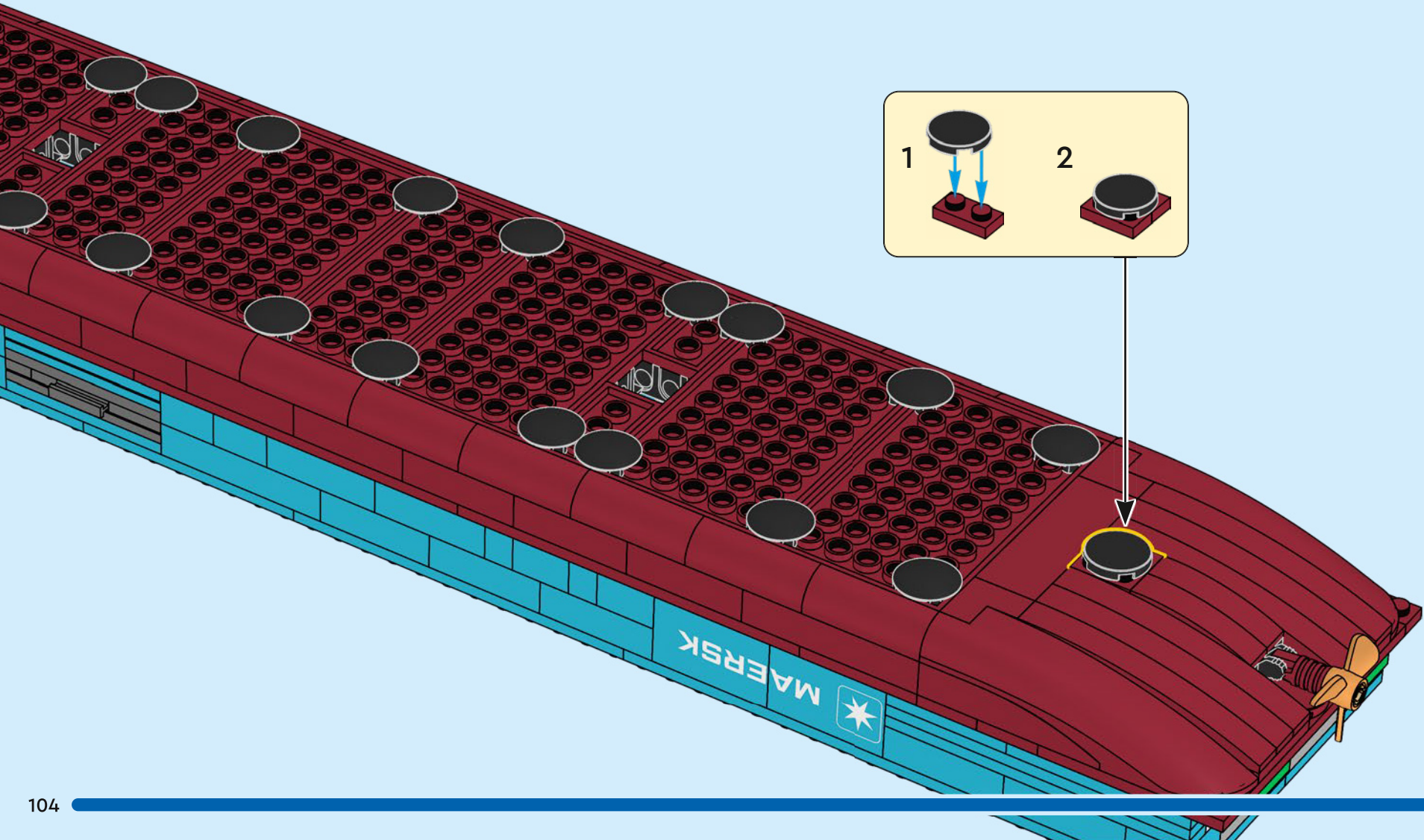

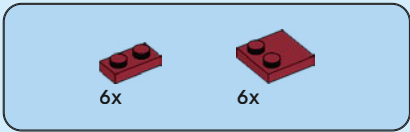

150

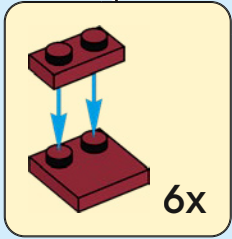
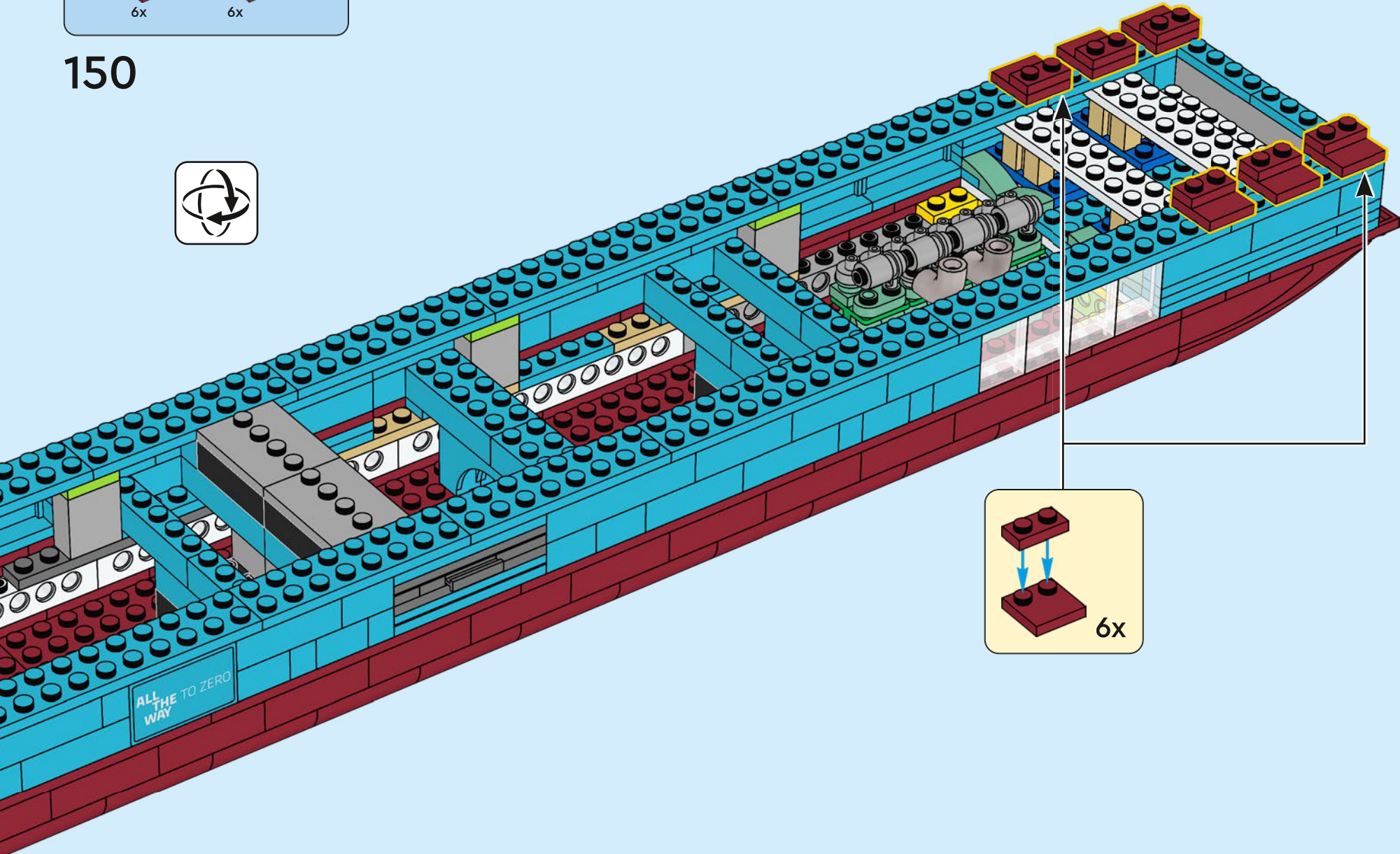

ALL
THE
WAY TO ZERO

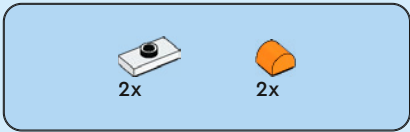

151

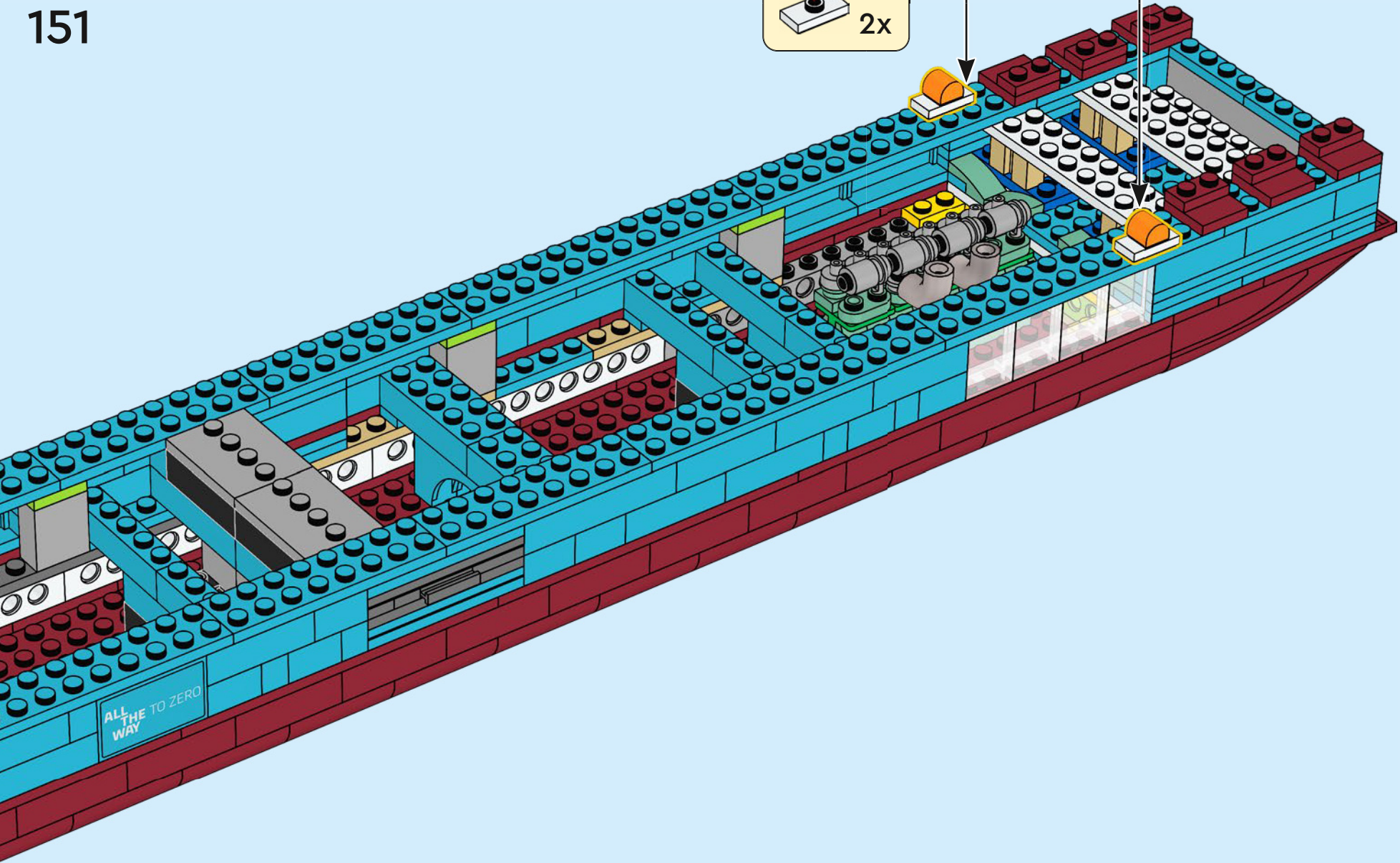
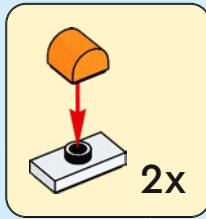

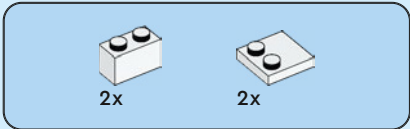

152

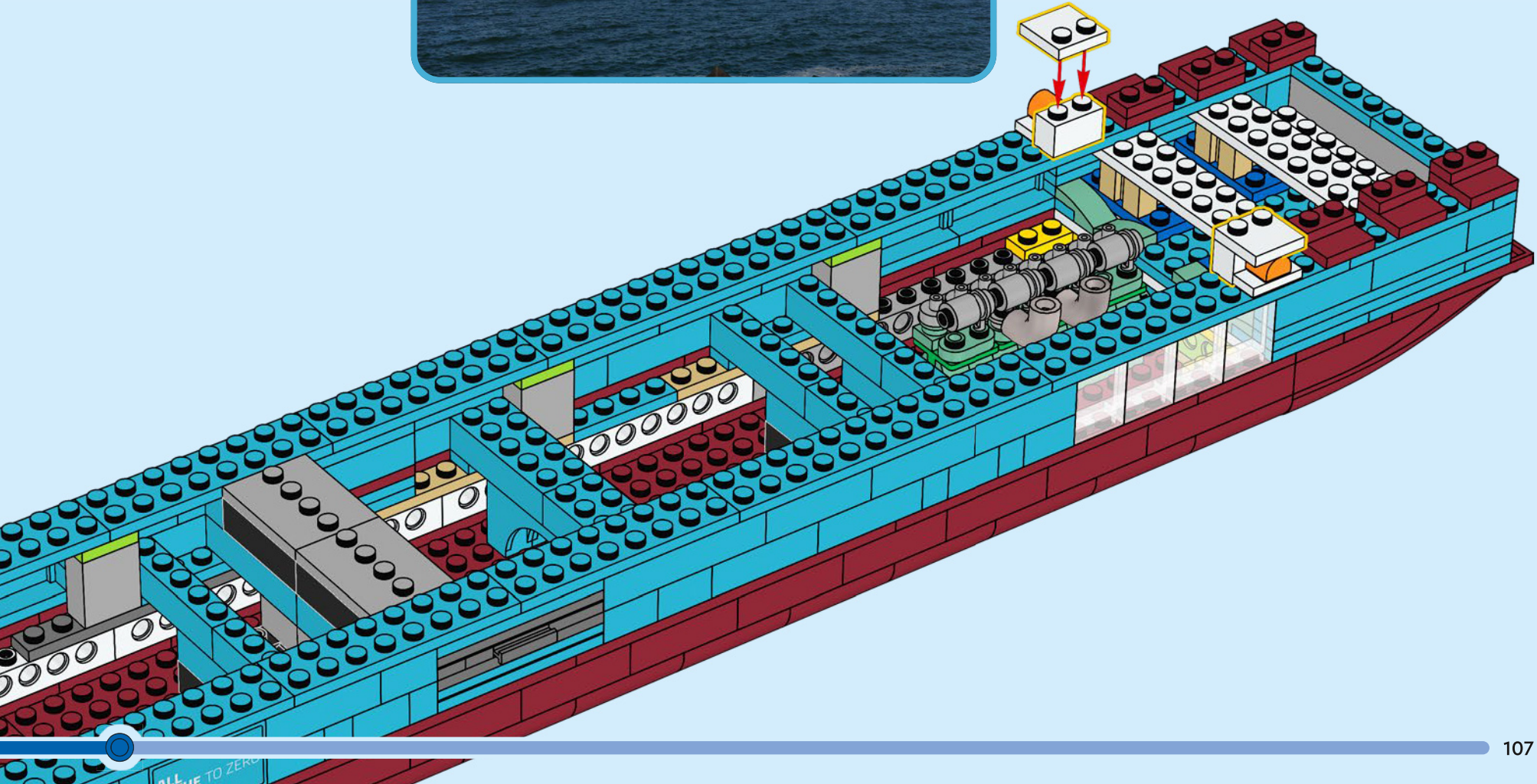
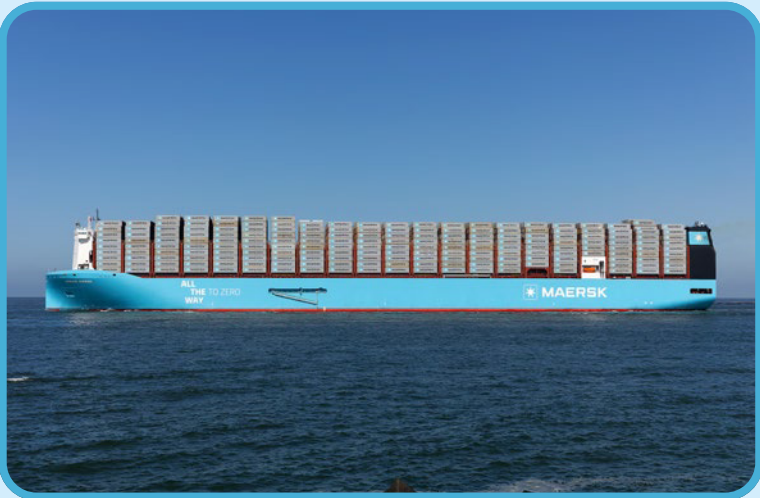

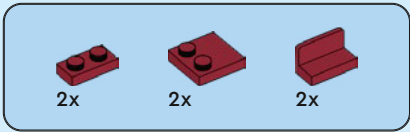

153

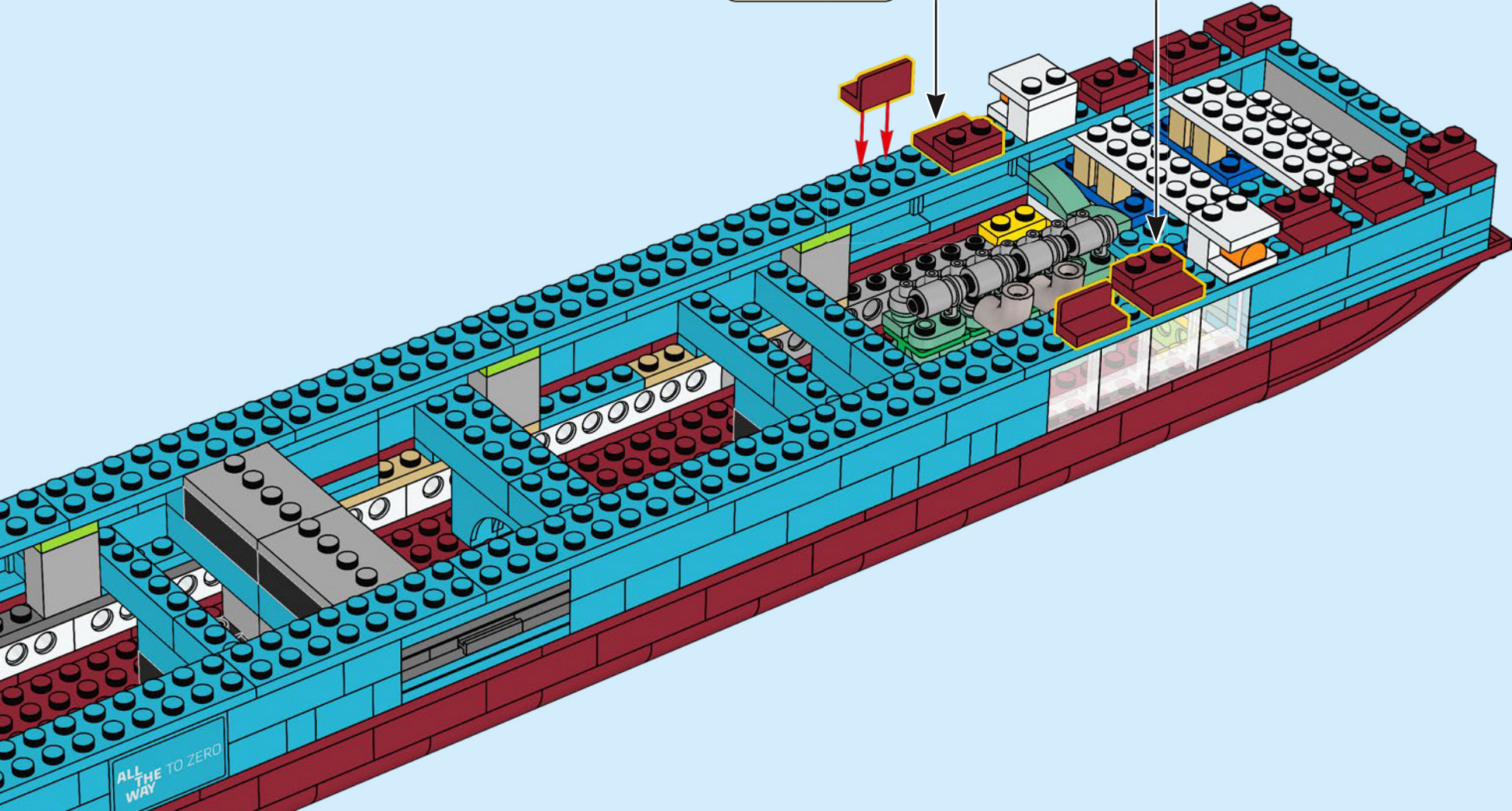
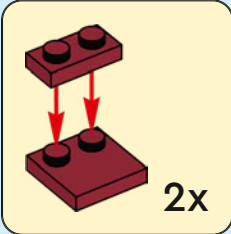

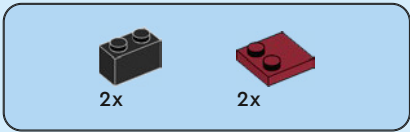

154

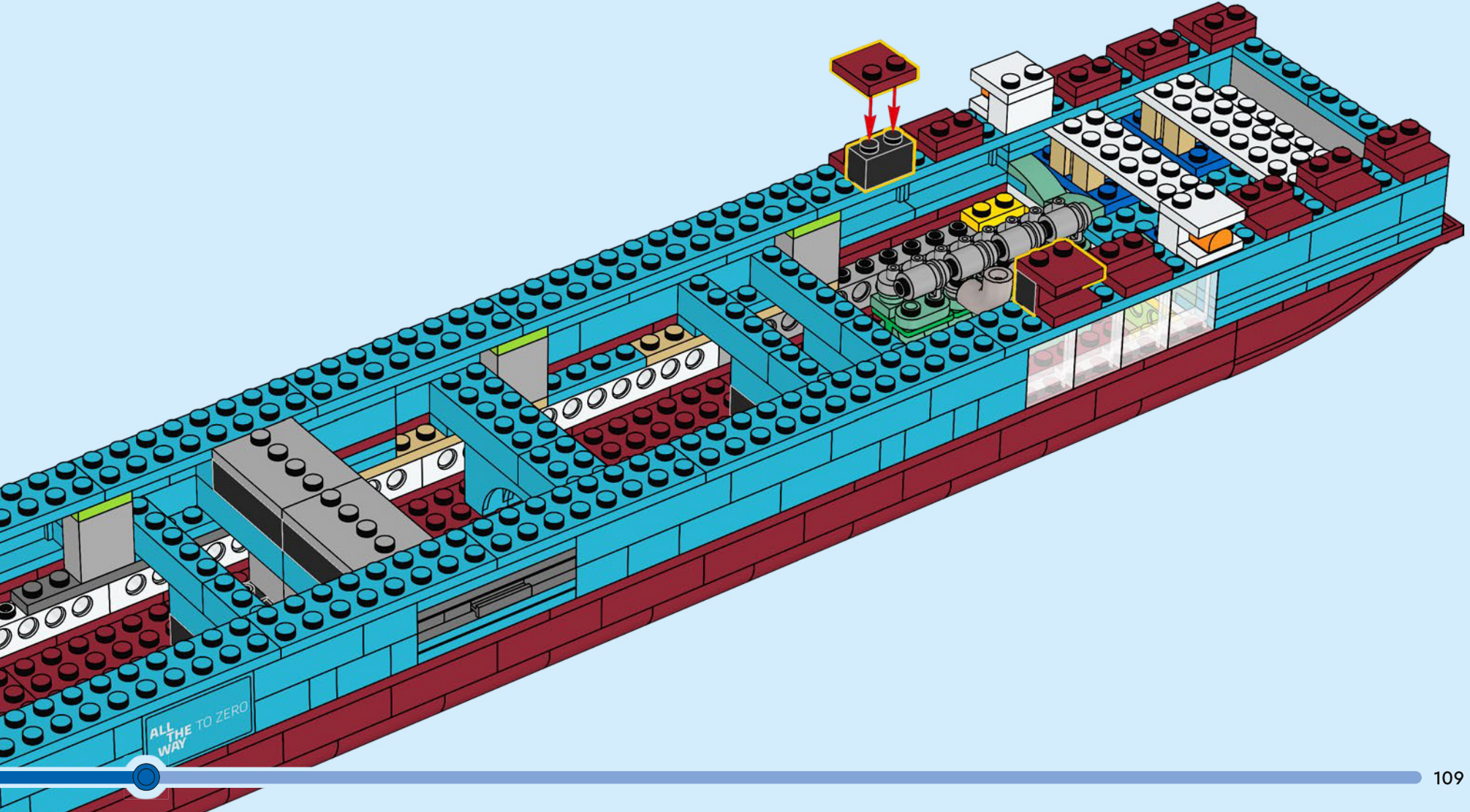

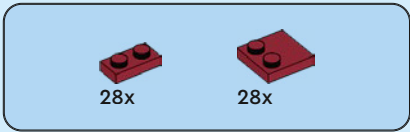

155

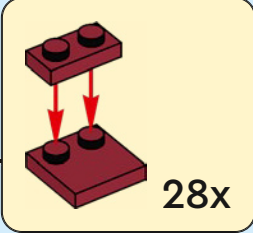
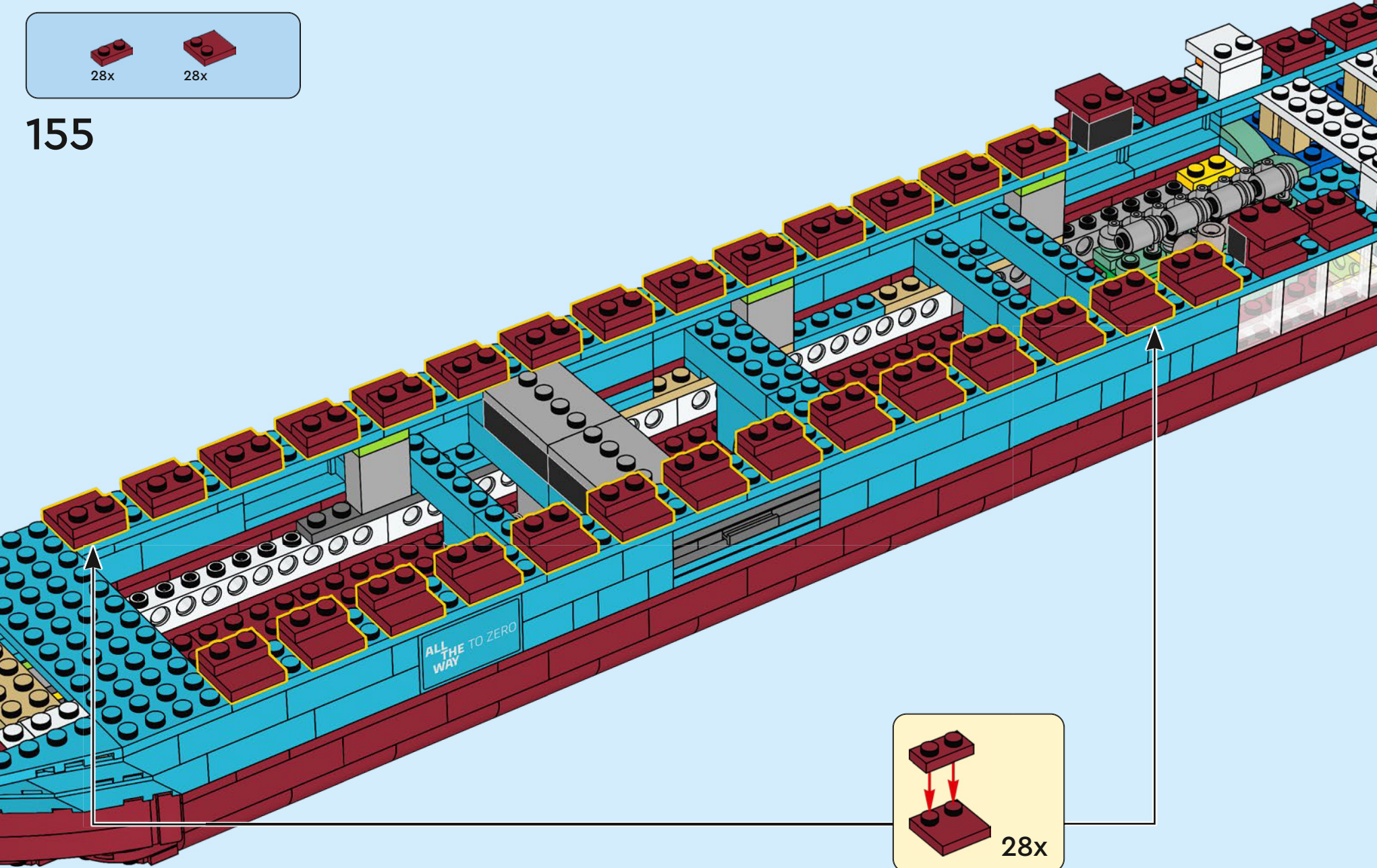

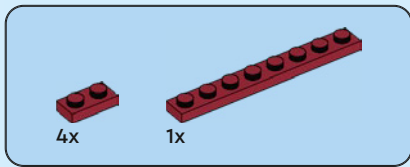

156

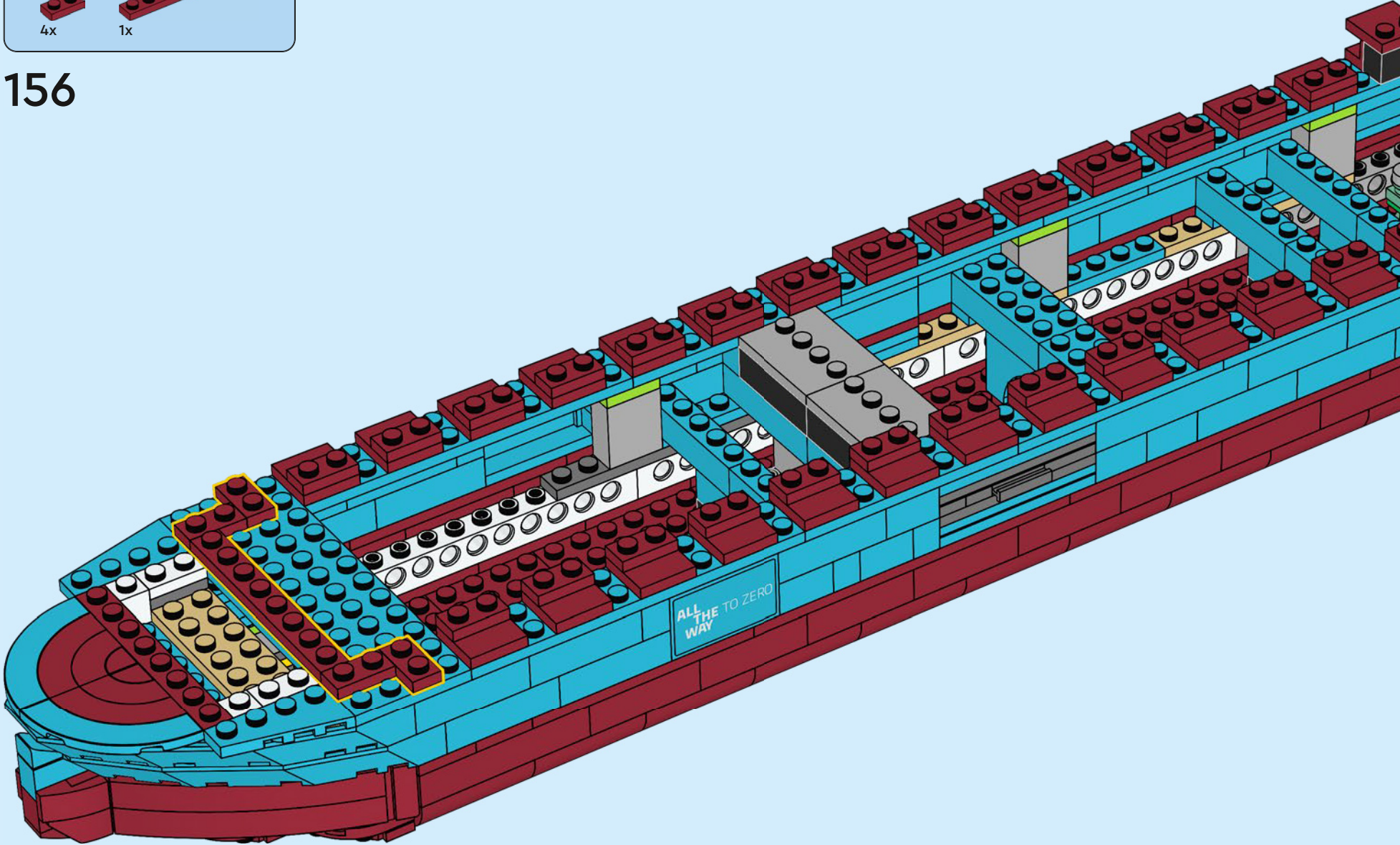

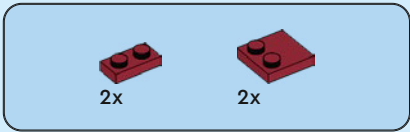

157

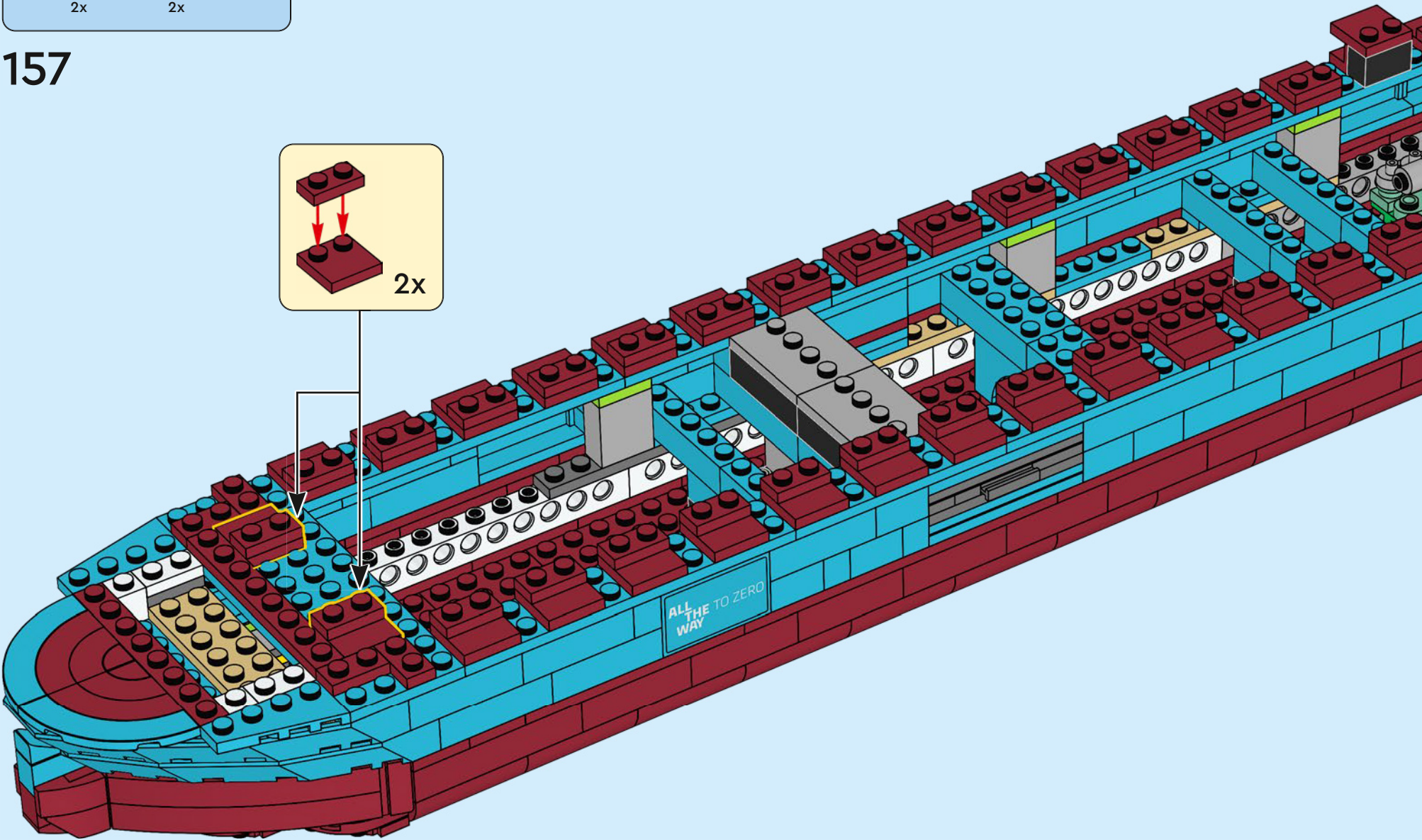
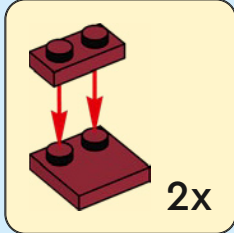

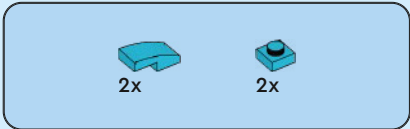

158

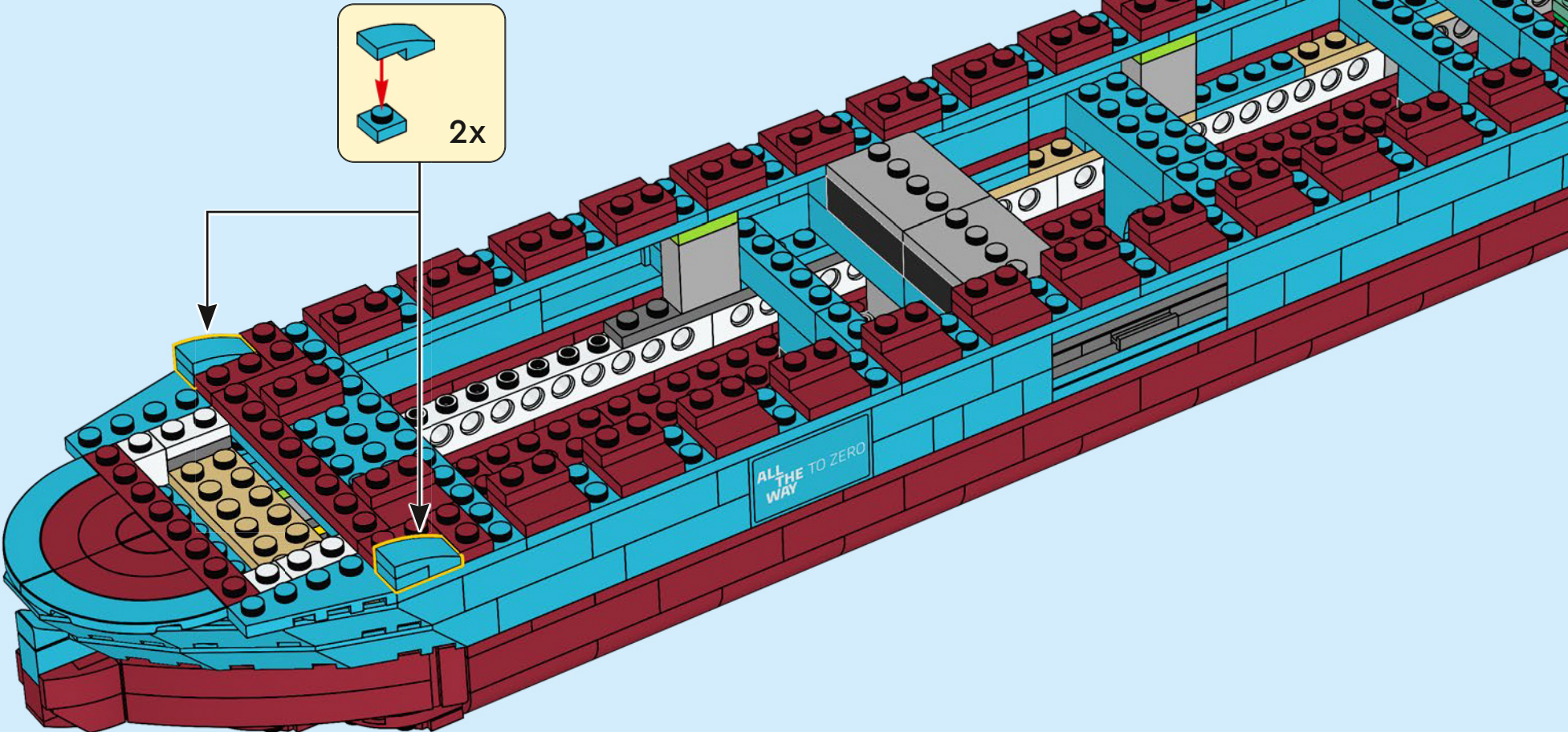

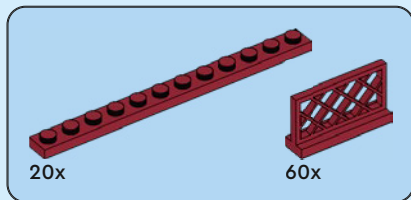
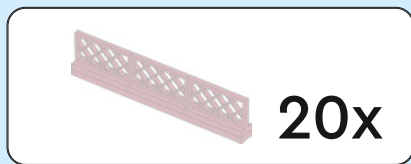

159

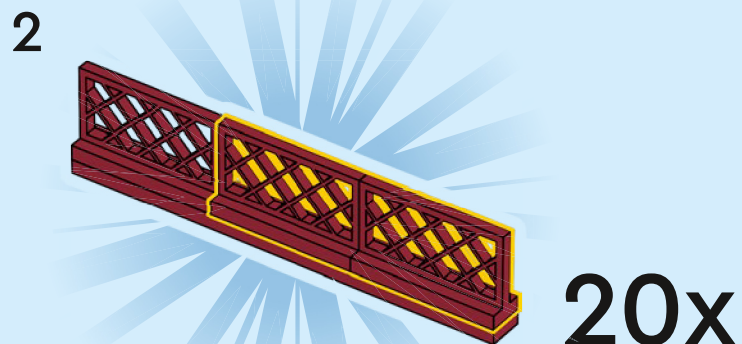
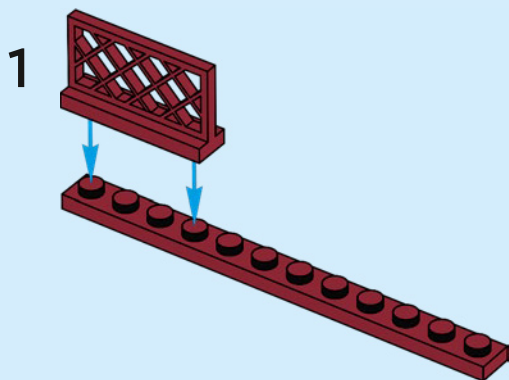
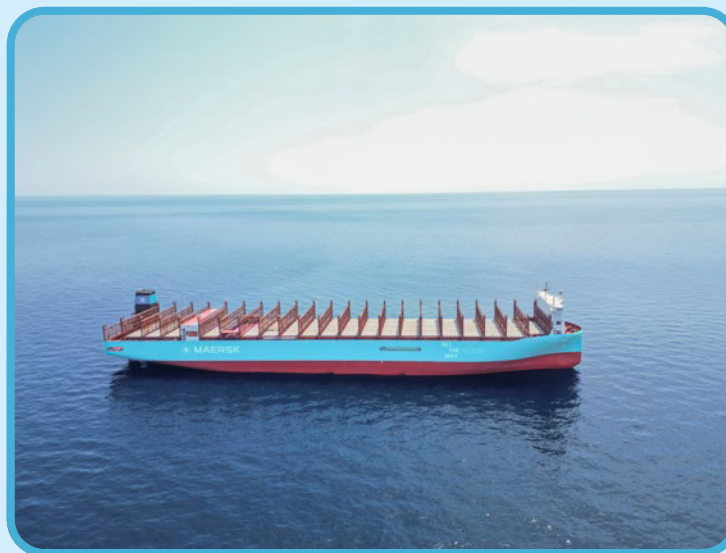

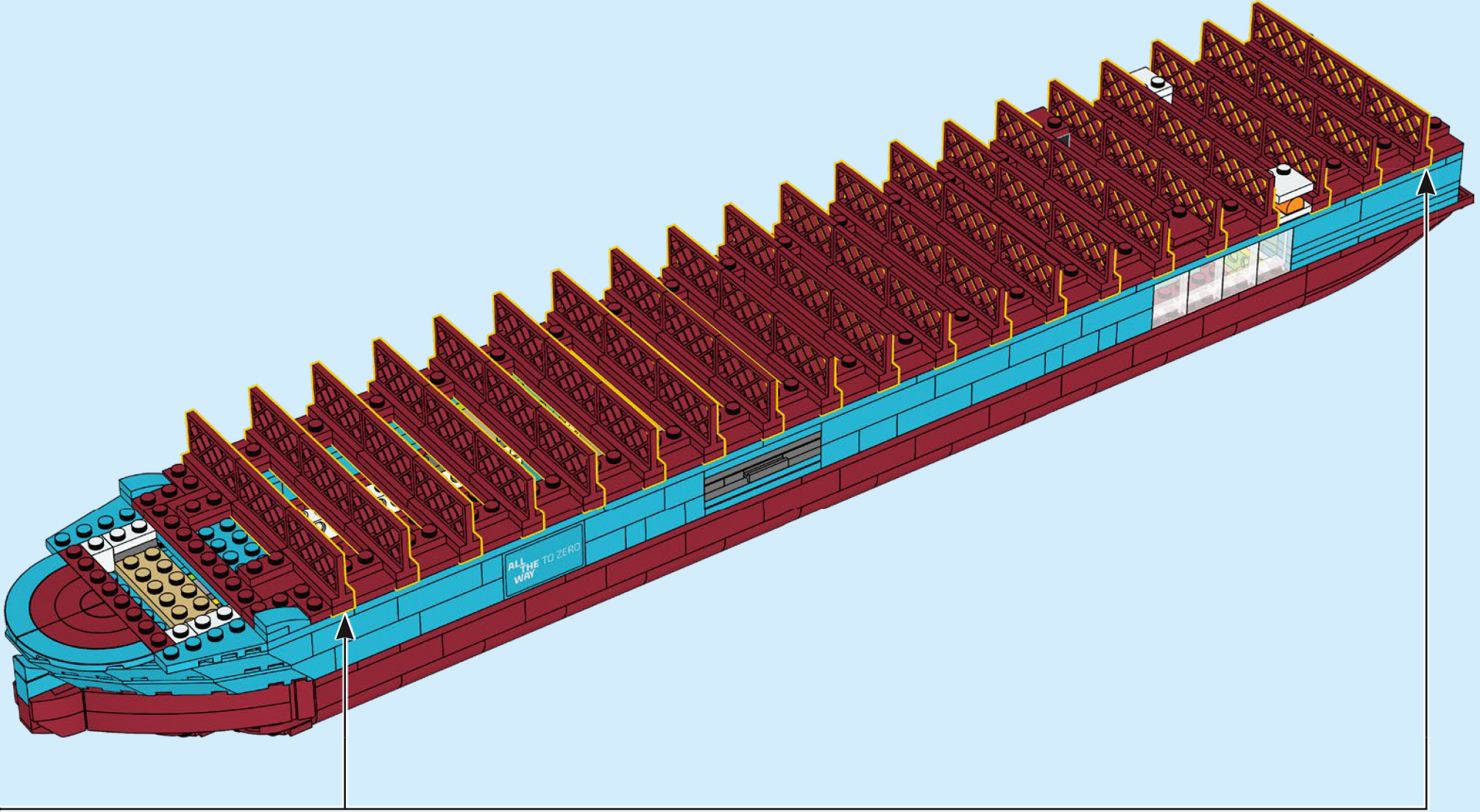

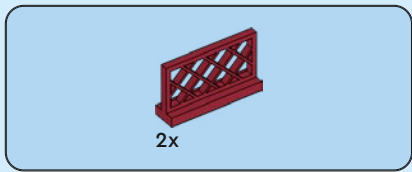

160

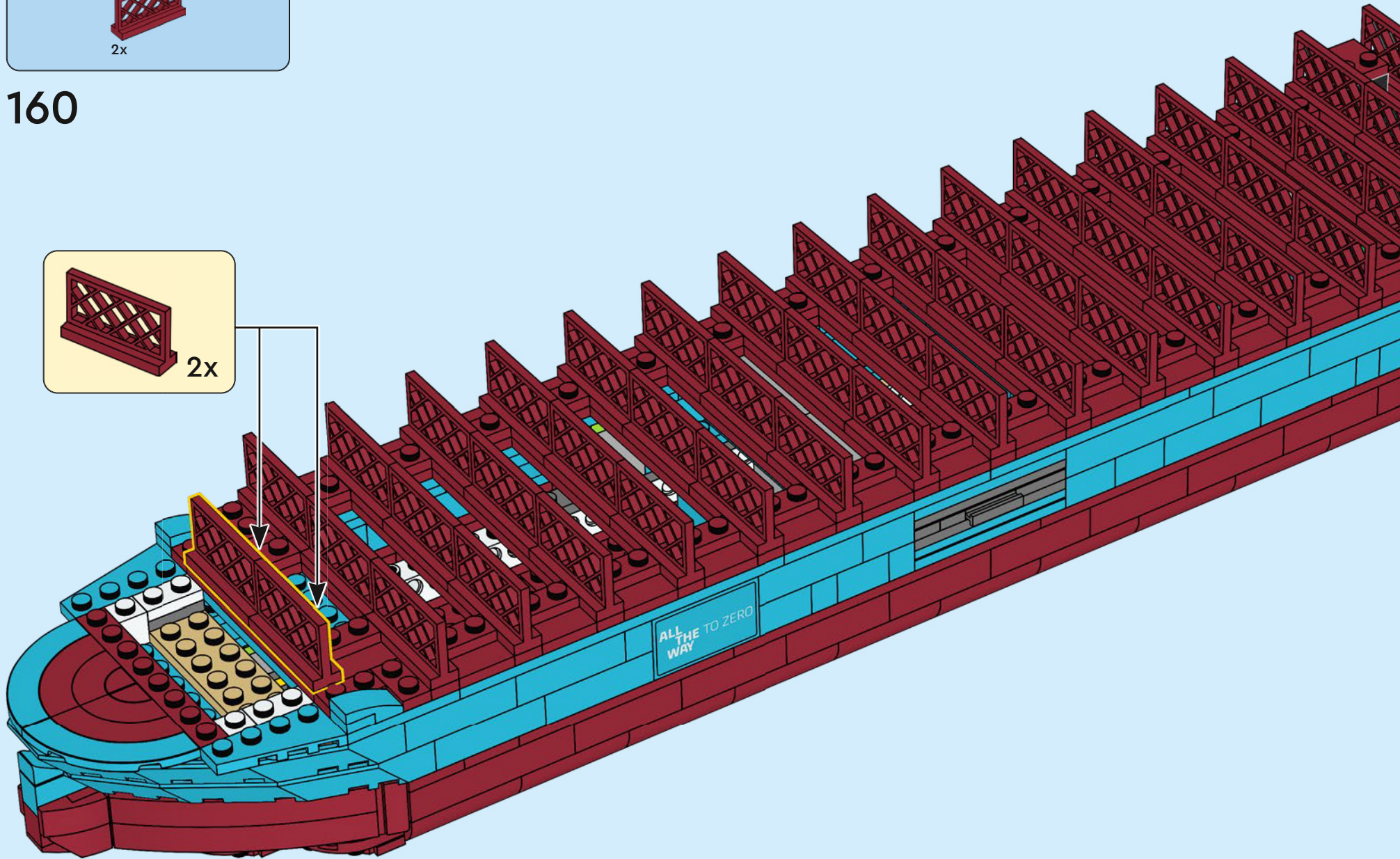
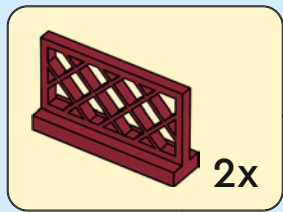

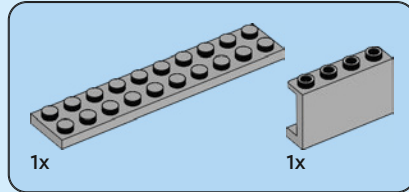
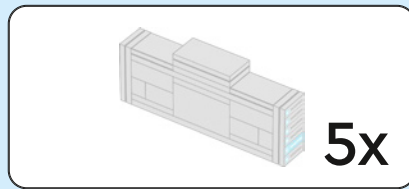

161

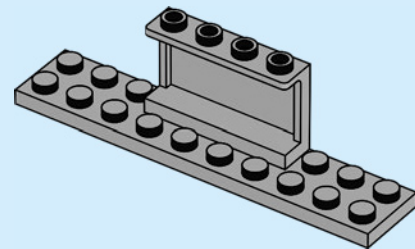
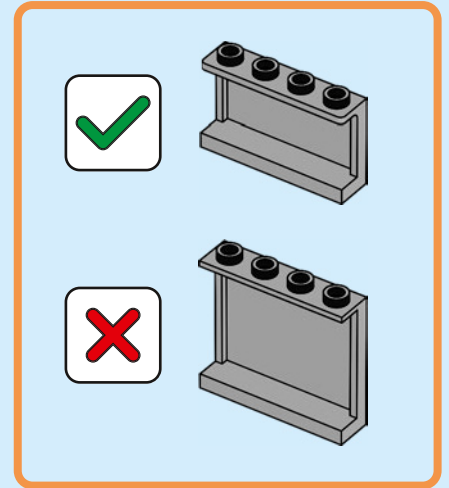

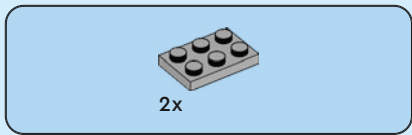

162

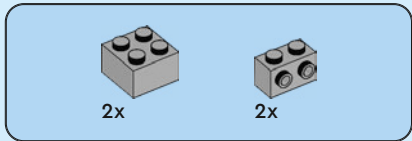
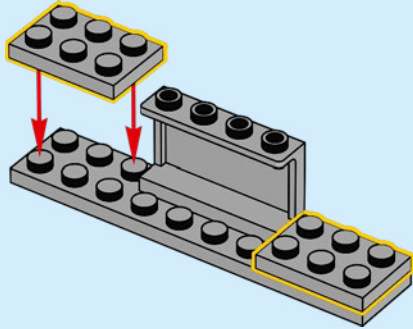

163

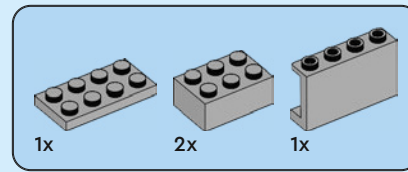
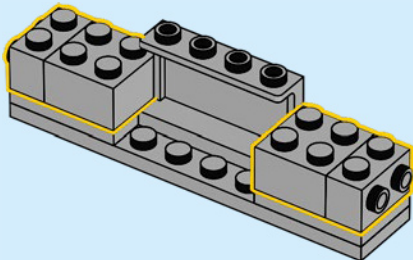

164

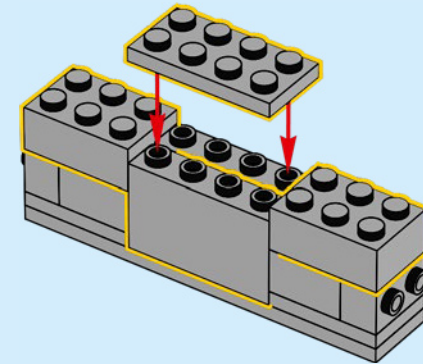

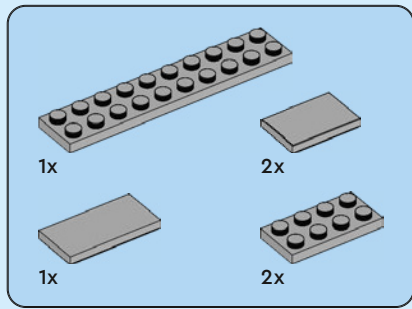

165

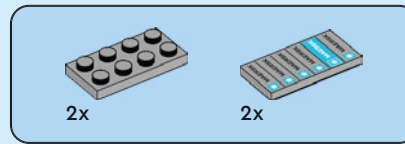
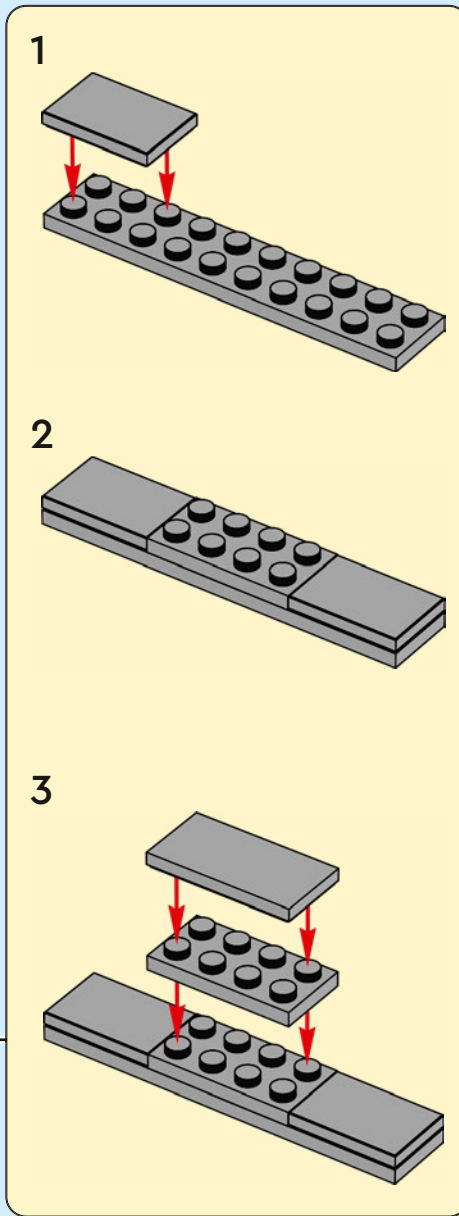
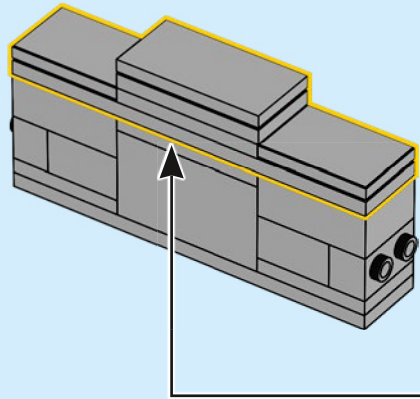

166

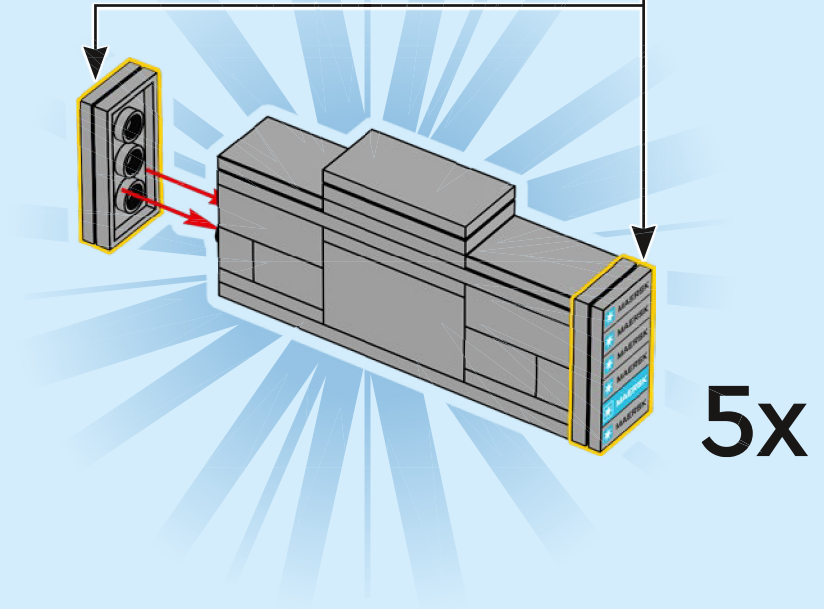
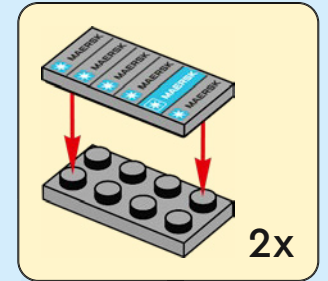

5x



167

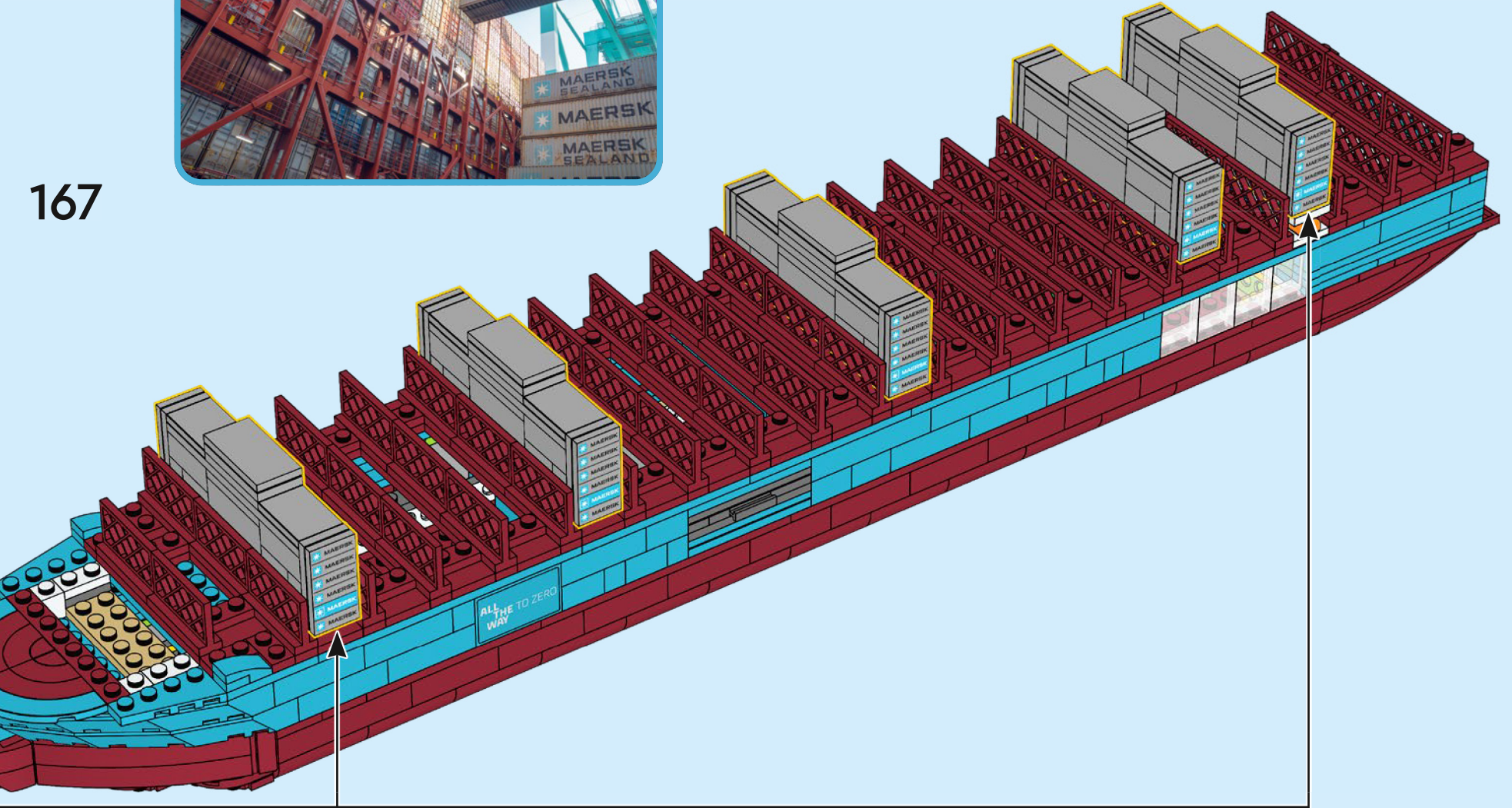

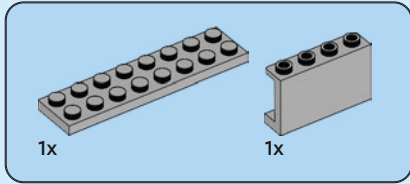
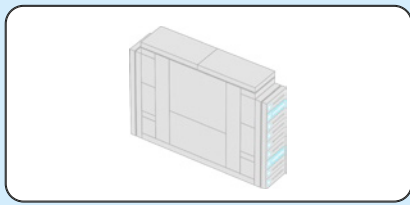

168

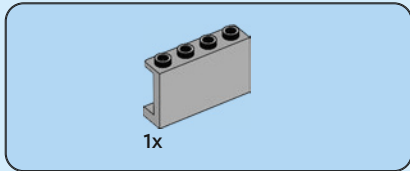
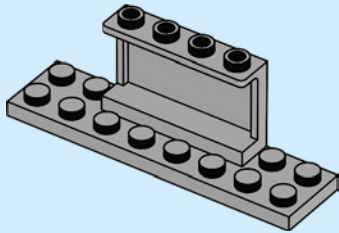

169

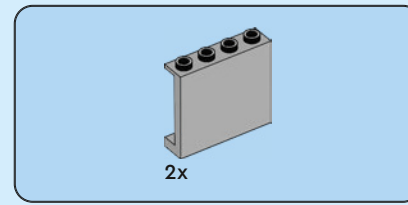
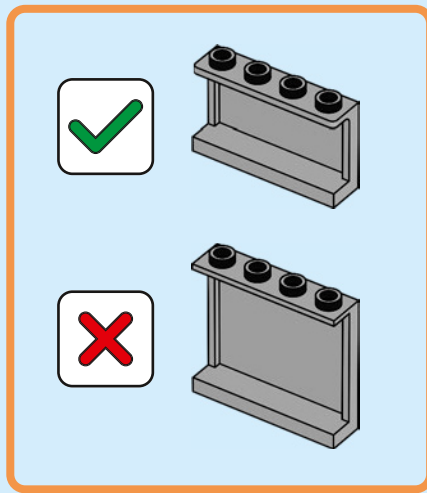
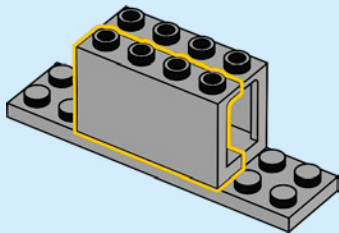

170

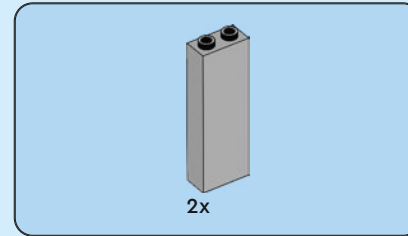
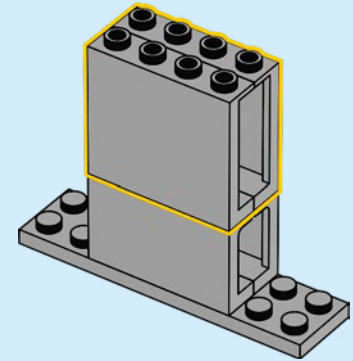

171

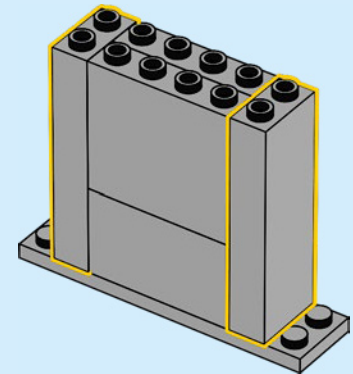

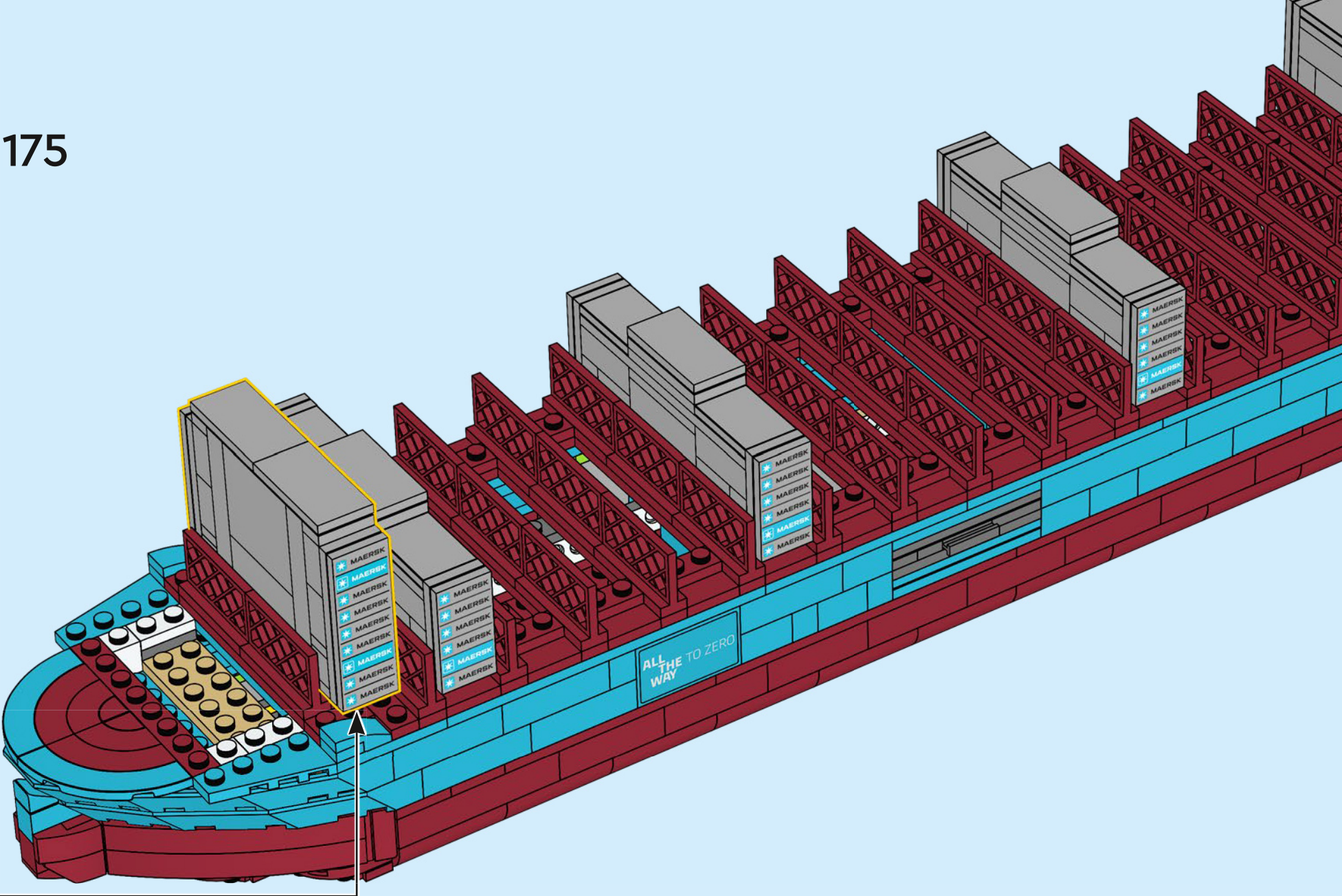

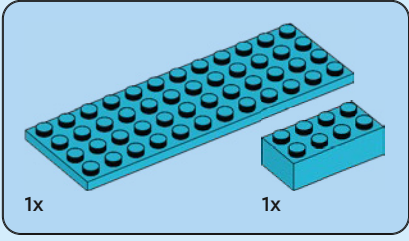
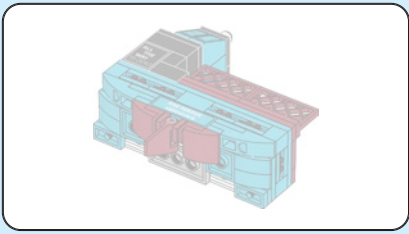

176

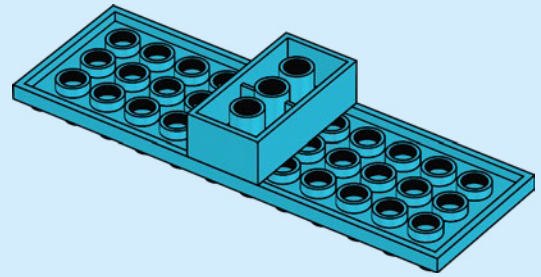

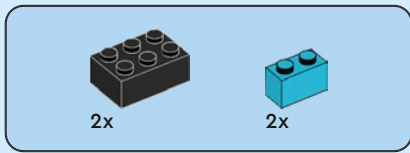

177

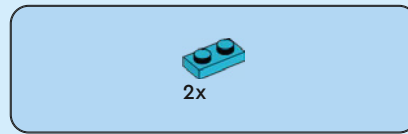
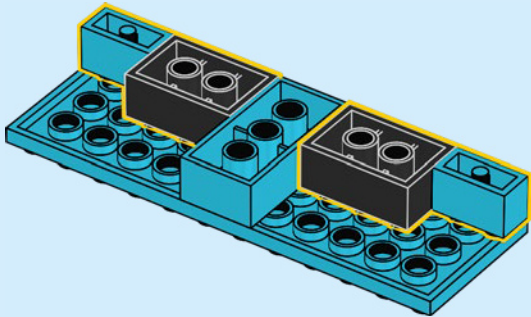

178

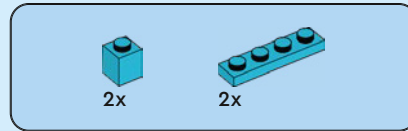
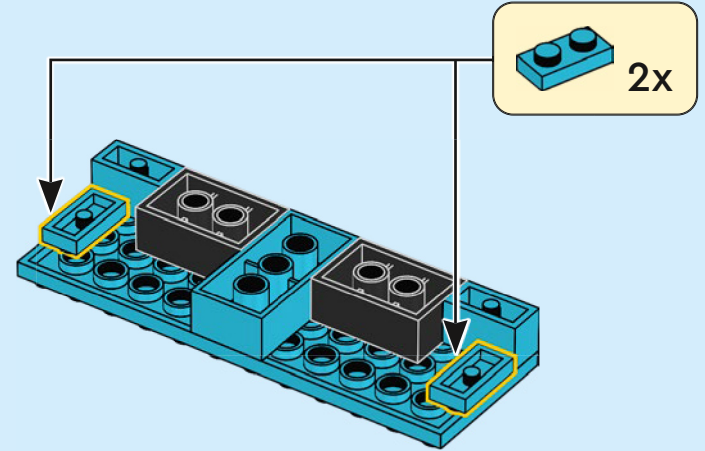

179

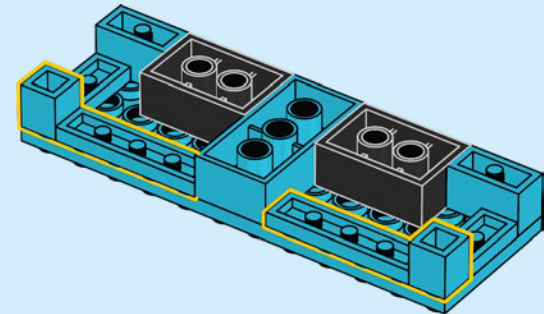

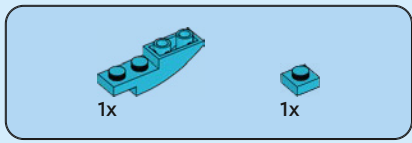

180

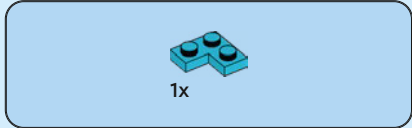
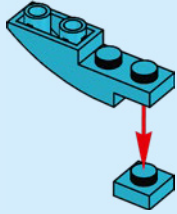

181

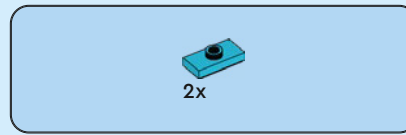
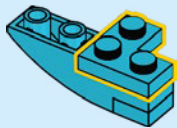

182

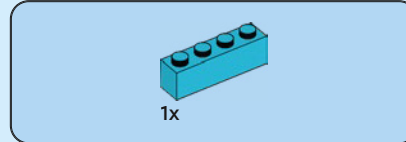
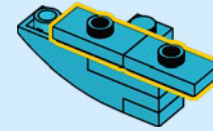

183

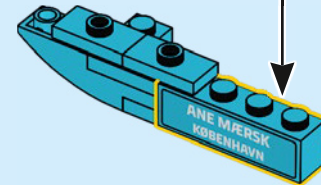
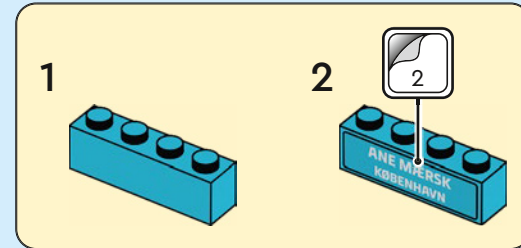

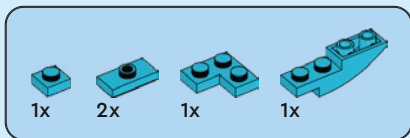

184

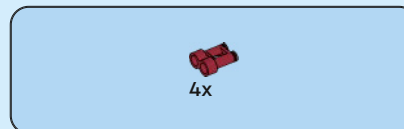
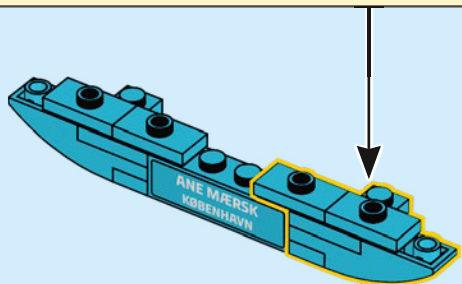
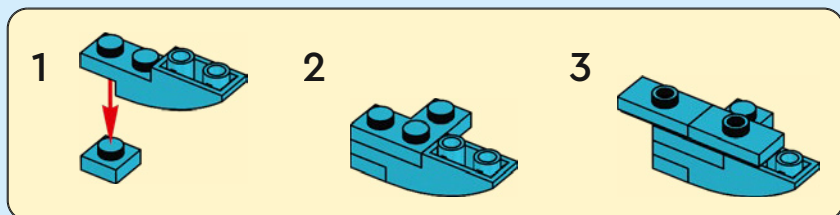

185

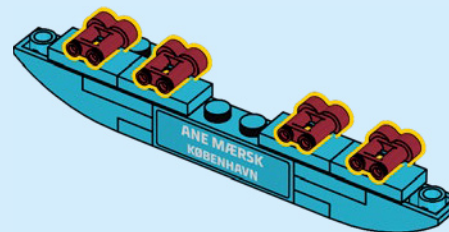

186

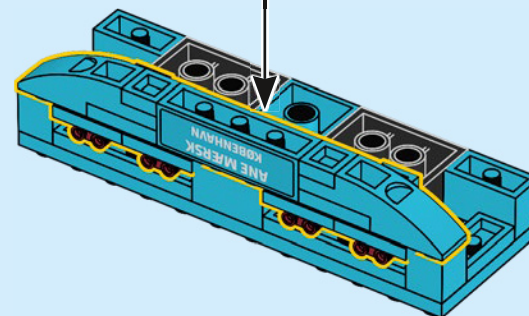

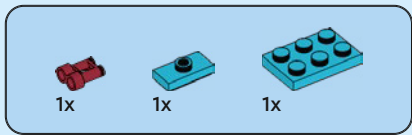

187

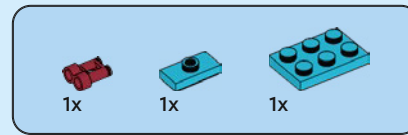
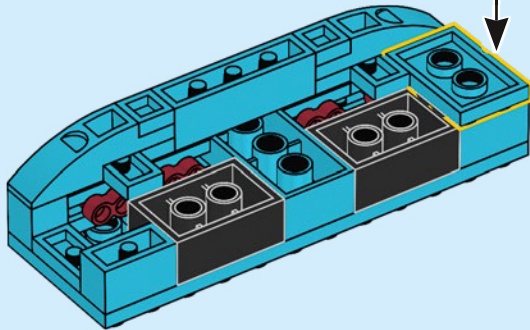
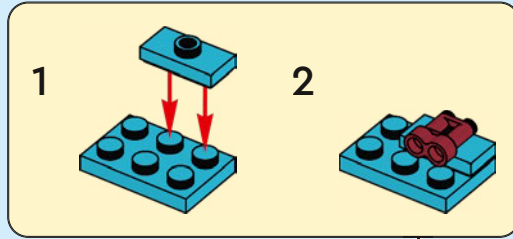

188

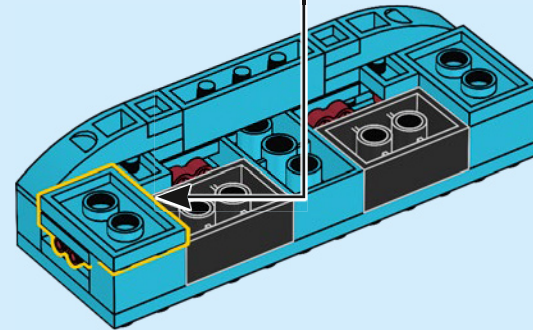
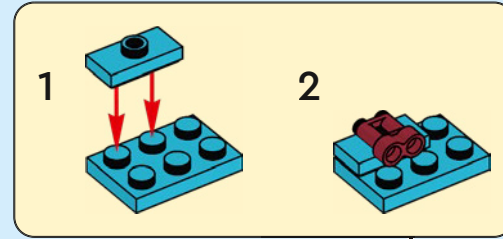

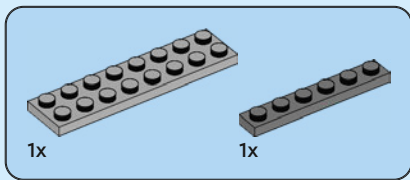

189

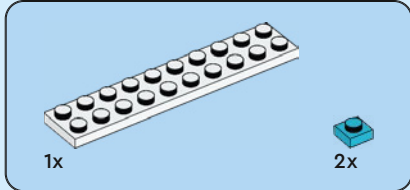
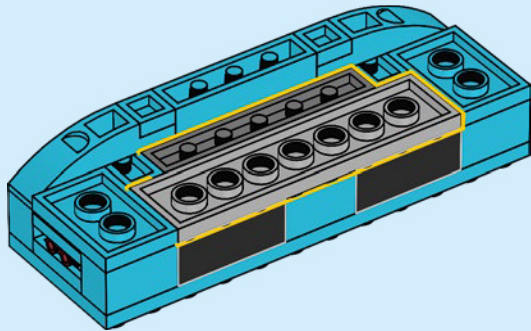

190

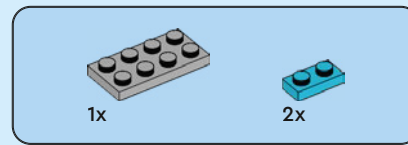
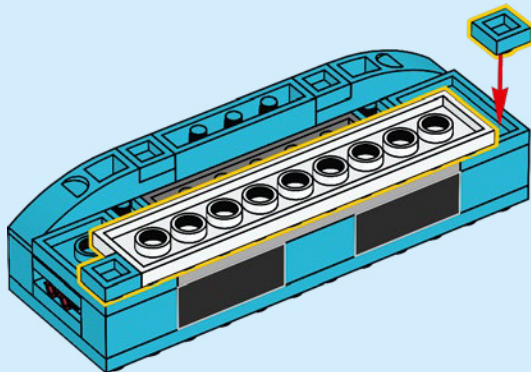

191

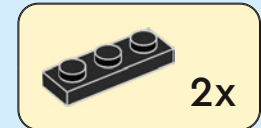
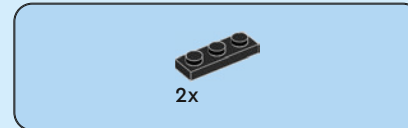
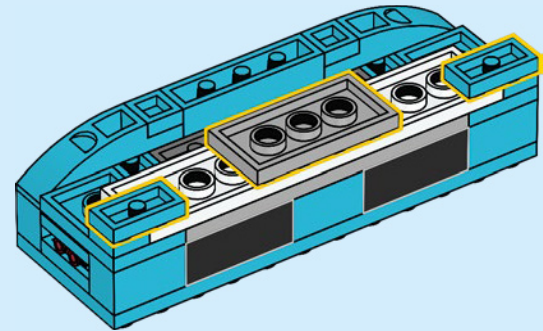

192

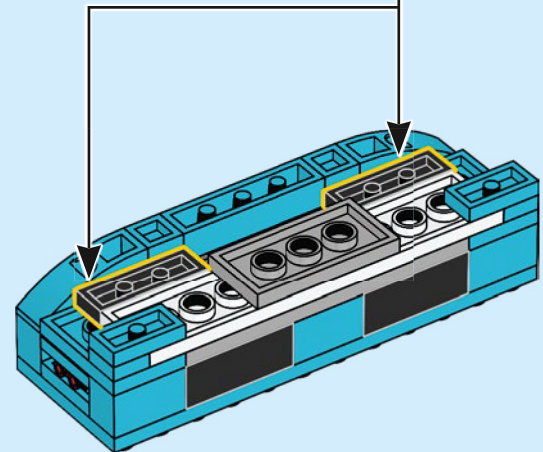



4x

193

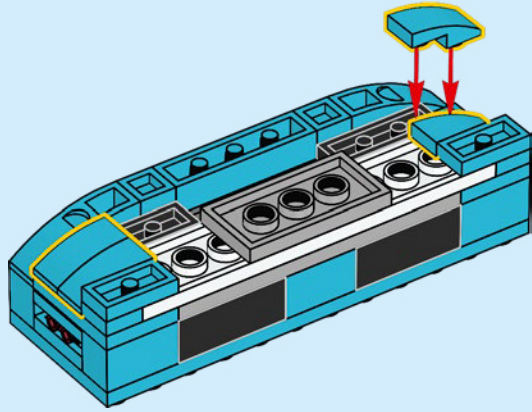

2x

194

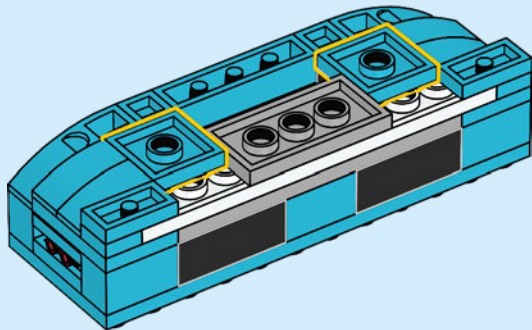

1x



1x



1x

195

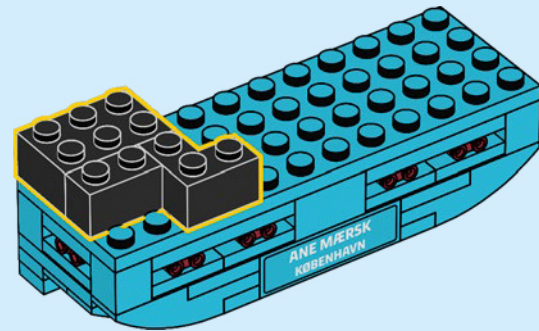

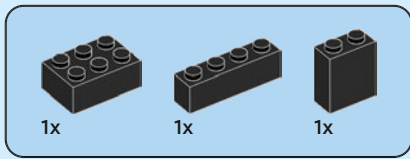

196

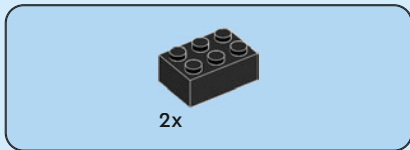
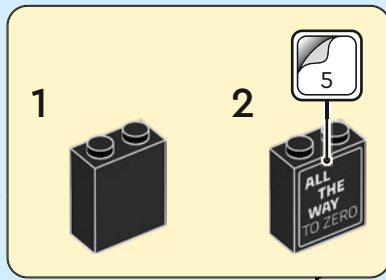
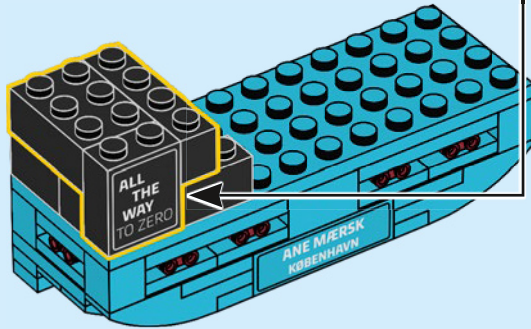

197

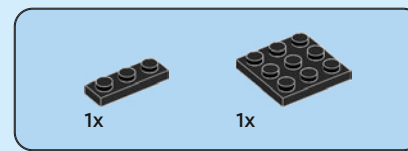
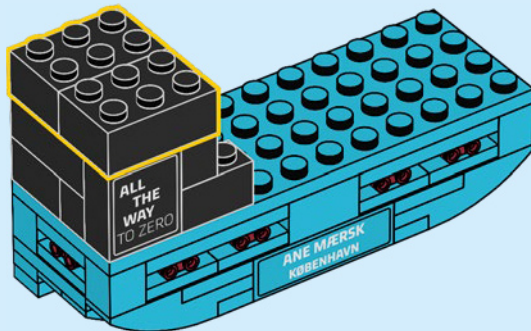

198

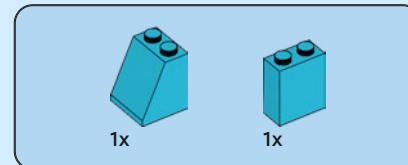
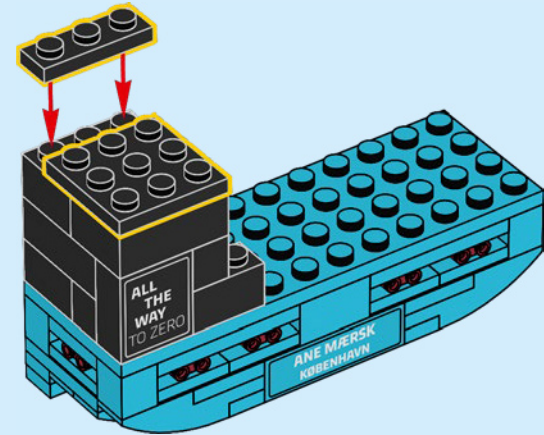

199

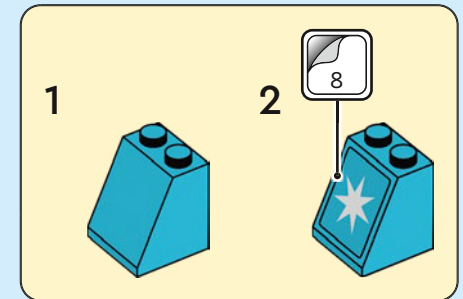
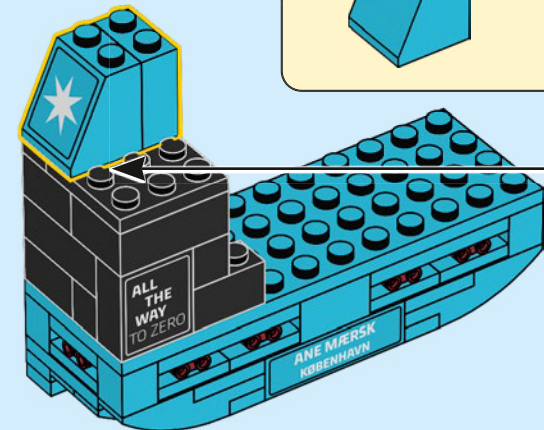

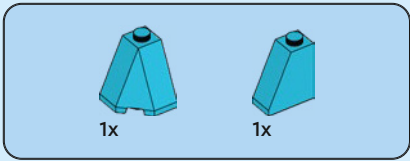

200

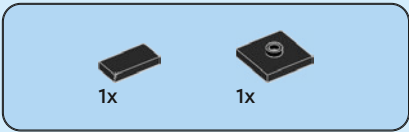
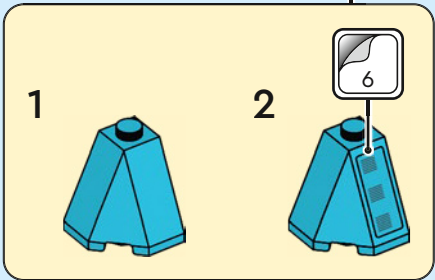
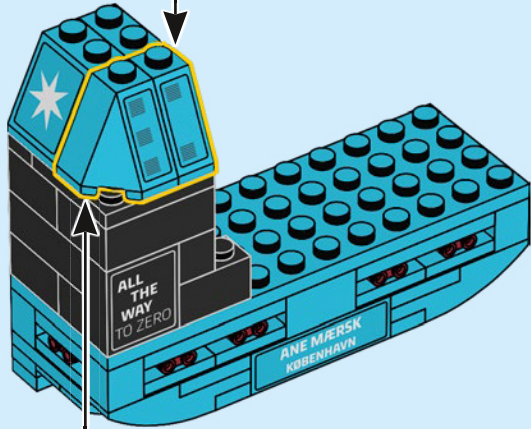
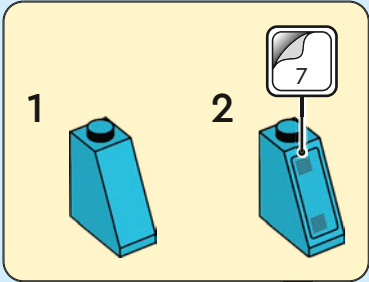

201

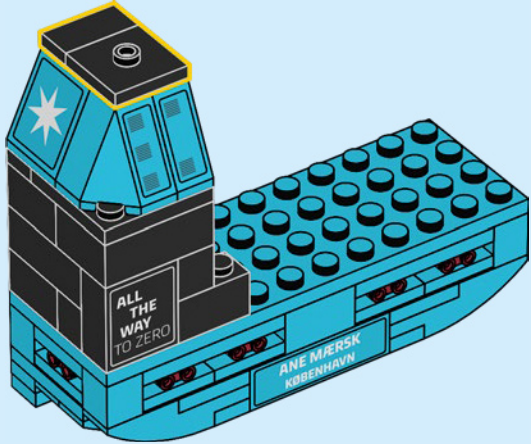



1x



1x

202

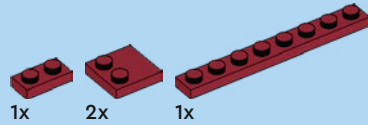
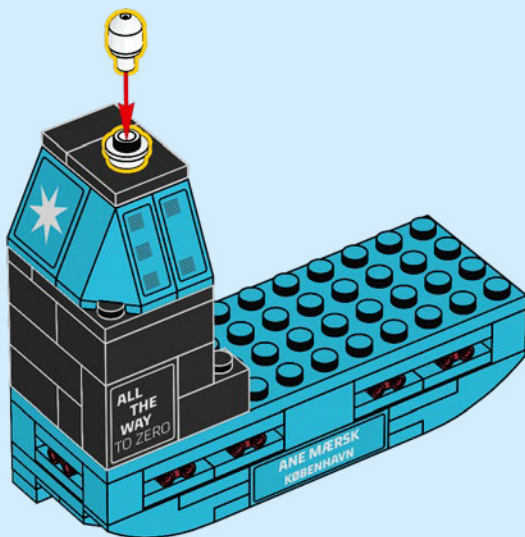

1x

2x

1x

203

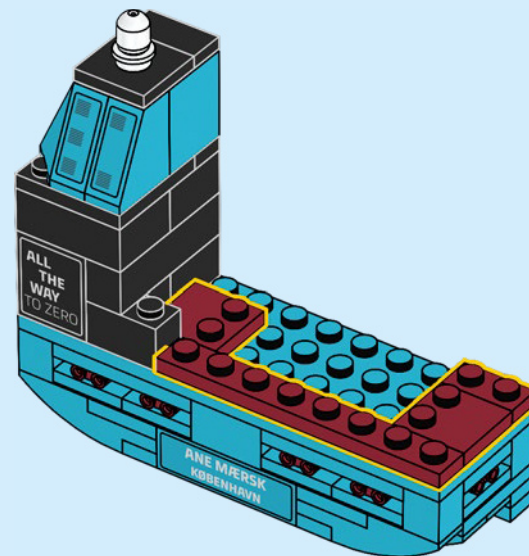



2x

204

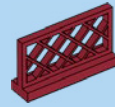
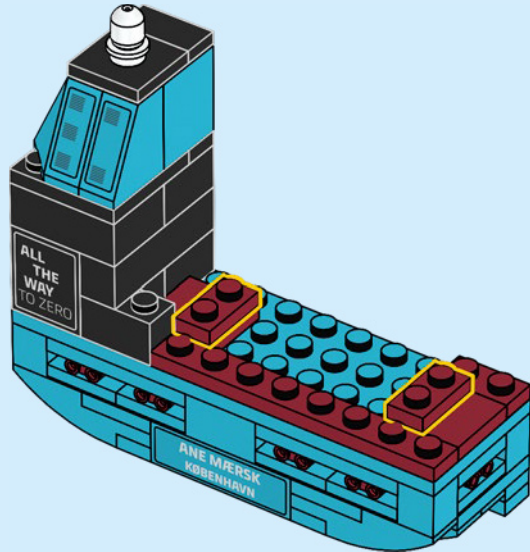

2x

205

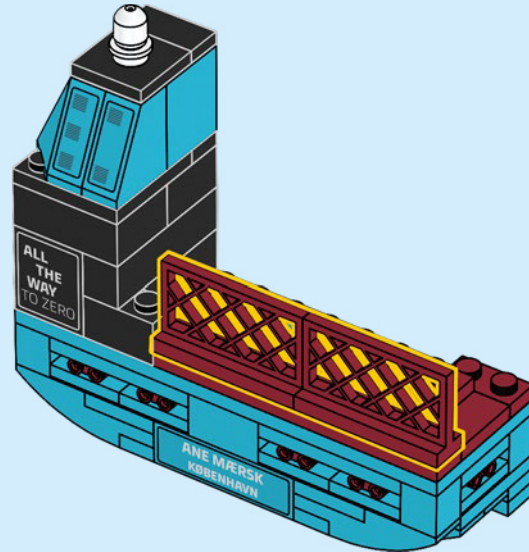

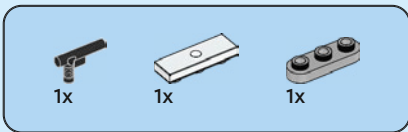

206

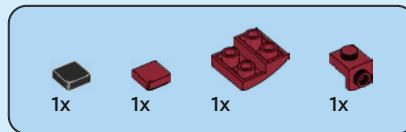
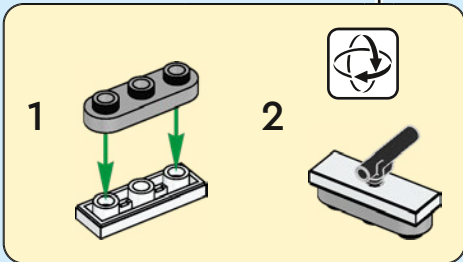
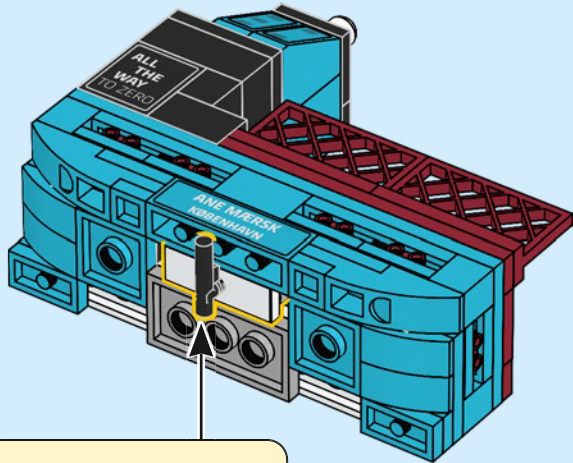

207

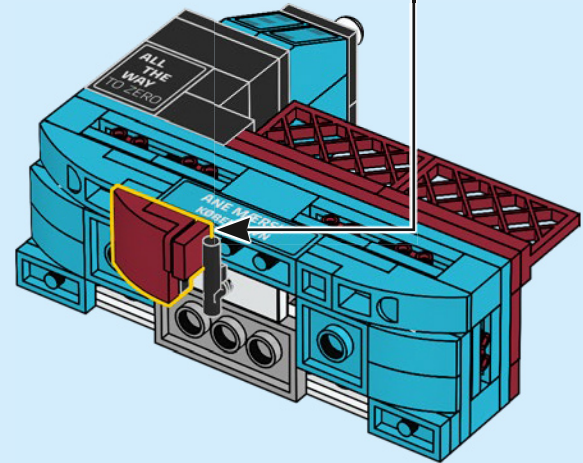
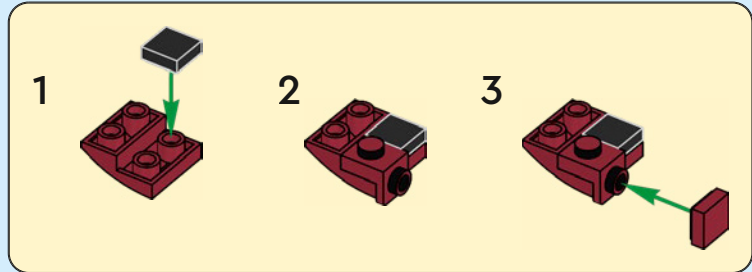

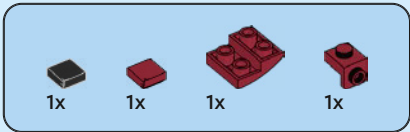

208

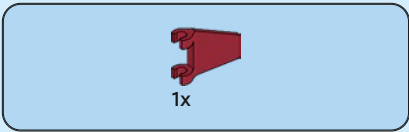
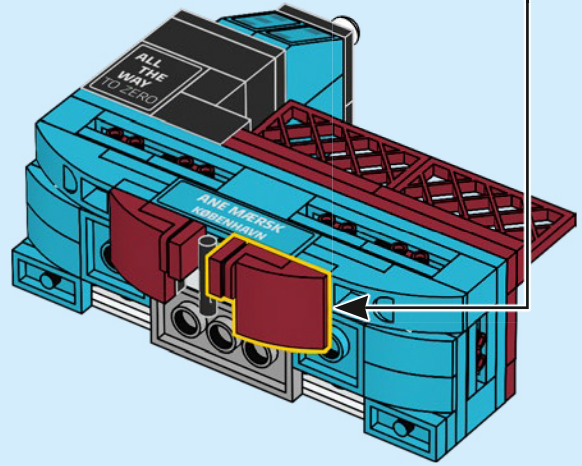

209

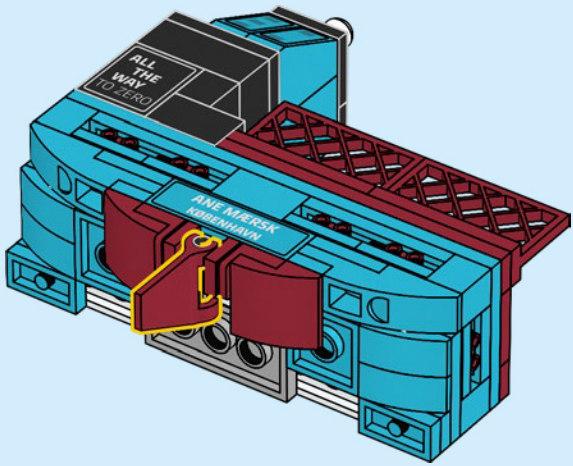

210

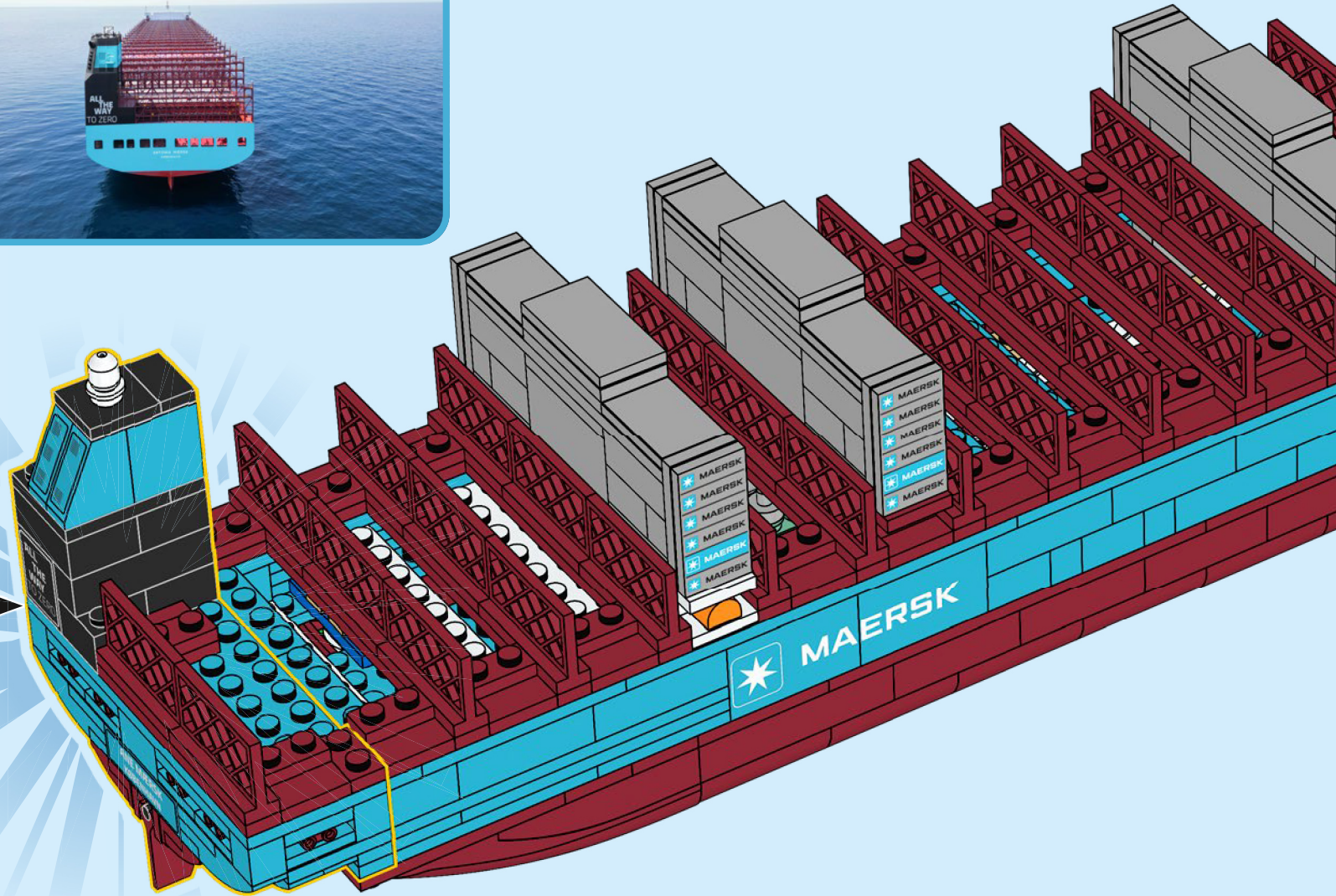
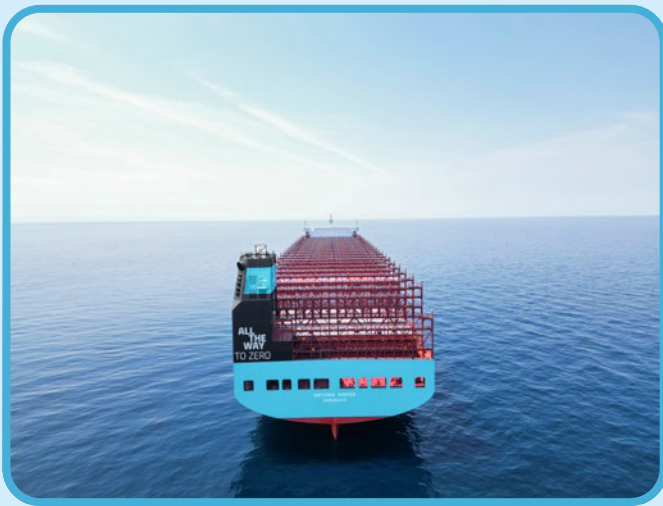

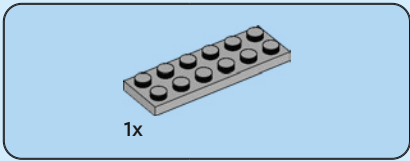

211

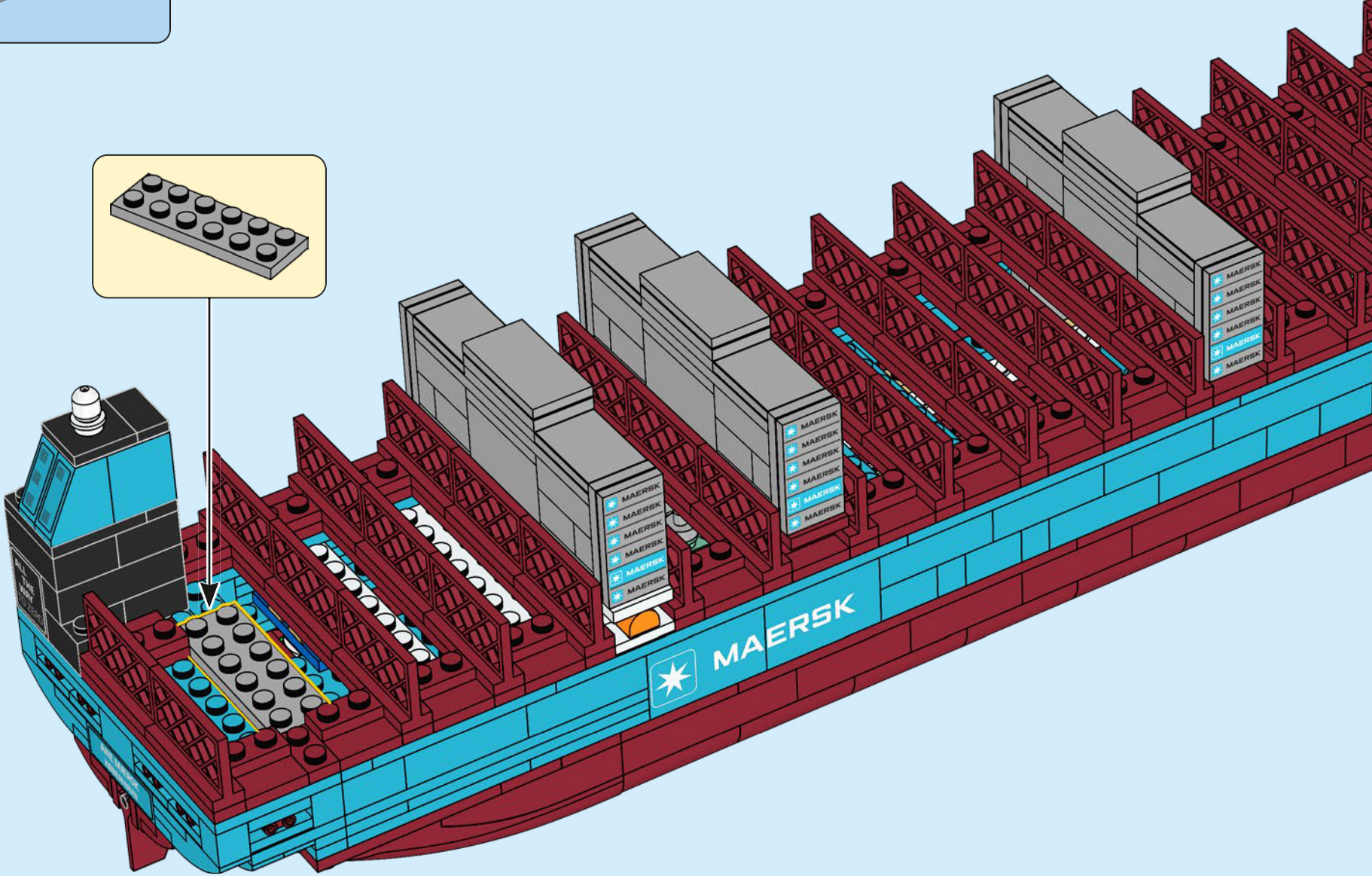
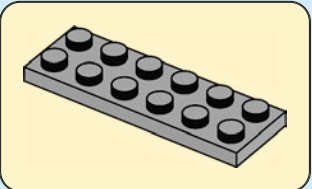

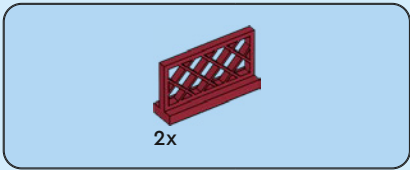

212

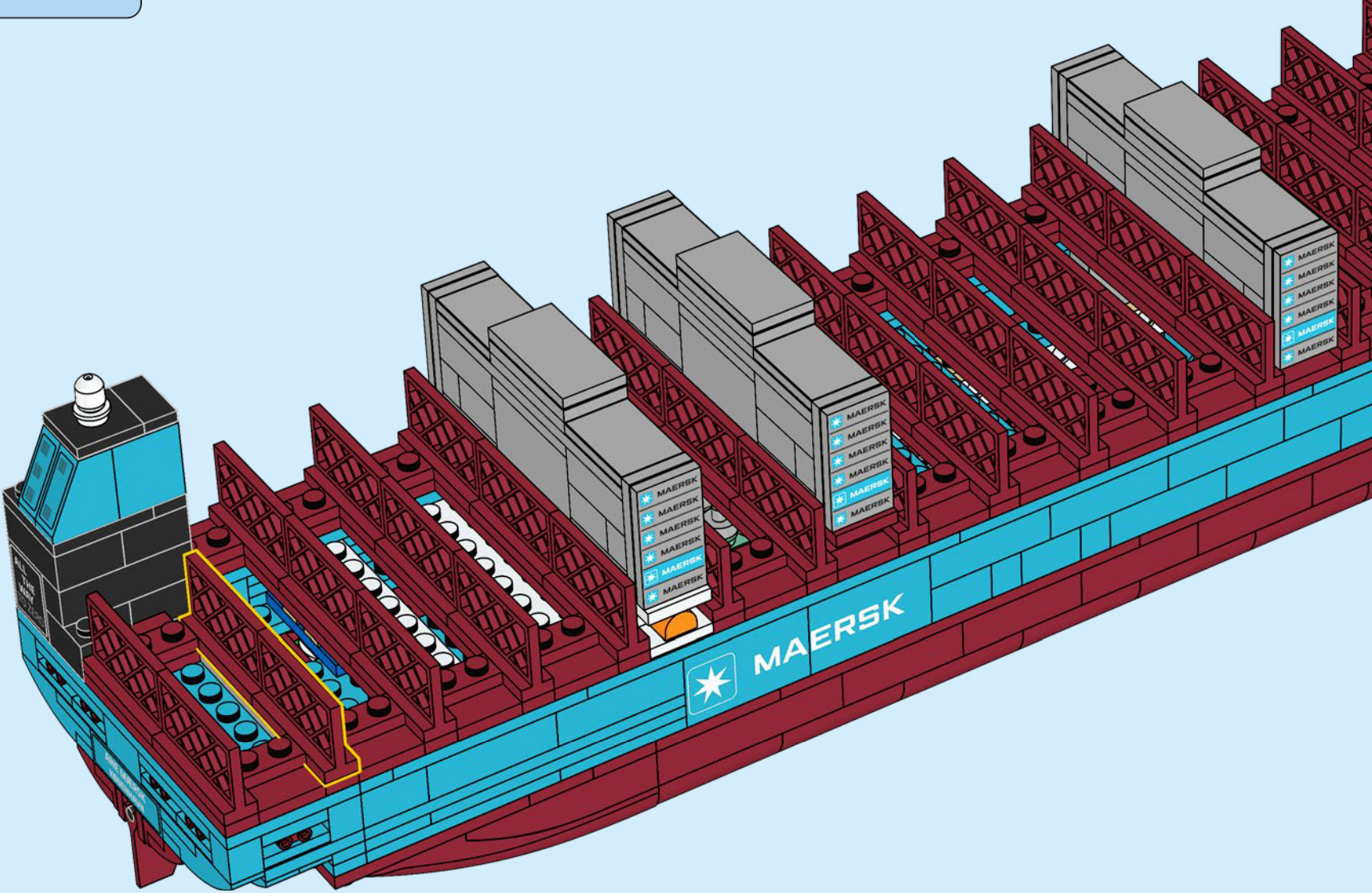

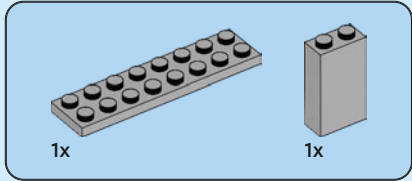
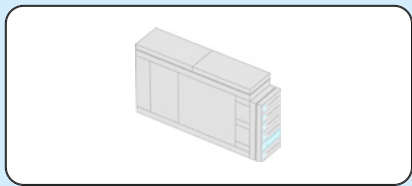

213

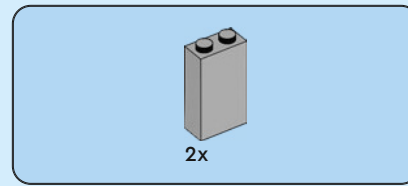
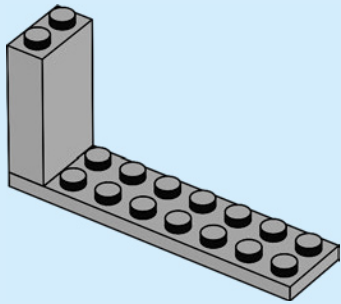

214

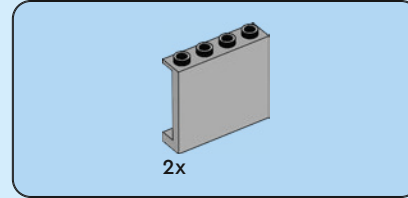
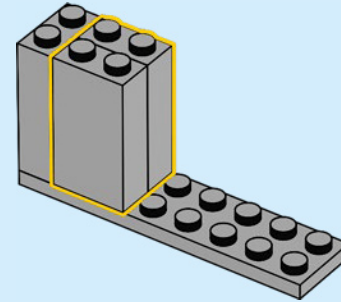

215

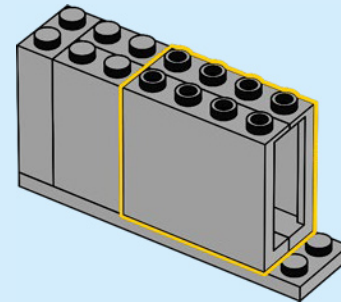

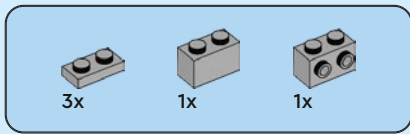

216

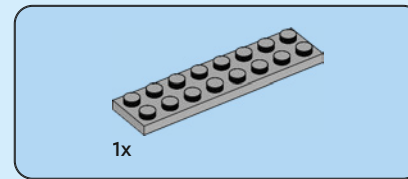
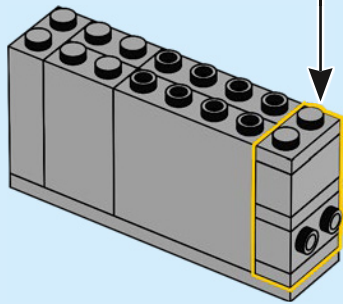
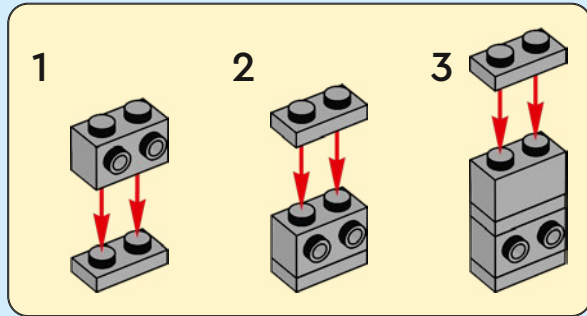

217

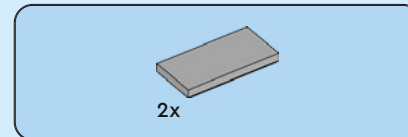
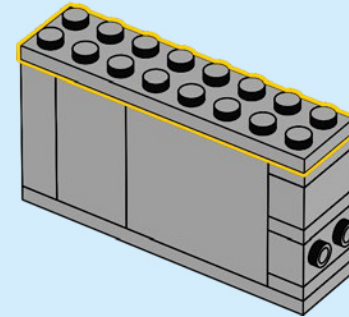

218

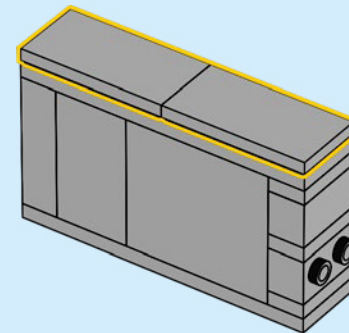

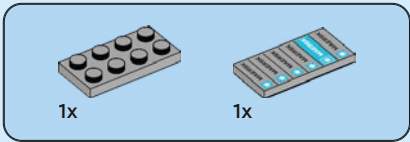

219

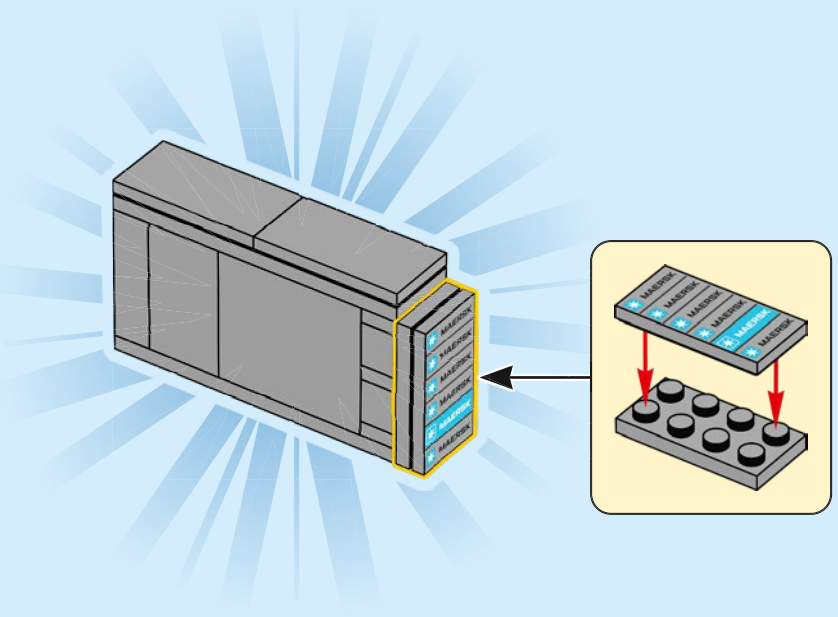

220

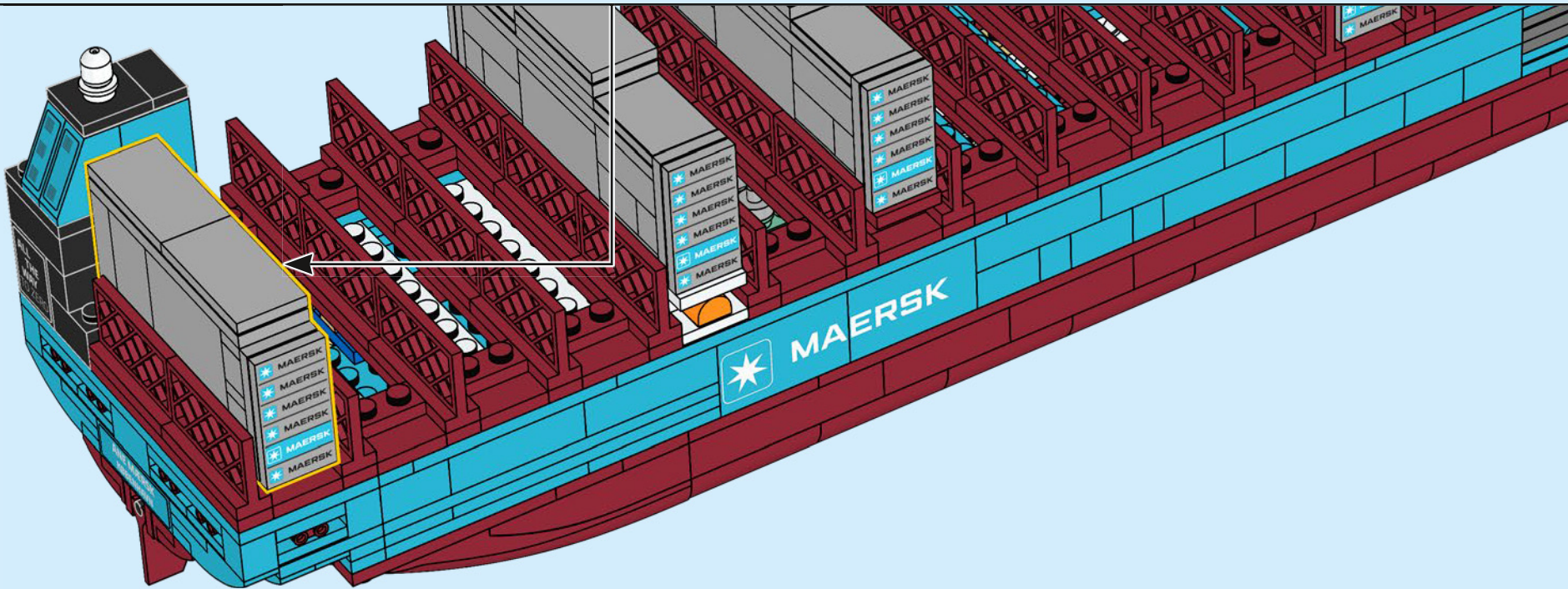

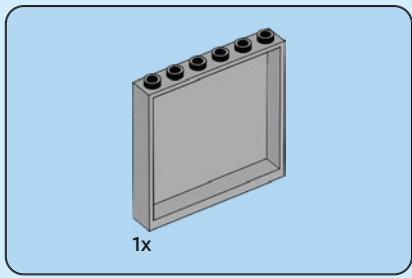

222

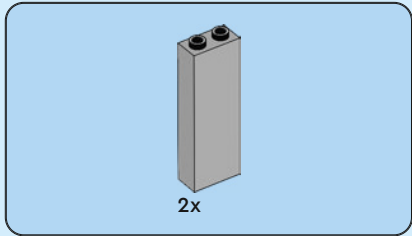
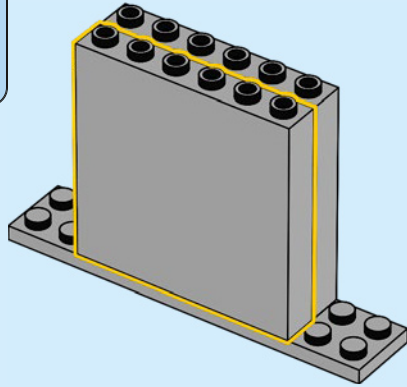

223

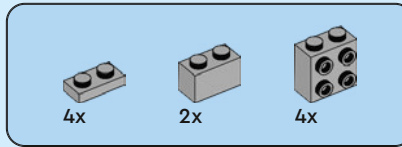
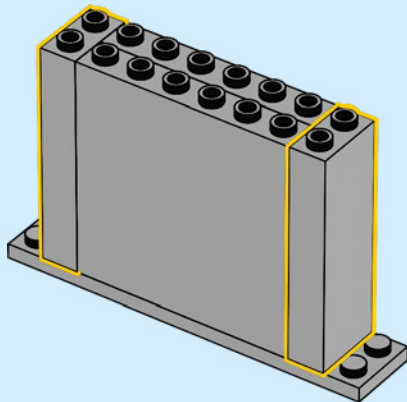

224

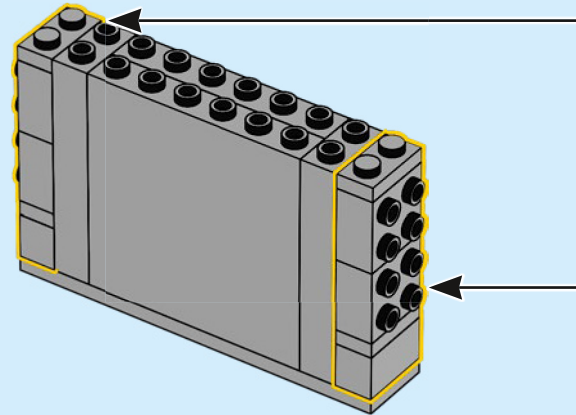
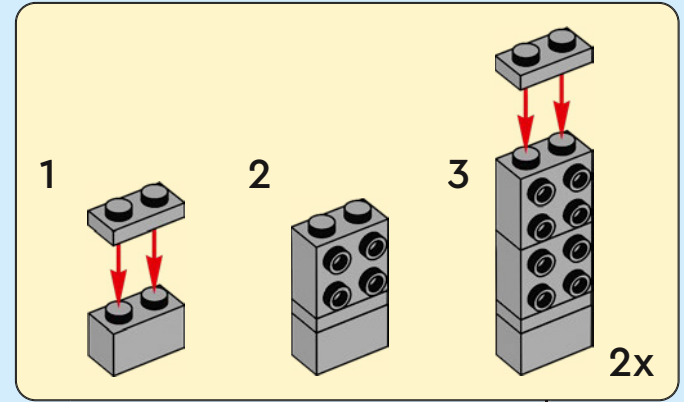

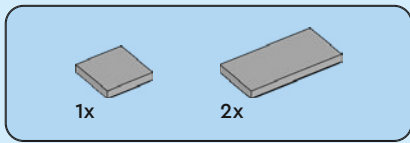

225

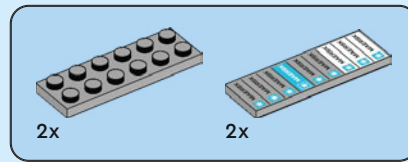
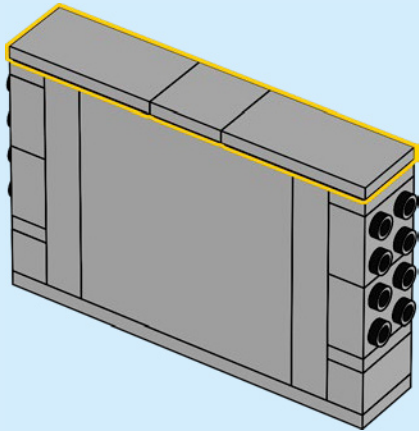

226

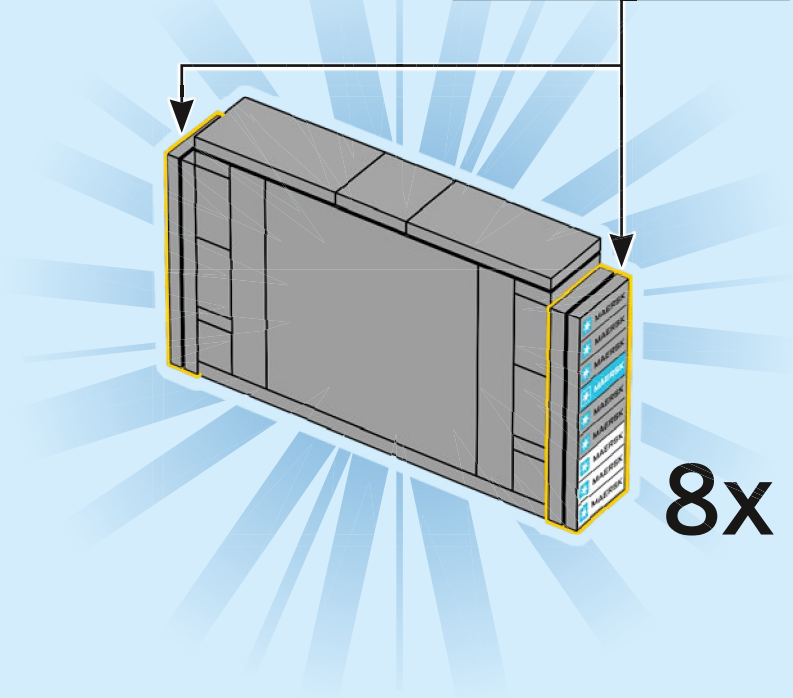
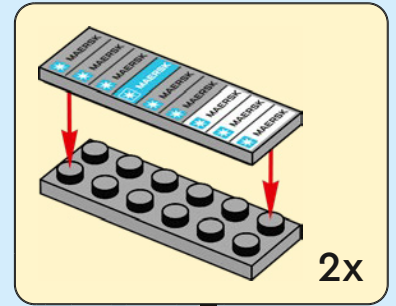

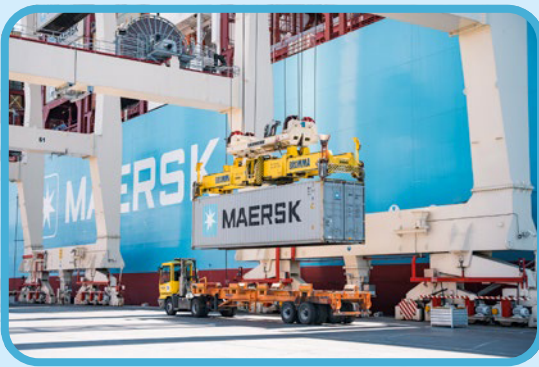

227

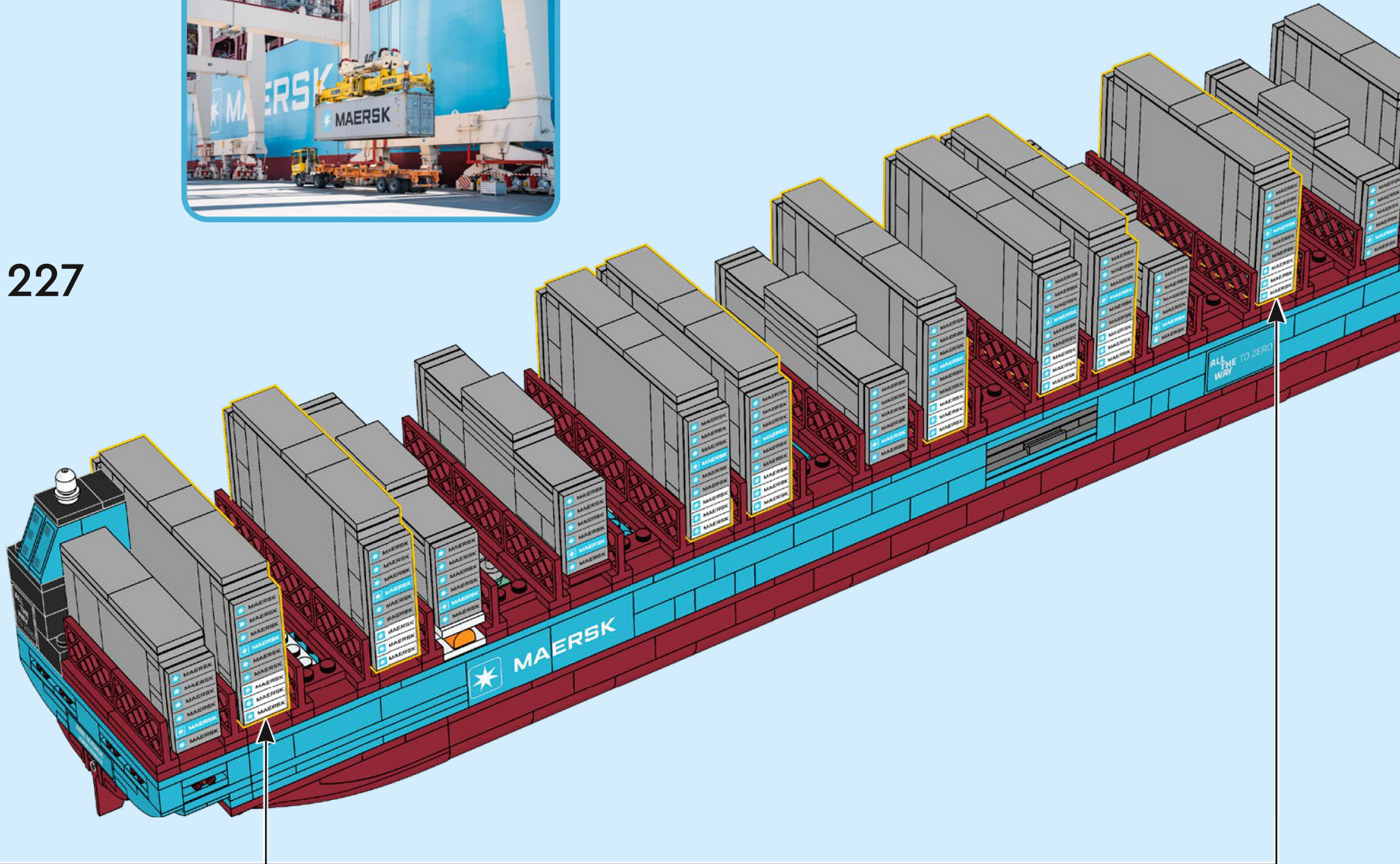





228

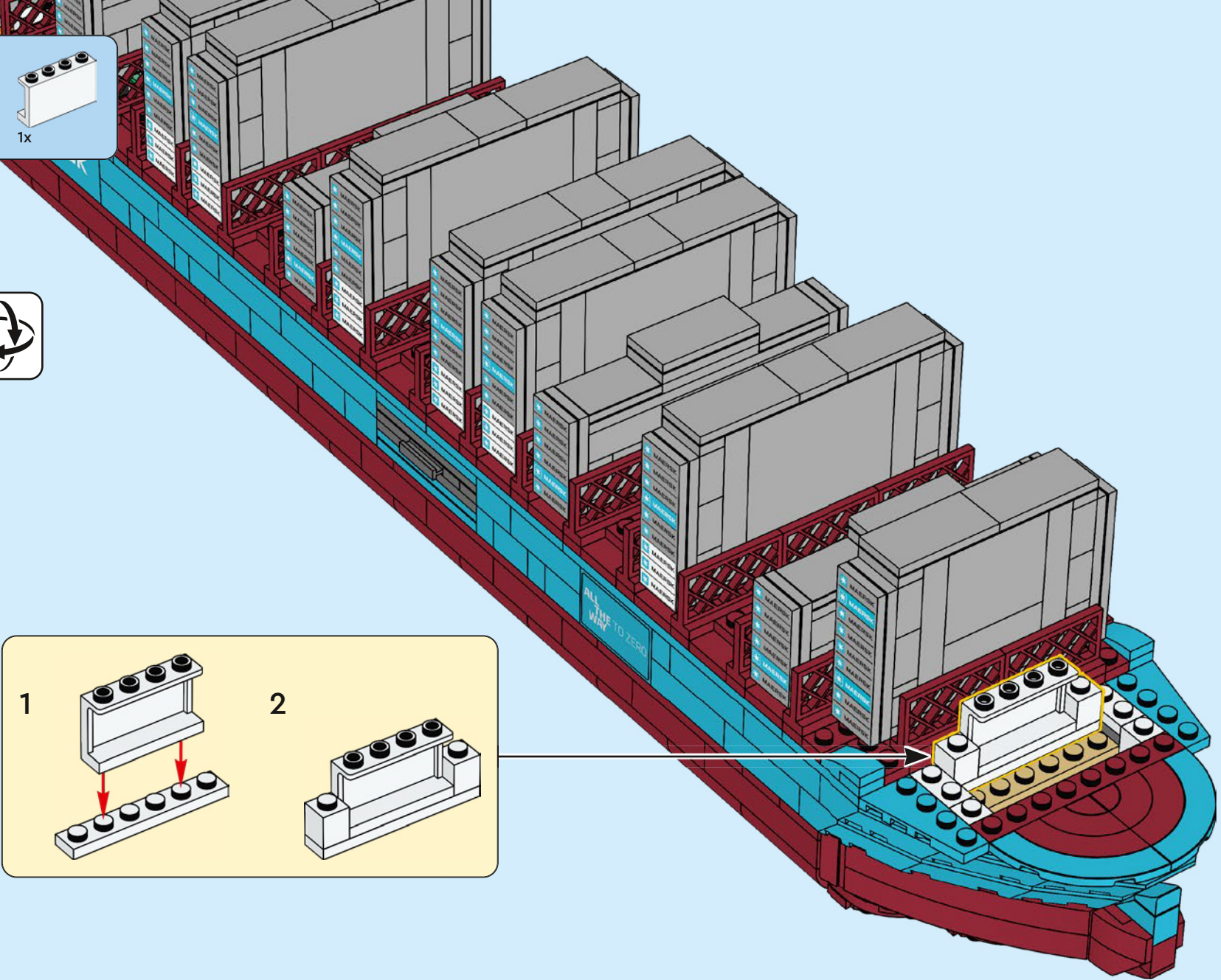
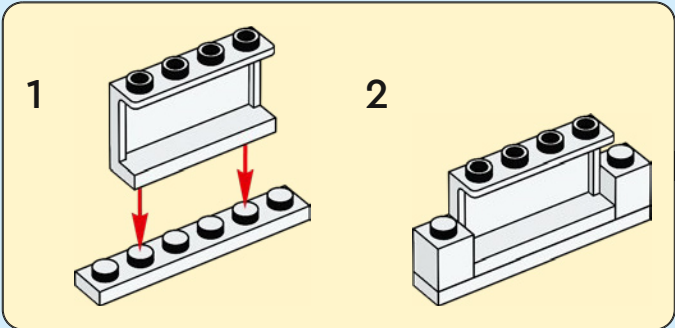

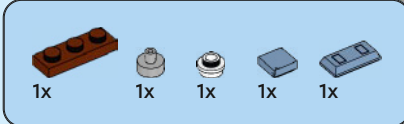

229

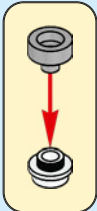
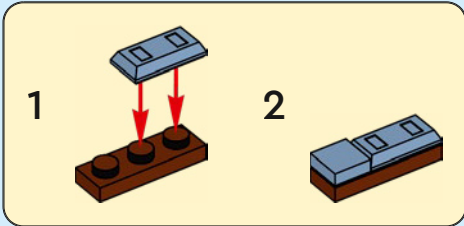

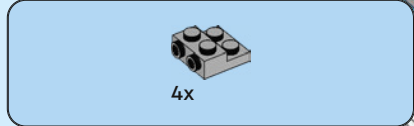

230

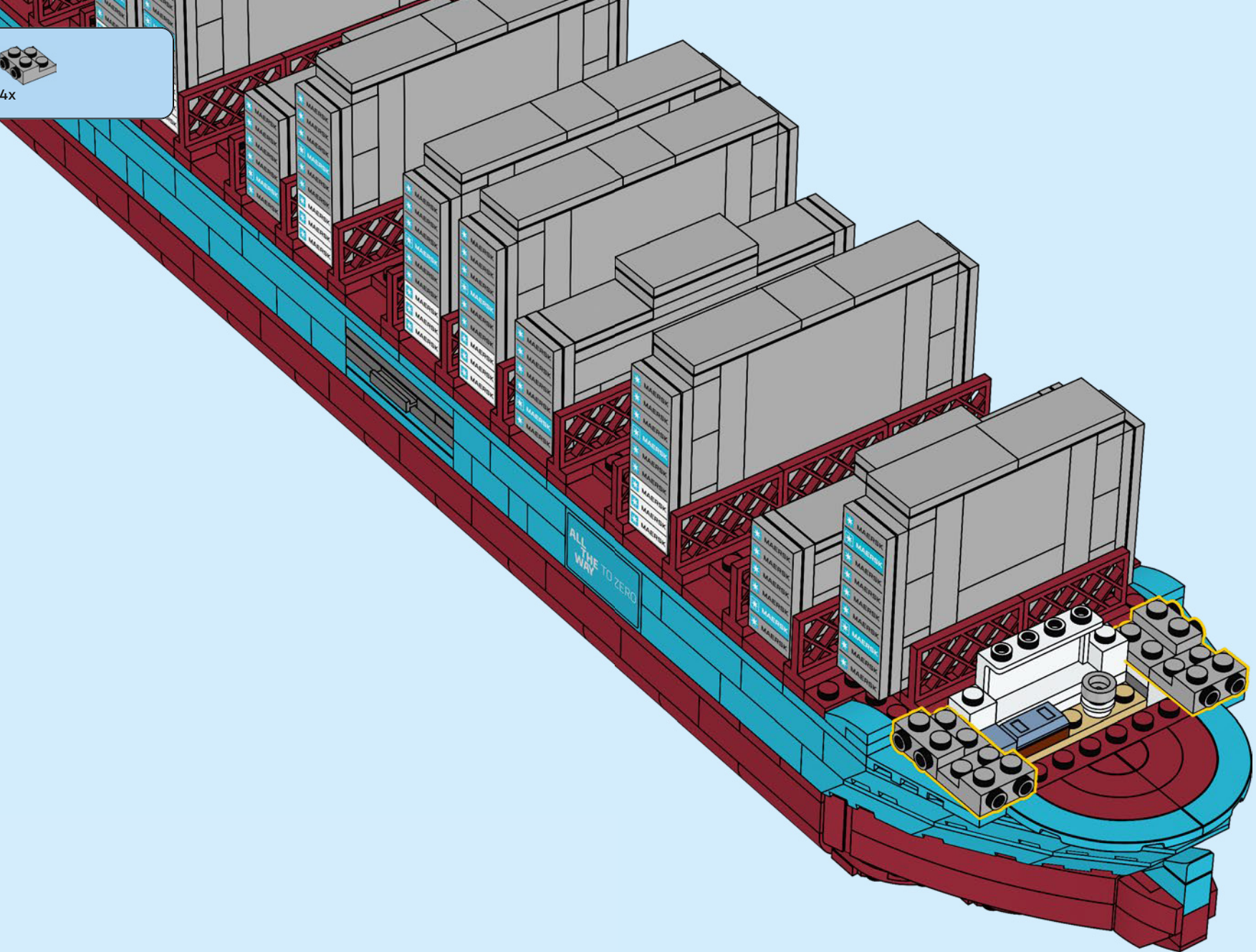

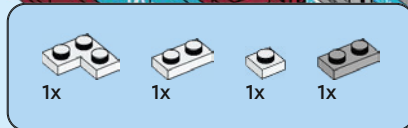

231

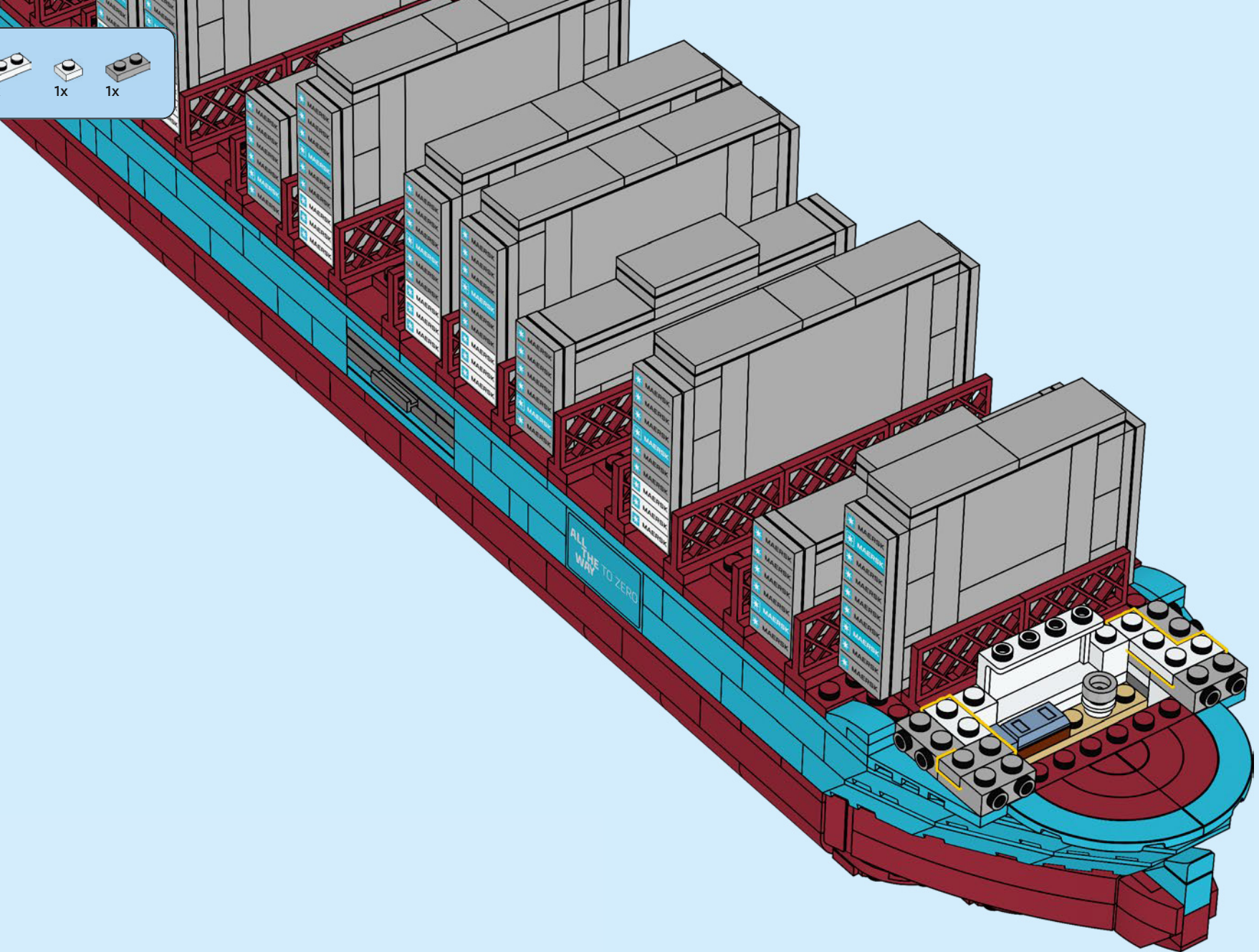

1x 1x 1x 2x

232

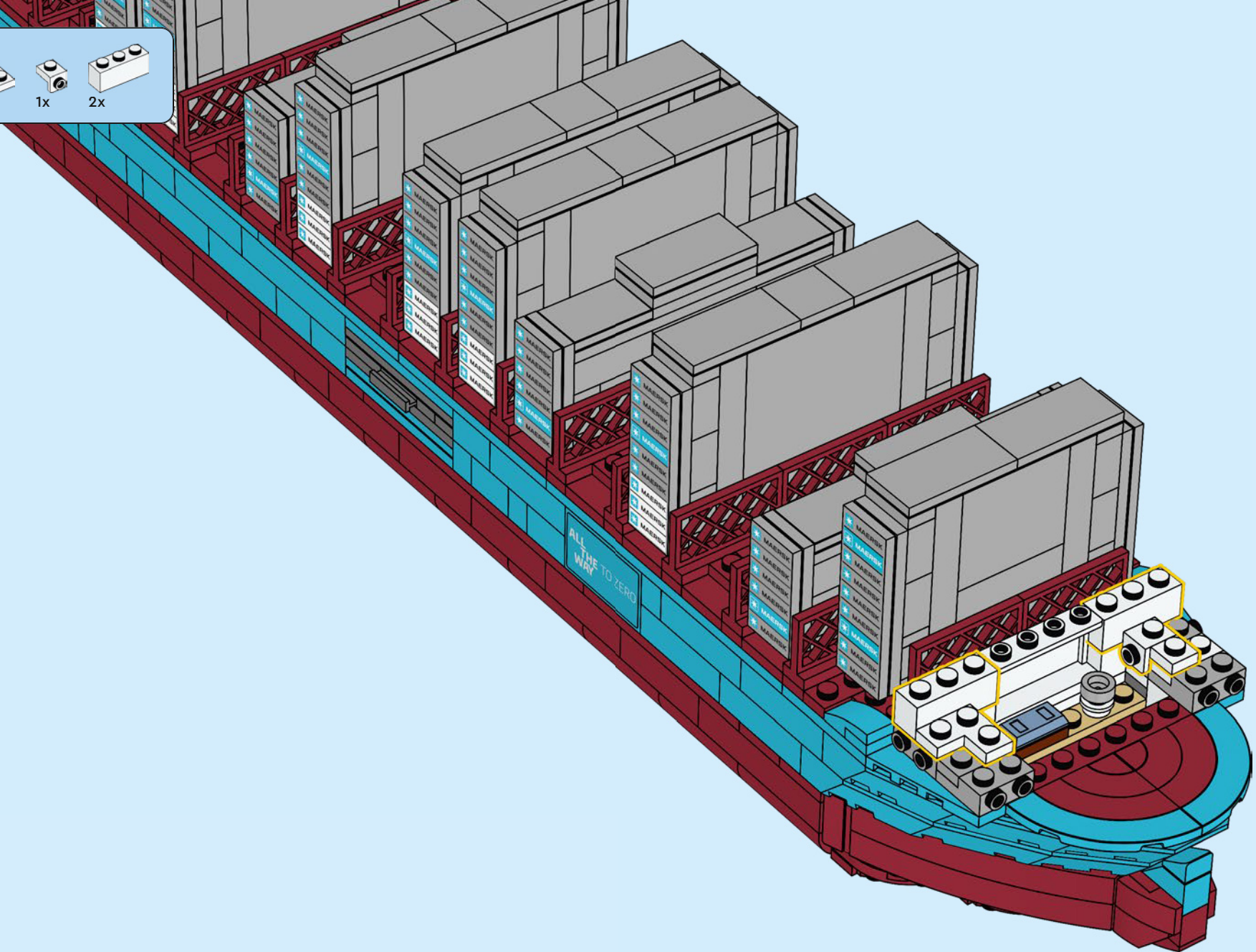

1x 1x 4x

233

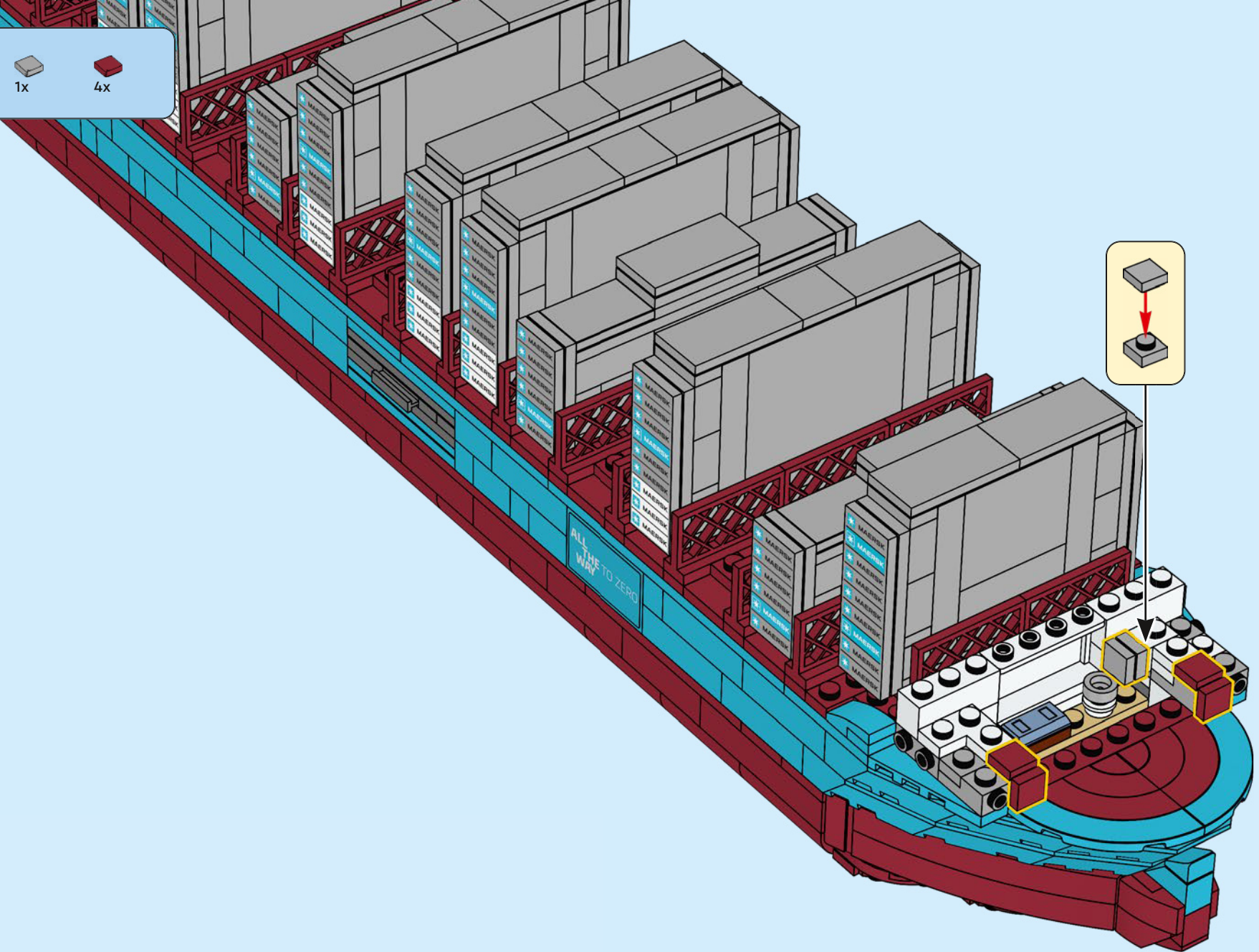

3x
2x
2x

234

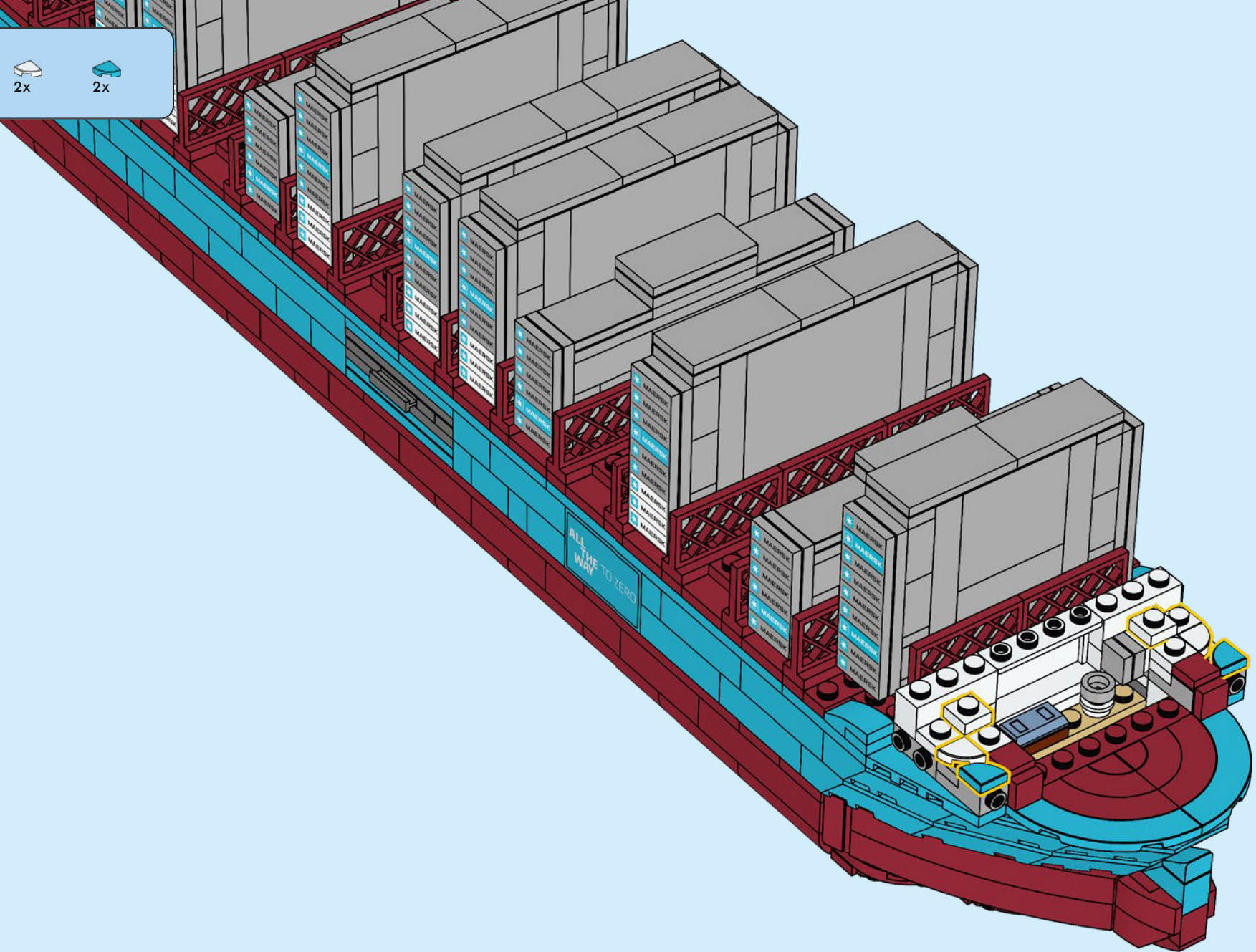

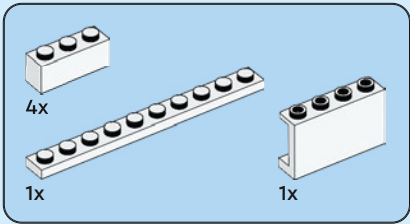

236

1

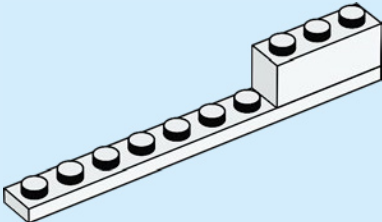

2

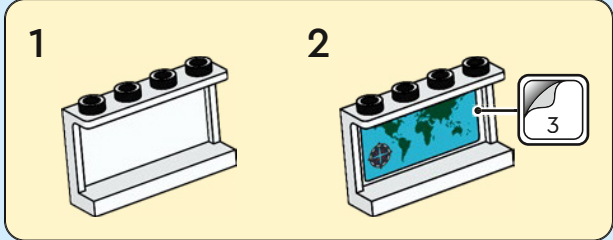
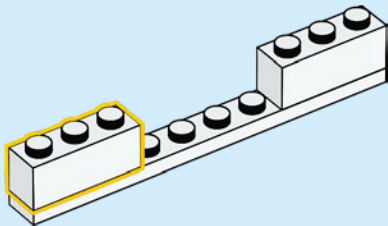

3

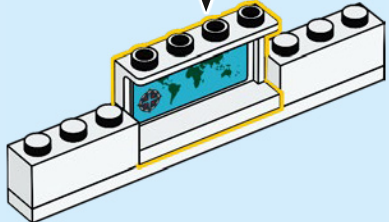

4

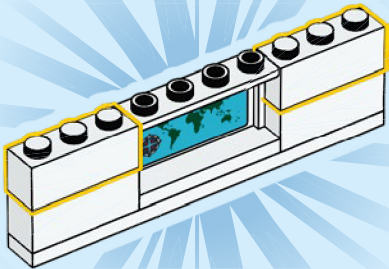

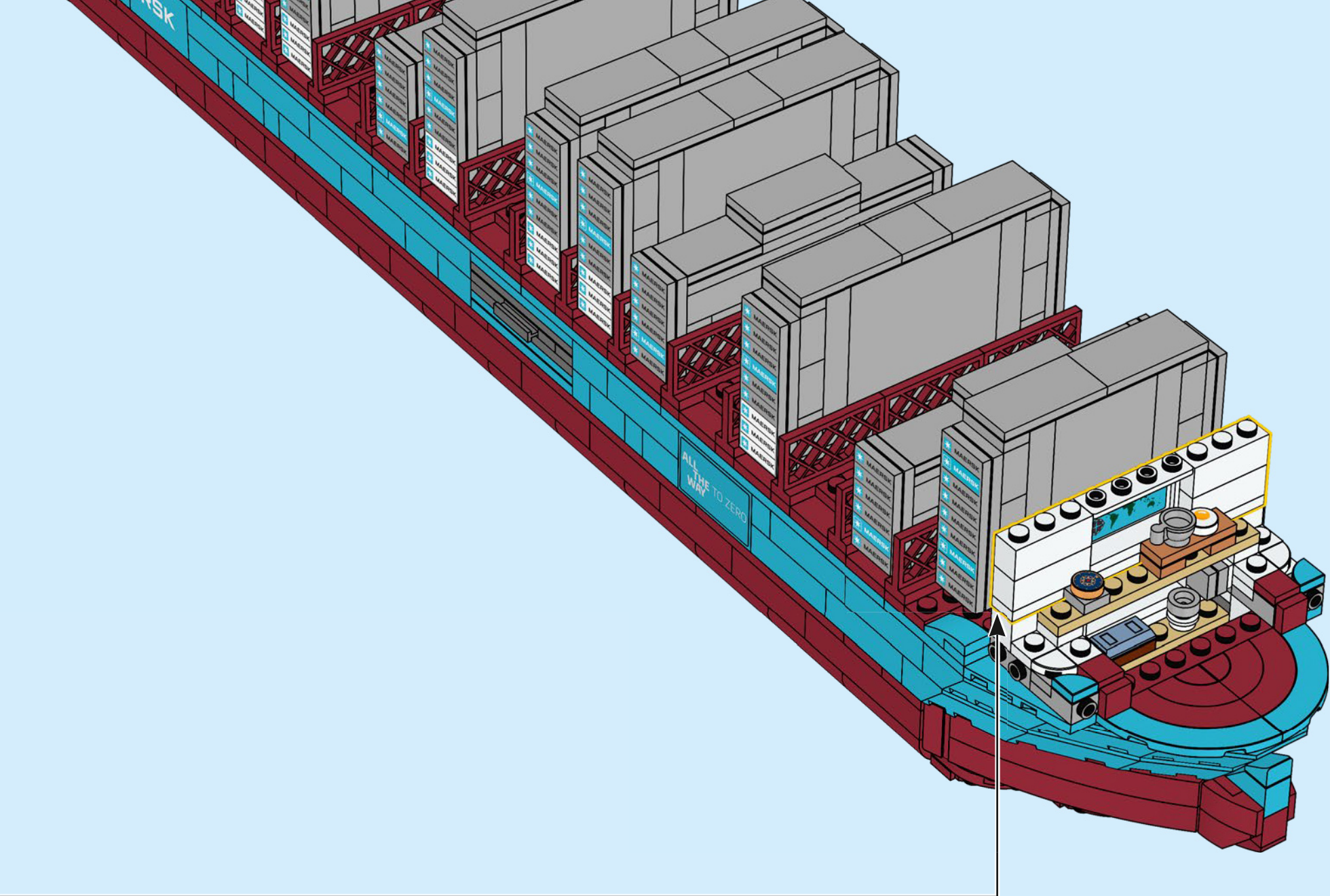

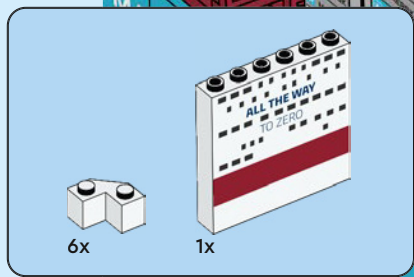

237

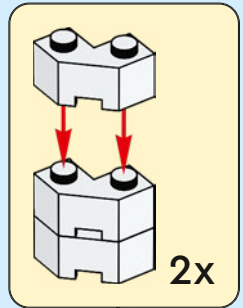
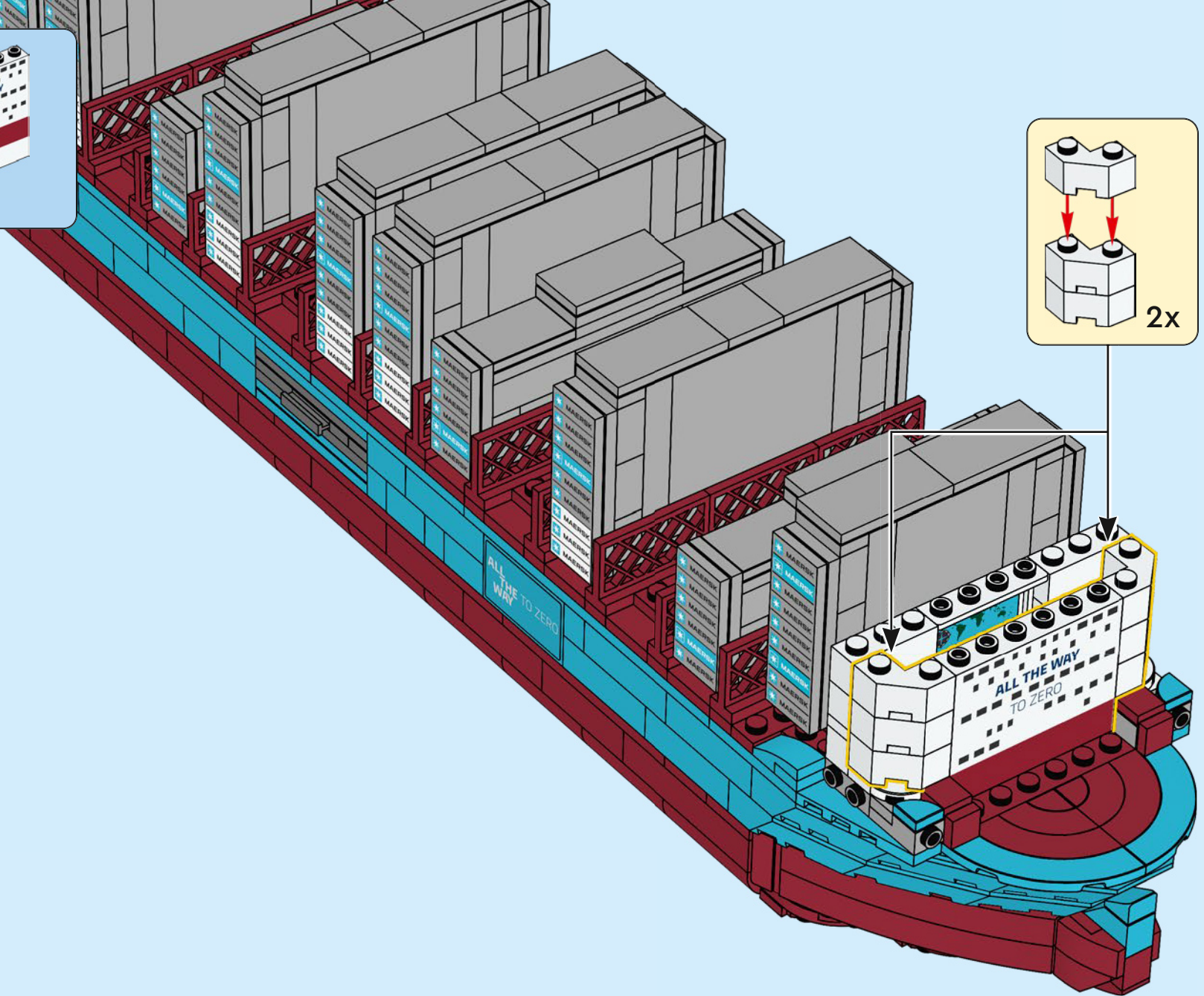

2x 1x

238

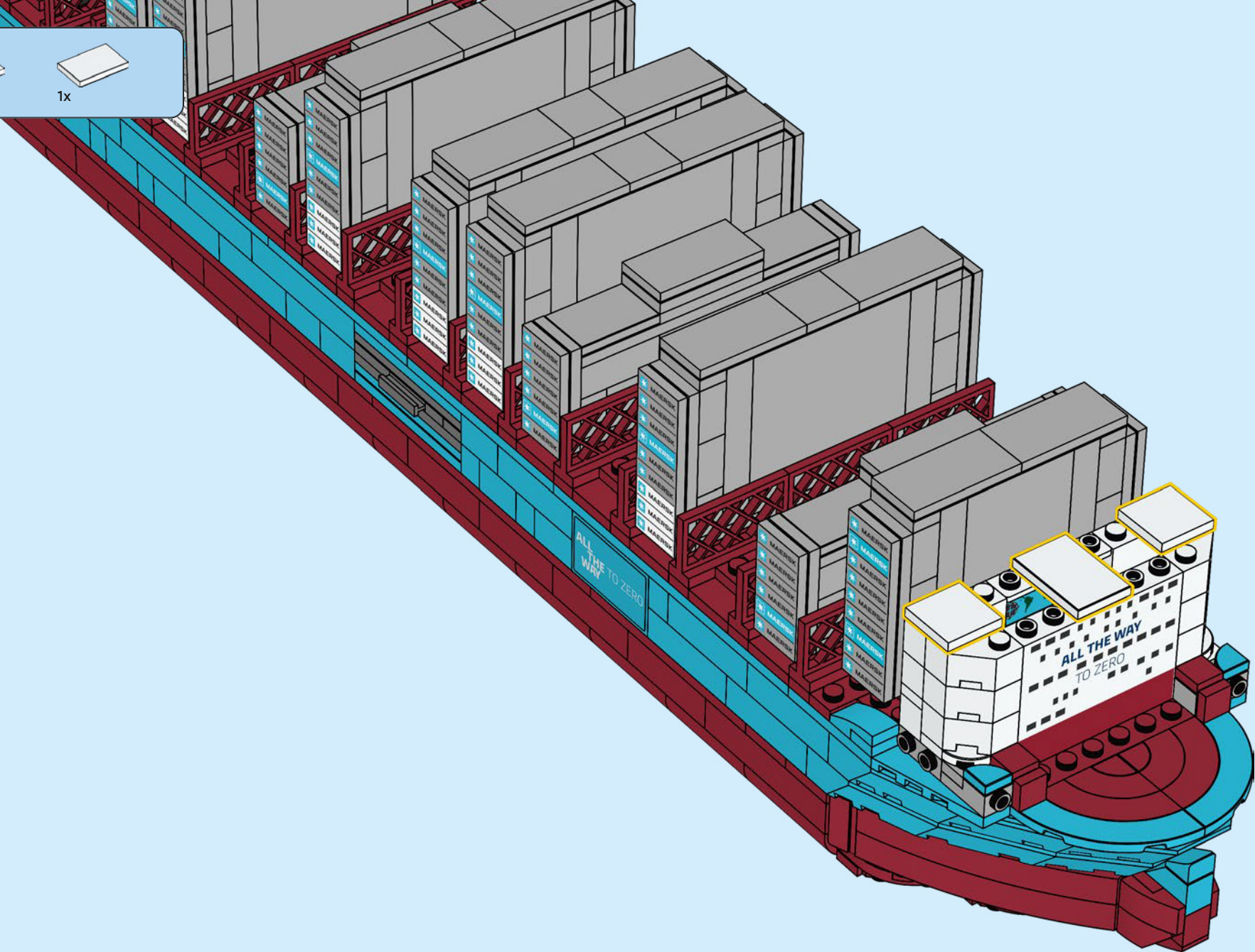

2x 1x 1x

239

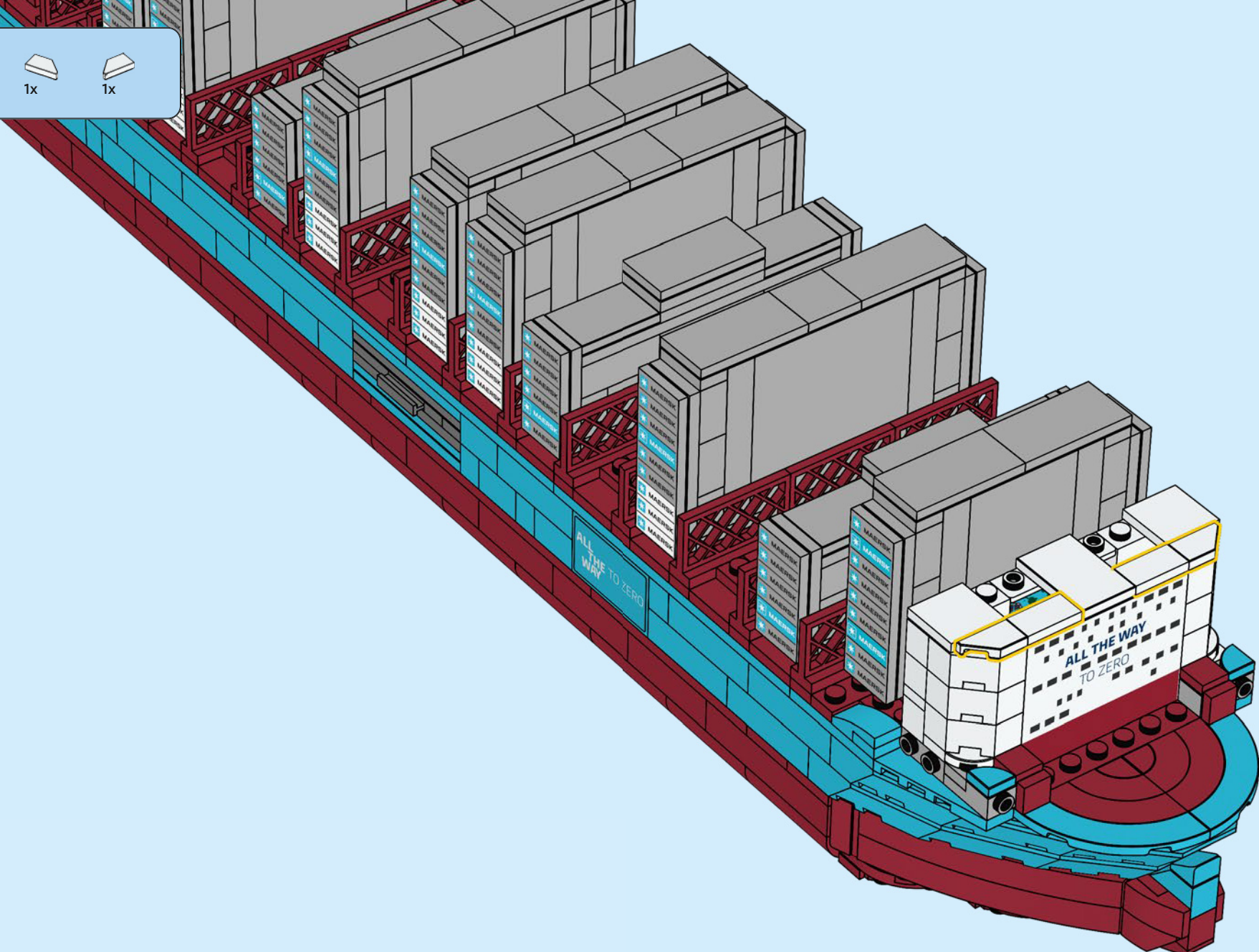

2x  2x  2x 

240

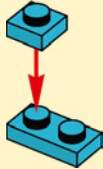
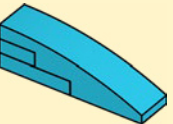
1  2  2x

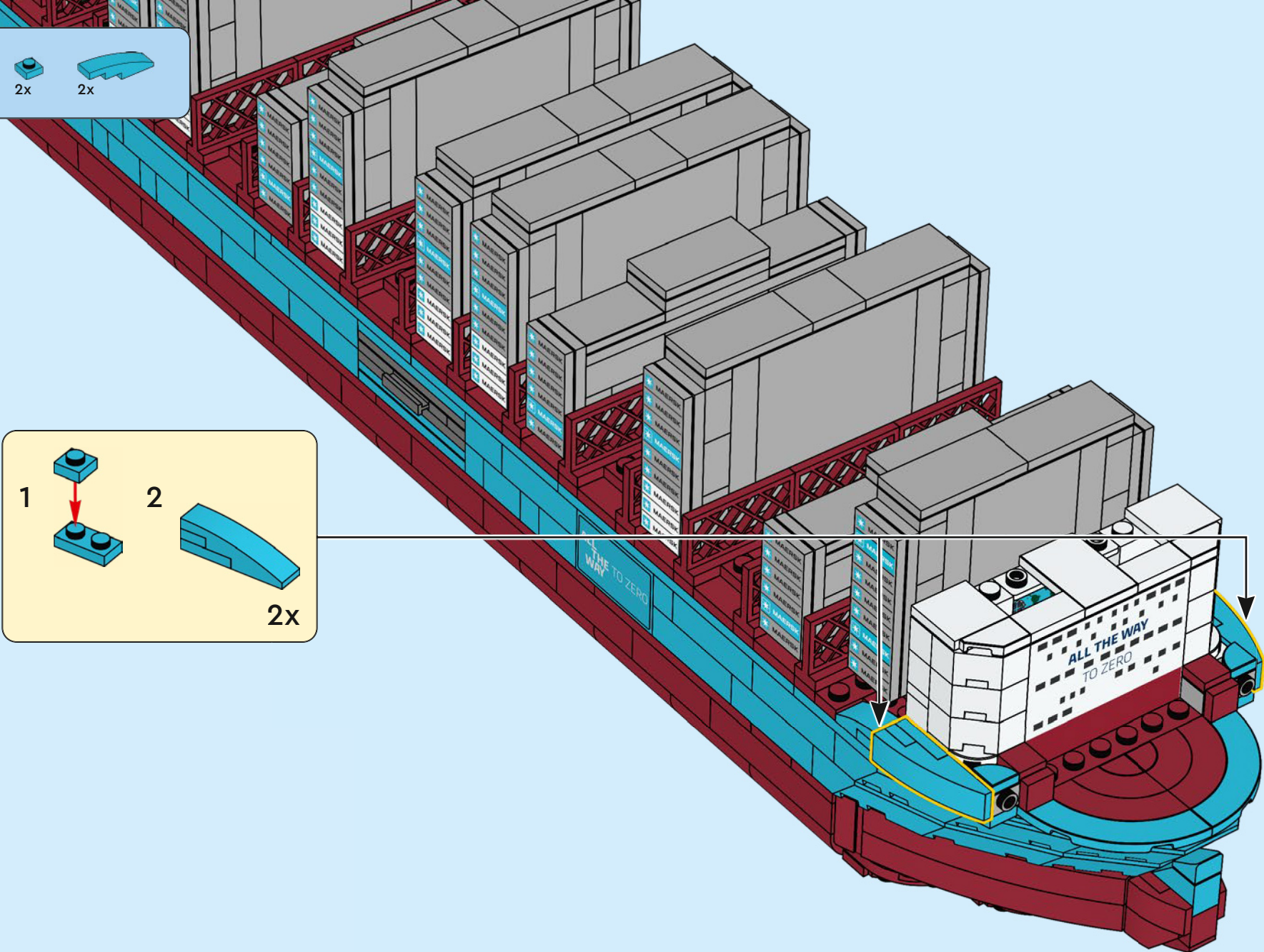

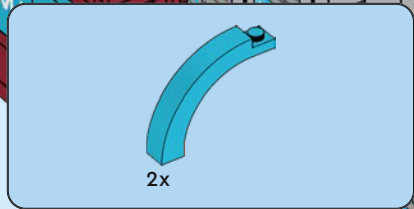

241

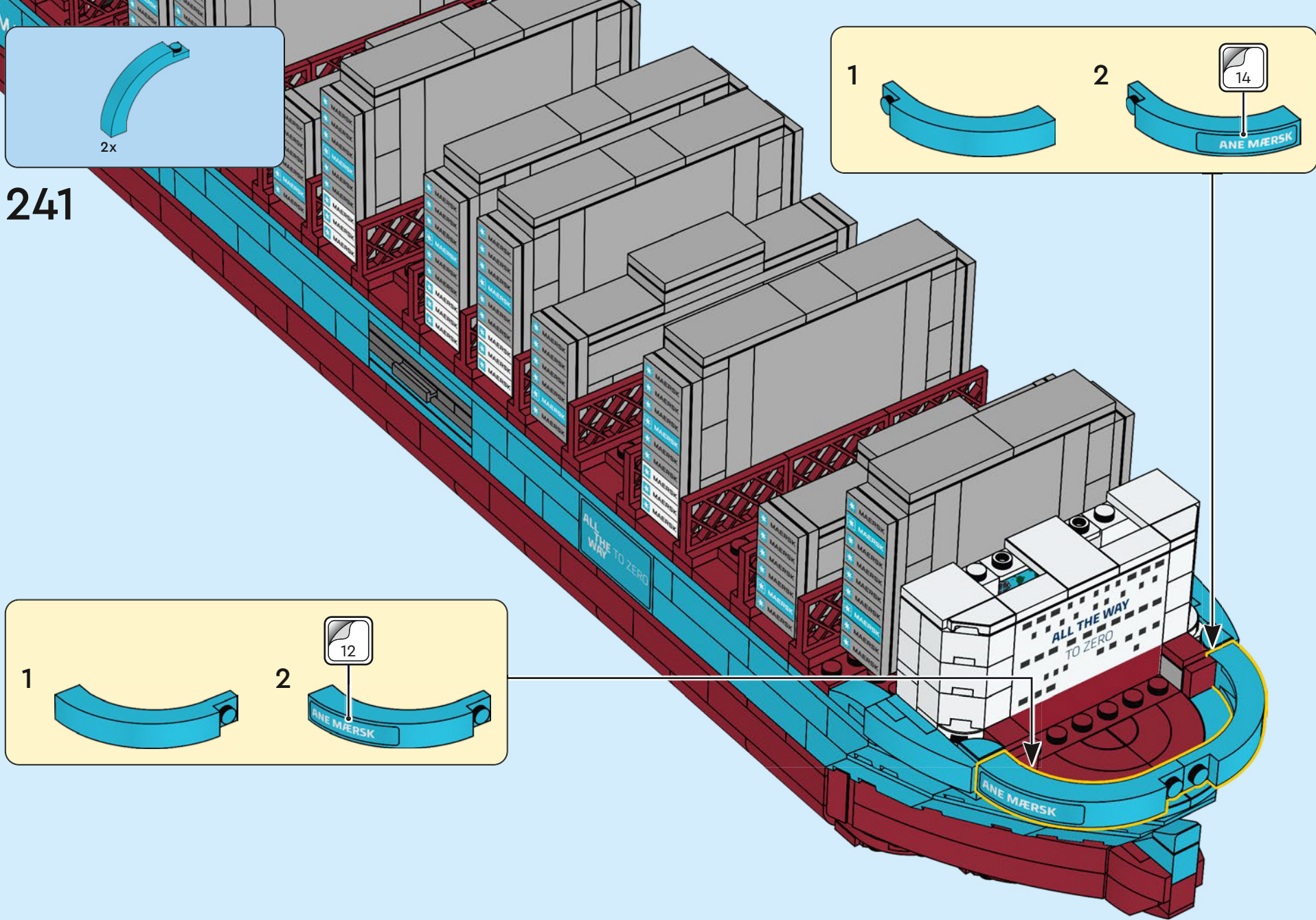
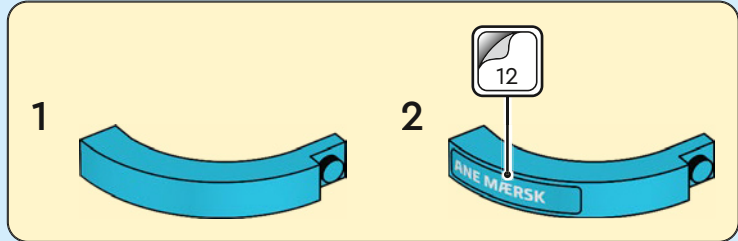
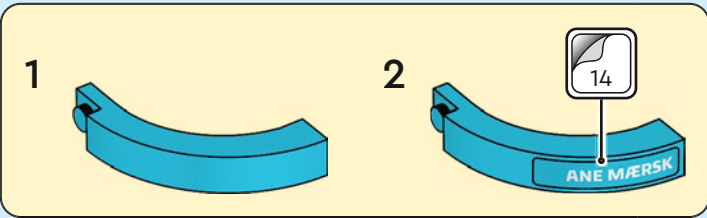



1x

242

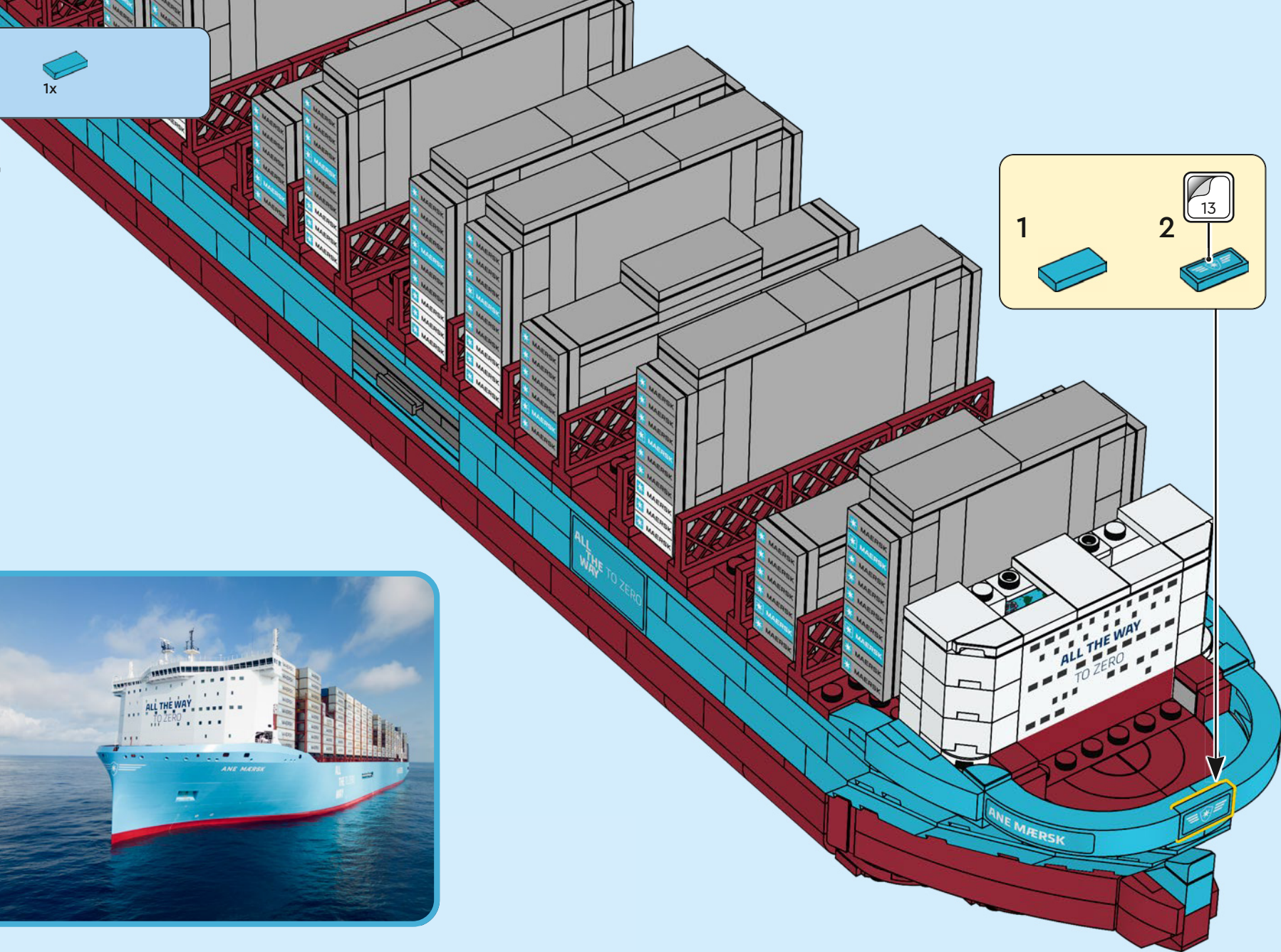
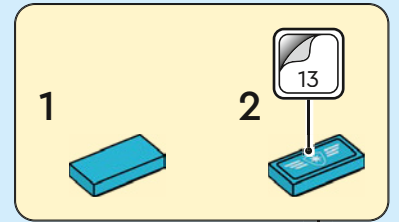

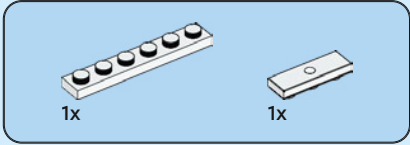
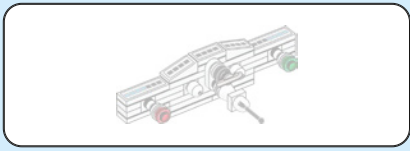

243

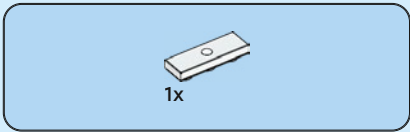
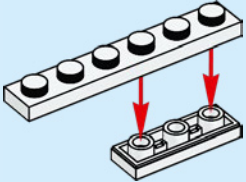

244

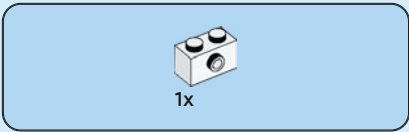
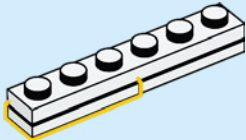

245

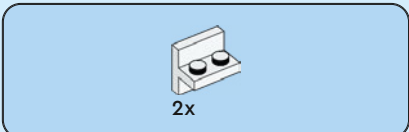
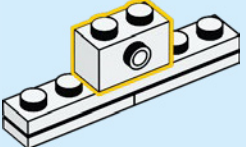

246

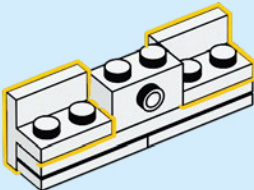



2x

247

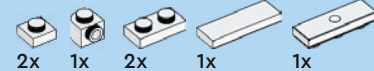
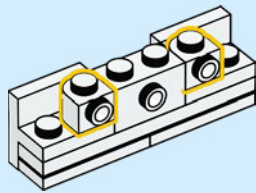

248

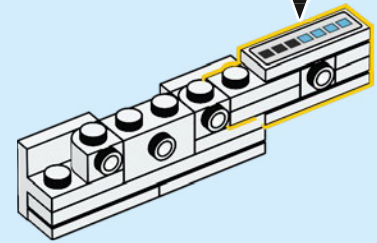
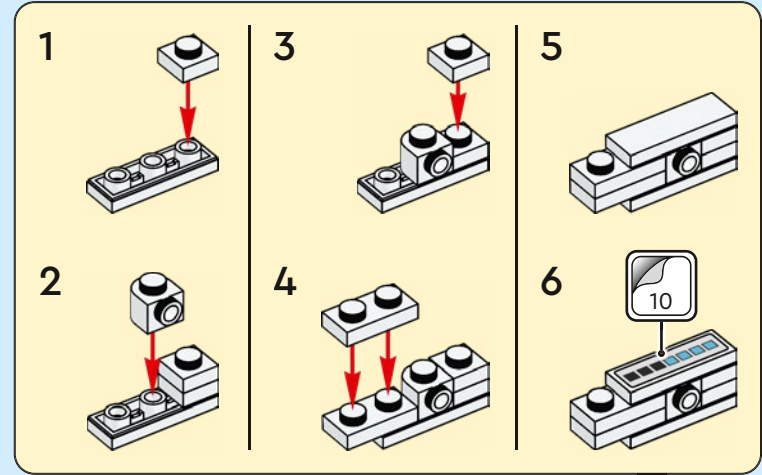

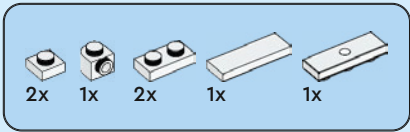

249

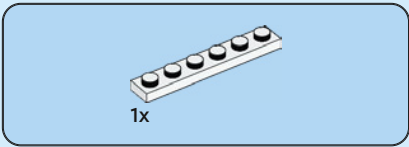
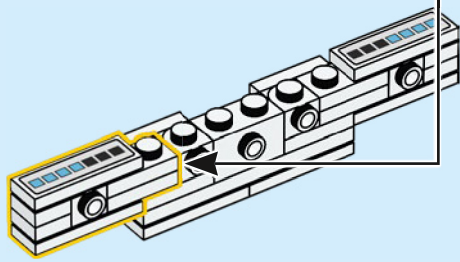
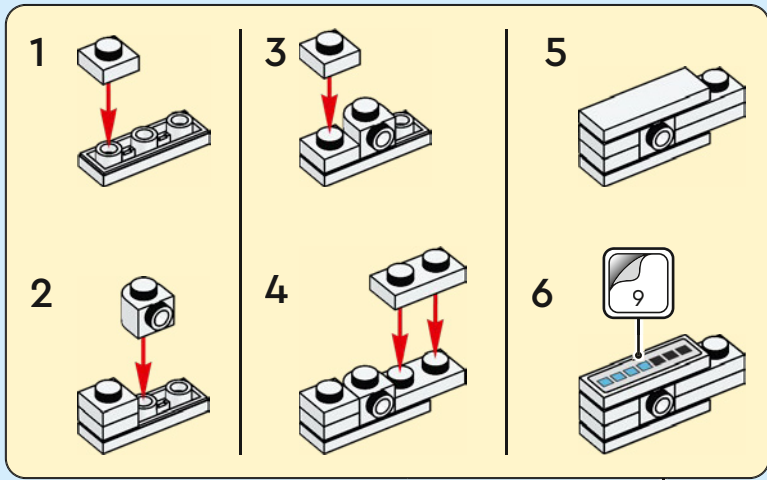

250

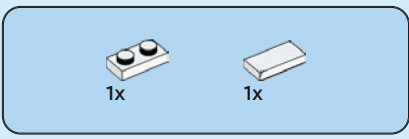
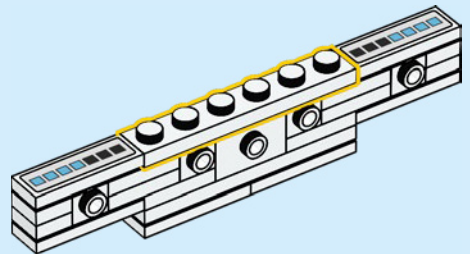

251

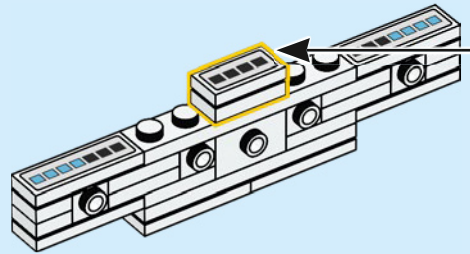
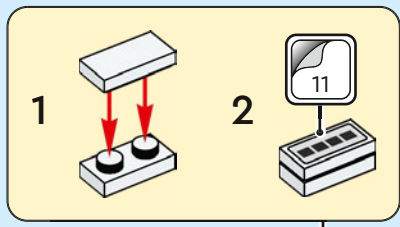

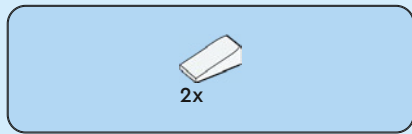

252

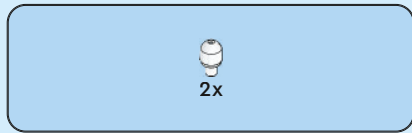
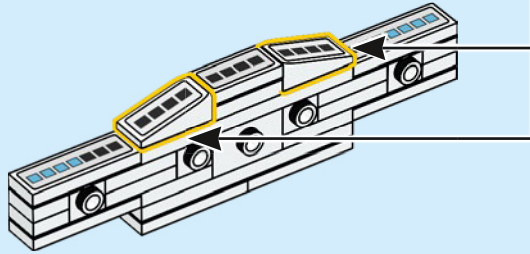
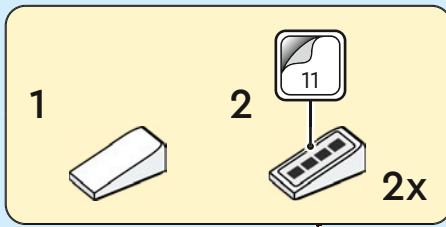

253

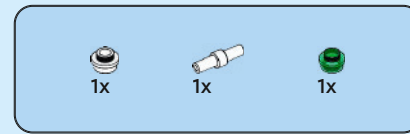
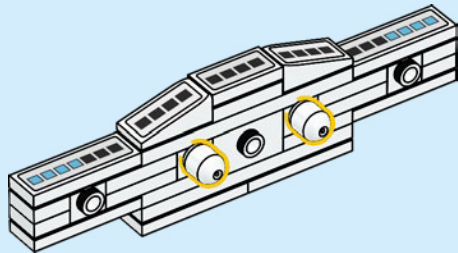

254

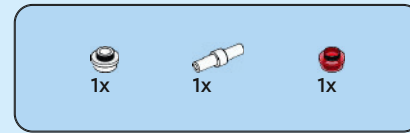
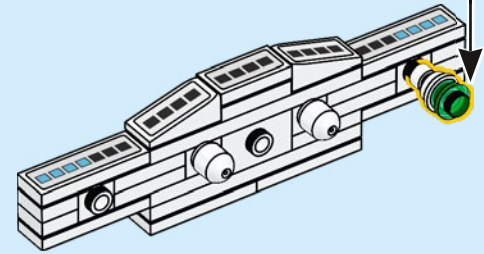
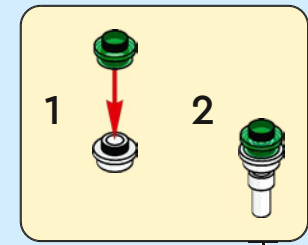

255

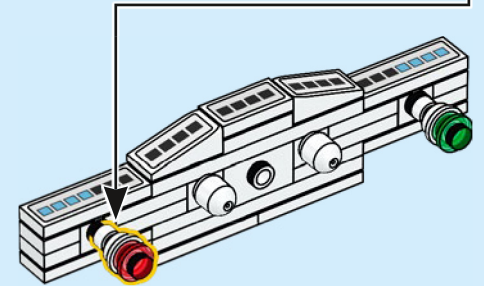
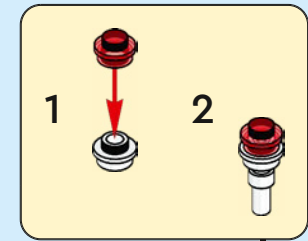

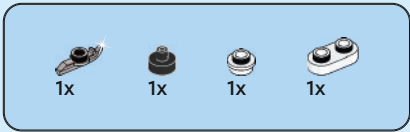

256

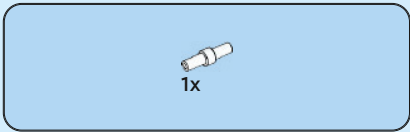
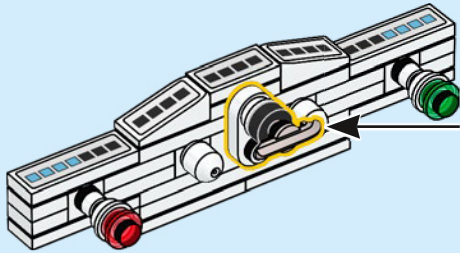
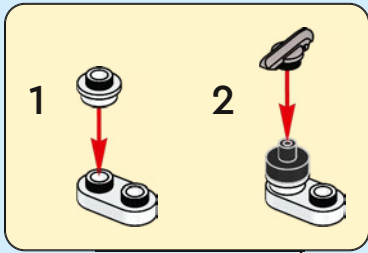

257

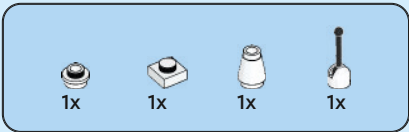
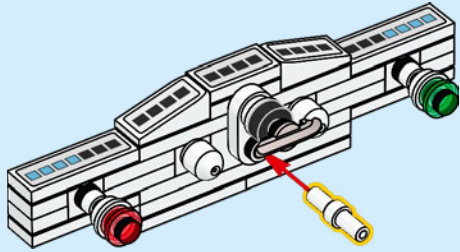

258

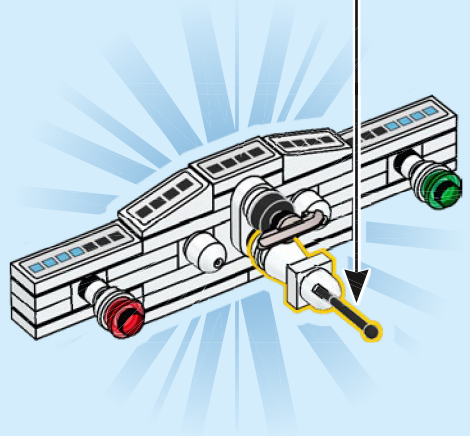
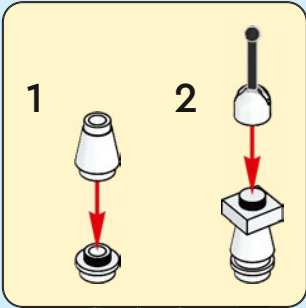

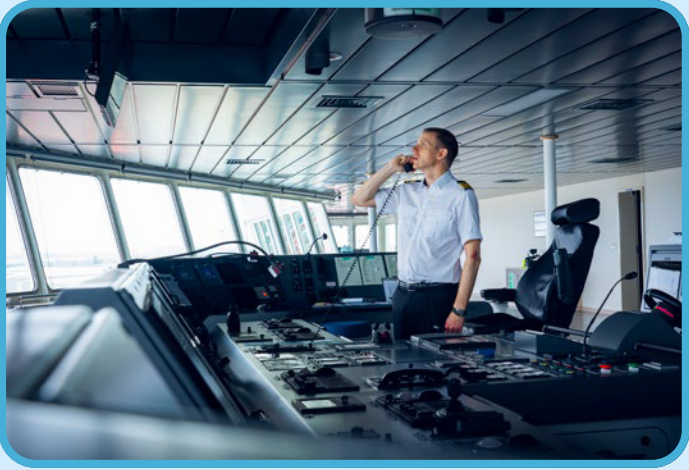
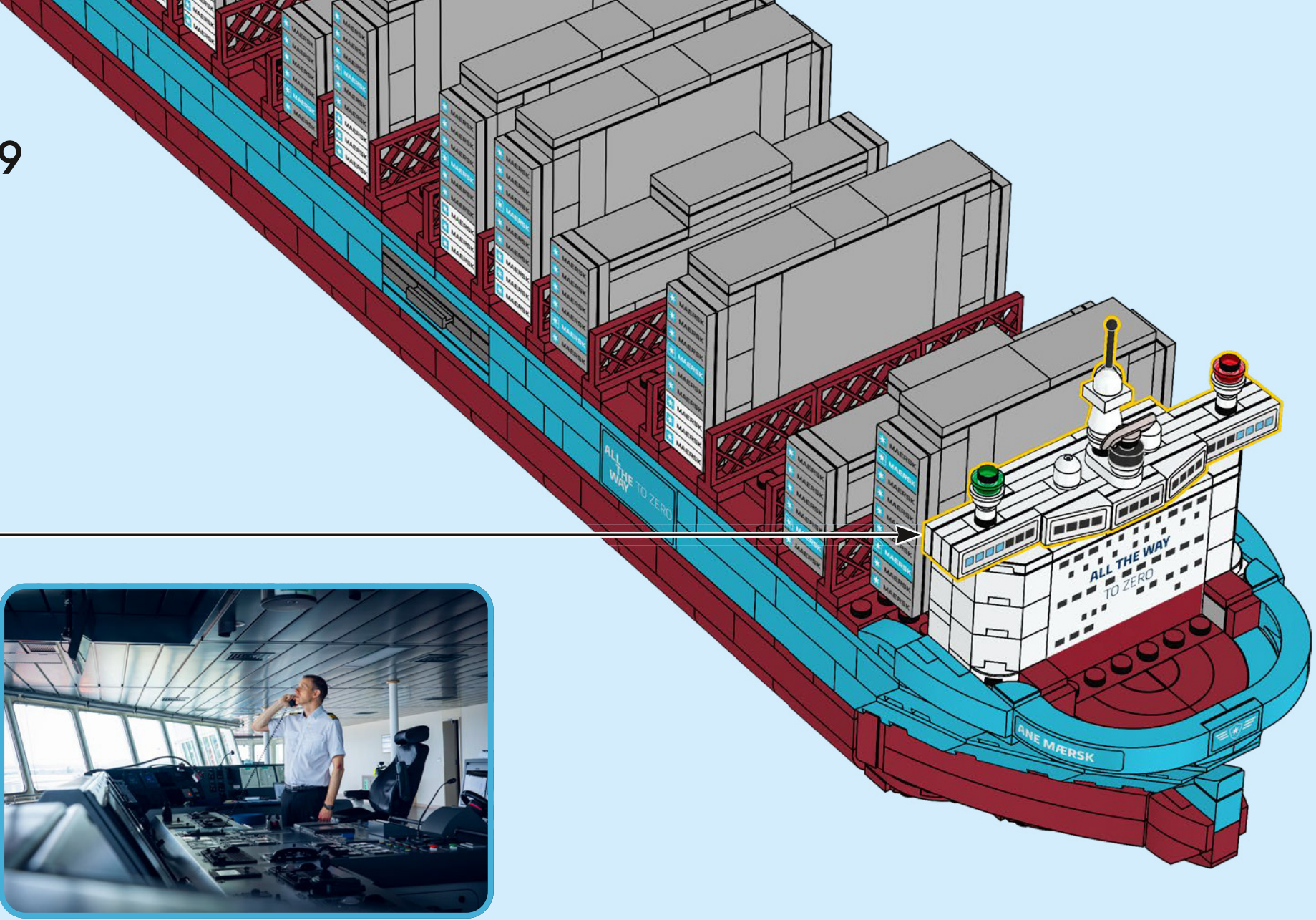

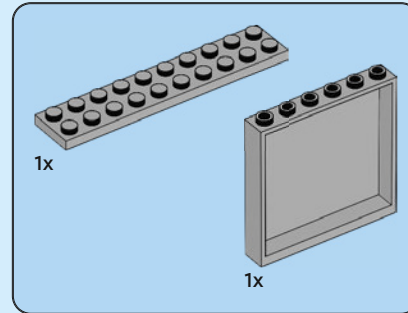
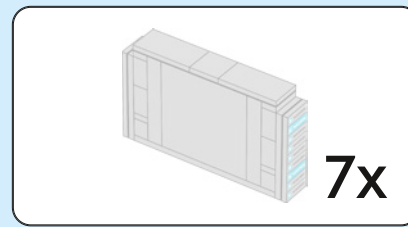

260

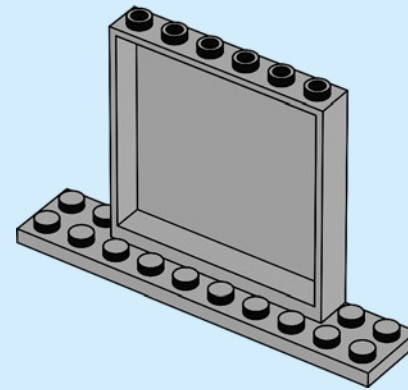

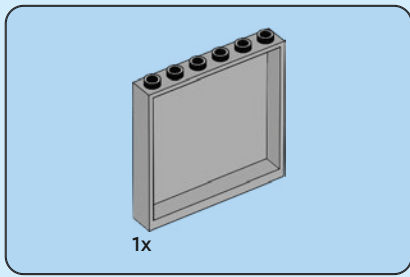

261

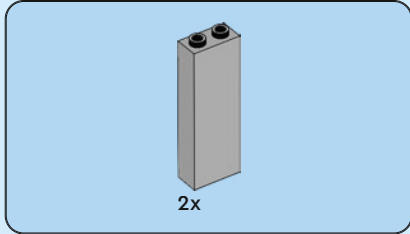
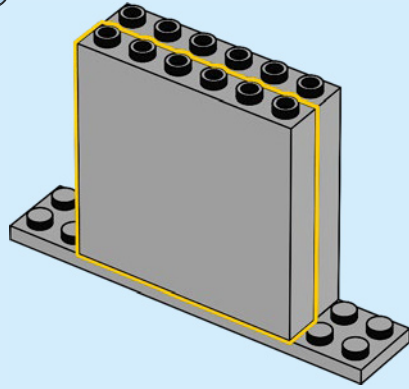

262

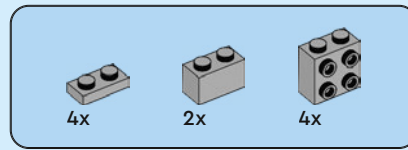
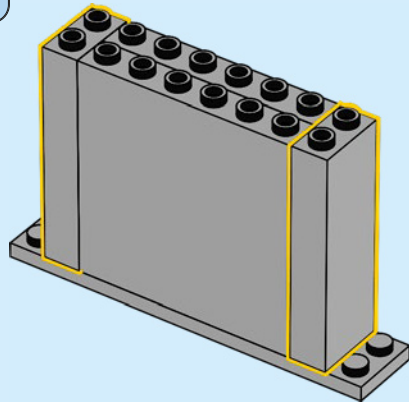

263

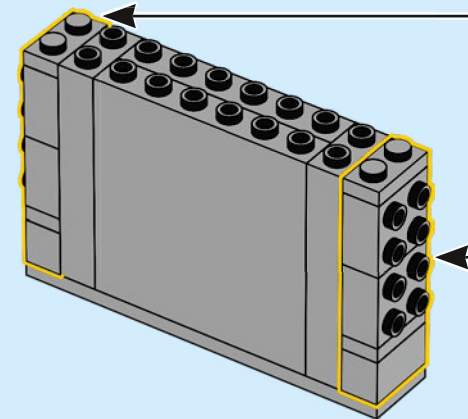
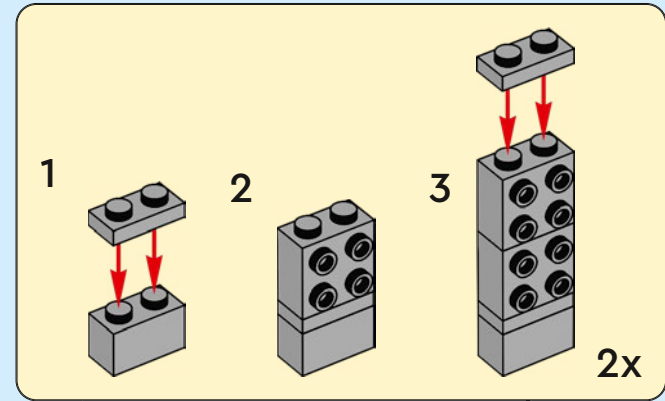

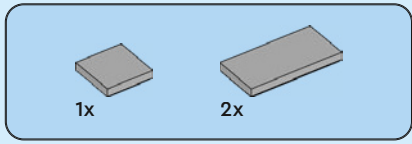

264

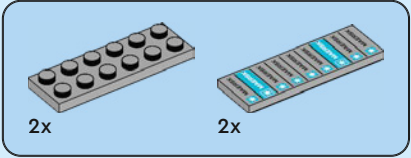
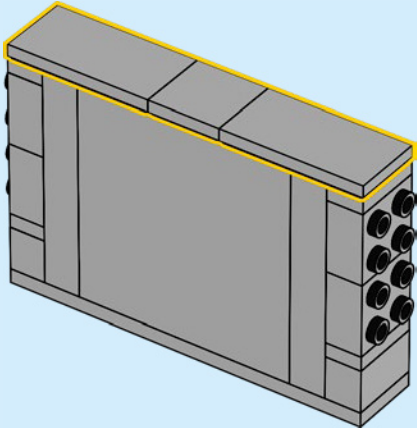

265

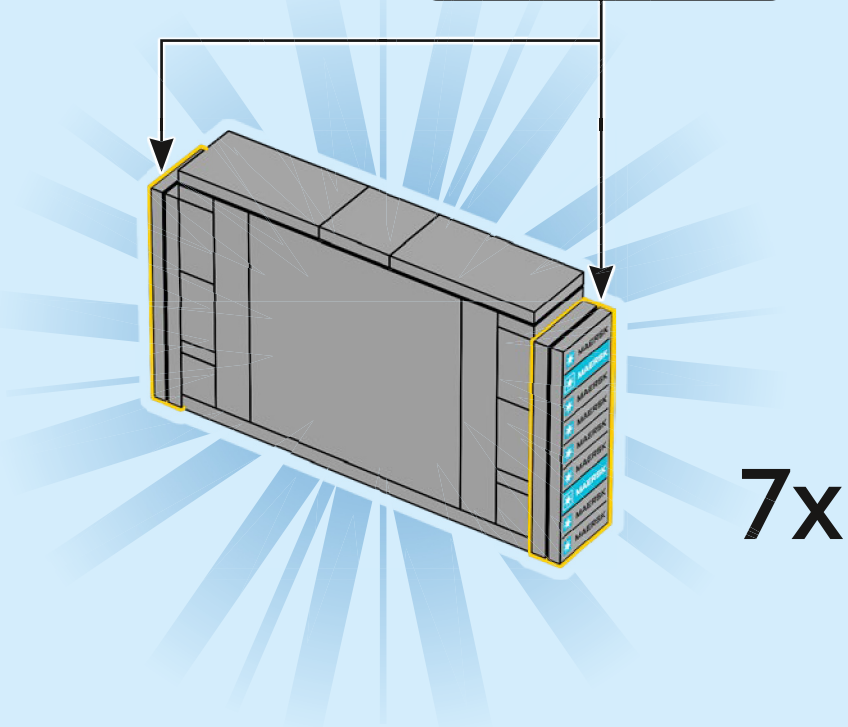
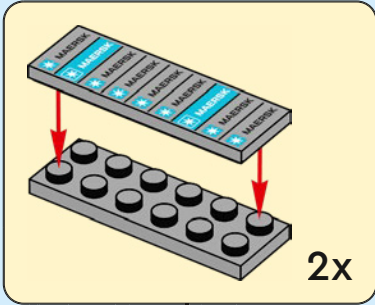

266

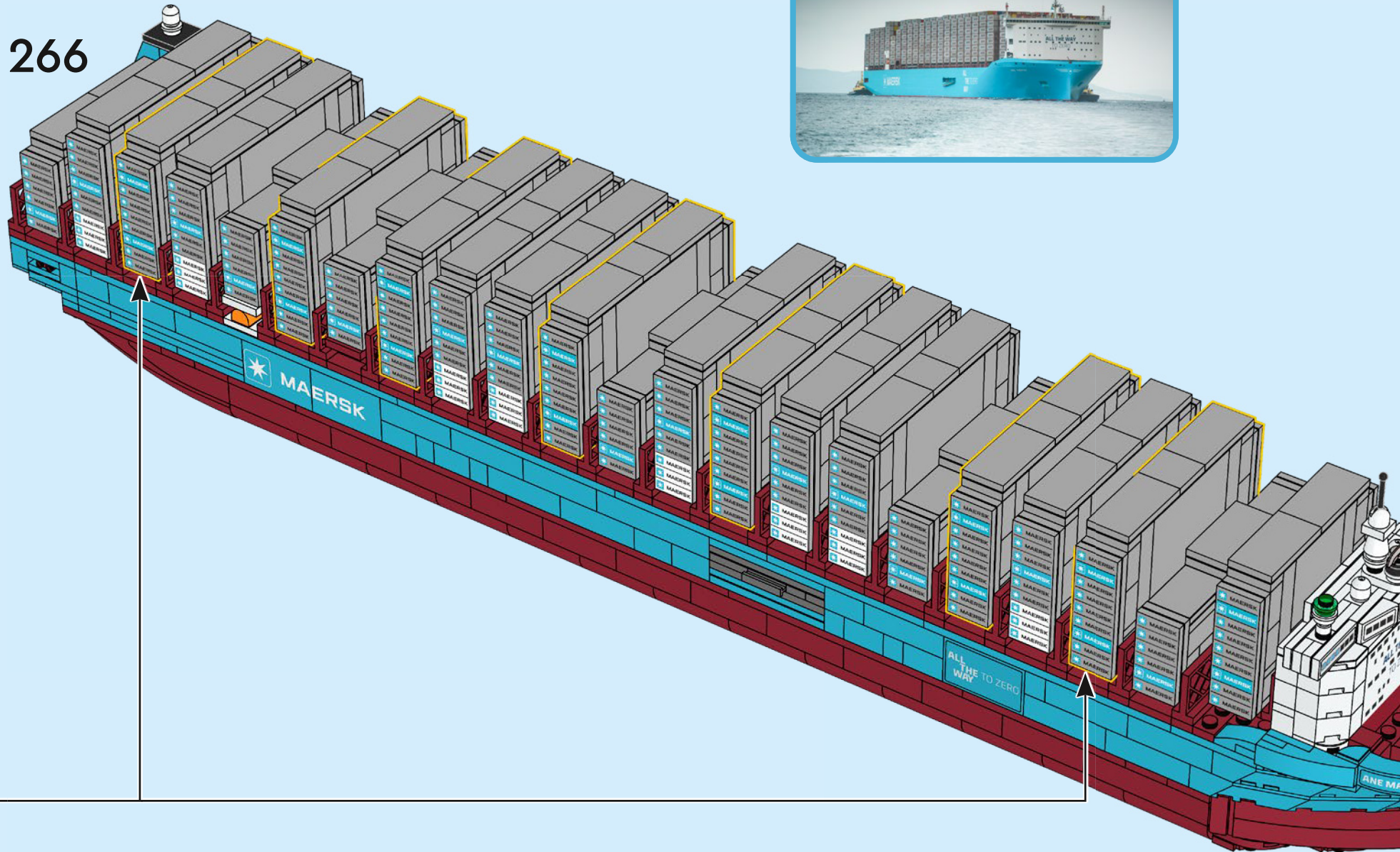

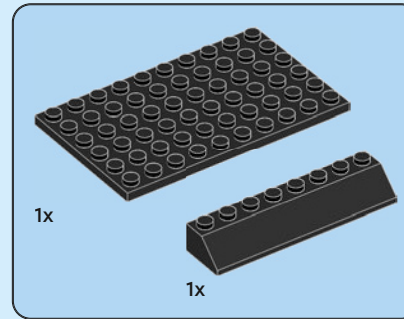
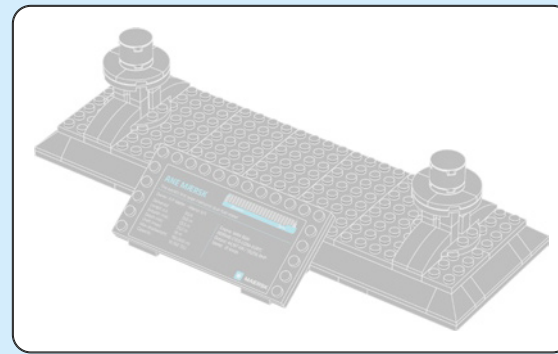

267

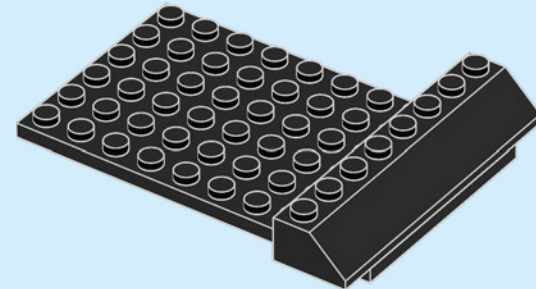

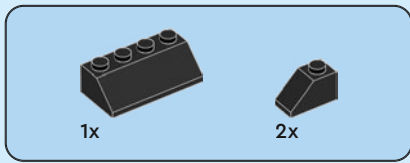

268

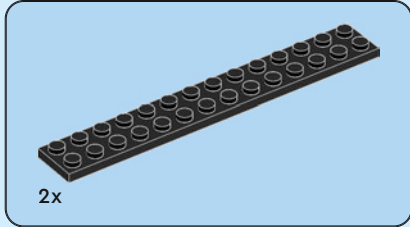
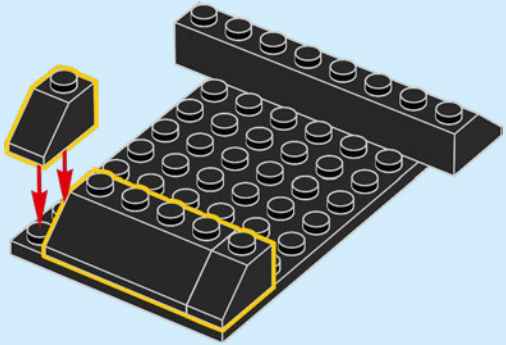

269

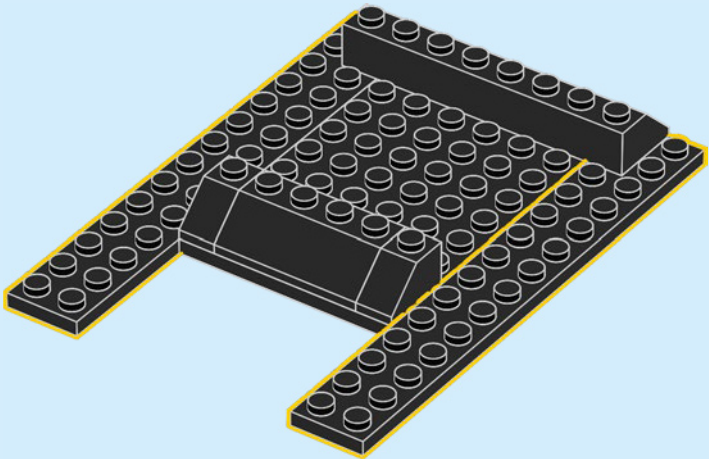

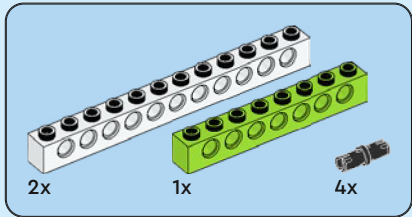
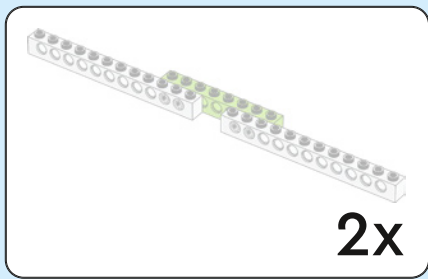

270

1

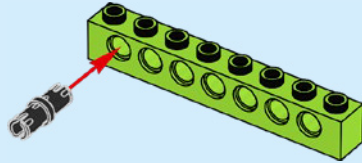

2

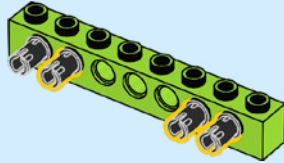

3

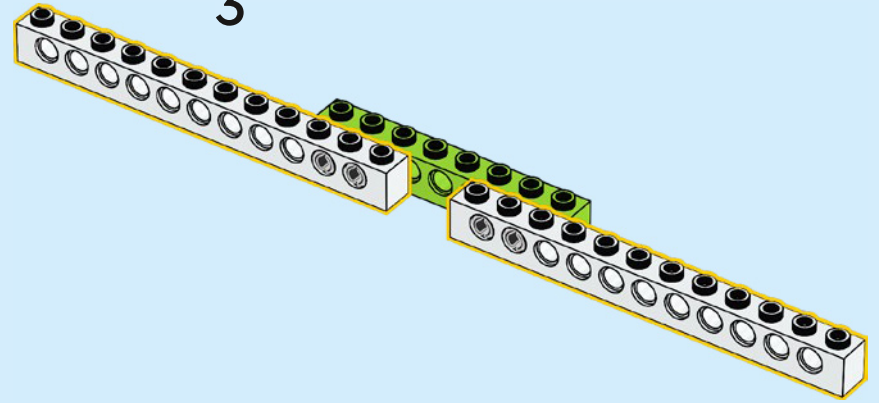

2x

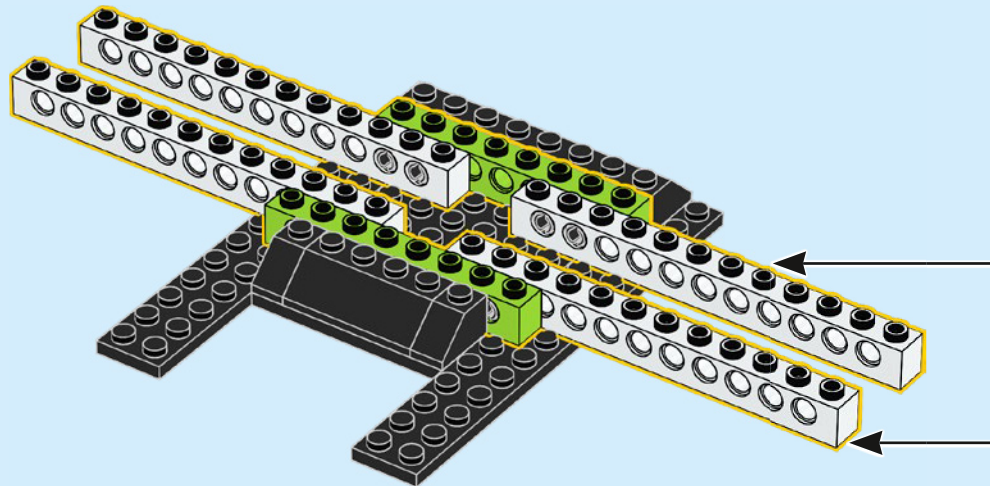

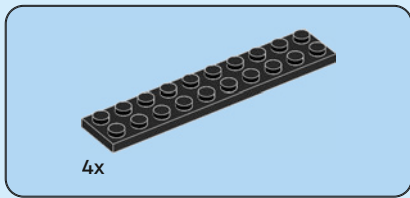

271

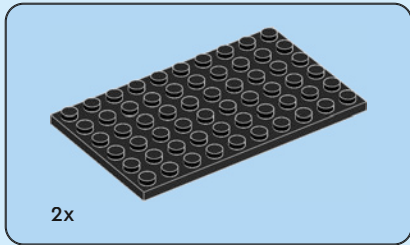
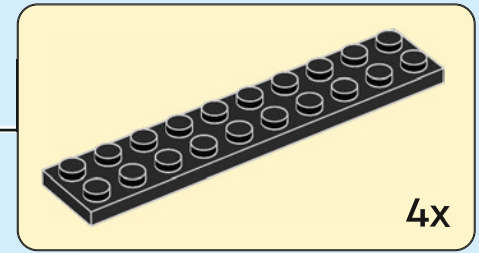
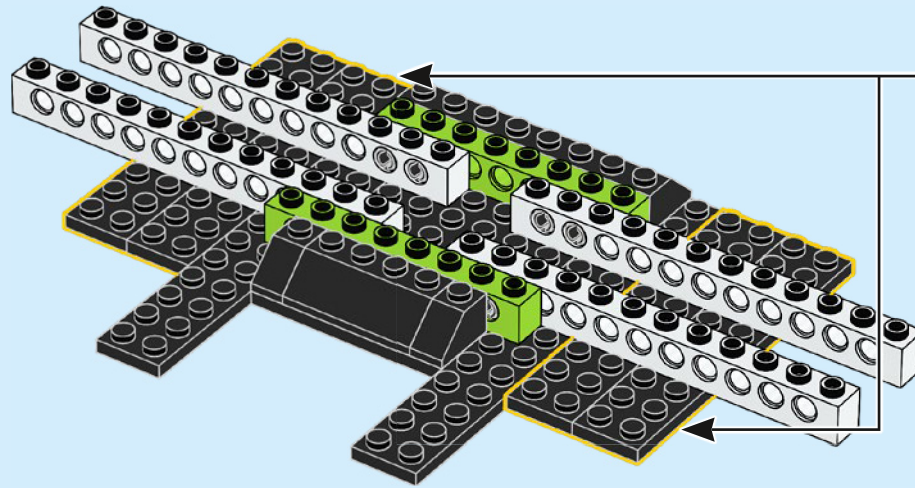

272

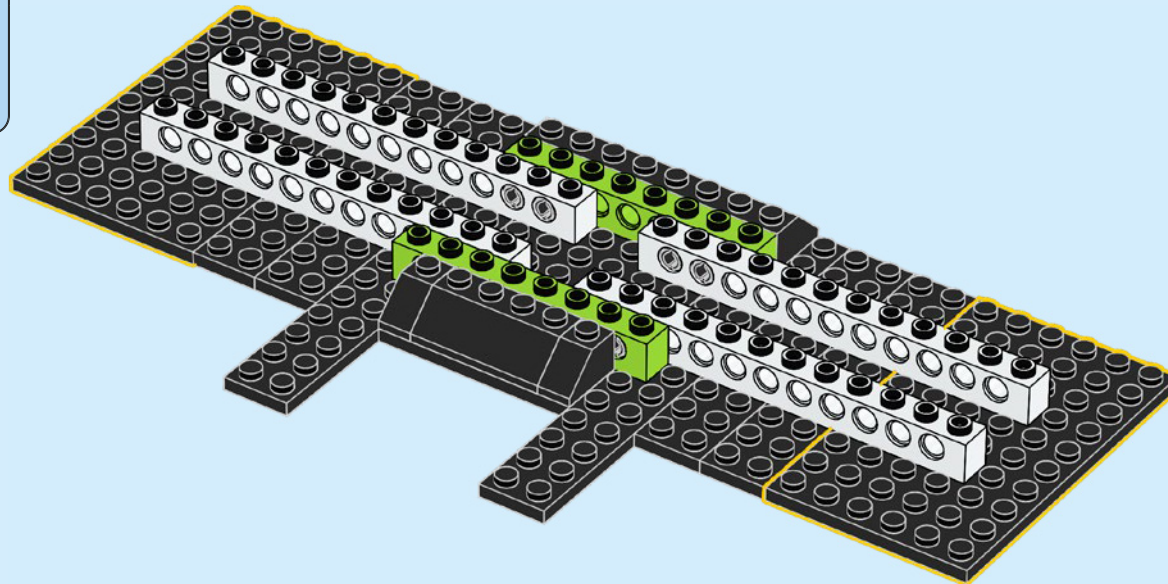

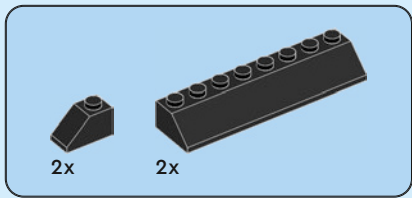

273

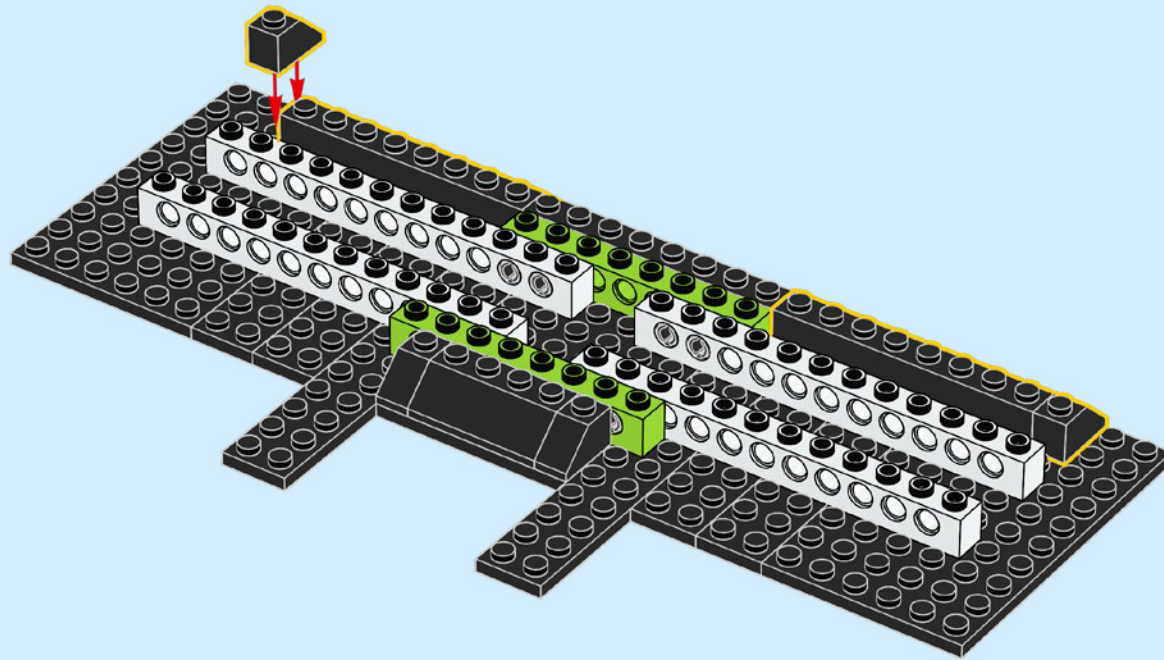

274

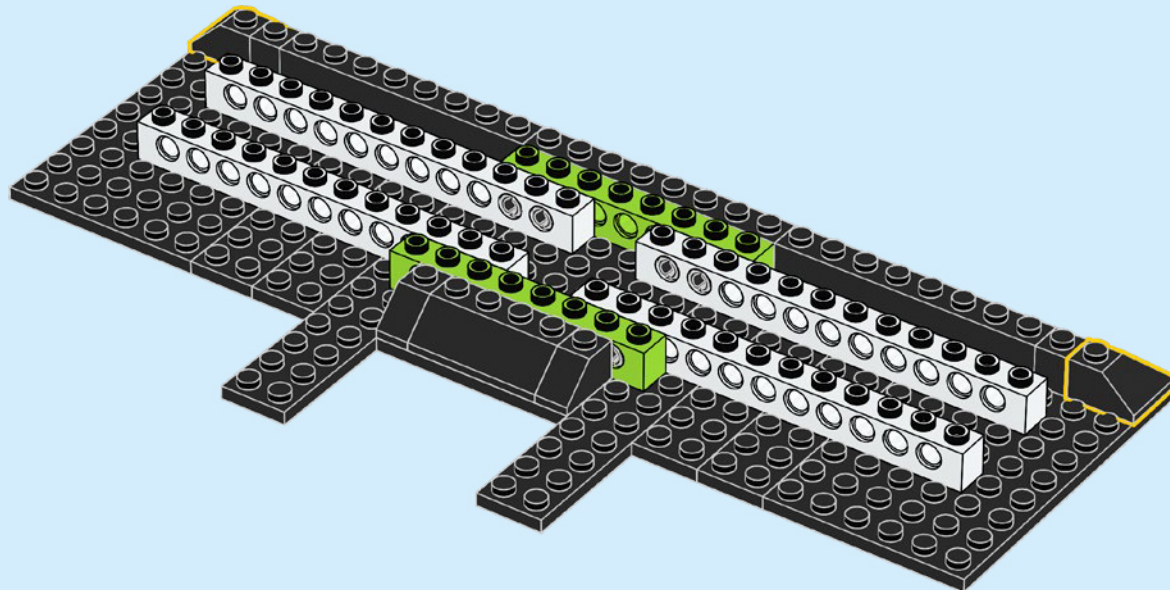

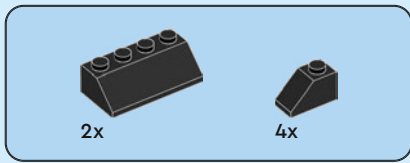

275

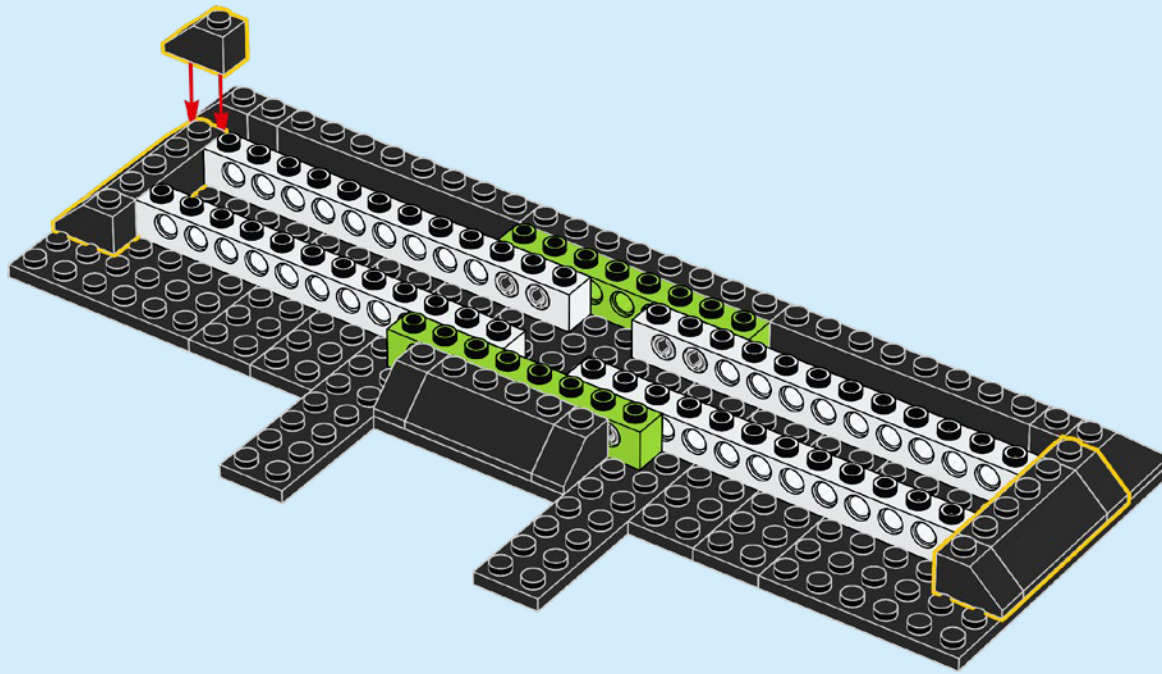

276

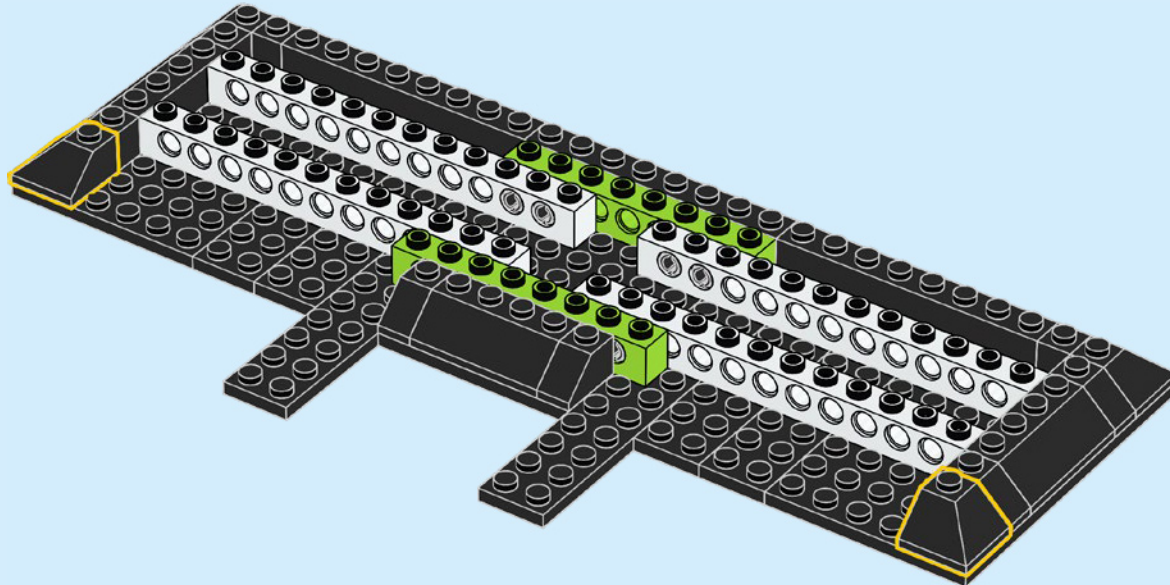



2x



2x

277

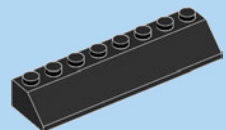
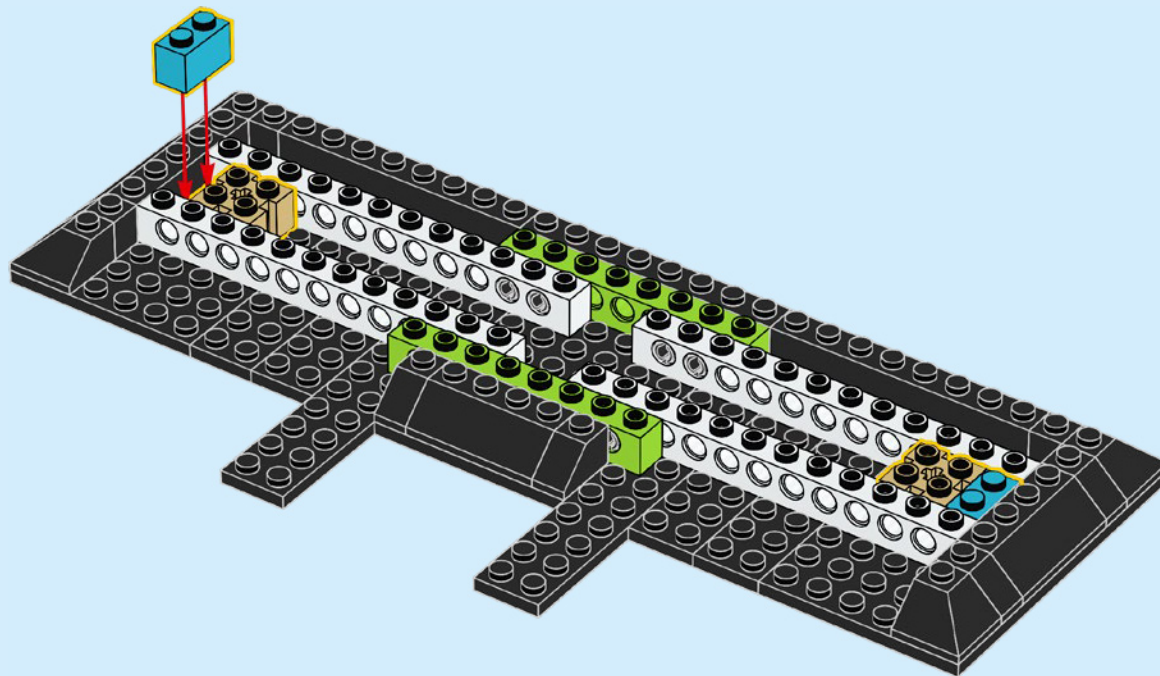

2x

278

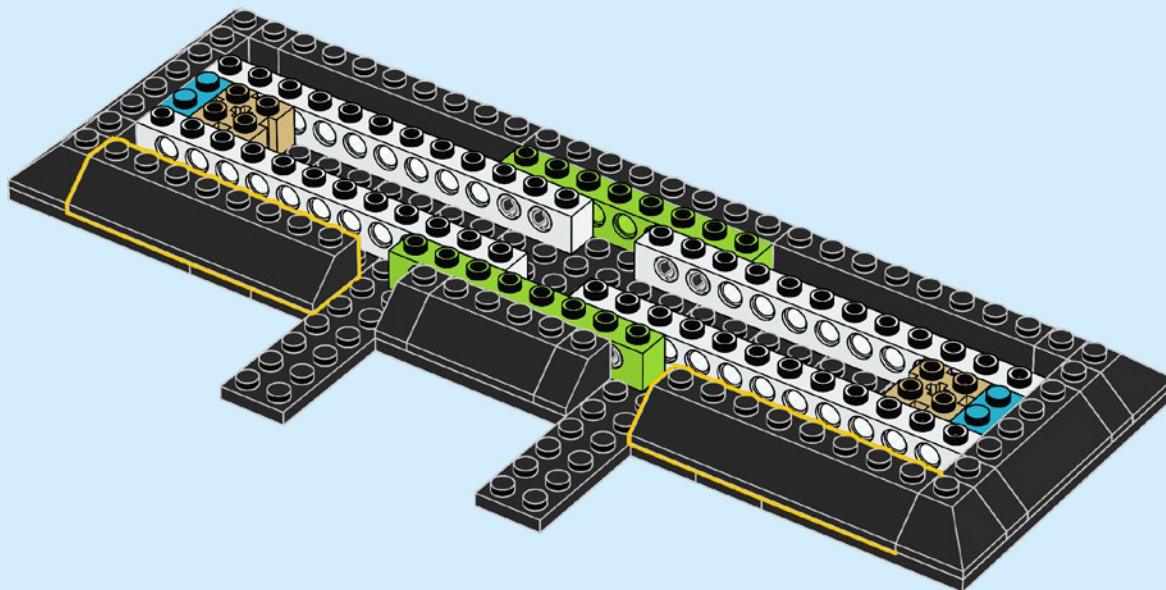

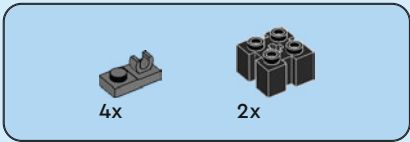

279

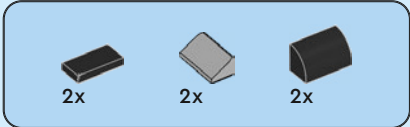
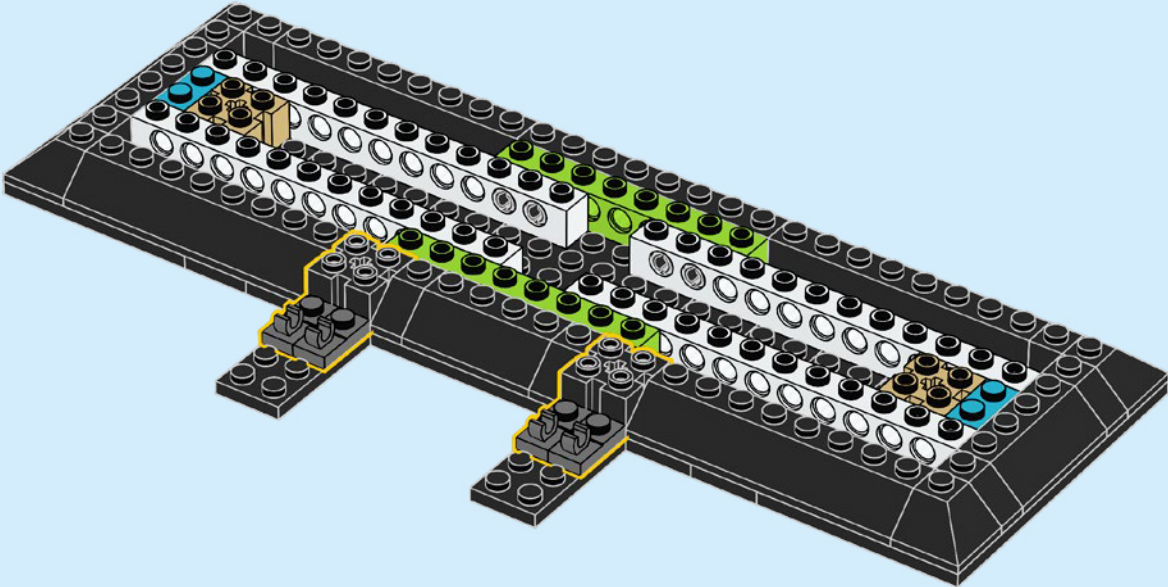

280

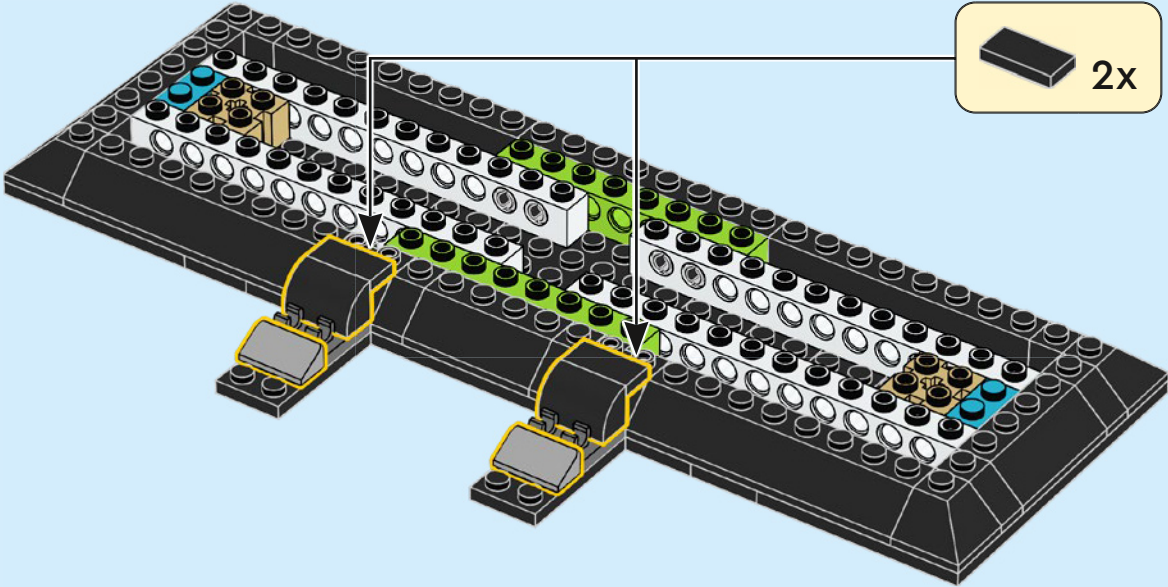

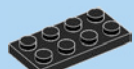

4x

281

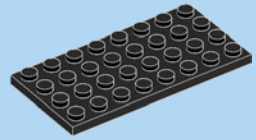
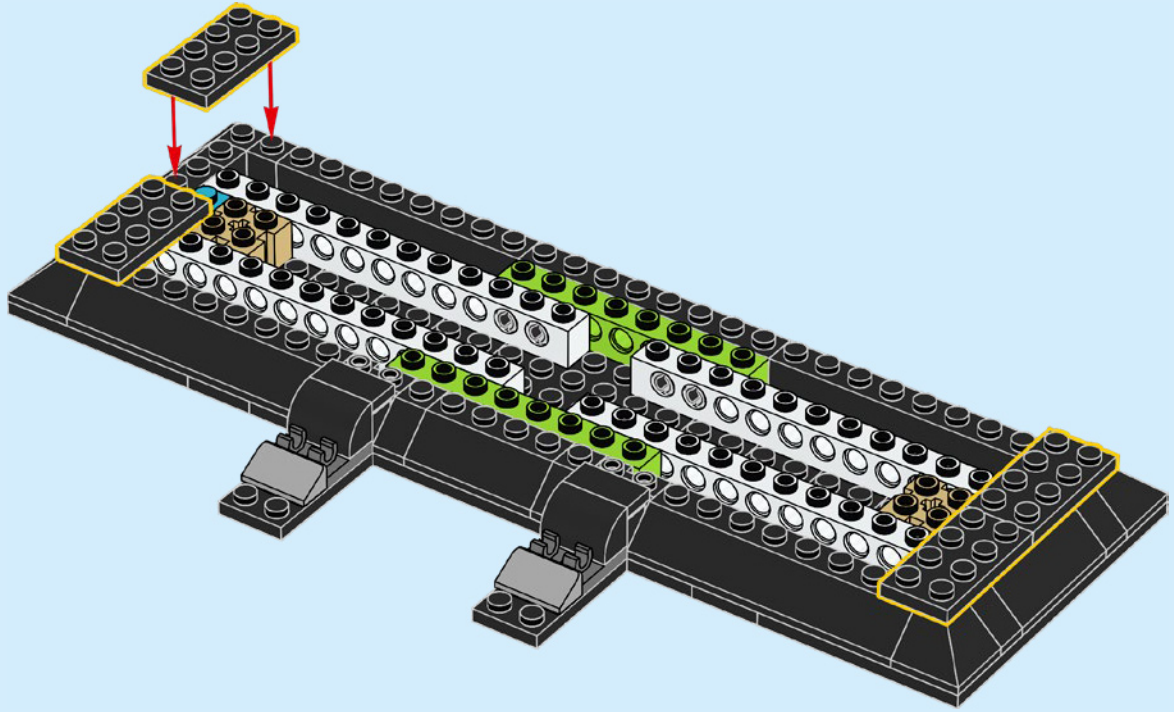

5x

282

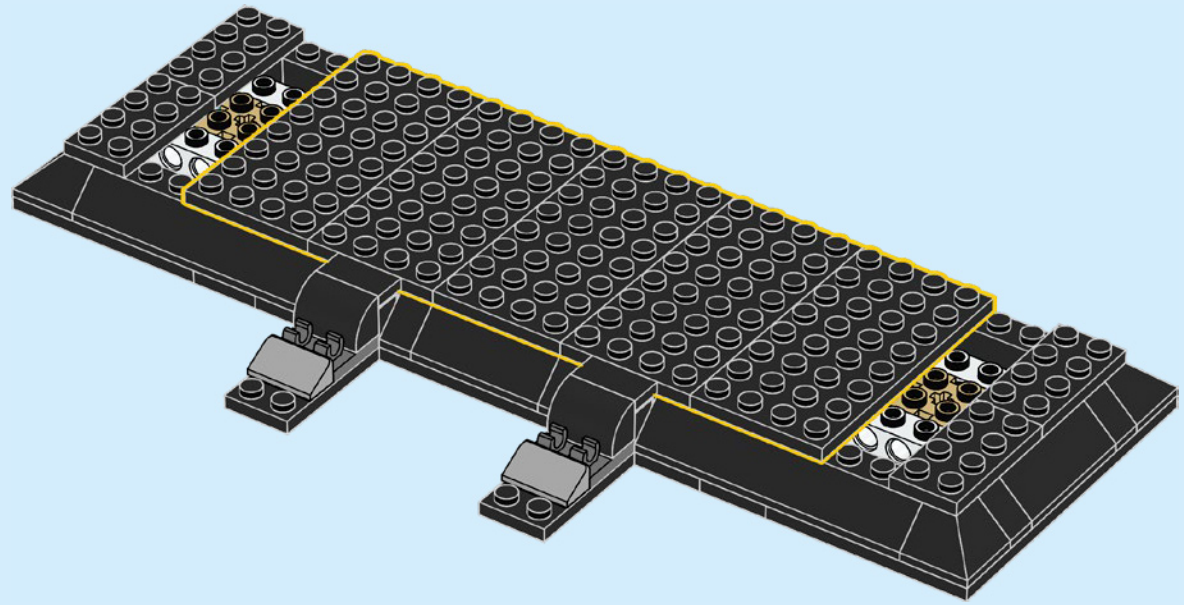

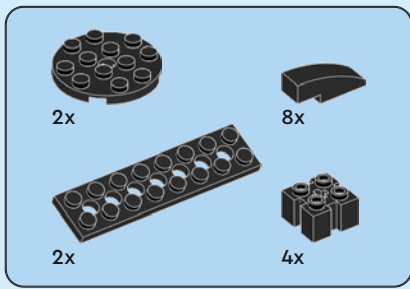

283

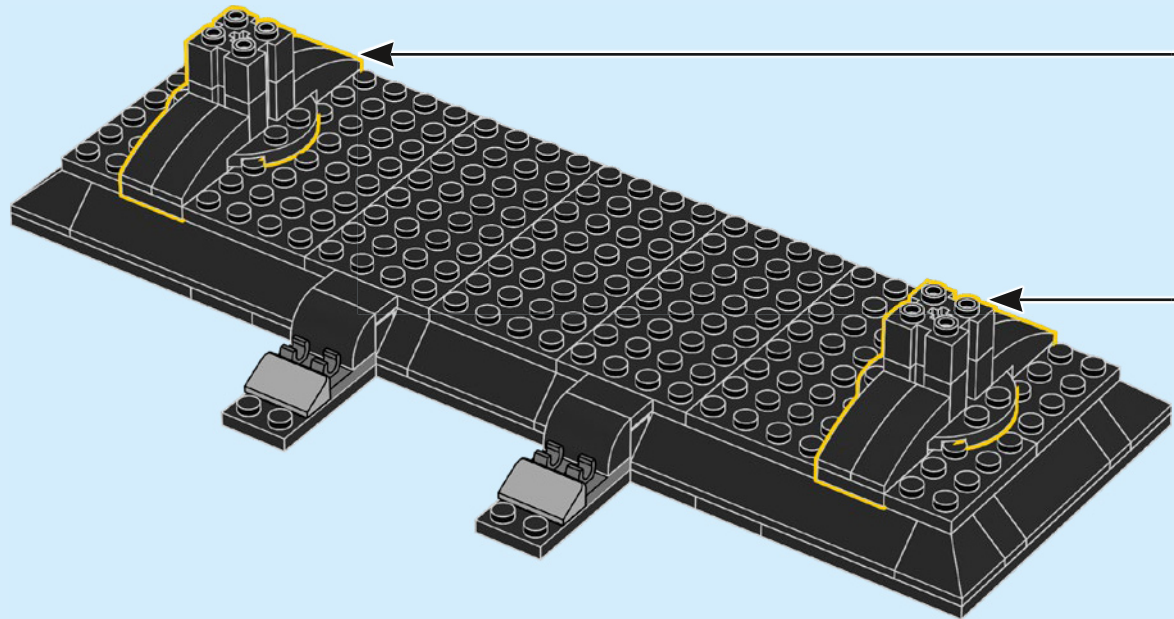
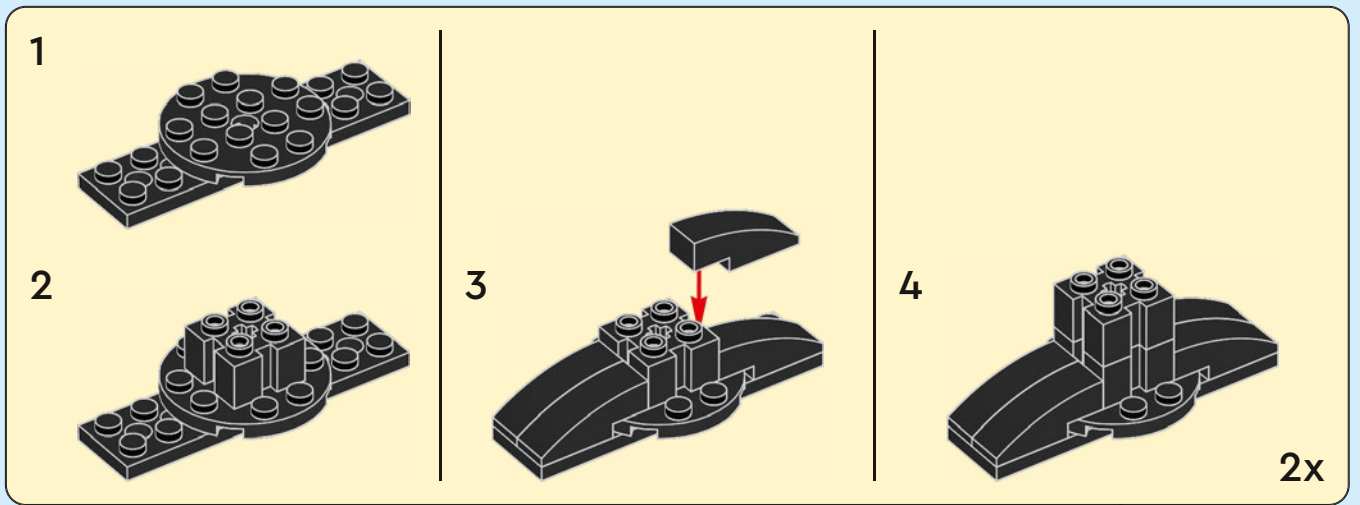

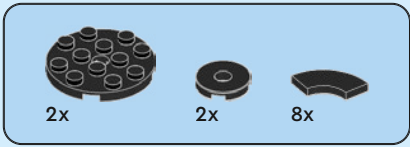

284

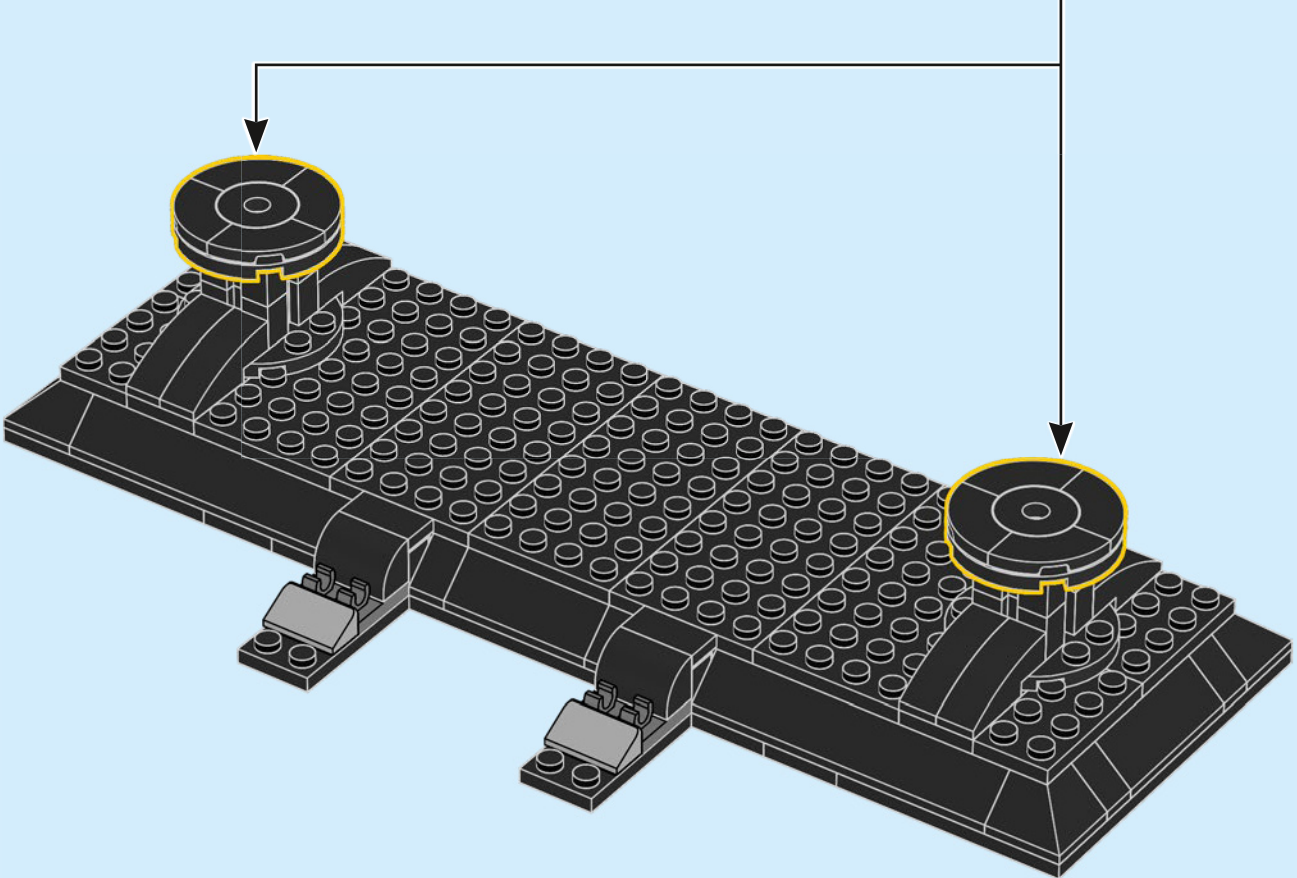
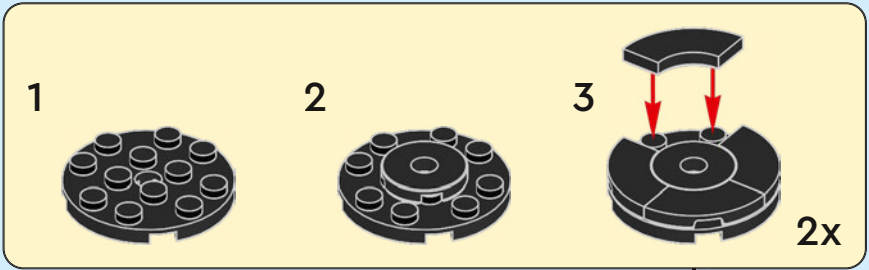

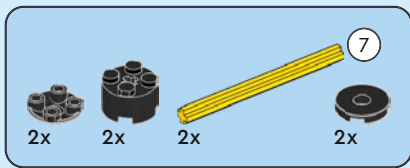

285

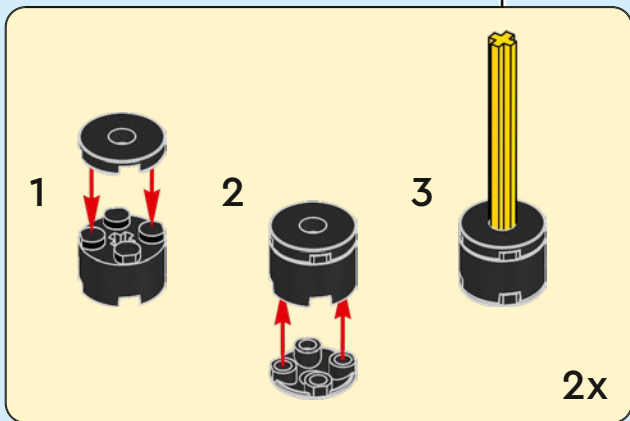
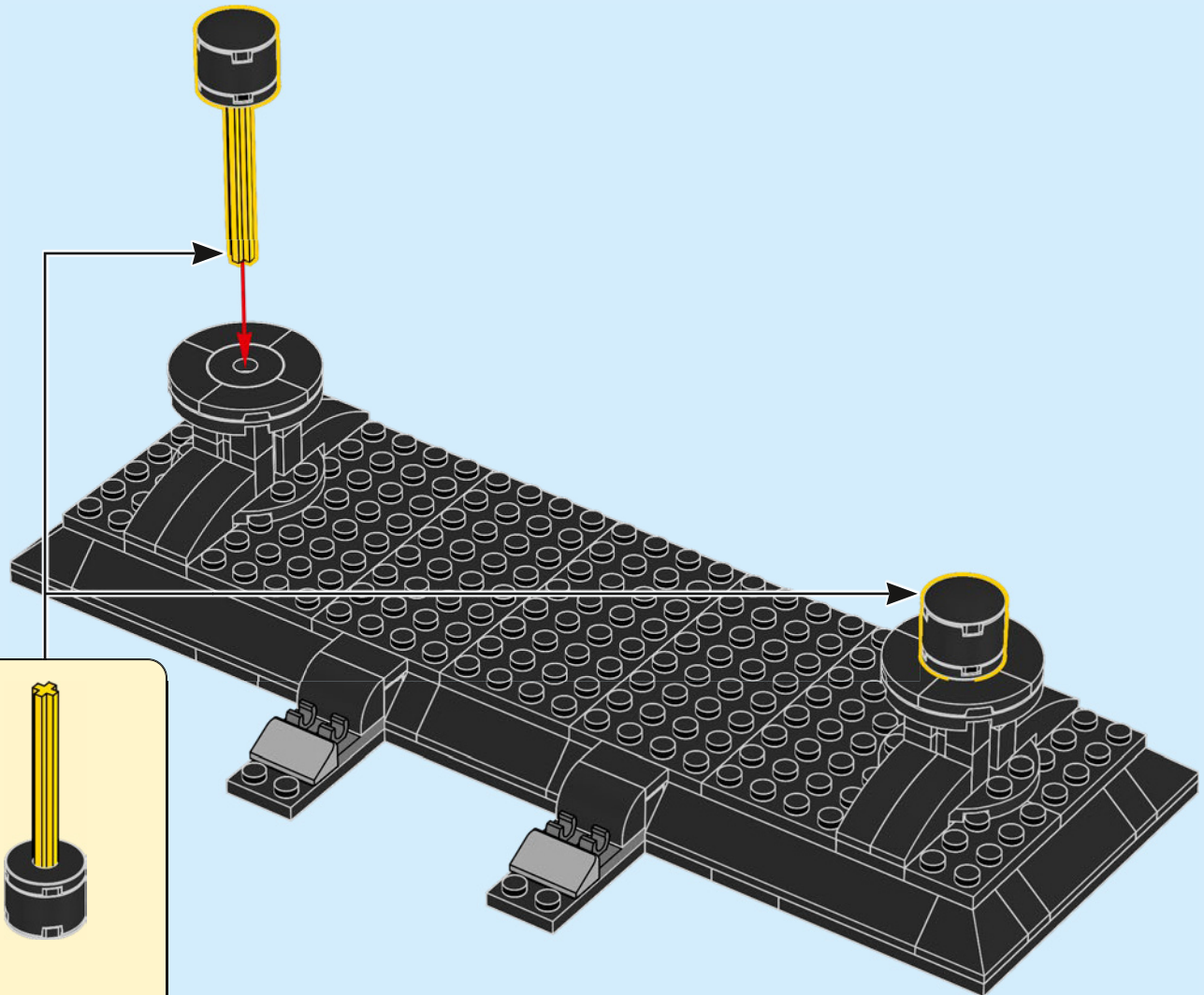

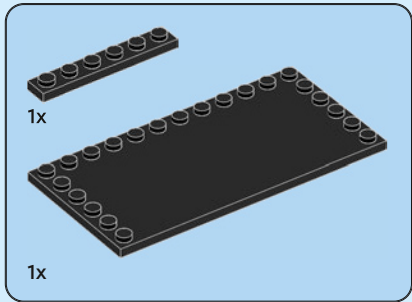

286

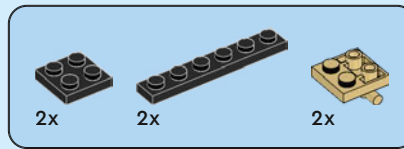
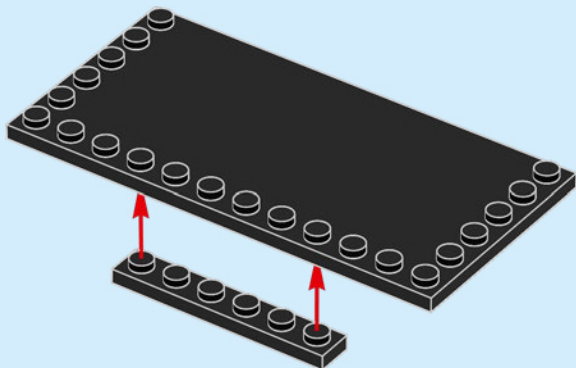

287

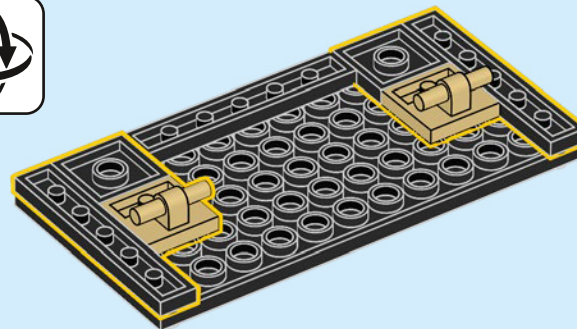
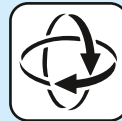

288

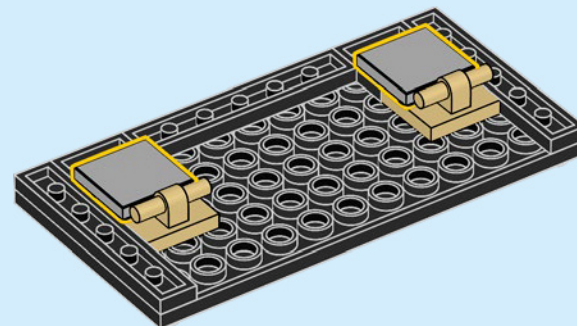

289

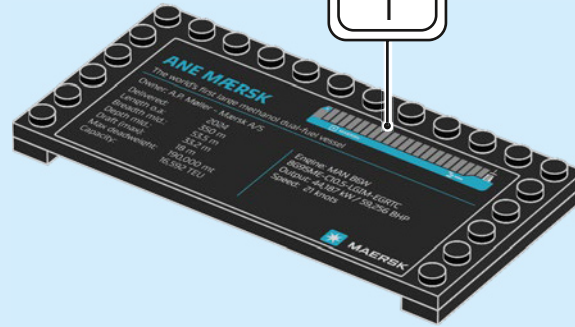

290

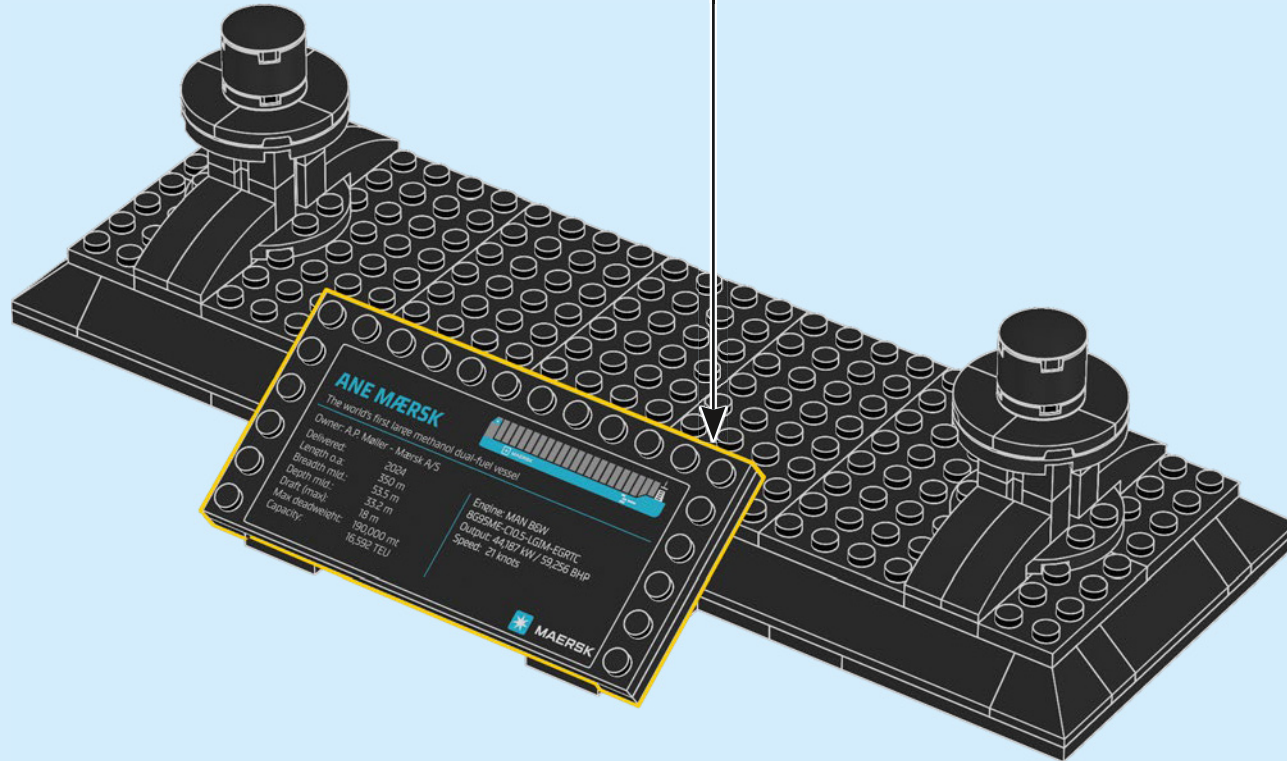

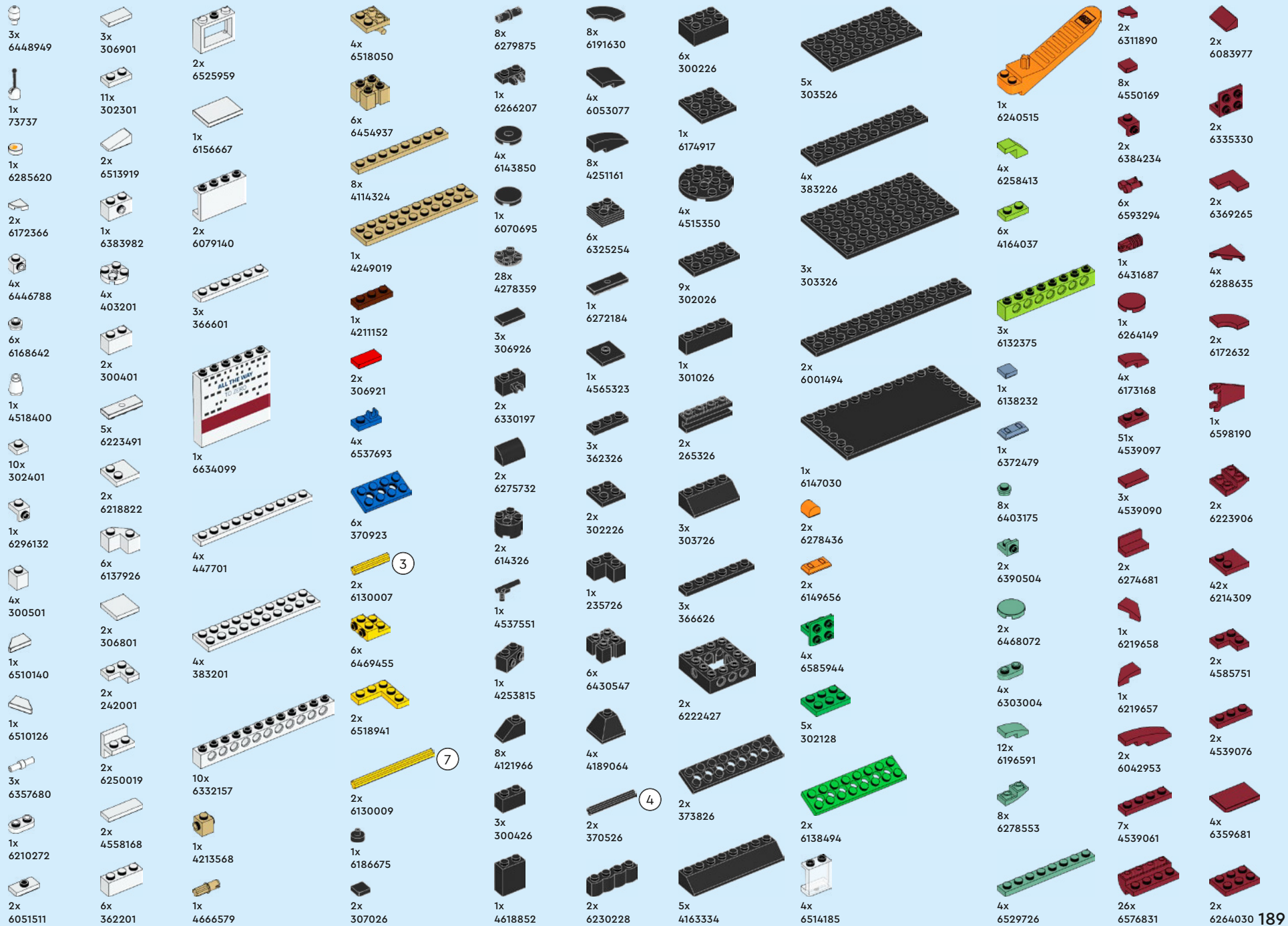

- 4x 6584062
- 4x 4541528
- 2x 6586652
- 1x 6335319
- 21x 6052777
- 6x 4541507
- 4x 4539071
- 10x 6576807
- 66x 6584063
- 1x 6465734
- 2x 6602414
- 2x 4539062
- 1x 6476042
- 1x 6350339
- 26x 6253142

- 4x 6186106
- 1x 6544174
- 6x 6440979
- 1x 4211392
- 6x 4211406
- 25x 4211462
- 2x 4211705
- 1x 6539385
- 9x 6258831
- 1x 4211415
- 4x 4211412
- 2x 4211399
- 6x 6227897
- 70x 4211398

- 27x 4211395
- 12x 6061675
- 4x 6059033
- 2x 6079461
- 30x 4527174
- 16x 6598025
- 16x 6595947
- 35x 4211452
- 64x 6123809
- 6x 4211564

- 3x 6170387
- 32x 4211363
- 4x 6469440
- 1x 6446028
- 2x 6132886
- 2x 6043639
- 2x 4211580
- 15x 4211413
- 4x 6258820
- 10x 4211387
- 10x 6171894
- 10x 4211396
- 12x 4211386

- 1x 6514057
- 1x 6514051
- 2x 4210719
- 2x 4211063
- 4x 6344754
- 1x 6514456
- 2x 6123814
- 4x 4543086
- 1x 4218696
- 6x 4211094
- 11x 4211056
- 2x 4210651
- 1x 6287847
- 1x 6322046

- 2x 6215606
- 1x 6292145
- 1x 6088641
- 2x 6335563
- 1x 6593293
- 2x 6603341
- 8x 6603339
- 2x 6603283
- 4x 6603285
- 6x 6603587
- 8x 6603337
- 2x 6603334
- 1x 6603315
- 4x 6603598
- 17x 6603336

- 1x 6603301
- 1x 6603600
- 1x 6603591
- 1x 6603586
- 1x 6603585
- 2x 6603590
- 2x 6603344
- 2x 6603309
- 3x 6603316
- 1x 6593286
- 2x 6604733
- 2x 6603601
- 7x 6603965

- 30x 6603319
- 2x 6603317
- 2x 6576809
- 2x 6603313
- 1x 6598028
- 2x 6576810
- 1x 6598027
- 2x 6603599
- 2x 6603596
- 2x 6603342
- 2x 6603312
- 10x 6603286

- 2x 6603333
- 10x 6603340
- 2x 6603318
- 4x 6603343
- 2x 6603335
- 4x 6603595
- 1x 6603594
- 6x 6603589
- 2x 6603332
- 2x 6576813



[LEGO.com/service](https://www.LEGO.com/service)

YOU COULD WIN



Scan this QR code or go to
LEGO.COM/PRODUCTFEEDBACK and give us
your short feedback about this LEGO® set
for a chance to win a cool LEGO prize.

Terms and Conditions apply*

EN: YOU COULD WIN. Terms and Conditions apply* **DE: Du könntest GEWINNEN.** Es gelten die Teilnahmebedingungen* **FR: Tu pourrais GAGNER.** Des conditions s'appliquent* **IT: Potresti VINCERE tu.** Termini e condizioni sono applicabili* **ES: Puedes GANAR.** Aplican términos y condiciones* **PT: PODERÁ GANHAR.** Aplicam-se Termos e Condições* **ZH: 轻松获奖.** 条款和条件适用* **PL: Szansa na WYGRANĄ.** Obowiązuje regulamin* **CS: Máte šanci VYHRÁT.** Platí všeobecné smluvní podmínky* **SK: Máte šancu VYHRÁT.** Platia všeobecné zmluvné podmienky* **HU: TE IS NYERHETSZ.** Felhasználási feltételek érvényesek* **UA: ВИ МОЖЕТЕ ВИГРАТИ.** Застосовуються загальні положення та умови* **RO: Ai putea CÂȘTIGA.** Se aplică termenii și condiții* **BG: Можете да СПЕЧЕЛИТЕ.** Има определени правила и условия* **LV: Tu vari LAIMĒT.** Ir spēkā noteikumi un nosacījumi.* **ET: Sul on võimalus VÕITA.** Kehtivad tingimused* **LT: Jūs galite LAIMĖTI.** Taikomos sąlygos*

*[LEGO.com/productfeedback-terms](https://www.lego.com/productfeedback-terms)

