



21066





LEGO.com/sustainable-packaging



FR
**DONNEZ
OU
RECYCLEZ**



ASSOCIATION

OU



MAGASIN

OU



DÉCHÈTERIE

Adresses sur quefairedemesdechets.fr



BUILDER



Apple and the Apple logo are trademarks of Apple Inc., registered in the U.S. and other countries and regions. App Store is a service mark of Apple Inc. Google Play and the Google Play logo are trademarks of Google LLC. Tencent and the Tencent logo are trademarks of Tencent Inc.

LEGO.com/devicecheck

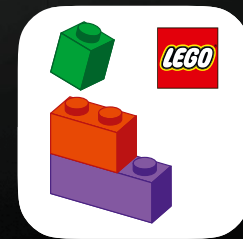

LEGO® Builder



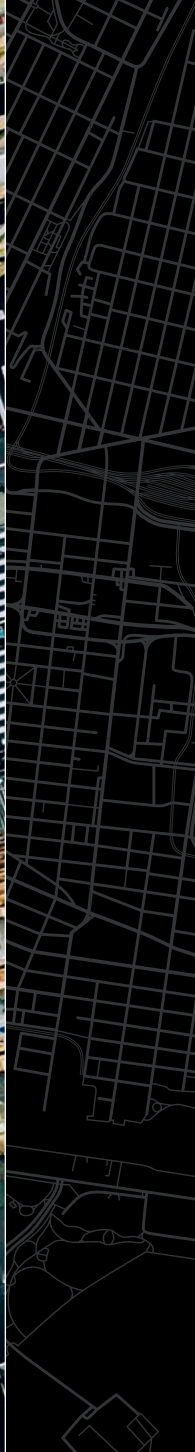



“大苹果”——纽约市

纽约，纽约——这座永不休眠的都市，这个孕育梦想的摇篮，亦被称作“大苹果”——这座拥有着诸多别称的城市，处处洋溢着无限的活力，遍地皆是机遇。这座城市在1624年始建时名为“新阿姆斯特丹”，如今已然蜕变成为一座活力四射的文化、贸易、艺术与创新之都。纽约市极具标志性的天际线，是由分布在其五个行政区内的诸多一眼便可辨识的地标共同构成的。无论是象征着包容与接纳、迎接新访客的自由女神像，还是处处涌动着逐梦热情的喧嚣街道，这座城市独有的节奏都让游客和居民心驰神往。曼哈顿区的面积仅23平方英里（约59平方公里），却容纳了超150万居民，堪称全球人口最稠密的区域之一。无论是沉醉于它流光溢彩的灯火与热闹非凡的氛围，还是倾心于中央公园宁静悠然的小径，这座城市的精神内核、悠久历史和多元魅力，都一定会让你记忆深刻。

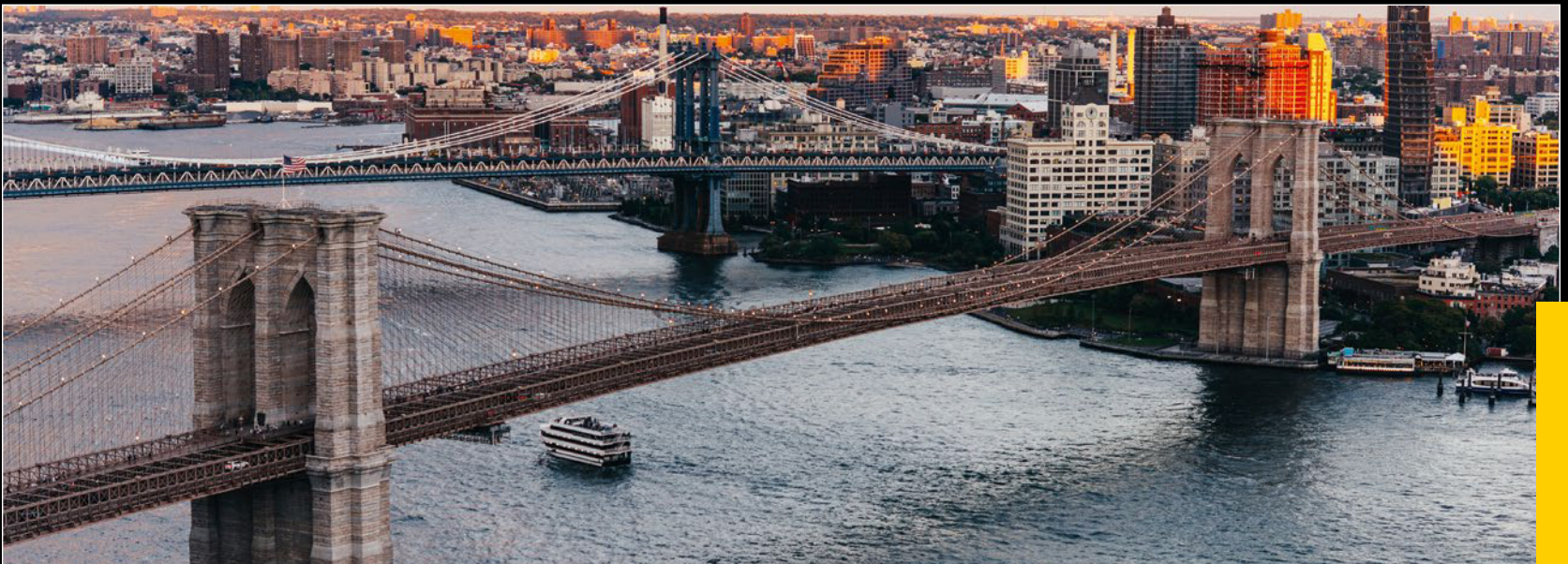



世界贸易中心一号楼 (2014)

迄今为止，西半球最高的建筑是世界贸易中心一号楼，它的建成凝聚着团结的力量，也象征着不屈的韧性。



帝国大厦(1931)

这座拥有102层的纽约地标坐落于曼哈顿中城核心区域，站在这里能将震撼人心的城市风光尽收眼底。



大都会艺术博物馆 (1870年)

大都会艺术博物馆成立于1870年，是世界上最大的博物馆之一，展出超过5000年的艺术史和现代杰作。



古根海姆博物馆(1959)

这座博物馆自对外开放起，便凭借其独特的螺旋式建筑外观以及堪称世界顶尖的现代与当代艺术藏品声名远扬。

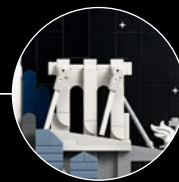
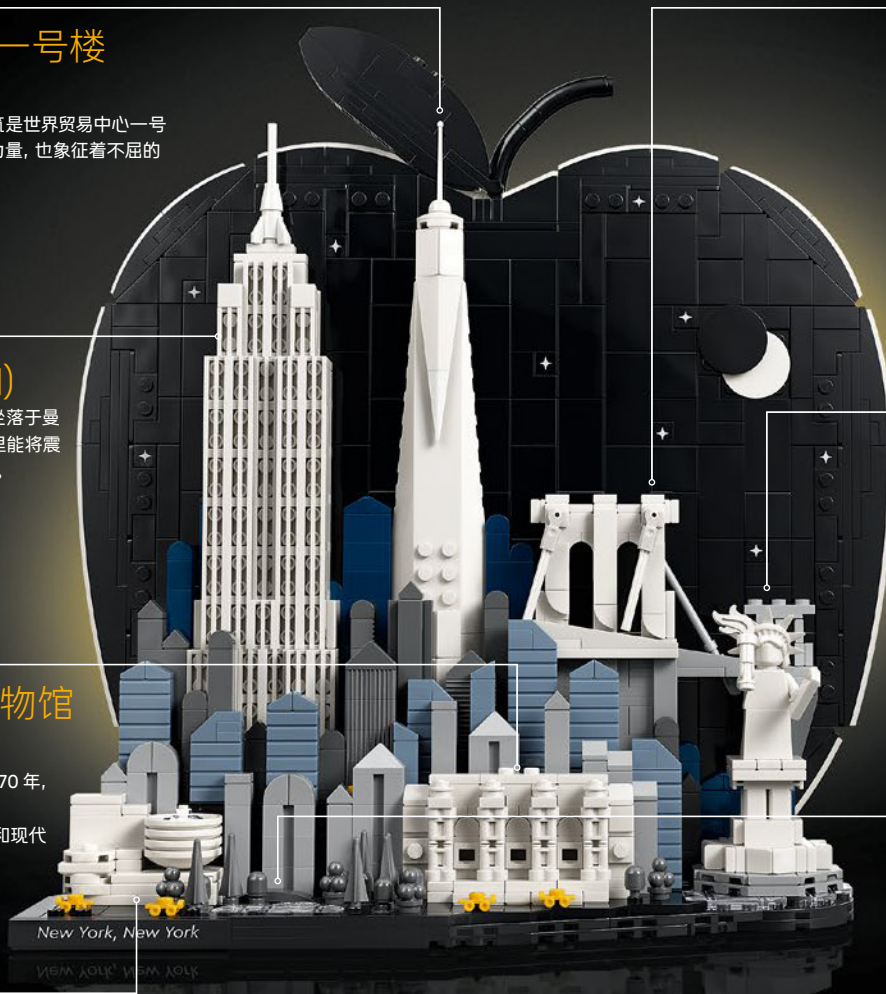

布鲁克林大桥 (1883年)

布鲁克林大桥全长逾一英里，在建成之际，是全球最长的悬索桥。

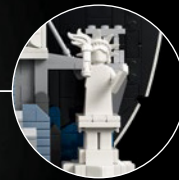

自由女神像 (1886)

这座新古典主义风格的宏伟雕像，坐落于曾是美国最知名入境港口的纽约港自由岛上。



中央公园 (1858年)

占地341.1公顷(843英亩)的中央公园，内有连片草地、蜿蜒小径与澄澈湖泊，每年都会迎来4200万游客前来游览。

乐高®建筑设计团队寄语

2026 年是美国《独立宣言》签署 250 周年，也是我们第一款建筑系列纽约天际线套装推出 10 周年！这一创意，让我们萌生了为这两个节日庆生的想法。我们以“大苹果”纽约为背景，将璀璨夜空作为画布，为这座城市的知名地标赋予全新诠释。我们借助多面体构件复刻世界贸易中心一号楼的复杂几何形态，它毗邻帝国大厦，仿佛依偎在其“肩头”，且随建筑高度攀升逐步收窄轮廓。帝国大厦的窗户和向上延伸的艺术生活系列线条是乐高格栅板构成的。强制透视效果在布鲁克林大桥的拼搭中得以运用，具体通过三种方式实现：一是对桥梁尺寸进行大幅调整，二是在两座桥塔上增添色彩变化，三是让道路呈现出轻微倾斜的角度。还有些标志性设计细节，比如“方头仔版自由女神”小人仔，愿您在拼搭与探索这座宏伟都市的过程中，收获满满的乐趣！



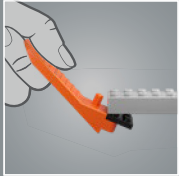
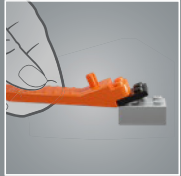
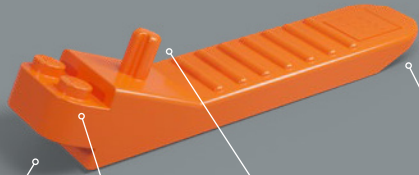

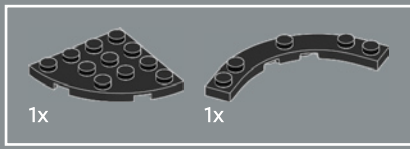

1

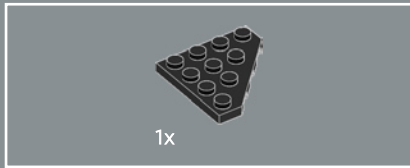
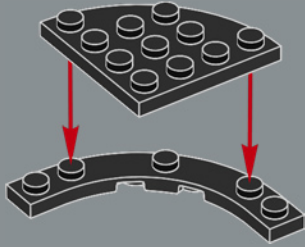

2

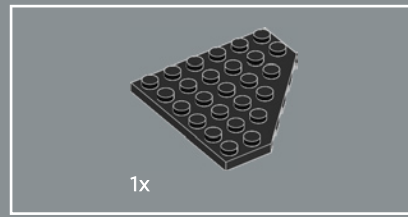
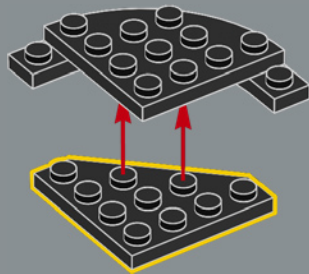

3

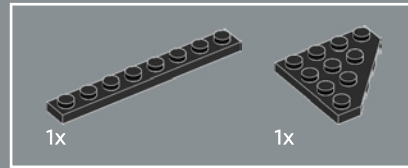
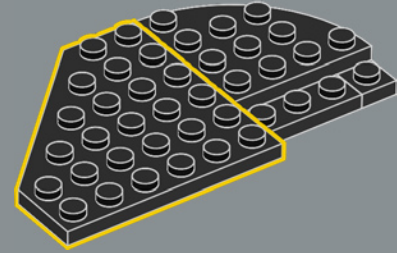

4

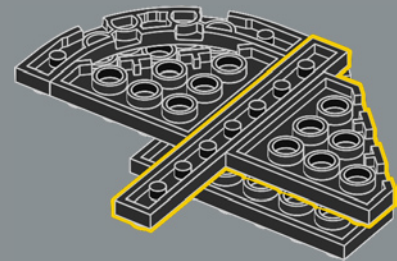

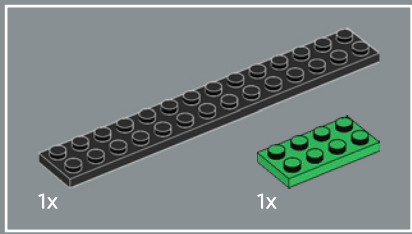

5

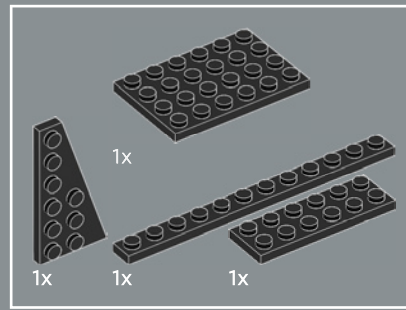
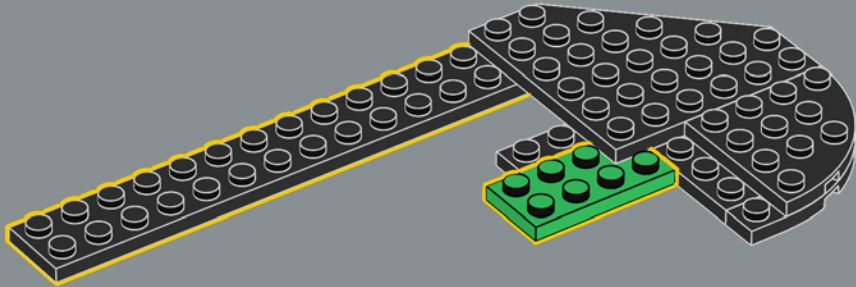

6

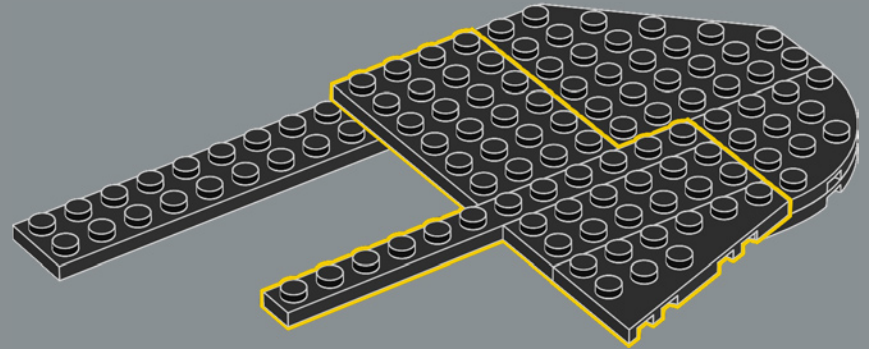

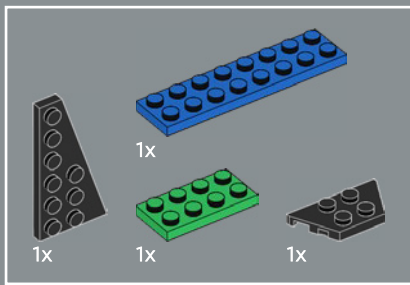

7

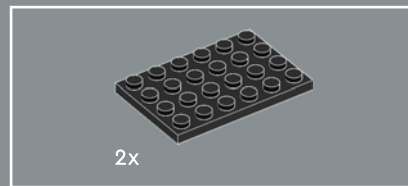
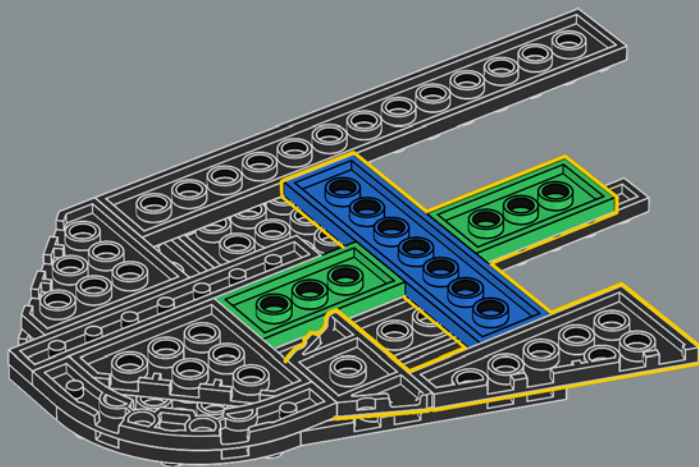

8

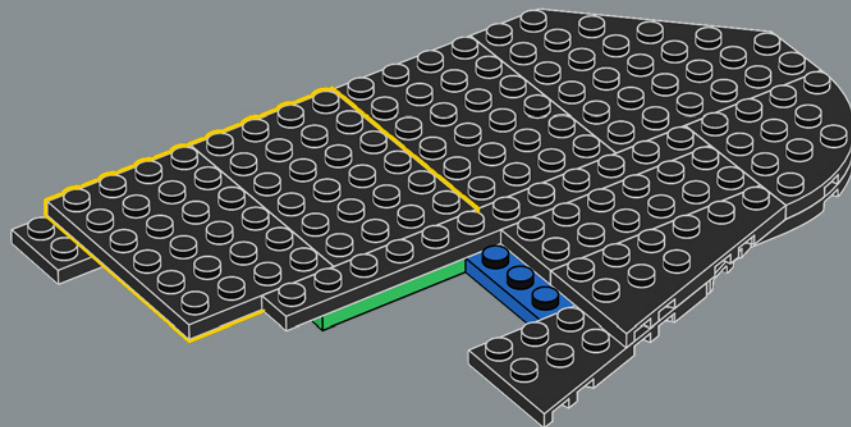

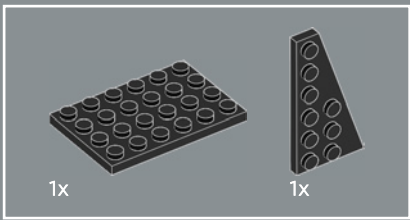

9

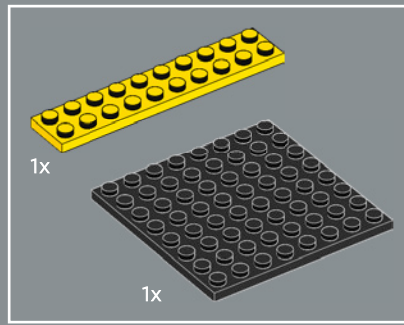
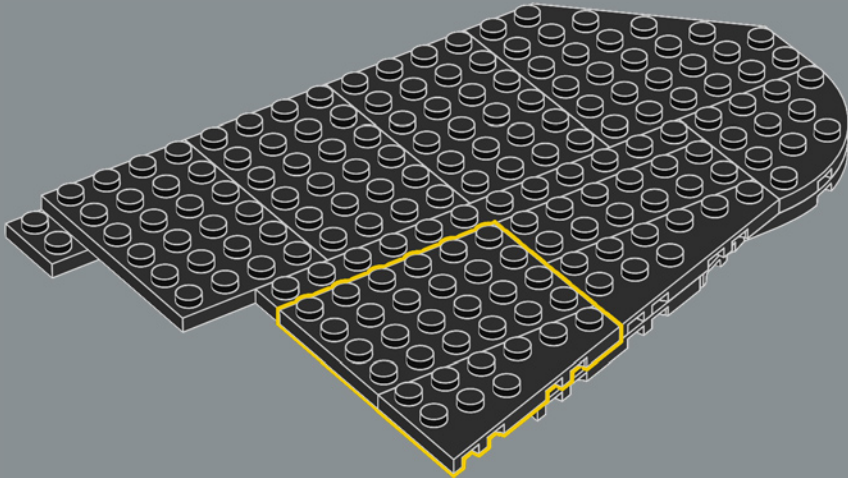

10

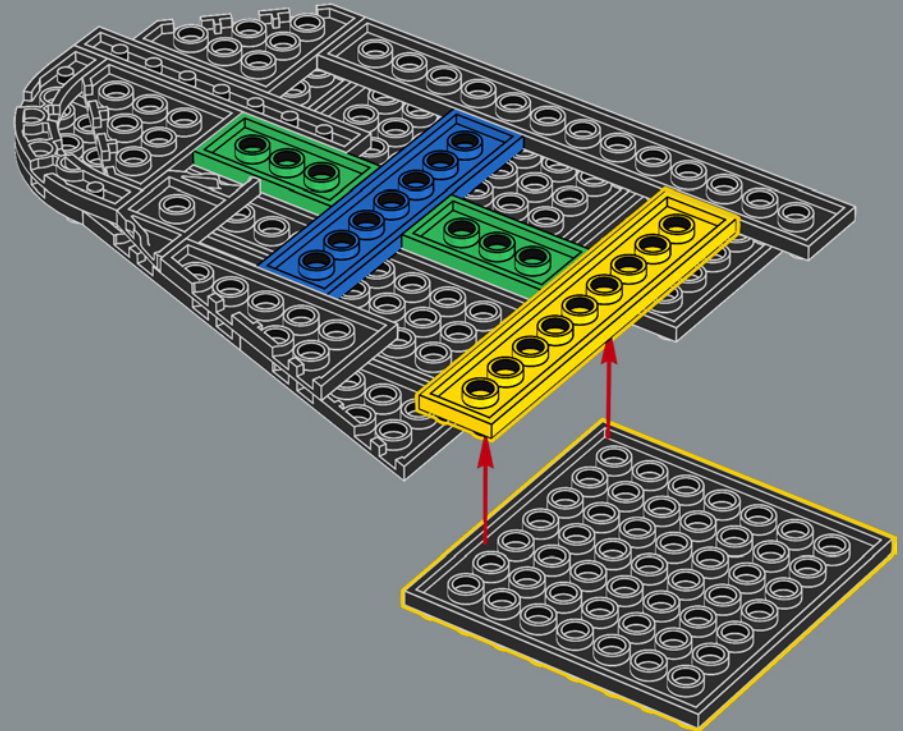

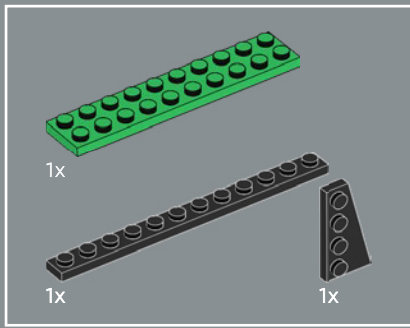

11

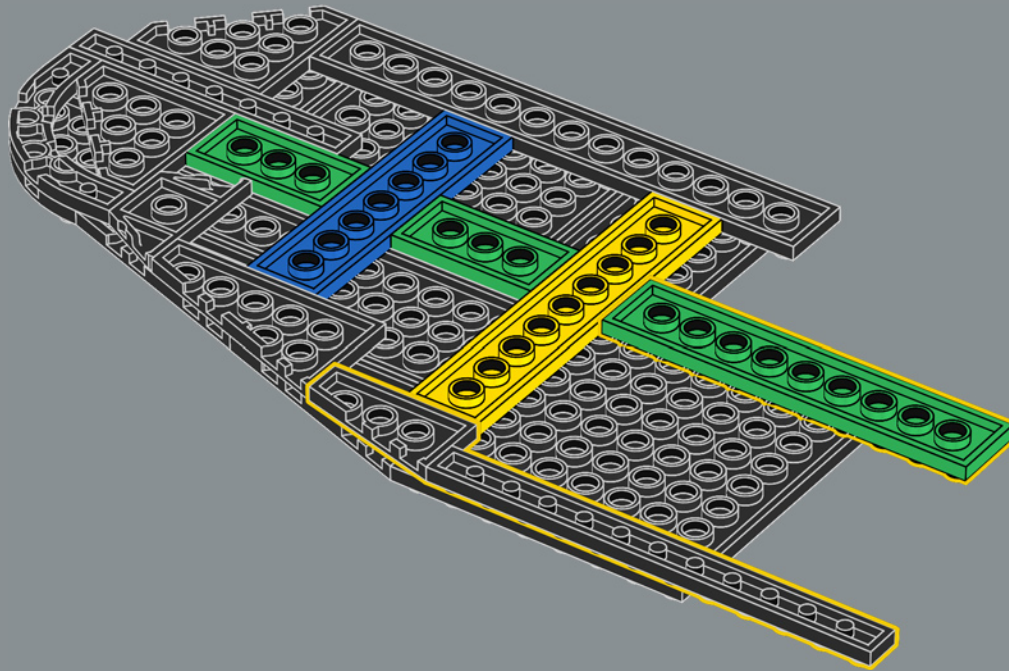

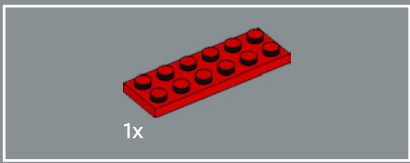

12

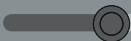
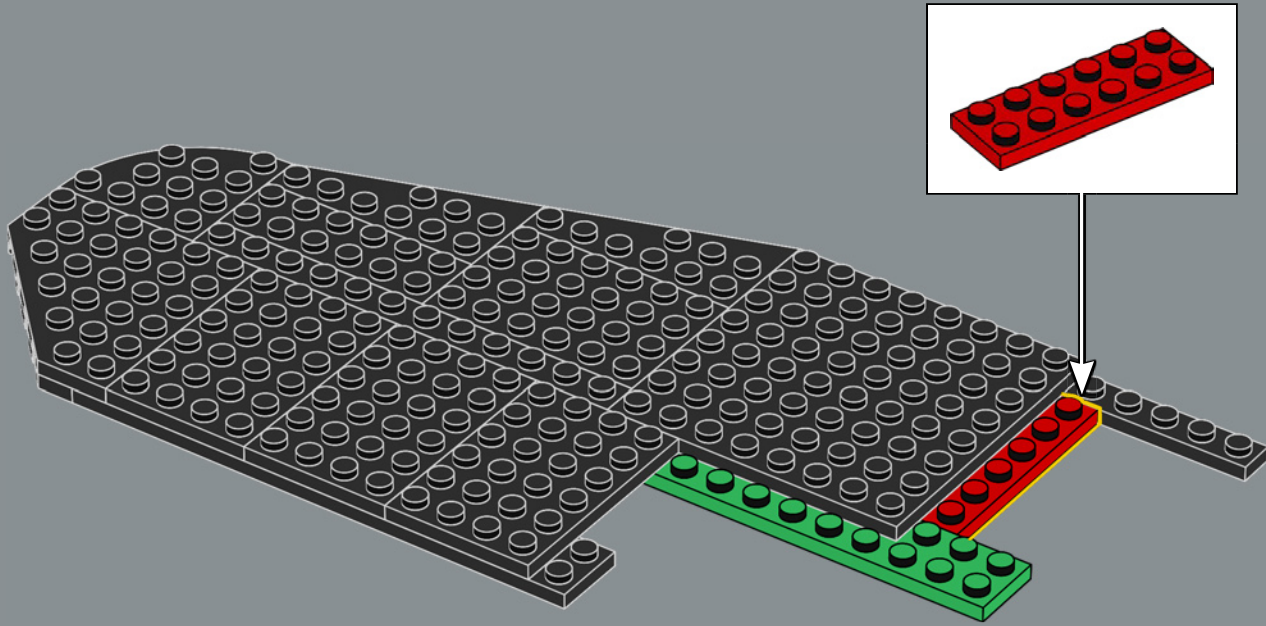

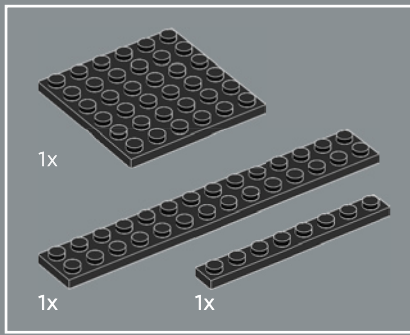

13

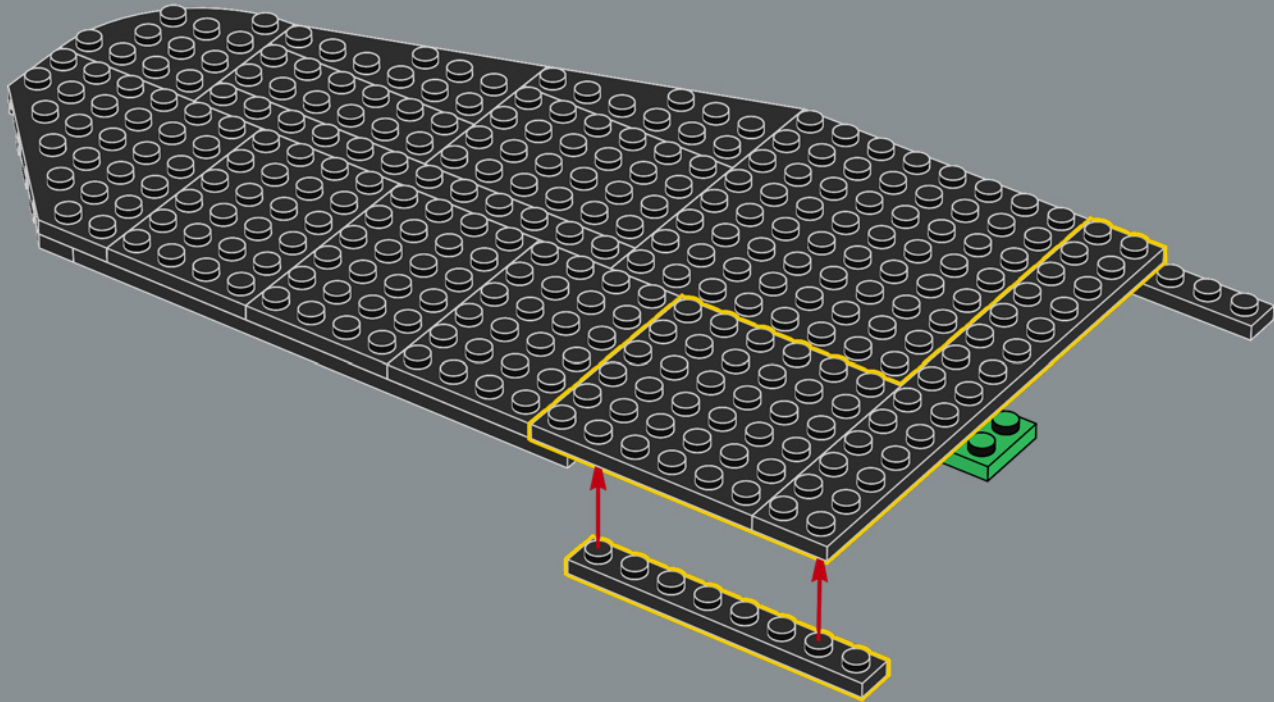

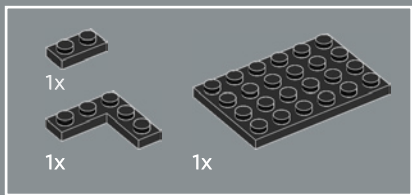

14

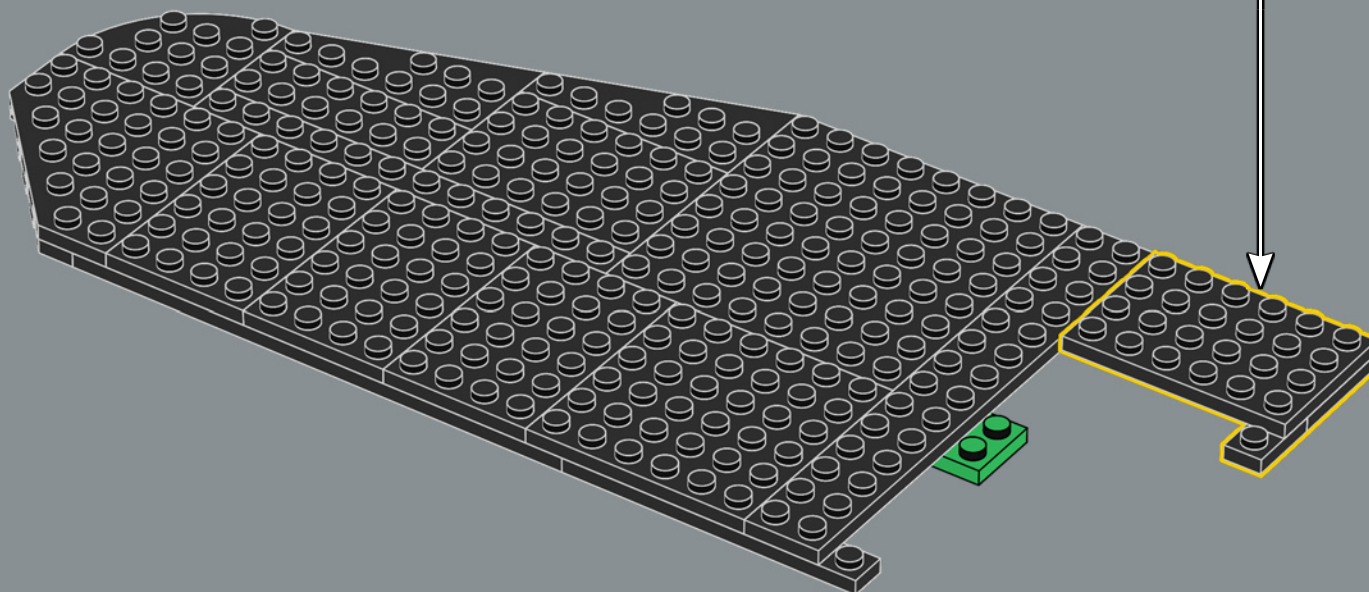
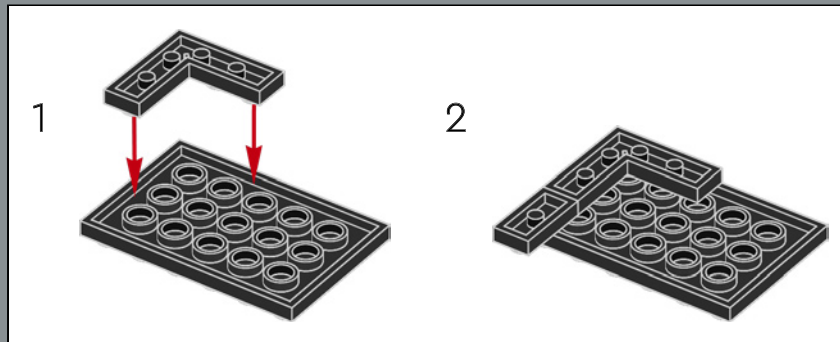

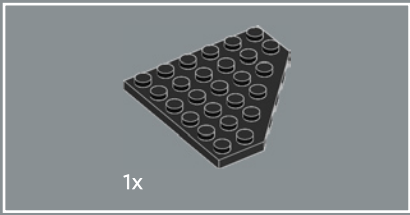

15

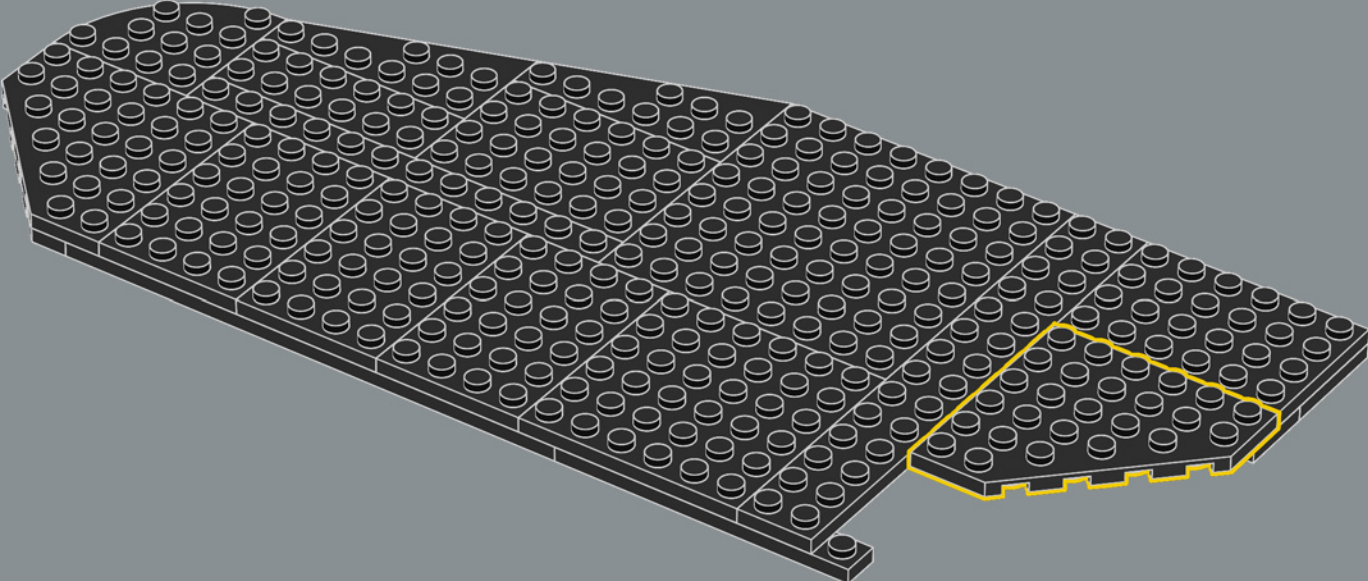

底座内色彩缤纷的乐高®板的设计灵感，源自串联起整座城市的36条地铁线路里的其中几条。

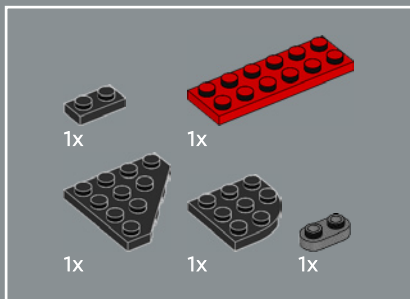

16

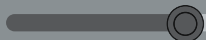
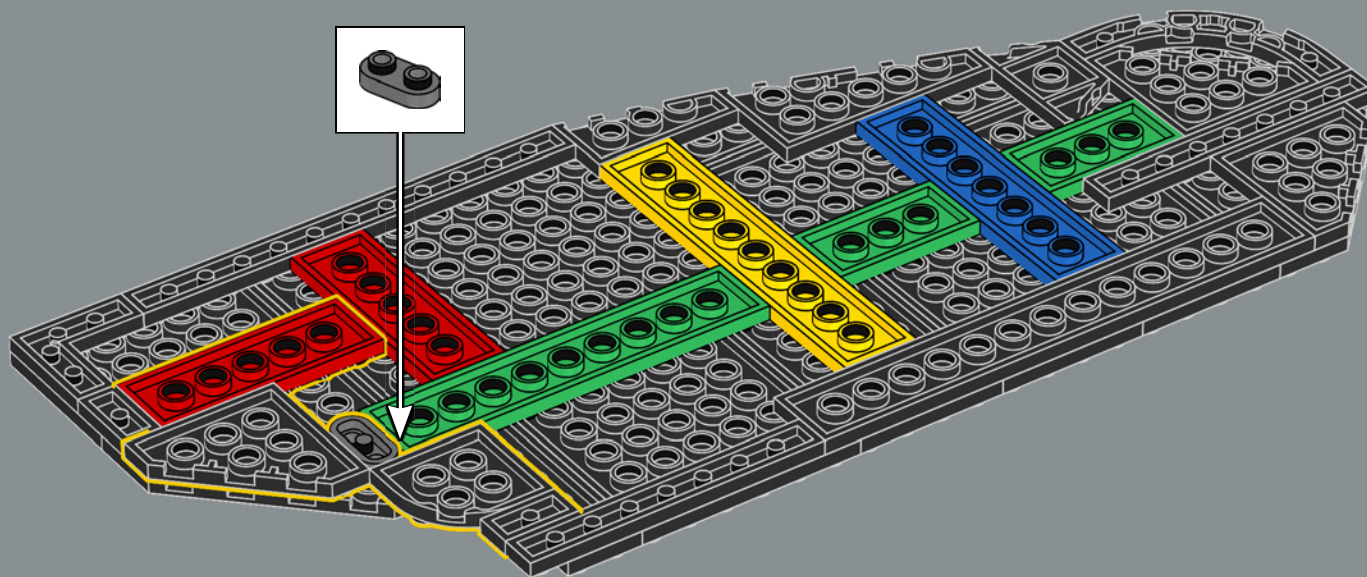

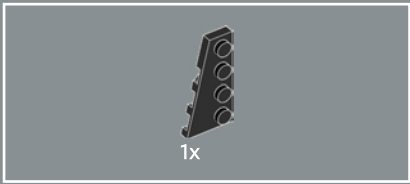

17

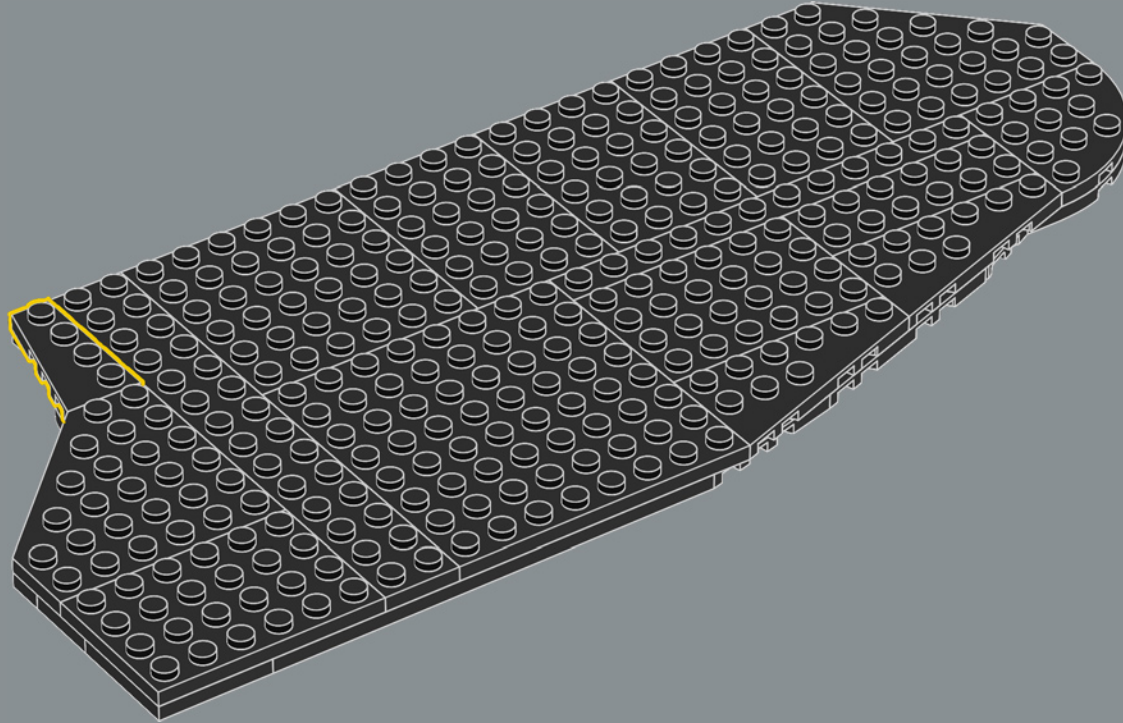

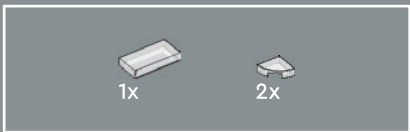

18



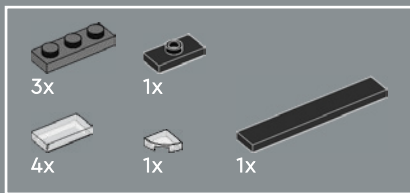

19

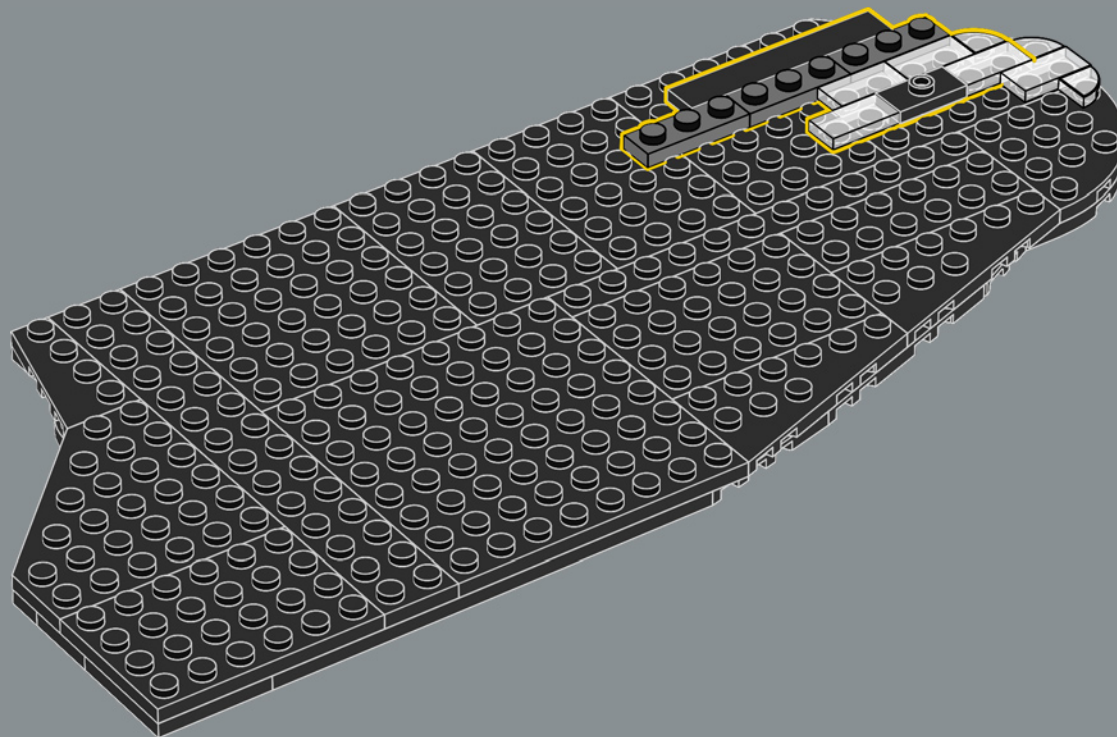

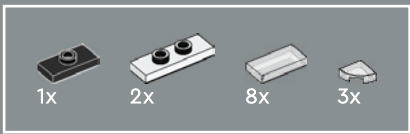

20

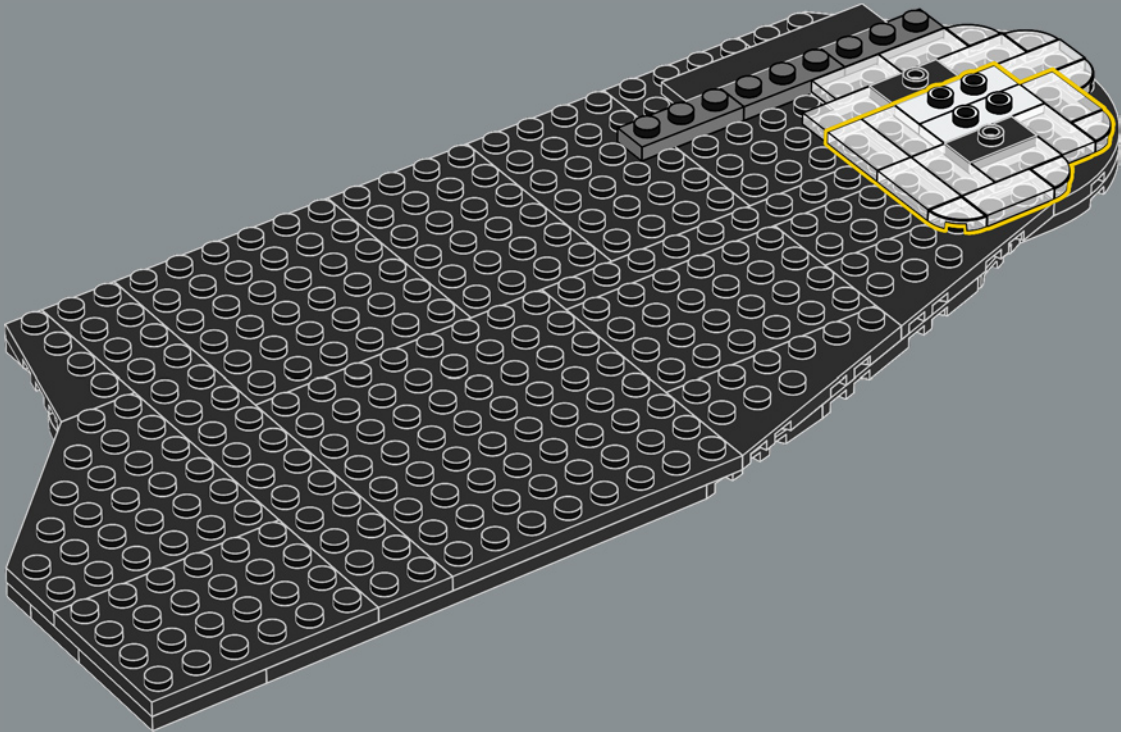

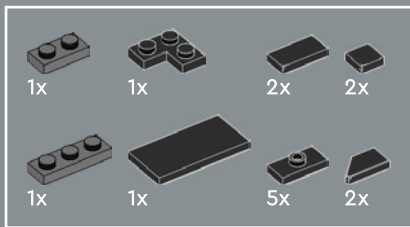

21

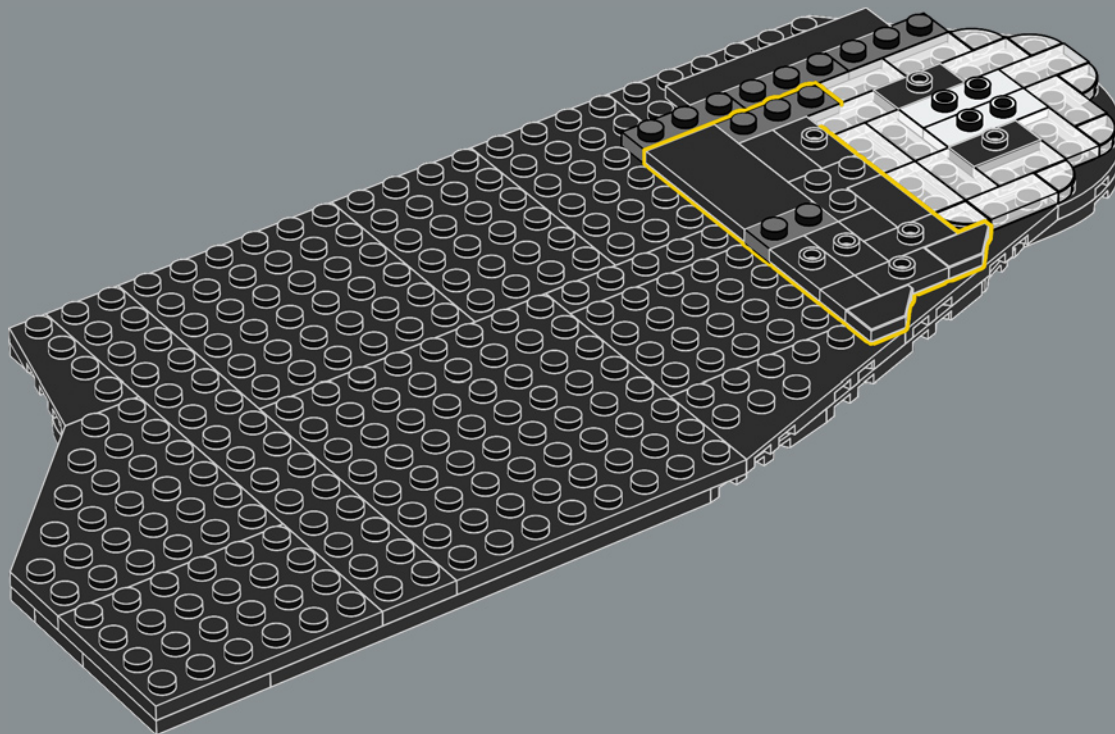

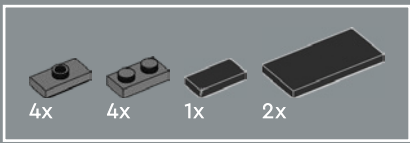

22

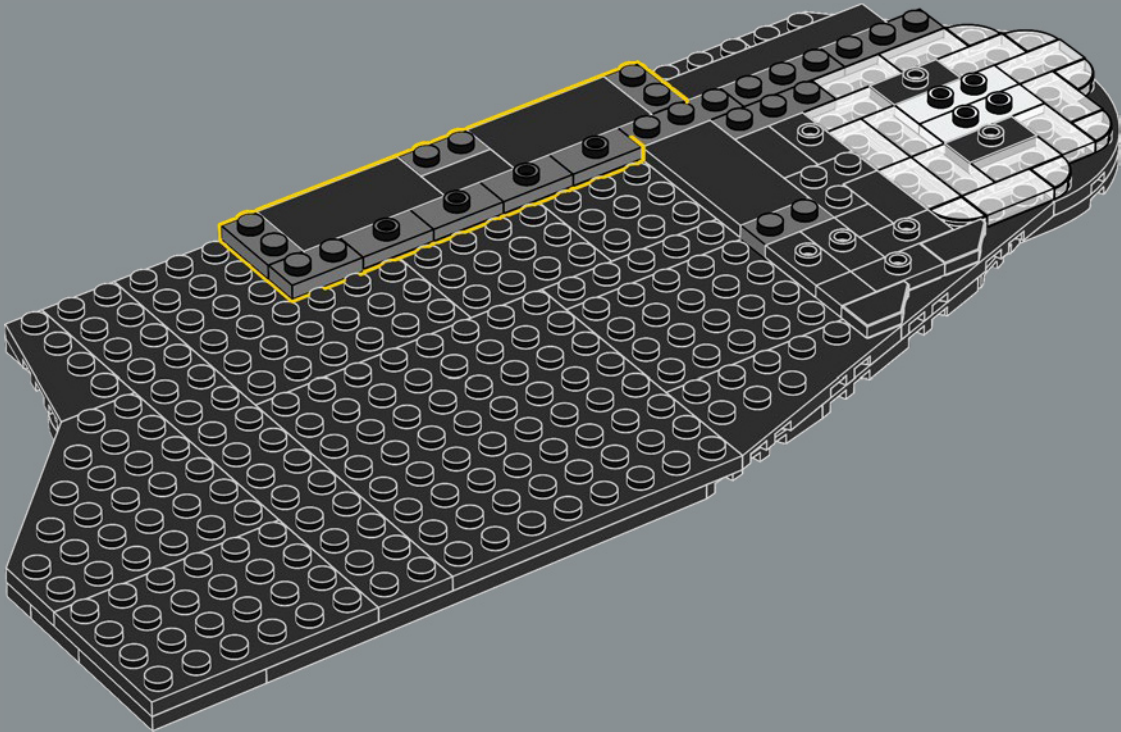

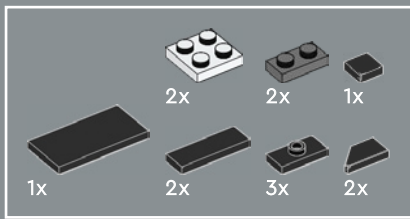

23

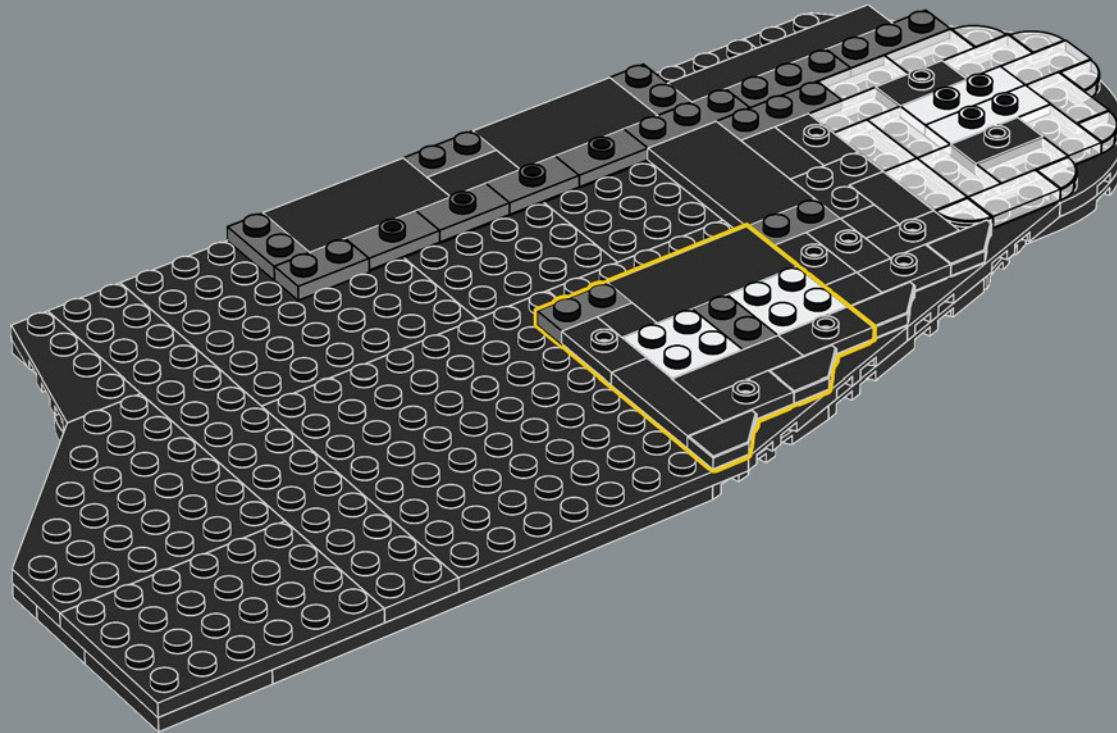

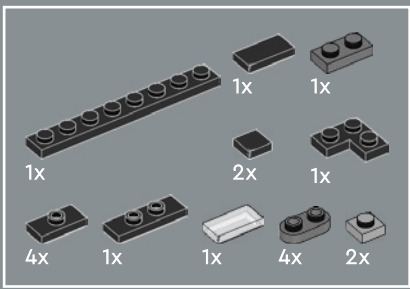

24

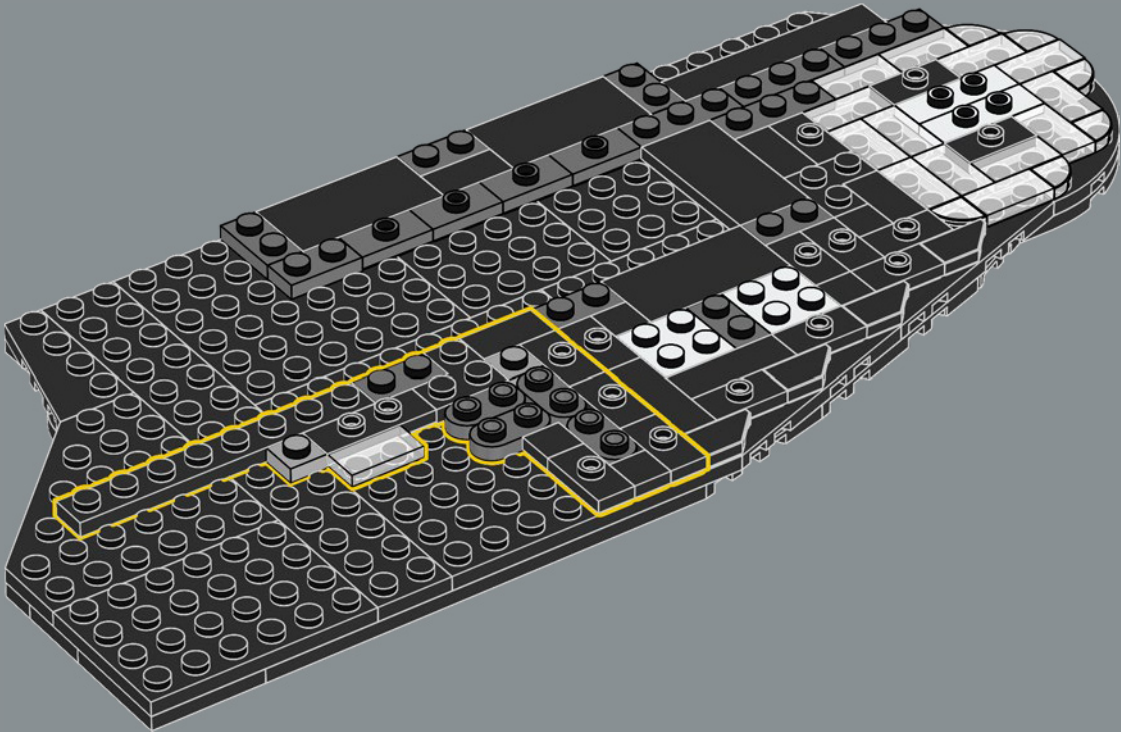

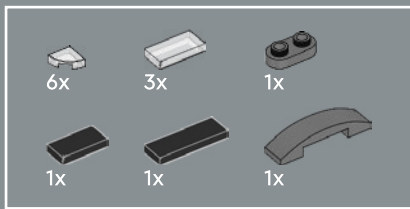

25

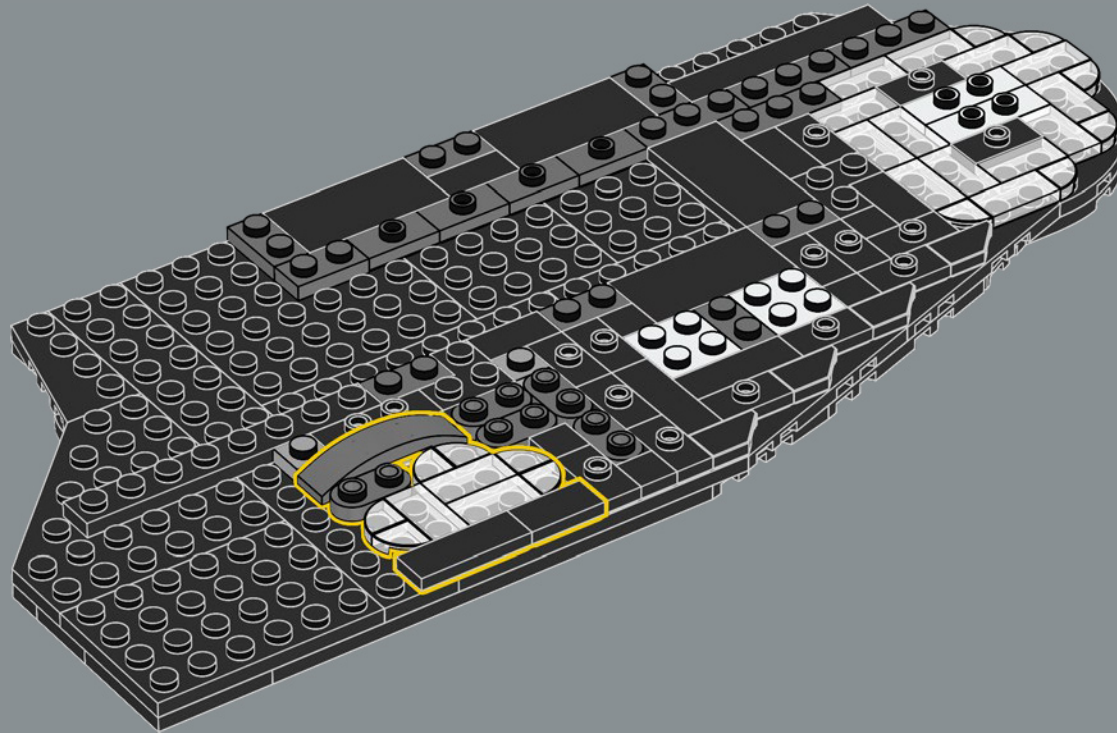

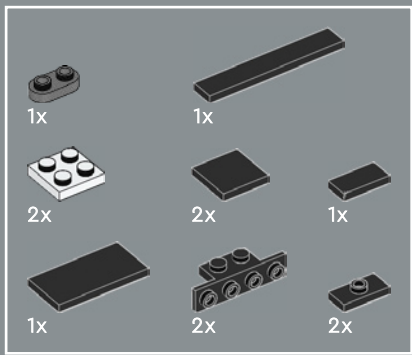

26

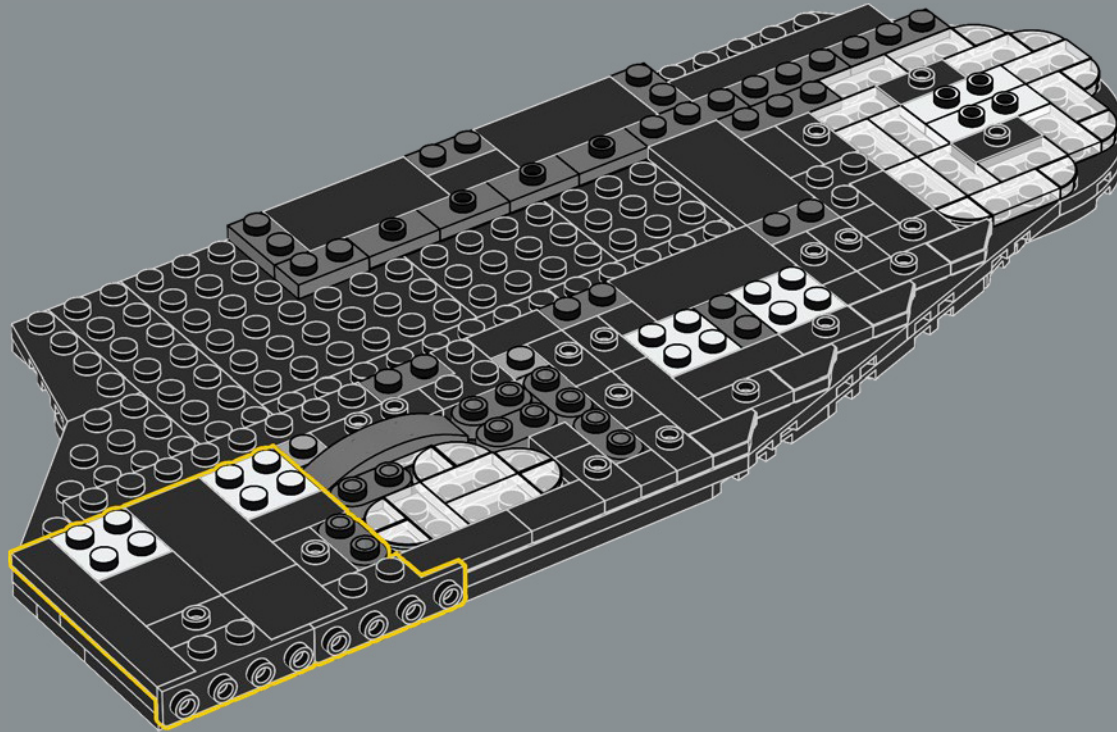

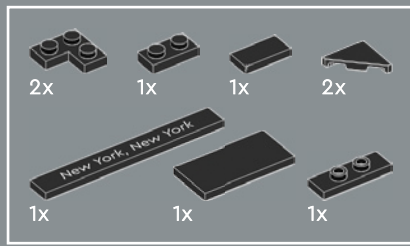

27

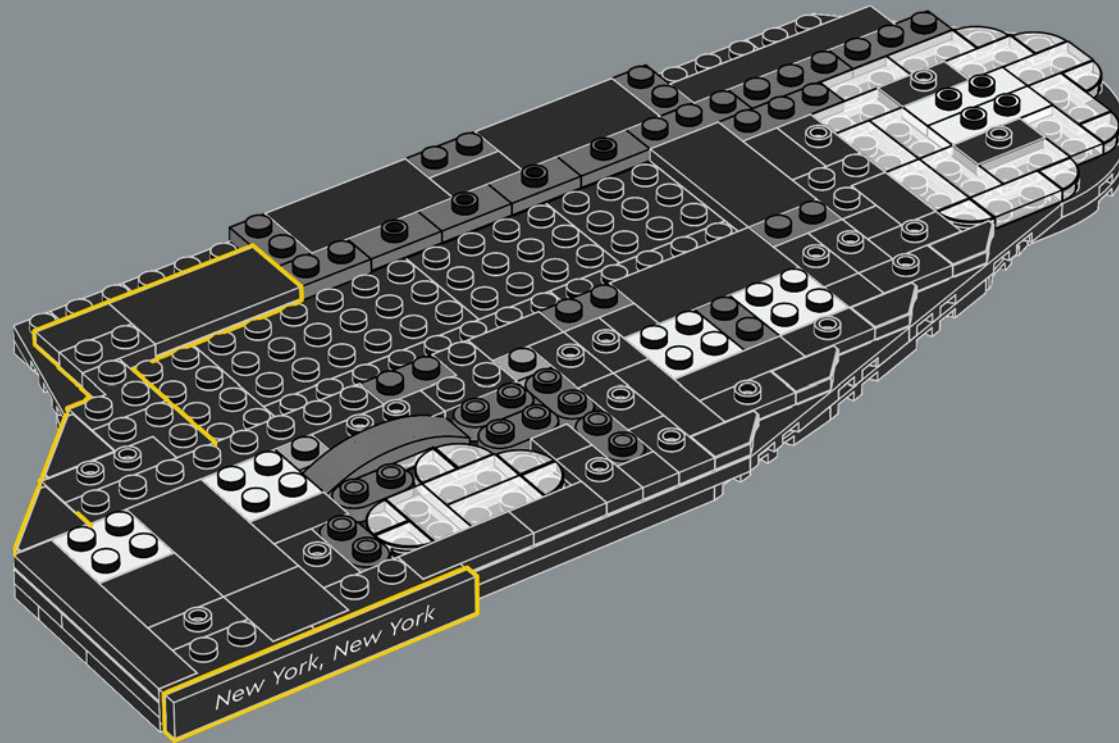

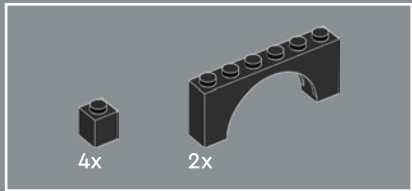

28

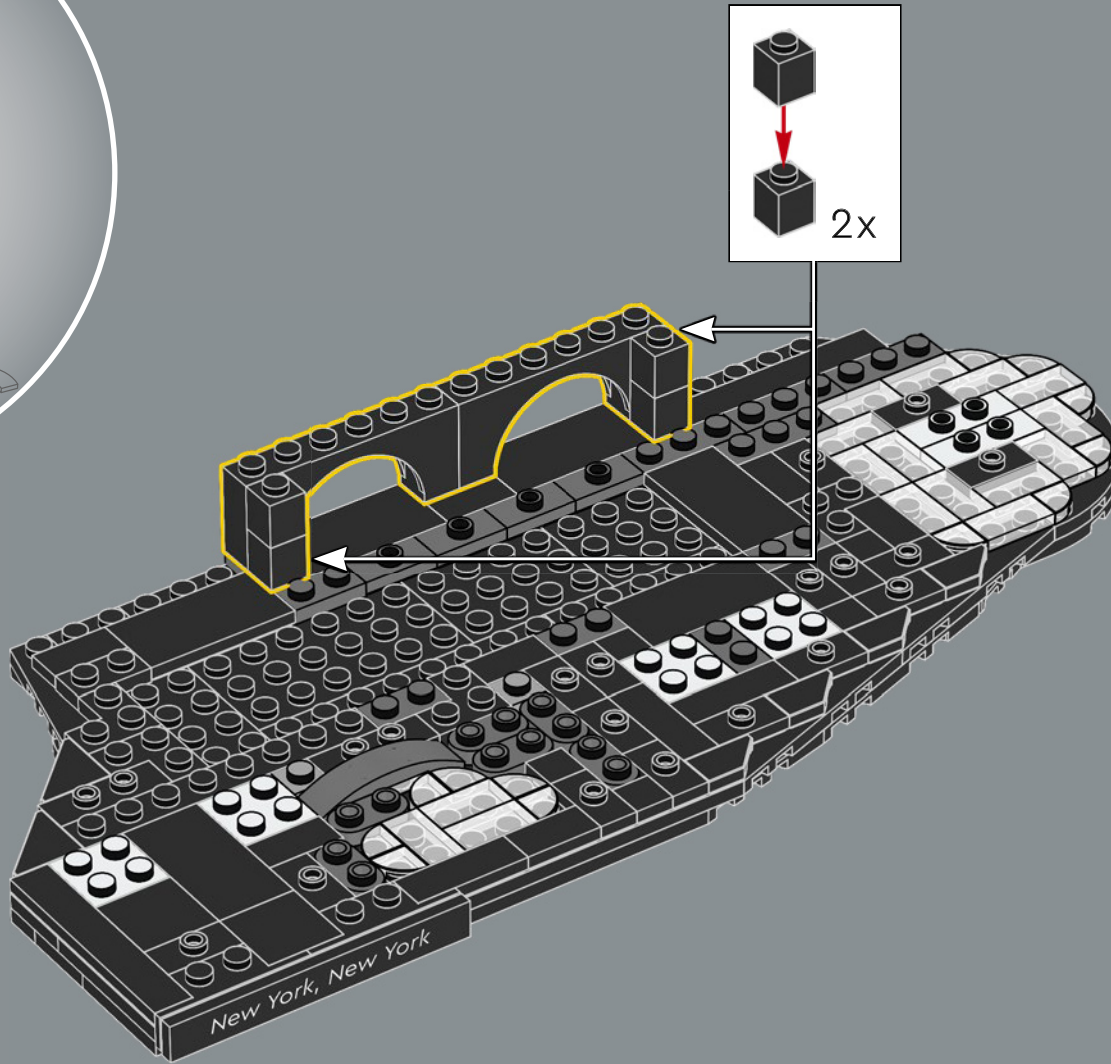

如果将纽约地铁系统的全部 842 英里 (1355 公里) 轨道拉成一条直线, 它们将从纽约一直延伸到芝加哥。



29

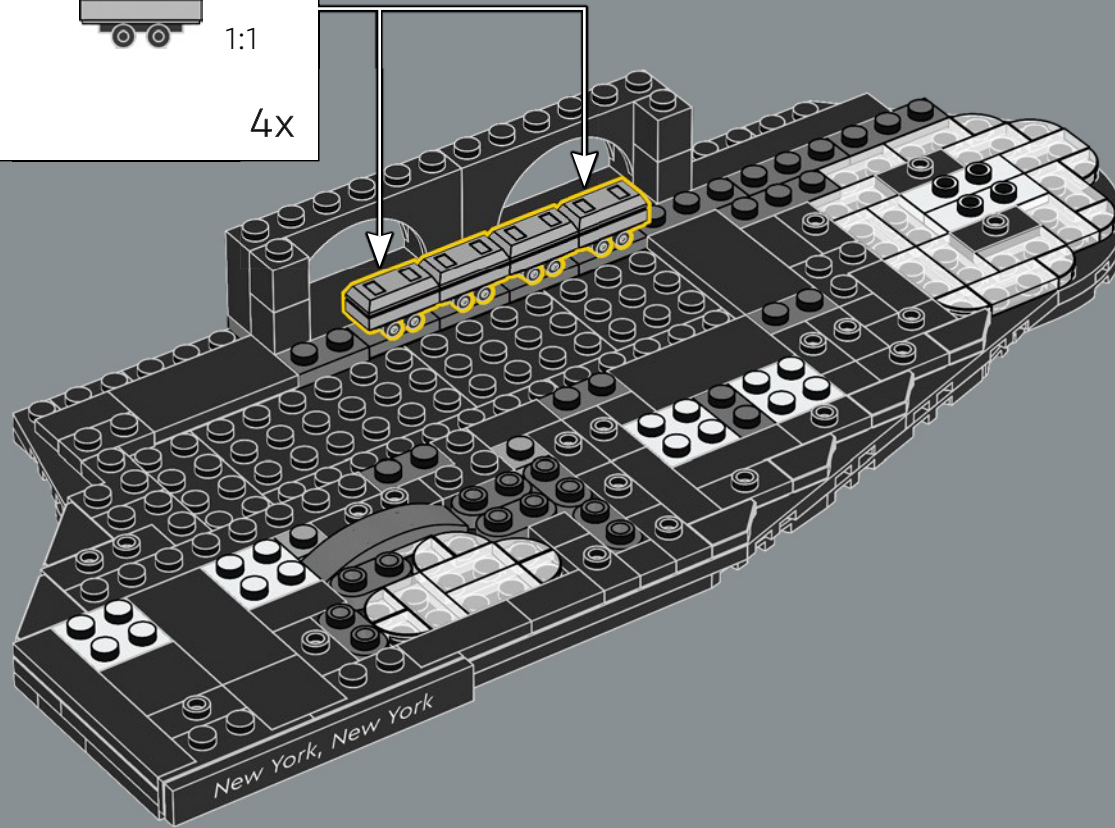
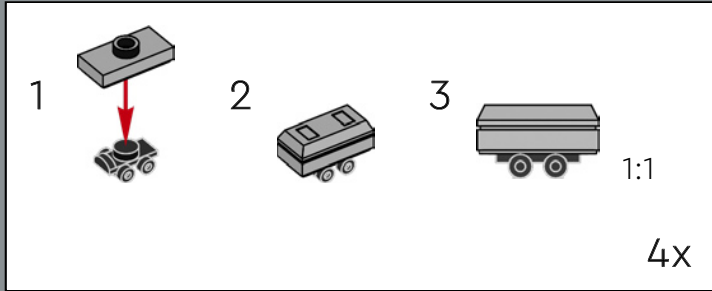

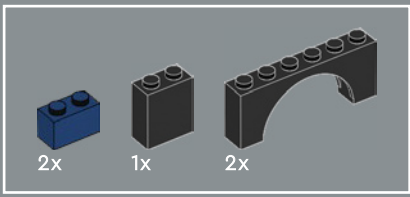

30

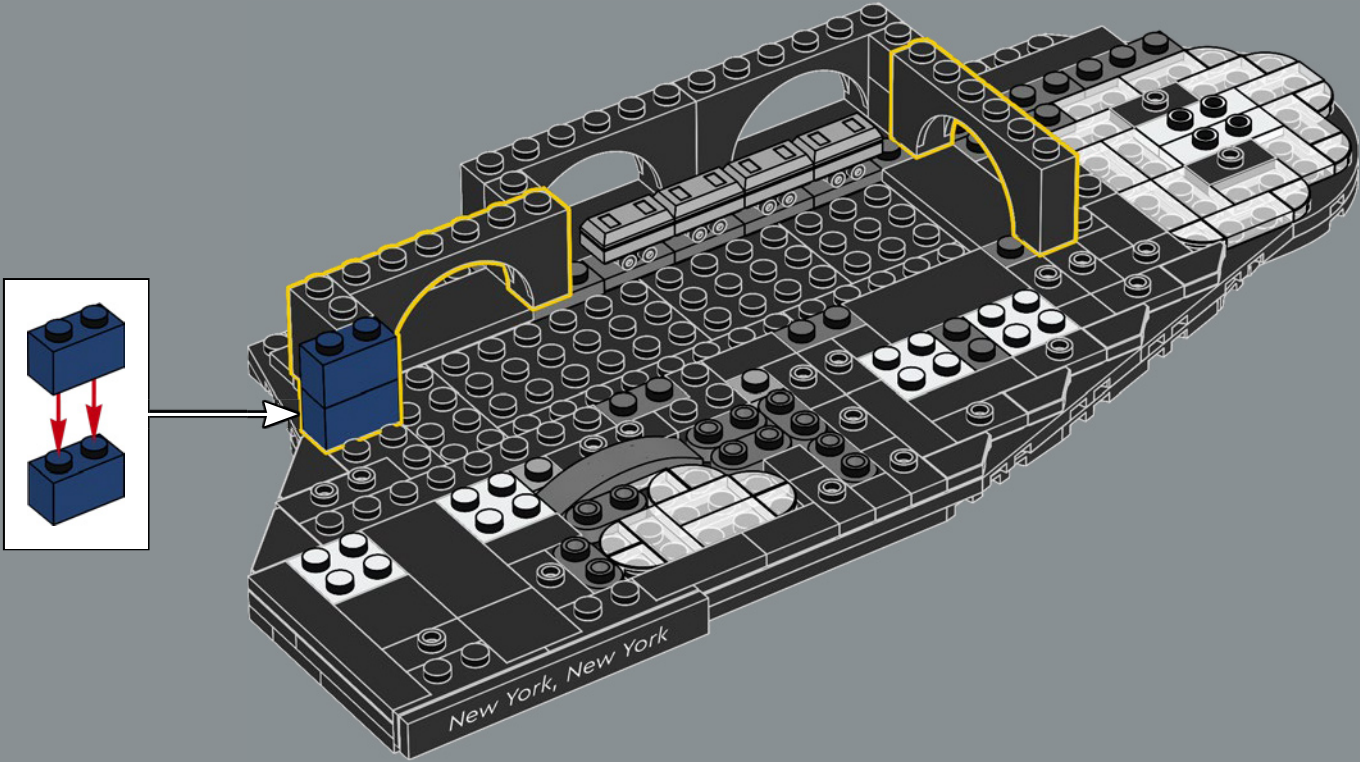

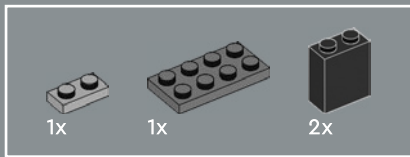

31

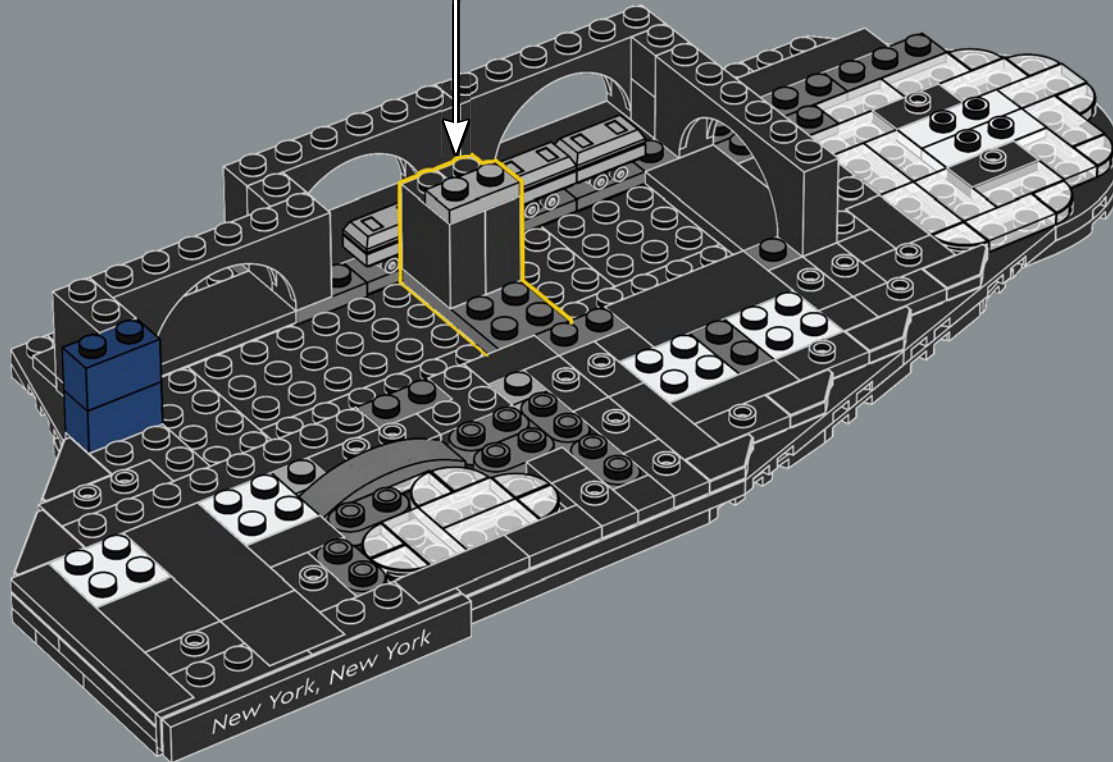
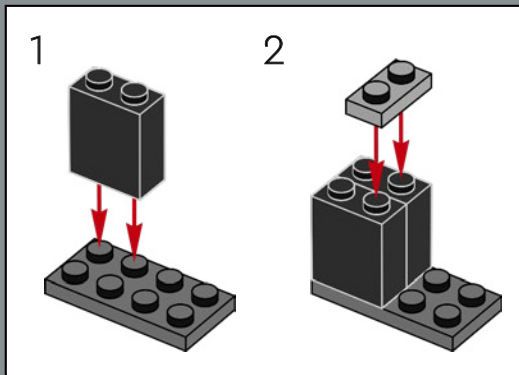

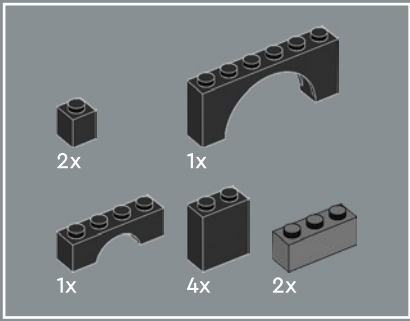

32

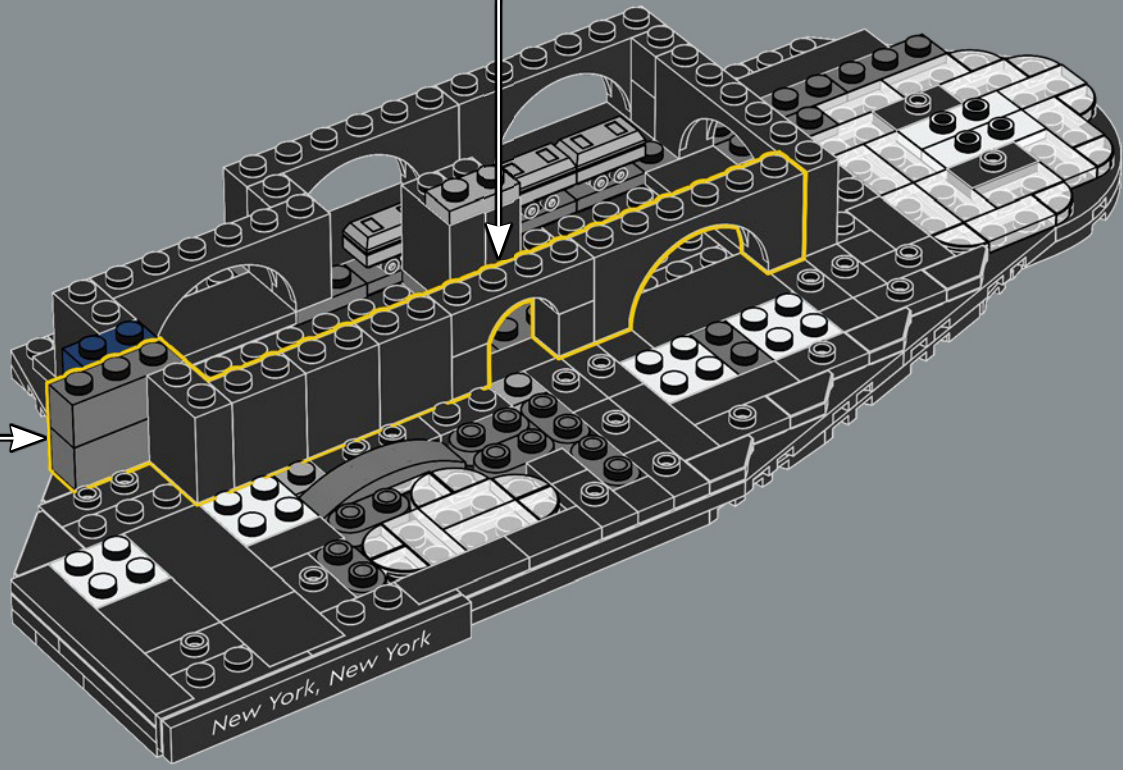
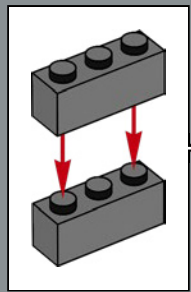
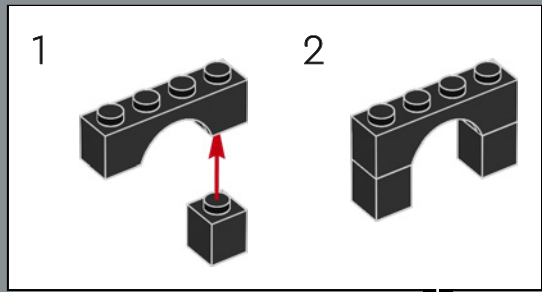

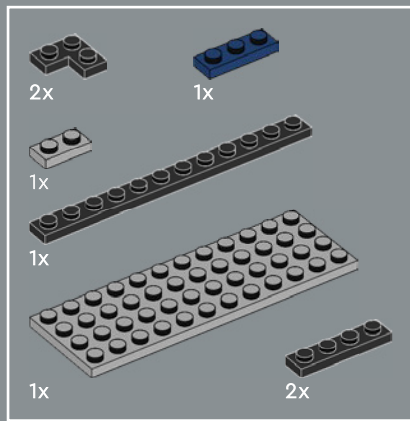

33

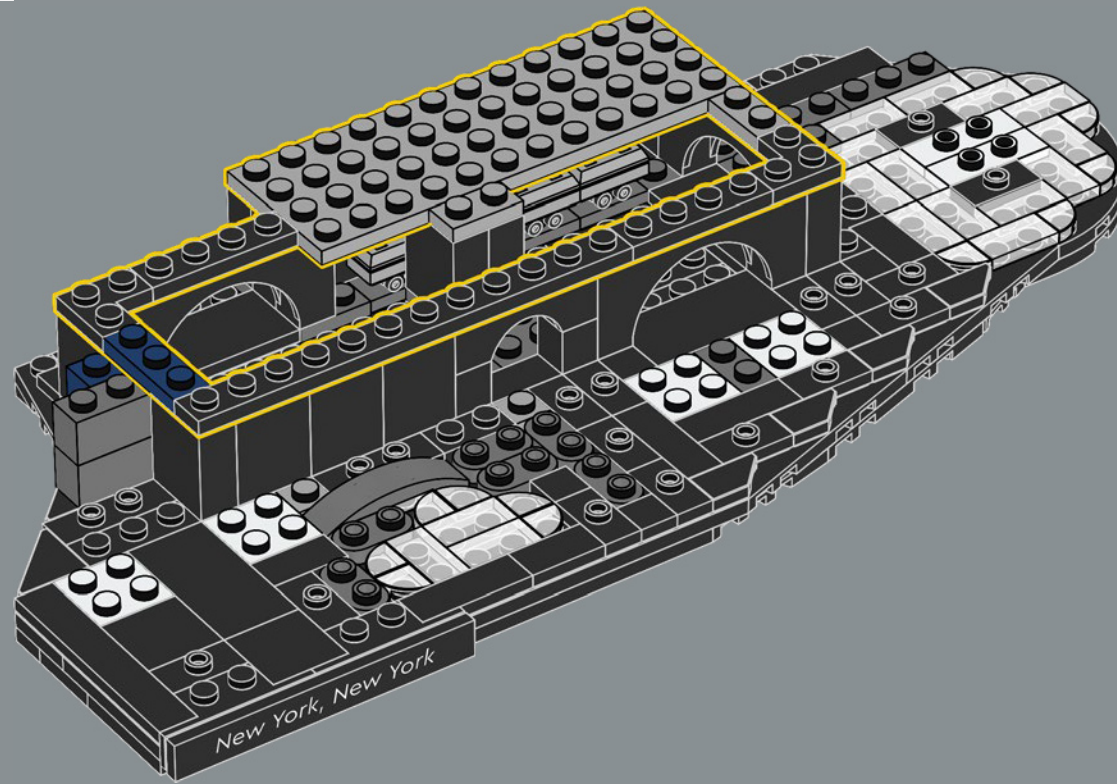

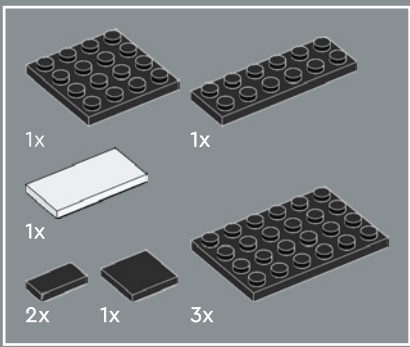

34

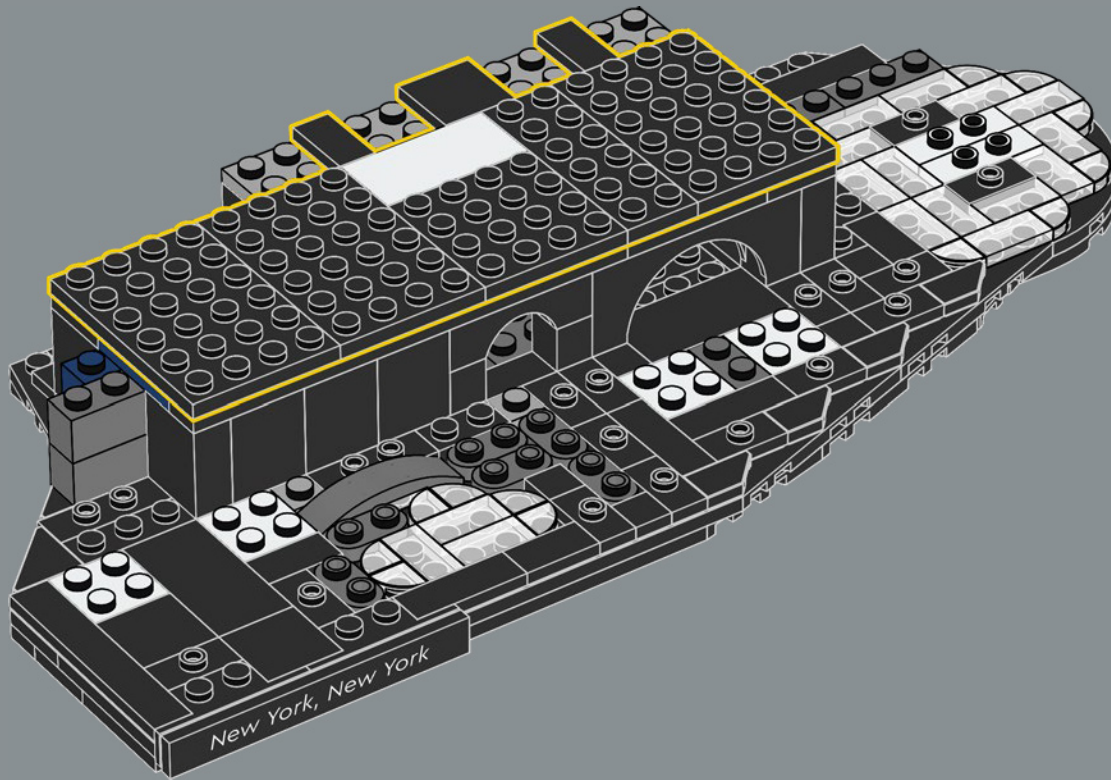

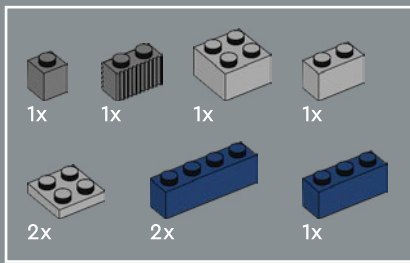

35

1

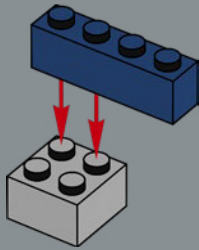

2

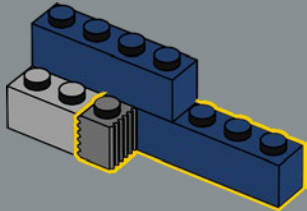

3

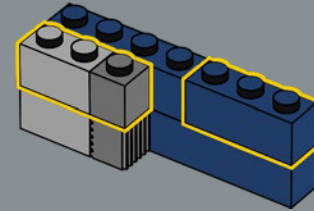

4

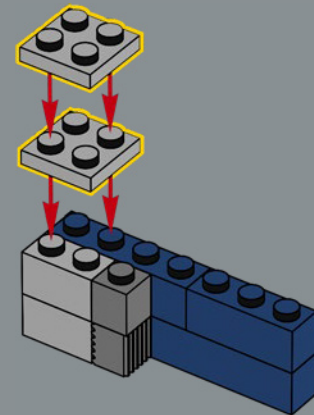

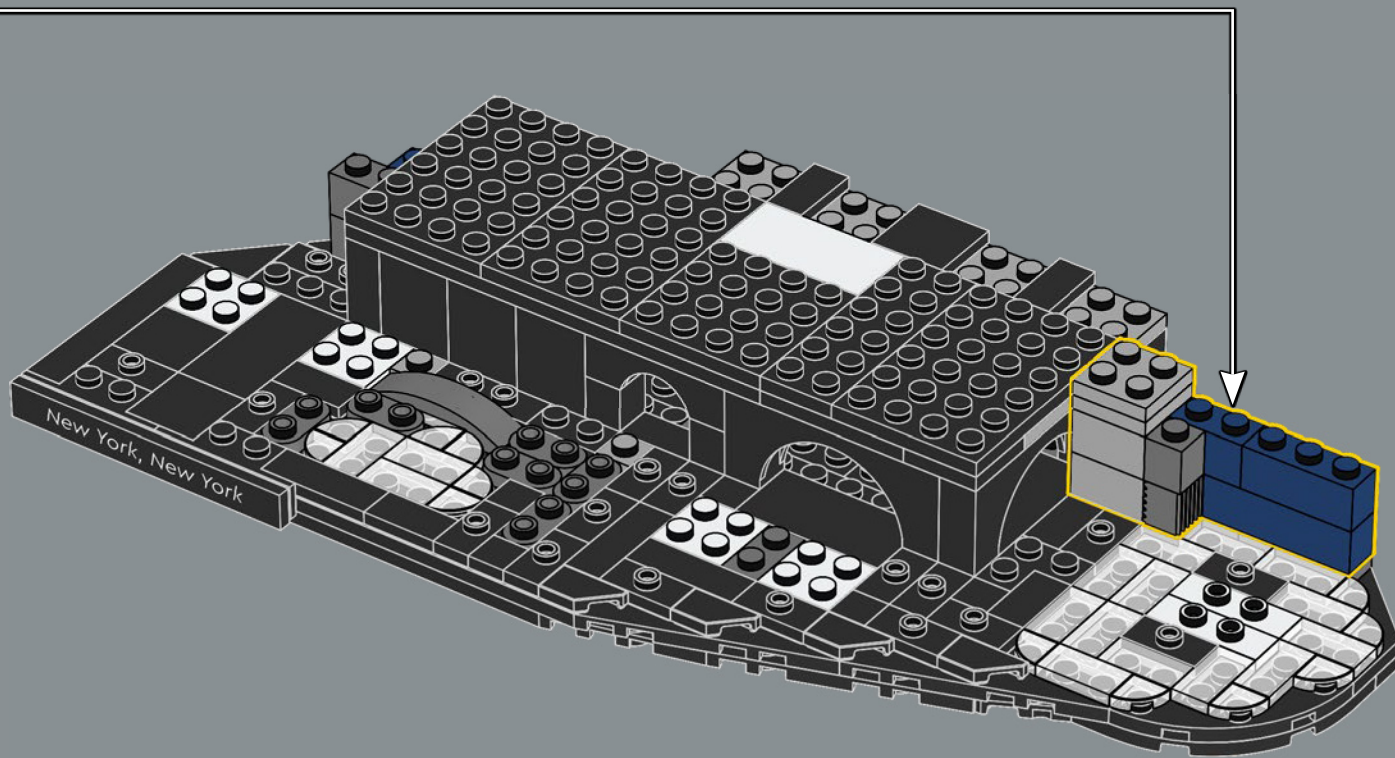

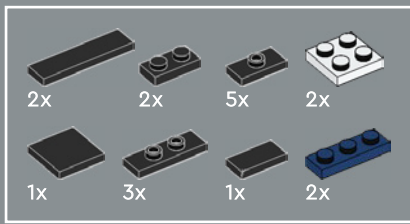

36

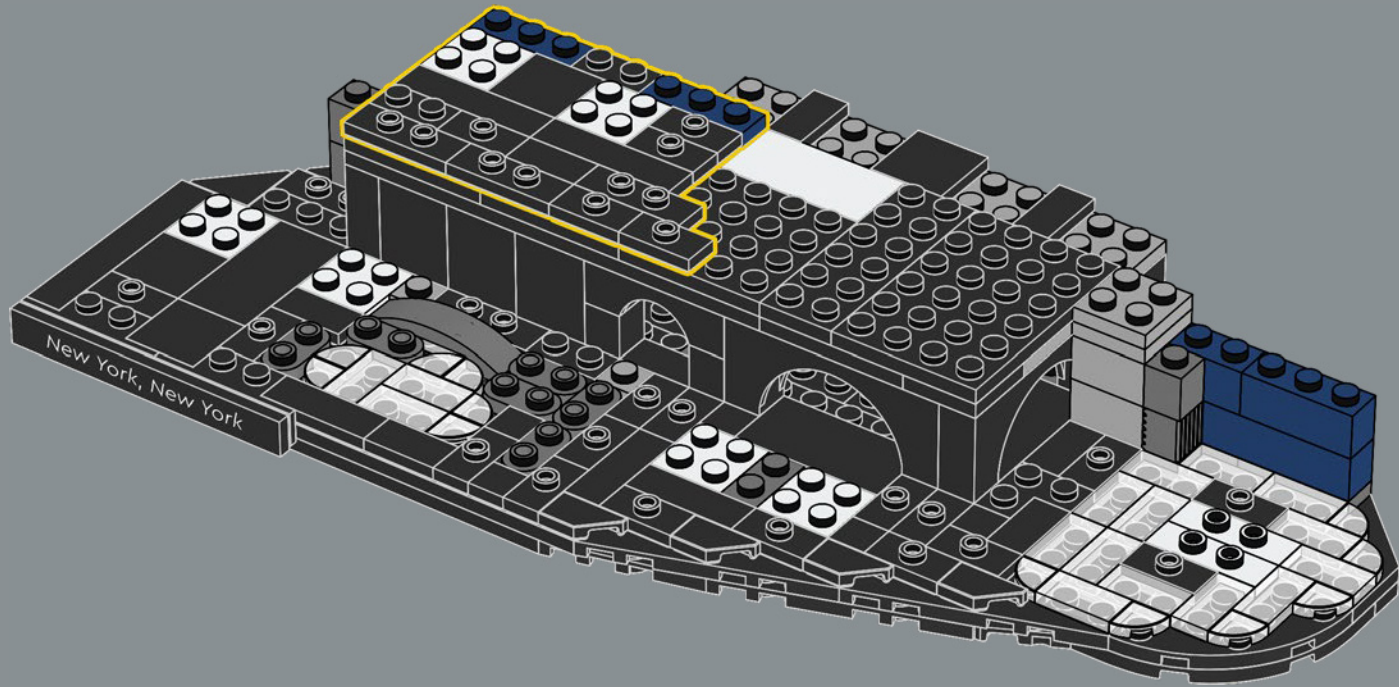

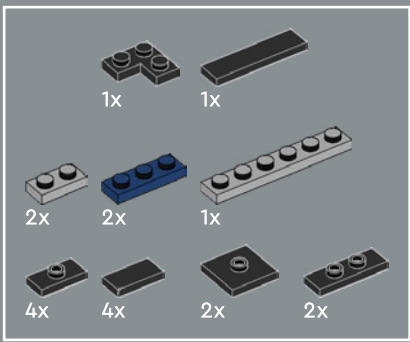

37

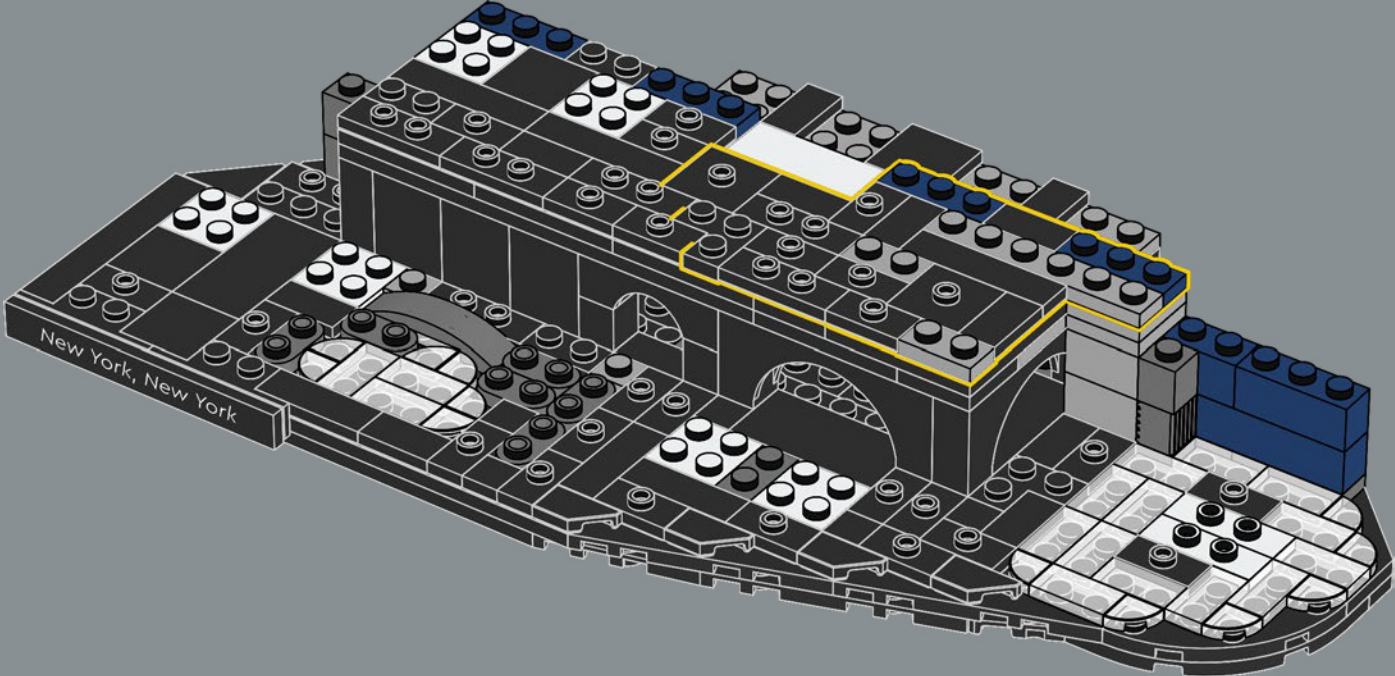

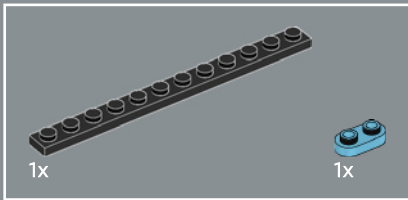
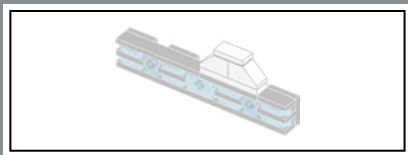

38

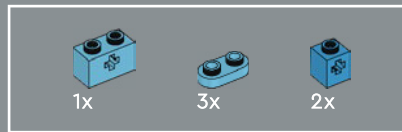
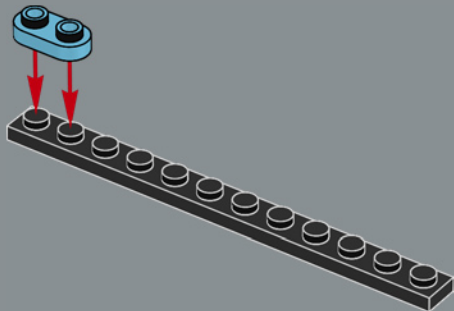

39

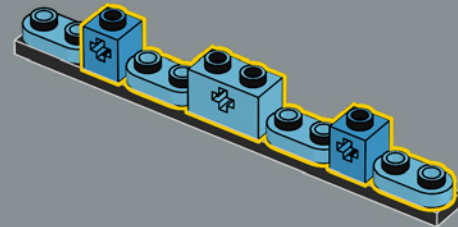

40

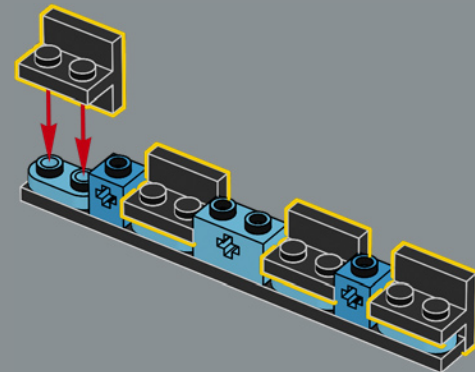

4x

41

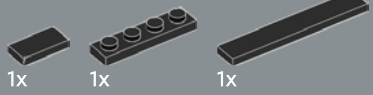
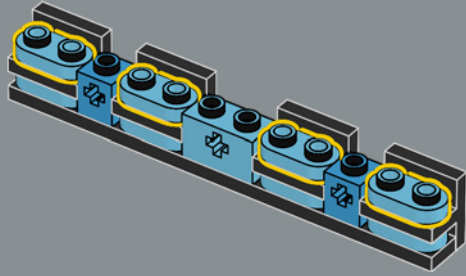

42

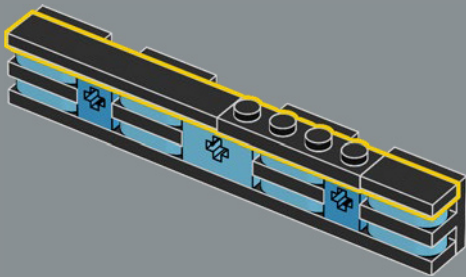

1x

1x

2x

43

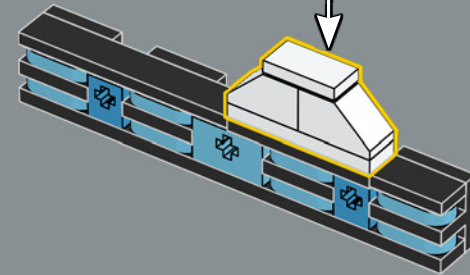
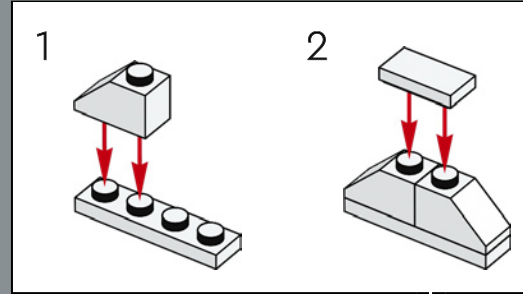

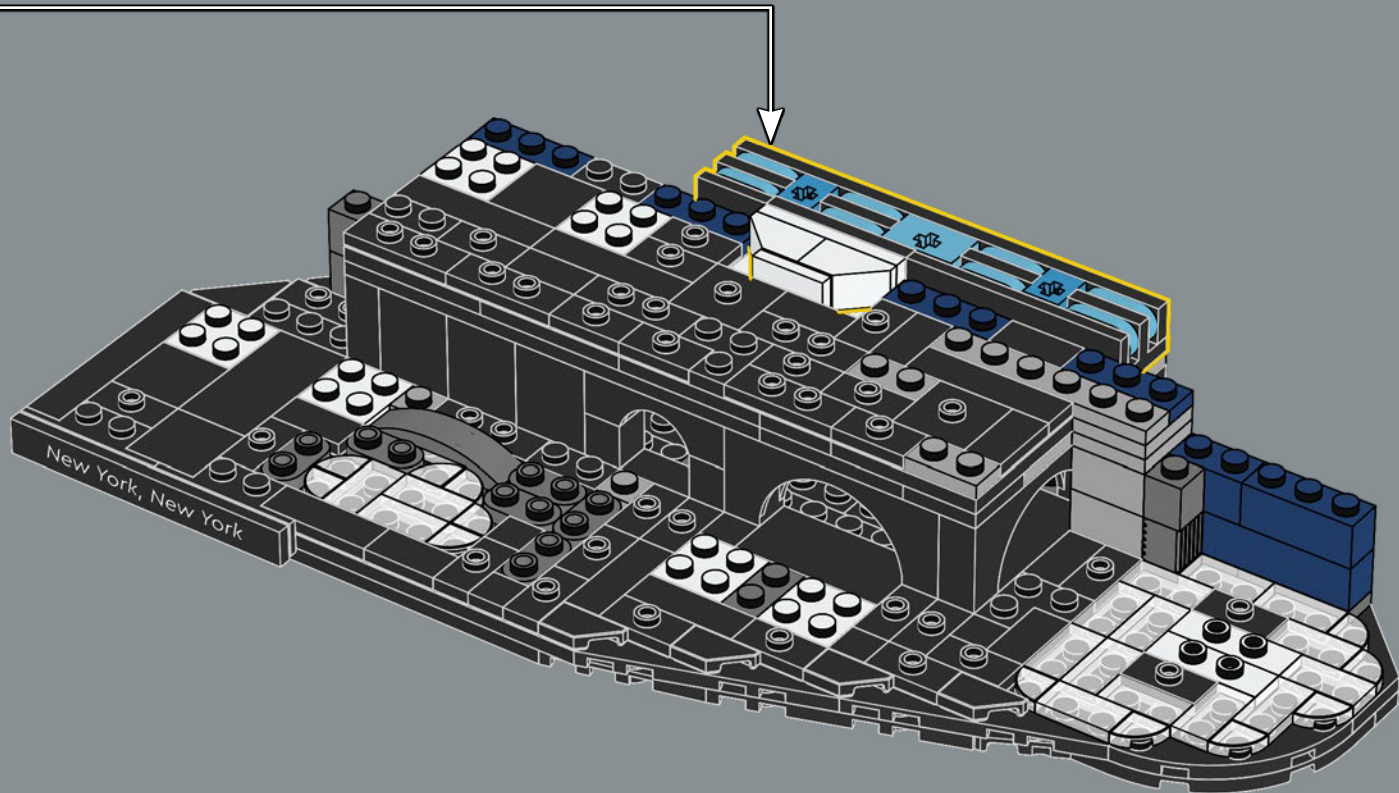

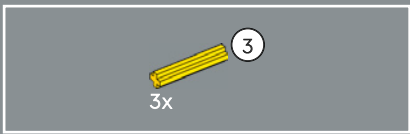

45

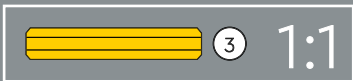
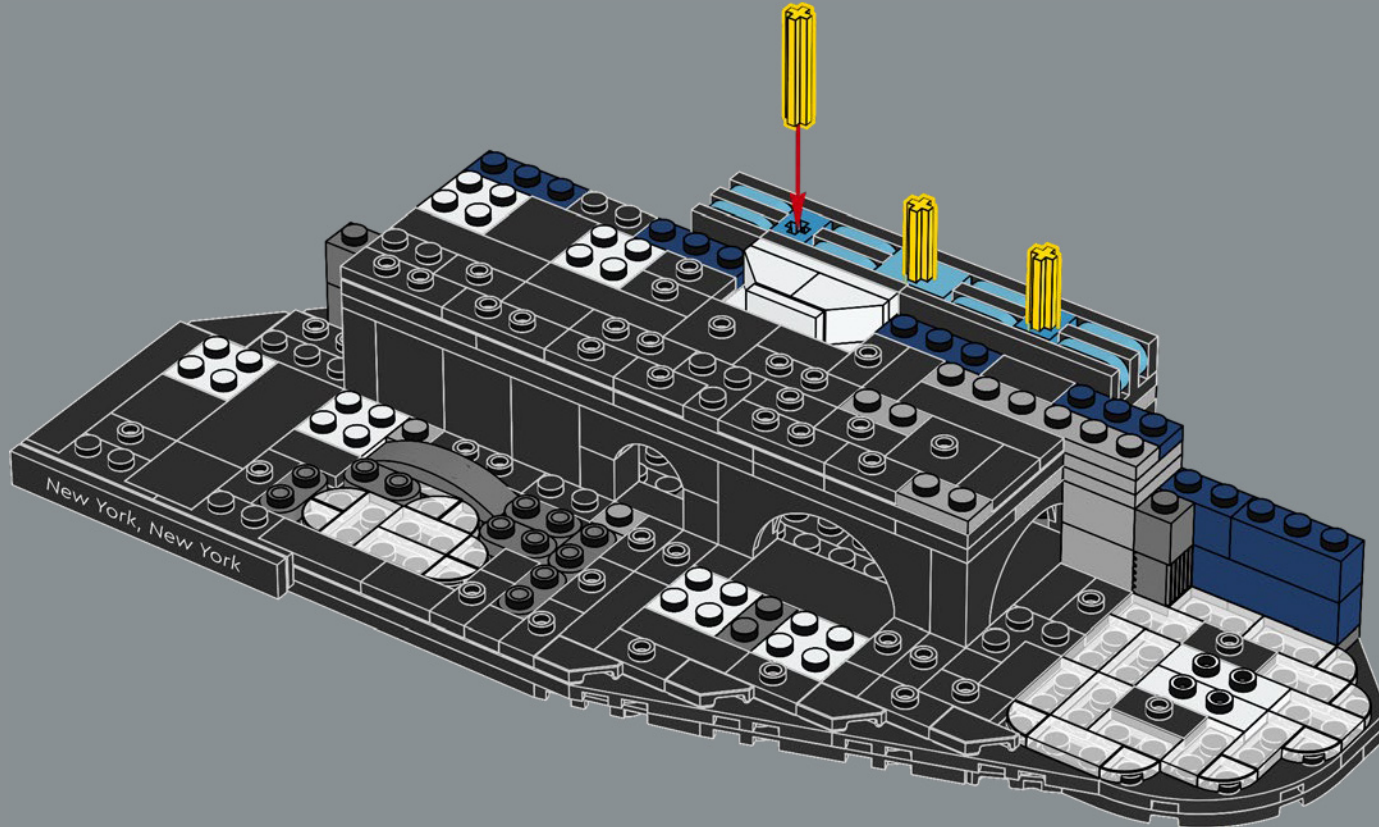

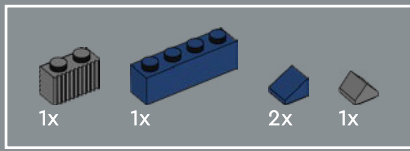

46

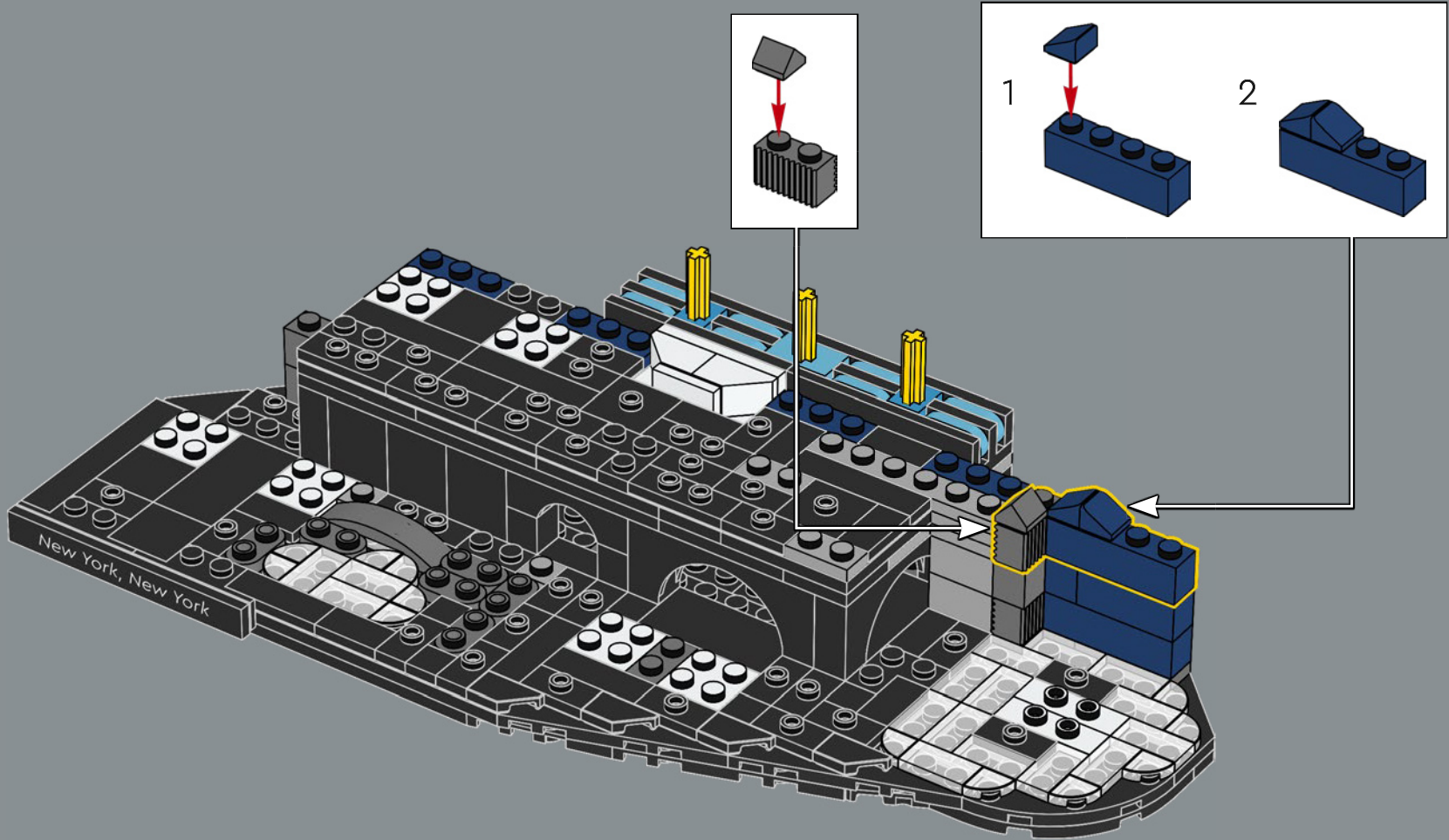

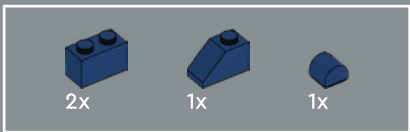

47

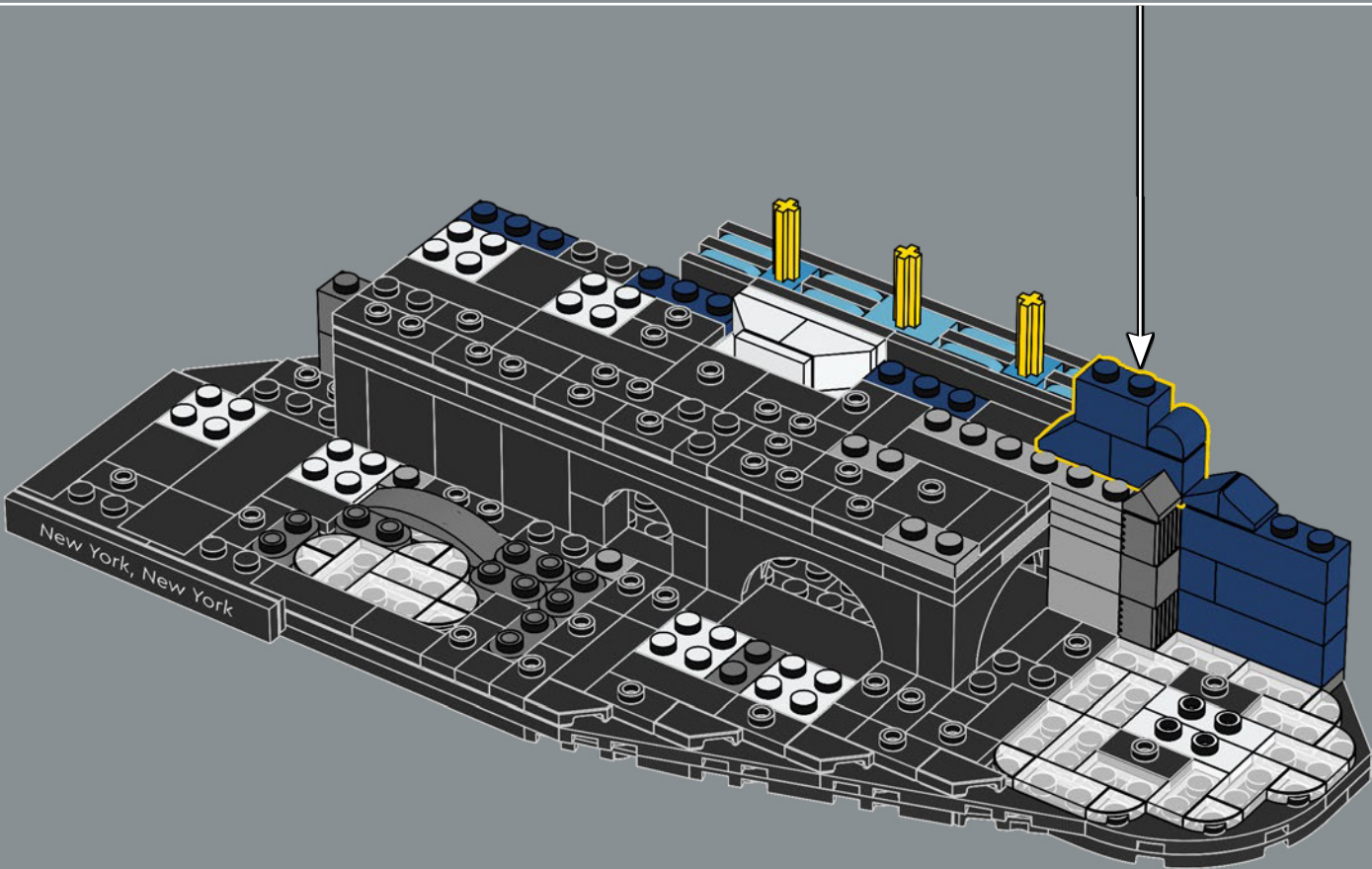
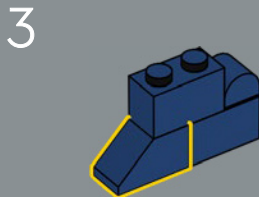
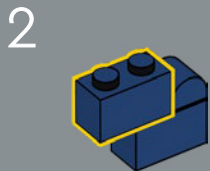
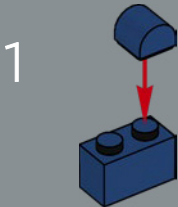

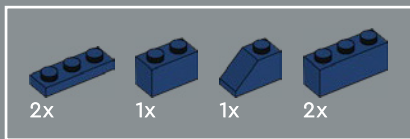

48

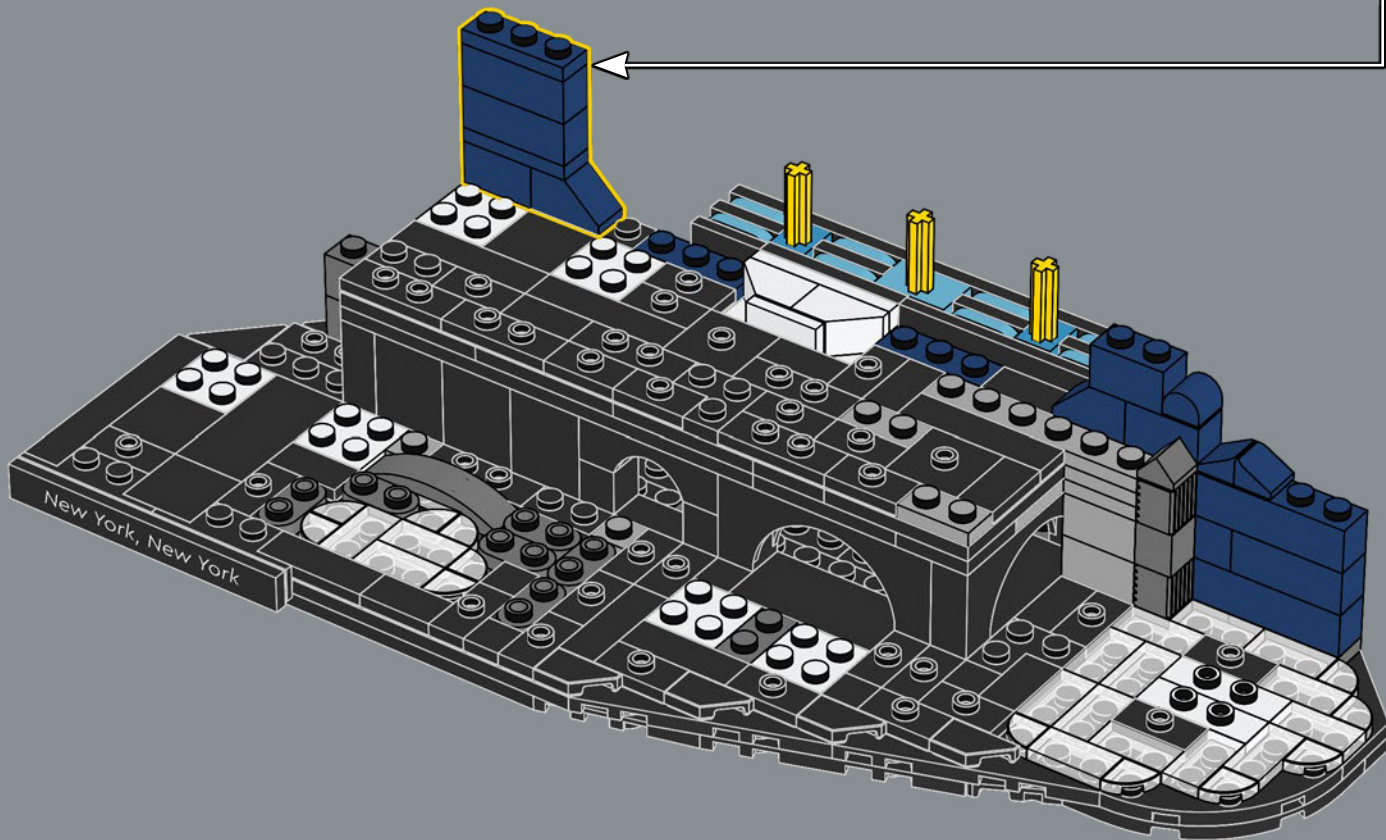

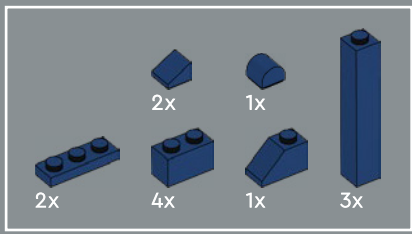

49

1

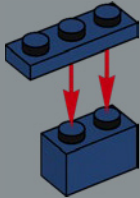

2

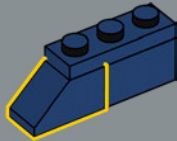

3

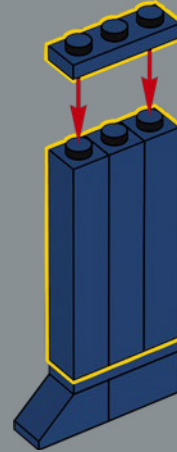

4

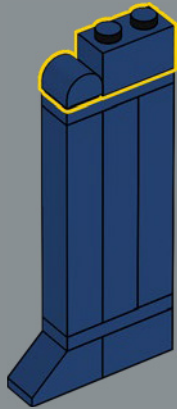

5

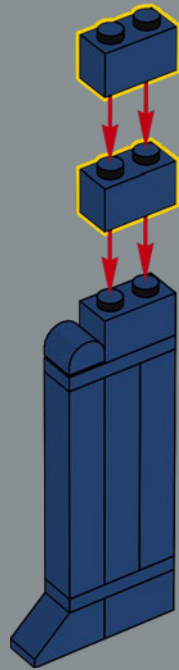

6

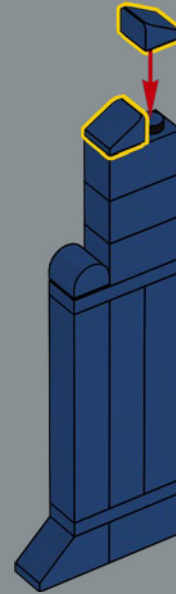

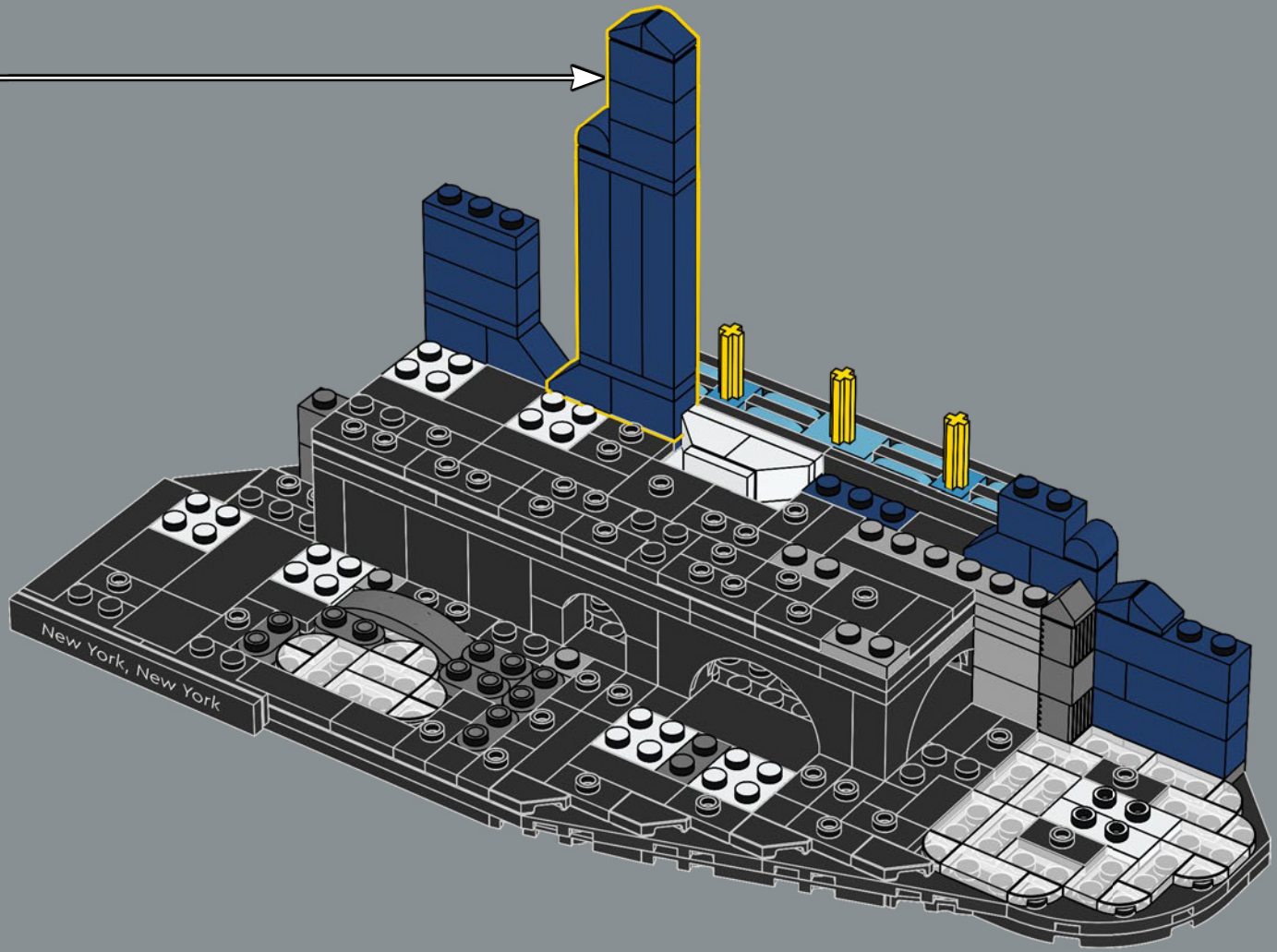

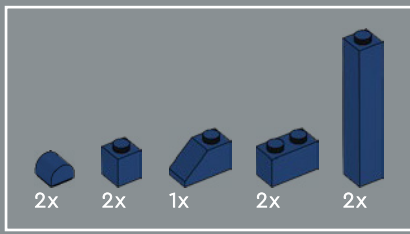

50

1

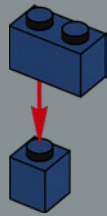

2

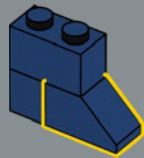

3

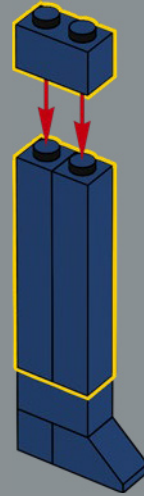

4

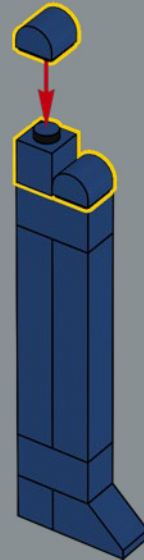

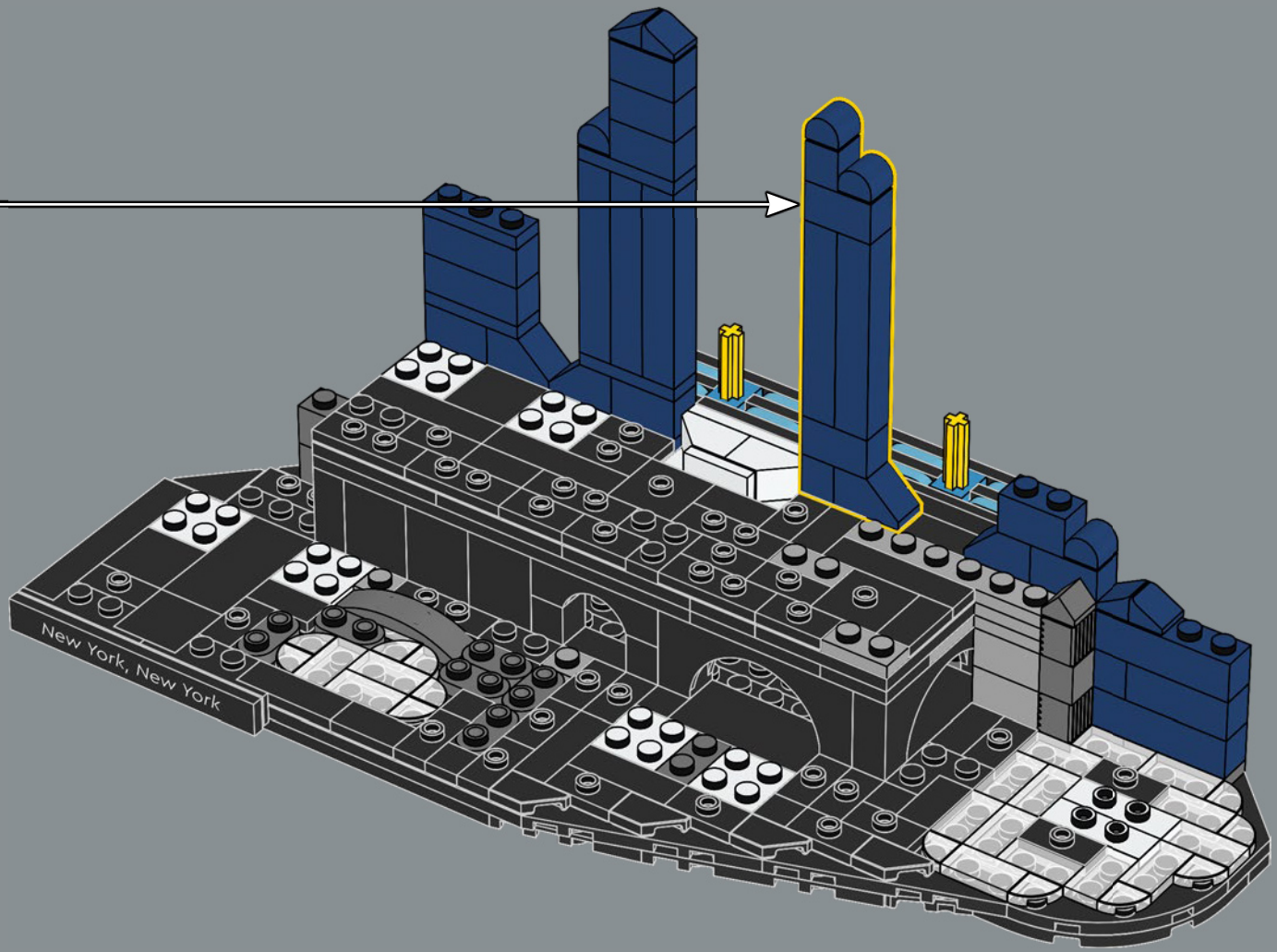

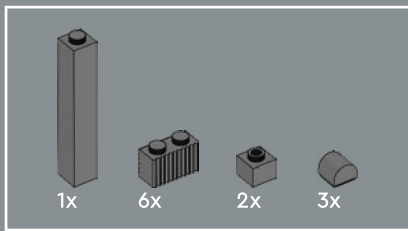

51

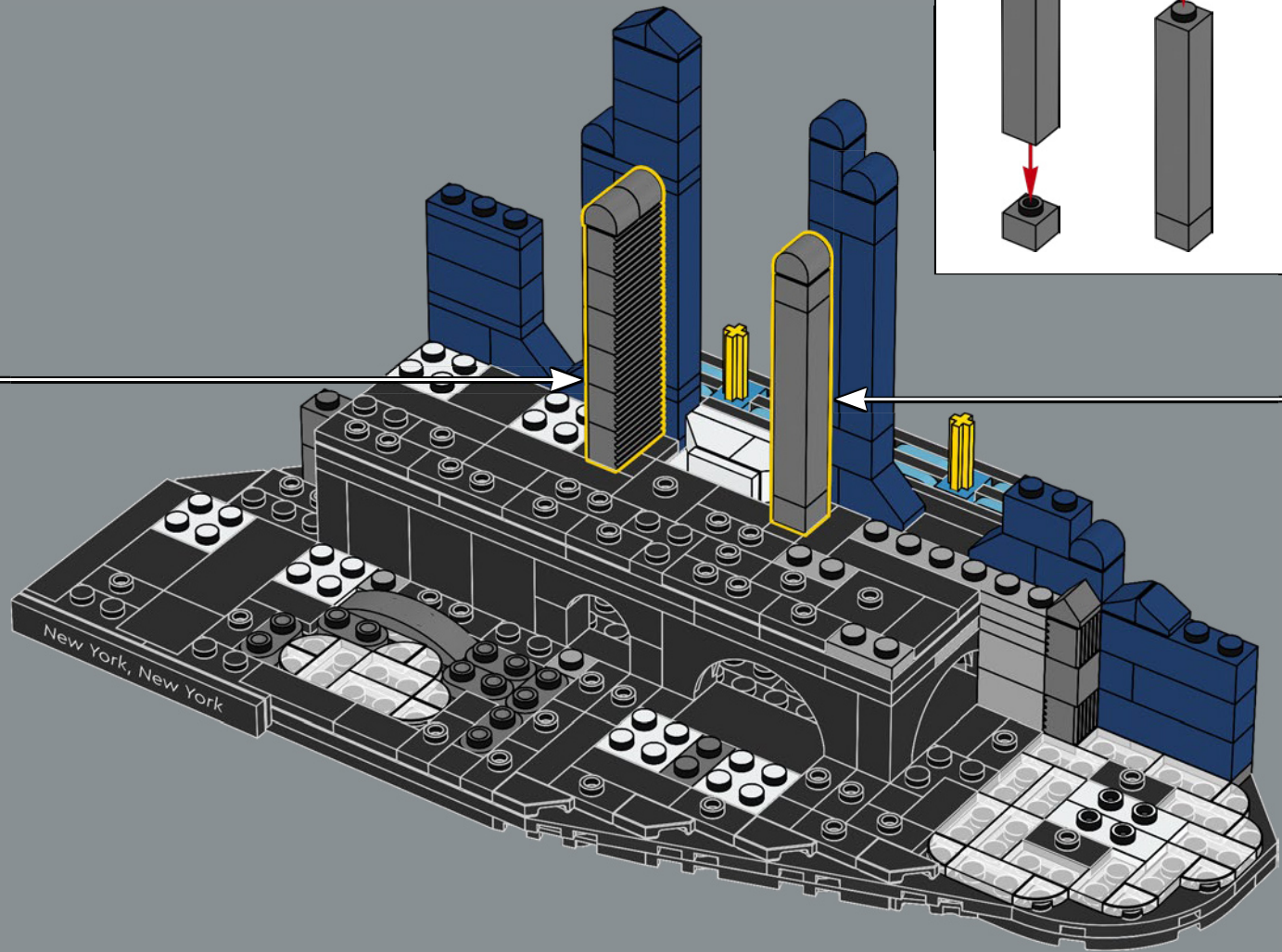
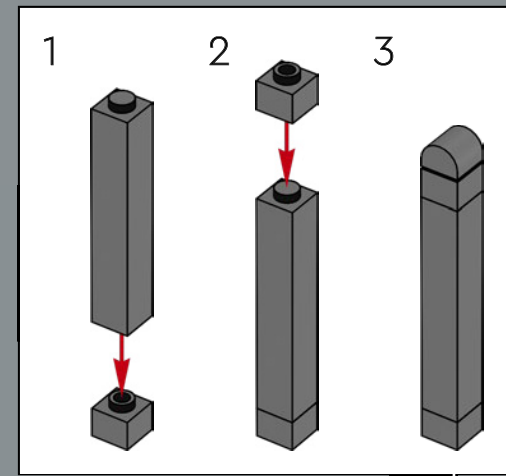
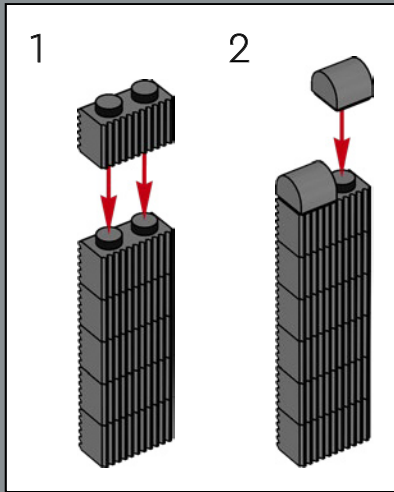

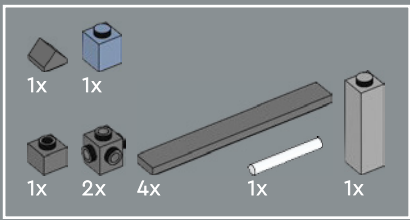

52

1

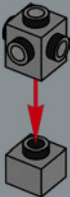

2



3



4



5

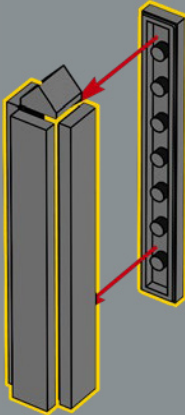

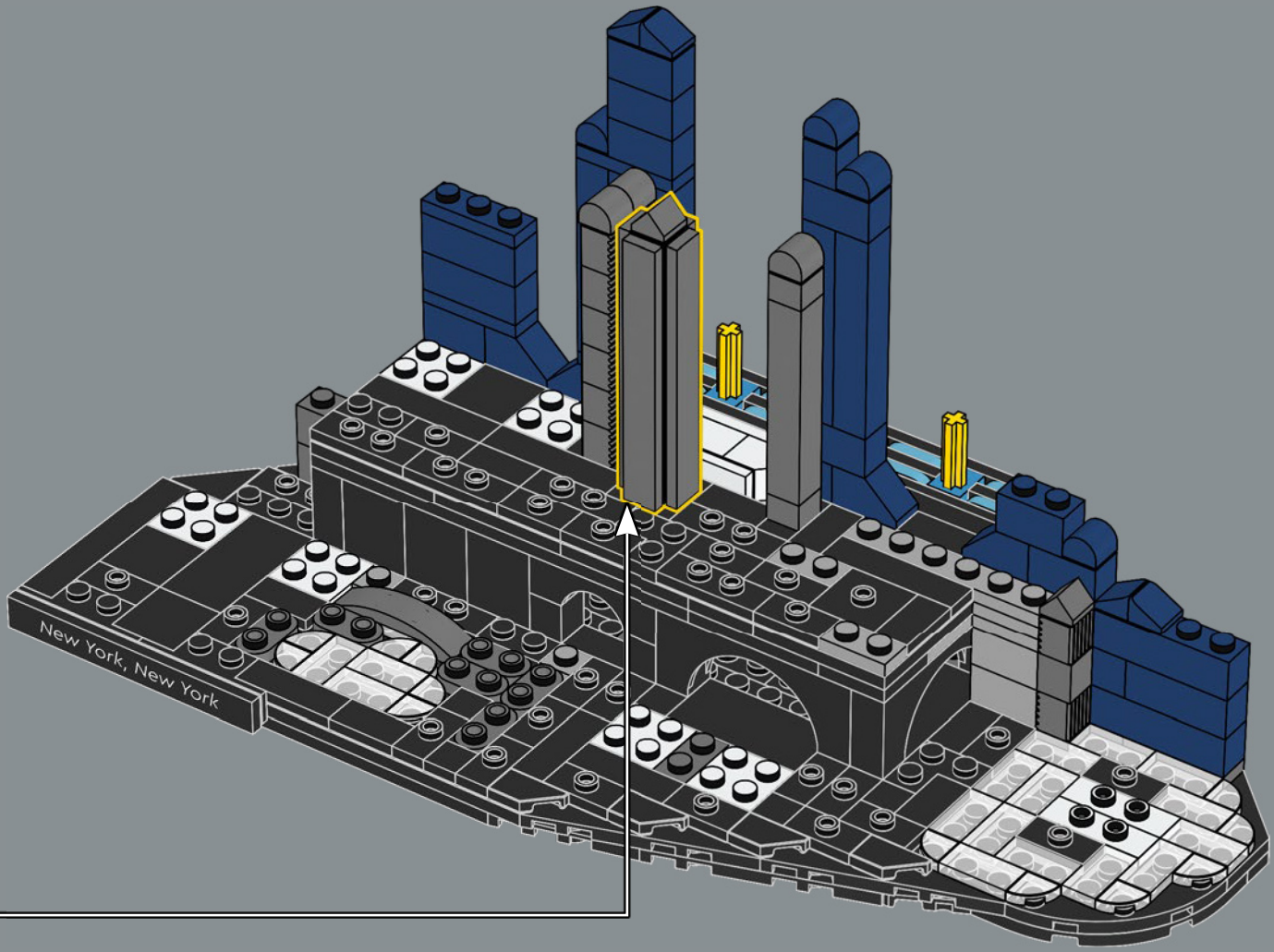

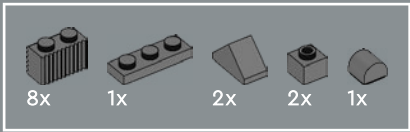

53

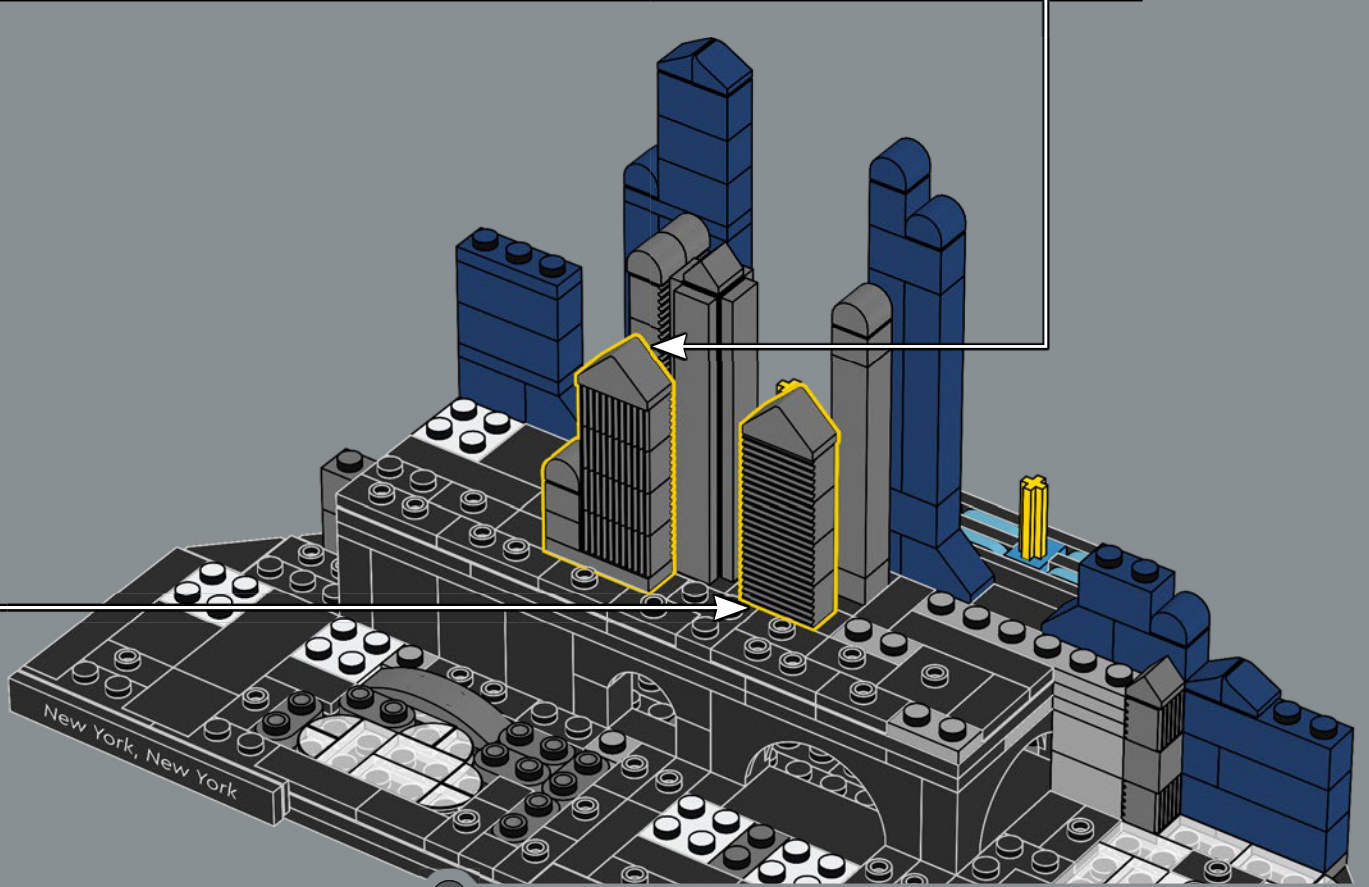
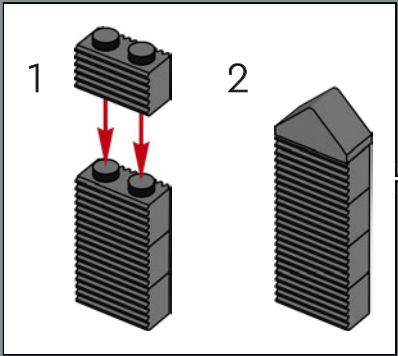
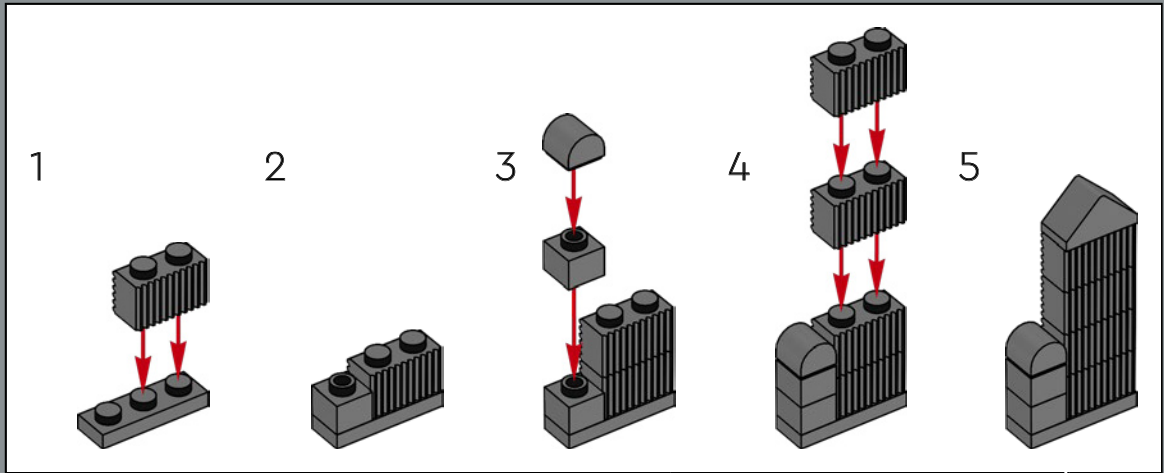

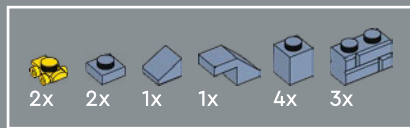

54

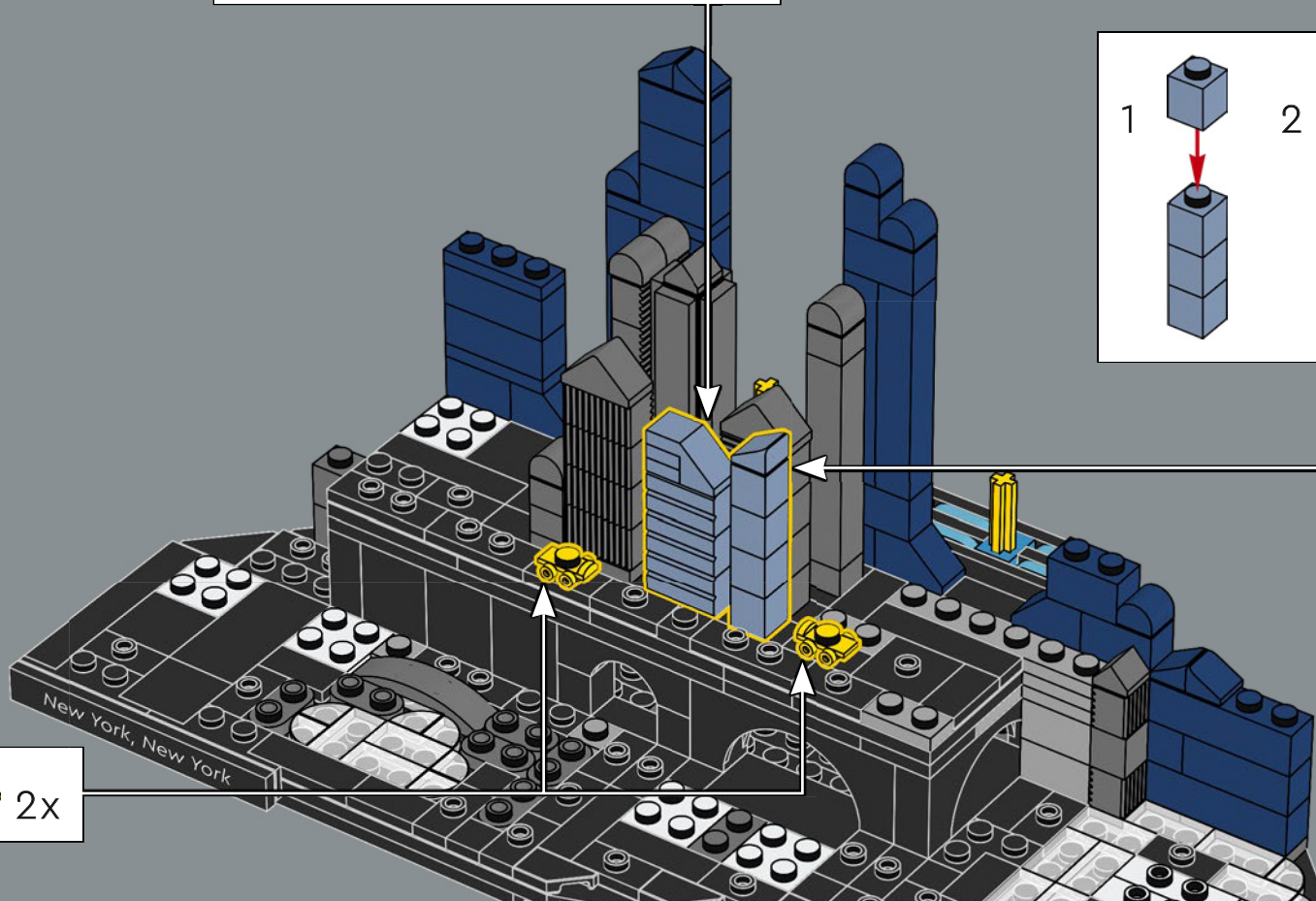
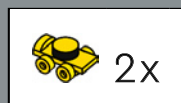
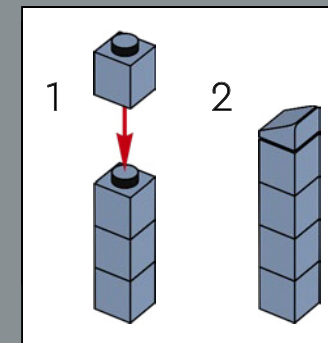
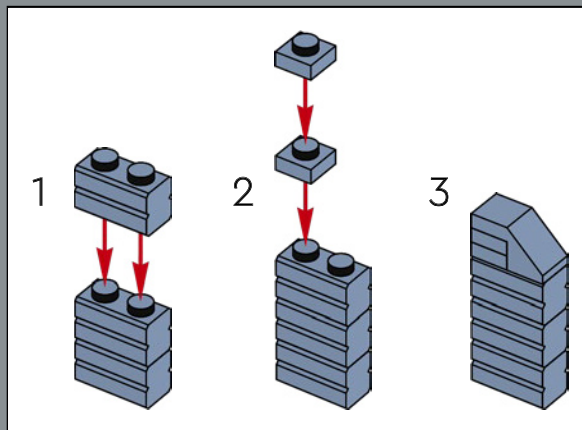

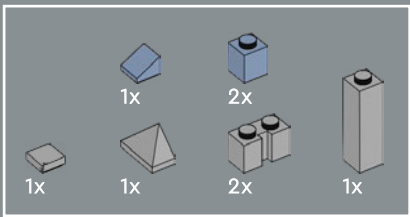

55

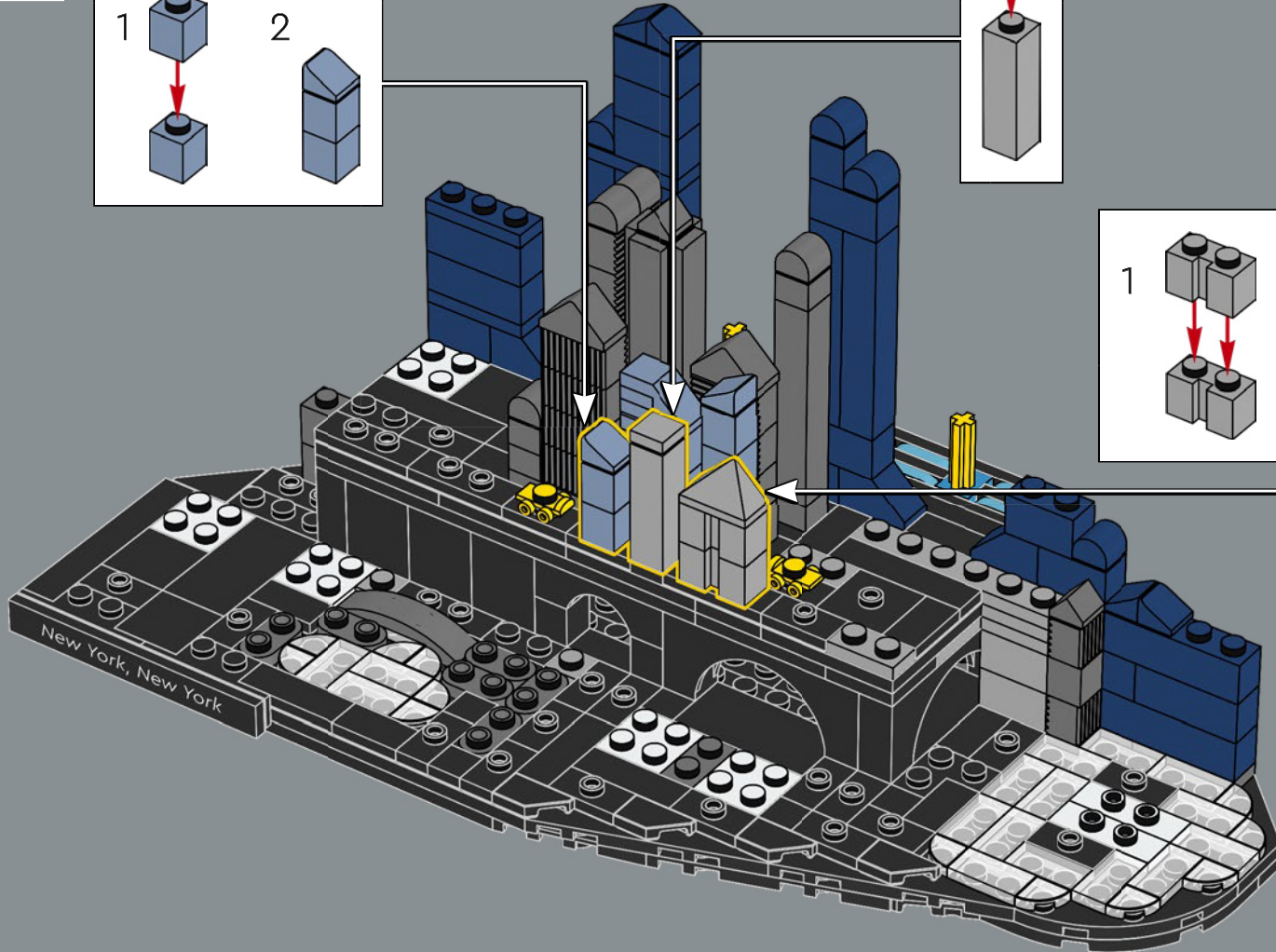
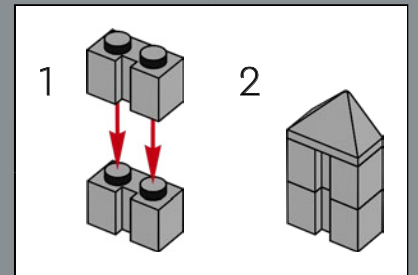
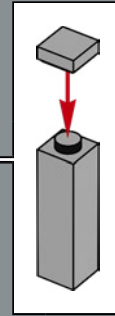
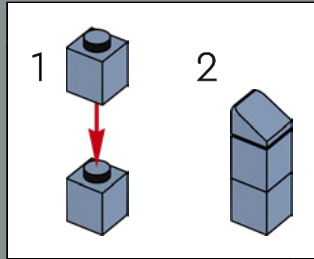

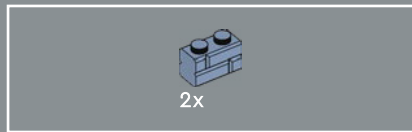

56

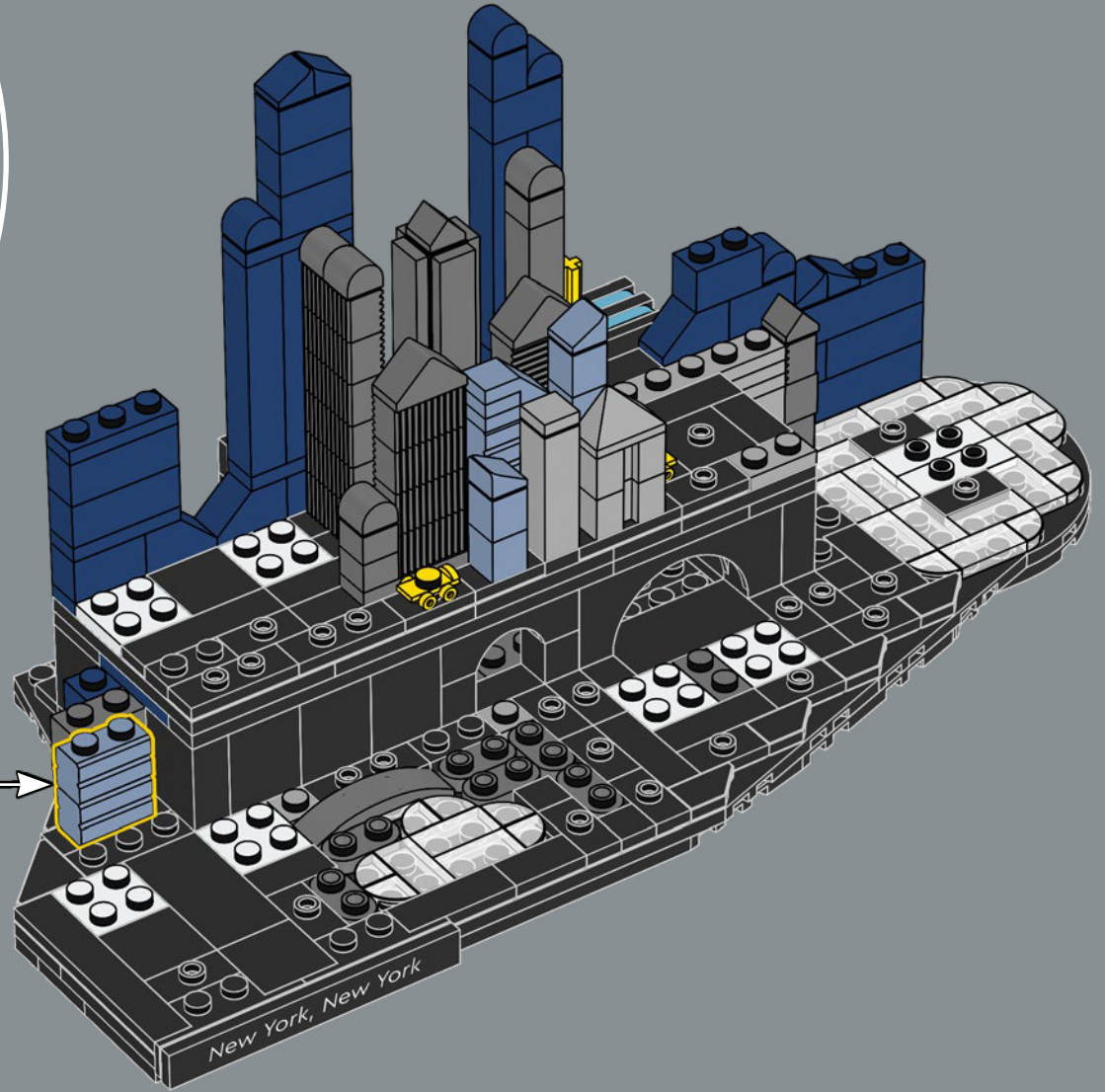
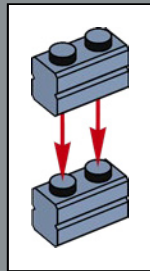

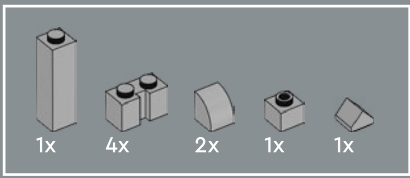

57

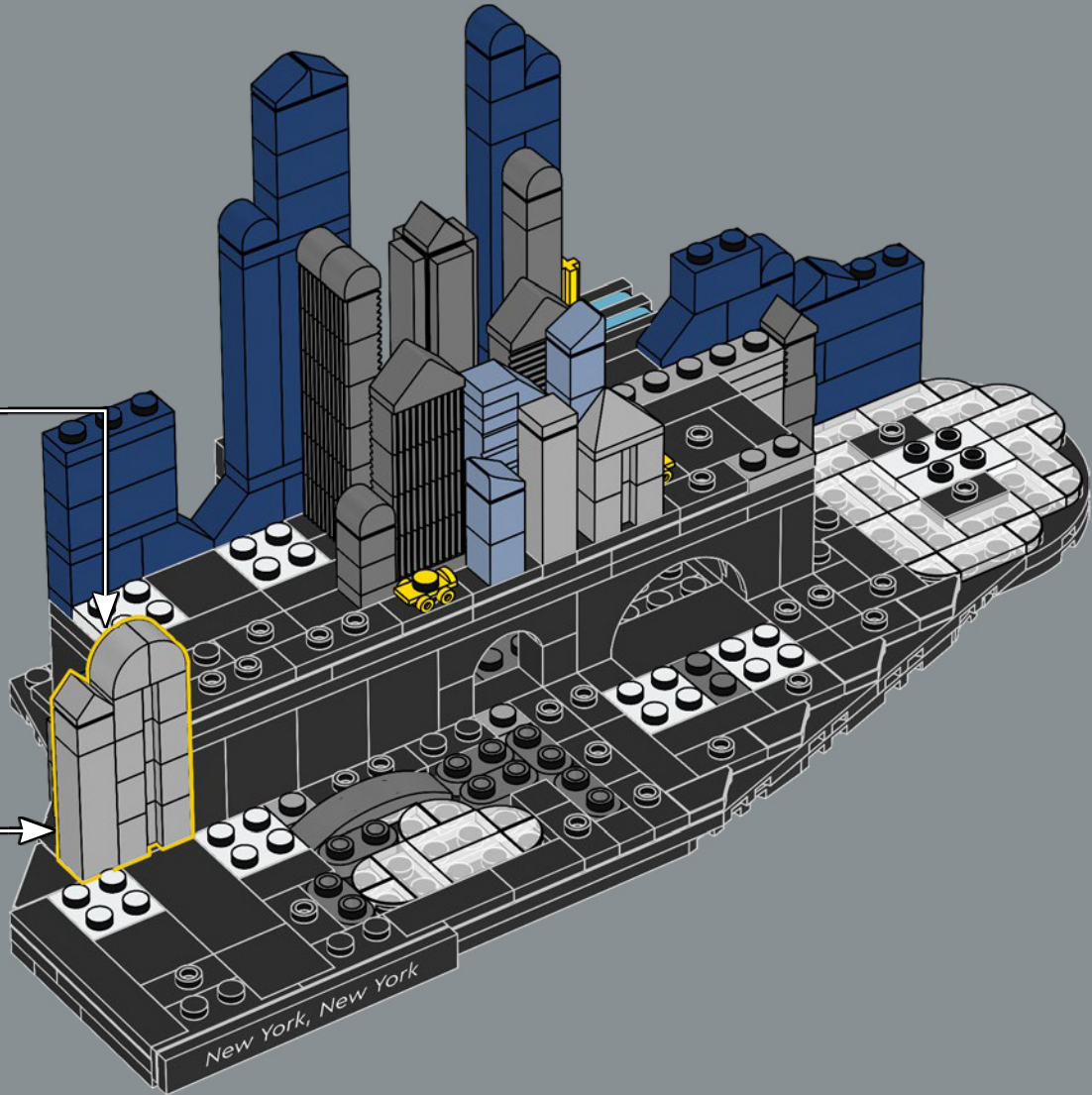
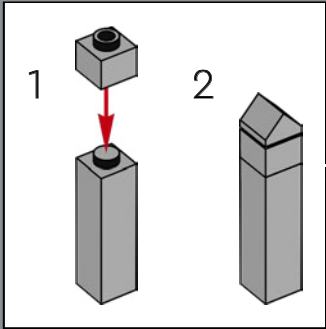
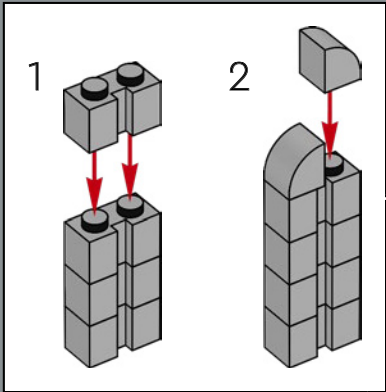

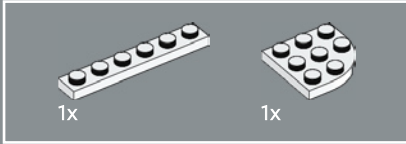
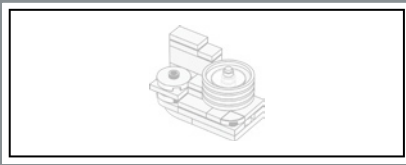

58

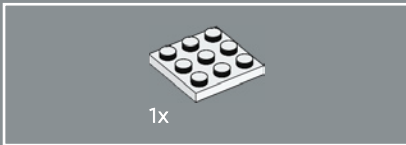
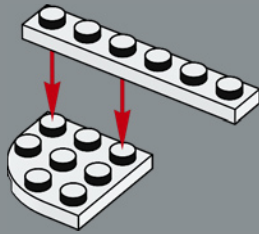

59

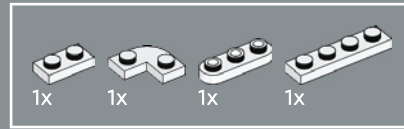
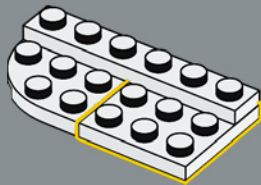

60

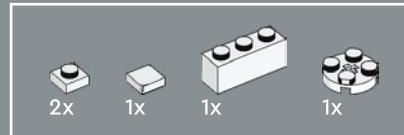
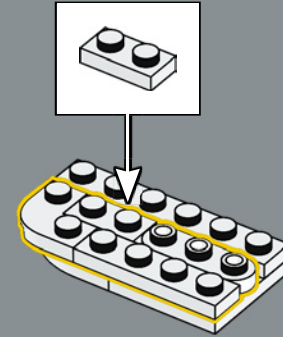

61

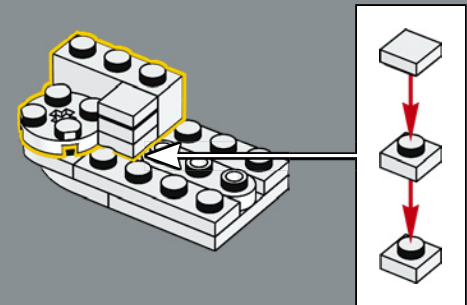



62

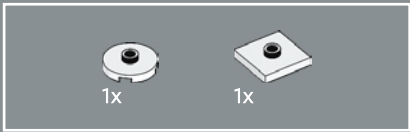
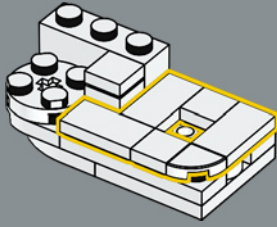

63

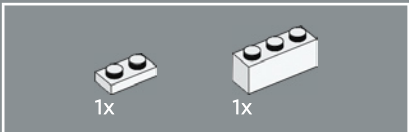
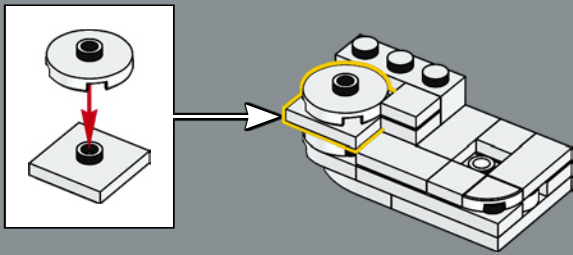

64

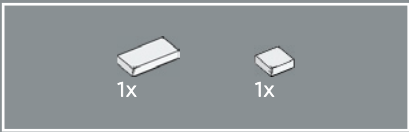
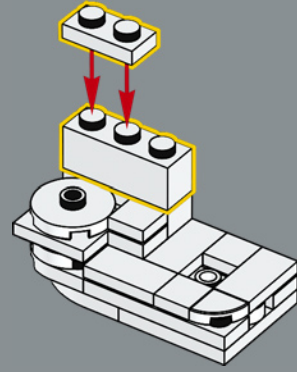

65

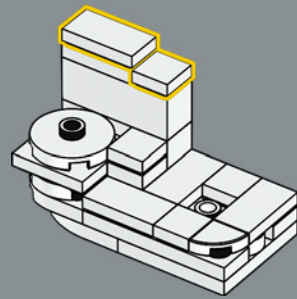

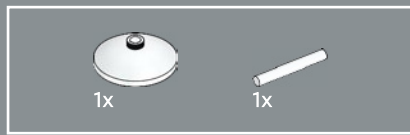

66

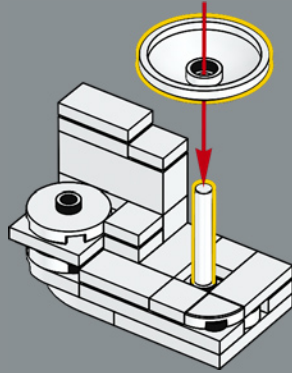

67

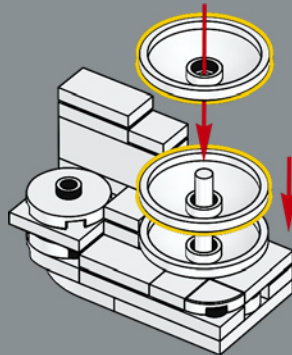

68

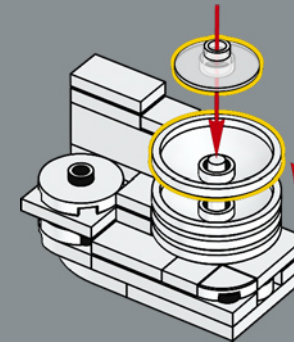

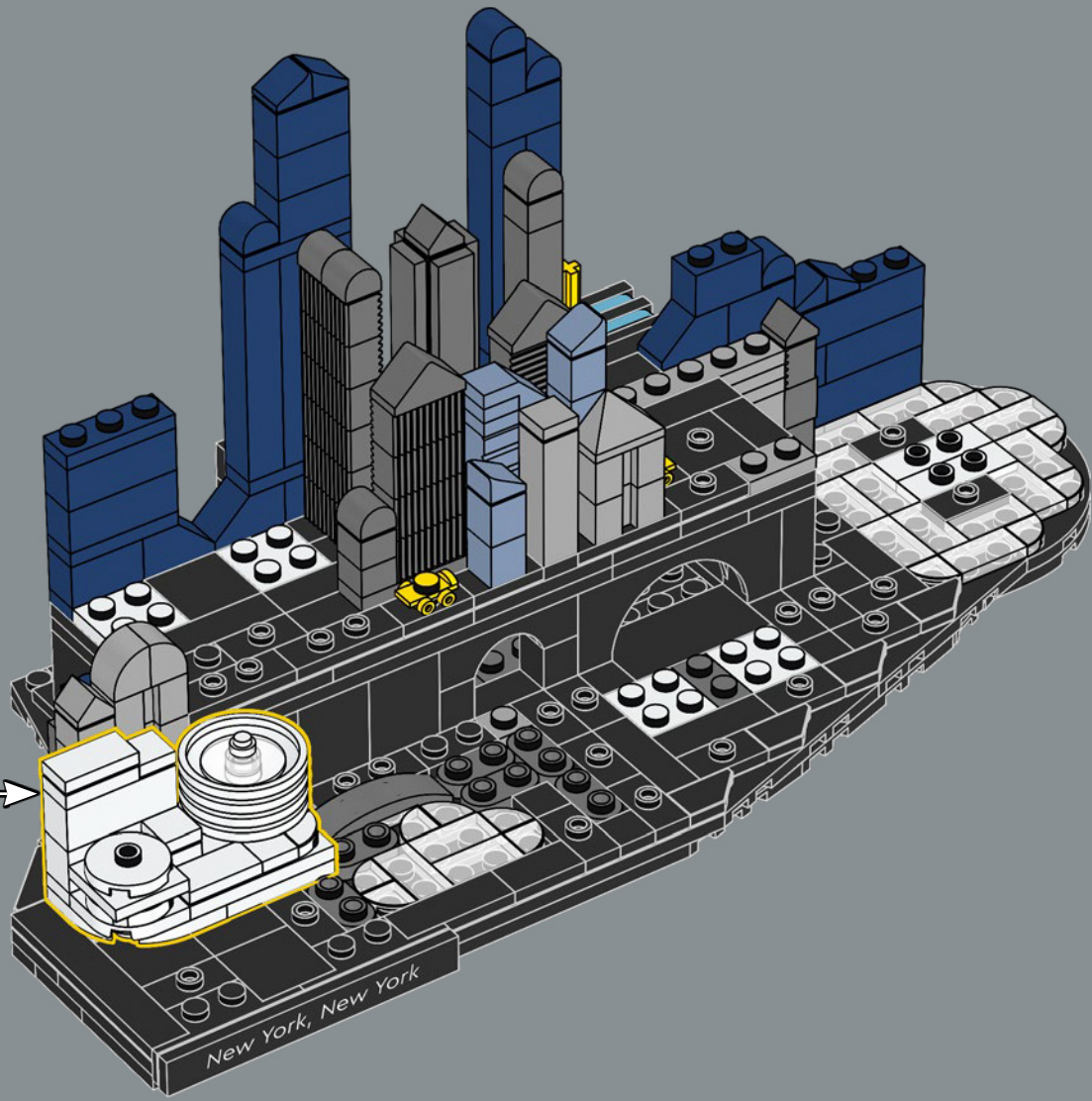

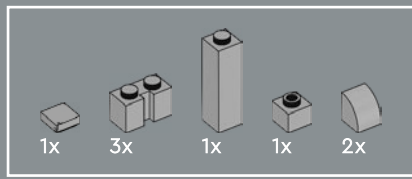

70

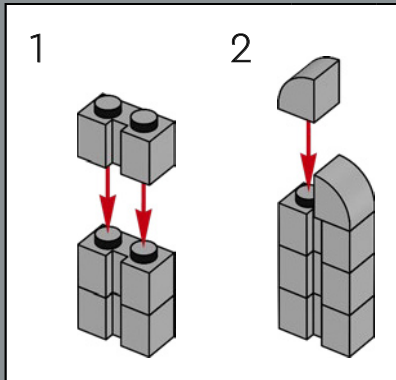
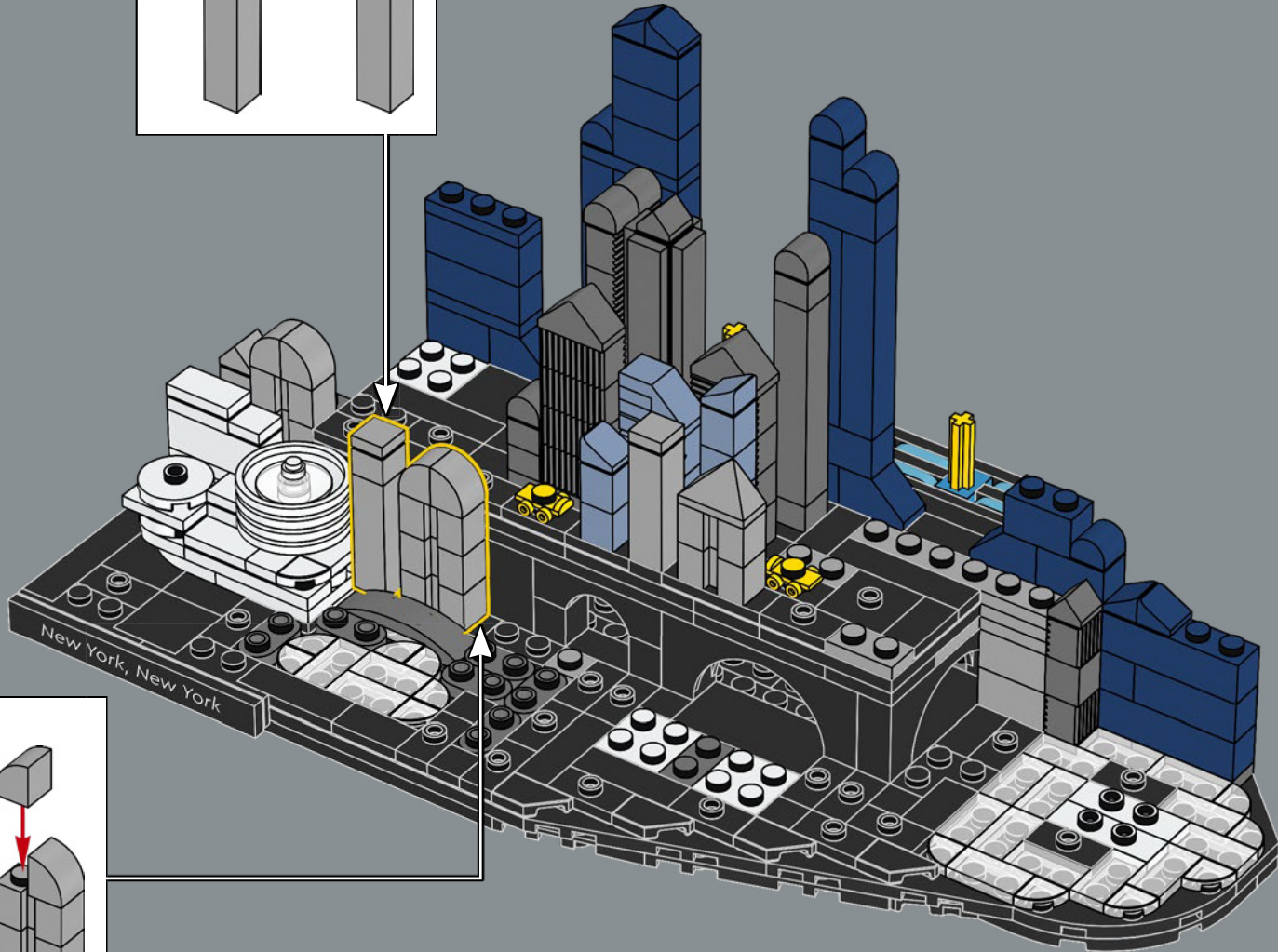
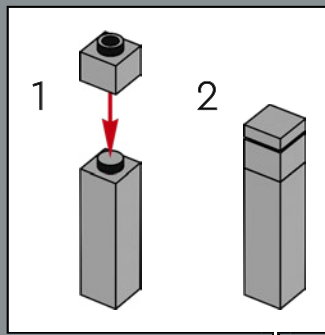

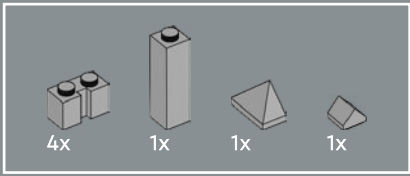

71

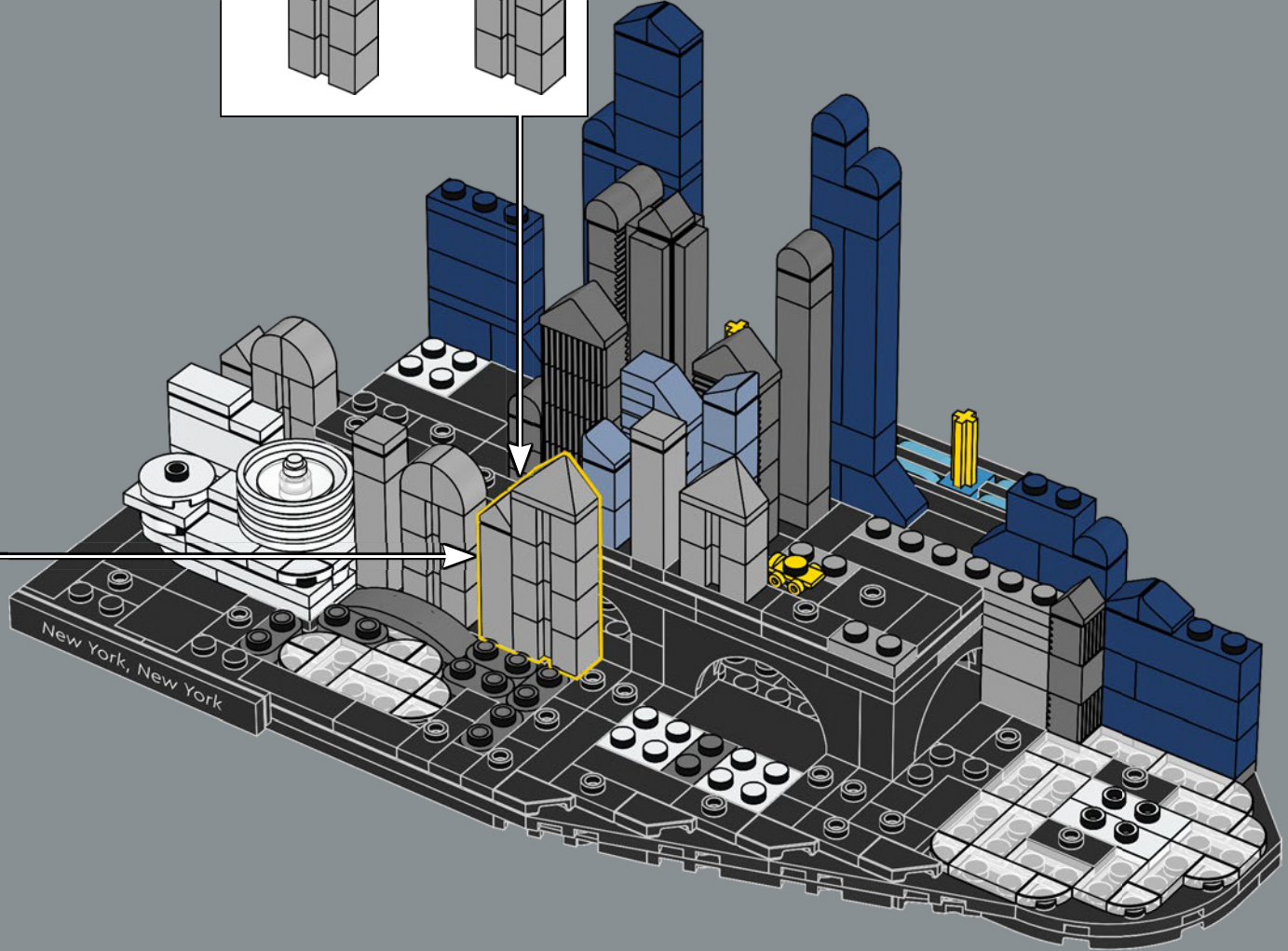
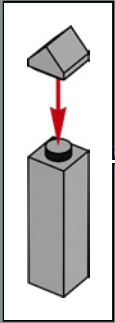
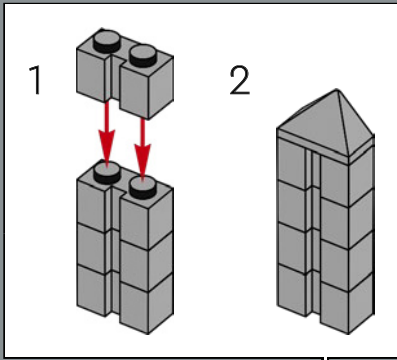



7x



3x

72

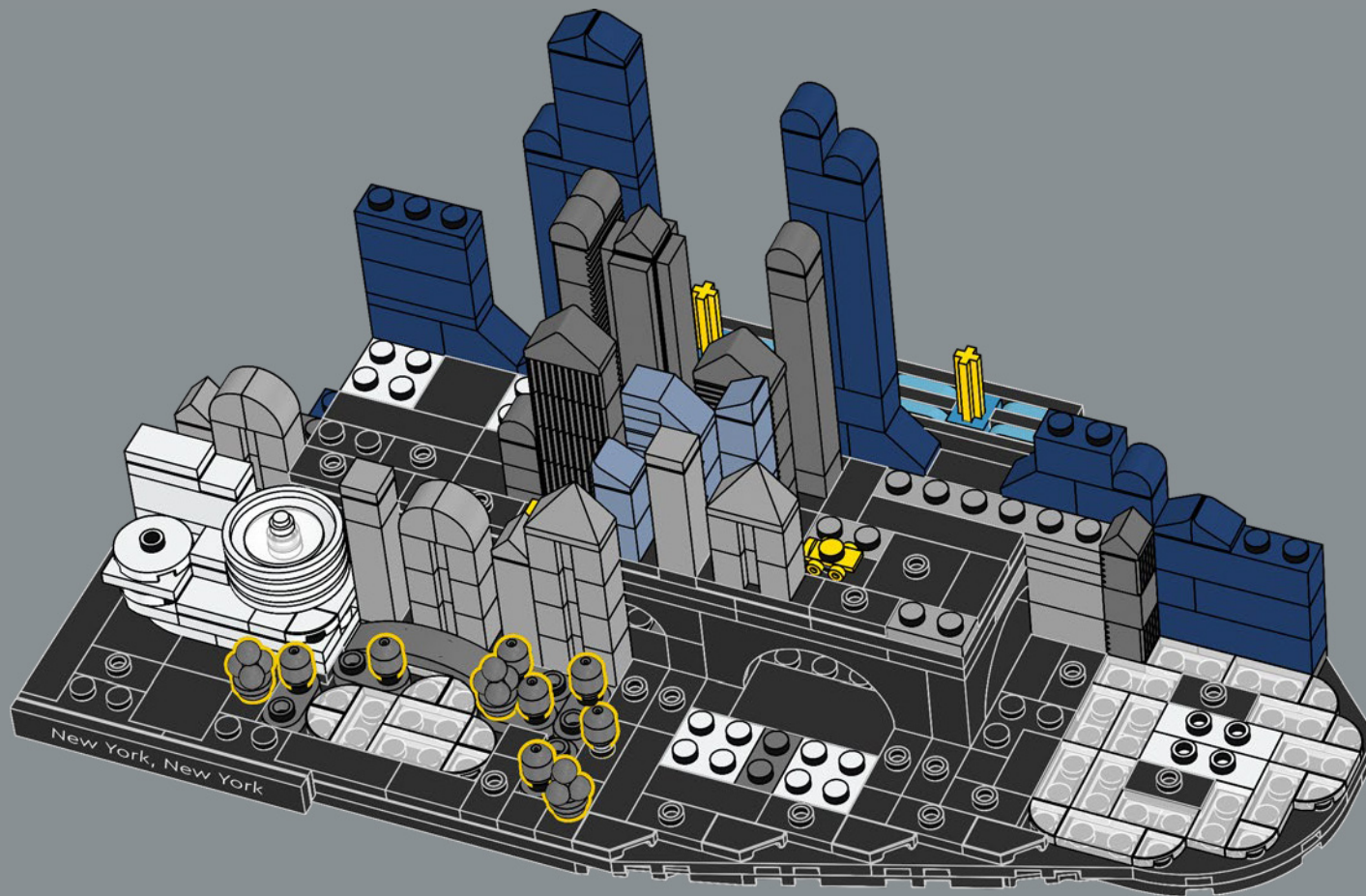



这里使用了乐高®冰淇淋组件、刀片和球体，来构成中央公园中大约 1.8 万棵裸树中的一部分。

73

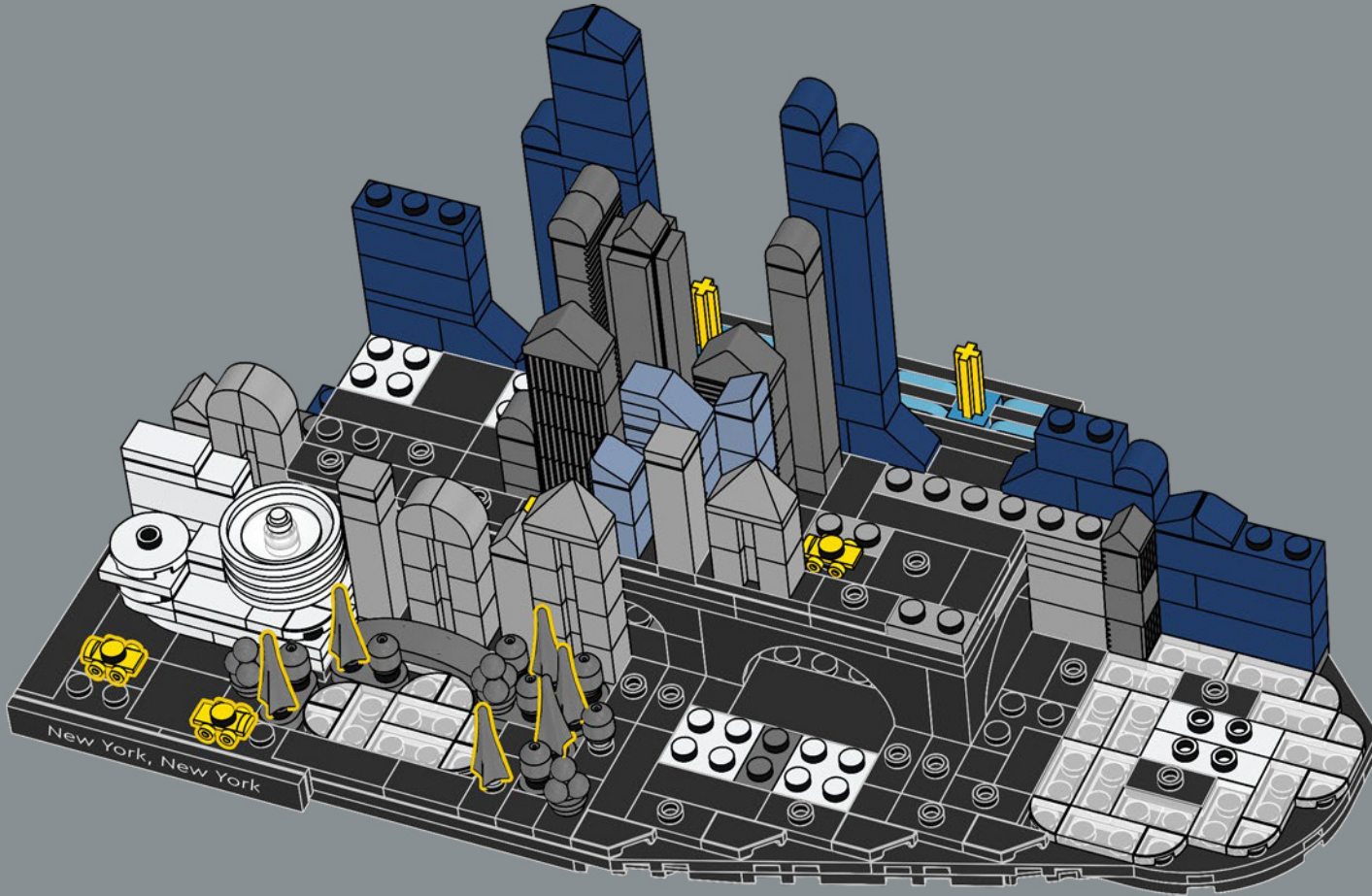

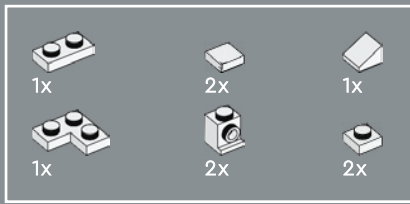

74

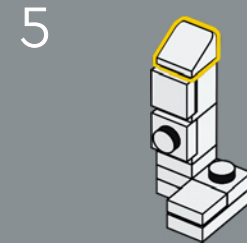
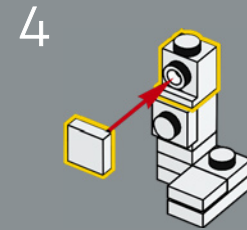
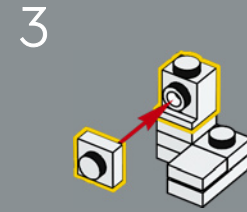
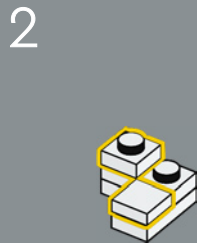
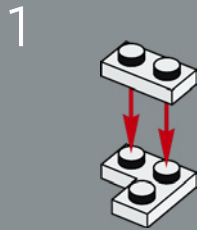

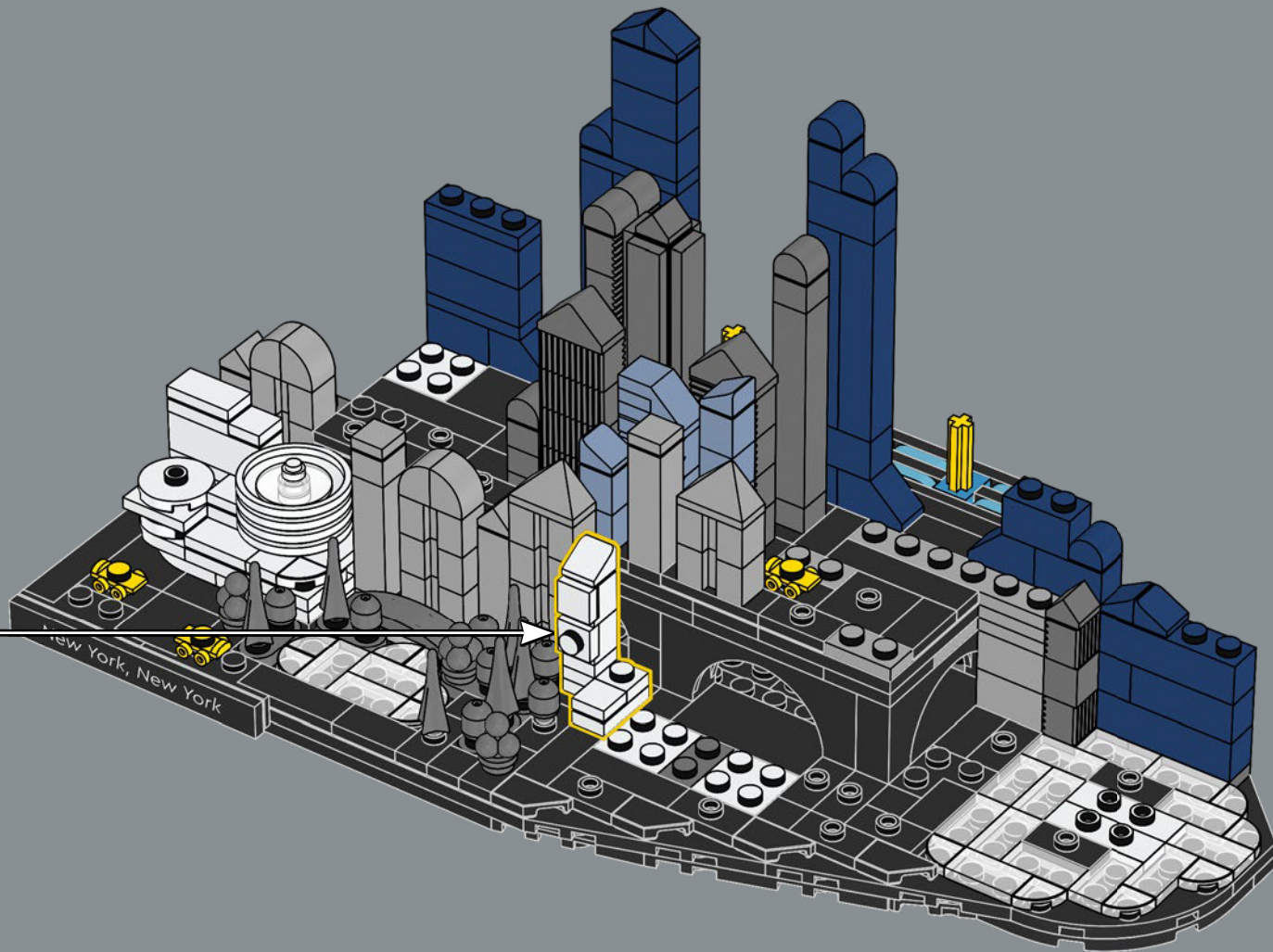

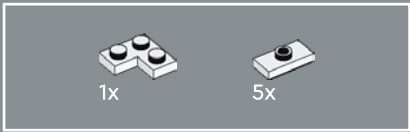

75

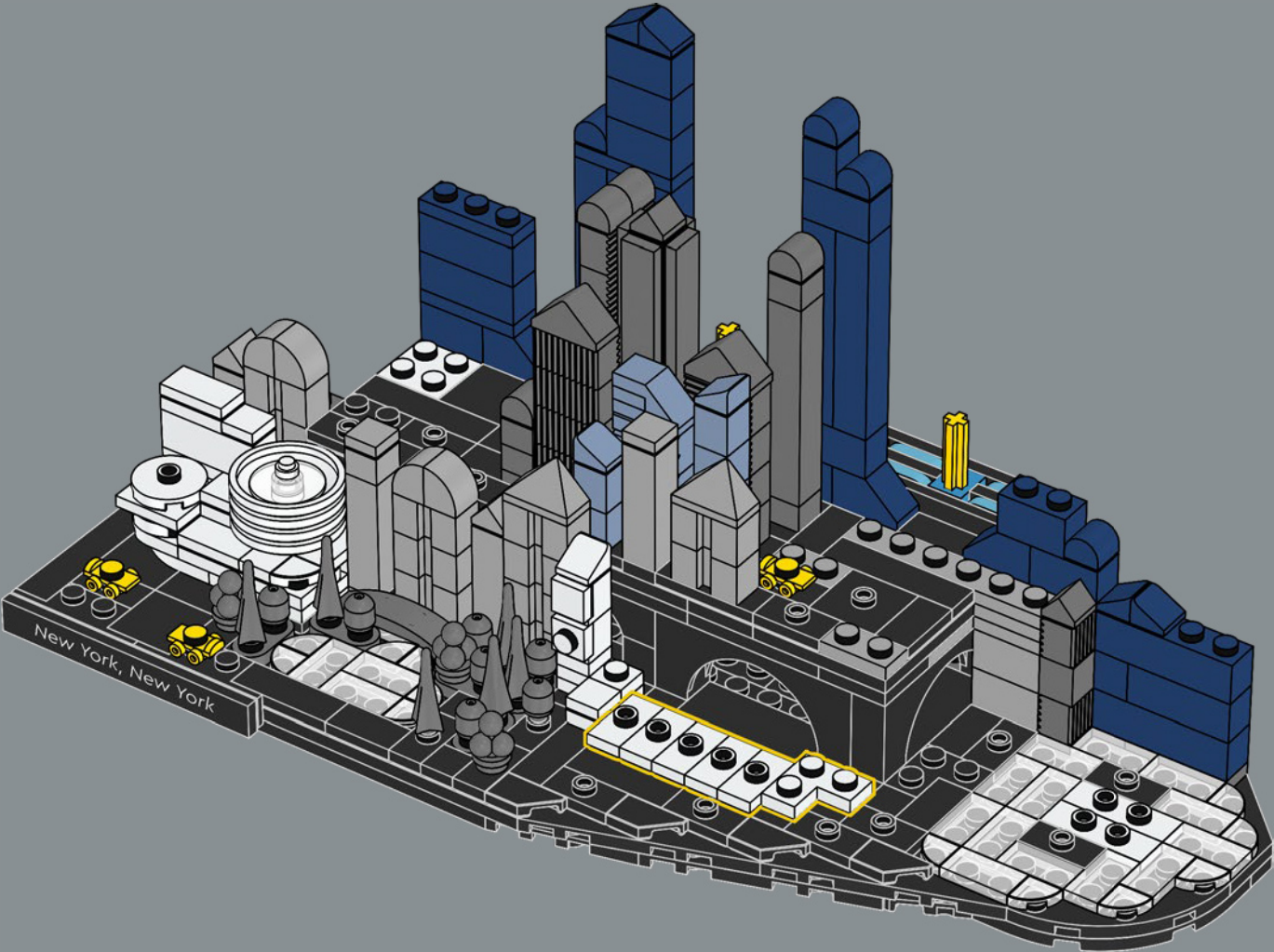

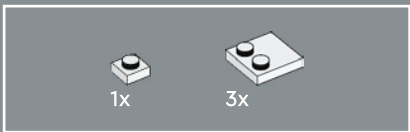

76

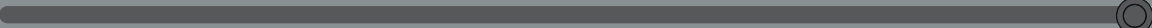
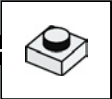
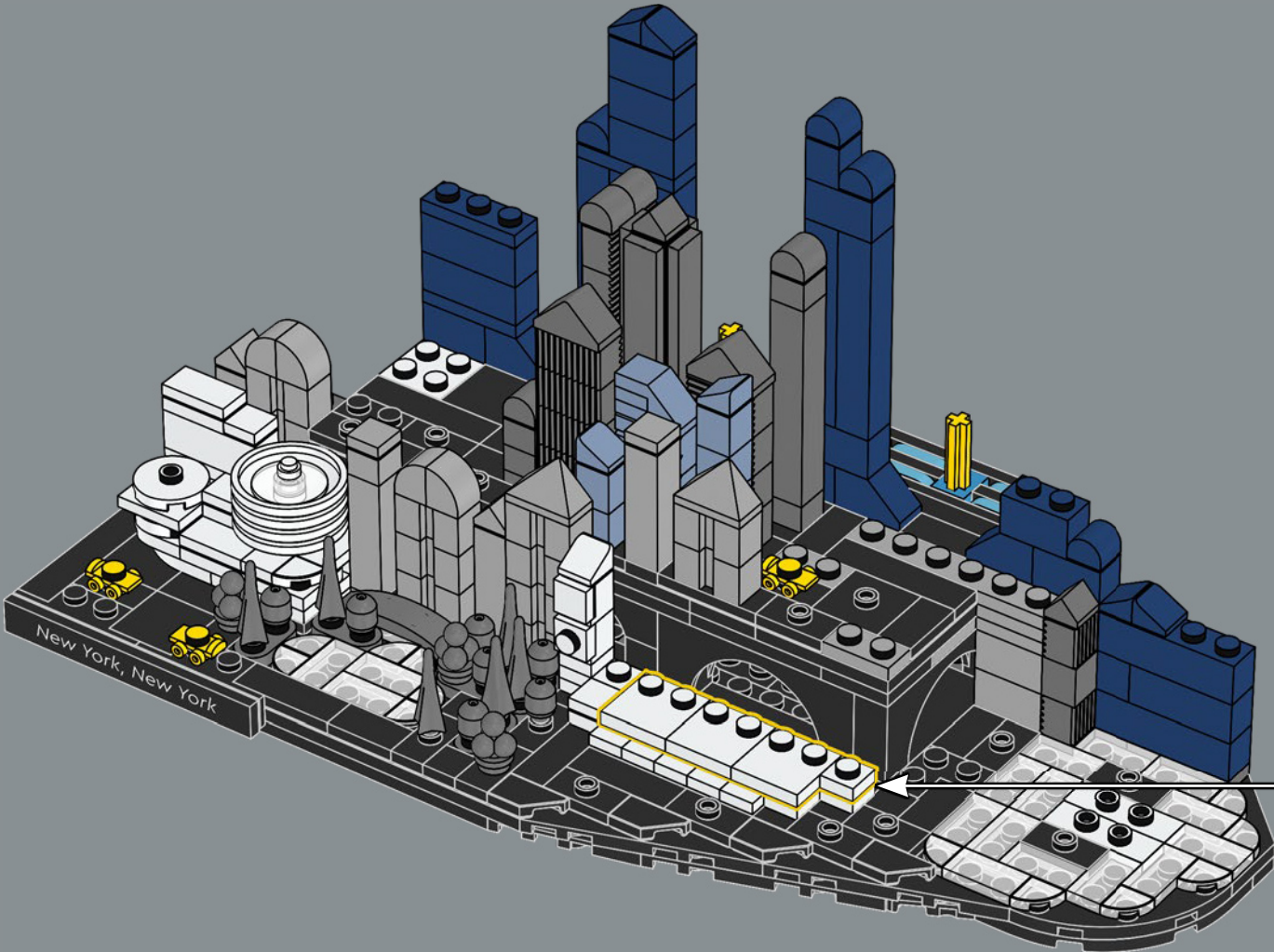

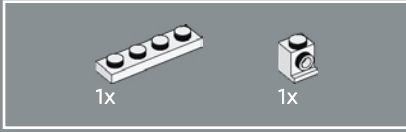
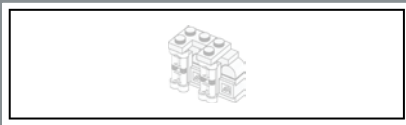

77

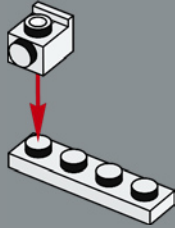

78

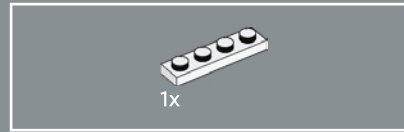
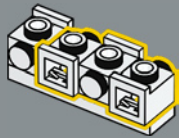

79

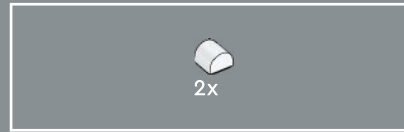
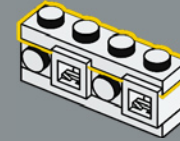

80

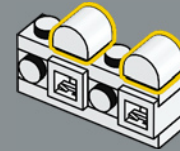

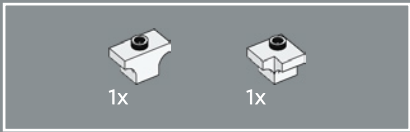

81

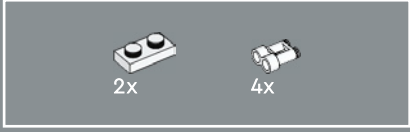
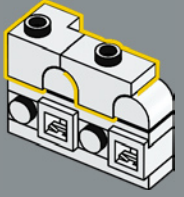

82

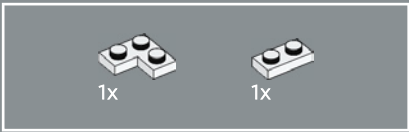
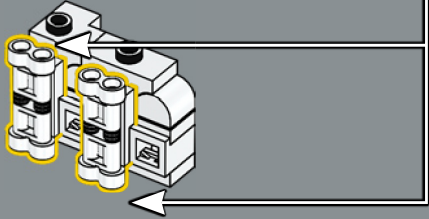
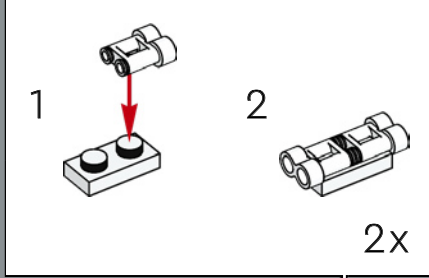

83

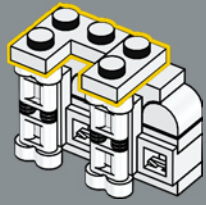

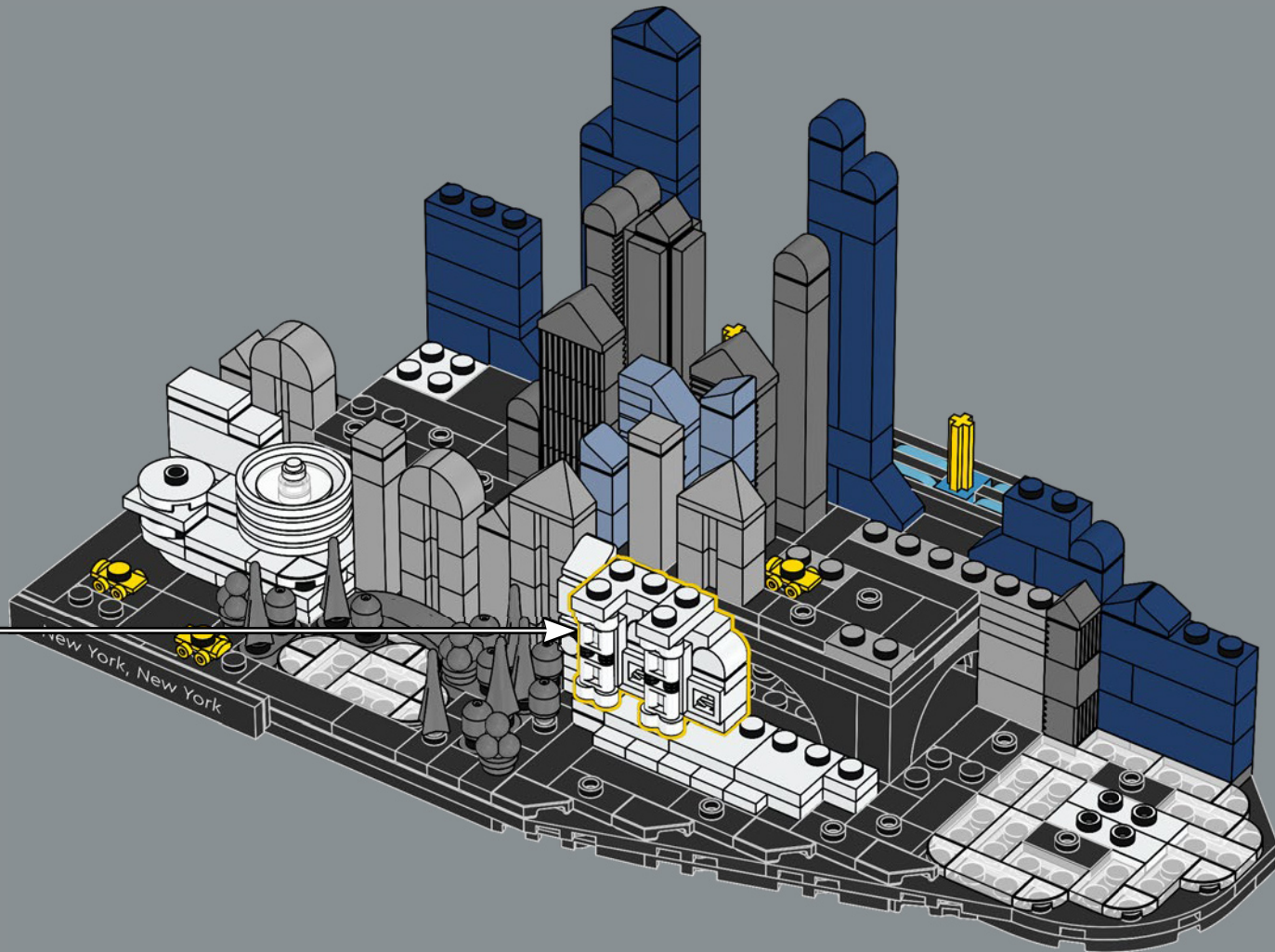

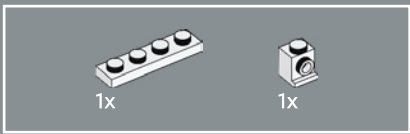

85

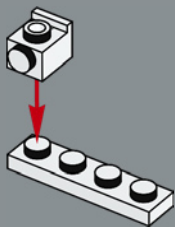

86

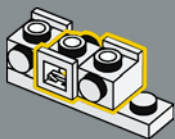

87

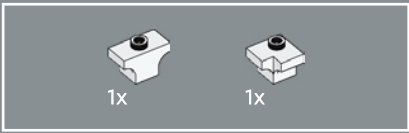
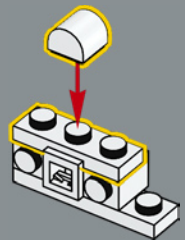

88

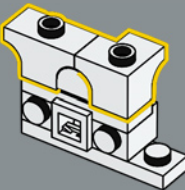

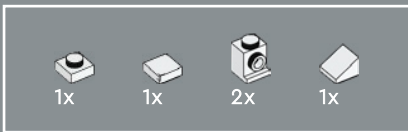

89

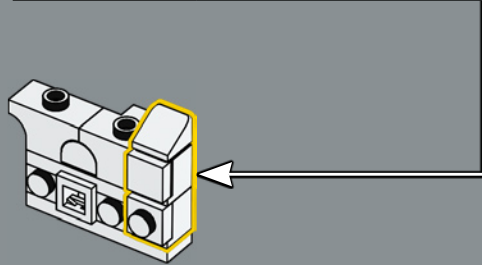
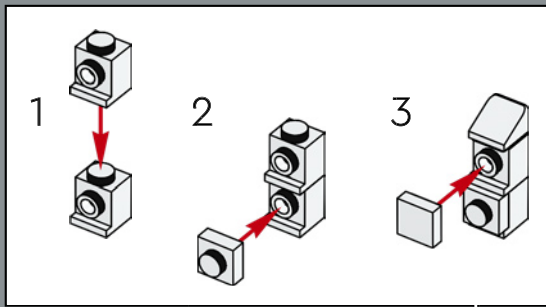

90

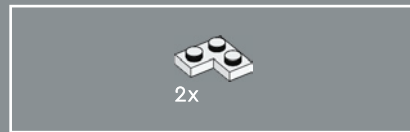
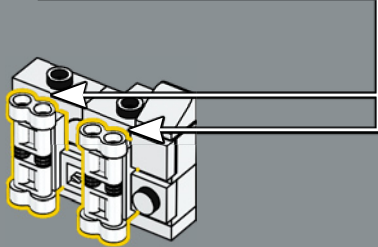
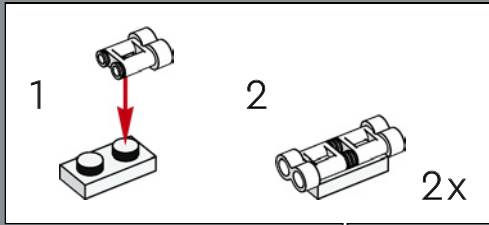

91

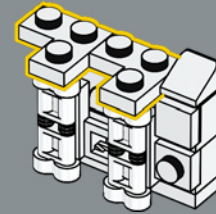

乐高®双筒望远镜组成了一对对微型立柱，装饰着大都会艺术生活系列博物馆的主入口。

92

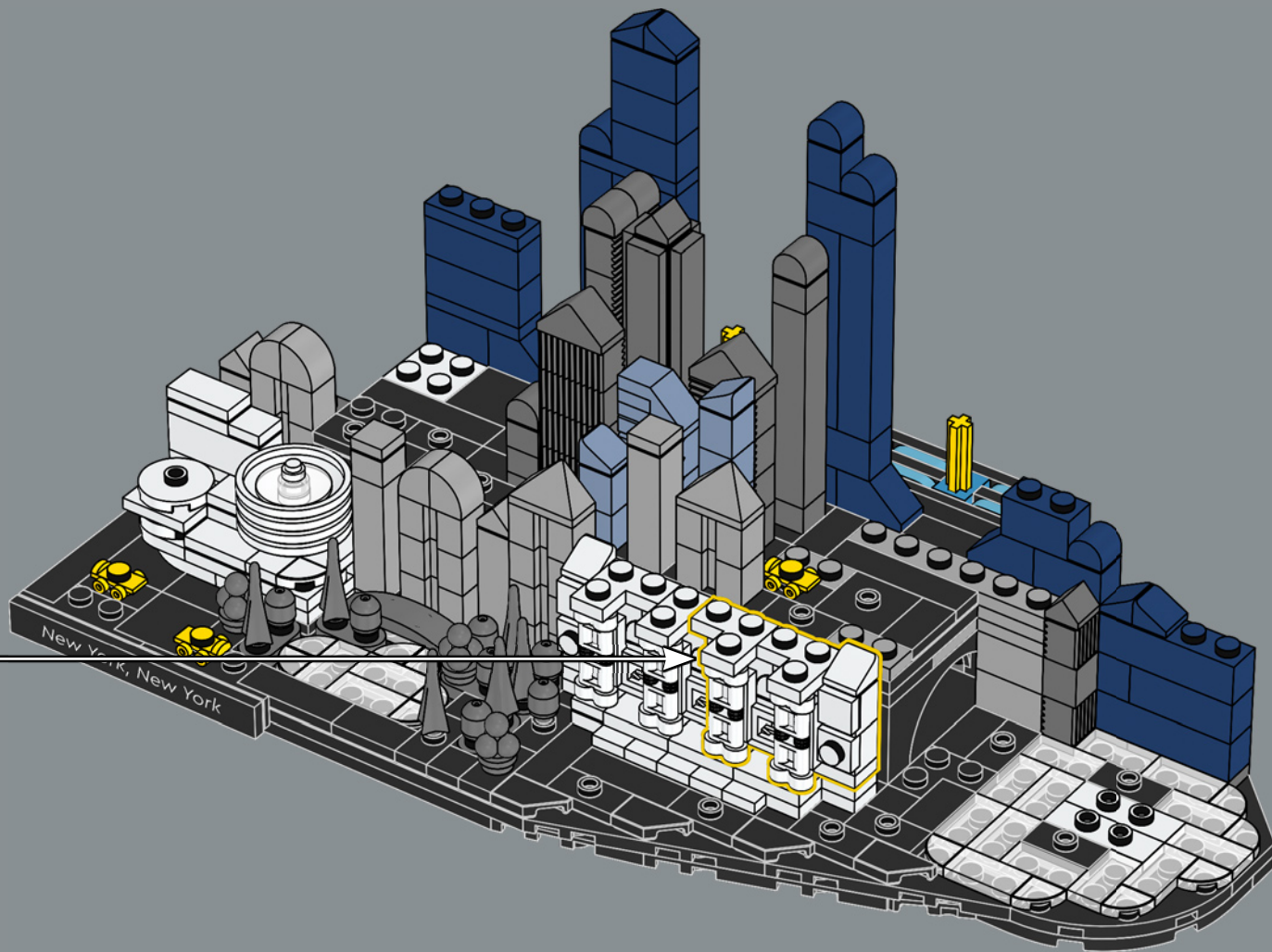

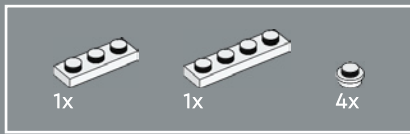

93

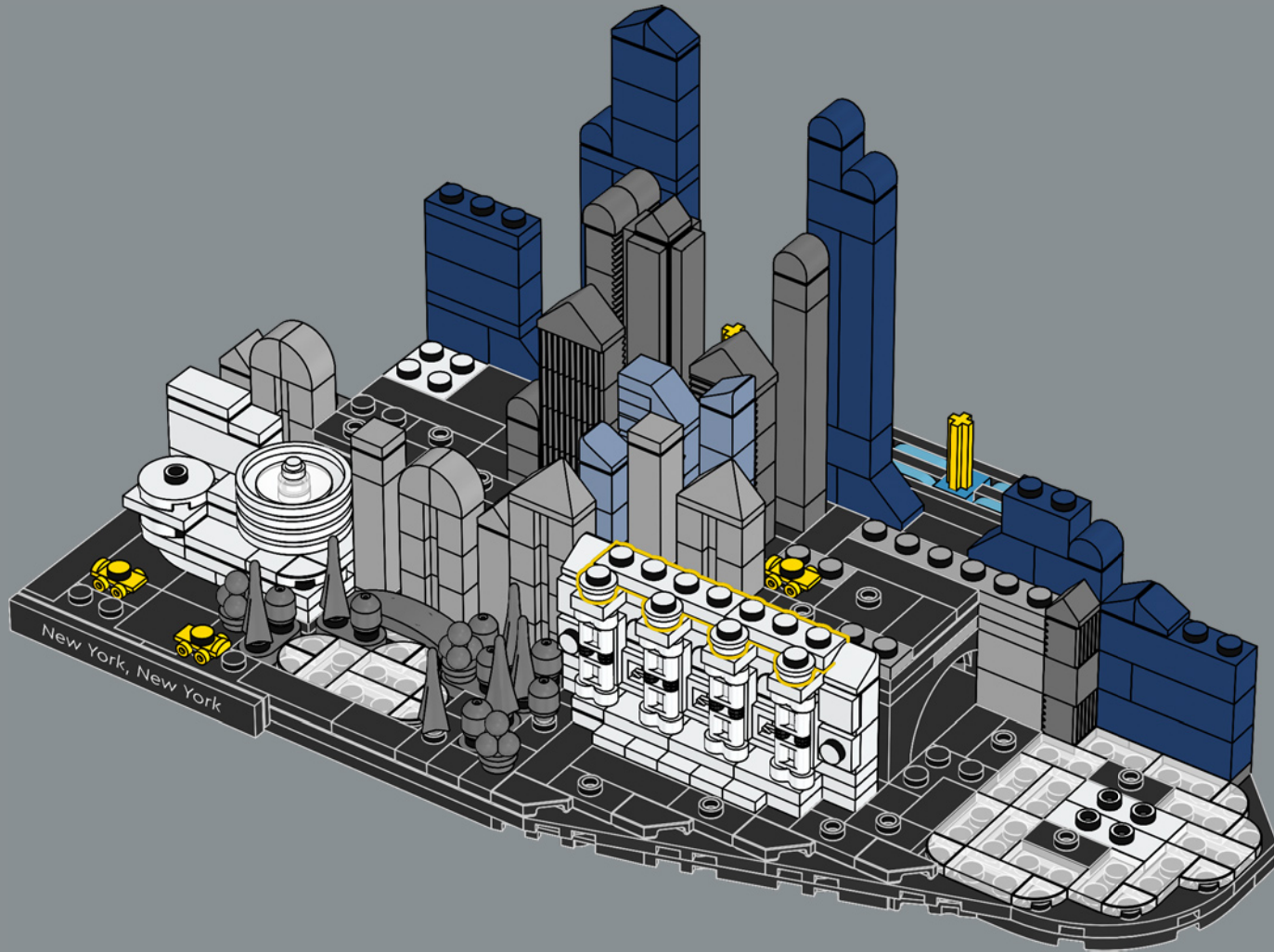

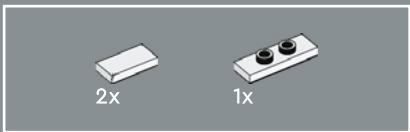

94

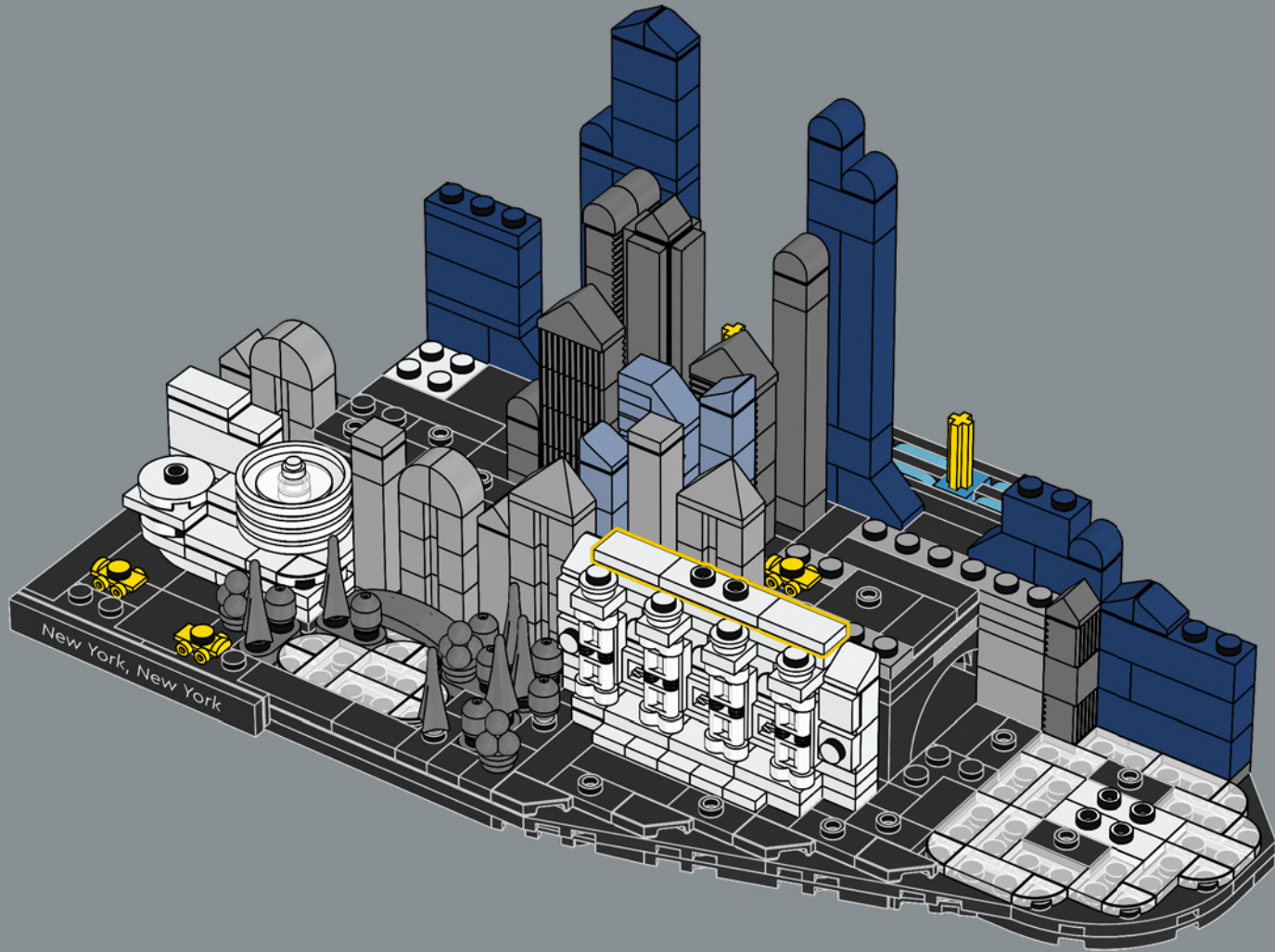



95

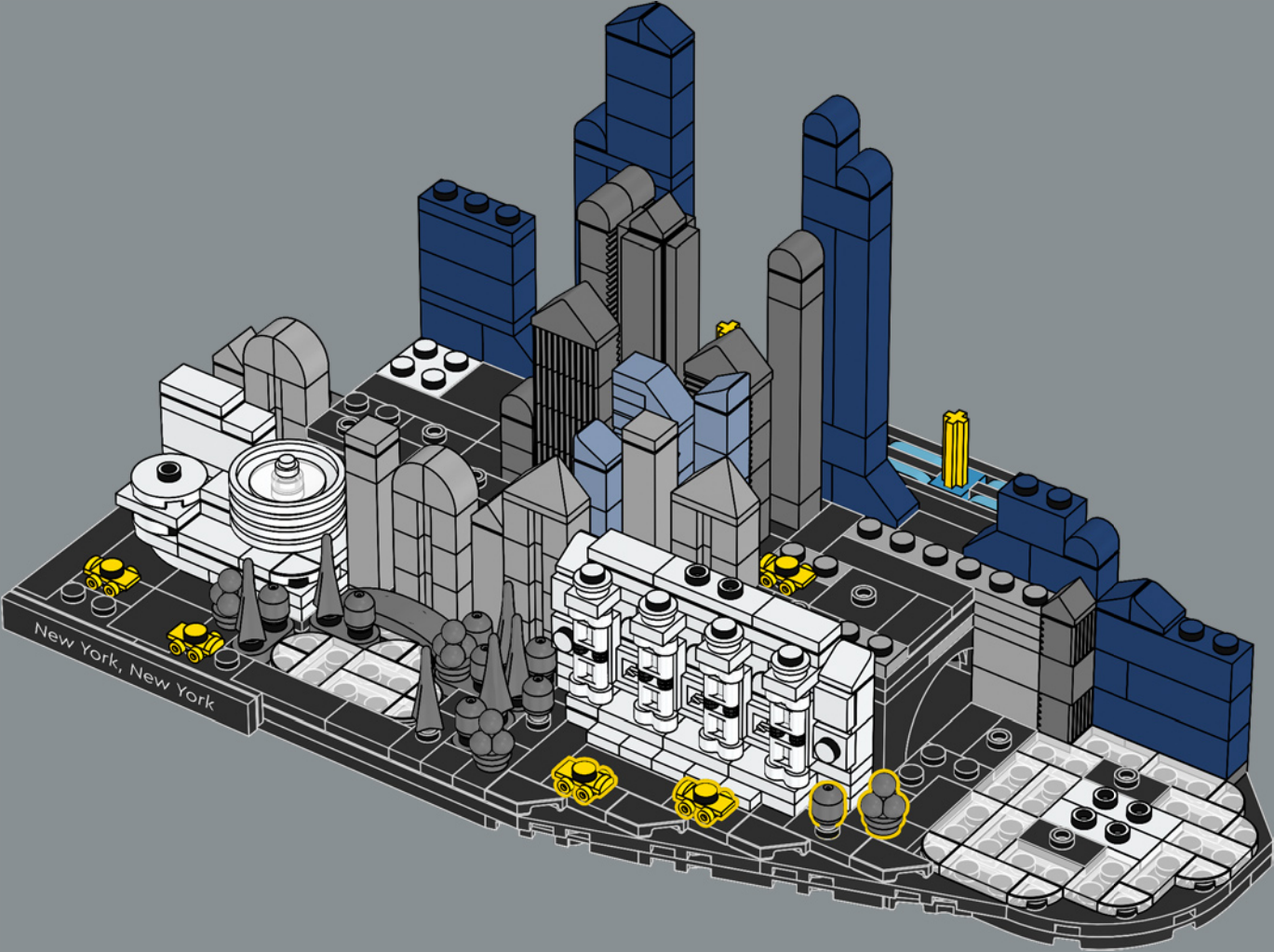

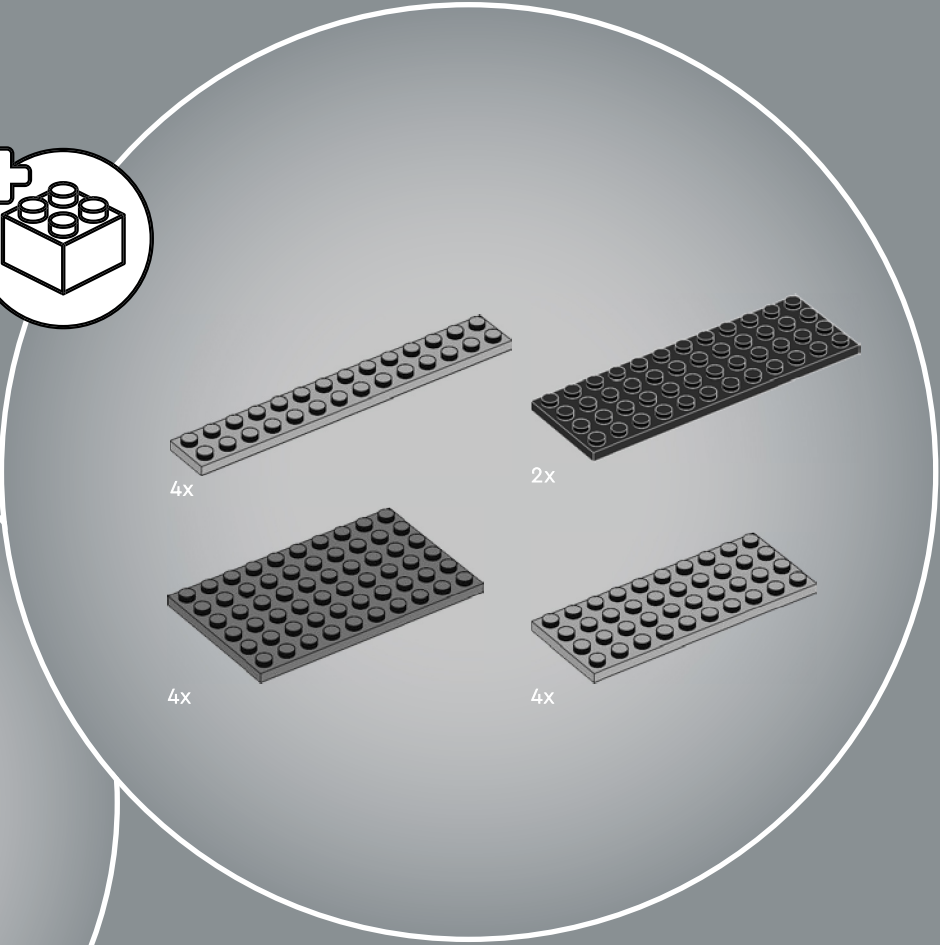
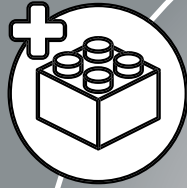

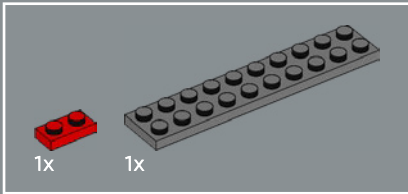
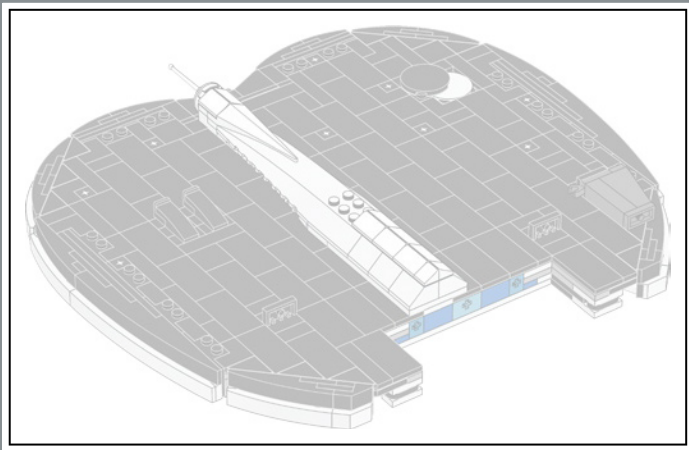

96

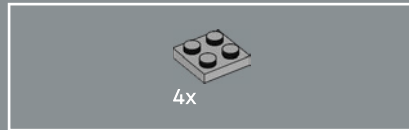
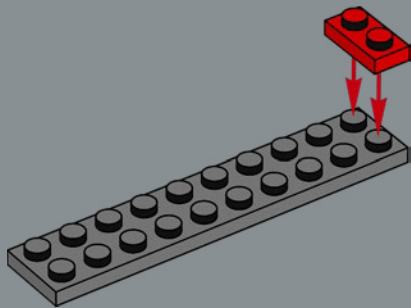

97

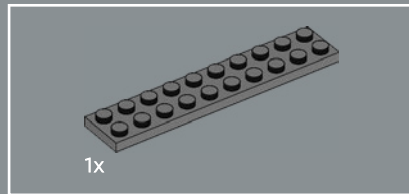
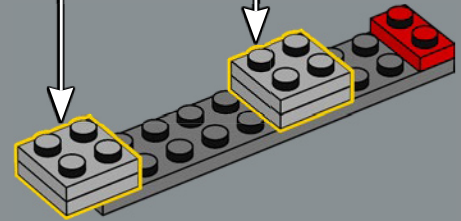
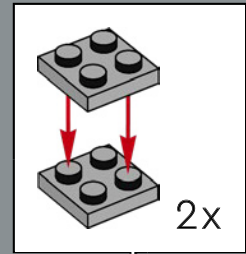

98

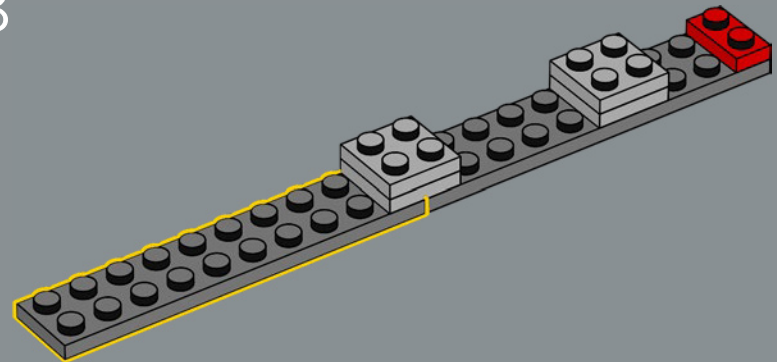

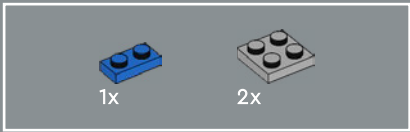

99

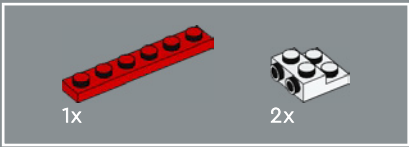
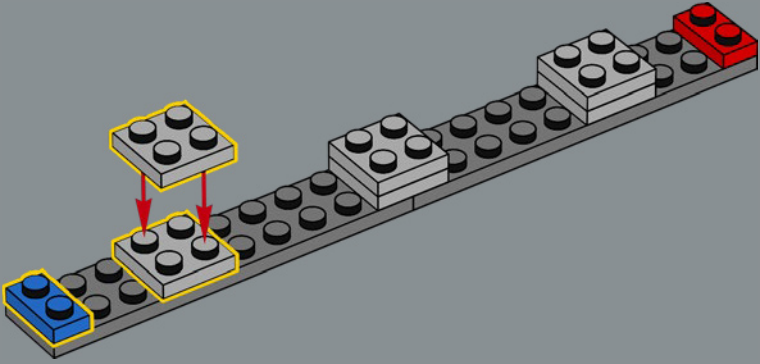

100

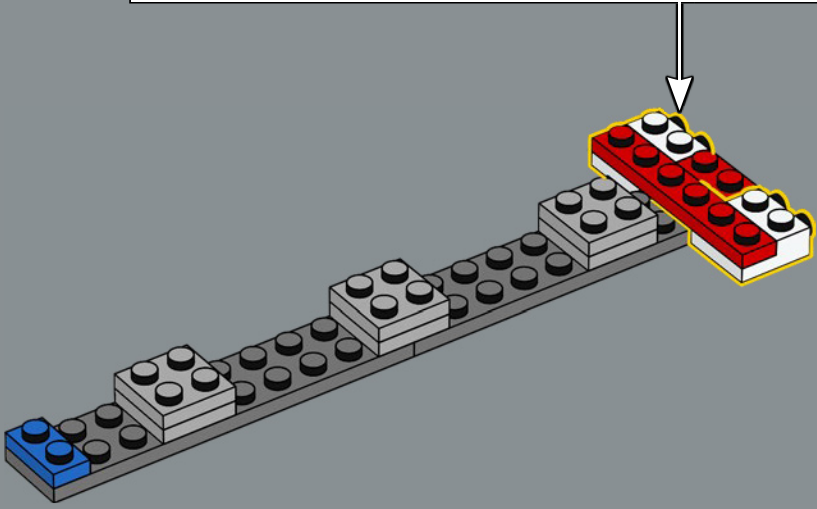
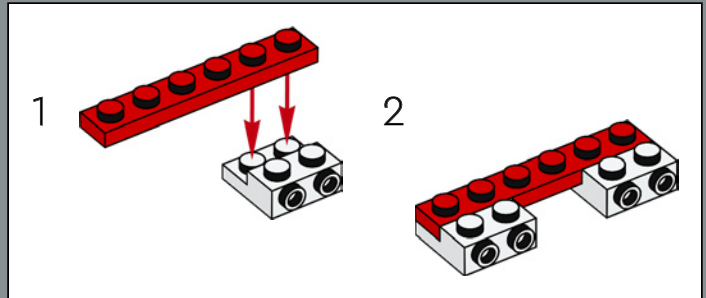

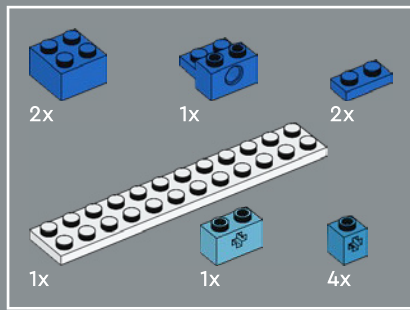

101

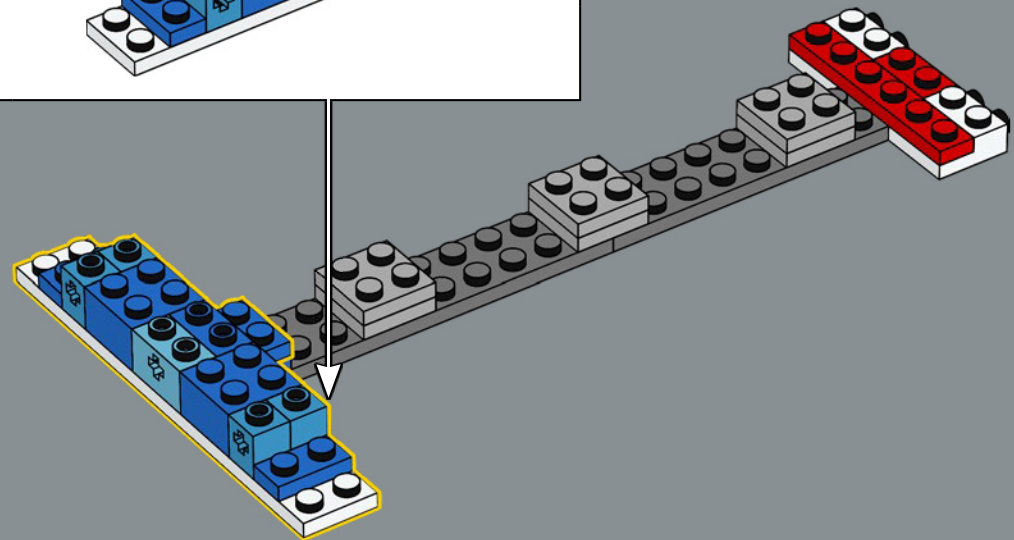
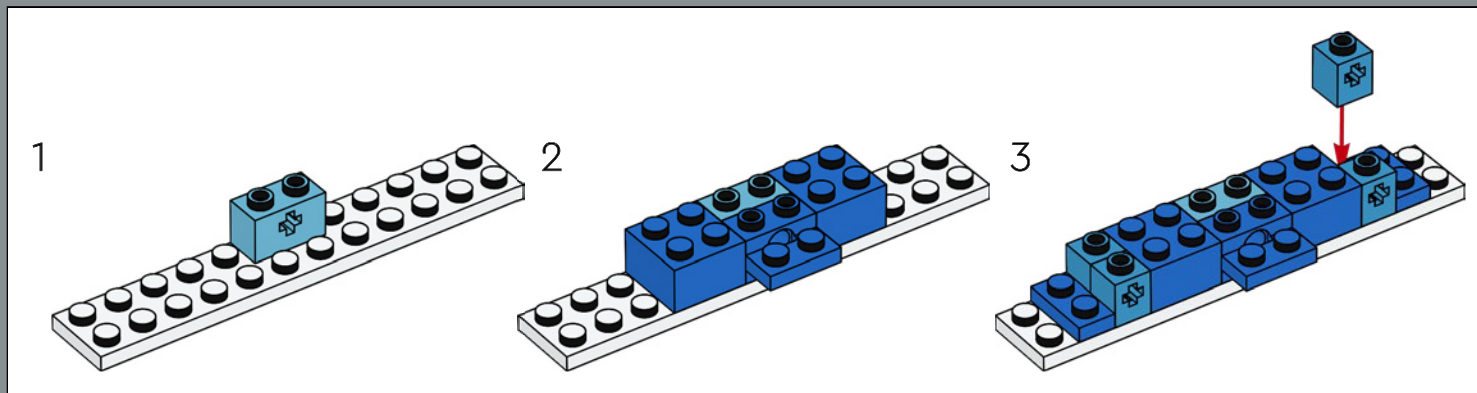

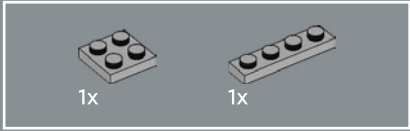
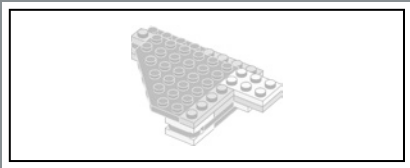

102

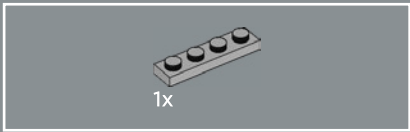
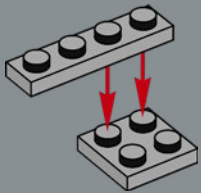

103

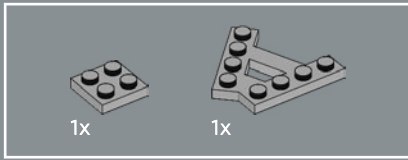
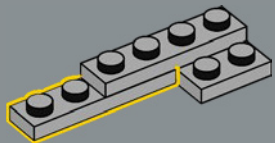

104

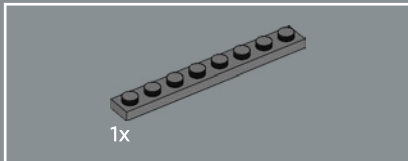
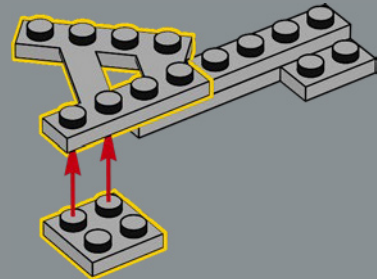

105

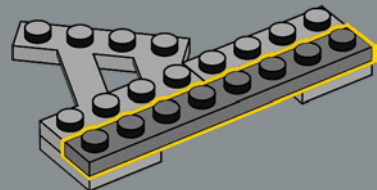



106

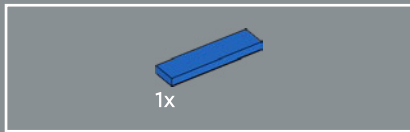
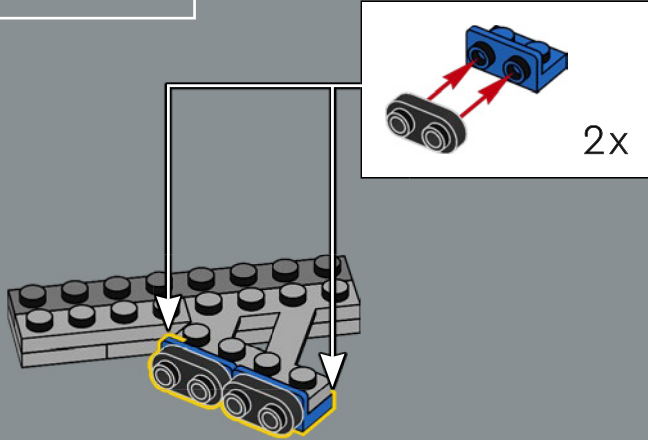

107

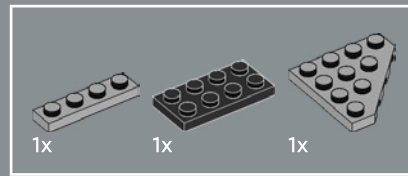
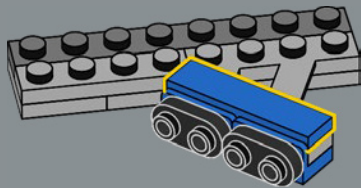

108

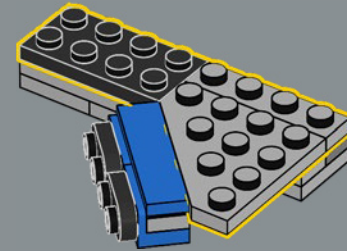

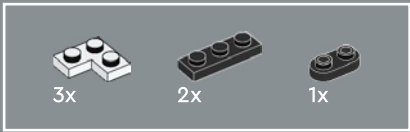

109

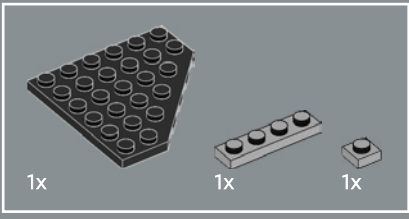
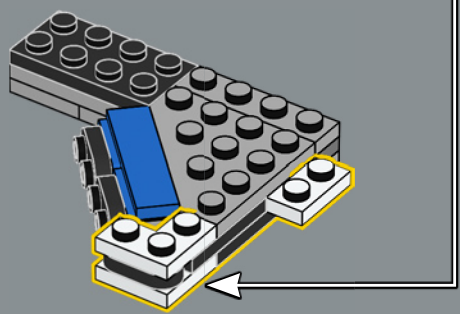
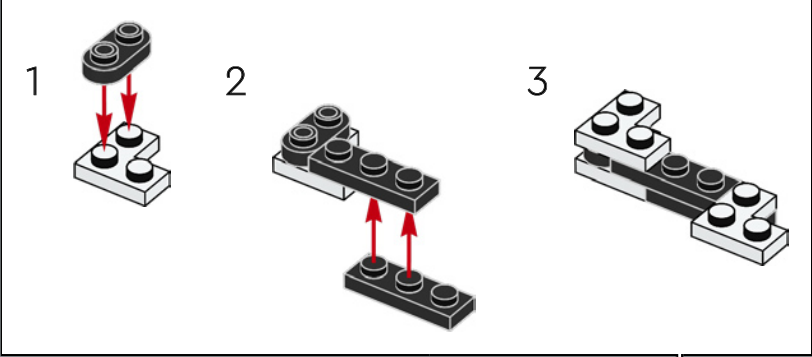

110

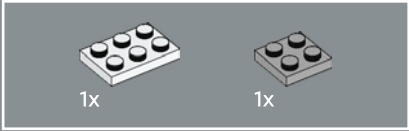
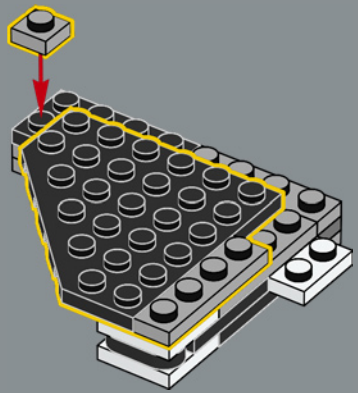

111

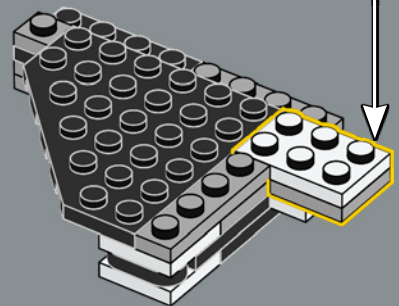
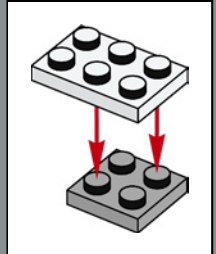

112

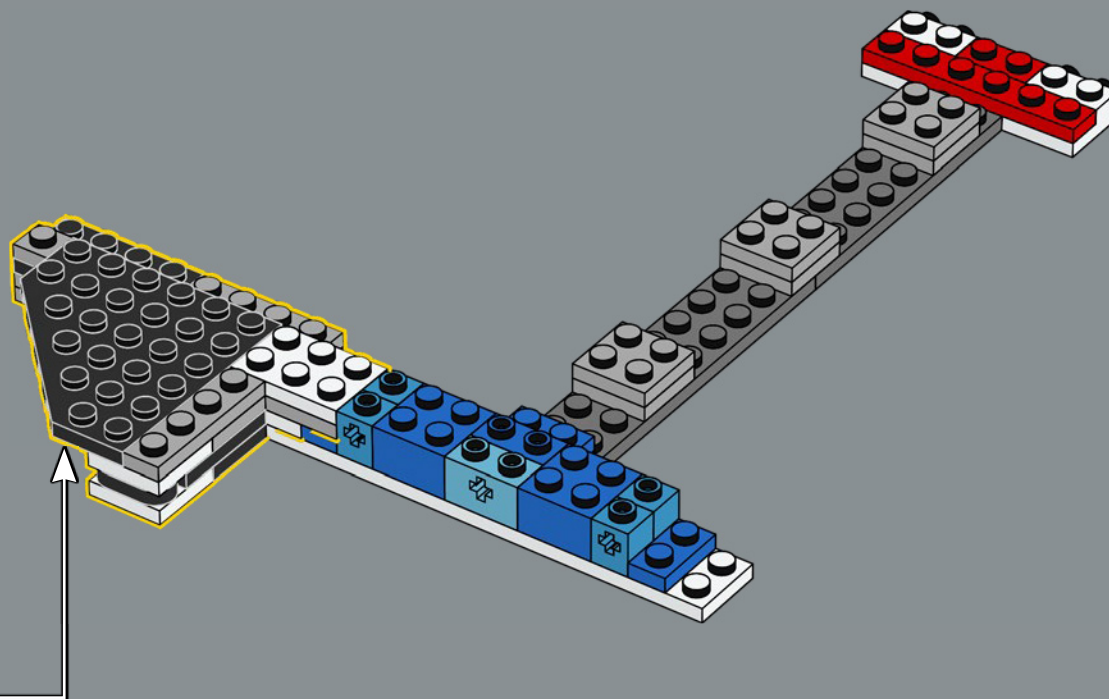

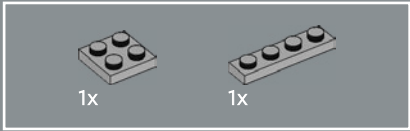
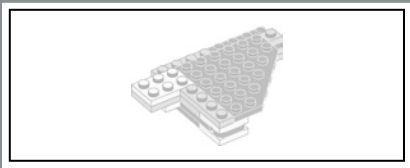

113

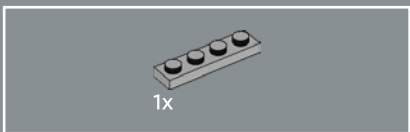
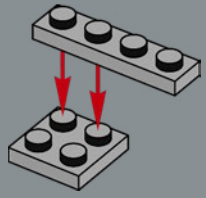

114

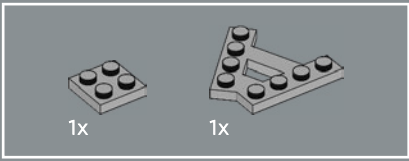
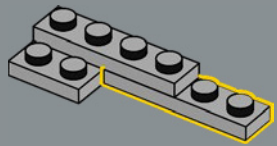

115

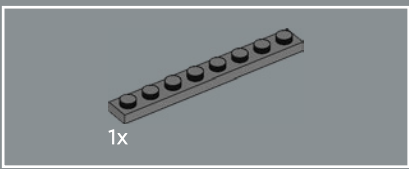
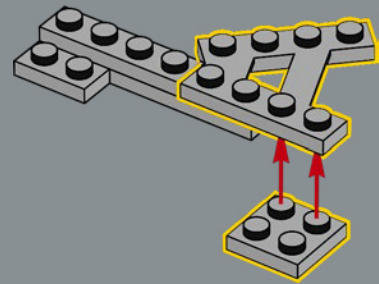

116

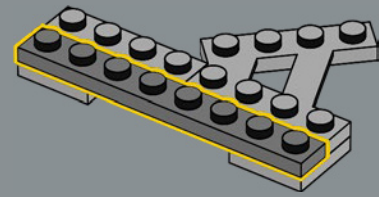



117

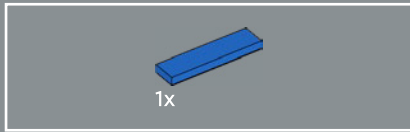
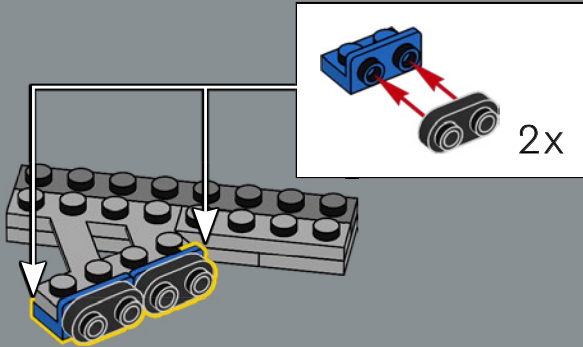

118

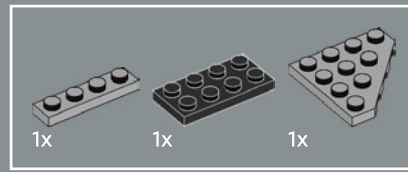
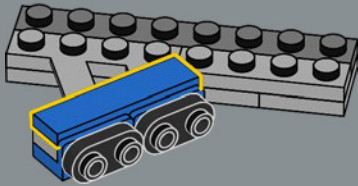

119

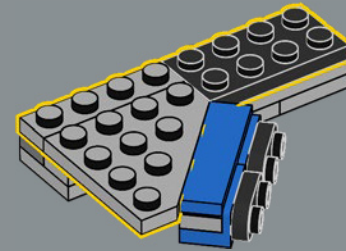

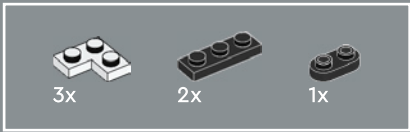

120

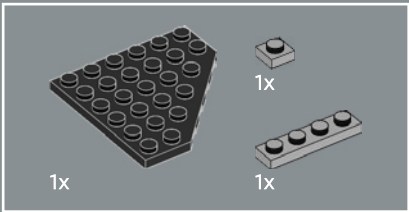
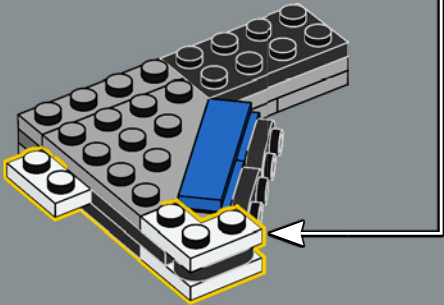
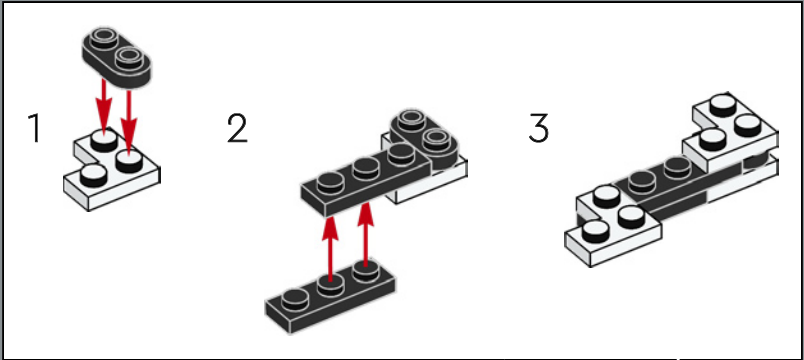

121

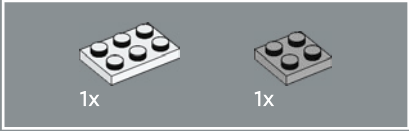
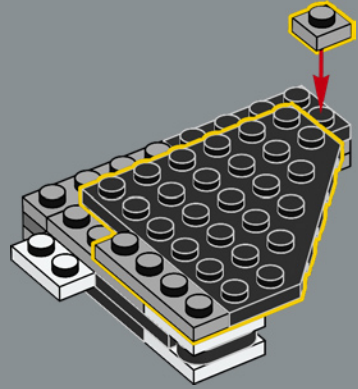

122

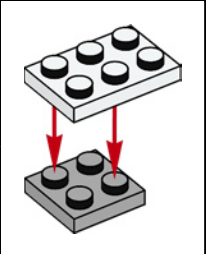
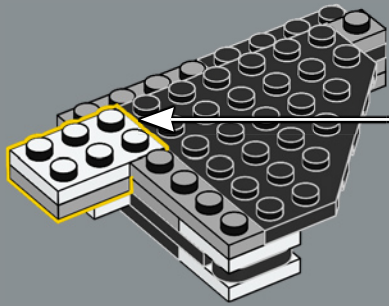

123

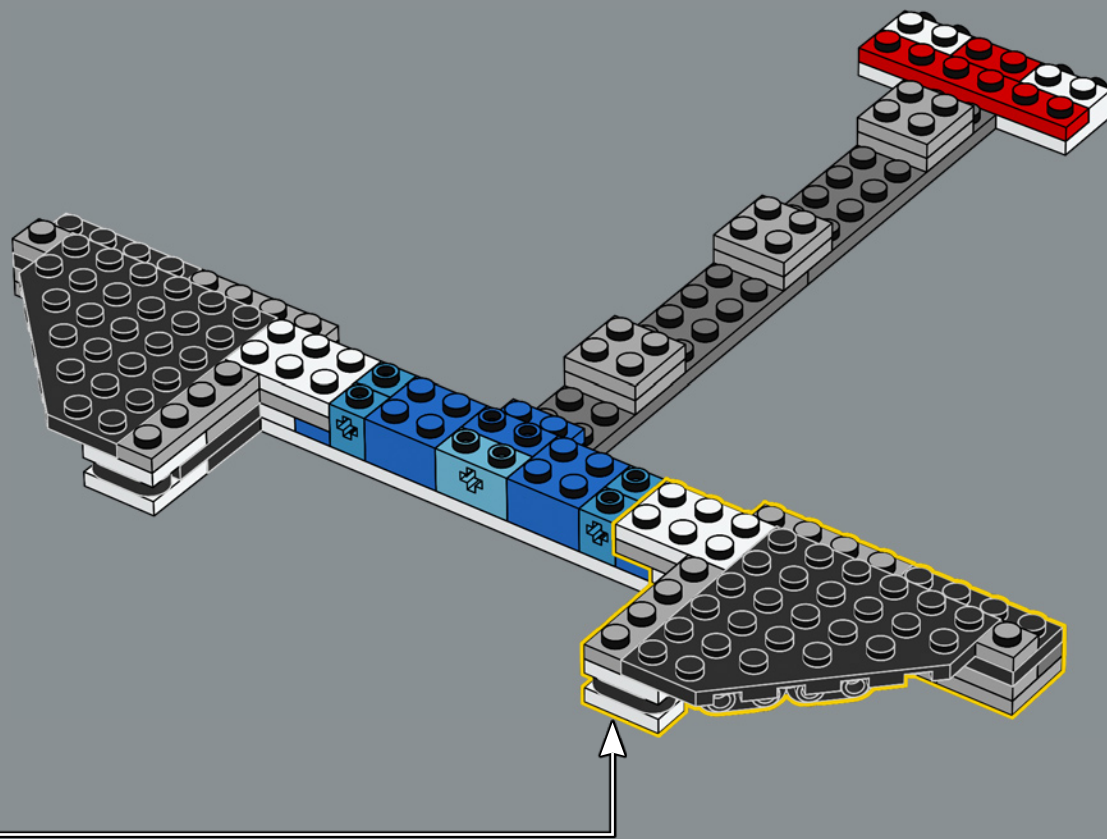

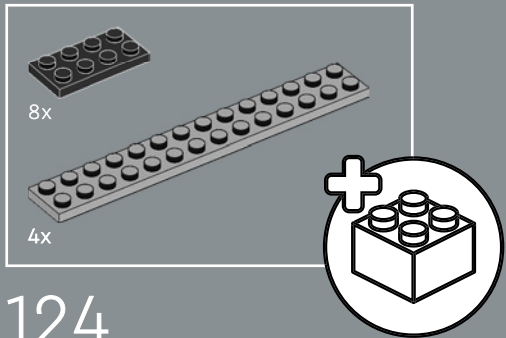
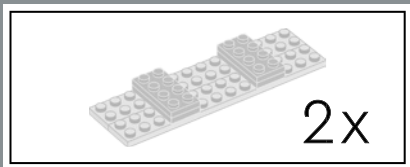

124

1

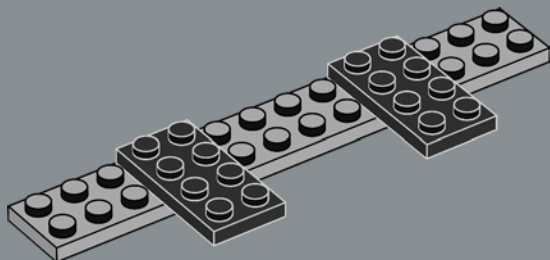

2

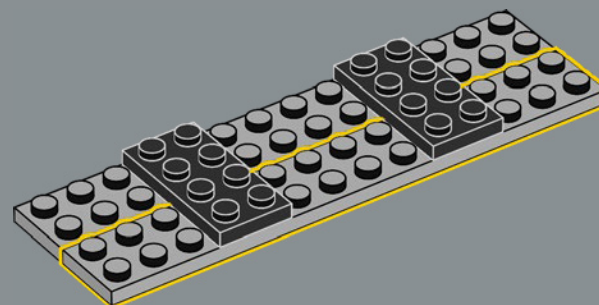

3

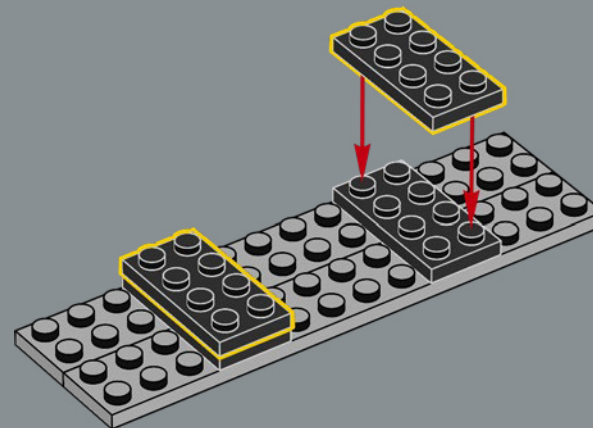

2x

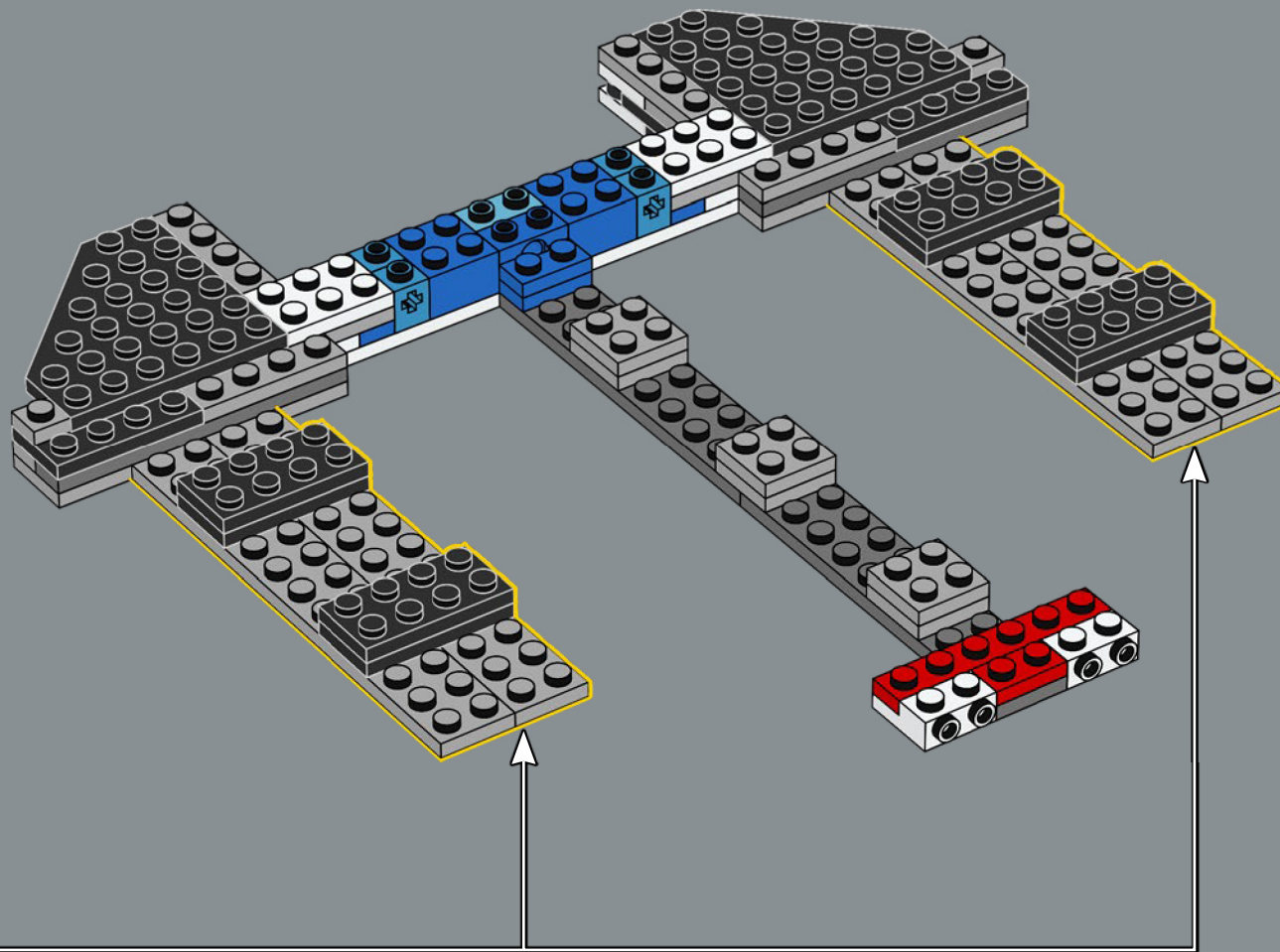

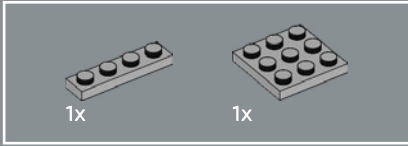
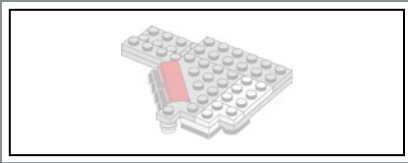

125

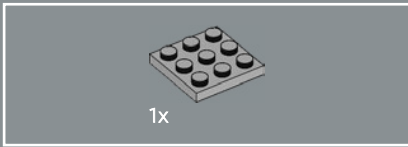
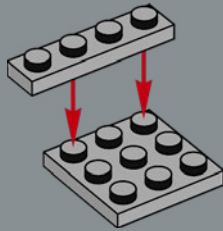

126

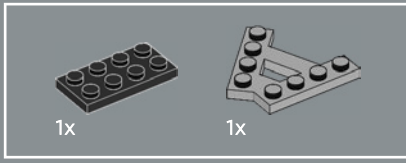
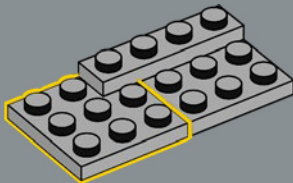

127

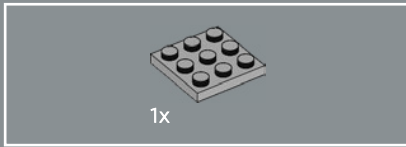
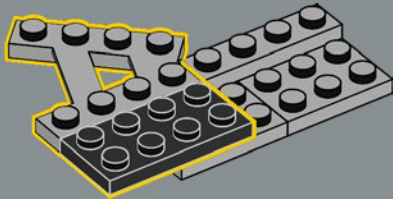

128

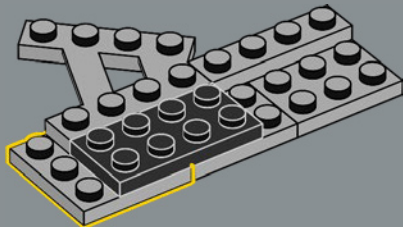



129

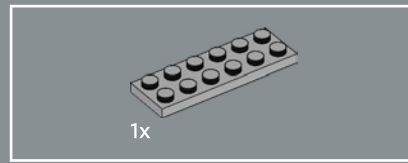
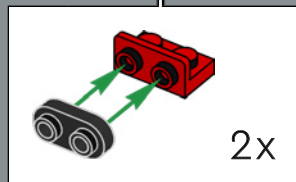
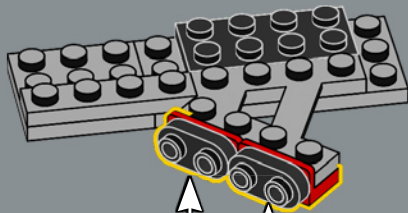

130

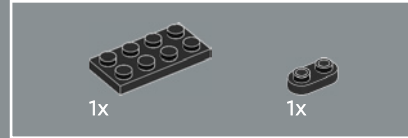
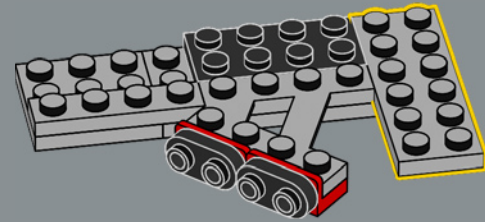

131

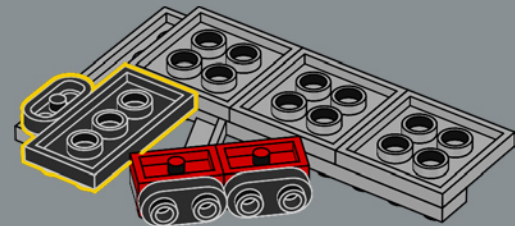



132

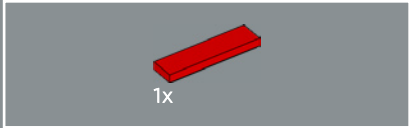
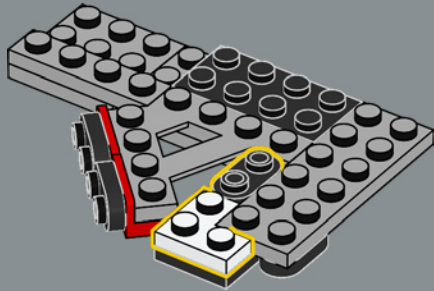

133

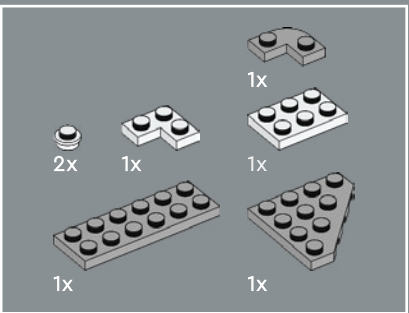
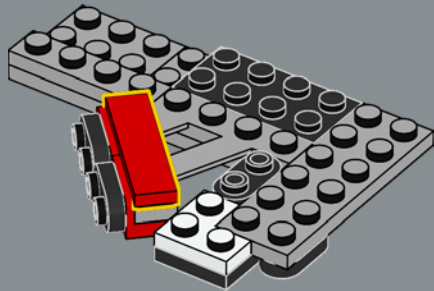

134

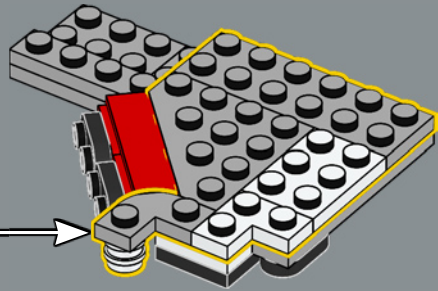
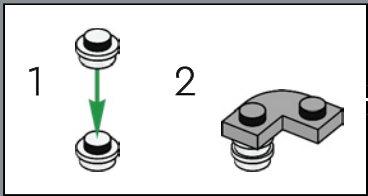

135

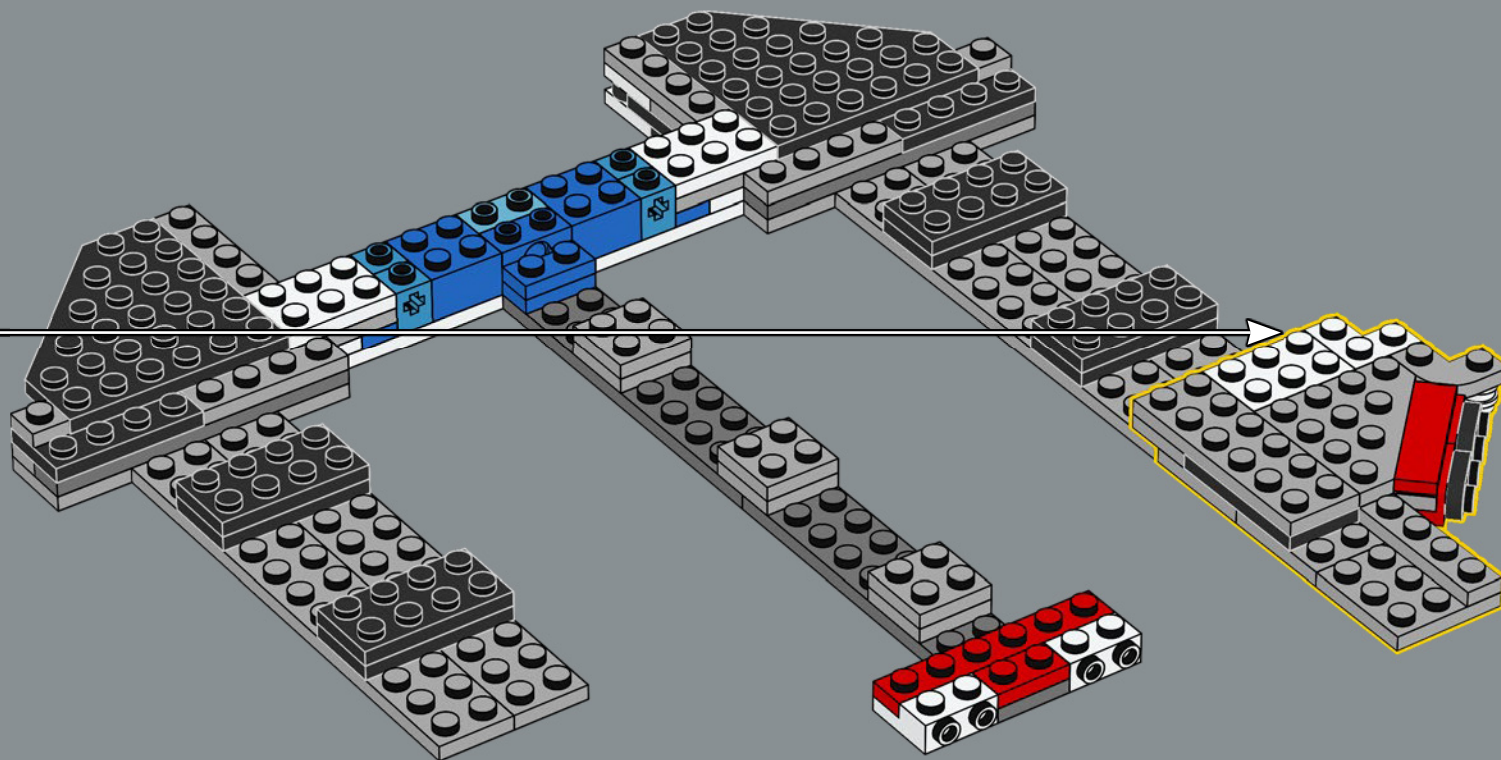

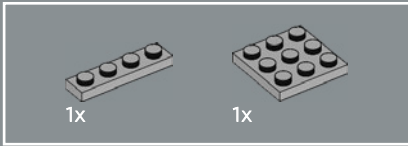
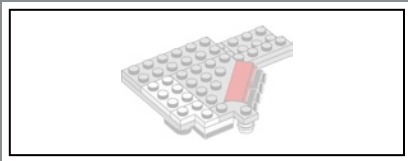

136

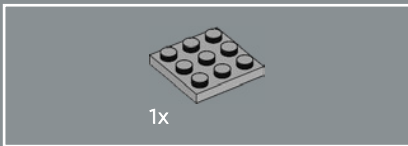
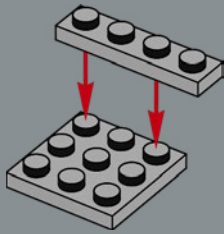

137

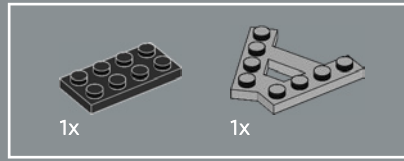
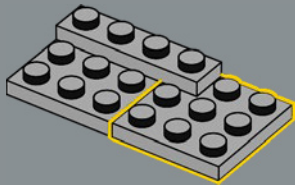

138

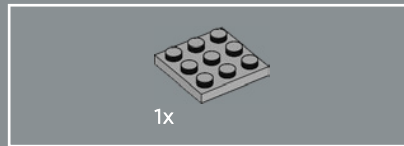
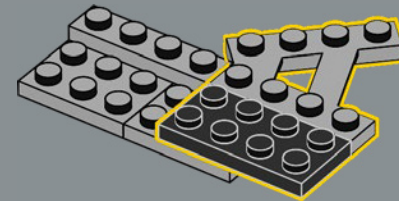

139

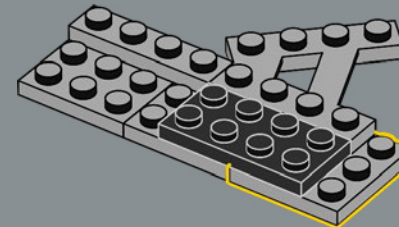



140

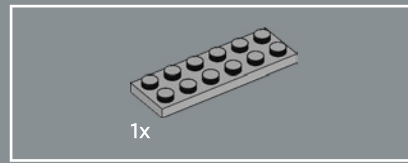
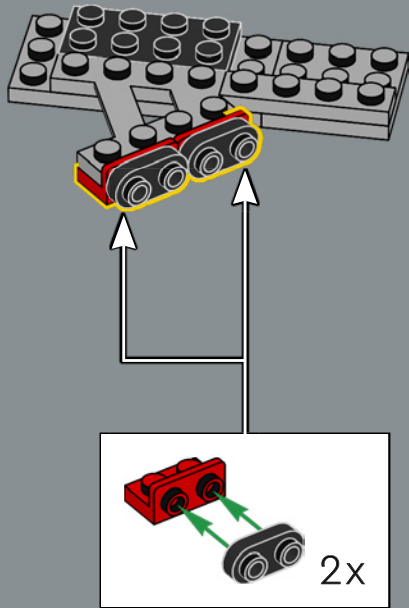

141

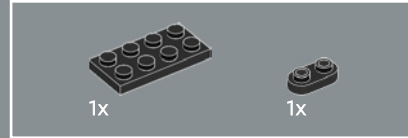
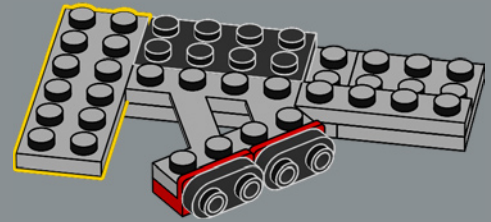

142

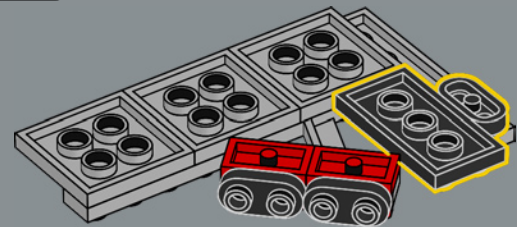



143

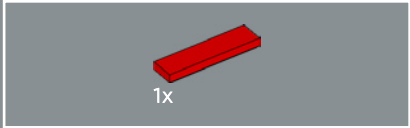
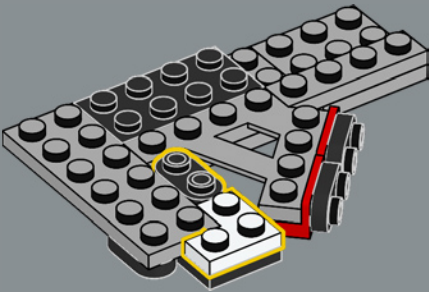

144

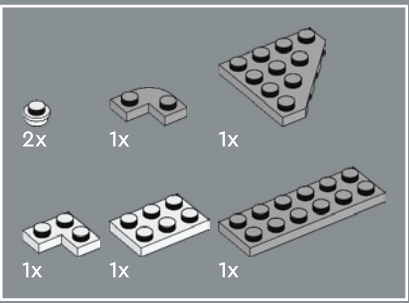
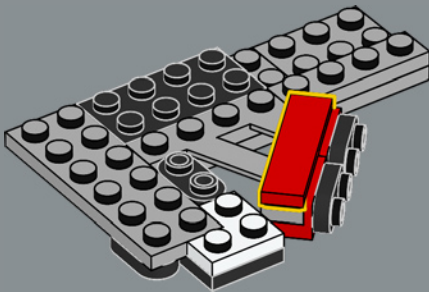

145

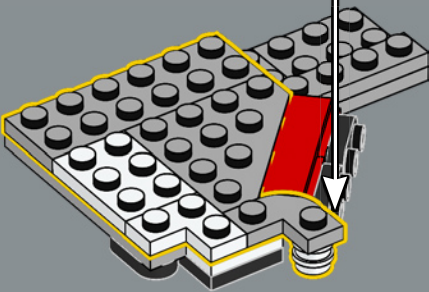
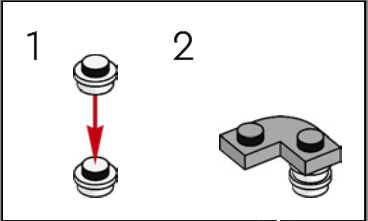

146

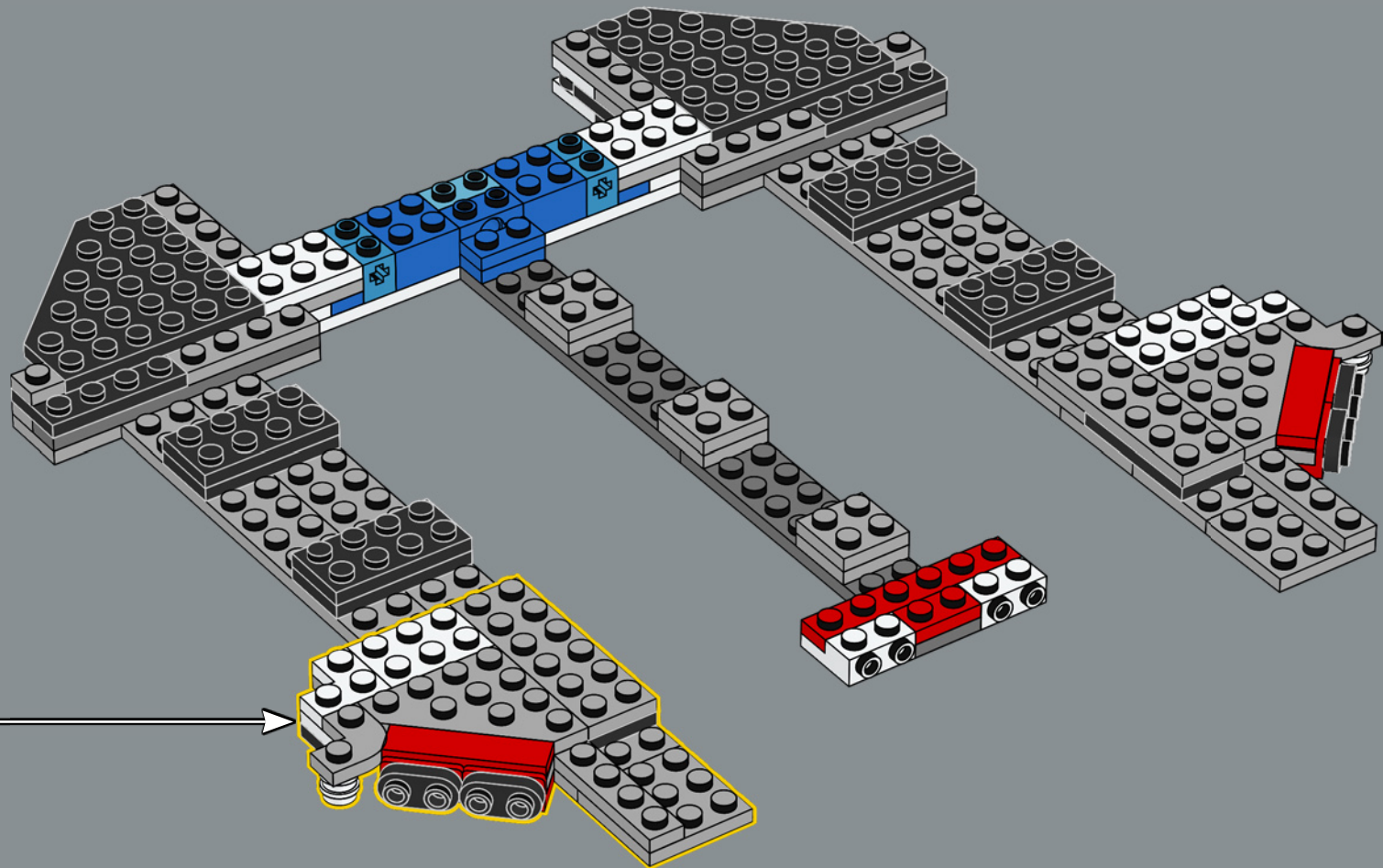

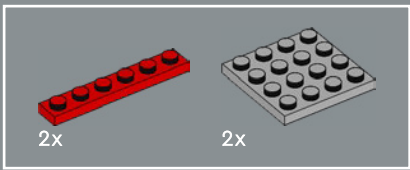

147

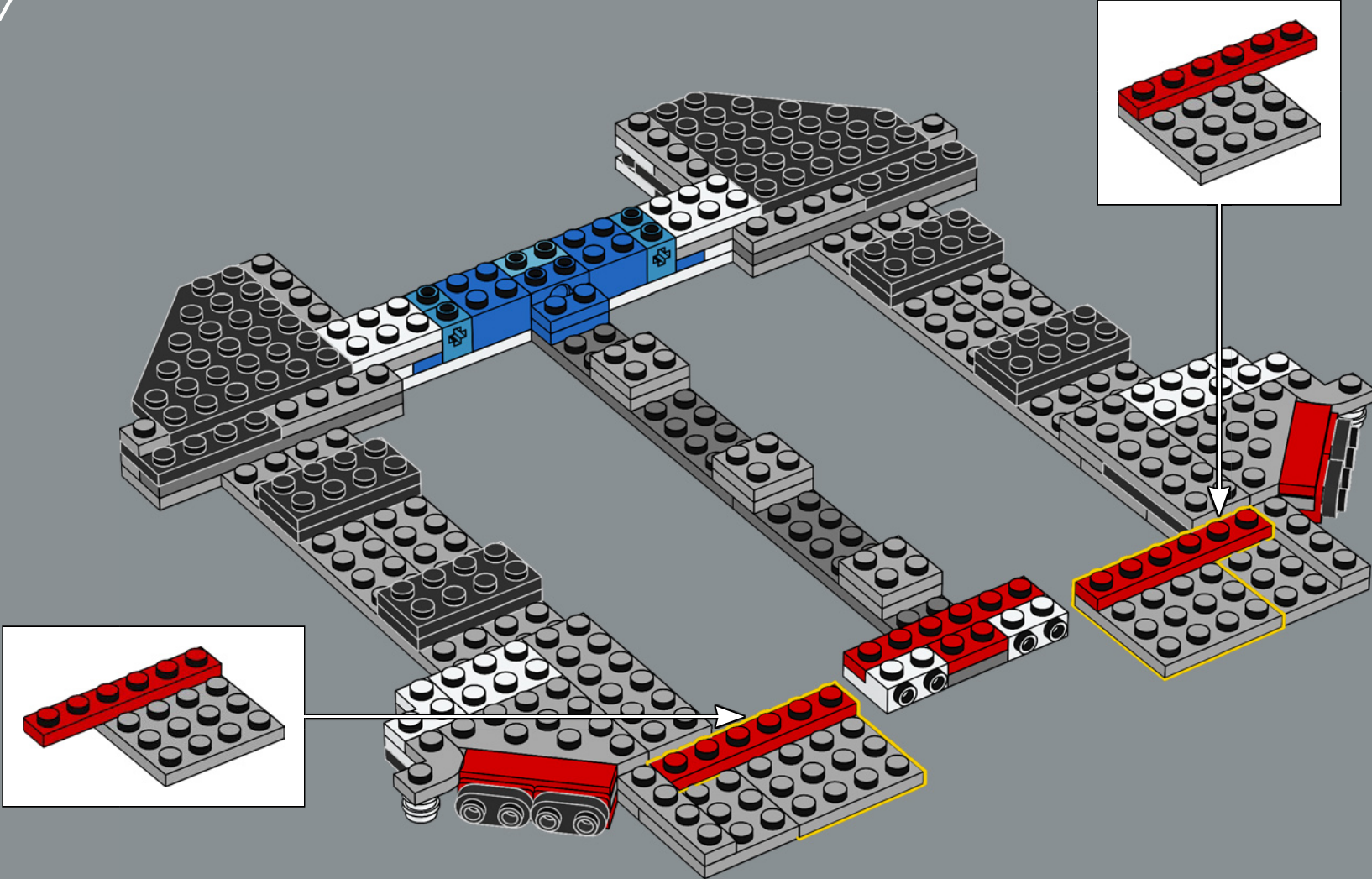

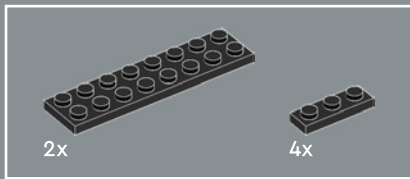

148

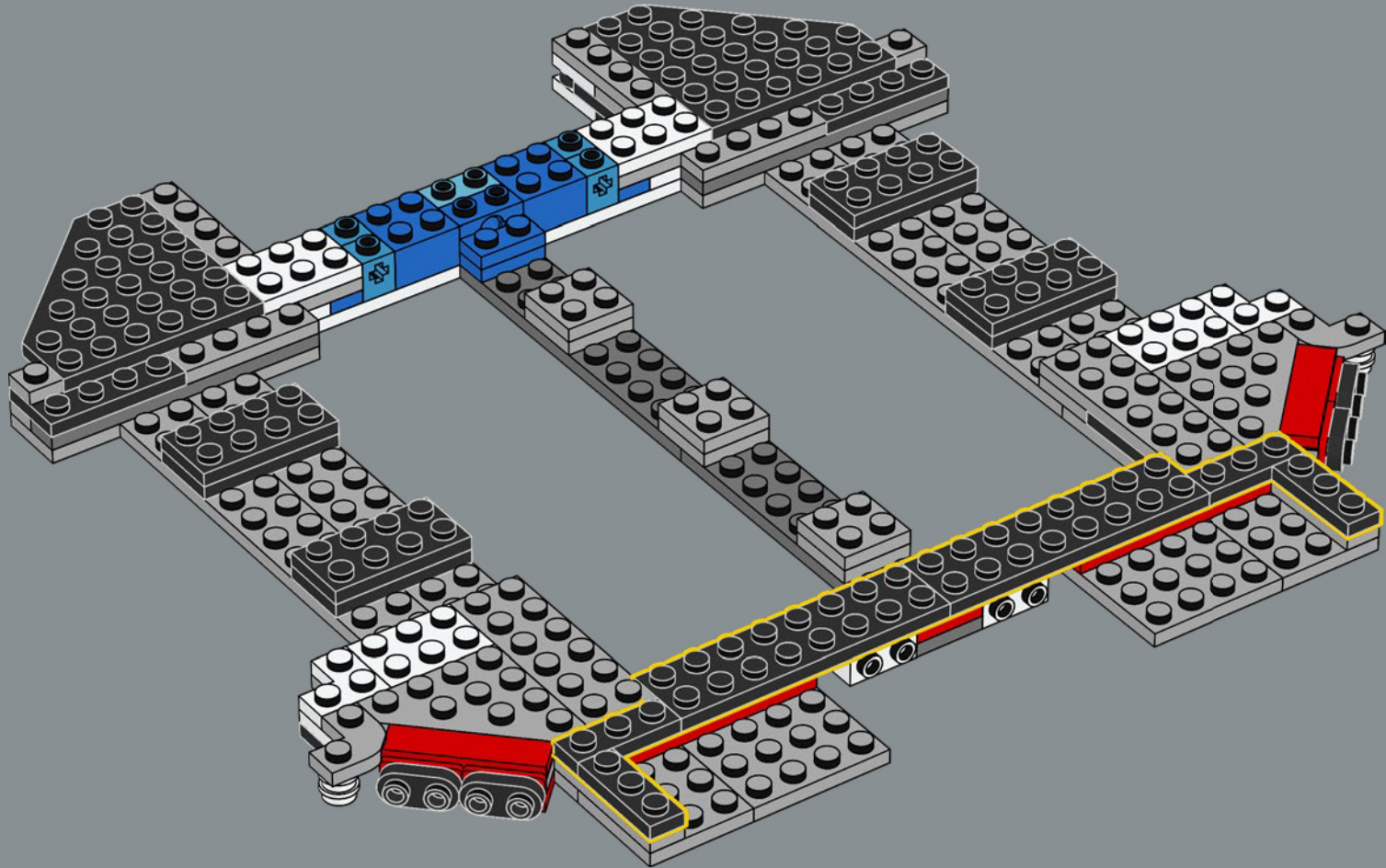

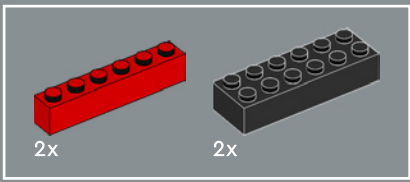

149

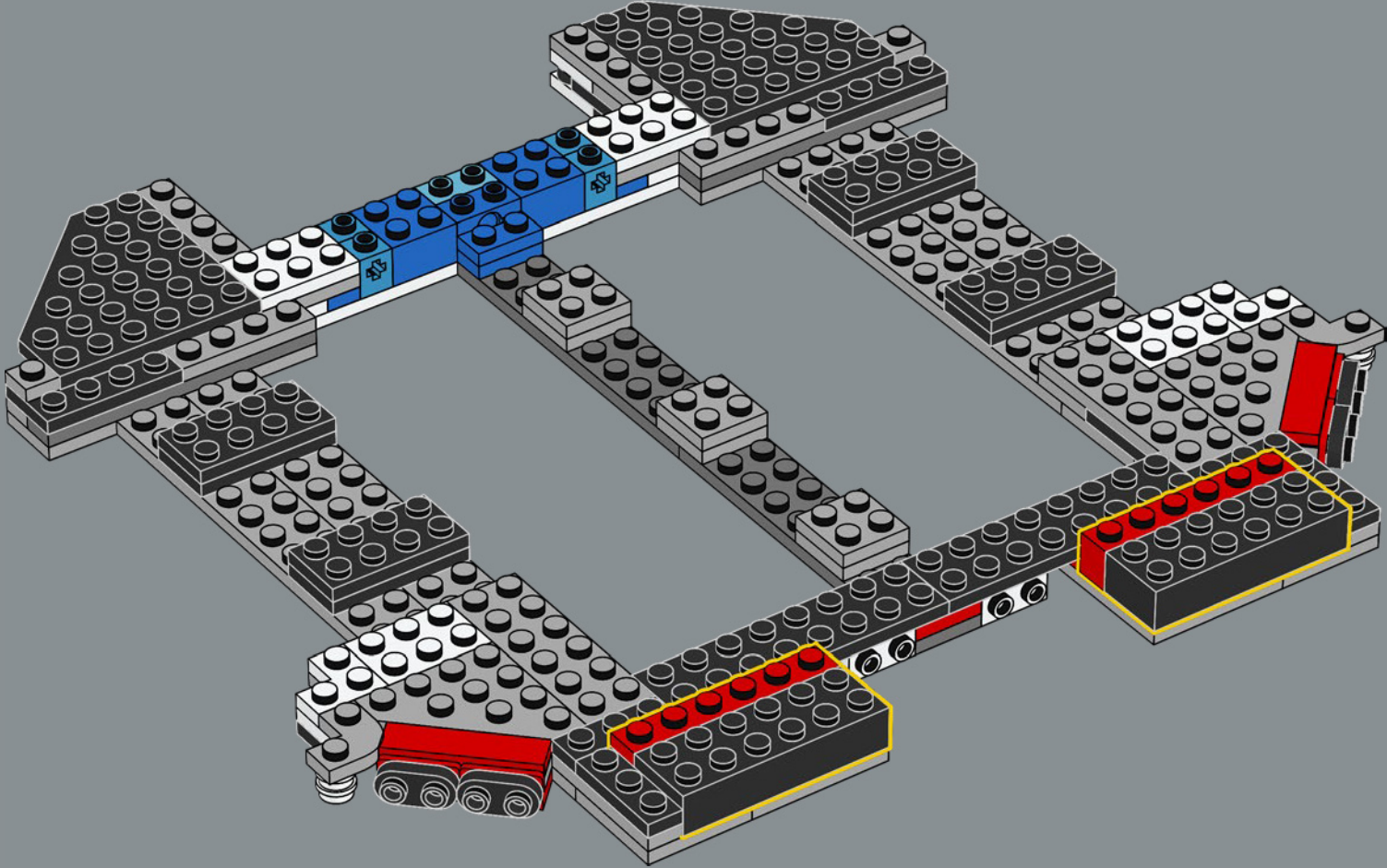

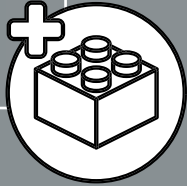
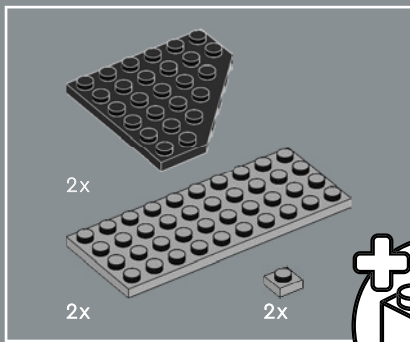

150

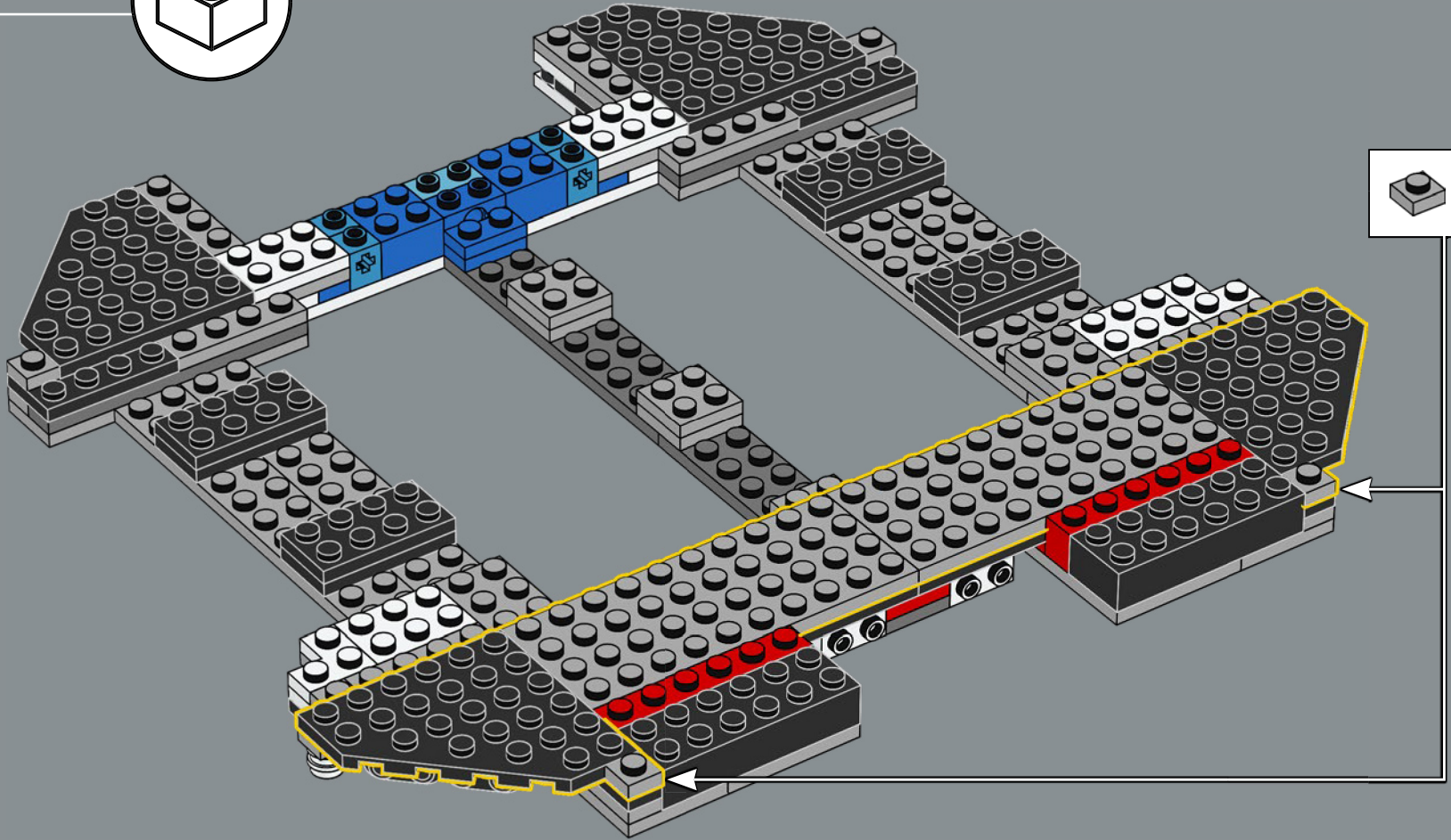

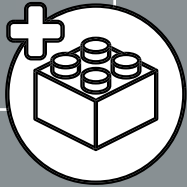
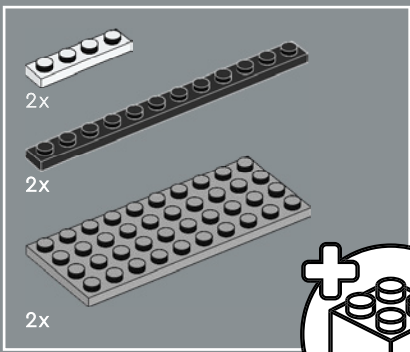

151

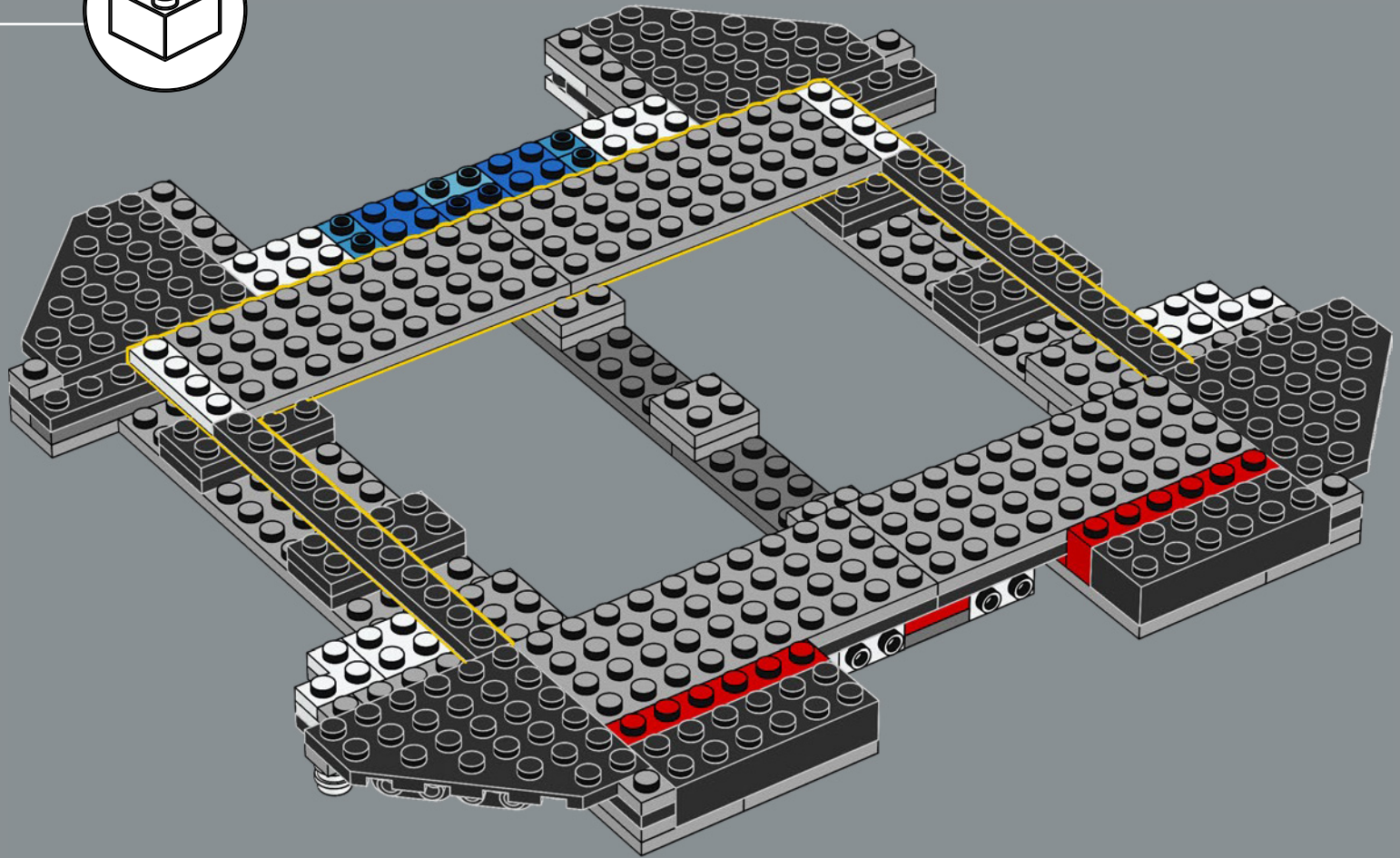

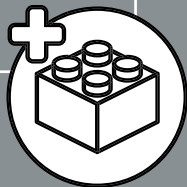
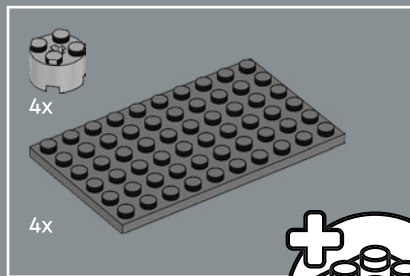

152

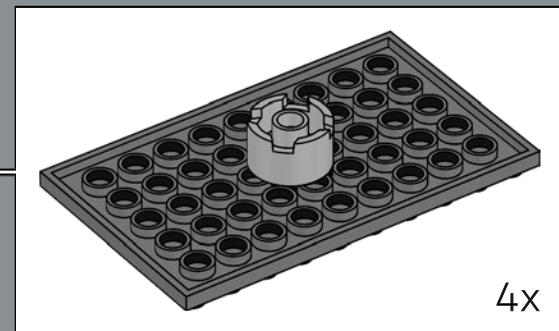
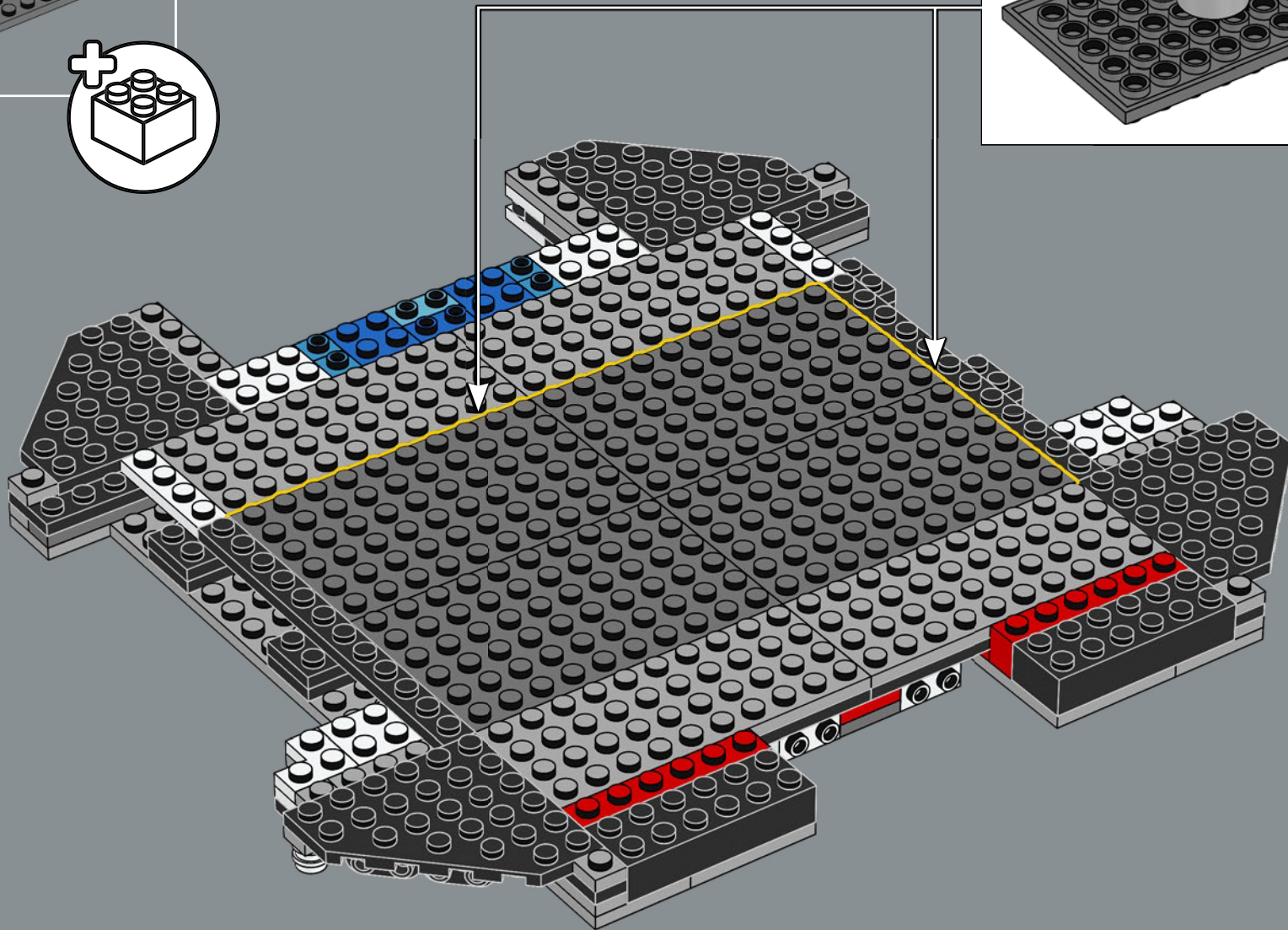

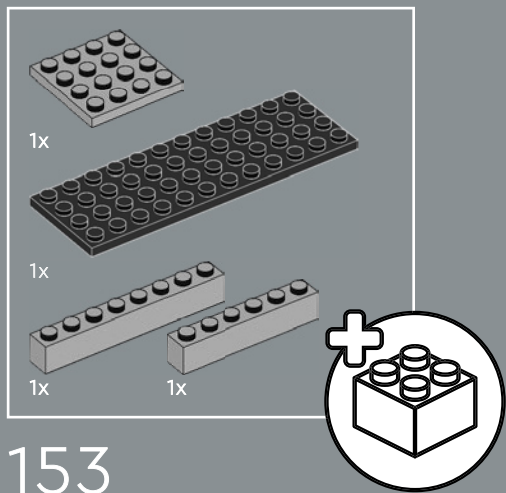

153

1

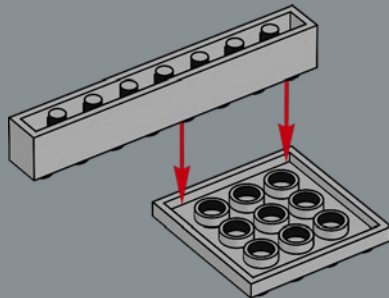

2

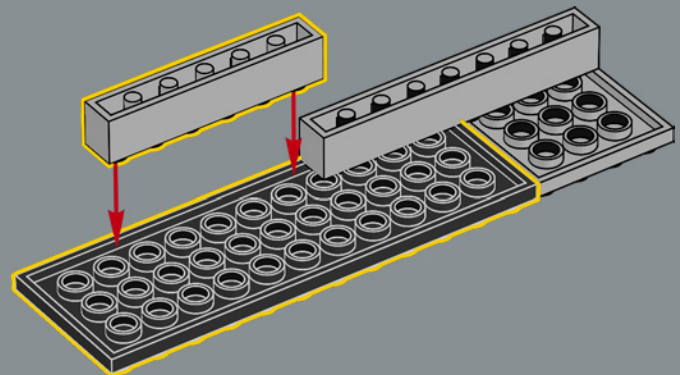

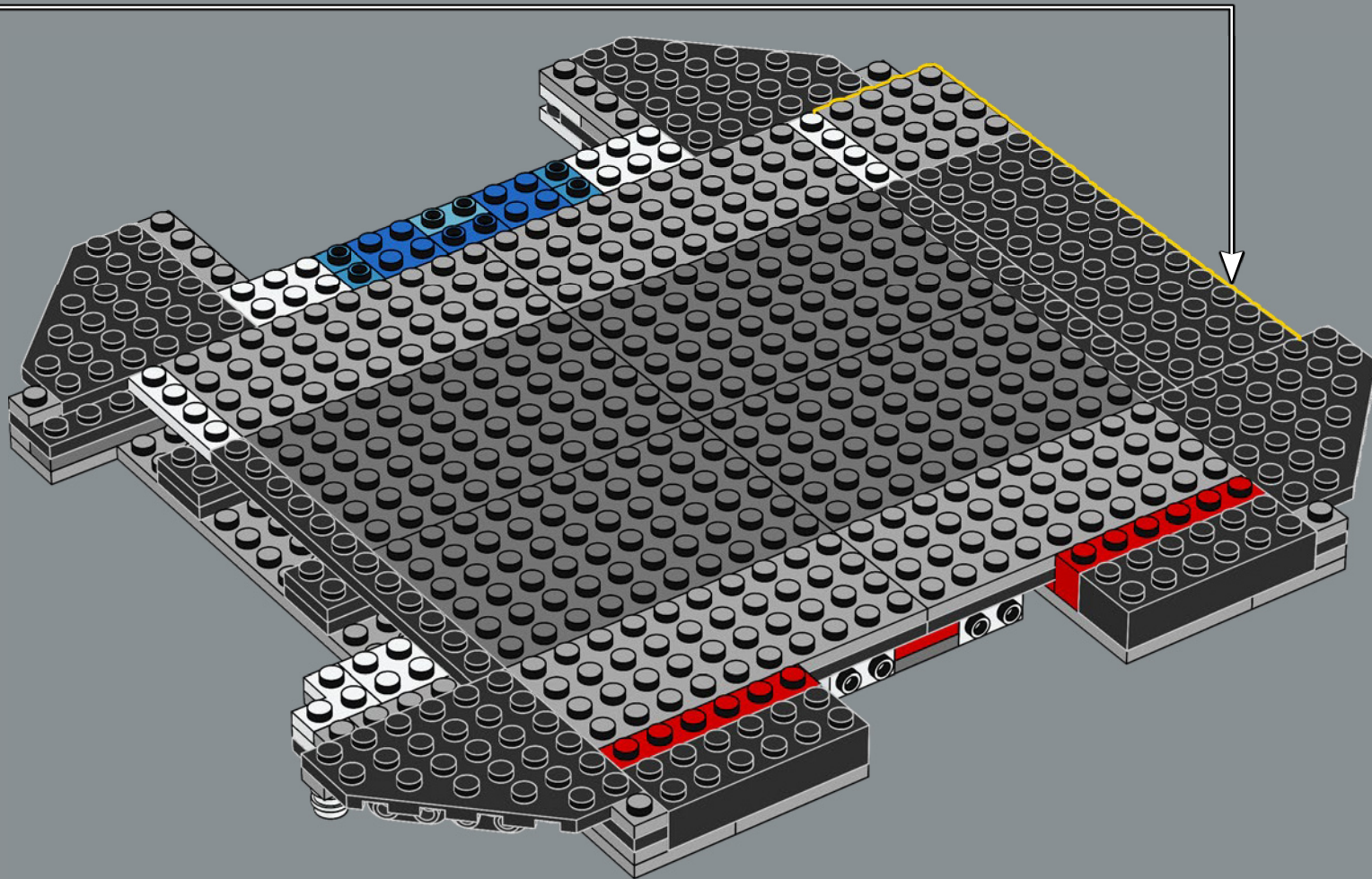

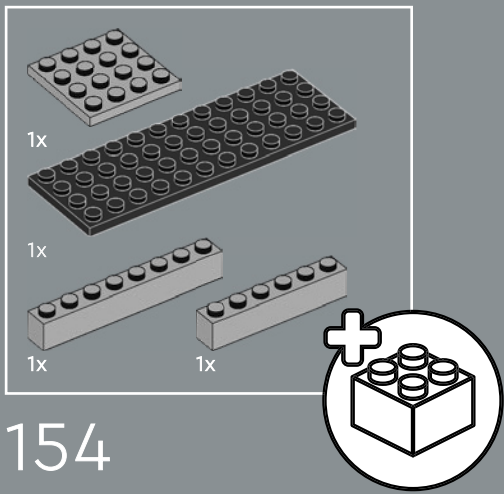

1

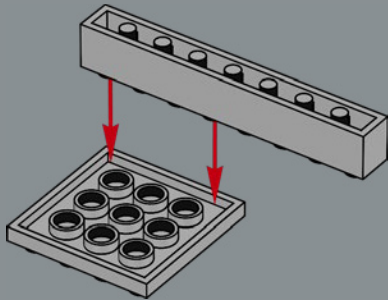

2

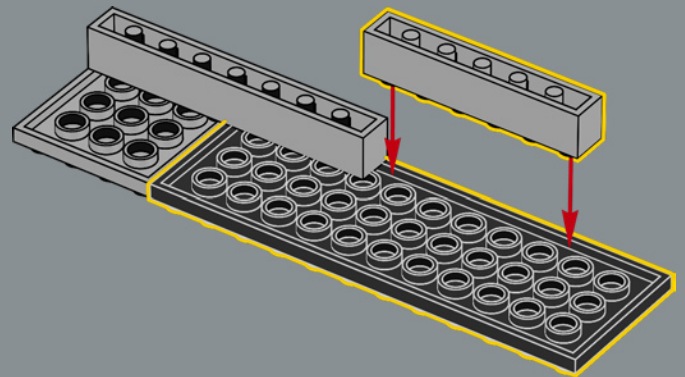

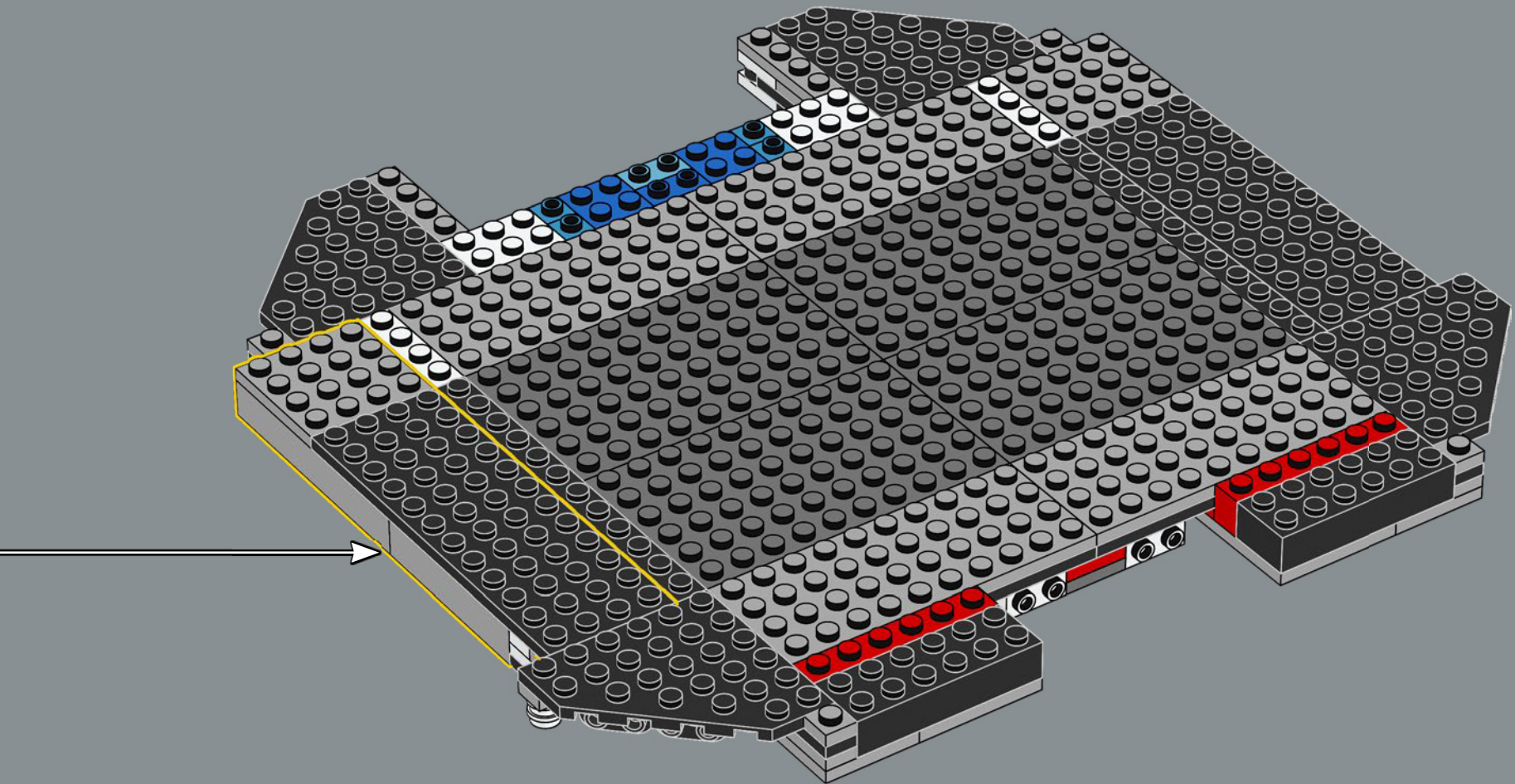

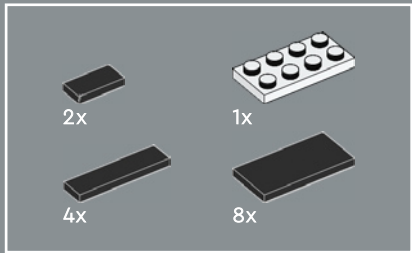

155

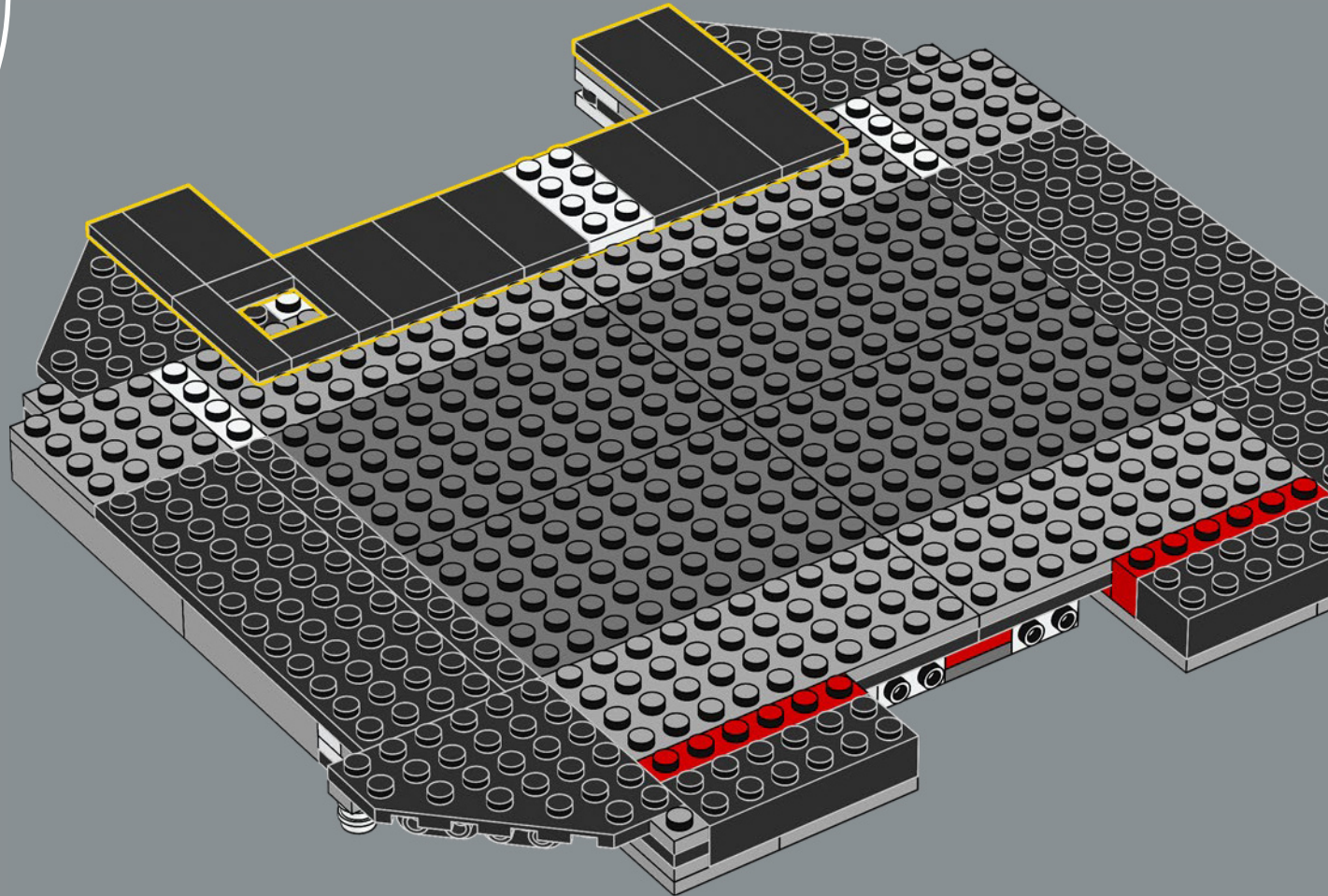

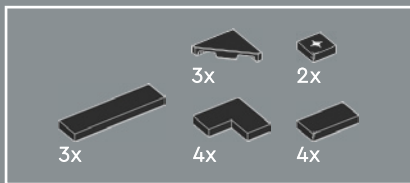

156

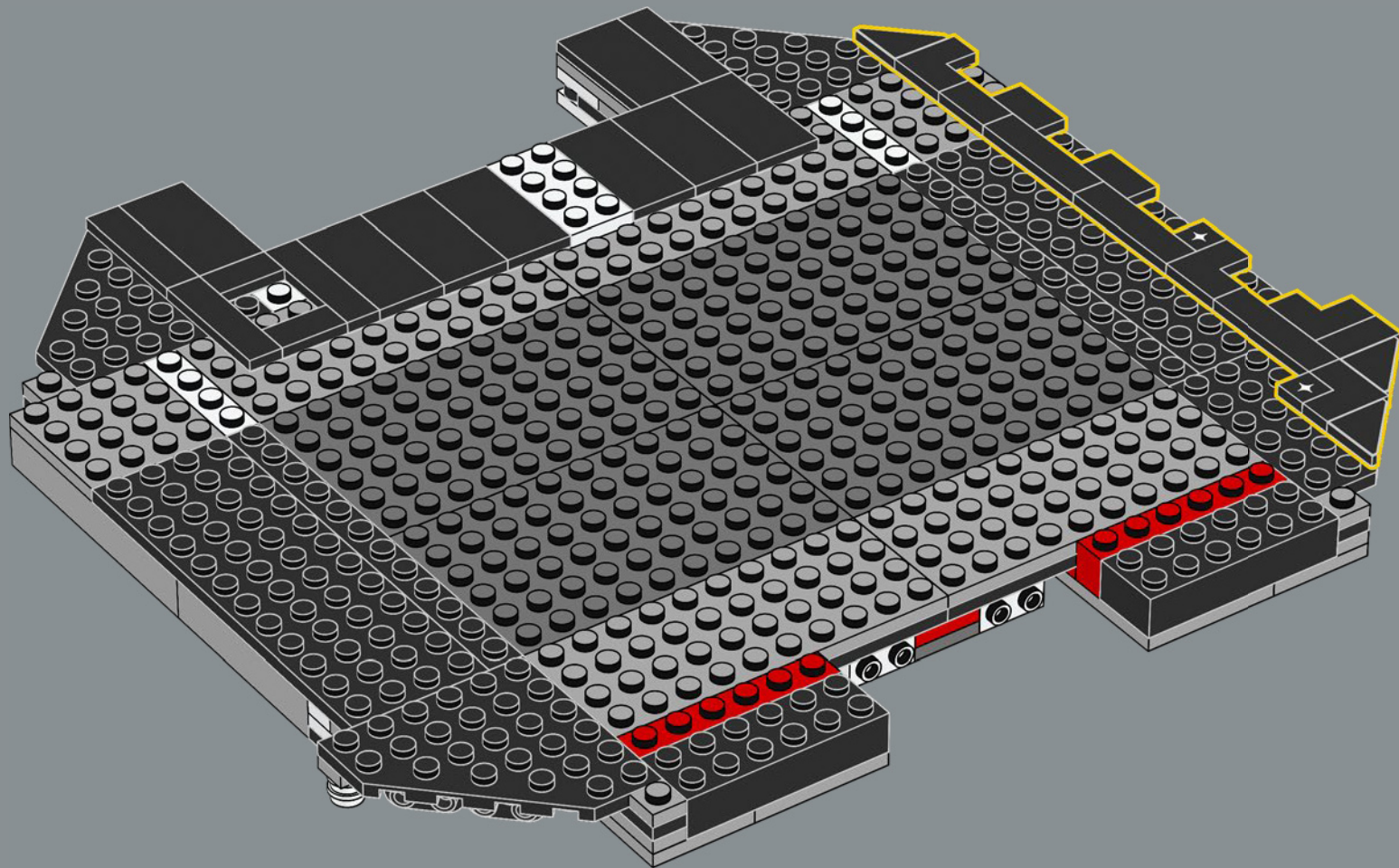

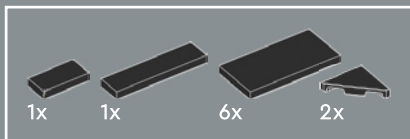

157

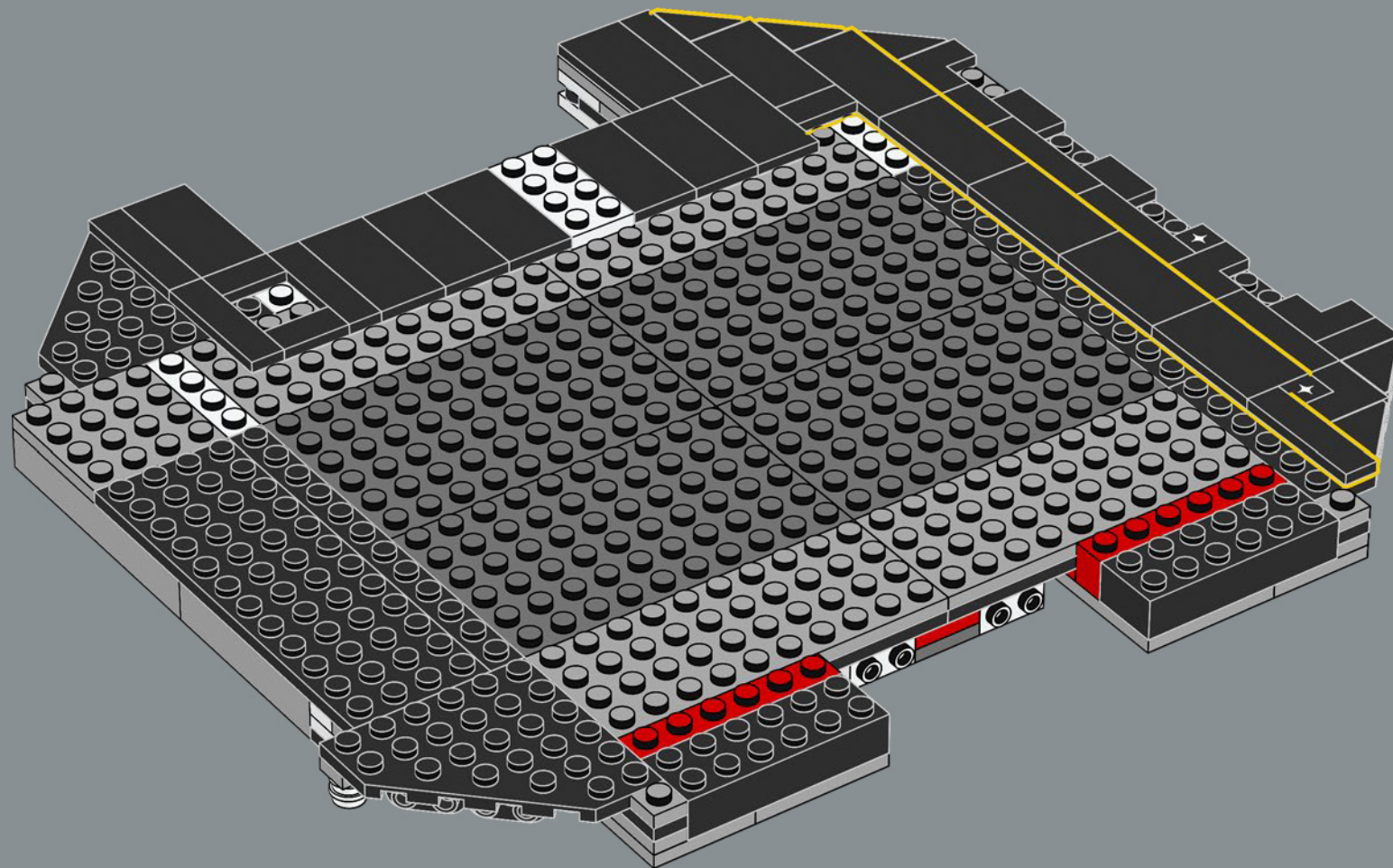

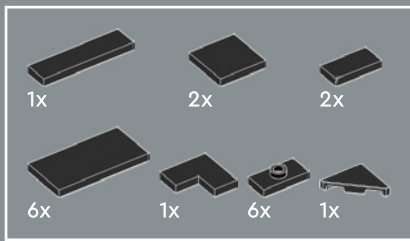

158

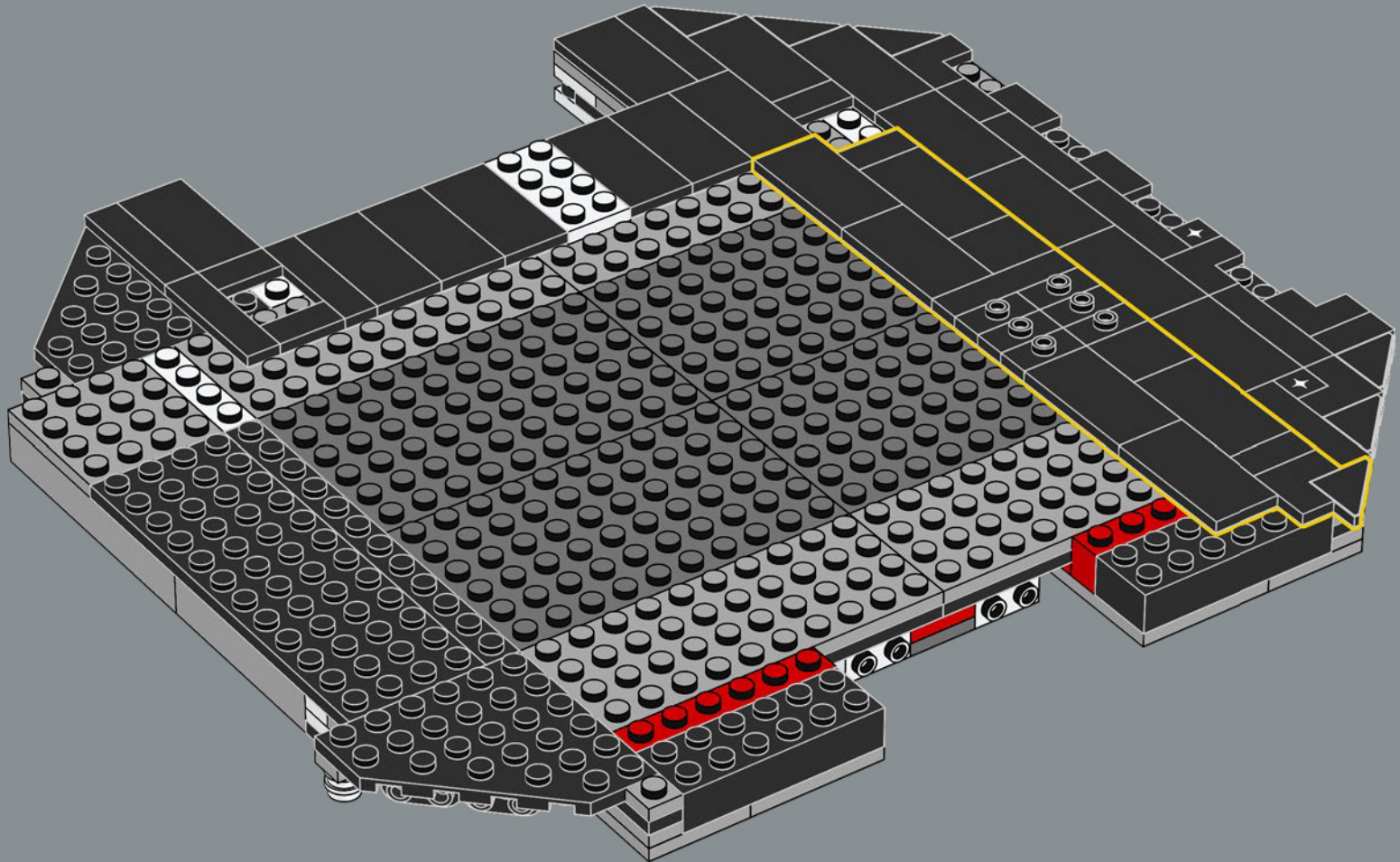

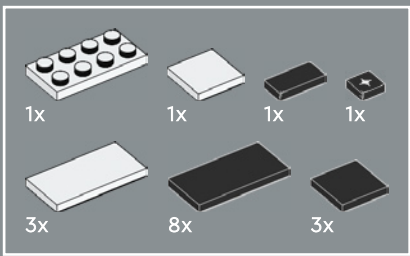

159

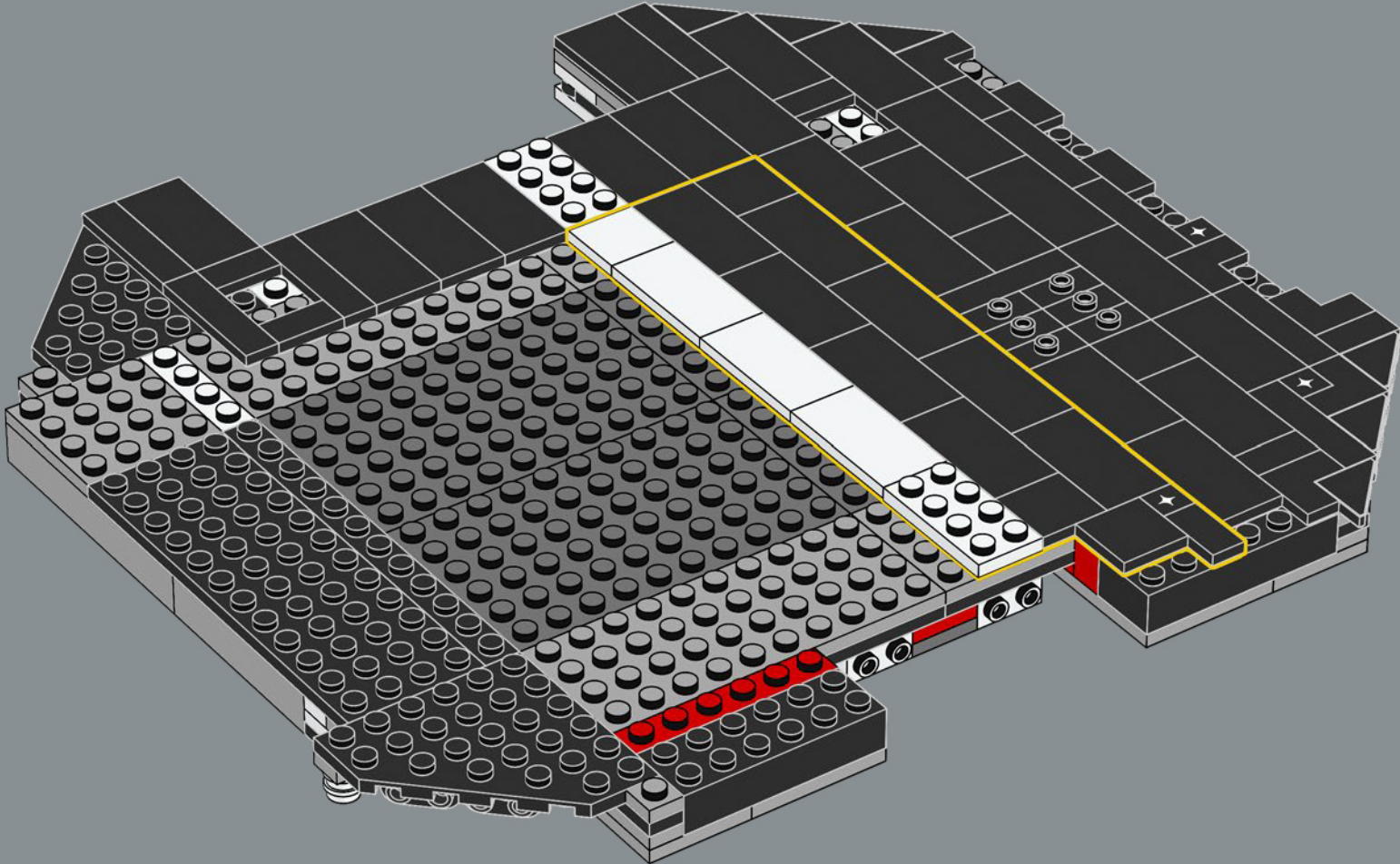

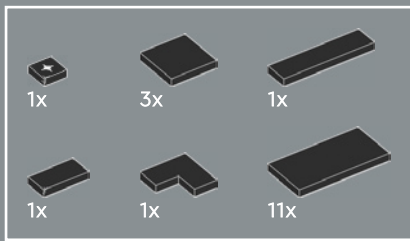

160

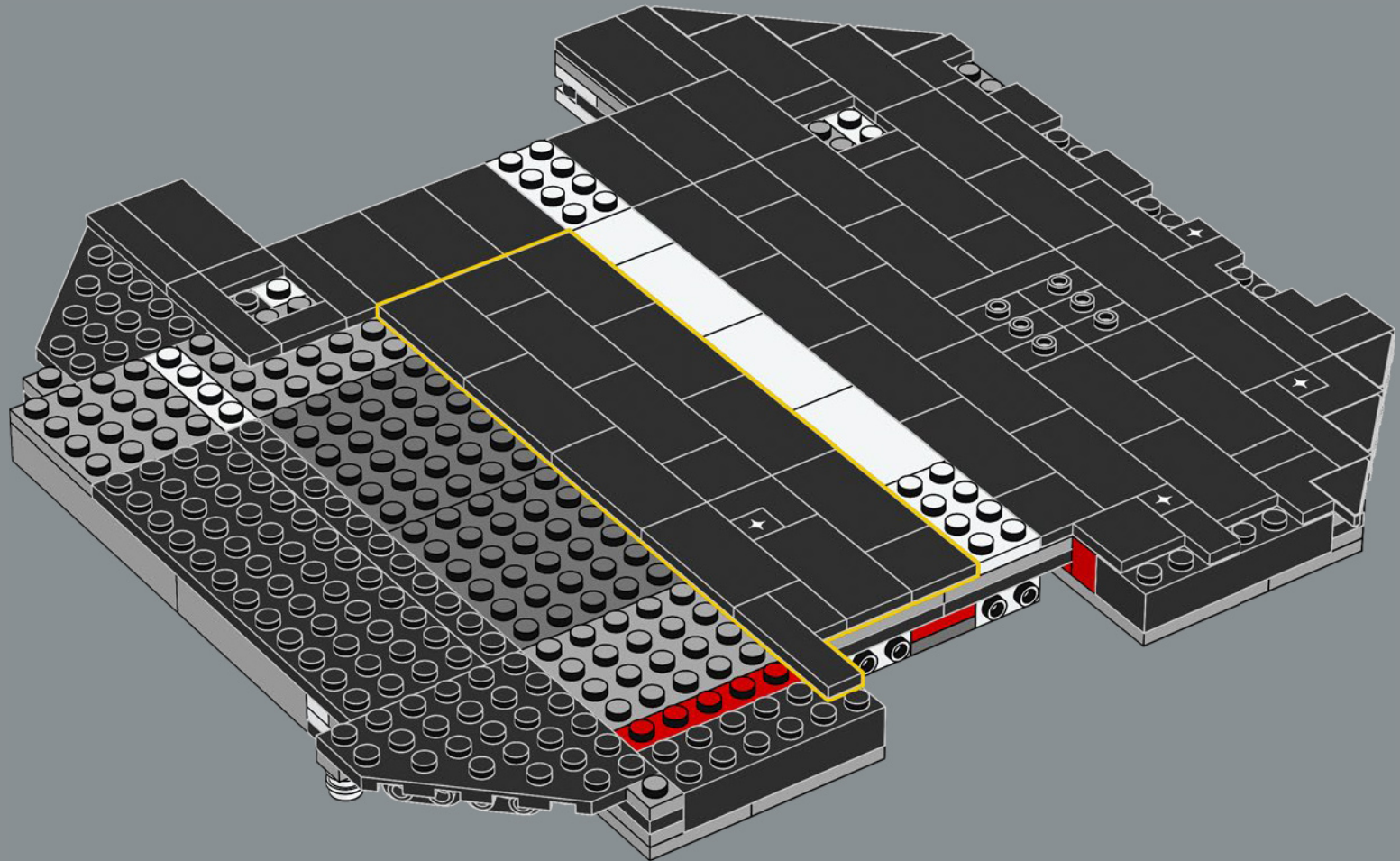

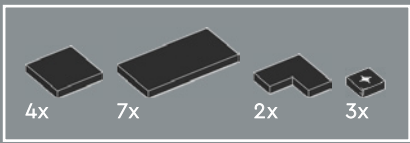

161

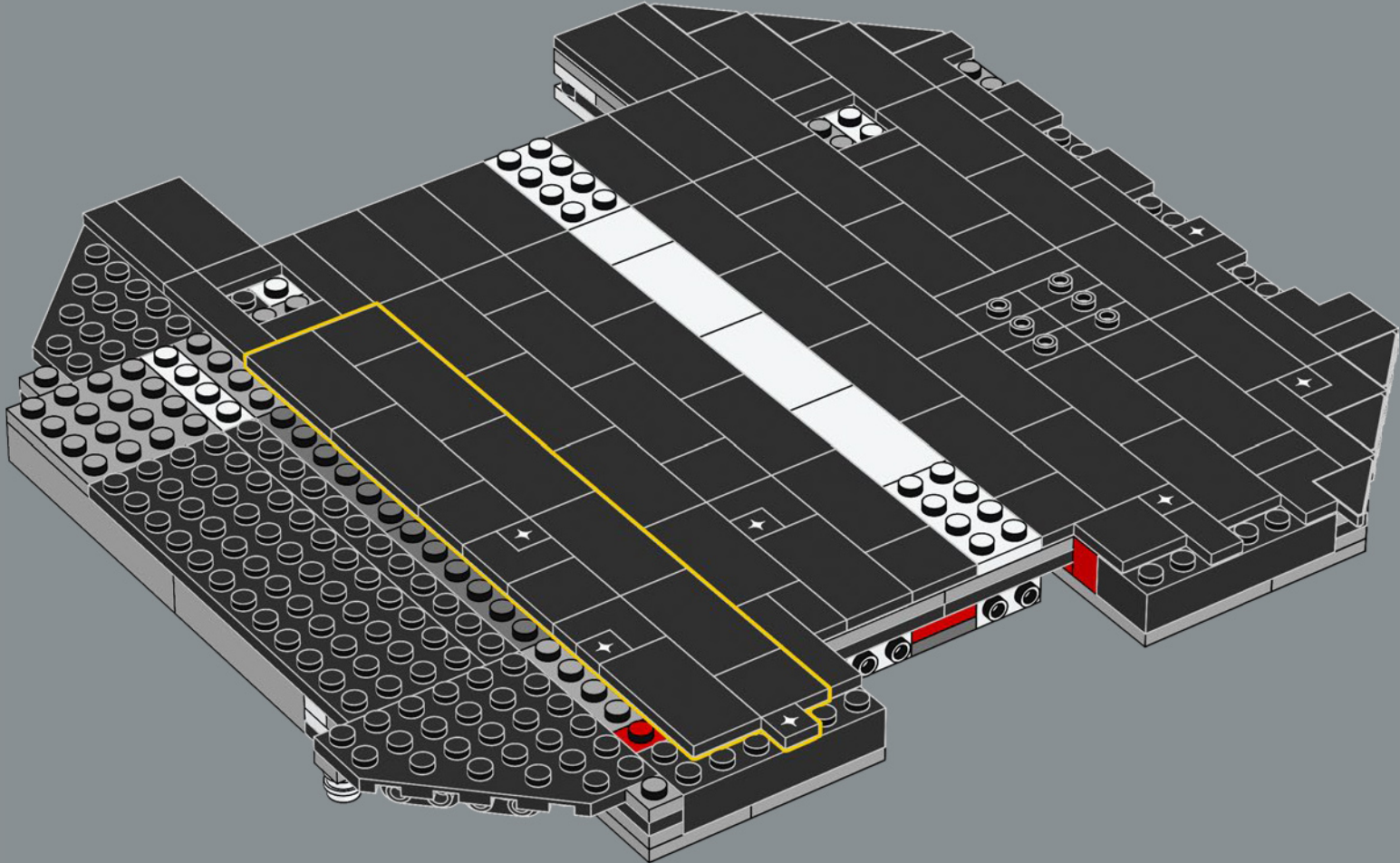

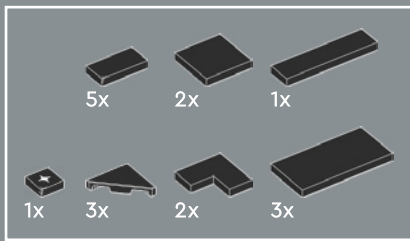

162

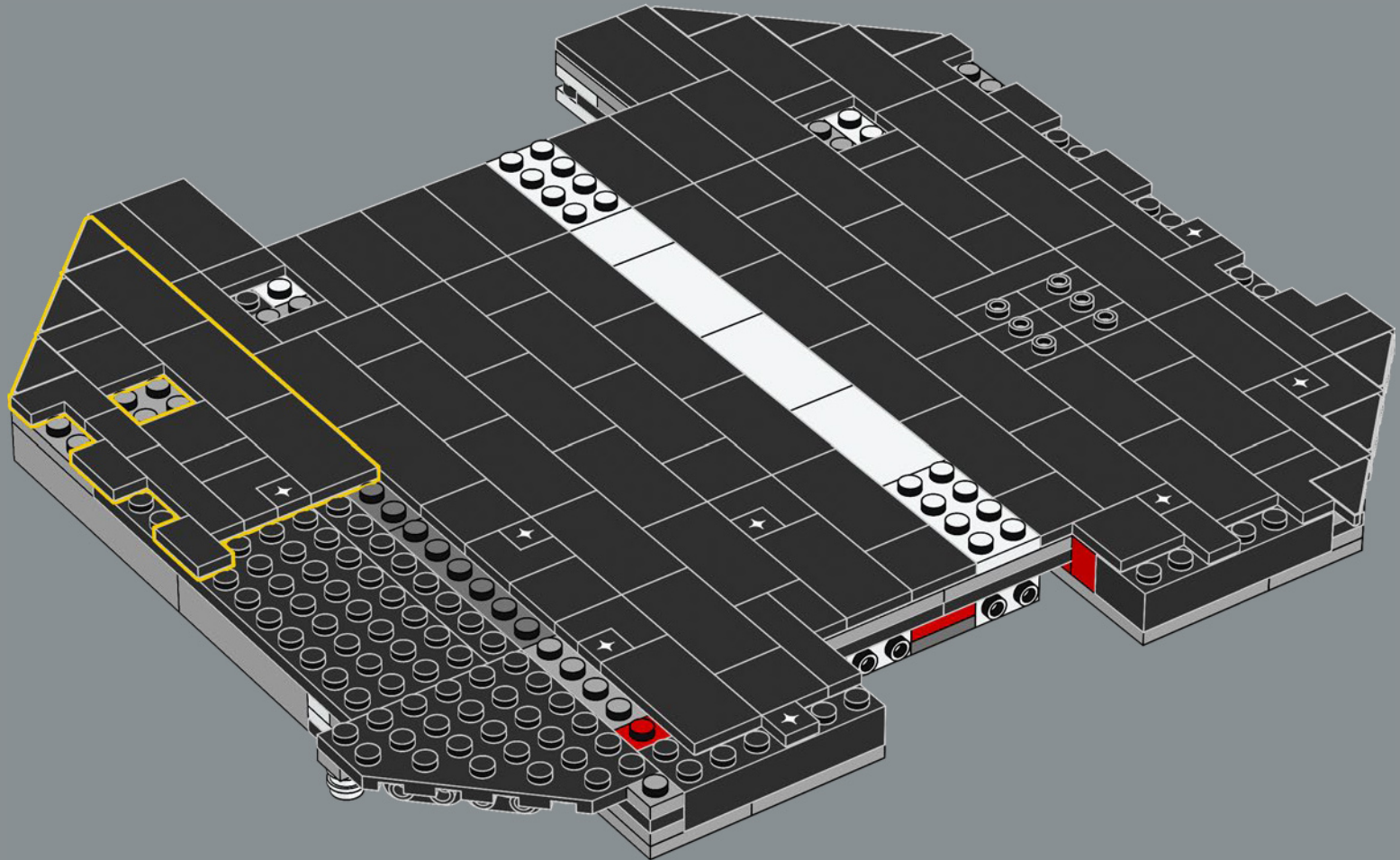

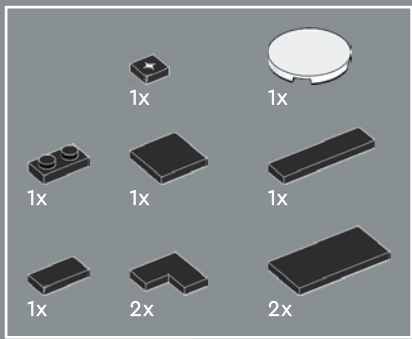

163

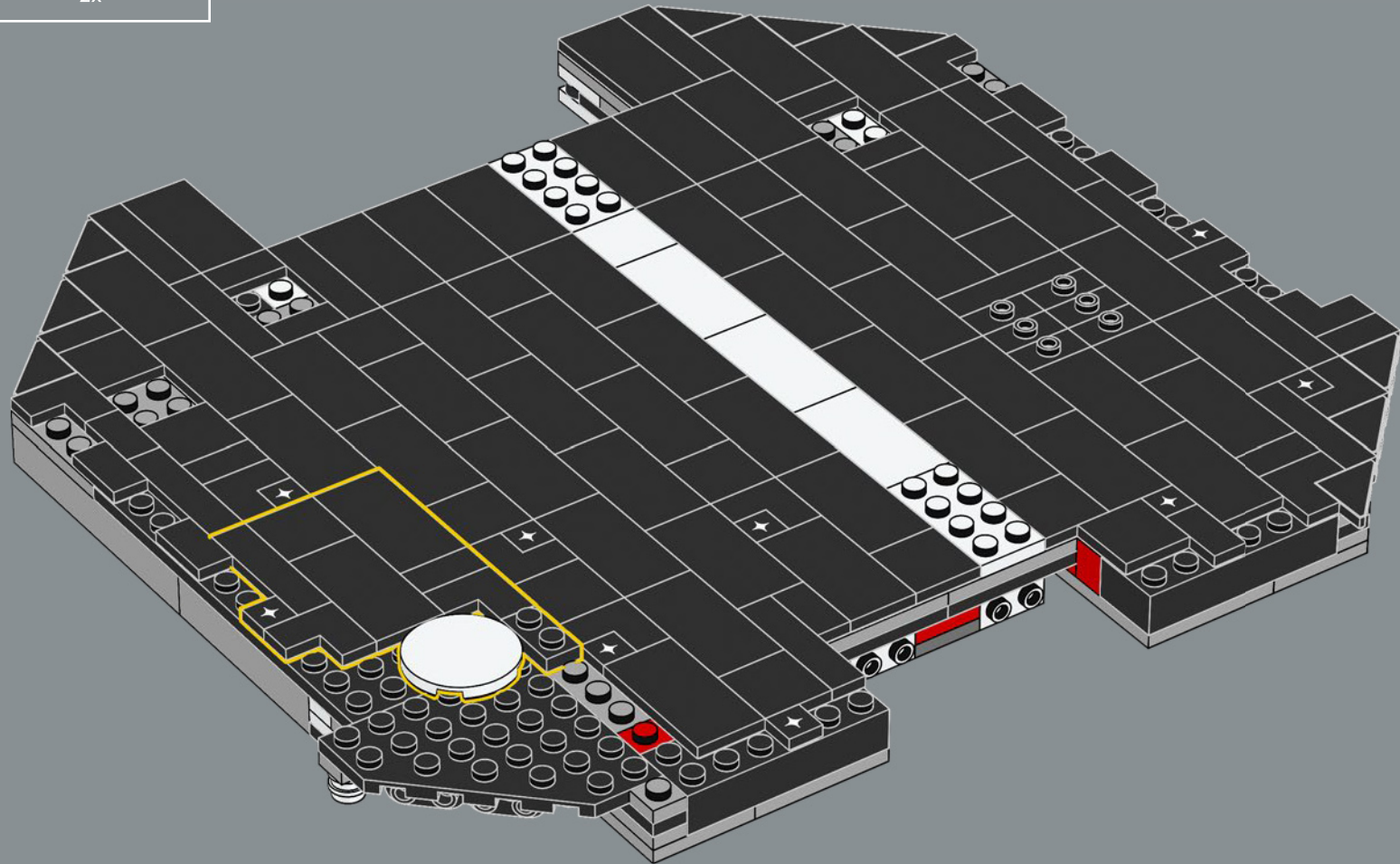

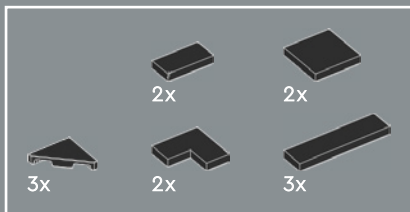

164

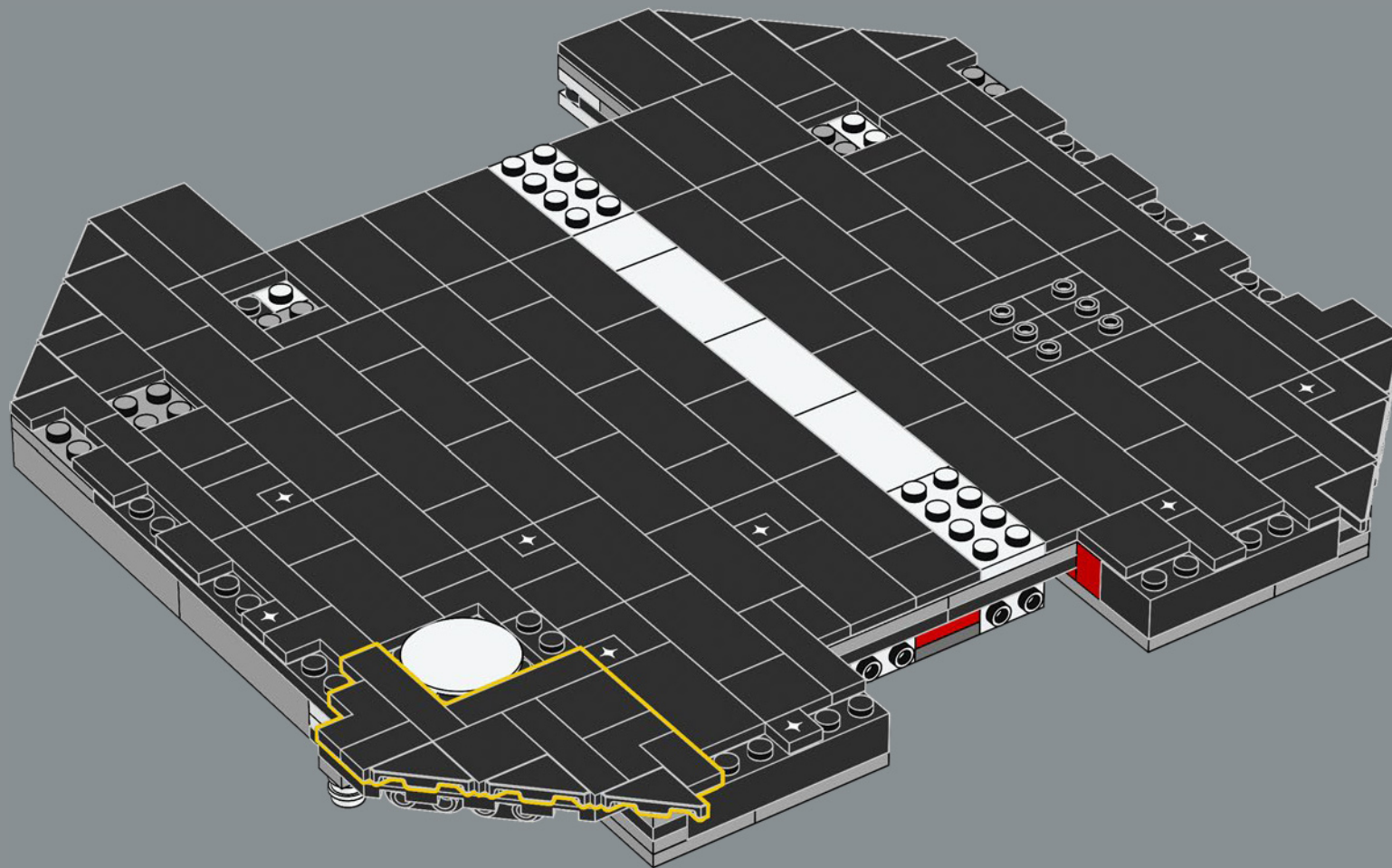

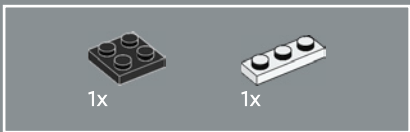

165

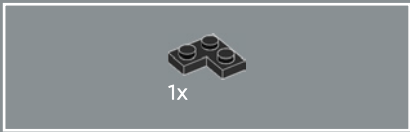
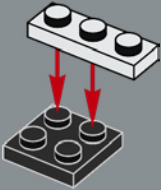

166

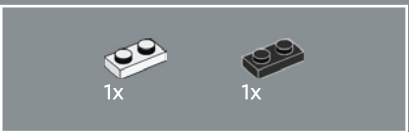
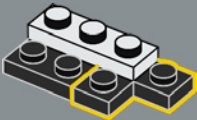

167

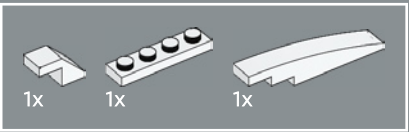
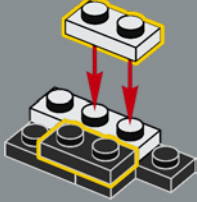

168

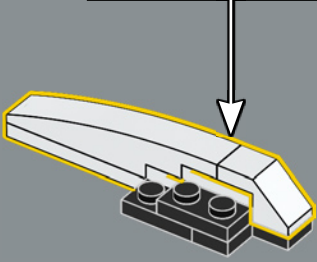
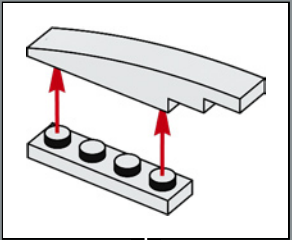

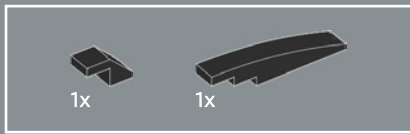

169

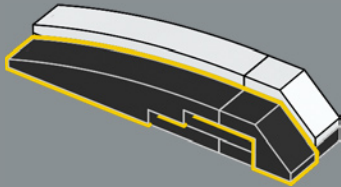

170

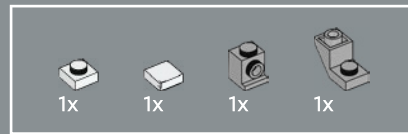
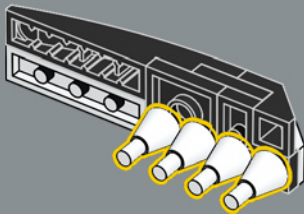

171

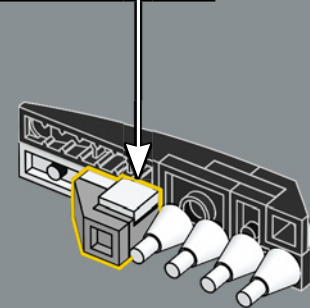
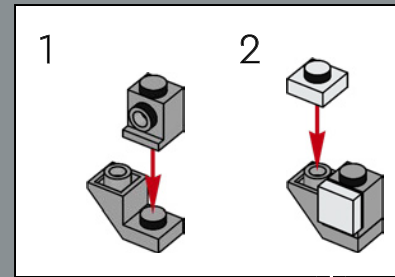

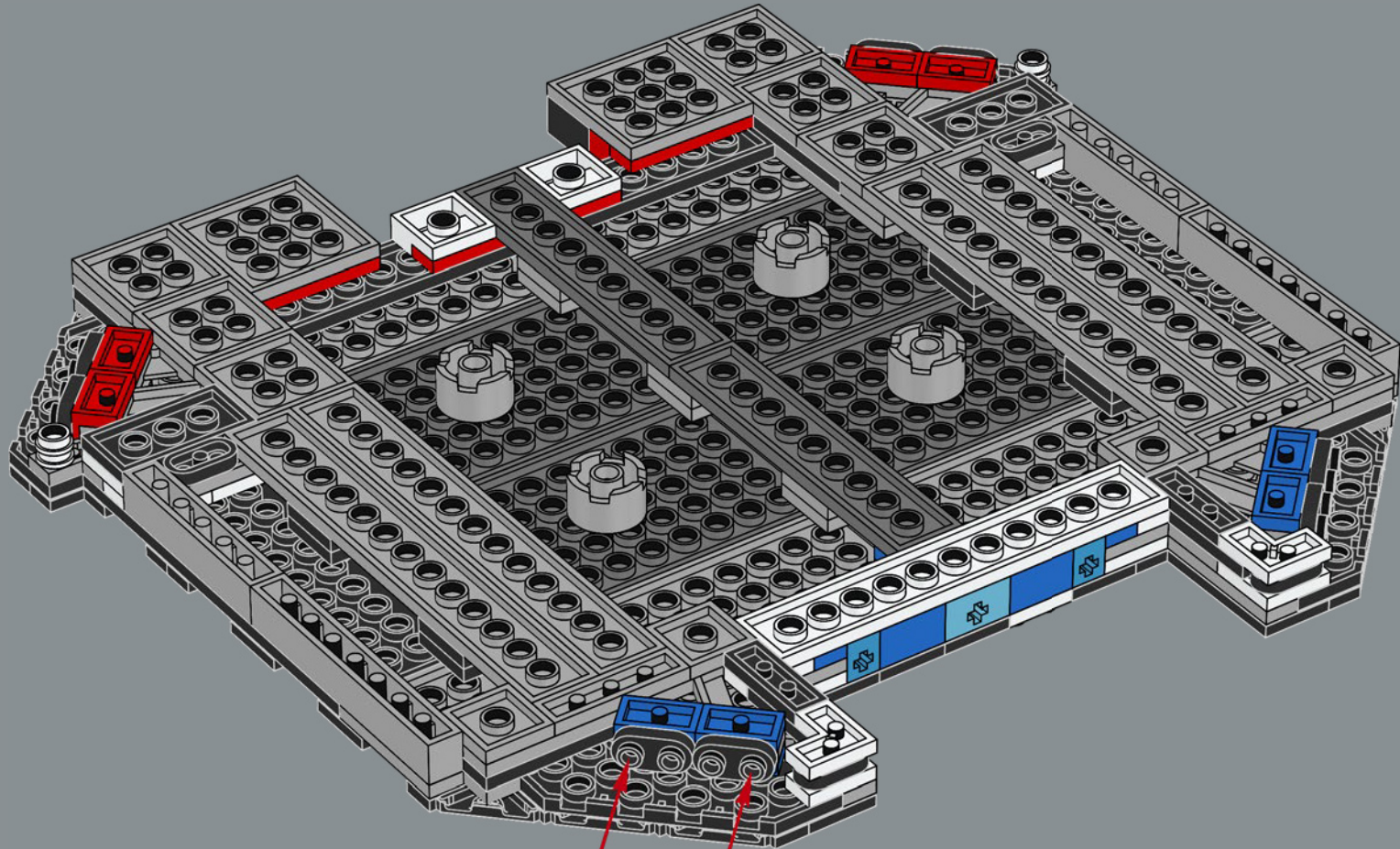

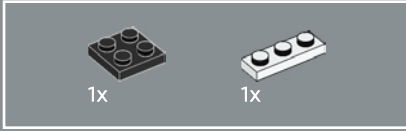
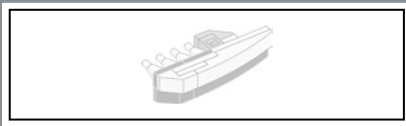

173

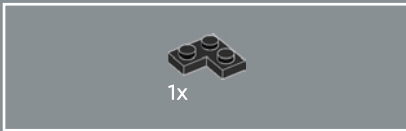
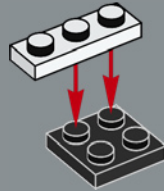

174

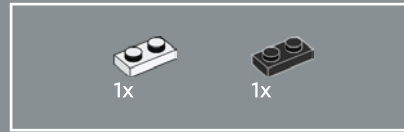
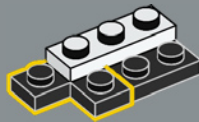

175

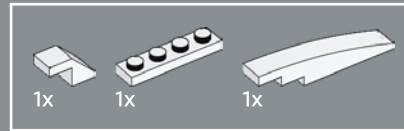
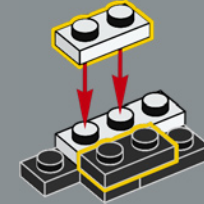

176

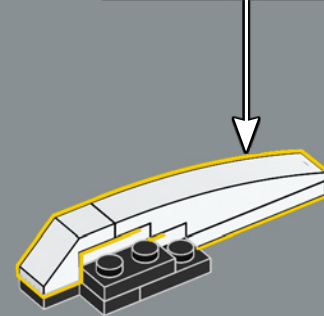
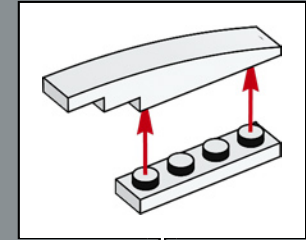

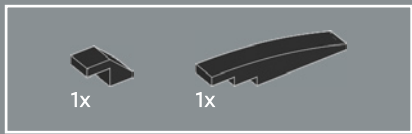

177

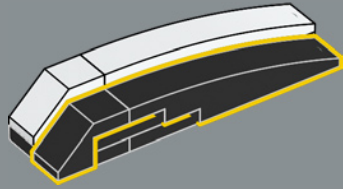

178

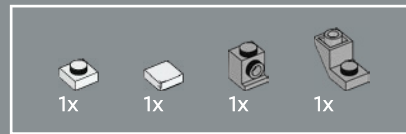
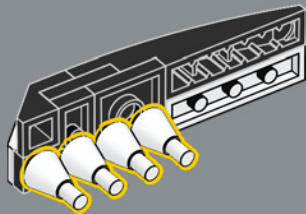

179

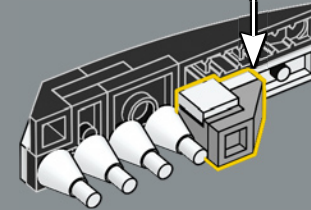
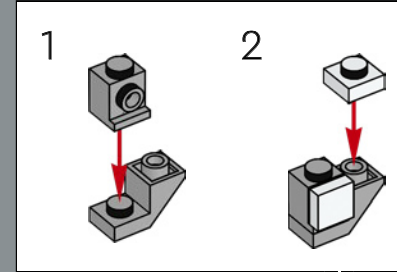

180

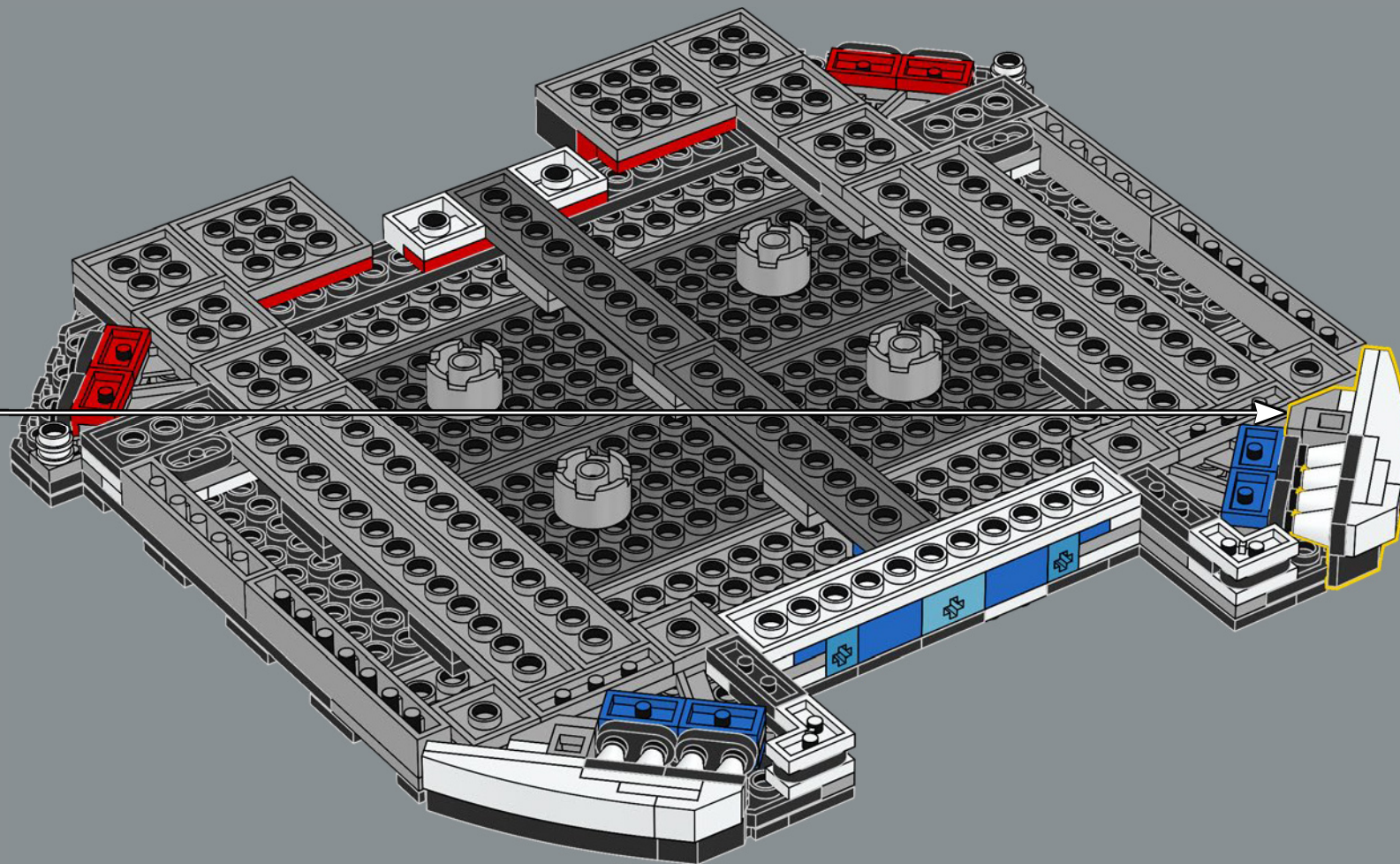

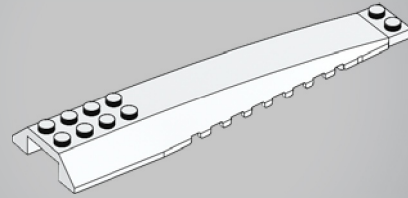
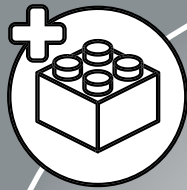

1x

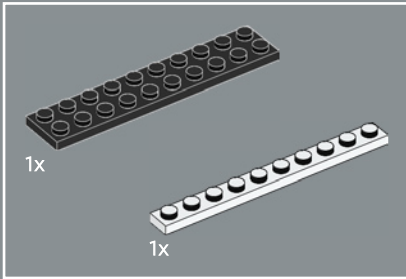
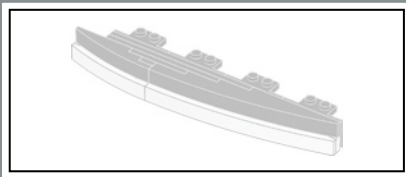

181

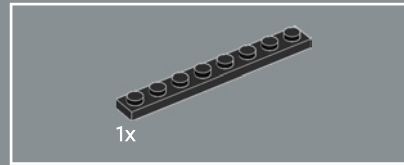
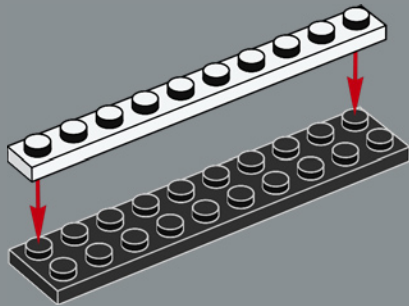

182

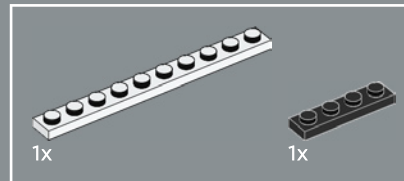
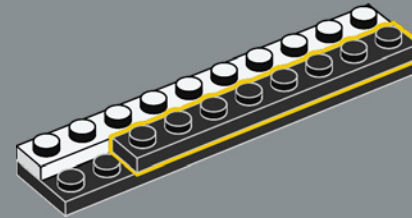

183

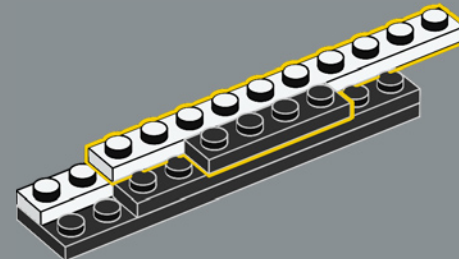

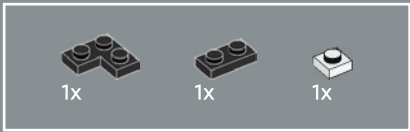

184

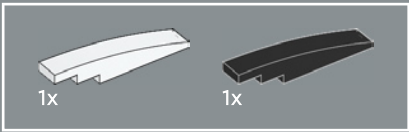
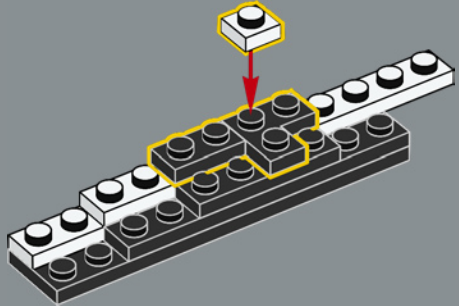

185

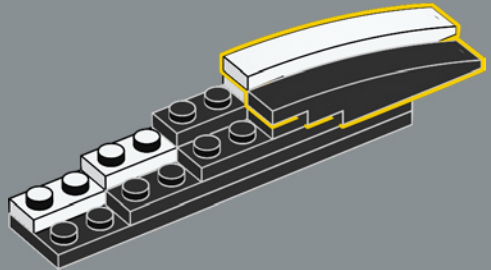

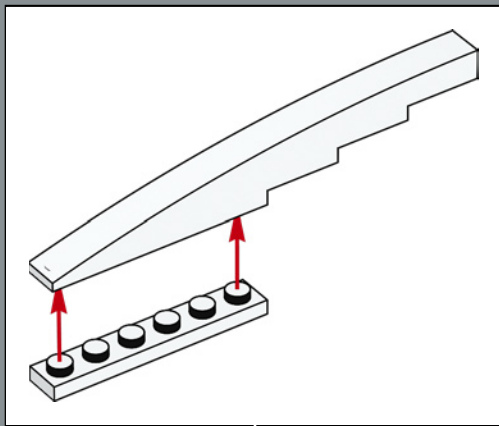
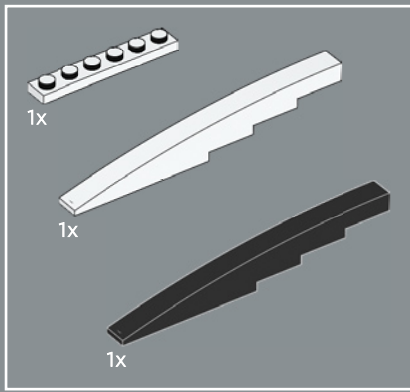

186

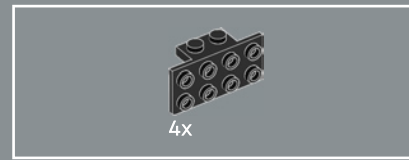
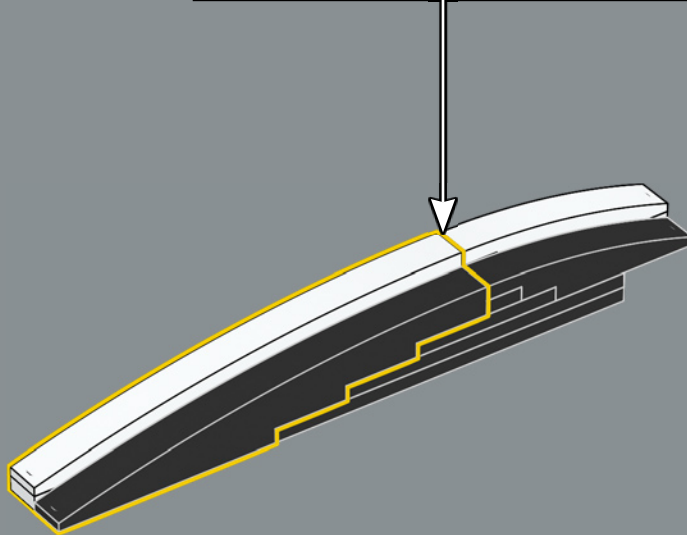

187

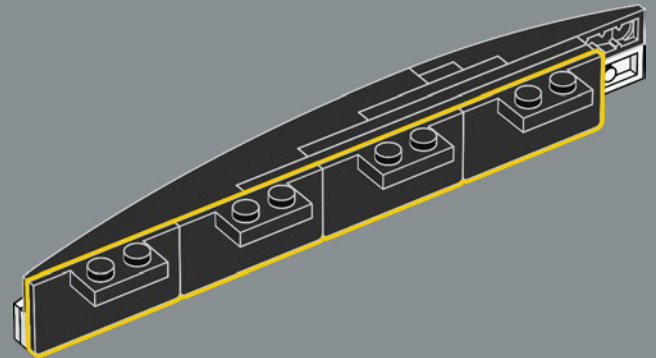

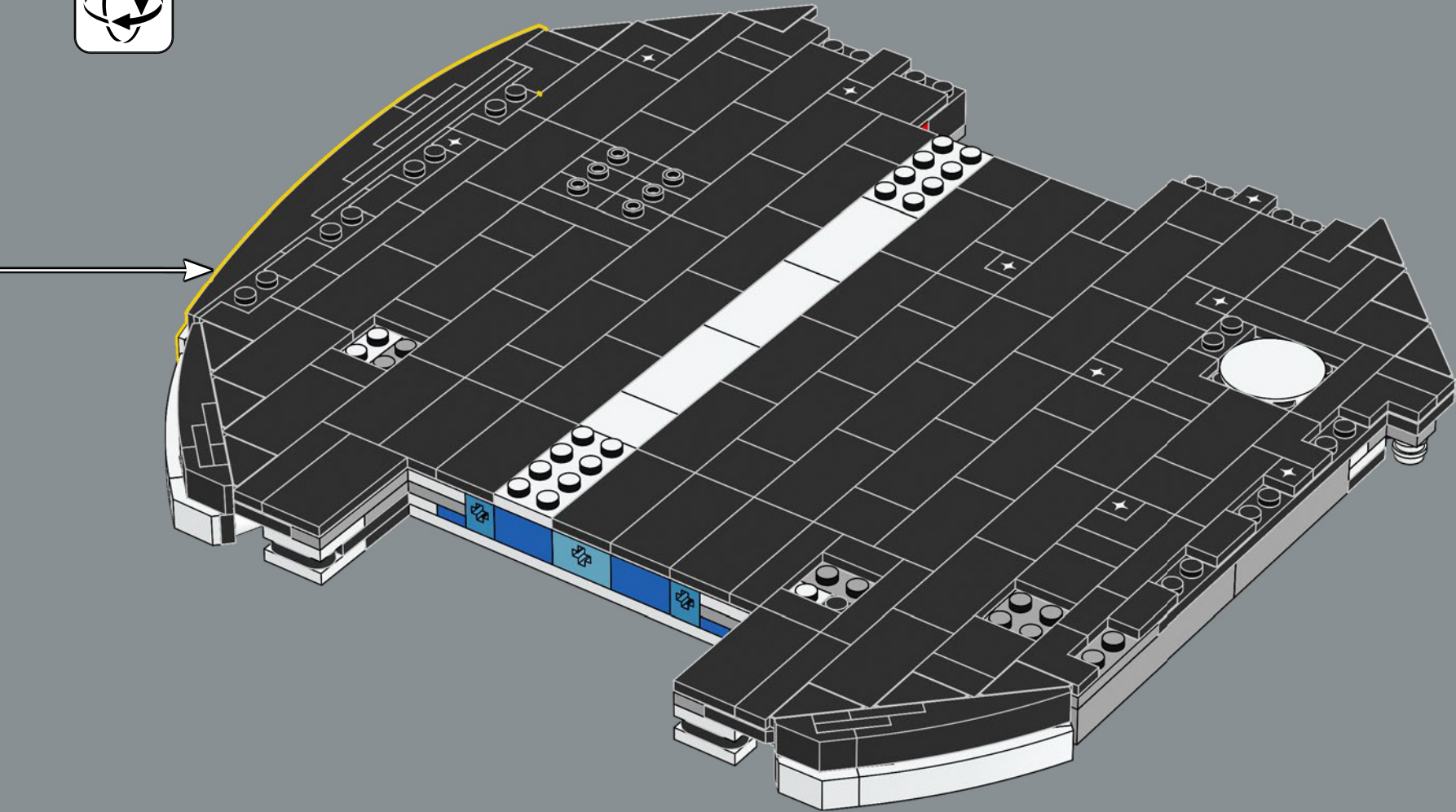

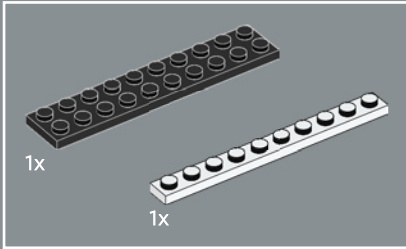
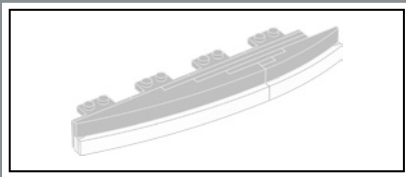

189

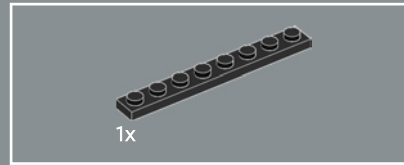
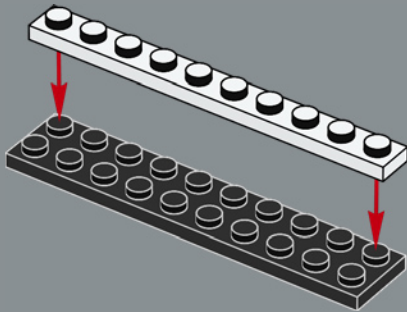

190

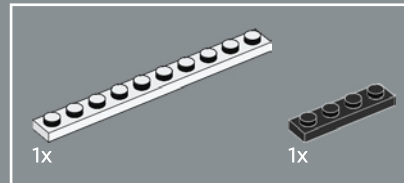
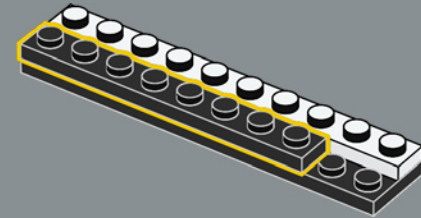

191

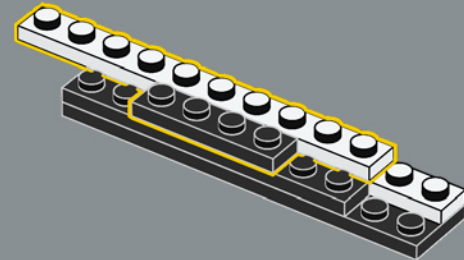

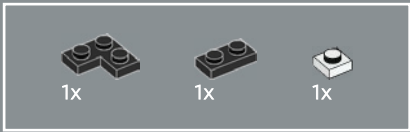

192

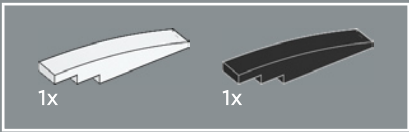
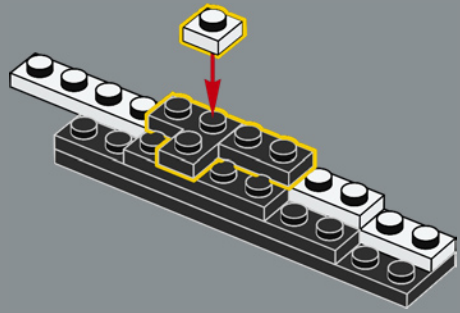

193

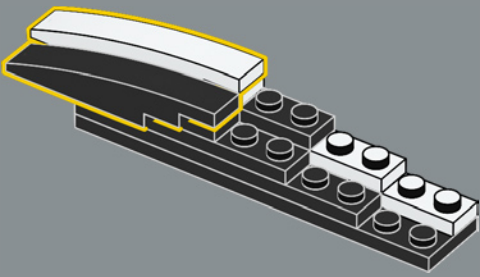

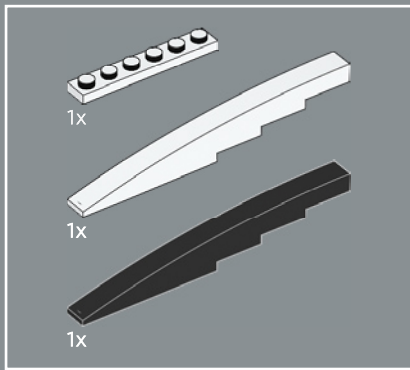

194

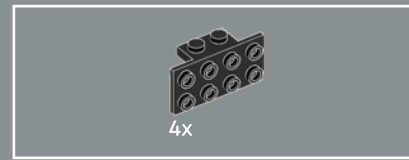
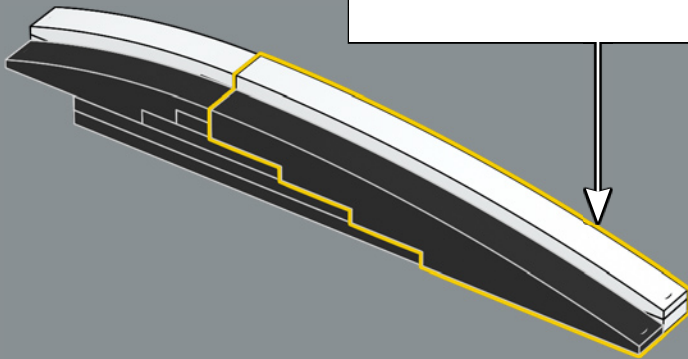
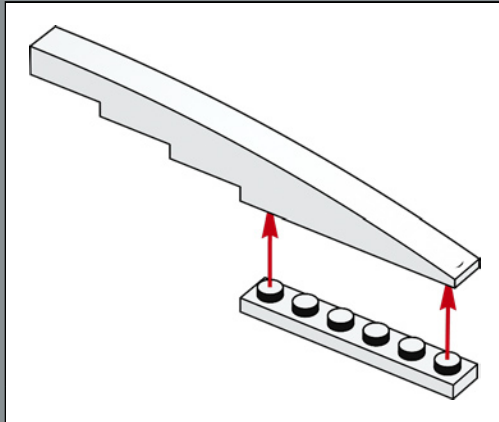

195

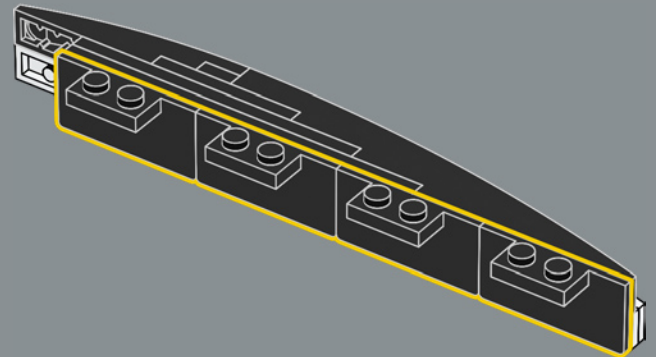

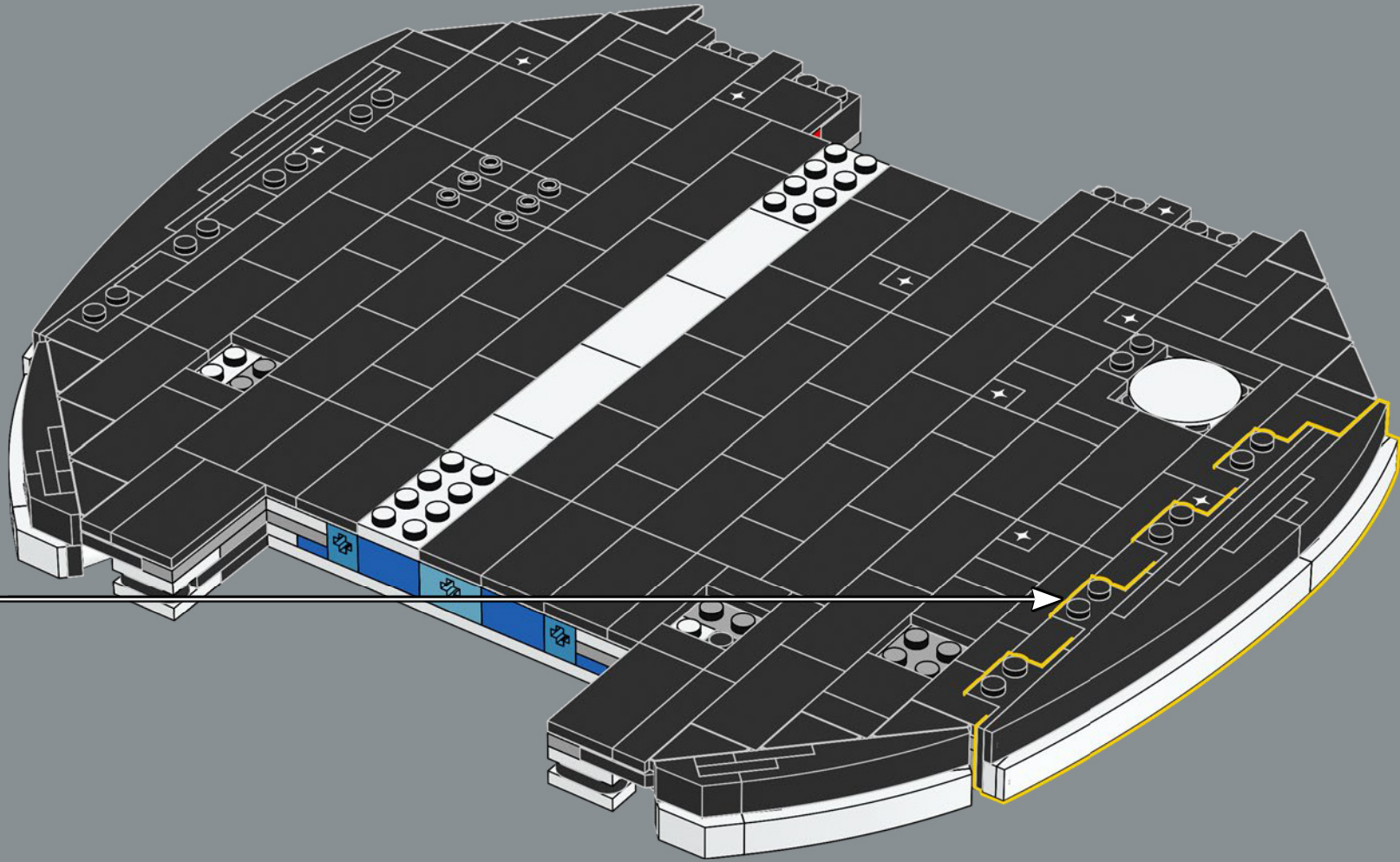

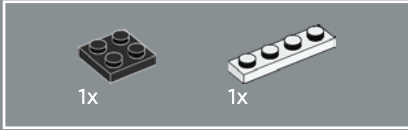
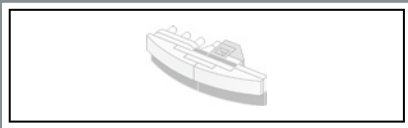

197

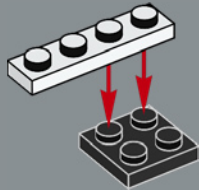

198

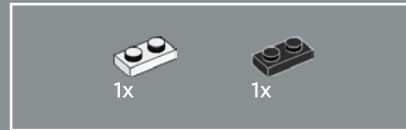
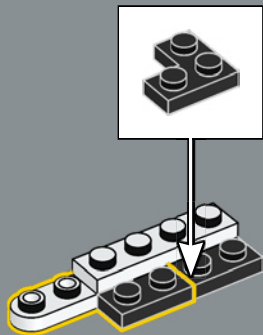

199

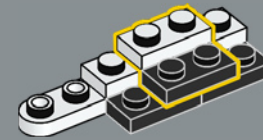

200

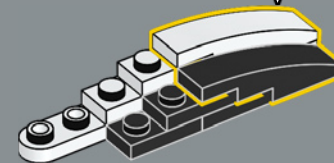
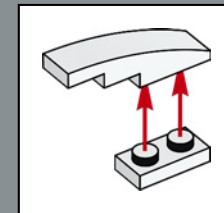

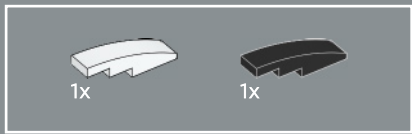

201

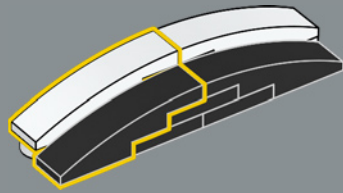

202

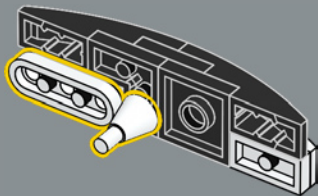

203

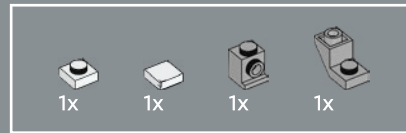
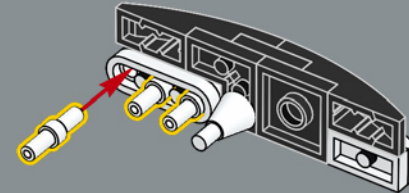

204

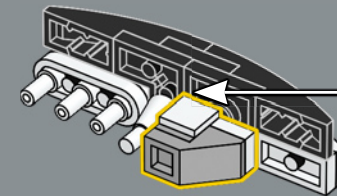
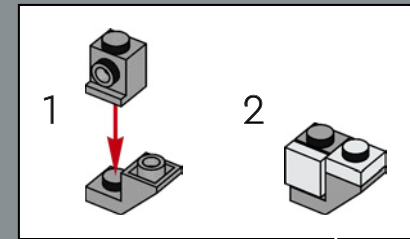

205

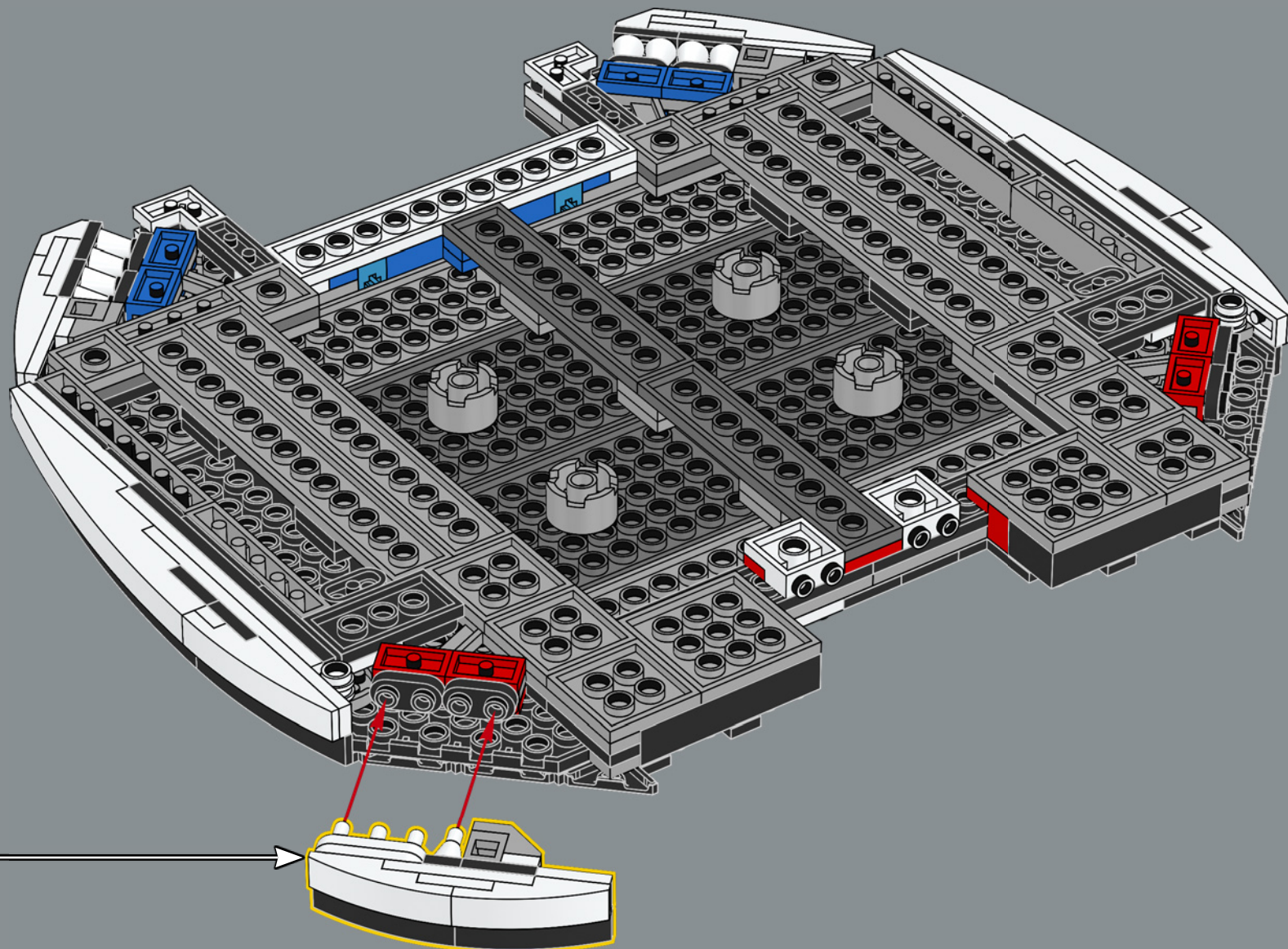

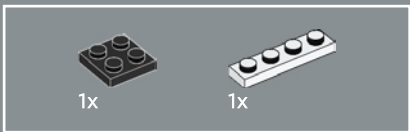

206

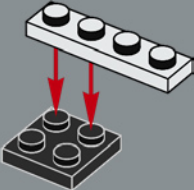

207

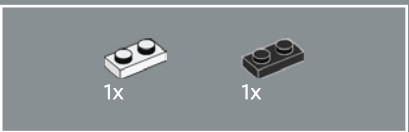
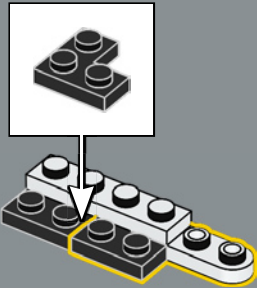

208

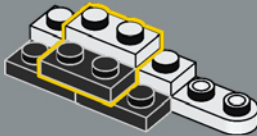

209

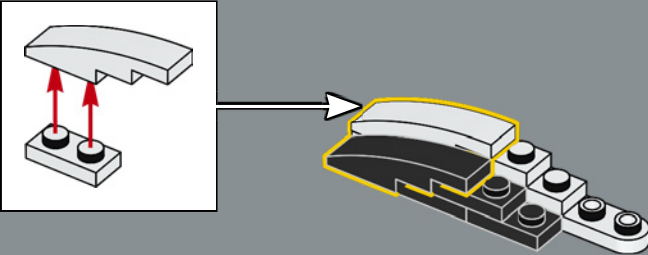

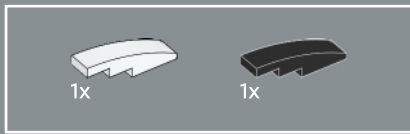

210

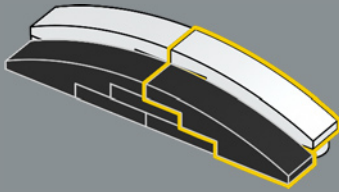

211

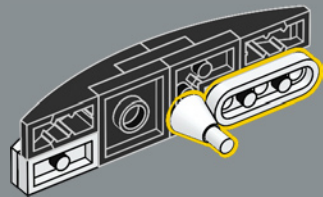

212

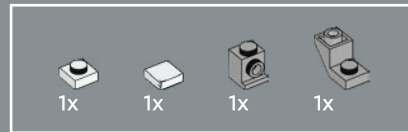
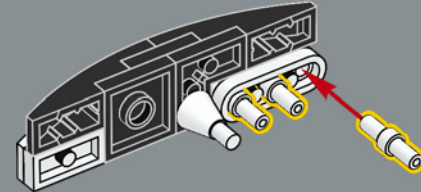

213

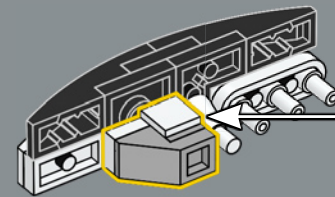
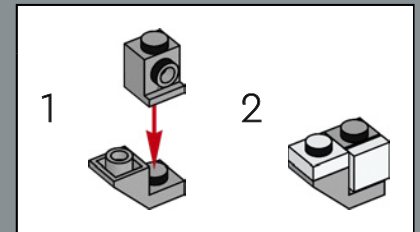

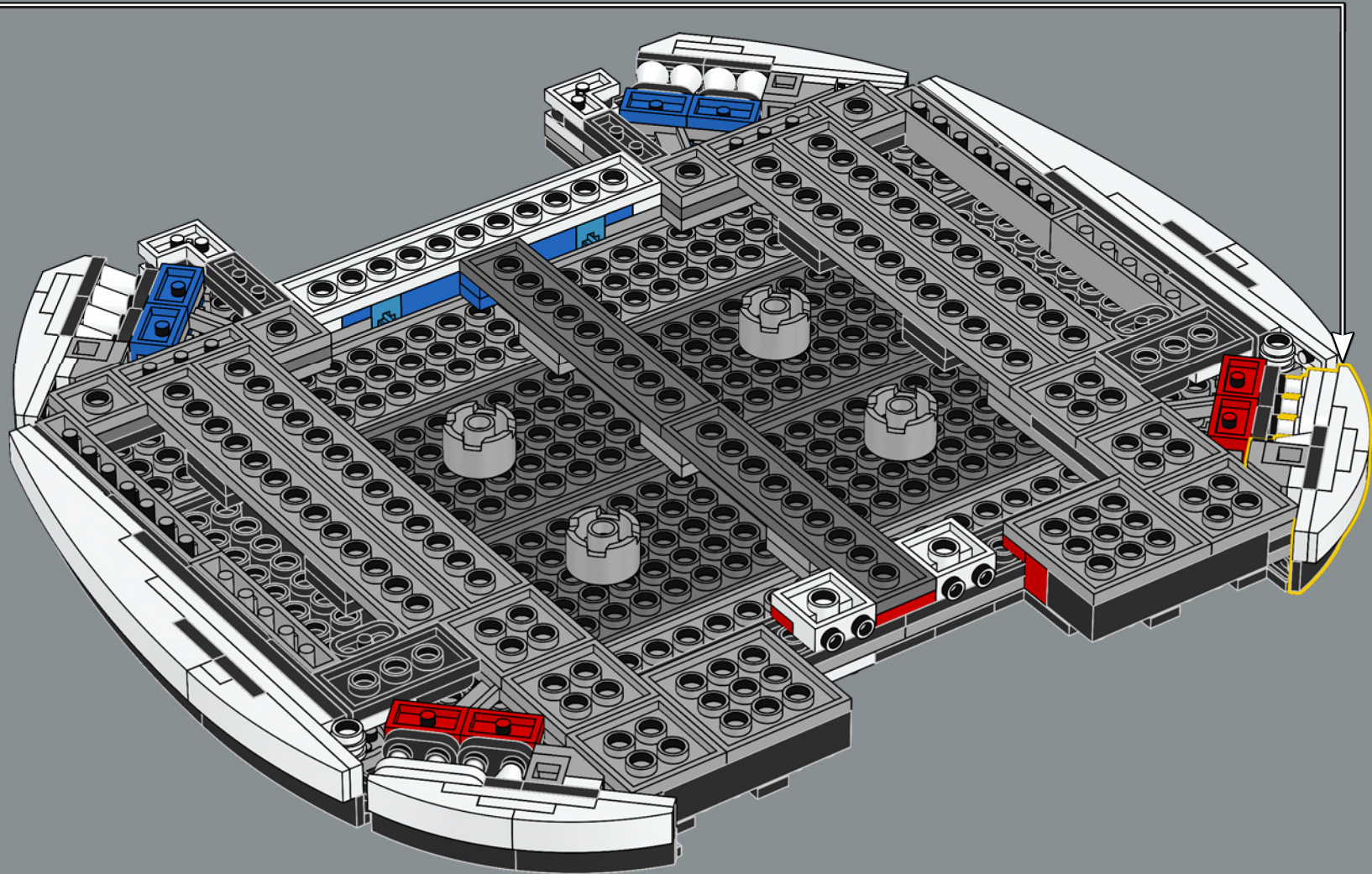

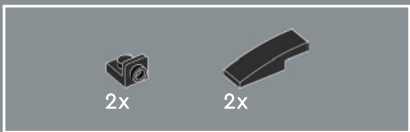

215

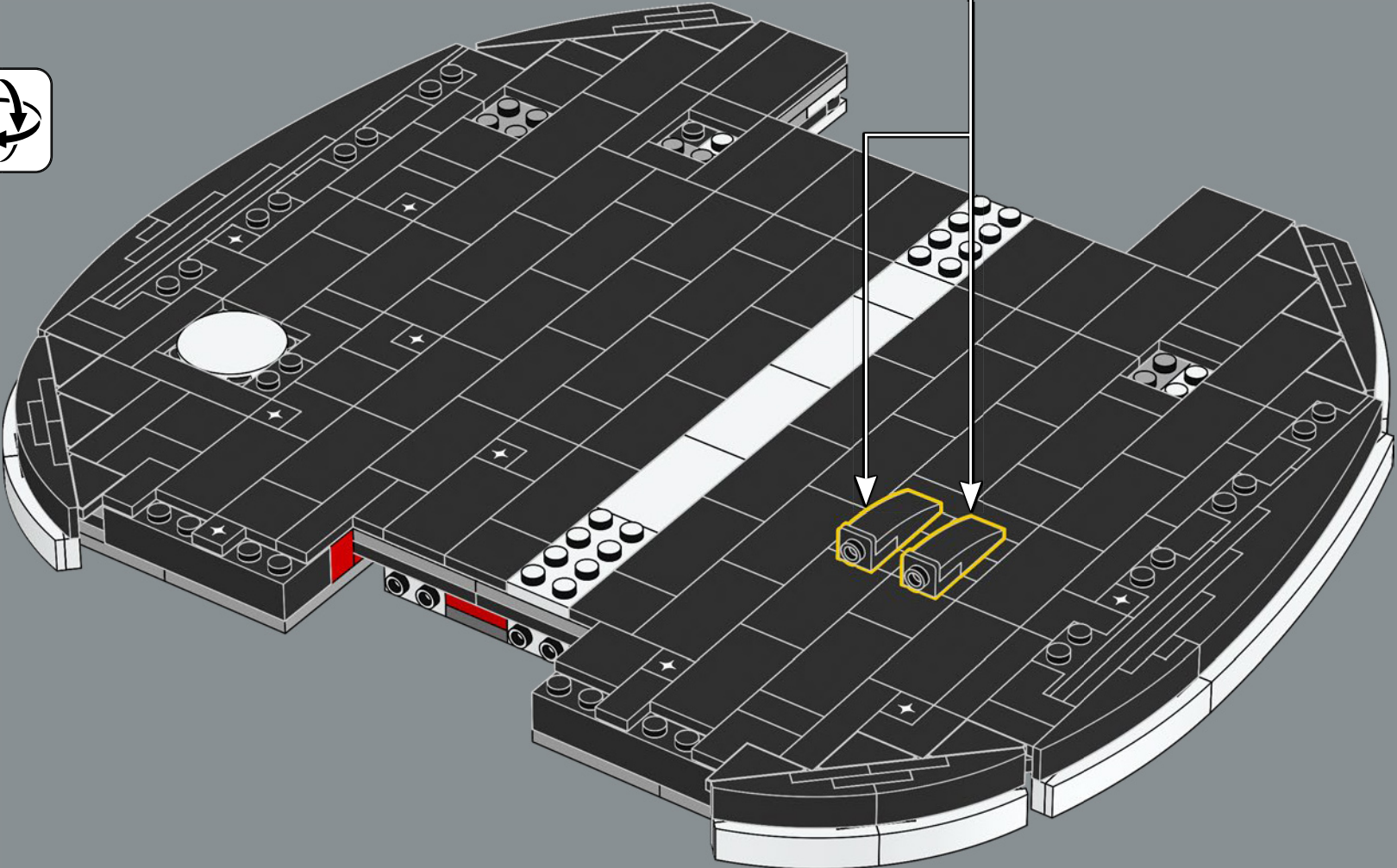
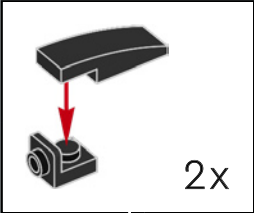

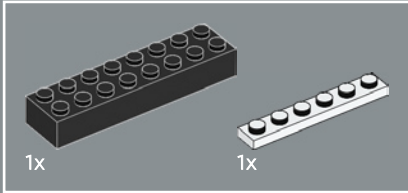
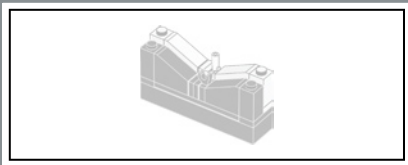

216

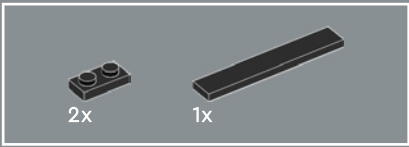
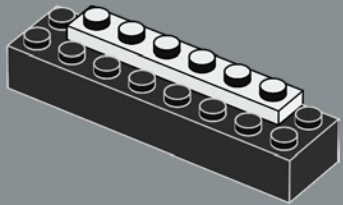

217

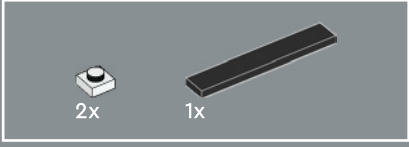
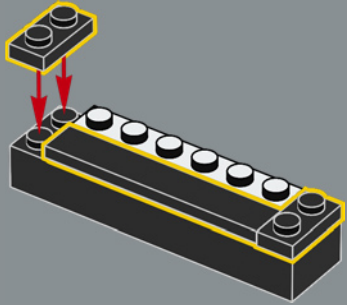

218

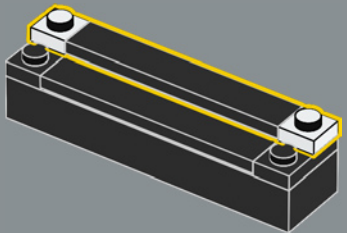



219

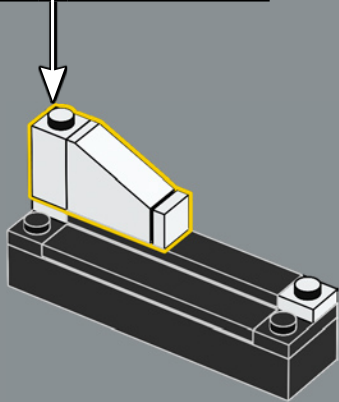
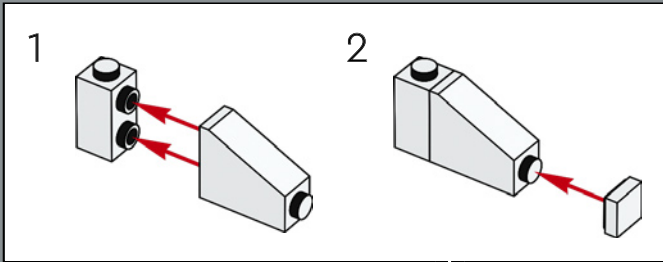

220

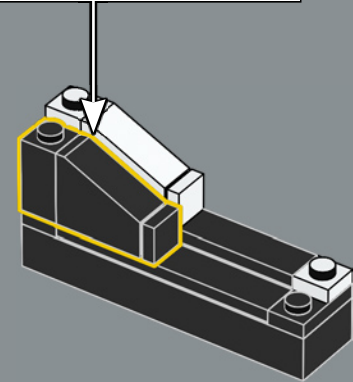
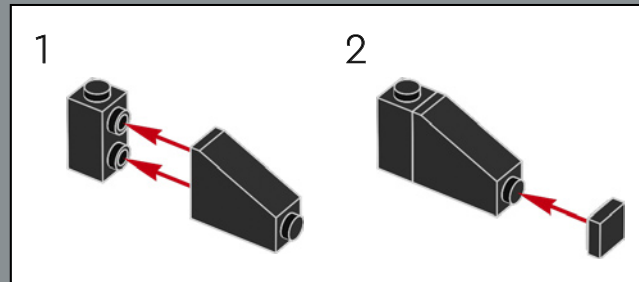

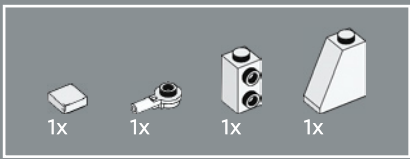

221

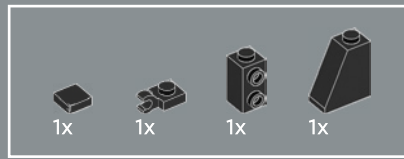
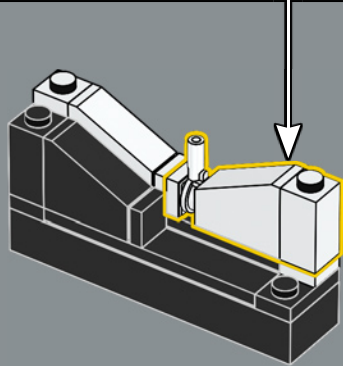
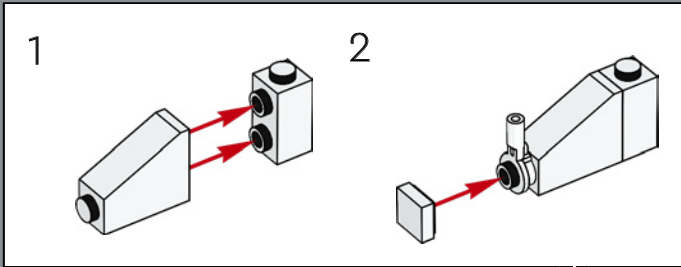

222

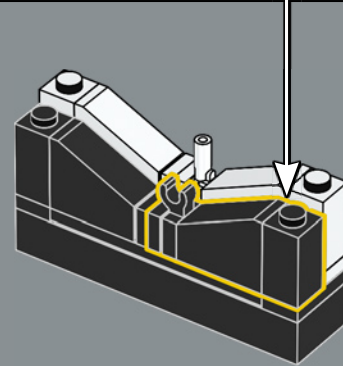
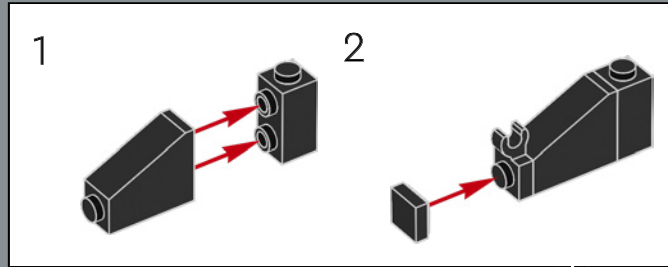

223

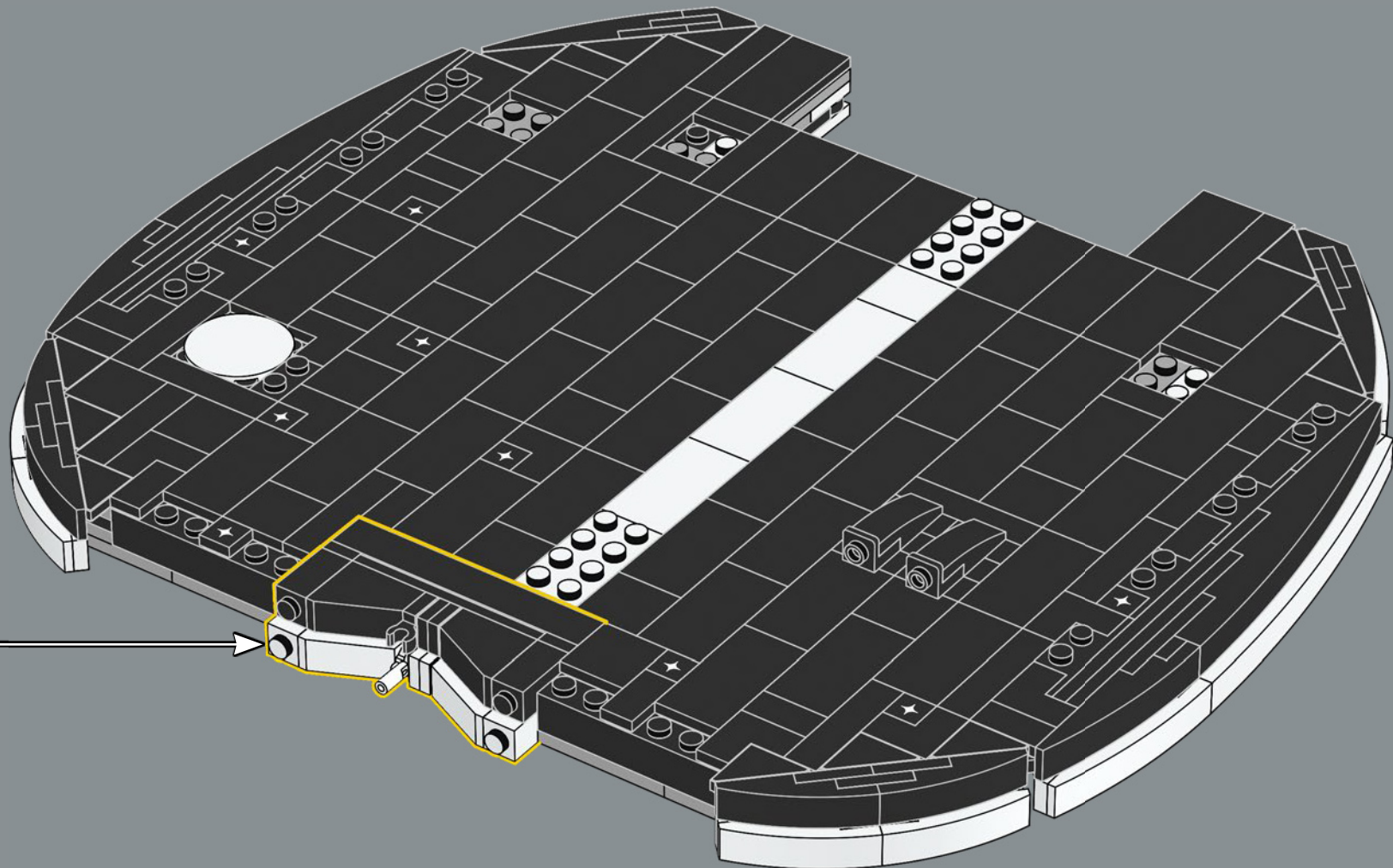

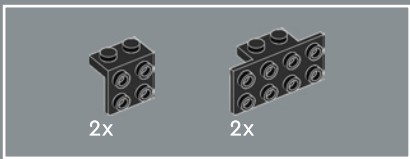

224

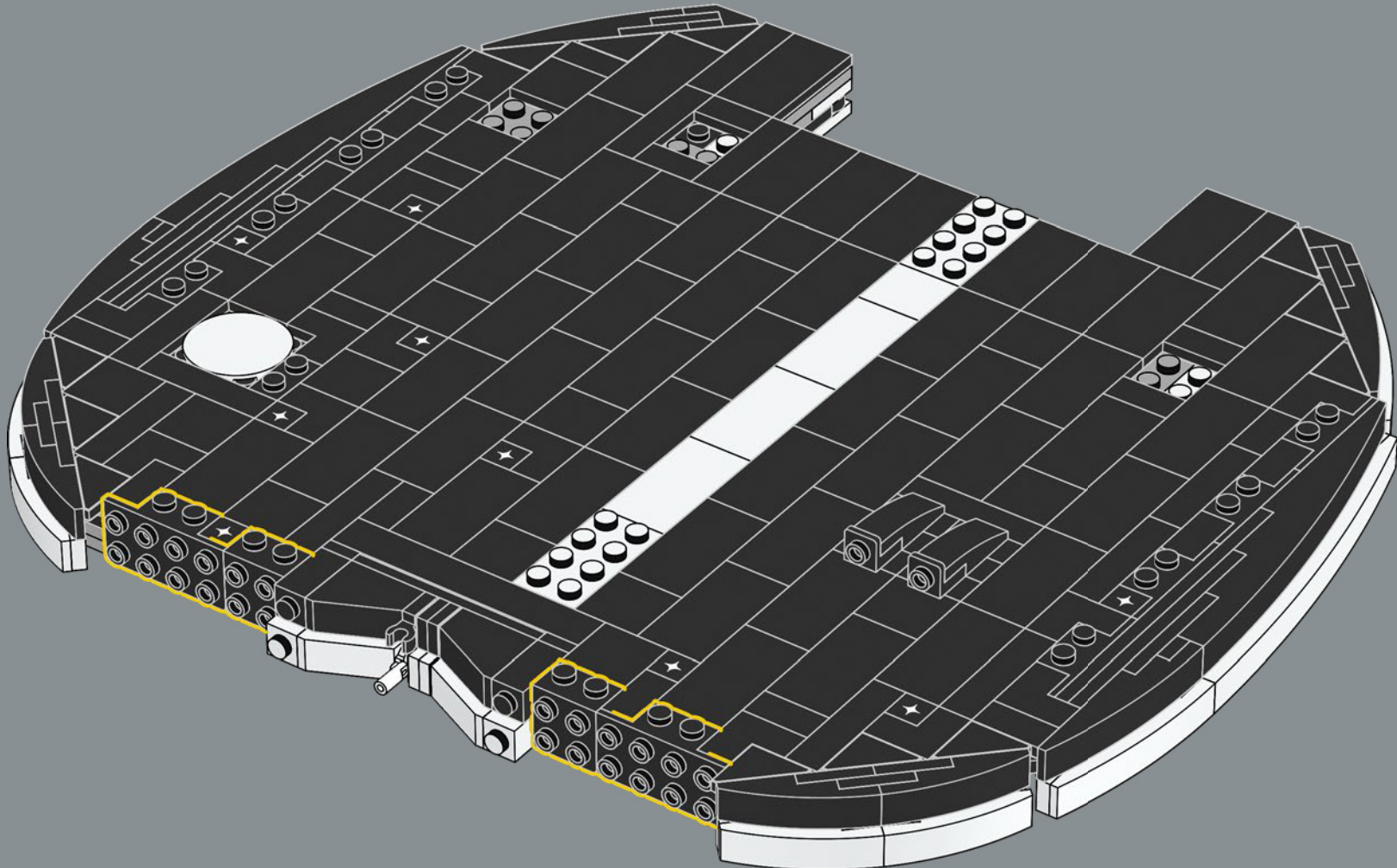

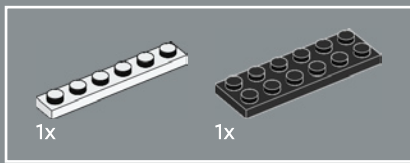

225

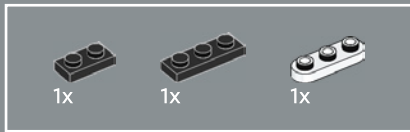
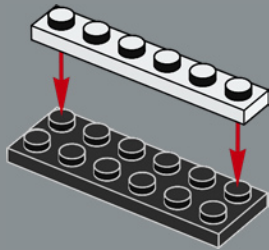

226

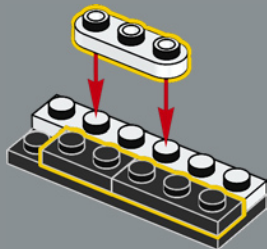

227

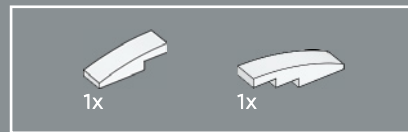
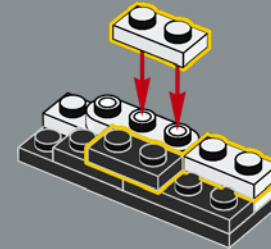

228

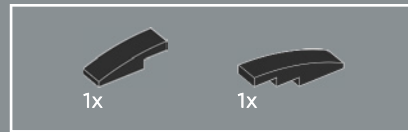
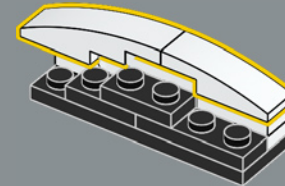

229

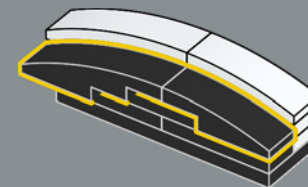

230

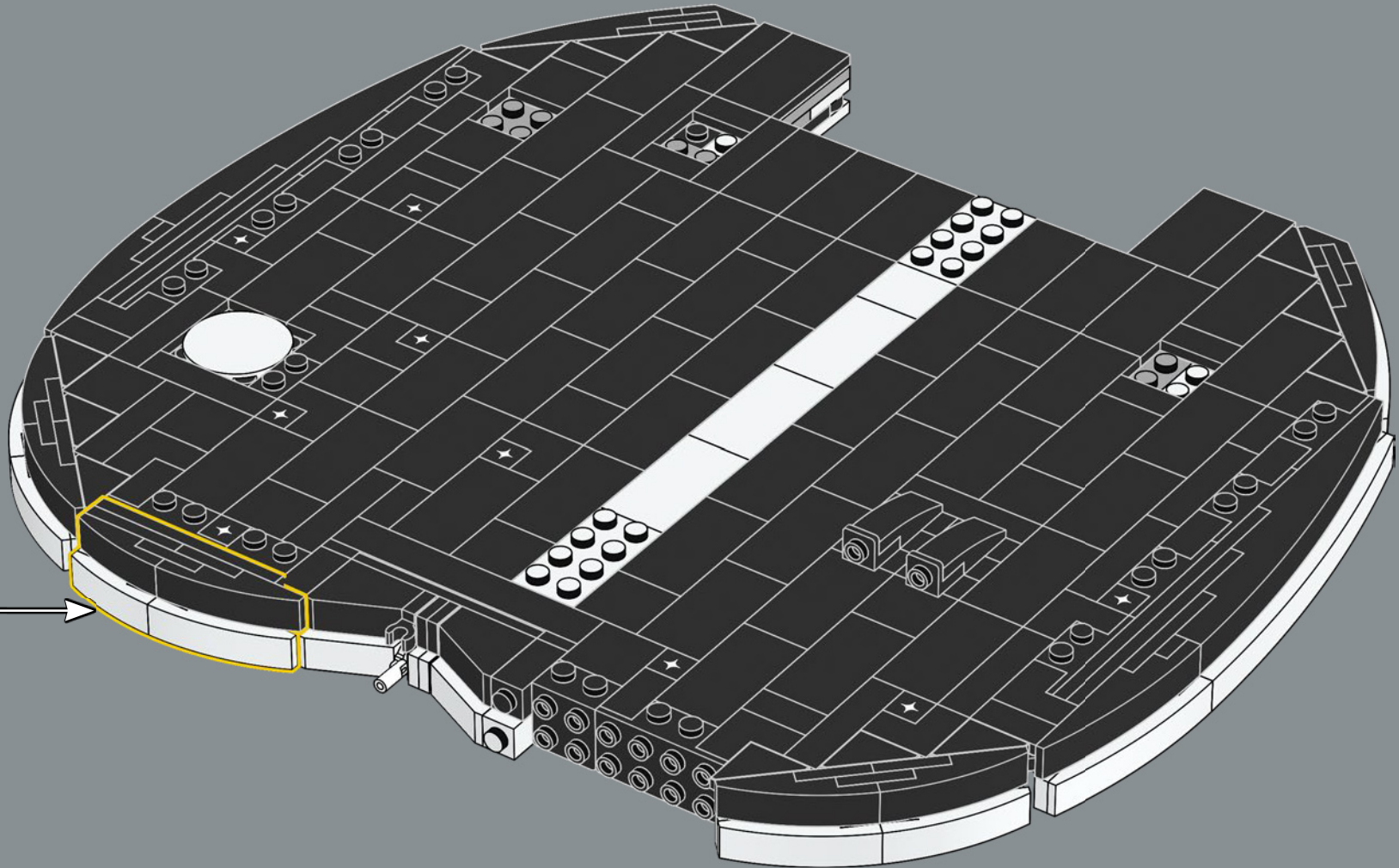

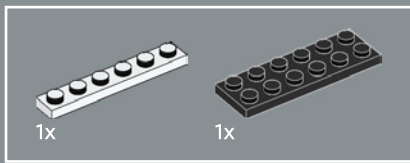

231

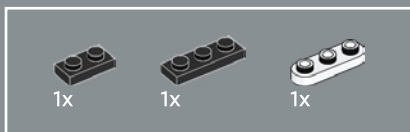
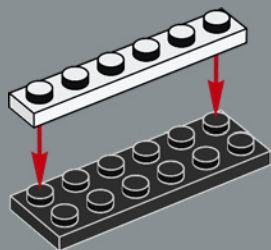

232

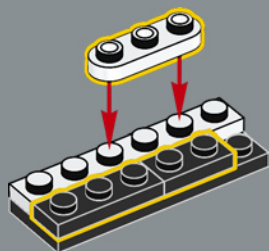

233

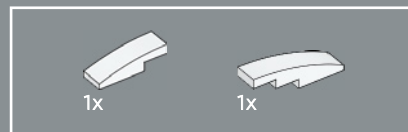
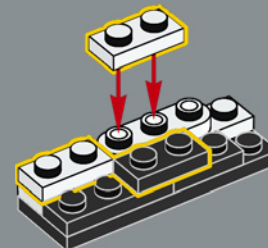

234

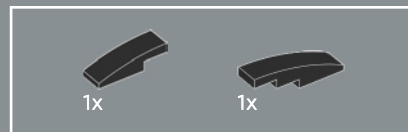
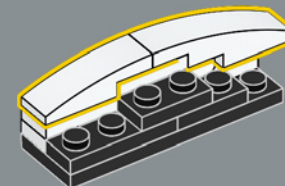

235

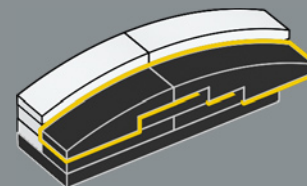

236

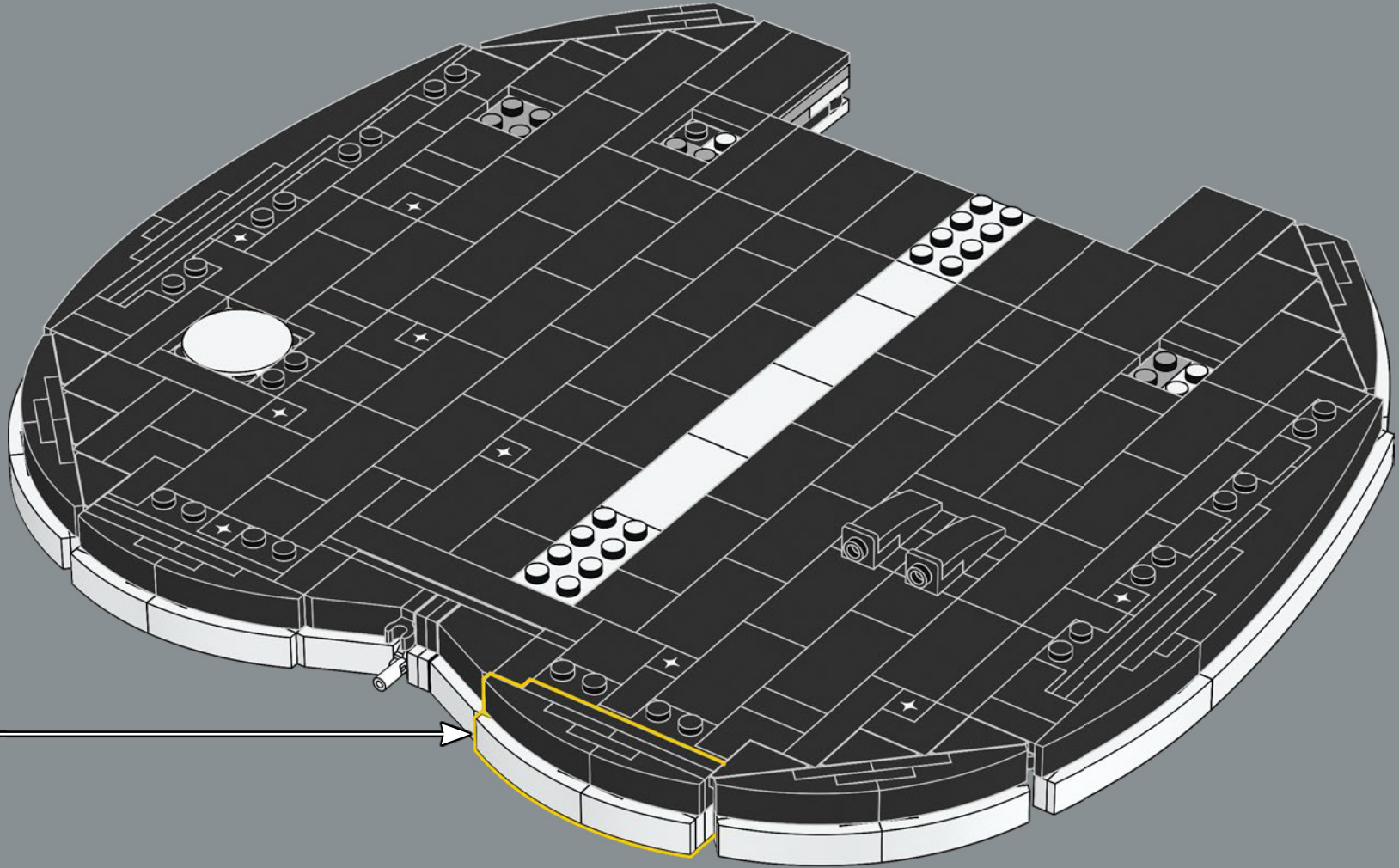

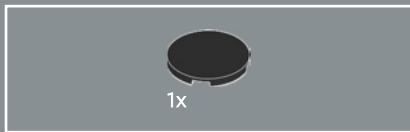

237

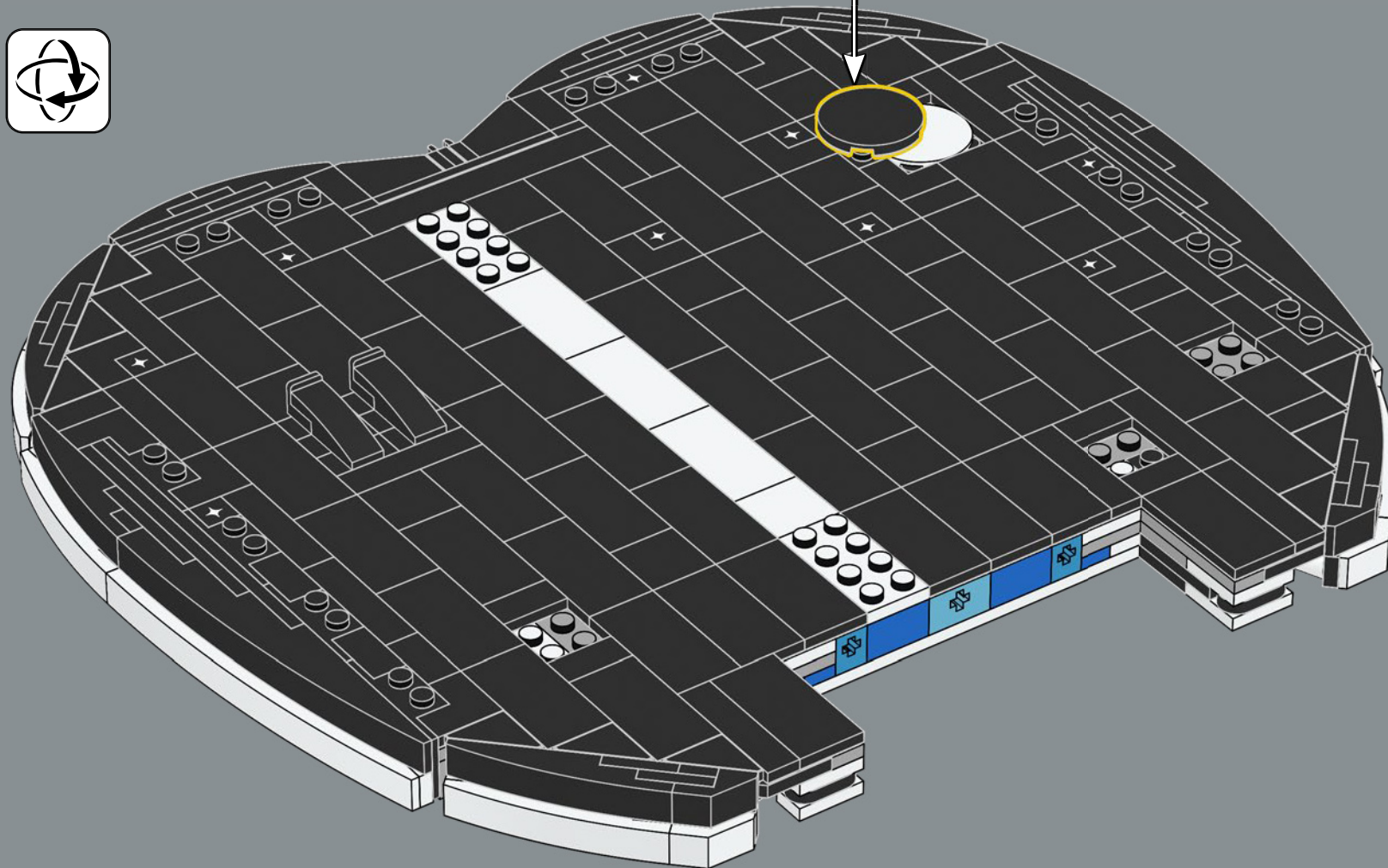

这可能是迄今为止乐高®套装中最大的苹果！我们堆叠了弧形组件，并运用了横向拼搭技术来捕捉纽约的这一标志性轮廓。



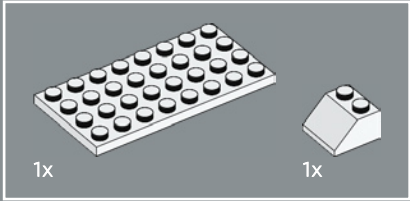
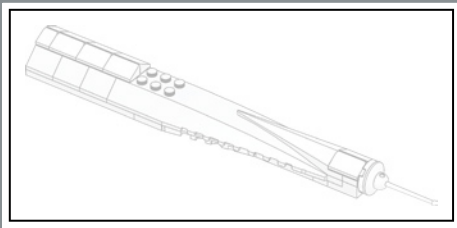

238

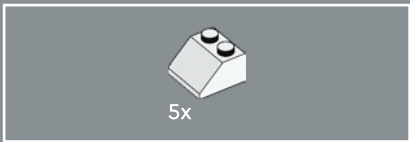
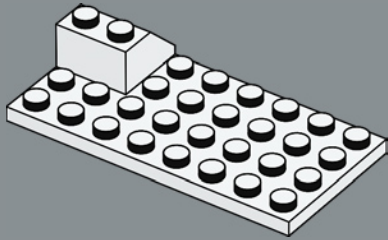

239

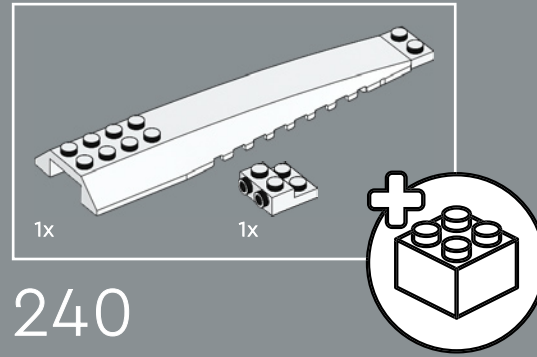
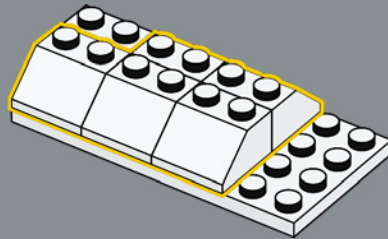

240

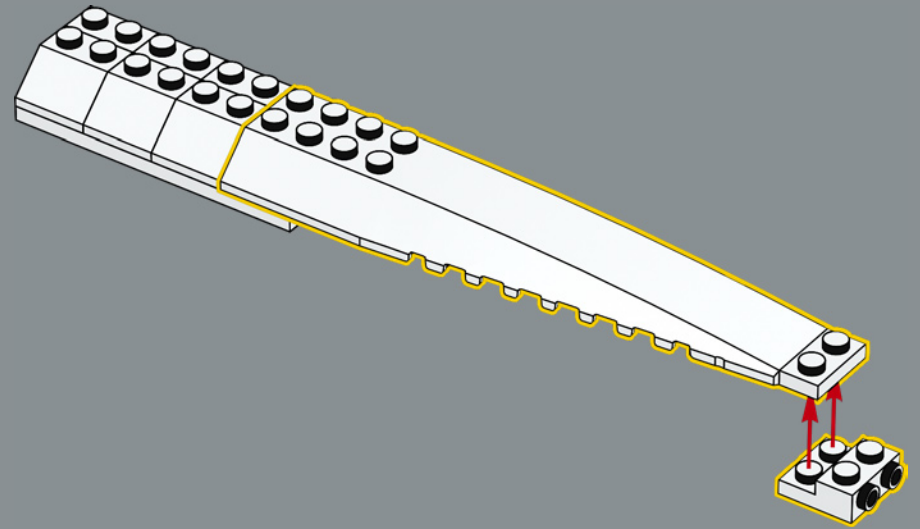

世界贸易中心一号楼高541.3米（合1776英尺），这一高度的设定是为了纪念美国《独立宣言》的签署。

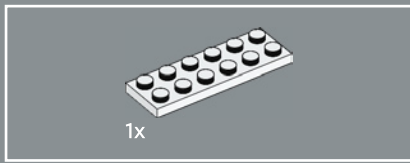

241

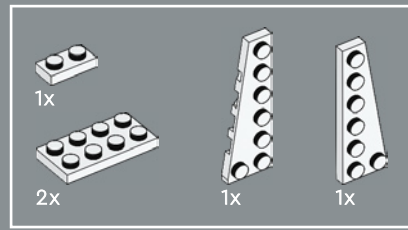
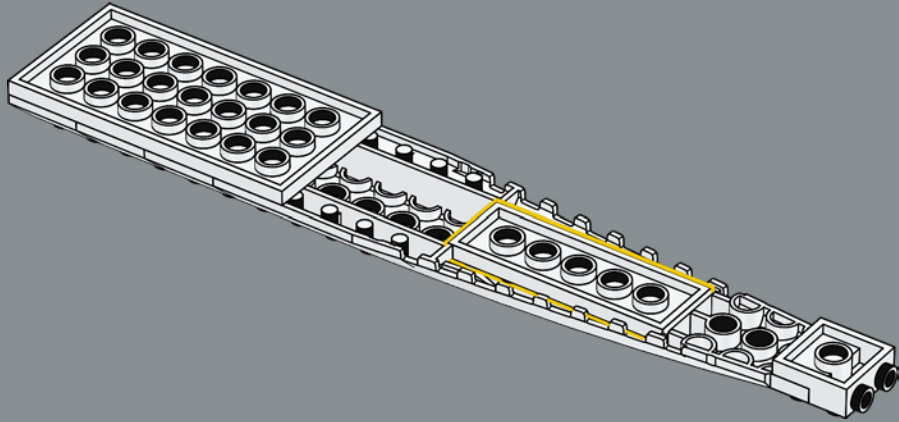

242

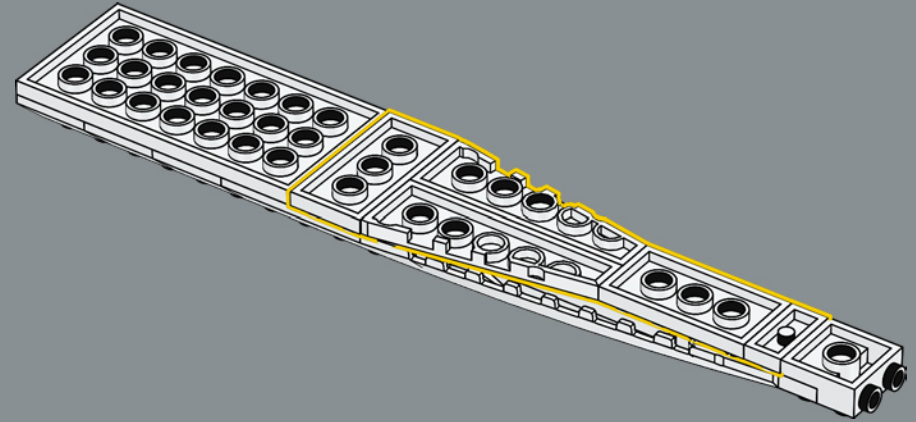



243

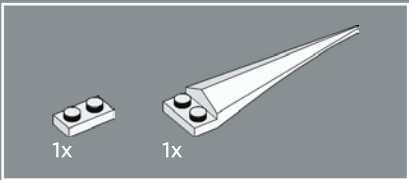
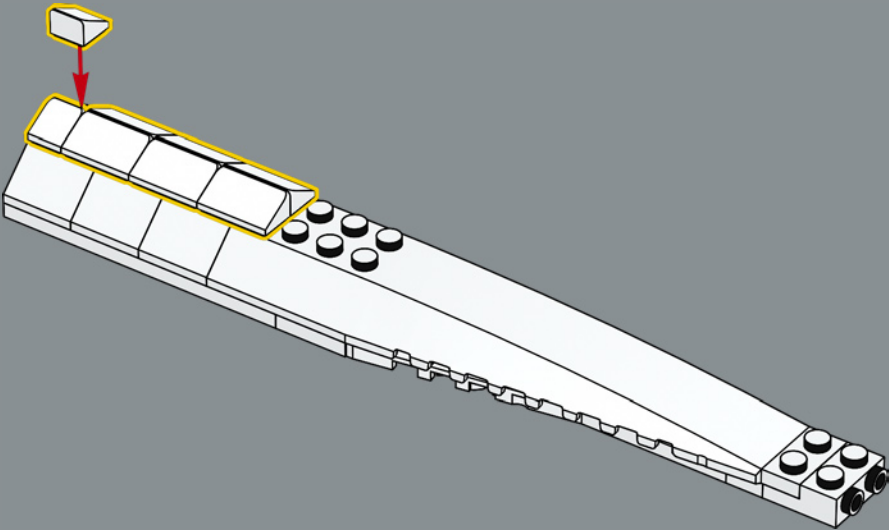

244

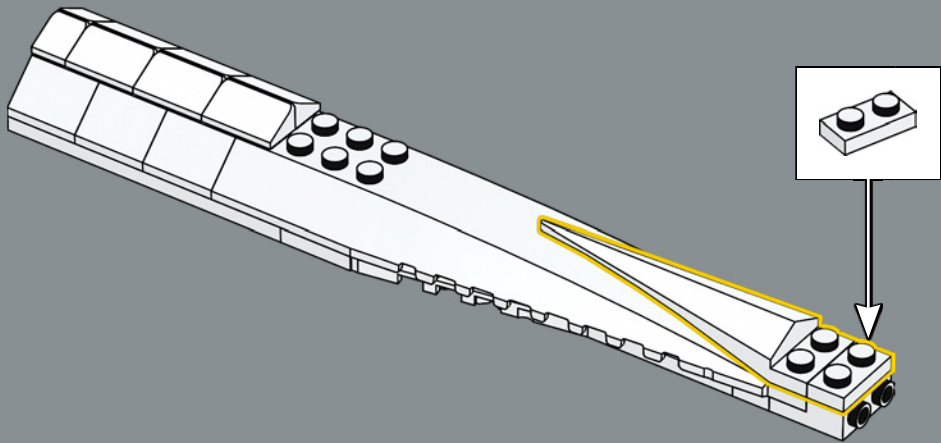



245

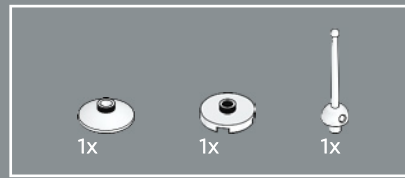
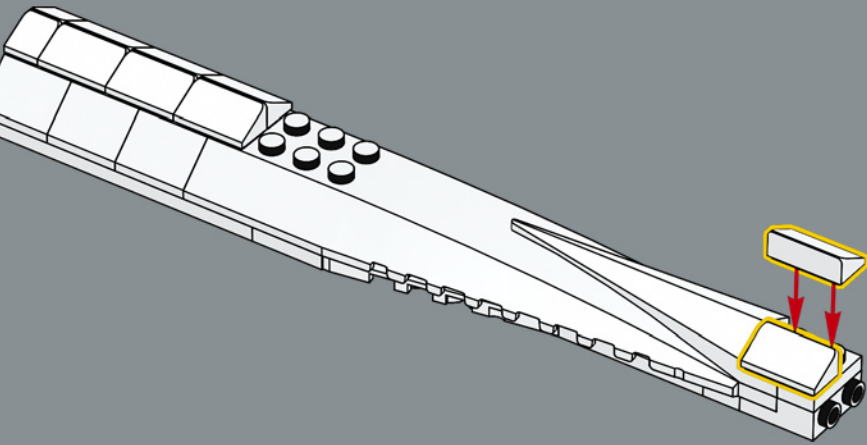

246

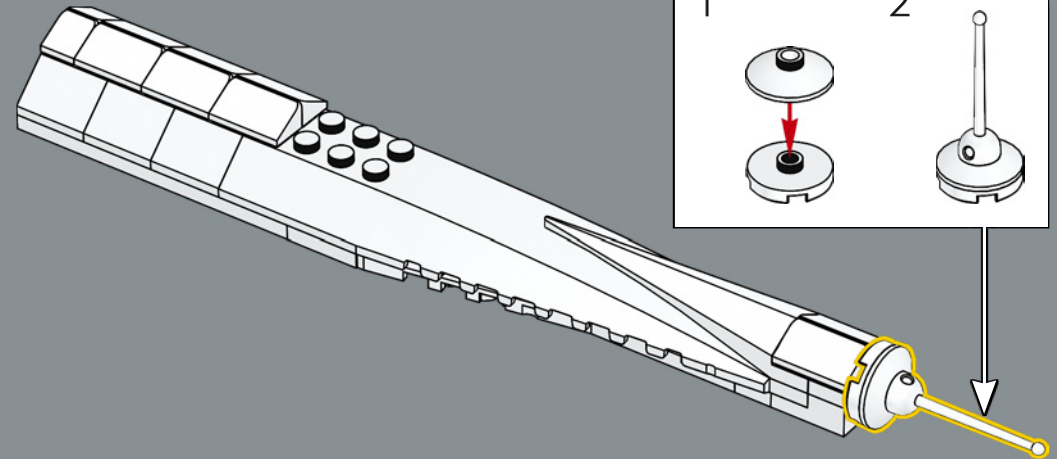

乐高®剑形组件构成了纽约市最高建筑——世界贸易中心一号楼的天线。
实际上，单是天线就有 124.3 米（407.9 英尺）高。

247

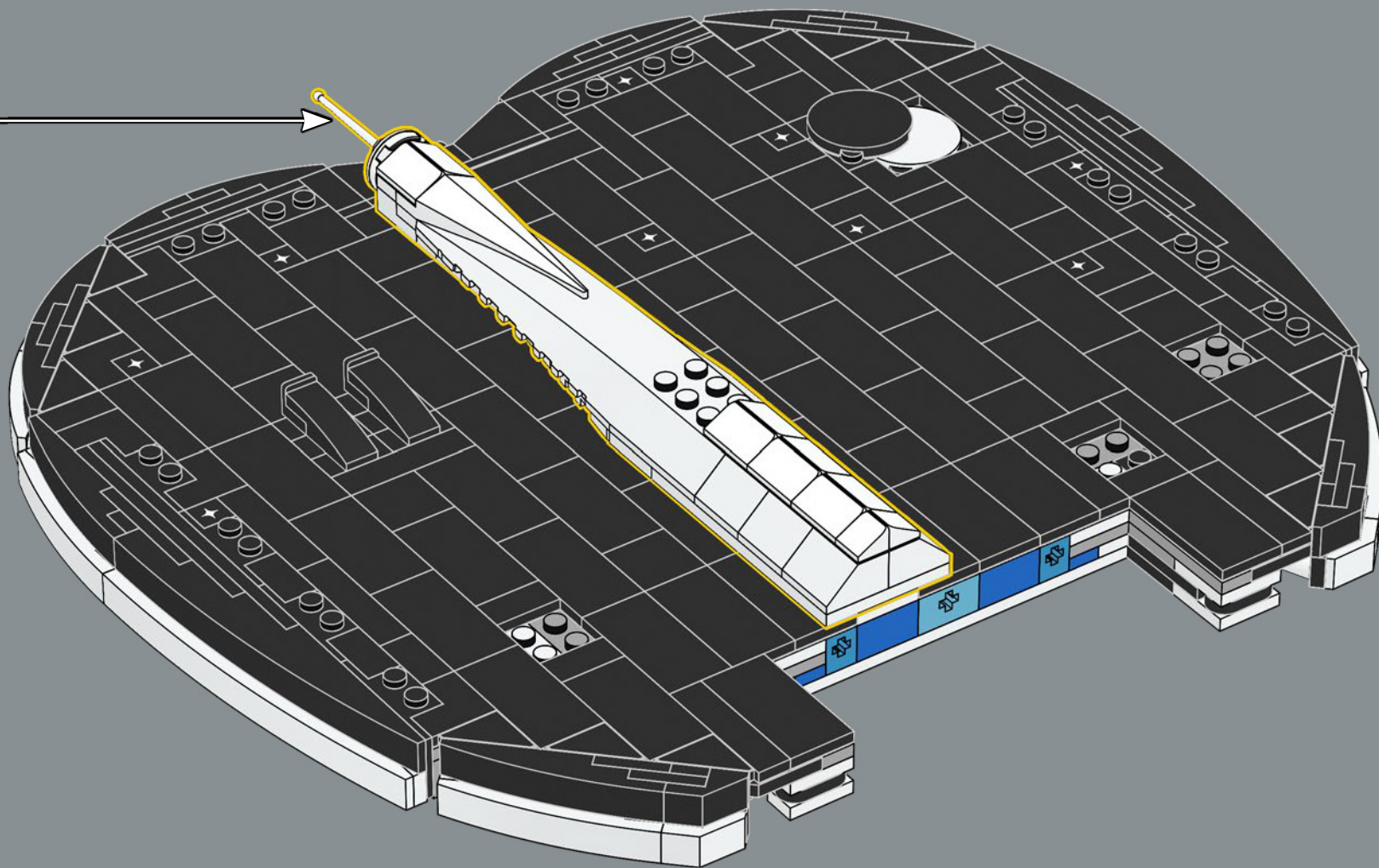



248

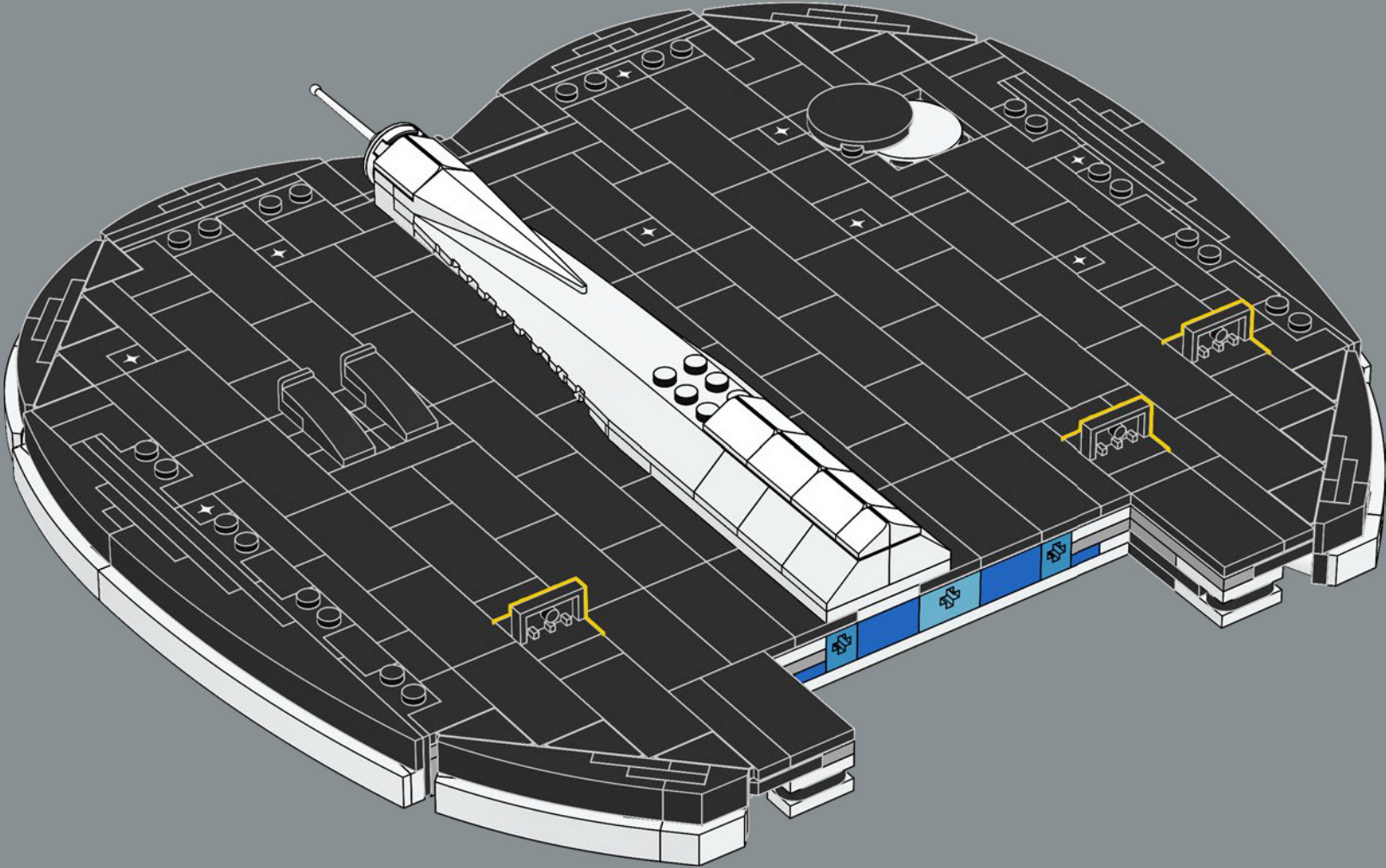

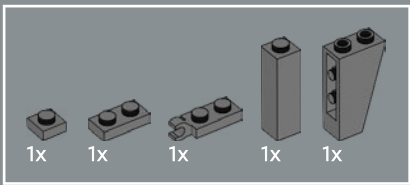

249

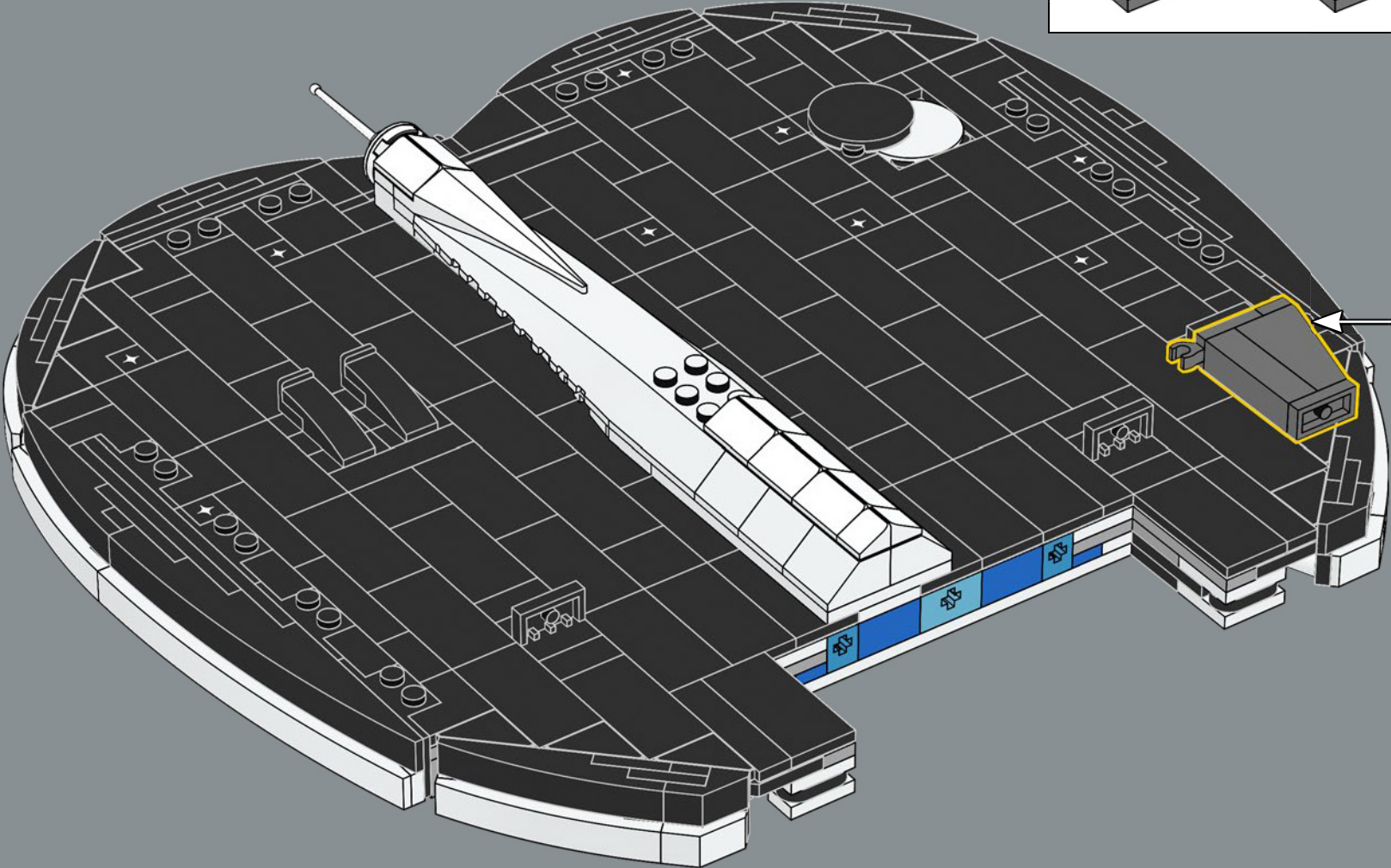
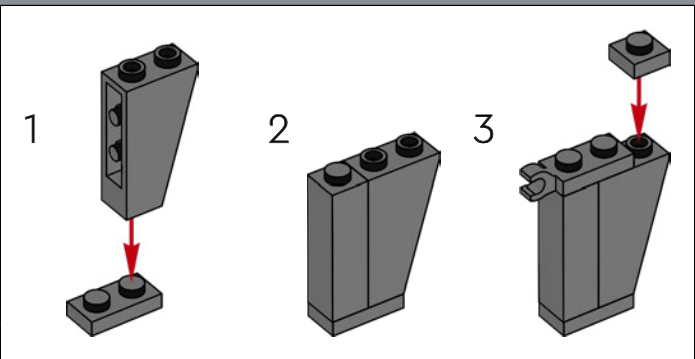

250

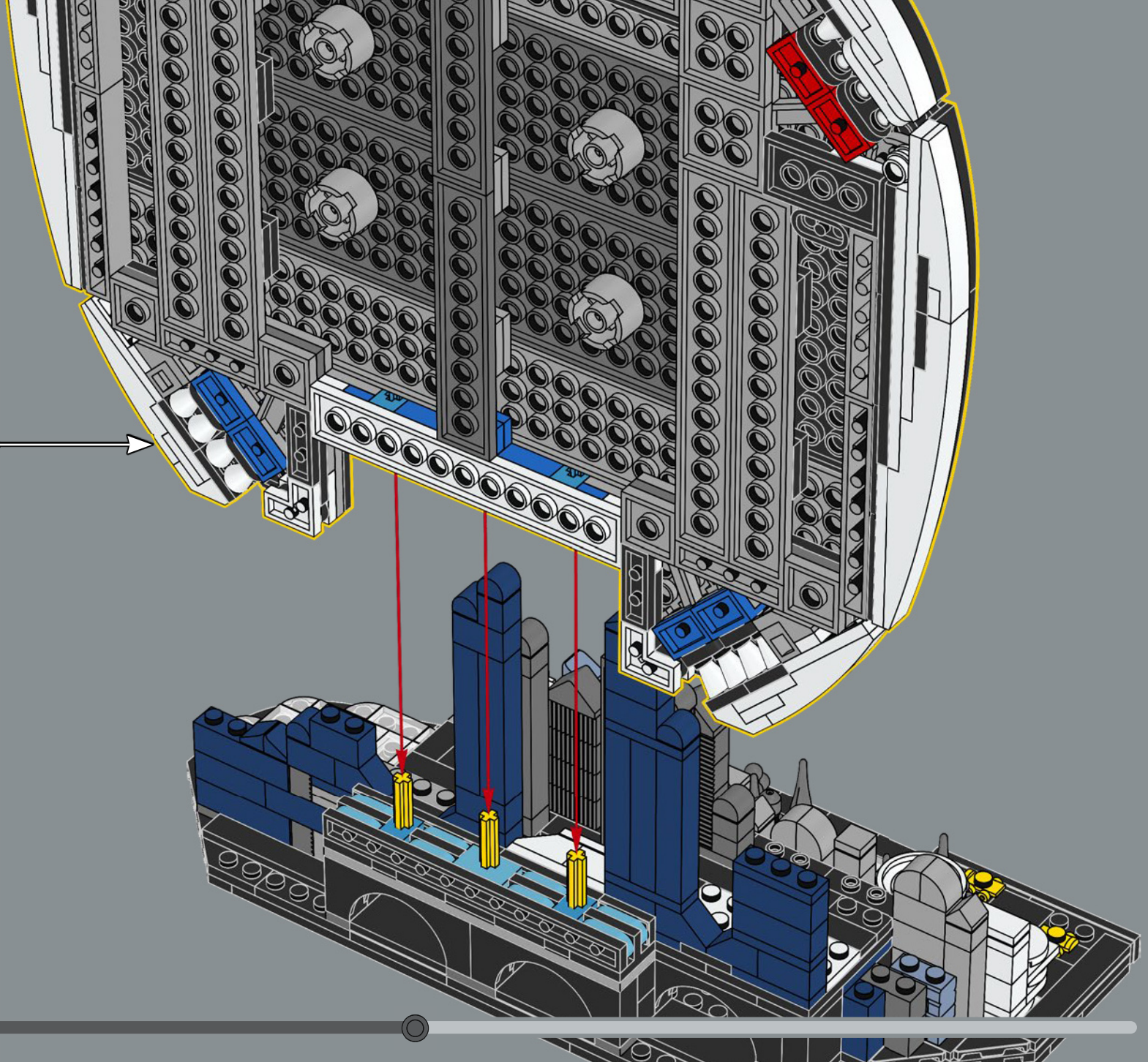

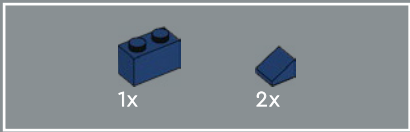

251

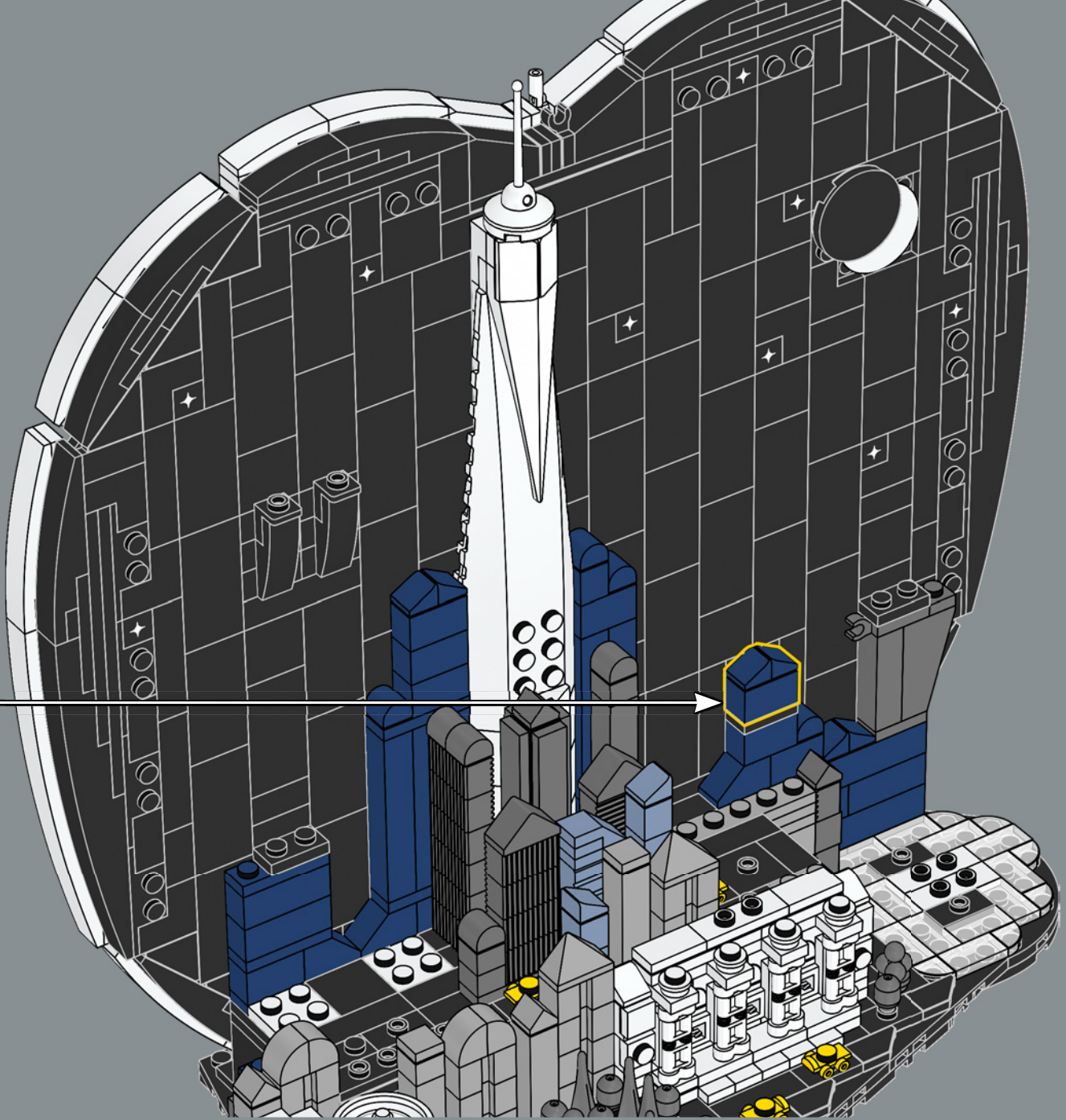
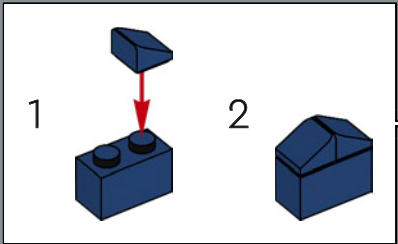

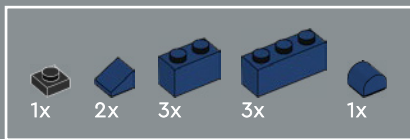

252

1

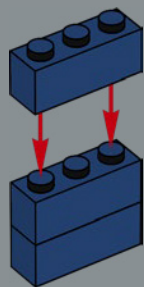

2

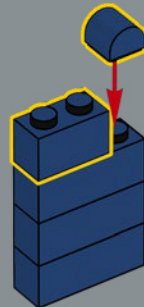

3

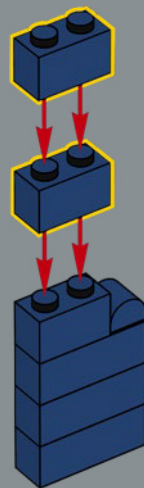

4

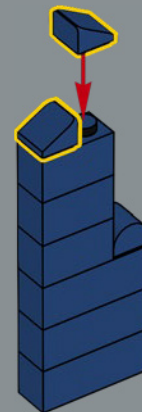

5



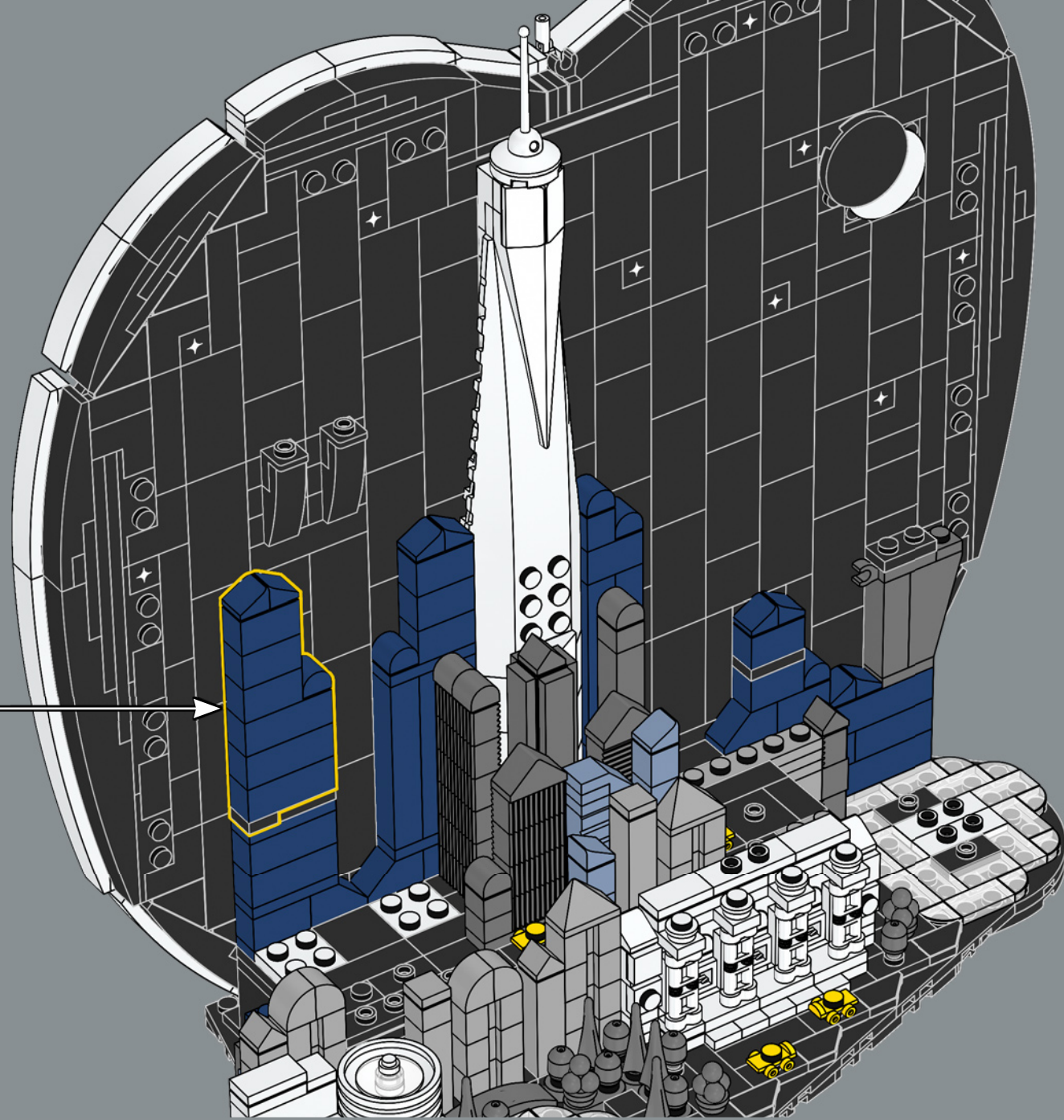

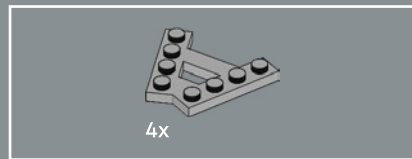

253

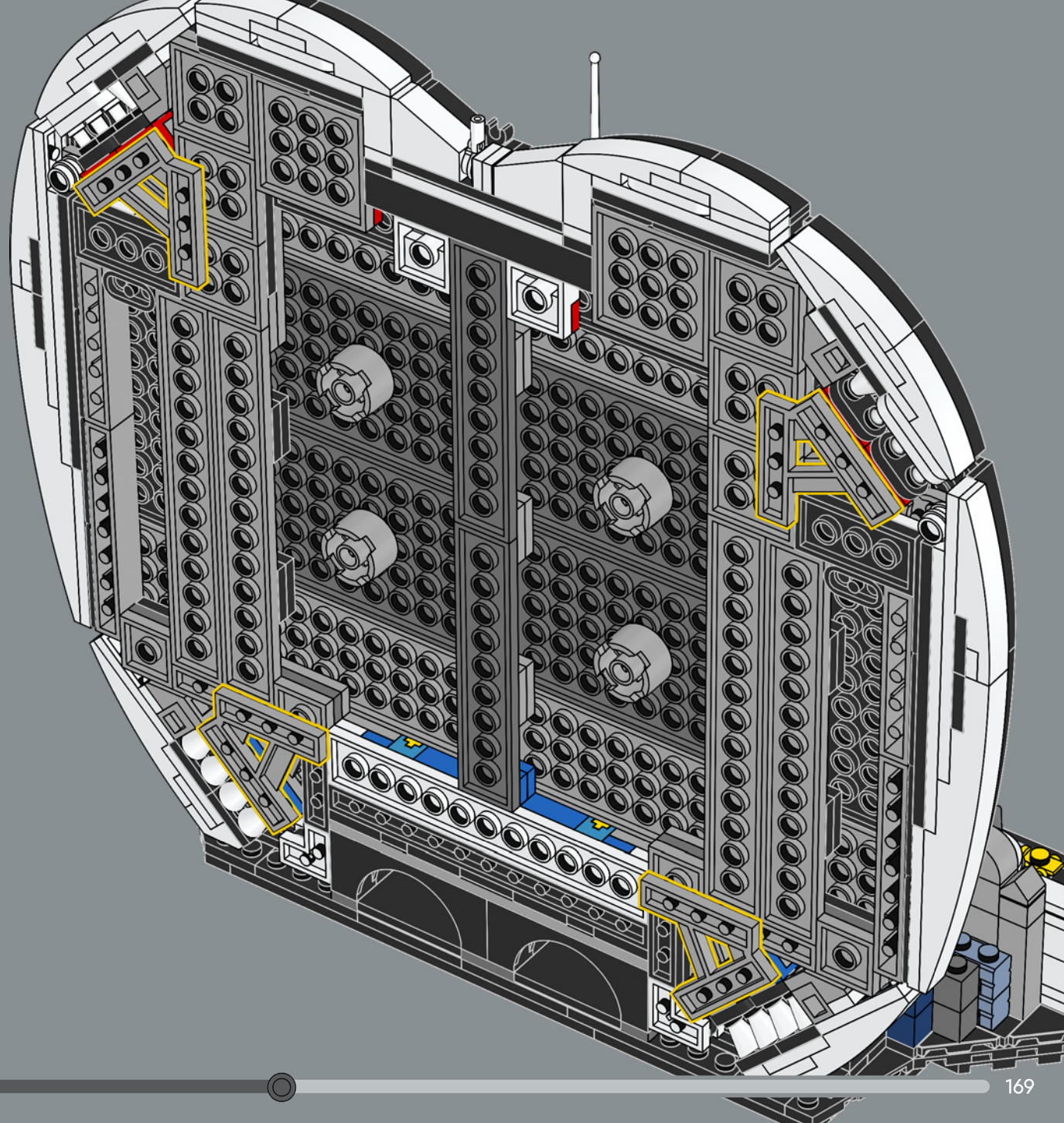

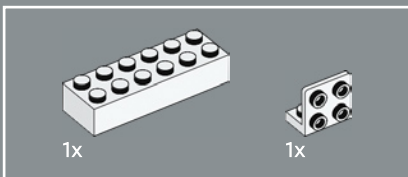
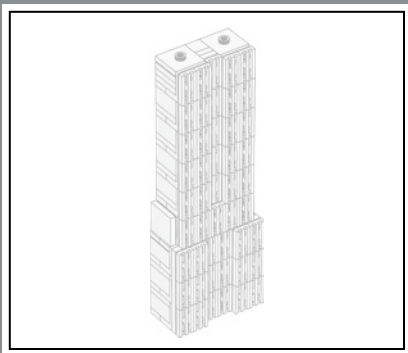

254

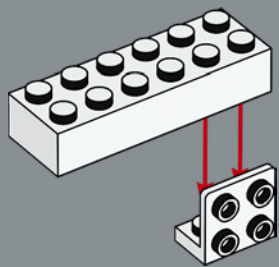

帝国大厦于 1931 年落成，至今仍是艺术生活系列风格的标志性建筑。作为世界上第一座超过 100 层的钢框架建筑，它曾是纽约天际线上最耀眼的地标，保持了近 40 年的世界最高建筑地位。



255

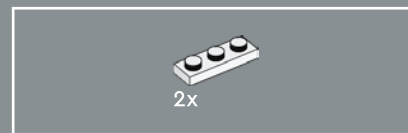
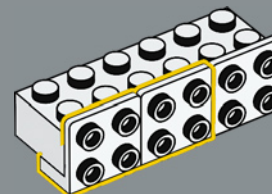

256

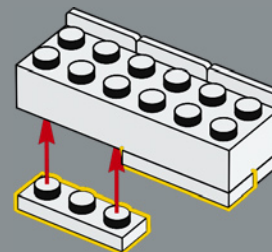

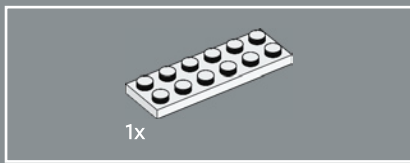

257

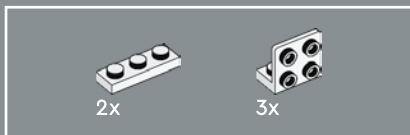
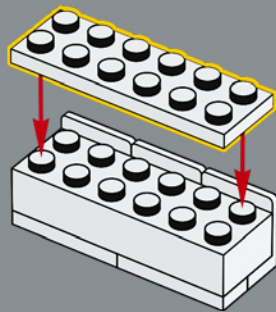

258

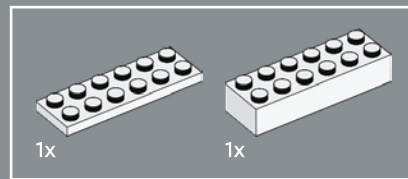
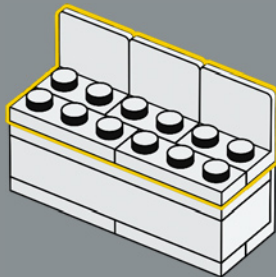

259

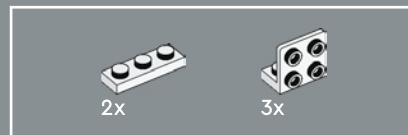
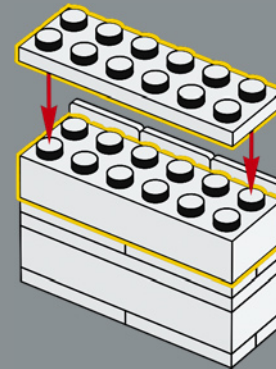

260

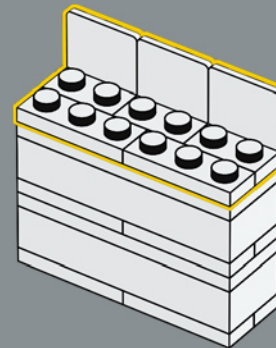

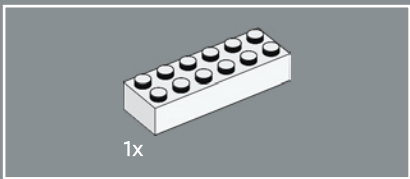

261

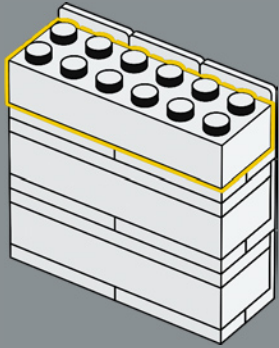

262

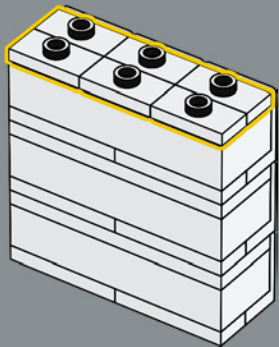

263

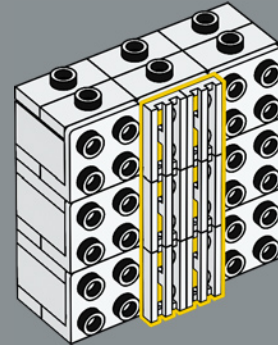

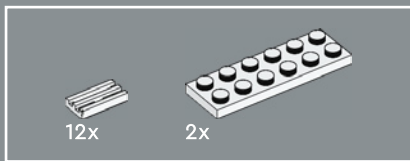

264

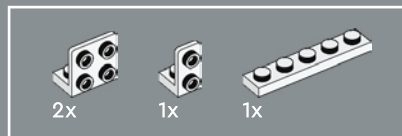
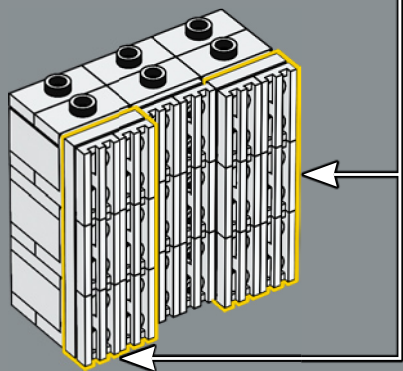
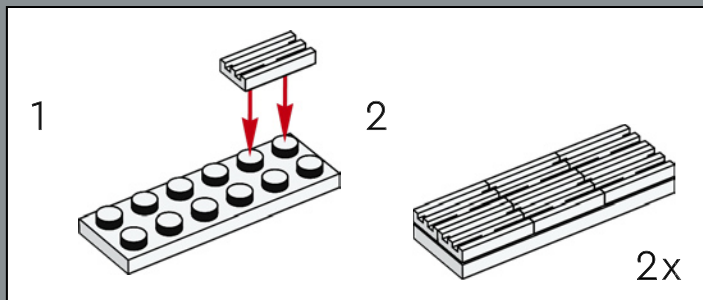

265

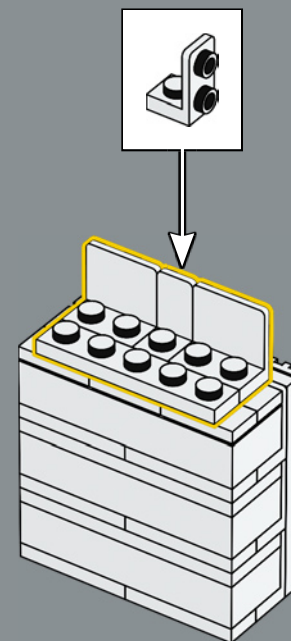

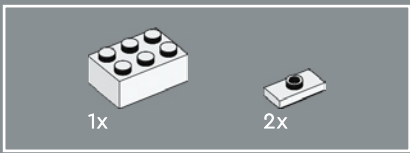

266

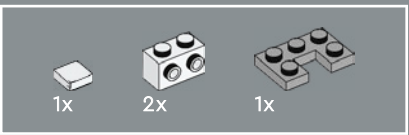
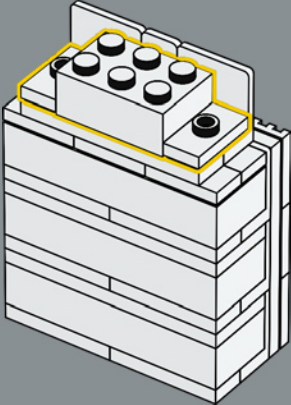

267

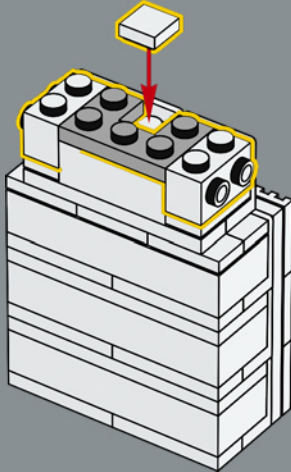

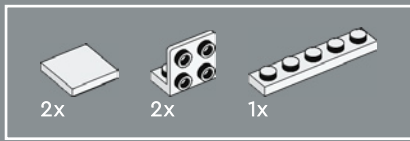

268

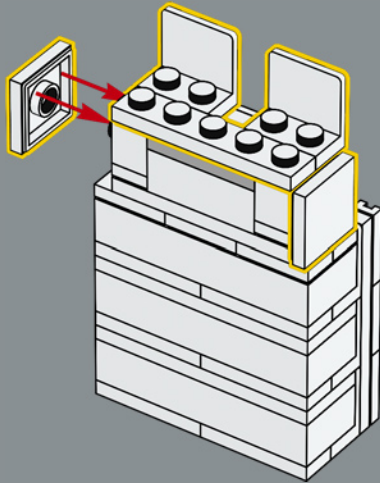

269

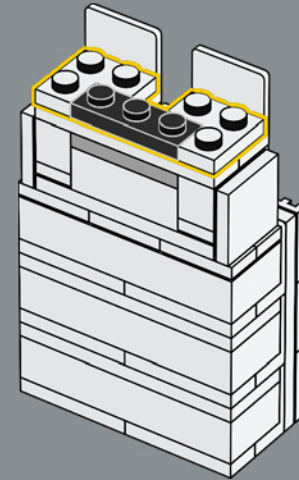

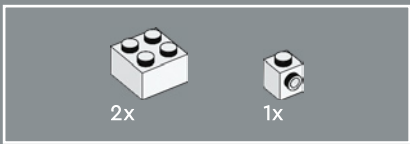

270

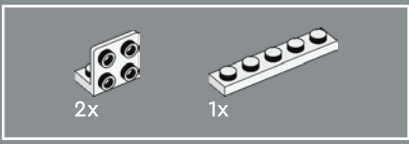
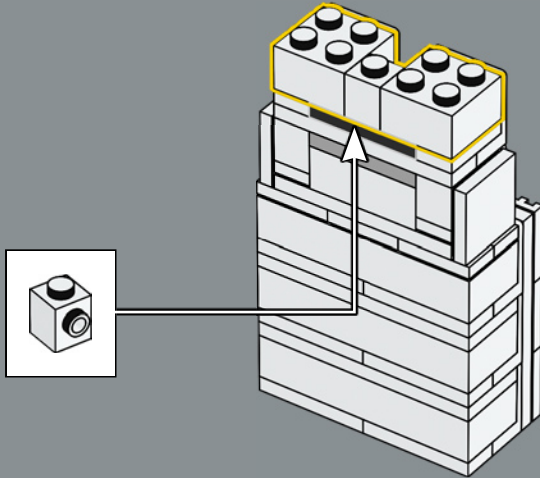

271

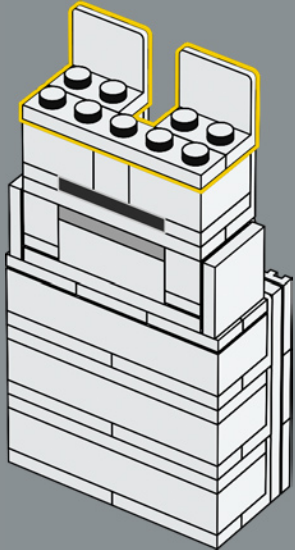

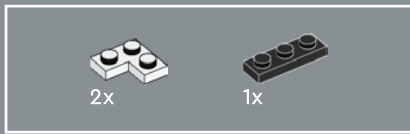

272

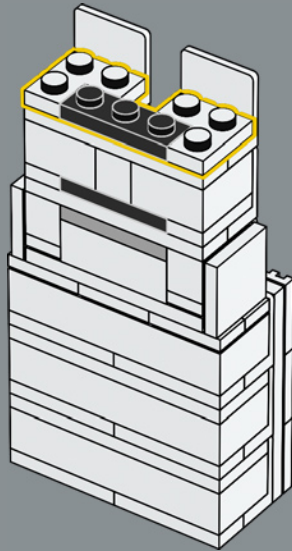

273

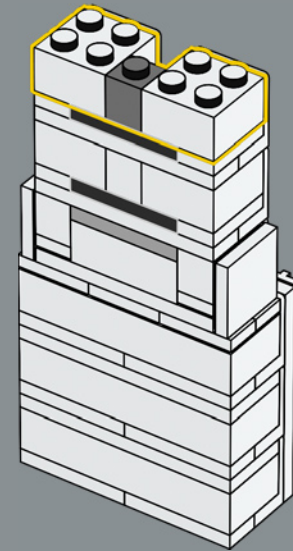

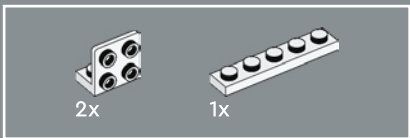

274

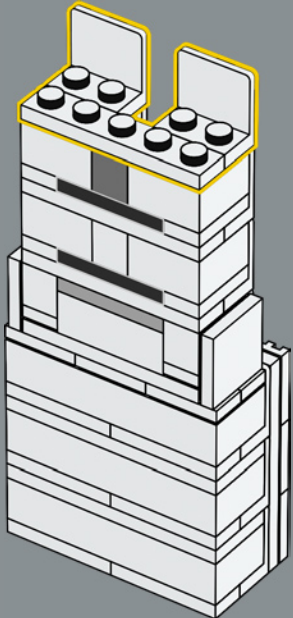

275

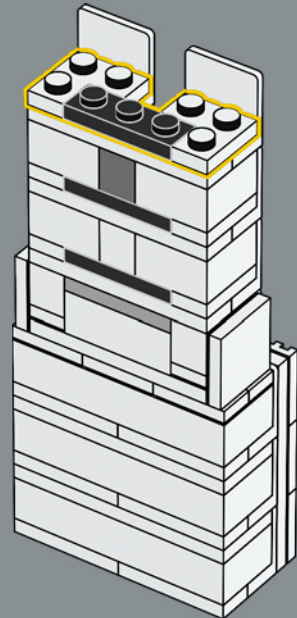

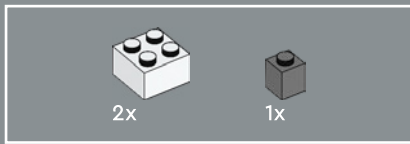

276

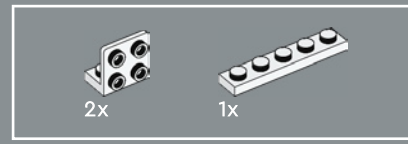
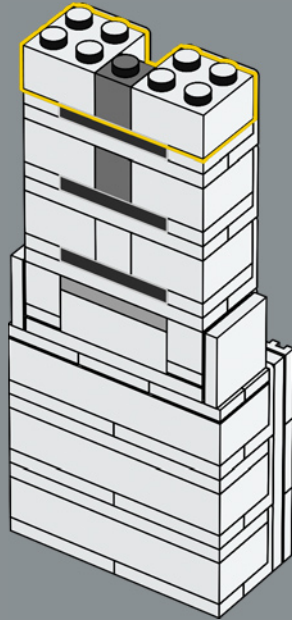

277

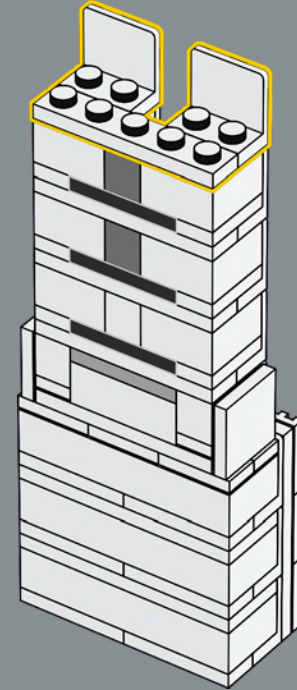



278

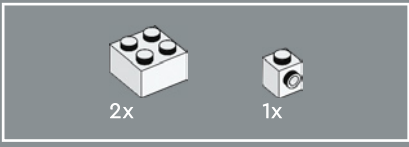
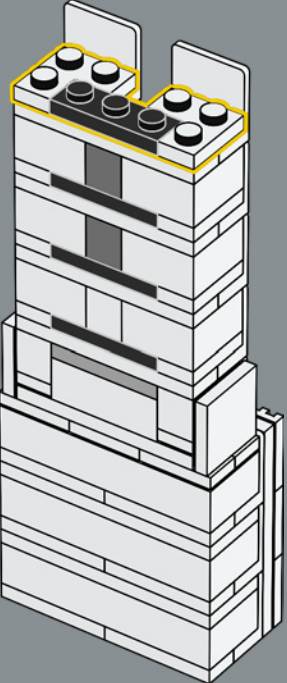

279

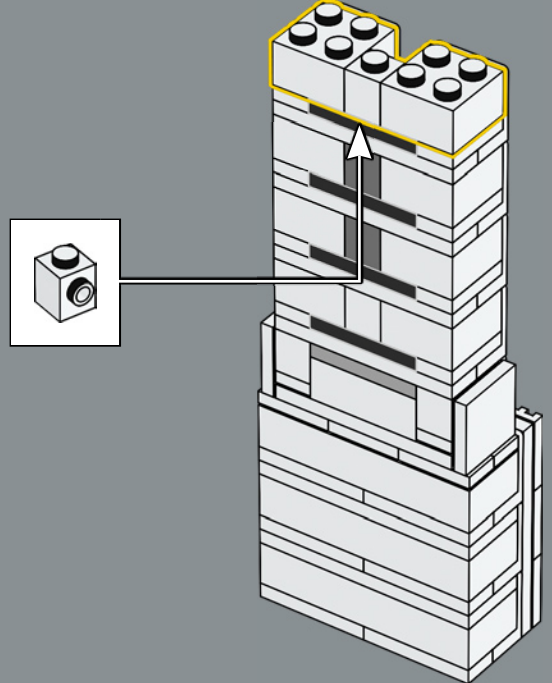

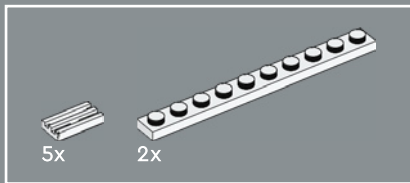

280

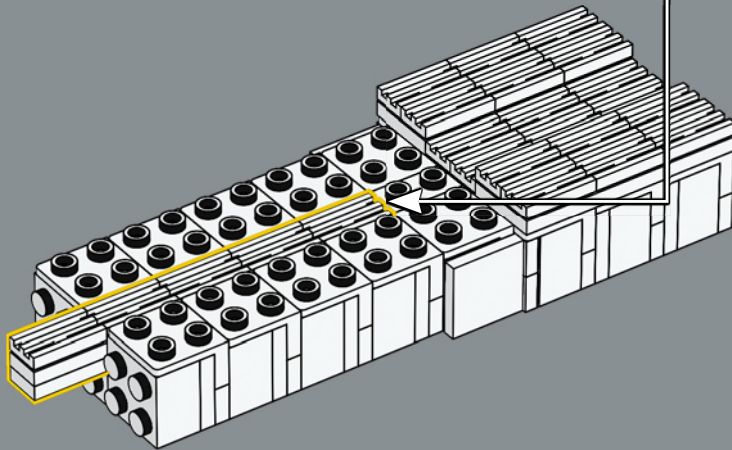
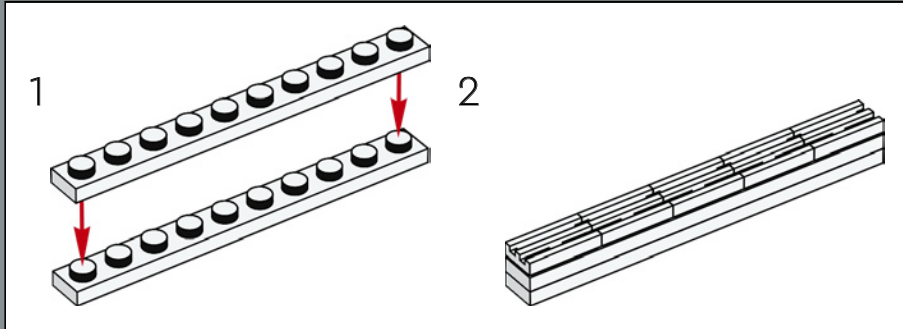

281

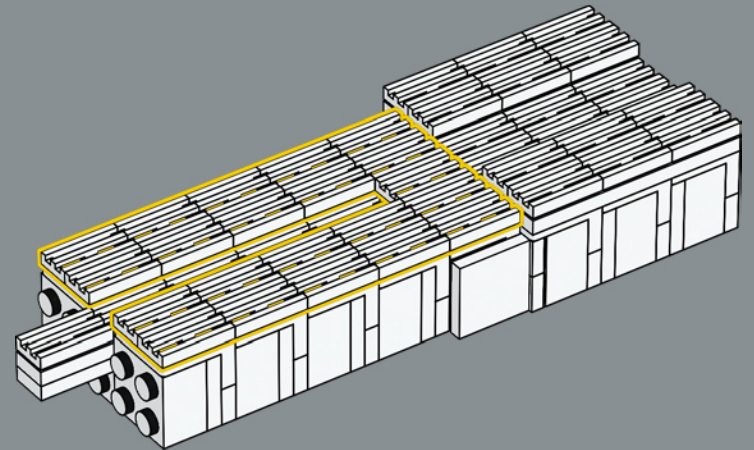

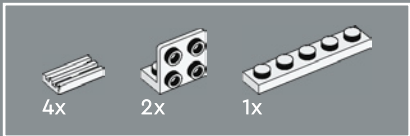

282

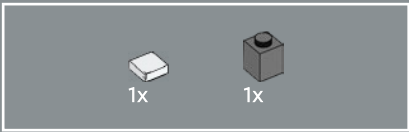
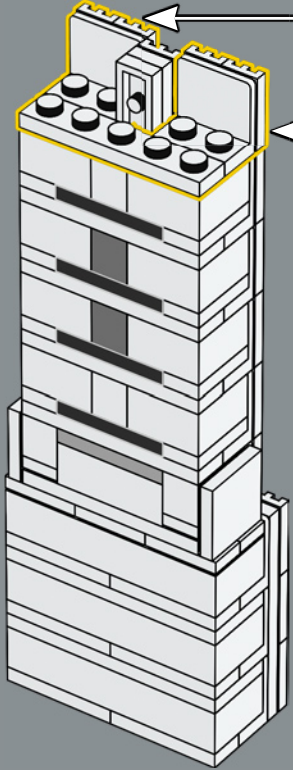
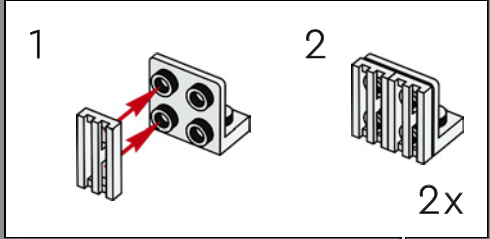

283

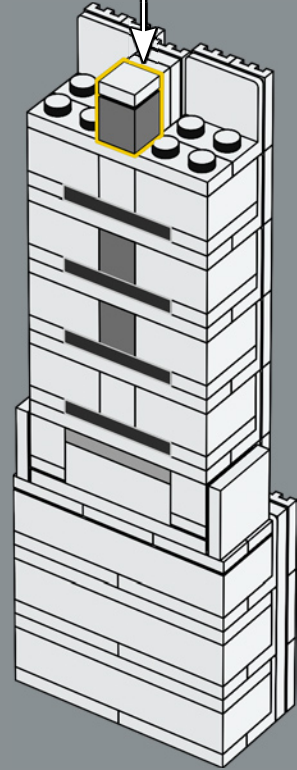
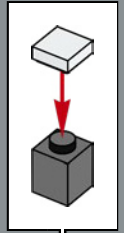

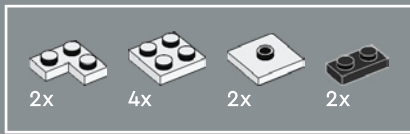

284

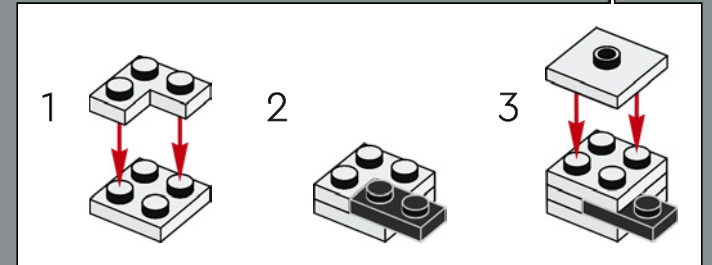
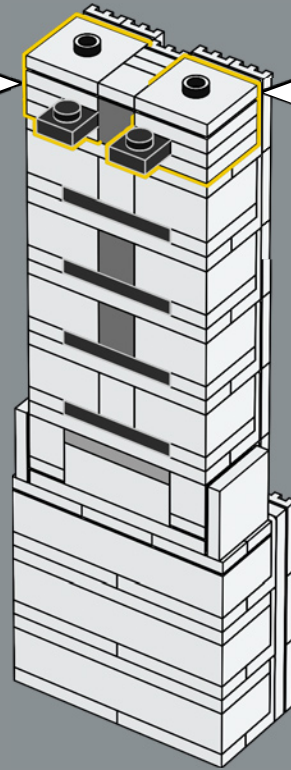
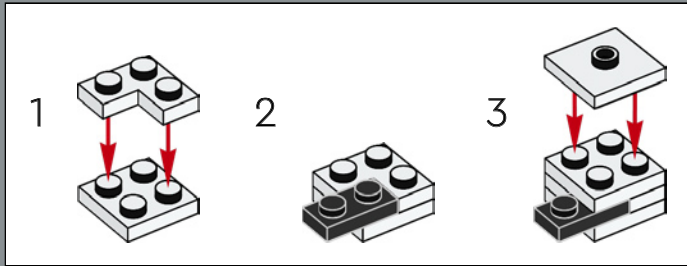

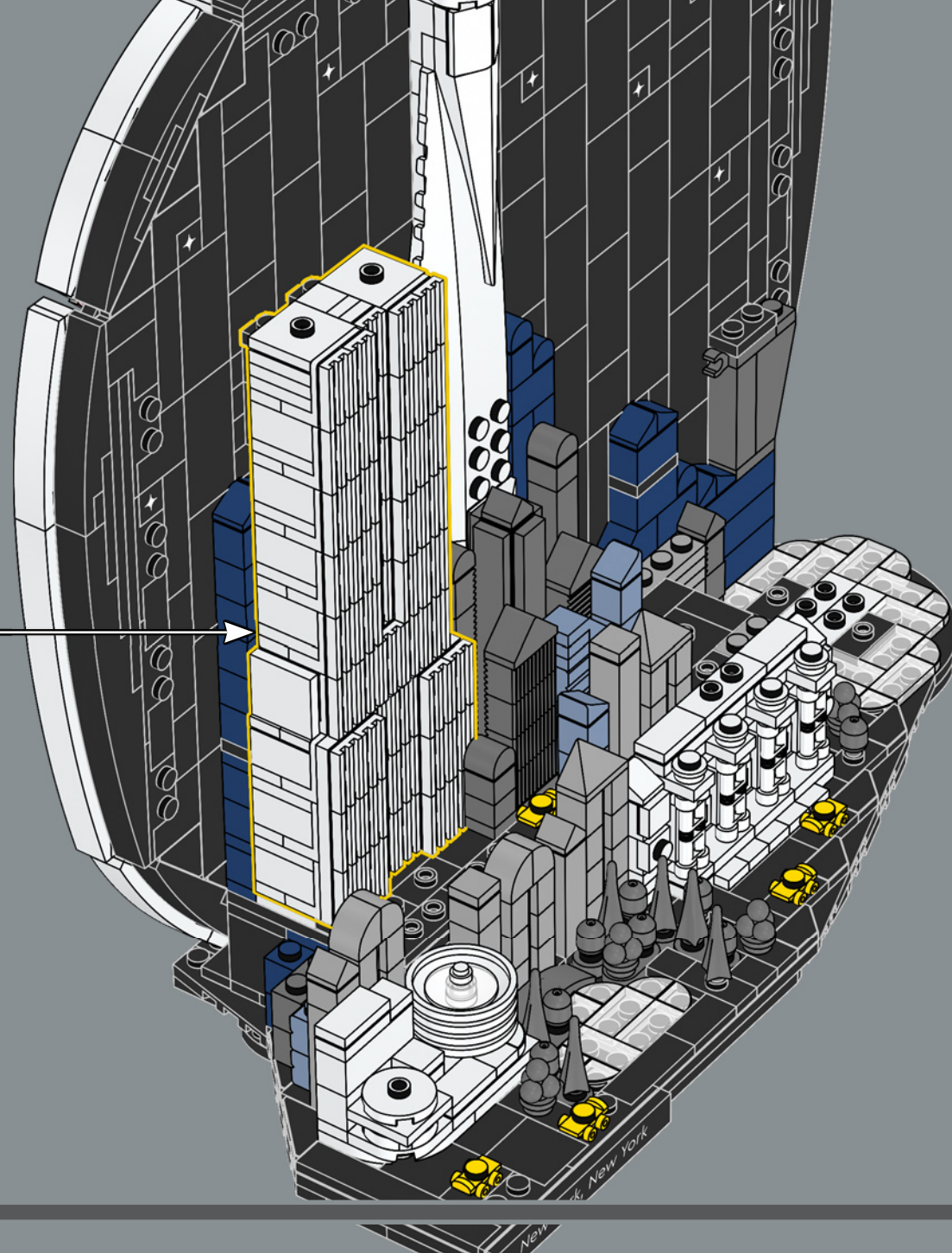

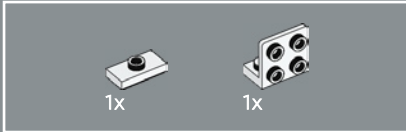
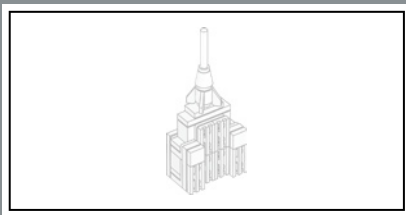

286

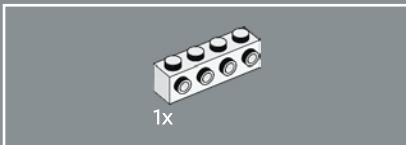
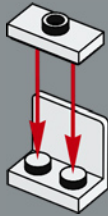

287

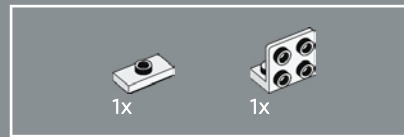
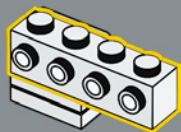

288

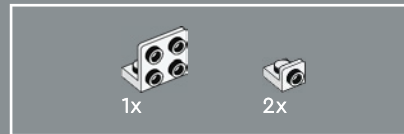
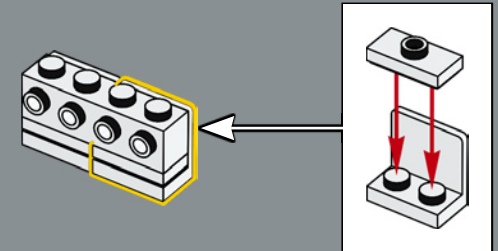

289

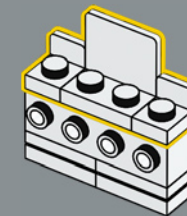



2x

290

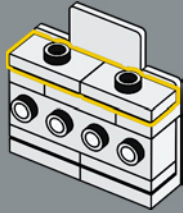

1x



1x

291

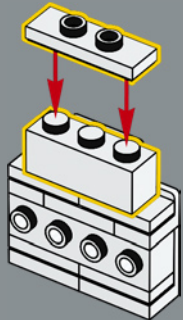

2x

292

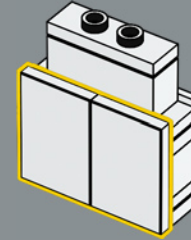

4x

293

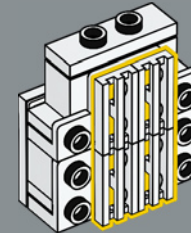



294

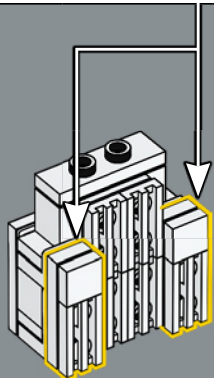
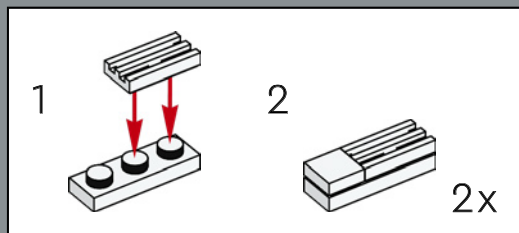

近年来，帝国大厦经过精心修复，以保护其原始设计和历史，使其能够世代传承。

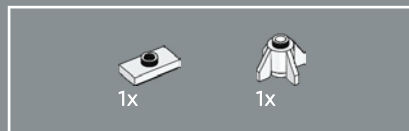

295

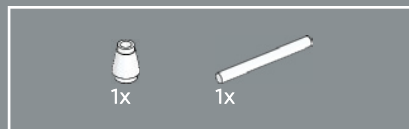
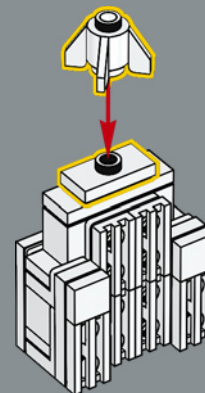

296

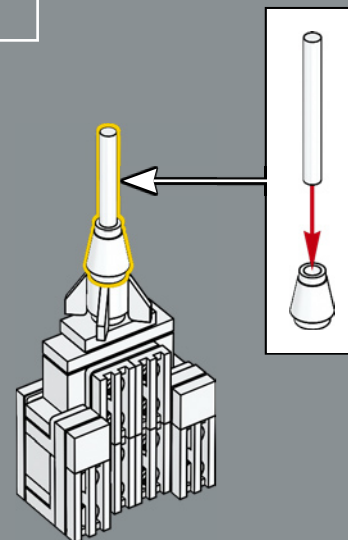

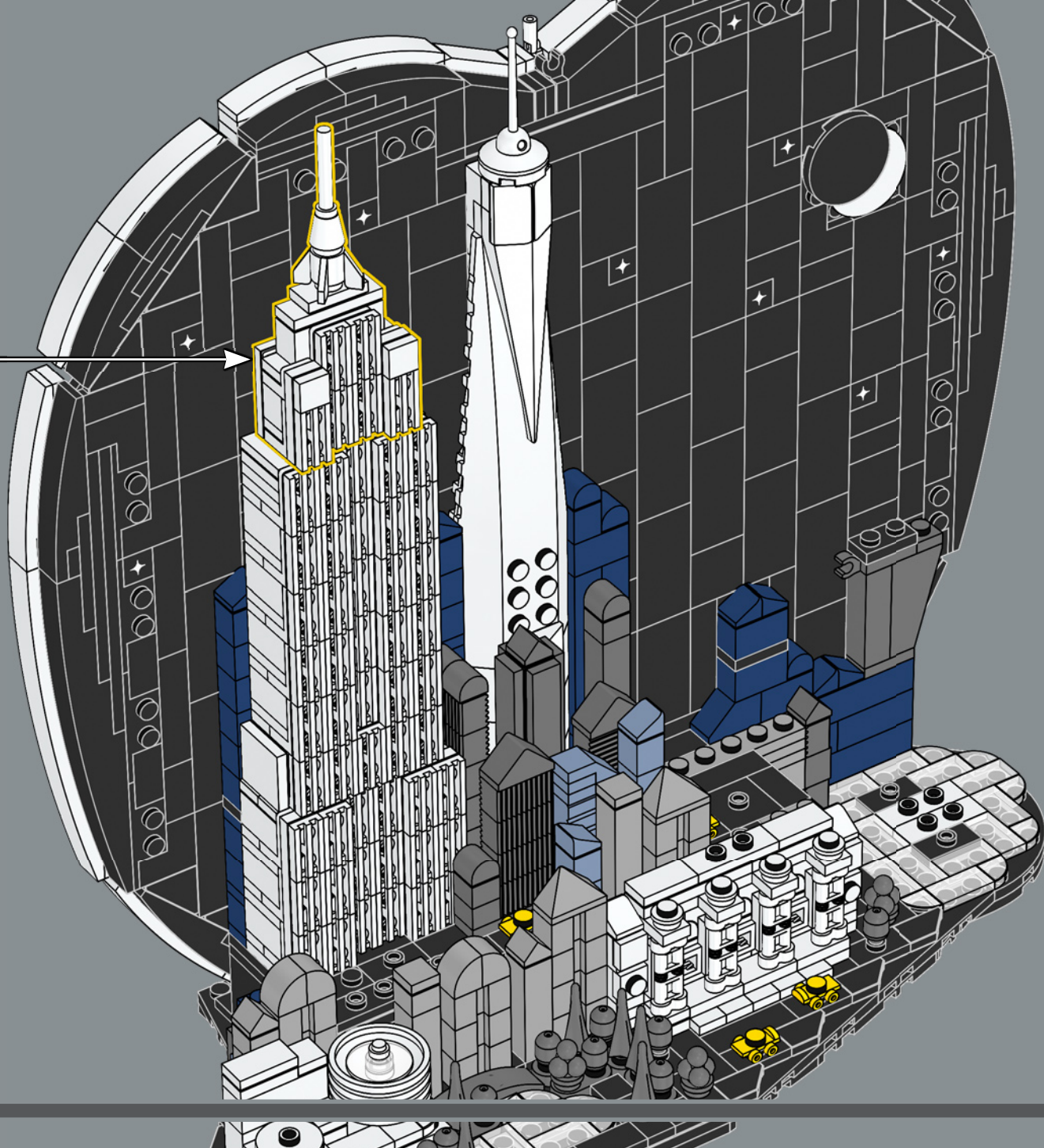

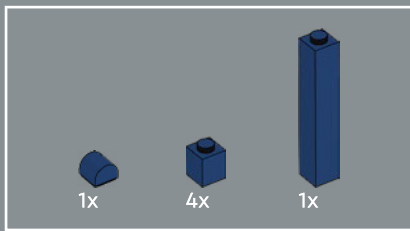

298

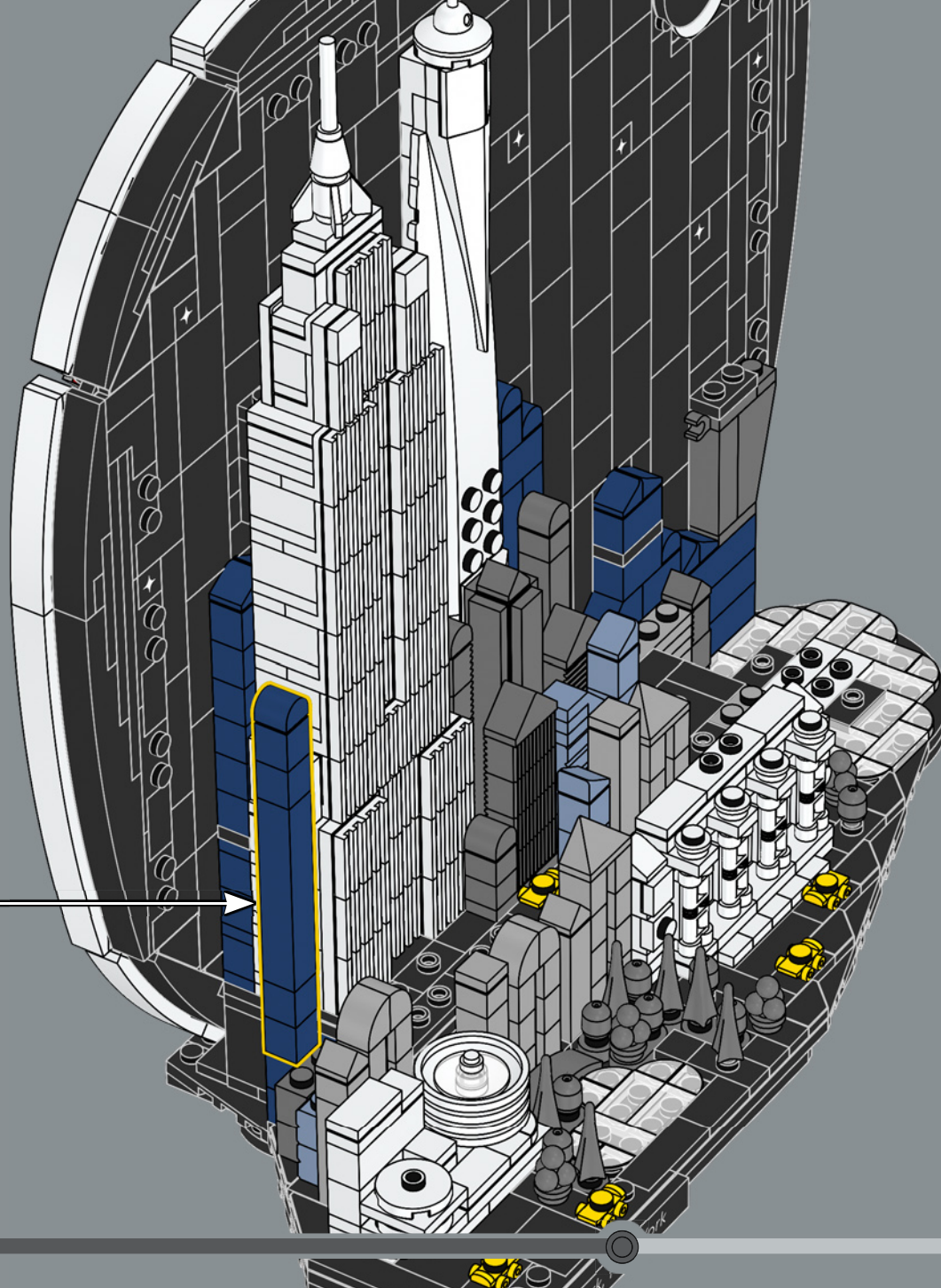
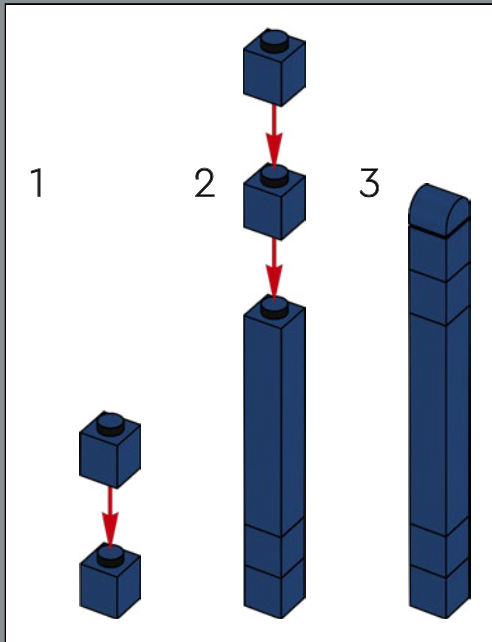

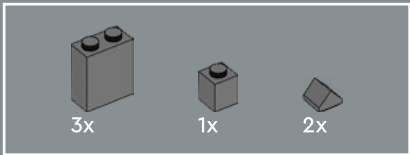

299

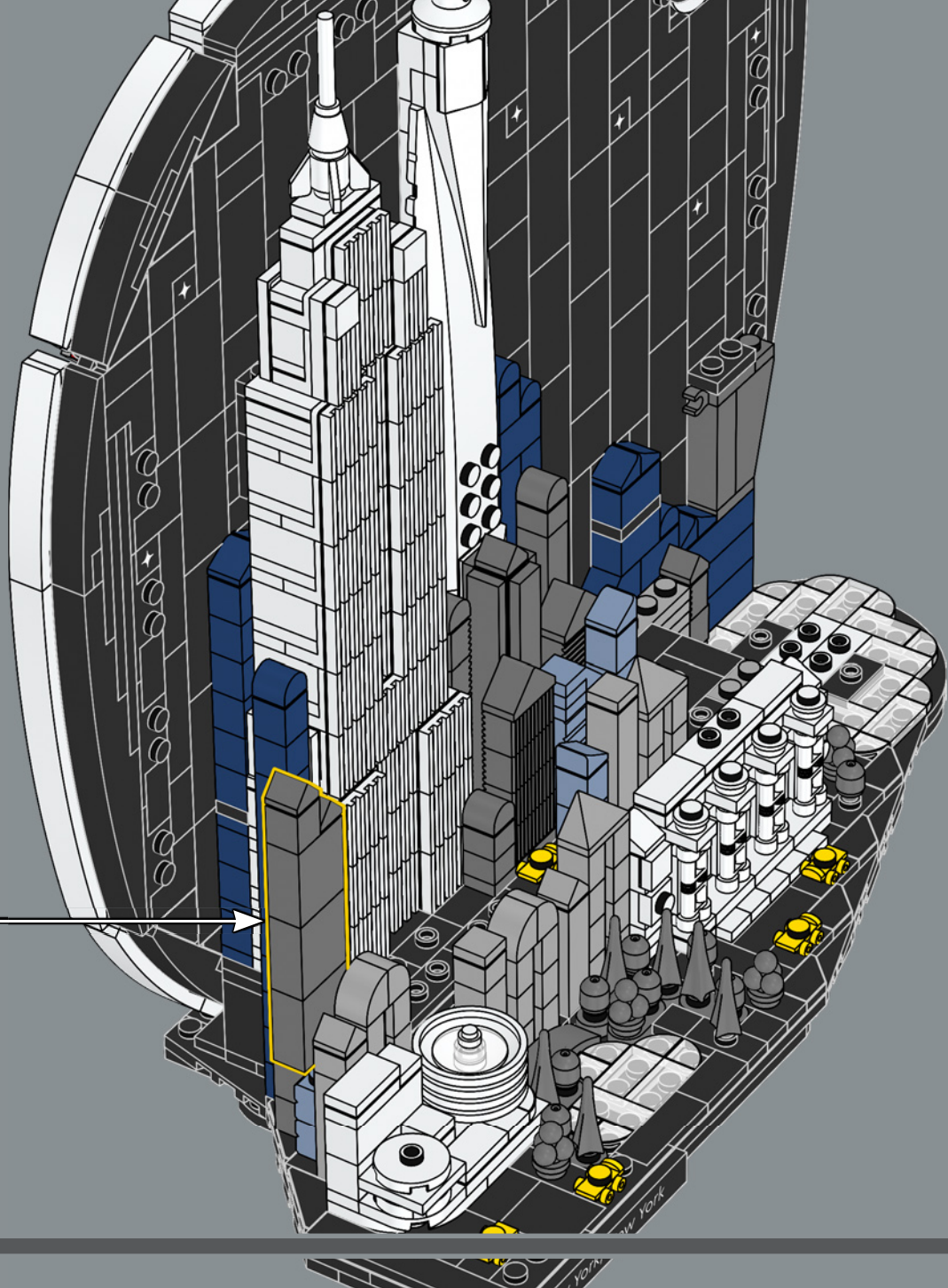
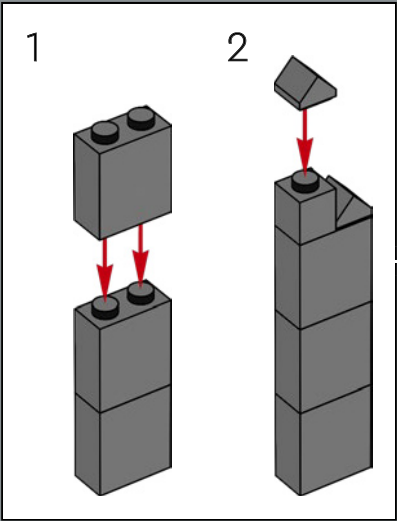

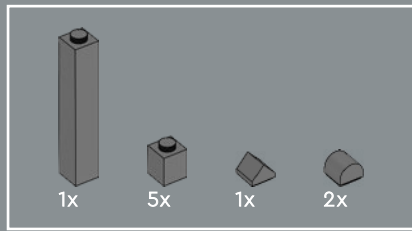

300

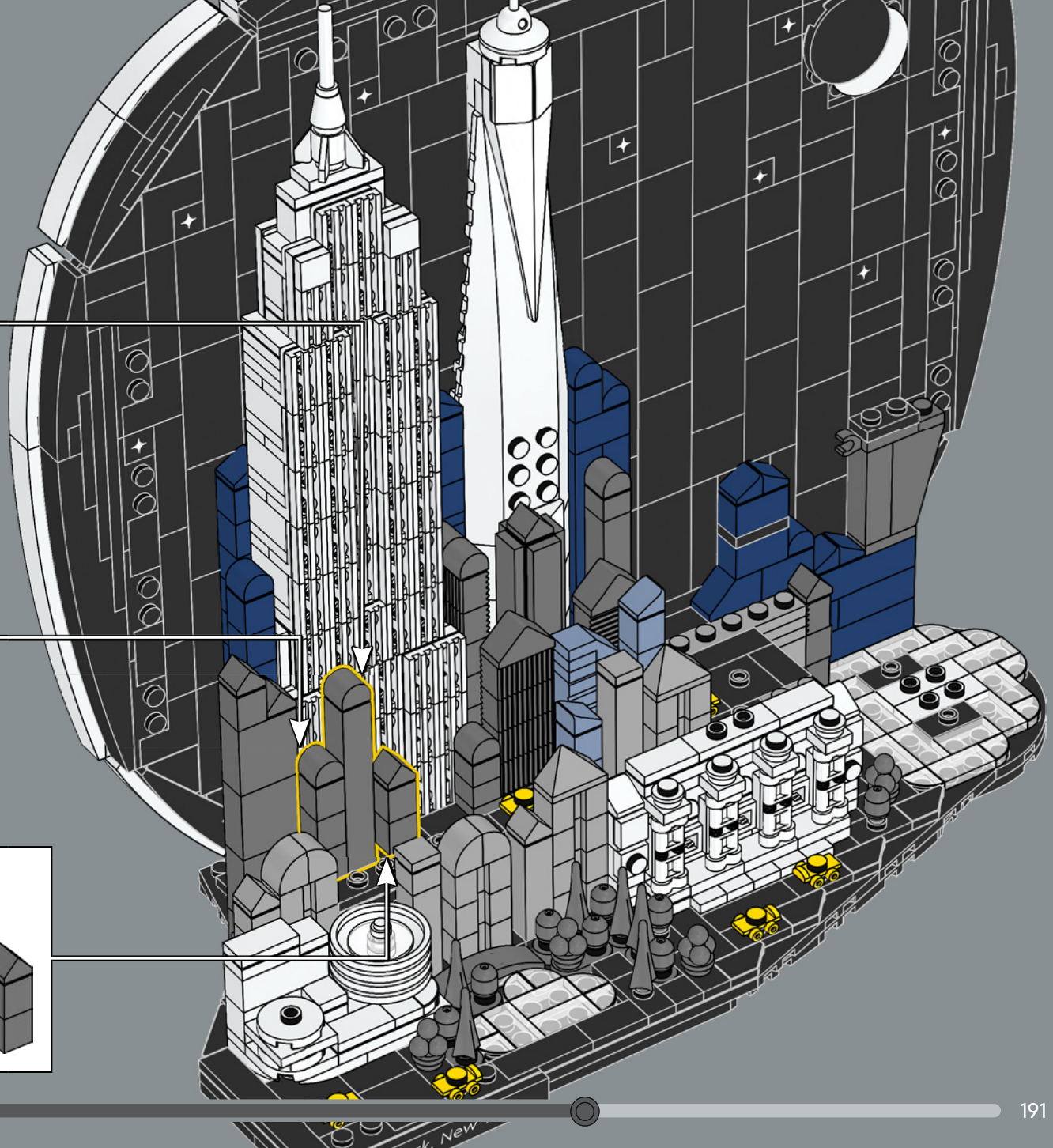
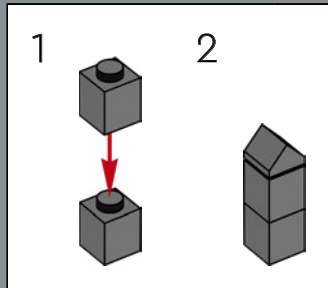
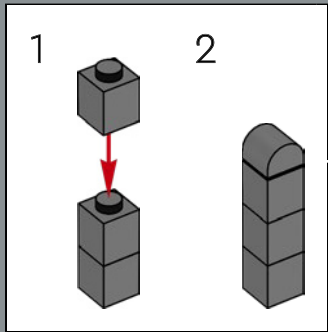
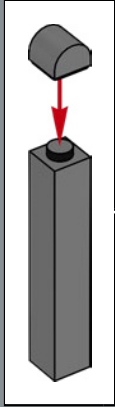



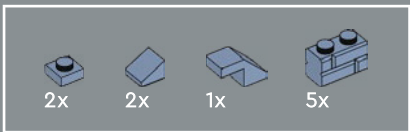

301

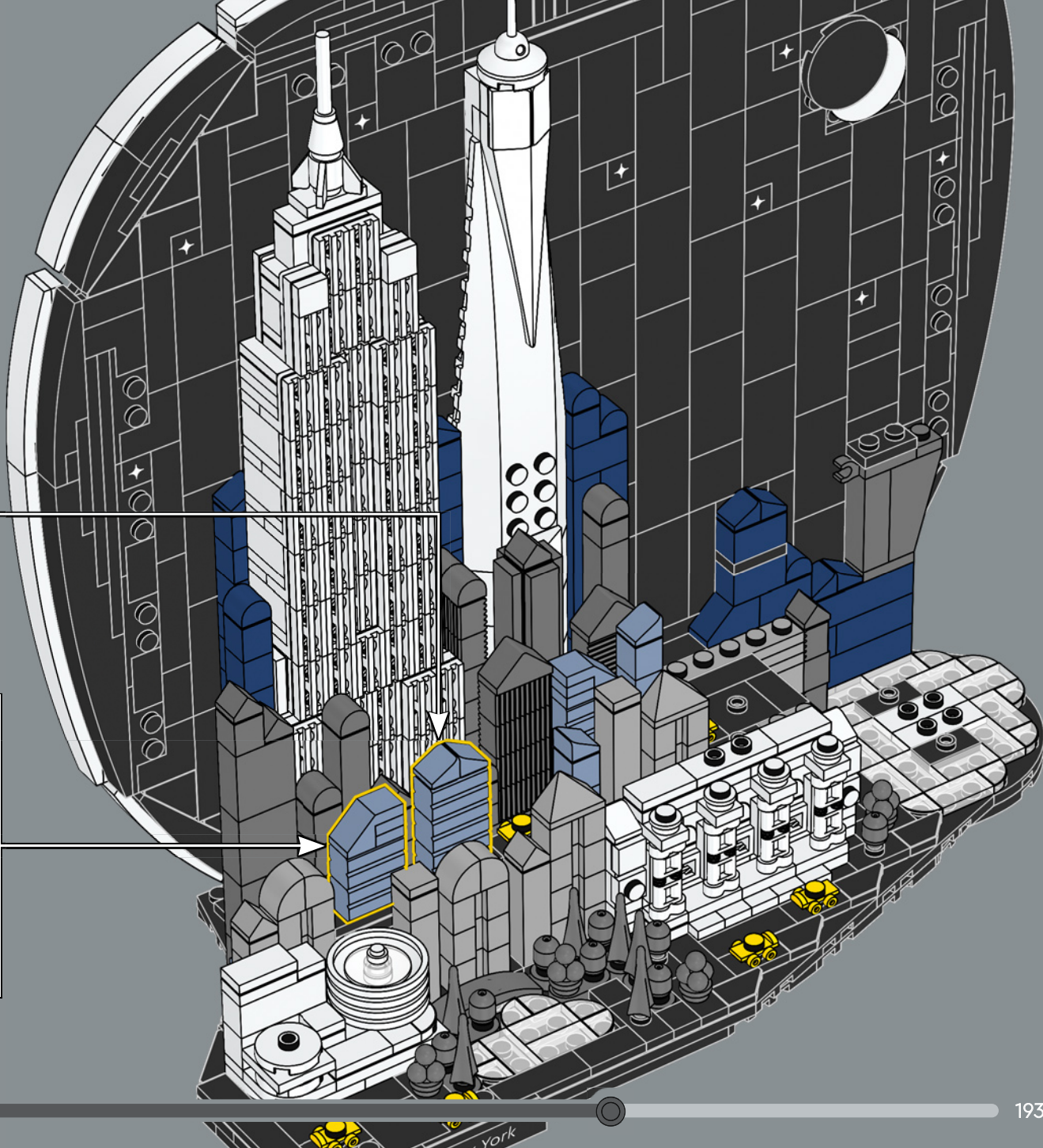
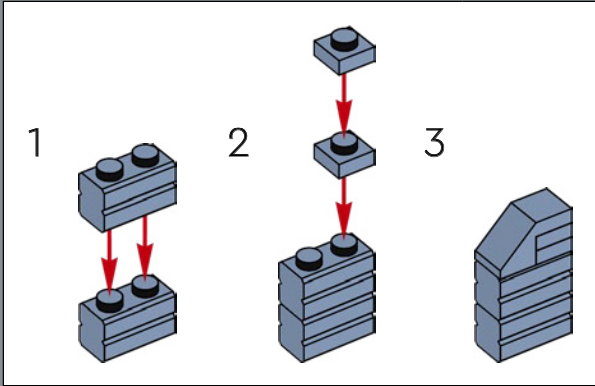
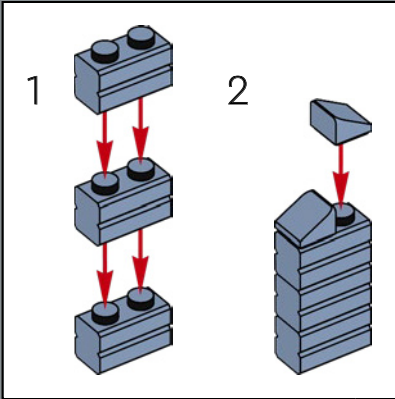

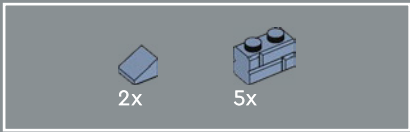

302

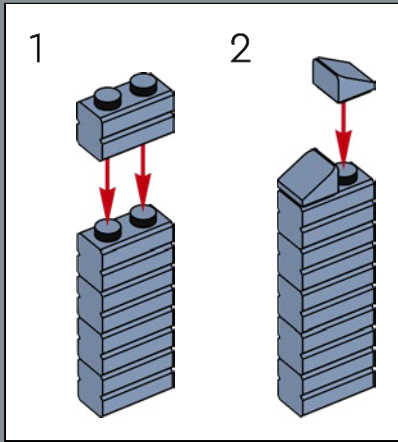
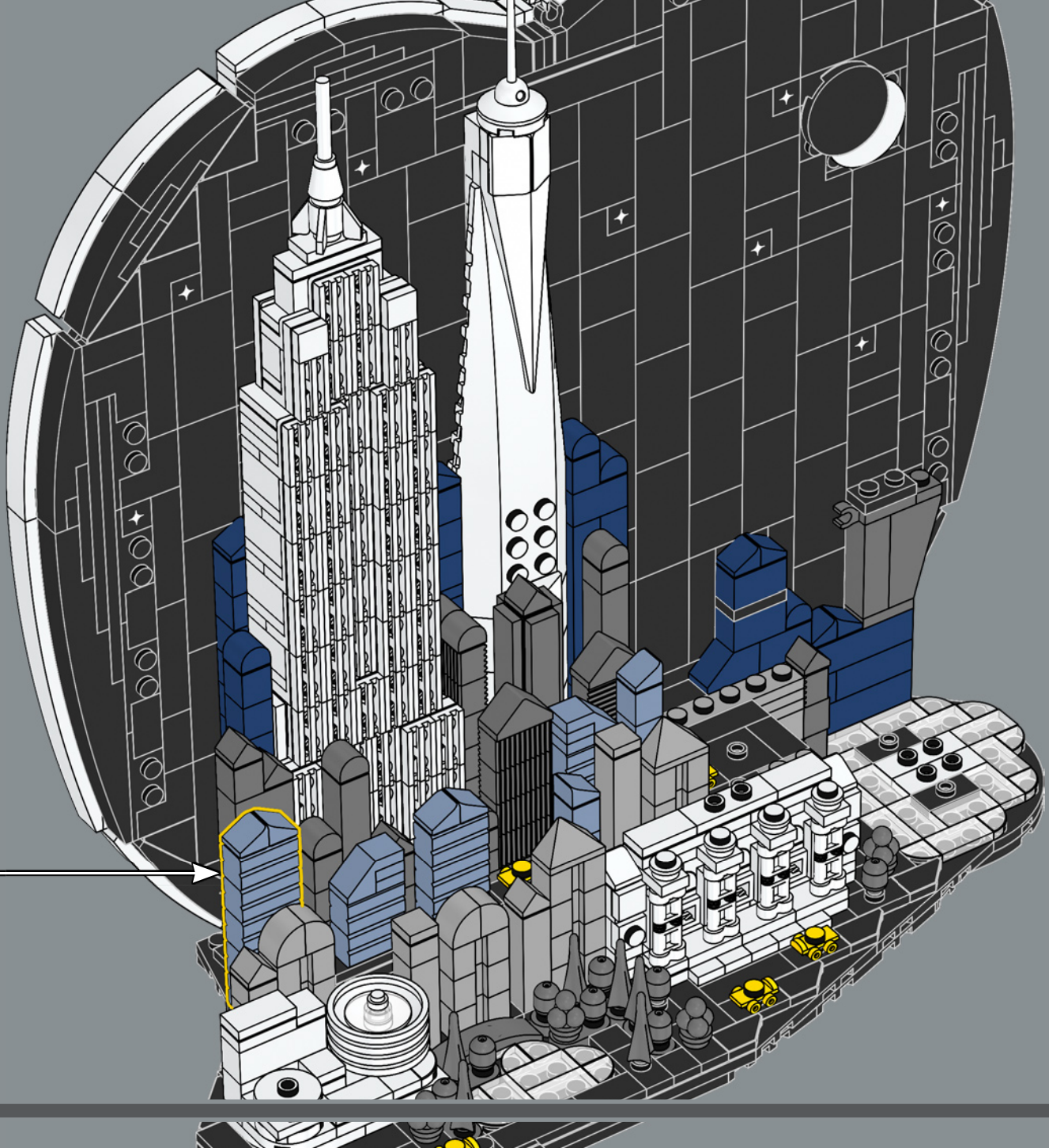



303

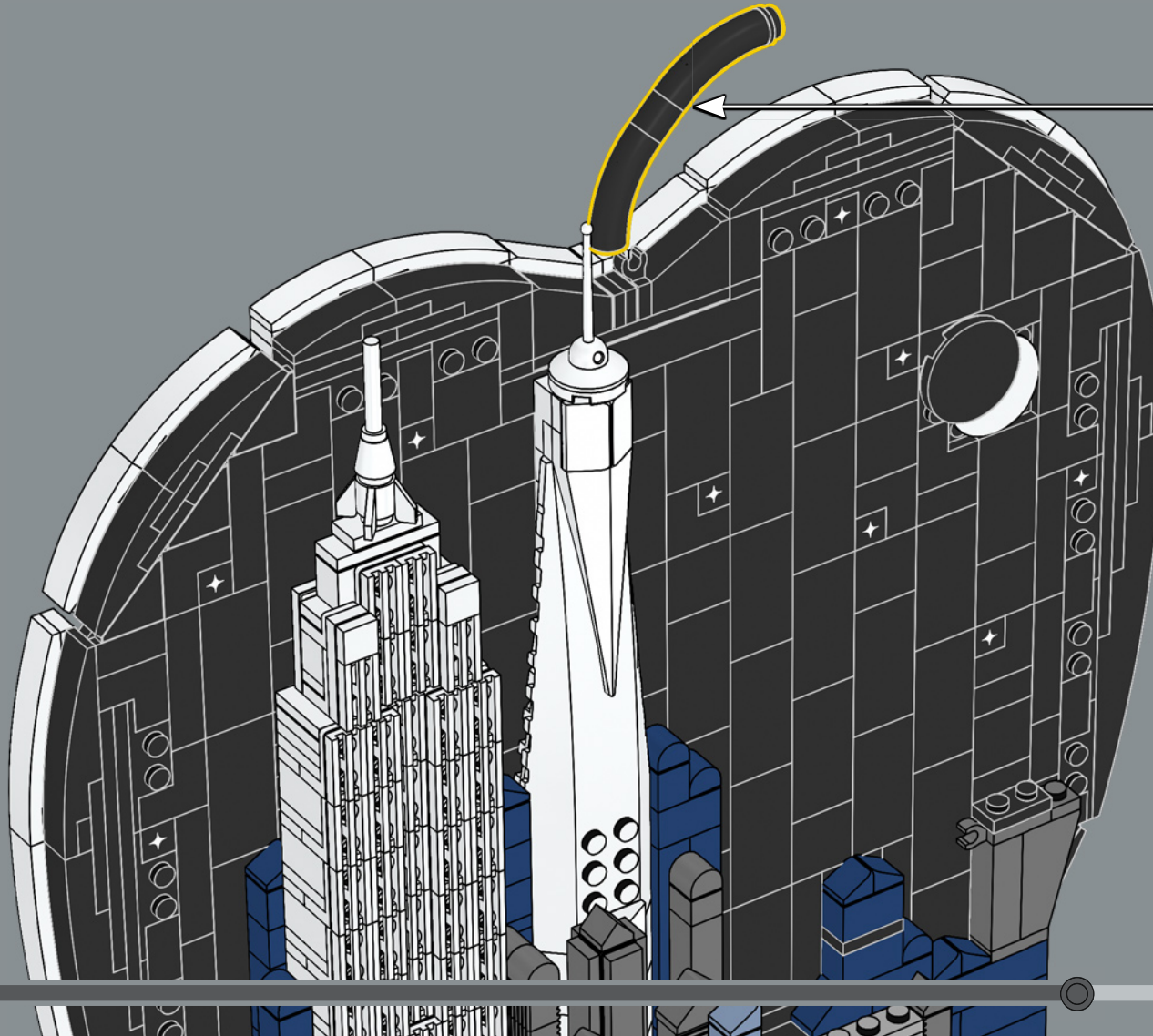
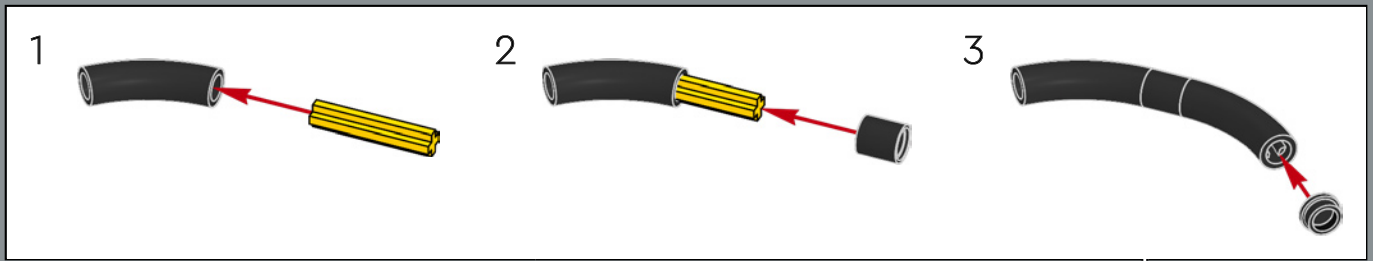

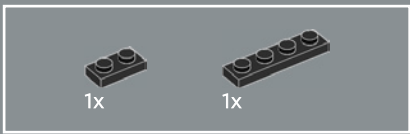

304

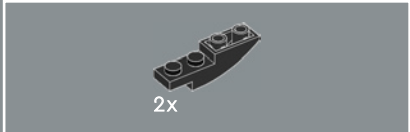
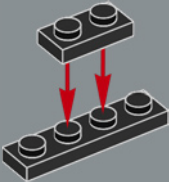

305

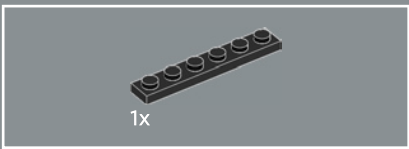
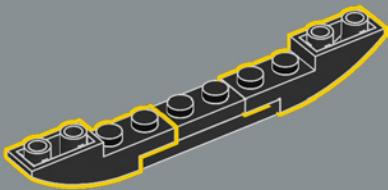

306

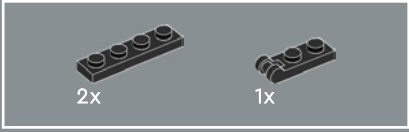
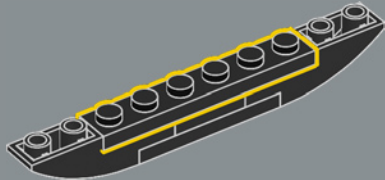

307

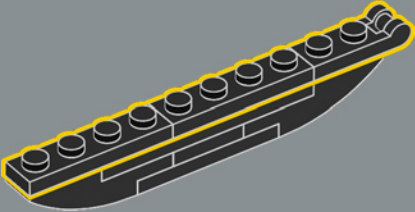

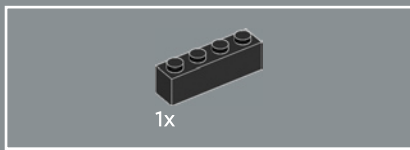

1x

308

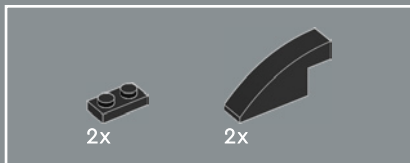
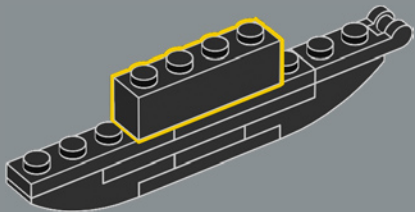

2x

2x

309

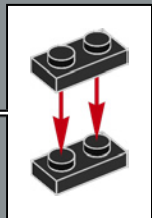
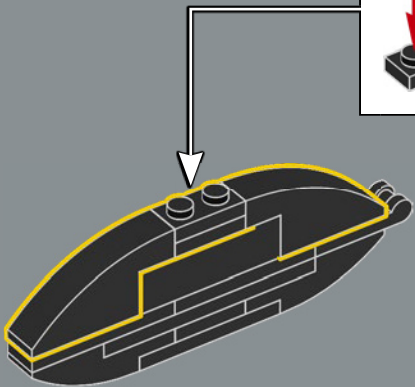

310

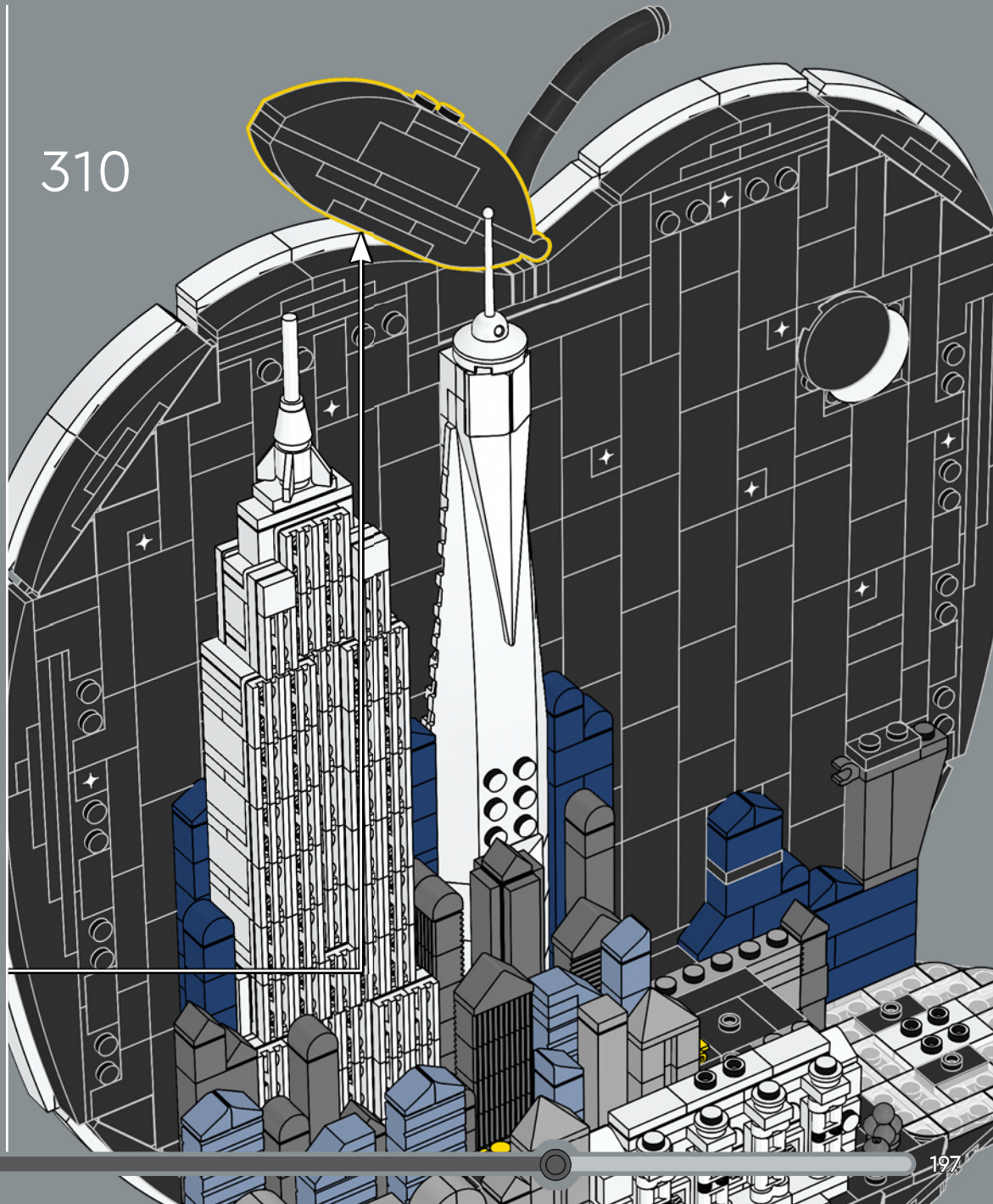

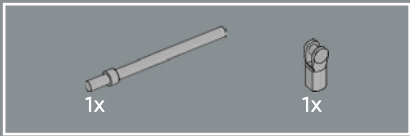

311

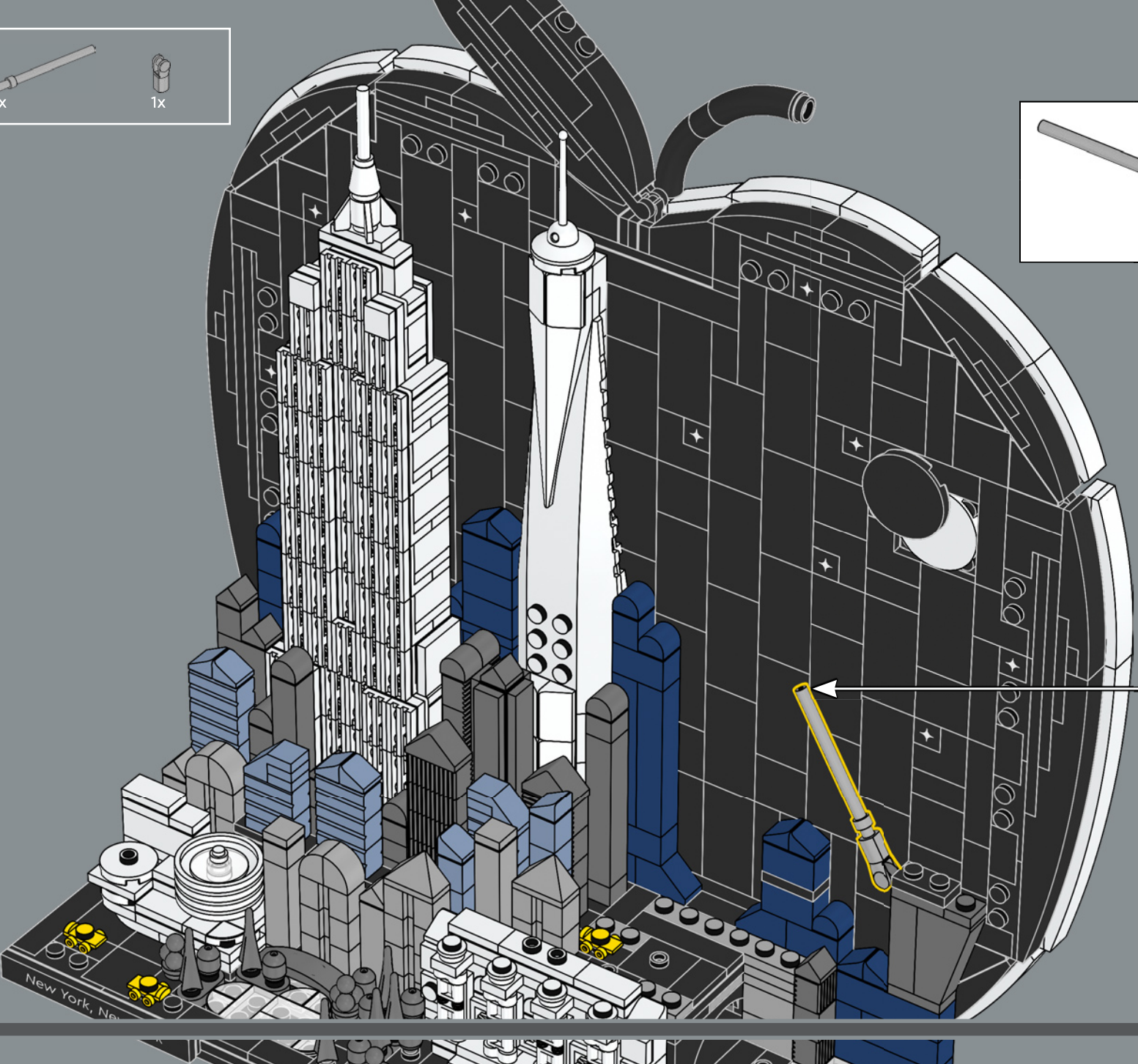
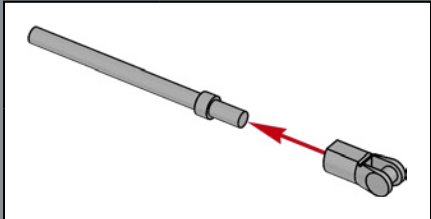

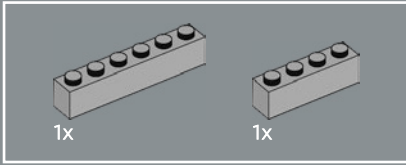
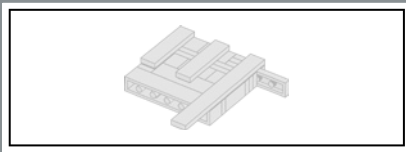

312

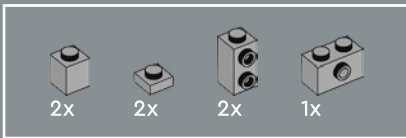
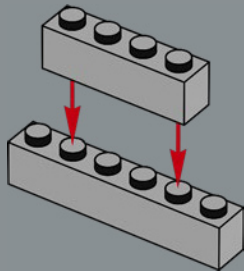

313

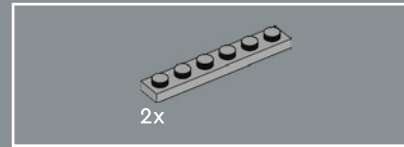
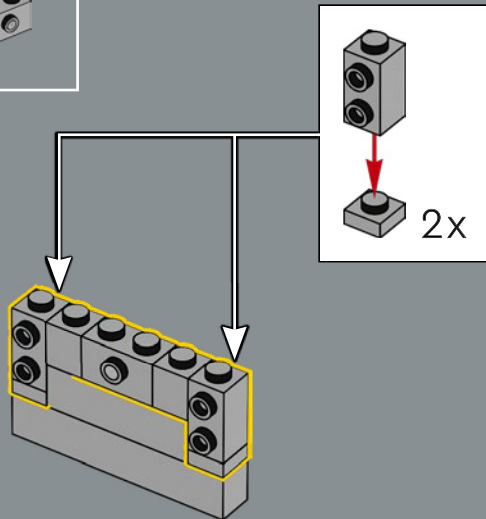

314

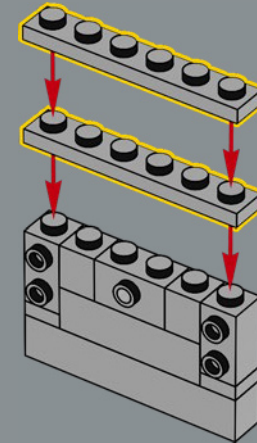

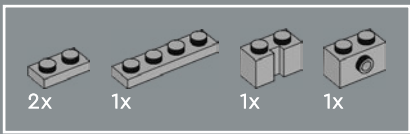

315

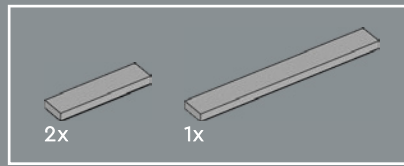
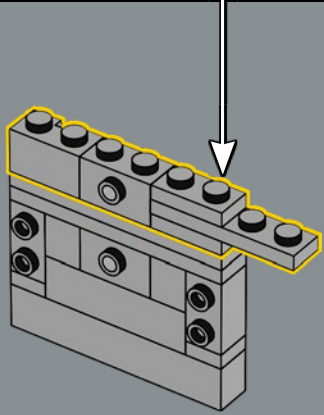
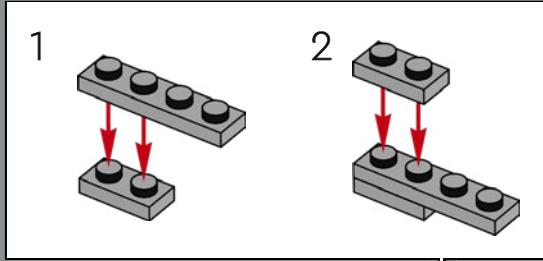

316

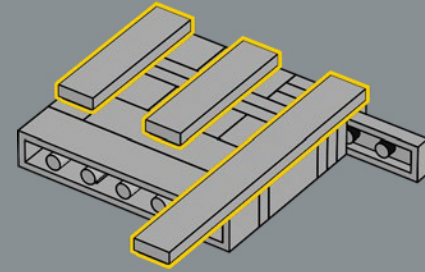

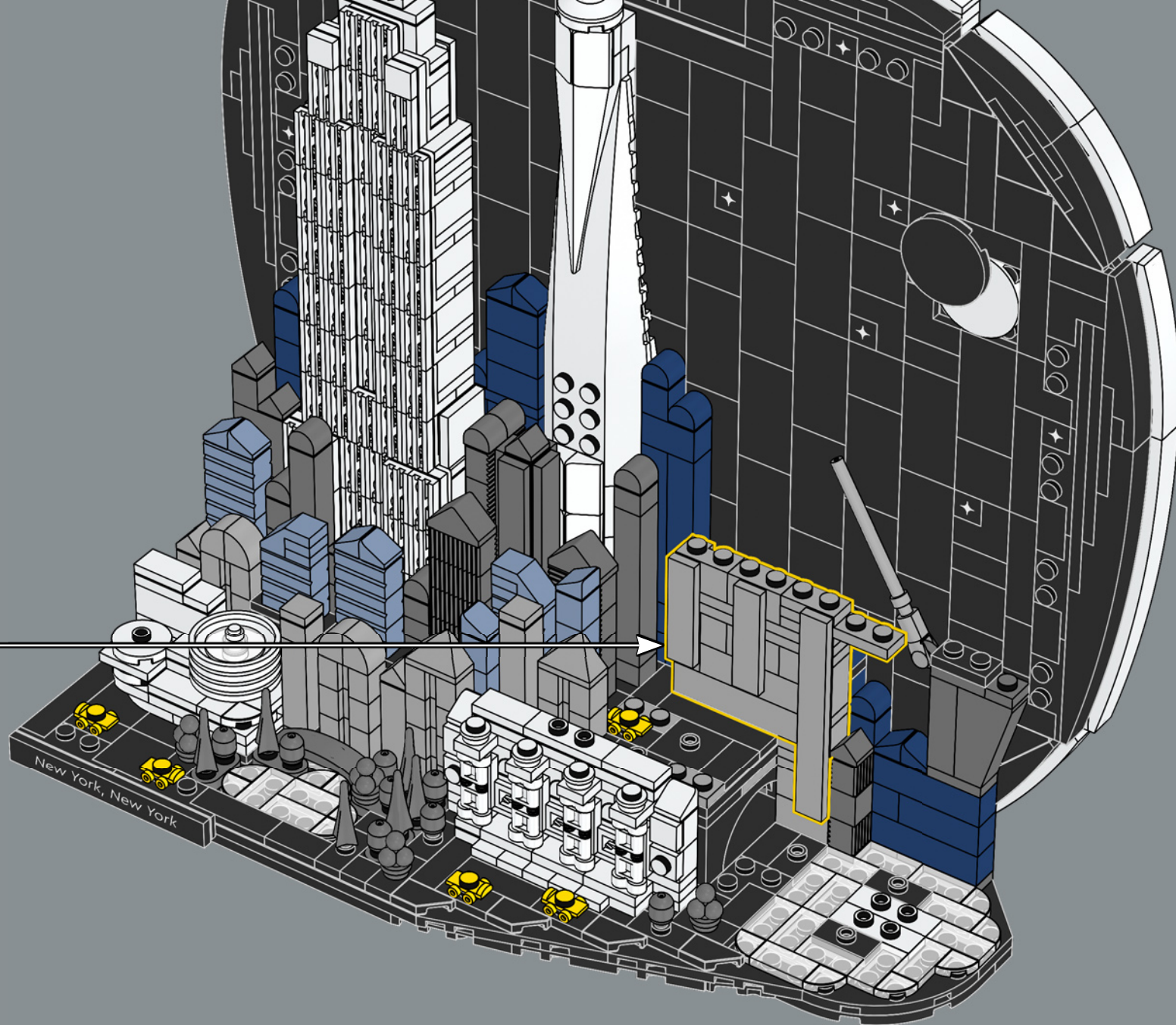

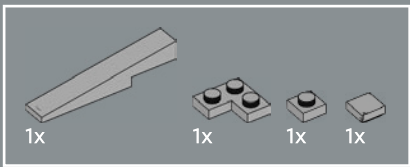

318

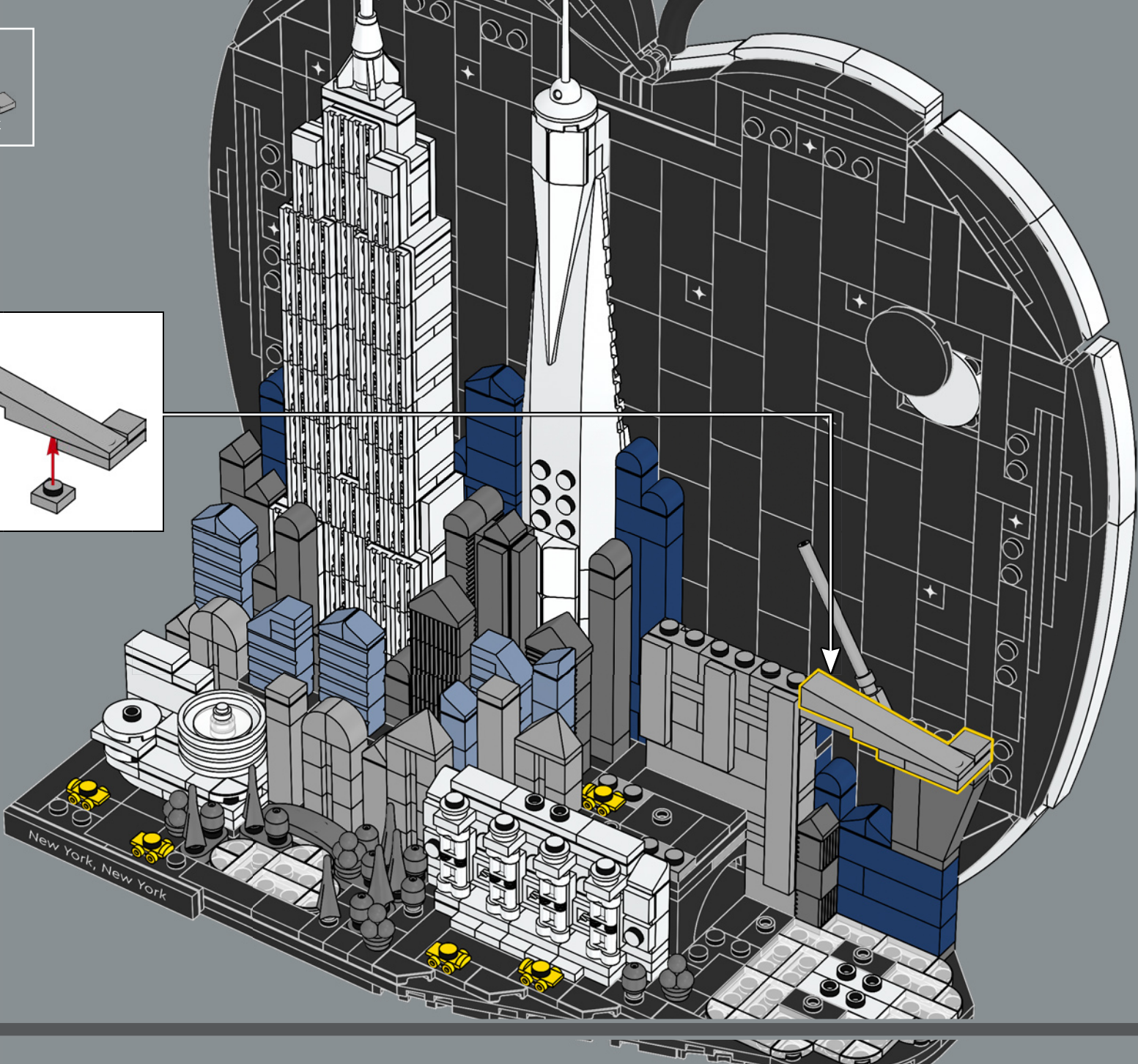
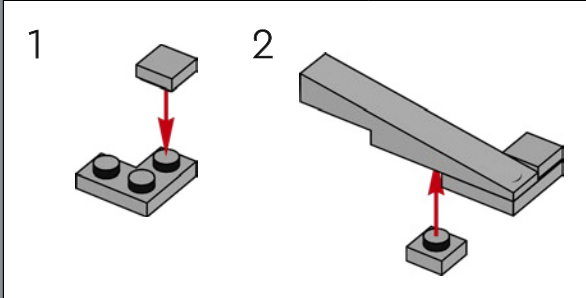



319

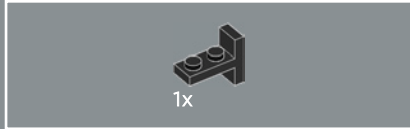

320



321

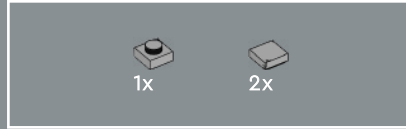
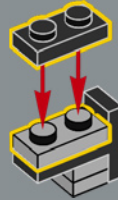

322

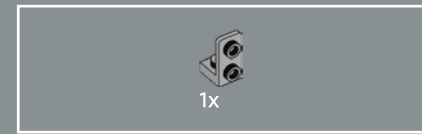
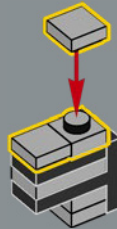

323

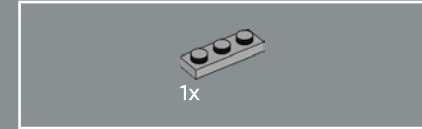
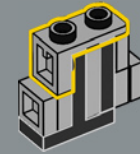

324

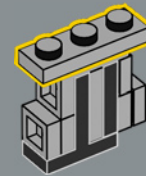

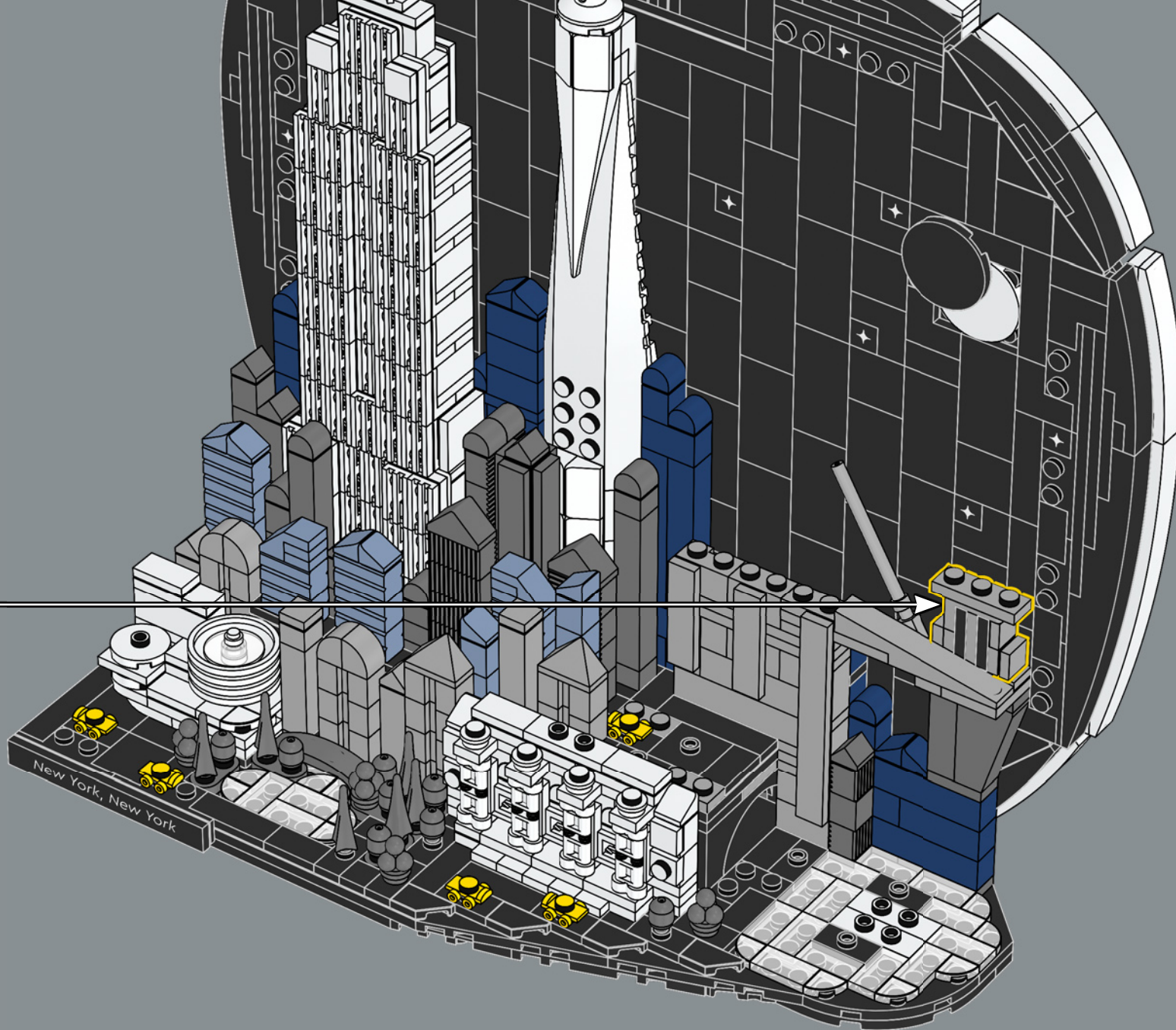

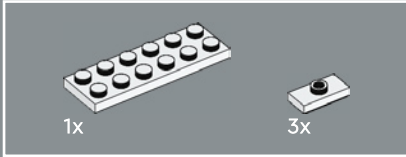
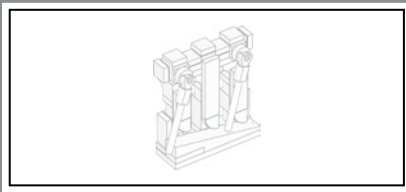

326

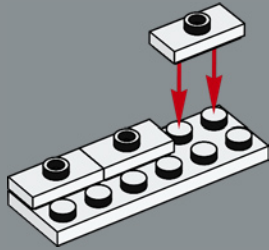

327

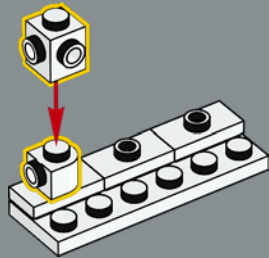

328

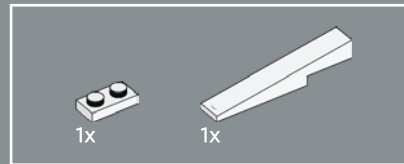
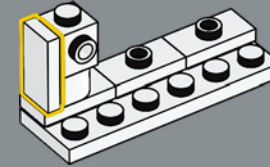

329

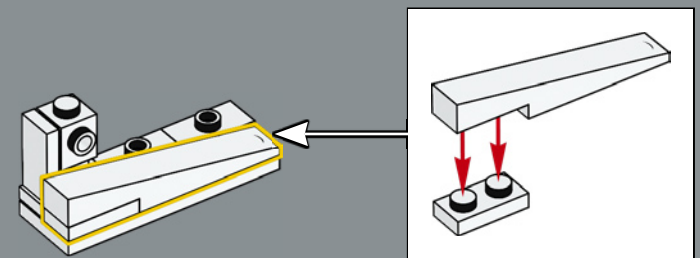

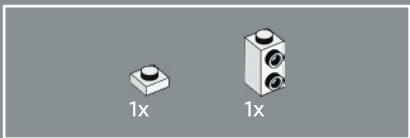

330

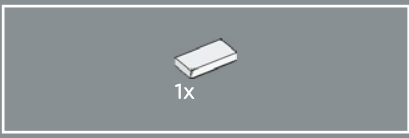
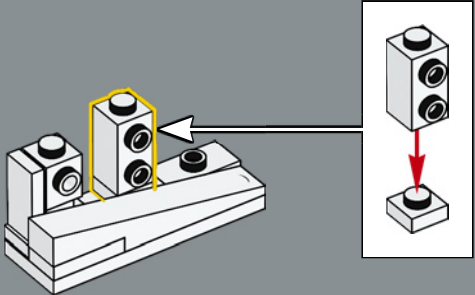

332

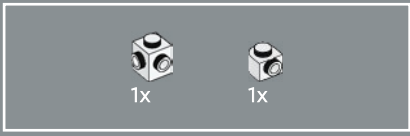
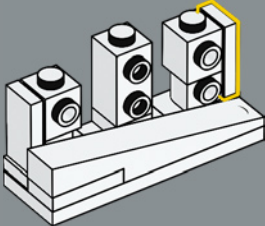

331

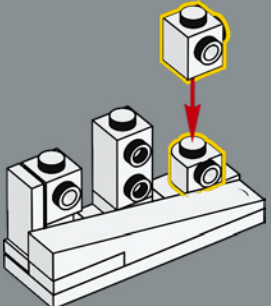

333

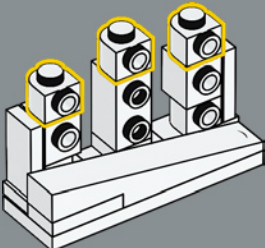



334

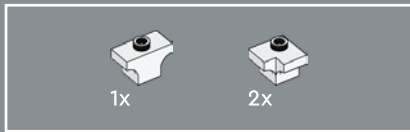
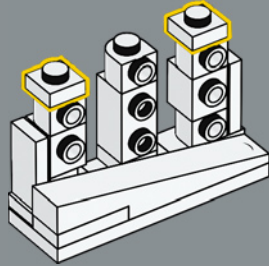

335

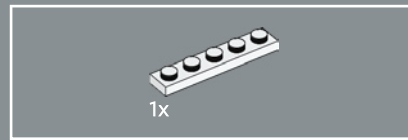
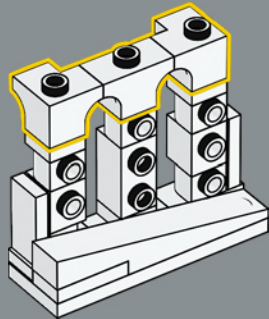

336

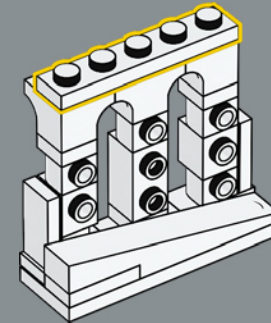

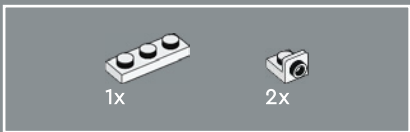

337

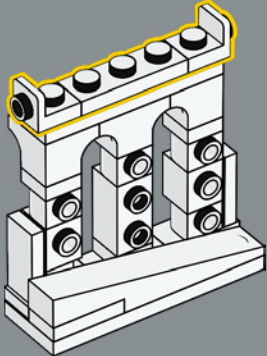

338

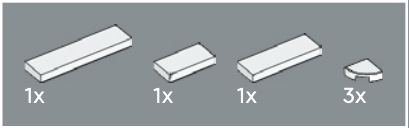
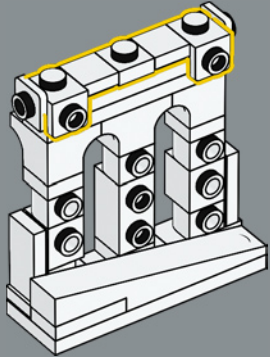

339

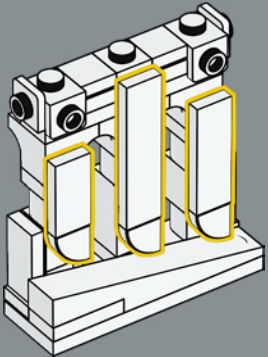



2x

340

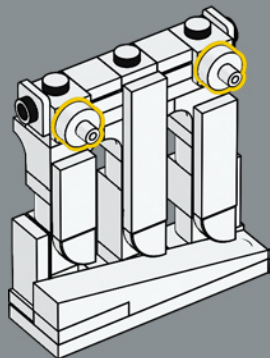

5x

341

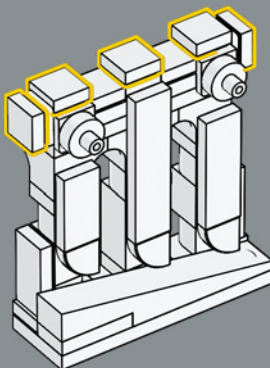

2x



2x

342

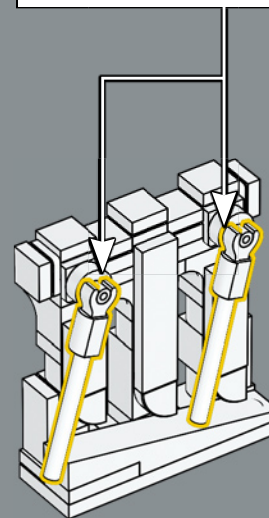
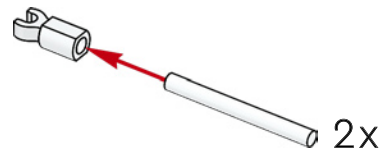

每天有超过 13.7万 人驾车、步行或骑自行车穿过布鲁克林大桥。
(卡车禁止上桥。)



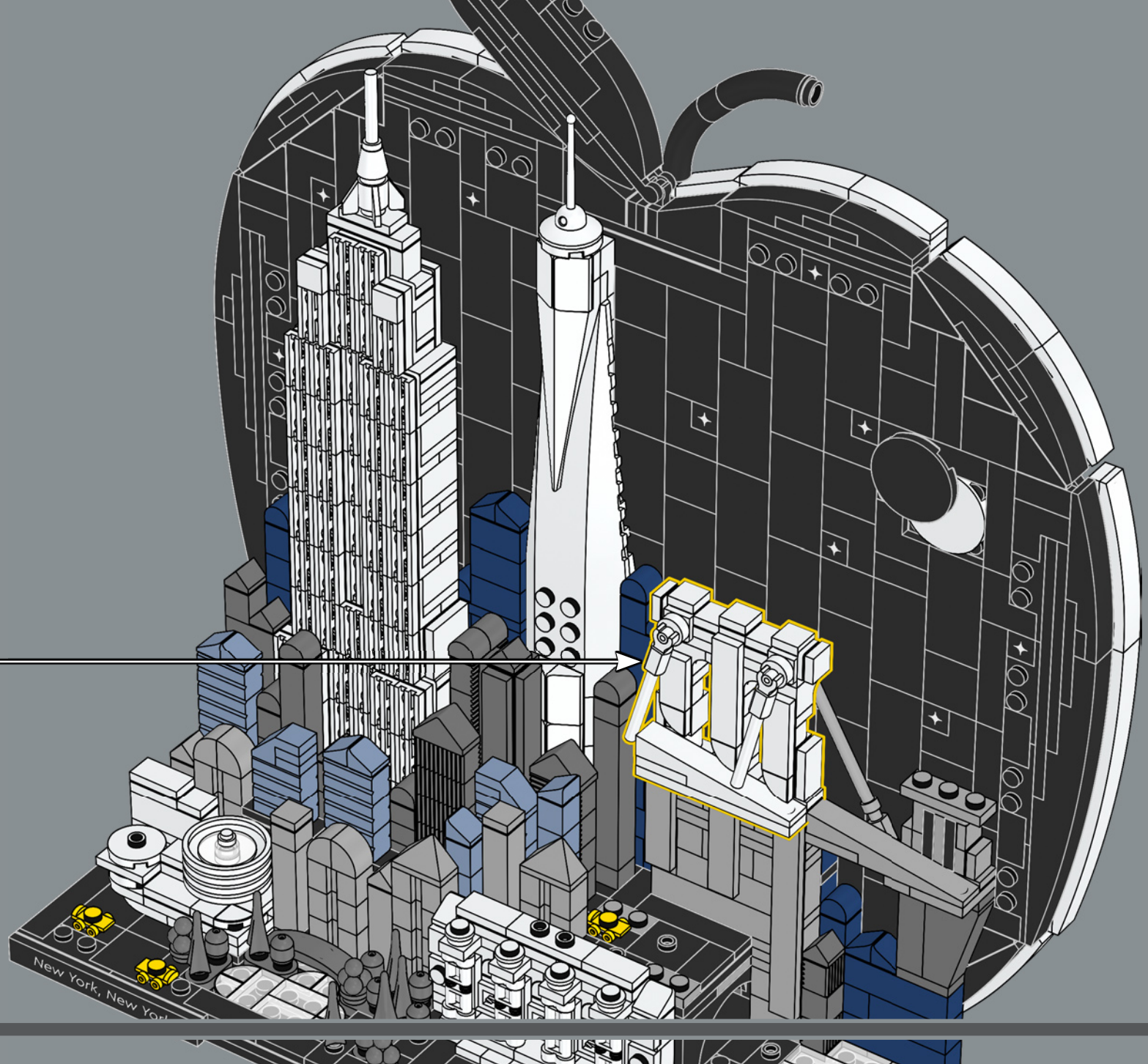

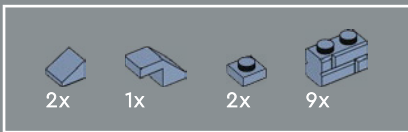

344

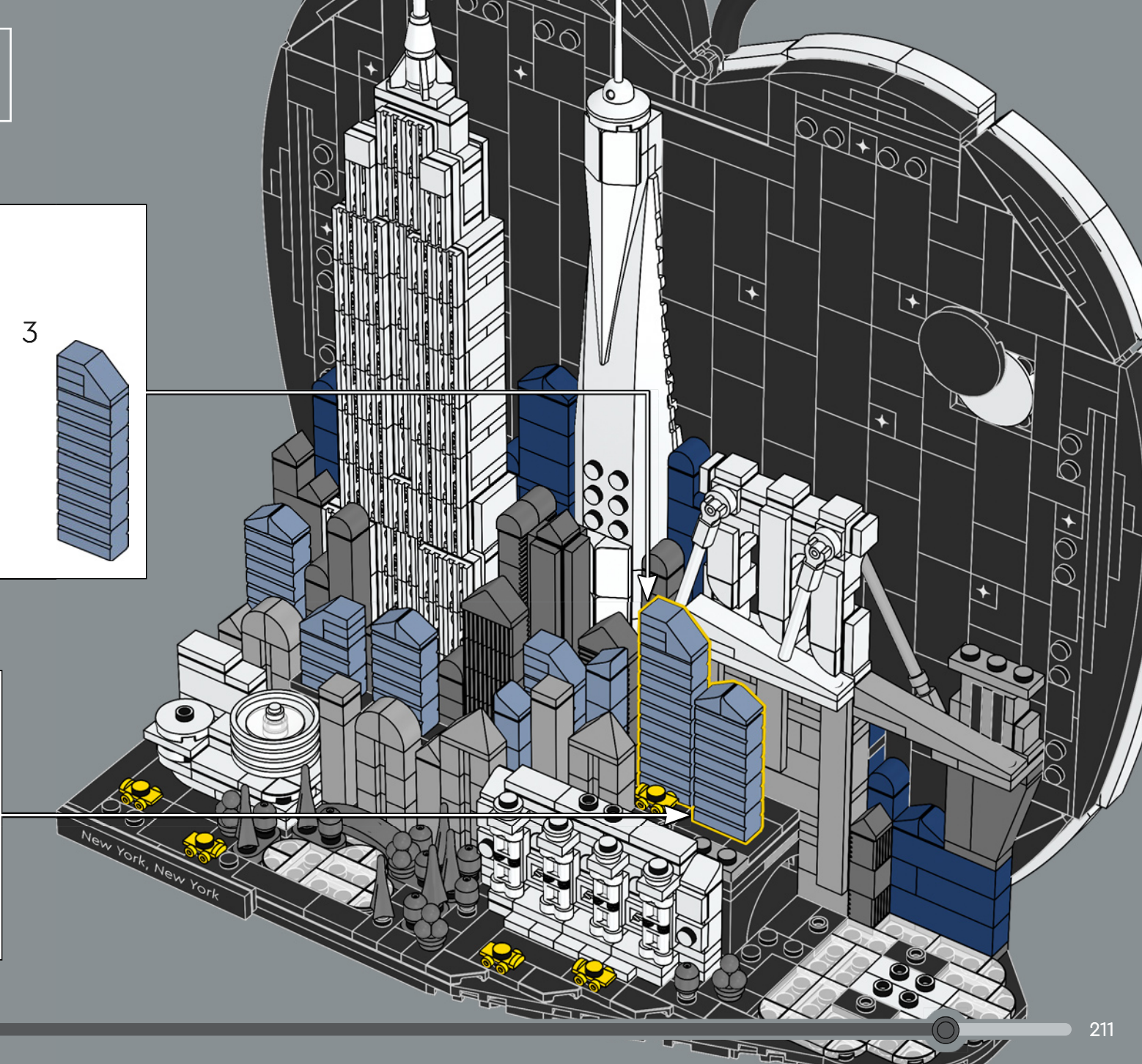
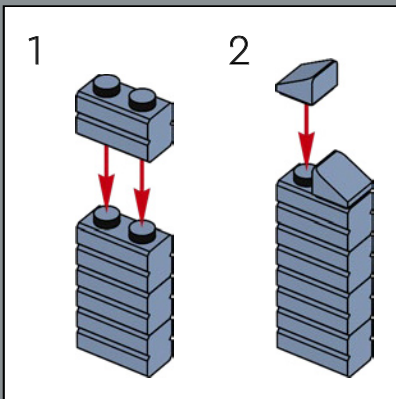
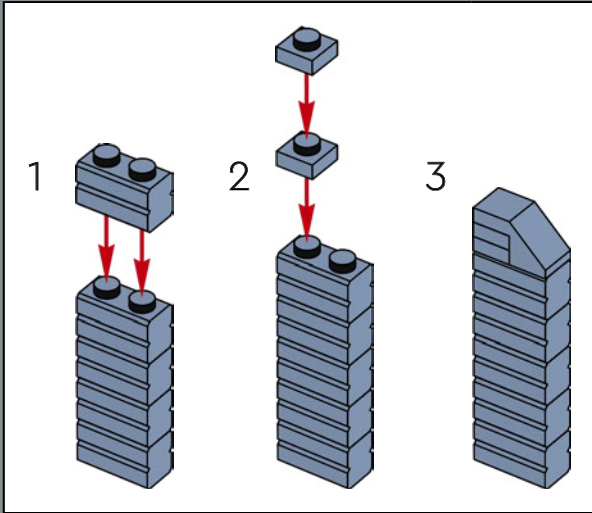

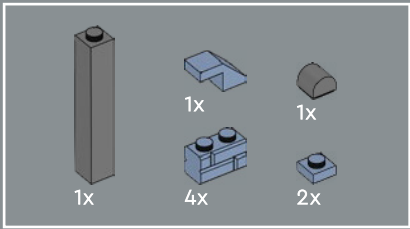

345

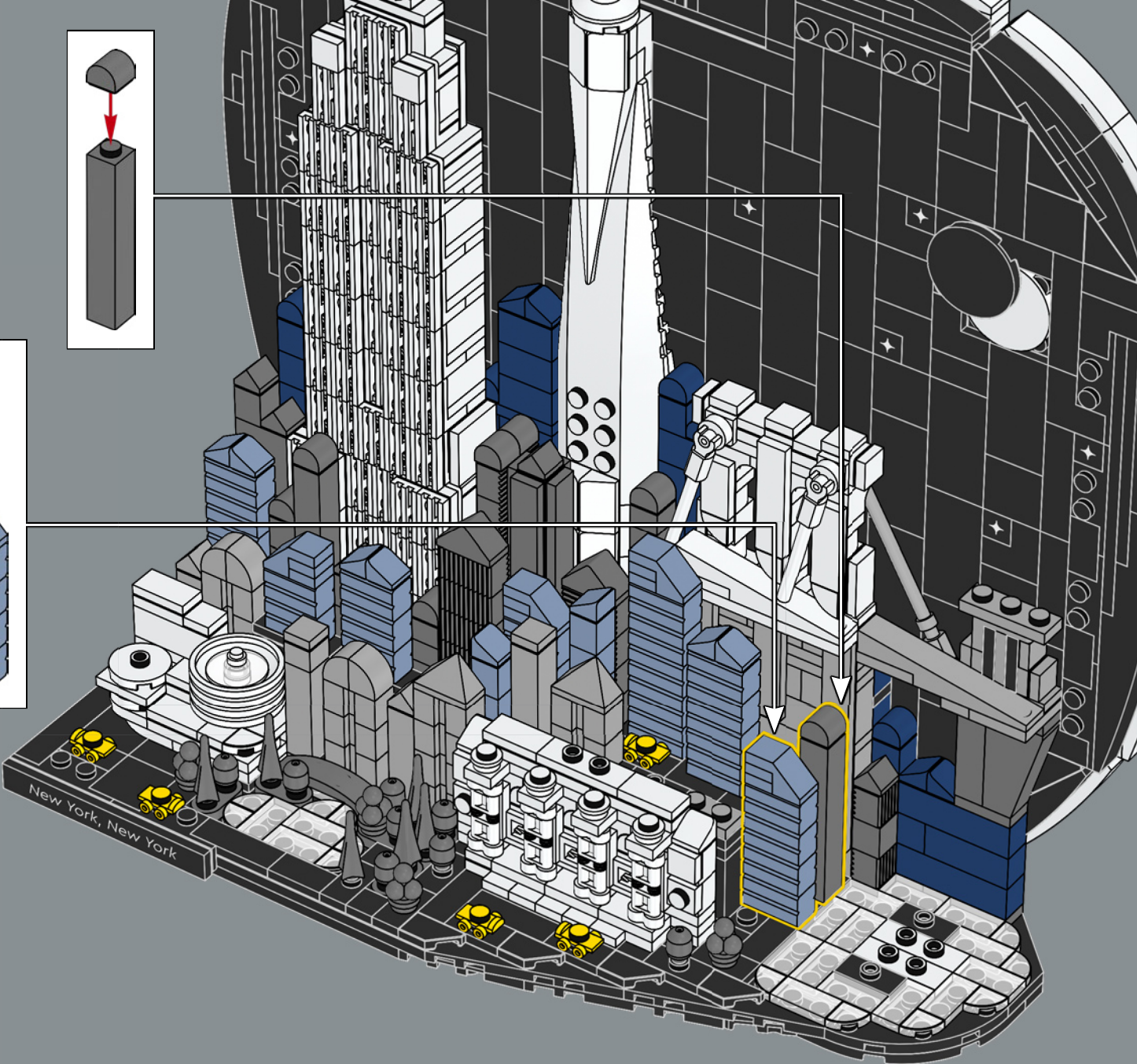
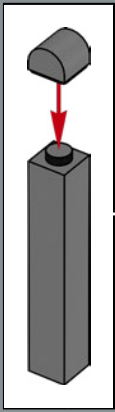
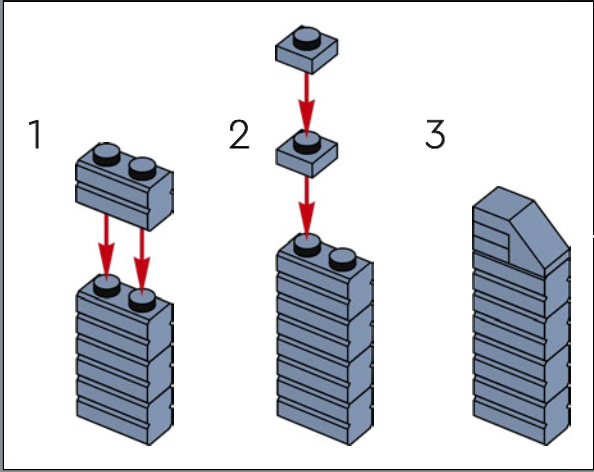

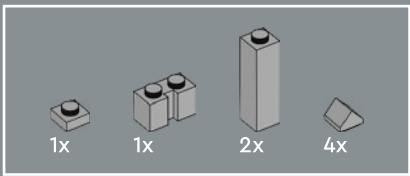

346

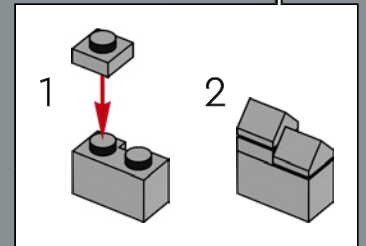
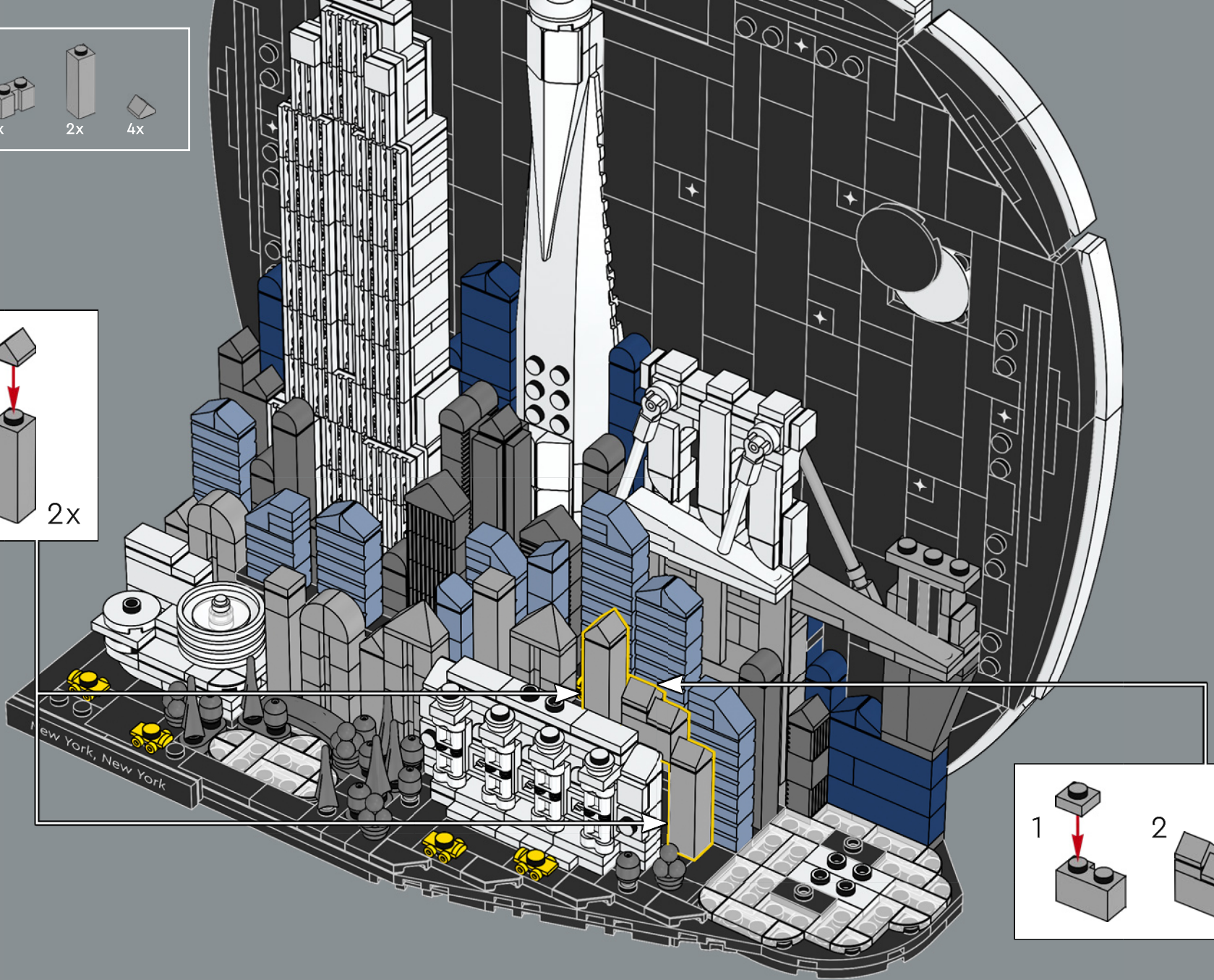
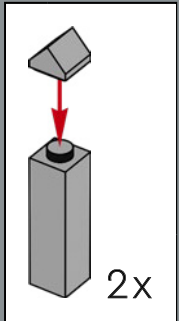

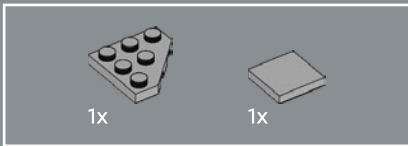

347

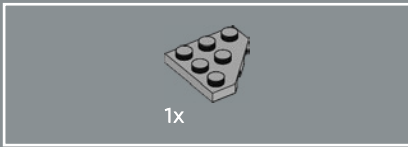
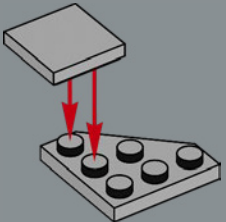

348

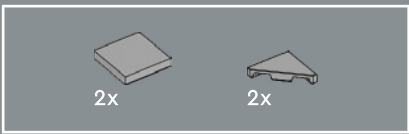
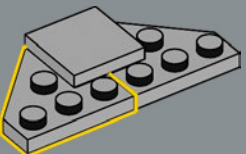

349

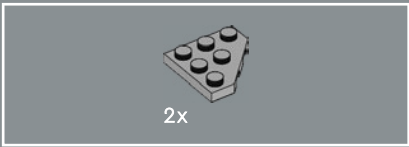
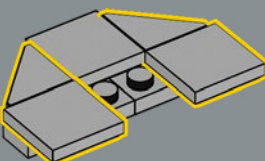

350

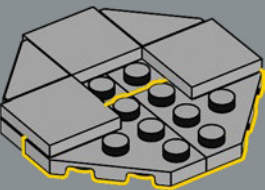

令人印象深刻的自由女神像高 92.9 米 (305 英尺)，从地面到火焰顶端，大约相当于一座 22 层楼的高度。

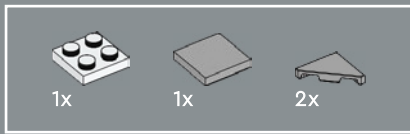

351

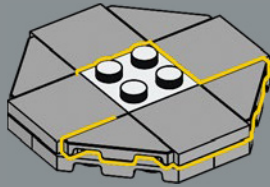

352

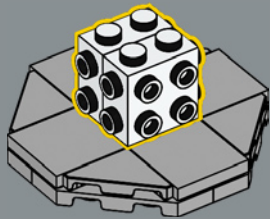

353

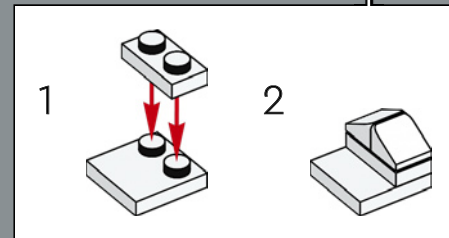
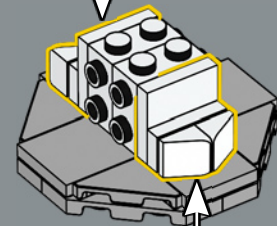
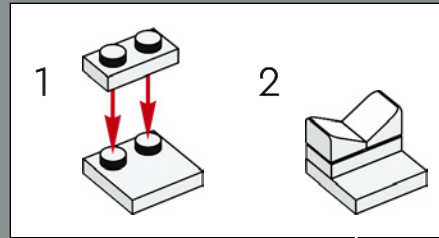



354

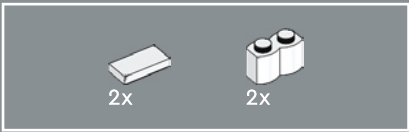
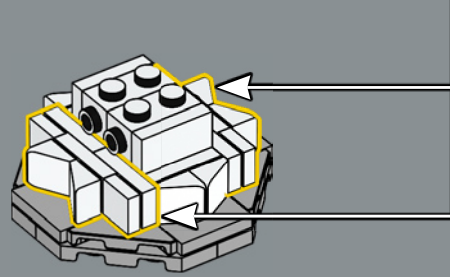
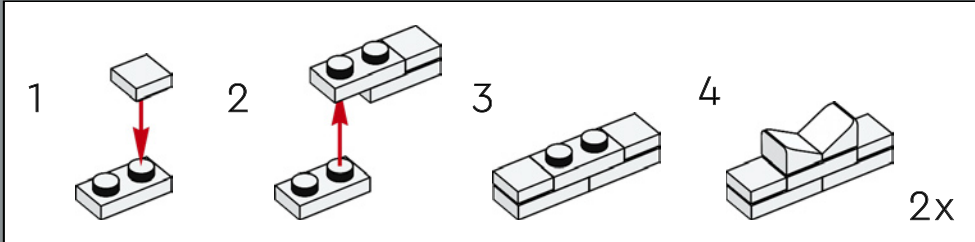

355

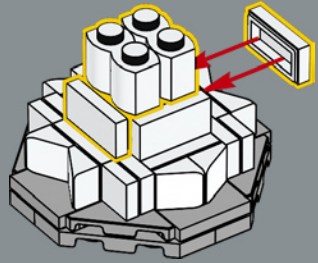



356

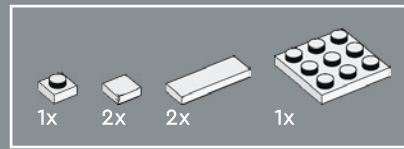
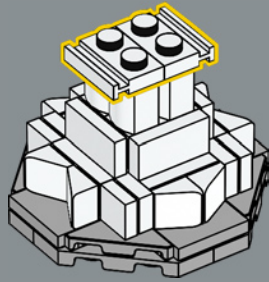

357

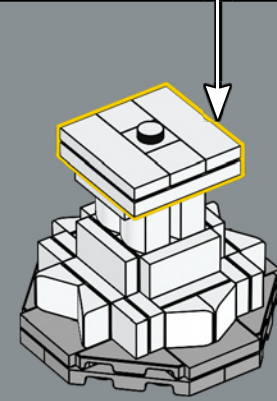
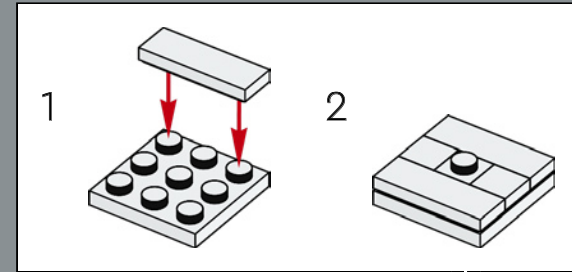

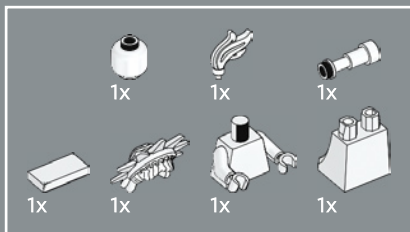

358

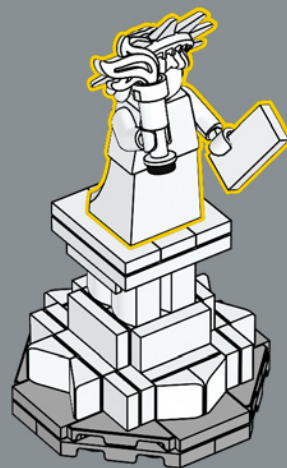
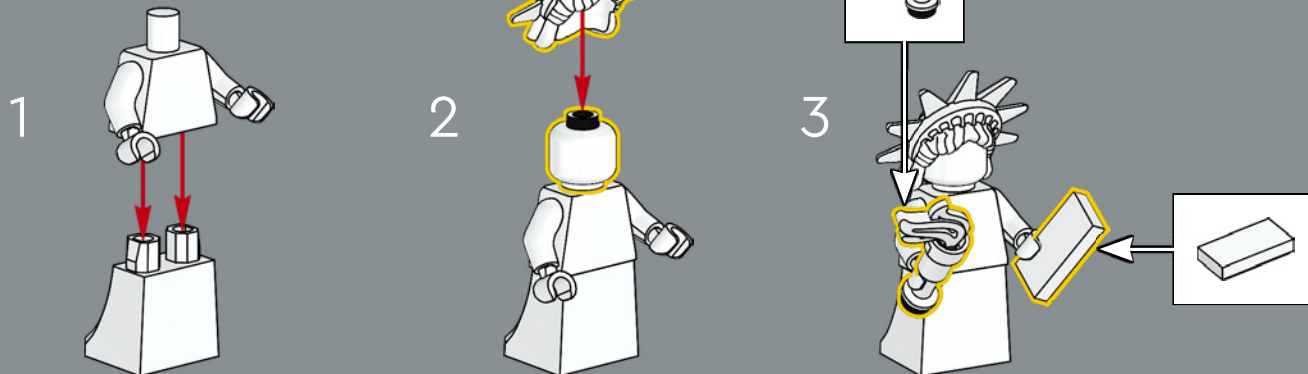

“方头仔-自由女神”此前曾多次以乐高®小人仔的形式出现——第一个是在 2012 年发布的。

359

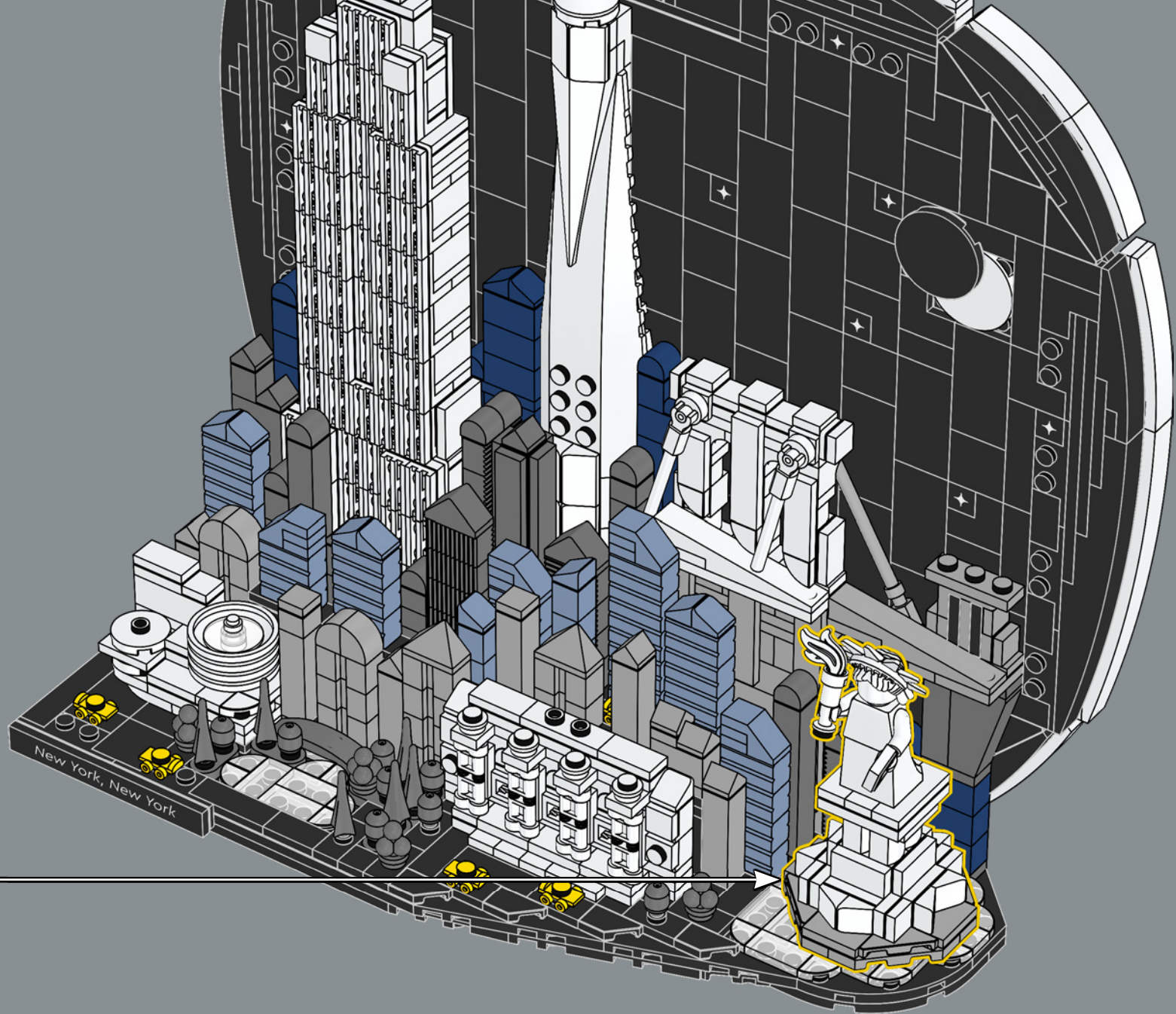

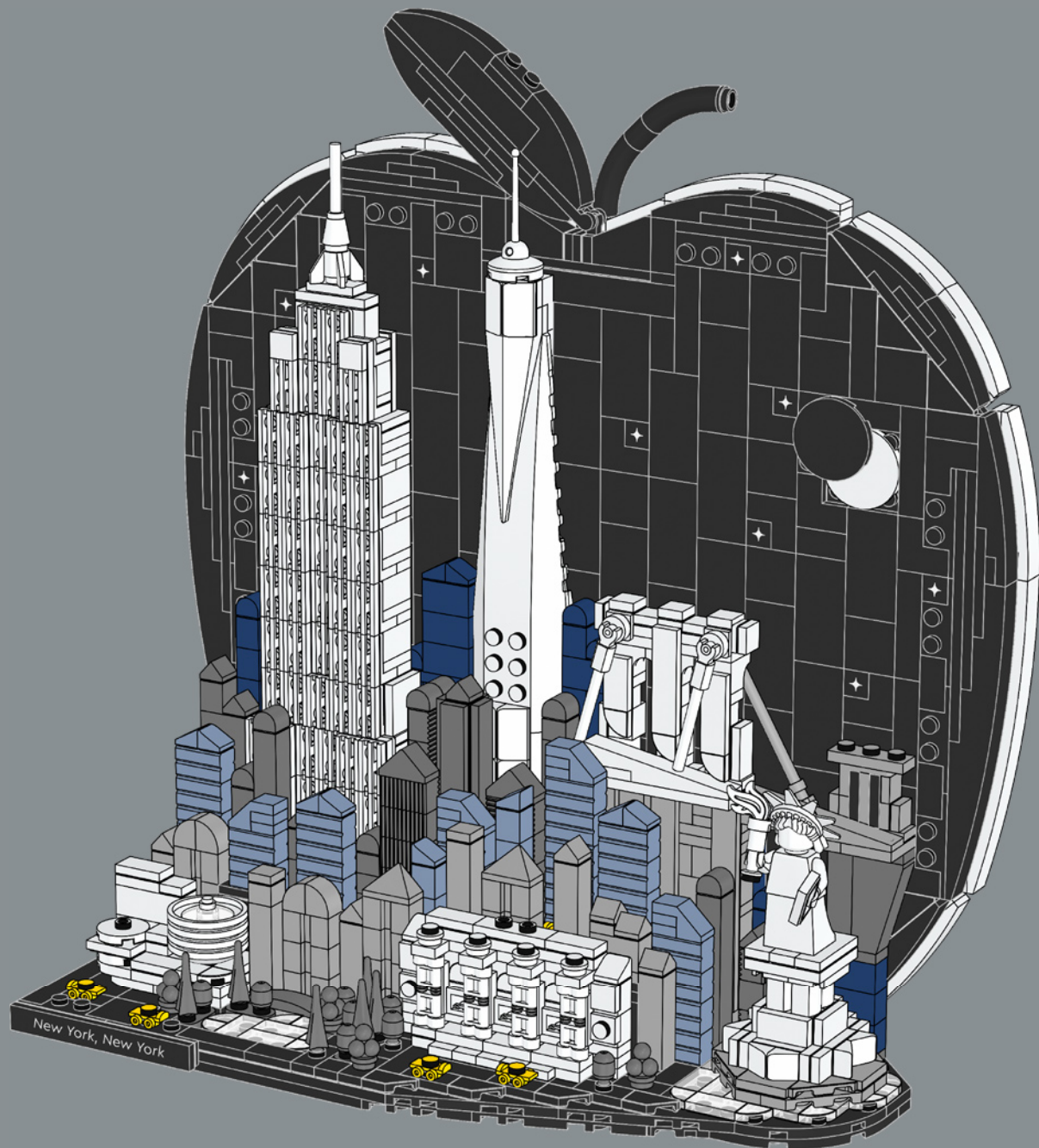

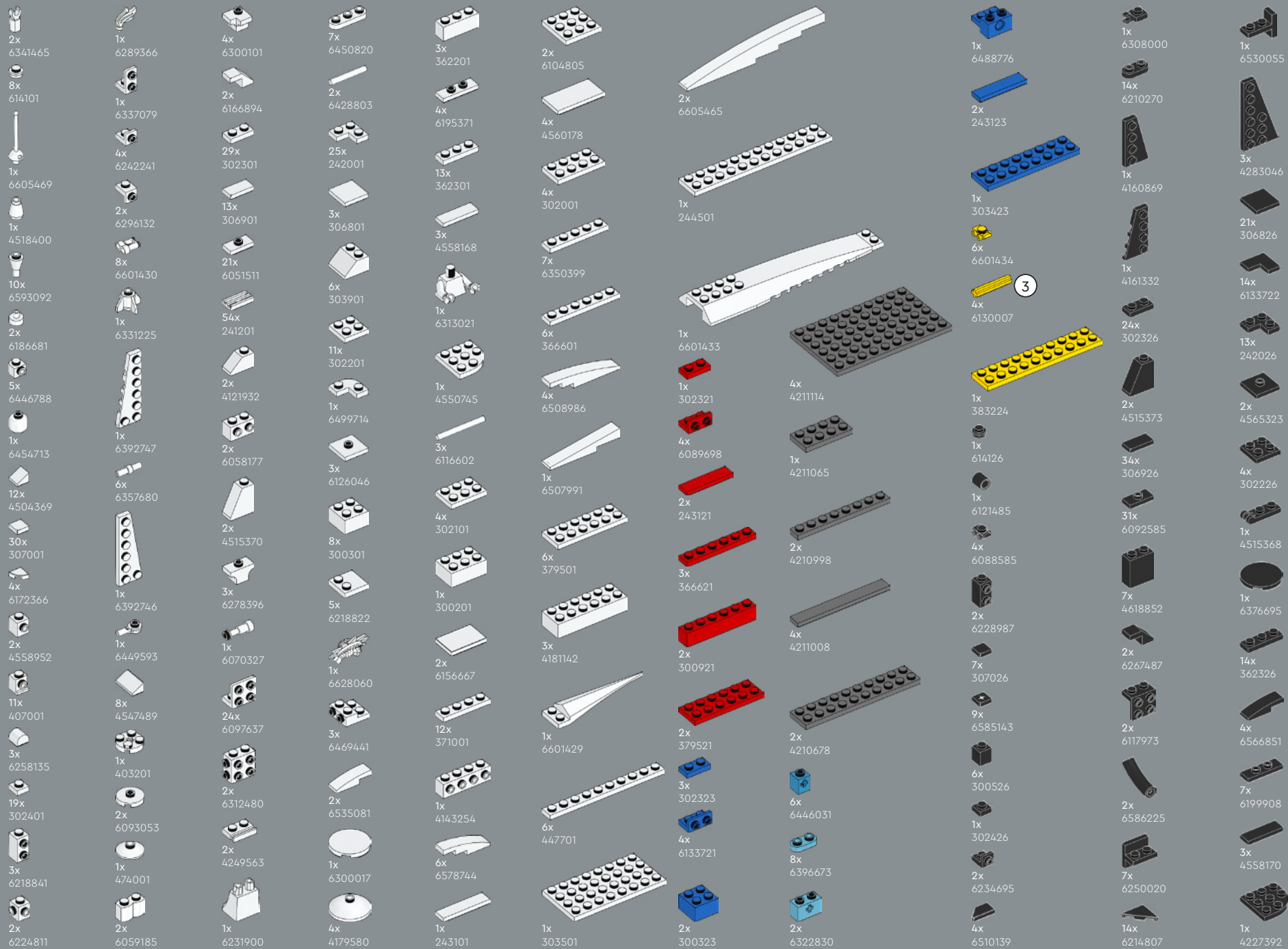

- 10x 6118829
- 2x 6168620
- 1x 4531412
- 6x 6580394
- 18x 243126
- 8x 371026
- 3x 4160025
- 1x 365926
- 1x 301026
- 2x 6039869
- 14x 302026
- 5x 663626
- 4x 6535144
- 5x 6184876
- 1x 366626
- 1x 4243819
- 1x 6101857
- 2x 4181144
- 57x 4560182
- 1x 6585142
- 8x 303226
- 2x 303426
- 1x 6037390
- 1x 395826
- 2x 383226
- 6x 4514845
- 2x 302926
- 2x 6001494
- 2x 6601431
- 1x 4166619
- 1x 6372045
- 5x 346026
- 4x 379526
- 6x 4106977
- 2x 6509390
- 1x 6439175
- 8x 4504374
- 6x 6403899
- 6x 4255413
- 6x 6595205
- 15x 4249891
- 4x 6103405
- 6x 6233955
- 9x 4177735
- 3x 4264569
- 1x 6343976
- 13x 4211399
- 6x 6253436
- 2x 6401023
- 2x 6225242
- 2x 4211389
- 5x 4211415
- 4x 4211476
- 4x 6522869
- 7x 6061702
- 1x 6345639
- 2x 6075075
- 4x 6407767
- 4x 4211526
- 15x 4617170
- 2x 6383177
- 7x 4211398
- 1x 4211388
- 4x 6066097
- 4x 6134378
- 4x 6217876
- 14x 4211397
- 1x 4211387
- 1x 4211353
- 4x 4211413
- 2x 6569357
- 1x 4211429
- 4x 4211361
- 1x 6421522
- 4x 4160560
- 11x 4211445
- 1x 4211394
- 2x 4211356
- 6x 6015347
- 8x 6442144
- 1x 6170418
- 3x 4211393
- 3x 4211438
- 1x 6508016
- 4x 4243797
- 4x 4211452
- 2x 4211392
- 1x 4211481
- 4x 4211402
- 1x 4211401
- 4x 4662161
- 3x 4210690
- 2x 4210700
- 7x 6221607
- 2x 4226221
- 12x 6514469
- 1x 6514246
- 17x 6514223
- 8x 6062686
- 7x 4620077
- 8x 6257079
- 4x 6248952
- 28x 6417947
- 1x 383228
- 2x 302028
- 8x 6344216
- 16x 4210636
- 9x 4211063
- 3x 4210978
- 4x 6092572
- 10x 4211098
- 5x 6262021
- 7x 6333129
- 1x 4210719
- 5x 6388133
- 8x 4648256
- 1x 4648256
- 1x 4500975
- 1x 6336990
- 2x 4211104
- 5x 4211133
- 1x 4648256
- 1x 6240515



 [LEGO.com/service](https://www.LEGO.com/service)



YOU COULD
WIN



**YOU COULD
WIN**

Your feedback will help shape the future development of this product series.

Visit:

**DU KÖNNTEST
GEWINNEN**

Dein Feedback trägt zur Weiterentwicklung dieser Produktreihe bei.

Geh auf:

**VOUS POURRIEZ
GAGNER**

Vos commentaires nous aideront à concevoir les futurs produits de cette gamme.

Visitez :

**POTRESTI
VINCERE TU**

La tua opinione ci aiuterà a migliorare la creazione futura di questa linea di prodotti.

Visita:

**PUEDES
GANAR**

Tu opinión contribuirá al futuro de esta serie de productos.

Visita:

轻松获奖

您的反馈将有助于我们在今后改进本产品系列。

请访问:

LEGO.com/productfeedback

You also have the chance to win a LEGO® set.

Terms and conditions apply.*

Außerdem hast du die Chance, ein LEGO® Set zu gewinnen.

Es gelten die Teilnahmebedingungen.*

Vous pourriez également gagner un ensemble LEGO®.

Des conditions s'appliquent.*

Hai anche la possibilità di vincere un set LEGO®.

Termini e condizioni sono applicabili.*

También tienes la oportunidad de ganar un set LEGO®.

Aplican términos y condiciones.*

您还有机会赢取乐高®套装。

条款和条件适用。*

*LEGO.com/productfeedback-terms

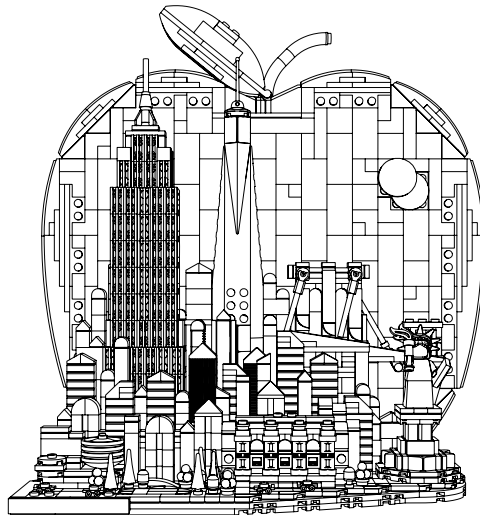

LEGO and the LEGO logo are trademarks of the LEGO Group. ©2026 The LEGO Group.

The EMPIRE STATE BUILDING name and image are registered trademarks and used with permission.

The name and building image of the Solomon R. Guggenheim Museum are trademarks of the Solomon R. Guggenheim Foundation. Used with permission.

® /™ /© Frank Lloyd Wright Foundation. All Rights Reserved.

One World Trade Center building design is a copyright of WTC Tower 1 LLC. Used under license.

Adam Reed Tucker is the co-developer of the LEGO® Architecture product line.