



21066





LEGO.com/sustainable-packaging



FR  
**DONNEZ**  
OU  
**RECYCLEZ**



OU



OU



ASSOCIATION    MAGASIN    DÉCHÈTERIE

Adresses sur [quefairedemesdechets.fr](http://quefairedemesdechets.fr)



# BUILDER



Apple and the Apple logo are trademarks of Apple Inc., registered in the U.S. and other countries and regions. App Store is a service mark of Apple Inc. Google Play and the Google Play logo are trademarks of Google LLC. Tencent and the Tencent logo are trademarks of Tencent Inc.

[LEGO.com/devicecheck](https://LEGO.com/devicecheck)

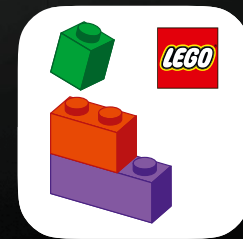

LEGO® Builder



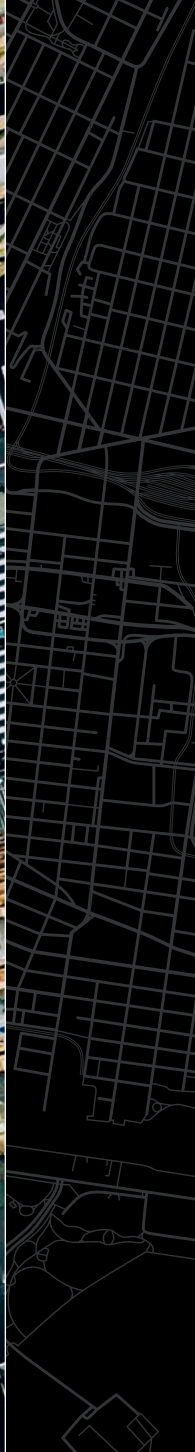



# LA GRANDE MELA

New York, New York – la città che non dorme mai, la città dei sogni, la Grande Mela – una città dai molti nomi, nota per essere un luogo di energia inesauribile e infinite opportunità. Fondata nel 1624 con il nome di “New Amsterdam”, si è evoluta diventando rapidamente un vibrante faro di cultura, commercio, arte e innovazione. L'iconica skyline di New York City vanta punti di riferimento immediatamente riconoscibili, distribuiti nei suoi cinque distretti. Dalla Statua della Libertà che accoglie i nuovi arrivati nelle strade animate che ci ispirano a inseguire i nostri sogni, il battito della città conquista il cuore di visitatori e residenti. Il quartiere di Manhattan, da solo, ospita oltre 1,5 milioni di persone in soli 59 km<sup>2</sup>, ed è uno dei luoghi più densamente popolati della Terra. Che tu sia attratto dalle sue luci sfavillanti e dal suo fermento, o dai sentieri tranquilli di Central Park, lo spirito della città, la sua ricca storia e la sua diversità lasceranno senz'altro un segno indelebile.

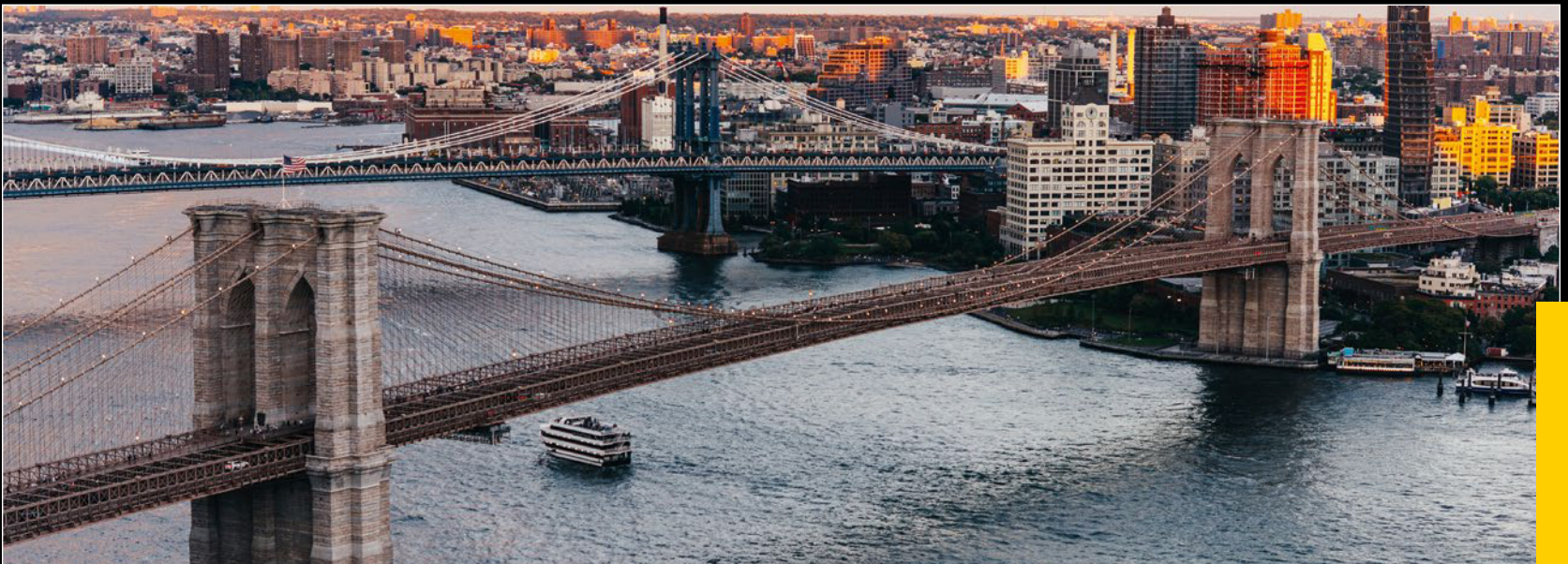



### ONE WORLD TRADE CENTER (2014)

Ad oggi, il One World Trade Center è l'edificio più alto dell'emisfero occidentale, costruito come simbolo di unità e resilienza.



### EMPIRE STATE BUILDING (1931)

L'icona di New York, che conta 102 piani, offre viste mozzafiato sulla città dal cuore di Midtown Manhattan.



### METROPOLITAN MUSEUM OF ART (1870)

Fondato nel 1870, The Met è uno dei musei più grandi al mondo e ospita oltre 5.000 anni di storia dell'arte e capolavori moderni.



### SOLOMON R. GUGGENHEIM MUSEUM (1959)

Sin dalla sua apertura, il museo è noto per la sua architettura a spirale e per la sua collezione di arte moderna e contemporanea di fama mondiale.

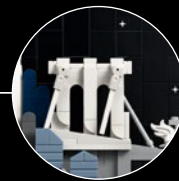
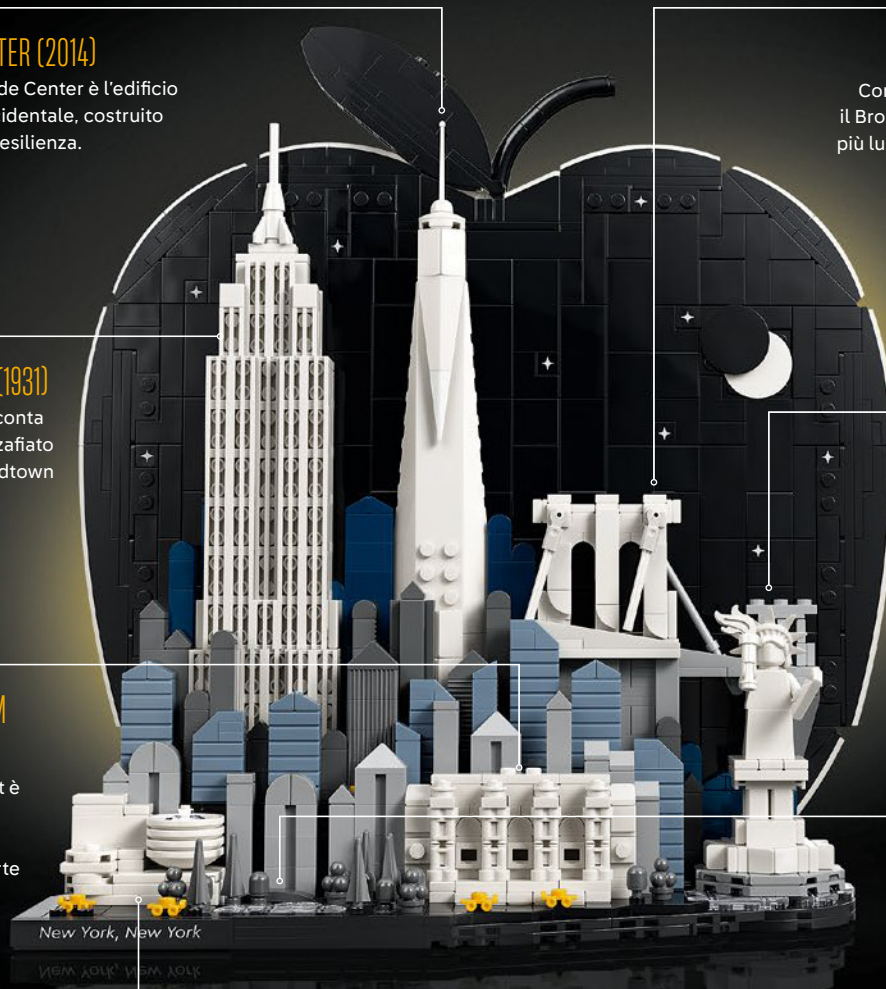

### PONTE DI BROOKLYN (1883)

Con un'estensione di oltre un miglio, il Brooklyn Bridge era il ponte sospeso più lungo del mondo al momento della sua inaugurazione.

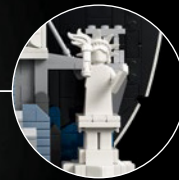

### STATUA DELLA LIBERTÀ (1886)

L'imponente statua neoclassica sorge su Liberty Island, nel porto di New York, originariamente il più celebre porto d'ingresso degli Stati Uniti.



### CENTRAL PARK (1858)

Central Park accoglie ogni anno 42 milioni di visitatori nei suoi 341,1 ettari di prati, sentieri e laghi.



# IL LEGO® ARCHITECTURE DESIGN TEAM

Il 2026 segna il 250° anniversario della firma della Dichiarazione d'Indipendenza degli Stati Uniti e il 10° anniversario del nostro primo set LEGO® Architecture New York City Skyline! Questo ci ha spinto a celebrare entrambe le ricorrenze, con i famosi monumenti di New York reinterpretati su uno sfondo della "Grande Mela" che ritrae un cielo notturno. Abbiamo utilizzato elementi sfaccettati per riprodurre l'intricata geometria del One World Trade Center, che poggia sulle "spalle" dell'Empire State Building e si assottiglia man mano che si eleva. Le basi a griglia LEGO costituiscono le finestre e le lunghe linee verticali Art Déco dell'Empire State Building. Il modello del Ponte di Brooklyn gioca con un effetto di prospettiva forzata, cambiando drasticamente in dimensione, aggiungendo variazioni di colore a entrambe le torri e conferendo una leggera angolazione alla strada. Insieme ad altri dettagli iconici, come la minifigure di "Lady Liberty", ci auguriamo che vi divertirete a costruire e a esplorare questa magnifica città!



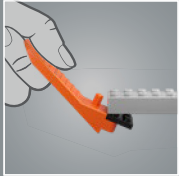
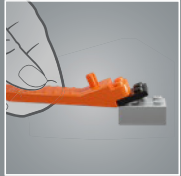
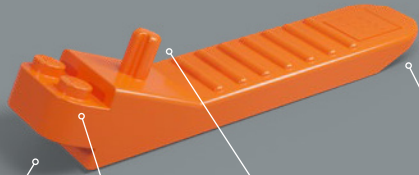

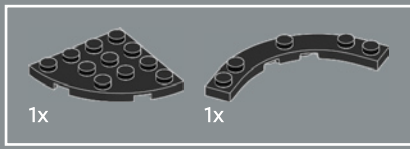

1

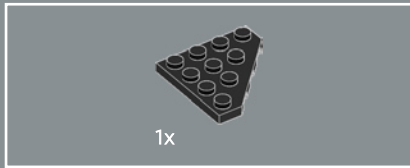
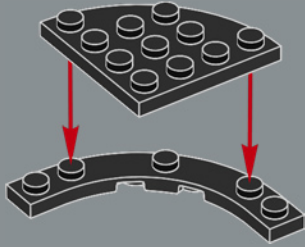

2

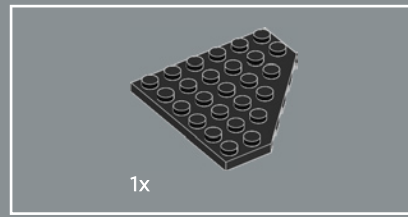
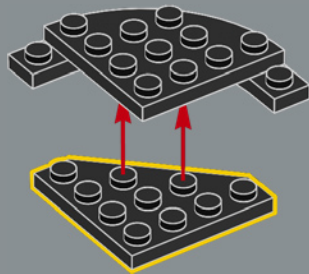

3

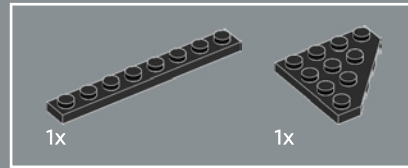
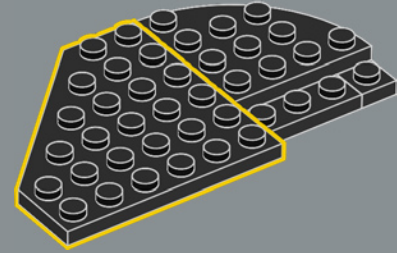

4

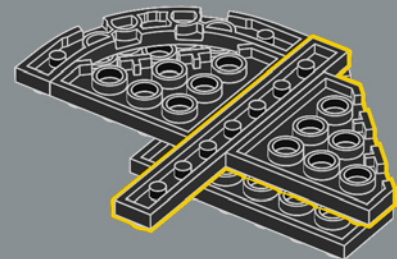

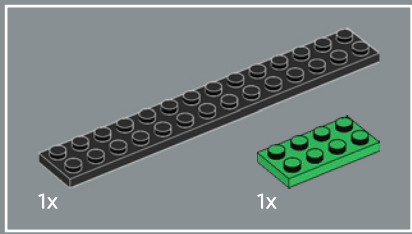

5

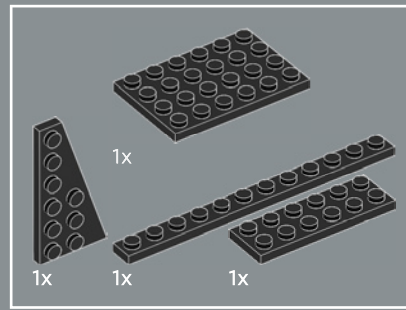
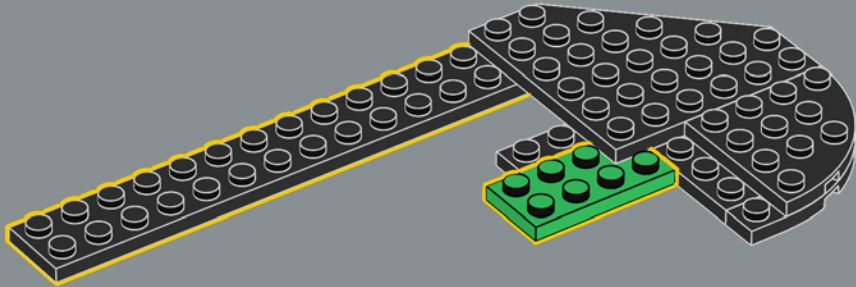

6

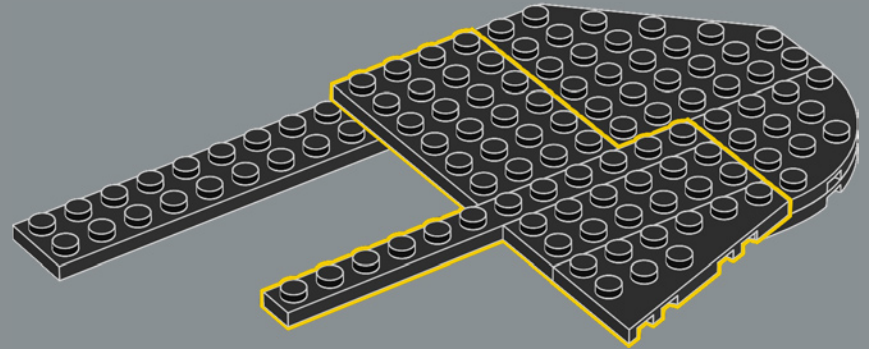

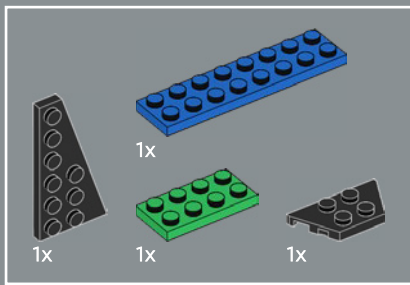

7

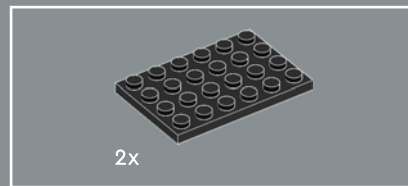
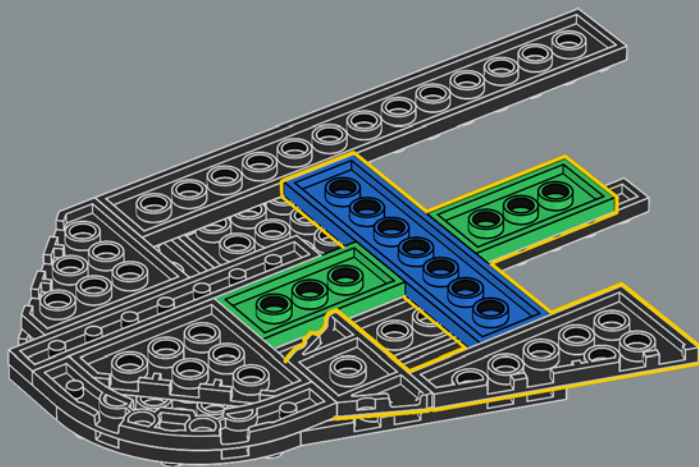

8

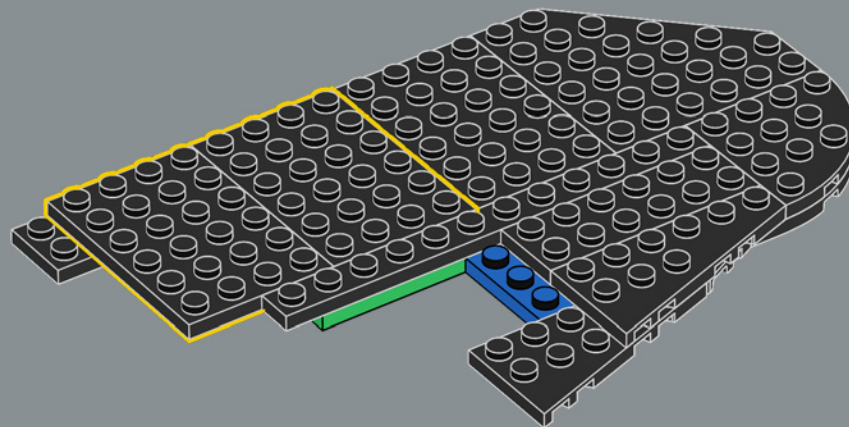

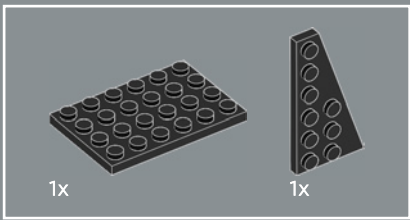

9

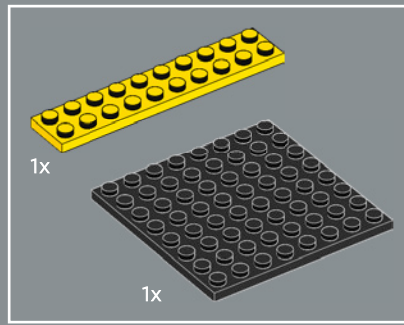
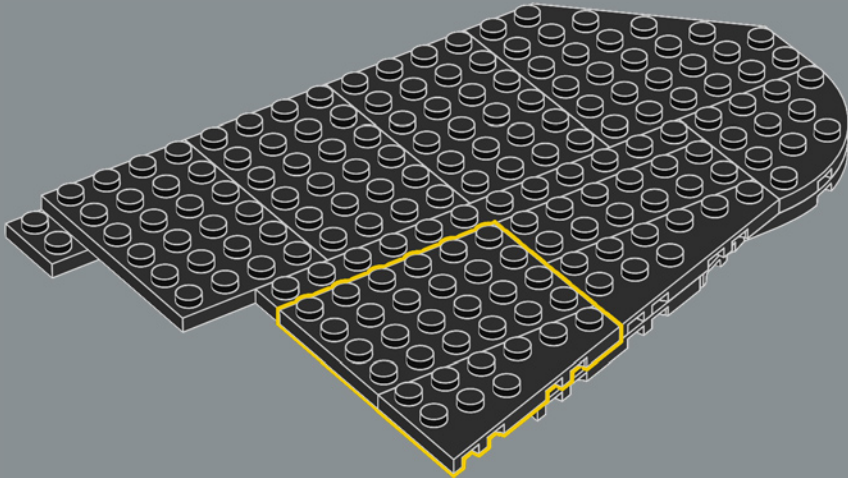

10

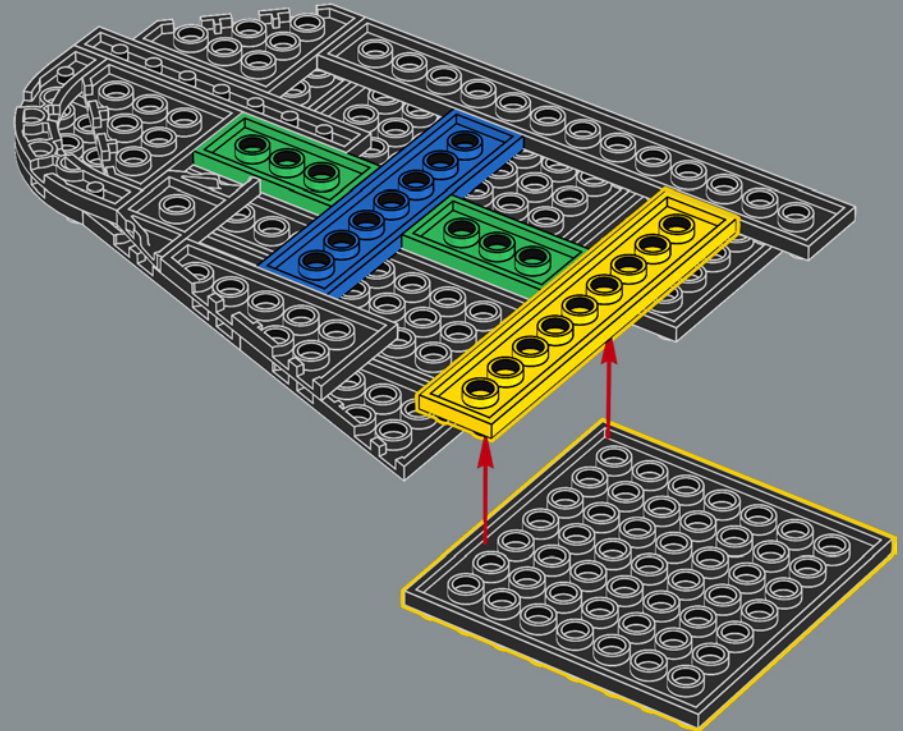

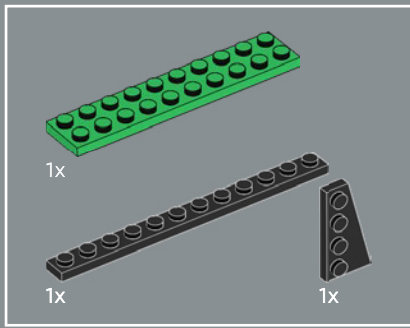

11

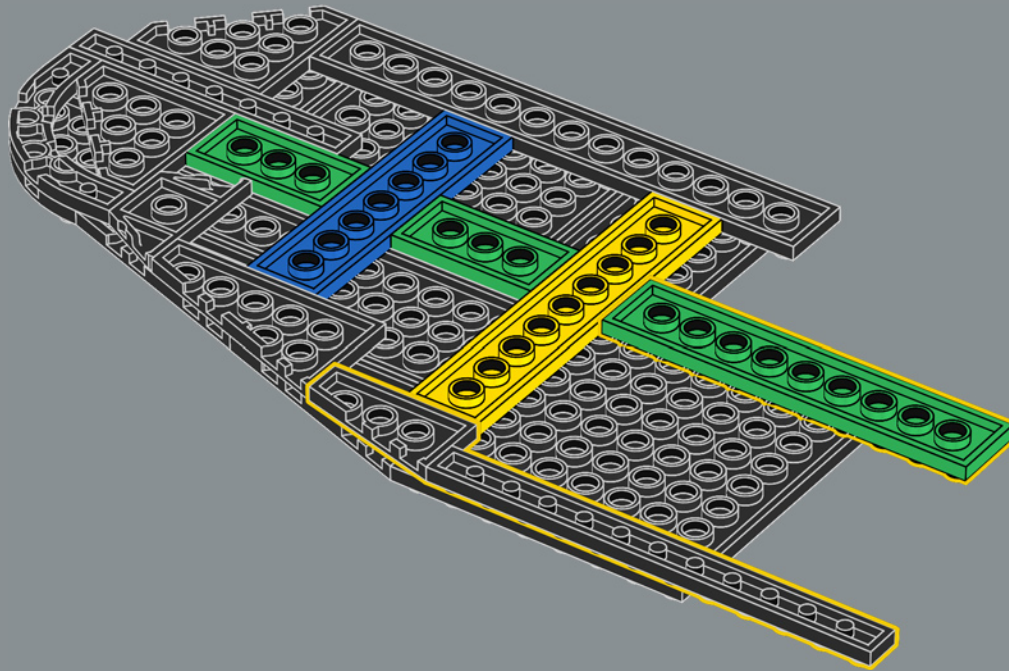

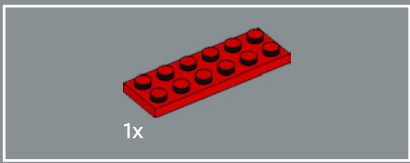

12

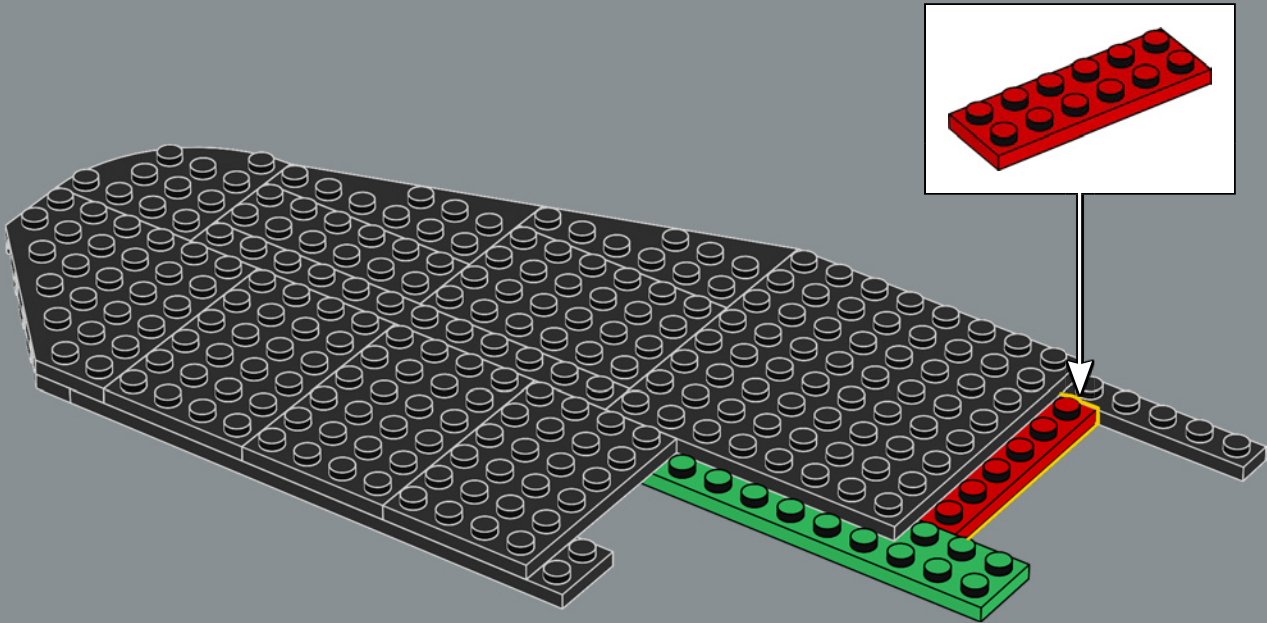

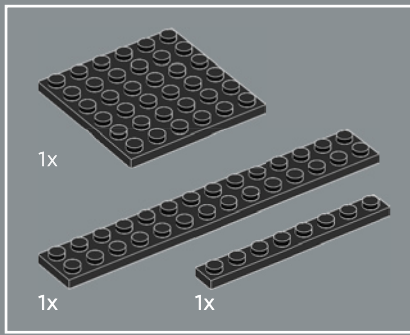

13

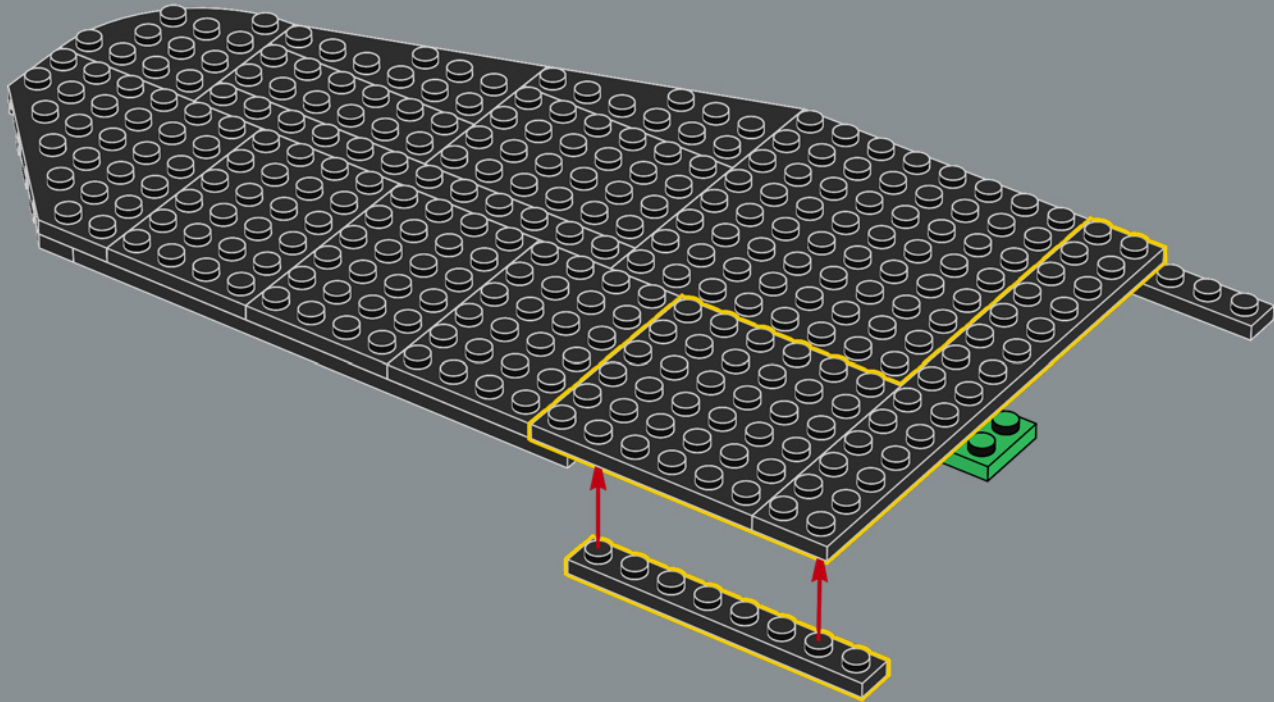

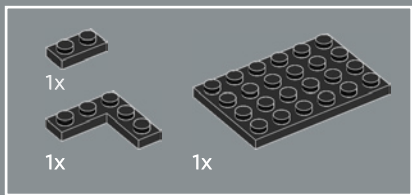

14

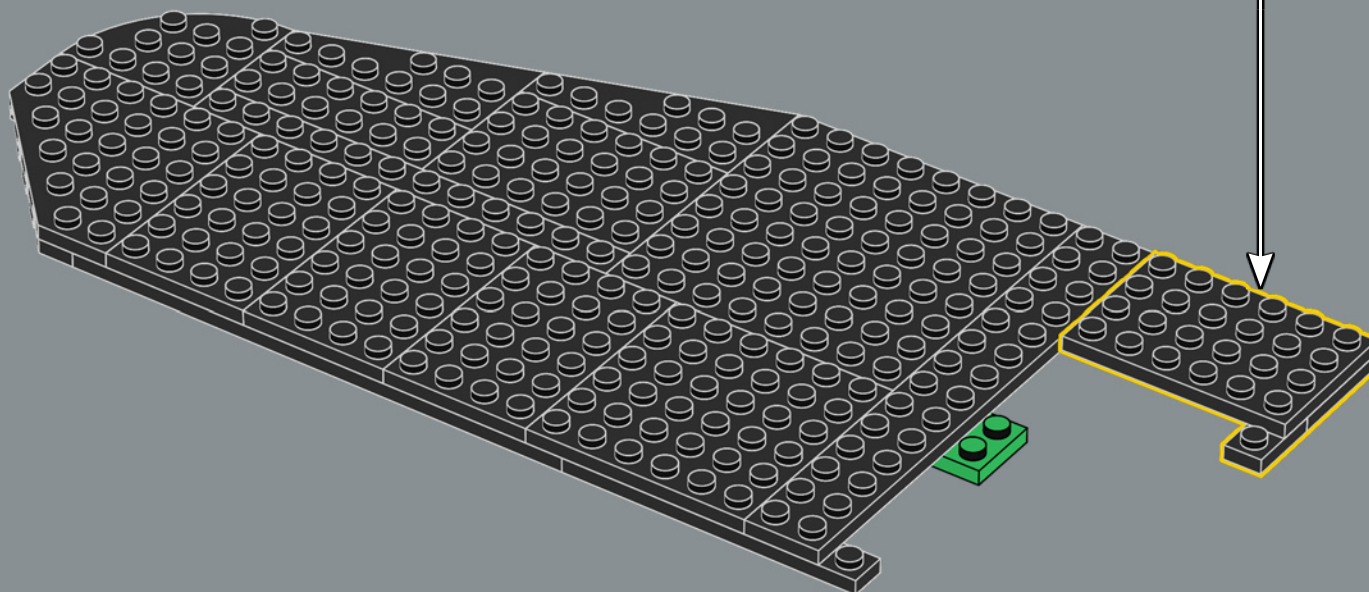
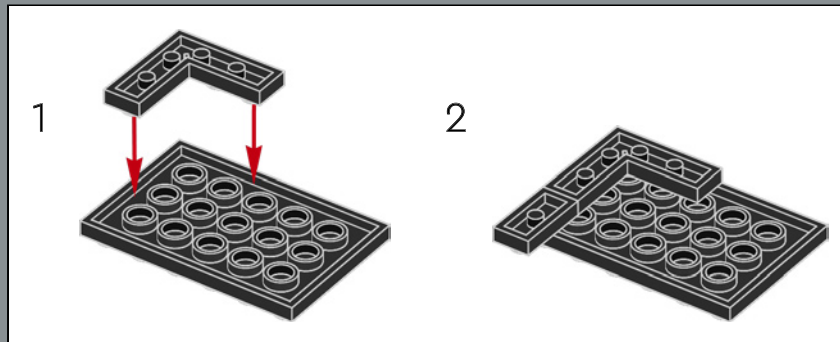

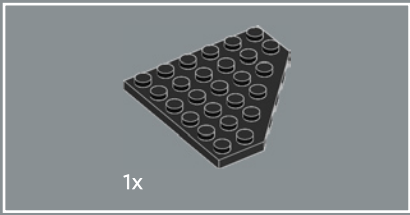

15

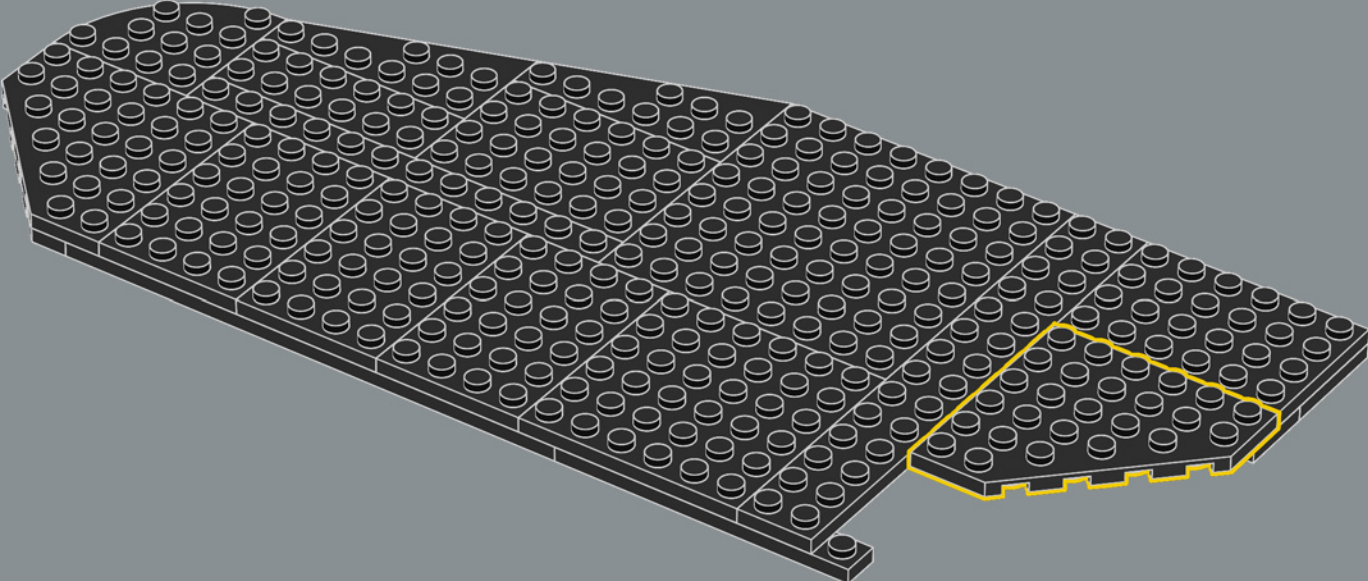

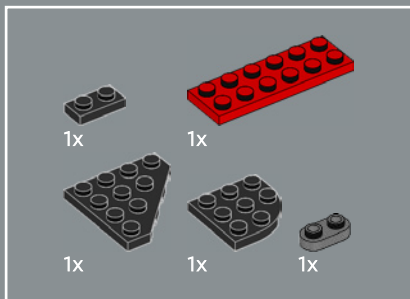

Le piastre LEGO® colorate all'interno della base si ispirano ad alcune delle 36 linee della metropolitana che collegano la città.

16

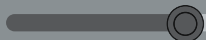
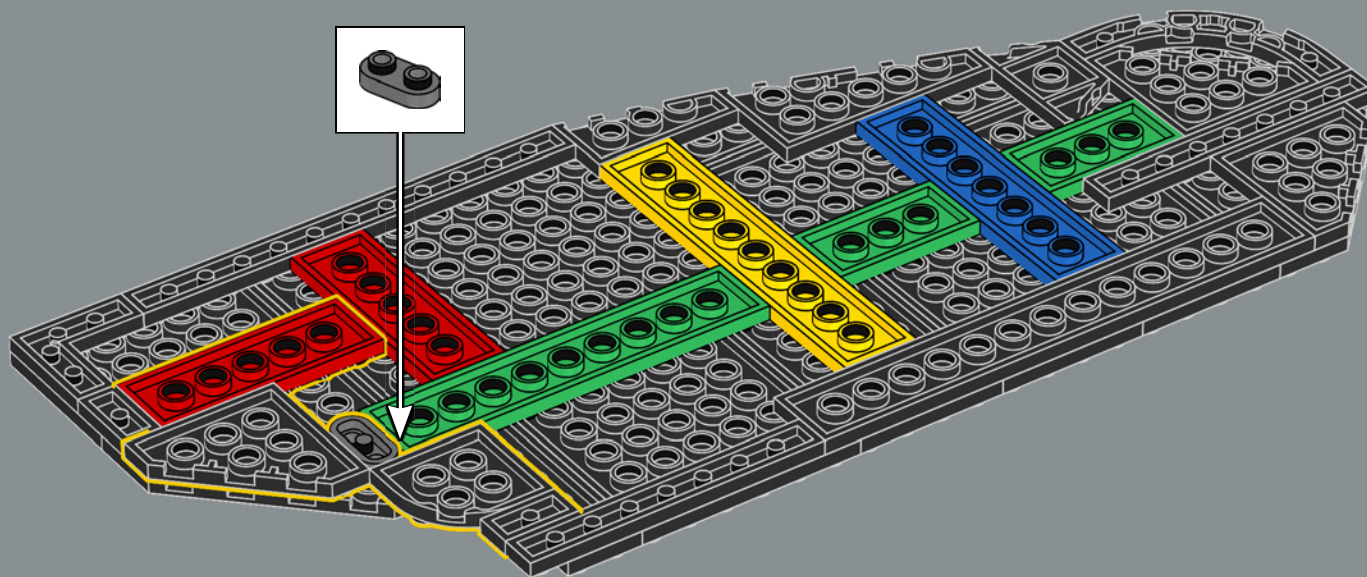

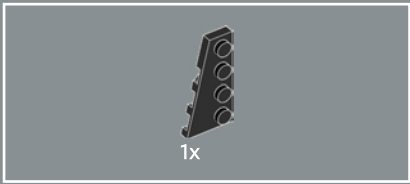

17

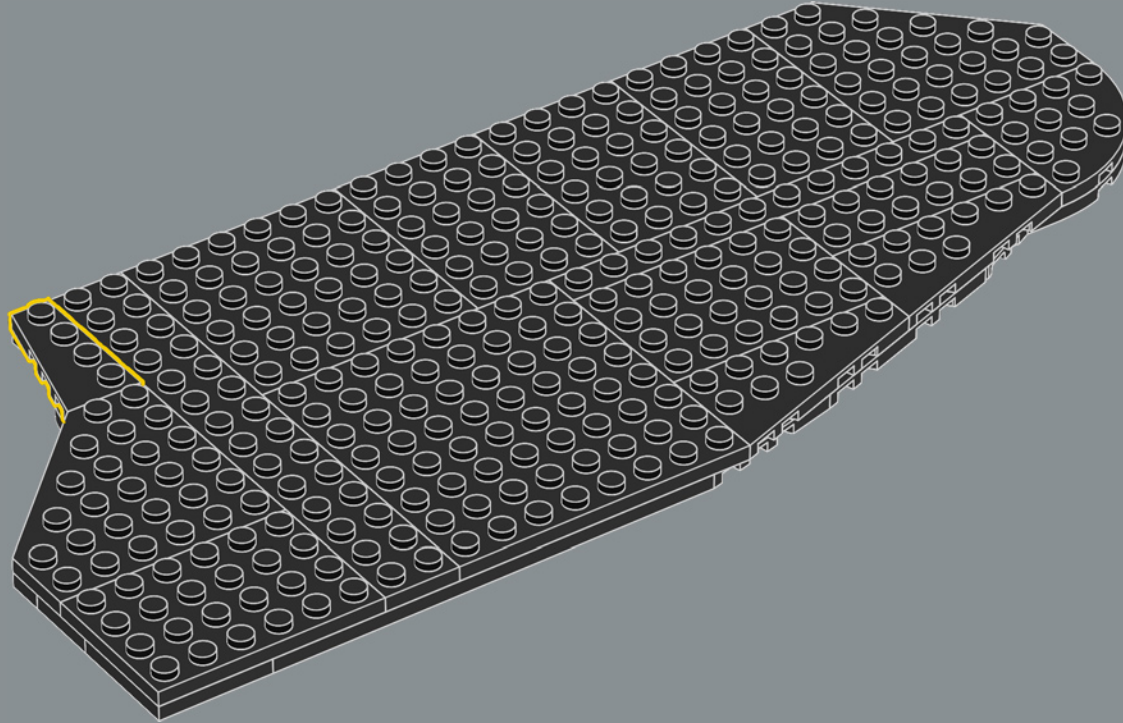

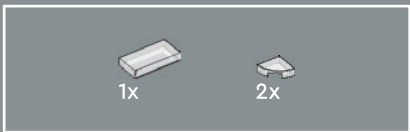

18



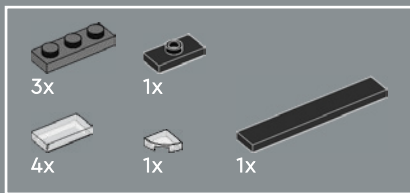

19

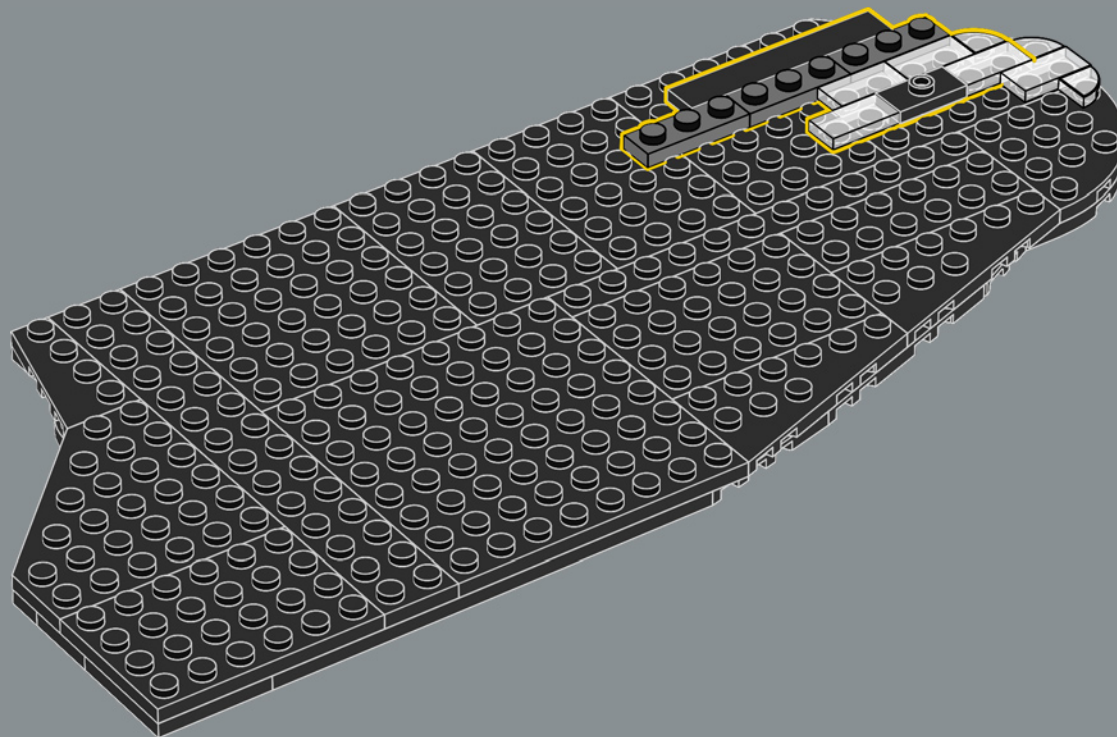

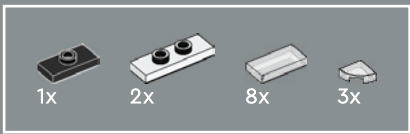

20

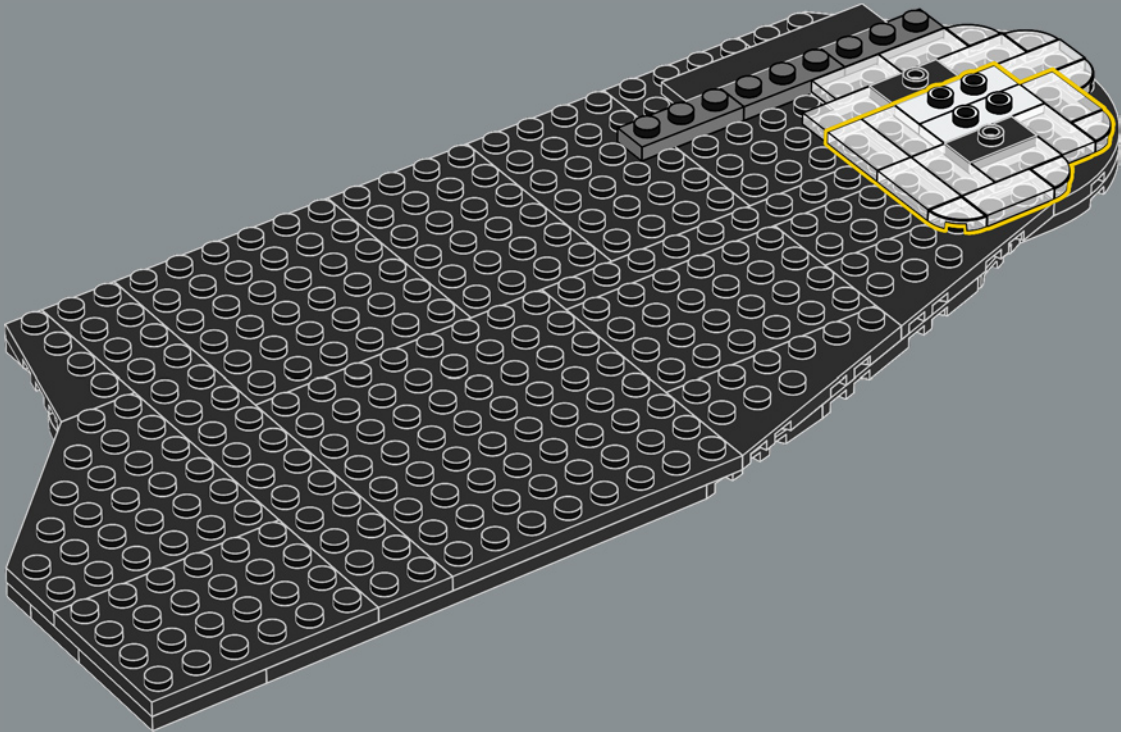

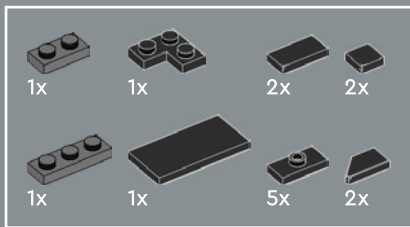

21

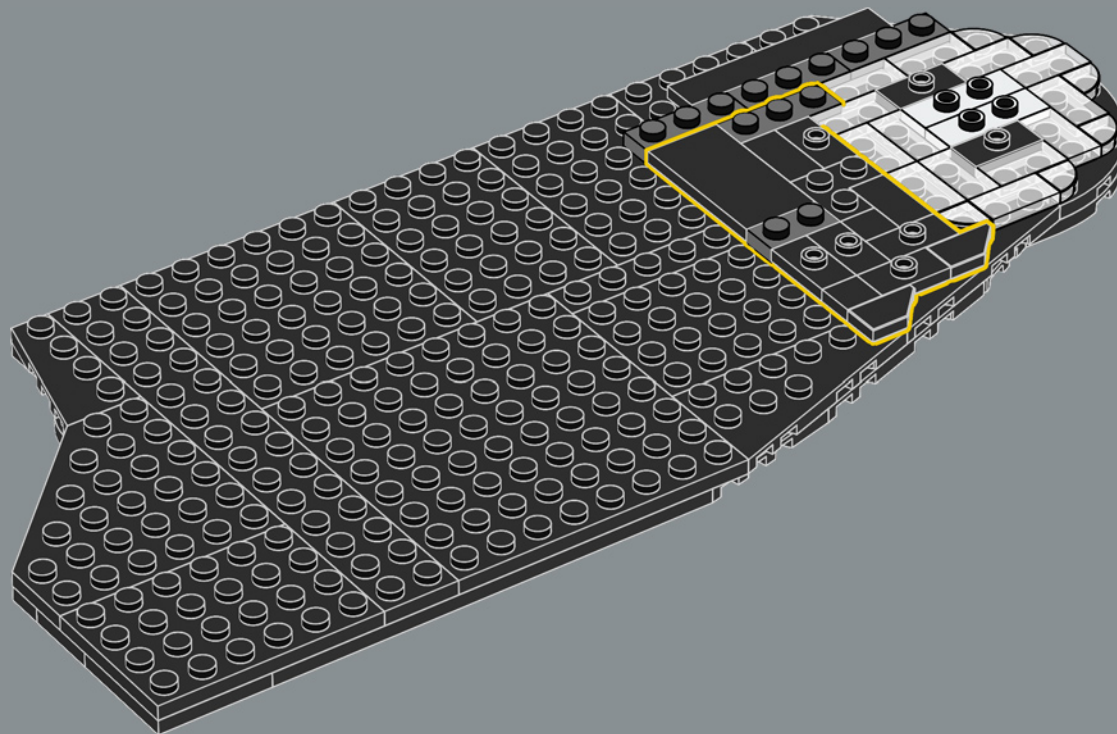

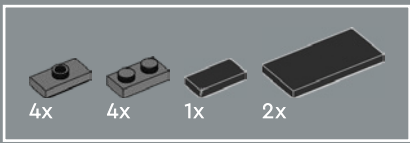

22

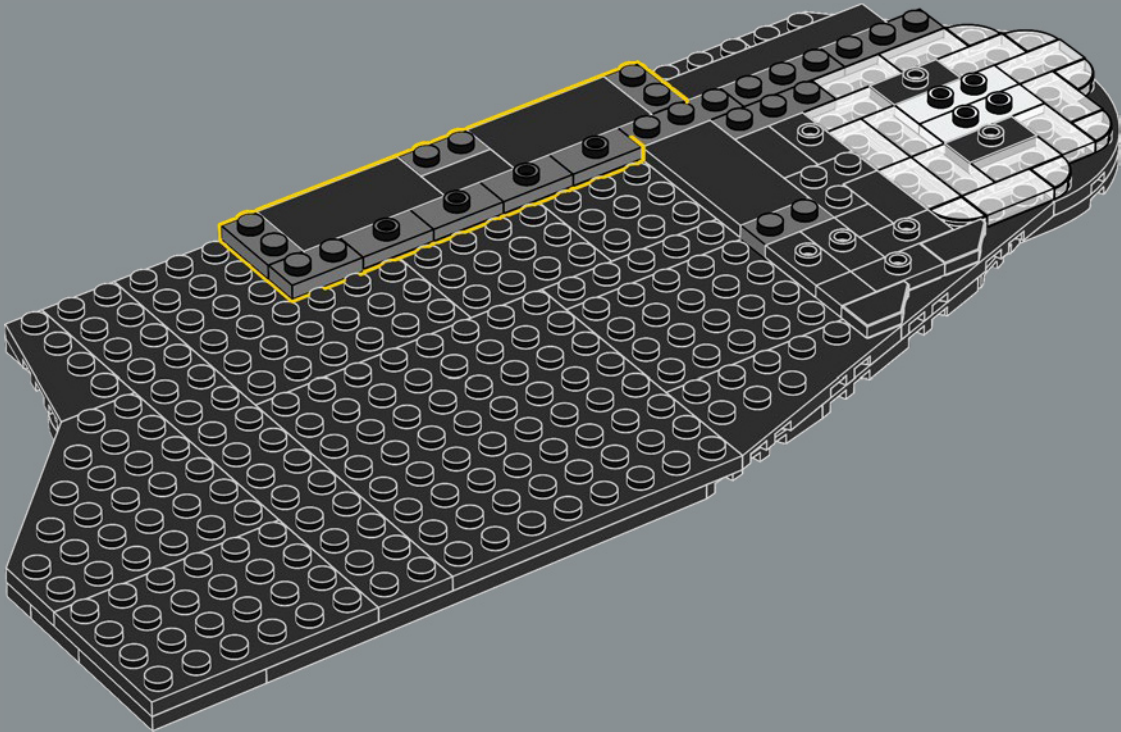

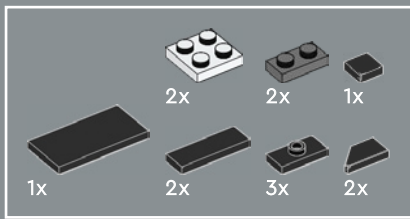

23

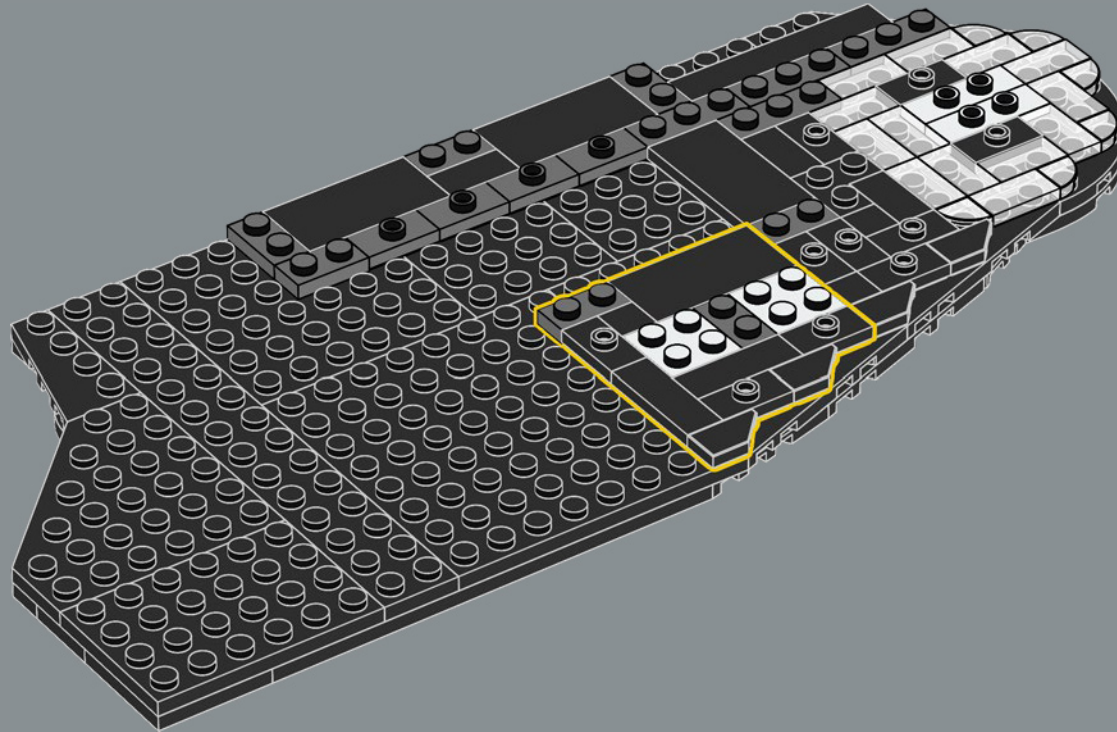



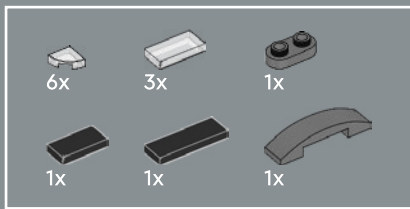

25

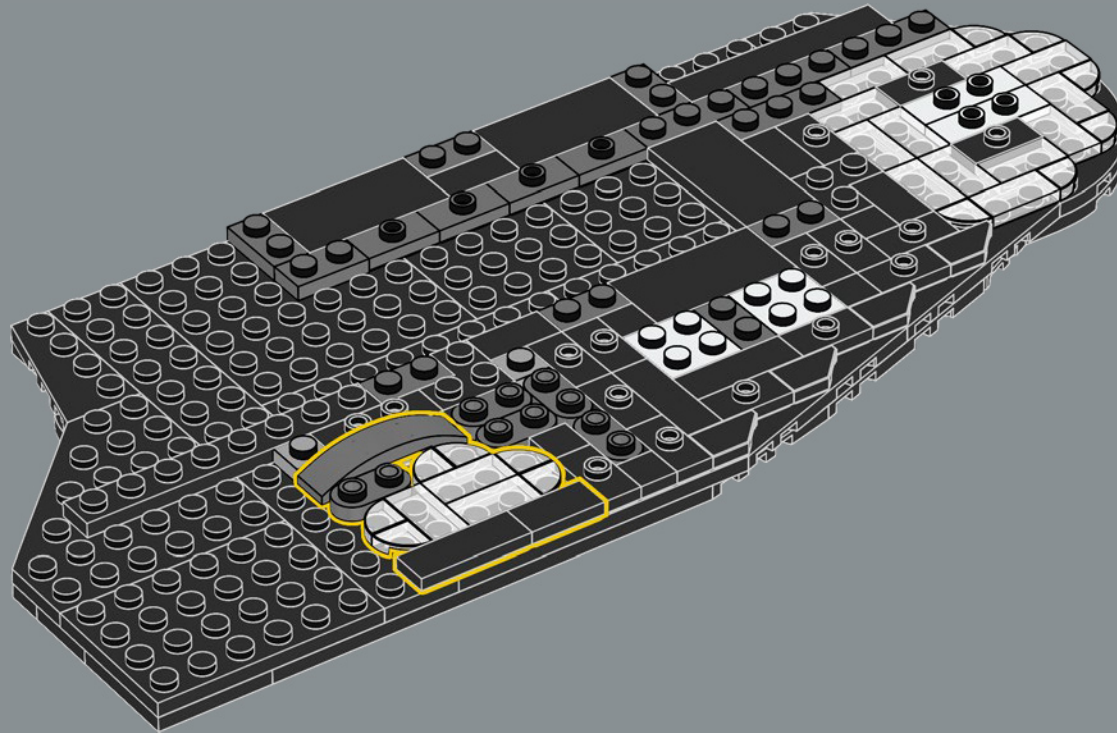

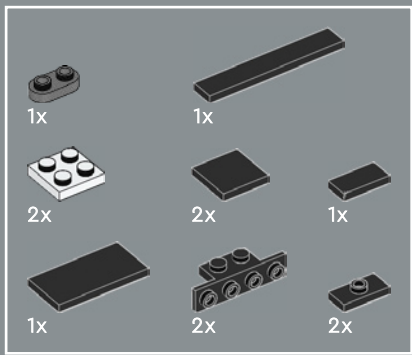

26

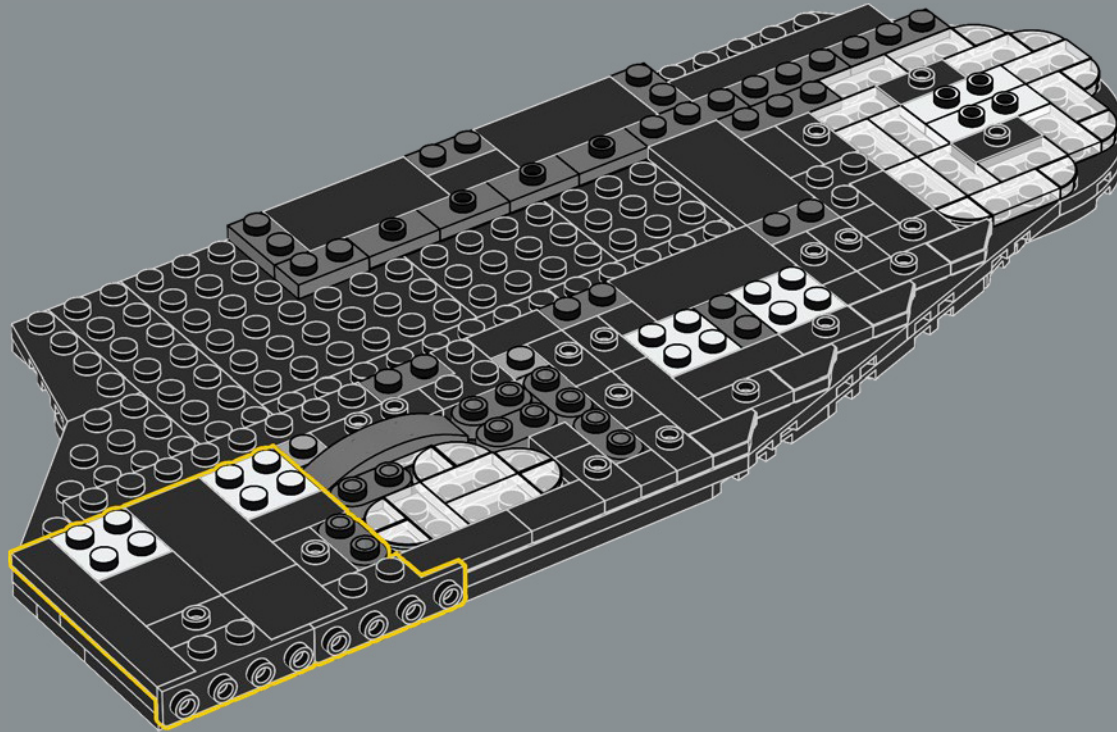

La base del modello si ispira al distretto più grande di New York, l'isola di Manhattan.

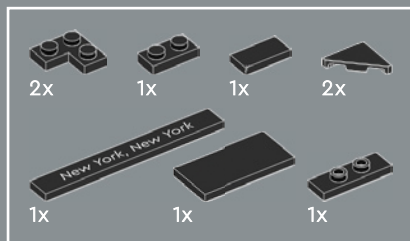

27

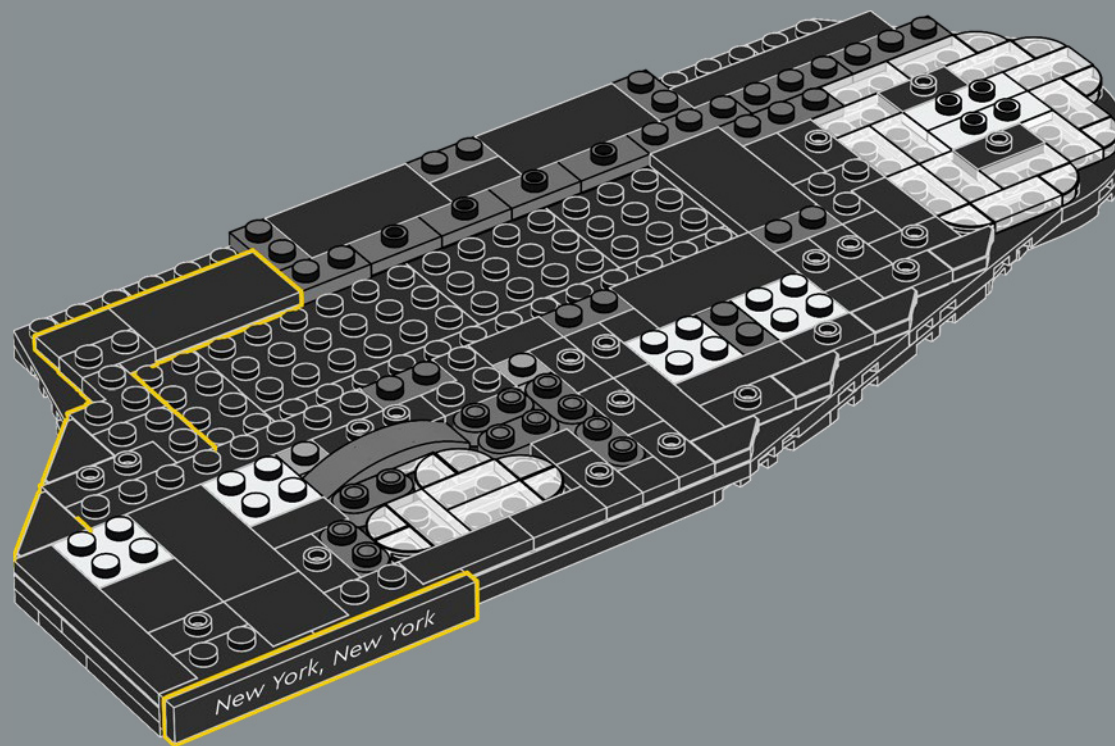

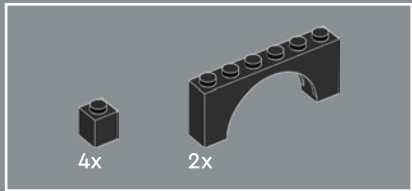

28

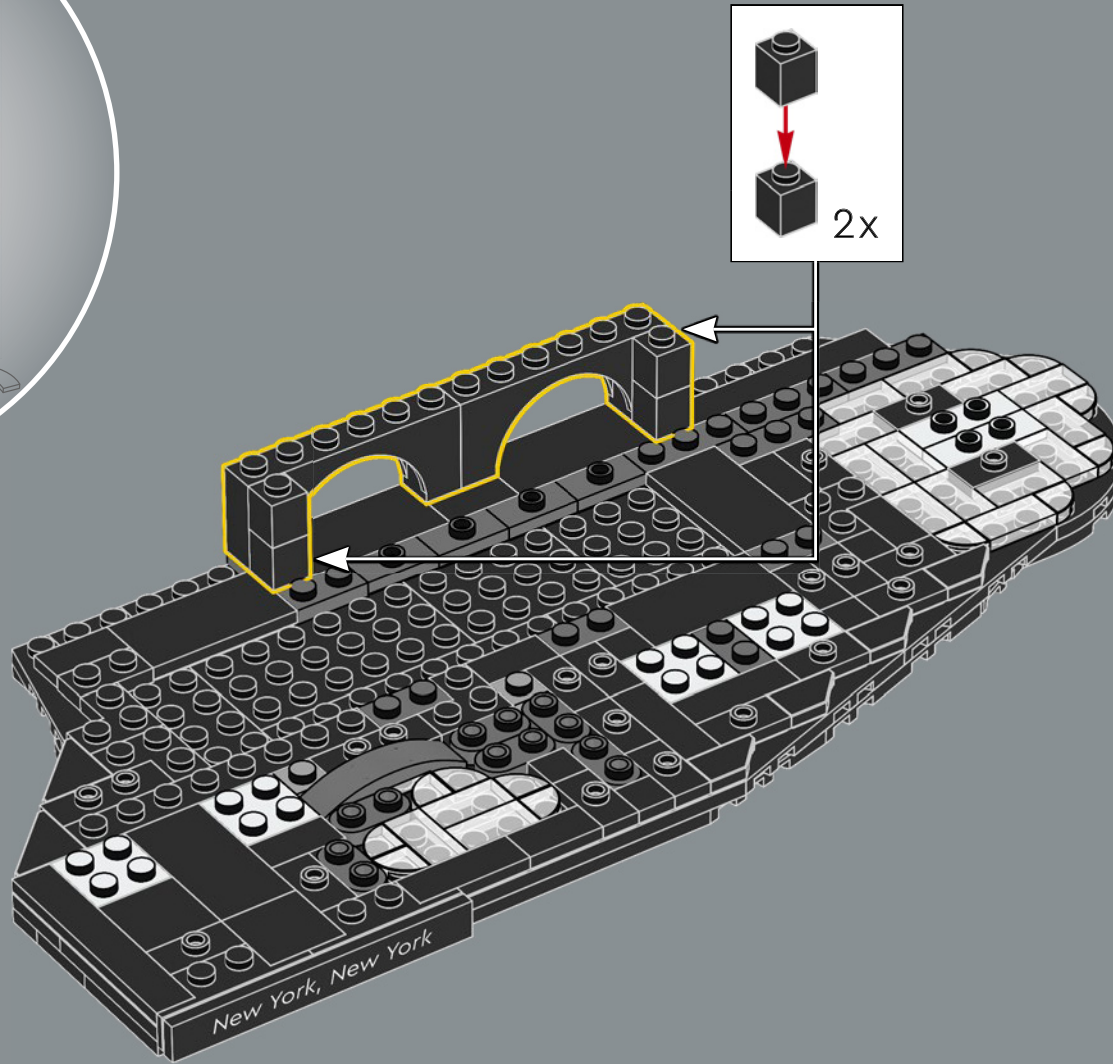

Se si disponessero in linea retta tutti i 1.355 km di binari della metropolitana di New York, arriverebbero fino a Chicago.



29

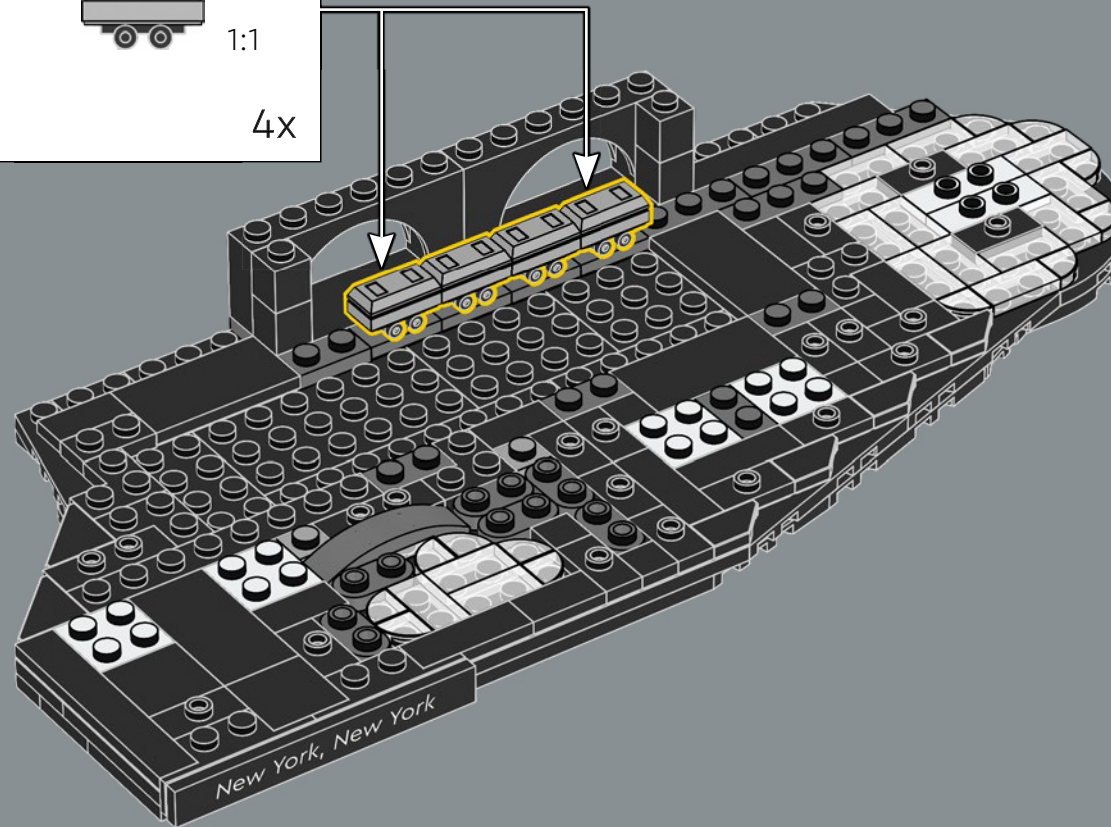
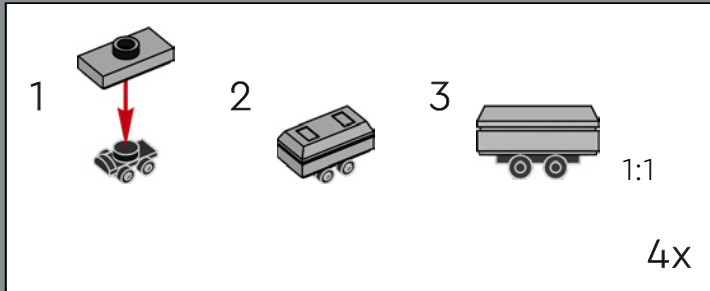

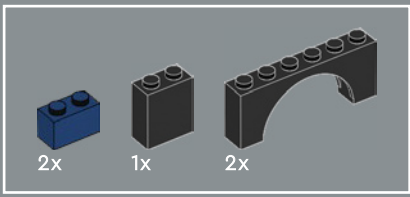

30

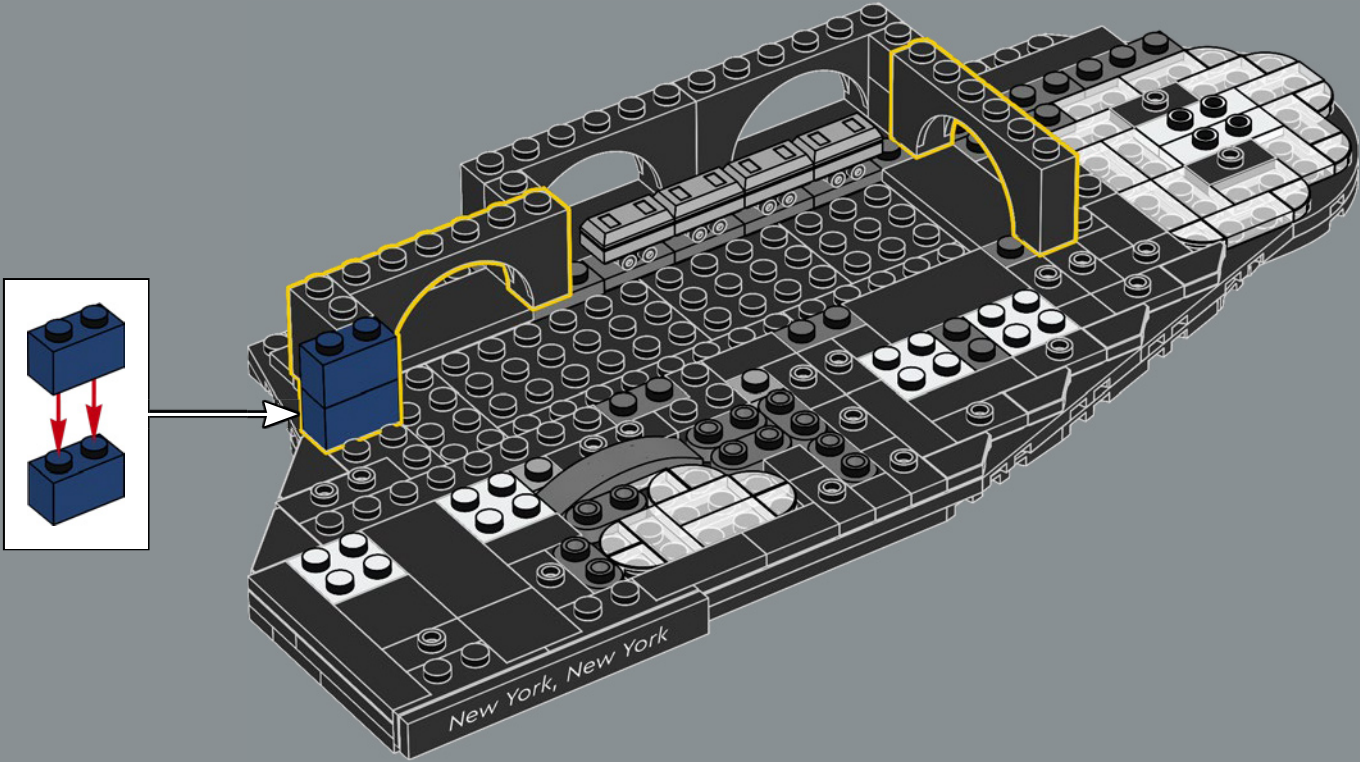

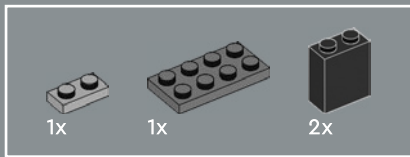

31

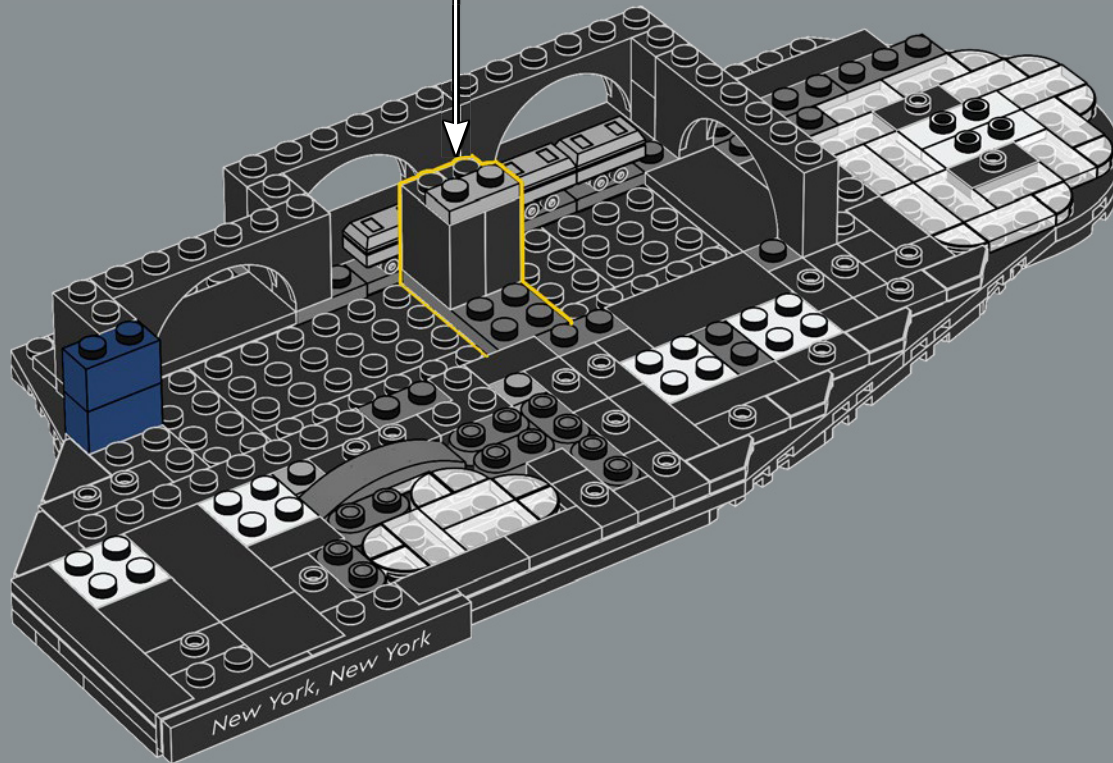
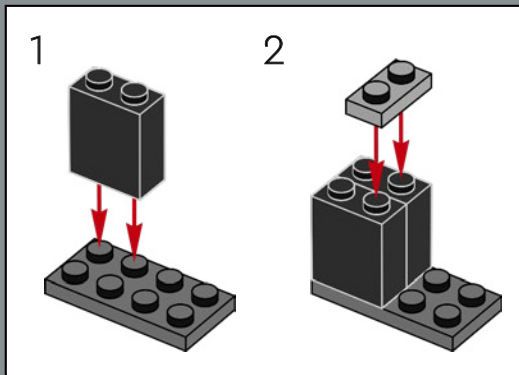

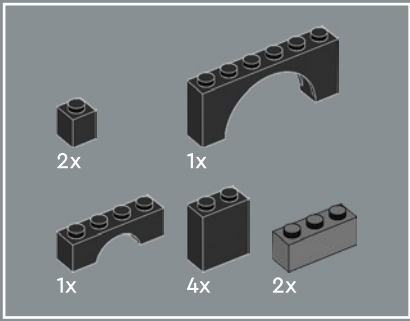

32

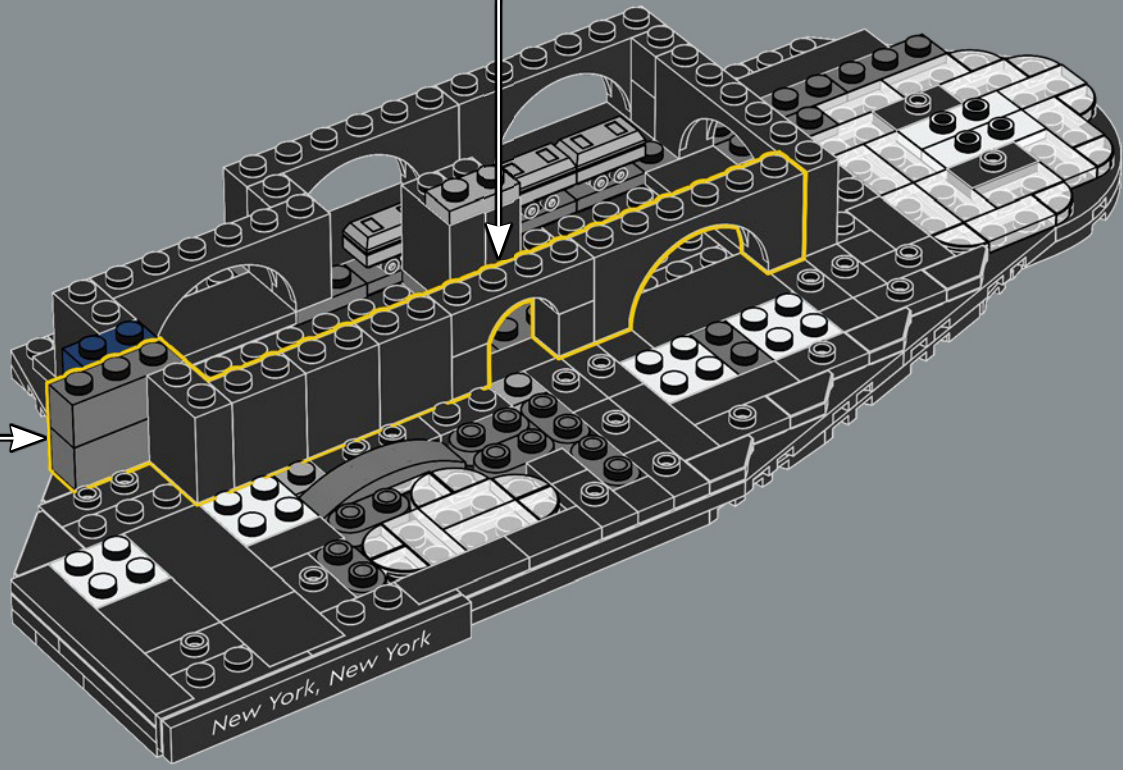
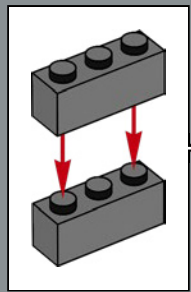
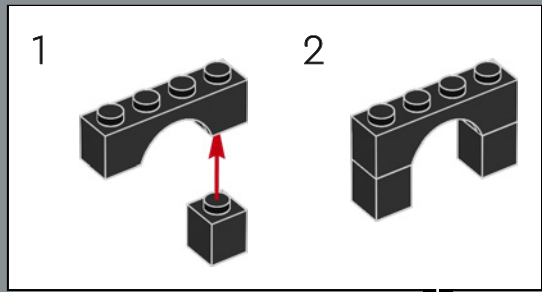

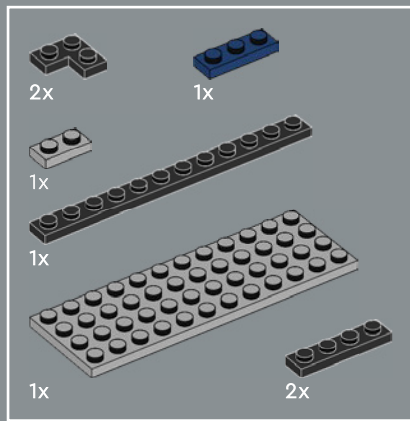

33

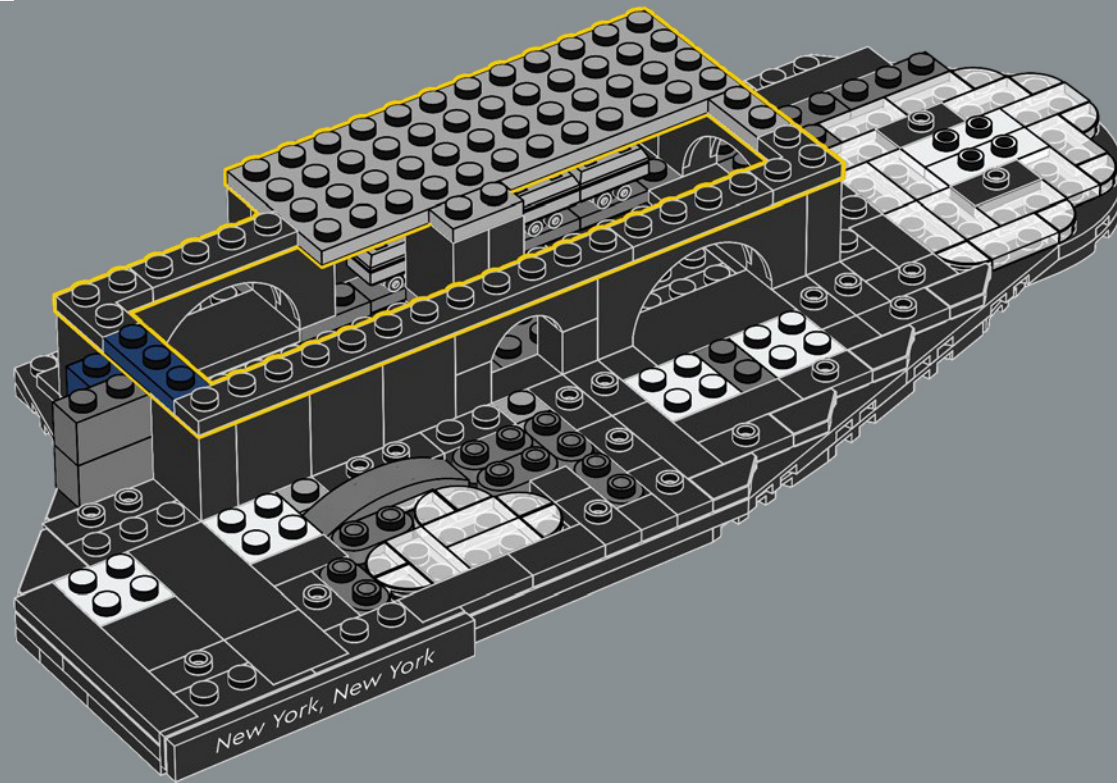

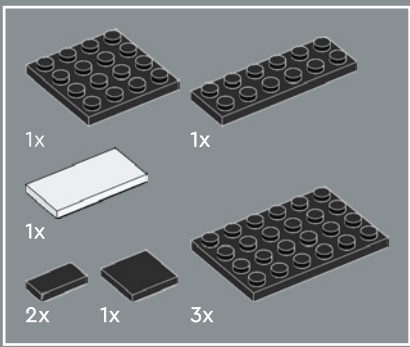

34

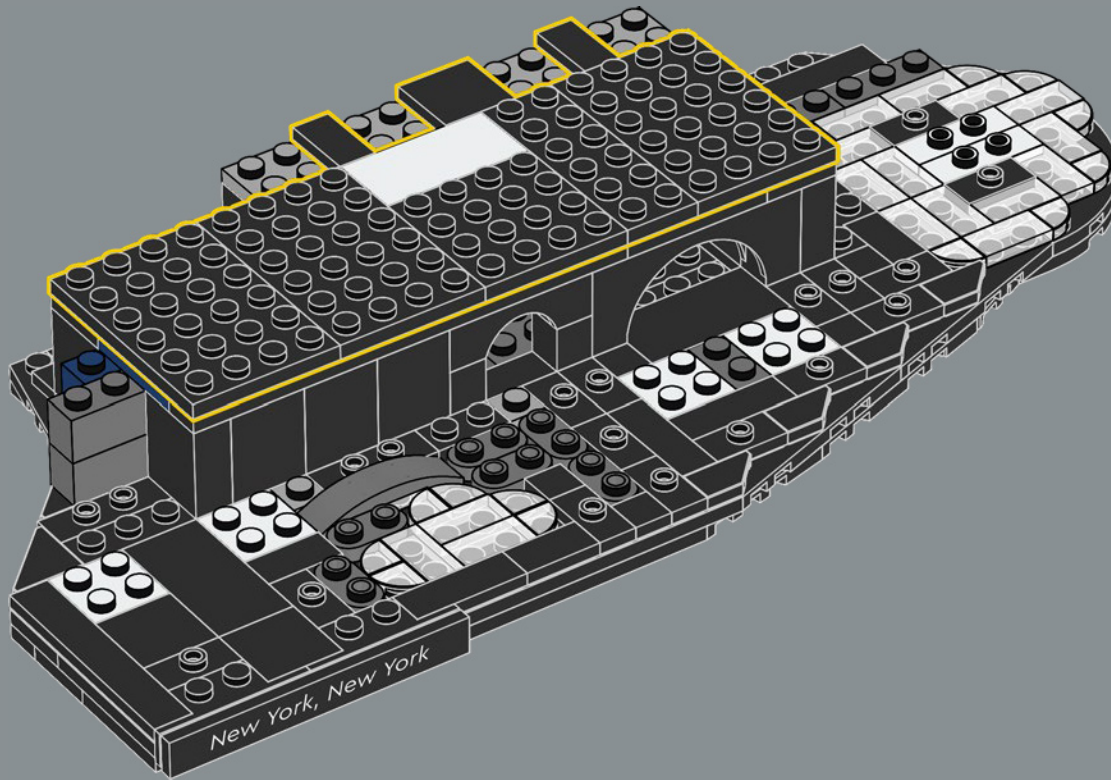

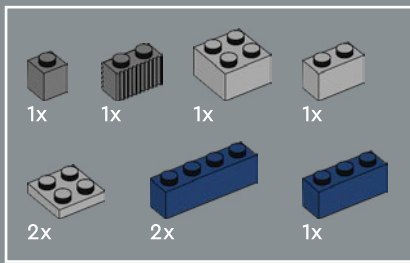

35

1

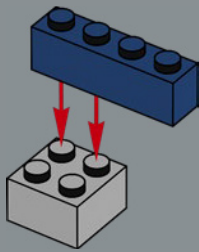

2

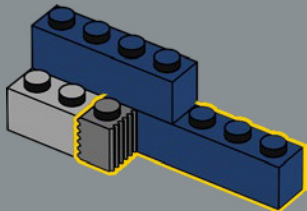

3

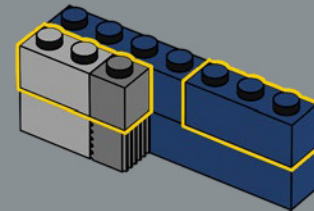

4

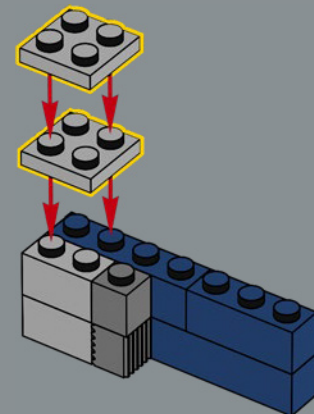

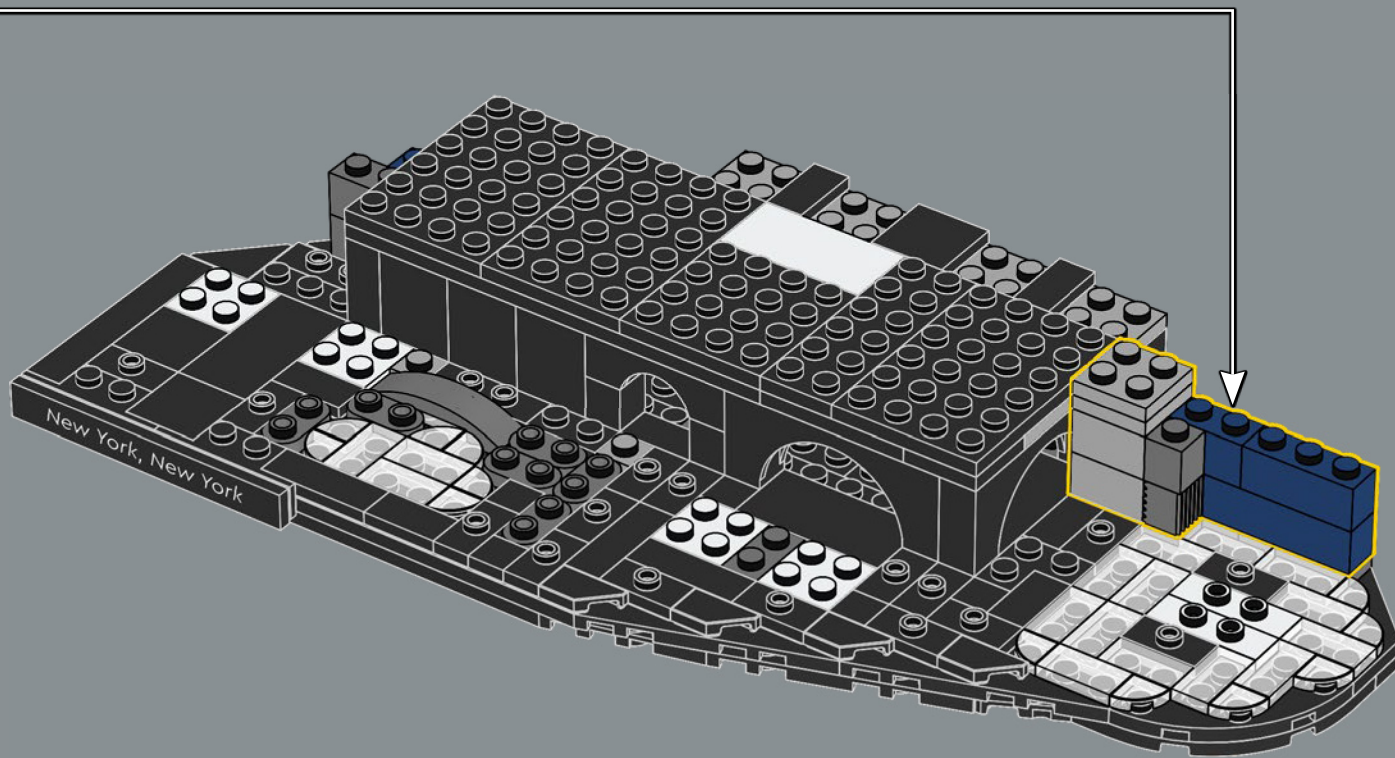

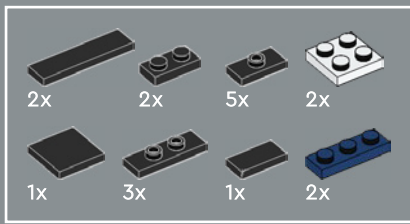

36

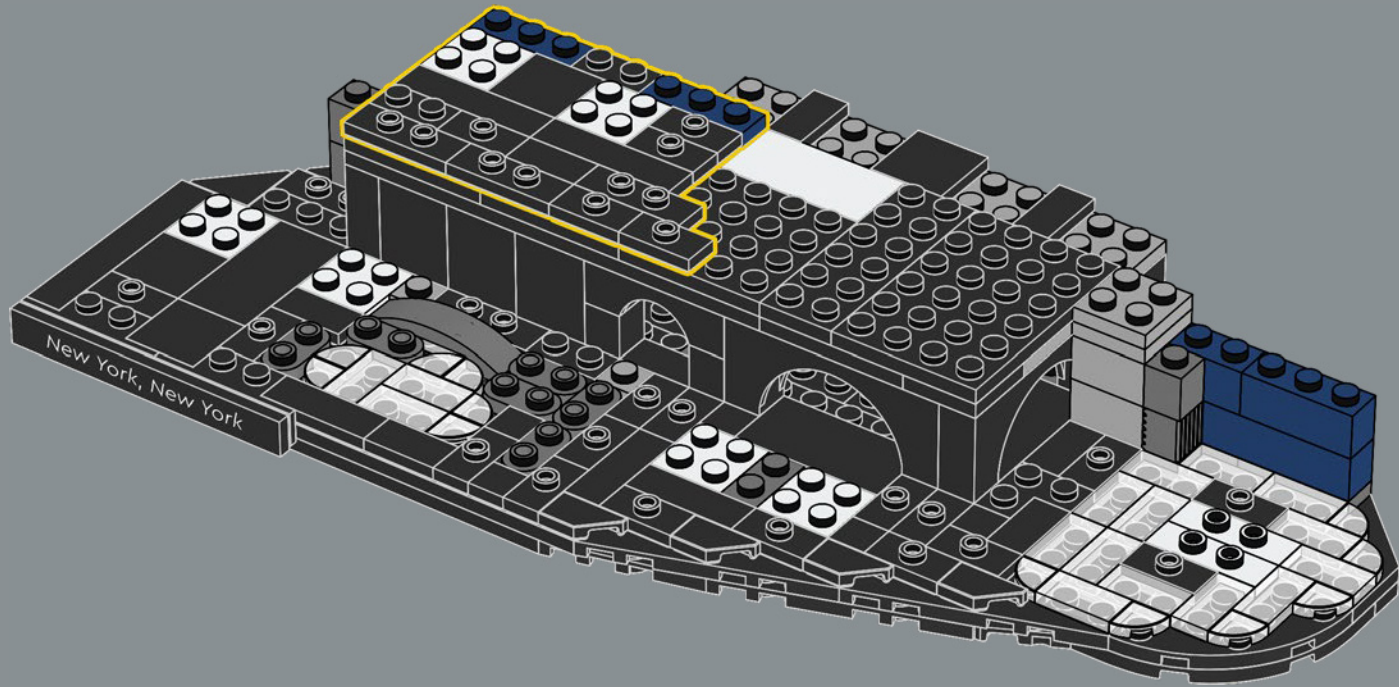

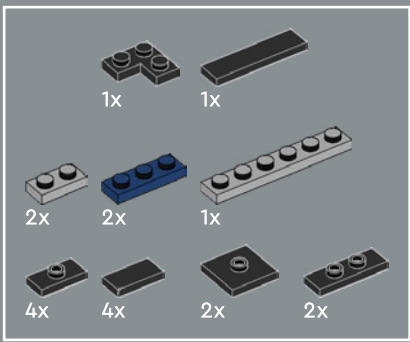

37

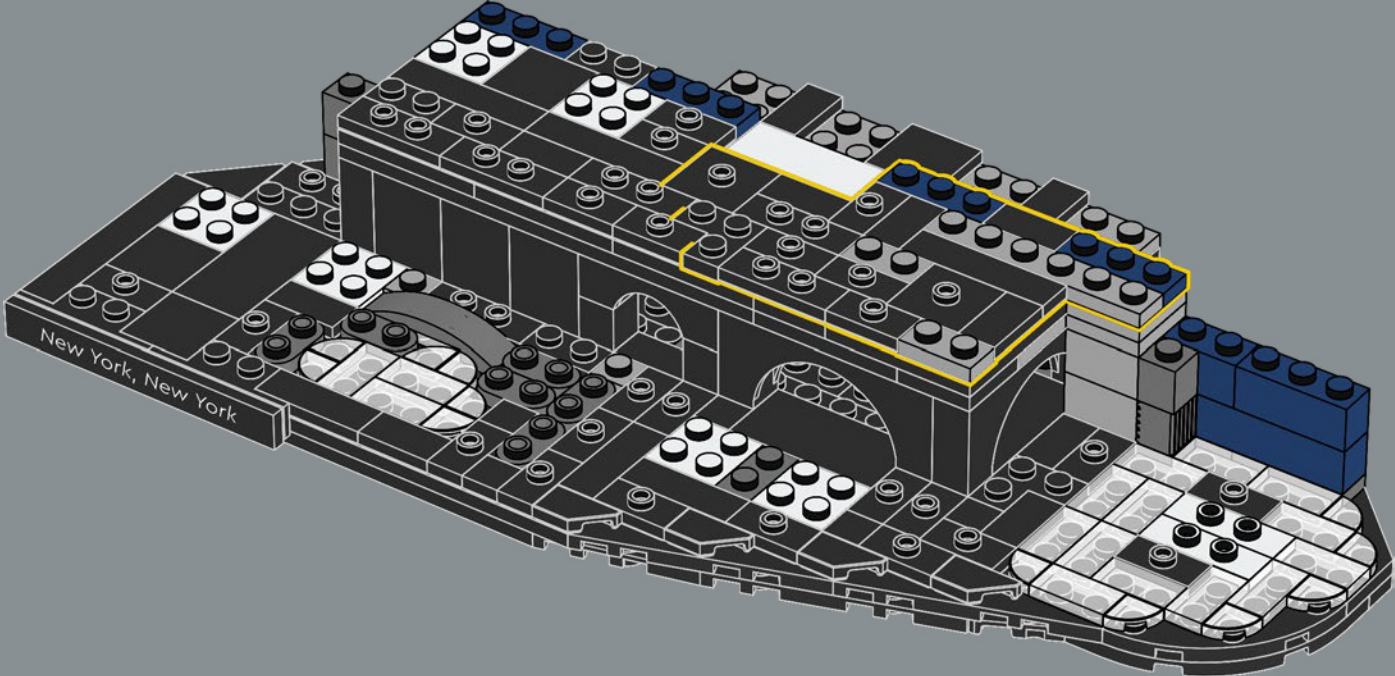

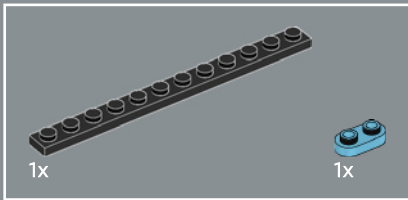
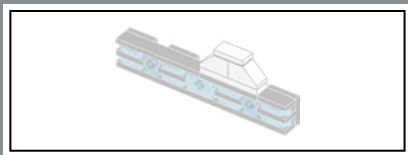

38

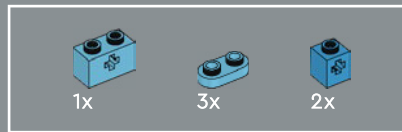
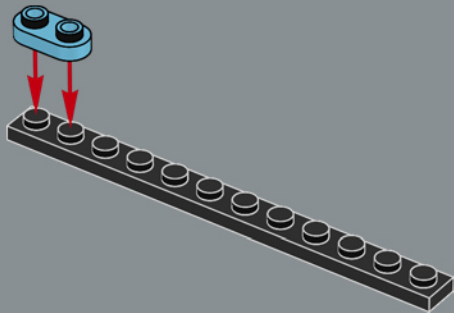

39

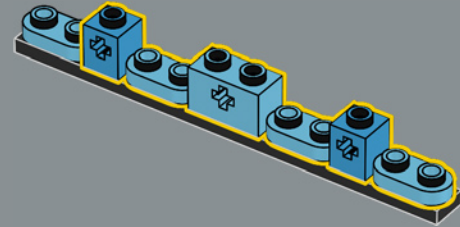

40

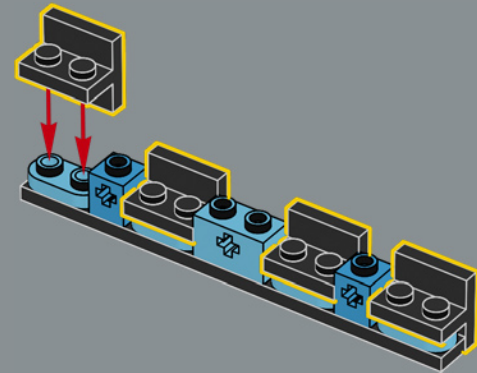

4x

41

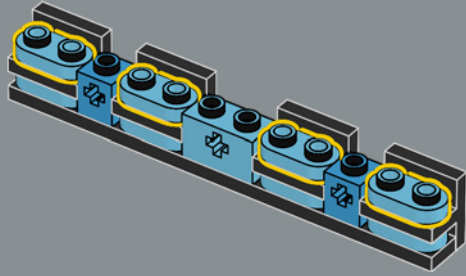

1x 1x 1x

42

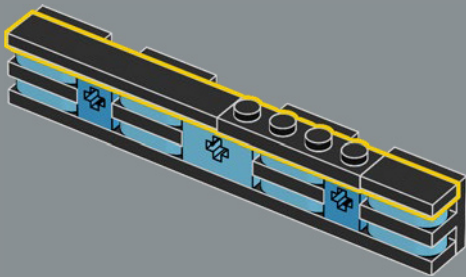

1x

1x

2x

43

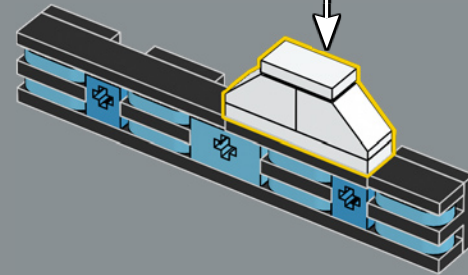
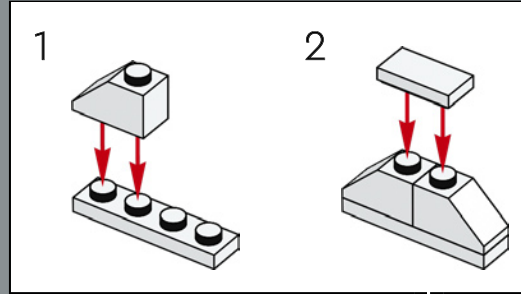

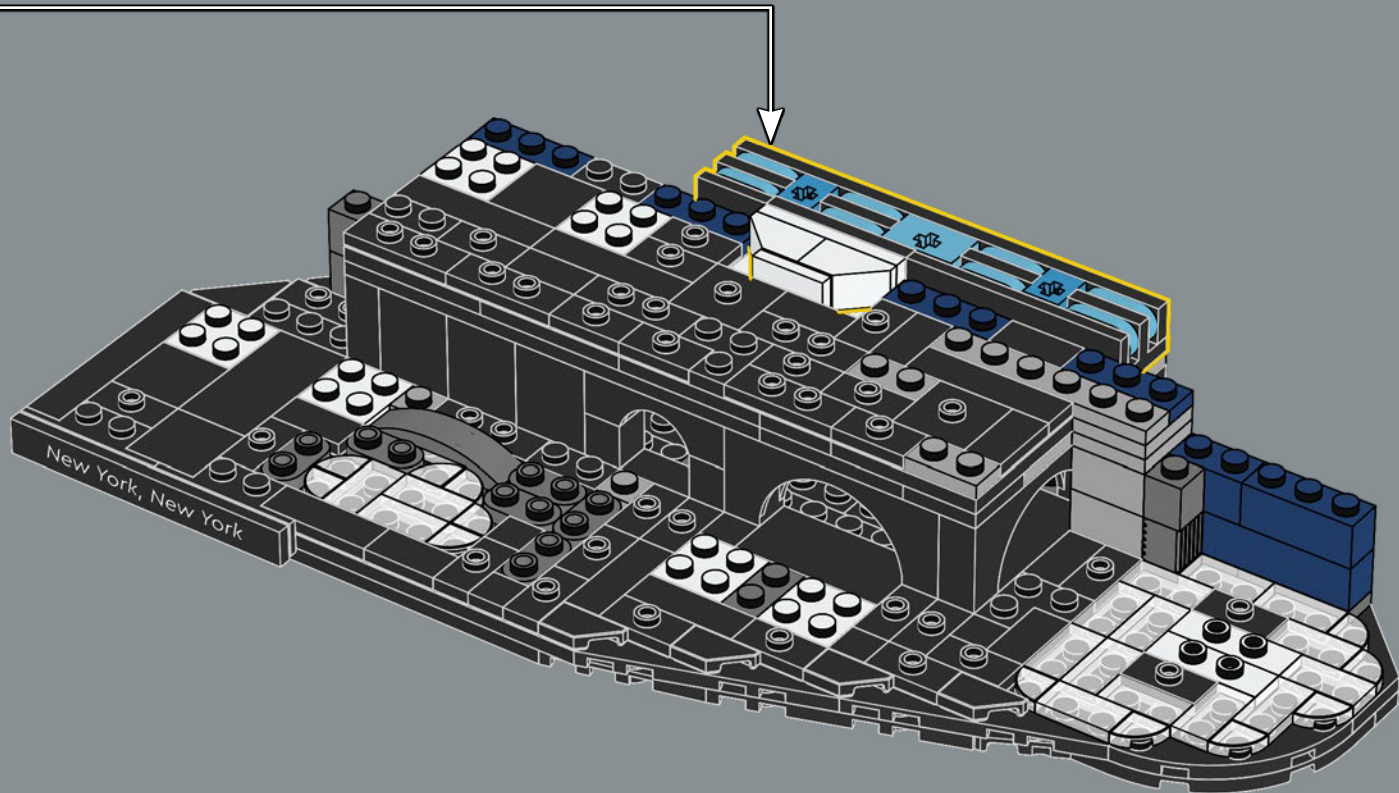

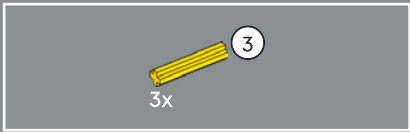

45

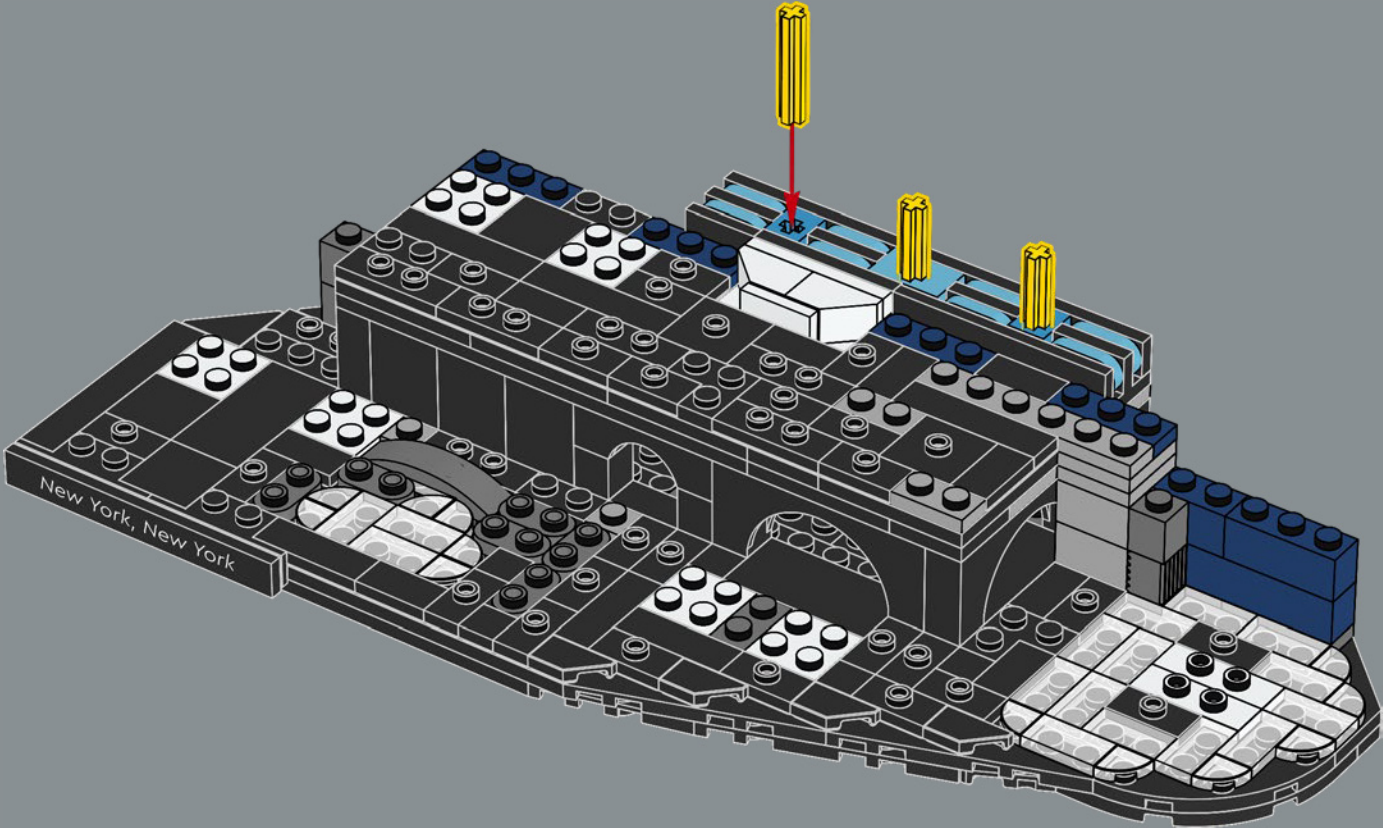

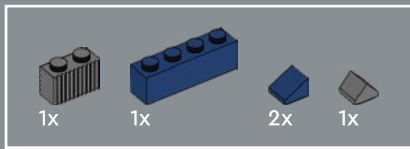

46

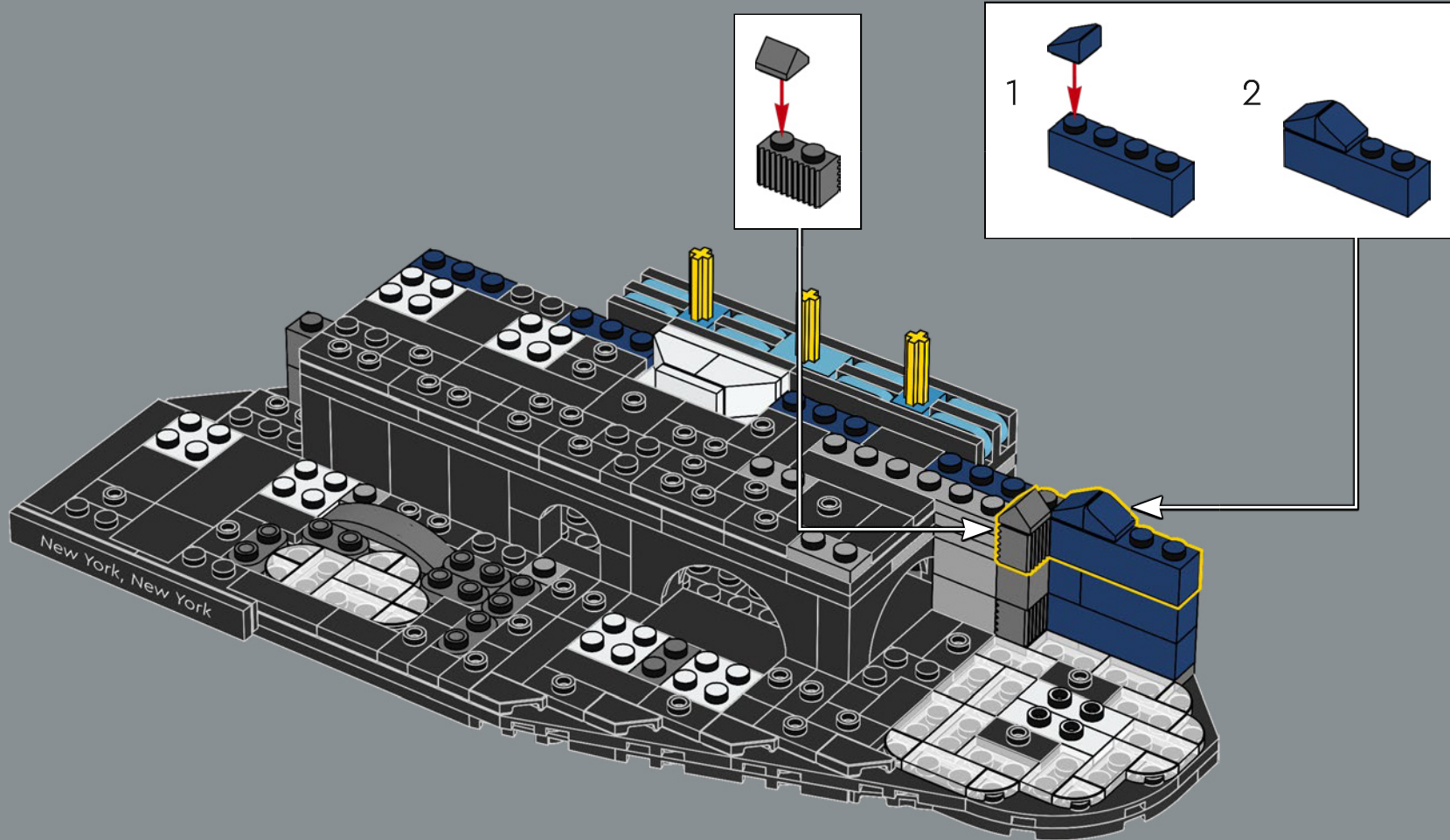

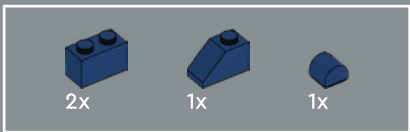

47

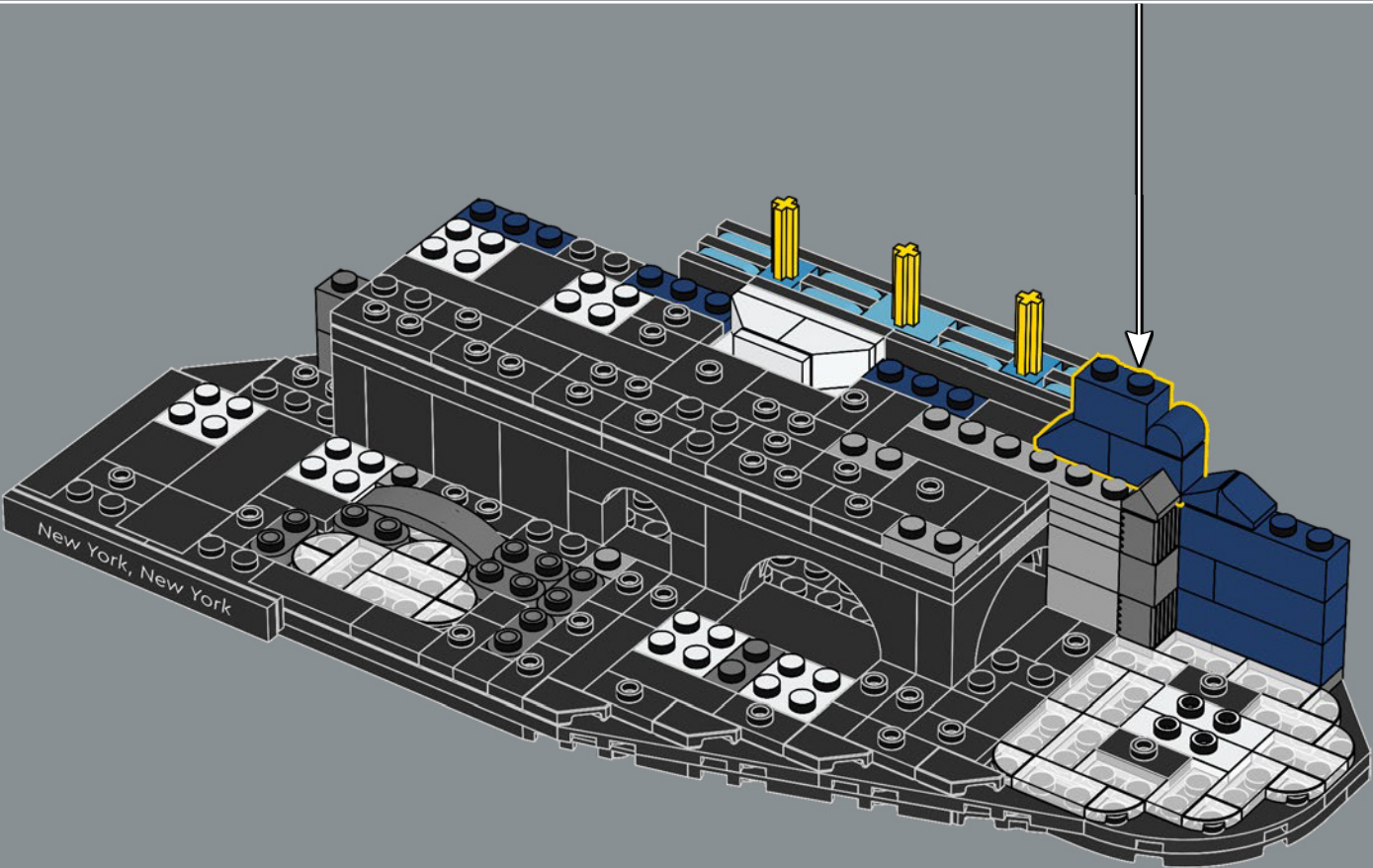
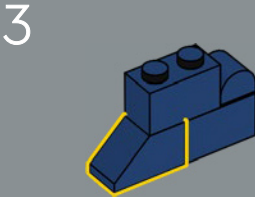
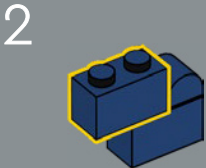
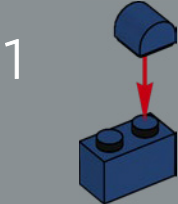

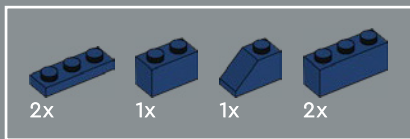

48

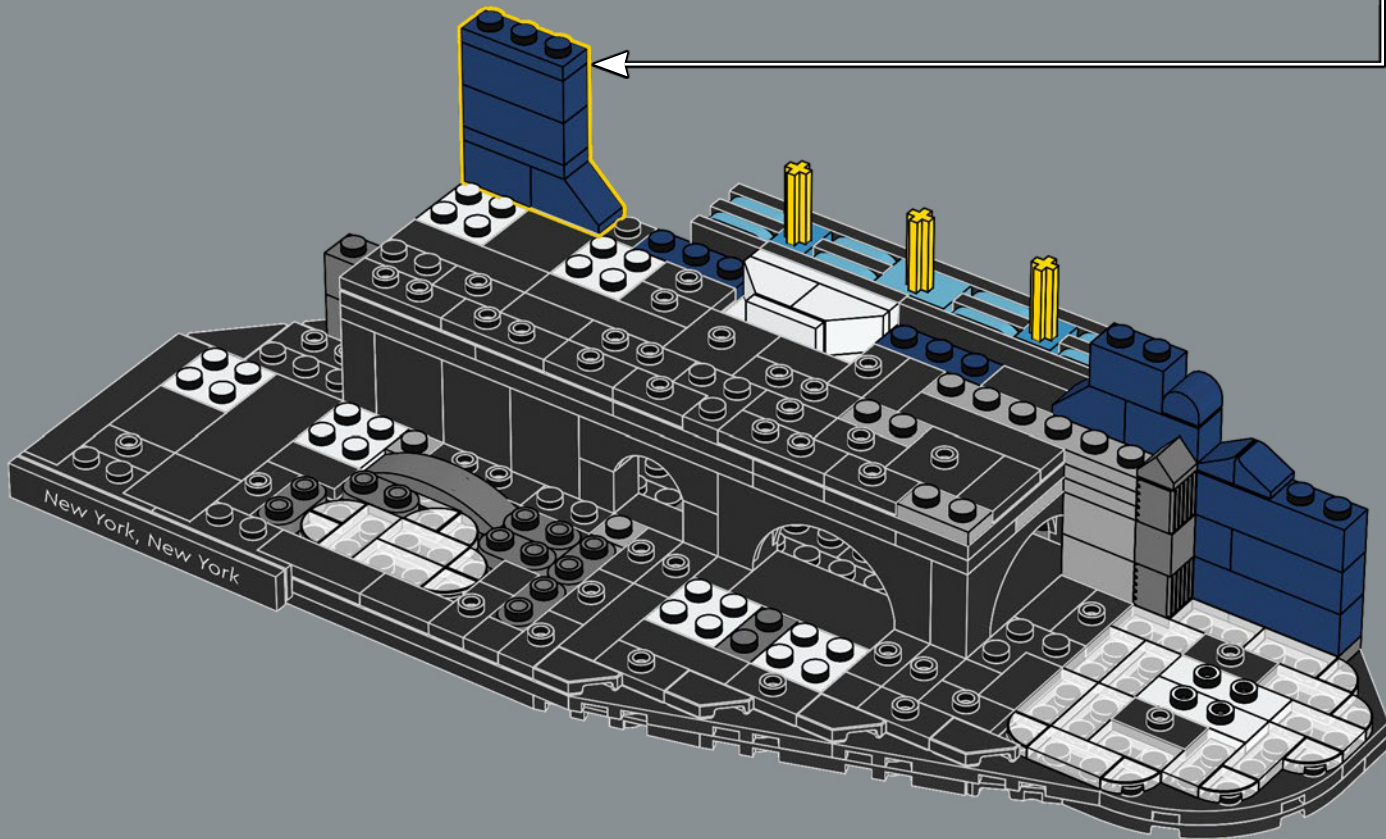

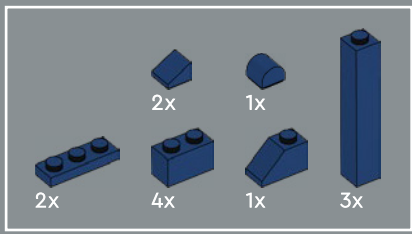

49

1

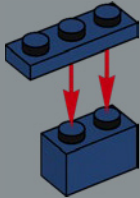

2

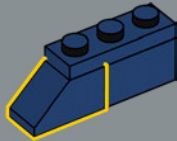

3

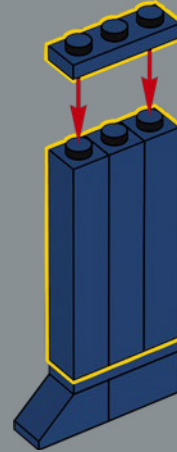

4

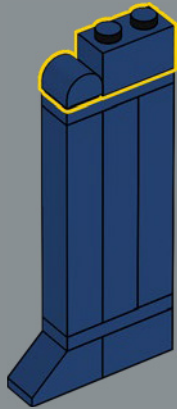

5

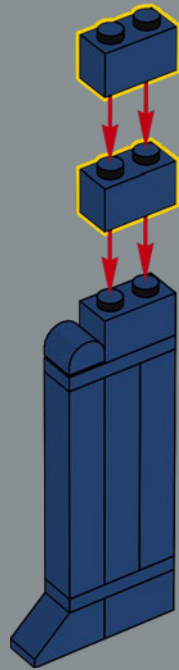

6

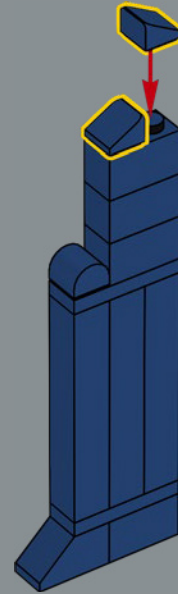

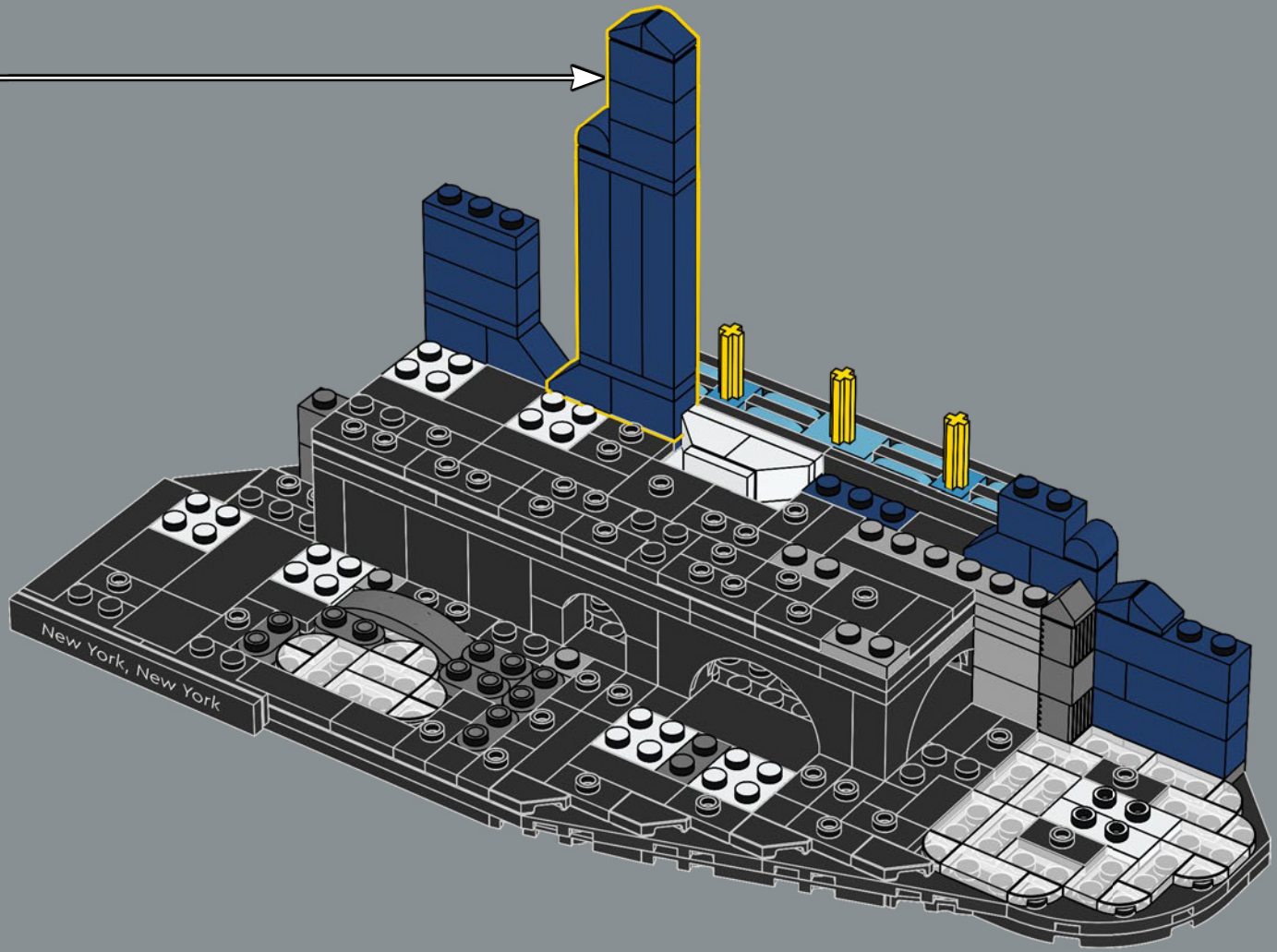

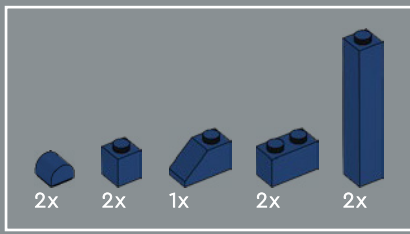

50

1

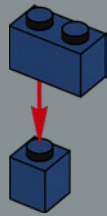

2

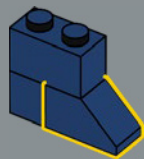

3

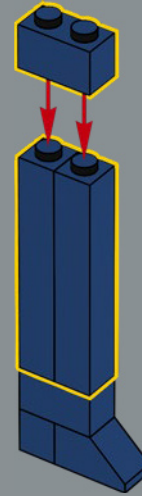

4

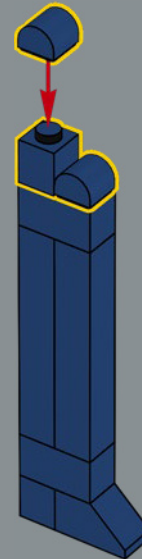

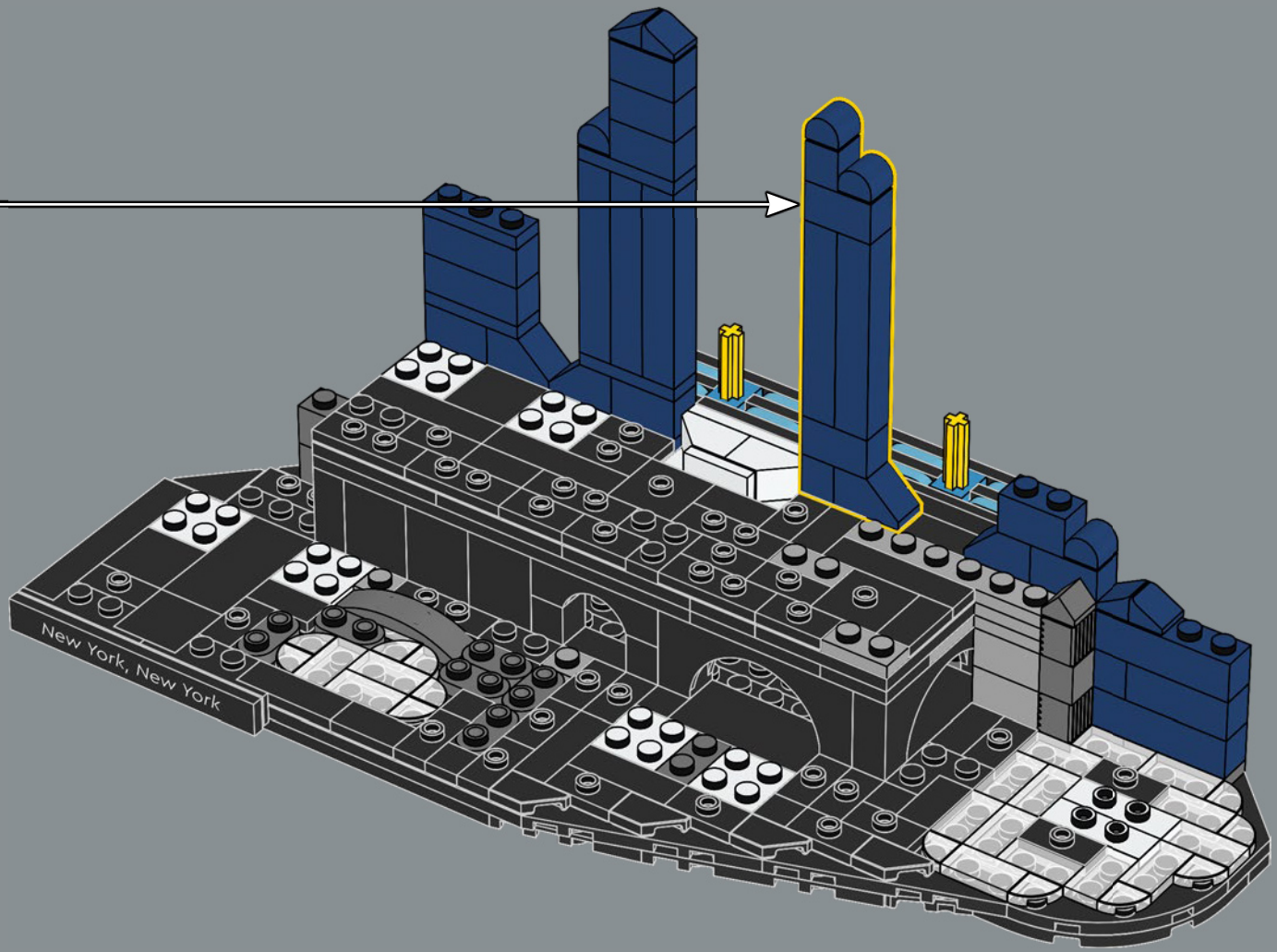

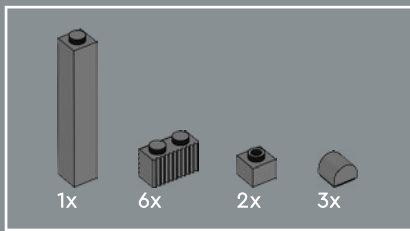

51

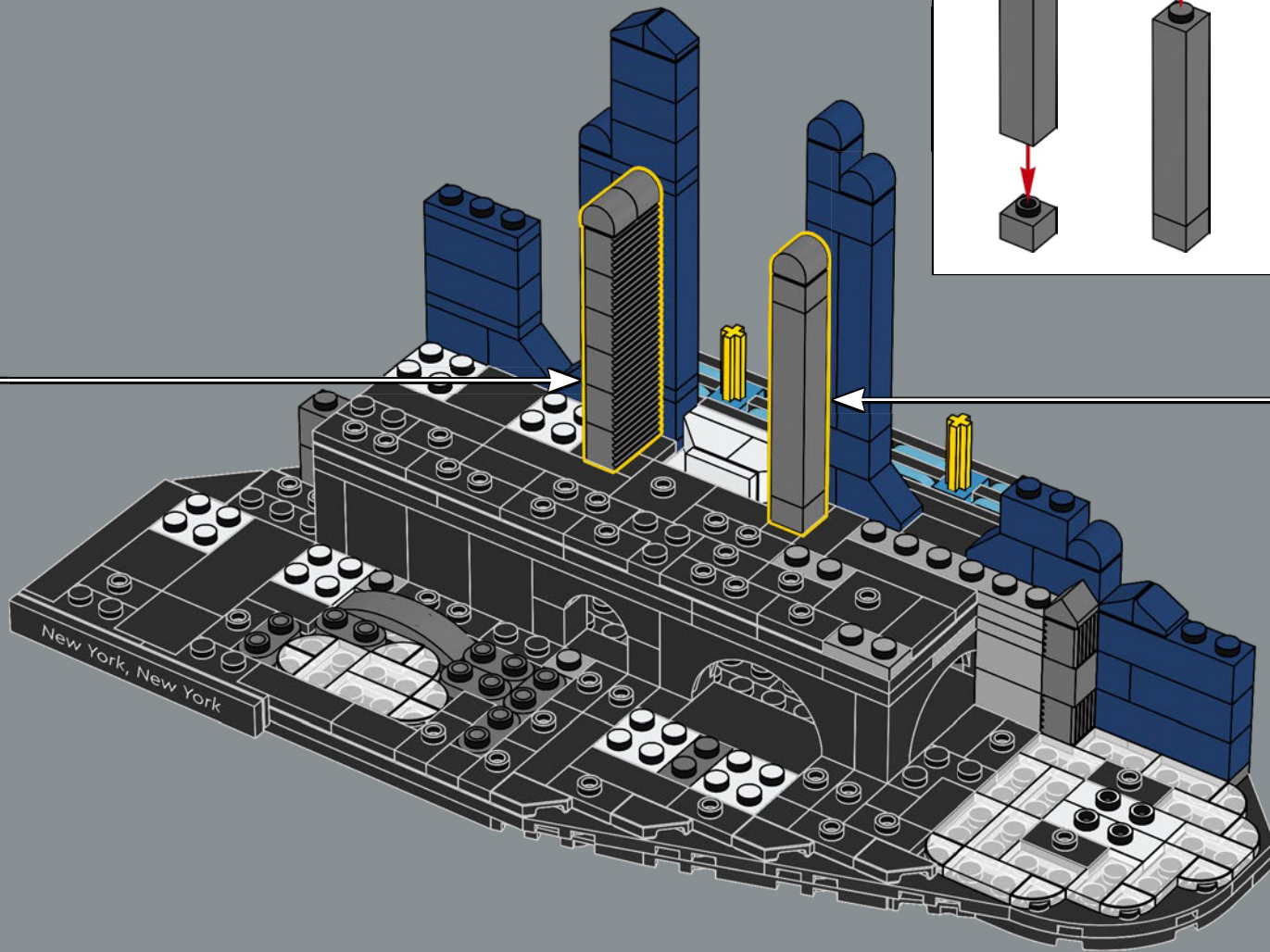
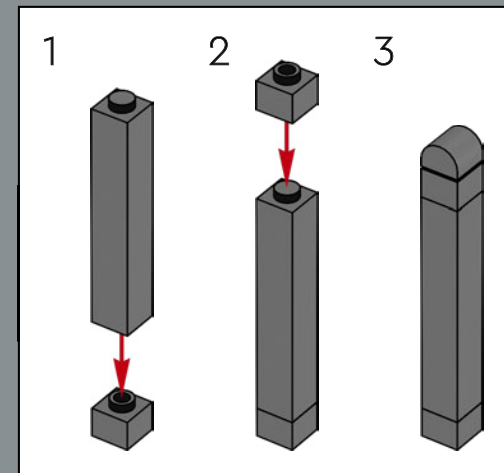
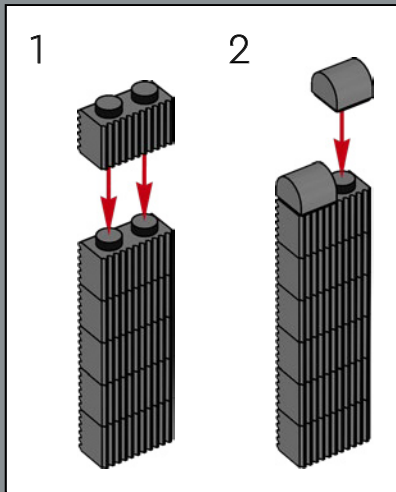

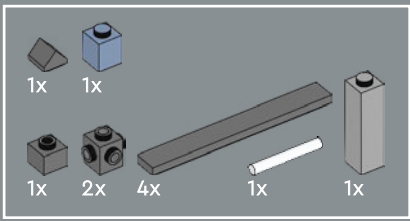

52

1

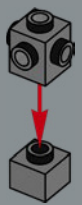

2

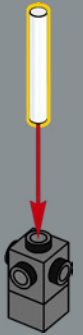

3



4

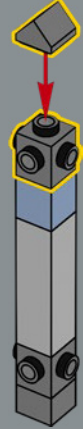

5

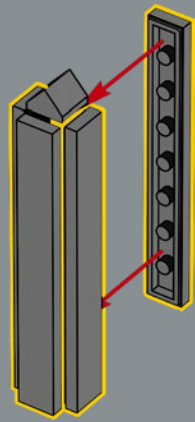

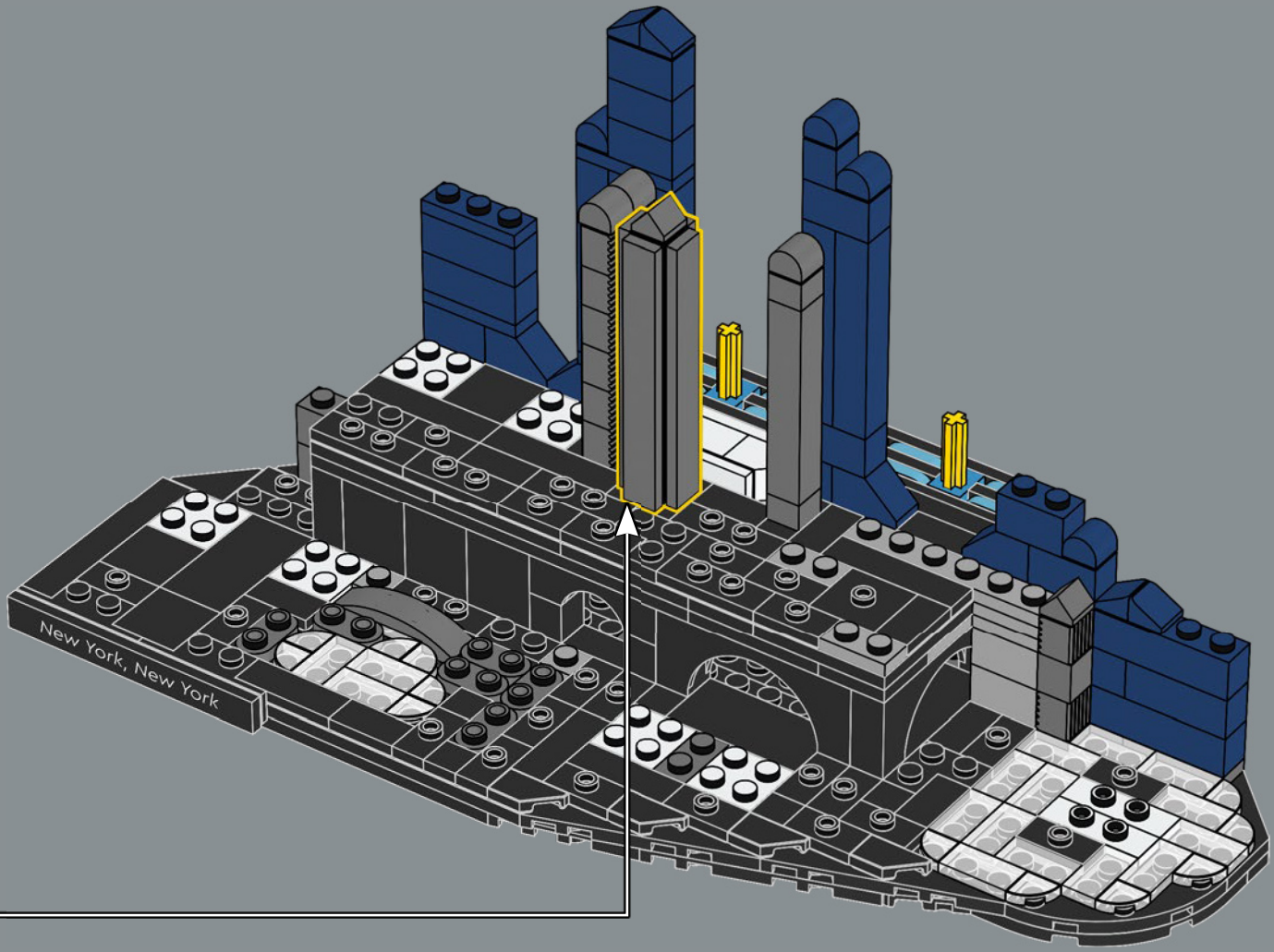

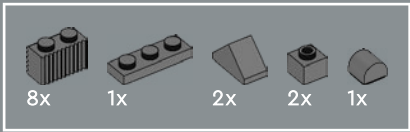

53

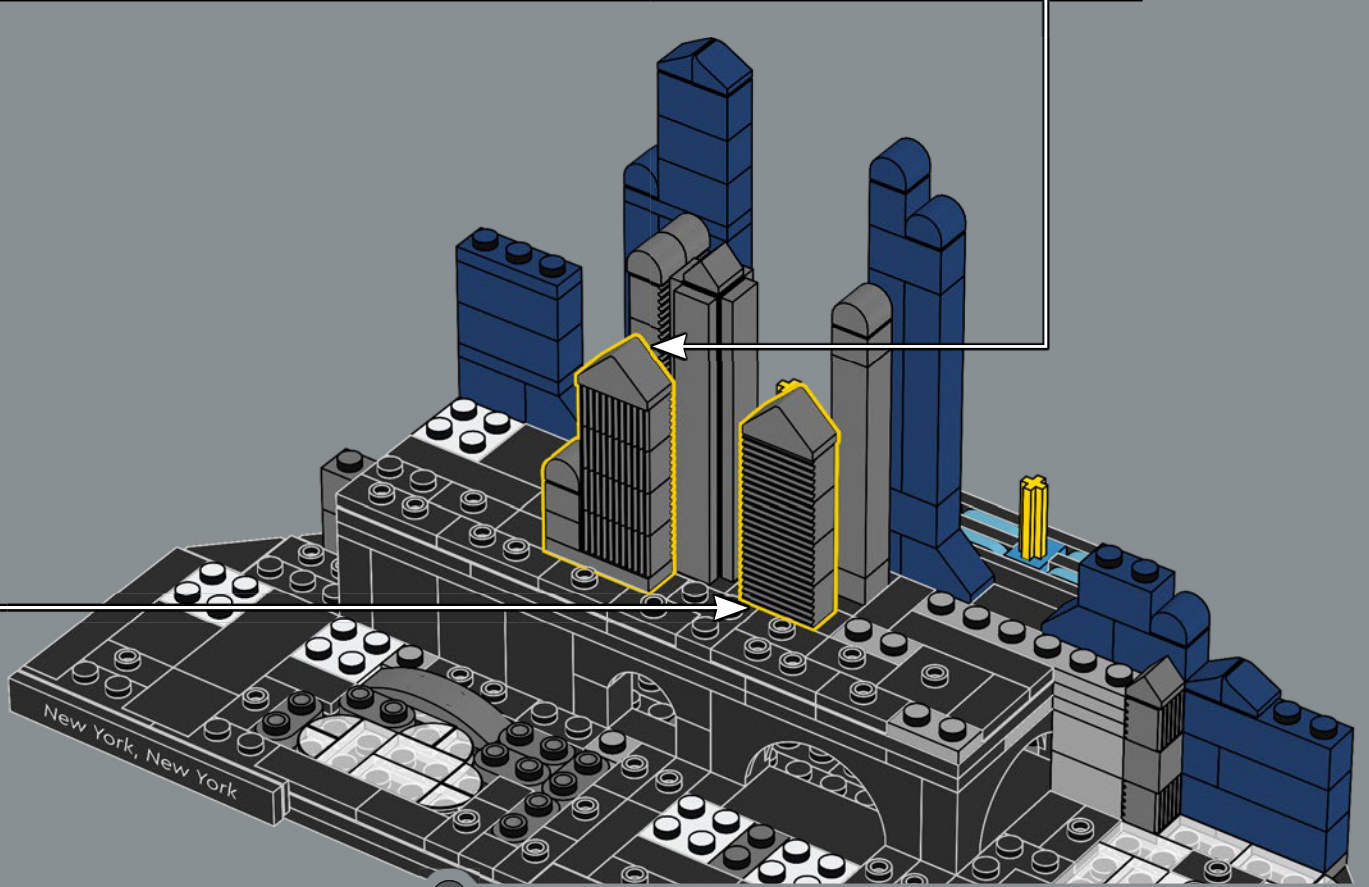
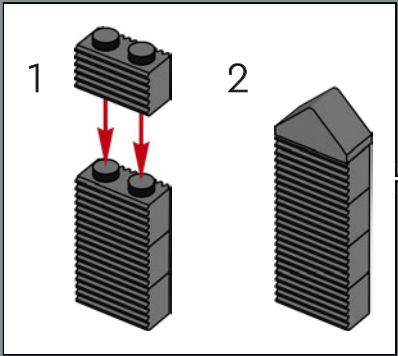
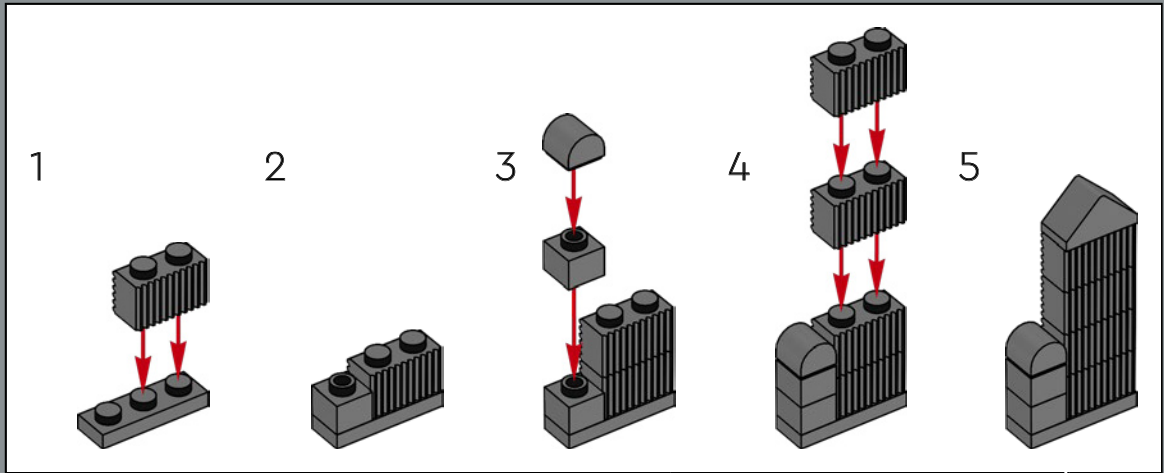

Questi pattini a rotelle gialli delle minifigure LEGO® rappresentano alcuni degli oltre 13.000 caratteristici taxi di New York City.

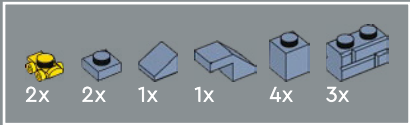

54

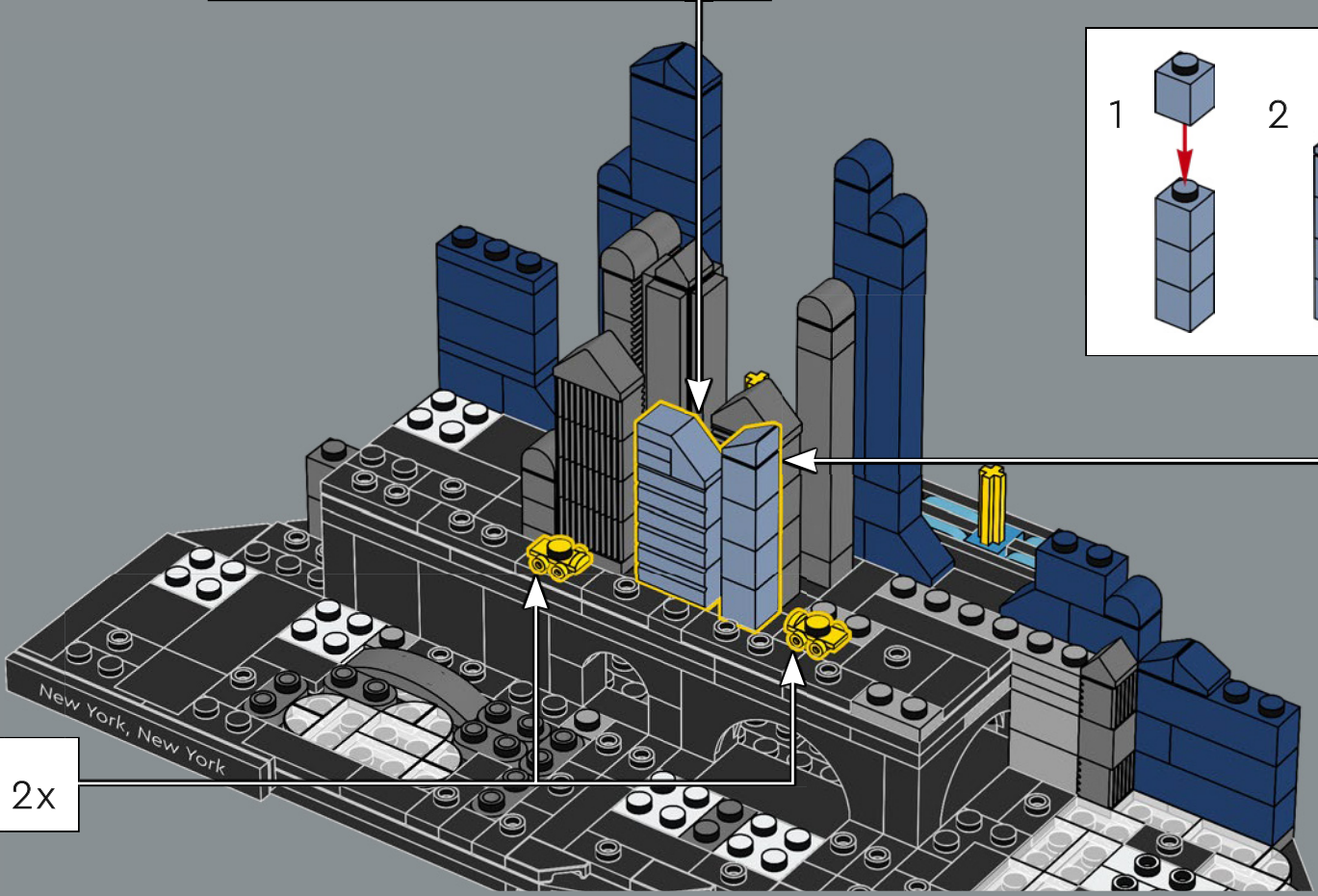
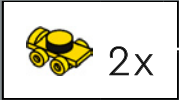
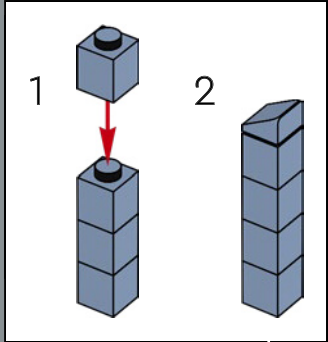
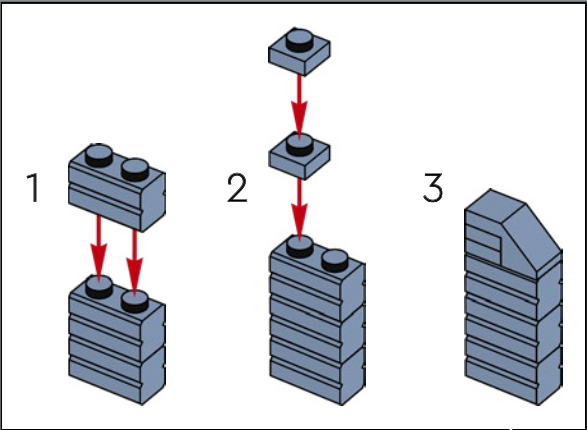

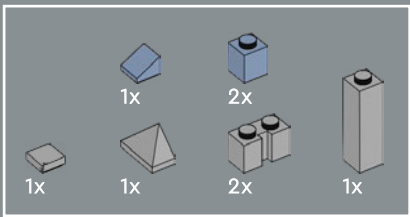

55

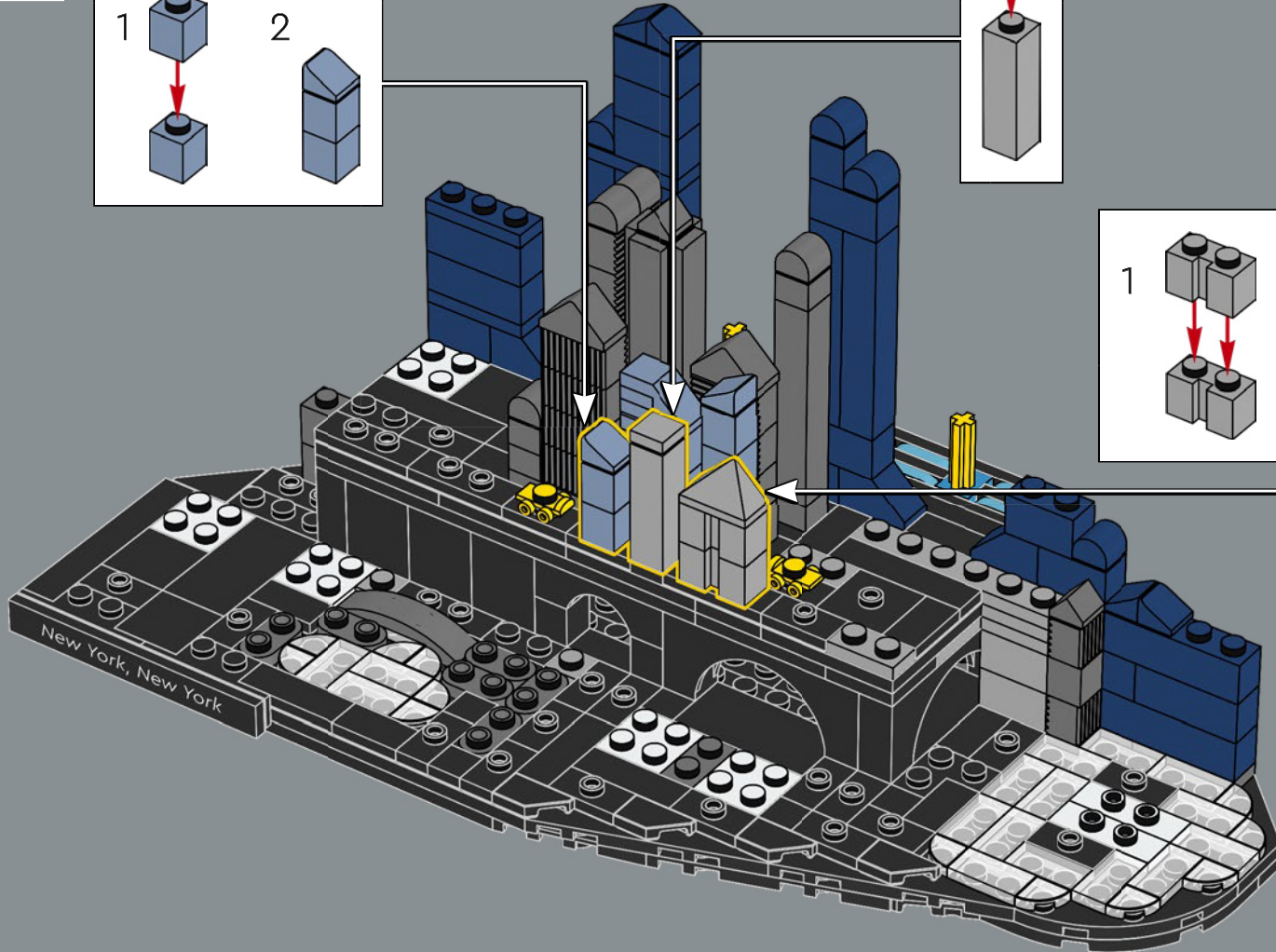
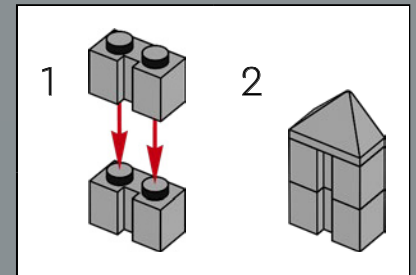
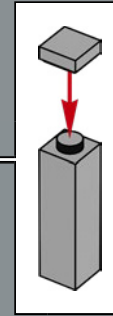
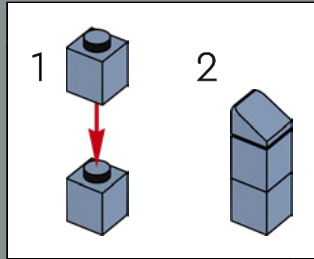

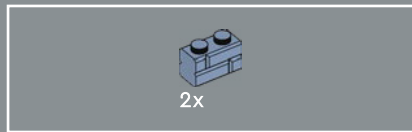

56

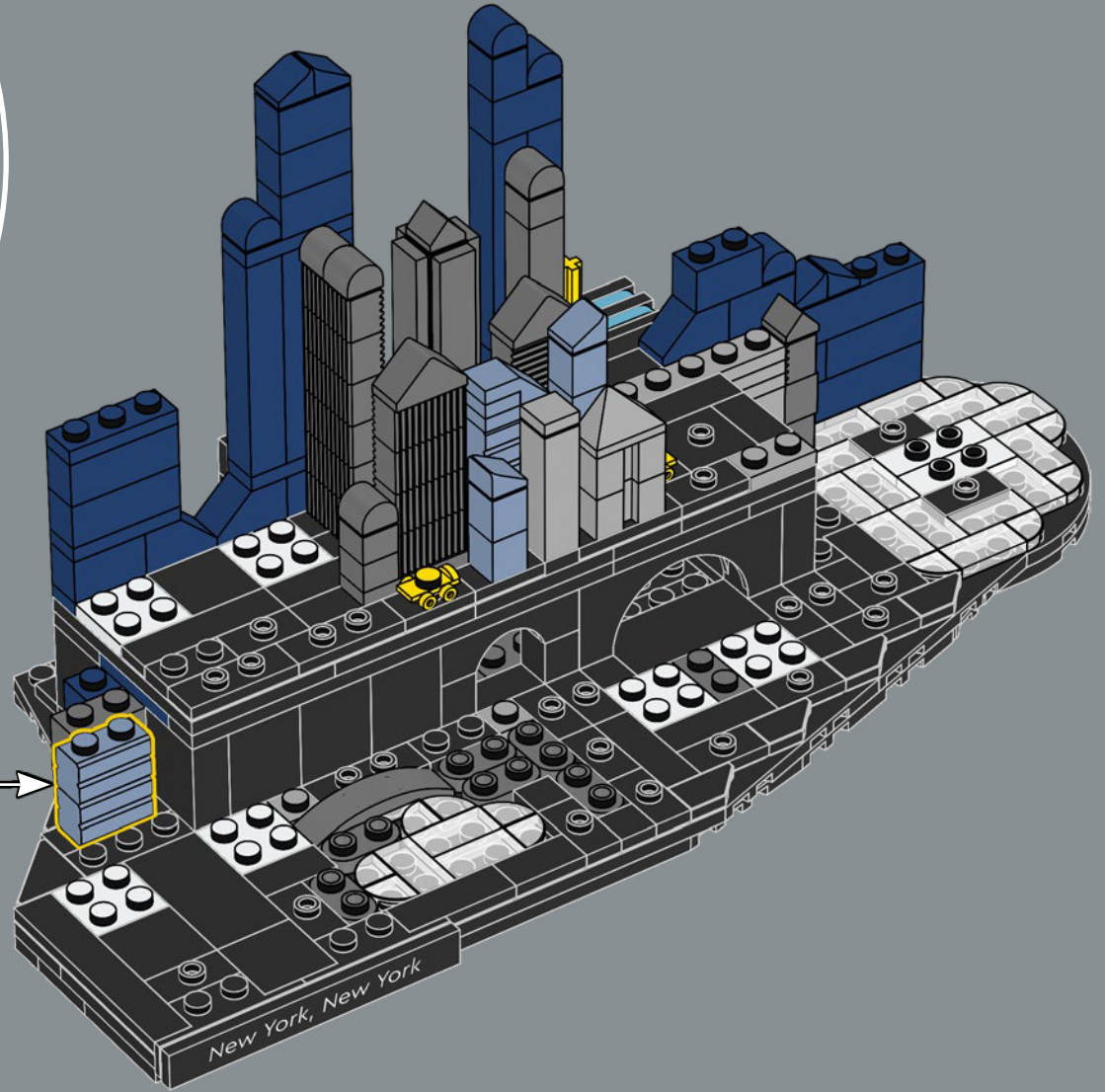
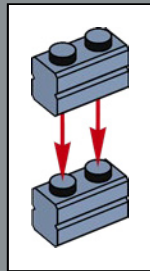

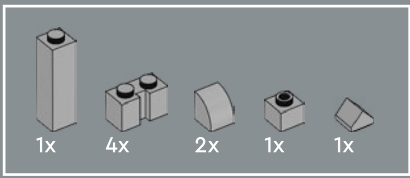

57

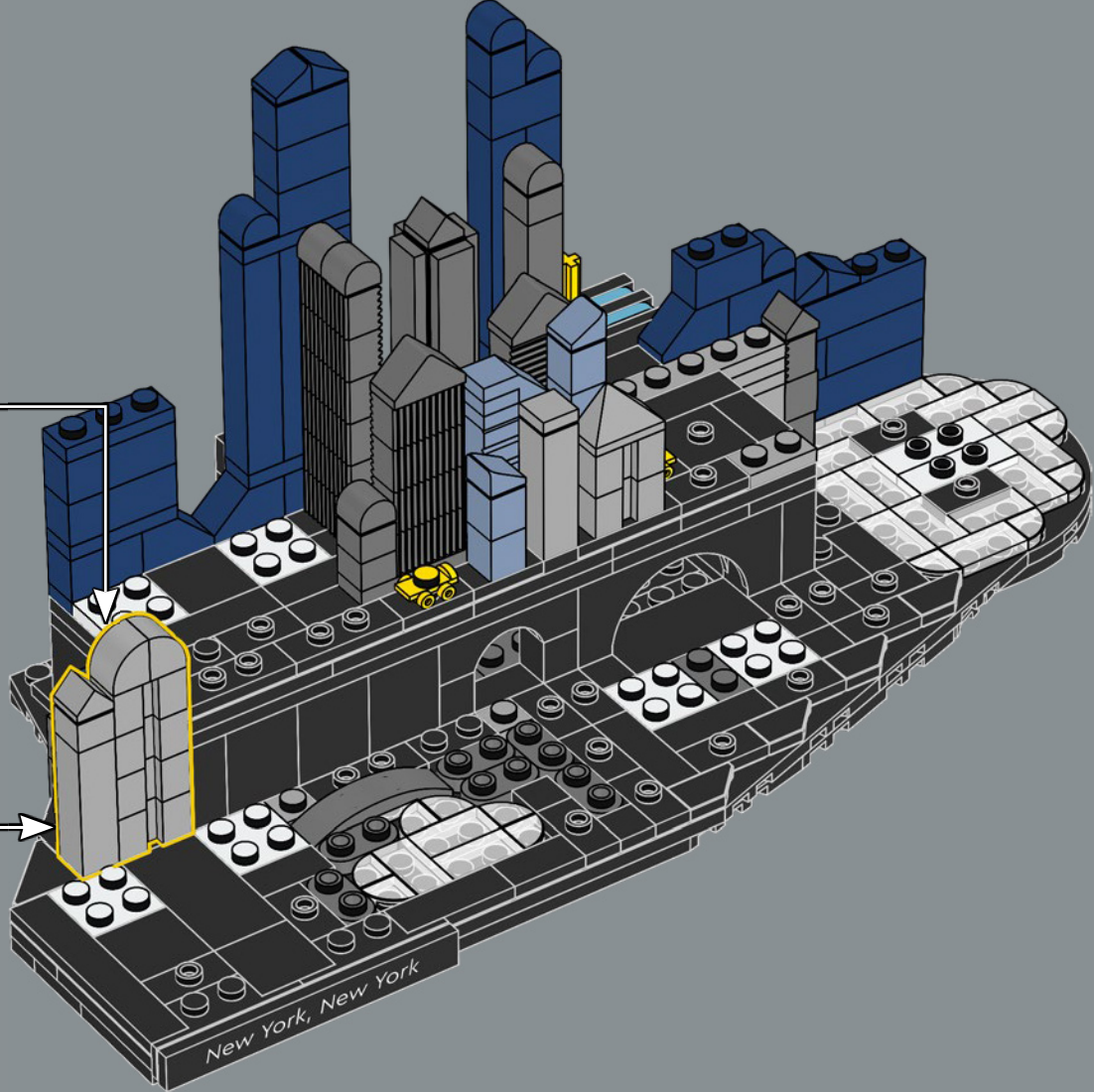
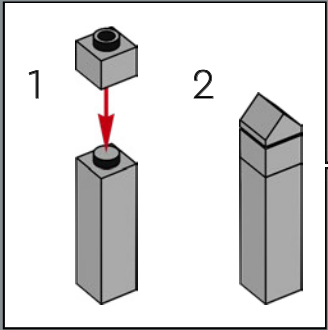
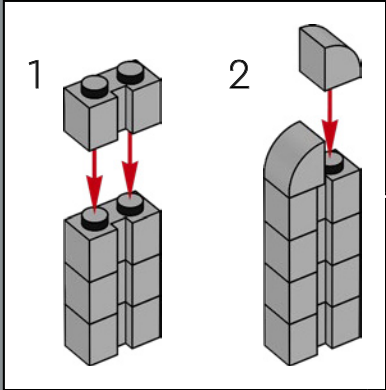

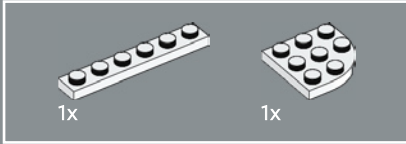
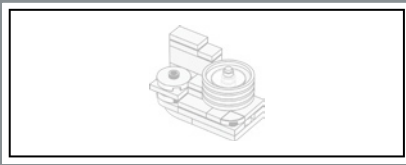

58

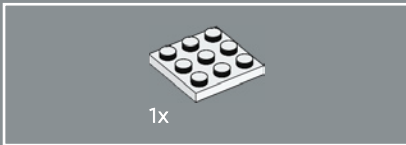
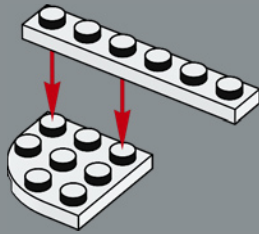

59

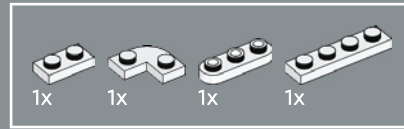
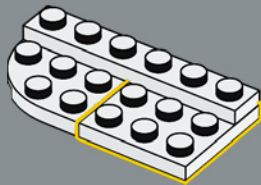

60

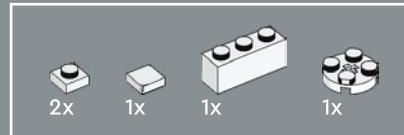
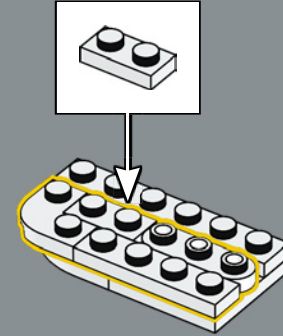

61

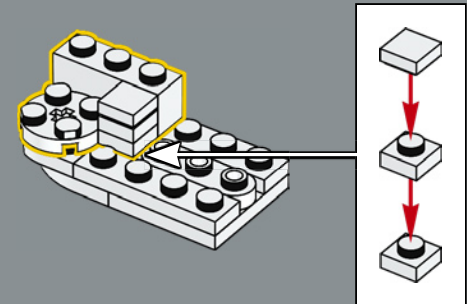



62

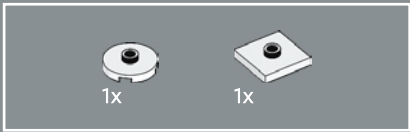
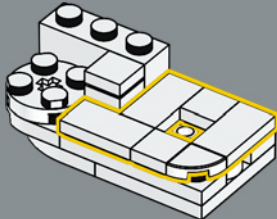

63

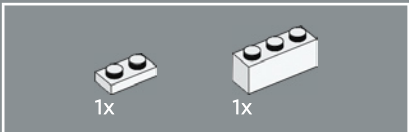
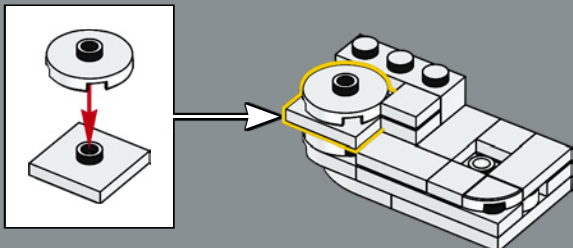

64

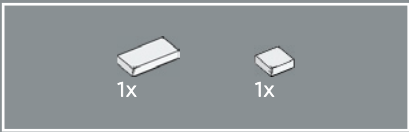
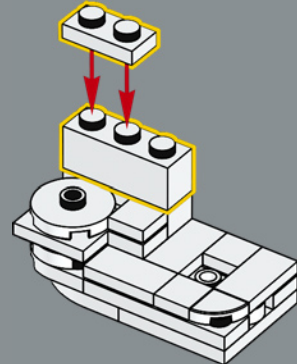

65

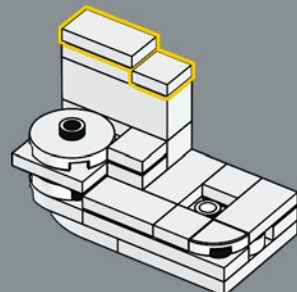

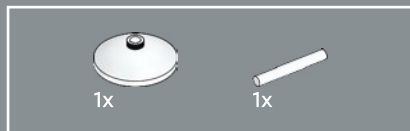

66

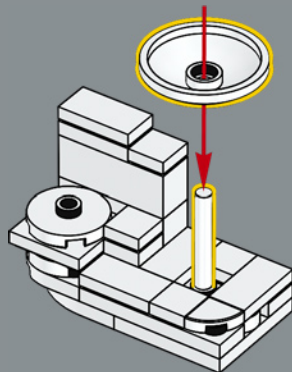

67

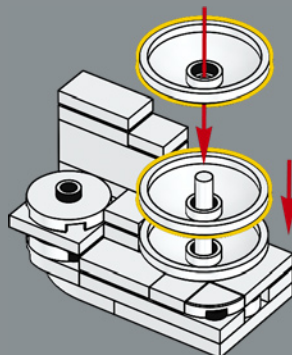

68

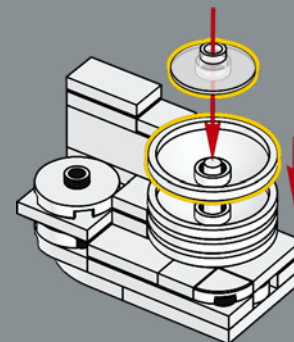

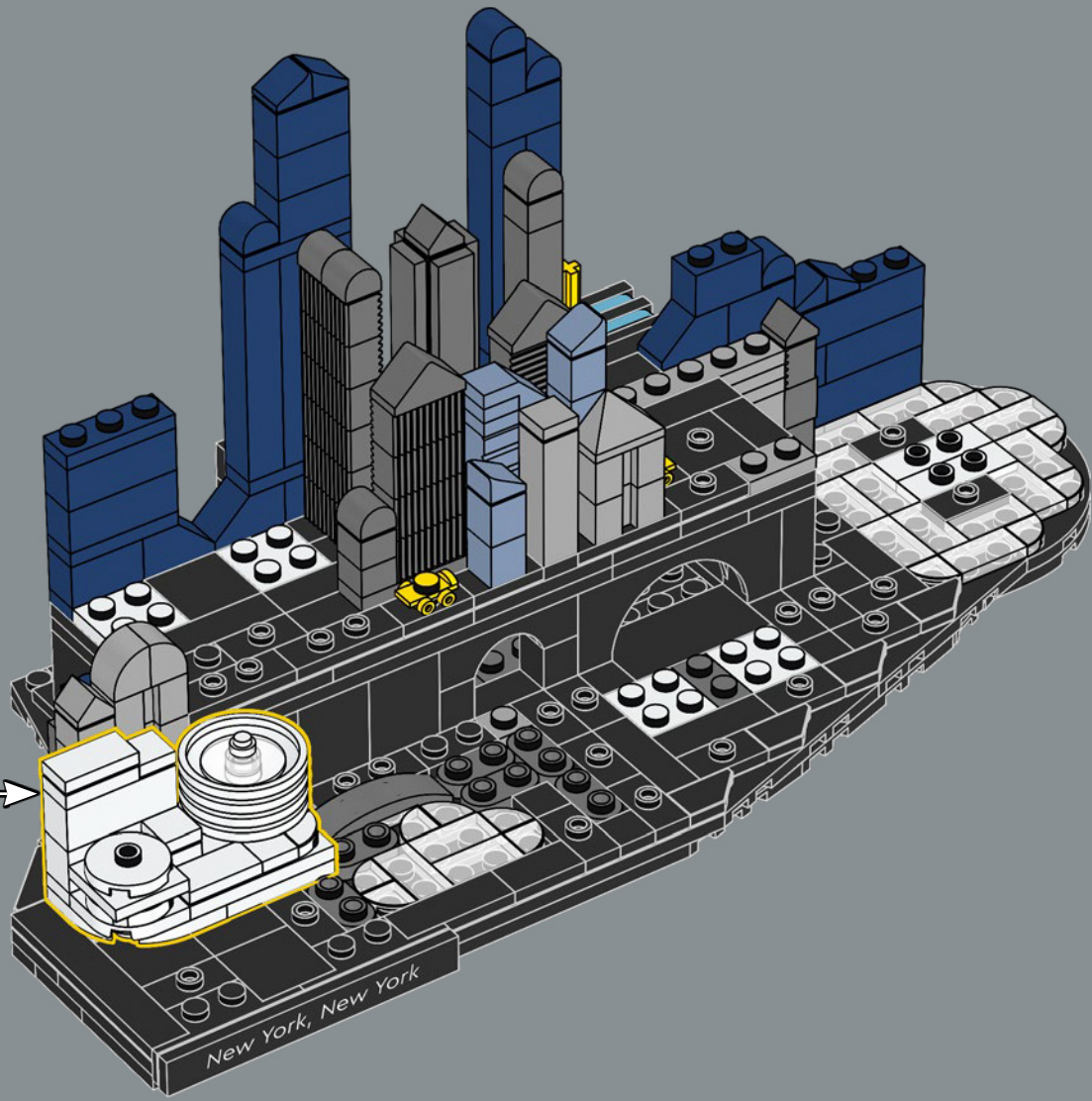

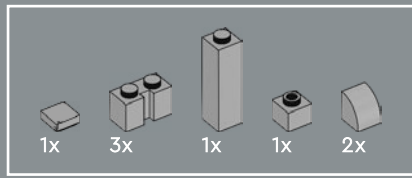

70

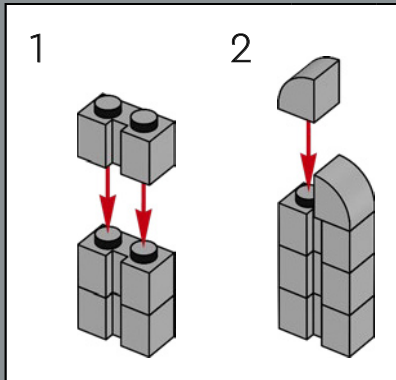
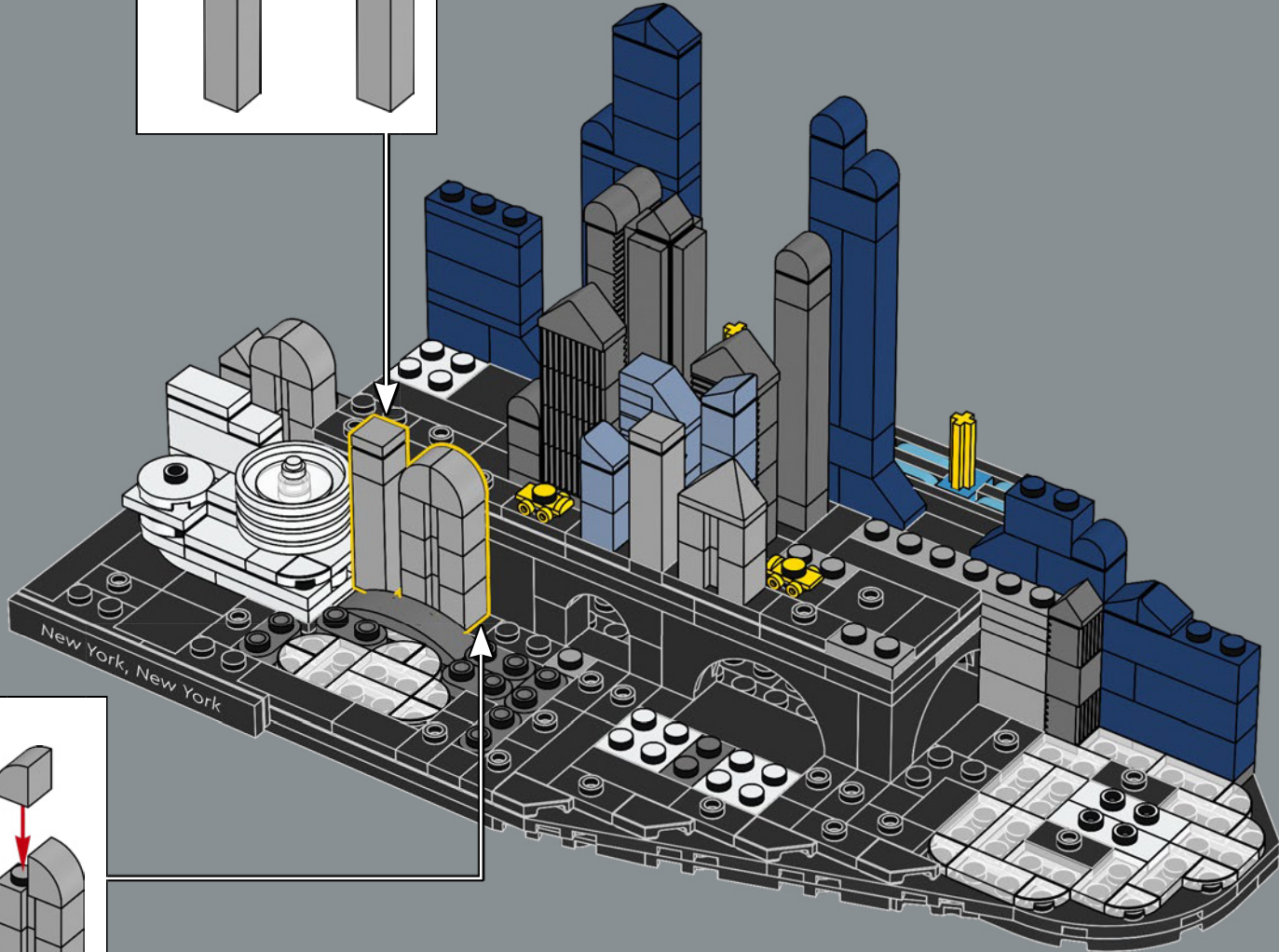
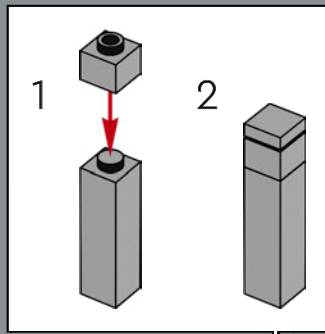

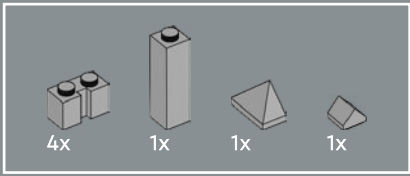

71

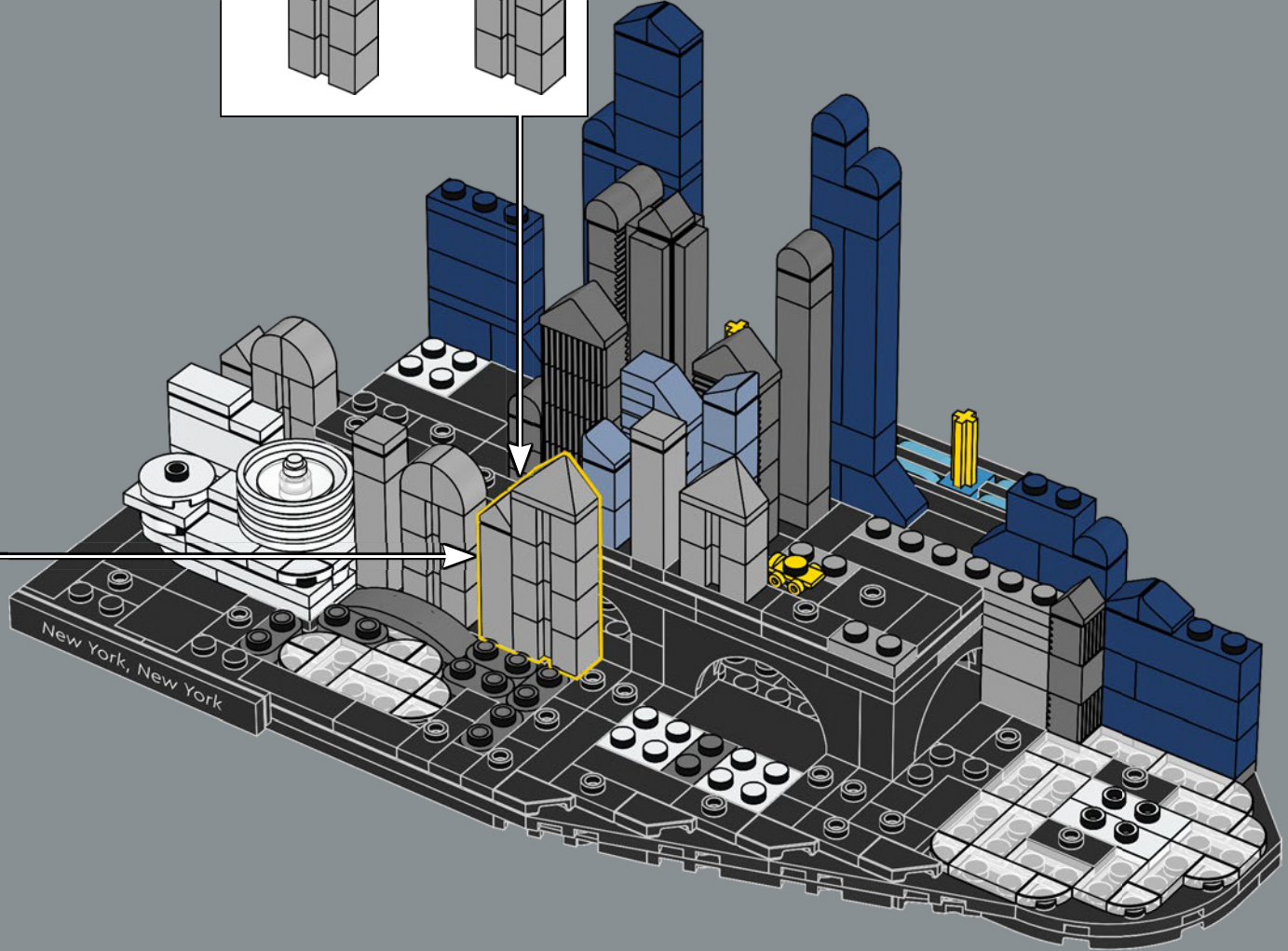
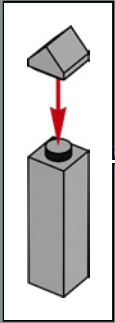
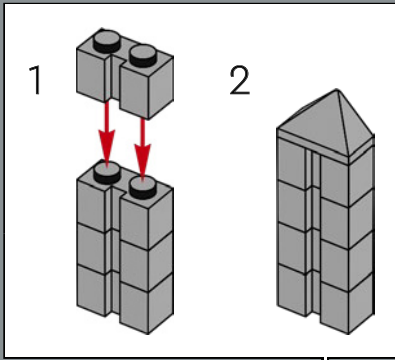



7x



3x

72

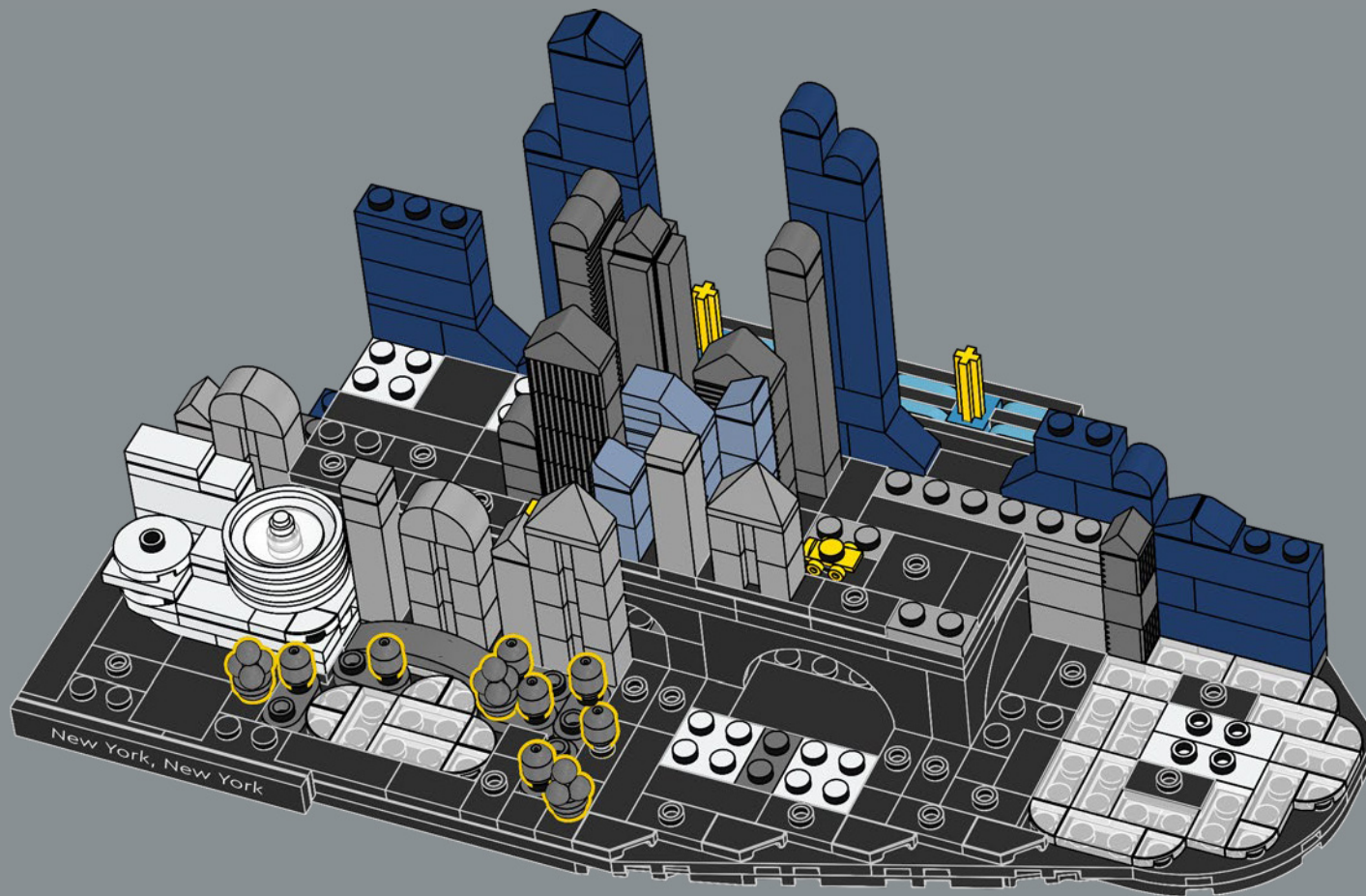



Elementi gelato, lame e globi LEGO® sono stati qui utilizzati per ricreare alcuni dei circa 18.000 alberi di Central Park.

73

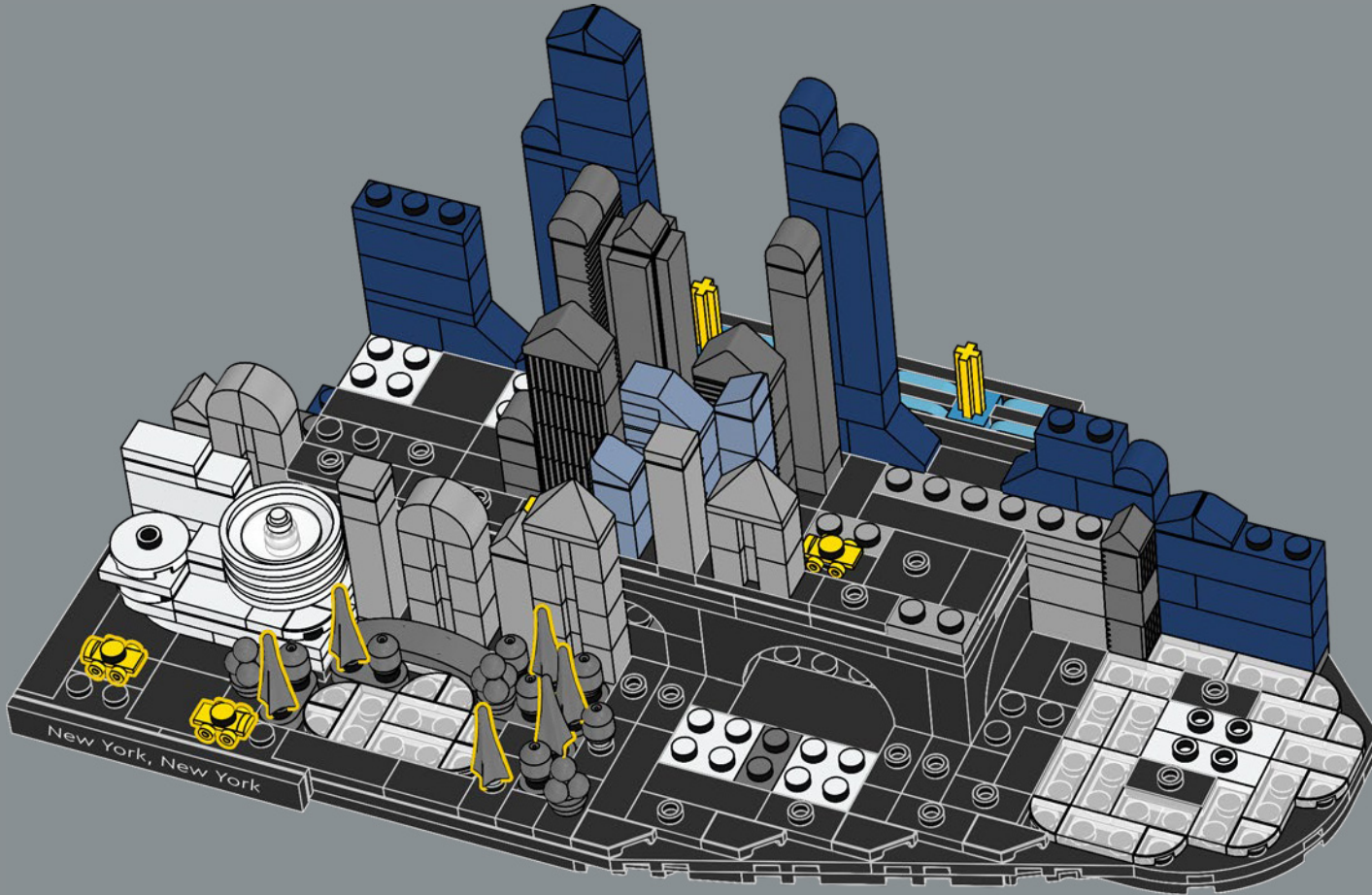

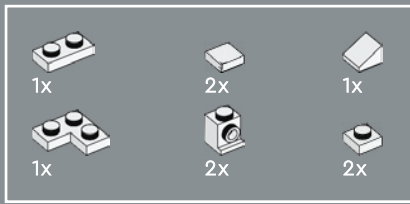

74

1

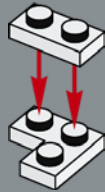

2



3

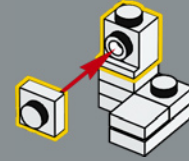

4

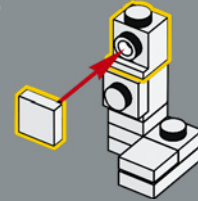

5

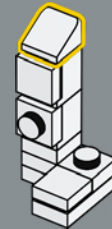

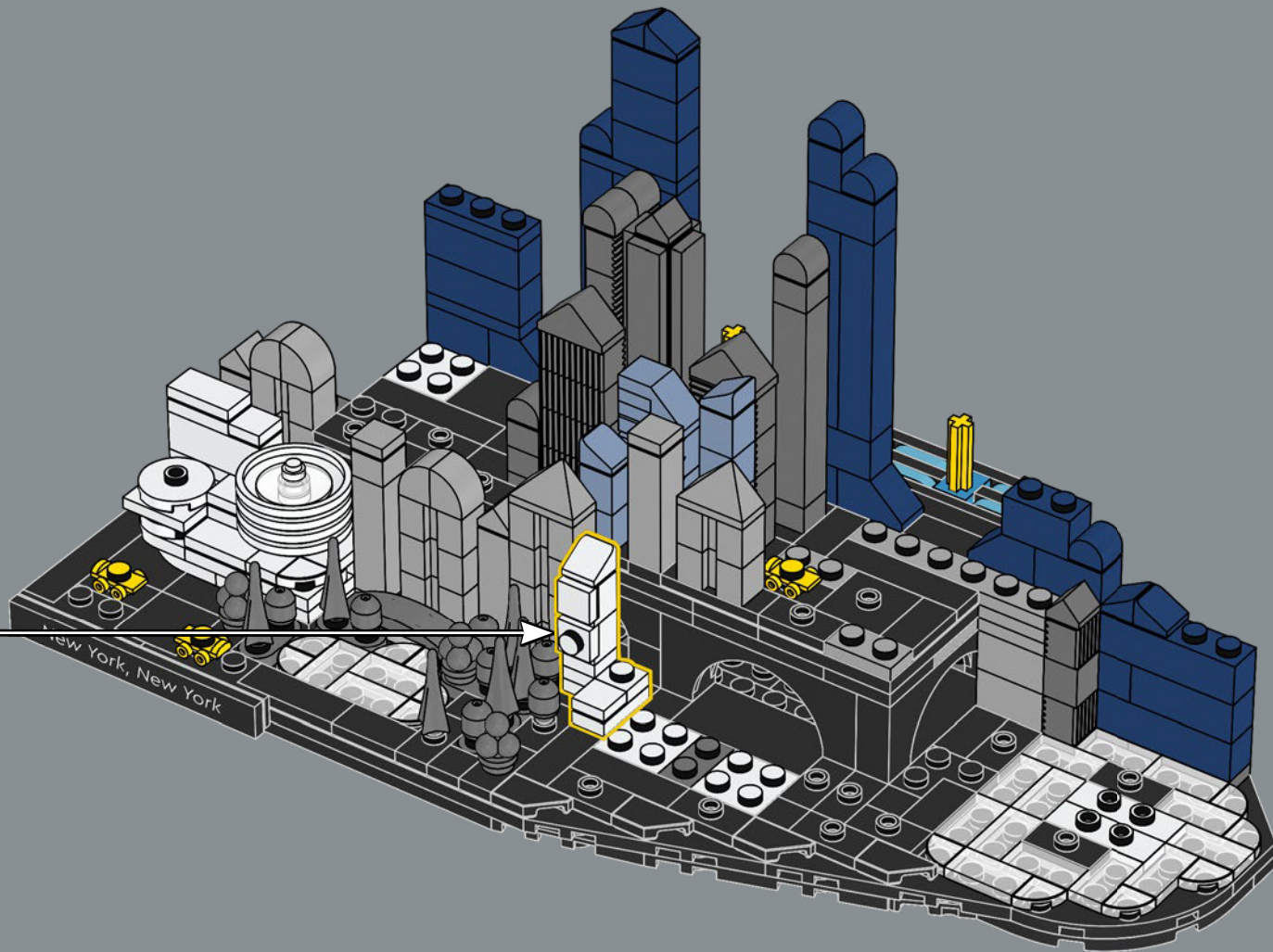

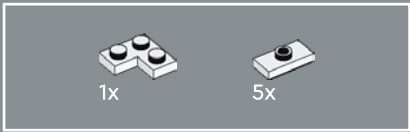

75

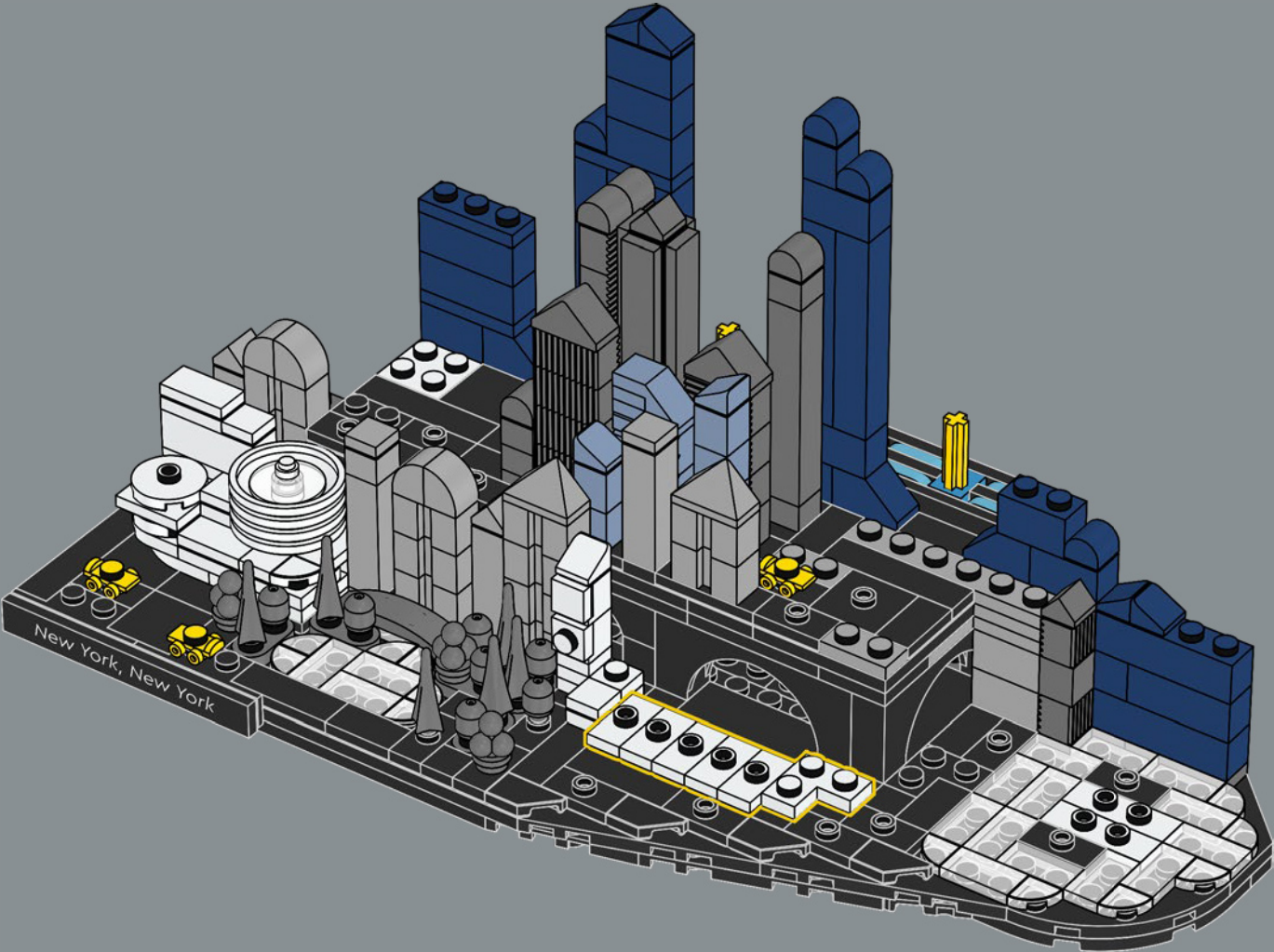

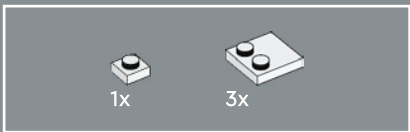

76

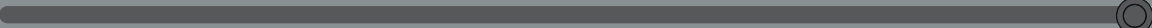
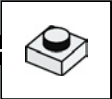
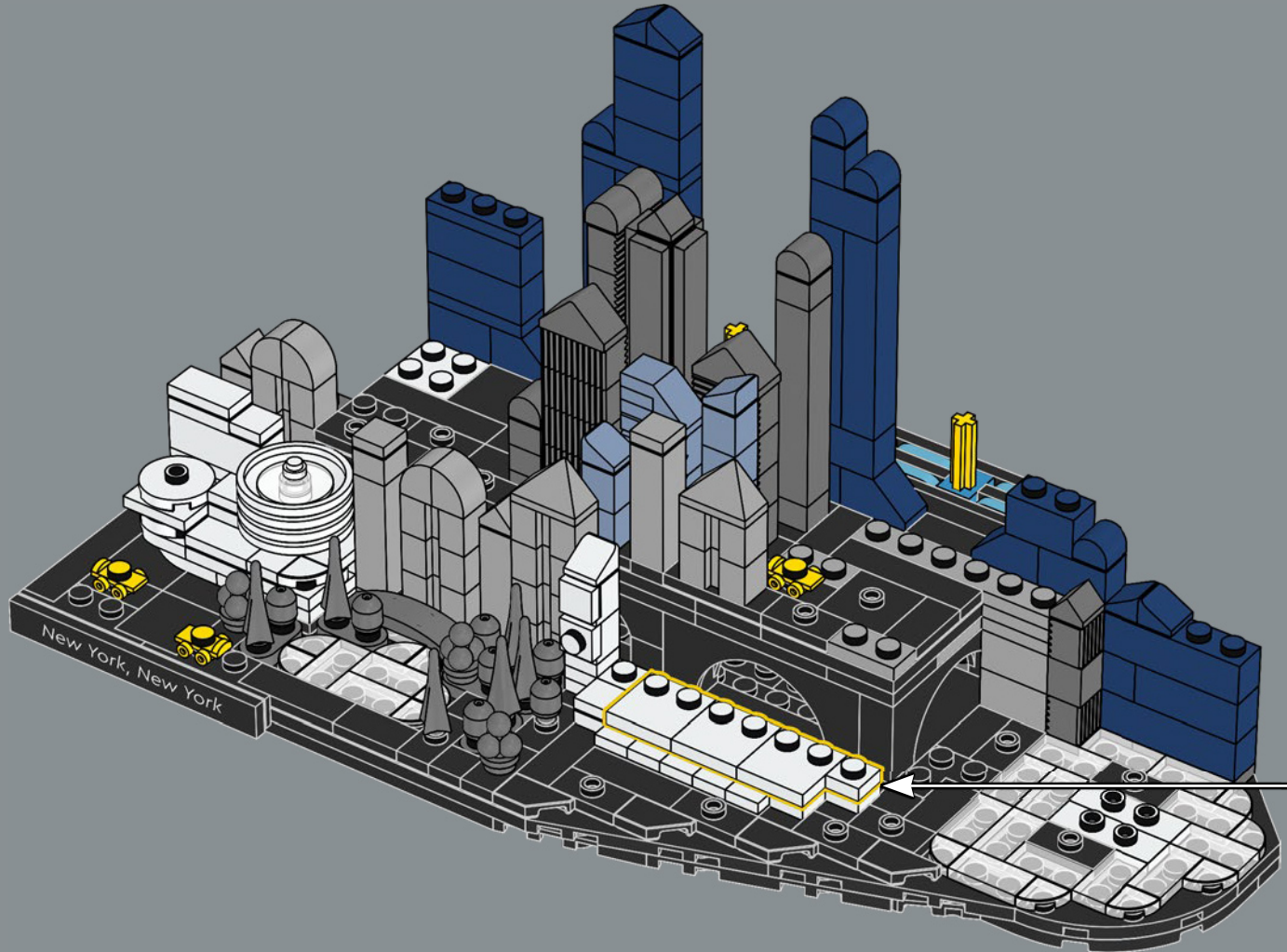

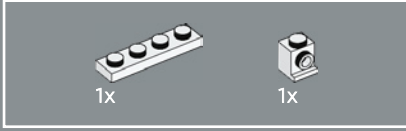
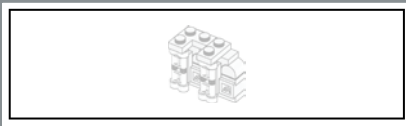

77

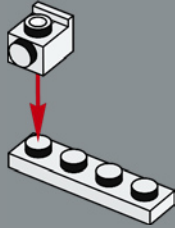

78

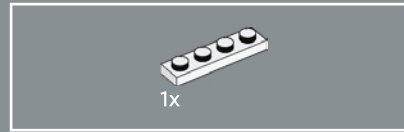
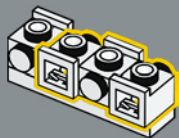

79

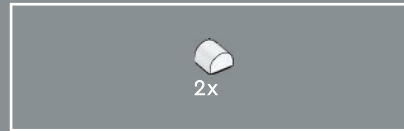
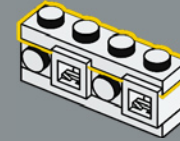

80

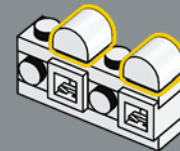

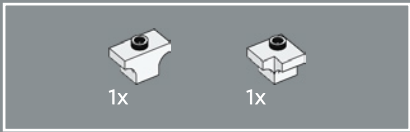

81

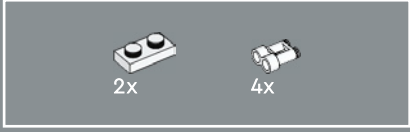
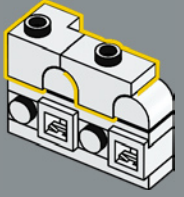

82

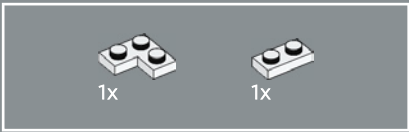
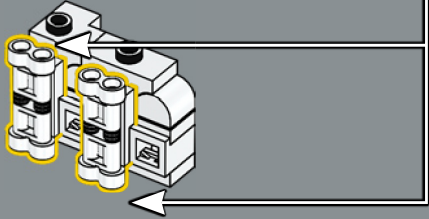
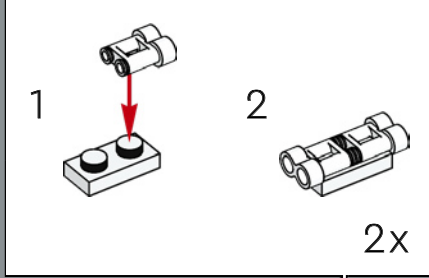

83

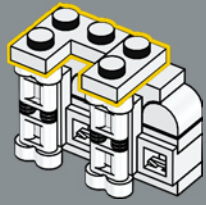

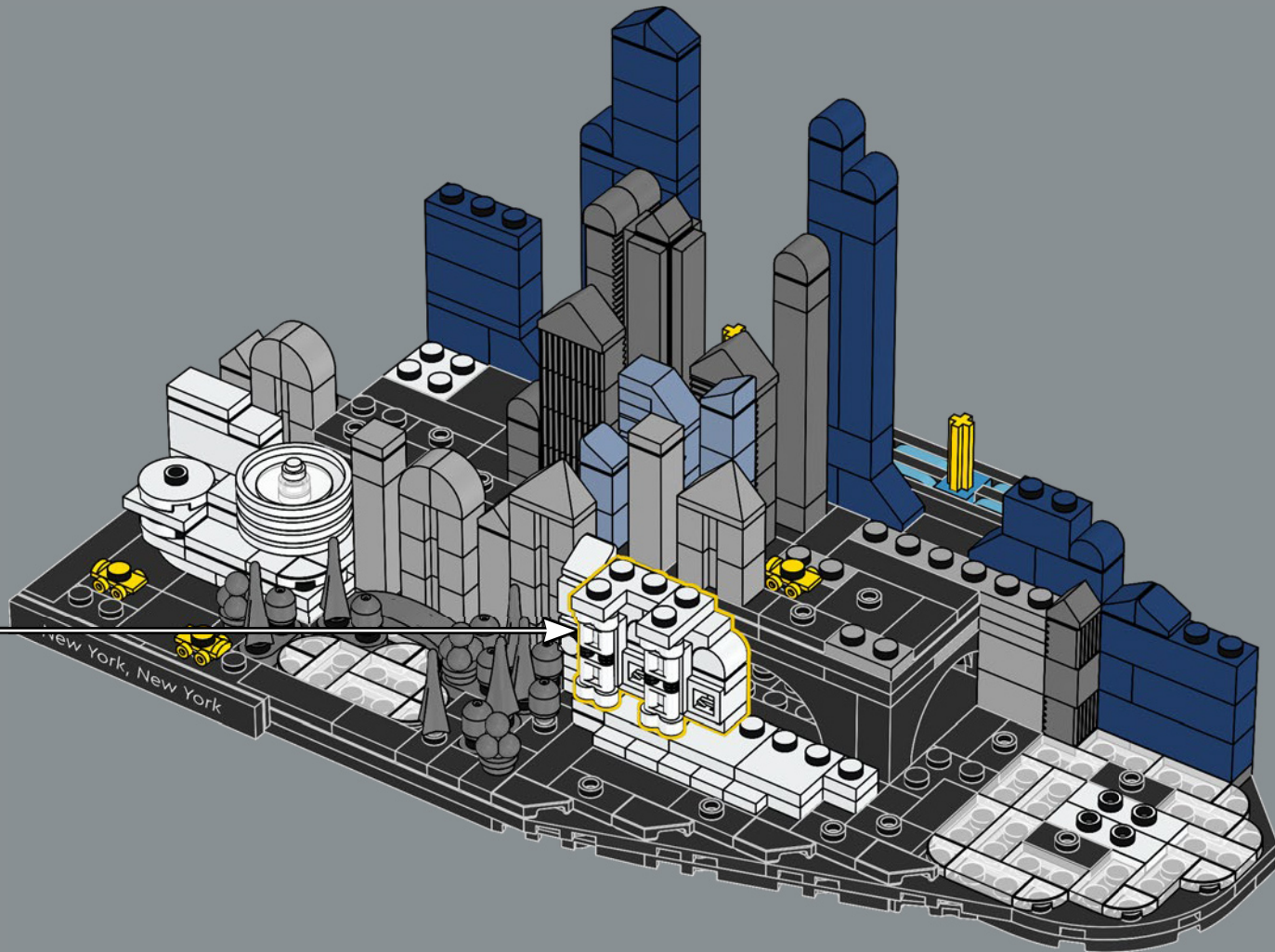

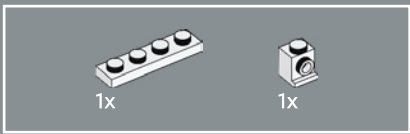

85

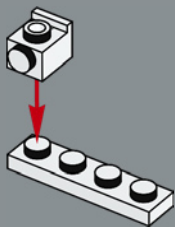

86

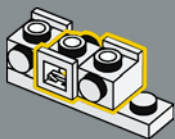

87

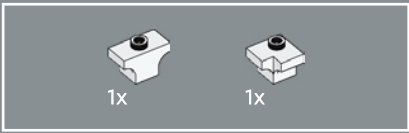
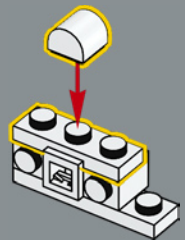

88

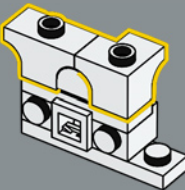

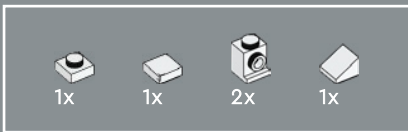

89

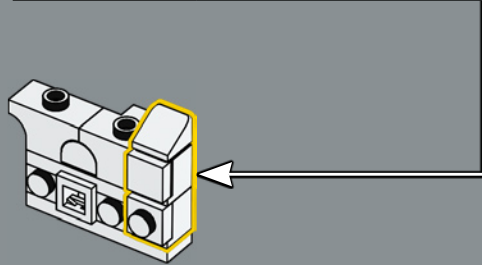
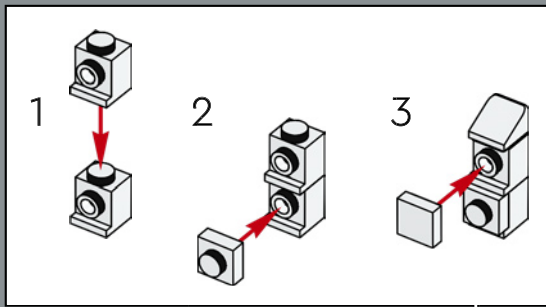

90

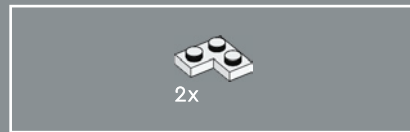
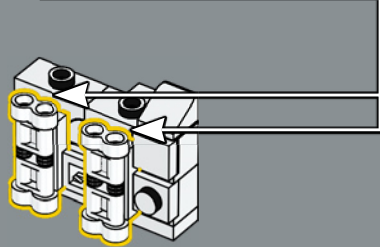
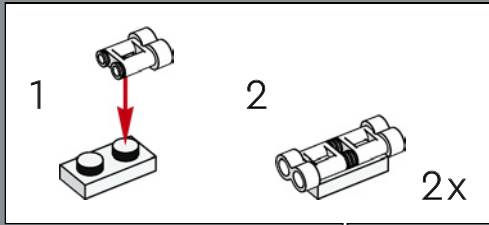

91

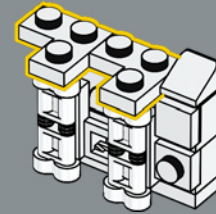

I binocoli LEGO® creano minuscole coppie di colonne che decorano l'ingresso principale del Metropolitan Museum of Art.

92

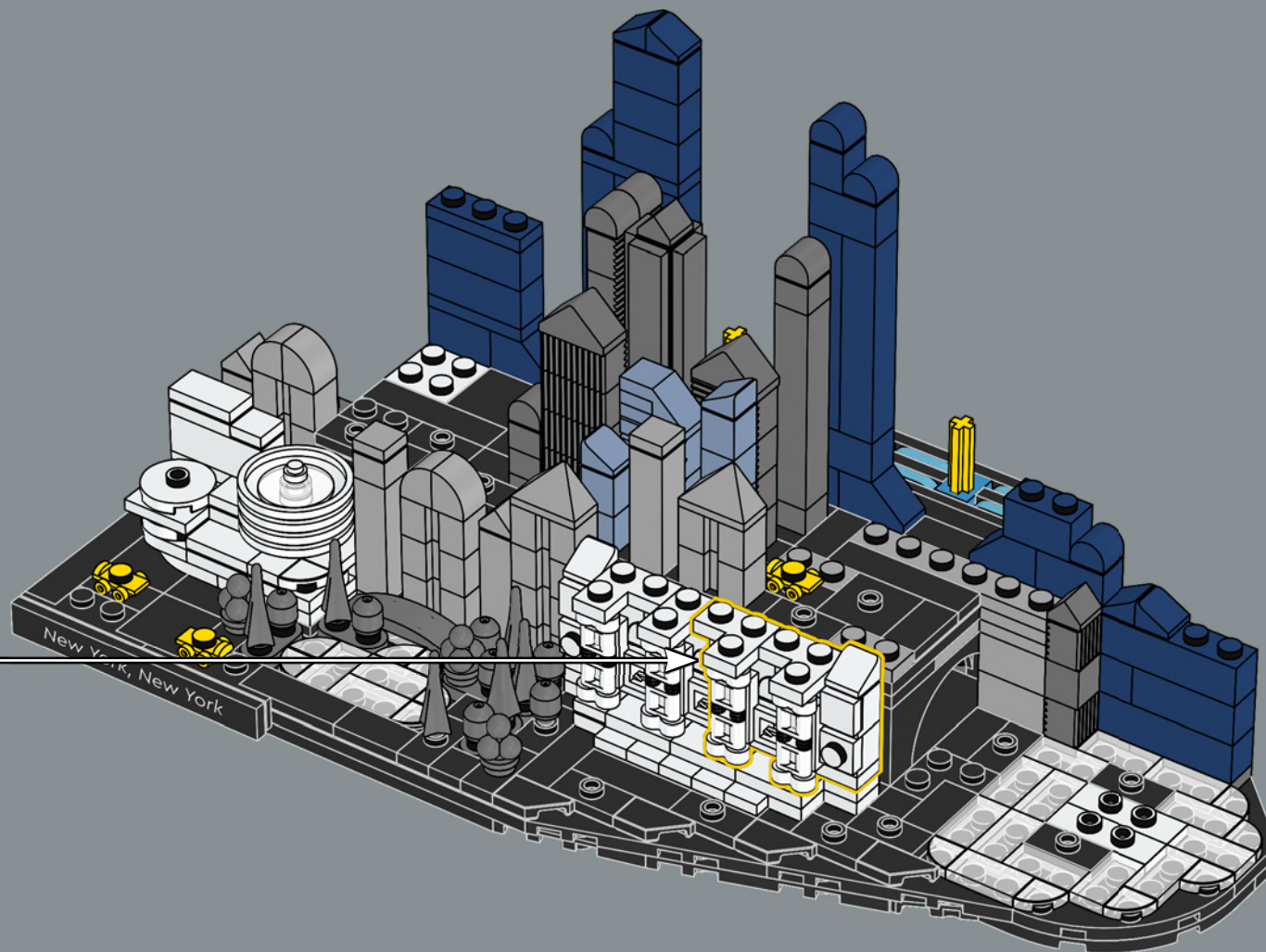

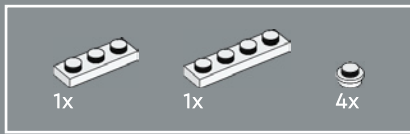

93

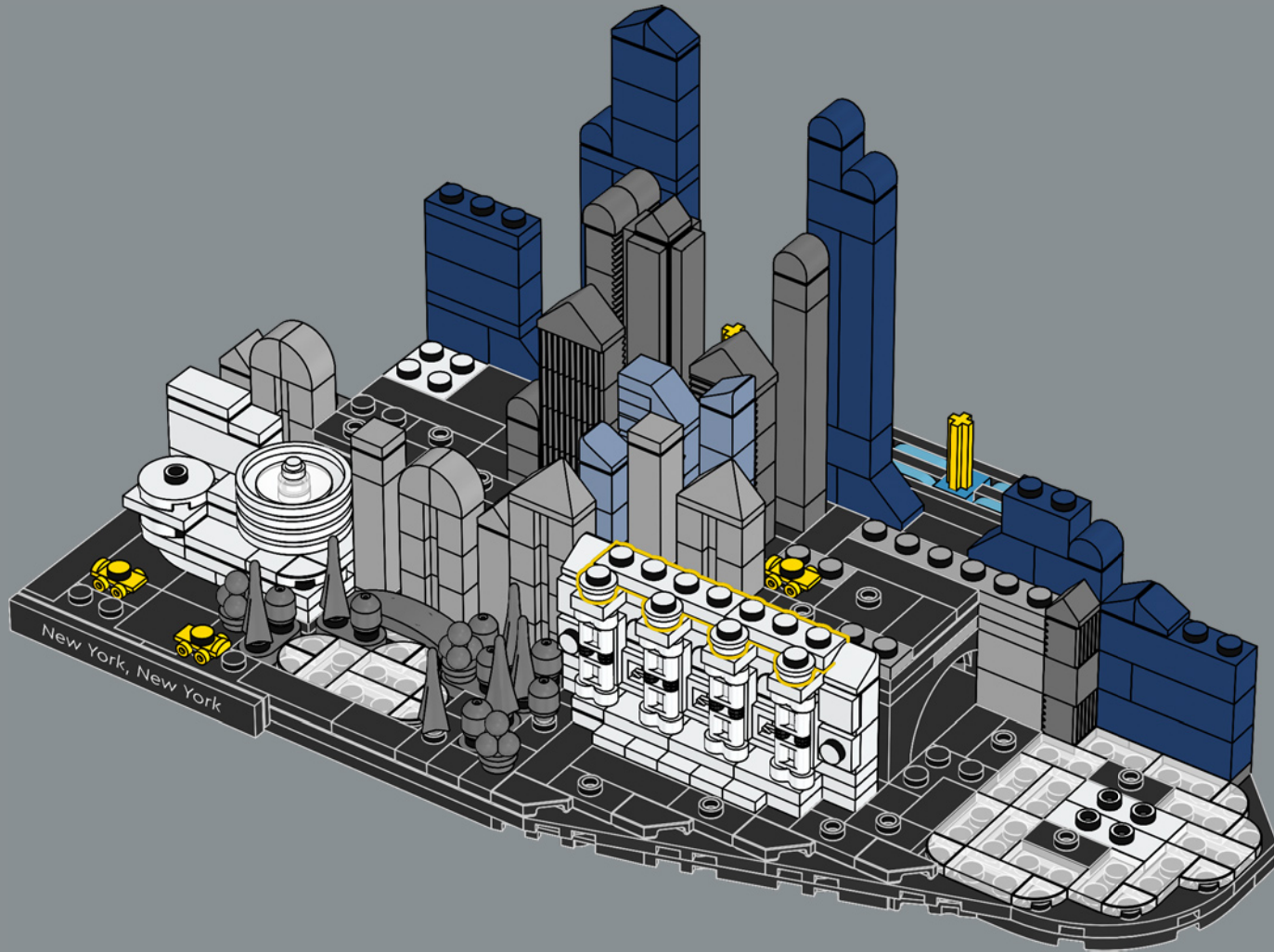

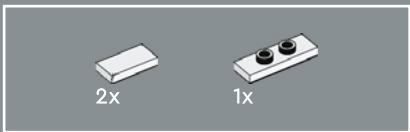

94

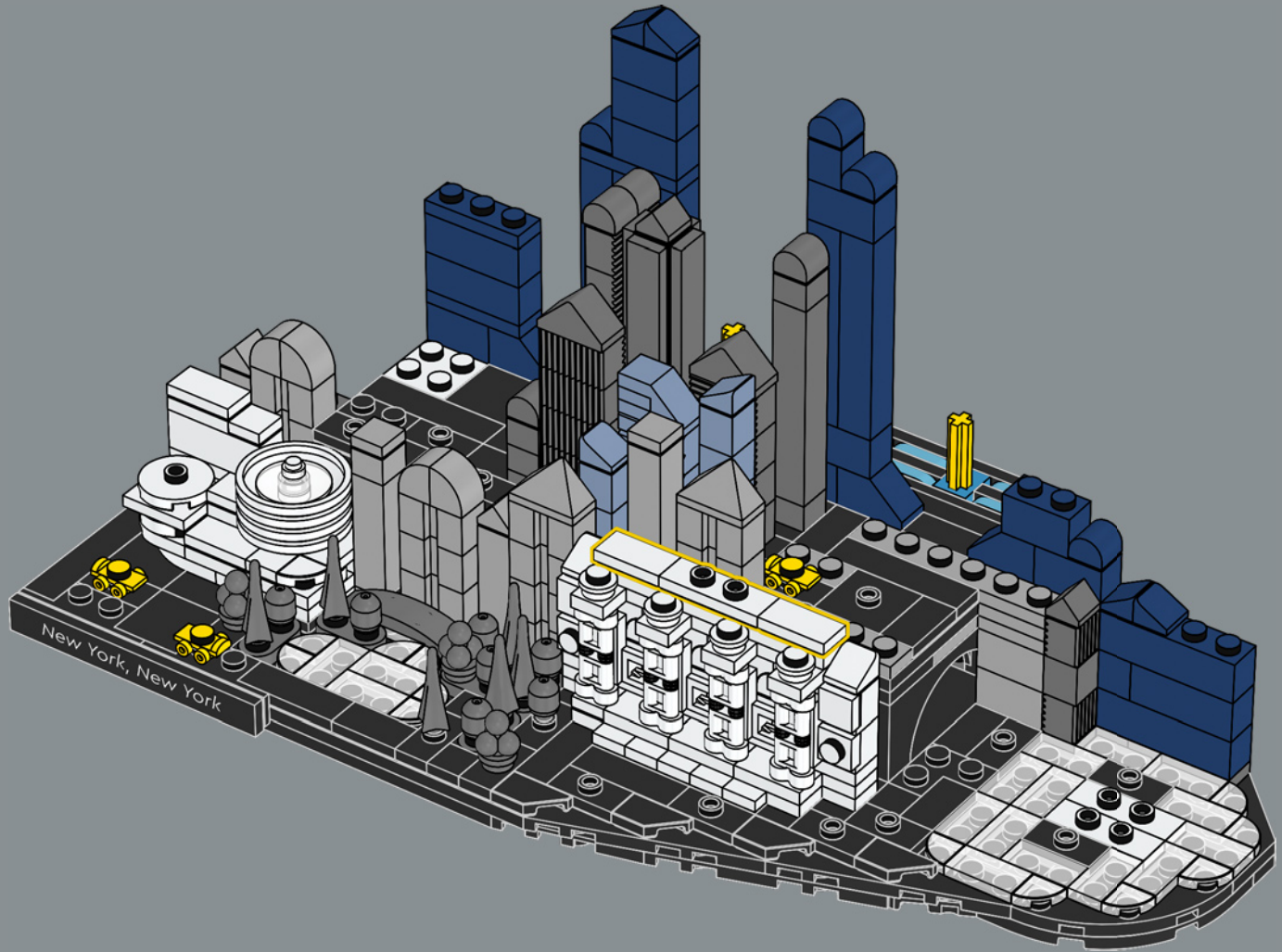

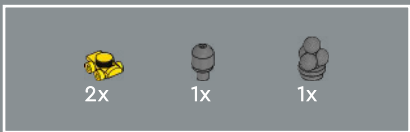

95

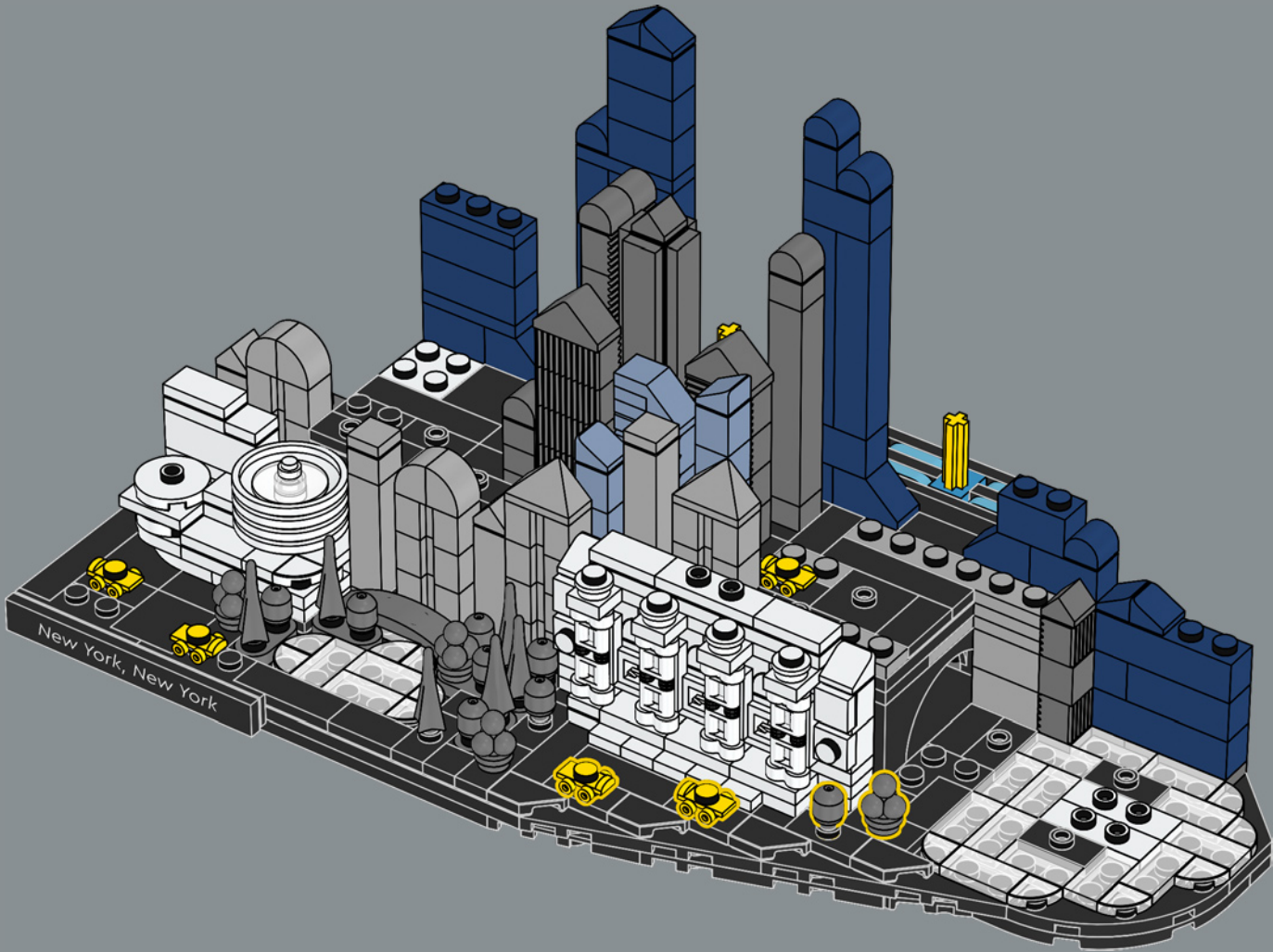

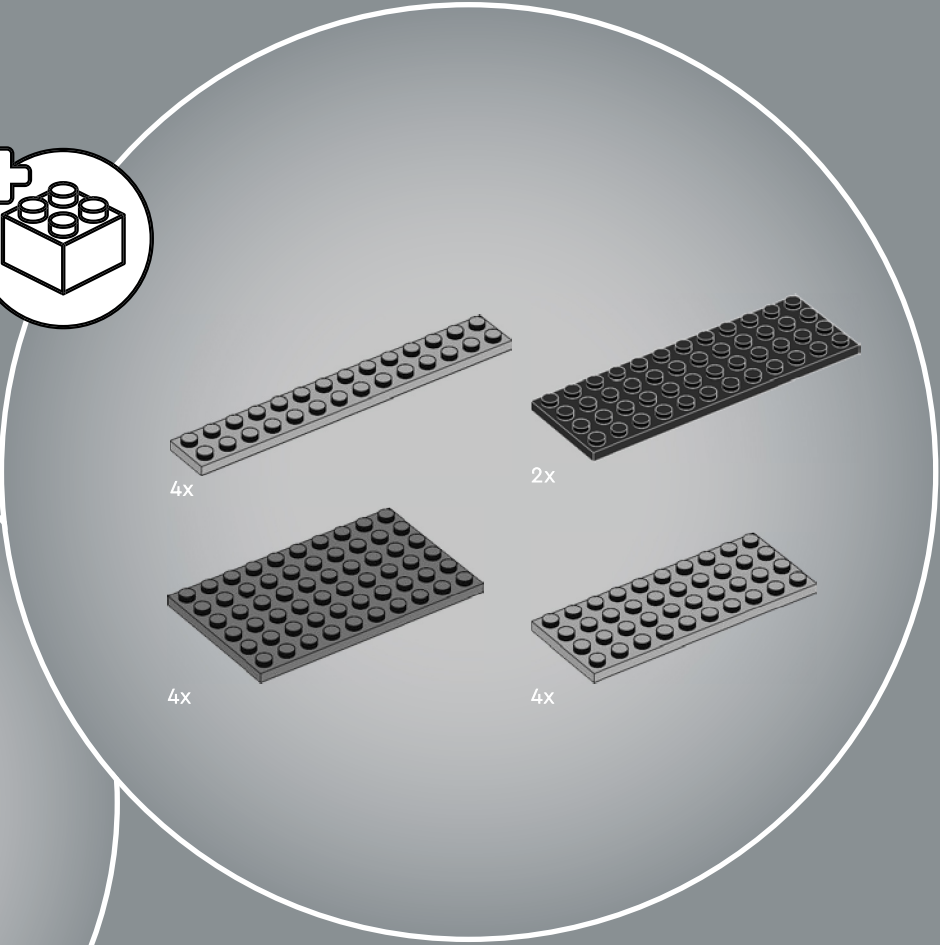
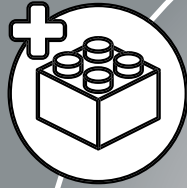

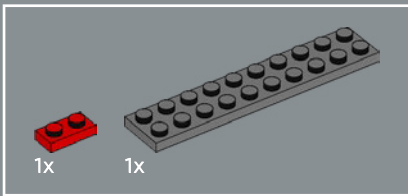
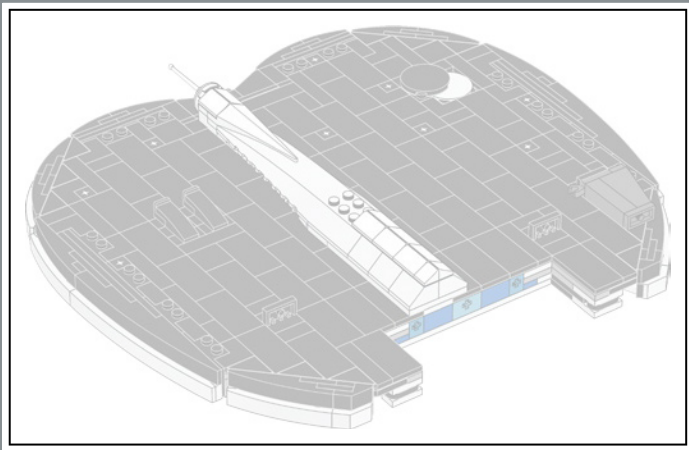

96

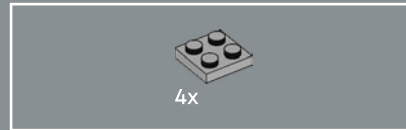
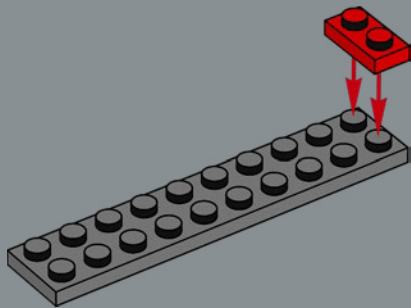

97

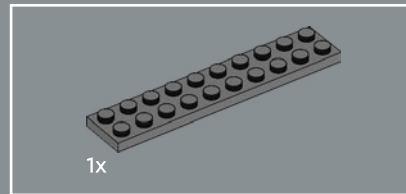
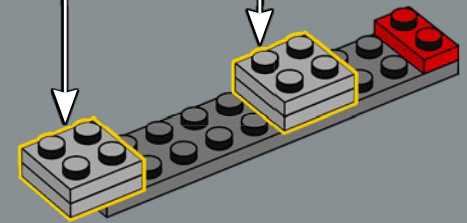
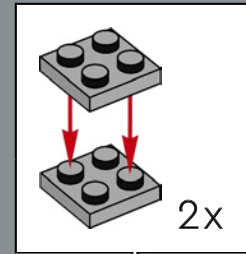

98

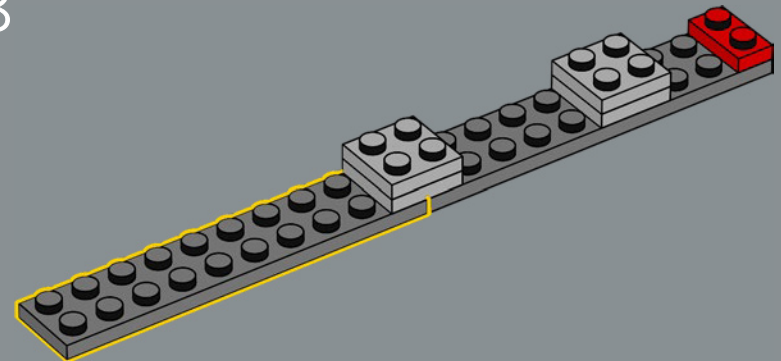

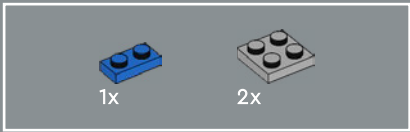

99

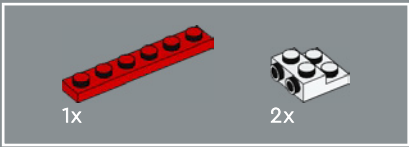
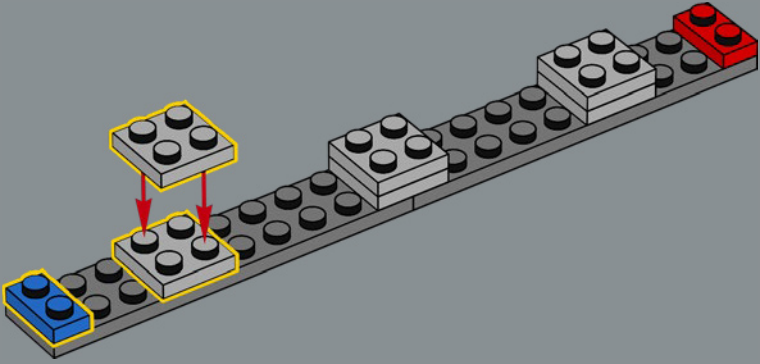

100

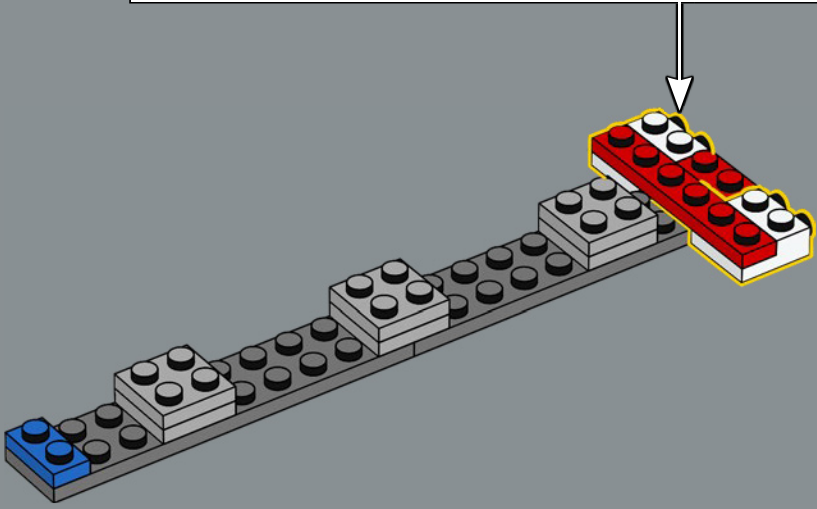
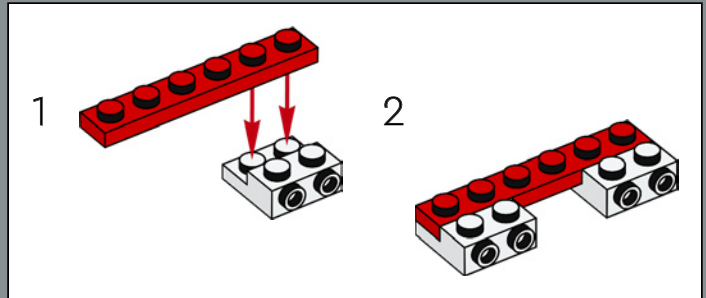

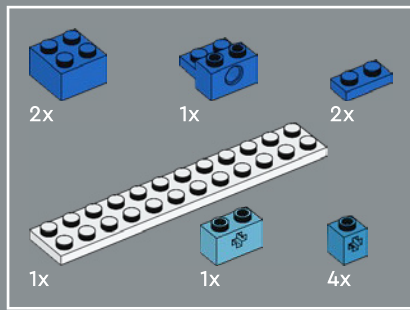

101

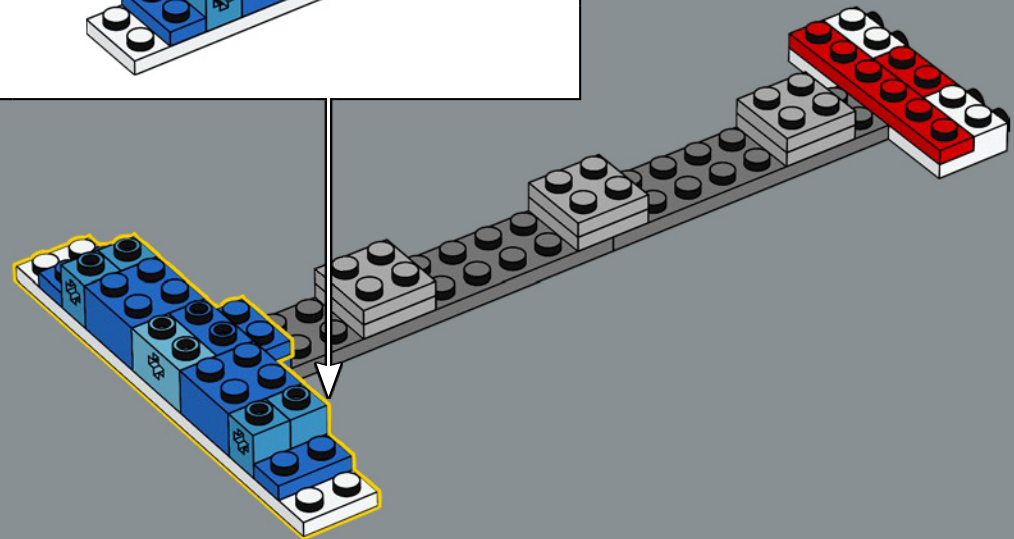
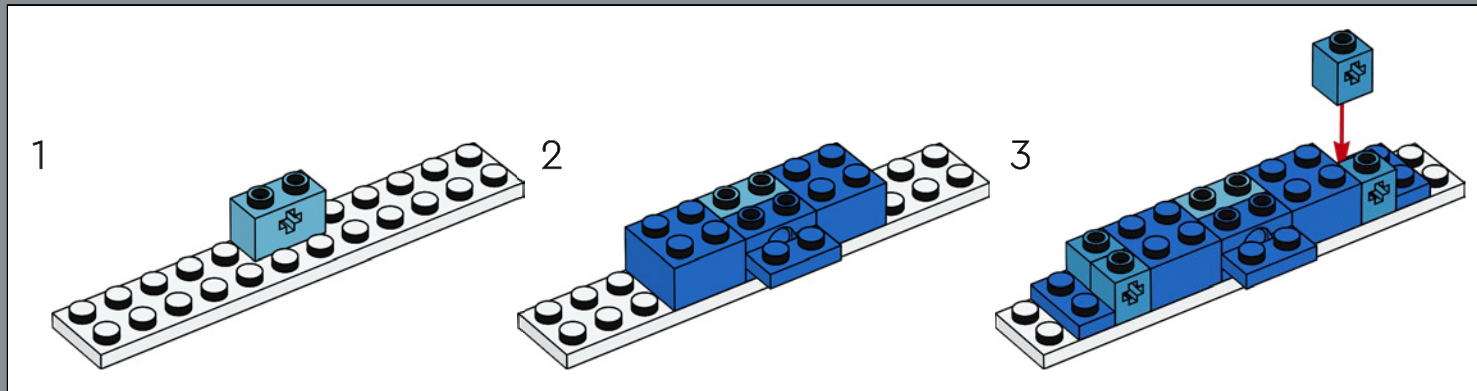

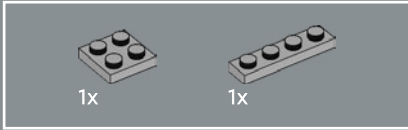
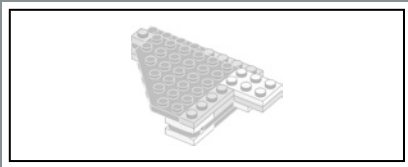

102

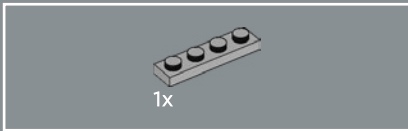
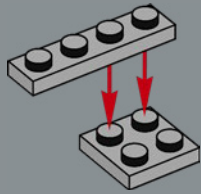

103

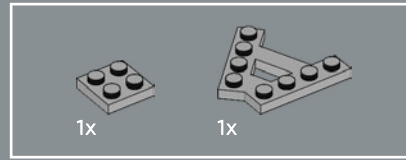
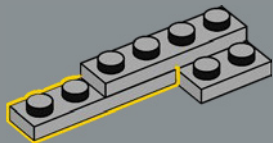

104

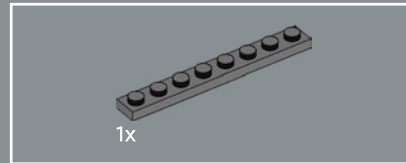
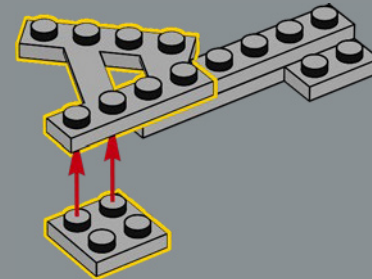

105

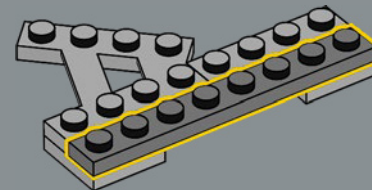



106

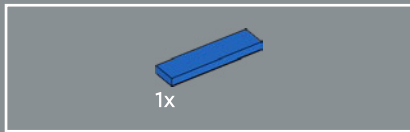
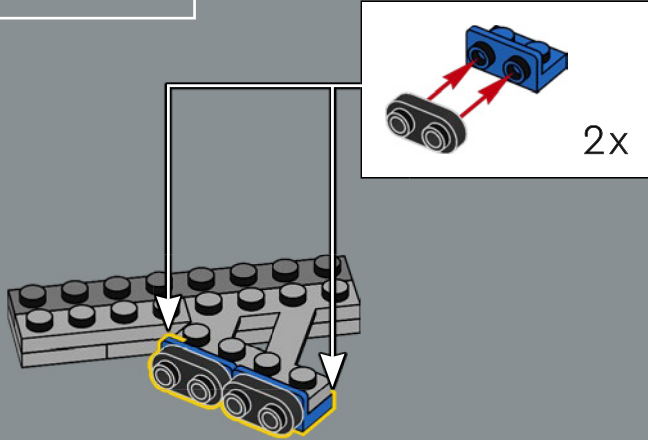

107

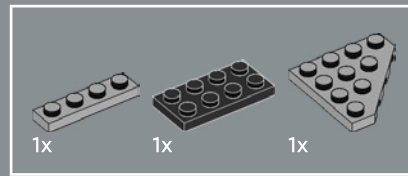
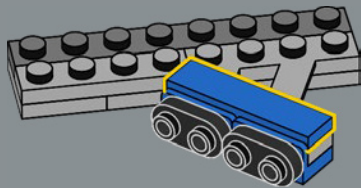

108

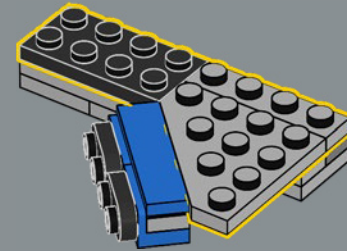

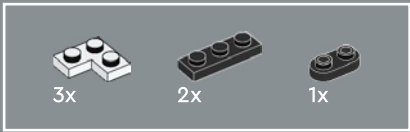

109

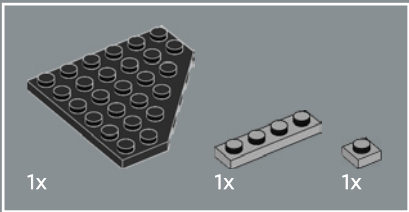
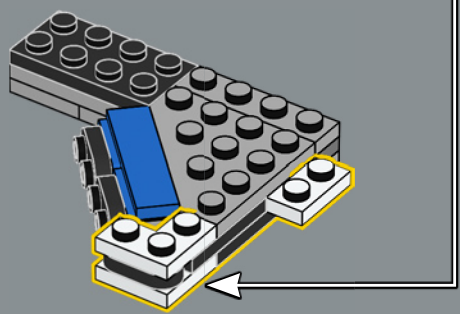
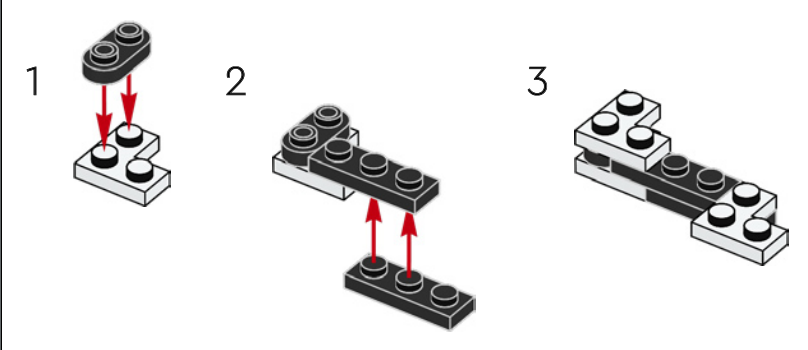

110

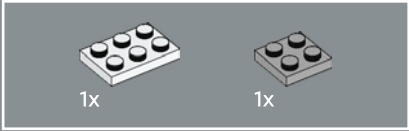
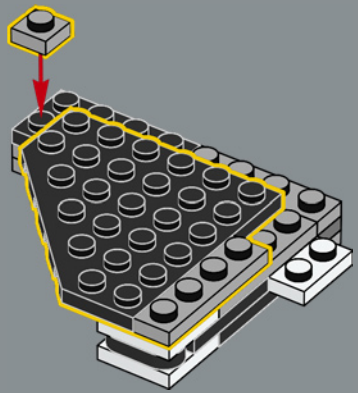

111

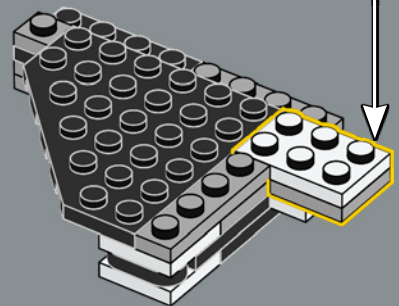
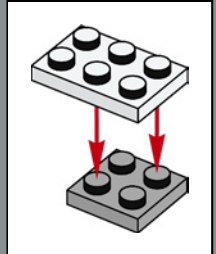

112

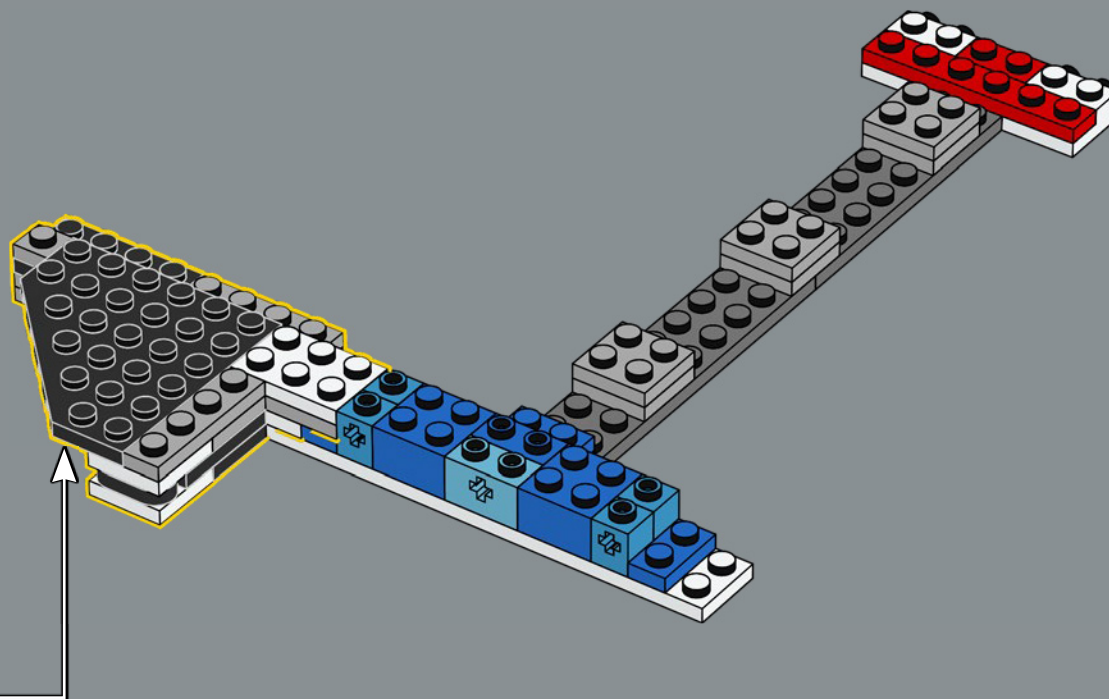

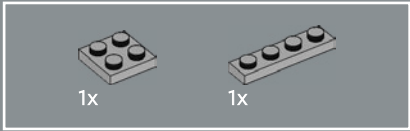
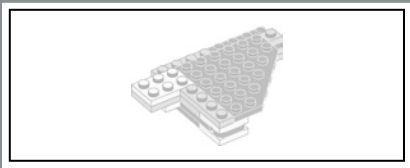

113

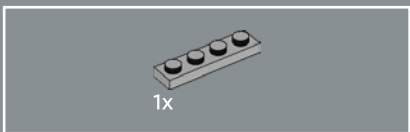
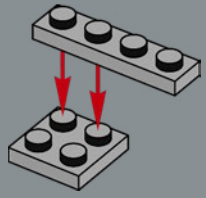

114

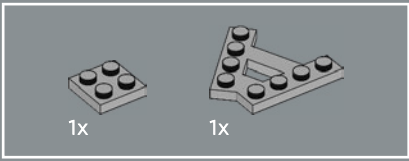
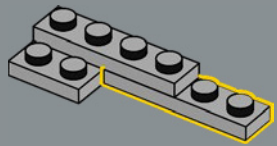

115

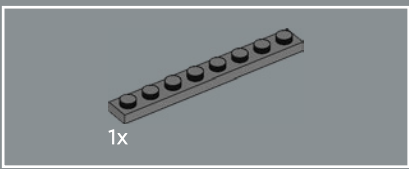
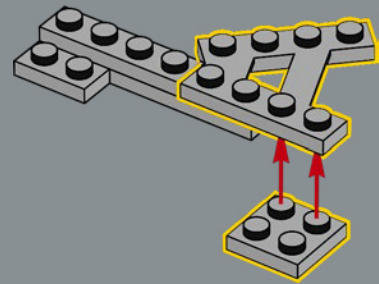

116

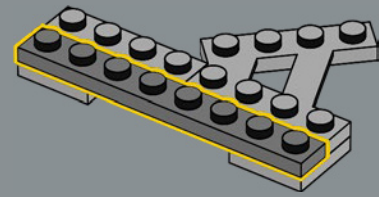



117

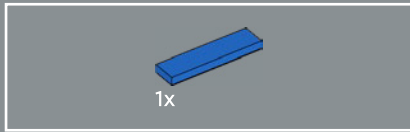
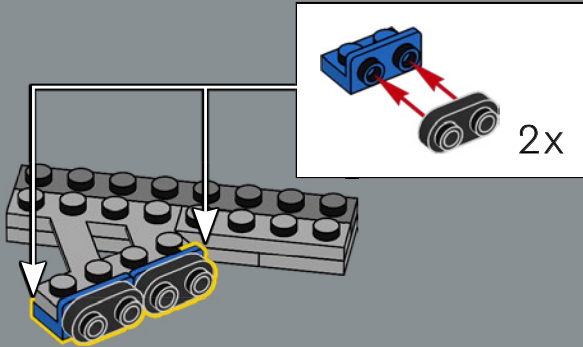

118

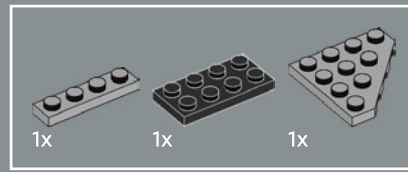
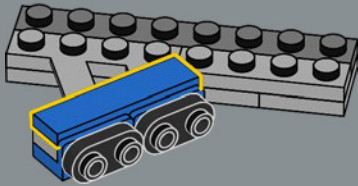

119

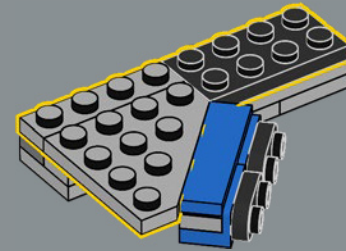

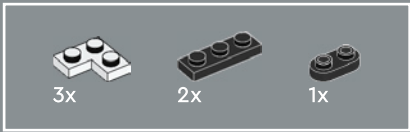

120

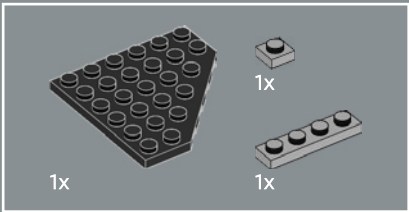
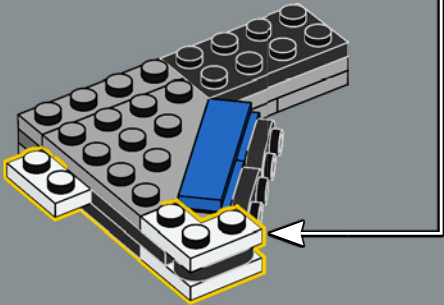
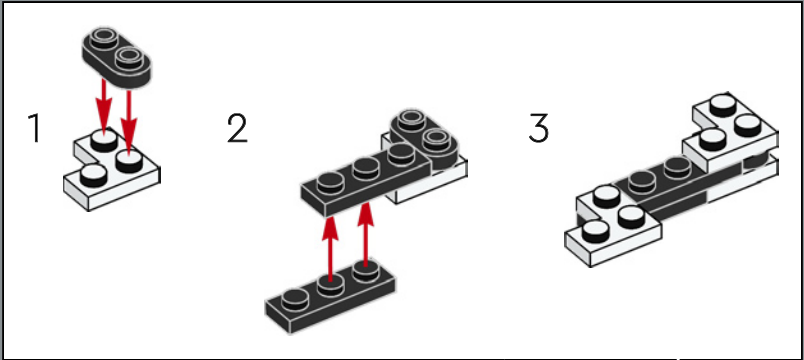

121

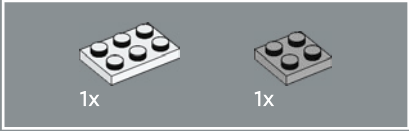
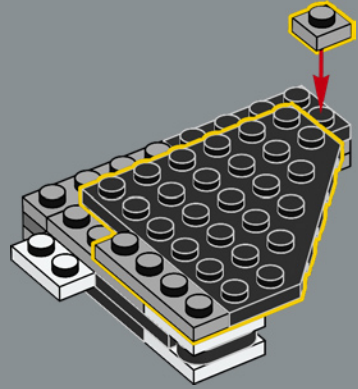

122

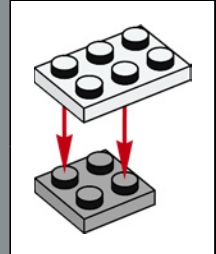
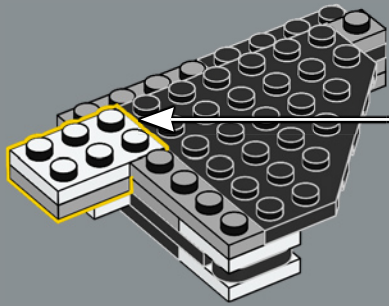

123

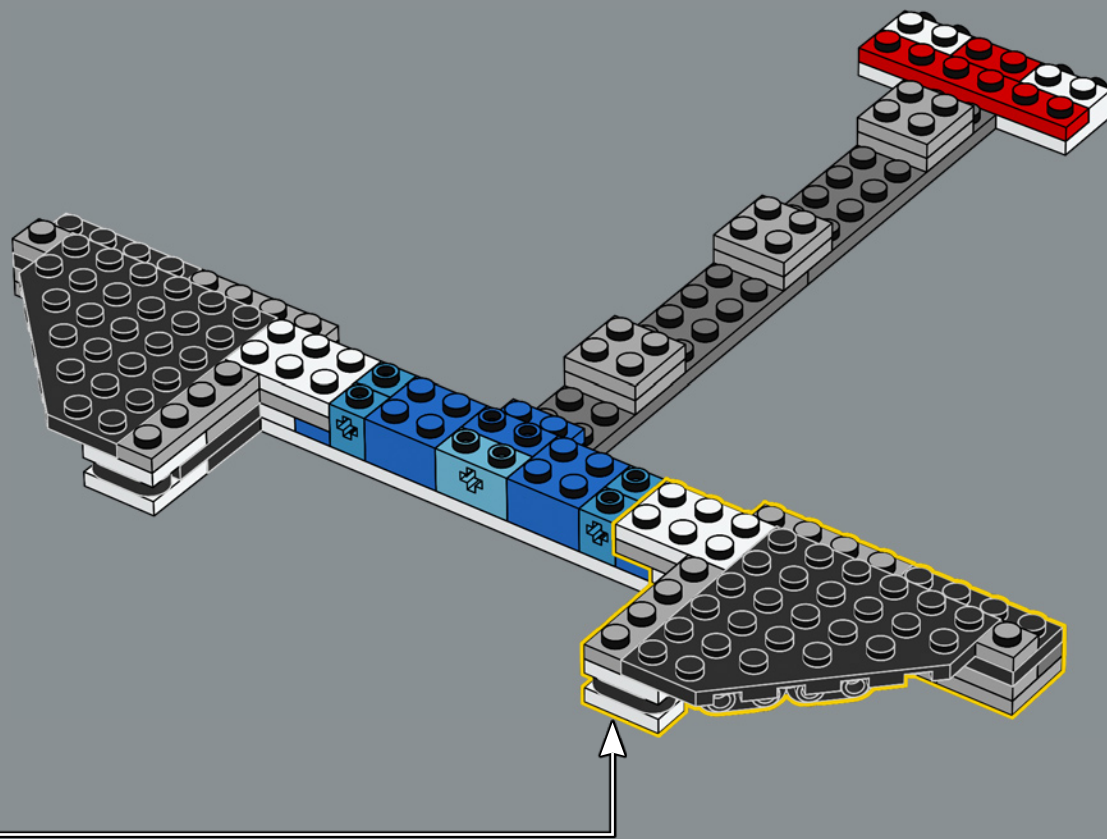

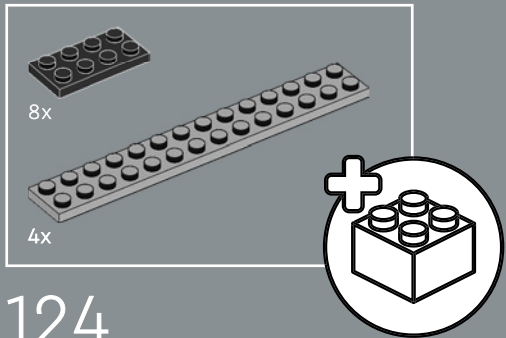
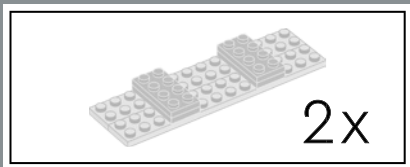

124

1

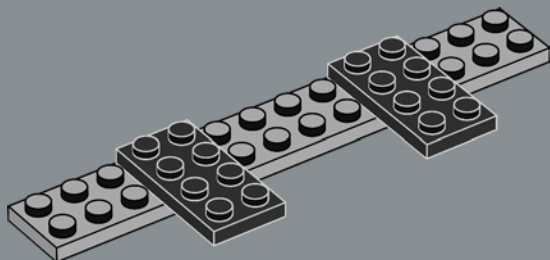

2

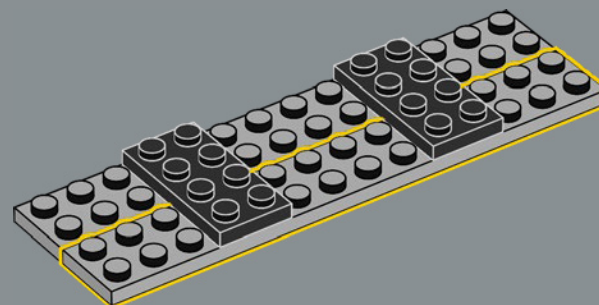

3

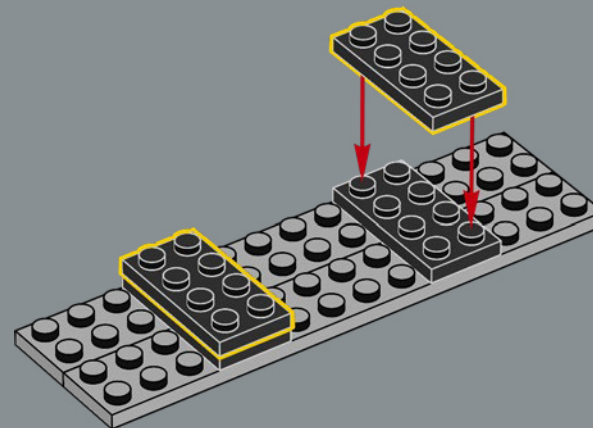

2x

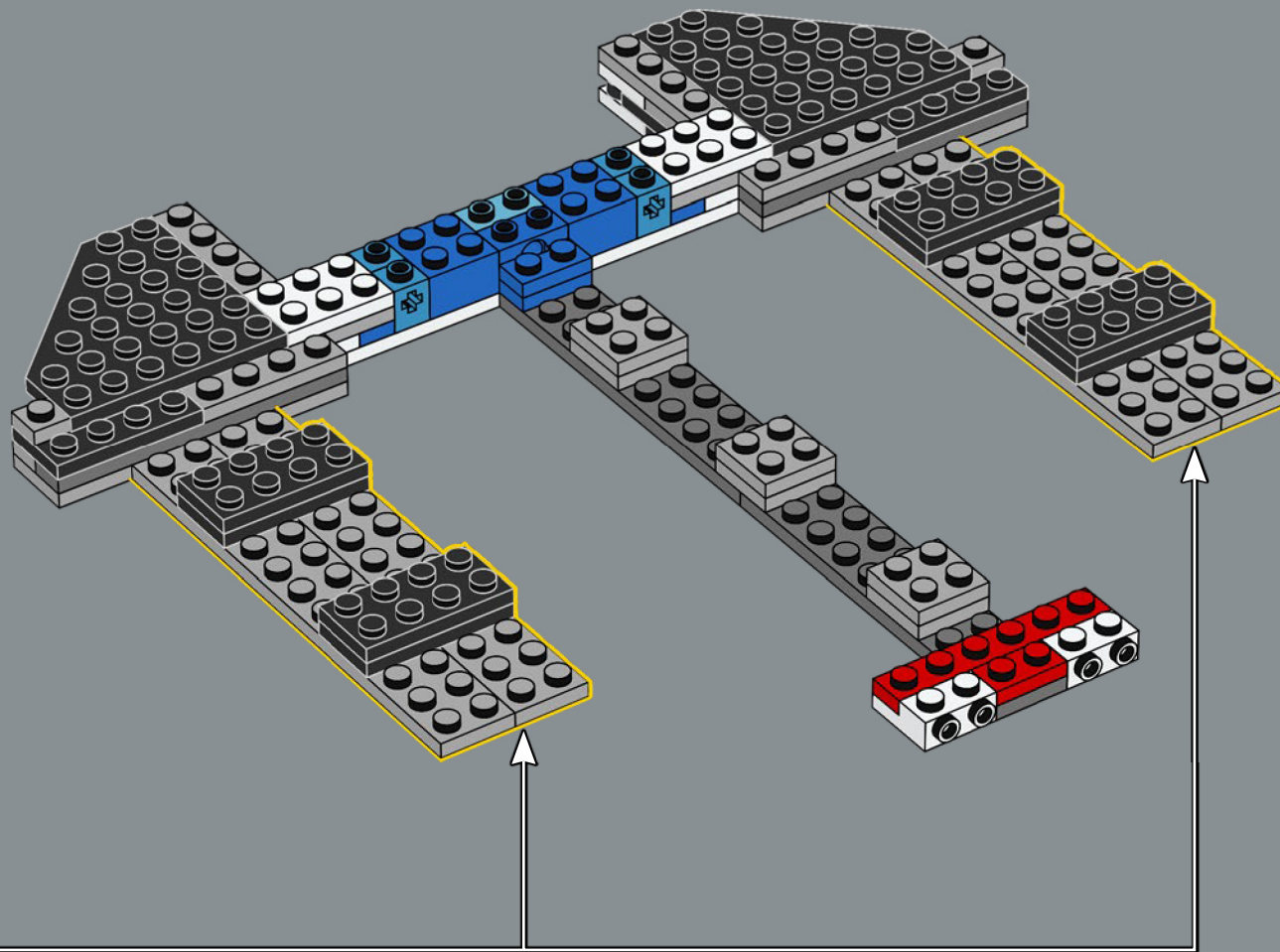

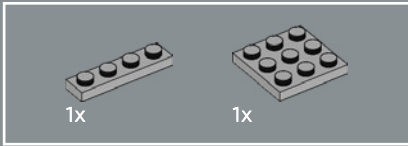
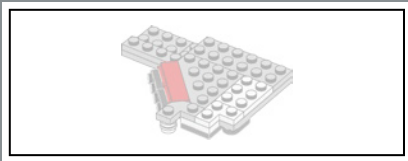

125

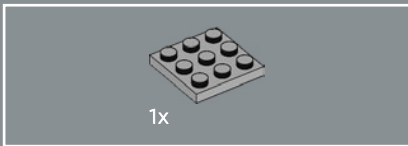
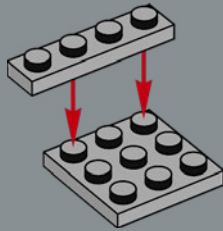

126

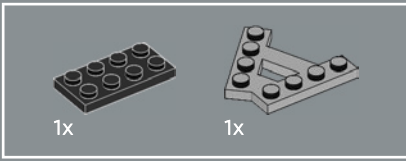
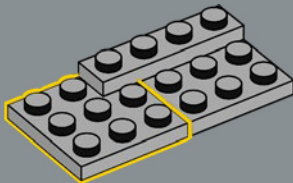

127

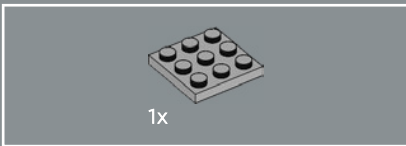
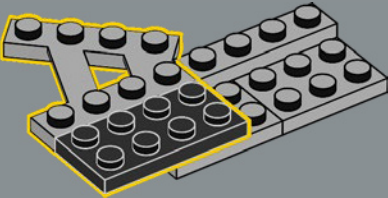

128

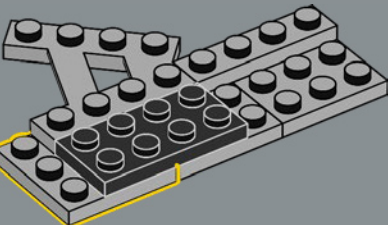



129

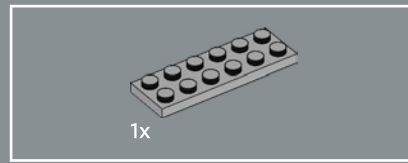
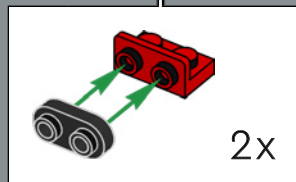
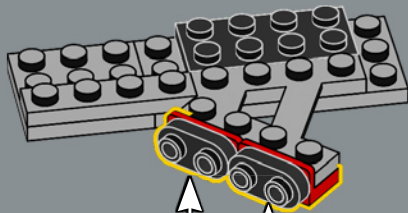

130

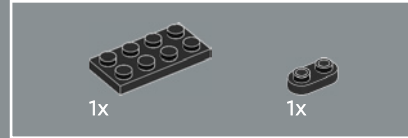
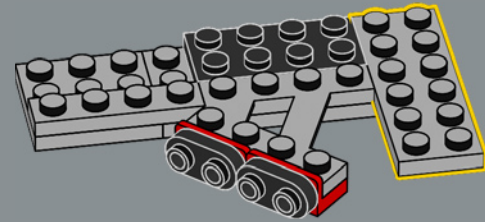

131

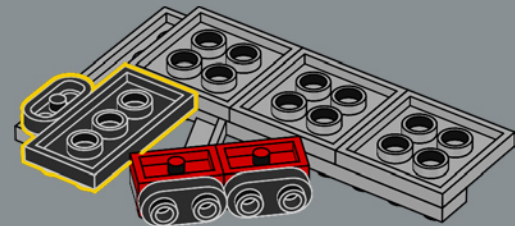



132

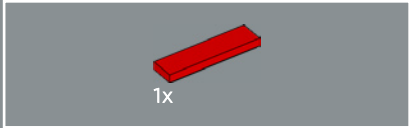
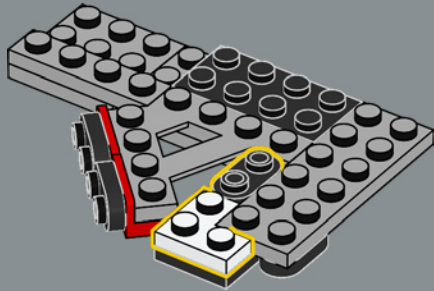

133

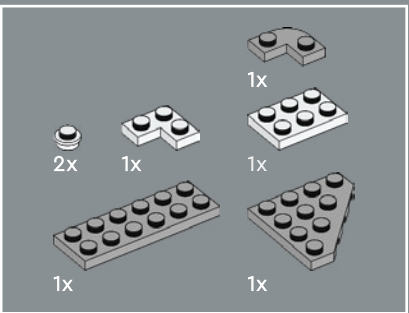
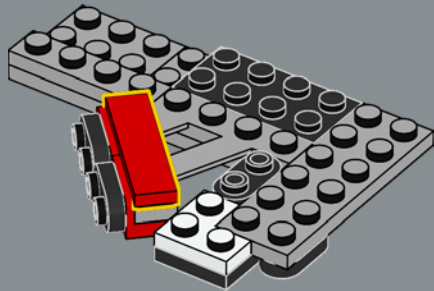

134

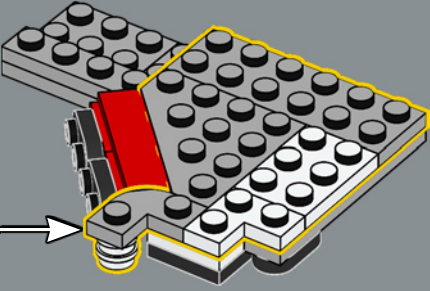
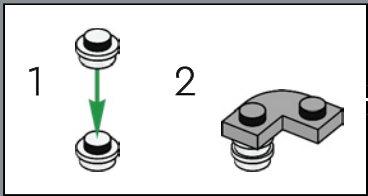

135

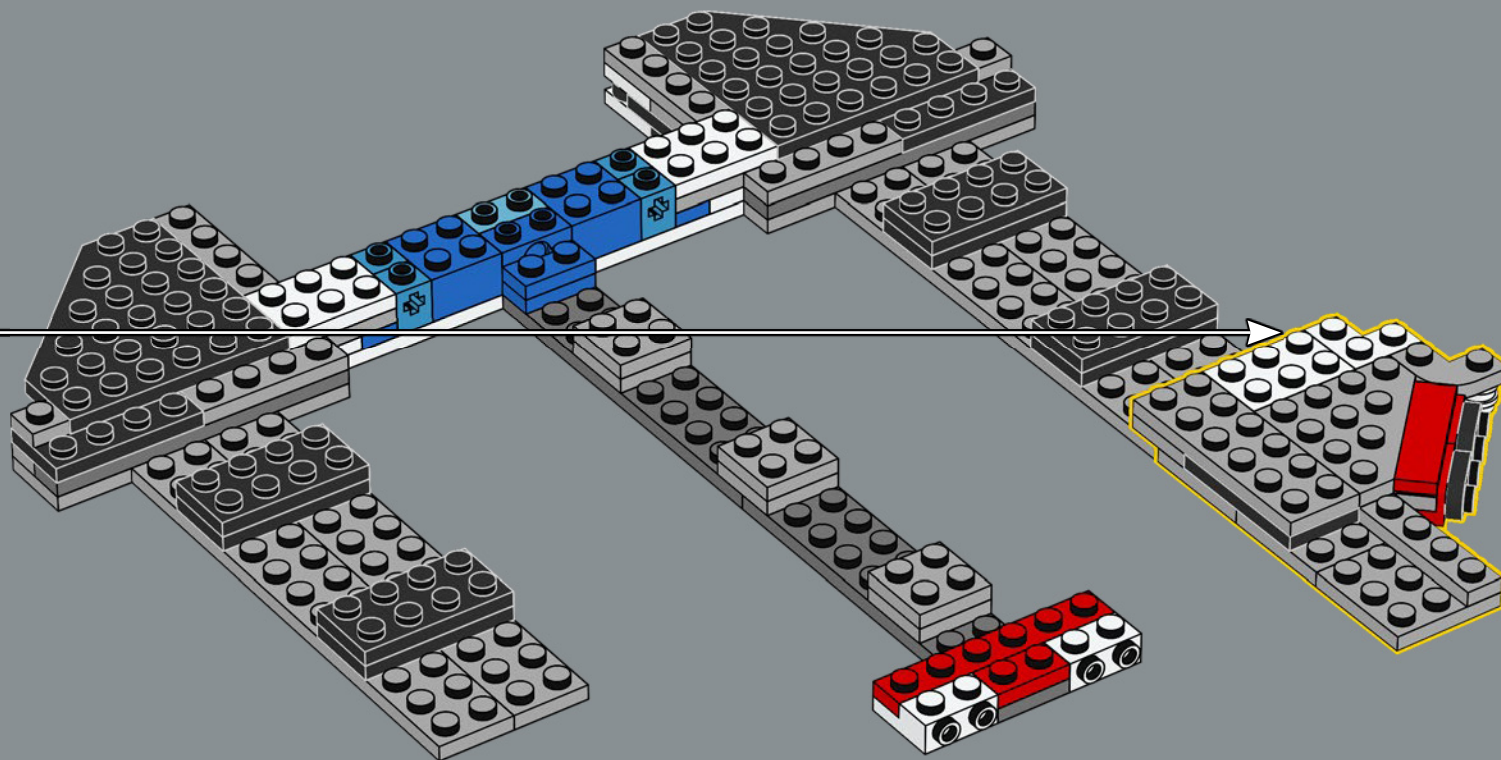

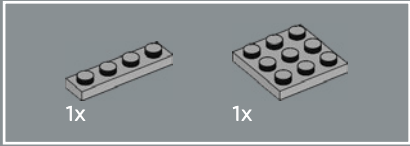
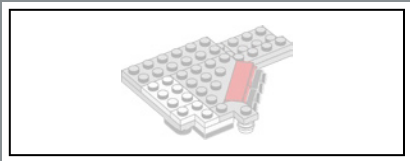

136

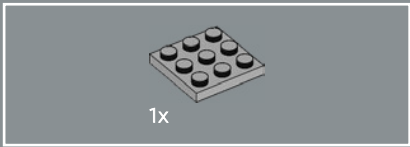
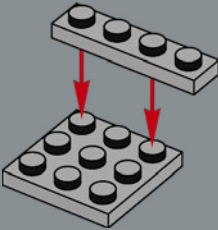

137

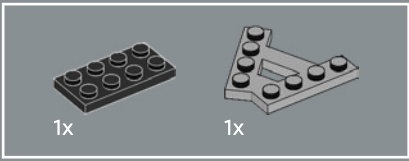
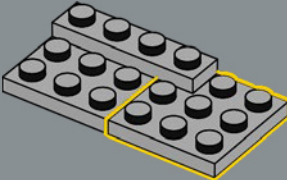

138

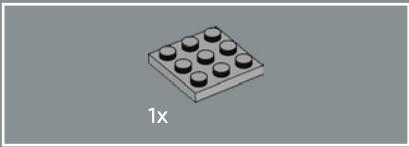
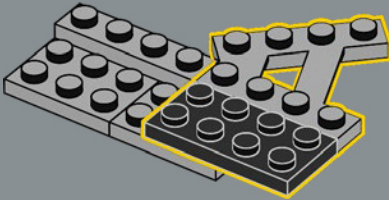

139

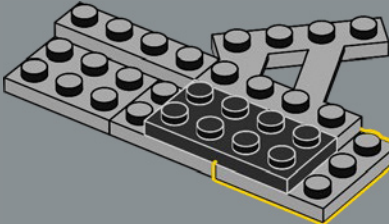



140

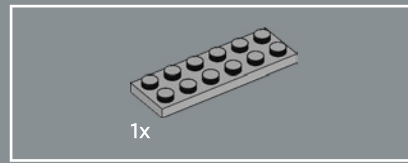
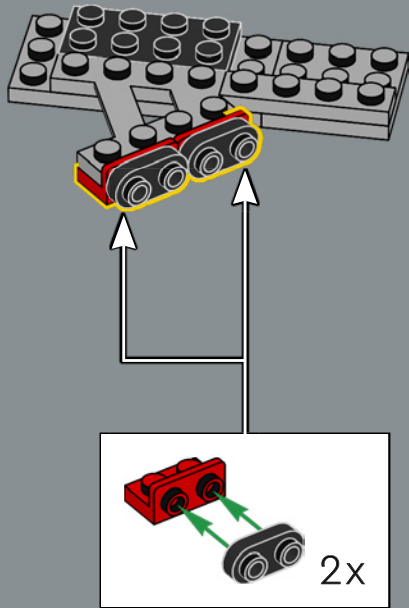

141

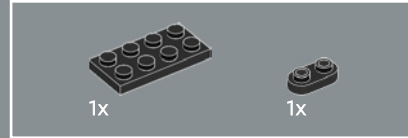
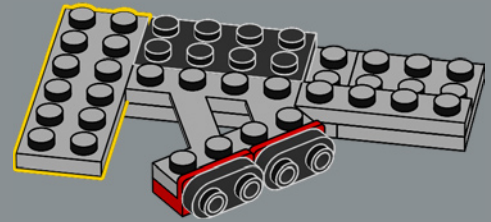

142

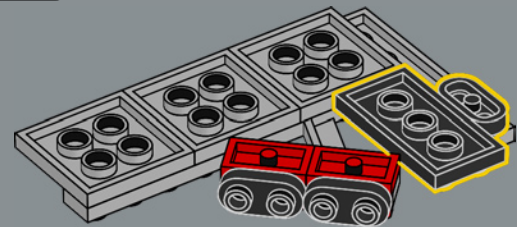



143

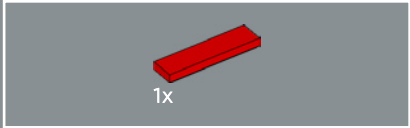
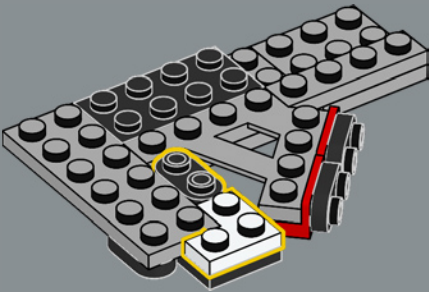

144

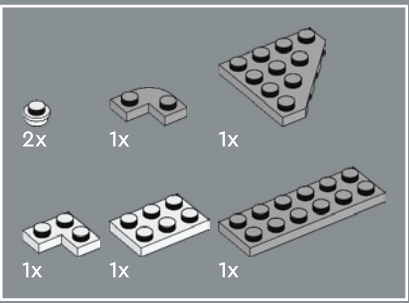
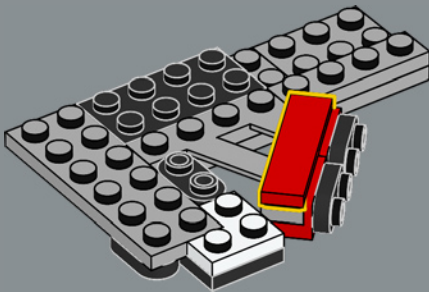

145

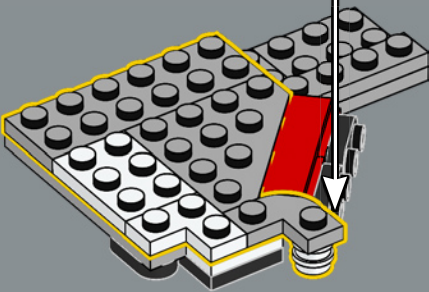
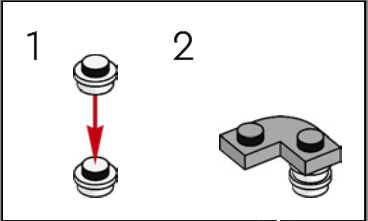

146

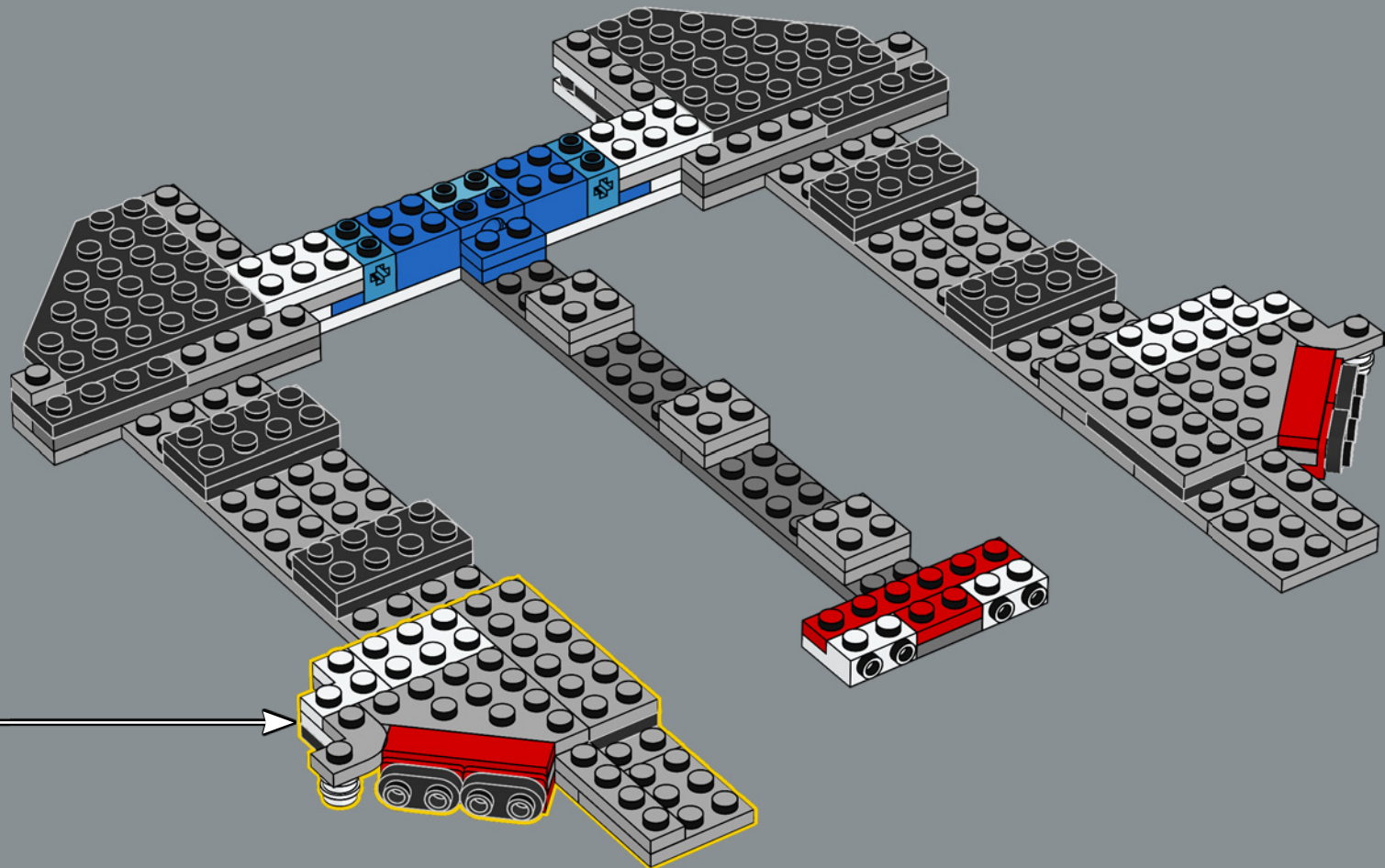

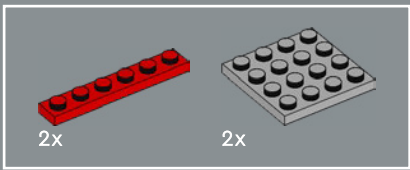

147

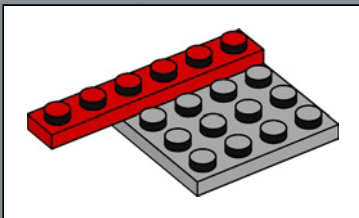
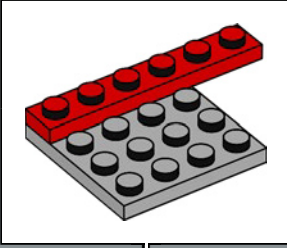
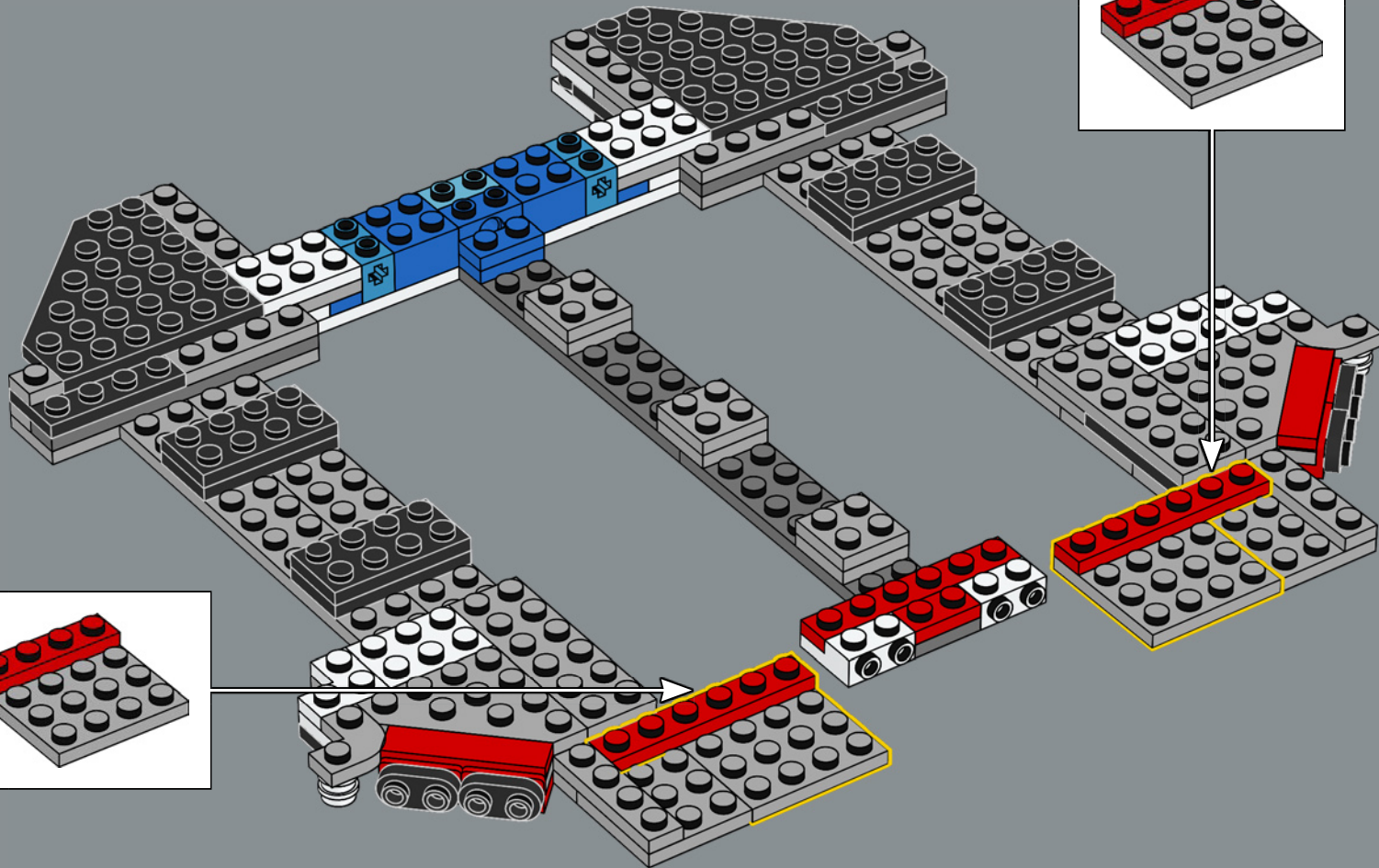

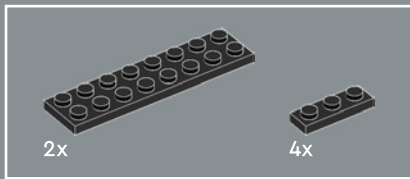

148

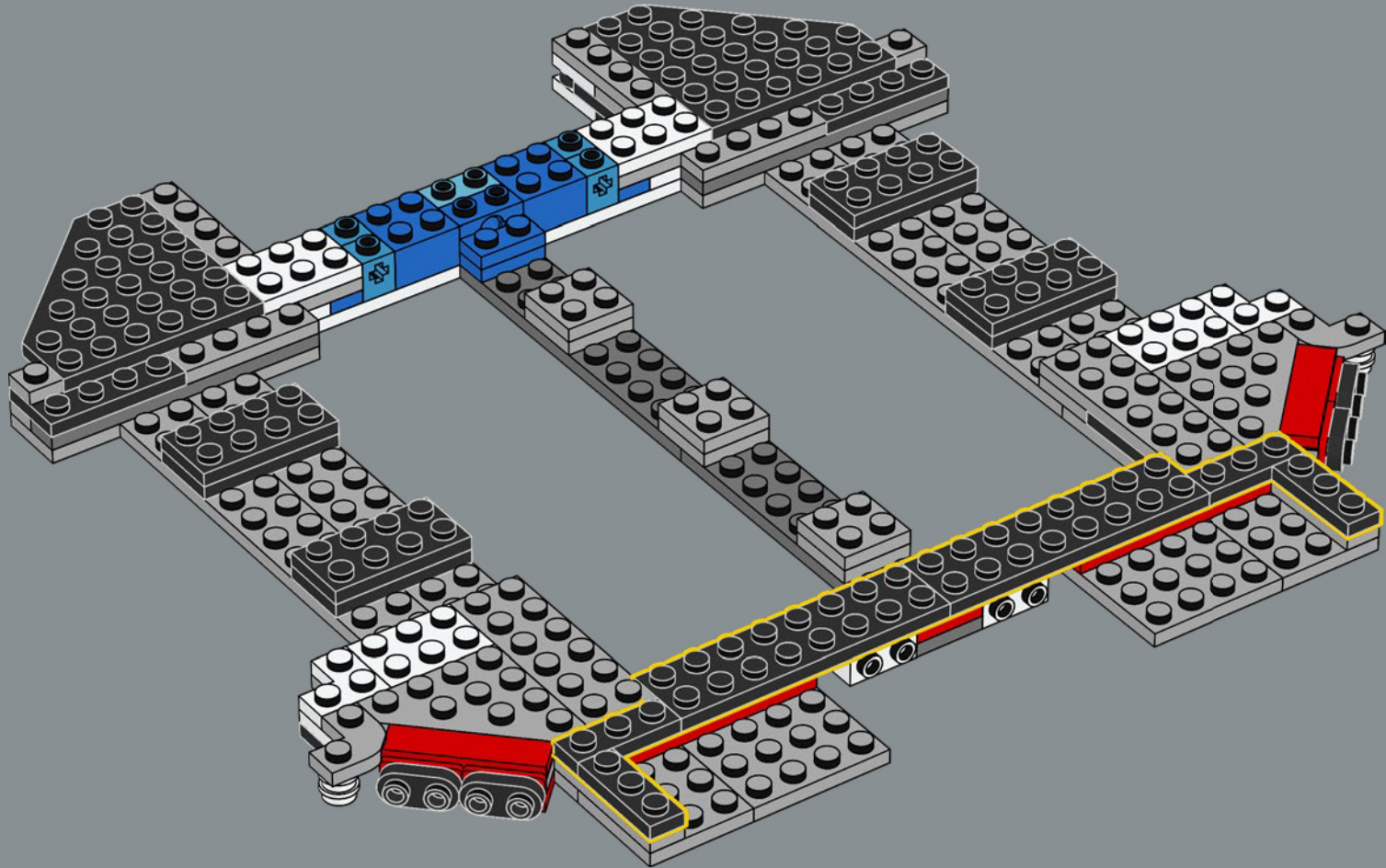

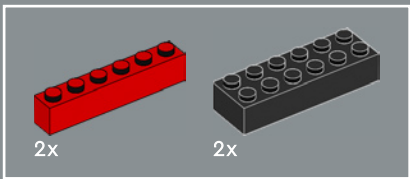

149

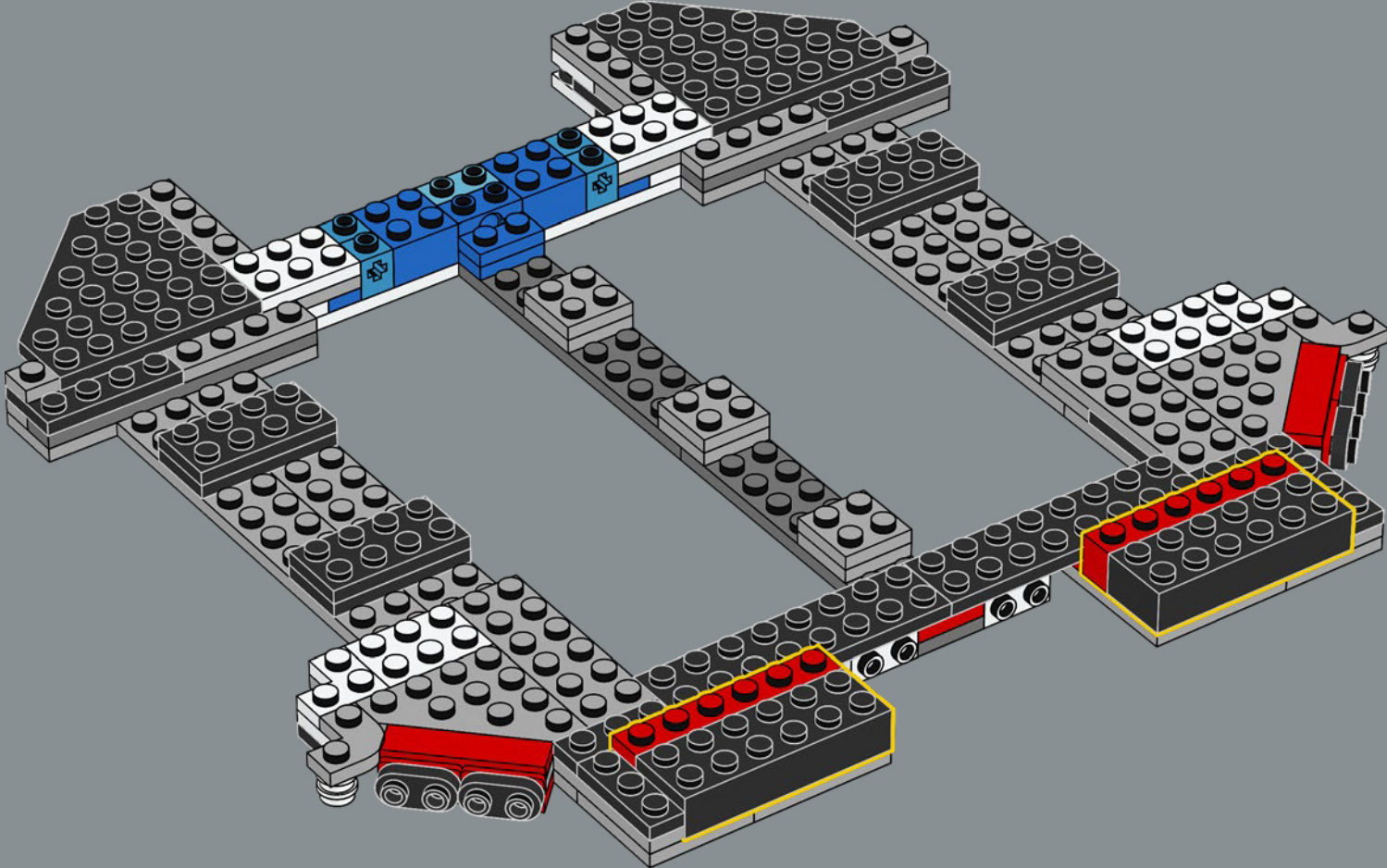

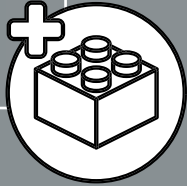
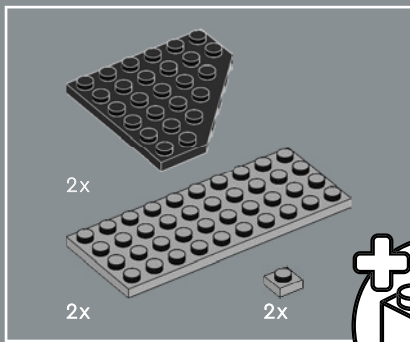

150

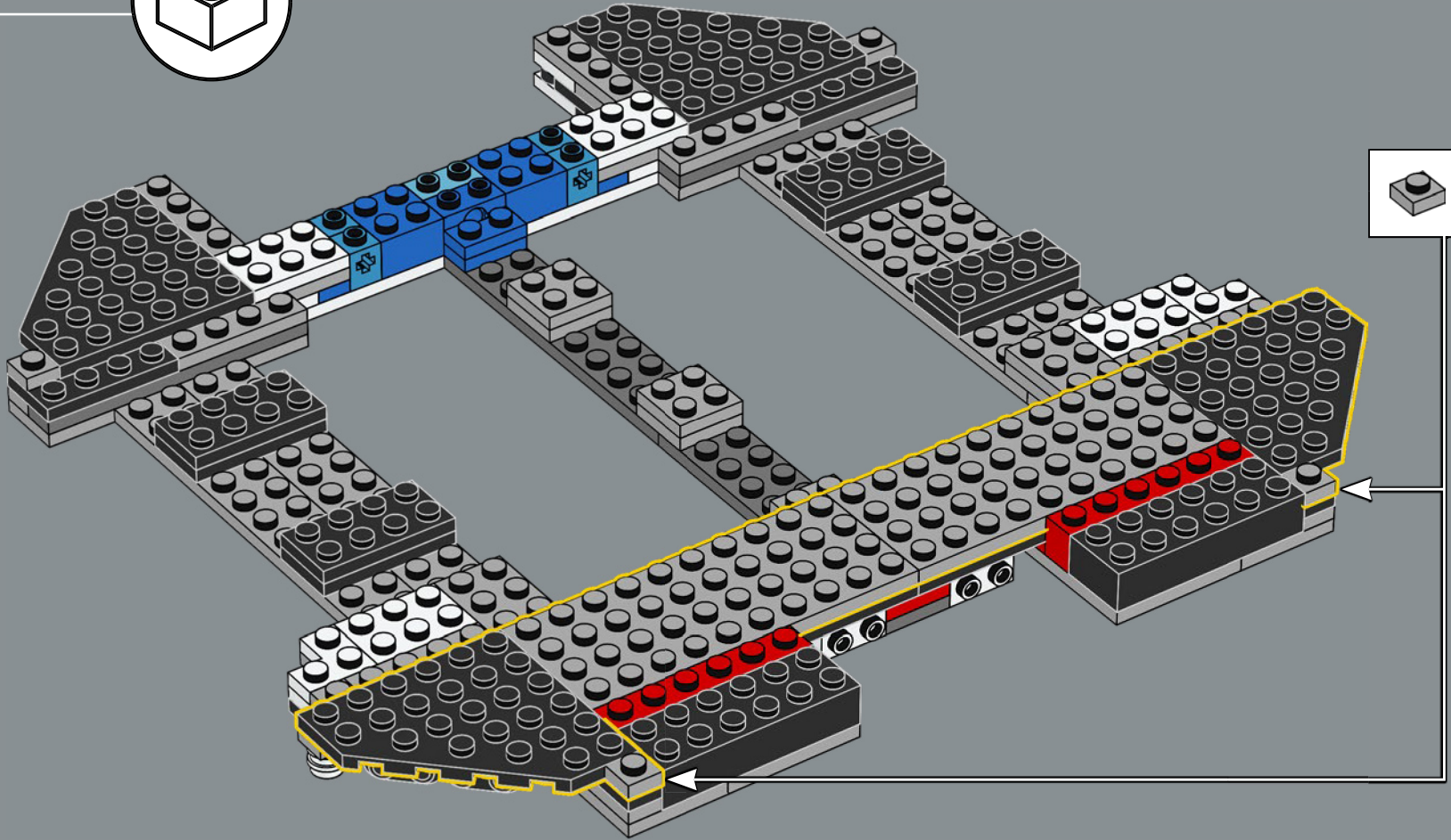

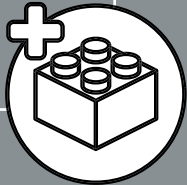
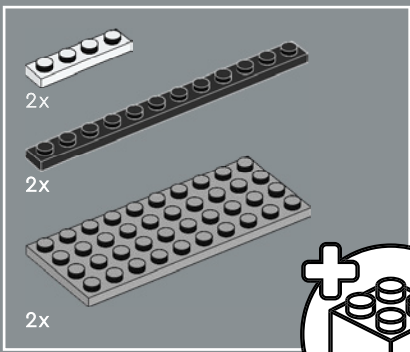

151

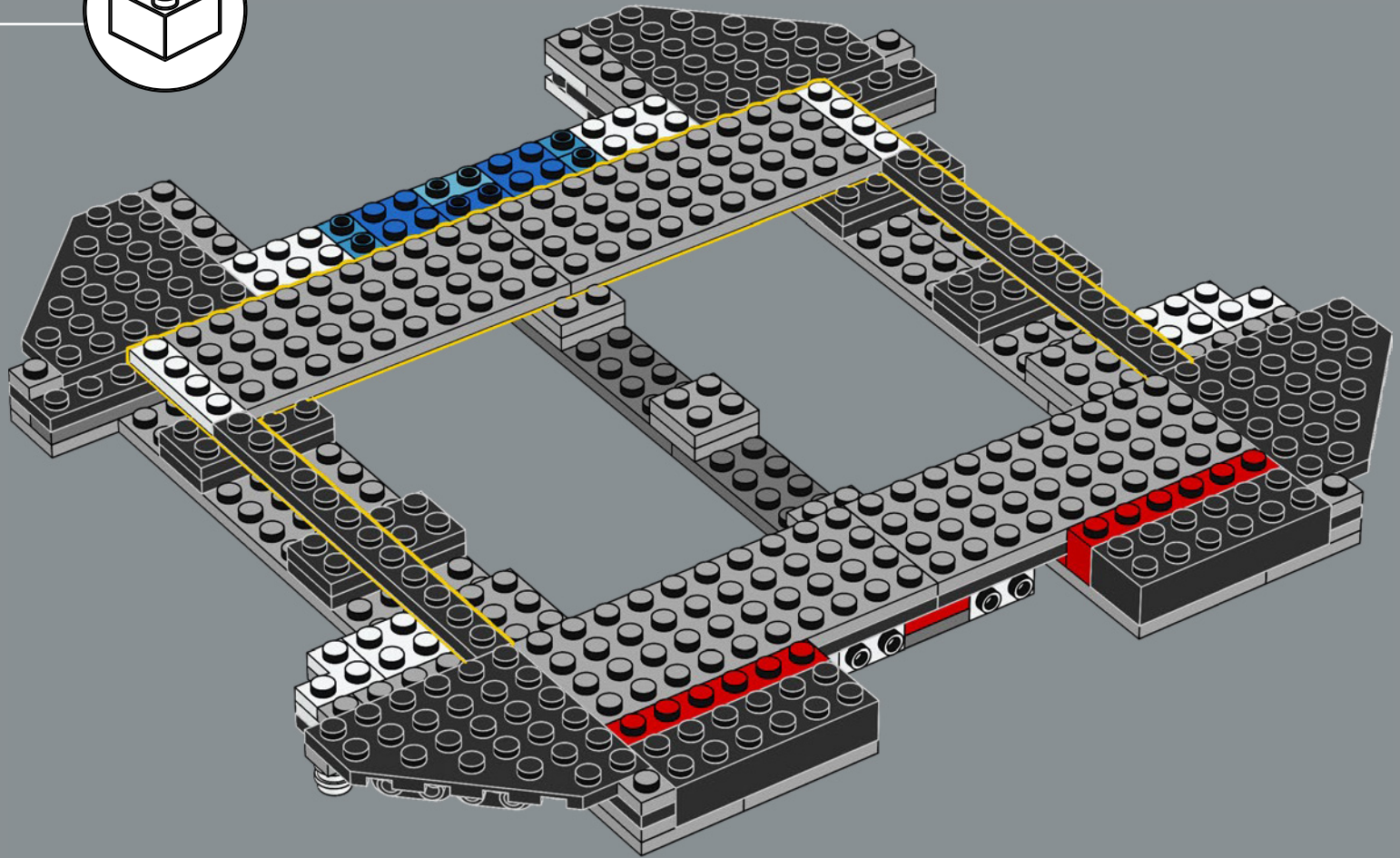

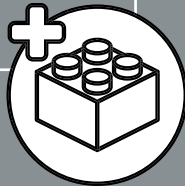
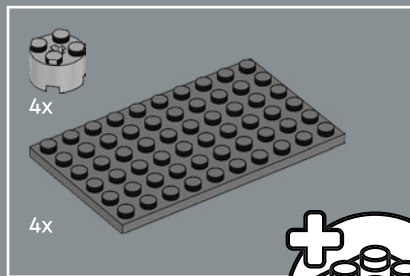

152

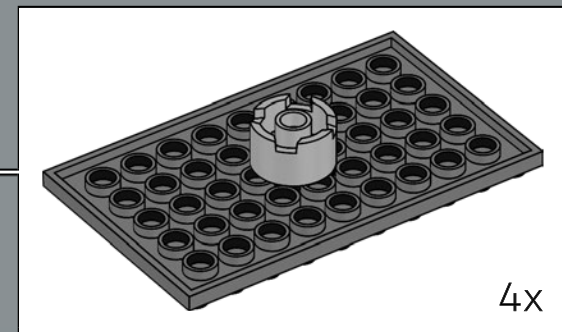
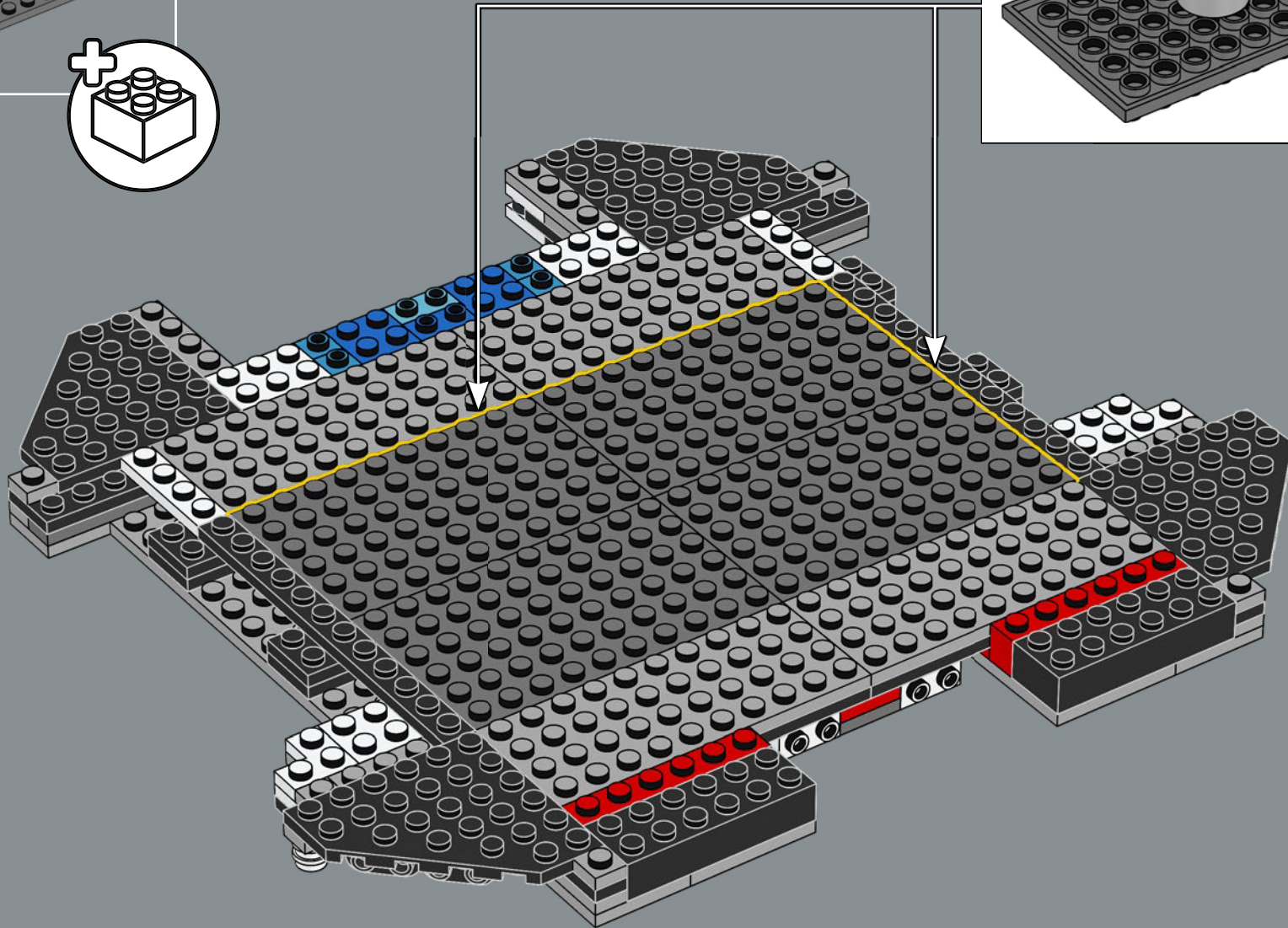

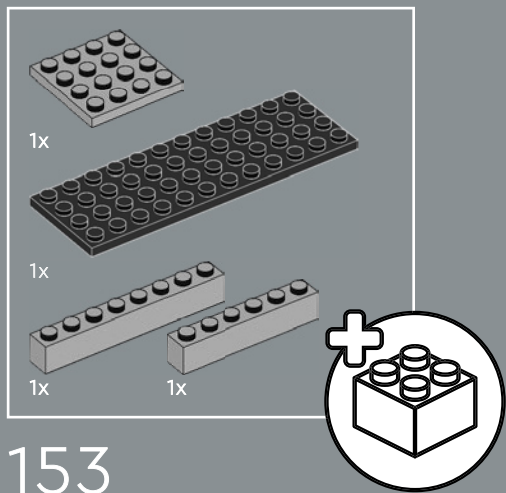

153

1

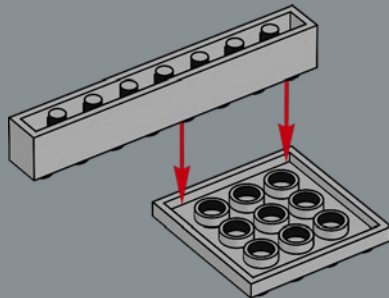

2

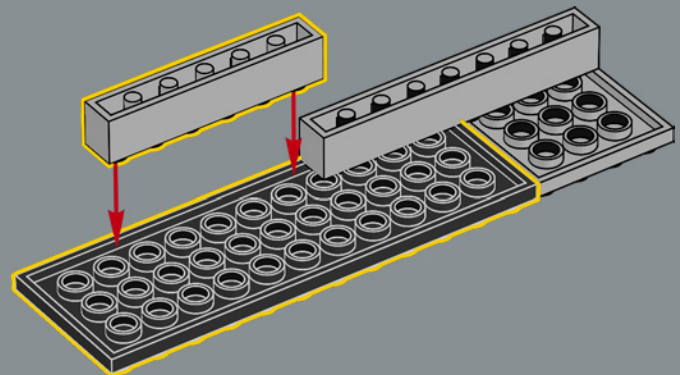

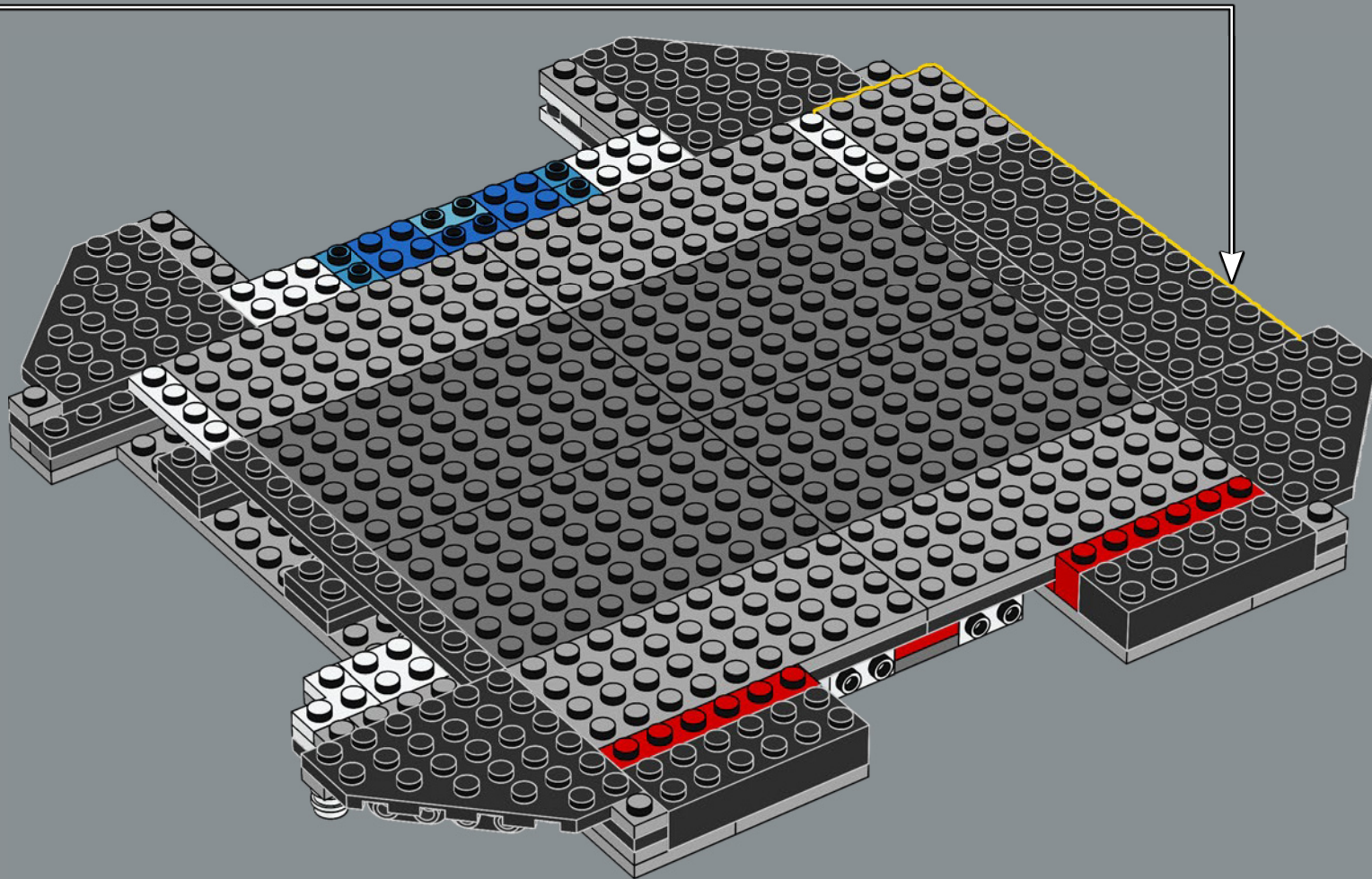

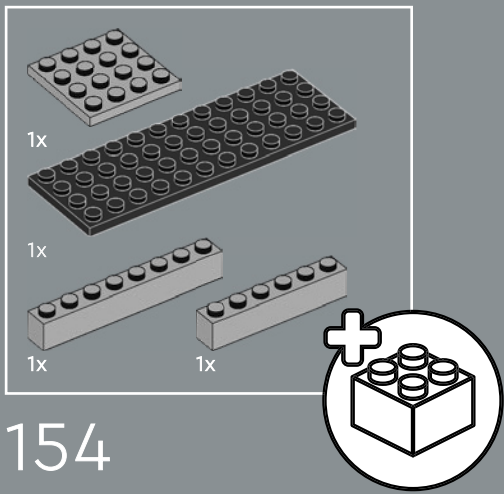

1

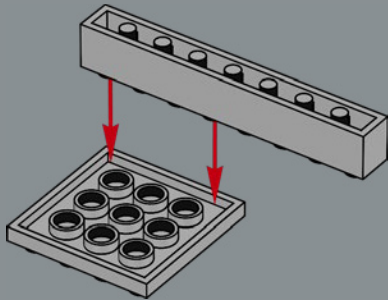

2

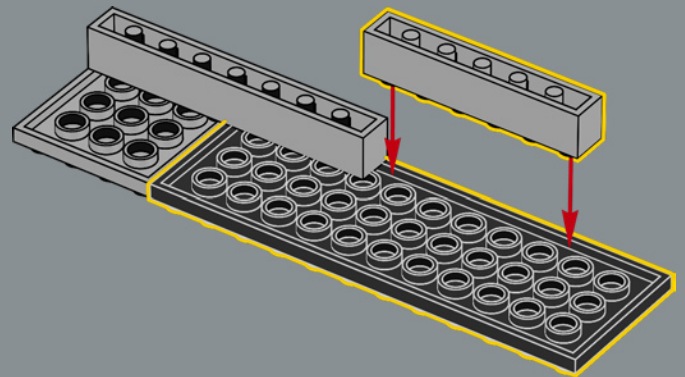

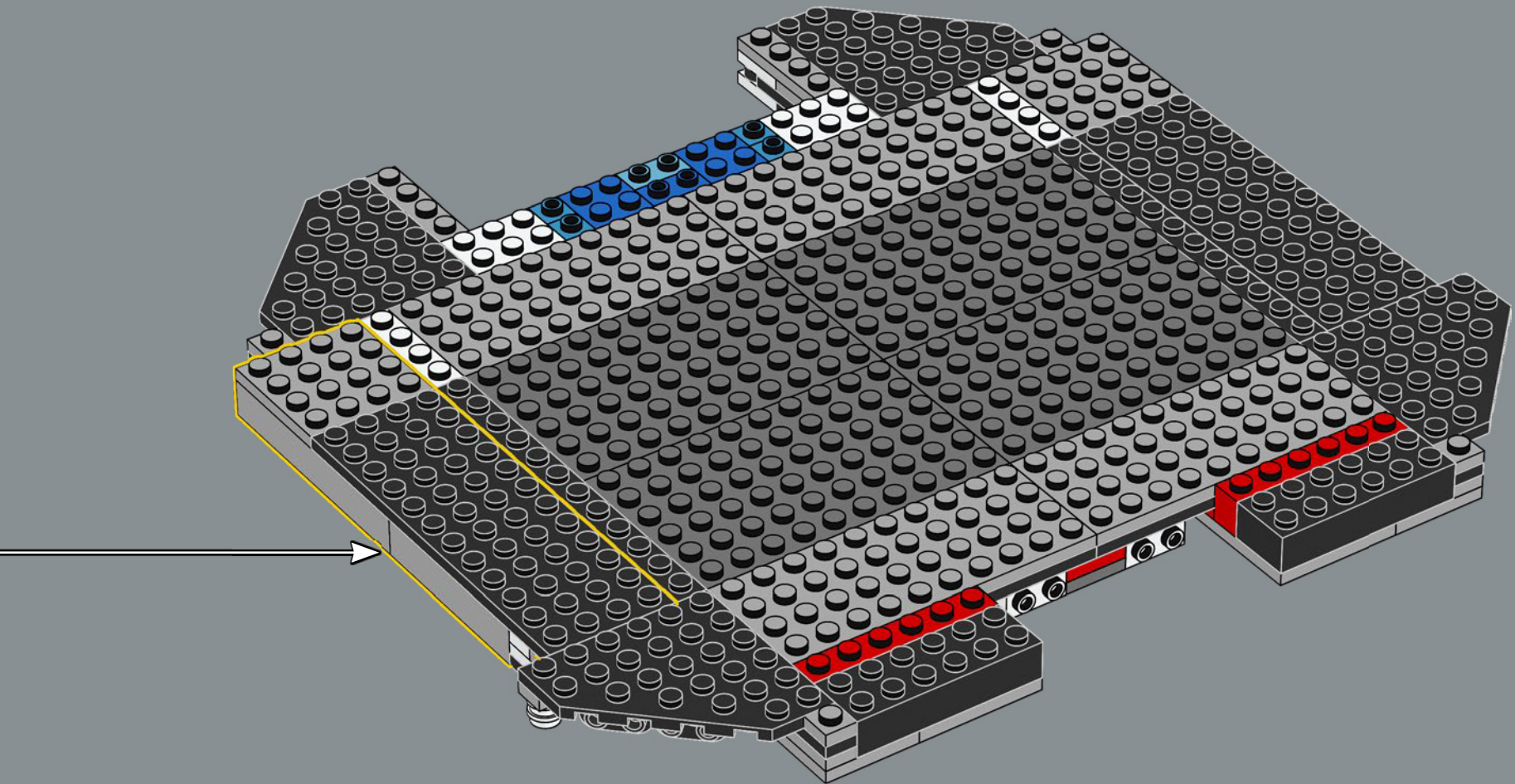

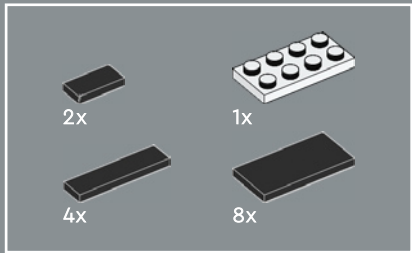

155

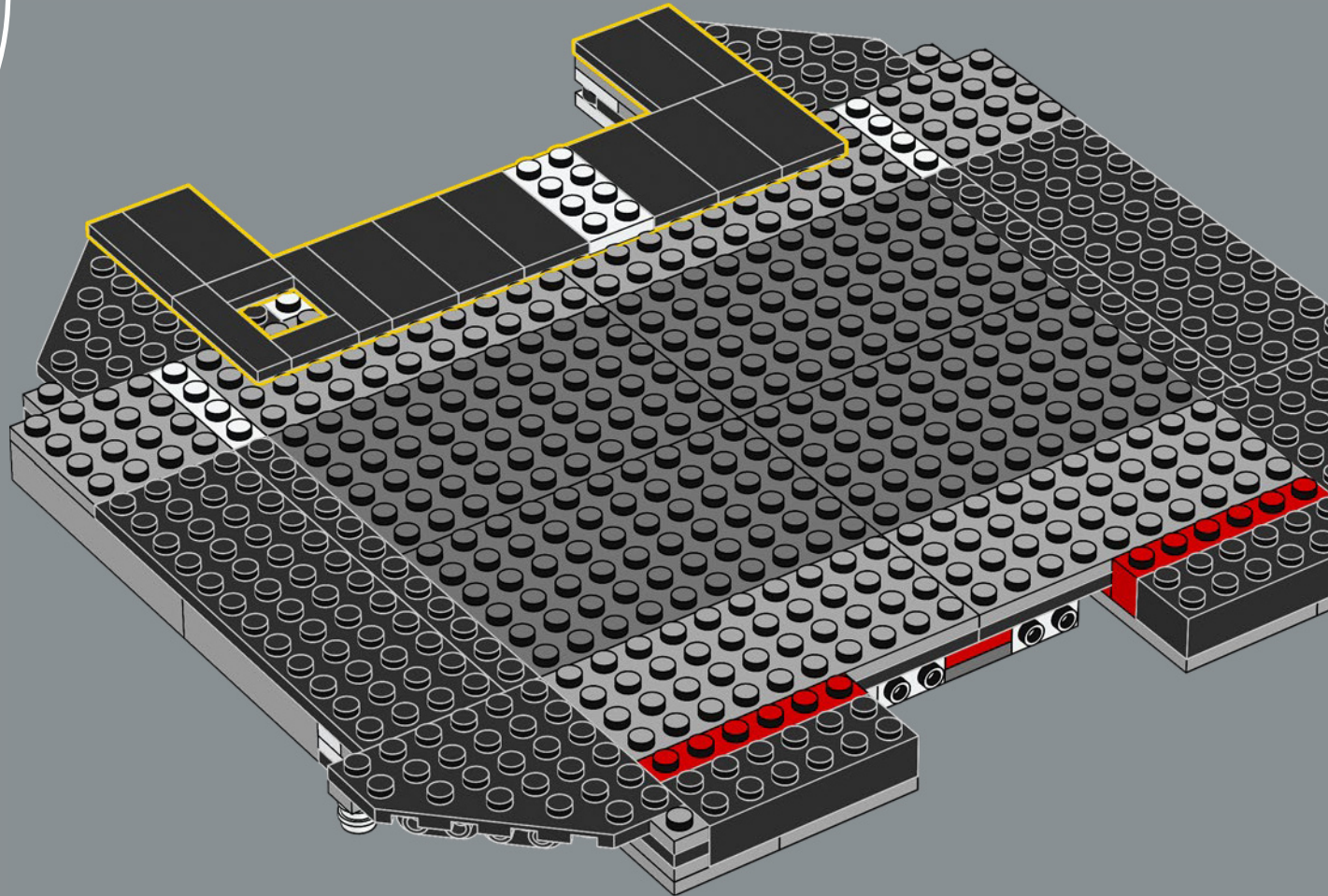

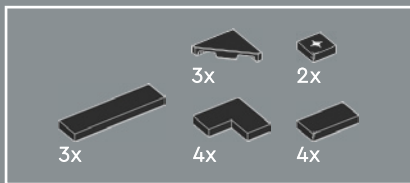

156

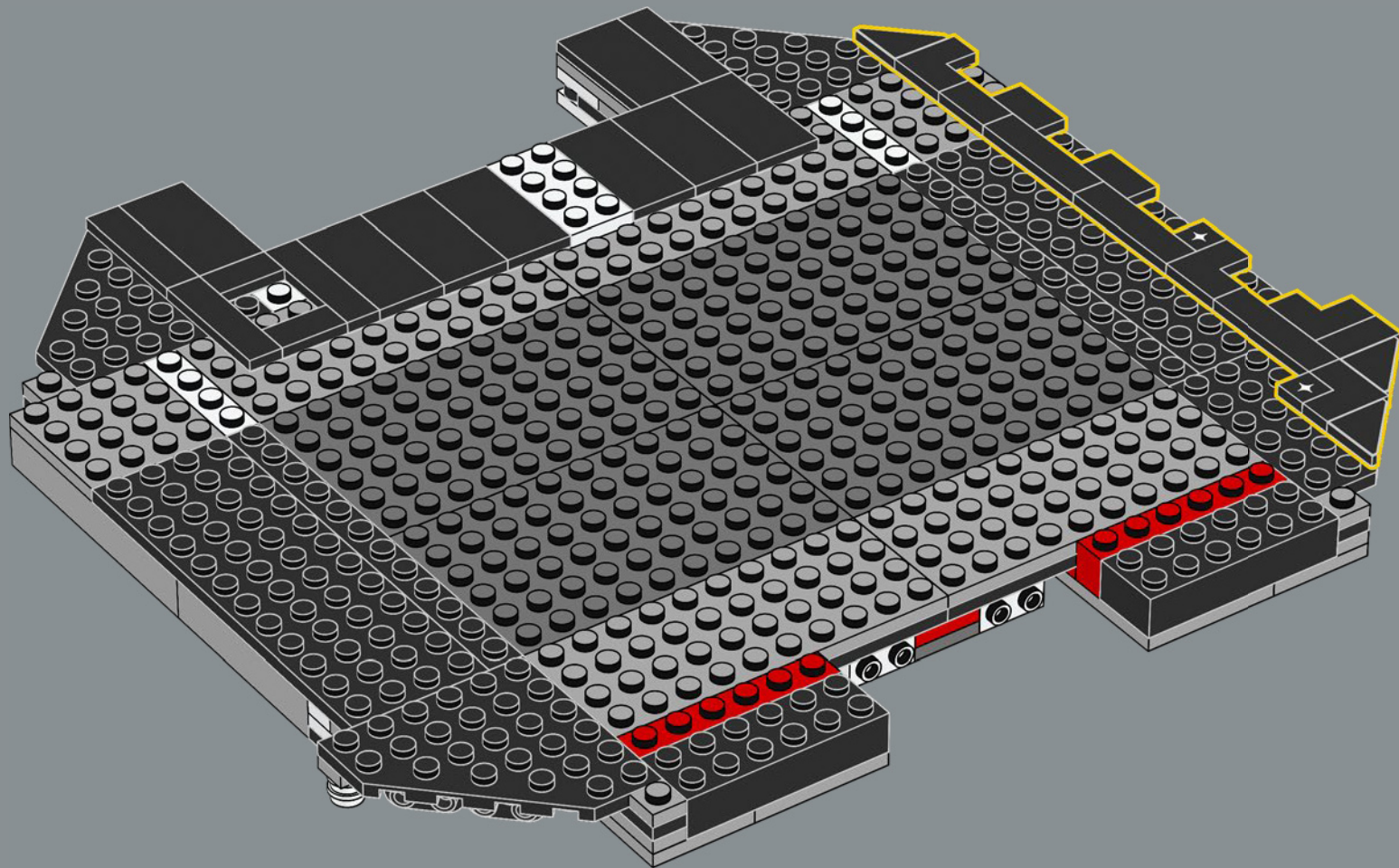

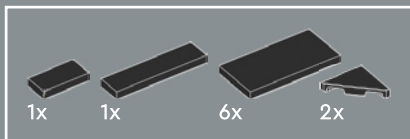

157

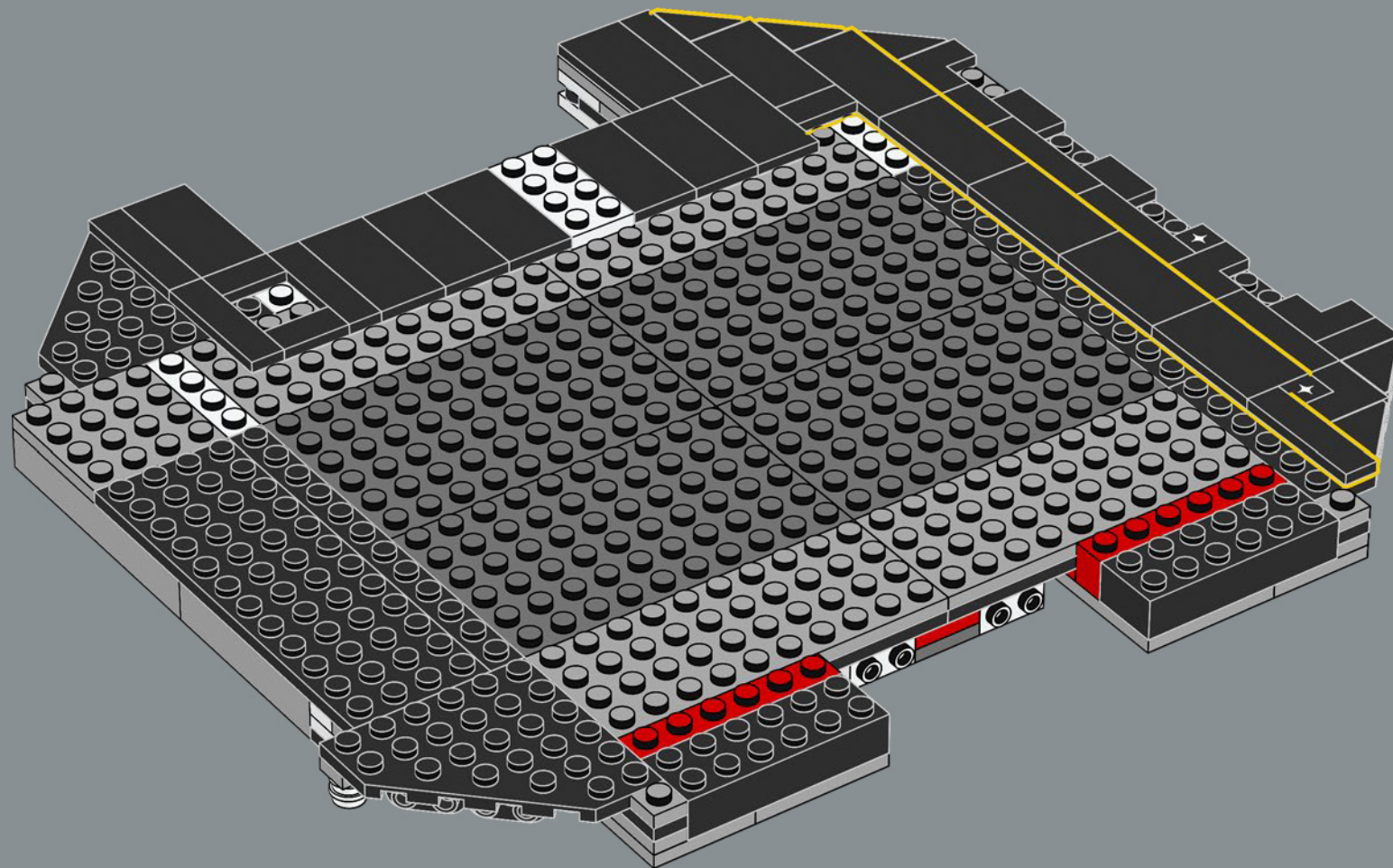

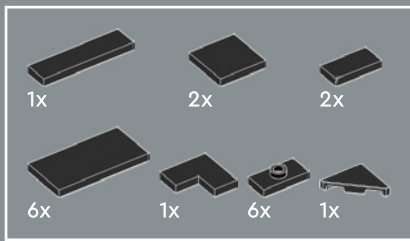

158

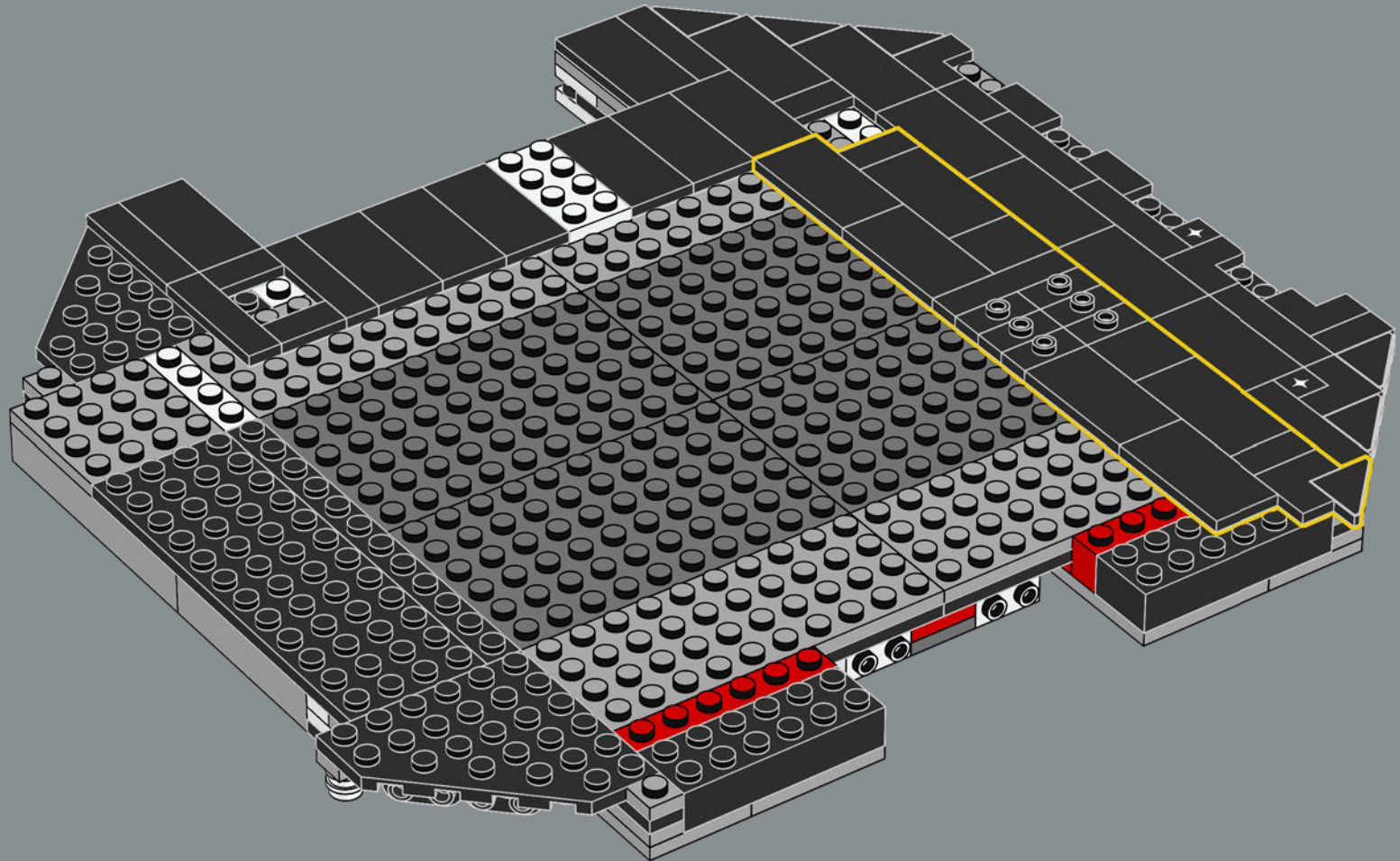

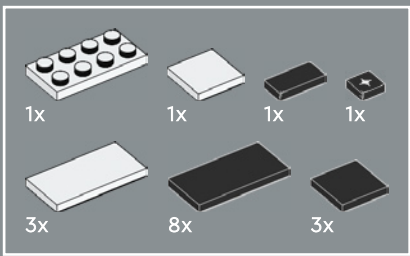

159

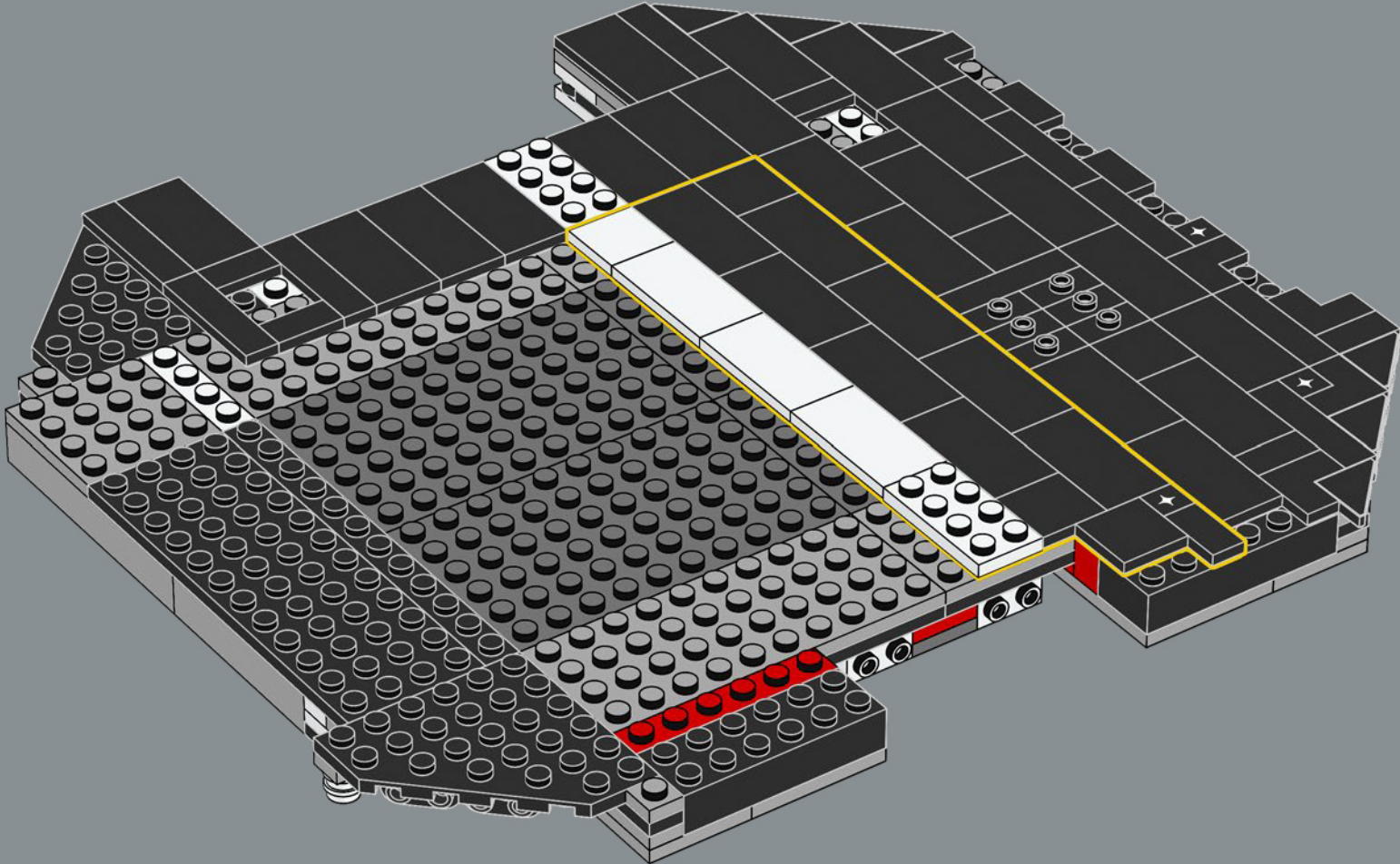

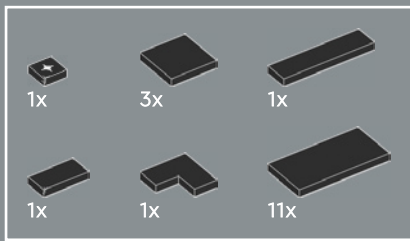

160

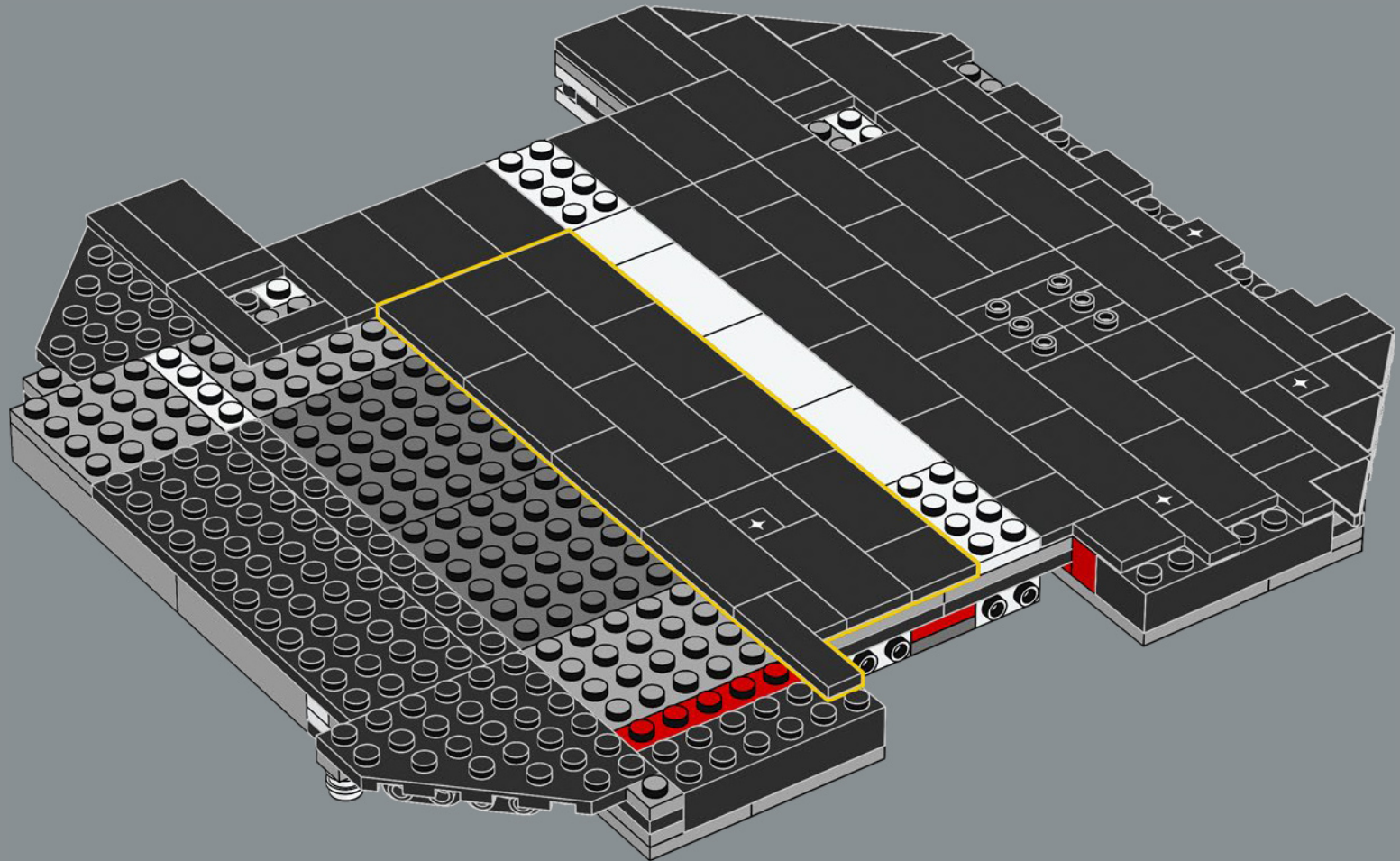

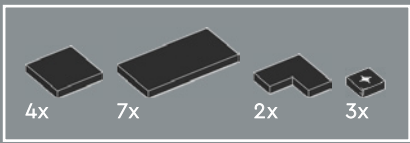

161

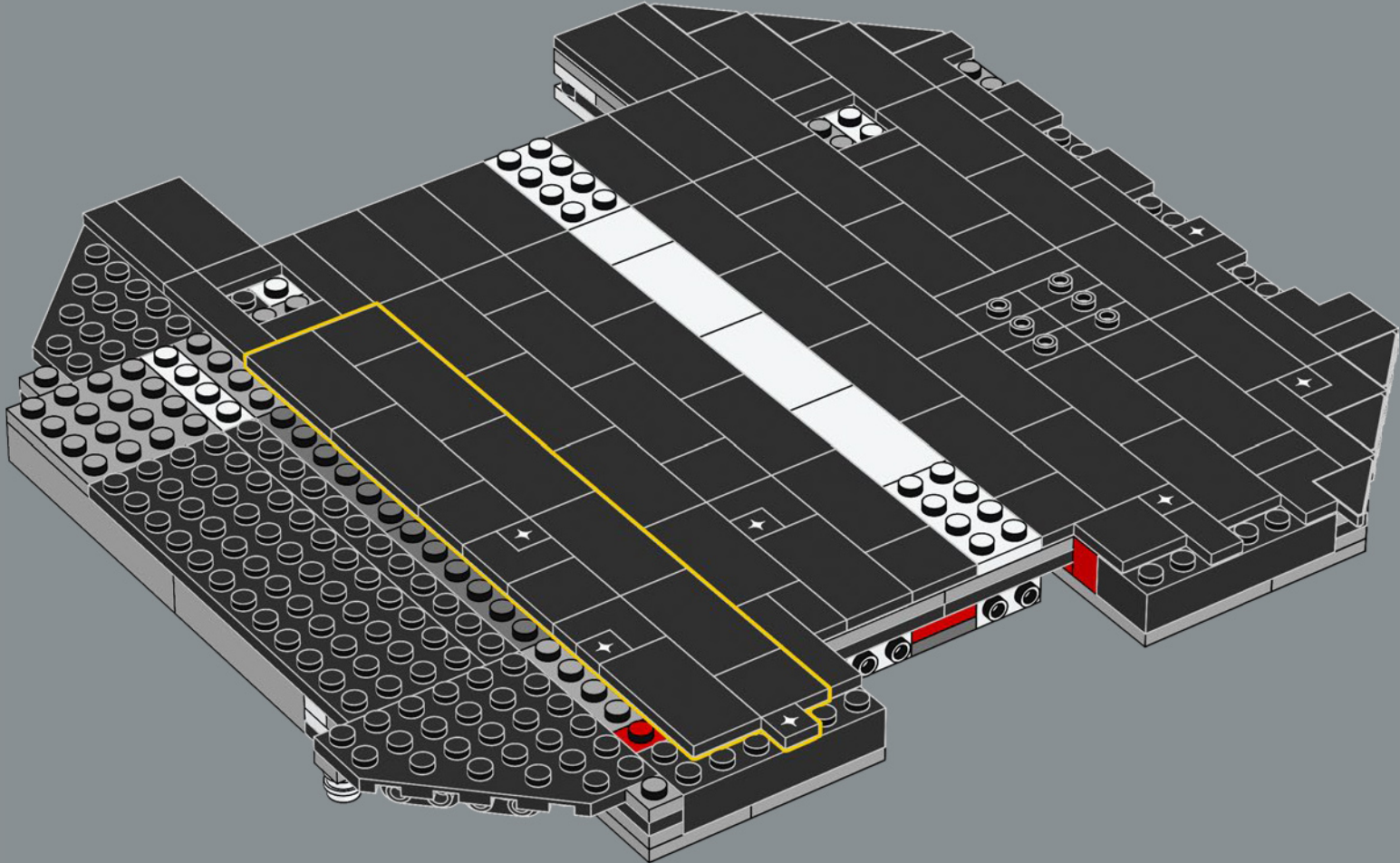

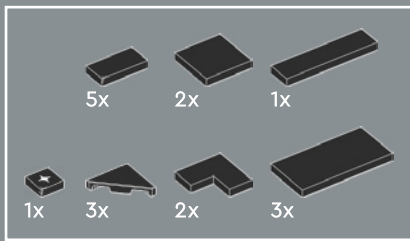

162

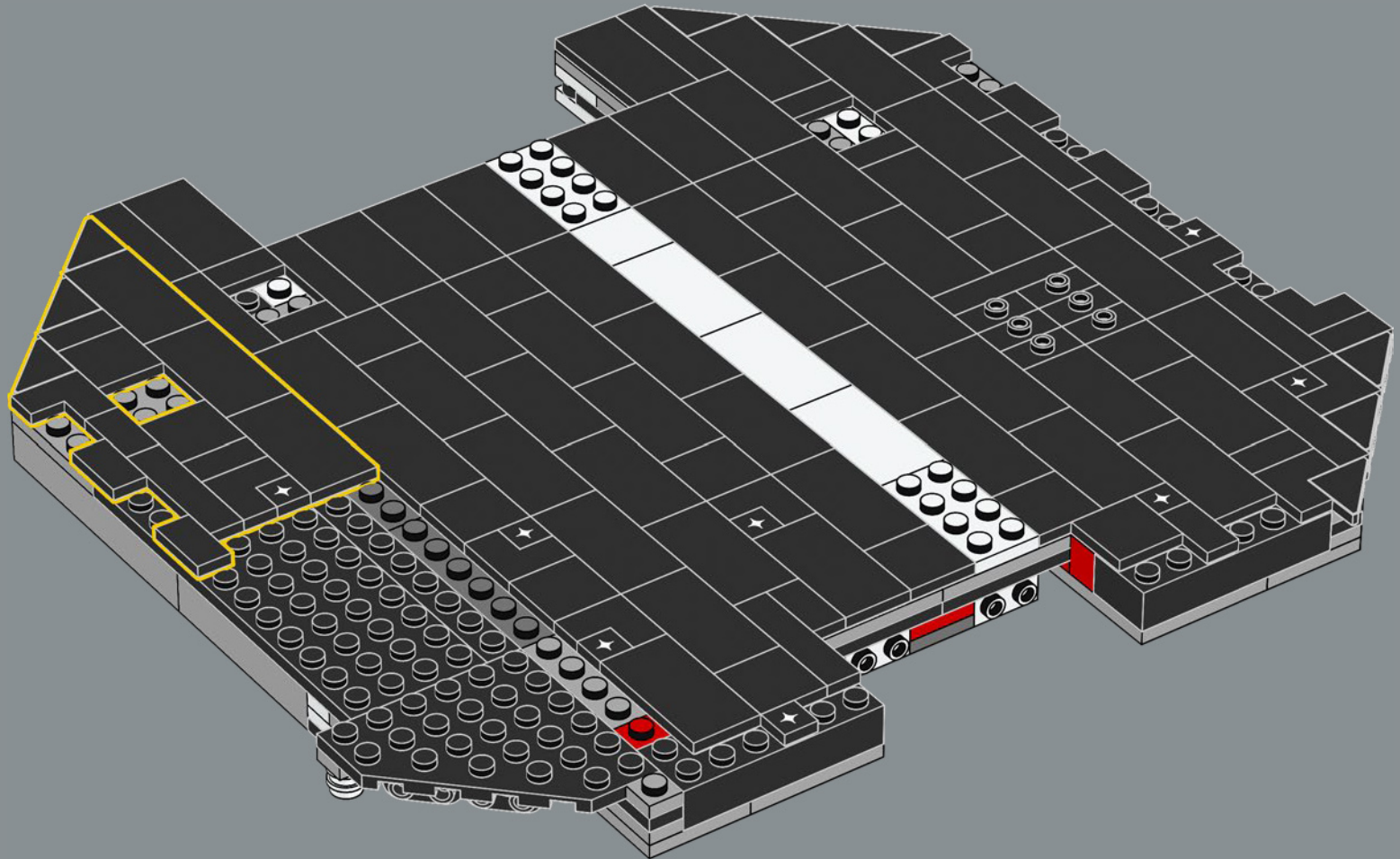

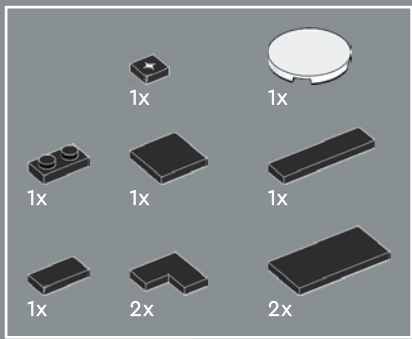

163

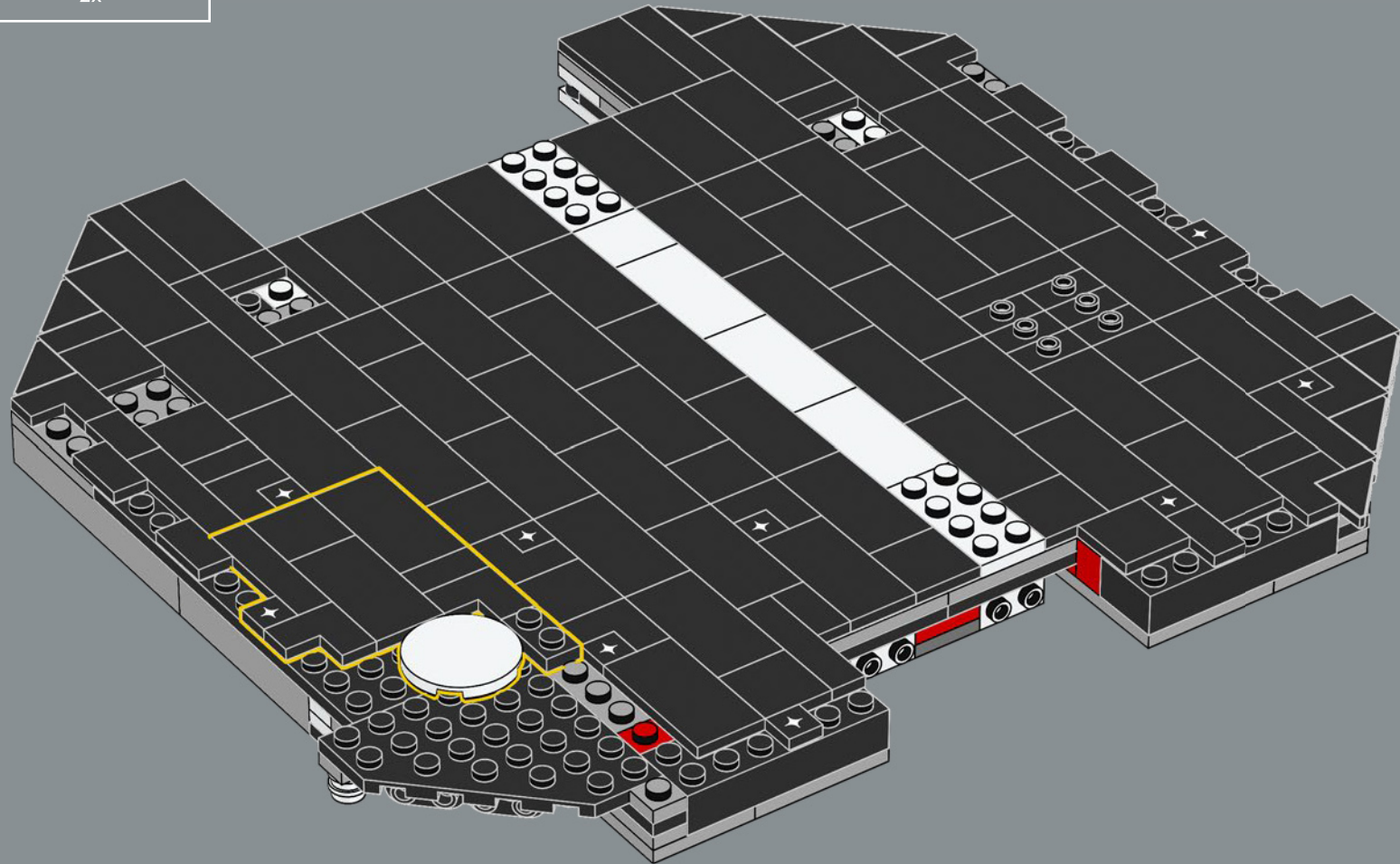

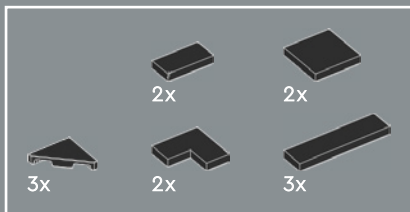

164

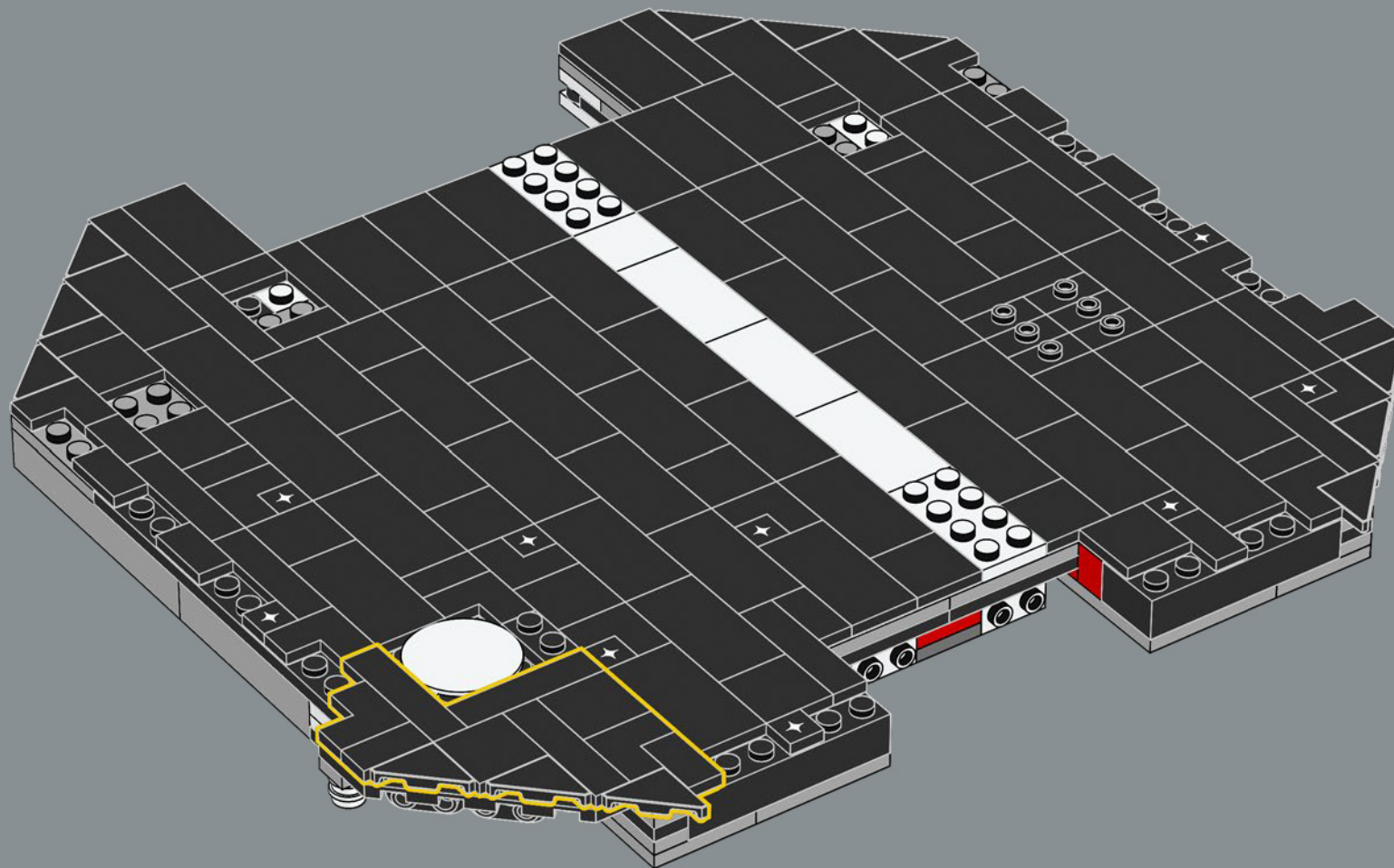

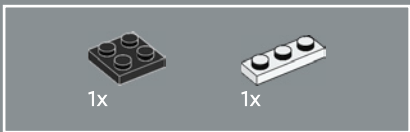

165

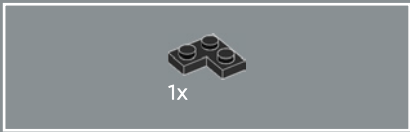
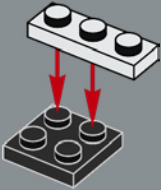

166

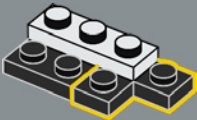

167

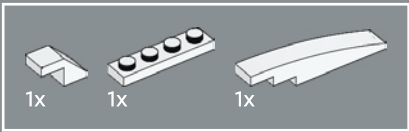
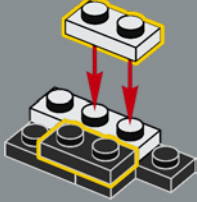

168

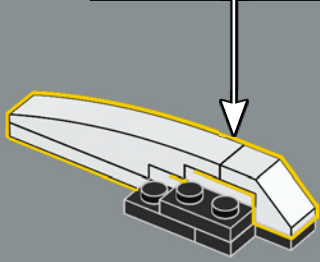
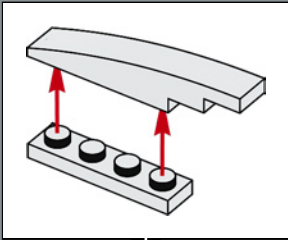

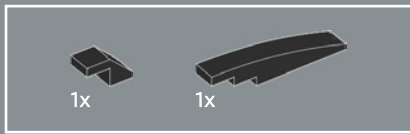

169

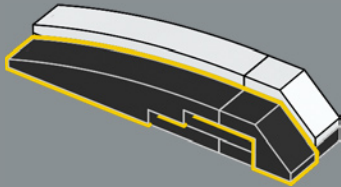

170

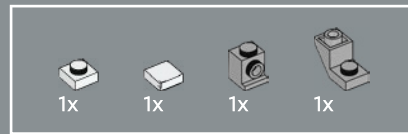
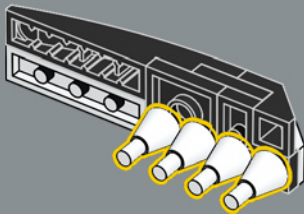

171

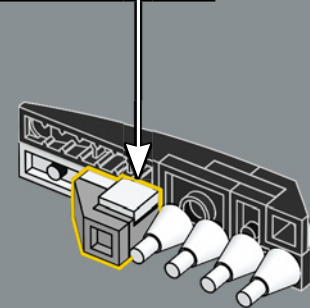
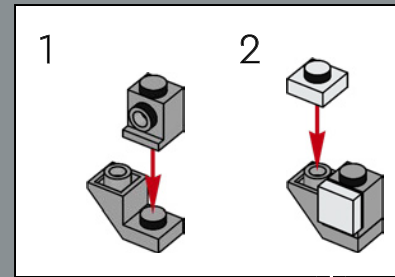

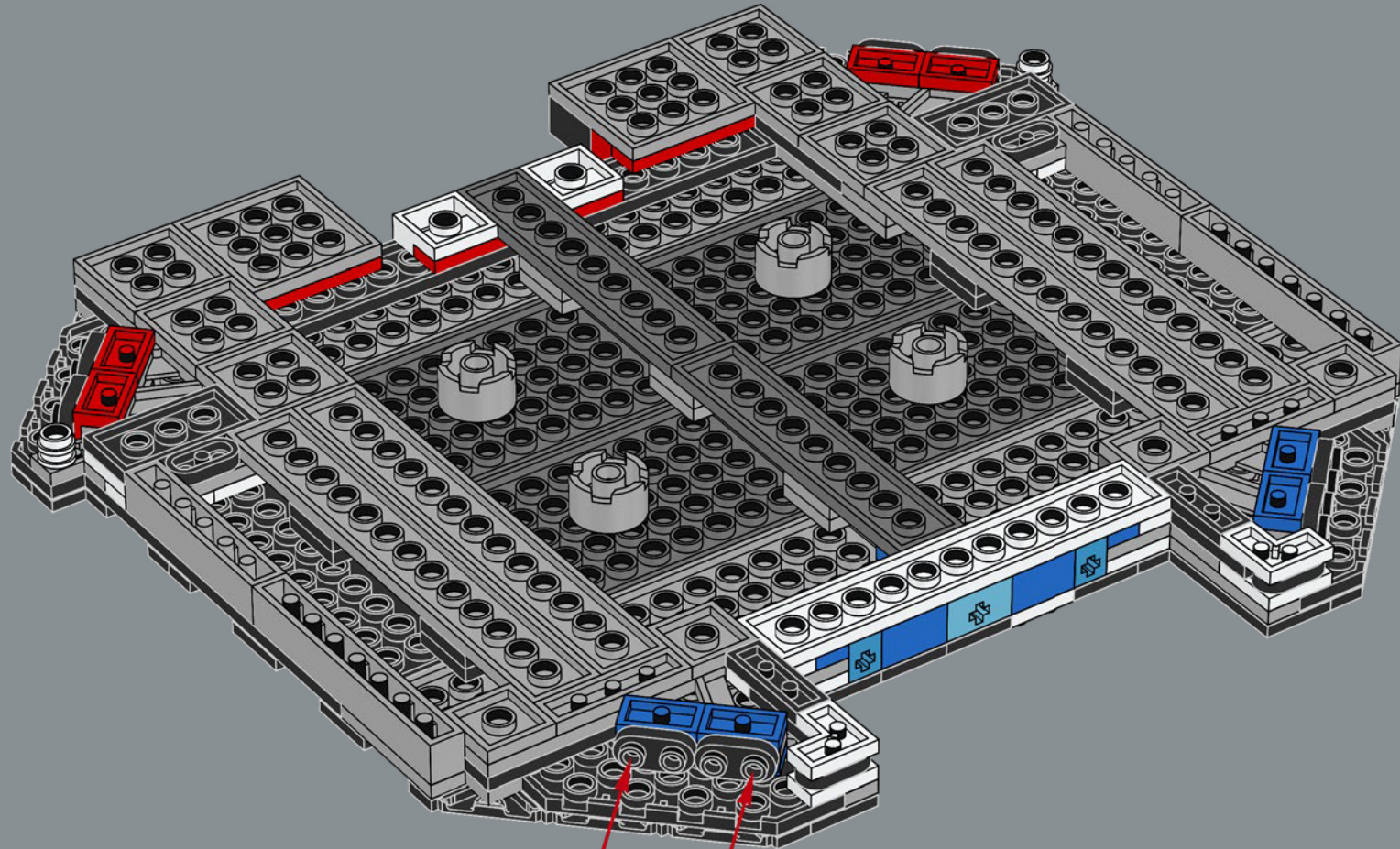

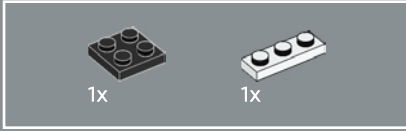
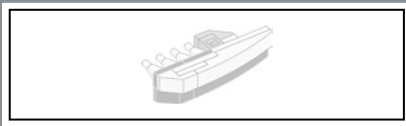

173

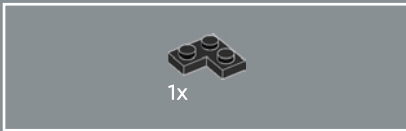
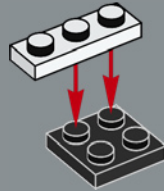

174

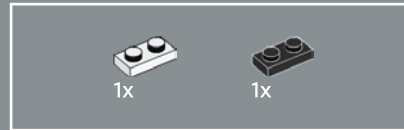
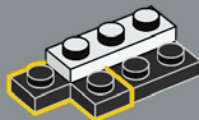

175

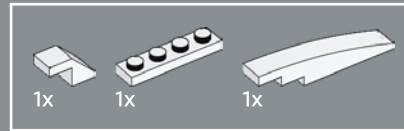
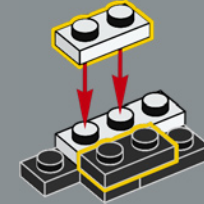

176

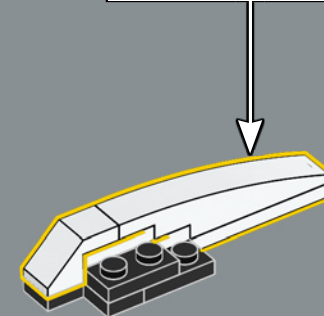
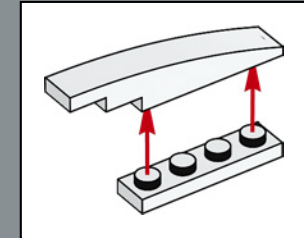

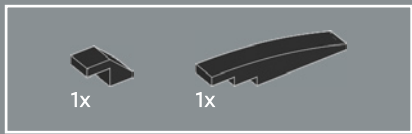

177

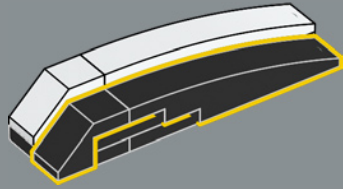

178

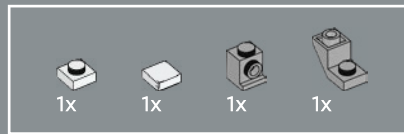
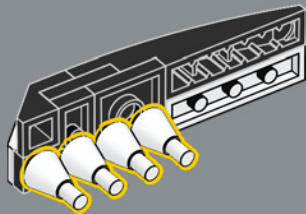

179

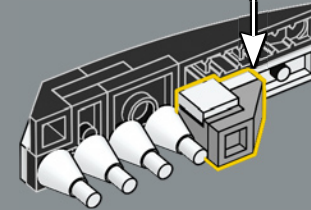
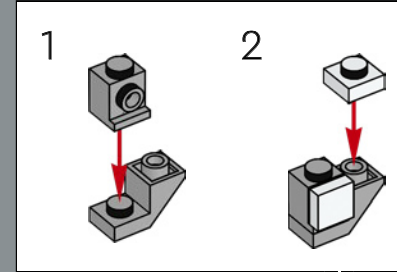

180

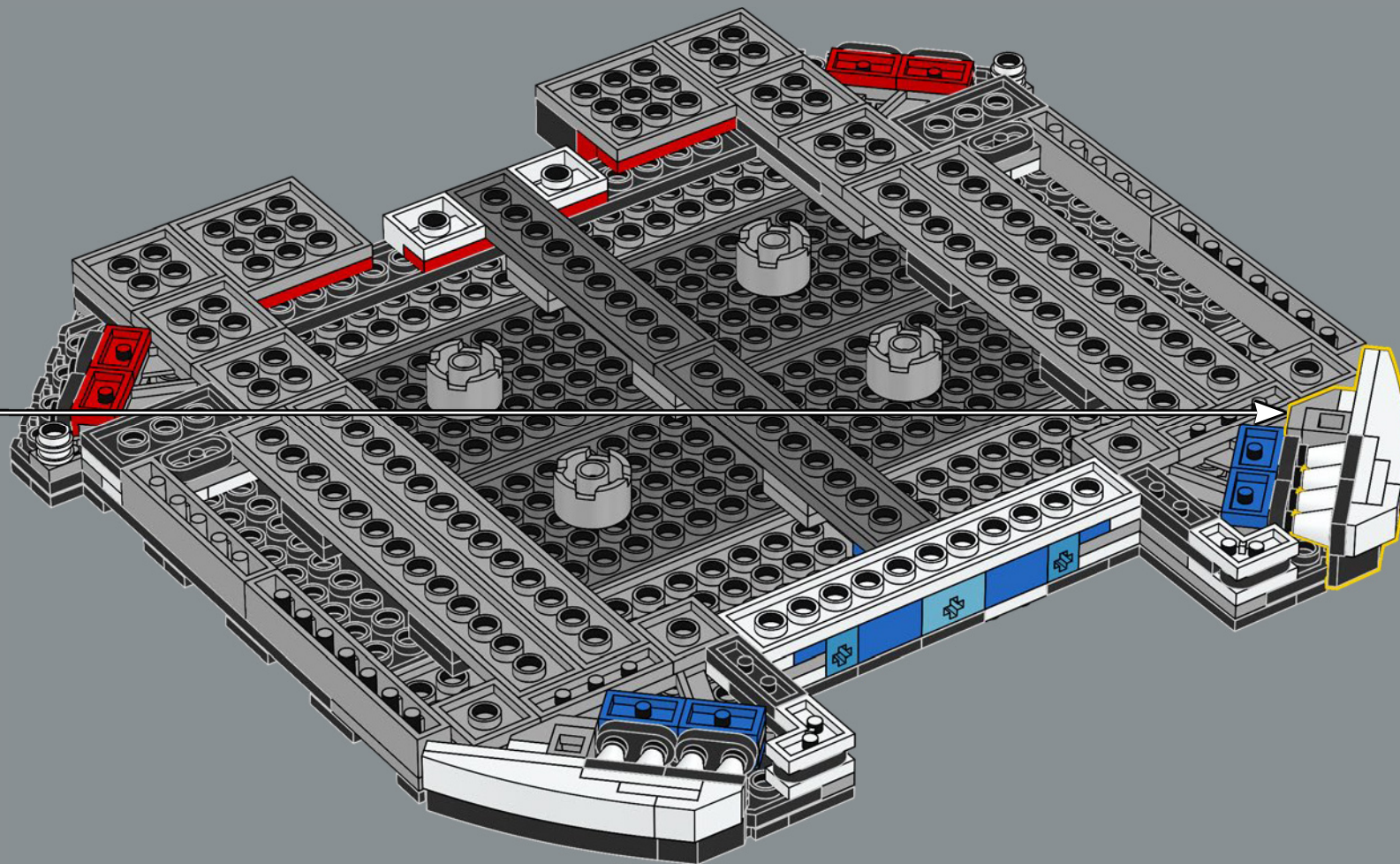

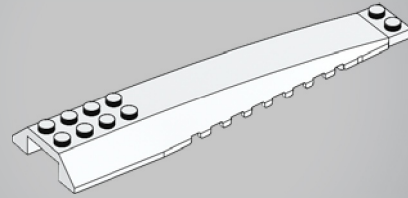
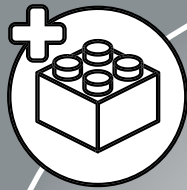

1x

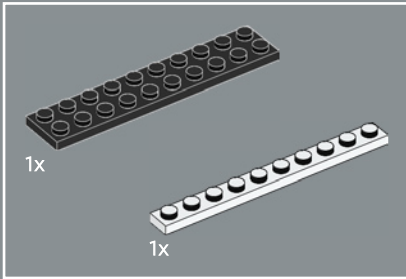
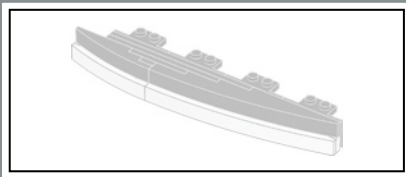

181

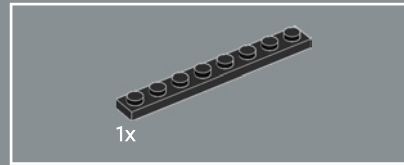
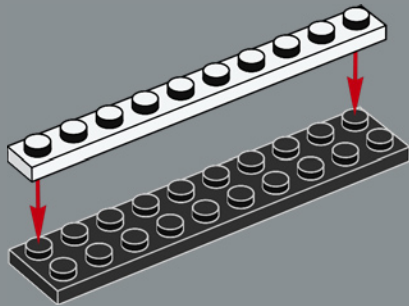

182

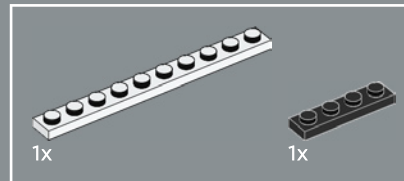
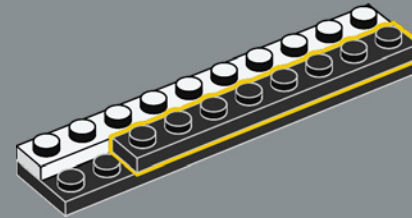

183

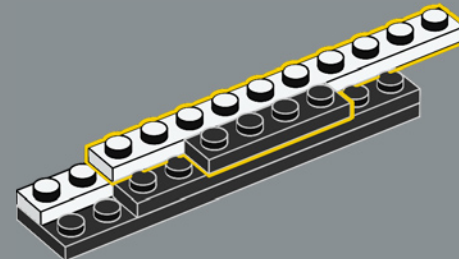

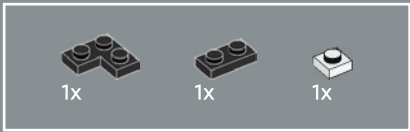

184

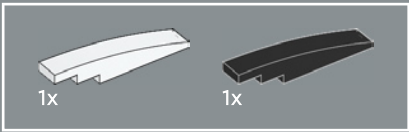
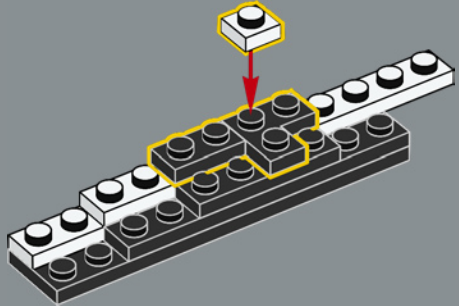

185

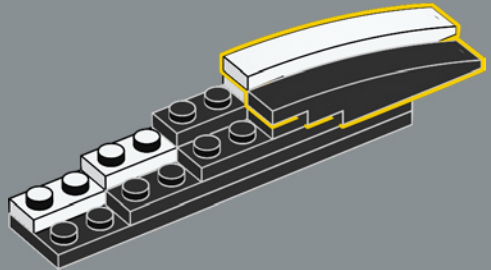

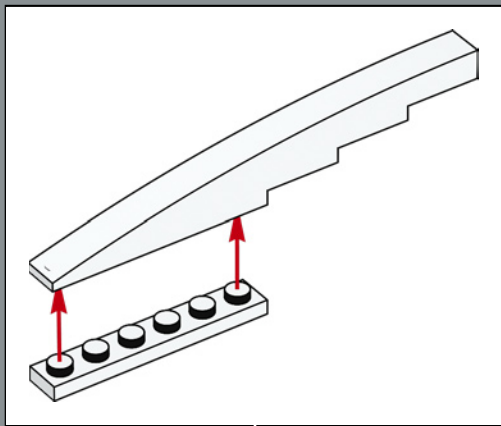
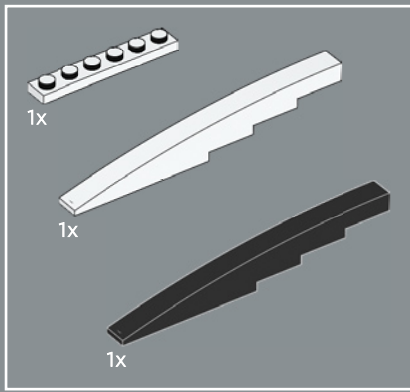

186

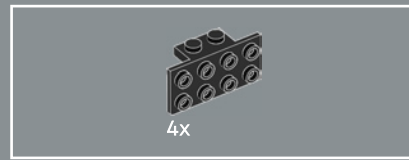
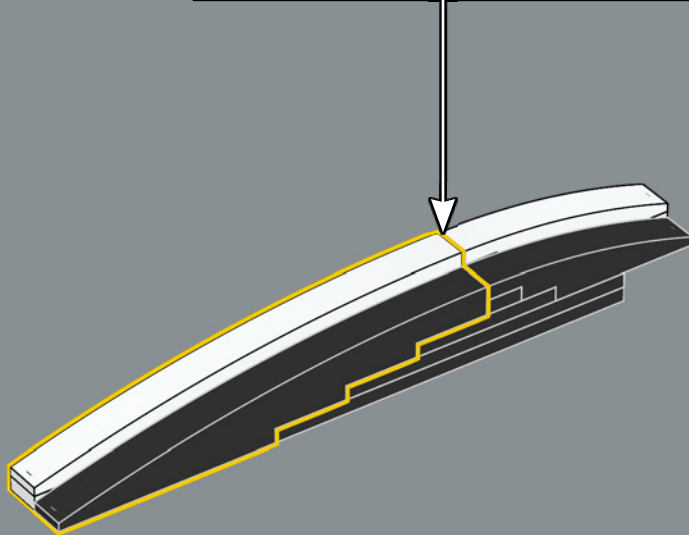

187

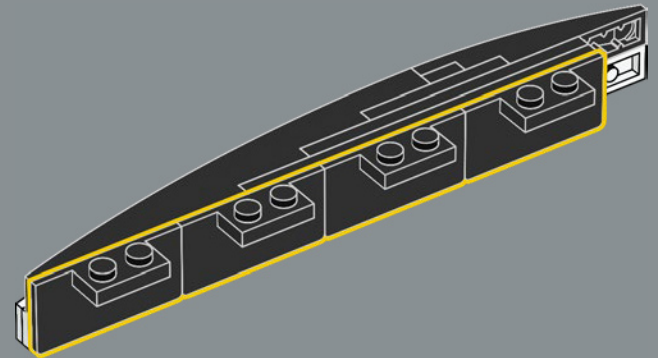

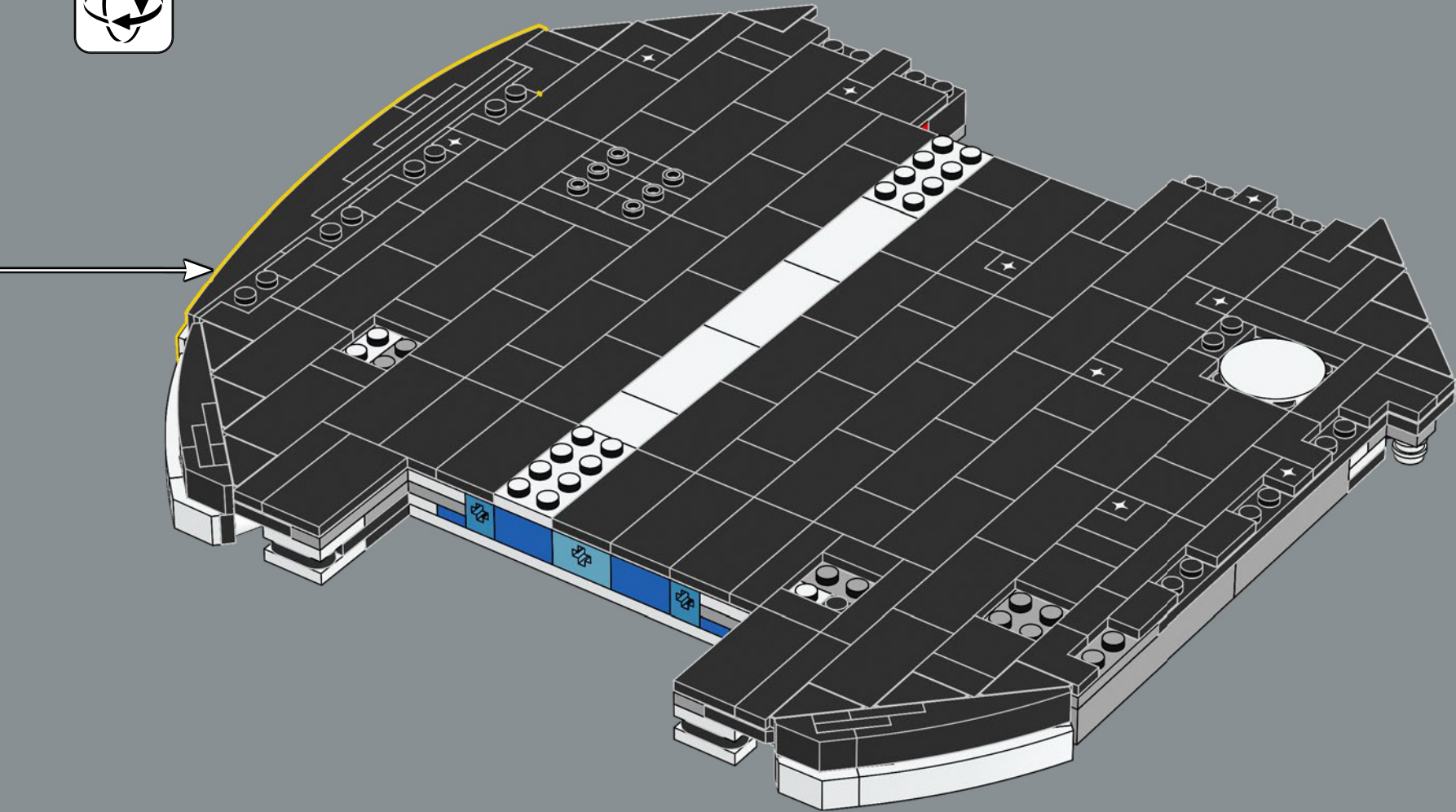

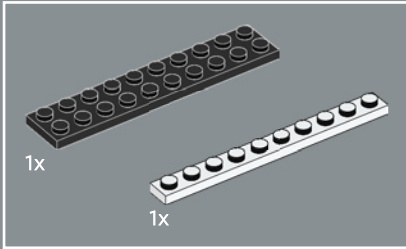
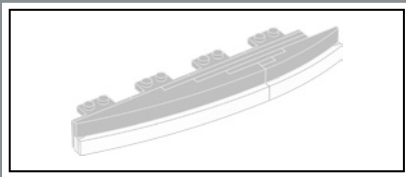

189

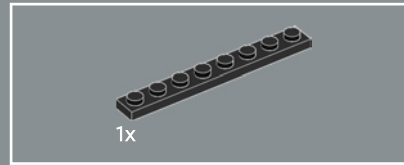
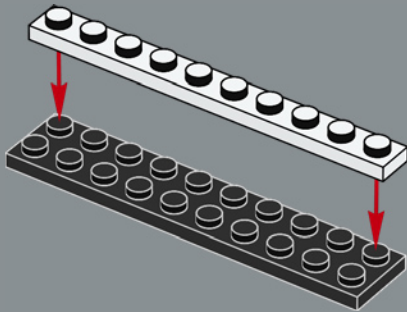

190

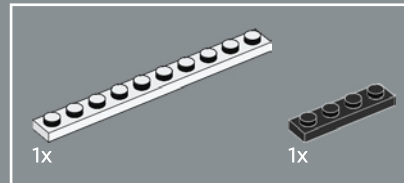
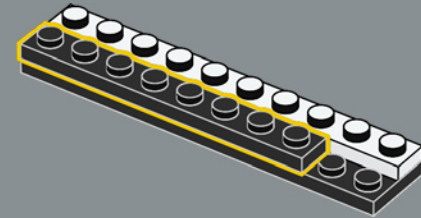

191

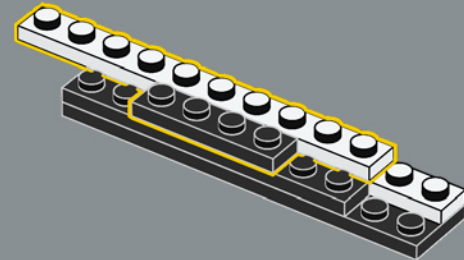

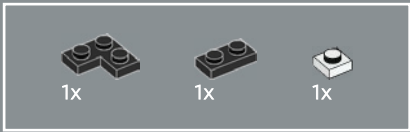

192

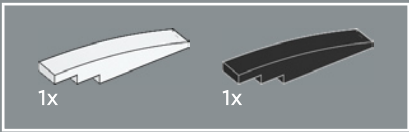
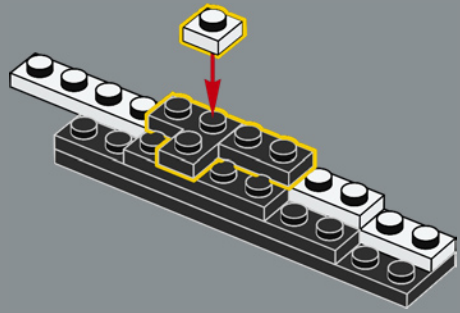

193

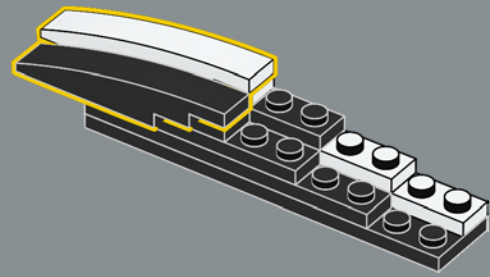

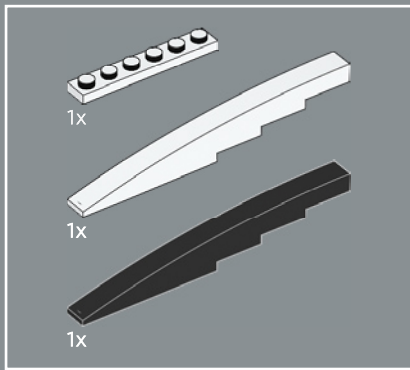

194

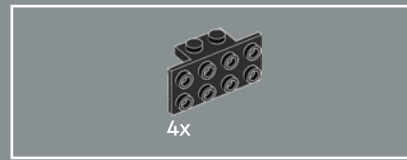
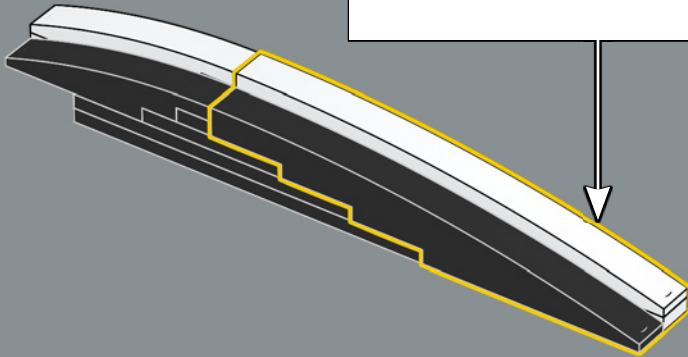
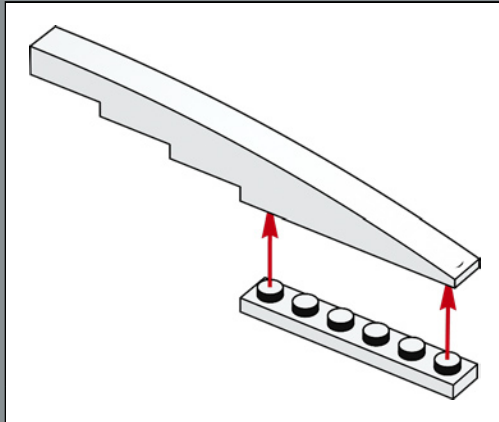

195

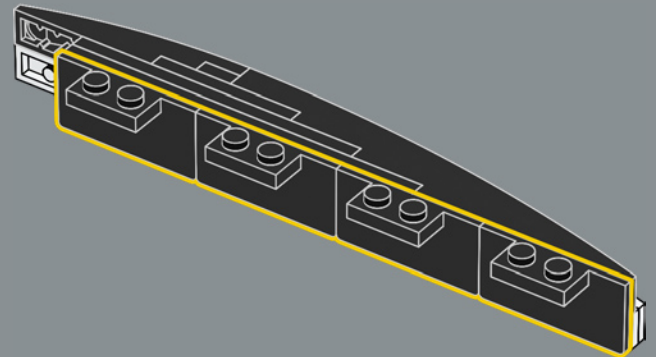

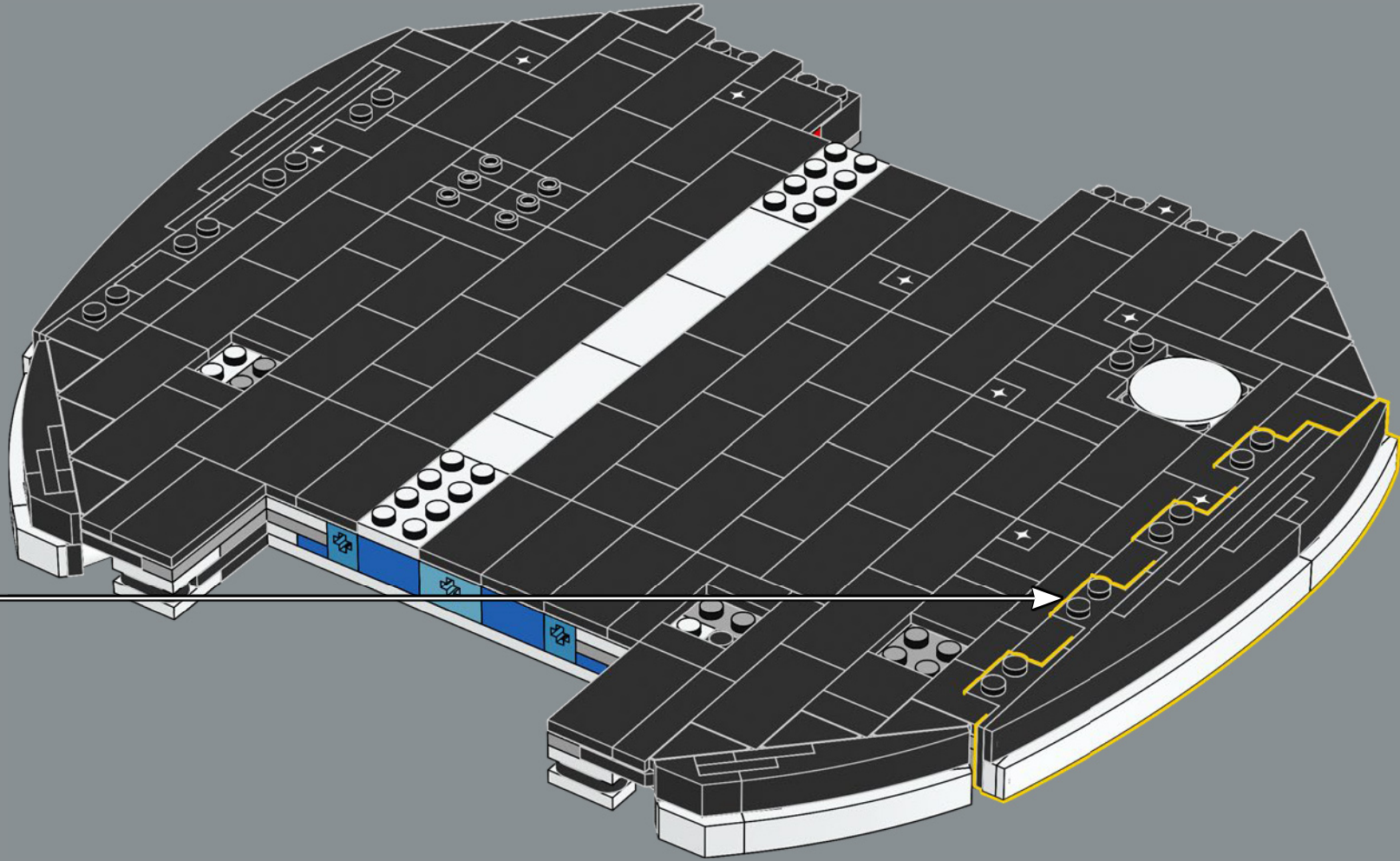

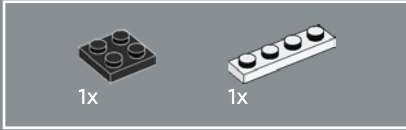
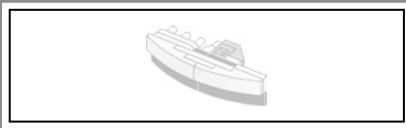

197

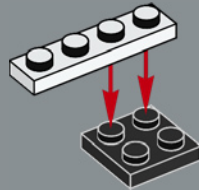

198

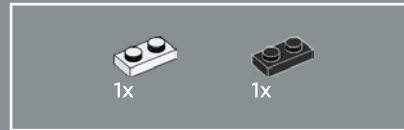
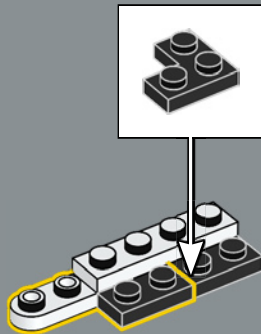

199

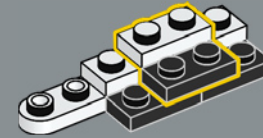

200

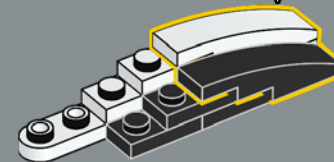
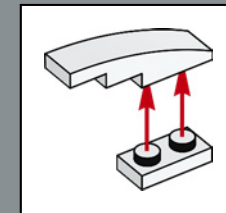

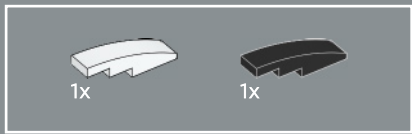

201

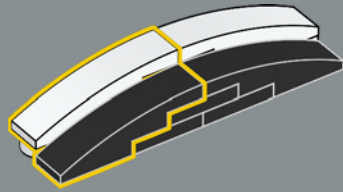

202

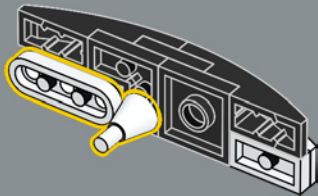

203

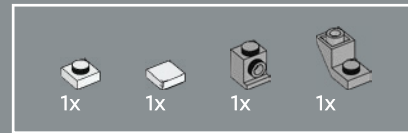
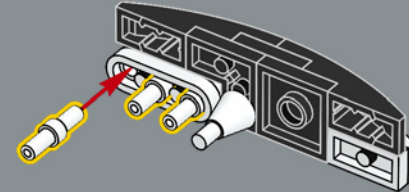

204

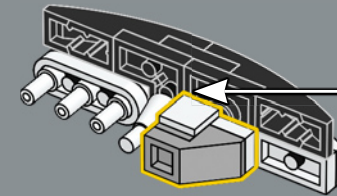
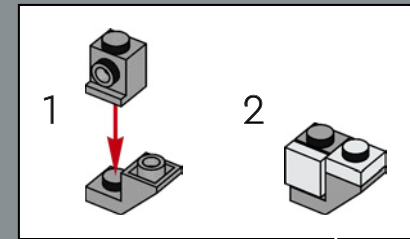

205

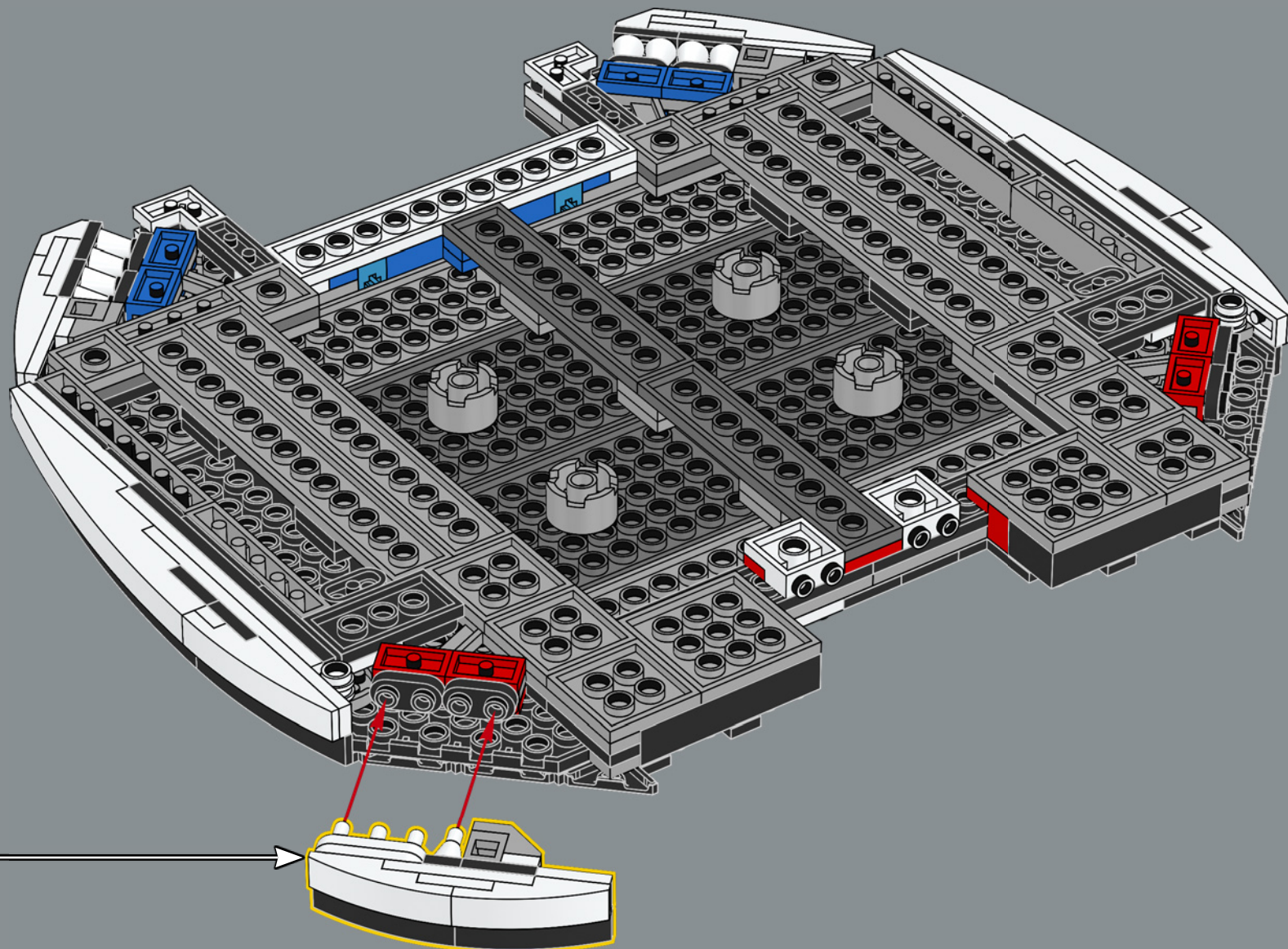

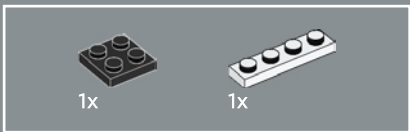

206

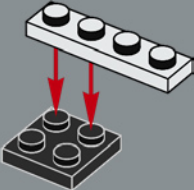

207

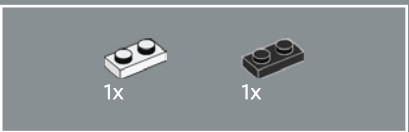
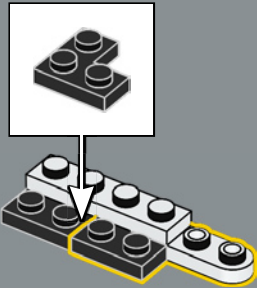

208

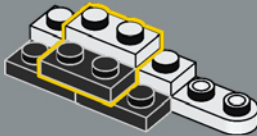

209

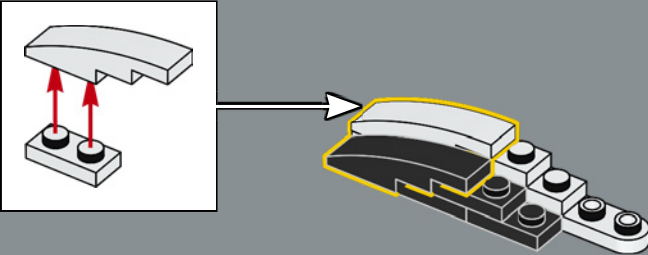

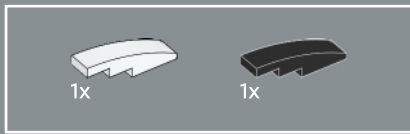

210

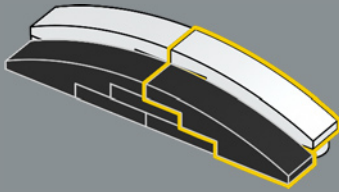

211

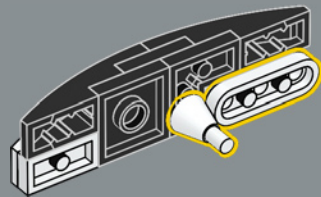

212

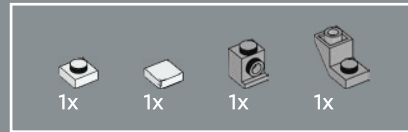
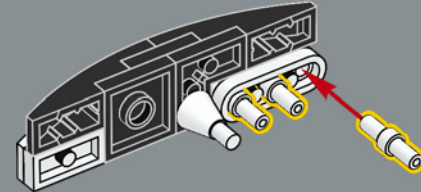

213

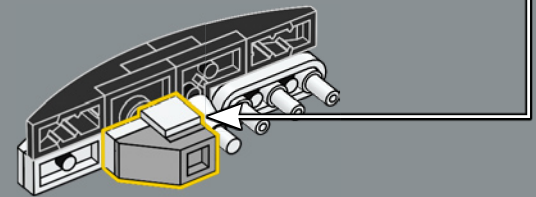
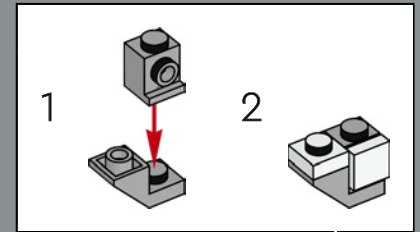

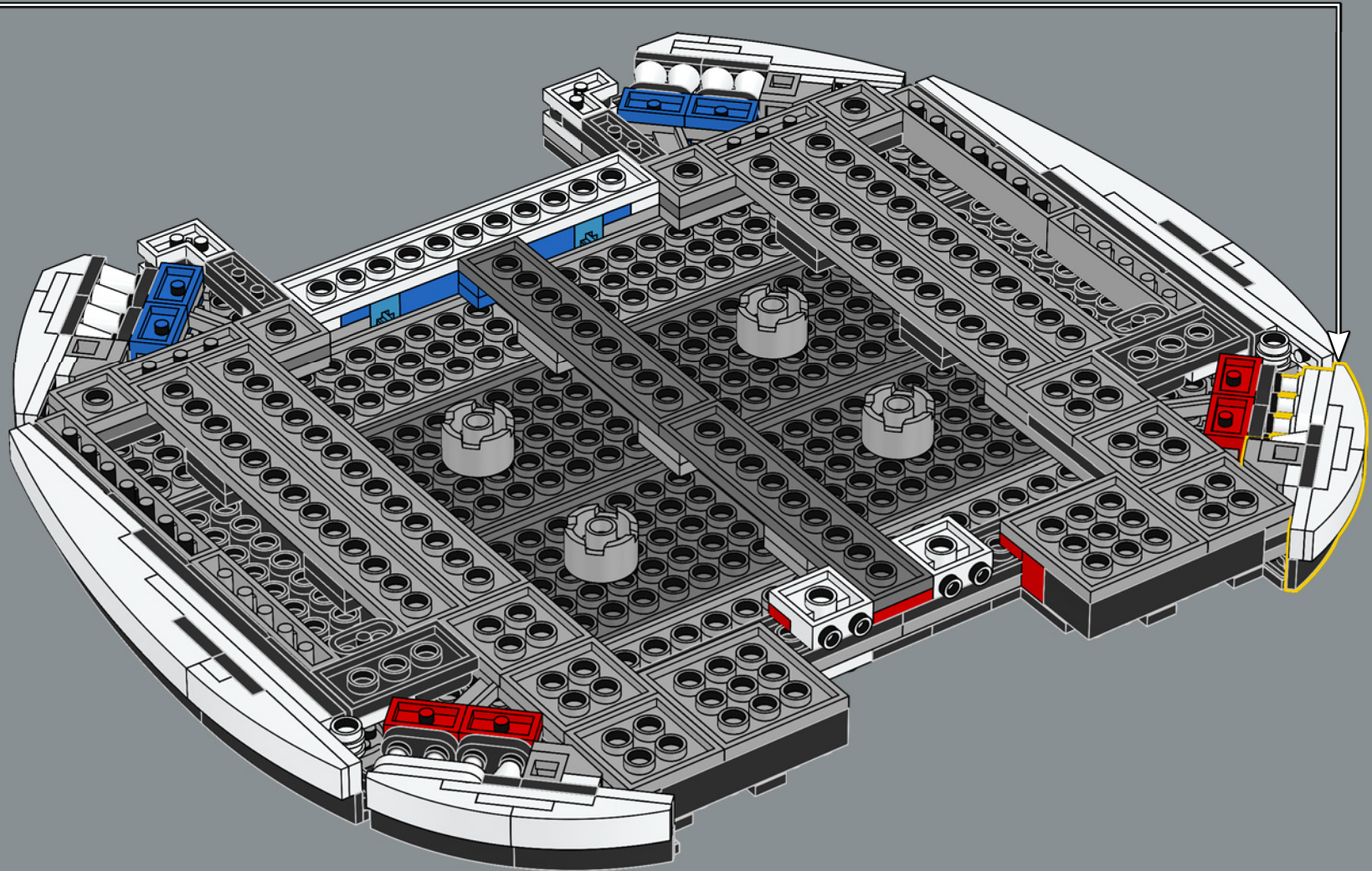

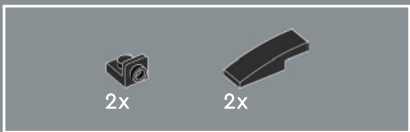

215

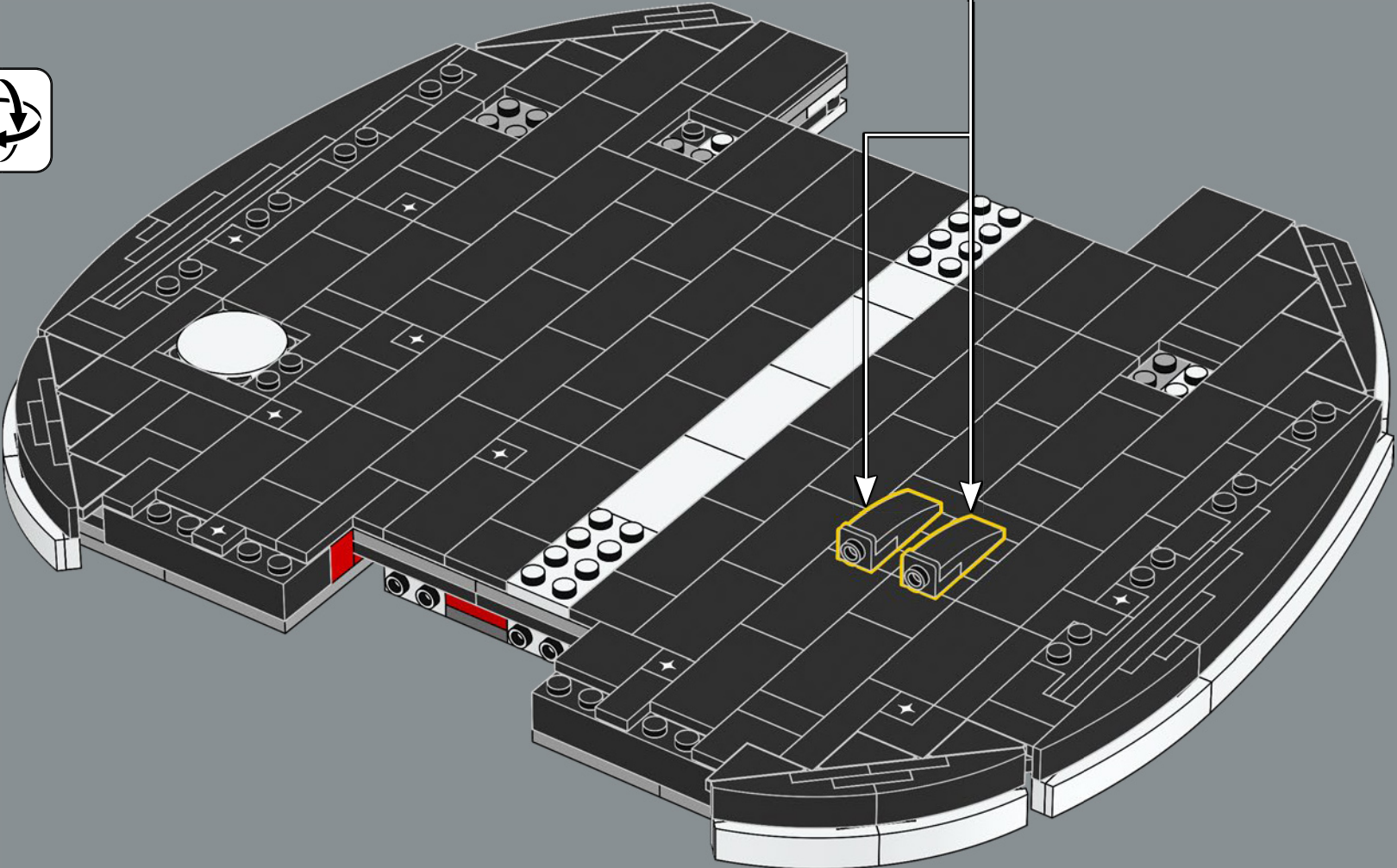
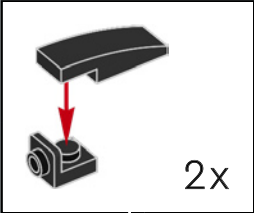

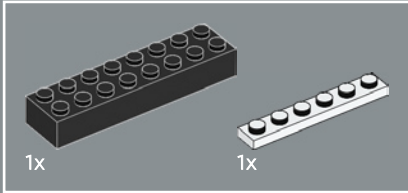
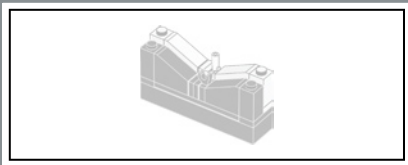

216

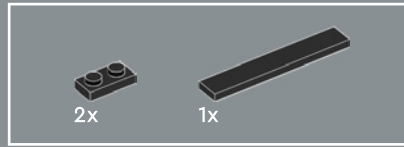
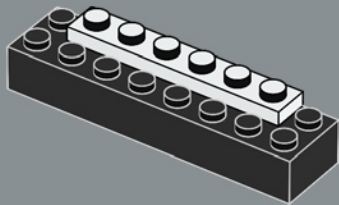

217

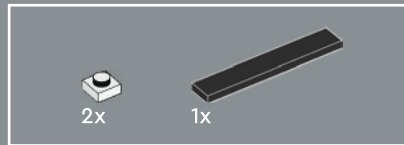
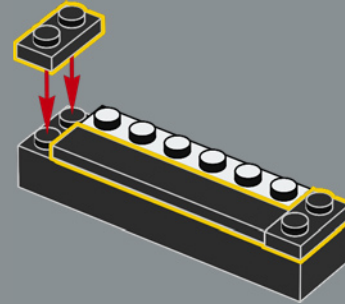

218

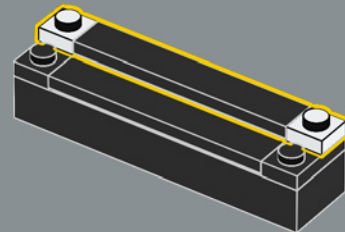



219

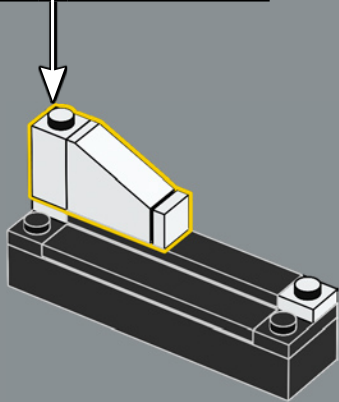
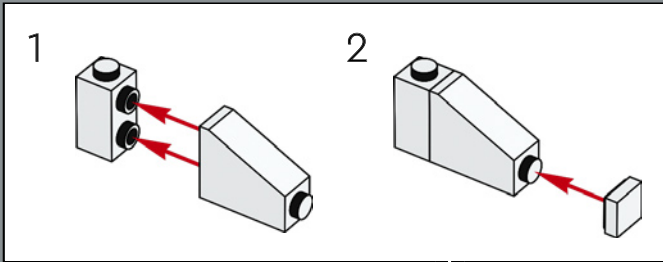

220

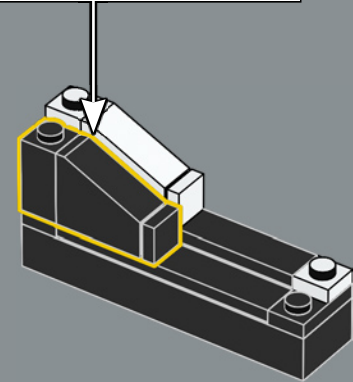
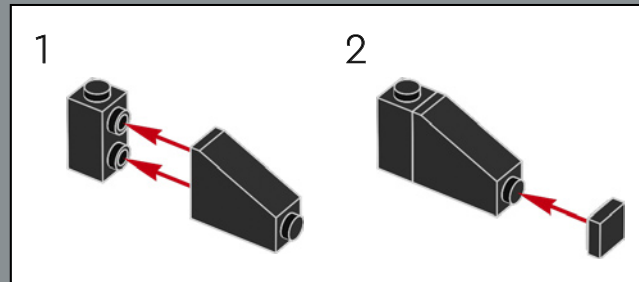

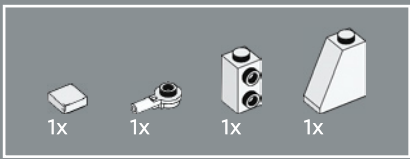

221

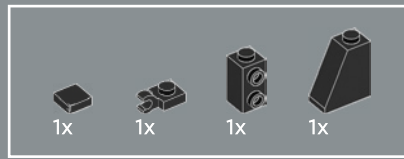
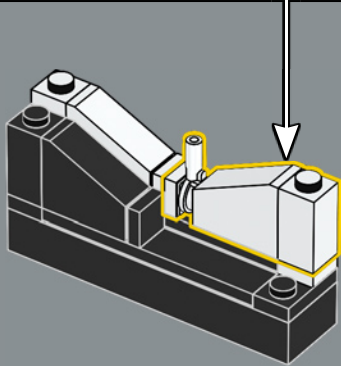
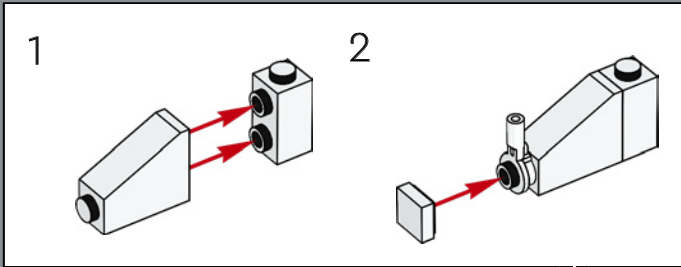

222

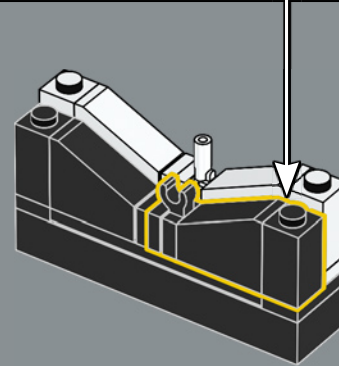
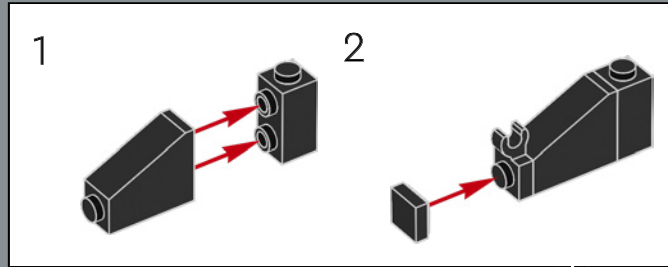

223

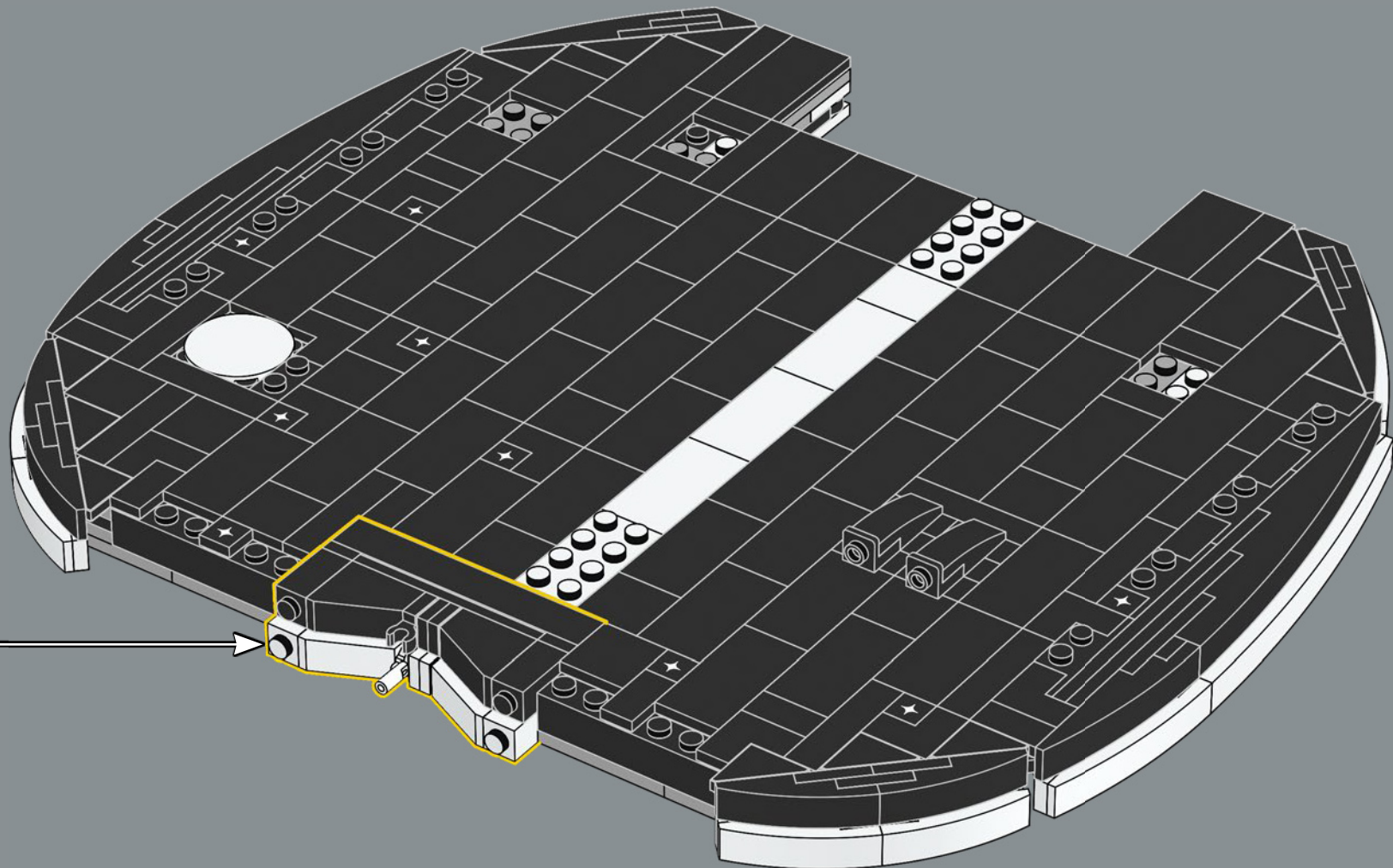

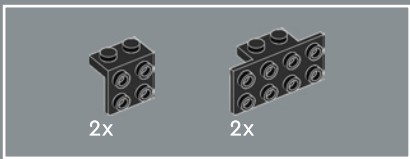

224

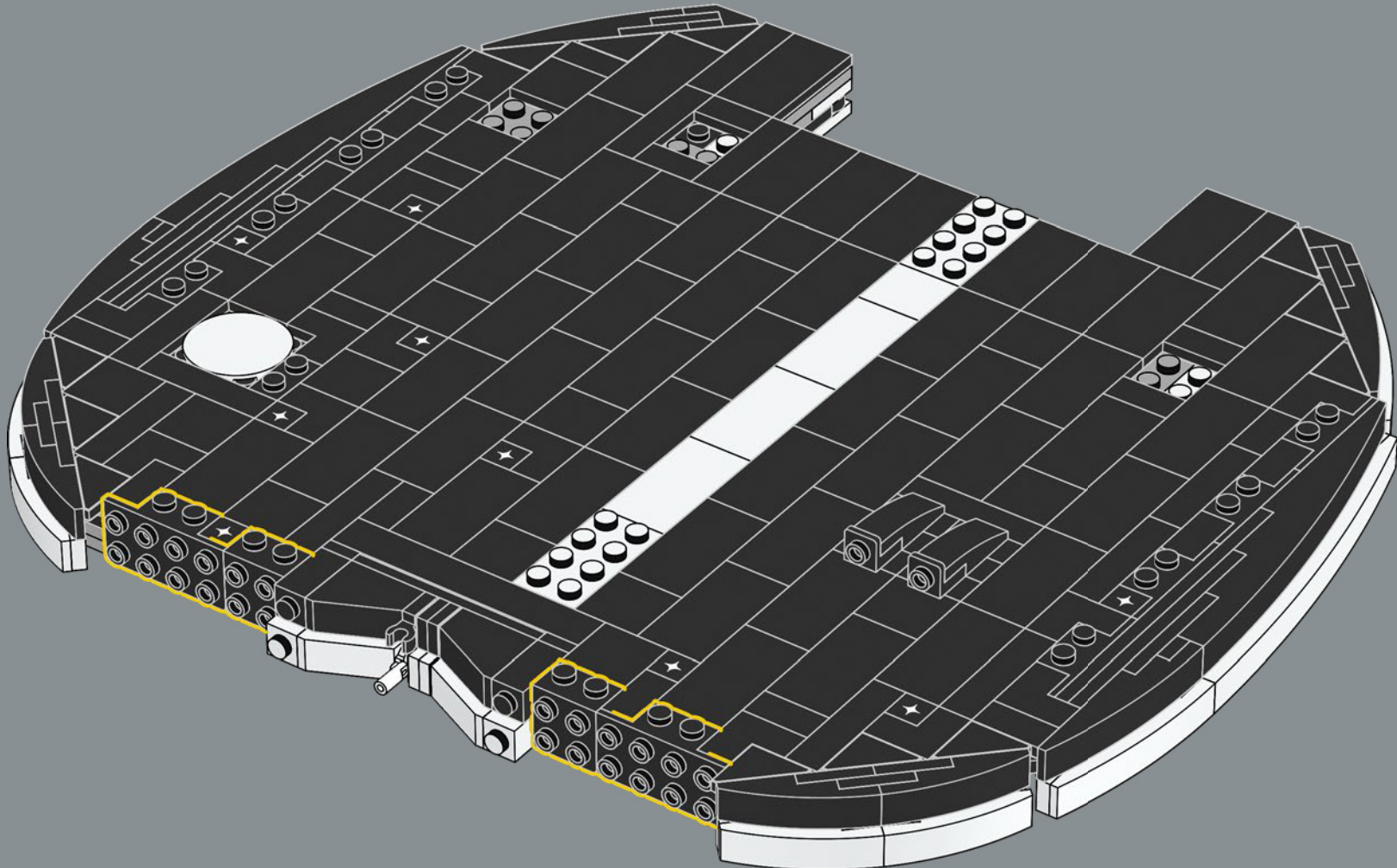

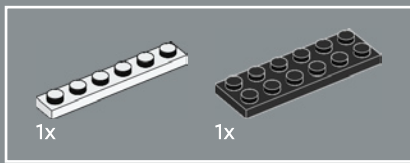

225

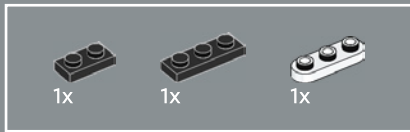
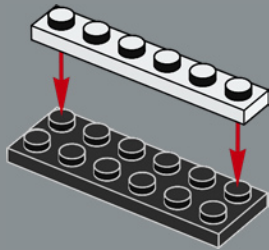

226

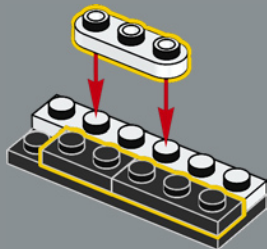

227

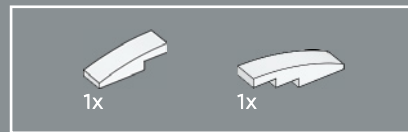
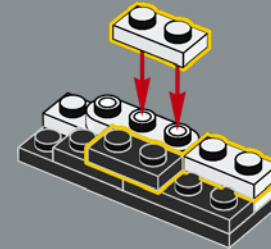

228

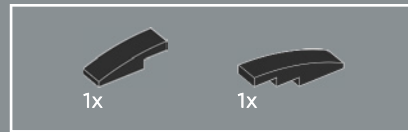
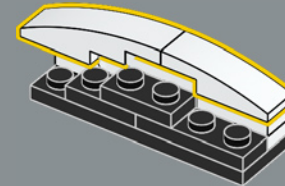

229

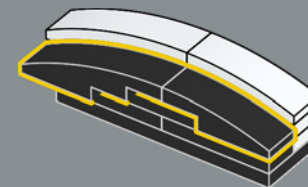

230

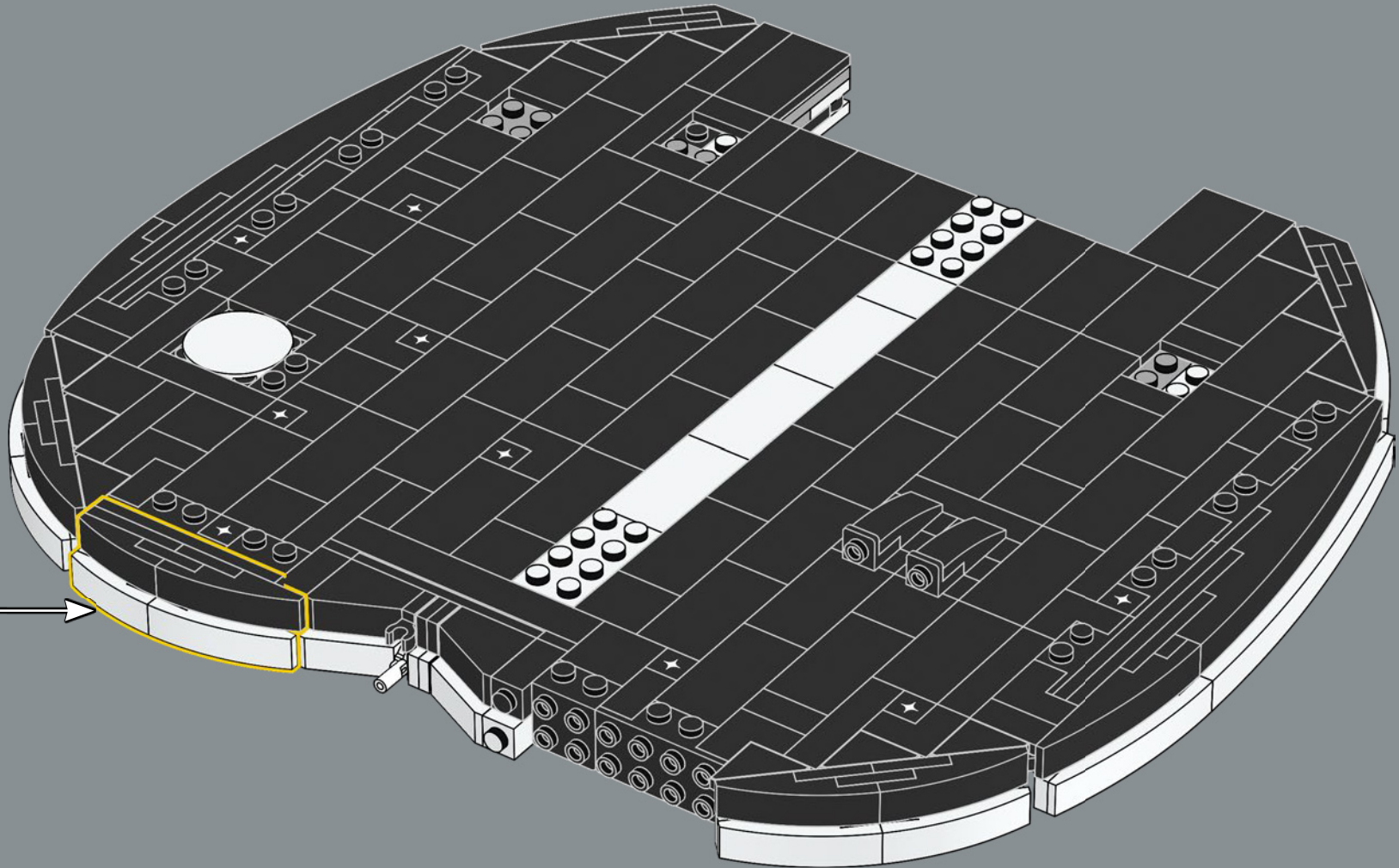

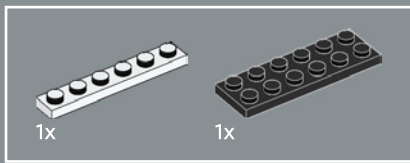

231

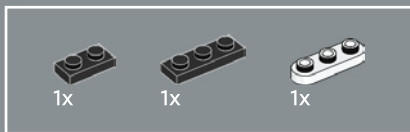
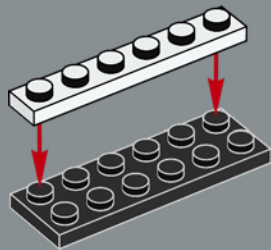

232

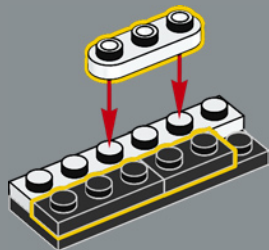

233

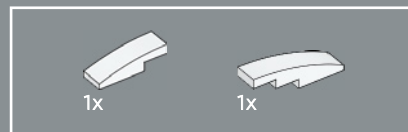
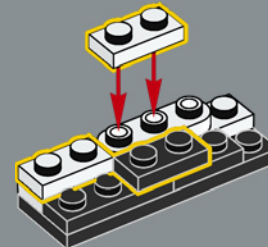

234

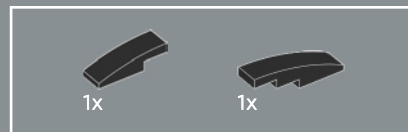
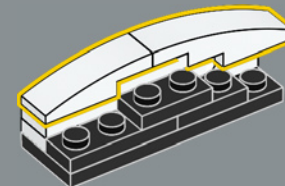

235

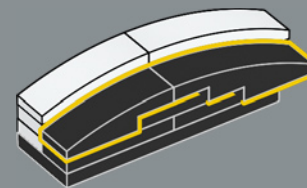

236

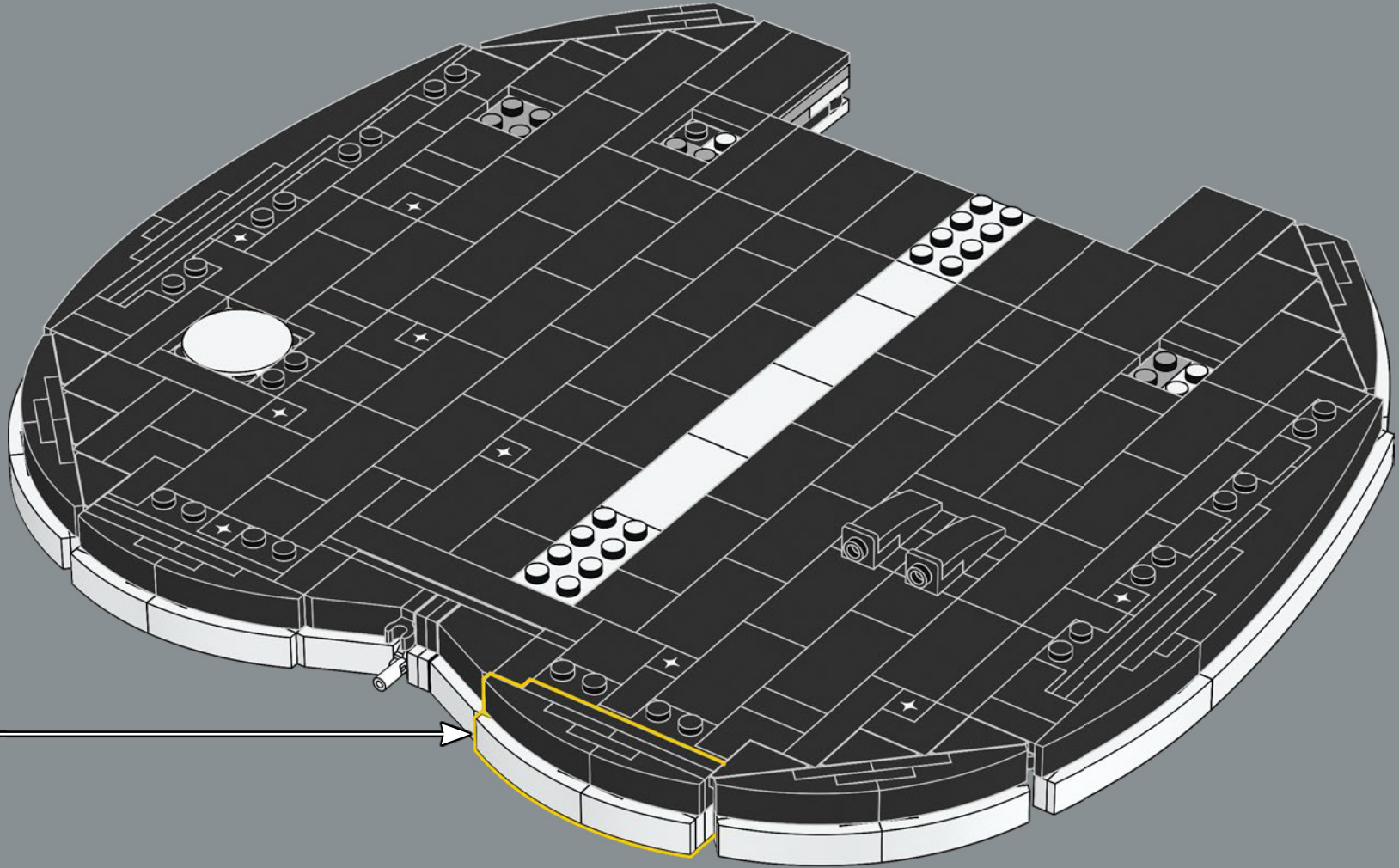



237

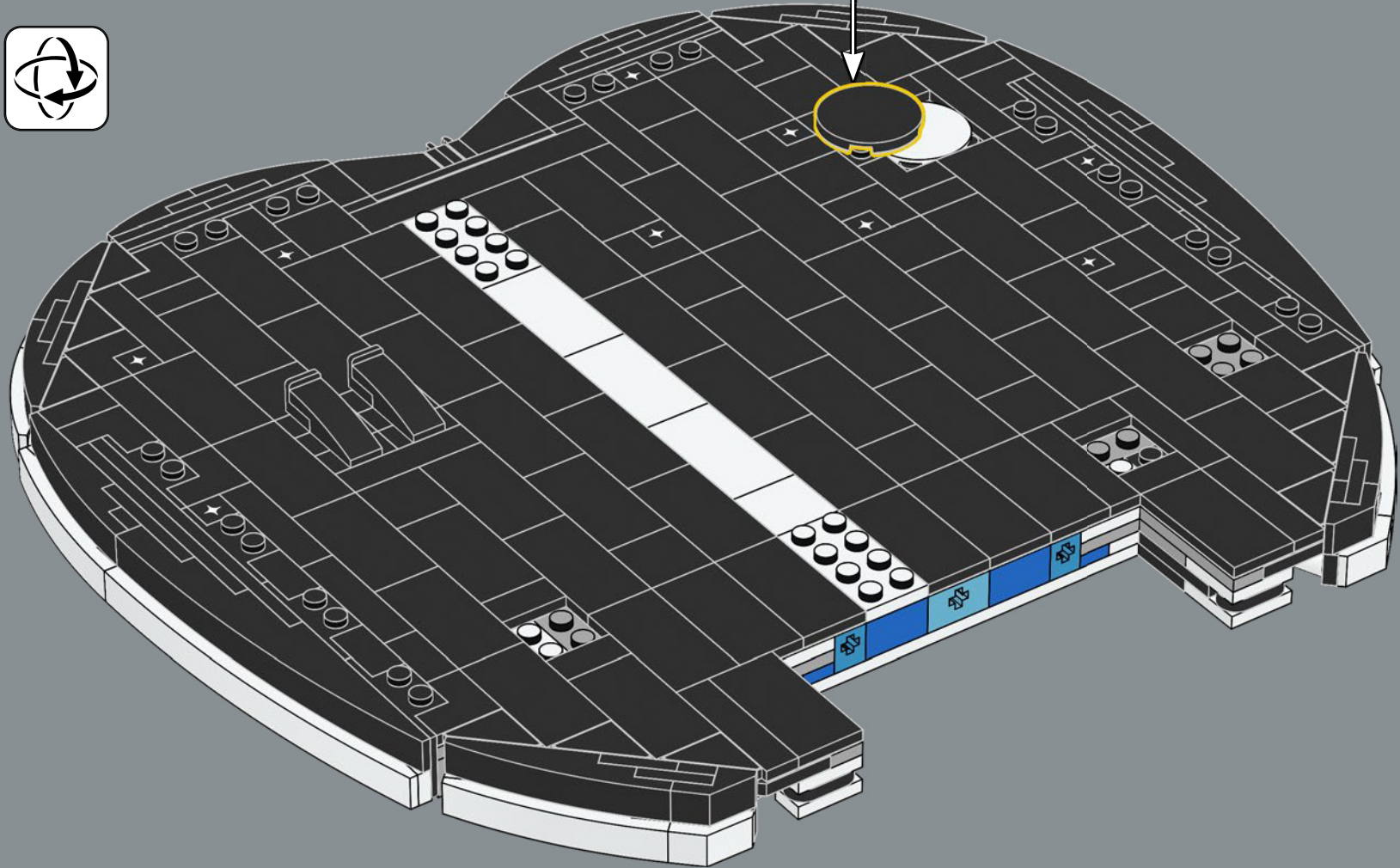

Questa potrebbe essere la mela più grande in assoluto in un set LEGO®! Abbiamo impilato elementi curvi e utilizzato tecniche di costruzione laterale per ricreare la silhouette di questo simbolo di New York City.



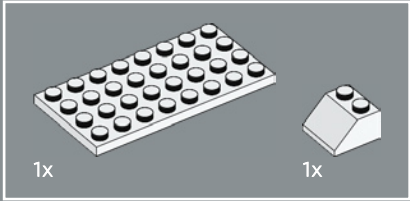
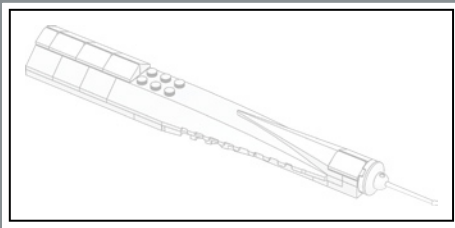

238

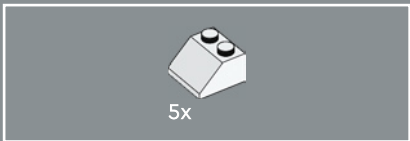
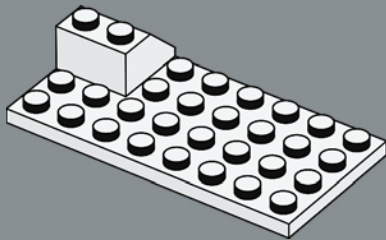

239

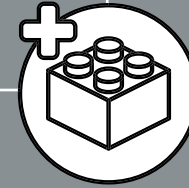
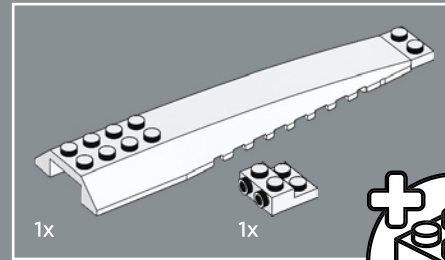
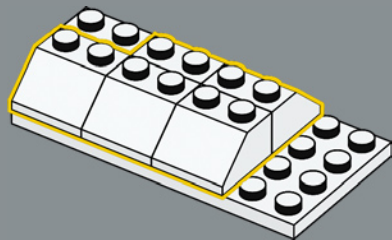

240

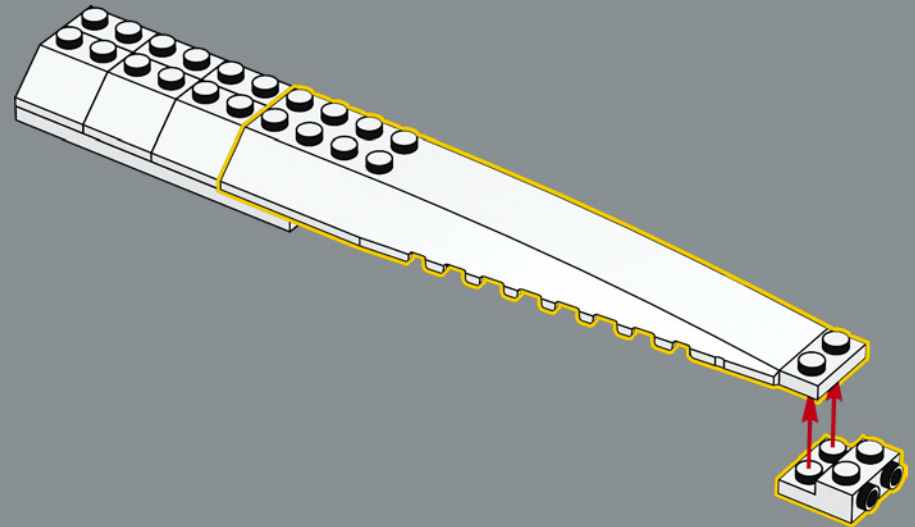

L'altezza del One World Trade Center è di 541,3 m (1.776 piedi) – un riferimento alla firma della Dichiarazione d'Indipendenza degli Stati Uniti.

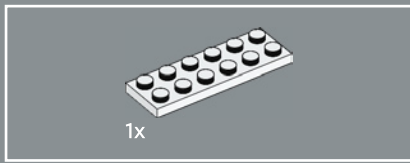

241

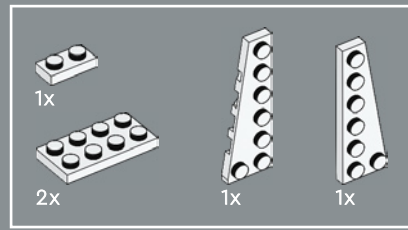
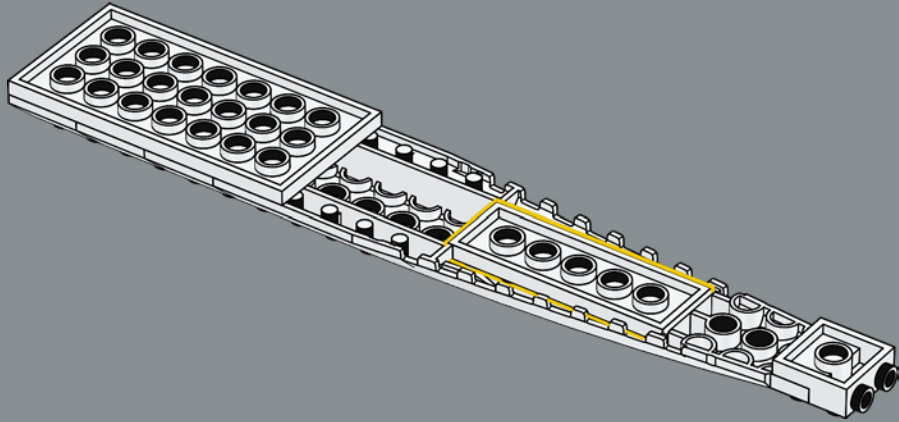

242

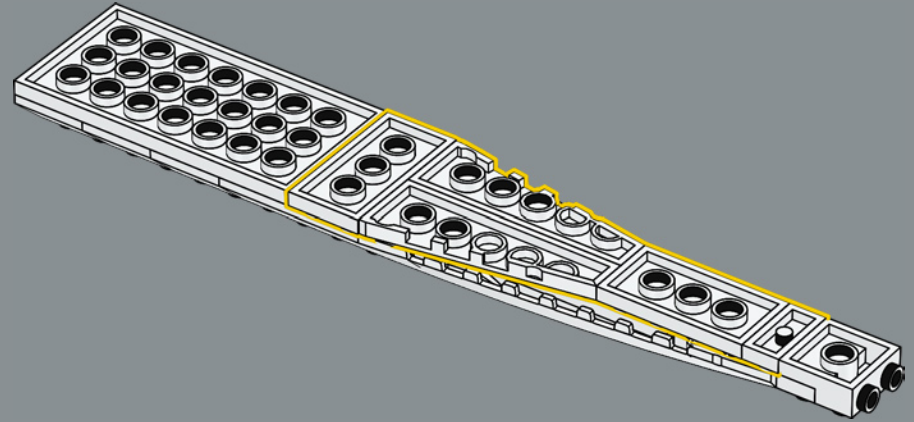



243

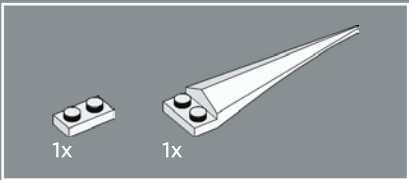
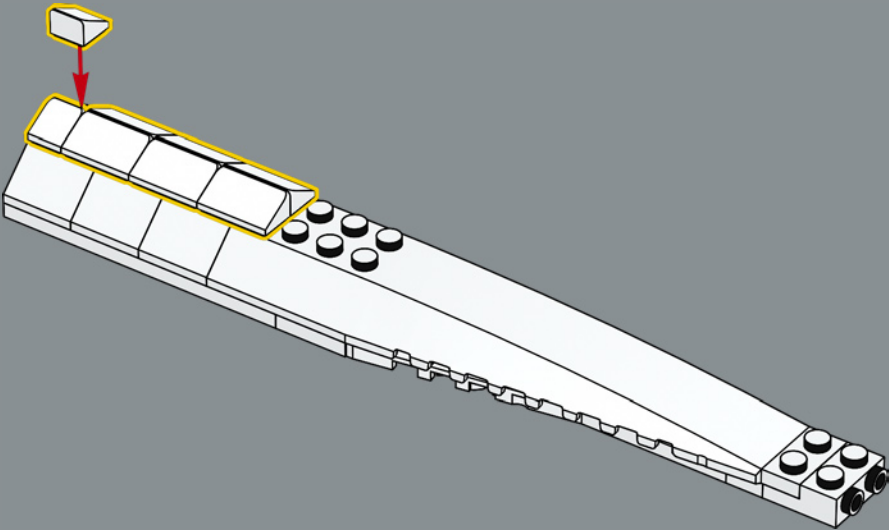

244

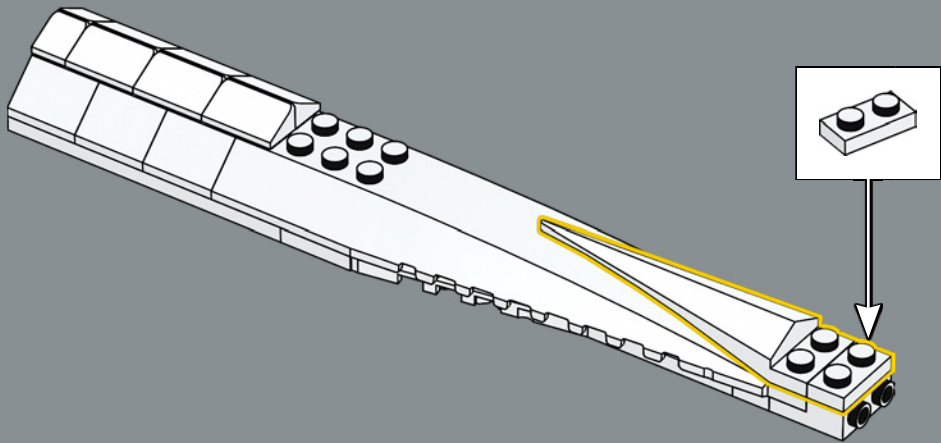



245

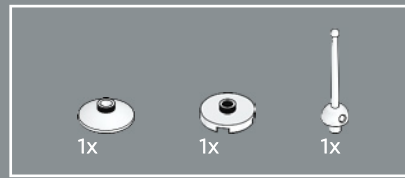
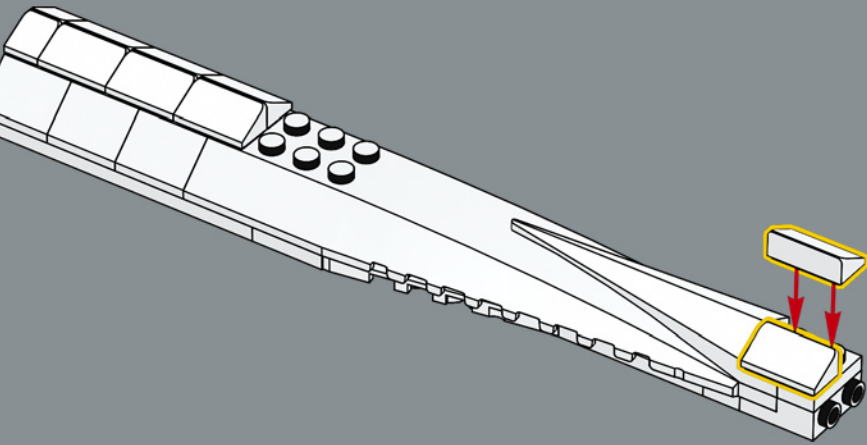

246

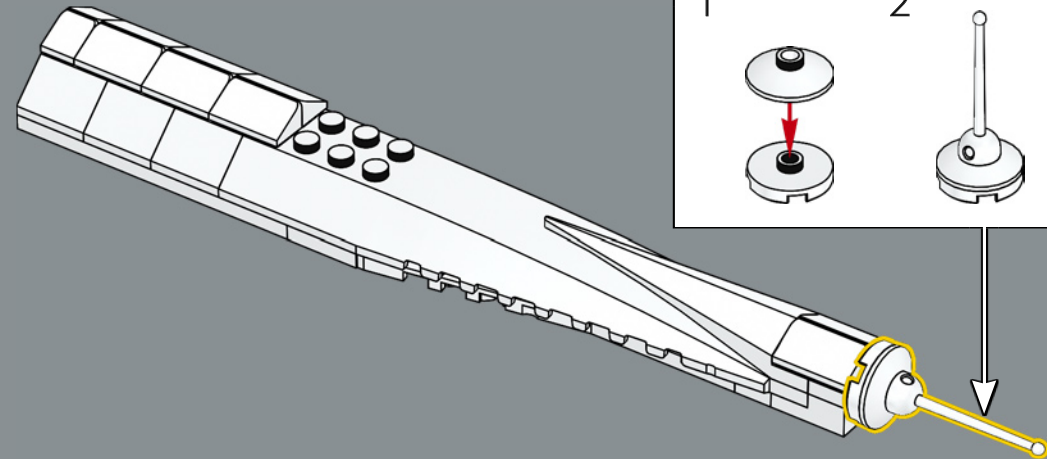

Un elemento spada da schermo LEGO® costituisce l'antenna dell'edificio più alto di New York, il One World Trade Center. Nella vita reale, l'antenna da sola è alta 124,3 m.

247

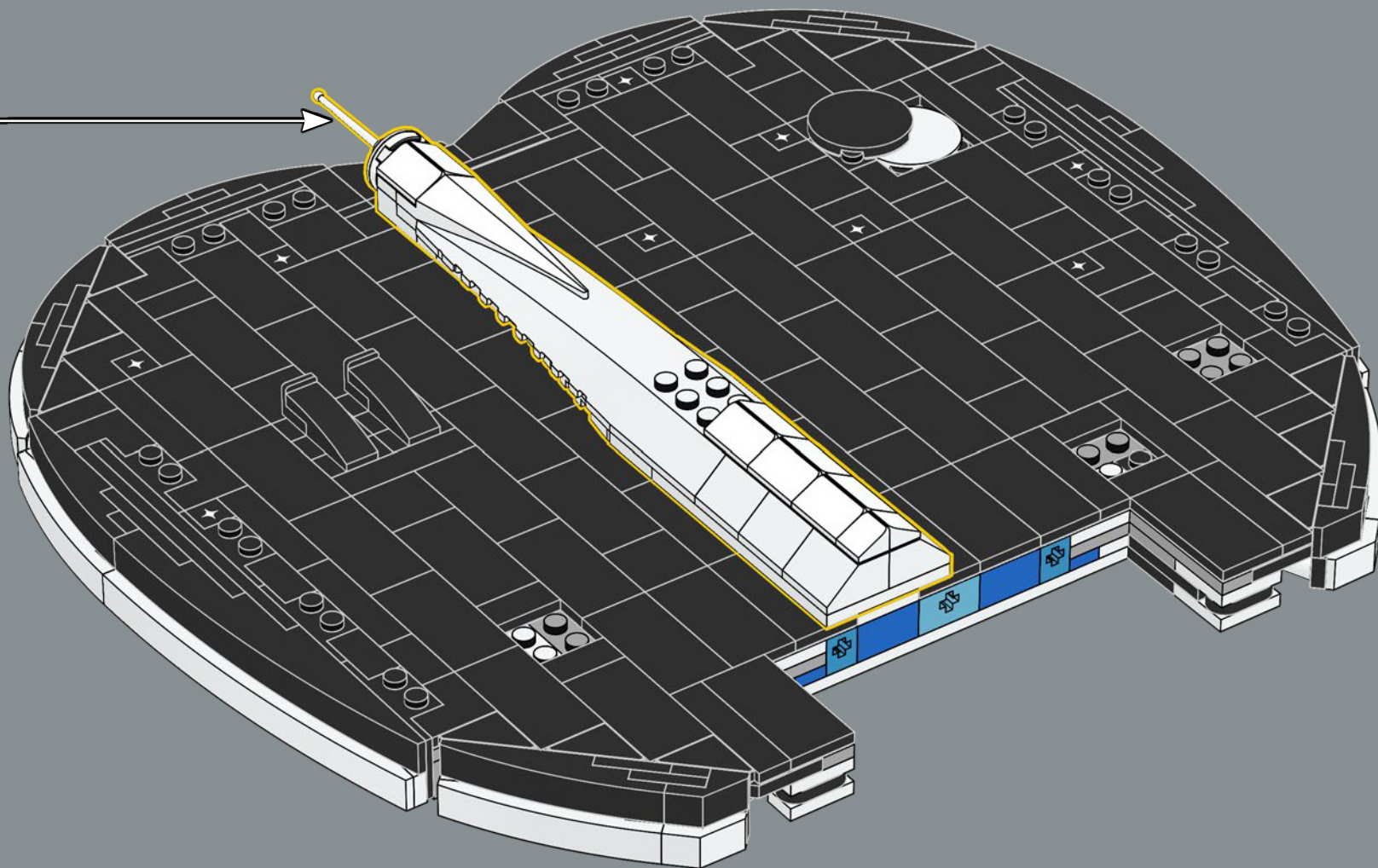



248

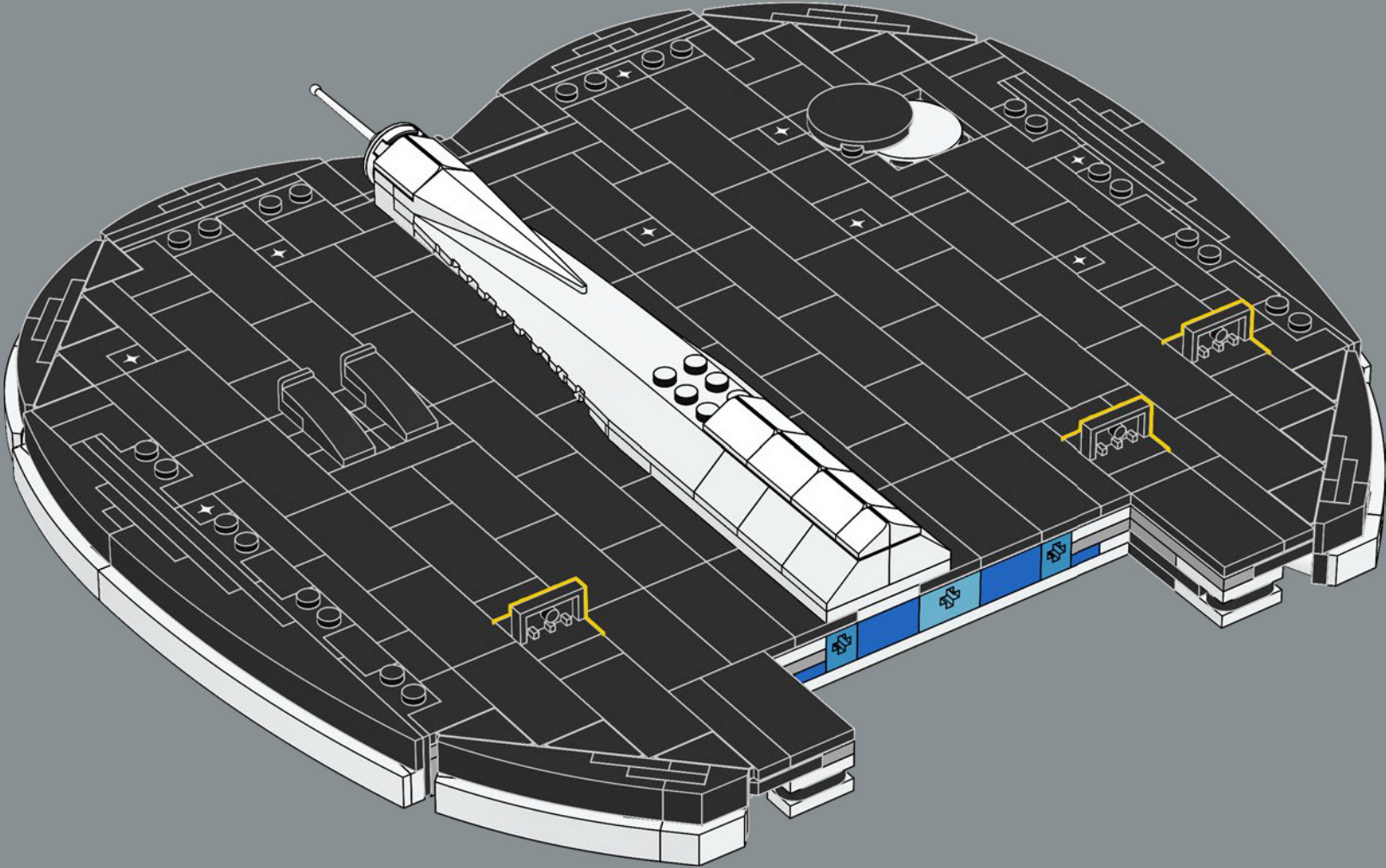

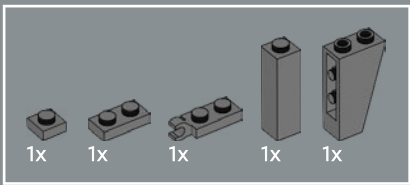

249

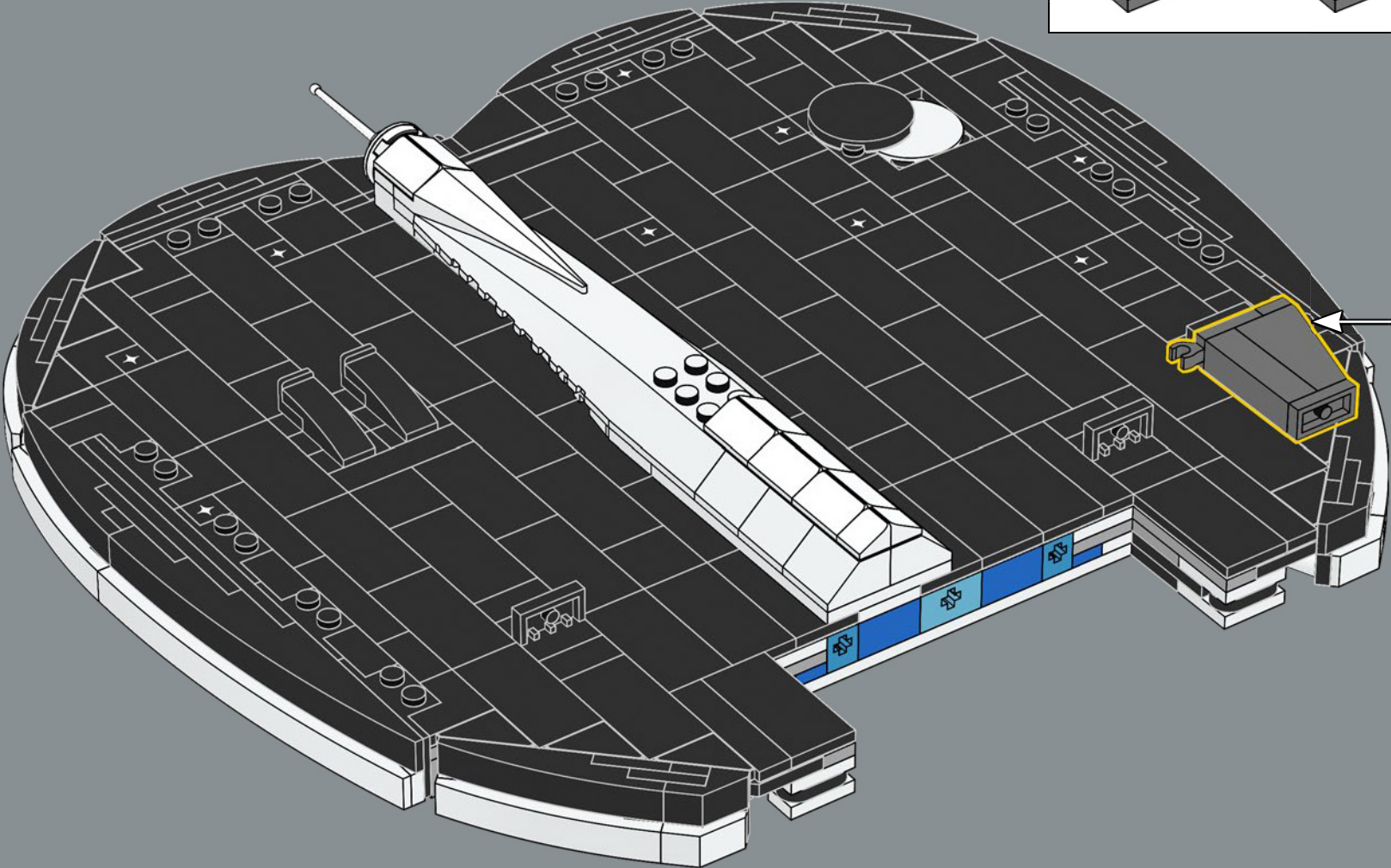
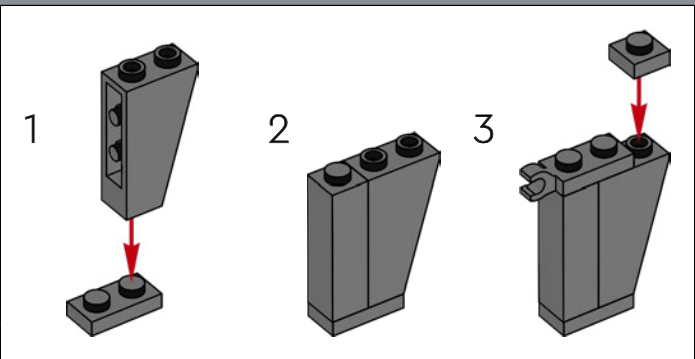

250

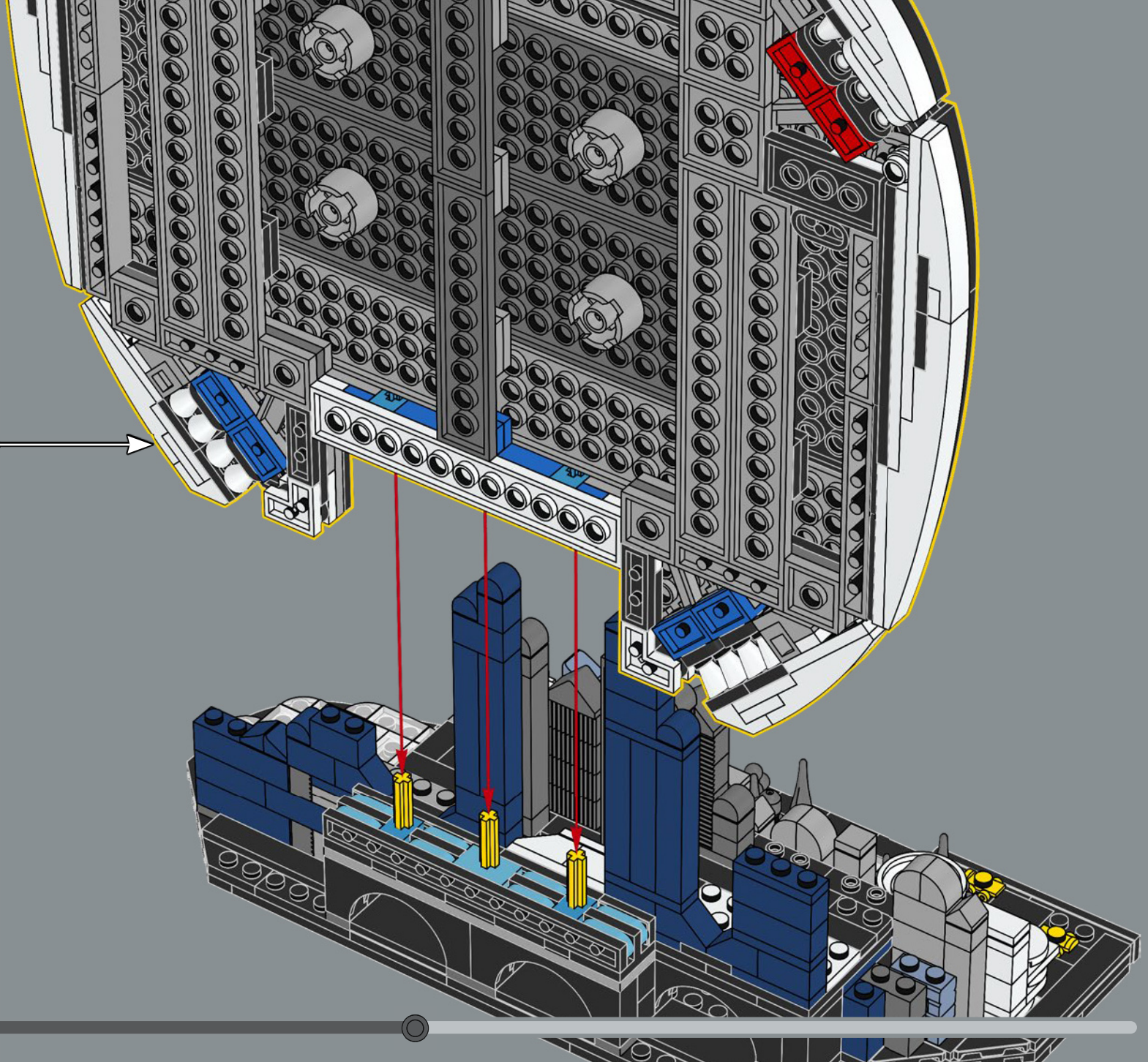

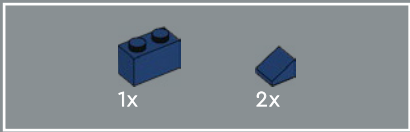

251

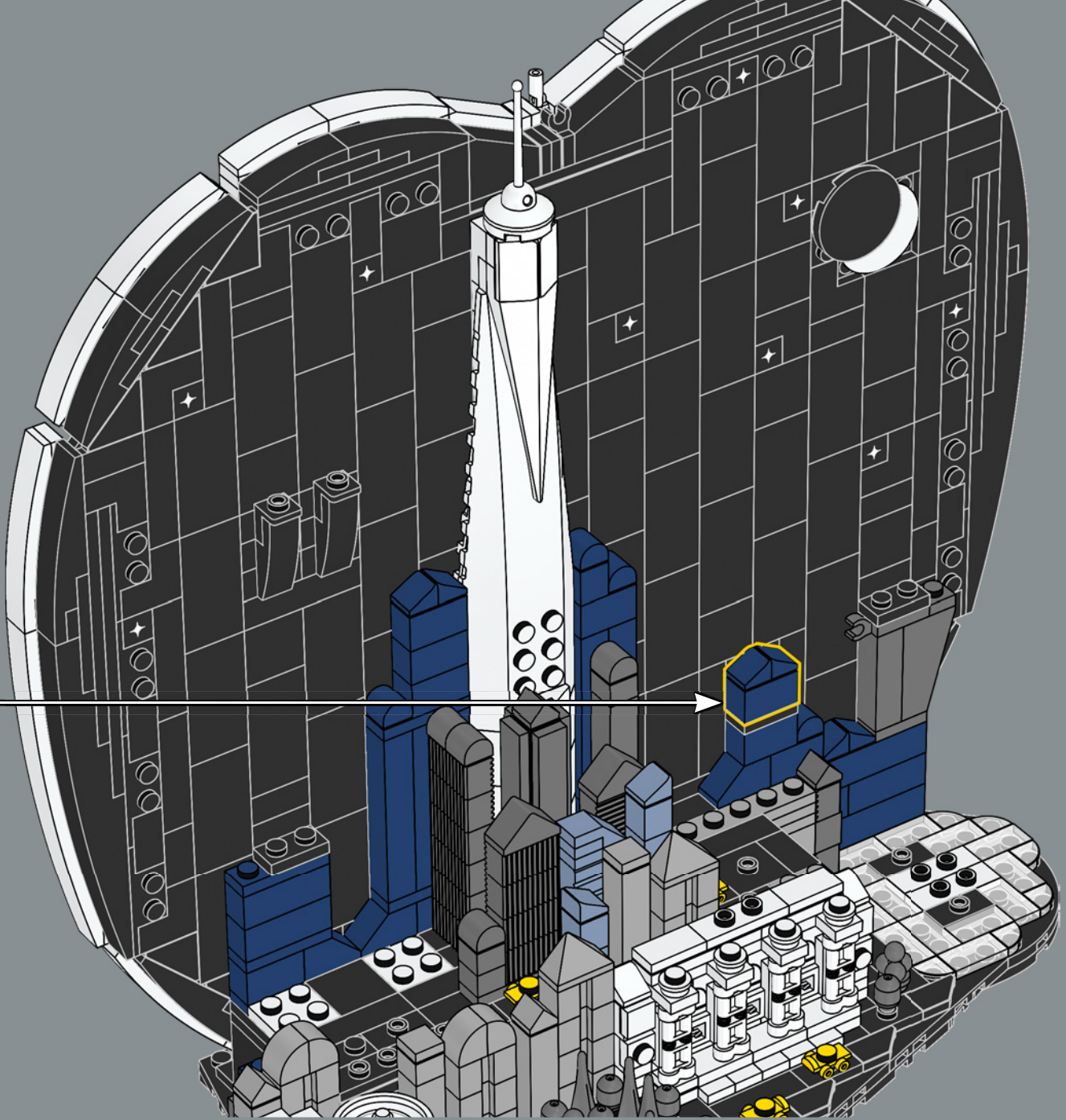
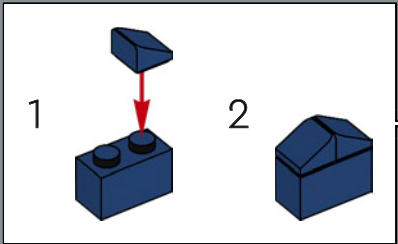

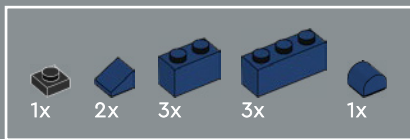

252

1

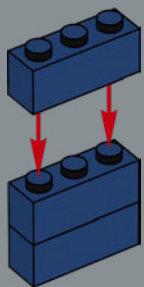

2

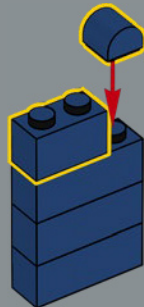

3

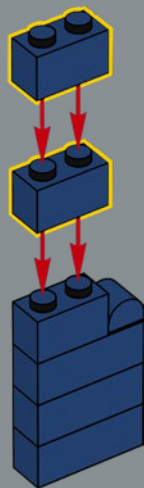

4

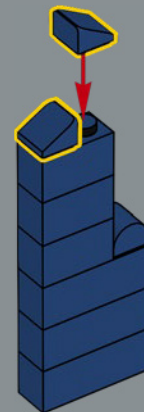

5



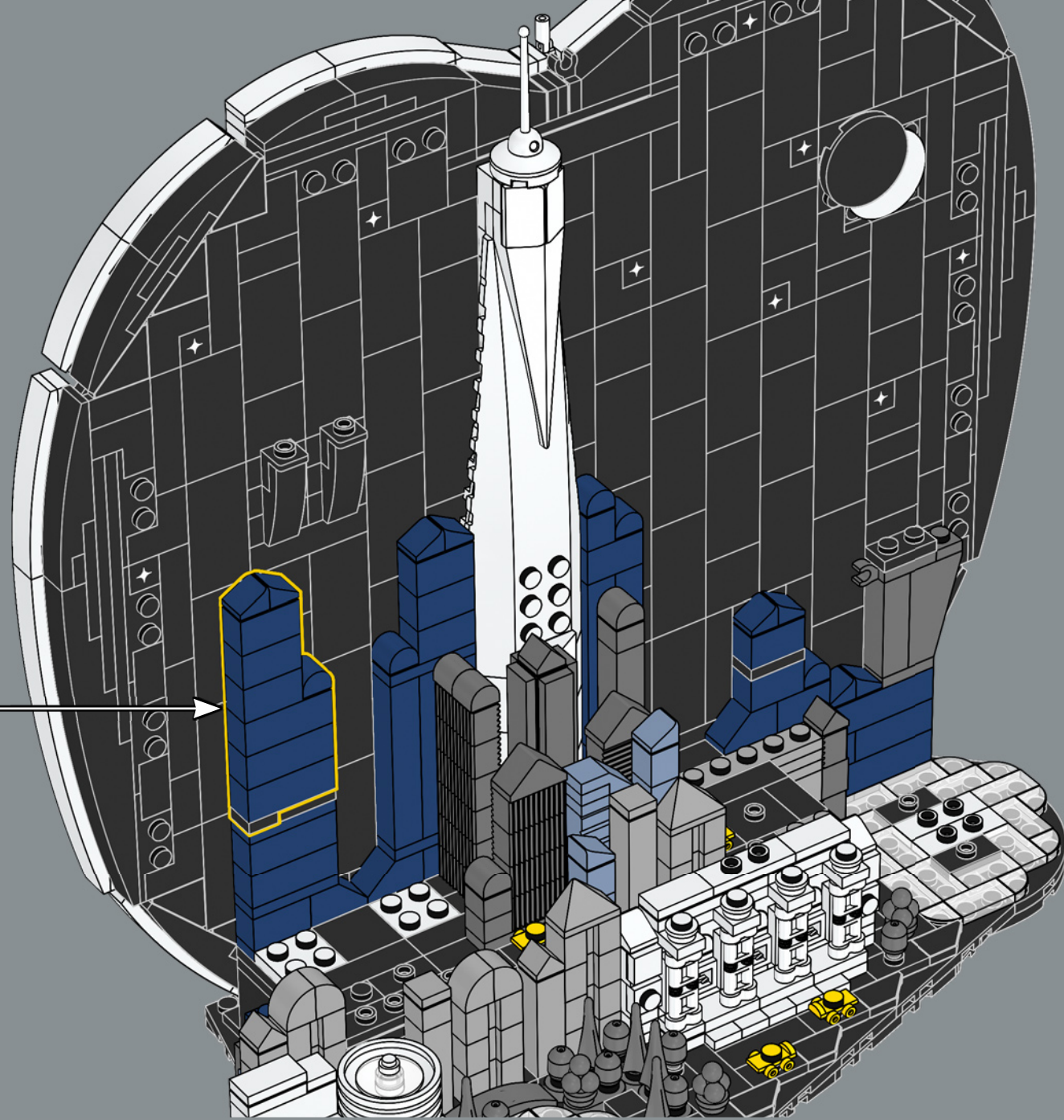

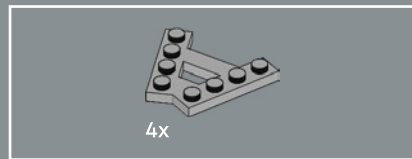

253

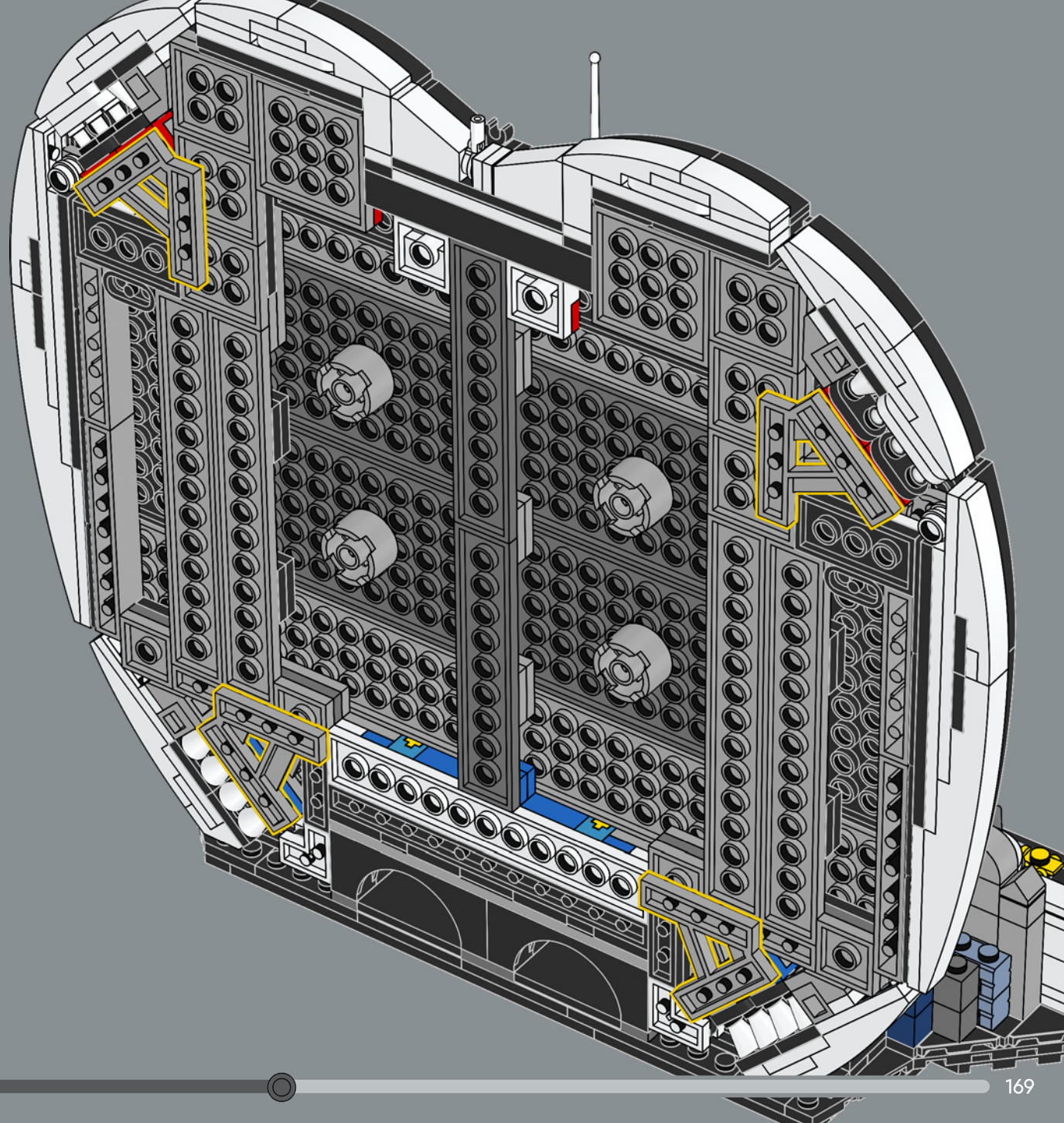

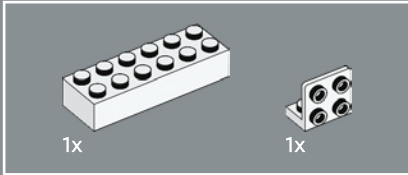
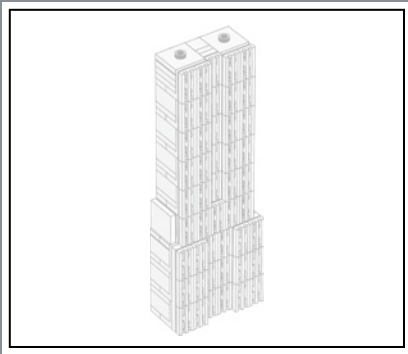

254

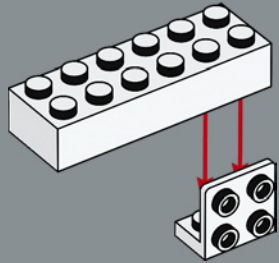

Inaugurato nel 1931, l'Empire State Building rimane un'icona dell'Art Déco. Primo edificio al mondo con struttura in acciaio a superare i 100 piani, ha dominato la skyline di New York come l'edificio più alto del mondo per quasi 40 anni.

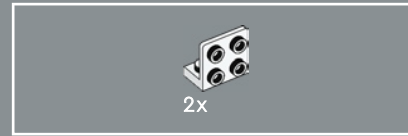

255

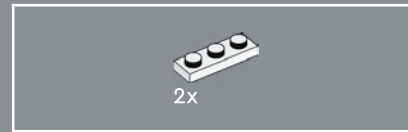
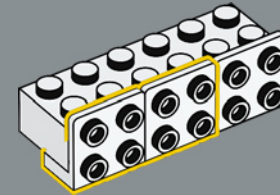

256

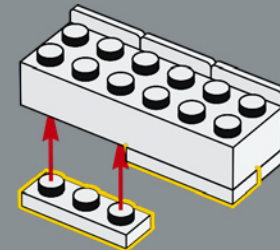

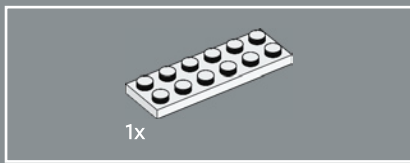

257

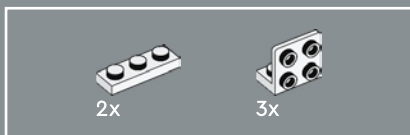
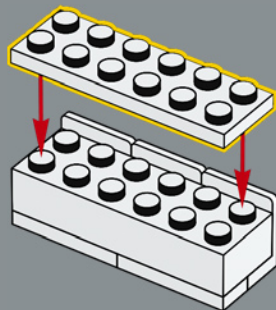

258

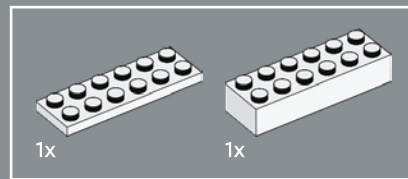
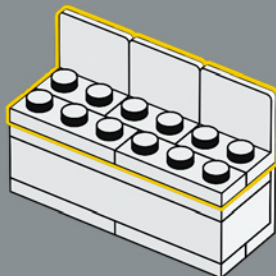

259

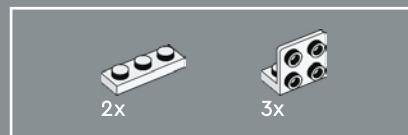
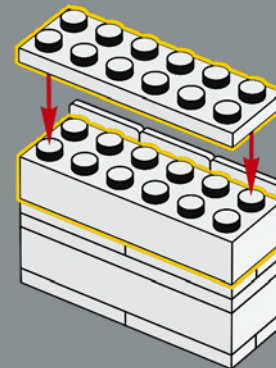

260

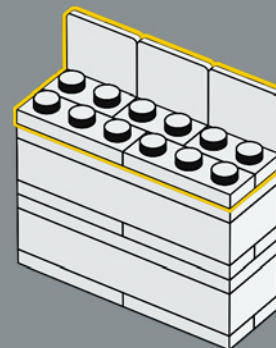

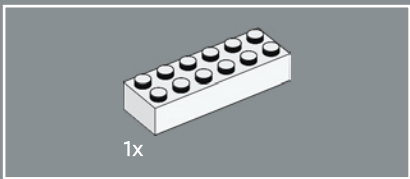

261

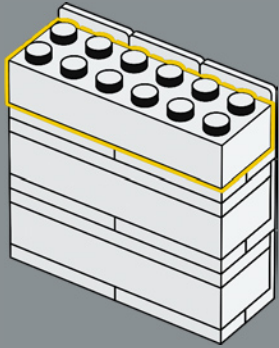

262

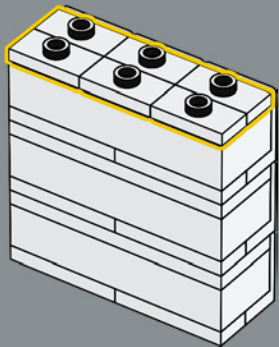

263

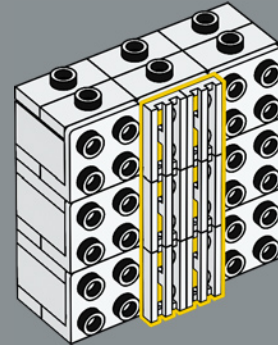

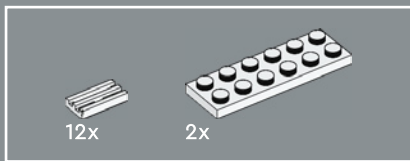

264

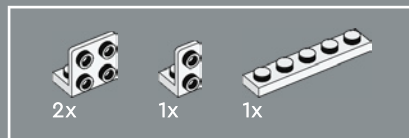
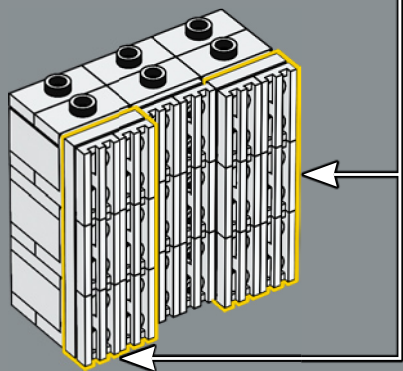
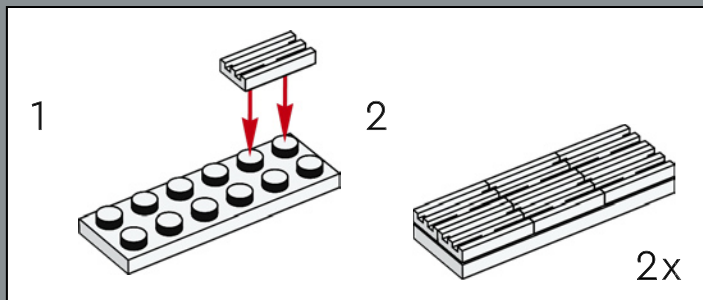

265

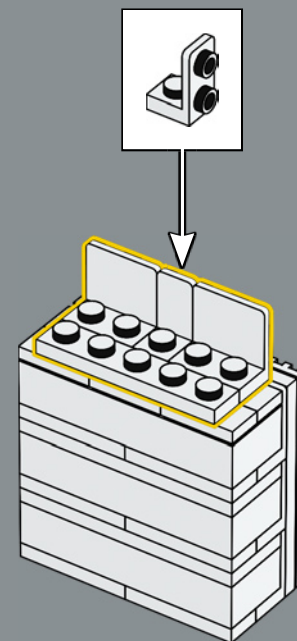

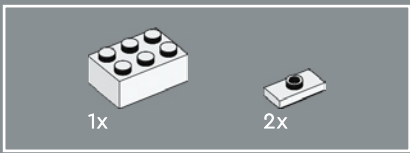

266

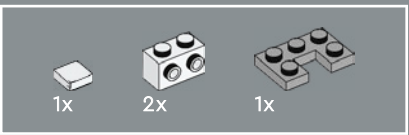
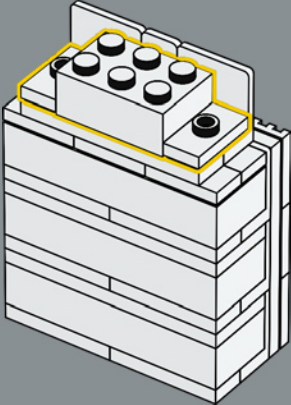

267

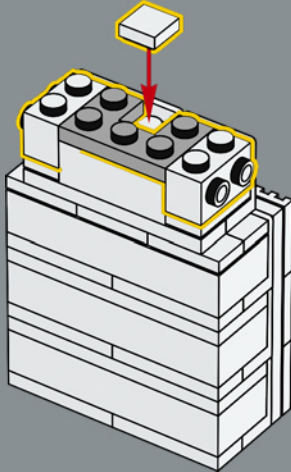

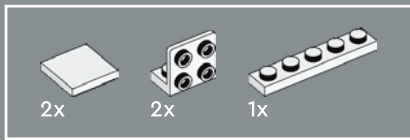

268

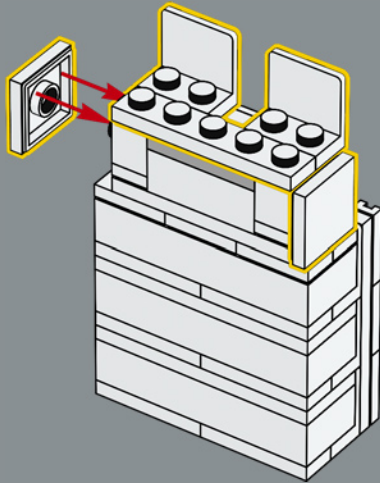

269

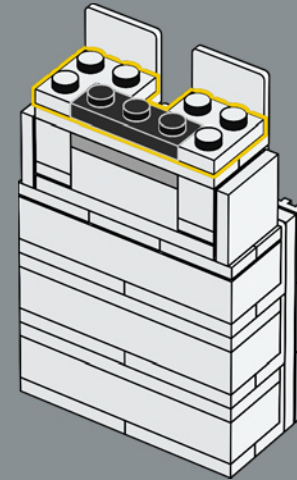

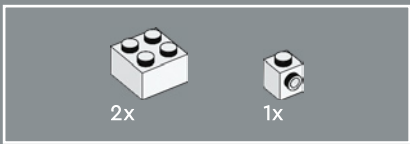

270

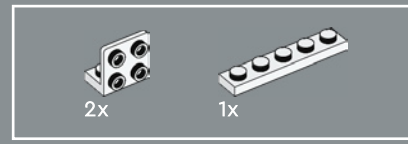
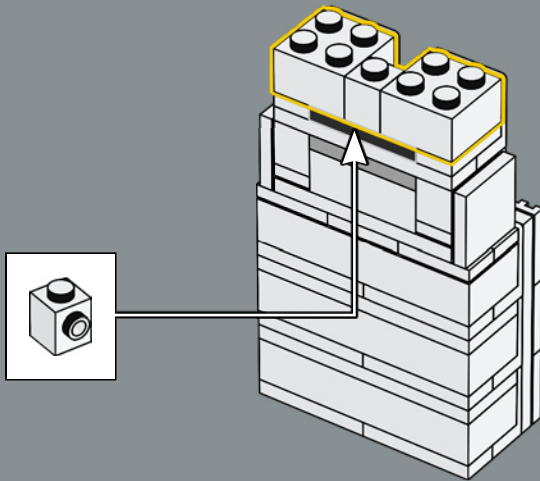

271

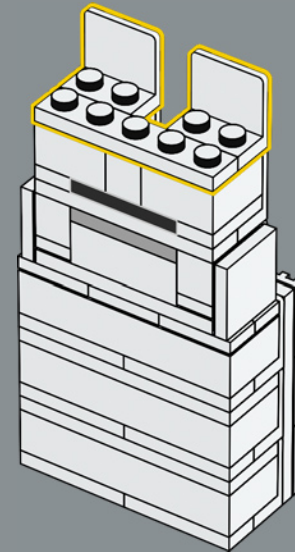

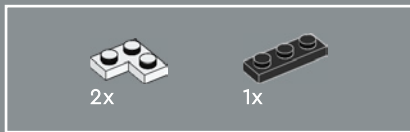

272

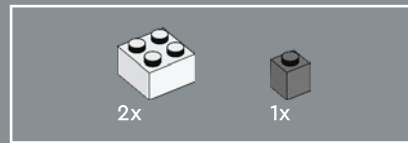
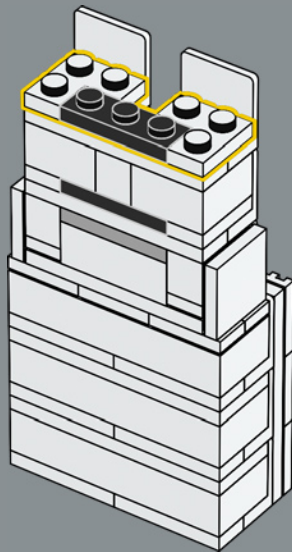

273

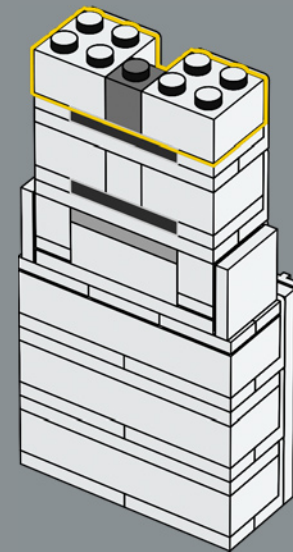

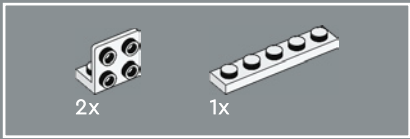

274

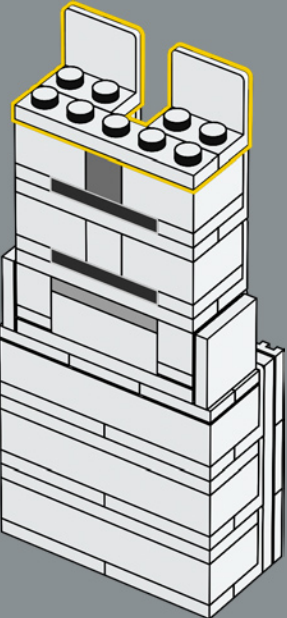

275

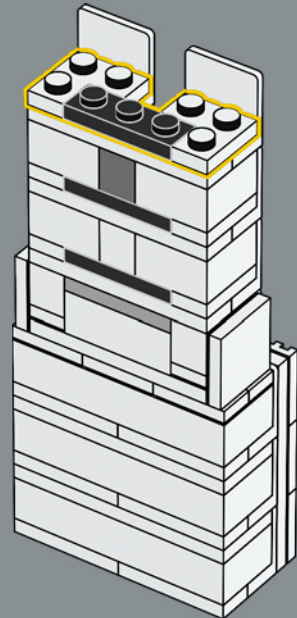

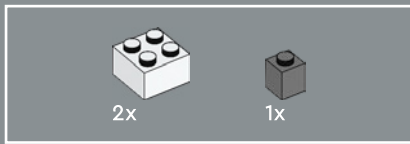

276

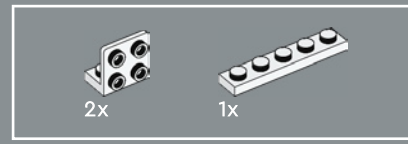
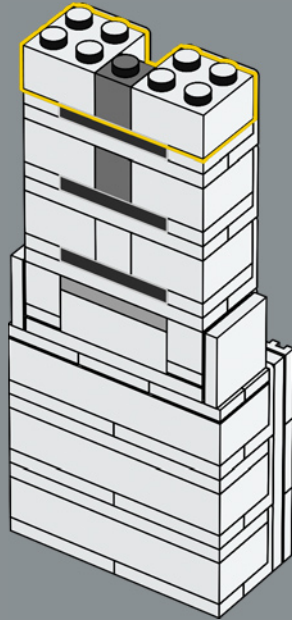

277

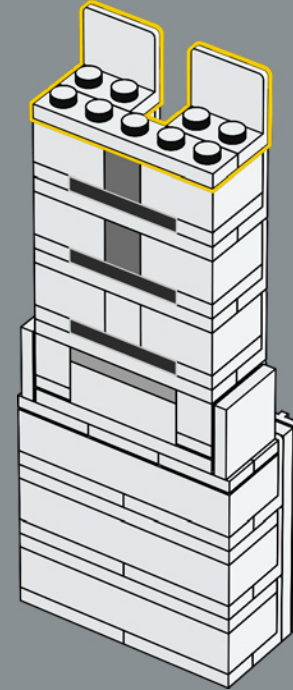



278

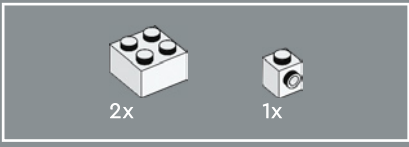
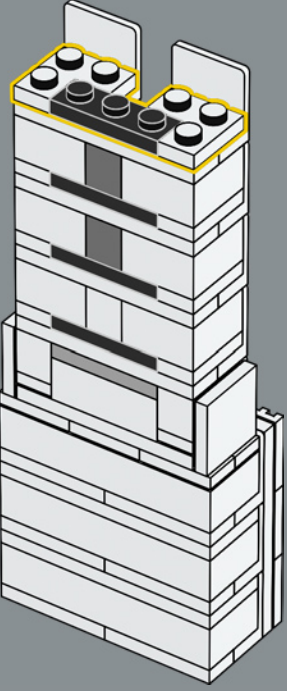

279

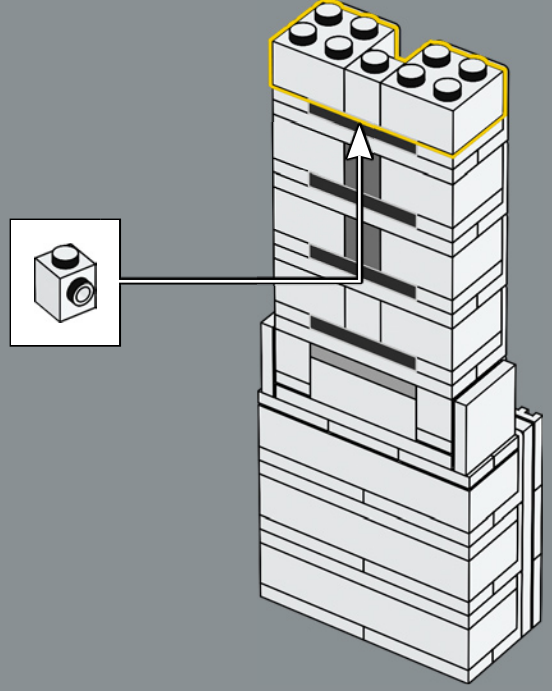

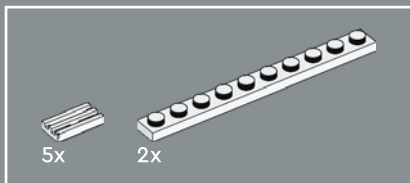

280

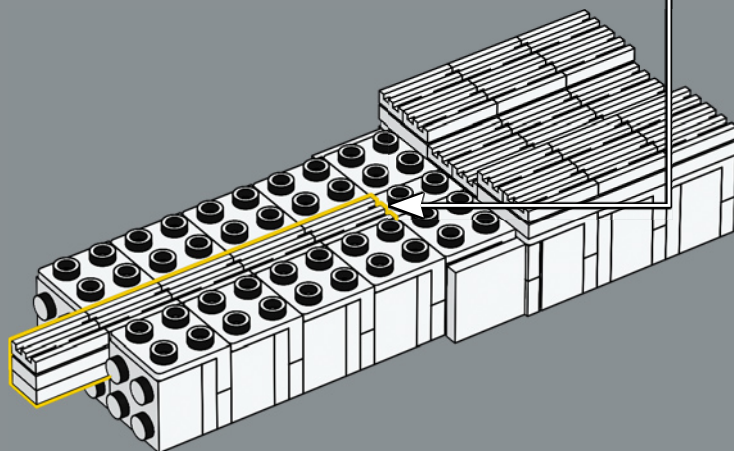
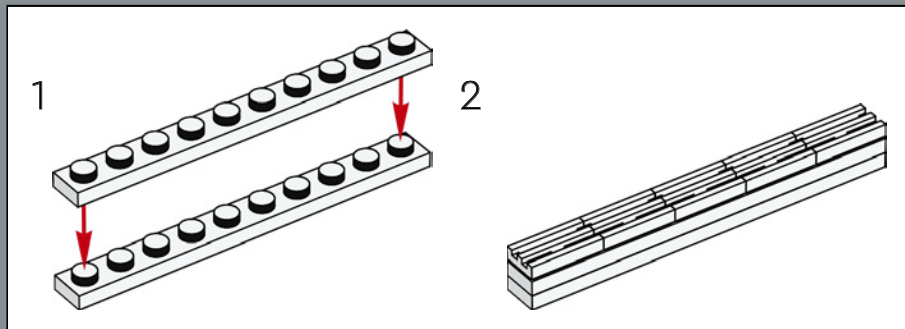

281

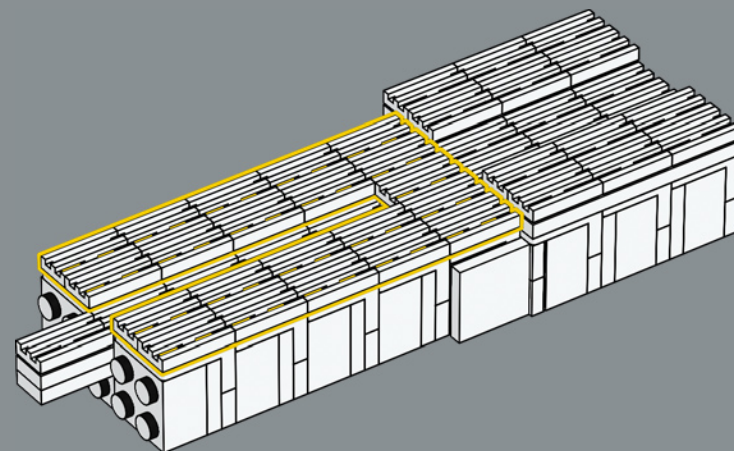

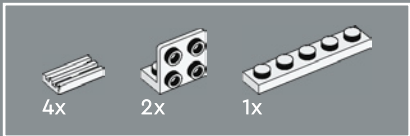

282

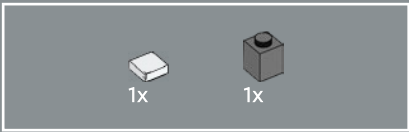
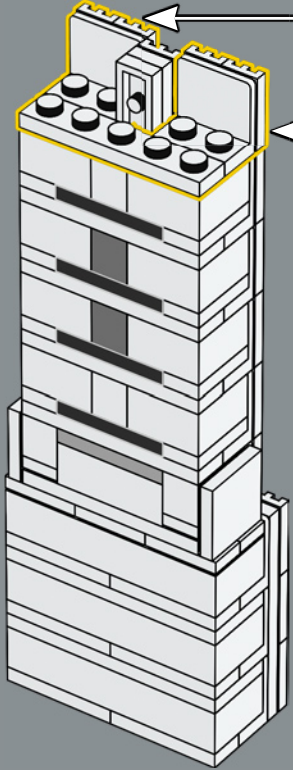
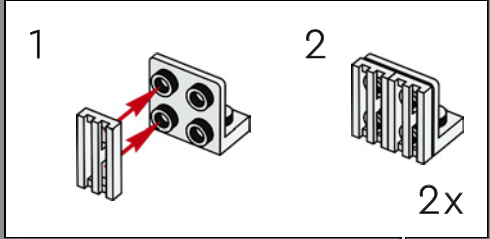

283

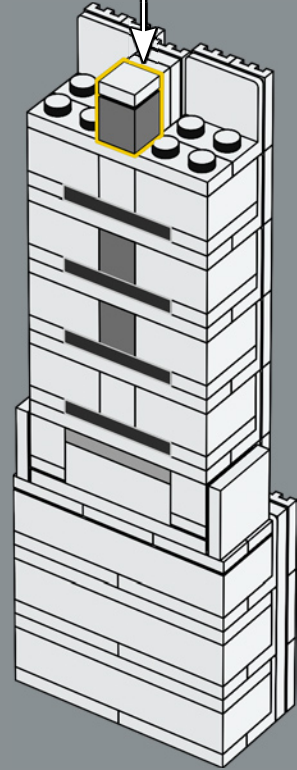
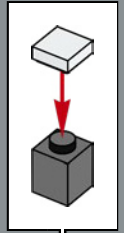

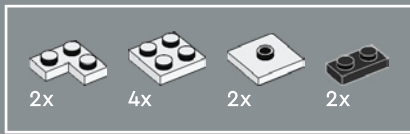

284

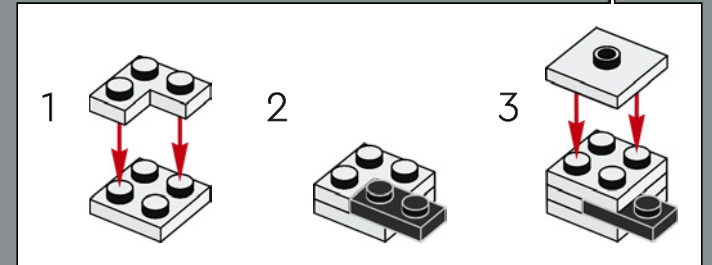
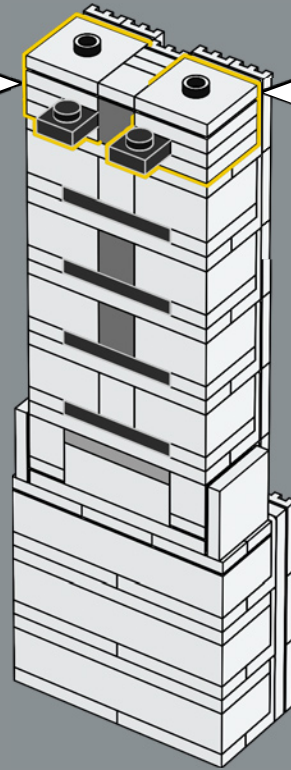
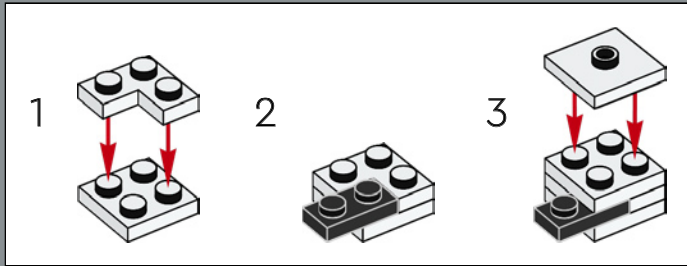

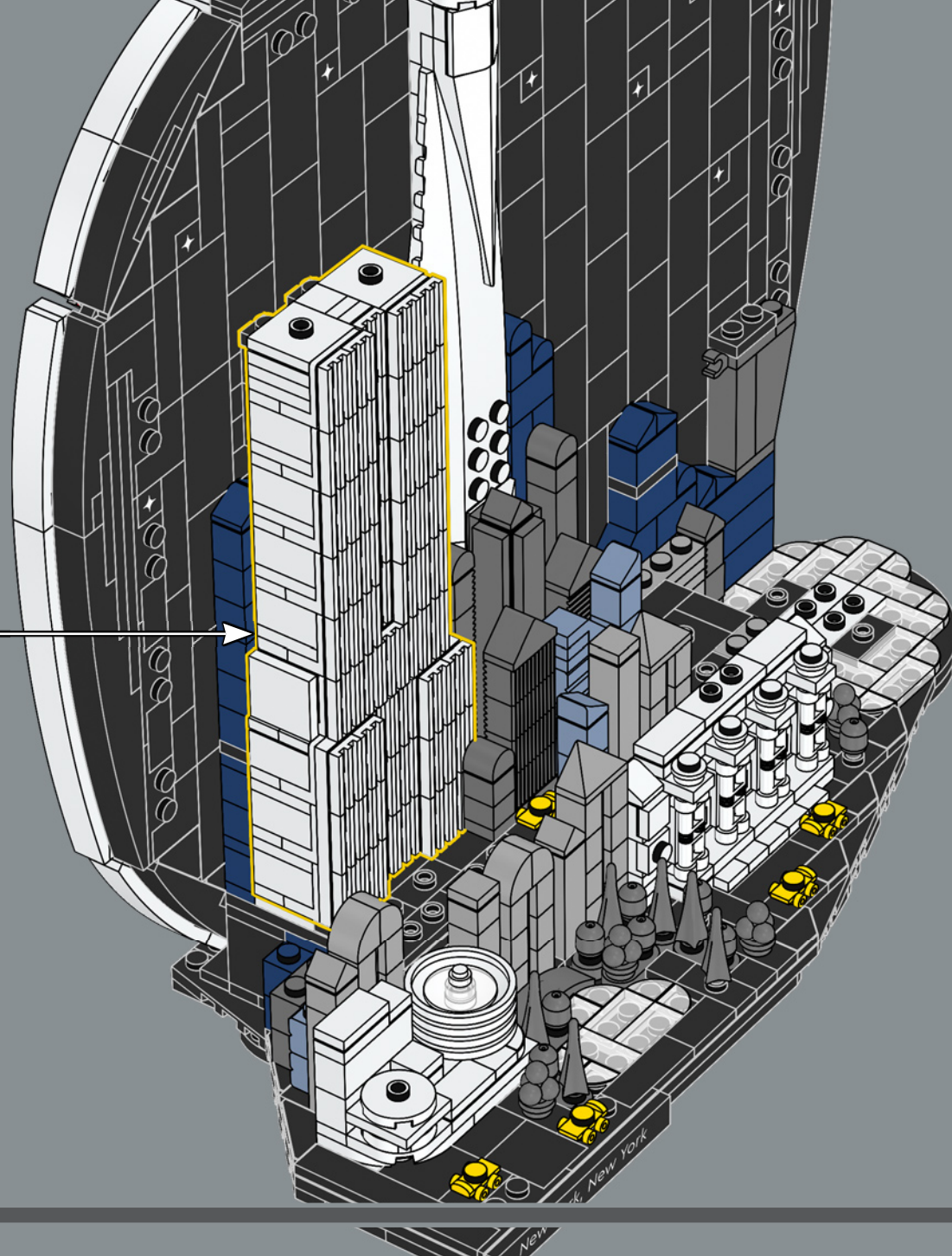

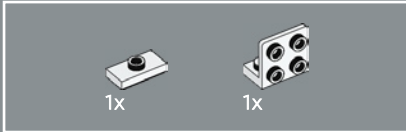
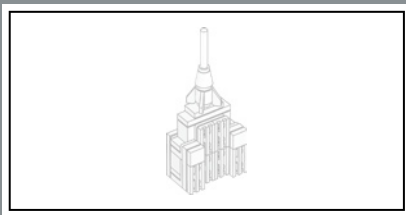

286

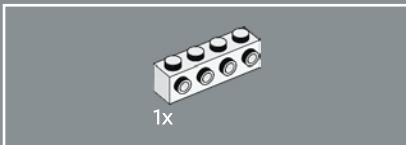
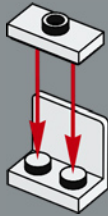

287

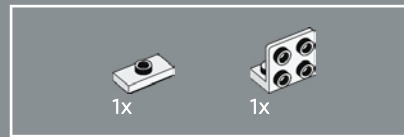
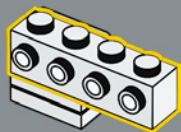

288

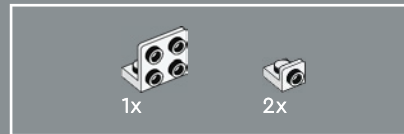
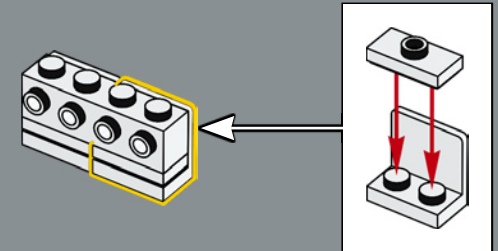

289

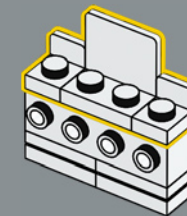



2x

290

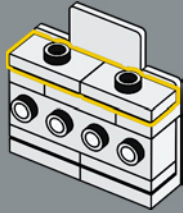

2x

292

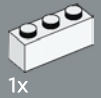
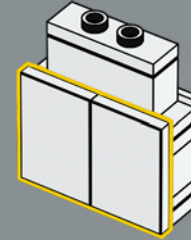

1x



1x

291



4x

293

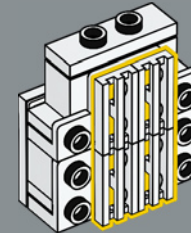



294

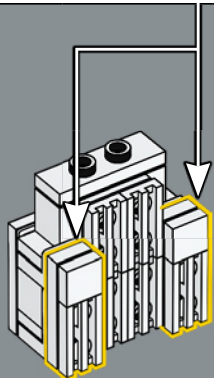
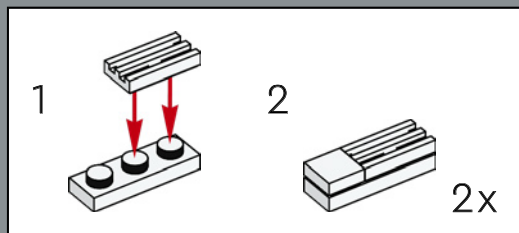

Negli ultimi anni, l'Empire State building è stato sottoposto a meticolosi interventi di restauro per preservarne il design originale e la storia per le generazioni a venire.

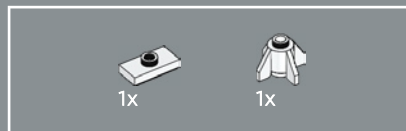

295

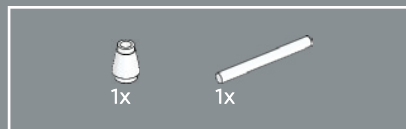
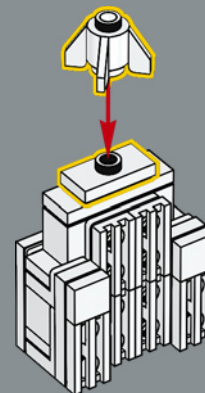

296

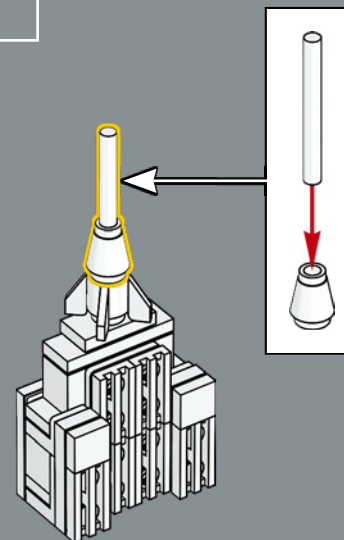

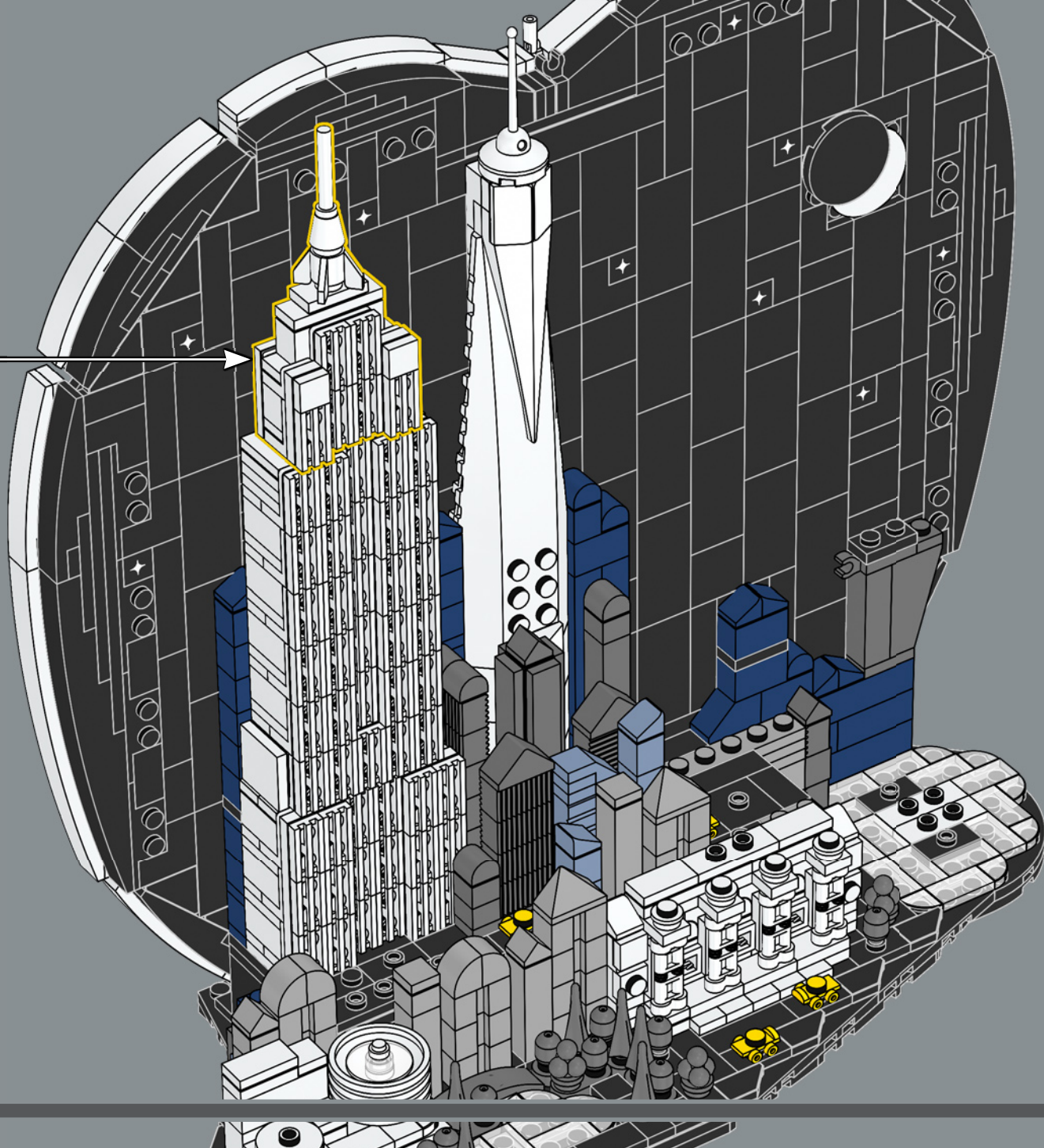

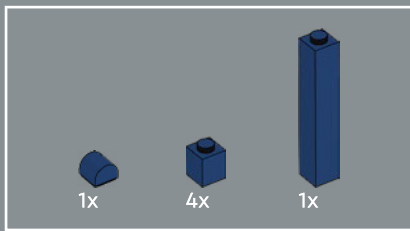

298

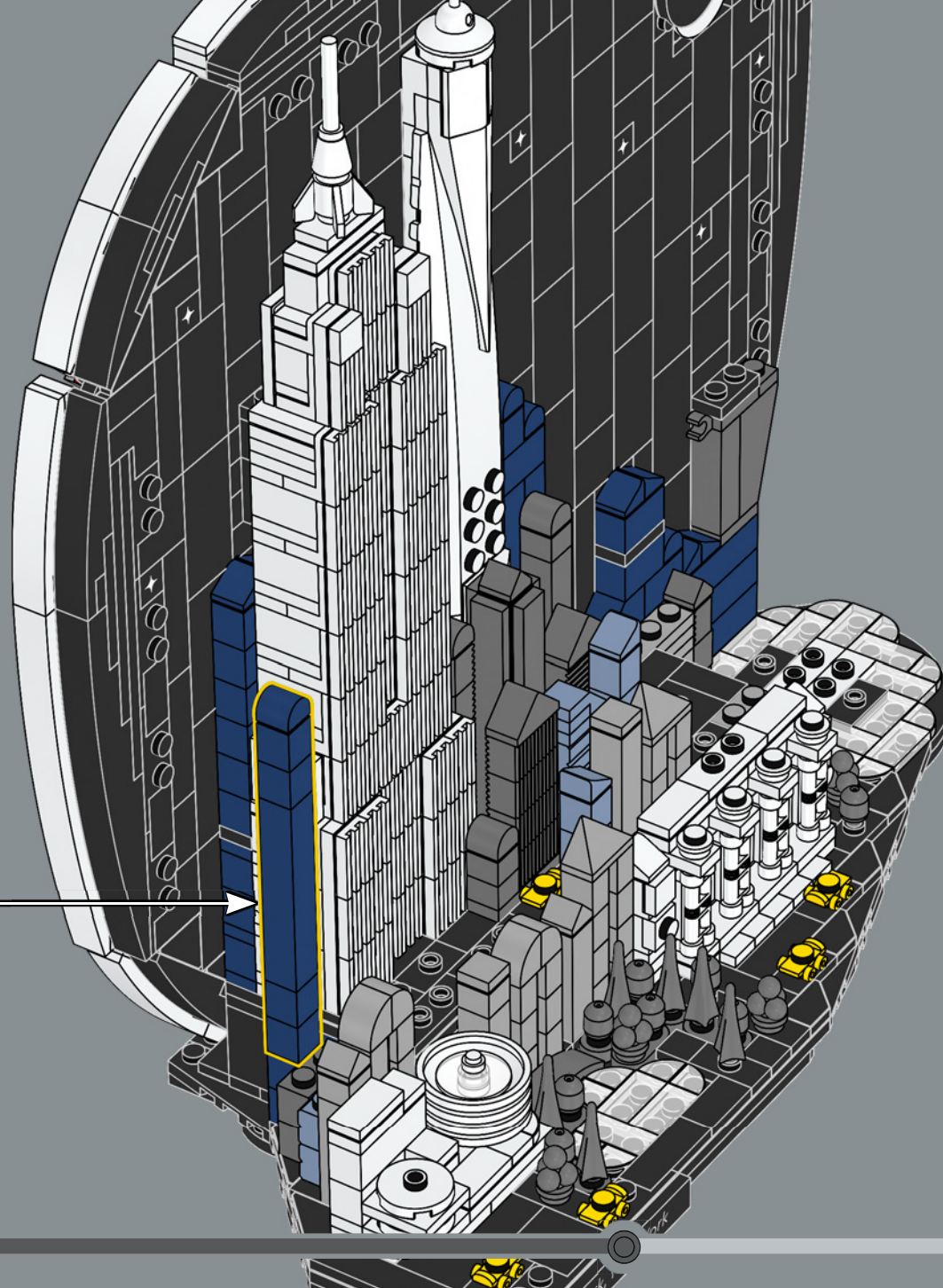
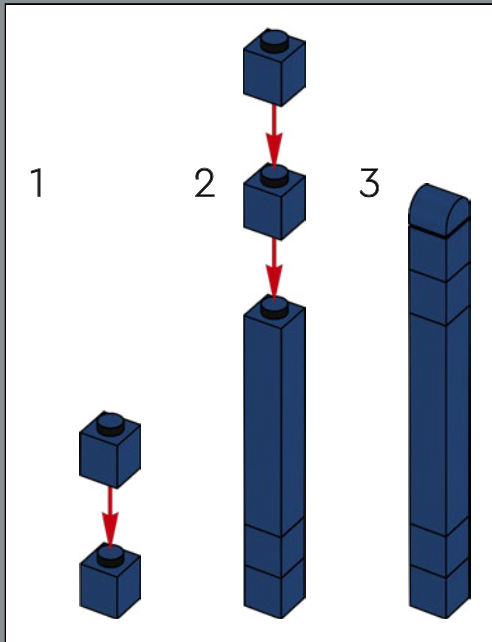

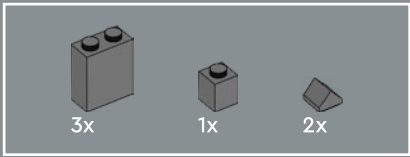

299

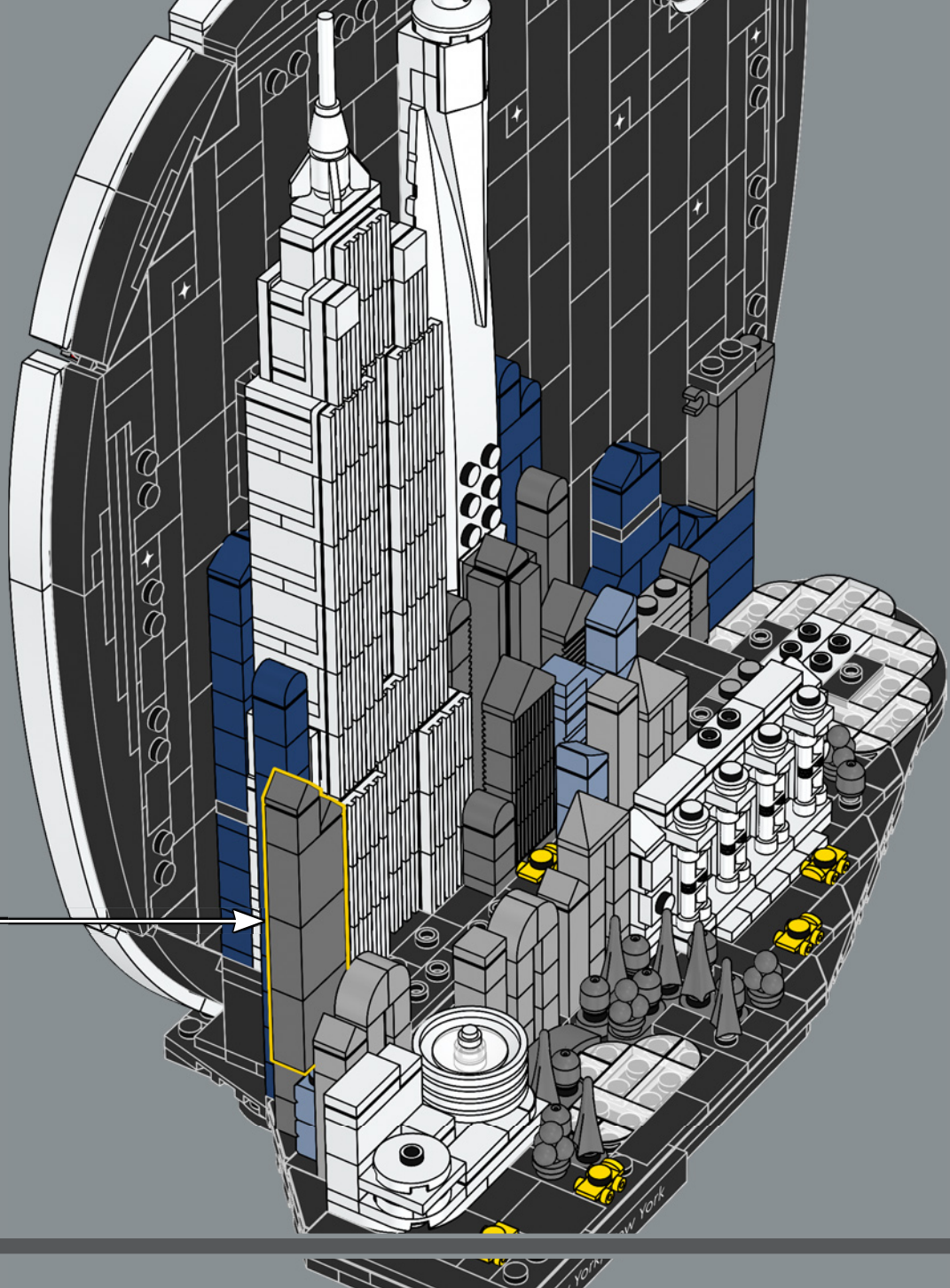
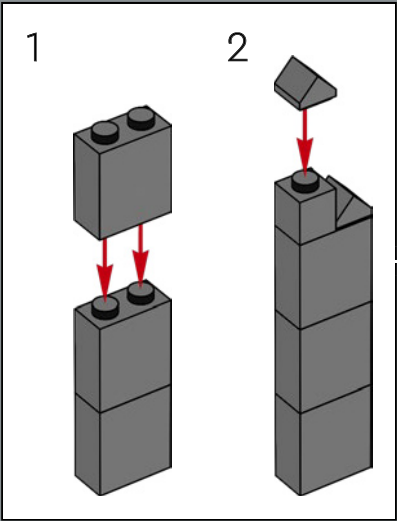

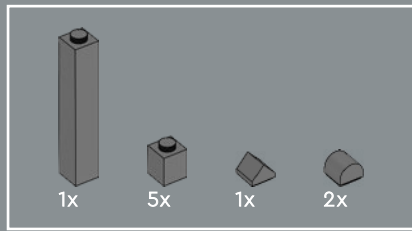

300

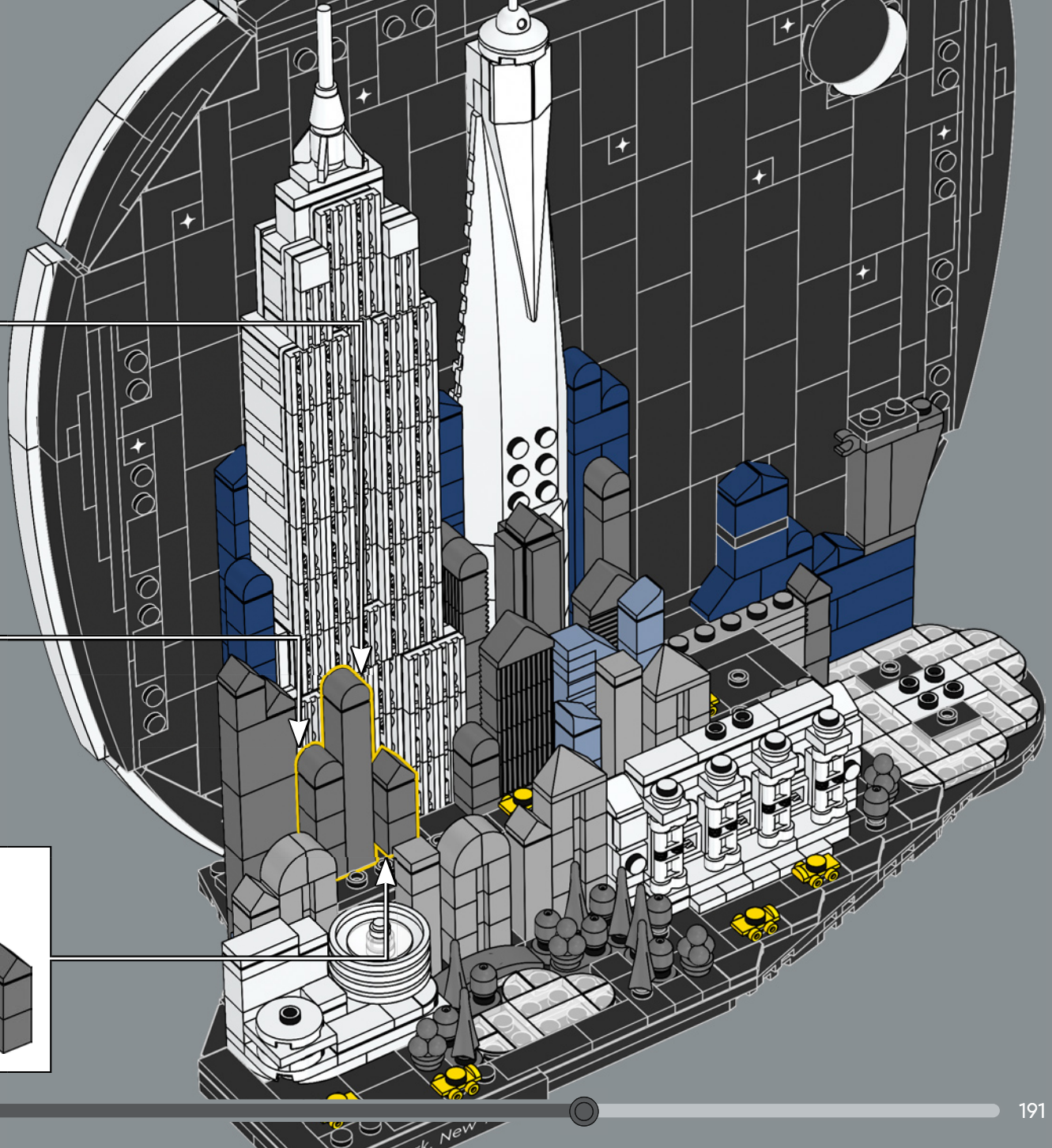
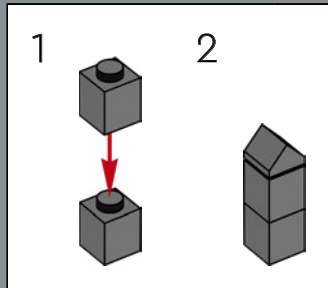
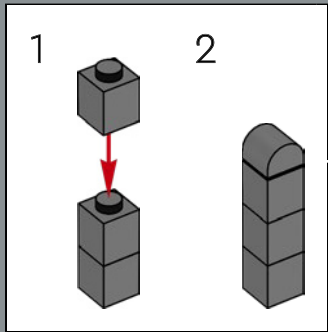
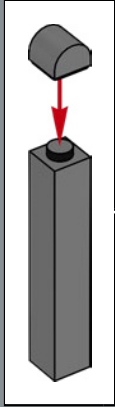



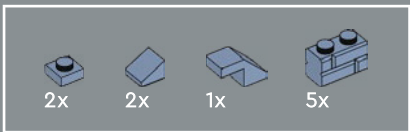

301

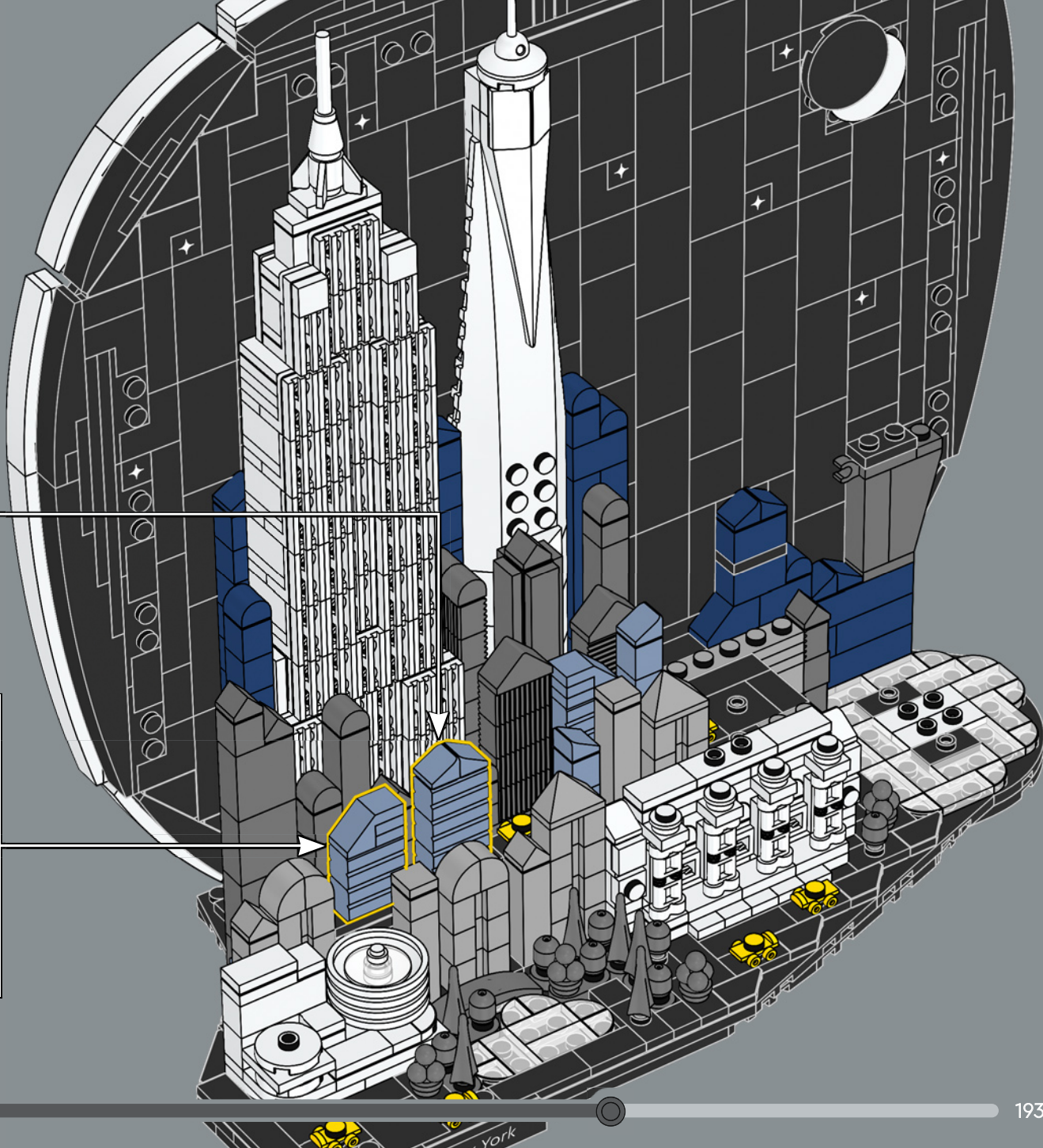
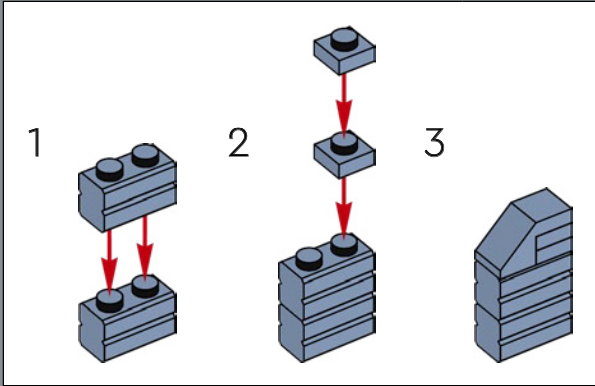
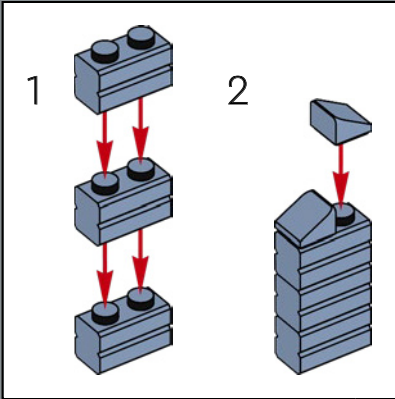

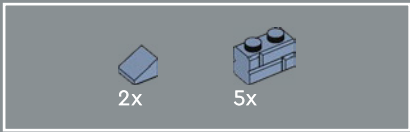

302

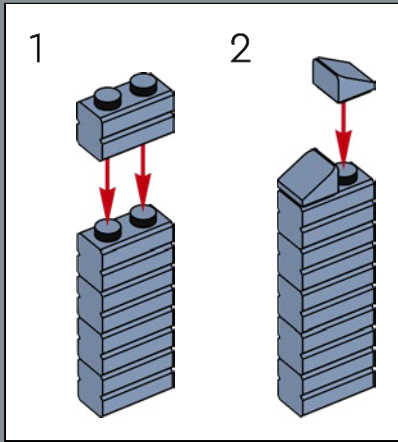
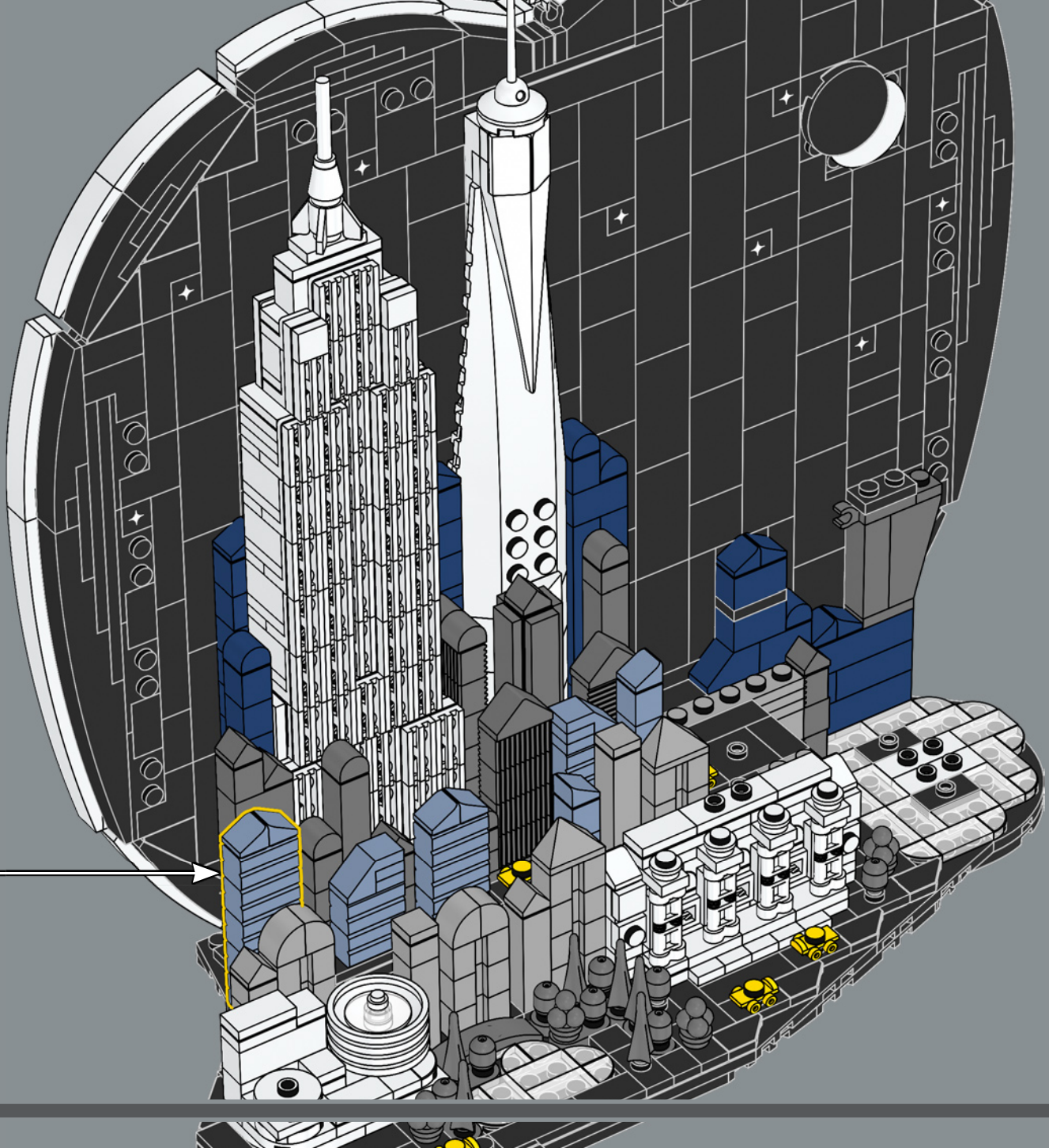



303

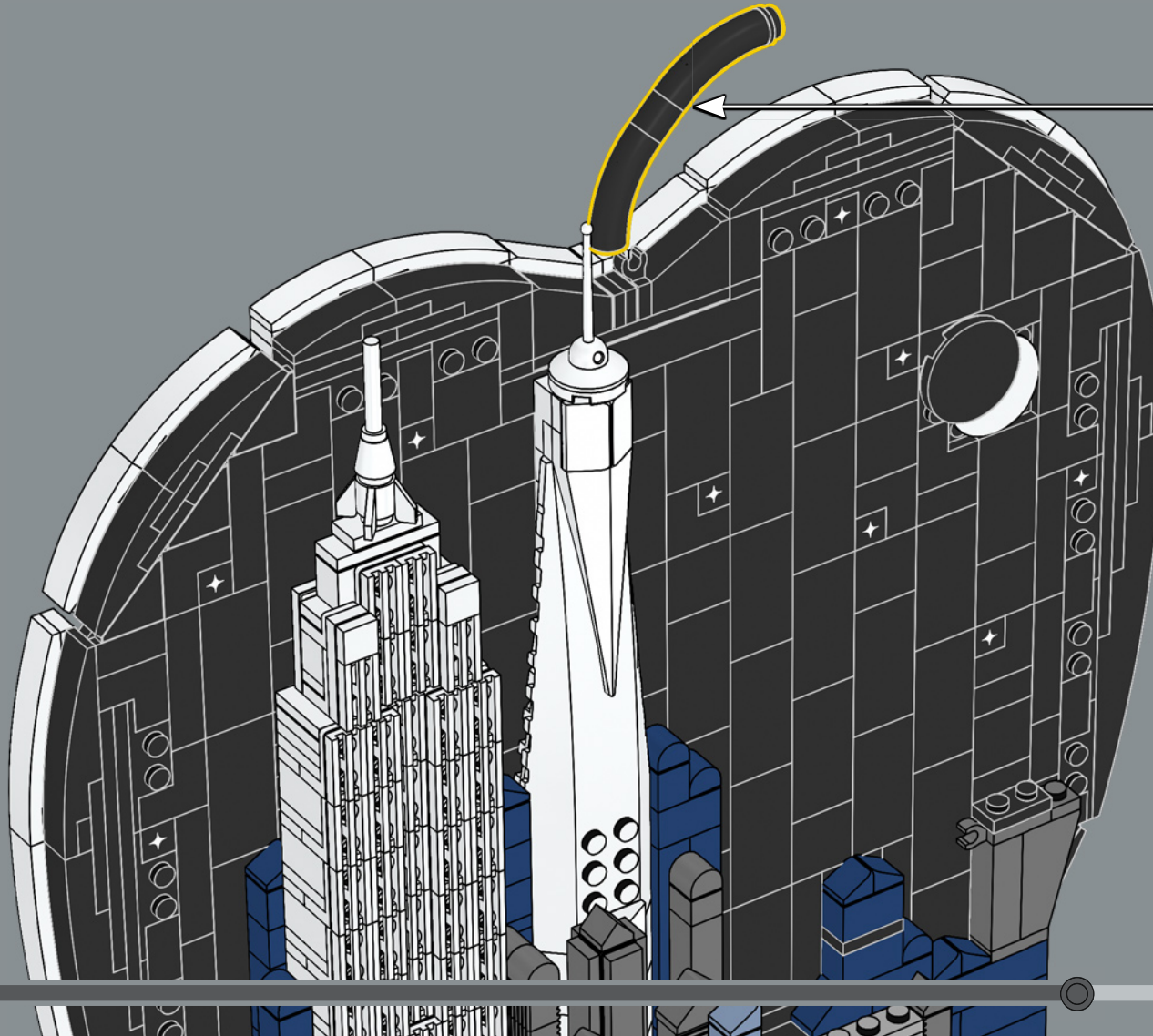
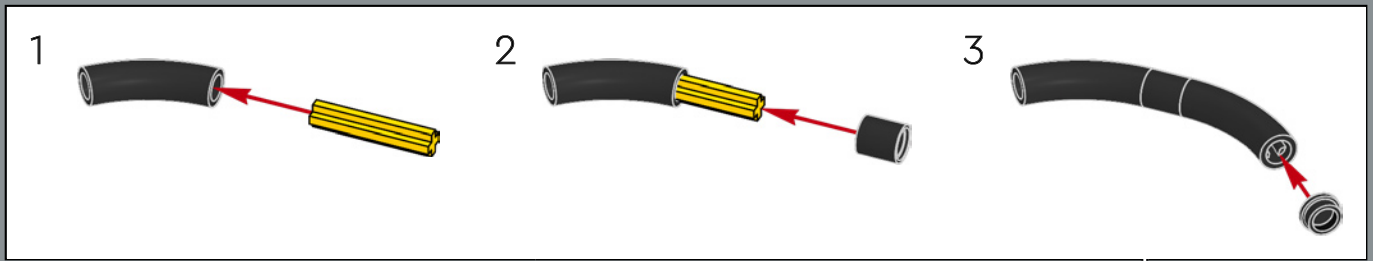

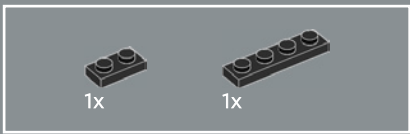

304

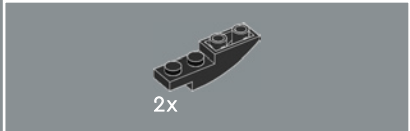
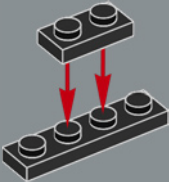

305

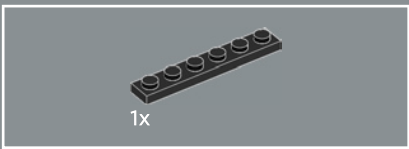
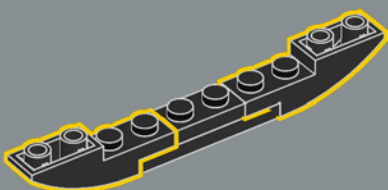

306

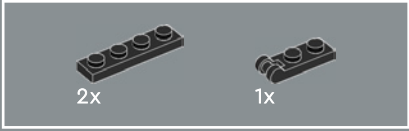
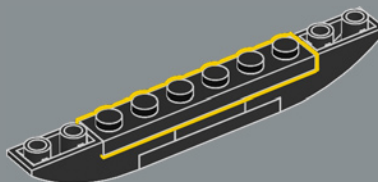

307

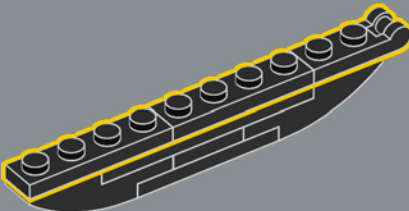

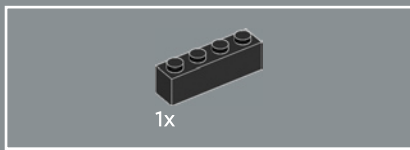

1x

308

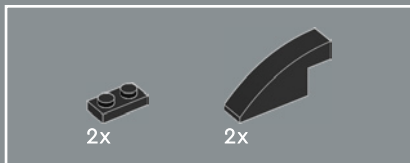
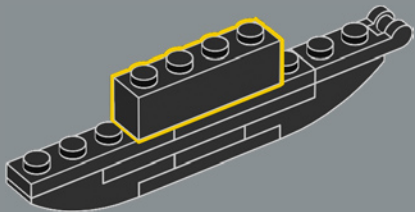

2x

2x

309

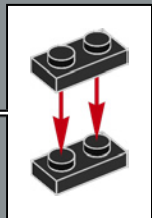
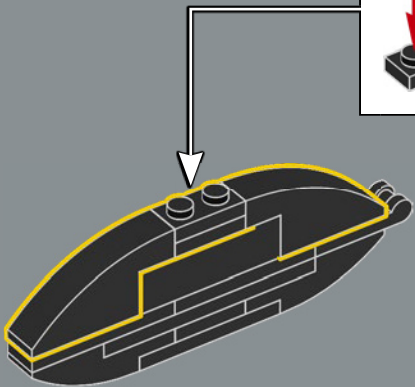

310

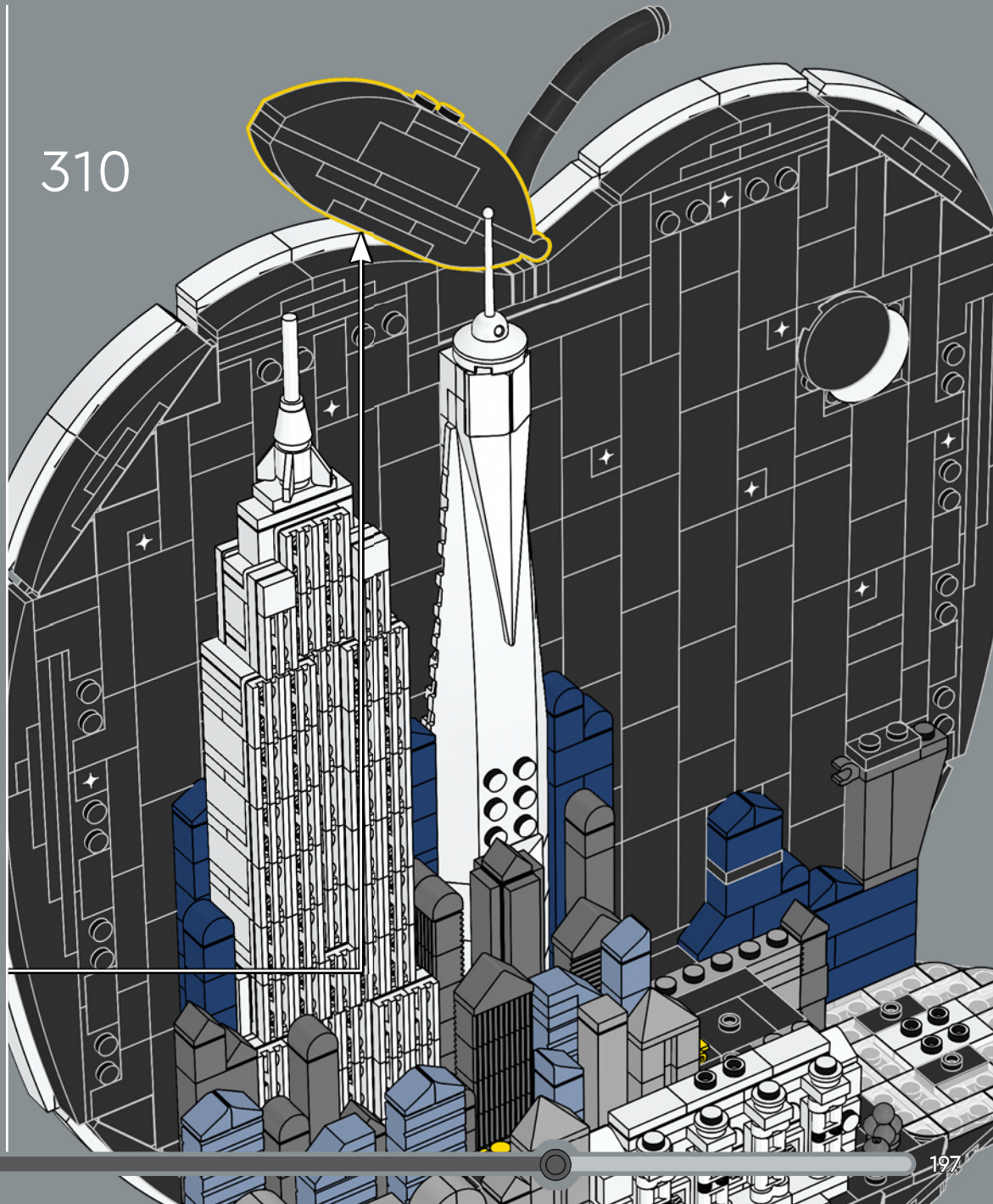

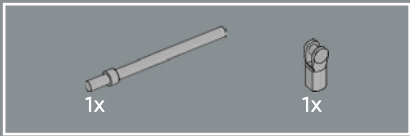

311

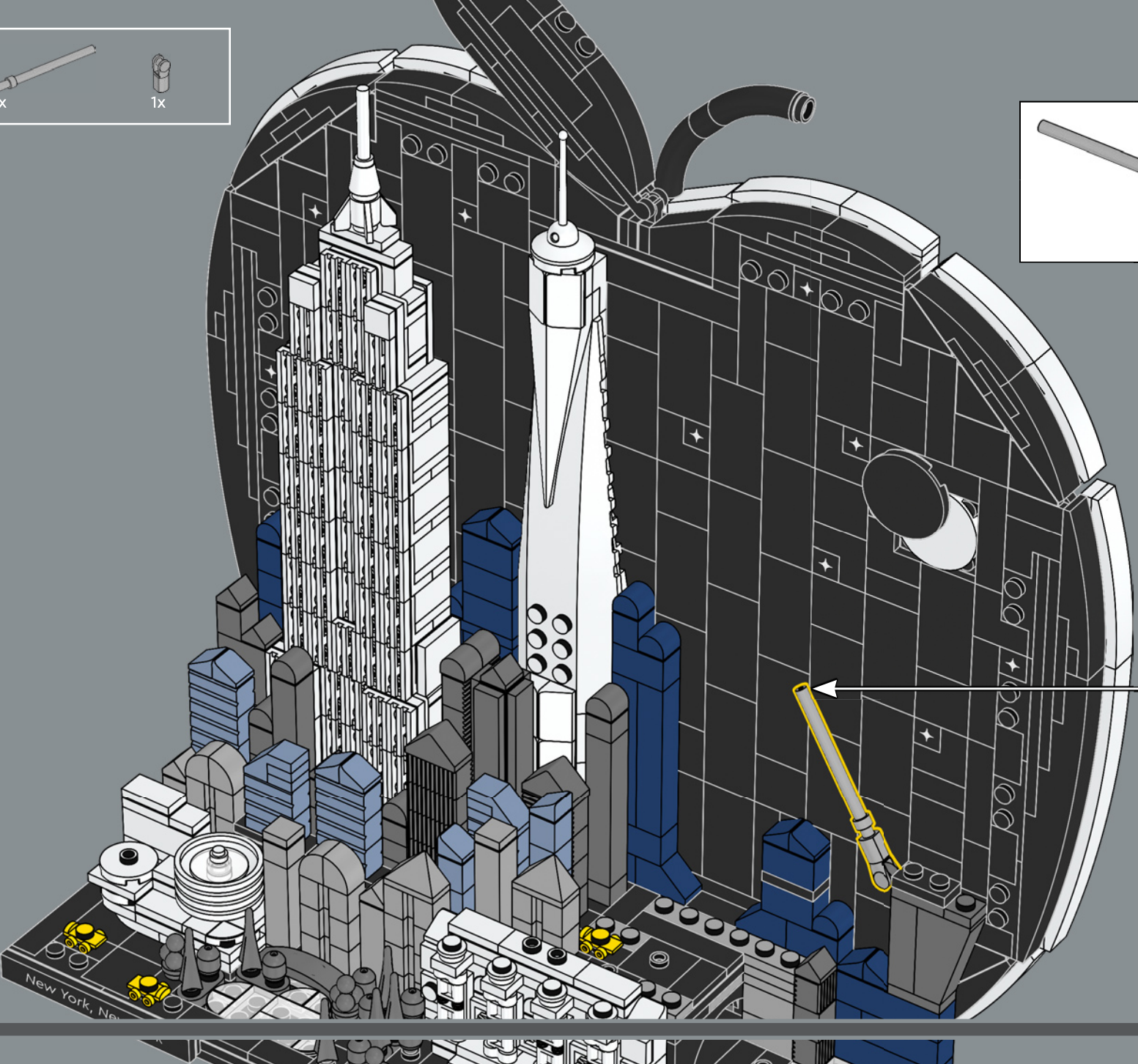
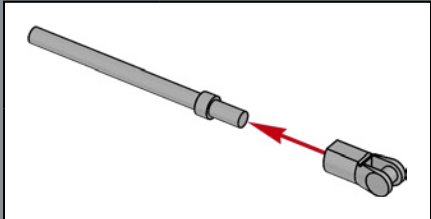

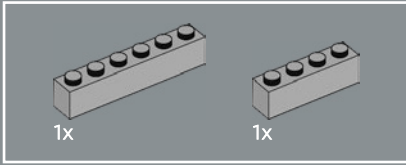
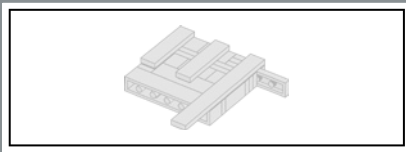

312

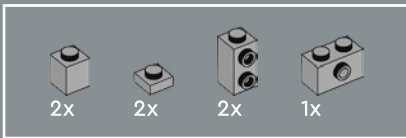
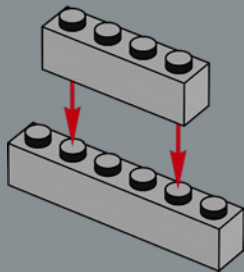

313

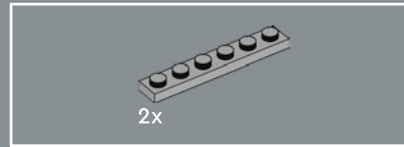
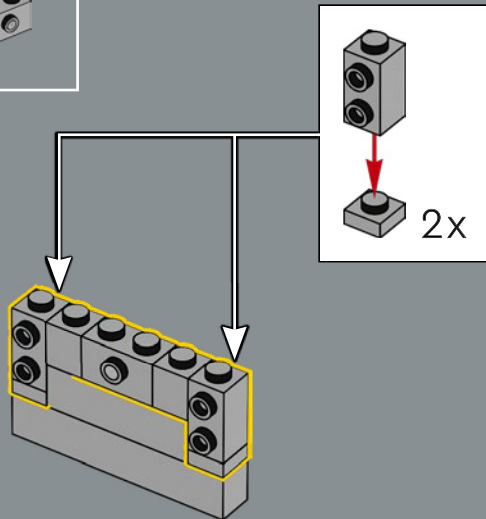

314

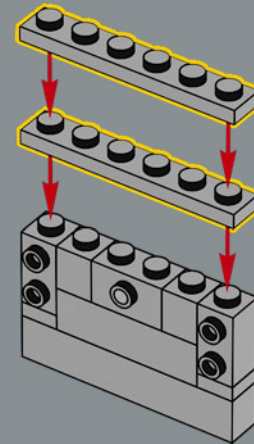

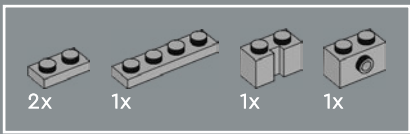

315

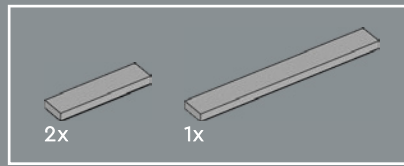
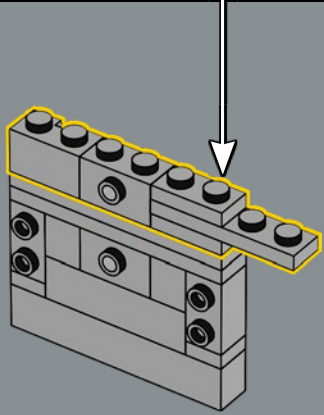
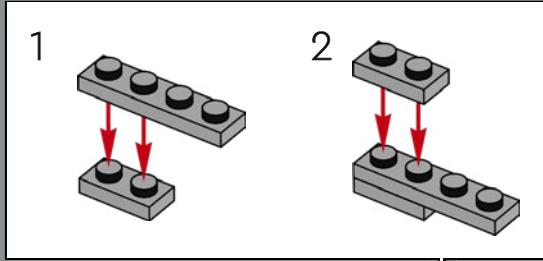

316

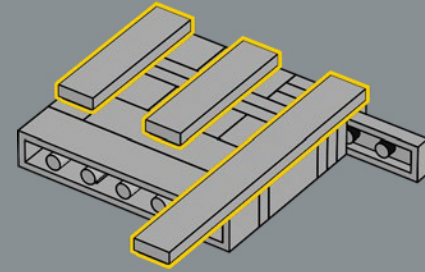

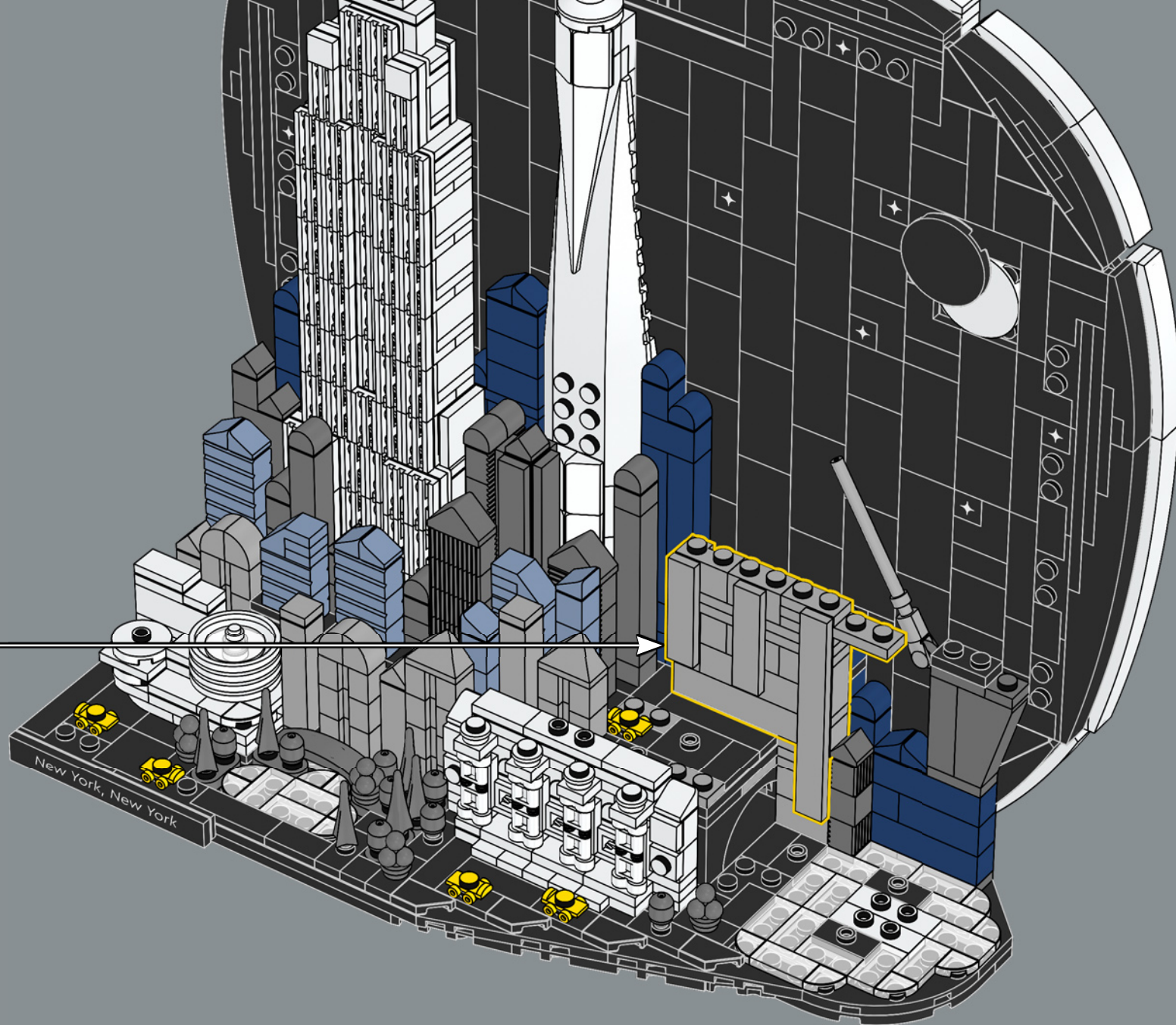

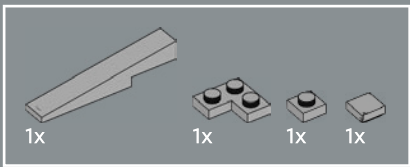

318

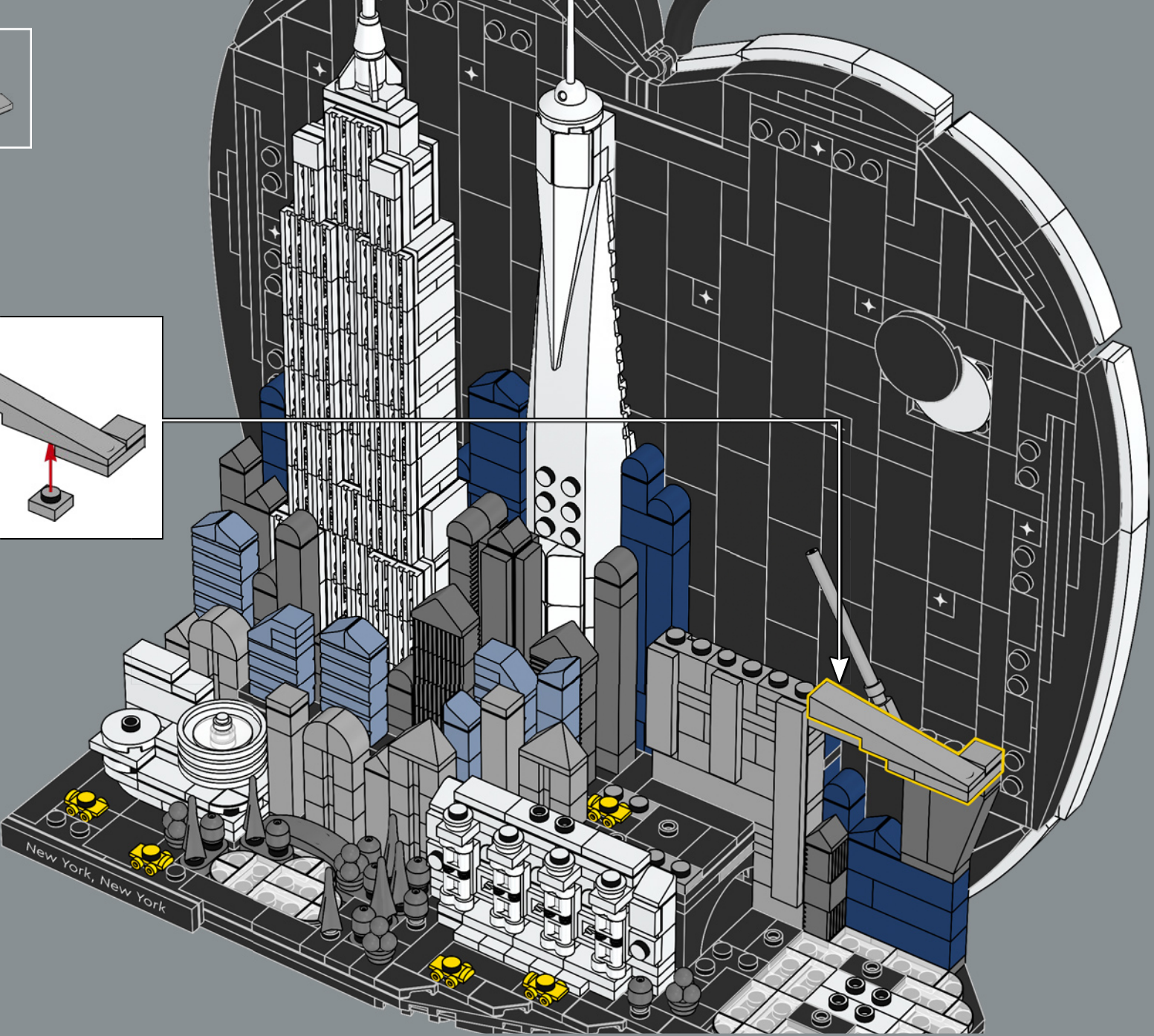
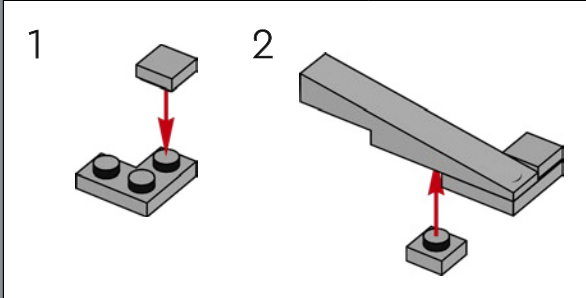



319

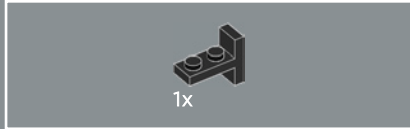

320



321

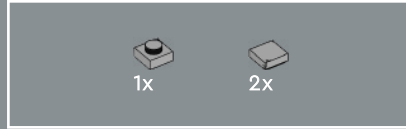
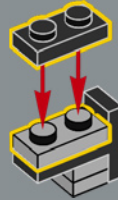

322

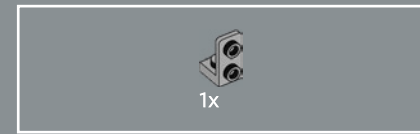
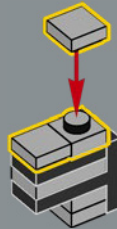

323

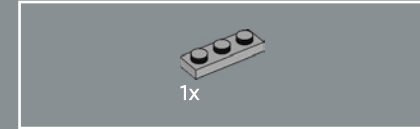
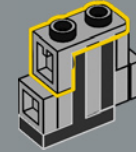

324

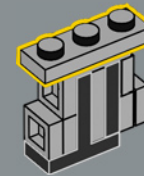

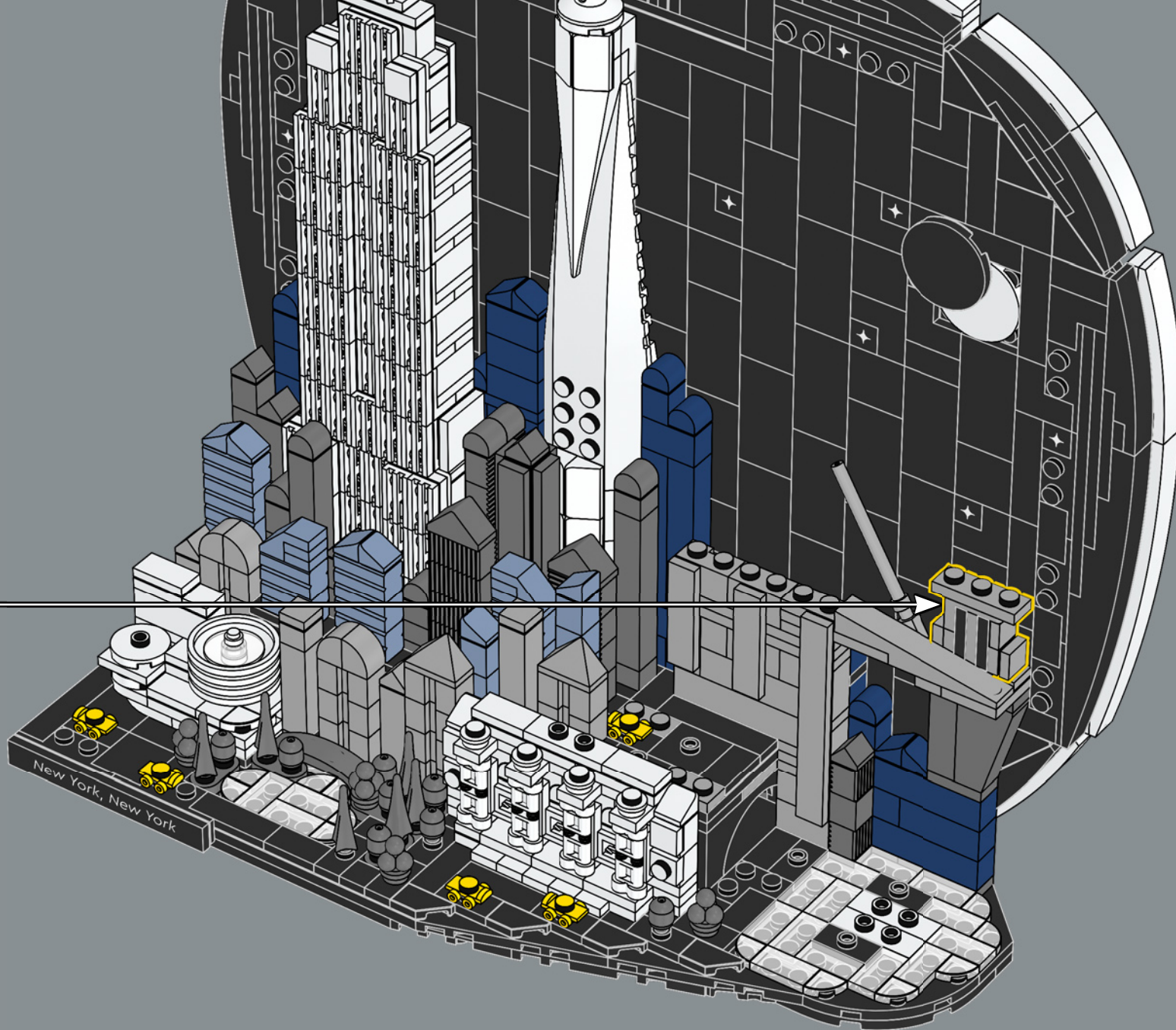

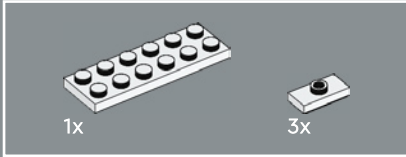
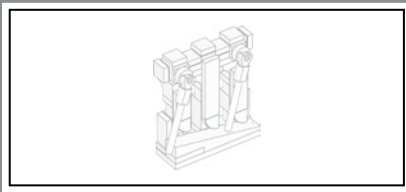

326

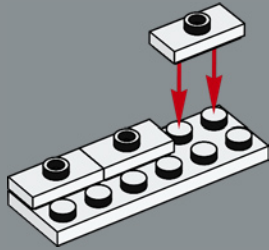

327

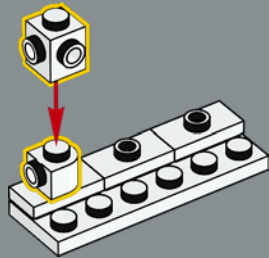

328

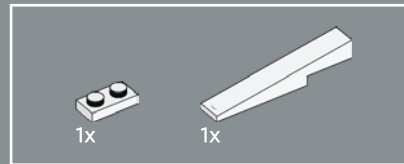
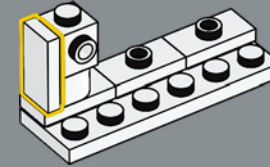

329

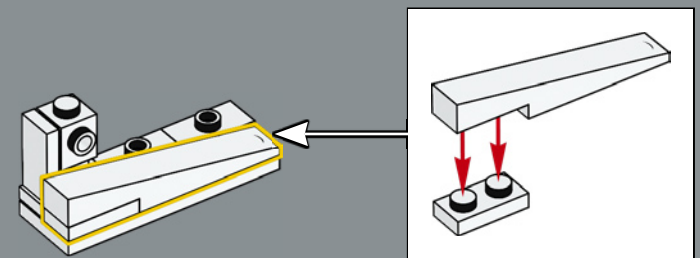

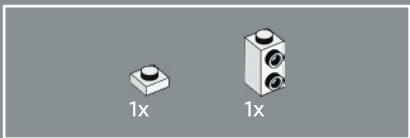

330

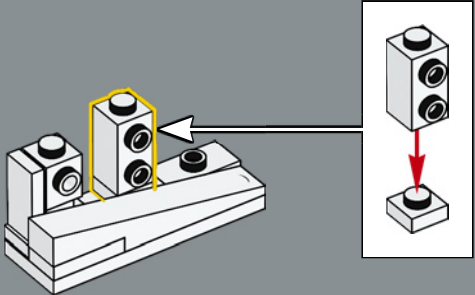

331

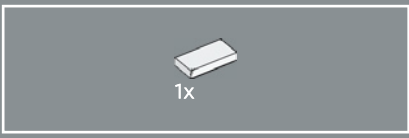
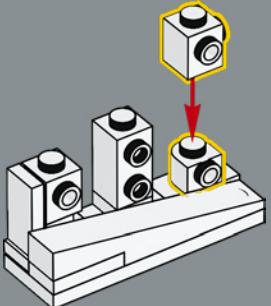

332

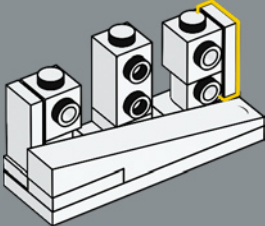

333

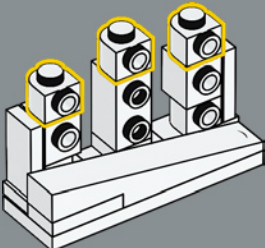



334

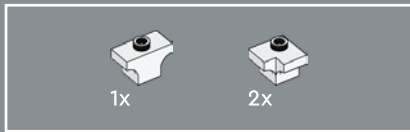
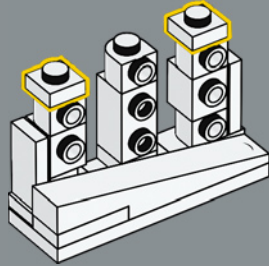

335

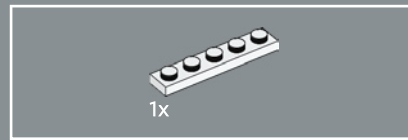
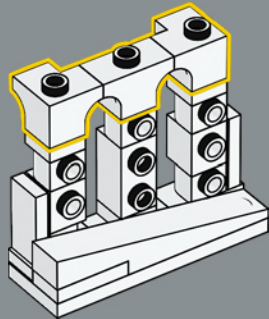

336

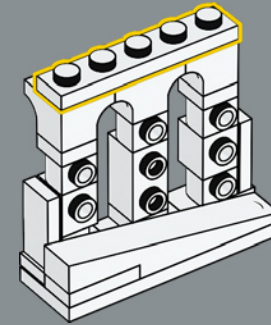

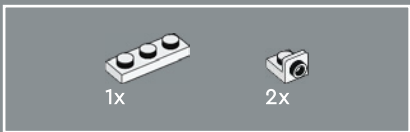

337

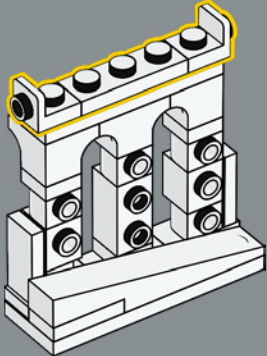

338

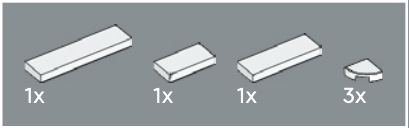
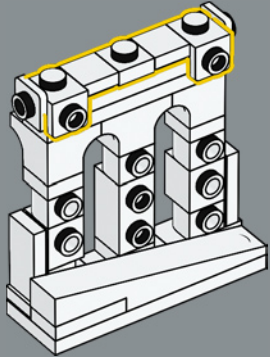

339

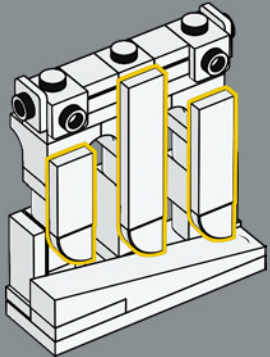



2x

# 340

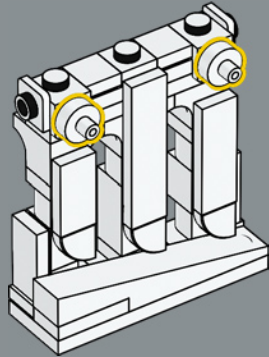

5x

# 341

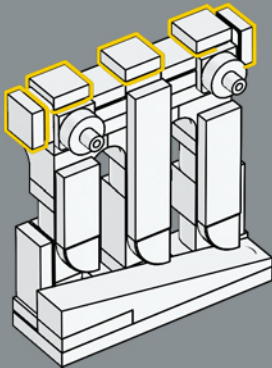

2x



2x

# 342

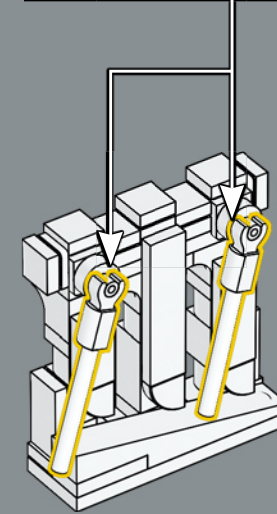
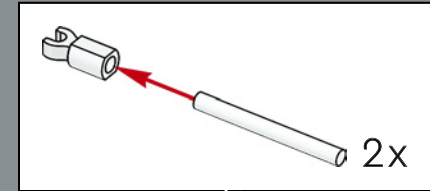

Oltre 137.000 persone attraversano il Ponte di Brooklyn ogni giorno in auto, a piedi o in bicicletta. (I camion non sono ammessi sul ponte.)



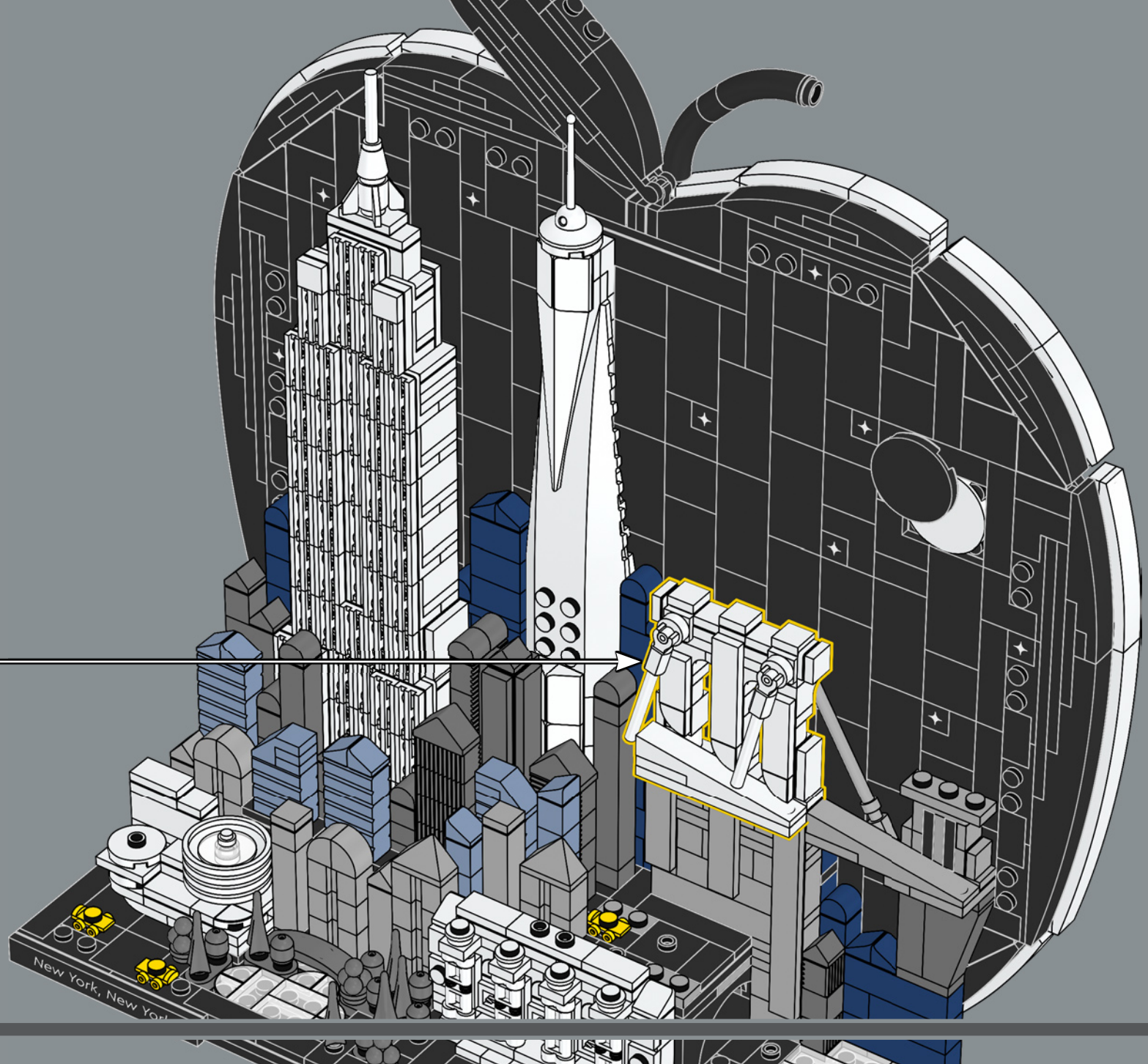

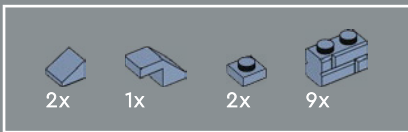

344

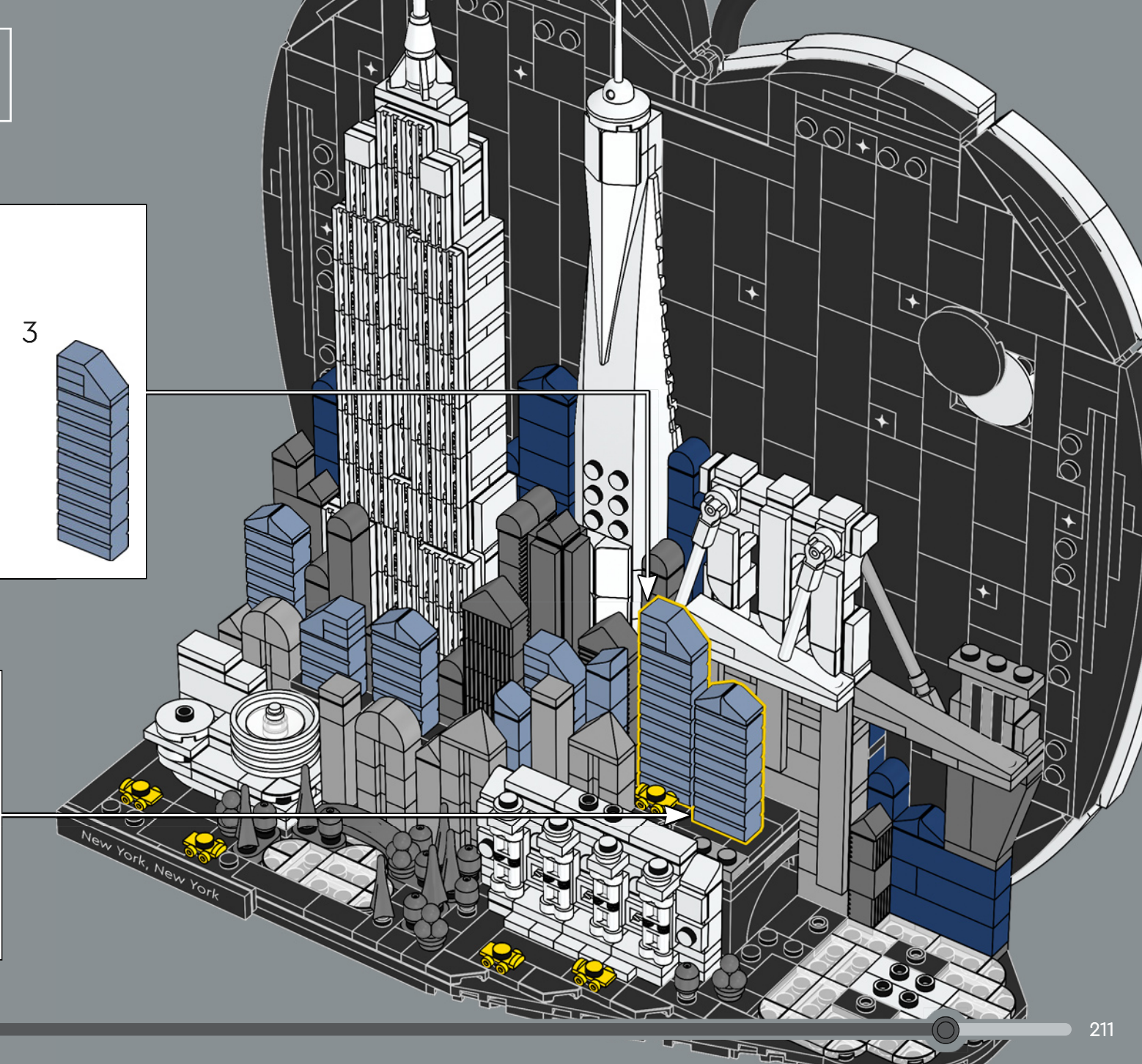
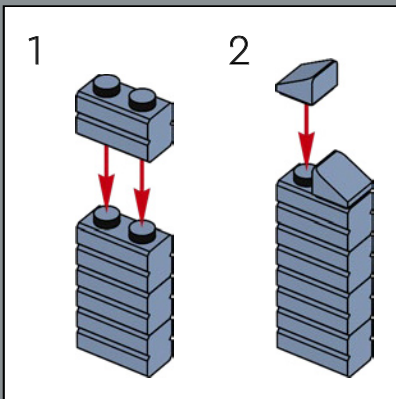
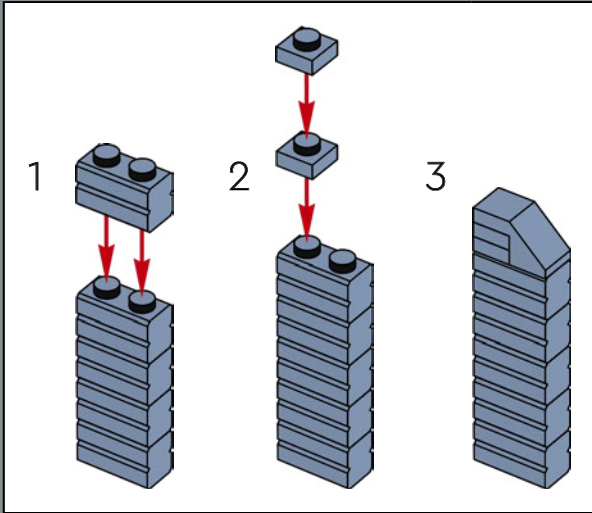

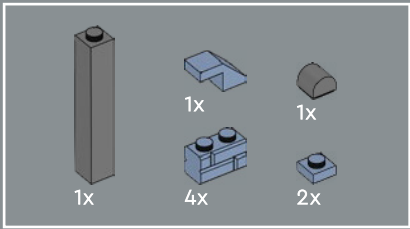

345

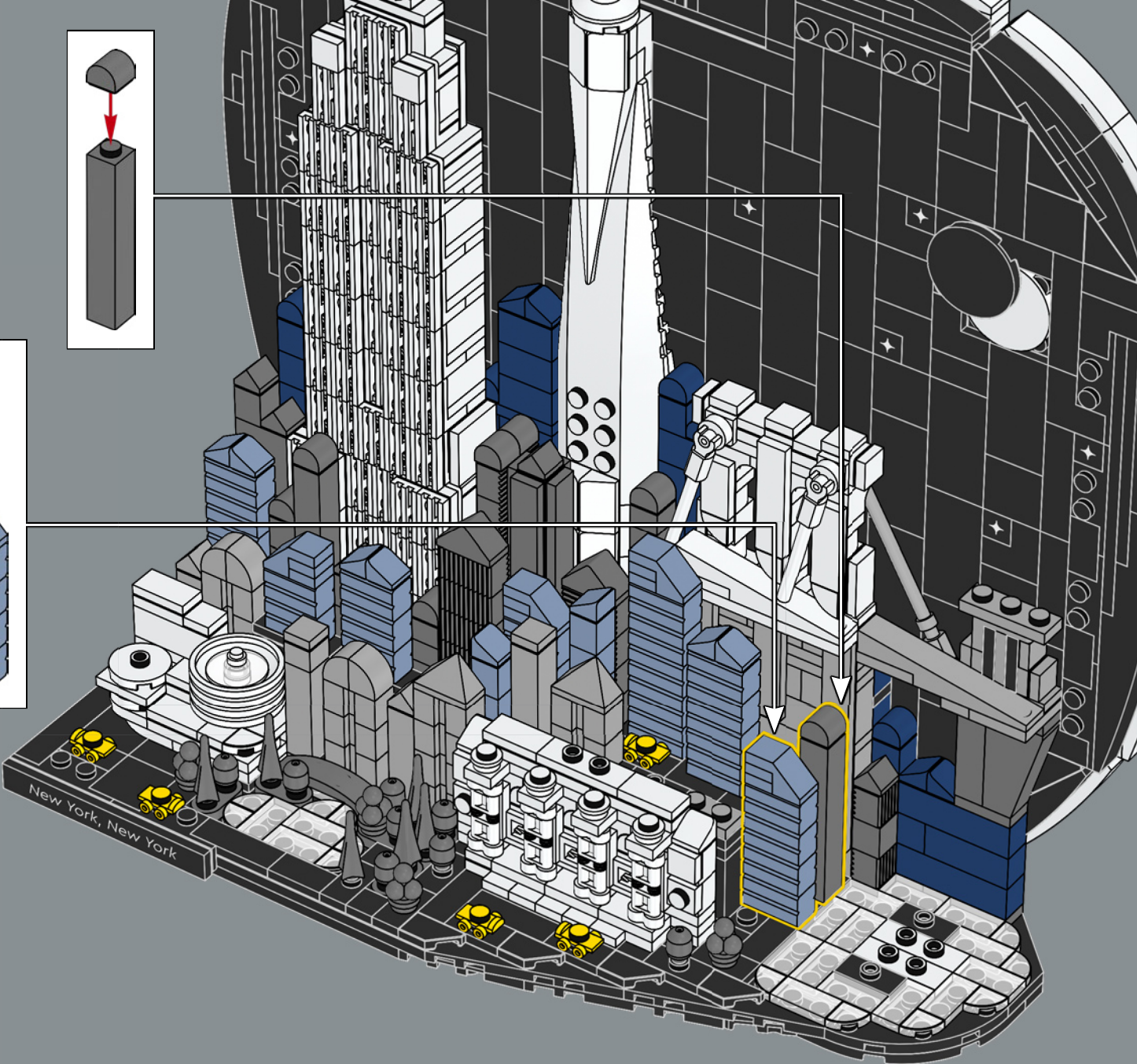
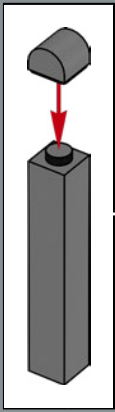
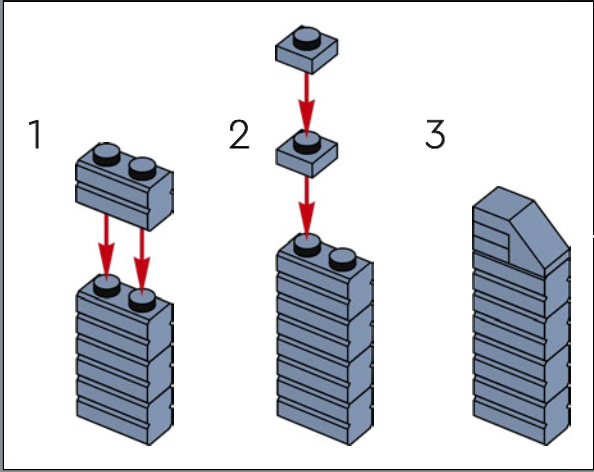

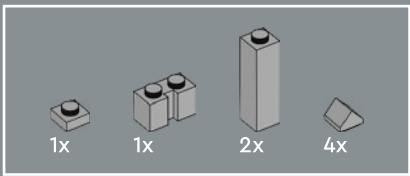

346

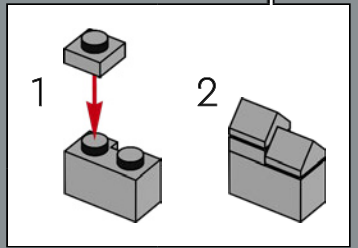
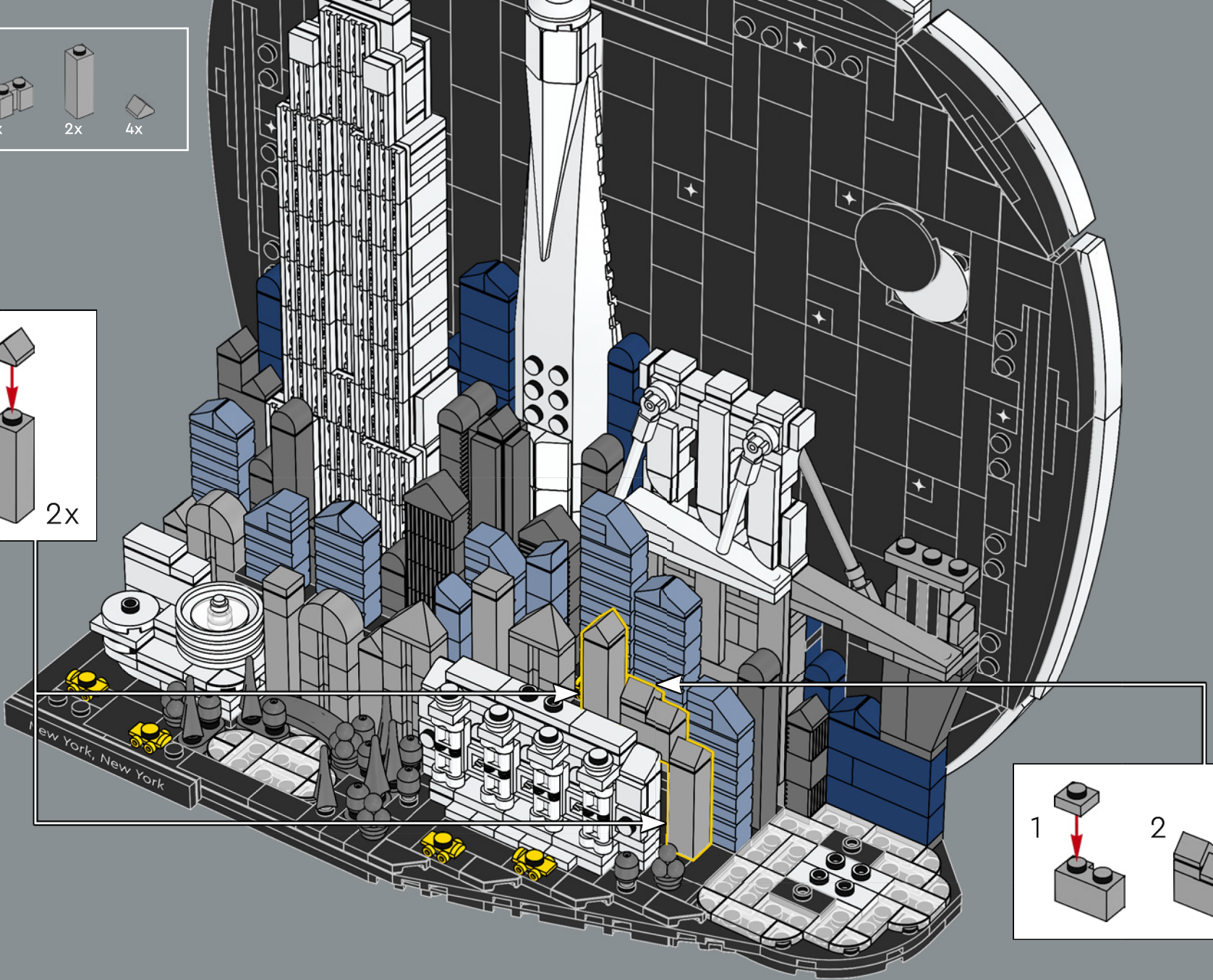
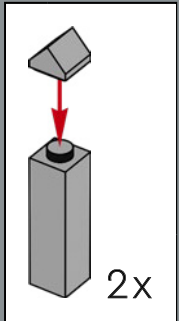

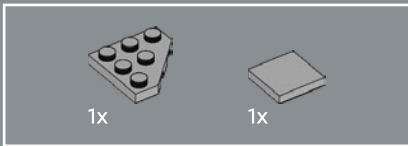

347

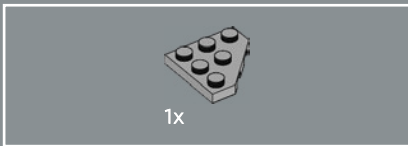
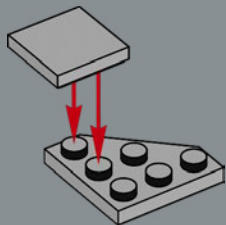

348

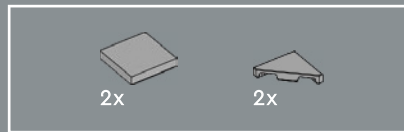
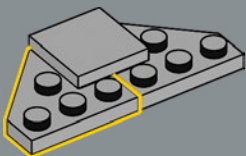

349

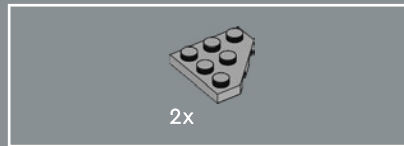
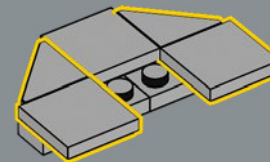

350

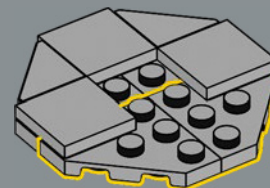

L'imponente Statua della Libertà in rame è alta 92,9 m, circa l'altezza di un edificio di 22 piani, dal suolo fino alla punta della fiamma.

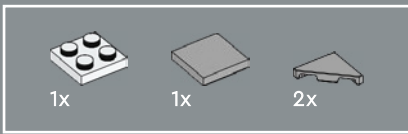

351

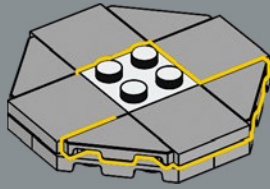

352

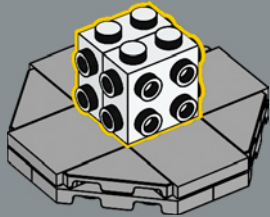

353

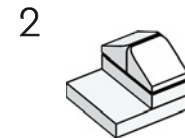
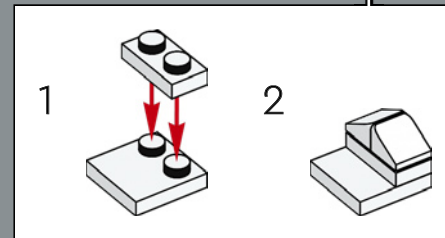
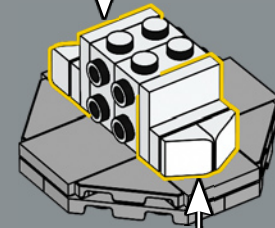
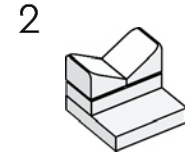
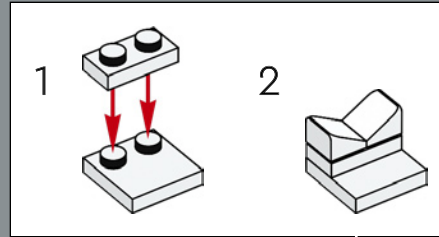



354

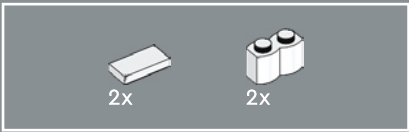
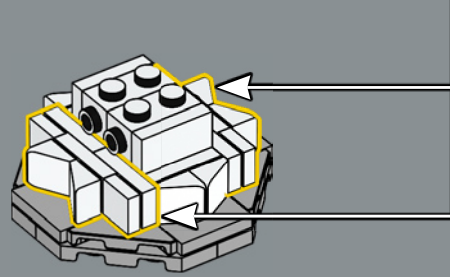
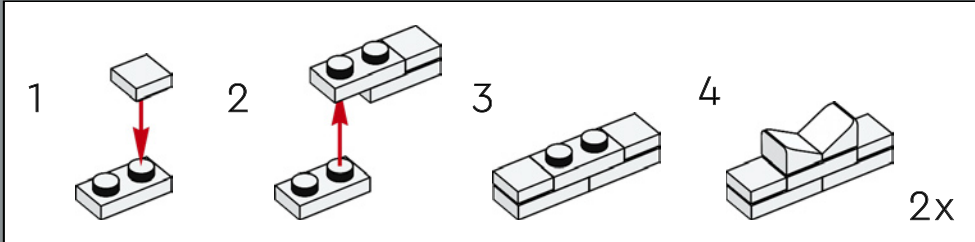

355

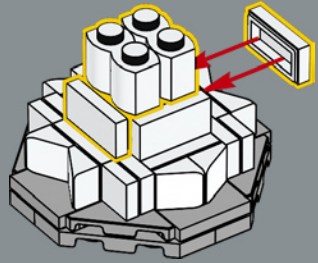



356

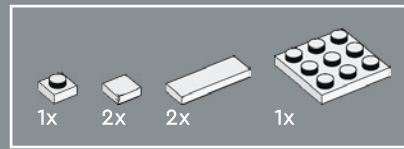
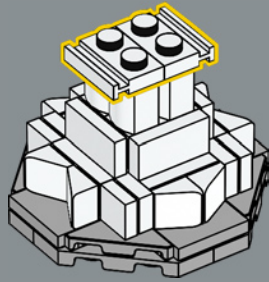

357

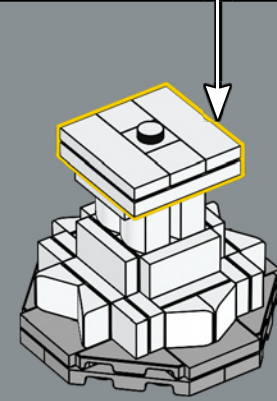
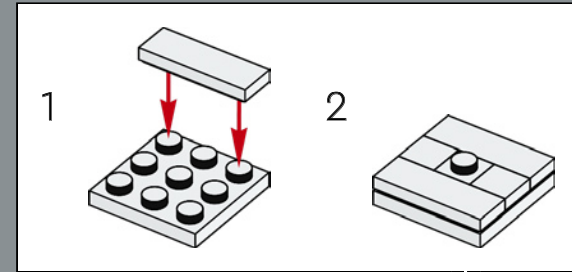

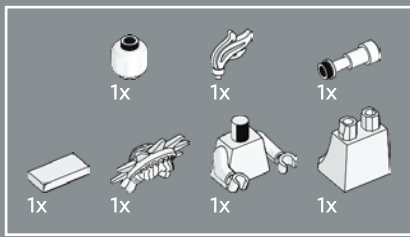

358

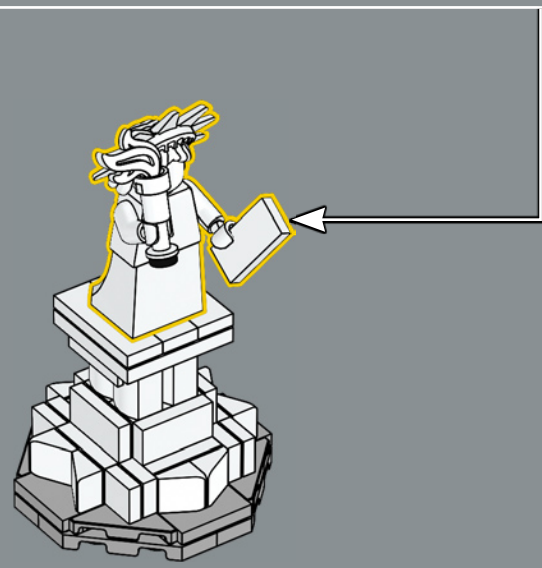
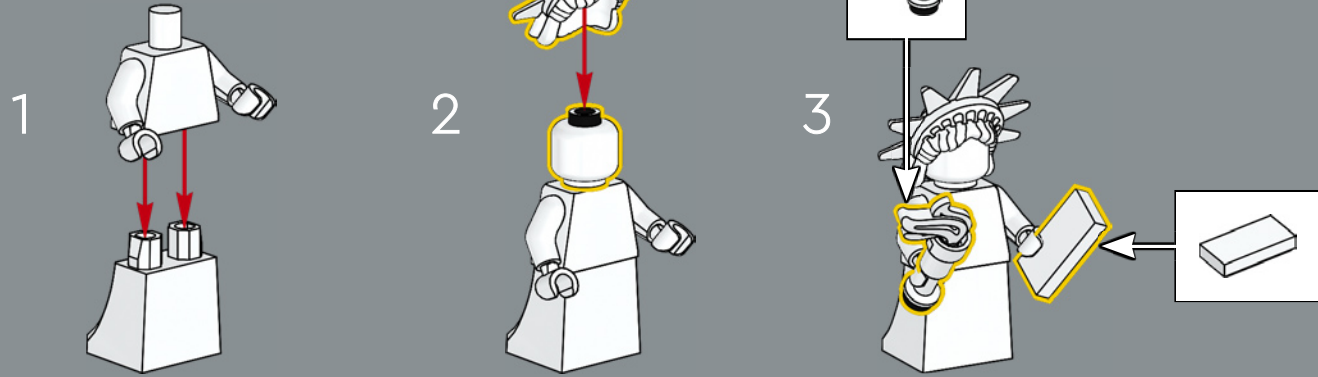

"Lady Liberty" è già apparsa sotto forma di minifigure LEGO® diverse volte: il debutto è avvenuto nel 2012.

359

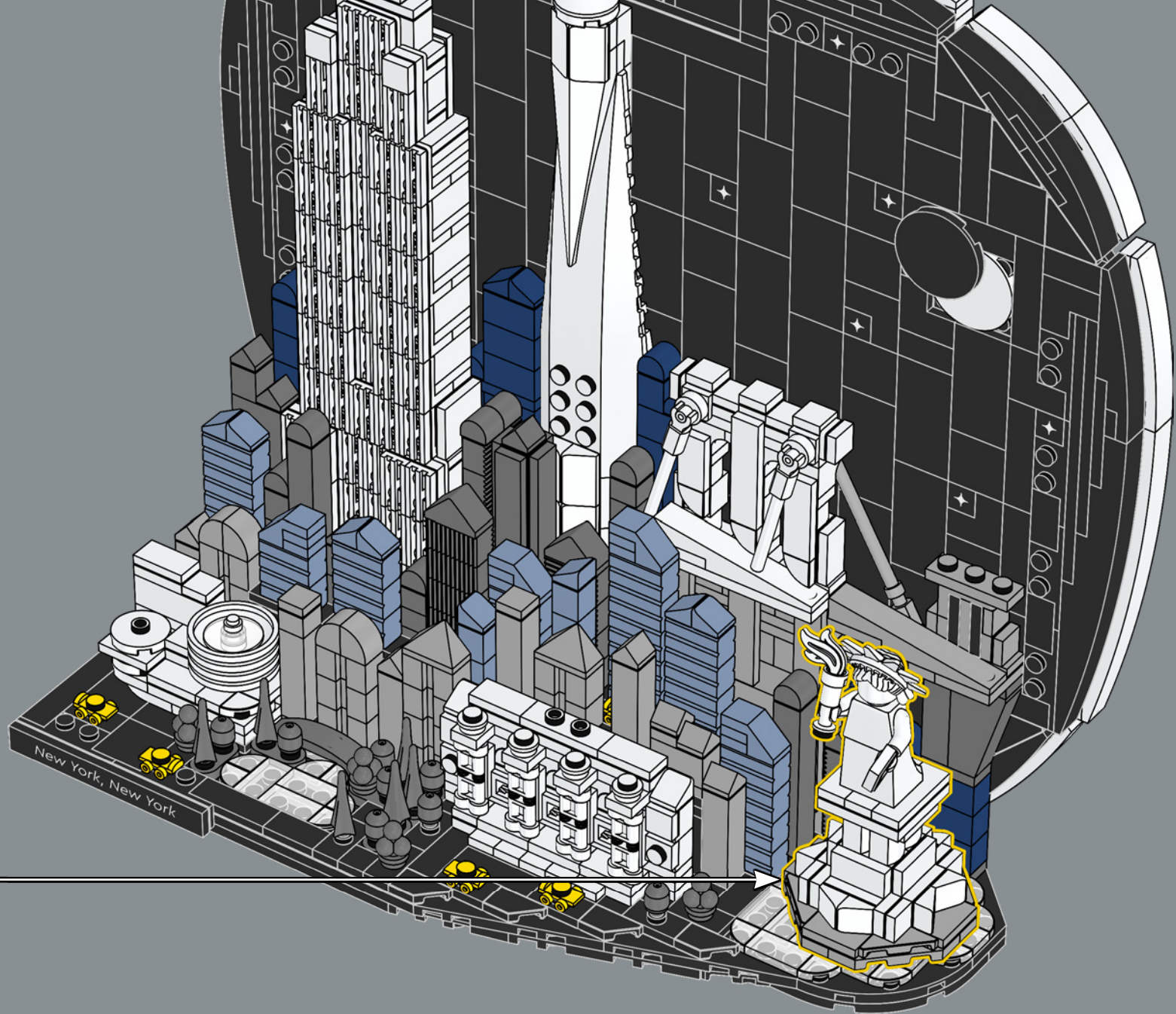

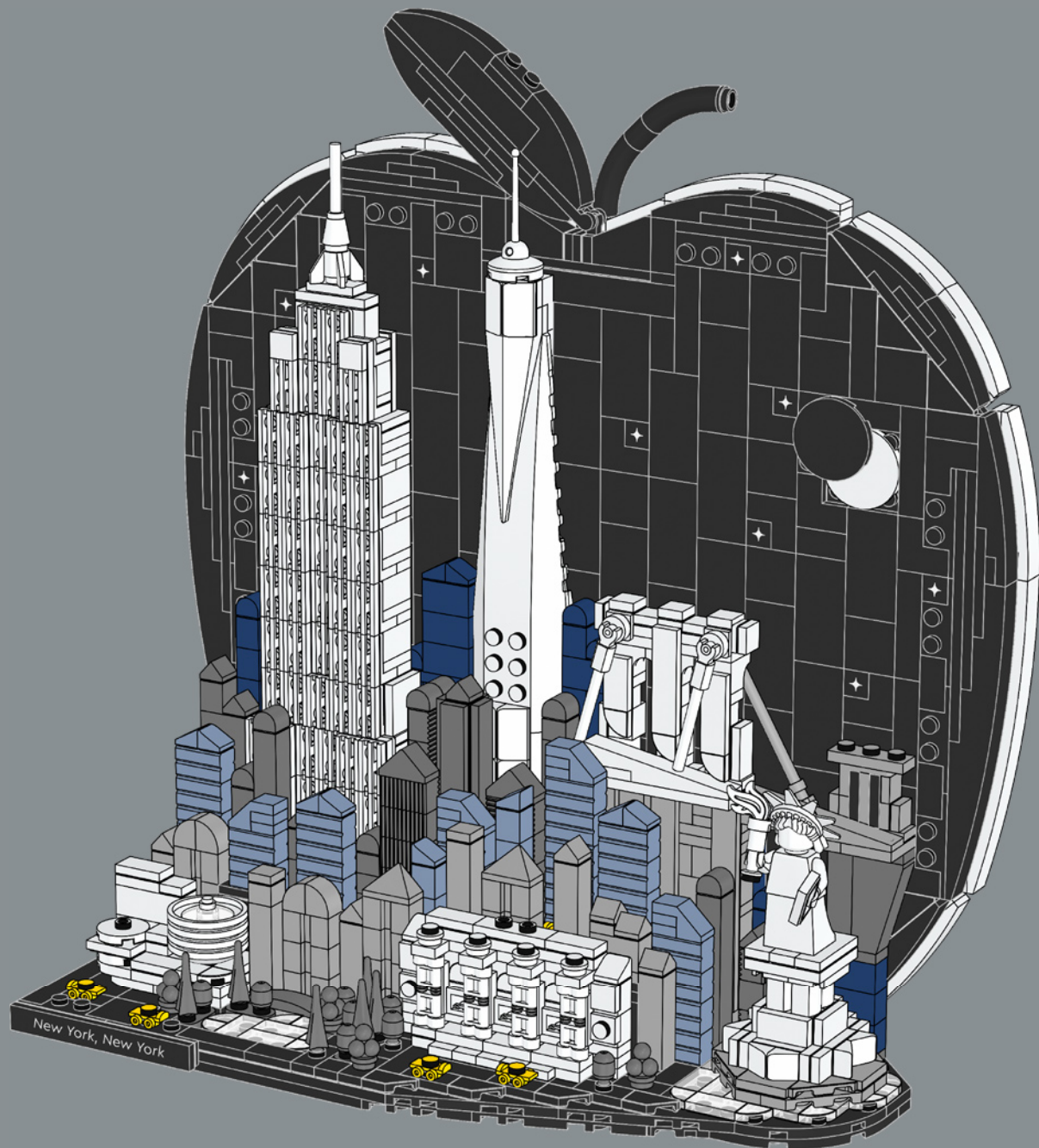

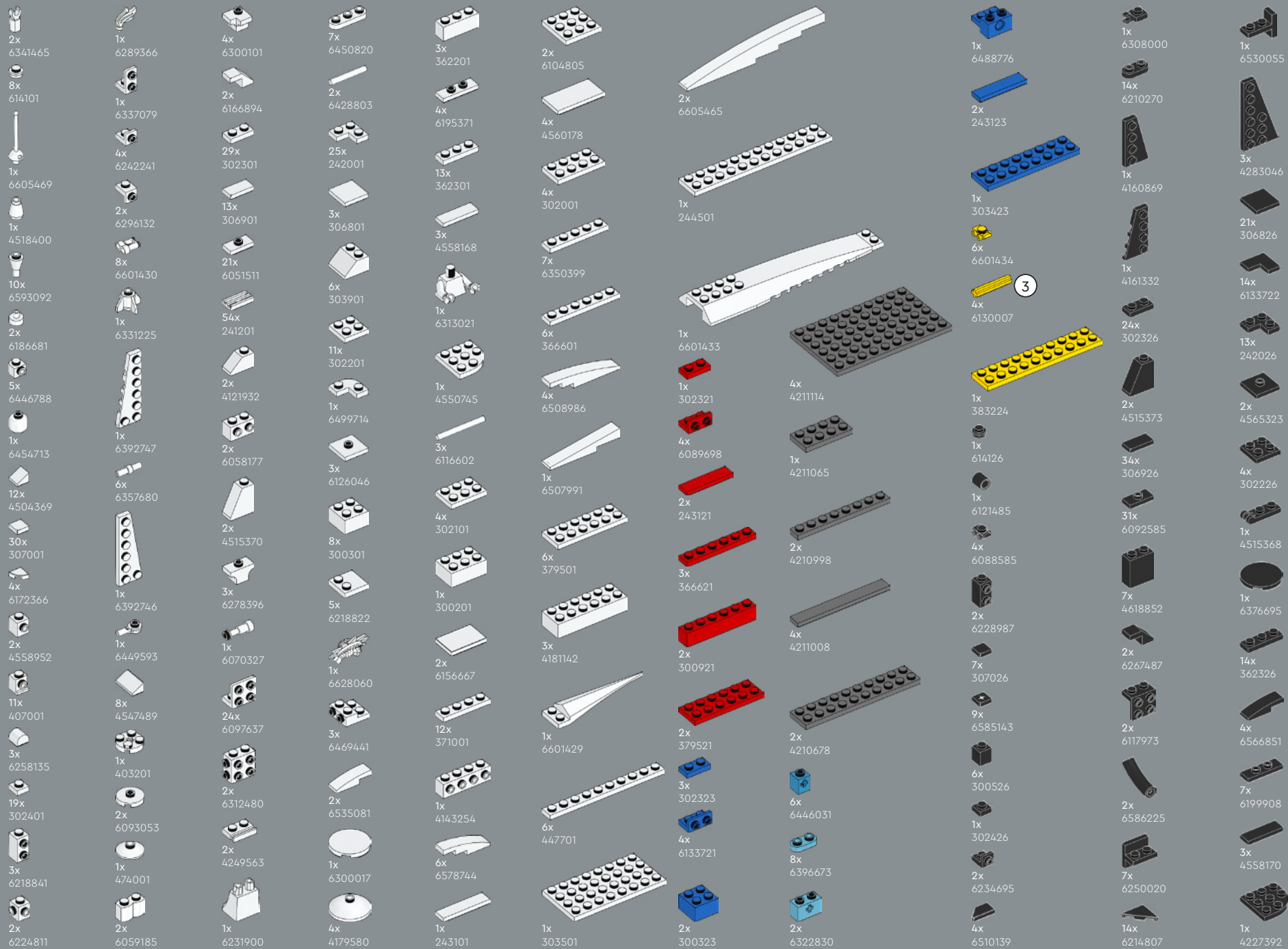

- 10x 6118829
- 2x 6168620
- 1x 4531412
- 6x 6580394
- 18x 243126
- 8x 371026
- 3x 4160025
- 1x 365926
- 1x 301026
- 2x 6039869
- 14x 302026
- 5x 663626
- 4x 6535144
- 5x 6184876
- 1x 366626
- 1x 4243819
- 1x 6101857
- 2x 4181144
- 57x 4560182
- 1x 6585142
- 8x 303226
- 2x 303426
- 1x 6037390
- 1x 395826
- 2x 383226
- 6x 4514845
- 2x 302926
- 2x 6001494
- 2x 6601431
- 1x 4166619
- 1x 6372045
- 5x 346026
- 4x 379526
- 6x 4106977
- 2x 6509390
- 1x 6439175
- 8x 4504374
- 6x 6403899
- 6x 4255413
- 6x 6595205
- 15x 4249891
- 4x 6103405
- 6x 6233955
- 9x 4177735
- 3x 4264569
- 1x 6343976
- 13x 4211399
- 6x 6253436
- 2x 6401023
- 2x 6225242
- 2x 4211389
- 5x 4211415
- 4x 4211476
- 4x 6522869
- 7x 6061702
- 1x 6345639
- 2x 6075075
- 4x 6407767
- 4x 4211526
- 15x 4617170
- 2x 6383177
- 7x 4211398
- 1x 4211388
- 4x 6066097
- 4x 6134378
- 4x 6217876
- 14x 4211397
- 1x 4211387
- 1x 4211353
- 4x 4211413
- 2x 6569357
- 1x 4211429
- 4x 4211361
- 1x 6421522
- 4x 4160560
- 11x 4211445
- 1x 4211394
- 2x 4211356
- 6x 6015347
- 8x 6442144
- 1x 6170418
- 3x 4211393
- 3x 4211438
- 1x 6508016
- 4x 4243797
- 4x 4211452
- 2x 4211392
- 1x 4211481
- 4x 4211402
- 1x 4211401
- 4x 4662161
- 3x 4210690
- 2x 4210700
- 7x 6221607
- 2x 4226221
- 12x 6514469
- 1x 6514246
- 17x 6514223
- 8x 6062686
- 7x 4620077
- 8x 6257079
- 4x 6248952
- 28x 6417947
- 1x 383228
- 2x 302028
- 8x 6344216
- 16x 4210636
- 6x 6269969
- 9x 4211063
- 4x 6601435
- 3x 4210978
- 1x 6396489
- 10x 4211098
- 5x 6262021
- 7x 6333129
- 1x 4210719
- 5x 6388133
- 8x 6062686
- 1x 4648256
- 1x 4500975
- 1x 6336990
- 2x 4211104
- 5x 4211133
- 1x 4648256
- 1x 6240515



[LEGO.com/service](https://www.LEGO.com/service)



**YOU** COULD  
**WIN**



**YOU COULD  
WIN**

Your feedback will help shape the future development of this product series.

Visit:

**DU KÖNNTEST  
GEWINNEN**

Dein Feedback trägt zur Weiterentwicklung dieser Produktreihe bei.

Geh auf:

**VOUS POURRIEZ  
GAGNER**

Vos commentaires nous aideront à concevoir les futurs produits de cette gamme.

Visitez :

**POTRESTI  
VINCERE TU**

La tua opinione ci aiuterà a migliorare la creazione futura di questa linea di prodotti.

Visita:

**PUEDES  
GANAR**

Tu opinión contribuirá al futuro de esta serie de productos.

Visita:

**轻松获奖**

您的反馈将有助于我们在今后改进本产品系列。

请访问:

---

**LEGO.com/productfeedback**

---

You also have the chance to win a LEGO® set.

Terms and conditions apply.\*

Außerdem hast du die Chance, ein LEGO® Set zu gewinnen.

Es gelten die Teilnahmebedingungen.\*

Vous pourriez également gagner un ensemble LEGO®.

Des conditions s'appliquent.\*

Hai anche la possibilità di vincere un set LEGO®.

Termini e condizioni sono applicabili.\*

También tienes la oportunidad de ganar un set LEGO®.

Aplican términos y condiciones.\*

您还有机会赢取乐高®套装。

条款和条件适用。\*

\*LEGO.com/productfeedback-terms

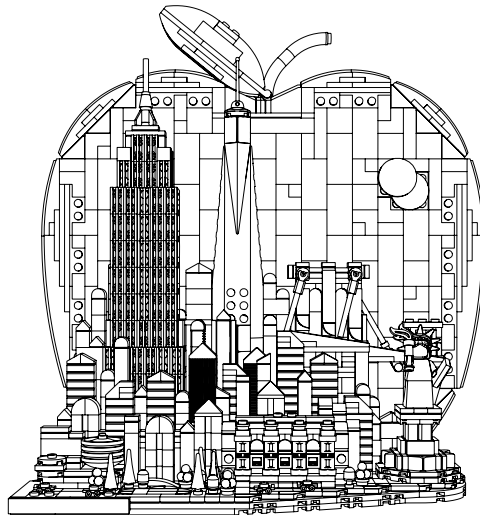

LEGO and the LEGO logo are trademarks of the LEGO Group. ©2026 The LEGO Group.

The EMPIRE STATE BUILDING name and image are registered trademarks and used with permission.

The name and building image of the Solomon R. Guggenheim Museum are trademarks of the Solomon R. Guggenheim Foundation. Used with permission.

® /™ /© Frank Lloyd Wright Foundation. All Rights Reserved.

One World Trade Center building design is a copyright of WTC Tower 1 LLC. Used under license.

Adam Reed Tucker is the co-developer of the LEGO® Architecture product line.