



21066





LEGO.com/sustainable-packaging



FR
**DONNEZ
OU
RECYCLEZ**



ASSOCIATION

OU



MAGASIN

OU



DÉCHÈTERIE

Adresses sur quefairedemesdechets.fr



BUILDER



Apple and the Apple logo are trademarks of Apple Inc., registered in the U.S. and other countries and regions. App Store is a service mark of Apple Inc. Google Play and the Google Play logo are trademarks of Google LLC. Tencent and the Tencent logo are trademarks of Tencent Inc.

LEGO.com/devicecheck

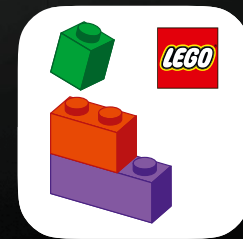

LEGO® Builder



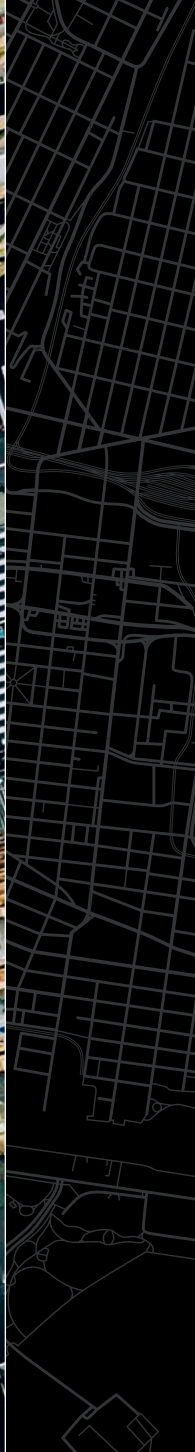



LA GROSSE POMME

New York, New York : la ville qui ne dort jamais, la ville des rêves, la Big Apple, la grosse pomme... une ville connue sous mille noms, symbole d'énergie et d'opportunités sans limites. Fondée en 1624 sous le nom de « New Amsterdam », elle s'est transformée au fil des siècles en un véritable phare de culture, de commerce, d'art et d'innovation. La silhouette emblématique de New York rassemble des monuments instantanément reconnaissables, répartis dans ses cinq arrondissements ou *boroughs*. De la Statue de la Liberté qui accueille les nouveaux arrivants aux rues animées qui vous donnent envie de poursuivre vos rêves, le rythme unique de la ville captive autant les visiteurs que ses habitants. Le quartier de Manhattan abrite à lui seul plus de 1,5 million de personnes sur seulement 59 km², ce qui en fait l'un des endroits les plus densément peuplés de la planète. Que vous soyez attiré(e) par ses lumières éclatantes et son agitation permanente, ou par les allées paisibles de Central Park, l'esprit de la ville, sa richesse historique et sa diversité vous laisseront à coup sûr une impression durable.

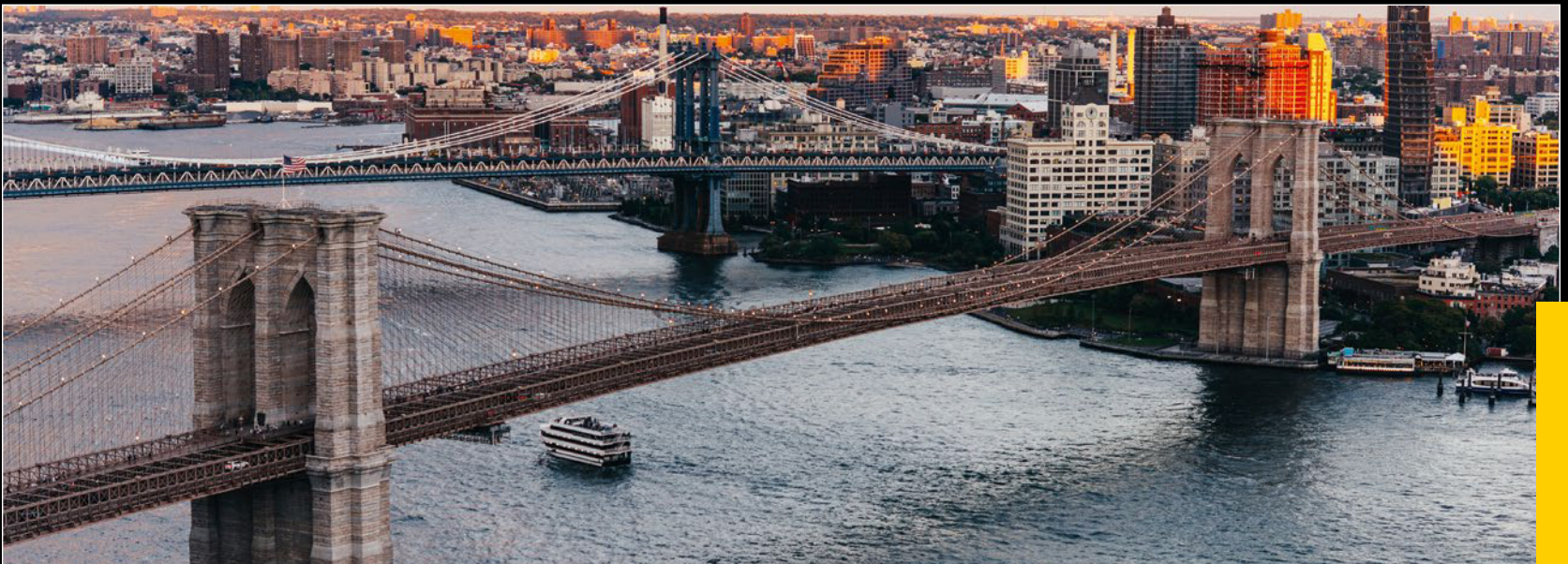



LE ONE WORLD TRADE CENTER (2014)

À ce jour, One World Trade Center est la tour la plus haute de l'hémisphère occidental, construite comme un symbole d'unité et de résilience.



L'EMPIRE STATE BUILDING (1931)

Ce monument new-yorkais de 102 étages offre des vues spectaculaires sur la ville depuis le cœur de Midtown Manhattan.



LE METROPOLITAN MUSEUM OF ART (1870)

Fondé en 1870, le Met est l'un des plus grands musées du monde, avec plus de 5 000 ans d'histoire de l'art et des chefs-d'œuvre modernes.



LE MUSÉE SOLOMON R. GUGGENHEIM (1959)

Depuis son ouverture, le musée est reconnu pour son architecture en spirale et sa collection de classe mondiale d'art moderne et contemporain.

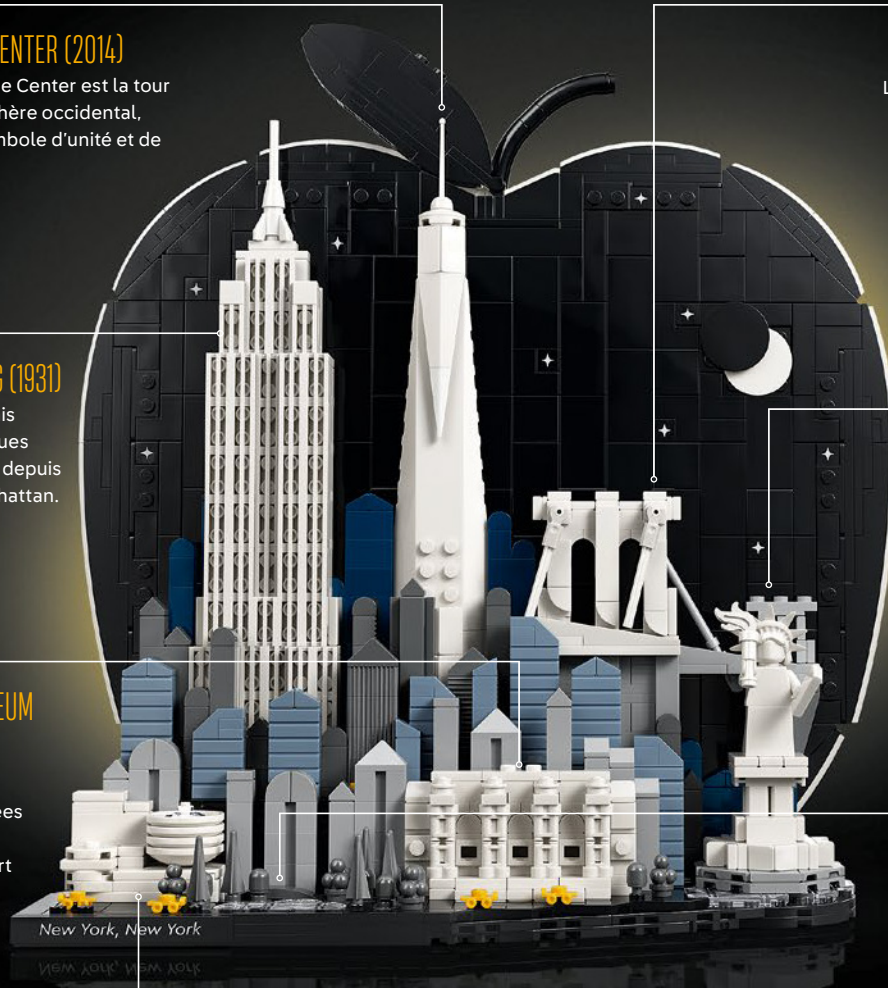

LE PONT DE BROOKLYN (1883)

Long de plus d'un mile, le pont de Brooklyn était le plus long pont suspendu du monde lors de son inauguration.



LA STATUE DE LA LIBERTÉ (1886)

Cette grande statue néoclassique surplombe Liberty Island dans le port de New York, autrefois le port d'entrée le plus célèbre des États-Unis.



CENTRAL PARK (1858)

Central Park accueille 42 millions de visiteurs chaque année sur ses 341,1 hectares de pelouses, de sentiers et de lacs.



LE MOT DE L'ÉQUIPE DE DESIGNERS LEGO® ARCHITECTURE

2026 marque le 250^e anniversaire de la signature de la Déclaration d'indépendance des États-Unis ET le 10^e anniversaire de notre tout premier set LEGO® Architecture New York City Skyline ! Cette double célébration nous a inspirés à revisiter les monuments les plus célèbres de New York dans un décor de « Big Apple » sous un ciel nocturne. Nous avons utilisé des éléments à facettes pour reproduire la géométrie complexe du One World Trade Center, posé sur les « épaules » de l'Empire State Building et qui s'affine à mesure qu'il s'élève. Des plaques de grille LEGO ont été utilisées pour créer les fenêtres et les longues lignes Art déco verticales de l'Empire State Building. La construction du pont de Brooklyn joue sur un effet de perspective forcée, en modifiant fortement les tailles, en ajoutant des variations de couleurs sur les deux tours et en inclinant légèrement la chaussée. Avec d'autres détails emblématiques, comme « Lady Liberty » en minifigurine, nous espérons que vous prendrez autant de plaisir à construire qu'à explorer cette ville magnifique !



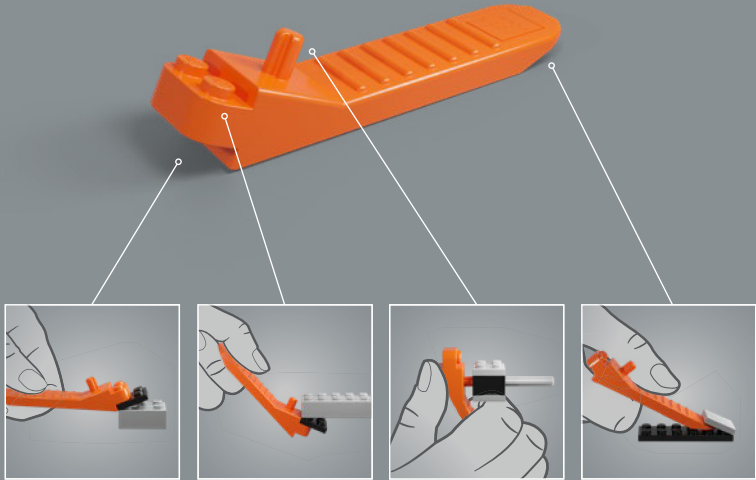

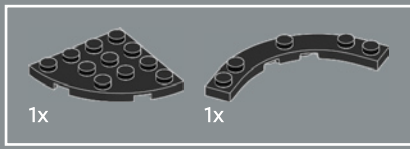

1

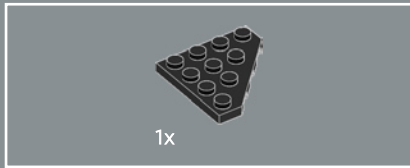
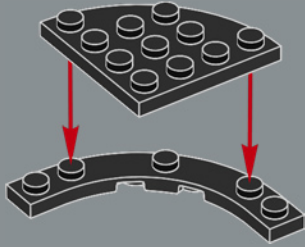

2

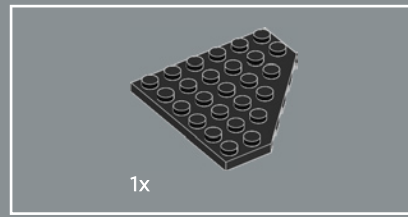
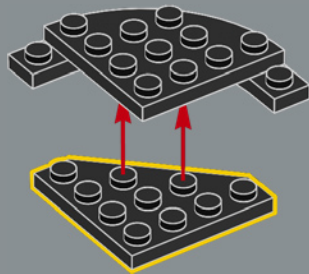

3

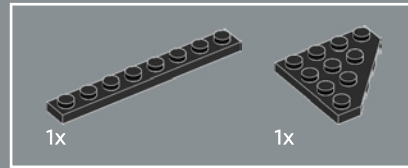
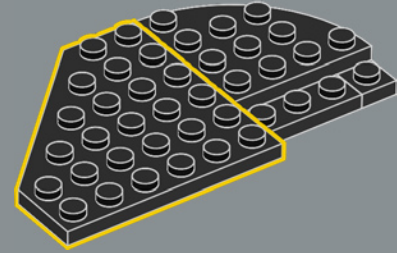

4

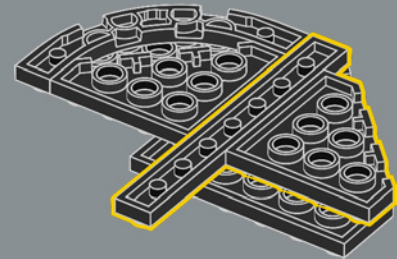

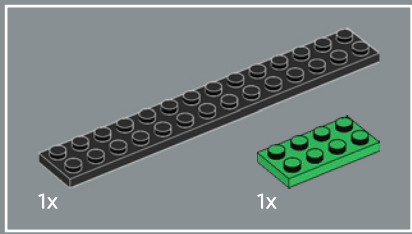

5

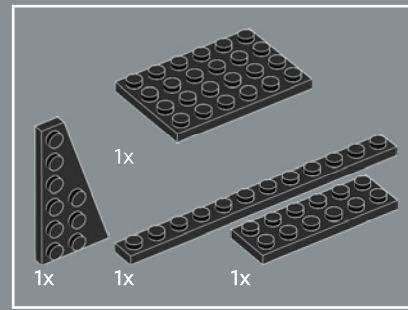
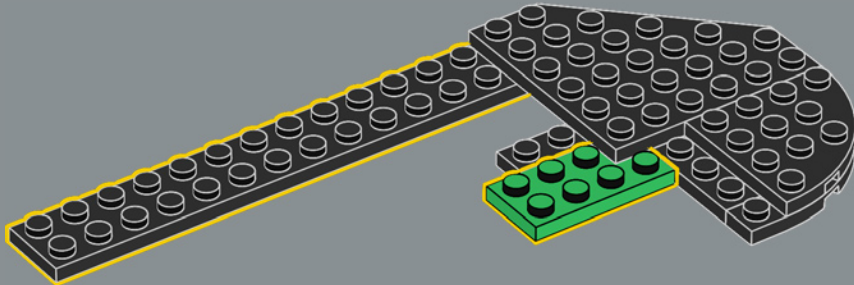

6

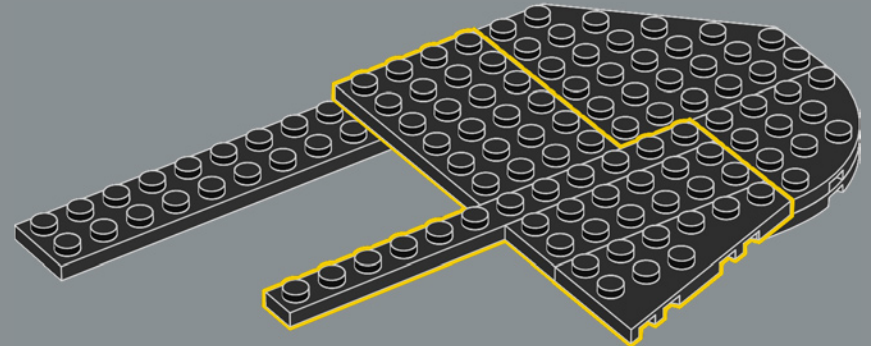

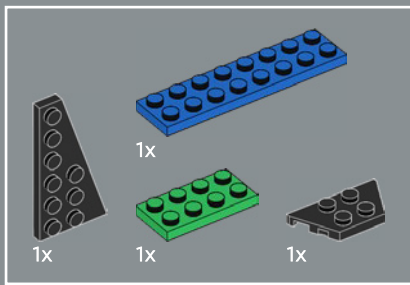

7

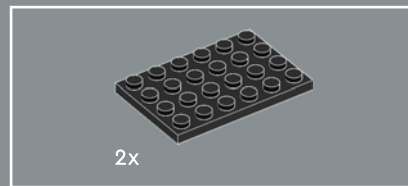
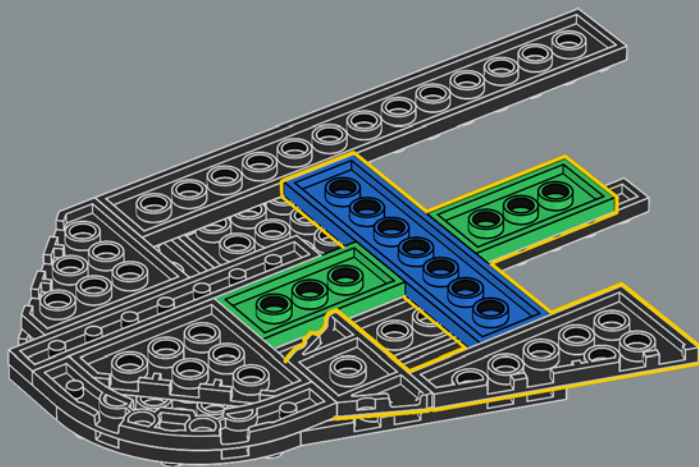

8

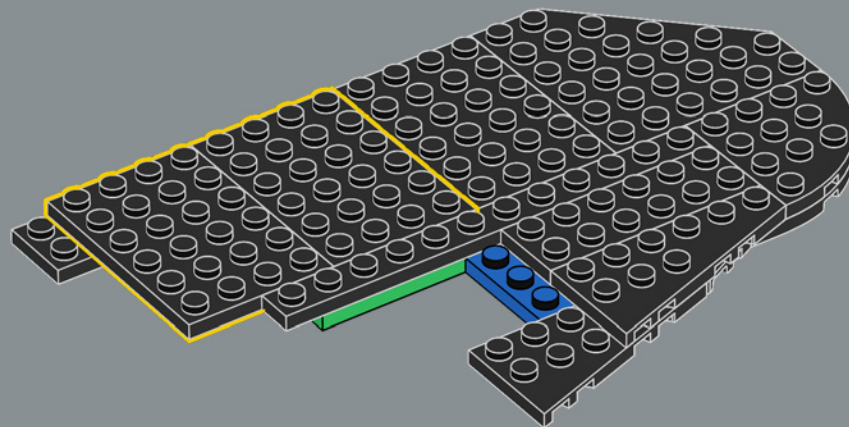

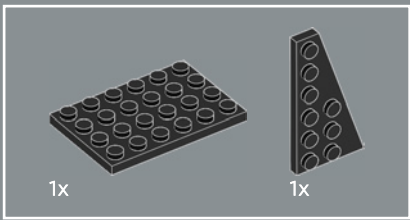

9

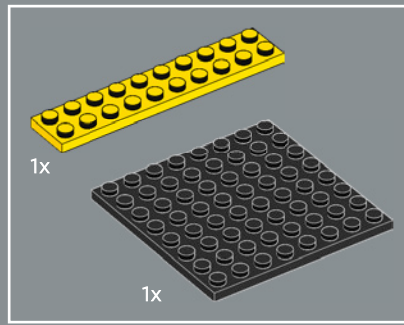
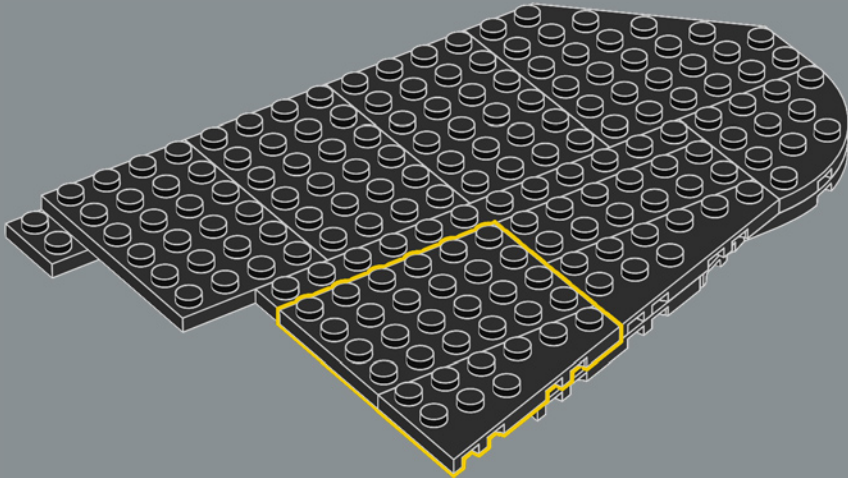

10

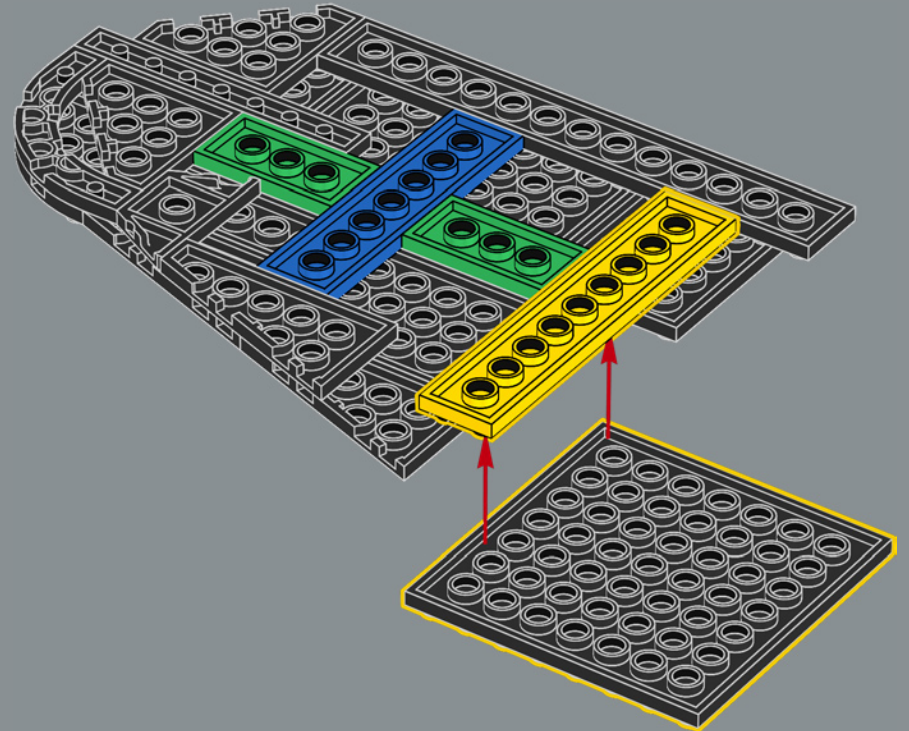

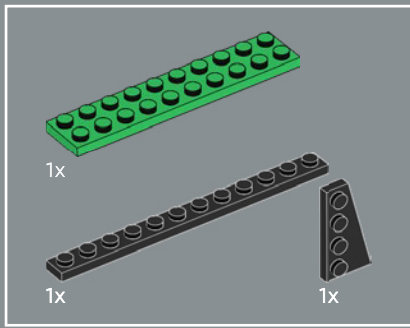

11

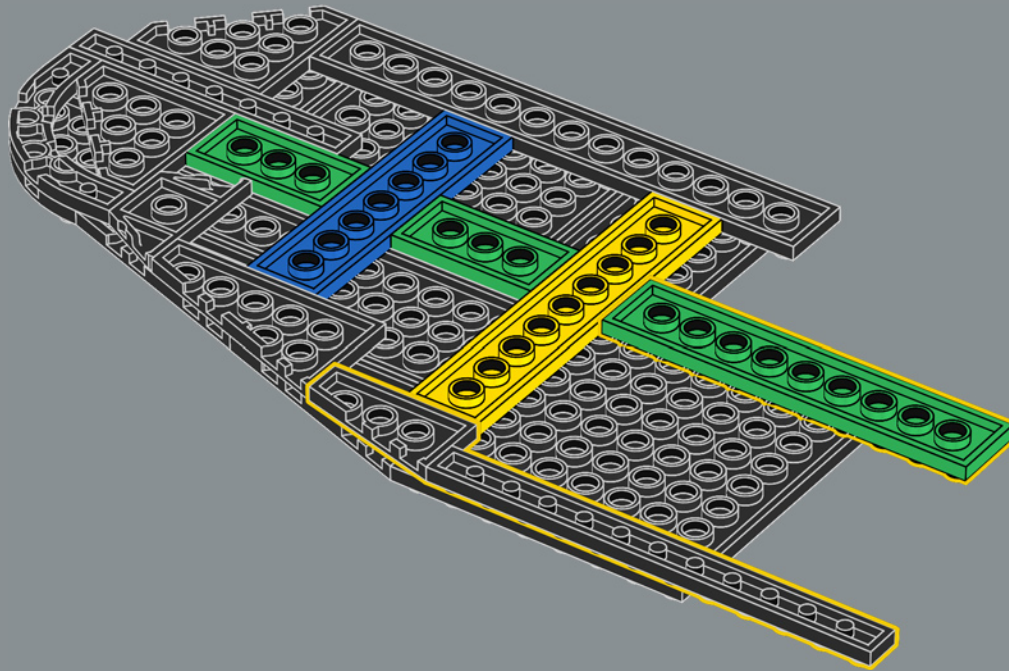

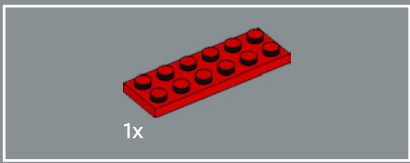

12

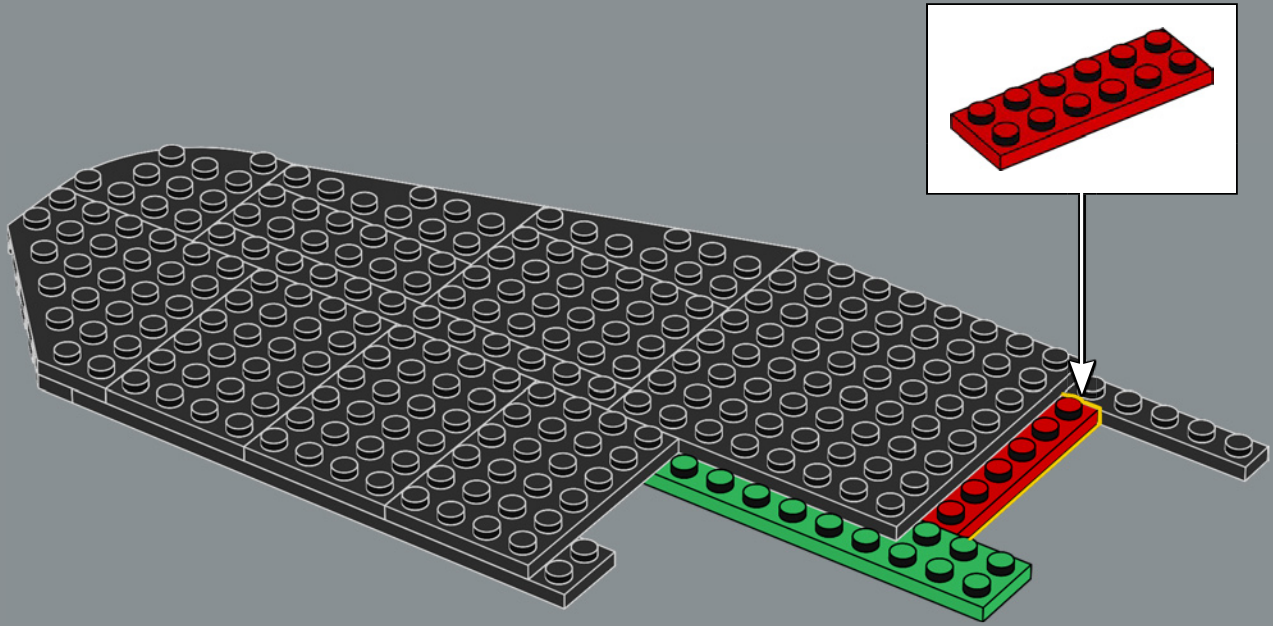

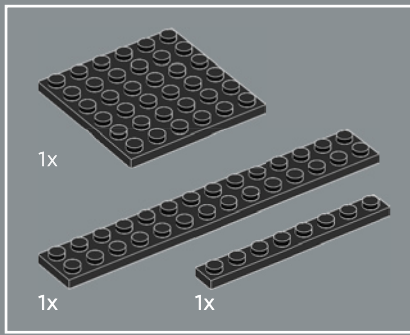

13

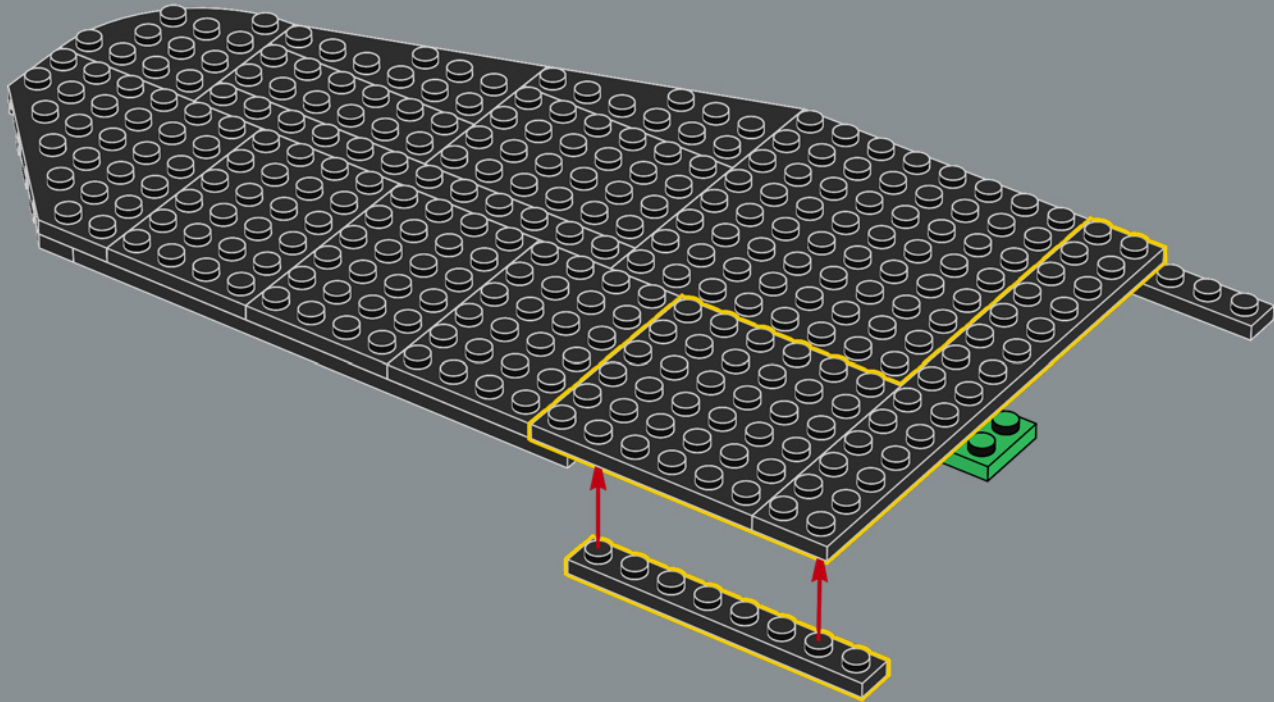

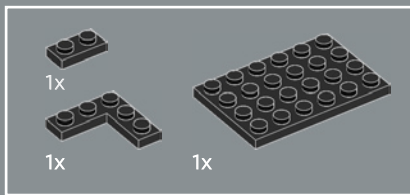

14

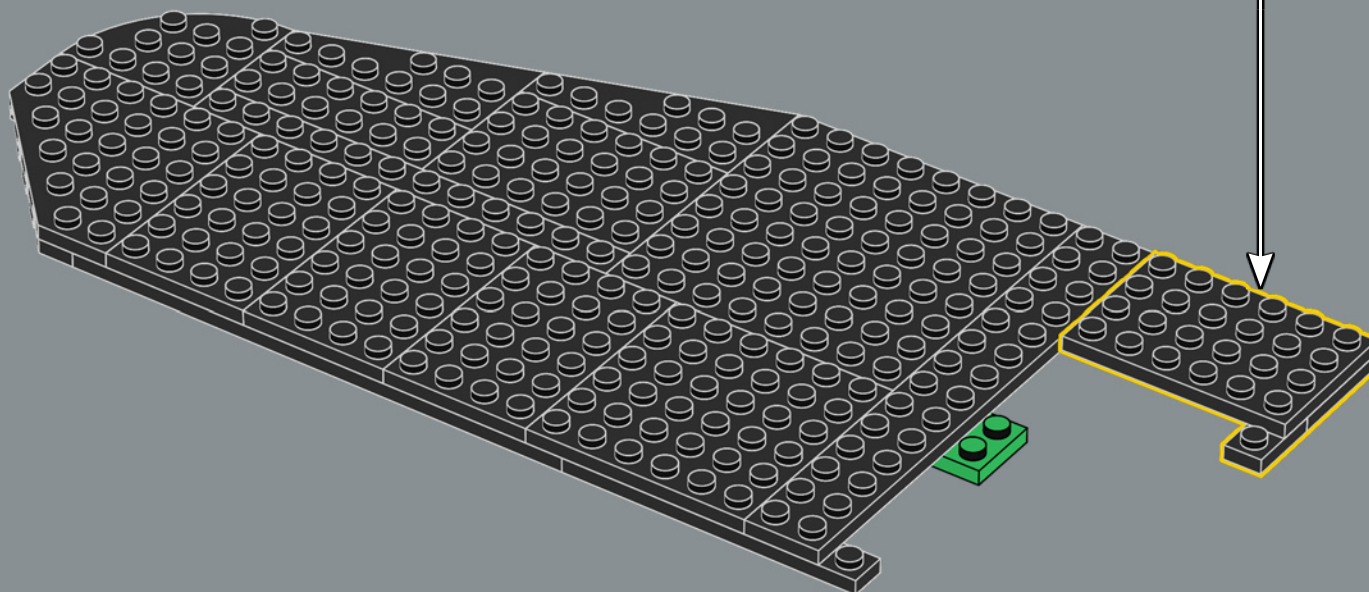
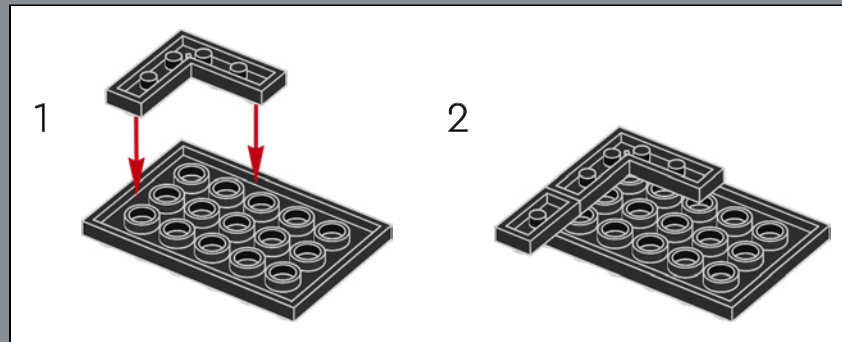

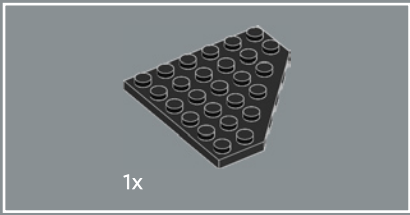

15

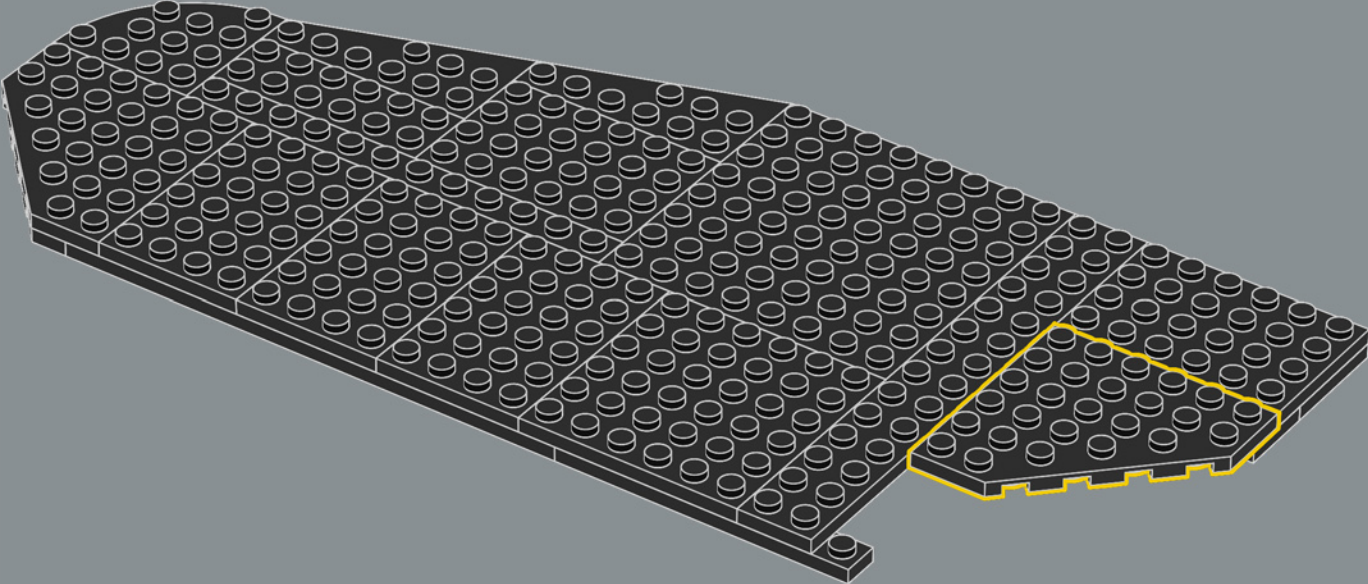

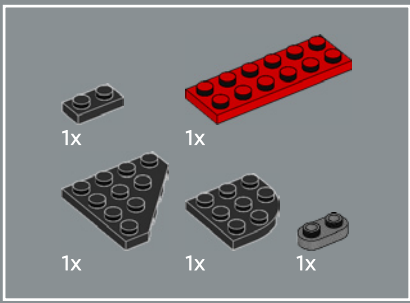

Les plaques LEGO® colorées à l'intérieur de la base s'inspirent de quelques-unes des 36 lignes de métro qui relient la ville.

16

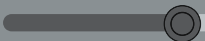
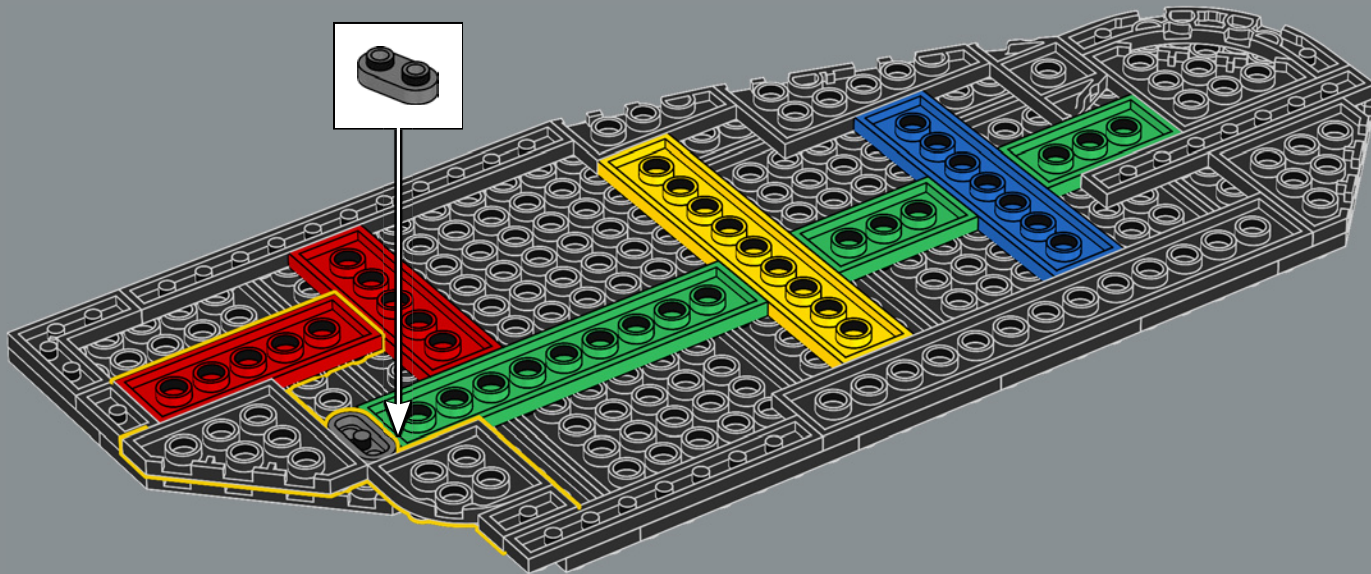

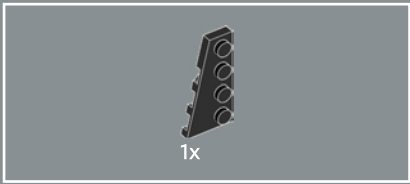

17

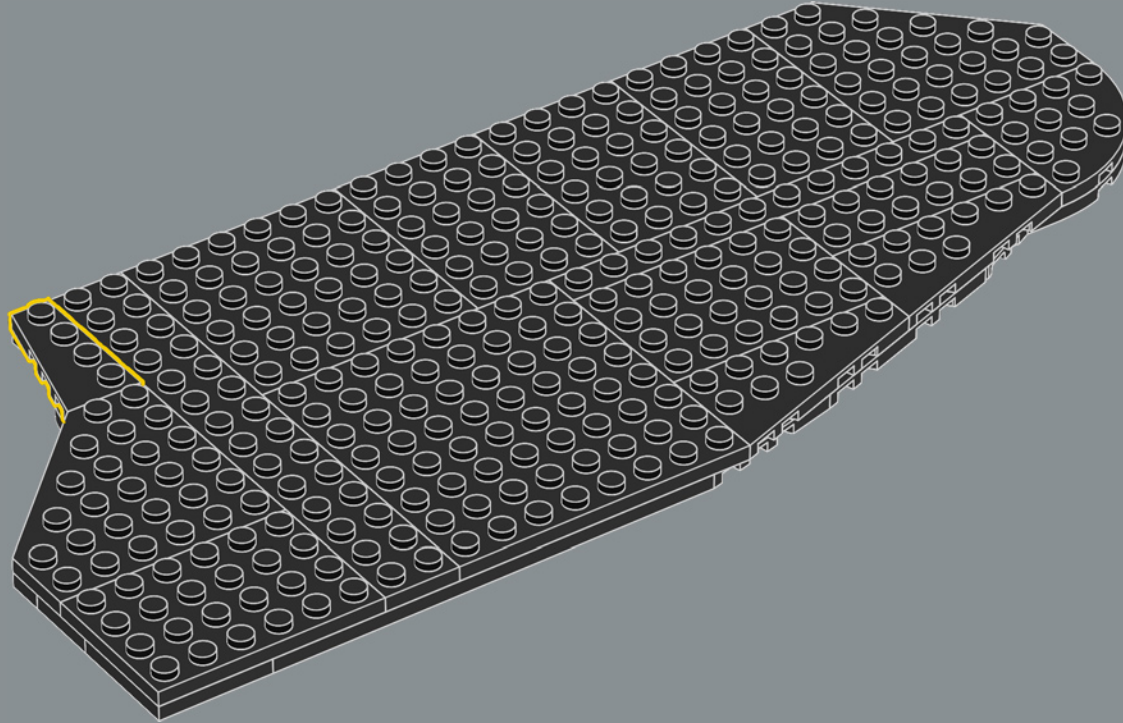

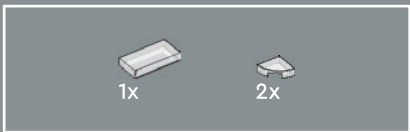

18



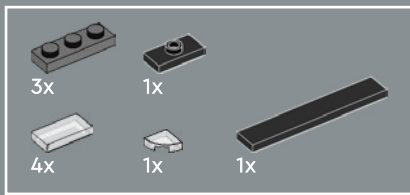

19

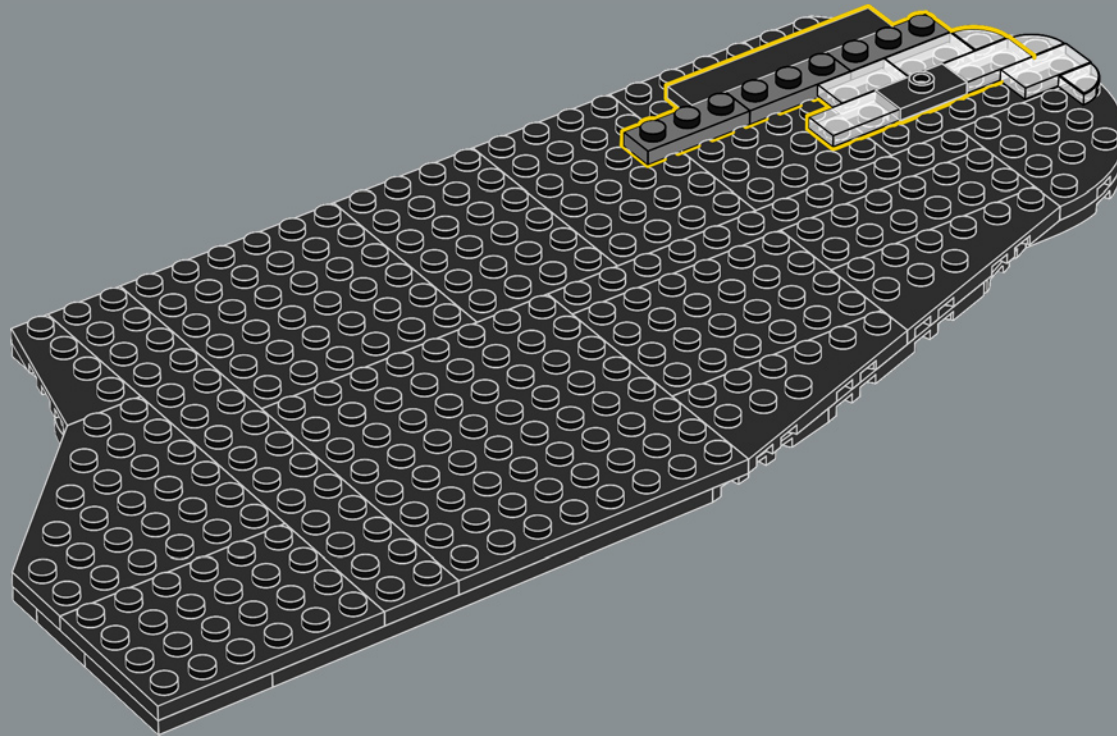

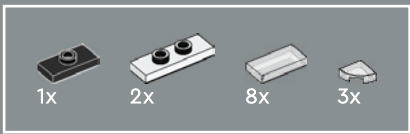

20

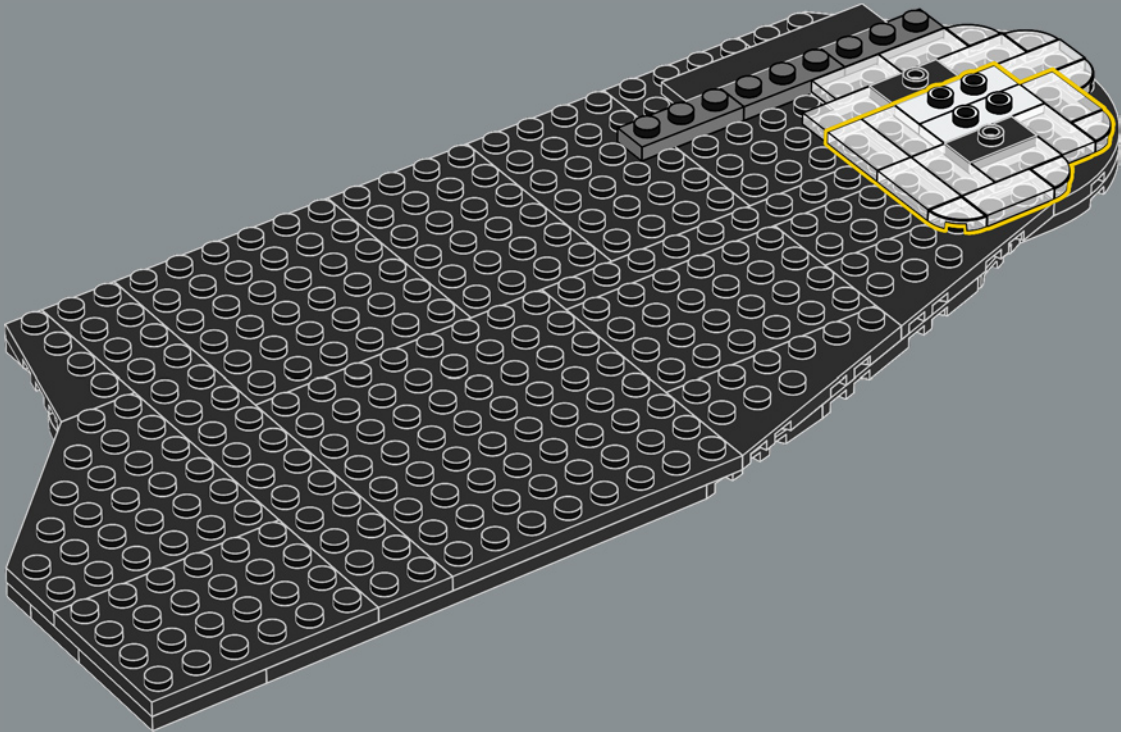

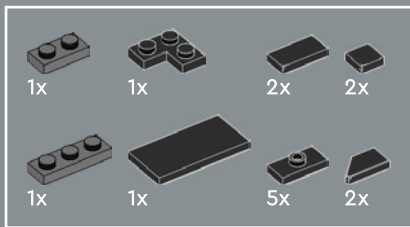

21

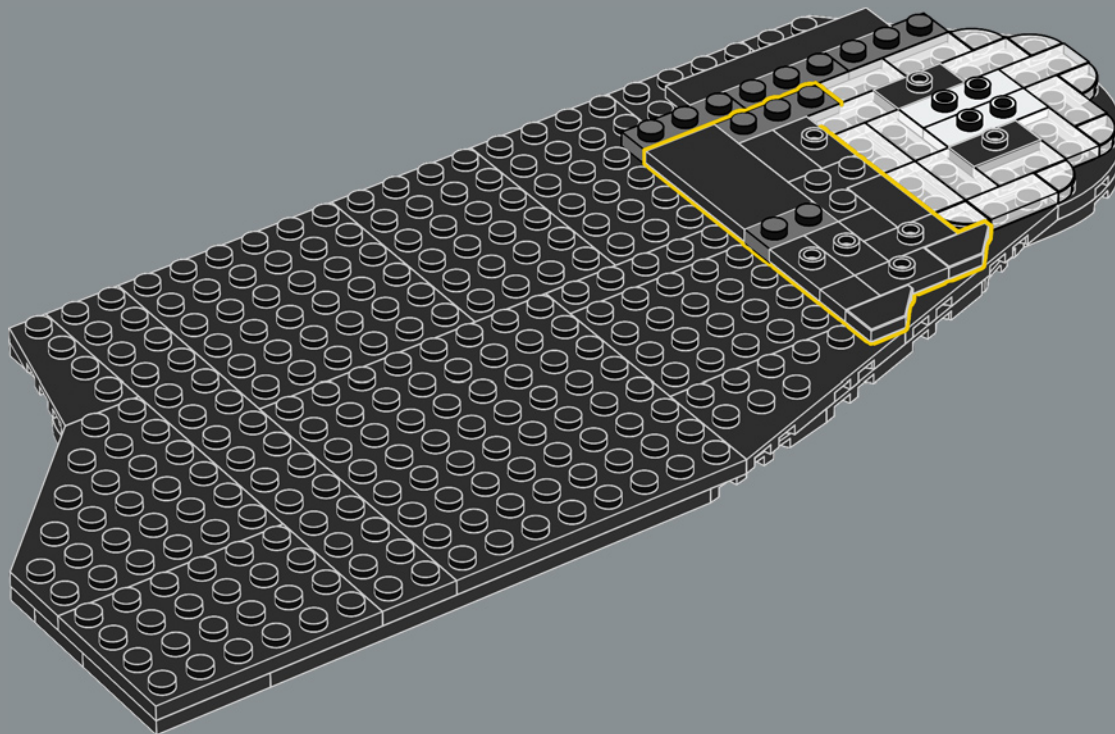

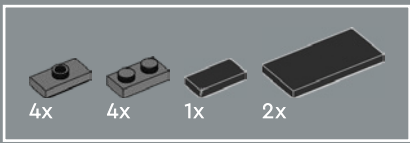

22

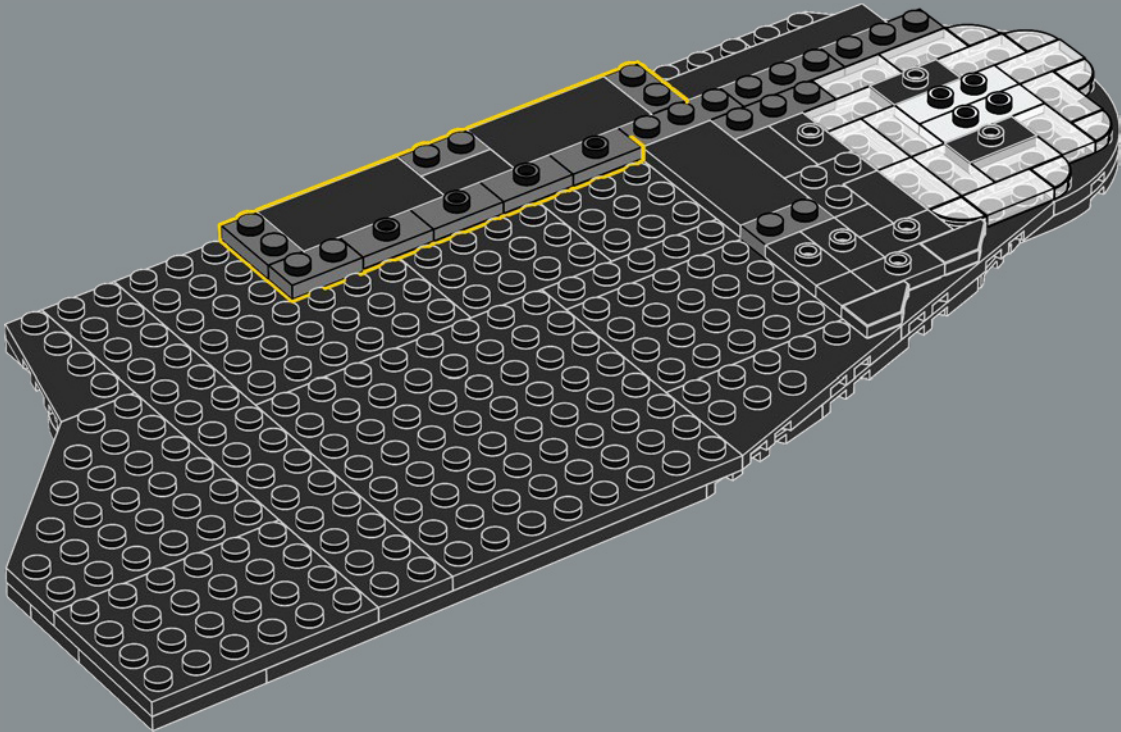

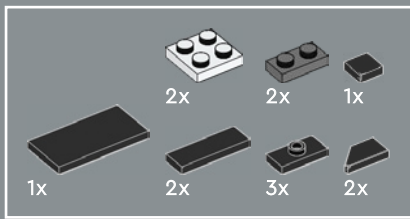

23

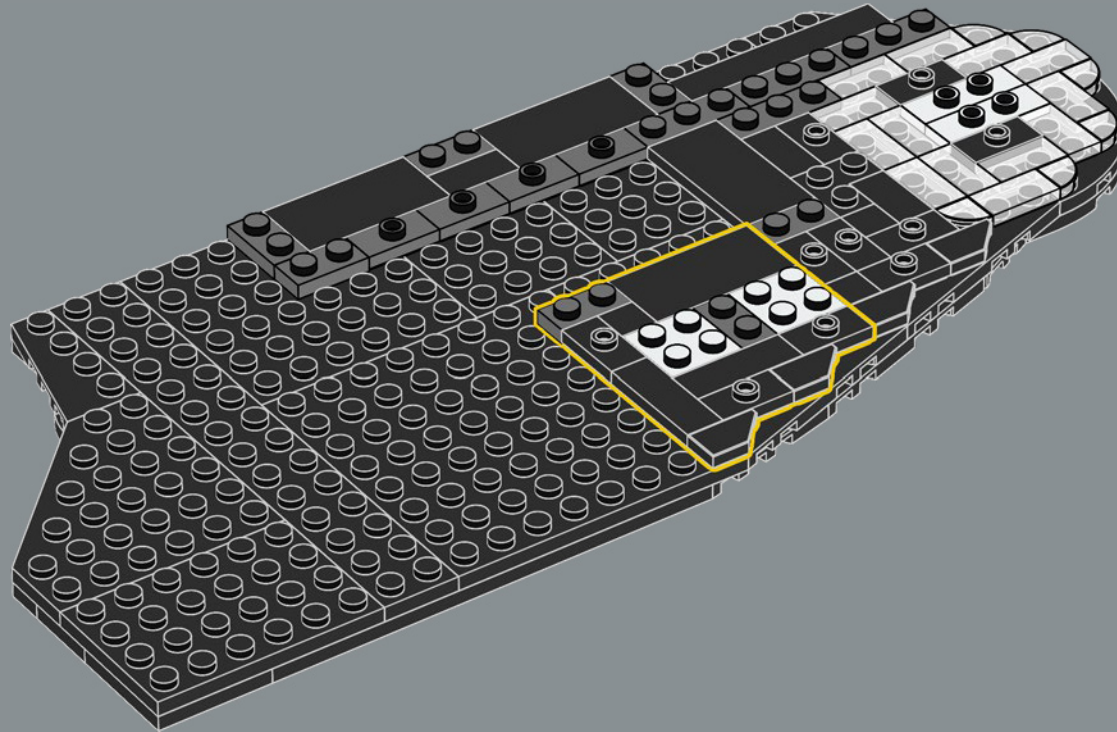

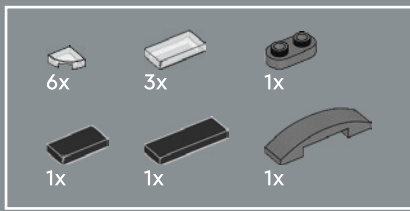

25

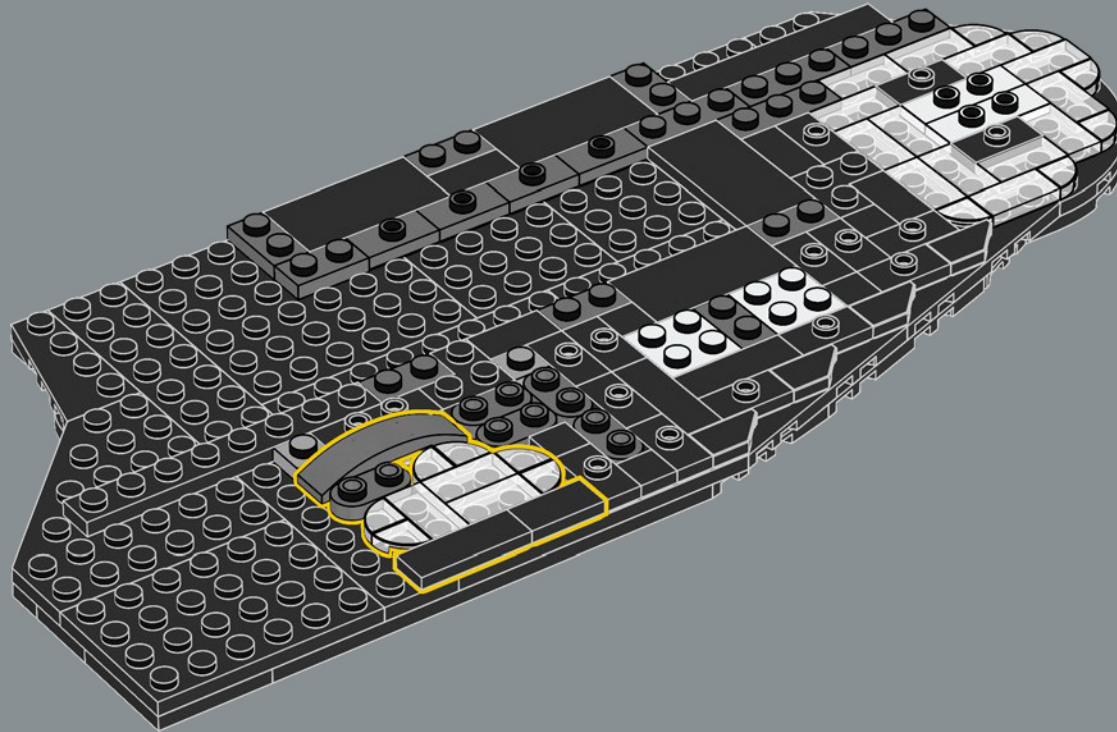

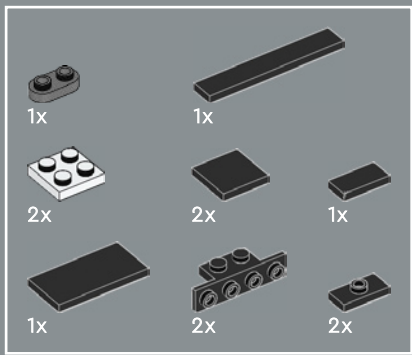

26

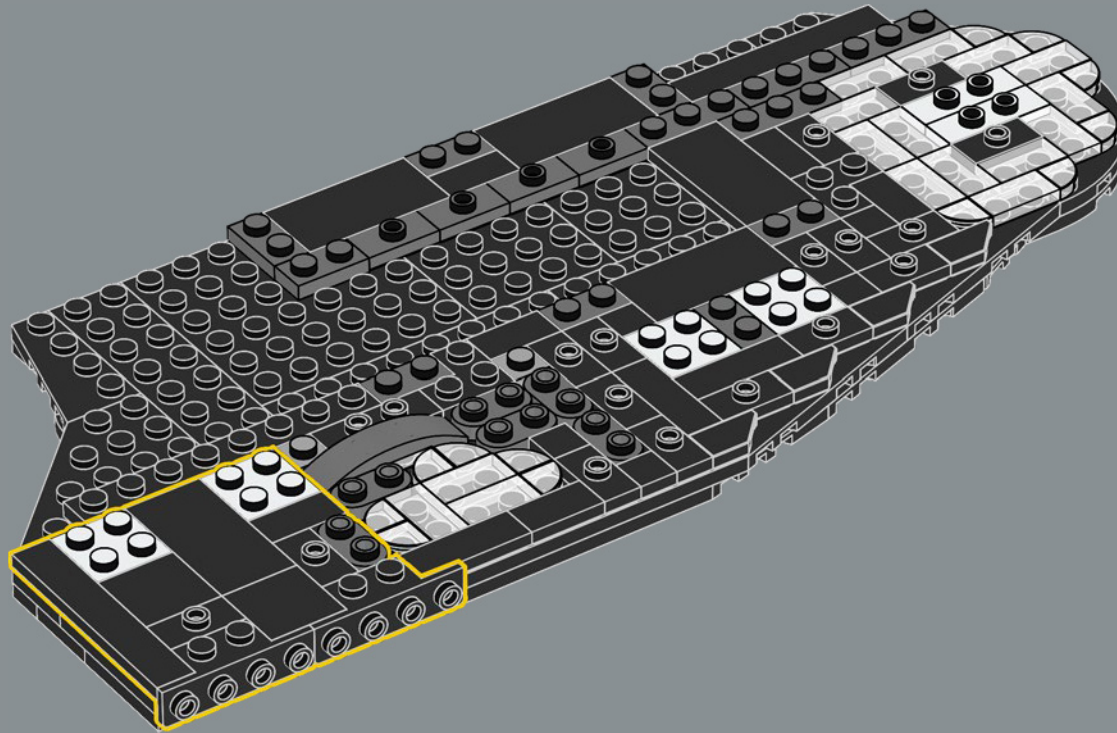

La base du modèle s'inspire du plus grand *borough* de New York, l'île de Manhattan.

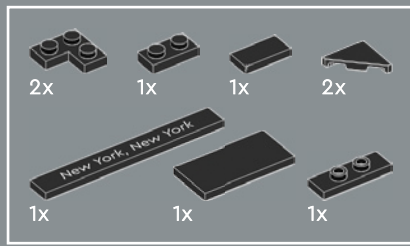

27

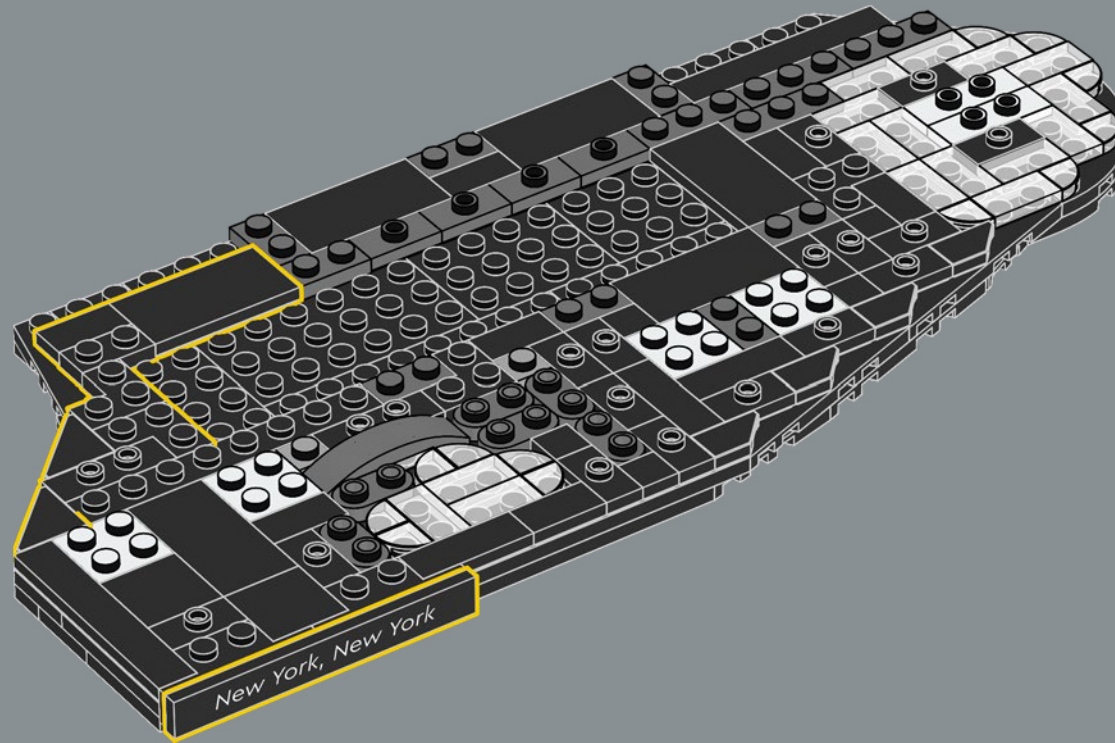

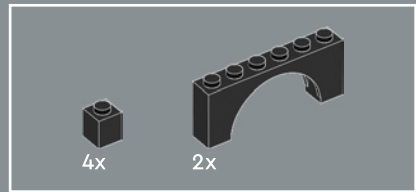

28

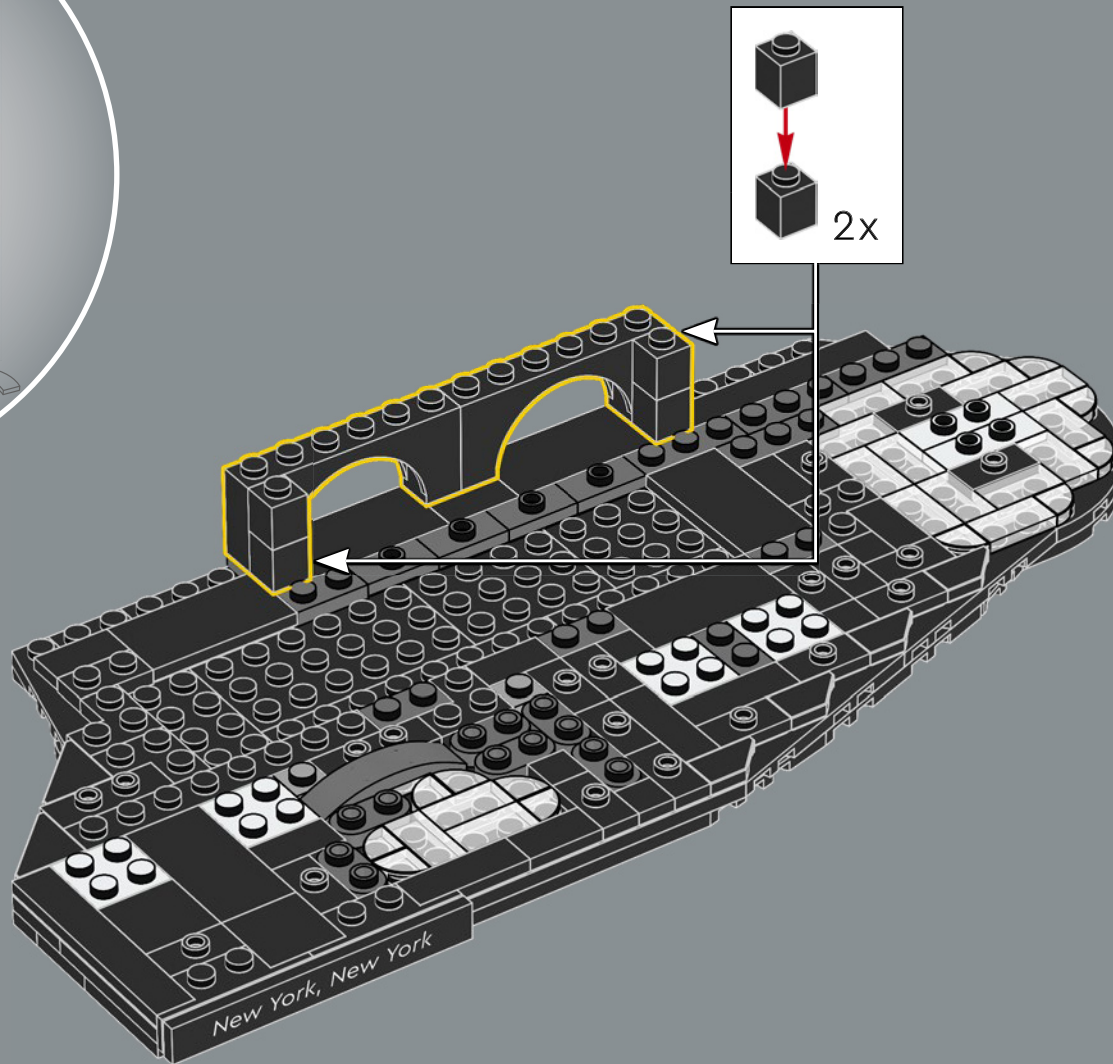

Si vous placez les 1 355 km de voies du métro new-yorkais en ligne droite, elles iraient de New York jusqu'à Chicago.



29

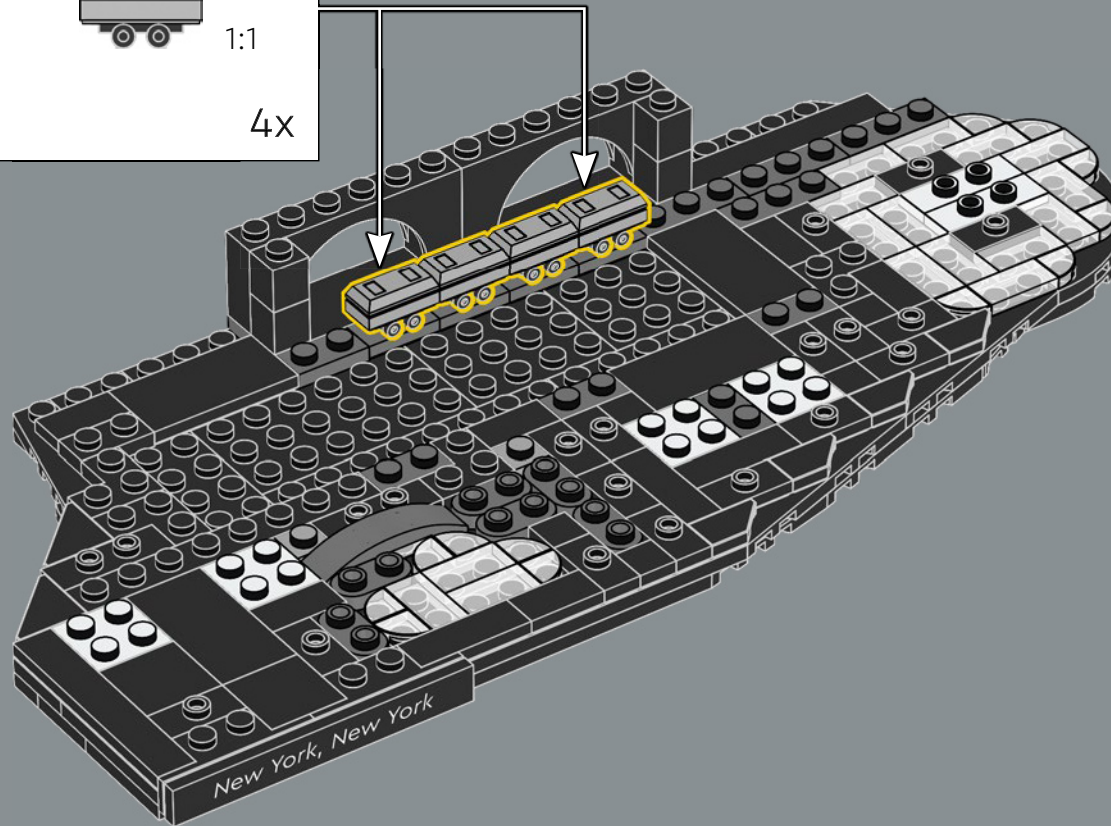
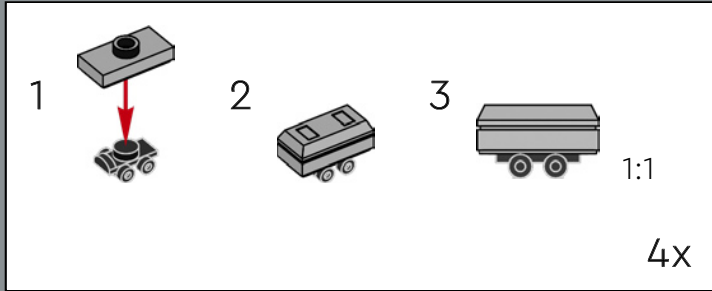

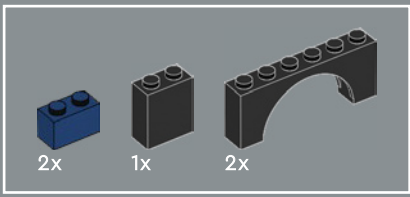

30

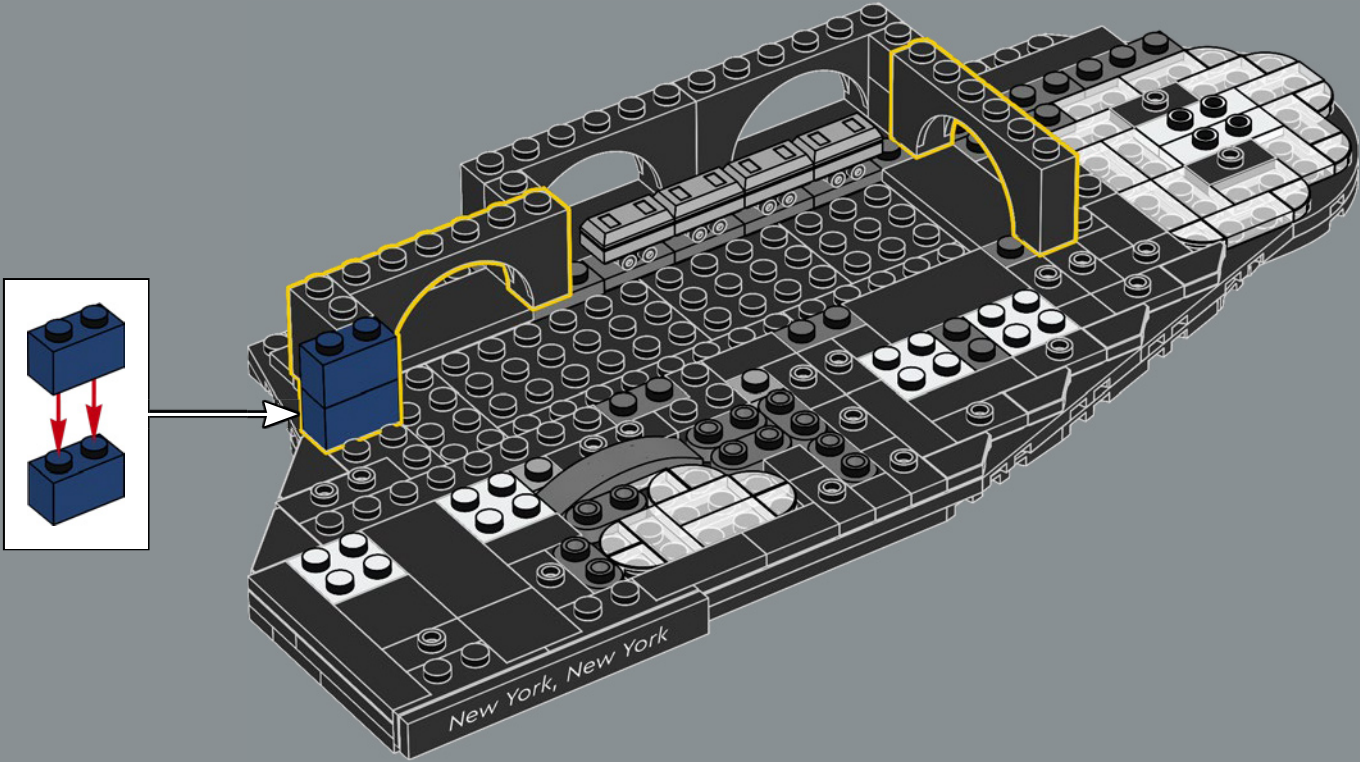

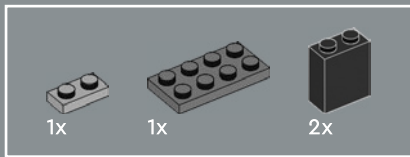

31

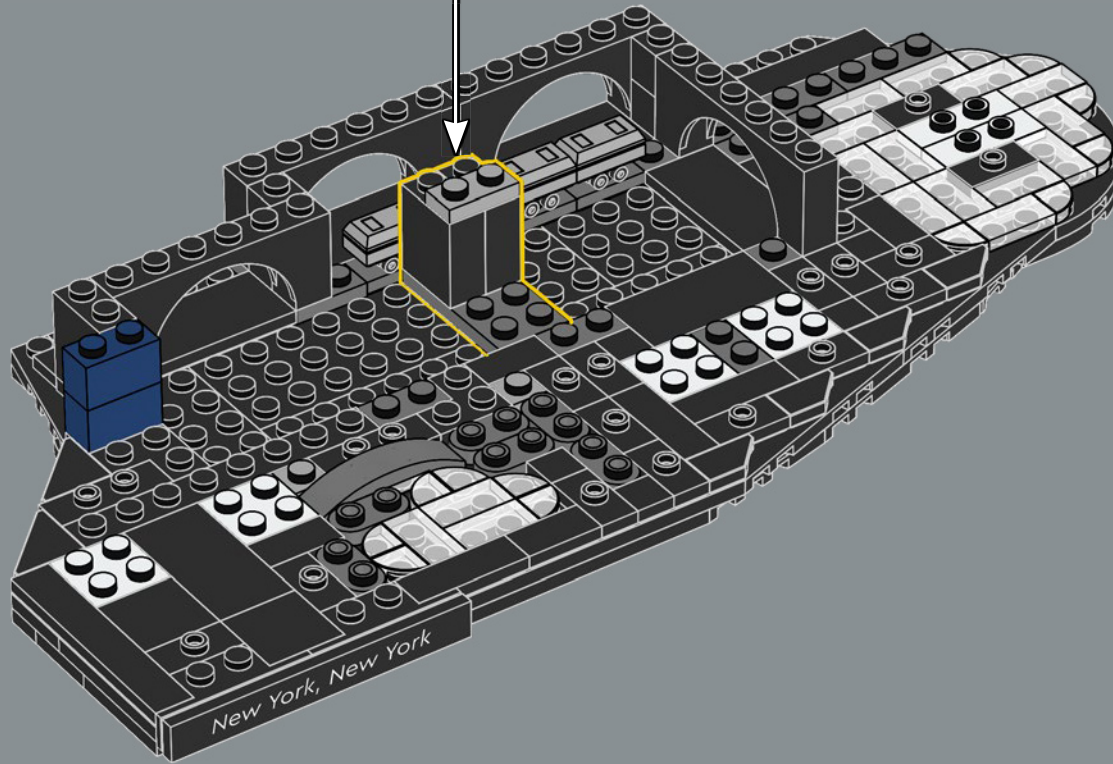
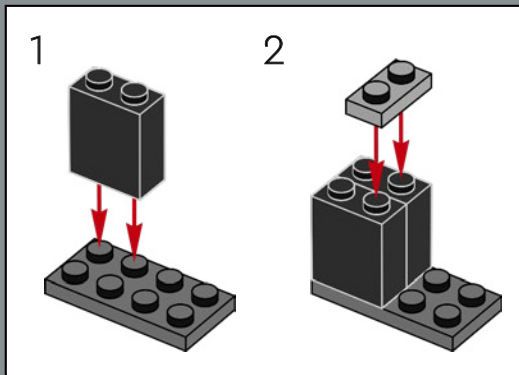

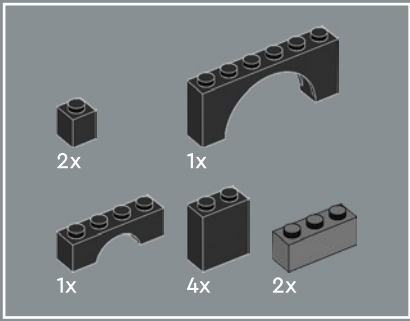

32

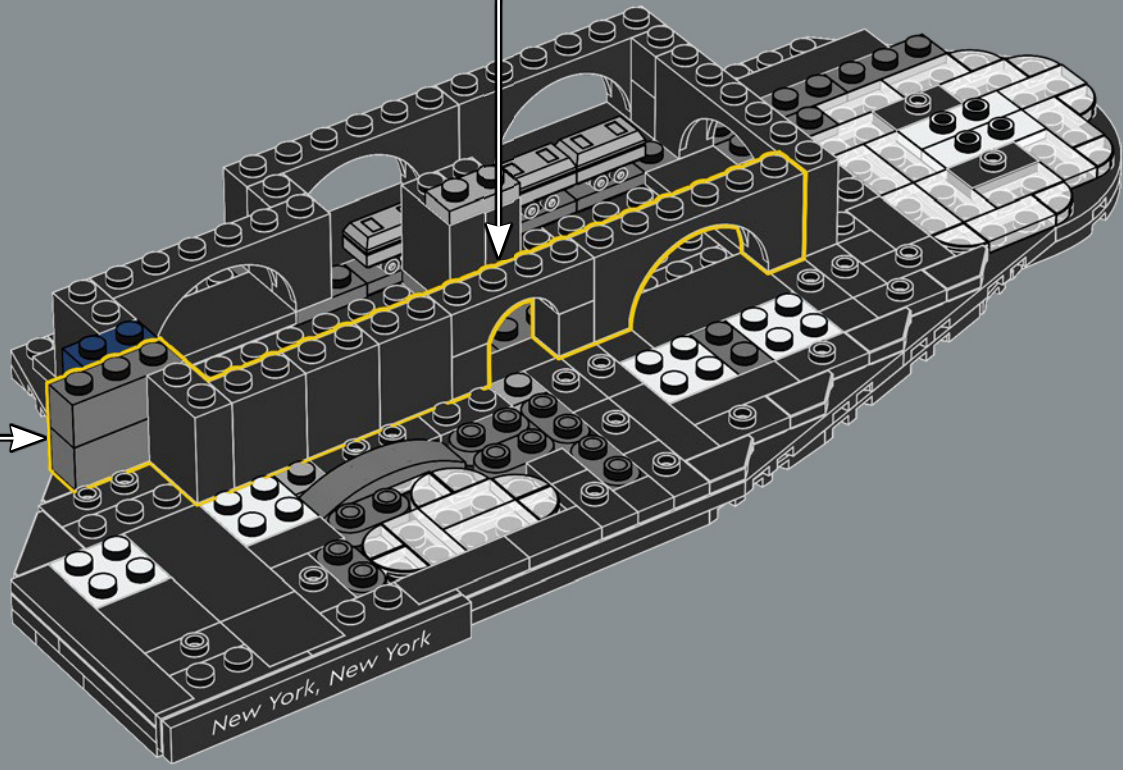
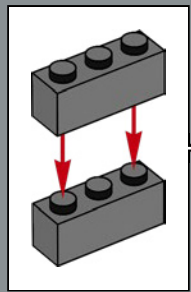
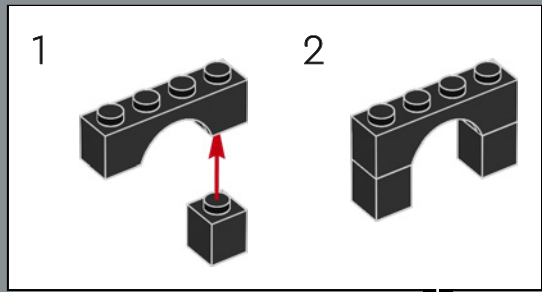

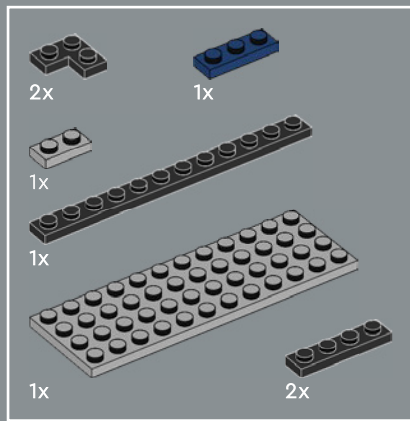

33

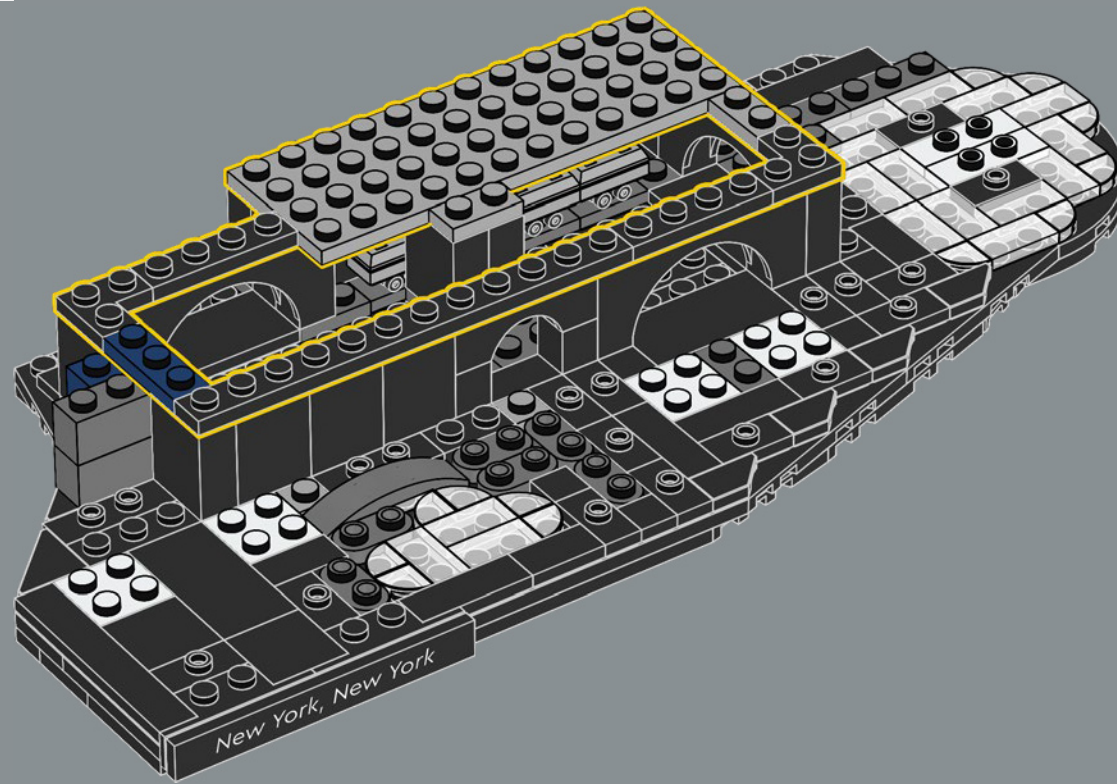

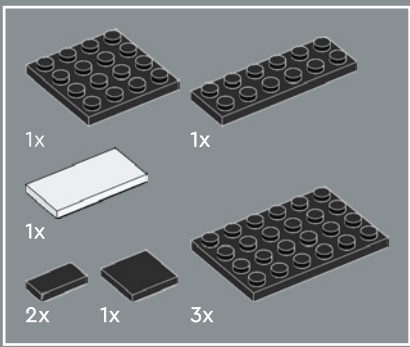

34

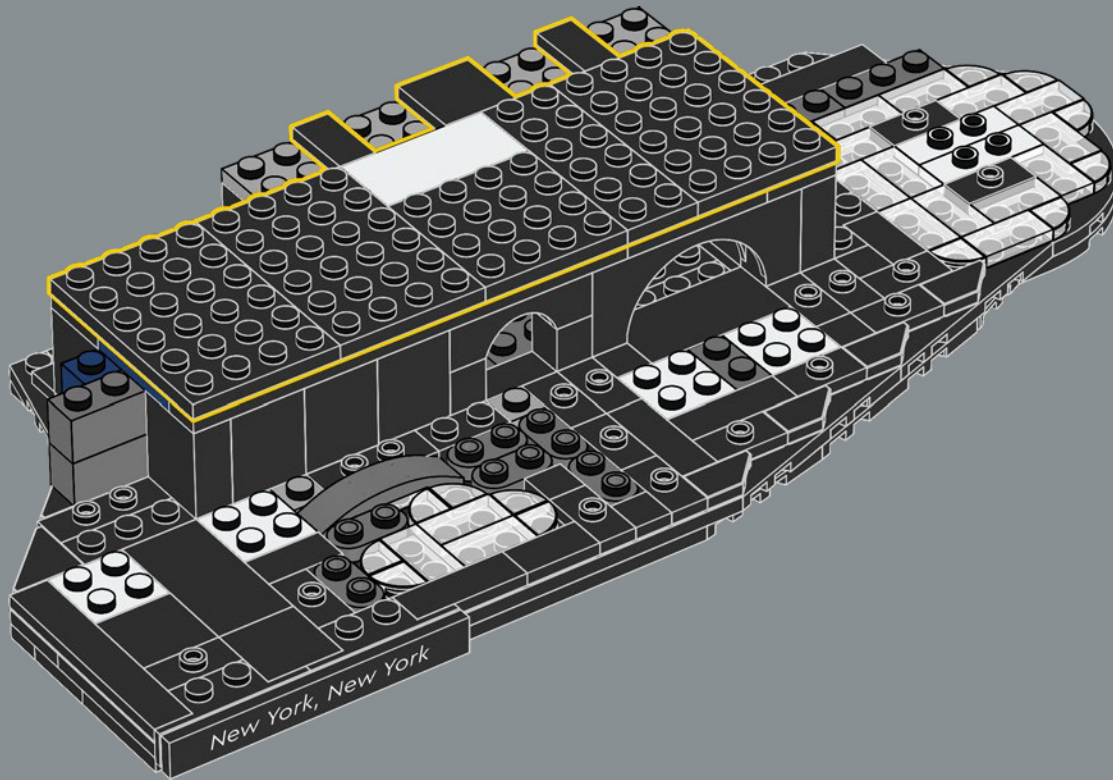

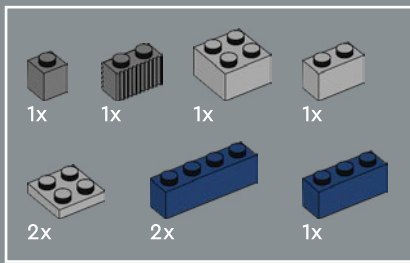

35

1

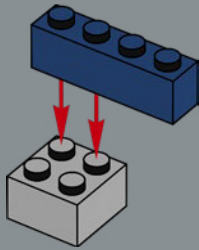

2

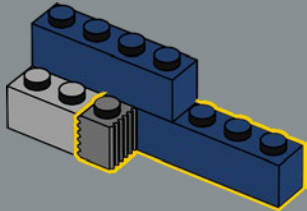

3

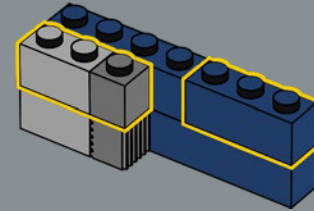

4

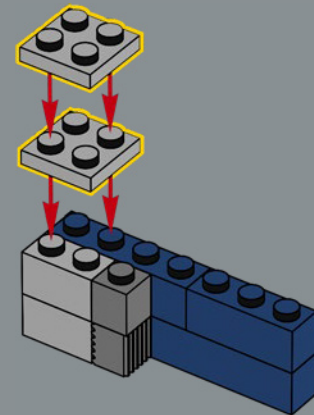

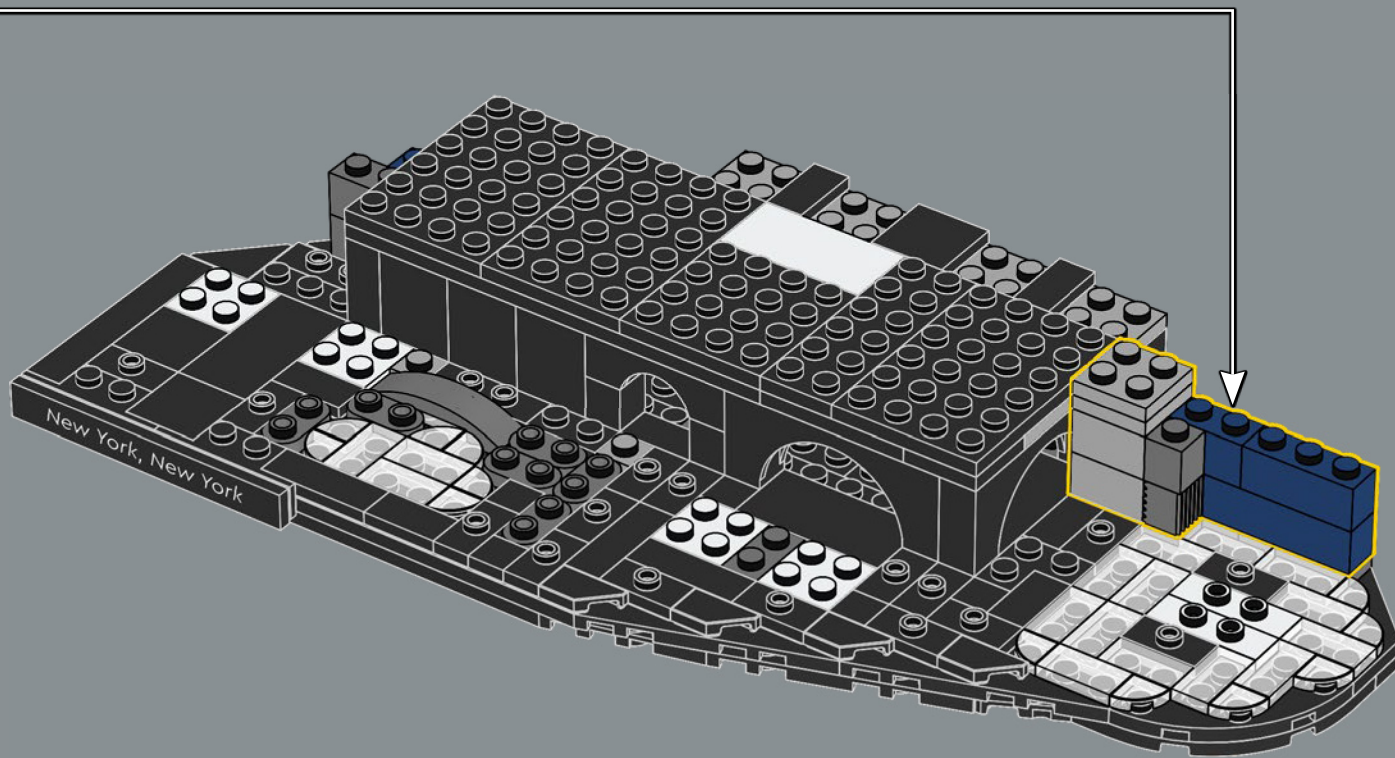

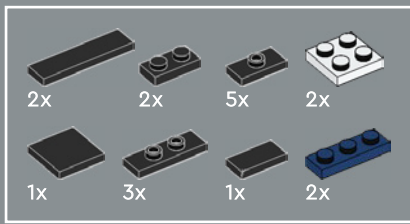

36

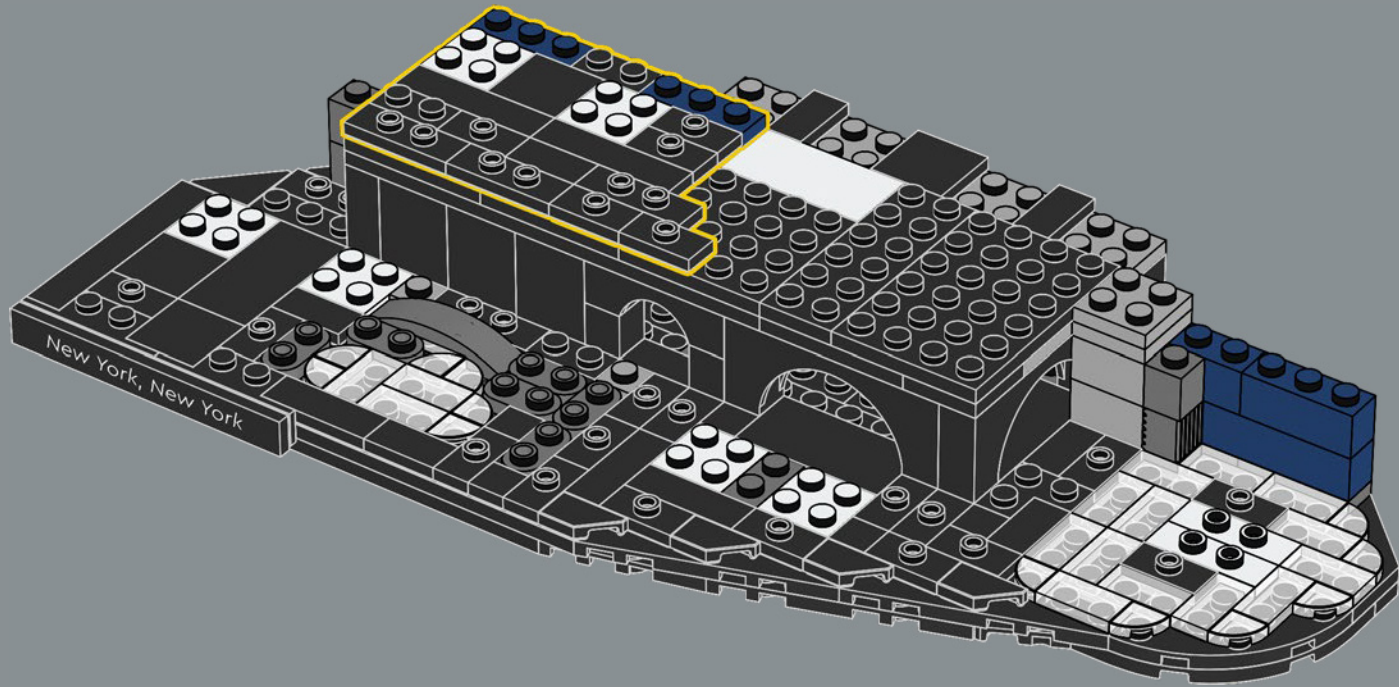

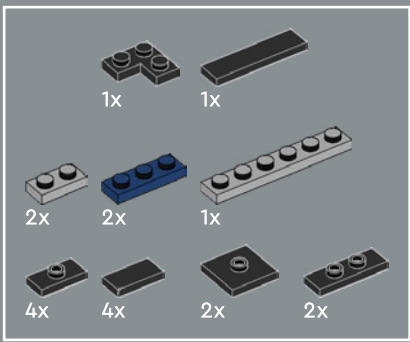

37

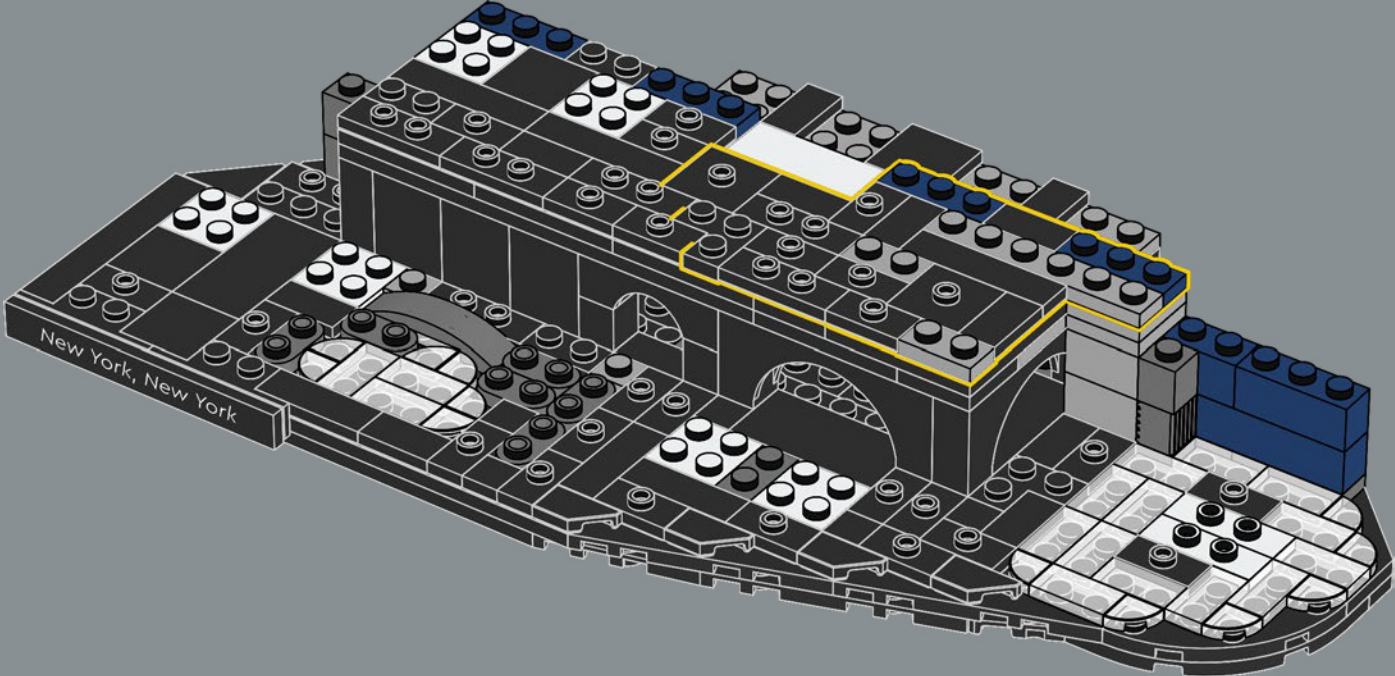

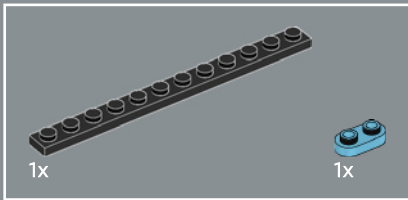
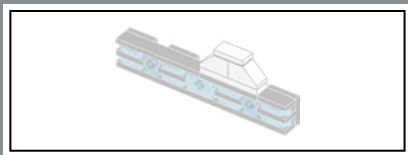

38

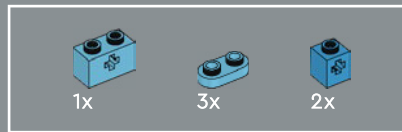
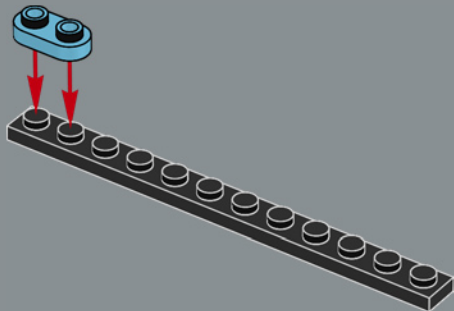

39

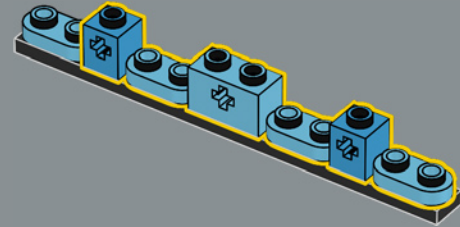

40

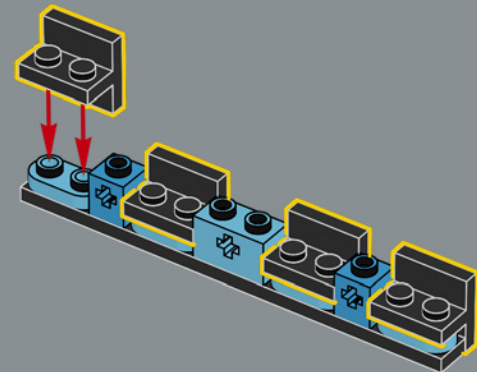

4x

41

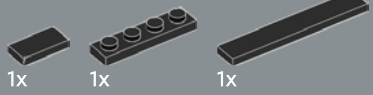
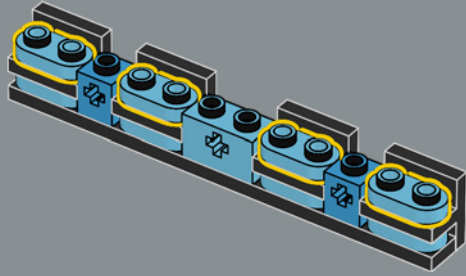

42

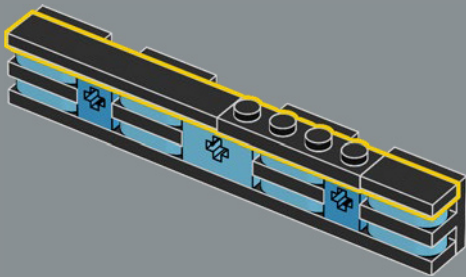

1x

1x

2x

43

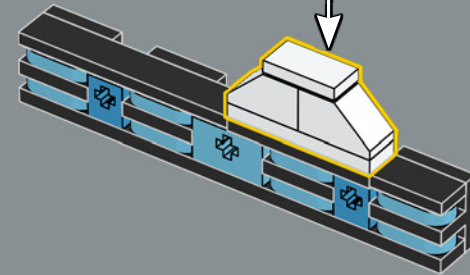
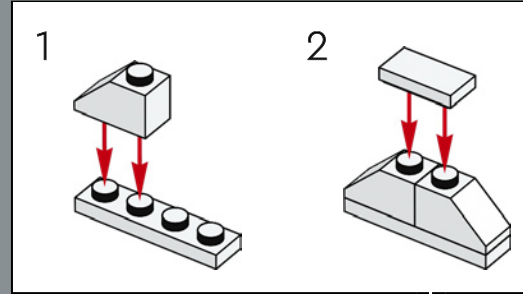

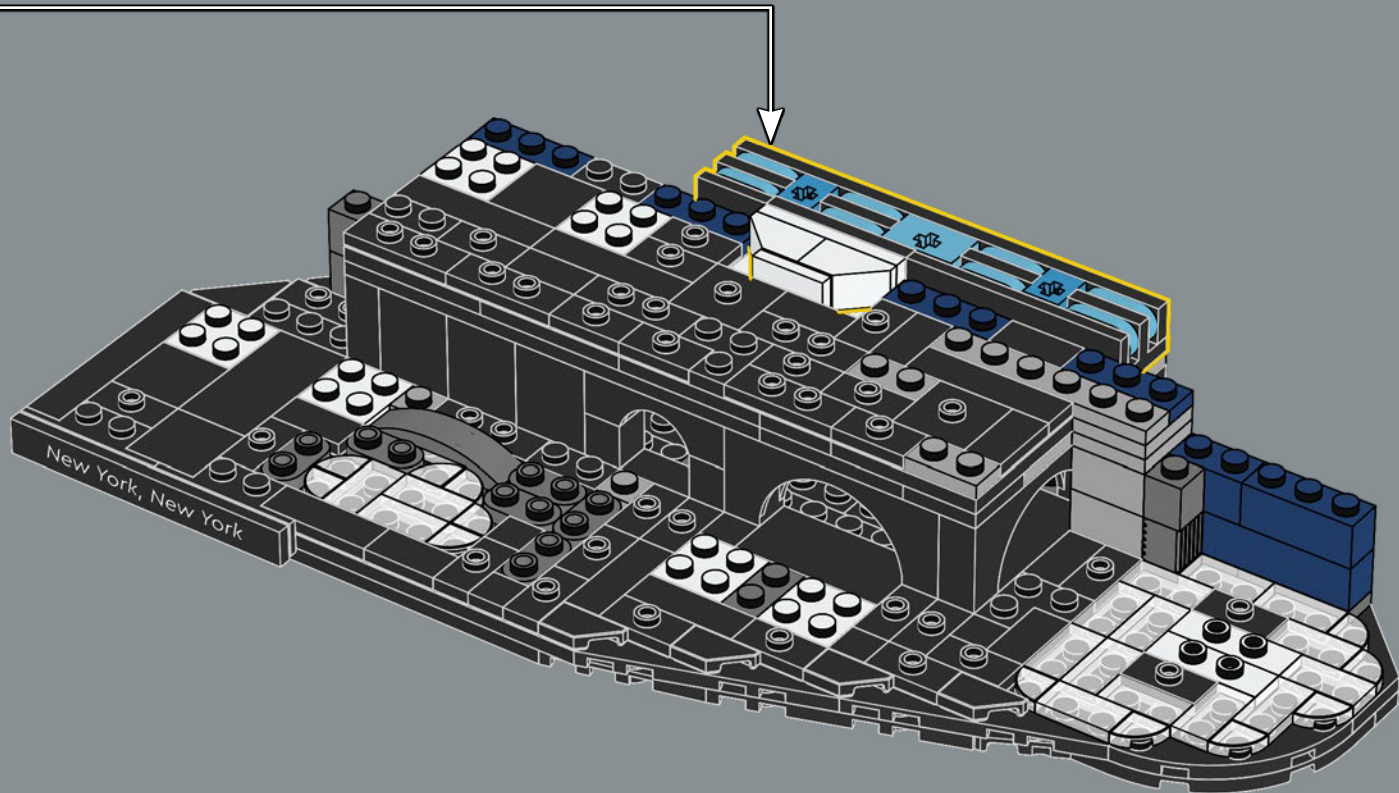

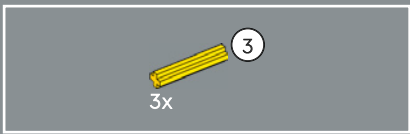

45

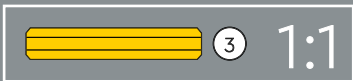
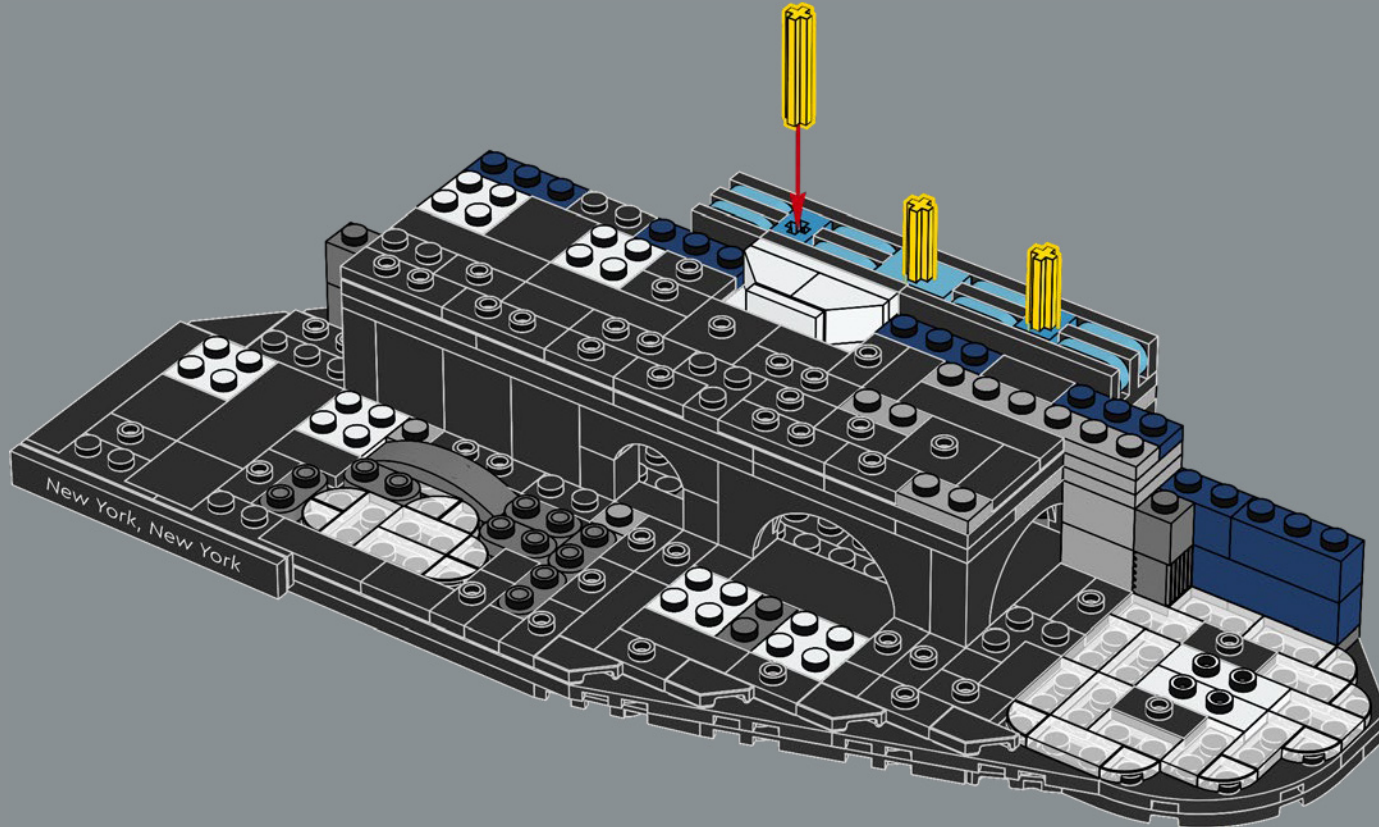

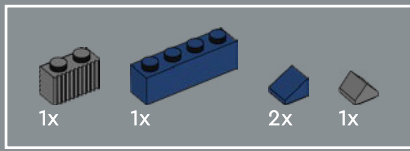

46

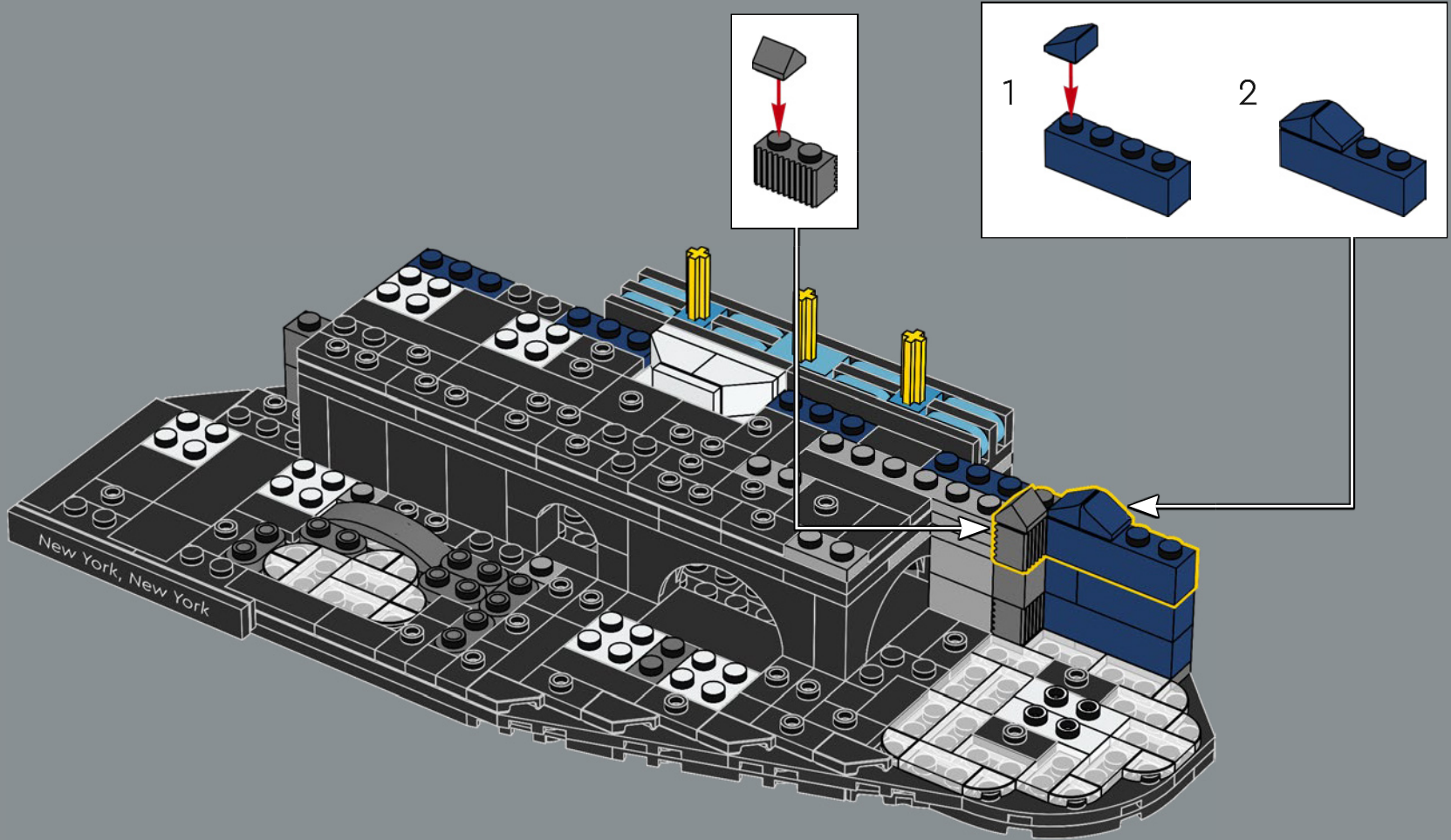

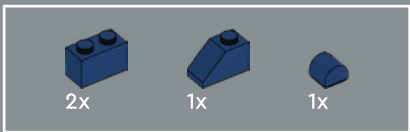

47

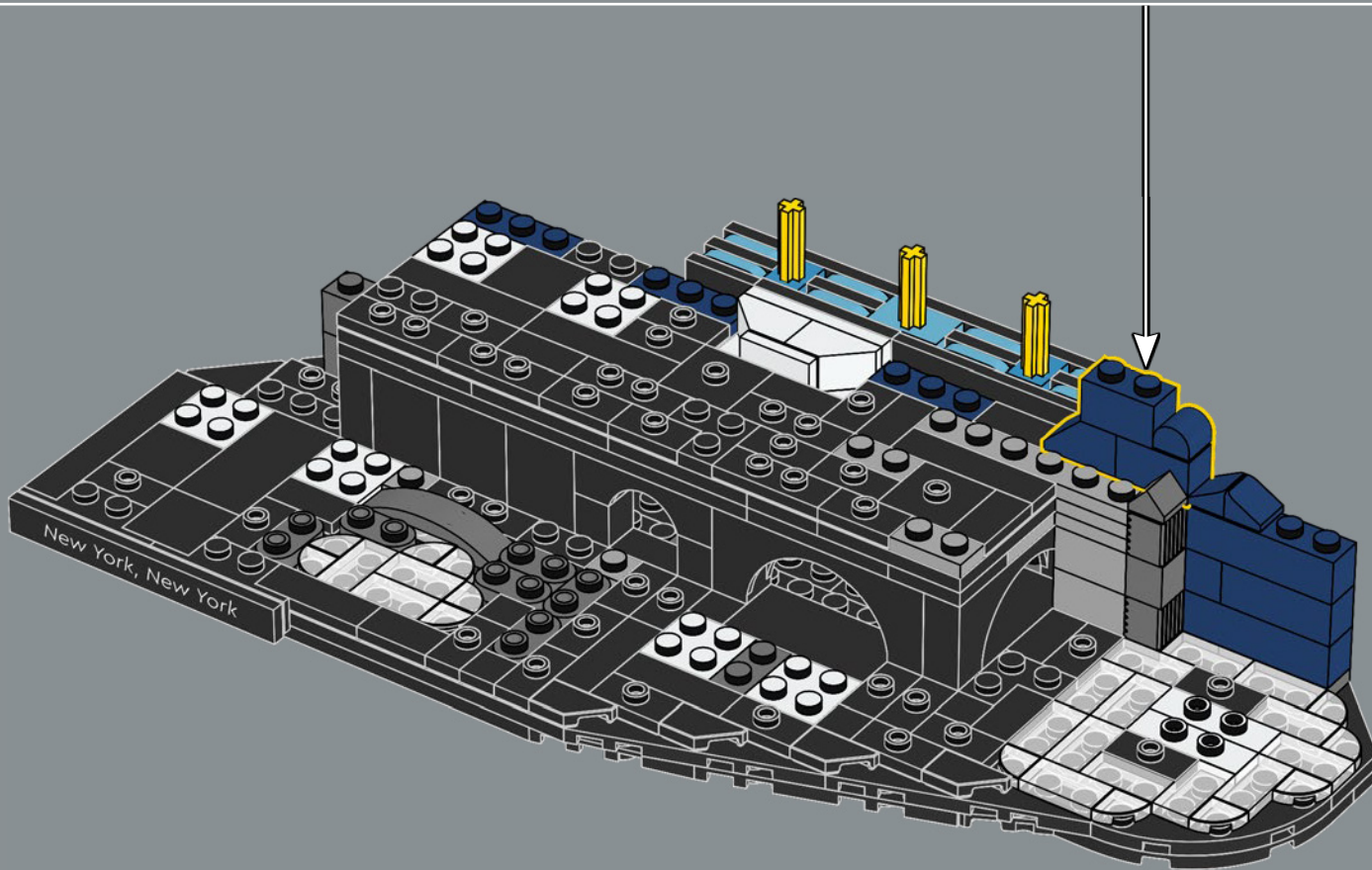
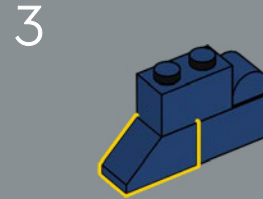
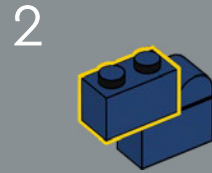
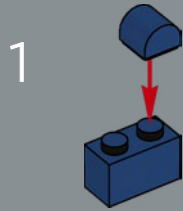

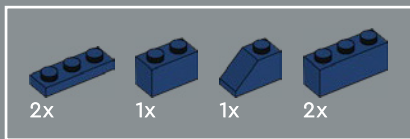

48

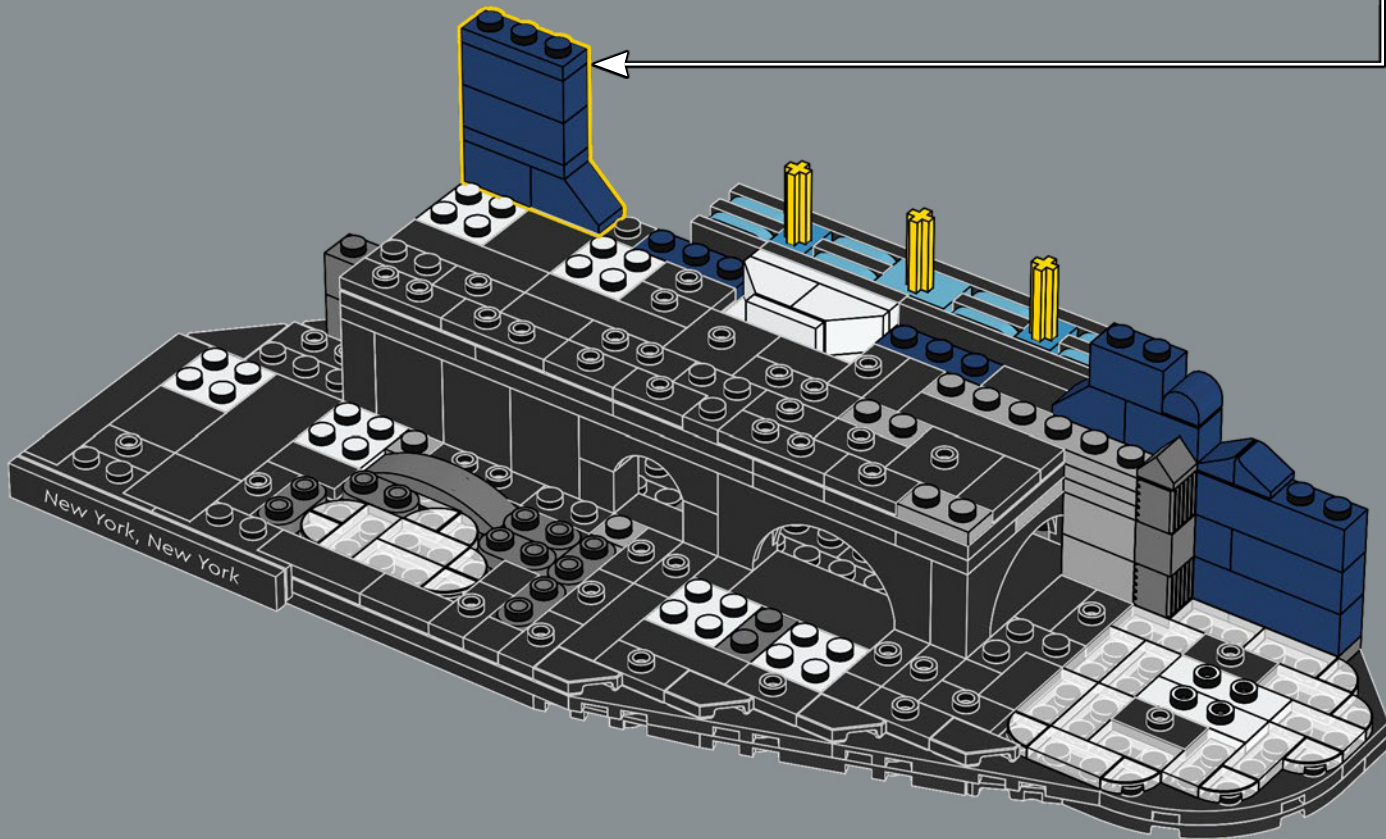

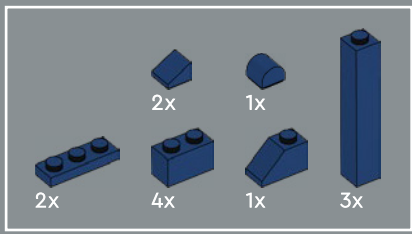

49

1

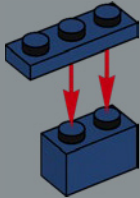

2

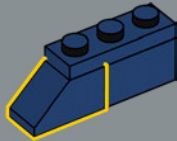

3

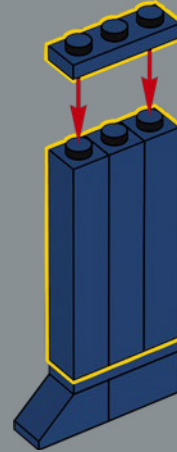

4

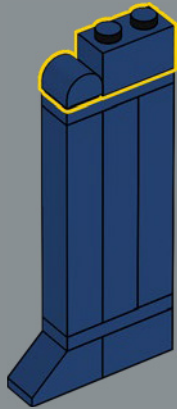

5

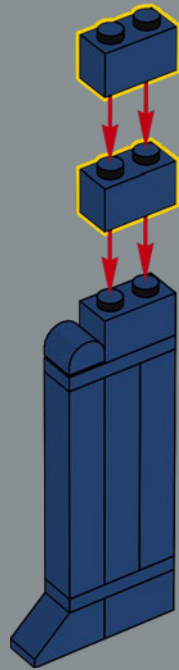

6

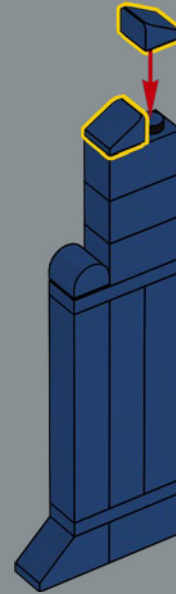

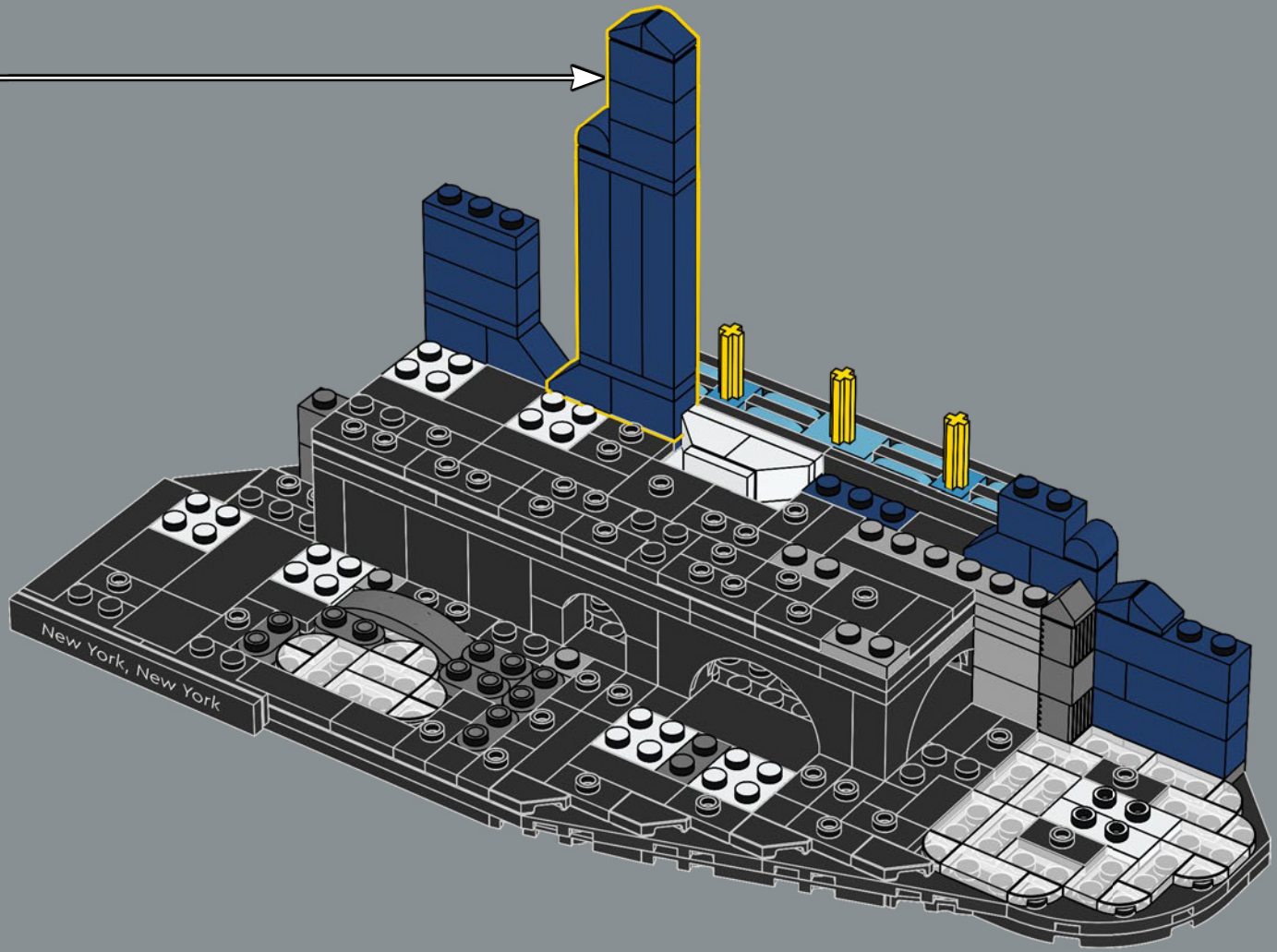

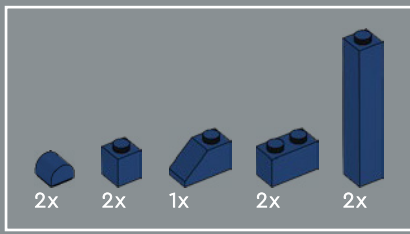

50

1

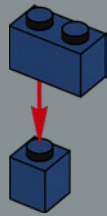

2

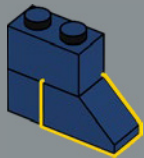

3

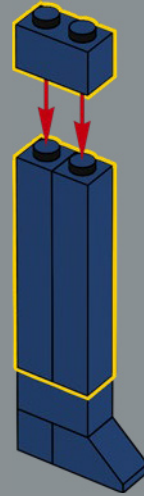

4

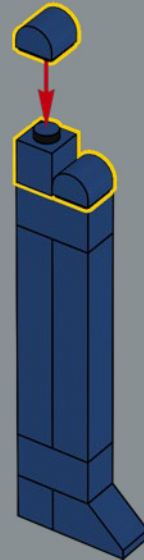

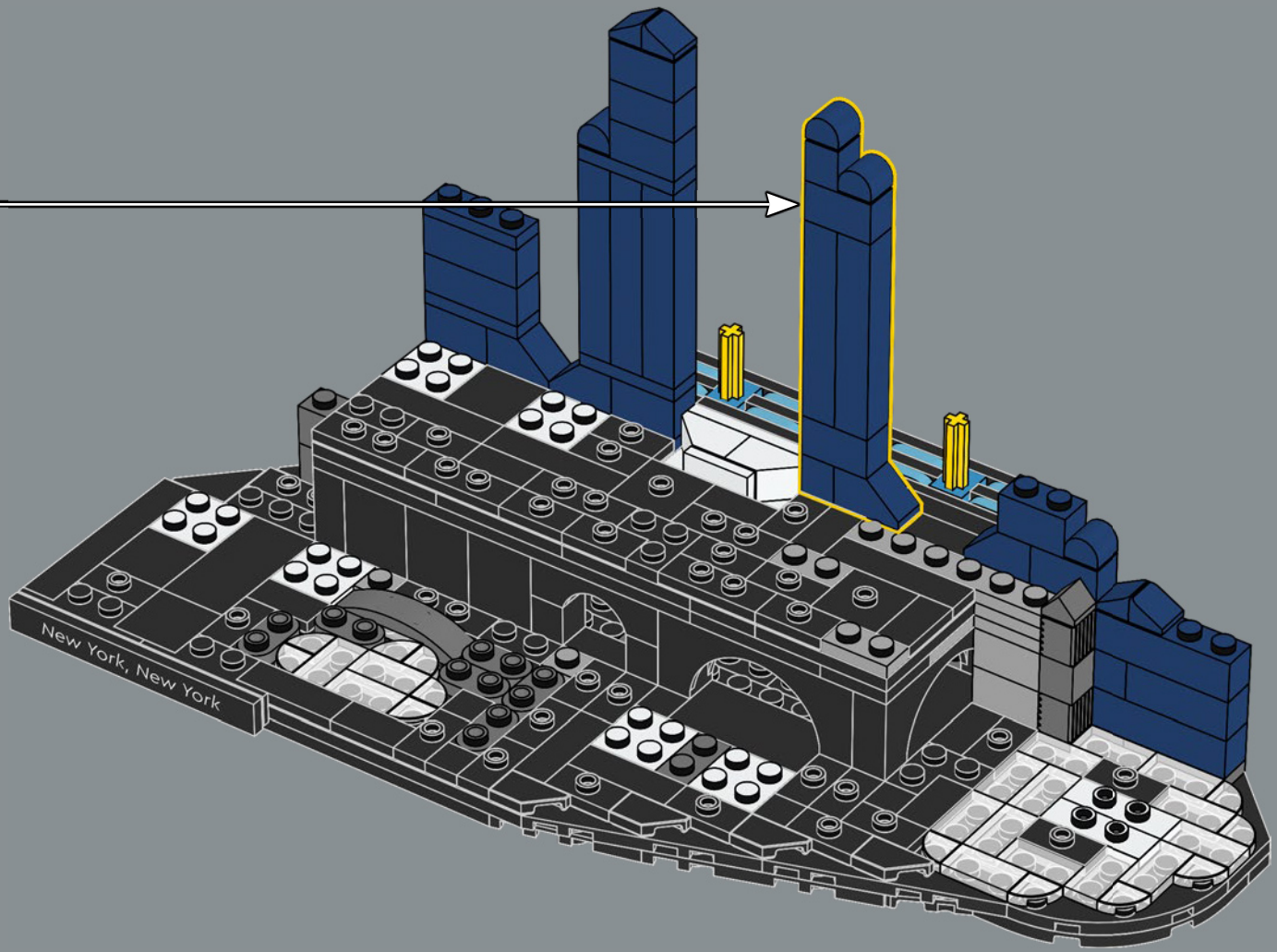

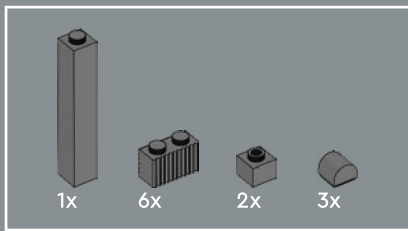

51

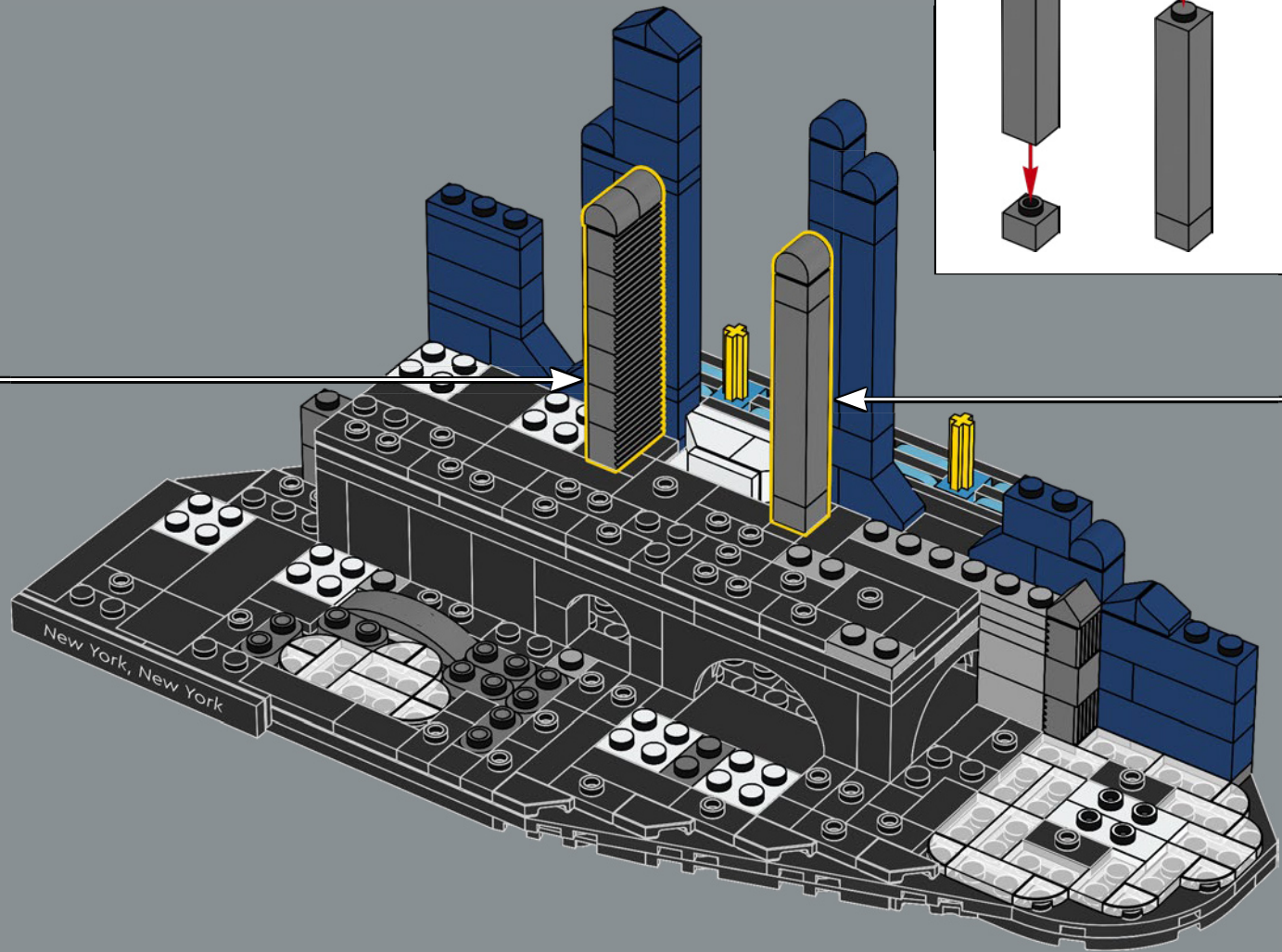
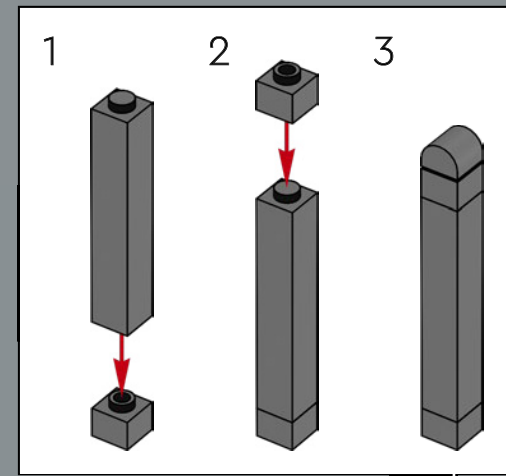
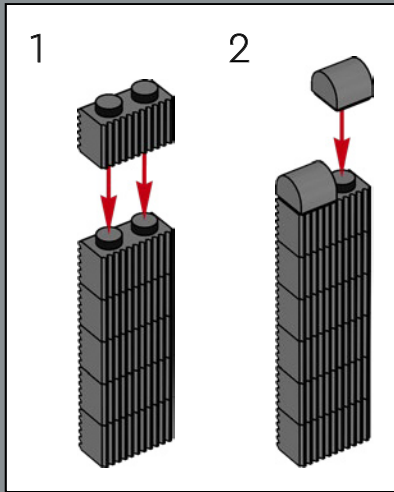

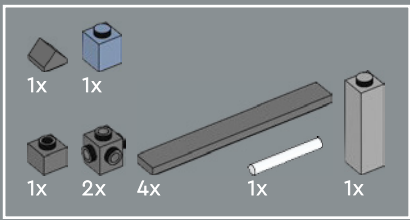

52

1

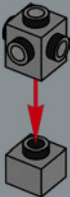

2



3



4



5

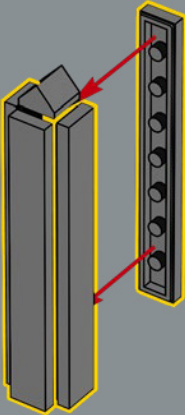

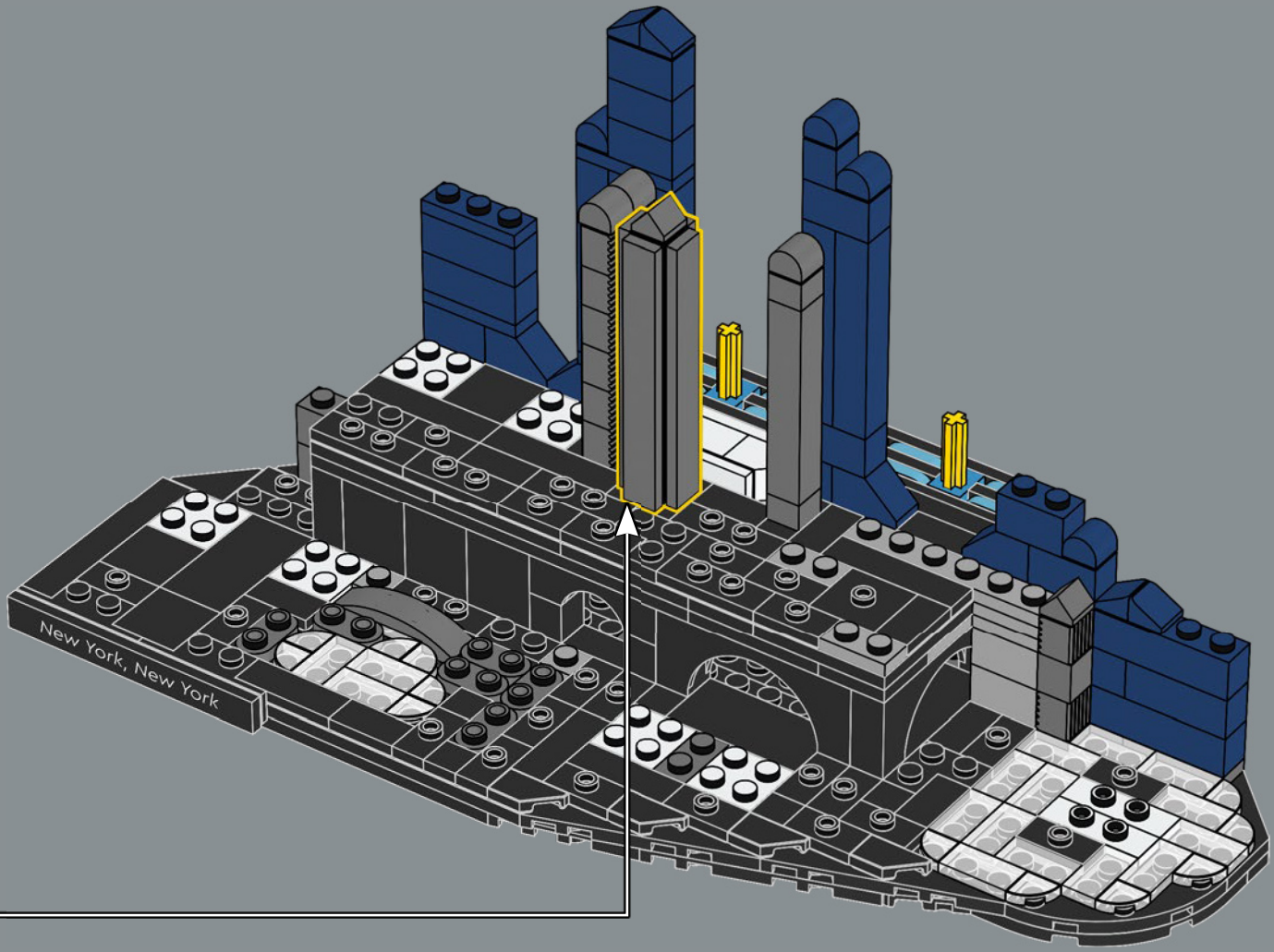

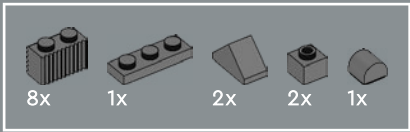

53

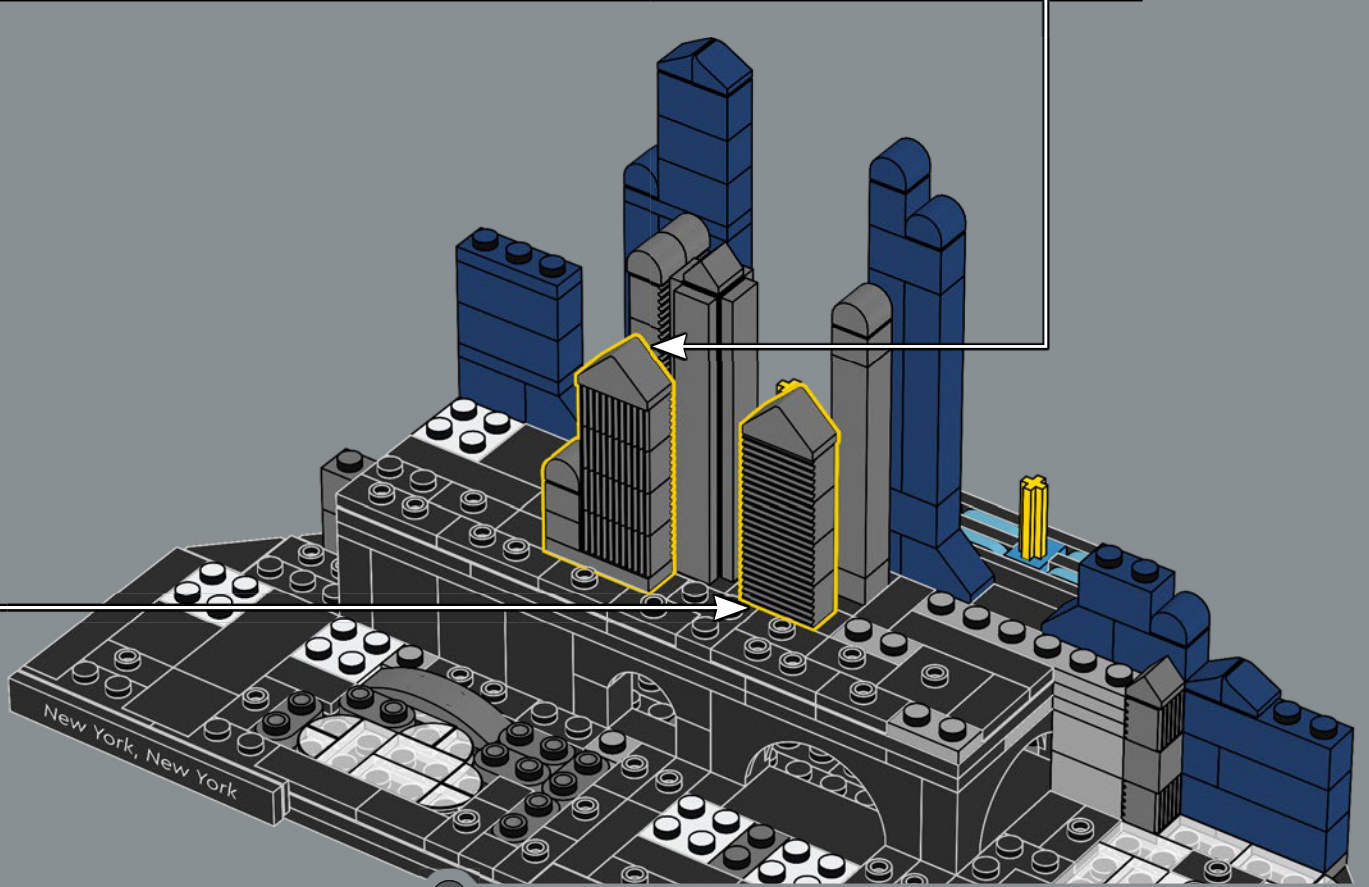
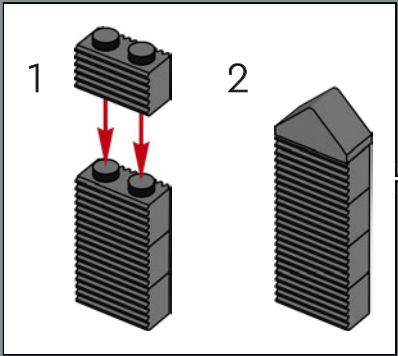
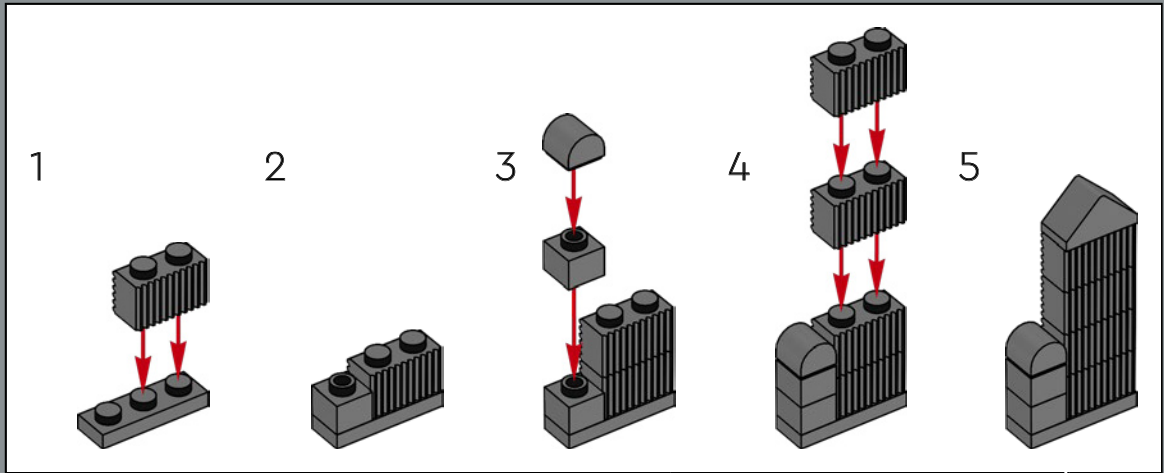

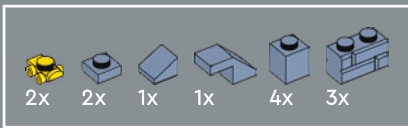

54

Ces éléments LEGO® de roulettes jaunes pour minifigurines représentent une partie des plus de 13 000 taxis caractéristiques de New York.

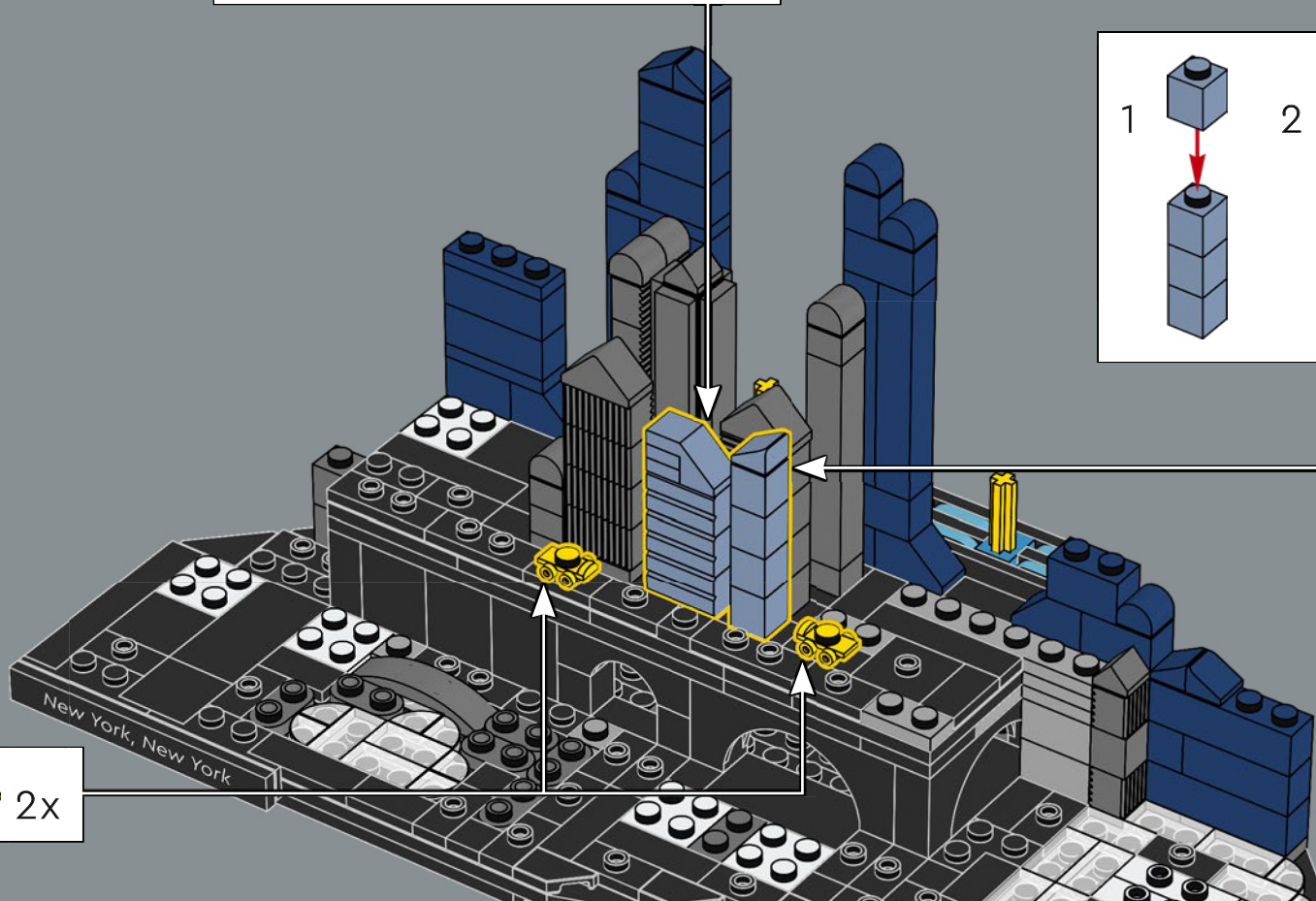
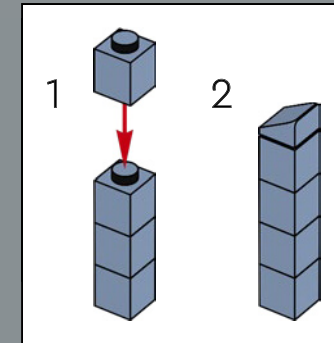
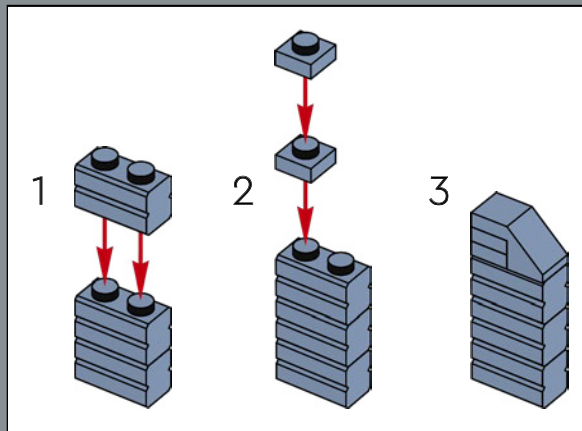

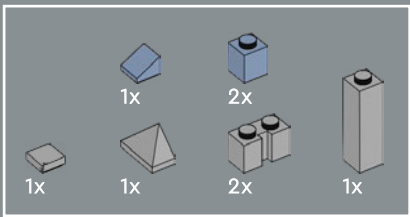

55

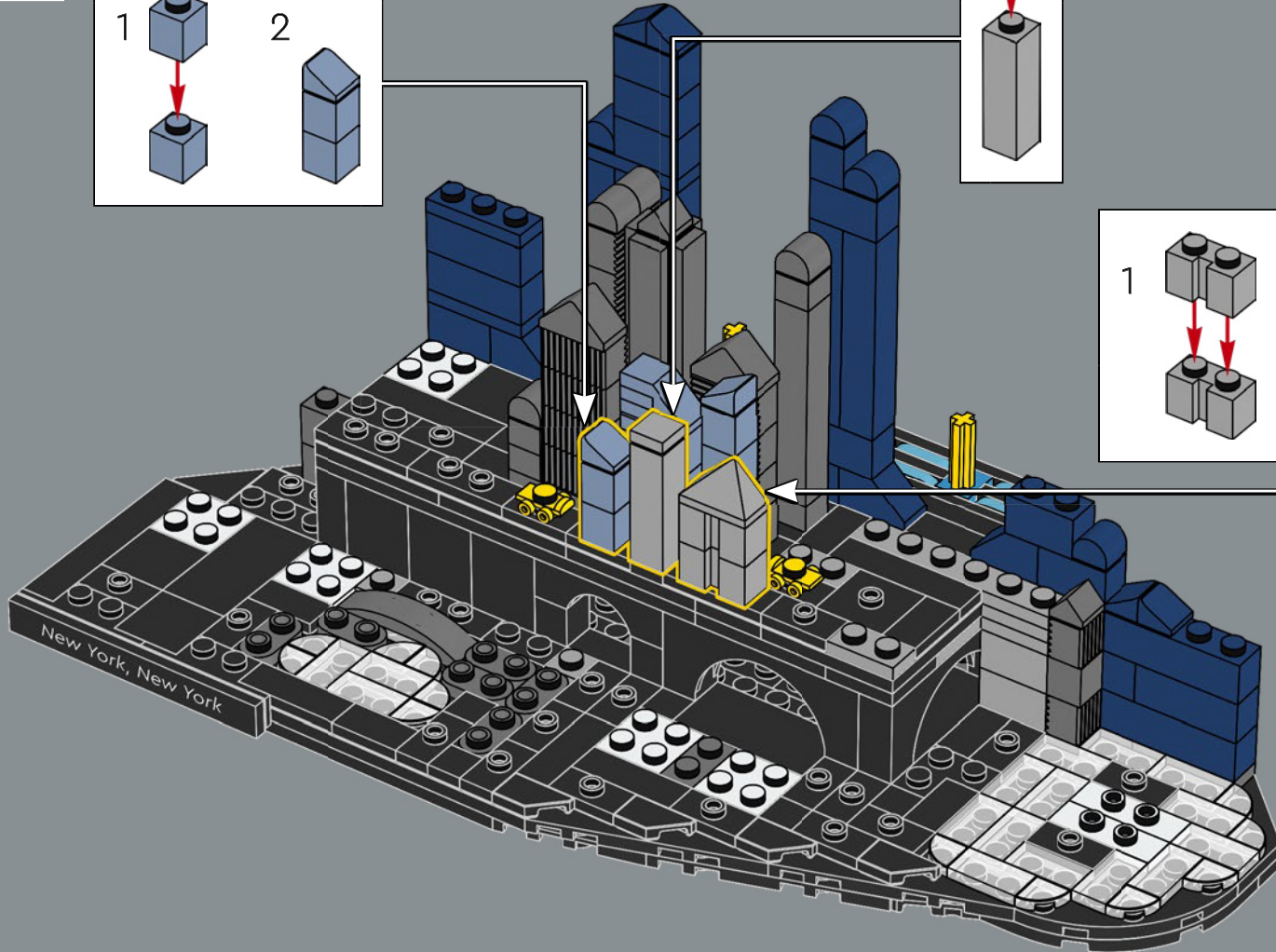
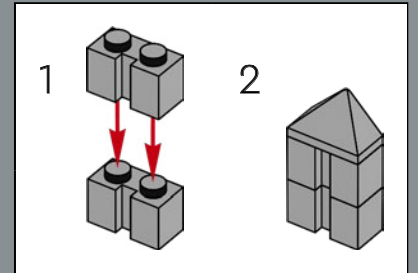
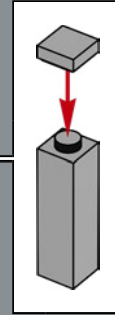
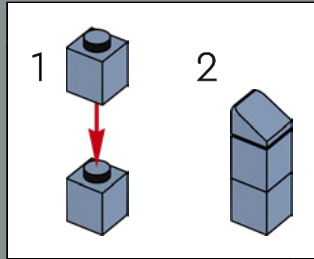

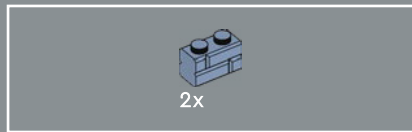

56

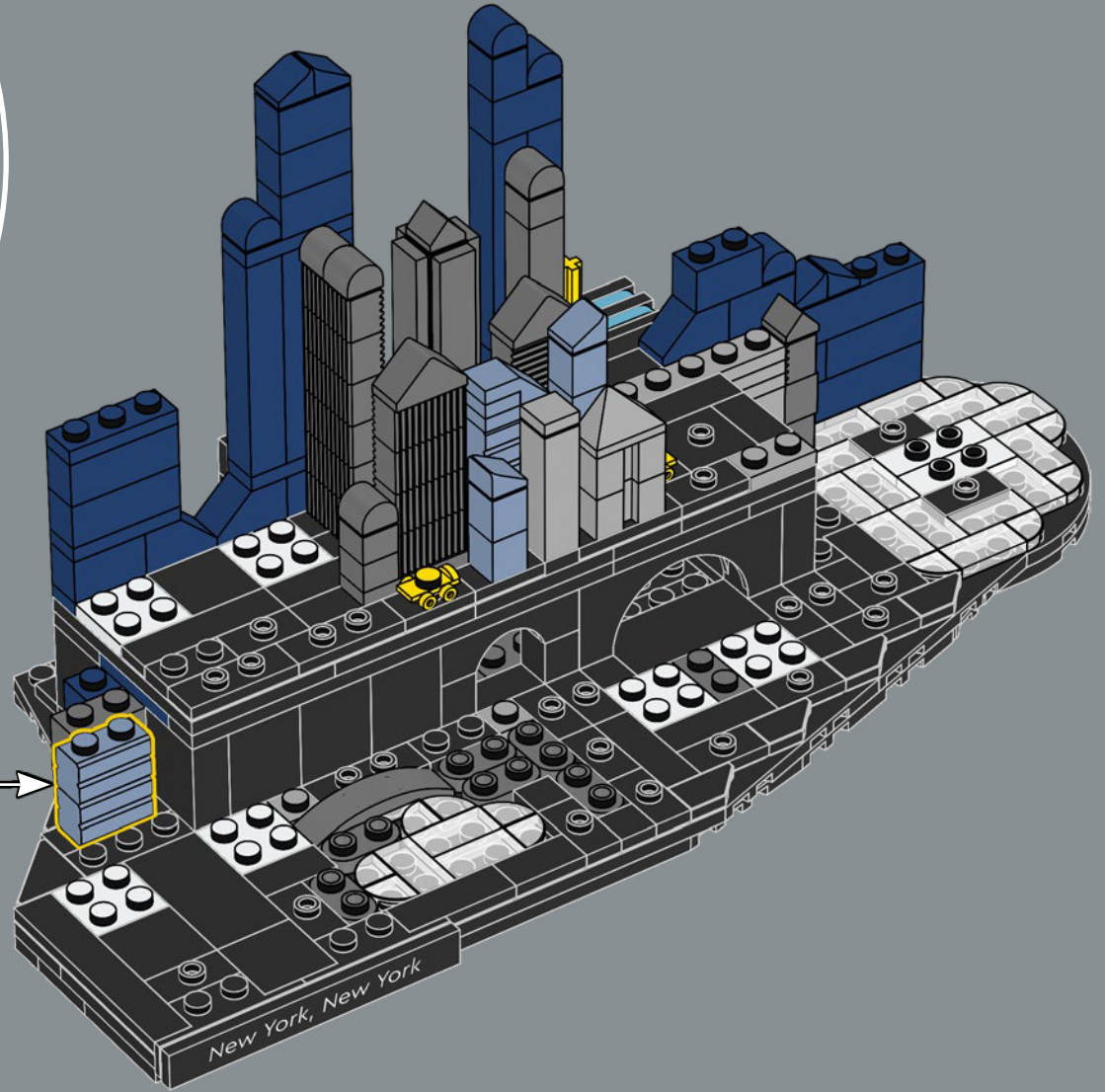
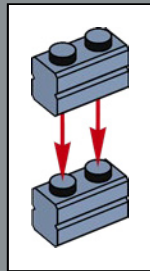

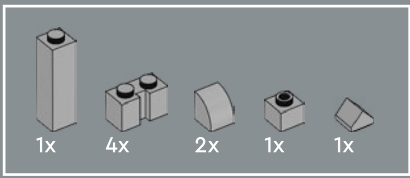

57

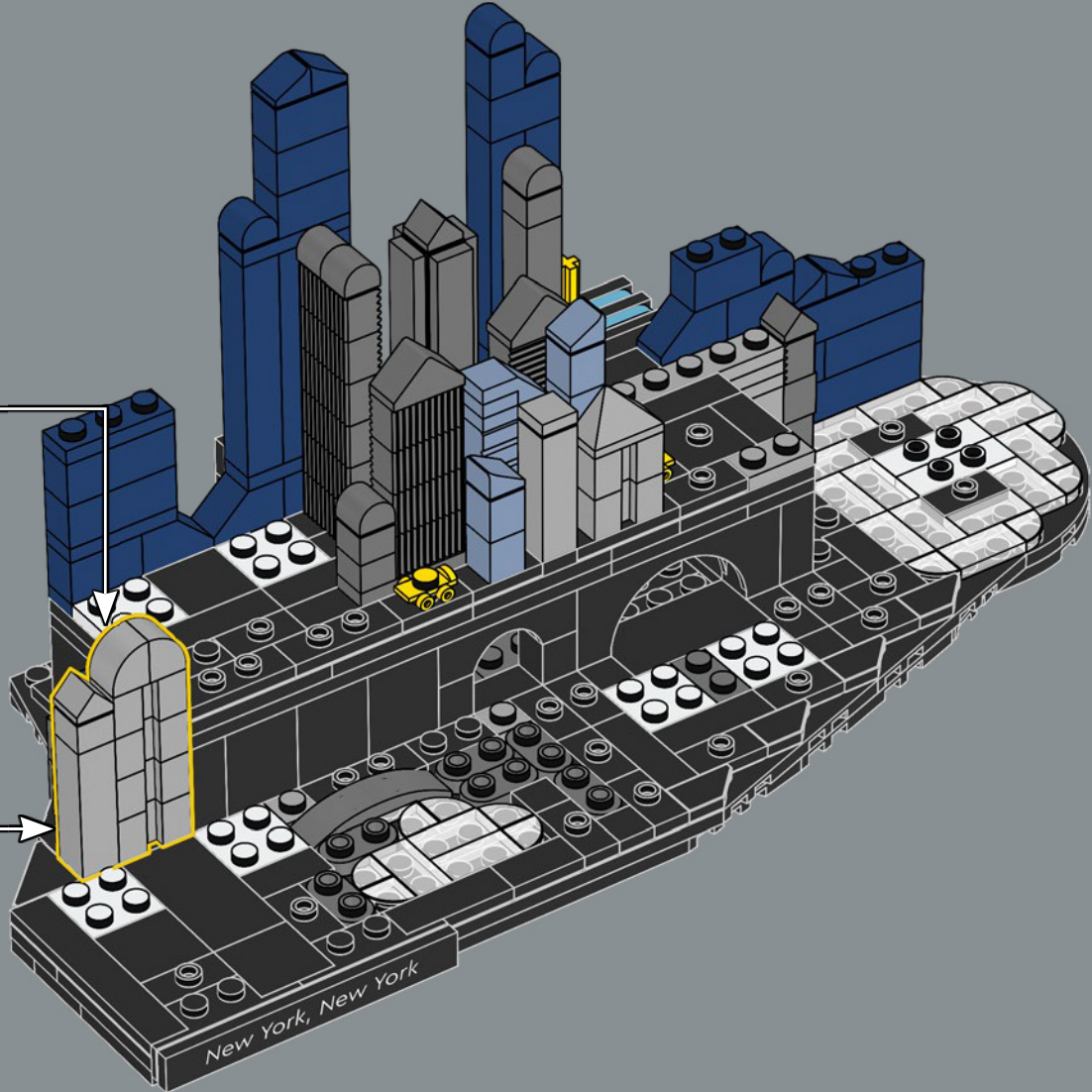
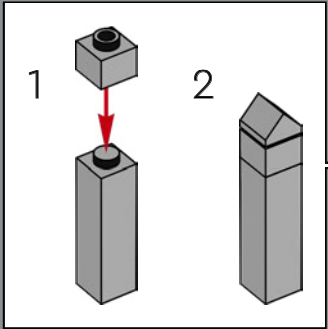
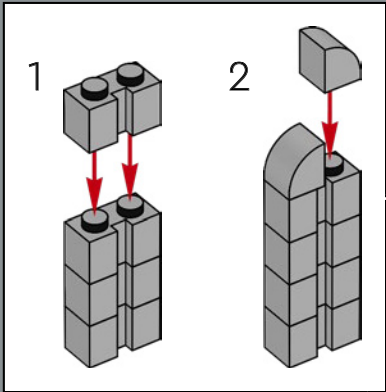

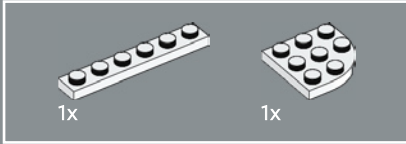
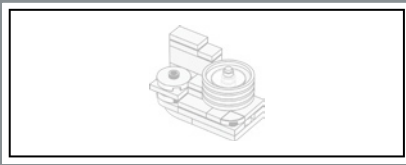

58

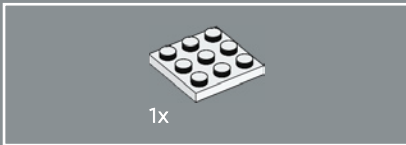
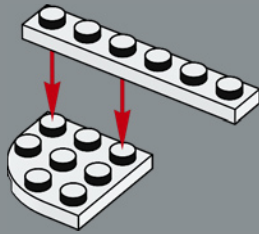

59

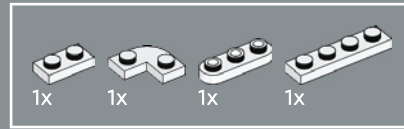
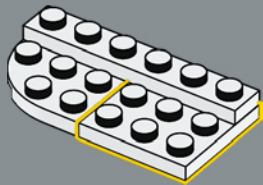

60

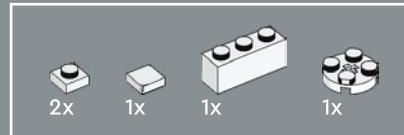
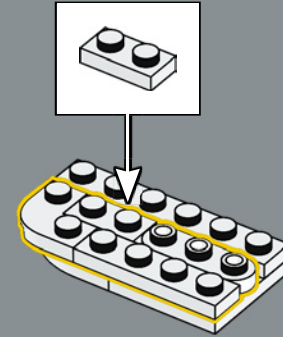

61

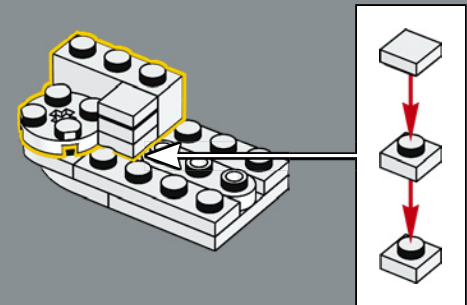



62

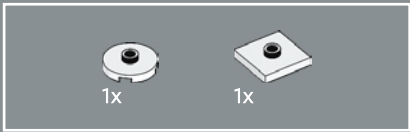
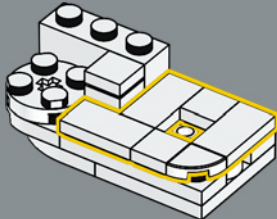

63

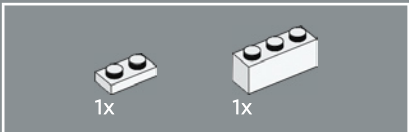
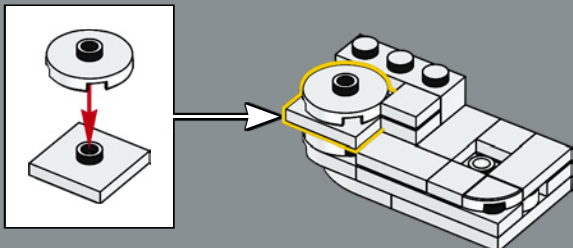

64

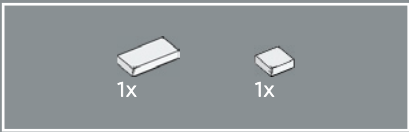
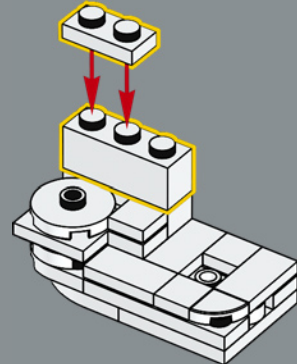

65

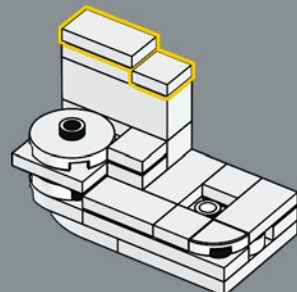

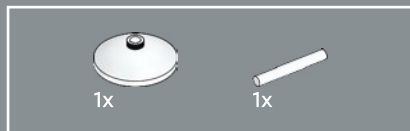

66

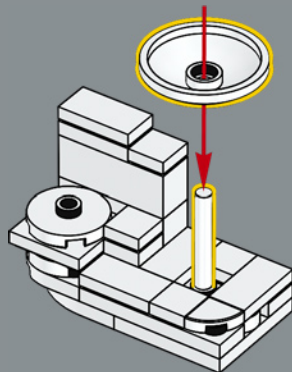

67

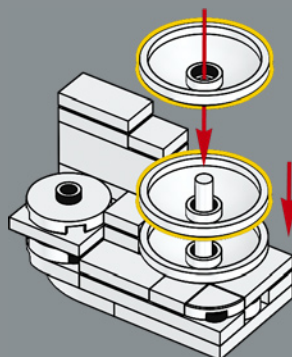

68

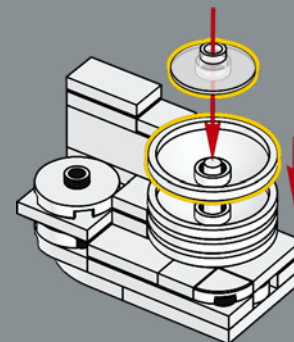

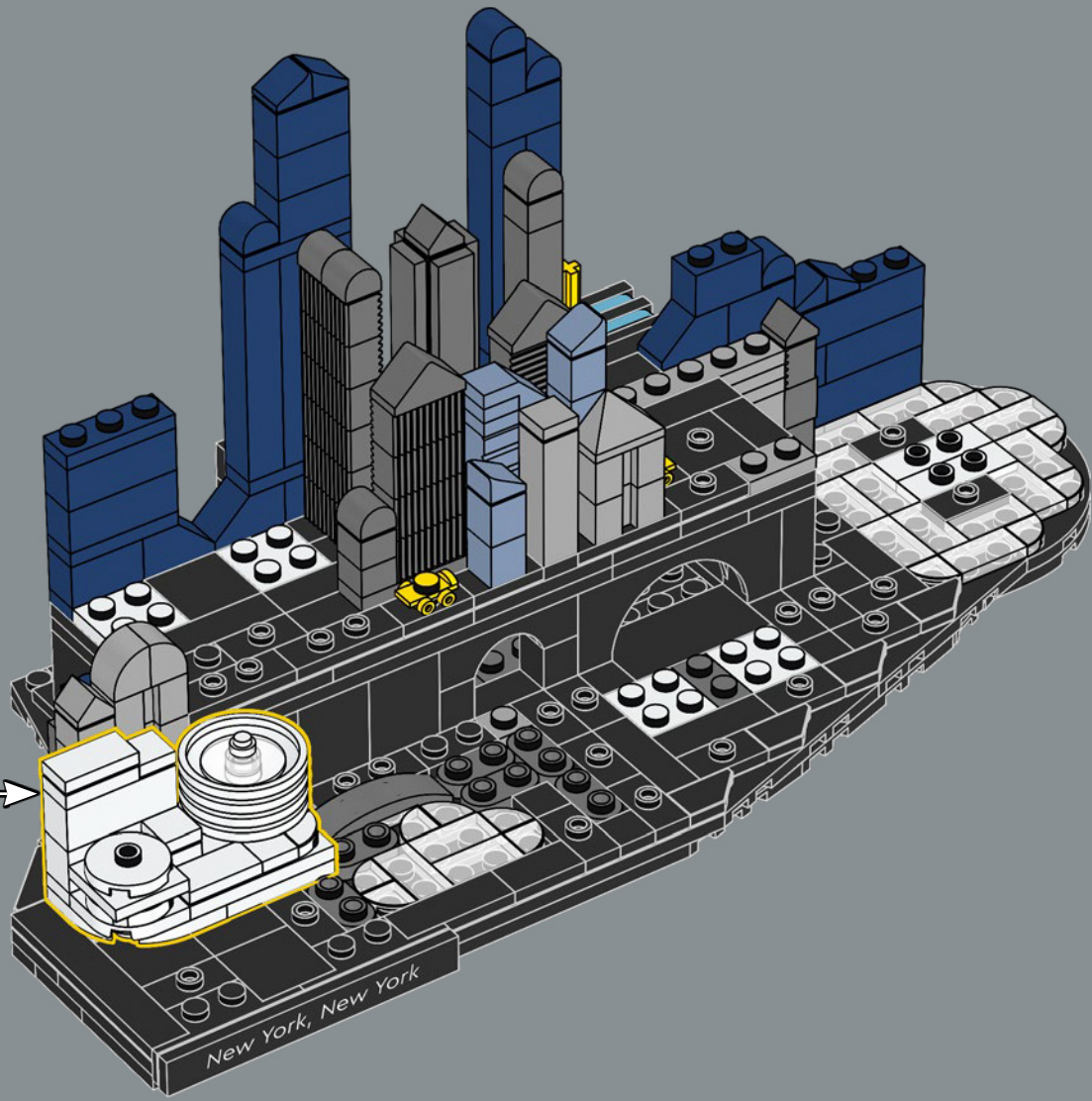

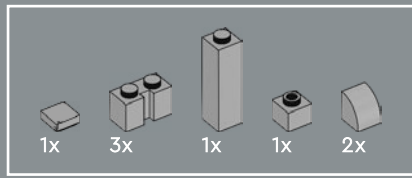

70

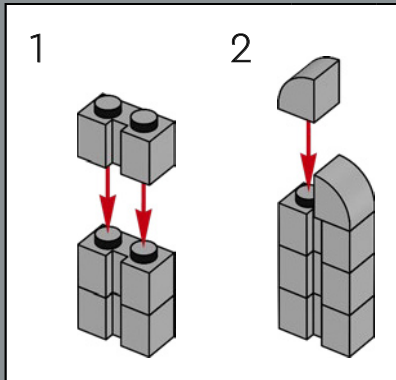
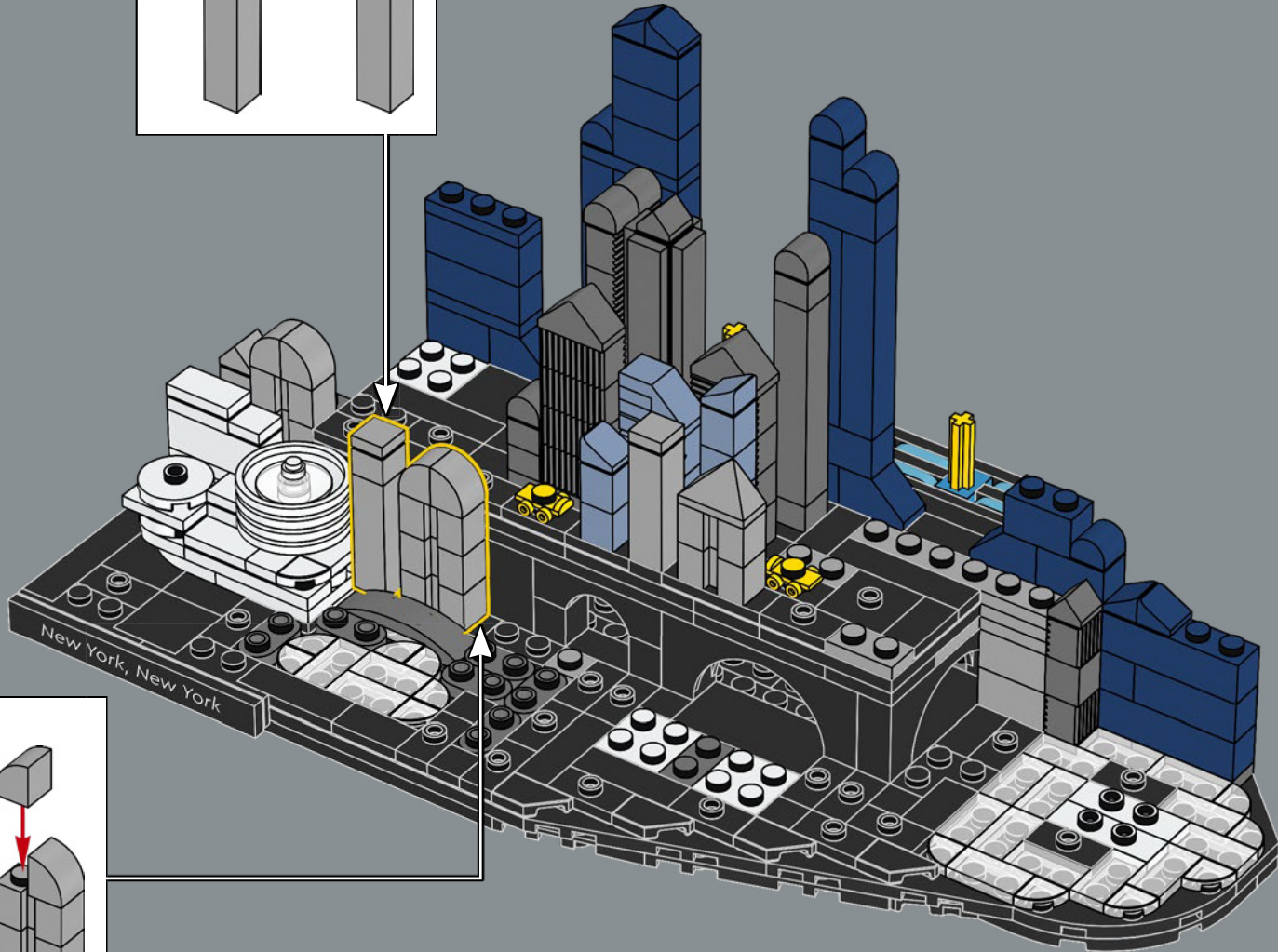
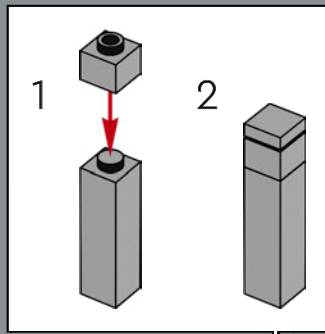

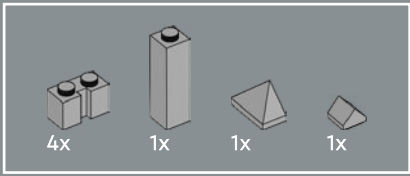

71

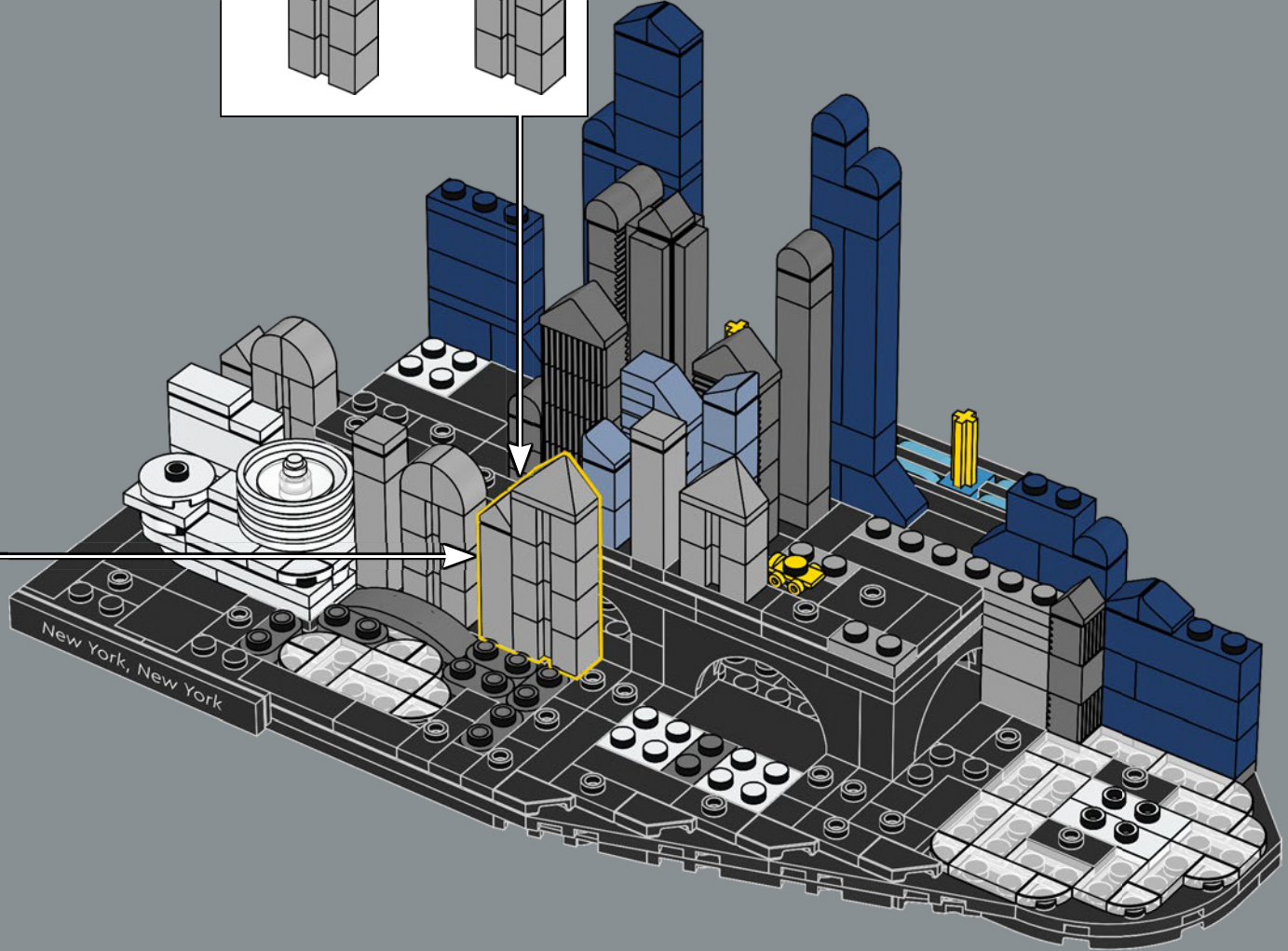
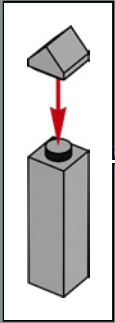
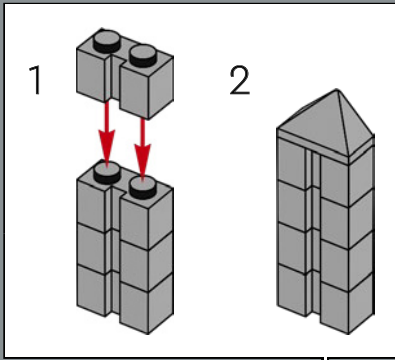



7x



3x

72

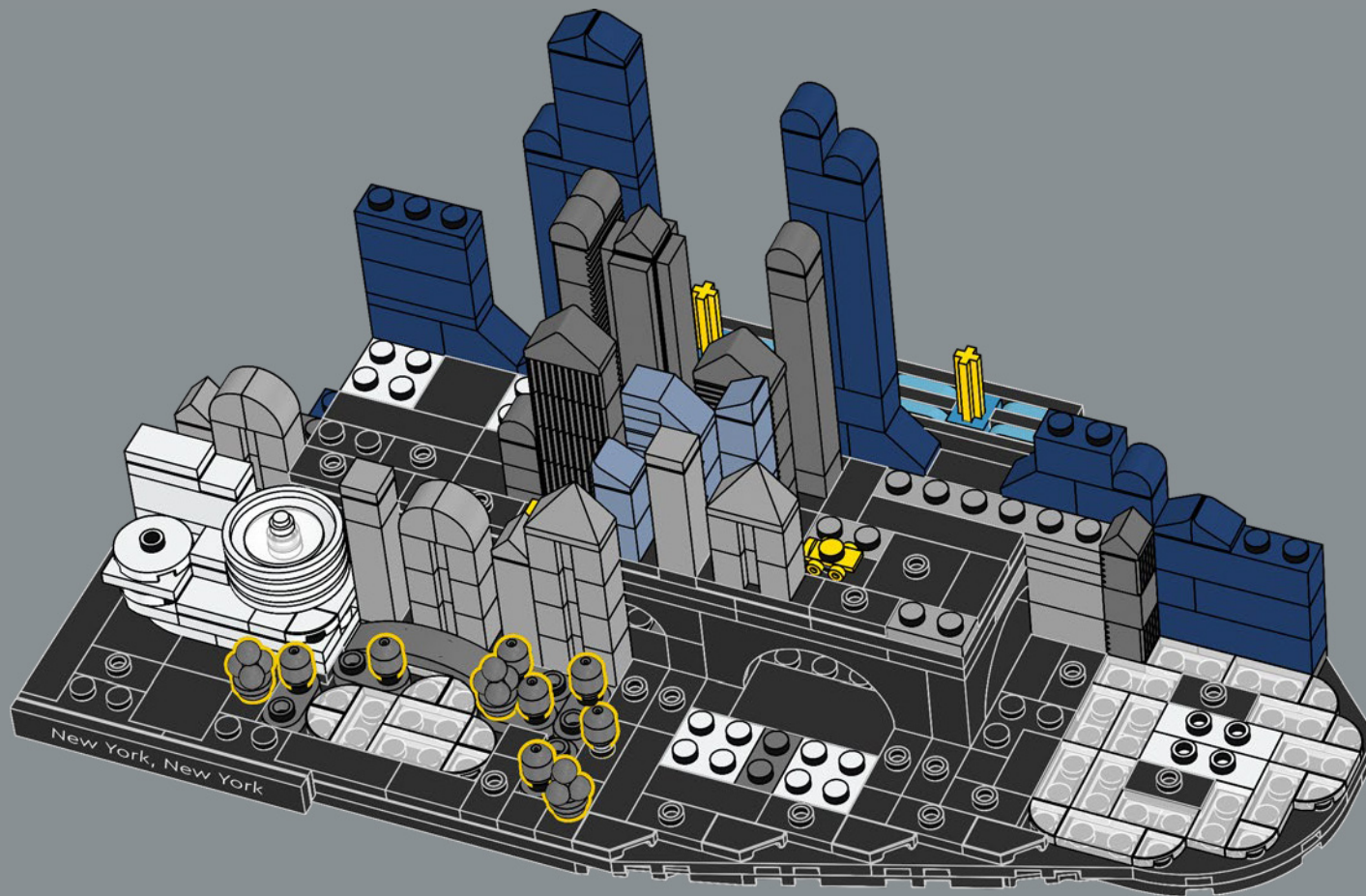



Des éléments LEGO® glace, lames et globes sont utilisés ici pour représenter une partie des quelque 18 000 arbres de Central Park.

73

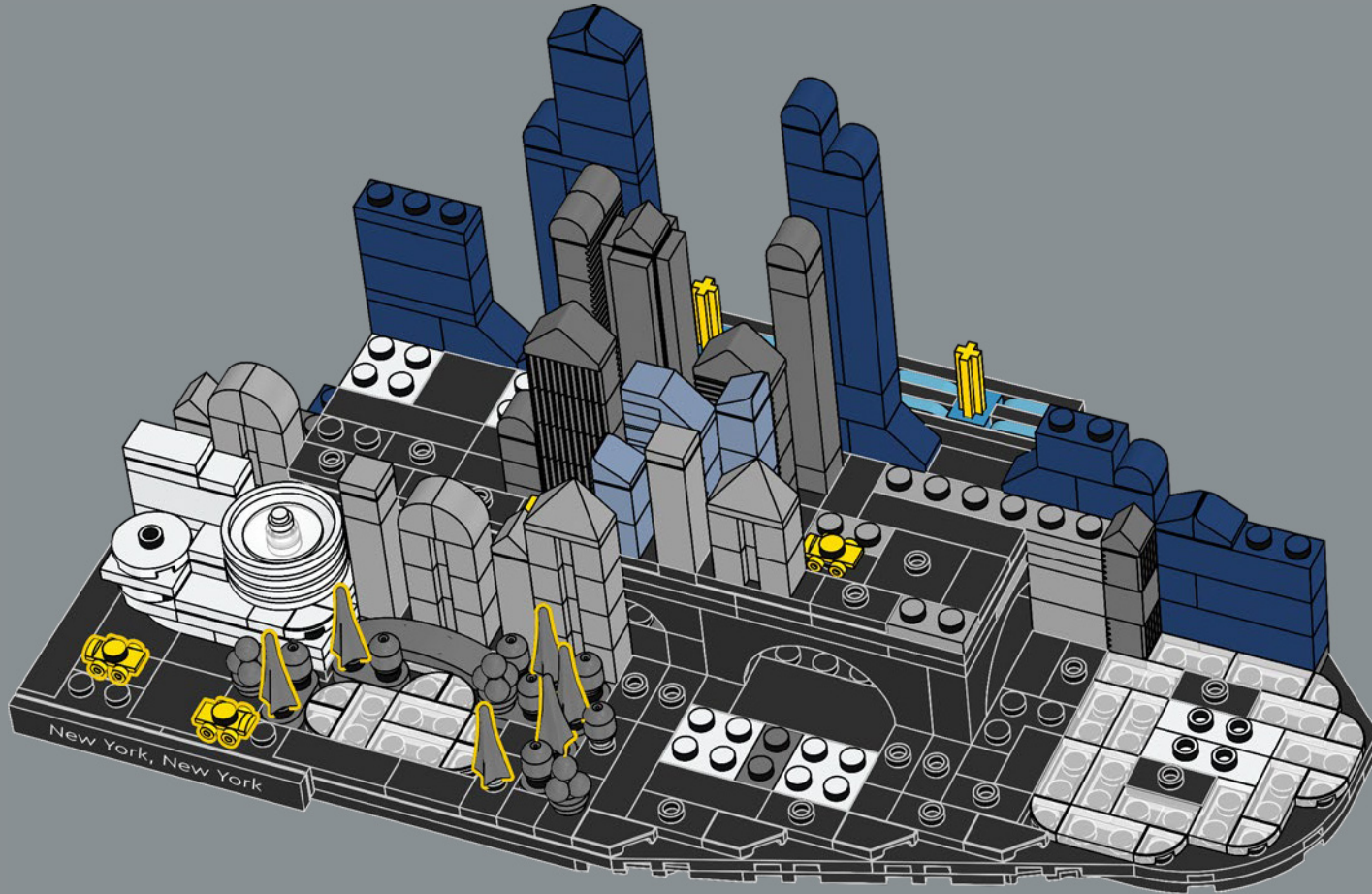

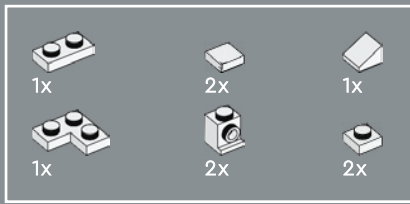

74

1

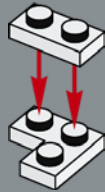

2



3

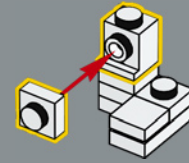

4

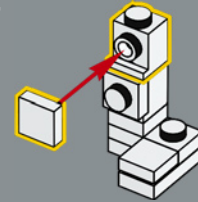

5

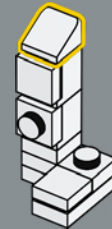

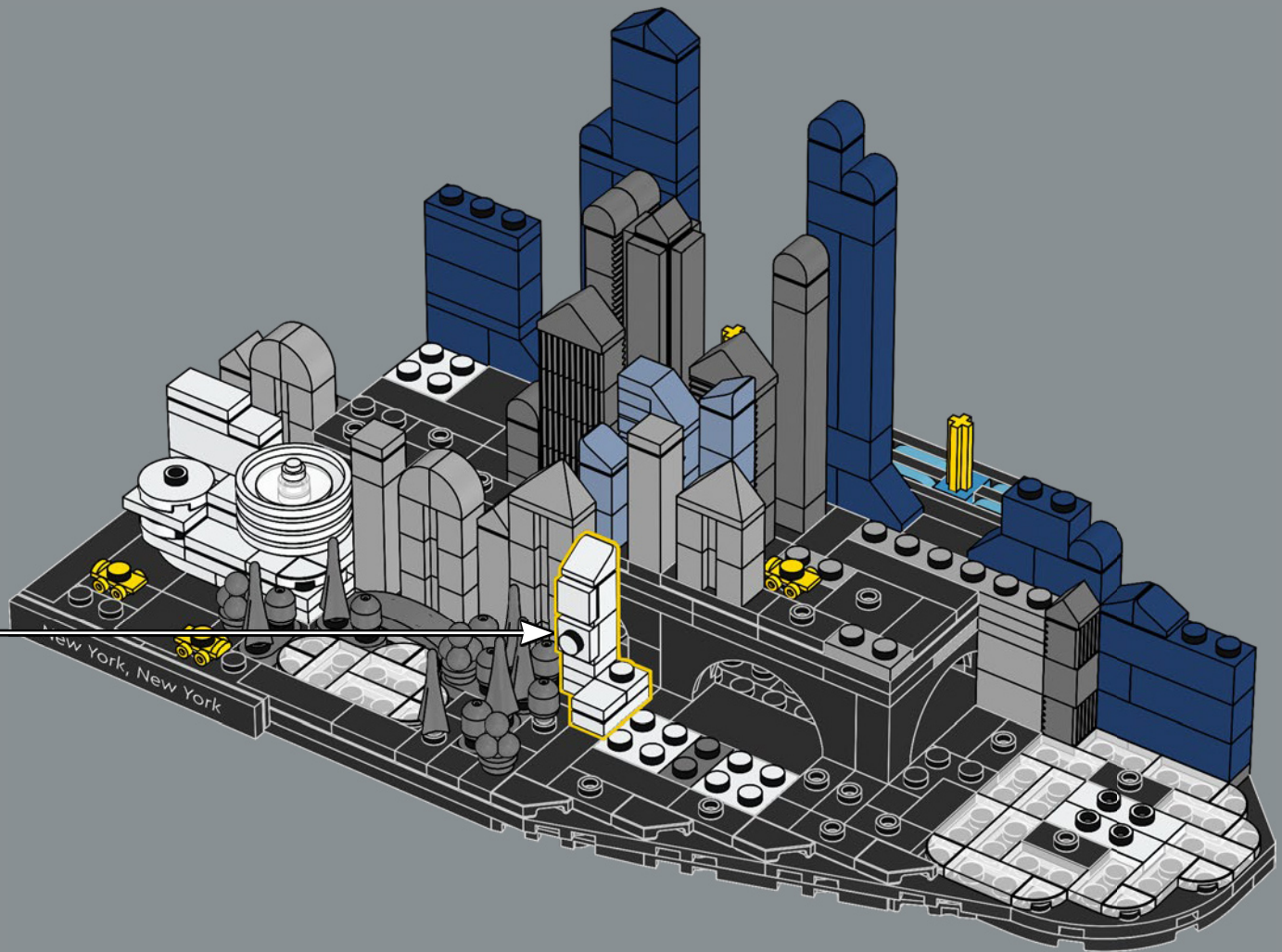

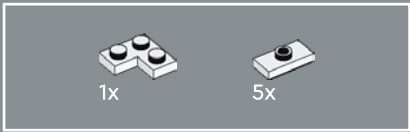

75

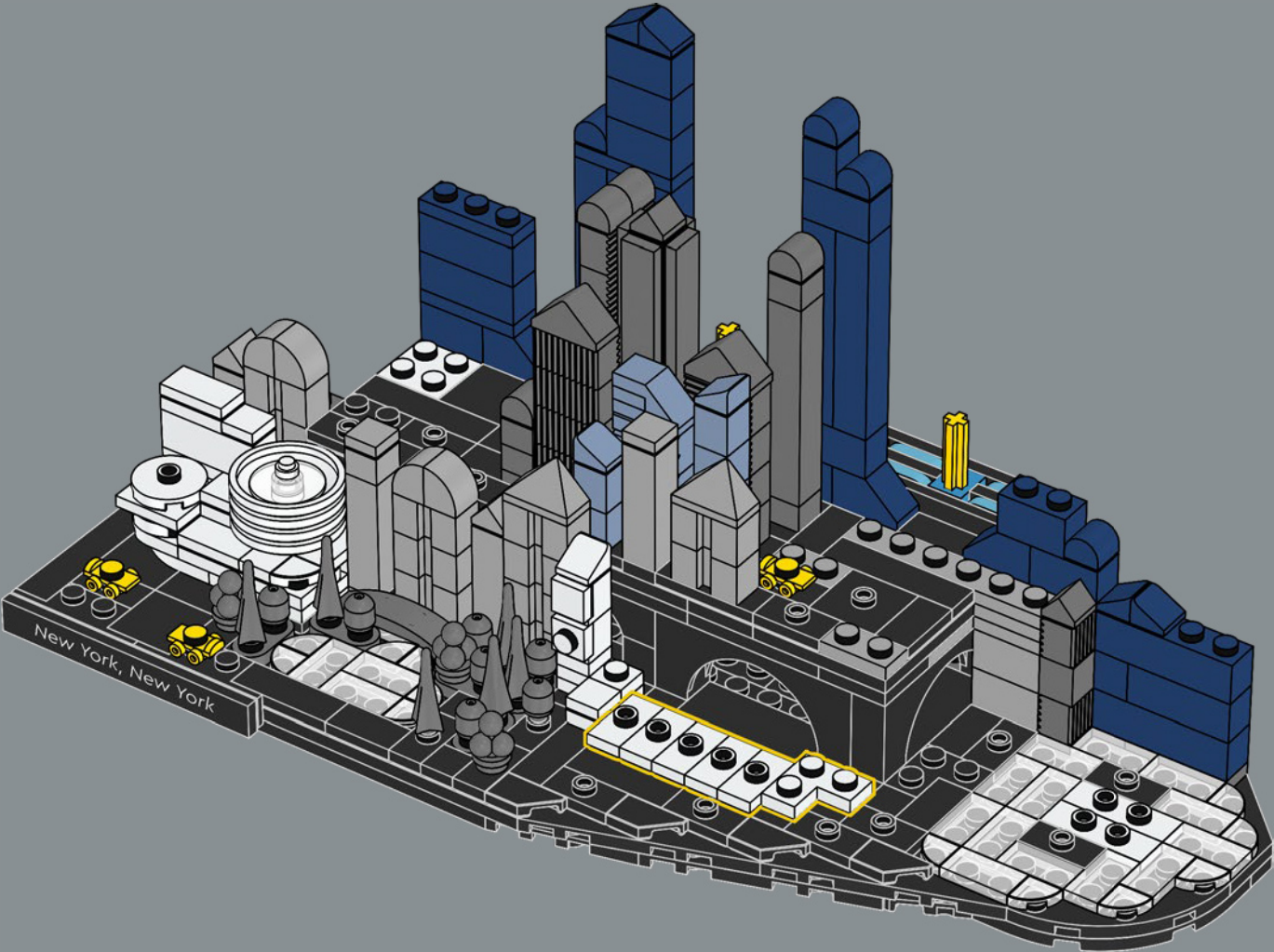

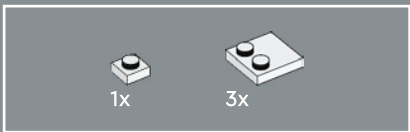

76

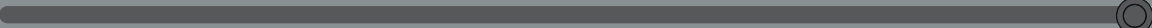
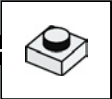
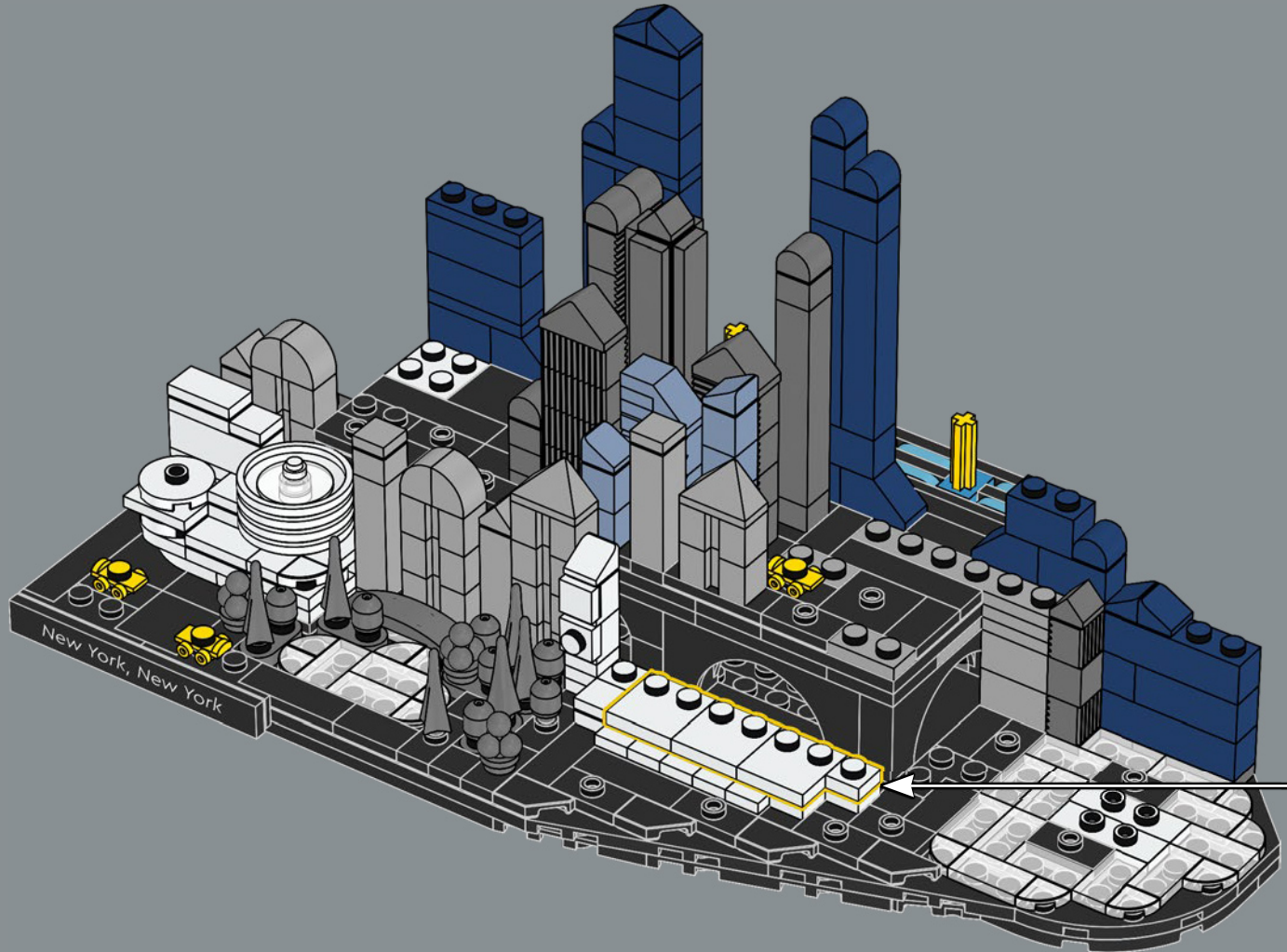

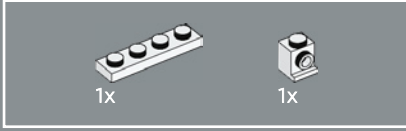
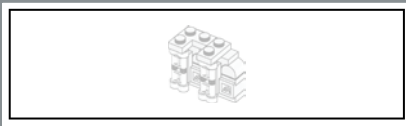

77

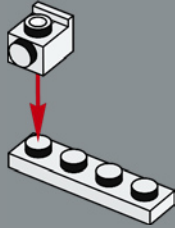

78

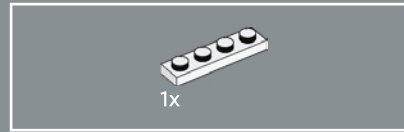
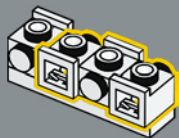

79

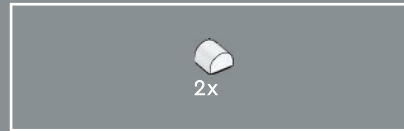
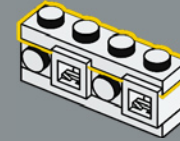

80

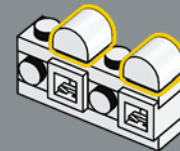

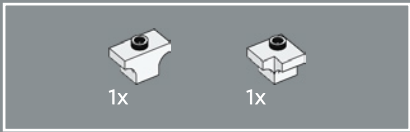

81

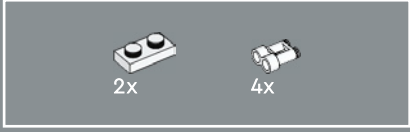
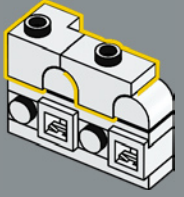

82

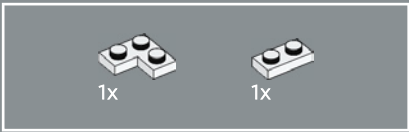
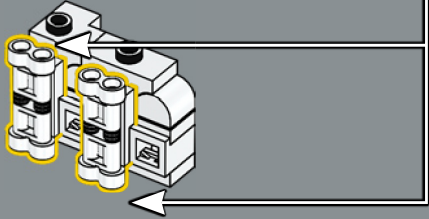
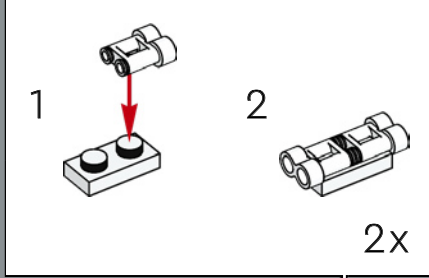

83

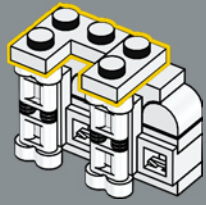

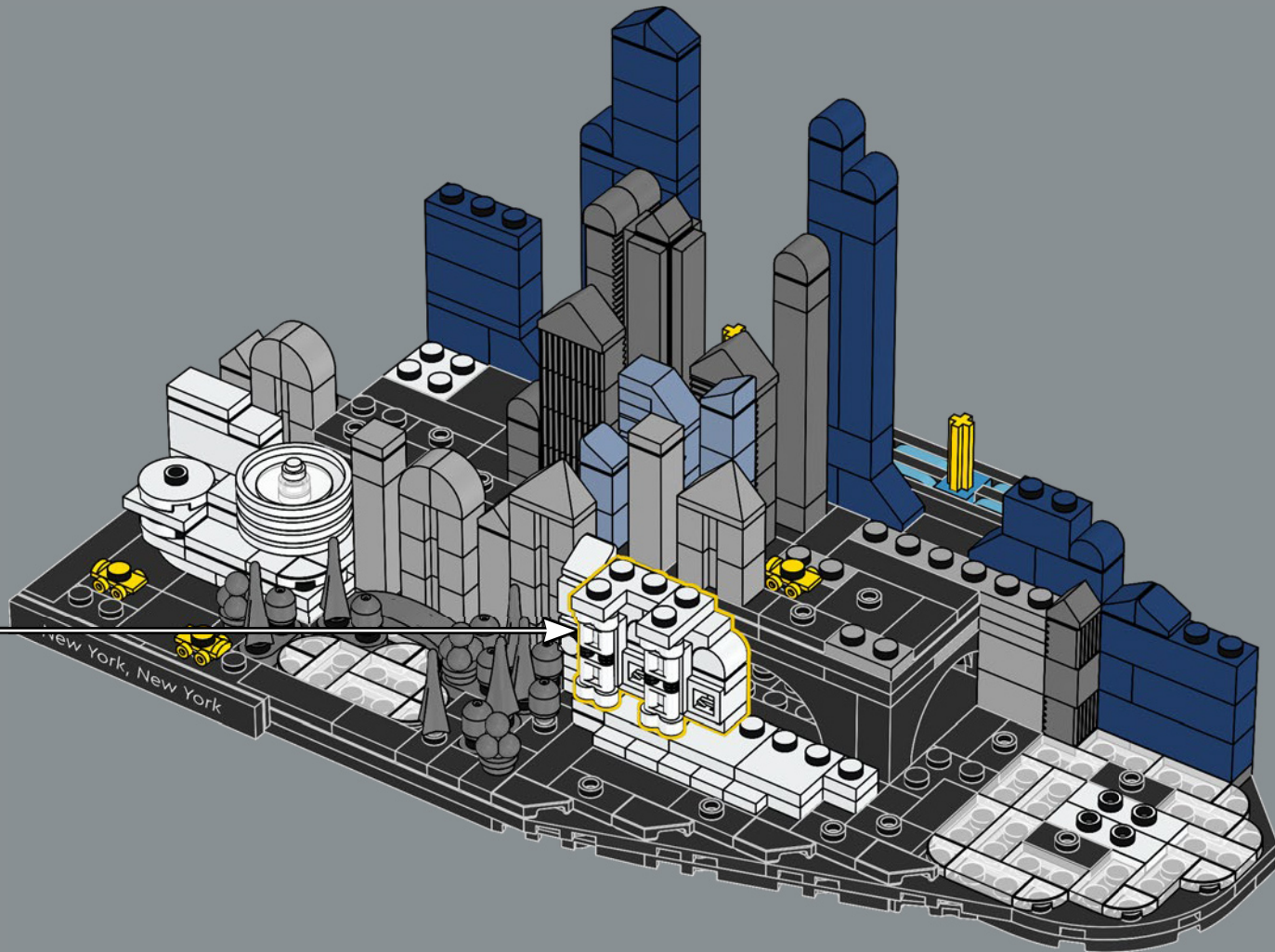

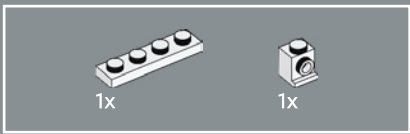

85

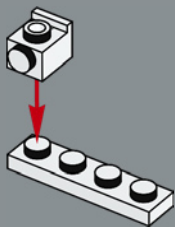

86

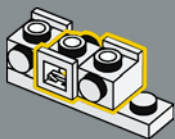

87

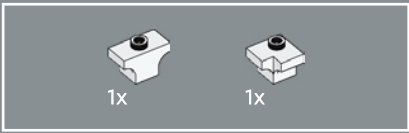
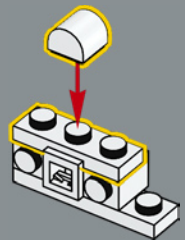

88

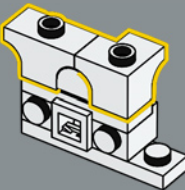

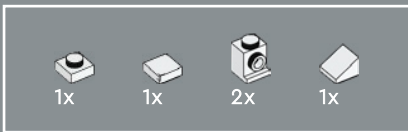

89

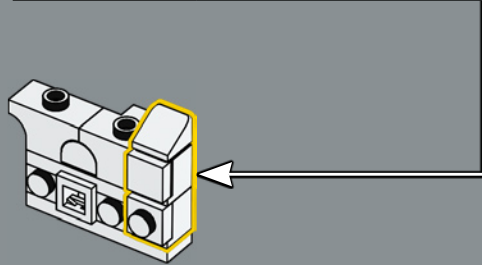
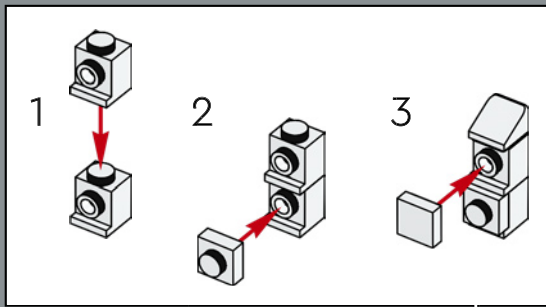

90

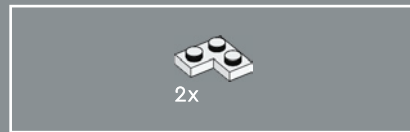
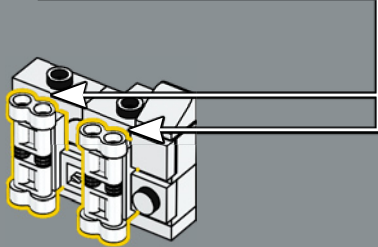
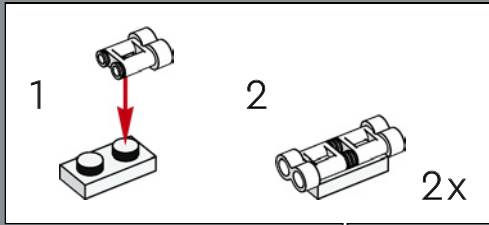

91

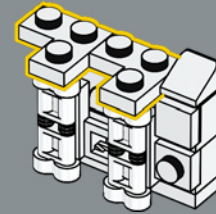

Des accessoires de jumelles LEGO® forment de minuscules paires de colonnes qui décorent l'entrée principale du Metropolitan Museum of Art.

92

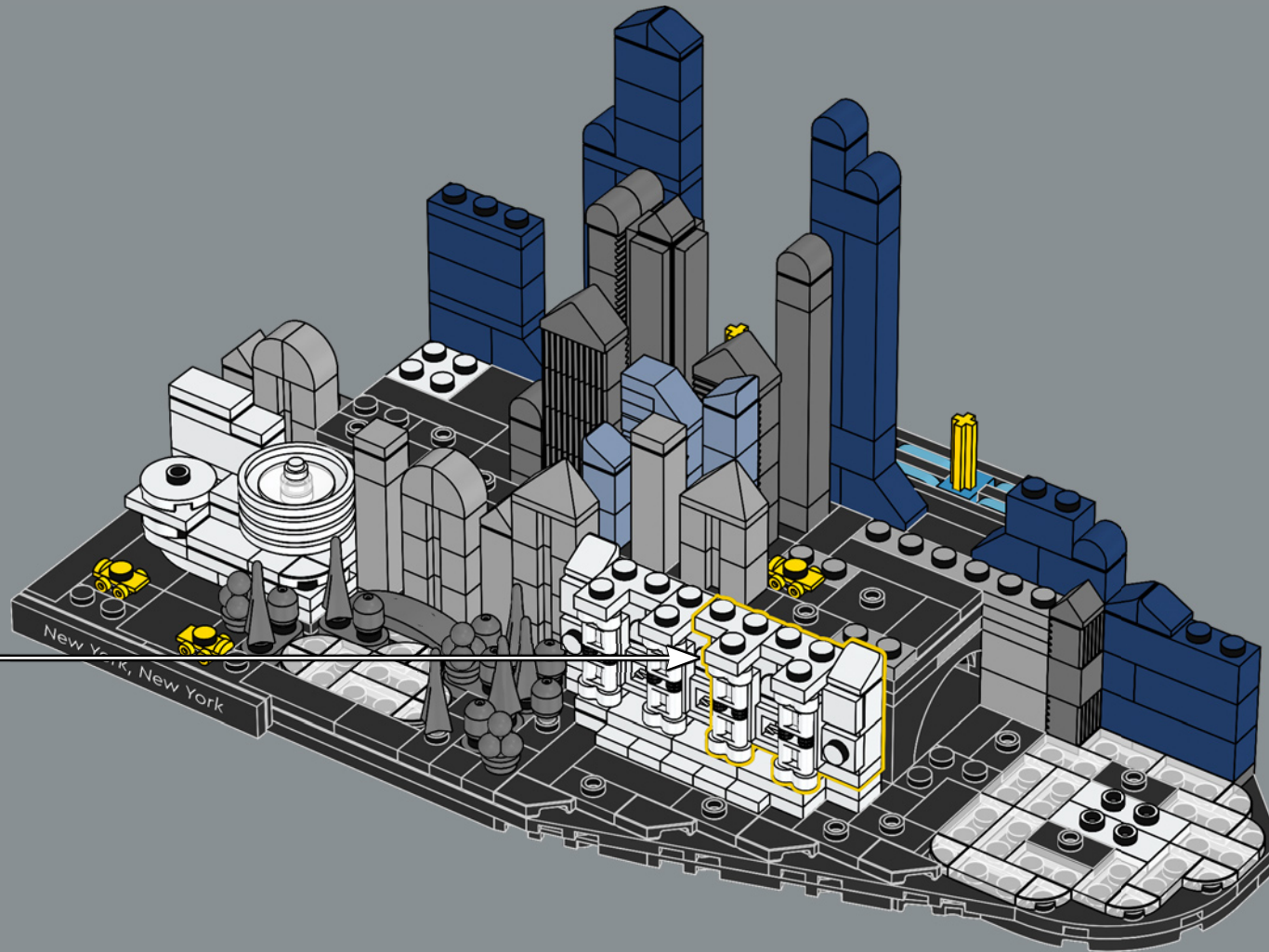

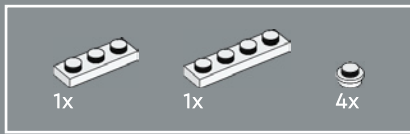

93

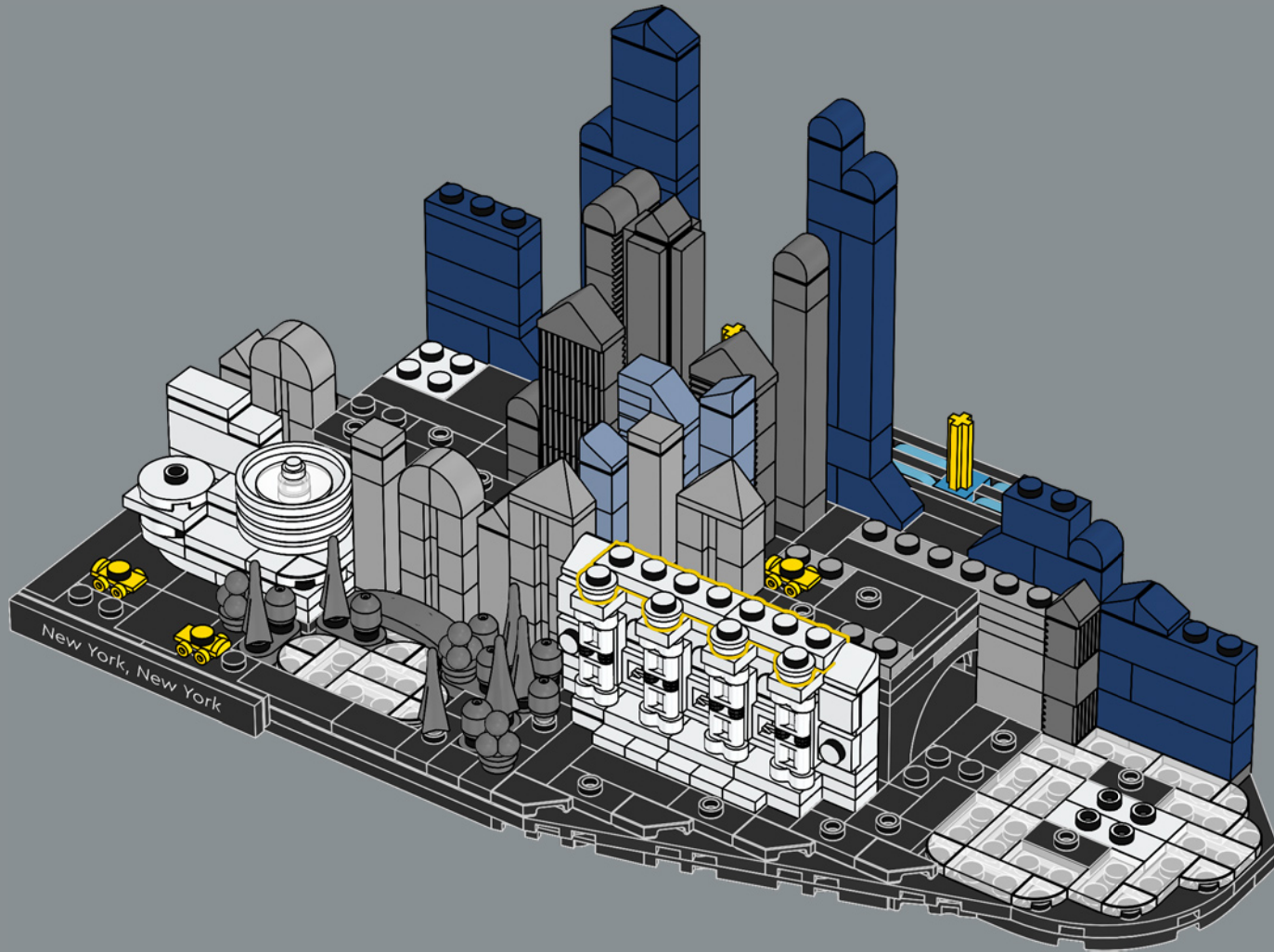

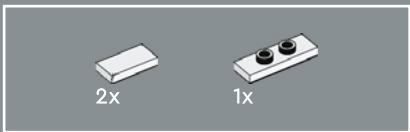

94

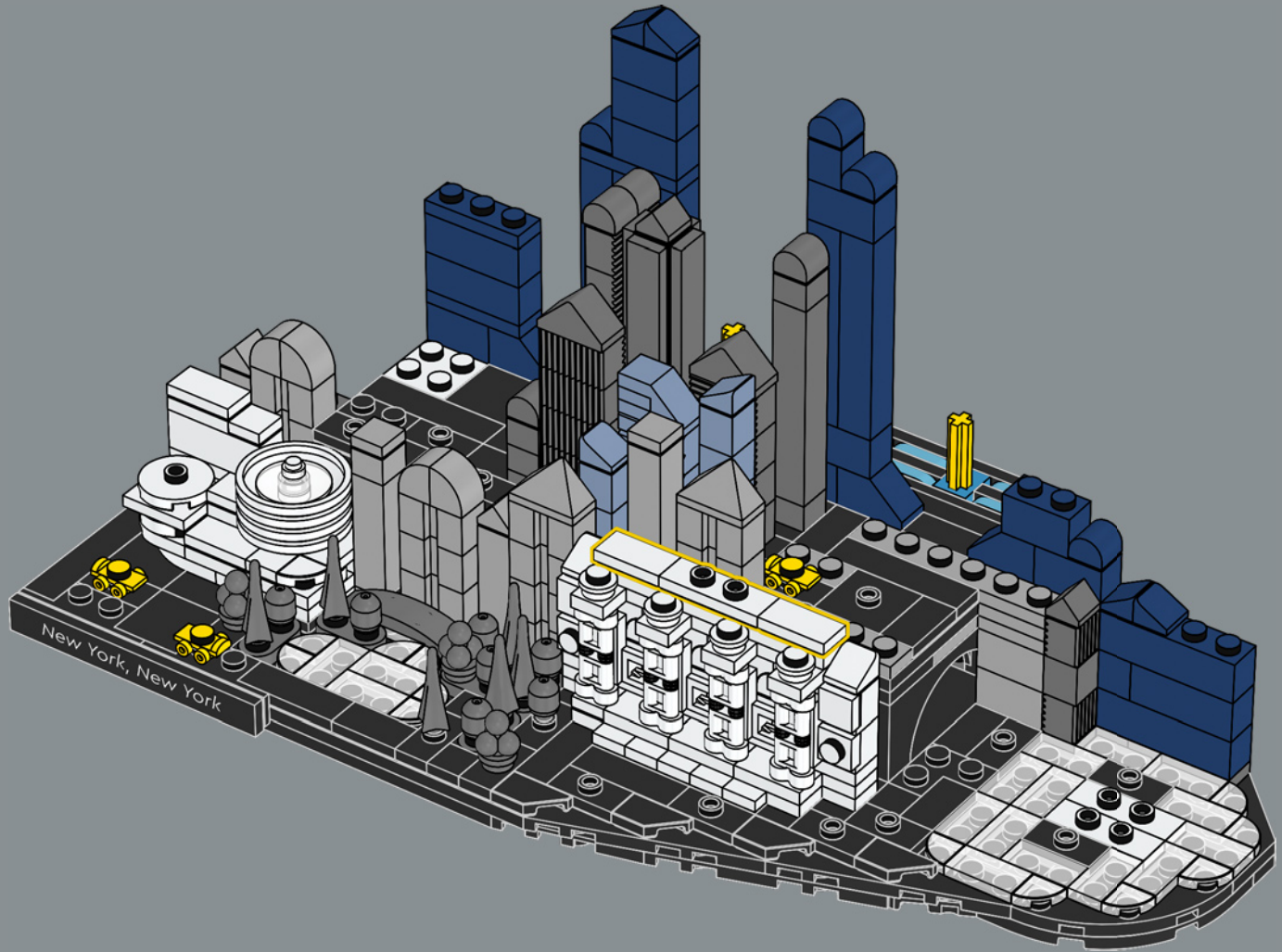



95

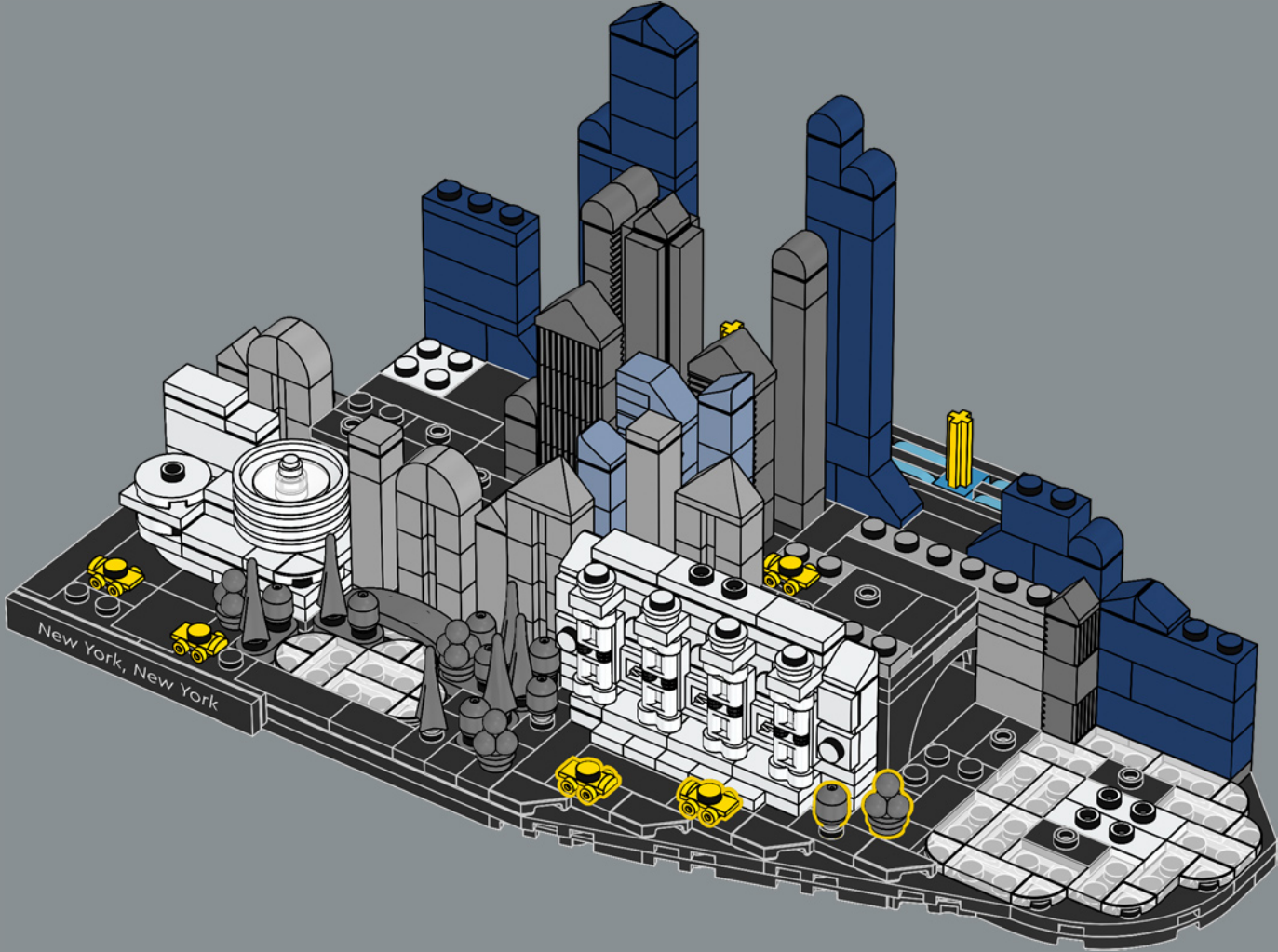

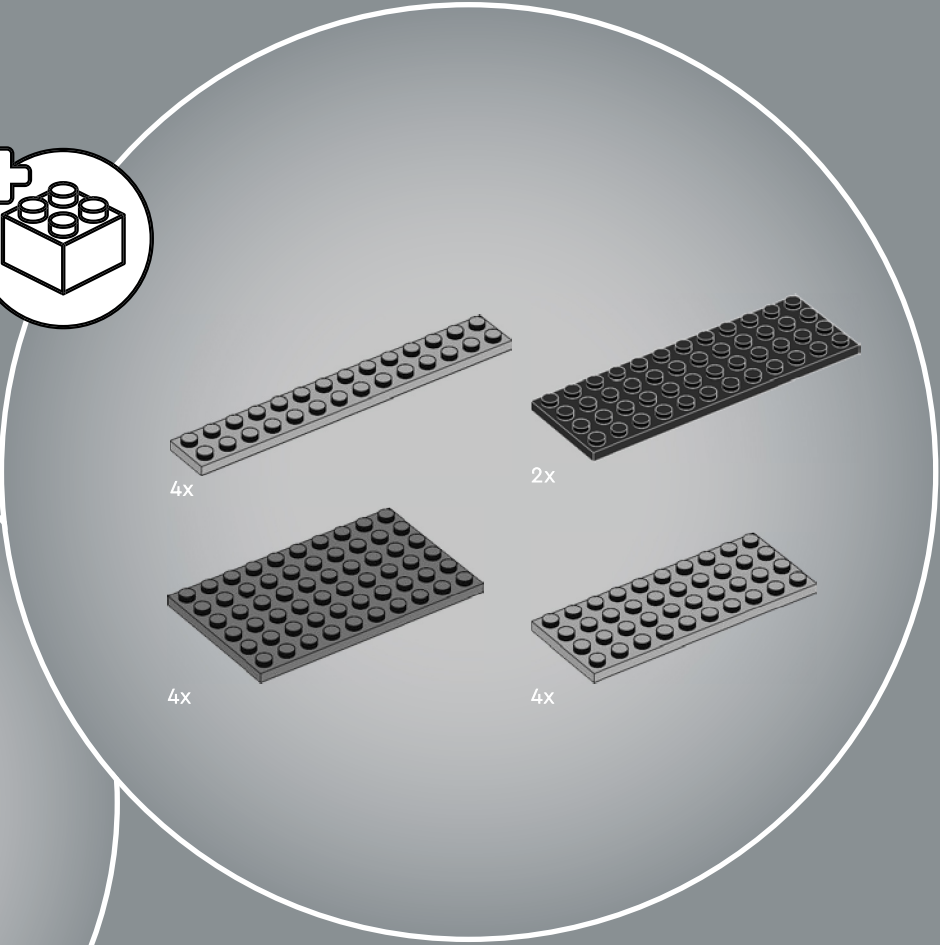
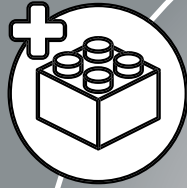

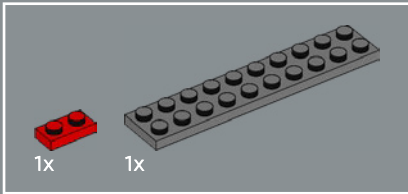
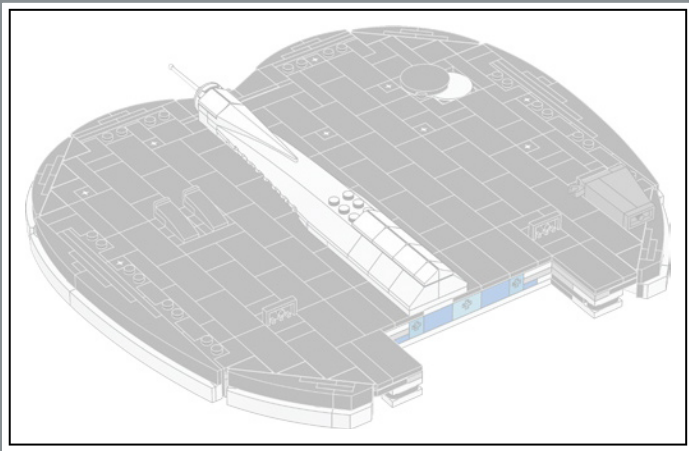

96

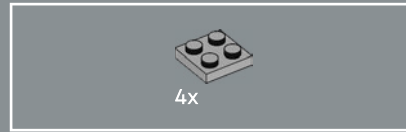
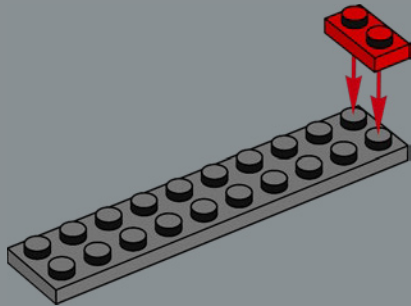

97

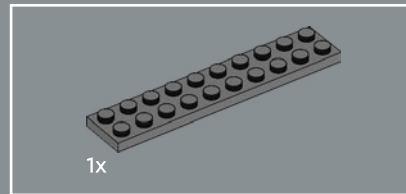
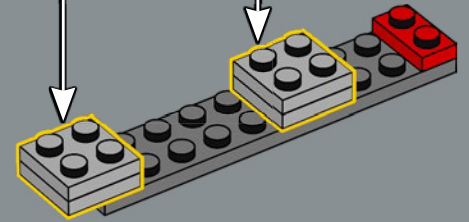
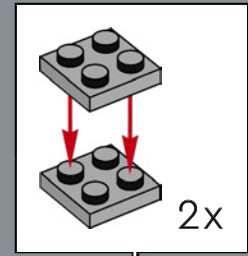

98

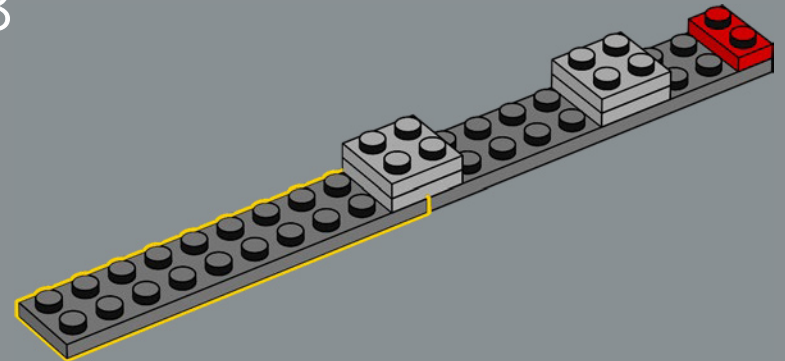

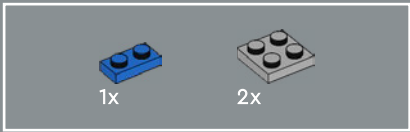

99

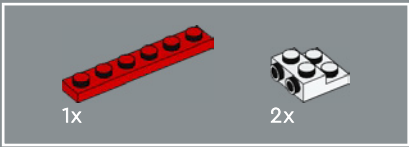
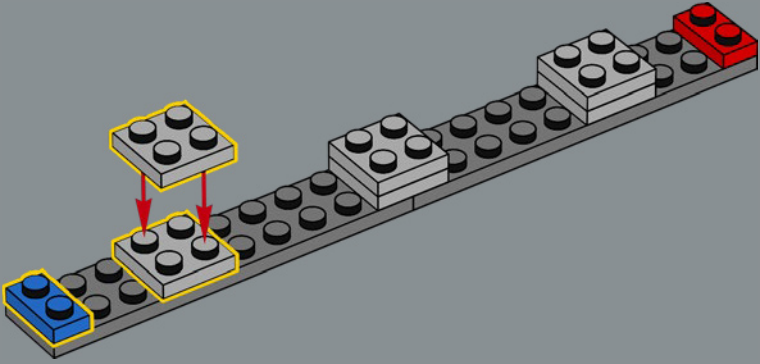

100

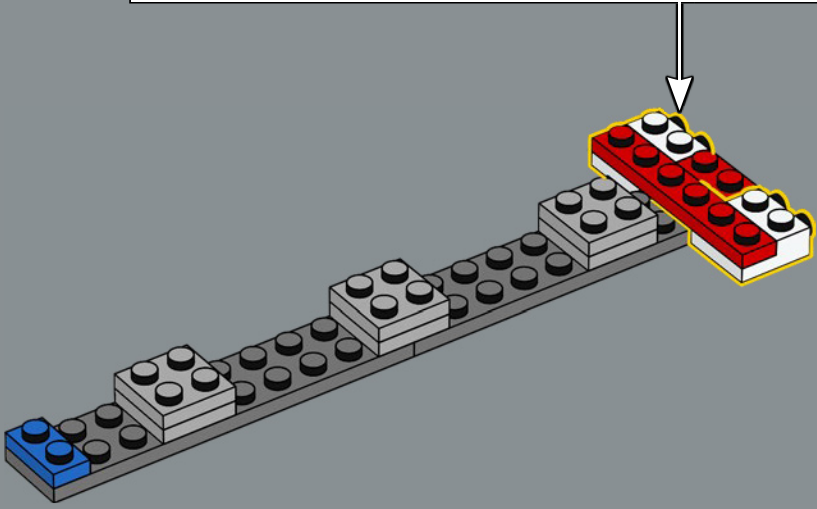
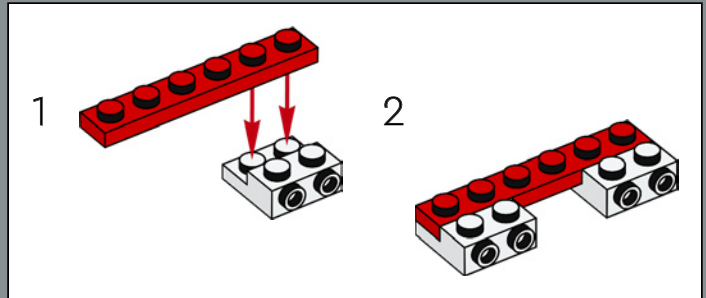

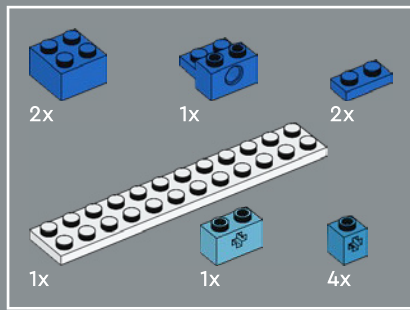

101

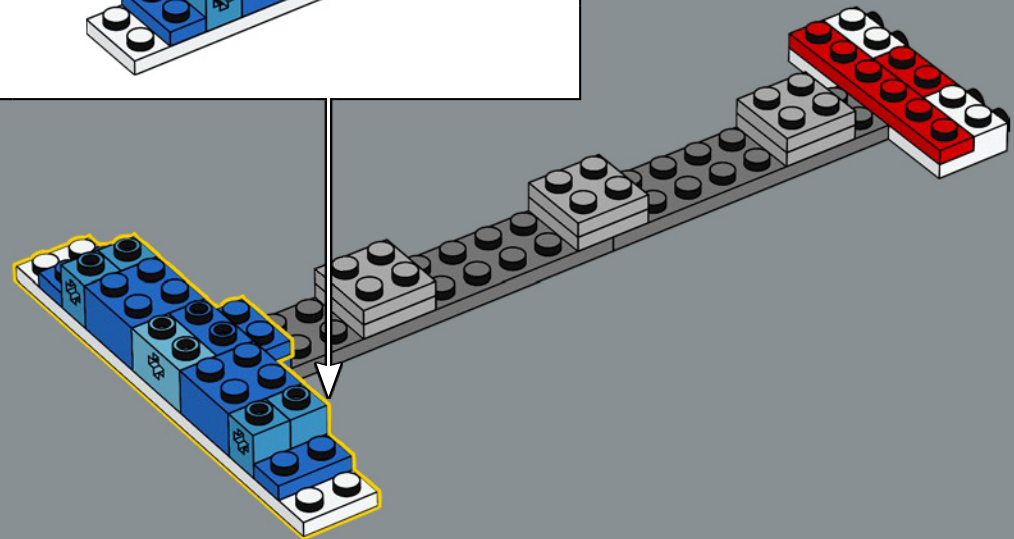
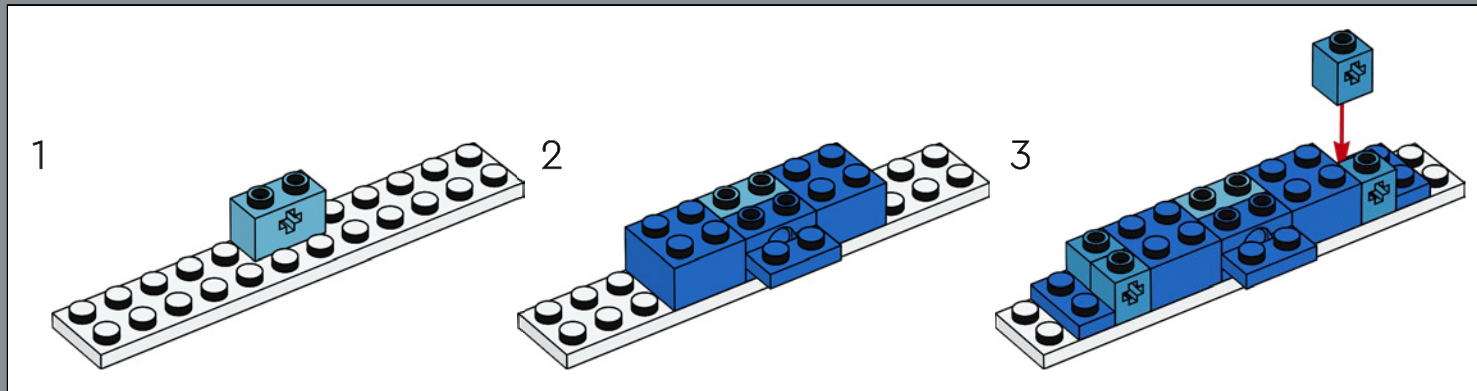

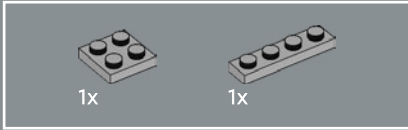
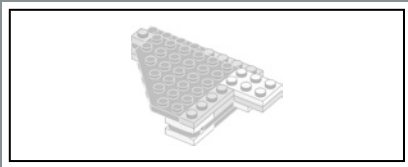

102

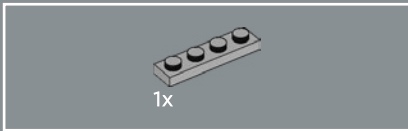
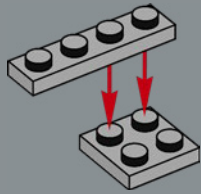

103

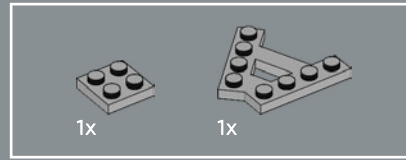
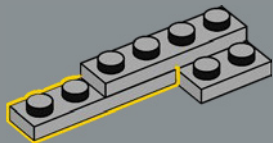

104

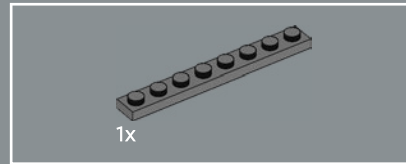
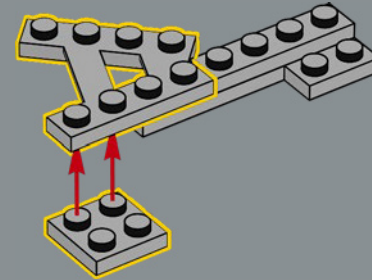

105

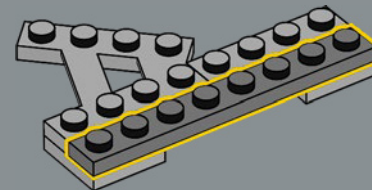



106

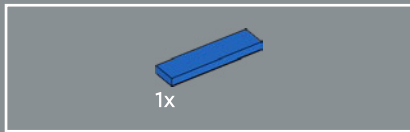
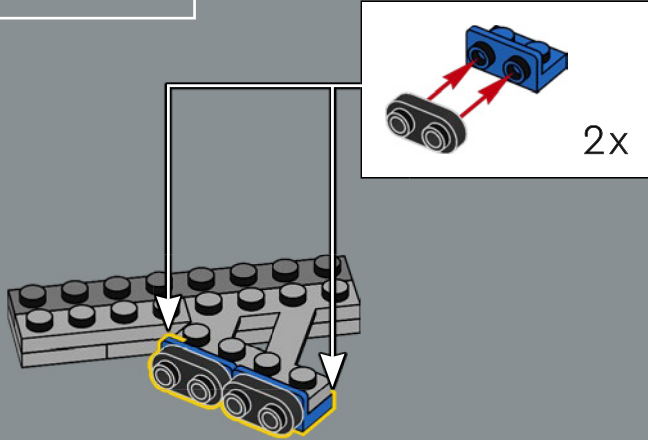

107

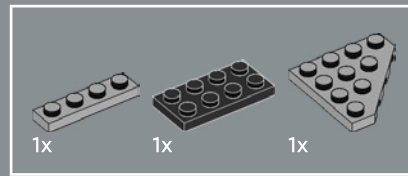
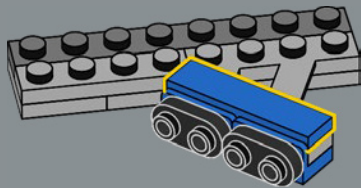

108

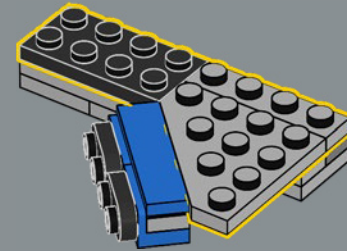

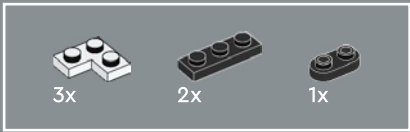

109

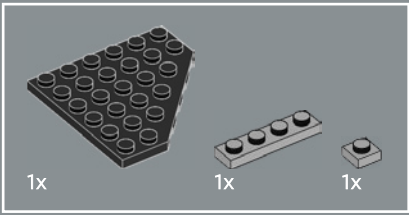
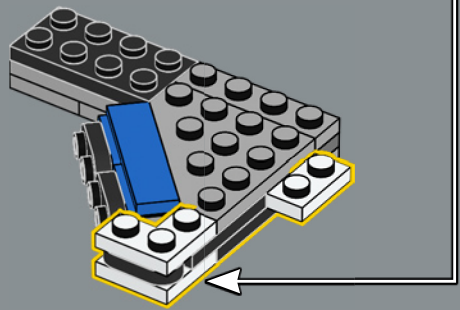
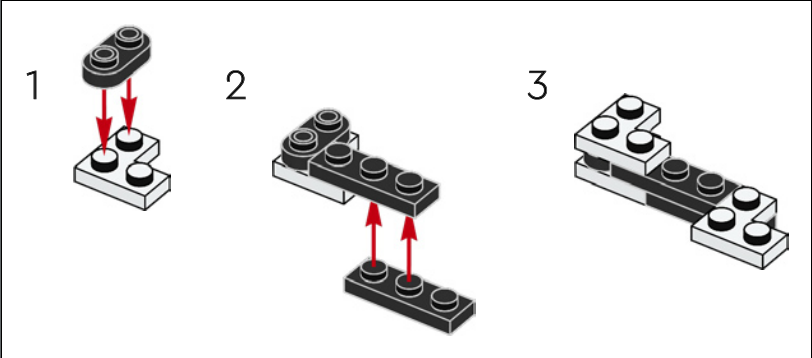

110

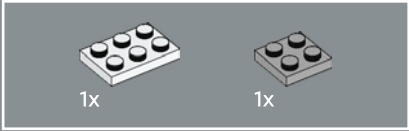
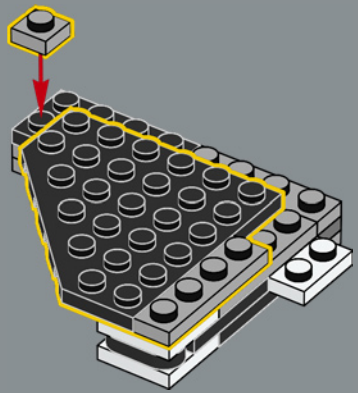

111

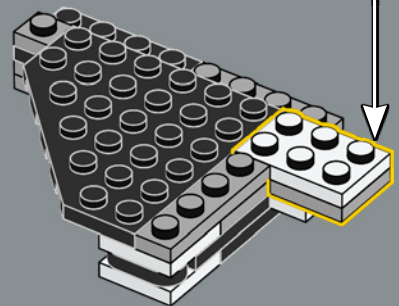
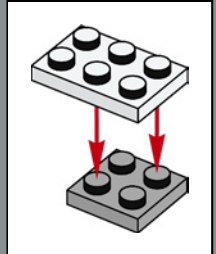

112

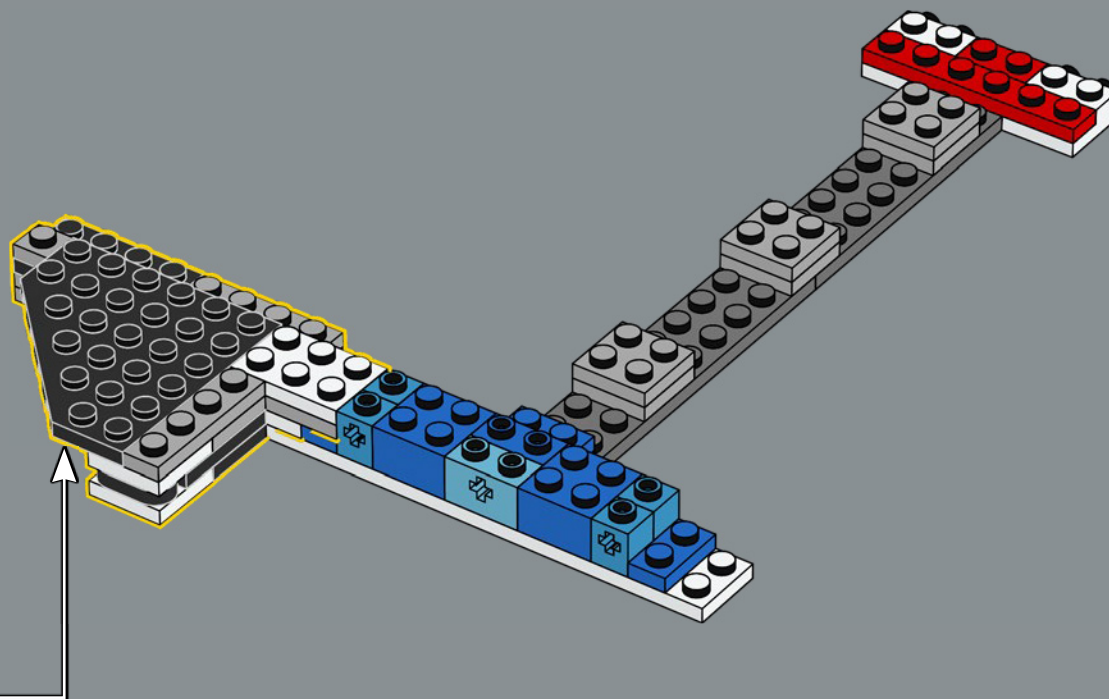



117

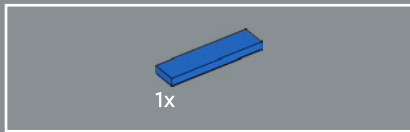
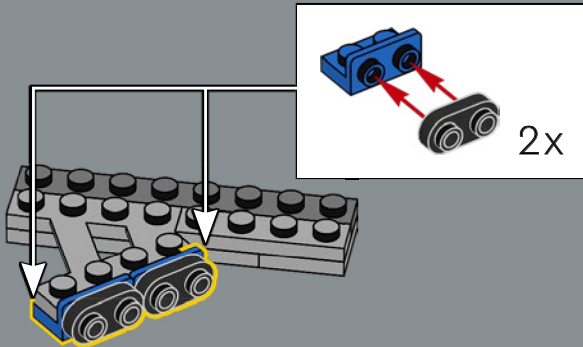

118

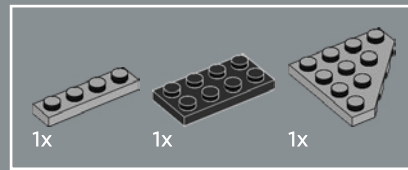
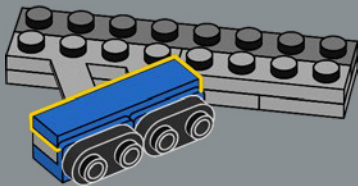

119

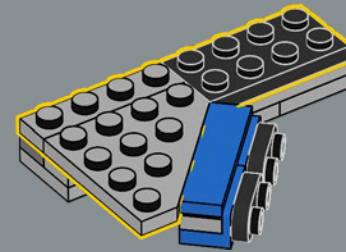

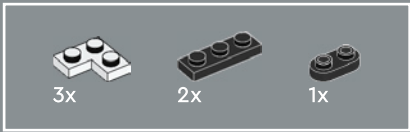

120

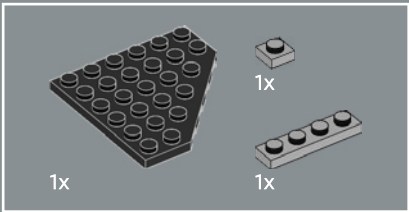
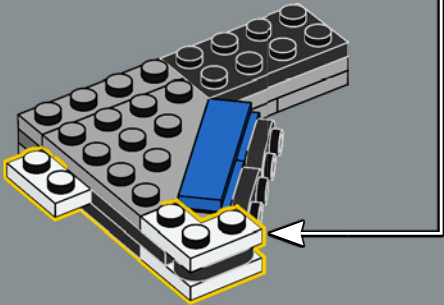
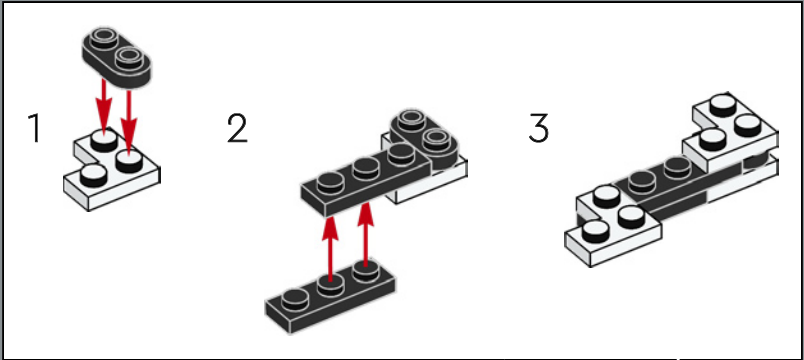

121

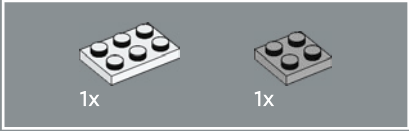
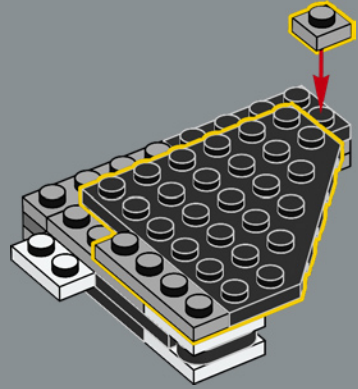

122

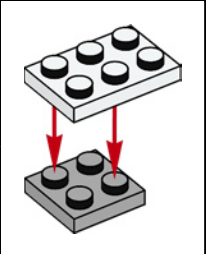
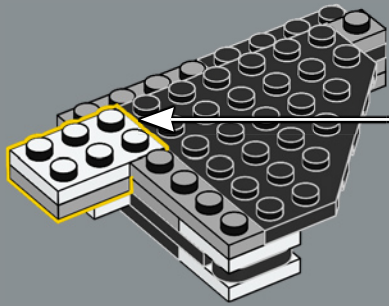

123

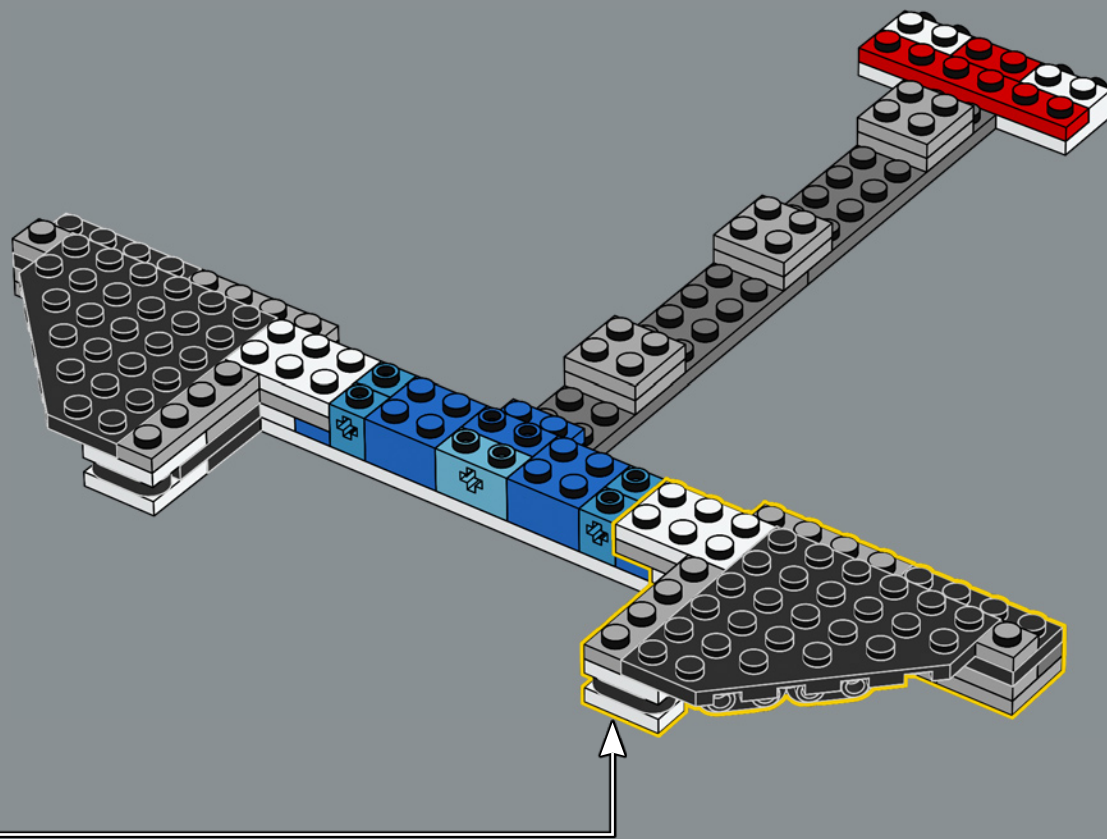

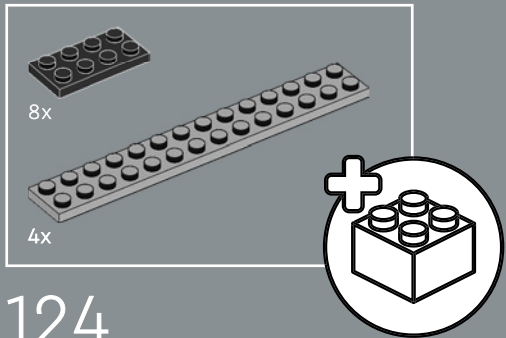
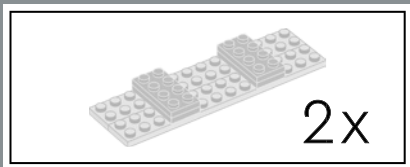

124

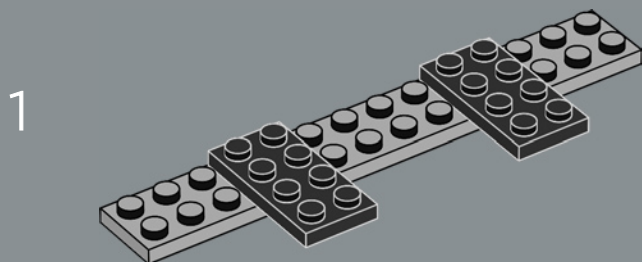

2

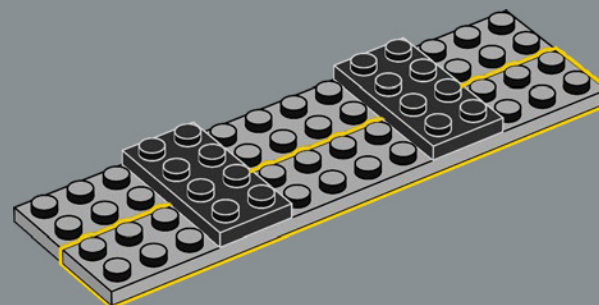

3

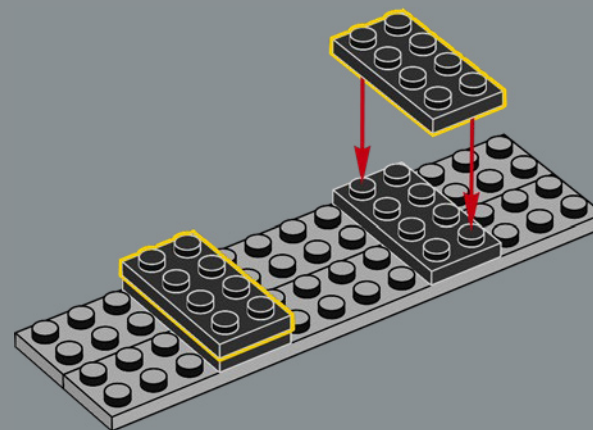

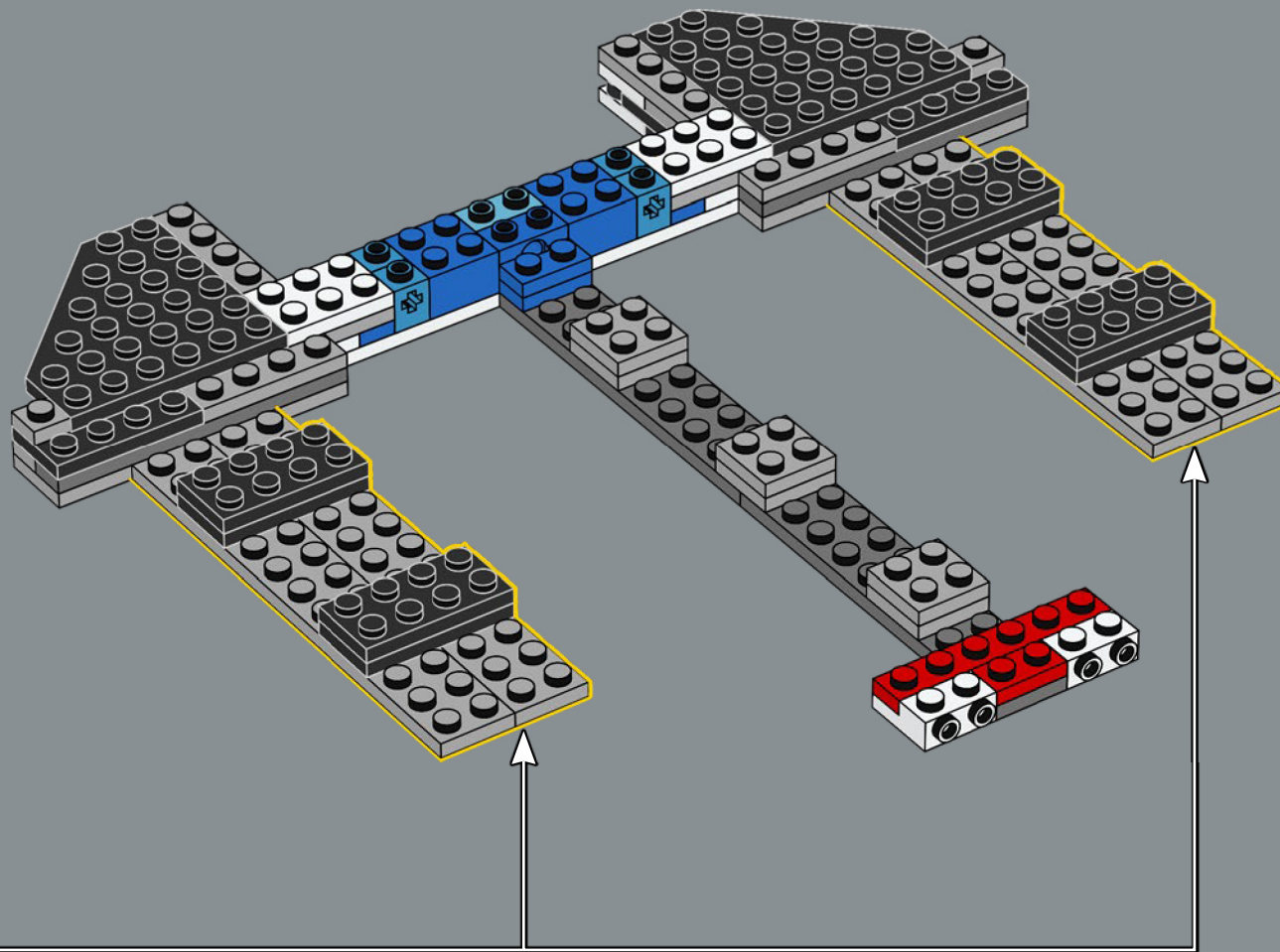

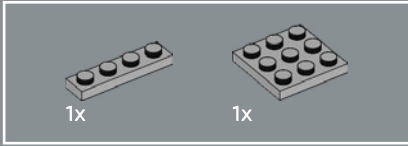
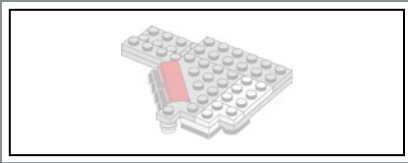

125

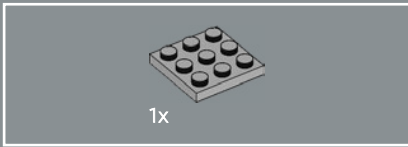
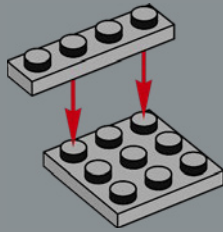

126

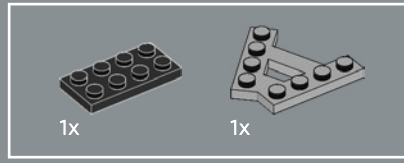
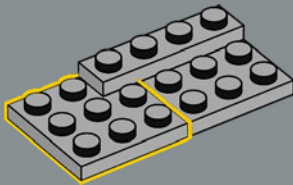

127

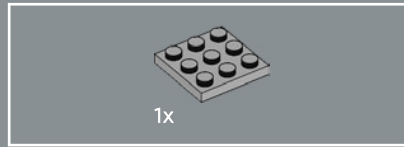
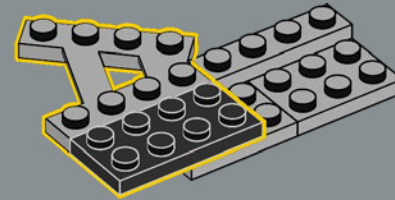

128

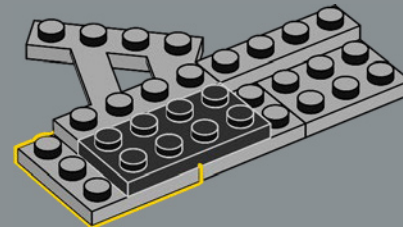



129

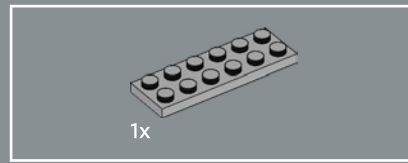
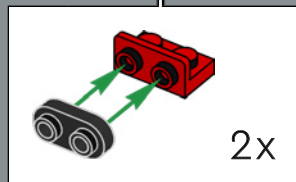
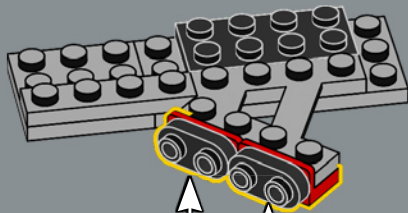

130

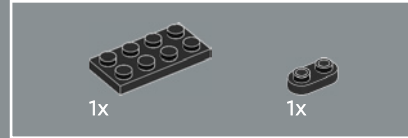
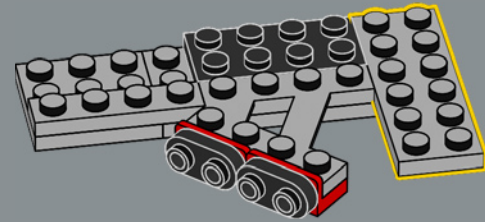

131

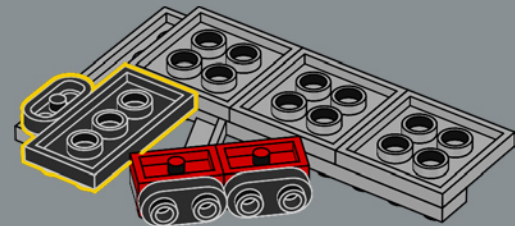

135

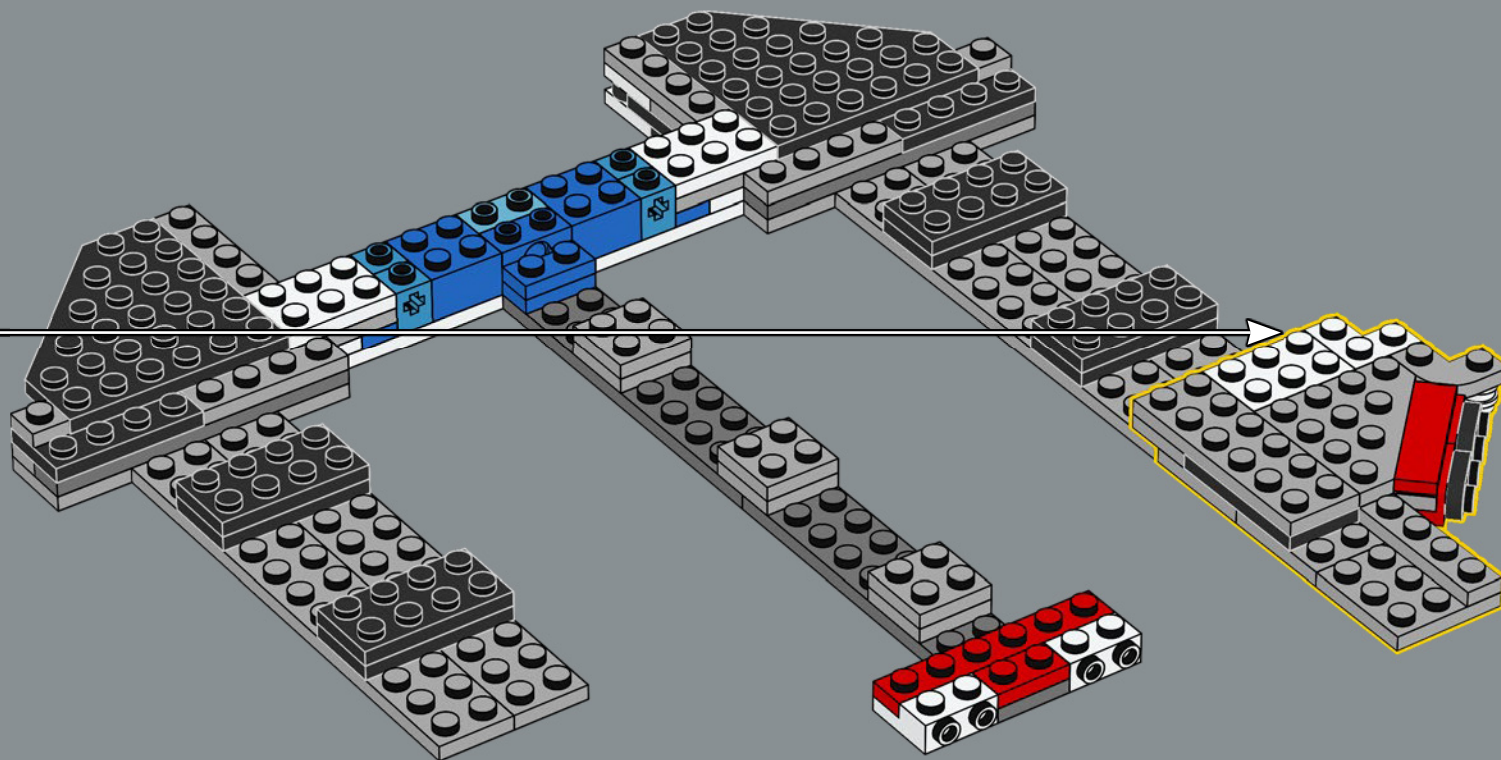

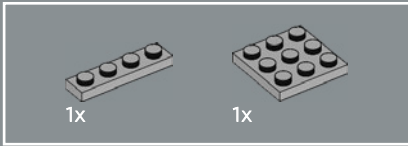
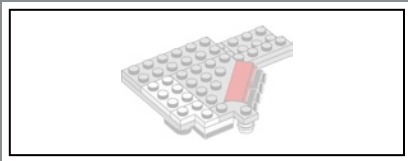

136

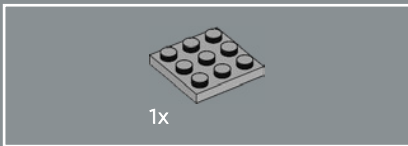
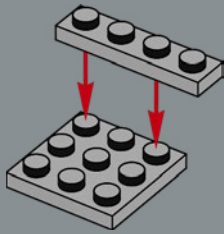

137

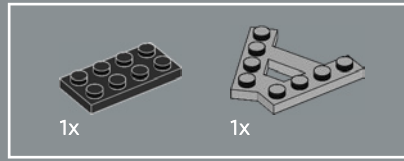
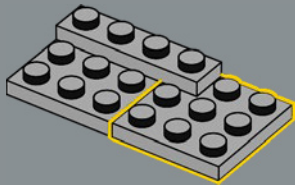

138

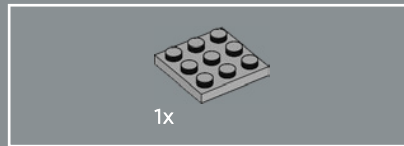
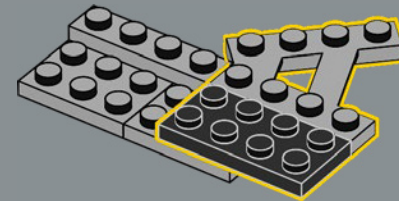

139

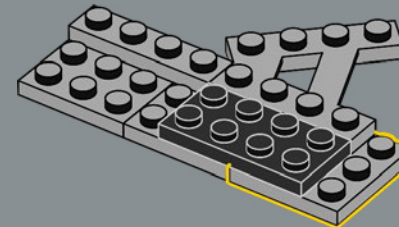



140

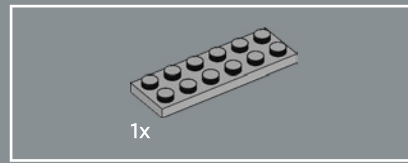
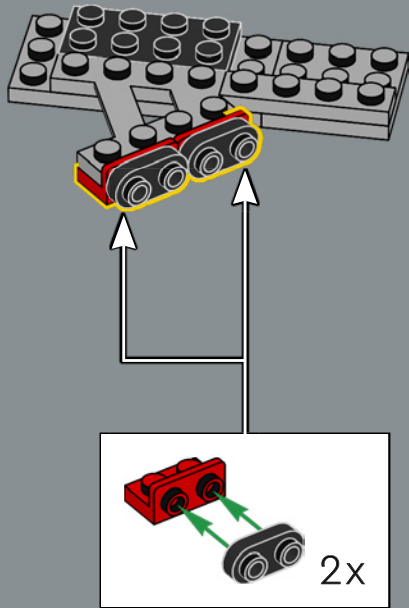

141

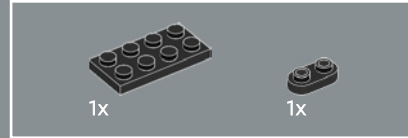
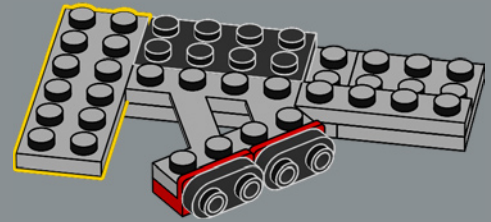

142

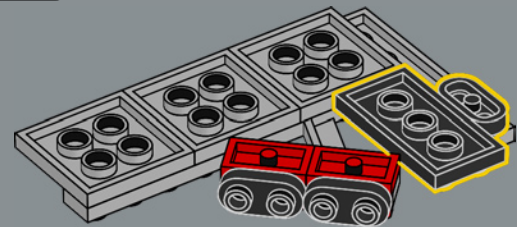



143

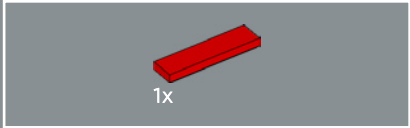
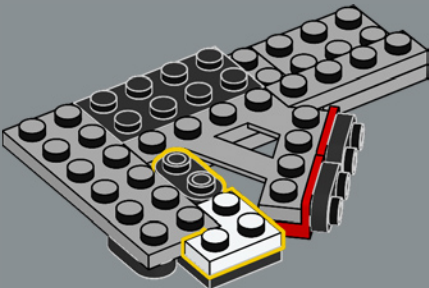

144

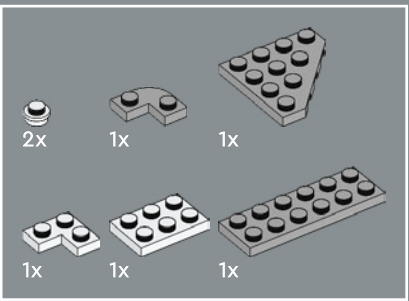
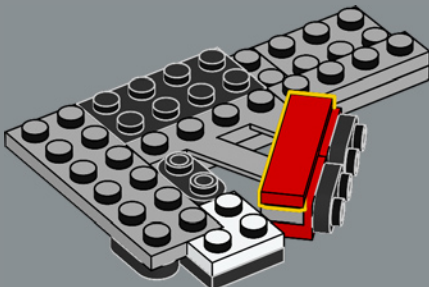

145

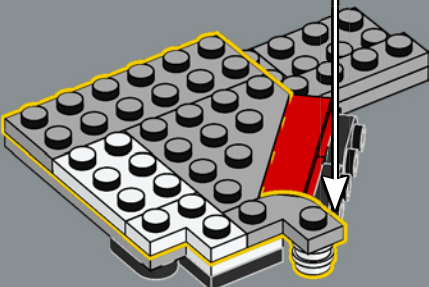
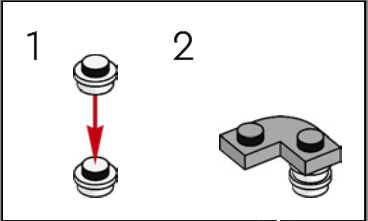

146

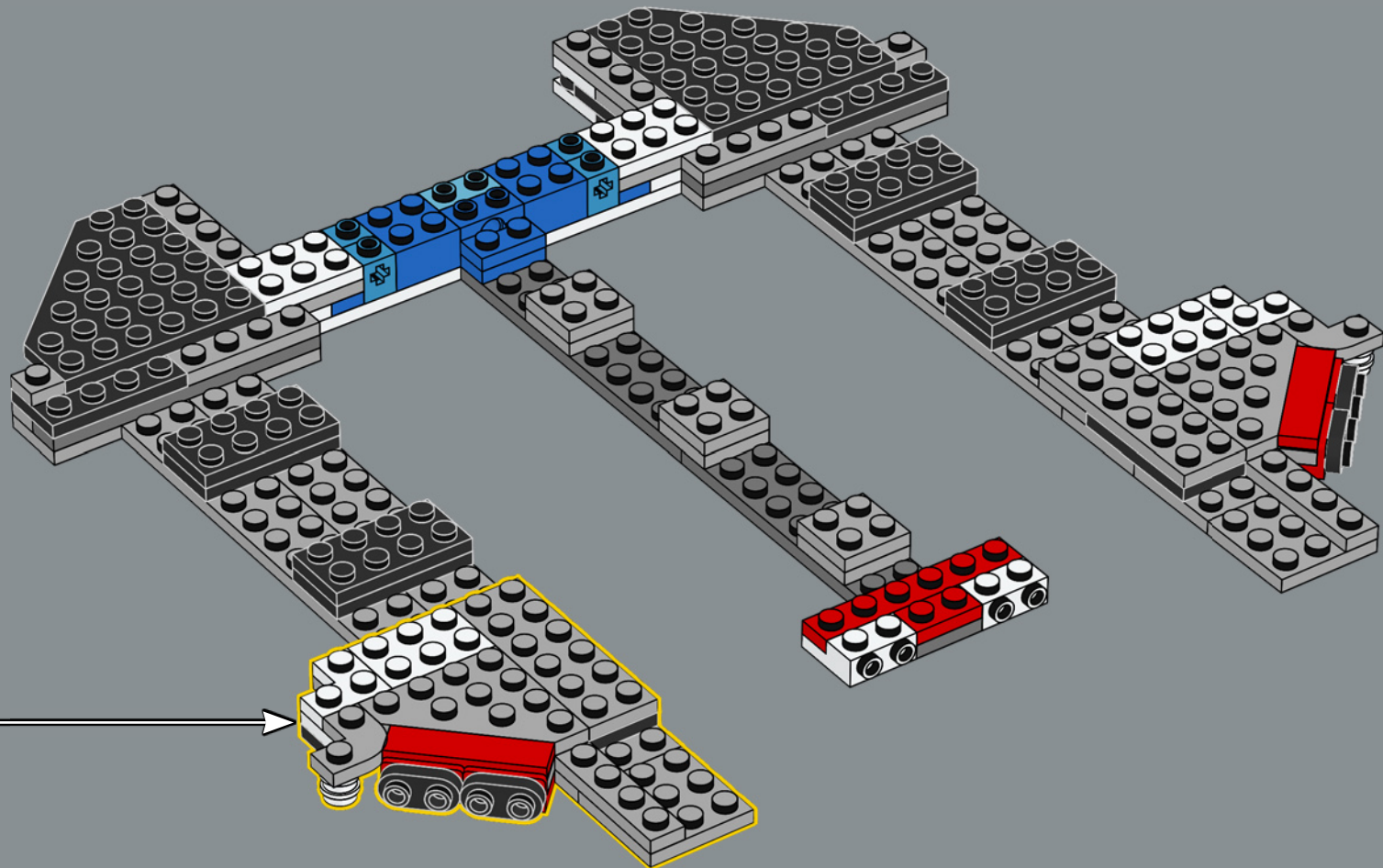

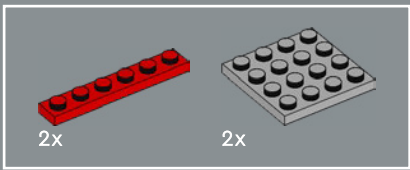

147

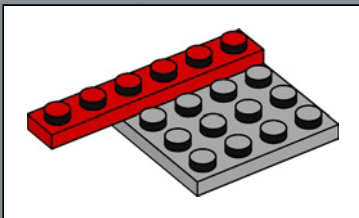
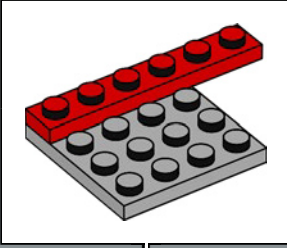
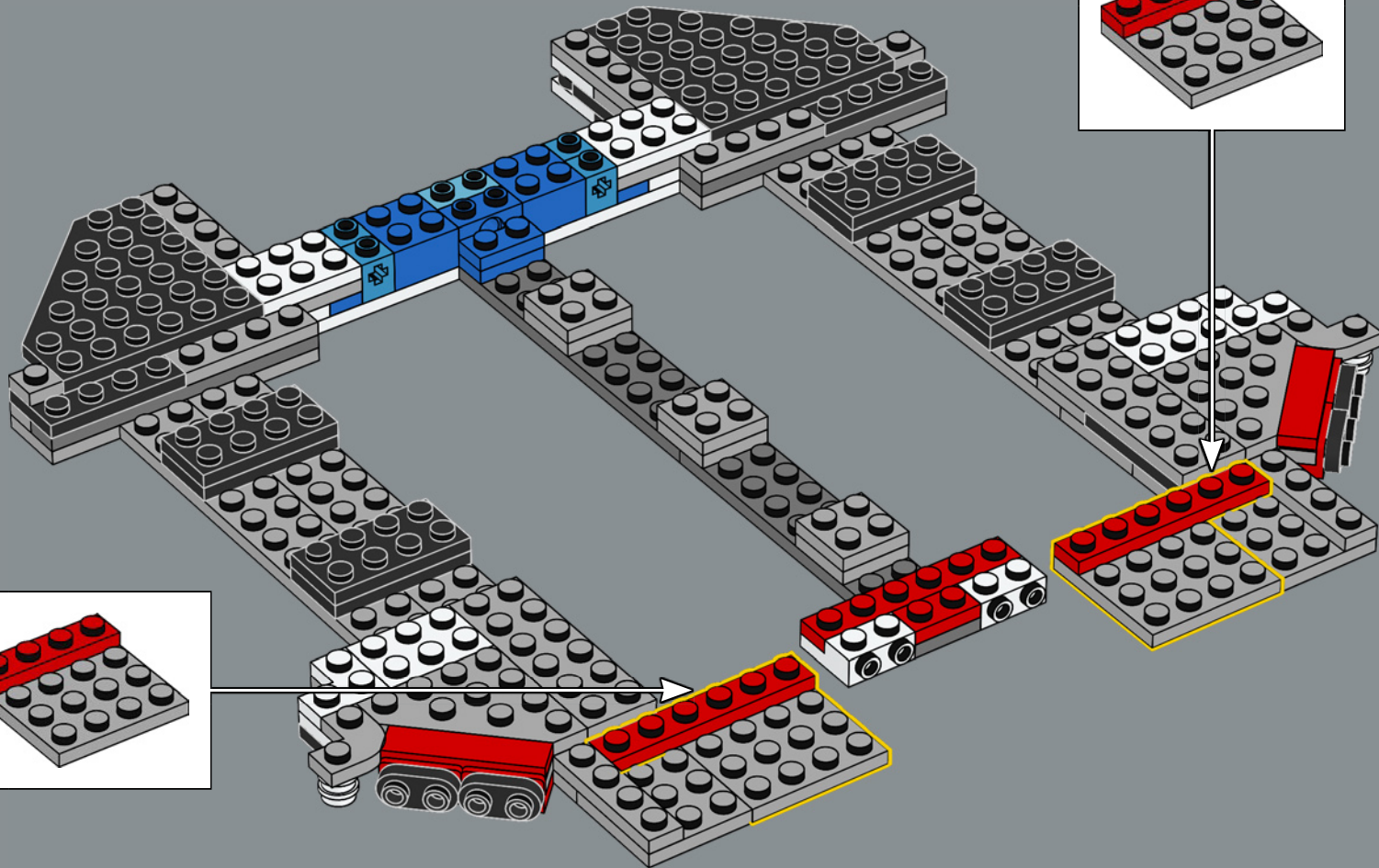

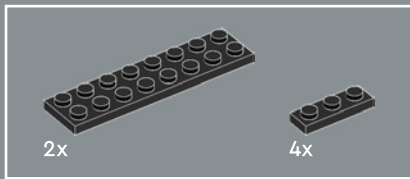

148

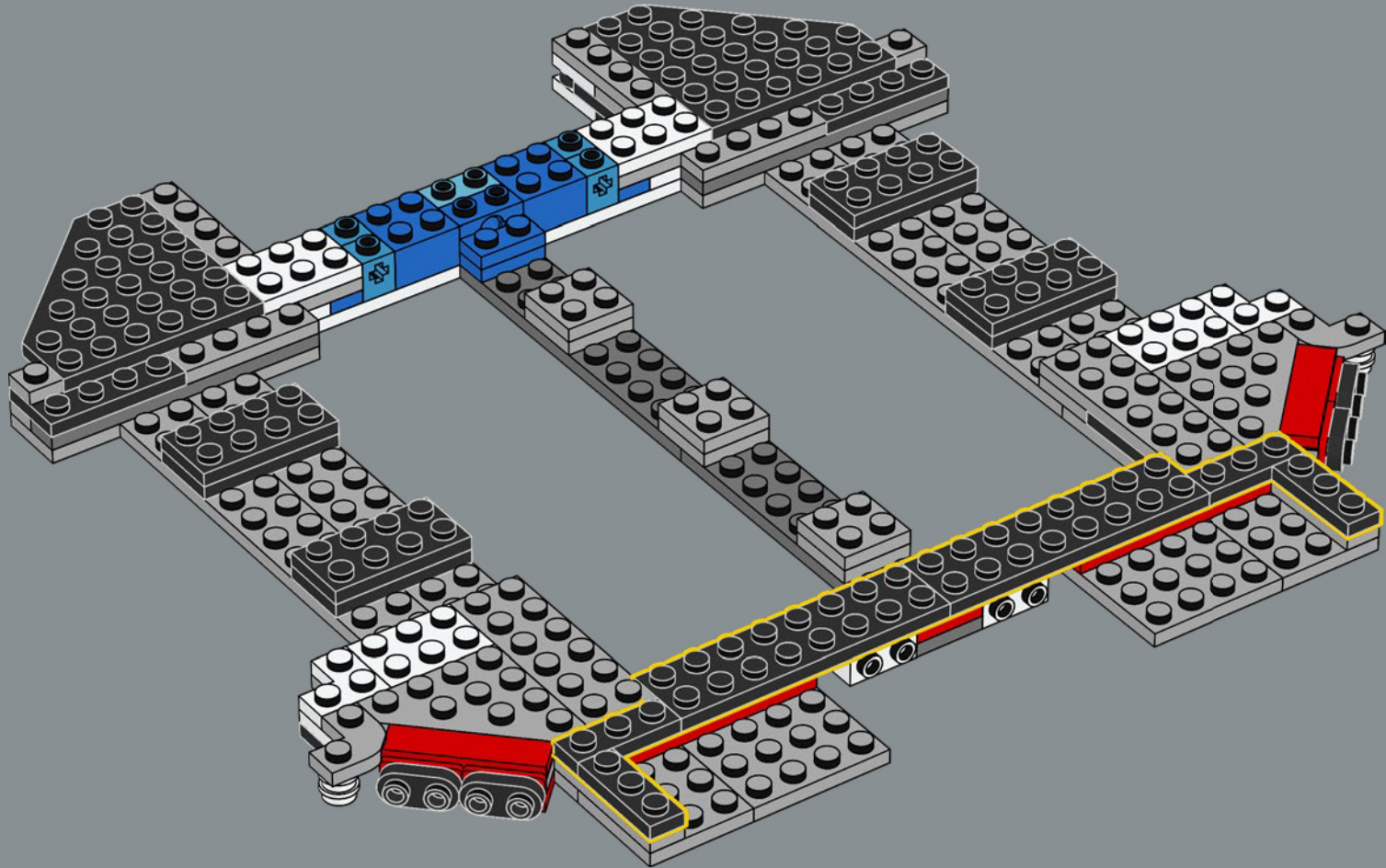

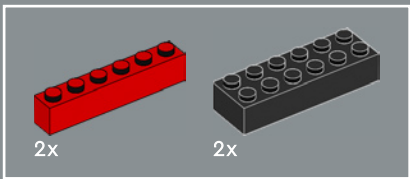

149

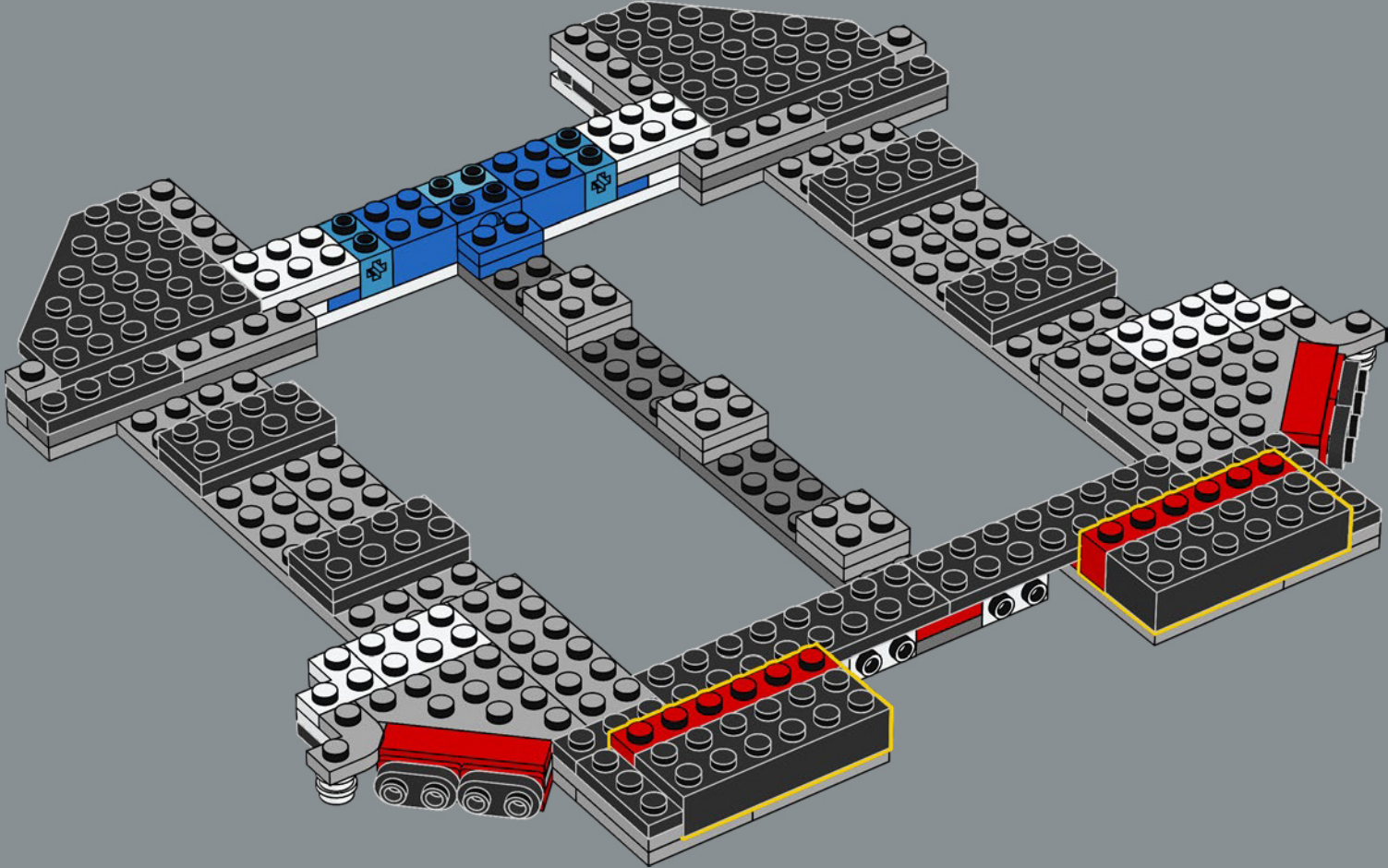

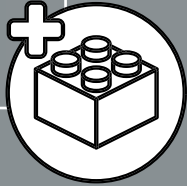
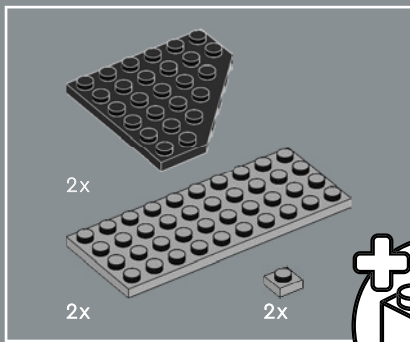

150

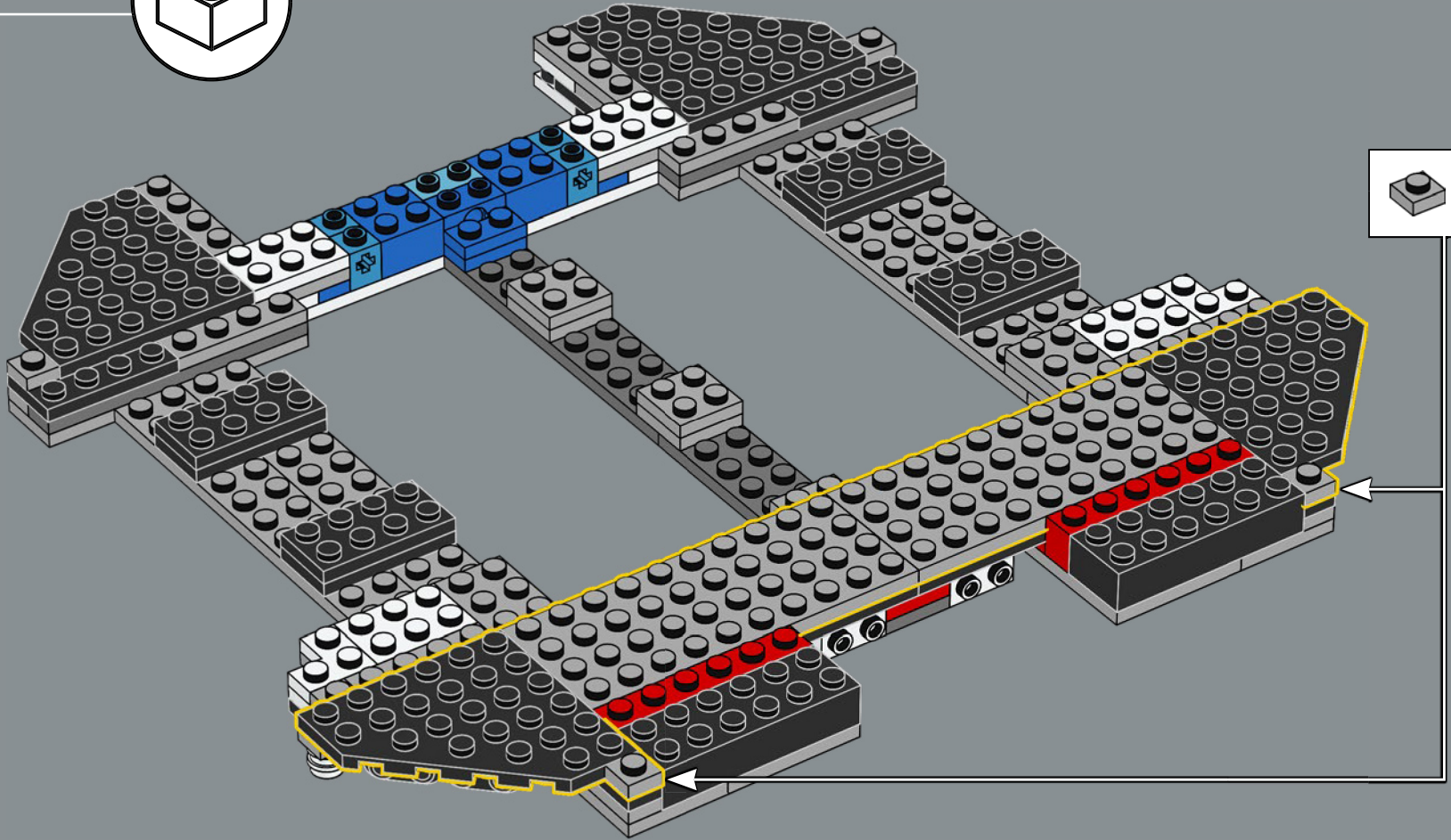

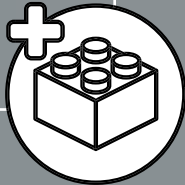
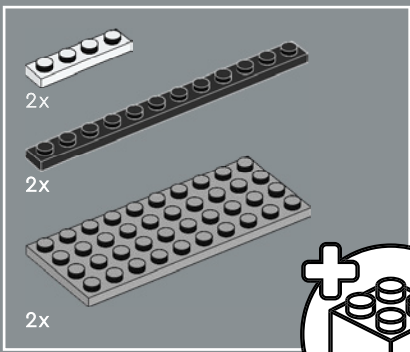

151

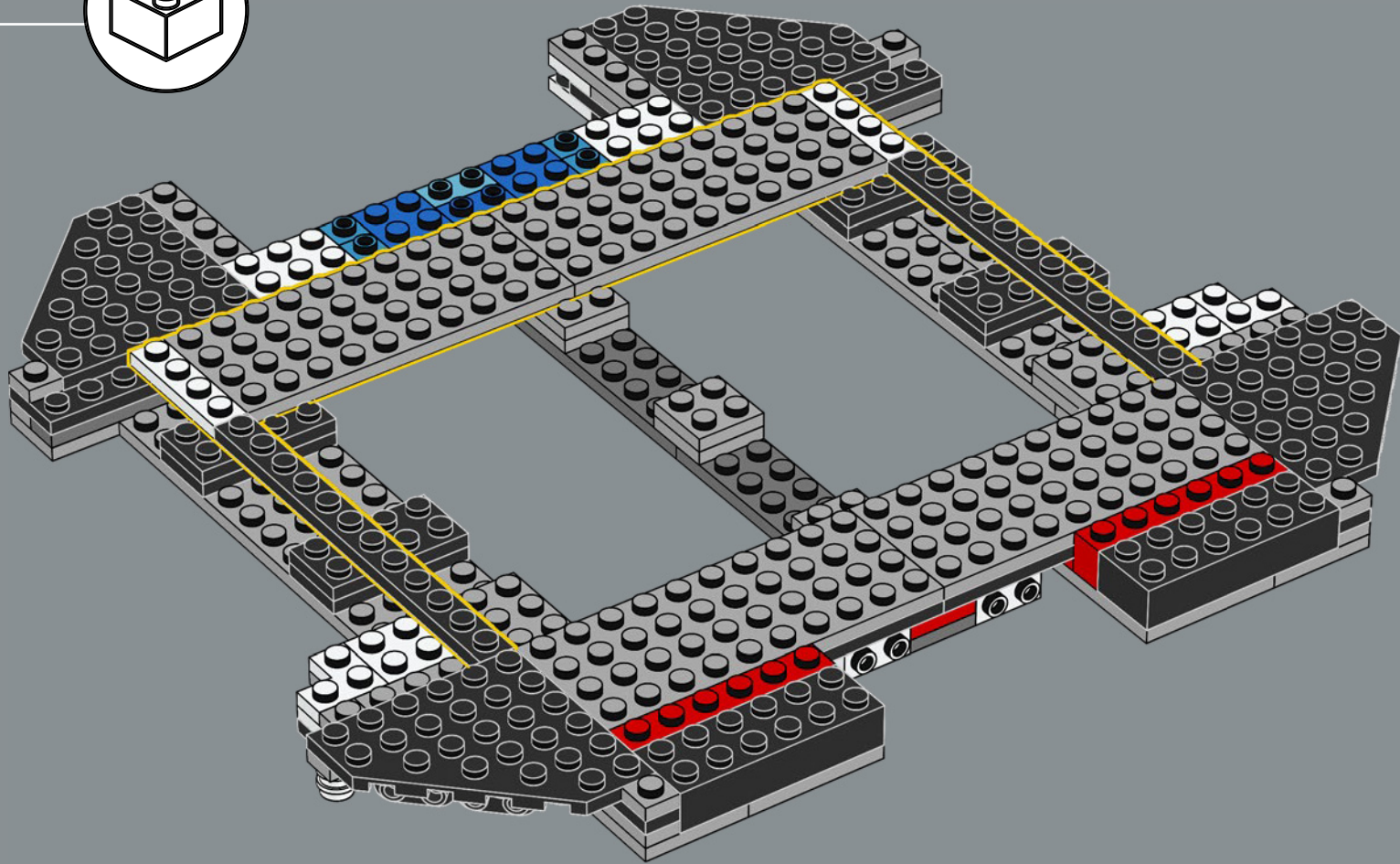

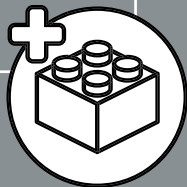
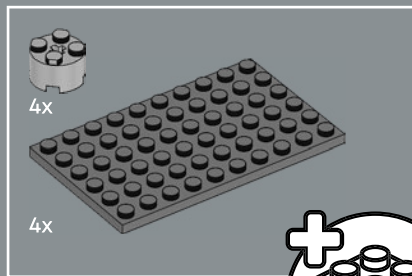

152

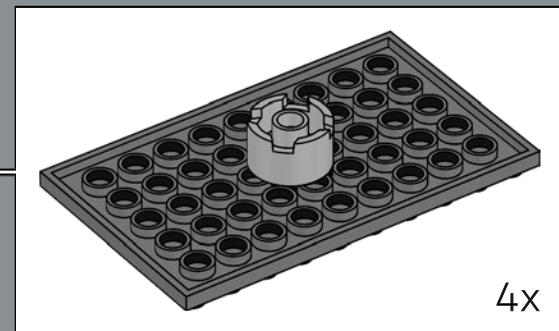
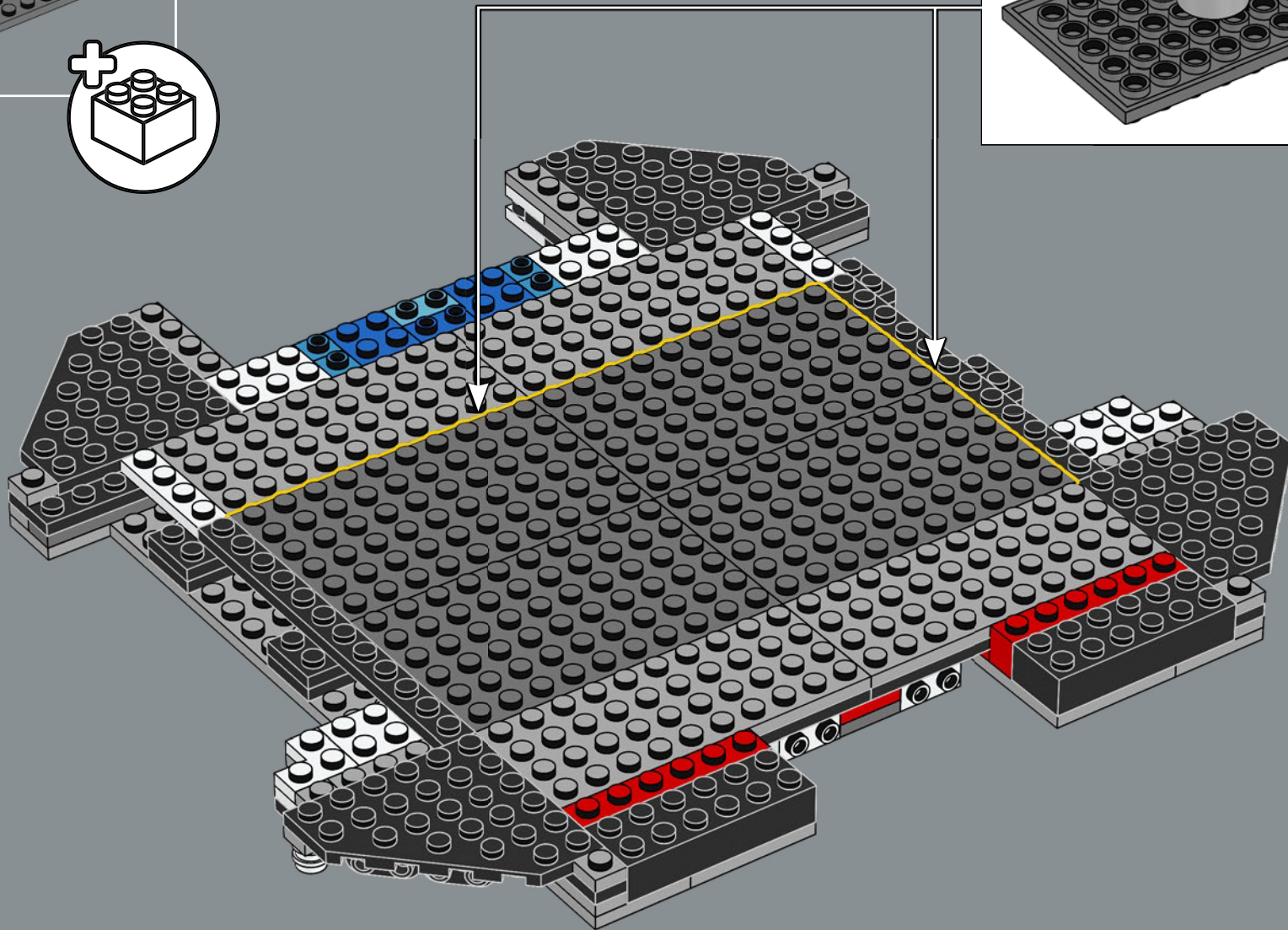

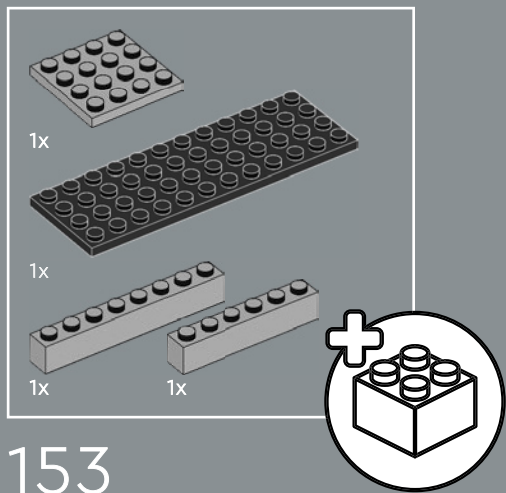

153

1

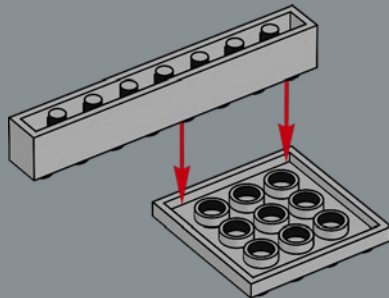

2

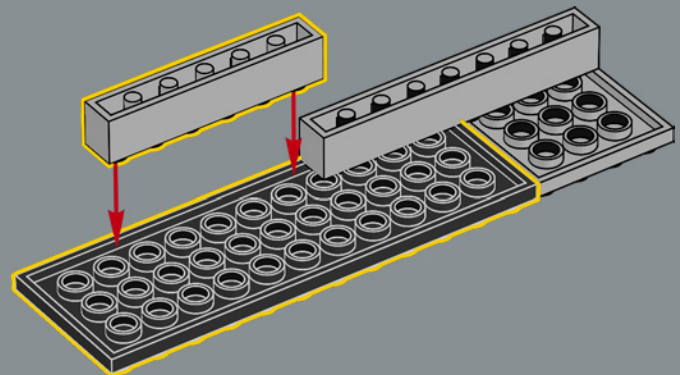

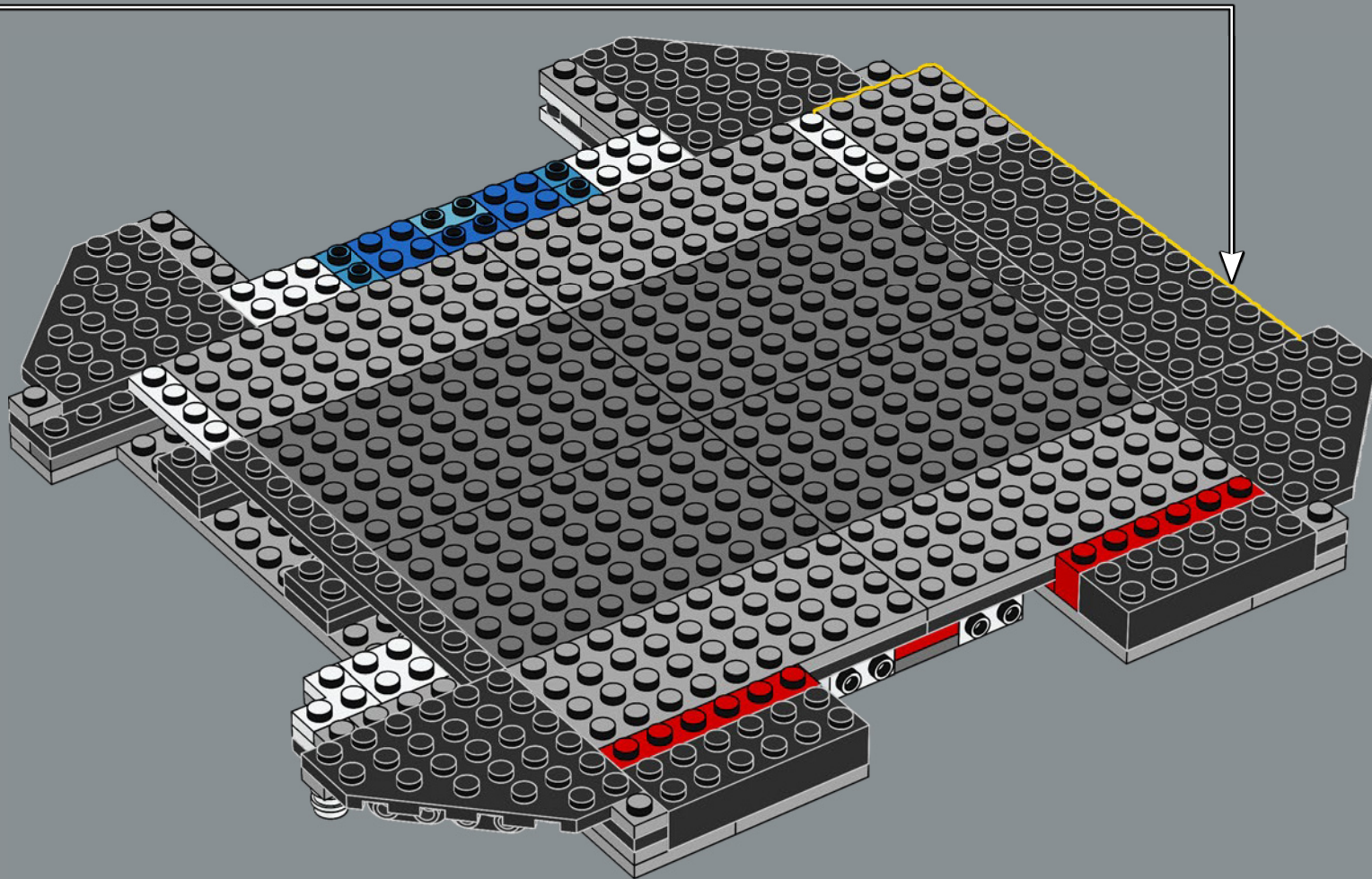

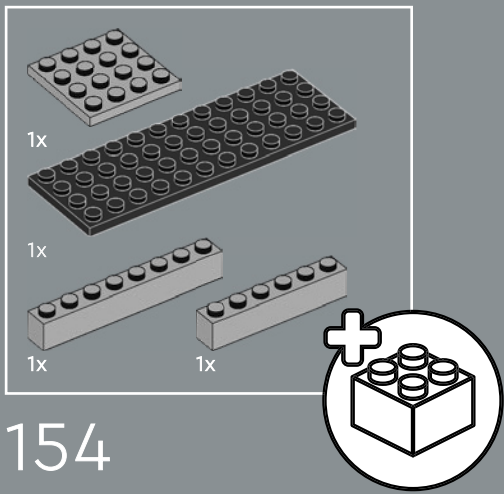

1

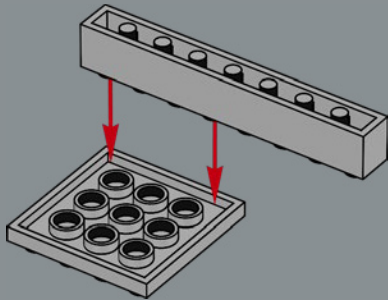

2

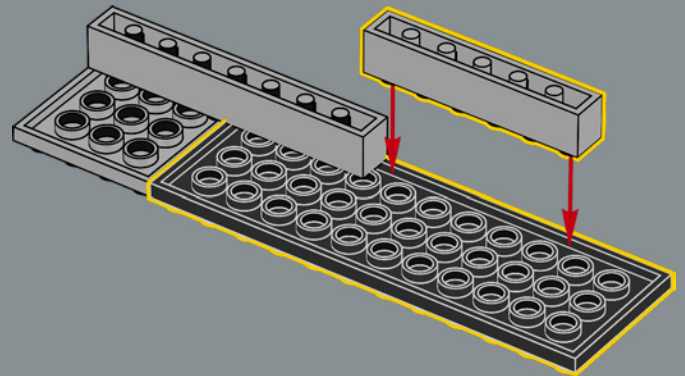

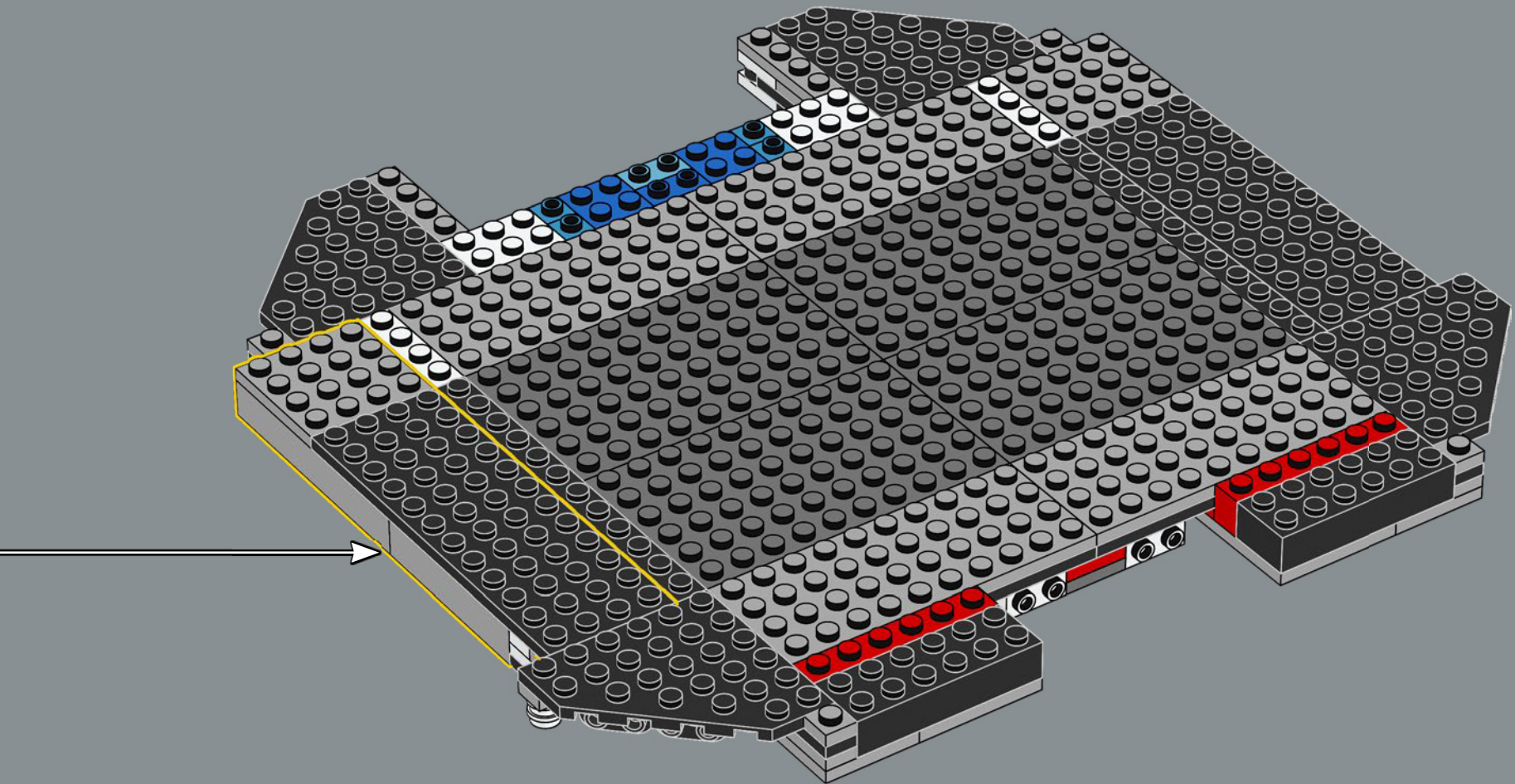

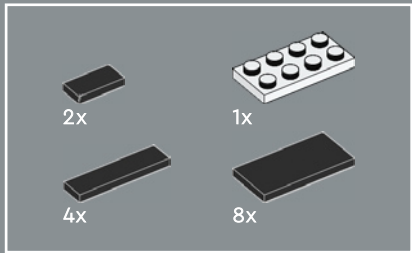

155

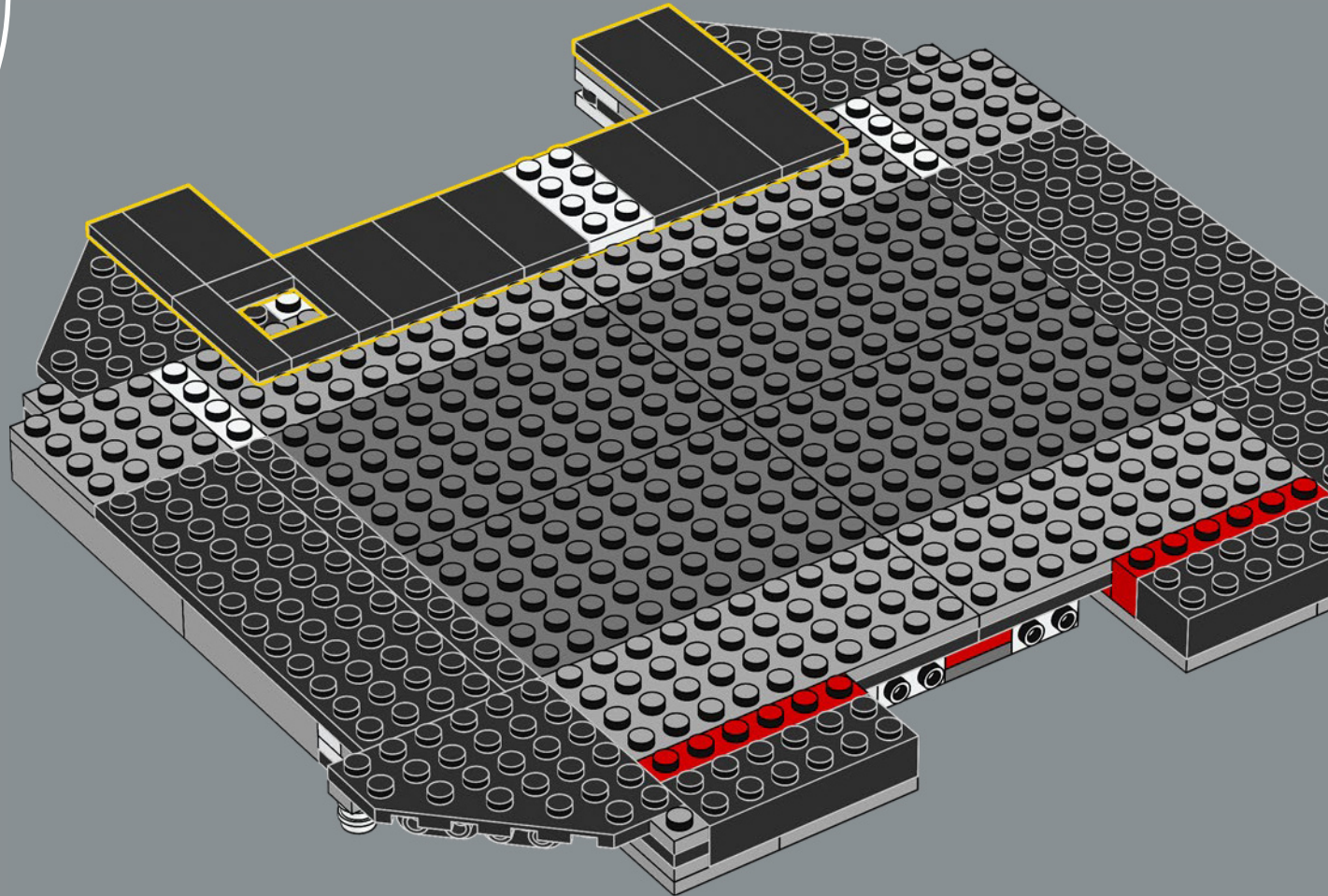

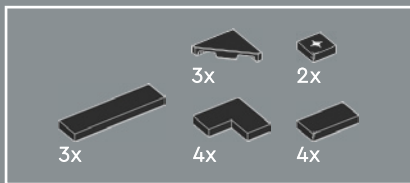

156

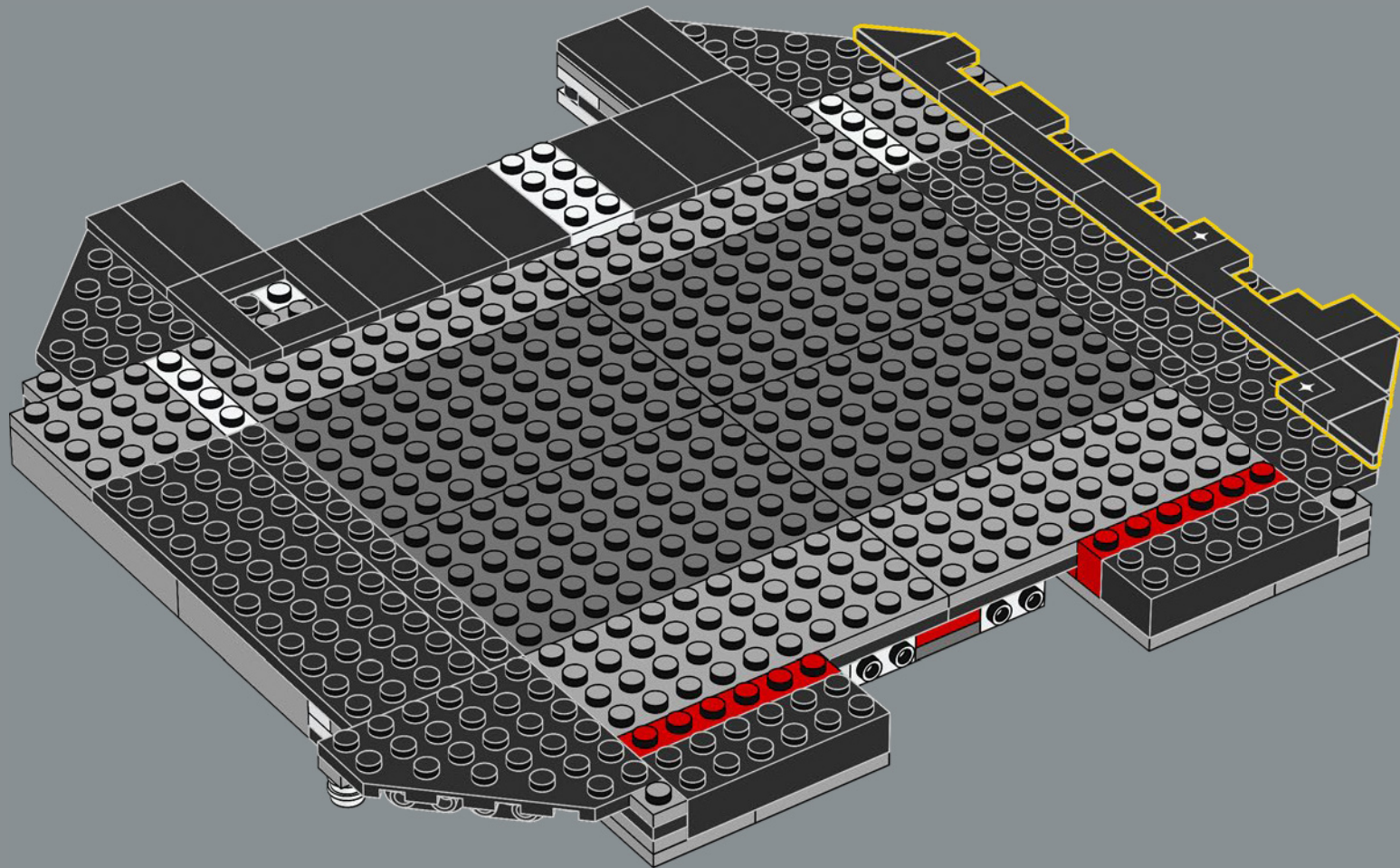

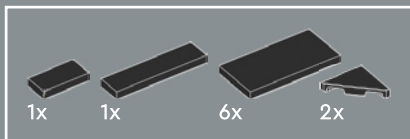

157

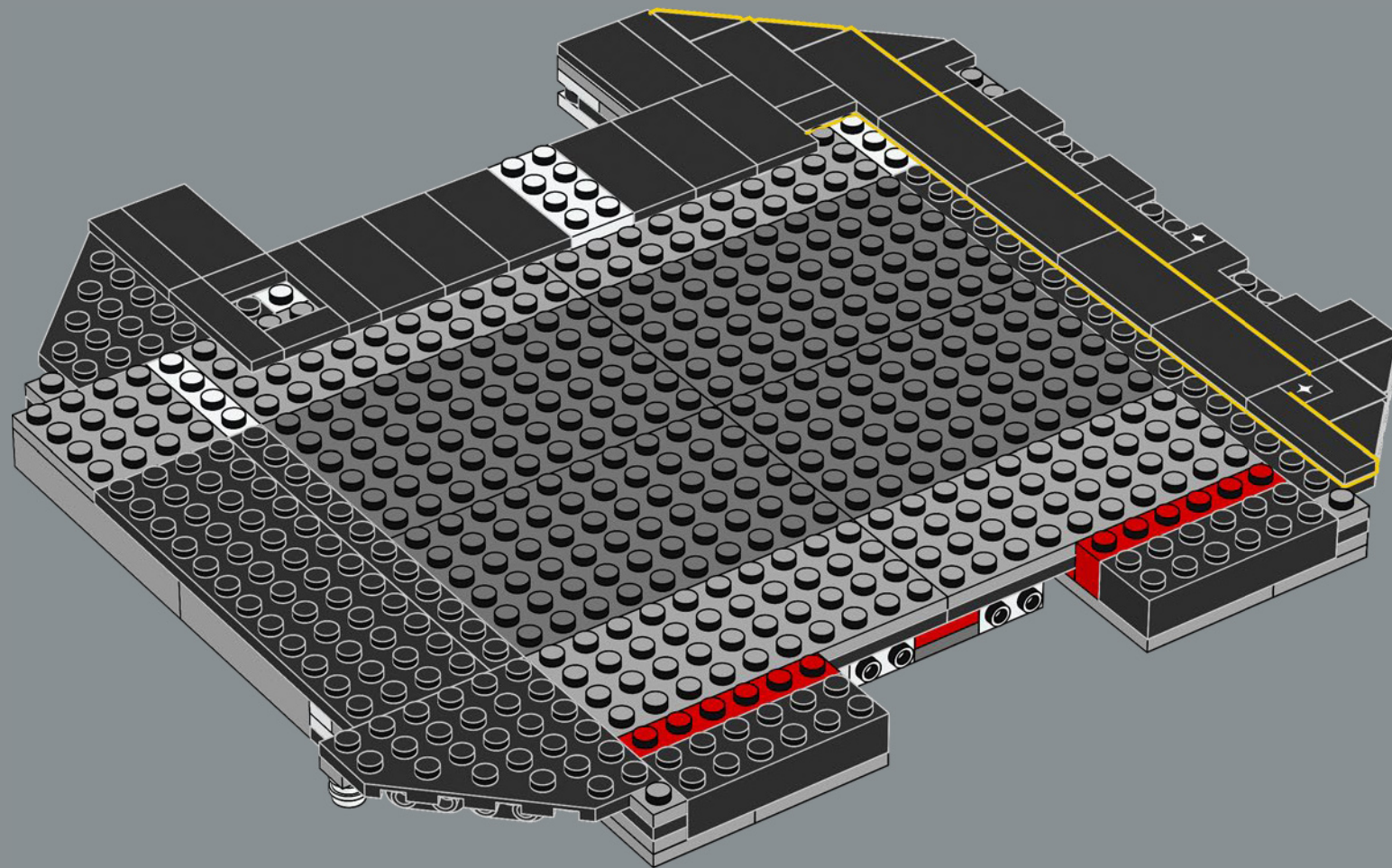

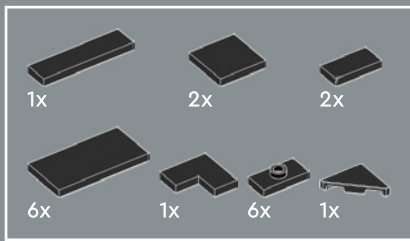

158

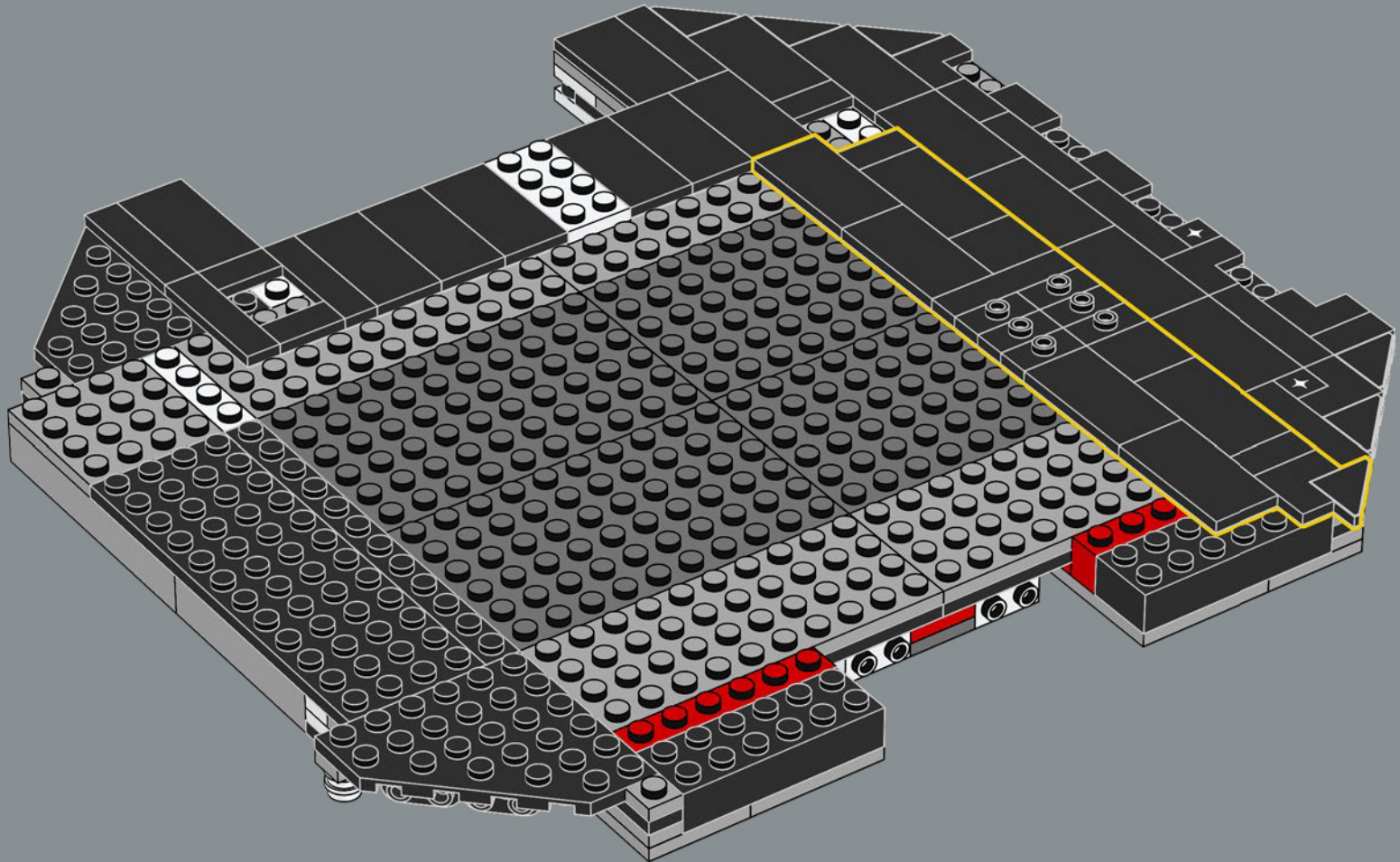

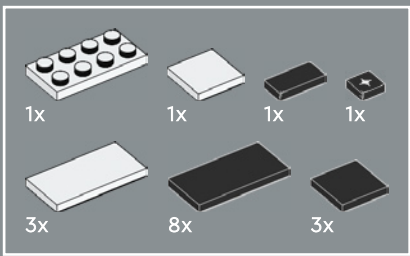

159

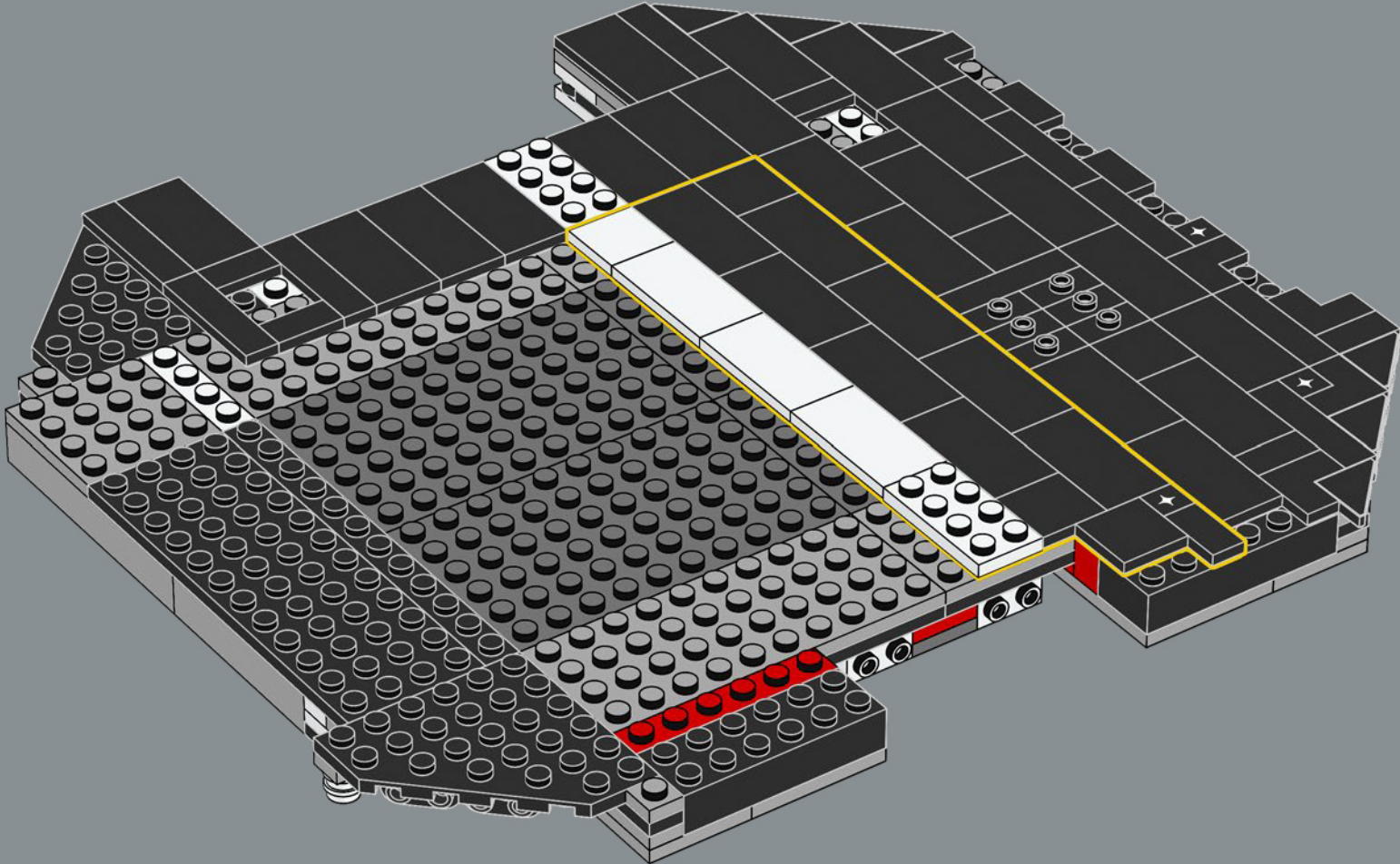

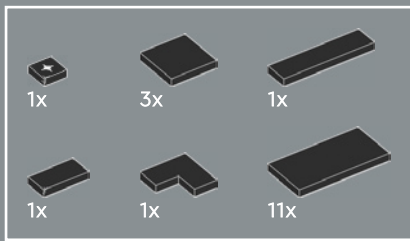

160

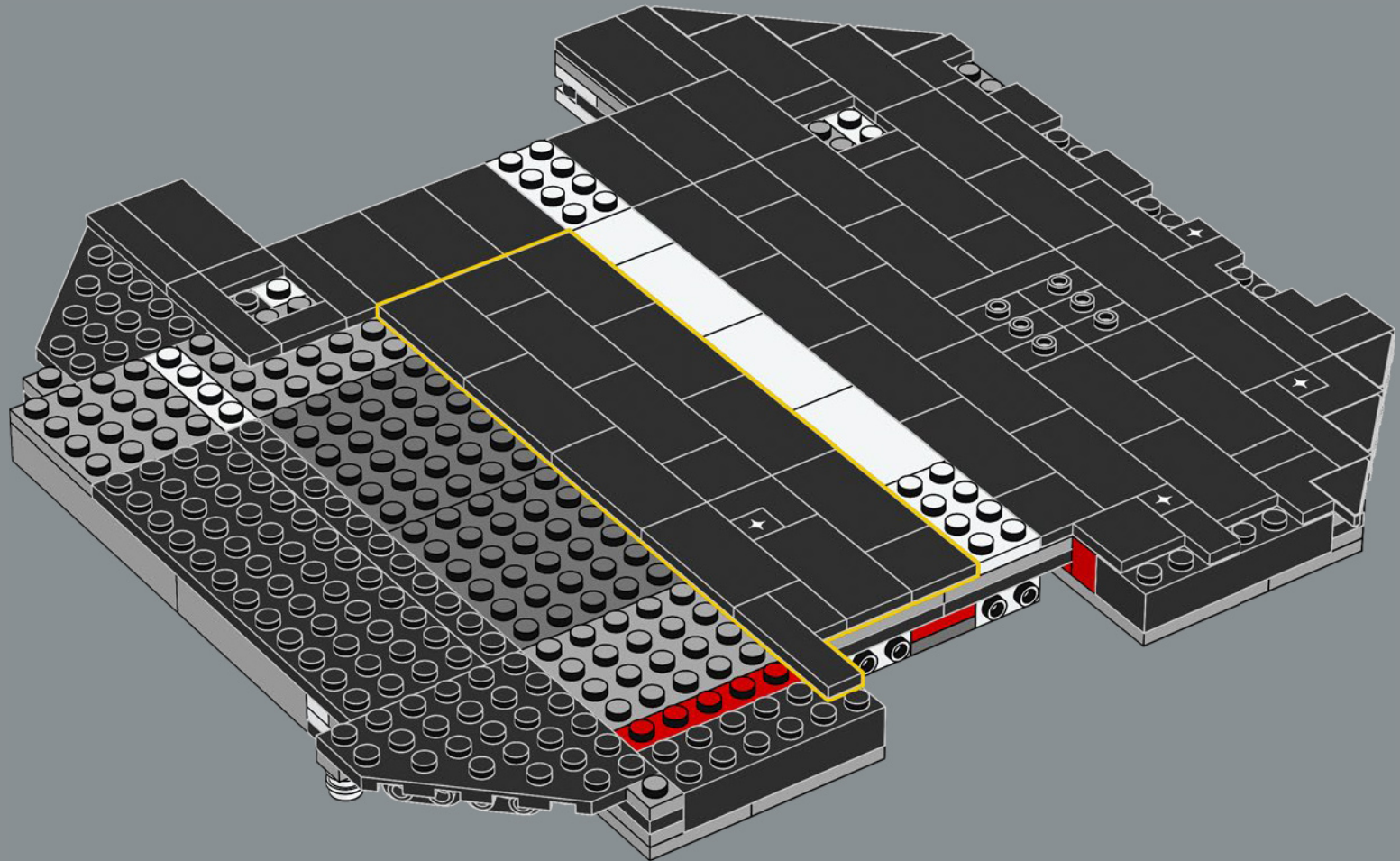

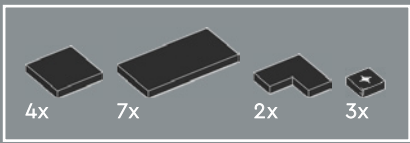

161

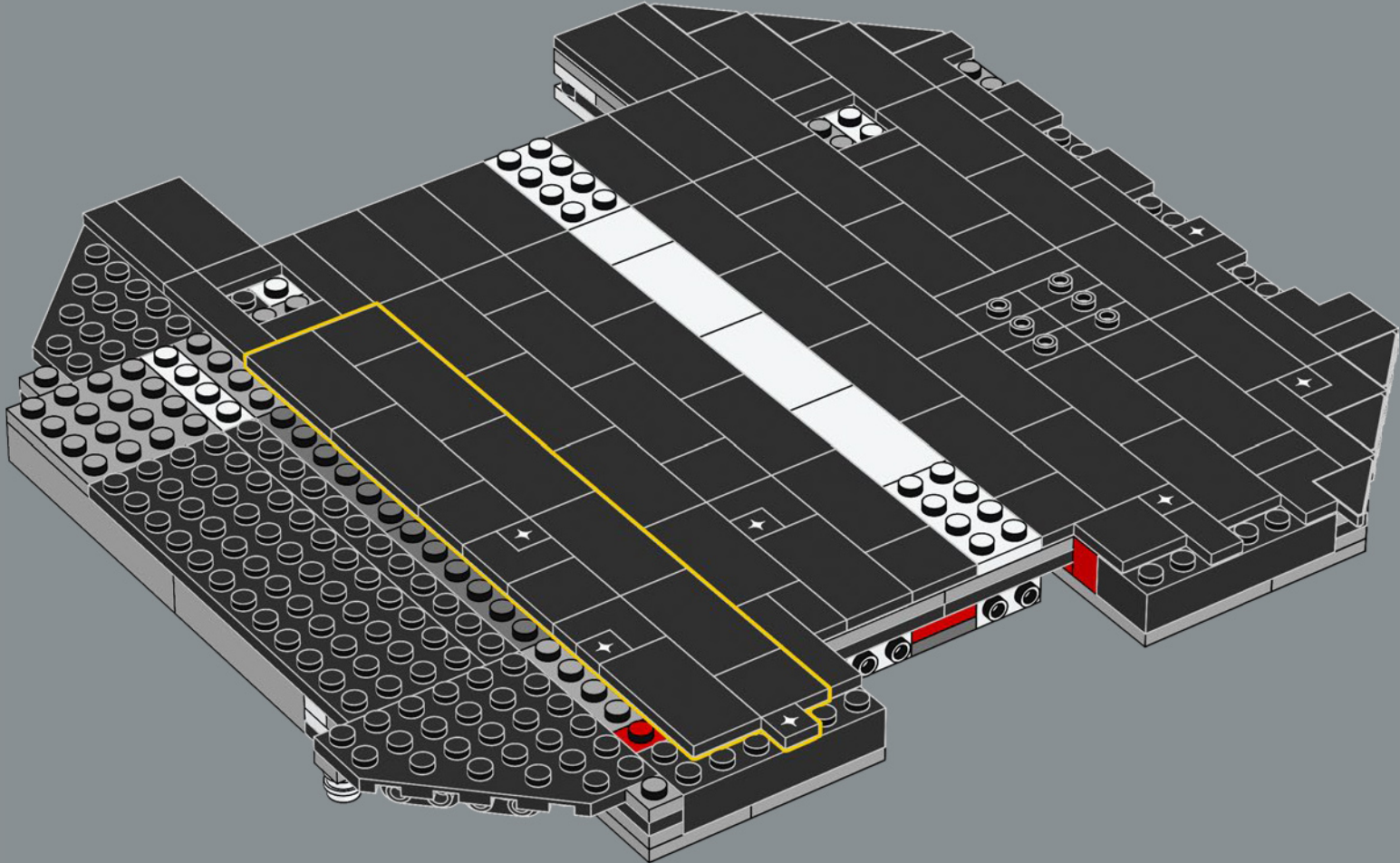

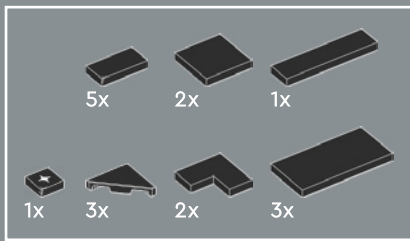

162

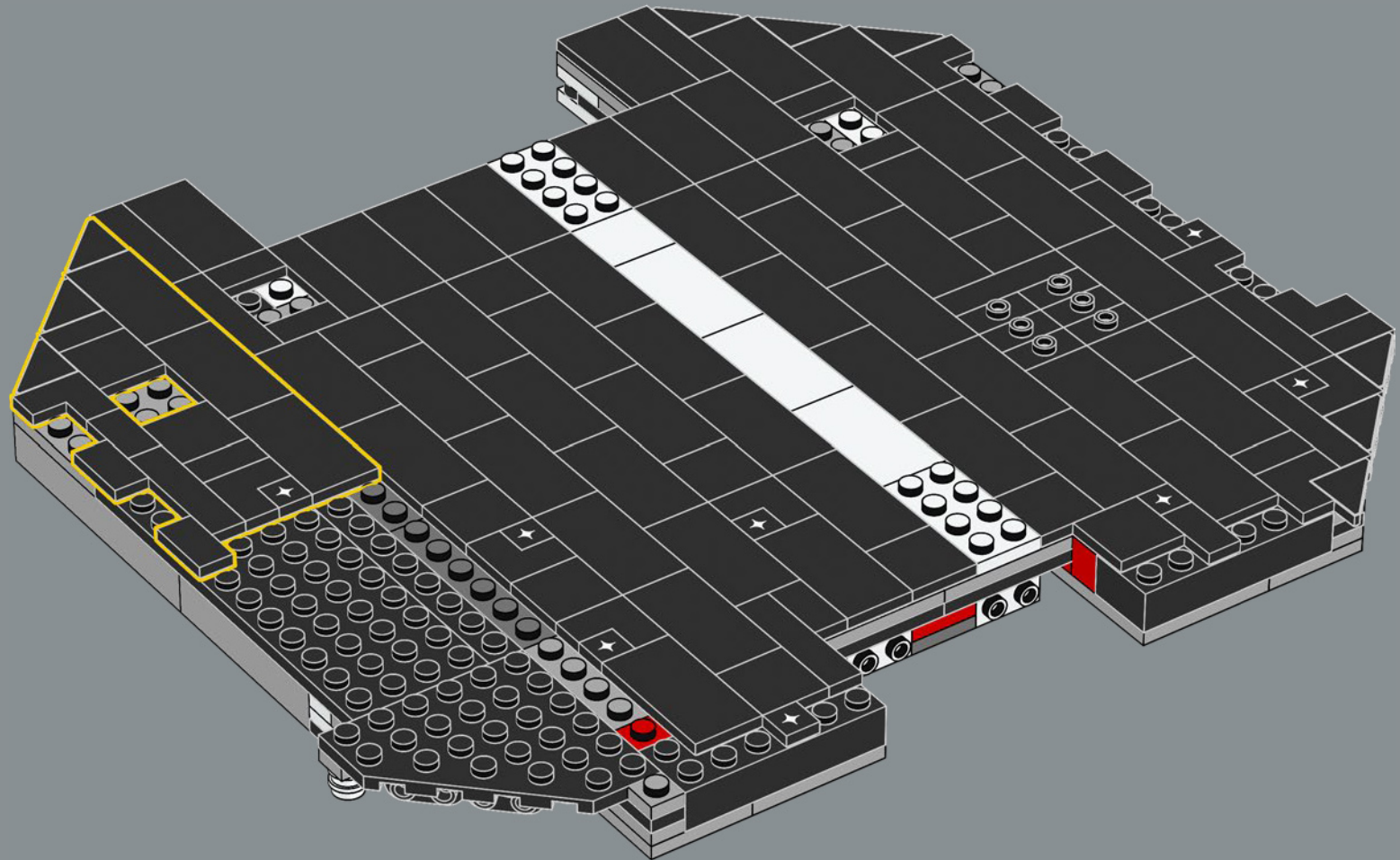

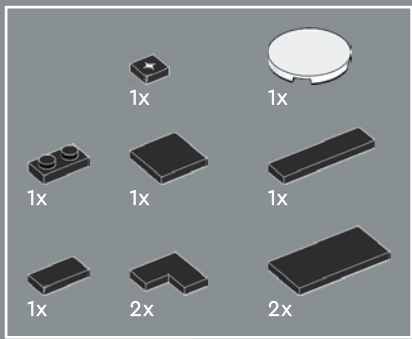

163

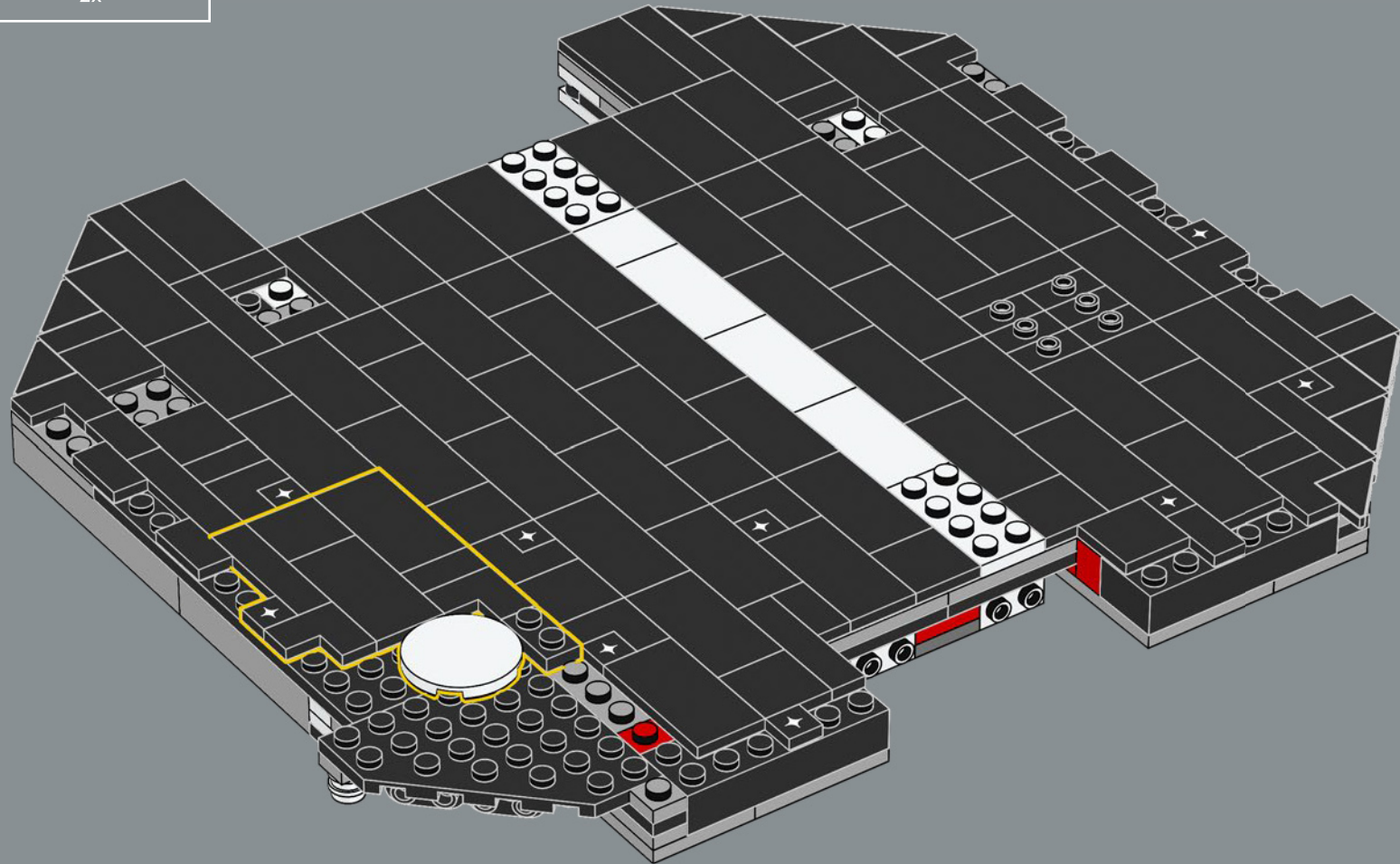

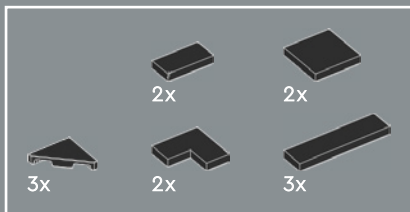

164

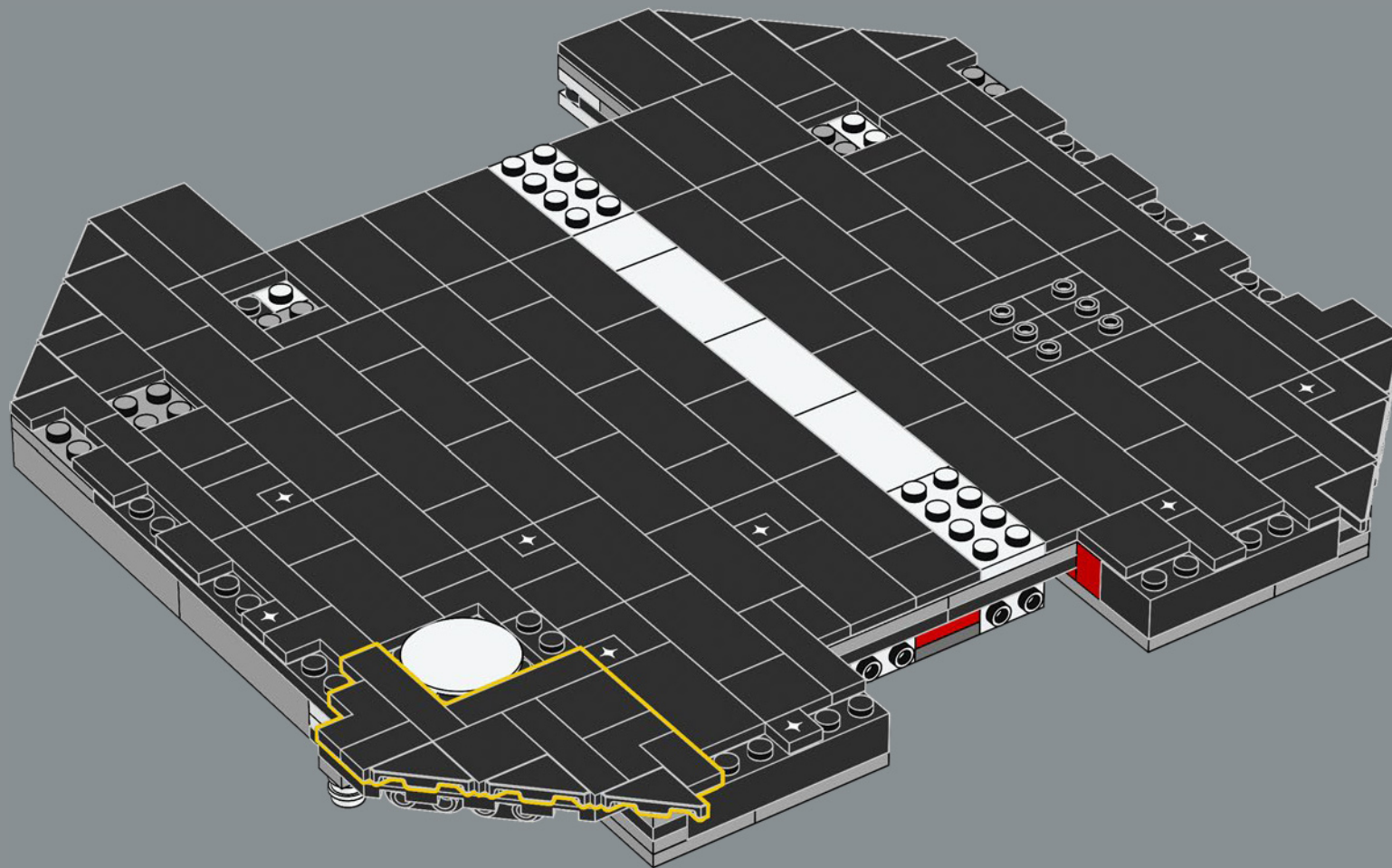

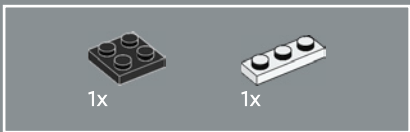

165

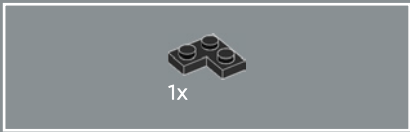
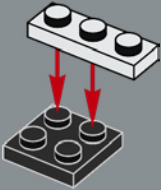

166

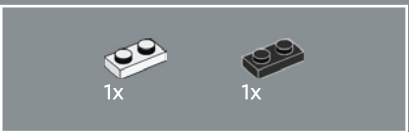
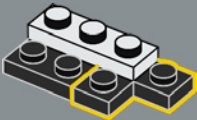

167

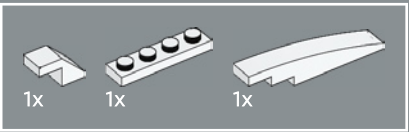
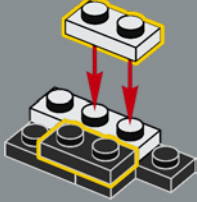

168

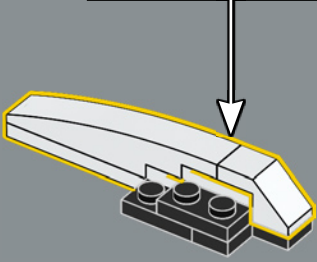
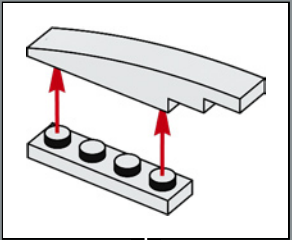

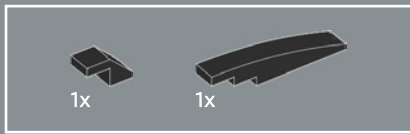

169

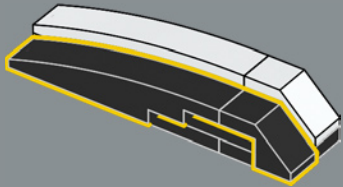

170

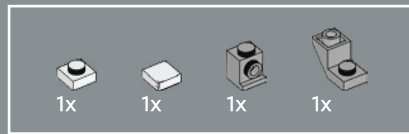
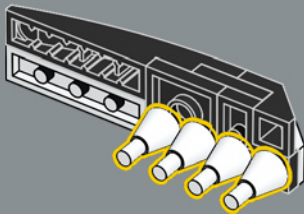

171

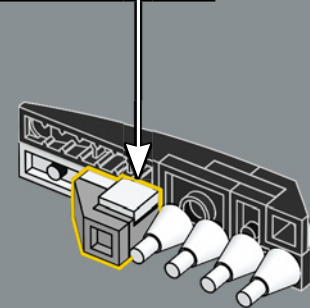
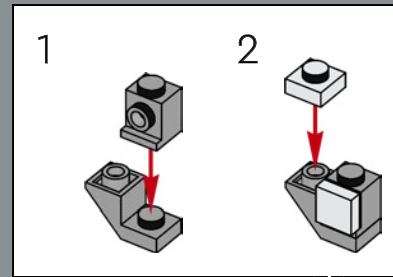

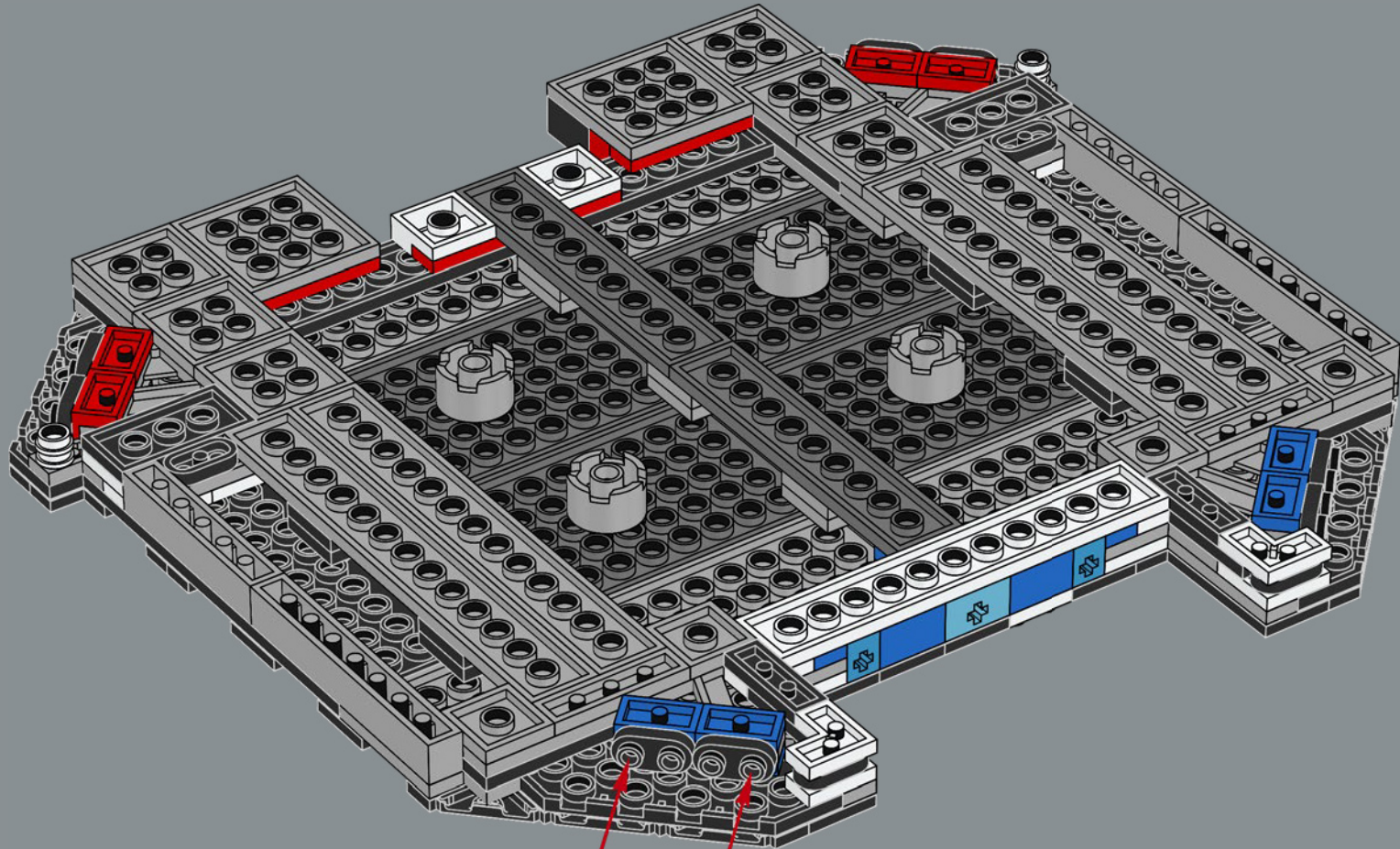

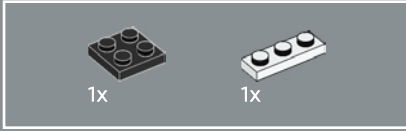
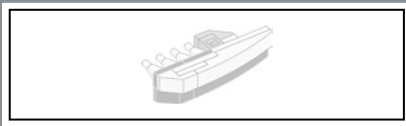

173

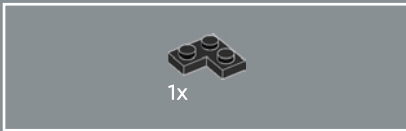
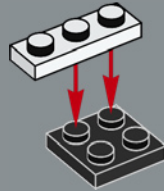

174

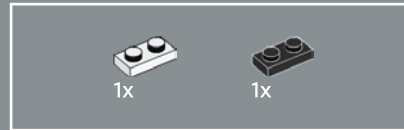
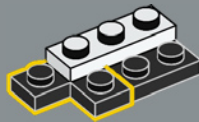

175

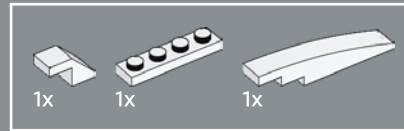
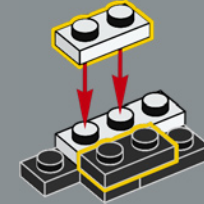

176

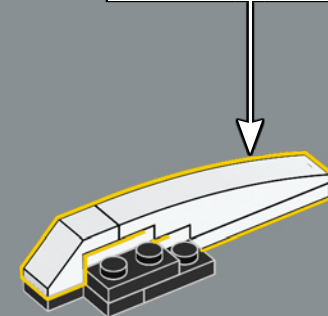
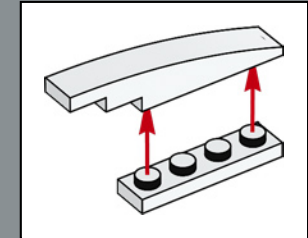

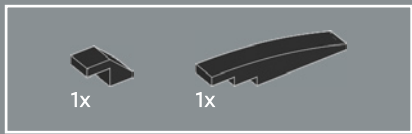

177

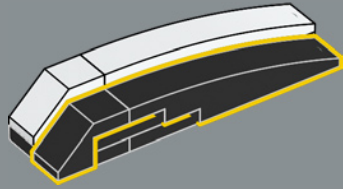

178

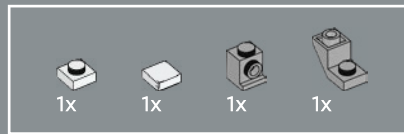
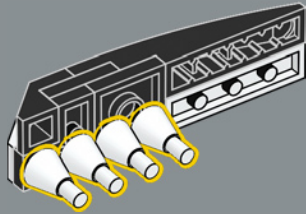

179

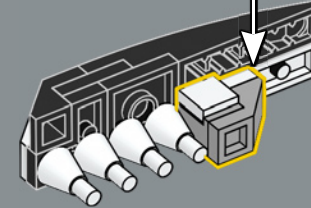
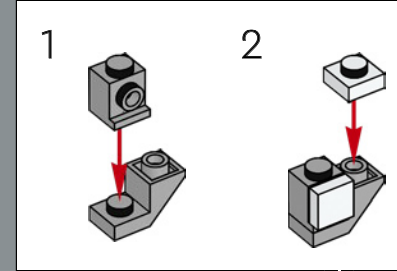

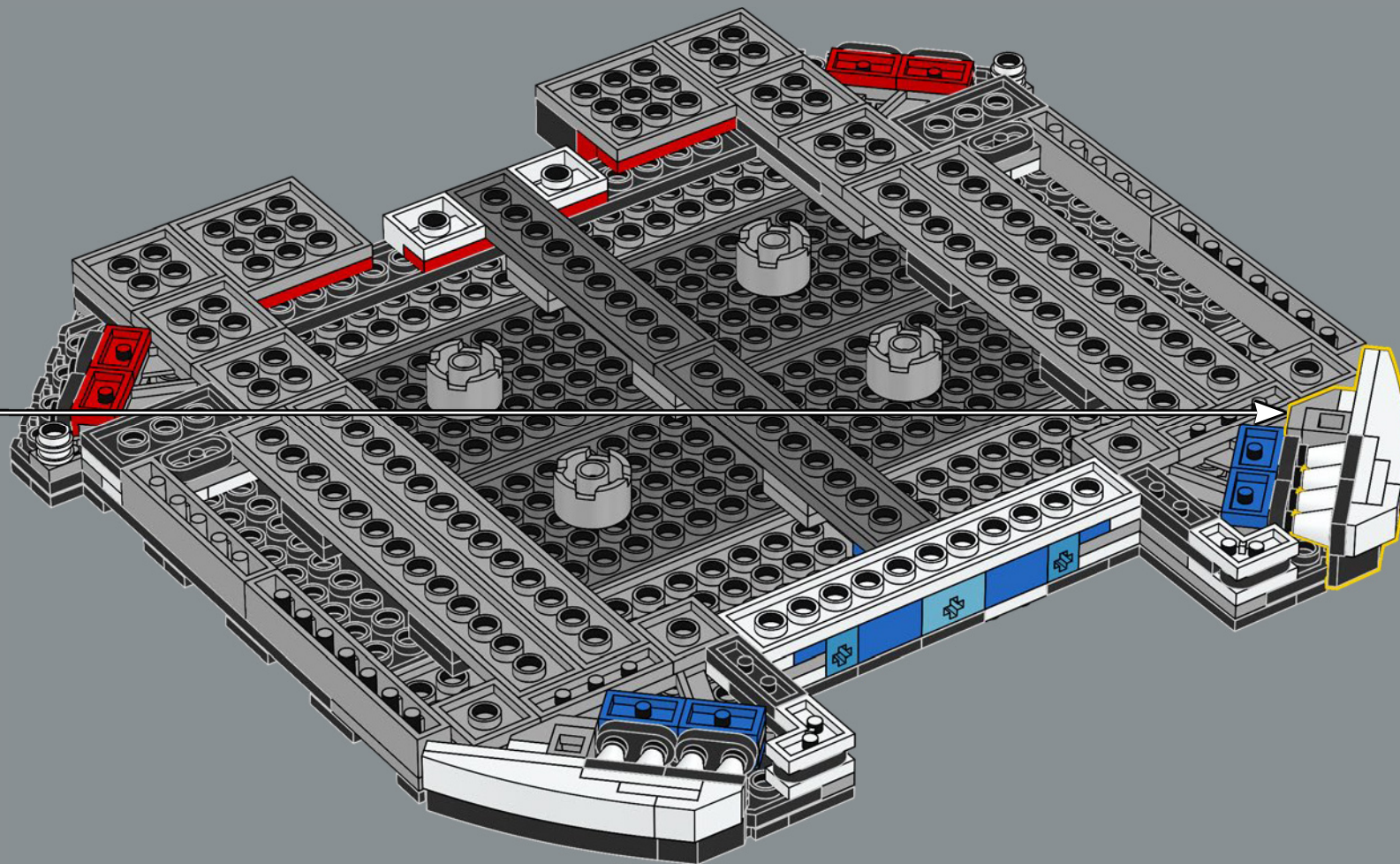

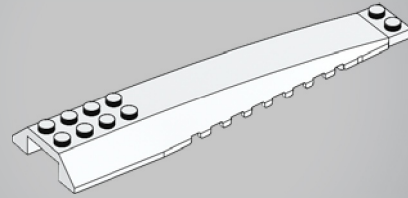
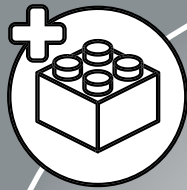

1x

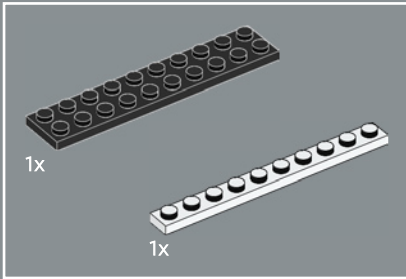
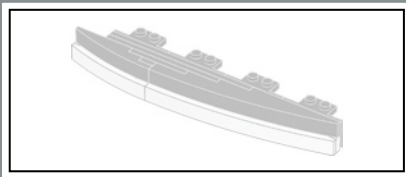

181

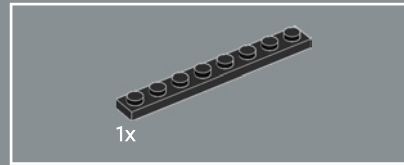
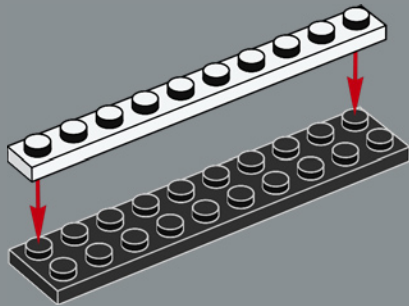

182

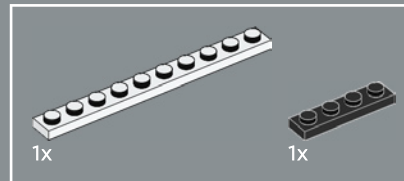
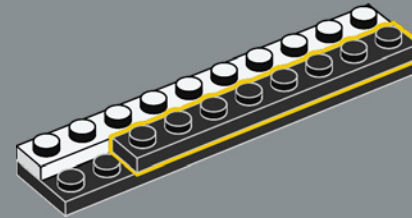

183

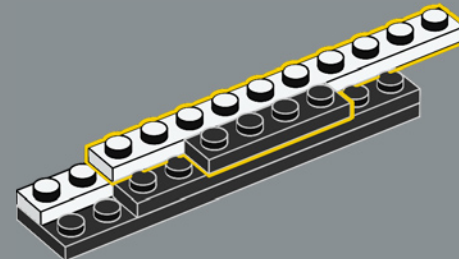

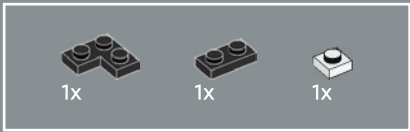

184

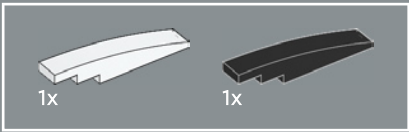
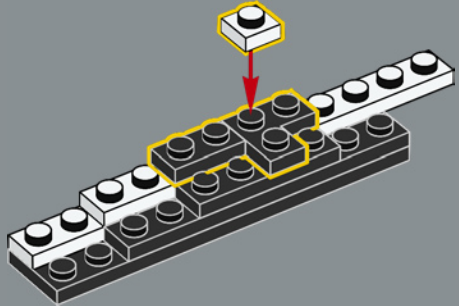

185

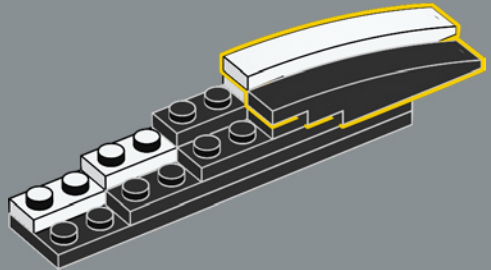

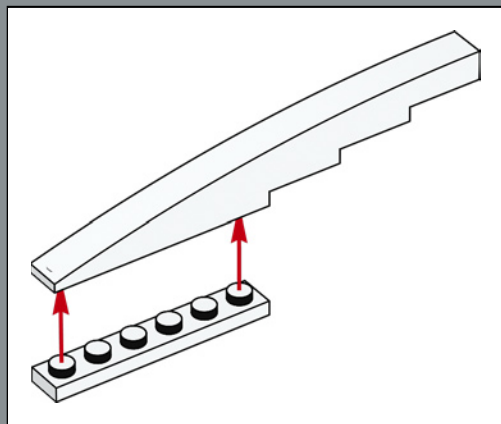
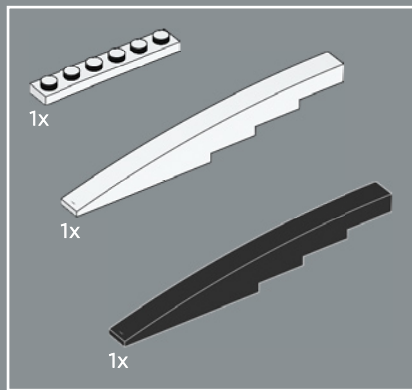

186

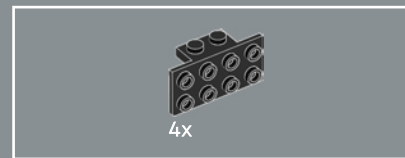
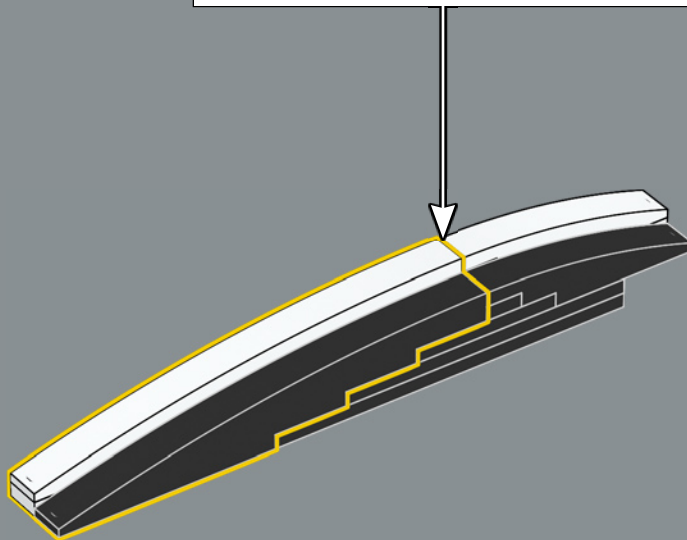

187

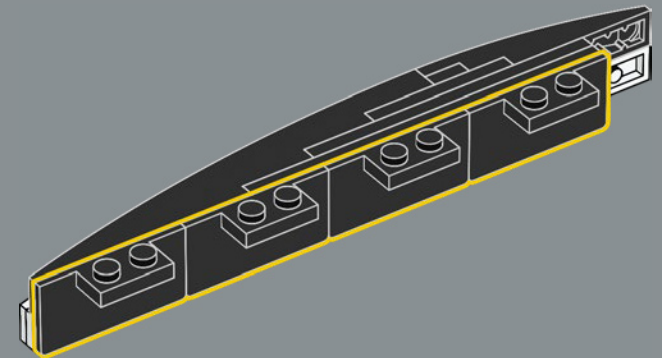

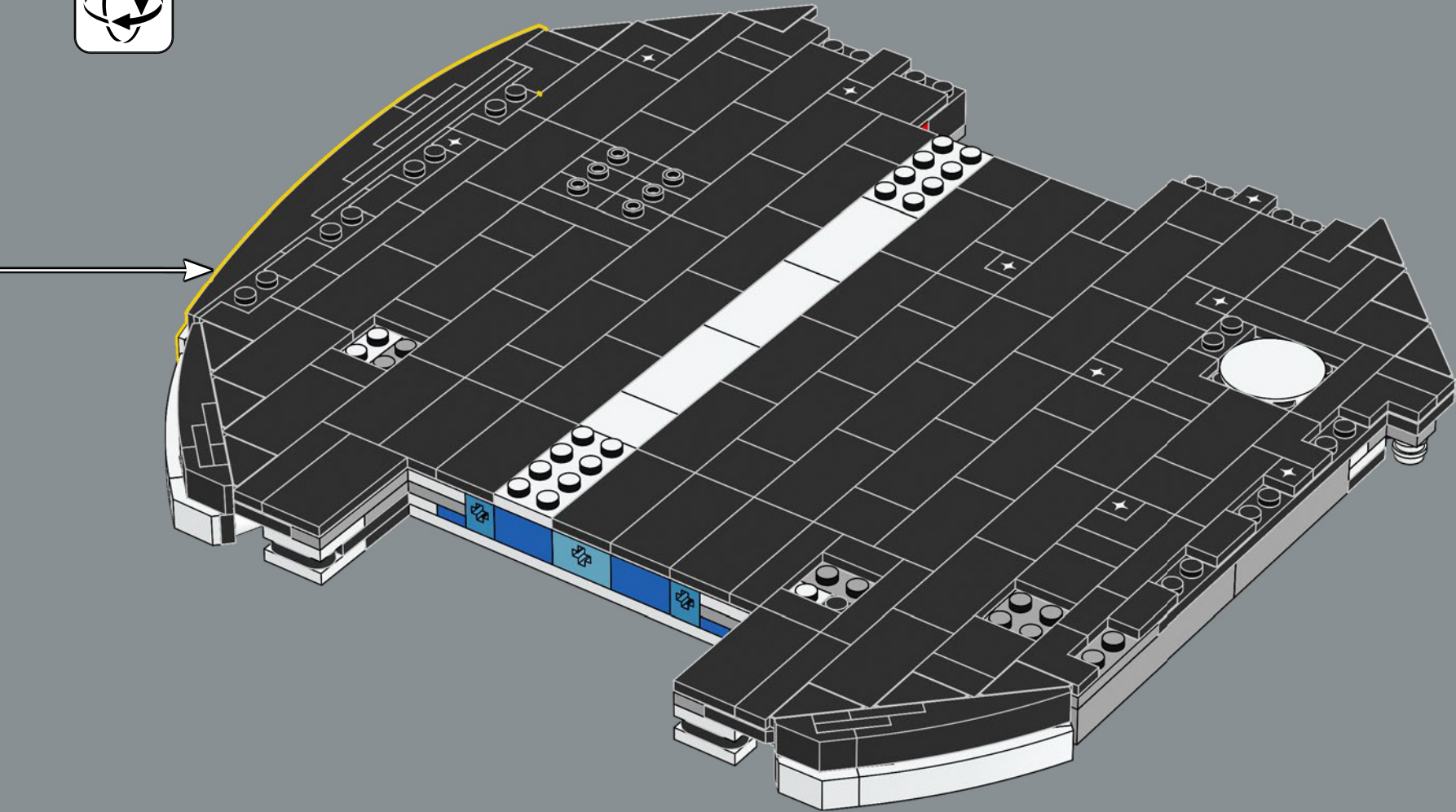

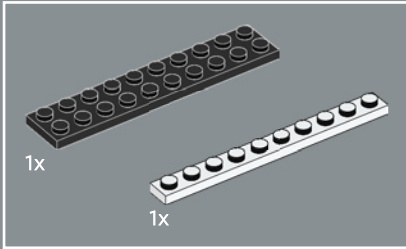
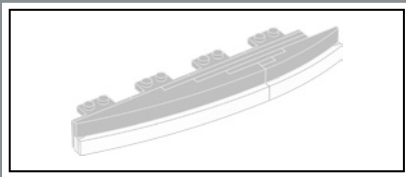

189

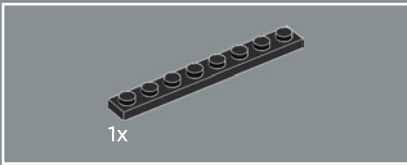
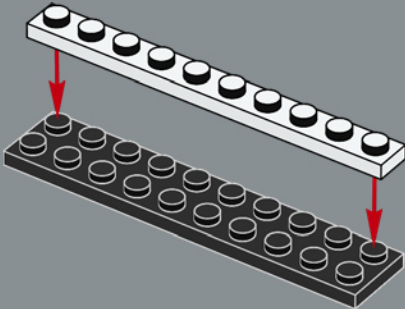

190

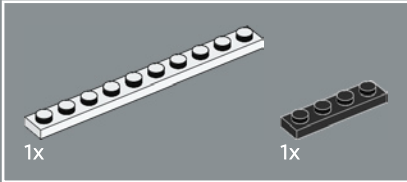
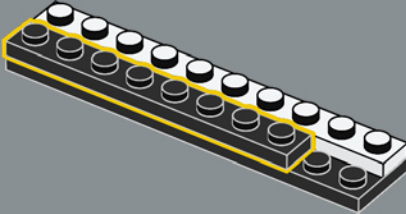

191

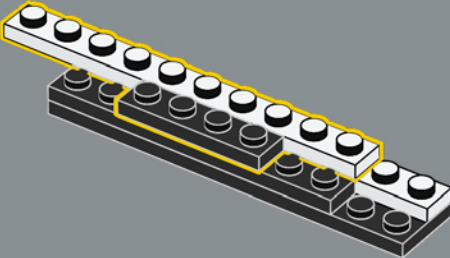

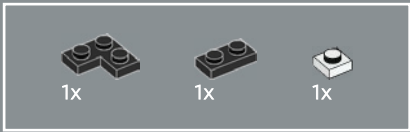

192

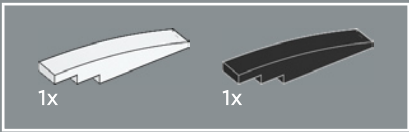
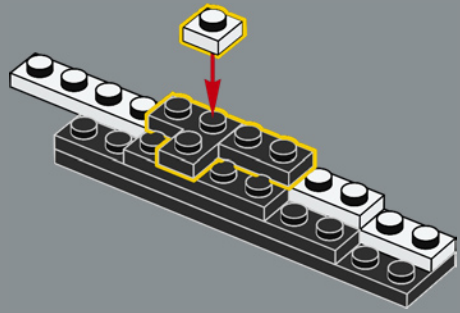

193

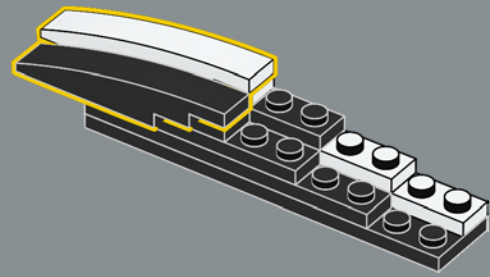

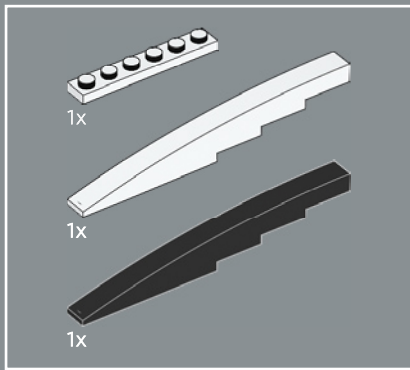

194

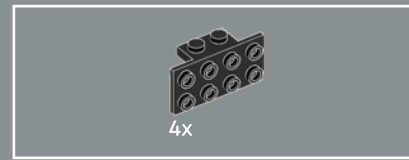
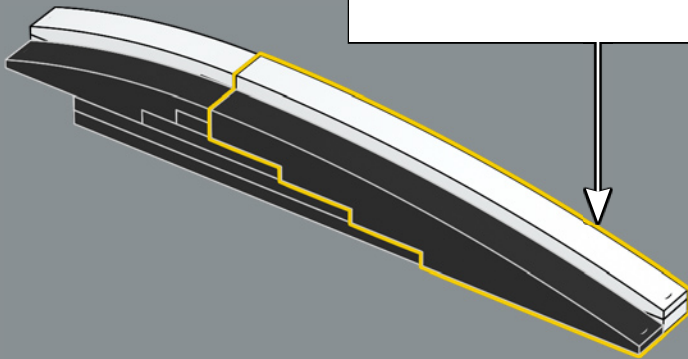
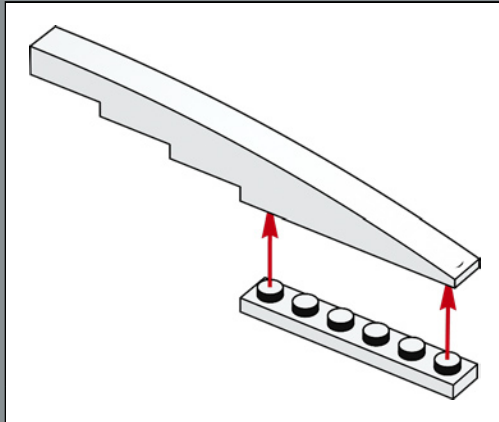

195

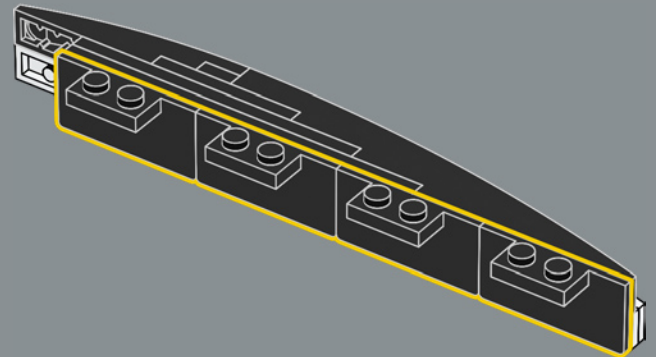

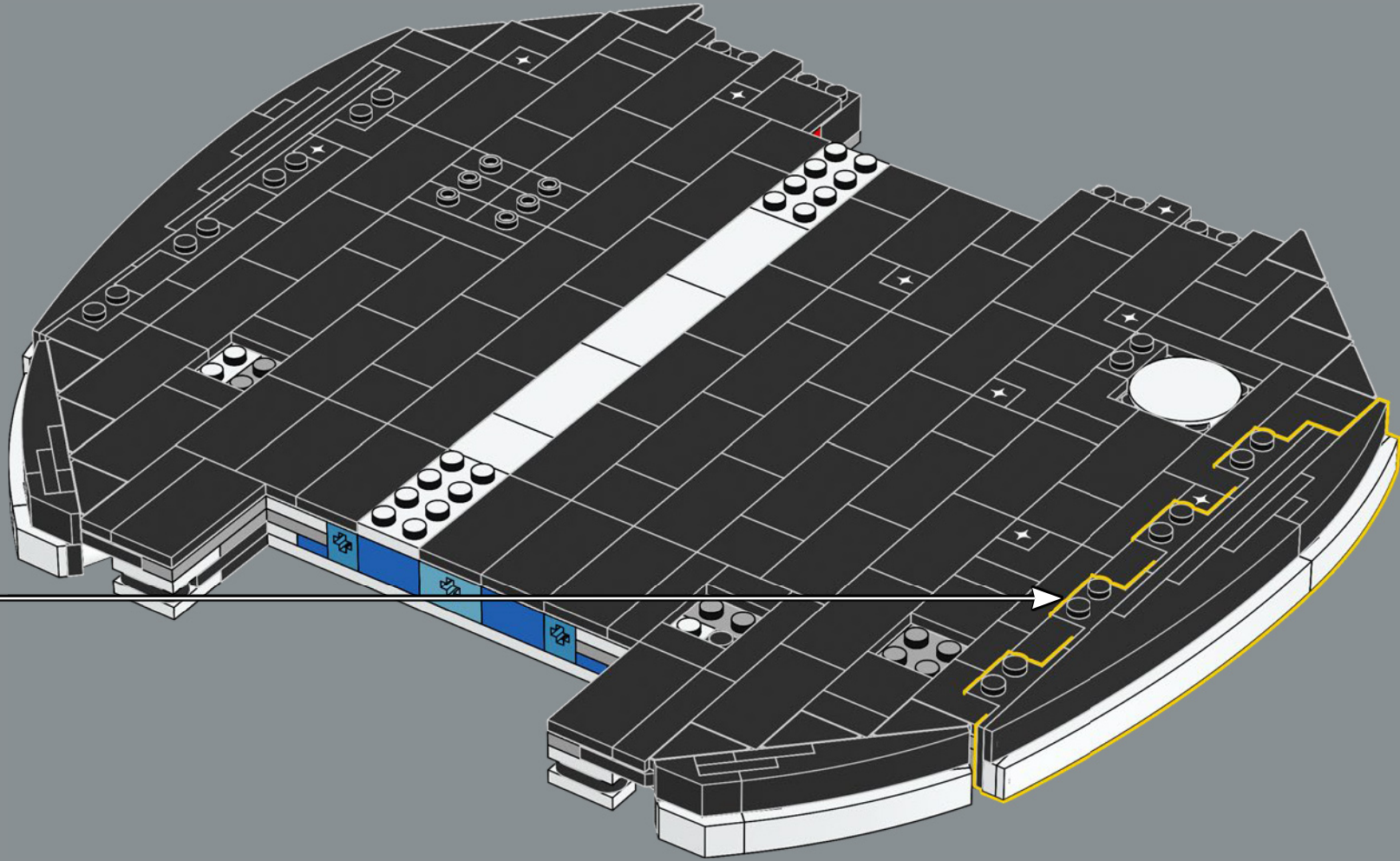

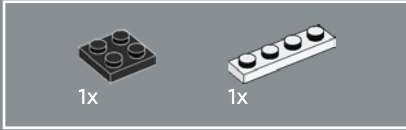
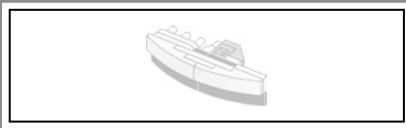

197

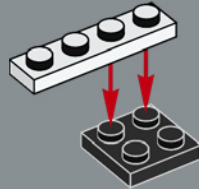

198

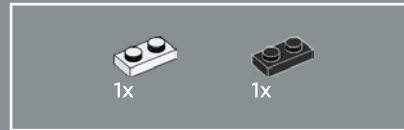
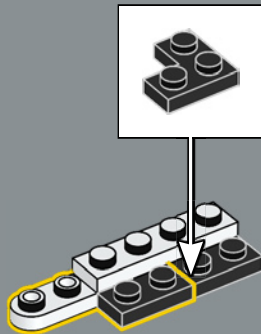

199

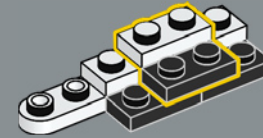

200

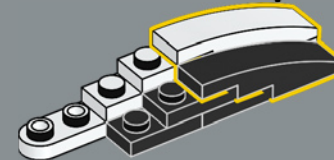
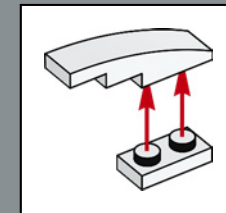

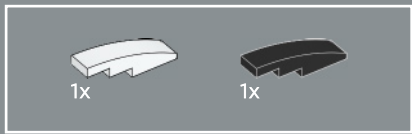

201

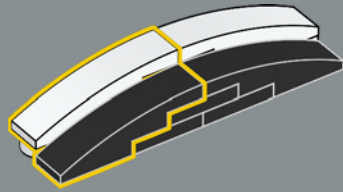

202

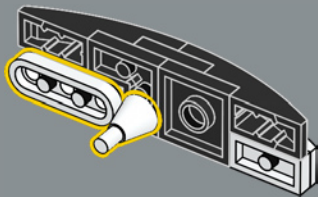

203

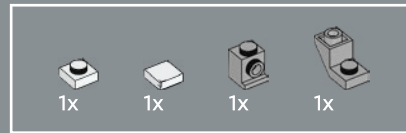
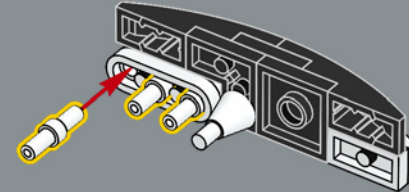

204

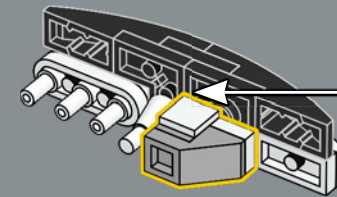
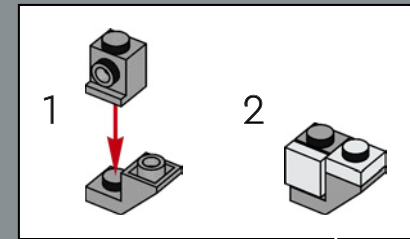

205

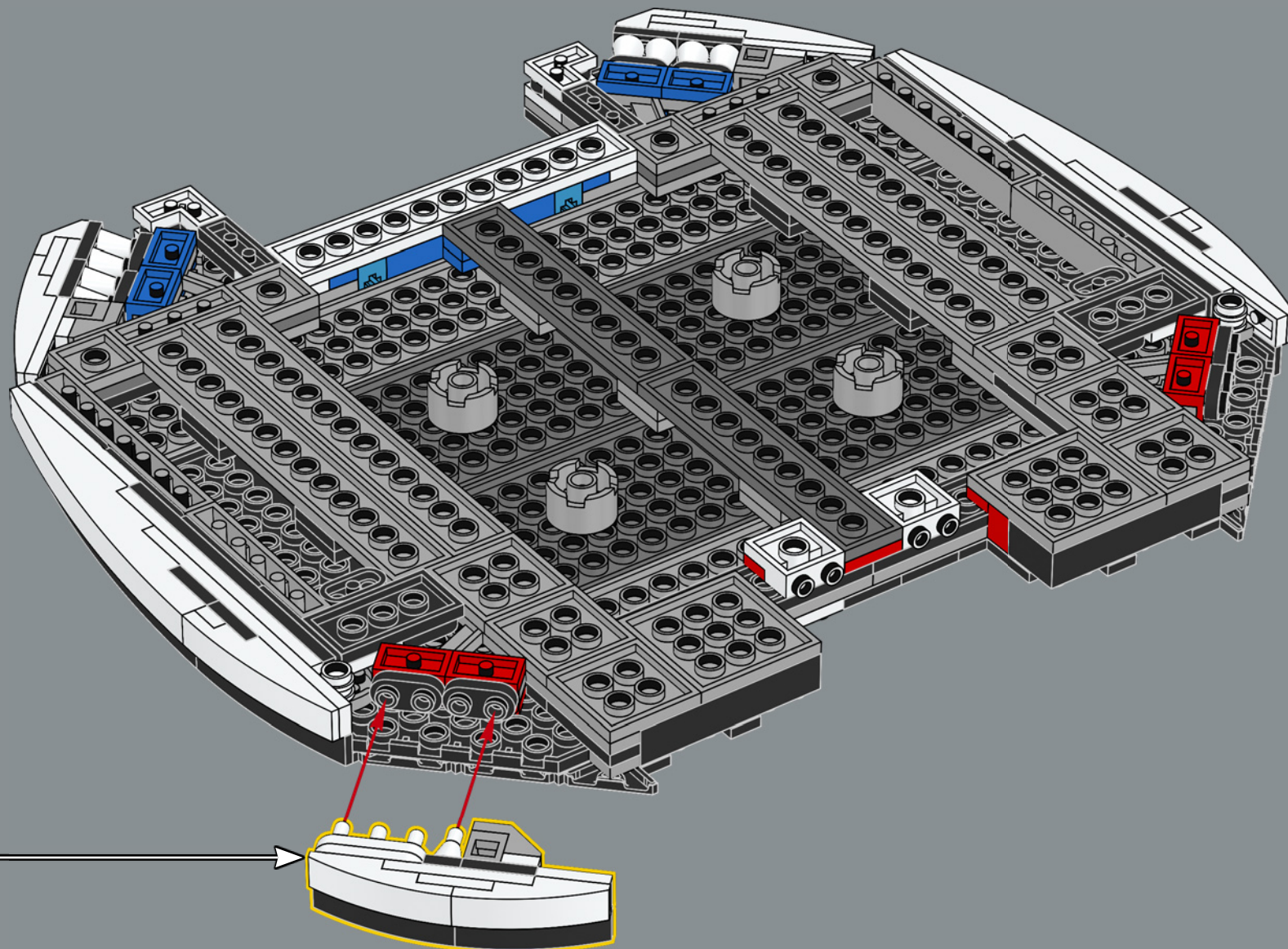

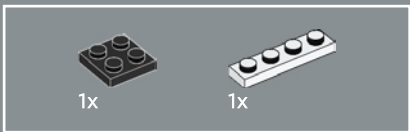

206

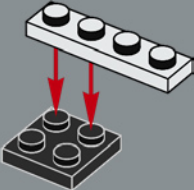

207

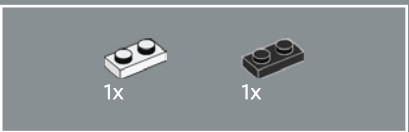
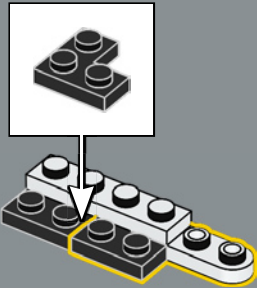

208

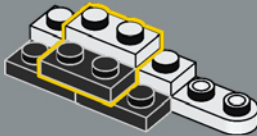

209

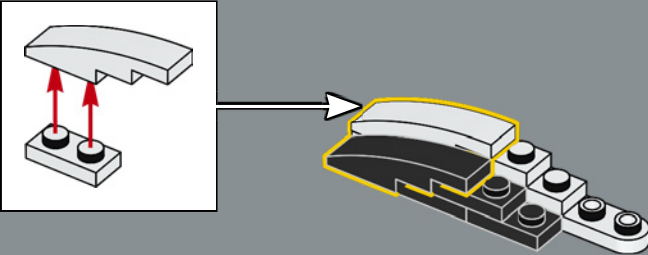

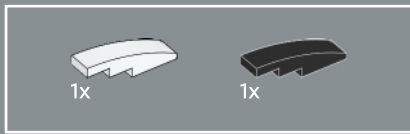

210

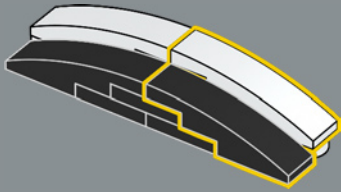

211

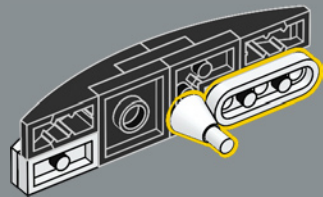

212

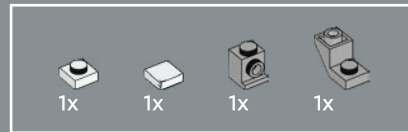
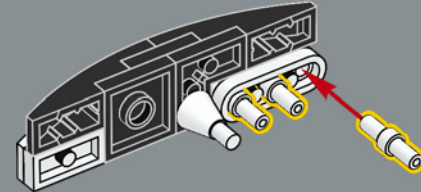

213

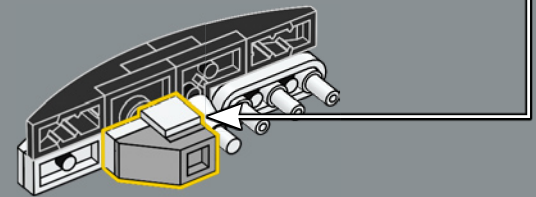
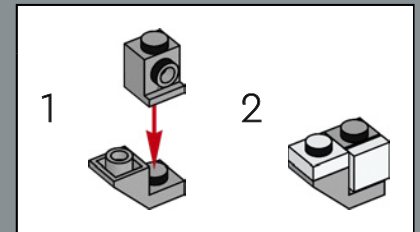

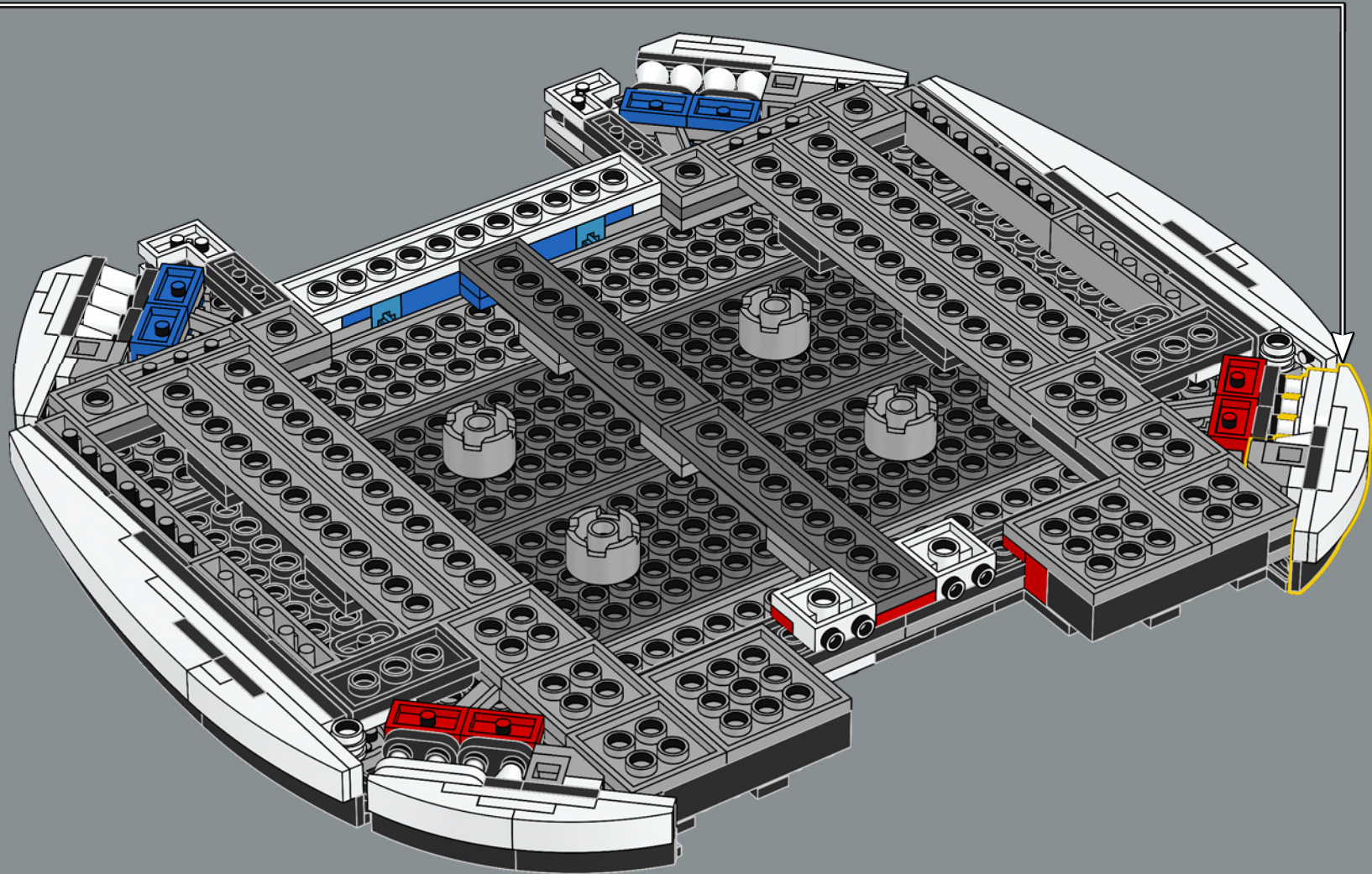

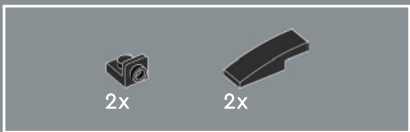

215

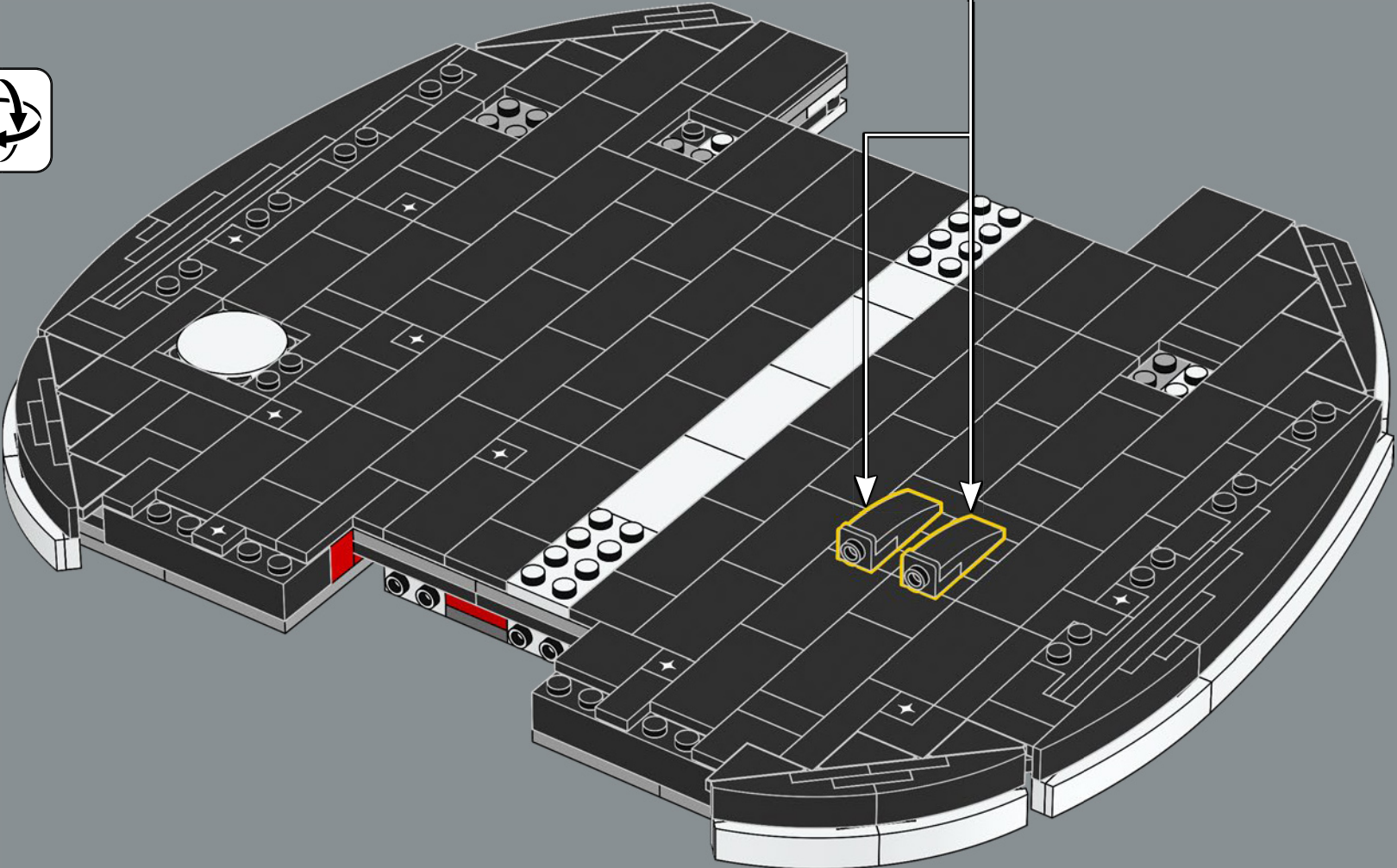
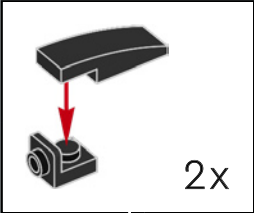

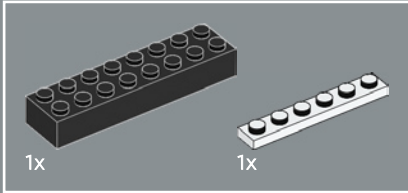
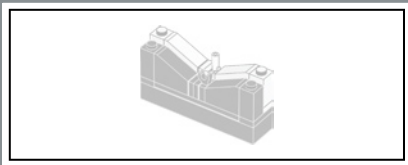

216

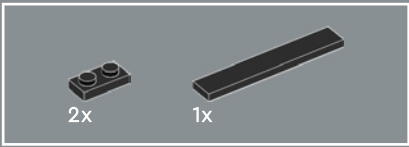
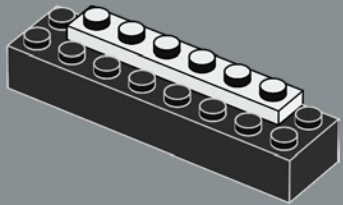

217

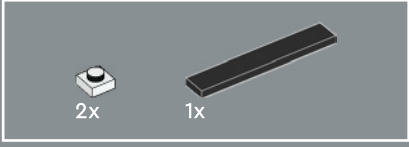
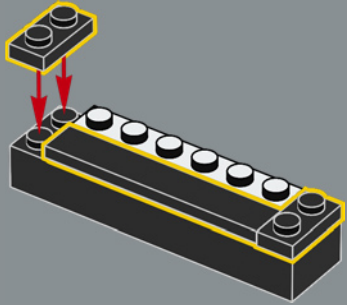

218

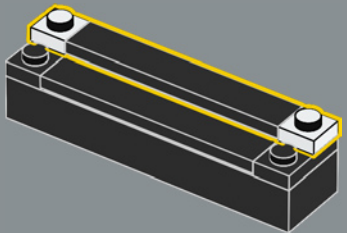



219

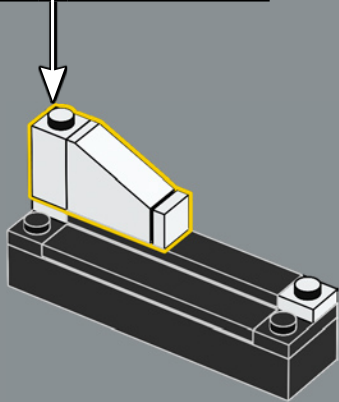
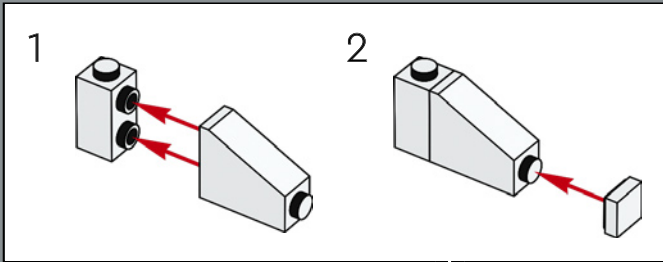

220

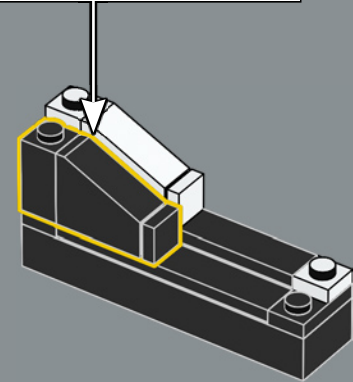
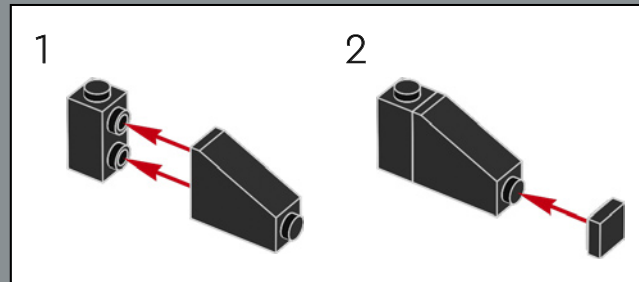

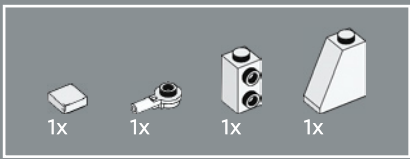

221

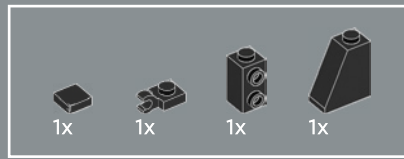
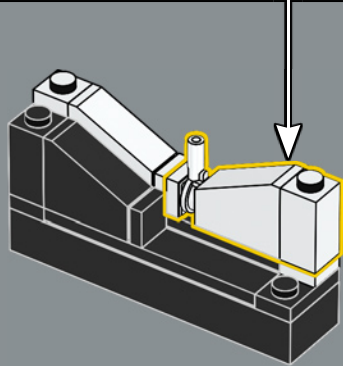
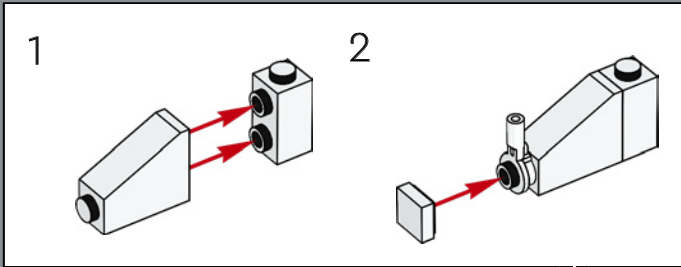

222

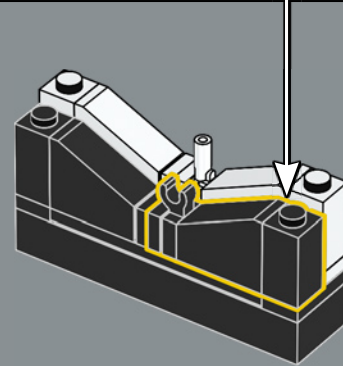
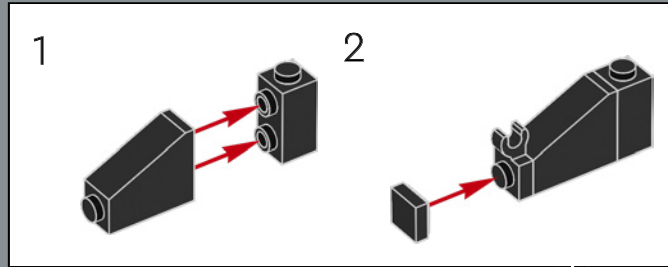

223

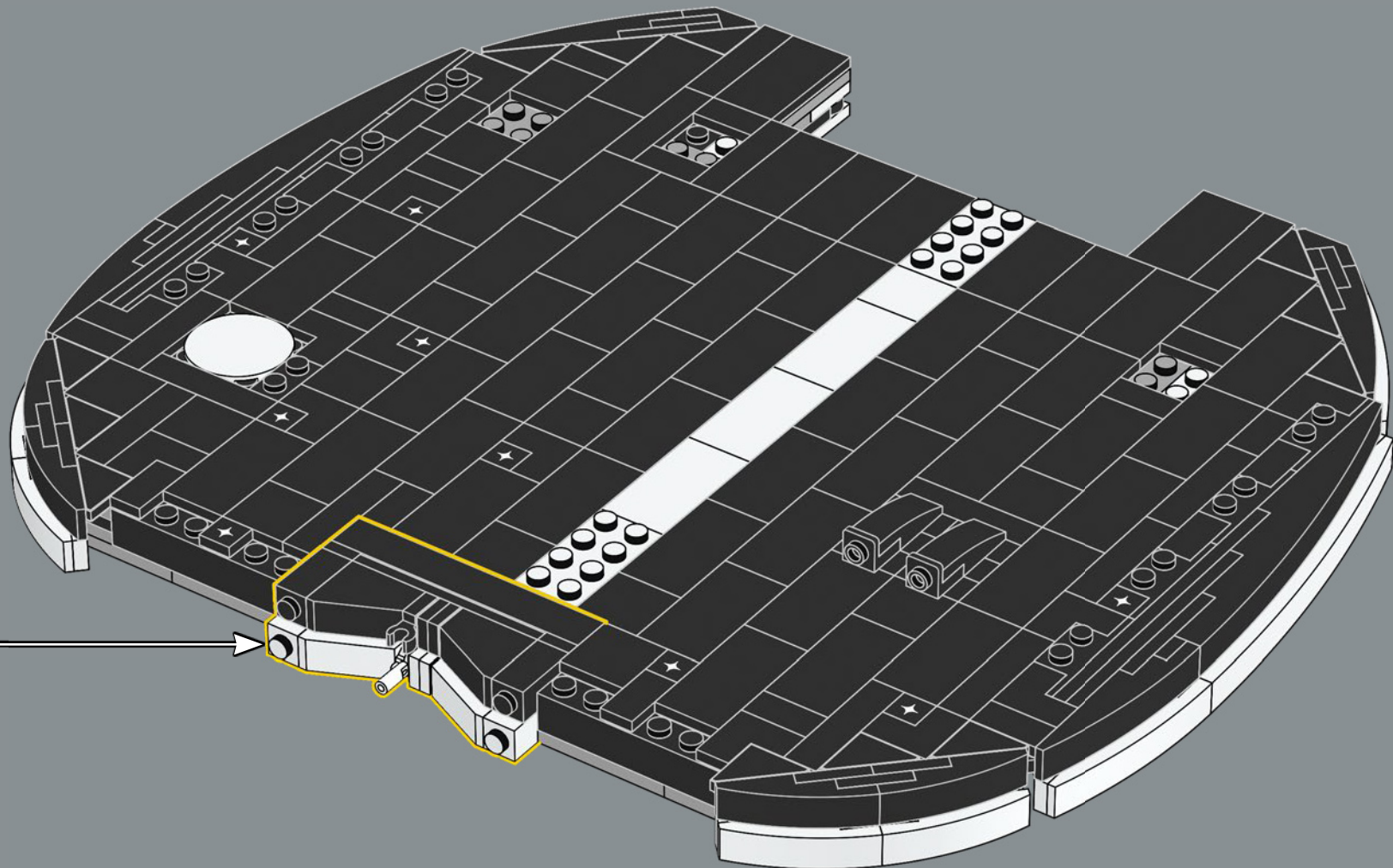

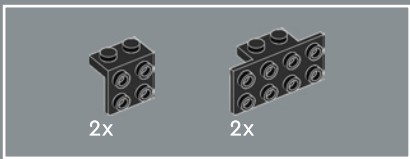

224

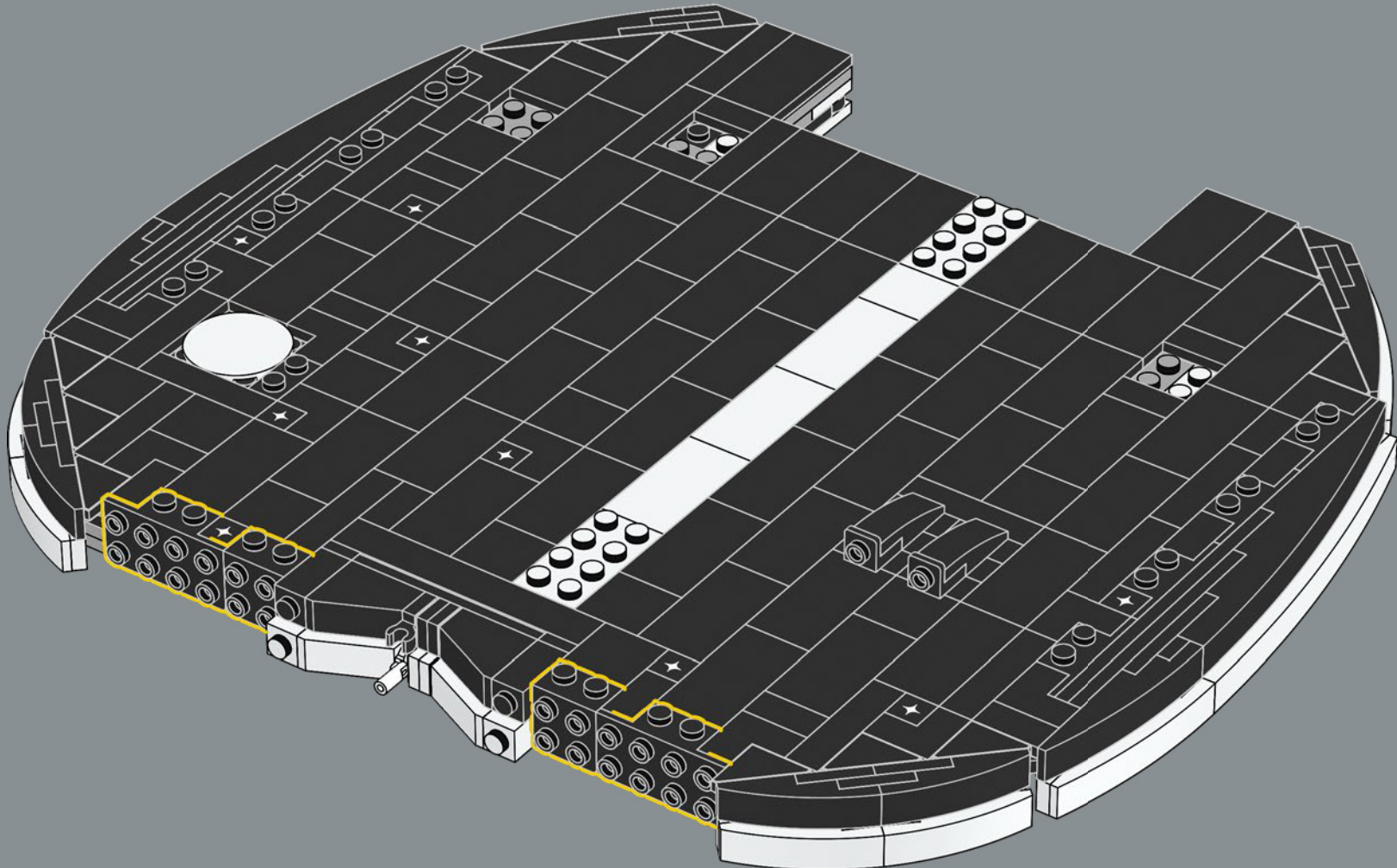

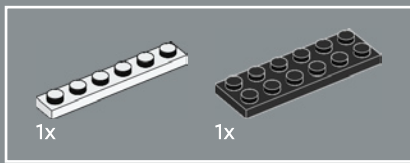

225

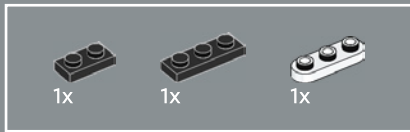
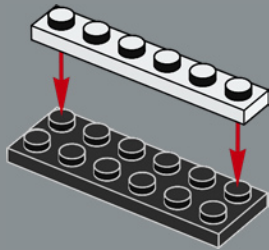

226

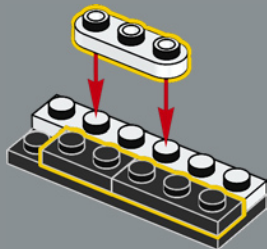

227

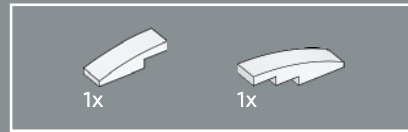
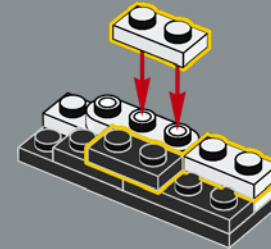

228

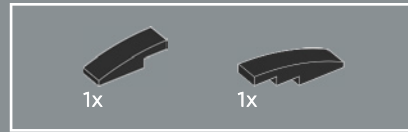
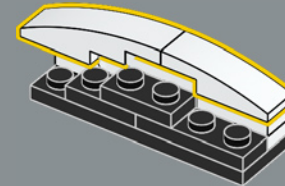

229

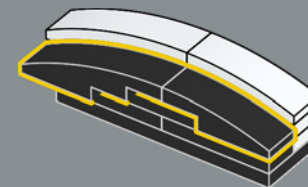

230

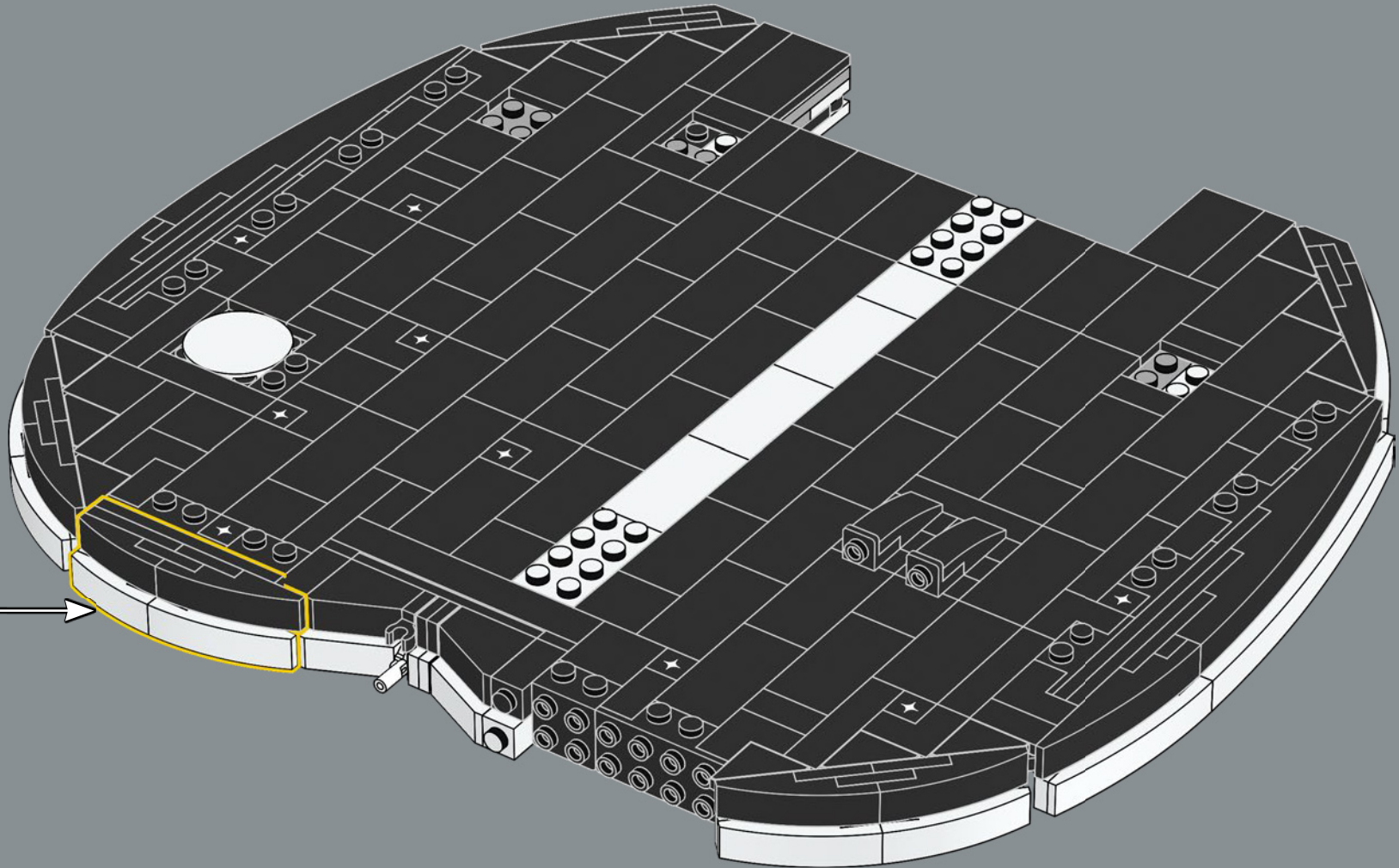

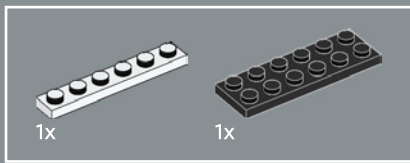

231

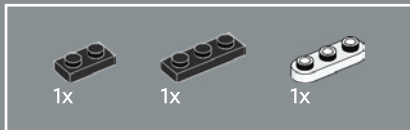
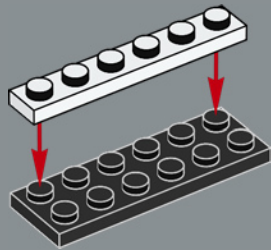

232

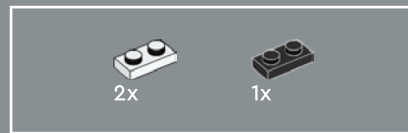
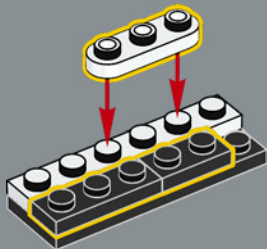

233

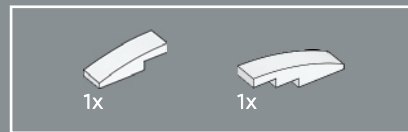
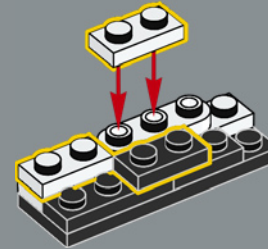

234

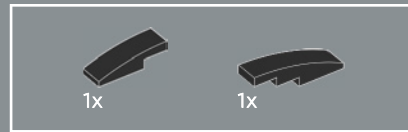
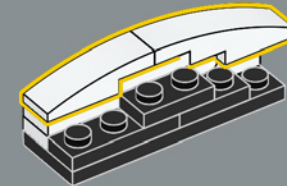

235

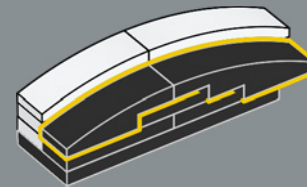

236

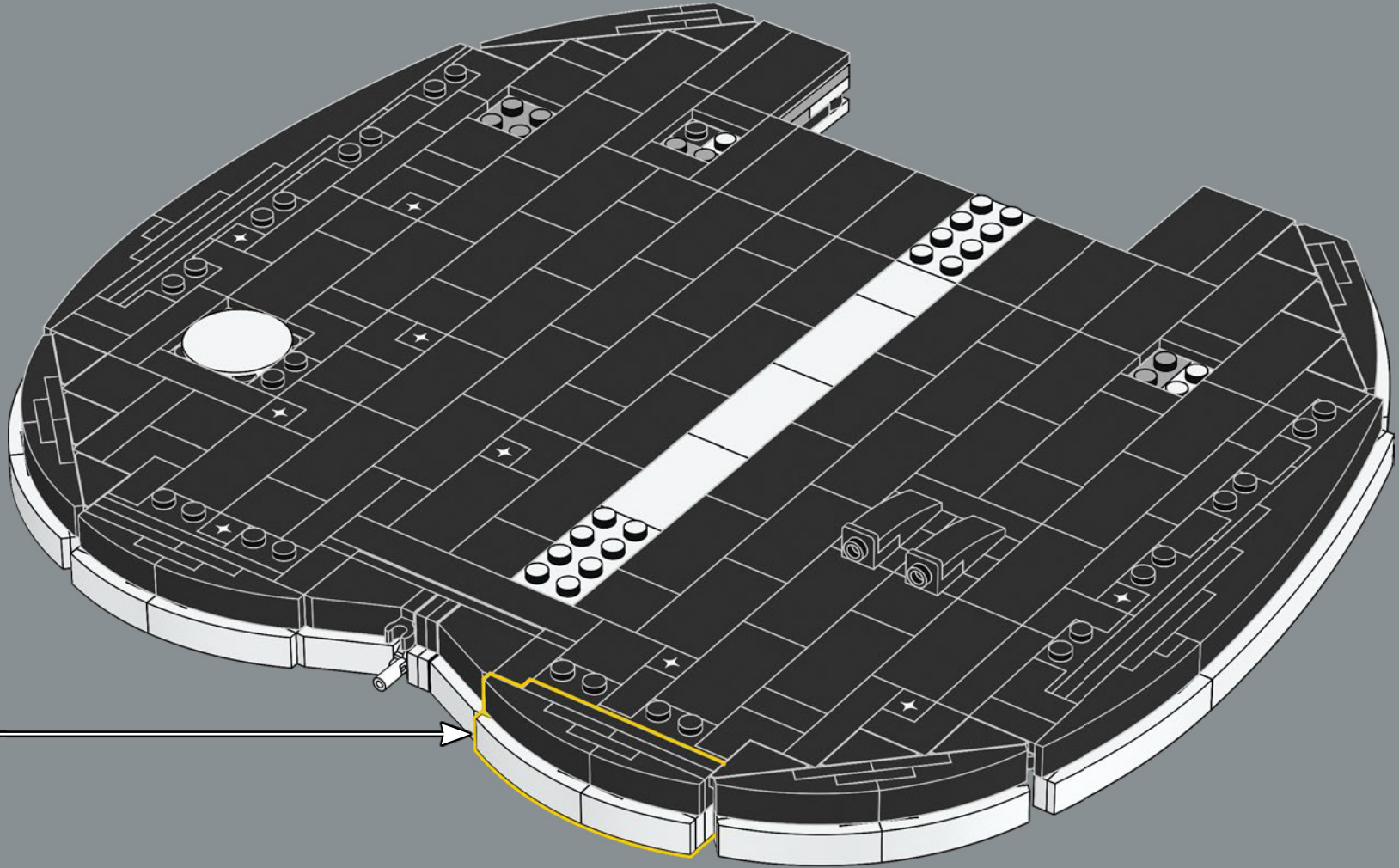



237

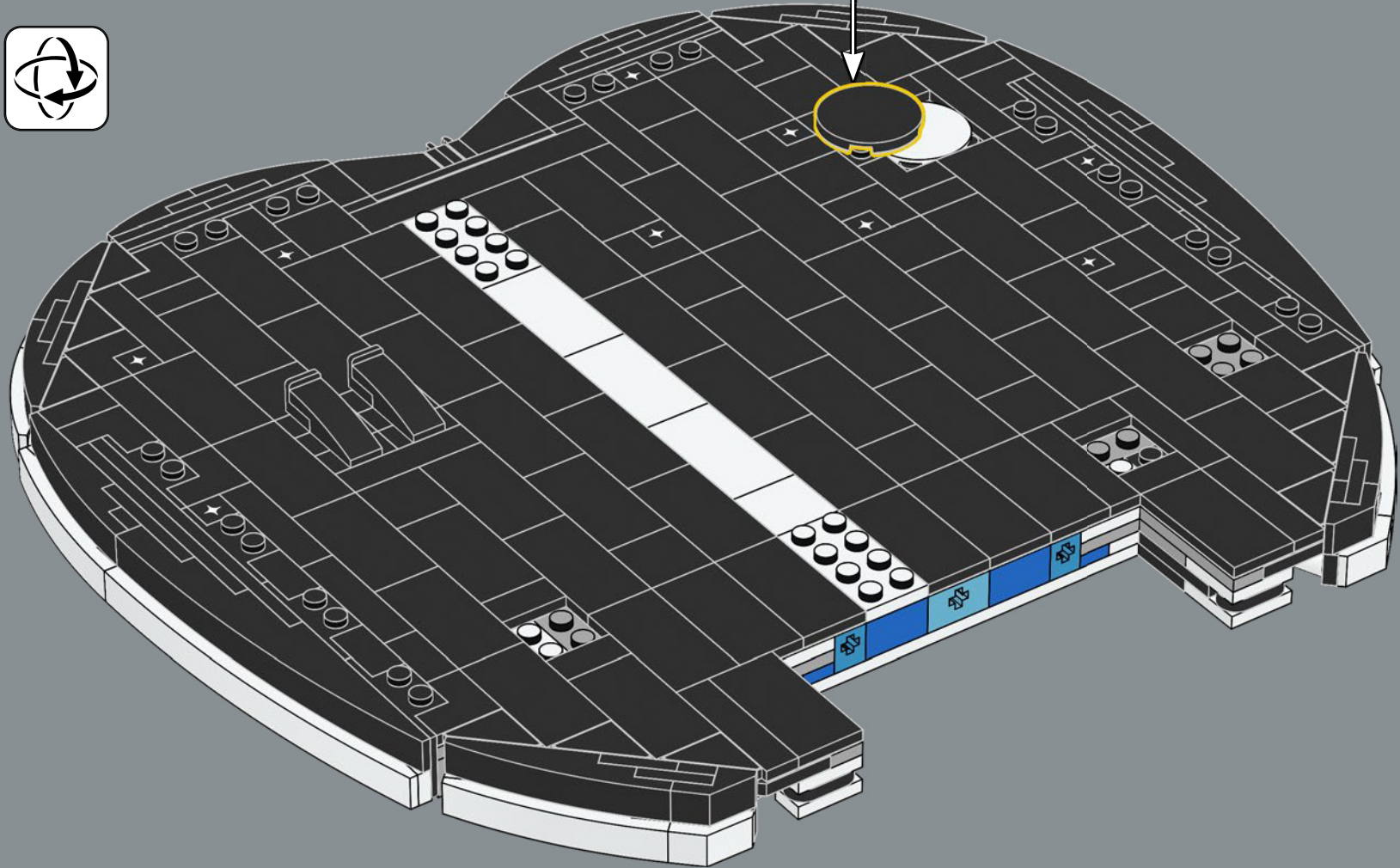

C'est peut-être la plus grosse pomme jamais créée dans un set LEGO® ! Nous avons empilé des éléments courbés et utilisé des techniques de construction latérales pour capturer cette silhouette emblématique de New York.



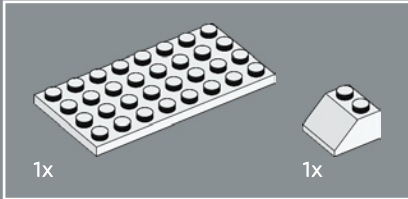
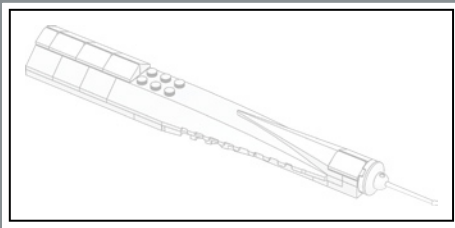

238

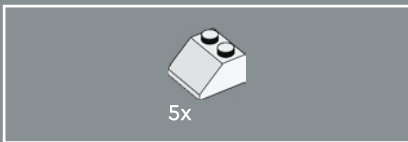
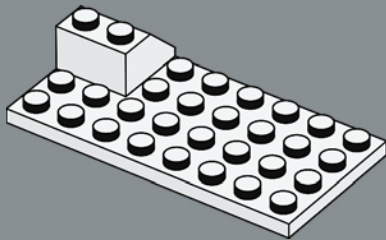

239

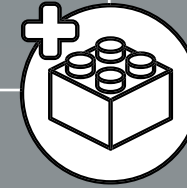
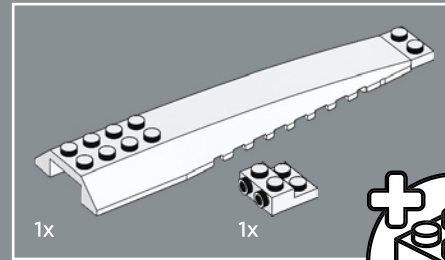
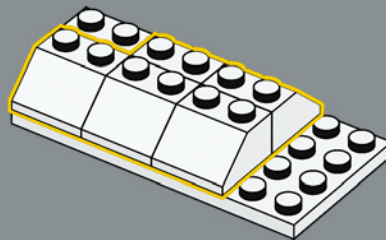

240

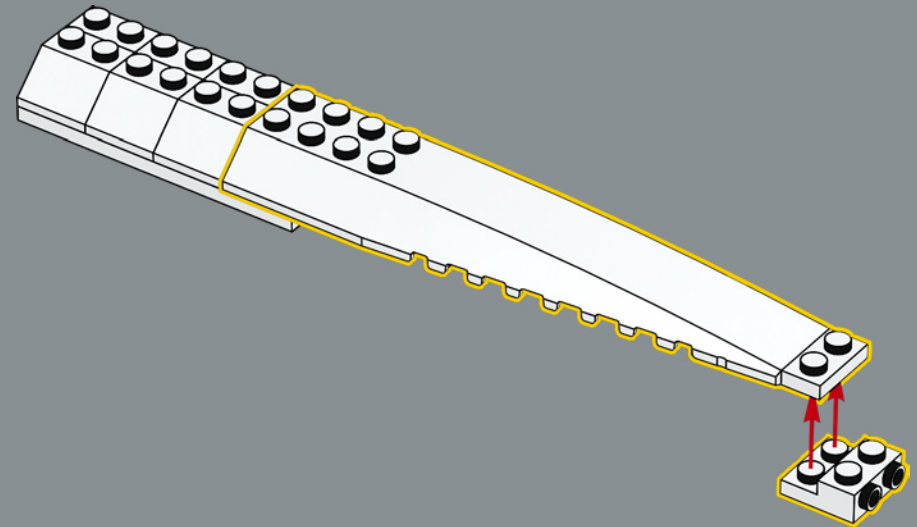

La hauteur du One World Trade Center est de 541,3 m – un clin d'œil à la signature de la Déclaration d'indépendance des États-Unis.

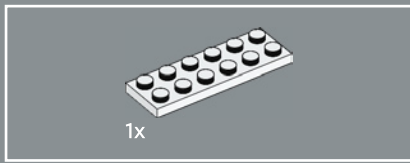

241

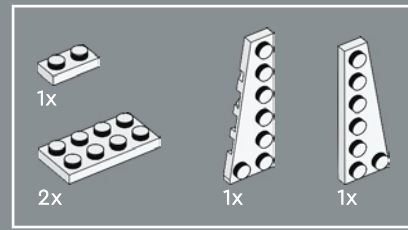
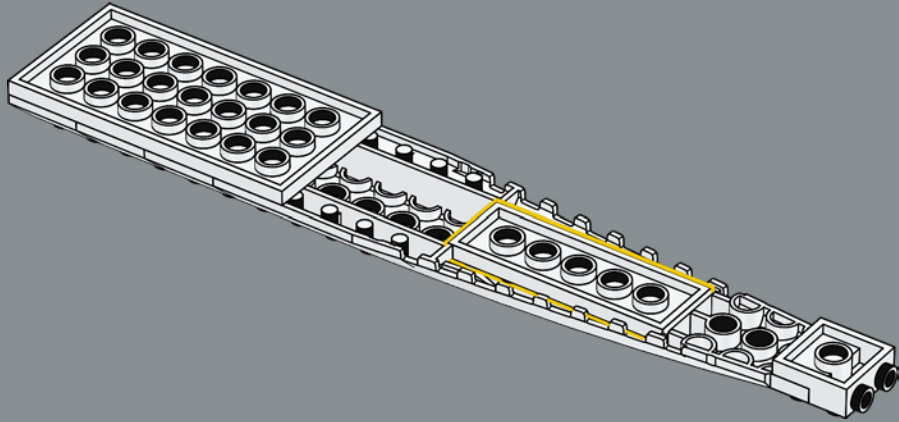

242

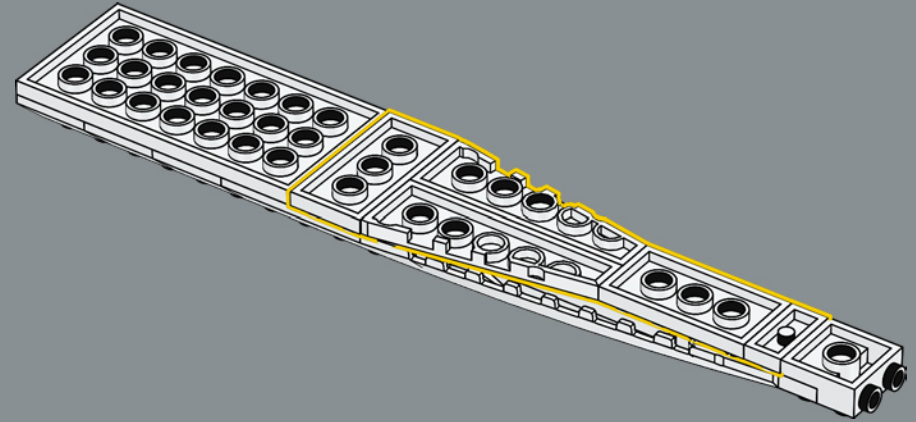



243

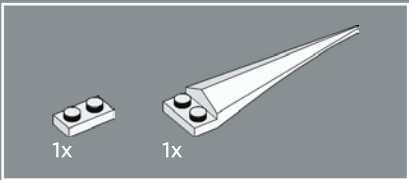
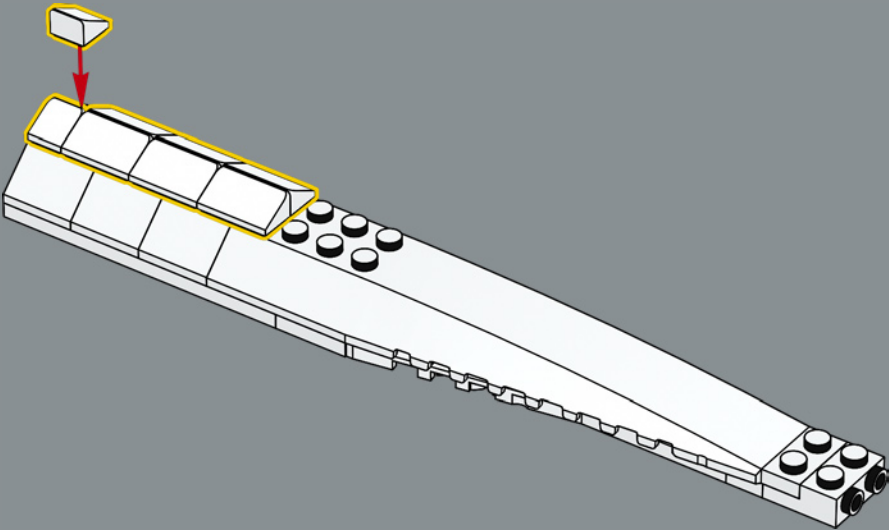

244

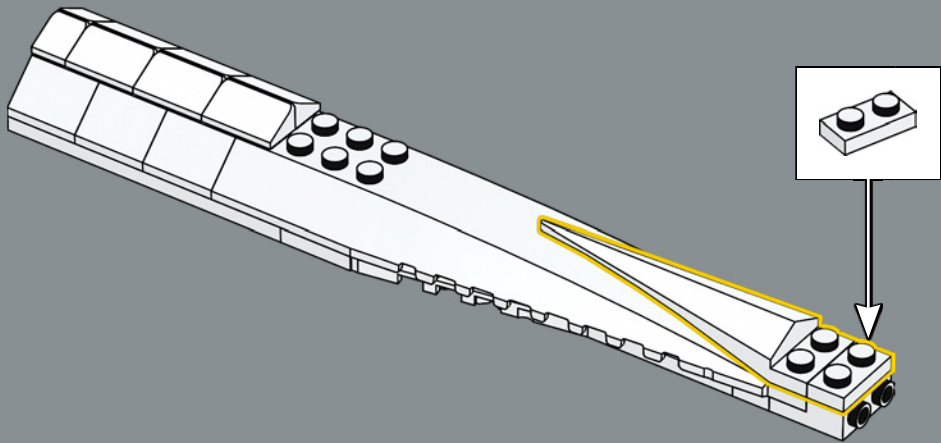



245

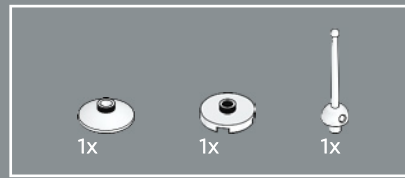
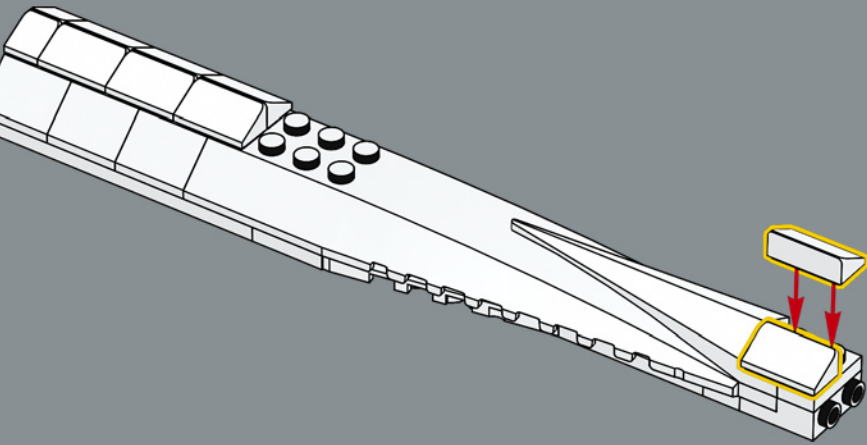

246

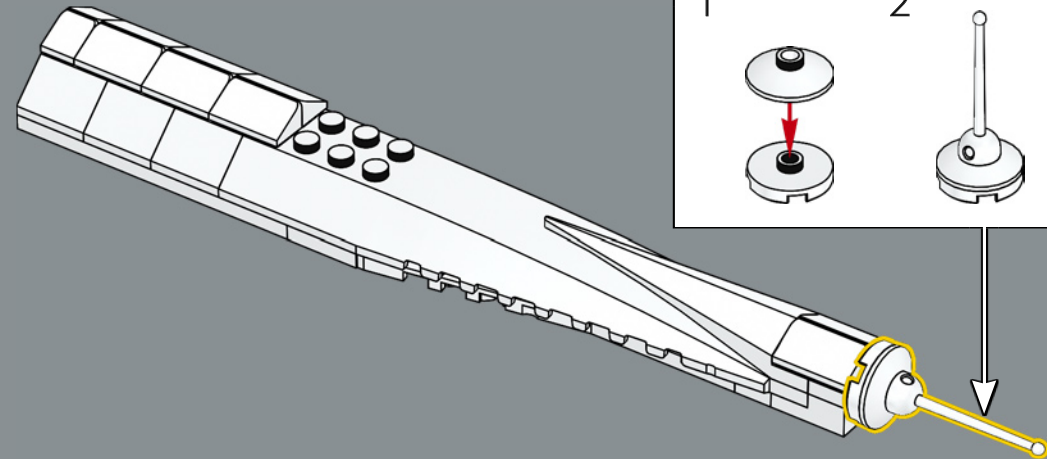

Un élément d'épée LEGO® permet de créer l'antenne de la plus haute tour de New York, le One World Trade Center. Dans la réalité, l'antenne seule mesure 124,3 m.

247

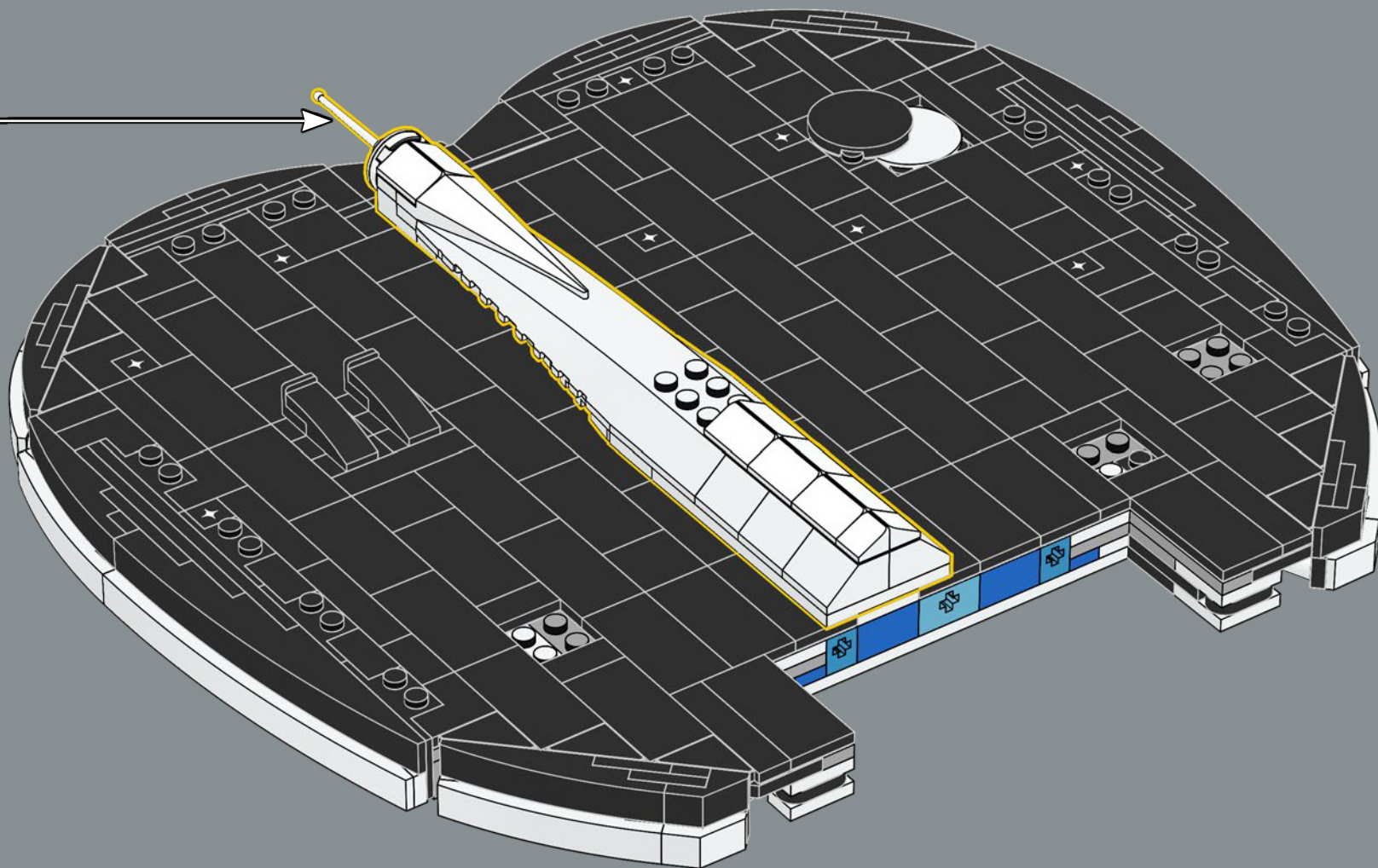



248

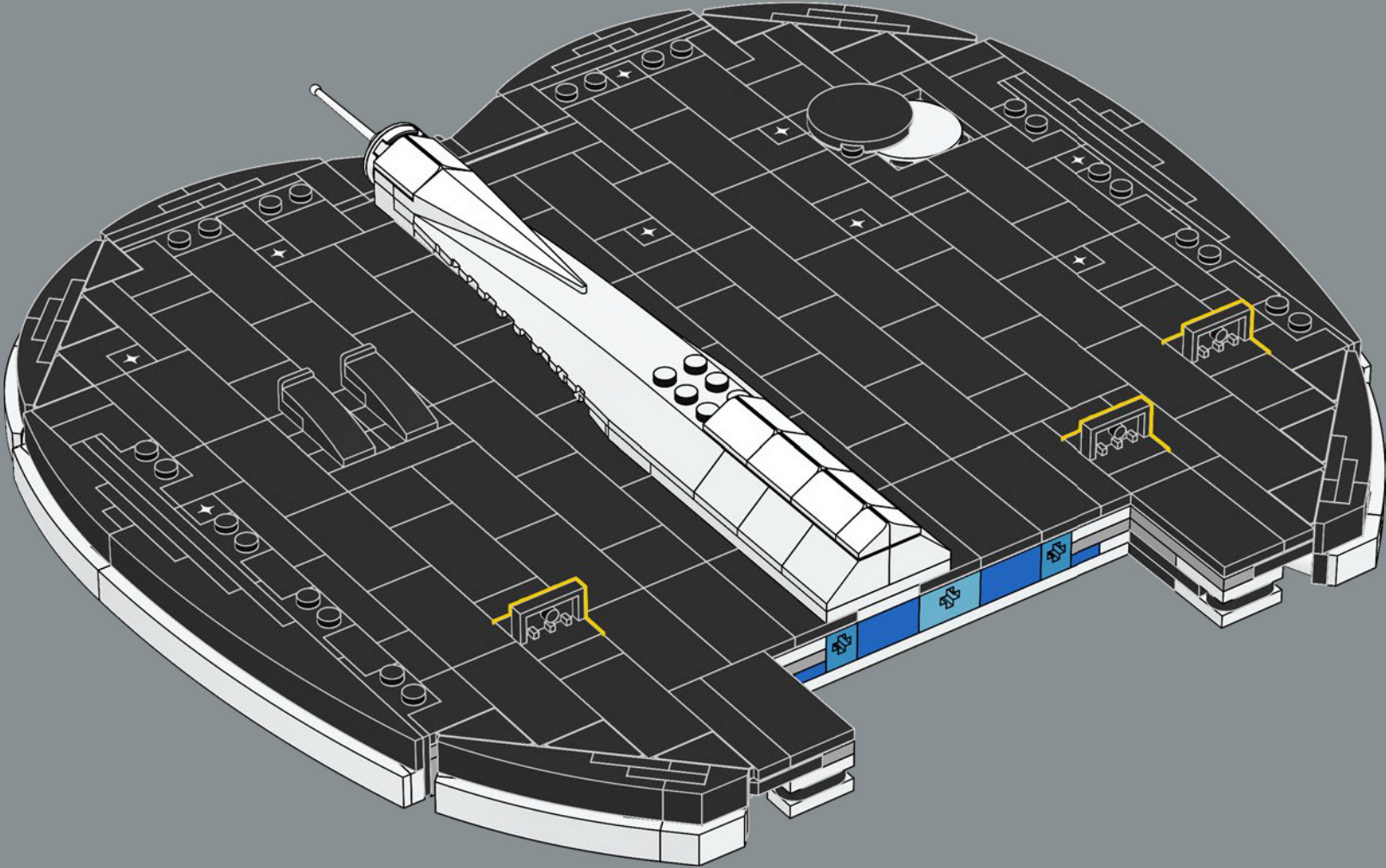

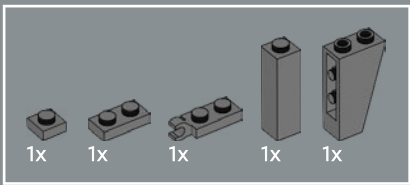

249

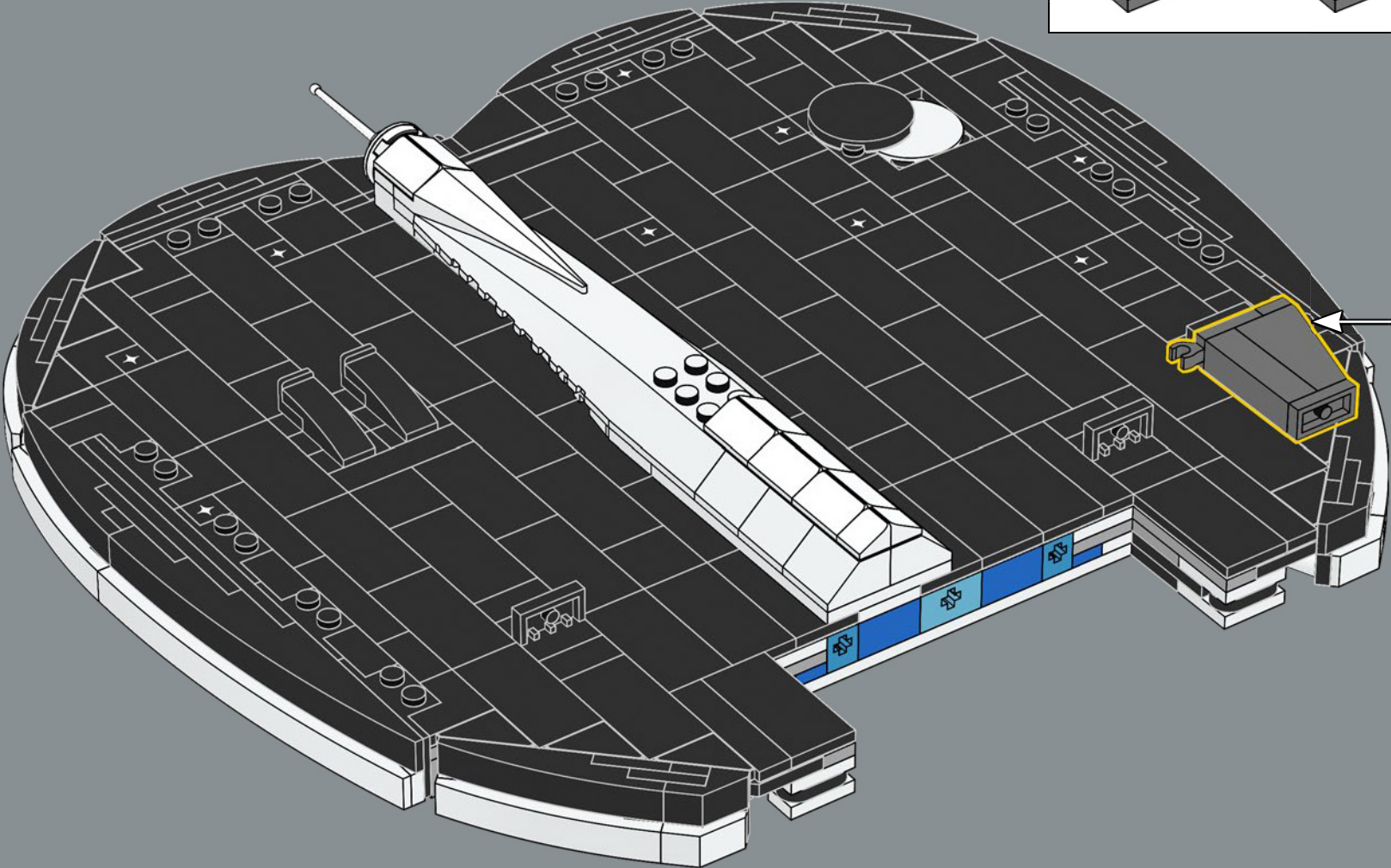
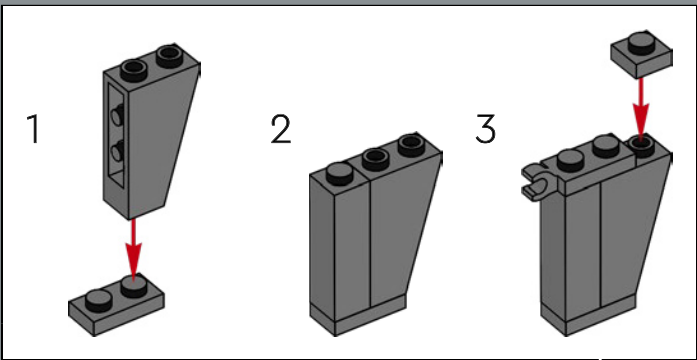

250

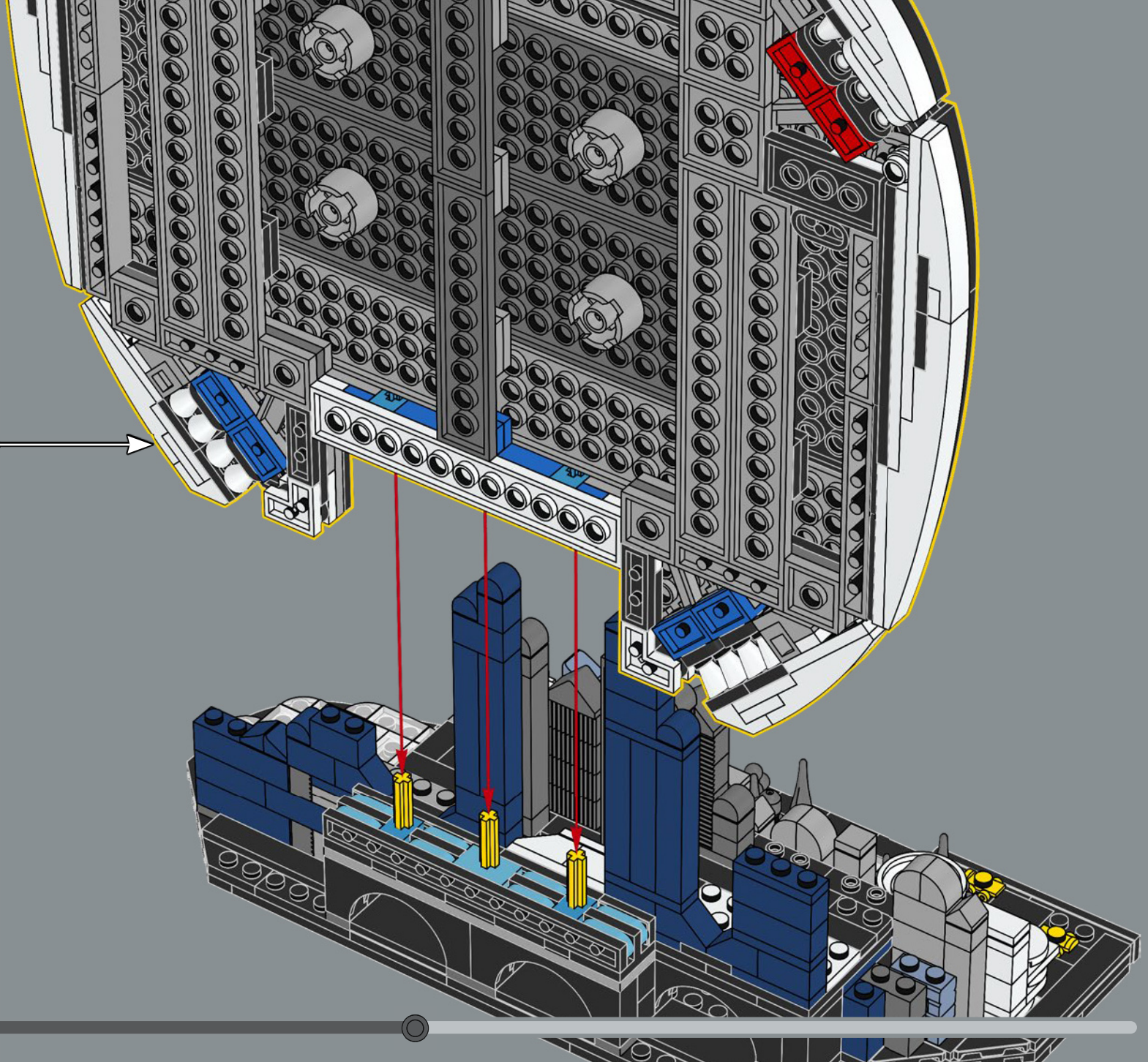

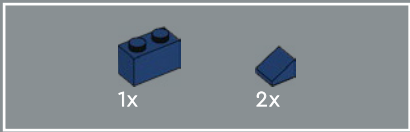

251

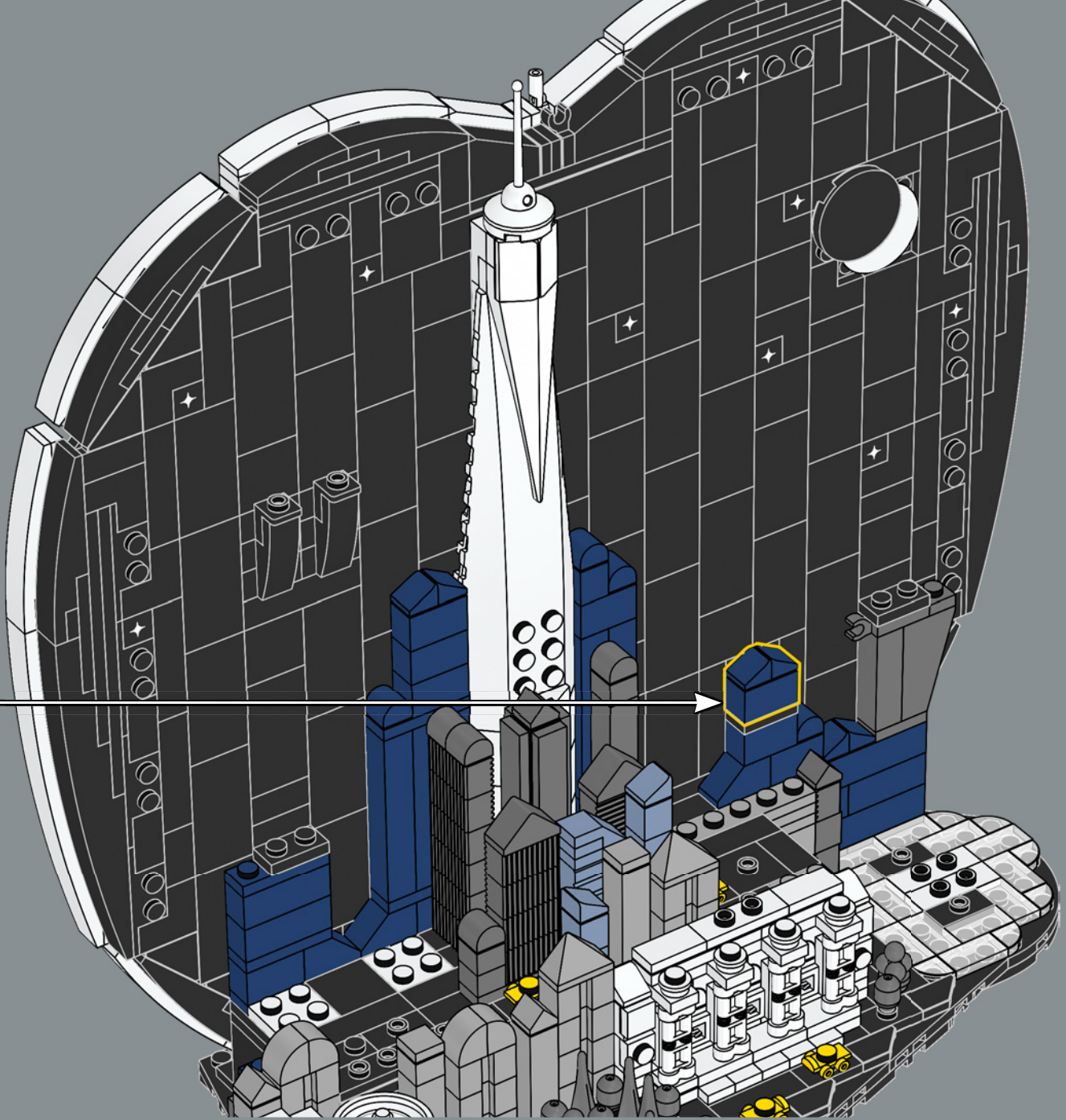
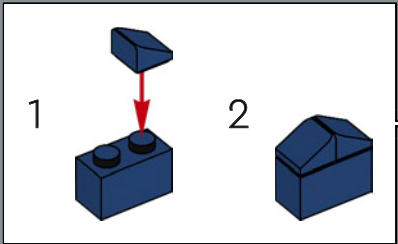

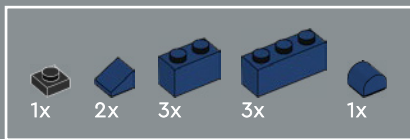

252

1

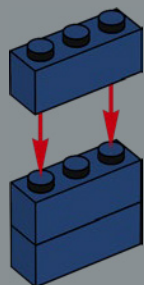

2

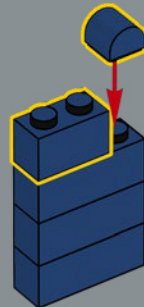

3

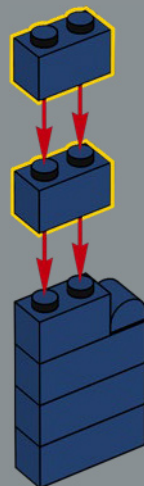

4

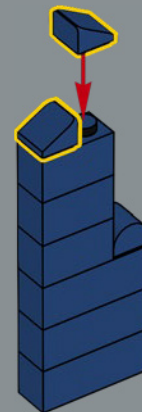

5



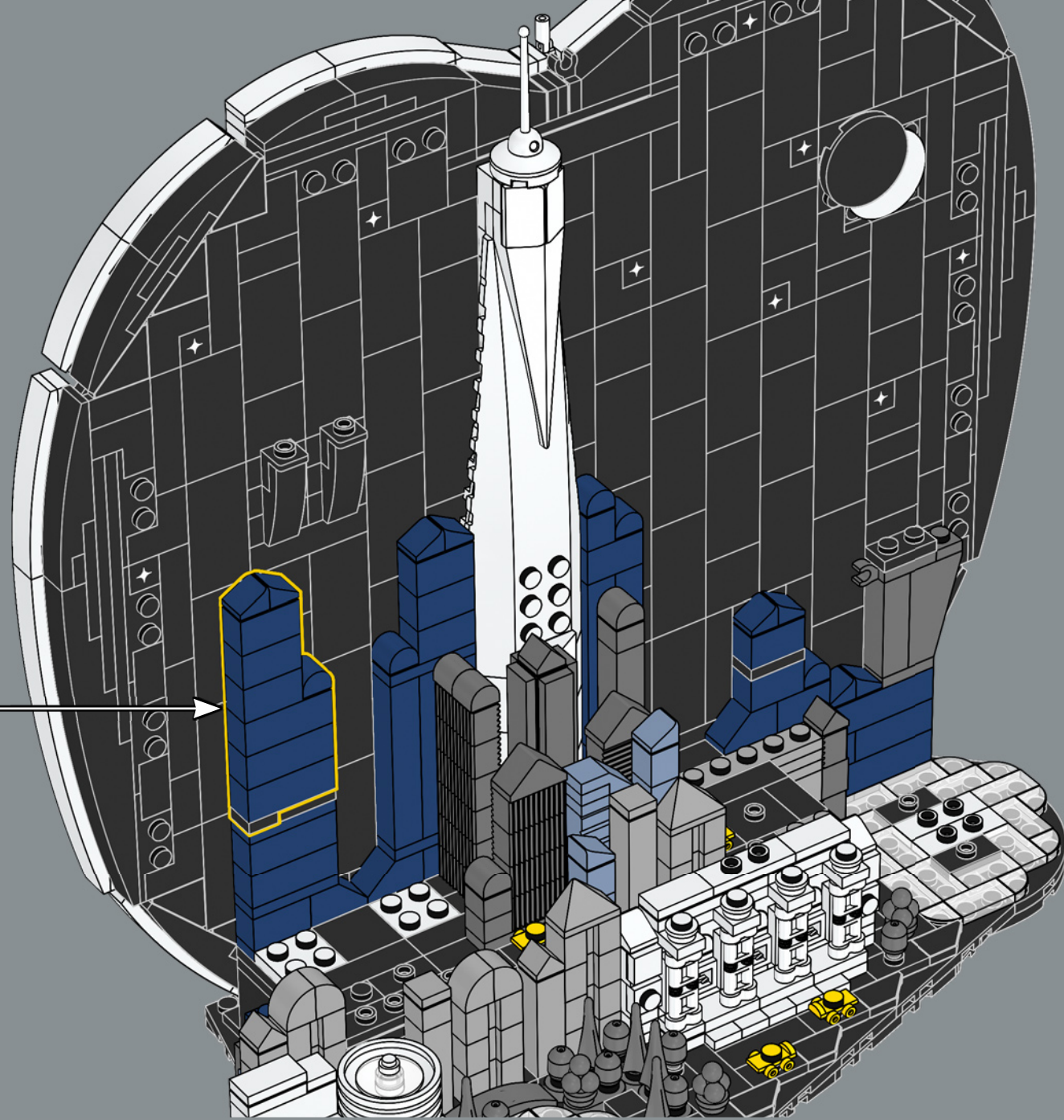

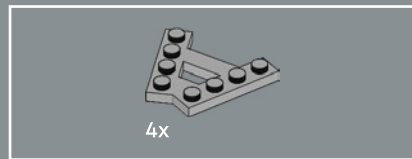

253

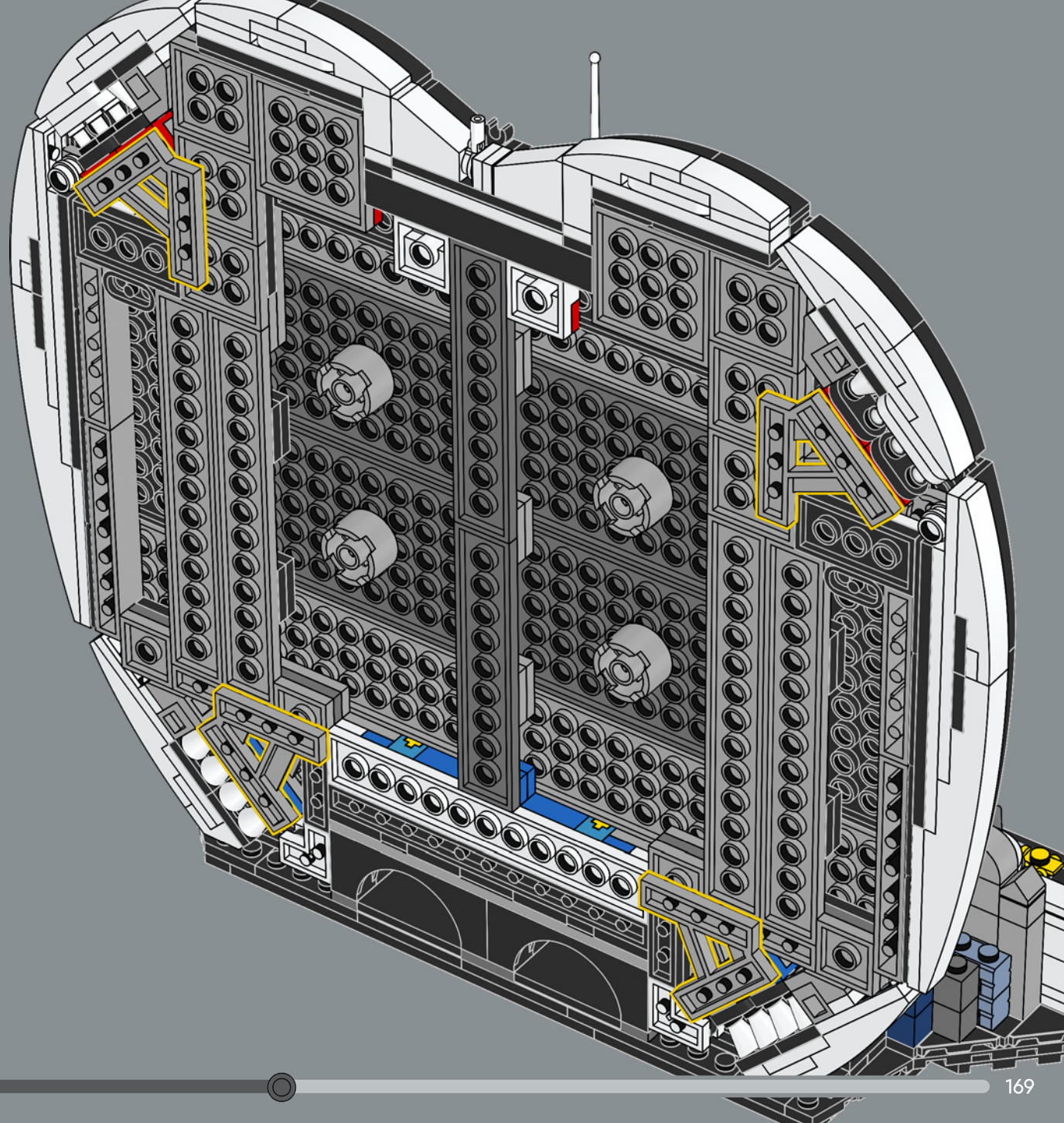

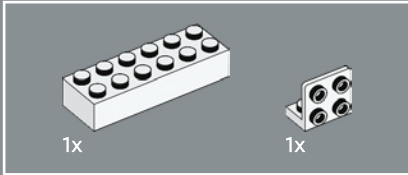
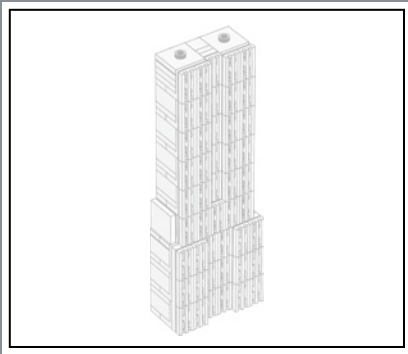

254

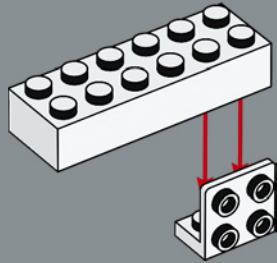

Inauguré en 1931, l'Empire State Building reste une icône de l'Art déco. Premier bâtiment au monde à structure en acier dépassant les 100 étages, il a dominé la silhouette de New York comme plus haut bâtiment du monde pendant près de 40 ans.

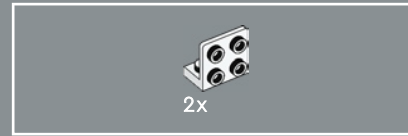

255

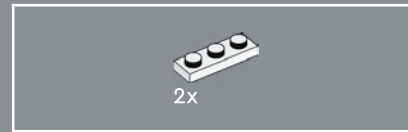
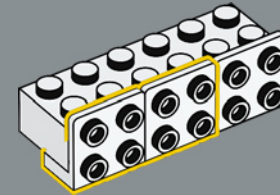

256

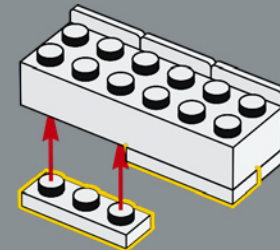

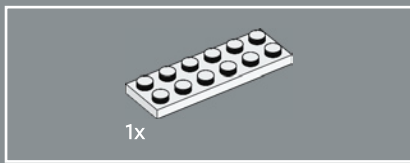

257

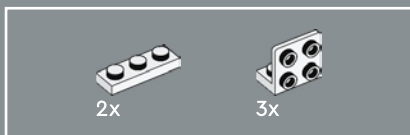
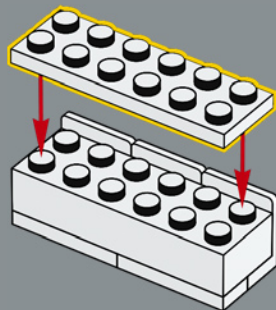

258

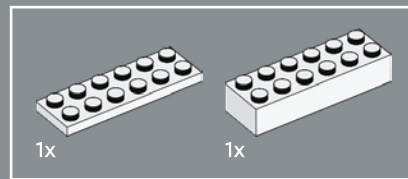
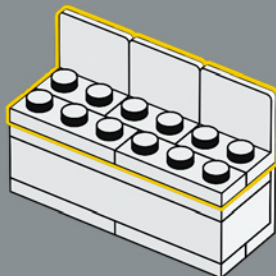

259

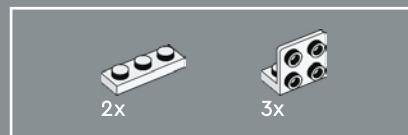
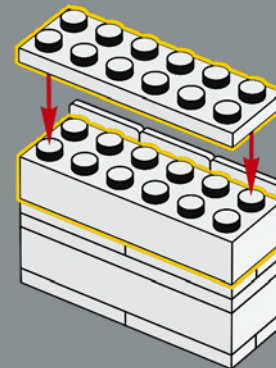

260

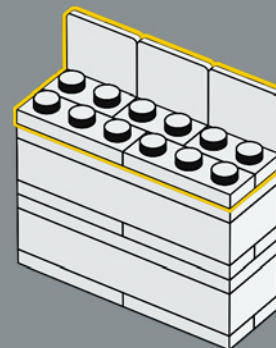

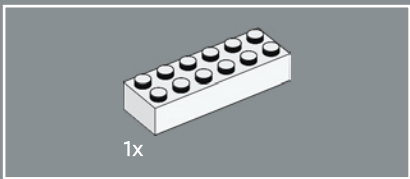

261

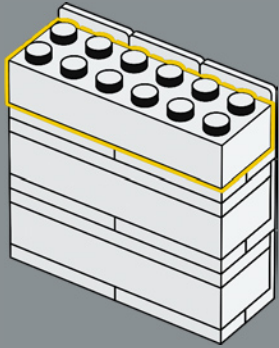

262

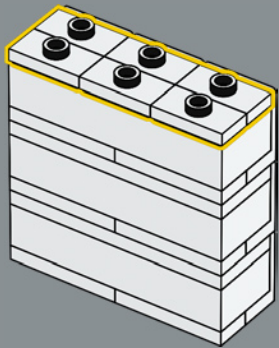

263

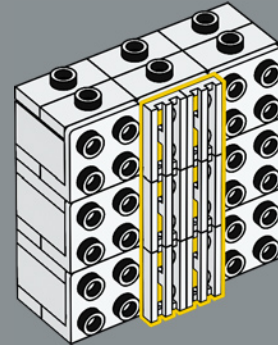

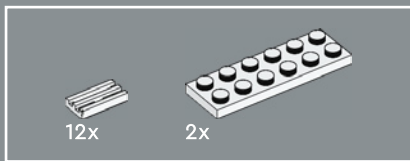

264

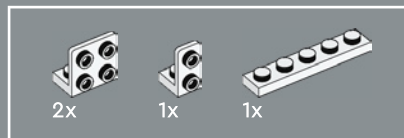
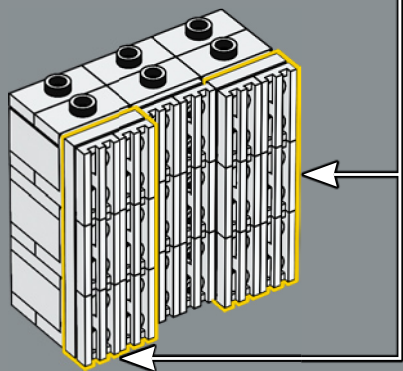
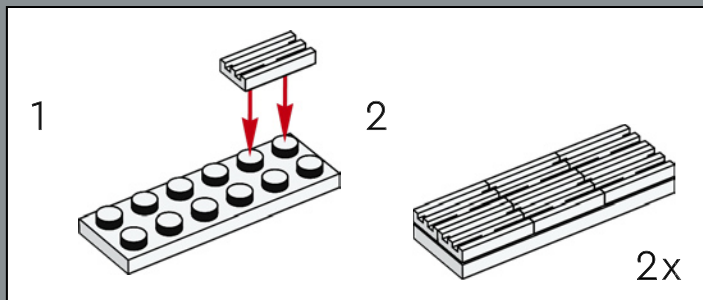

265

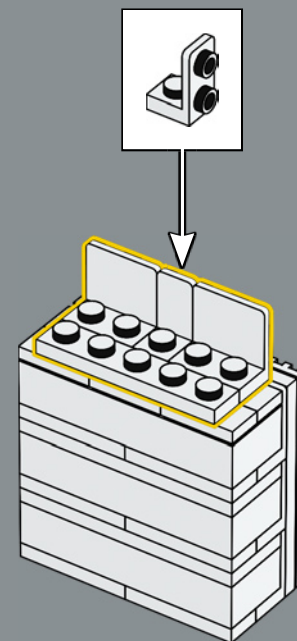

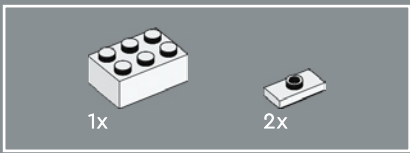

266

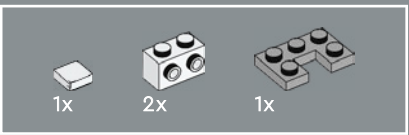
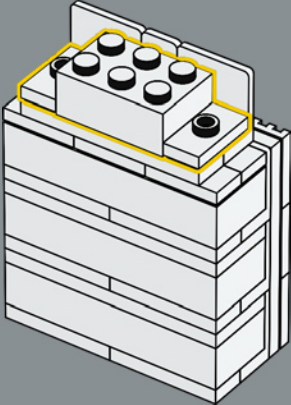

267

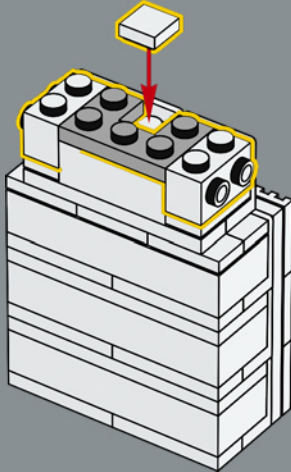

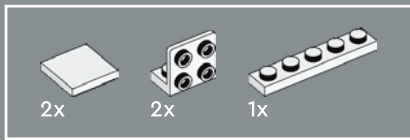

268

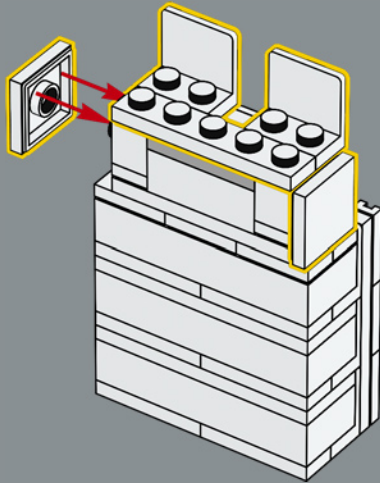

269

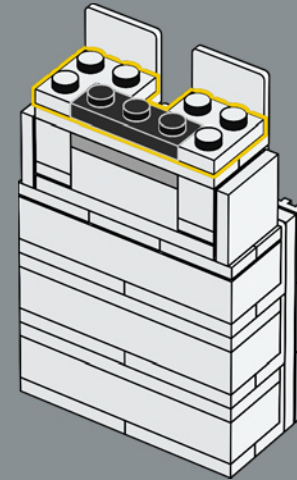

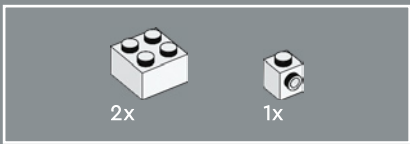

270

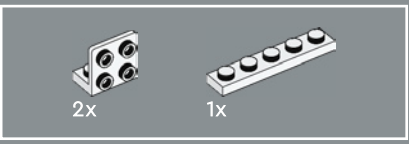
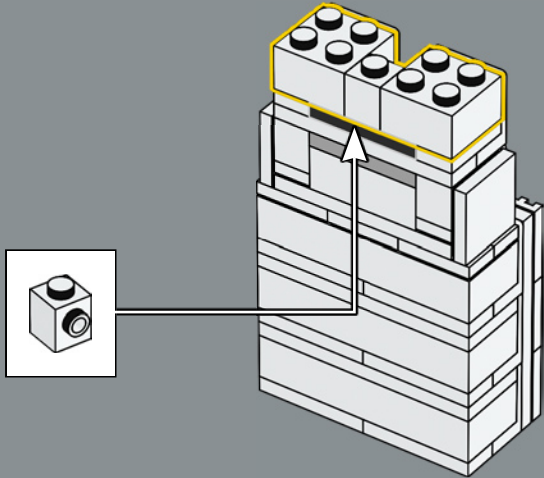

271

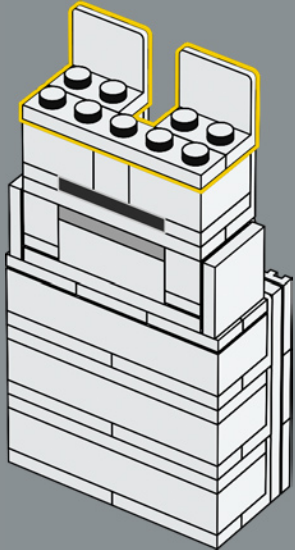

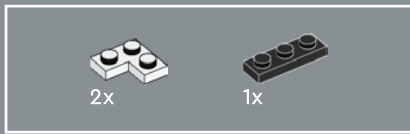

272

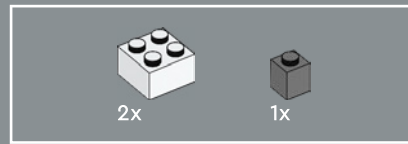
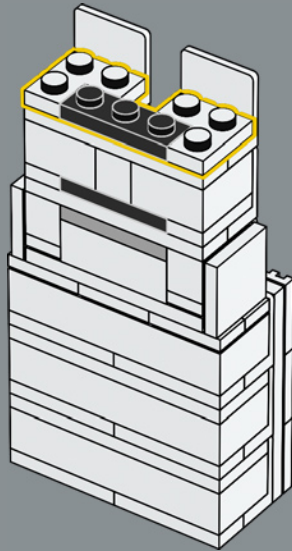

273

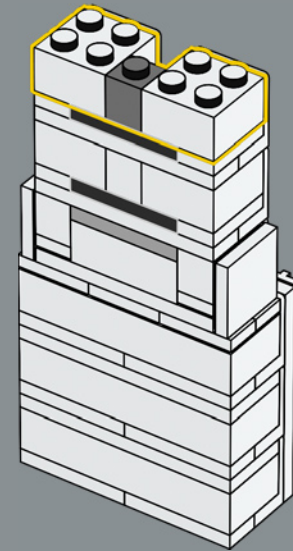

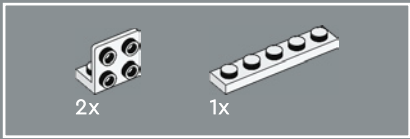

274

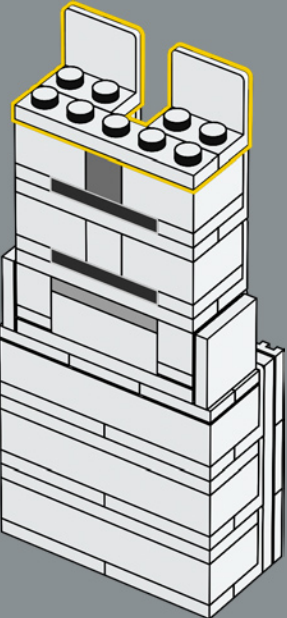

275

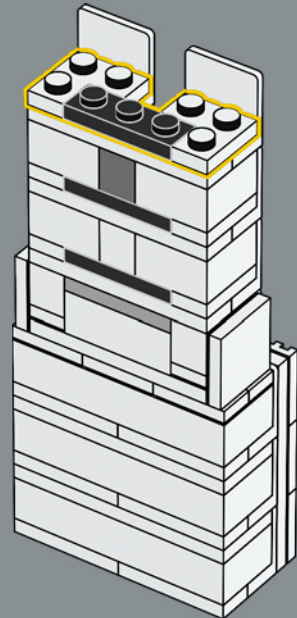

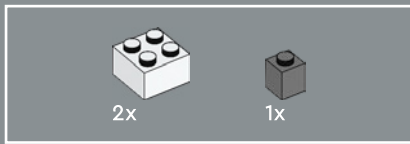

276

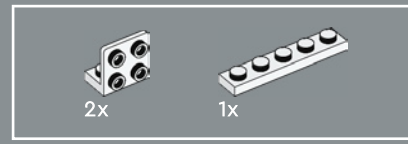
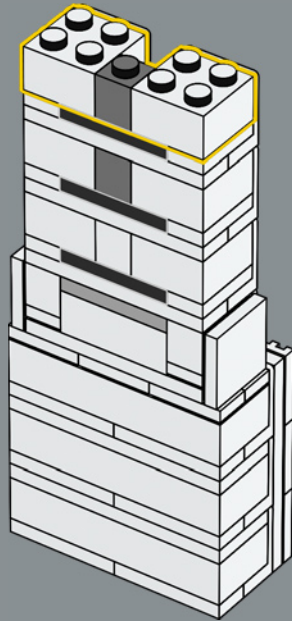

277

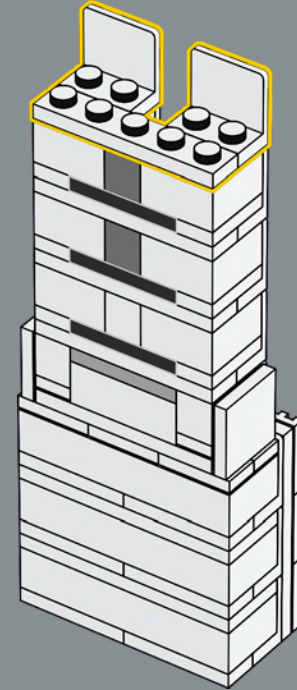



278

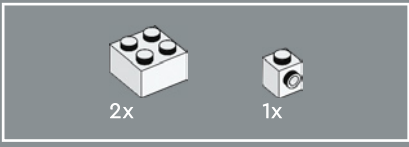
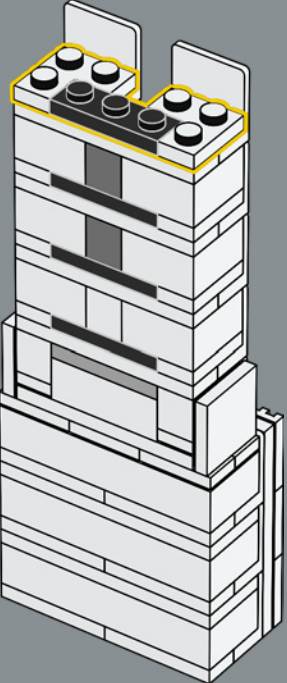

279

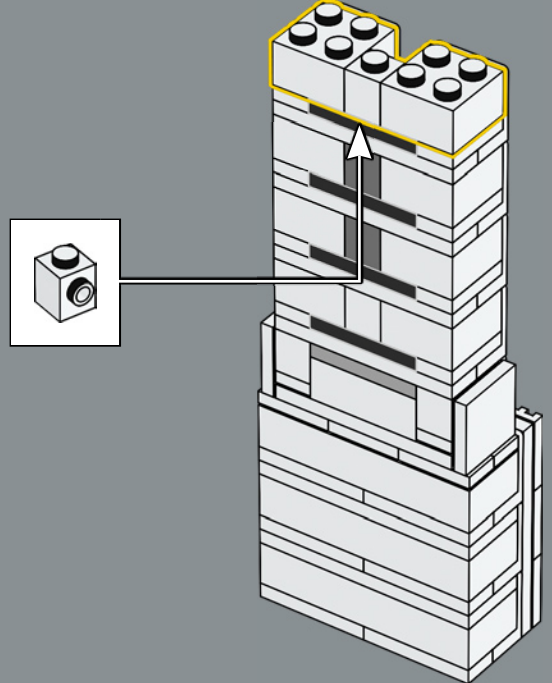

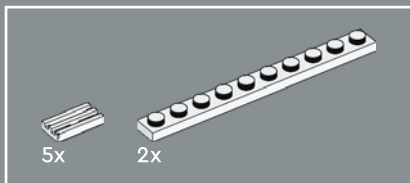

280

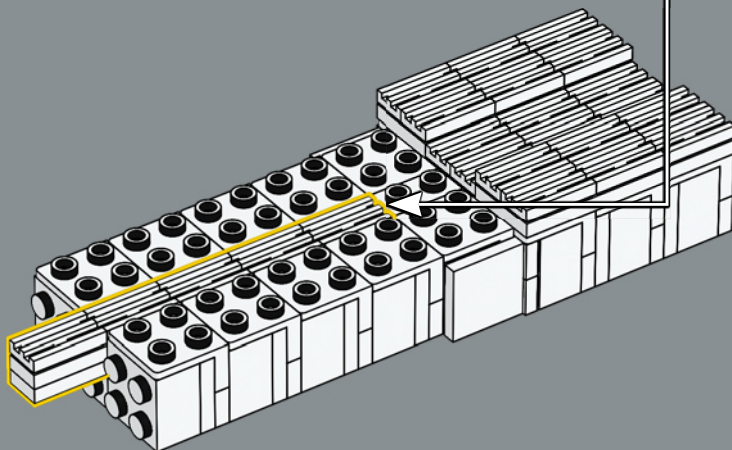
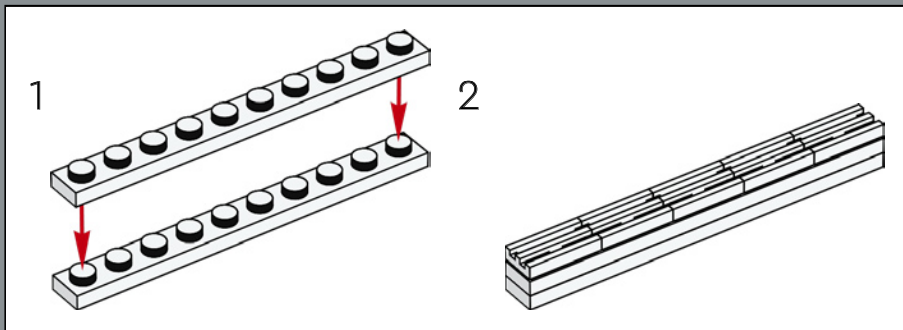

281

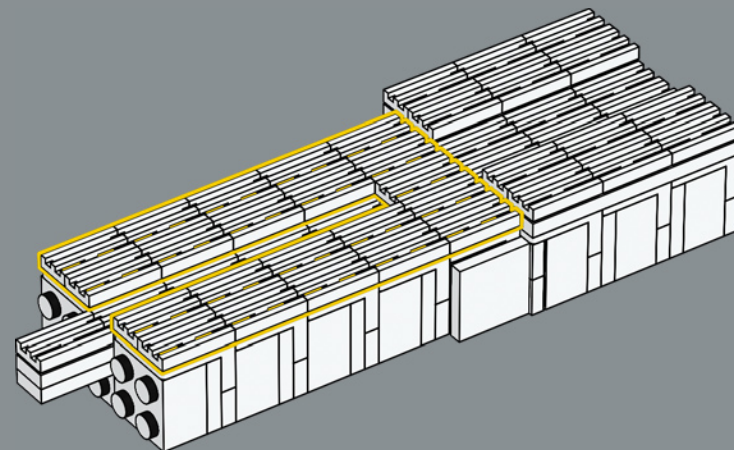

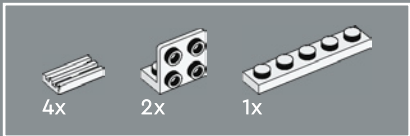

282

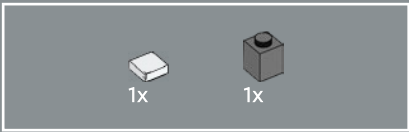
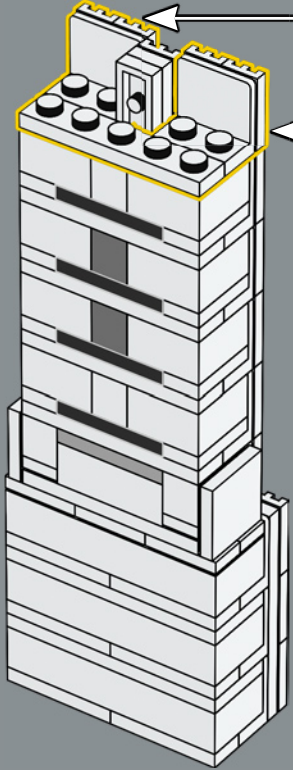
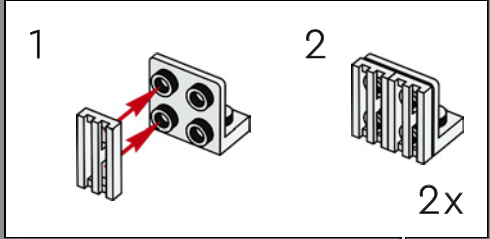

283

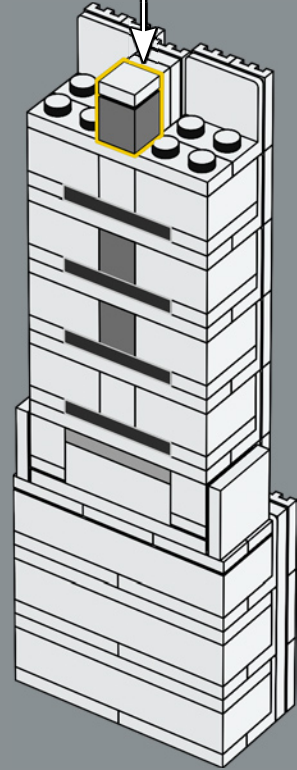
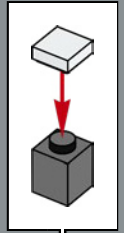

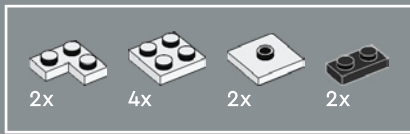

284

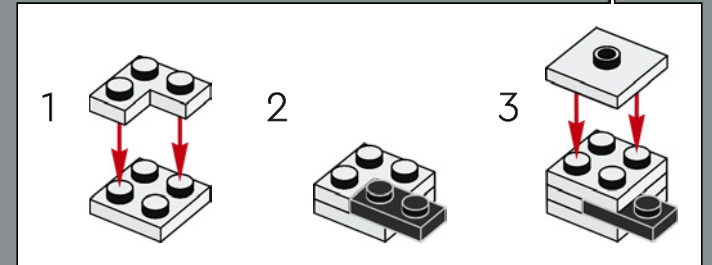
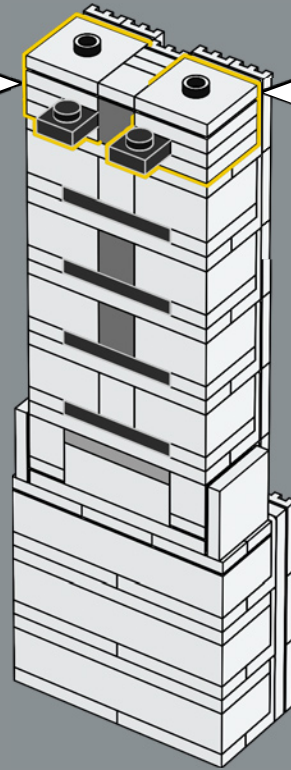
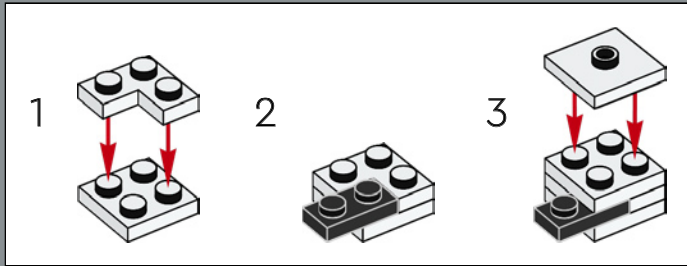

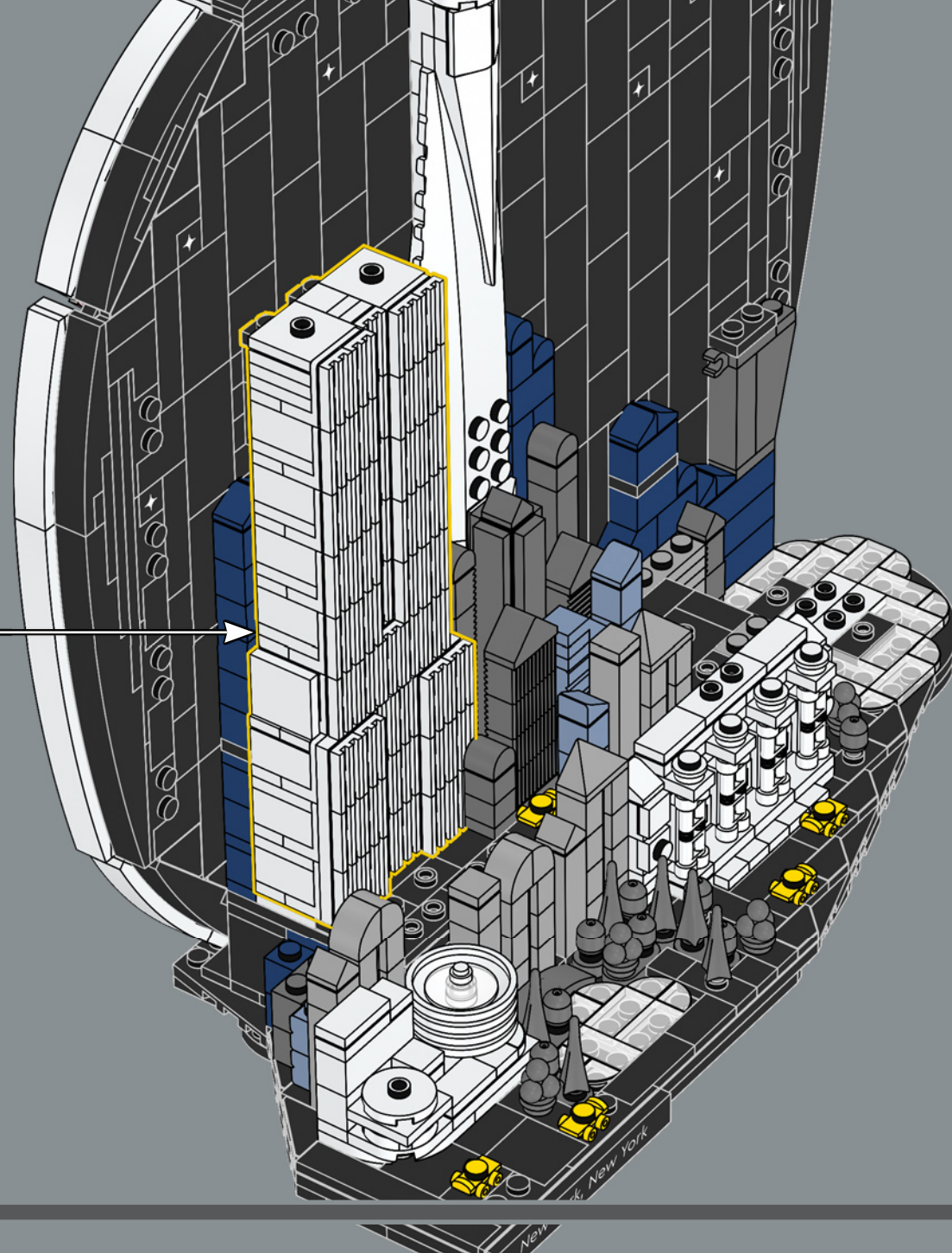

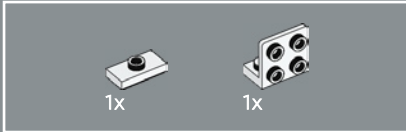
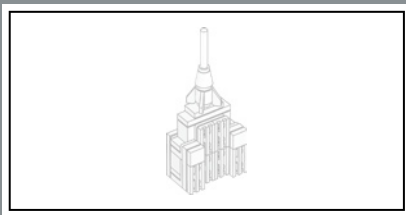

286

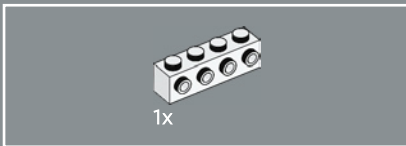
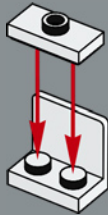

287

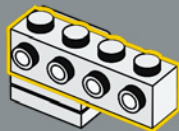

288

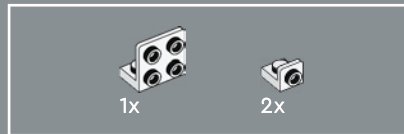
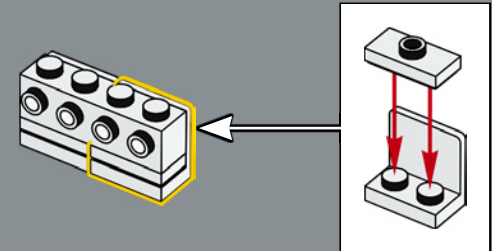

289

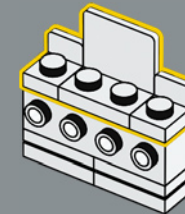



2x

290

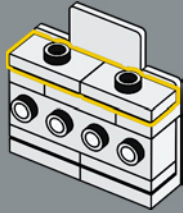

2x

292

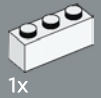
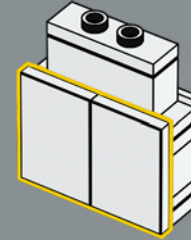

1x



1x

291



4x

293

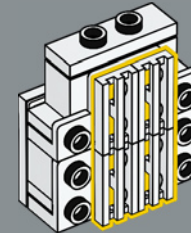

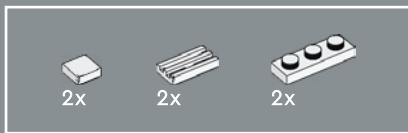

294

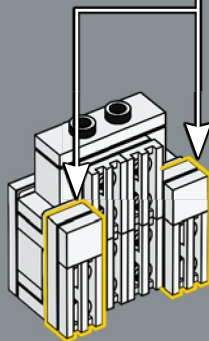
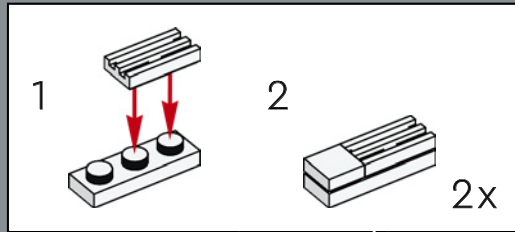

Ces dernières années, l'Empire State Building a fait l'objet de restaurations minutieuses afin de préserver son design d'origine et l'histoire du bâtiment pour les générations futures.

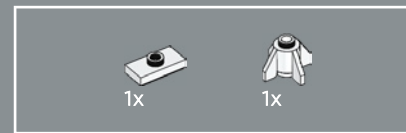

295

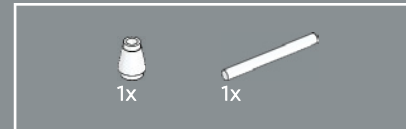
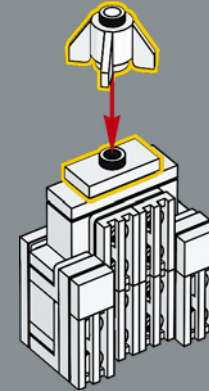

296

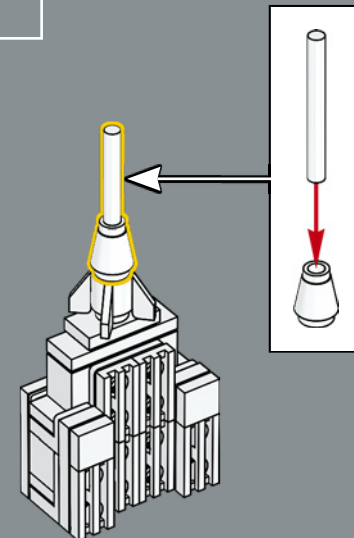

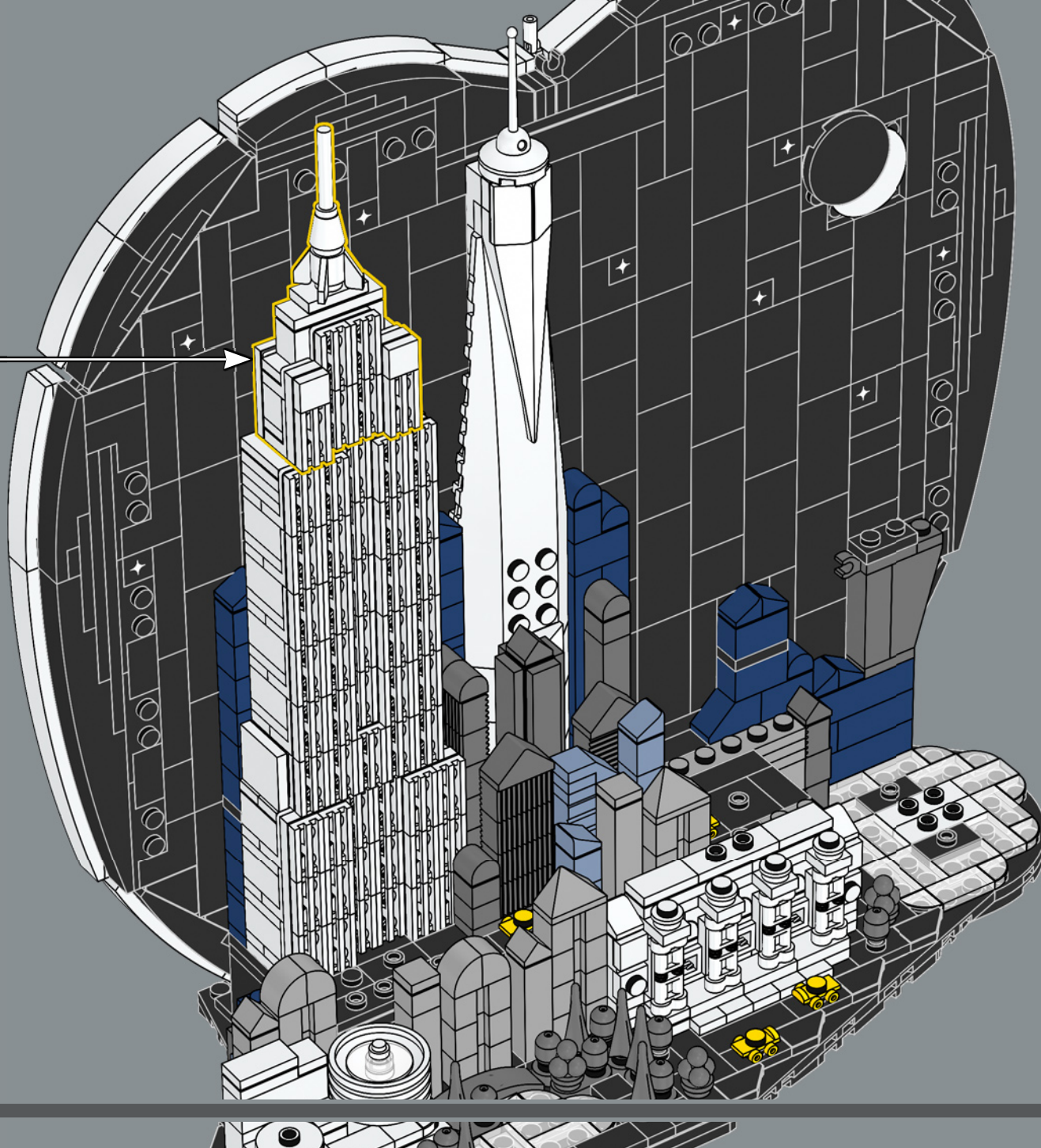

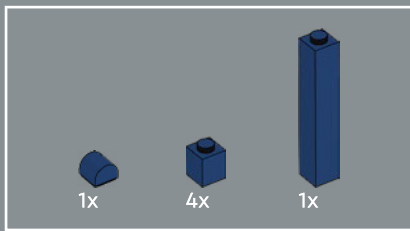

298

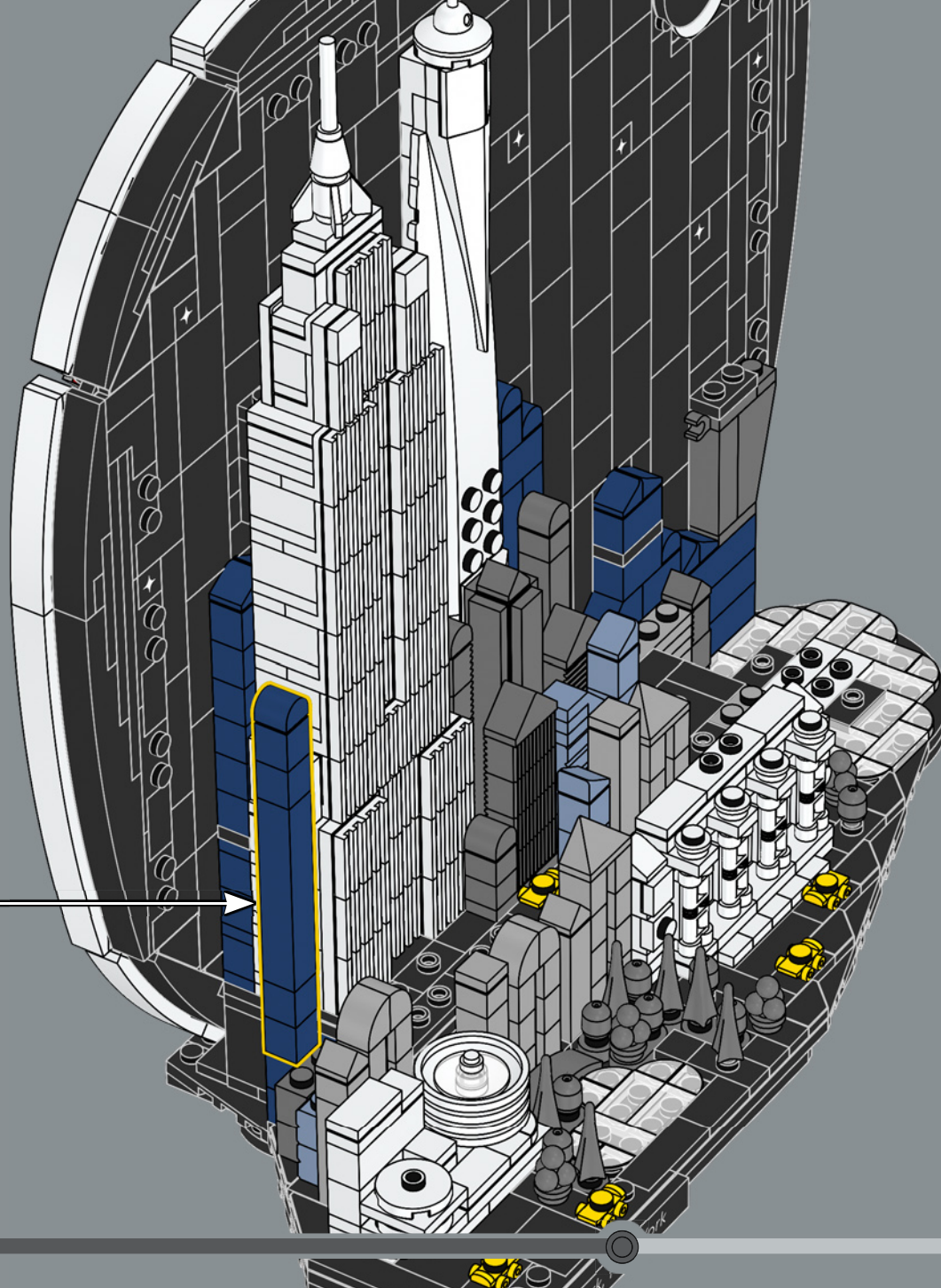
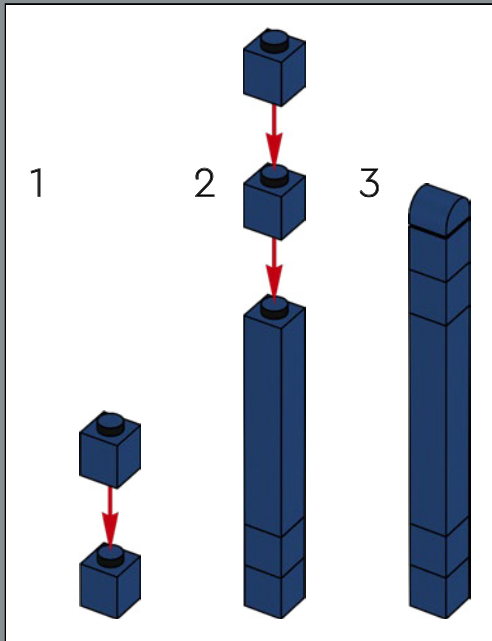

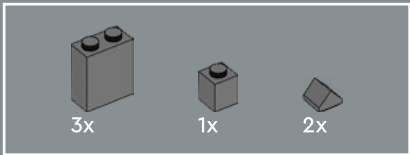

299

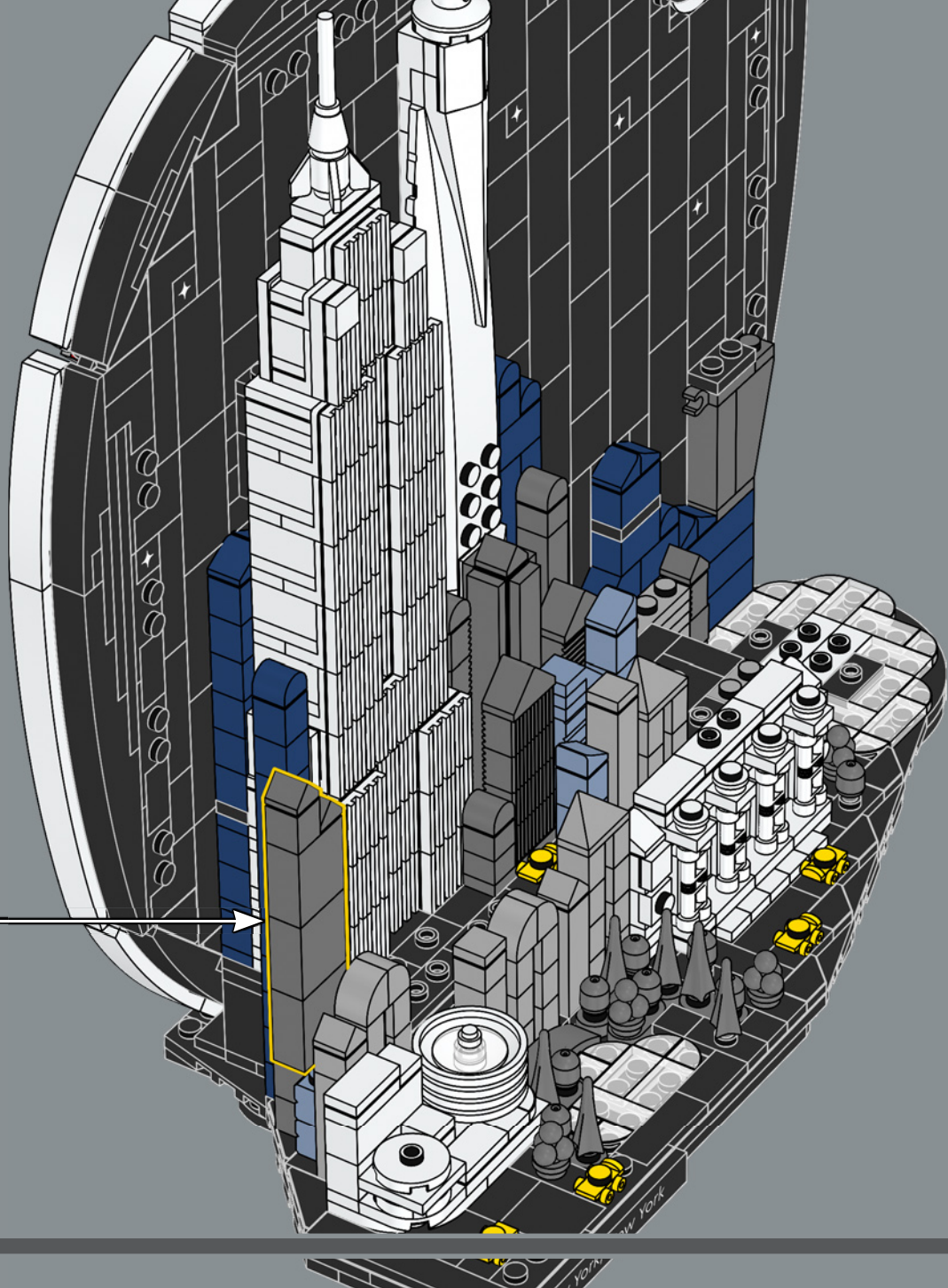
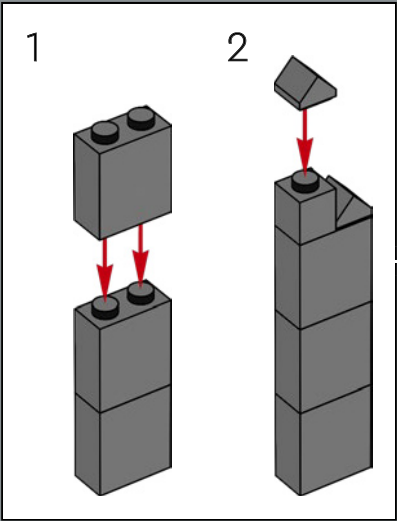

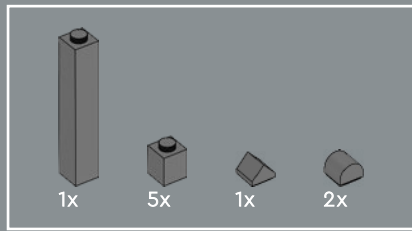

300

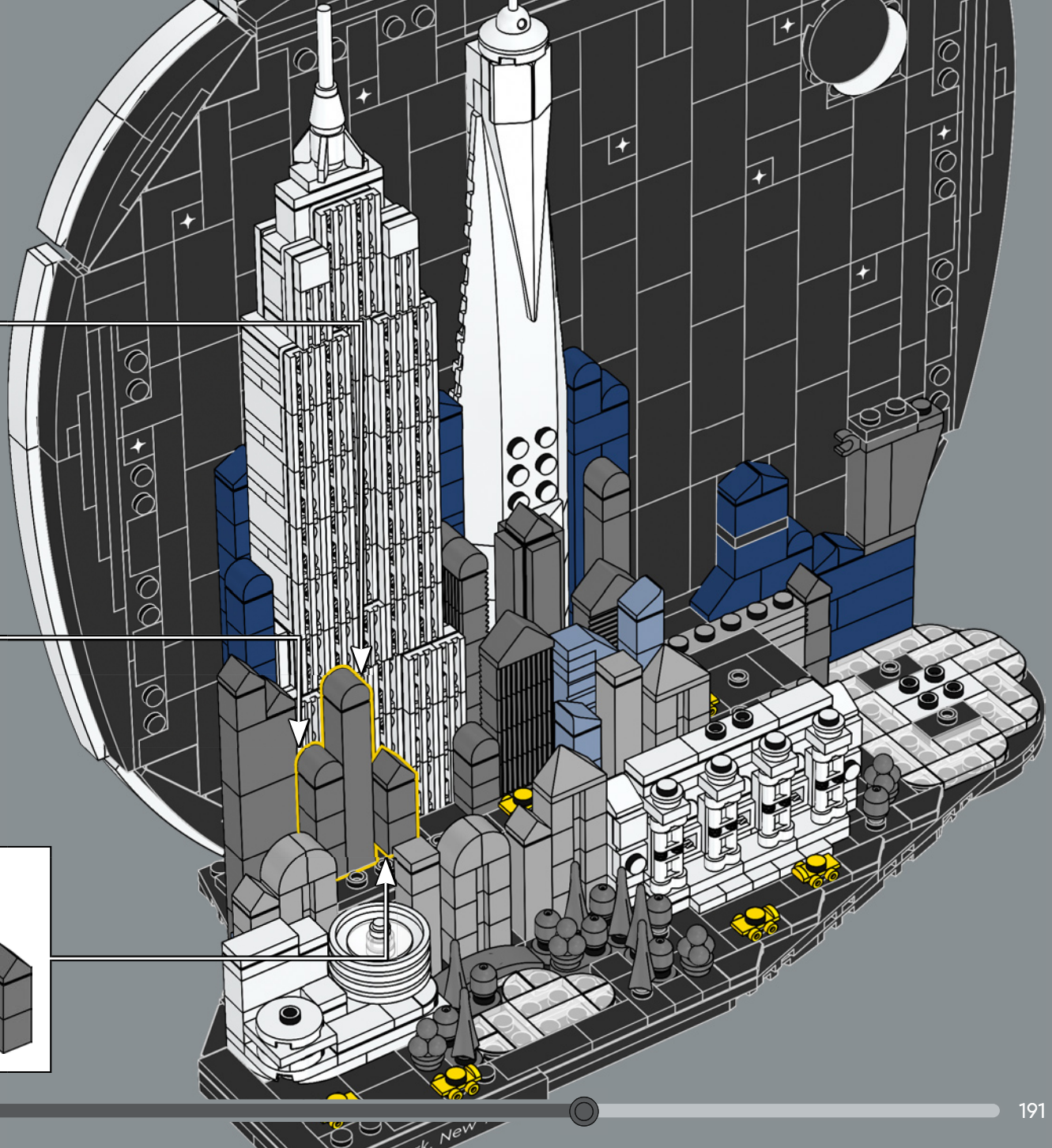
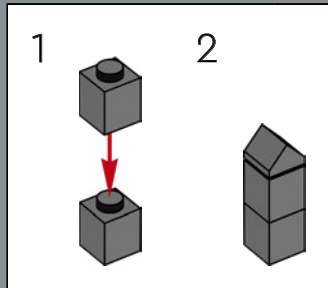
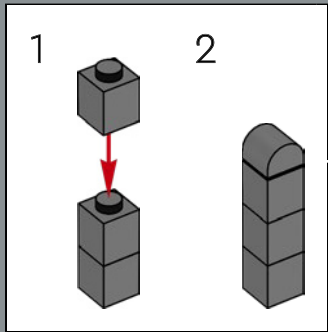
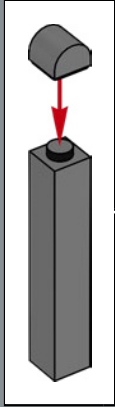



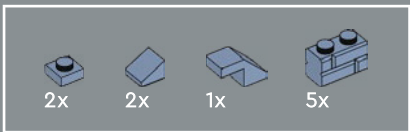

301

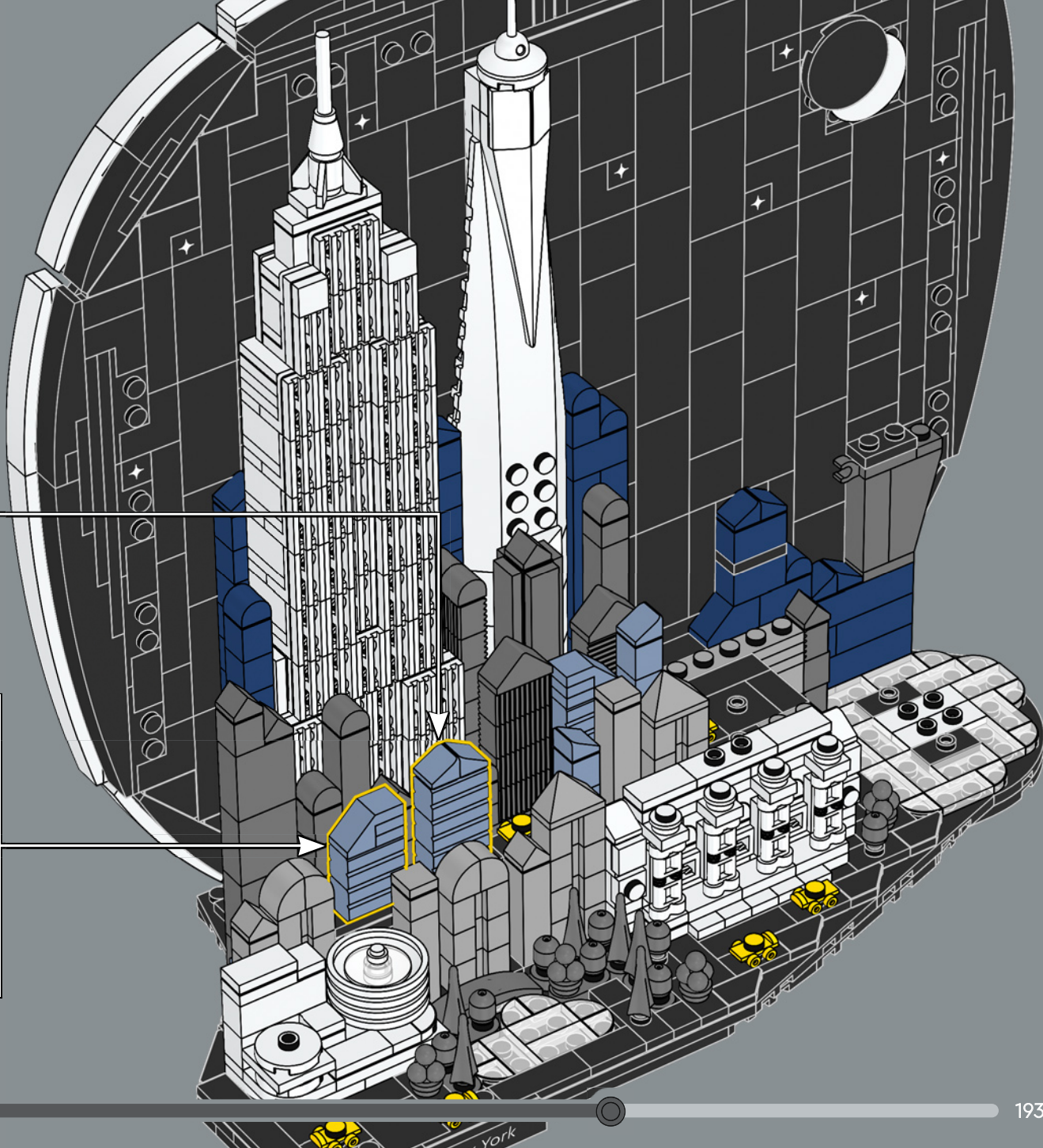
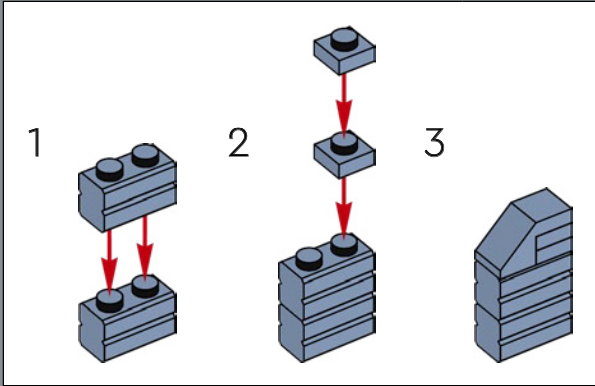
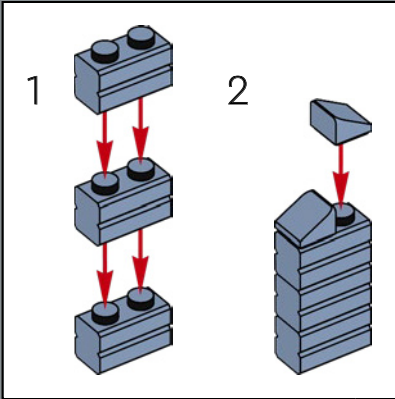

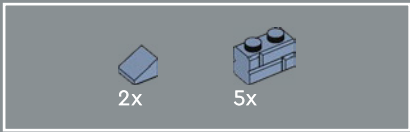

302

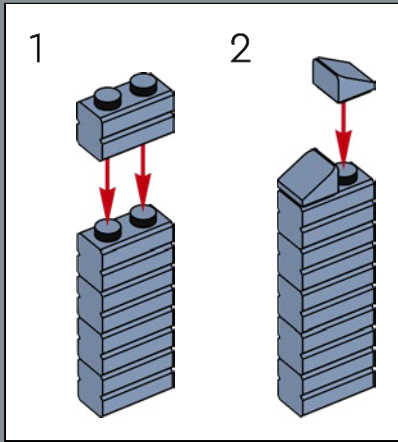
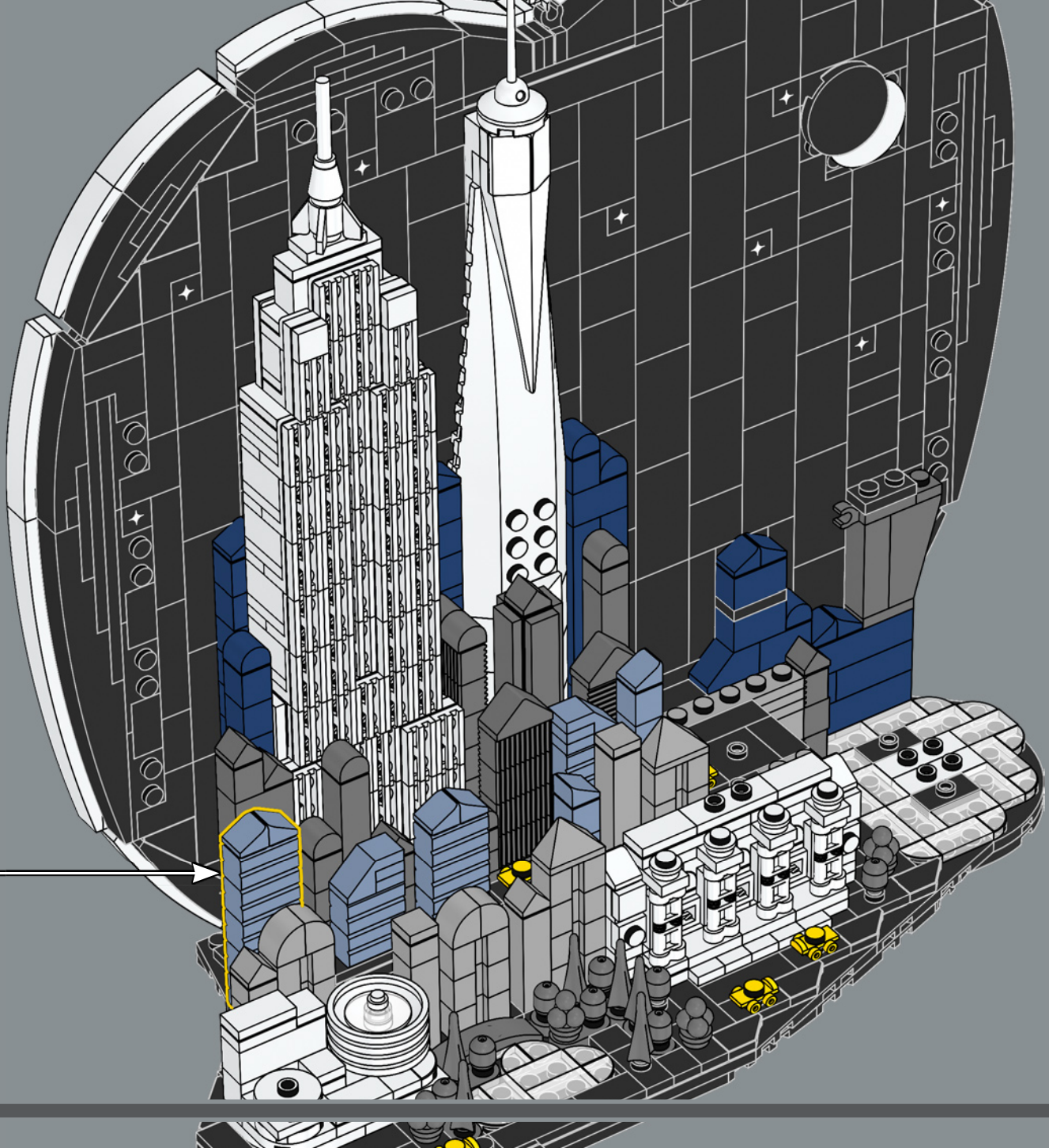



303

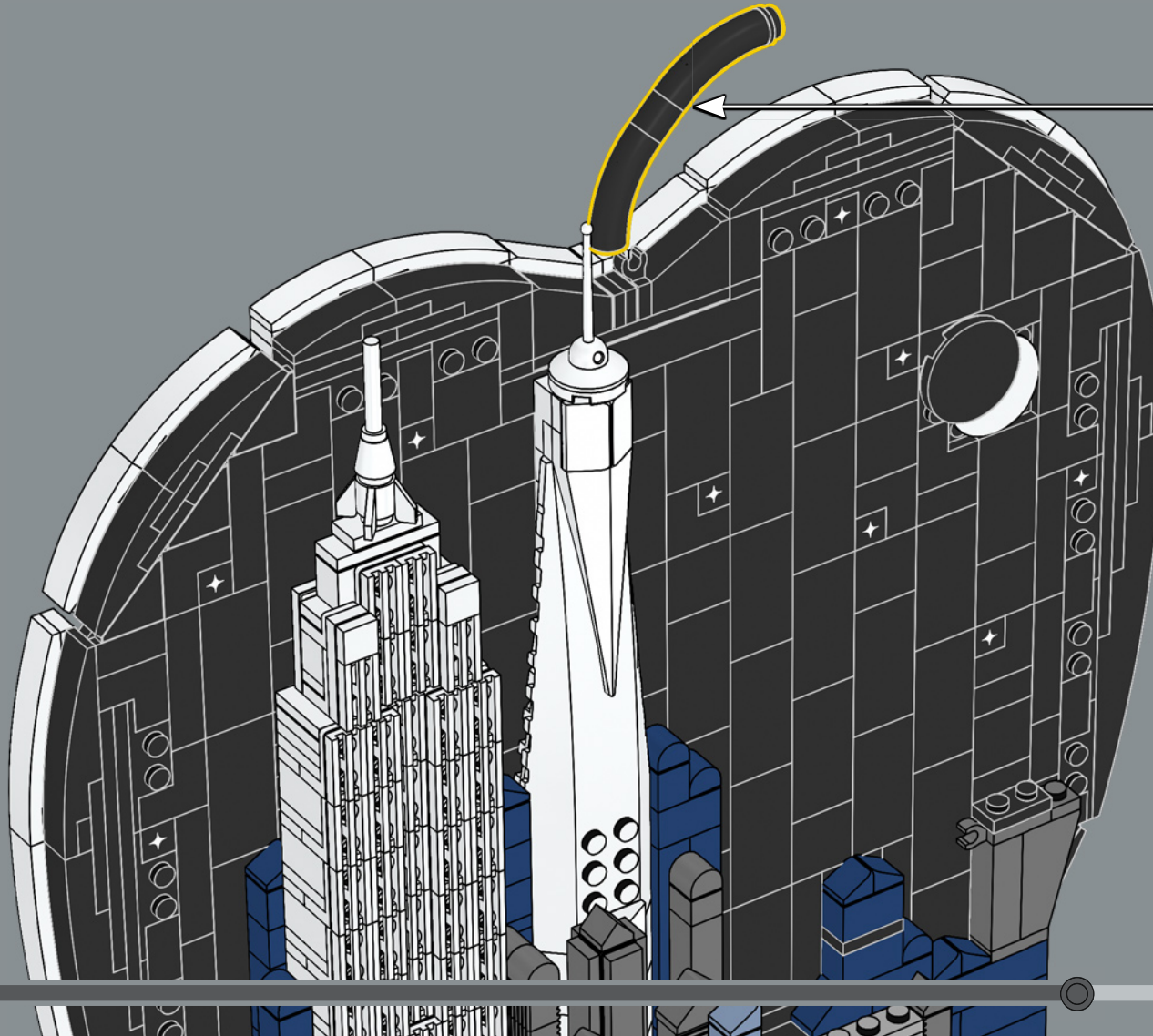
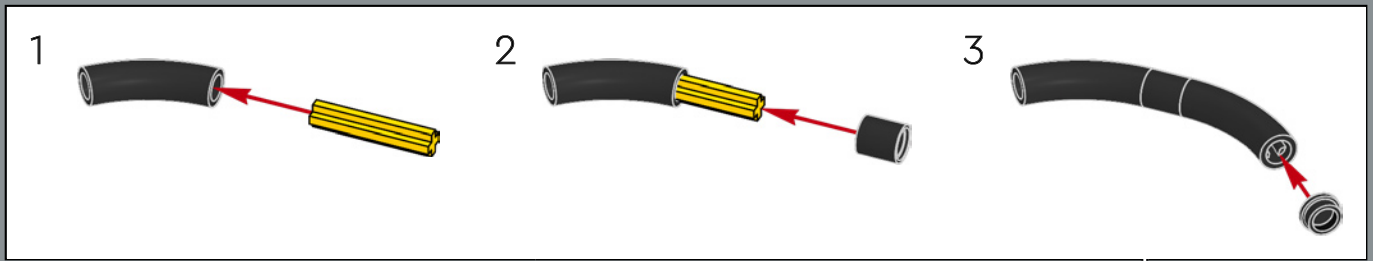

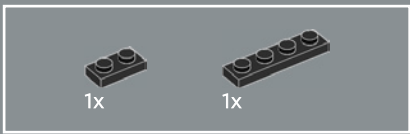

304

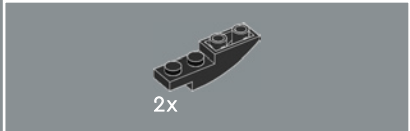
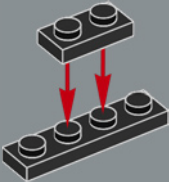

305

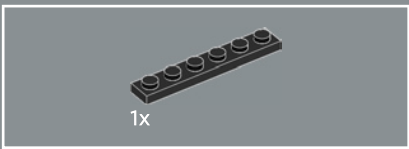
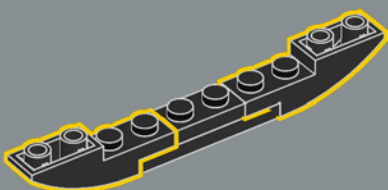

306

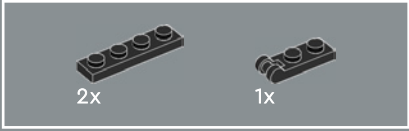
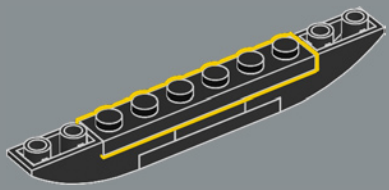

307

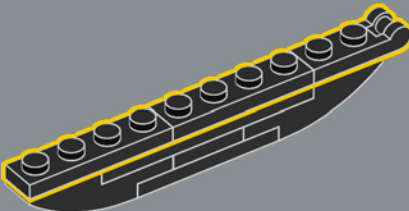

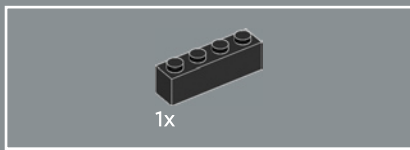

308

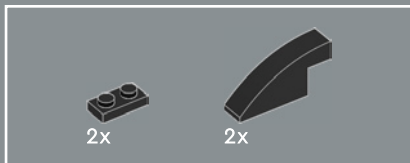
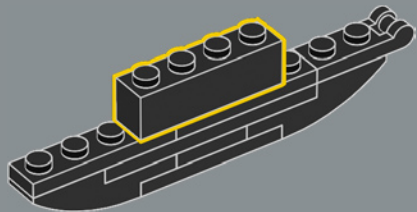

309

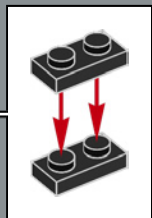
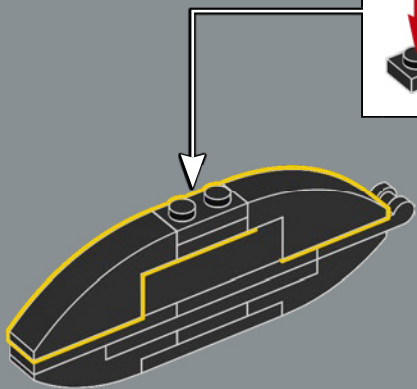

310

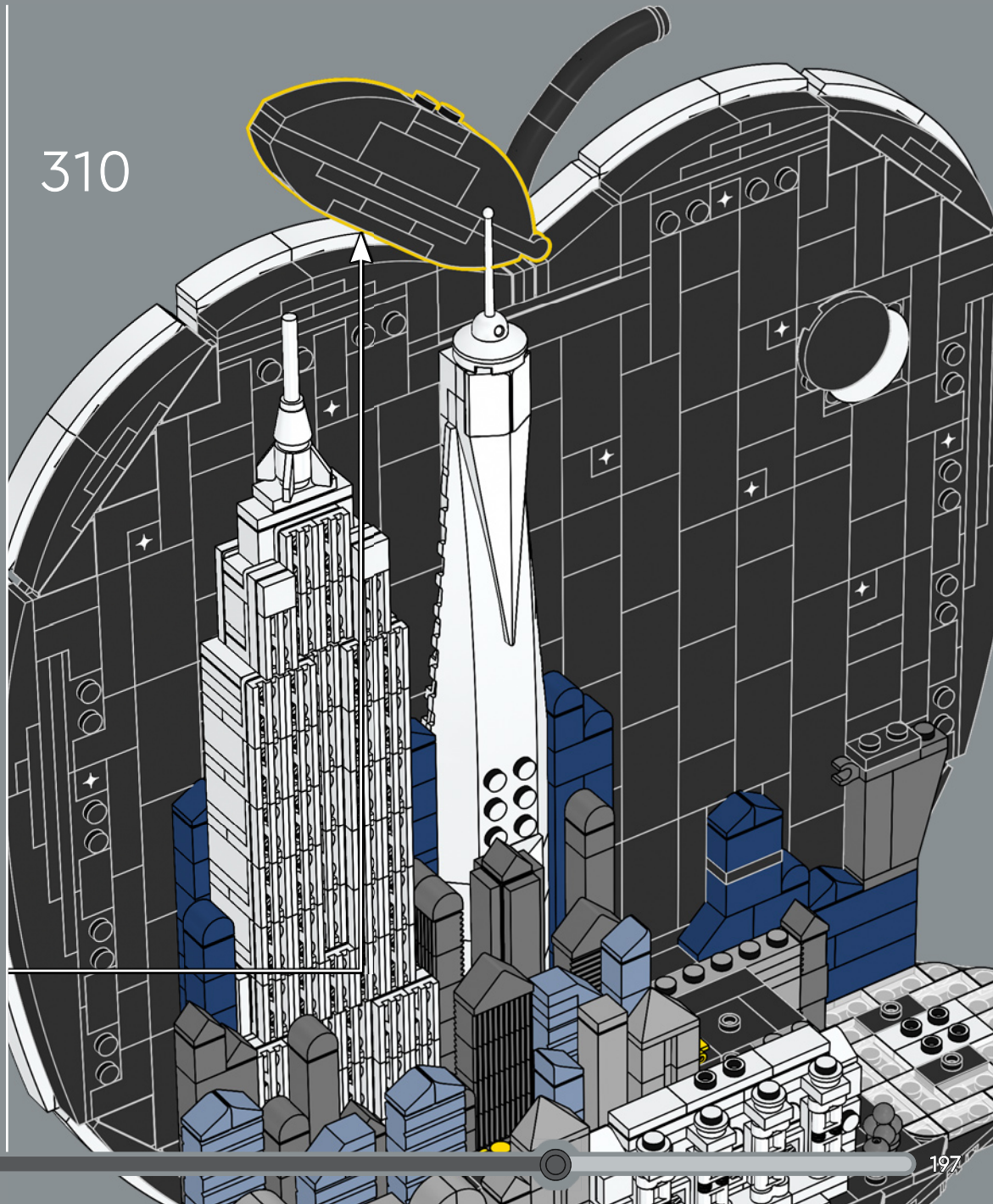

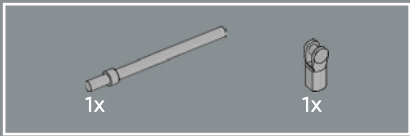

311

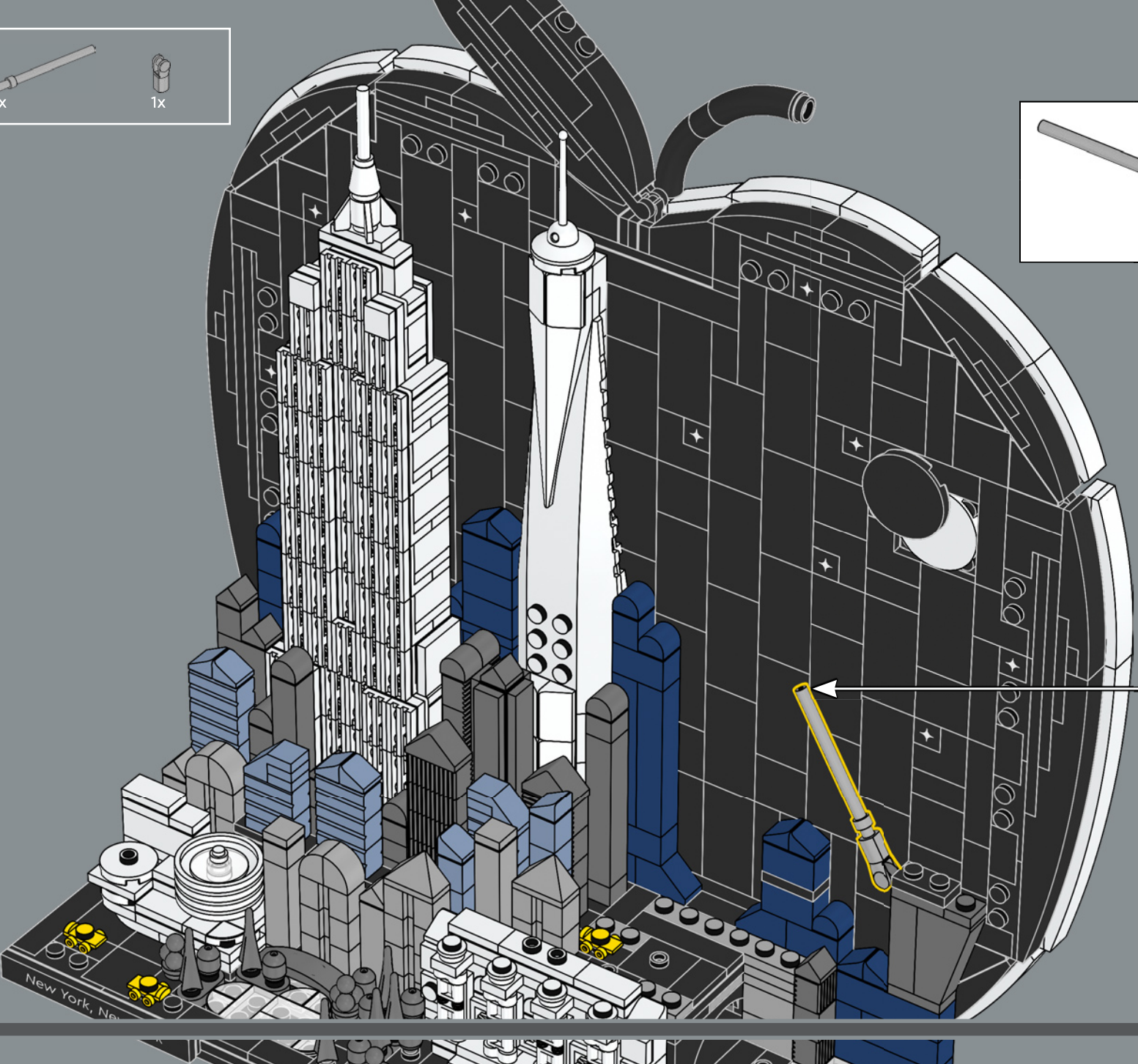
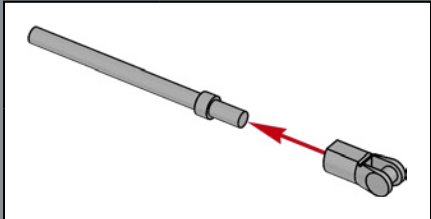

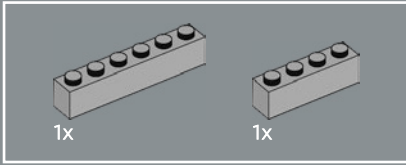
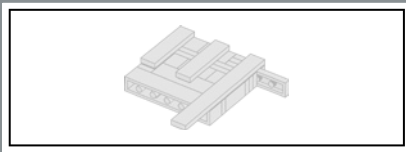

312

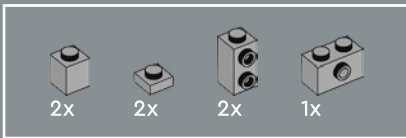
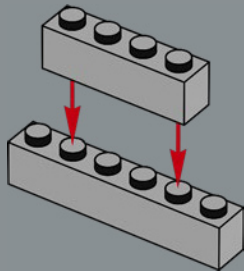

313

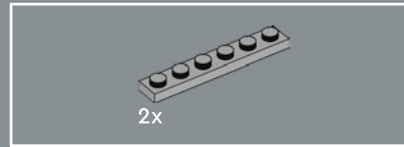
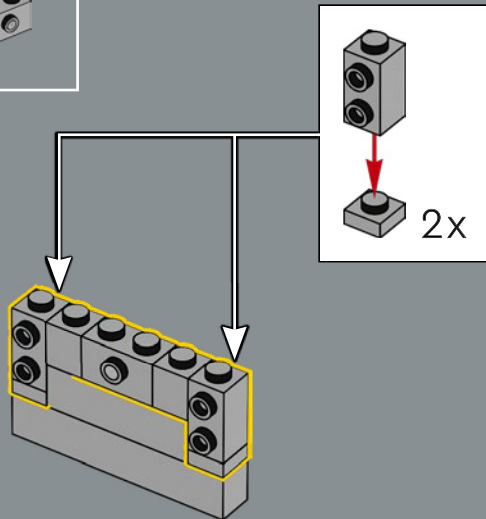

314

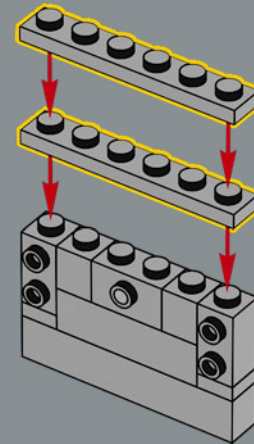

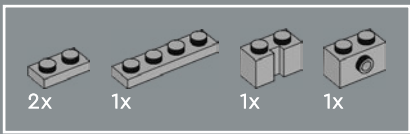

315

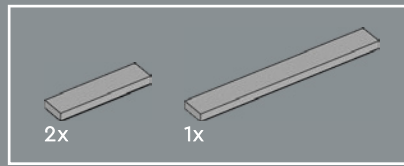
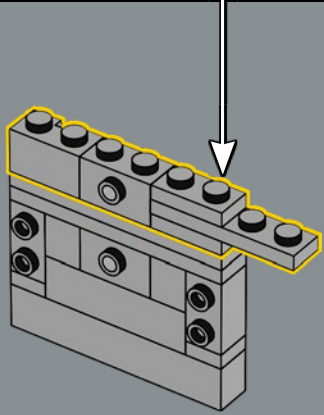
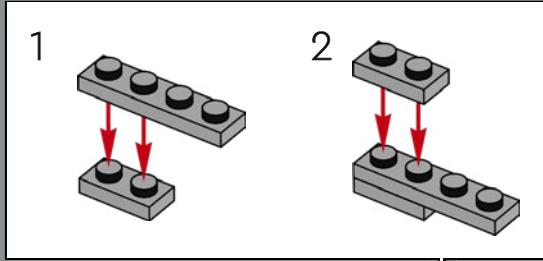

316

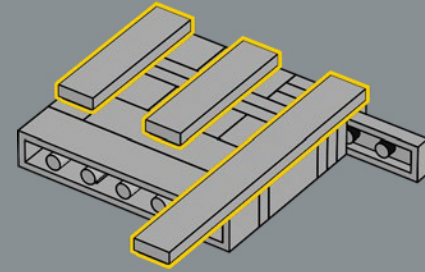

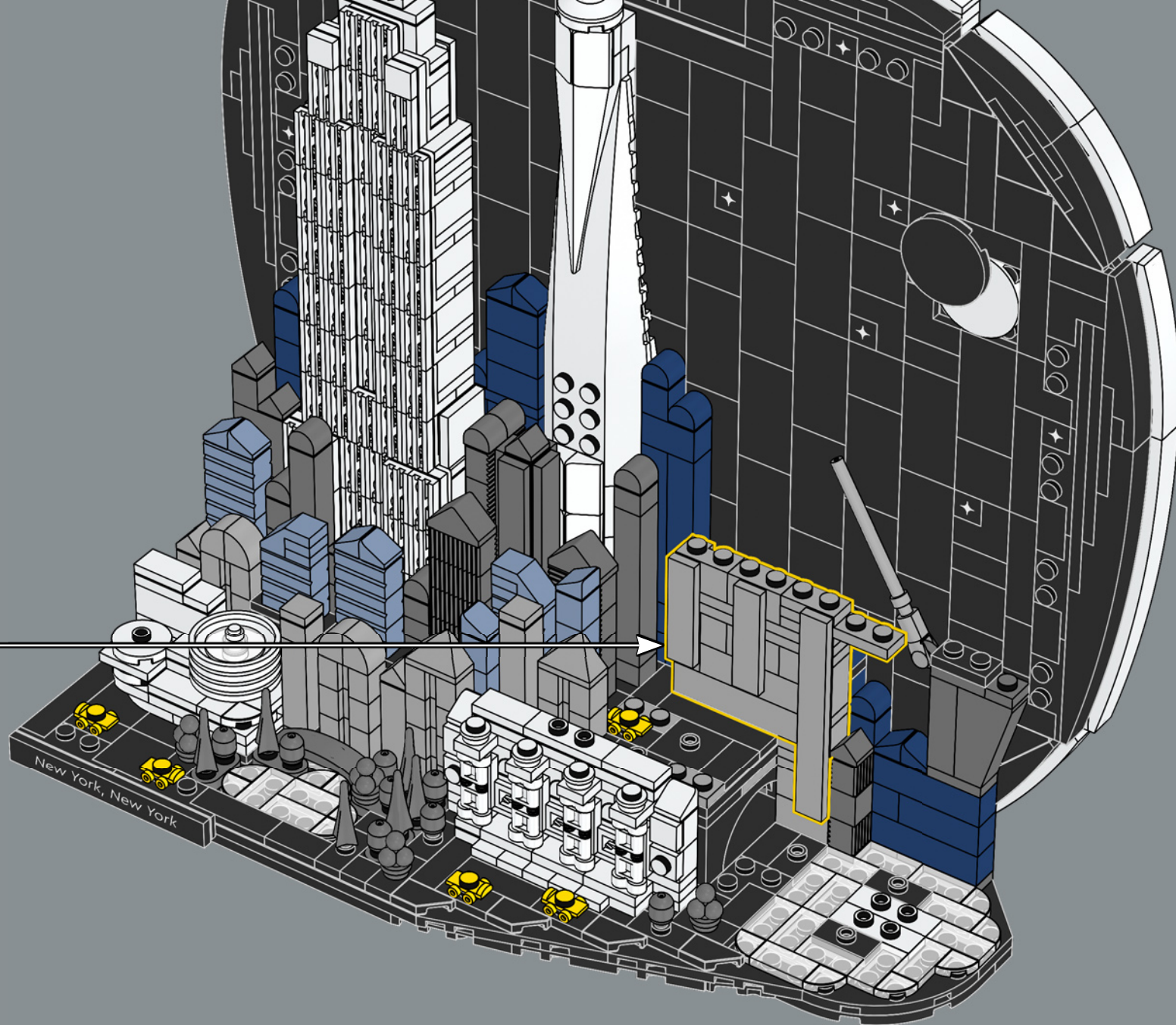

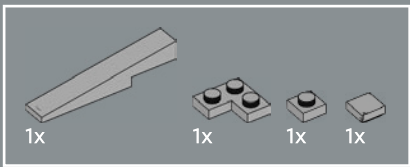

318

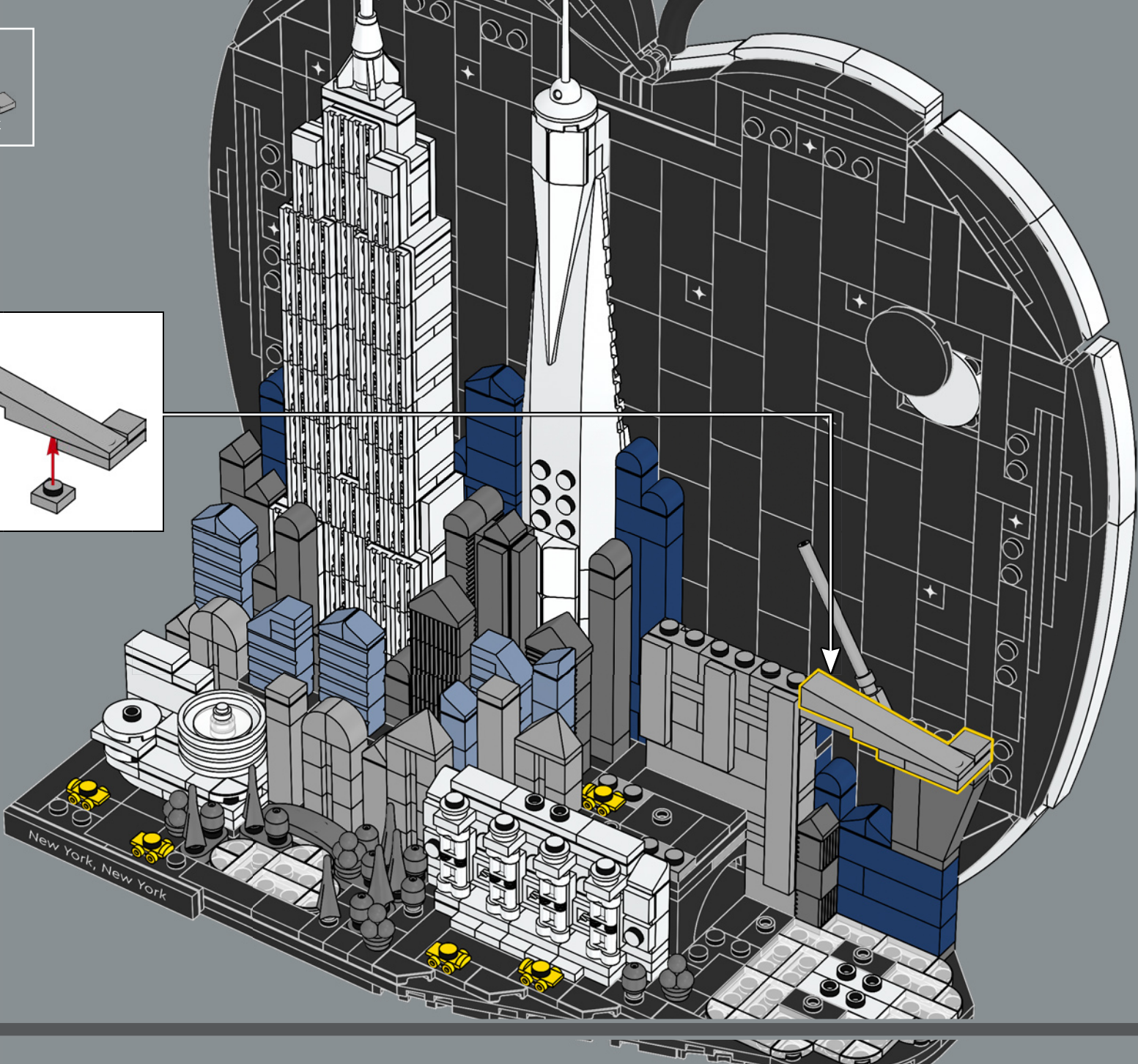
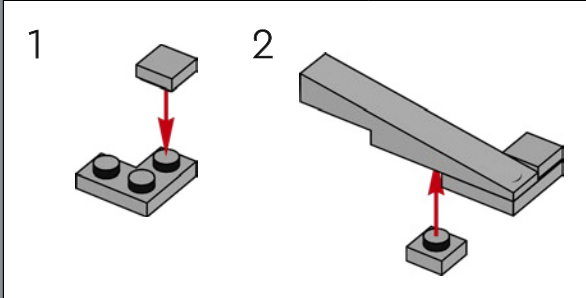



319

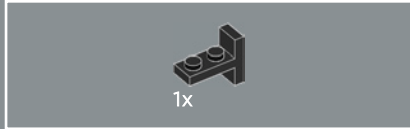

320



321

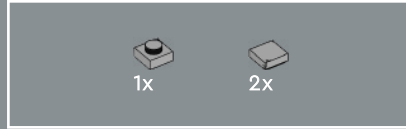
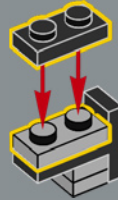

322

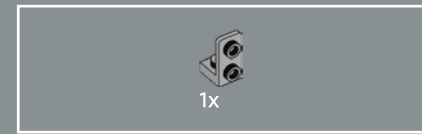
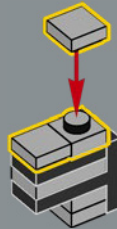

323

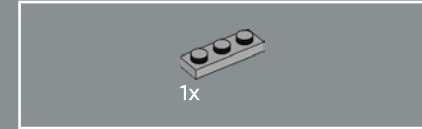
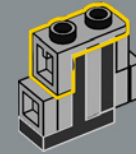

324

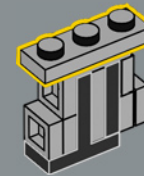

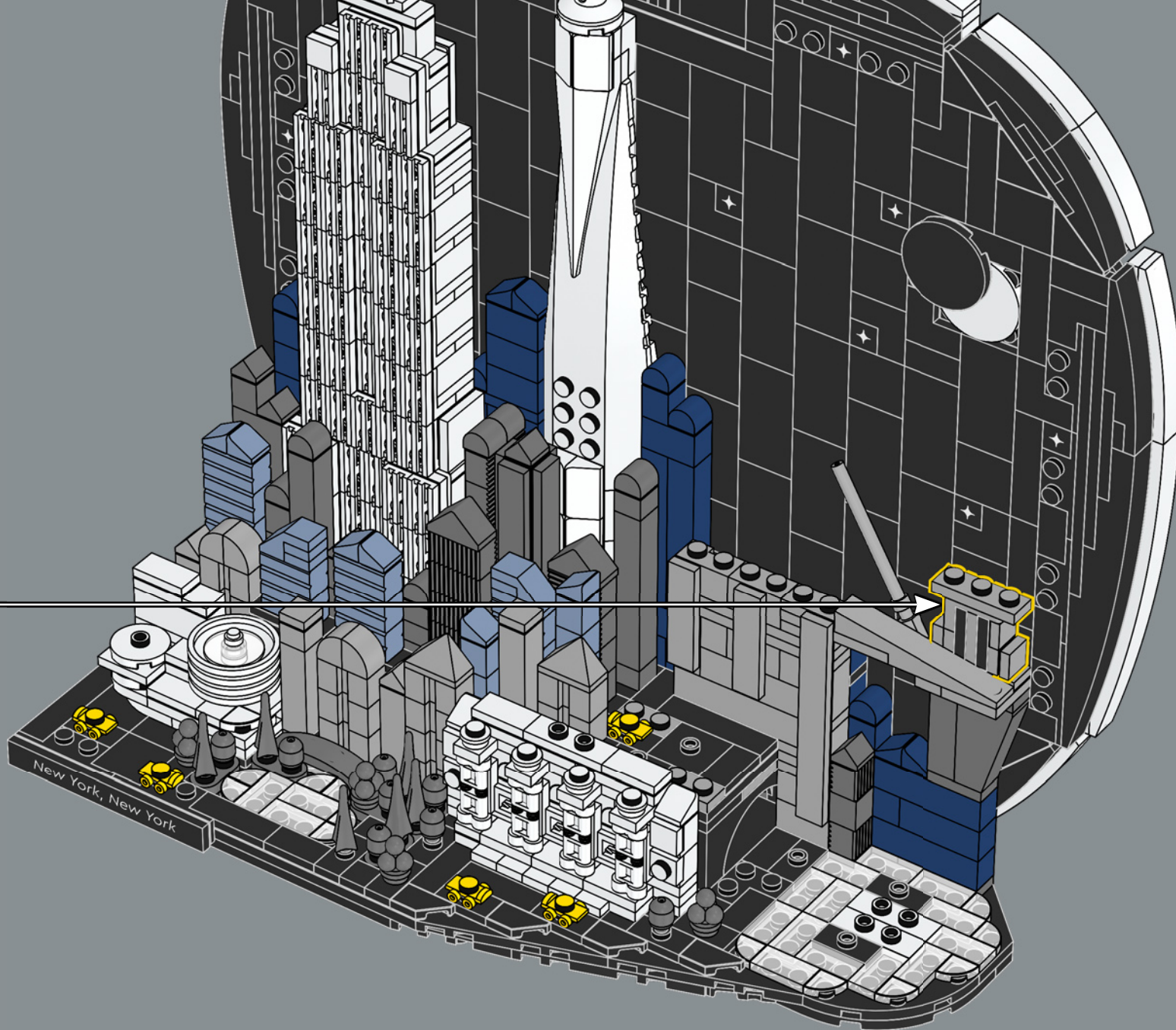

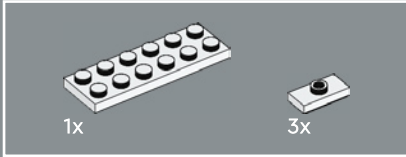
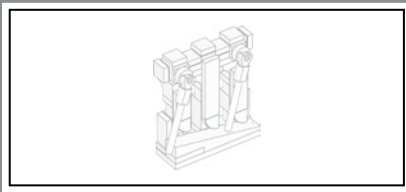

326

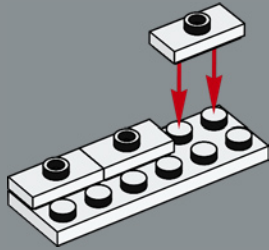

327

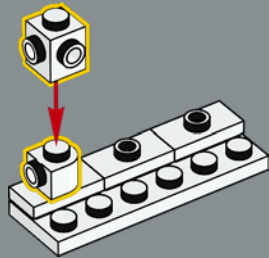

328

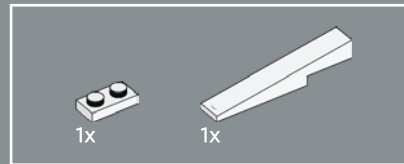
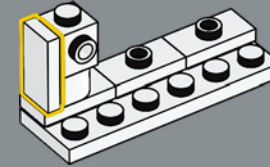

329

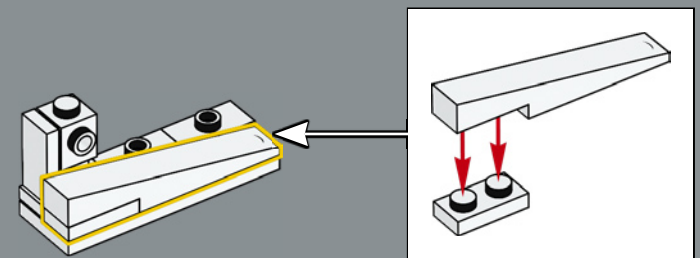

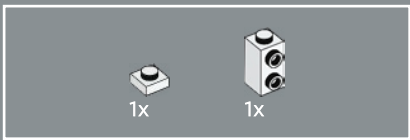

330

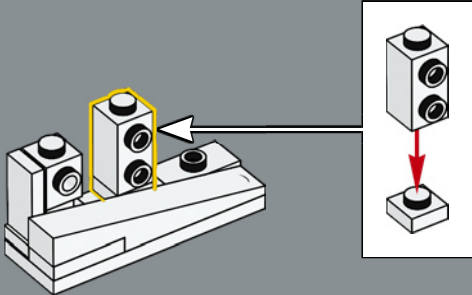

331

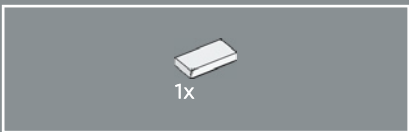
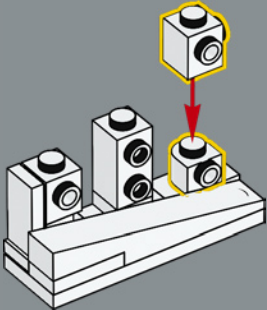

332

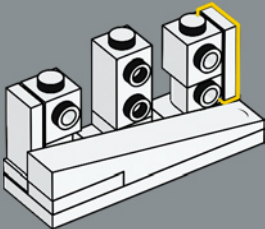

333

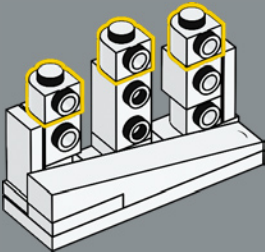



334

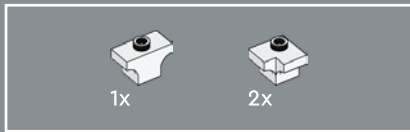
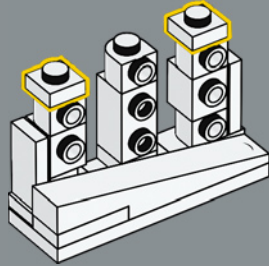

335

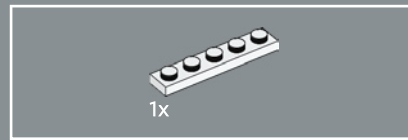
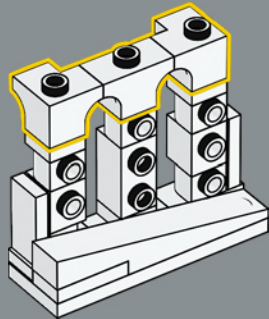

336

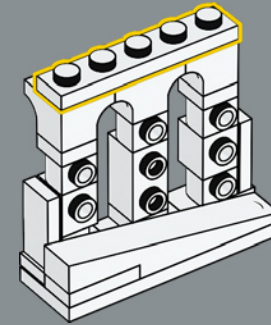

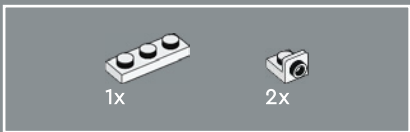

337

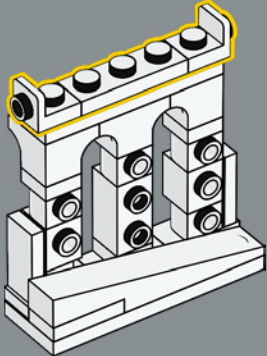

338

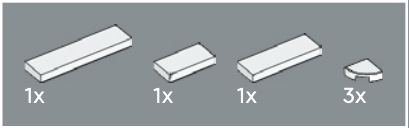
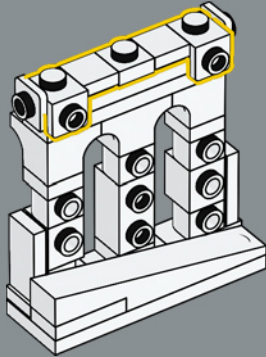

339

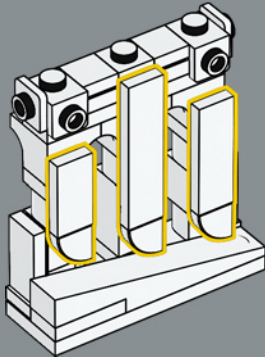



2x

340

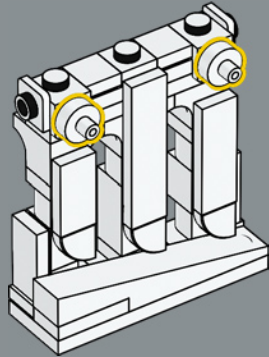

5x

341

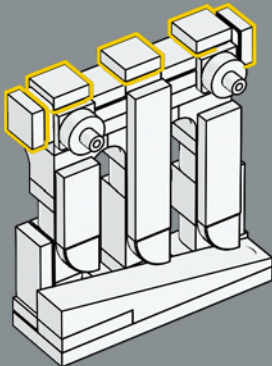

2x



2x

342

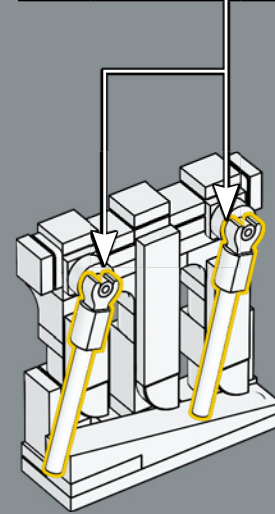
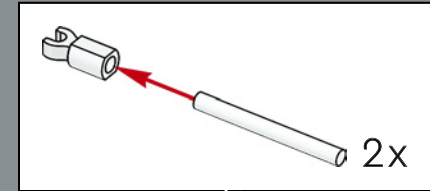

Plus de 137 000 personnes traversent le pont de Brooklyn chaque jour en voiture, à pied ou à vélo (les camions ne sont pas autorisés sur le pont).



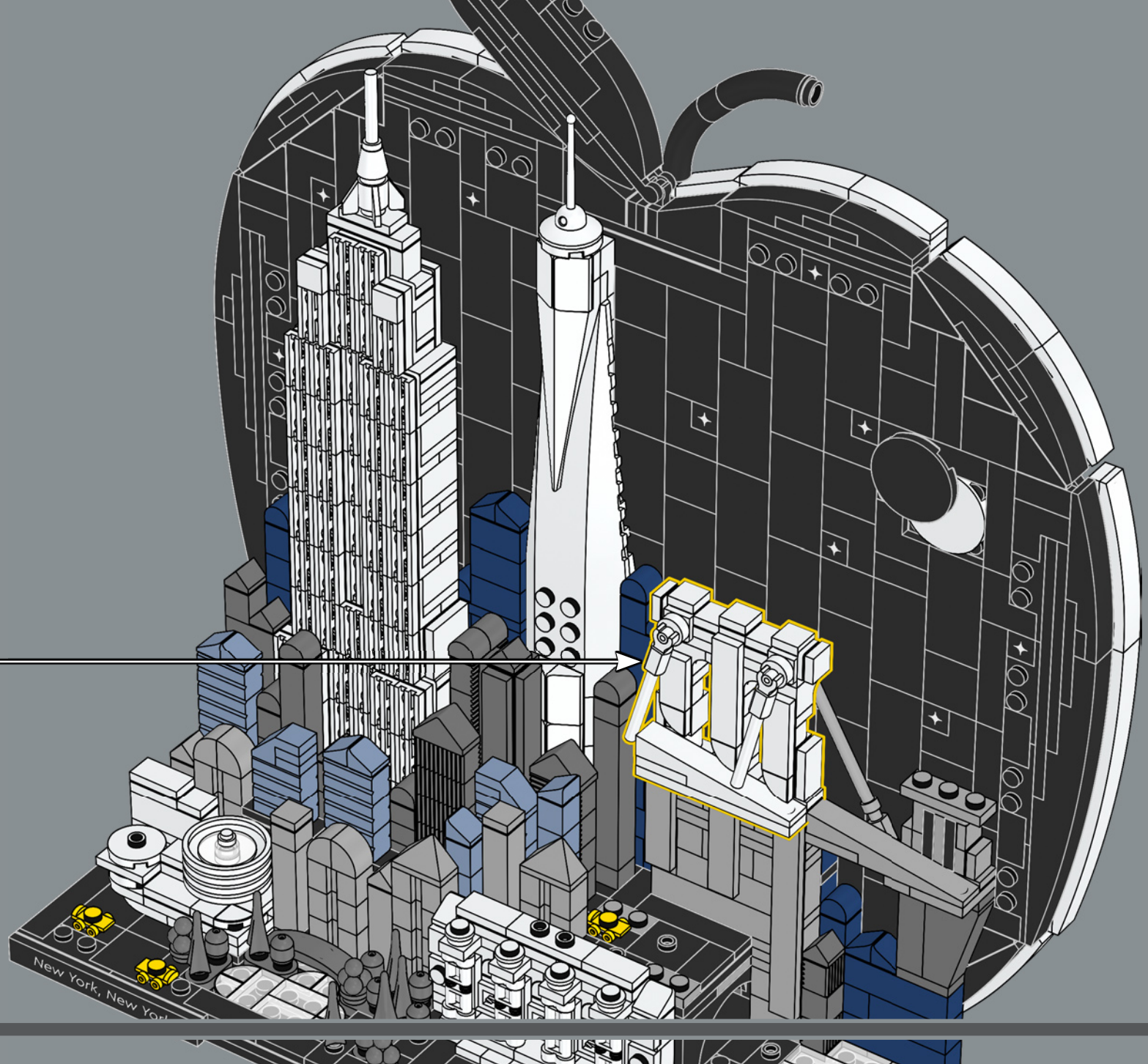

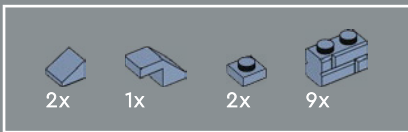

344

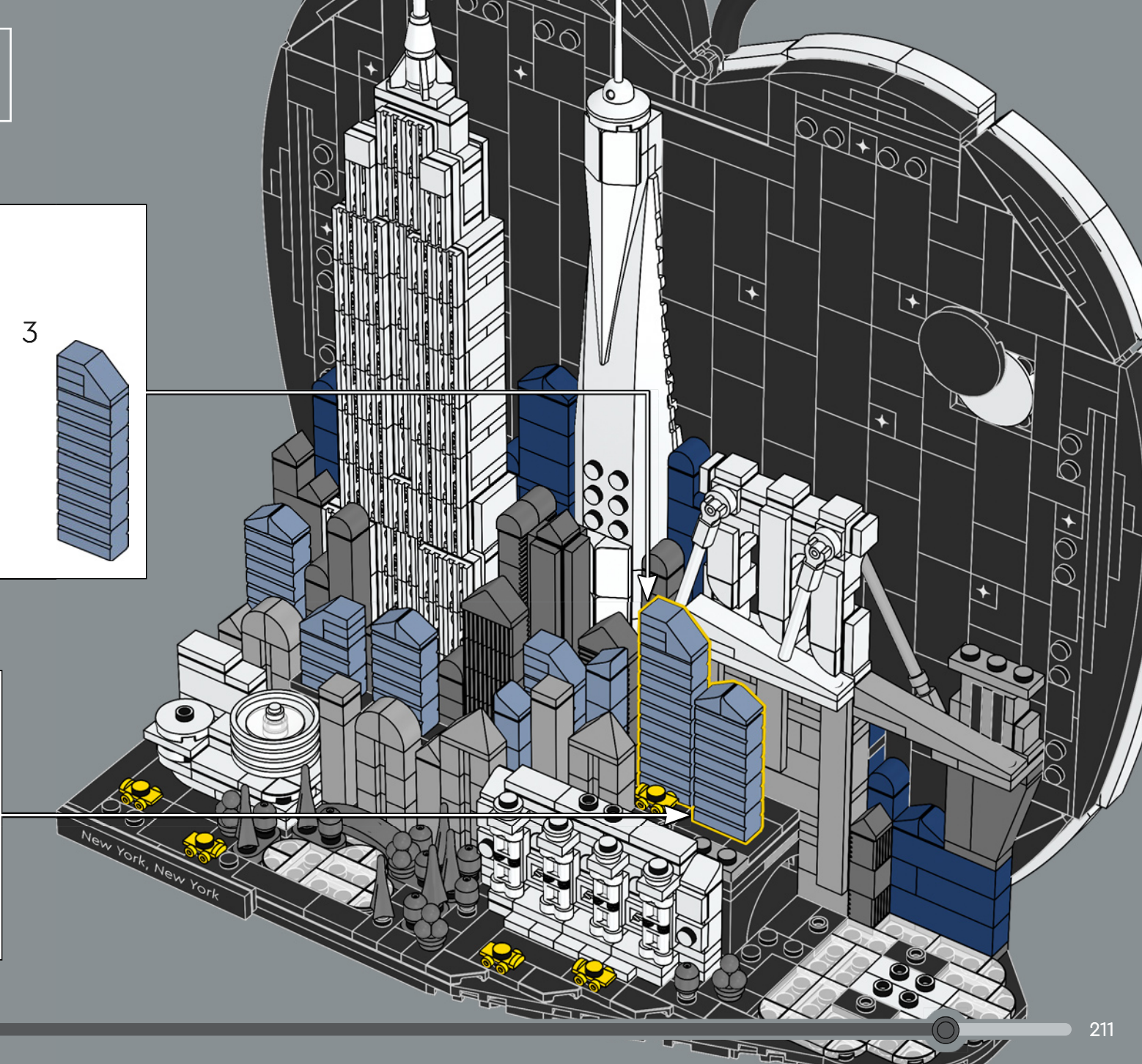
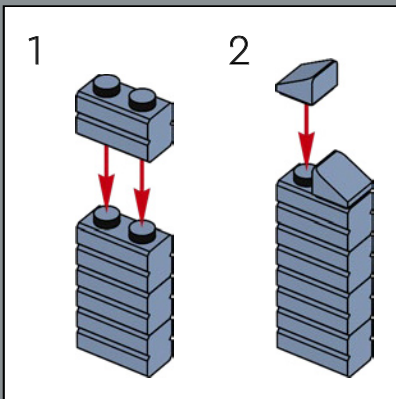
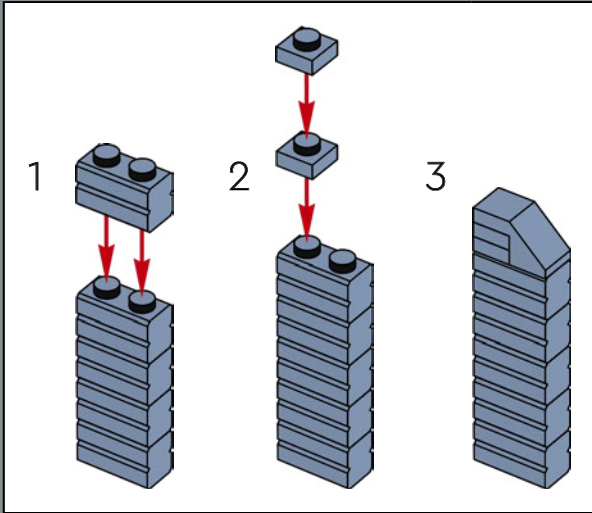

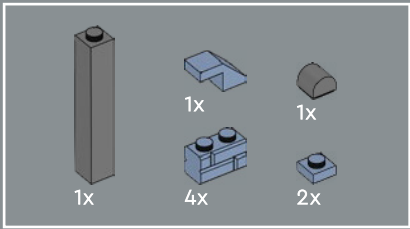

345

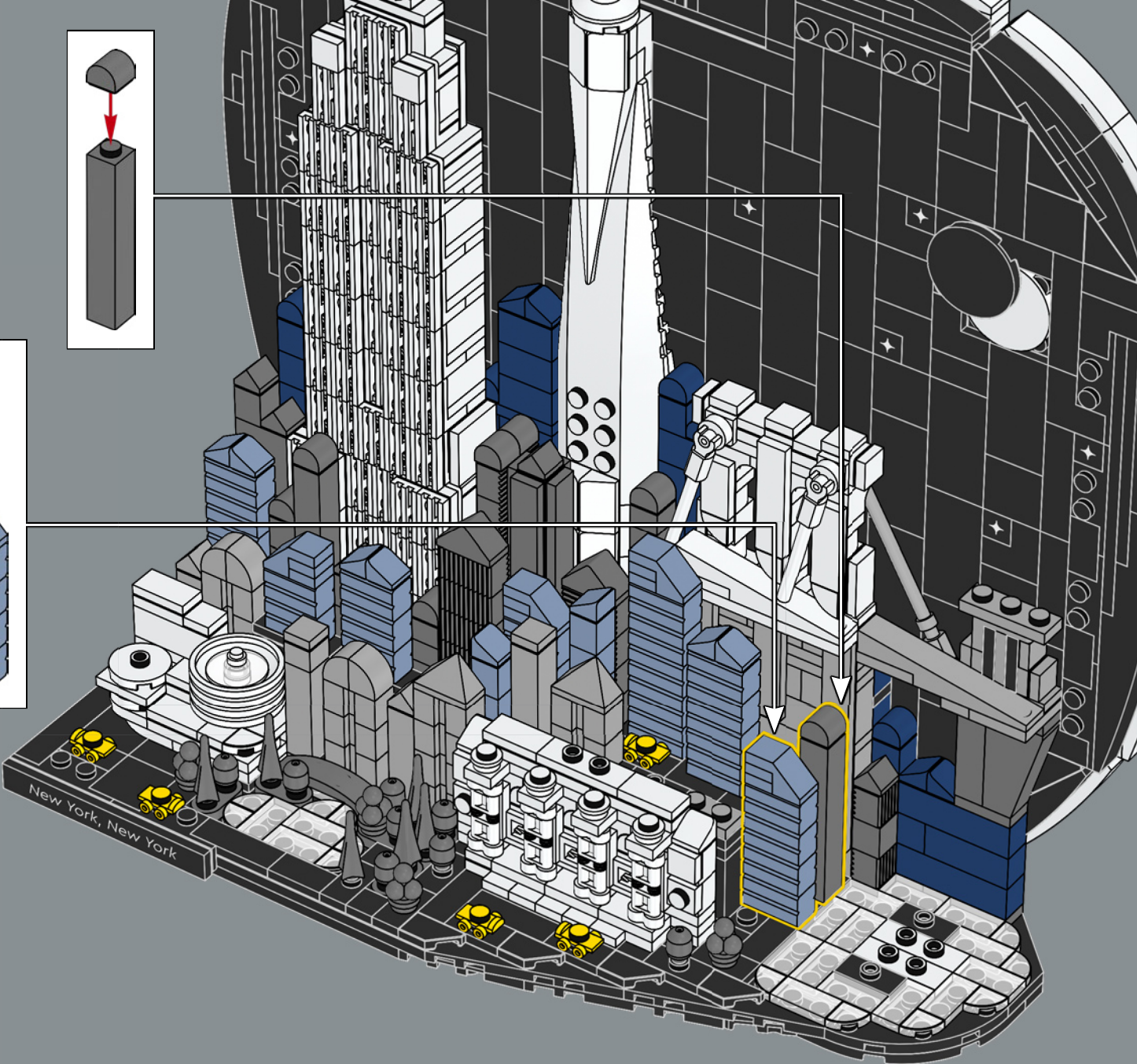
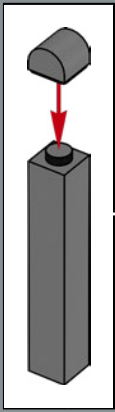
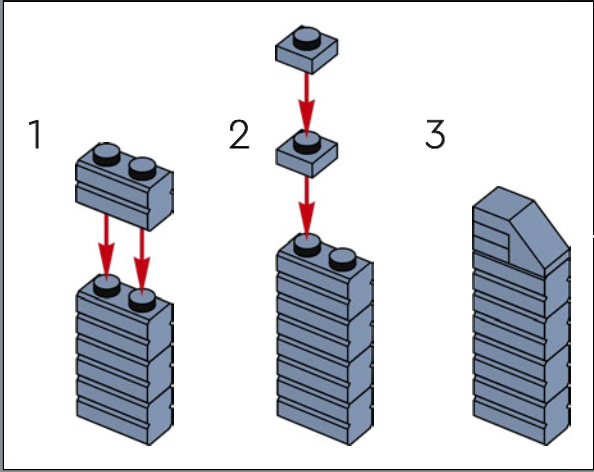

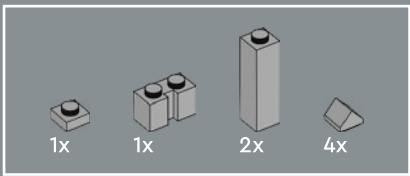

346

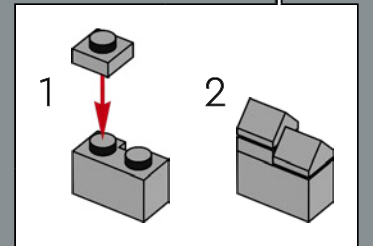
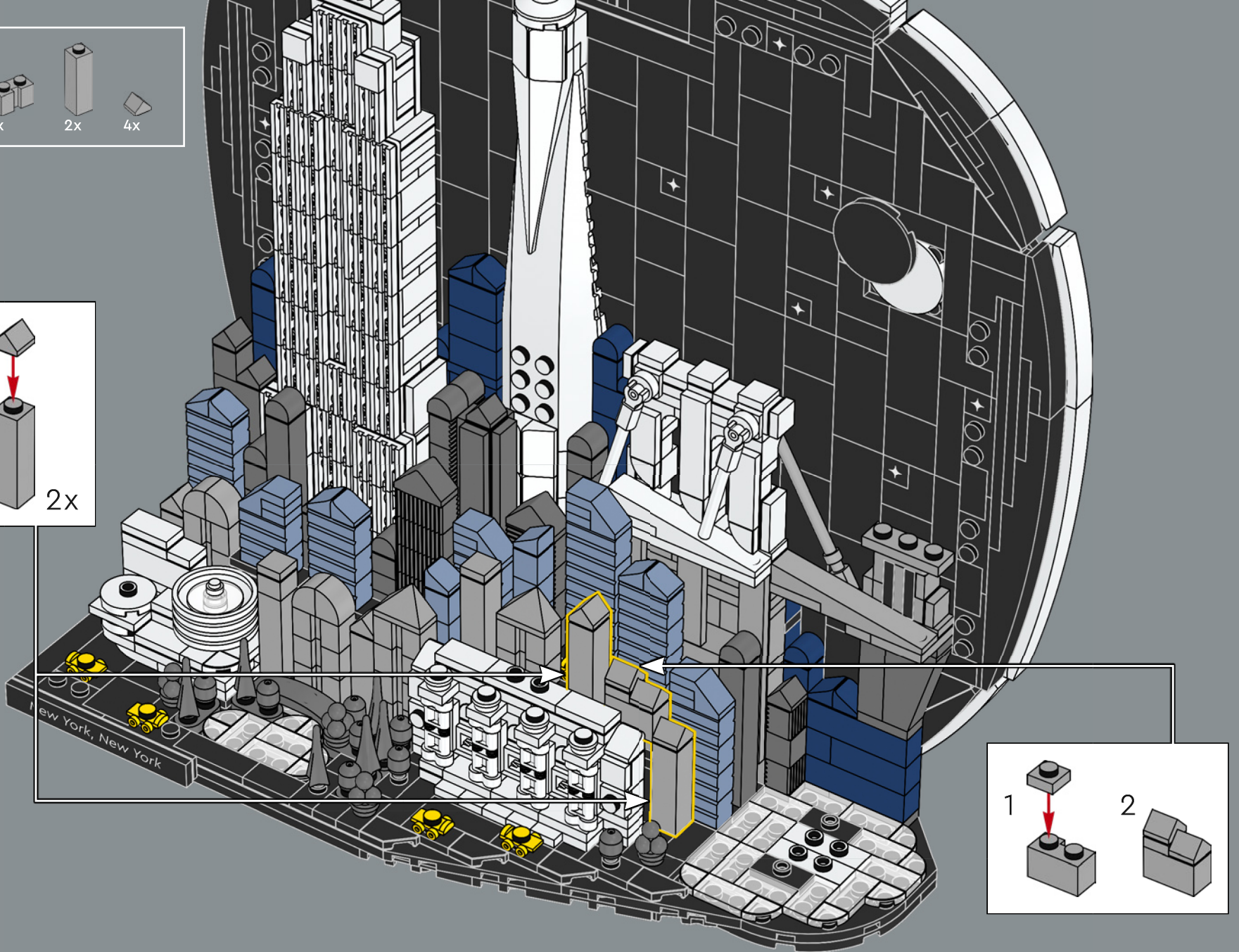
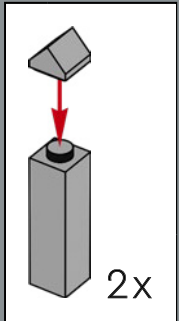

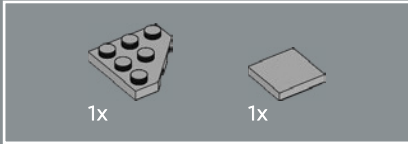

347

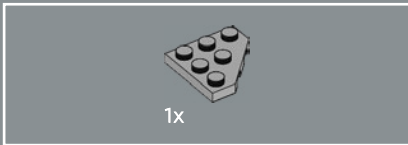
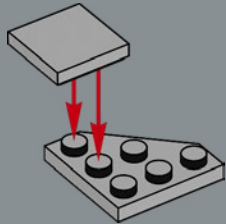

348

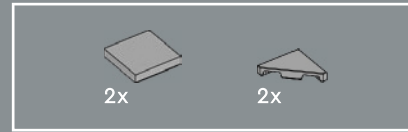
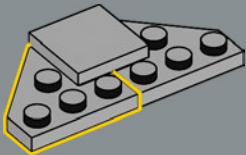

349

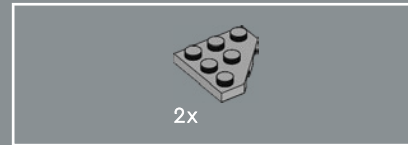
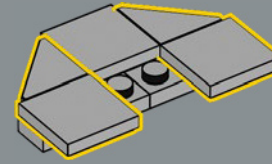

350

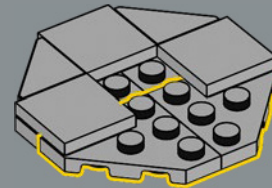

L'impressionnante Statue de la Liberté en cuivre mesure 92,9 m de haut – soit l'équivalent d'un immeuble d'environ 22 étages – du sol jusqu'au sommet de la flamme.

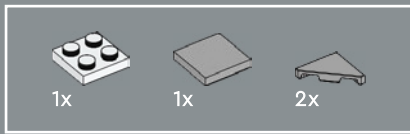

351

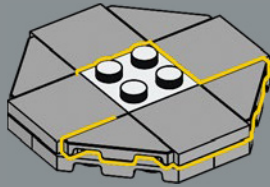

352

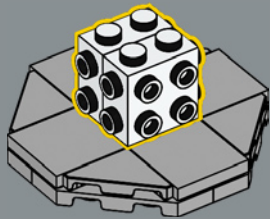

353

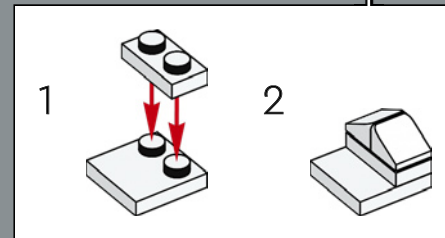
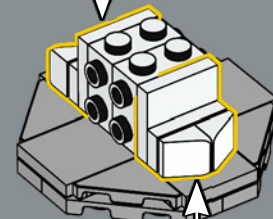
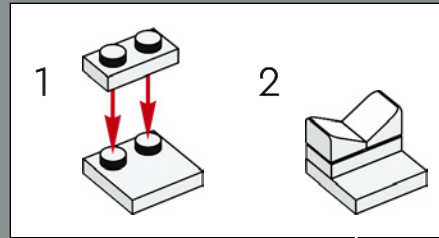



354

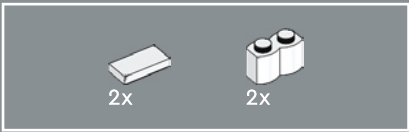
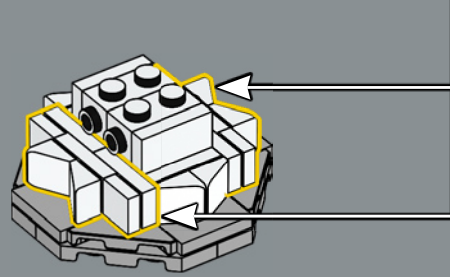
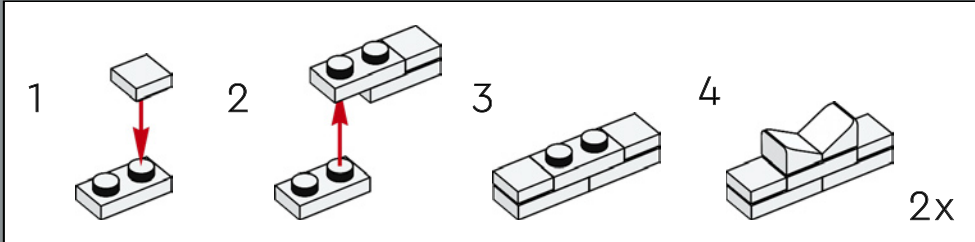

355

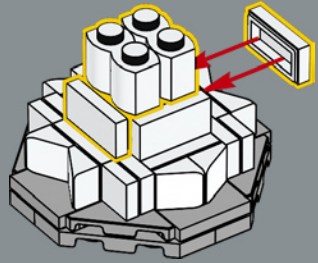



356

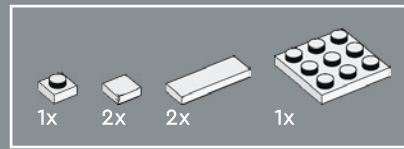
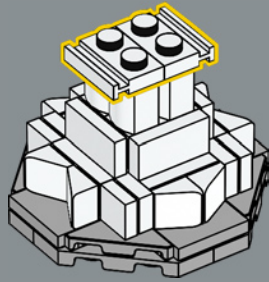

357

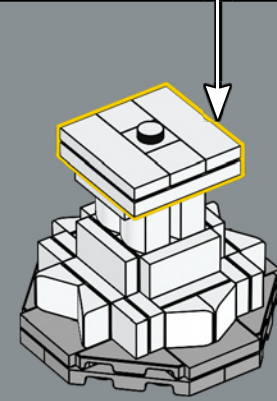
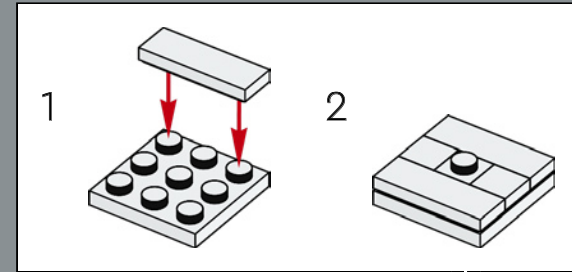

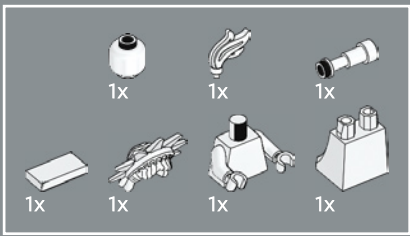

358

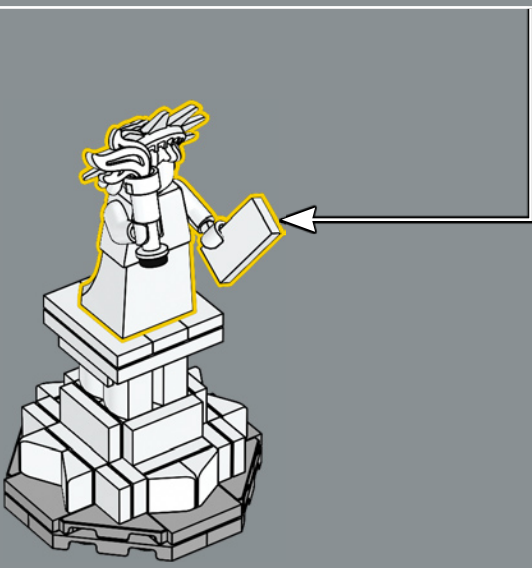
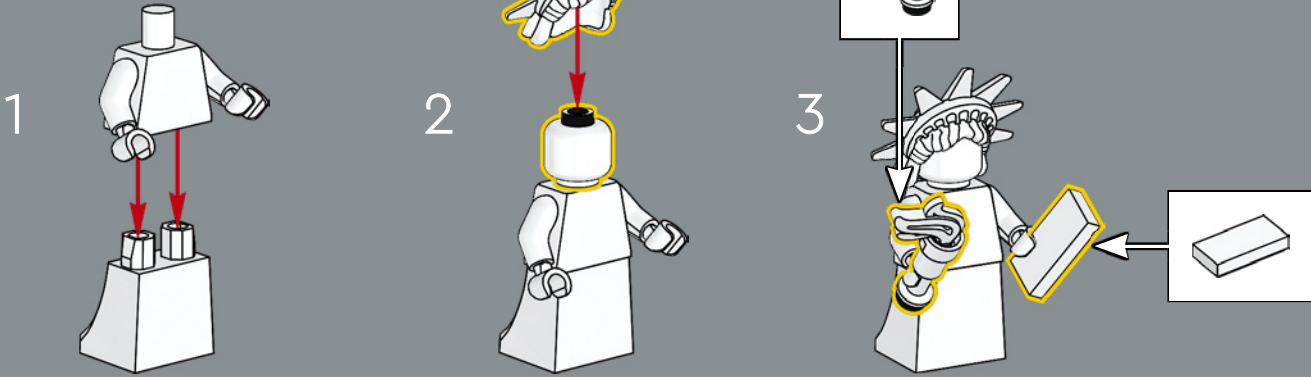

« Lady Liberty » est déjà apparue plusieurs fois sous forme de minifigurine LEGO® – la première ayant été lancée en 2012.

359

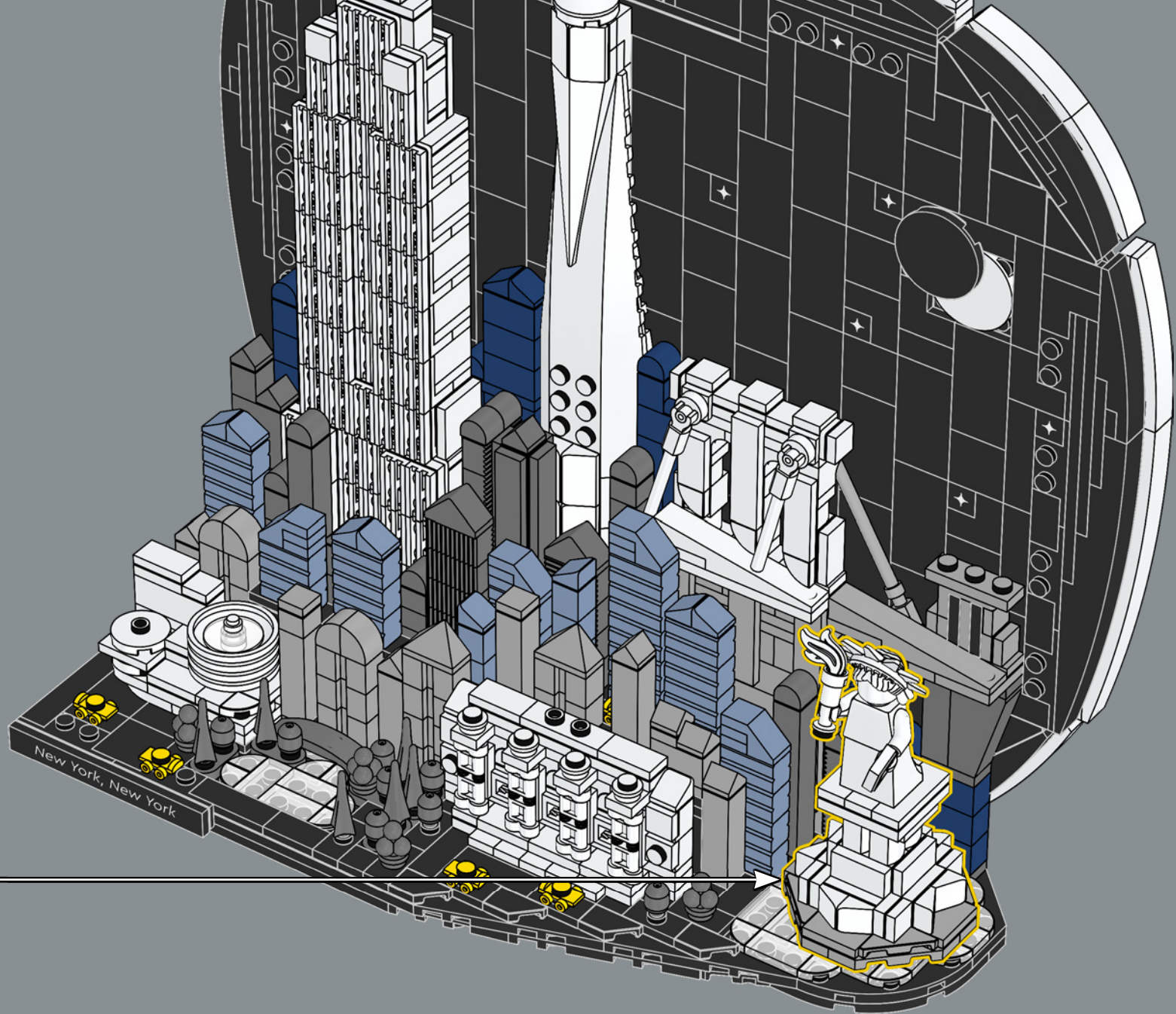

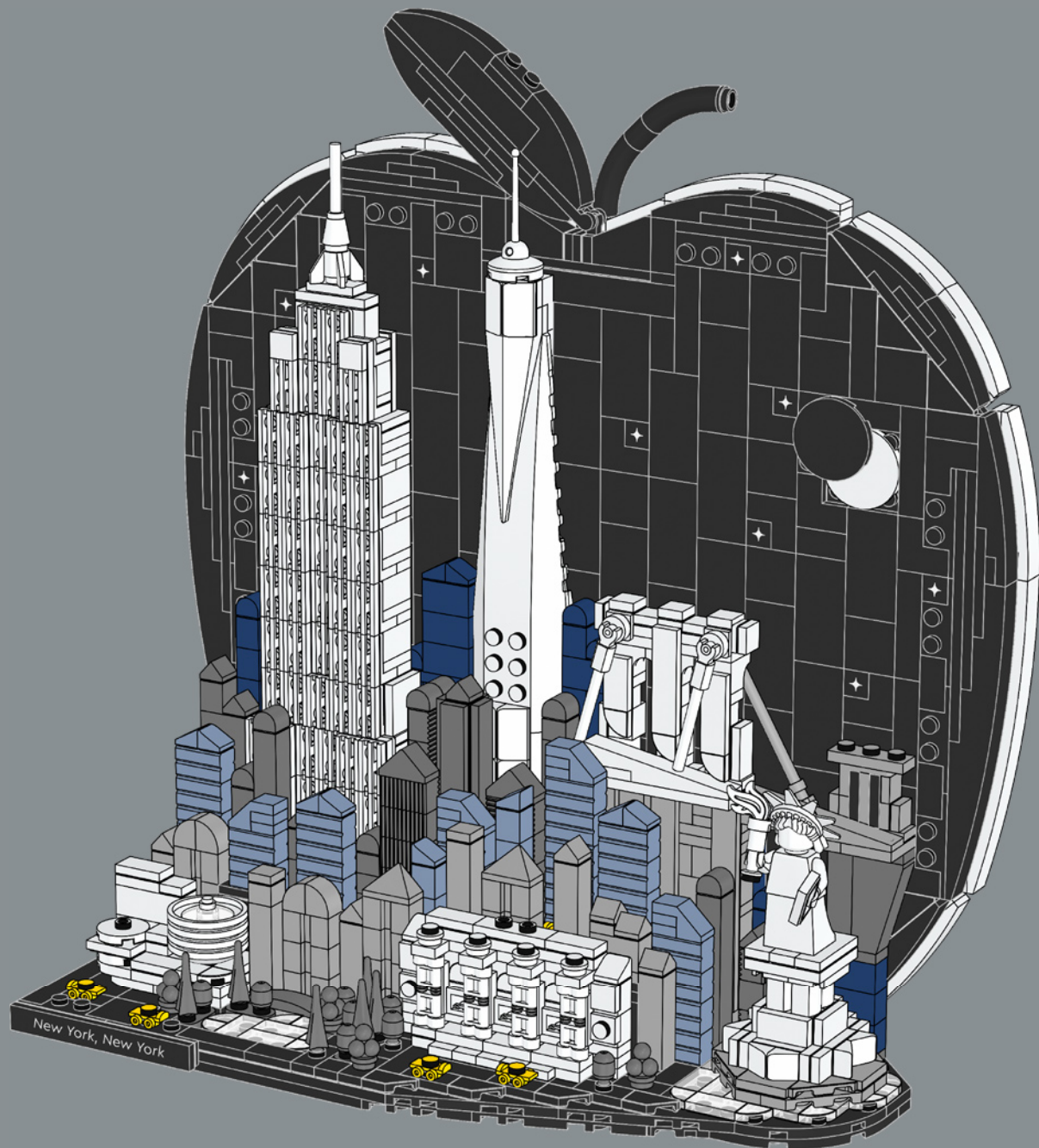

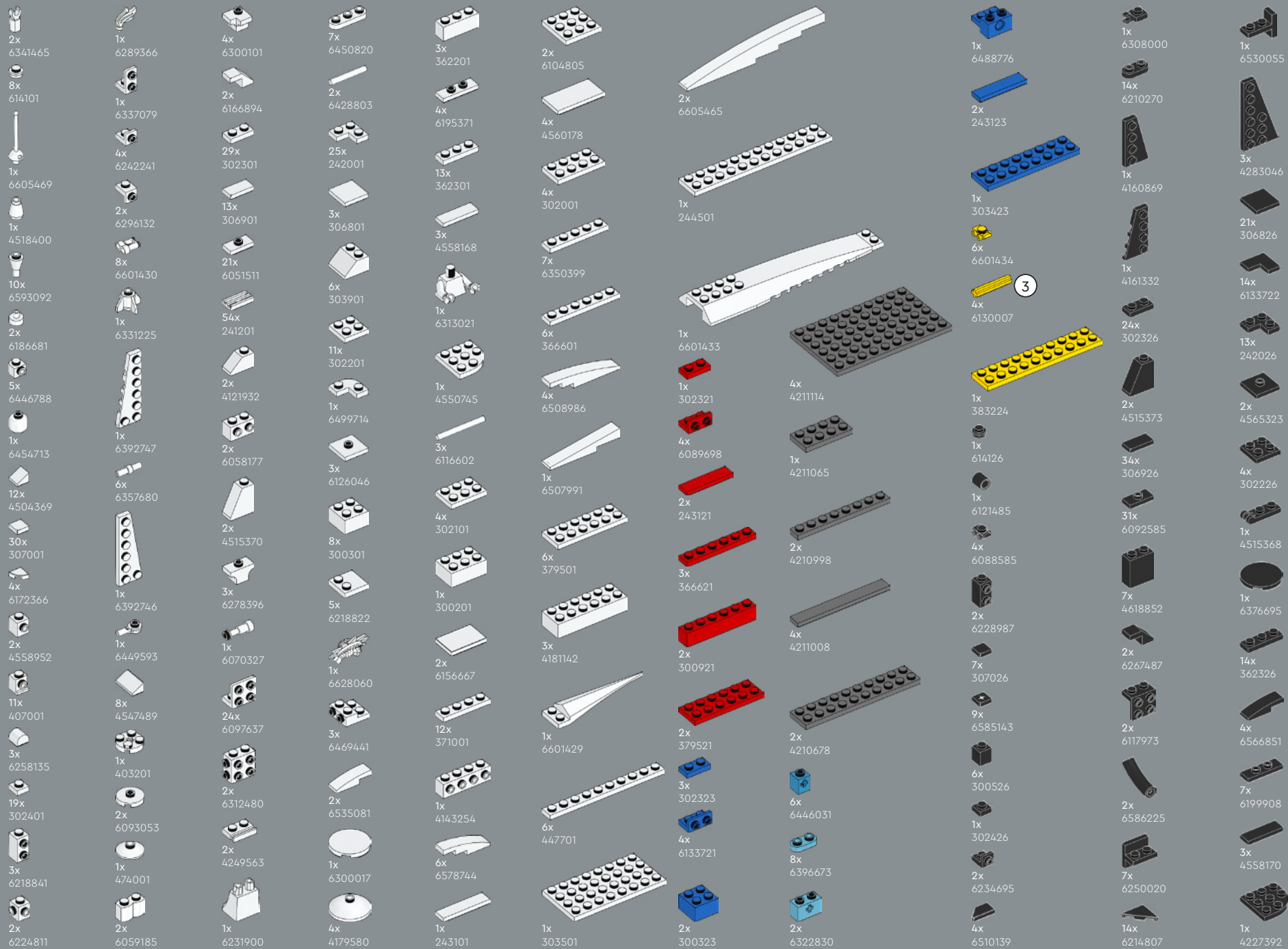

- 10x 6118829
- 2x 6168620
- 1x 4531412
- 6x 6580394
- 18x 243126
- 8x 371026
- 3x 4160025
- 1x 365926
- 1x 301026
- 2x 6039869
- 14x 302026
- 5x 663626
- 4x 6535144
- 5x 6184876
- 1x 366626
- 1x 4243819
- 1x 6101857
- 2x 4181144
- 57x 4560182
- 1x 6585142
- 8x 303226
- 2x 303426
- 1x 6037390
- 1x 4243819
- 1x 395826
- 2x 383226
- 6x 4514845
- 2x 302926
- 2x 6001494
- 2x 6601431
- 1x 4166619
- 1x 6372045
- 5x 346026
- 4x 379526
- 6x 4106977
- 2x 6509390
- 1x 6439175
- 8x 4504374
- 6x 6403899
- 6x 4255413
- 6x 6595205
- 15x 4249891
- 4x 6103405
- 6x 6233955
- 9x 4177735
- 3x 4264569
- 1x 6343976
- 13x 4211399
- 6x 6253436
- 2x 6401023
- 2x 6225242
- 2x 4211389
- 5x 4211415
- 4x 4211476
- 4x 6522869
- 7x 6061702
- 1x 6345639
- 2x 6075075
- 4x 6407767
- 4x 4211526
- 15x 4617170
- 2x 6383177
- 7x 4211398
- 1x 4211388
- 4x 6066097
- 4x 6134378
- 4x 6217876
- 14x 4211397
- 1x 4211387
- 1x 4211353
- 4x 4211413
- 2x 6569357
- 1x 4211429
- 4x 4211361
- 1x 6421522
- 4x 4160560
- 11x 4211445
- 1x 4211394
- 2x 4211356
- 6x 6015347
- 8x 6442144
- 1x 6170418
- 3x 4211393
- 3x 4211438
- 1x 6508016
- 4x 4243797
- 4x 4211452
- 2x 4211392
- 1x 4211481
- 4x 4211402
- 1x 4211401
- 4x 4662161
- 3x 4210690
- 2x 4210700
- 7x 6221607
- 2x 4226221
- 12x 6514469
- 1x 6514246
- 17x 6514223
- 8x 6062686
- 7x 4620077
- 8x 6257079
- 4x 6248952
- 28x 6417947
- 1x 383228
- 2x 302028
- 8x 6344216
- 16x 4210636
- 9x 4211063
- 3x 4210978
- 4x 6092572
- 10x 4211098
- 5x 6262021
- 7x 6333129
- 1x 4210719
- 5x 6388133
- 8x 4648256
- 1x 4648256
- 1x 4500975
- 1x 6336990
- 2x 4211104
- 5x 4211133
- 1x 4648256
- 1x 6240515



 [LEGO.com/service](https://www.LEGO.com/service)



YOU COULD
WIN



**YOU COULD
WIN**

Your feedback will help shape the future development of this product series.

Visit:

**DU KÖNNTEST
GEWINNEN**

Dein Feedback trägt zur Weiterentwicklung dieser Produktreihe bei.

Geh auf:

**VOUS POURRIEZ
GAGNER**

Vos commentaires nous aideront à concevoir les futurs produits de cette gamme.

Visitez :

**POTRESTI
VINCERE TU**

La tua opinione ci aiuterà a migliorare la creazione futura di questa linea di prodotti.

Visita:

**PUEDES
GANAR**

Tu opinión contribuirá al futuro de esta serie de productos.

Visita:

轻松获奖

您的反馈将有助于我们在今后改进本产品系列。

请访问:

LEGO.com/productfeedback

You also have the chance to win a LEGO® set.

Terms and conditions apply.*

Außerdem hast du die Chance, ein LEGO® Set zu gewinnen.

Es gelten die Teilnahmebedingungen.*

Vous pourriez également gagner un ensemble LEGO®.

Des conditions s'appliquent.*

Hai anche la possibilità di vincere un set LEGO®.

Termini e condizioni sono applicabili.*

También tienes la oportunidad de ganar un set LEGO®.

Aplican términos y condiciones.*

您还有机会赢取乐高®套装。

条款和条件适用。*

*LEGO.com/productfeedback-terms

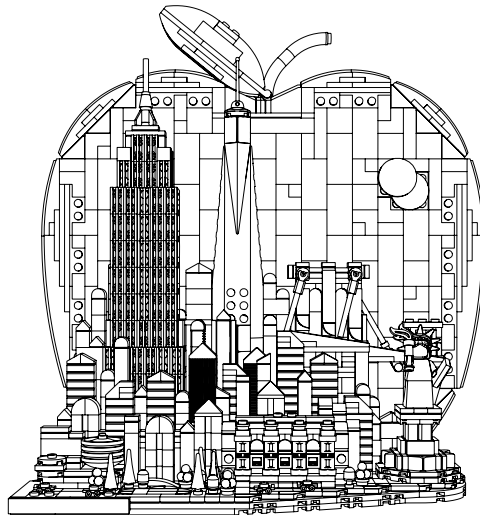

LEGO and the LEGO logo are trademarks of the LEGO Group. ©2026 The LEGO Group.

The EMPIRE STATE BUILDING name and image are registered trademarks and used with permission.

The name and building image of the Solomon R. Guggenheim Museum are trademarks of the Solomon R. Guggenheim Foundation. Used with permission.

® /™ /© Frank Lloyd Wright Foundation. All Rights Reserved.

One World Trade Center building design is a copyright of WTC Tower 1 LLC. Used under license.

Adam Reed Tucker is the co-developer of the LEGO® Architecture product line.