



21066





[LEGO.com/sustainable-packaging](https://LEGO.com/sustainable-packaging)



FR  
**DONNEZ  
OU  
RECYCLEZ**



ASSOCIATION

OU



MAGASIN

OU



DÉCHÈTERIE

Adresses sur [quefairedemesdechets.fr](https://quefairedemesdechets.fr)



# BUILDER



Apple and the Apple logo are trademarks of Apple Inc., registered in the U.S. and other countries and regions. App Store is a service mark of Apple Inc. Google Play and the Google Play logo are trademarks of Google LLC. Tencent and the Tencent logo are trademarks of Tencent Inc.

[LEGO.com/devicecheck](https://LEGO.com/devicecheck)

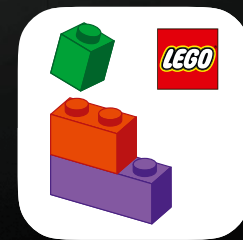

LEGO® Builder



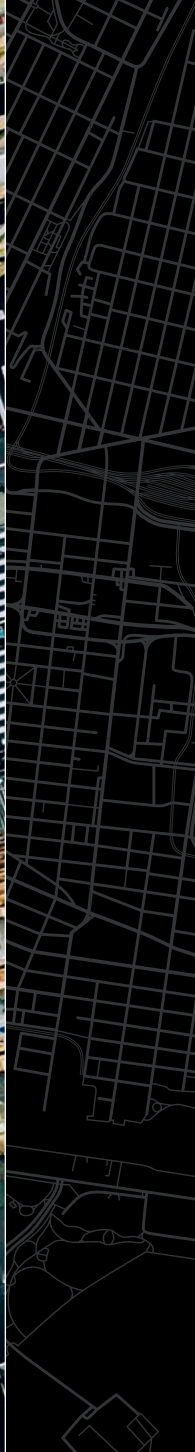



# LA GRAN MANZANA

Nueva York: la ciudad que nunca duerme, la ciudad de los sueños, la Gran Manzana. Una urbe con muchos nombres que aluden a un lugar repleto de energía y oportunidades. Fundada en 1624 como Nueva Ámsterdam, ha evolucionado hasta convertirse en un referente cultural, comercial, artístico y de innovación de primer orden. La emblemática silueta urbana de Nueva York presenta monumentos inconfundibles repartidos por sus cinco distritos. Desde la Estatua de la Libertad dando la bienvenida a los recién llegados hasta las animadas calles que nos inspiran a perseguir nuestros sueños, el incomparable pulso de esta ciudad conquista el corazón de visitantes y residentes por igual. Solo en el distrito de Manhattan viven más de 1,5 millones de personas concentradas en apenas 59 km<sup>2</sup>, lo que lo convierte en uno de los lugares con mayor densidad de población del planeta. Tanto si te atraen el fulgor de sus luces y su bullicio como si anhelas perderte por los apacibles senderos de Central Park, no cabe duda de que el espíritu, la rica historia y la diversidad de esta ciudad dejarán en ti una huella imborrable.

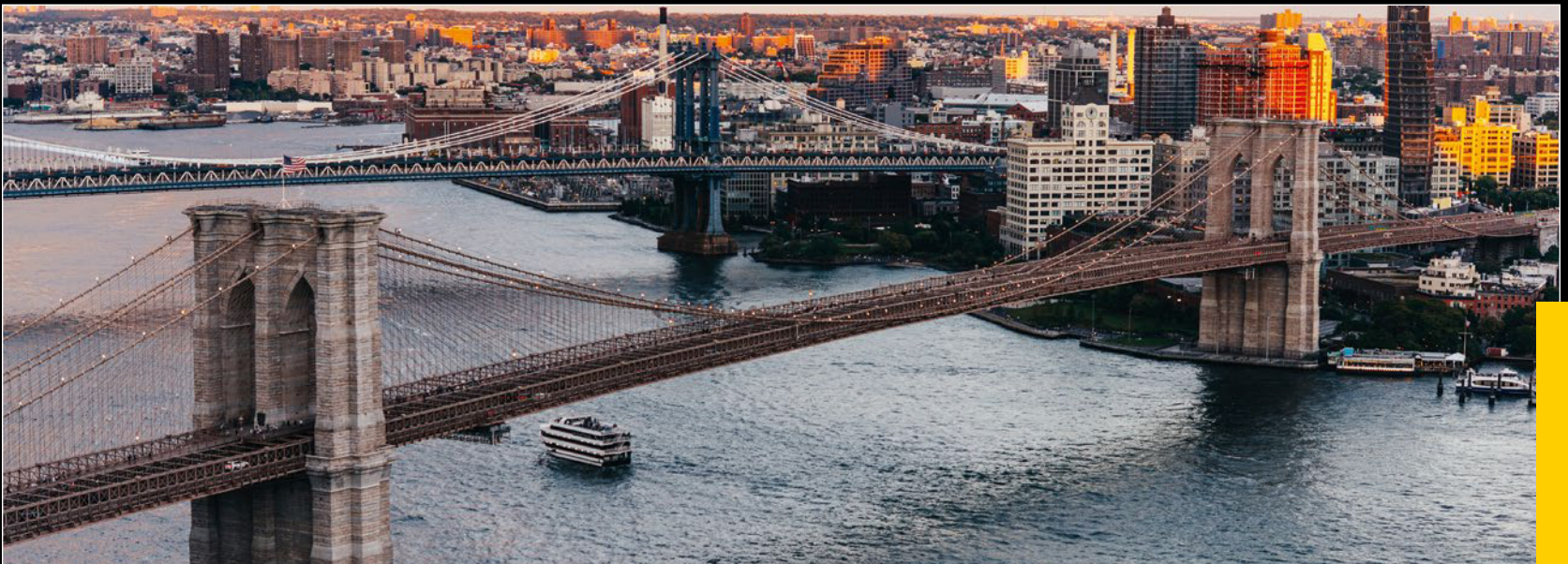



### ONE WORLD TRADE CENTER (2014)

Hasta la fecha, el One World Trade Center, construido como símbolo de unidad y resiliencia, es el edificio más alto del hemisferio occidental.



### EMPIRE STATE BUILDING (1931)

Este icono neoyorquino de 102 plantas ofrece unas vistas impresionantes de la ciudad desde el corazón de Midtown Manhattan.



### MUSEO METROPOLITANO DE ARTE (1870)

Fundado en 1870, el Met, uno de los museos más grandes del mundo, exhibe más de 5000 años de historia del arte y obras maestras modernas.



### MUSEO SOLOMON R. GUGGENHEIM (1959)

Desde su apertura, el museo es célebre por su arquitectura en espiral y su colección de arte moderno y contemporáneo de talla mundial.

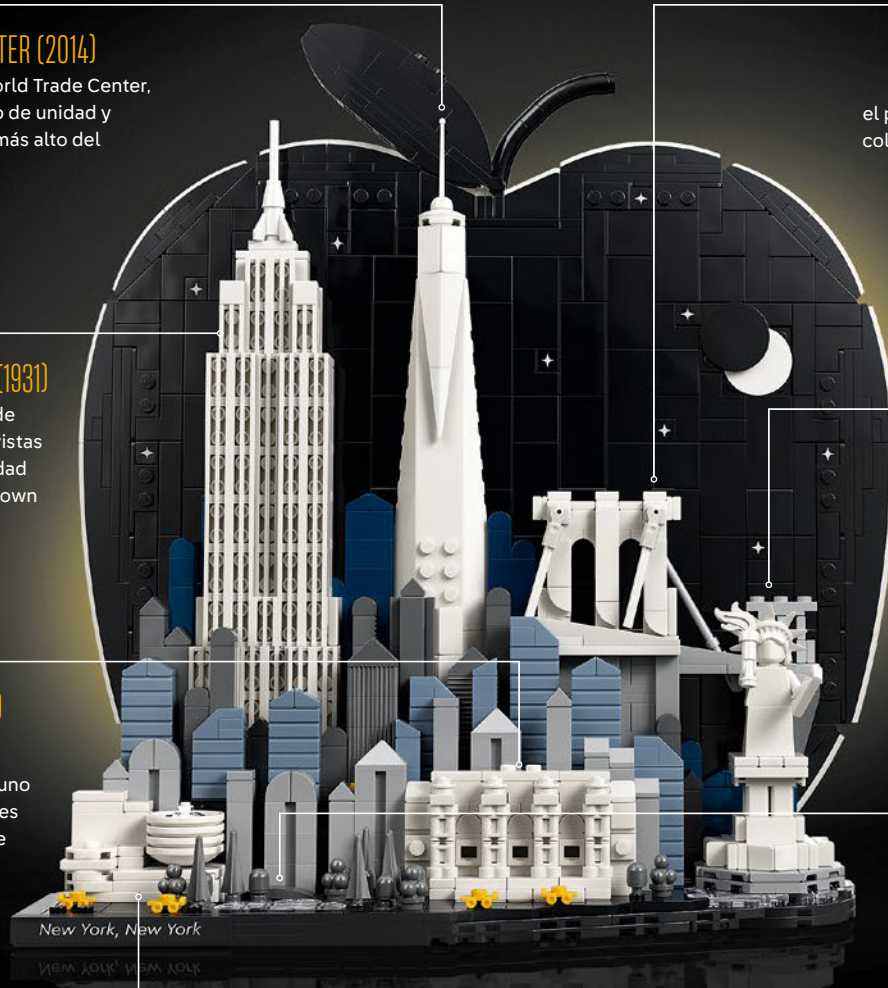

### PUENTE DE BROOKLYN (1883)

Con más de 1,8 km de longitud, el puente de Brooklyn fue el puente colgante más largo del mundo en el momento de su inauguración.



### ESTATUA DE LA LIBERTAD (1886)

Esta gran estatua neoclásica se alza en Liberty Island, una isla ubicada en el puerto de Nueva York que fue, en su día, el más célebre punto de entrada a Estados Unidos.



### CENTRAL PARK (1858)

Central Park recibe 42 millones de visitantes al año en sus más de 341 hectáreas de praderas, senderos y lagos.



# IMPRESIONES DEL EQUIPO DE DISEÑO DE LEGO® ARCHITECTURE

En 2026 se cumplen 250 años de la firma de la Declaración de Independencia de los Estados Unidos, efeméride que coincide con el 10.º aniversario de nuestro primer set LEGO® Architecture con la silueta urbana de Nueva York. Animados por ambos eventos, decidimos celebrarlos recreando algunos de los monumentos neoyorquinos más populares, reinterpretados contra un fondo que representa el cielo nocturno de la Gran Manzana. Usamos elementos facetados para reproducir la compleja geometría del One World Trade Center, que se apoya sobre los “hombros” del Empire State Building y se estrecha a medida que gana altura. Las ventanas y las largas líneas verticales *art déco* del Empire State Building se reproducen usando placas de rejilla LEGO. El modelo del Puente de Brooklyn juega con un efecto de perspectiva forzada mediante el drástico cambio de tamaño, las variaciones de color de ambas torres y la ligera inclinación de la calzada. Esperamos que disfrutes construyendo y explorando esta magnífica ciudad, que incluye otros inconfundibles detalles, ¡como la Dama de la Libertad en forma de minifigura!



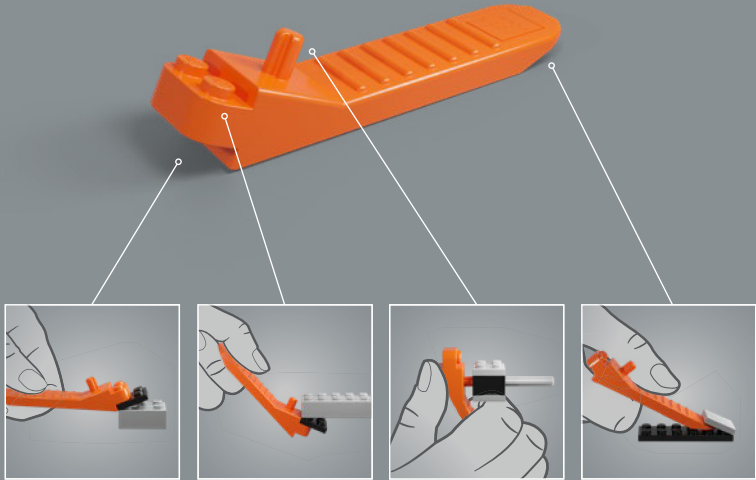

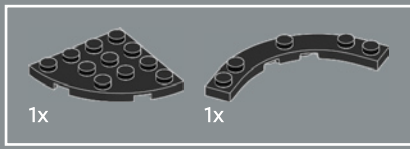

1

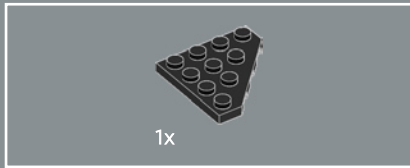
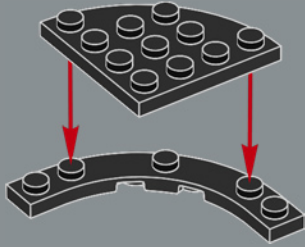

2

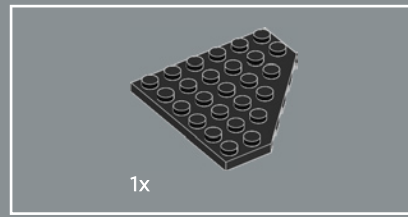
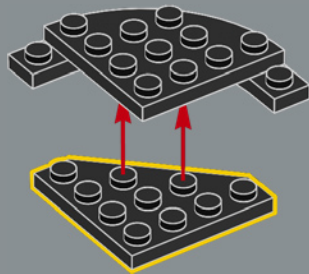

3

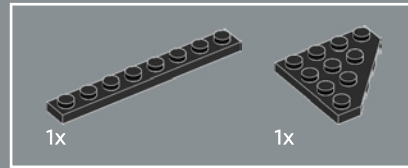
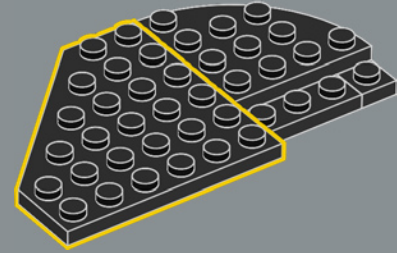

4

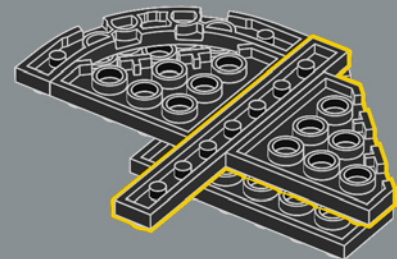

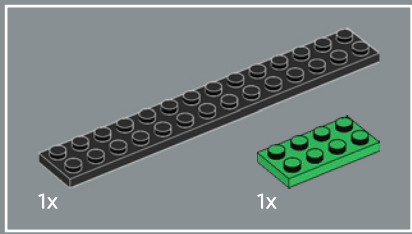

5

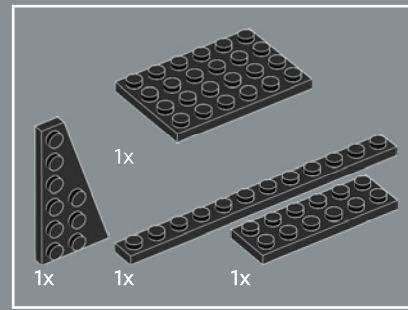
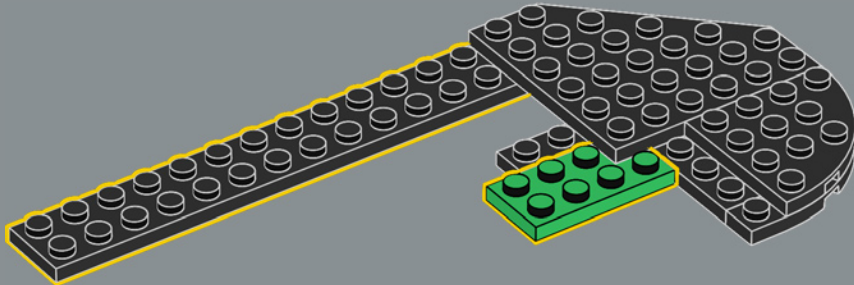

6

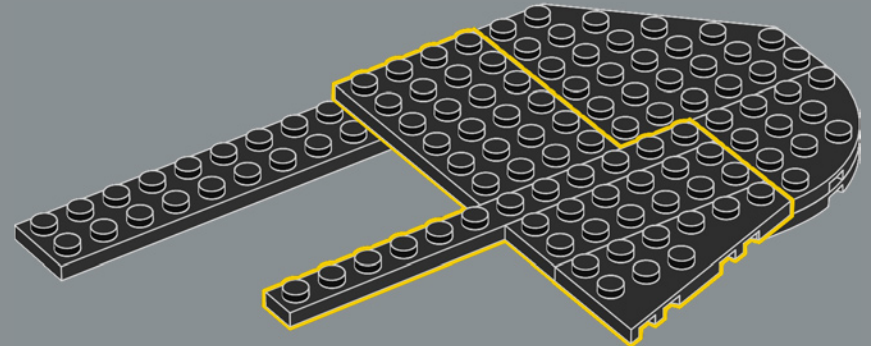

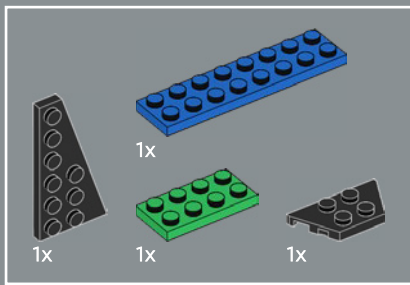

7

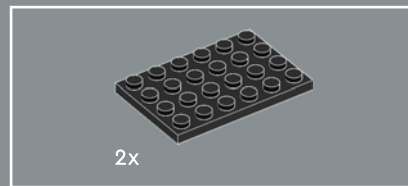
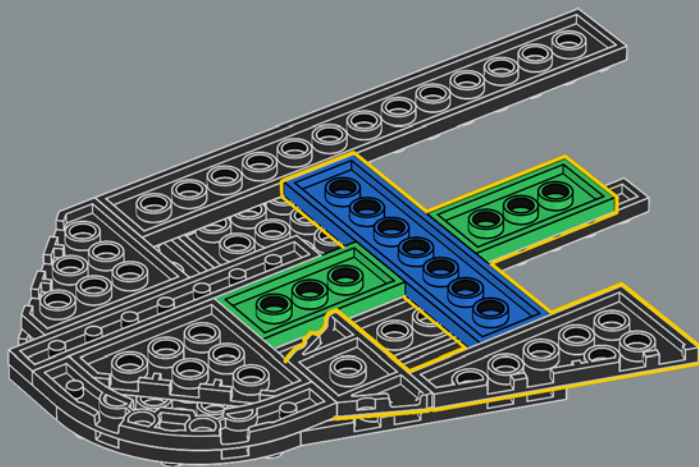

8

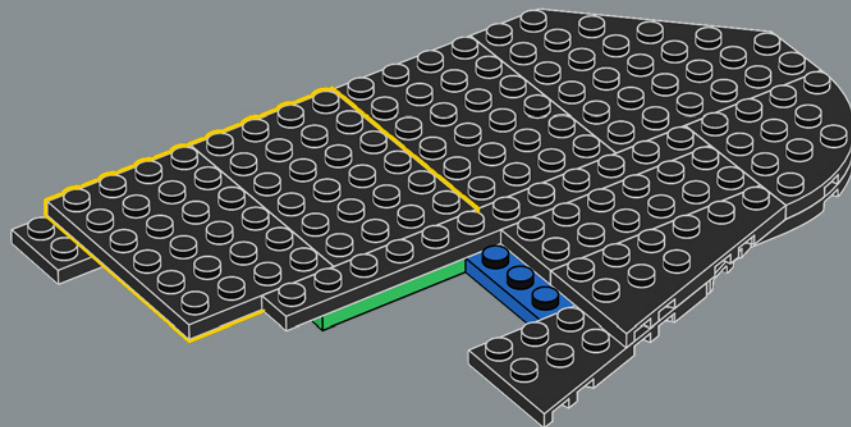

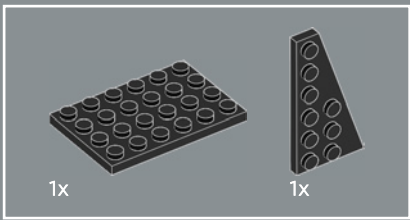

9

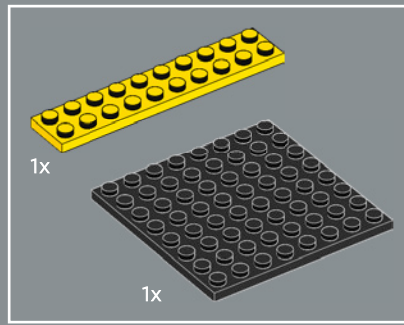
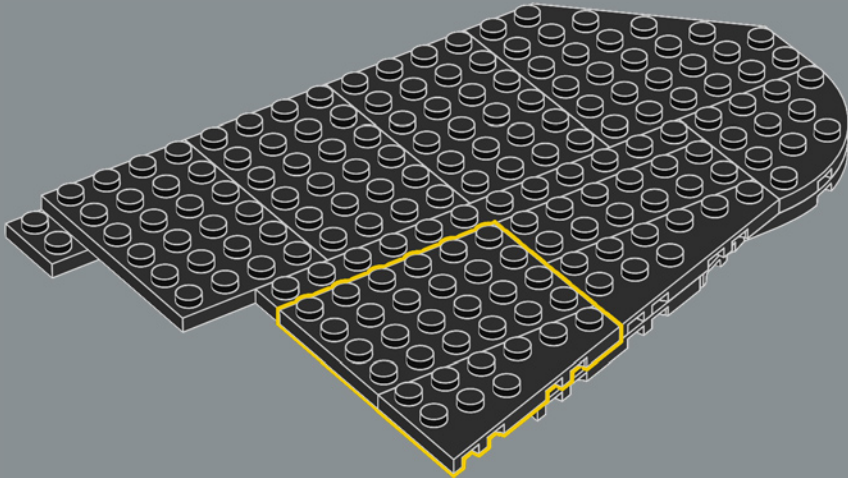

10

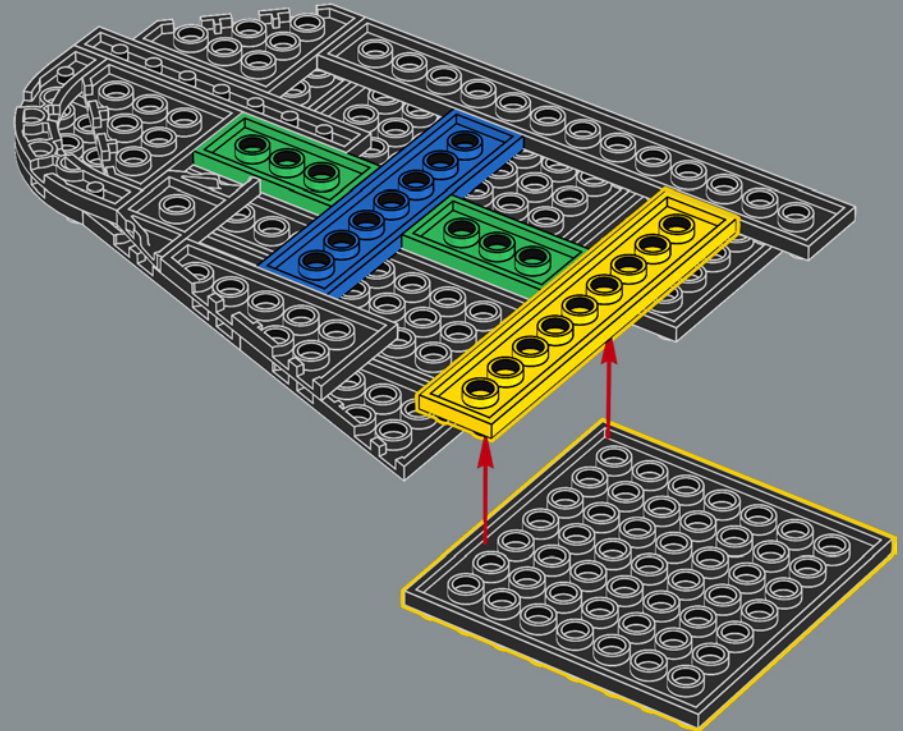

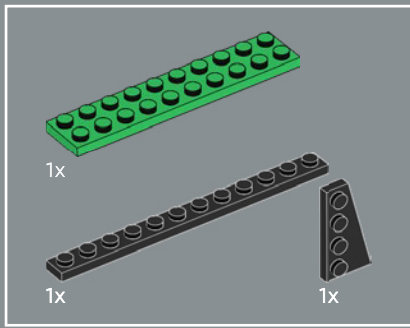

11

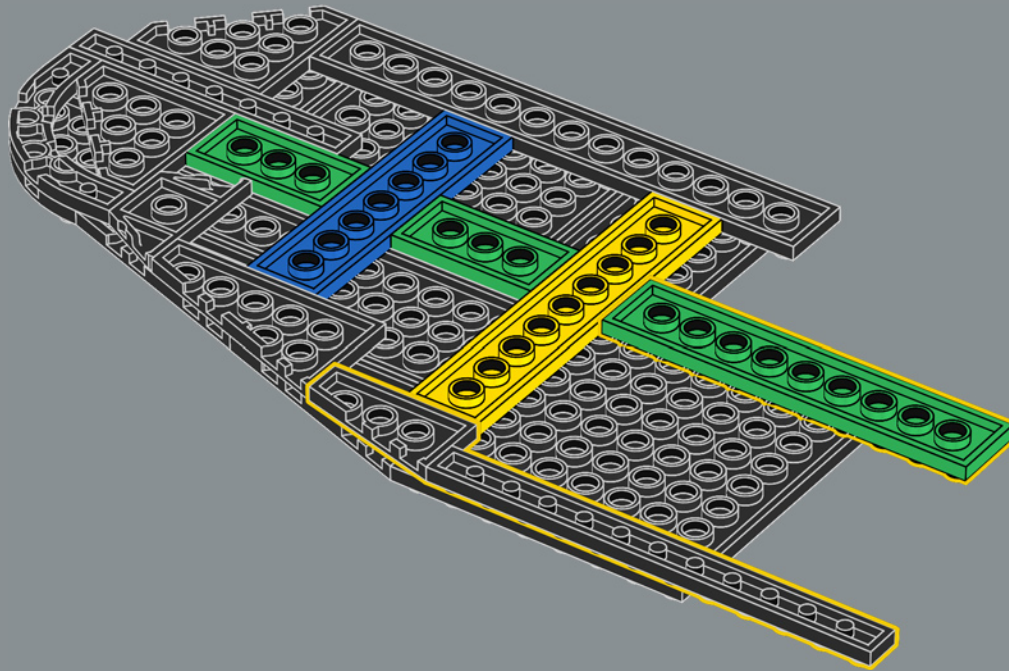

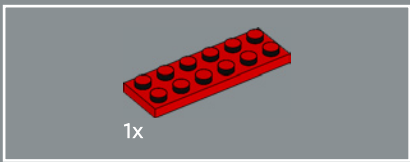

12

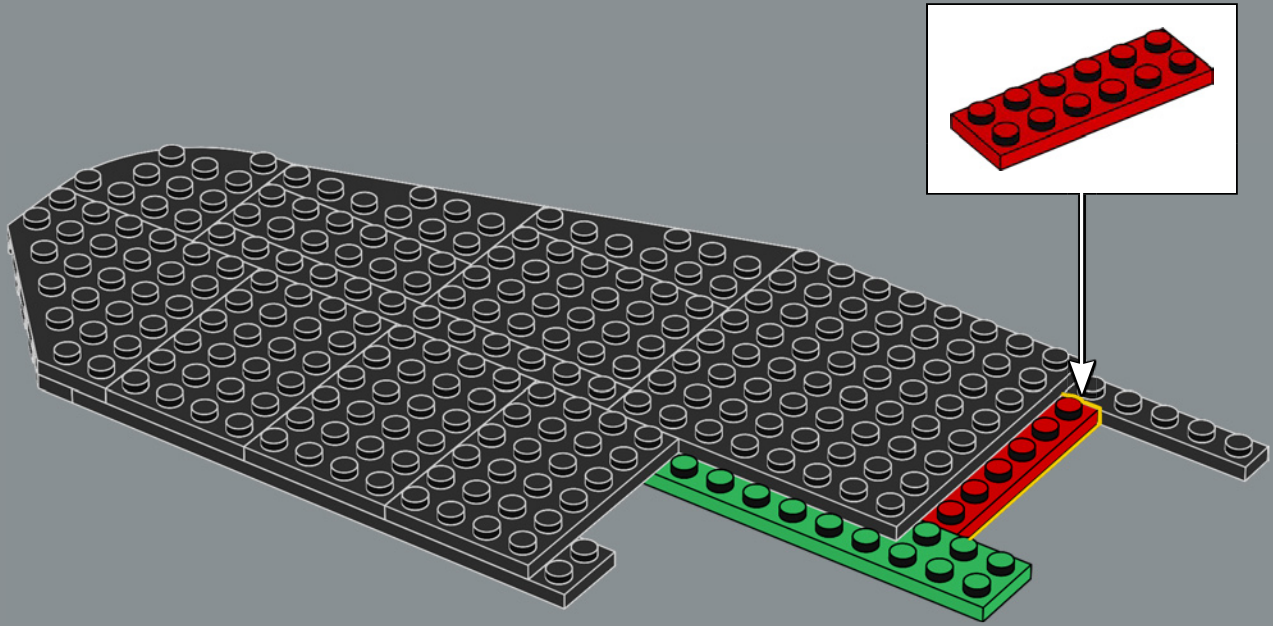

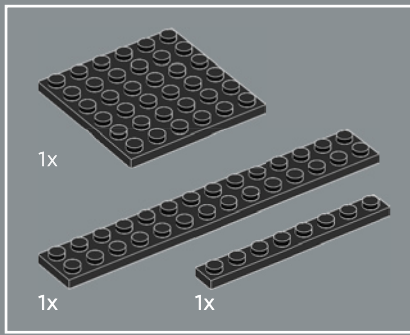

13

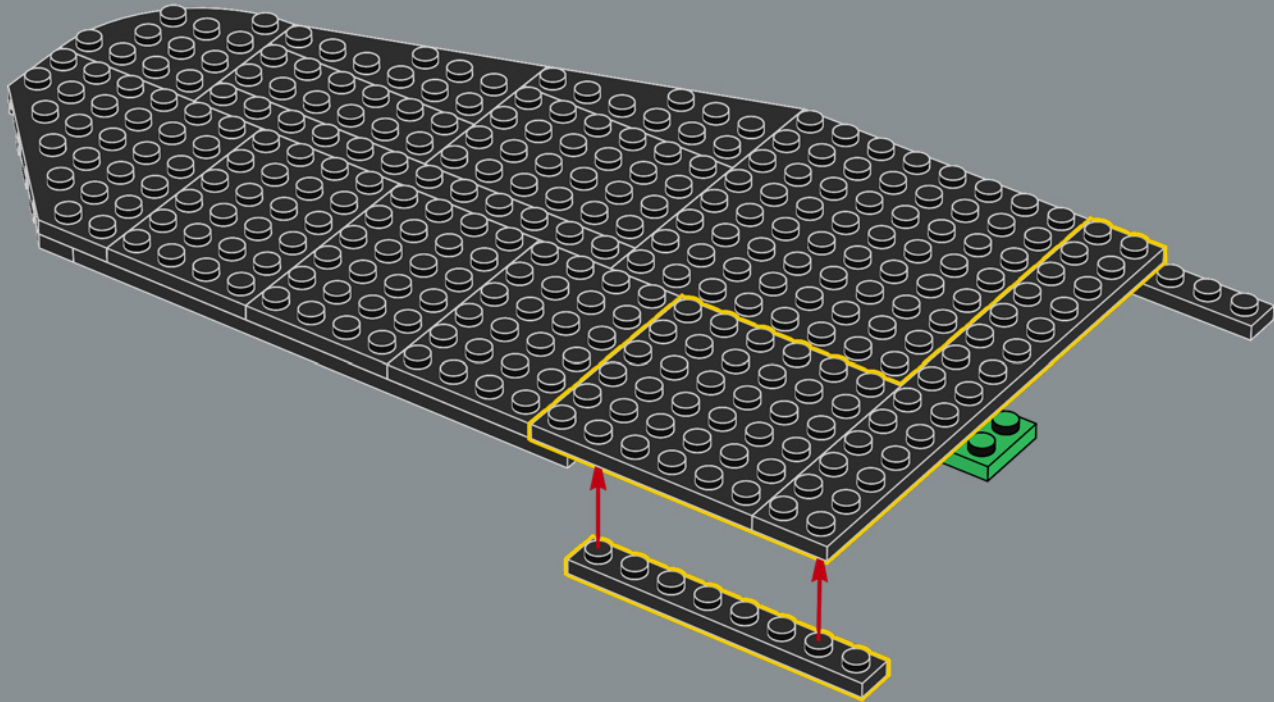

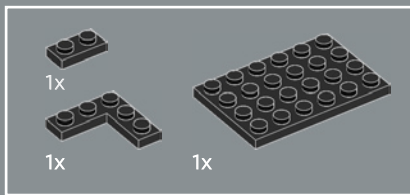

14

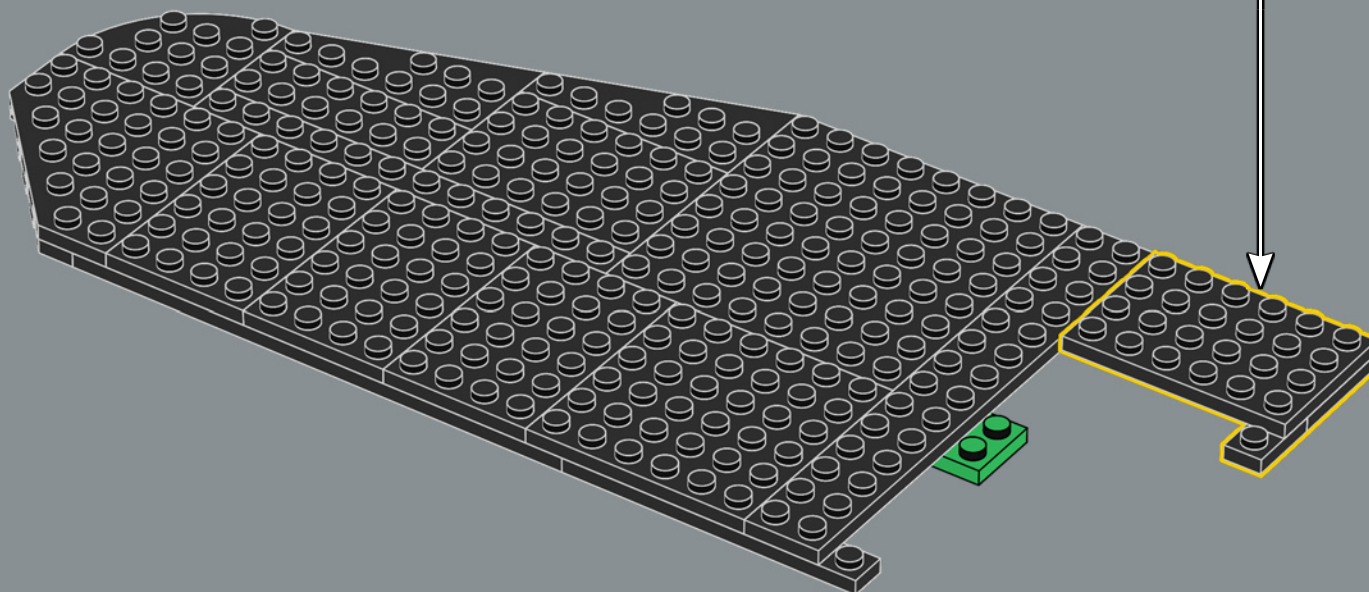
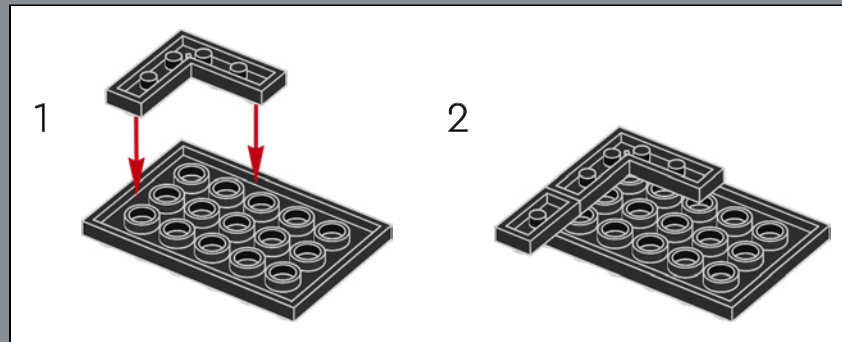

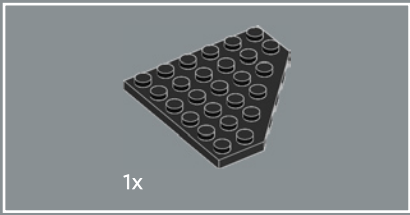

15

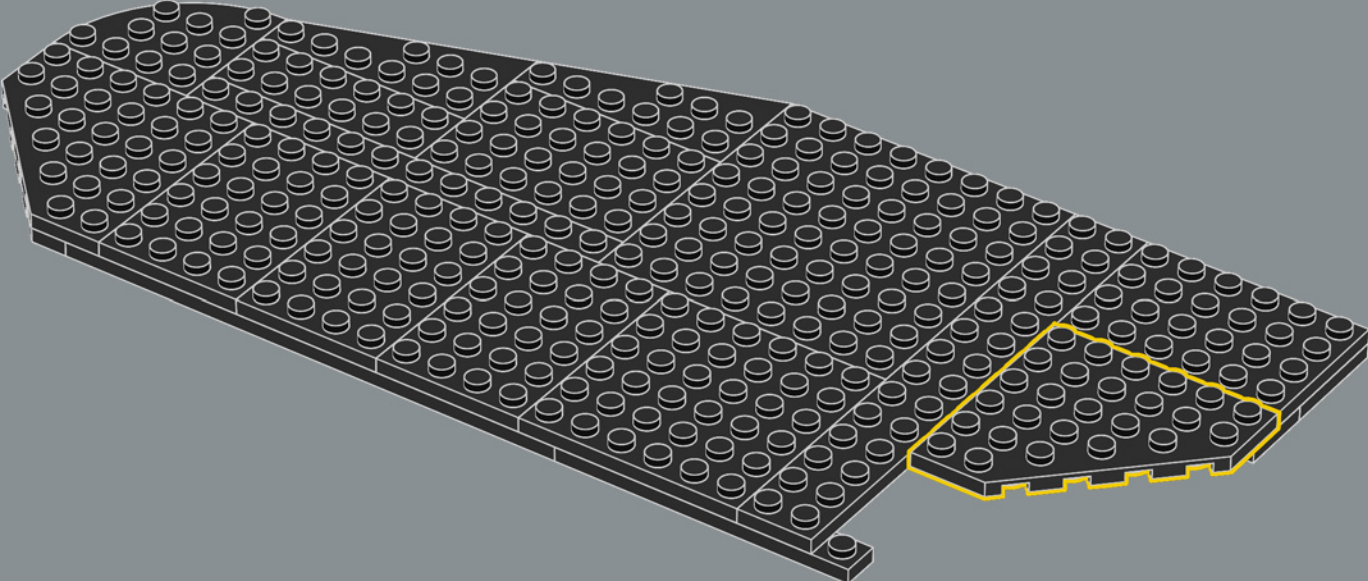

Las coloridas placas LEGO® de la base reflejan algunas de las 36 líneas de metro que atraviesan la ciudad.

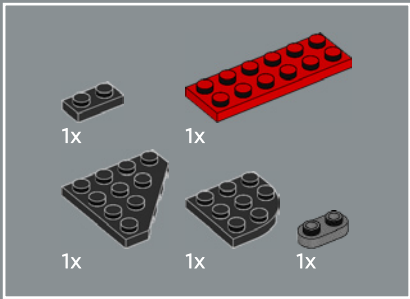

16

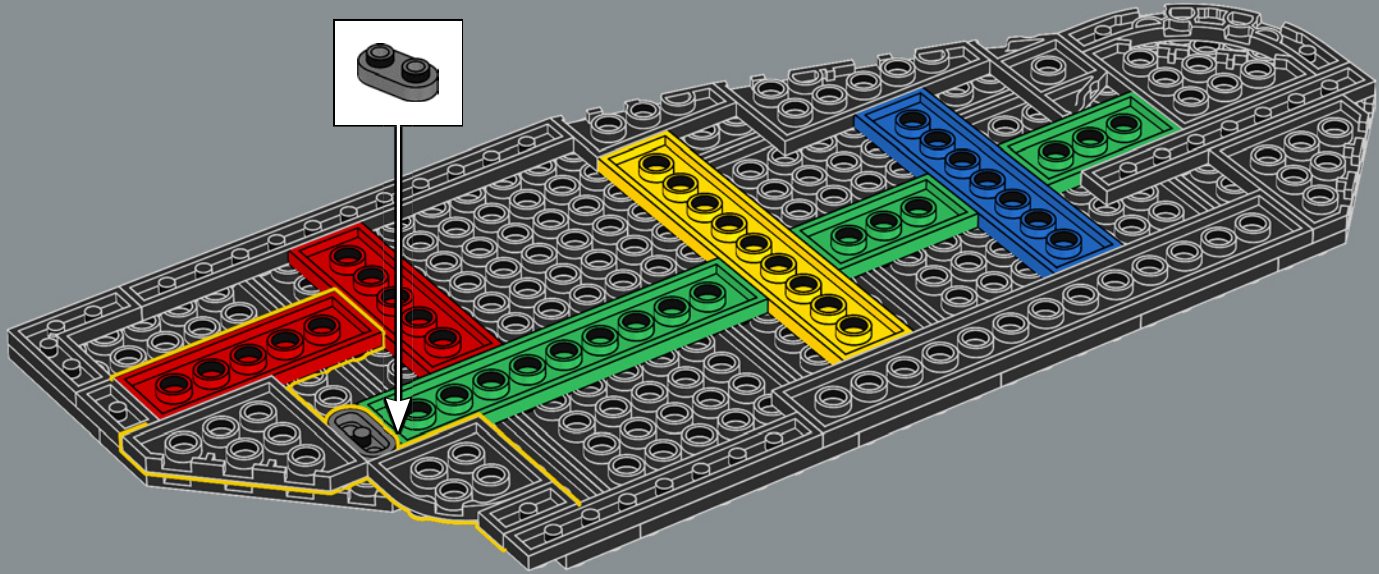

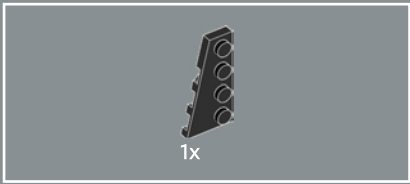

17

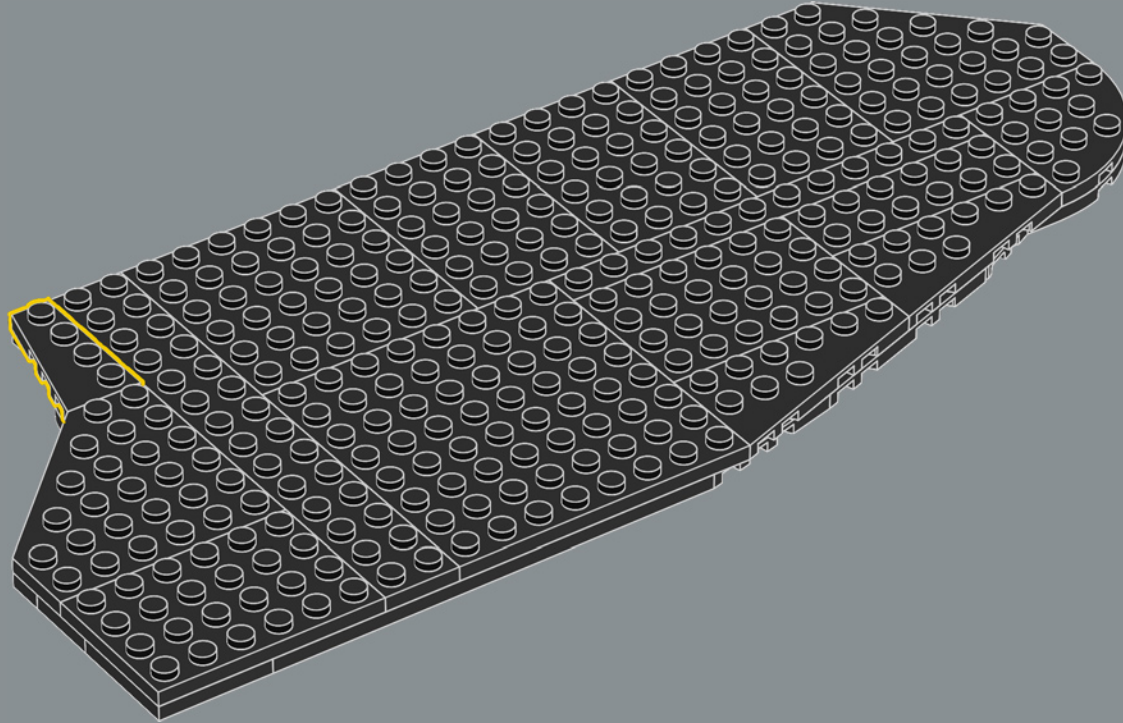

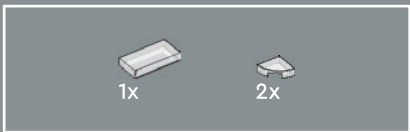

18



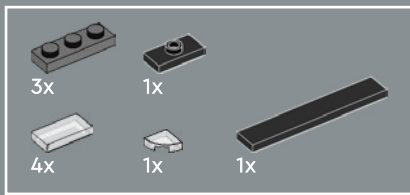

19

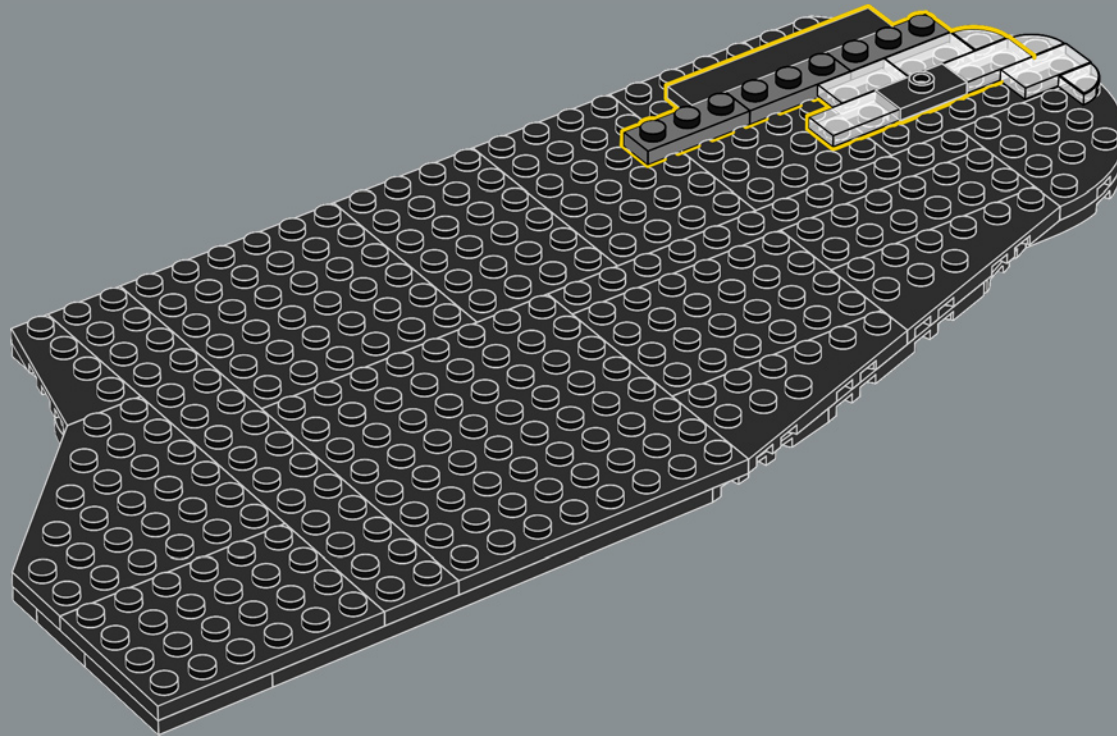

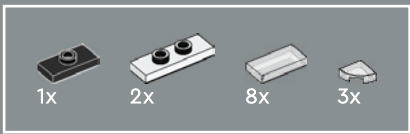

20

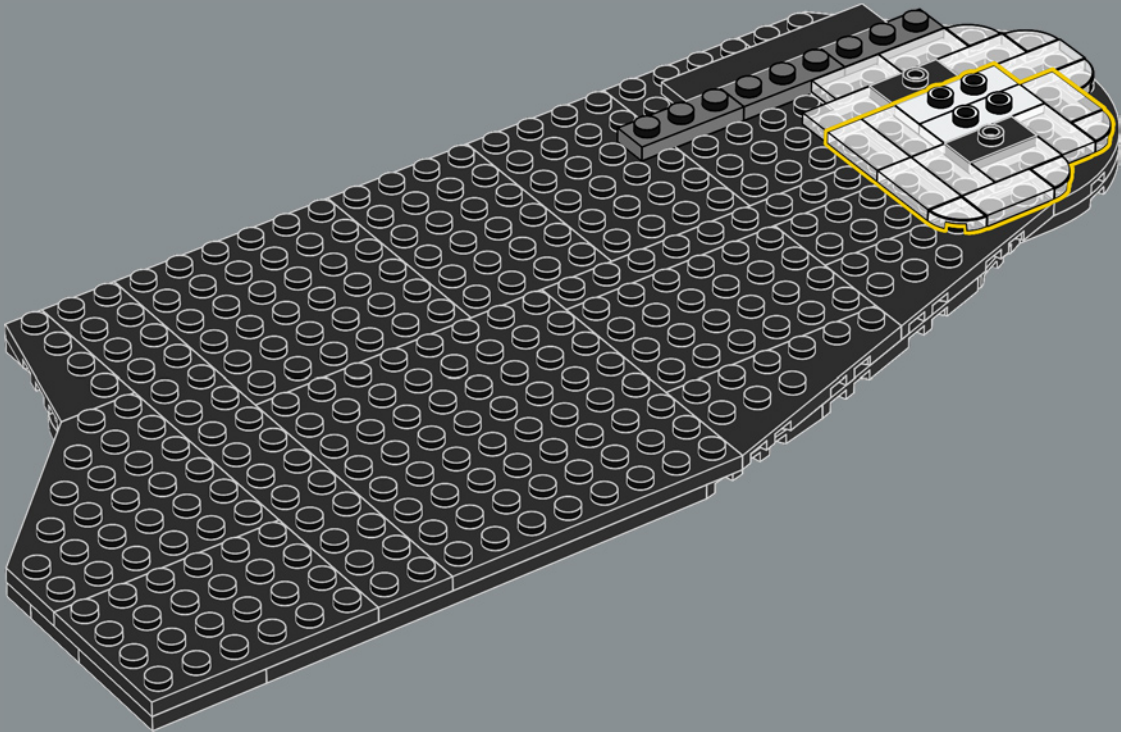

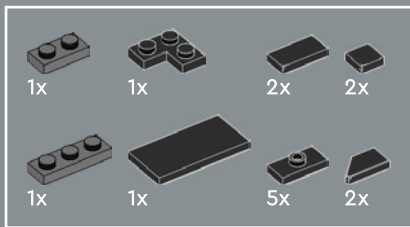

21

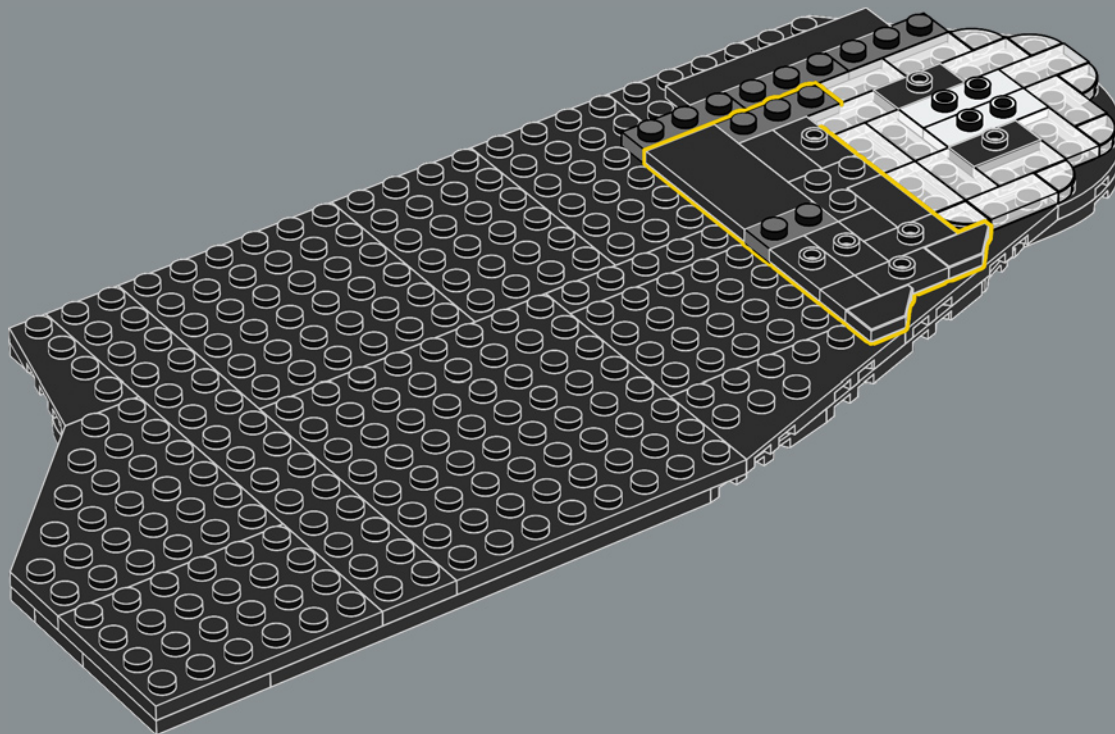

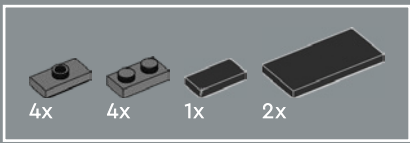

22

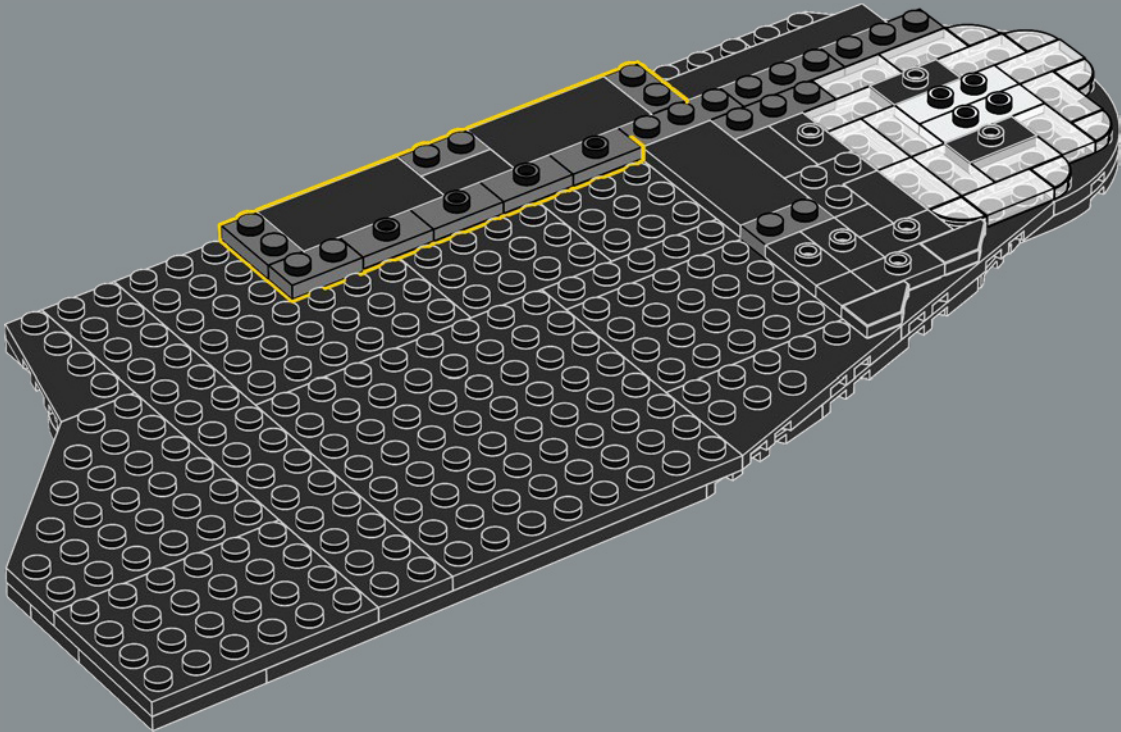

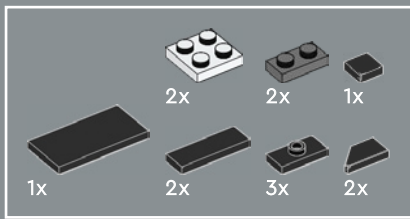

23

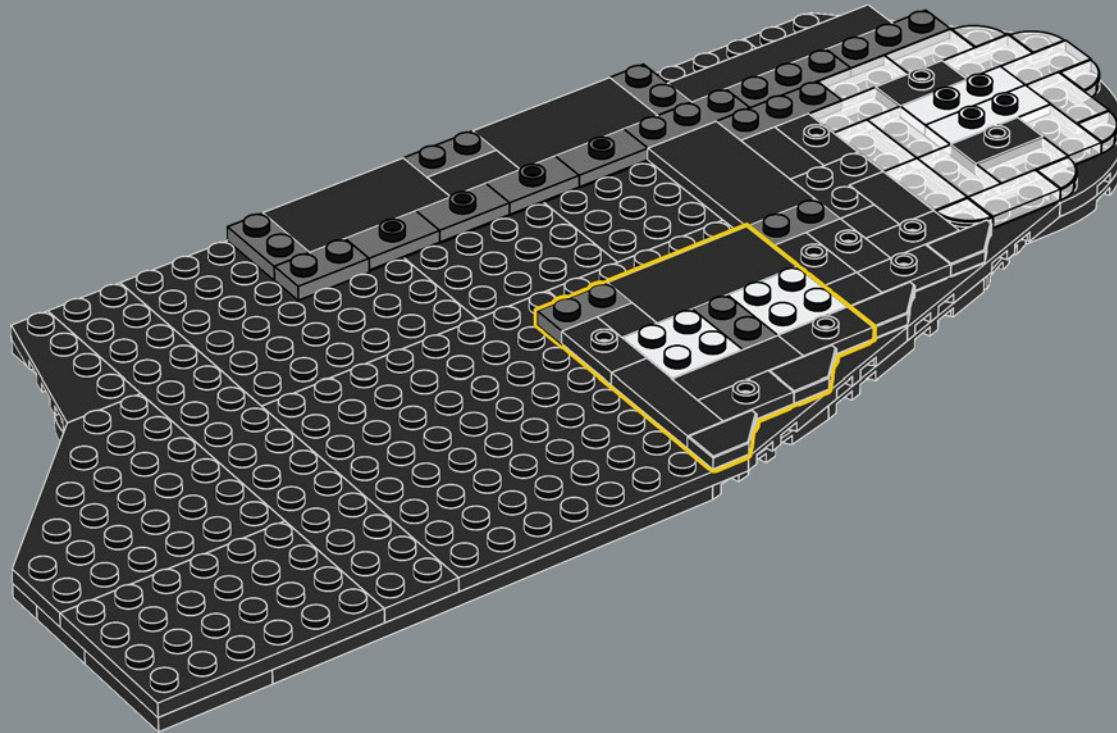

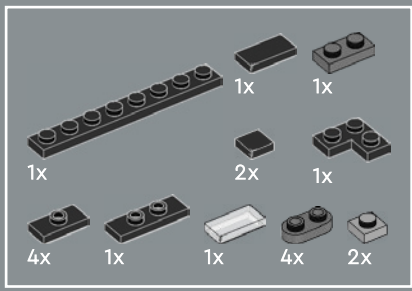

24

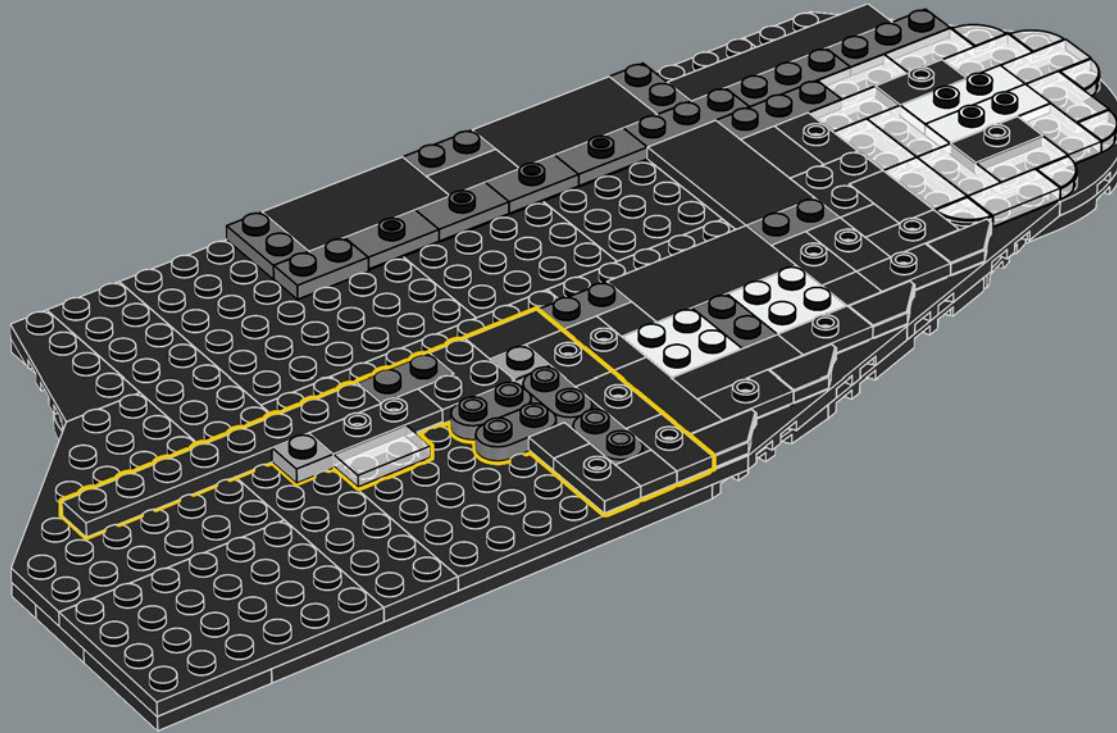

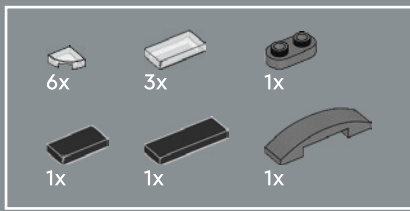

25

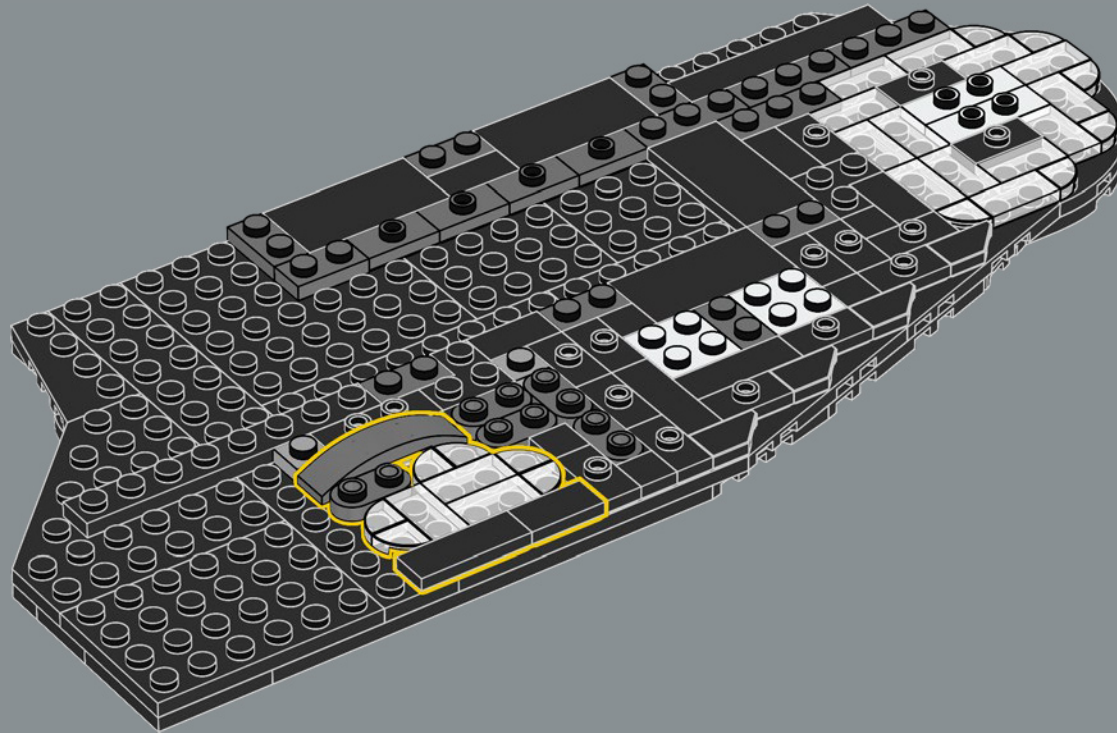

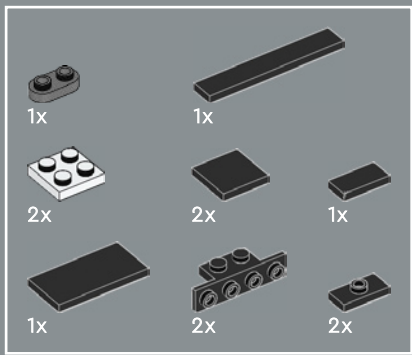

26

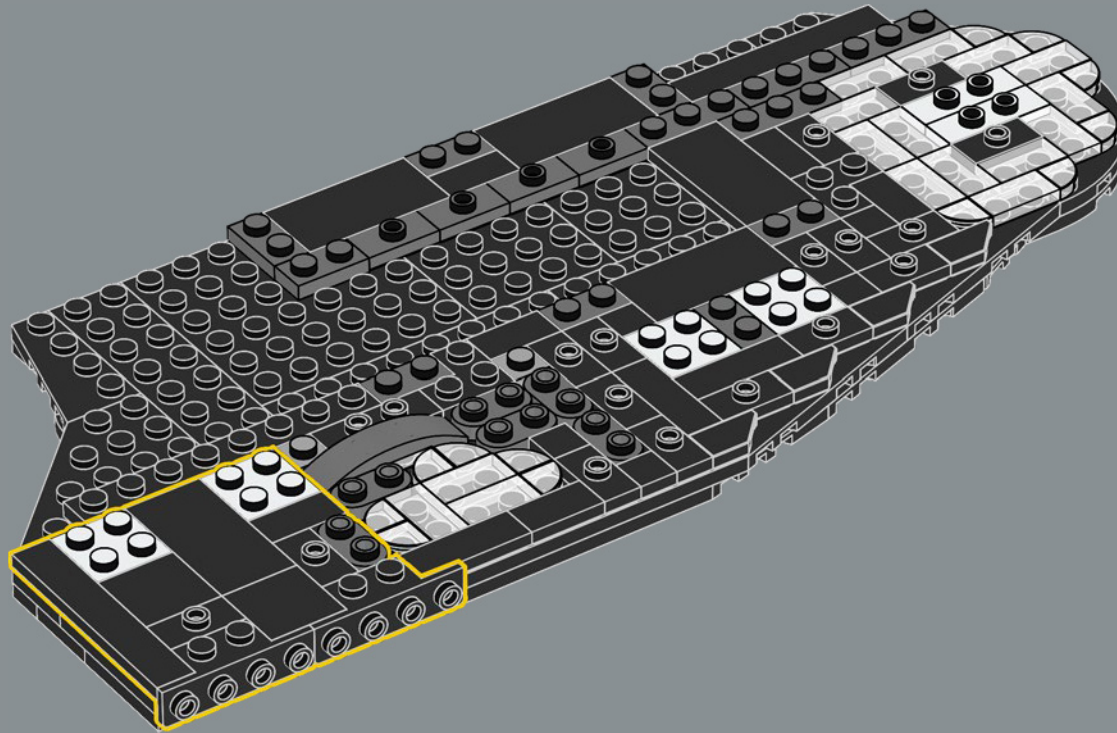

La base del modelo se inspira en el distrito más representativo de Nueva York: la isla de Manhattan.

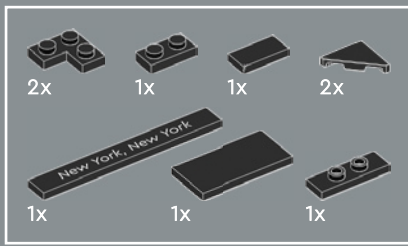

27

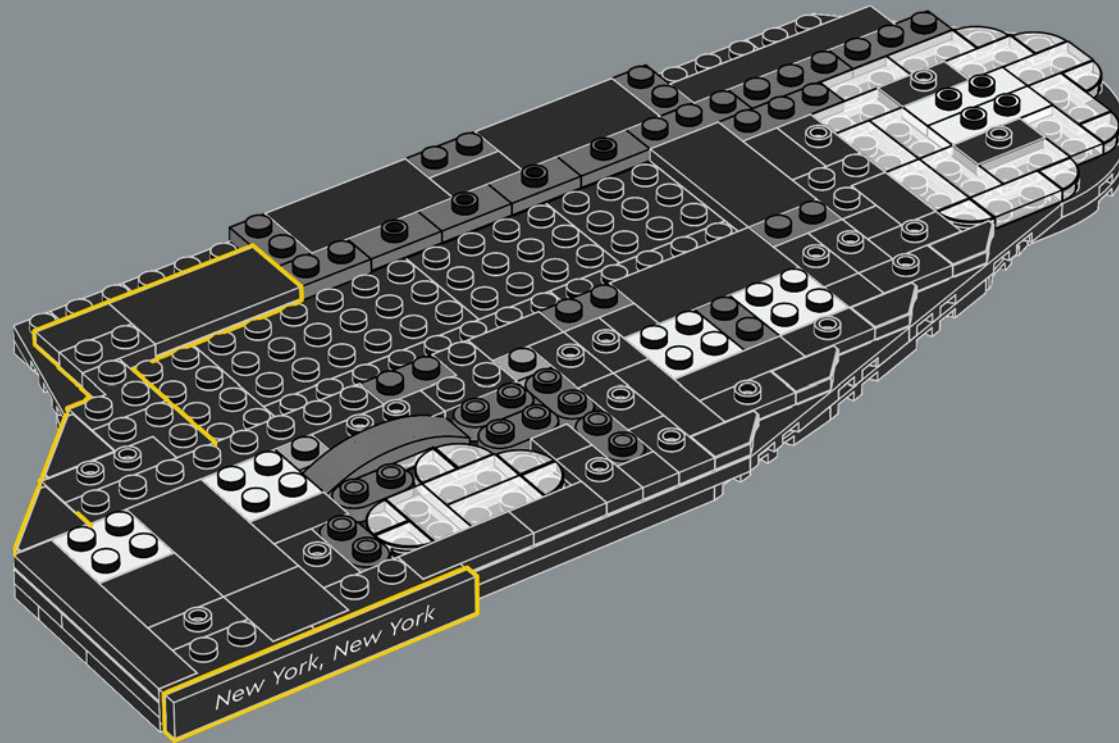

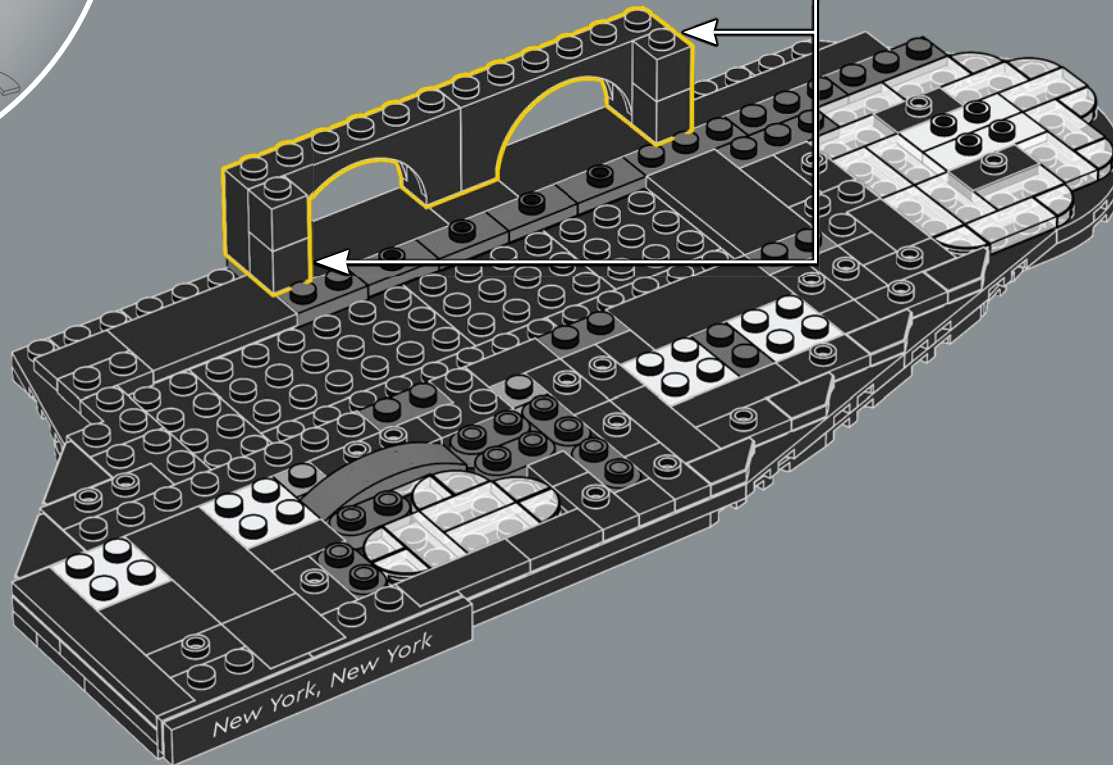
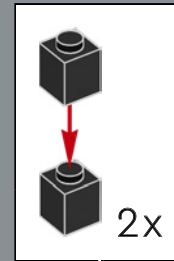
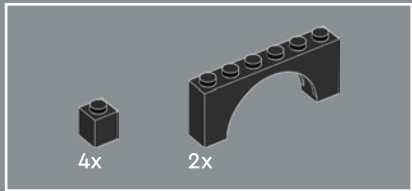

28



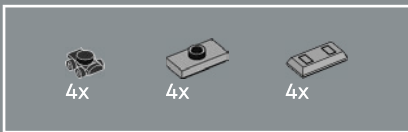

29

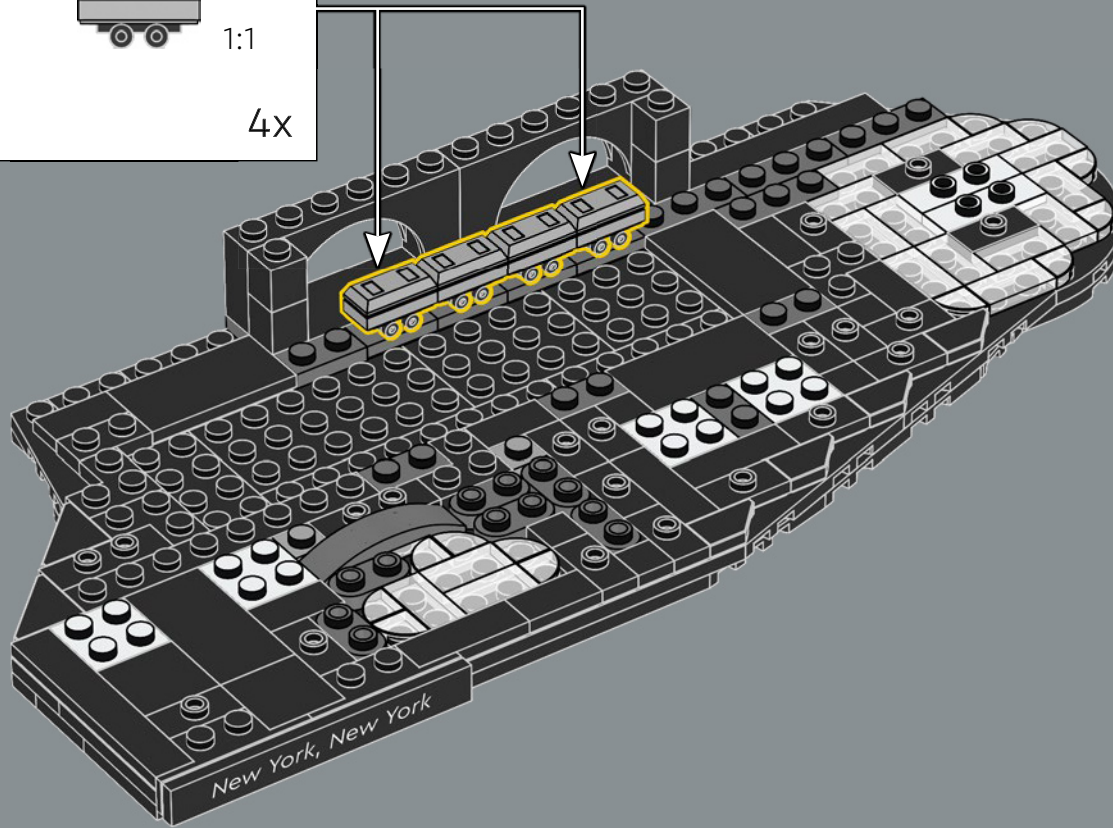
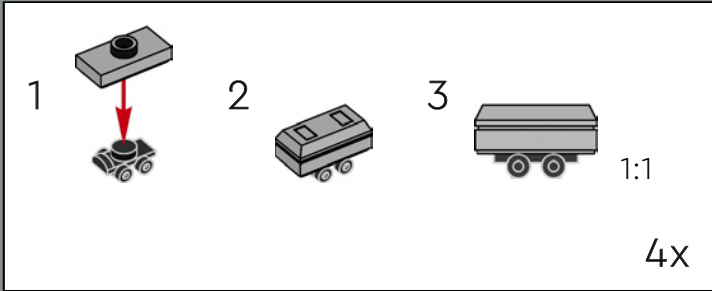

Si formaras una línea recta con los 1355 km de vías que componen el metro de Nueva York, llegarían desde Nueva York hasta Chicago.

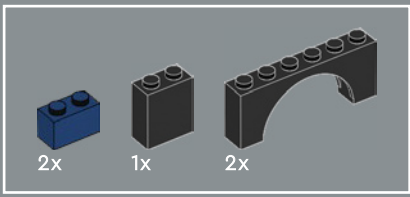

30

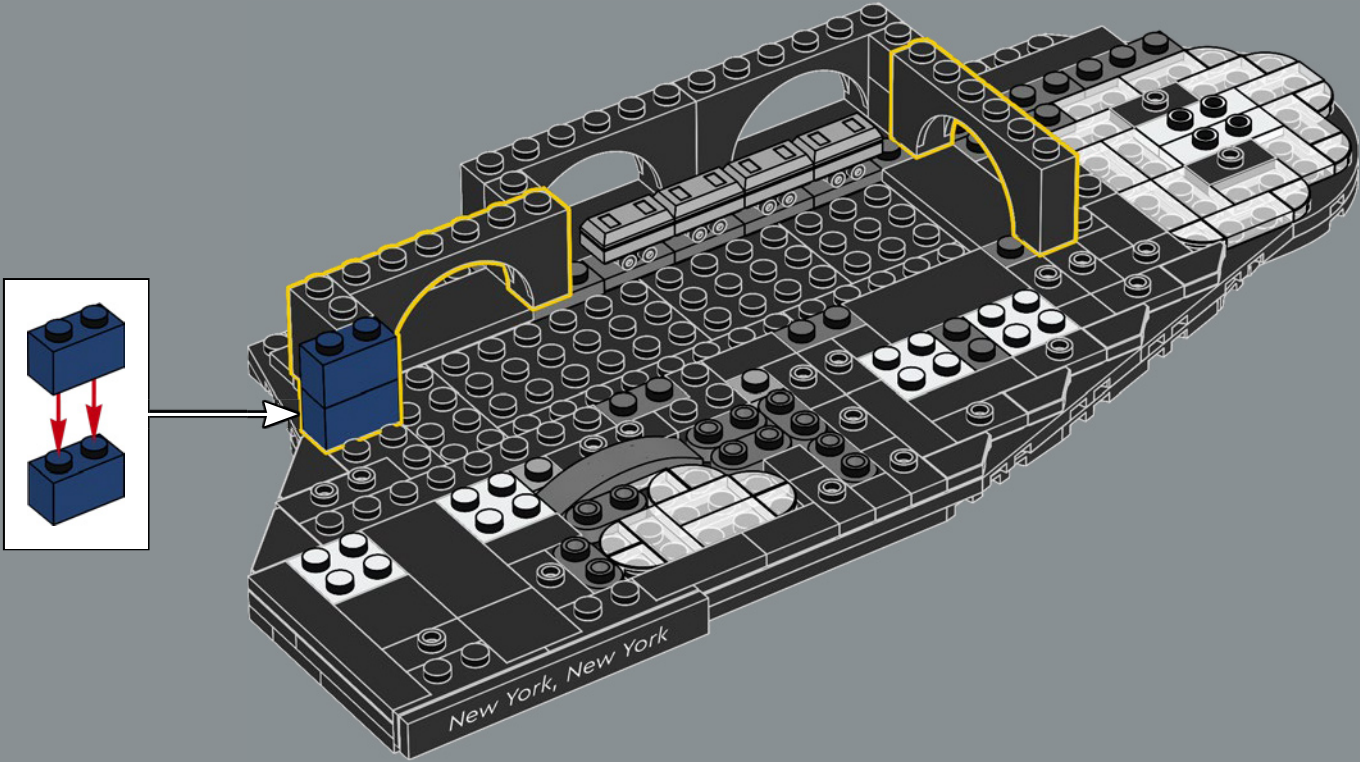

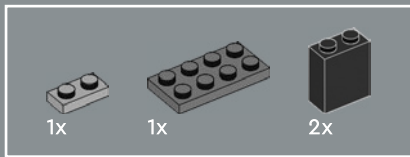

31

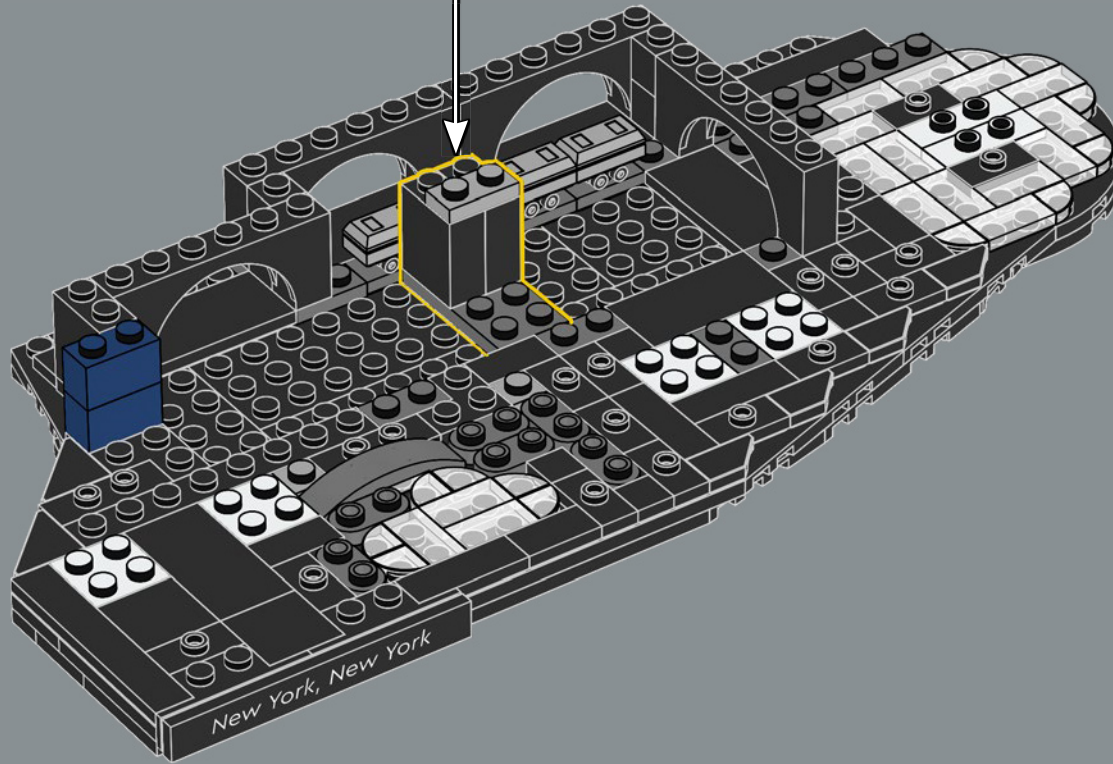
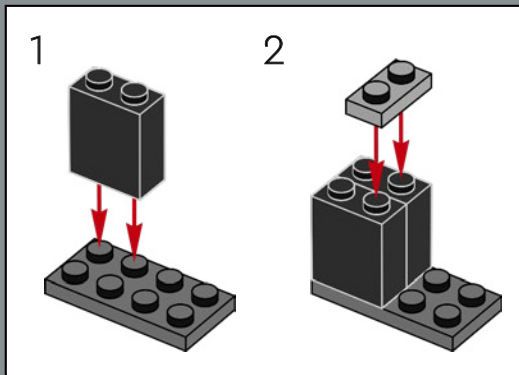

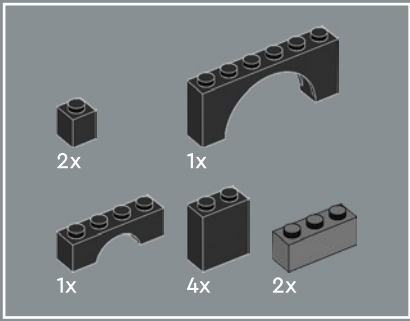

32

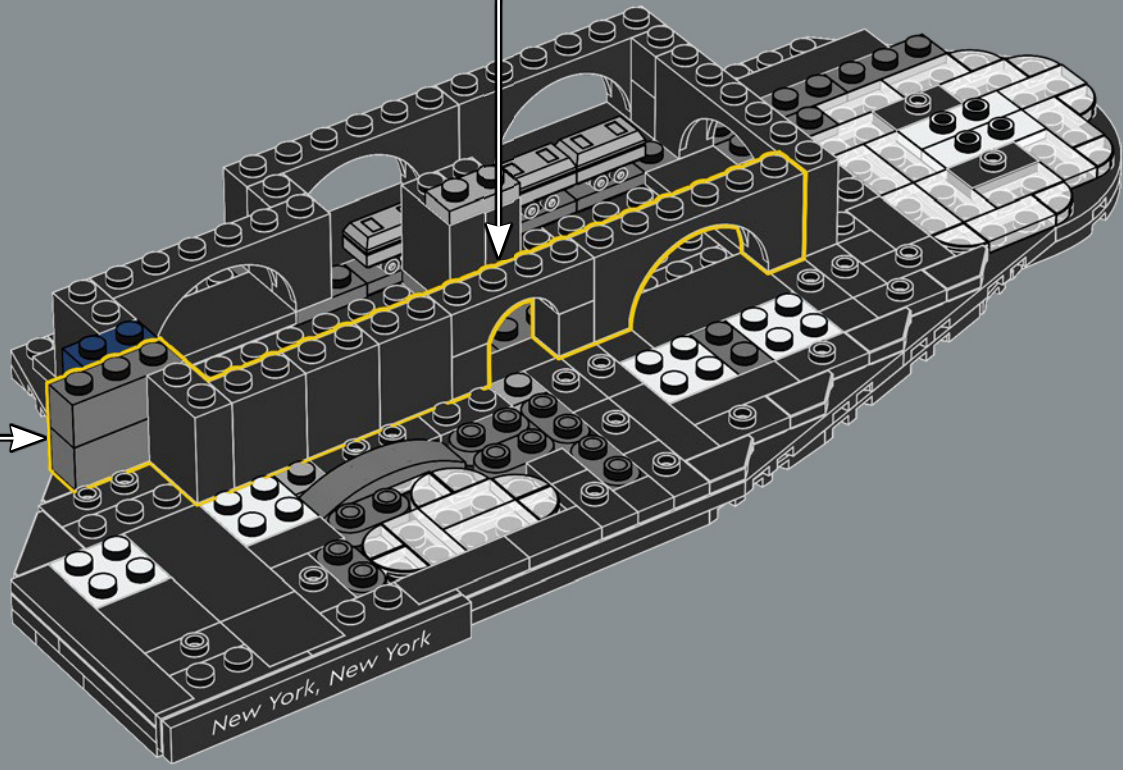
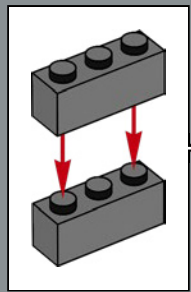
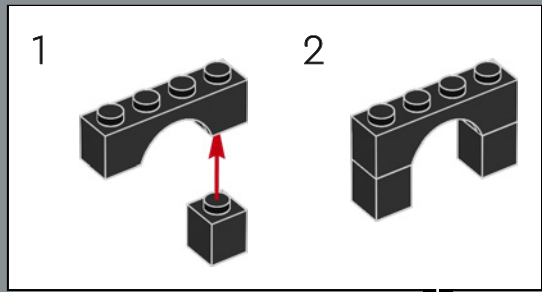

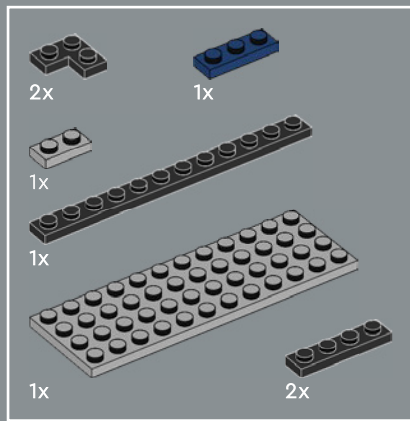

33

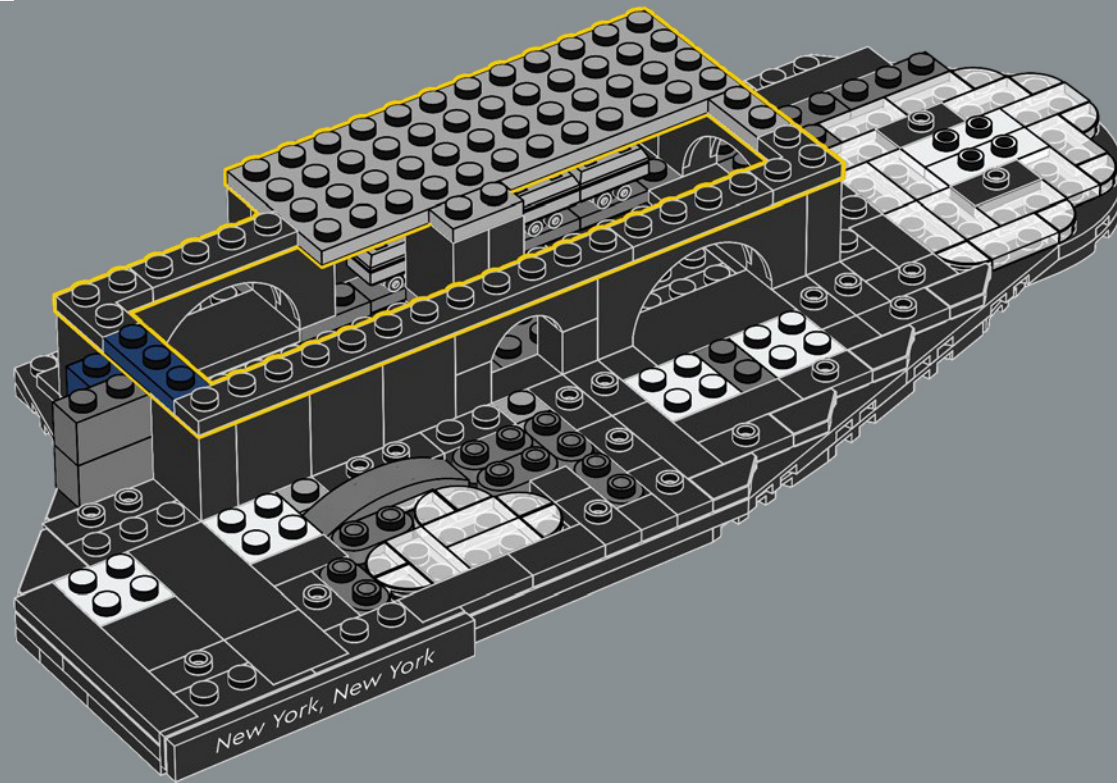

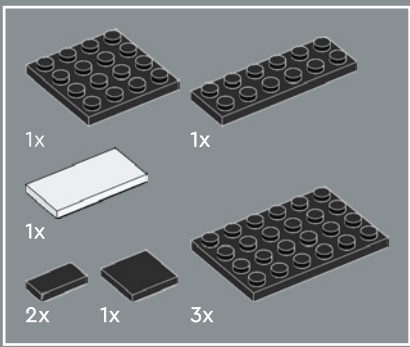

34

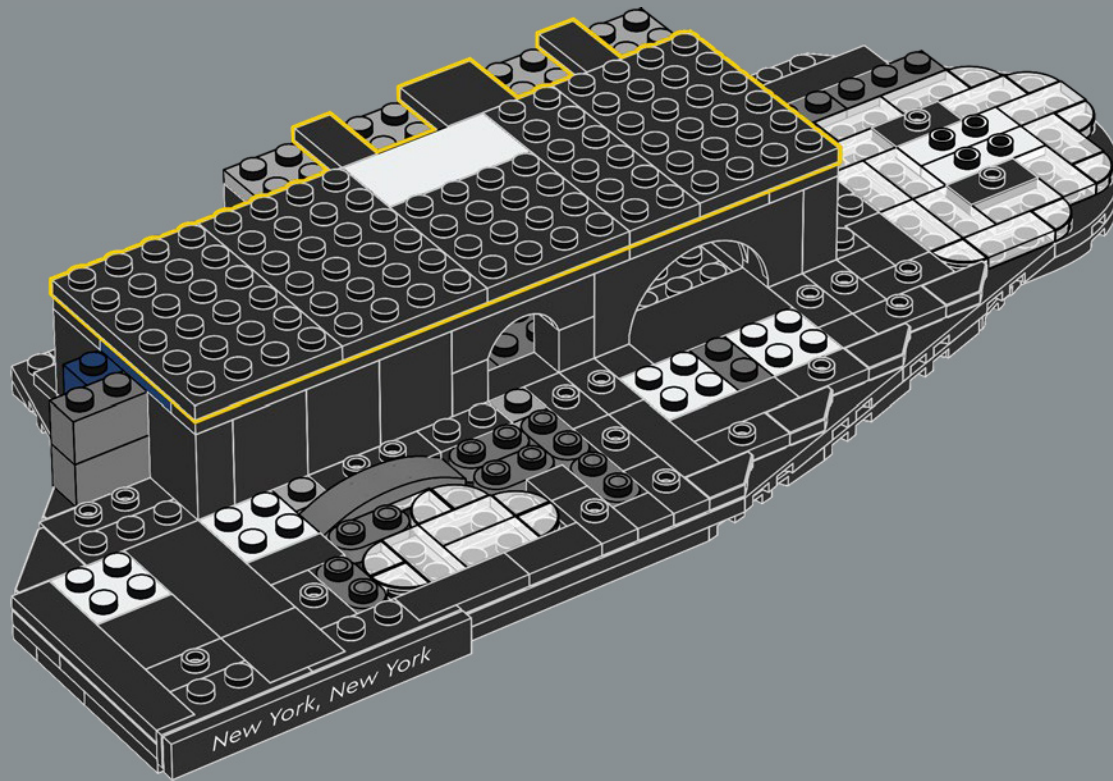

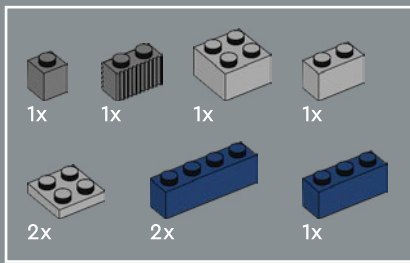

35

1

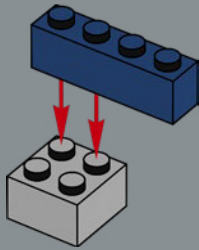

2

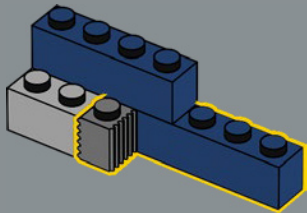

3

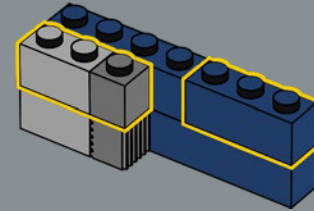

4

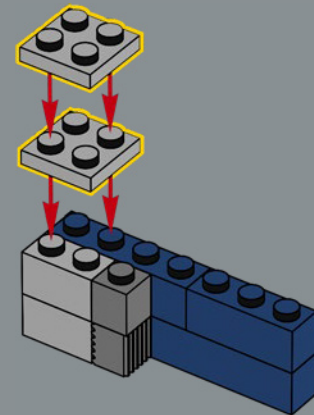

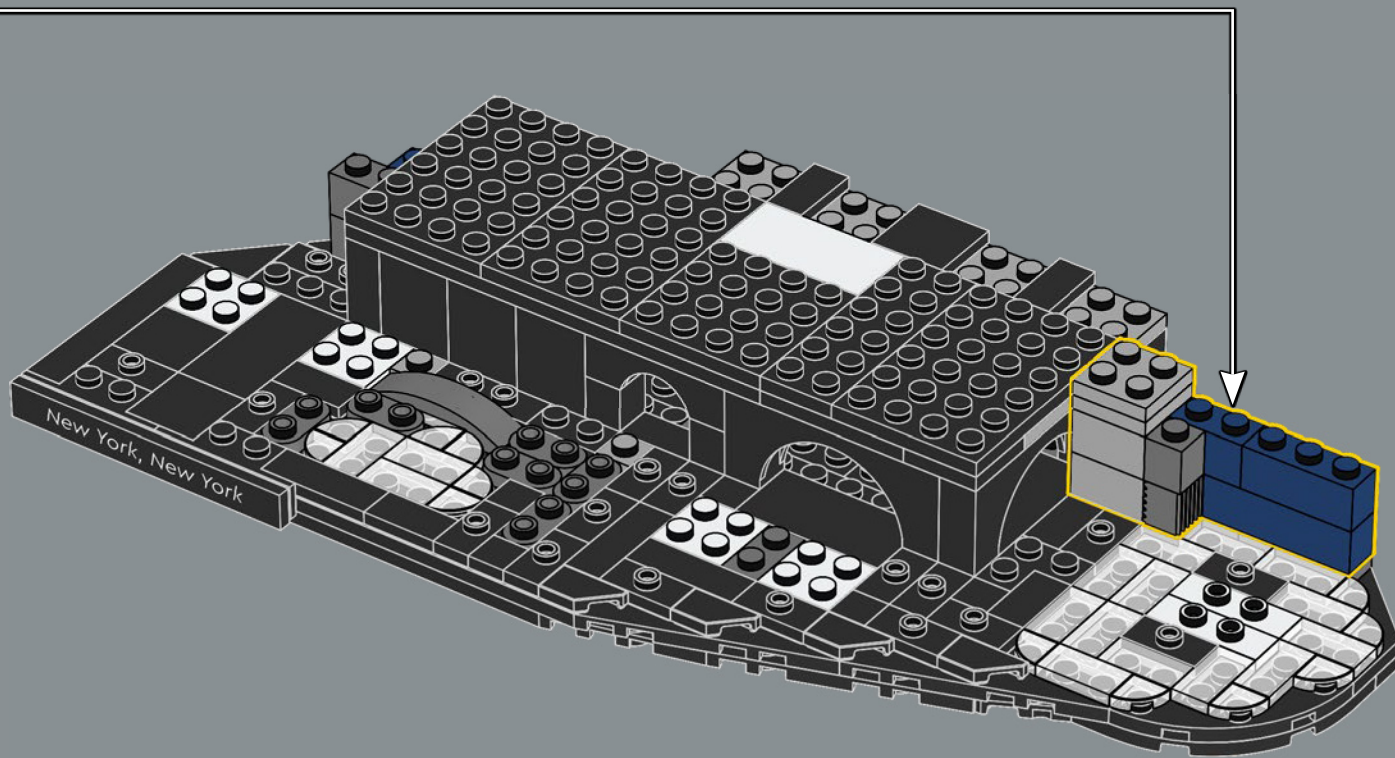

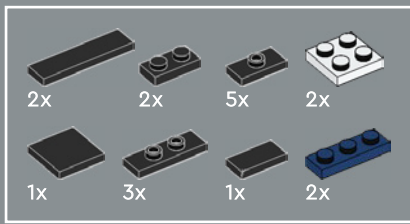

36

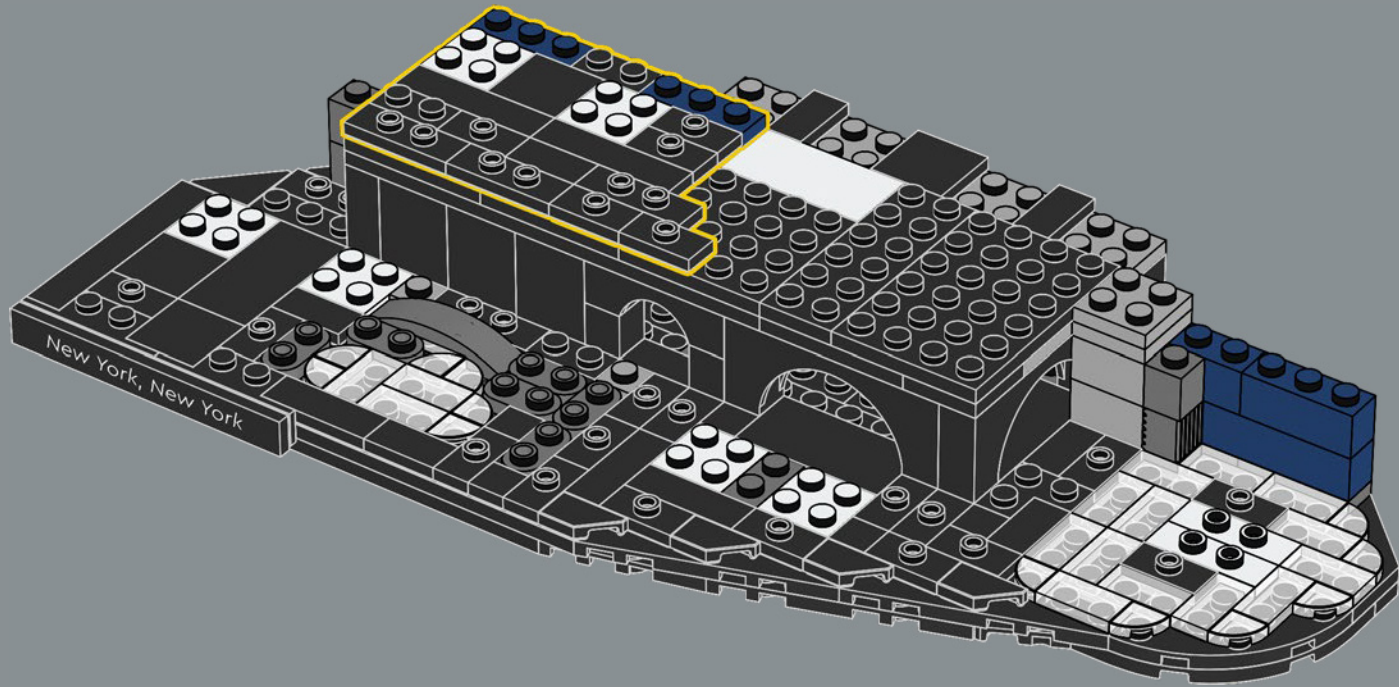

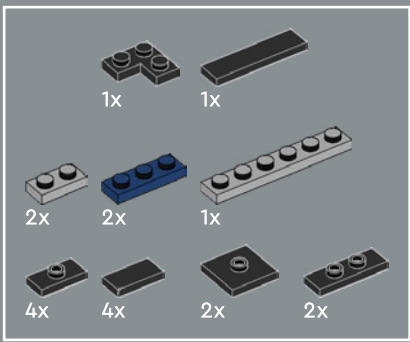

37

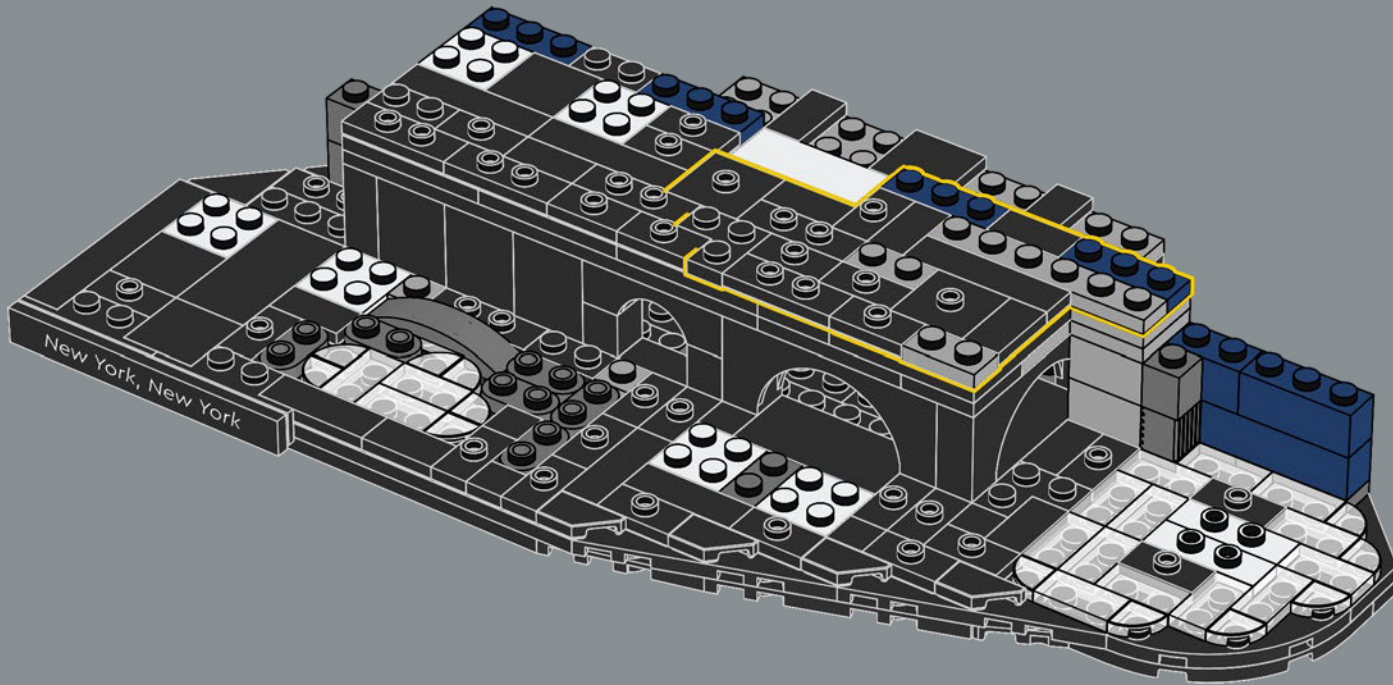

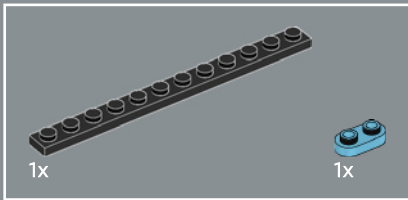
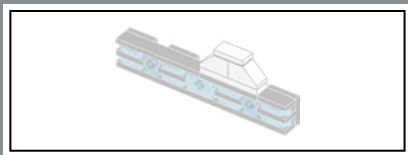

38

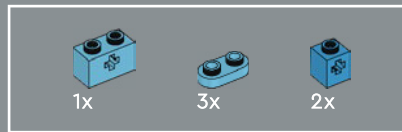
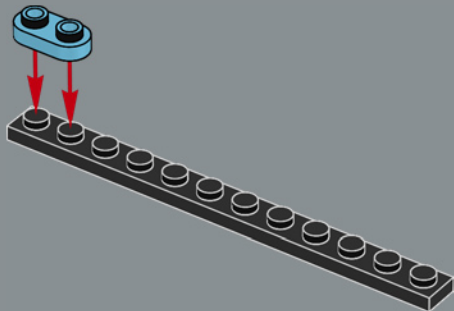

39

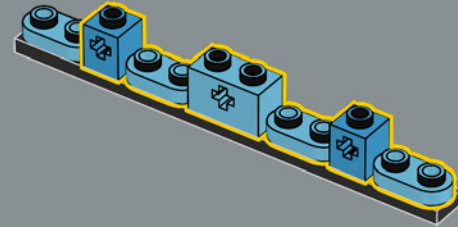

40

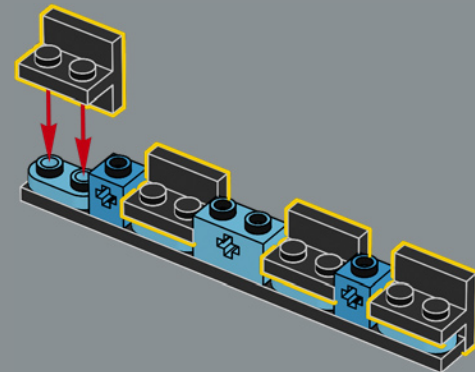

4x

41

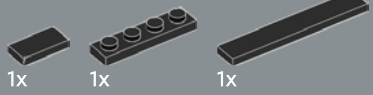
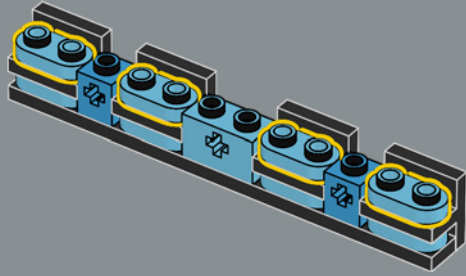

42

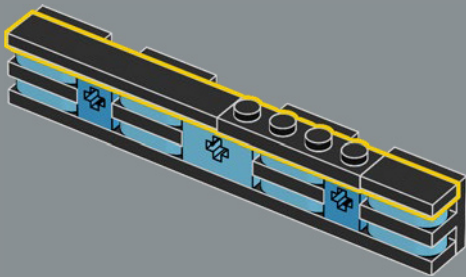

1x

1x

2x

43

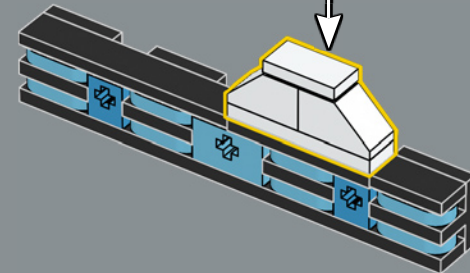
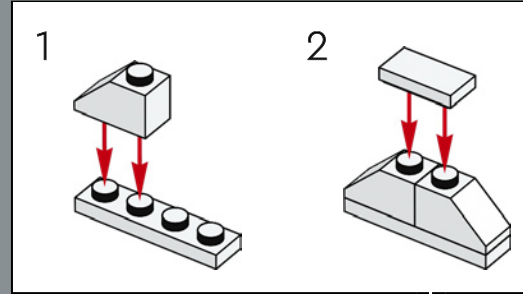

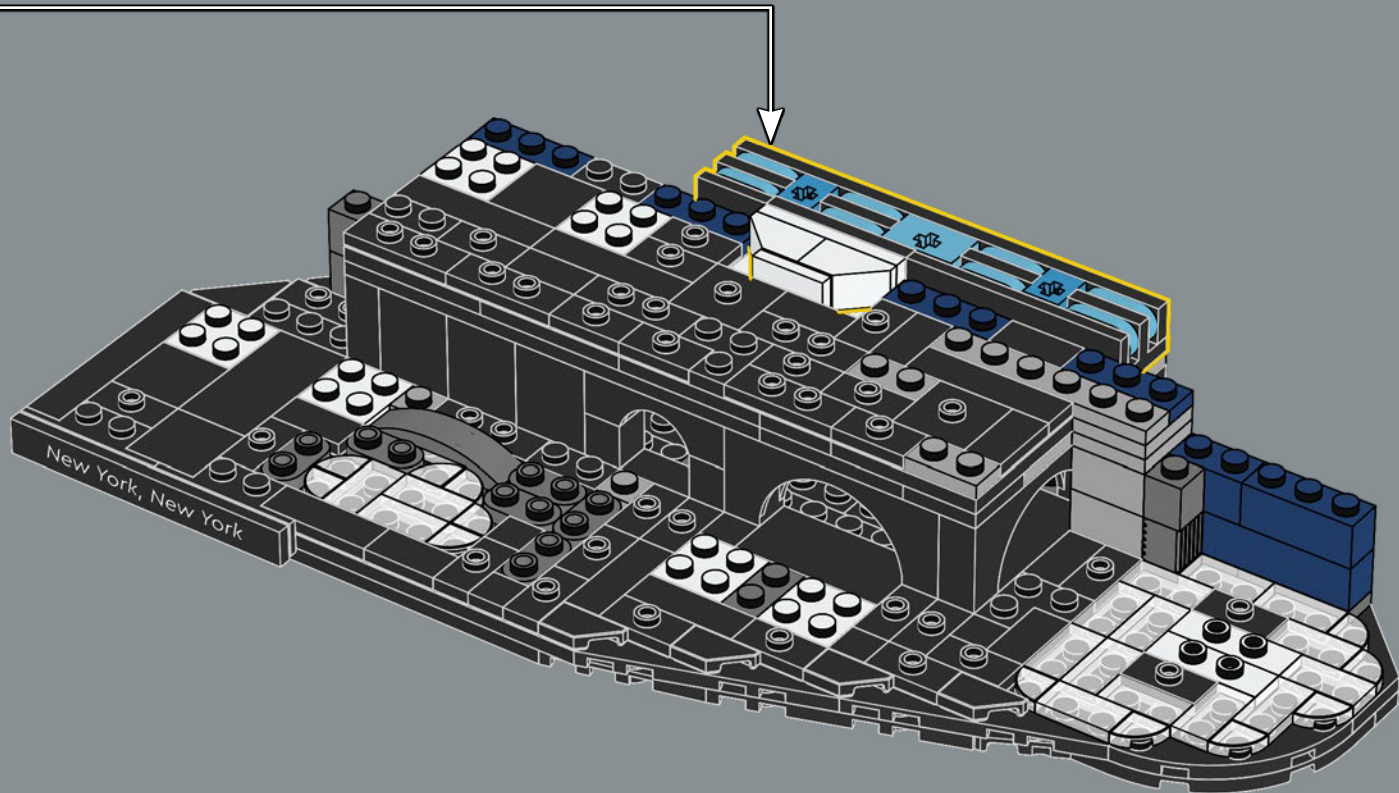

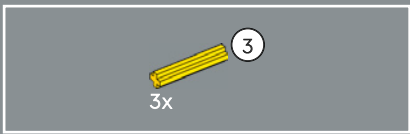

45

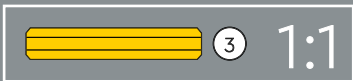
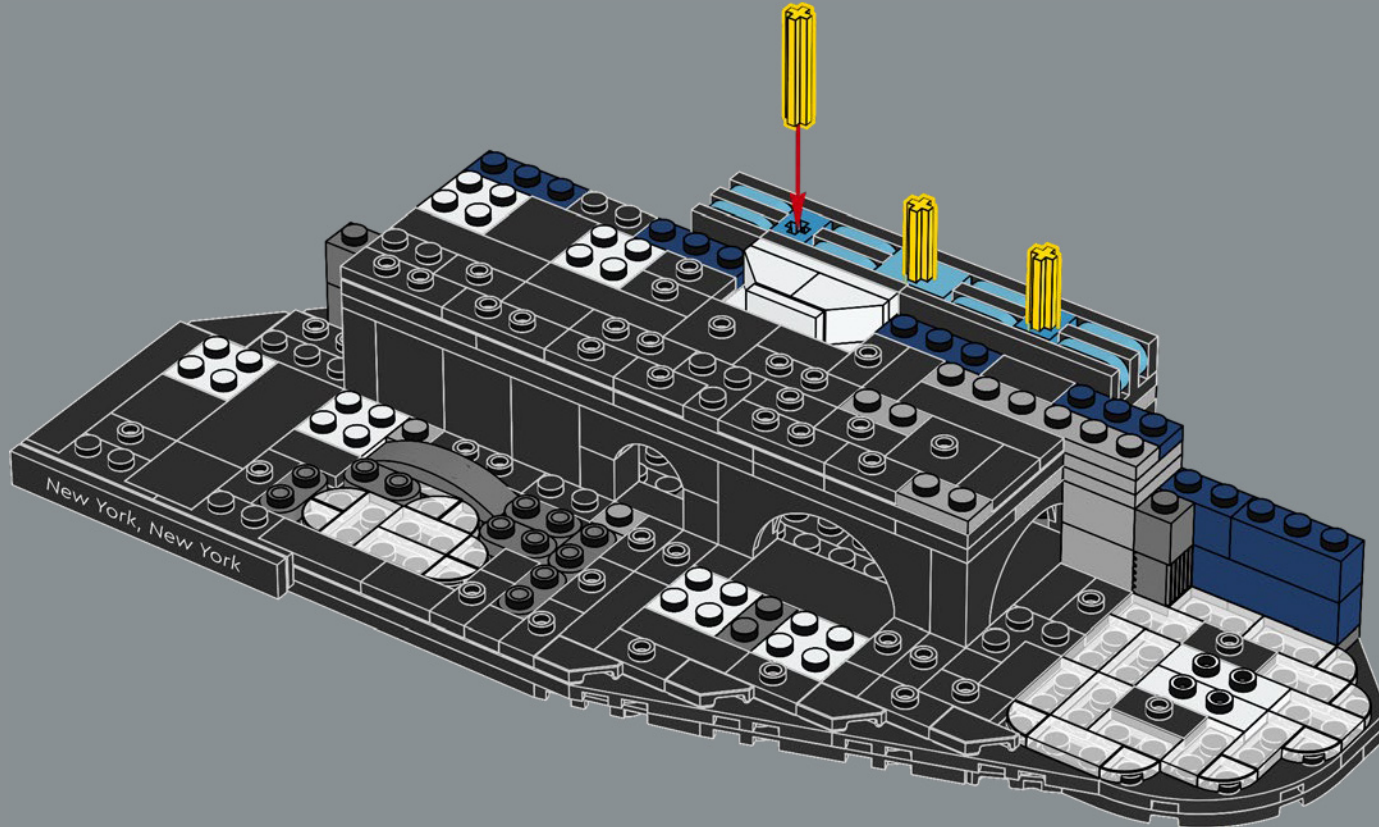

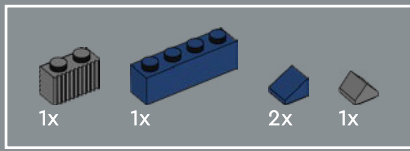

46

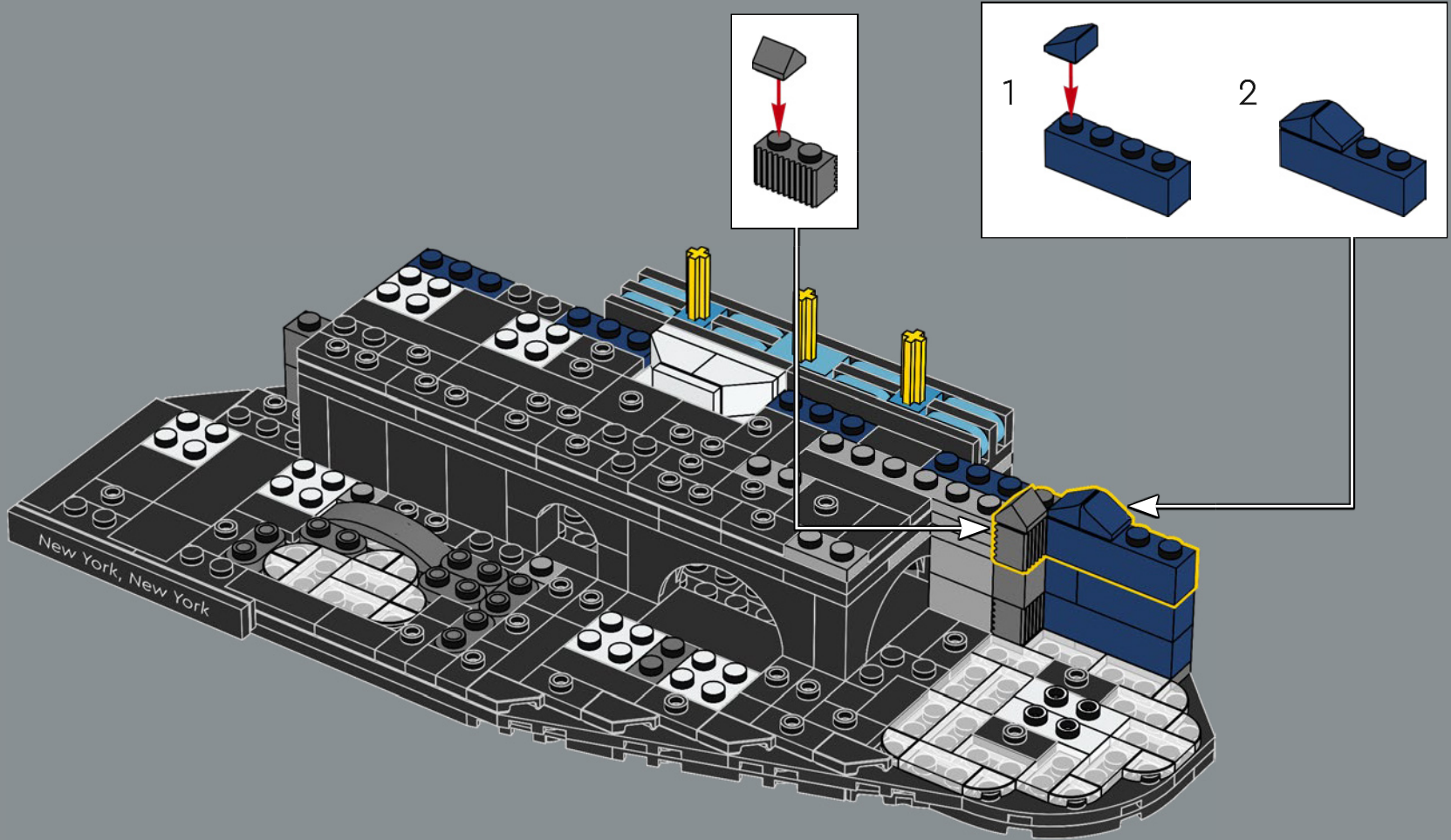

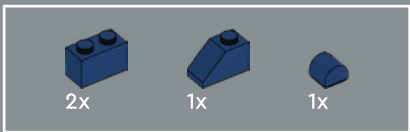

47

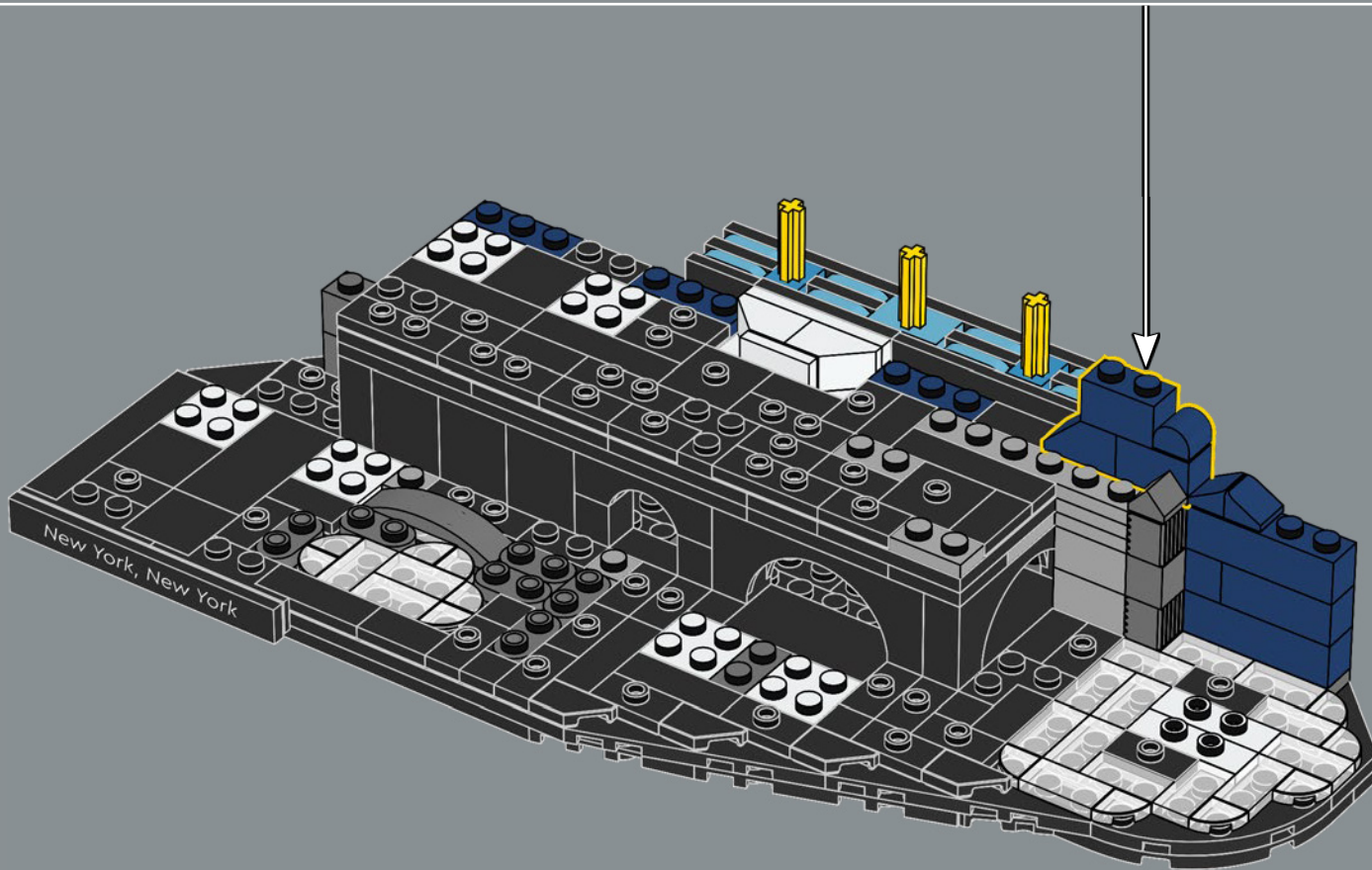
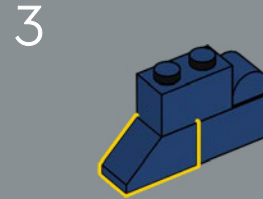
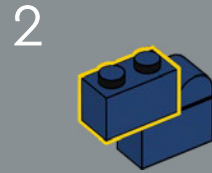
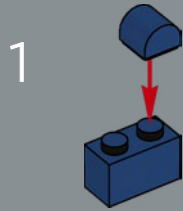

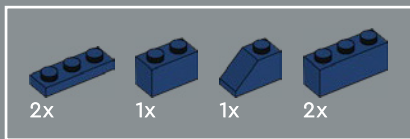

48

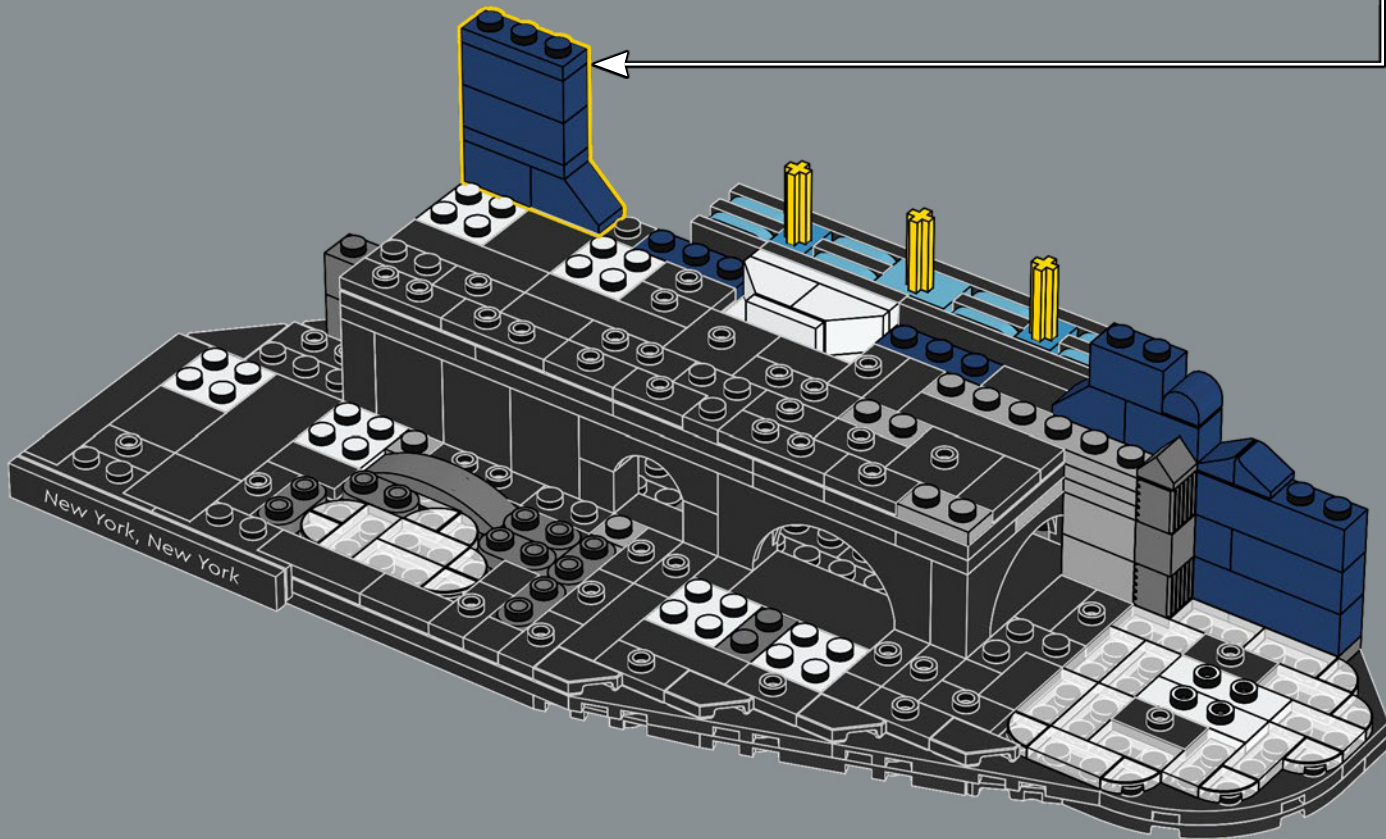

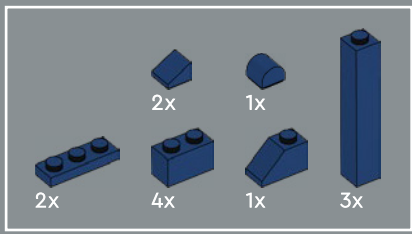

49

1

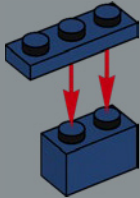

2

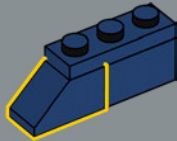

3

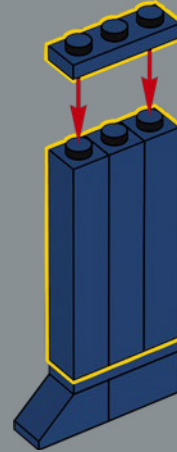

4

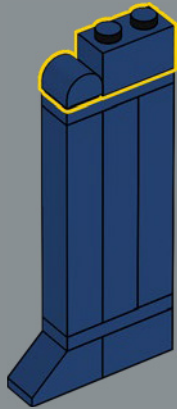

5

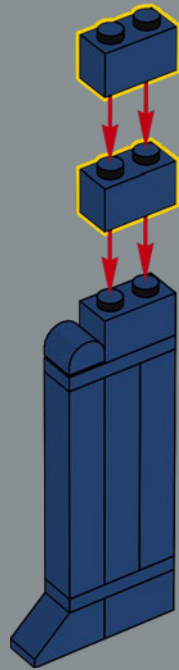

6

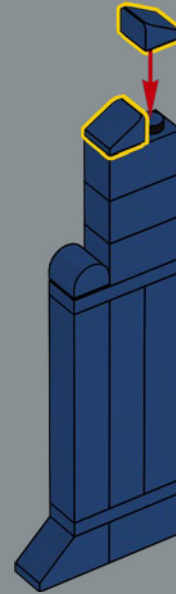

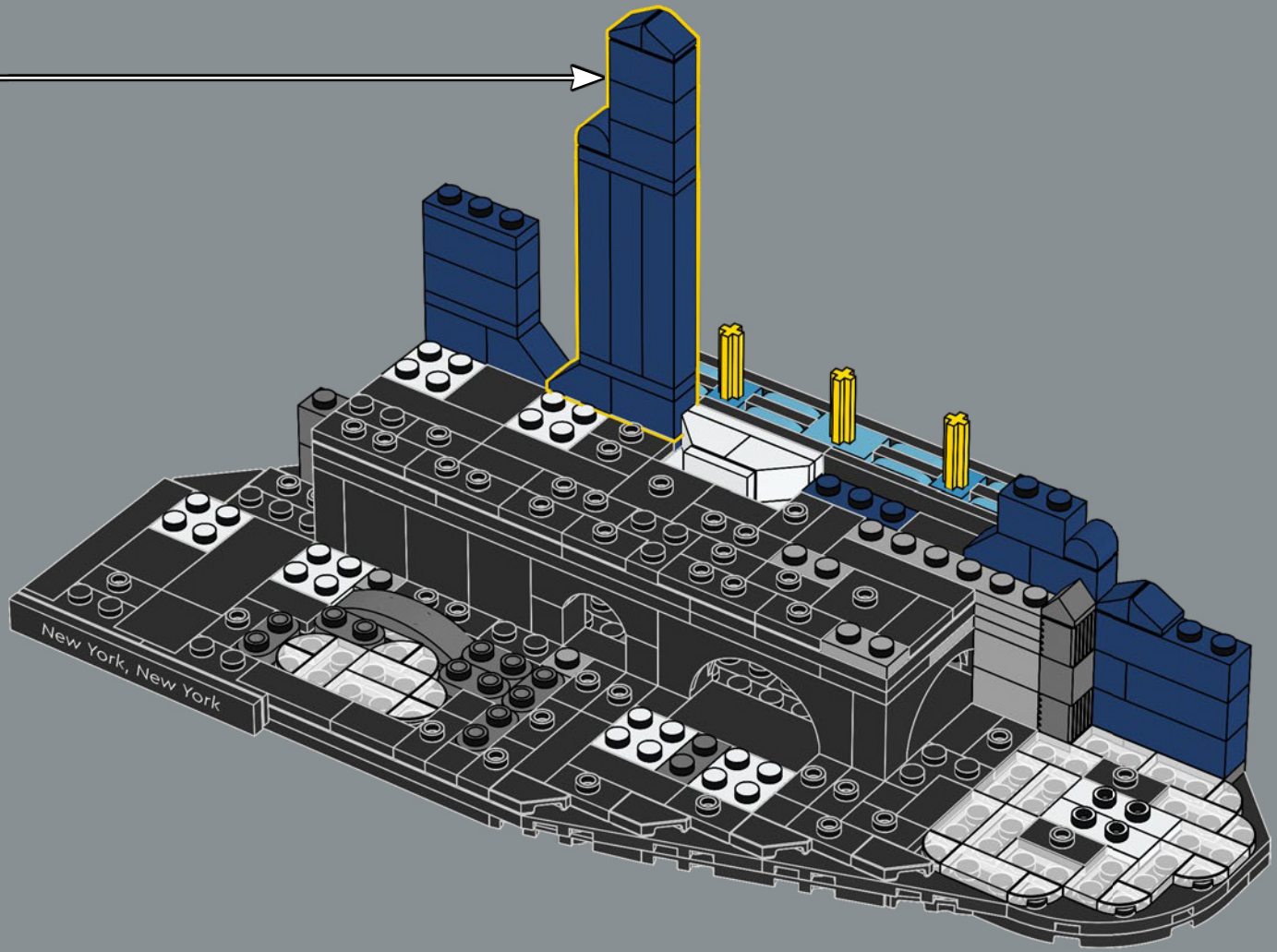

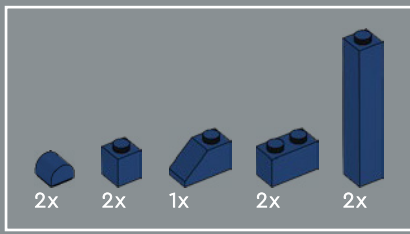

50

1

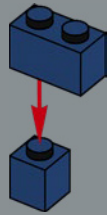

2

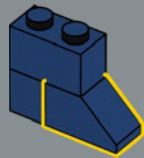

3

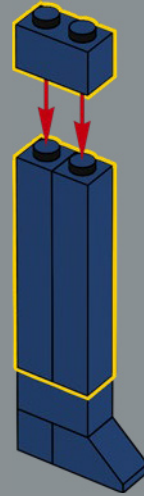

4

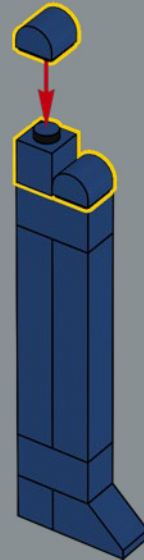

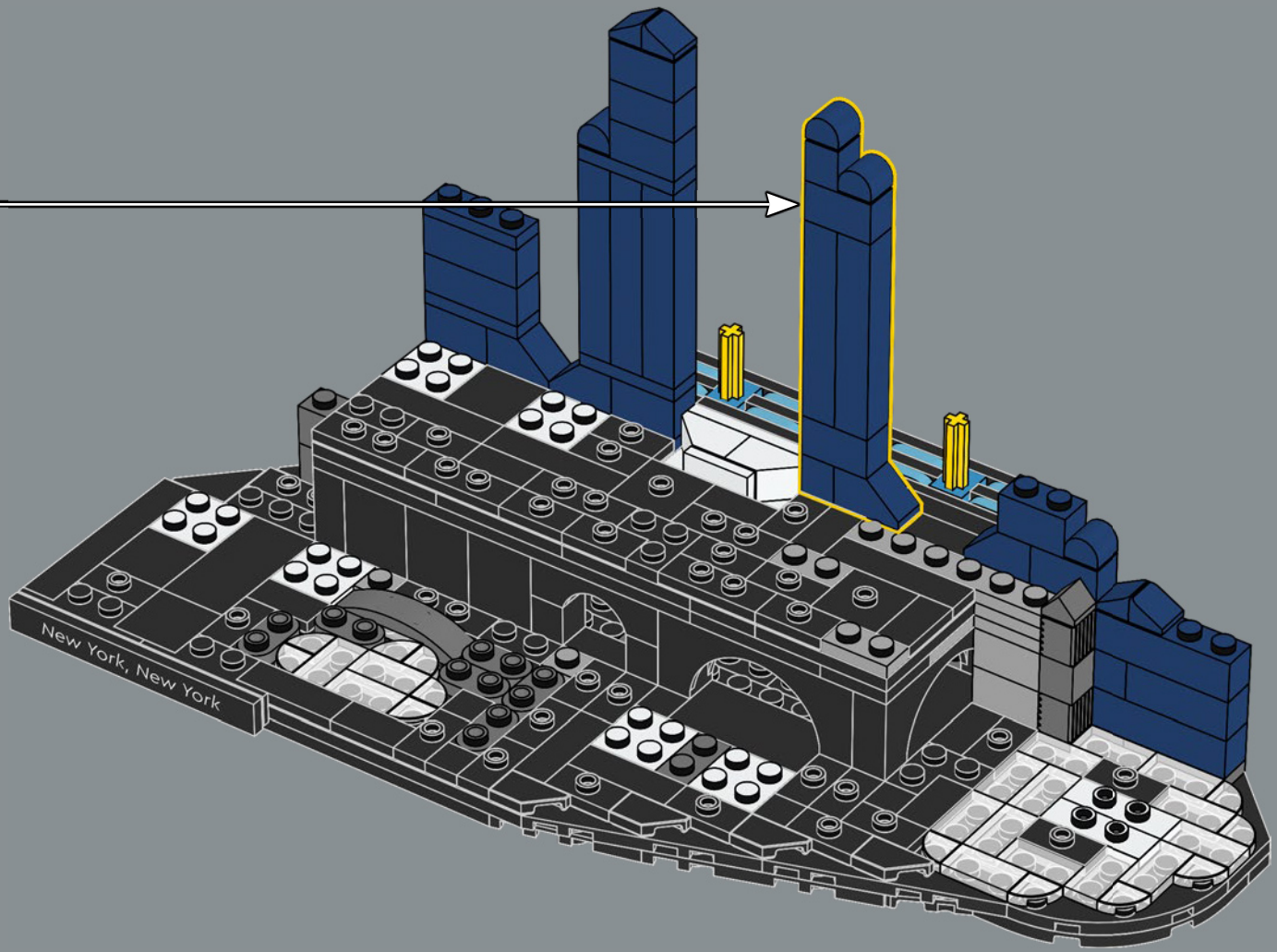

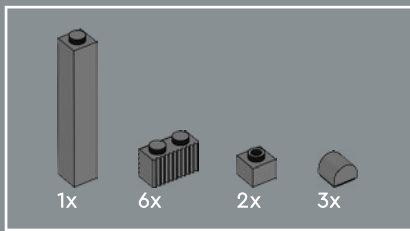

51

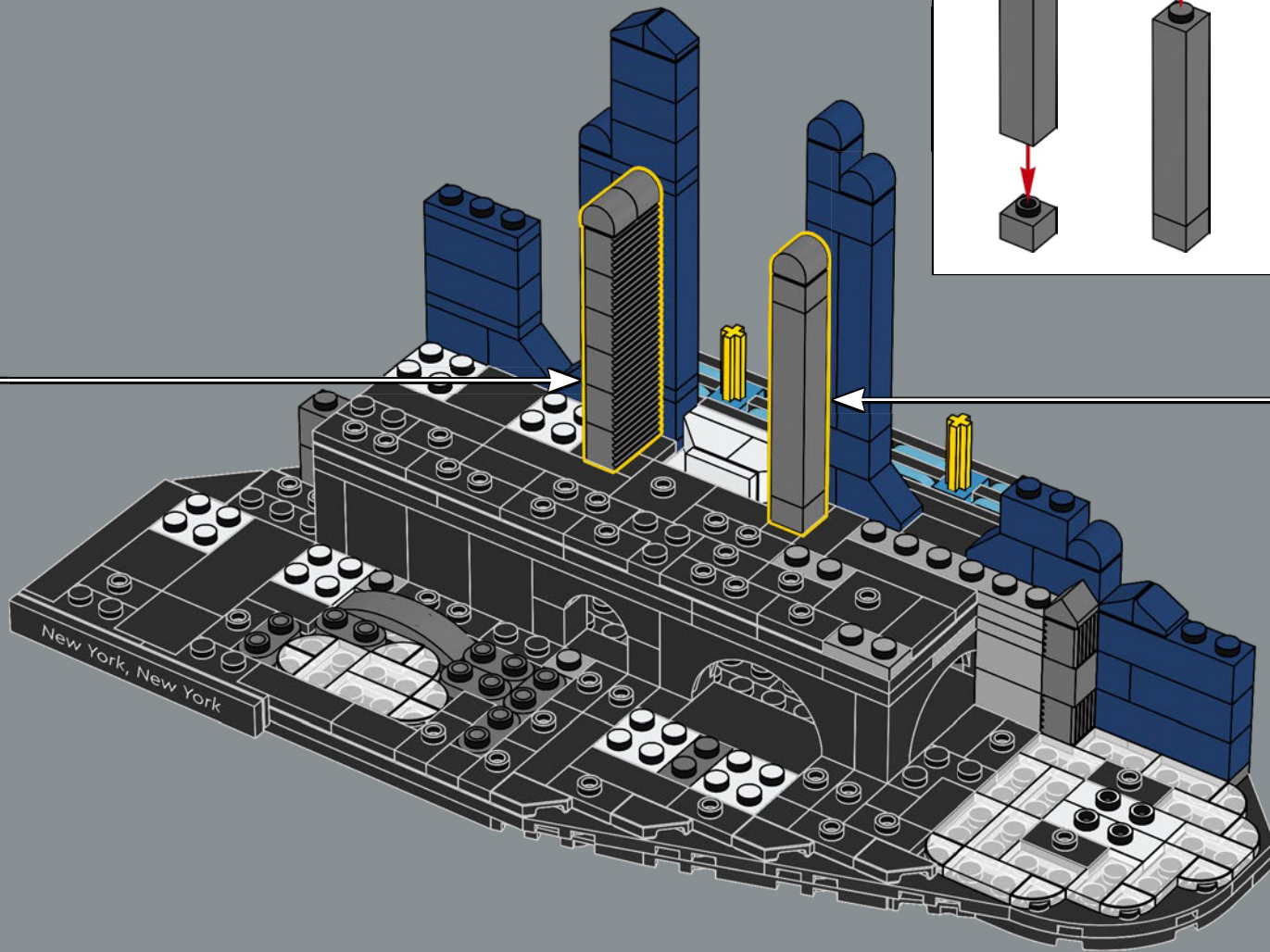
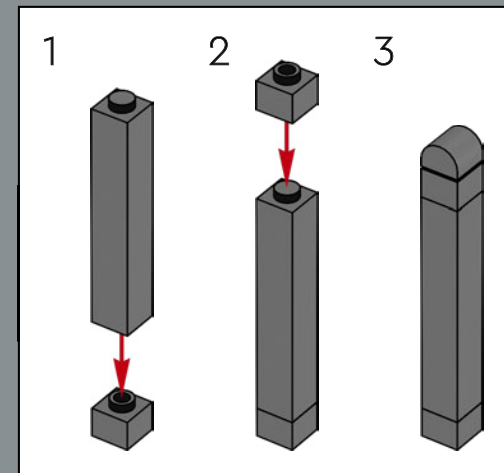
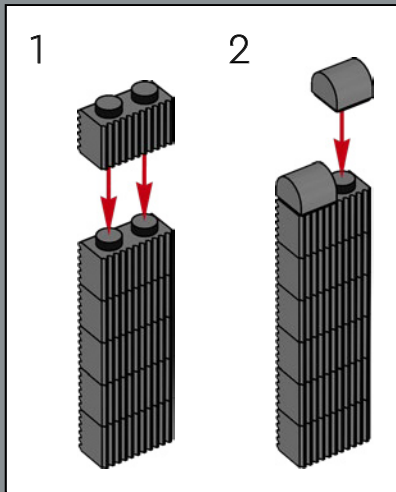

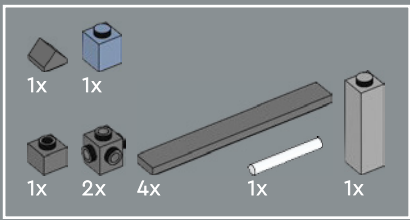

52

1

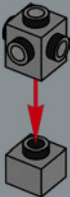

2



3



4



5

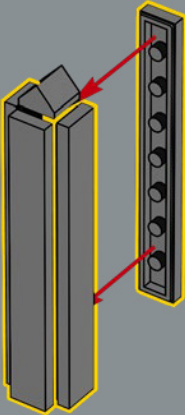

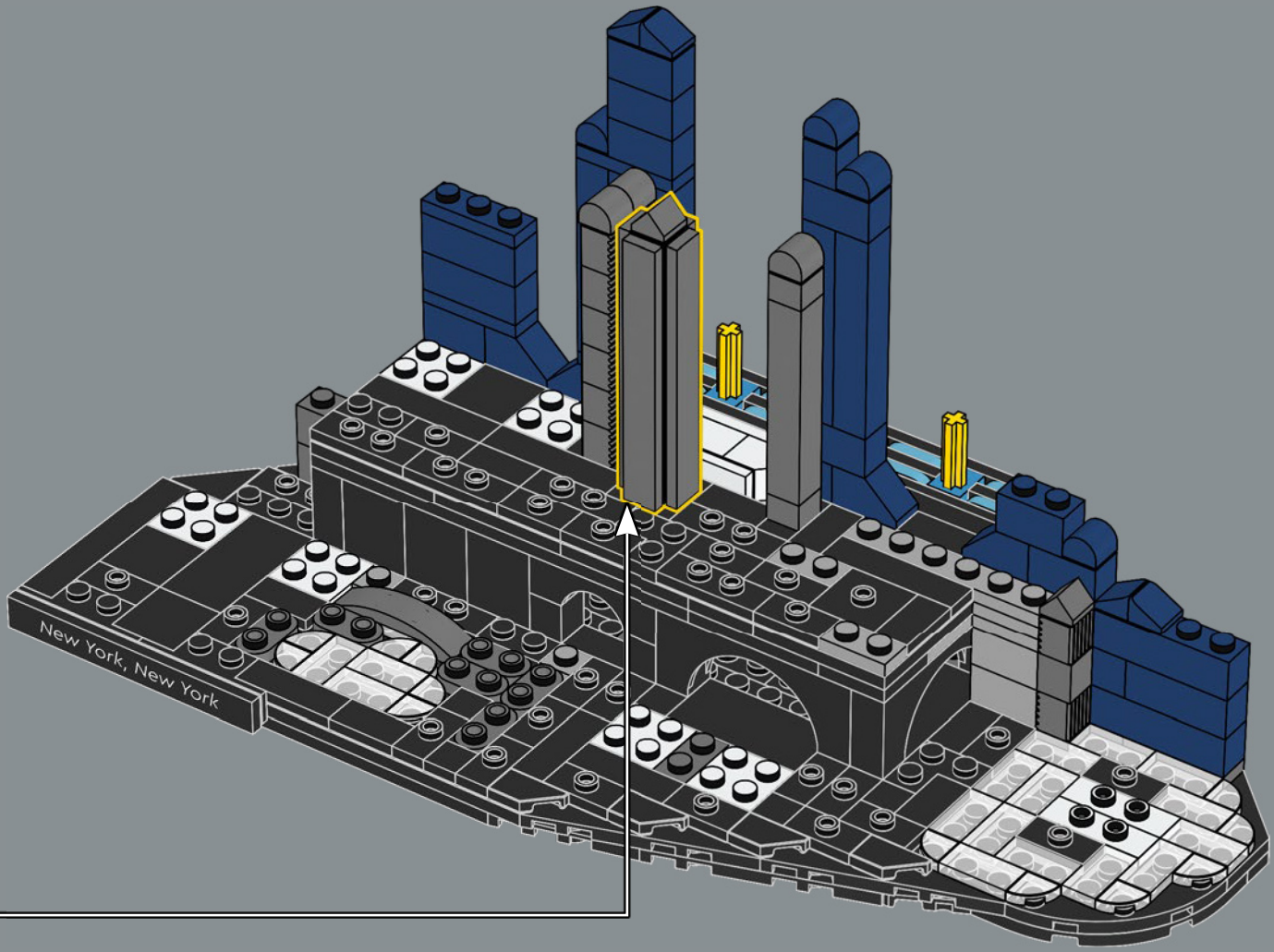

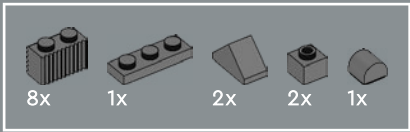

53

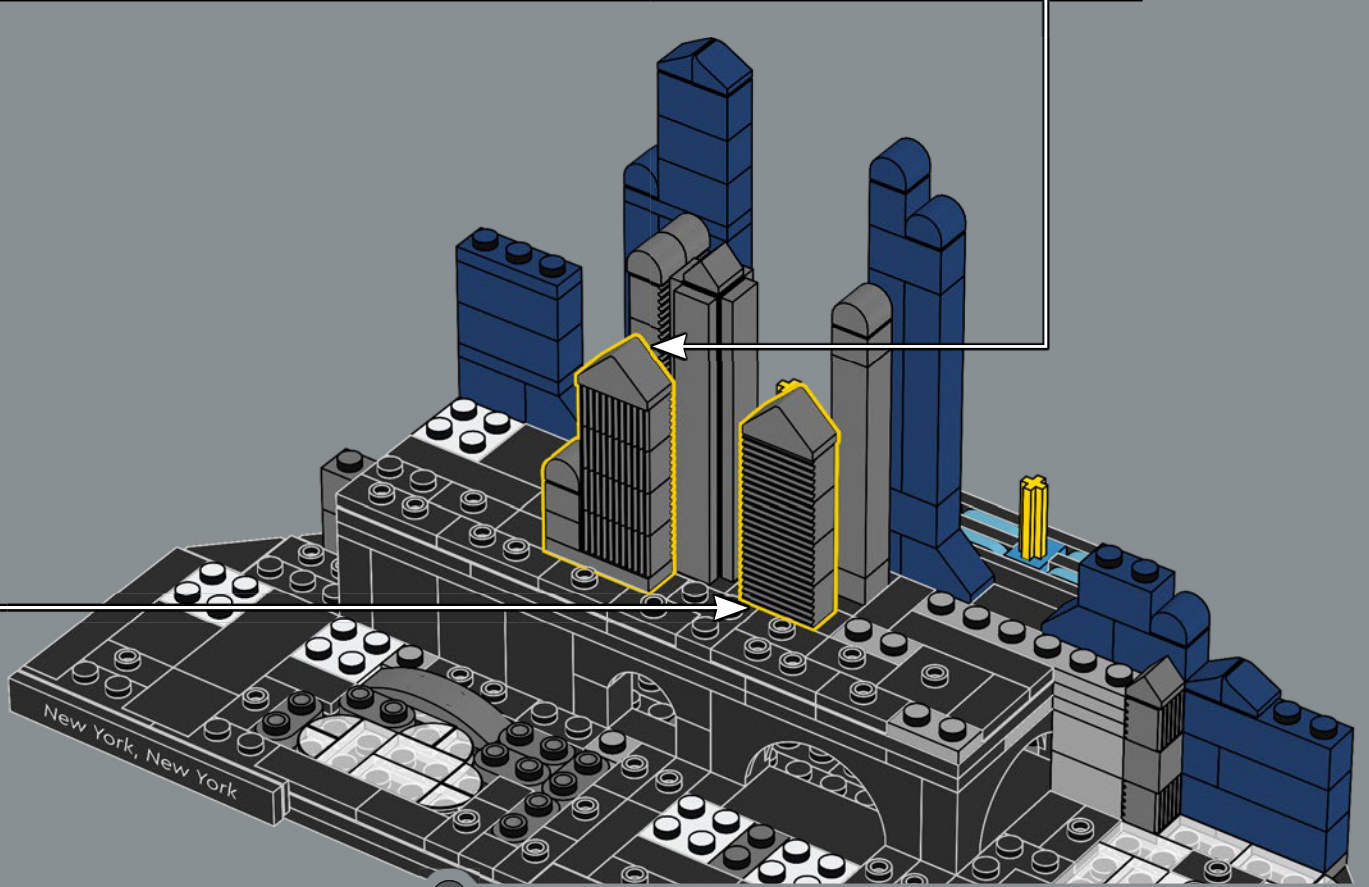
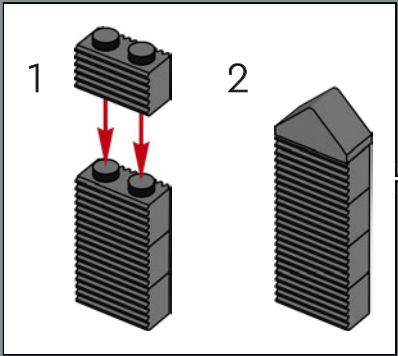
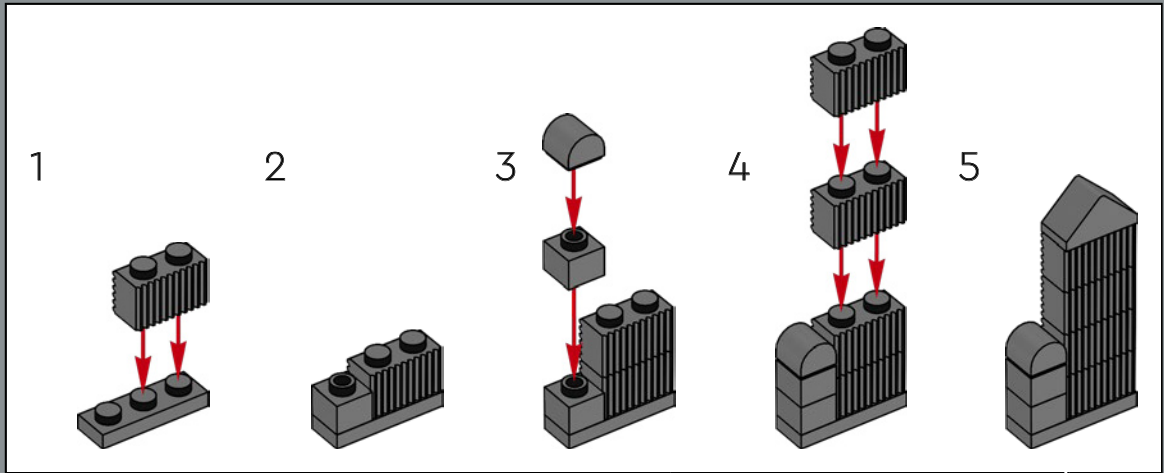

Estos patines de minifigura LEGO® amarillos representan algunos de los más de 13.000 taxis típicos de Nueva York.

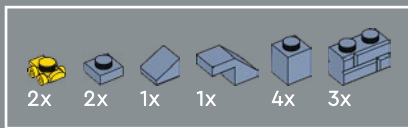

54

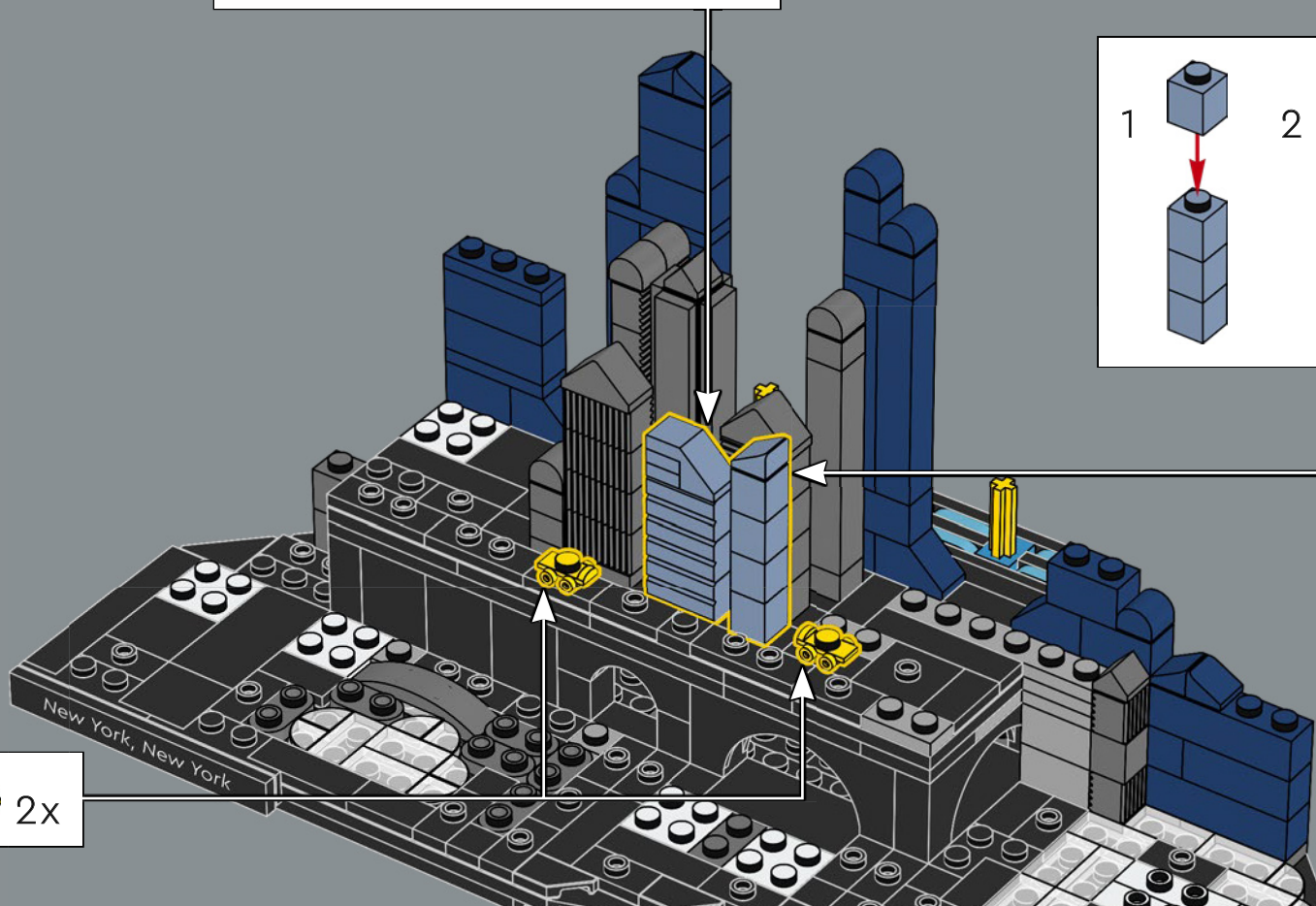
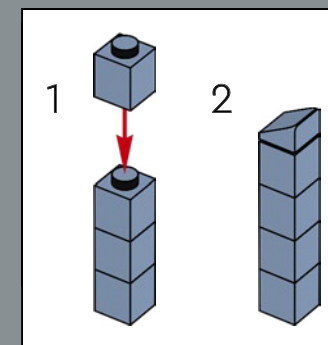
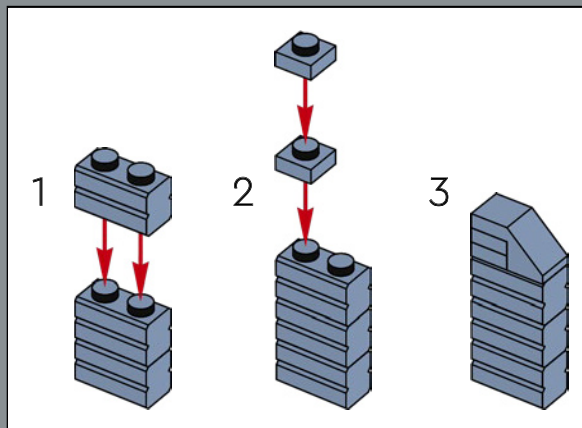

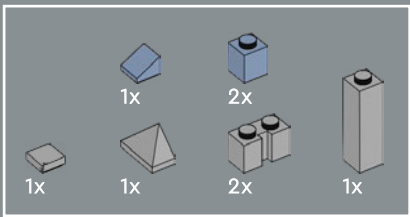

55

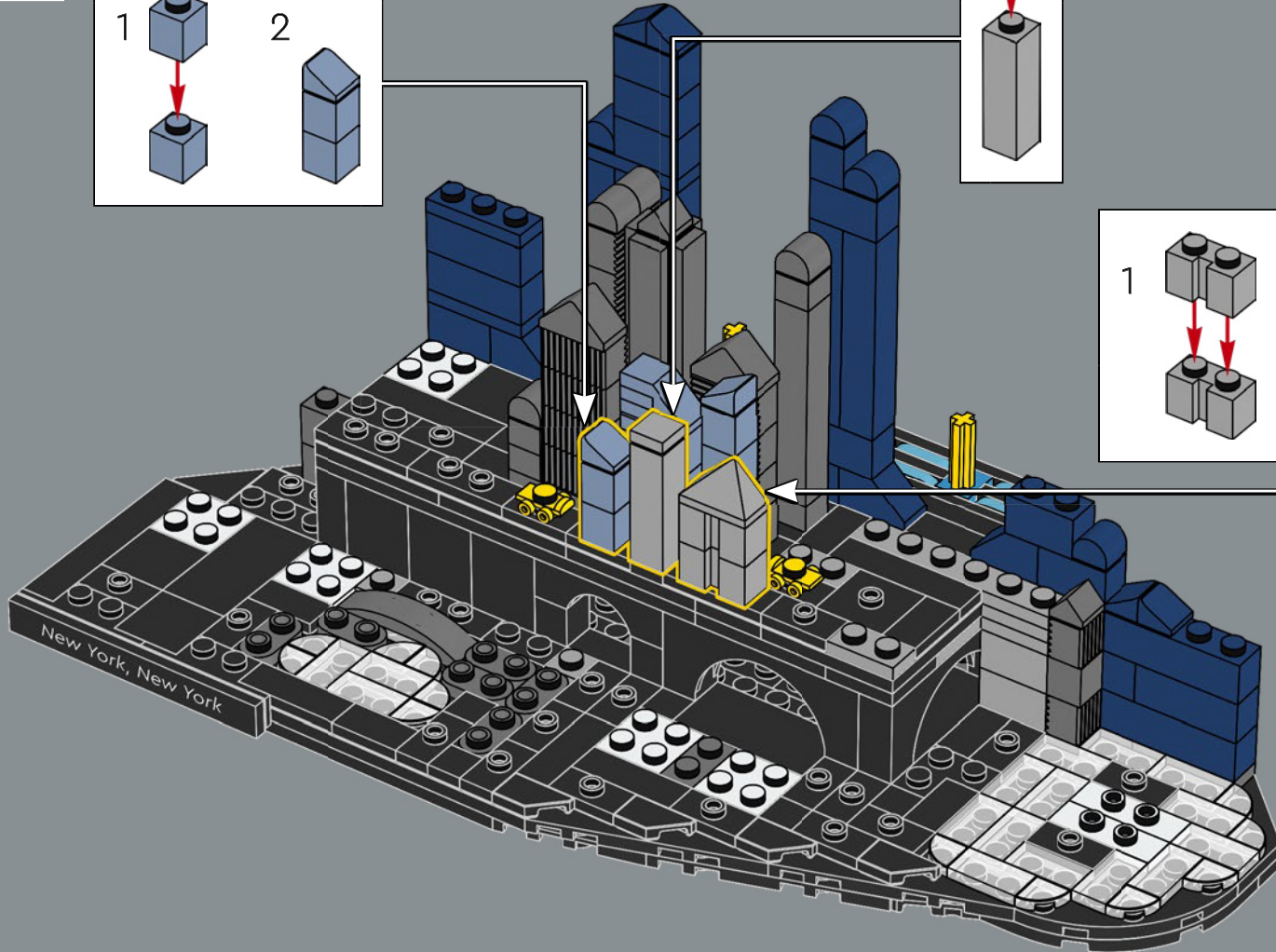
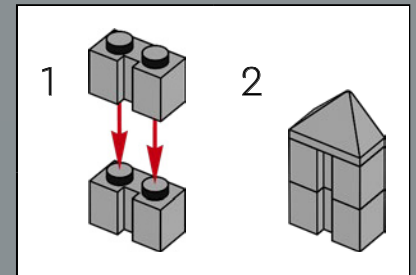
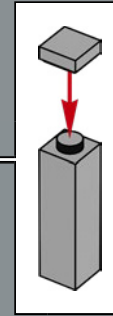
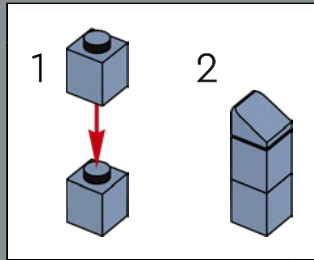

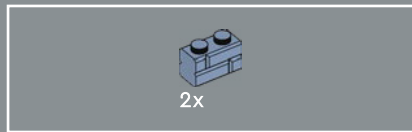

56

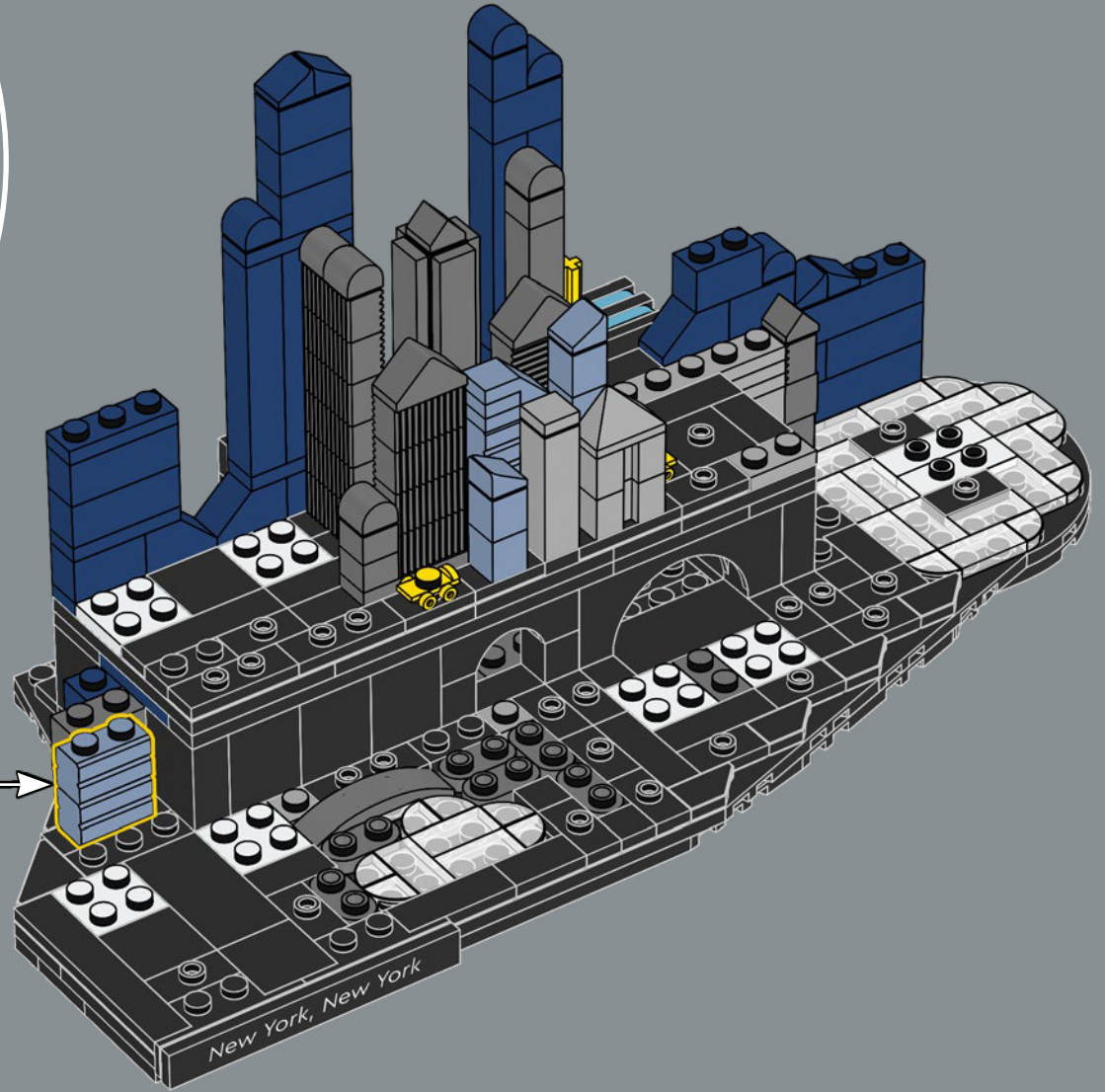
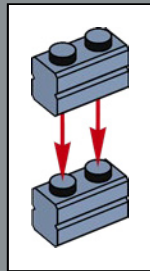

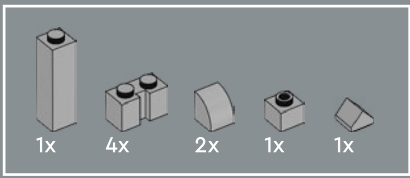

57

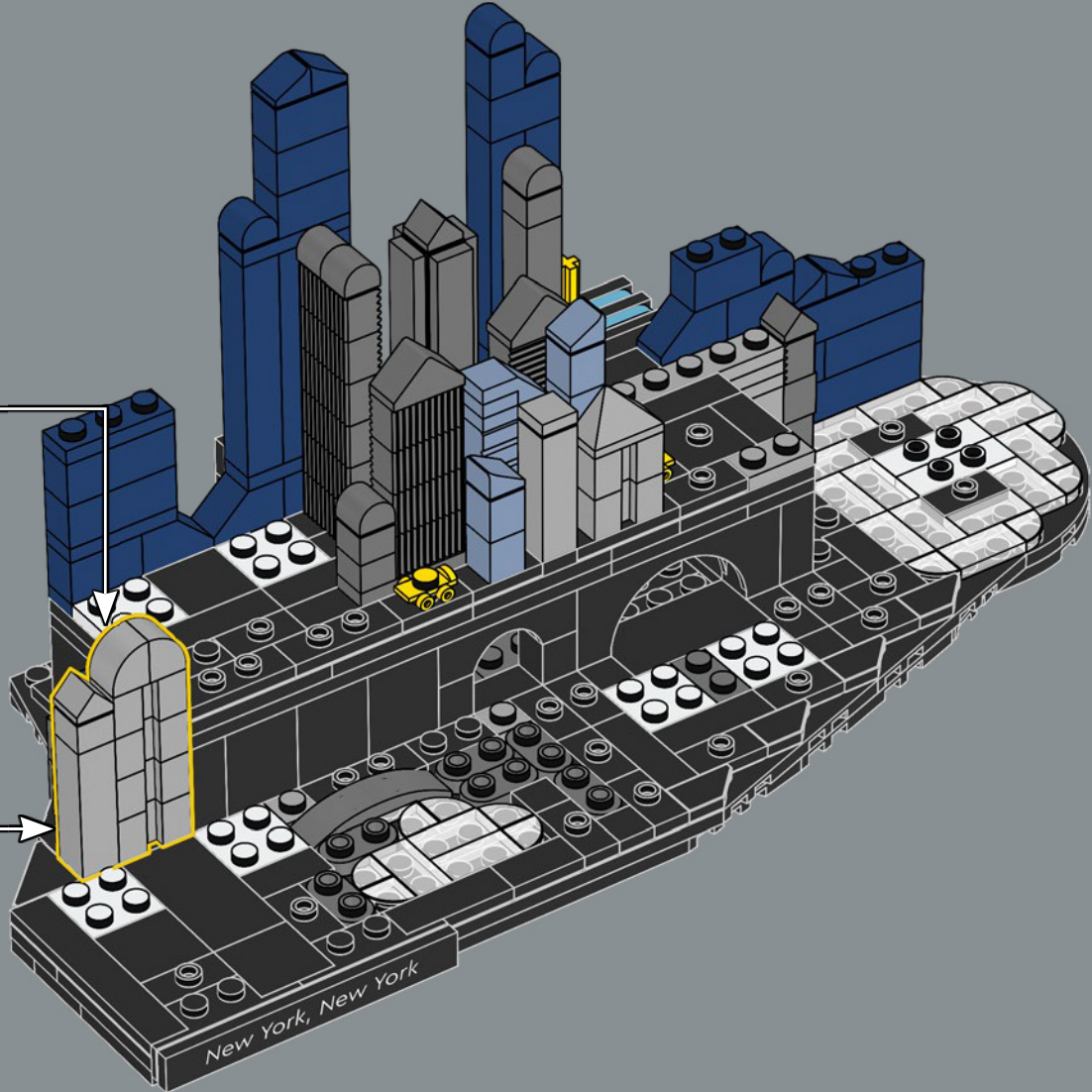
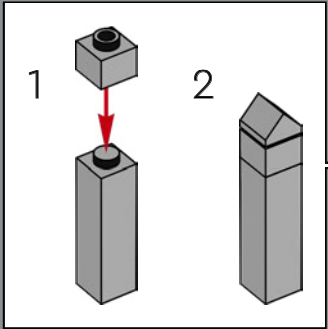
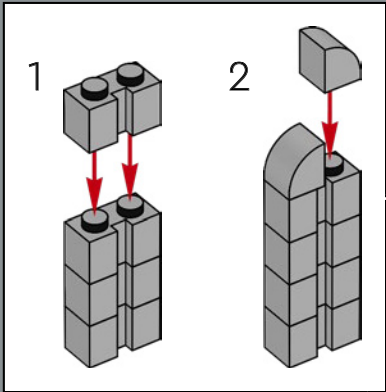

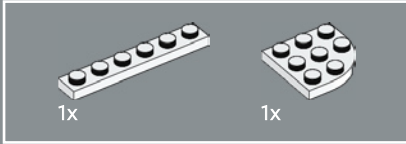
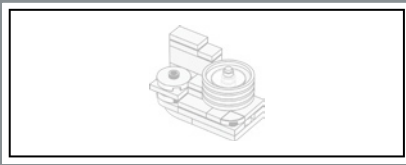

58

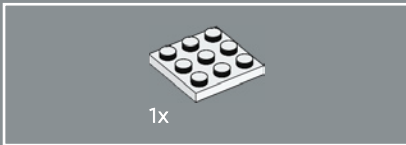
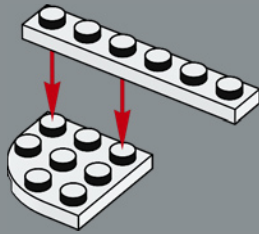

59

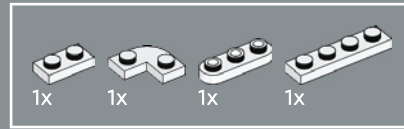
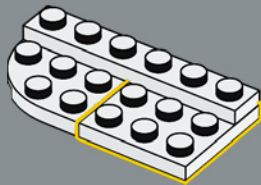

60

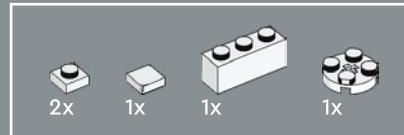
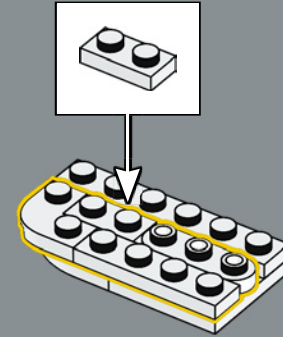

61

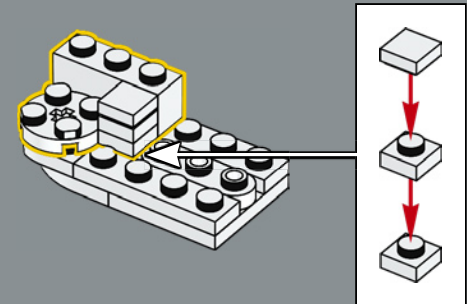



62

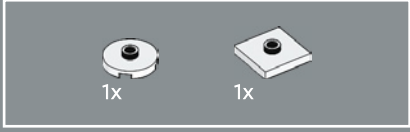
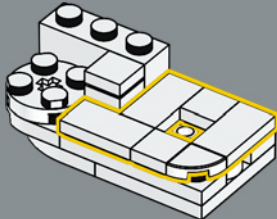

63

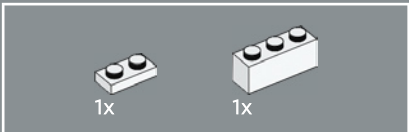
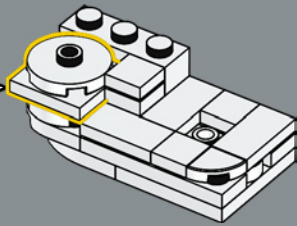
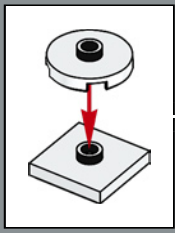

64

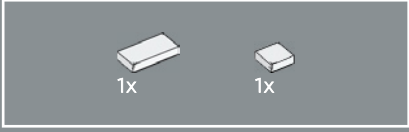
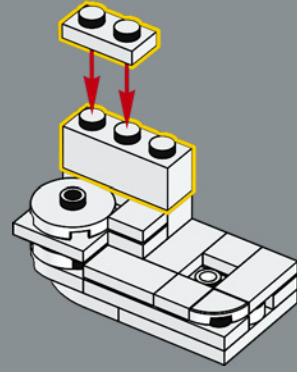

65

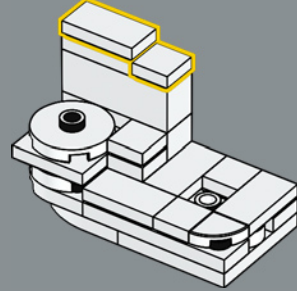

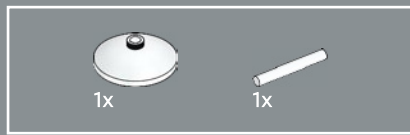

66

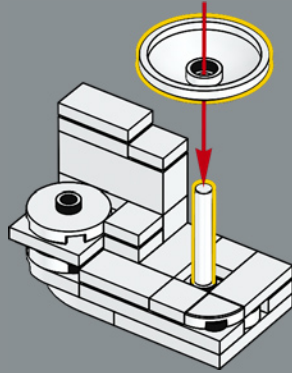

67

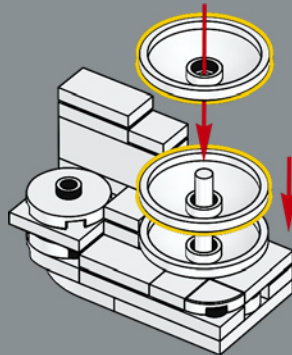

68

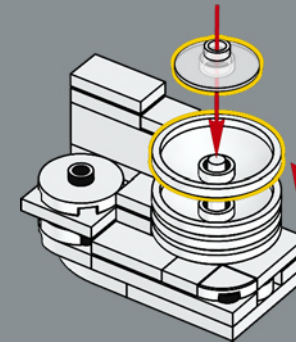

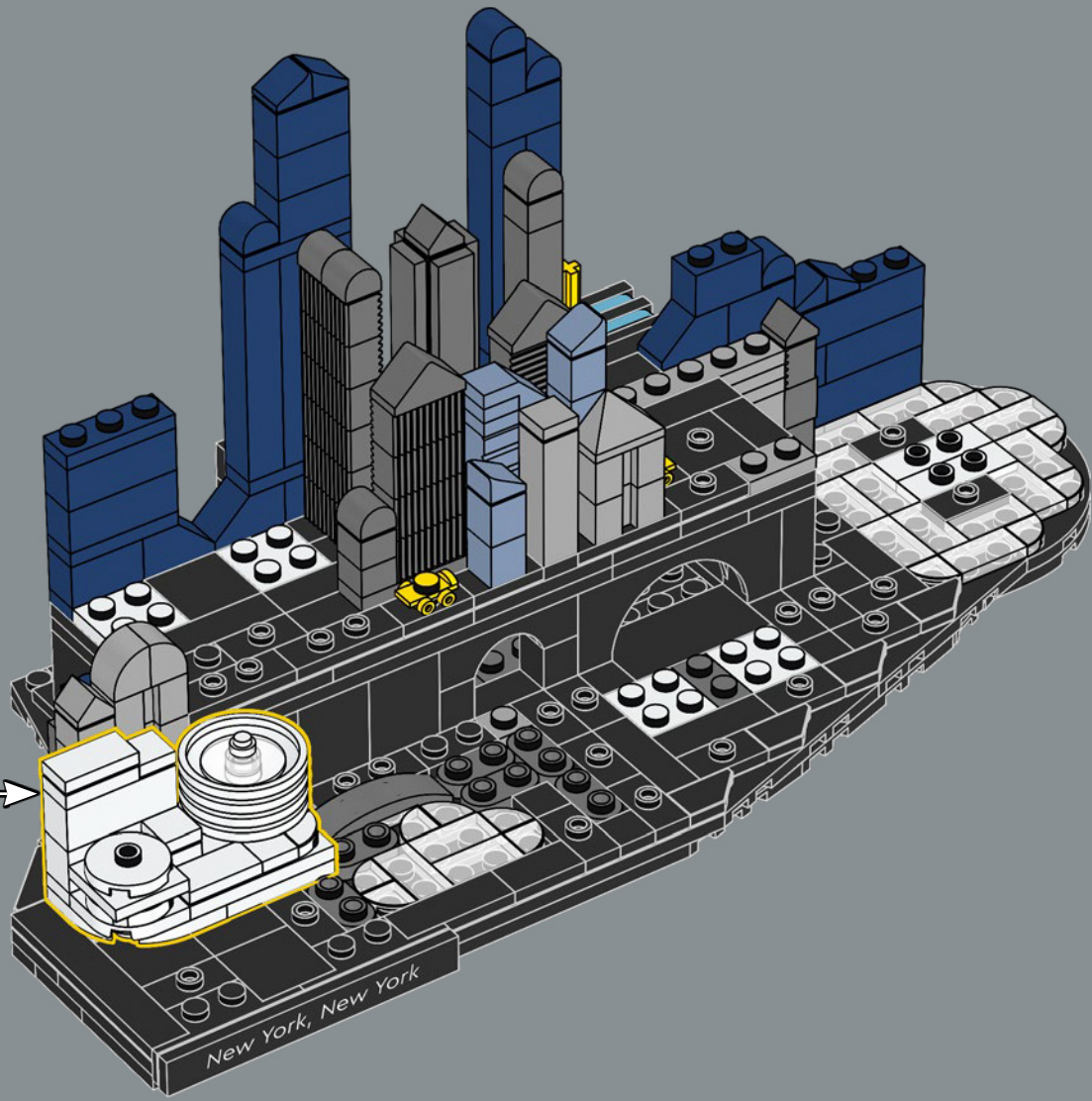

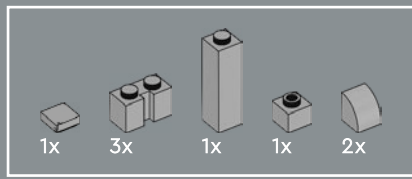

70

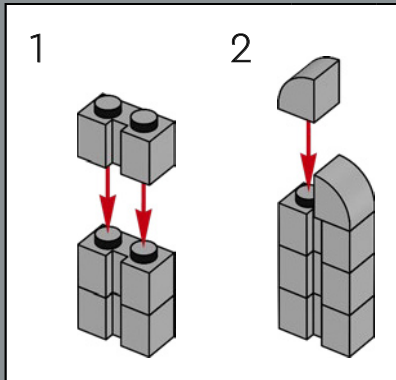
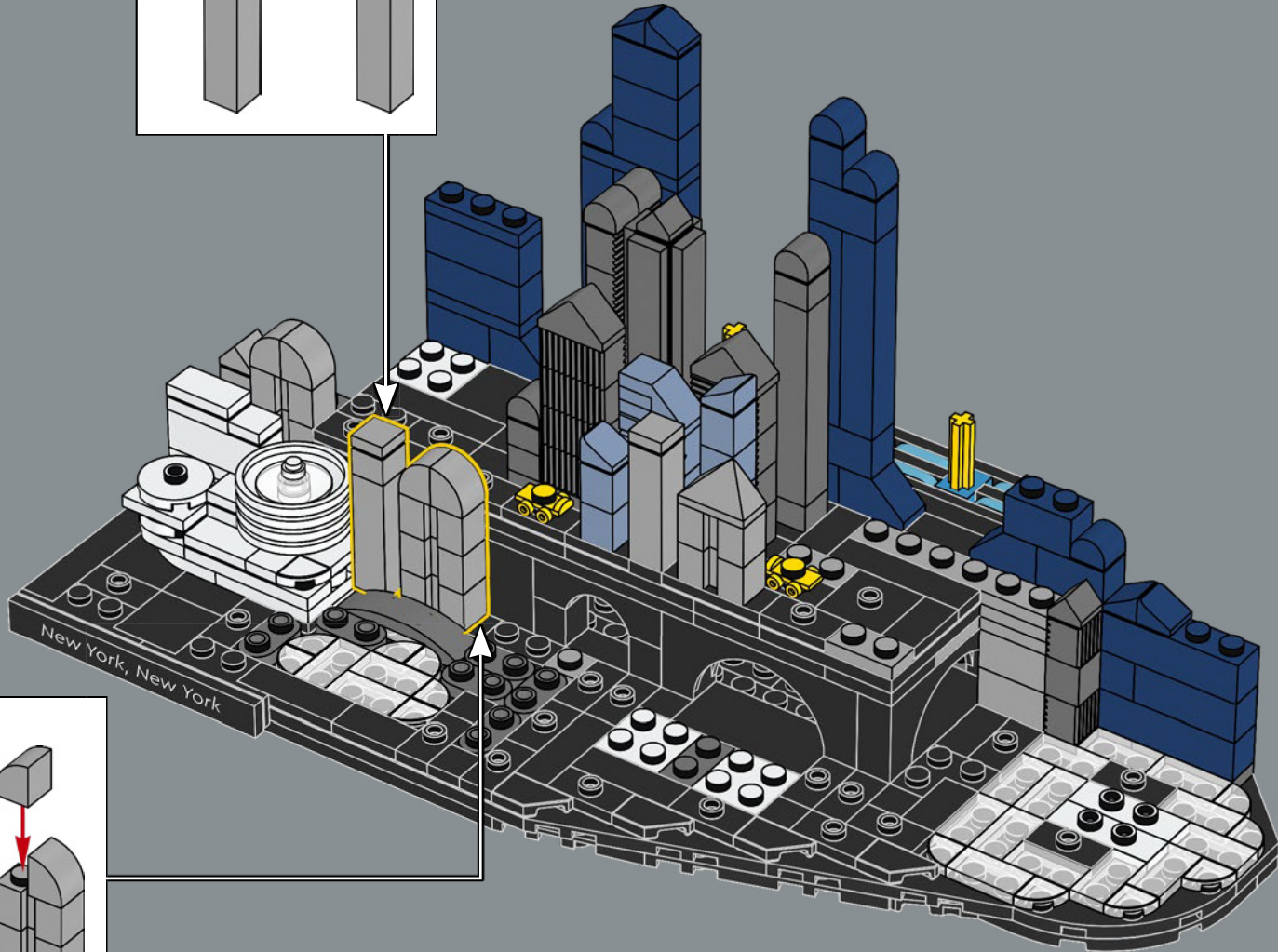
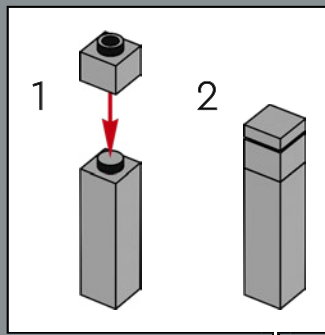

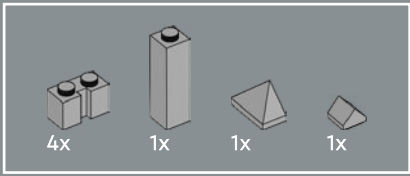

71

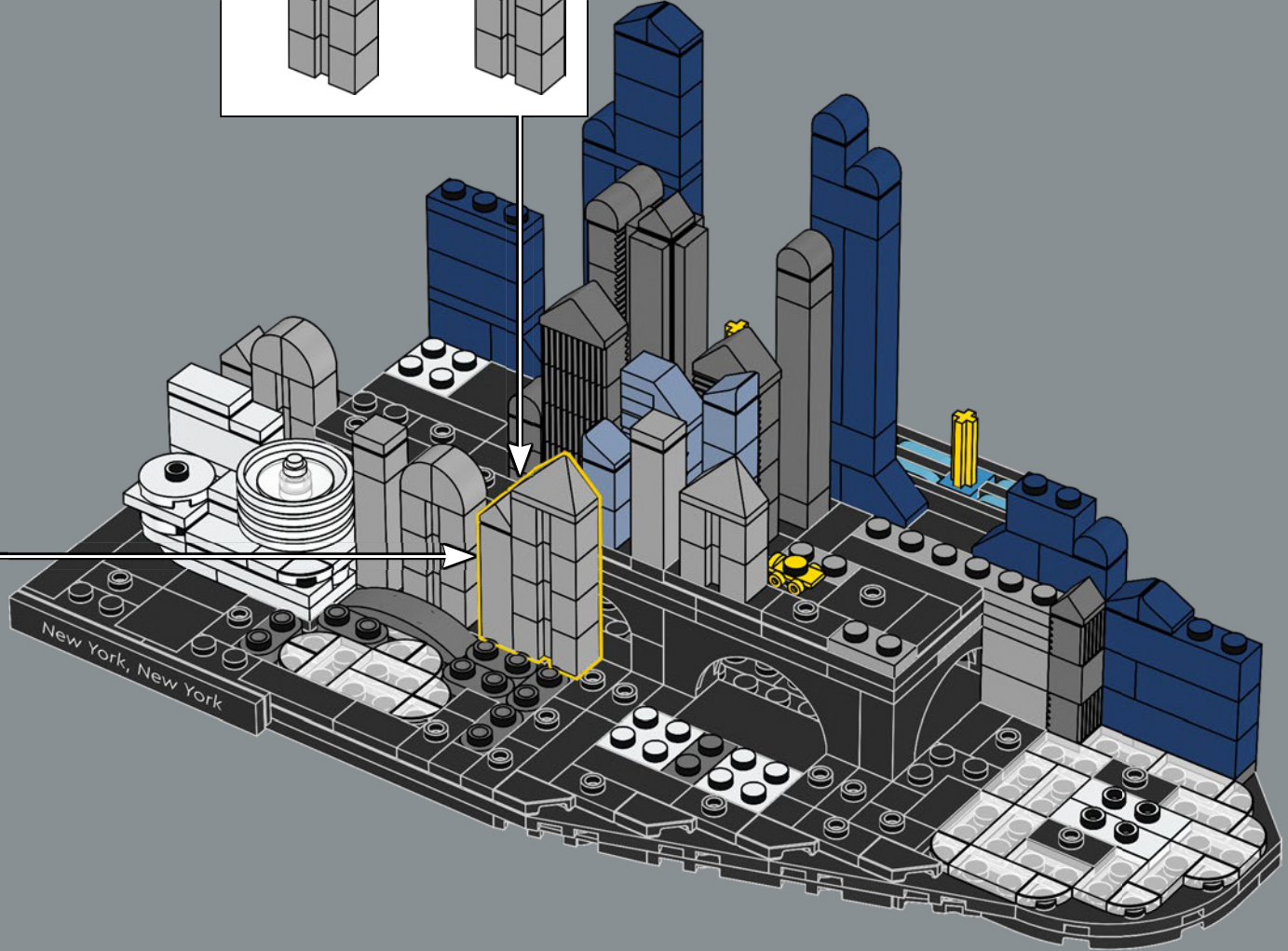
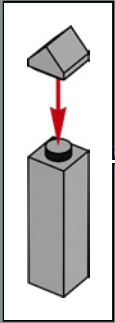
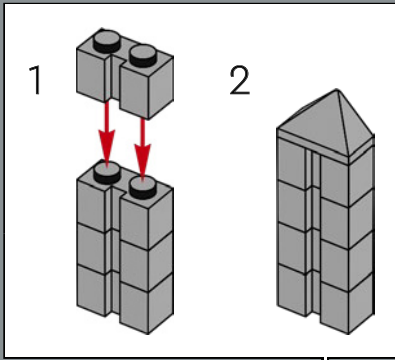



7x



3x

72

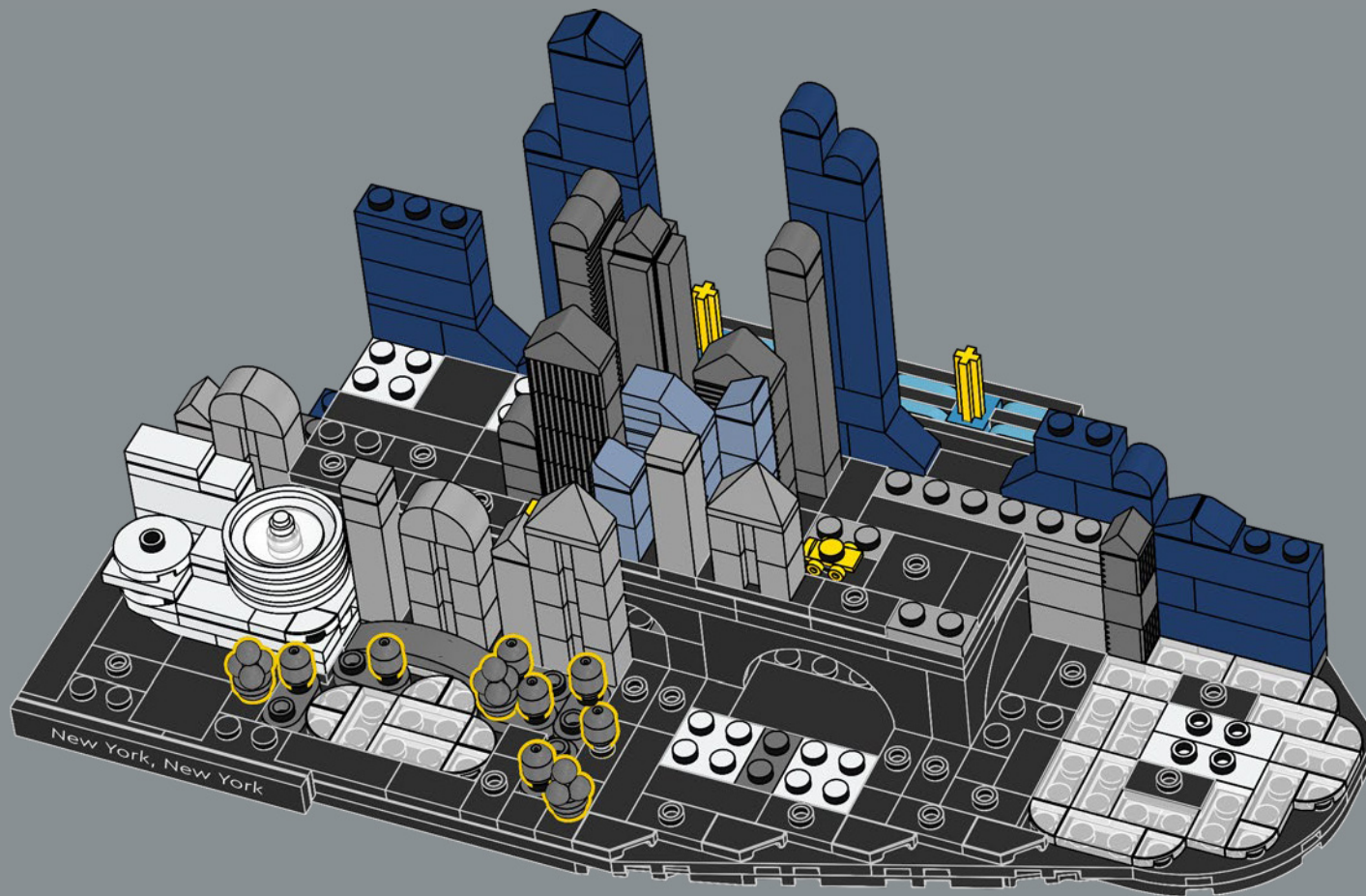



Usamos elementos LEGO® que representan helados, palas y globos para recrear algunos de los 18.000 árboles que, según se calcula, alberga Central Park.

73

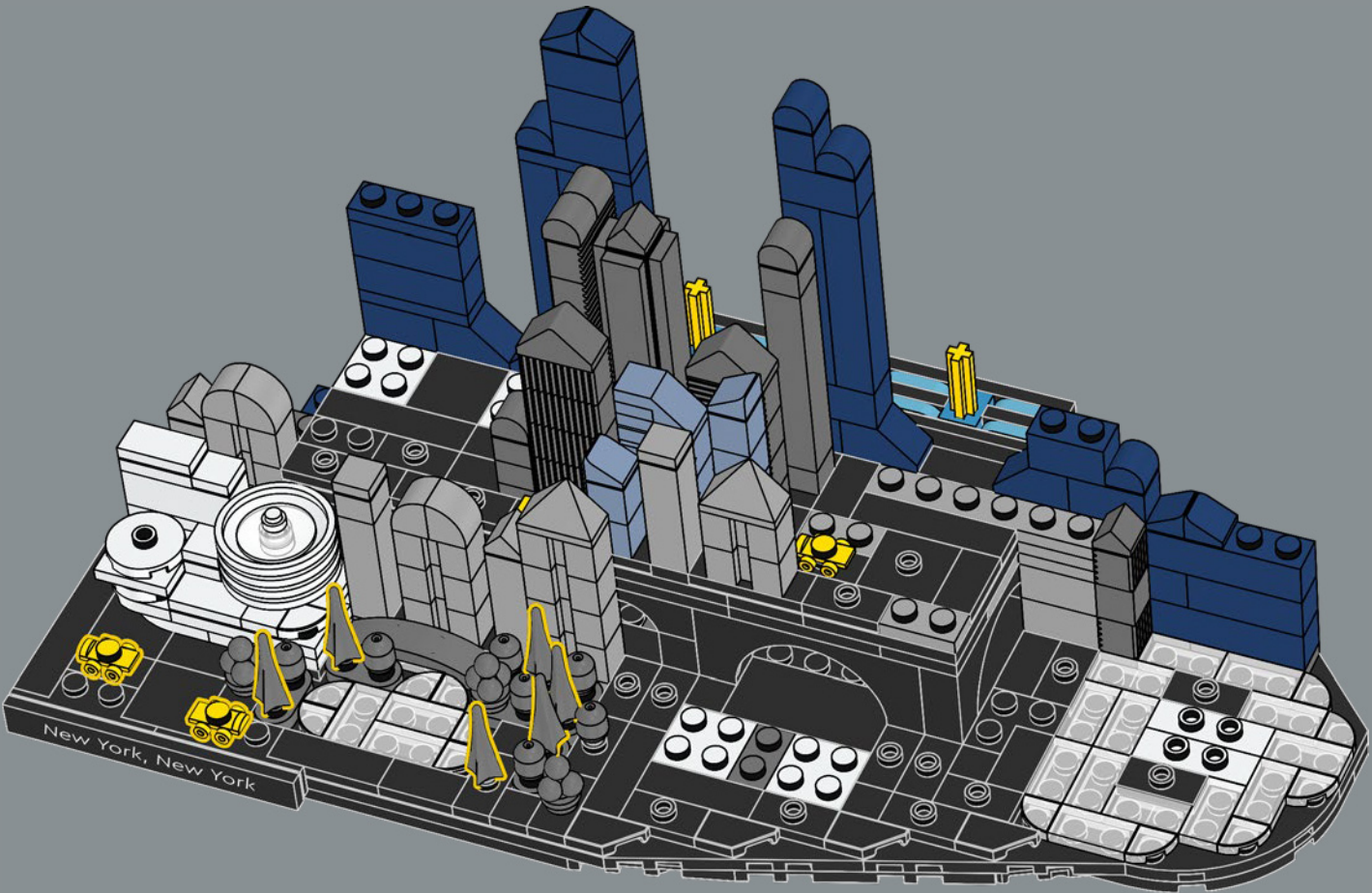

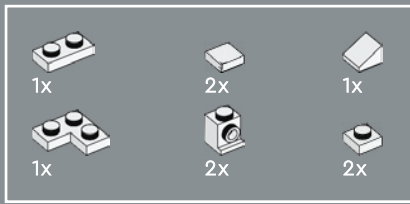

74

1

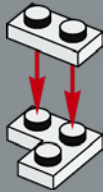

2



3

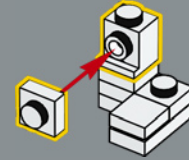

4

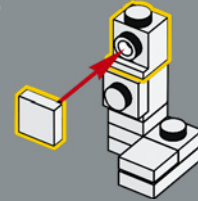

5

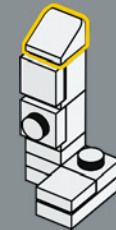

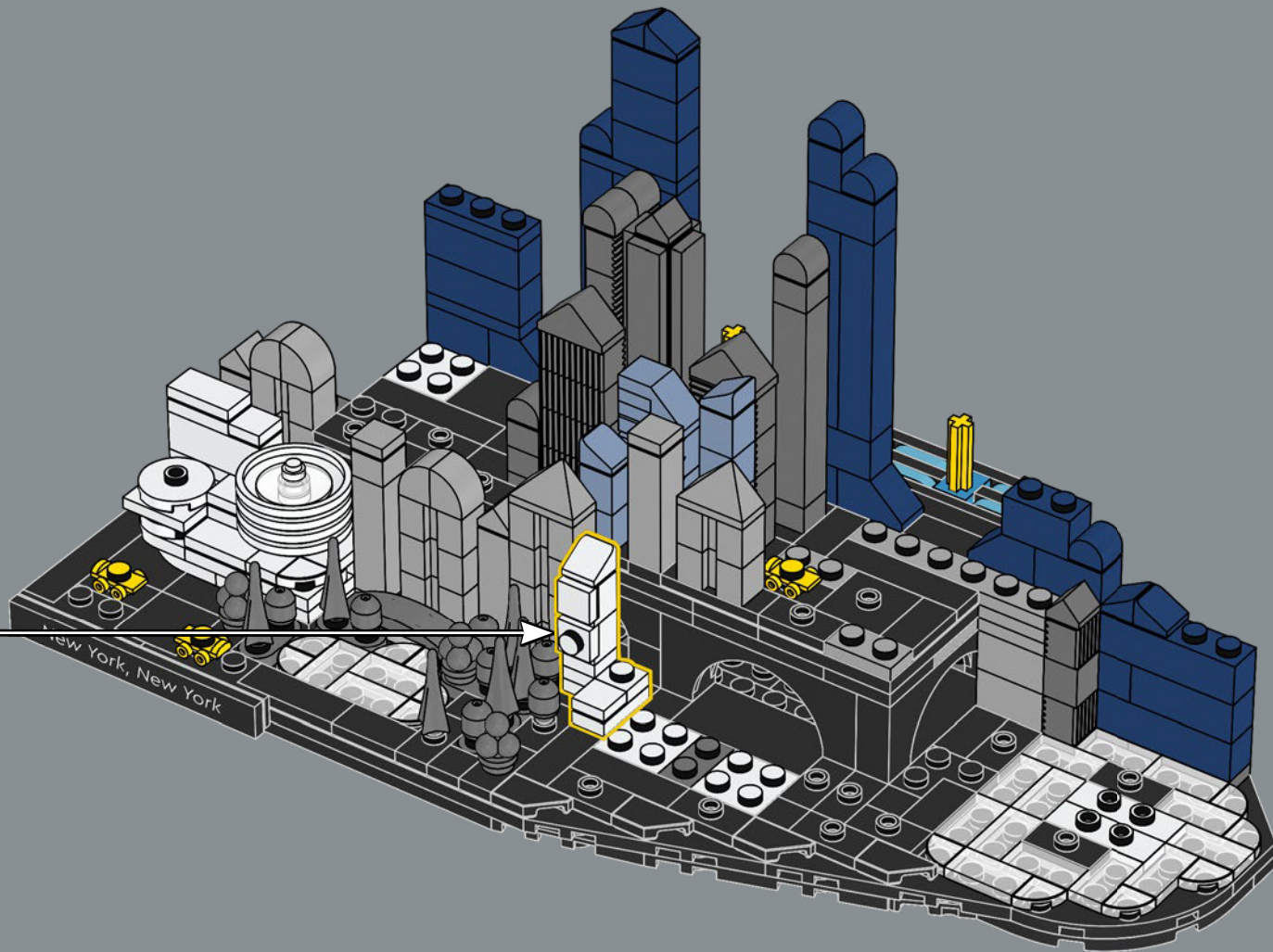

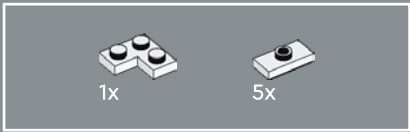

75

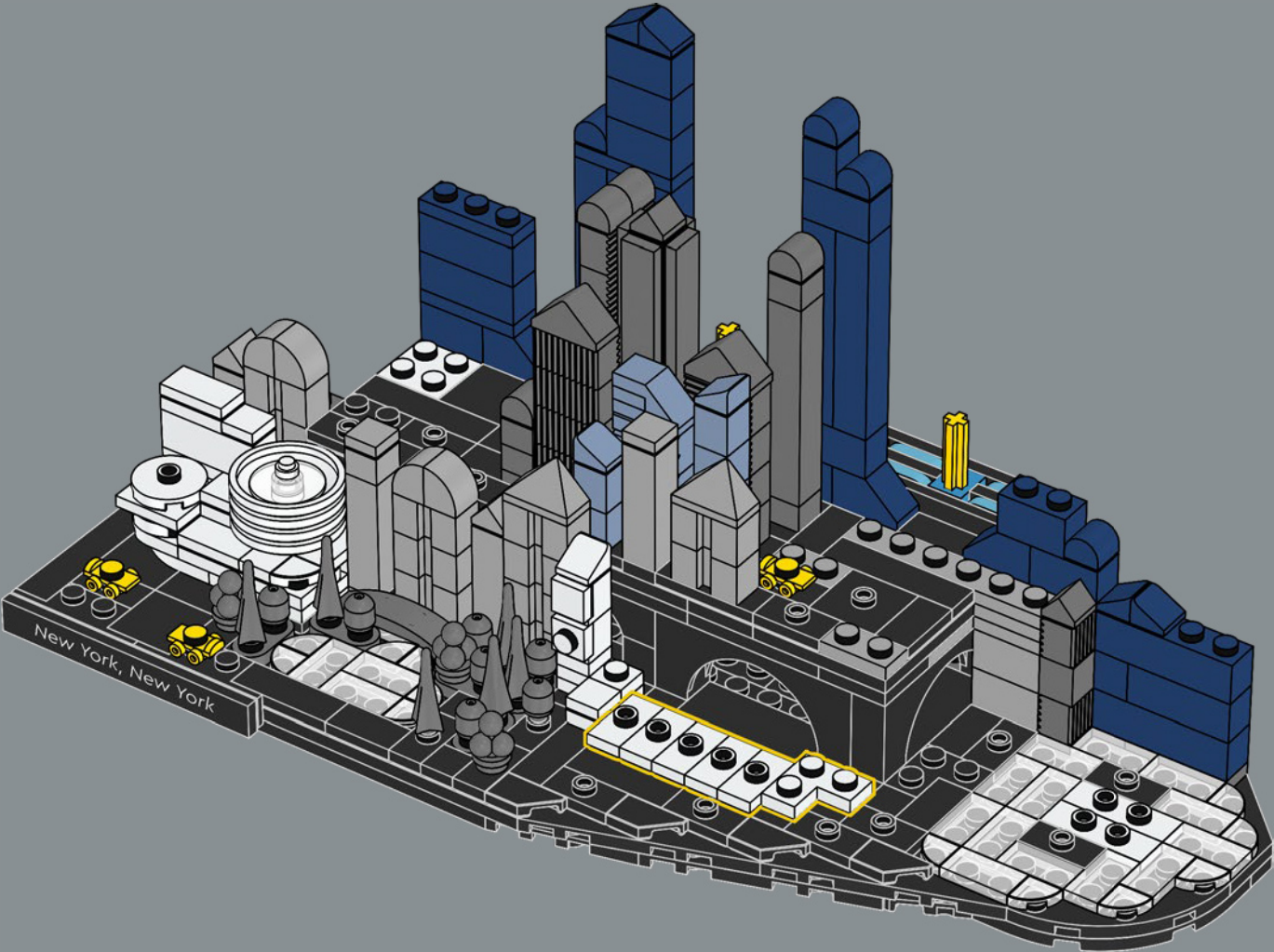

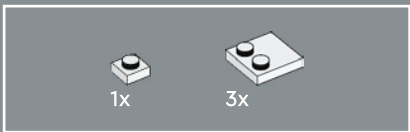

76

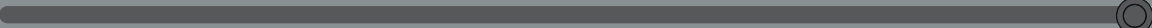
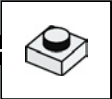
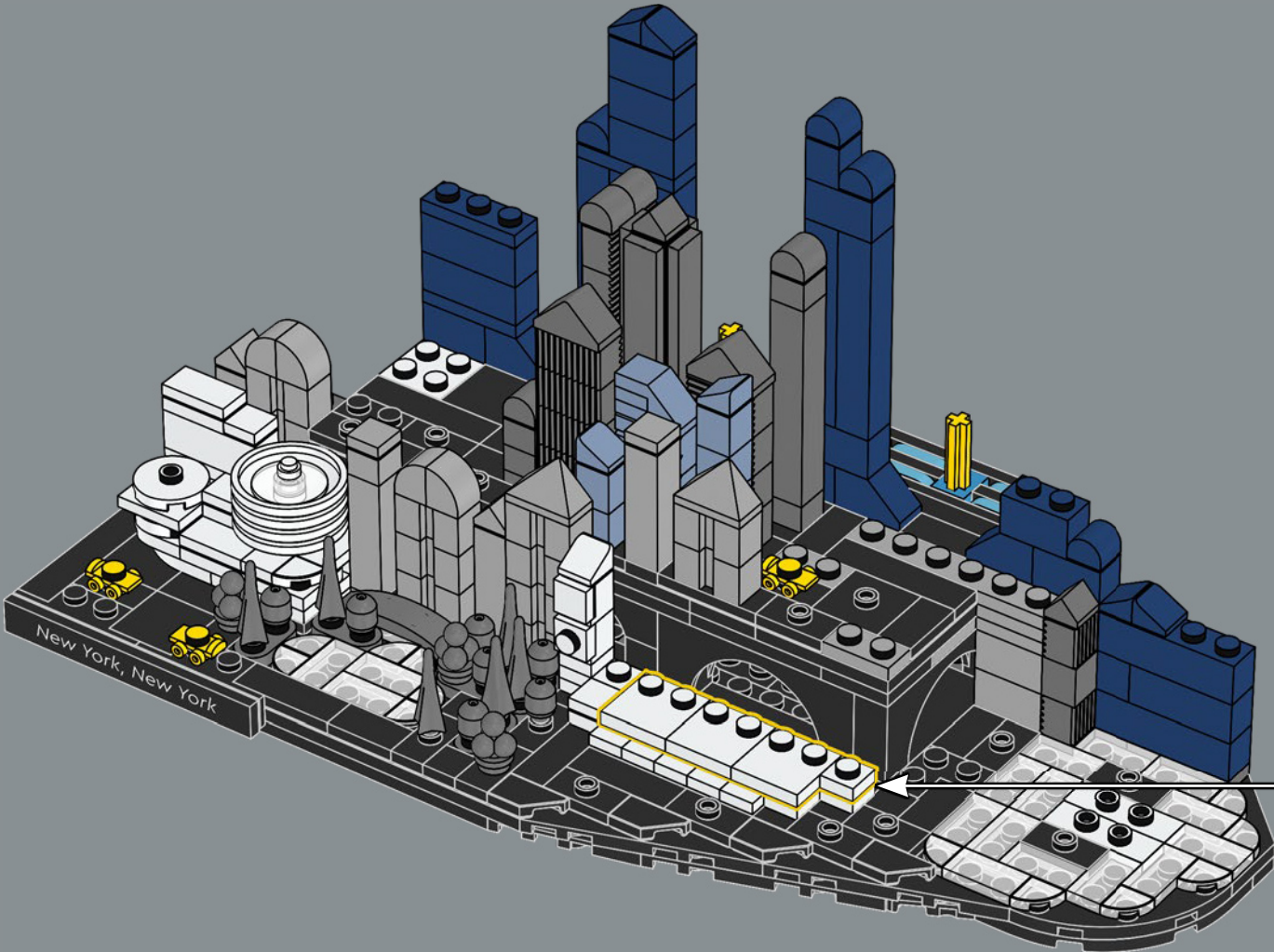

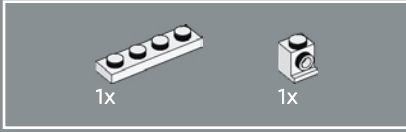
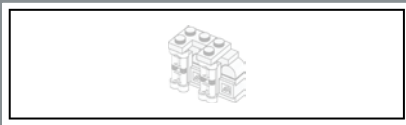

77

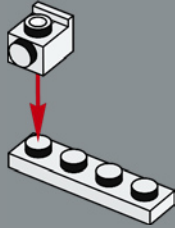

78

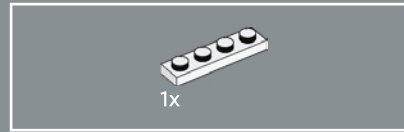
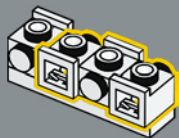

79

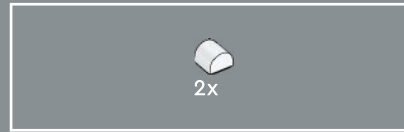
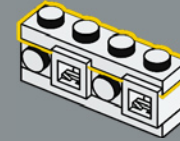

80

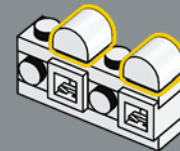

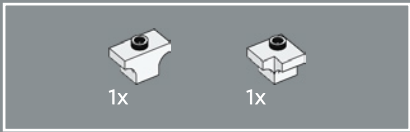

81

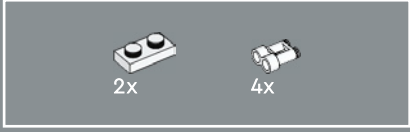
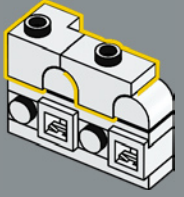

82

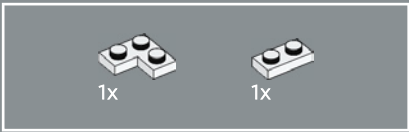
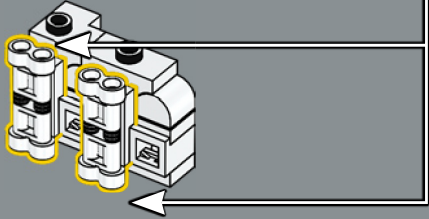
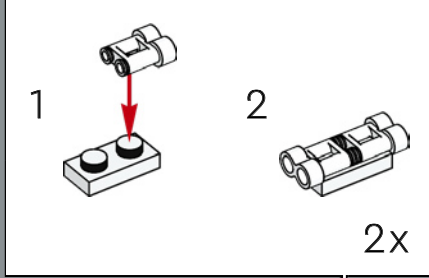

83

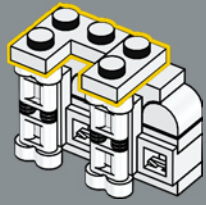

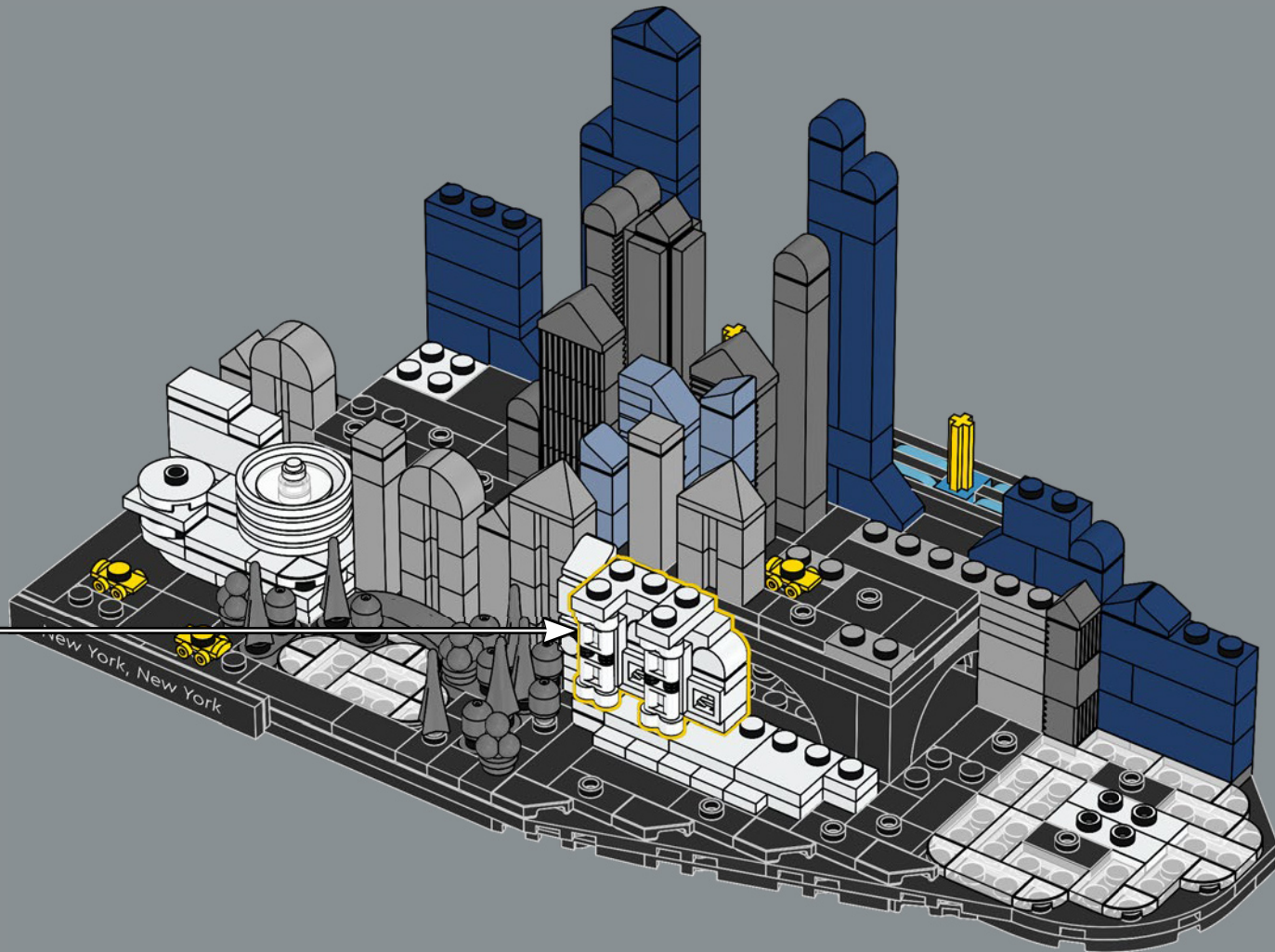

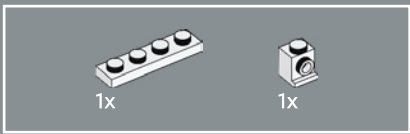

85

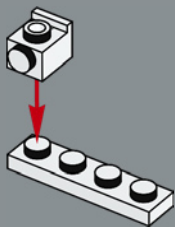

86

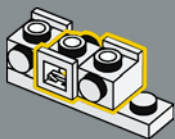

87

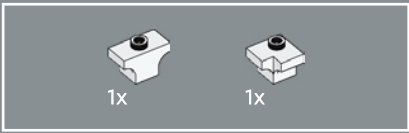
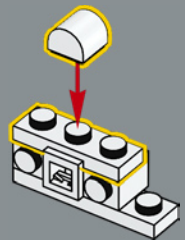

88

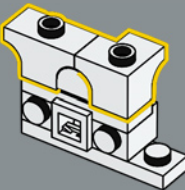

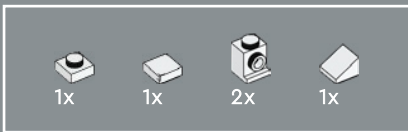

89

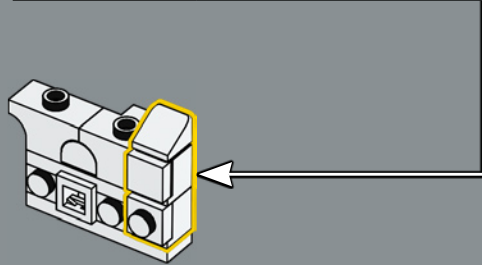
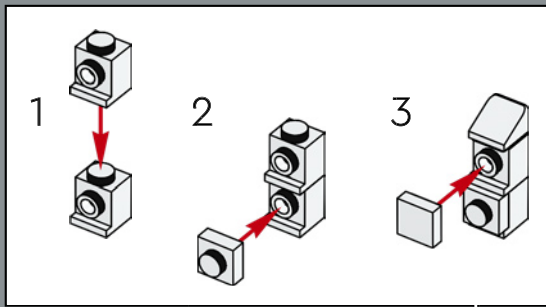

90

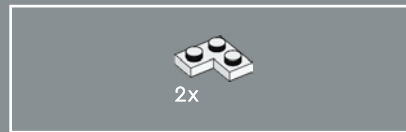
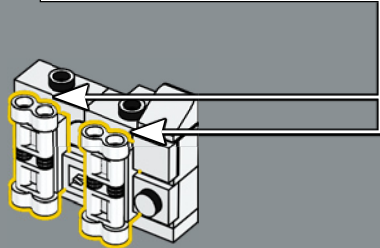
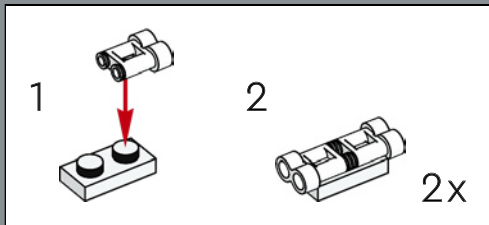

91

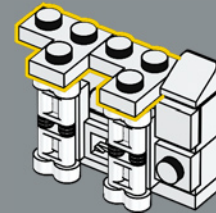

Los prismáticos LEGO® forman diminutos pares de columnas que decoran la entrada principal del Museo Metropolitano de Arte.

92

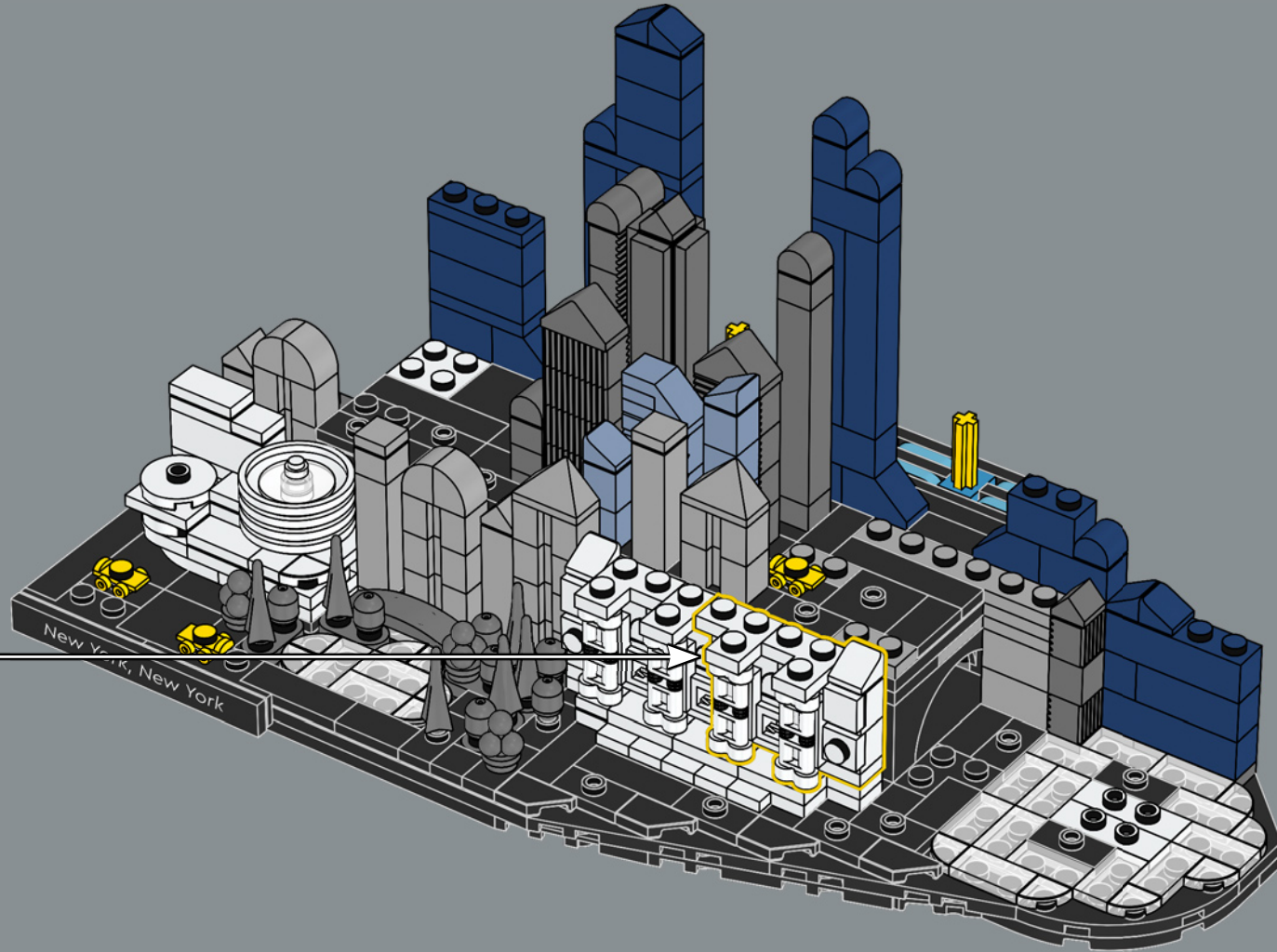

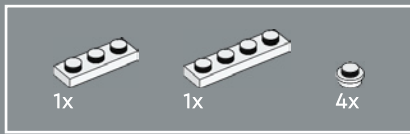

93

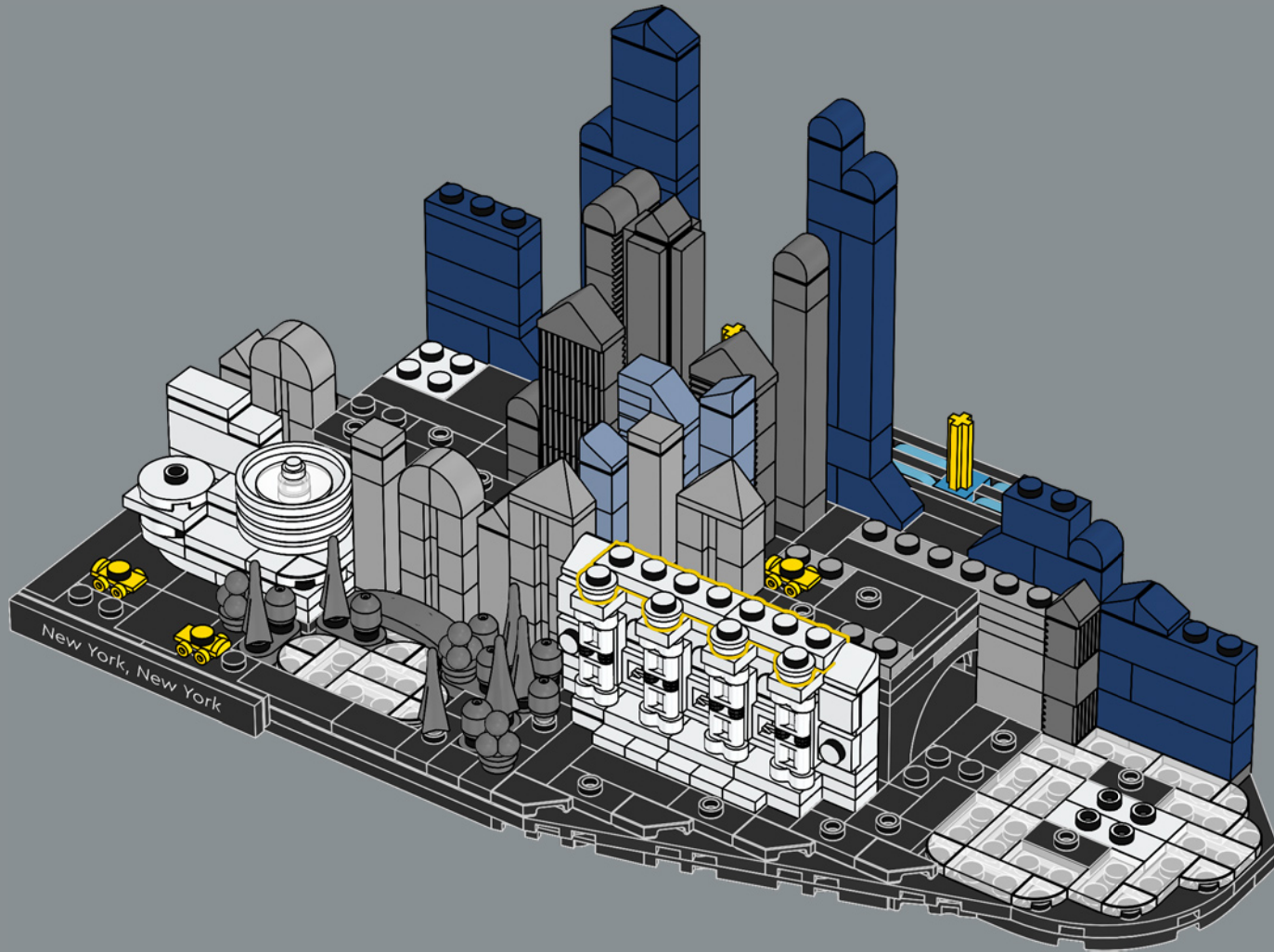

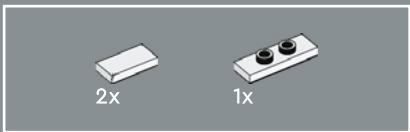

94

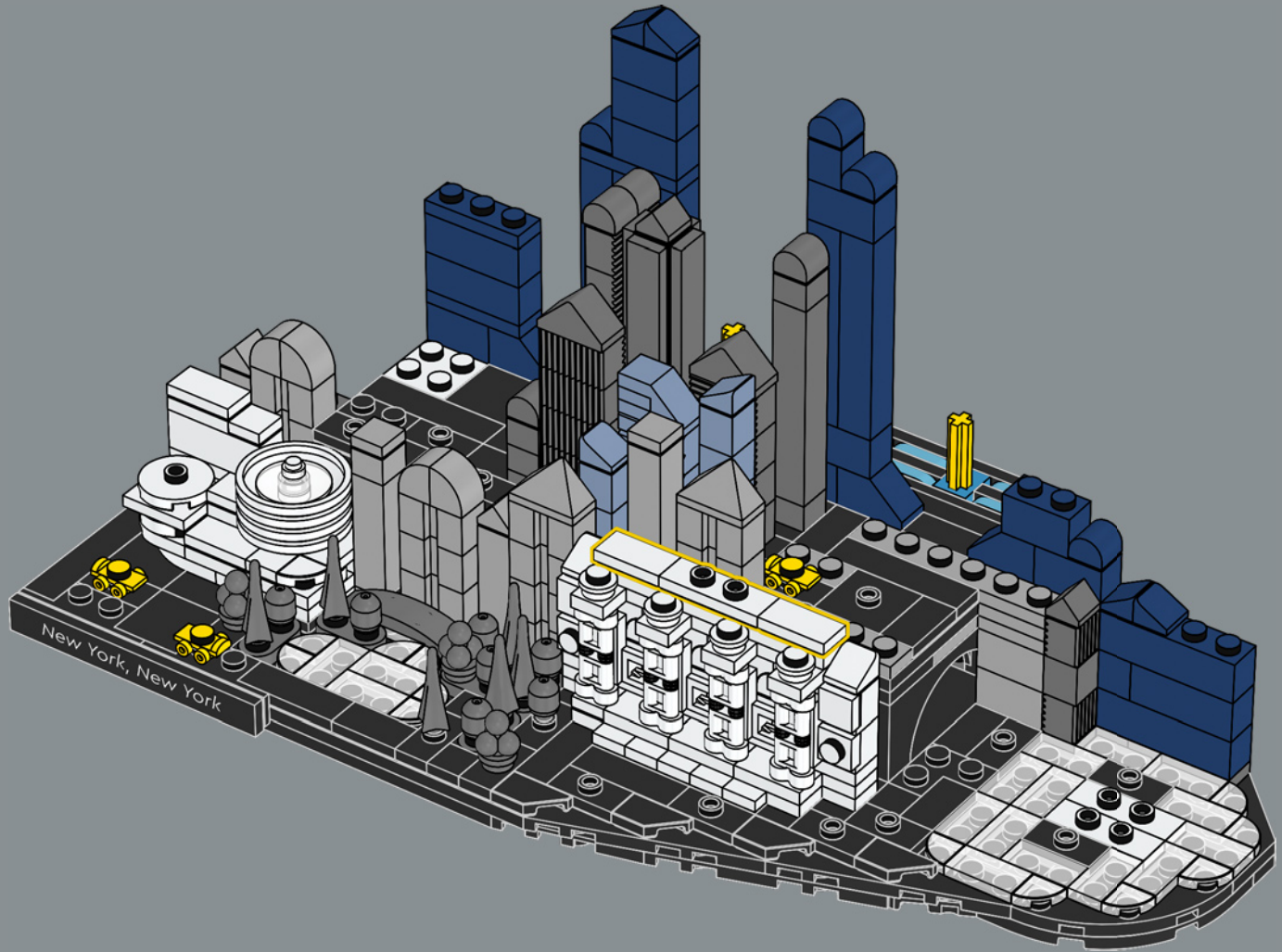



95

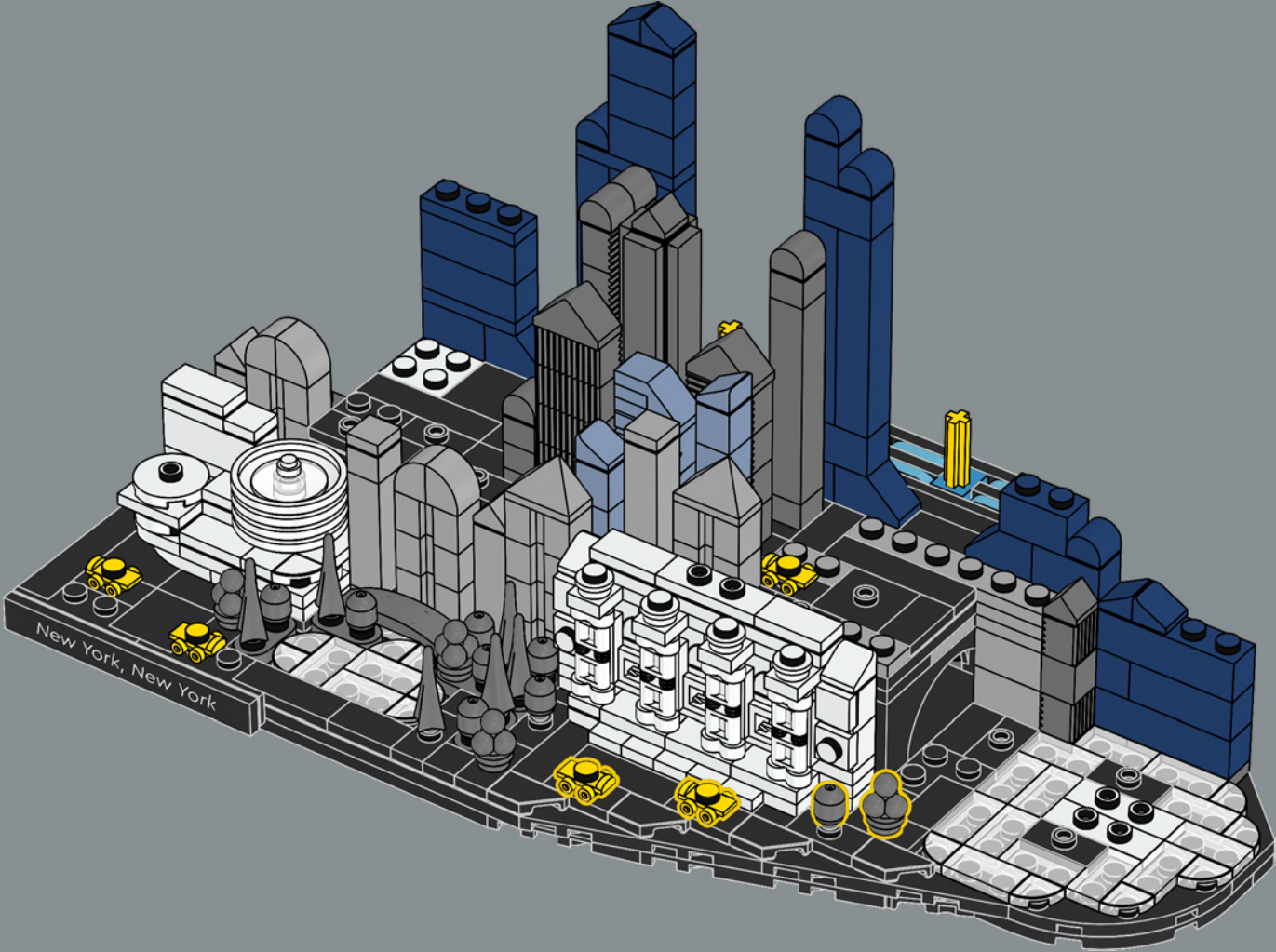

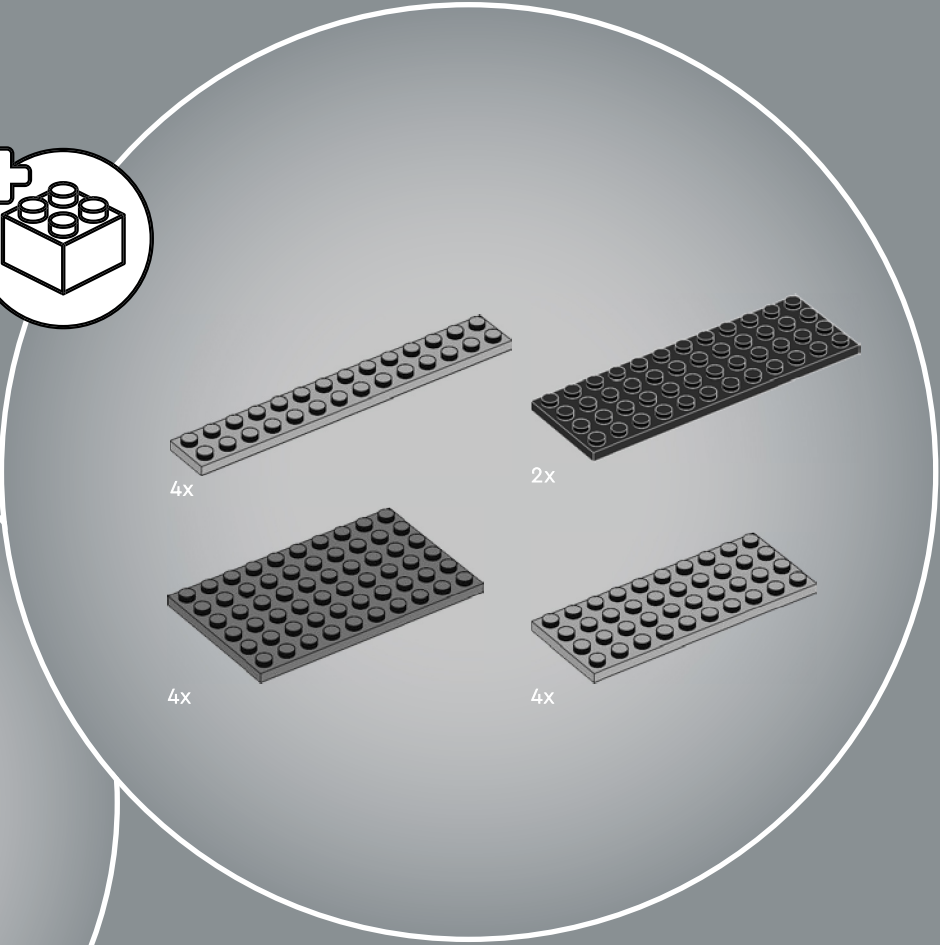
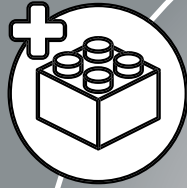

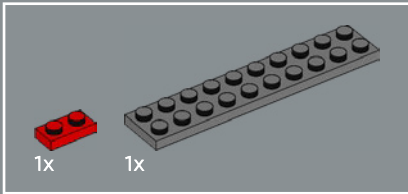
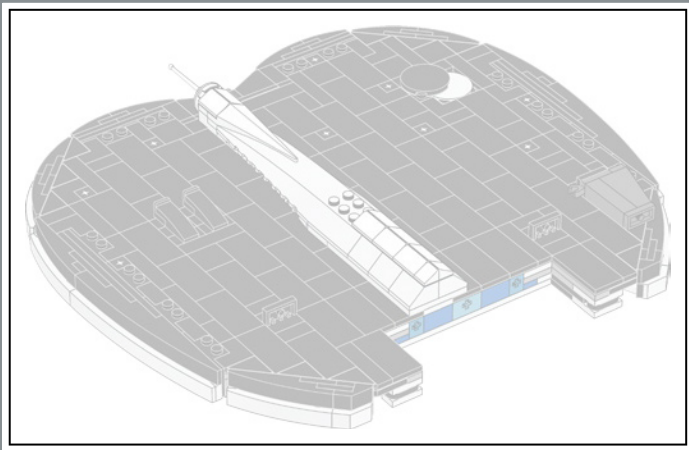

96

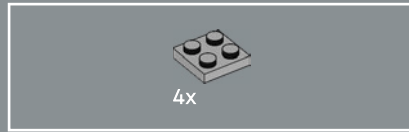
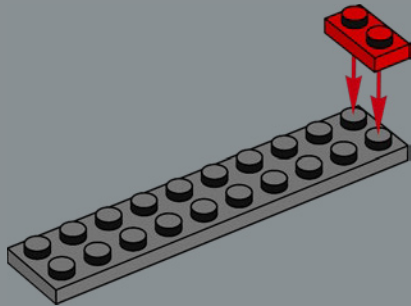

97

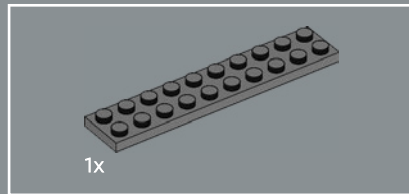
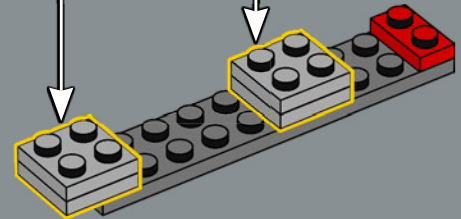
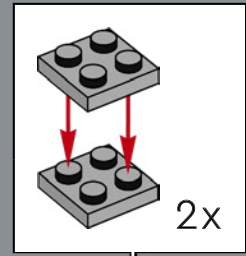

98

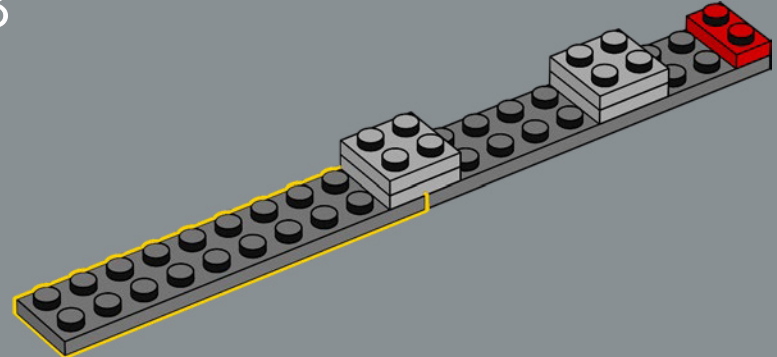

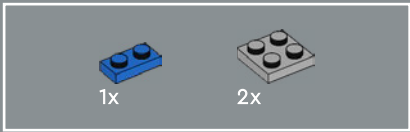

99

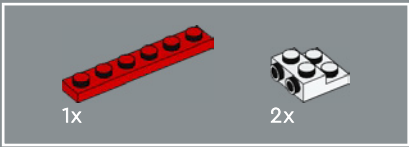
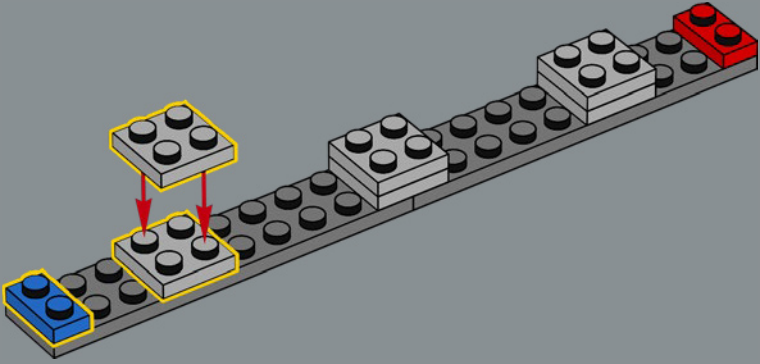

100

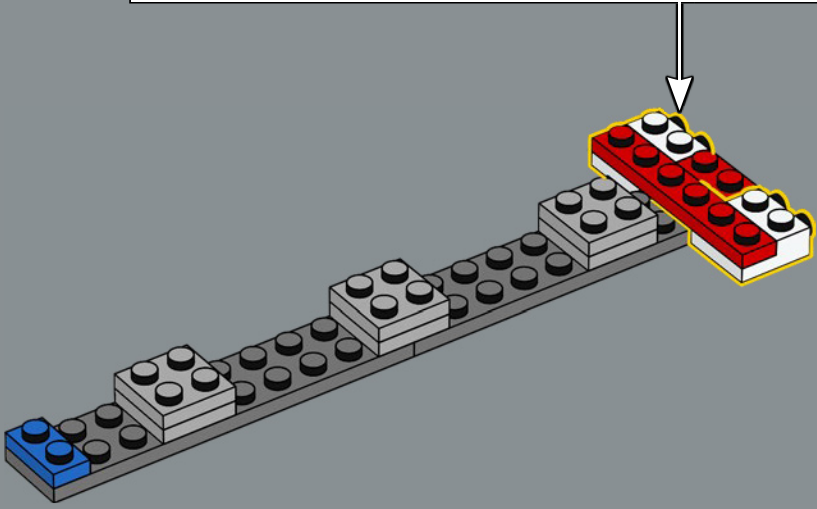
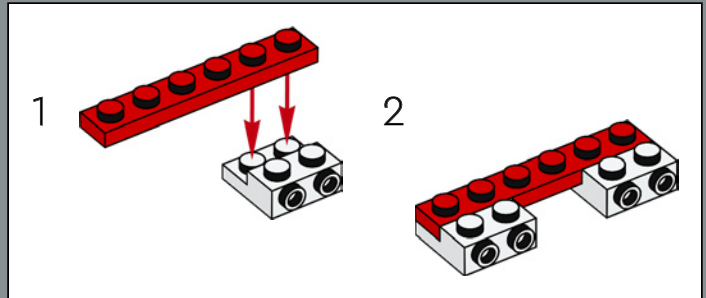

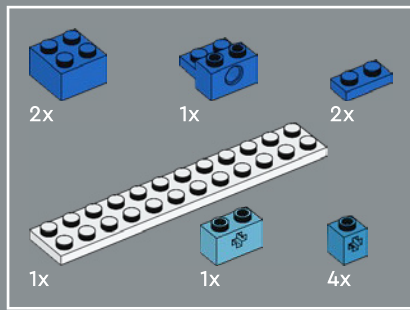

101

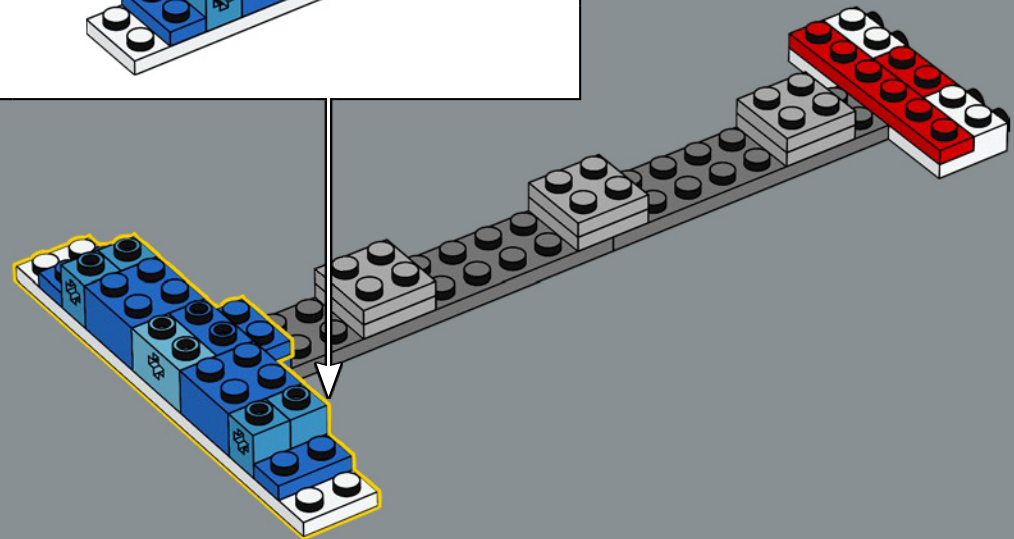
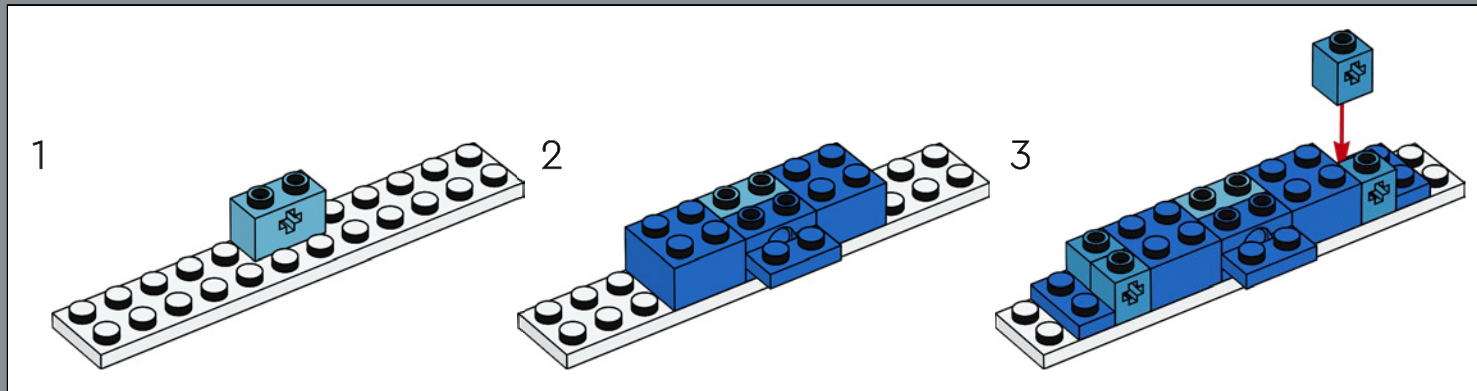

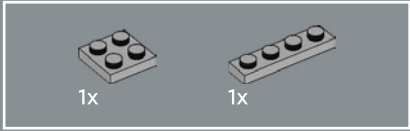
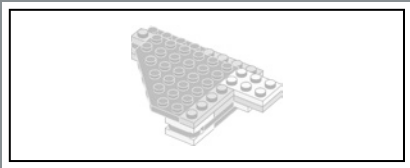

102

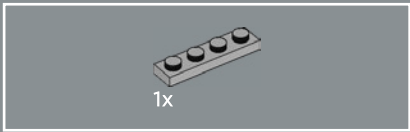
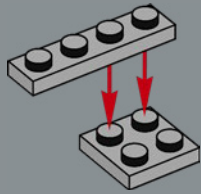

103

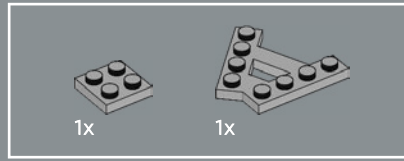
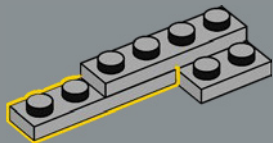

104

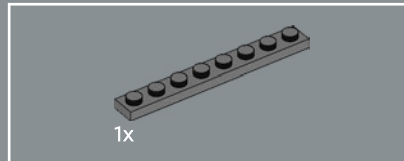
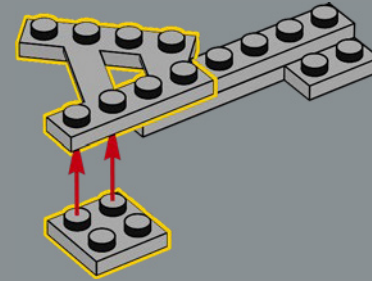

105

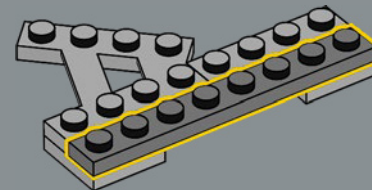



106

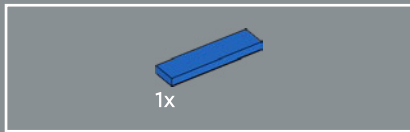
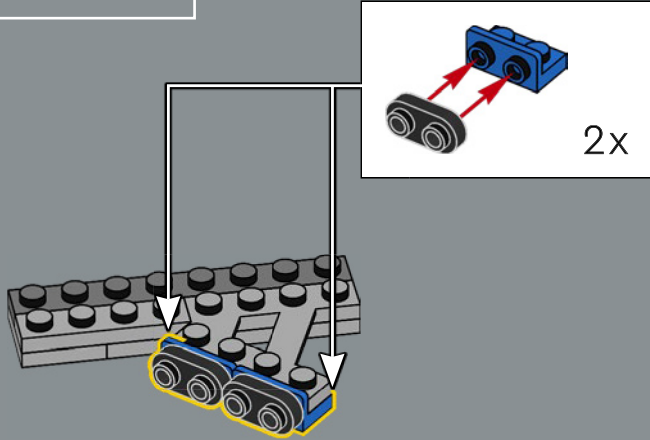

107

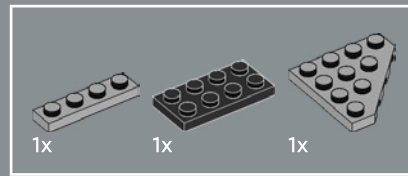
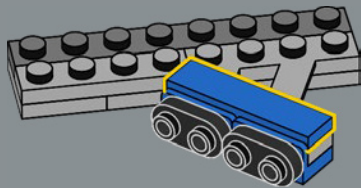

108

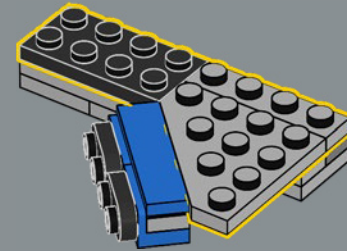

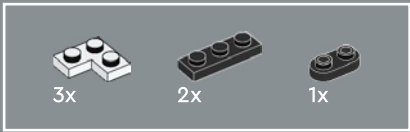

109

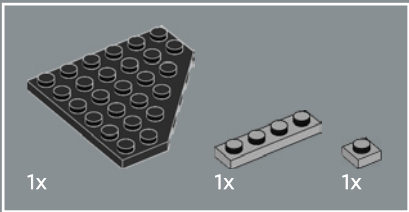
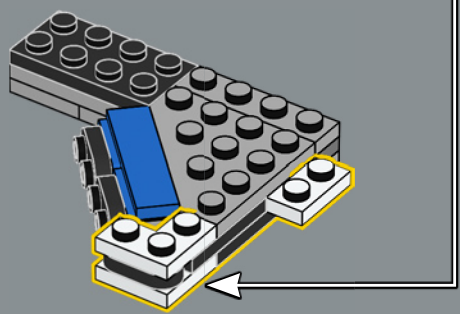
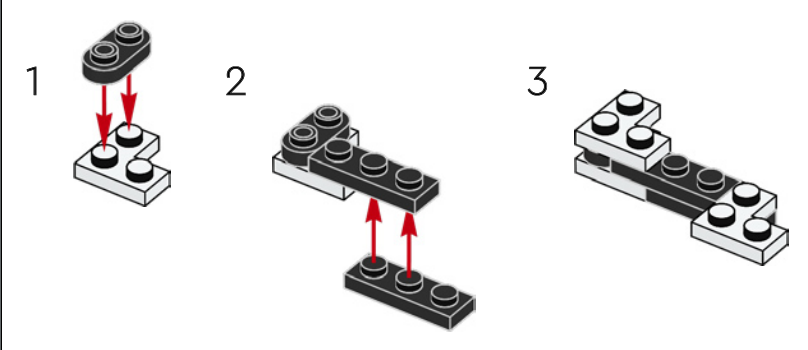

110

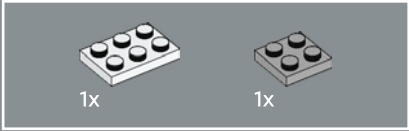
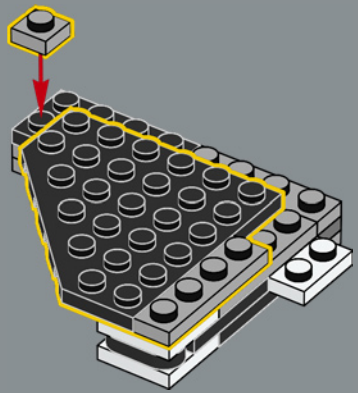

111

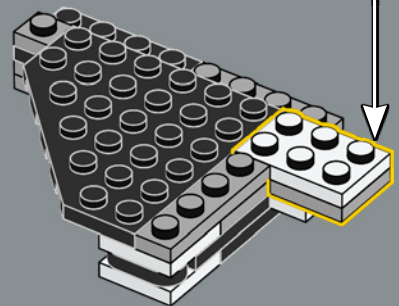
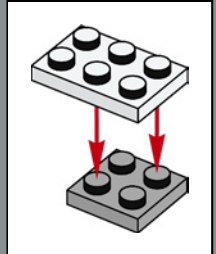

112

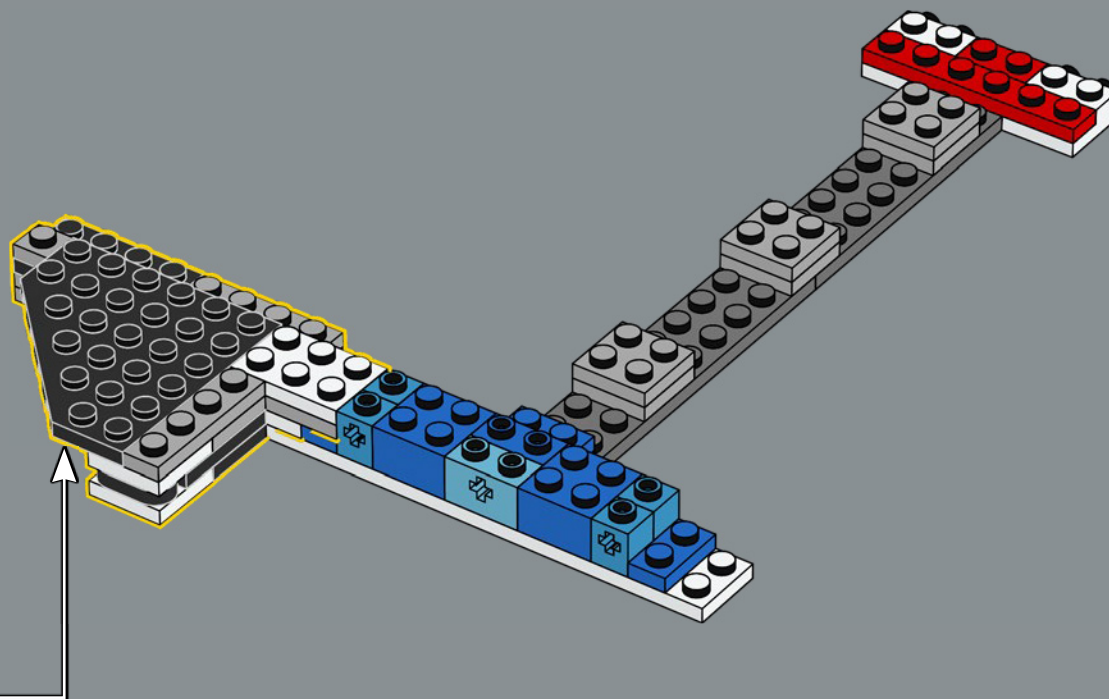

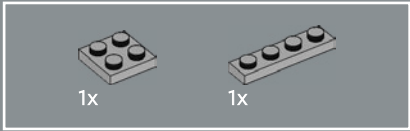
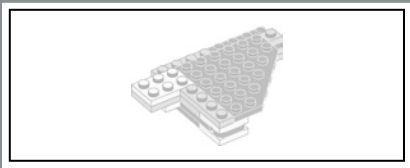

113

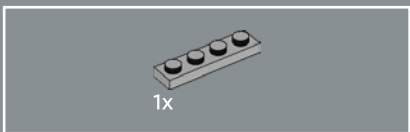
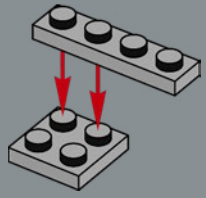

114

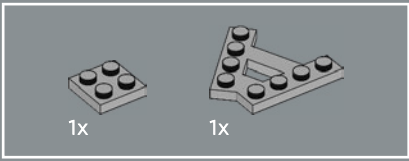
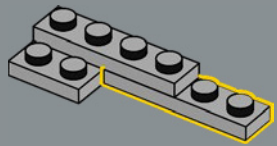

115

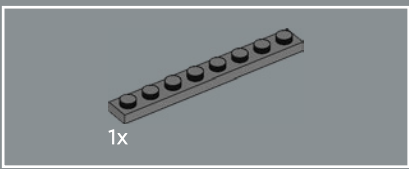
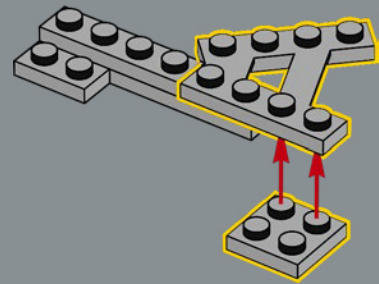

116

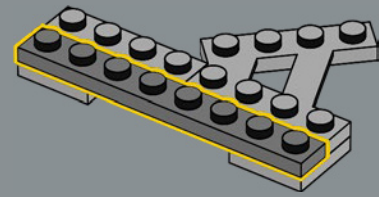



117

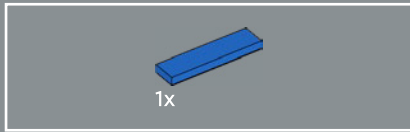
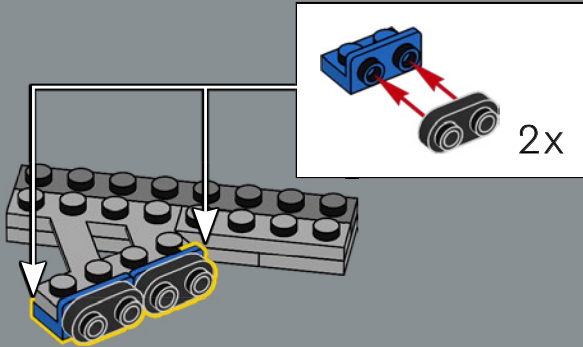

118

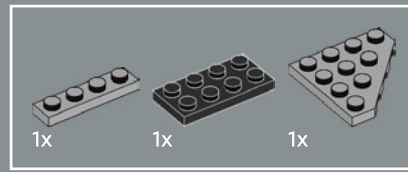
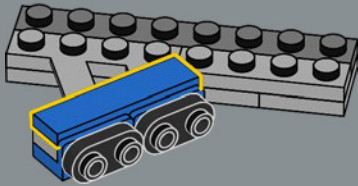

119

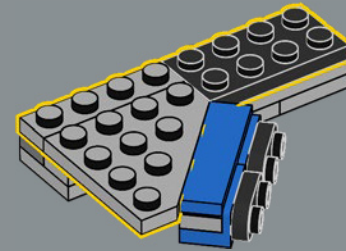

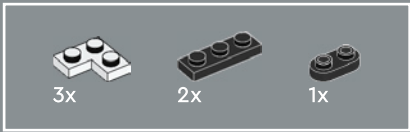

120

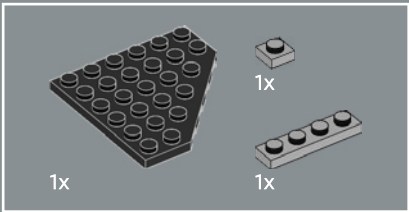
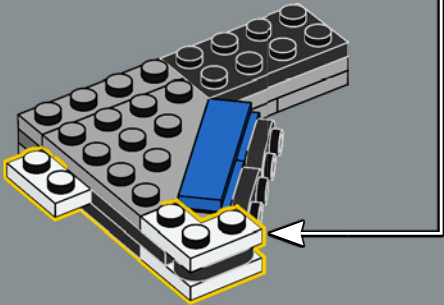
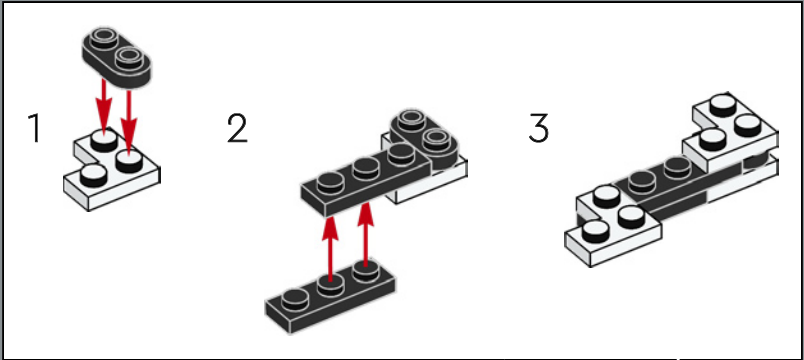

121

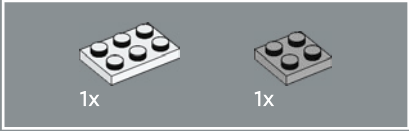
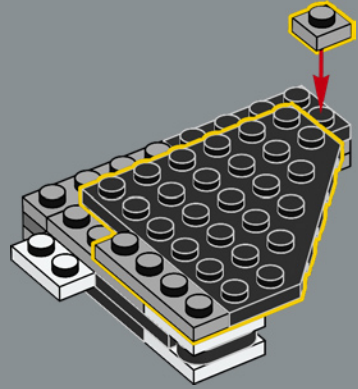

122

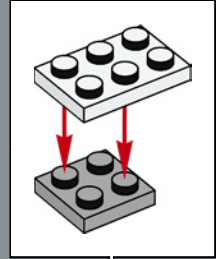
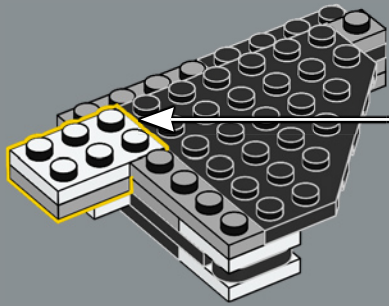

123

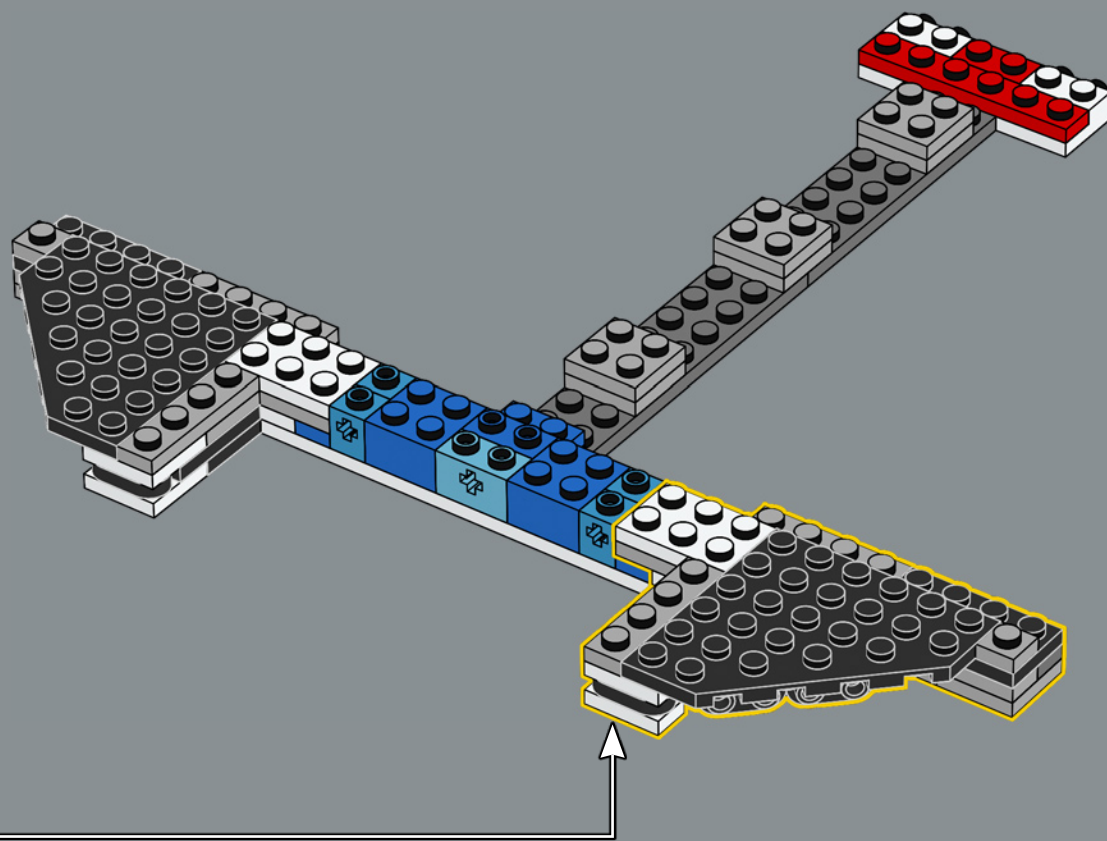

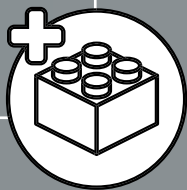
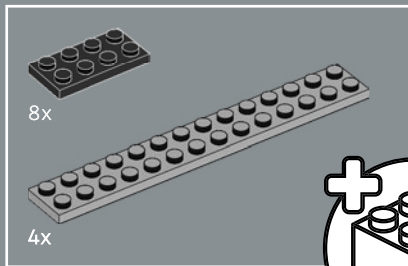
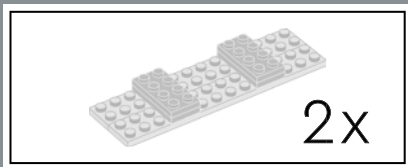

124

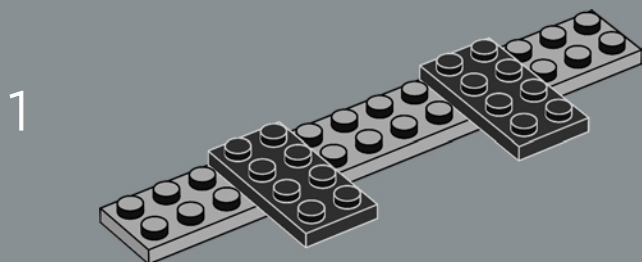

2

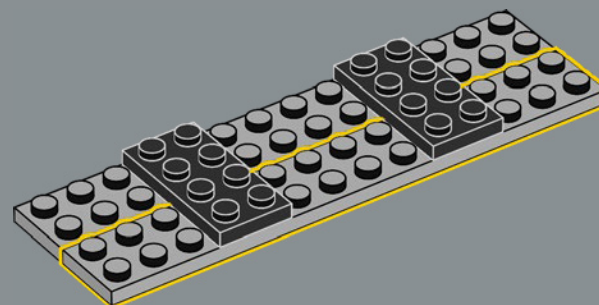

3

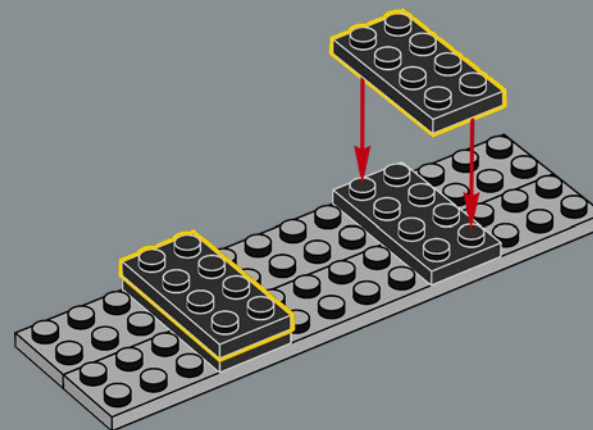

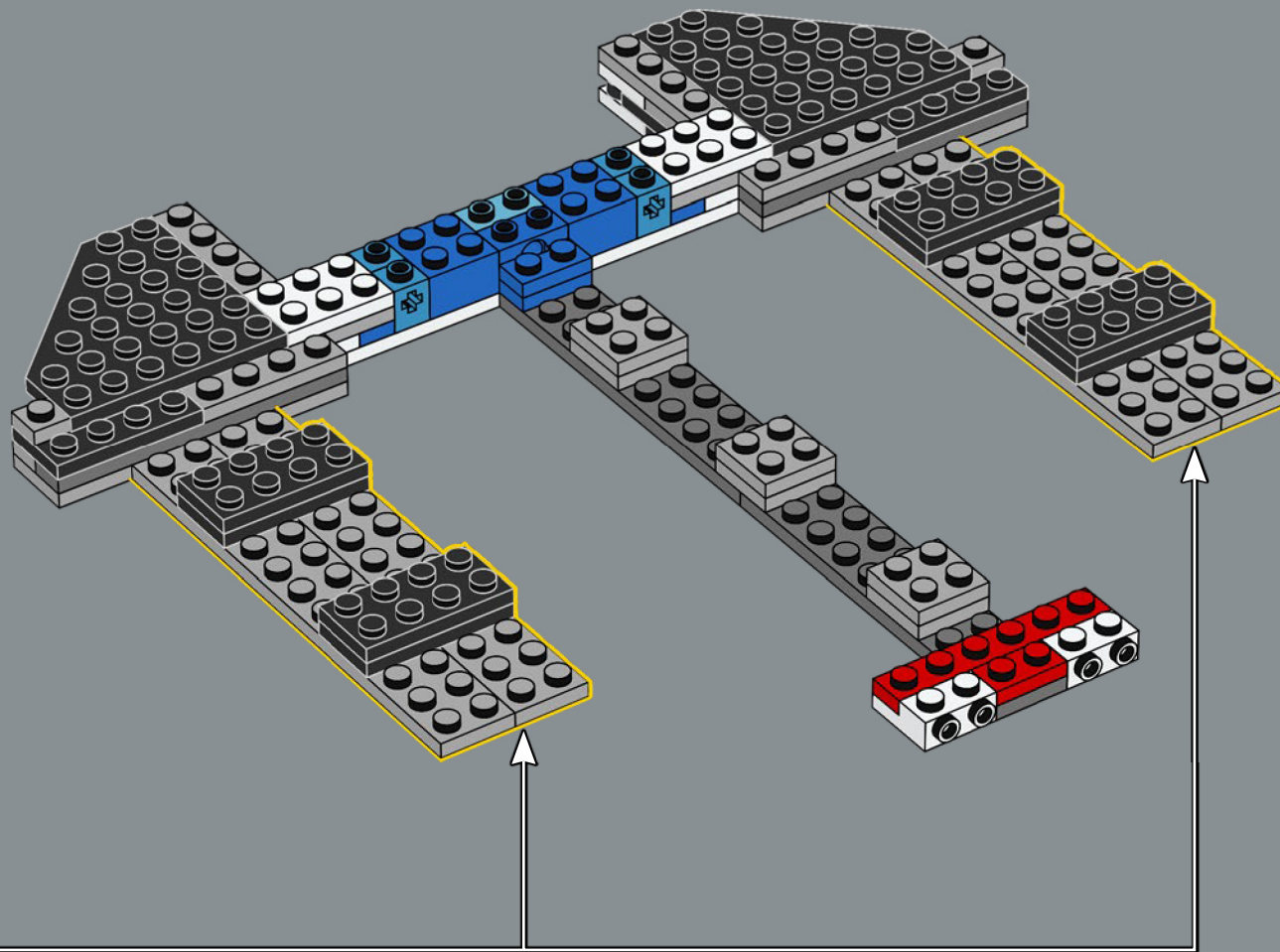

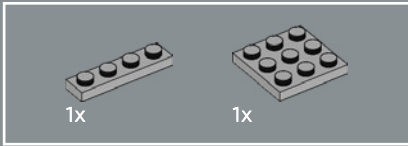
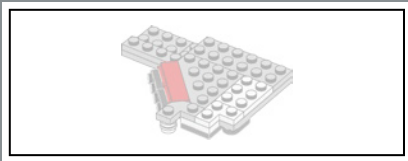

125

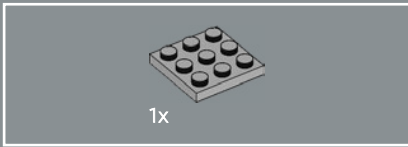
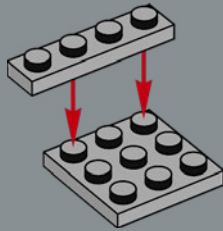

126

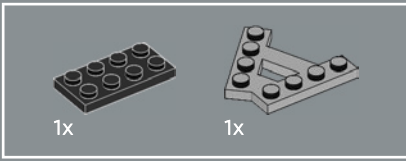
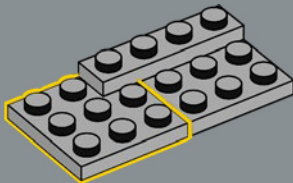

127

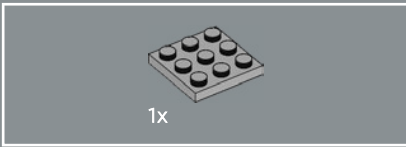
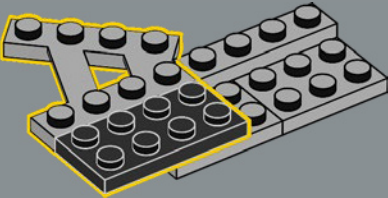

128

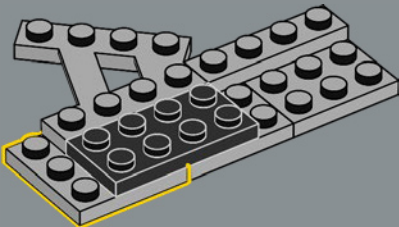



129

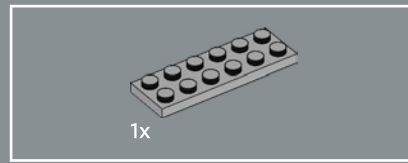
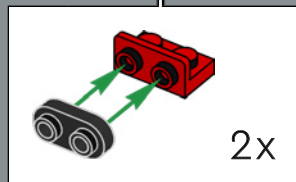
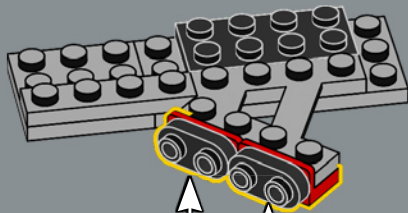

130

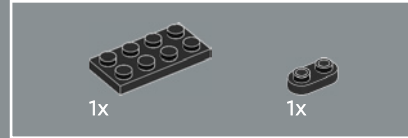
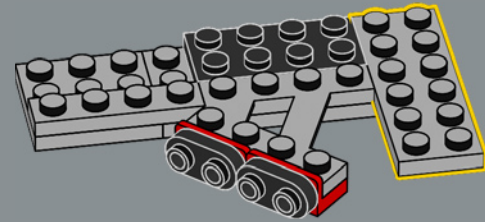

131

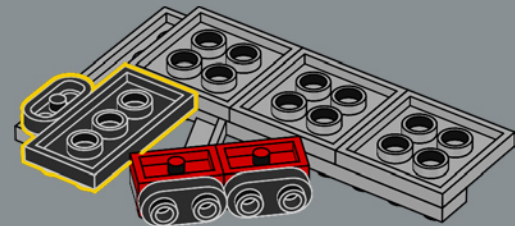



132

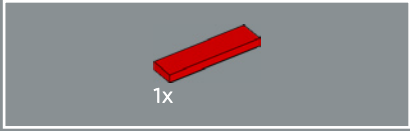
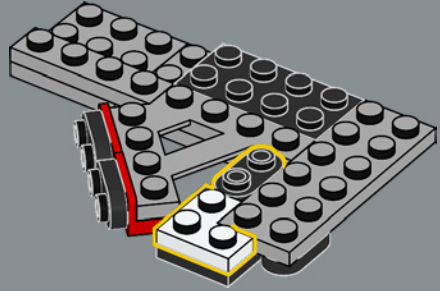

133

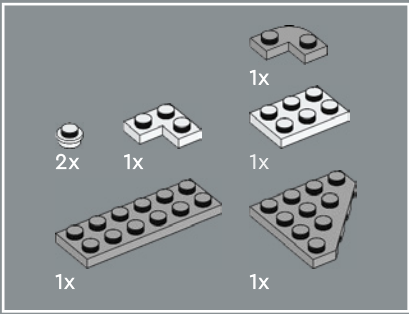
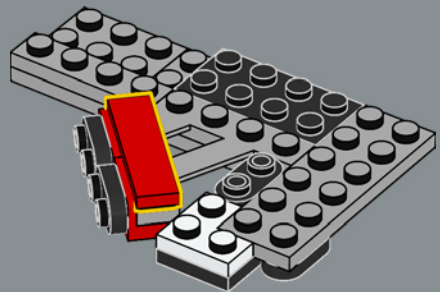

134

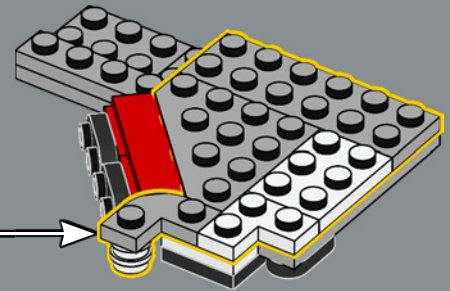
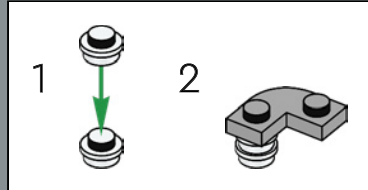

135

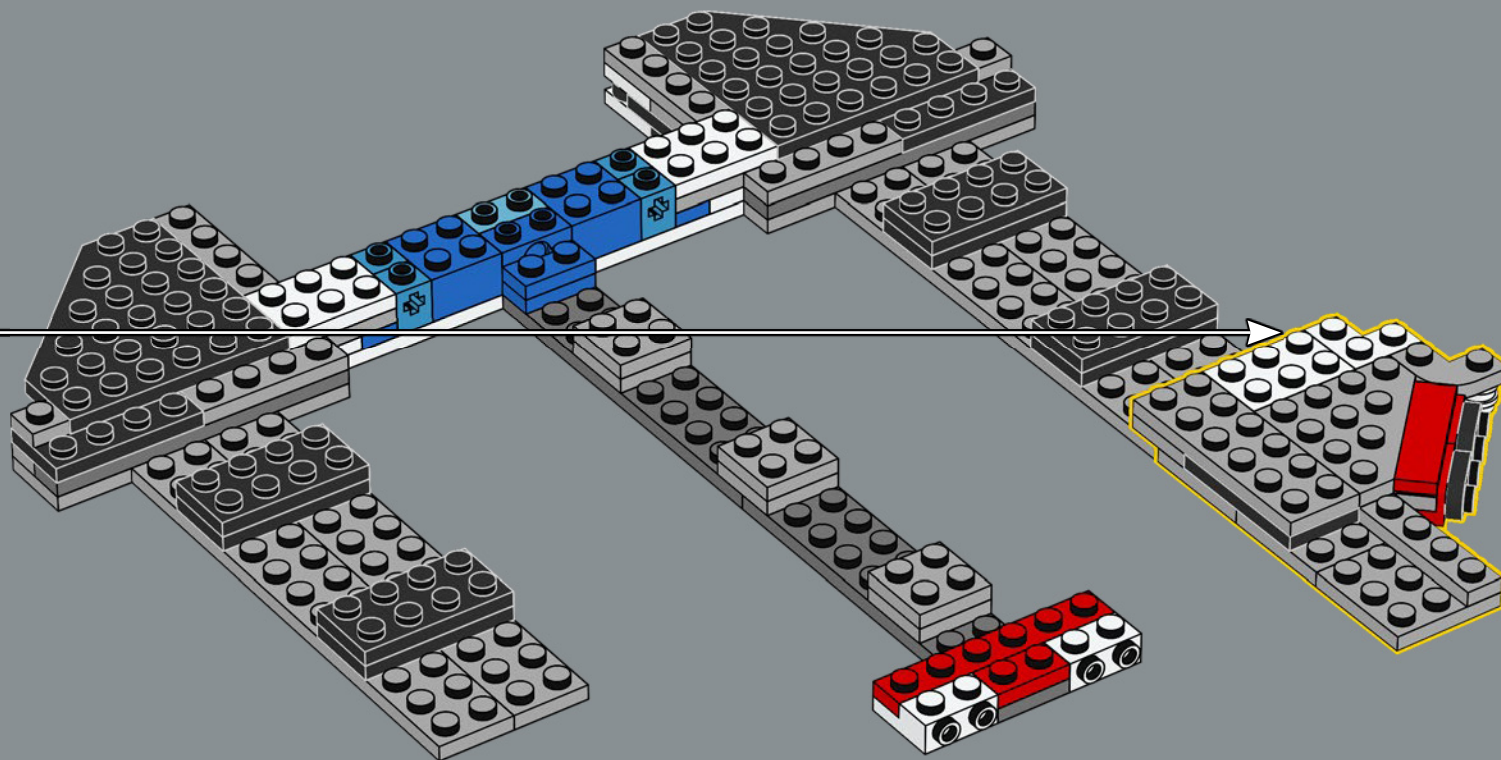

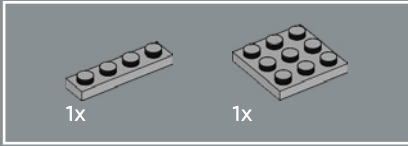
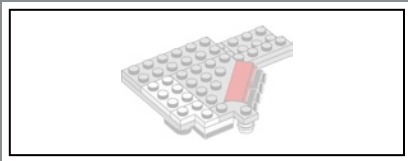

136

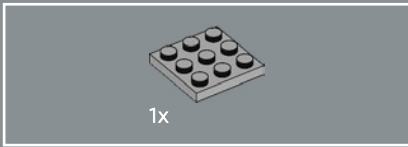
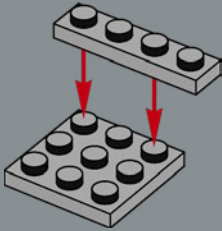

137

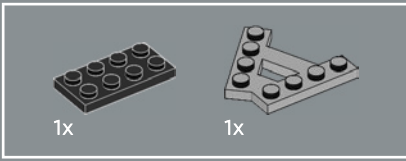
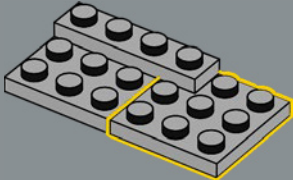

138

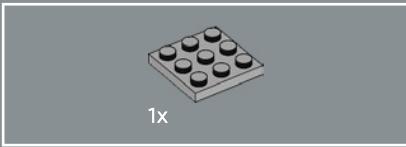
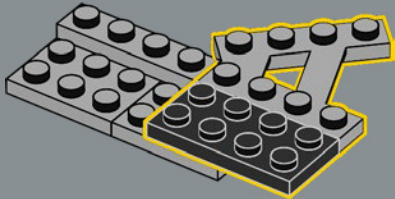

139

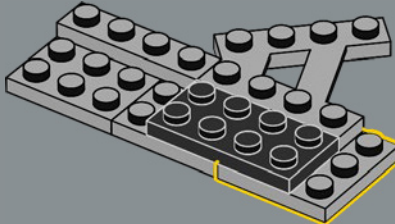



140

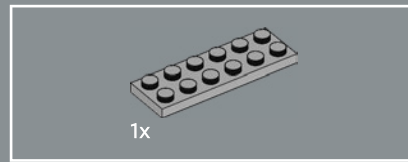
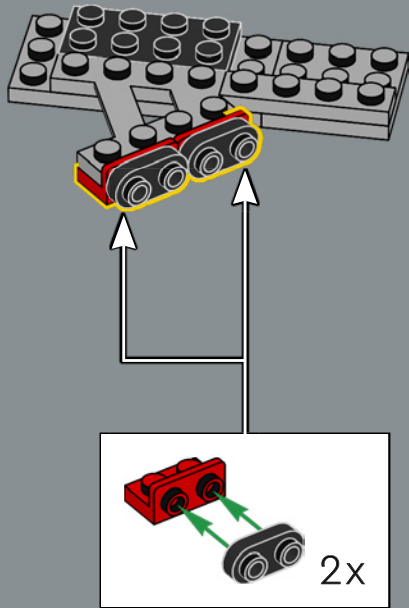

141

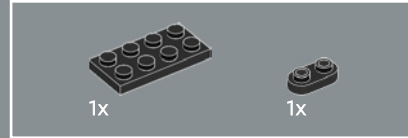
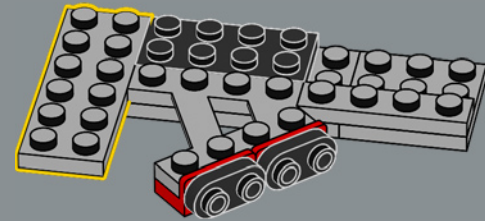

142

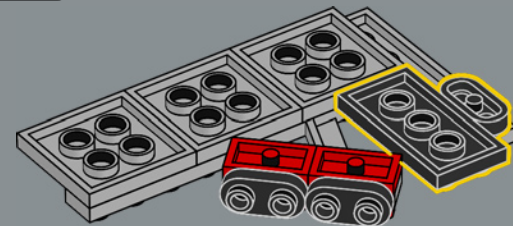



143

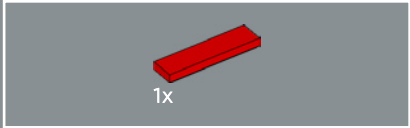
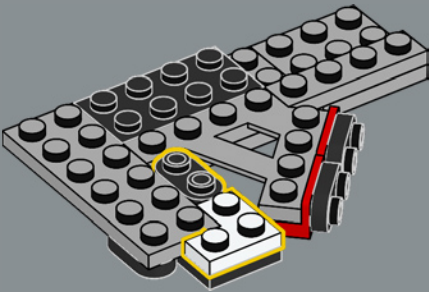

144

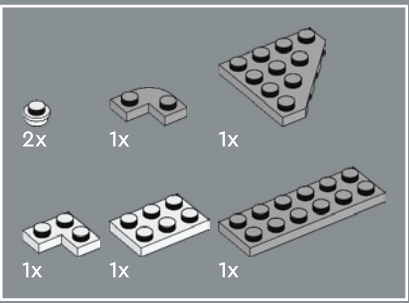
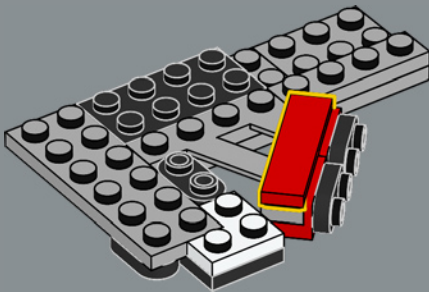

145

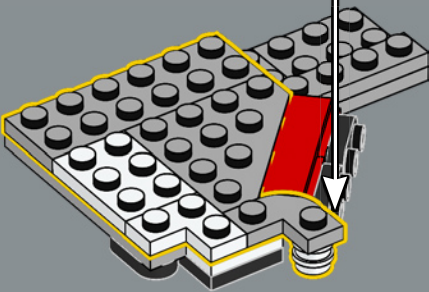
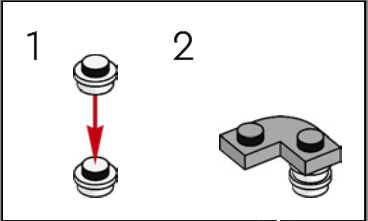

146

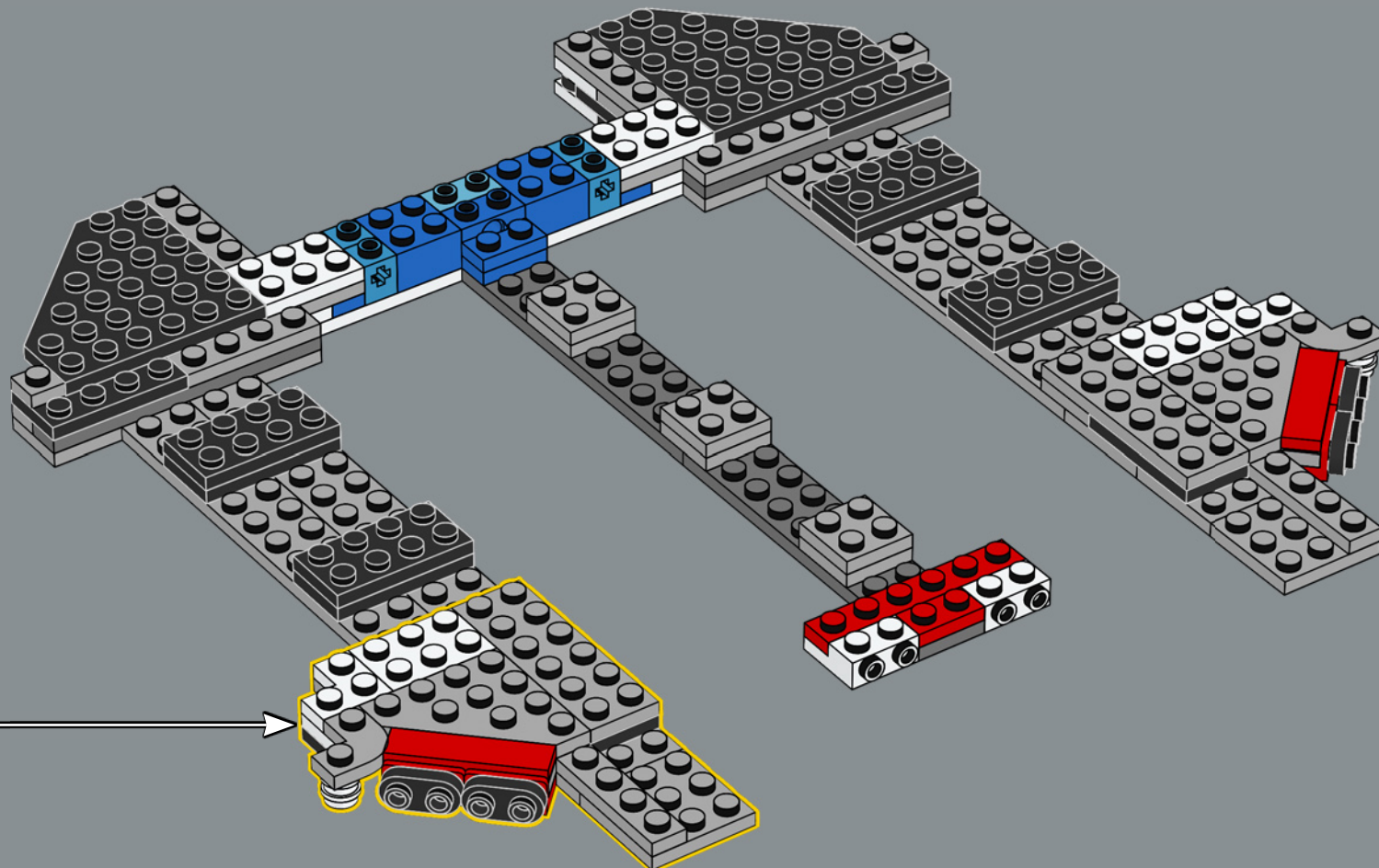

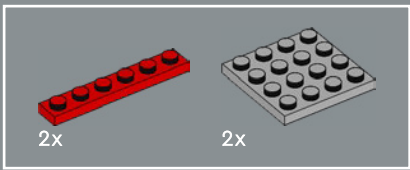

147

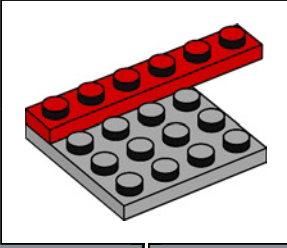
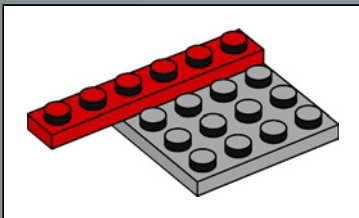
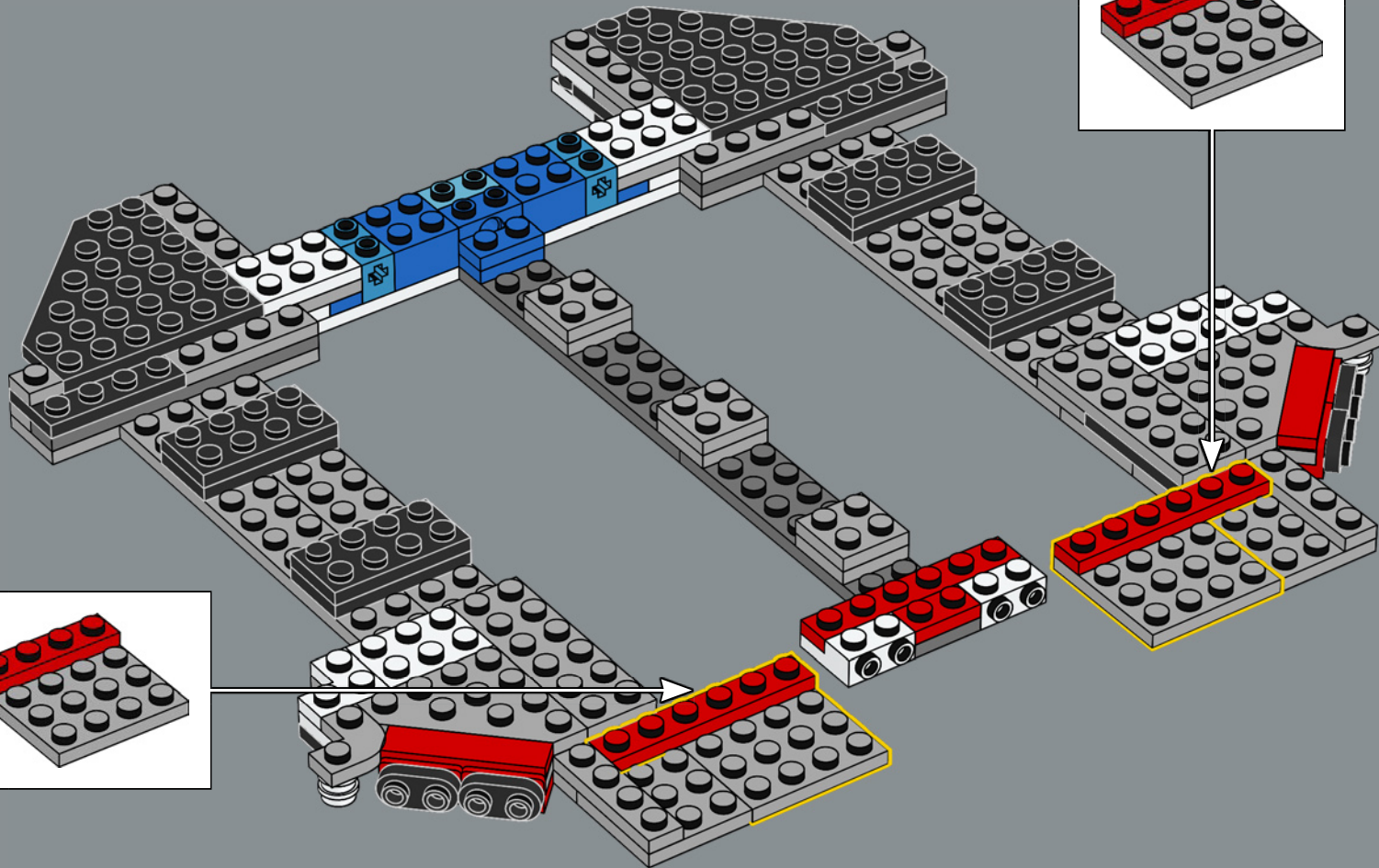

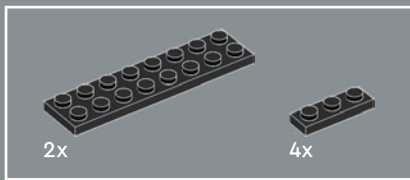

148

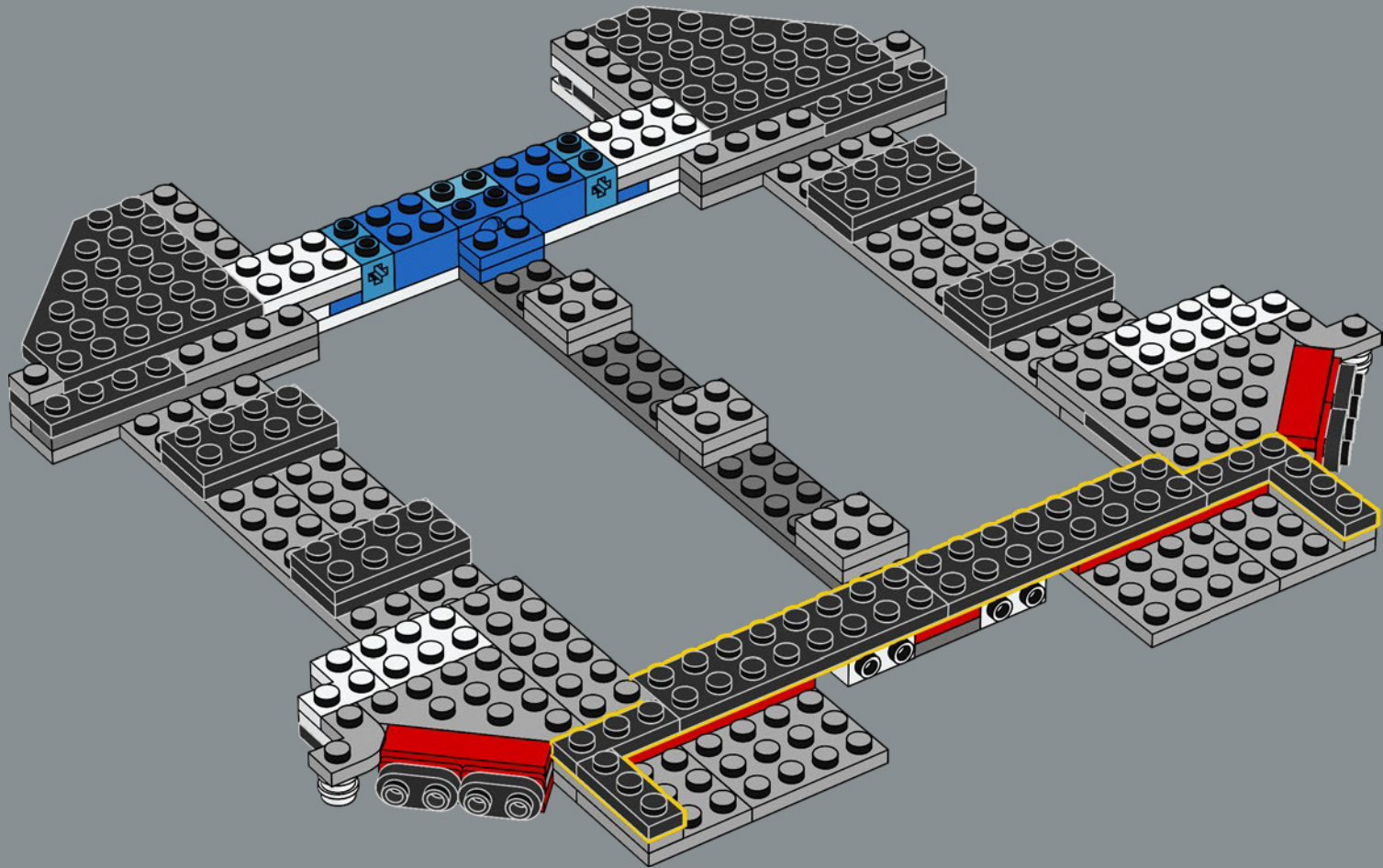

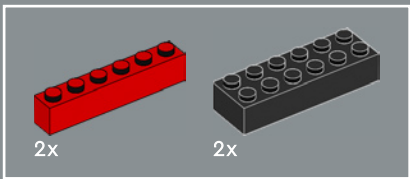

149

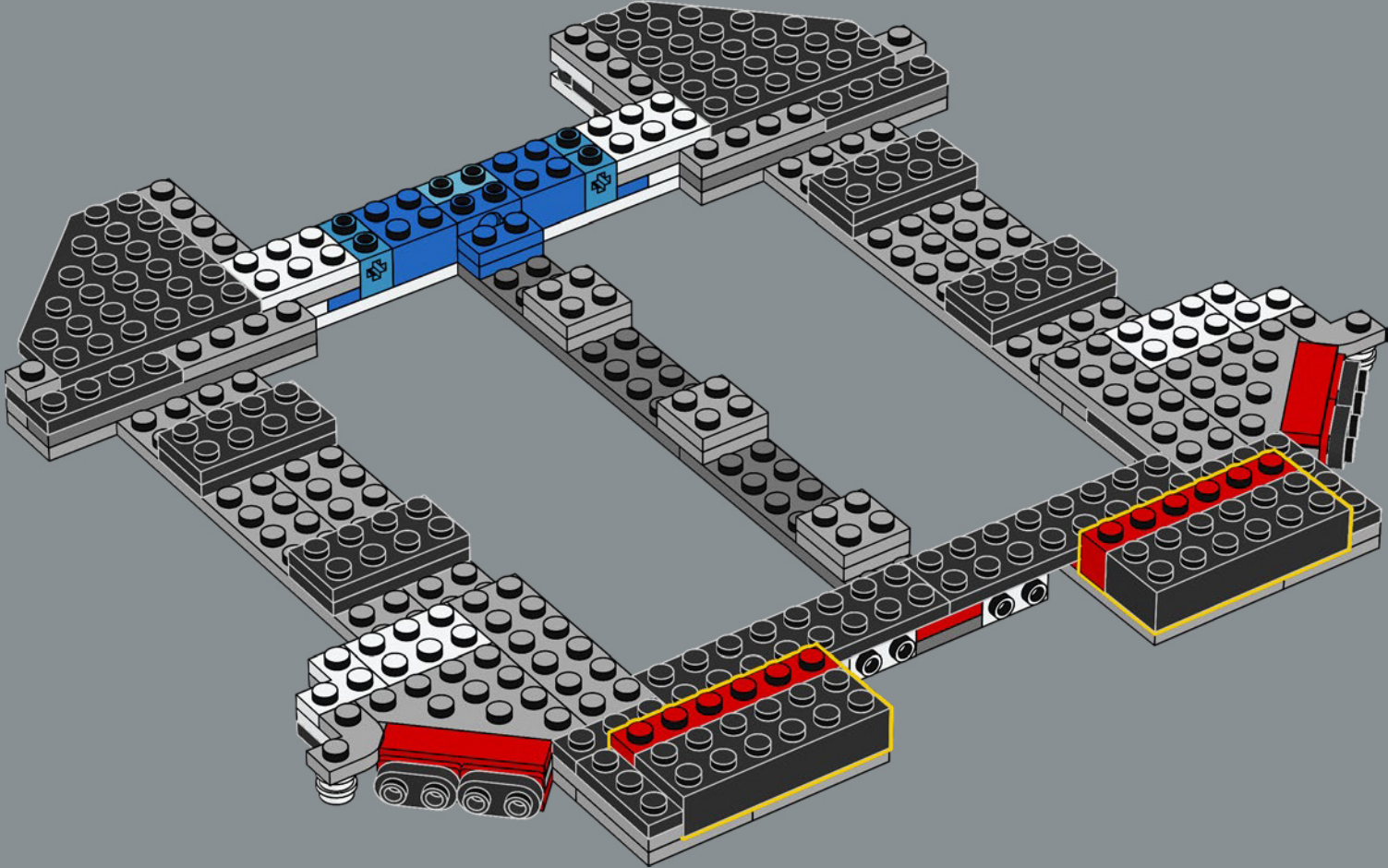

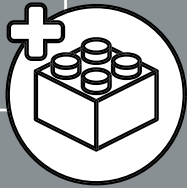
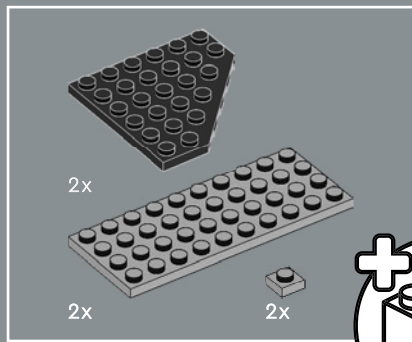

150

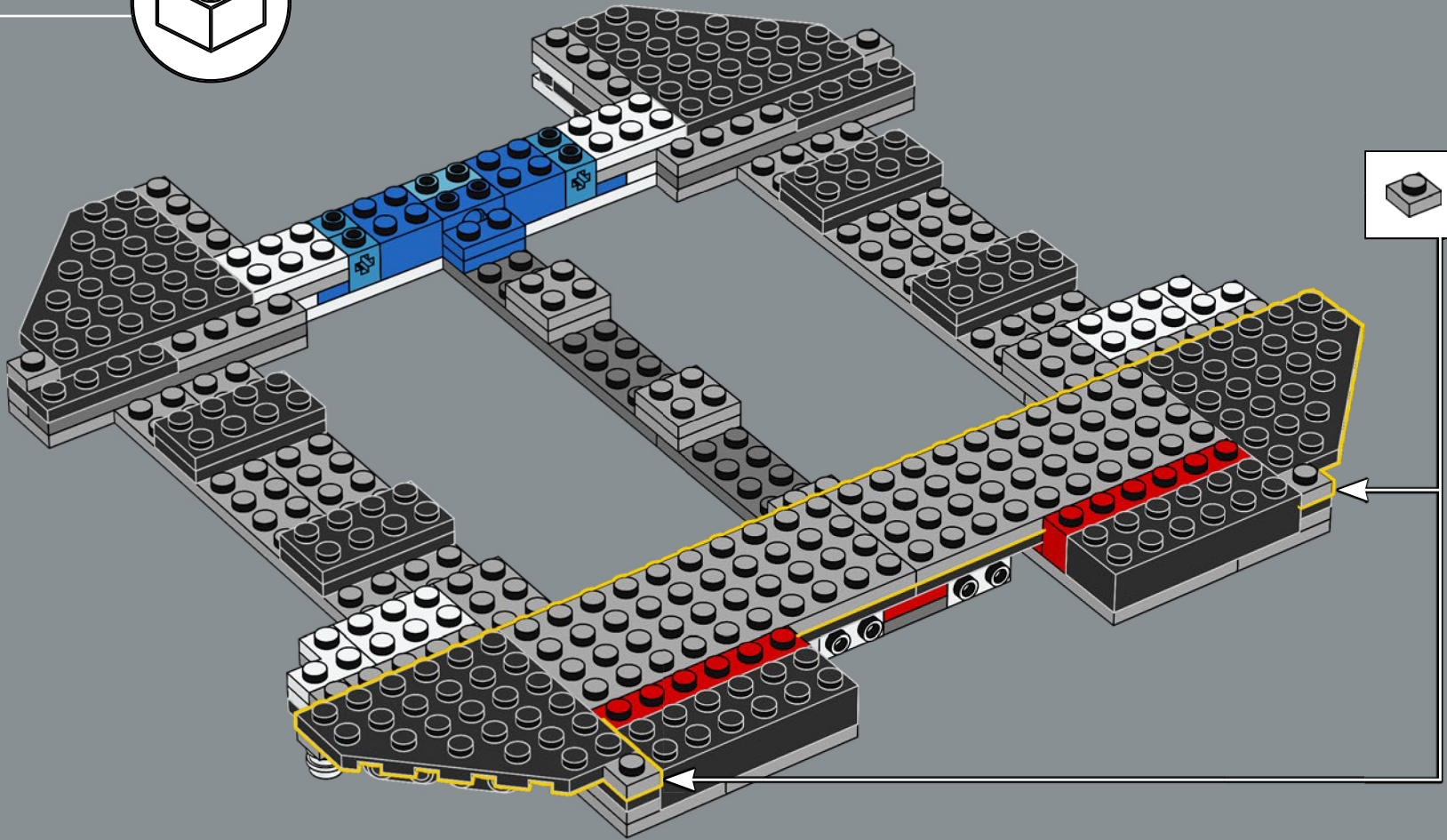

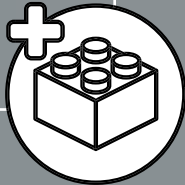
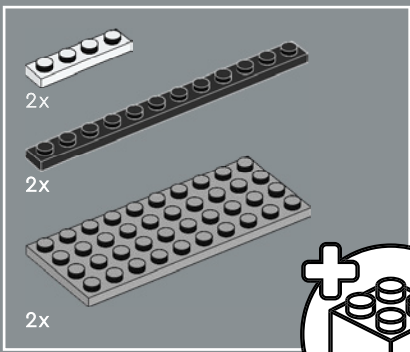

151

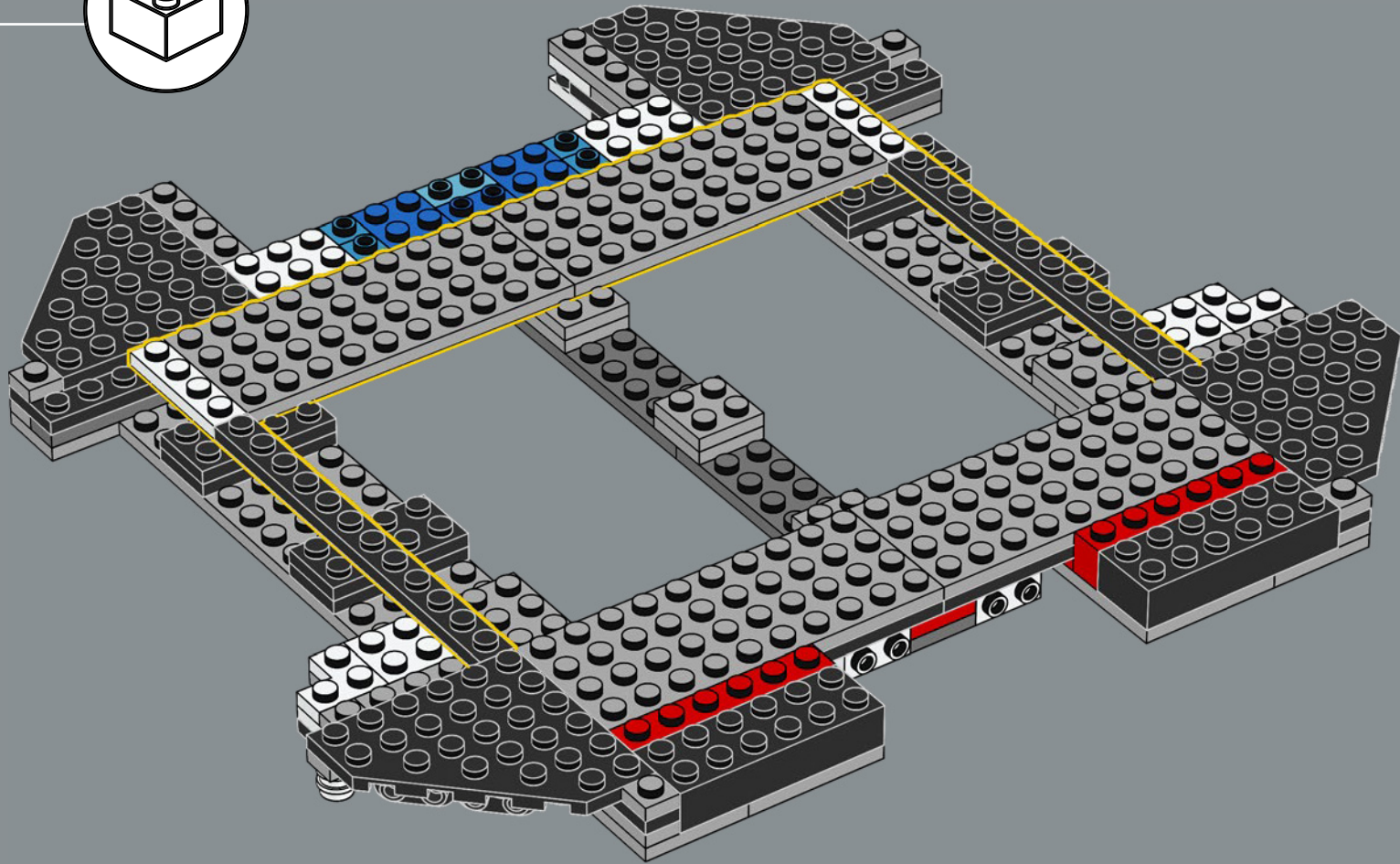

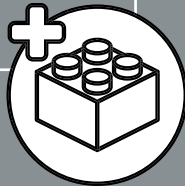
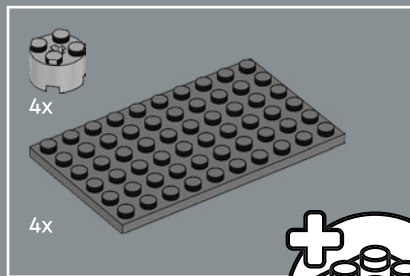

152

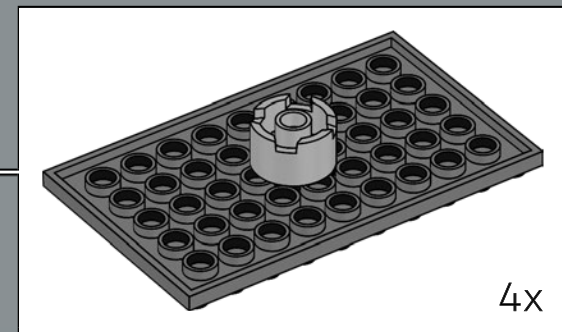
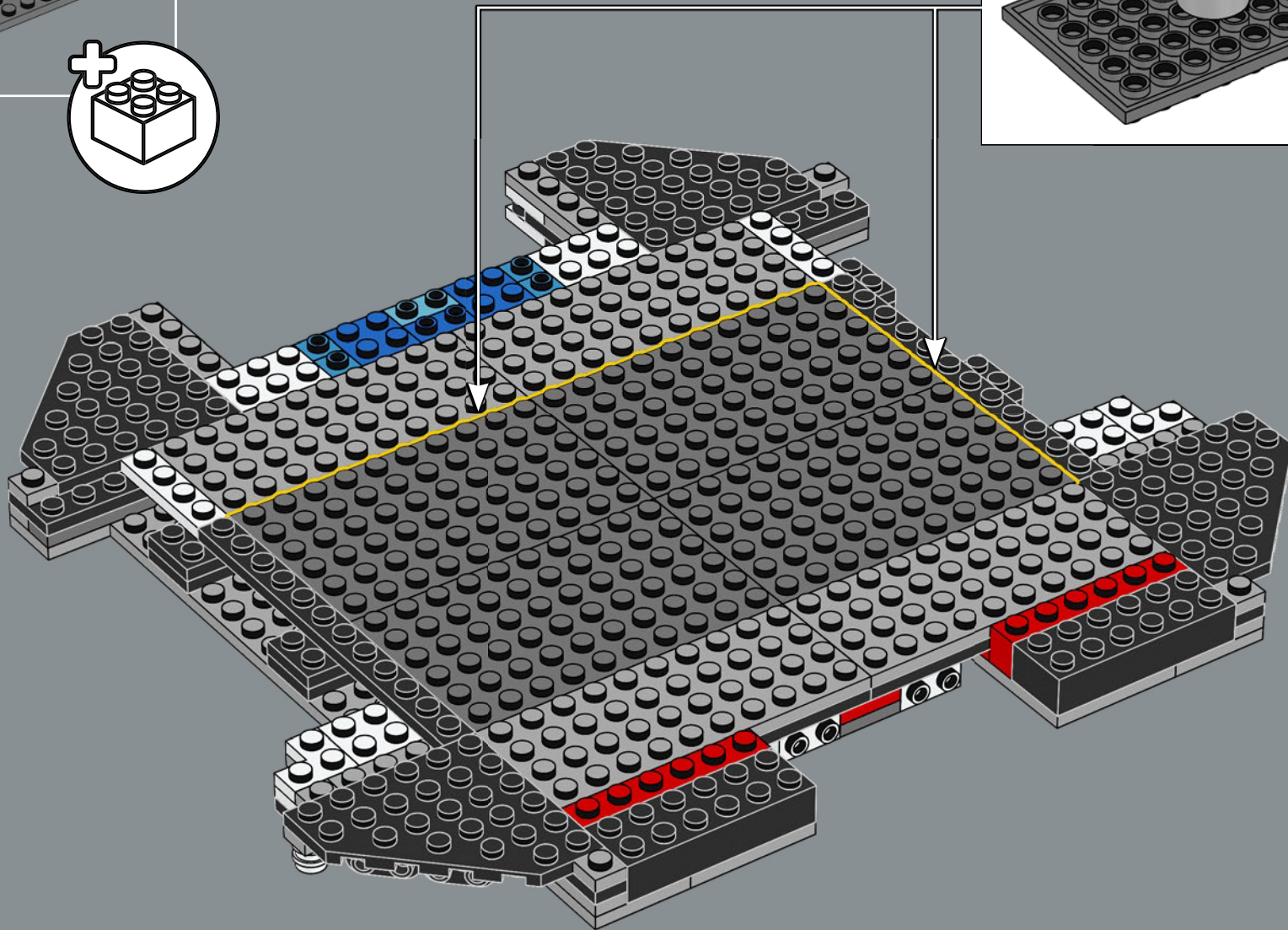

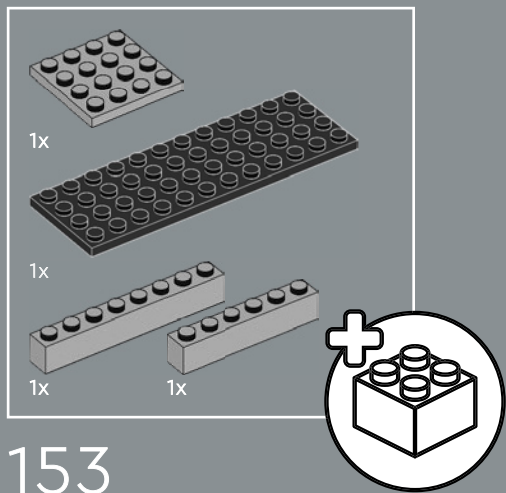

153

1

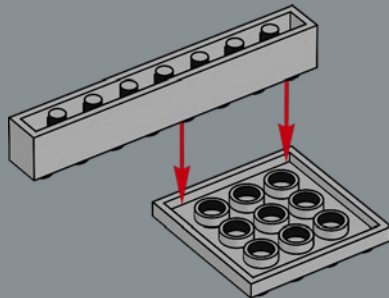

2

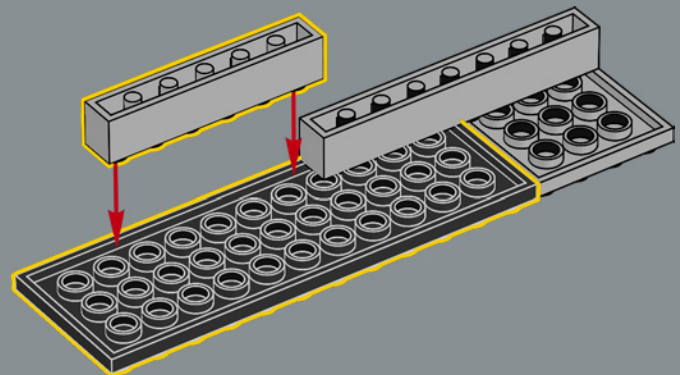

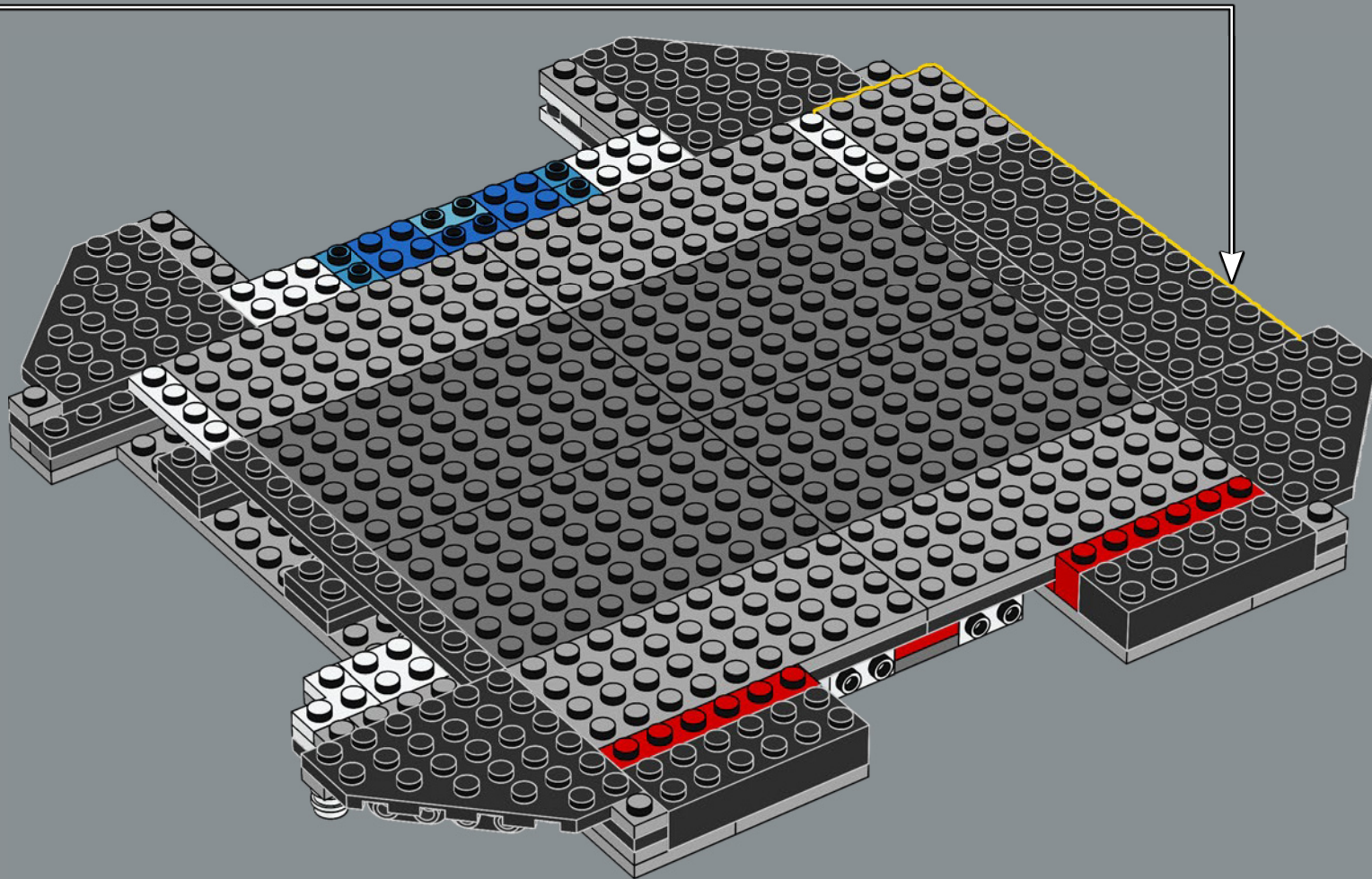

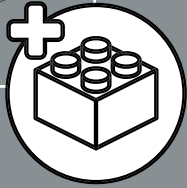
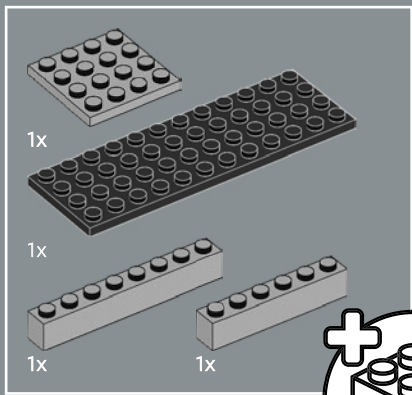

154

1

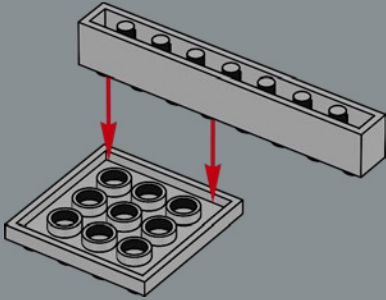

2

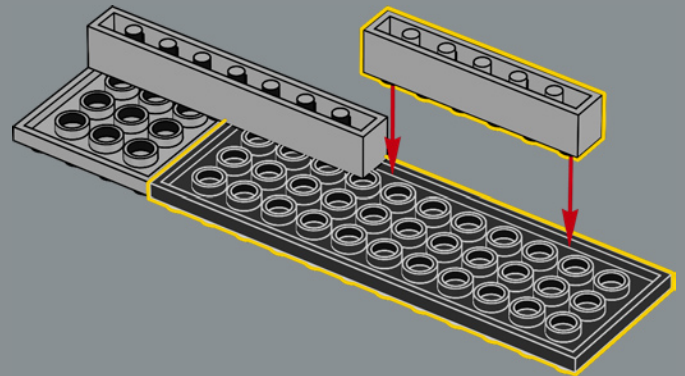

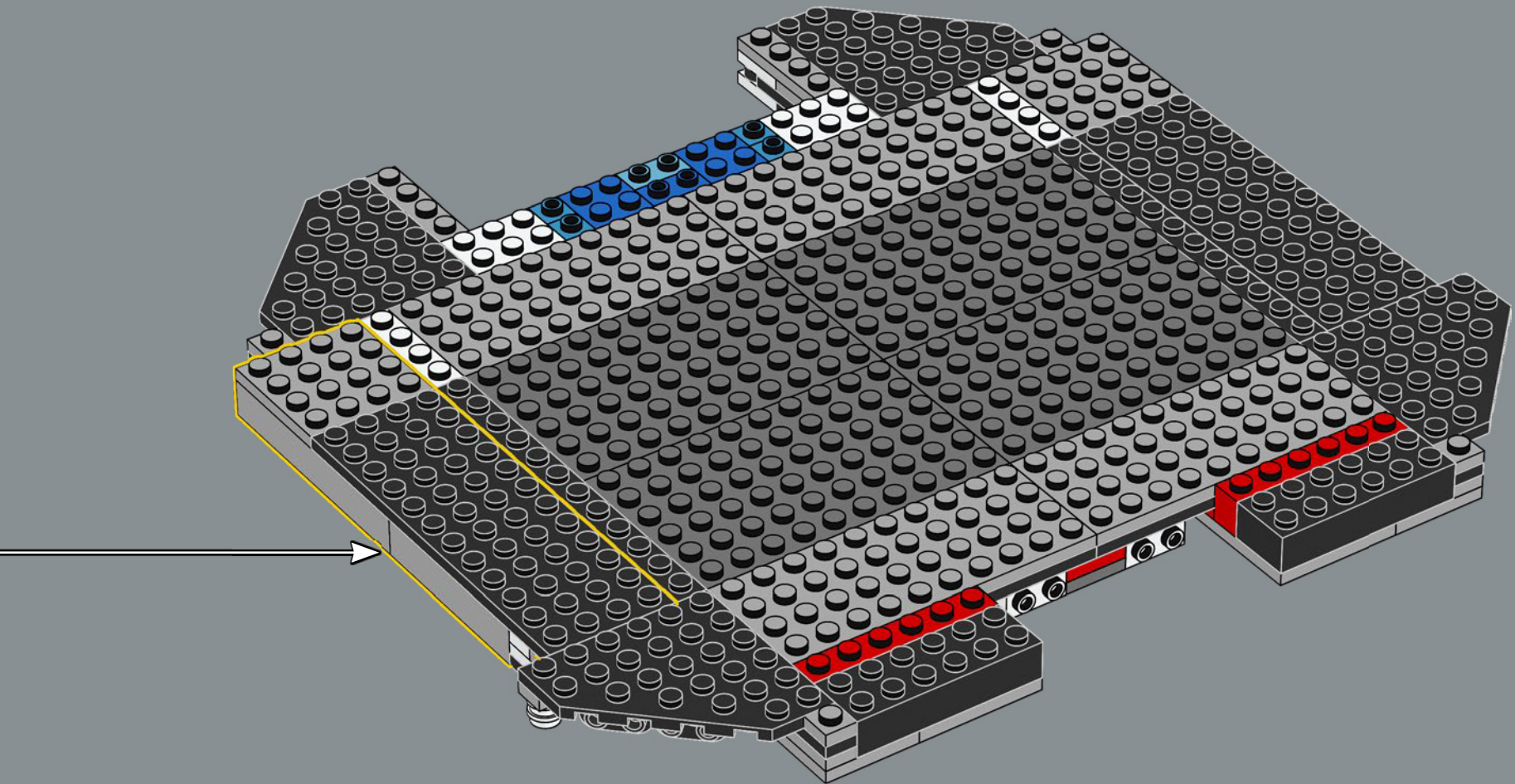

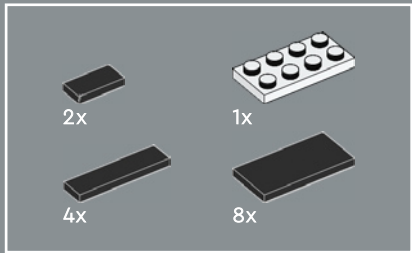

155

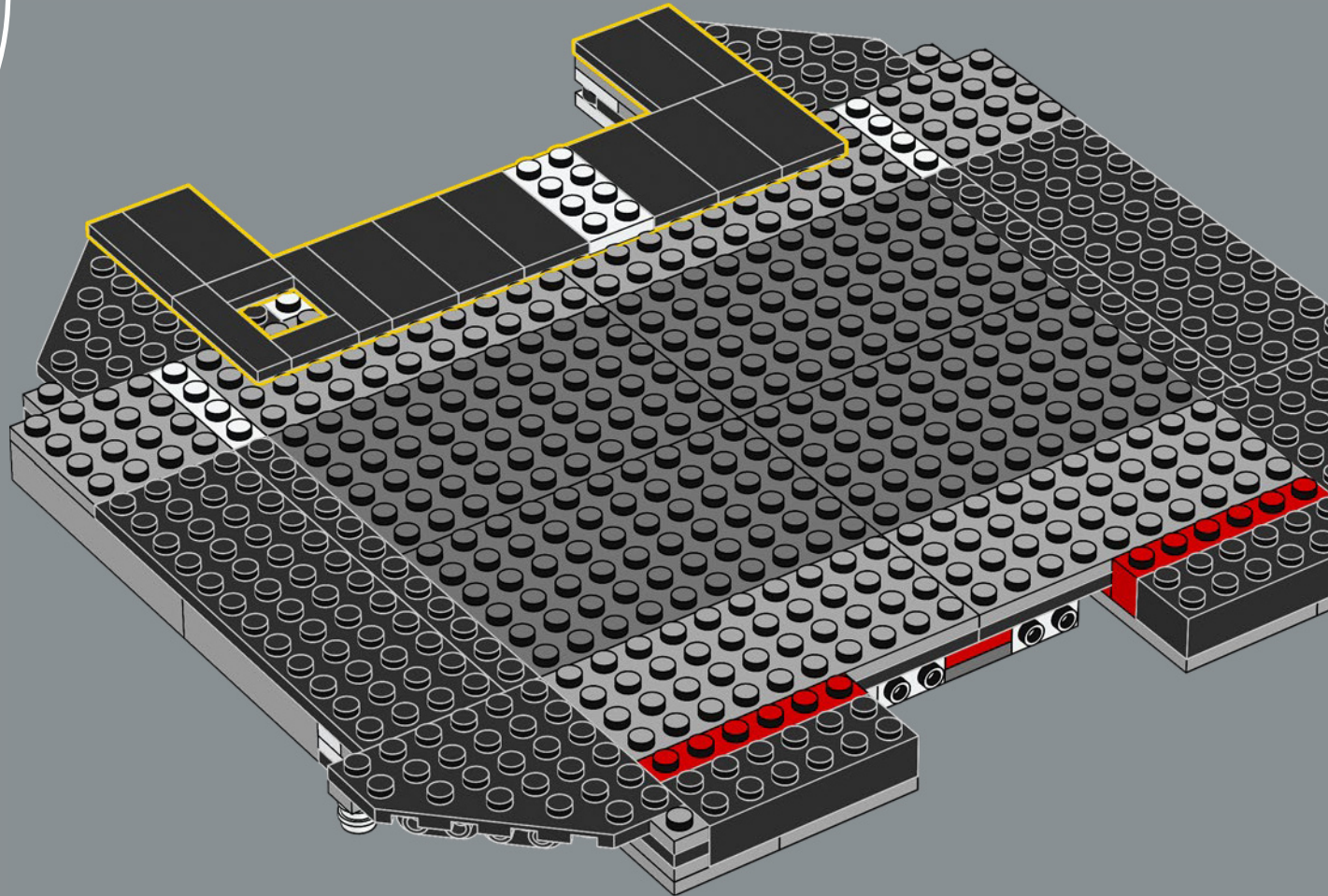

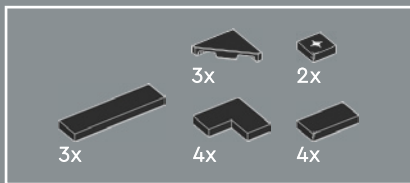

156

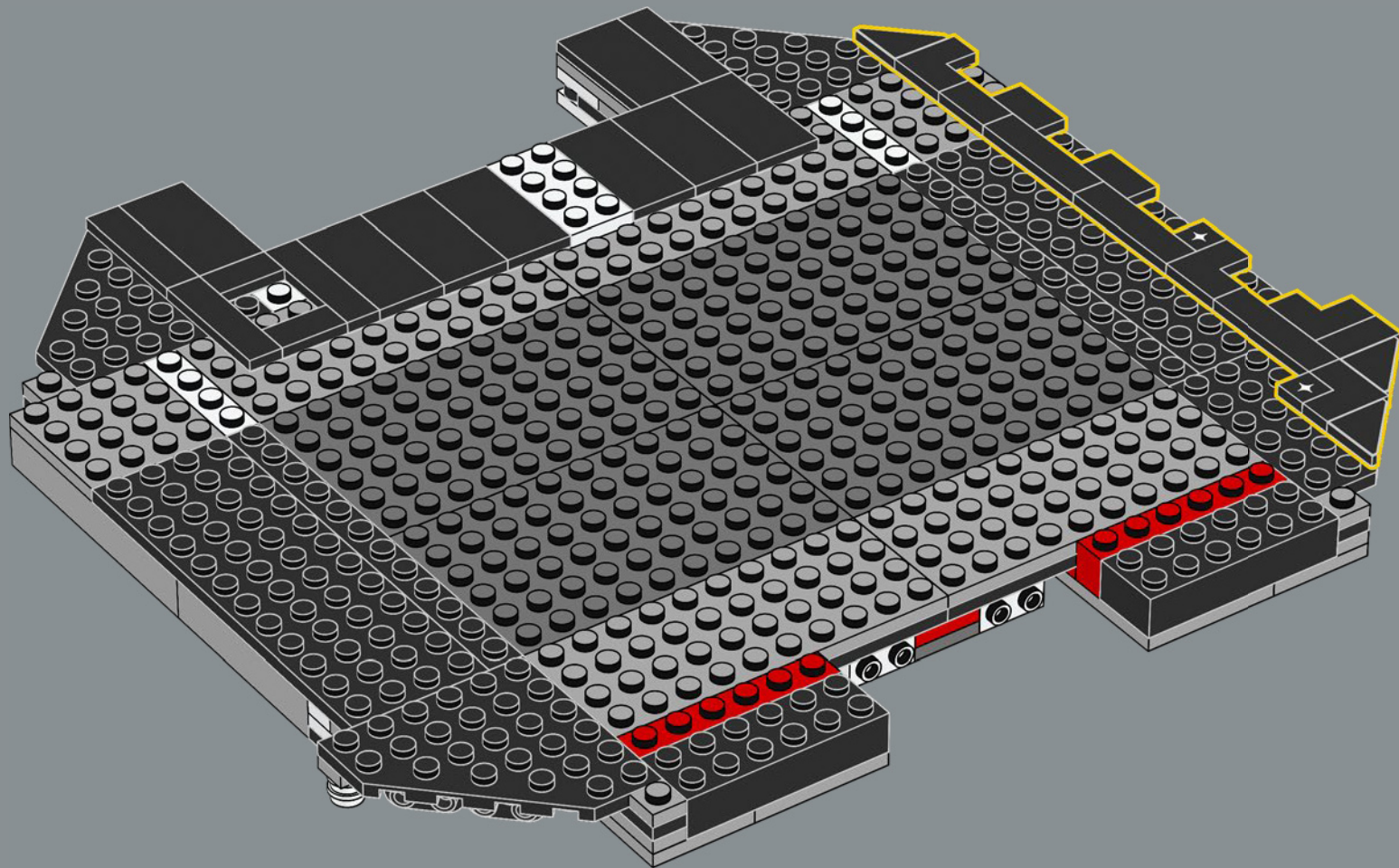

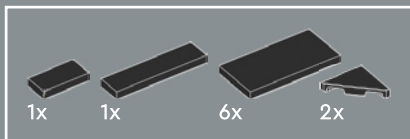

157

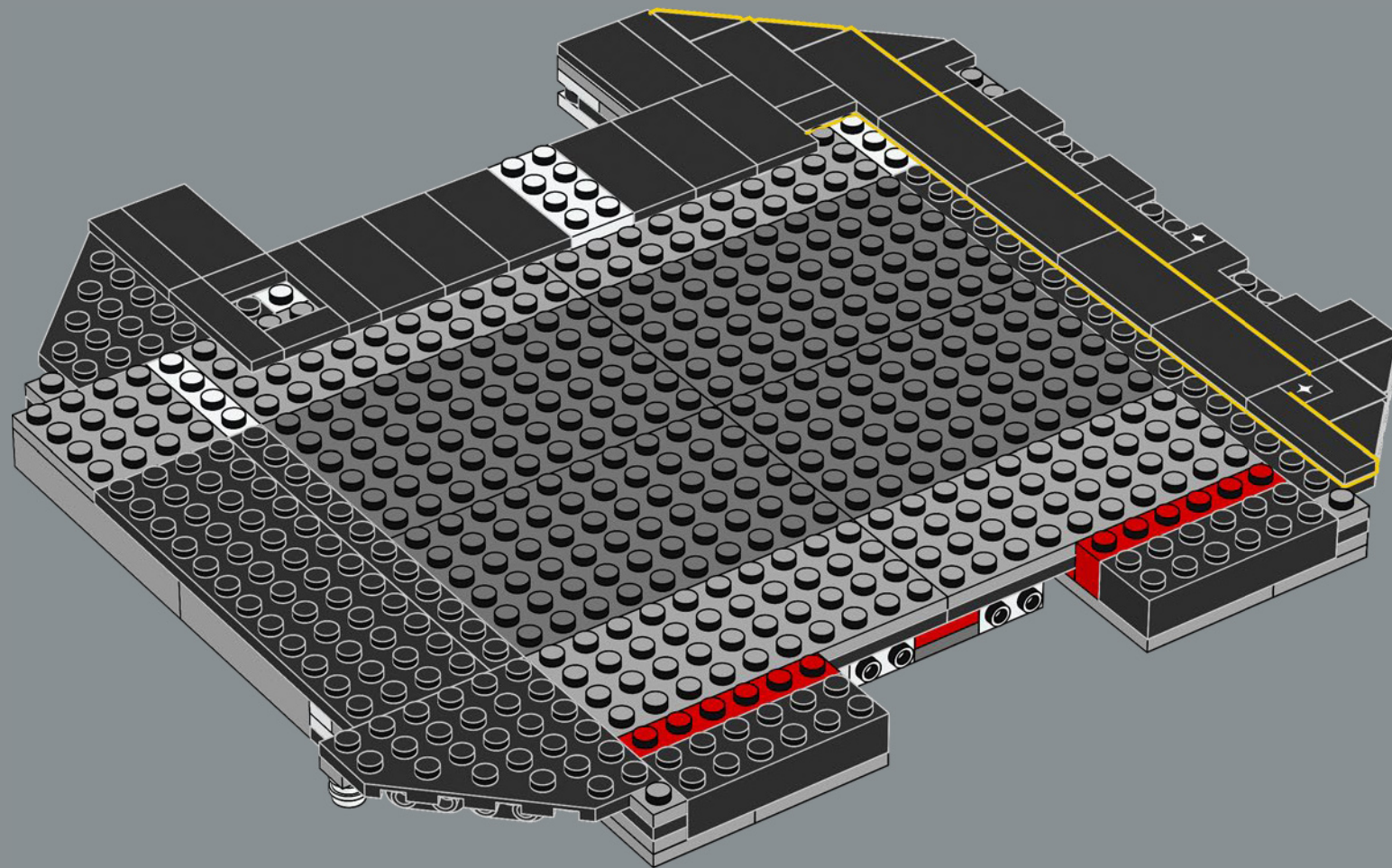

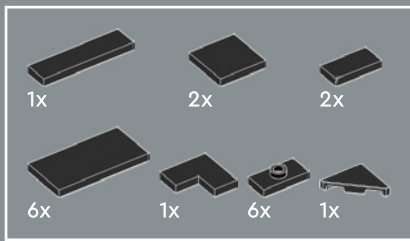

158

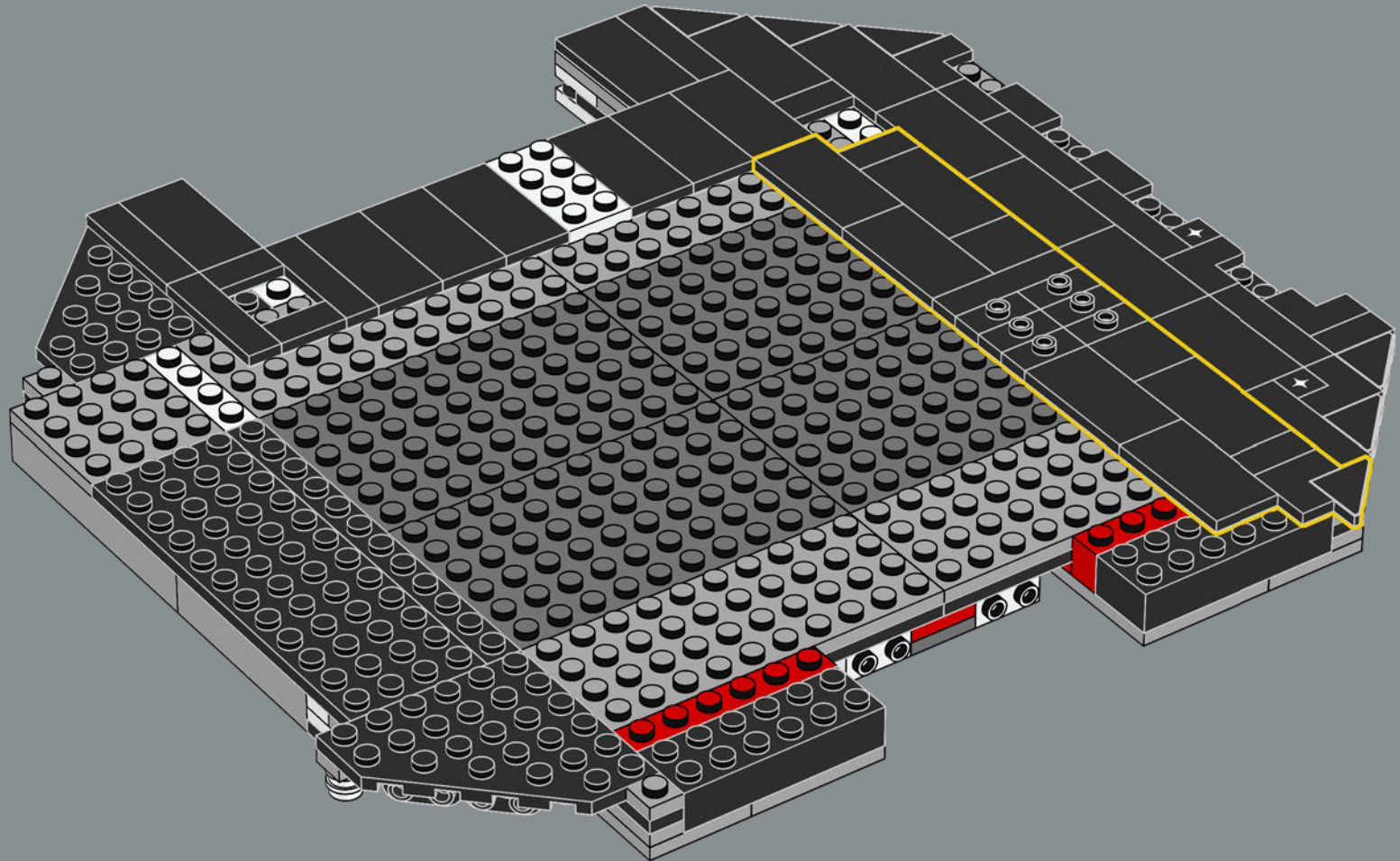

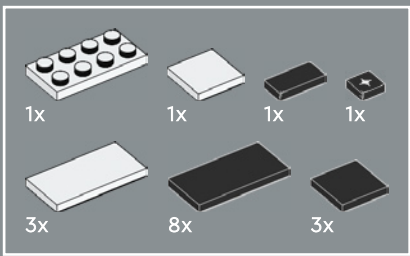

159

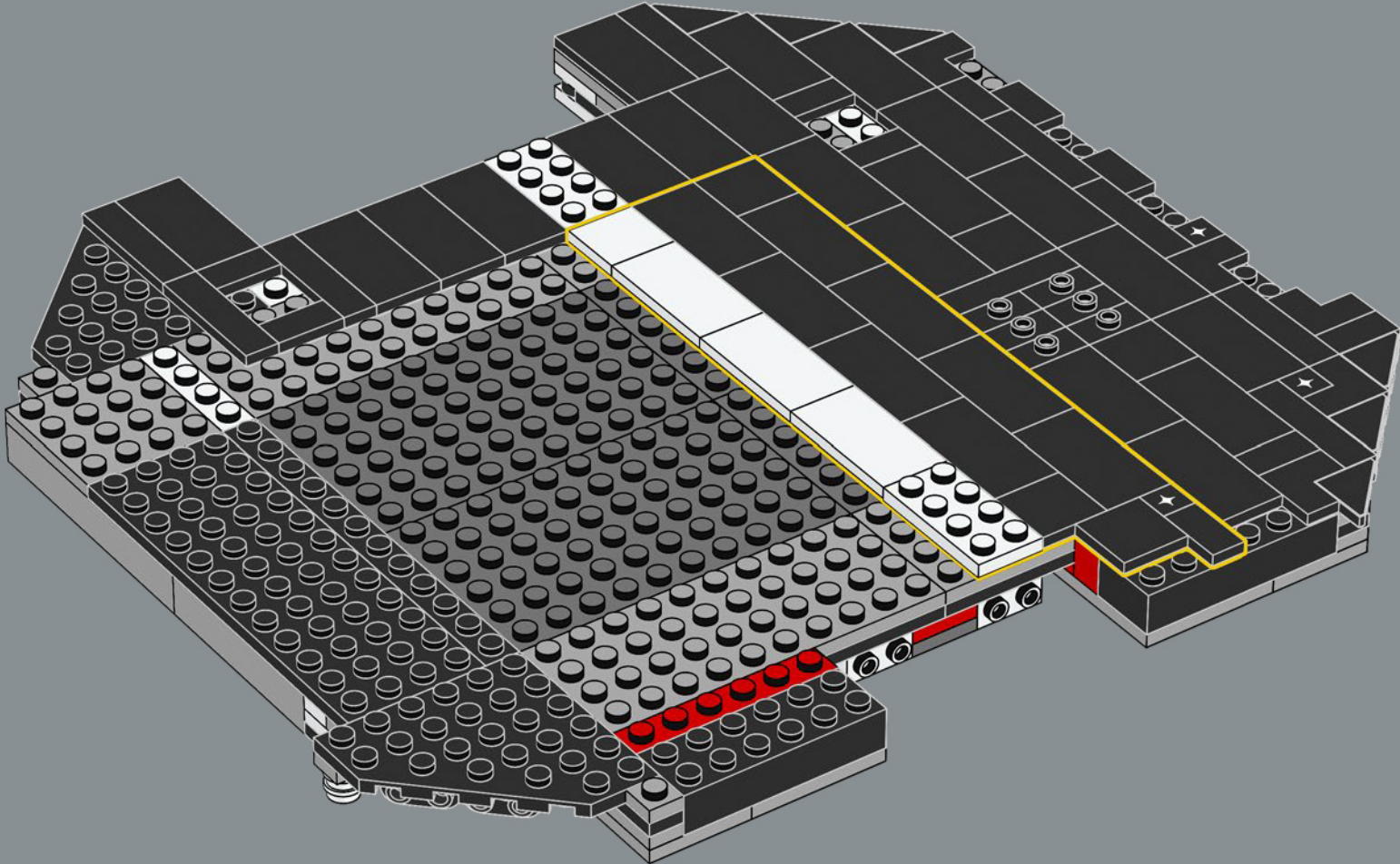

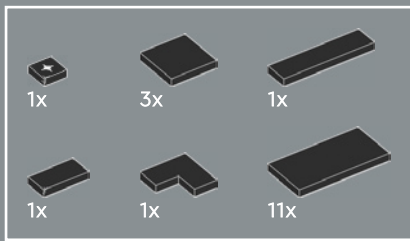

160

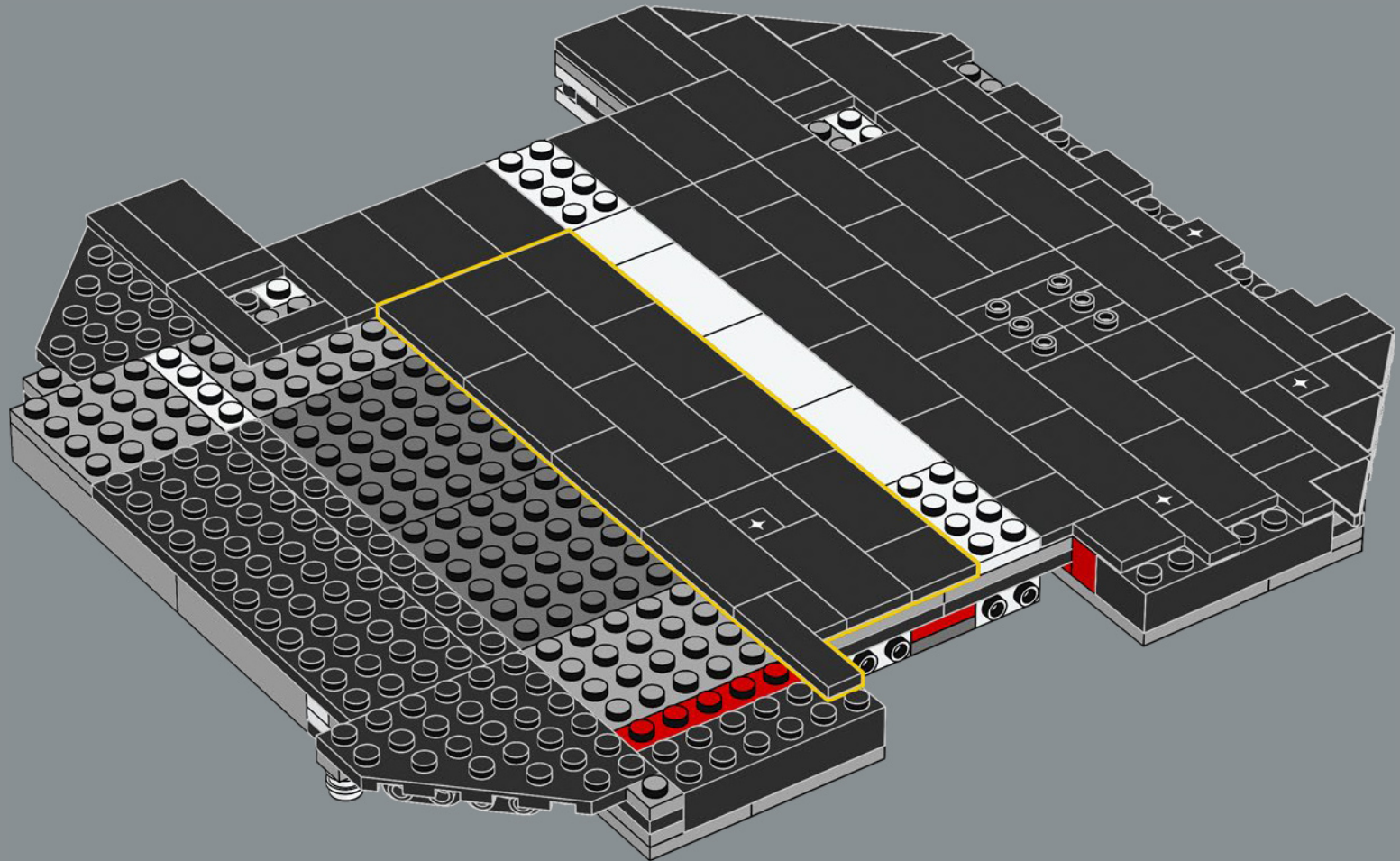

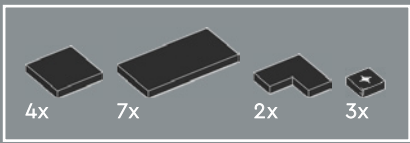

161

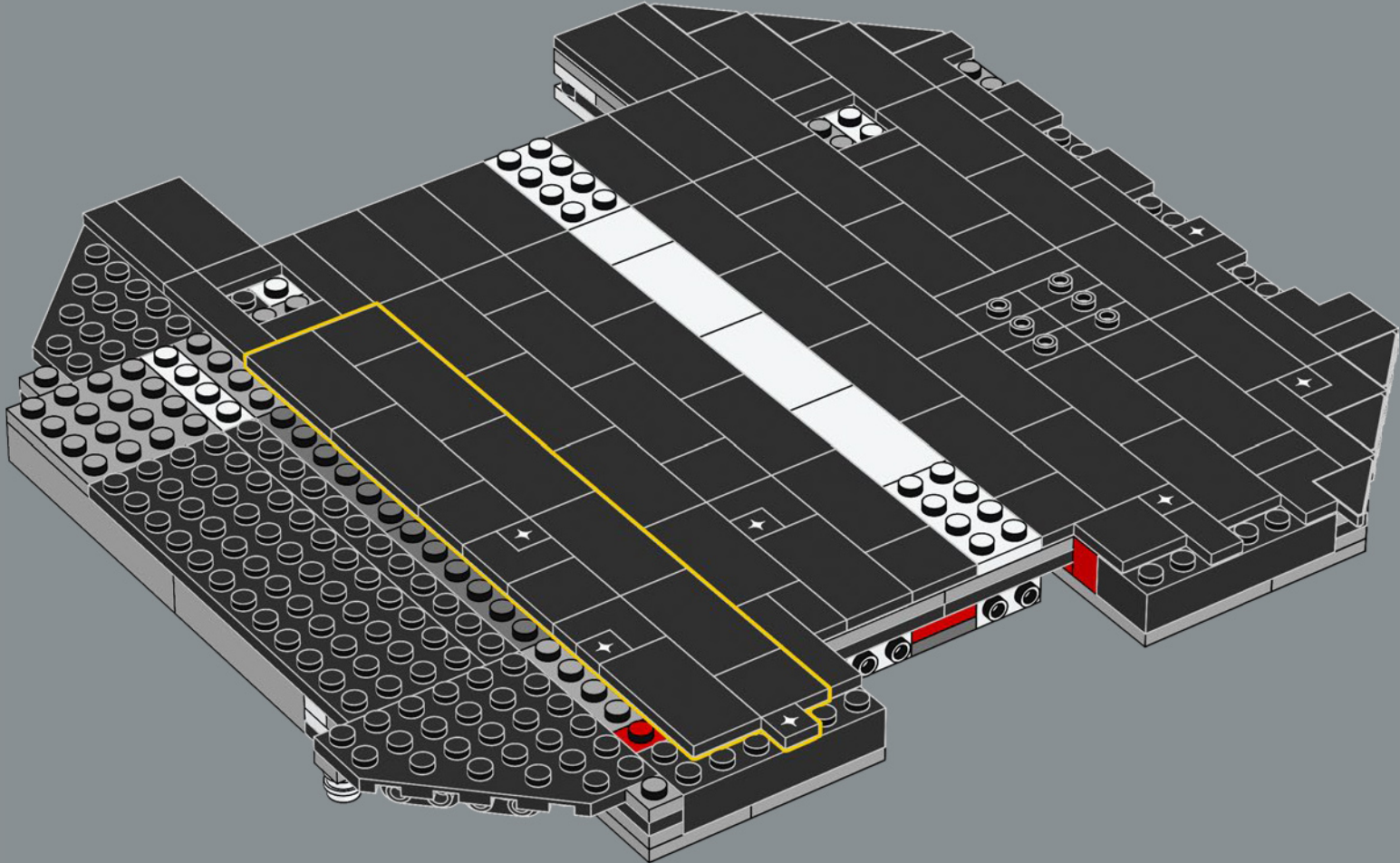

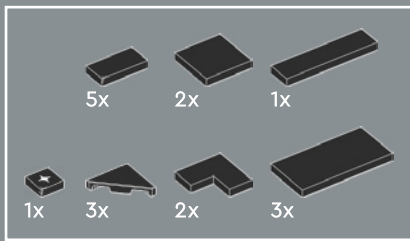

162

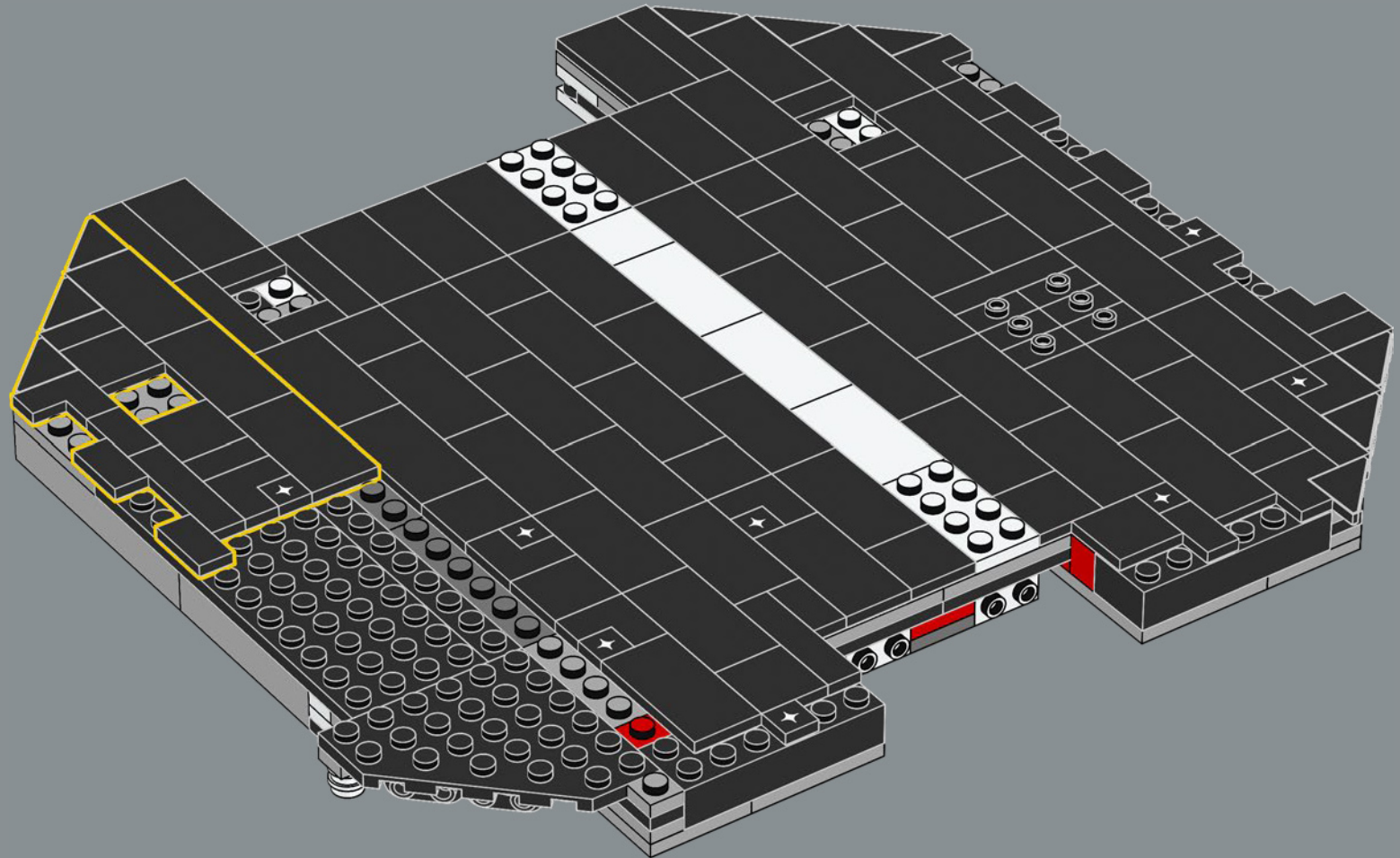

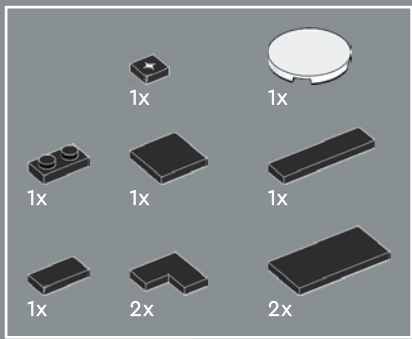

163

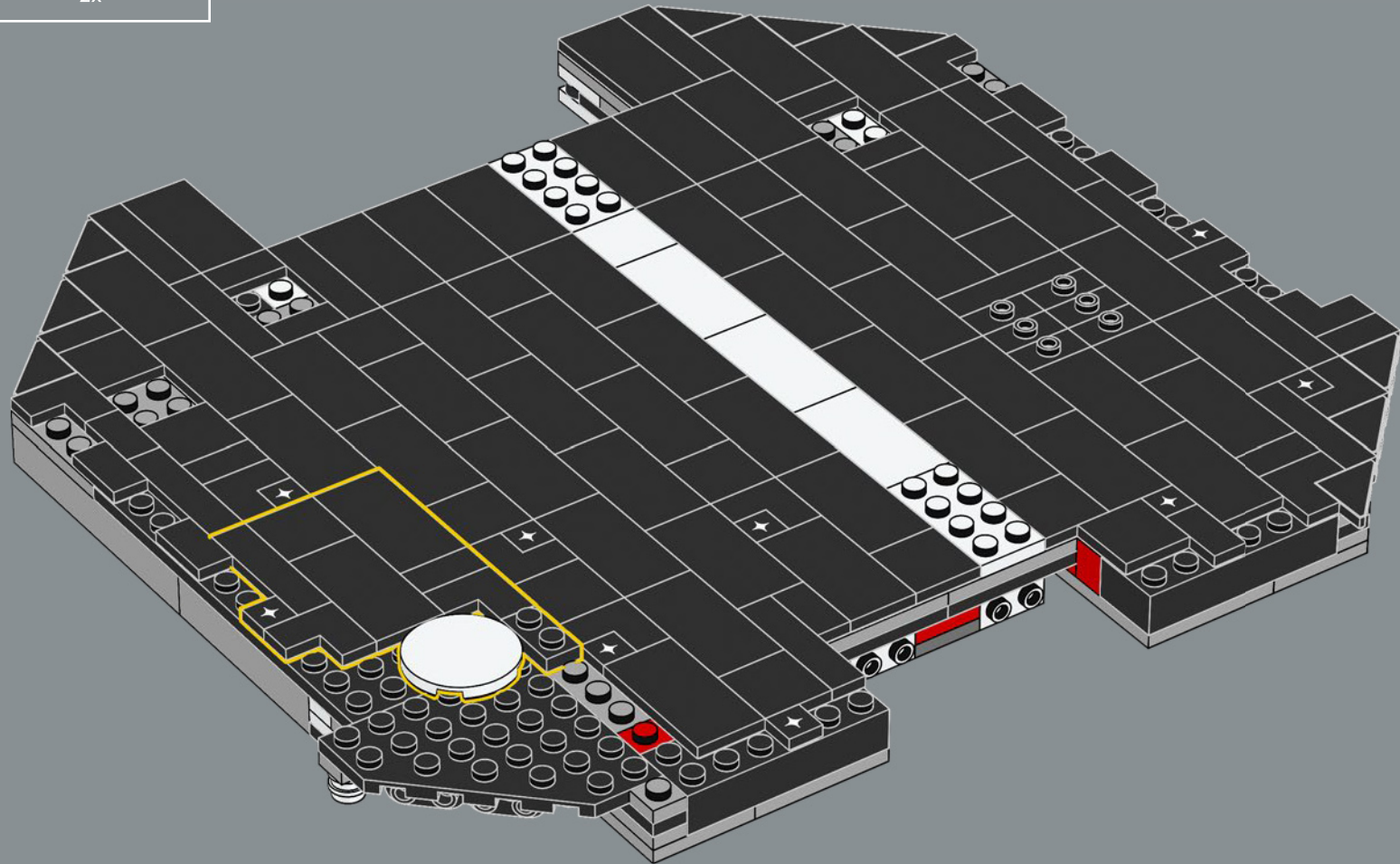

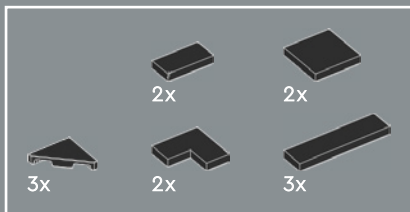

164

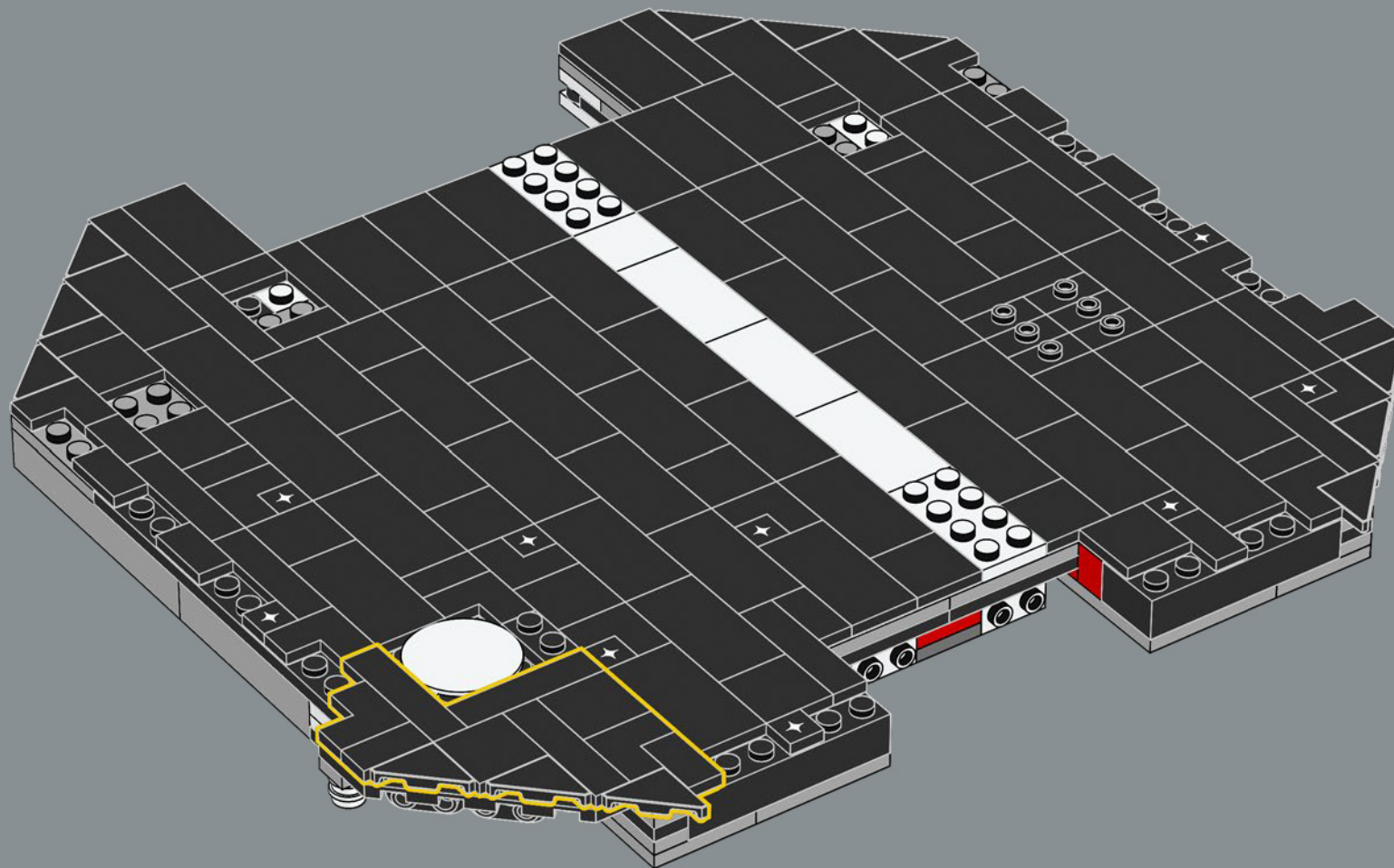

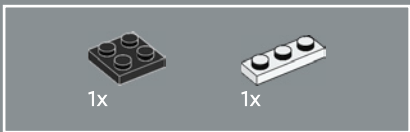

165

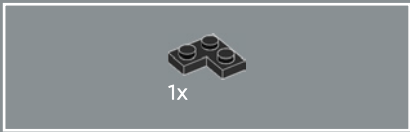
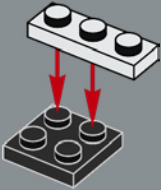

166

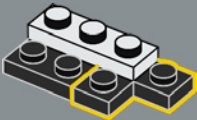

167

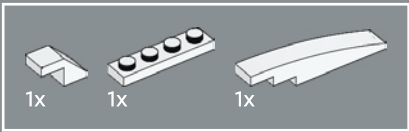
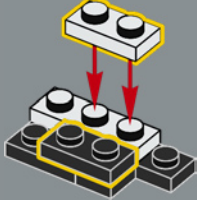

168

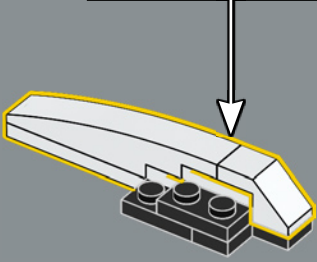
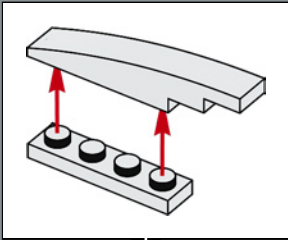

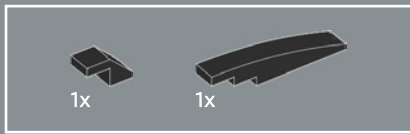

169

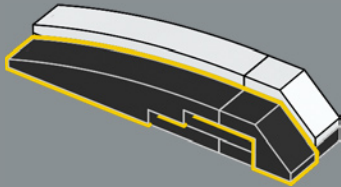

170

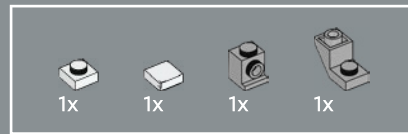
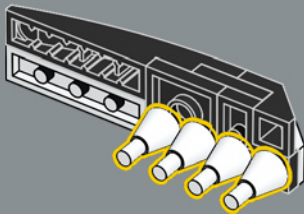

171

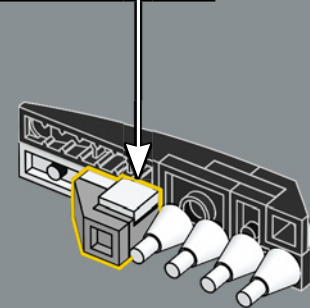
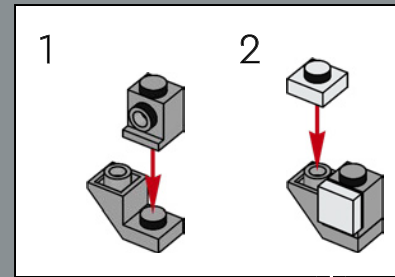

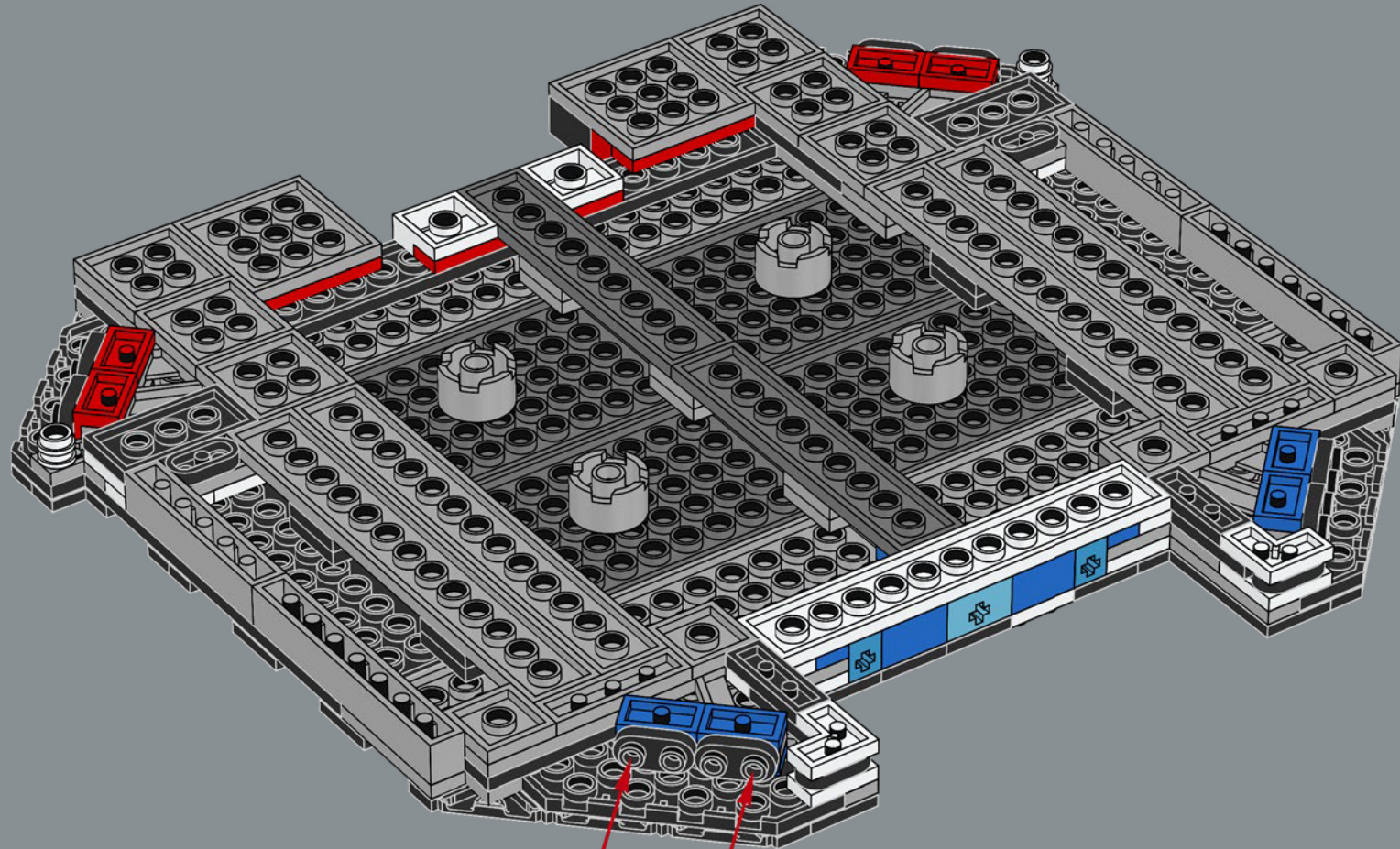

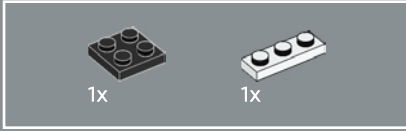
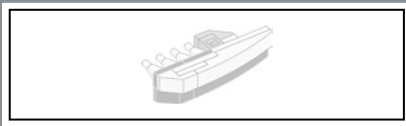

173

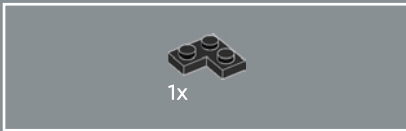
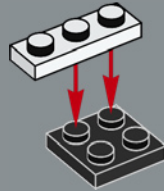

174

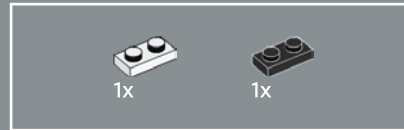
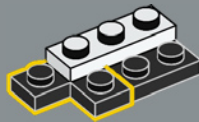

175

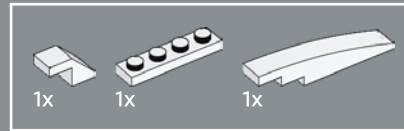
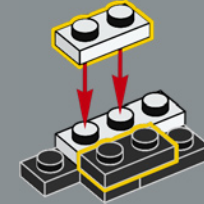

176

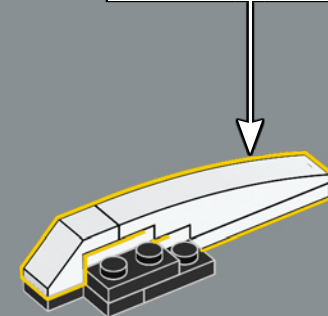
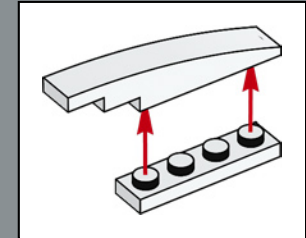

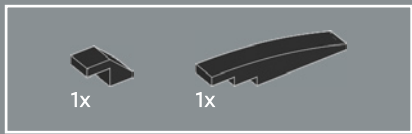

177

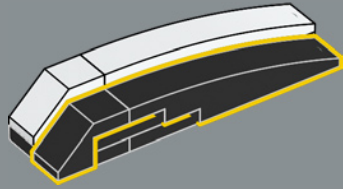

178

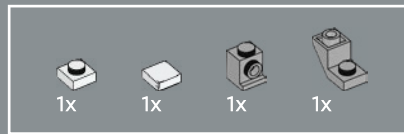
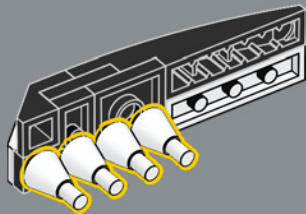

179

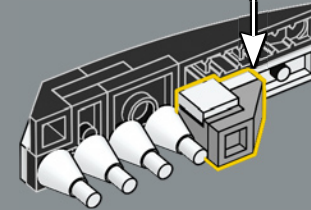
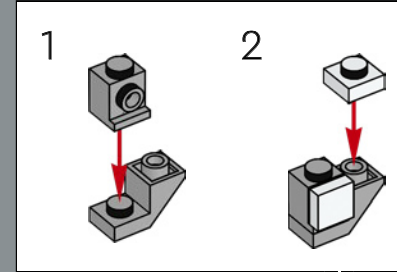

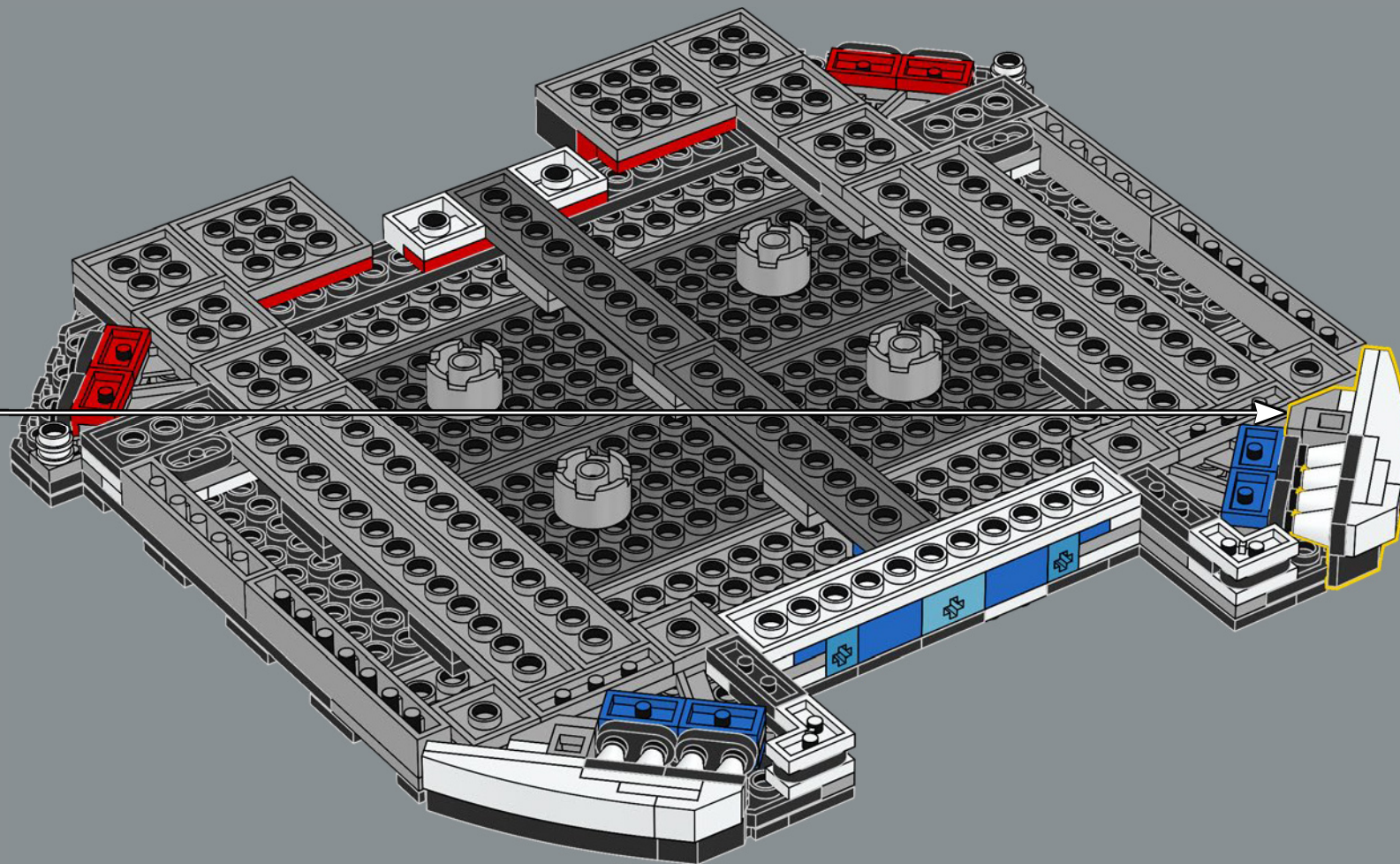

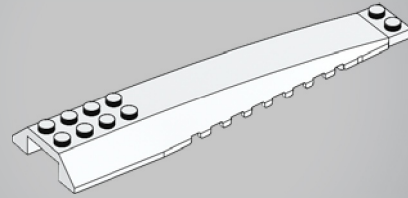
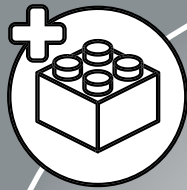

1x

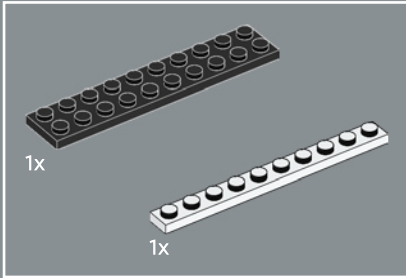
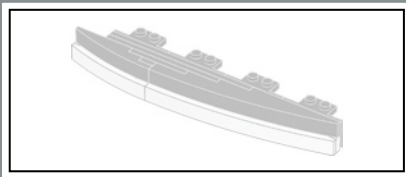

181

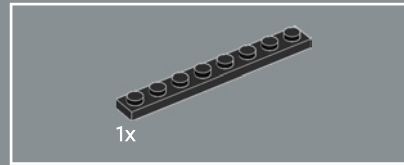
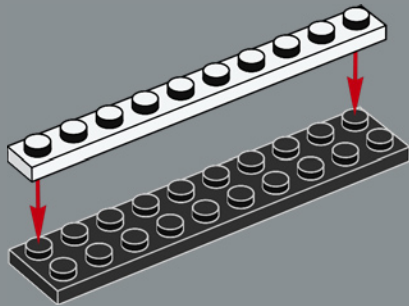

182

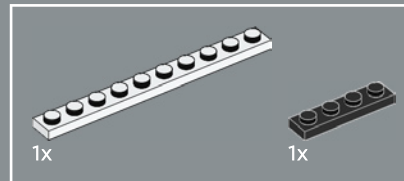
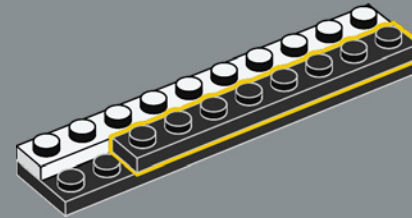

183

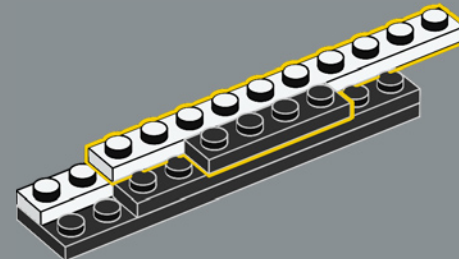

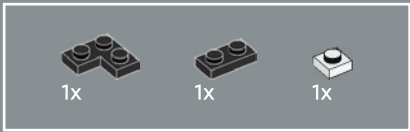

184

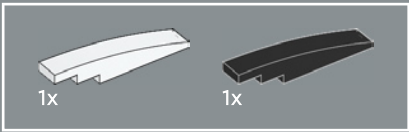
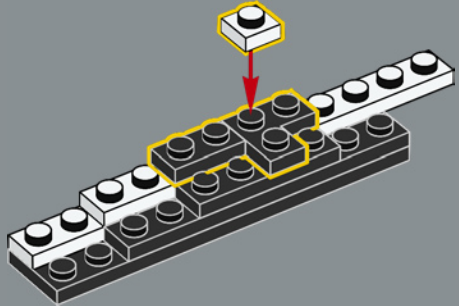

185

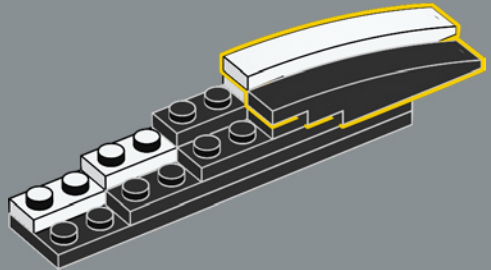

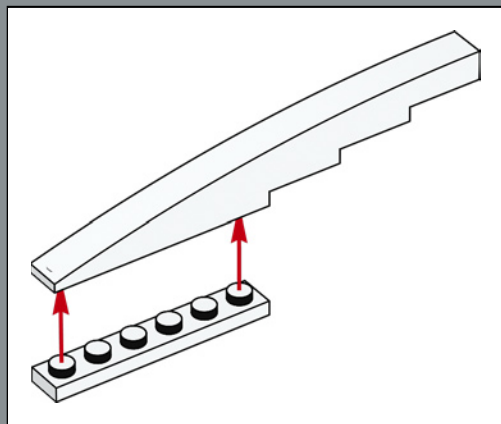
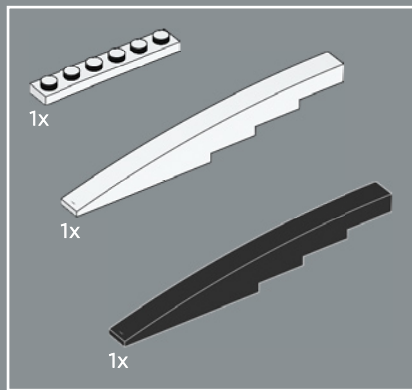

186

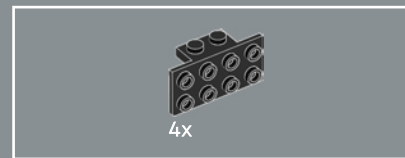
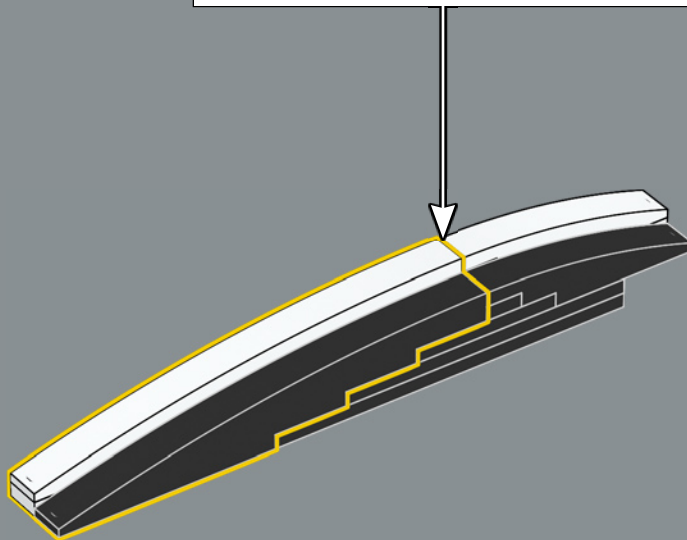

187

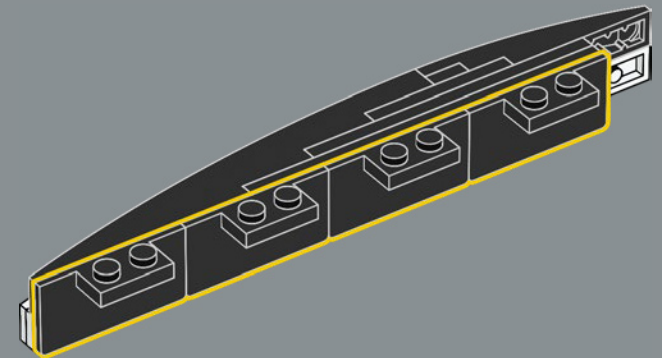

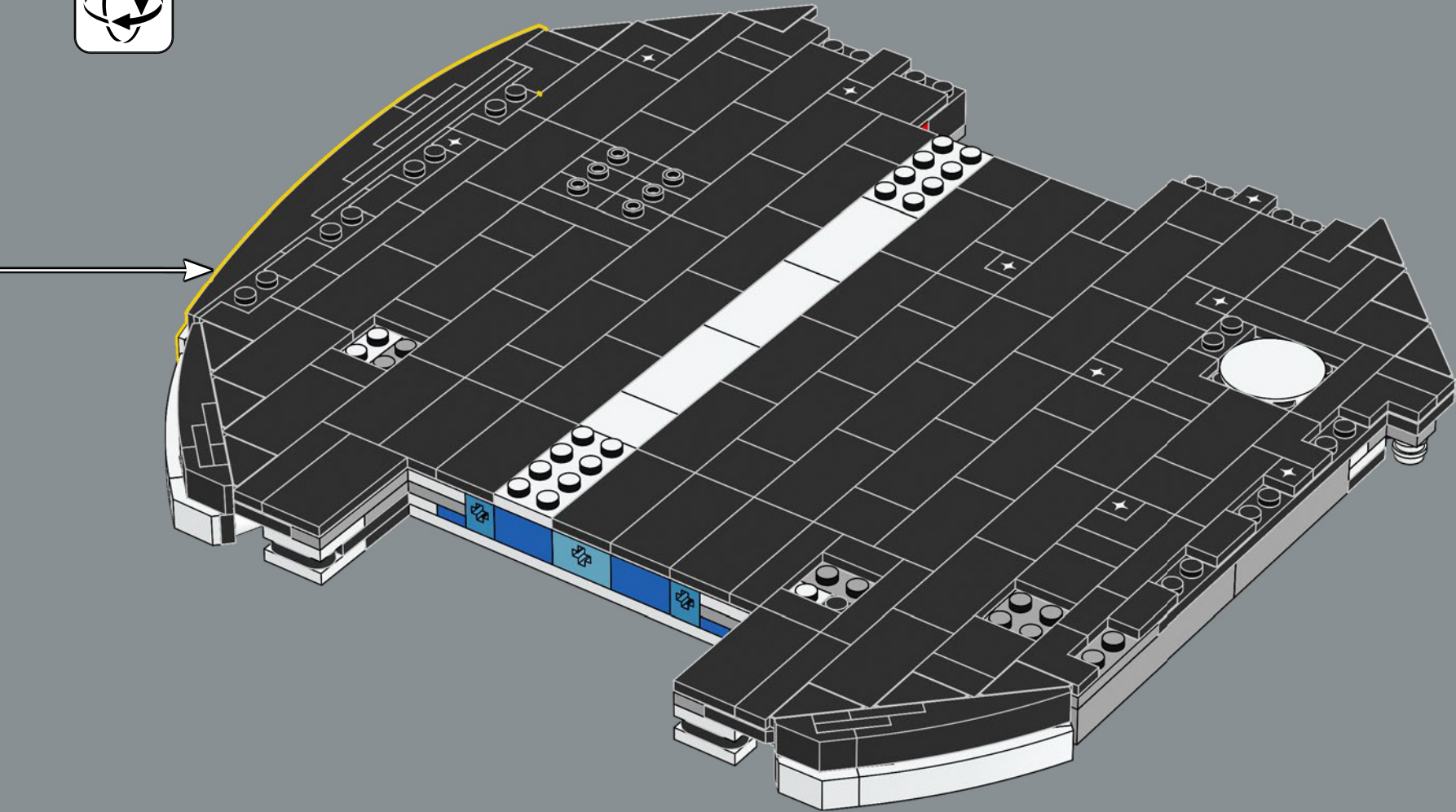

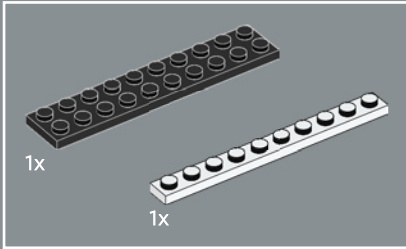
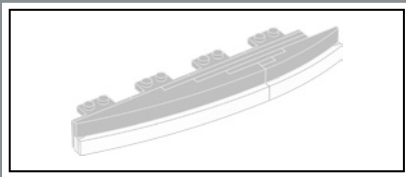

189

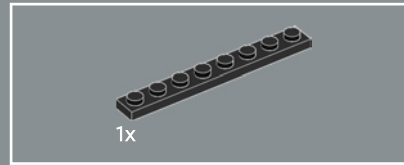
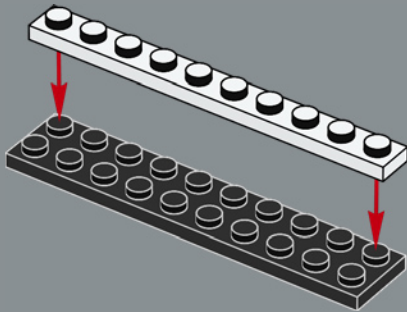

190

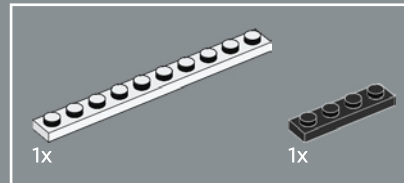
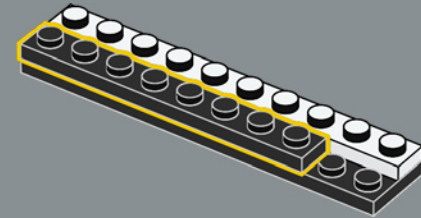

191

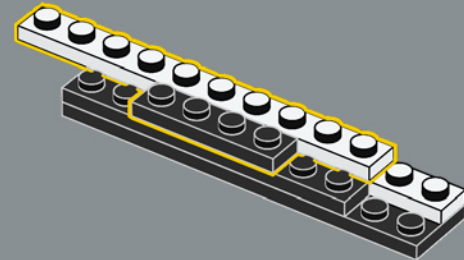

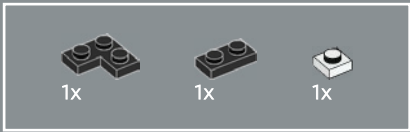

192

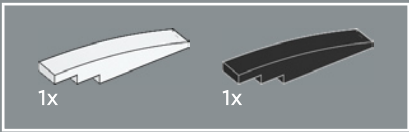
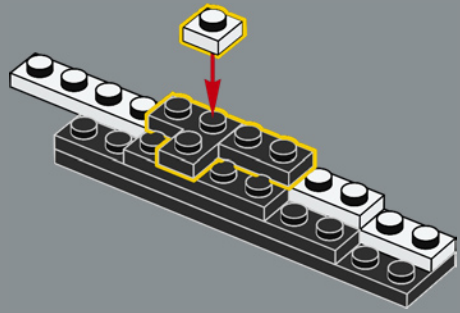

193

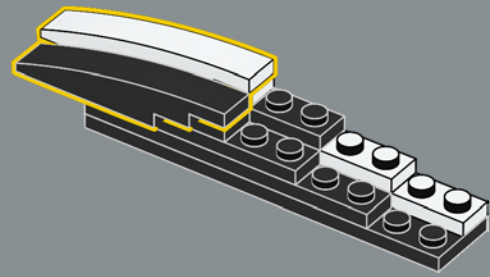

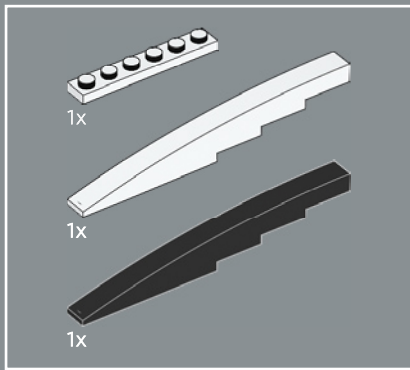

194

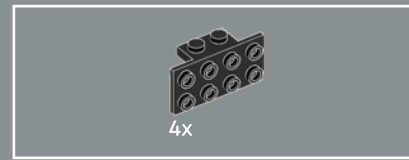
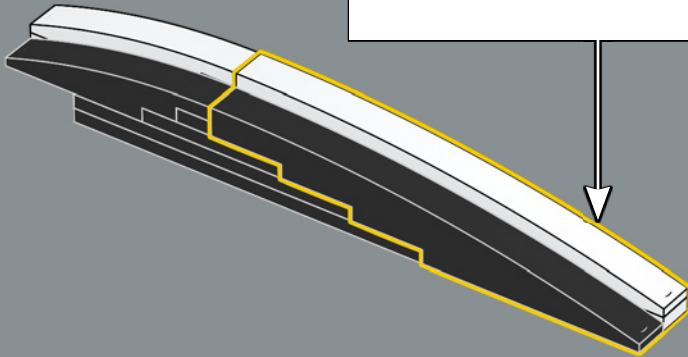
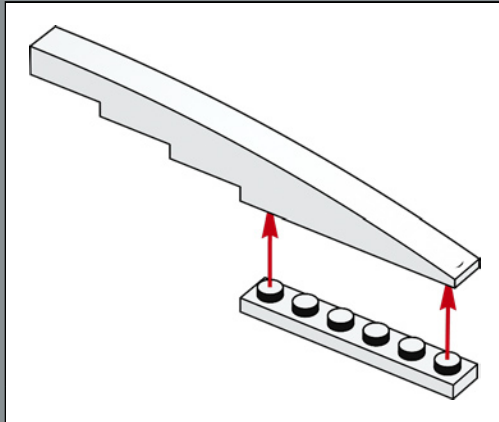

195

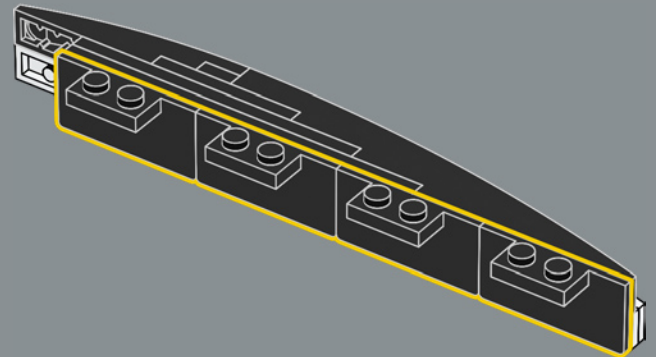

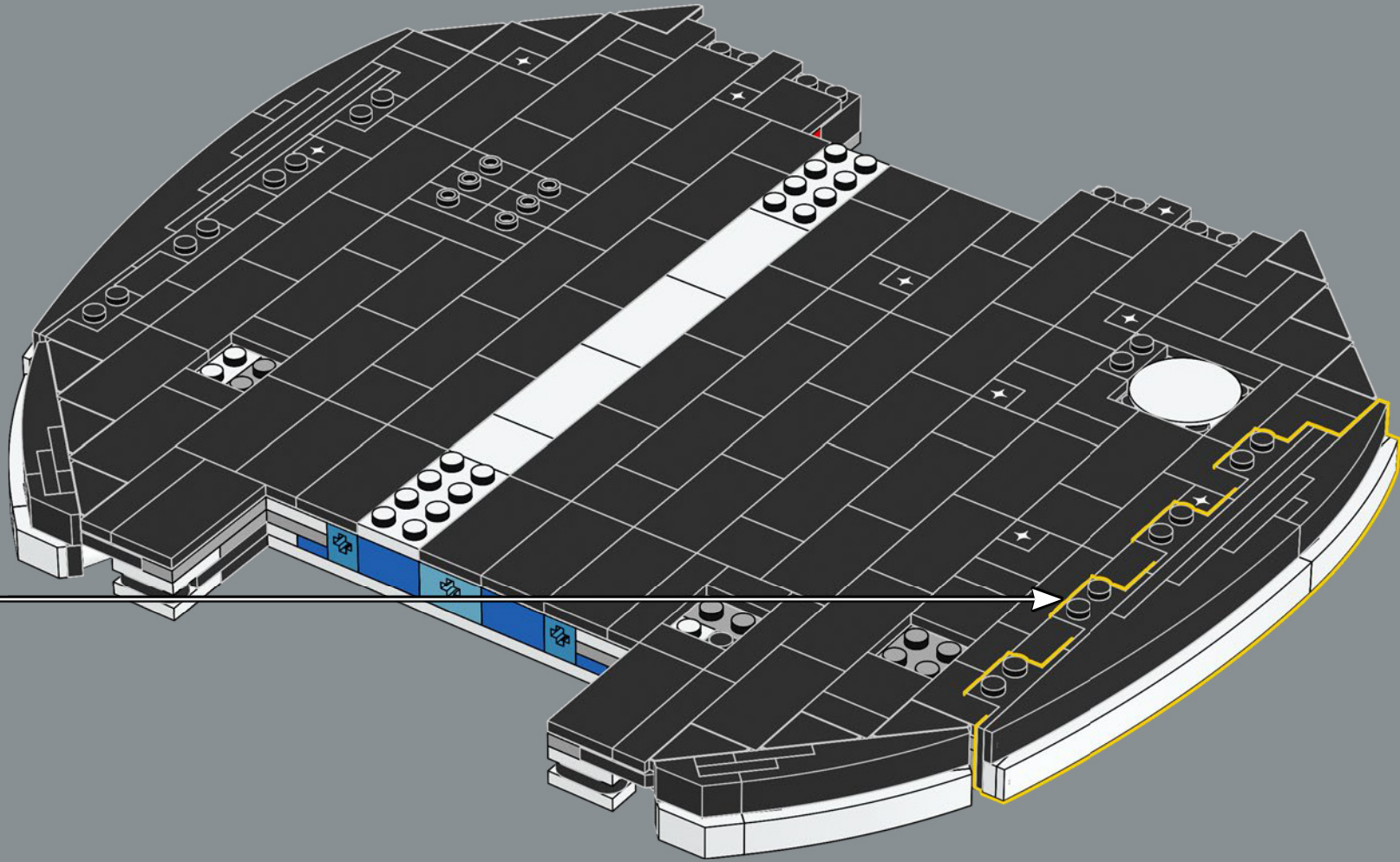

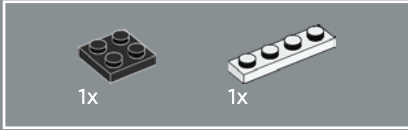
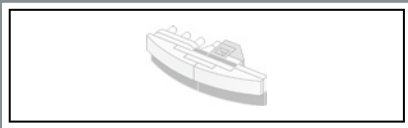

197

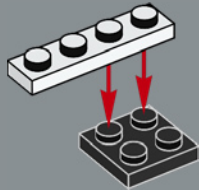

198

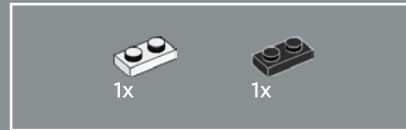
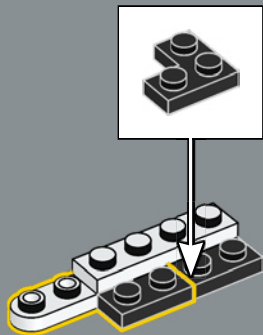

199

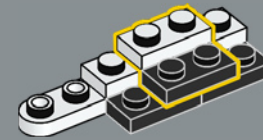

200

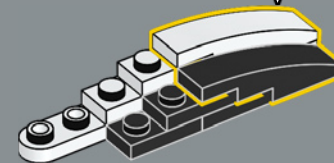
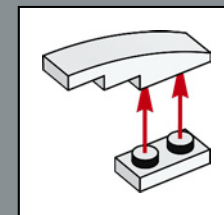

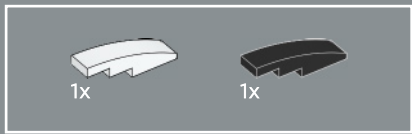

201

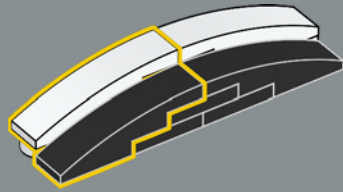

202

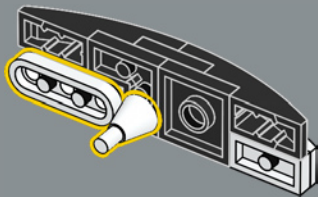

203

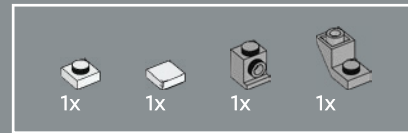
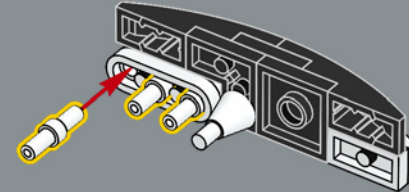

204

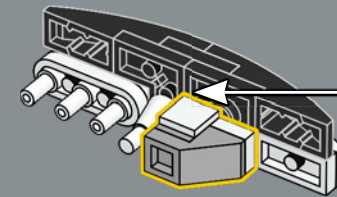
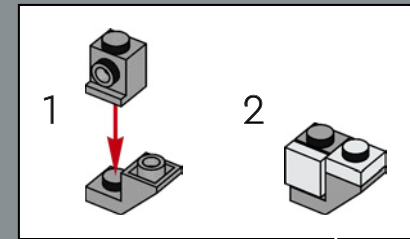

205

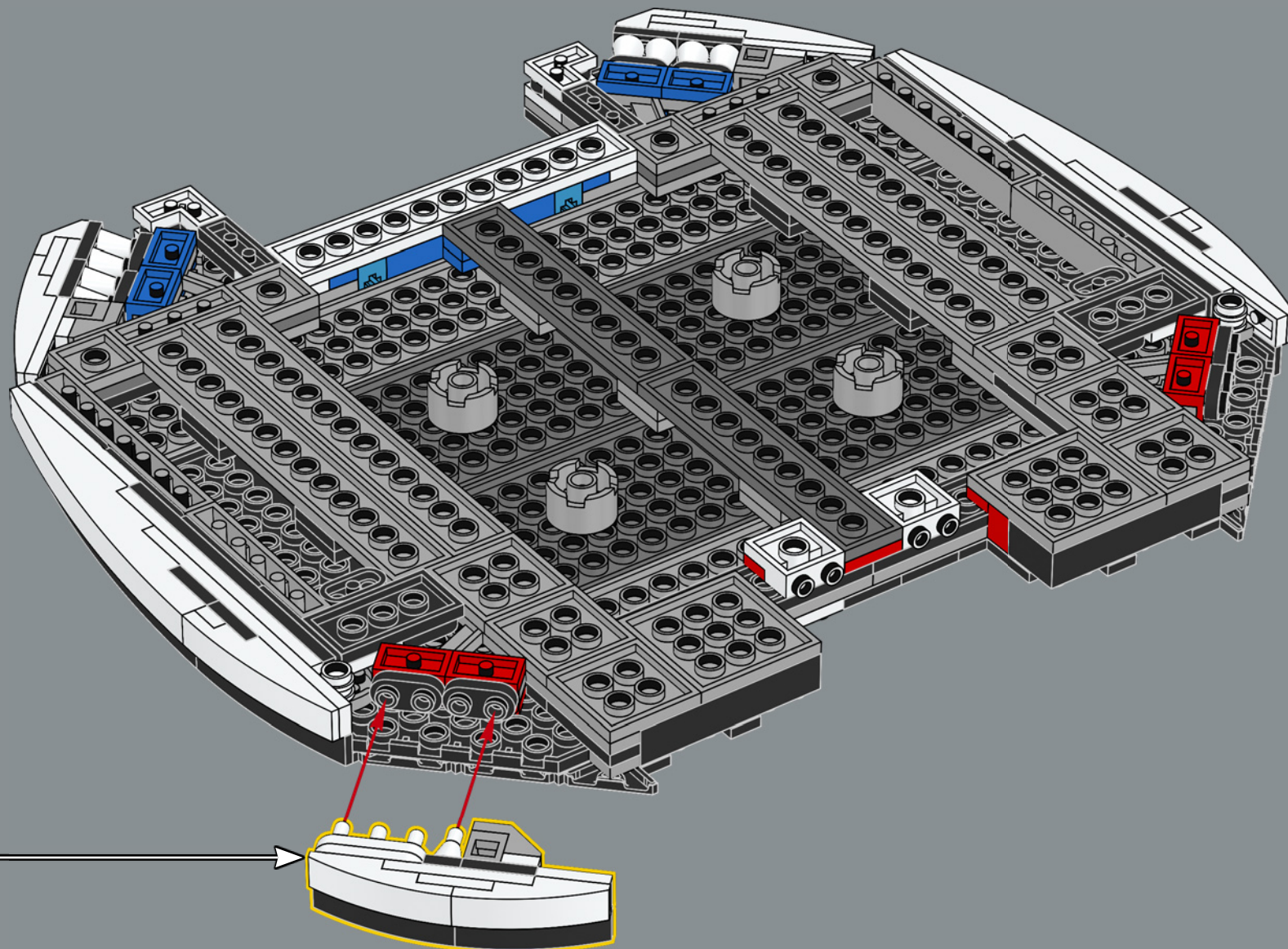

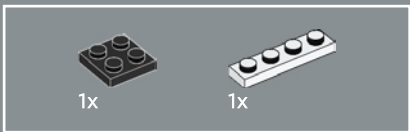

206

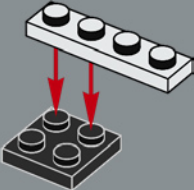

207

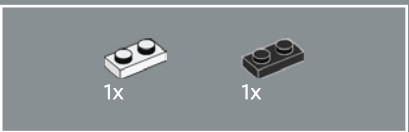
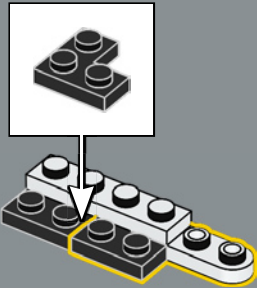

208

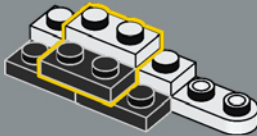

209

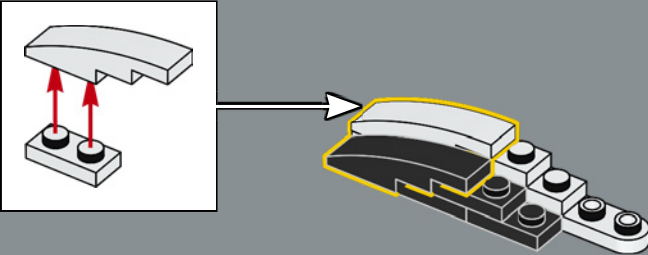

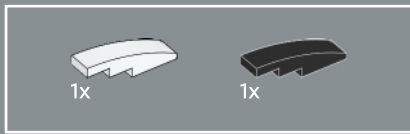

210

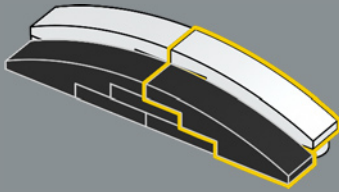

211

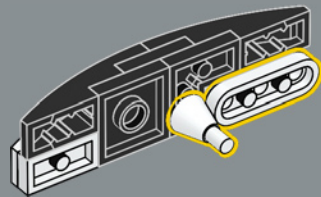

212

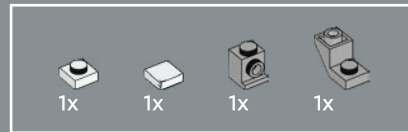
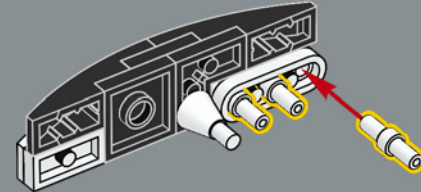

213

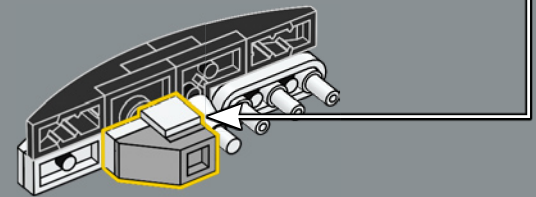
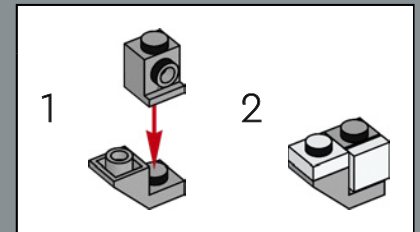

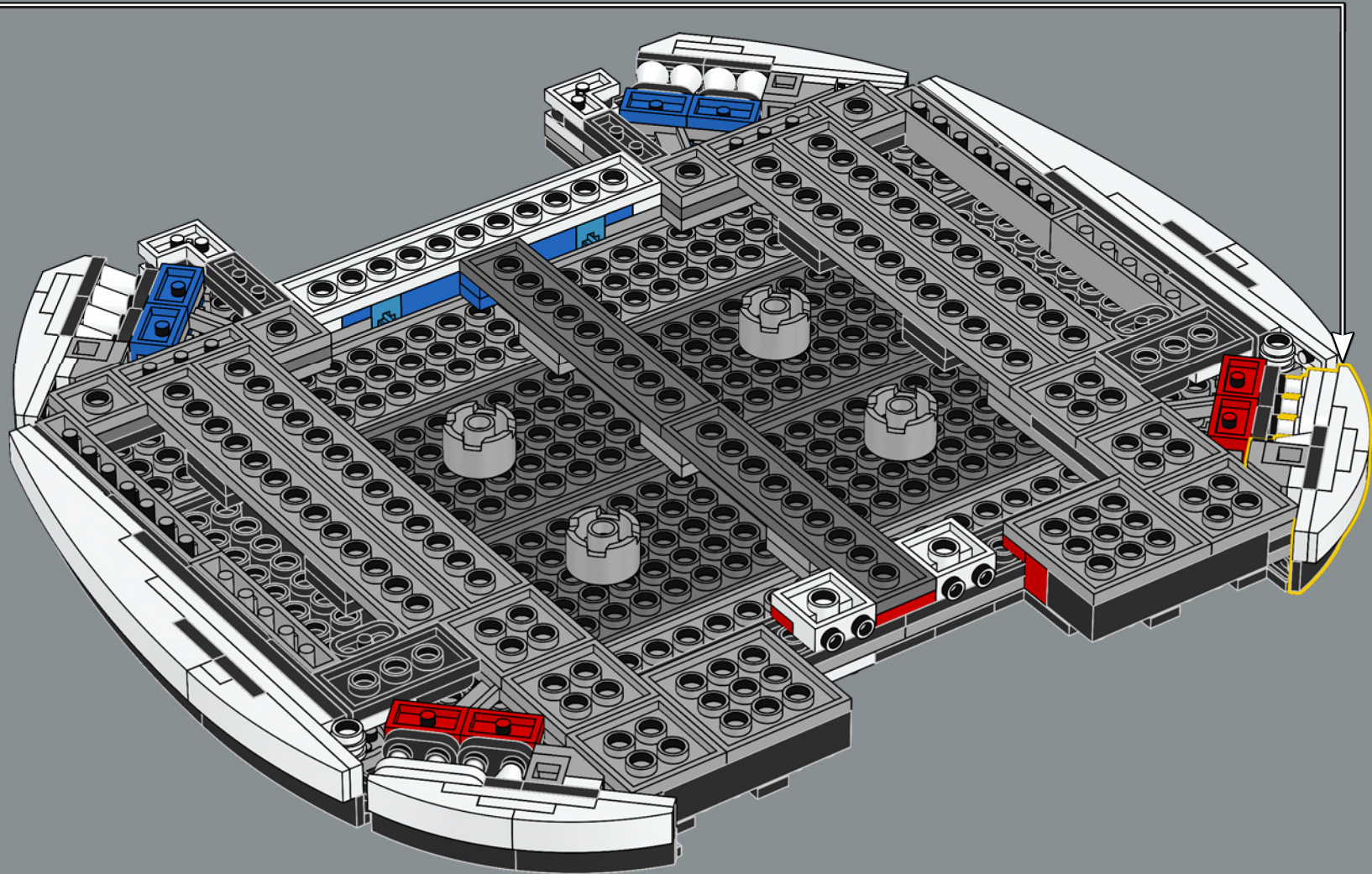

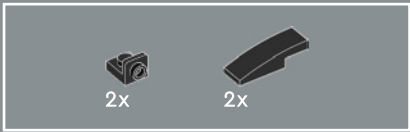

215

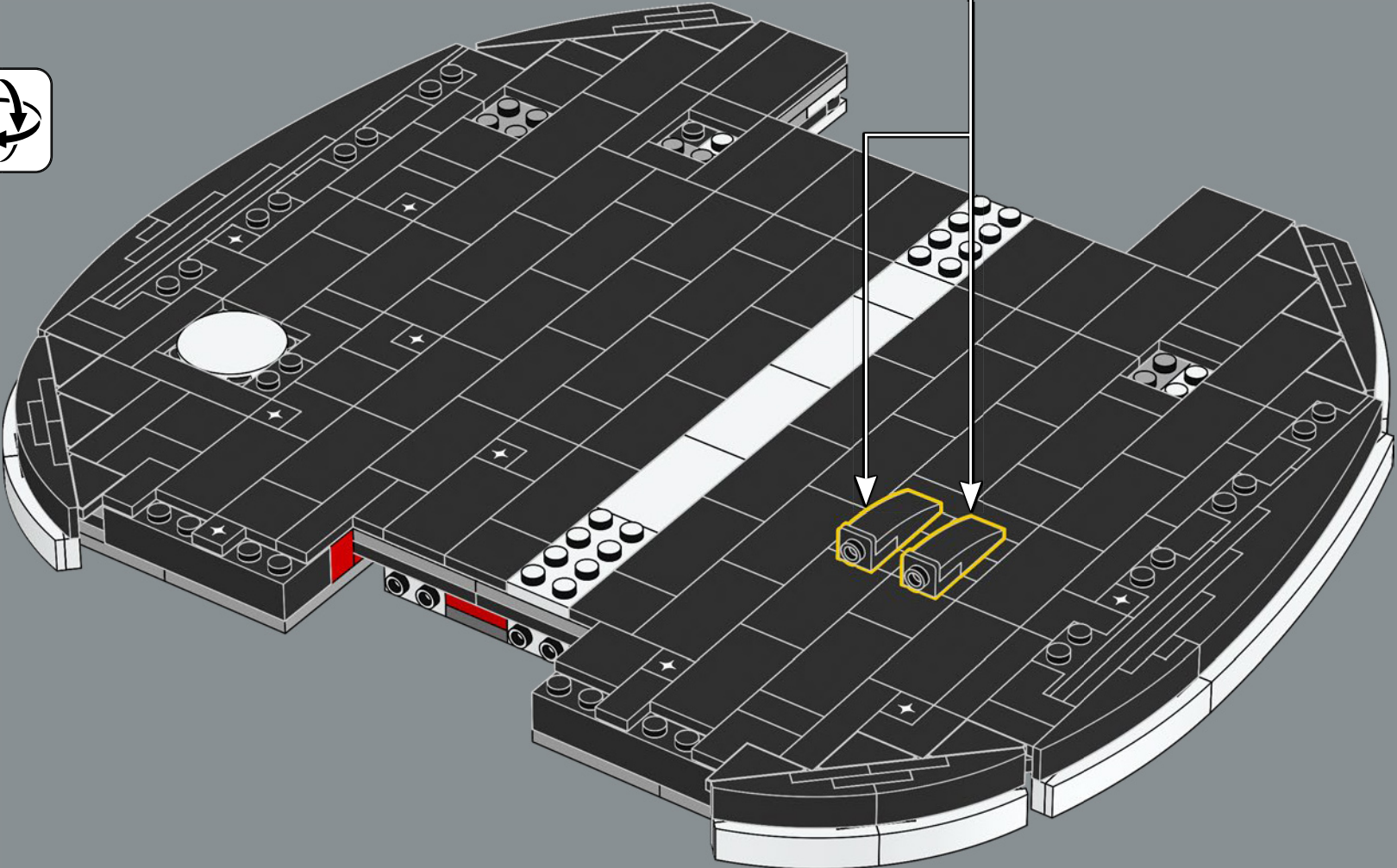
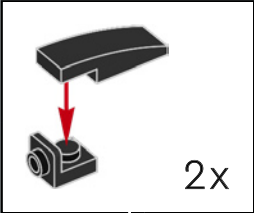

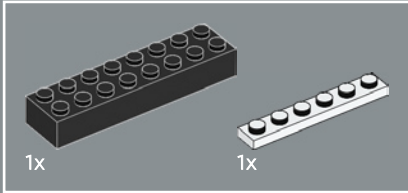
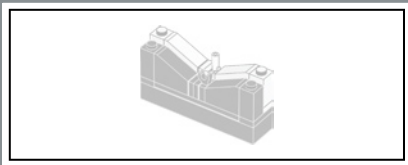

216

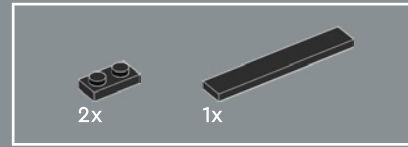
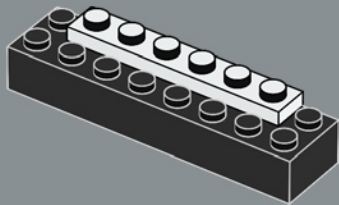

217

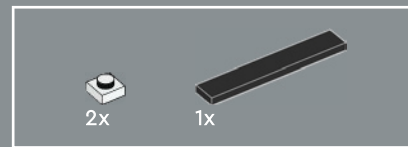
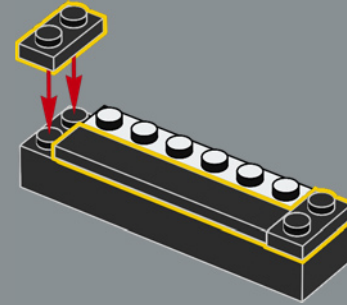

218

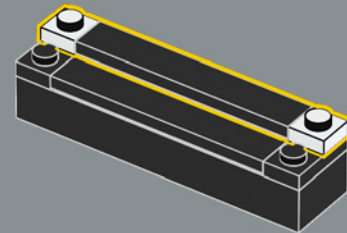



219

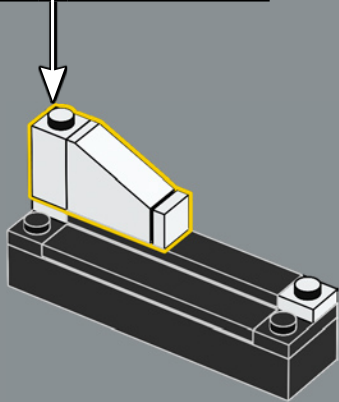
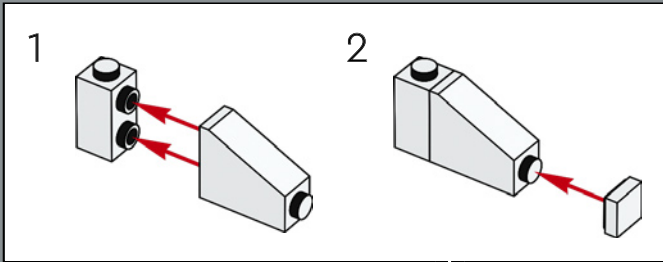

220

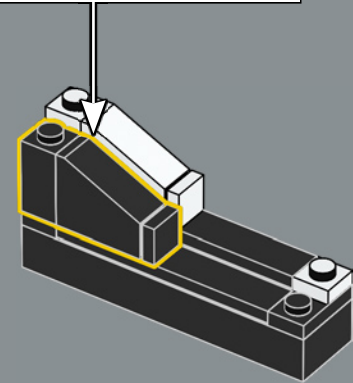
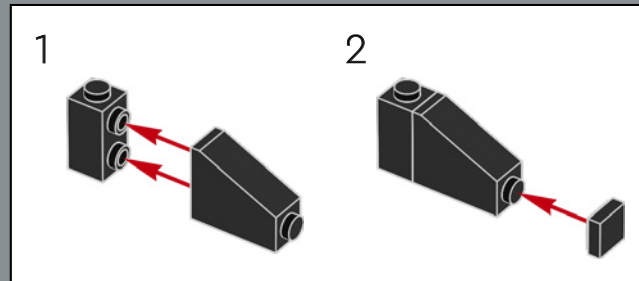

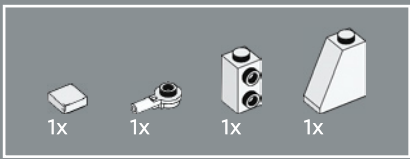

221

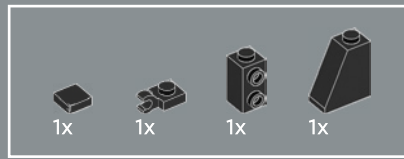
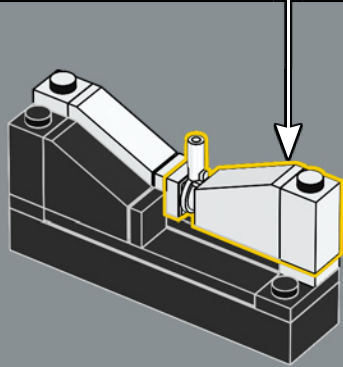
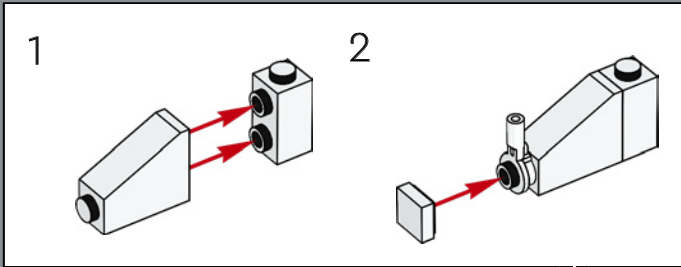

222

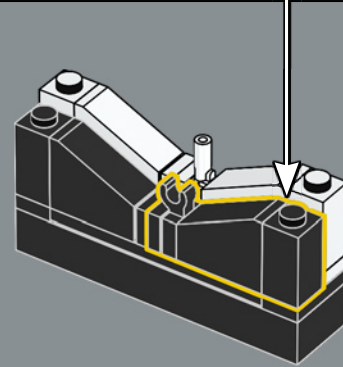
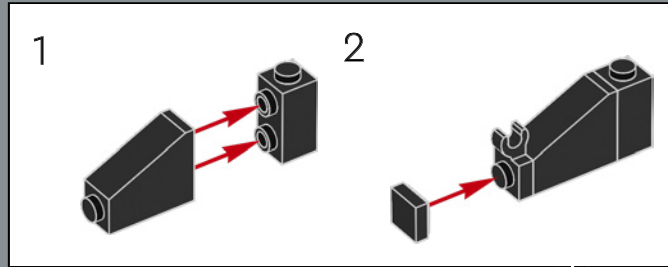

223

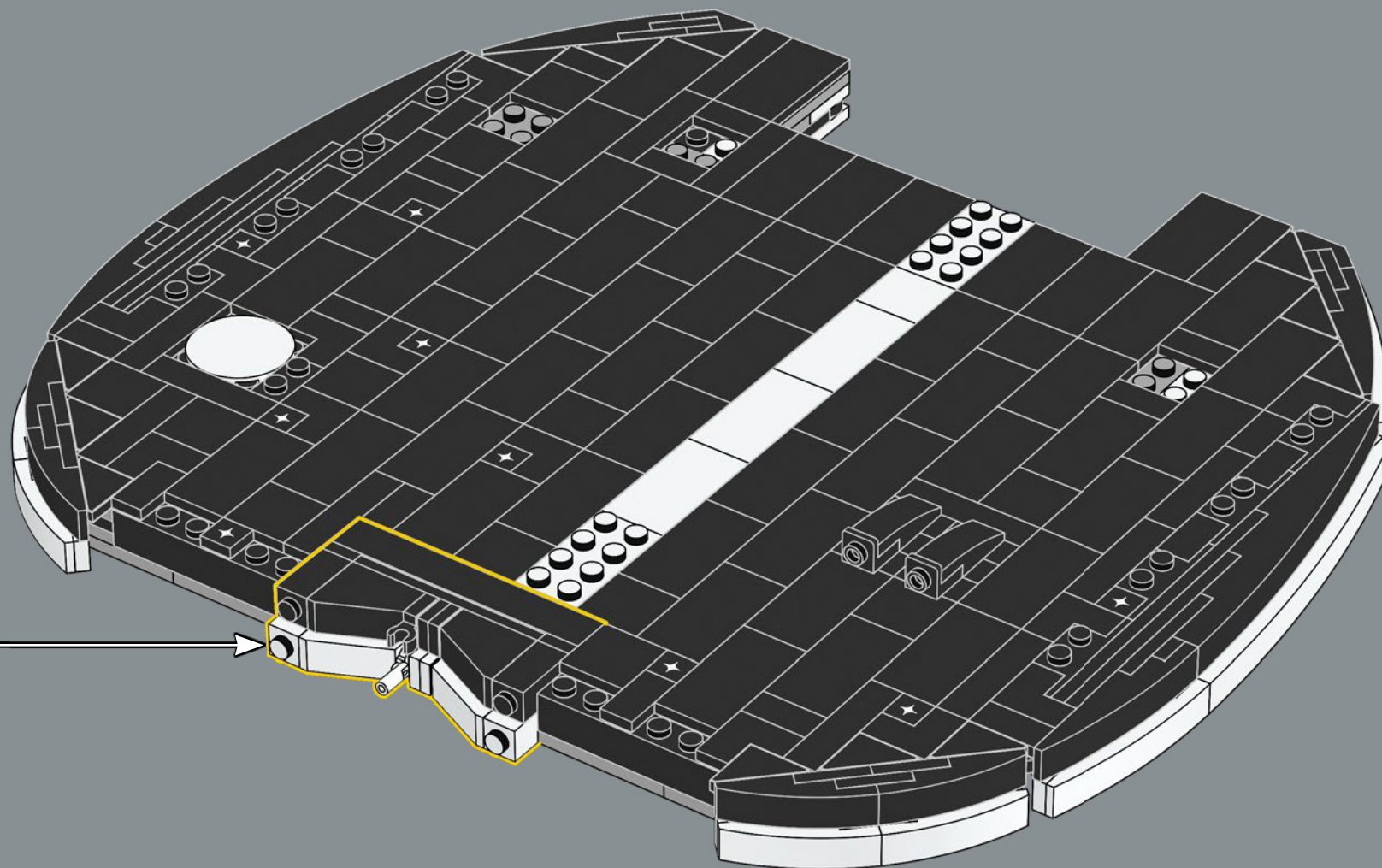

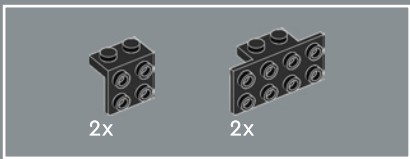

224

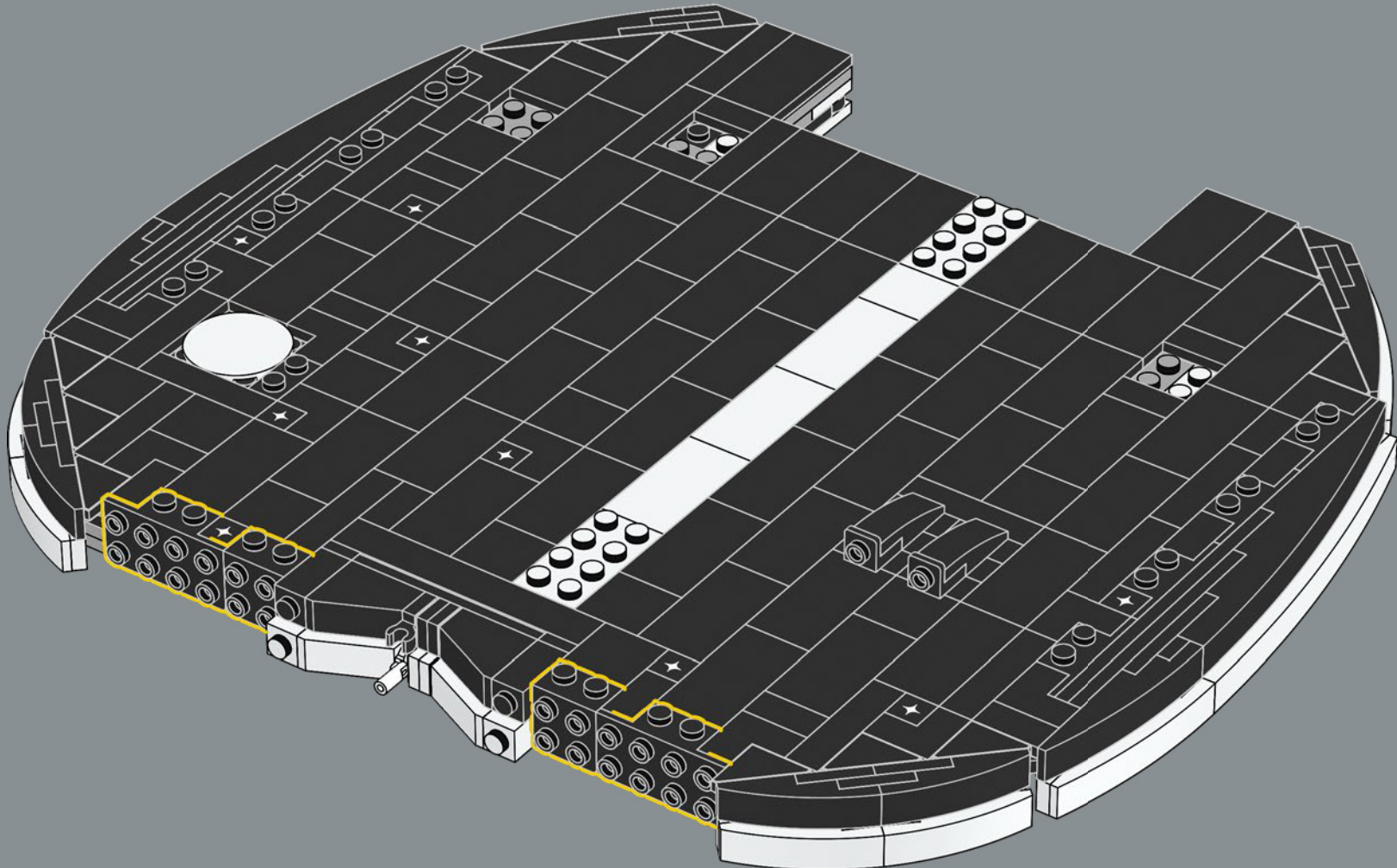

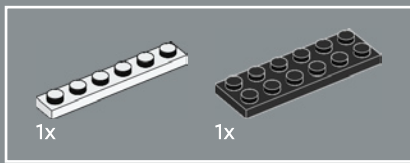

225

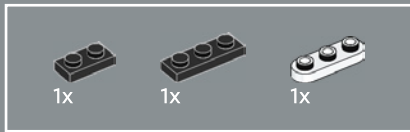
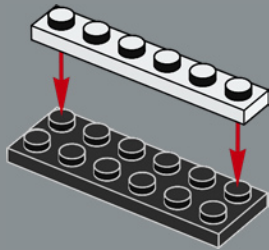

226

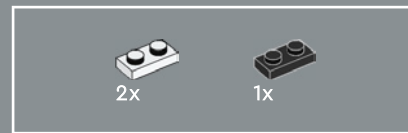
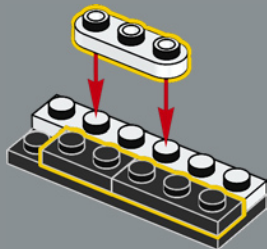

227

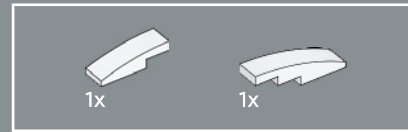
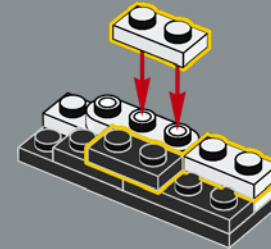

228

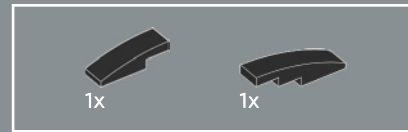
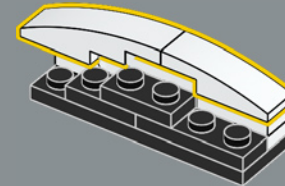

229

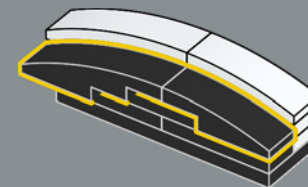

230

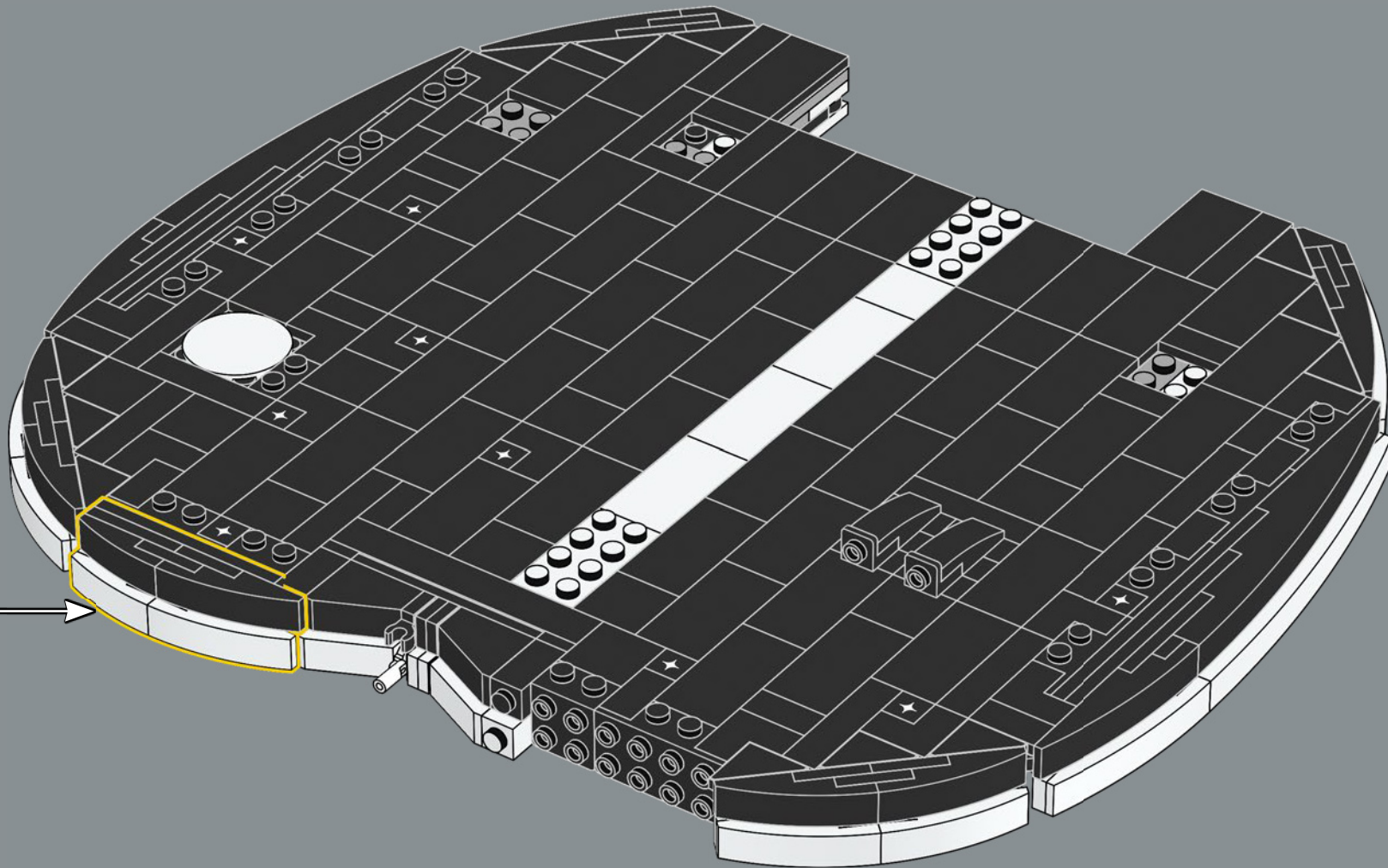

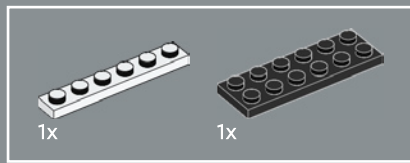

231

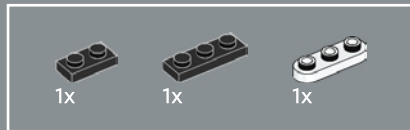
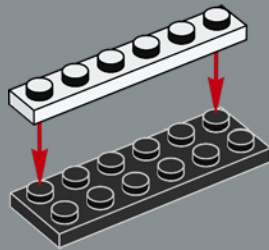

232

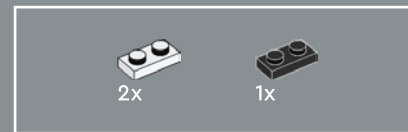
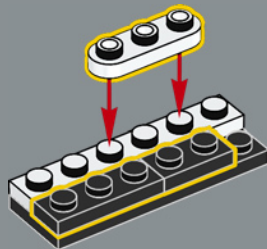

233

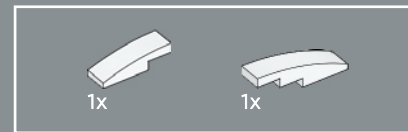
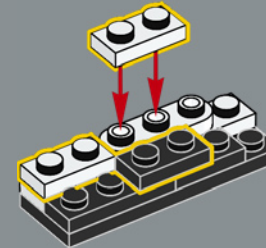

234

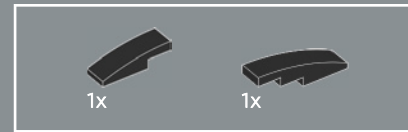
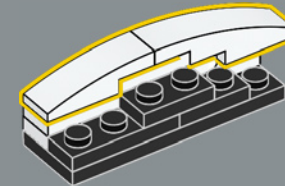

235

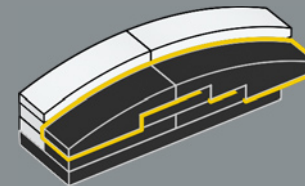

236

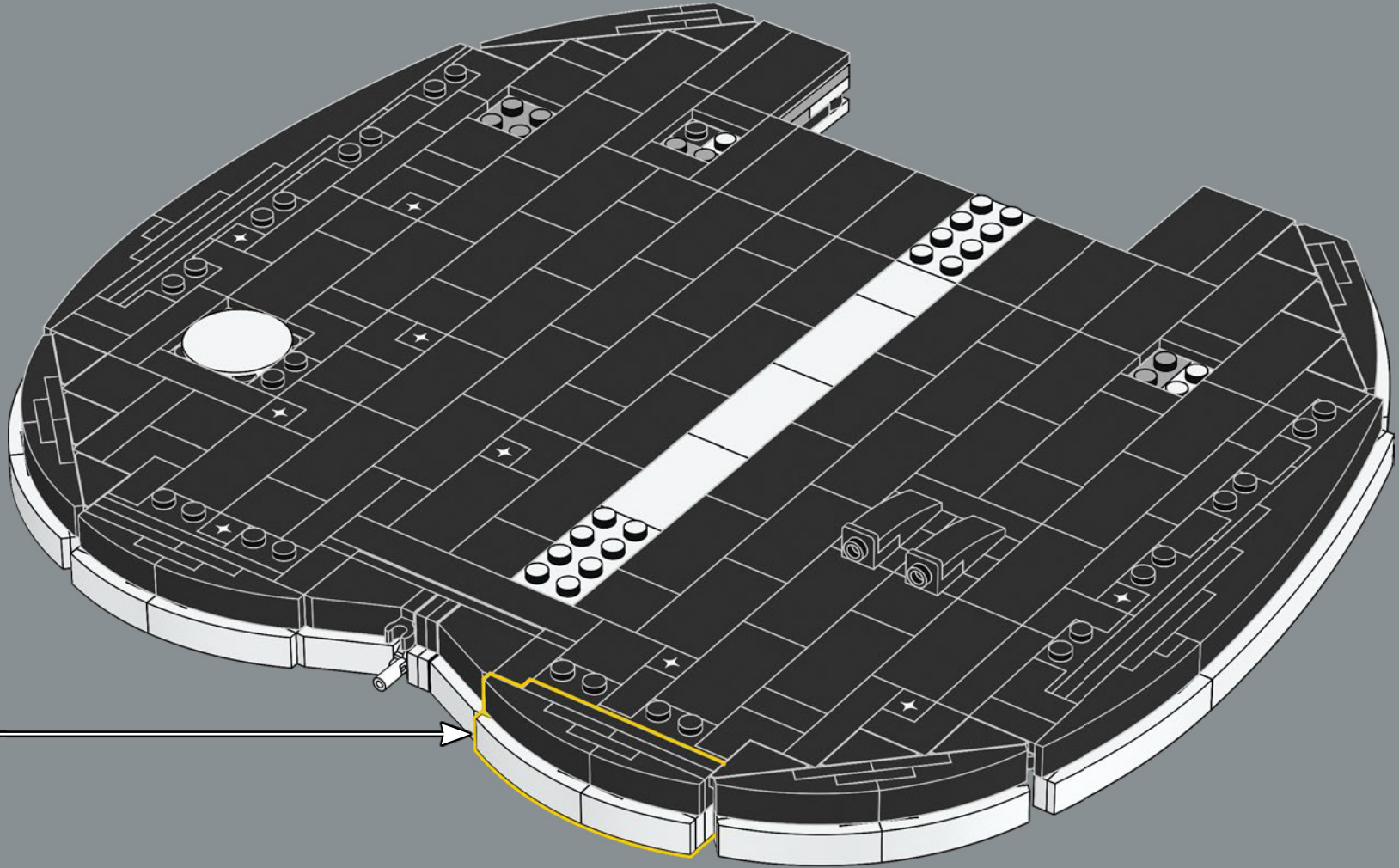



237

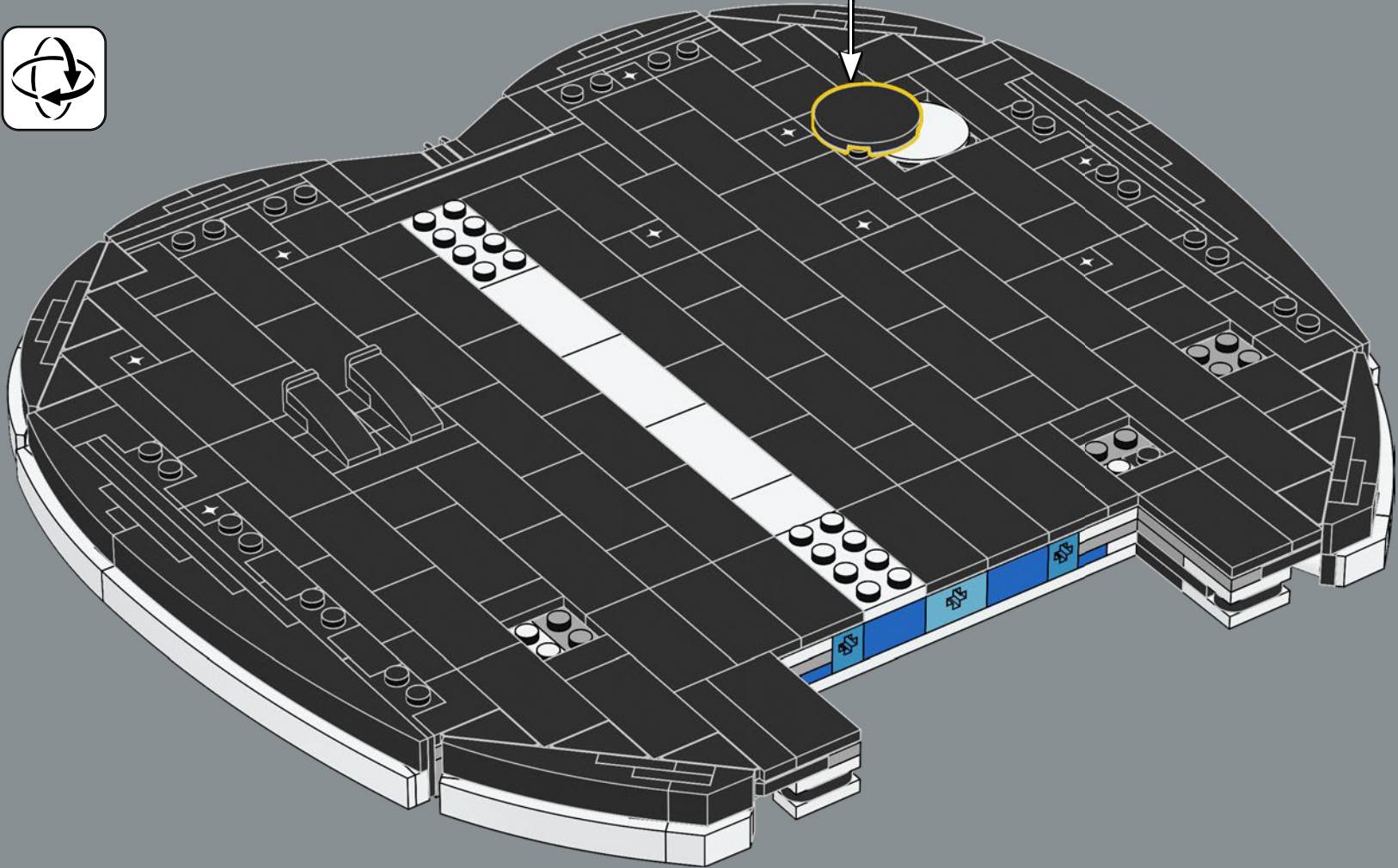

¡Esta podría ser la manzana más grande incluida en un set LEGO® hasta la fecha! Apilamos elementos curvos y aplicamos técnicas de construcción lateral para capturar su silueta, símbolo de la ciudad de Nueva York.



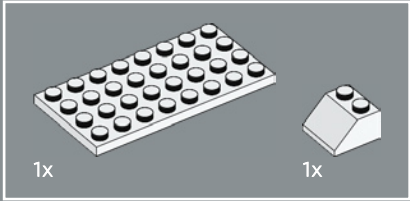
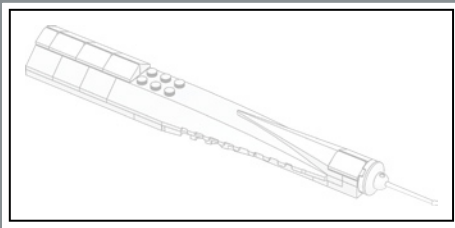

238

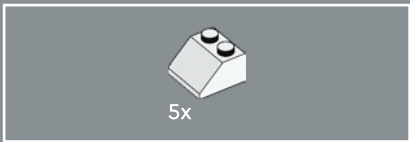
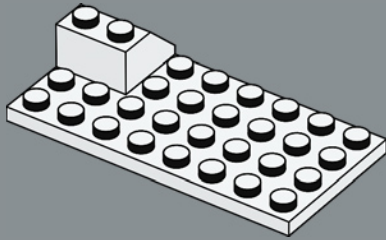

239

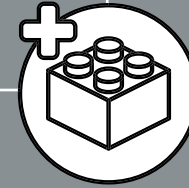
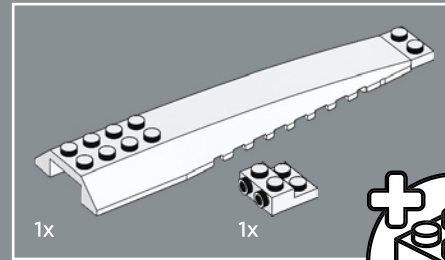
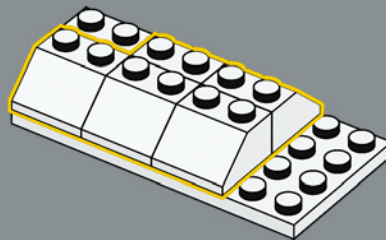

240

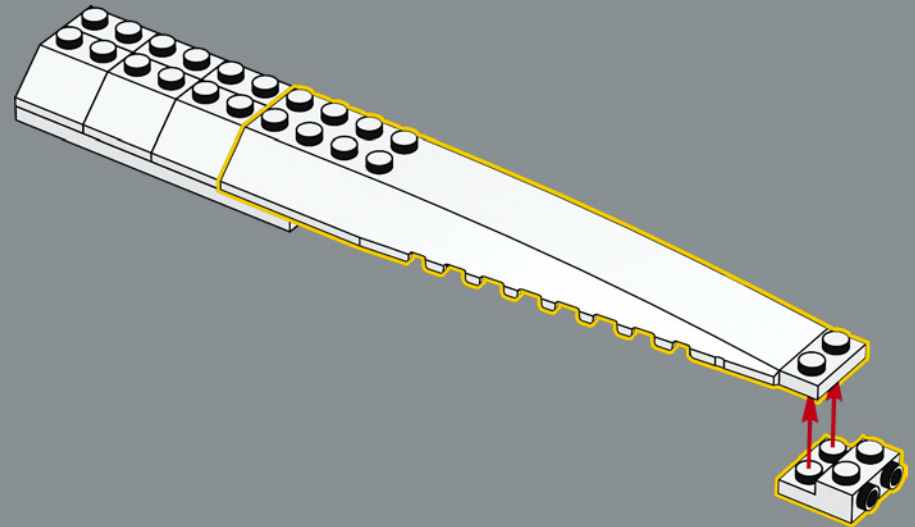

La altura del One World Trade Center expresada en pies (1776 ft o 541,3 m) es un guiño al año en que se firmó la Declaración de Independencia de los Estados Unidos: 1776.

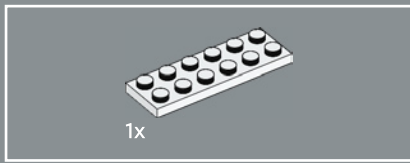

241

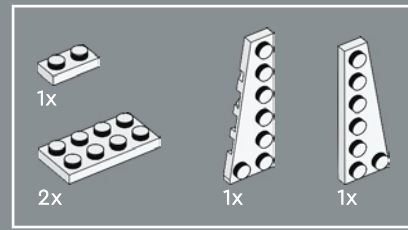
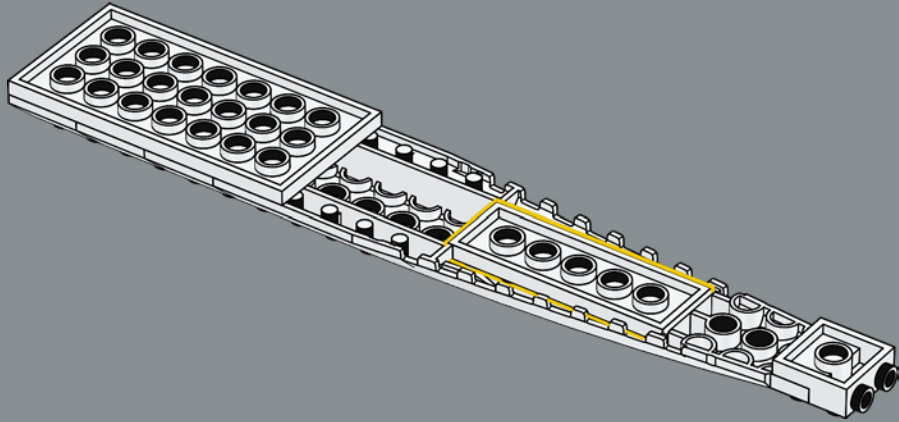

242

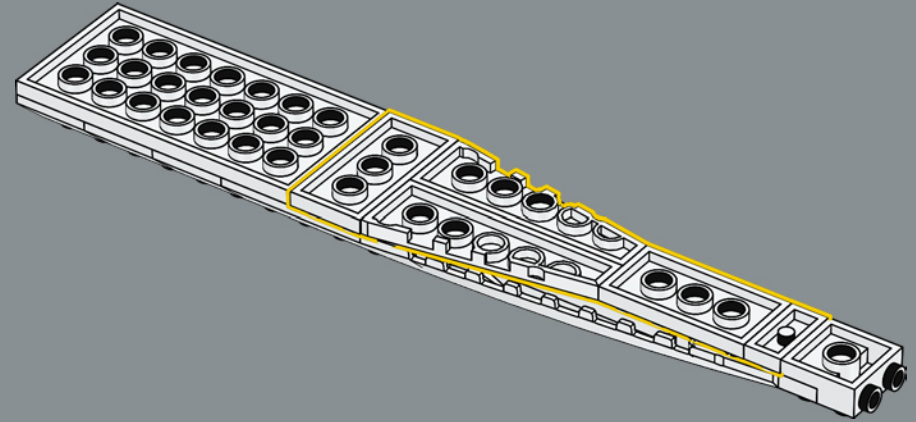

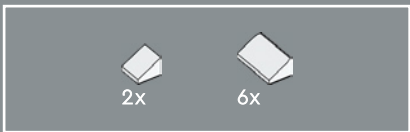

243

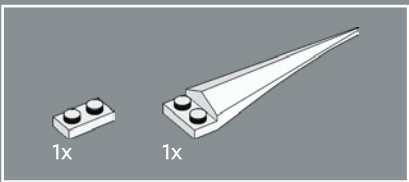
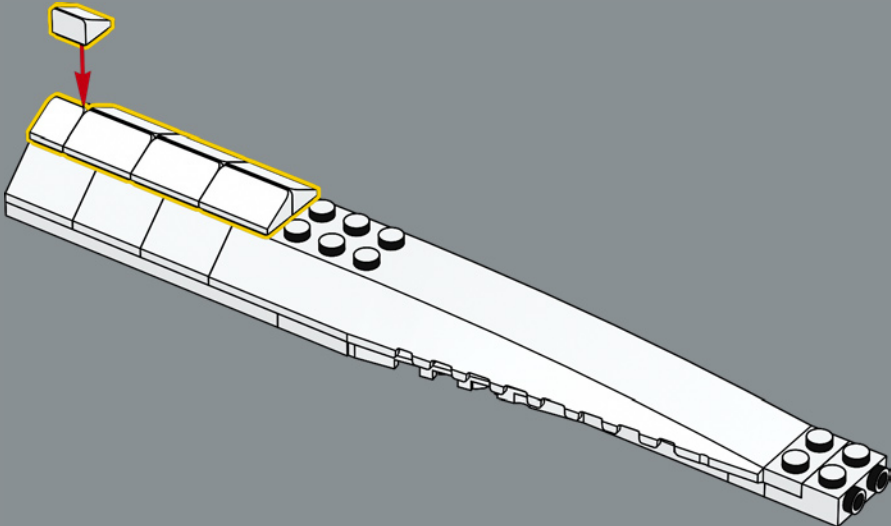

244

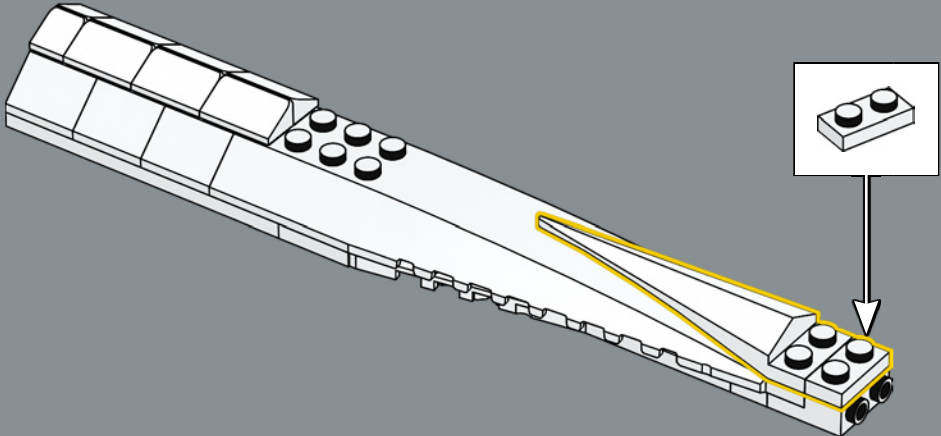



245

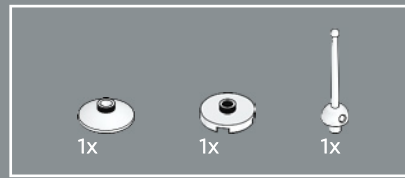
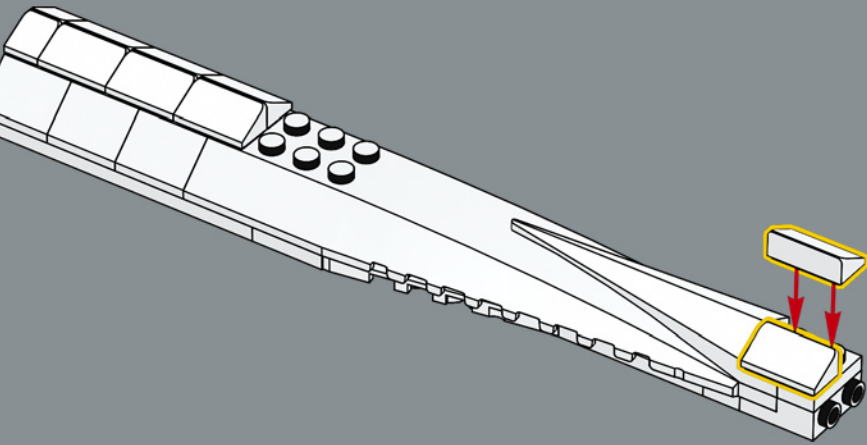

246

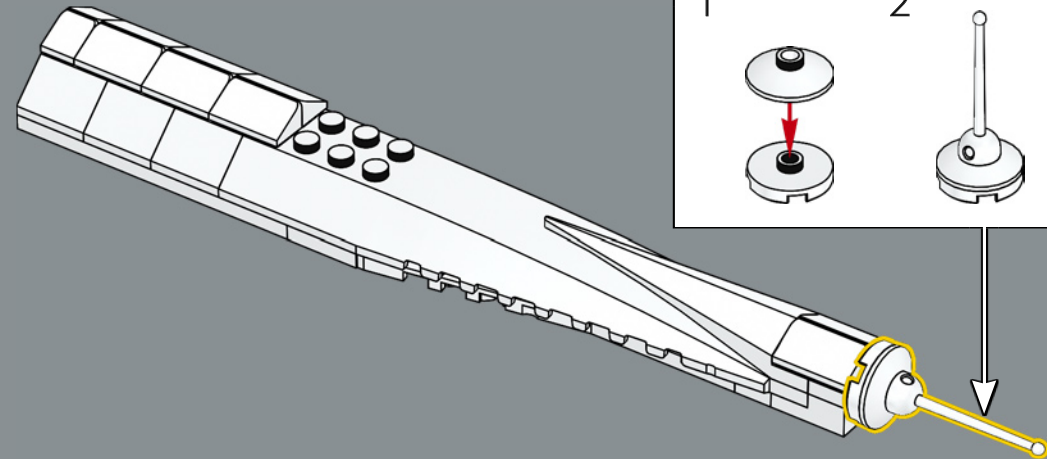

Una espada de esgrima LEGO® da forma a la antena del edificio más alto de Nueva York, el One World Trade Center. La antena de verdad mide 124,3 m.

247

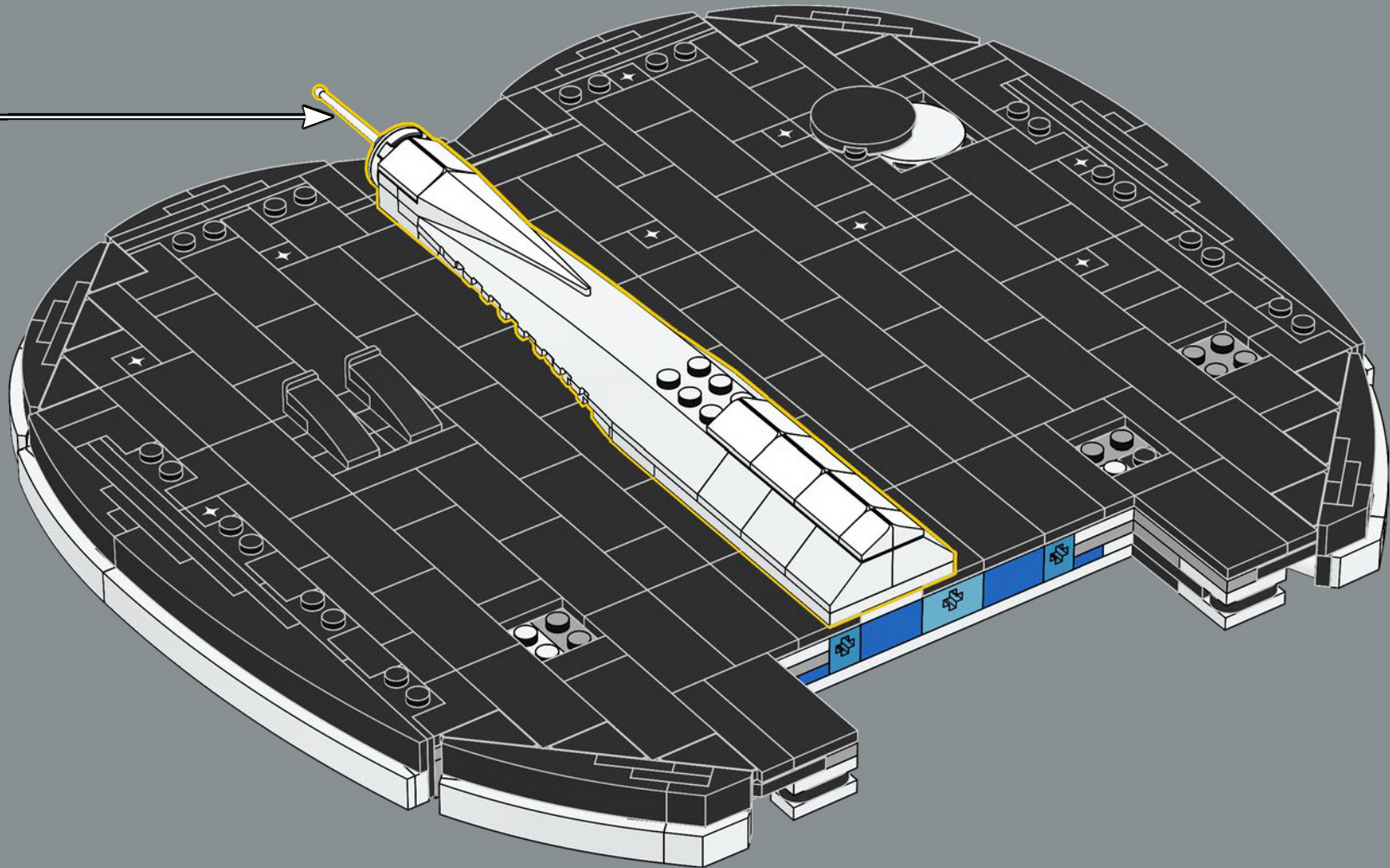



248

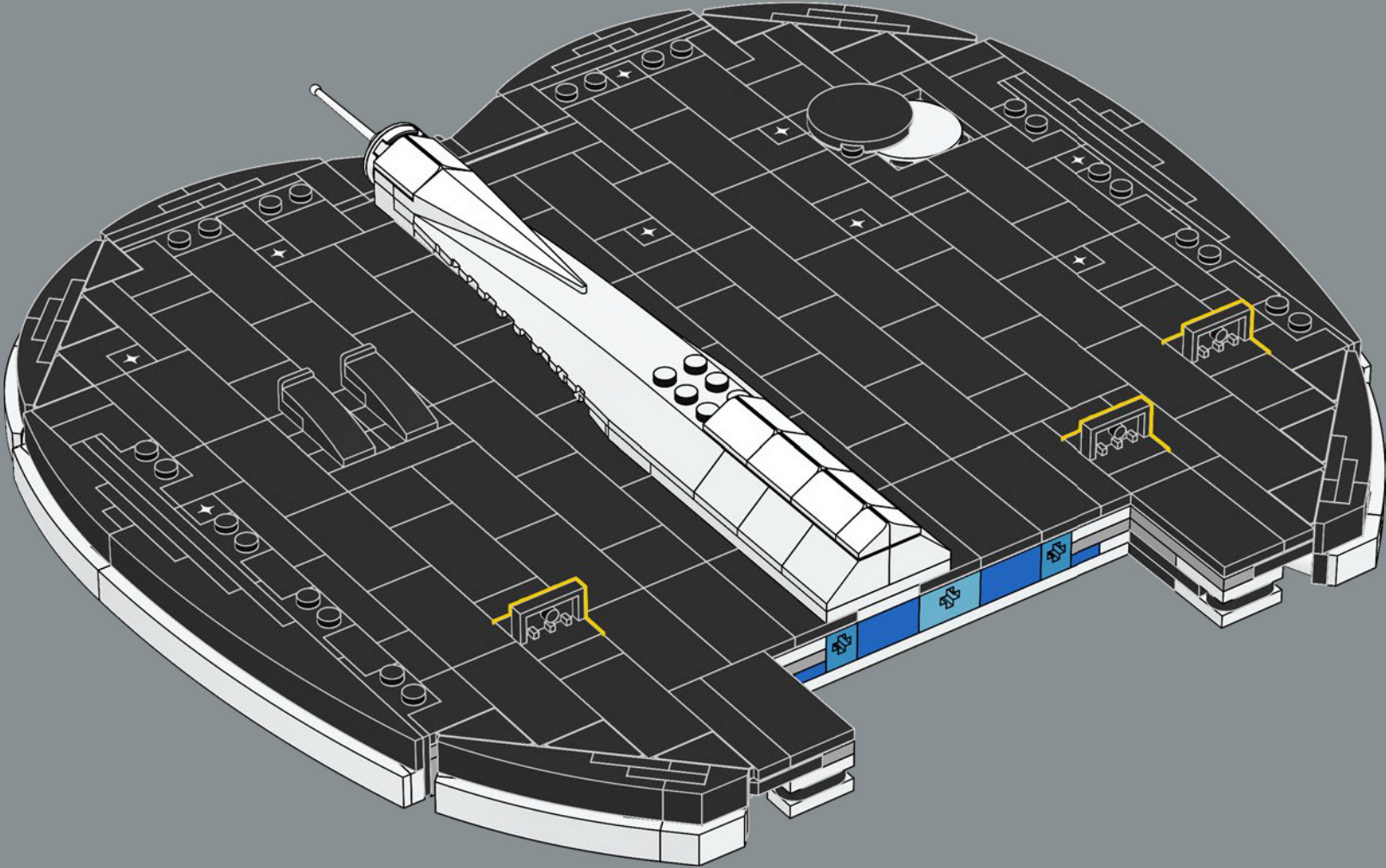

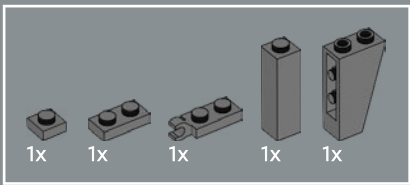

249

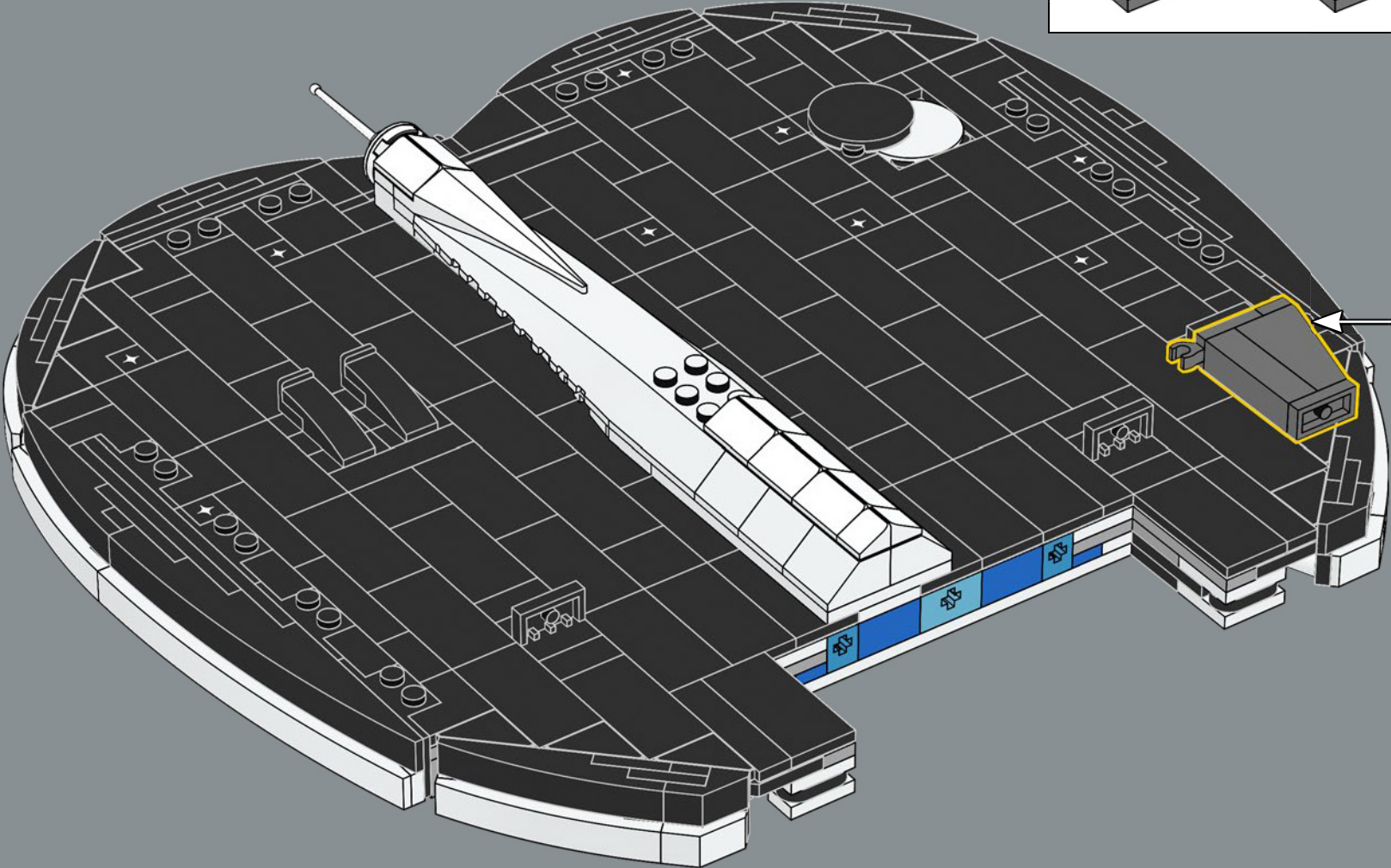
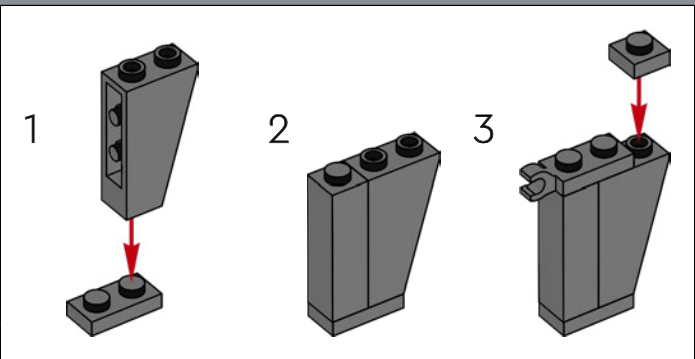

250

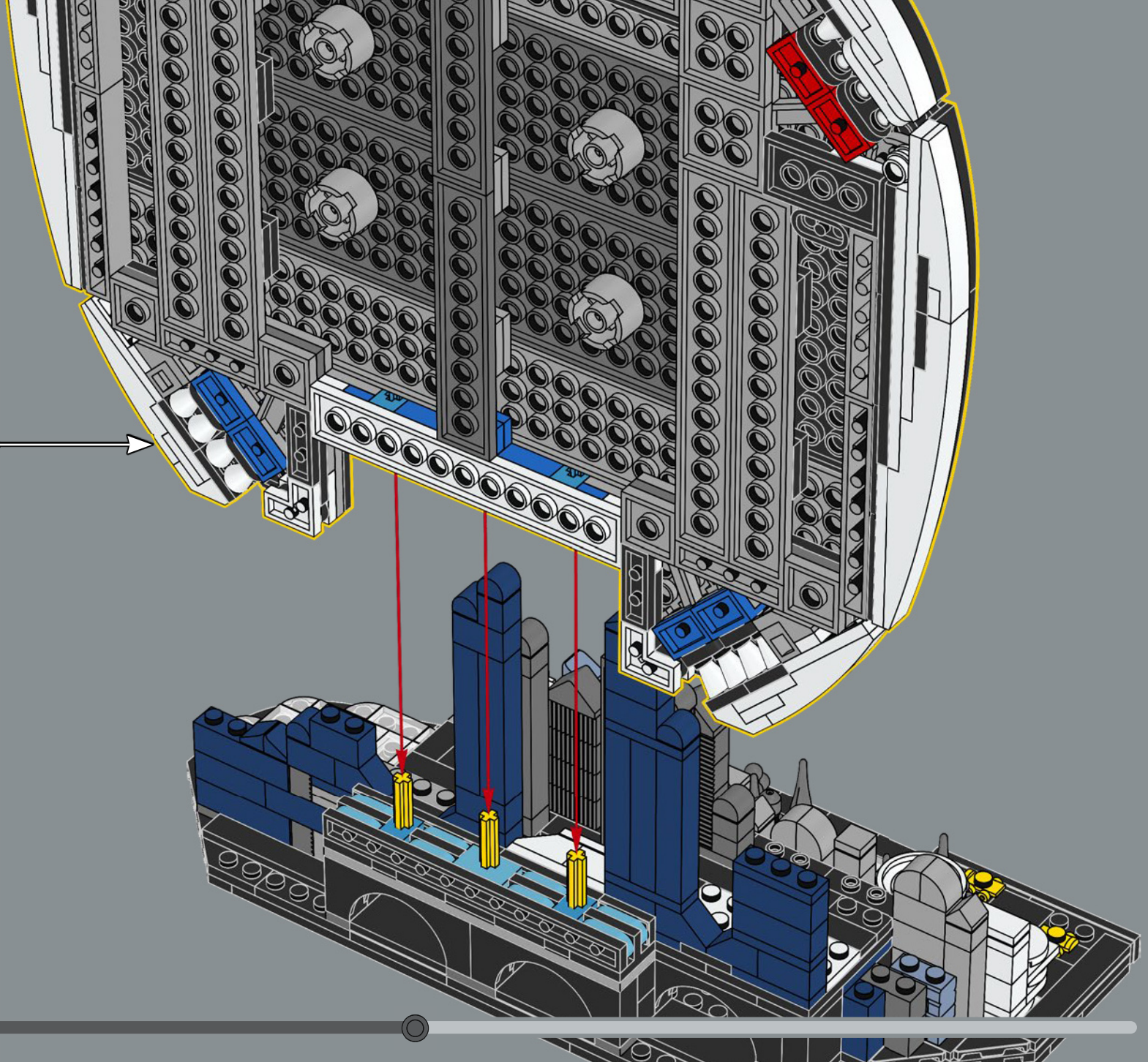

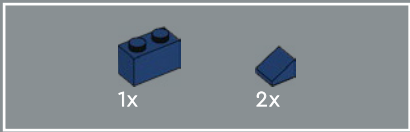

251

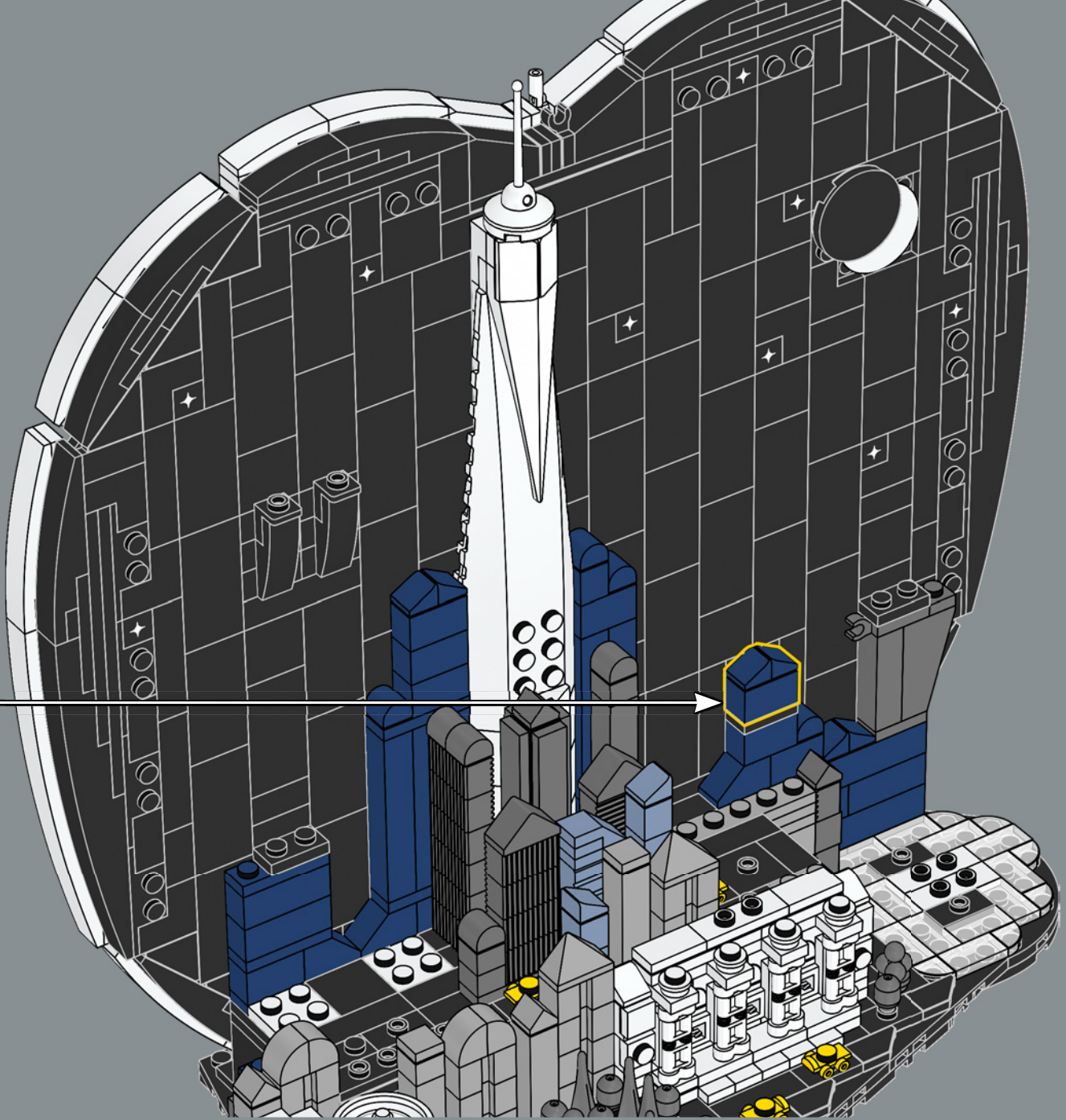
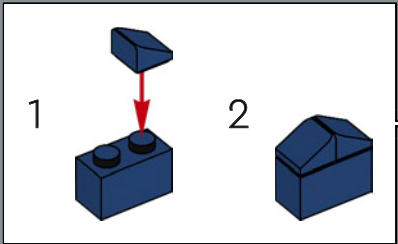

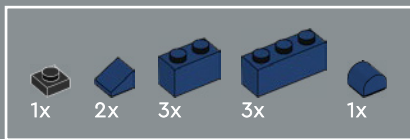

252

1

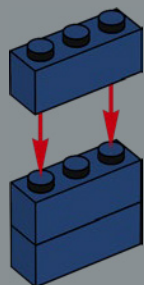

2

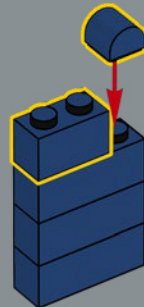

3

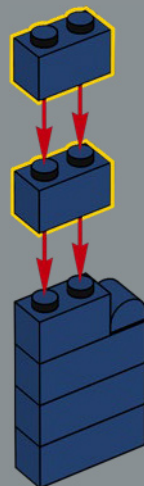

4

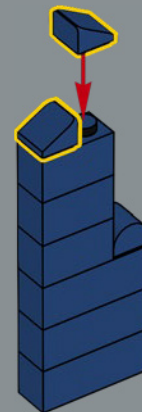

5



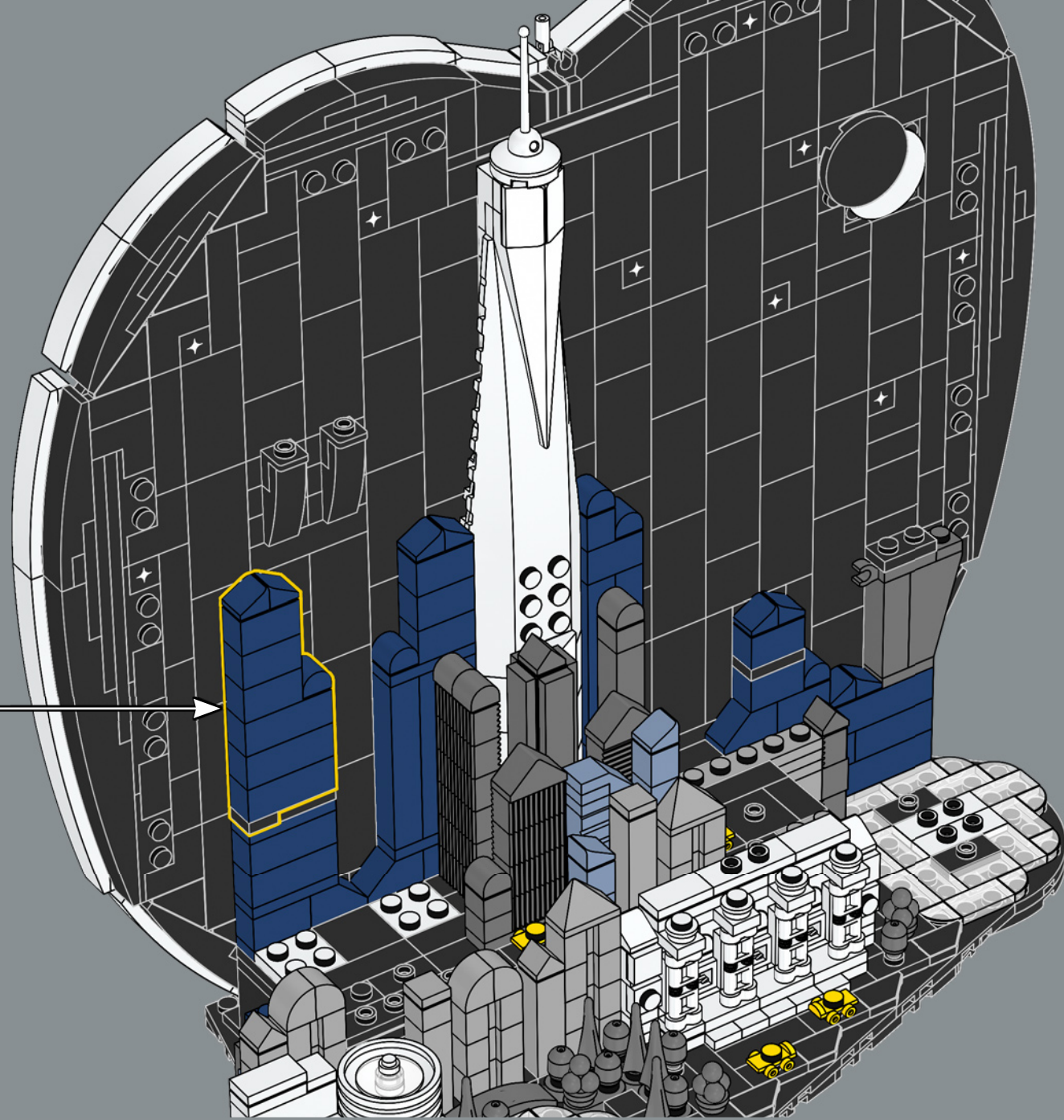

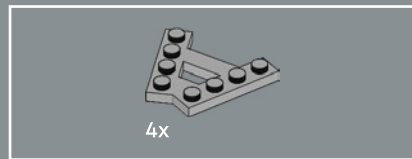

253

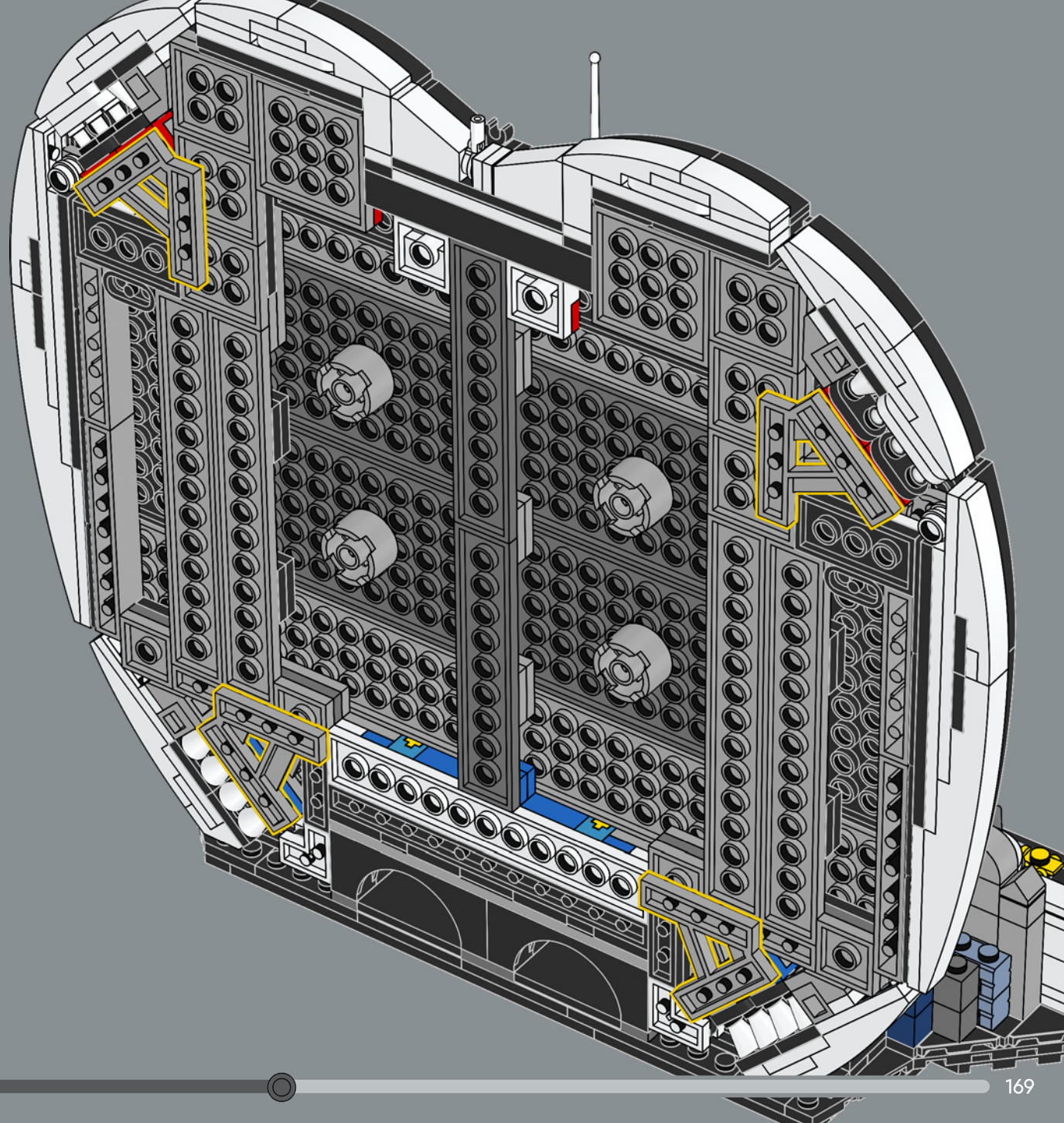

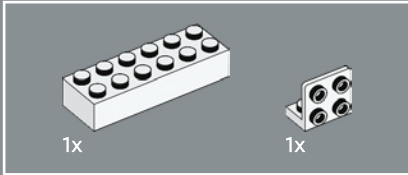
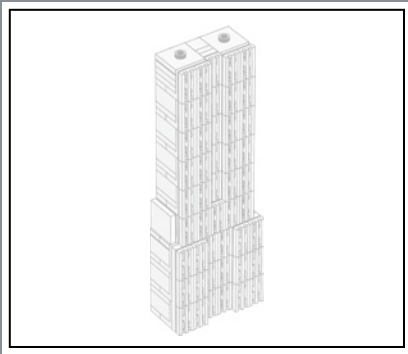

254

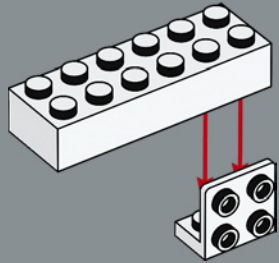

Inaugurado en 1931, el Empire State Building se mantiene como un ícono del *art déco*. Fue el primer edificio del mundo con estructura de acero y más de 100 plantas, y dominó el horizonte de Nueva York como el más alto del planeta durante casi 40 años.

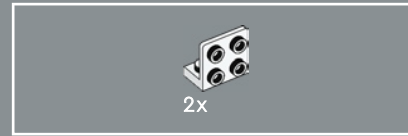

255

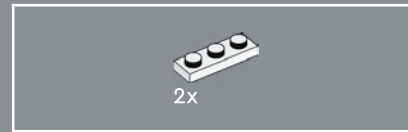
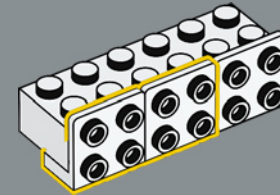

256

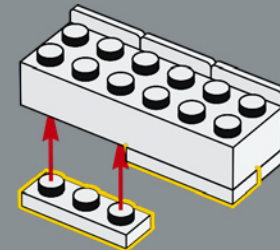

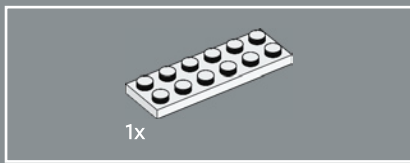

257

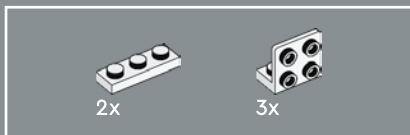
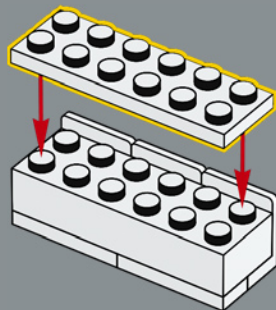

258

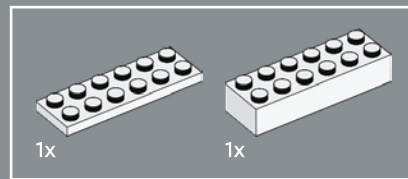
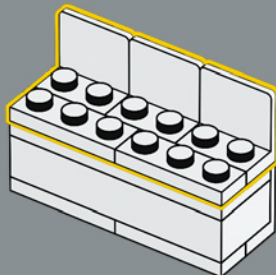

259

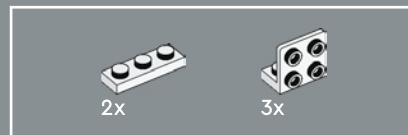
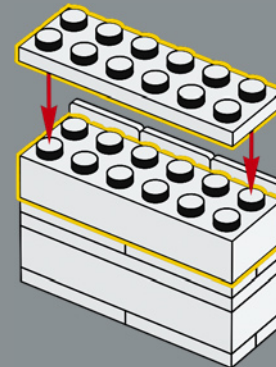

260

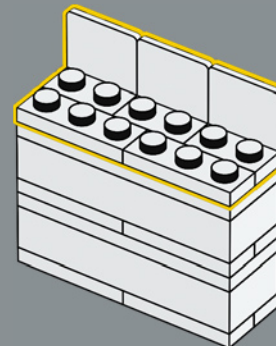

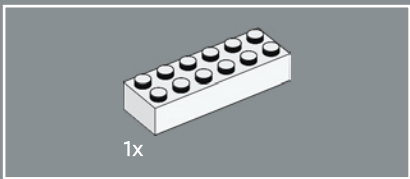

261

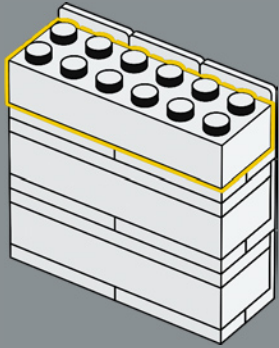

262

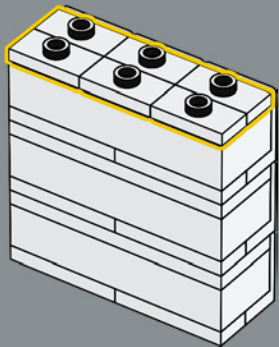

263

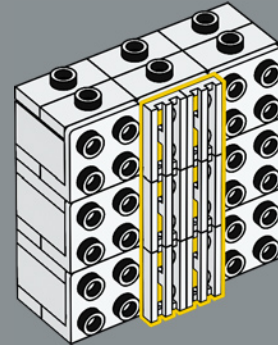

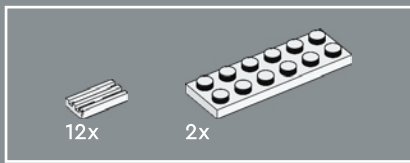

264

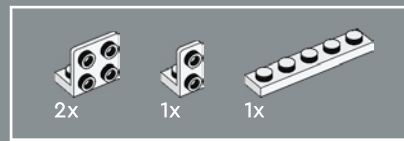
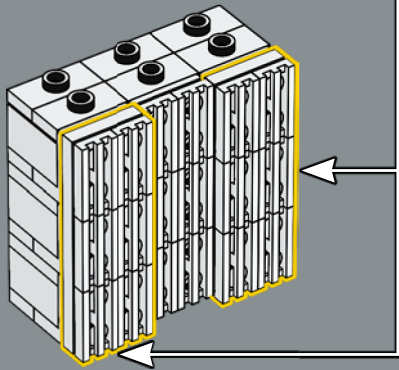
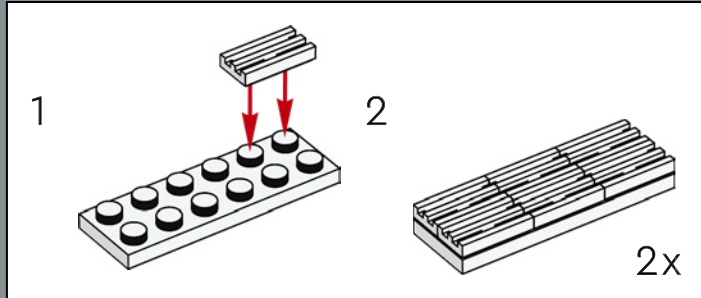

265

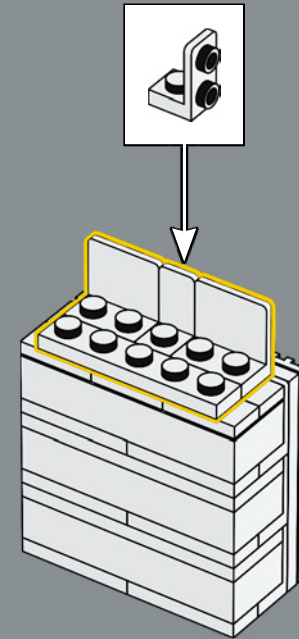

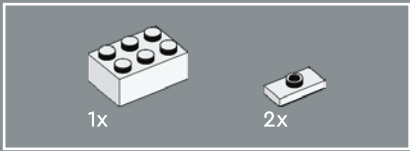

266

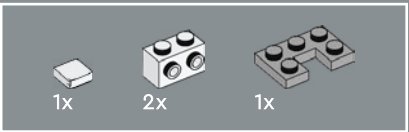
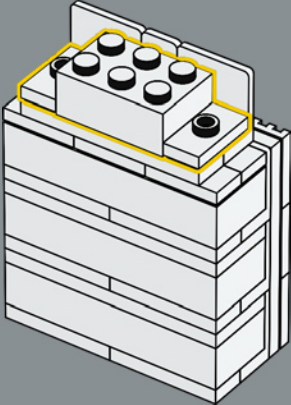

267

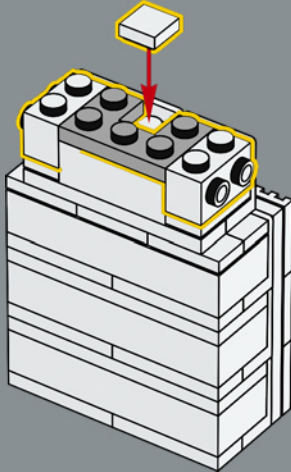

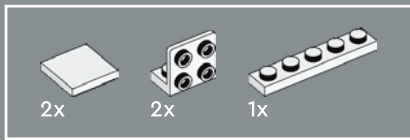

268

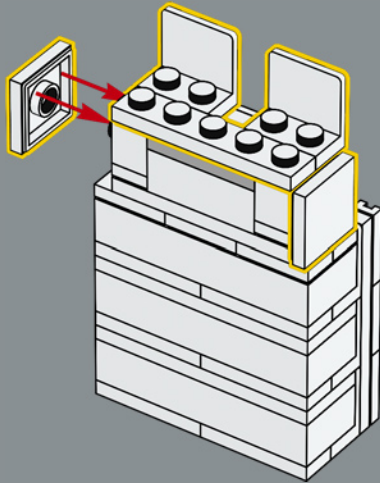

269

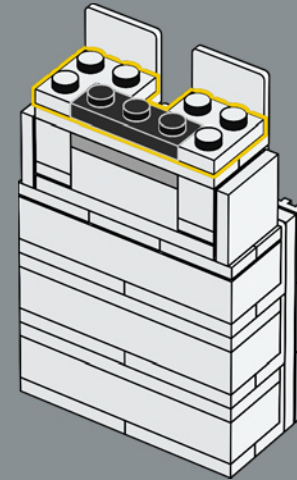

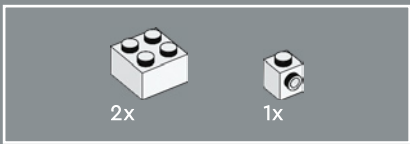

270

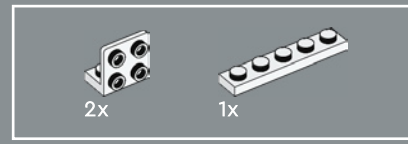
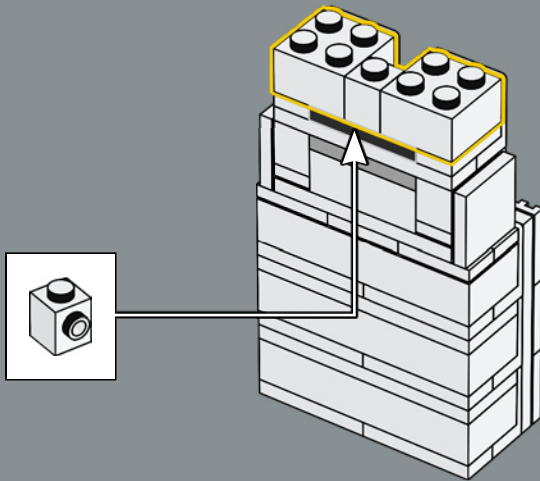

271

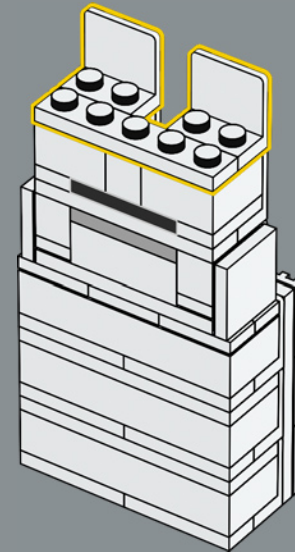

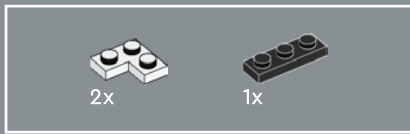

272

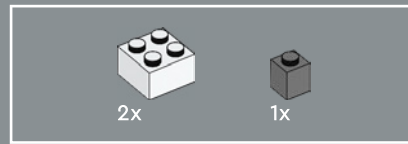
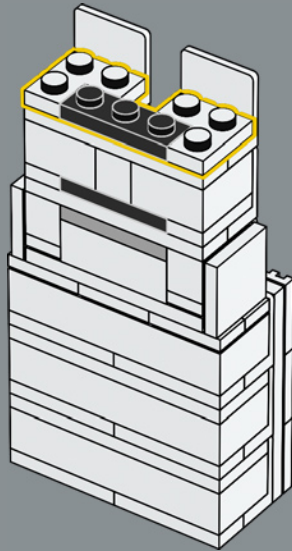

273

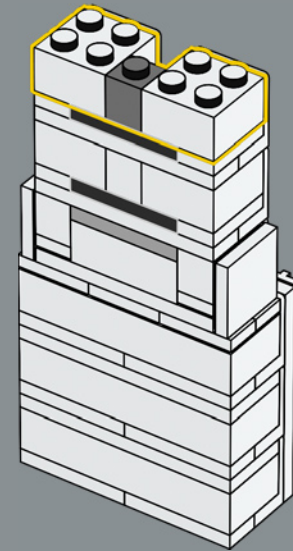

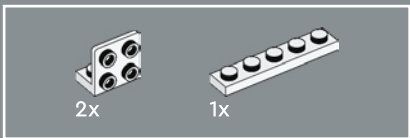

274

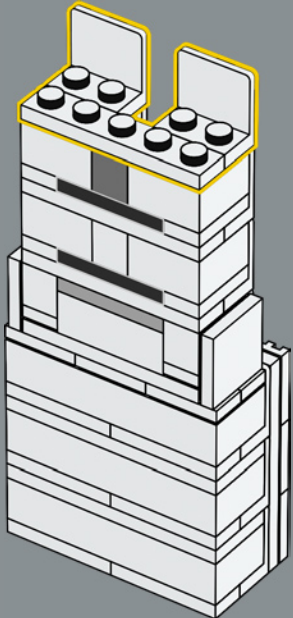

275

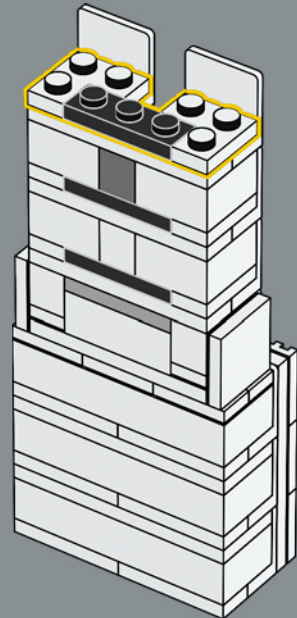

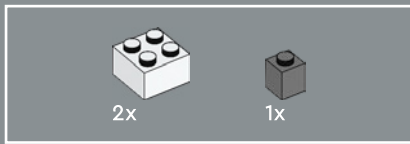

276

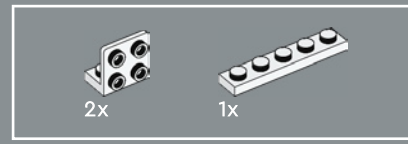
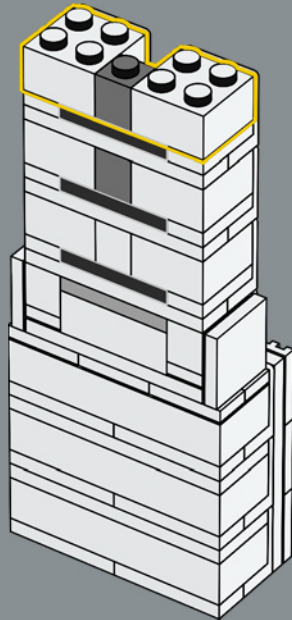

277

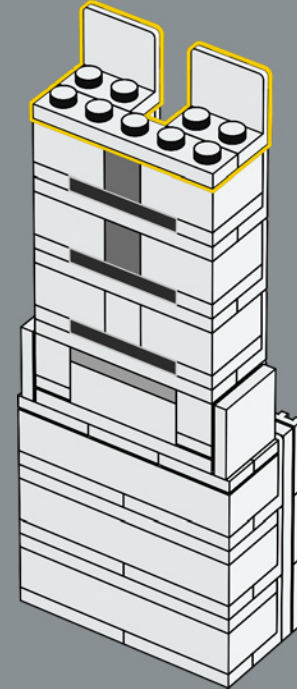



278

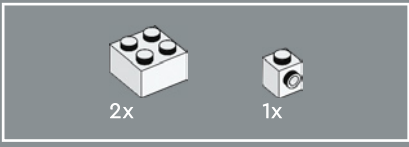
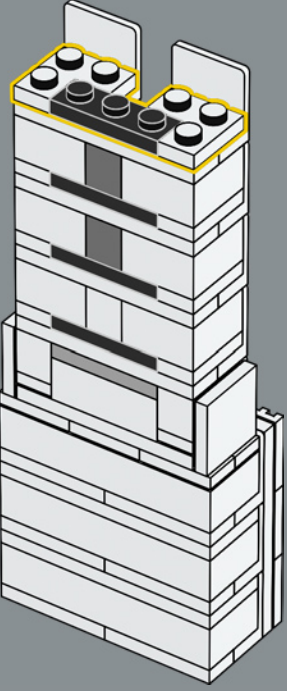

279

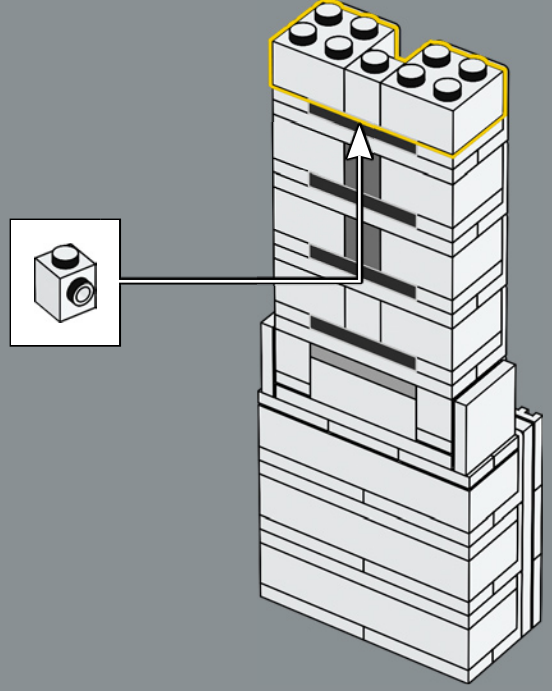

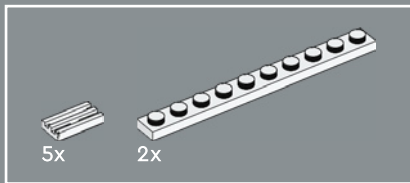

280

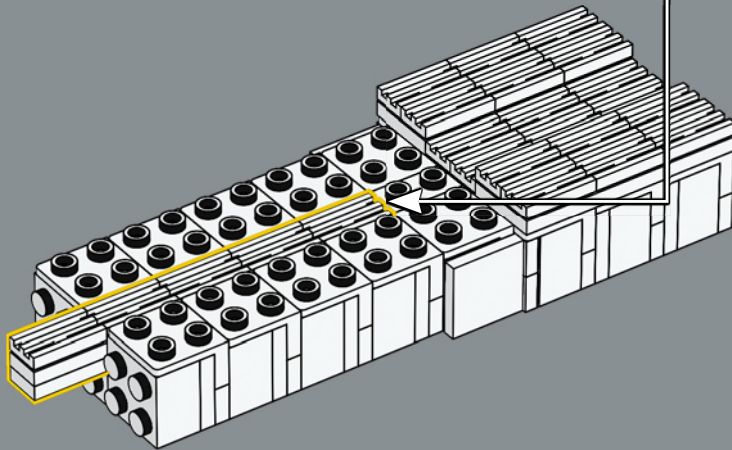
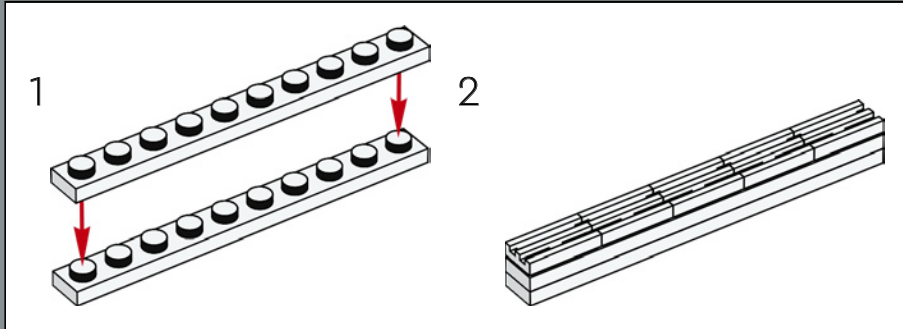

281

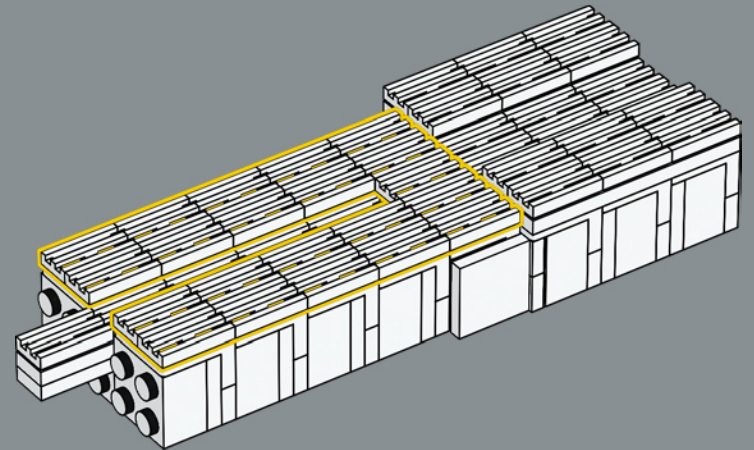

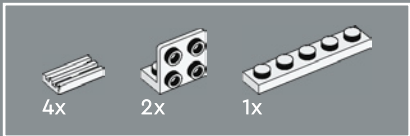

282

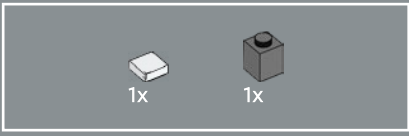
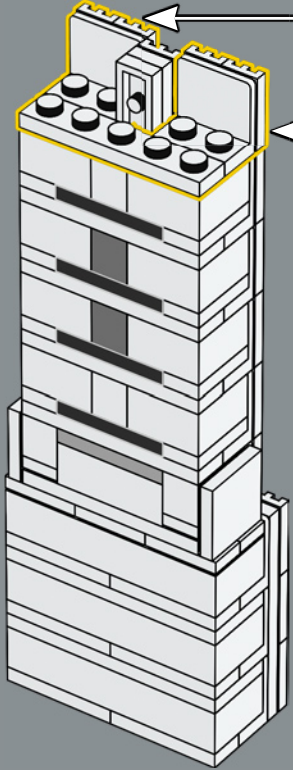
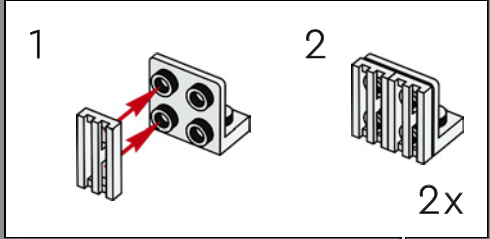

283

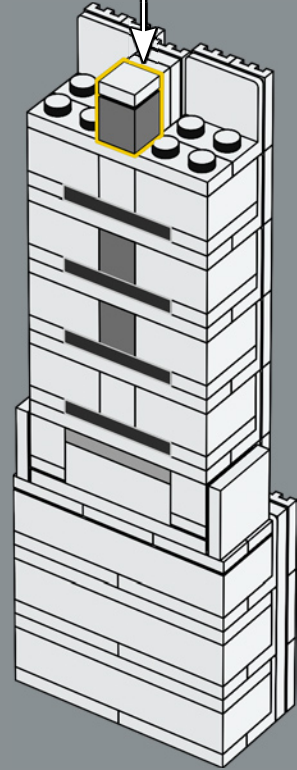
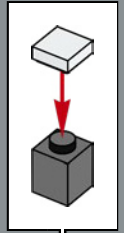

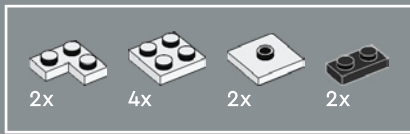

284

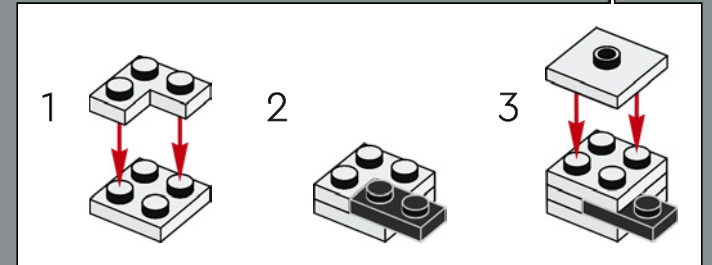
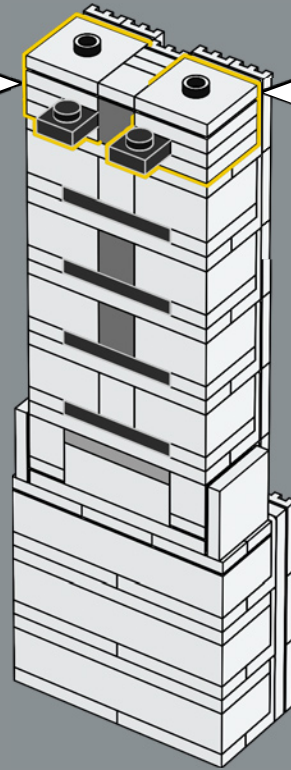
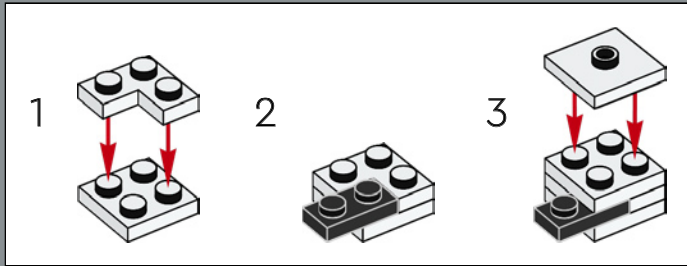

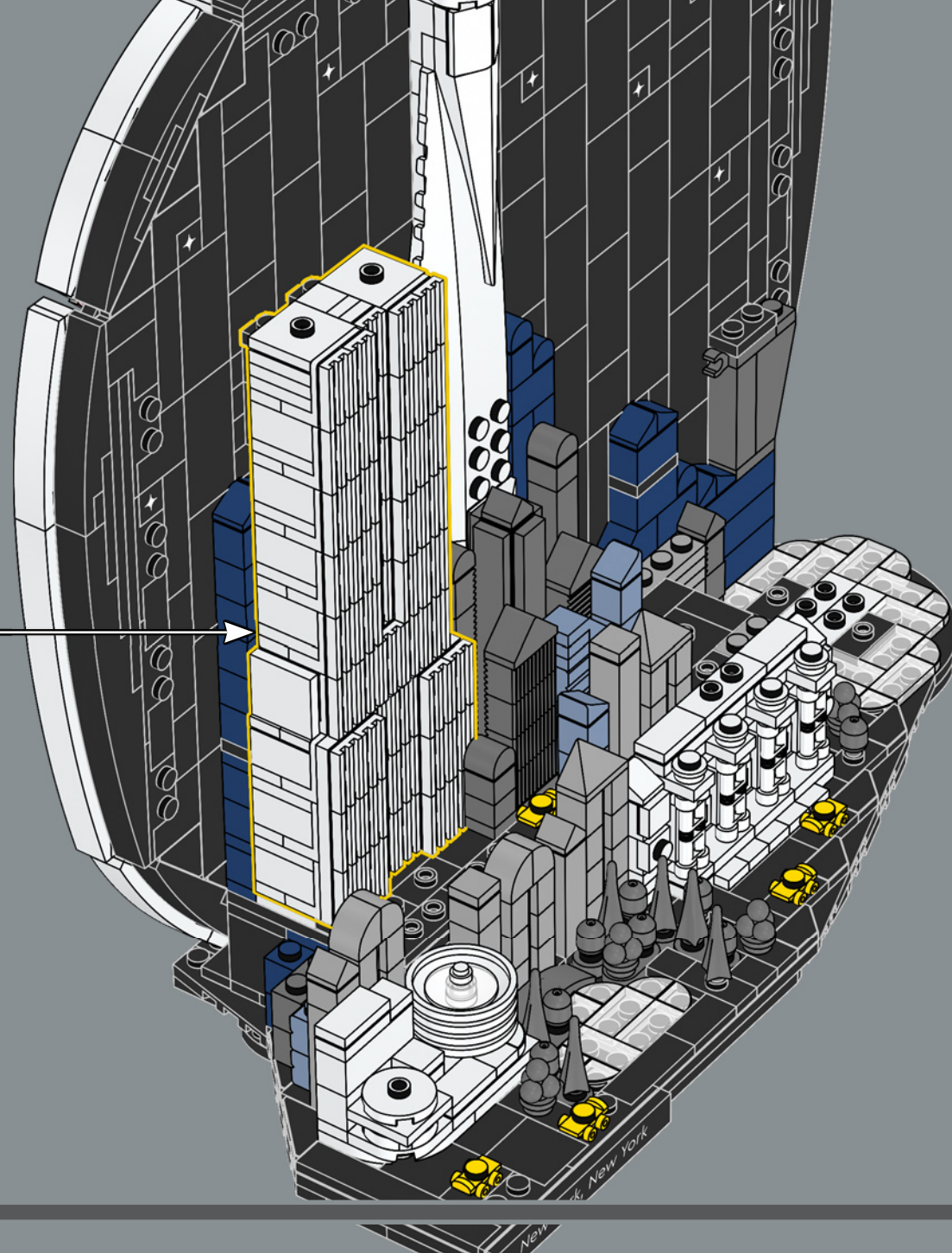

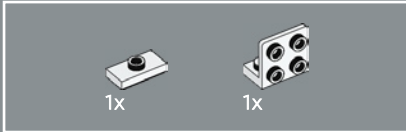
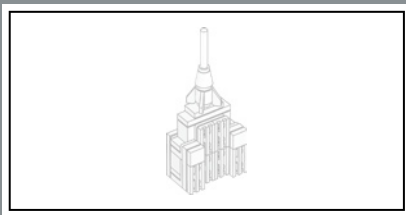

286

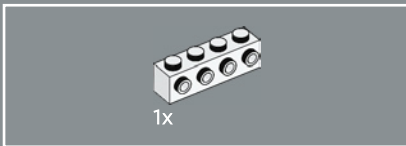
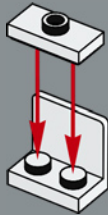

287

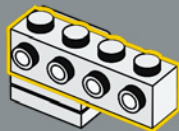

288

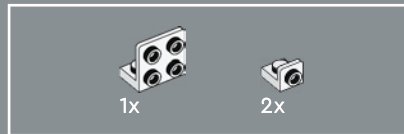
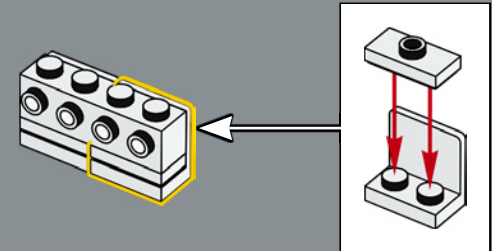

289

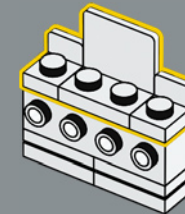



2x

290

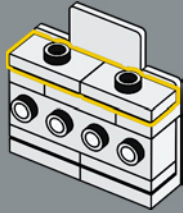

2x

292

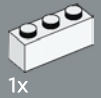
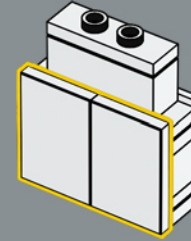

1x



1x

291



4x

293

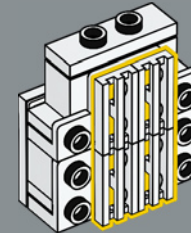

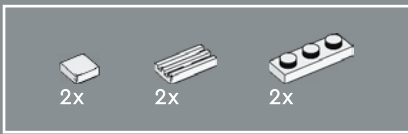

294

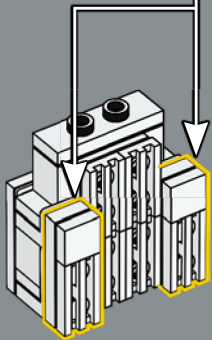
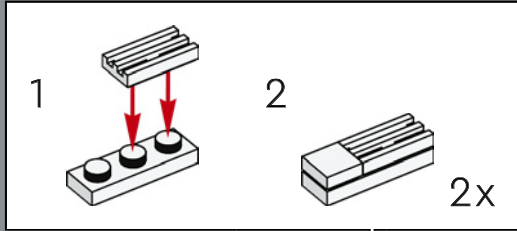

En los últimos años, el Empire State Building ha sido sometido a meticulosas restauraciones con el fin de preservar su diseño original y su historia para las generaciones venideras.



295

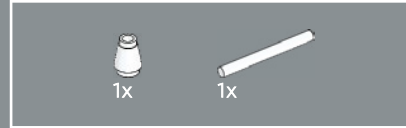
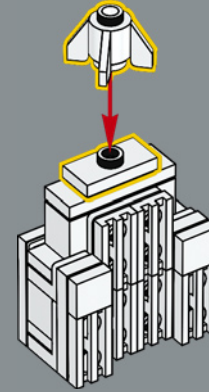

296

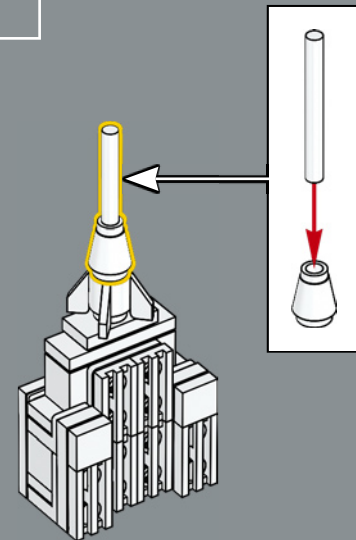

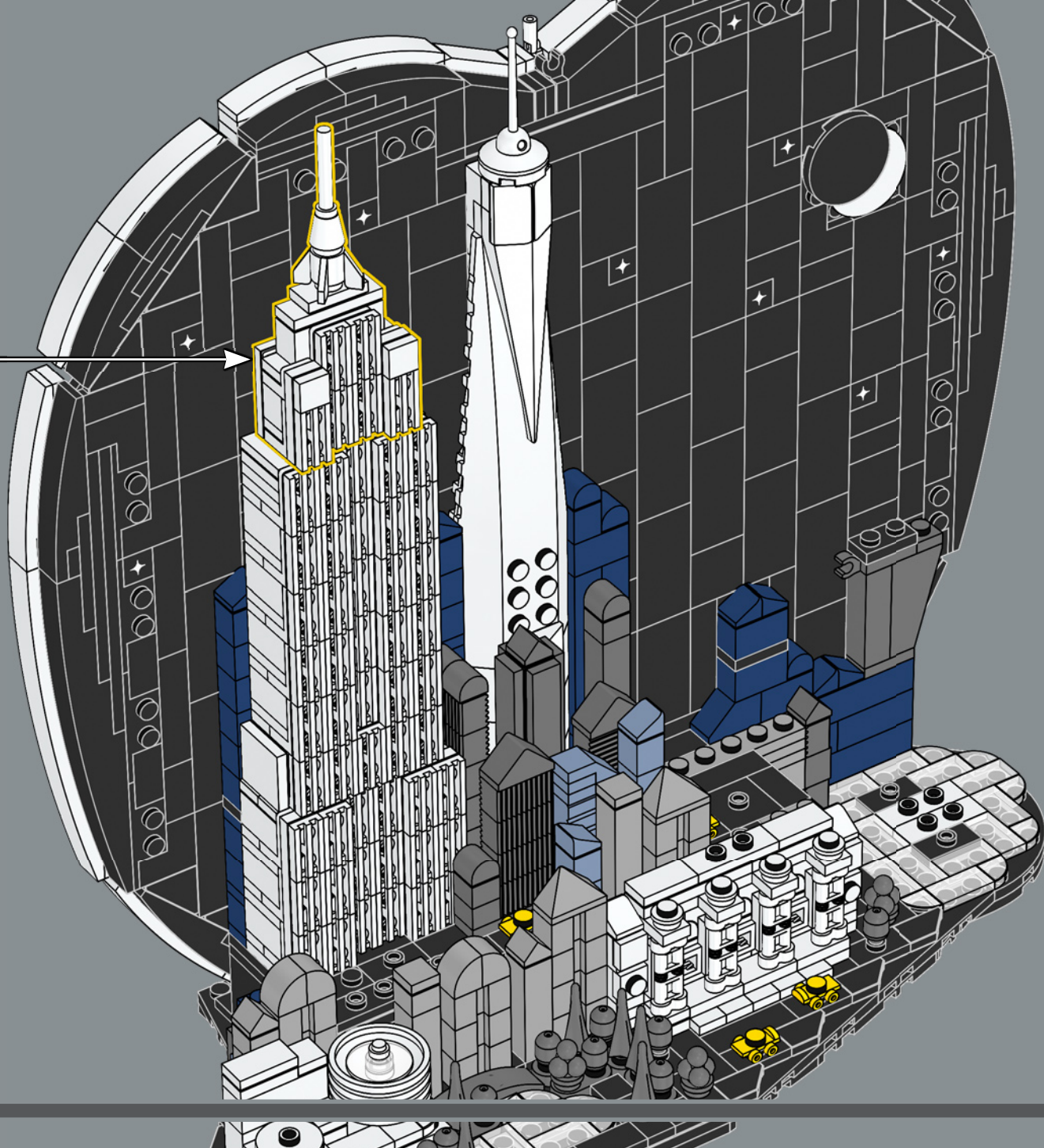

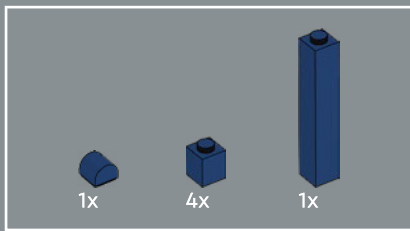

298

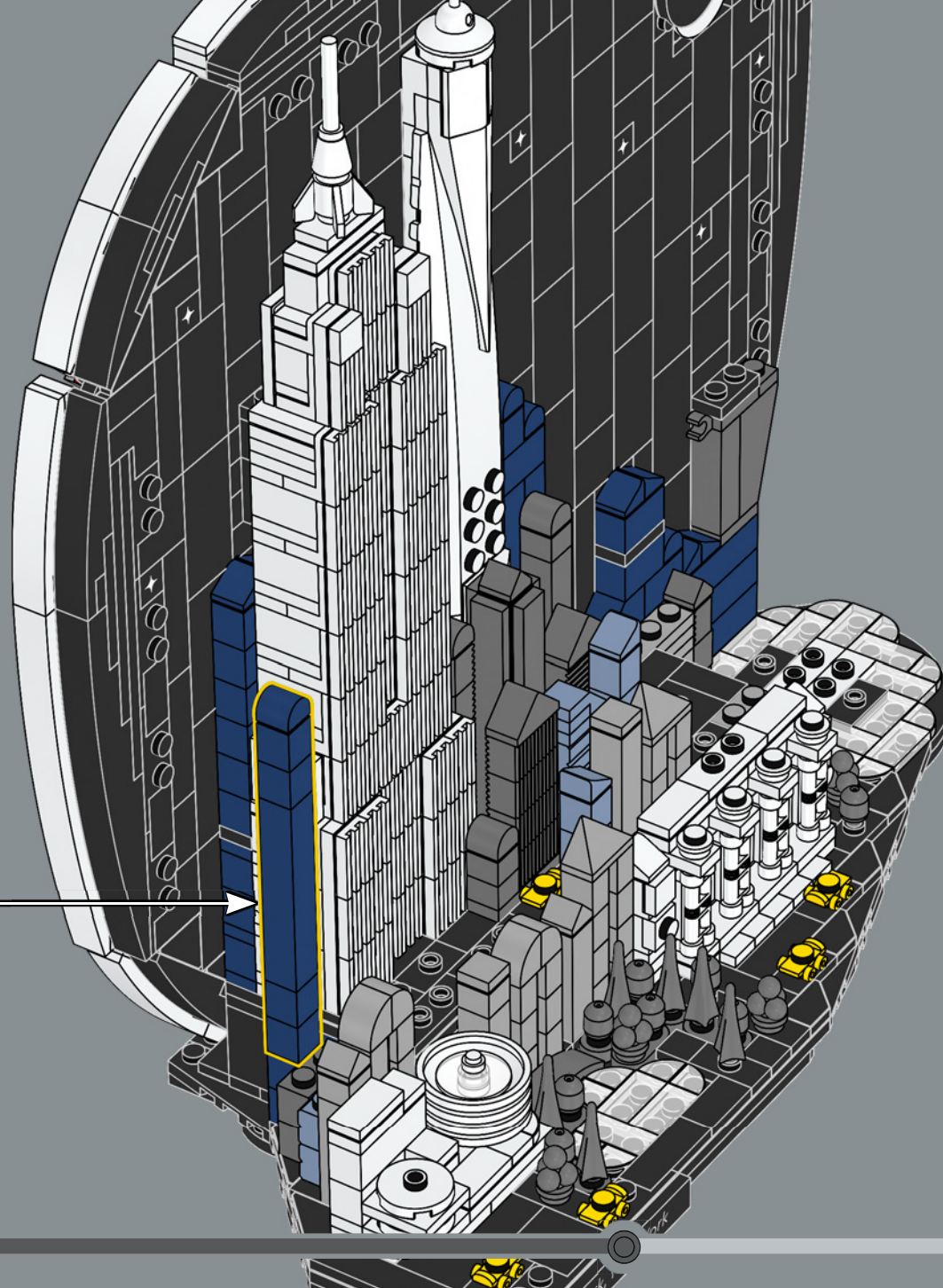
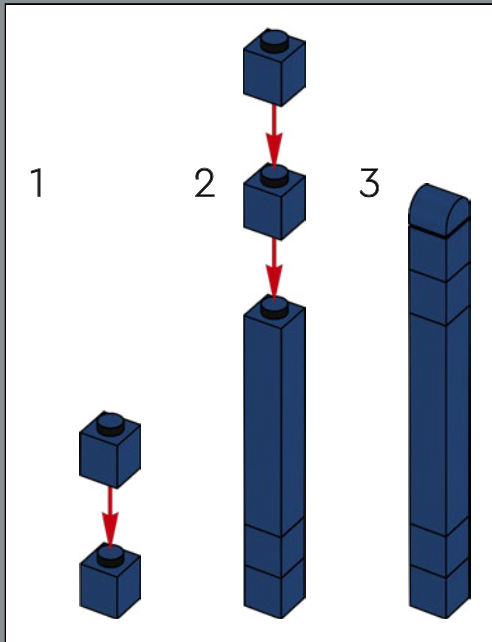

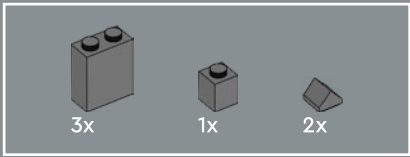

299

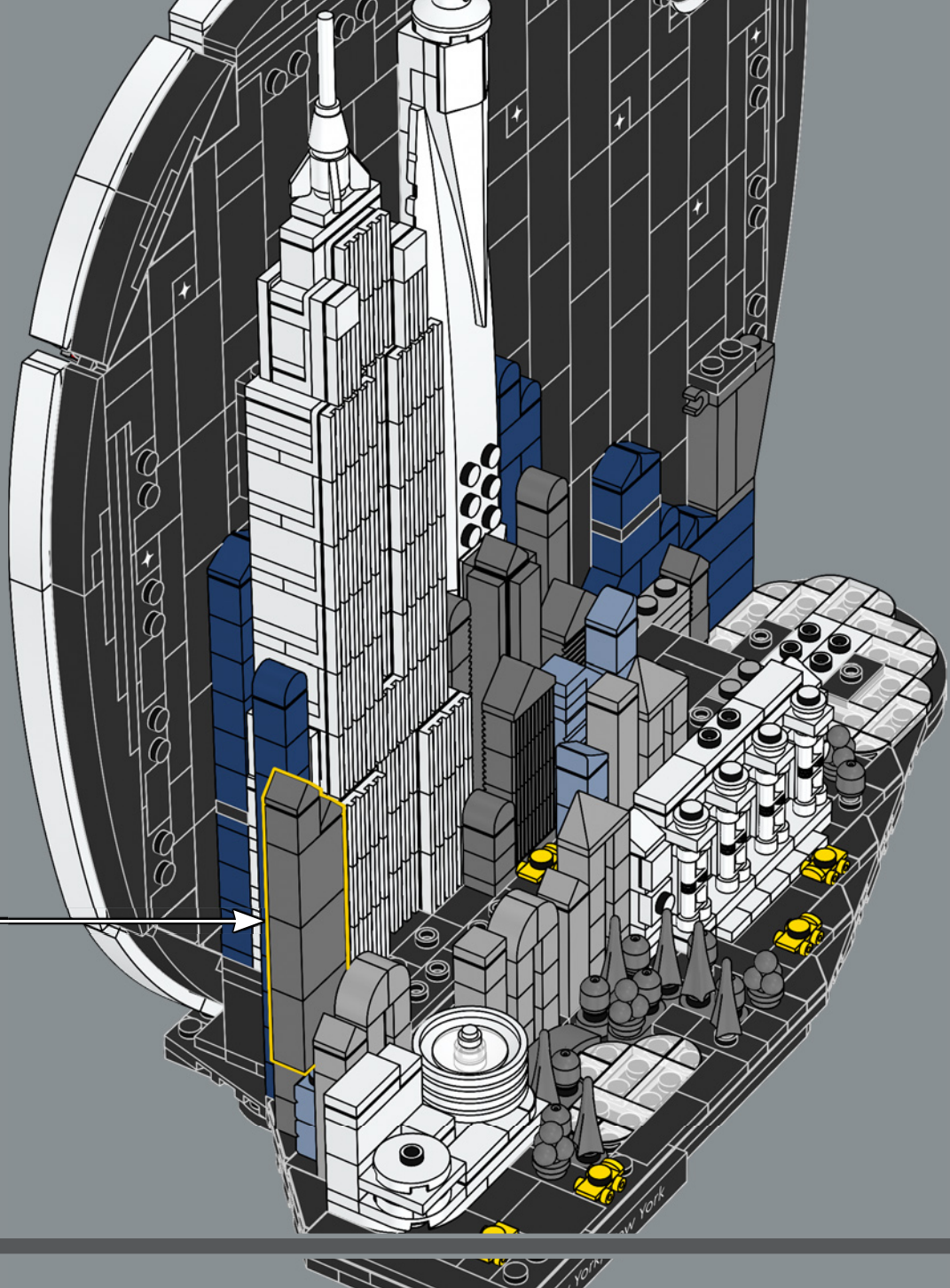
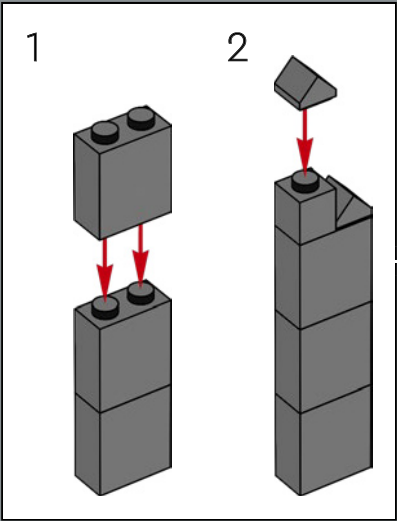

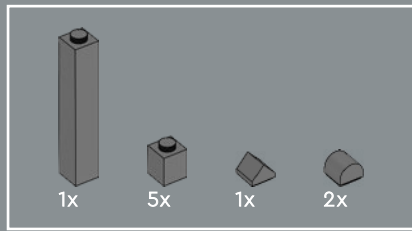

300

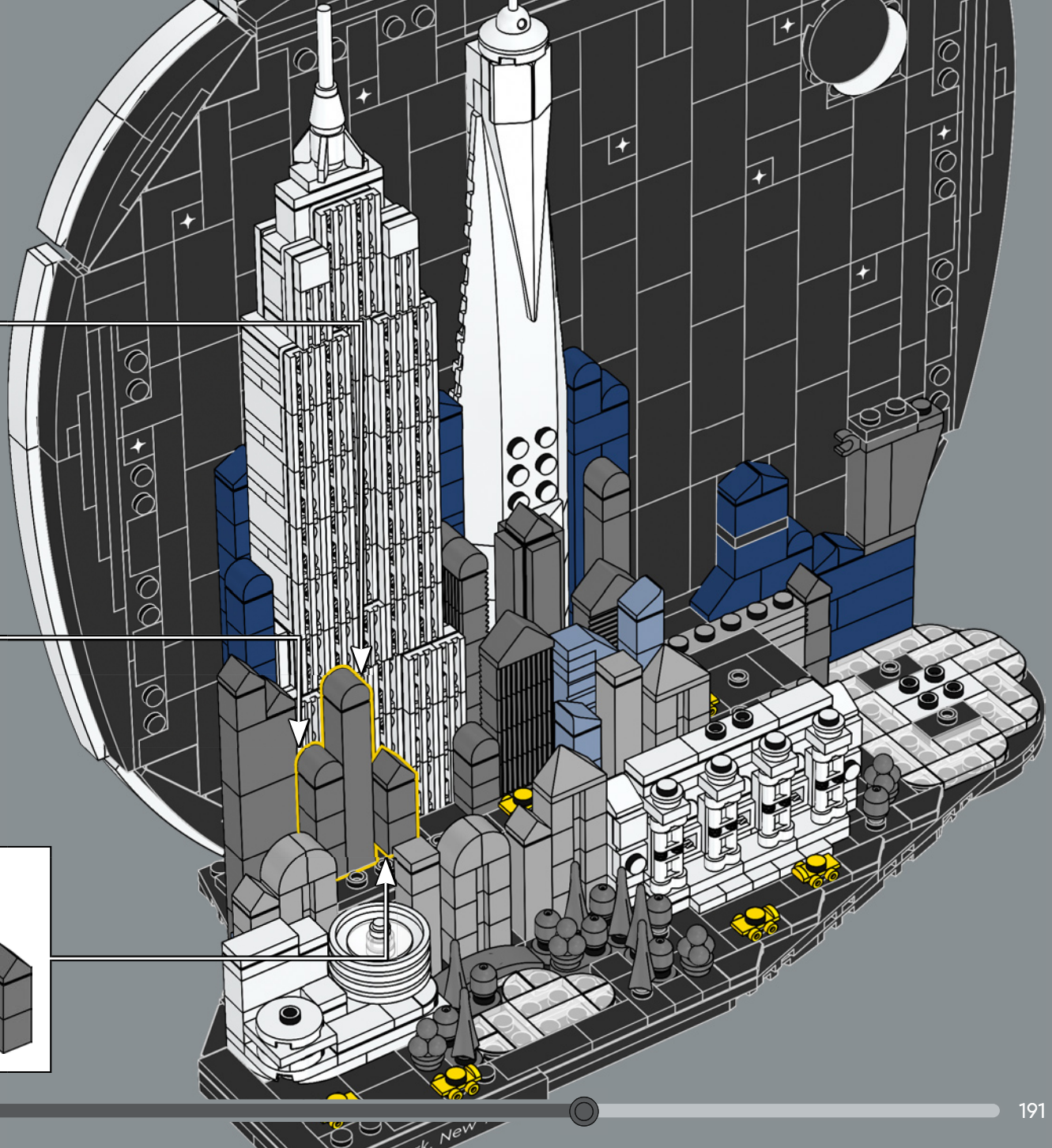
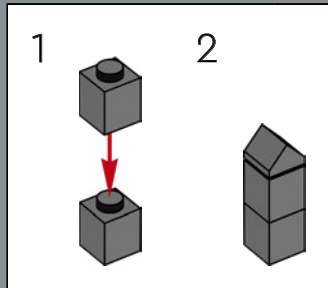
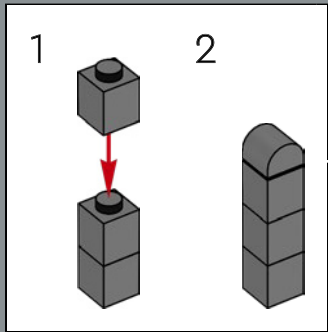
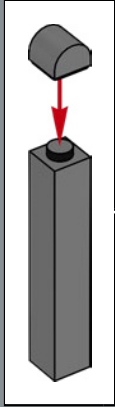



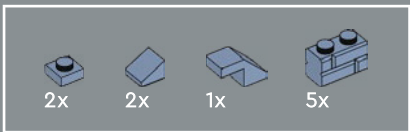

301

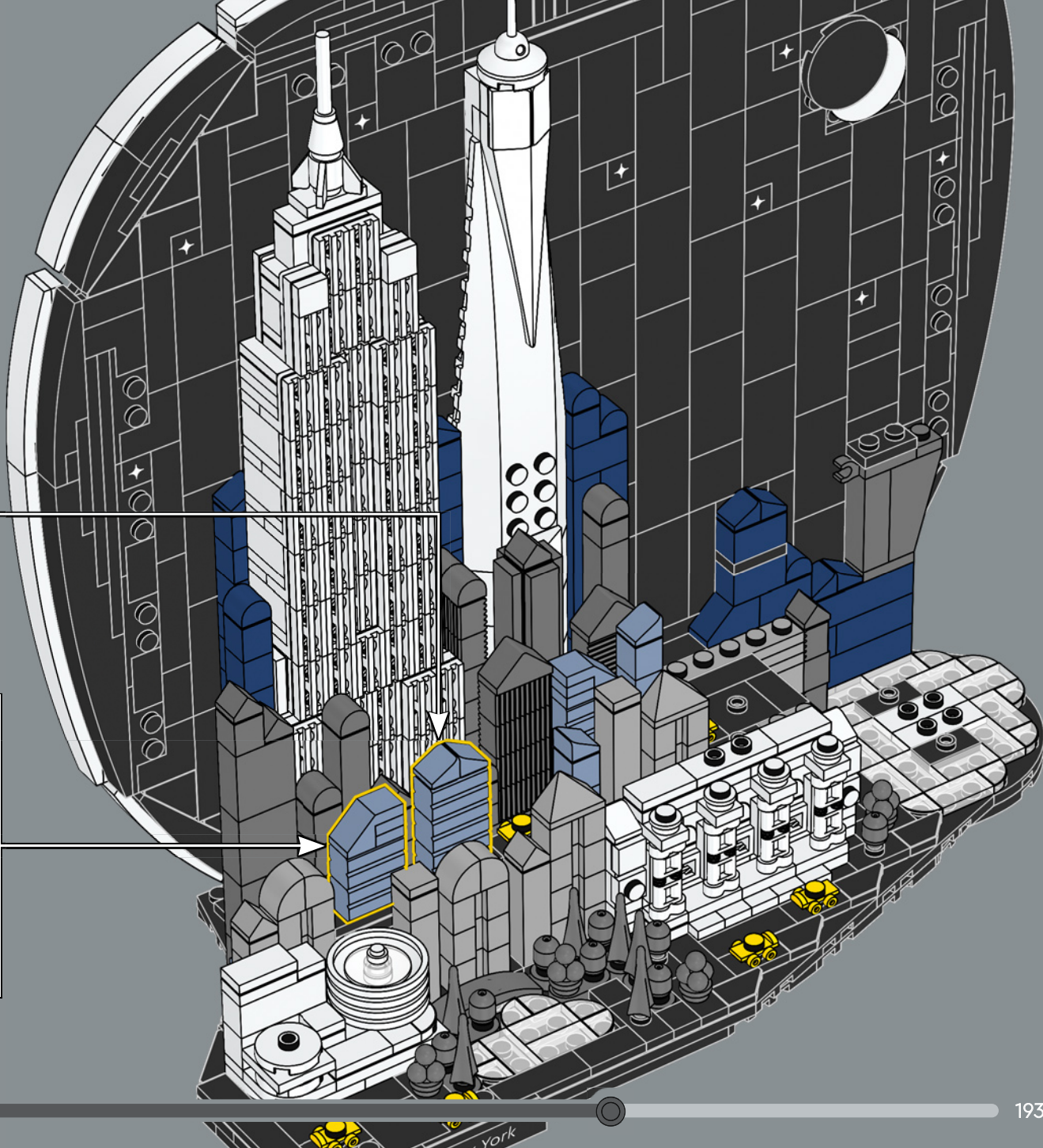
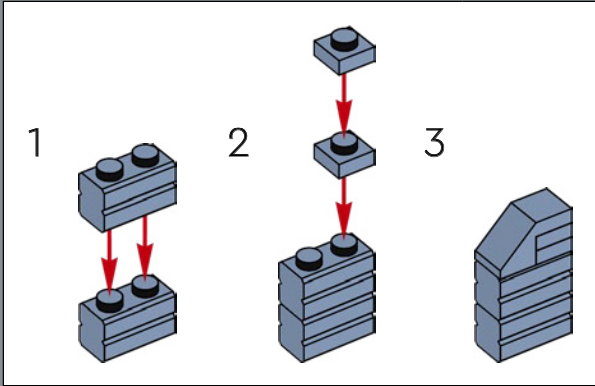
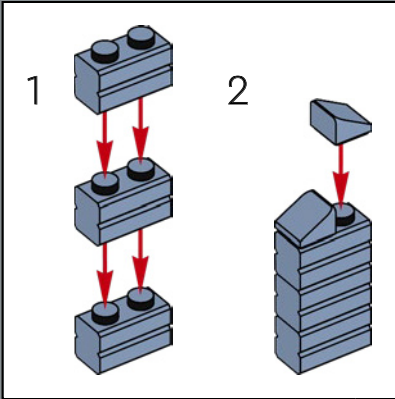

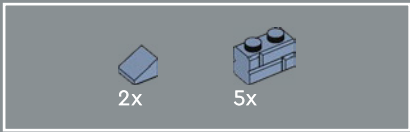

302

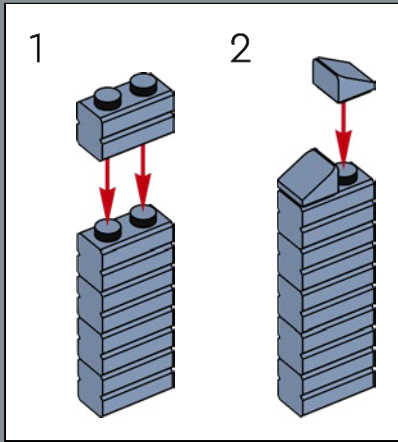
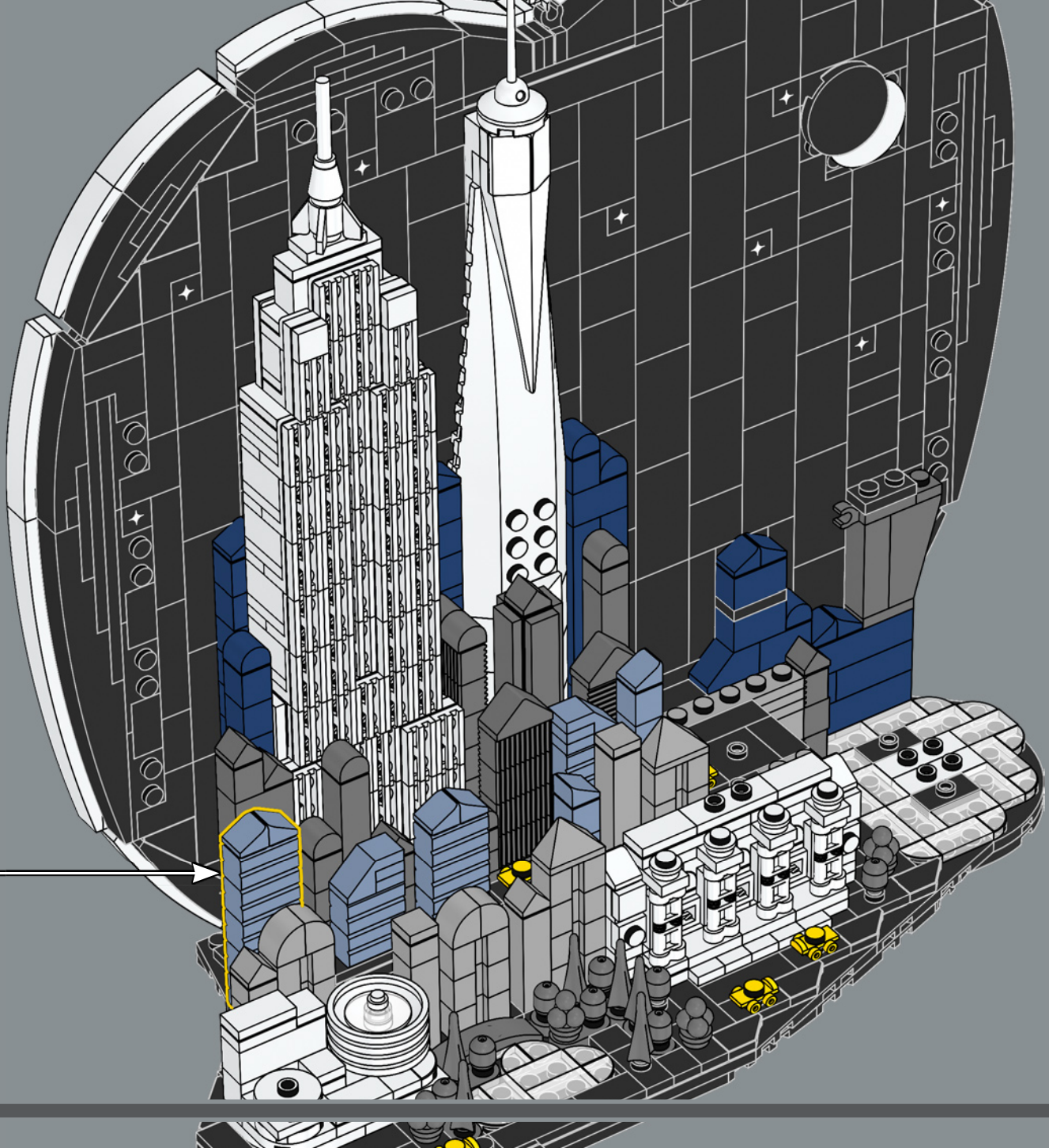



303

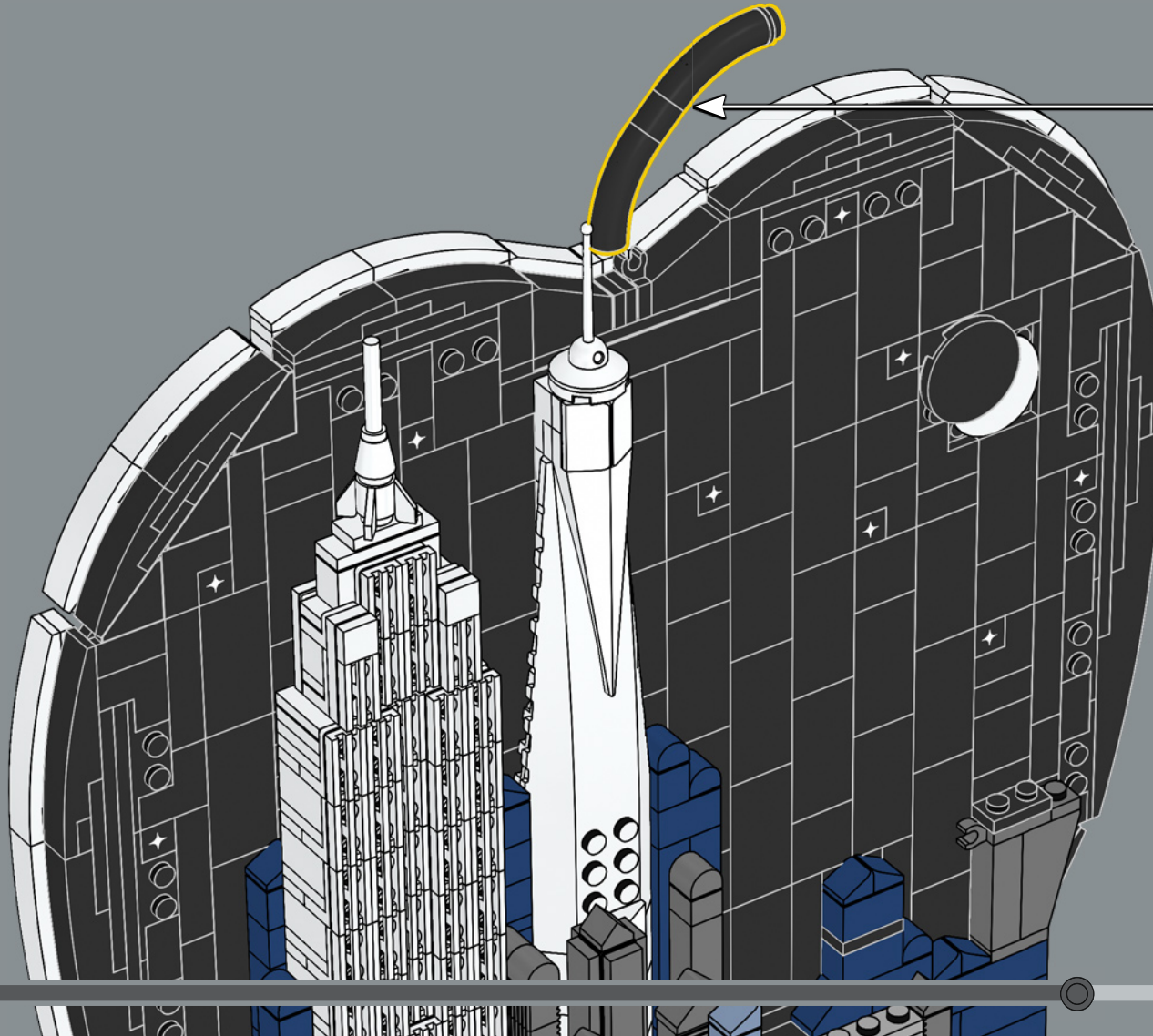
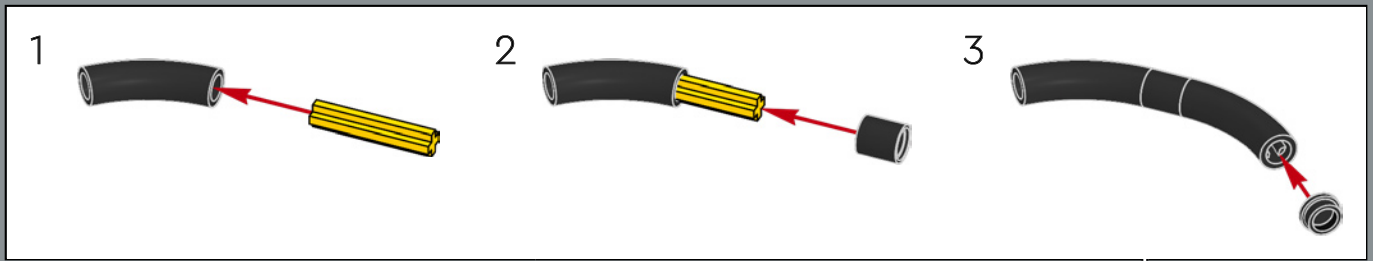

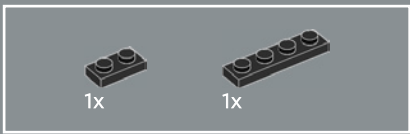

304

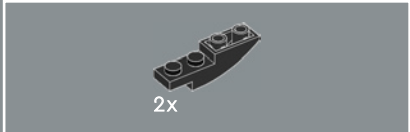
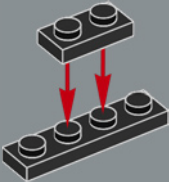

305

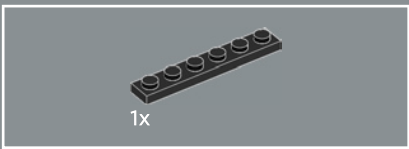
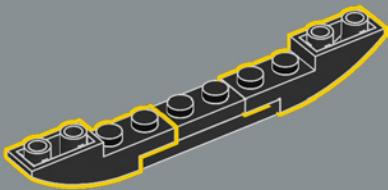

306

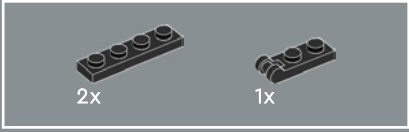
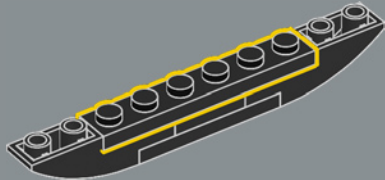

307

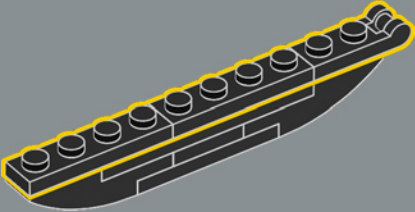

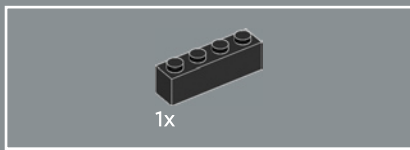

1x

308

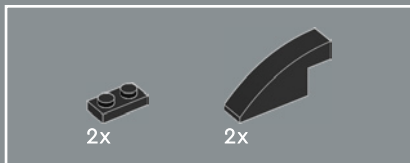
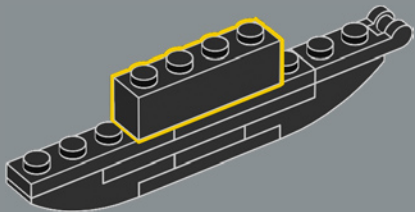

2x

2x

309

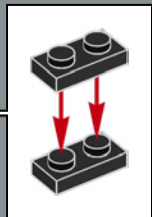
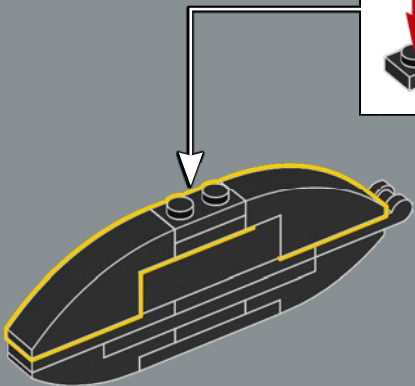

310

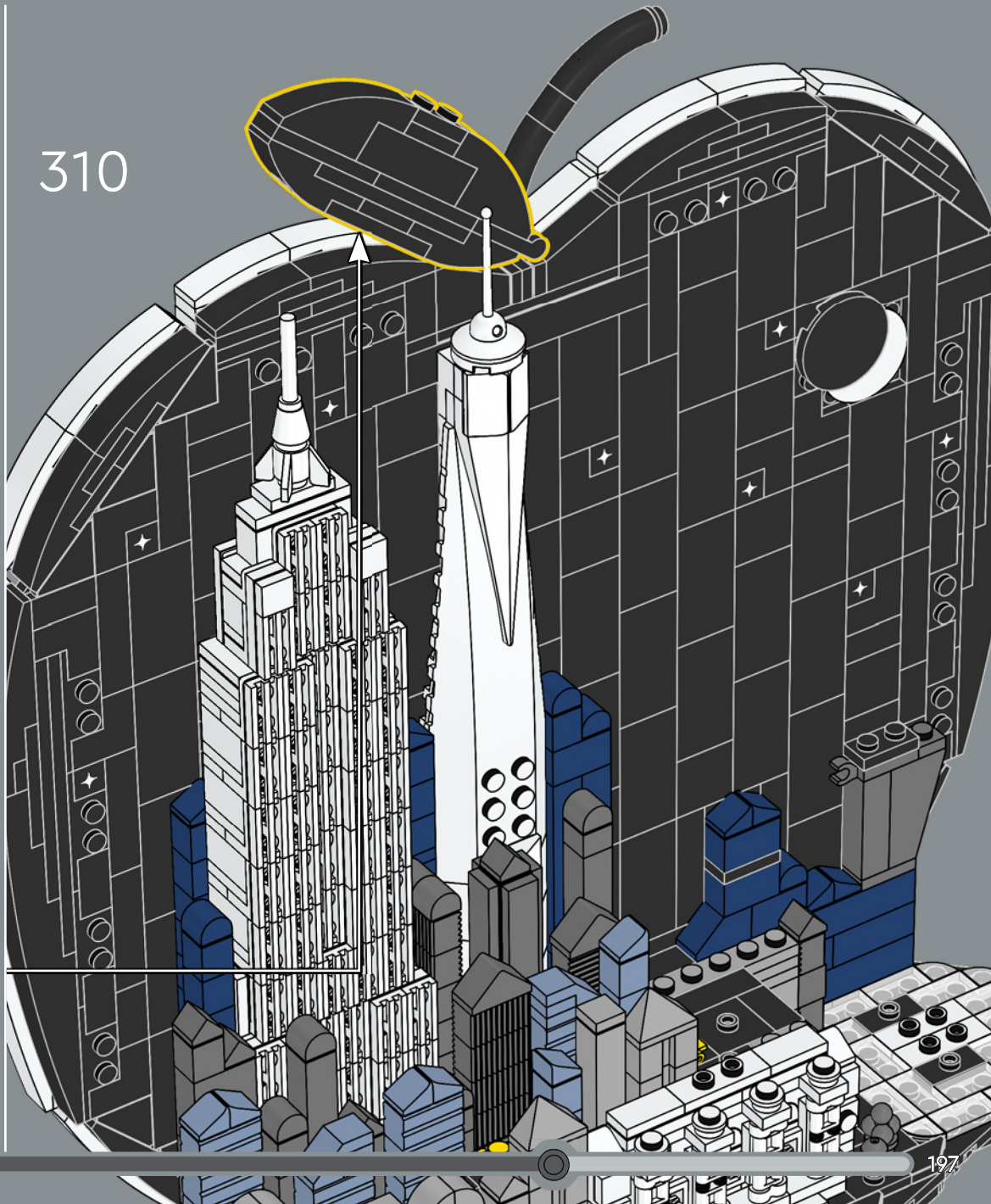

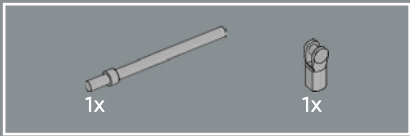

311

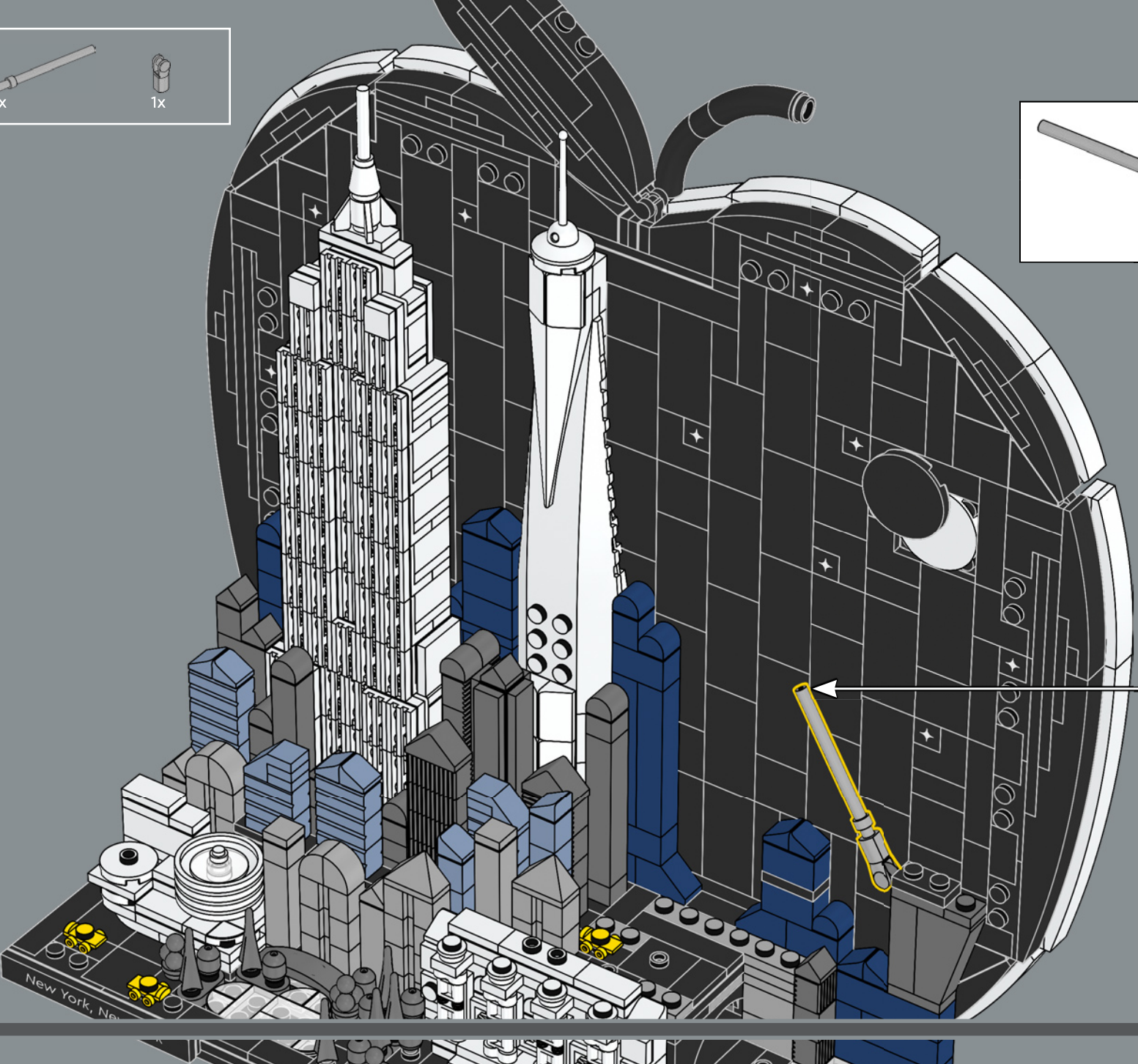
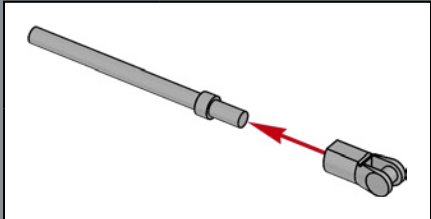

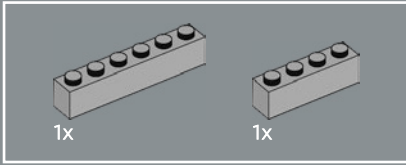
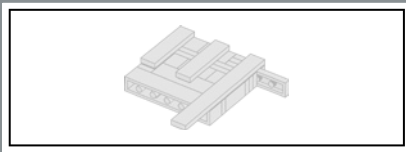

312

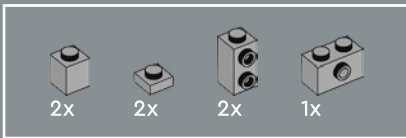
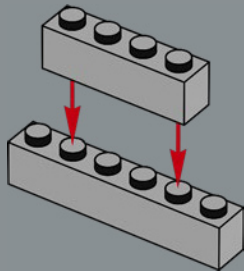

313

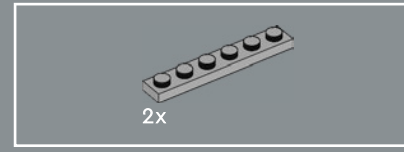
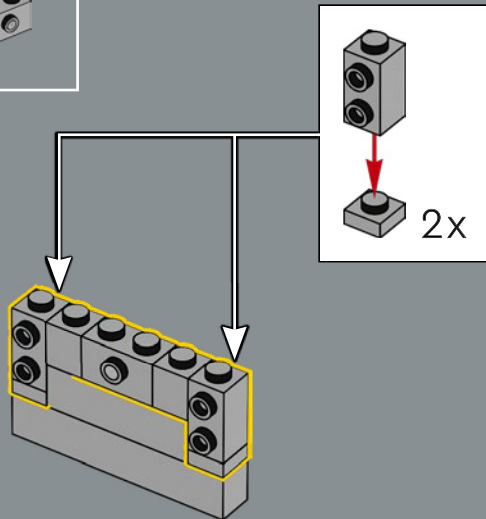

314

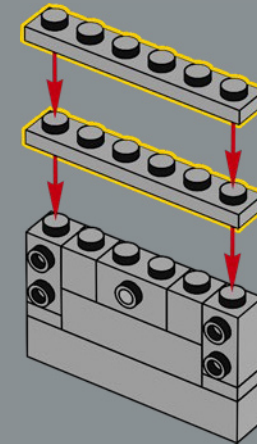

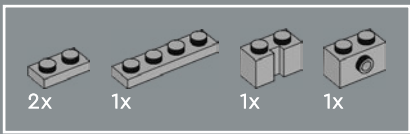

315

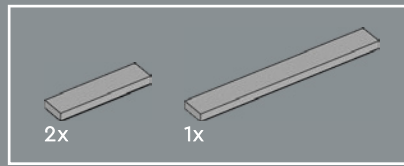
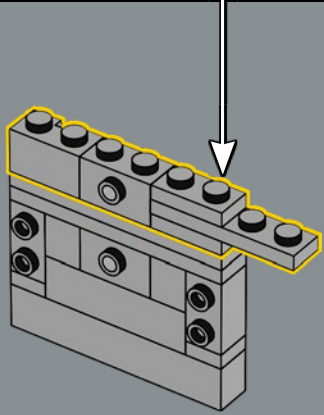
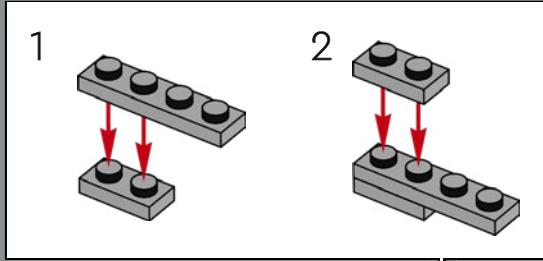

316

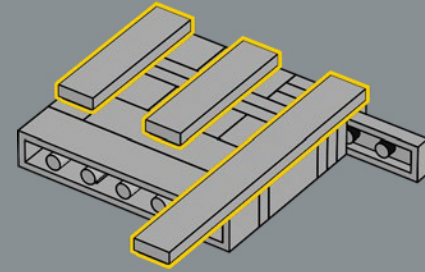

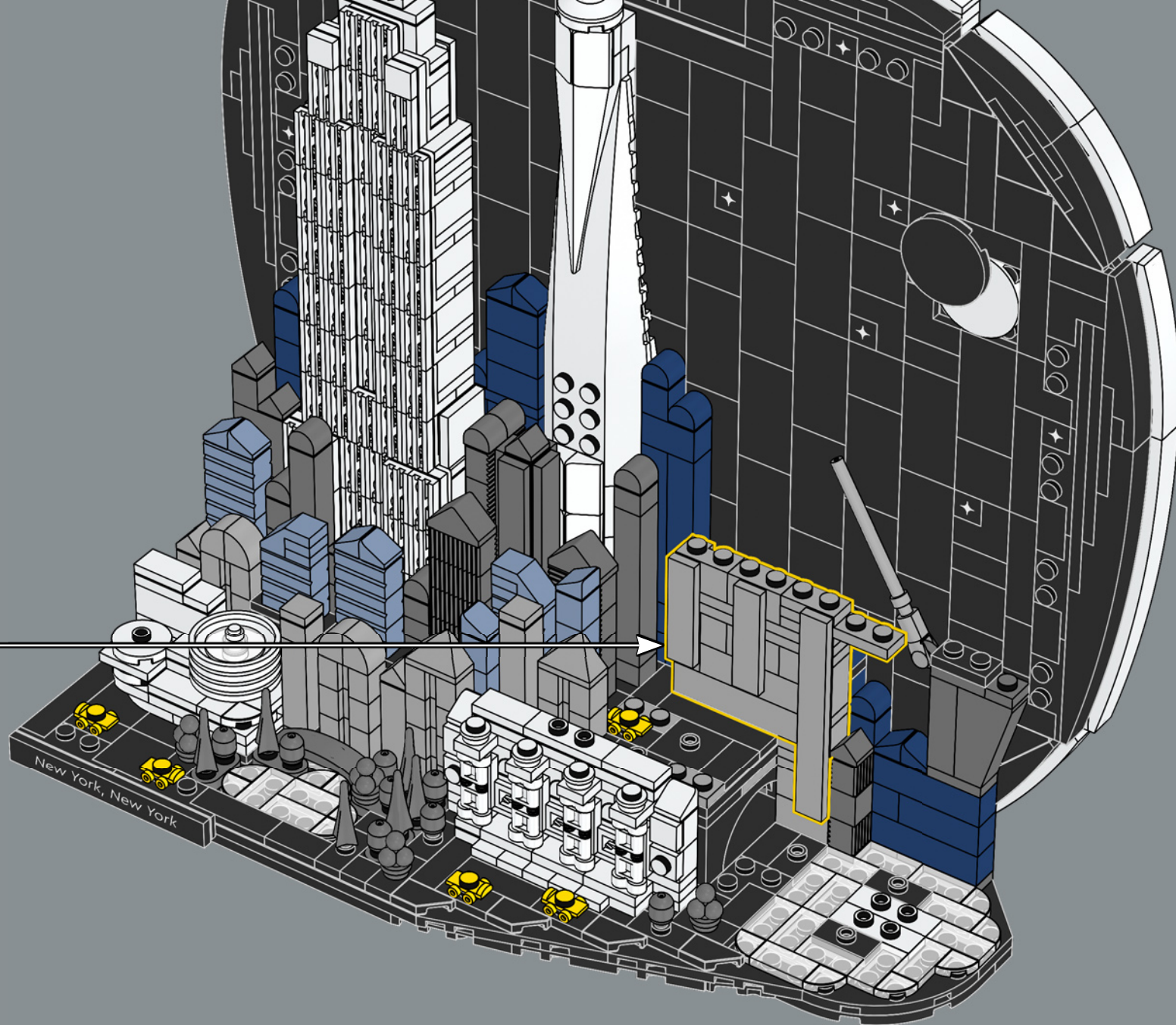

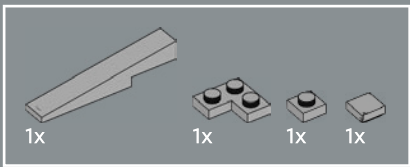

318

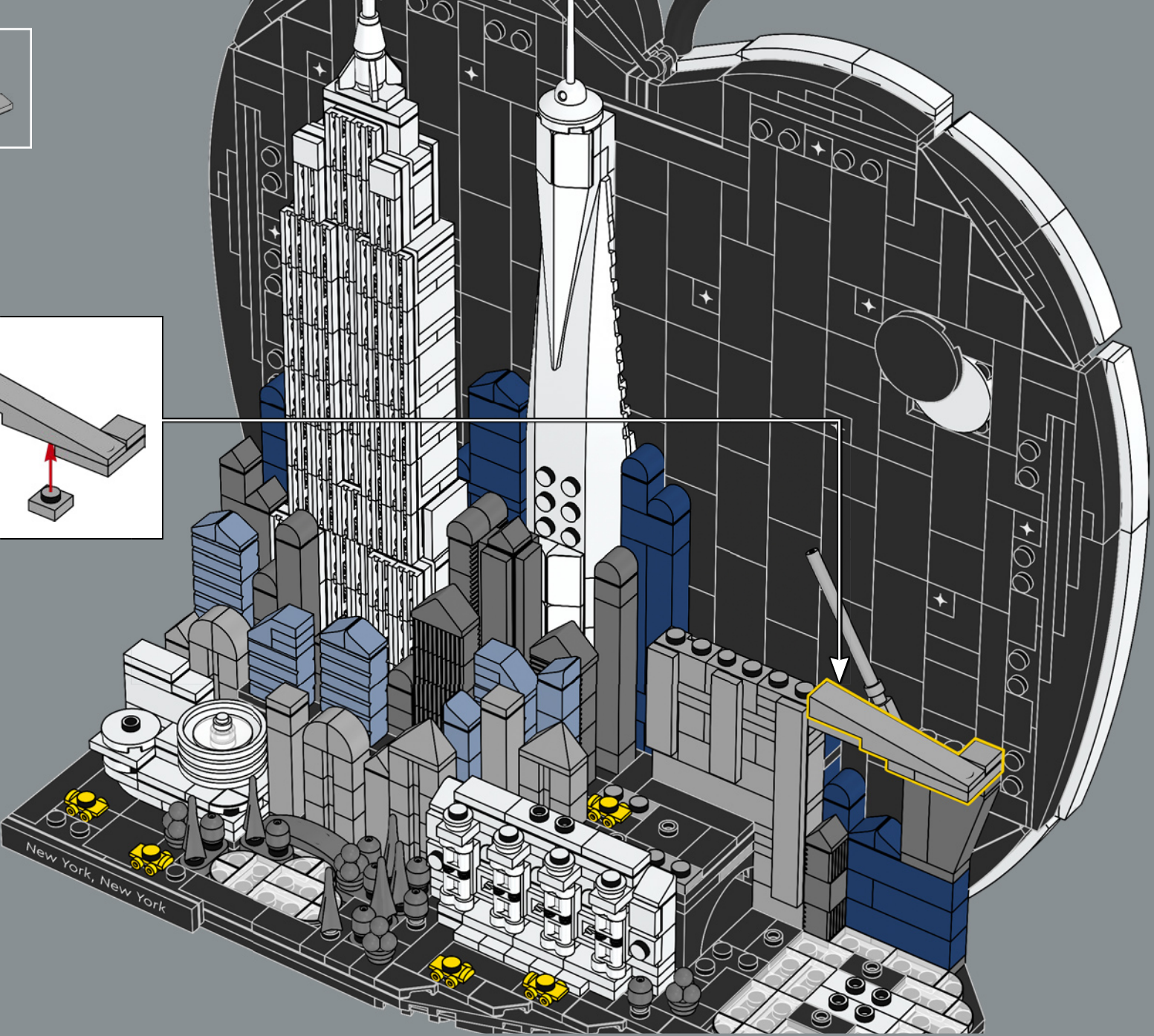
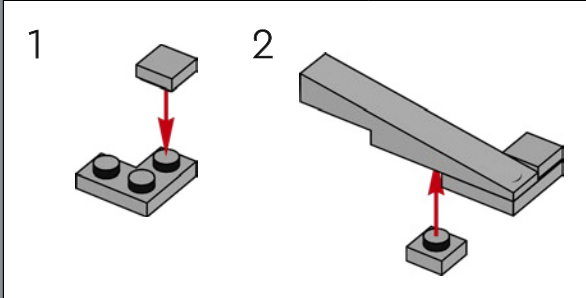



319

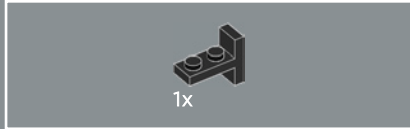

320



321

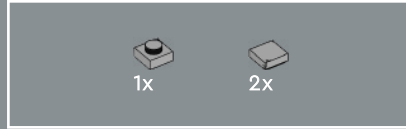
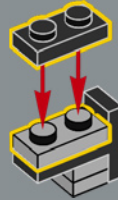

322

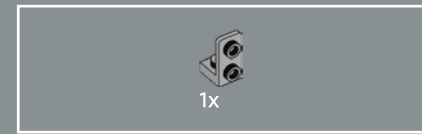
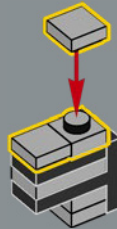

323

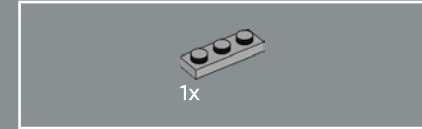
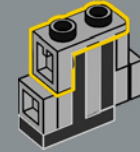

324

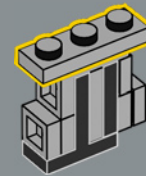

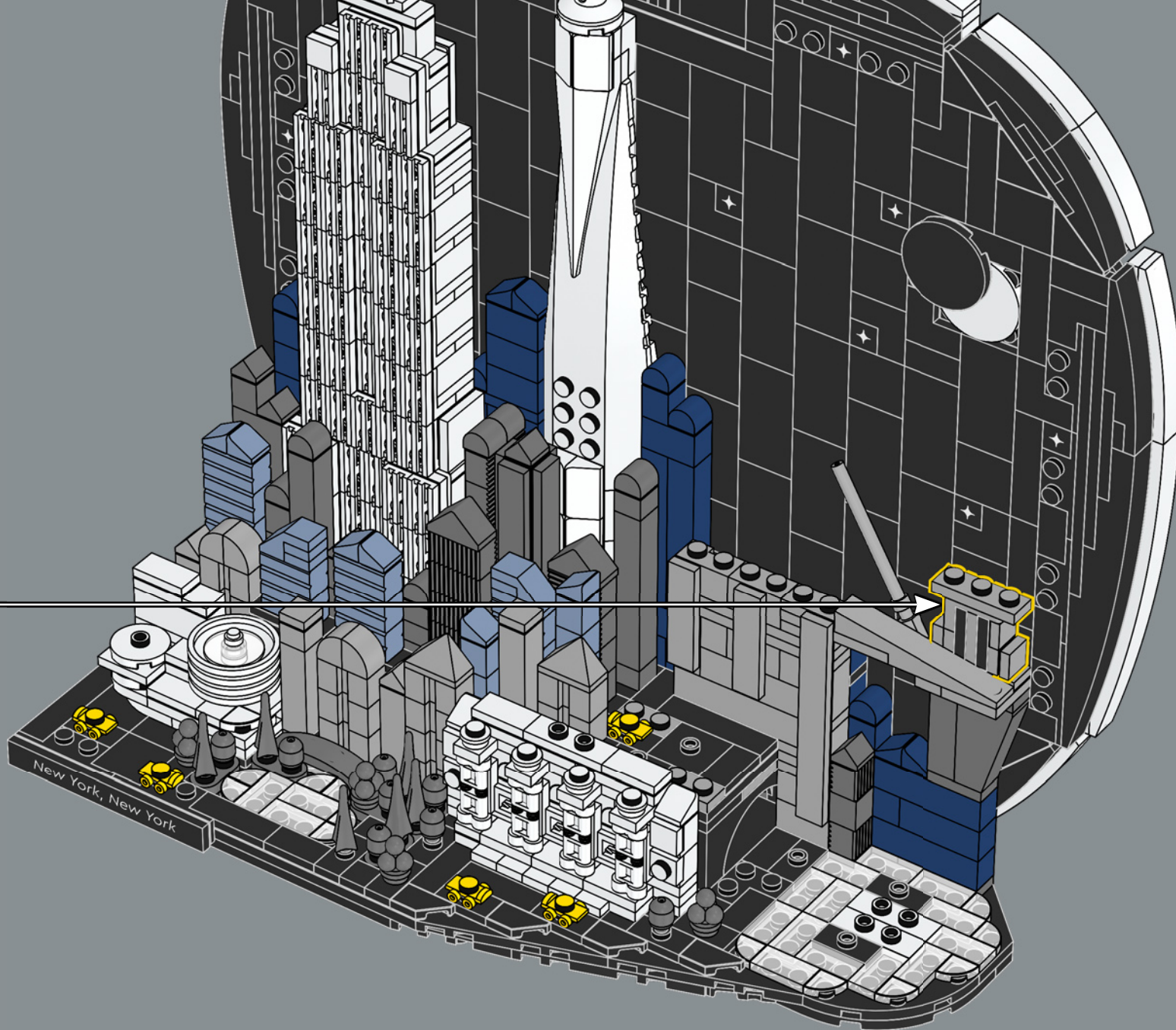

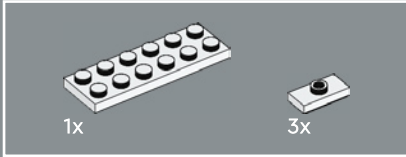
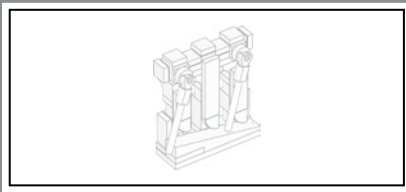

326

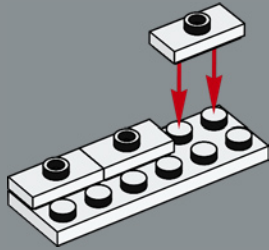

327

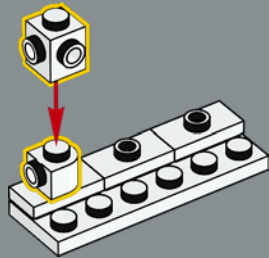

328

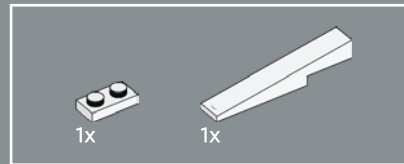
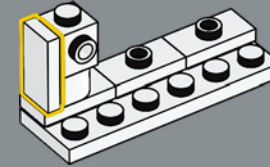

329

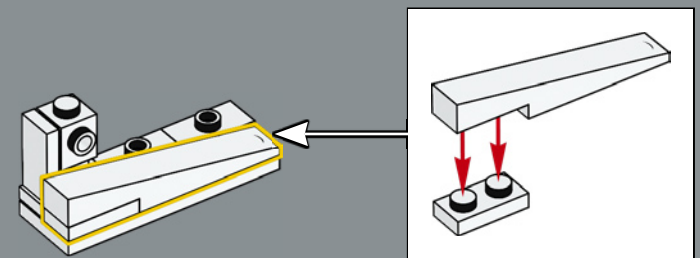

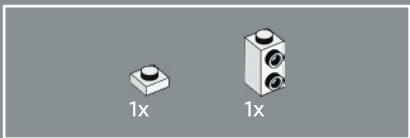

330

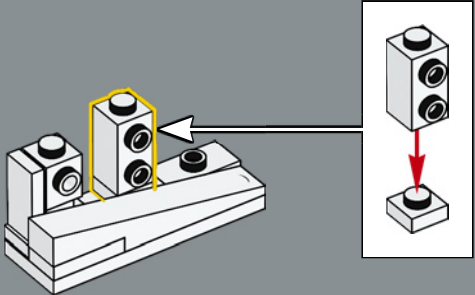

331

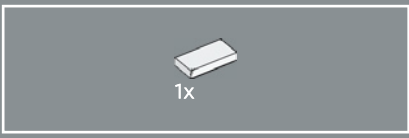
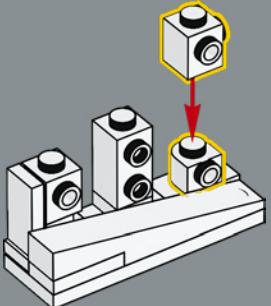

332

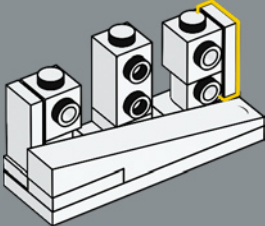

333

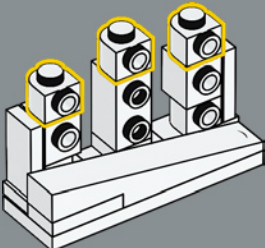



334

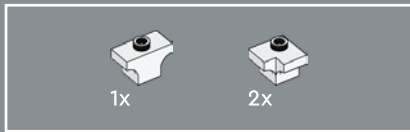
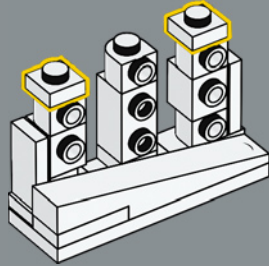

335

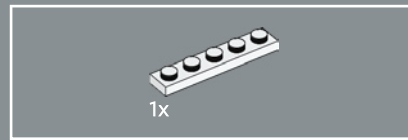
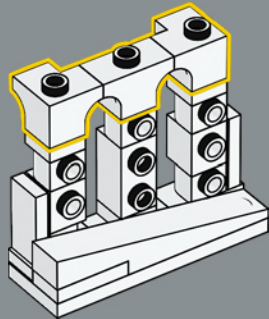

336

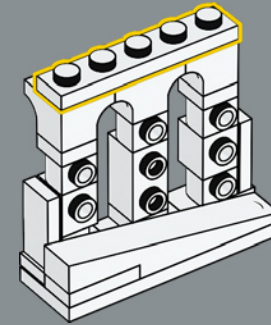

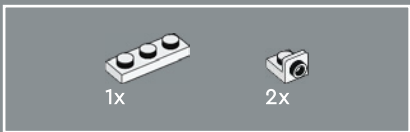

337

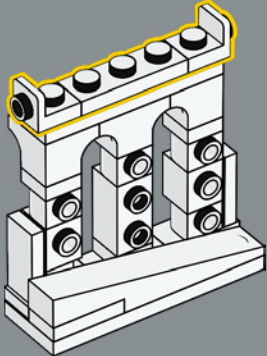

338

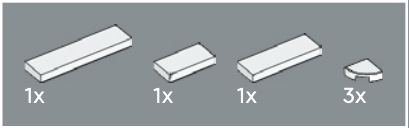
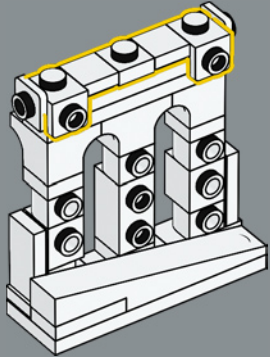

339

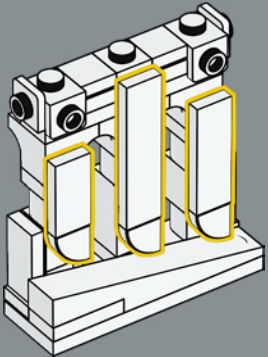



2x

# 340

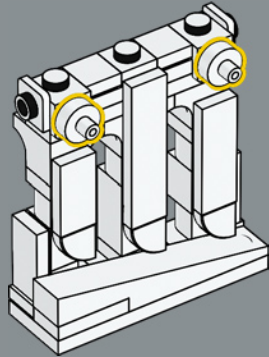

5x

# 341

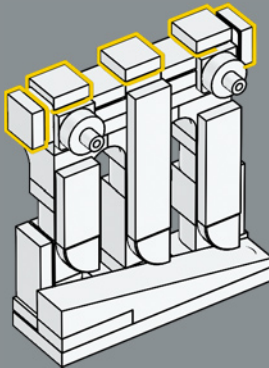

2x



2x

# 342

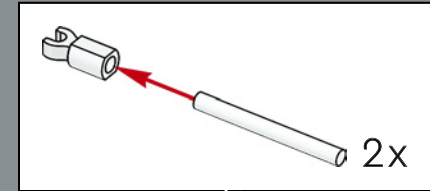

2x

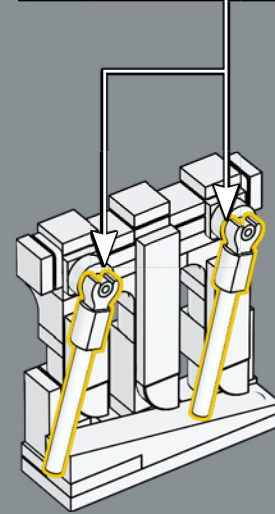

Más de 137.000 personas cruzan el puente de Brooklyn a diario en coche, a pie o en bicicleta (los camiones no tienen permitido el paso).



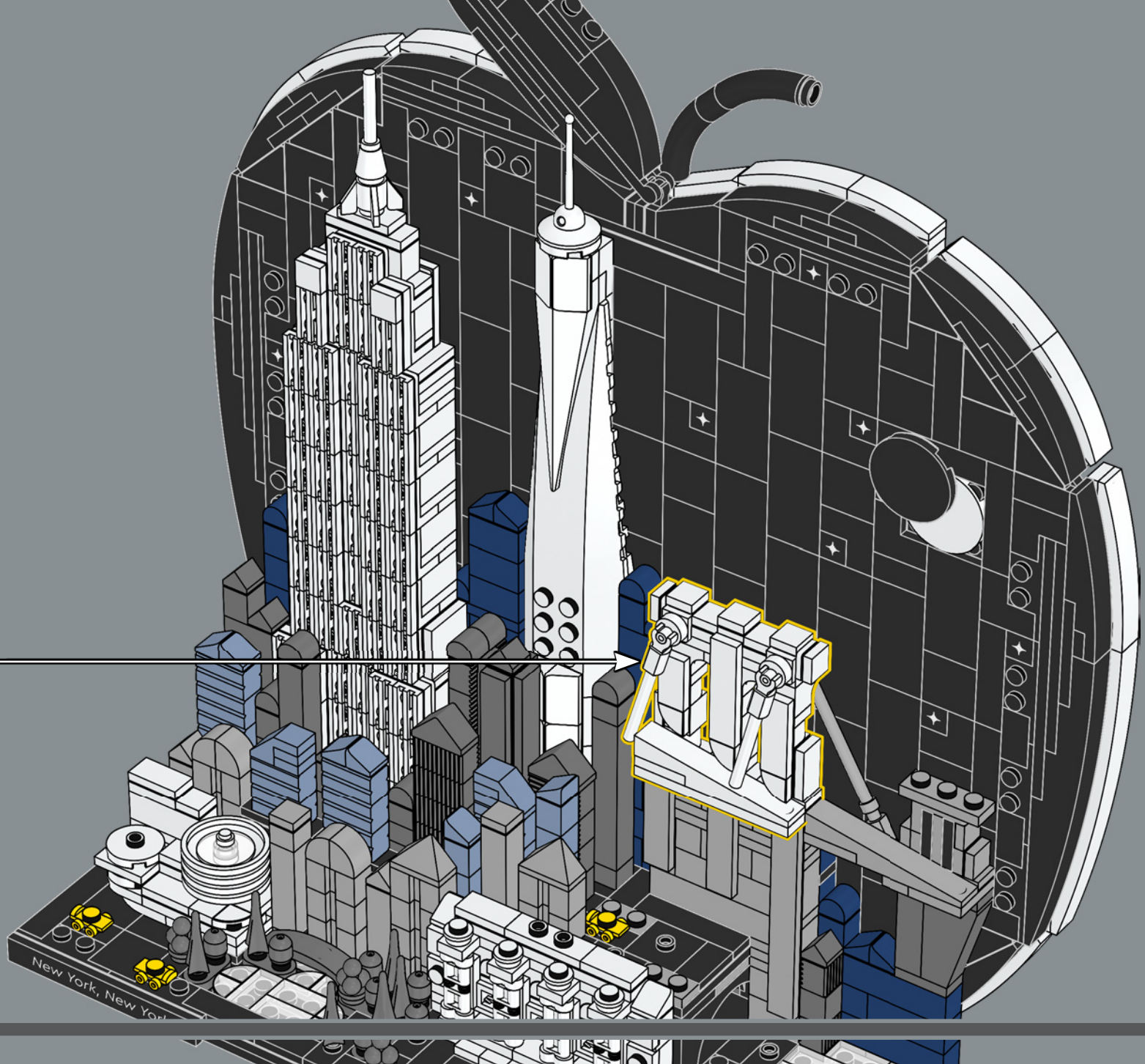

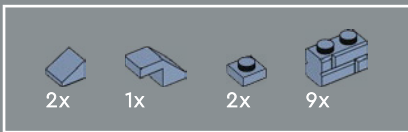

344

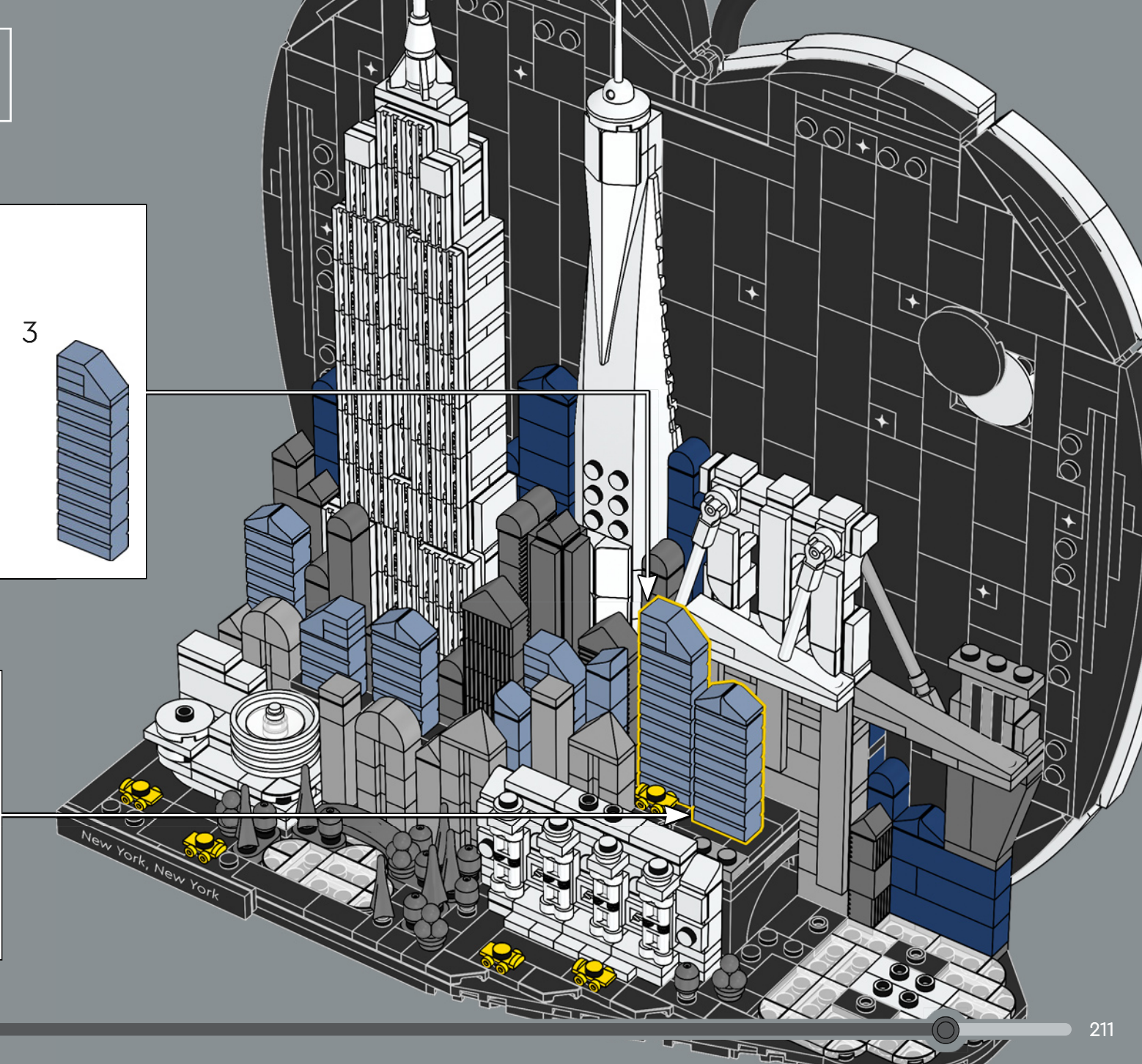
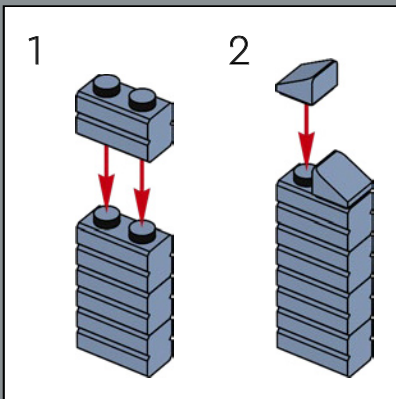
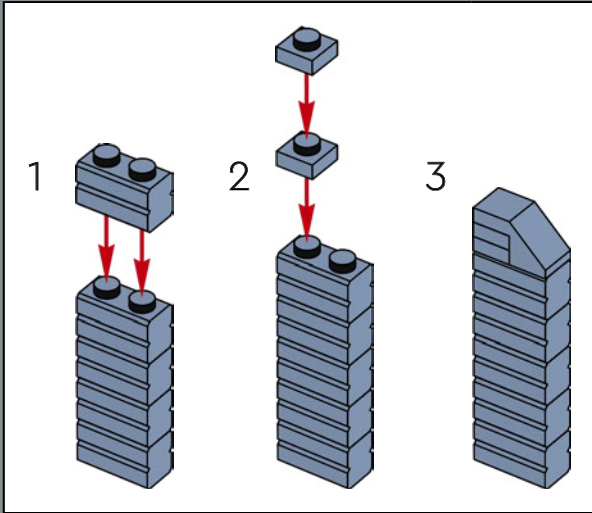

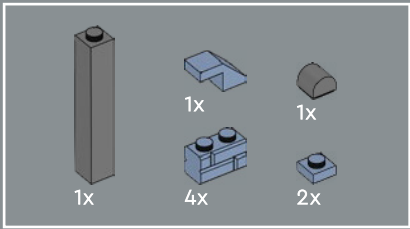

345

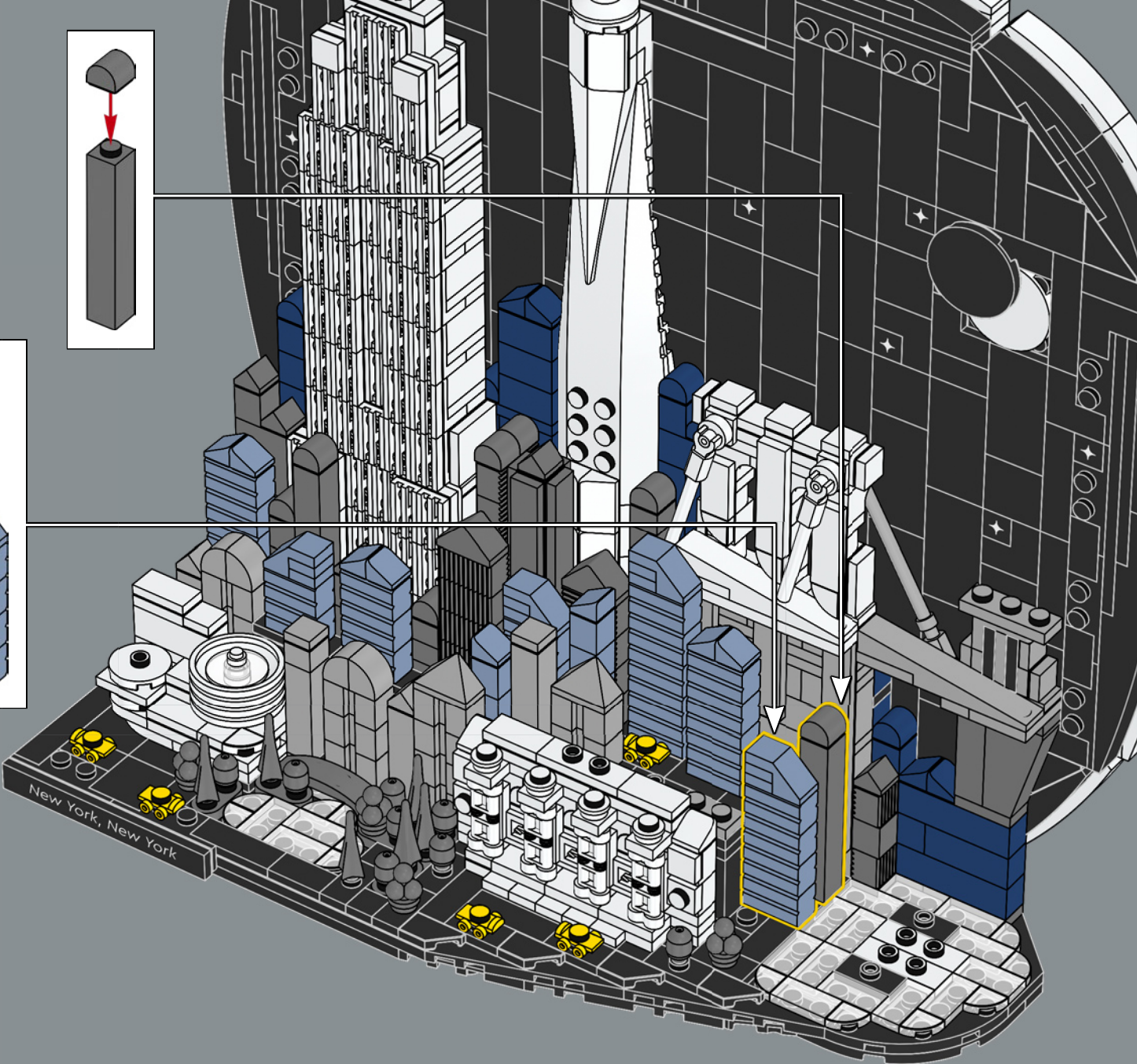
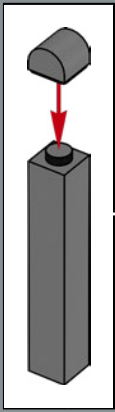
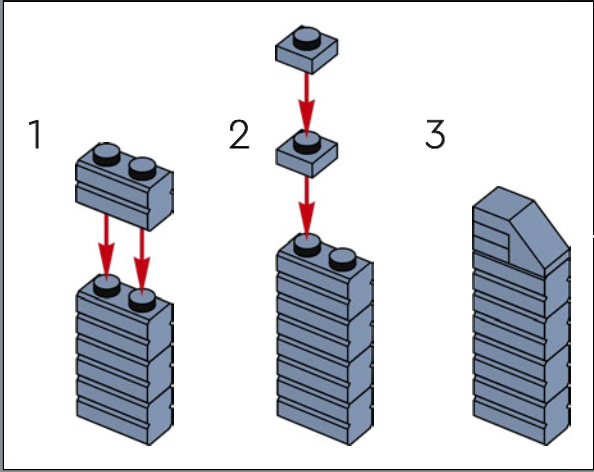

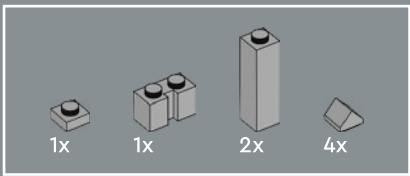

346

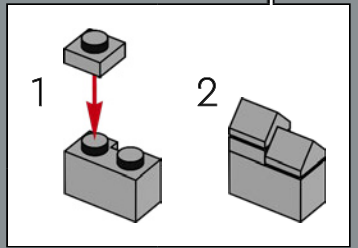
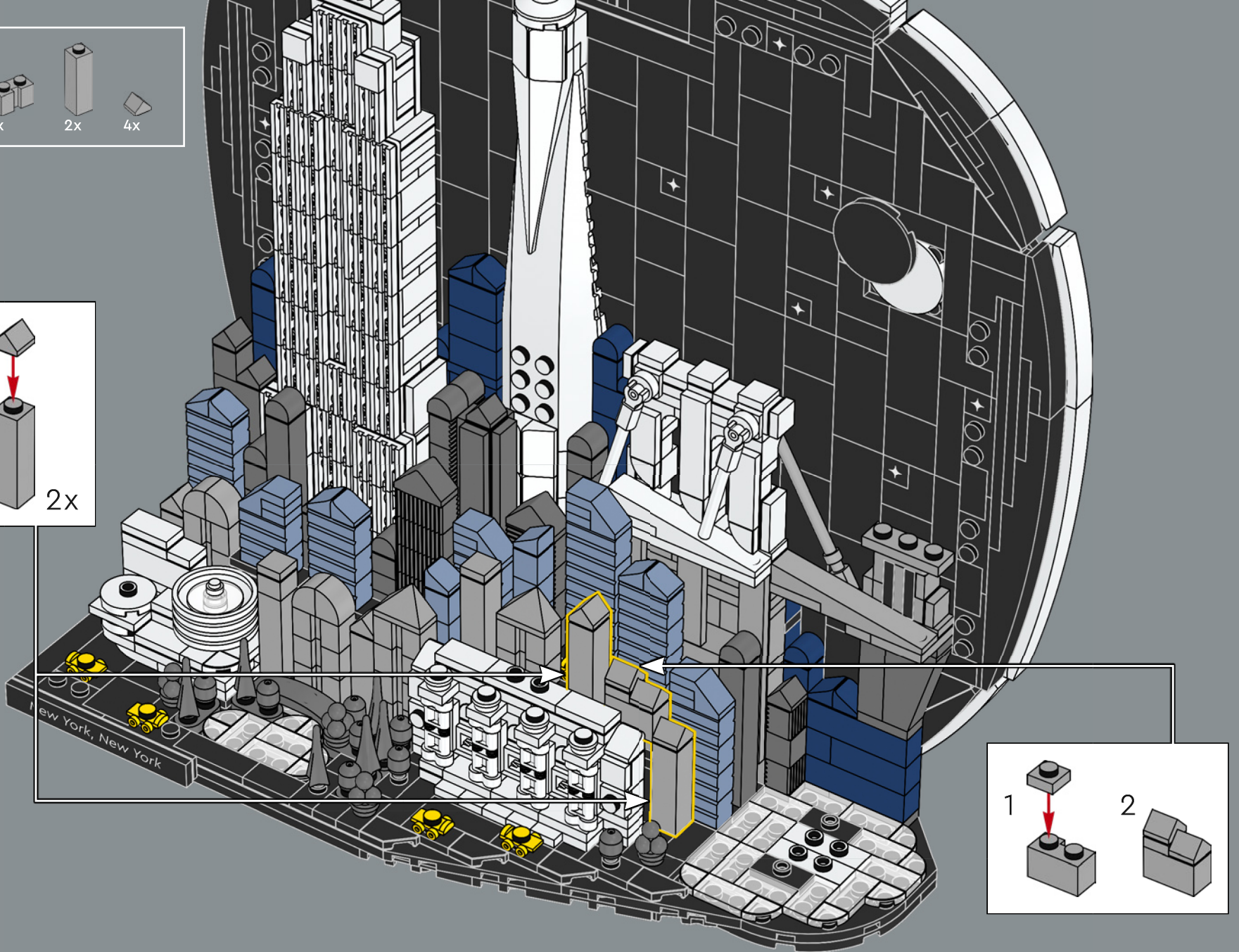
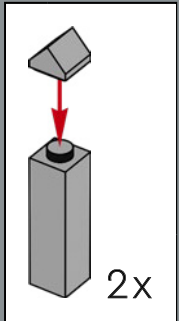

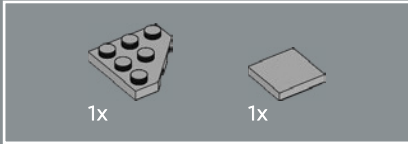

347

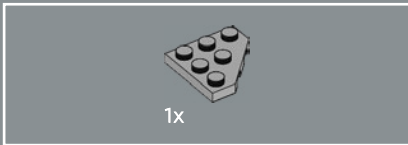
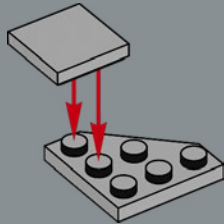

348

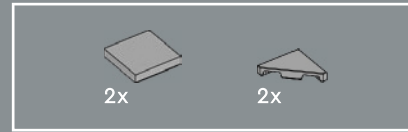
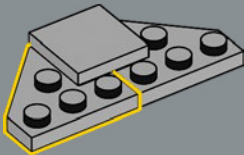

349

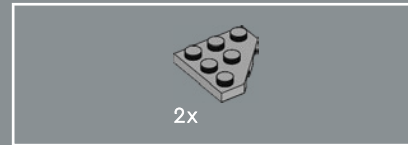
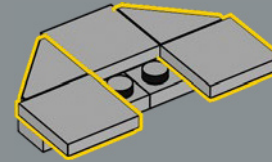

350

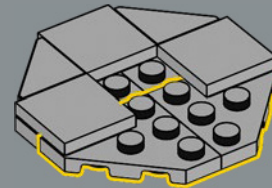

La impresionante Estatua de la Libertad, revestida de cobre, mide 92,9 m de altura desde el suelo hasta el extremo de la llama; más o menos como un edificio de 22 plantas.

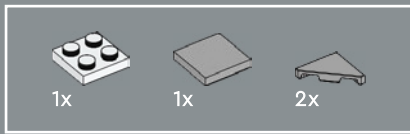

351

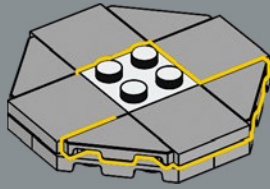

352

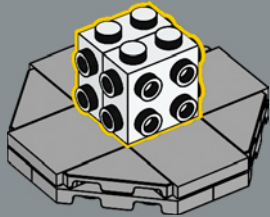

353

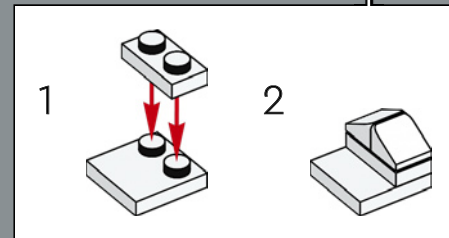
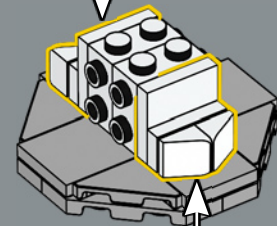
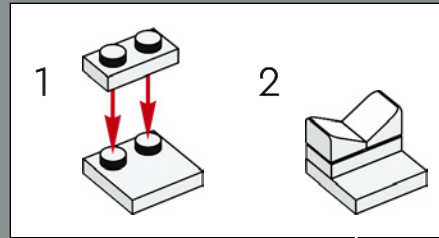



354

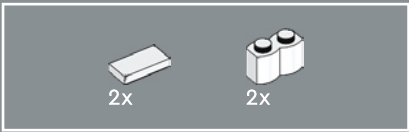
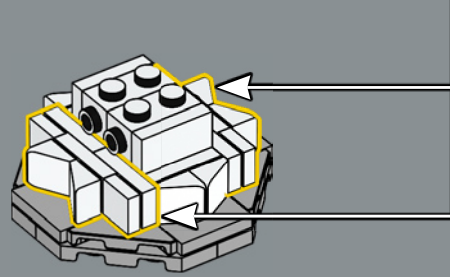
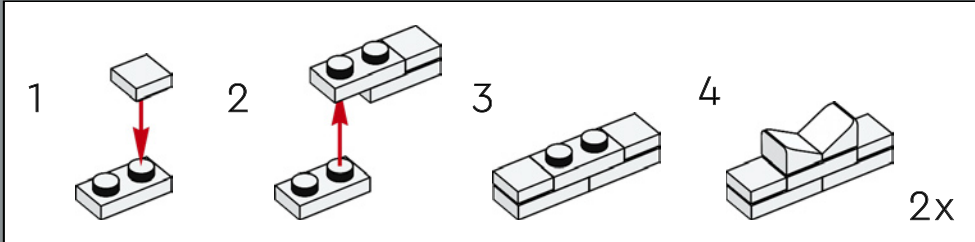

355

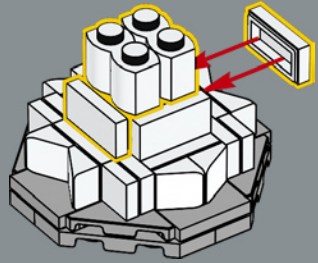



356

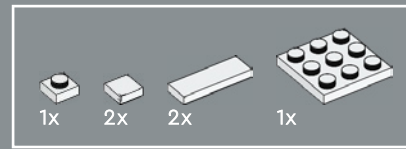
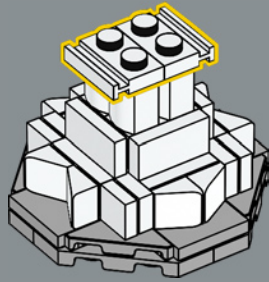

357

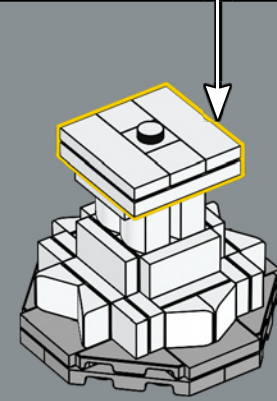
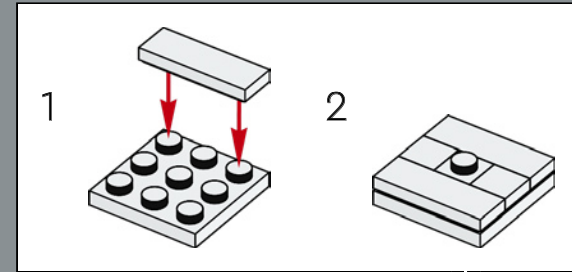

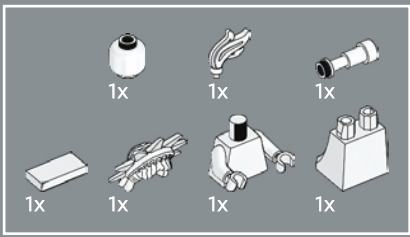

358

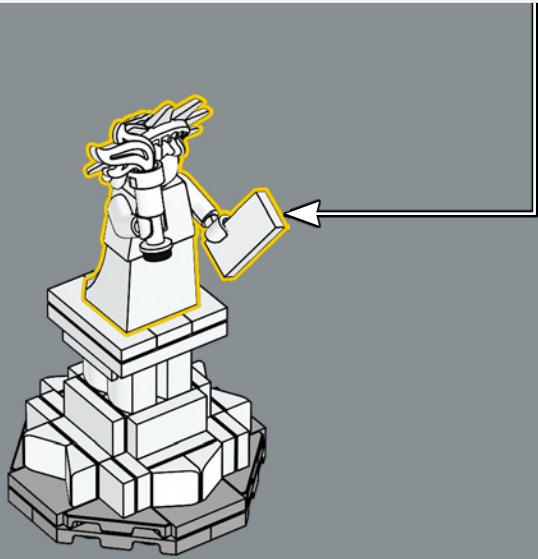
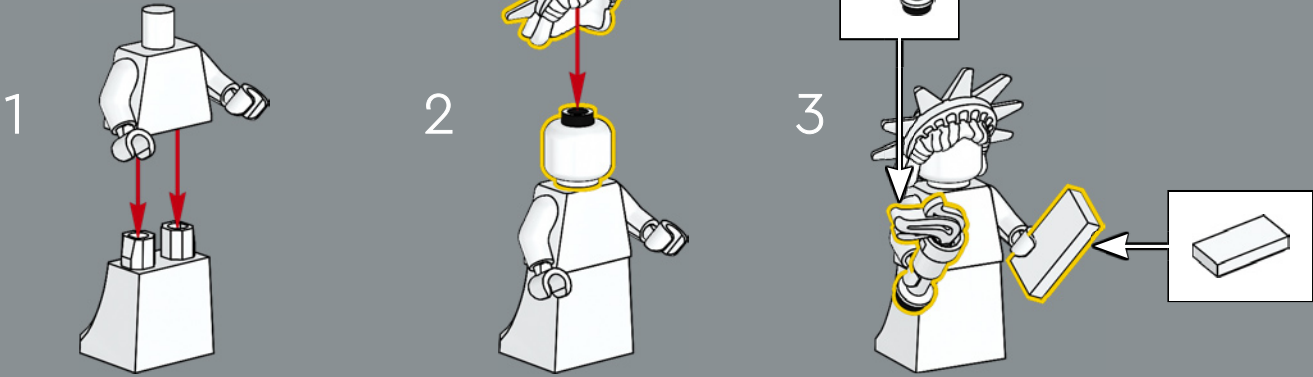

La Dama de la Libertad ya ha aparecido en formato de minifigura LEGO® en varias ocasiones: la primera vez fue en 2012.

359

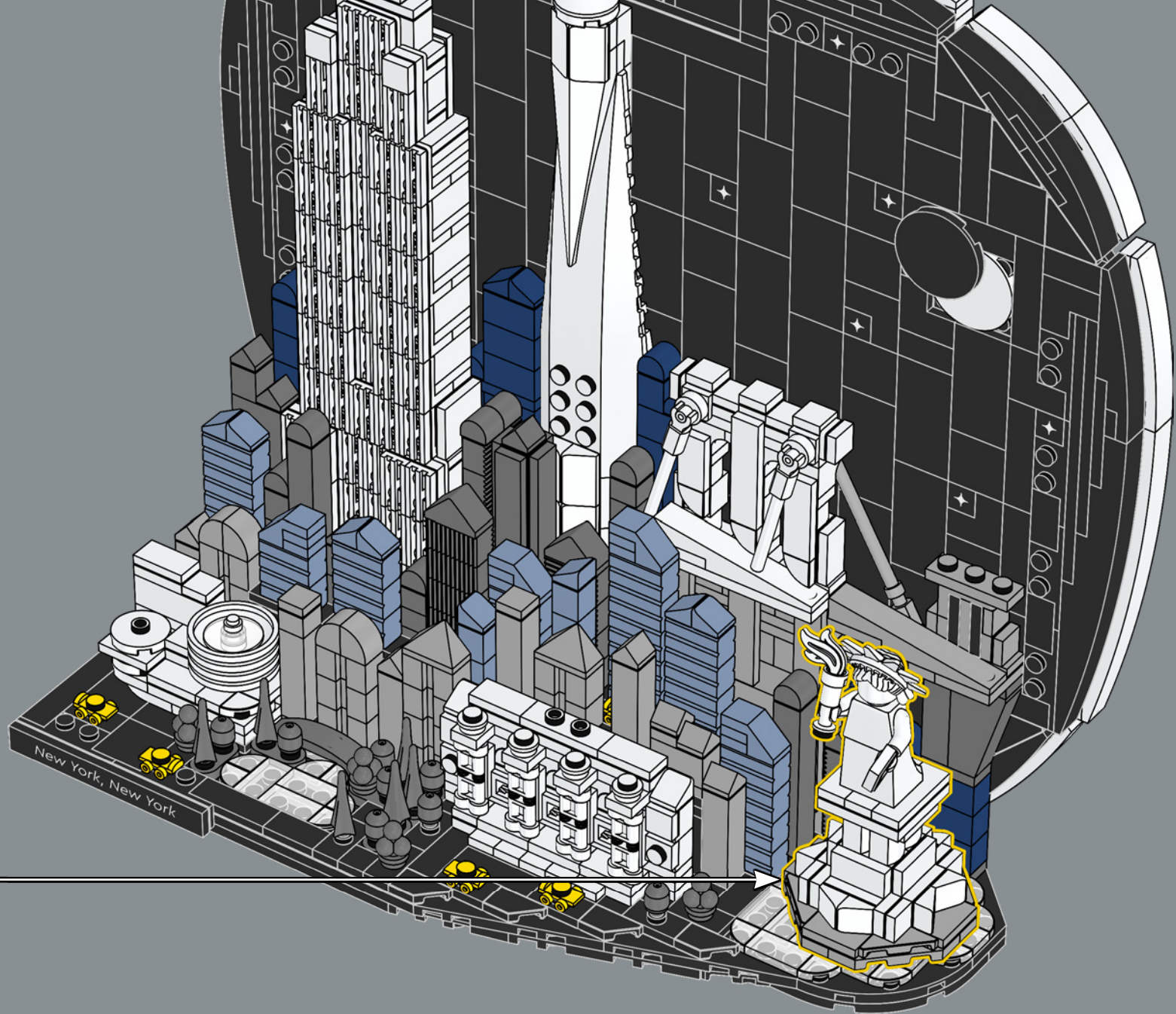

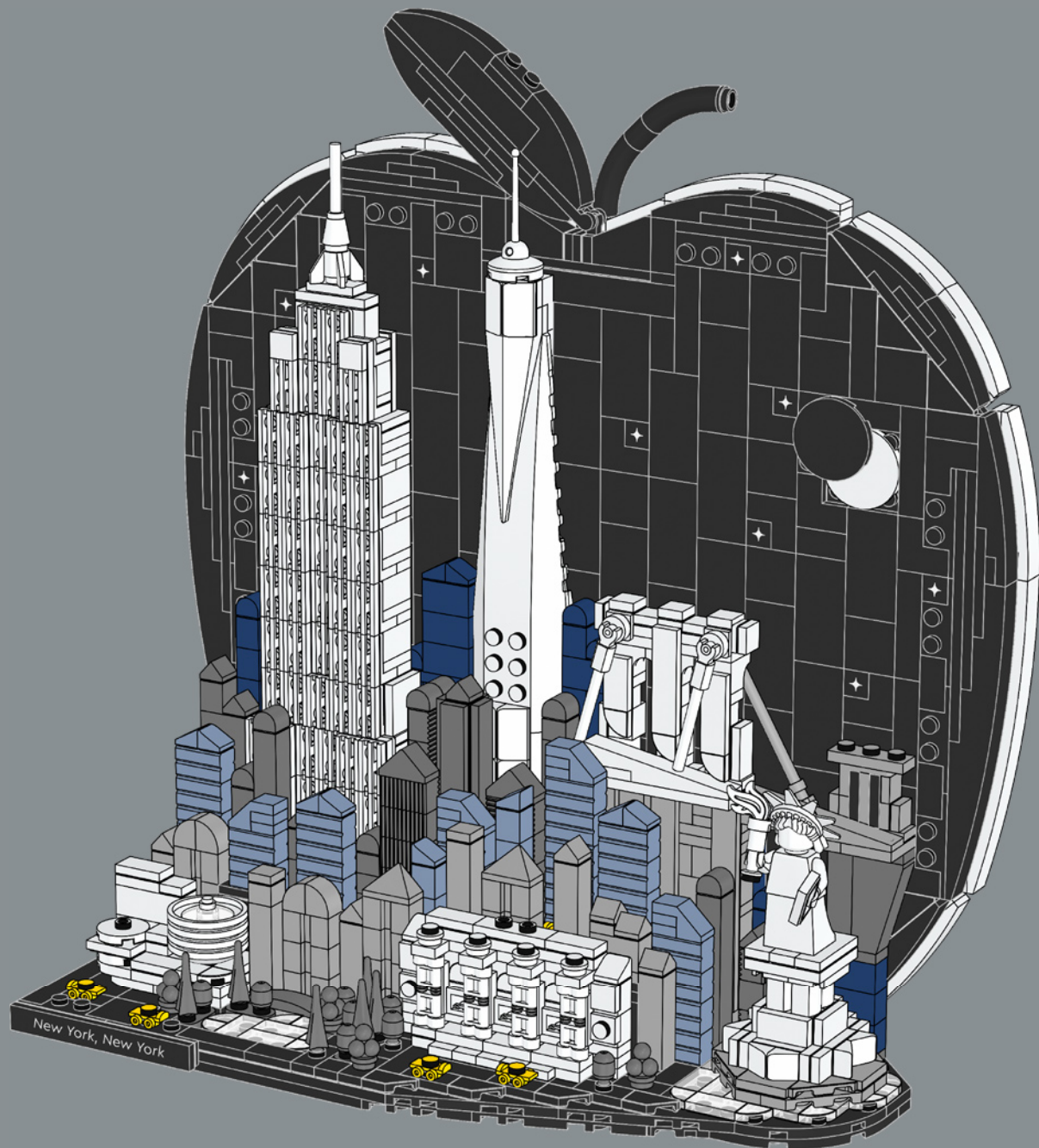

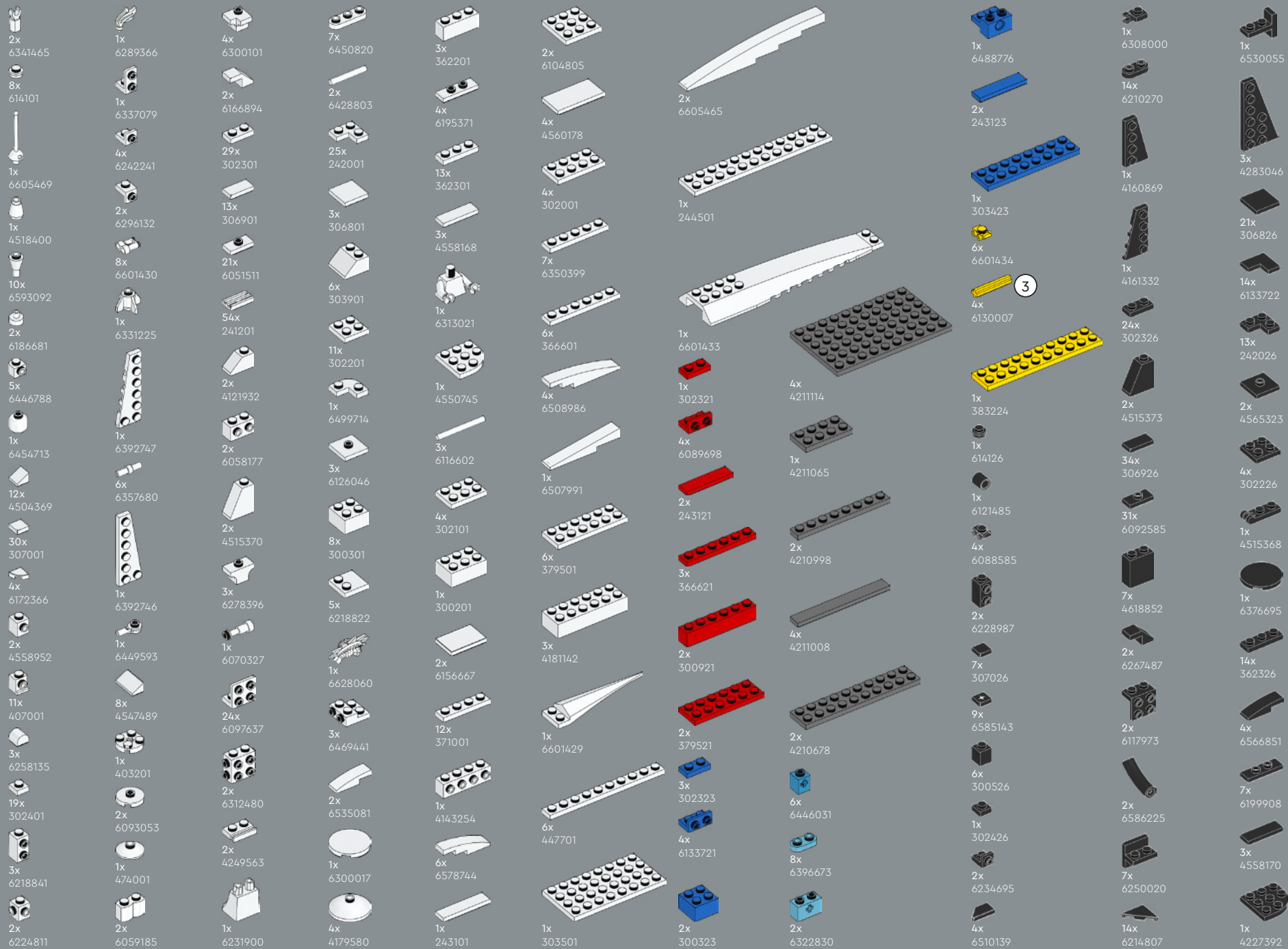

- 10x 6118829
- 2x 6168620
- 1x 4531412
- 6x 6580394
- 18x 243126
- 8x 371026
- 3x 4160025
- 1x 365926
- 1x 301026
- 2x 6039869
- 14x 302026
- 5x 663626
- 4x 6535144
- 5x 6184876
- 1x 366626
- 1x 4243819
- 1x 6101857
- 2x 4181144
- 57x 4560182
- 1x 6585142
- 8x 303226
- 2x 303426
- 1x 6037390
- 1x 4243819
- 1x 395826
- 2x 383226
- 6x 4514845
- 2x 302926
- 2x 6001494
- 2x 6601431
- 1x 4166619
- 1x 6372045
- 5x 346026
- 4x 379526
- 6x 4106977
- 2x 6509390
- 1x 6439175
- 8x 4504374
- 6x 6403899
- 6x 4255413
- 6x 6595205
- 15x 4249891
- 4x 6103405
- 6x 6233955
- 9x 4177735
- 3x 4264569
- 1x 6343976
- 13x 4211399
- 6x 6253436
- 2x 6401023
- 2x 6225242
- 2x 4211389
- 5x 4211415
- 4x 4211476
- 4x 6522869
- 7x 6061702
- 1x 6345639
- 2x 6075075
- 4x 6407767
- 4x 4211526
- 15x 4617170
- 2x 6383177
- 7x 4211398
- 1x 4211388
- 4x 6066097
- 4x 6134378
- 4x 6217876
- 14x 4211397
- 1x 4211387
- 1x 4211353
- 4x 4211413
- 2x 6569357
- 1x 4211429
- 4x 4211361
- 1x 6421522
- 4x 4160560
- 11x 4211445
- 1x 4211394
- 2x 4211356
- 6x 6015347
- 8x 6442144
- 1x 6170418
- 3x 4211393
- 3x 4211438
- 1x 6508016
- 4x 4243797
- 4x 4211452
- 2x 4211392
- 1x 4211481
- 4x 4211402
- 1x 4211401
- 4x 4662161
- 3x 4210690
- 2x 4210700
- 7x 6221607
- 2x 4226221
- 12x 6514469
- 1x 6514246
- 17x 6514223
- 8x 6062686
- 7x 4620077
- 8x 6257079
- 4x 6248952
- 28x 6417947
- 1x 383228
- 2x 302028
- 8x 6344216
- 16x 4210636
- 9x 4211063
- 3x 4210978
- 4x 6092572
- 10x 4211098
- 5x 6262021
- 7x 6333129
- 1x 4210719
- 5x 6388133
- 1x 4211104
- 5x 4211133
- 1x 4648256
- 1x 4500975
- 1x 6336990
- 2x 4211104
- 5x 4211133
- 1x 4648256
- 1x 6240515



[LEGO.com/service](https://www.LEGO.com/service)



**YOU** COULD  
**WIN**



**YOU COULD  
WIN**

Your feedback will help shape the future development of this product series.

Visit:

**DU KÖNNTEST  
GEWINNEN**

Dein Feedback trägt zur Weiterentwicklung dieser Produktreihe bei.

Geh auf:

**VOUS POURRIEZ  
GAGNER**

Vos commentaires nous aideront à concevoir les futurs produits de cette gamme.

Visitez :

**POTRESTI  
VINCERE TU**

La tua opinione ci aiuterà a migliorare la creazione futura di questa linea di prodotti.

Visita:

**PUEDES  
GANAR**

Tu opinión contribuirá al futuro de esta serie de productos.

Visita:

**轻松获奖**

您的反馈将有助于我们在今后改进本产品系列。

请访问:

---

**LEGO.com/productfeedback**

---

You also have the chance to win a LEGO® set.

Terms and conditions apply.\*

Außerdem hast du die Chance, ein LEGO® Set zu gewinnen.

Es gelten die Teilnahmebedingungen.\*

Vous pourriez également gagner un ensemble LEGO®.

Des conditions s'appliquent.\*

Hai anche la possibilità di vincere un set LEGO®.

Termini e condizioni sono applicabili.\*

También tienes la oportunidad de ganar un set LEGO®.

Aplican términos y condiciones.\*

您还有机会赢取乐高®套装。

条款和条件适用。\*

\*LEGO.com/productfeedback-terms

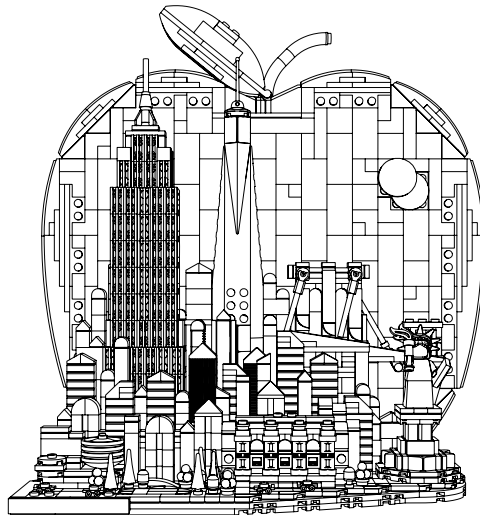

LEGO and the LEGO logo are trademarks of the LEGO Group. ©2026 The LEGO Group.

The EMPIRE STATE BUILDING name and image are registered trademarks and used with permission.

The name and building image of the Solomon R. Guggenheim Museum are trademarks of the Solomon R. Guggenheim Foundation. Used with permission.

® /™ /© Frank Lloyd Wright Foundation. All Rights Reserved.

One World Trade Center building design is a copyright of WTC Tower 1 LLC. Used under license.

Adam Reed Tucker is the co-developer of the LEGO® Architecture product line.