



21066





LEGO.com/sustainable-packaging



FR
DONNEZ
OU
RECYCLEZ



ASSOCIATION

OU



MAGASIN

OU



DÉCHÈTERIE

Adresses sur quefairedemesdechets.fr



BUILDER



Apple and the Apple logo are trademarks of Apple Inc., registered in the U.S. and other countries and regions. App Store is a service mark of Apple Inc. Google Play and the Google Play logo are trademarks of Google LLC. Tencent and the Tencent logo are trademarks of Tencent Inc.

LEGO.com/devicecheck

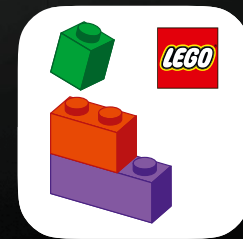

LEGO® Builder



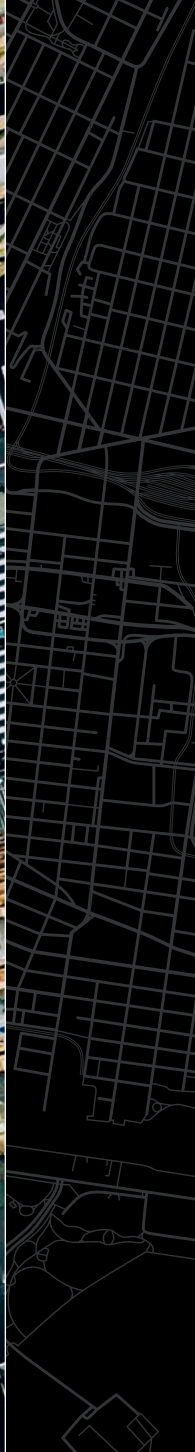



THE BIG APPLE

New York, New York – die Stadt, die niemals schläft, Stadt der Träume, der Big Apple – die Stadt, die unter vielen Namen bekannt ist als Ort grenzenloser Energie und Möglichkeiten. Die Stadt wurde 1624 unter dem Namen „New Amsterdam“ gegründet und hat sich zu einem pulsierenden Leuchtturm für Kultur, Handel, Kunst und Innovation entwickelt. Die berühmte Skyline von New York City zeichnet sich durch unverkennbare Wahrzeichen aus, die über die fünf Stadtbezirke verteilt sind. Von der Freiheitsstatue, die Neuankömmlinge willkommen heißt, bis hin zu den belebten Straßen, die uns dazu inspirieren, unsere Träume zu verwirklichen – der einzigartige Puls der Stadt erobert die Herzen von Besuchern und Einwohnern gleichermaßen. Allein im Stadtteil Manhattan leben über 1,5 Millionen Menschen auf einer Fläche von nur 59 km², was ihn zu einem der am dichtesten besiedelten Orte der Welt macht. Ganz gleich, ob dich die strahlenden Lichter und das pulsierende Leben der Stadt oder die ruhigen Wege im Central Park anziehen – der Geist der Stadt, ihre reiche Geschichte und ihre Vielfalt werden garantiert einen bleibenden Eindruck hinterlassen.

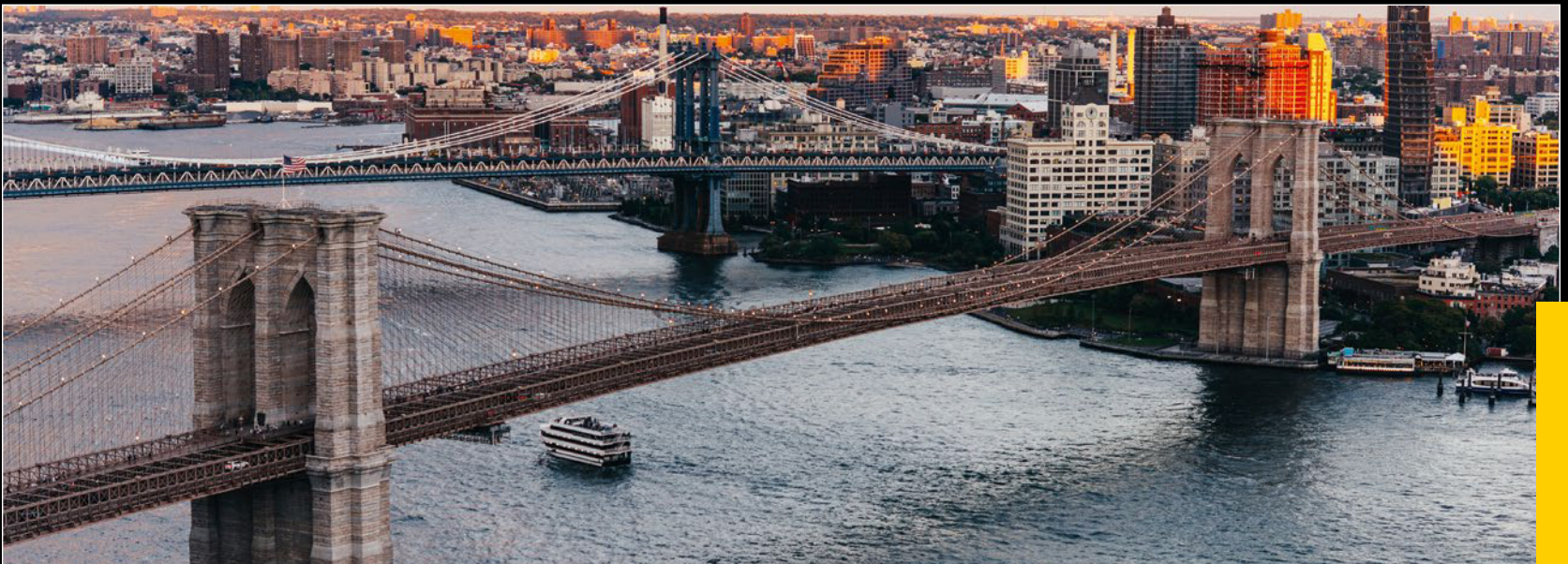



ONE WORLD TRADE CENTER (2014)

Bis heute ist das One World Trade Center das höchste Gebäude der westlichen Hemisphäre und wurde als Symbol für Einheit und Resilienz gebaut.



EMPIRE STATE BUILDING (1931)

Das 102-stöckige Wahrzeichen New Yorks bietet einen atemberaubenden Blick auf die Stadt aus dem Herzen von Midtown Manhattan.



METROPOLITAN MUSEUM OF ART (1870)

Das 1870 gegründete Met ist eines der größten Museen der Welt und präsentiert Kunstgeschichte aus über 5.000 Jahren sowie moderne Meisterwerke.



SOLOMON R. GUGGENHEIM MUSEUM (1959)

Seit seiner Eröffnung ist das Museum mit seiner spiralförmigen Architektur für seine erstklassige Sammlung moderner und zeitgenössischer Kunst bekannt.

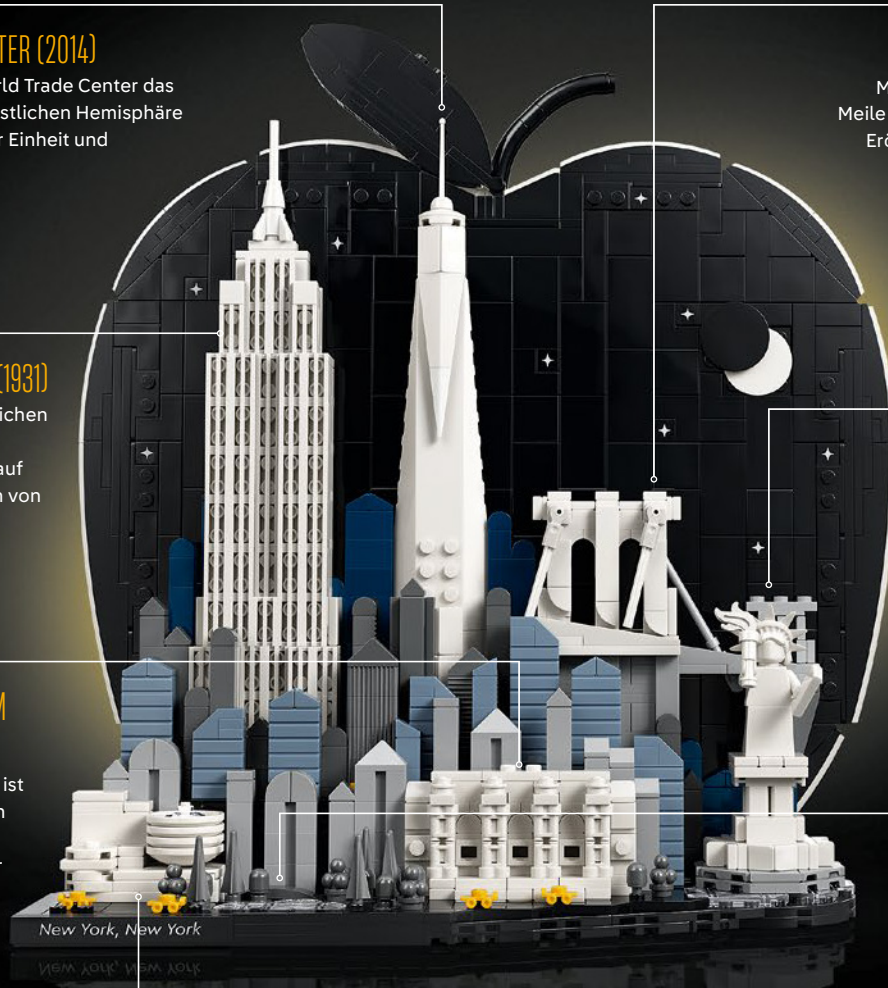

BROOKLYN BRIDGE (1883)

Mit einer Länge von mehr als einer Meile war die Brooklyn Bridge bei ihrer Eröffnung die längste Hängebrücke der Welt.



FREIHEITSSTATUE (1886)

Die imposante neoklassizistische Statue steht auf Liberty Island im New Yorker Hafen, der einst als berühmtester Einreisehafen der USA galt.



CENTRAL PARK (1858)

Der Central Park empfängt jährlich 42 Millionen Besucher auf seinen 341,1 Hektar mit Wiesen, Wanderwegen und Seen.



ANMERKUNGEN DES LEGO® ARCHITECTURE DESIGNTEAMS

2026 jährt sich die Unterzeichnung der Unabhängigkeitserklärung der Vereinigten Staaten zum 250. Mal UND unser erstes LEGO® Architecture Set „New York City Skyline“ feiert sein 10-jähriges Jubiläum! Das hat uns dazu angeregt, beide Anlässe zu feiern und berühmte New Yorker Sehenswürdigkeiten vor dem Hintergrund des „Big Apple“ vor einem Nachthimmel neu zu interpretieren. Wir haben facettierte Elemente verwendet, um die komplexe Geometrie des One World Trade Center nachzubilden, das auf den „Schultern“ des Empire State Building ruht und sich nach oben hin verjüngt. Die Fenster und die langen, nach oben verlaufenden Art-déco-Linien des Empire State Building bestehen aus LEGO Gitterplatten. Bei der Darstellung der Brooklyn Bridge wird mit einem Effekt der erzwungenen Perspektive gespielt, indem die Größe drastisch verändert wurde, bei beiden Türmen Farbvariationen hinzugefügt wurden und die Straße leicht schräg dargestellt wird. Mit weiteren bekannten Details, wie der Minifigur „Lady Liberty“, wünschen wir euch viel Spaß beim Bauen und bei der Erkundung dieser großartigen Stadt!



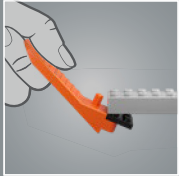
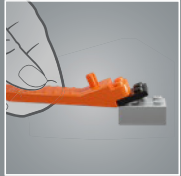
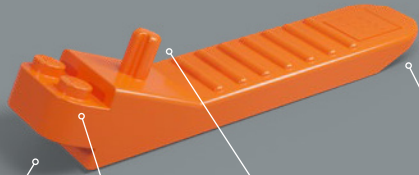

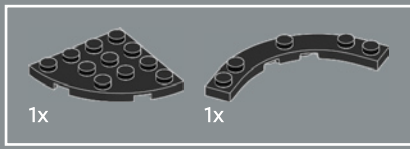

1

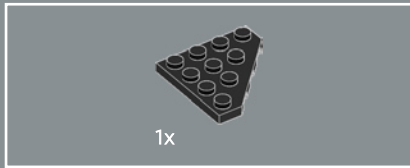
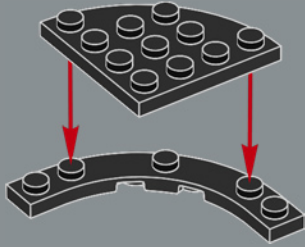

2

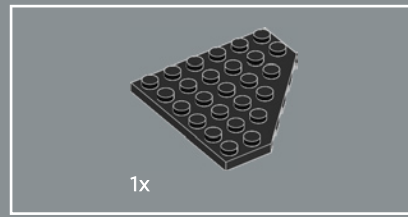
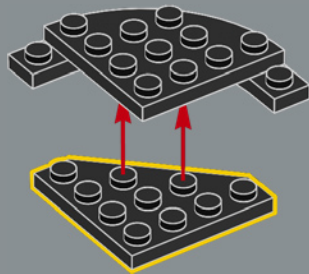

3

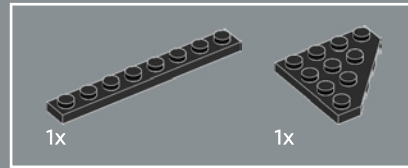
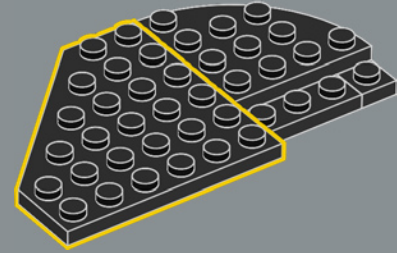

4

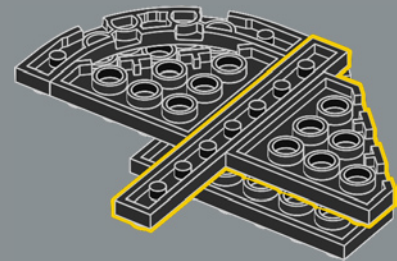

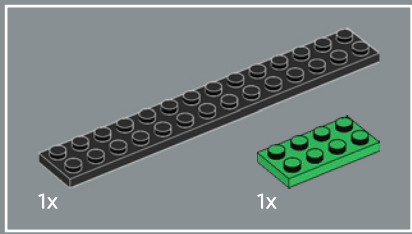

5

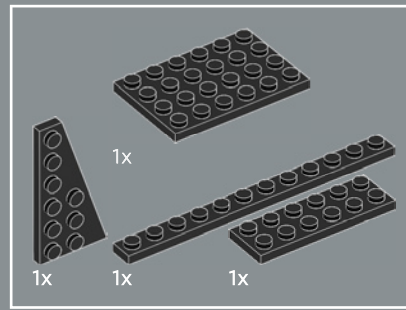
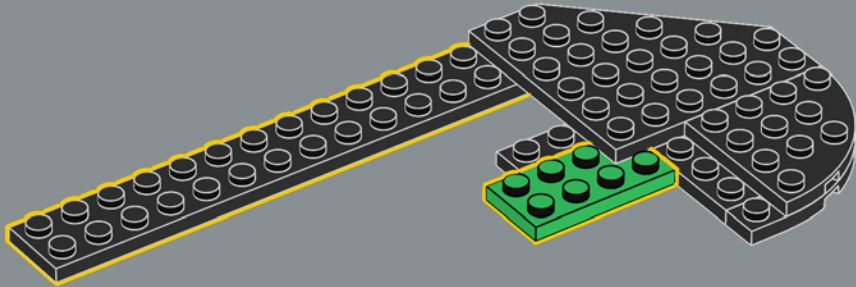

6

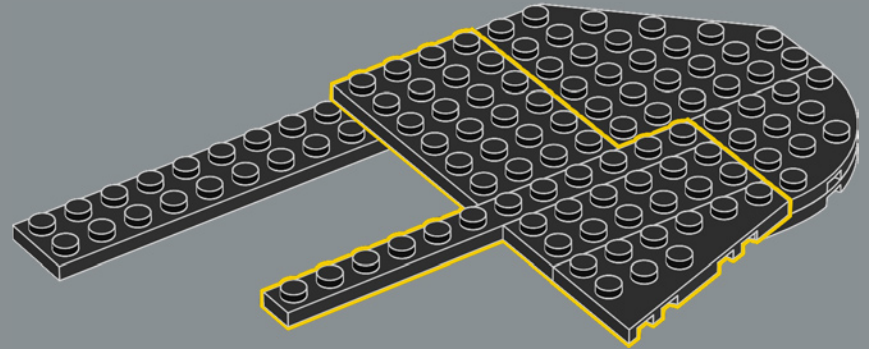

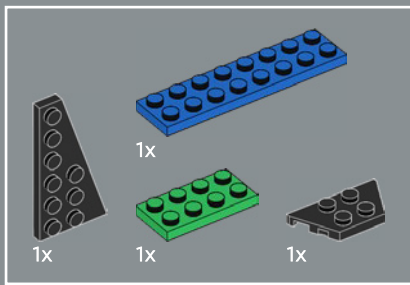

7

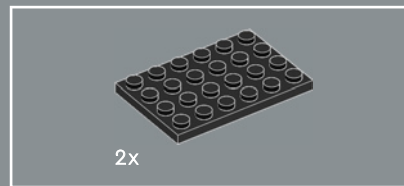
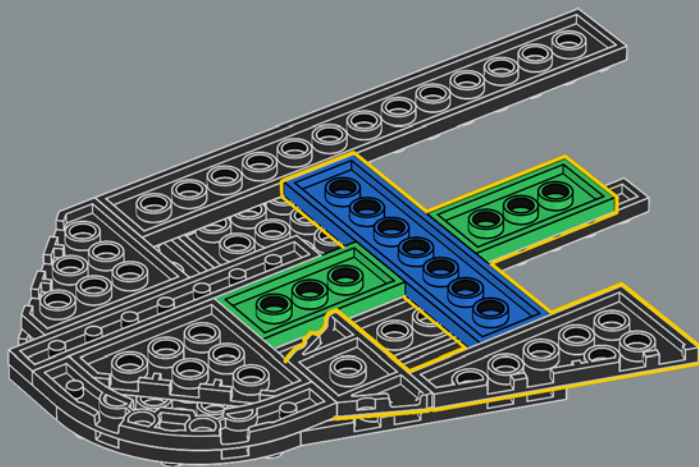

8

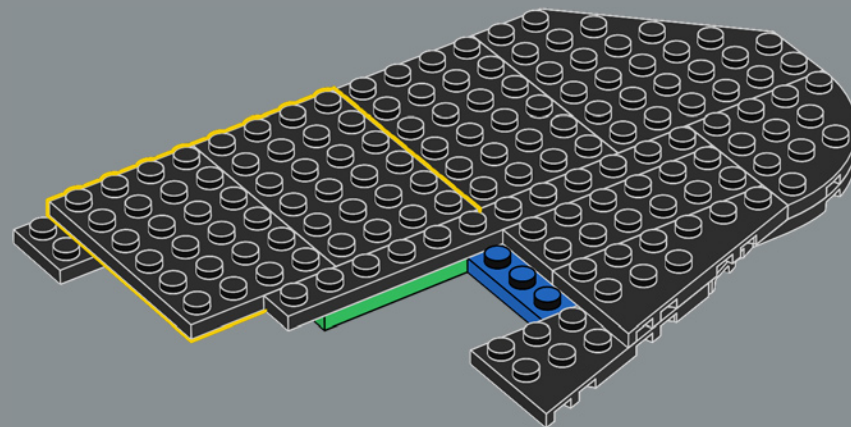

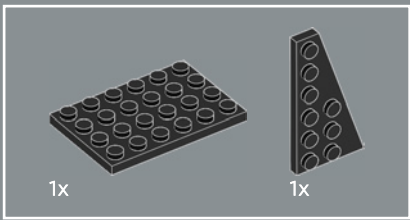

9

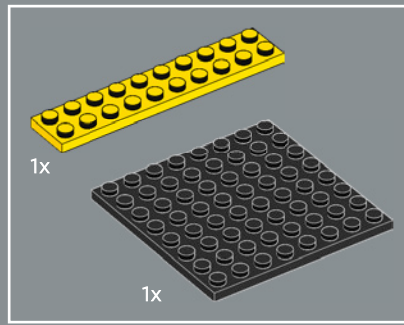
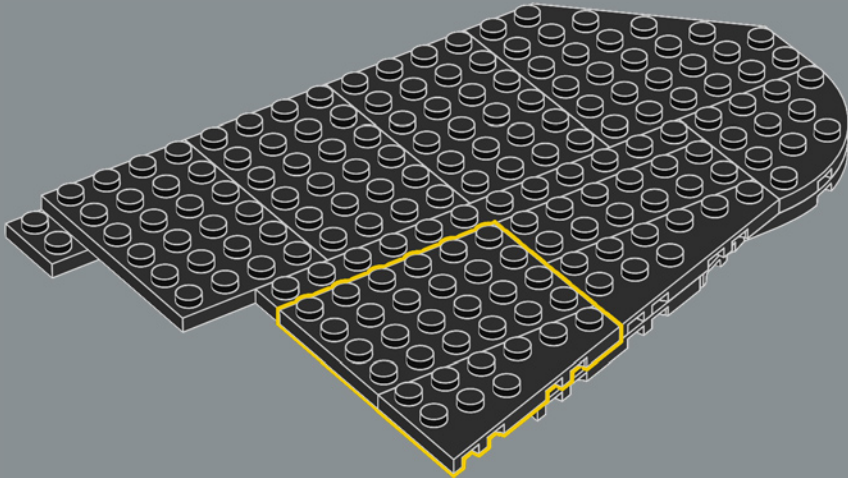

10

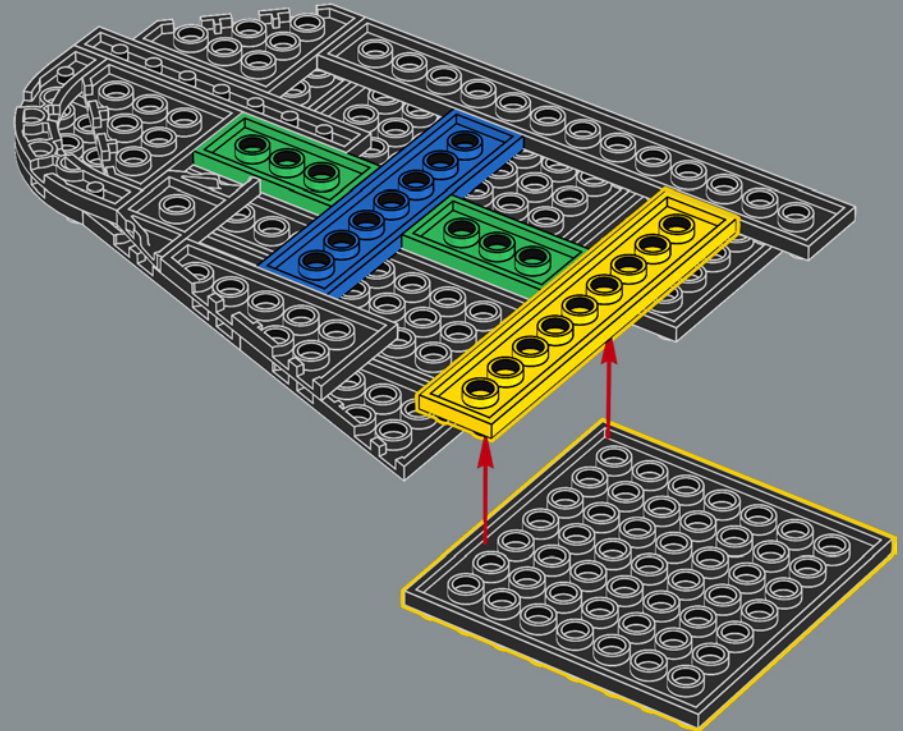

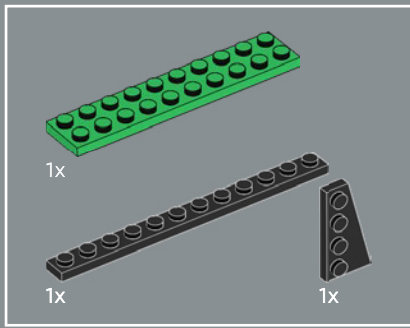

11

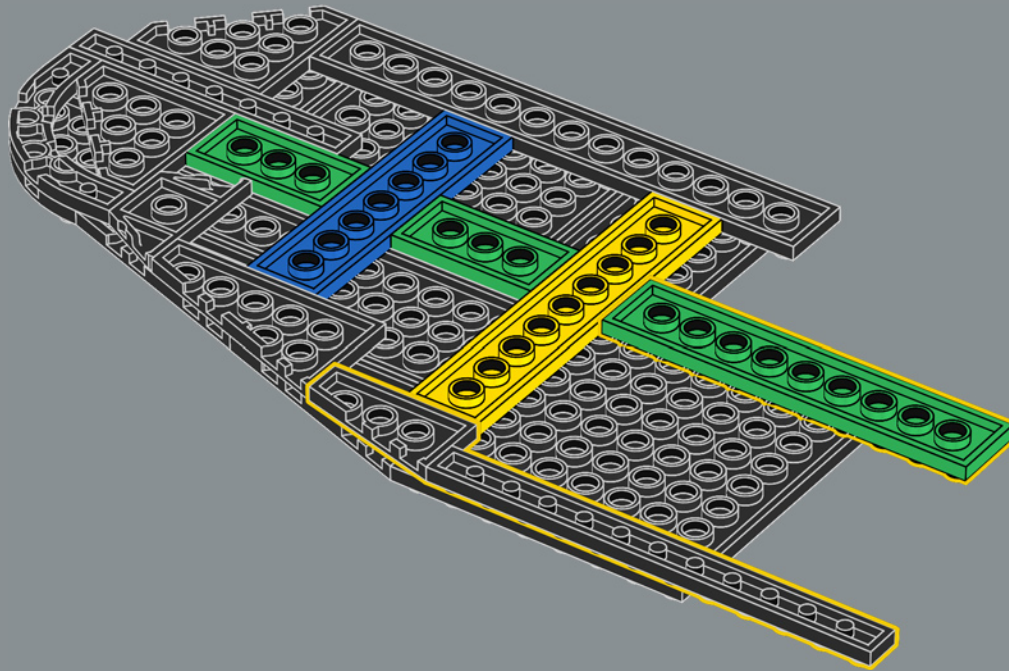

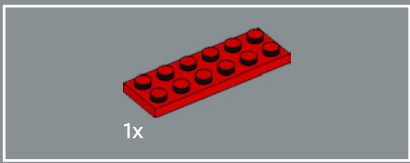

12

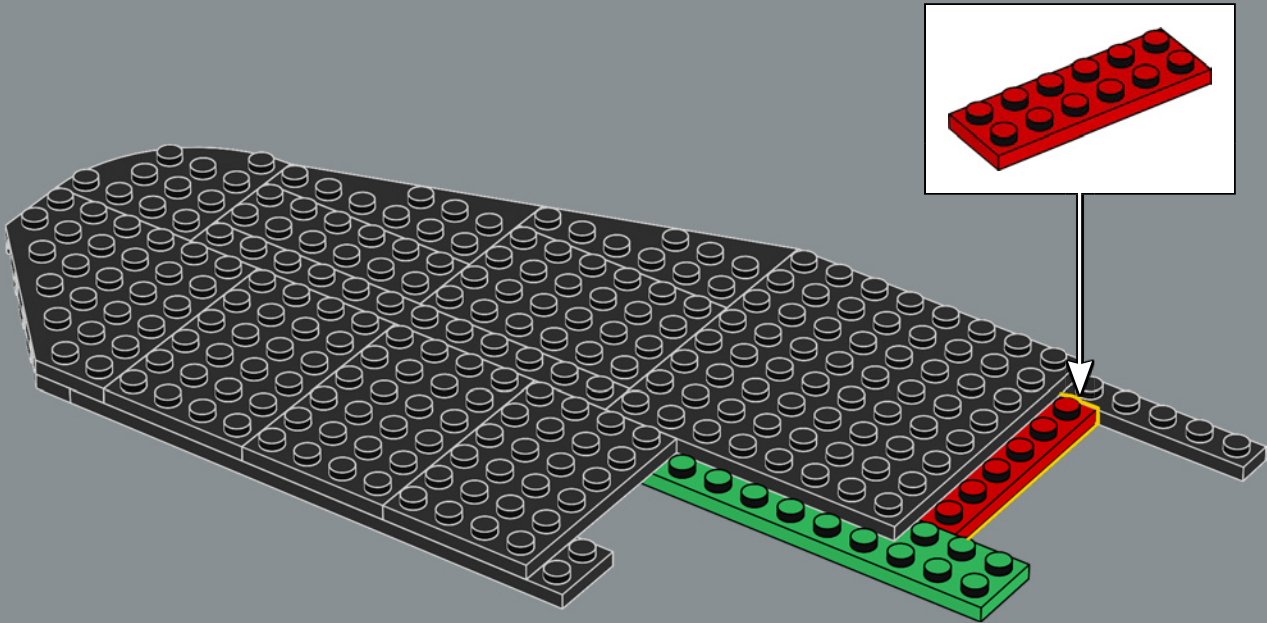

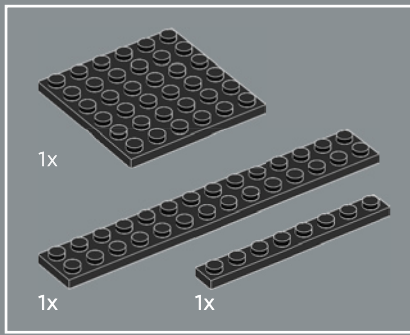

13

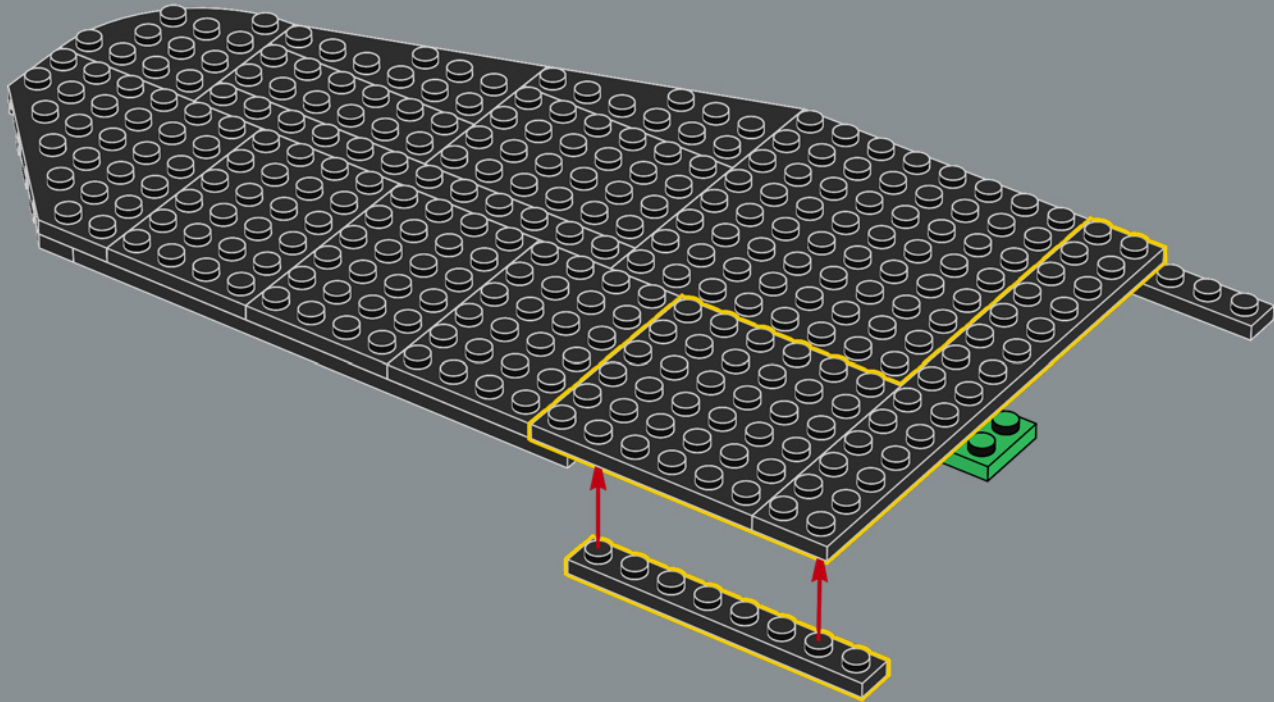

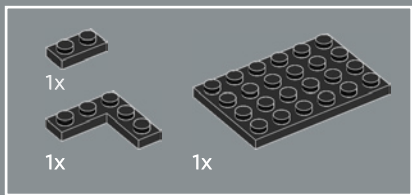

14

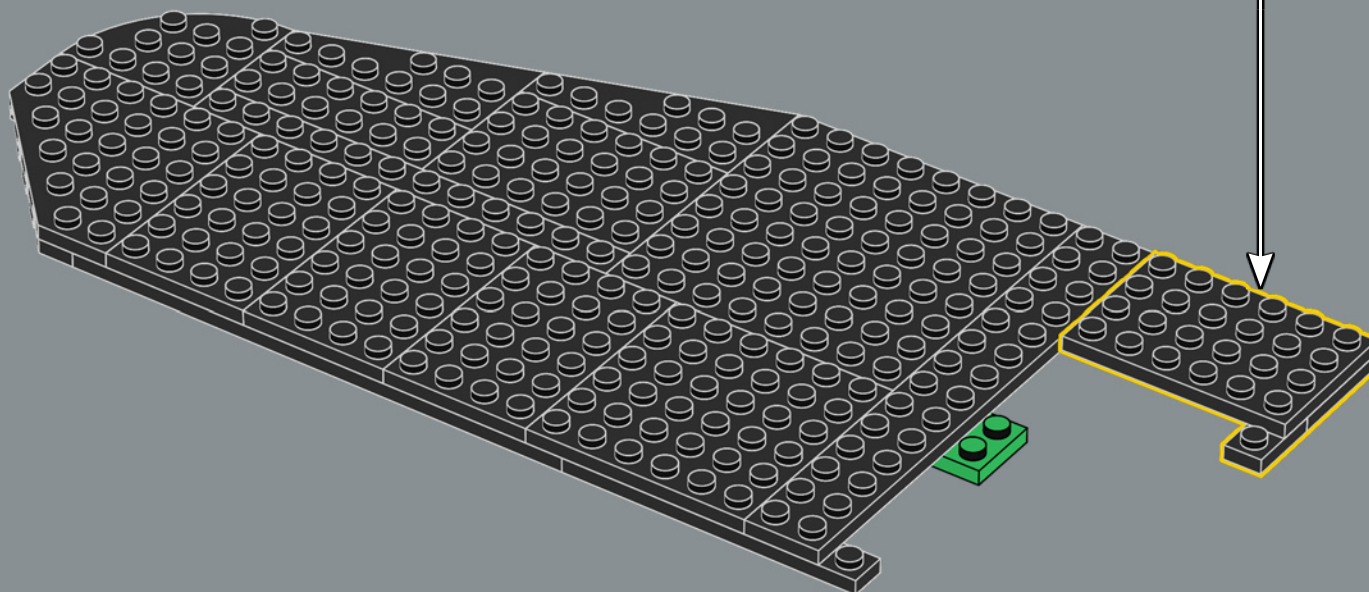
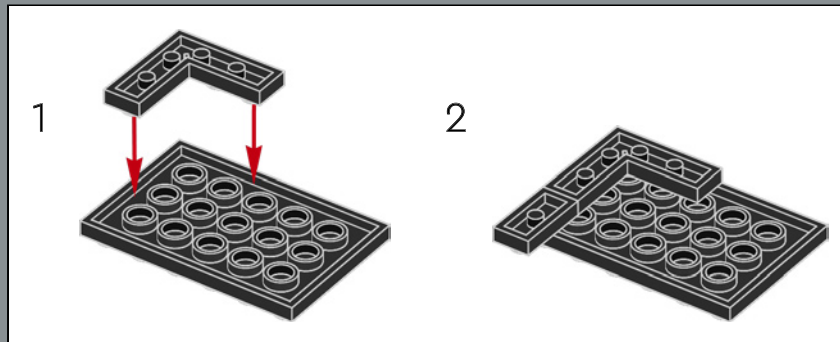

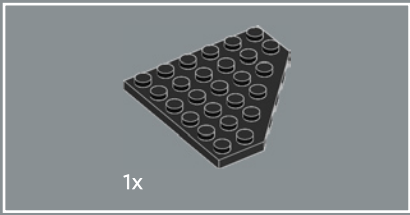

15

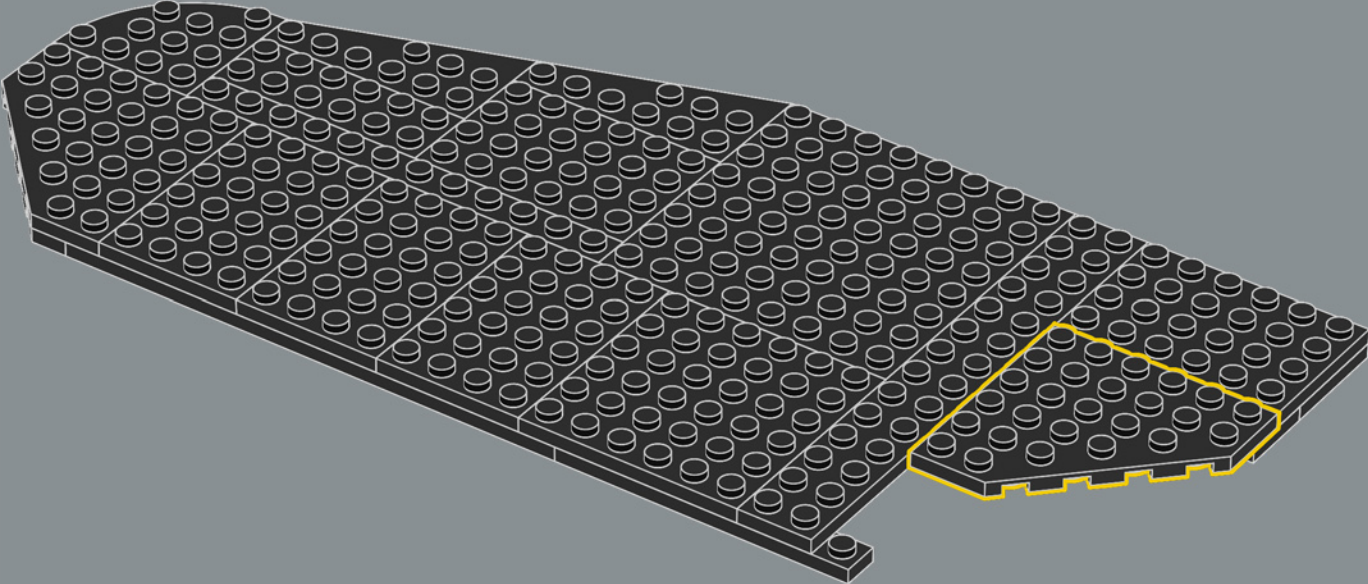

Die bunten LEGO® Platten im Sockel sind von einigen der 36 U-Bahn-Linien inspiriert, die die Stadt verbinden.

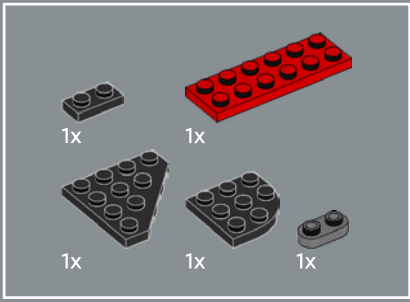

16

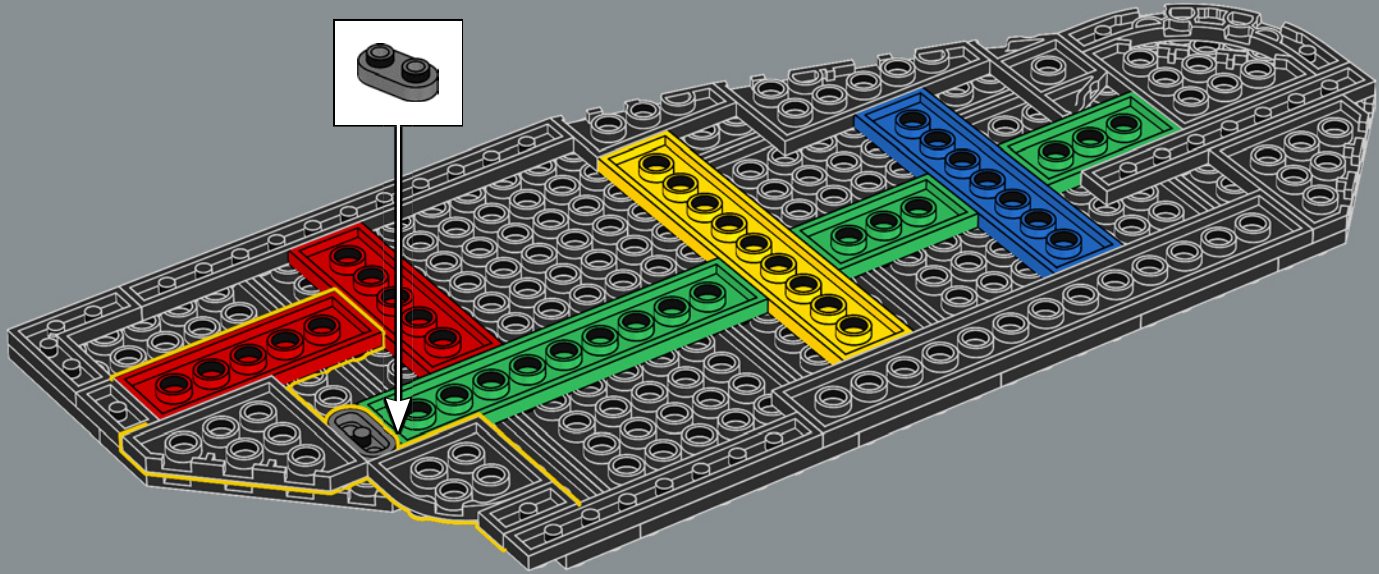

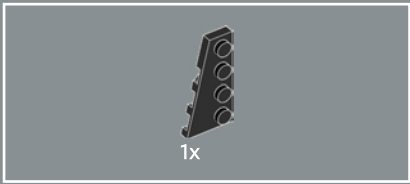

17

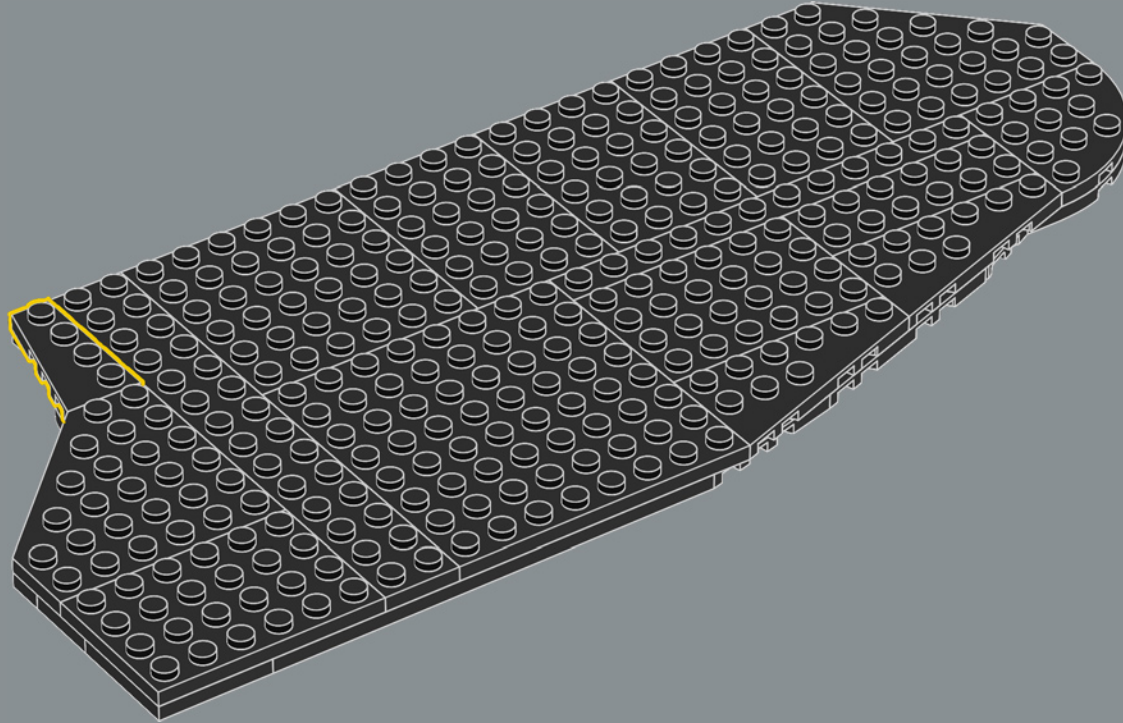

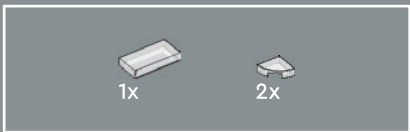

18



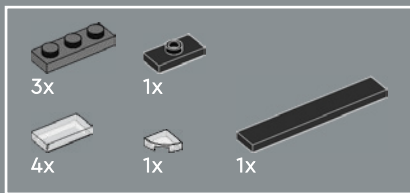

19

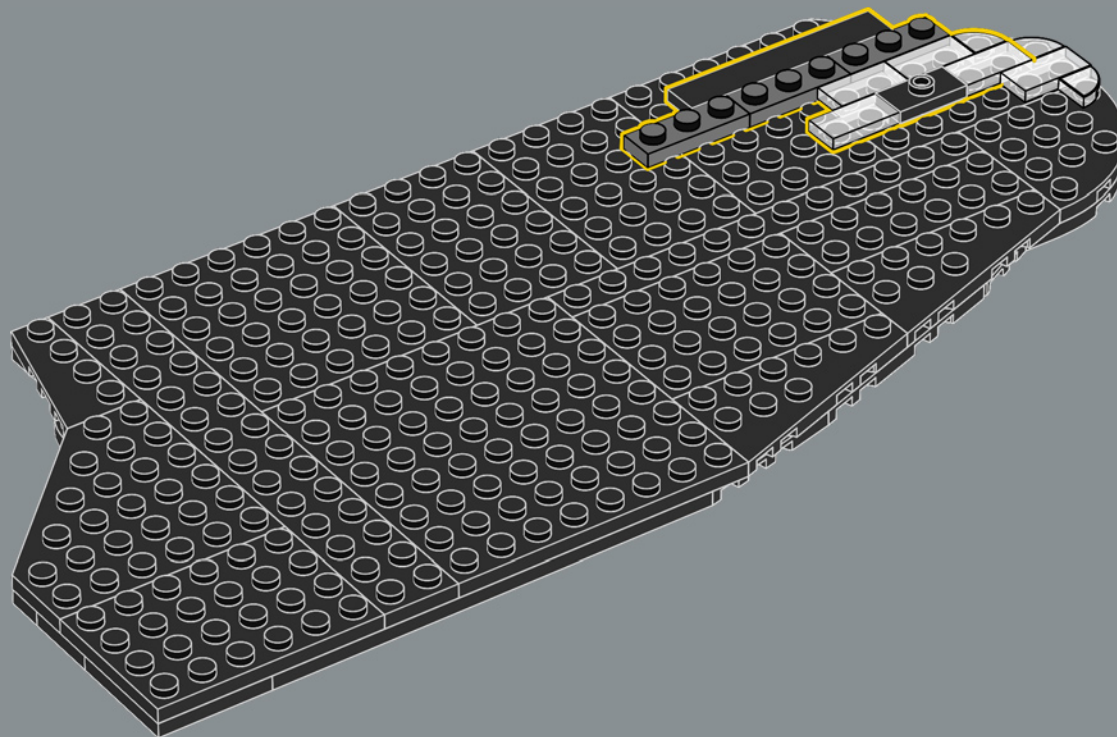

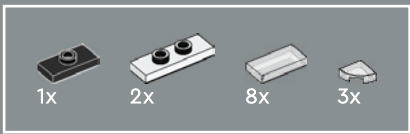

20

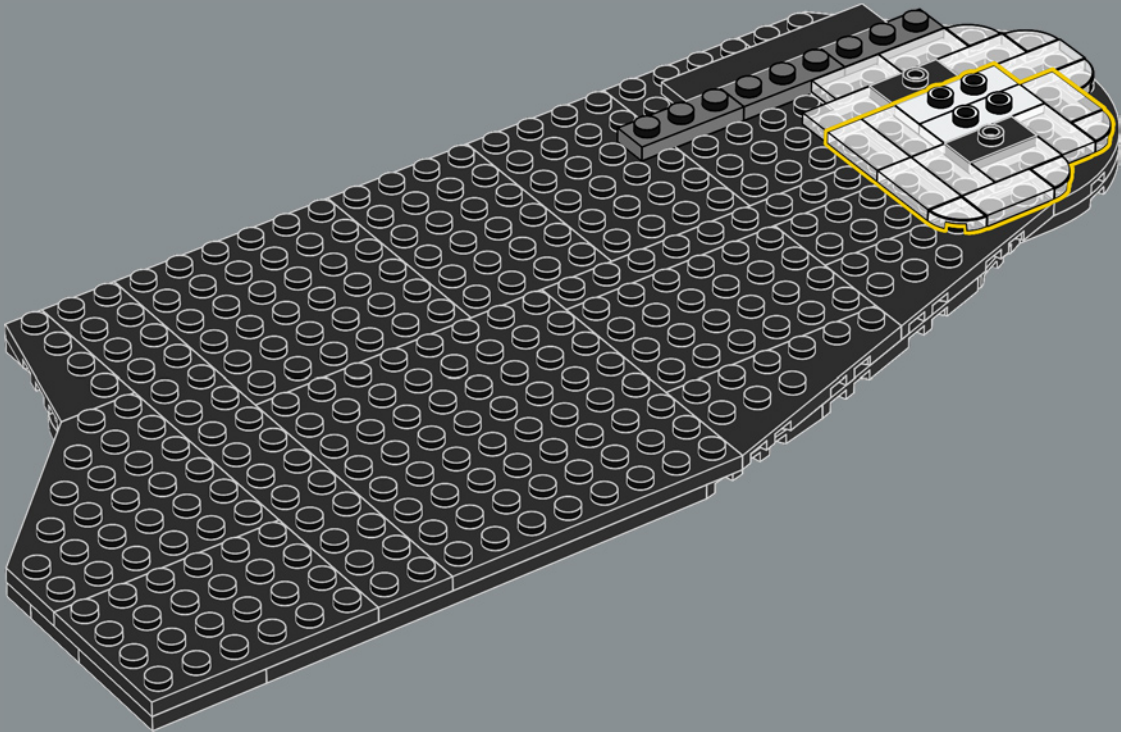

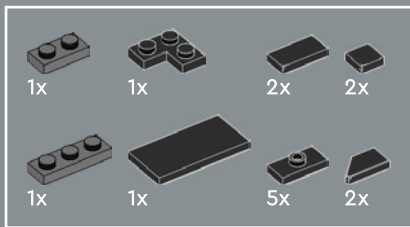

21

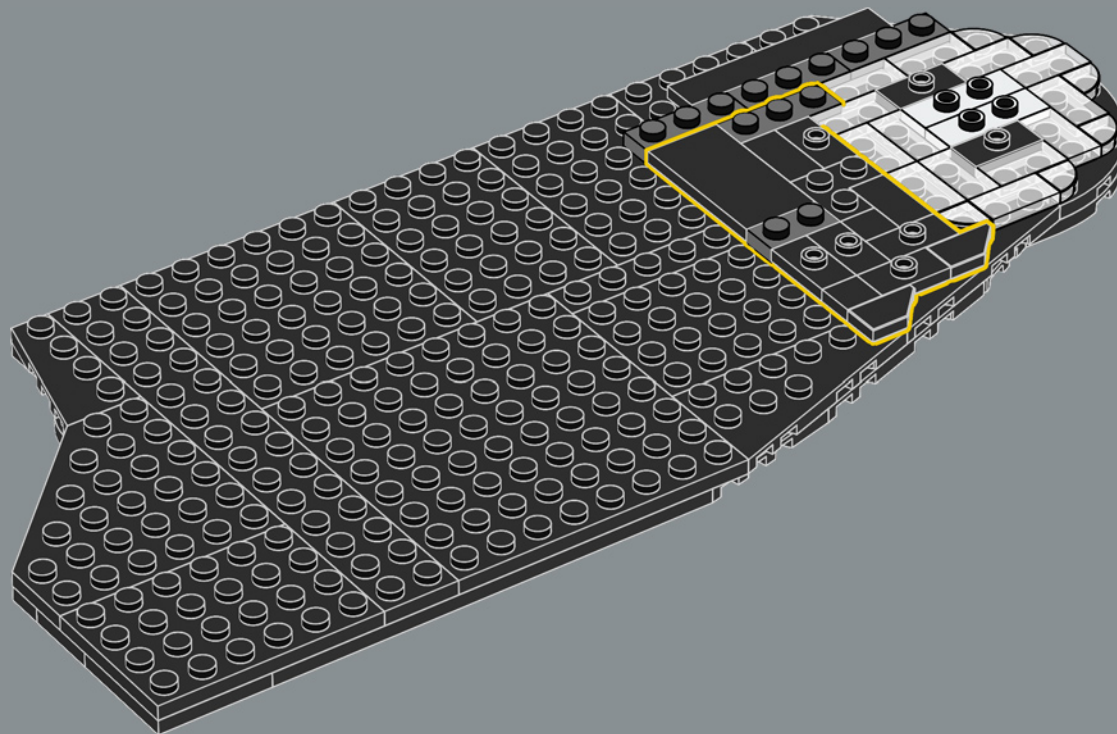

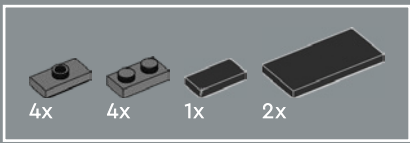

22

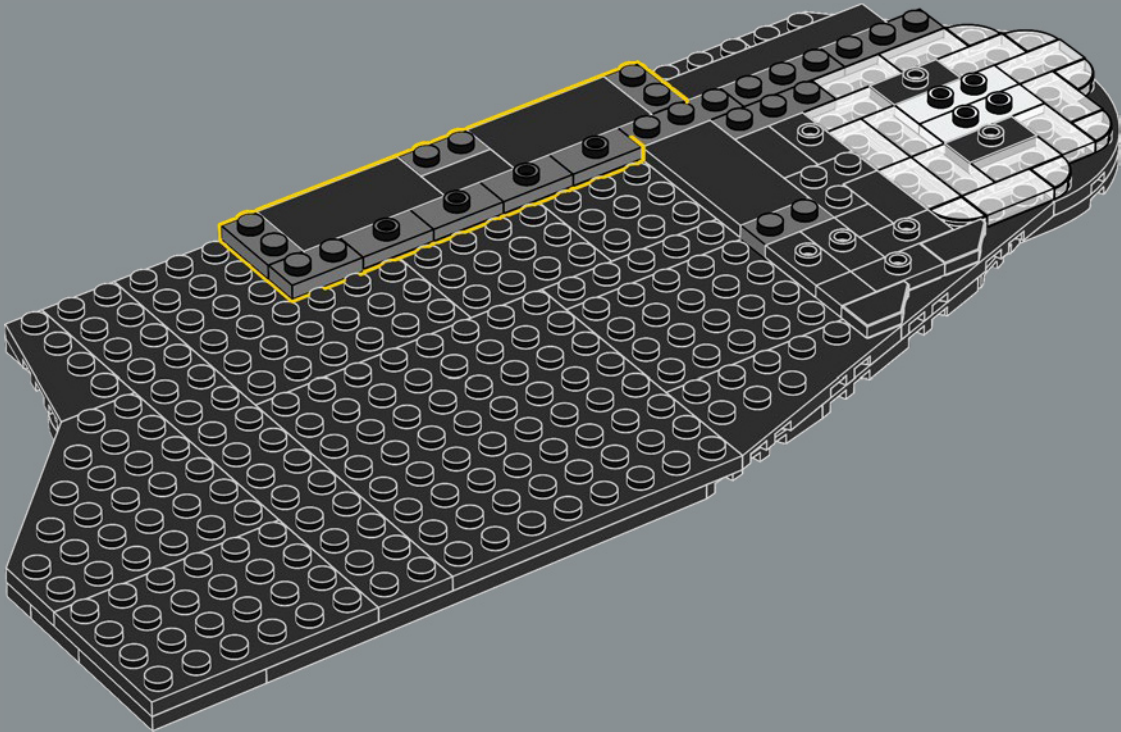

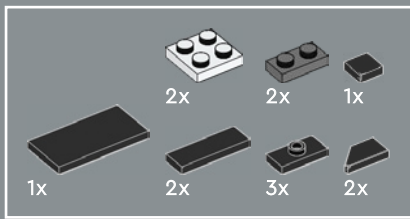

23

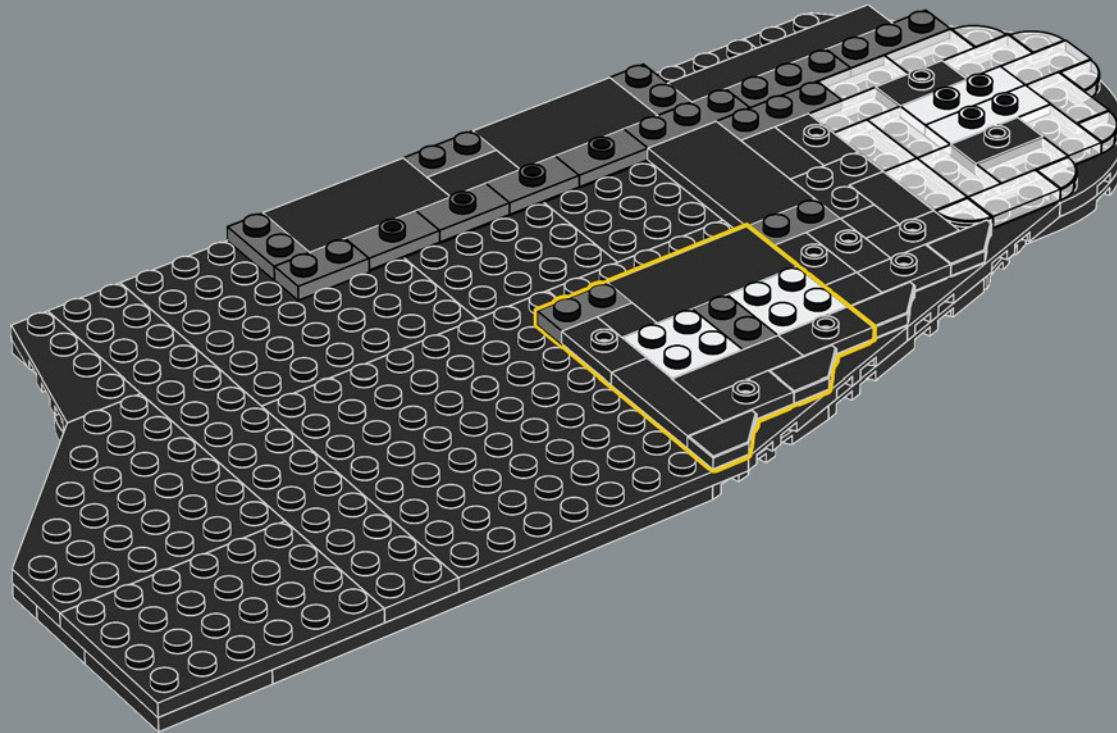

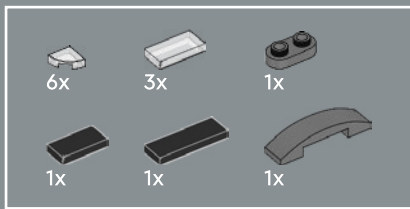

25

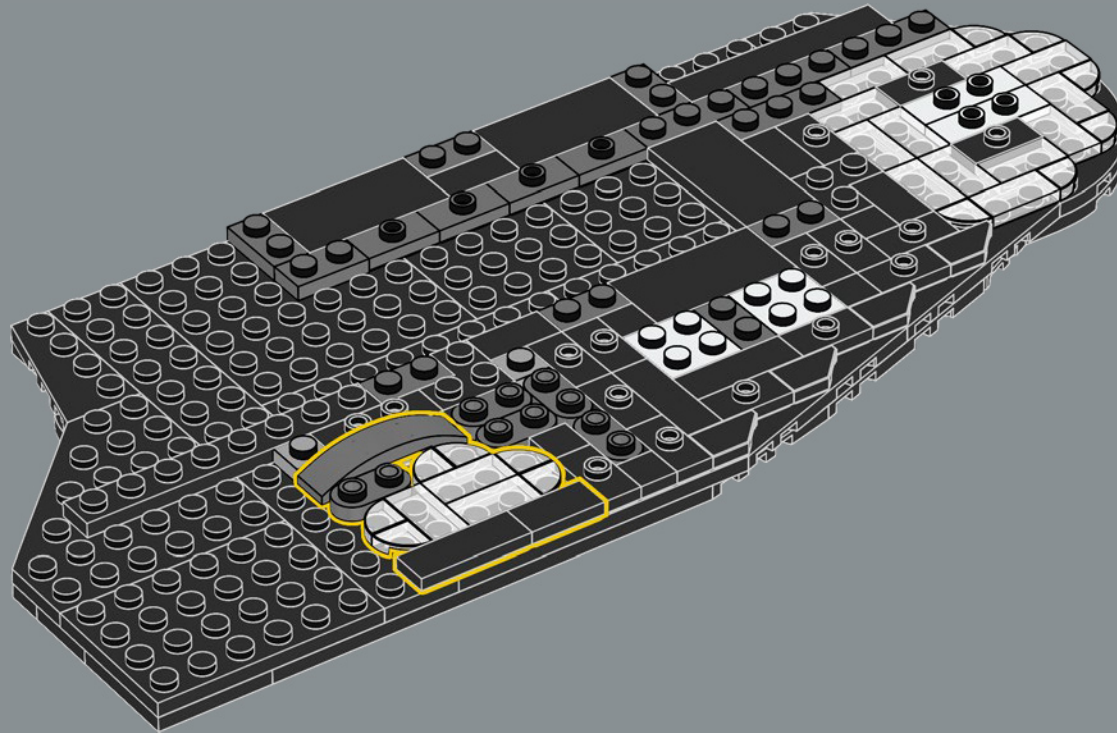

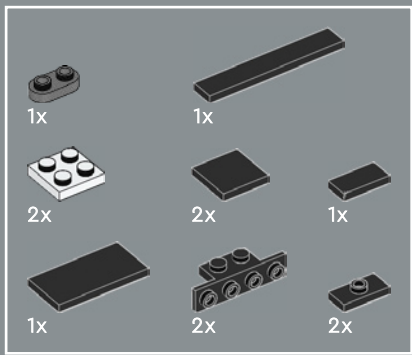

26

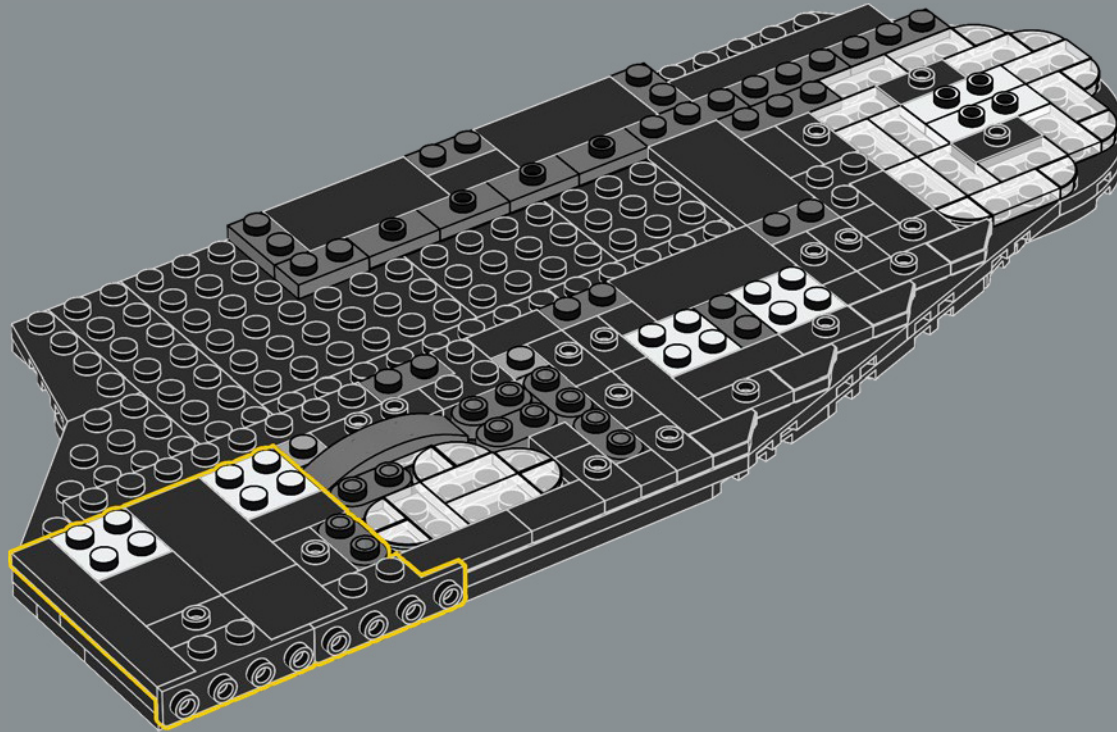

Die Grundlage des Modells ist inspiriert von der Insel Manhattan, dem größten Stadtbezirk New Yorks.

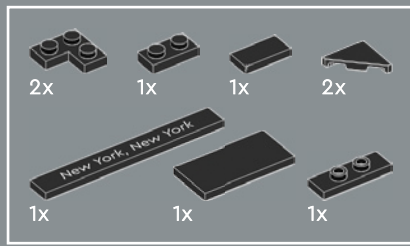

27

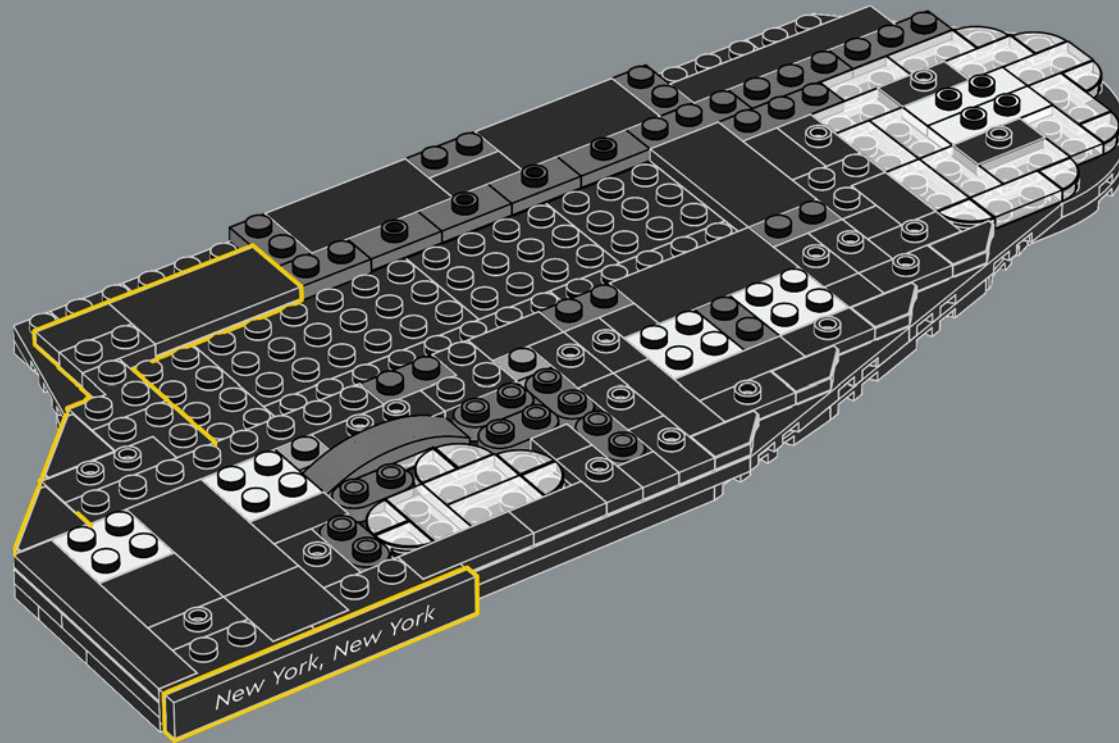

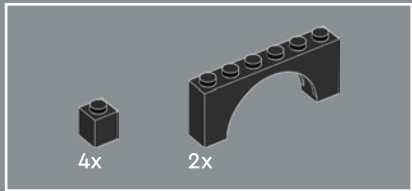

28

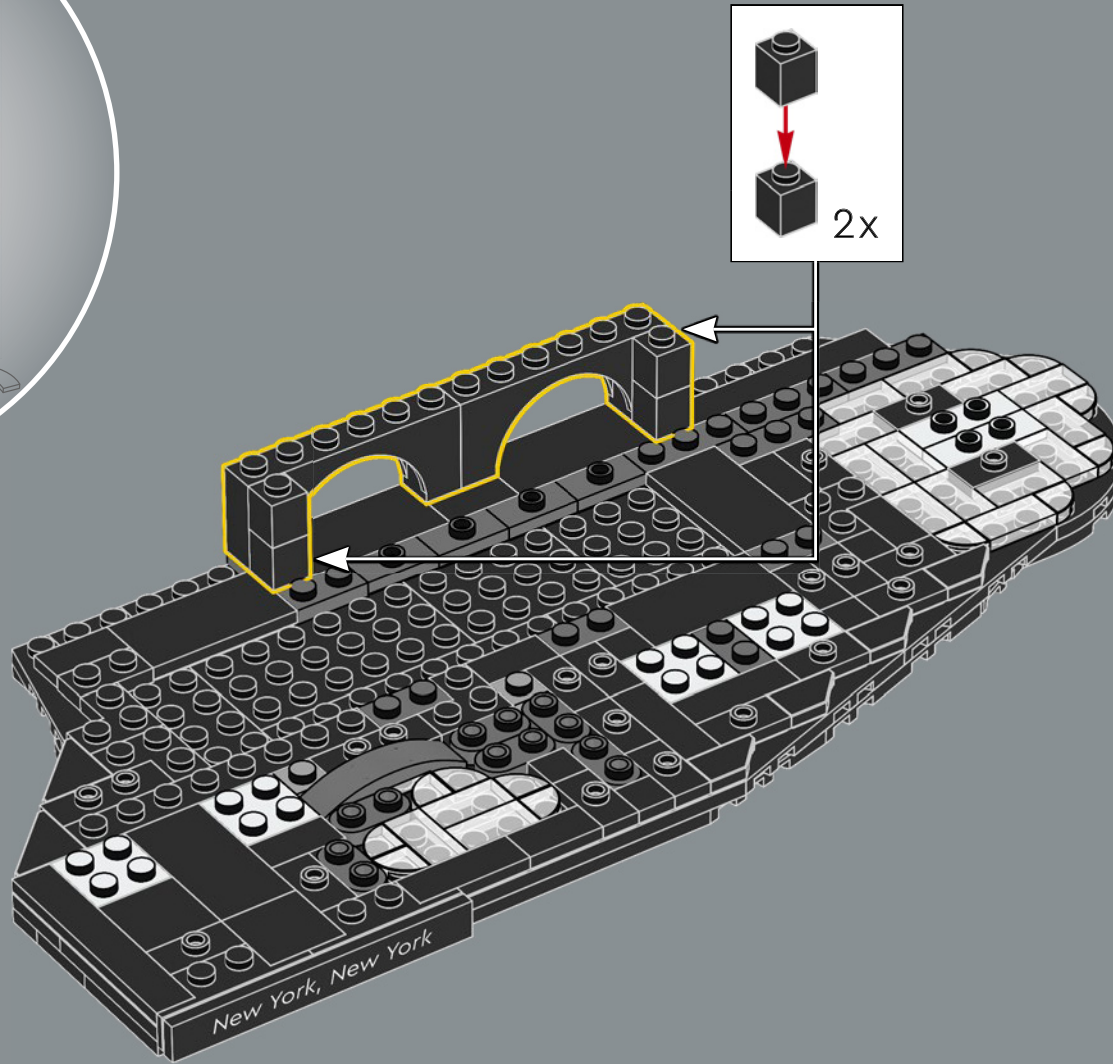

Würde man die gesamten 1.355 km Schienen des New Yorker U-Bahn-Netzes in einer geraden Linie auslegen, würden sie von New York City bis nach Chicago reichen.



29

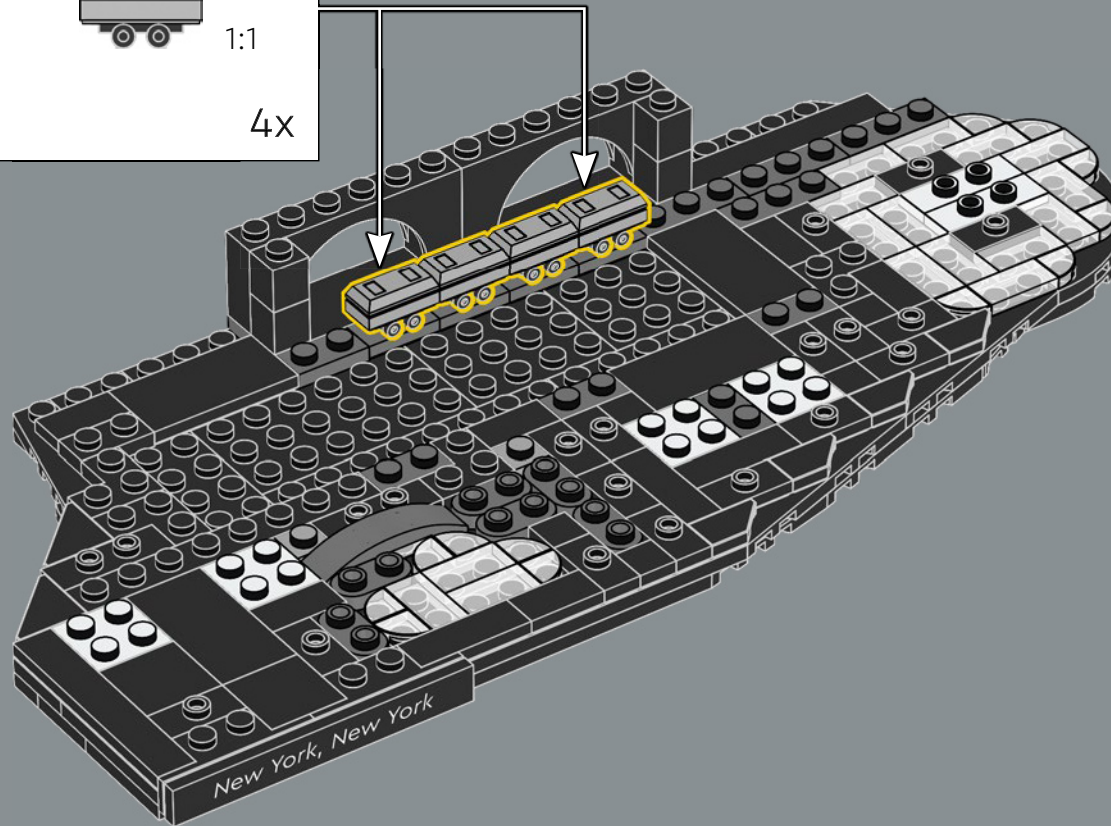
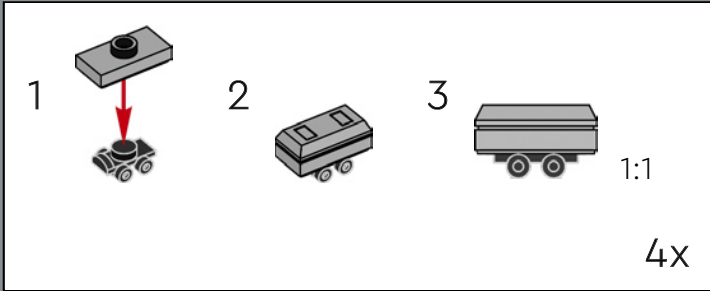

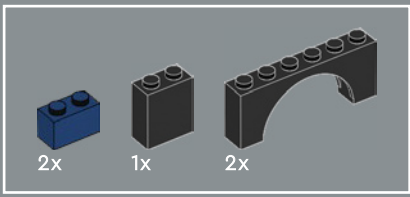

30

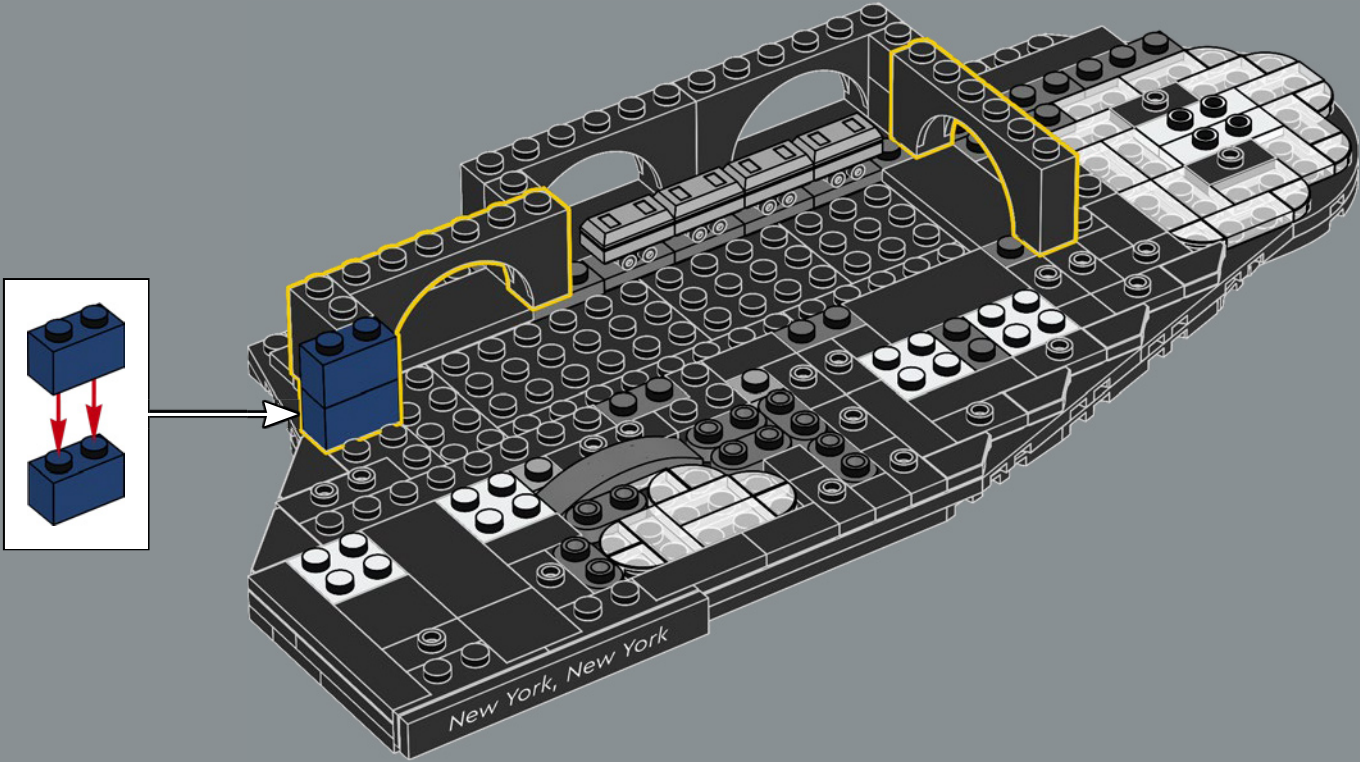

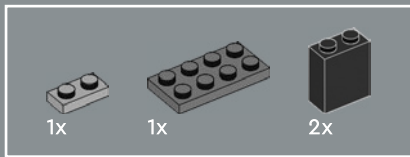

31

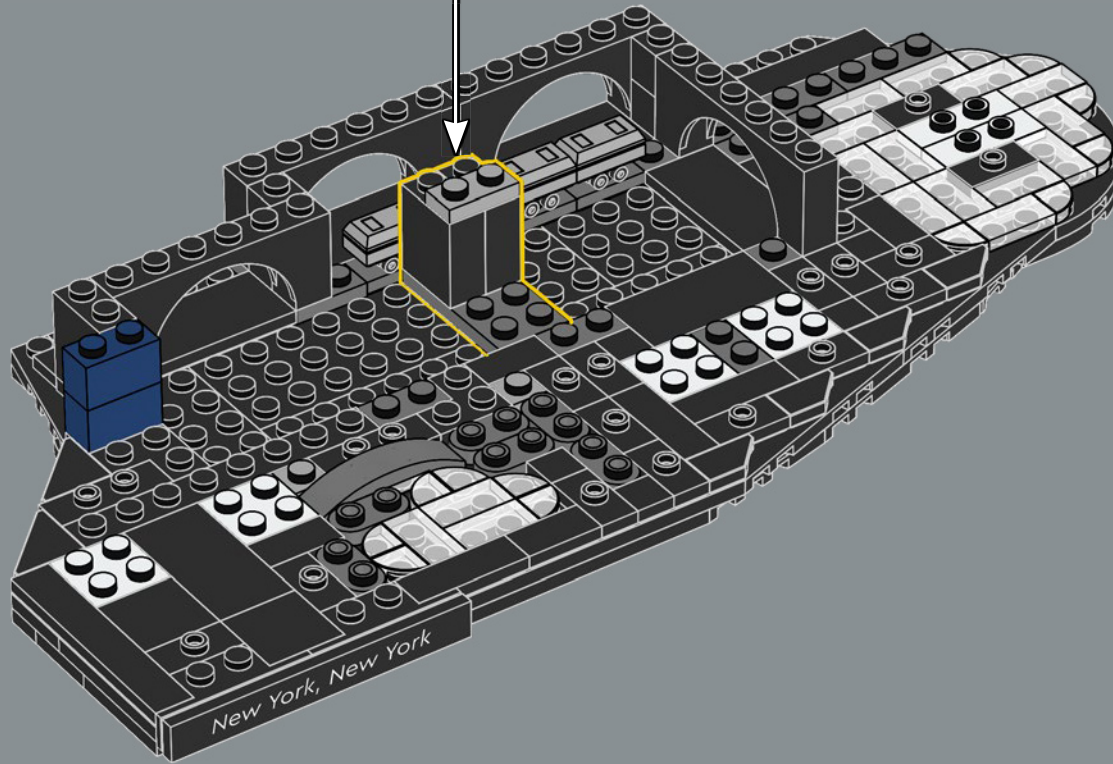
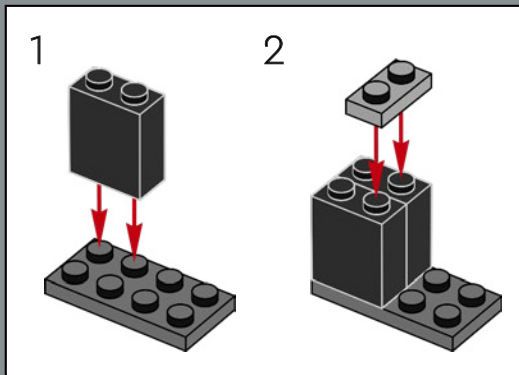

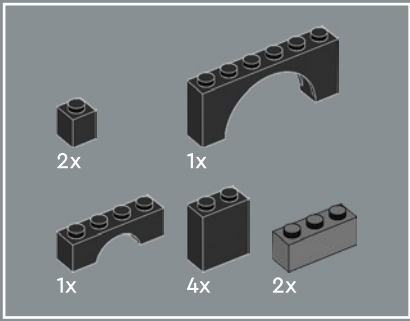

32

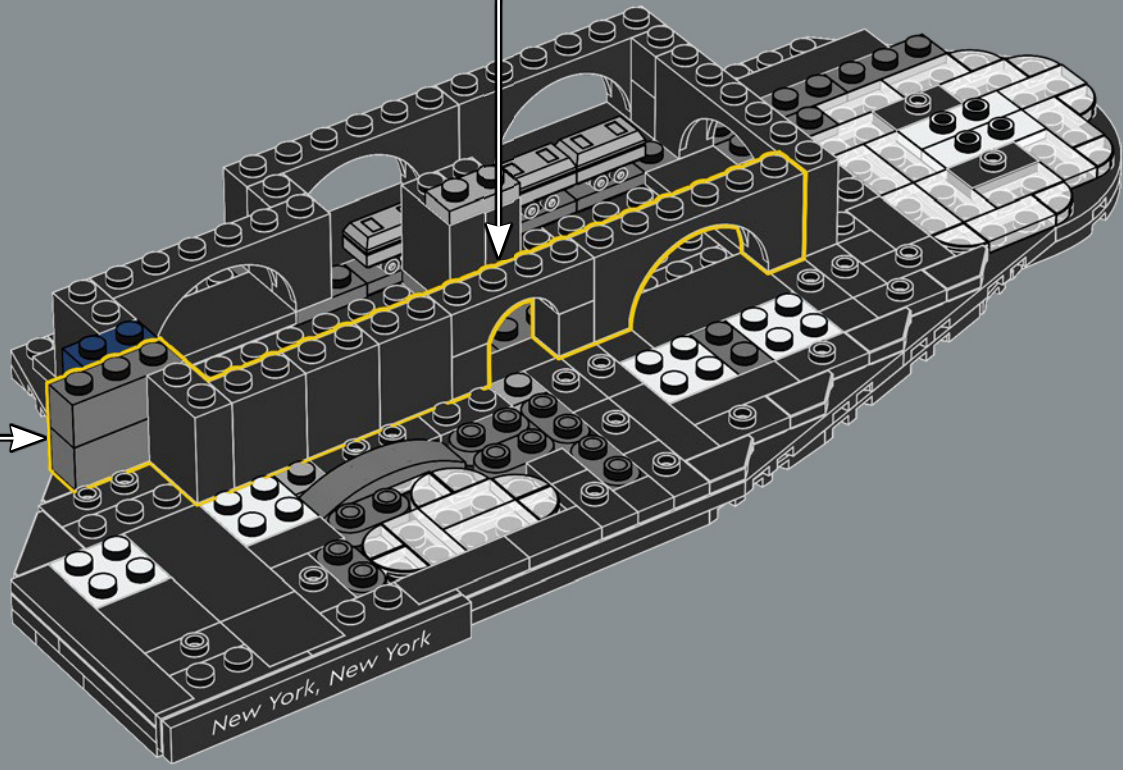
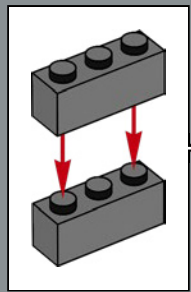
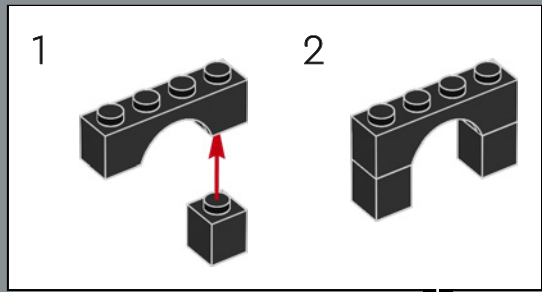

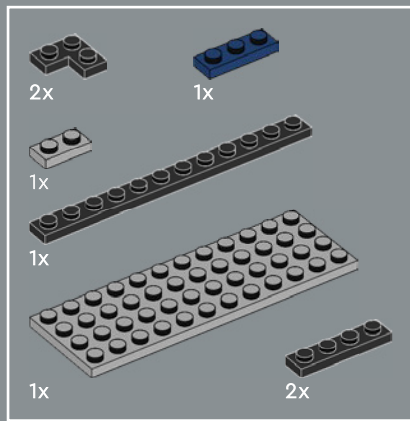

33

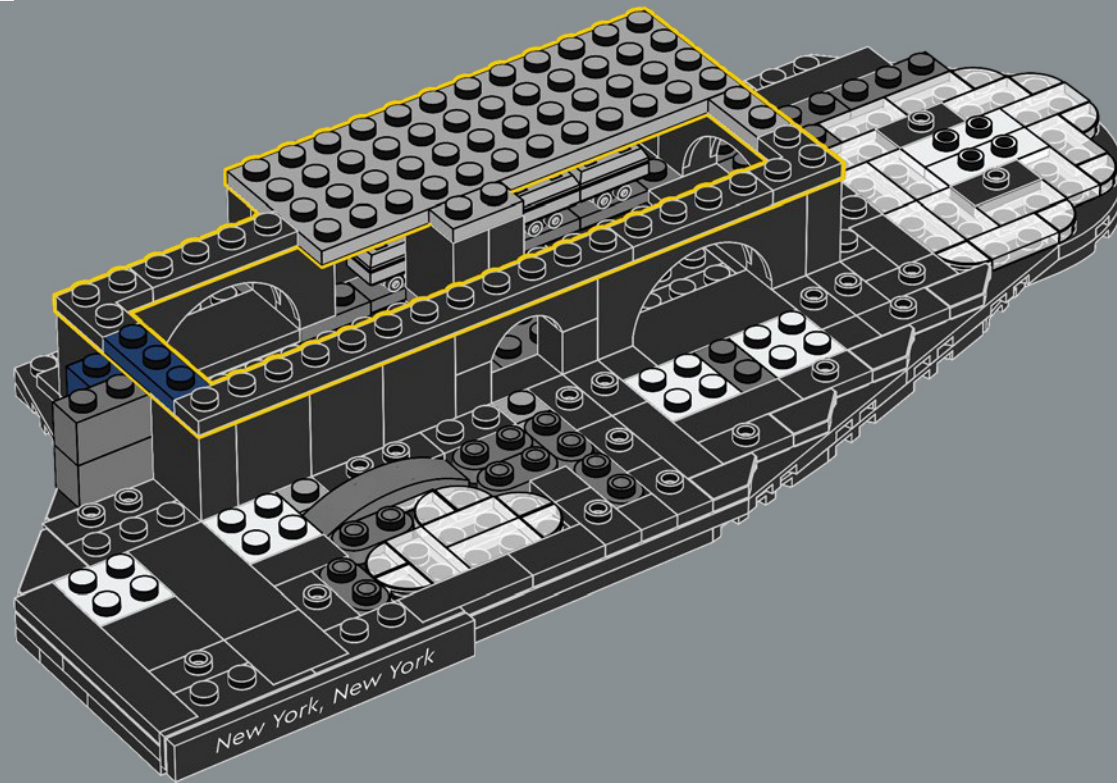

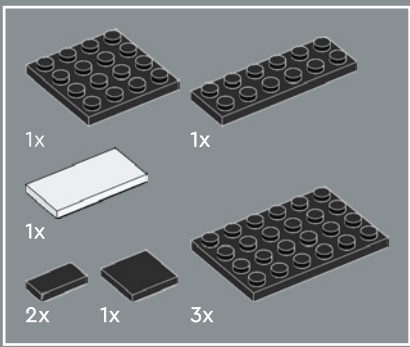

34

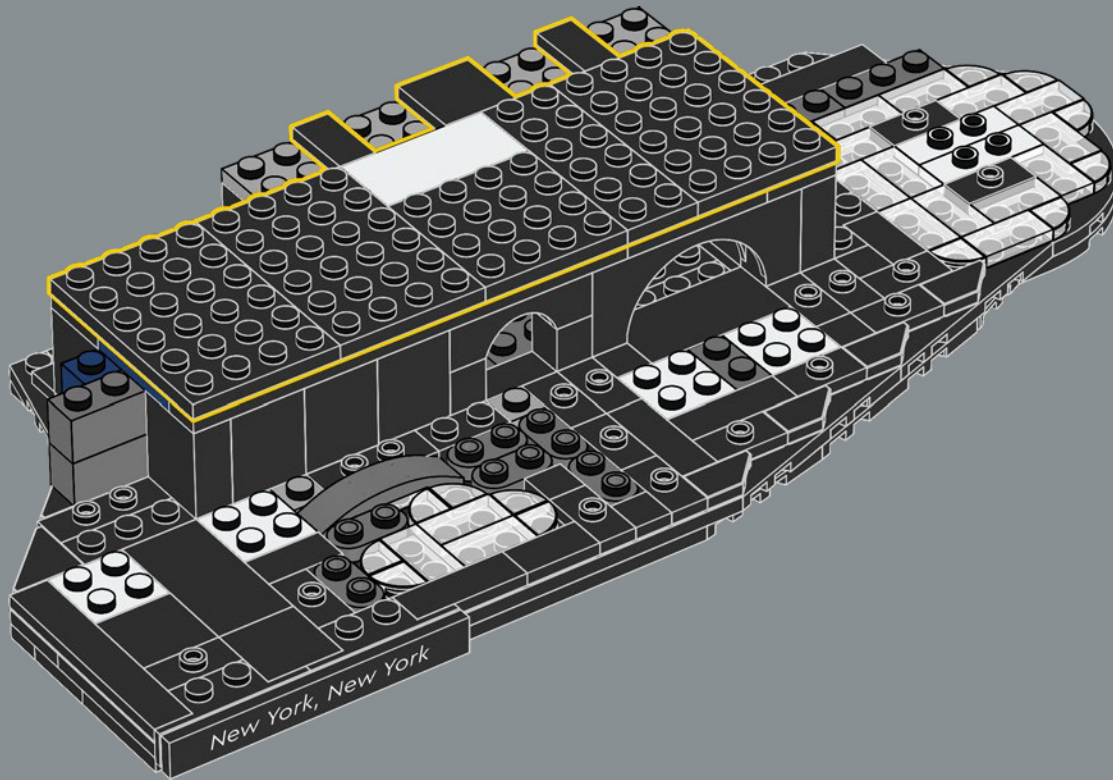

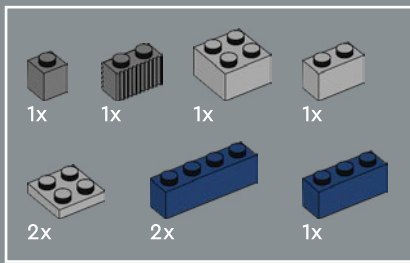

35

1

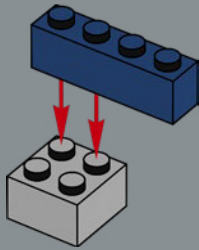

2

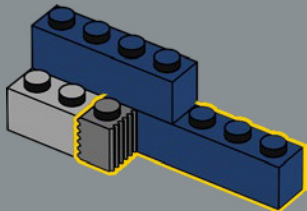

3

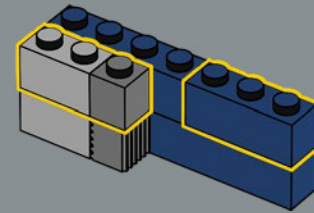

4

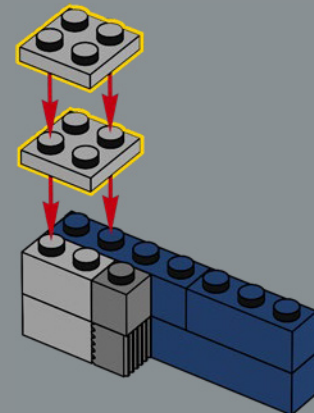

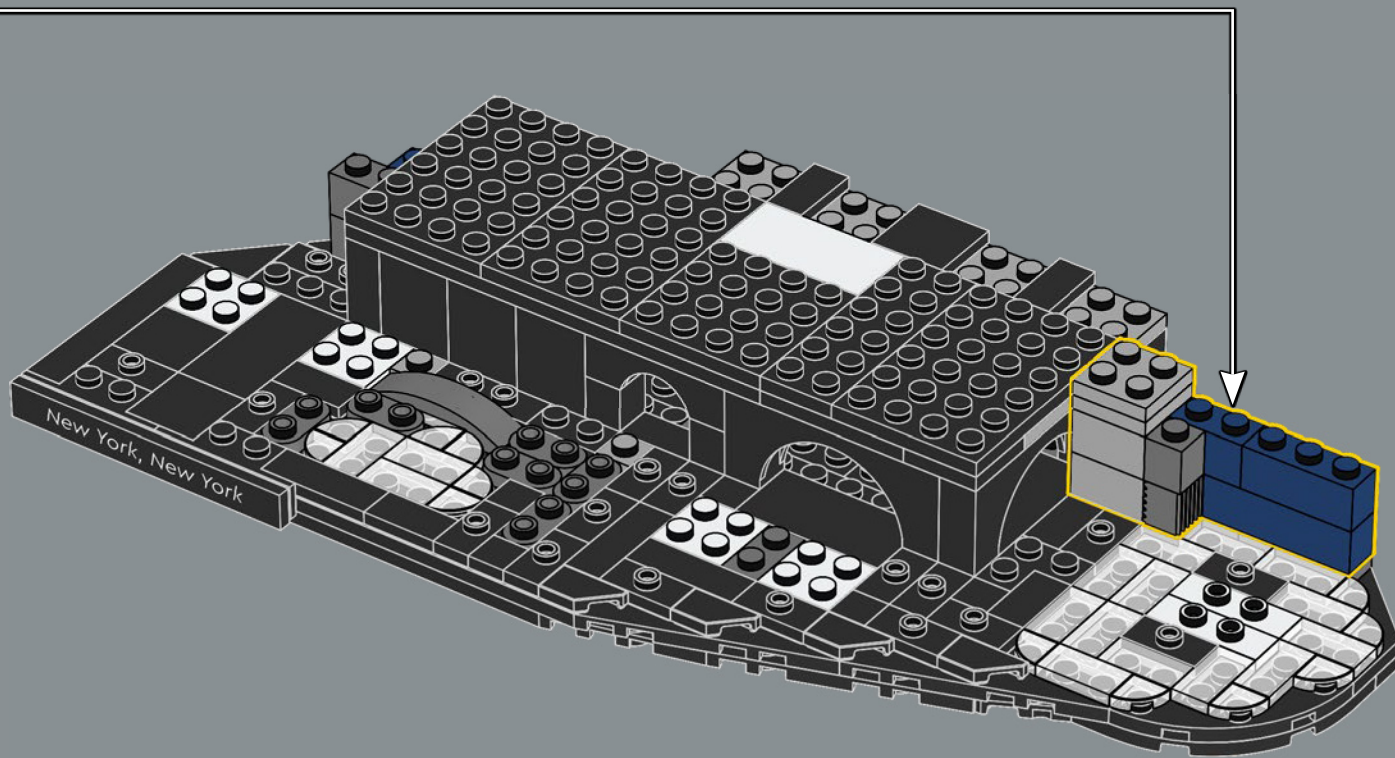

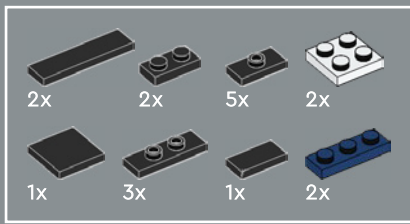

36

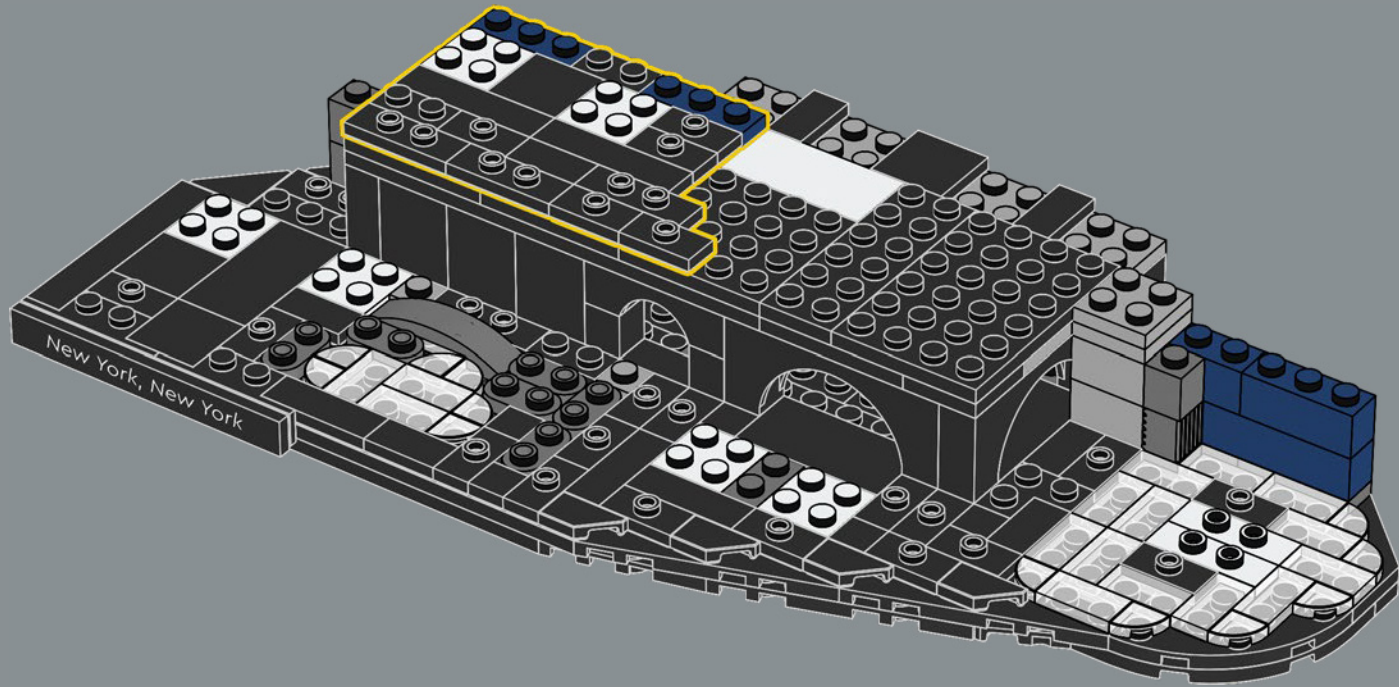

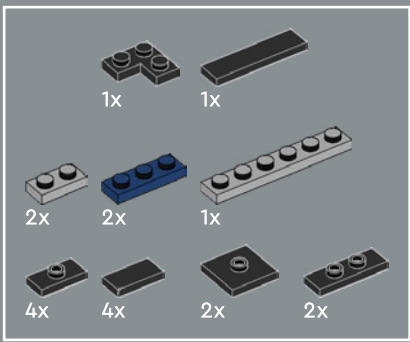

37

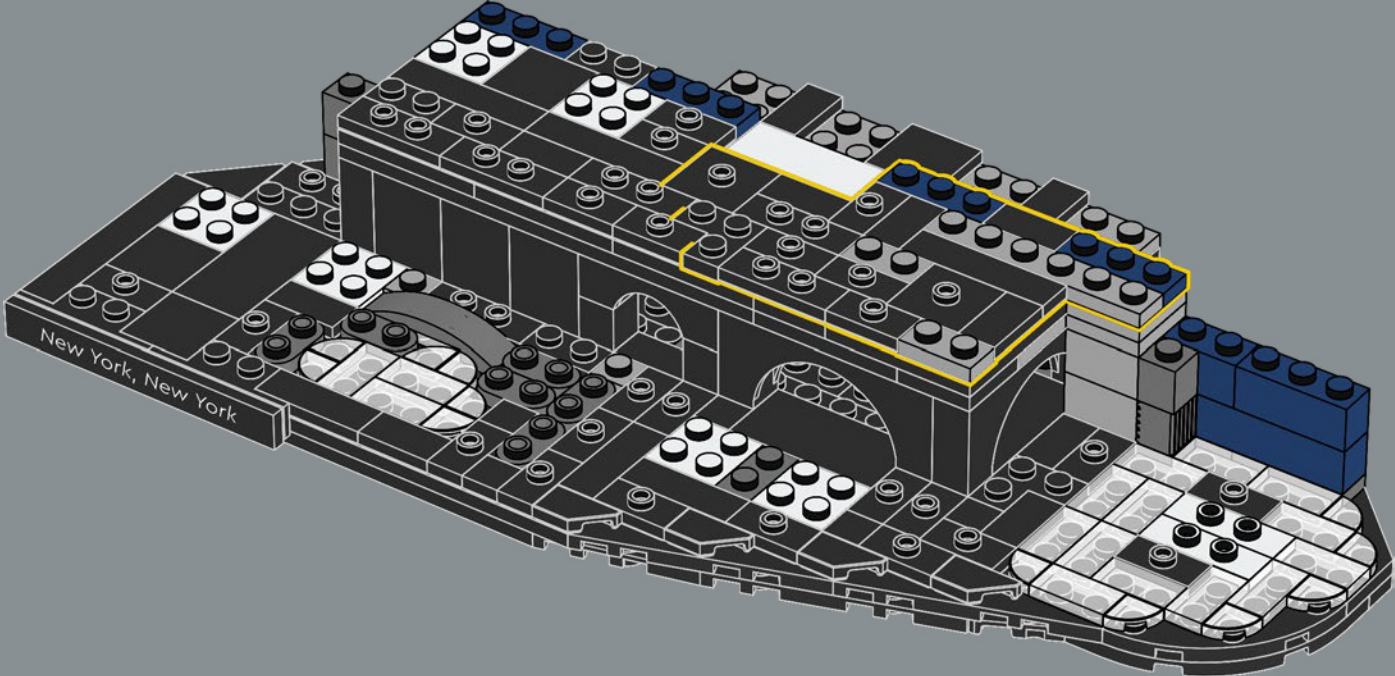

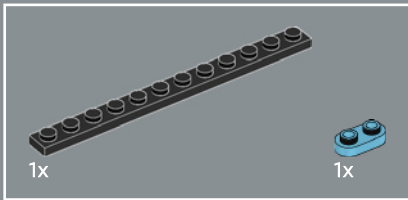
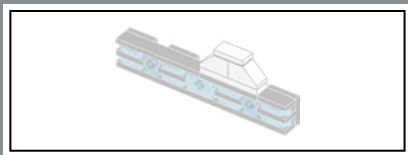

38

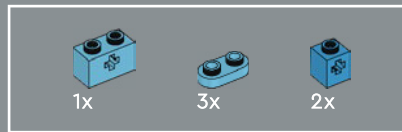
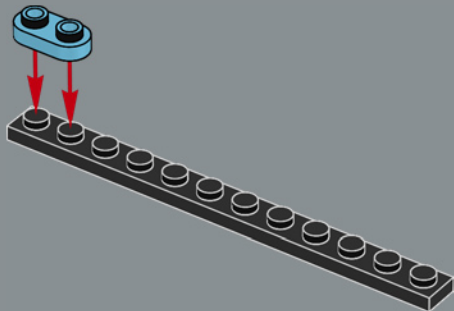

39

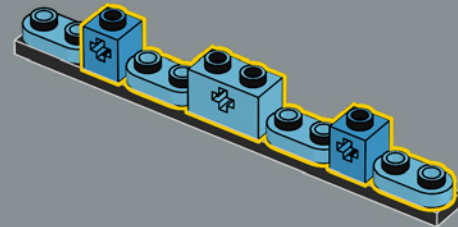

40

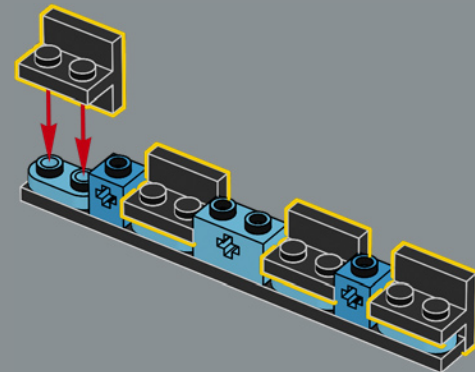

4x

41

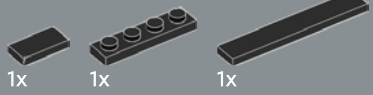
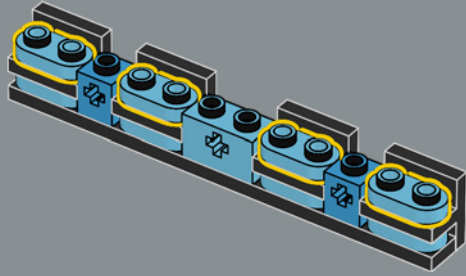

42

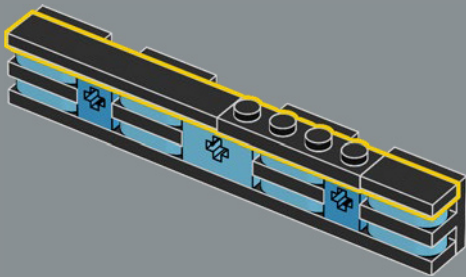

1x

1x

2x

43

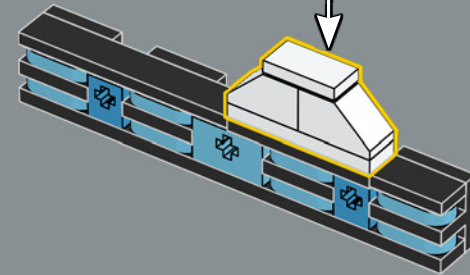
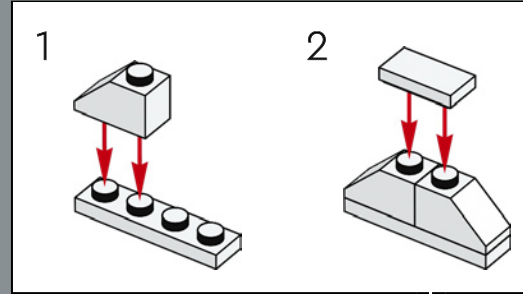

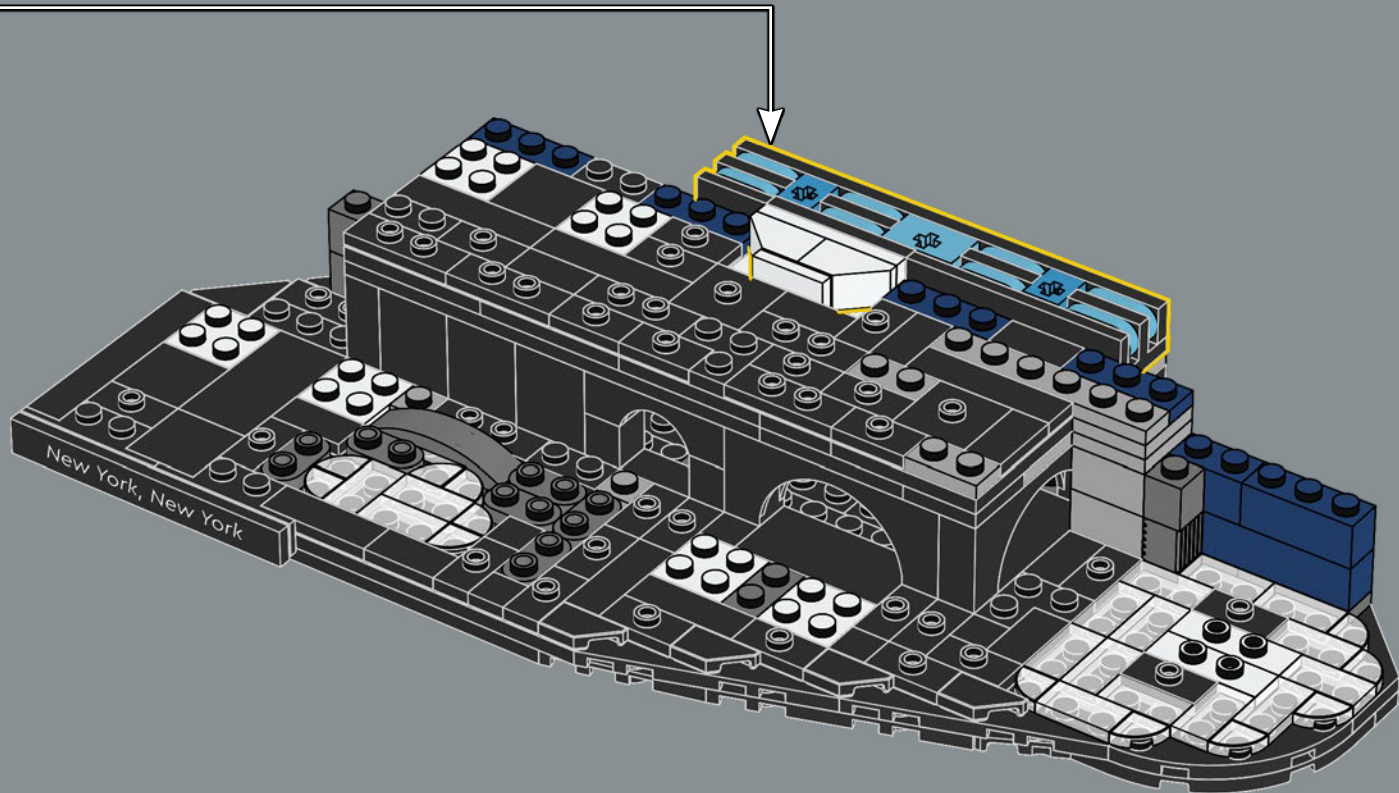

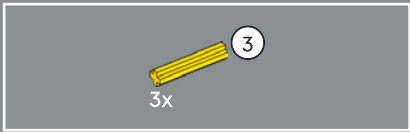

45

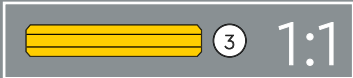
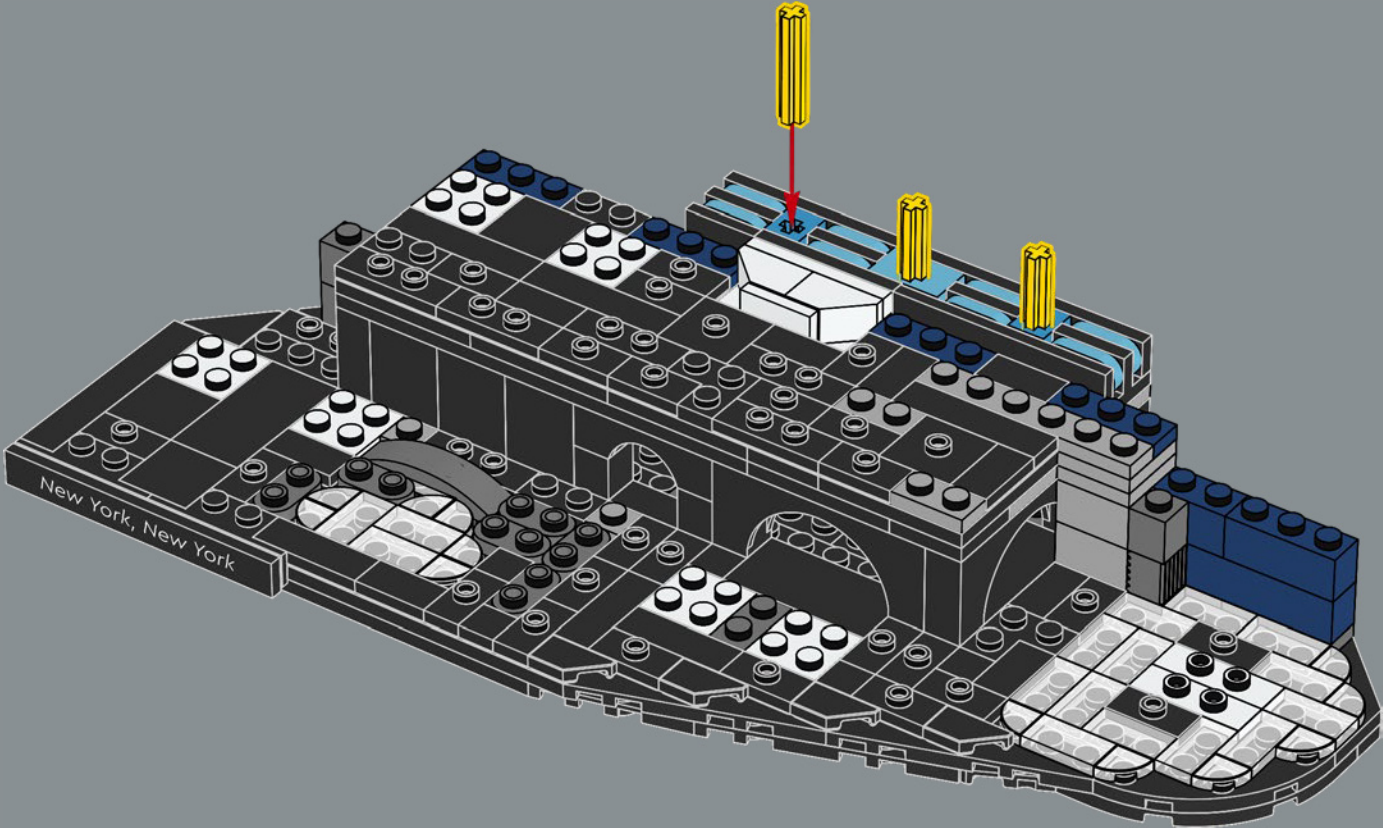

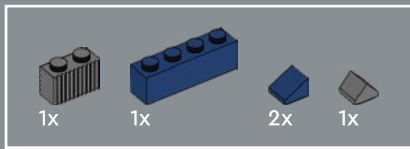

46

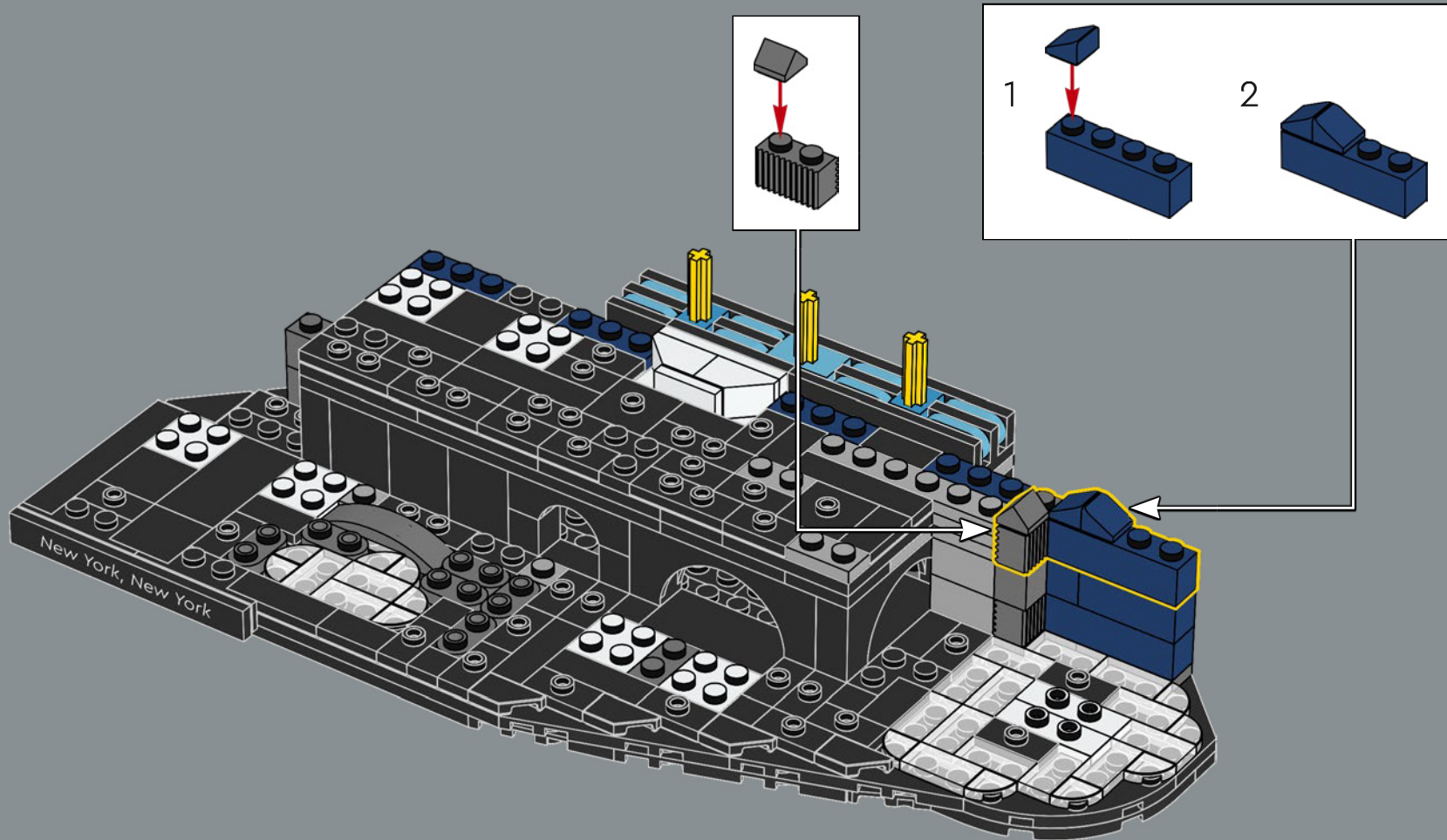

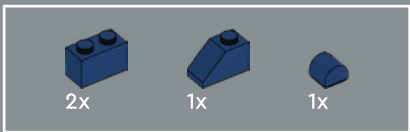

47

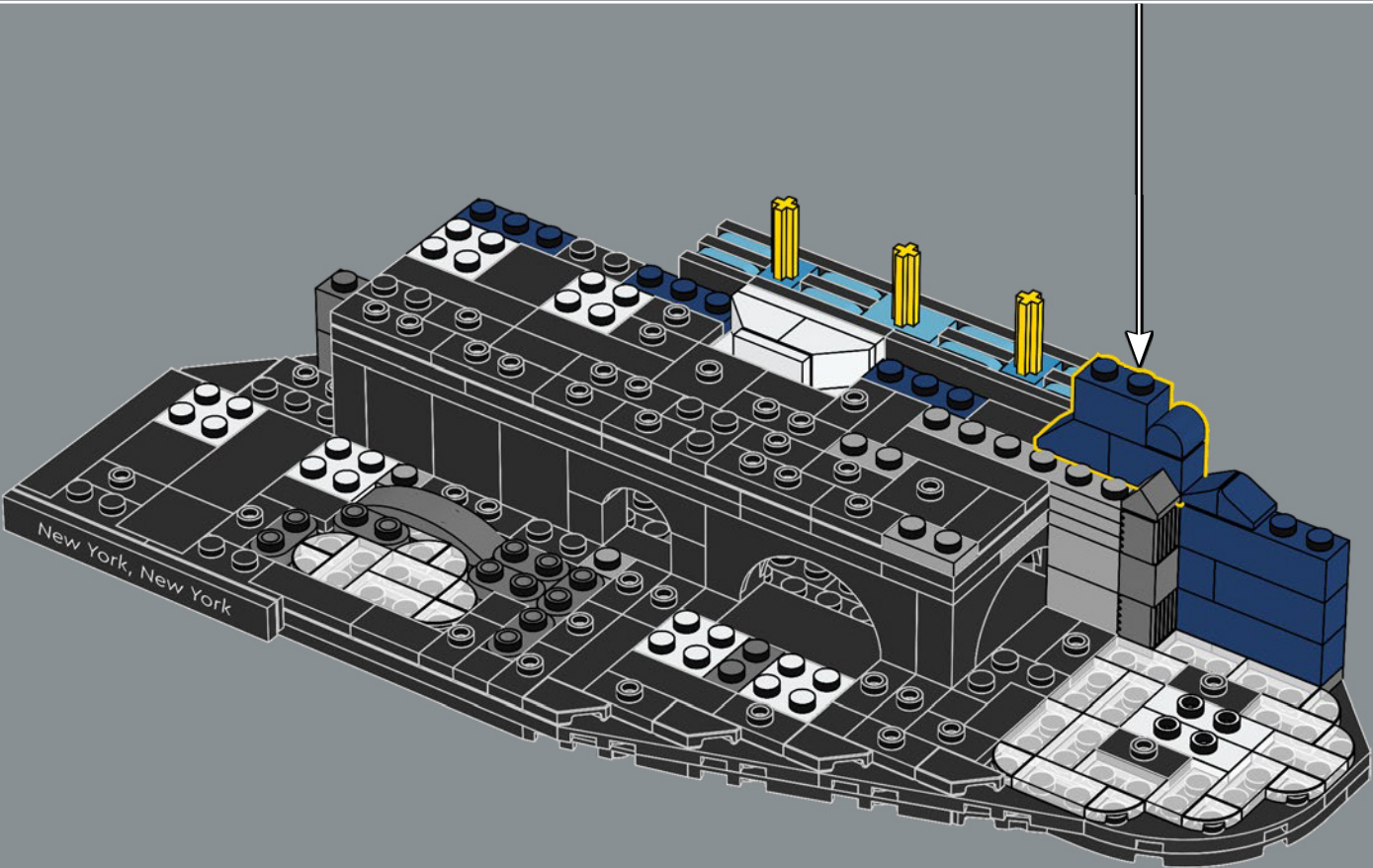
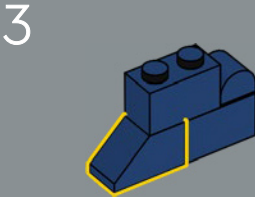
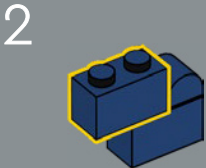
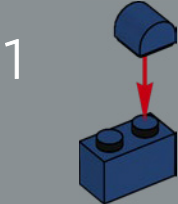

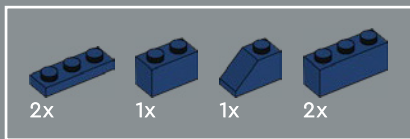

48

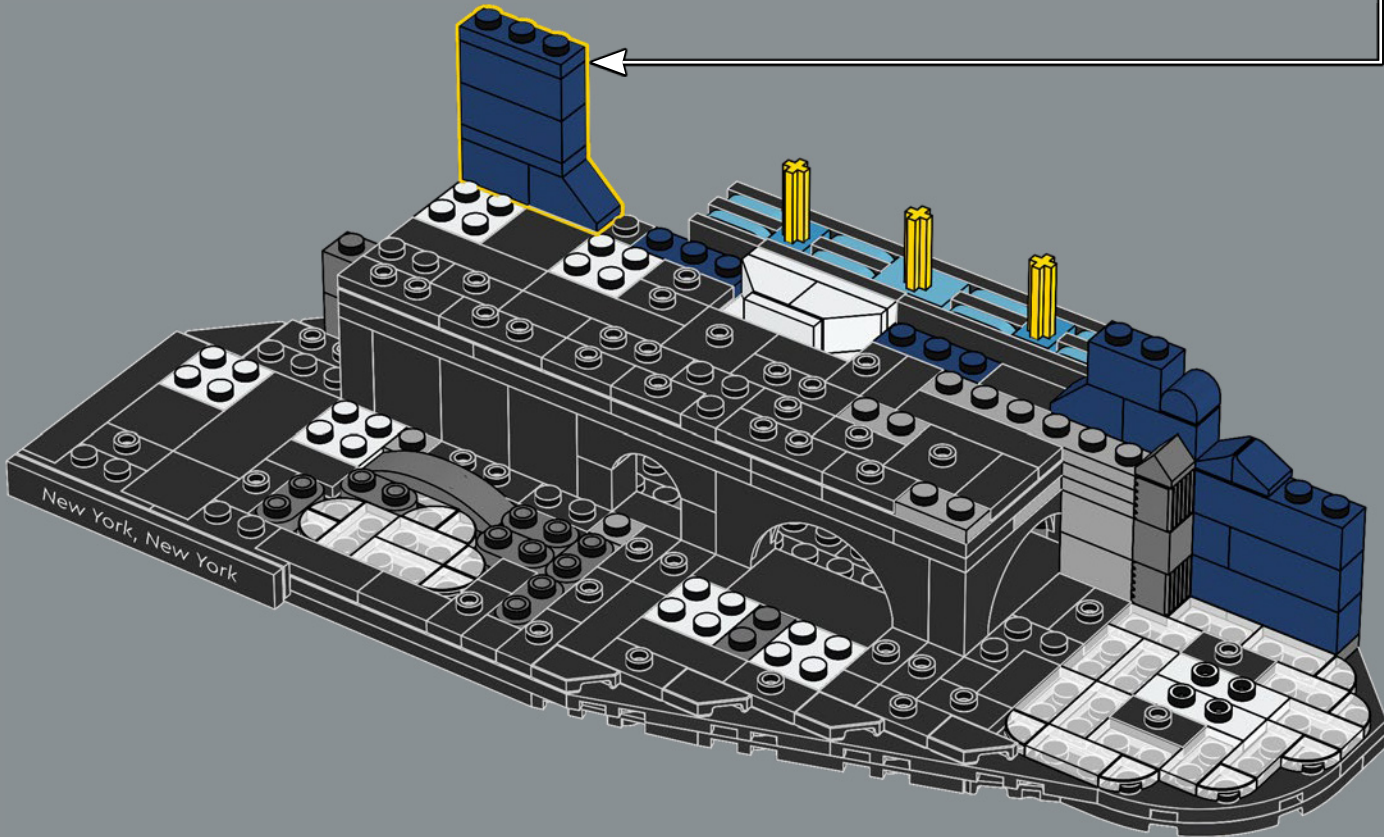

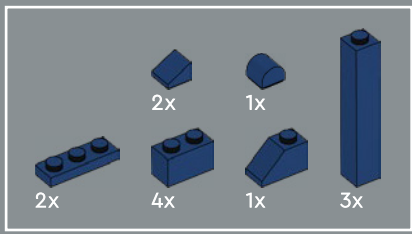

49

1

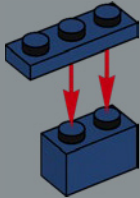

2

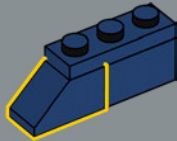

3

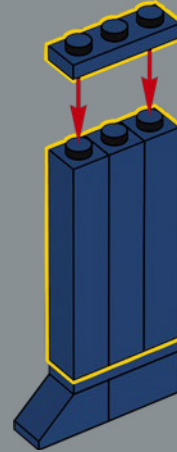

4

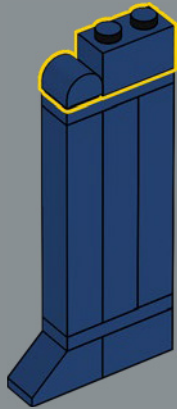

5

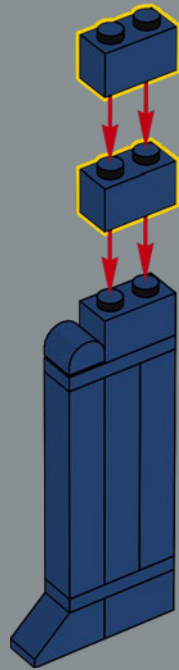

6

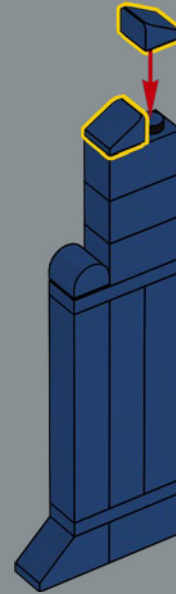

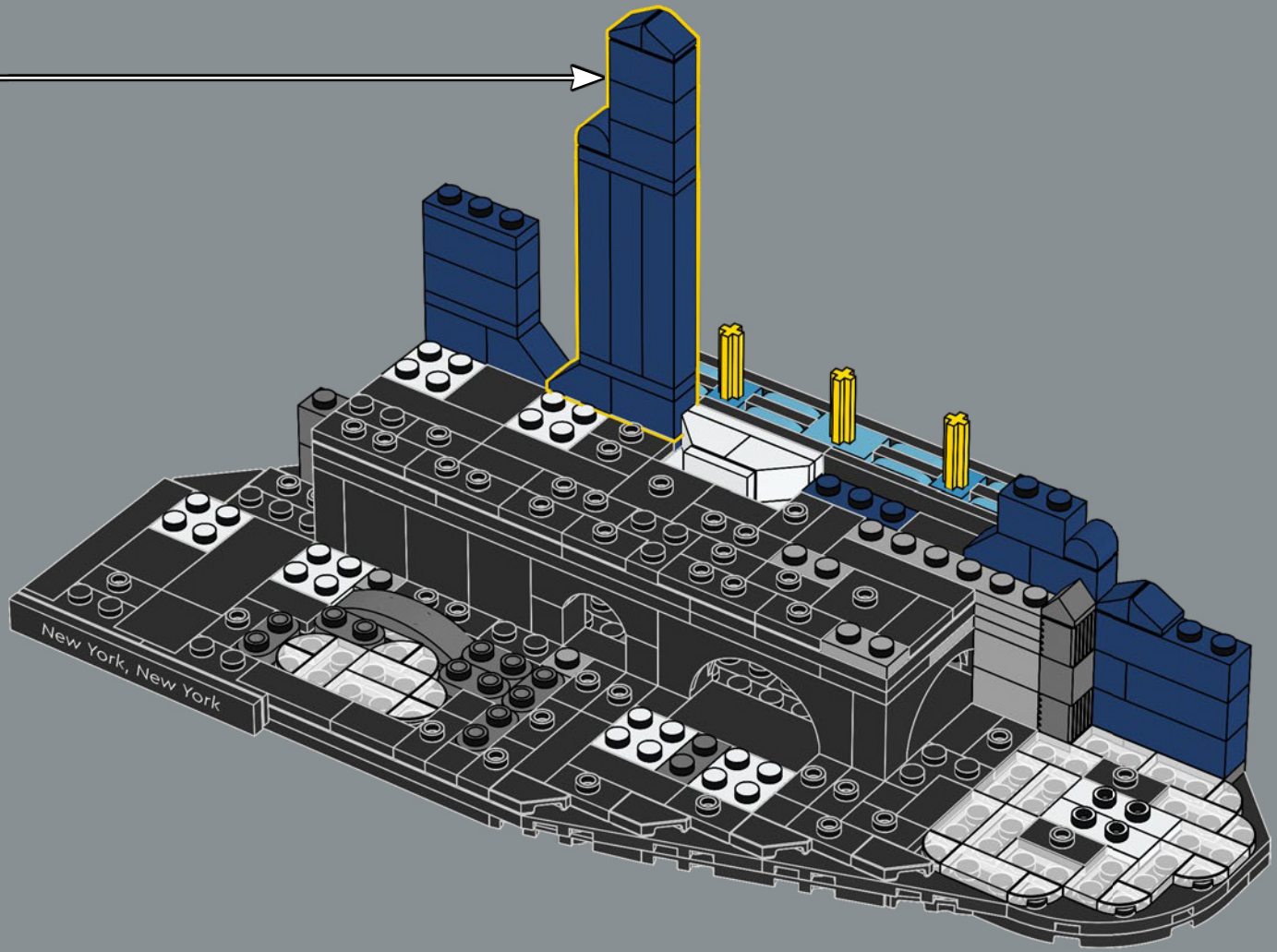

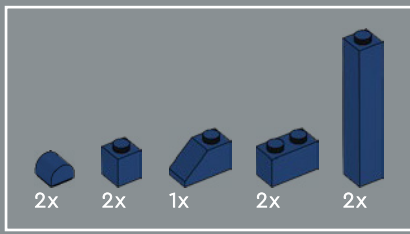

50

1

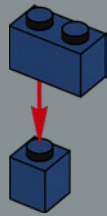

2

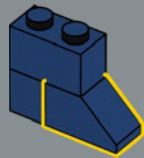

3

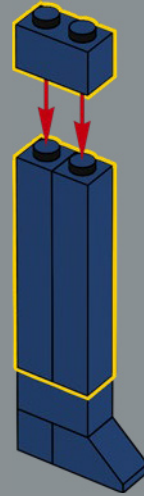

4

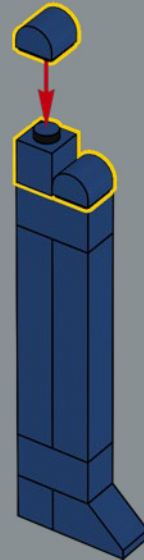

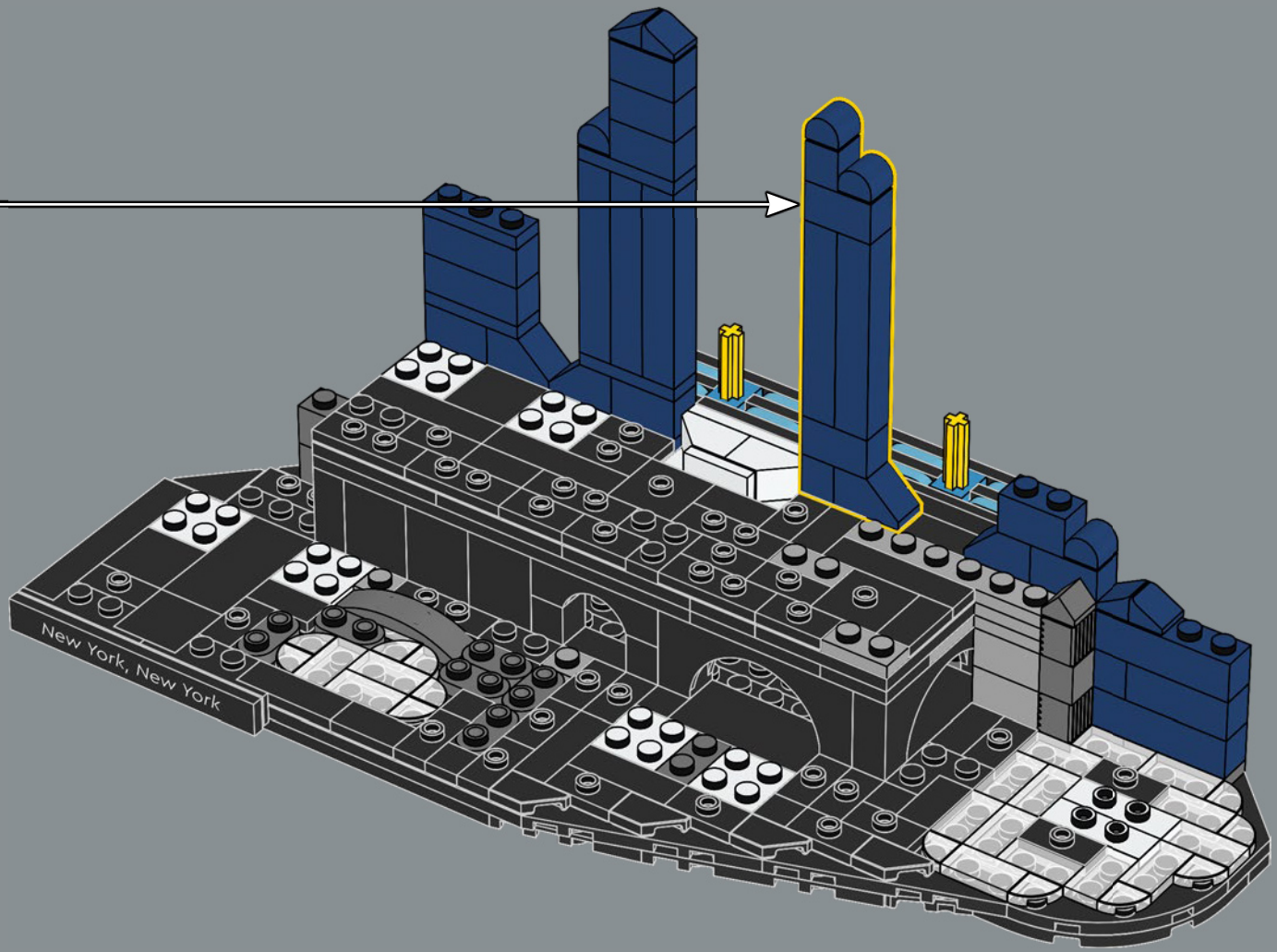

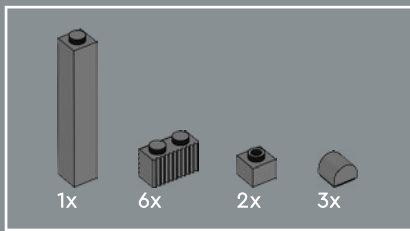

51

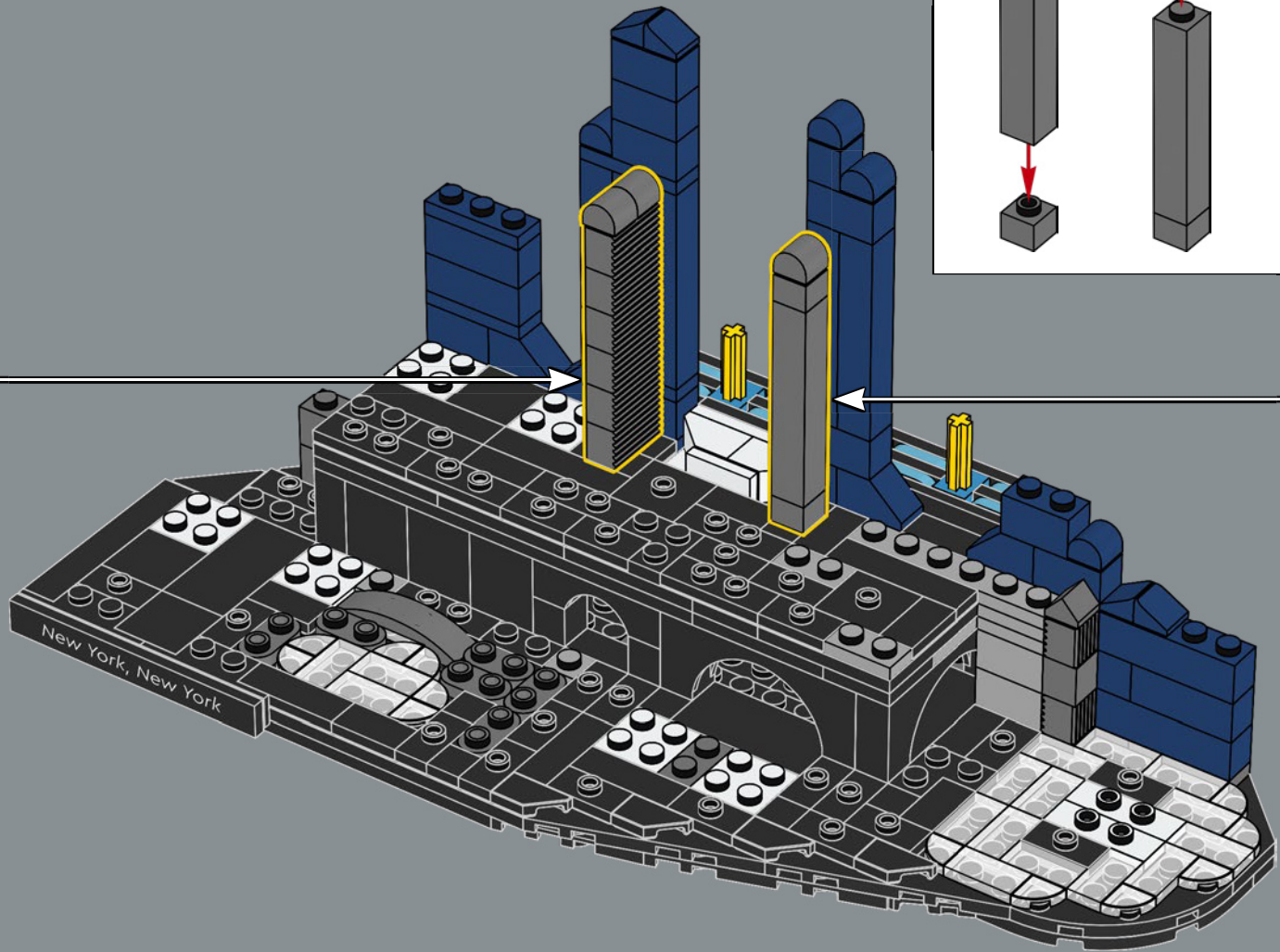
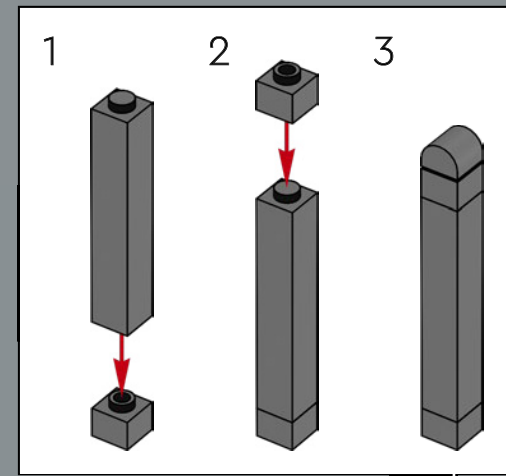
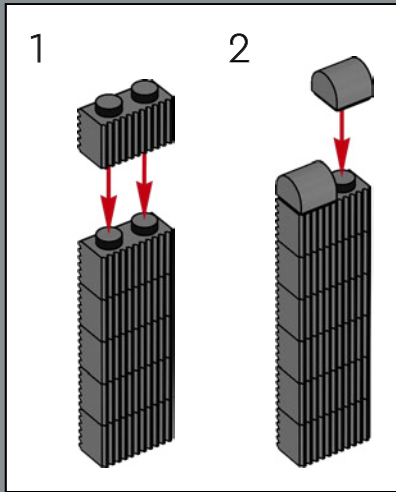

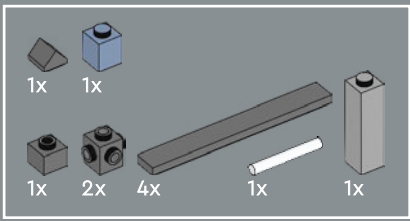

52

1

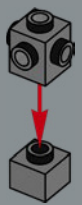

2

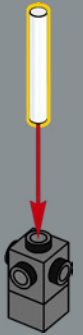

3



4

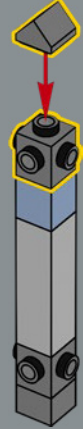

5

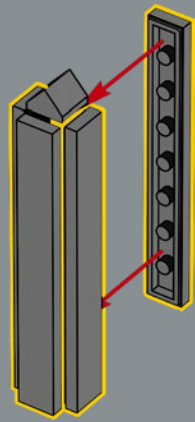

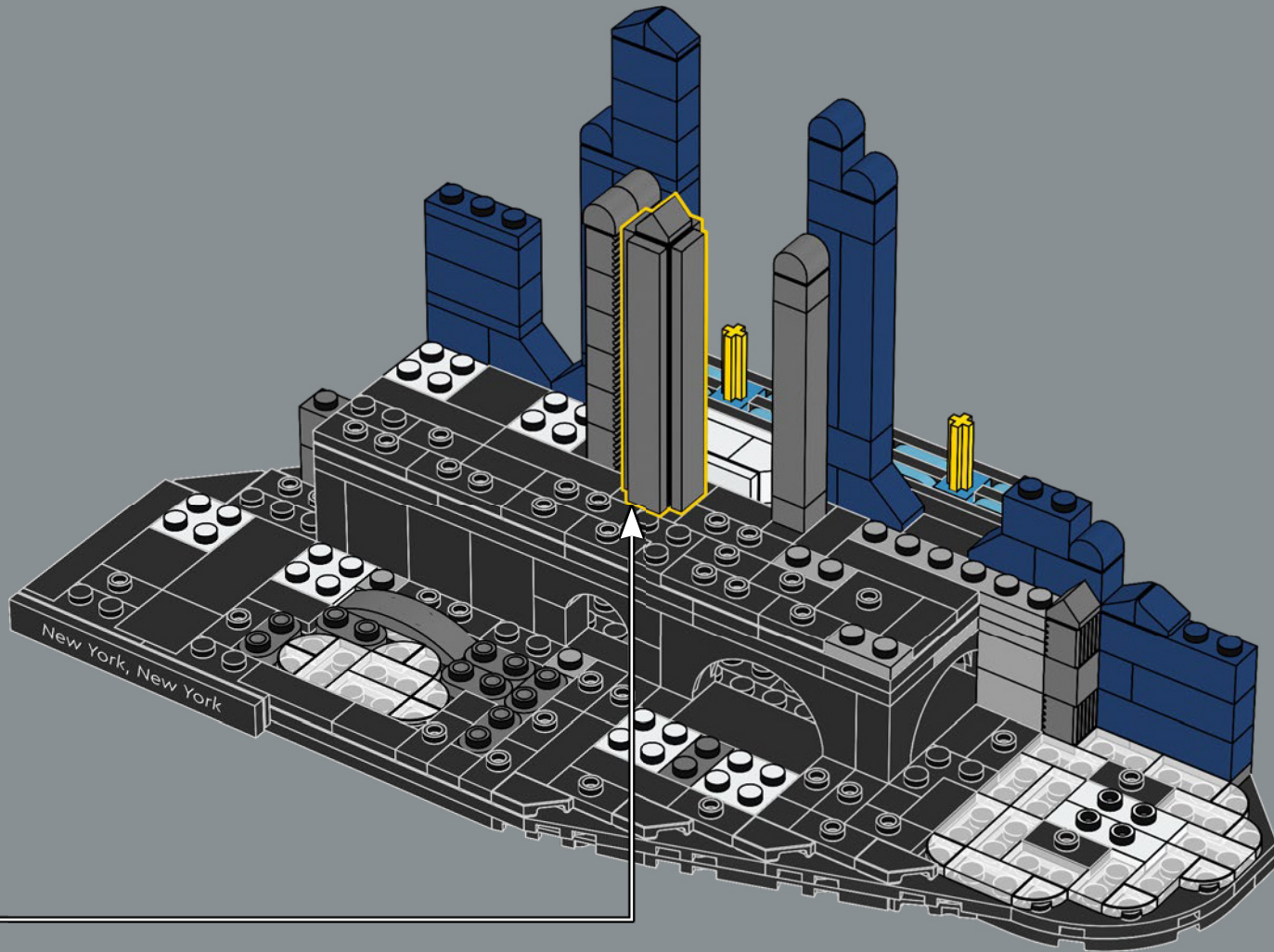

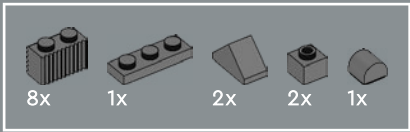

53

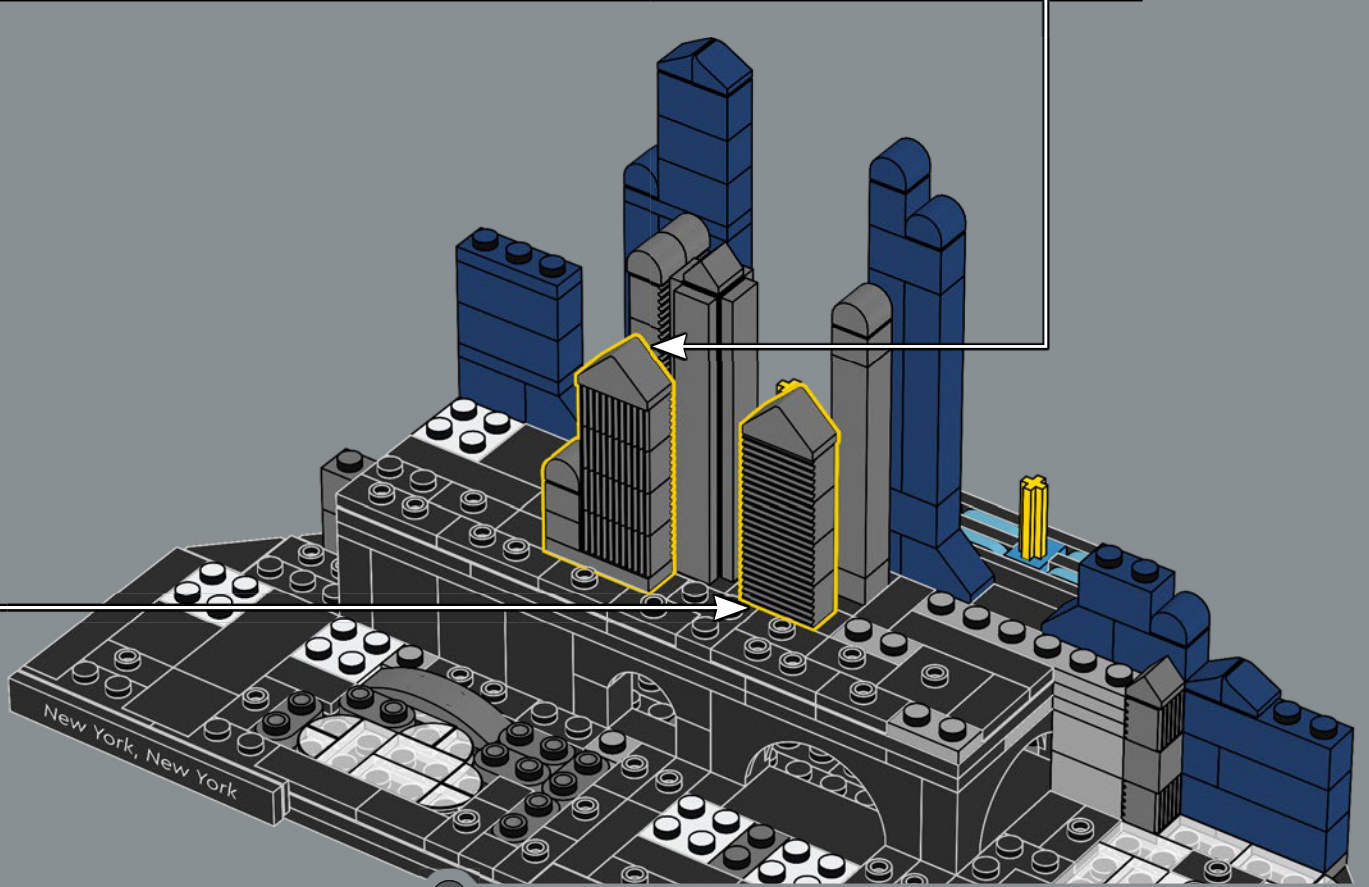
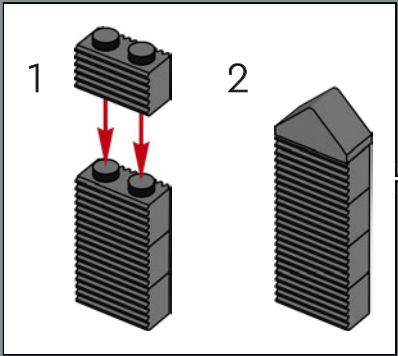
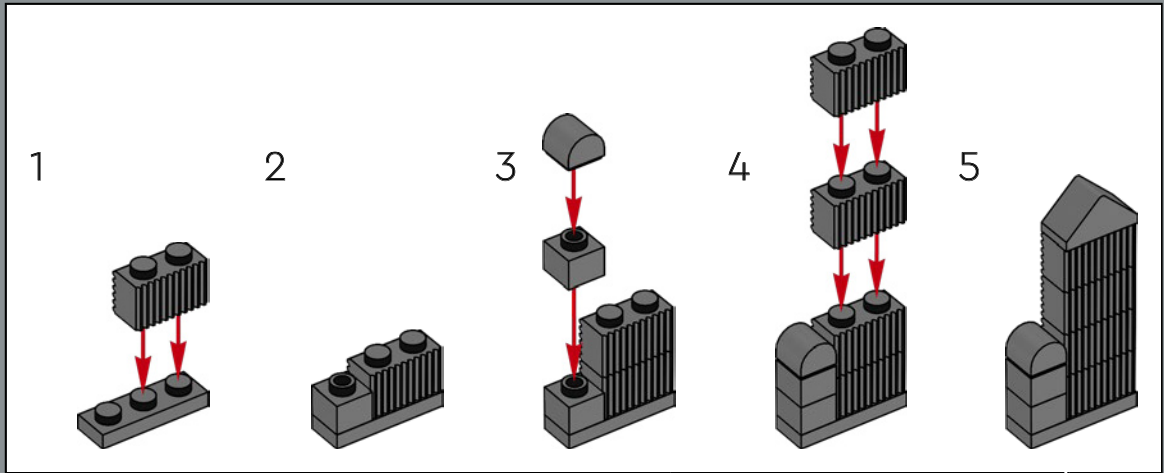

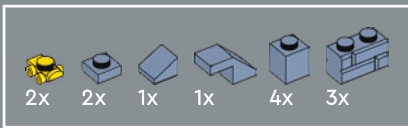

54

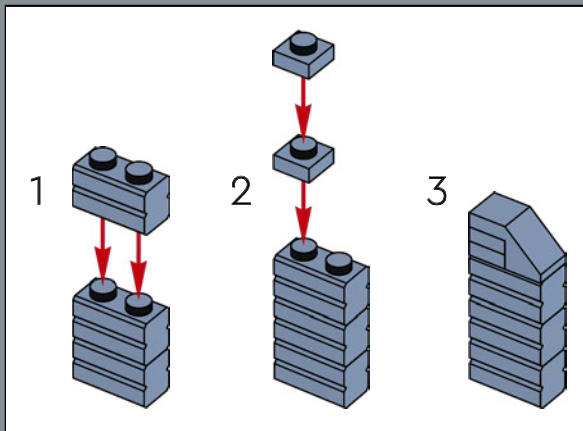

Diese gelben LEGO® Minifiguren-Rollschuhelemente stellen die typischen Taxis in New York City dar, von denen es über 13.000 gibt.

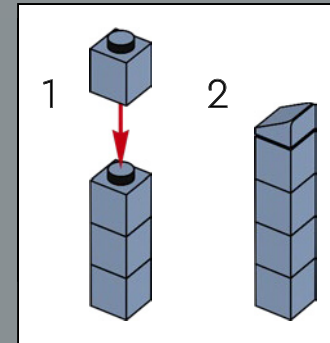
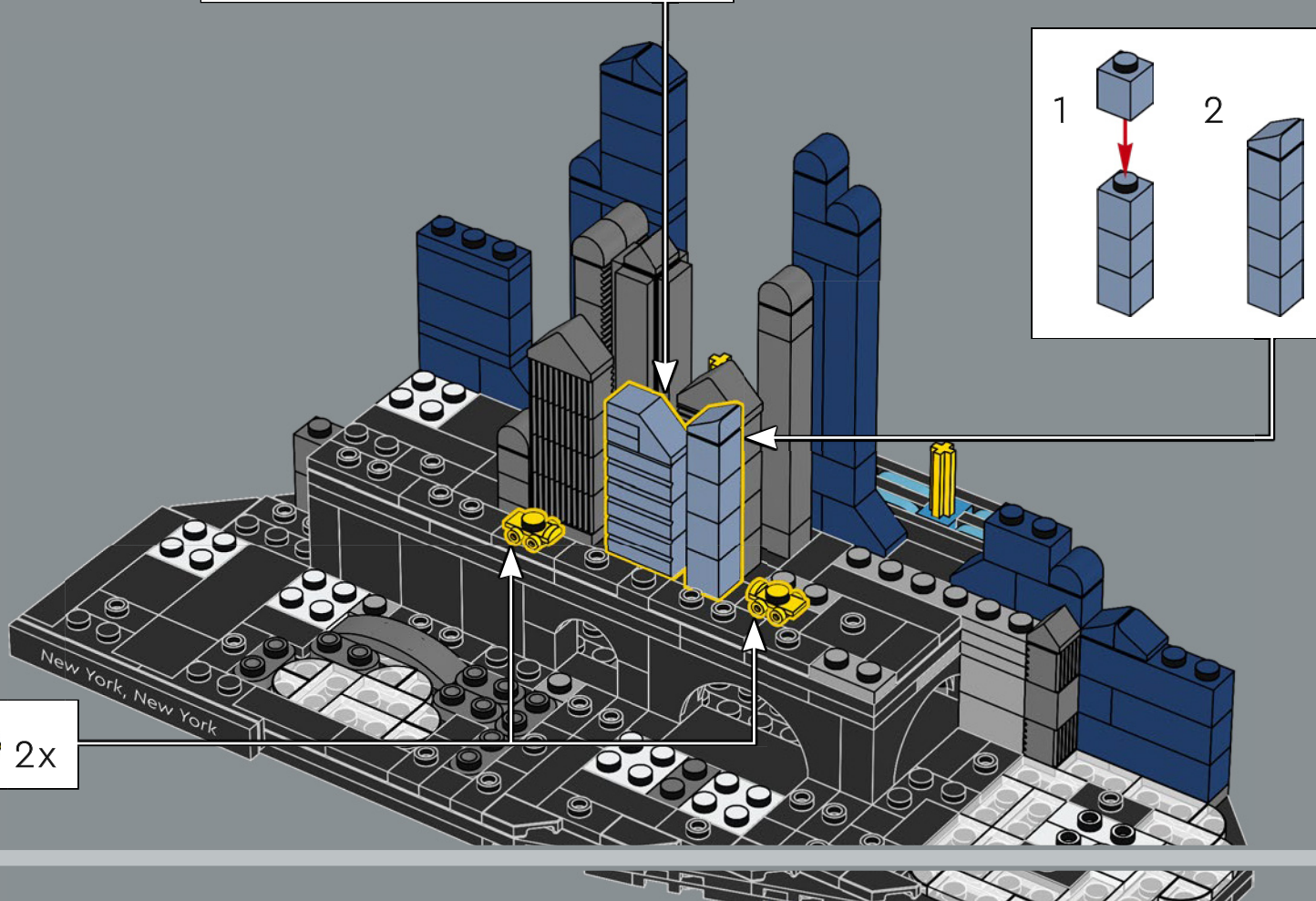

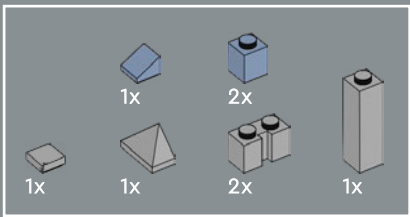

55

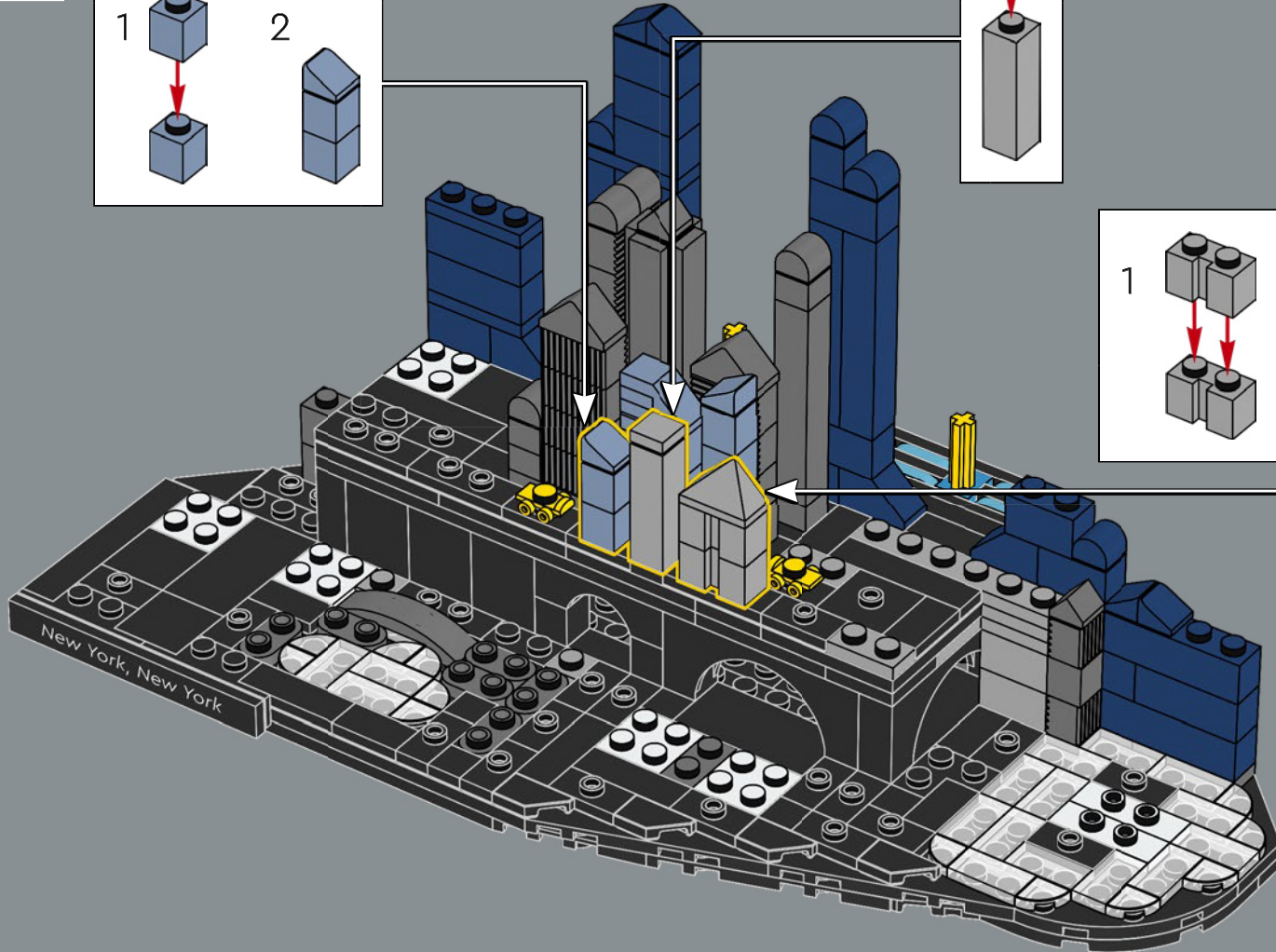
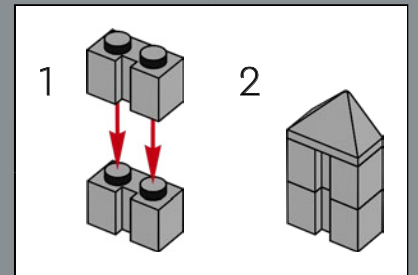
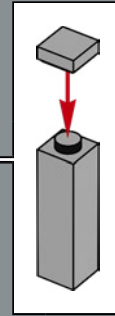
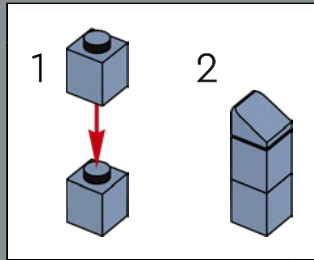

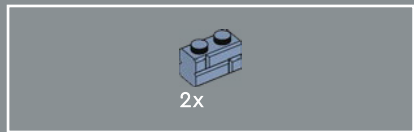

56

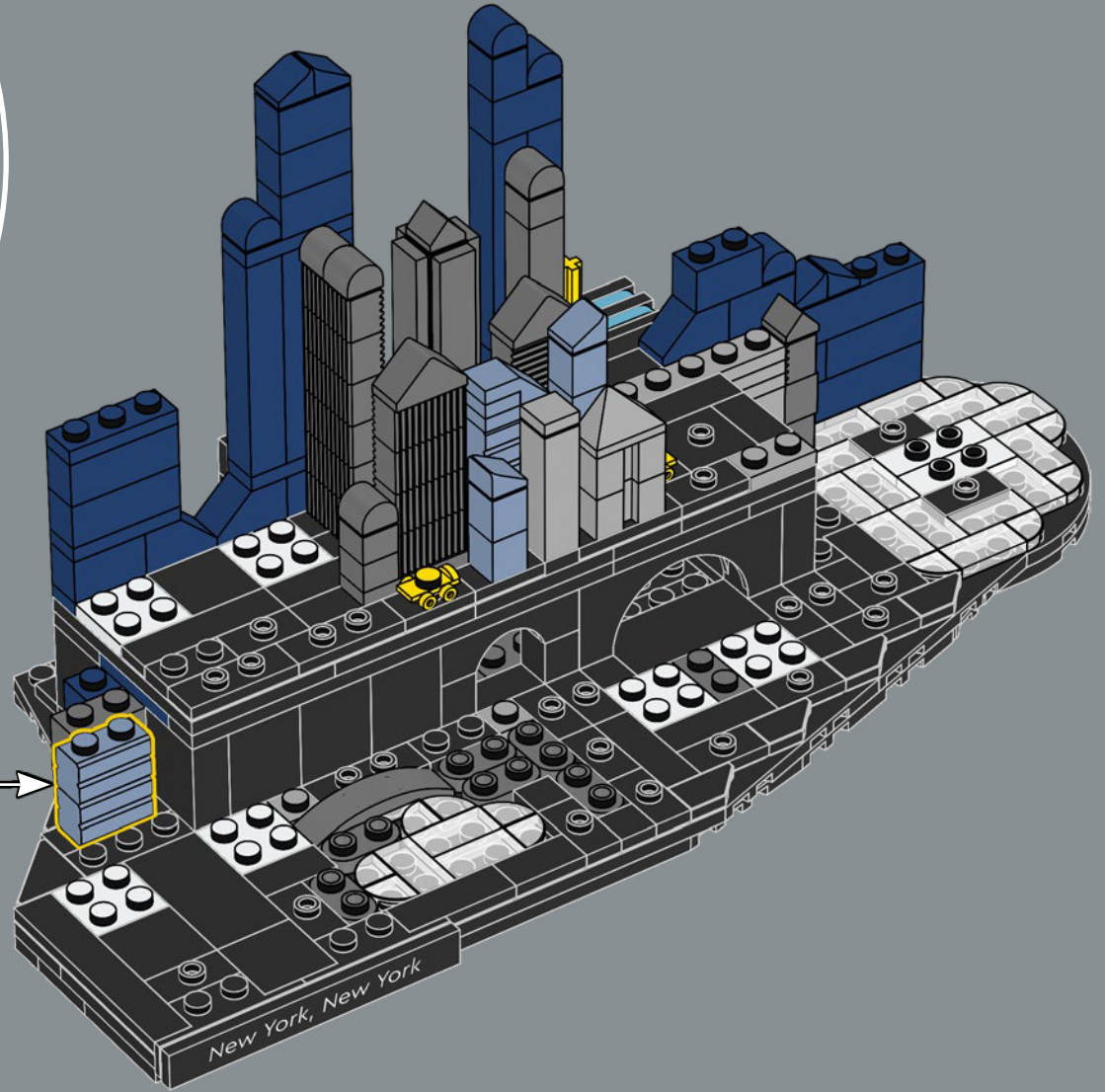
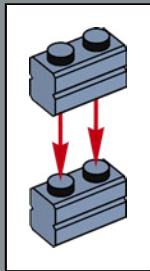

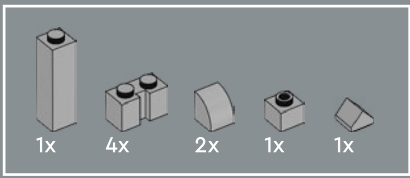

57

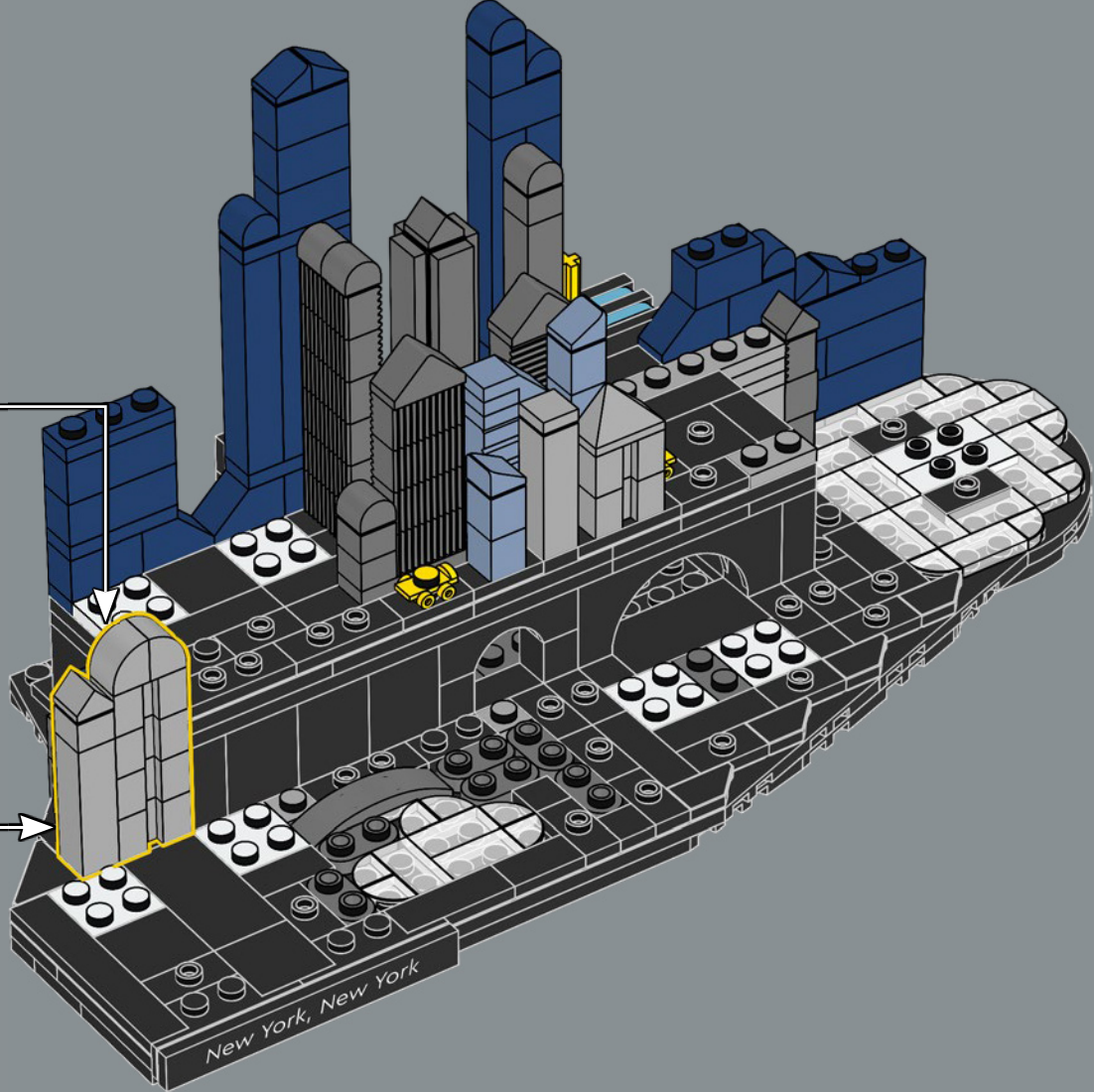
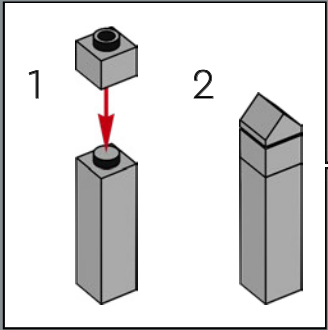
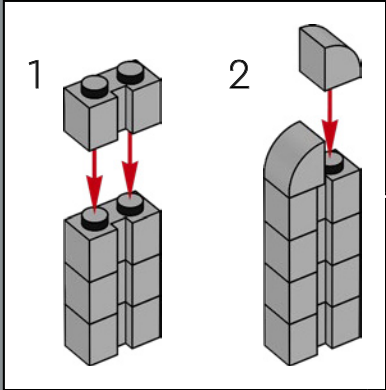

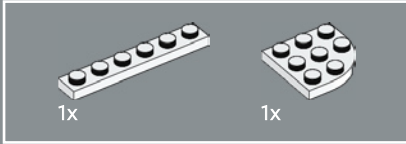
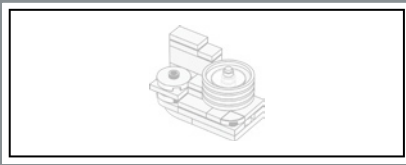

58

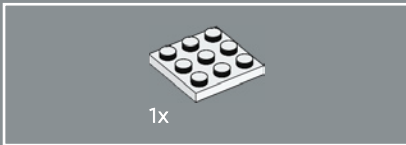
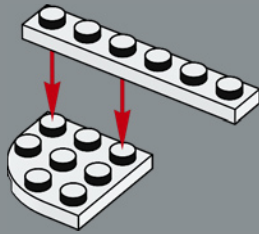

59

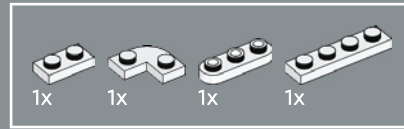
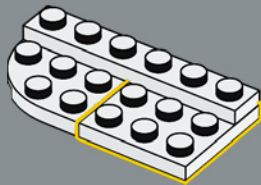

60

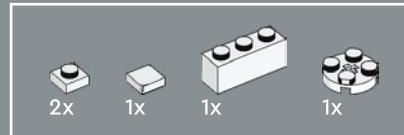
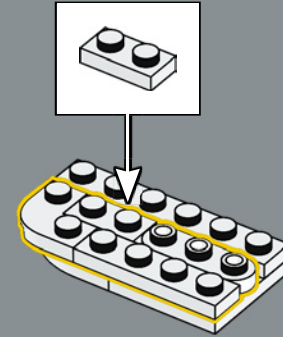

61

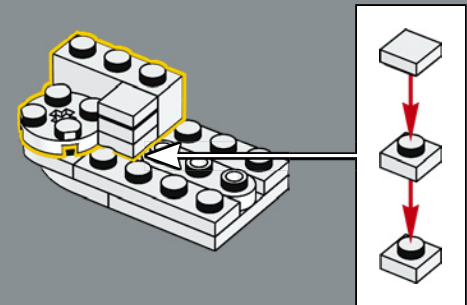

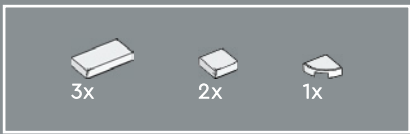

62

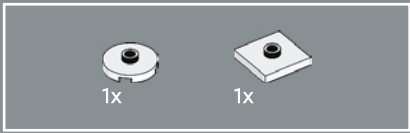
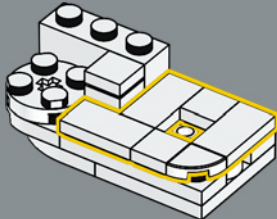

63

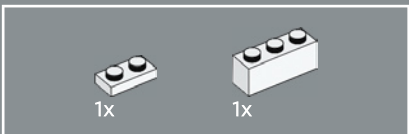
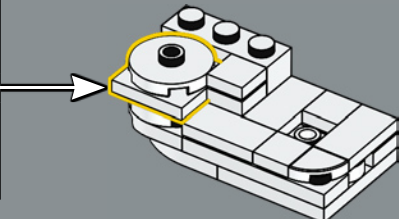
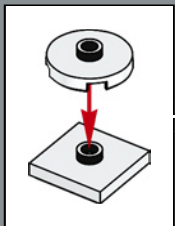

64

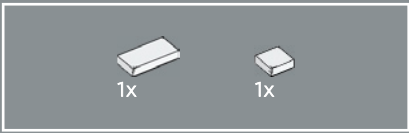
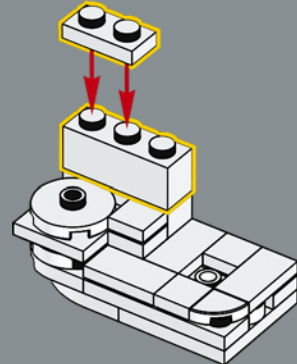

65

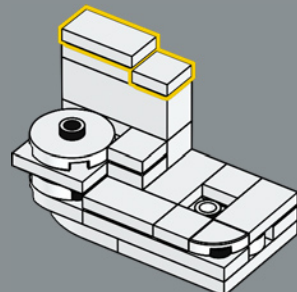

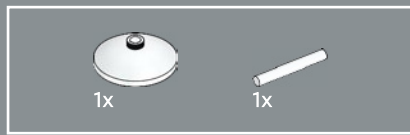

66

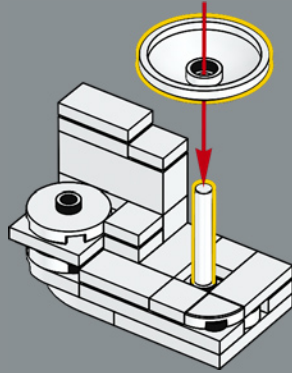

67

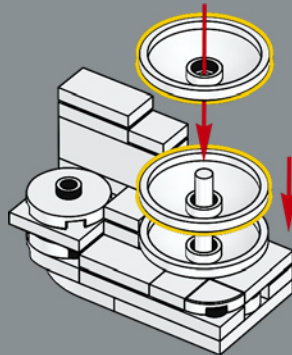

68

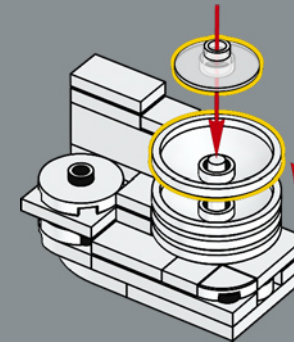

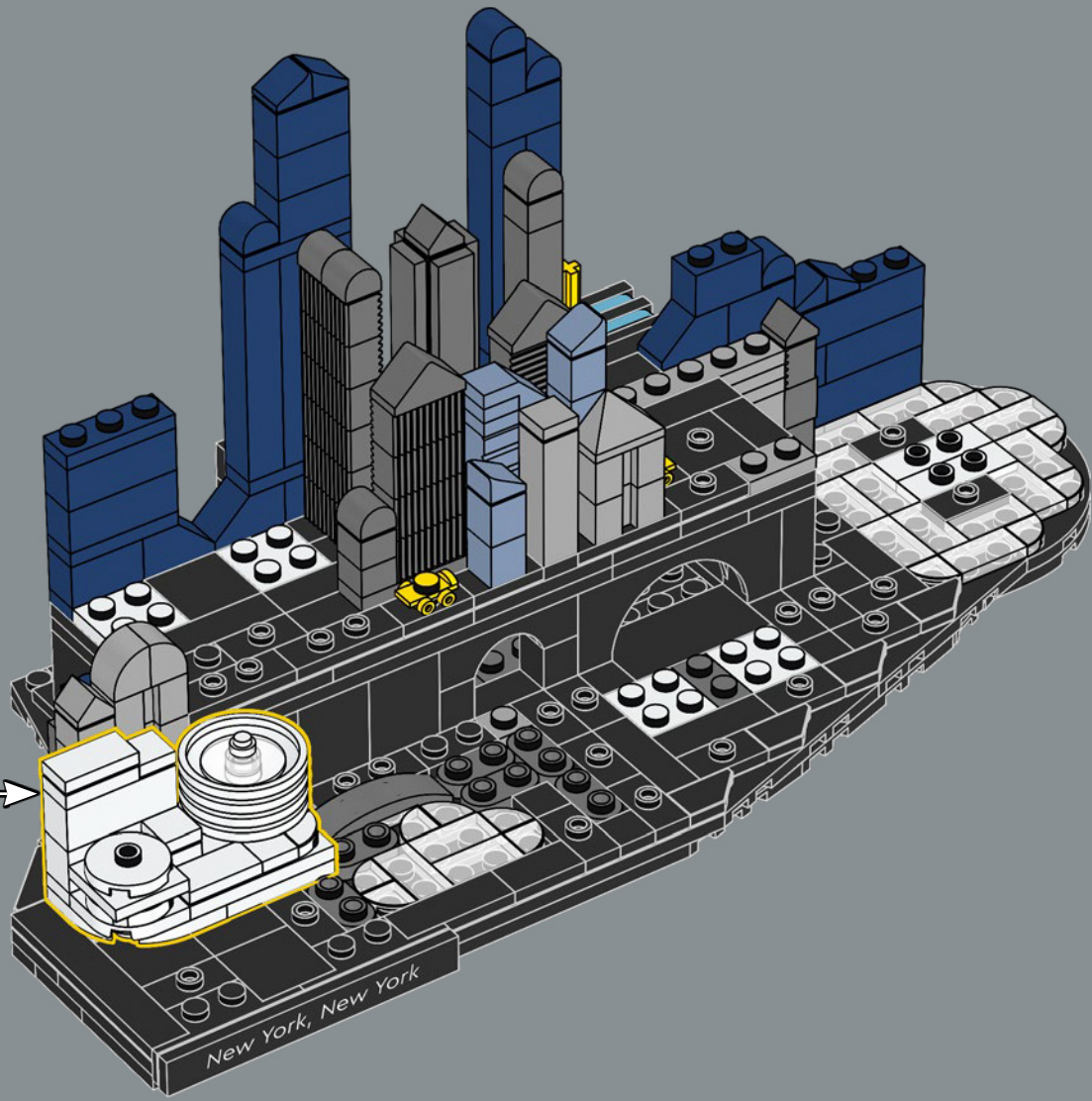

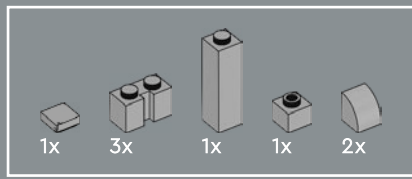

70

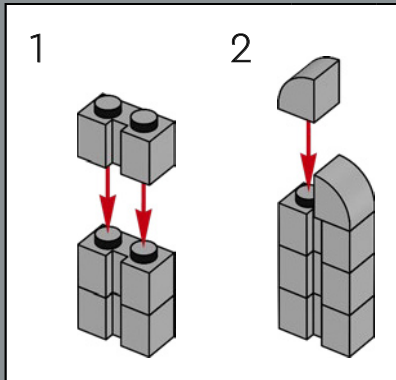
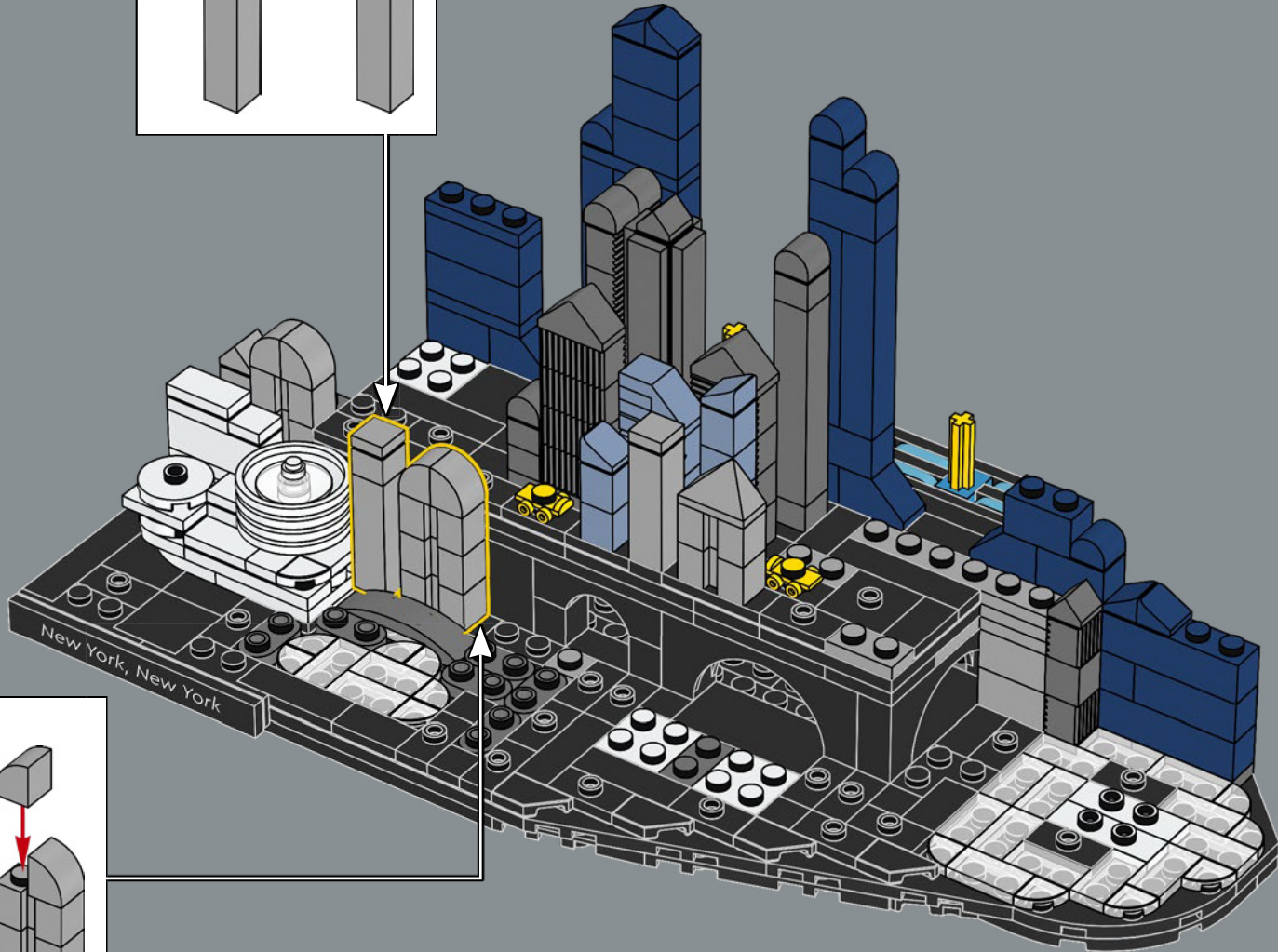
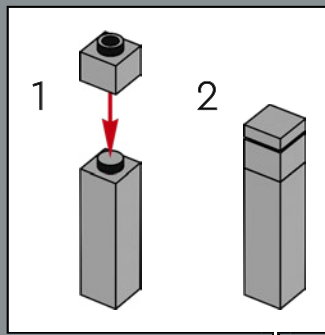

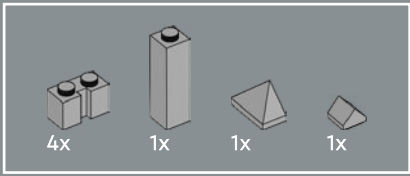

71

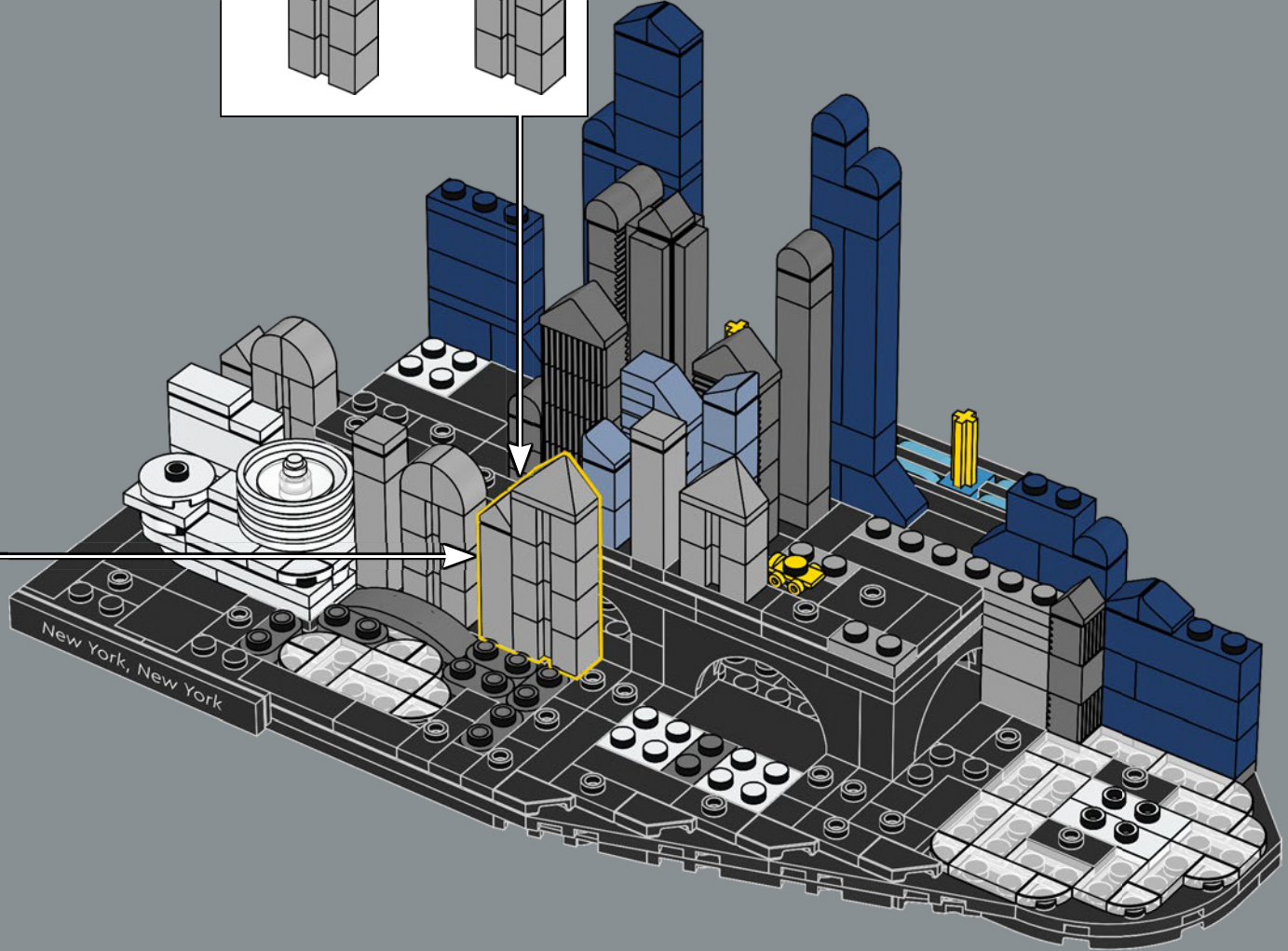
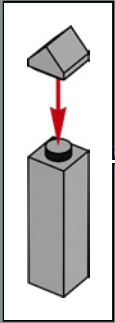
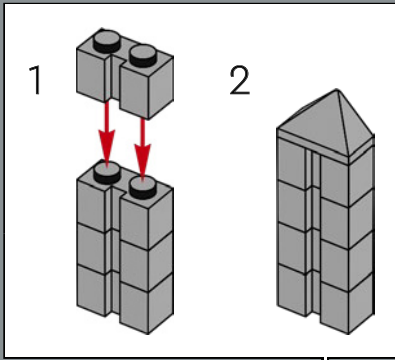



7x



3x

72

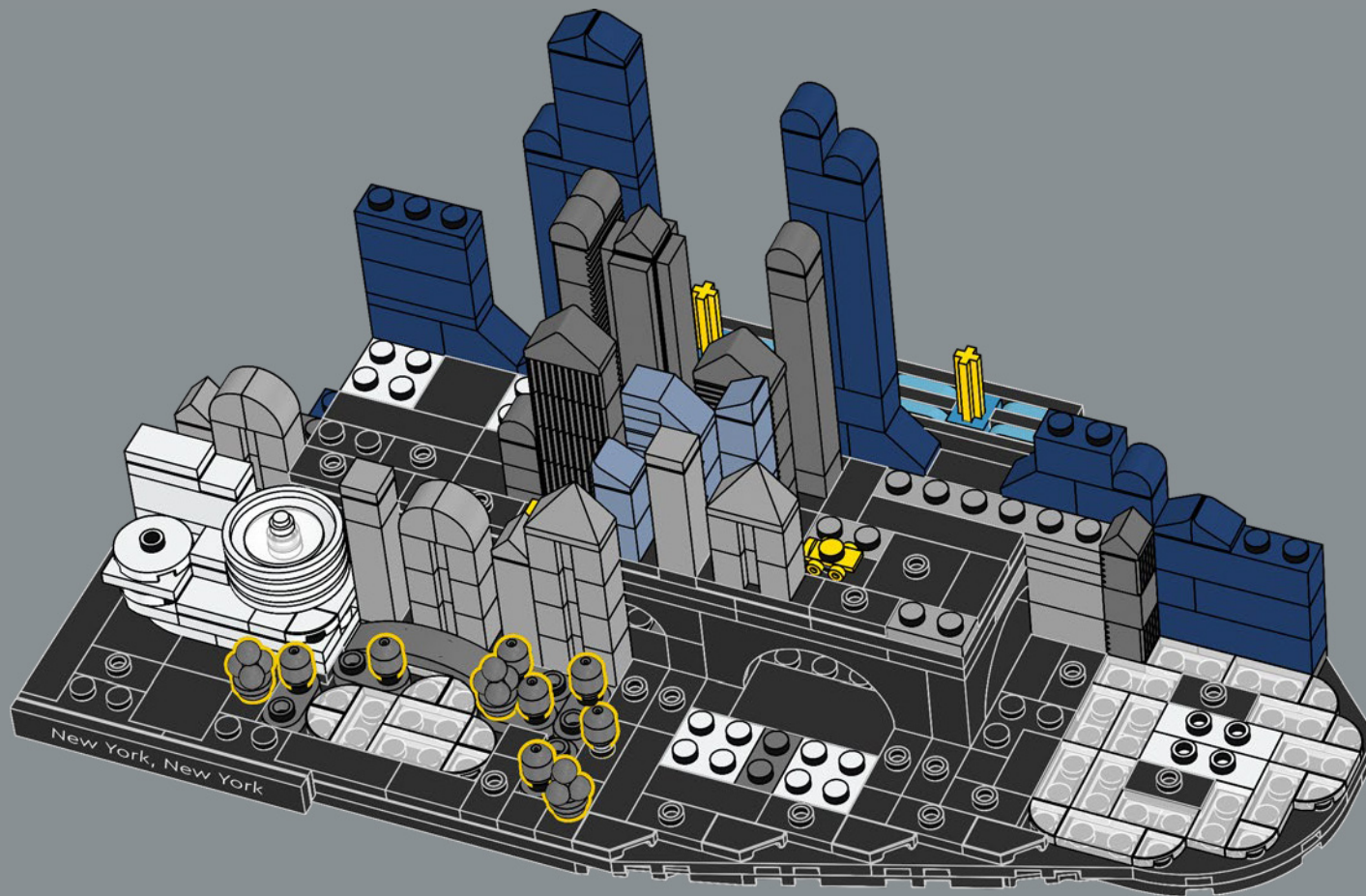



LEGO® Eiscreme-, Klingen- und Kugel-Elemente werden hier verwendet, um einen Teil der geschätzten 18.000 Bäume im Central Park nachzubilden.

73

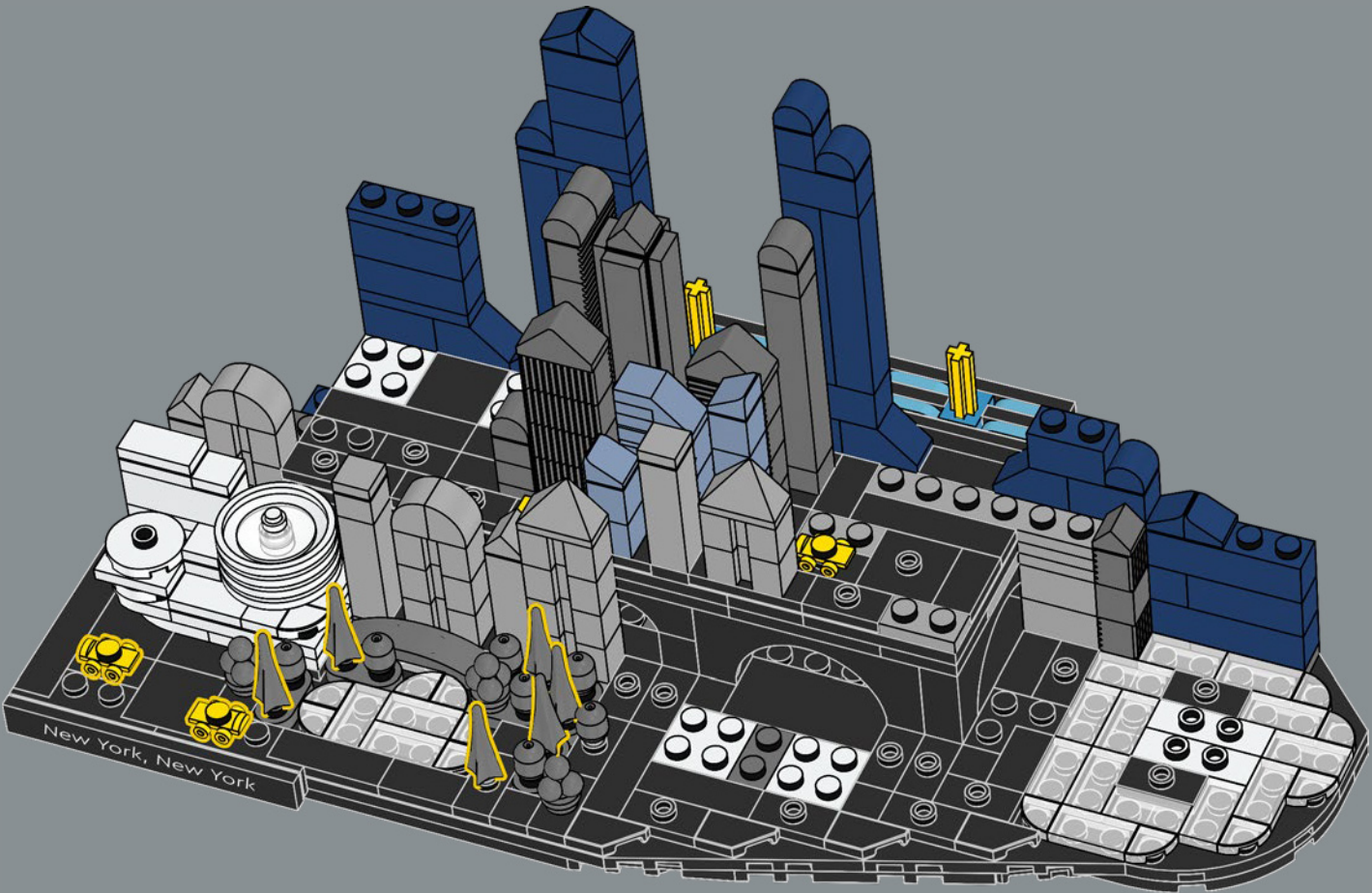

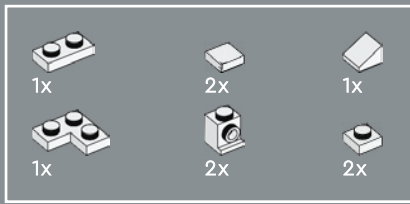

74

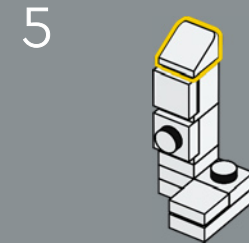
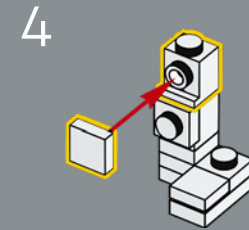
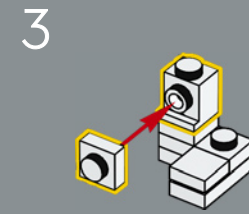
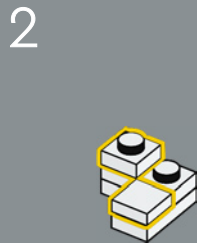
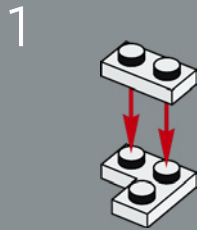

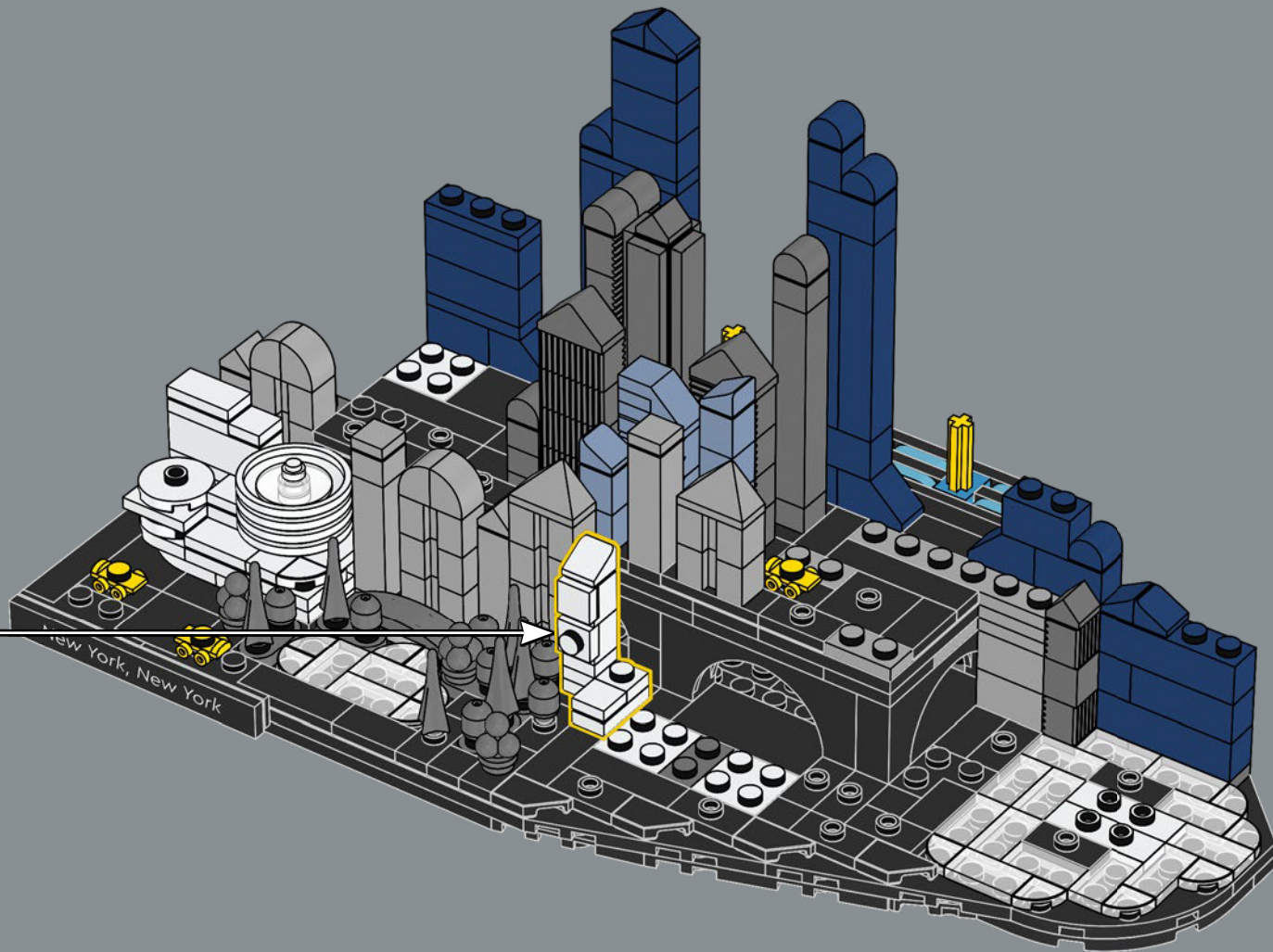

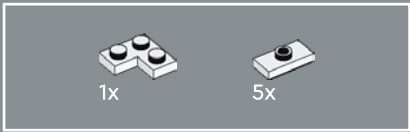

75

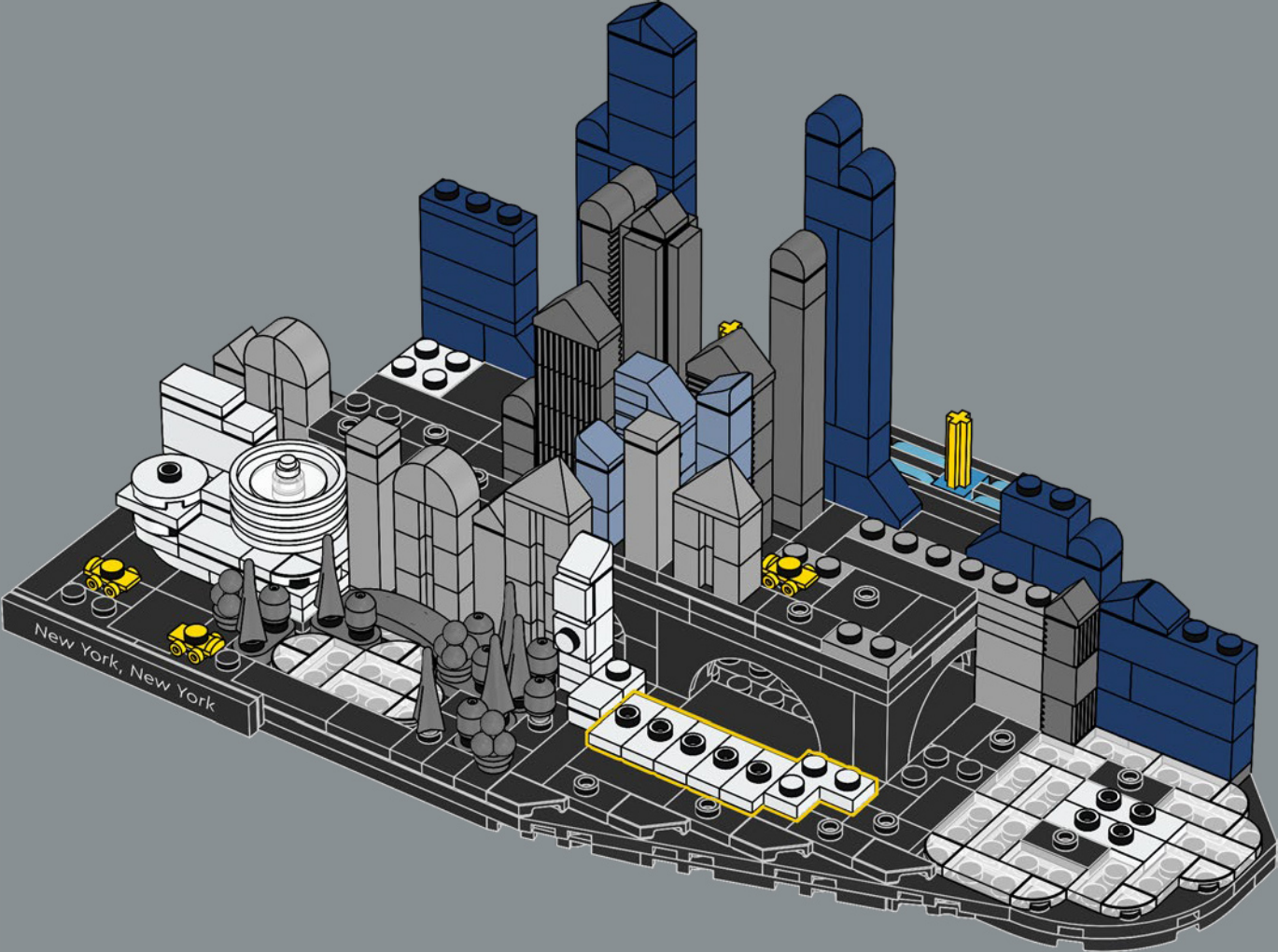

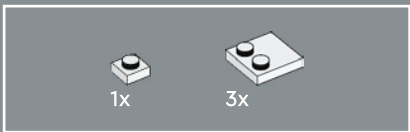

76

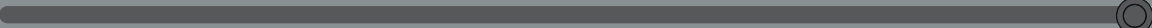
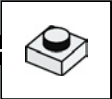
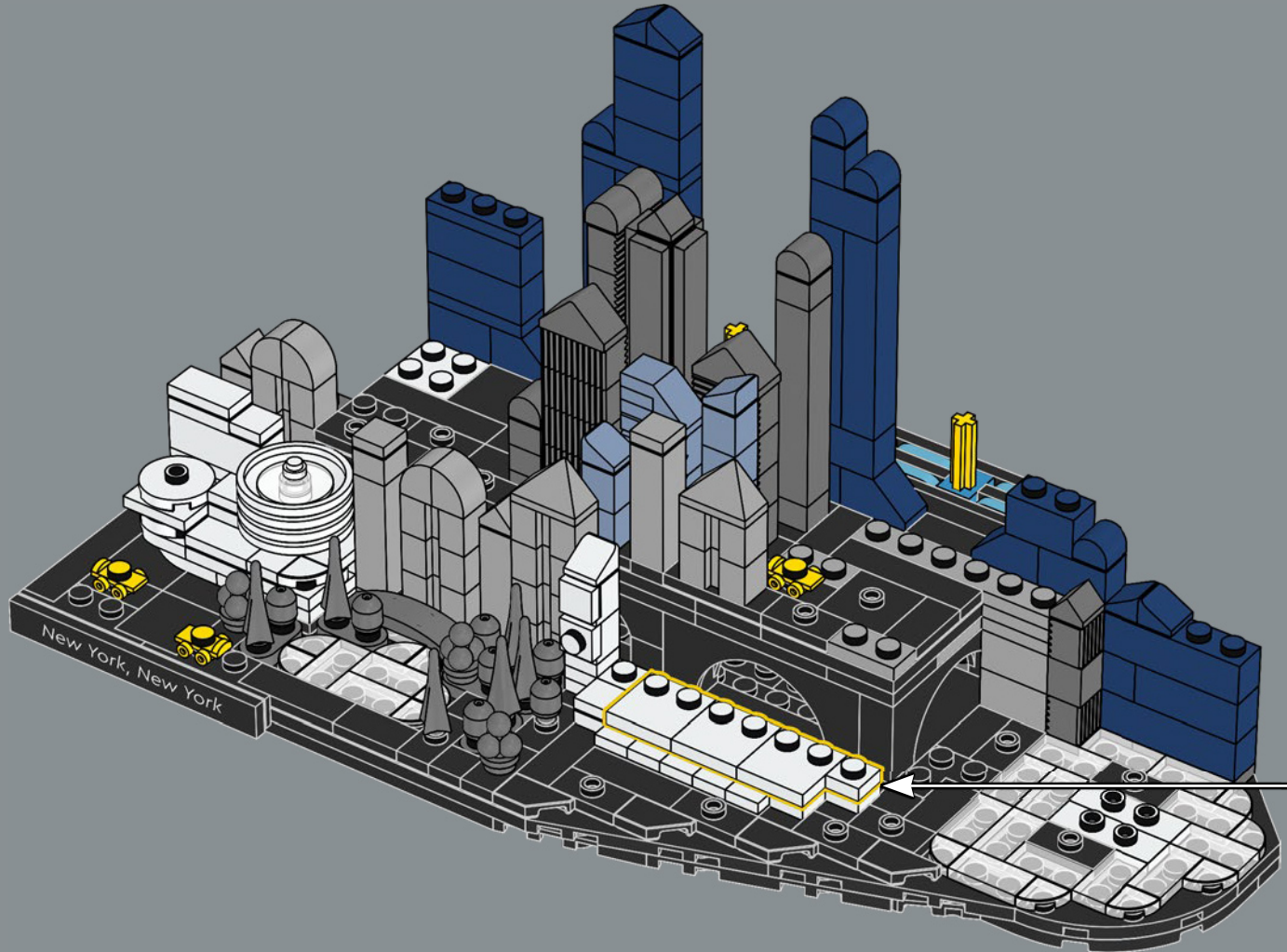

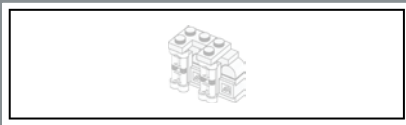

77

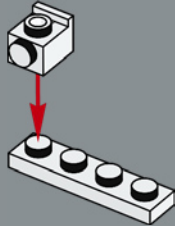

78

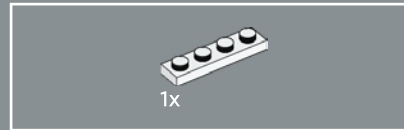
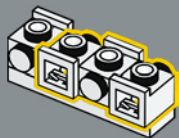

79

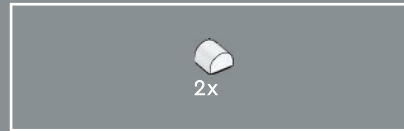
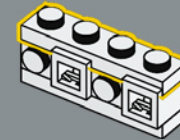

80

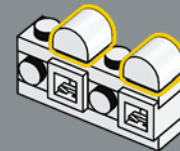

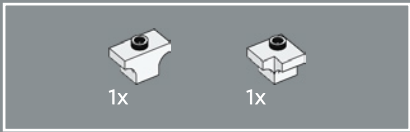

81

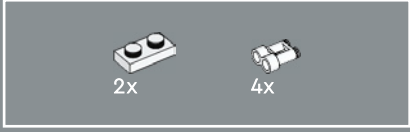
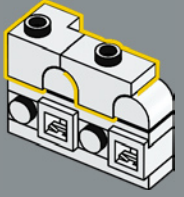

82

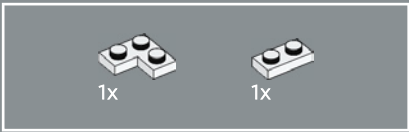
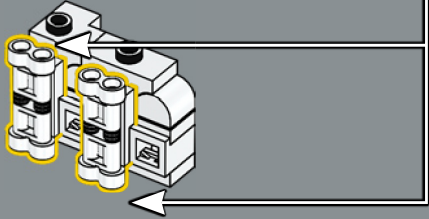
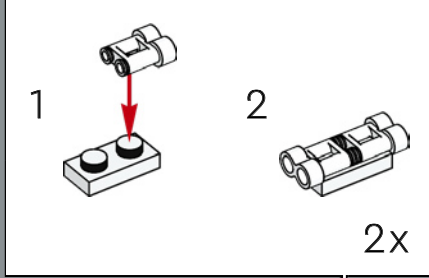

83

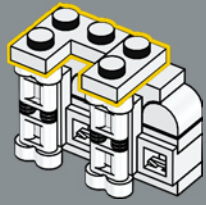

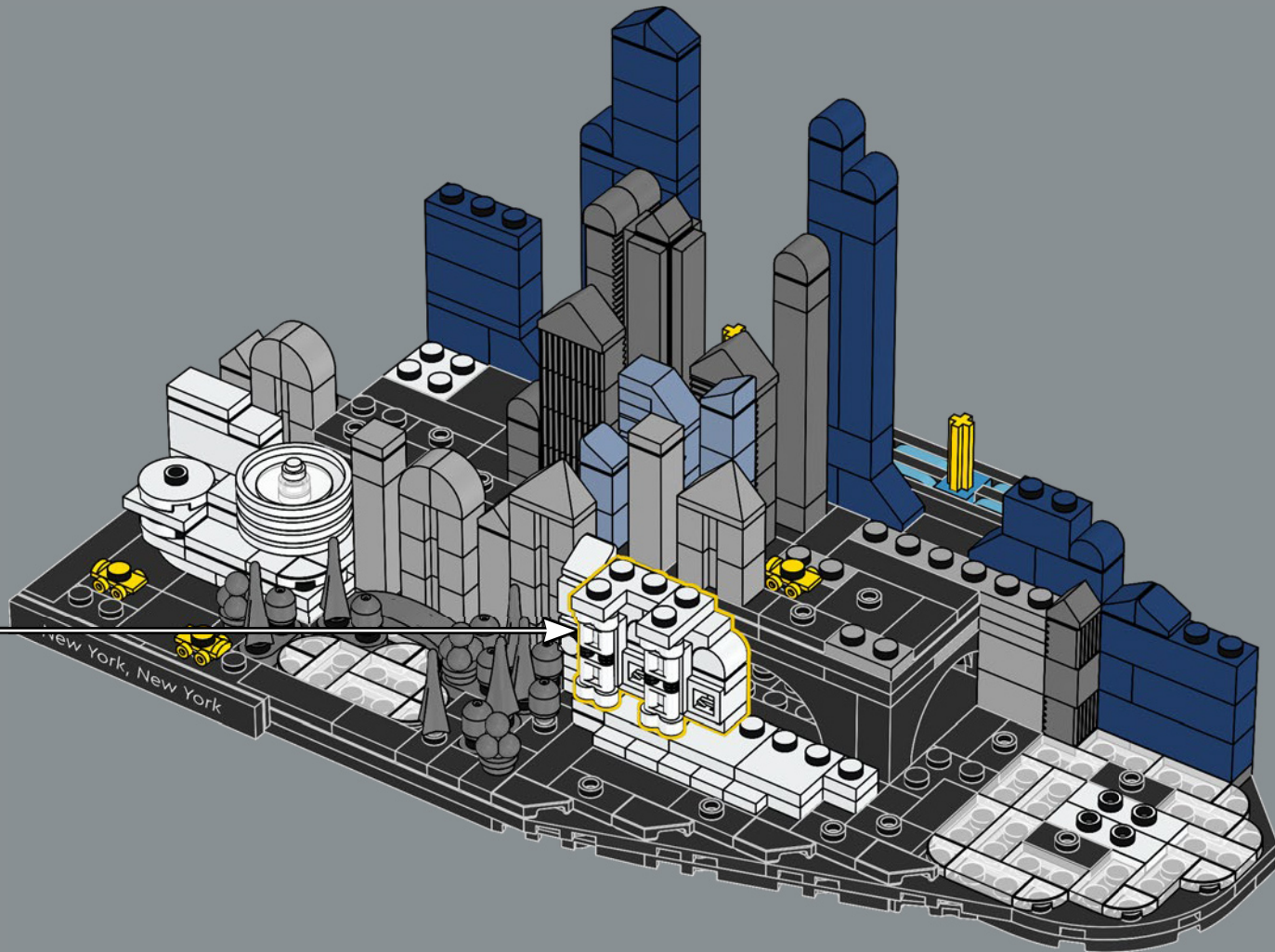

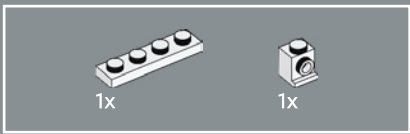

85

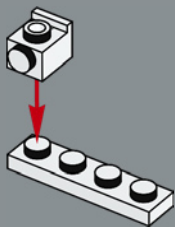

86

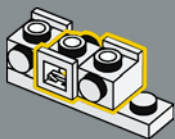

87

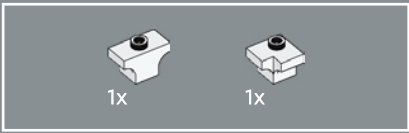
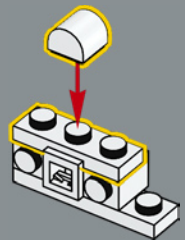

88

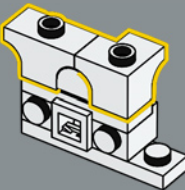

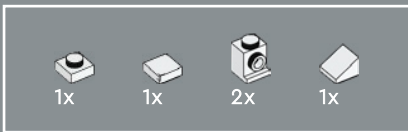

89

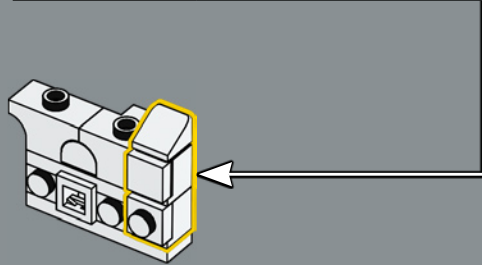
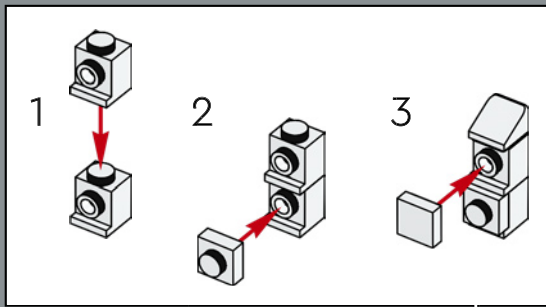

90

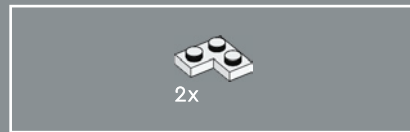
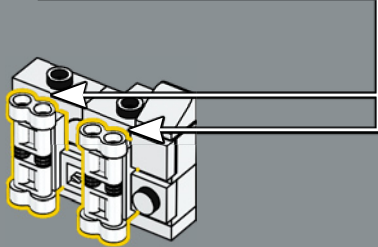
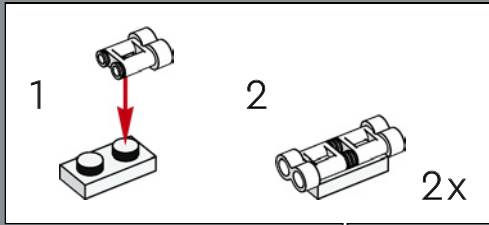

91

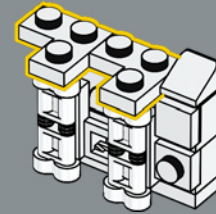

Mit LEGO® Ferngläsern werden kleine Säulenpaare erzeugt, die die Dekoration des Haupteingangs des Metropolitan Museum of Art bilden.

92

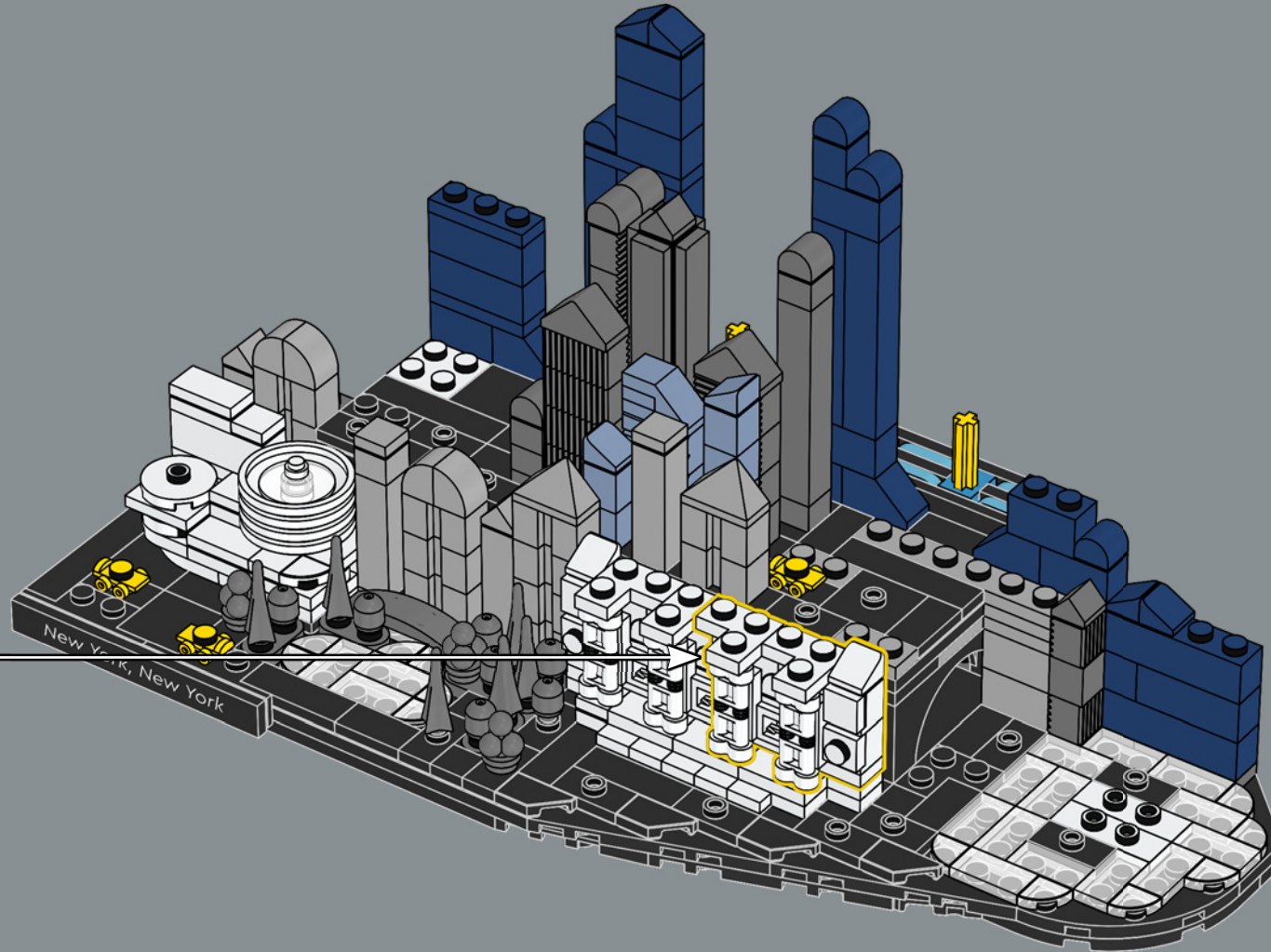

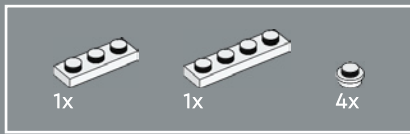

93

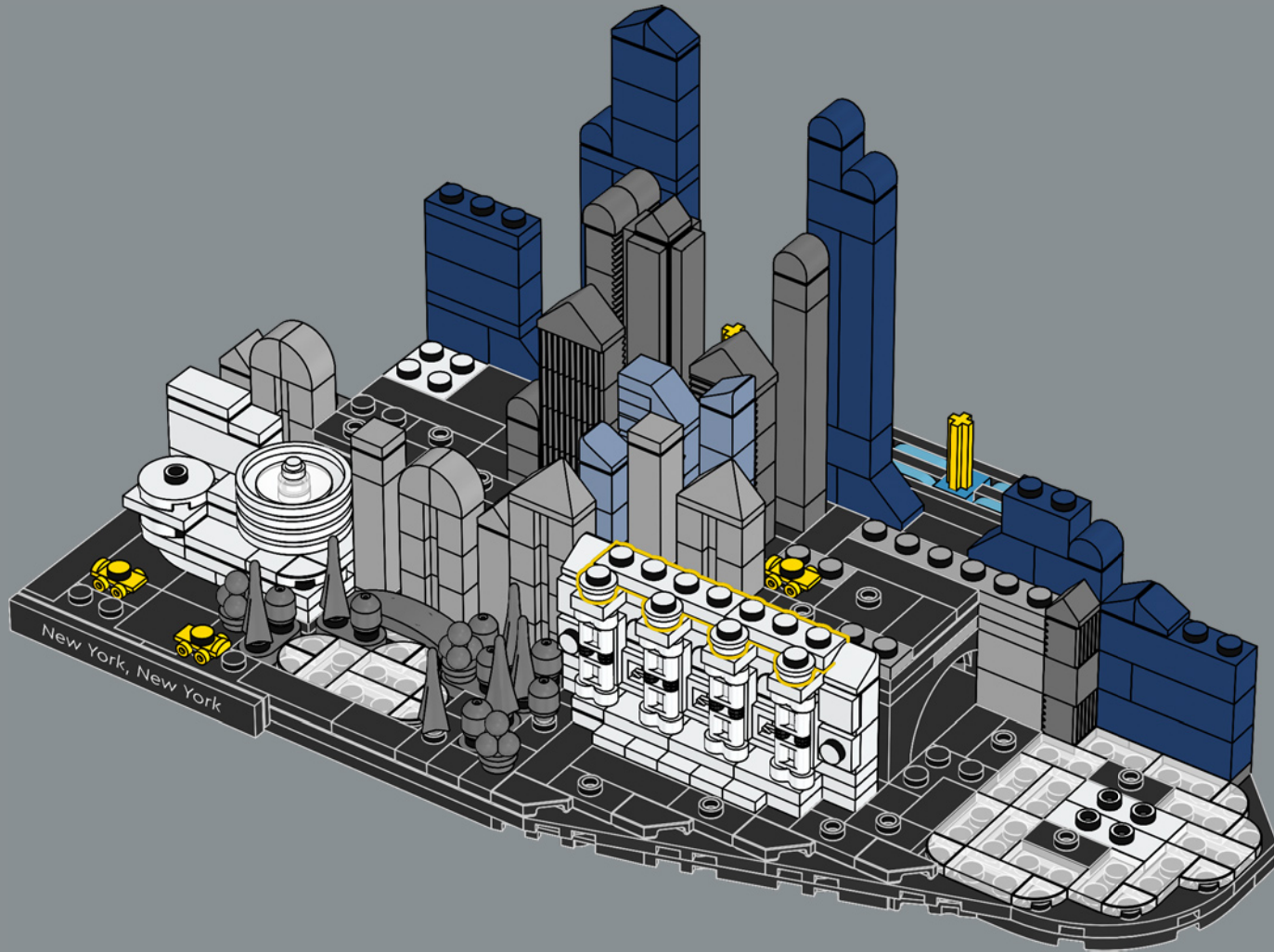

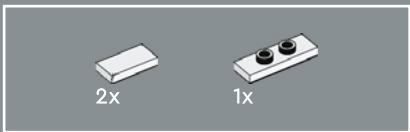

94

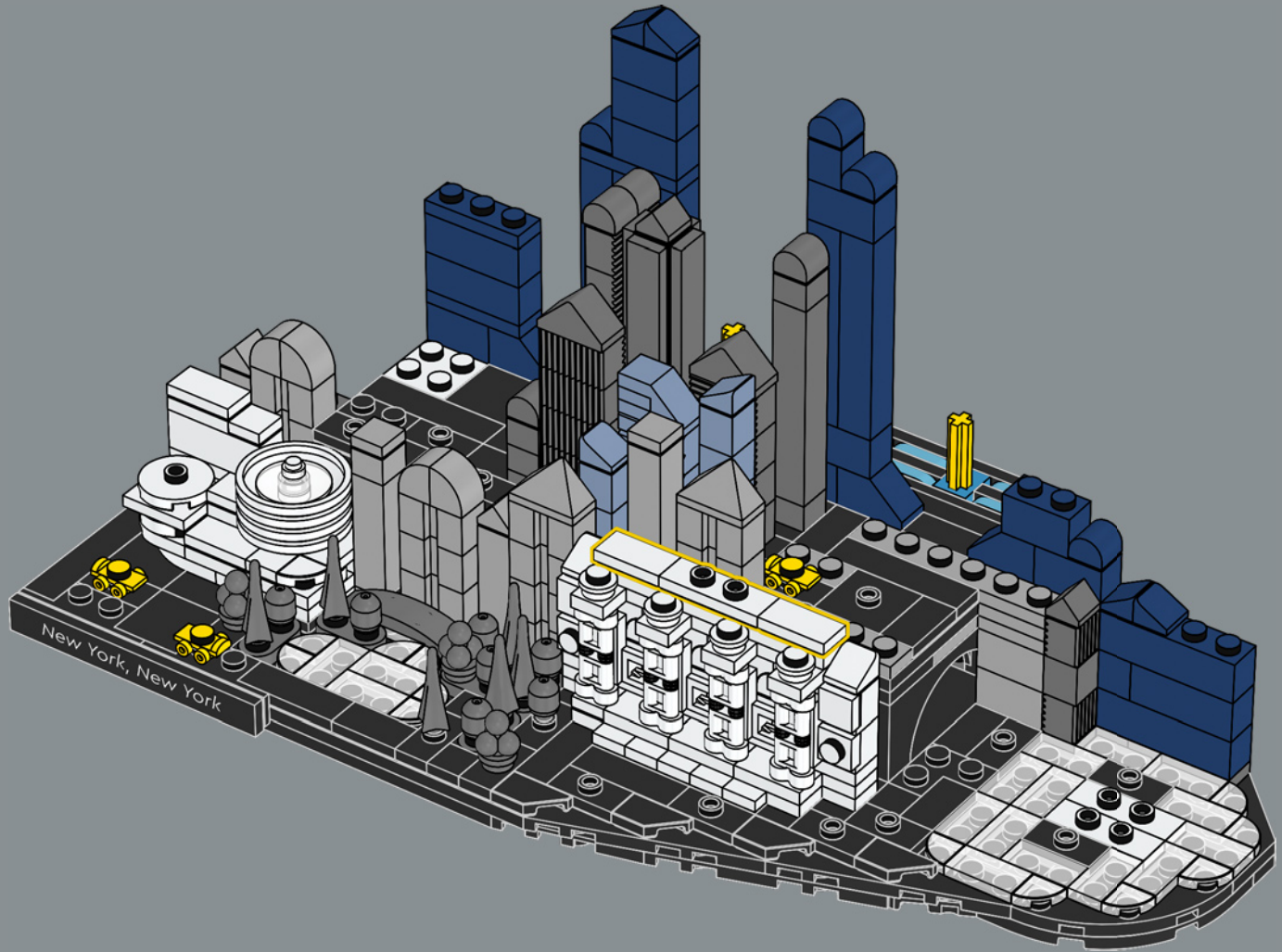



95

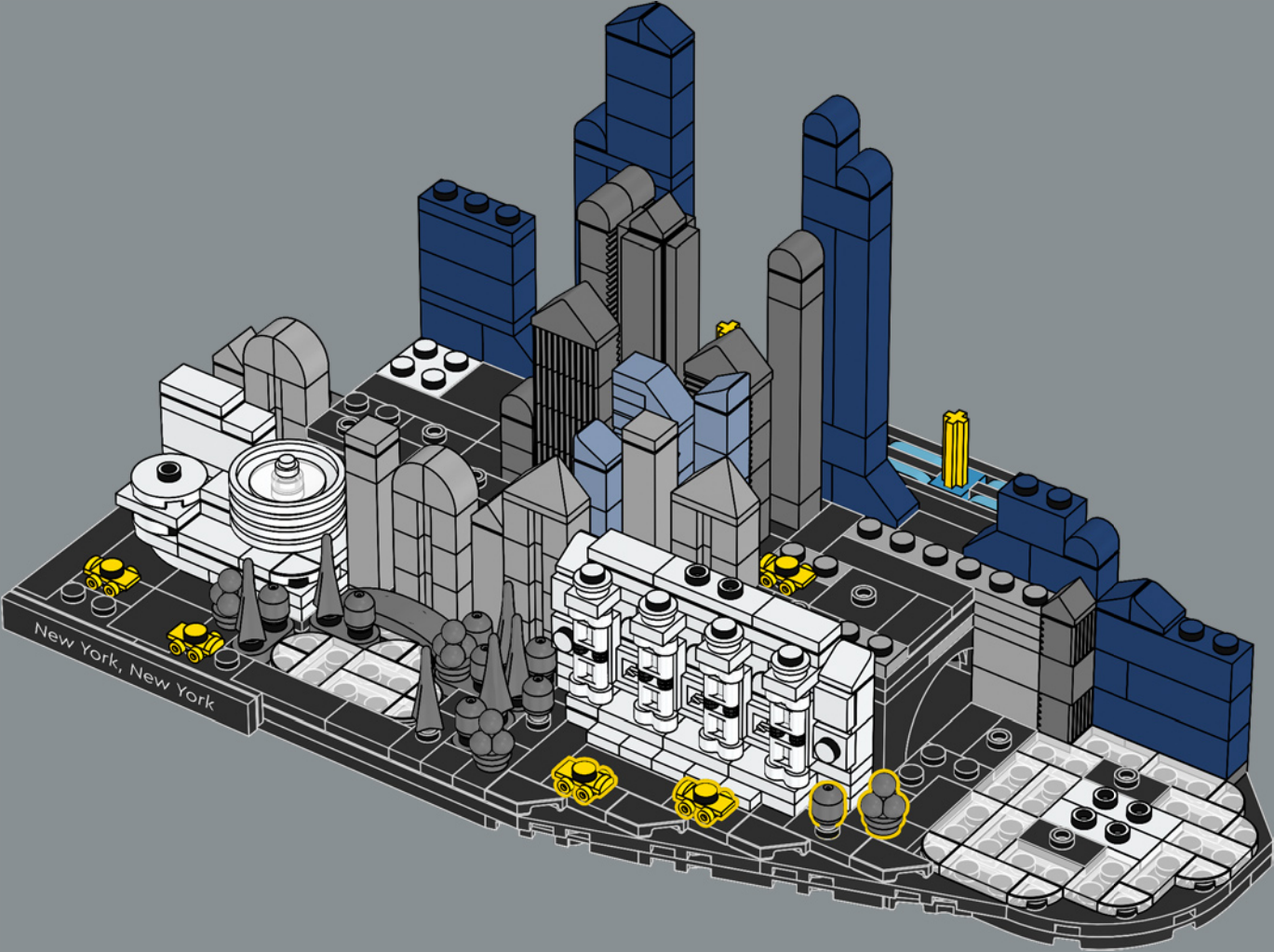

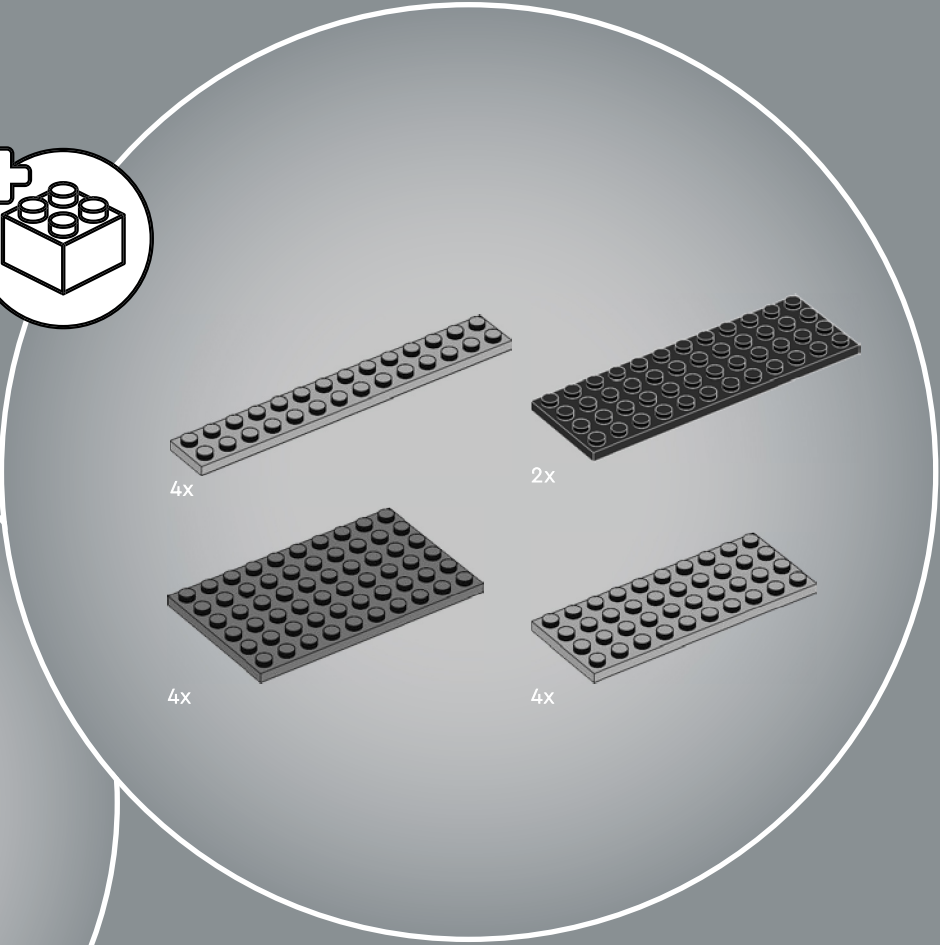
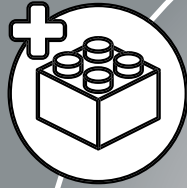

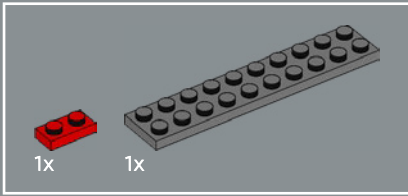
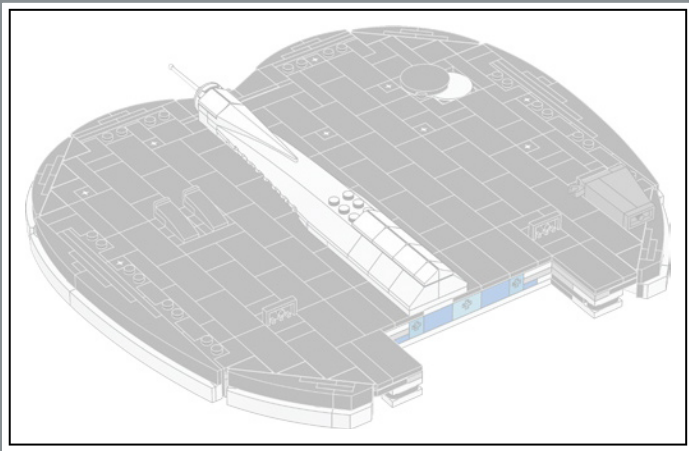

96

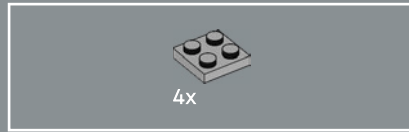
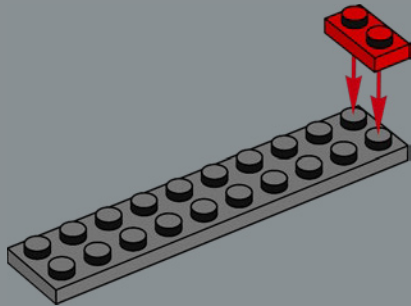

97

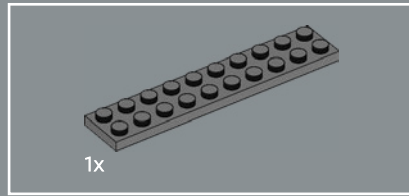
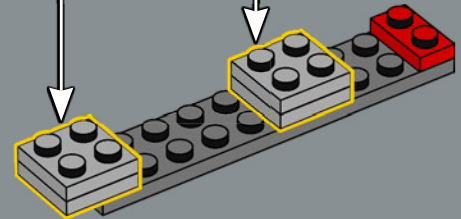
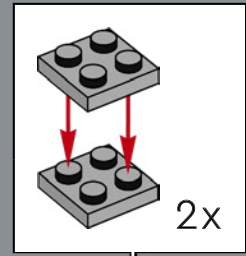

98

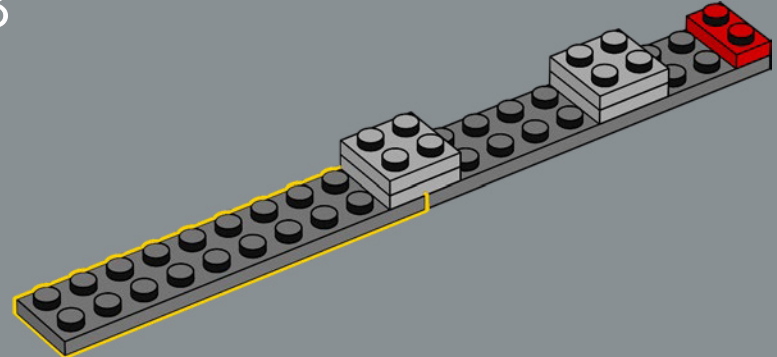

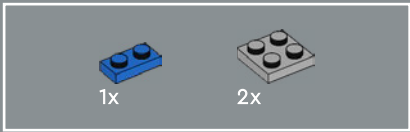

99

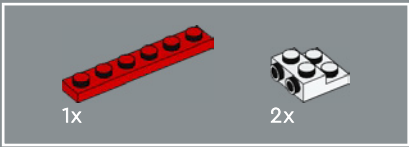
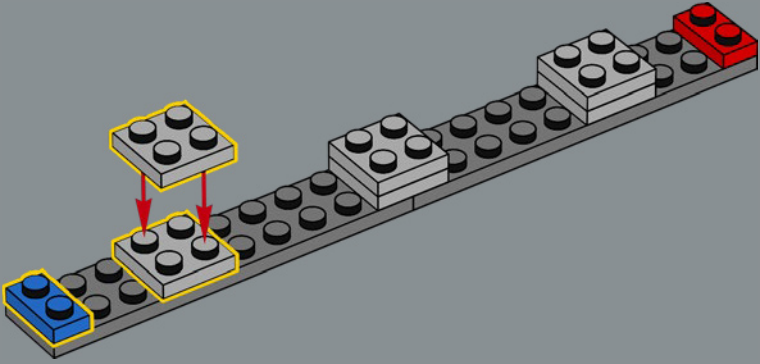

100

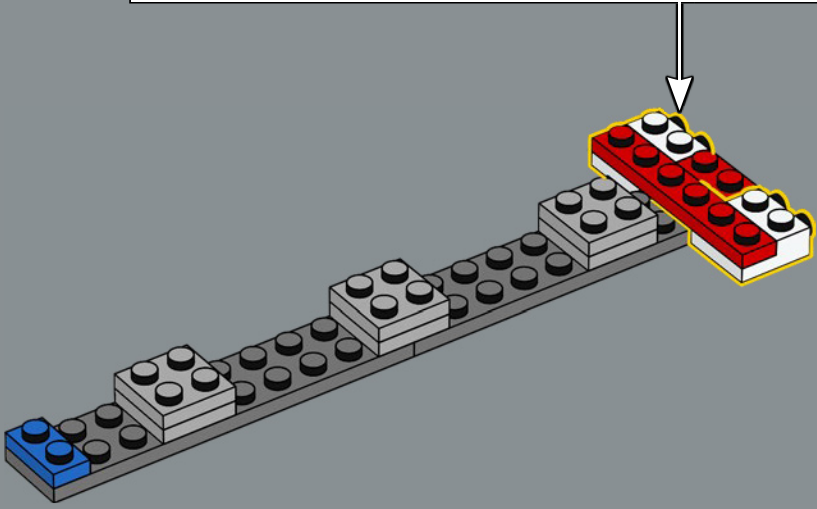
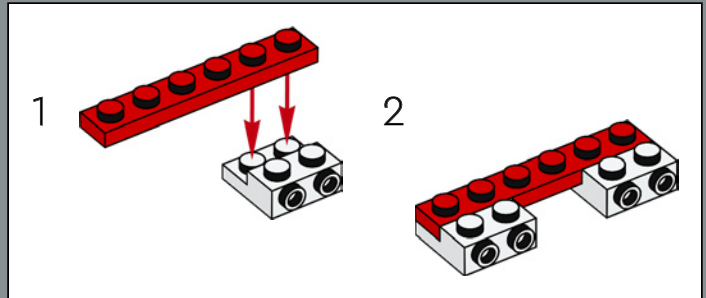

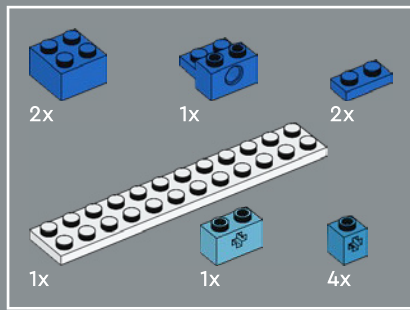

101

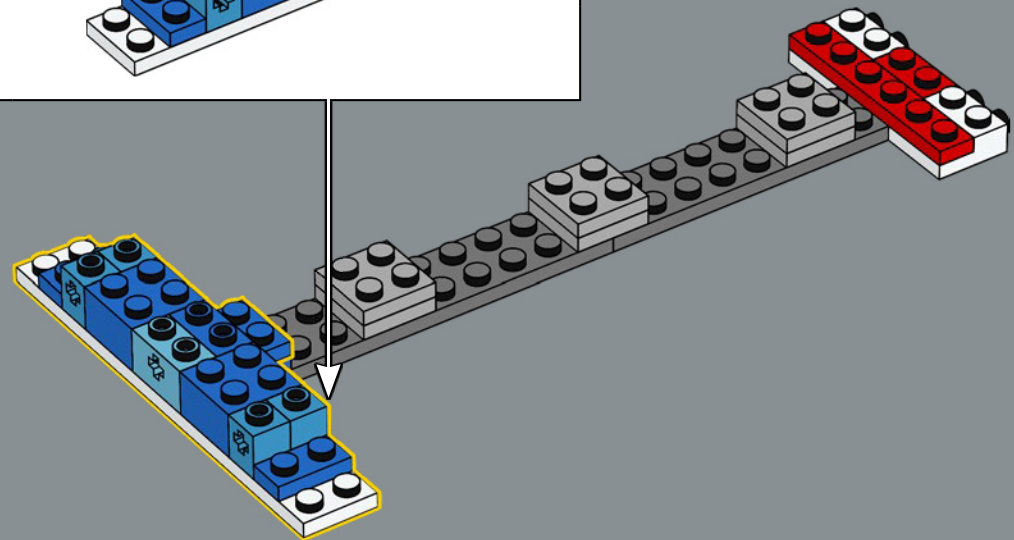
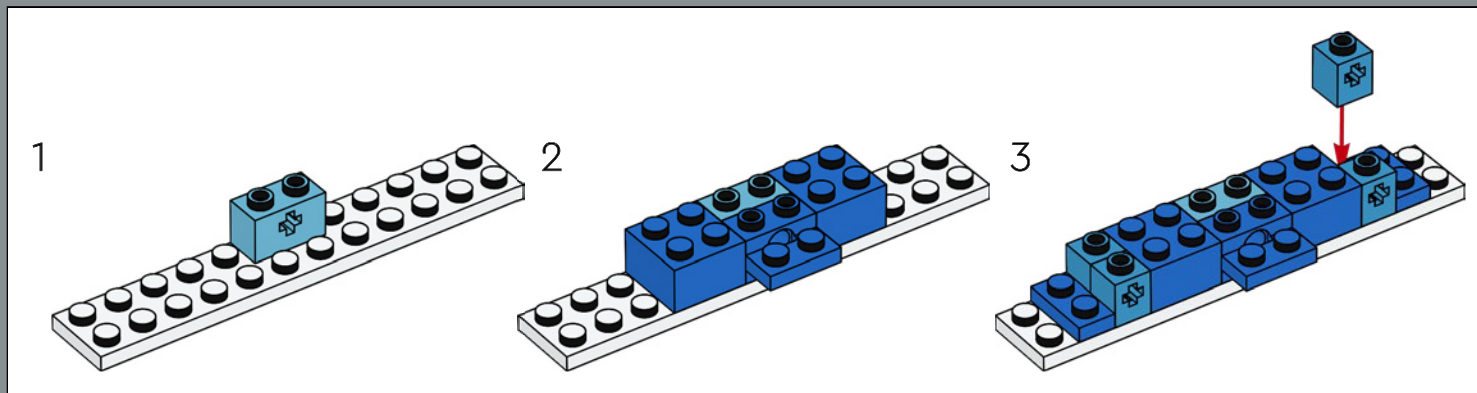

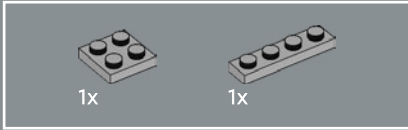
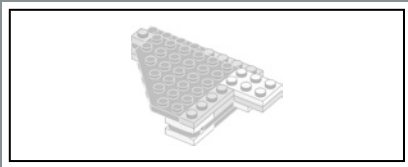

102

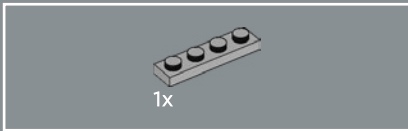
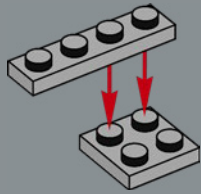

103

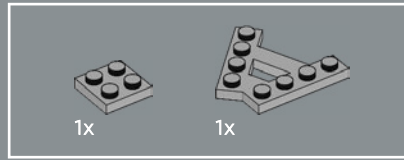
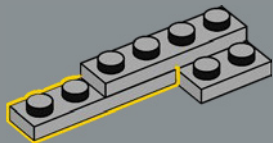

104

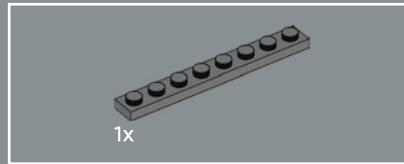
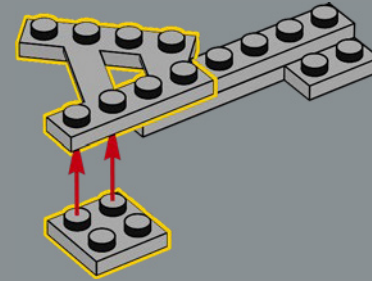

105

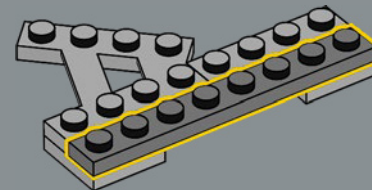



106

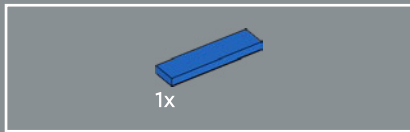
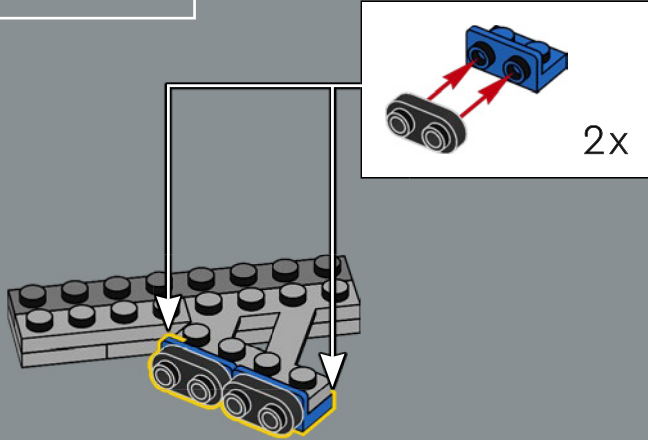

107

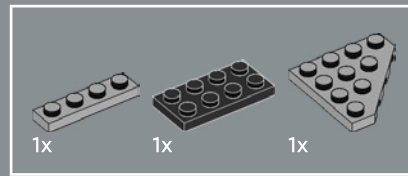
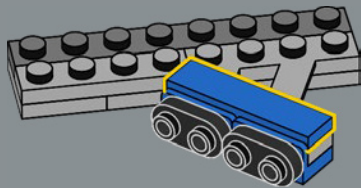

108

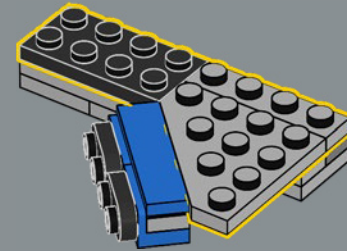

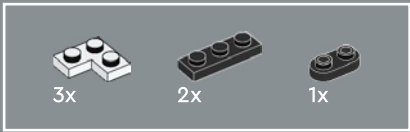

109

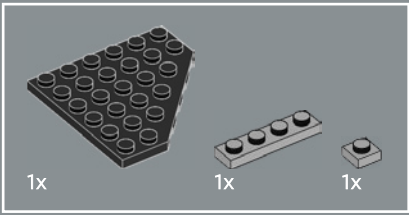
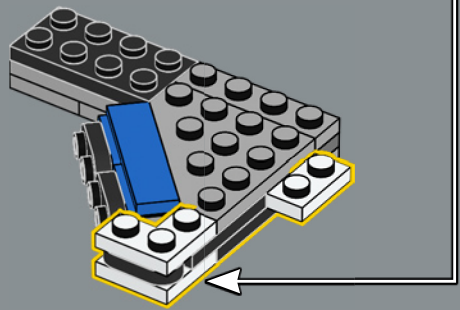
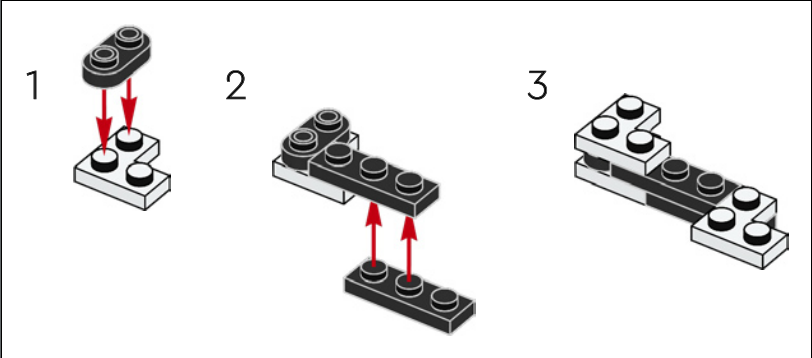

110

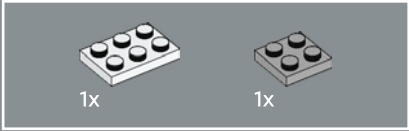
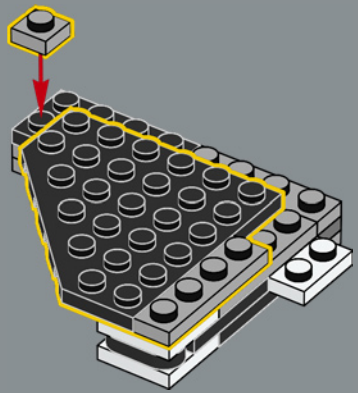

111

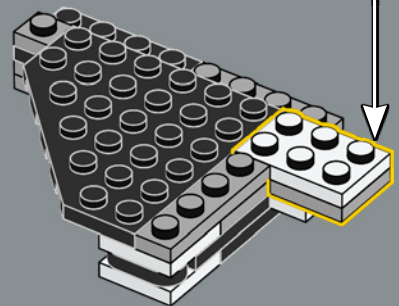
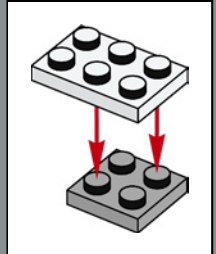

112

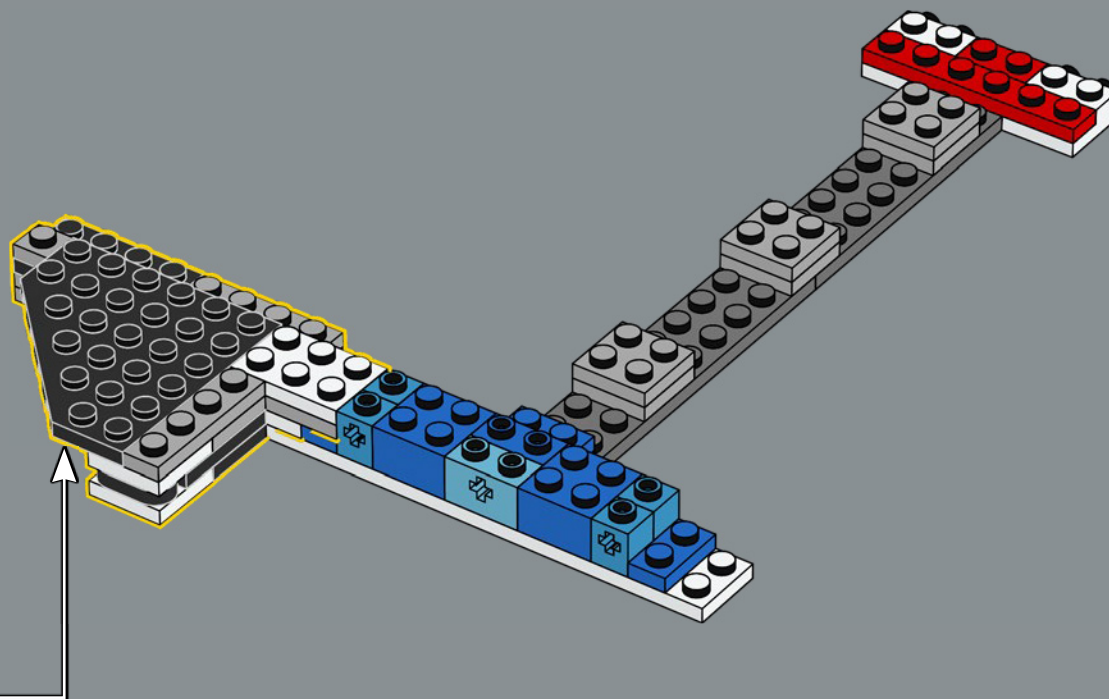

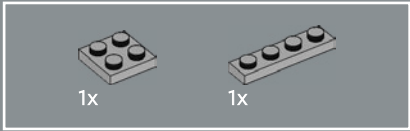
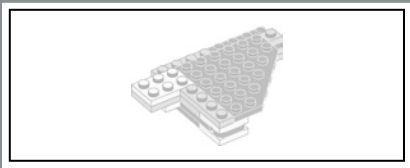

113

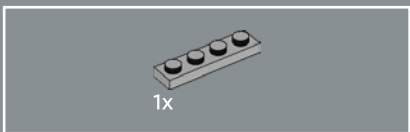
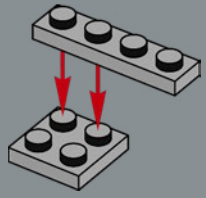

114

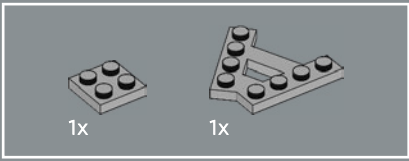
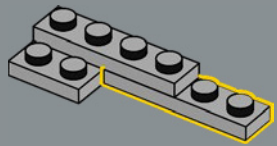

115

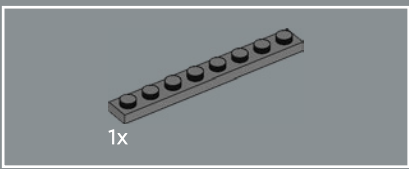
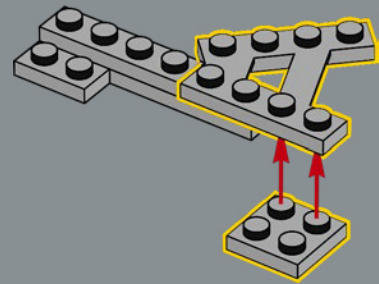

116

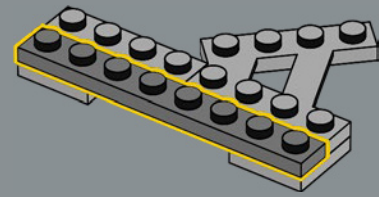



117

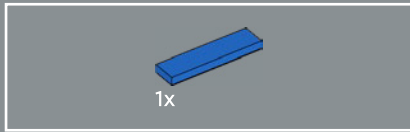
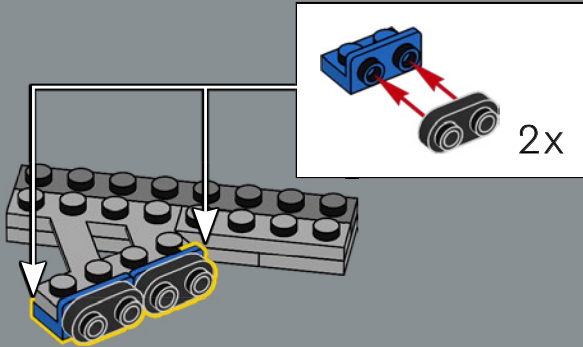

118

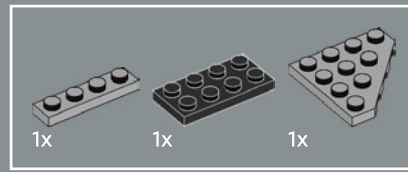
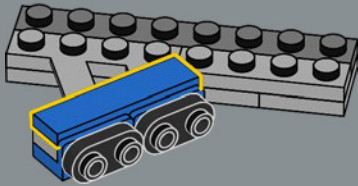

119

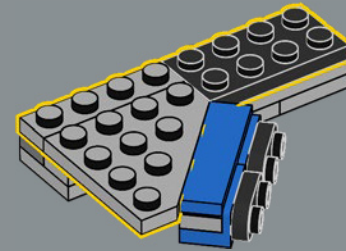

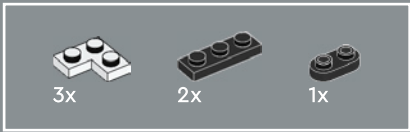

120

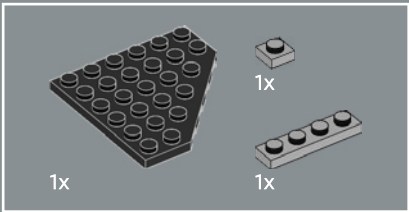
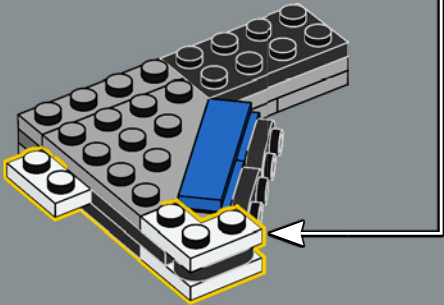
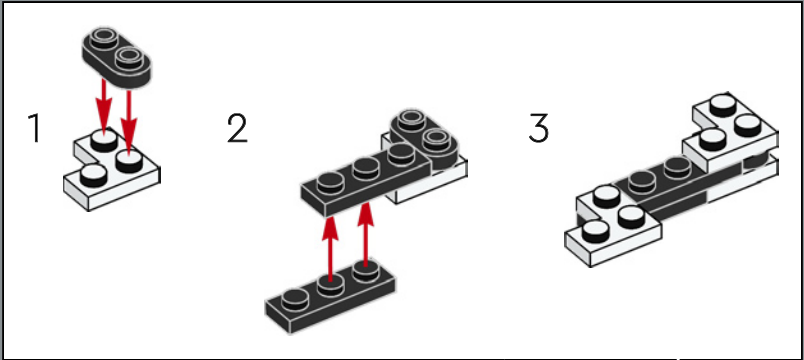

121

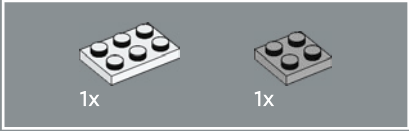
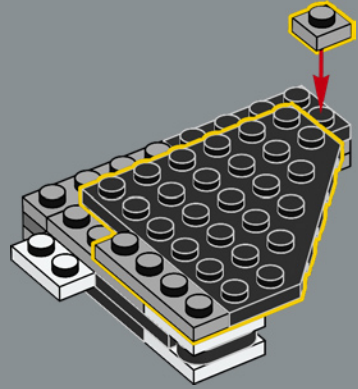

122

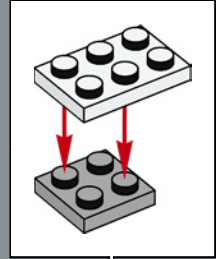
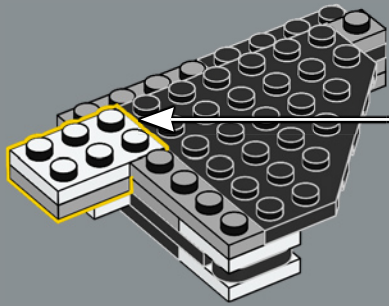

123

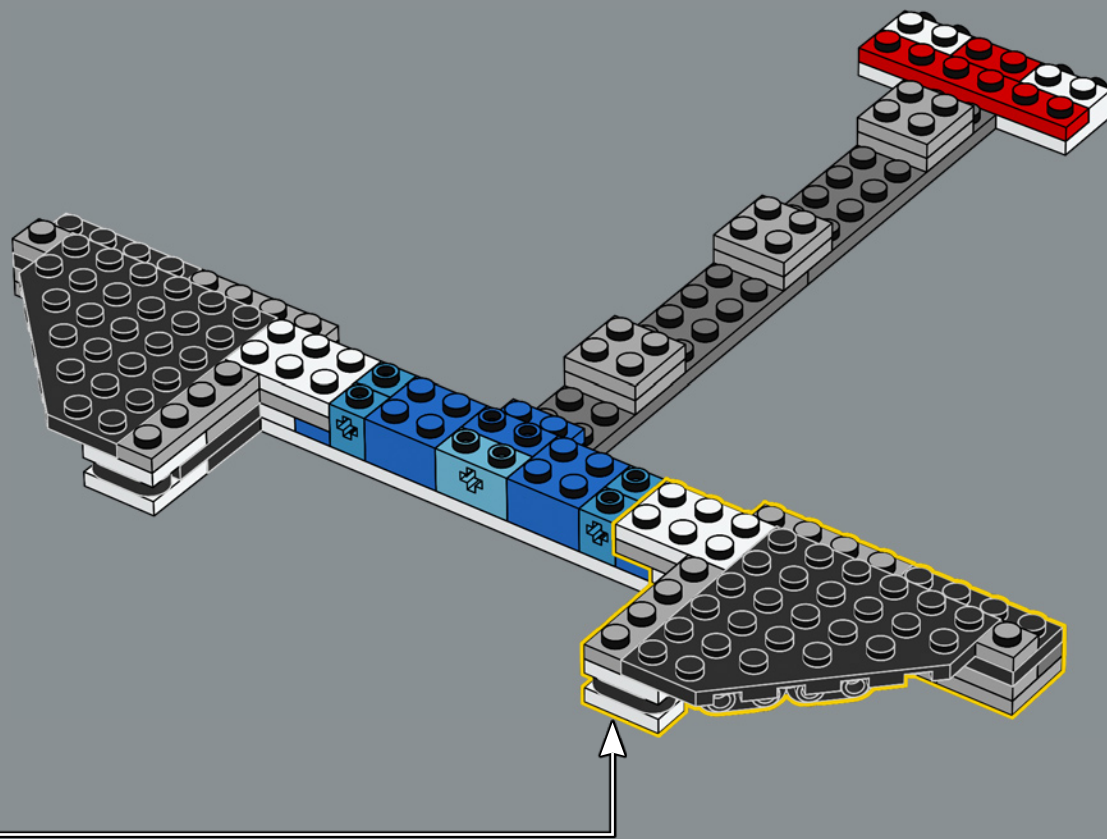

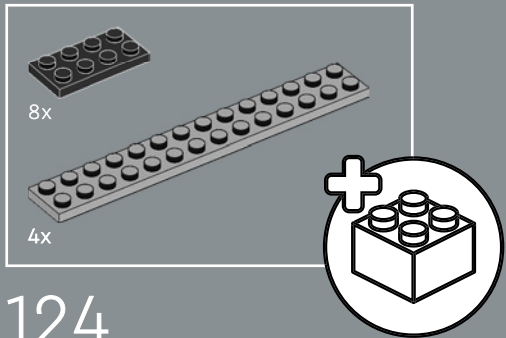
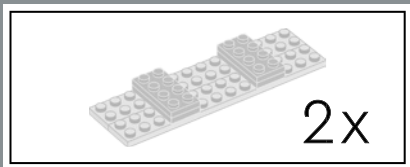

124

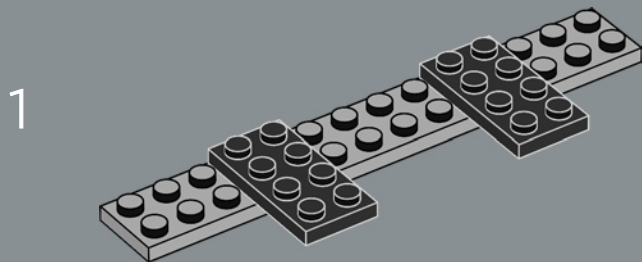

2

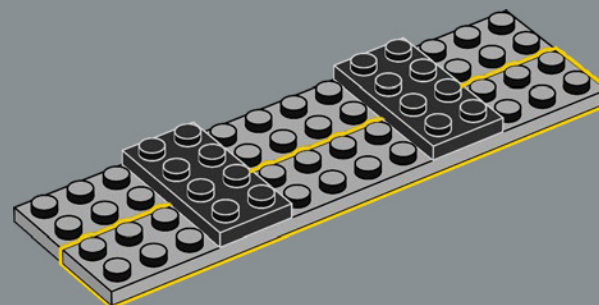

3

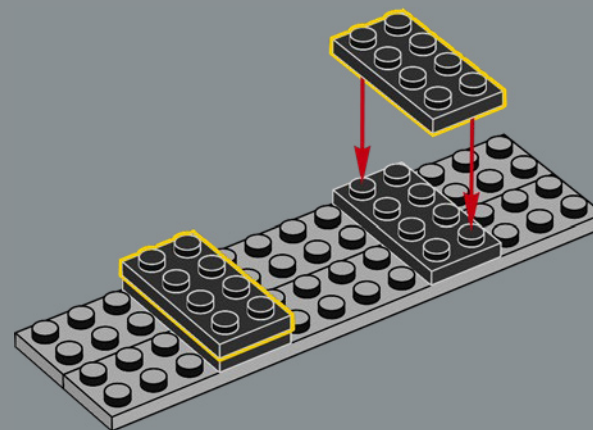

2x

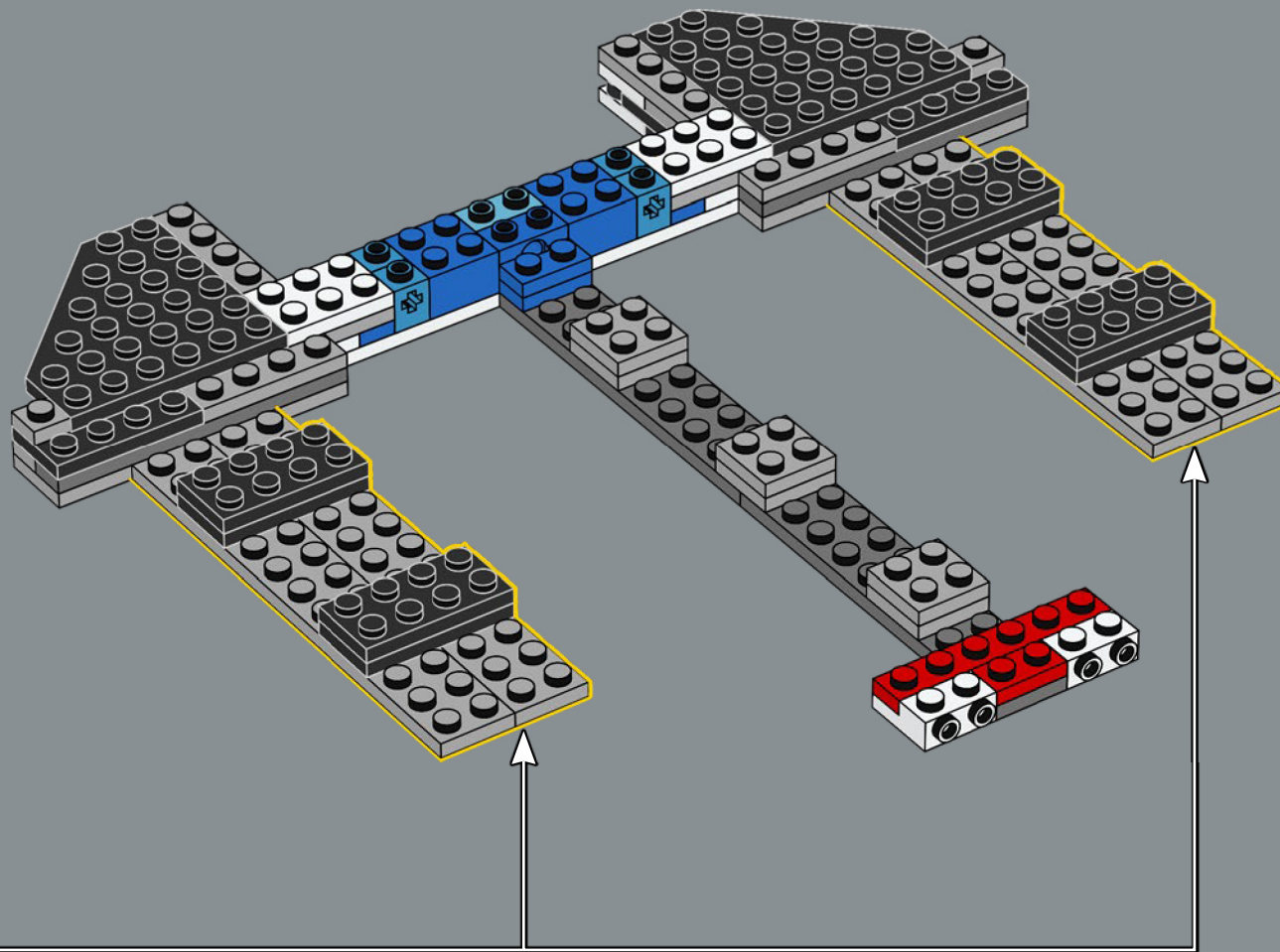

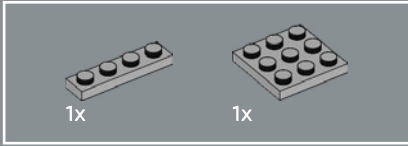
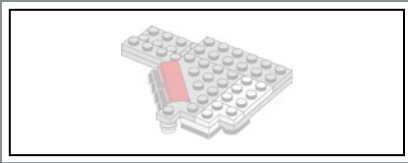

125

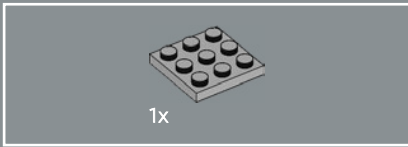
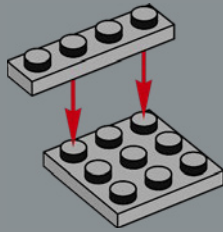

126

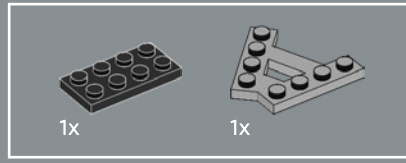
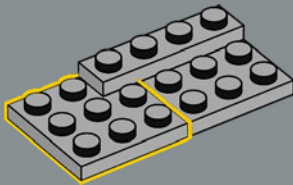

127

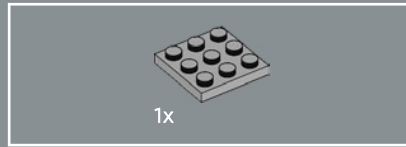
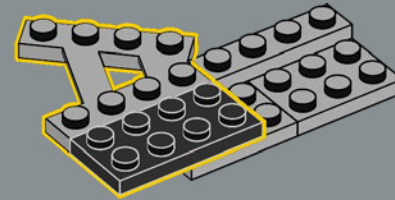

128

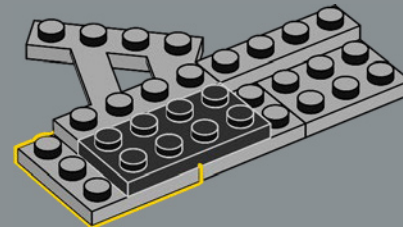



129

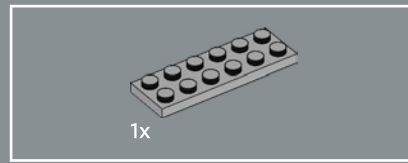
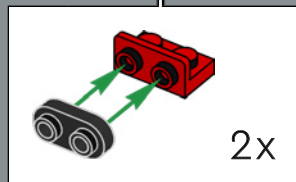
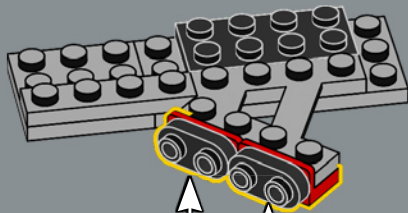

130

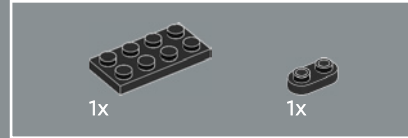
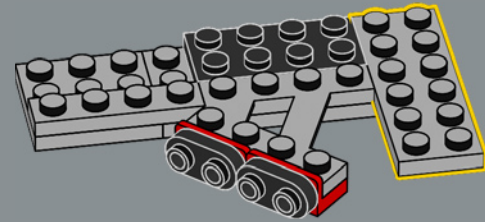

131

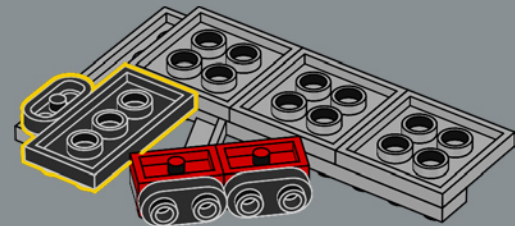



132

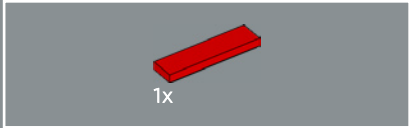
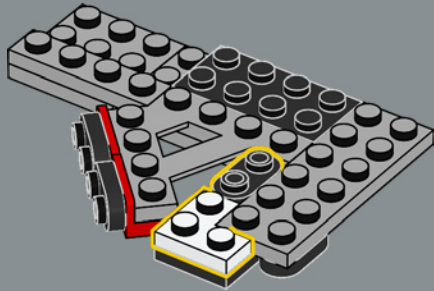

133

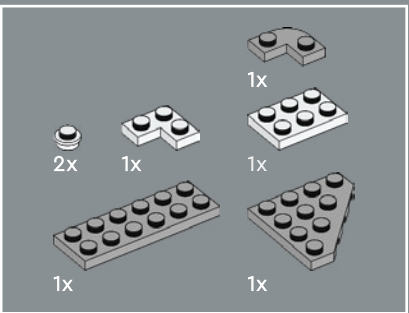
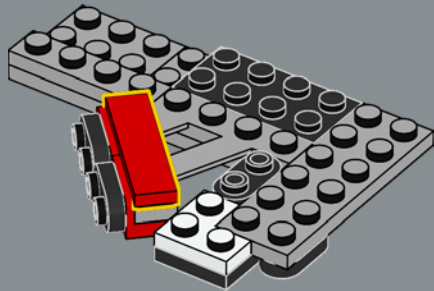

134

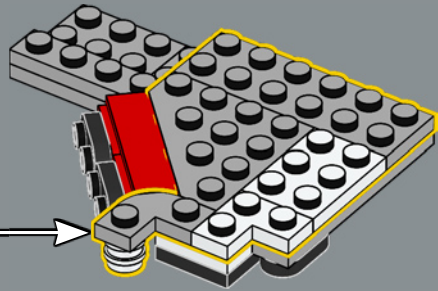
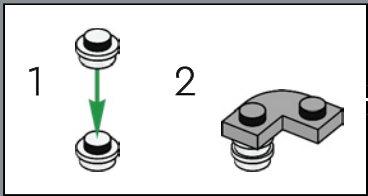

135

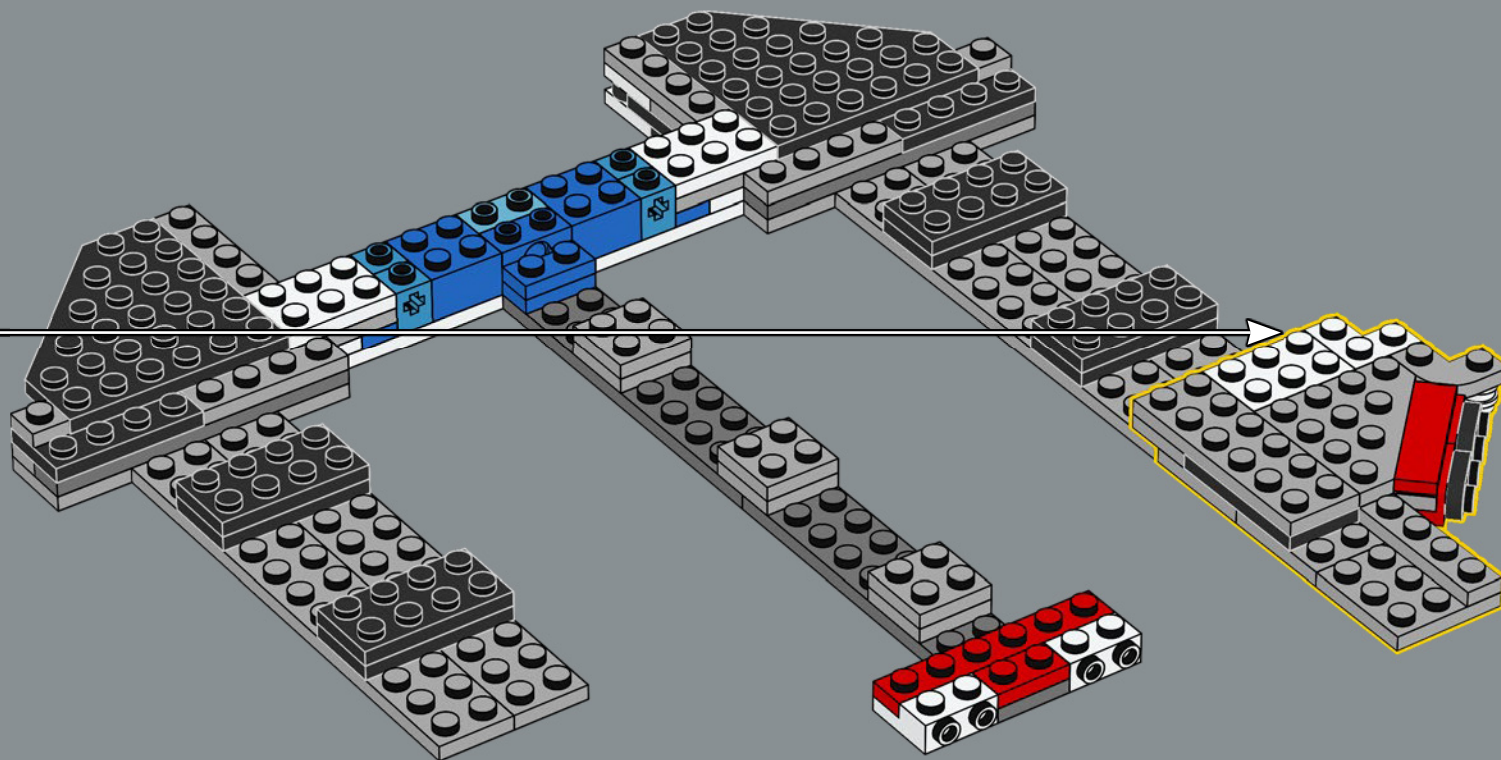

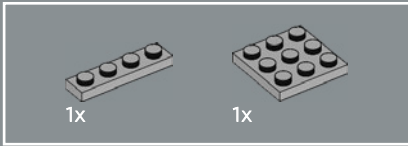
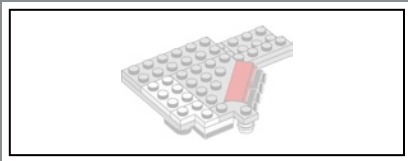

136

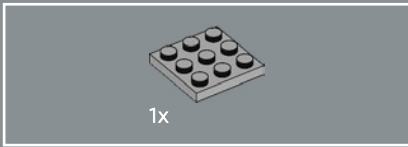
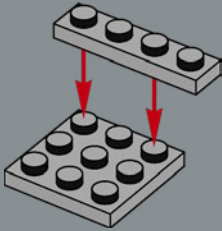

137

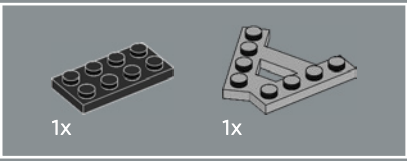
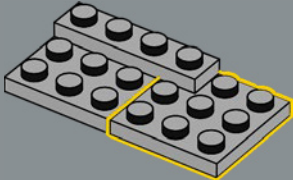

138

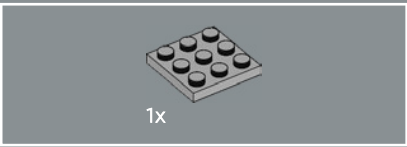
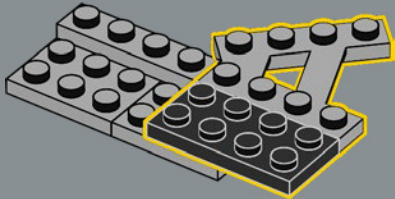

139

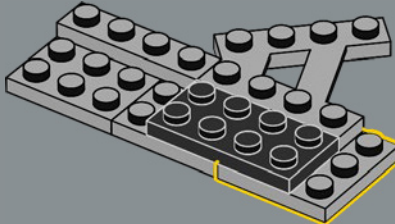



140

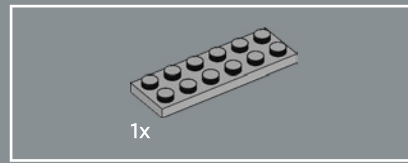
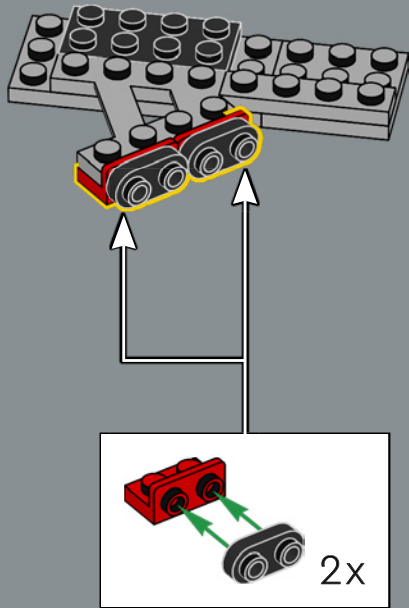

141

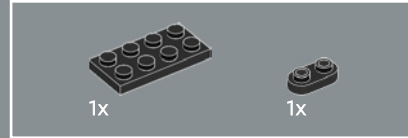
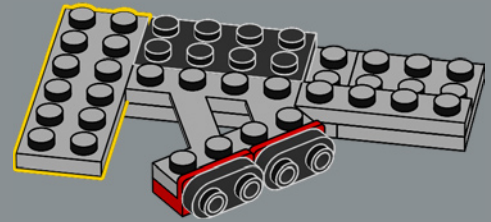

142

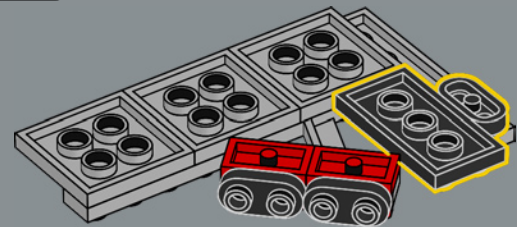



143

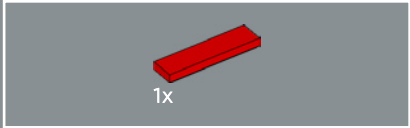
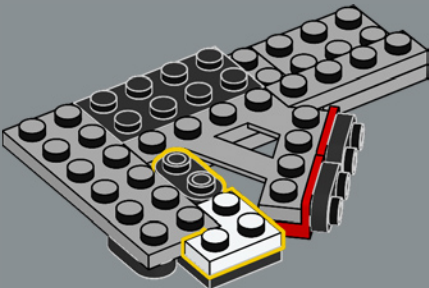

144

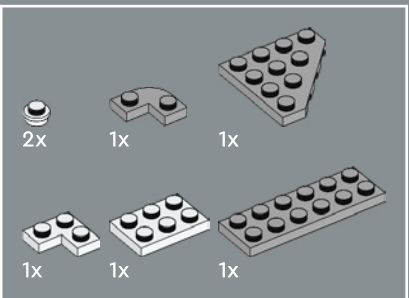
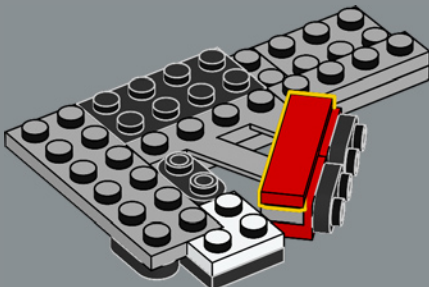

145

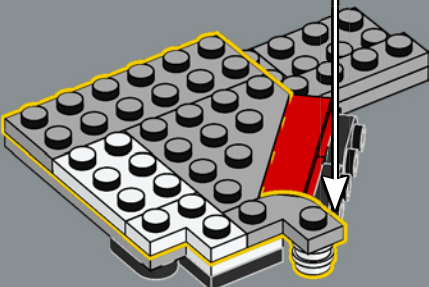
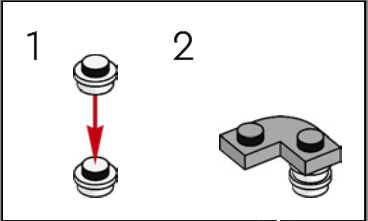

146

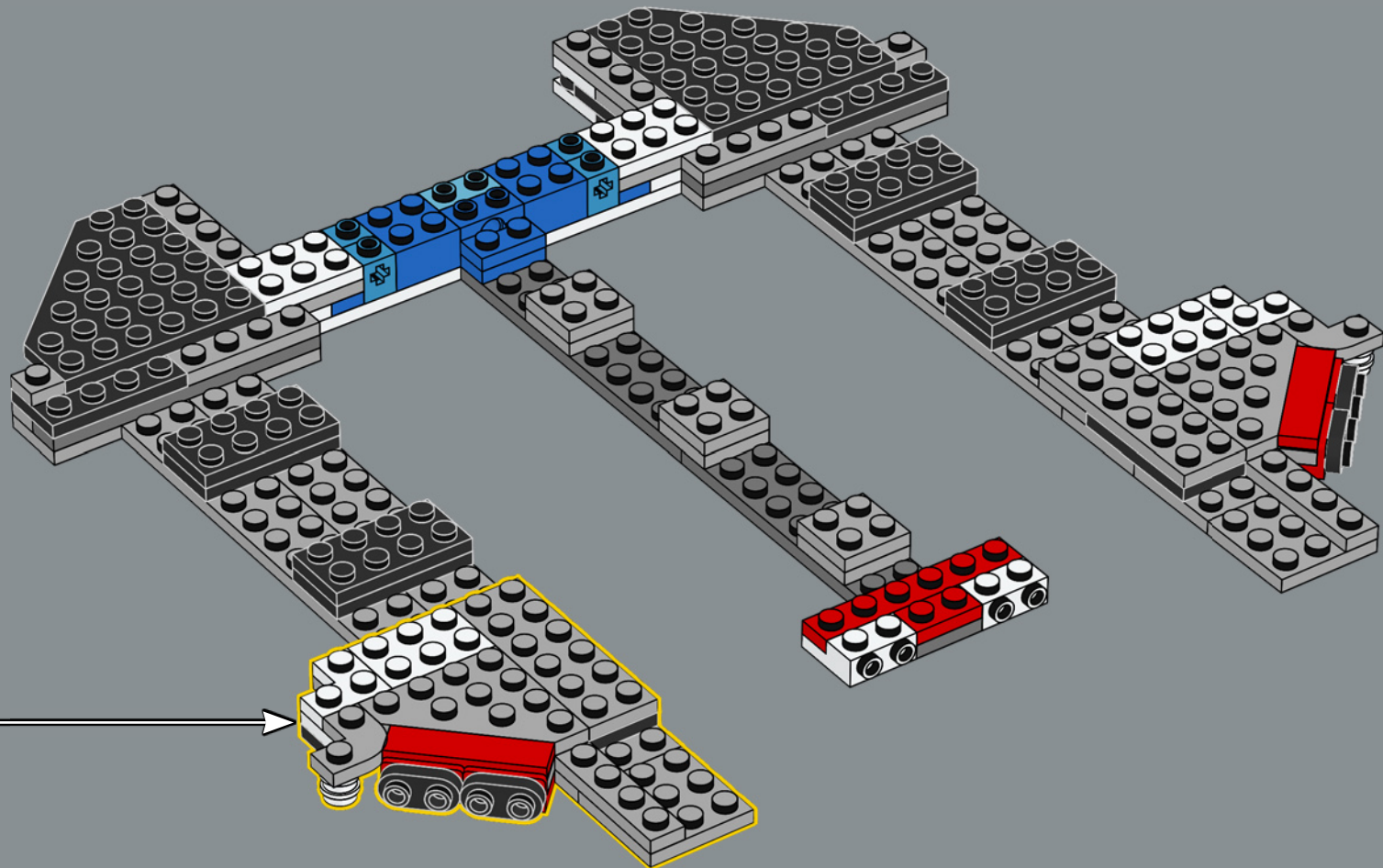

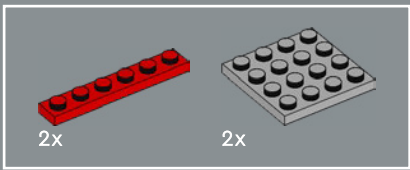

147

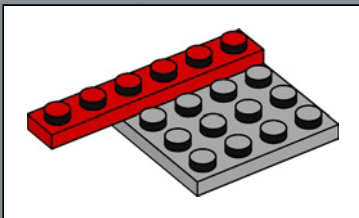
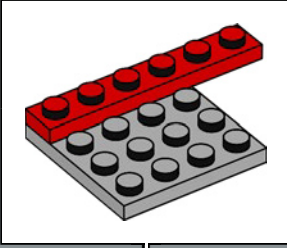
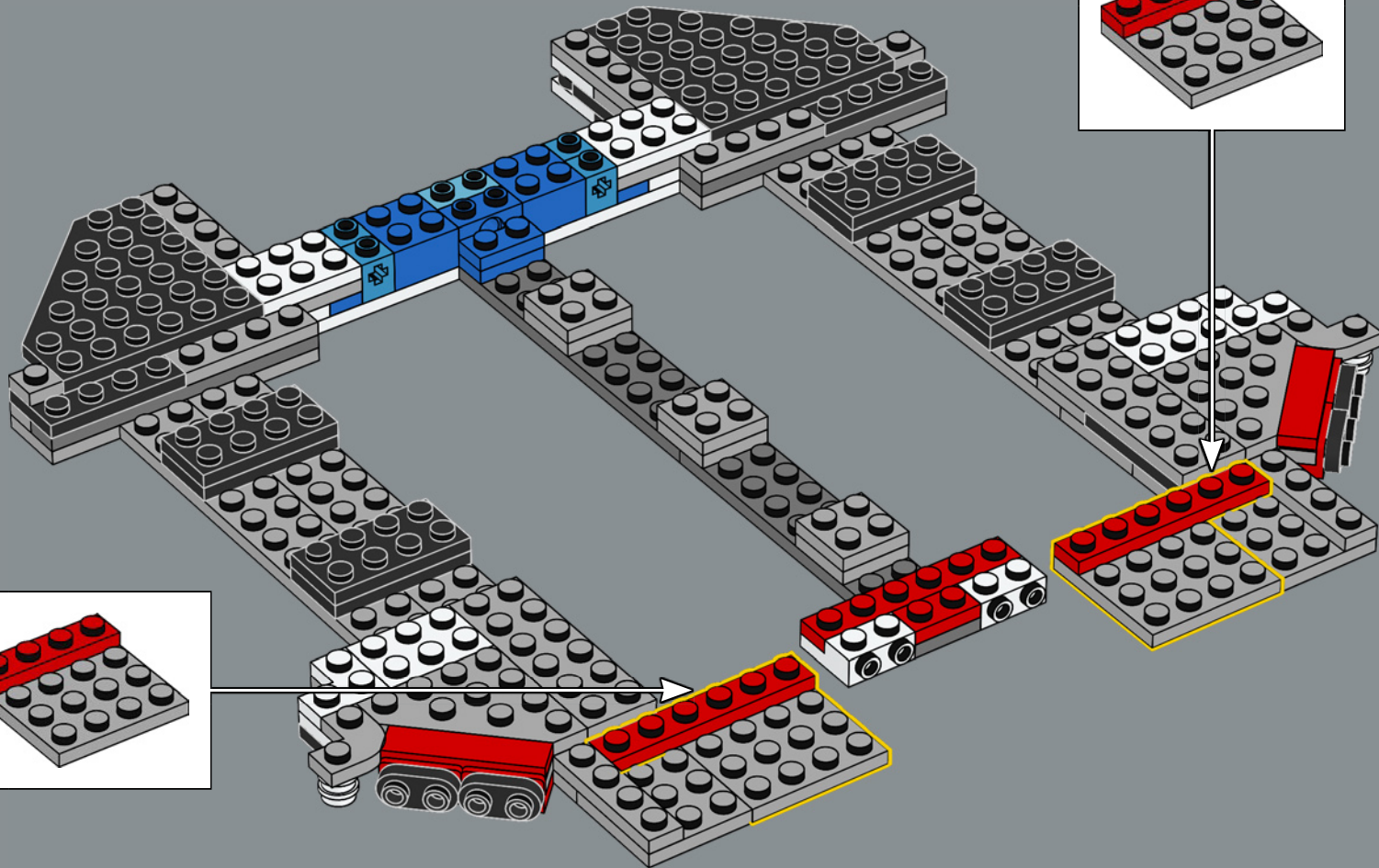

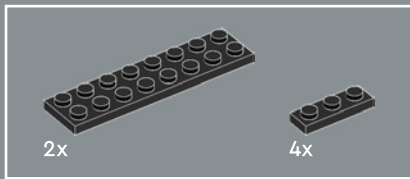

148

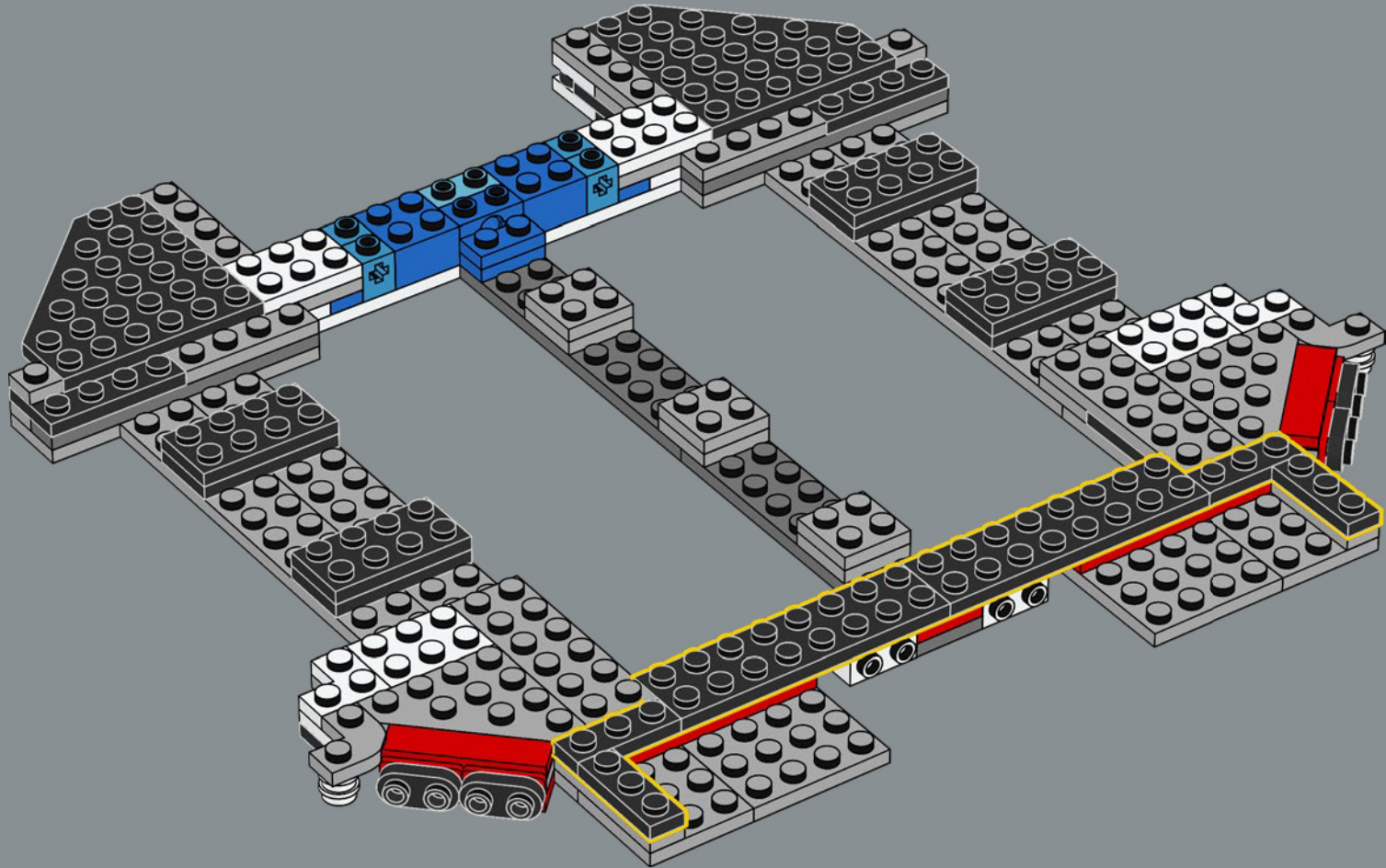

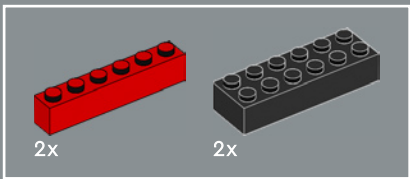

149

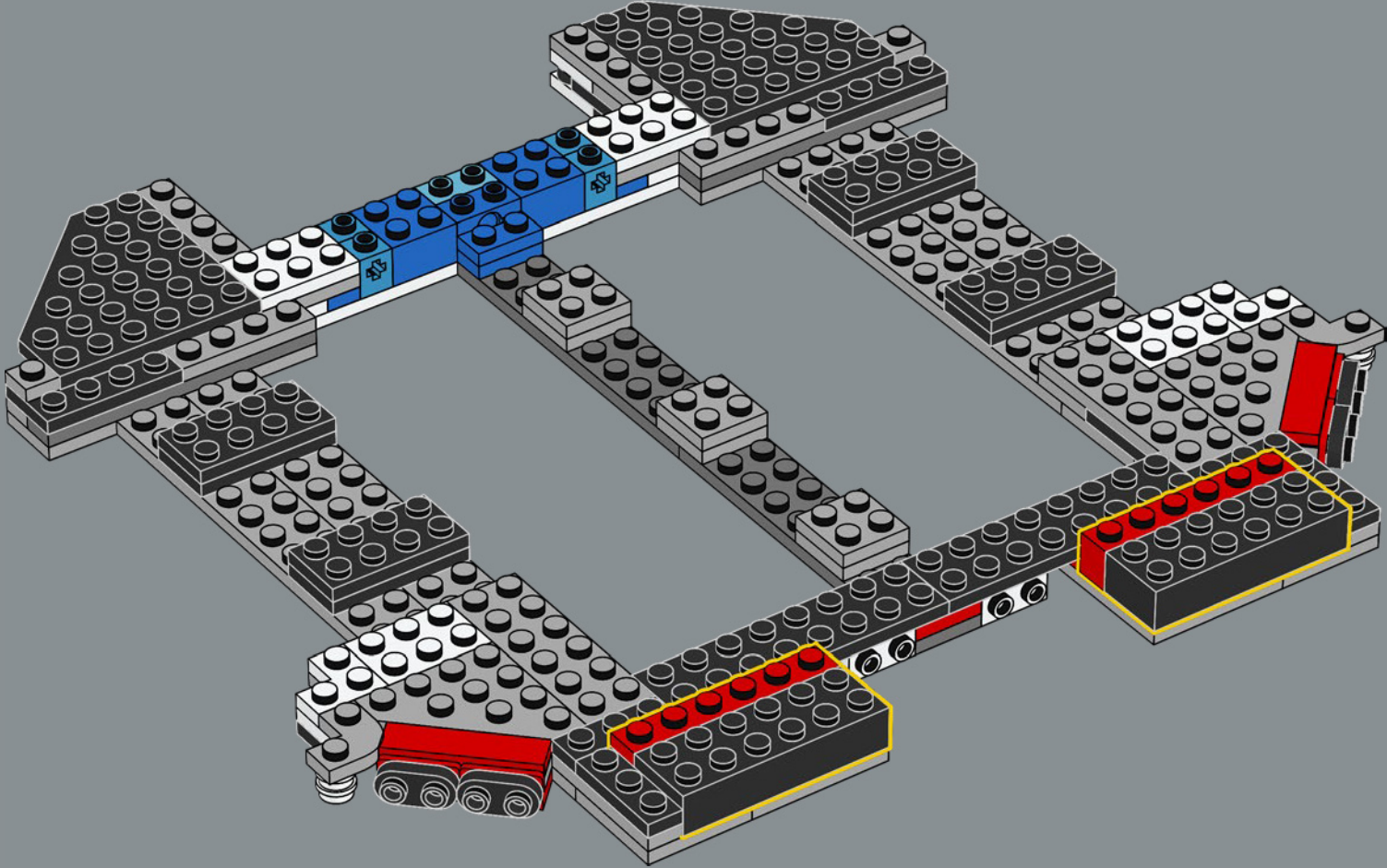

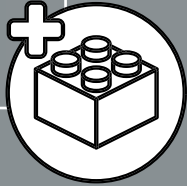
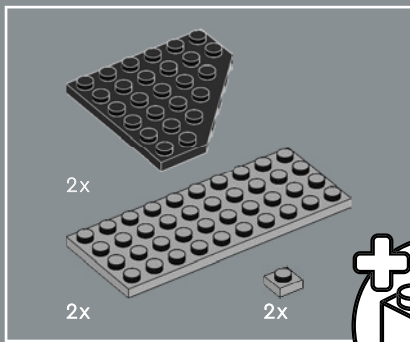

150

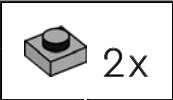
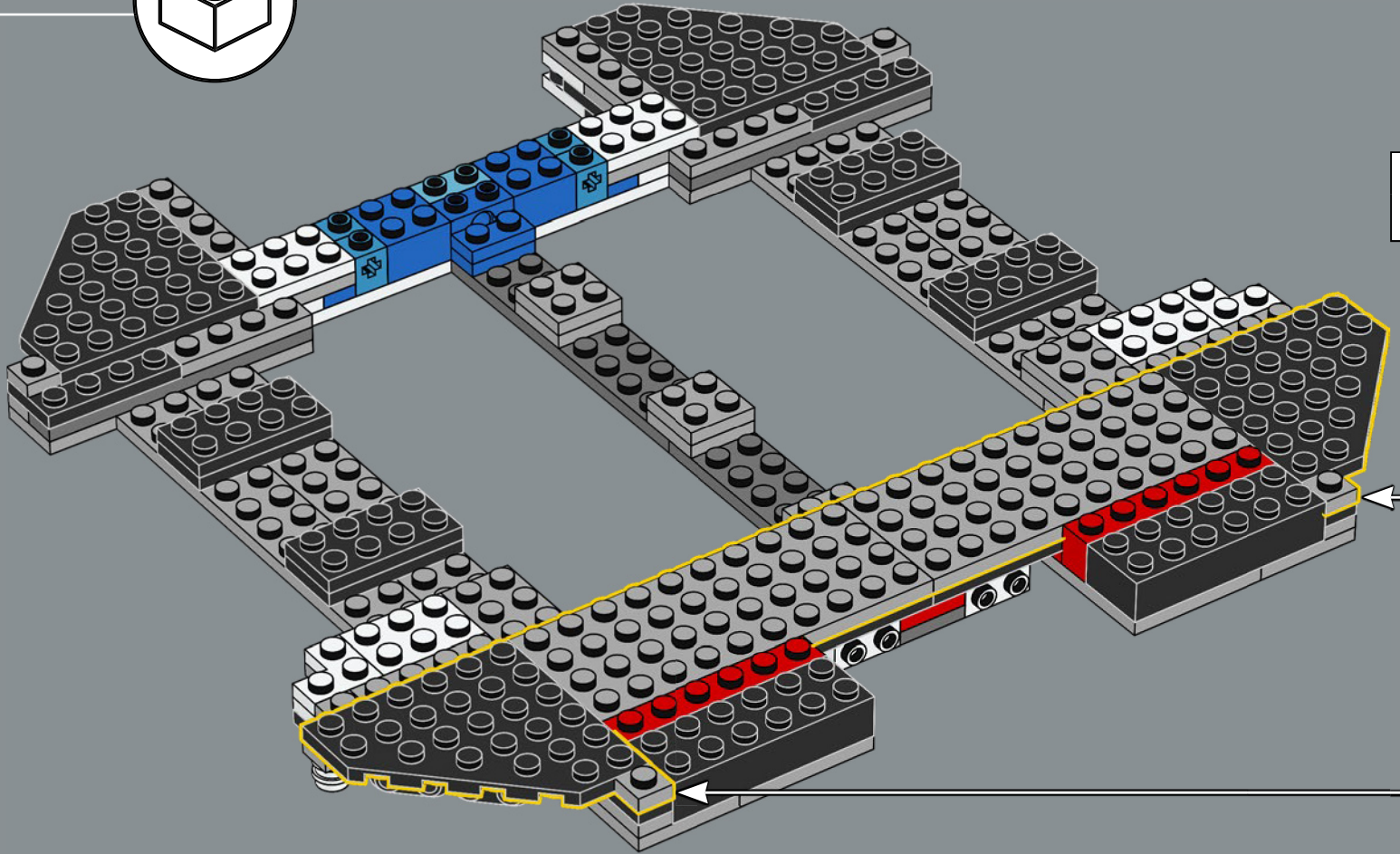

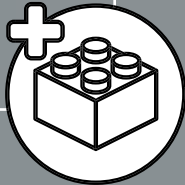
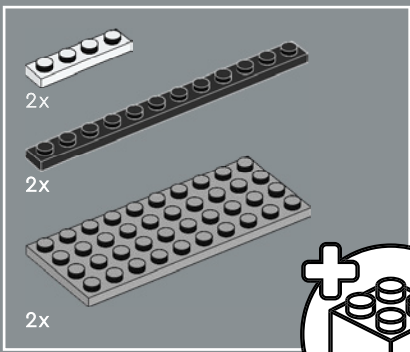

151

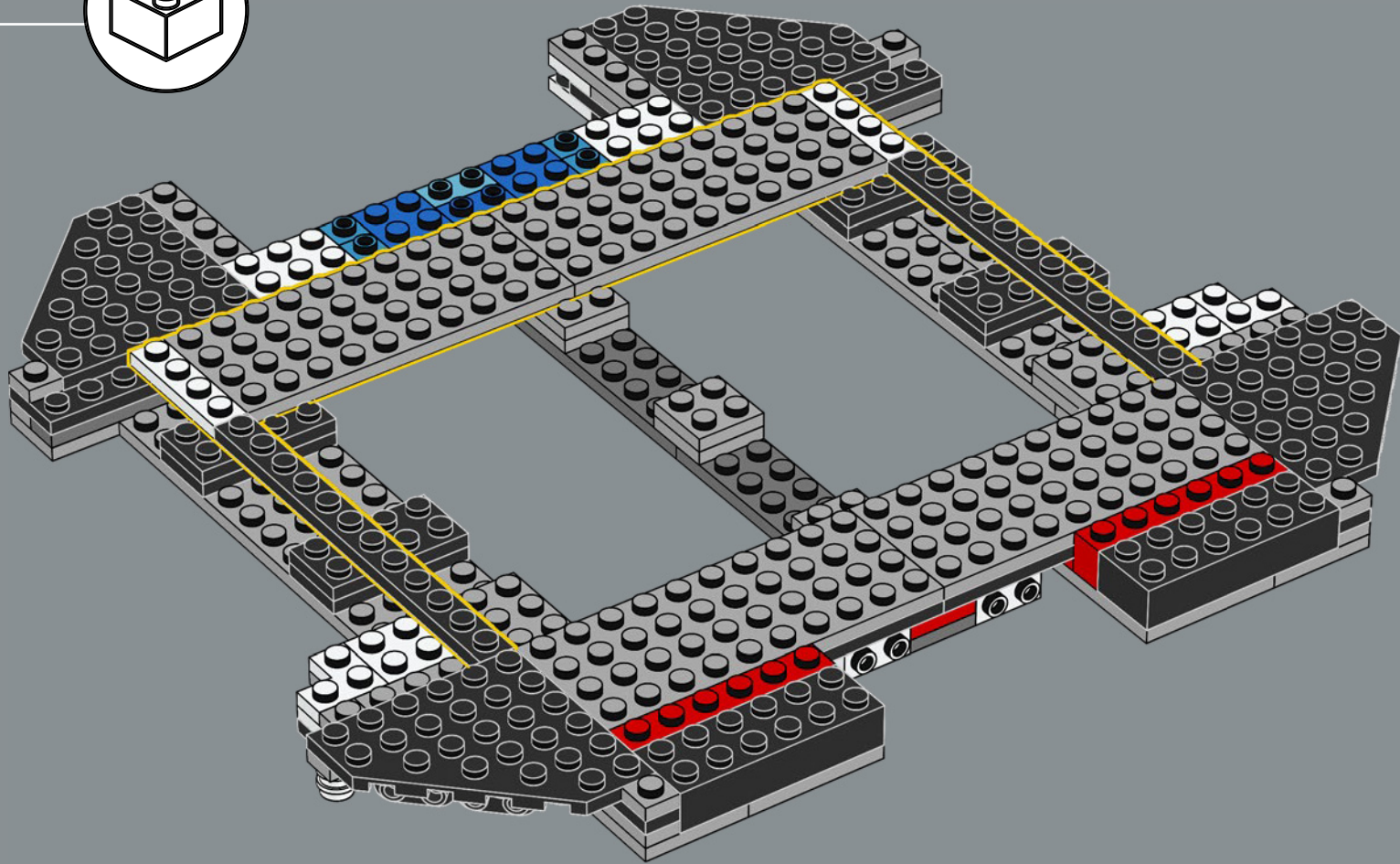

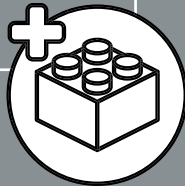
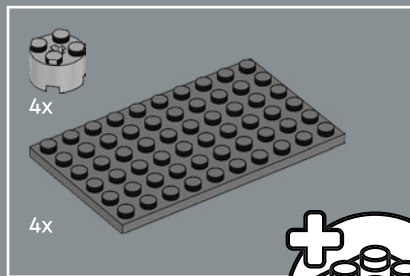

152

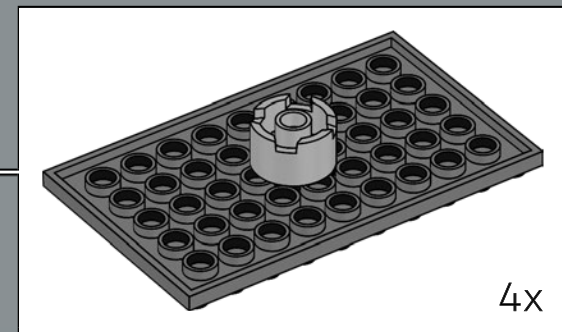
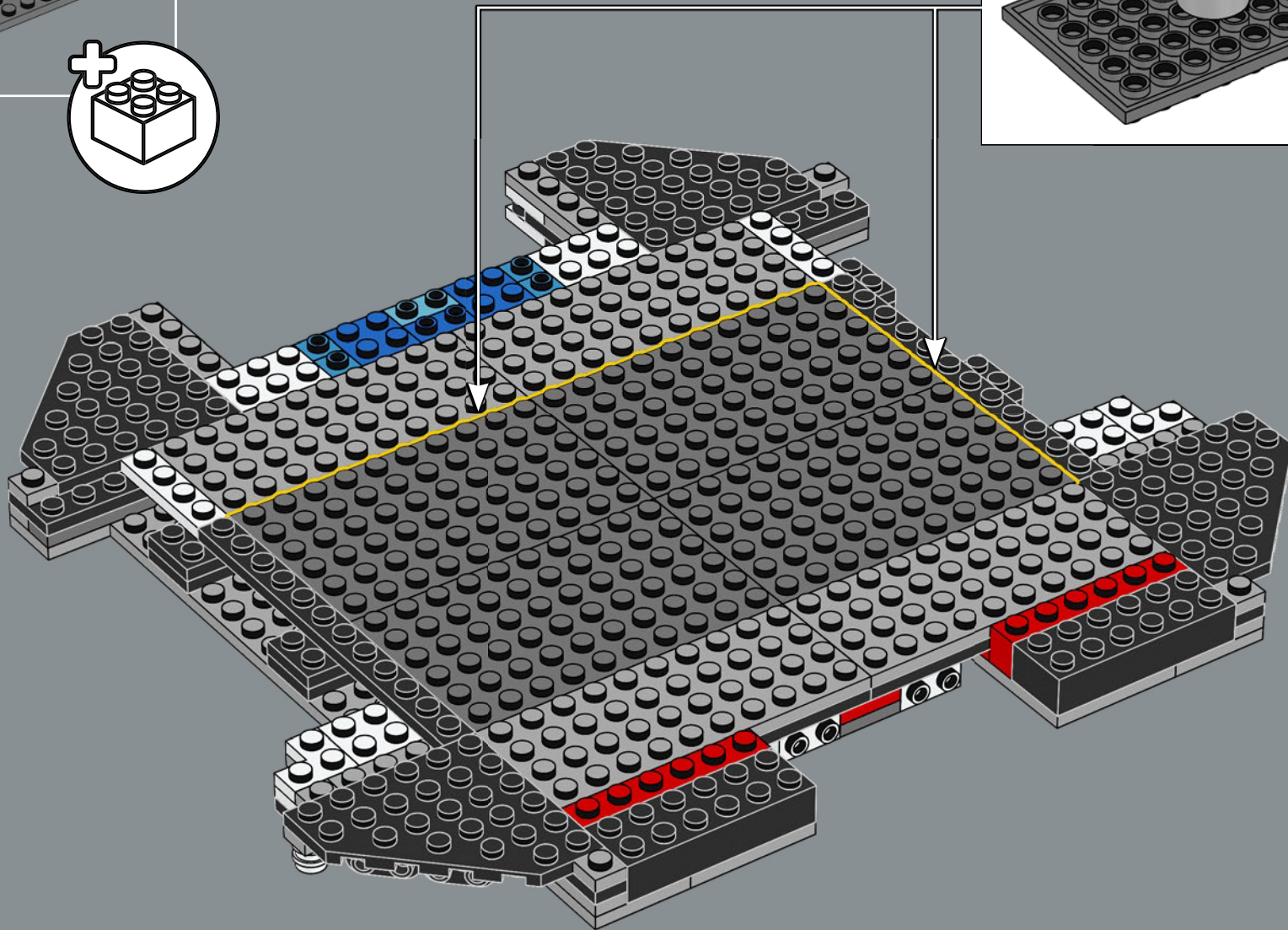

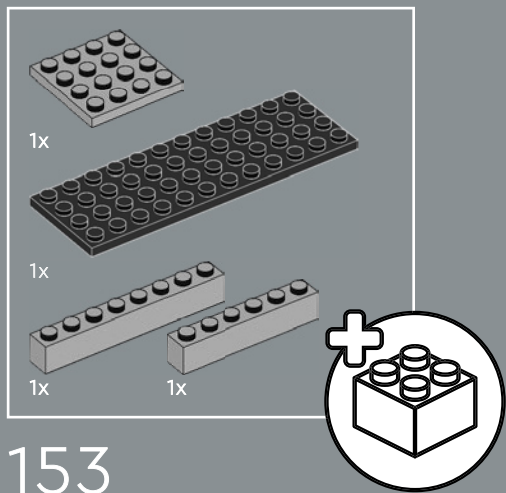

153

1

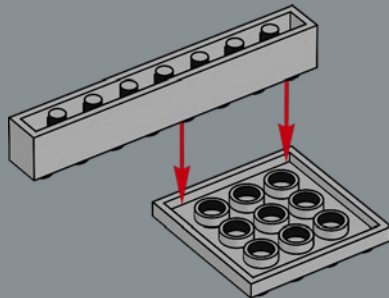

2

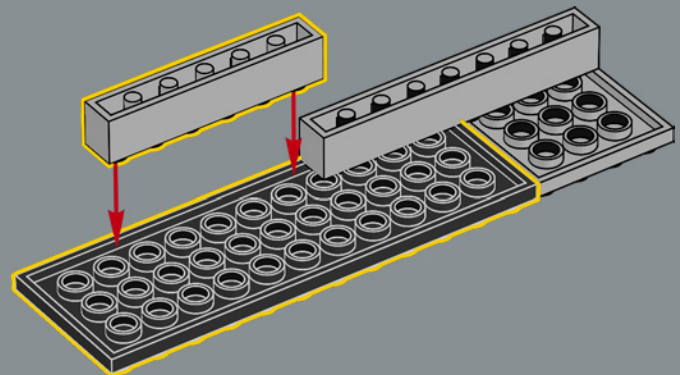

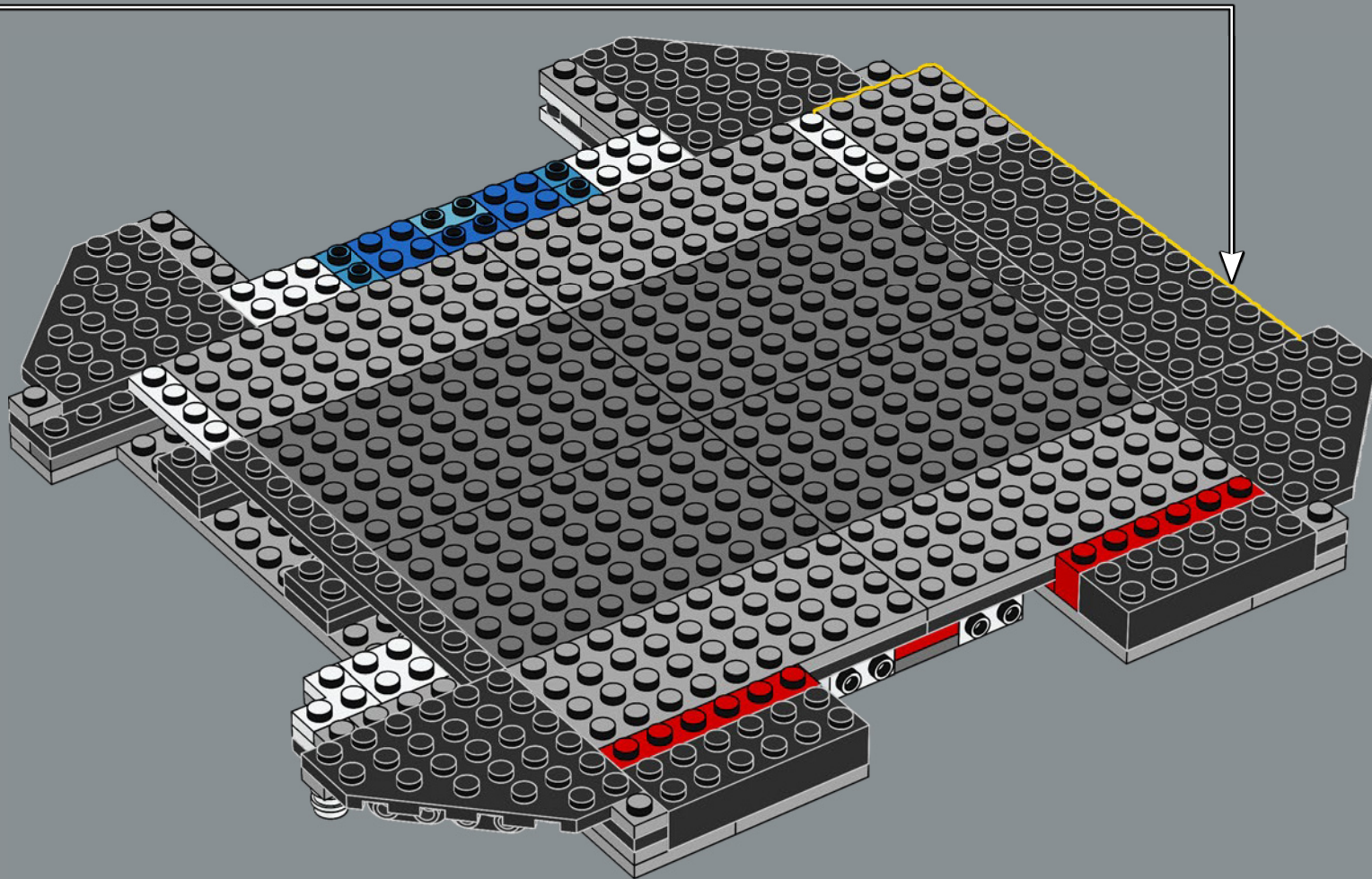

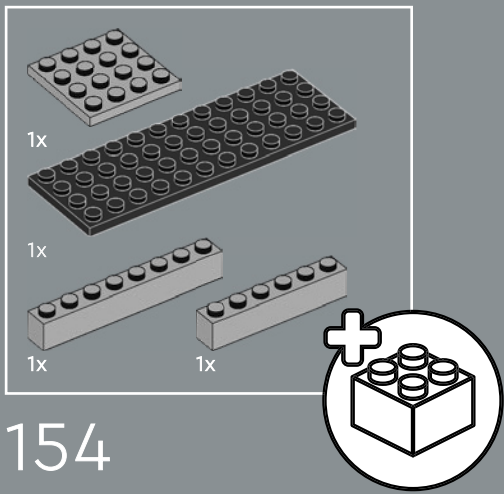

1

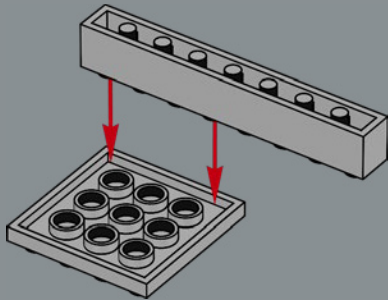

2

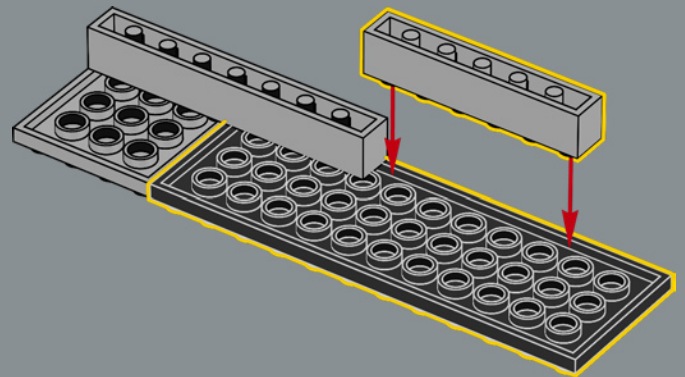

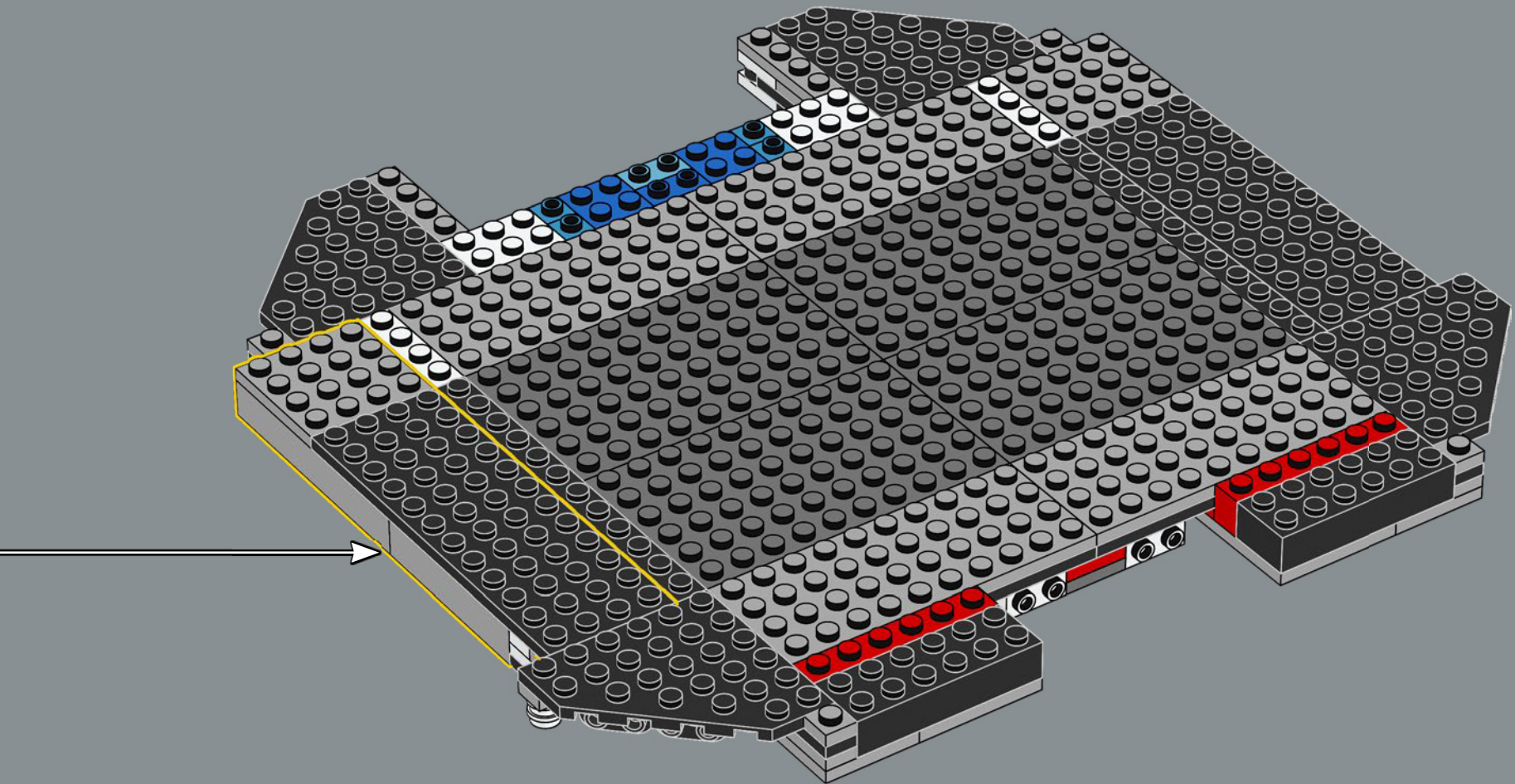

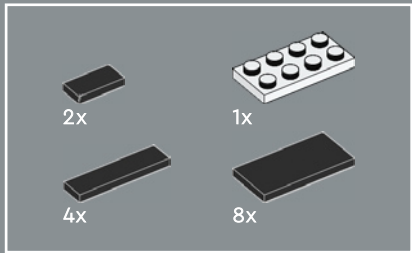

155

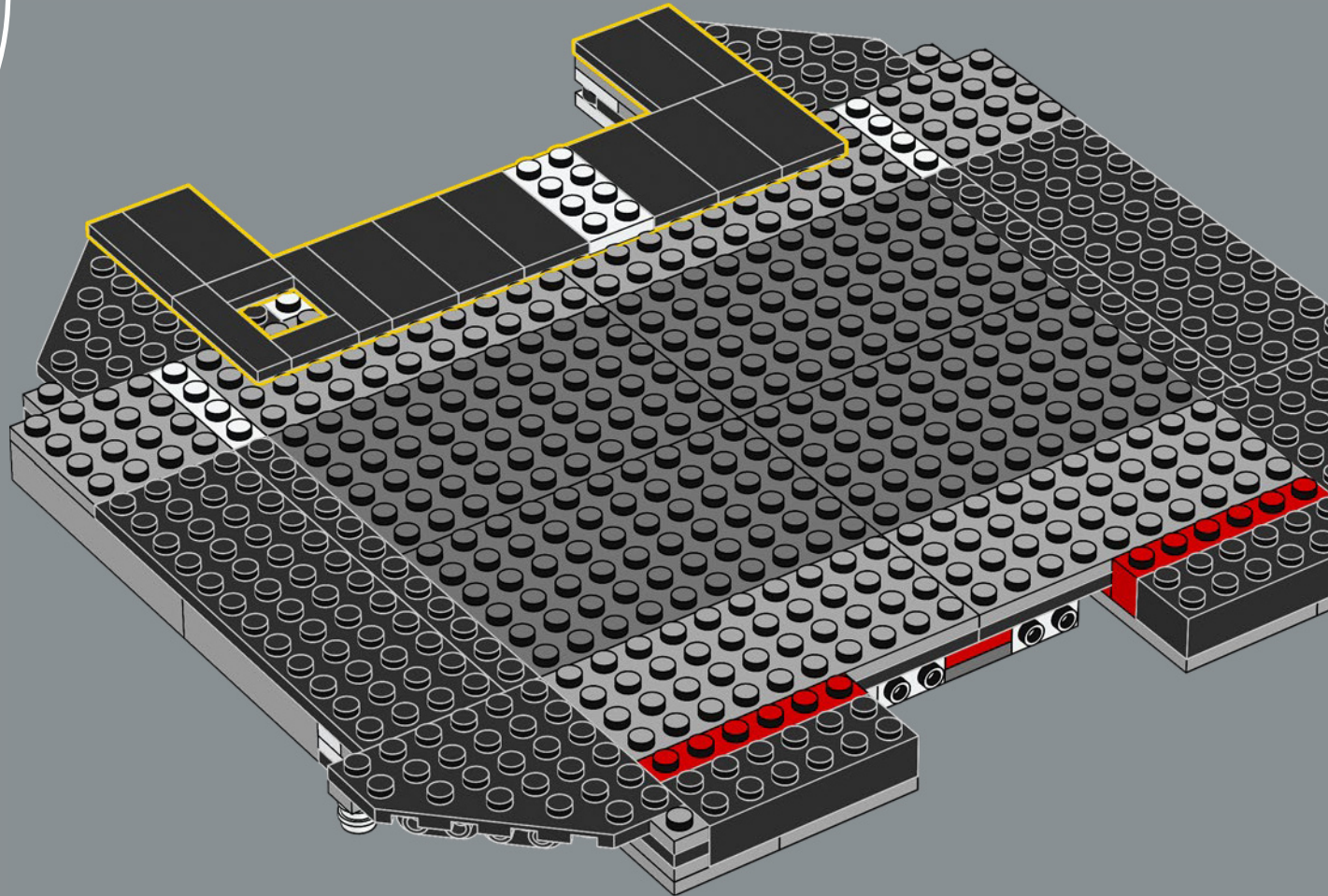

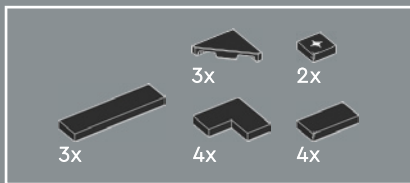

156

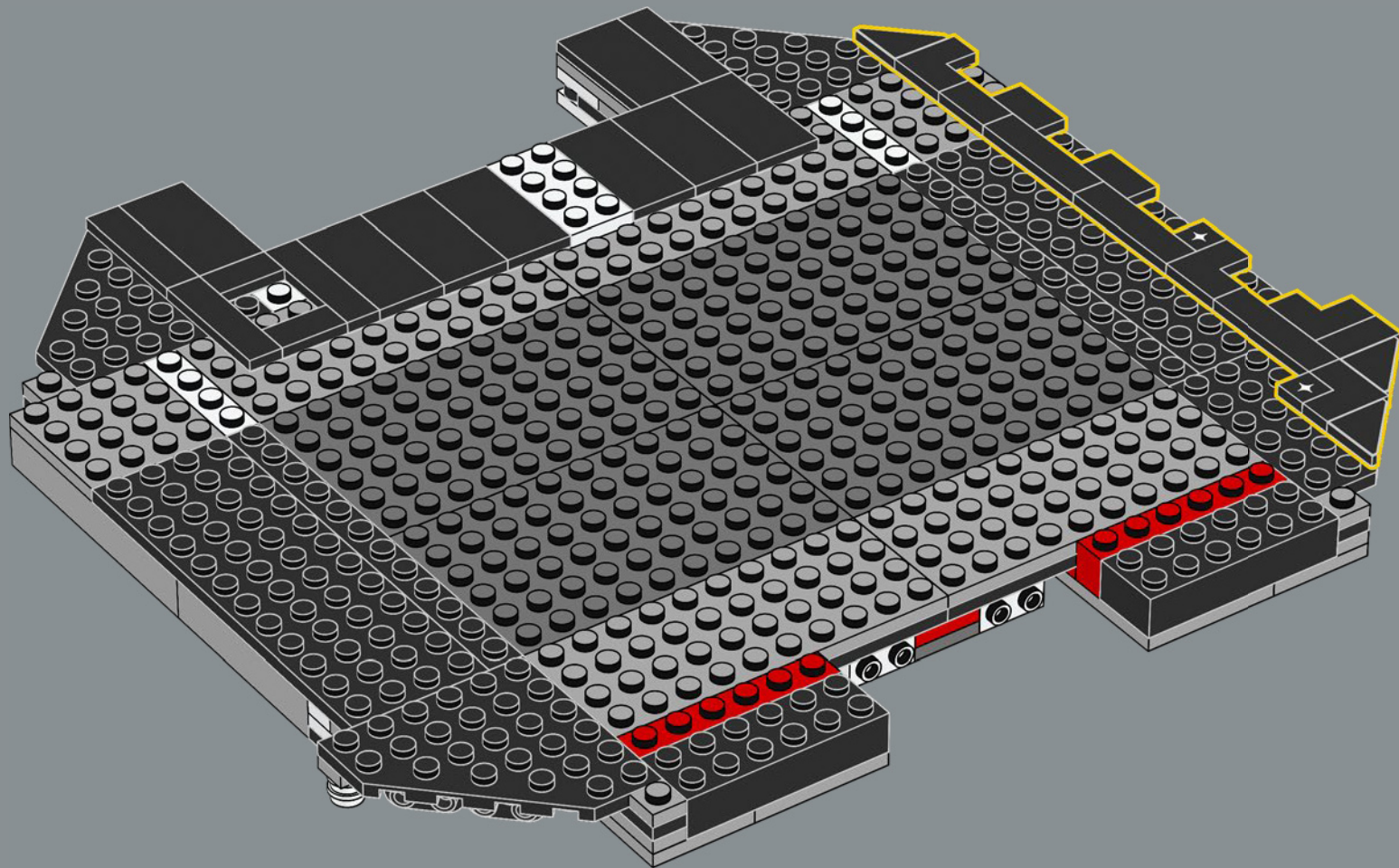

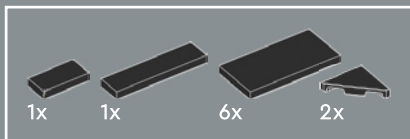

157

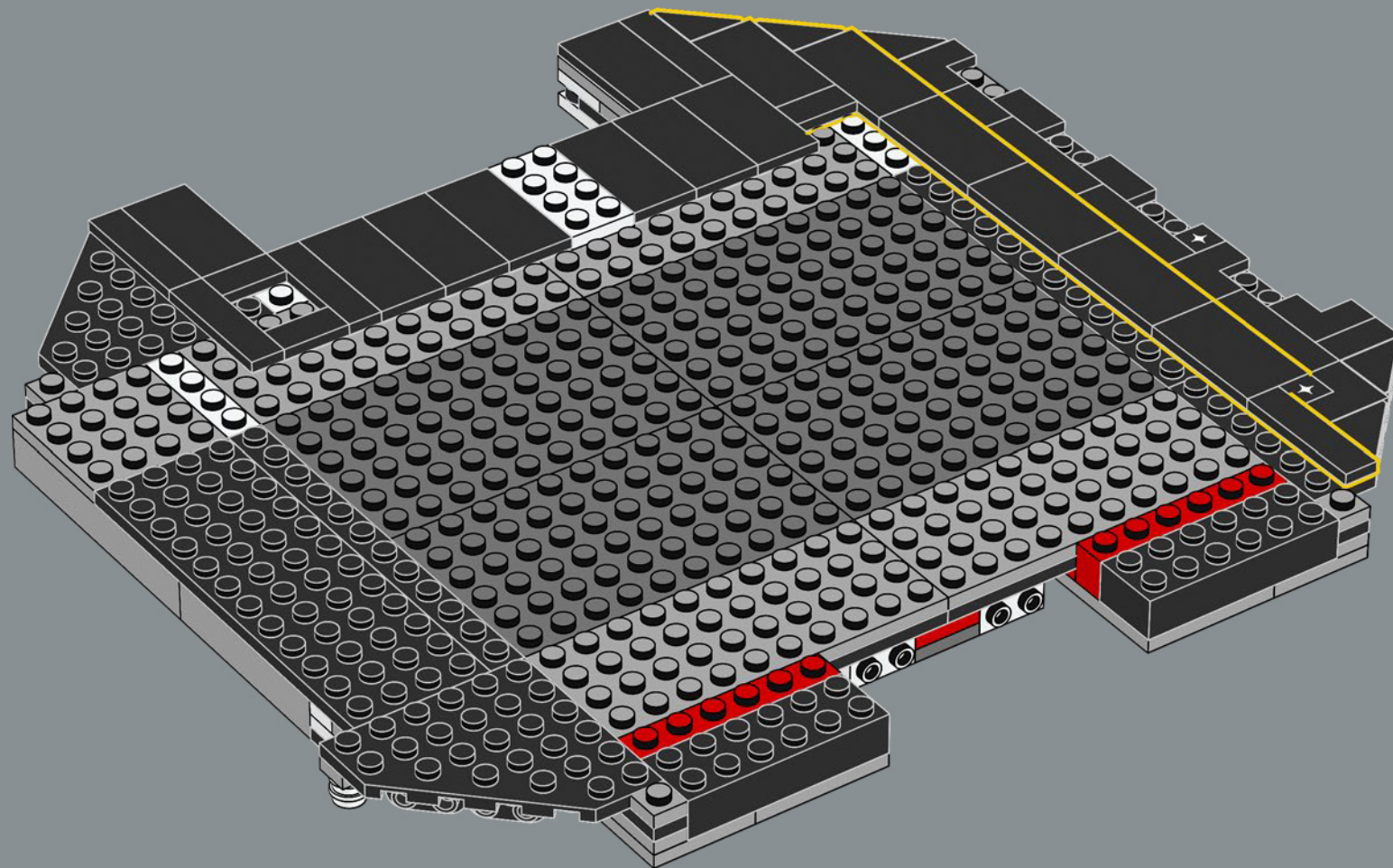

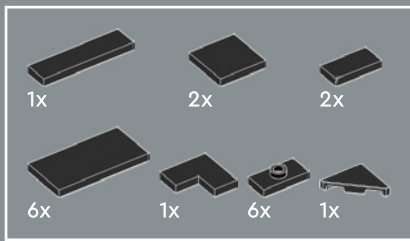

158

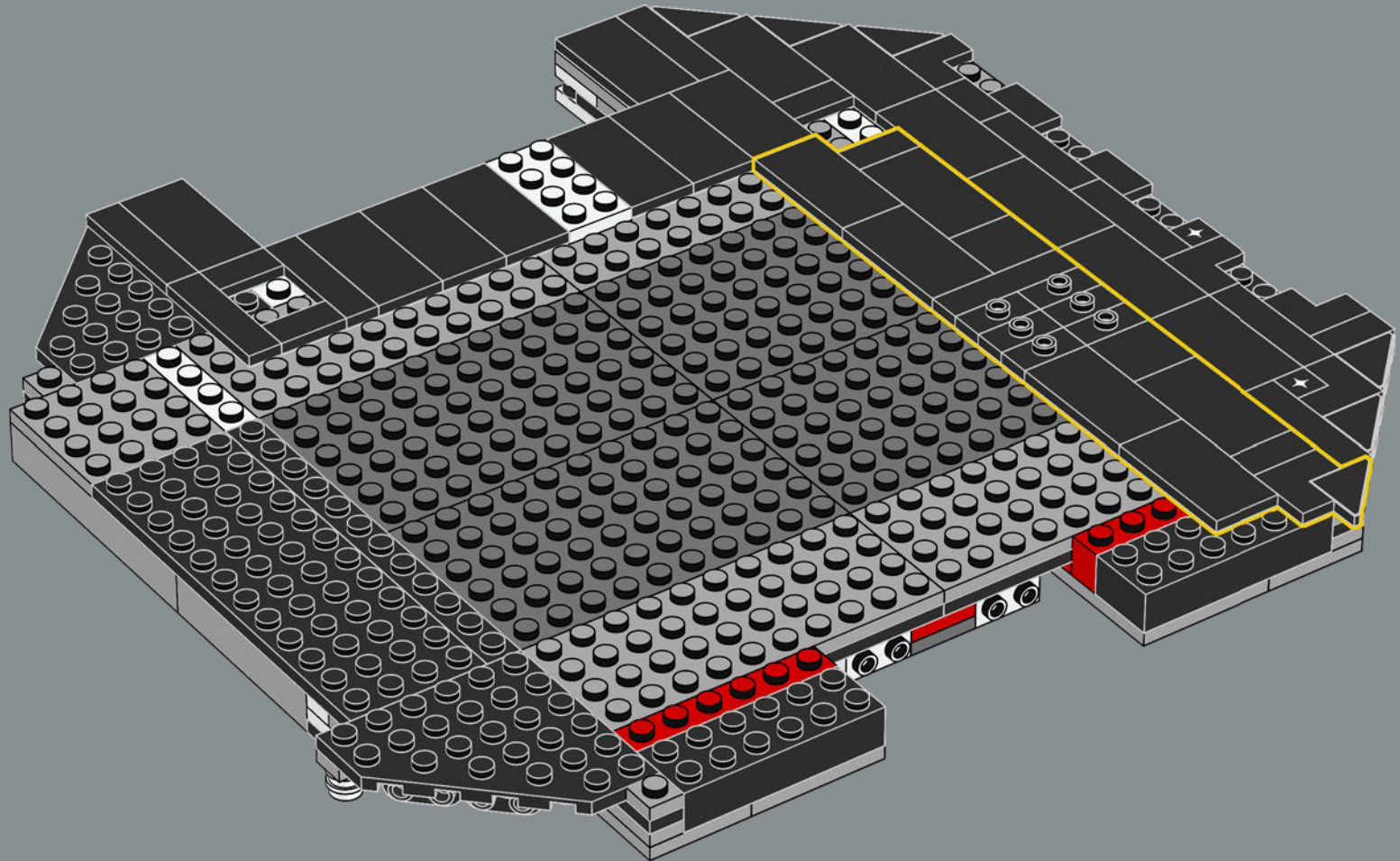

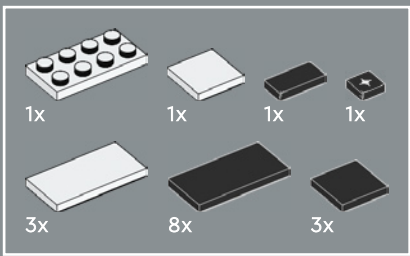

159

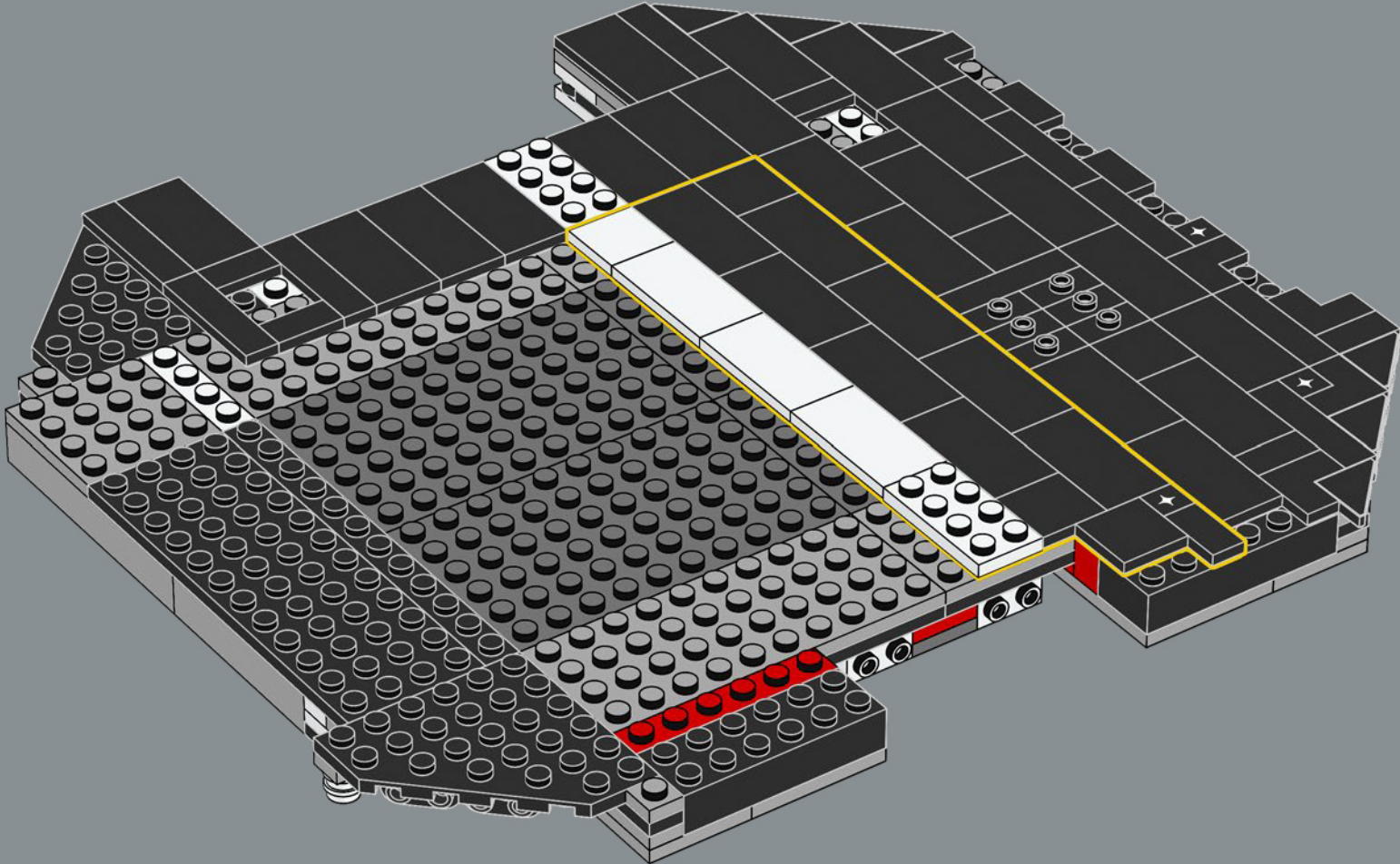

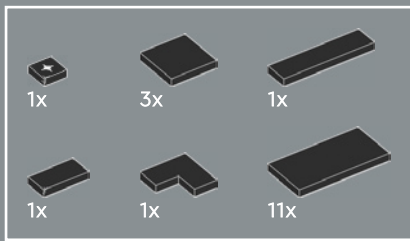

160

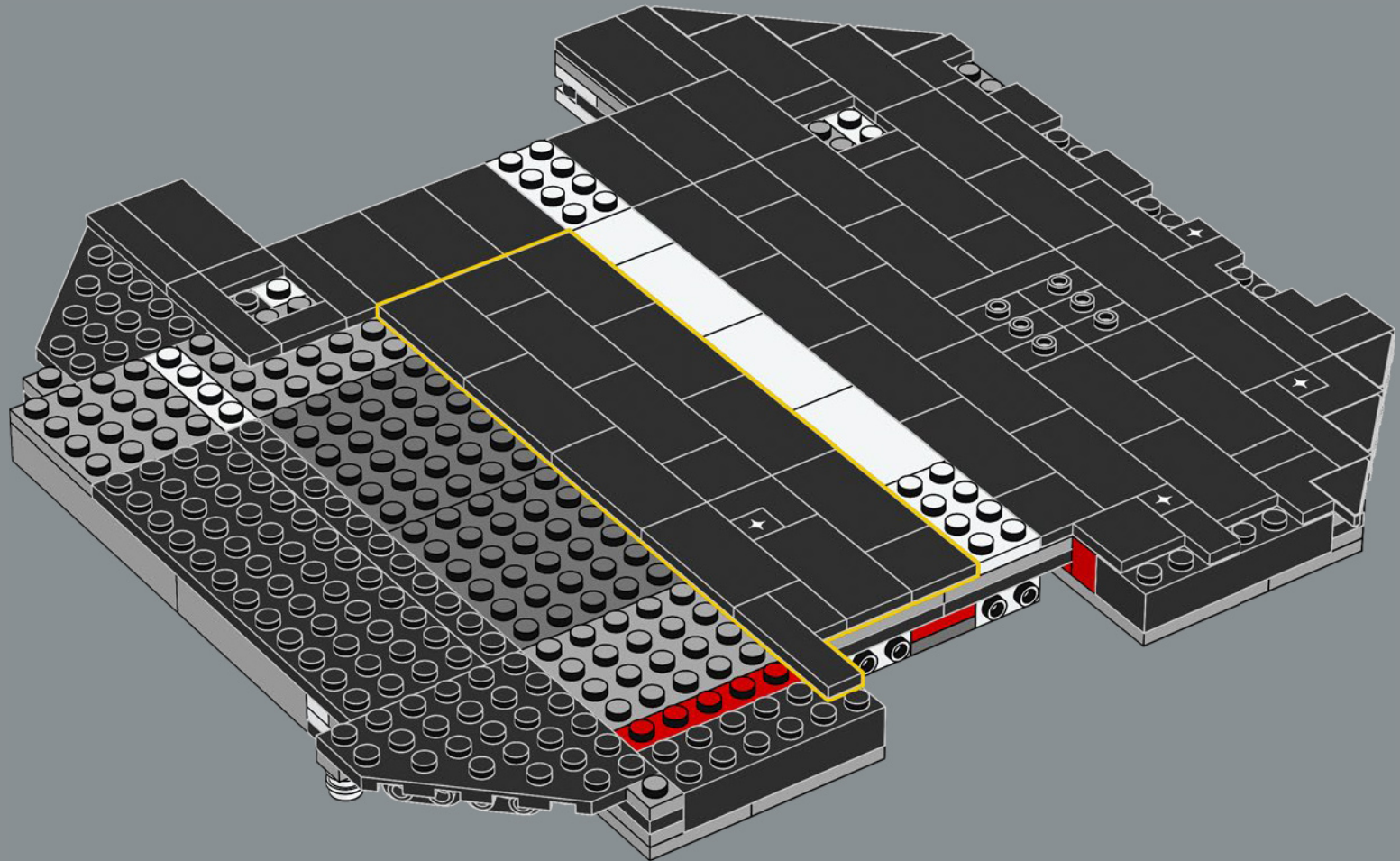

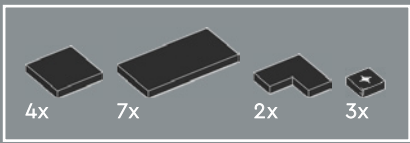

161

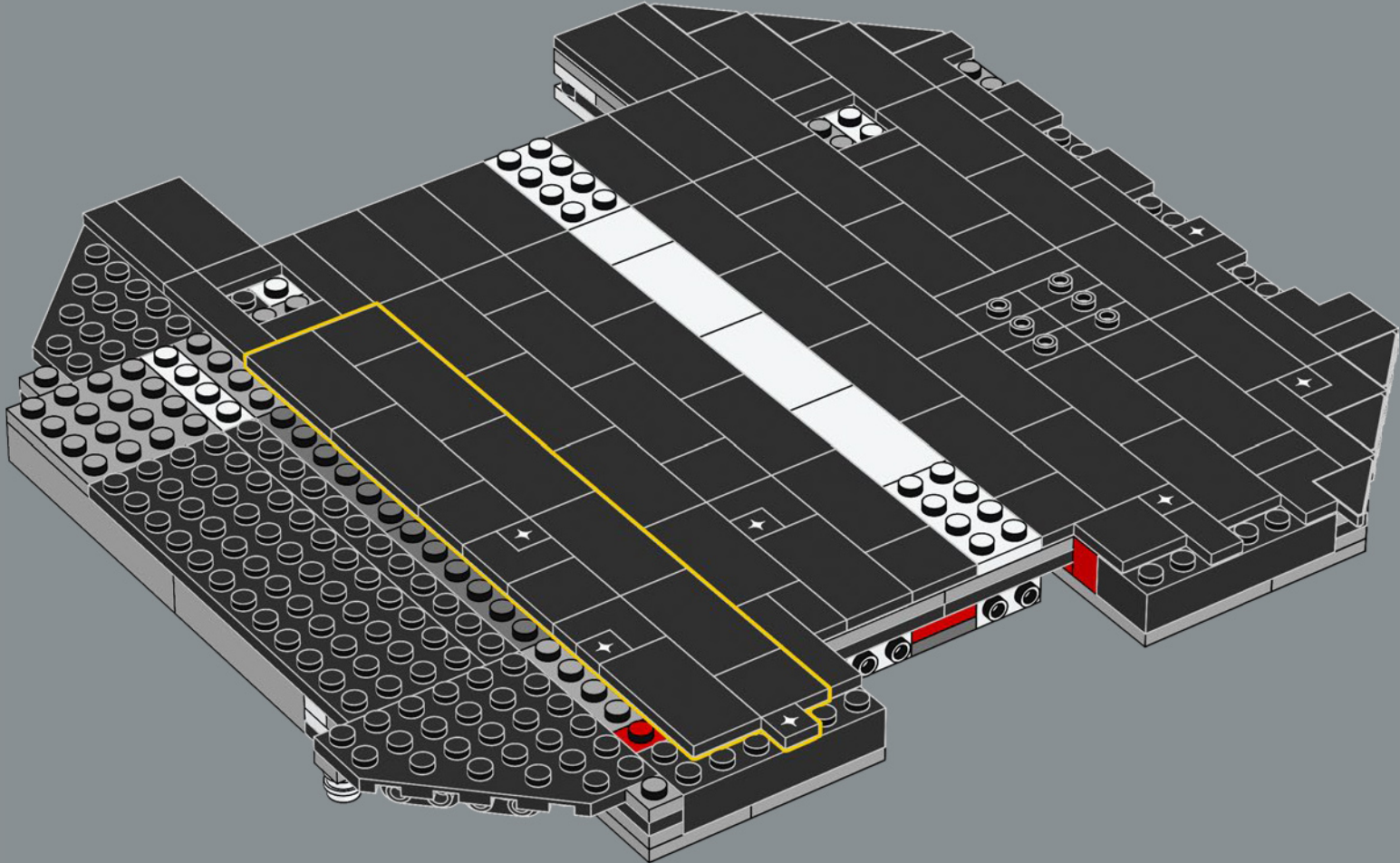

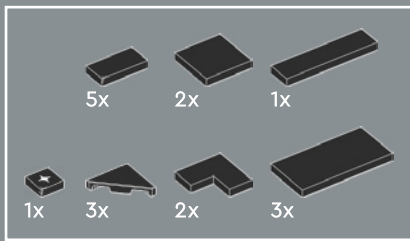

162

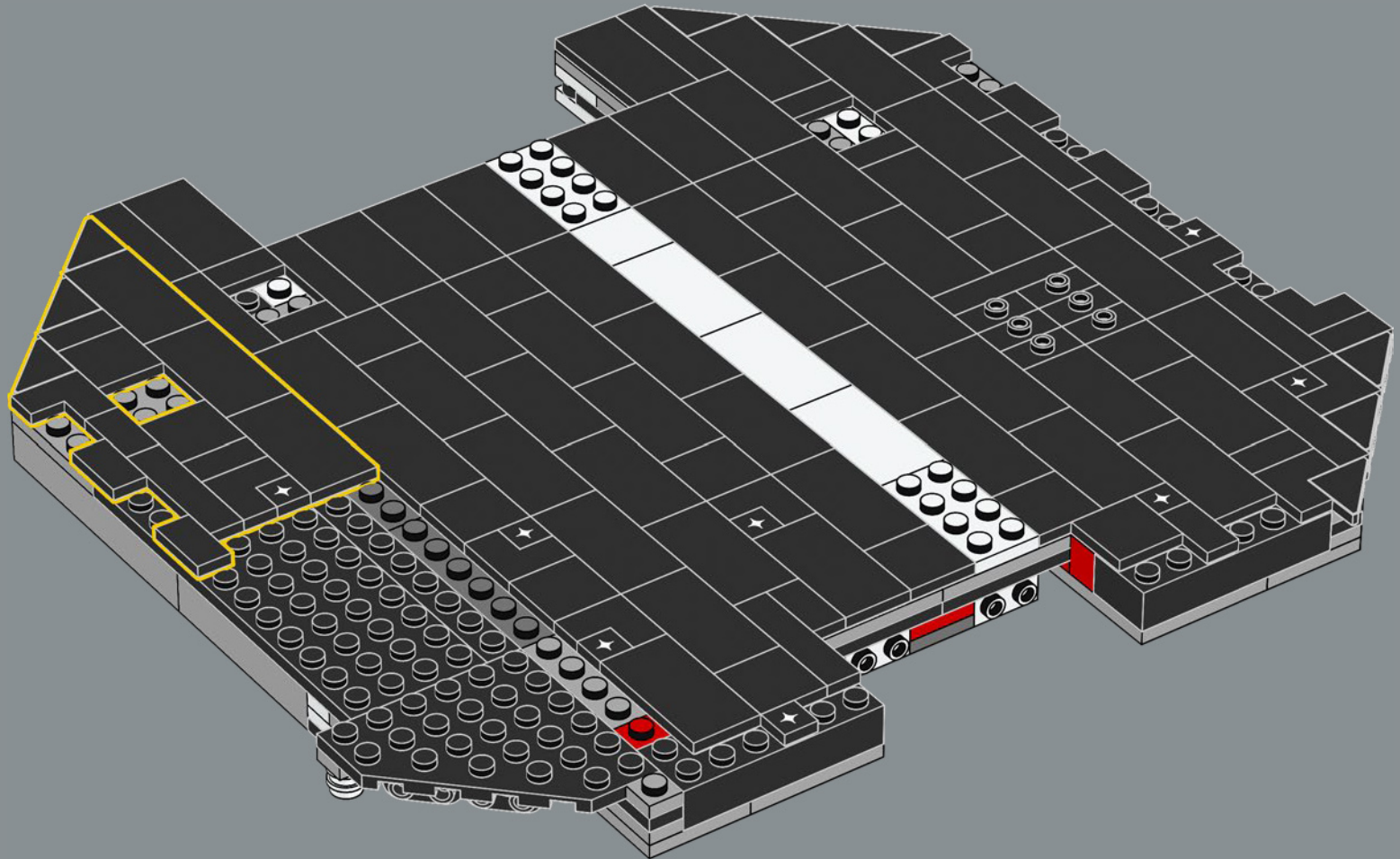

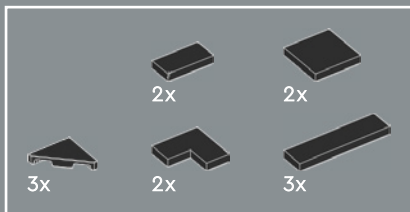

164

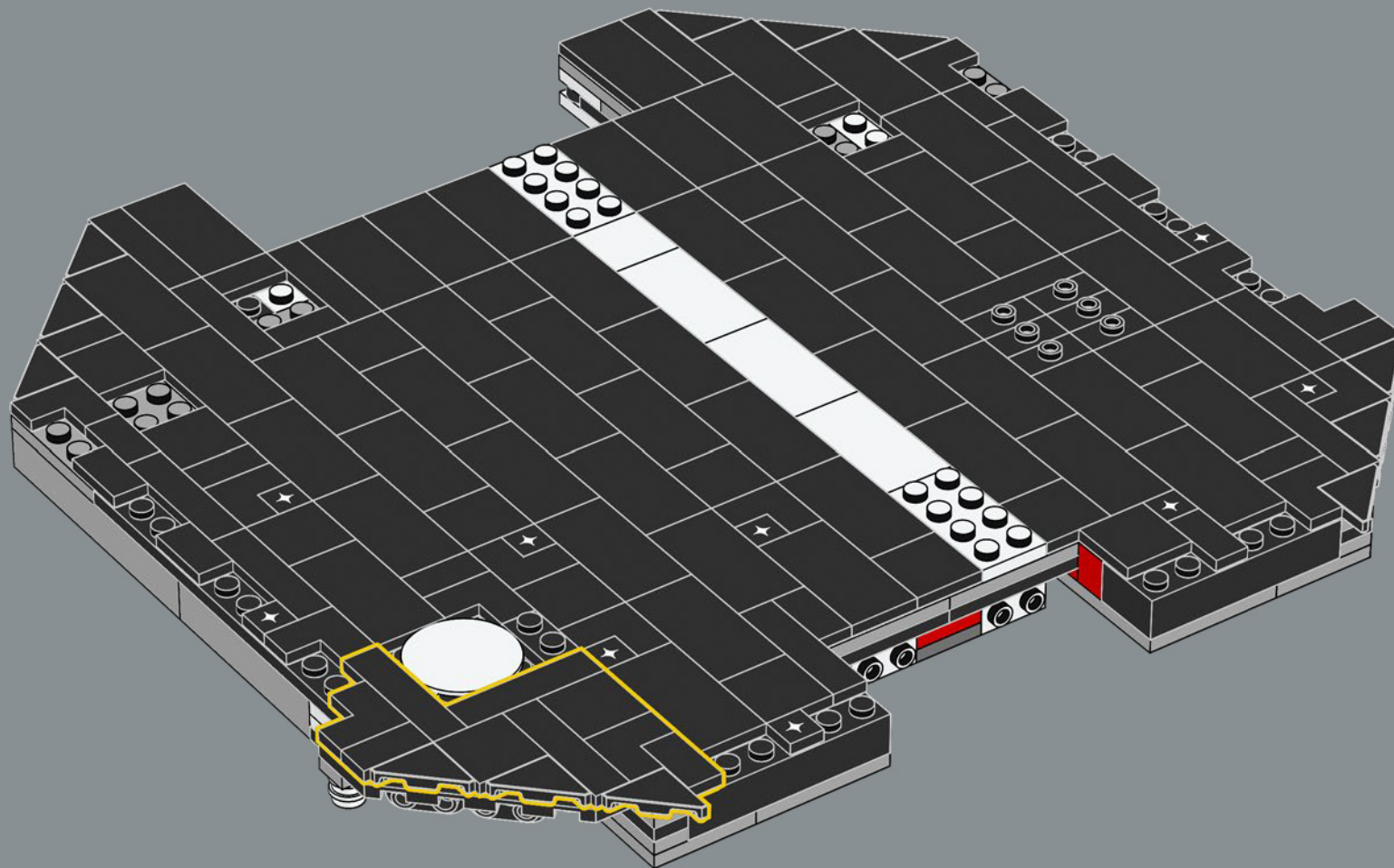

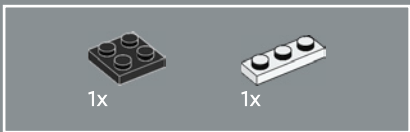

165

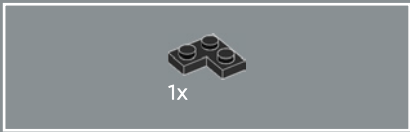
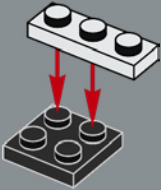

166

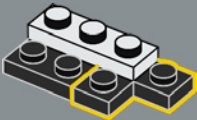

167

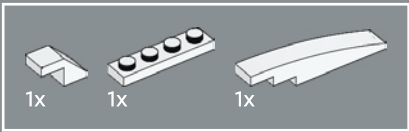
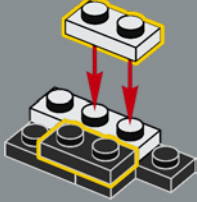

168

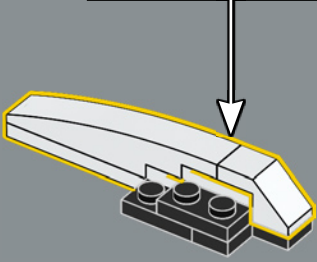
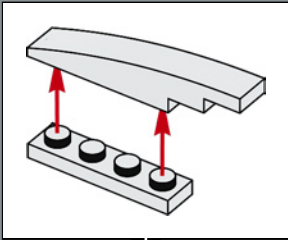

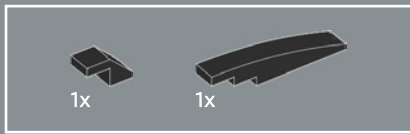

169

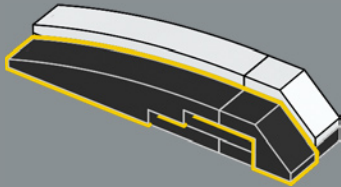

170

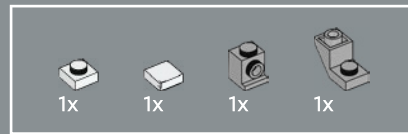
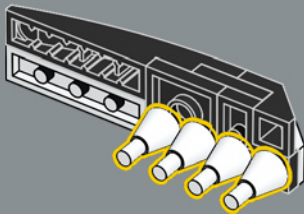

171

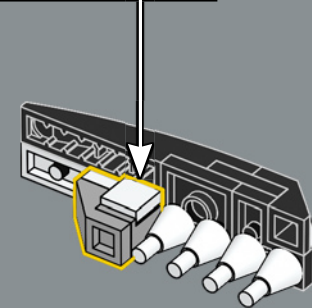
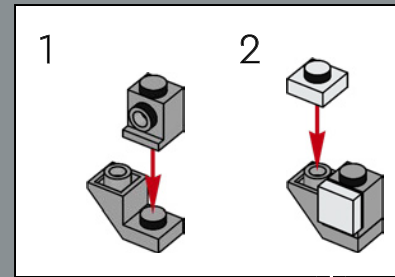

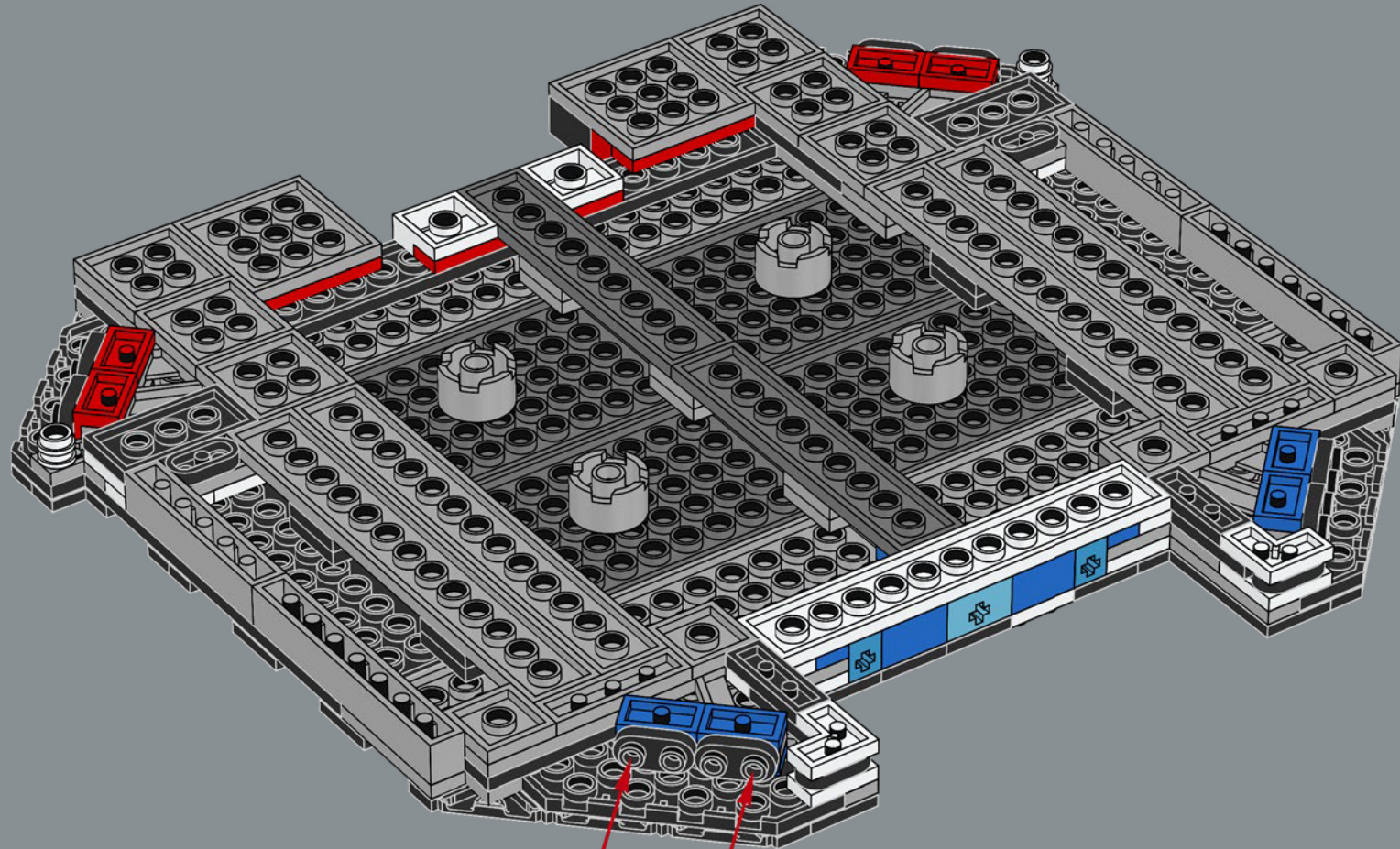

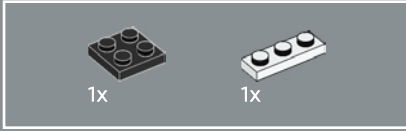
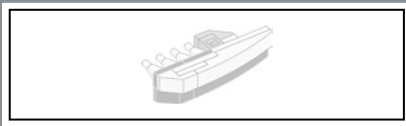

173

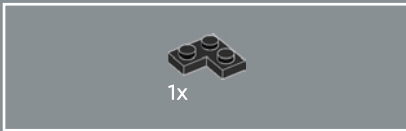
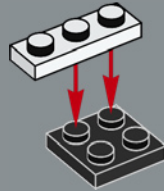

174

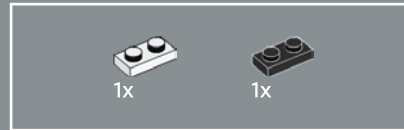
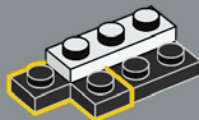

175

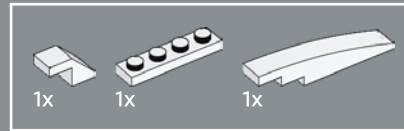
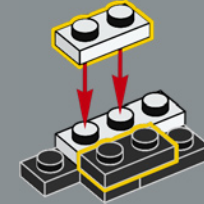

176

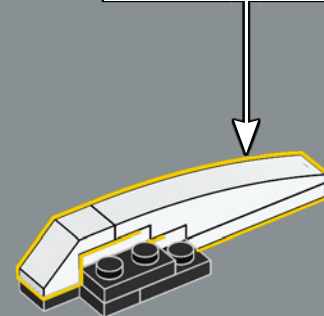
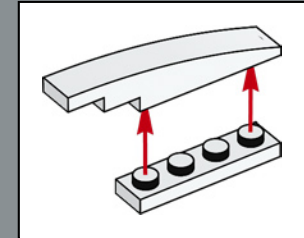

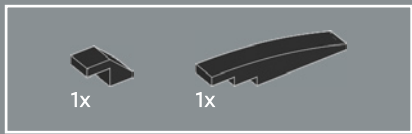

177

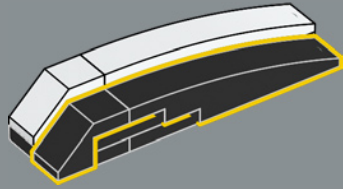

178

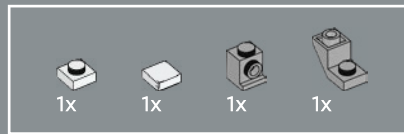
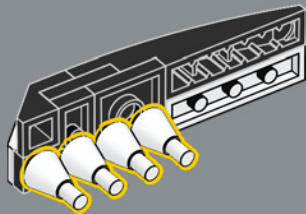

179

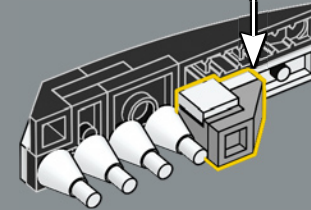
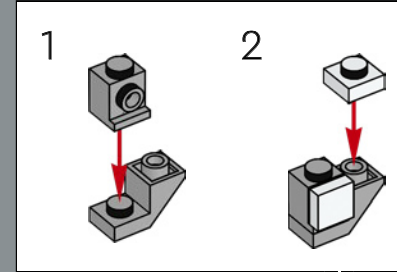

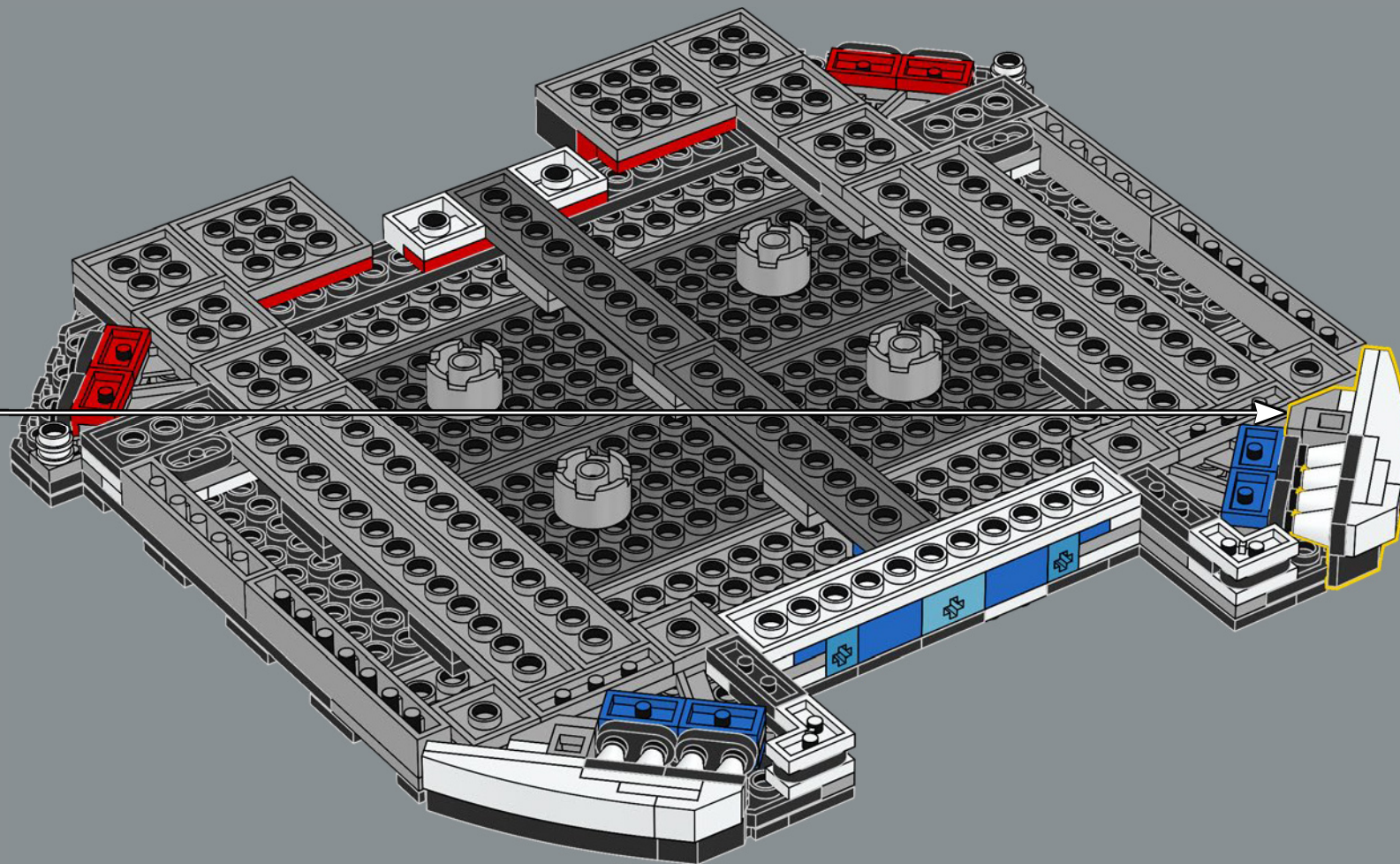

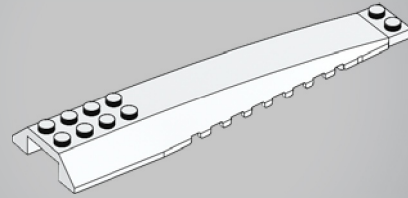
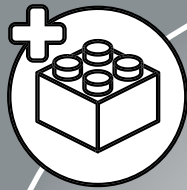

1x

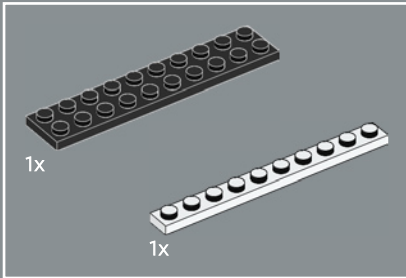
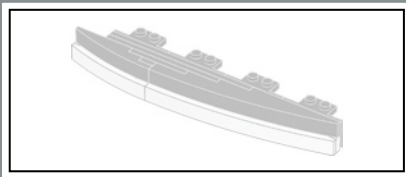

181

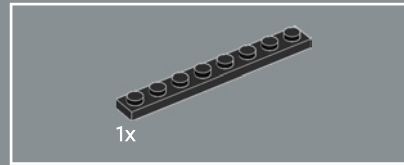
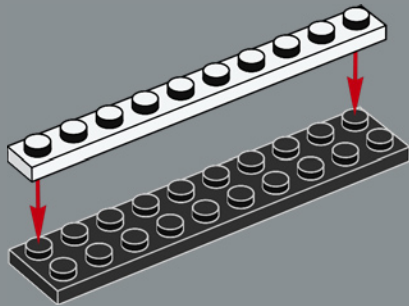

182

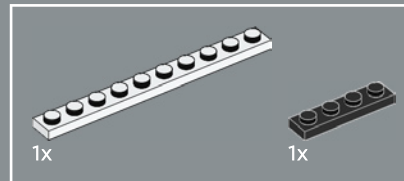
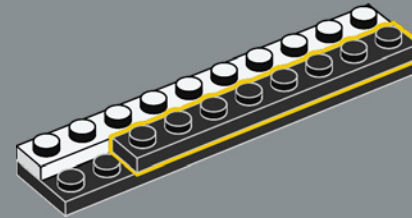

183

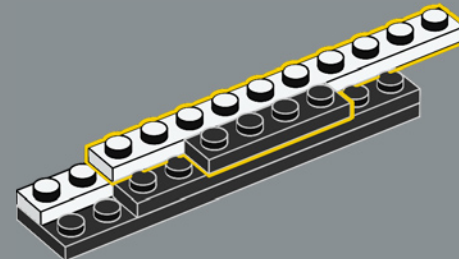

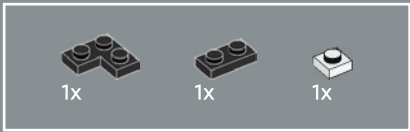

184

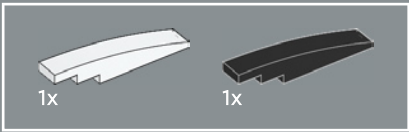
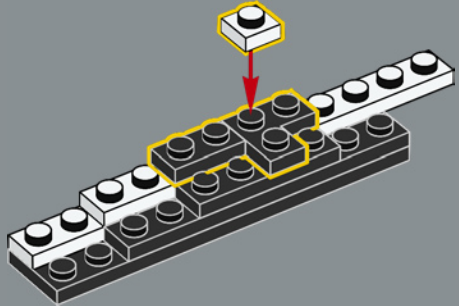

185

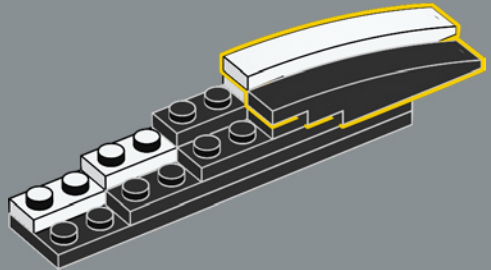

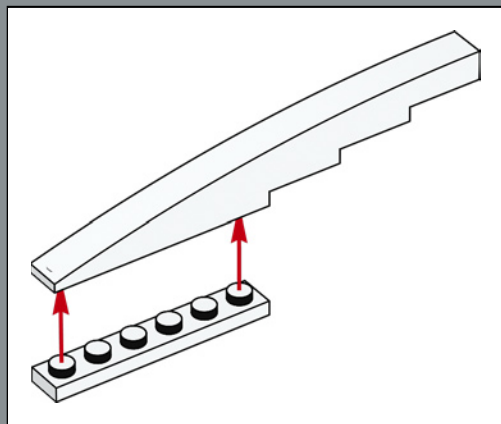
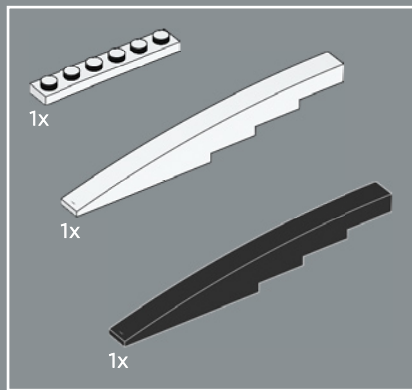

186

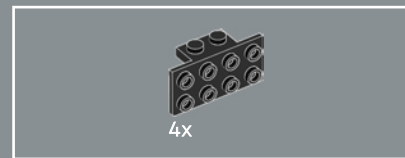
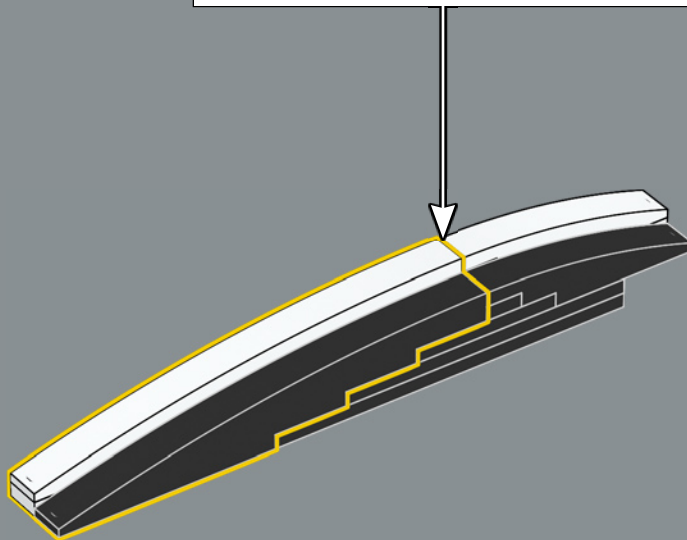

187

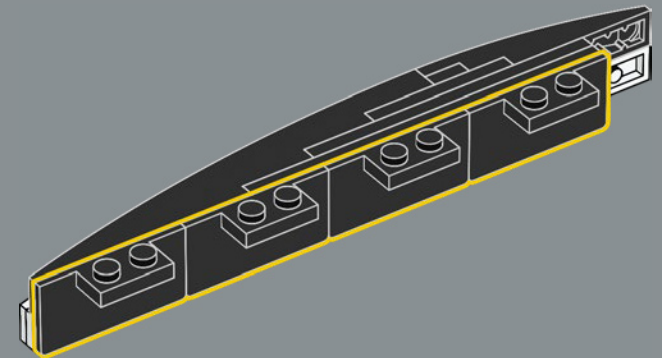

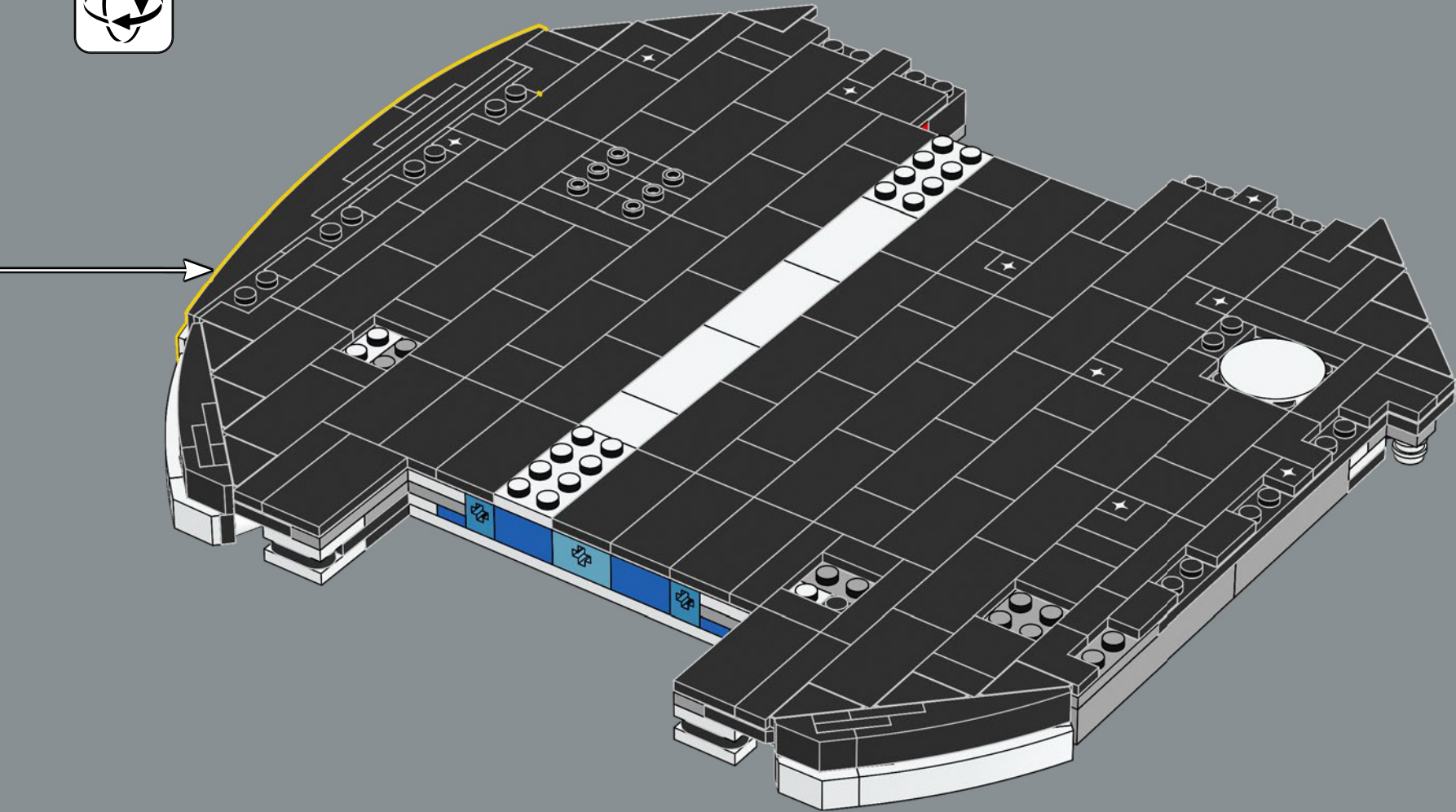

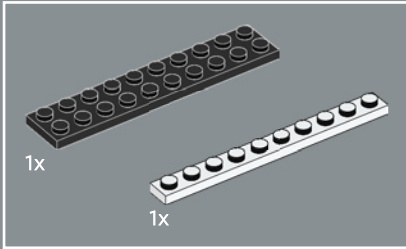
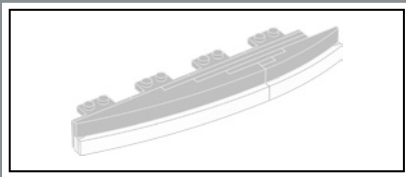

189

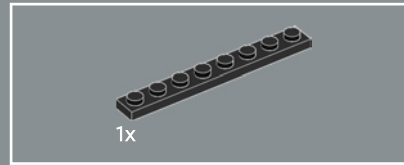
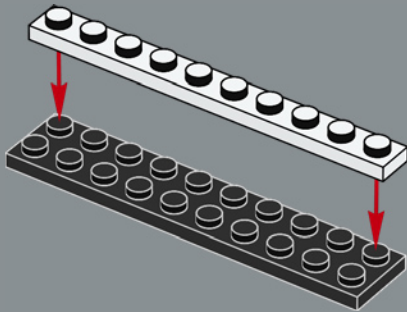

190

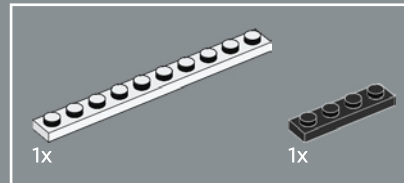
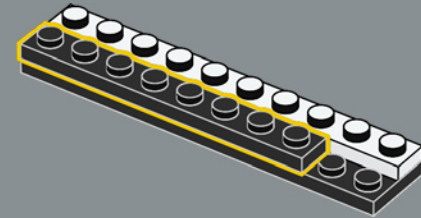

191

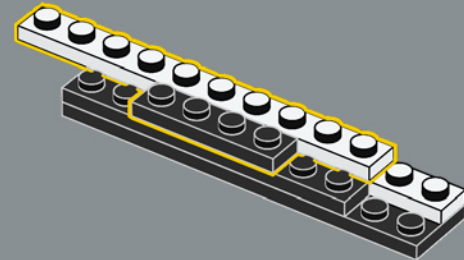

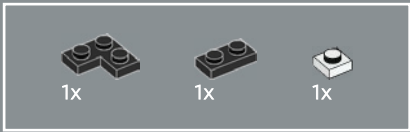

192

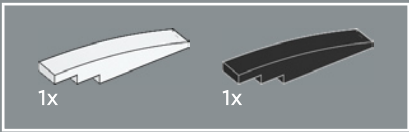
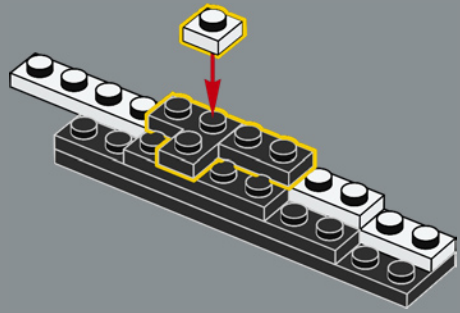

193

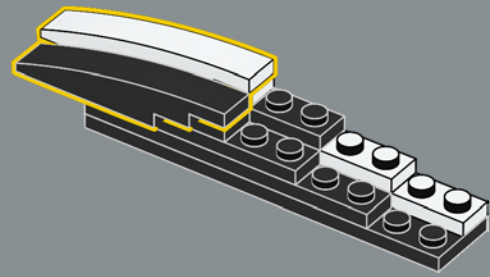

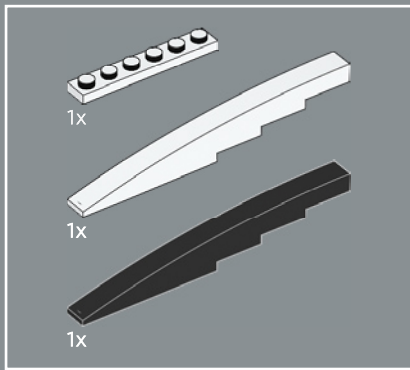

194

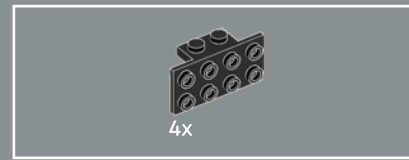
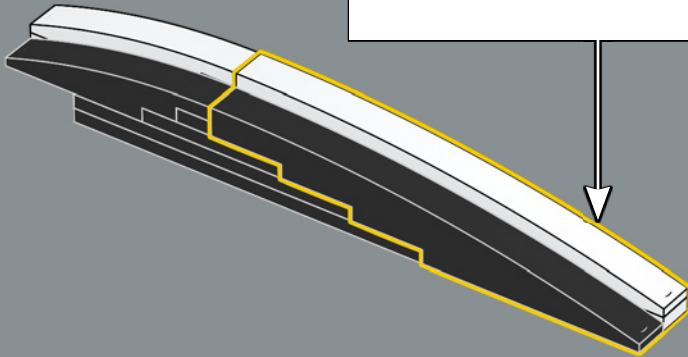
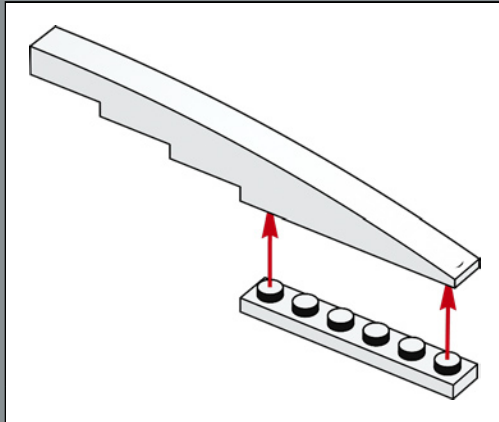

195

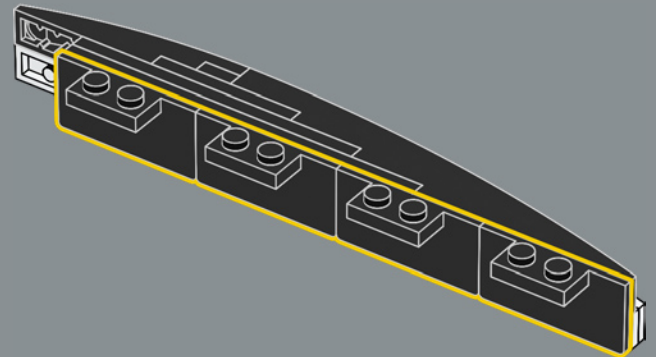

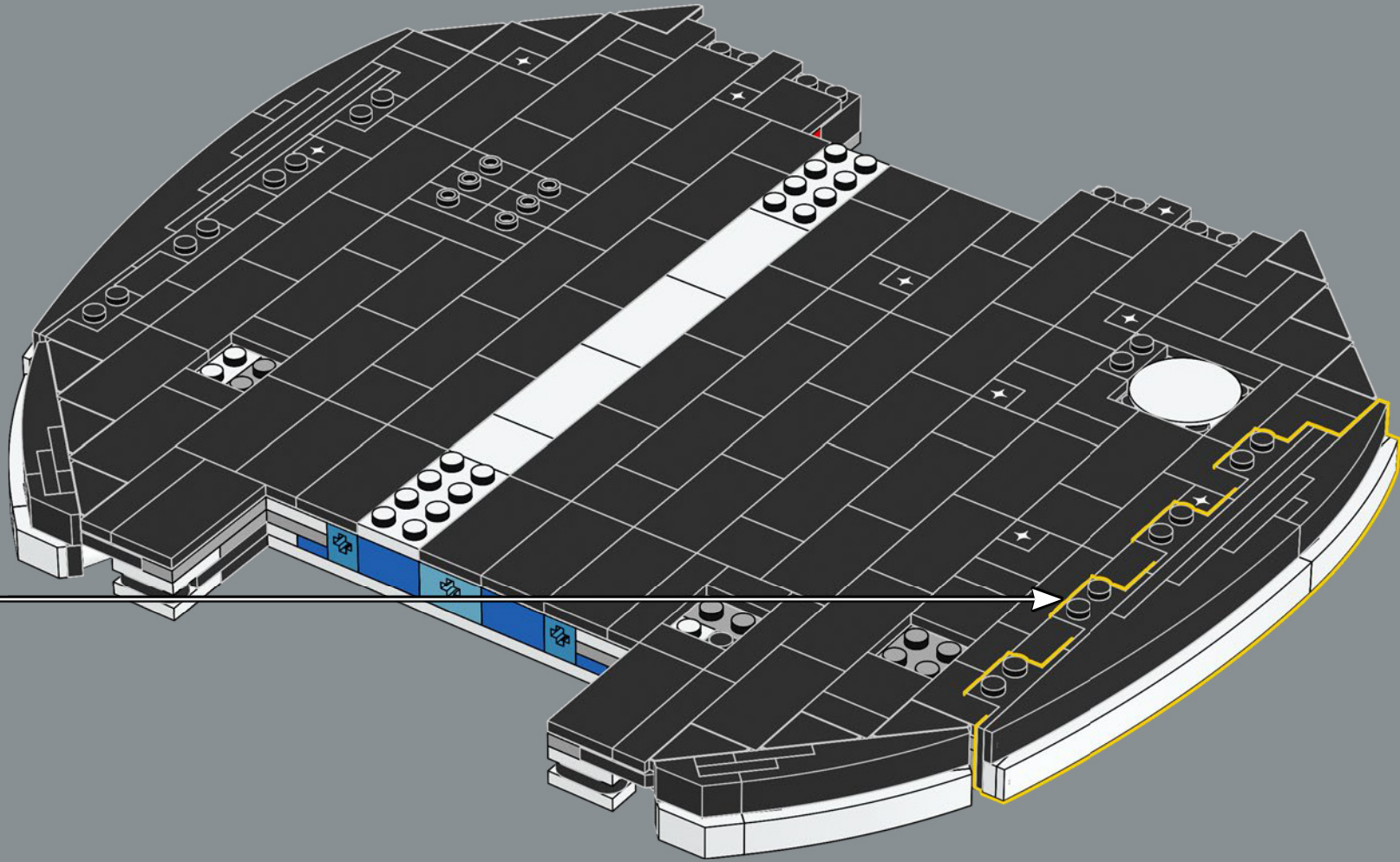

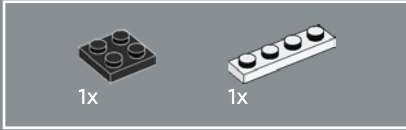
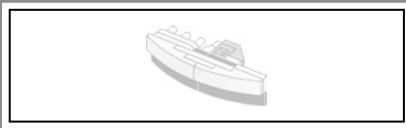

197

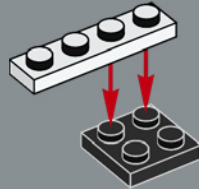

198

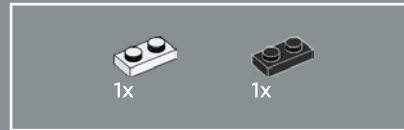
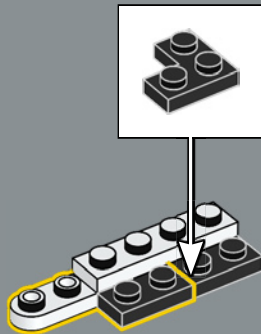

199

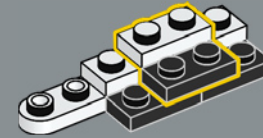

200

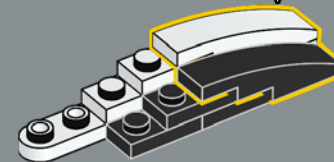
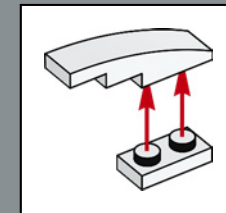

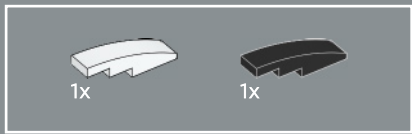

201

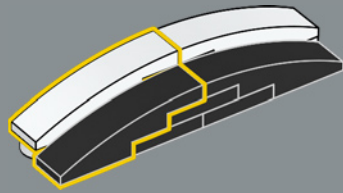

202

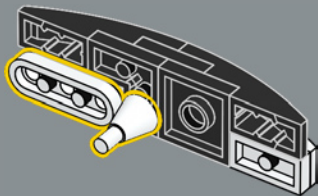

203

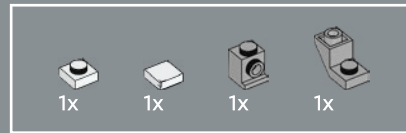
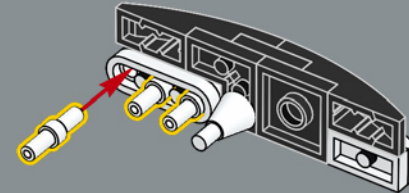

204

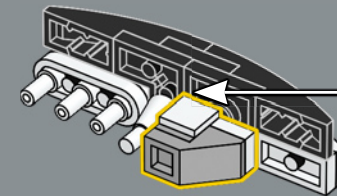
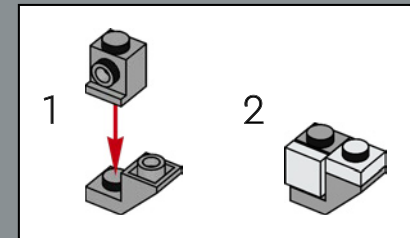

205

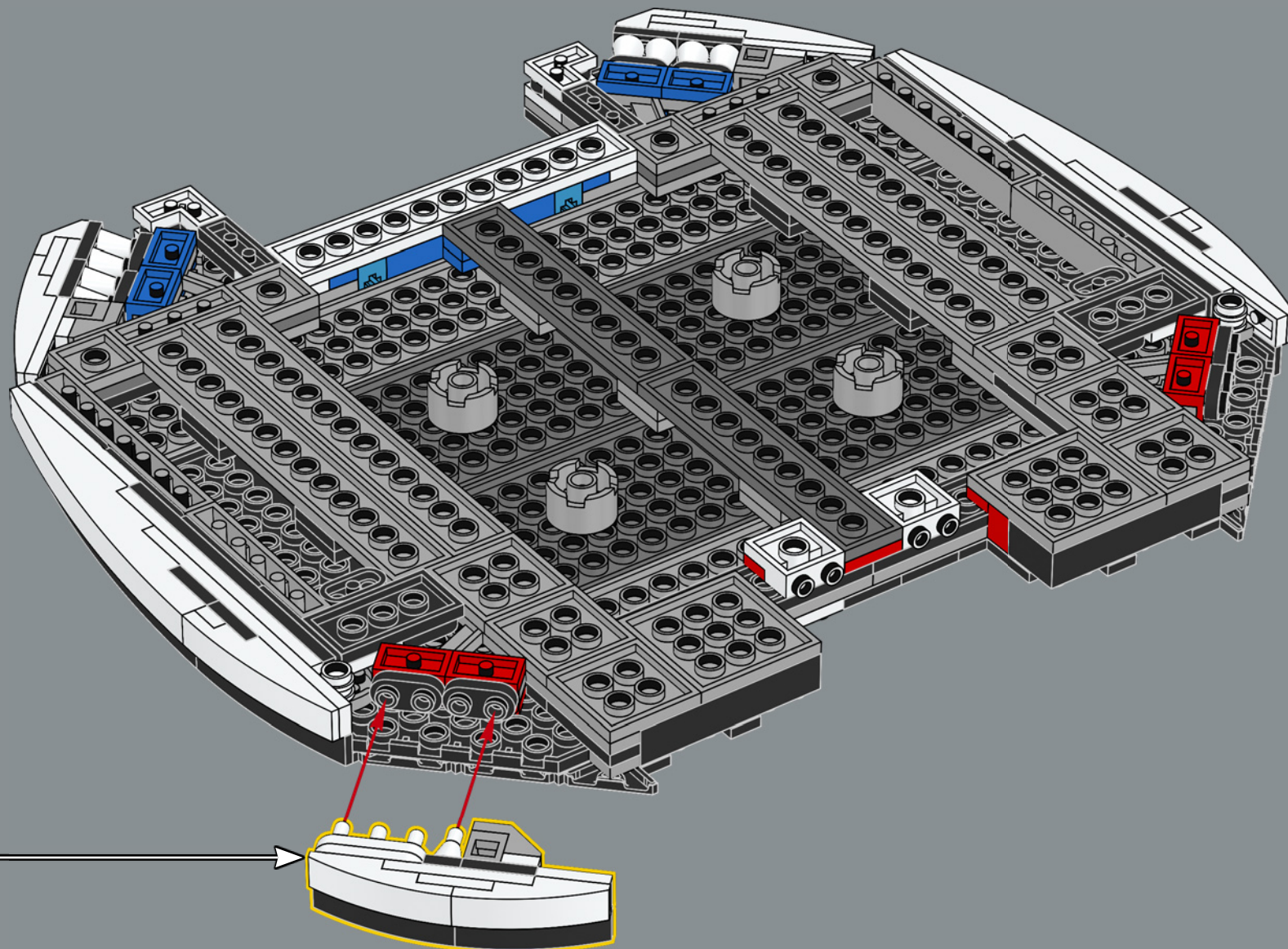

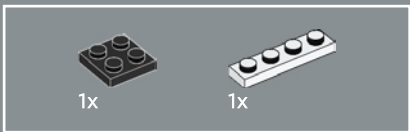

206

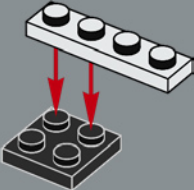

207

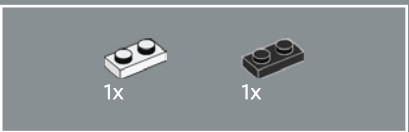
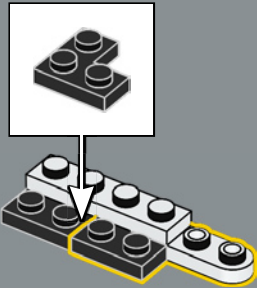

208

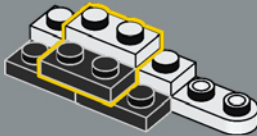

209

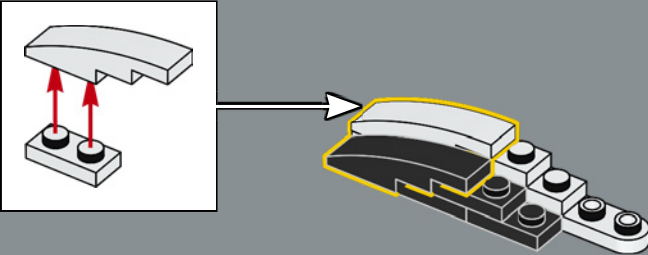

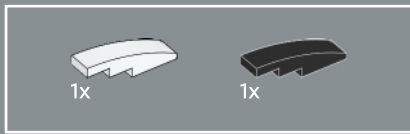

210

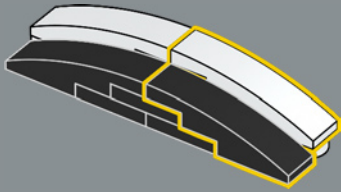

211

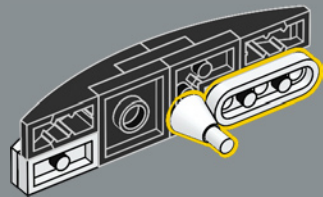

212

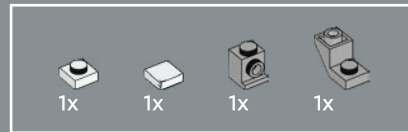
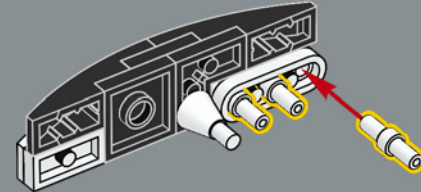

213

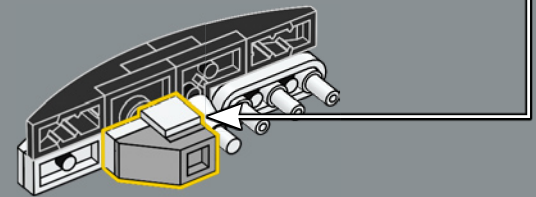
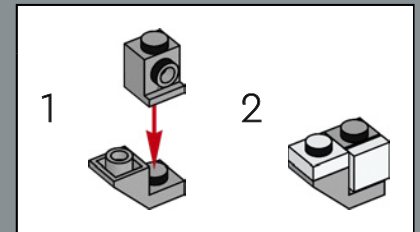

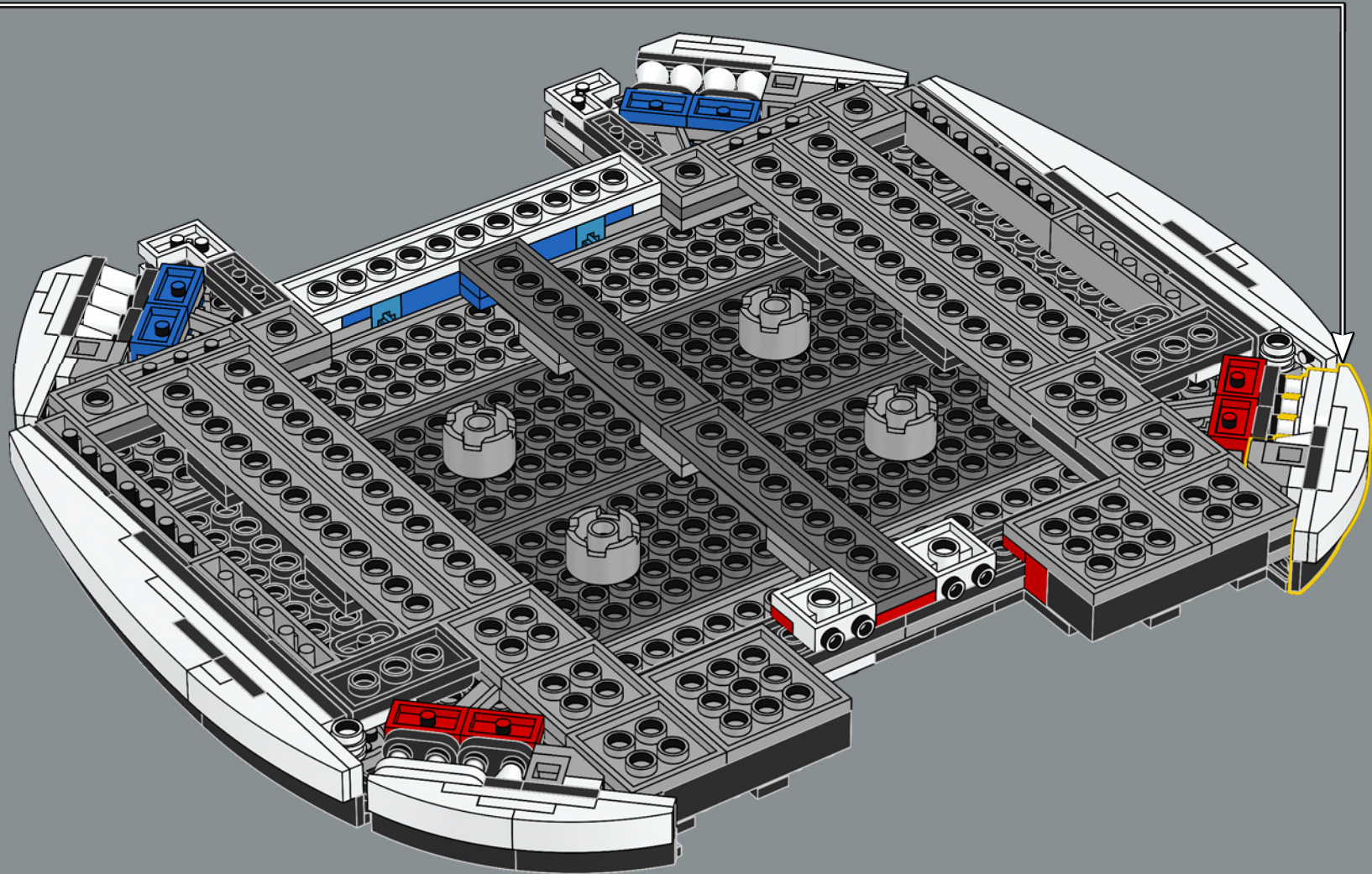

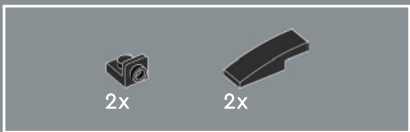

215

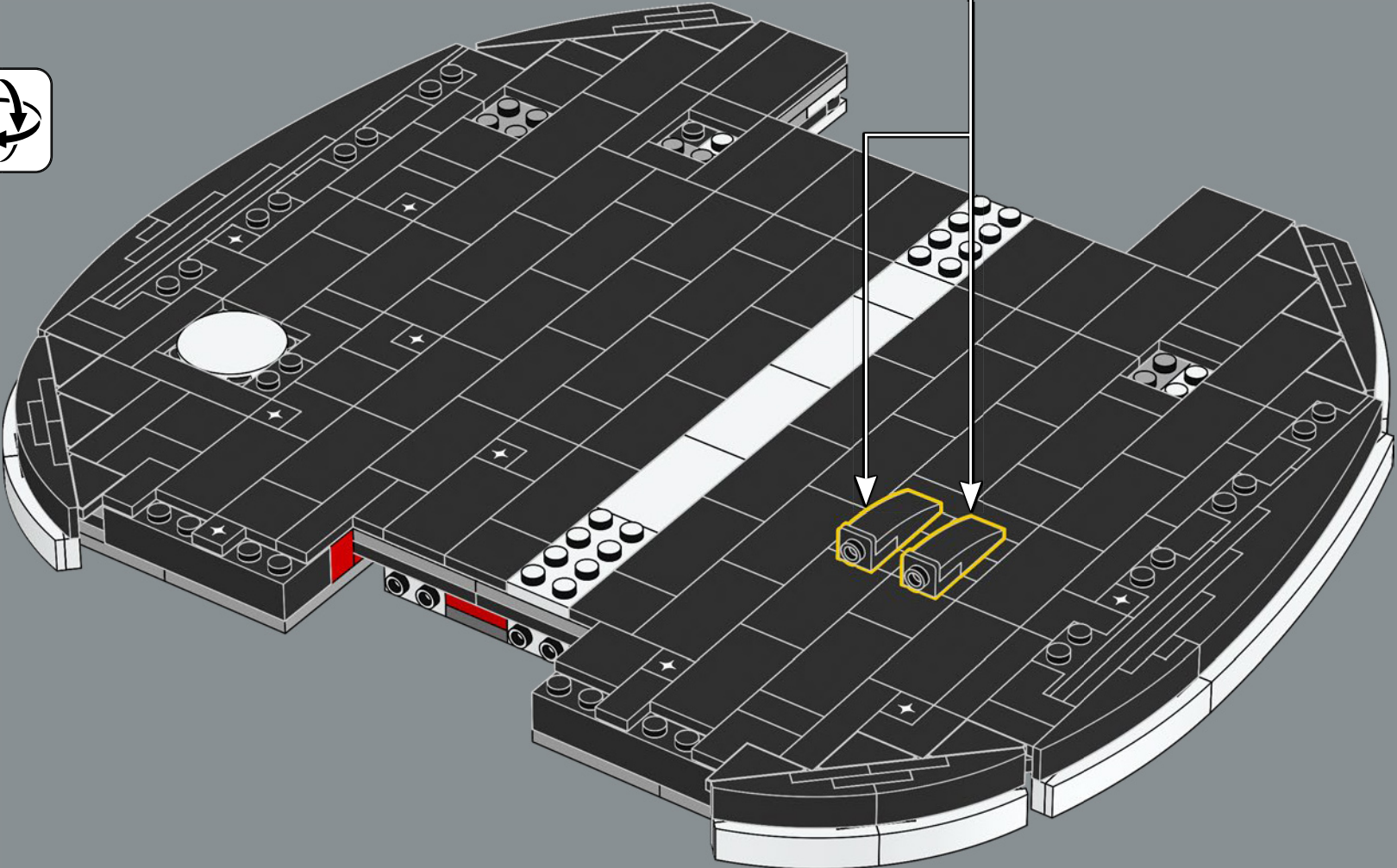
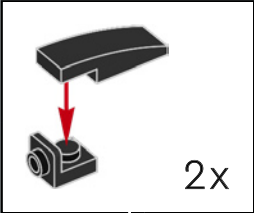

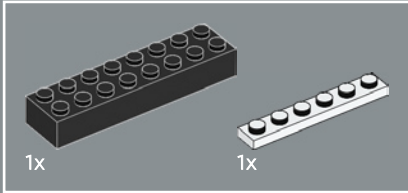
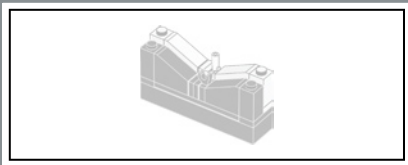

216

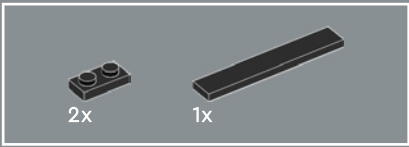
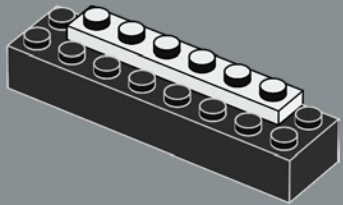

217

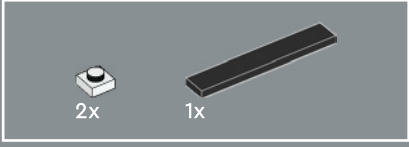
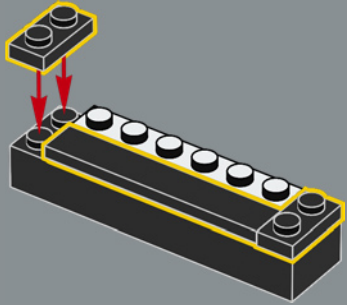

218

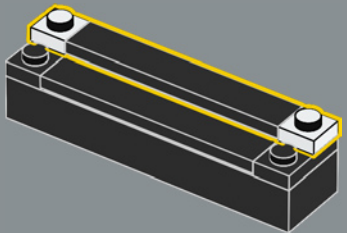



219

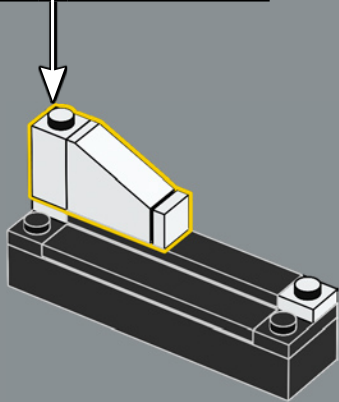
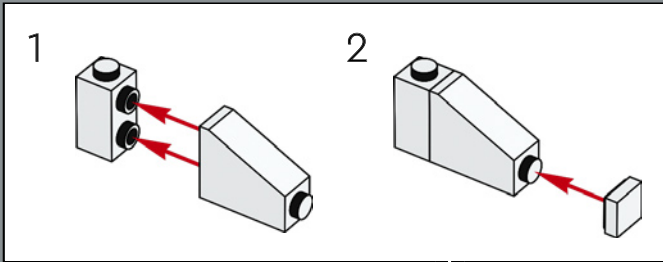

220

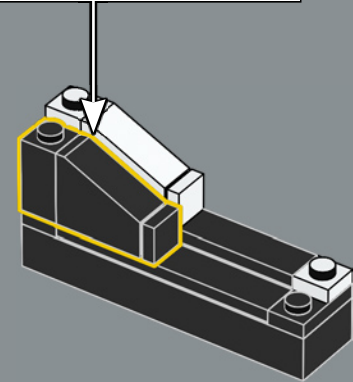
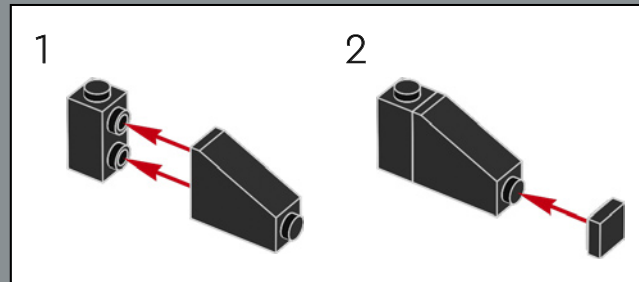

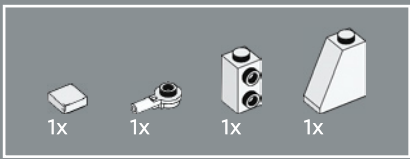

221

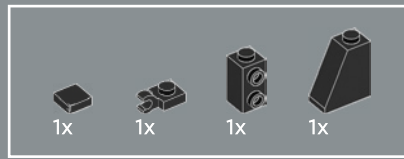
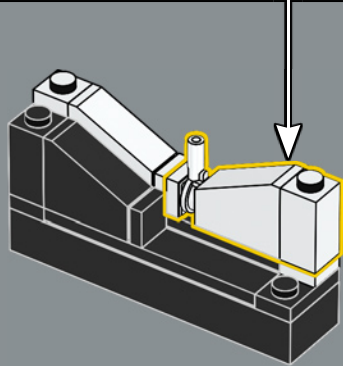
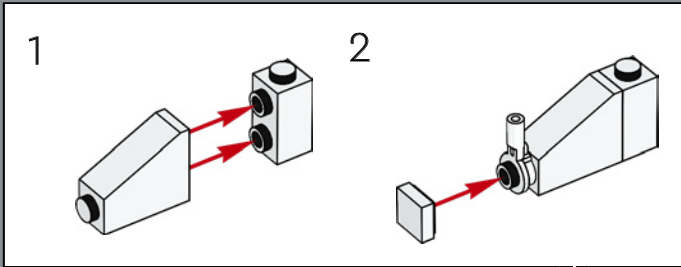

222

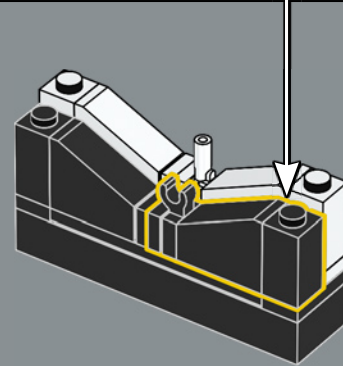
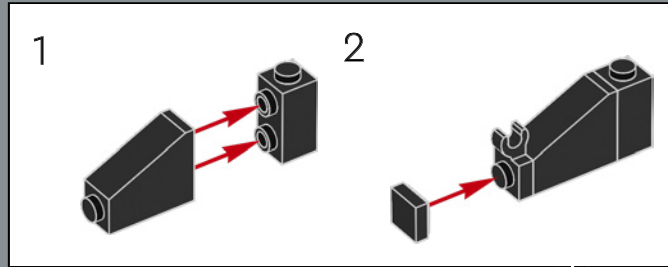

223

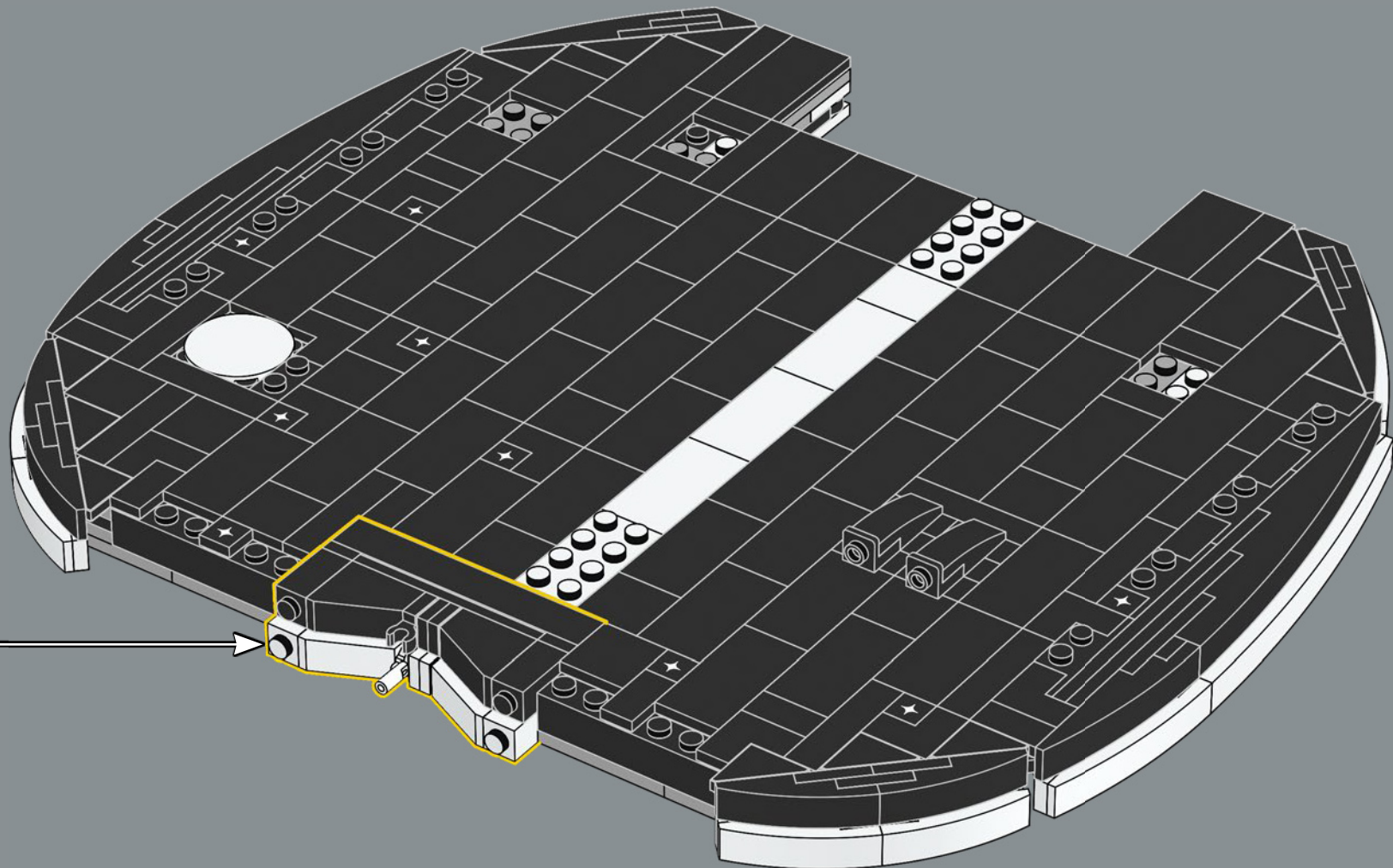

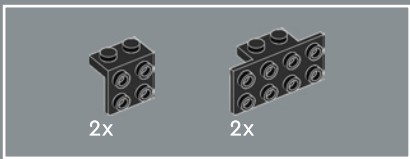

224

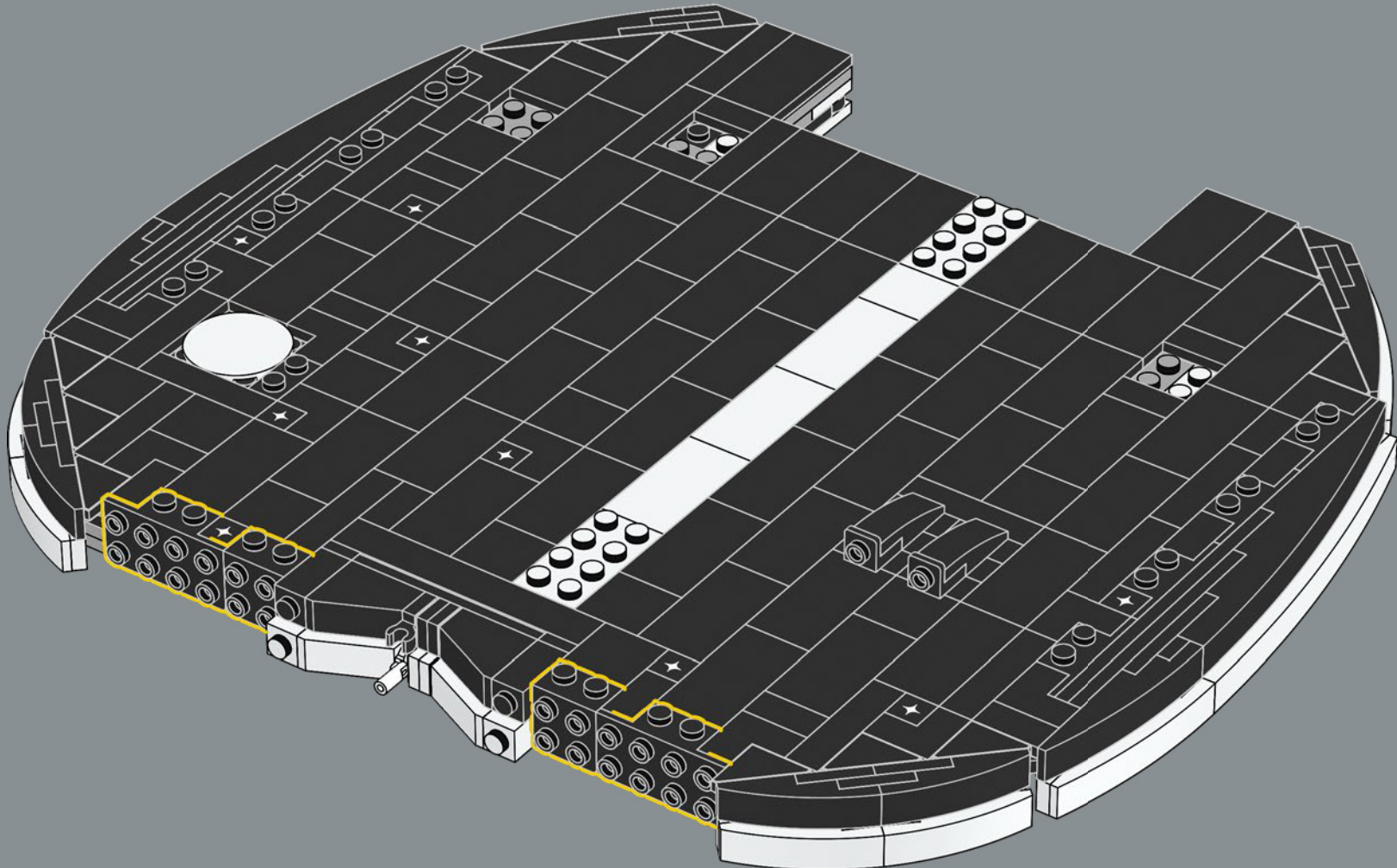

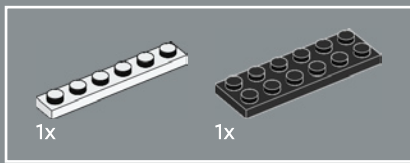

225

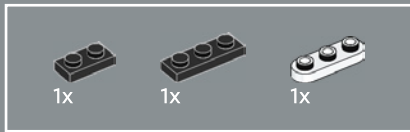
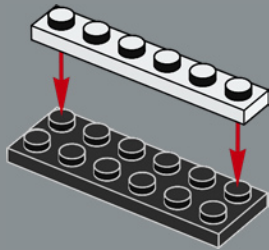

226

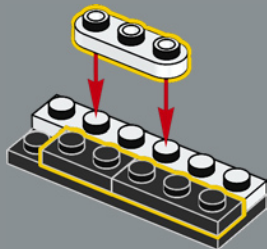

227

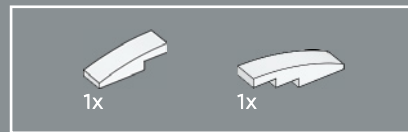
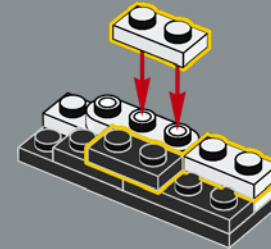

228

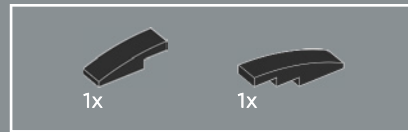
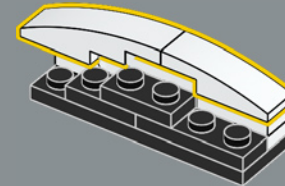

229

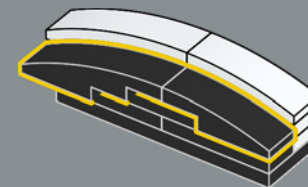

230

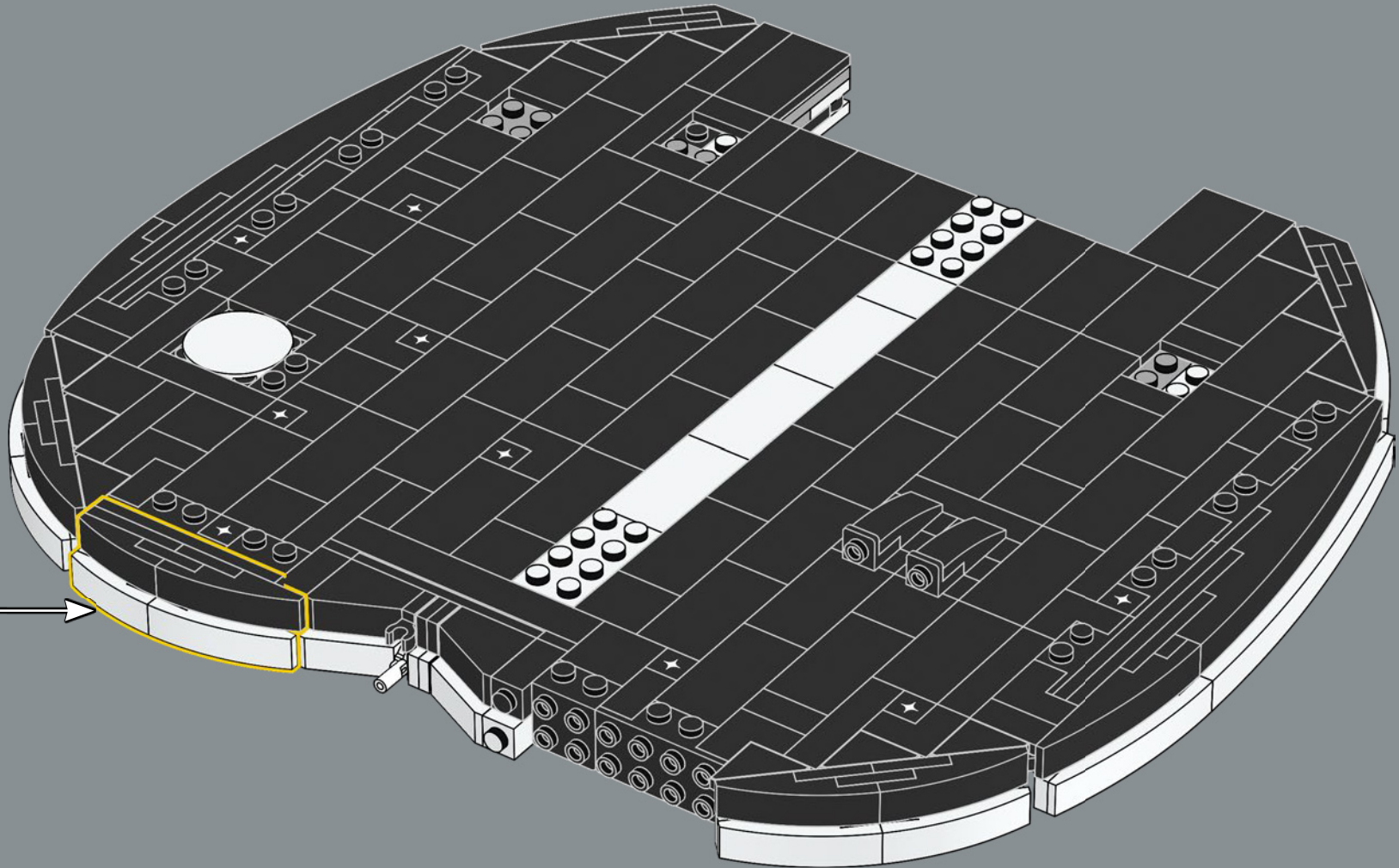

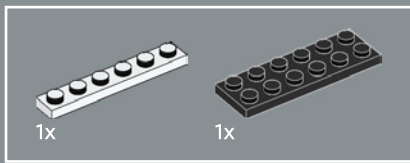

231

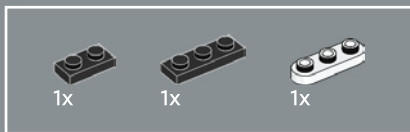
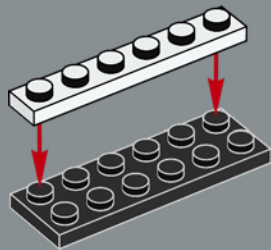

232

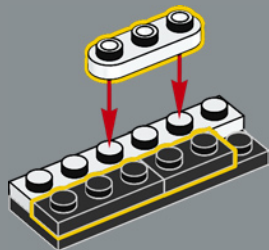

233

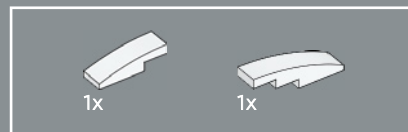
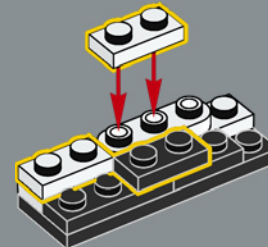

234

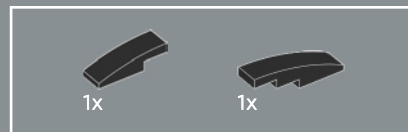
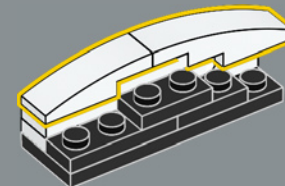

235

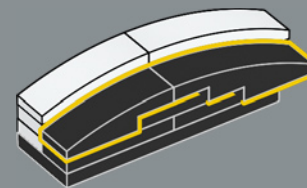

236

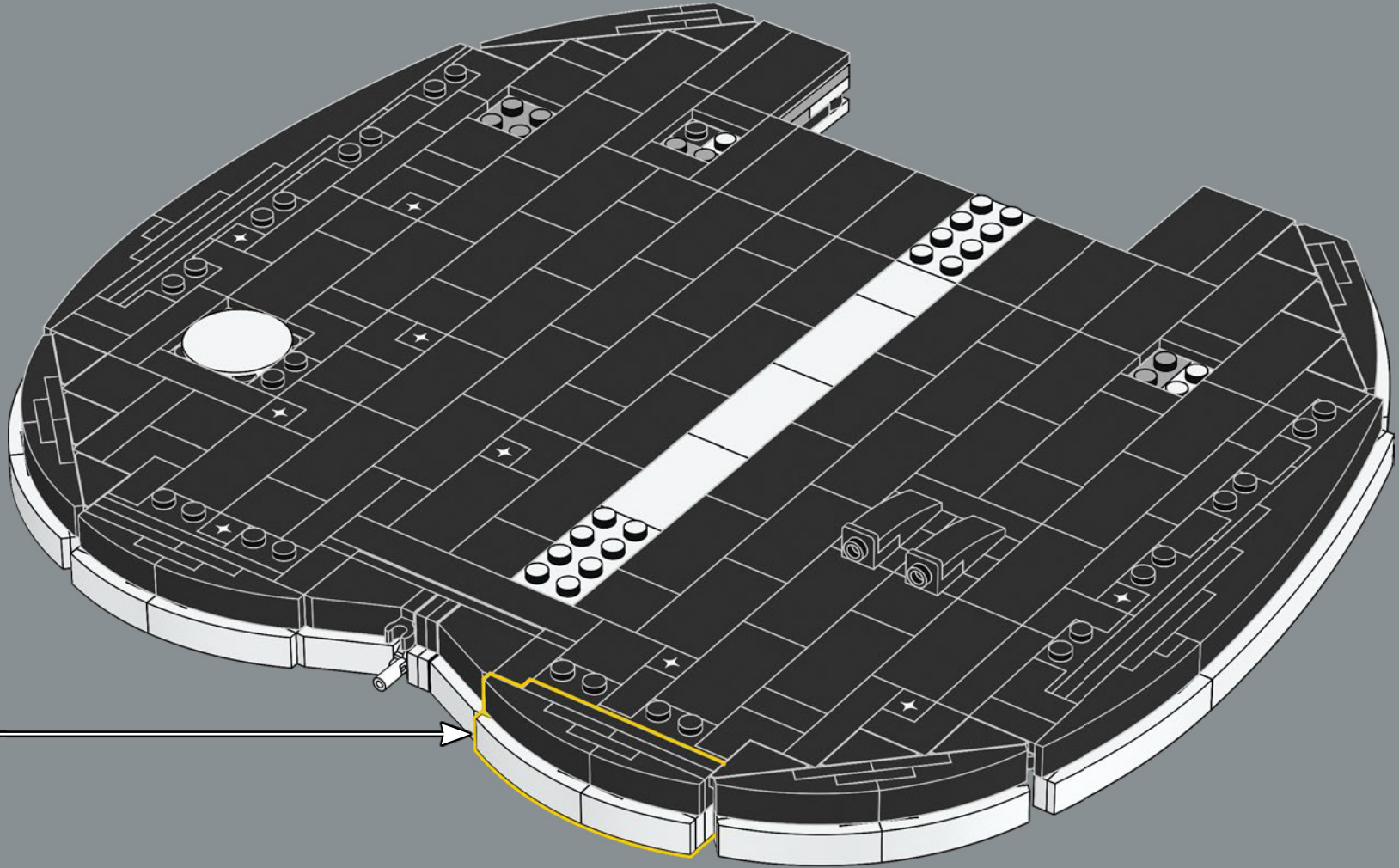



237



Das könnte der bisher größte Apfel in einem LEGO® Set sein!
Wir haben geschwungene Elemente übereinandergestapelt und
seitliche Bautechniken genutzt, um diese für New York City so
charakteristische Silhouette nachzubilden.

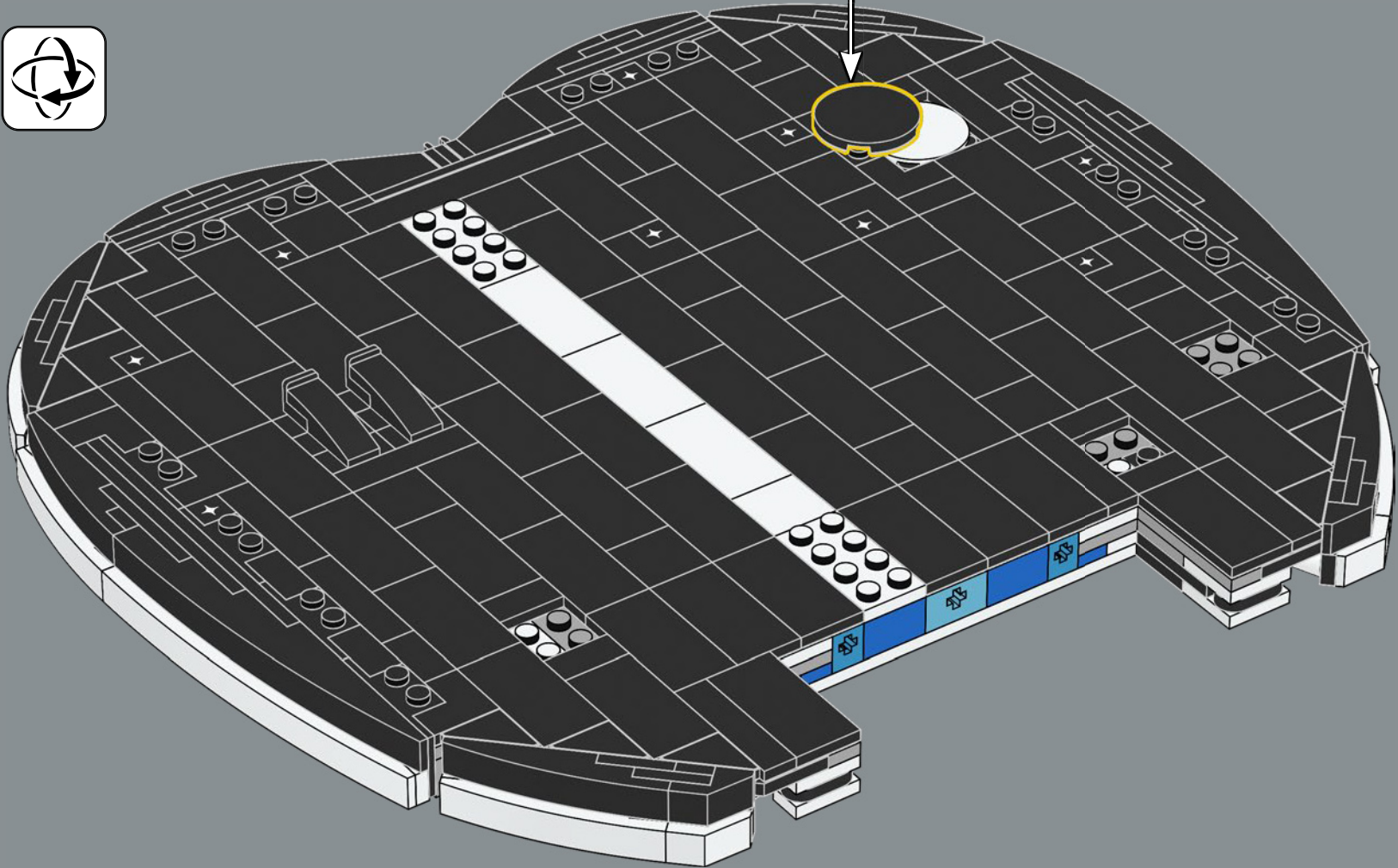

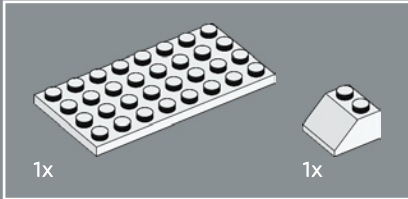
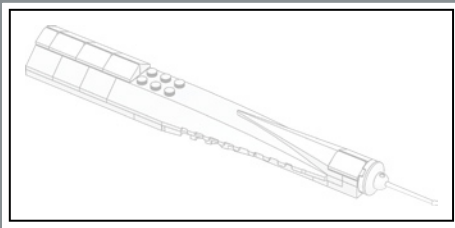

238

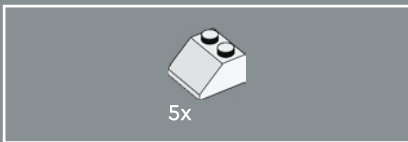
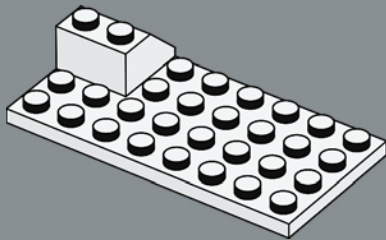

239

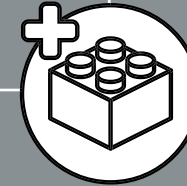
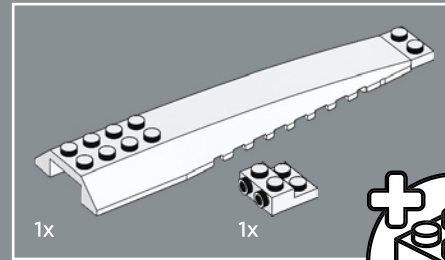
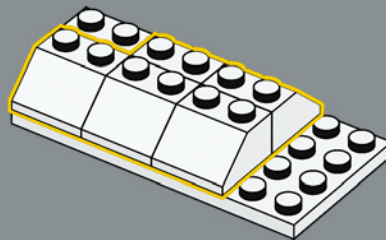

240

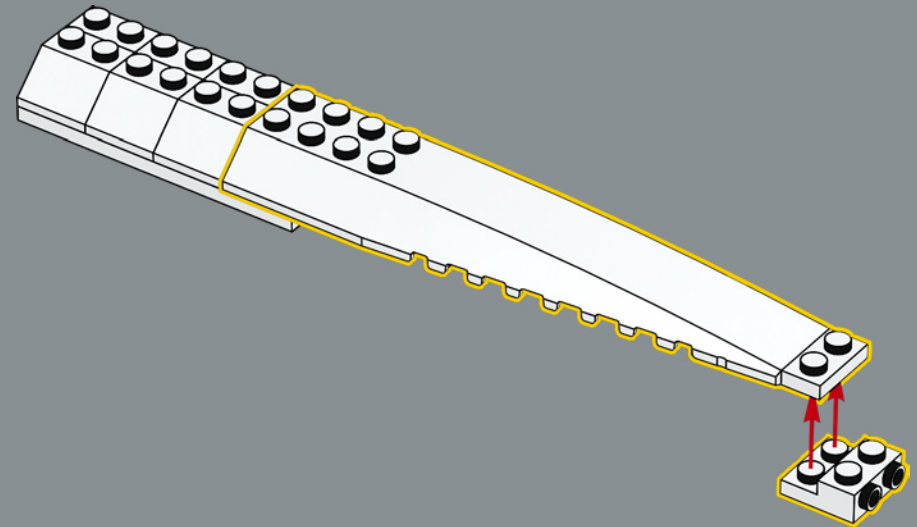

Das One World Trade Center ist 1776 Fuß, also 541,3 m, hoch – eine Anspielung auf das Jahr der Unterzeichnung der Erklärung zur Unabhängigkeit der Vereinigten Staaten.

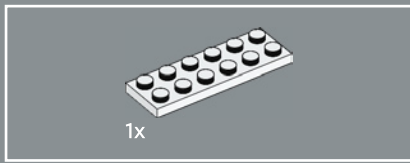

241

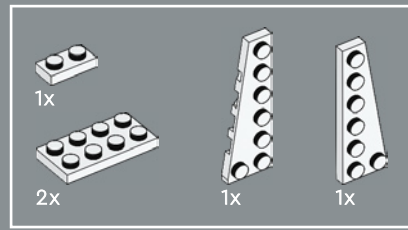
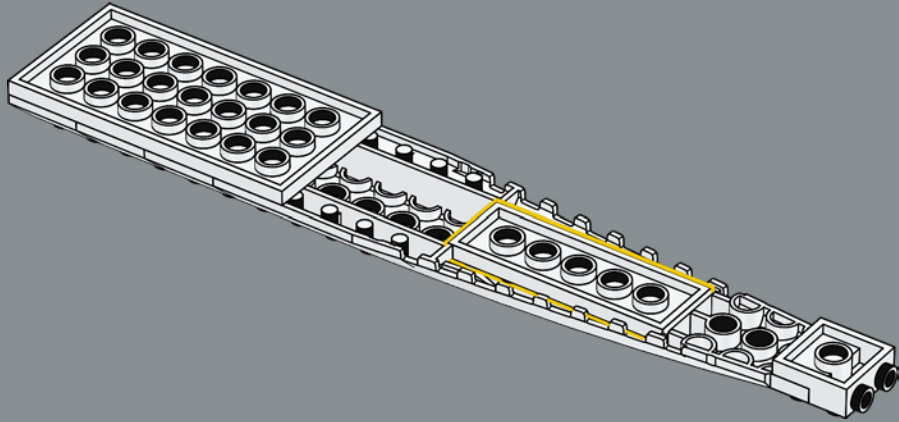

242

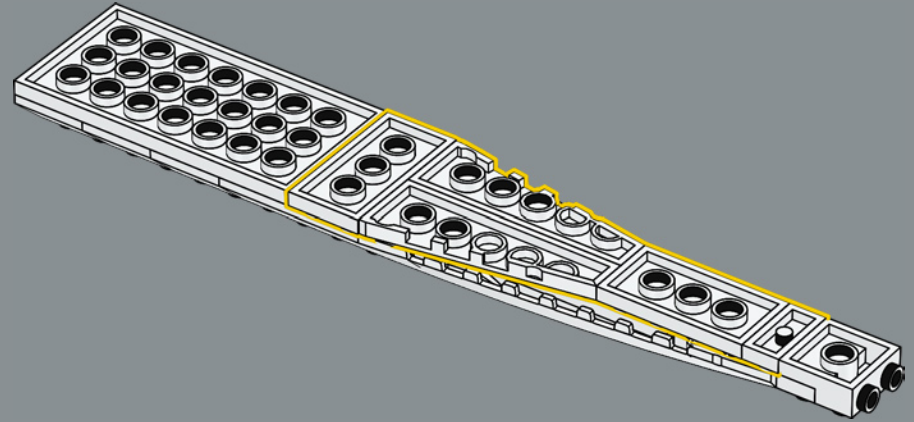



243

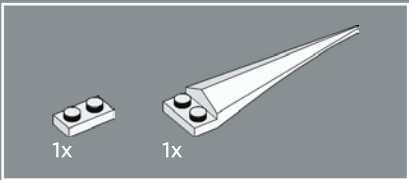
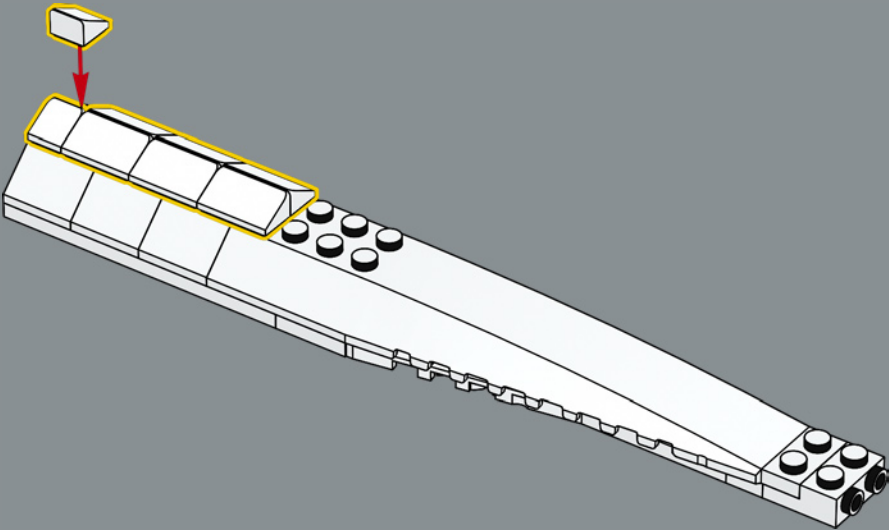

244

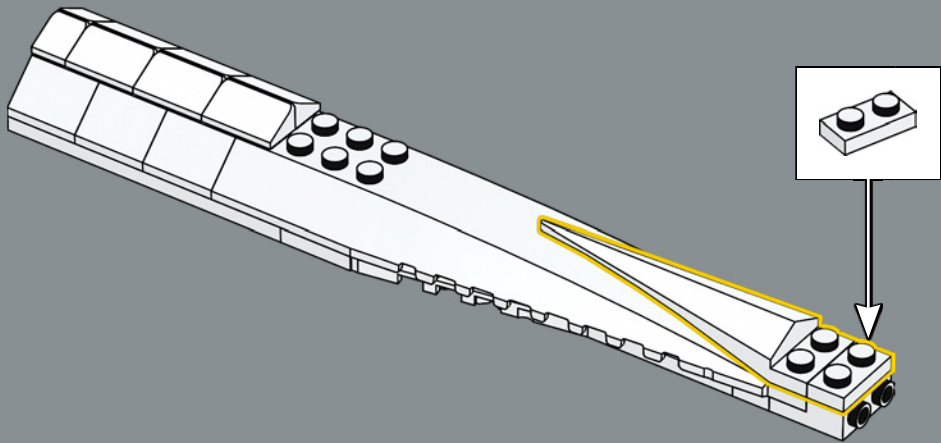



245

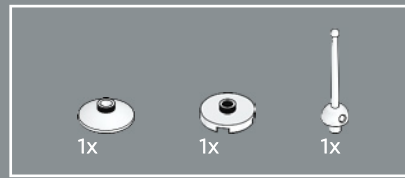
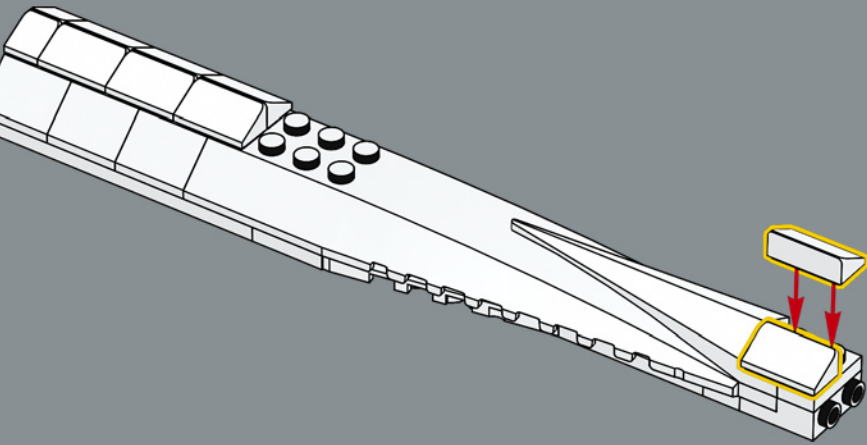

246

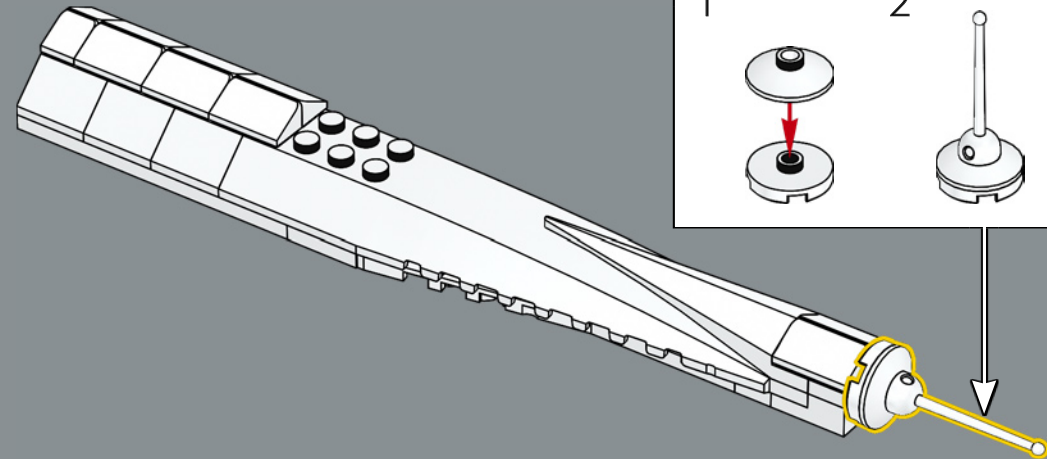

Ein LEGO® Schwertelement stellt die Antenne des höchsten Gebäudes in New York City, des One World Trade Center, dar. In Wirklichkeit ist die Antenne allein 124,3 m hoch.

247

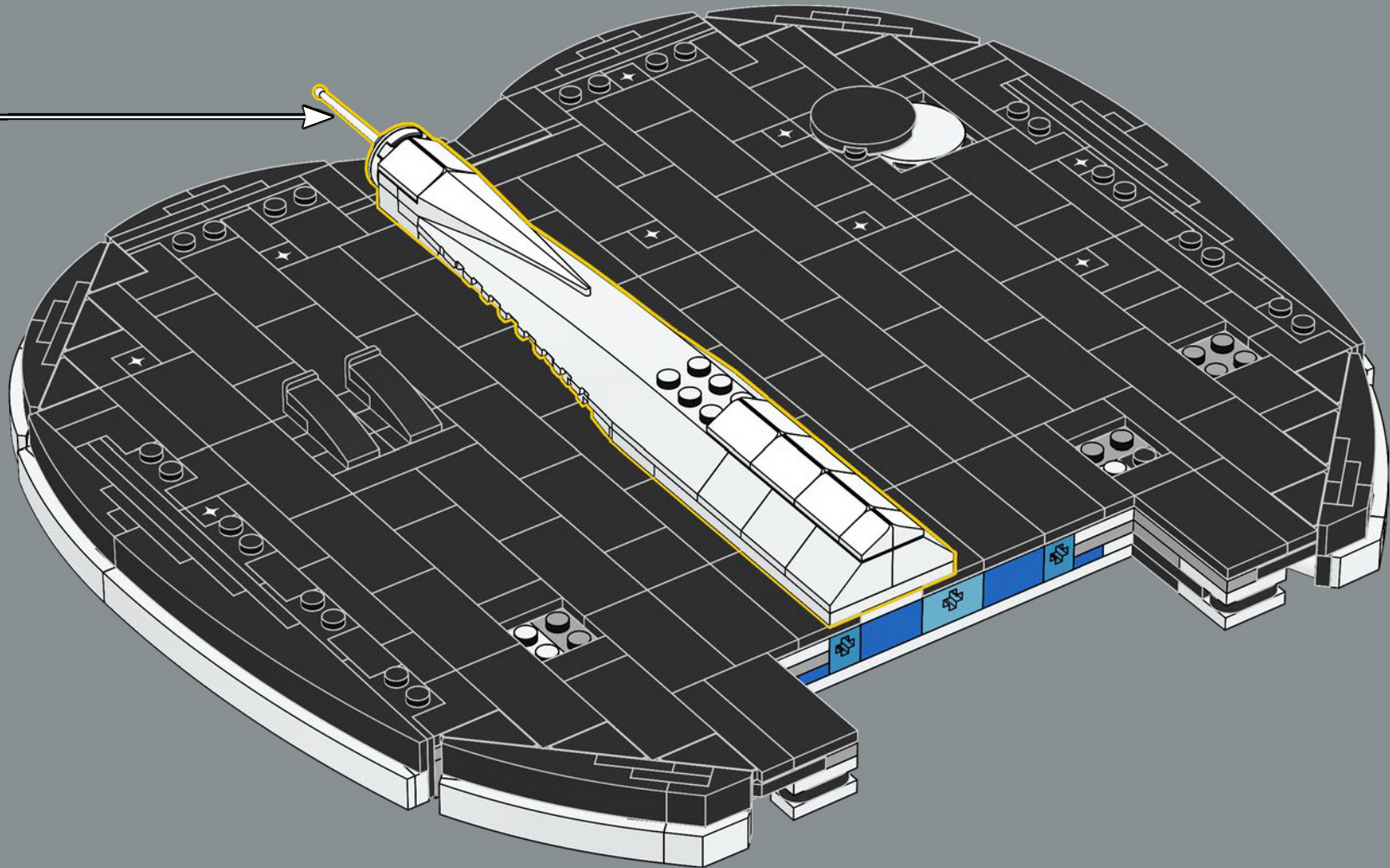



248

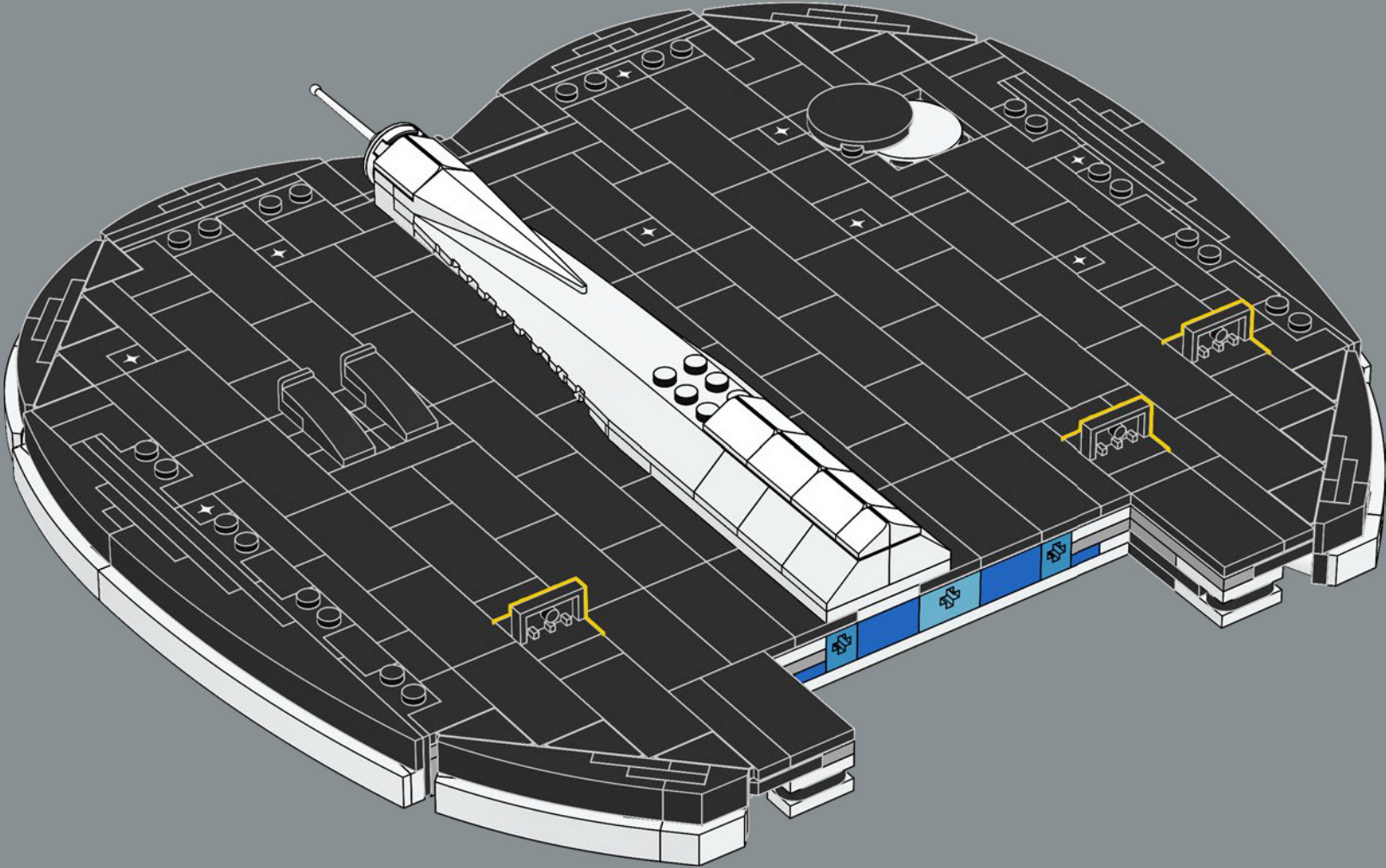

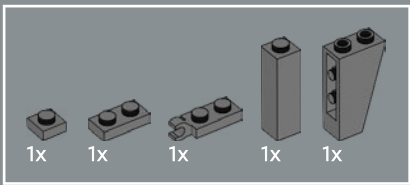

249

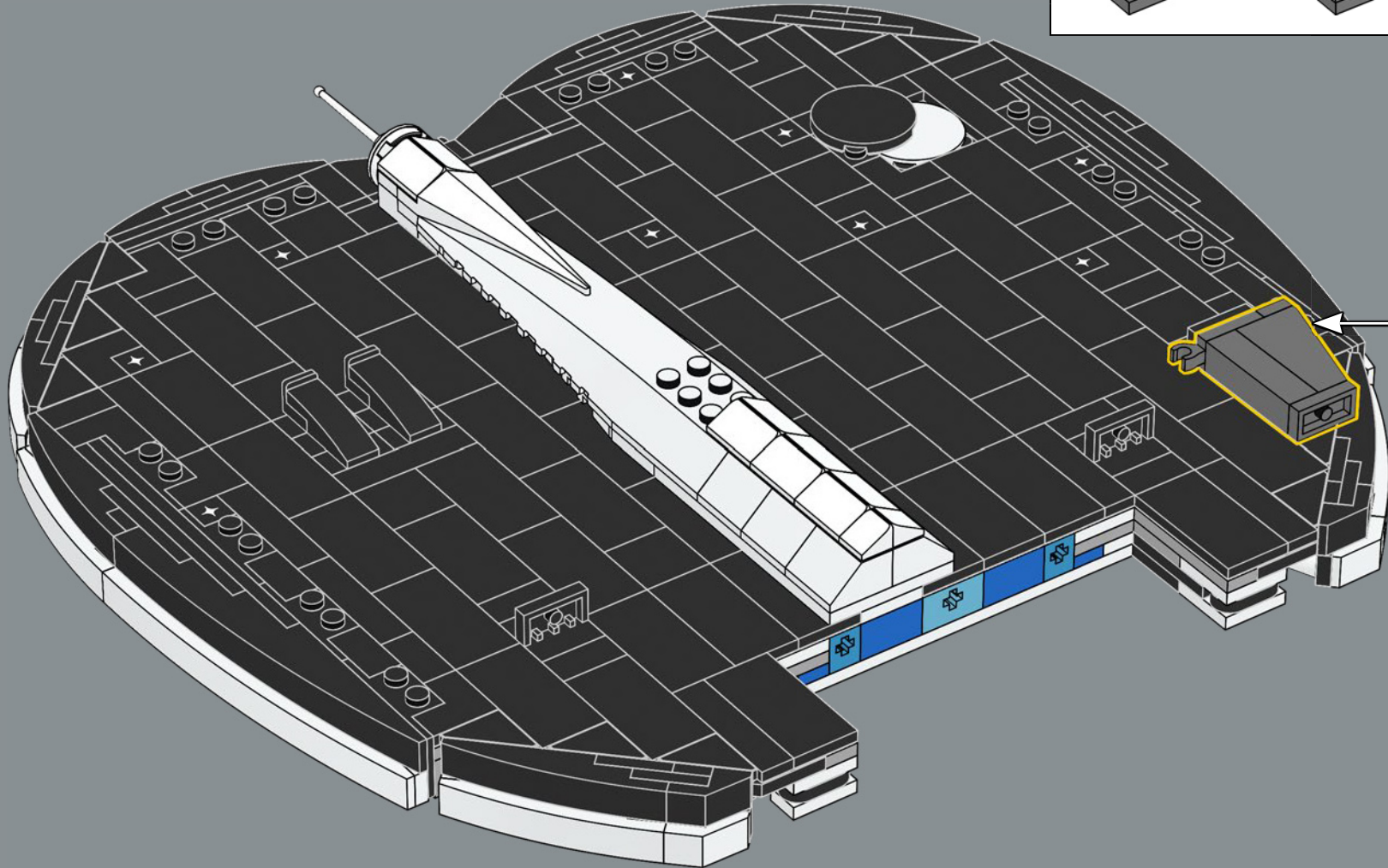
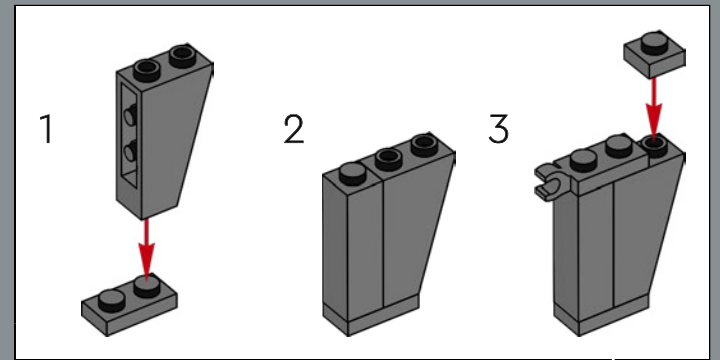

250

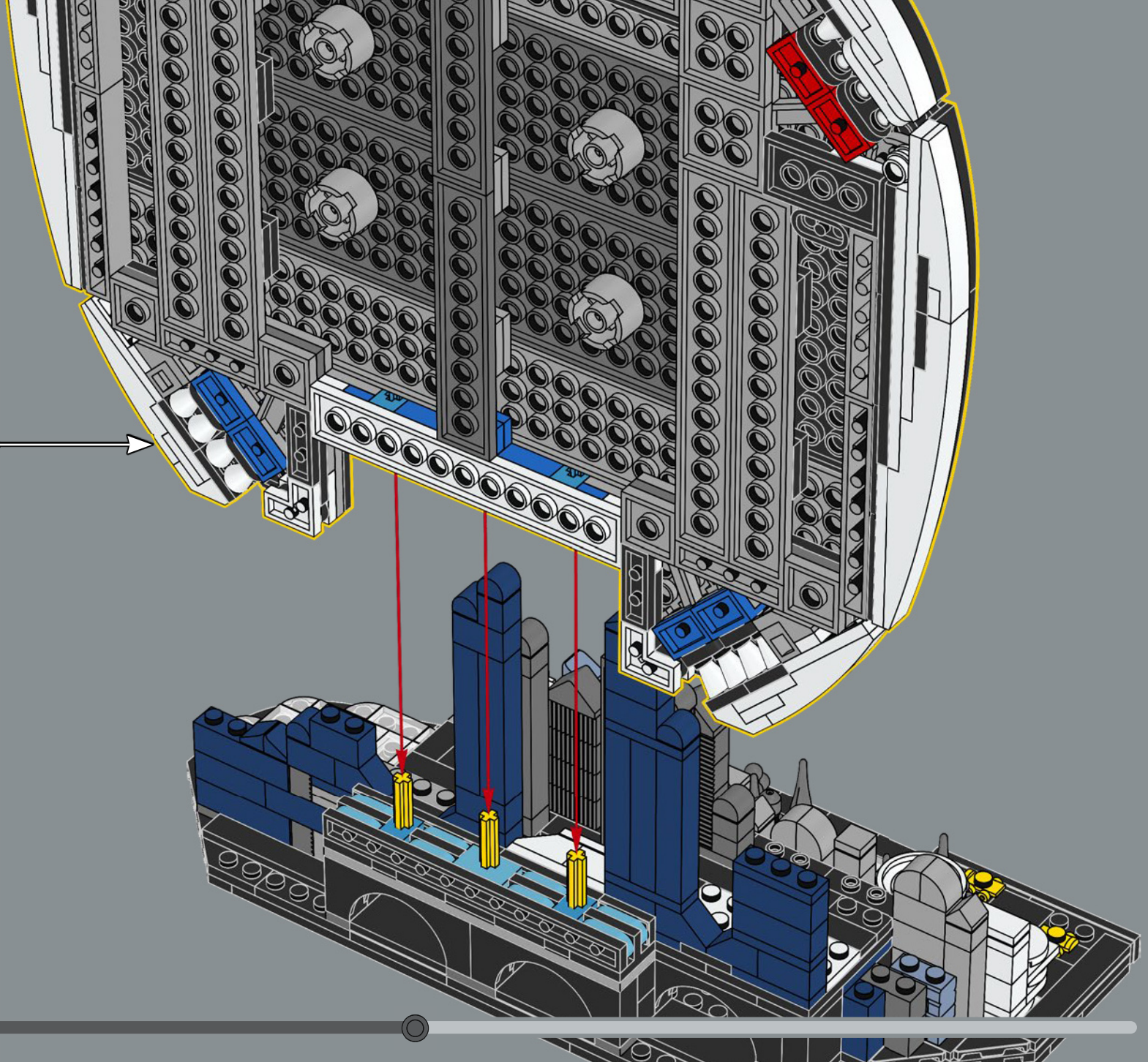

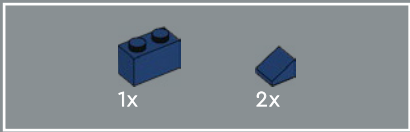

251

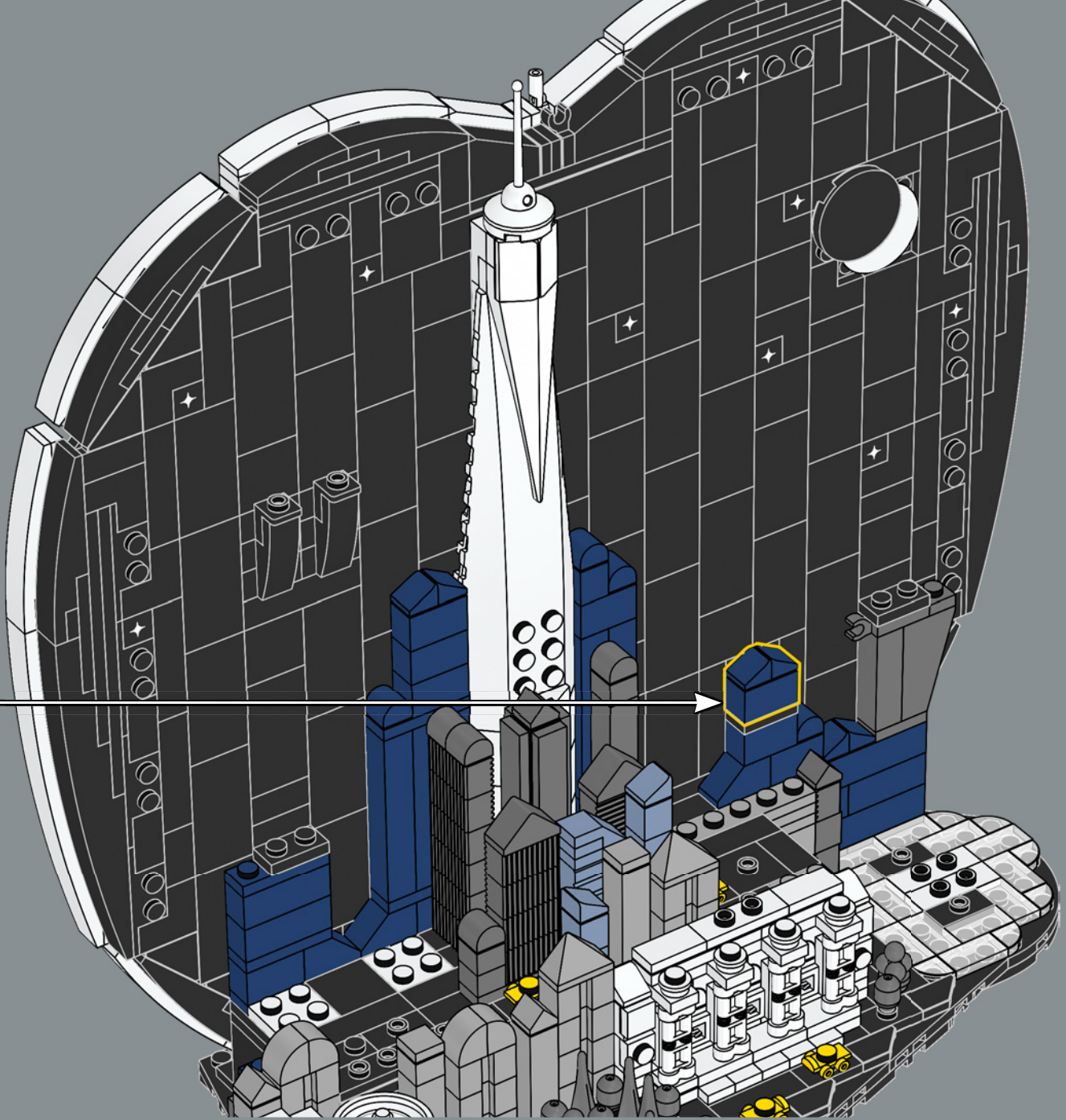
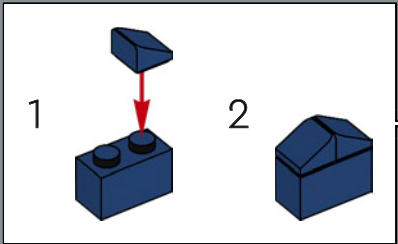

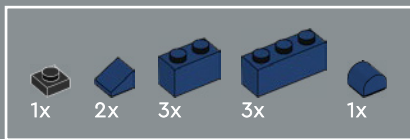

252

1

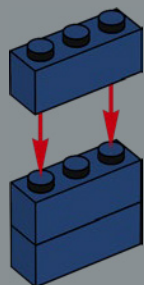

2

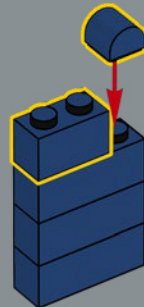

3

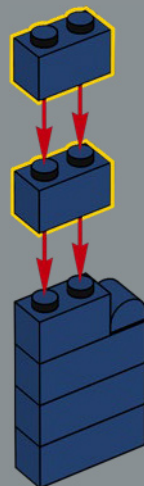

4

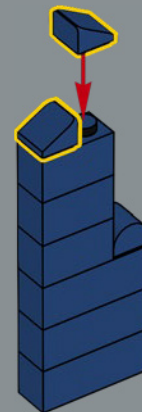

5



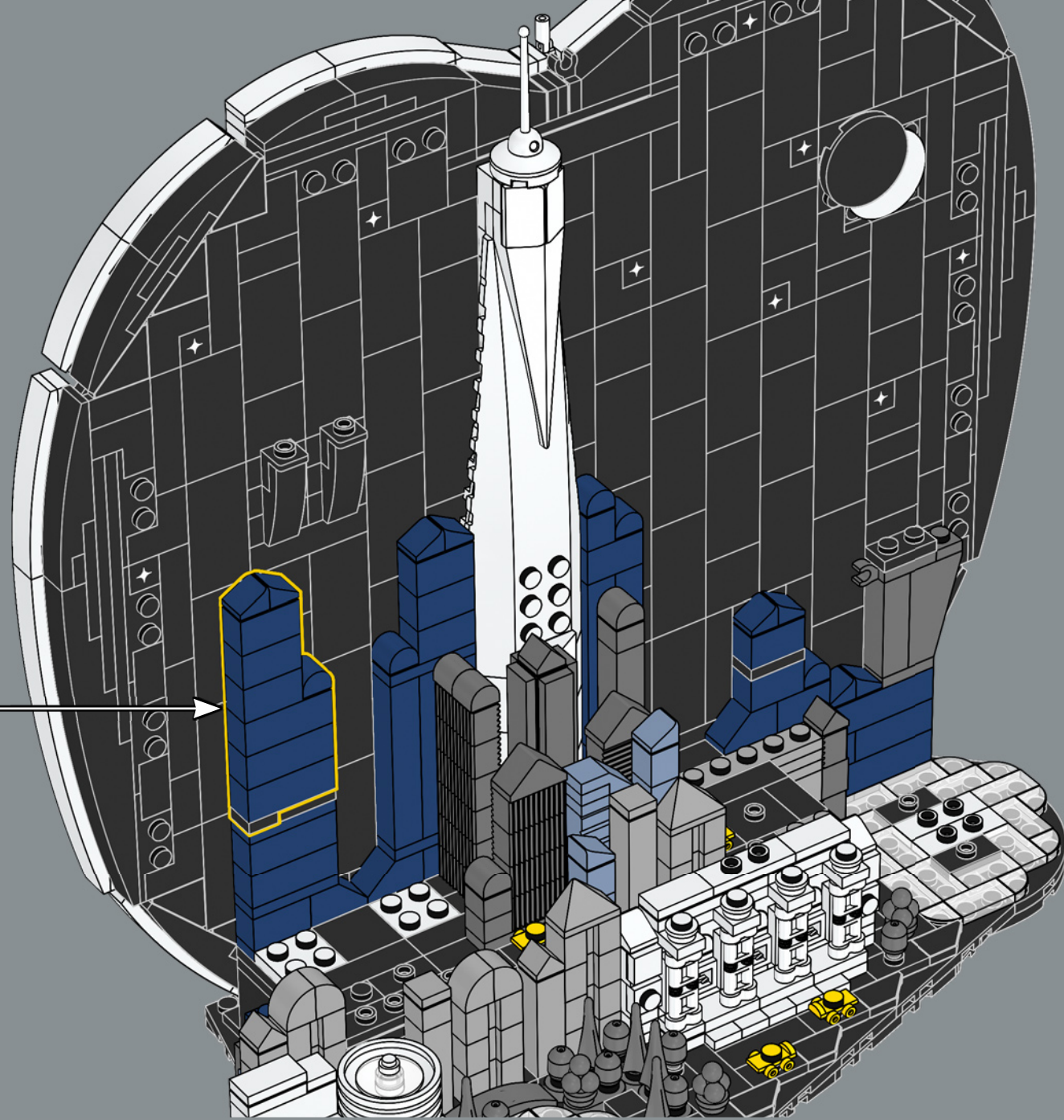

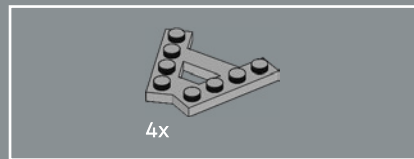

253

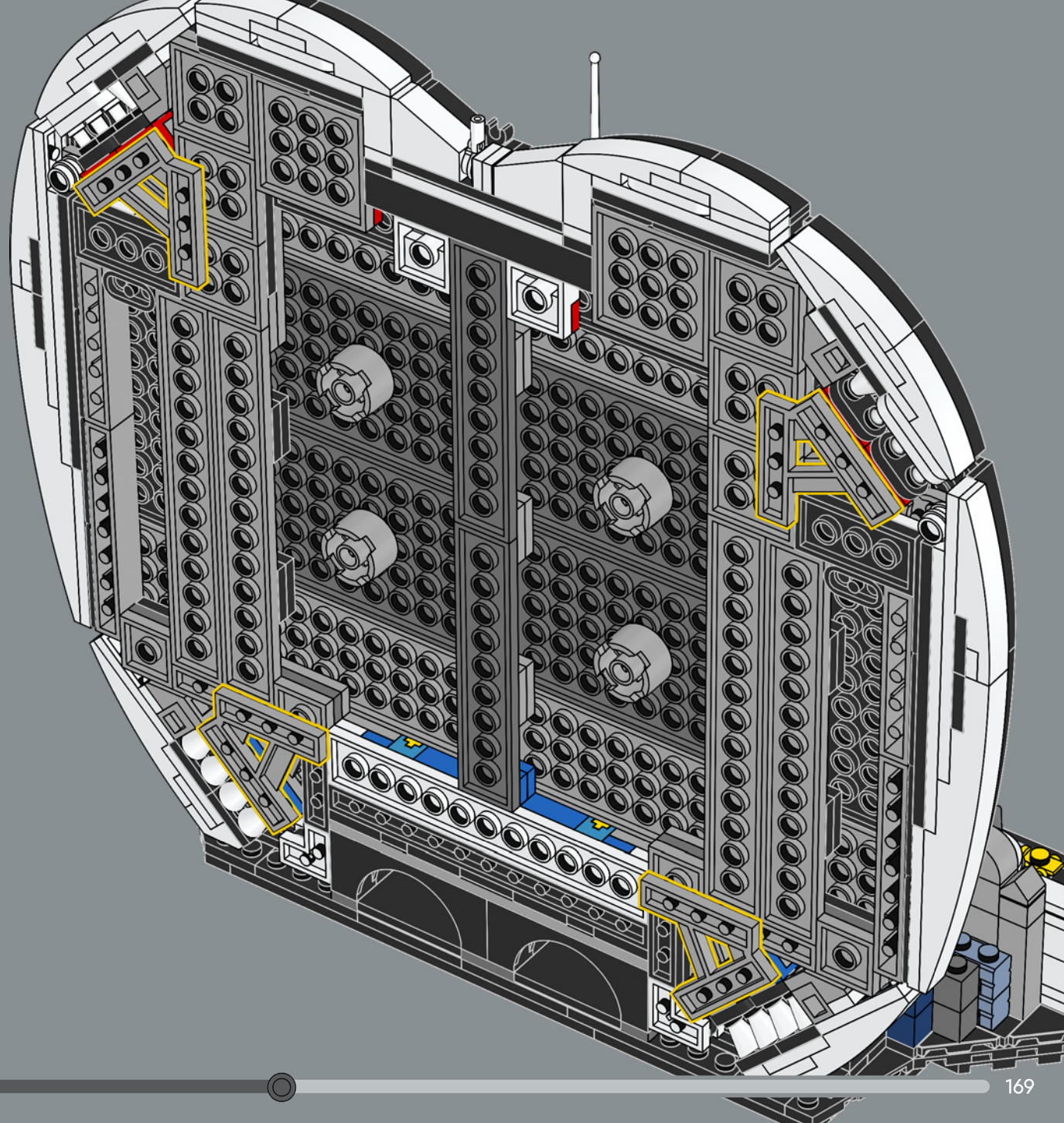

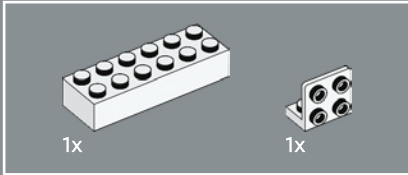
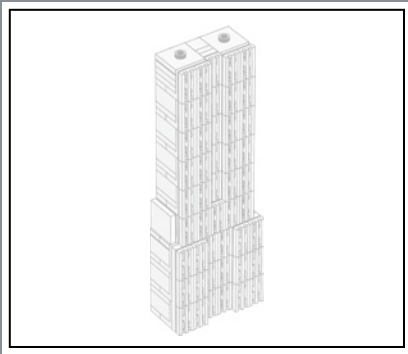

254

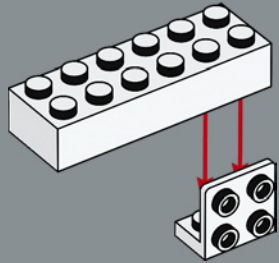

Das 1931 eröffnete Empire State Building ist bis heute eine Ikone des Art déco. Als weltweit erstes Hochhaus mit Stahlskelettkonstruktion und mehr als 100 Stockwerken dominierte es fast 40 Jahre lang als höchstes Gebäude der Welt die Skyline von New York.

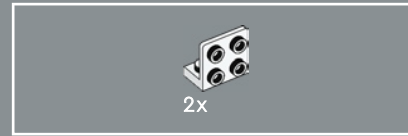

255

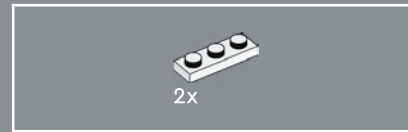
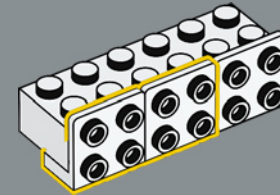

256

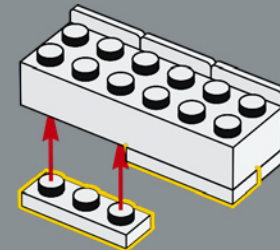

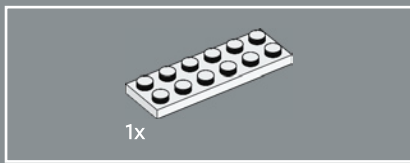

257

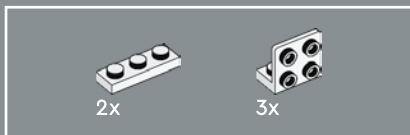
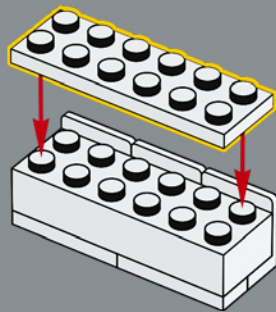

258

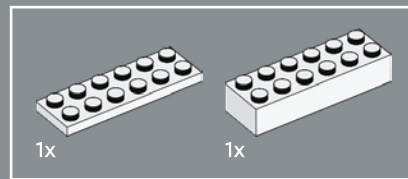
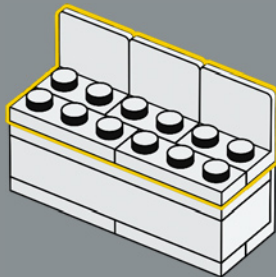

259

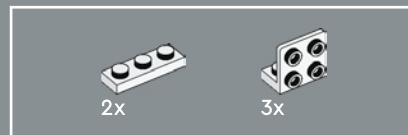
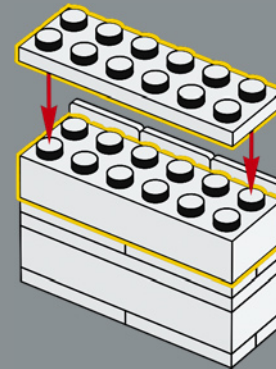

260

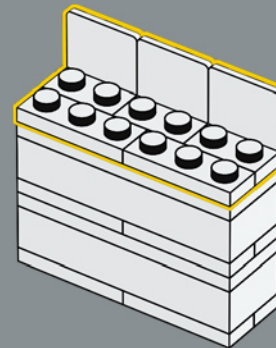

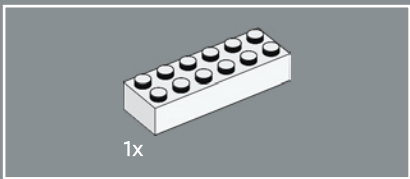

261

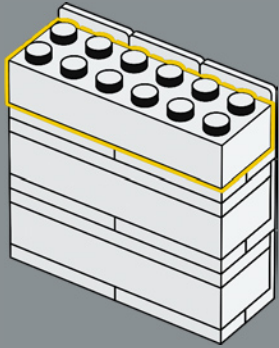

262

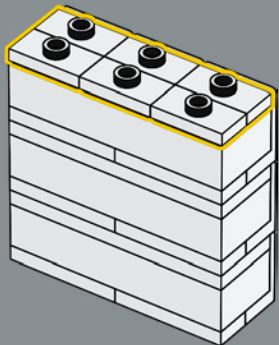

263

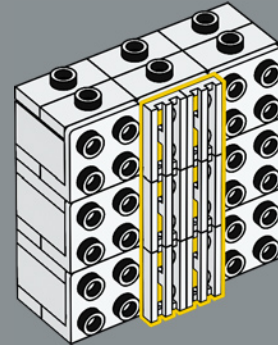

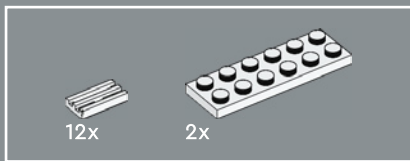

264

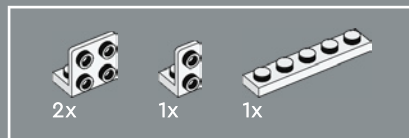
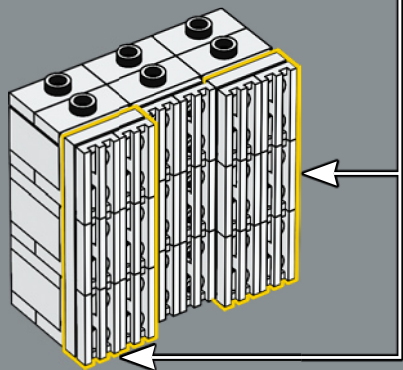
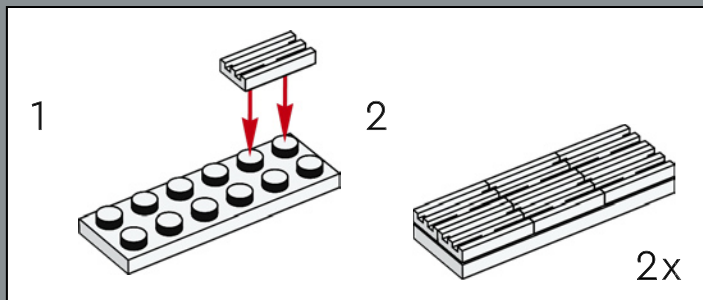

265

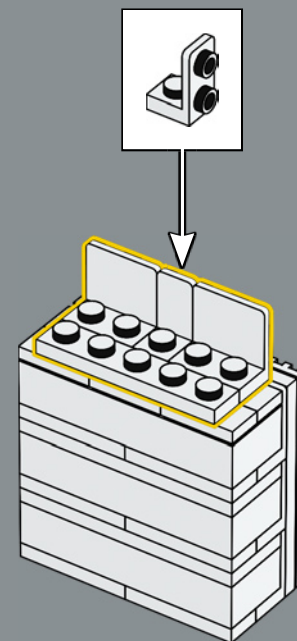

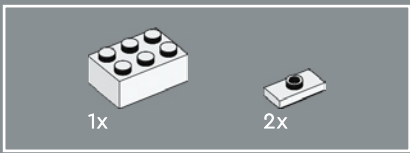

266

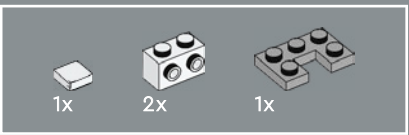
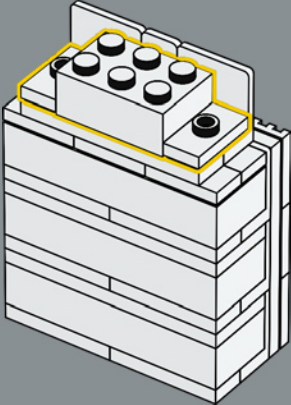

267

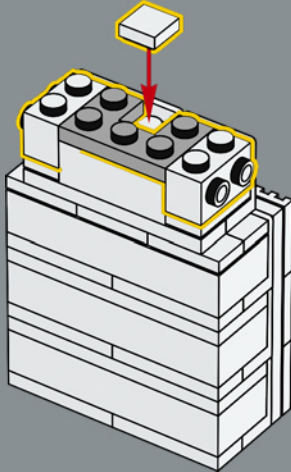

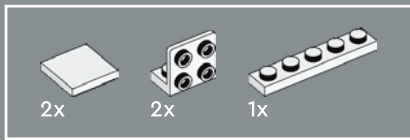

268

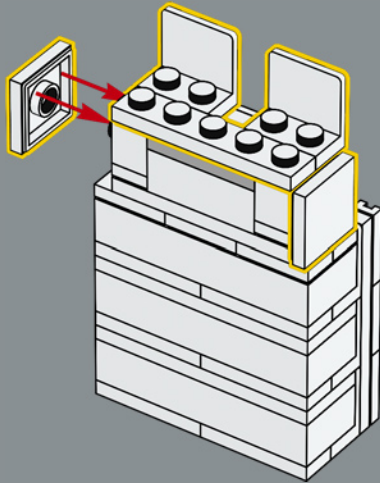

269

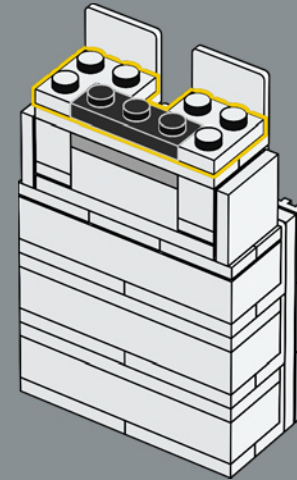

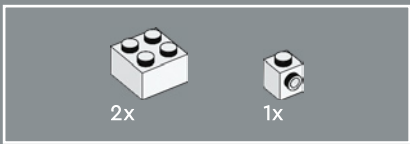

270

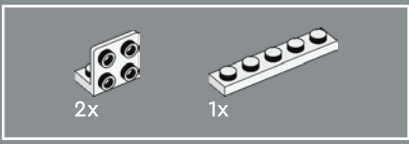
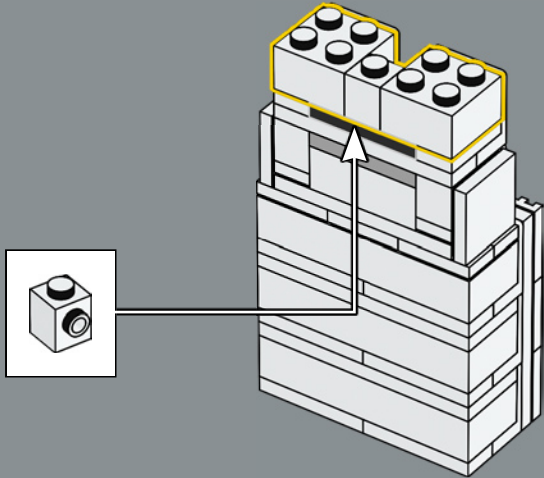

271

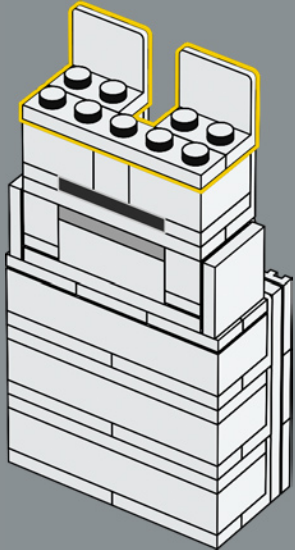

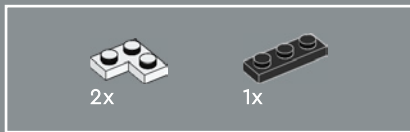

272

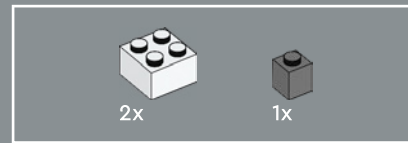
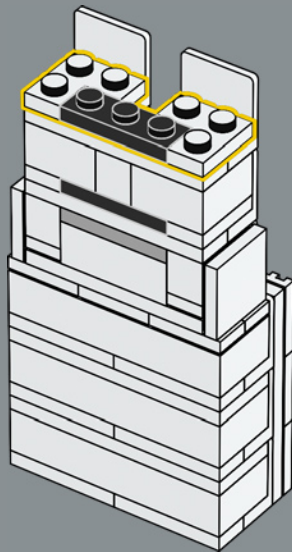

273

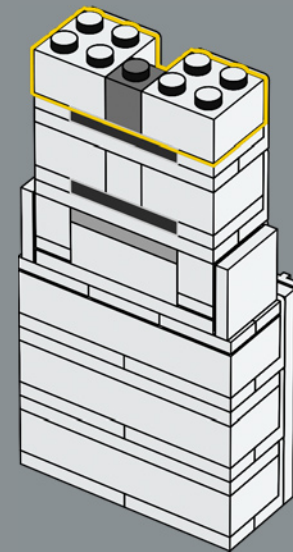

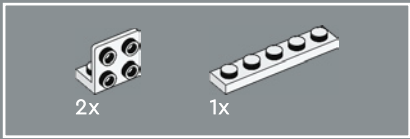

274

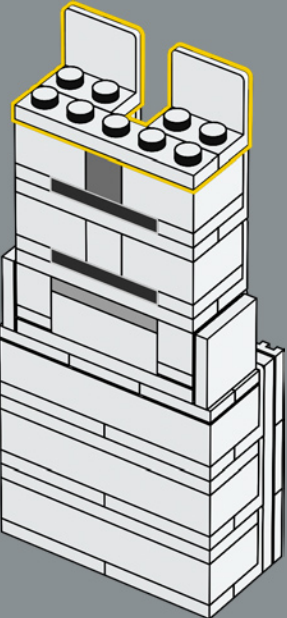

275

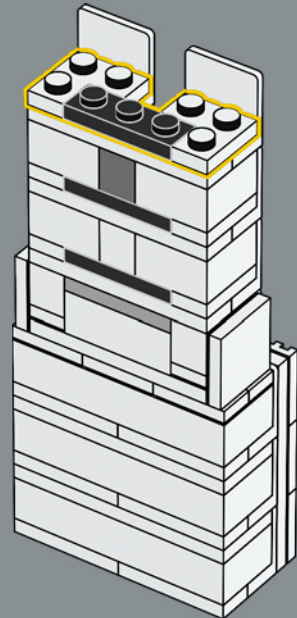

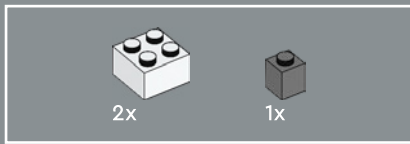

276

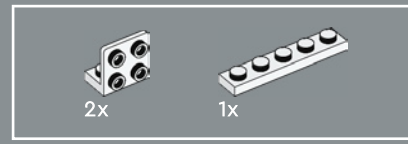
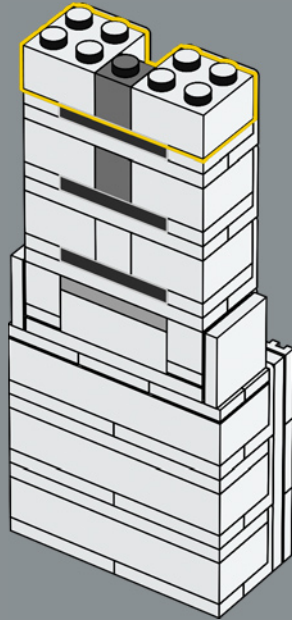

277

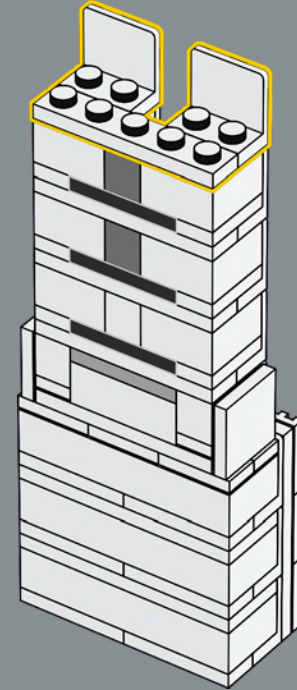



278

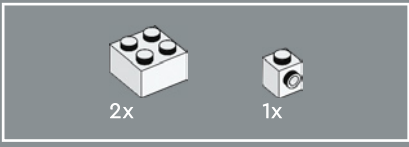
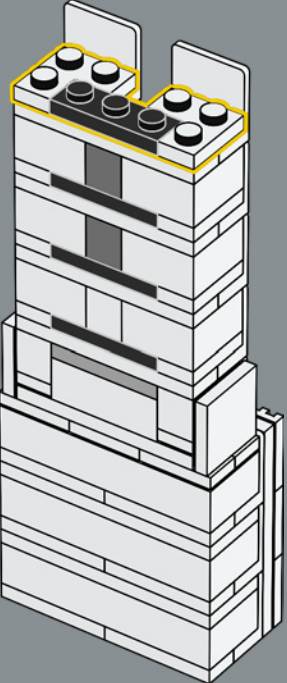

279

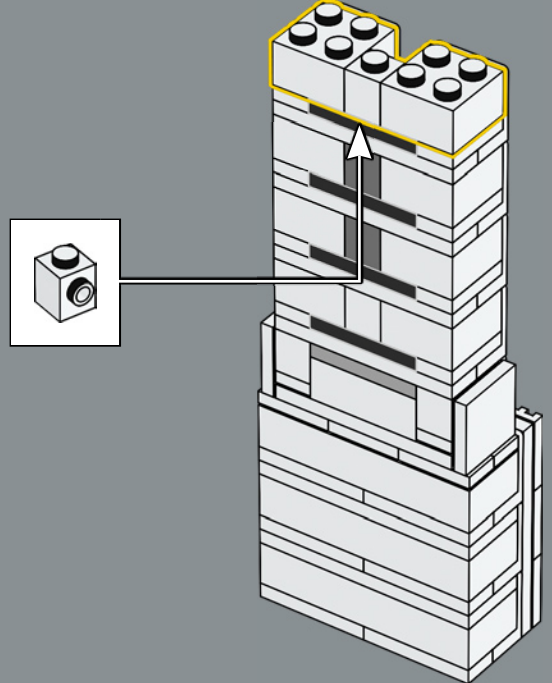

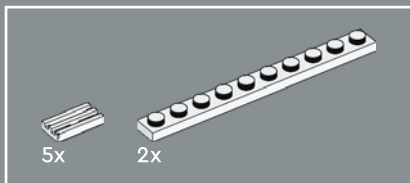

280

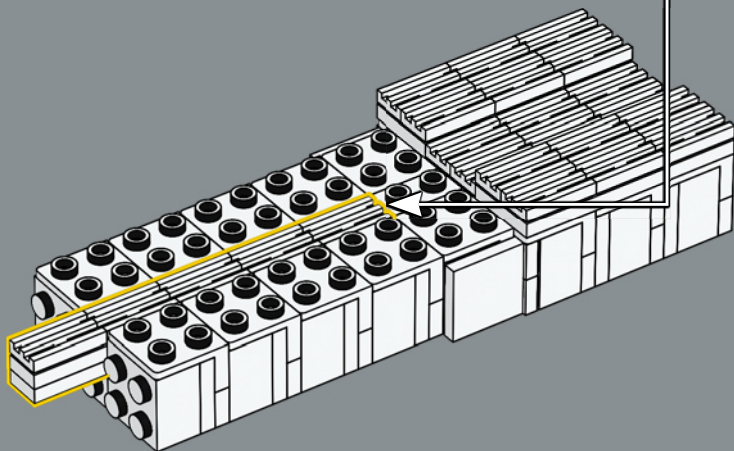
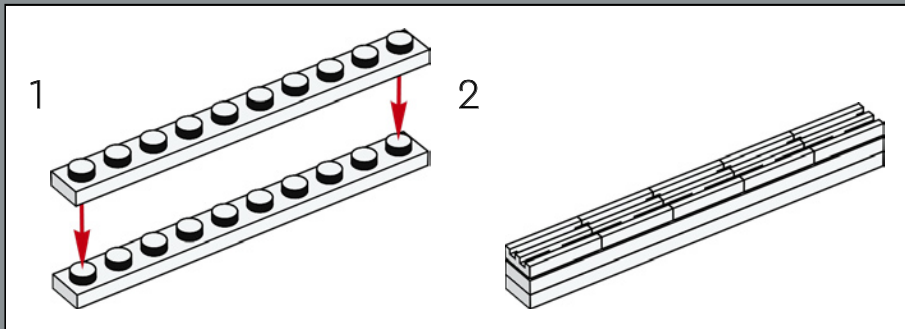

281

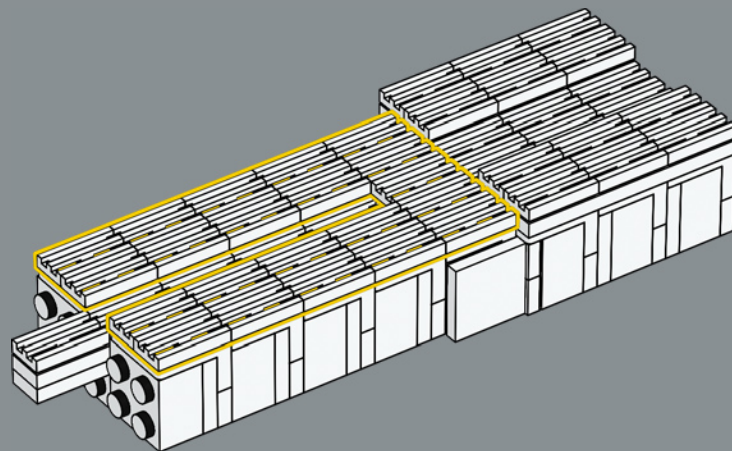

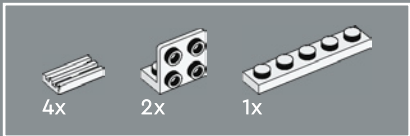

282

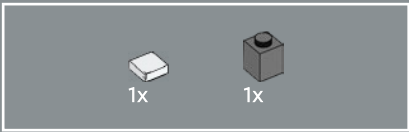
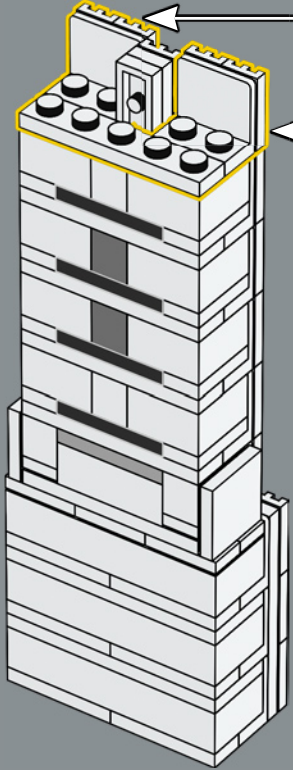
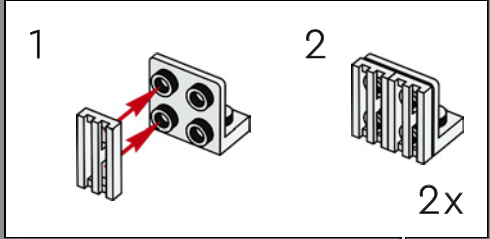

283

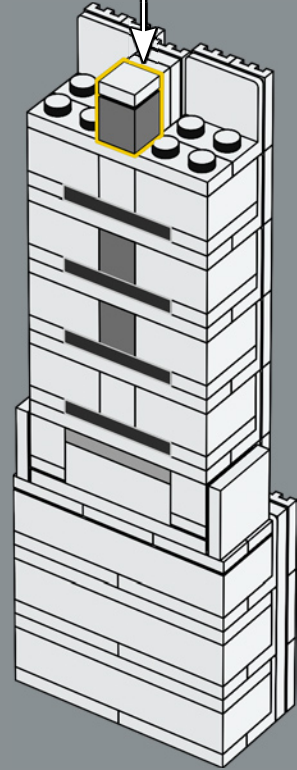
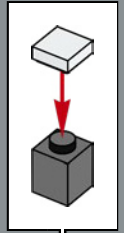

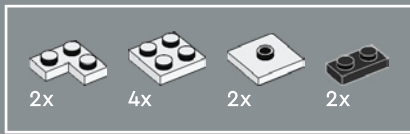

284

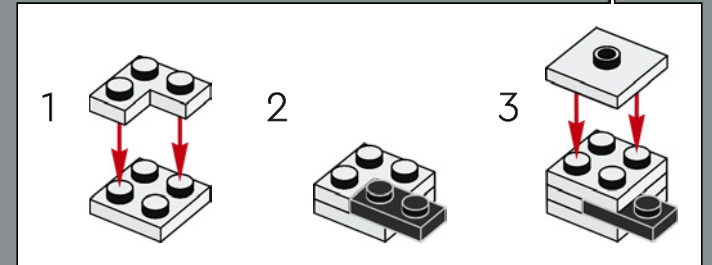
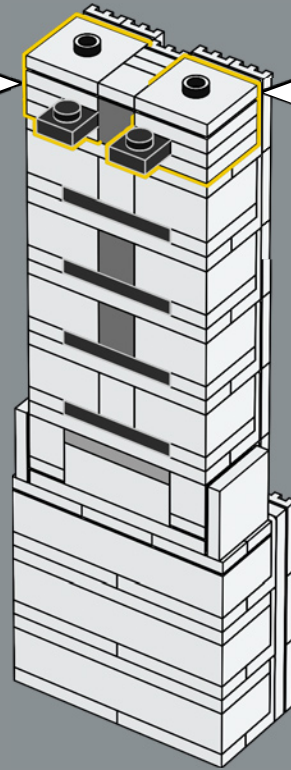
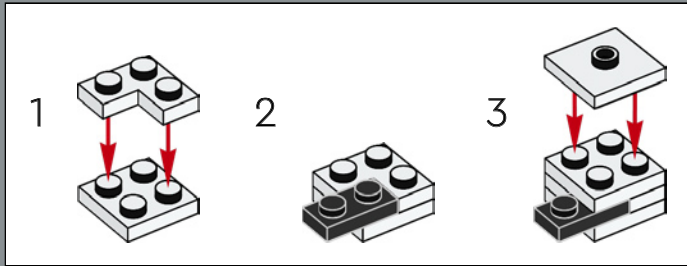

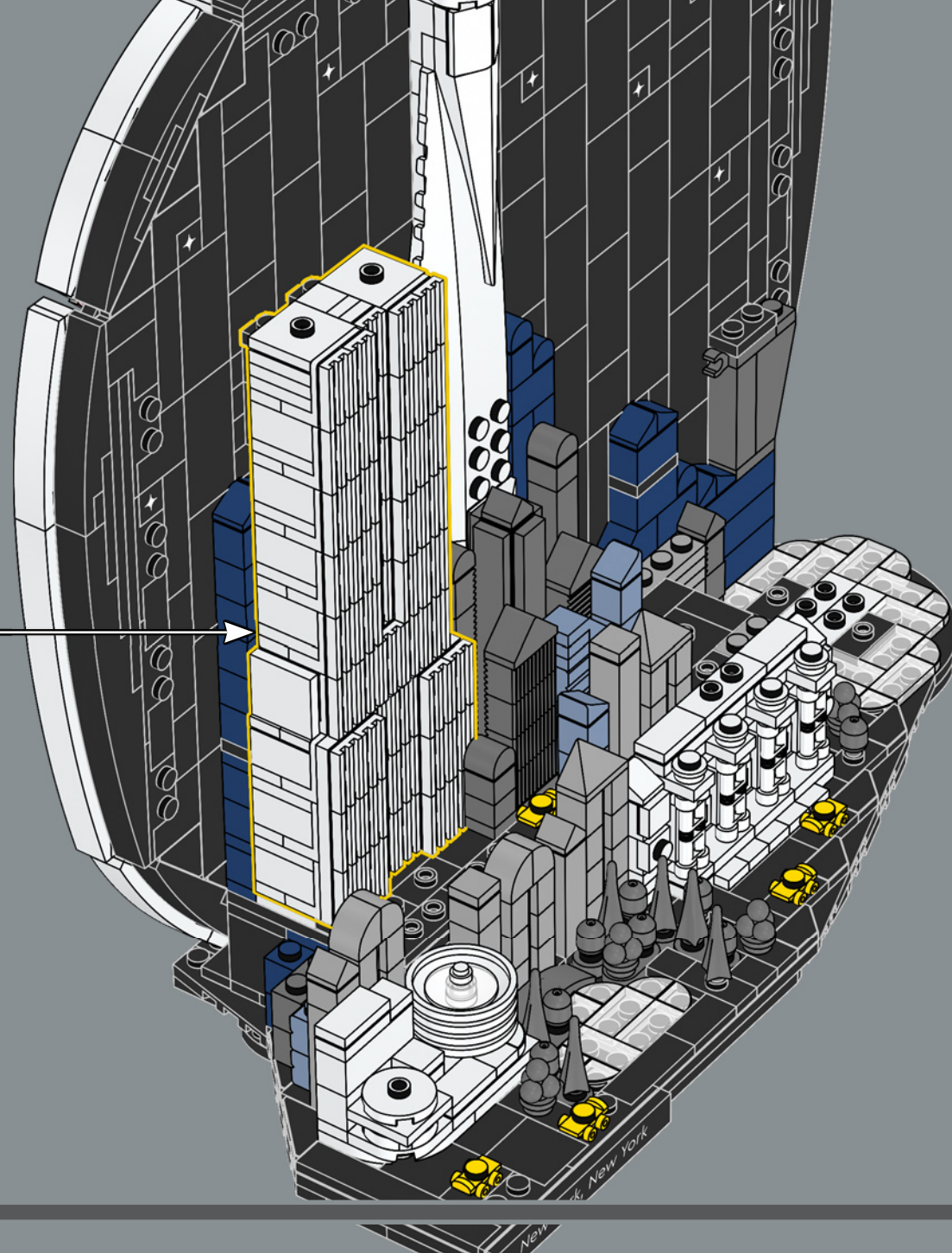

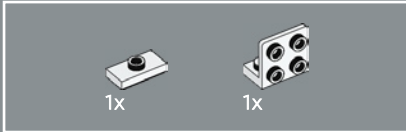
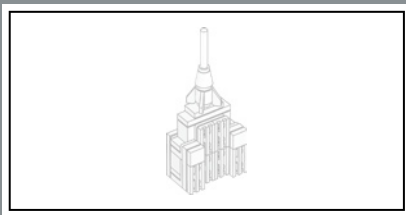

286

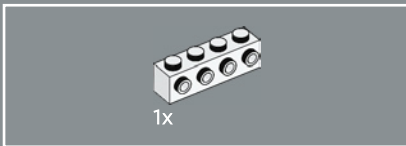
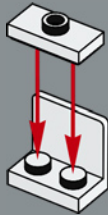

287

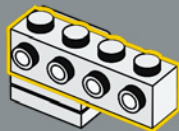

288

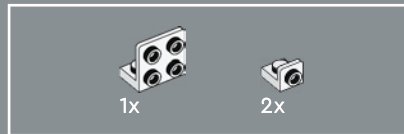
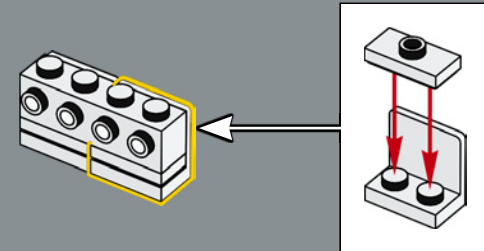

289

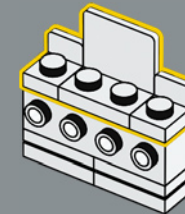



2x

290

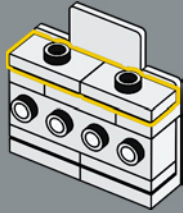

2x

292

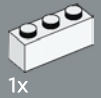
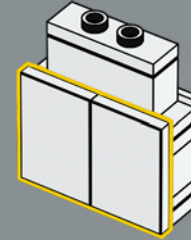

1x



1x

291



4x

293

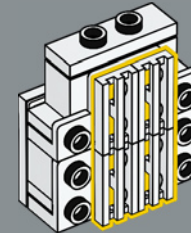

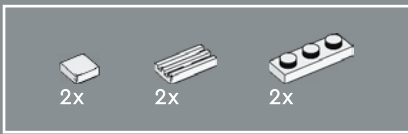

294

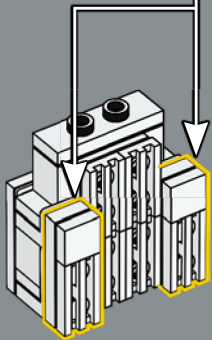
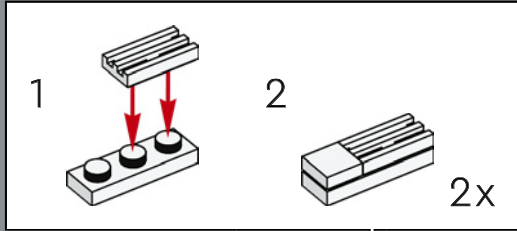

In den letzten Jahren wurde das Empire State Building sorgfältig restauriert, um sein ursprüngliches Erscheinungsbild und die Geschichte des Gebäudes für künftige Generationen zu bewahren.



295

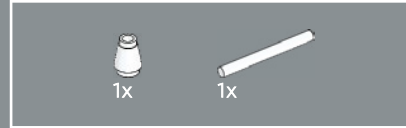
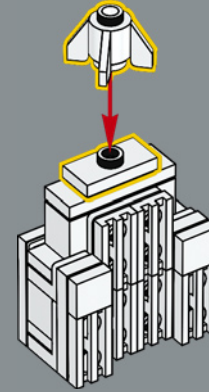

296

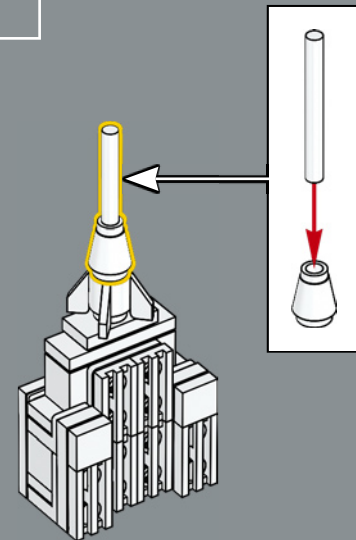

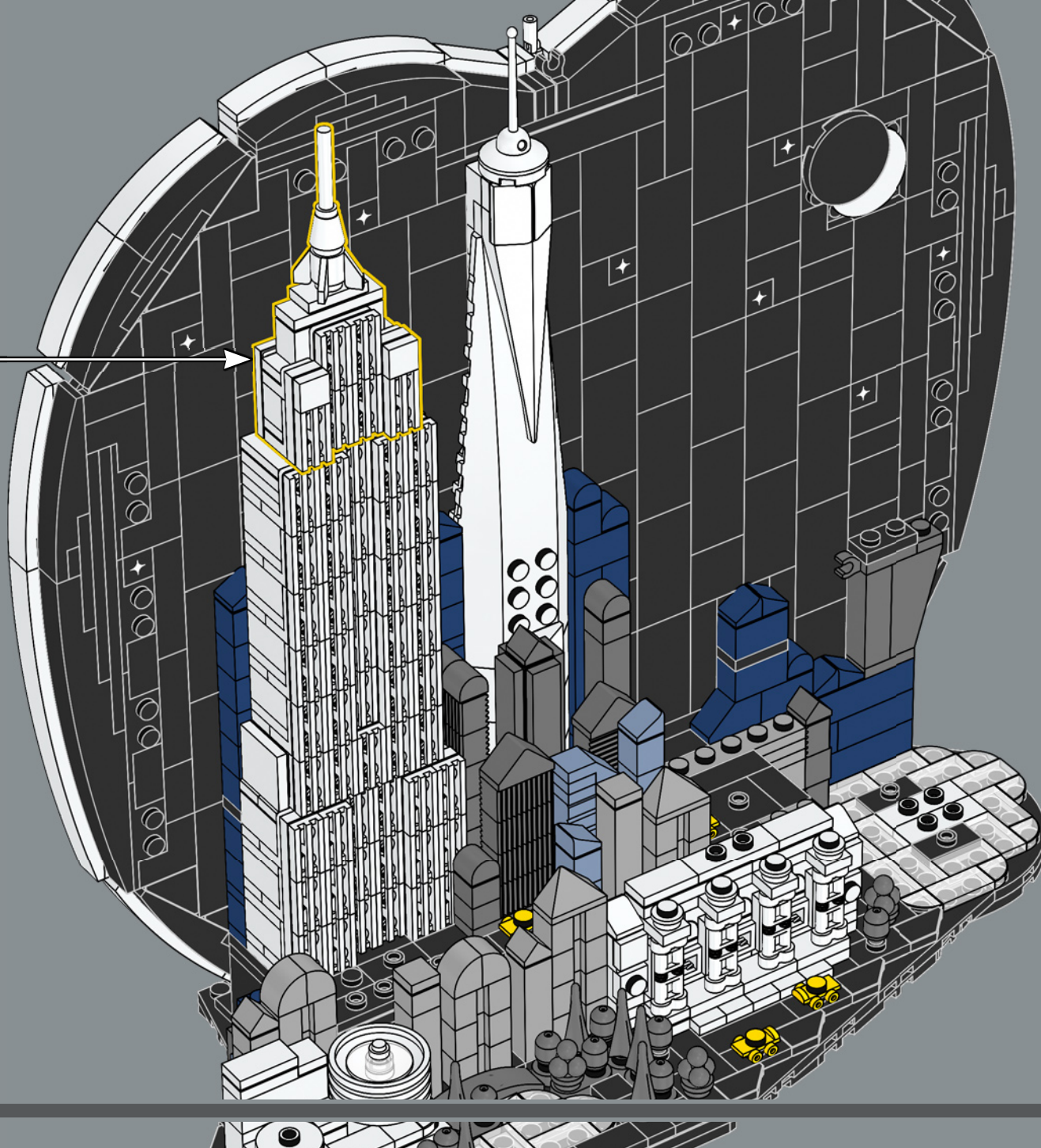

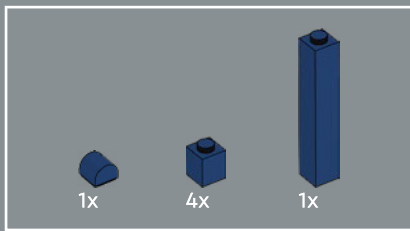

298

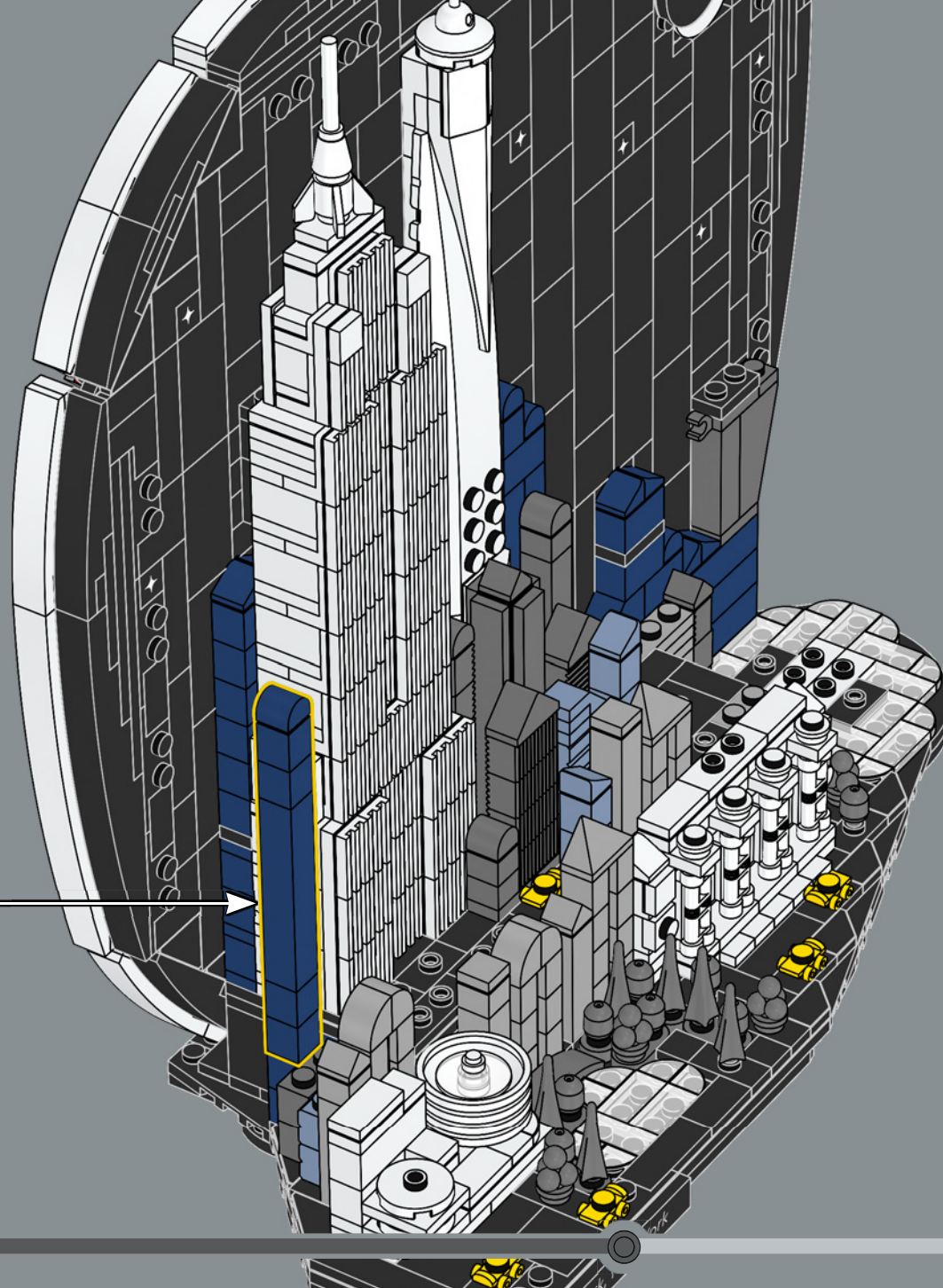
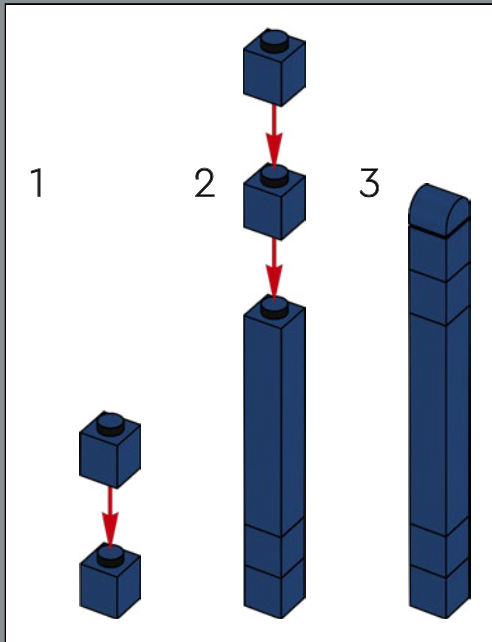

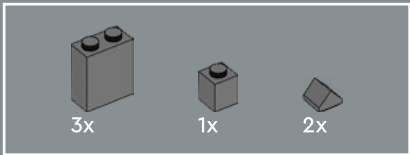

299

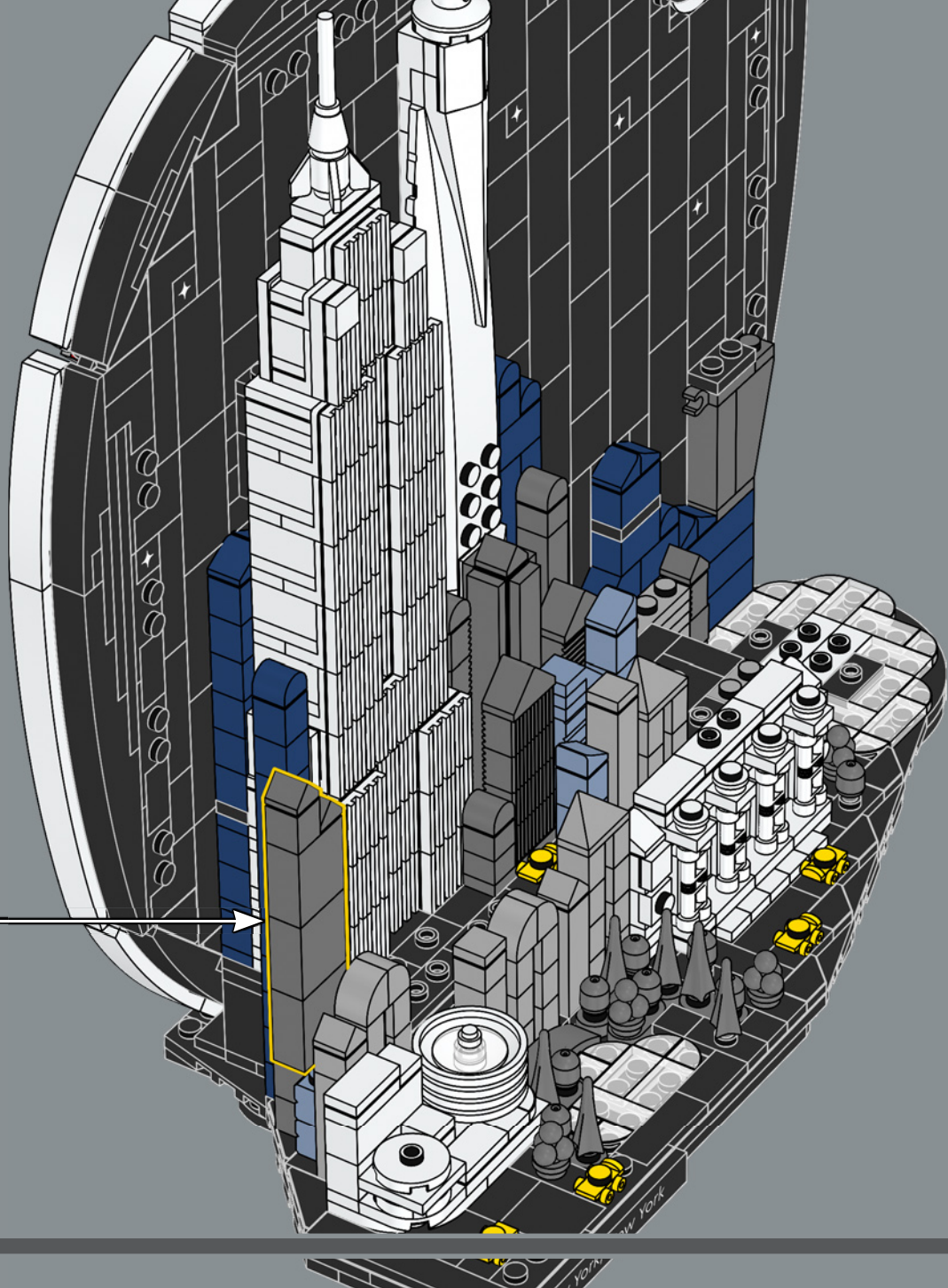
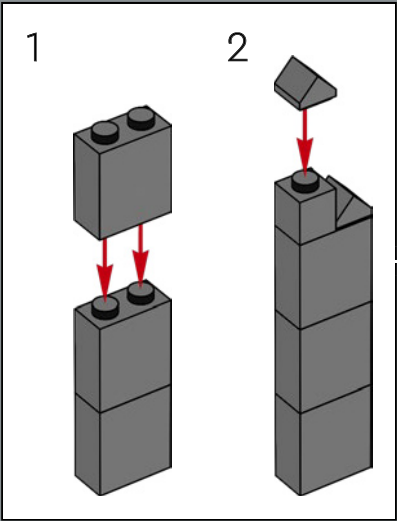

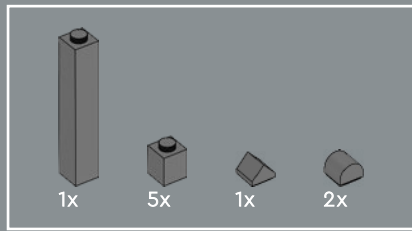

300

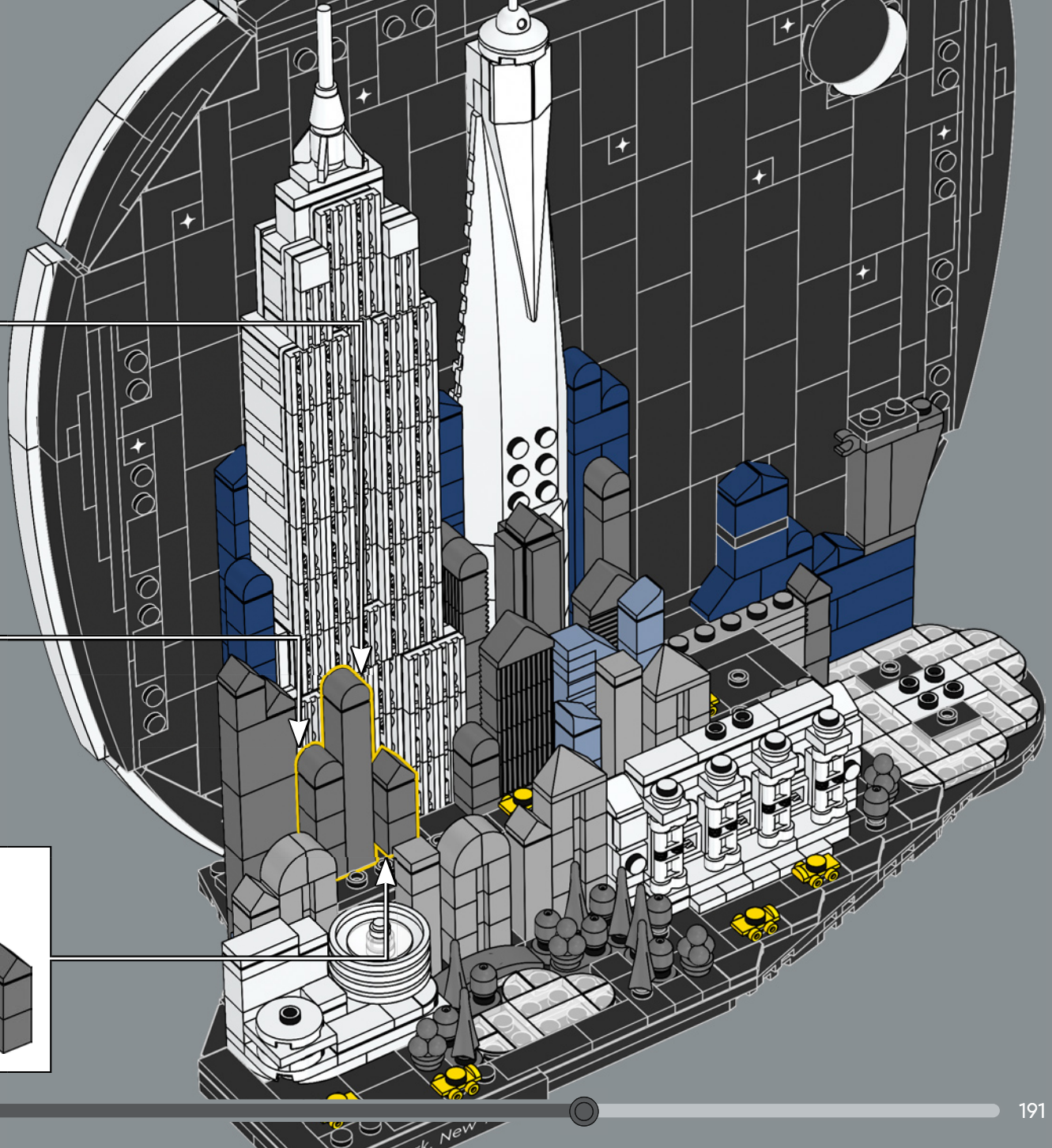
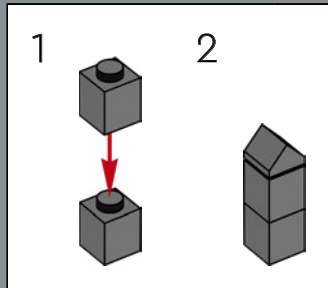
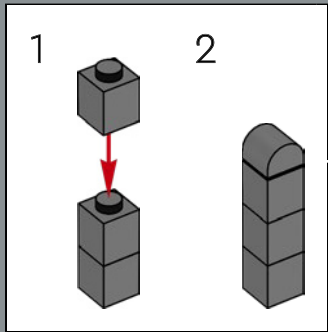
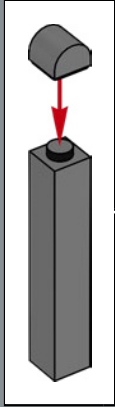



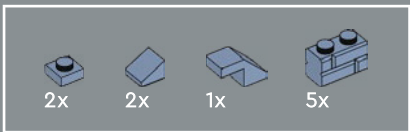

301

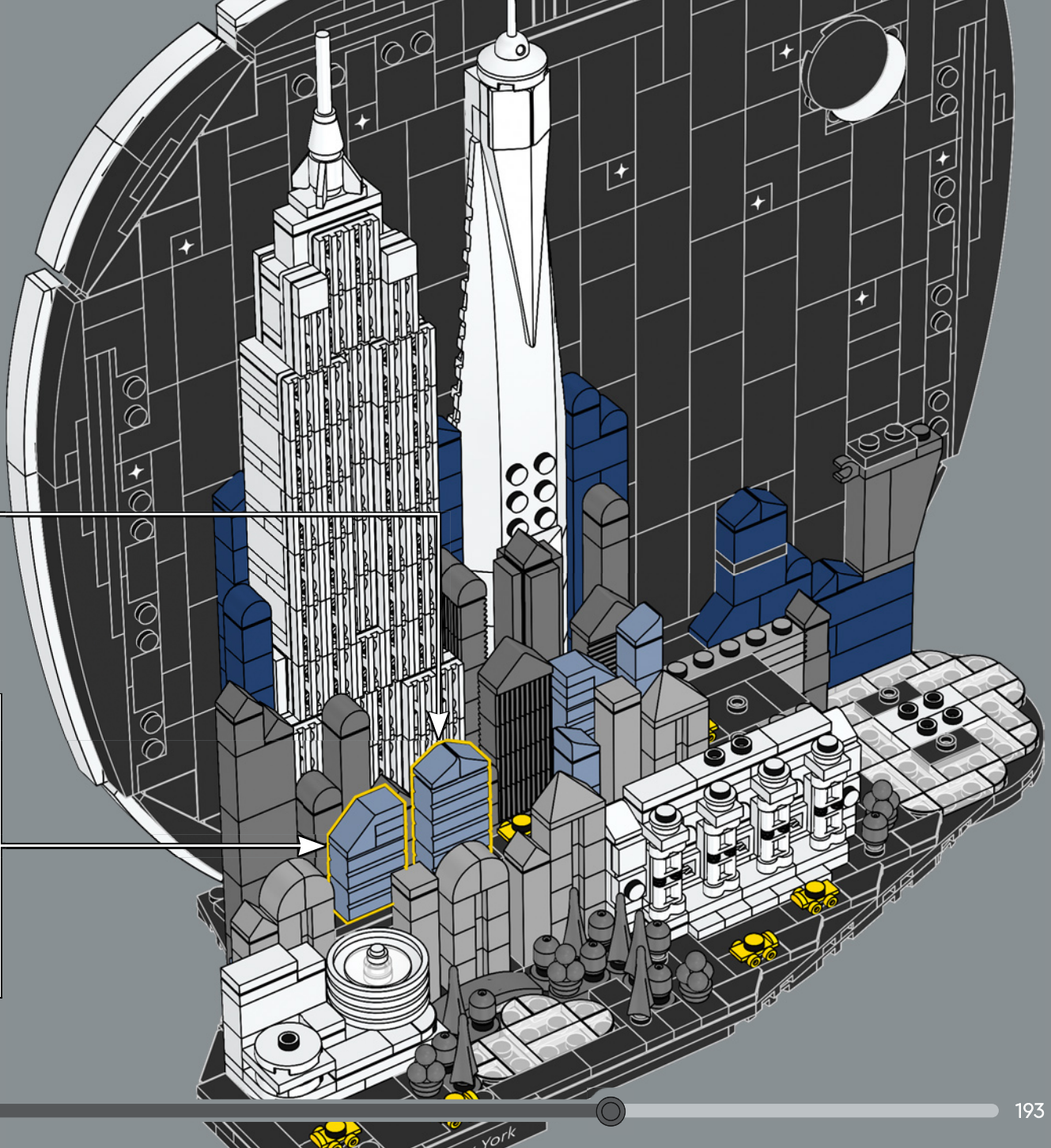
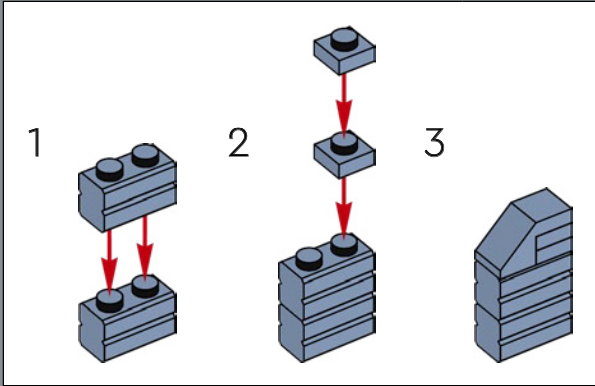
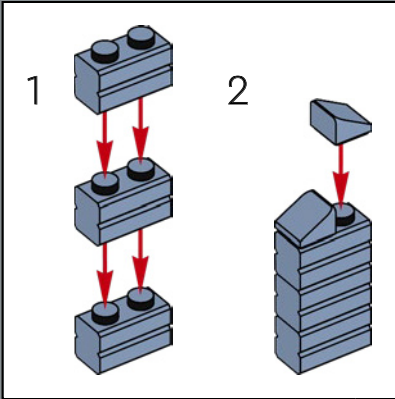

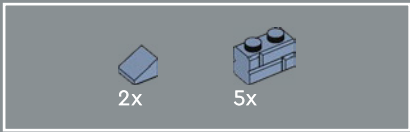

302

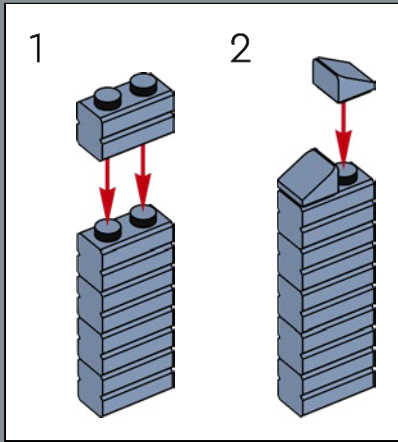
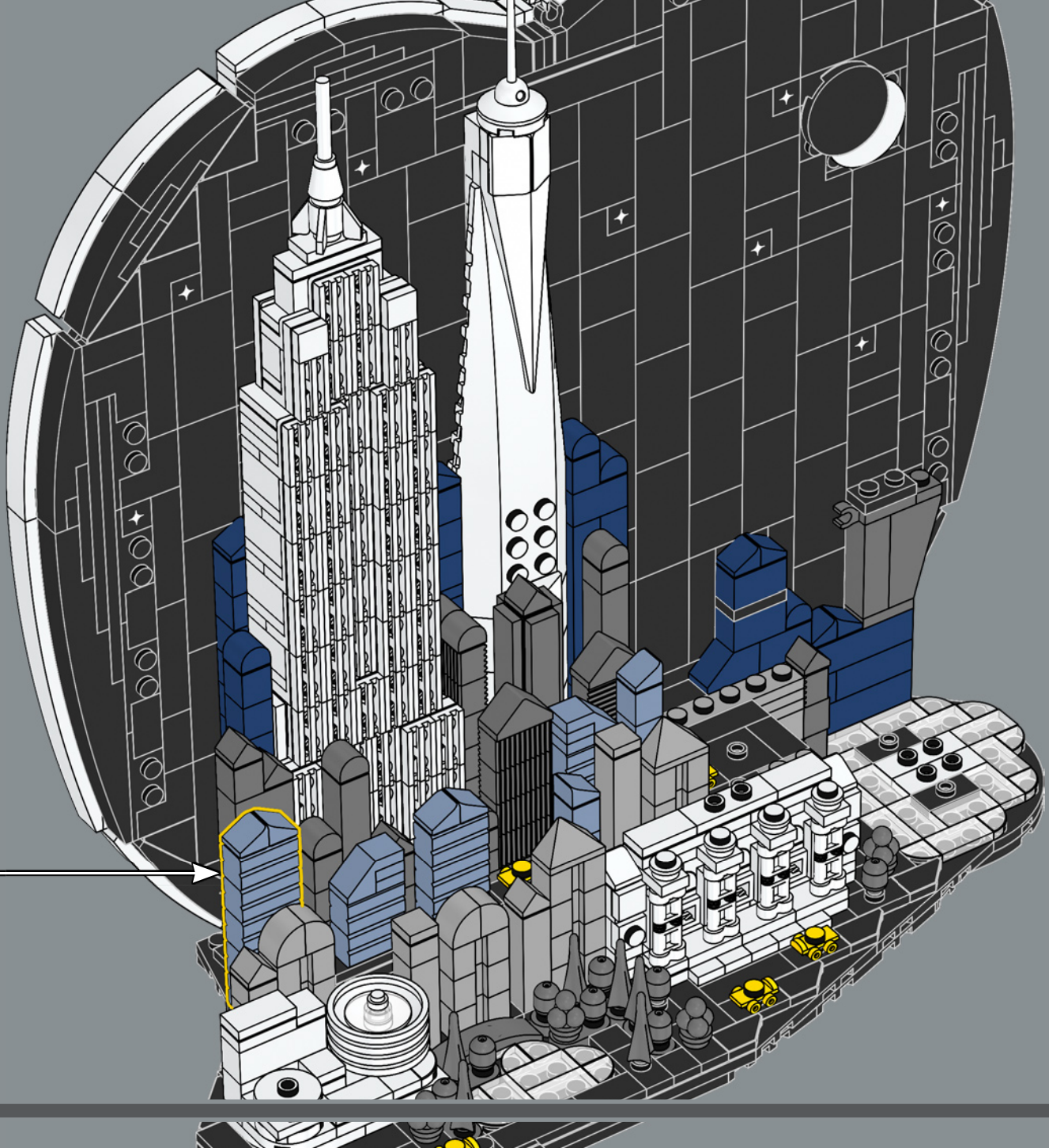



303

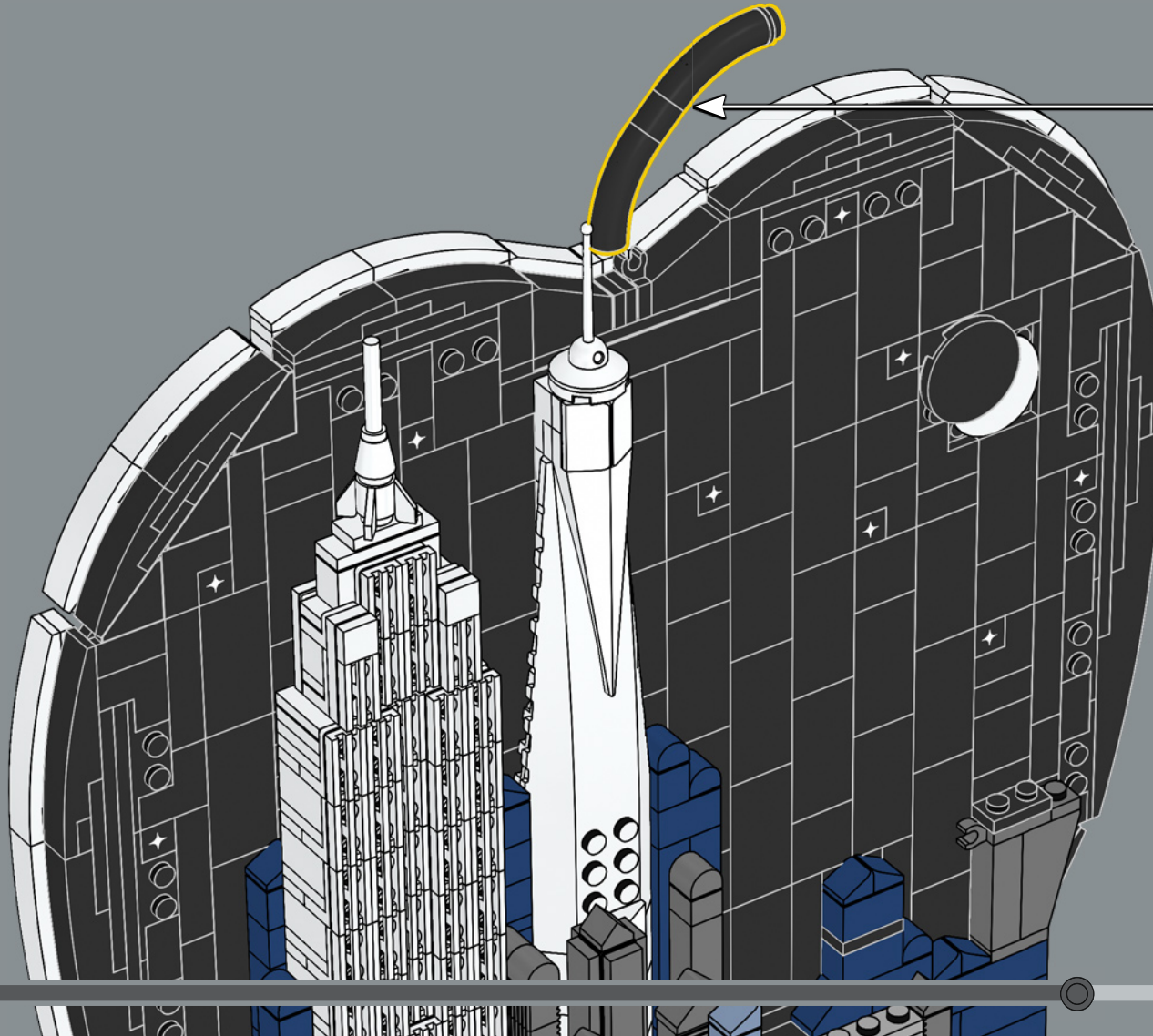
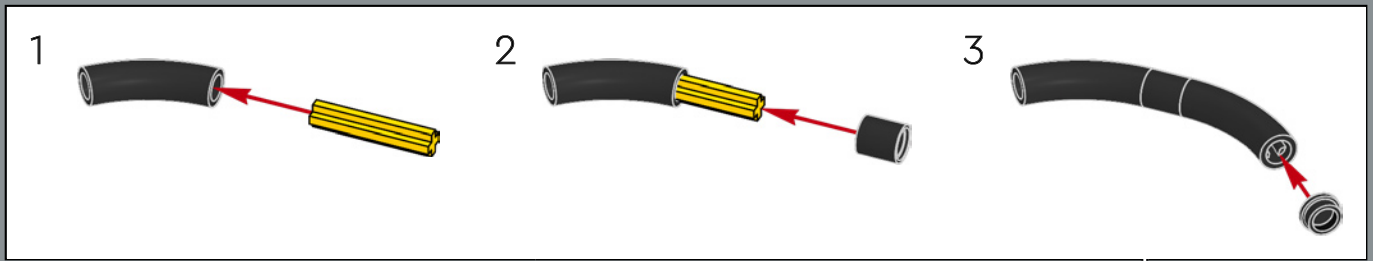

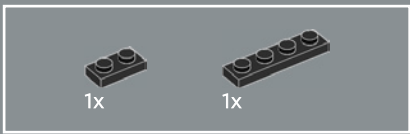

304

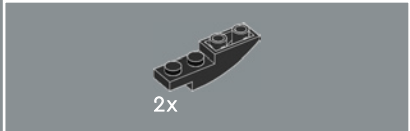
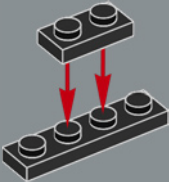

305

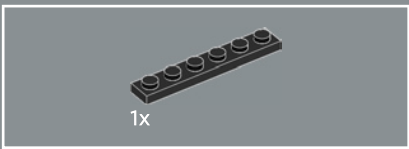
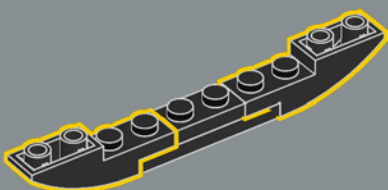

306

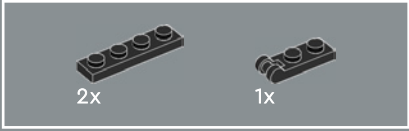
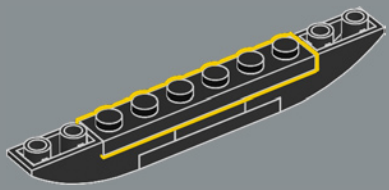

307

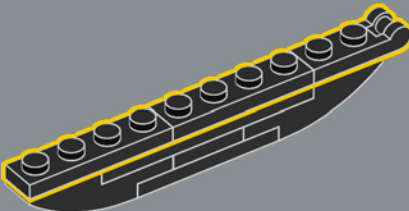

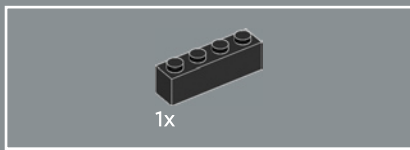

1x

308

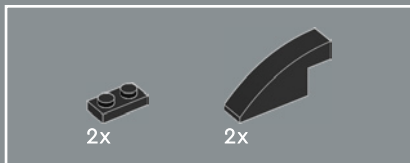
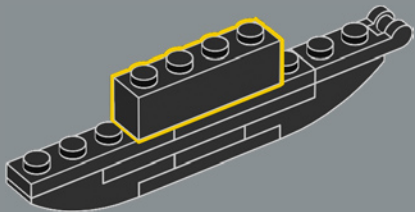

2x

2x

309

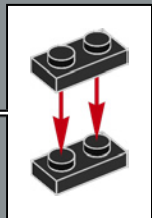
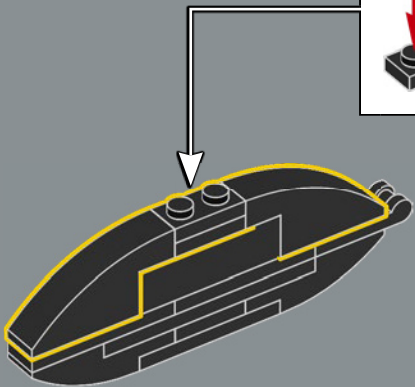

310

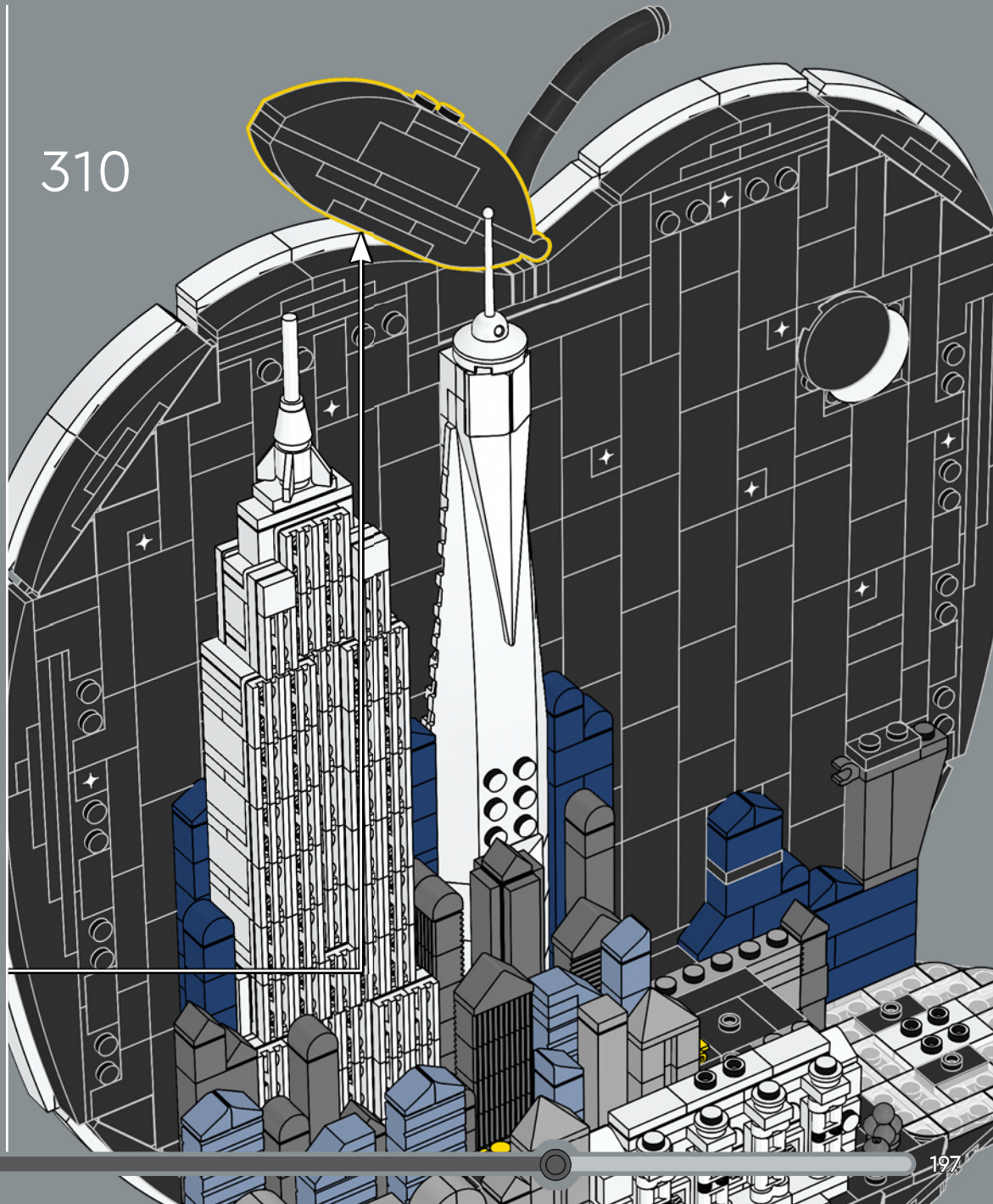

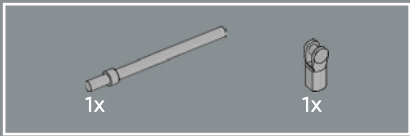

311

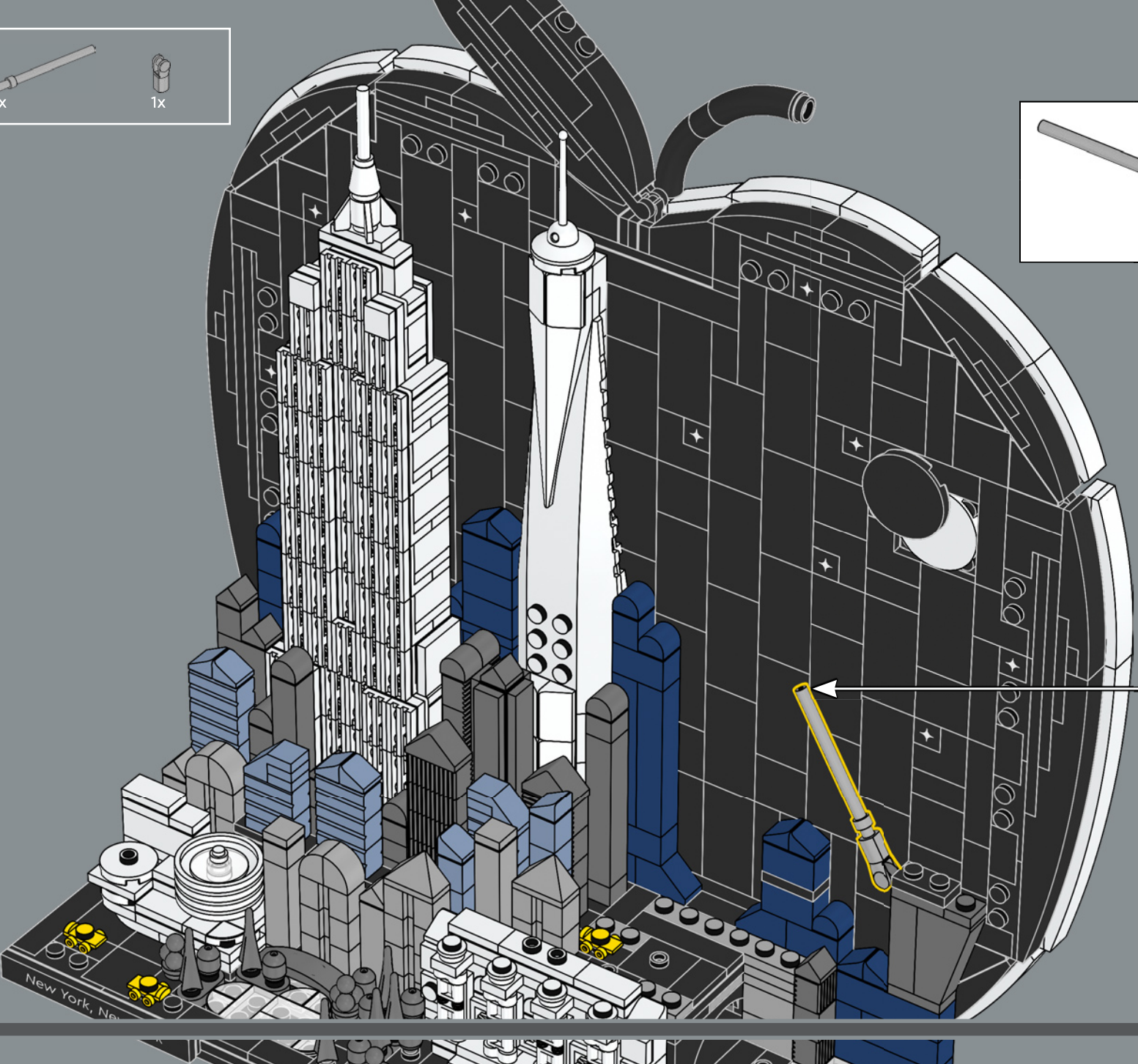
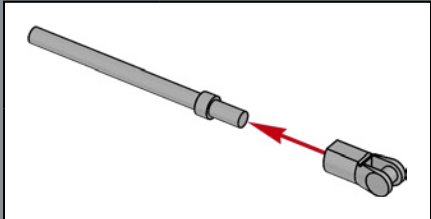

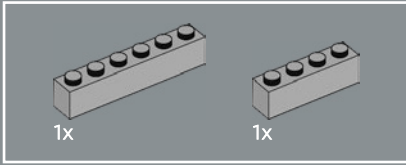
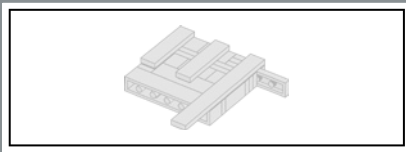

312

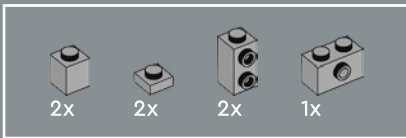
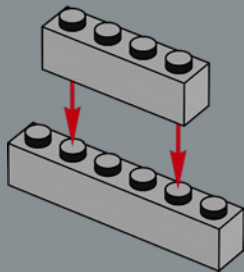

313

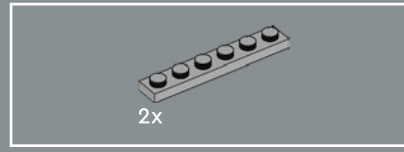
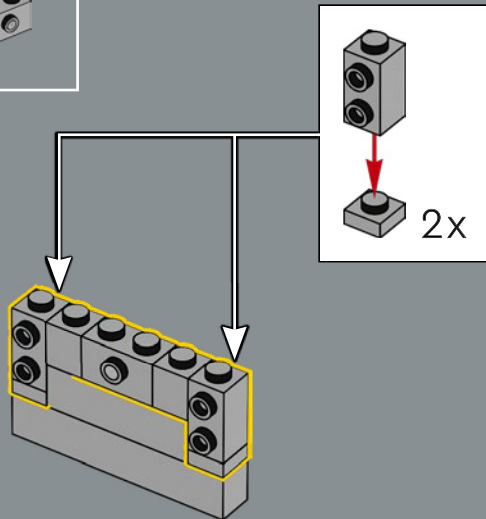

314

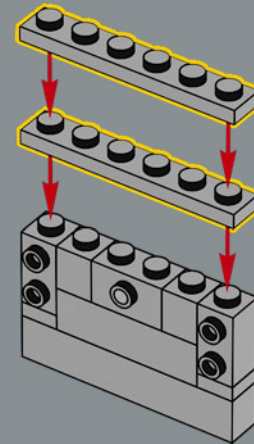

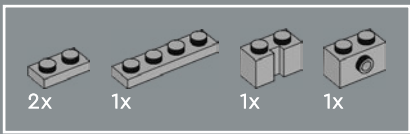

315

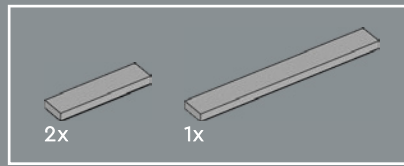
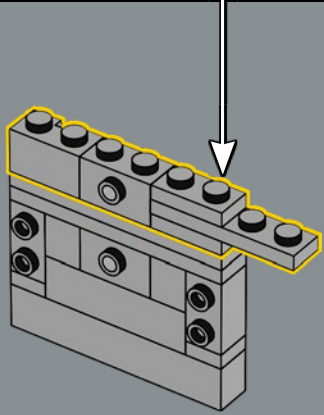
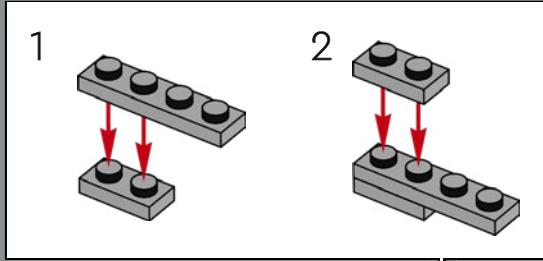

316

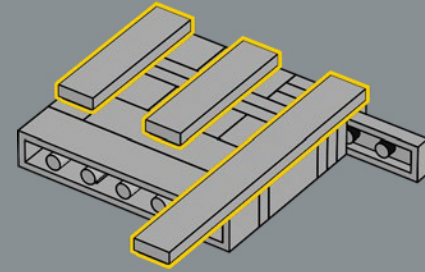

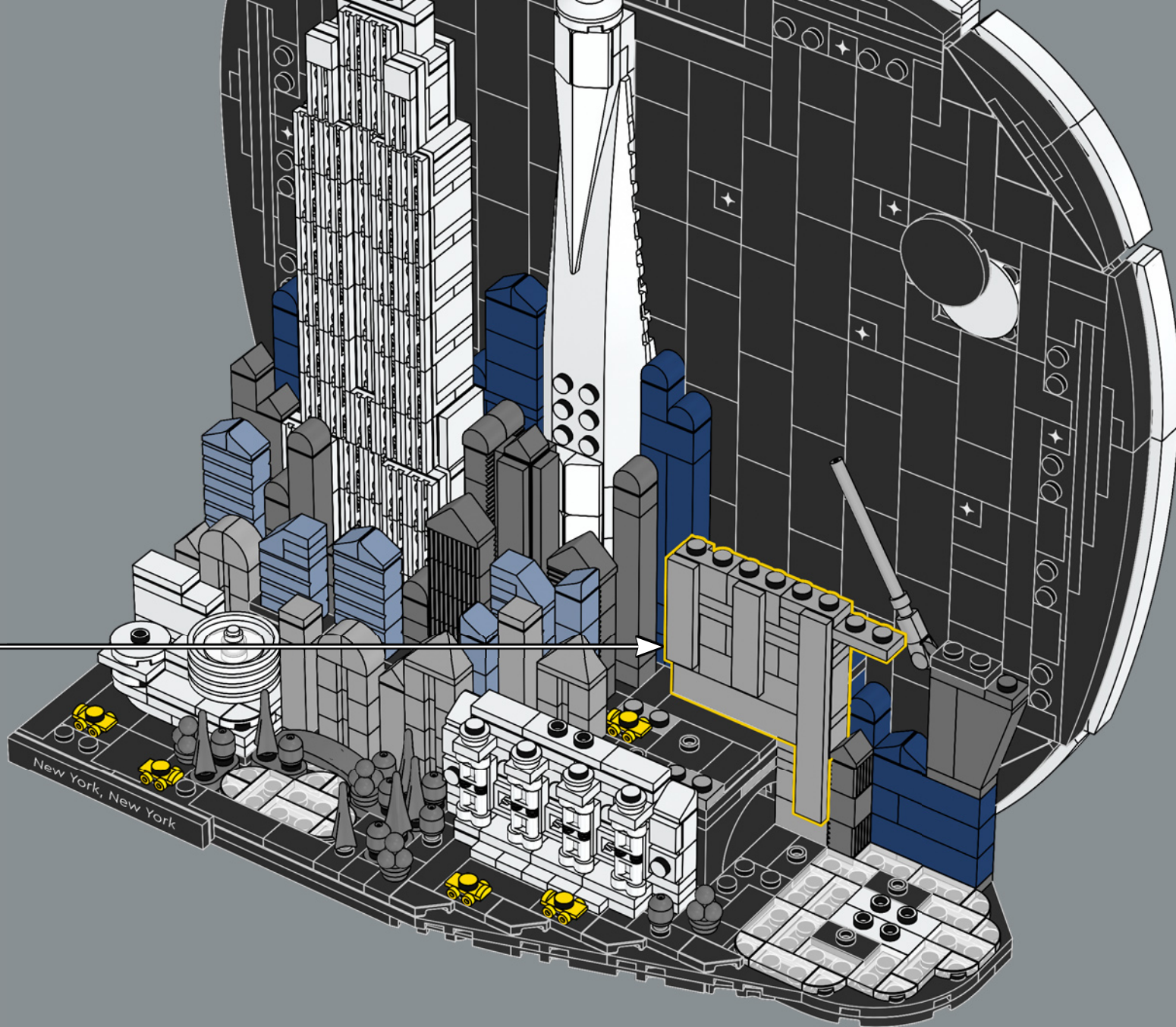

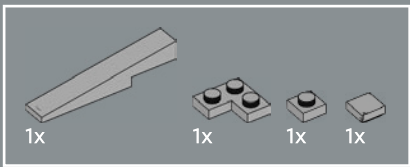

318

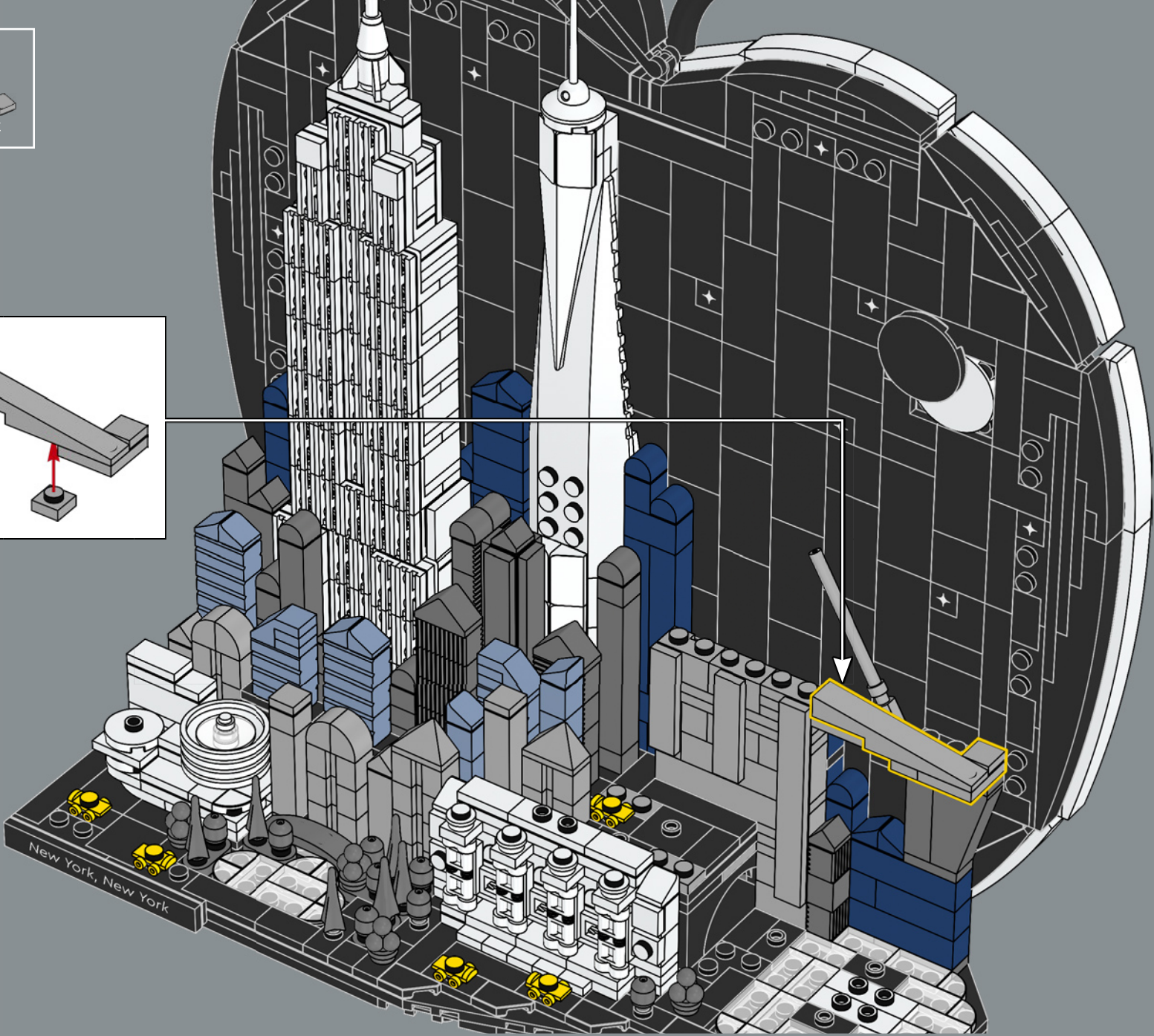
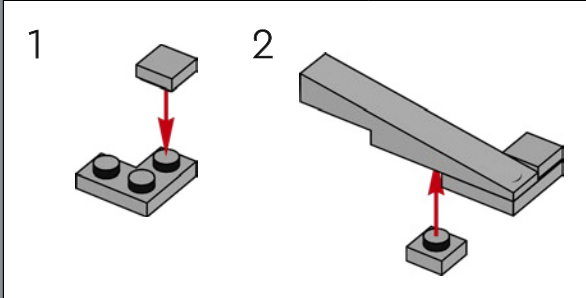



319

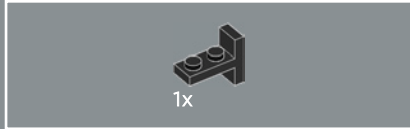

320



321

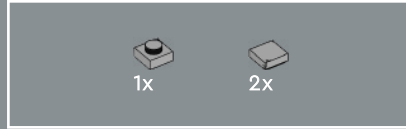
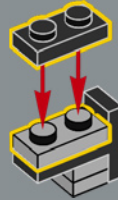

322

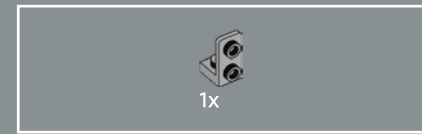
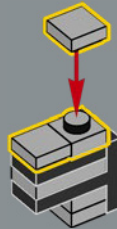

323

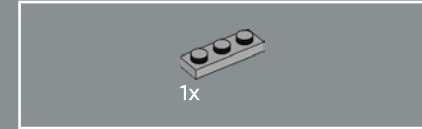
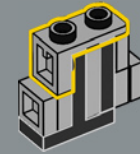

324

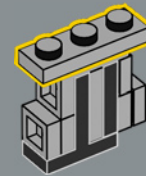

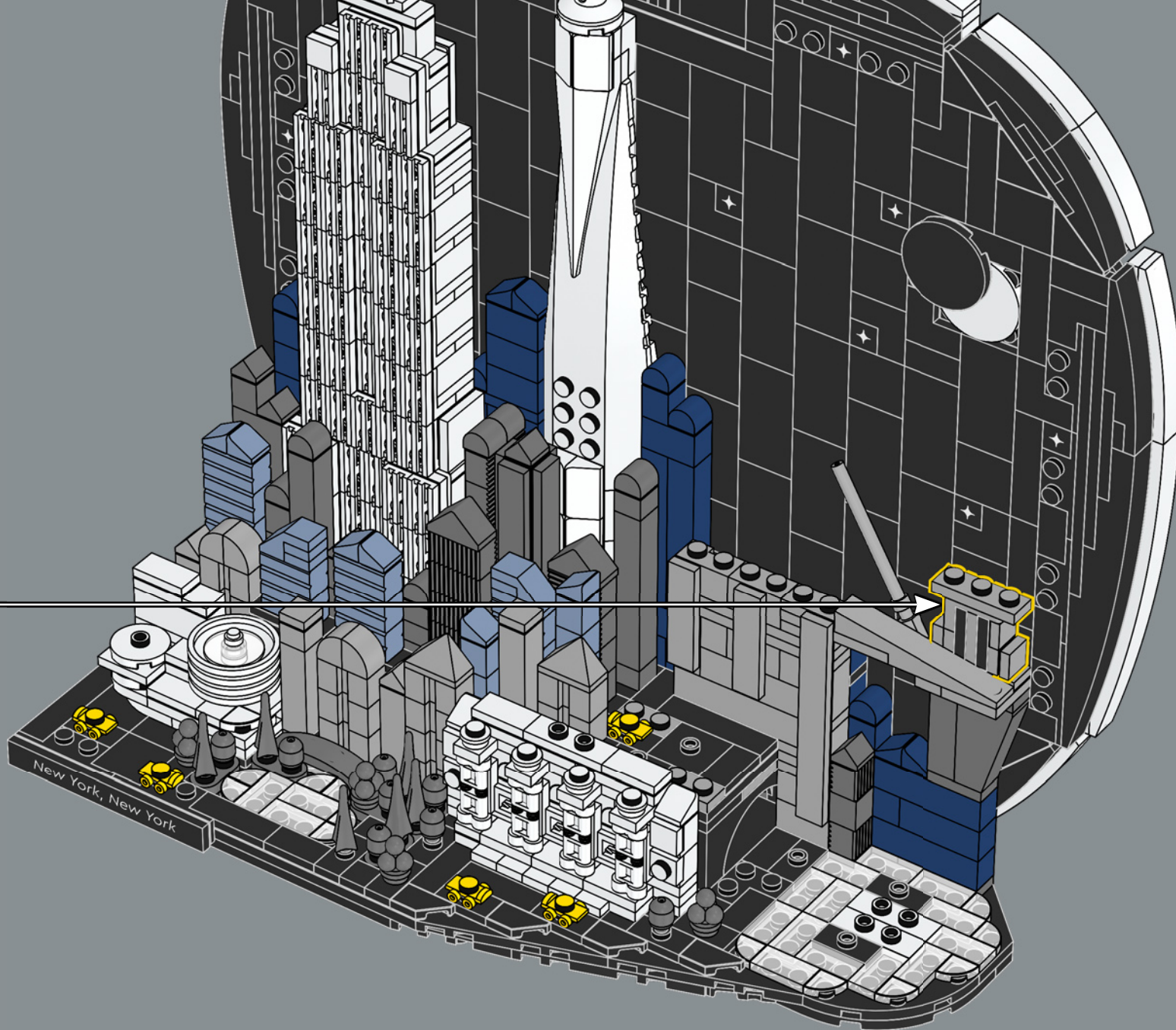

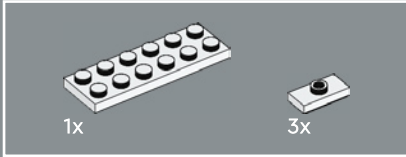
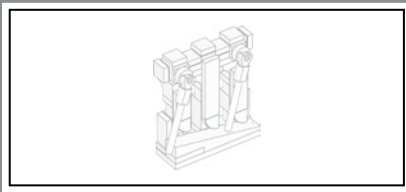

326

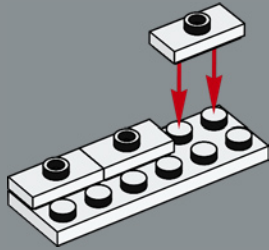

327

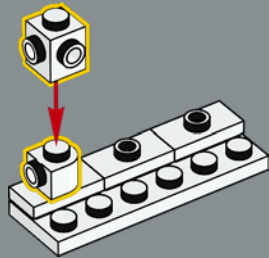

328

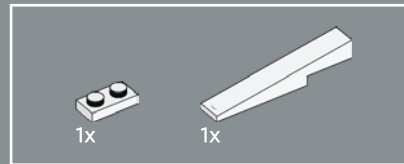
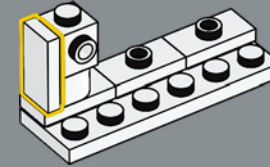

329

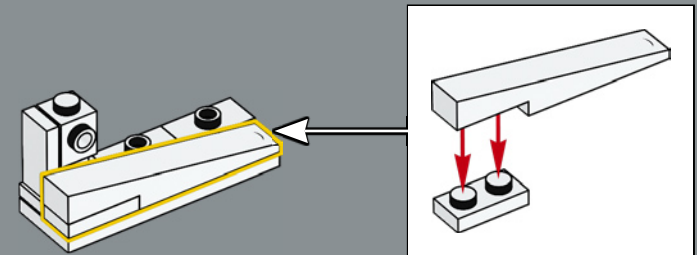

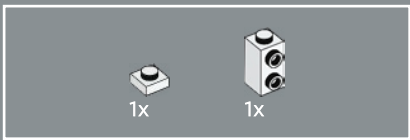

330

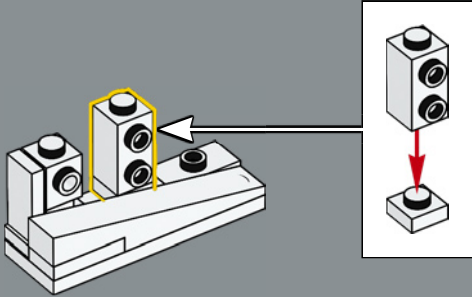

331

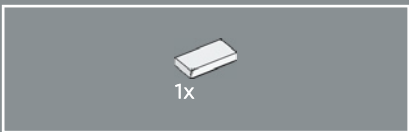
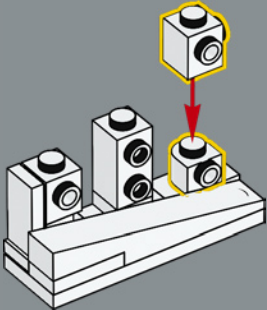

332

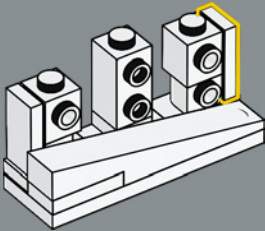

333

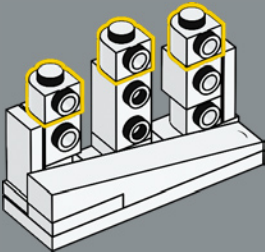



334

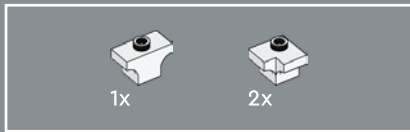
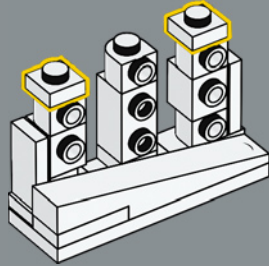

335

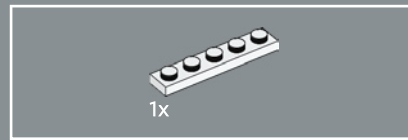
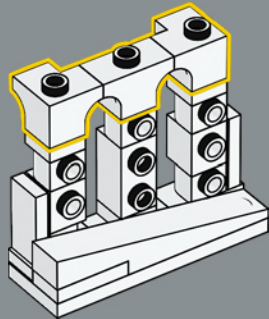

336

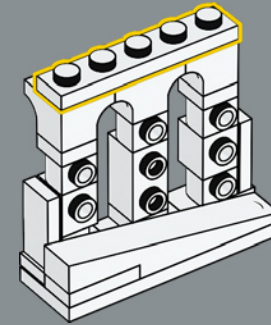

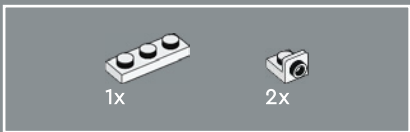

337

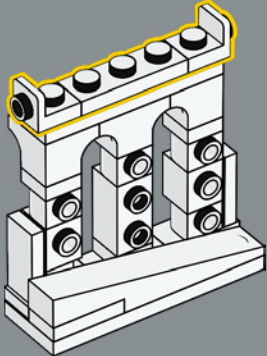

338

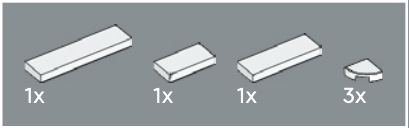
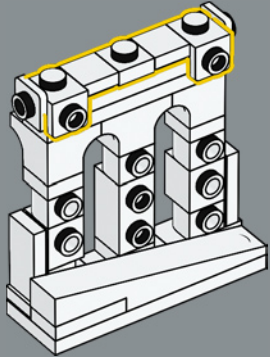

339

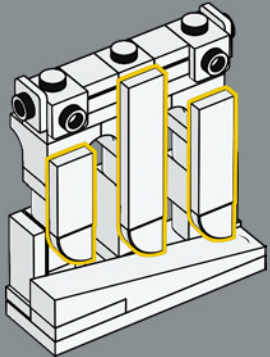



2x

340

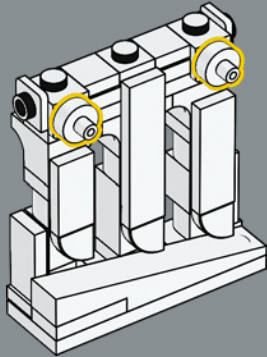

5x

341

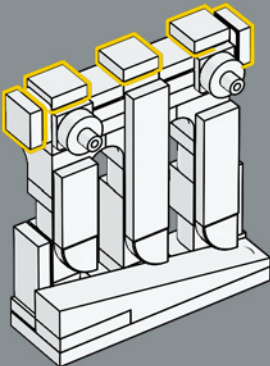

2x



2x

342

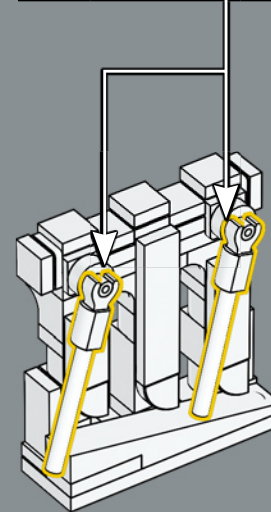
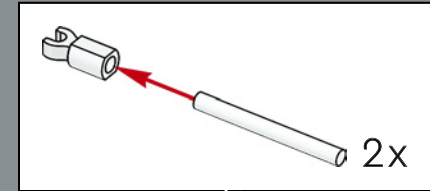

Täglich überqueren mehr als 137.000 Menschen die Brooklyn Bridge mit dem Auto, zu Fuß oder mit dem Fahrrad. (LKWs dürfen die Brücke nicht befahren.)



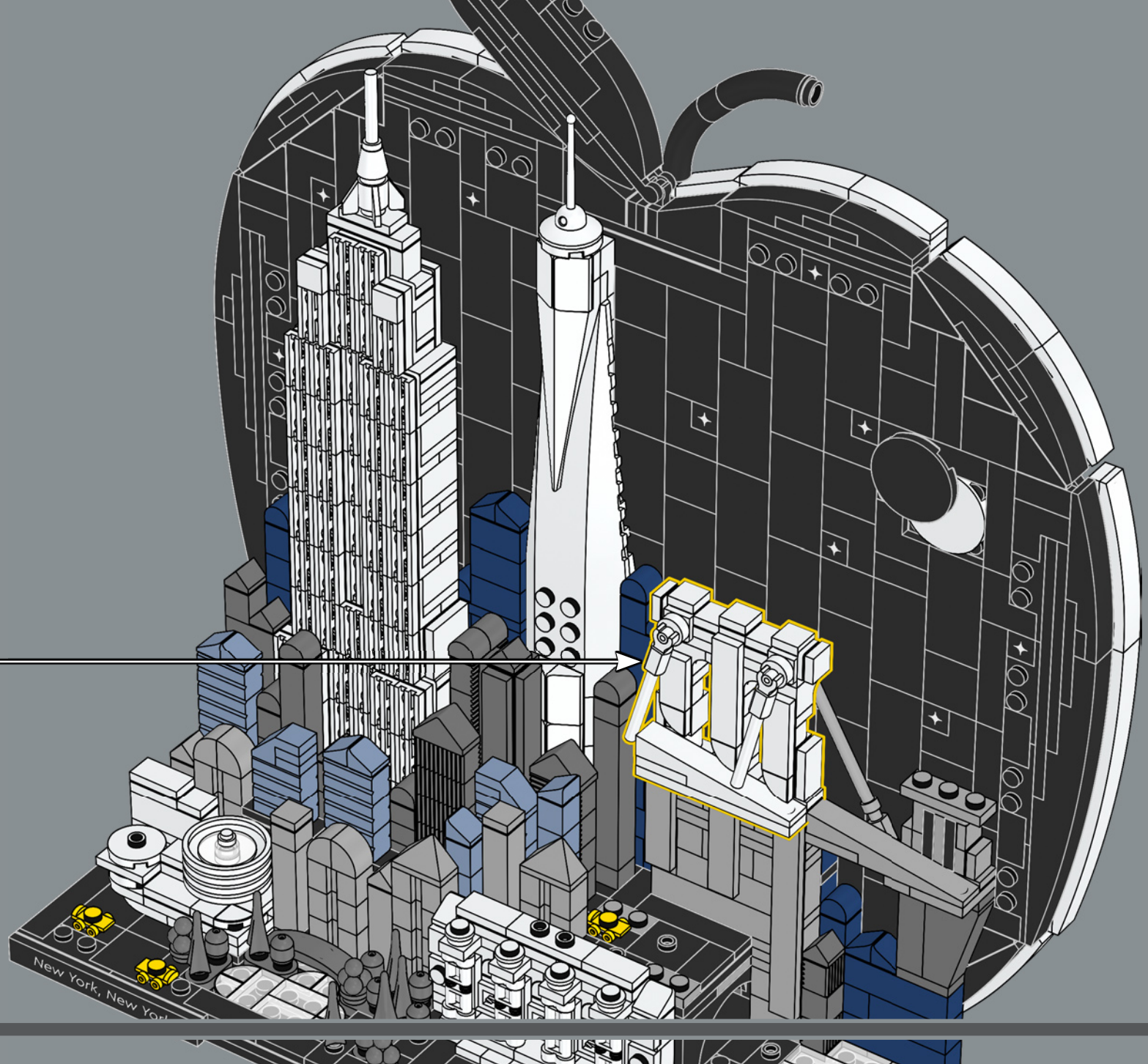

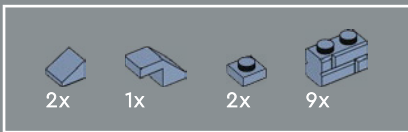

344

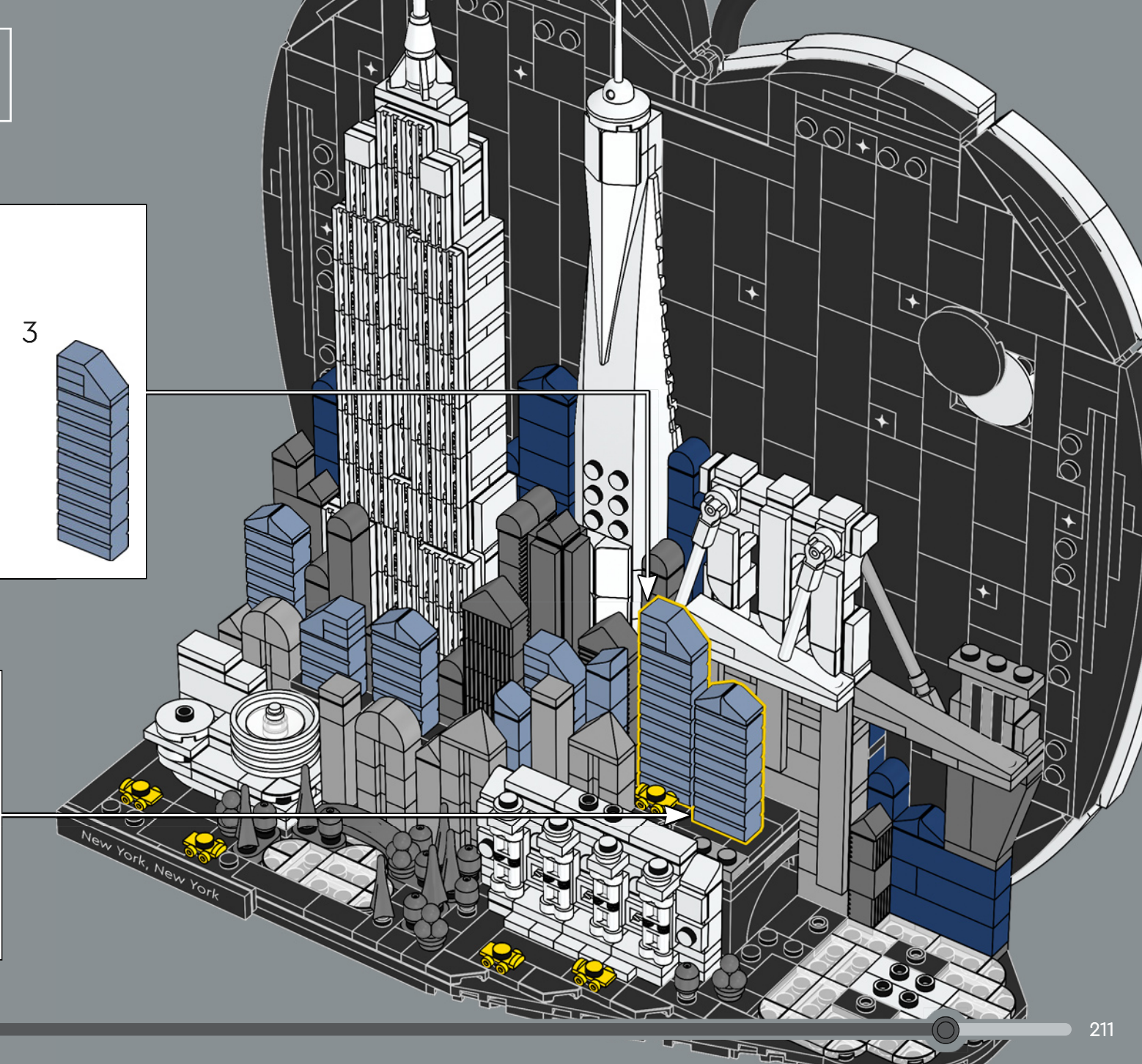
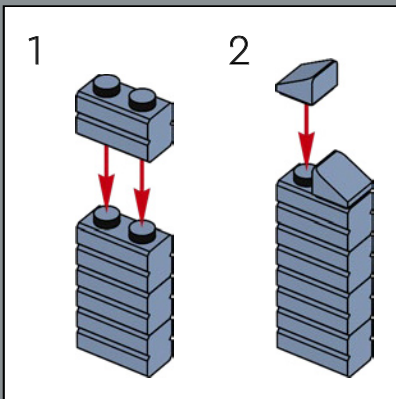
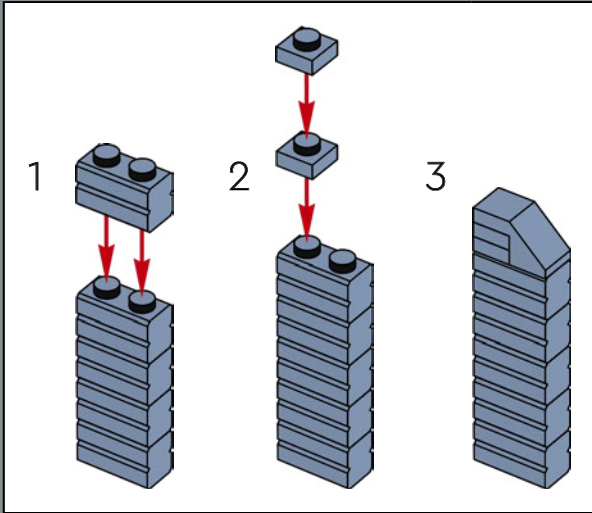

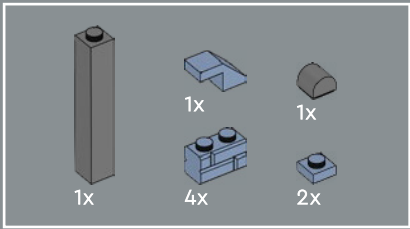

345

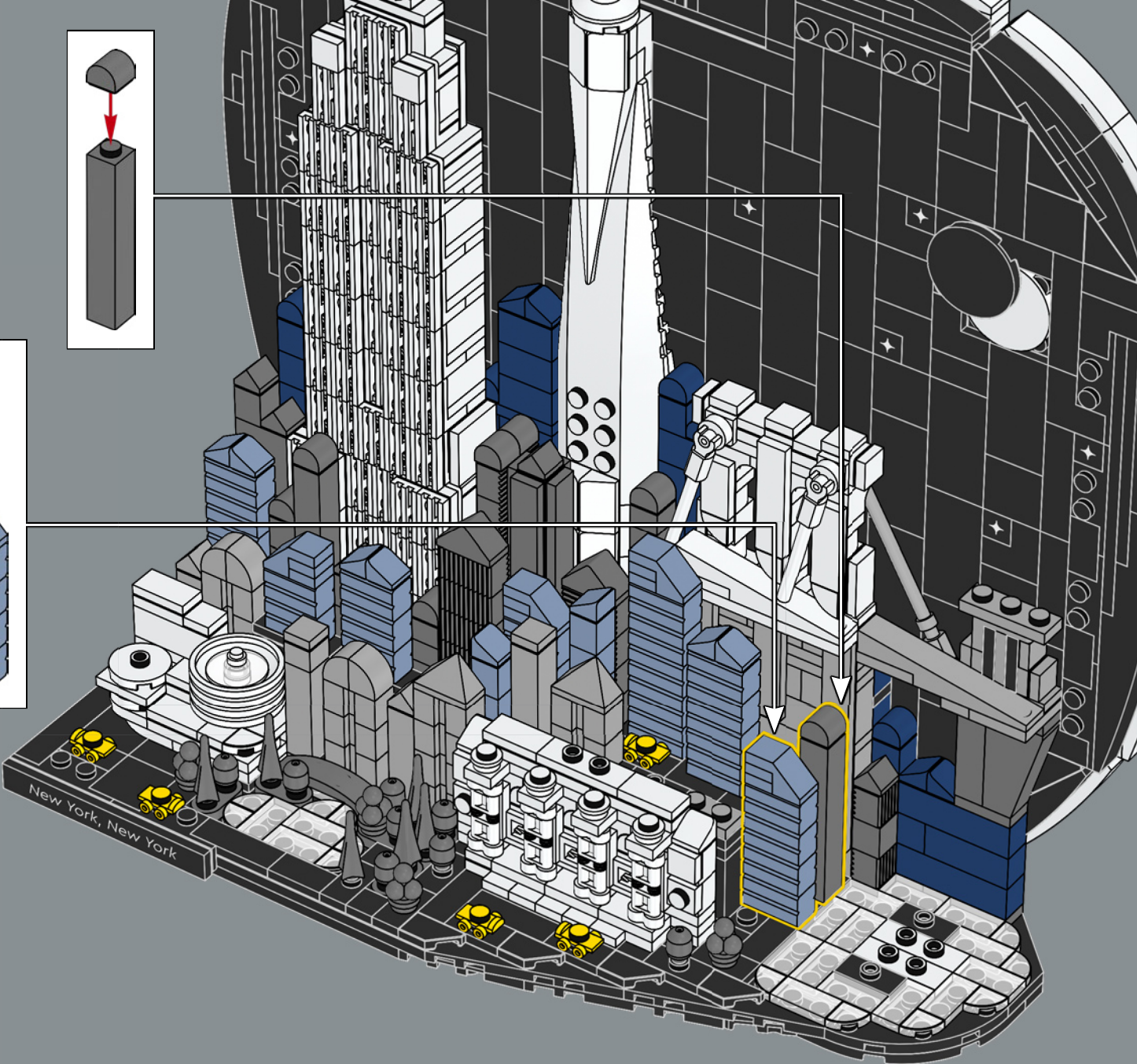
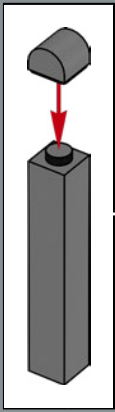
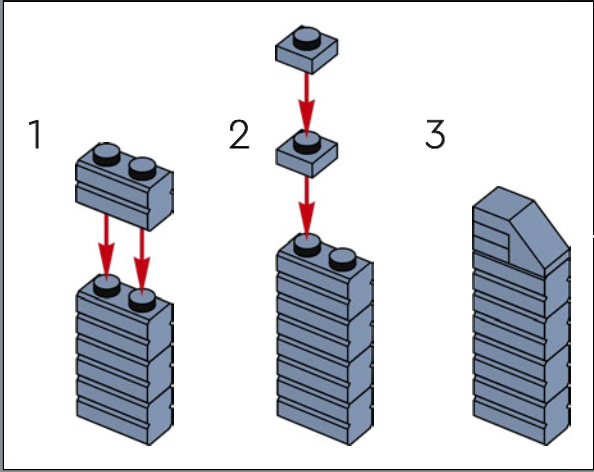

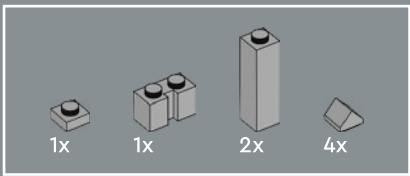

346

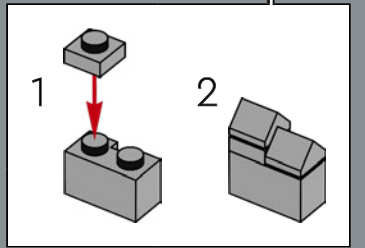
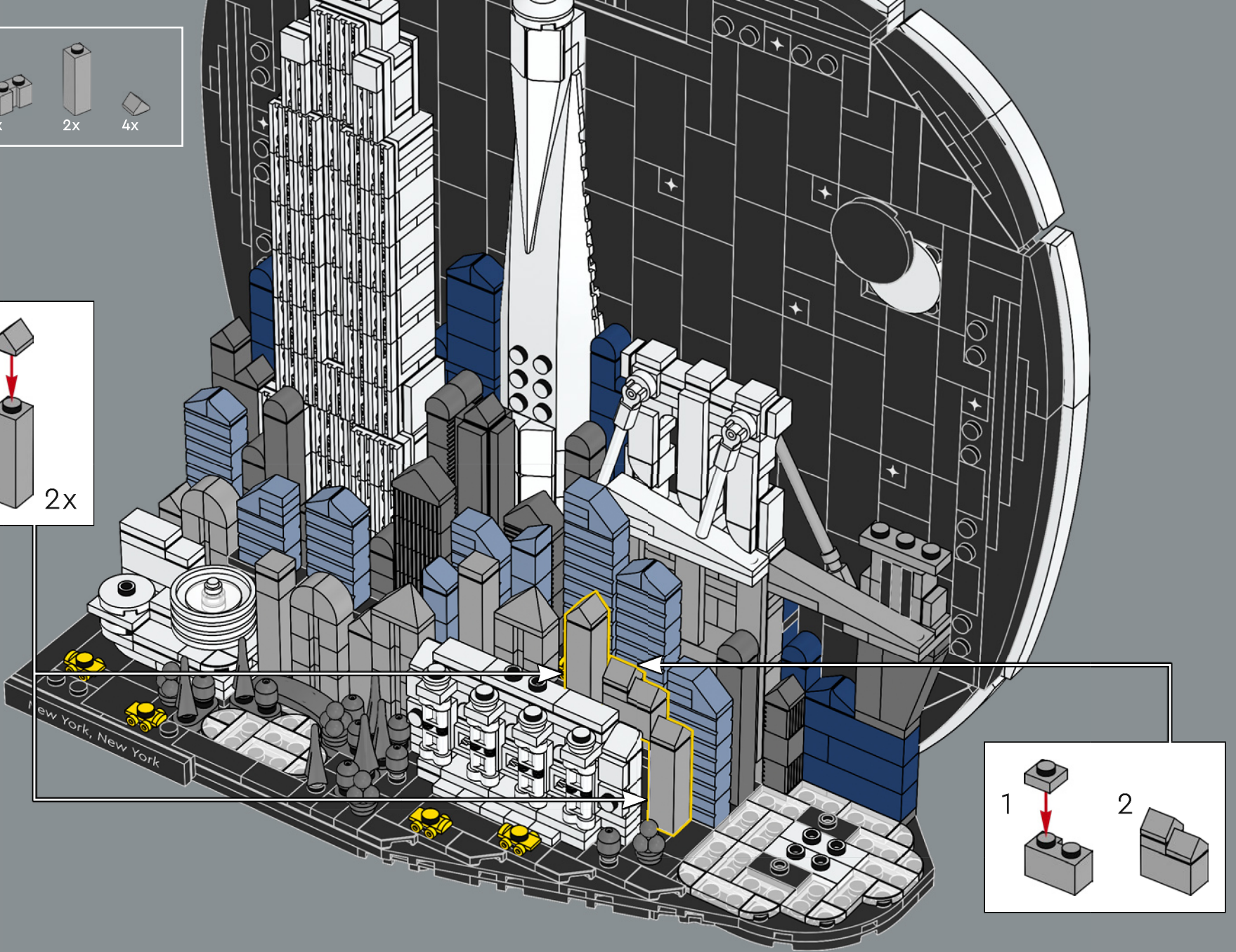
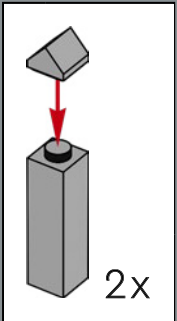

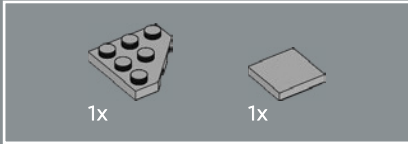

347

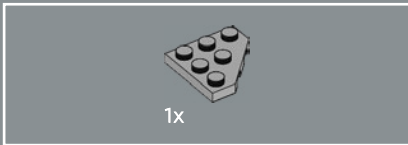
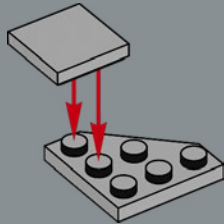

348

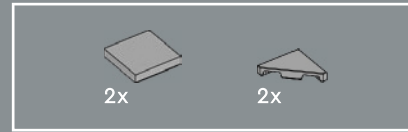
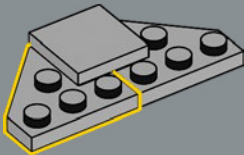

349

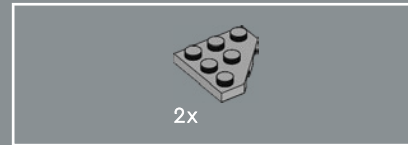
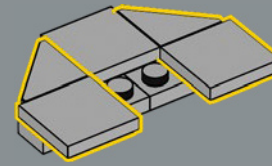

350

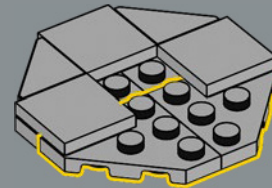

Die beeindruckende Freiheitsstatue aus Kupfer ist vom Boden bis zur Spitze der Fackel 92,9 m hoch – das entspricht in etwa der Höhe eines 22-stöckigen Gebäudes.

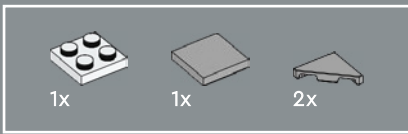

351

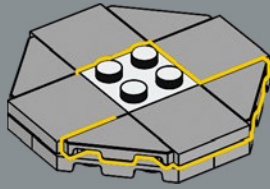

352

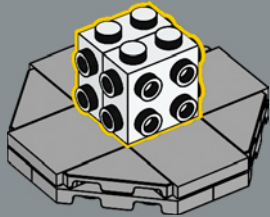

353

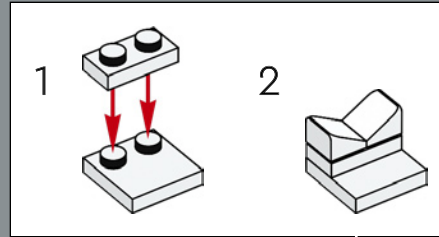

2

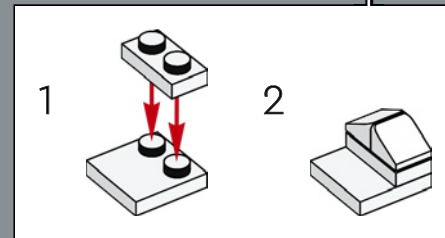
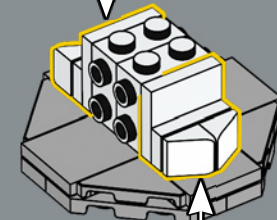
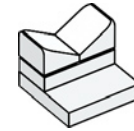

2

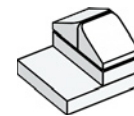



354

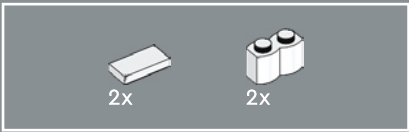
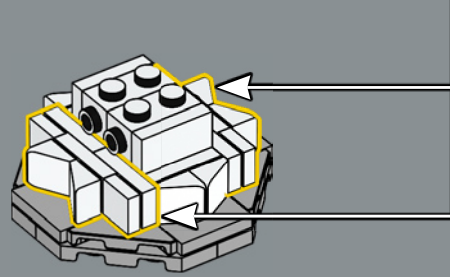
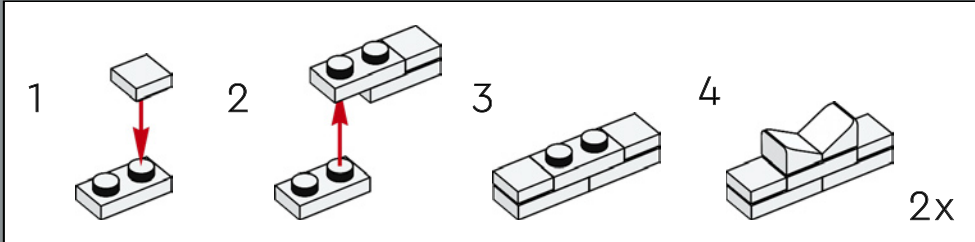

355

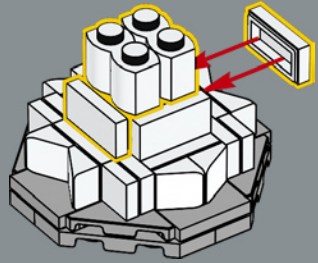



356

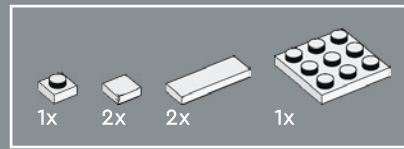
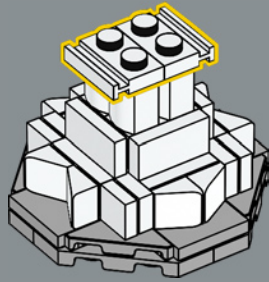

357

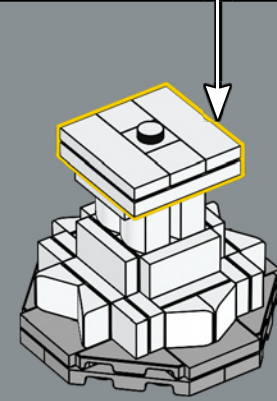
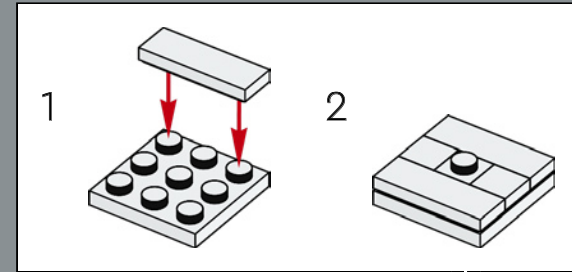

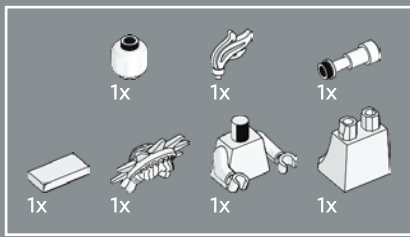

358

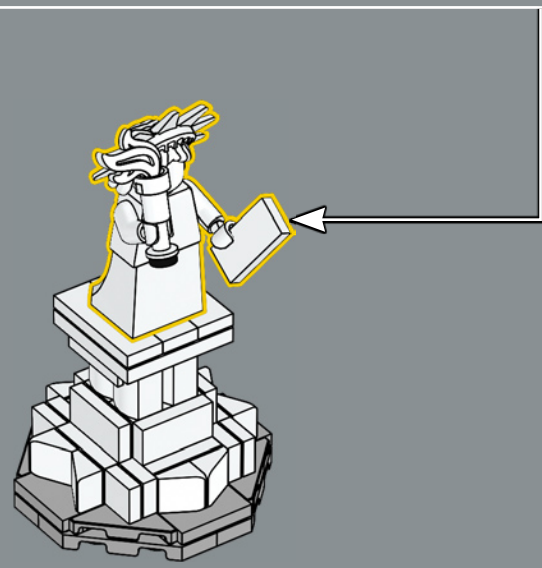
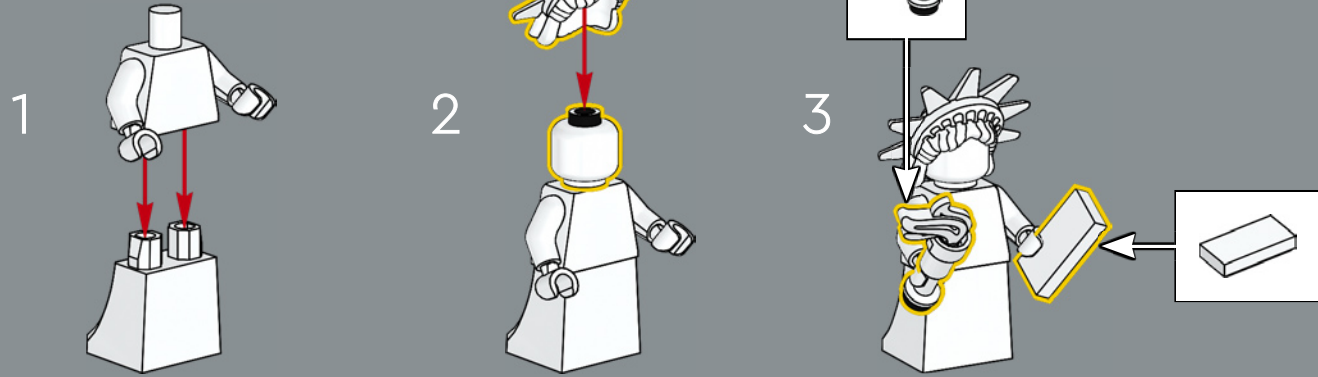

„Lady Liberty“ ist bereits einige Male als LEGO® Minifigur erschienen – die erste davon kam 2012 auf den Markt.

359

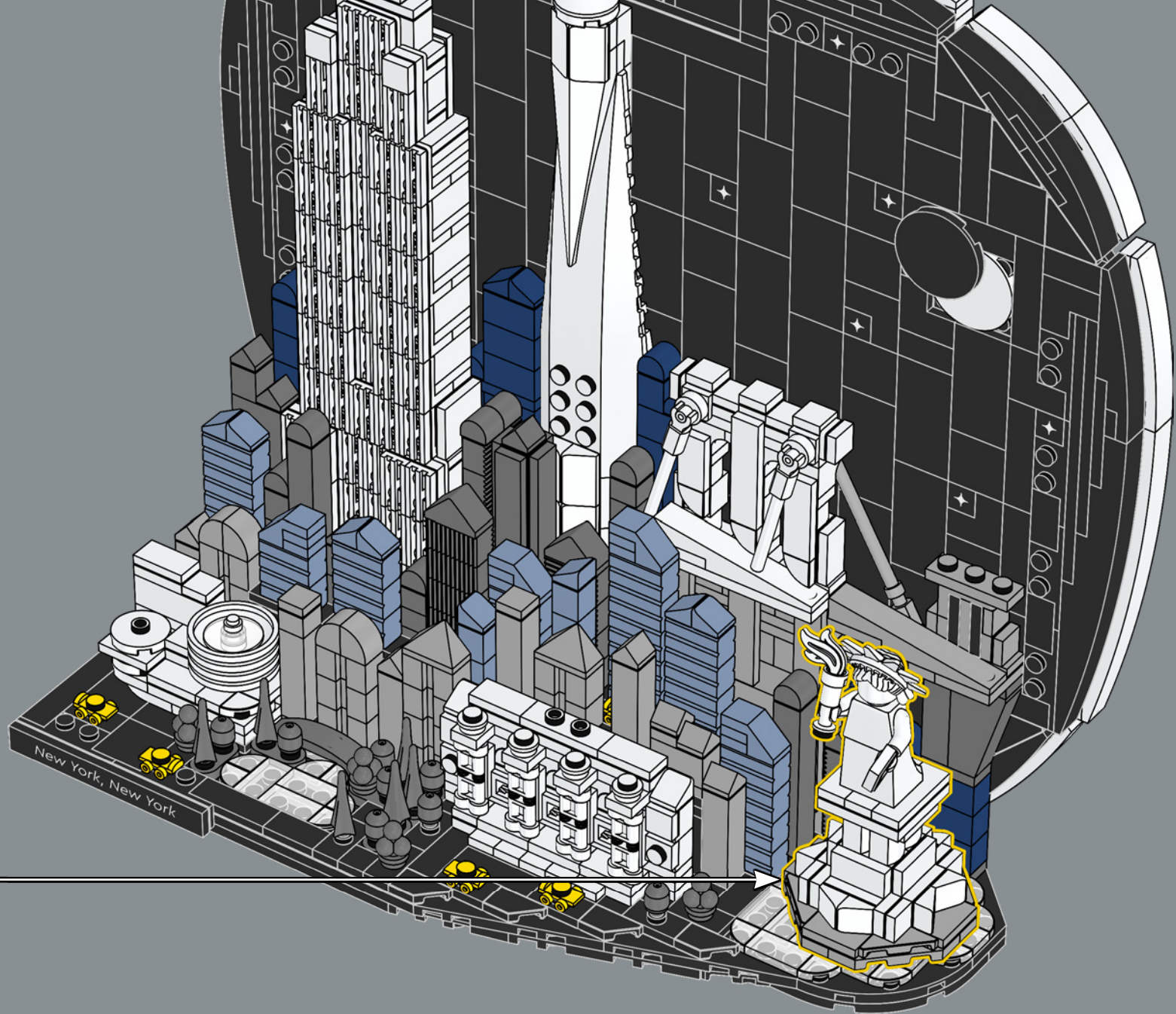

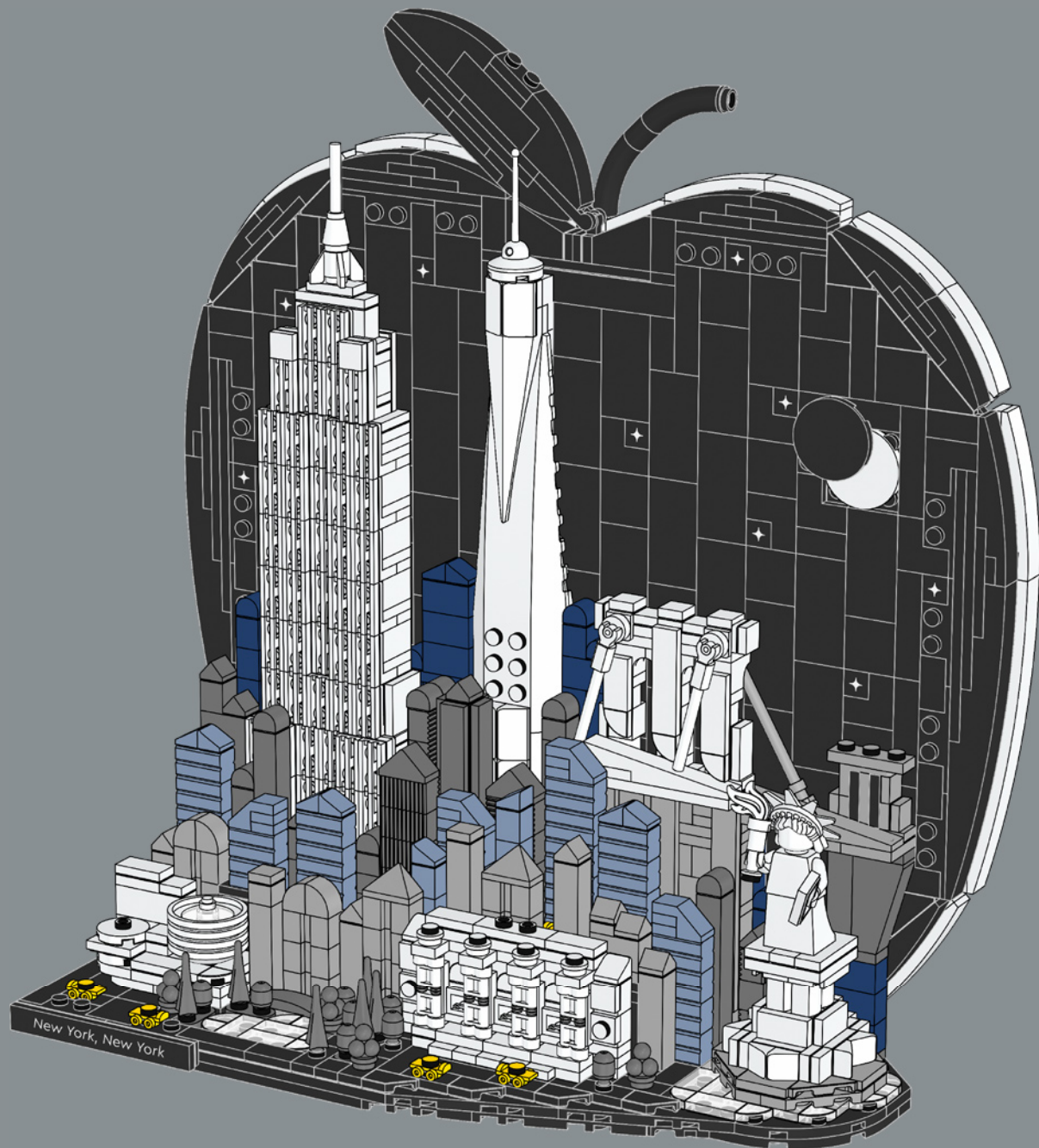

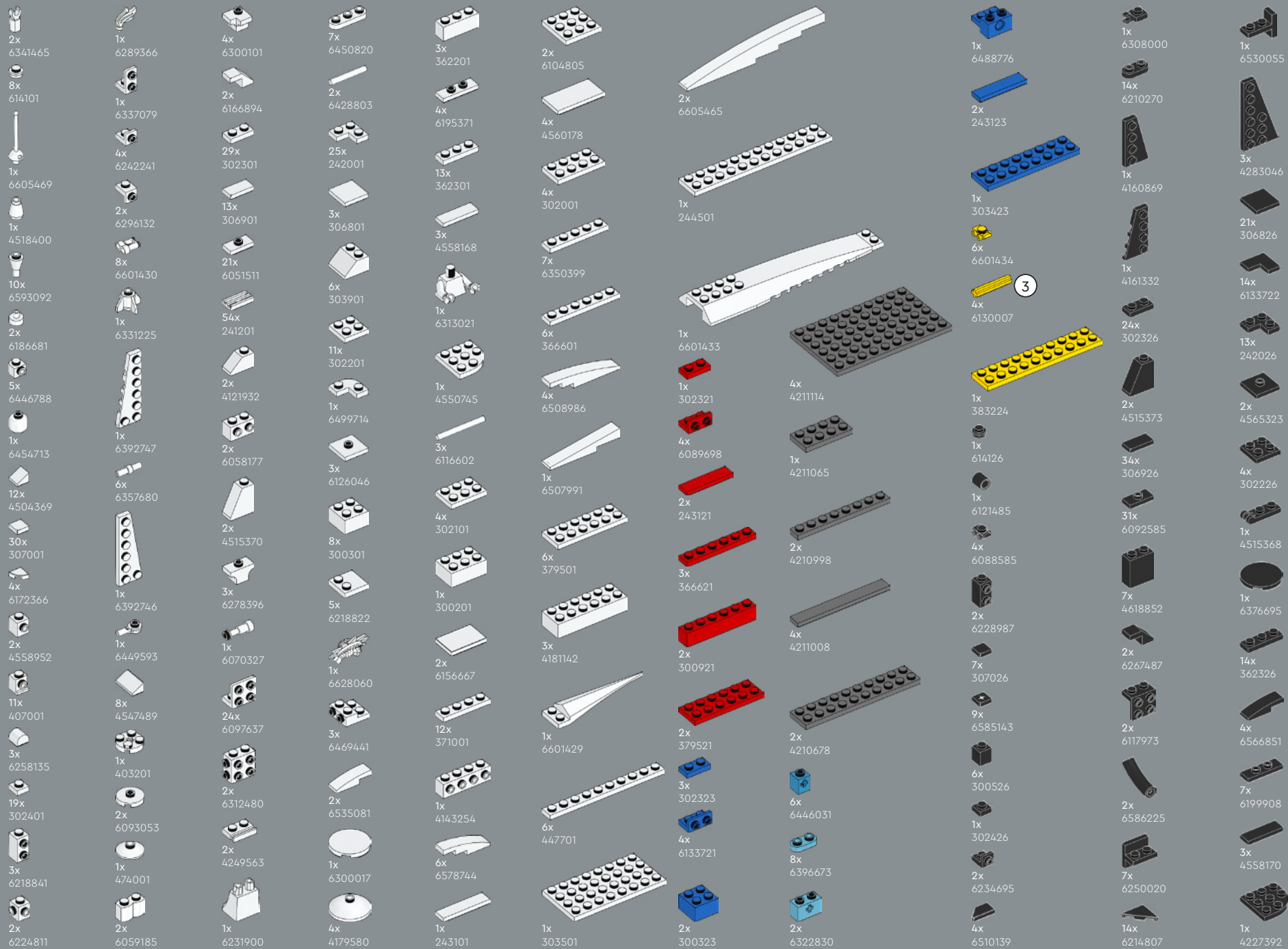

- 10x 6118829
- 2x 6168620
- 1x 4531412
- 6x 6580394
- 18x 243126
- 8x 371026
- 3x 4160025
- 1x 365926
- 1x 301026
- 2x 6039869
- 14x 302026
- 5x 663626
- 4x 6535144
- 5x 6184876
- 1x 366626
- 1x 4243819
- 1x 6101857
- 2x 4181144
- 57x 4560182
- 1x 6585142
- 8x 303226
- 2x 303426
- 1x 6037390
- 1x 4243819
- 1x 395826
- 2x 383226
- 6x 4514845
- 2x 302926
- 2x 6001494
- 2x 6601431
- 1x 4166619
- 1x 6372045
- 5x 346026
- 4x 379526
- 6x 4106977
- 2x 6509390
- 1x 6439175
- 8x 4504374
- 6x 6403899
- 6x 4255413
- 6x 6595205
- 15x 4249891
- 4x 6103405
- 6x 6233955
- 9x 4177735
- 3x 4264569
- 1x 6343976
- 13x 4211399
- 6x 6253436
- 2x 6401023
- 2x 6225242
- 2x 4211389
- 5x 4211415
- 4x 4211476
- 4x 6522869
- 7x 6061702
- 1x 6345639
- 2x 6075075
- 4x 6407767
- 4x 4211526
- 15x 4617170
- 2x 6383177
- 7x 4211398
- 1x 4211388
- 4x 6066097
- 4x 6134378
- 4x 6217876
- 14x 4211397
- 1x 4211387
- 1x 4211353
- 4x 4211413
- 2x 6569357
- 1x 4211429
- 4x 4211361
- 1x 6421522
- 4x 4160560
- 11x 4211445
- 1x 4211394
- 2x 4211356
- 6x 6015347
- 8x 6442144
- 1x 6170418
- 3x 4211393
- 3x 4211438
- 1x 6508016
- 4x 4243797
- 4x 4211452
- 2x 4211392
- 1x 4211481
- 4x 4211402
- 1x 4211401
- 4x 4662161
- 3x 4210690
- 2x 4210700
- 7x 6221607
- 2x 4226221
- 12x 6514469
- 1x 6514246
- 17x 6514223
- 8x 6062686
- 7x 4620077
- 8x 6257079
- 4x 6248952
- 28x 6417947
- 1x 383228
- 2x 302028
- 8x 6344216
- 16x 4210636
- 9x 4211063
- 3x 4210978
- 4x 6092572
- 10x 4211098
- 5x 6262021
- 7x 6333129
- 1x 4210719
- 5x 6388133
- 1x 4211104
- 5x 4211133
- 1x 4648256
- 1x 4500975
- 1x 6336990
- 2x 4211104
- 5x 4211133
- 1x 4648256
- 1x 6240515



[LEGO.com/service](https://www.LEGO.com/service)



YOU COULD
WIN



**YOU COULD
WIN**

Your feedback will help shape the future development of this product series.

Visit:

**DU KÖNNTEST
GEWINNEN**

Dein Feedback trägt zur Weiterentwicklung dieser Produktreihe bei.

Geh auf:

**VOUS POURRIEZ
GAGNER**

Vos commentaires nous aideront à concevoir les futurs produits de cette gamme.

Visitez :

**POTRESTI
VINCERE TU**

La tua opinione ci aiuterà a migliorare la creazione futura di questa linea di prodotti.

Visita:

**PUEDES
GANAR**

Tu opinión contribuirá al futuro de esta serie de productos.

Visita:

轻松获奖

您的反馈将有助于我们在今后改进本产品系列。

请访问:

LEGO.com/productfeedback

You also have the chance to win a LEGO® set.

Terms and conditions apply.*

Außerdem hast du die Chance, ein LEGO® Set zu gewinnen.

Es gelten die Teilnahmebedingungen.*

Vous pourriez également gagner un ensemble LEGO®.

Des conditions s'appliquent.*

Hai anche la possibilità di vincere un set LEGO®.

Termini e condizioni sono applicabili.*

También tienes la oportunidad de ganar un set LEGO®.

Aplican términos y condiciones.*

您还有机会赢取乐高®套装。

条款和条件适用。*

*LEGO.com/productfeedback-terms

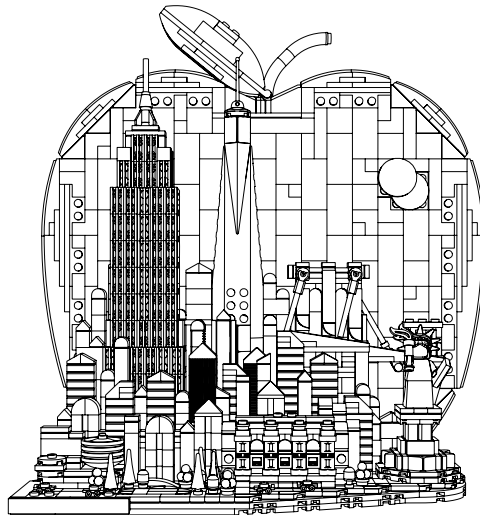

LEGO and the LEGO logo are trademarks of the LEGO Group. ©2026 The LEGO Group.

The EMPIRE STATE BUILDING name and image are registered trademarks and used with permission.

The name and building image of the Solomon R. Guggenheim Museum are trademarks of the Solomon R. Guggenheim Foundation. Used with permission.

® /™ /© Frank Lloyd Wright Foundation. All Rights Reserved.

One World Trade Center building design is a copyright of WTC Tower 1 LLC. Used under license.

Adam Reed Tucker is the co-developer of the LEGO® Architecture product line.