



21064





LEGO.com/sustainable-packaging



FR

DONNEZ
OU
RECYCLEZ



ASSOCIATION

OU



MAGASIN

OU



DÉCHÈTERIE

Adresses sur quefairedemesdechets.fr



BUiLDER



Apple and the Apple logo are trademarks of Apple Inc., registered in the U.S. and other countries and regions. App Store is a service mark of Apple Inc. Google Play and the Google Play logo are trademarks of Google LLC. Tencent and the Tencent logo are trademarks of Tencent Inc.

Q LEGO.com/devicecheck



Q LEGO® Builder

SIMBOLI MONUMENTALI DELLA

Città dell'amore

Da secoli, la capitale francese ha attratto, ispirato e ospitato alcuni degli artisti e architetti più celebri della storia. Sebbene sia conosciuta come Città dell'Amore, questo nome racchiude un significato che va ben oltre i semplici ideali dell'affetto romantico. I monumenti più iconici di Parigi si ergono come simboli duraturi di un profondo desiderio collettivo di celebrare l'audace espressione creativa, la storia e una bellezza senza tempo. Forse la città occupa un posto speciale nel tuo cuore per il suo fascino storico autentico o per l'armoniosa fusione di innovazione e tradizione nell'arte, nella musica e nella moda. Oppure, se hai già visitato la città, ci auguriamo che questo modello-tributo ravvivi bei ricordi; se ancora non hai avuto questo piacere, speriamo che tu possa assaporare l'atmosfera straordinaria che questa famosa città offre.



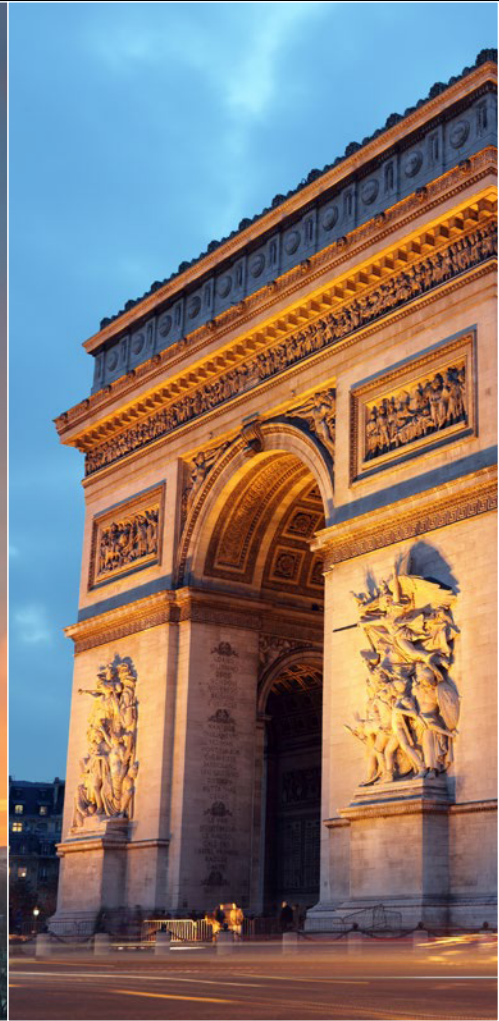
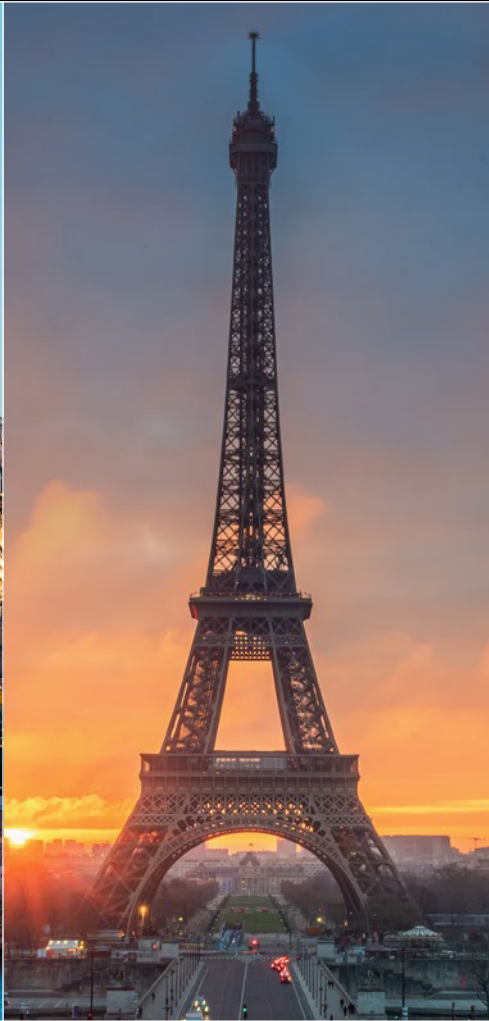



Notre-Dame de Paris

La costruzione di Notre-Dame de Paris iniziò nel 1163, e oggi la cattedrale si erge come un'icona gotica, simbolo della profonda resilienza che caratterizza la storia francese. Ricostruita e riaperta nel 2024, ha resistito a rivoluzioni, incendi e alla prova del tempo. La famosa cattedrale viene visitata da 15 milioni di persone ogni anno.

Torre Eiffel

Costruita da Gustave Eiffel in occasione dell'Esposizione Universale del 1889, la "Dama di Ferro" è alta 300 m e accoglie sei milioni di visitatori ogni anno. Originariamente progettata per durare 20 anni, fu completata in poco più di due anni. La sua silhouette distintiva è diventata da tempo un'icona globale della Francia.

Arco di Trionfo

Commissionato da Napoleone nel 1806 e completato nel 1836, l'Arco di Trionfo celebra le gesta degli eserciti francesi, passati e presenti. Sotto di esso si trova la Tomba del Milite Ignoto, rendendolo un simbolo di trionfo e un luogo solenne di commemorazione nazionale.

Il Louvre

Aperto al pubblico dal 1793, il Louvre è oggi uno dei musei più grandi del mondo. Costruito dopo la Rivoluzione francese e depositario di preziose collezioni reali, questo storico palazzo, già dimora dei re di Francia, ha sempre rappresentato e interpretato le vicende della storia nazionale e internazionale.





Una cornice bianca minimalista contiene la scena, rendendo il modello facile da esporre sugli scaffali o da appendere a una parete.

IL LEGO® ARCHITECTURE

Design Team

Questo modello vuole interpretare l'emozione e l'estetica di Parigi in un raffinato oggetto decorativo, una rappresentazione artistica di alcuni dei suoi monumenti più iconici. Assieme ai caratteristici edifici parigini e alle sagome della skyline cittadina, crea un'ambientazione affascinante e coinvolgente. Se sei un fan dei modelli LEGO® Architecture, questa serie offre una nuova prospettiva della nostra collezione Skyline. Le strutture iconiche dei monumenti vengono ancora catturate con un alto livello di dettaglio, ma qui l'attenzione è più rivolta a creare un'atmosfera e una scena complessiva piuttosto che aderire strettamente alla realtà. Considerando le dimensioni ridotte, abbiamo sperimentato con vari elementi per trovare i pezzi LEGO più adatti a rappresentare i diversi dettagli. Più indietro si va nel modello, più piccola diventa la scala, donando alla scena una profondità suggestiva (come gli alberi che incorniciano la strada). Diverse sezioni del modello vengono sovrapposte per creare l'illusione di profondità, nonostante l'ingombro ridotto. Poiché il modello è composto da piccole sezioni per ogni struttura, tutte racchiuse all'interno della cornice espositiva, è possibile costruire le sezioni singolarmente e vedere il tutto prendere forma come un puzzle o una cartolina tridimensionale.

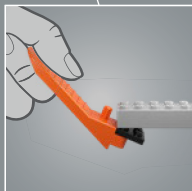
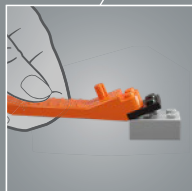
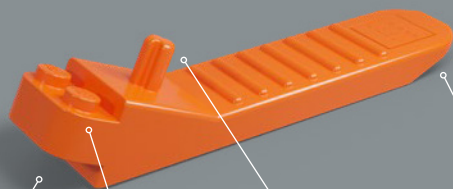

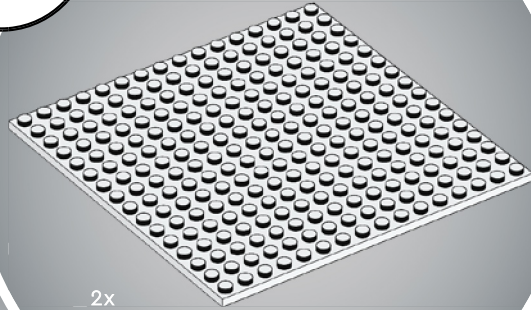
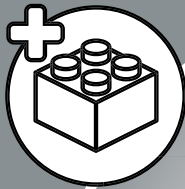

2x

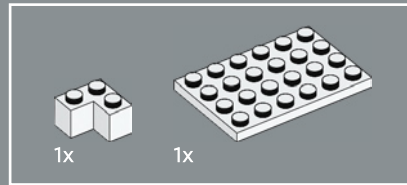

1

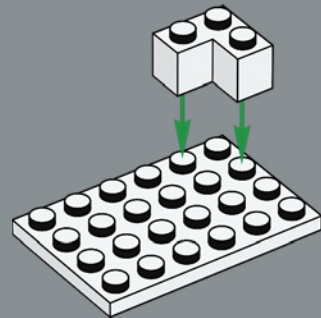

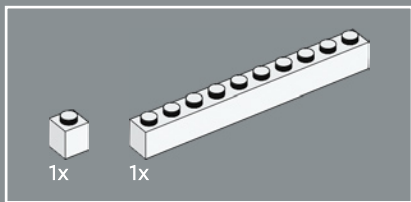

2

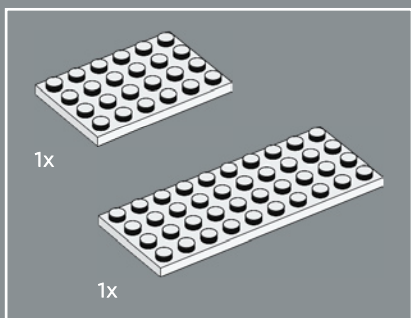
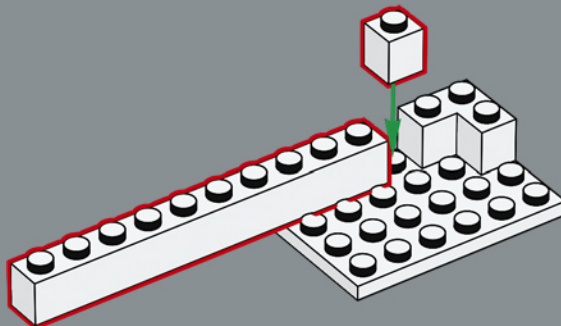

3

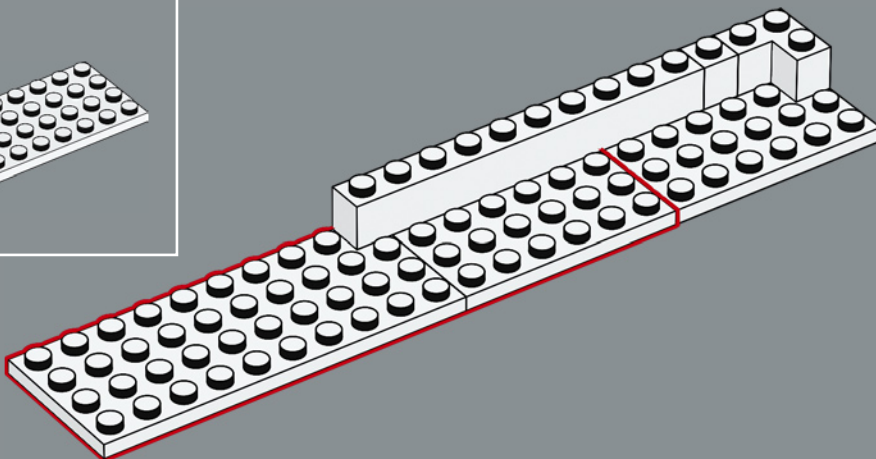

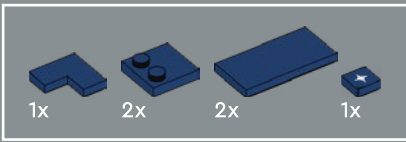

4

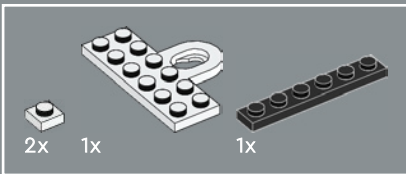
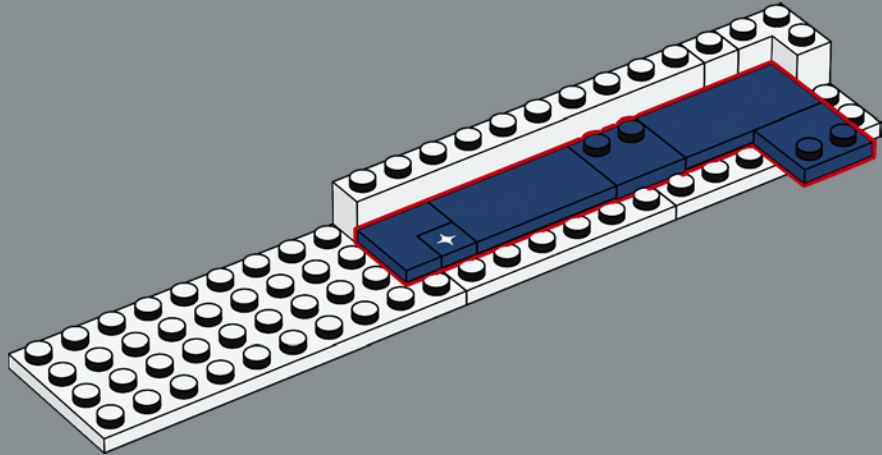

5

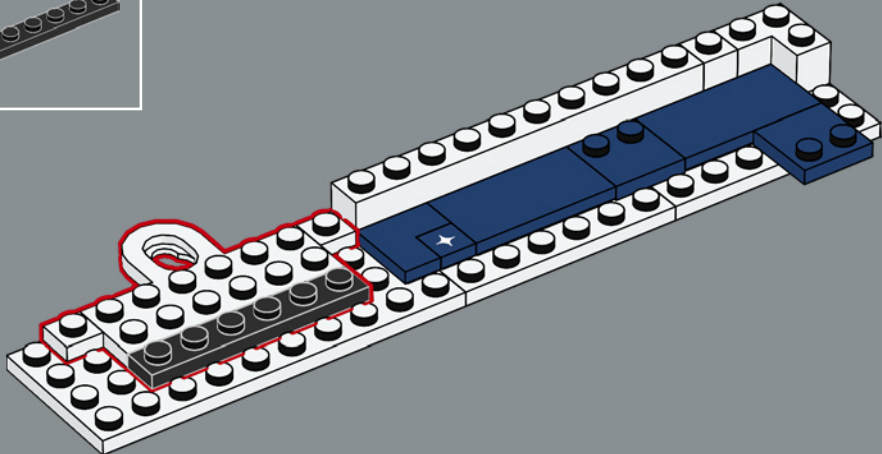

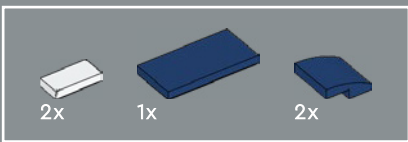

6

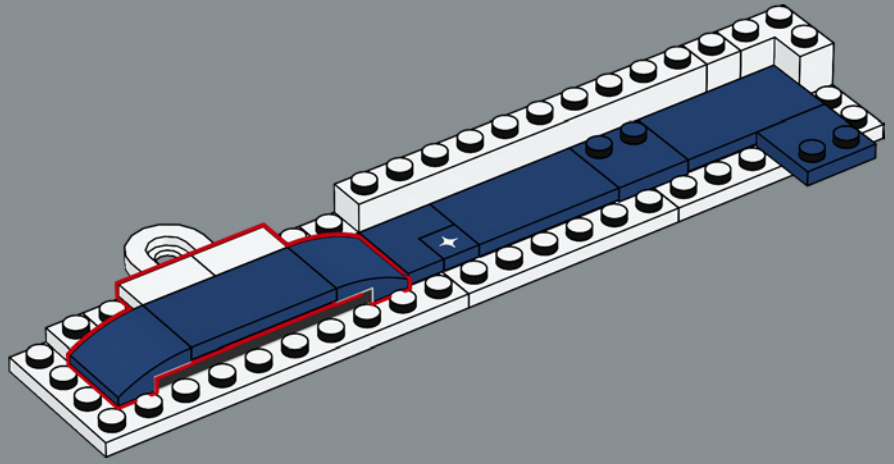

7

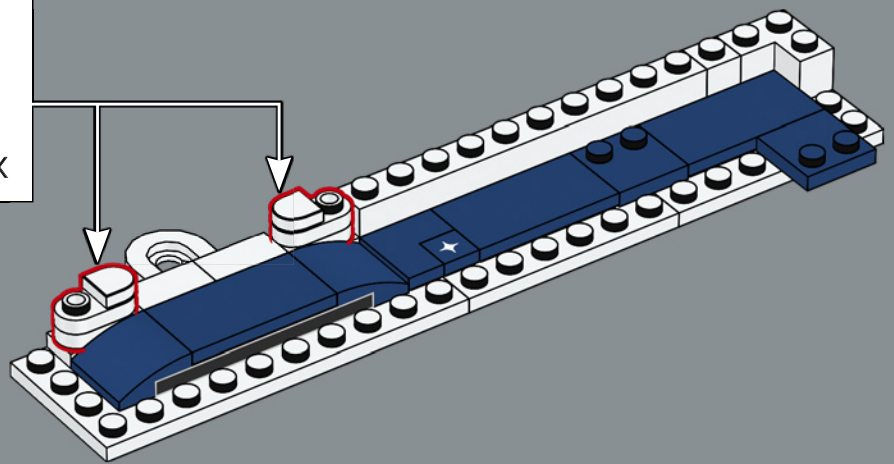
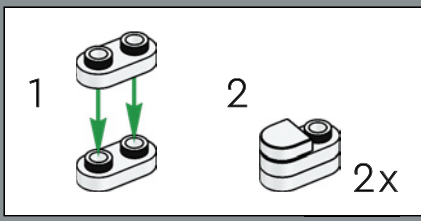

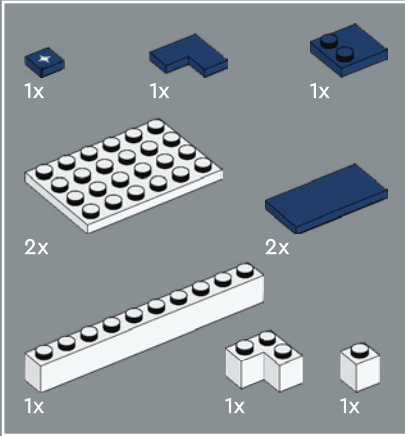
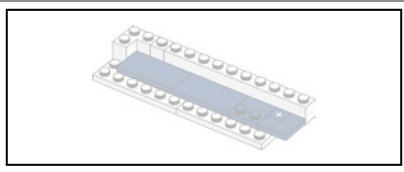

8

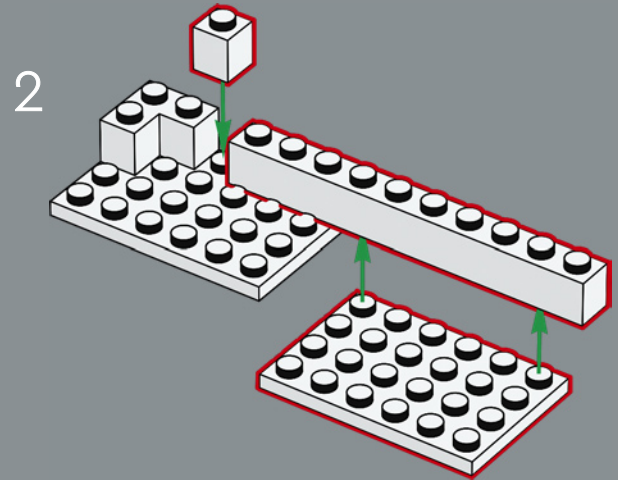
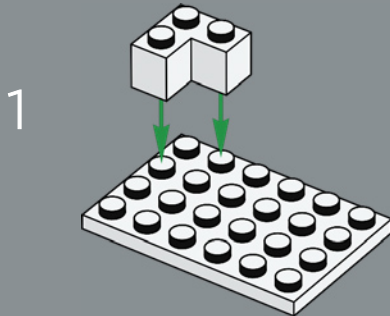

3

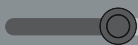
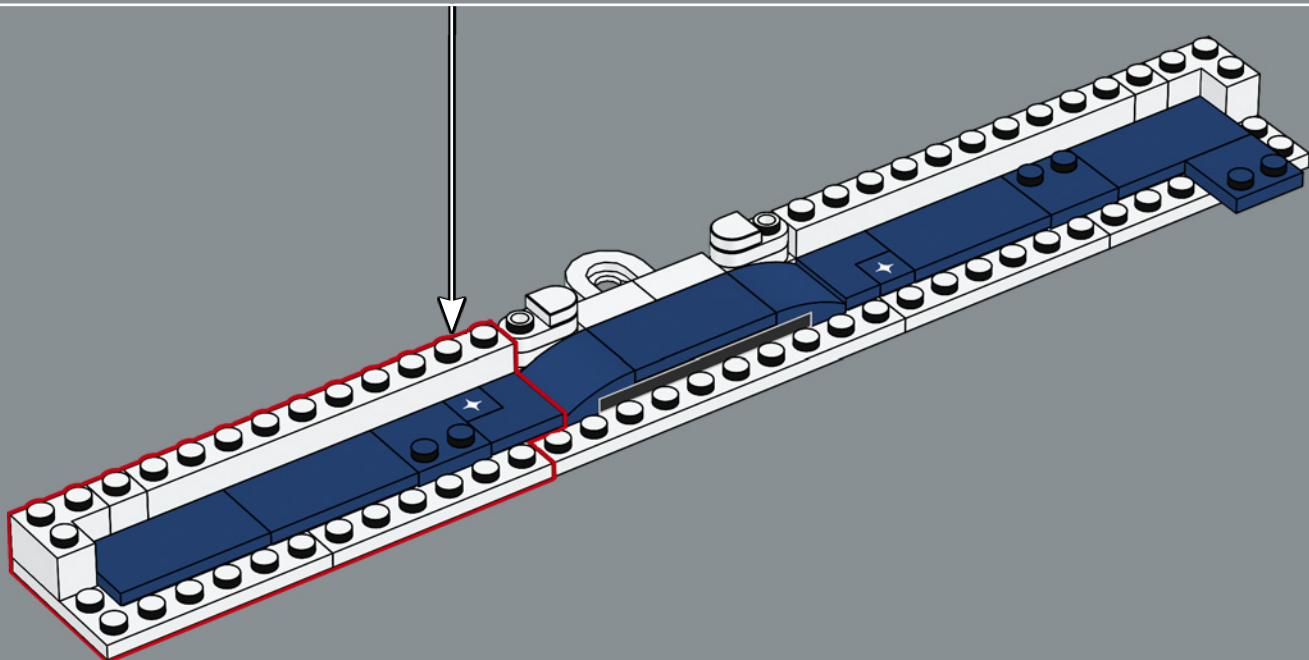
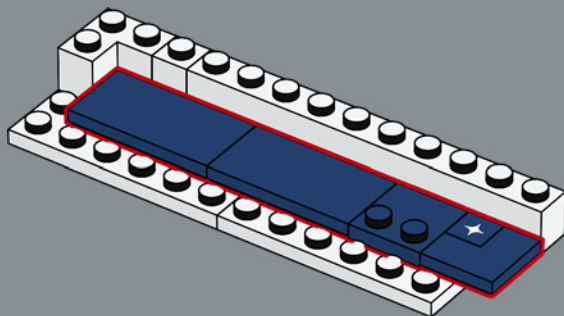

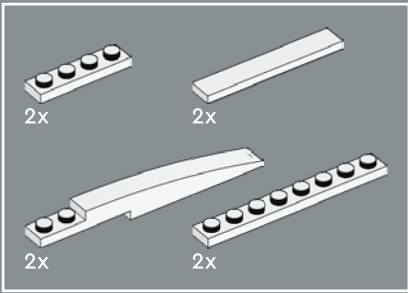

9

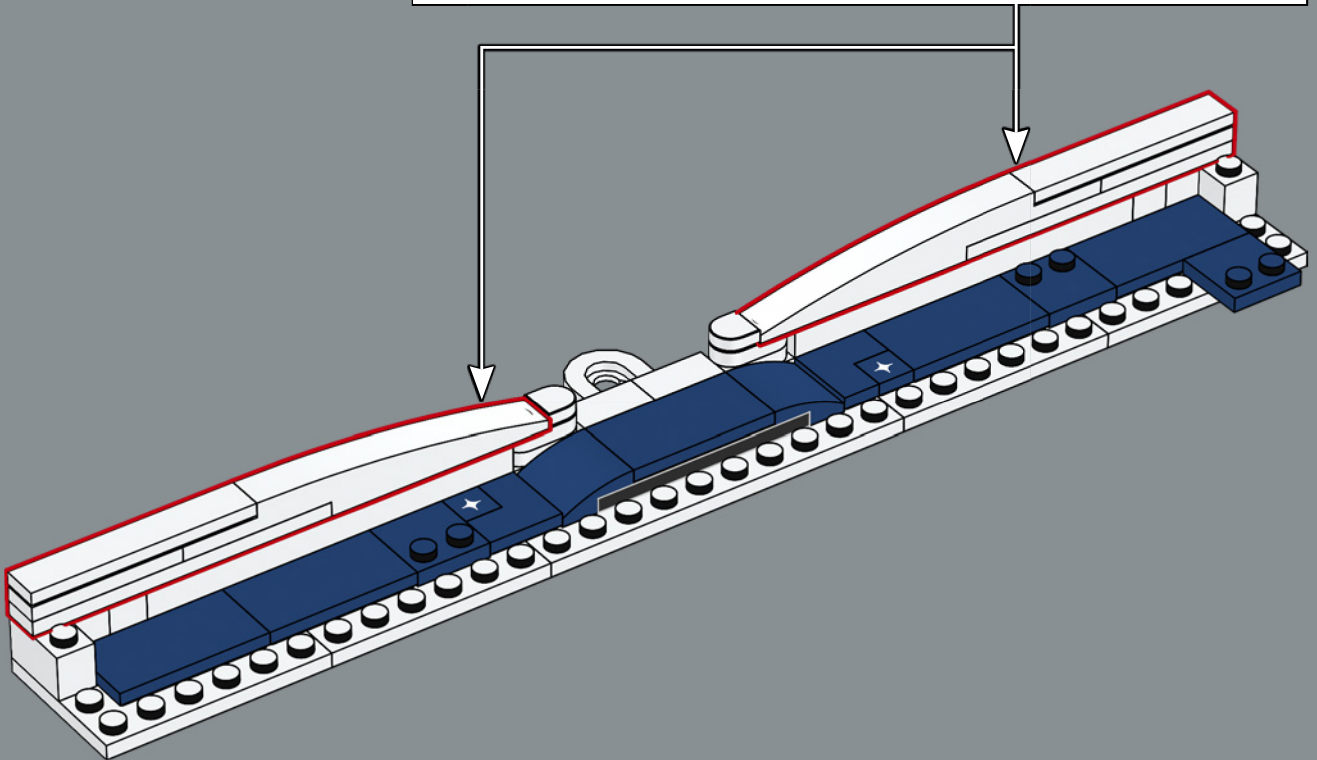
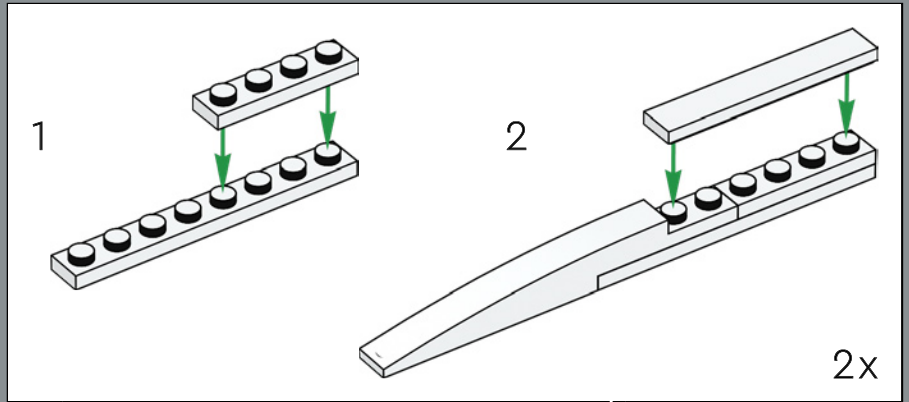

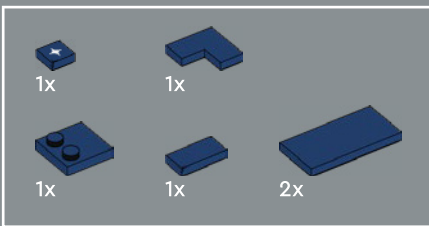

10

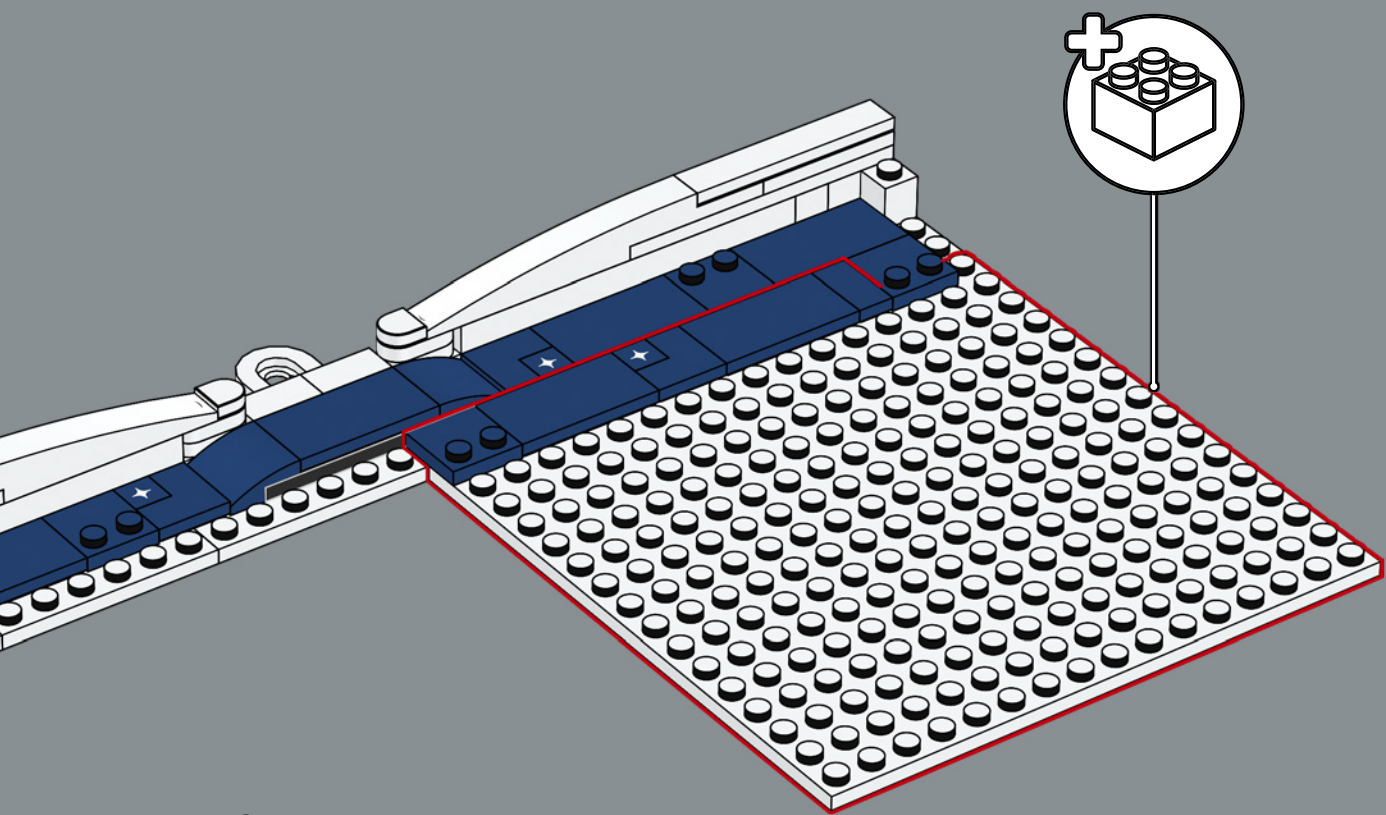

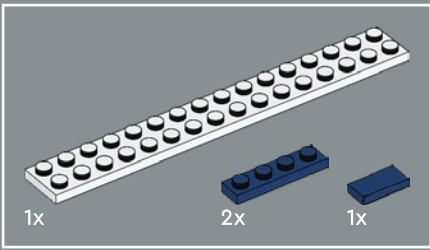

11

1

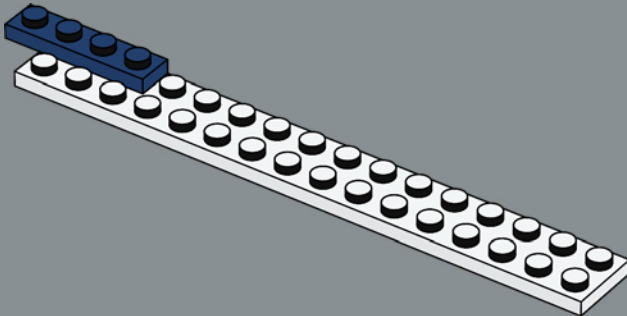

2

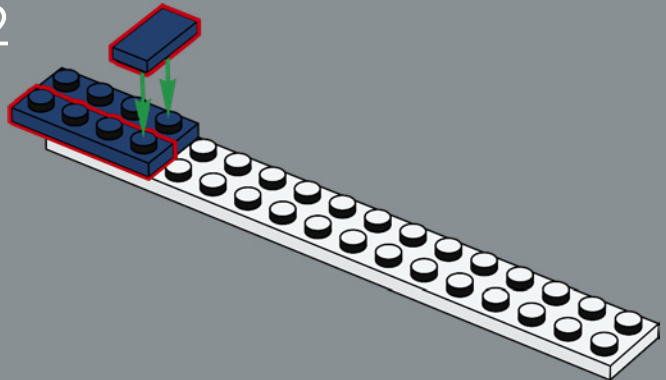

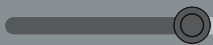
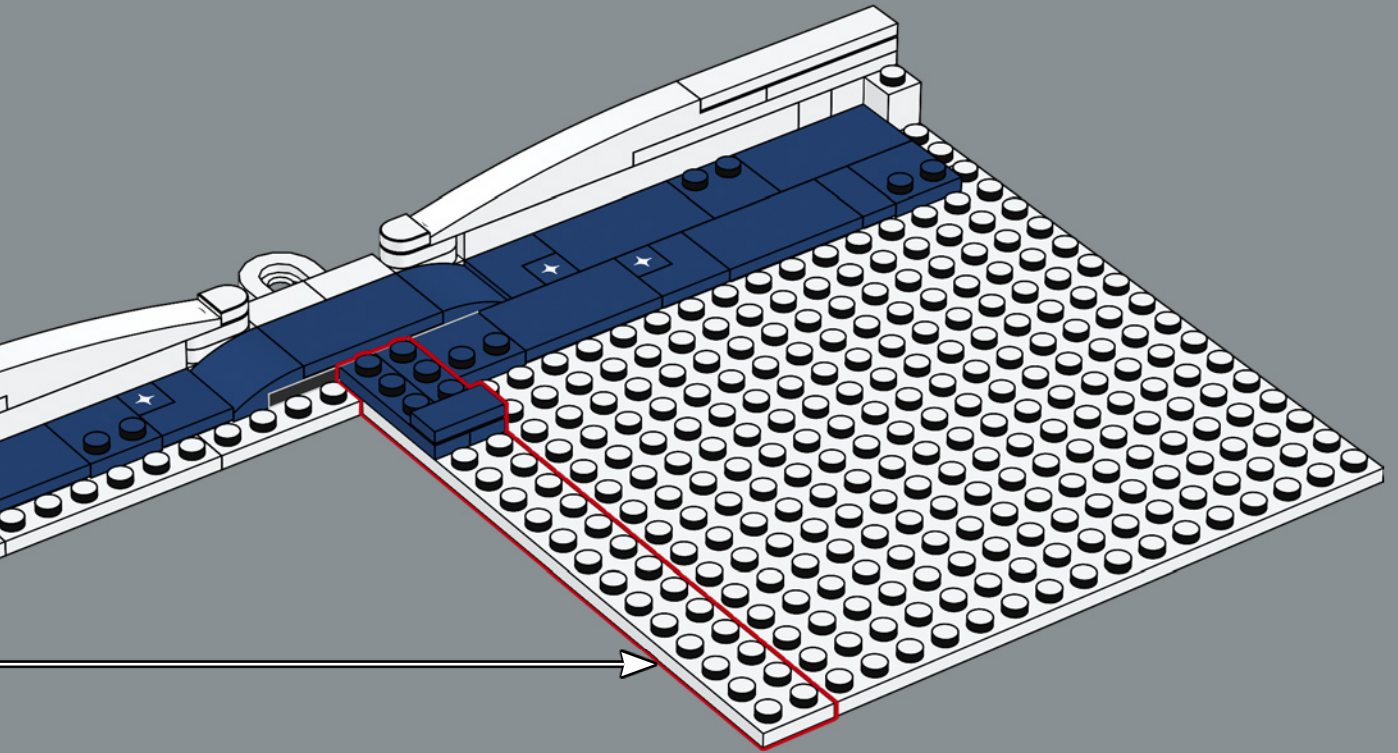

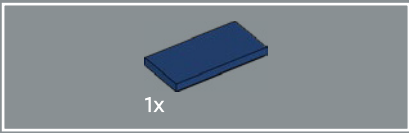

12

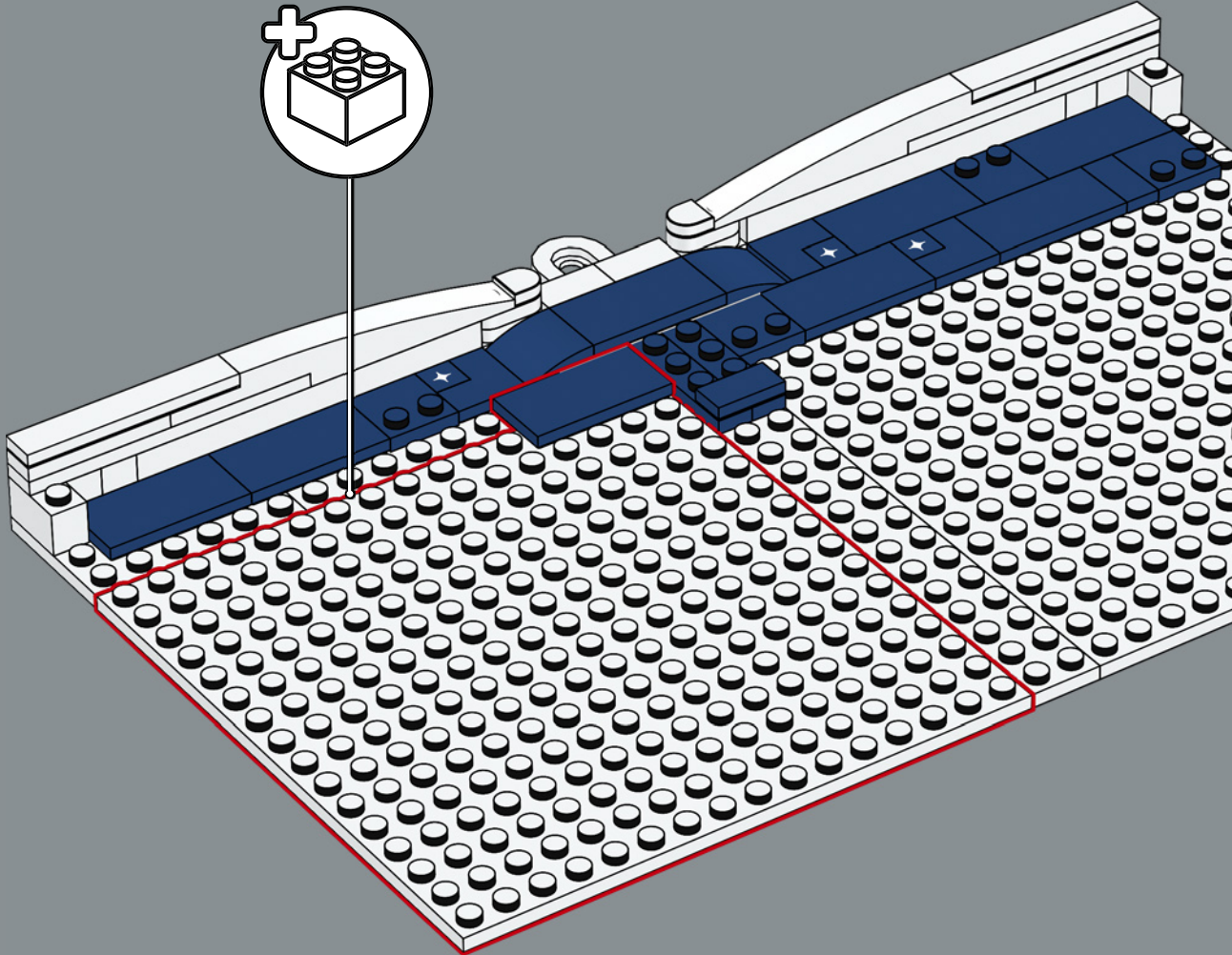

Parigi - la Città dell'Amore, è uno dei luoghi più romantici al mondo per fare una proposta di matrimonio!

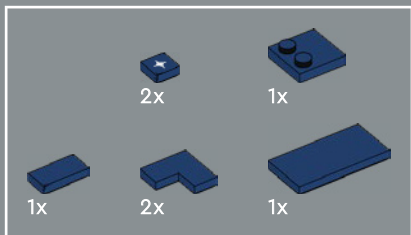

13

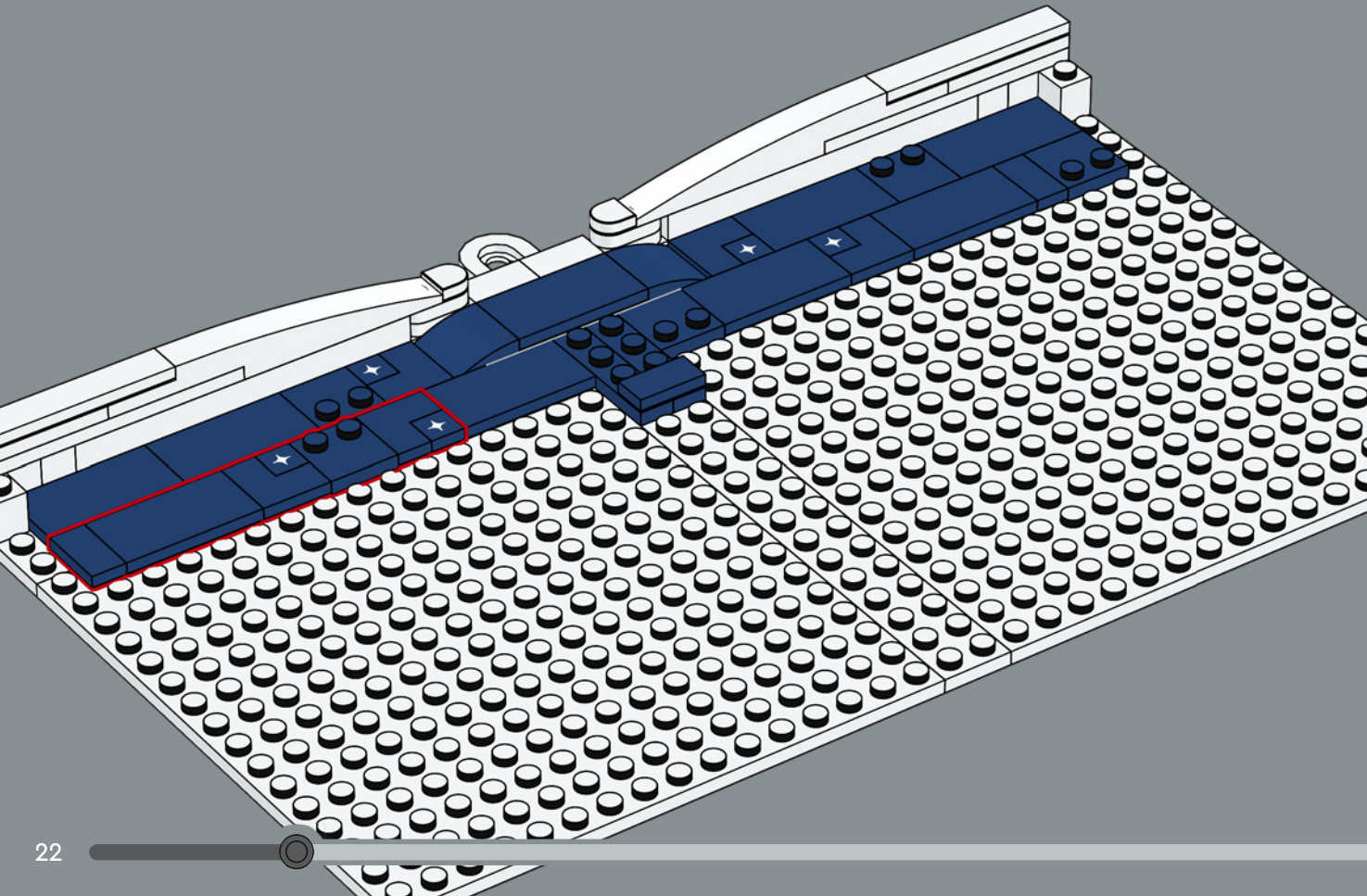

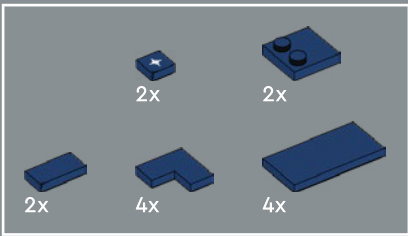

14

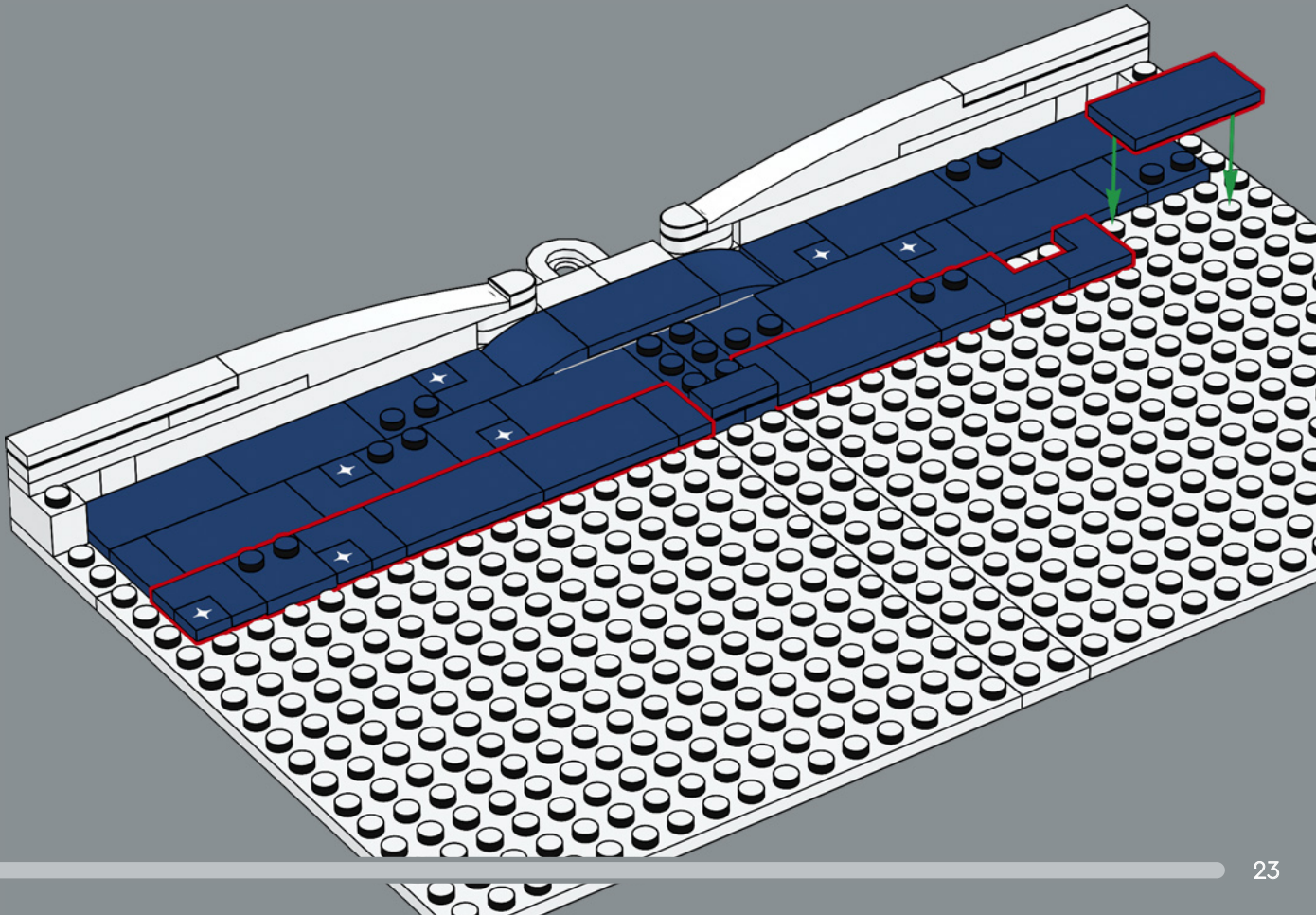

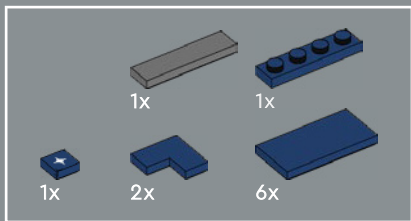

15

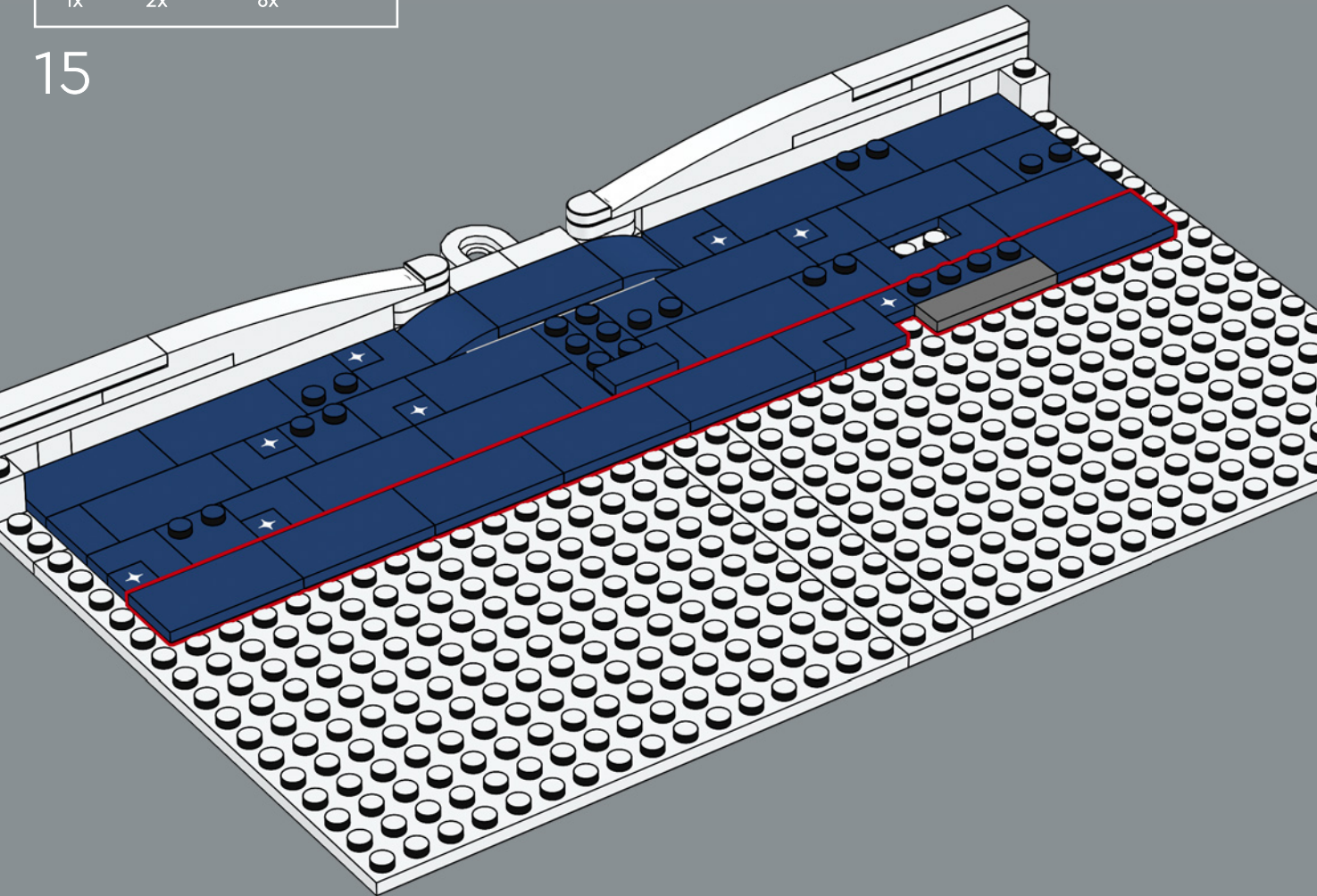

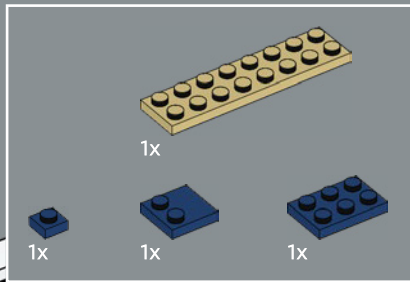

16

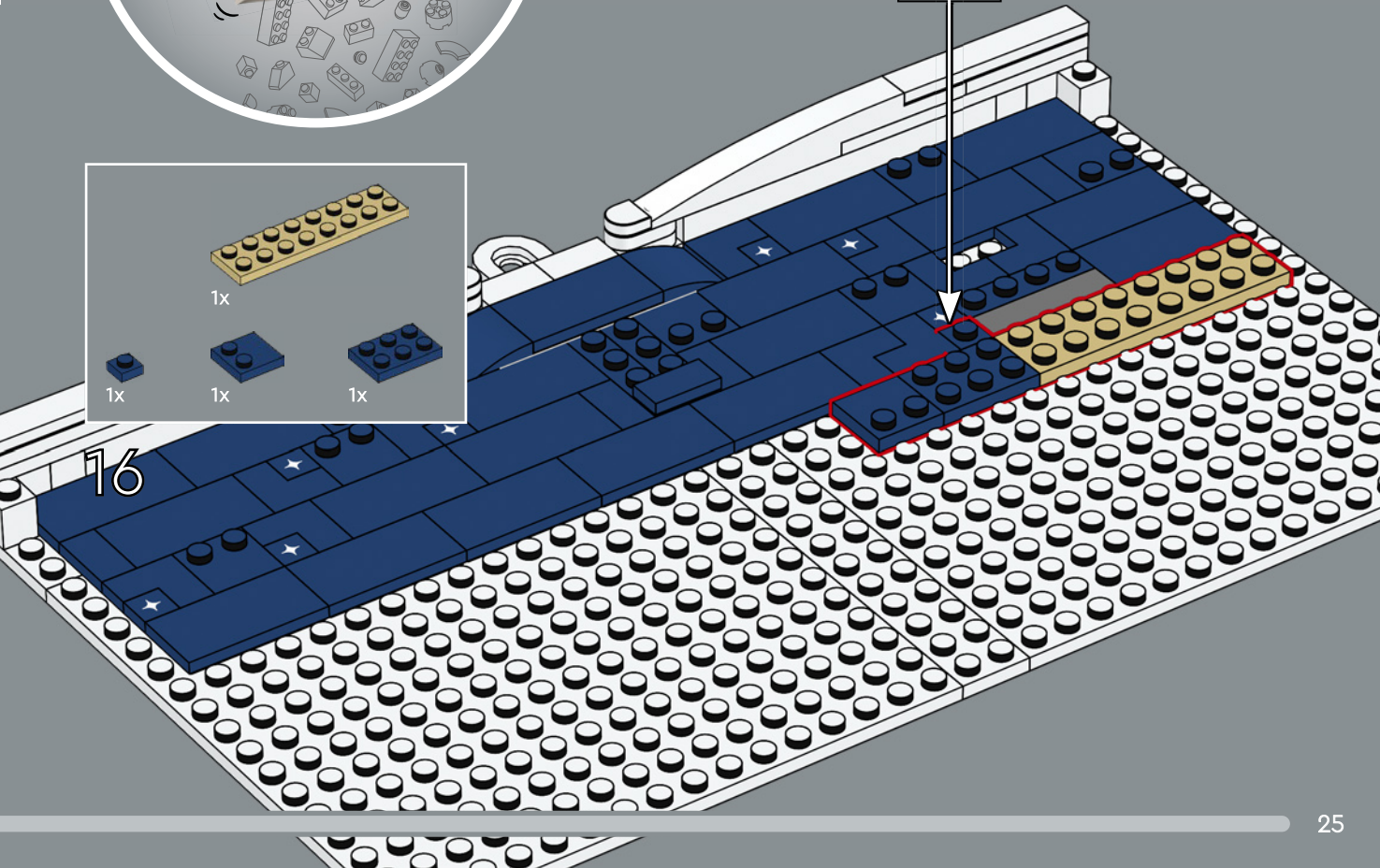

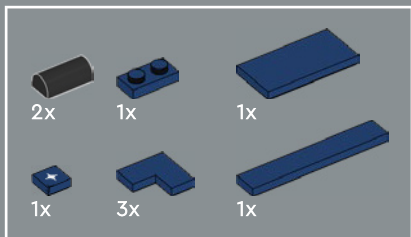

17

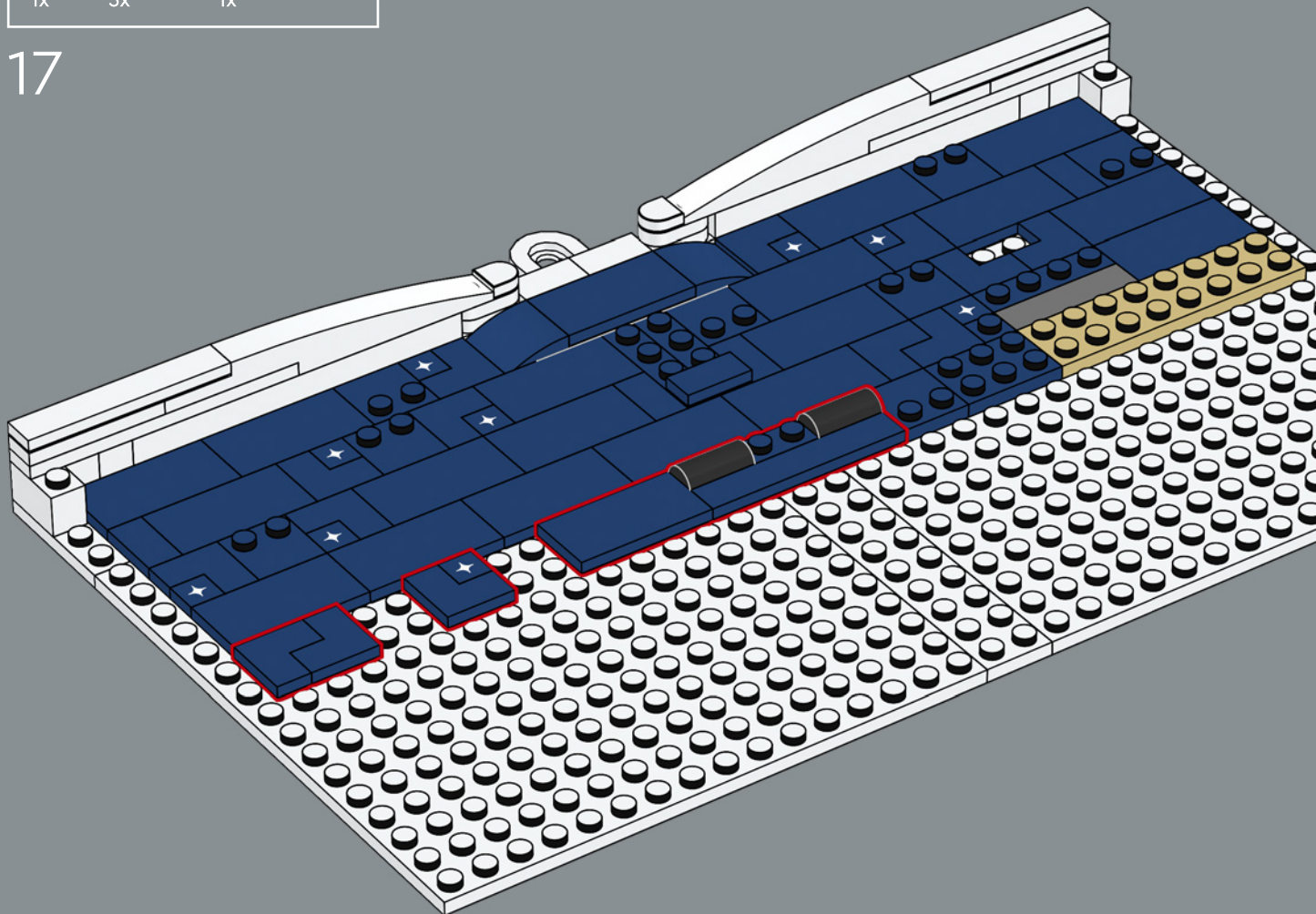

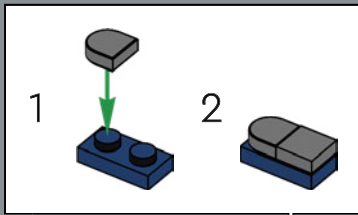
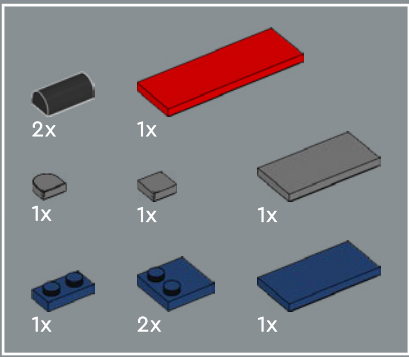

18

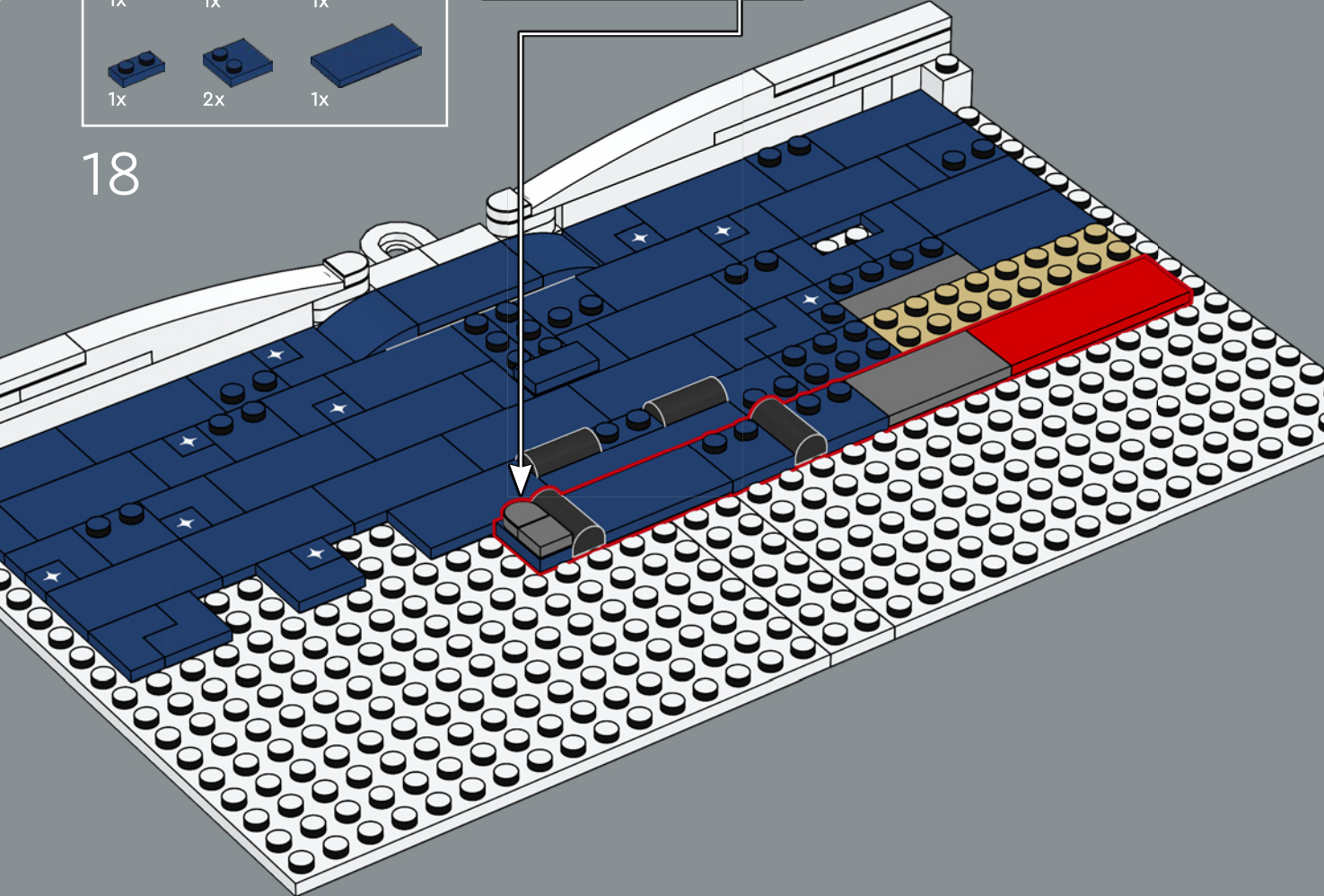

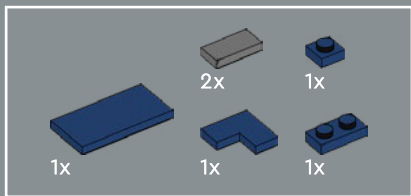

19

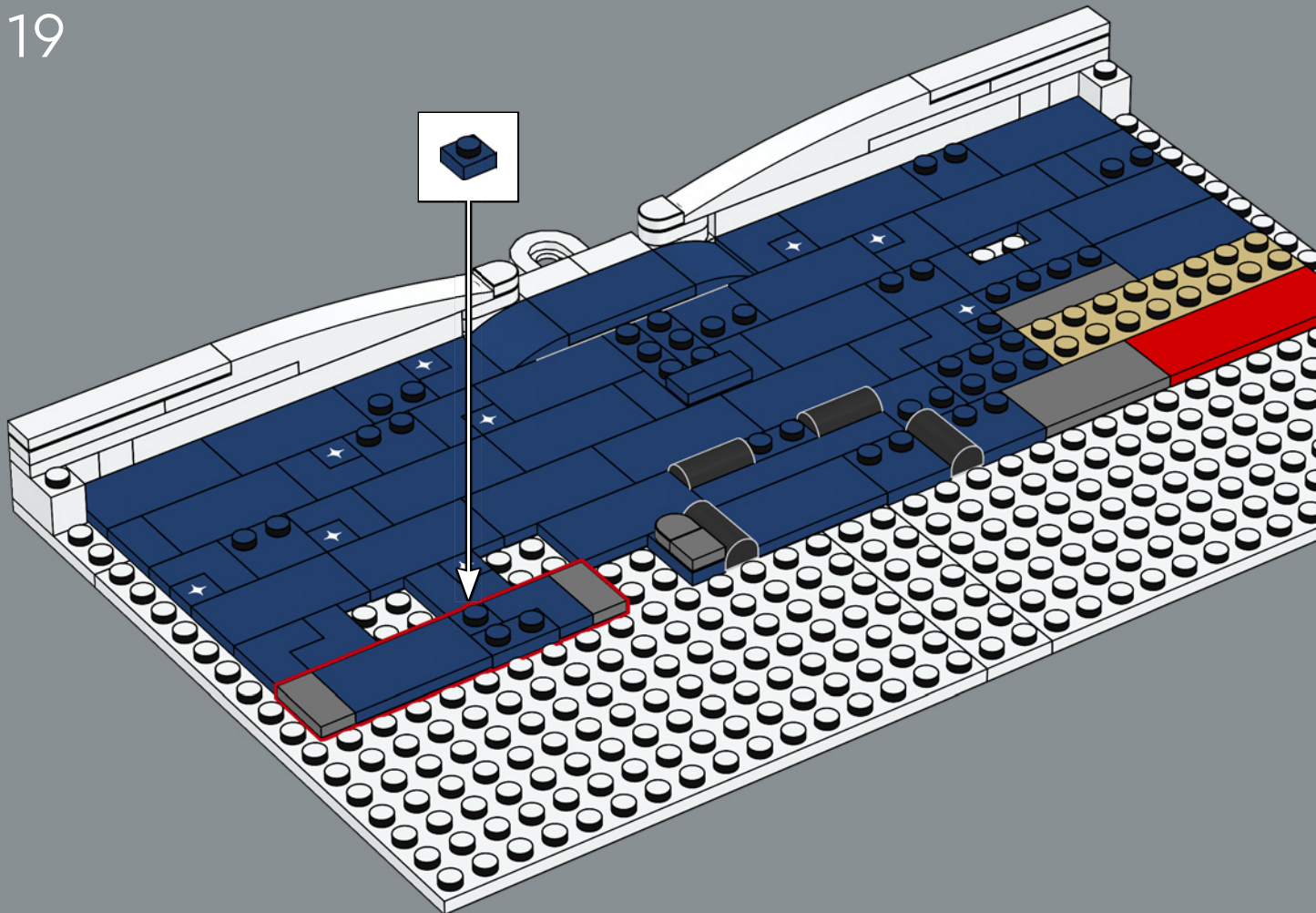

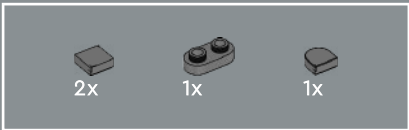

20

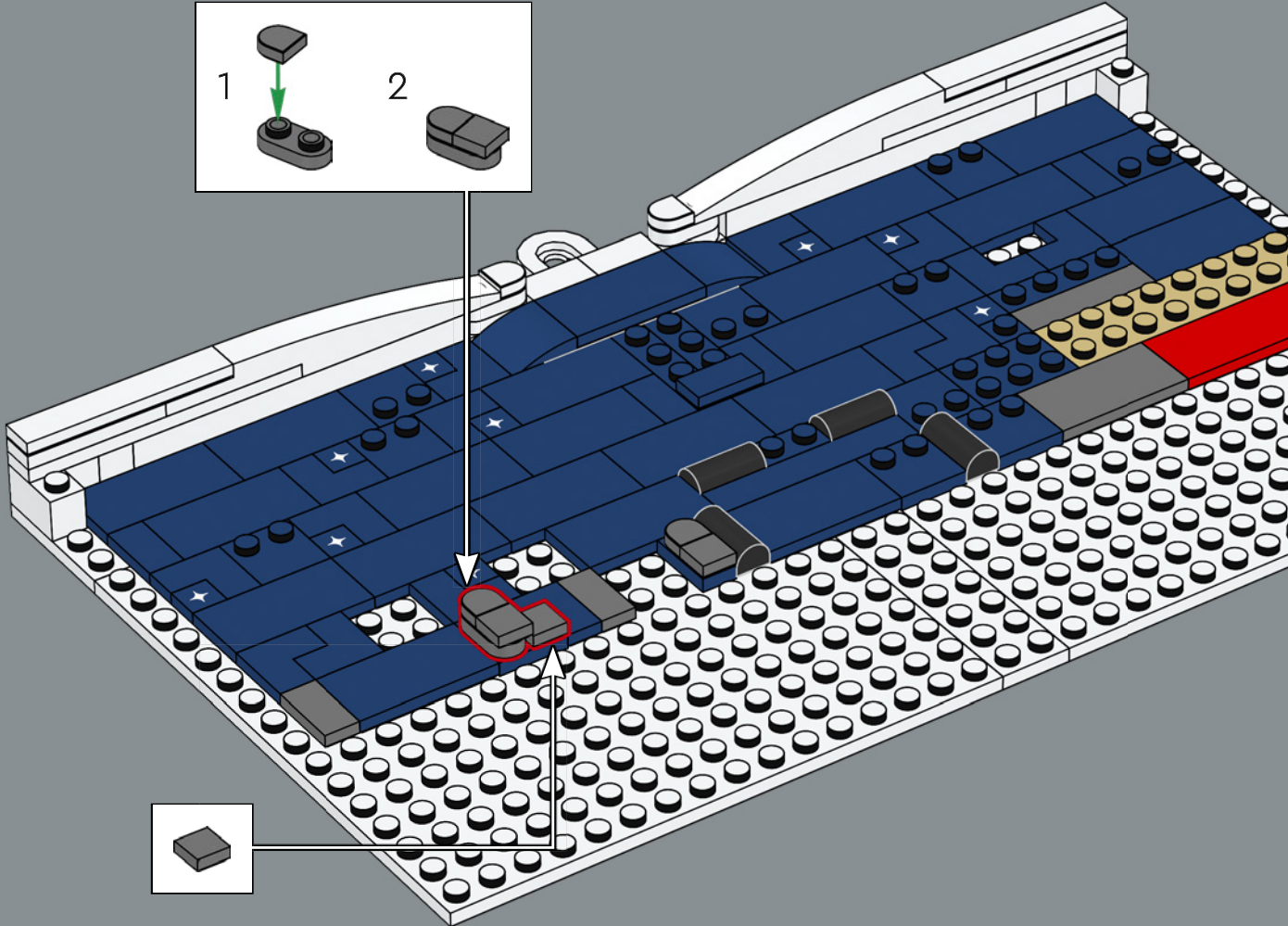
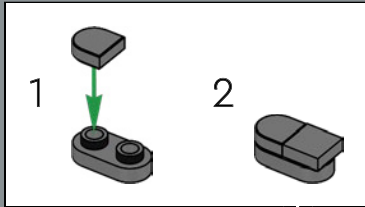

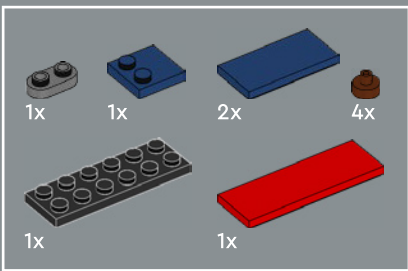

21

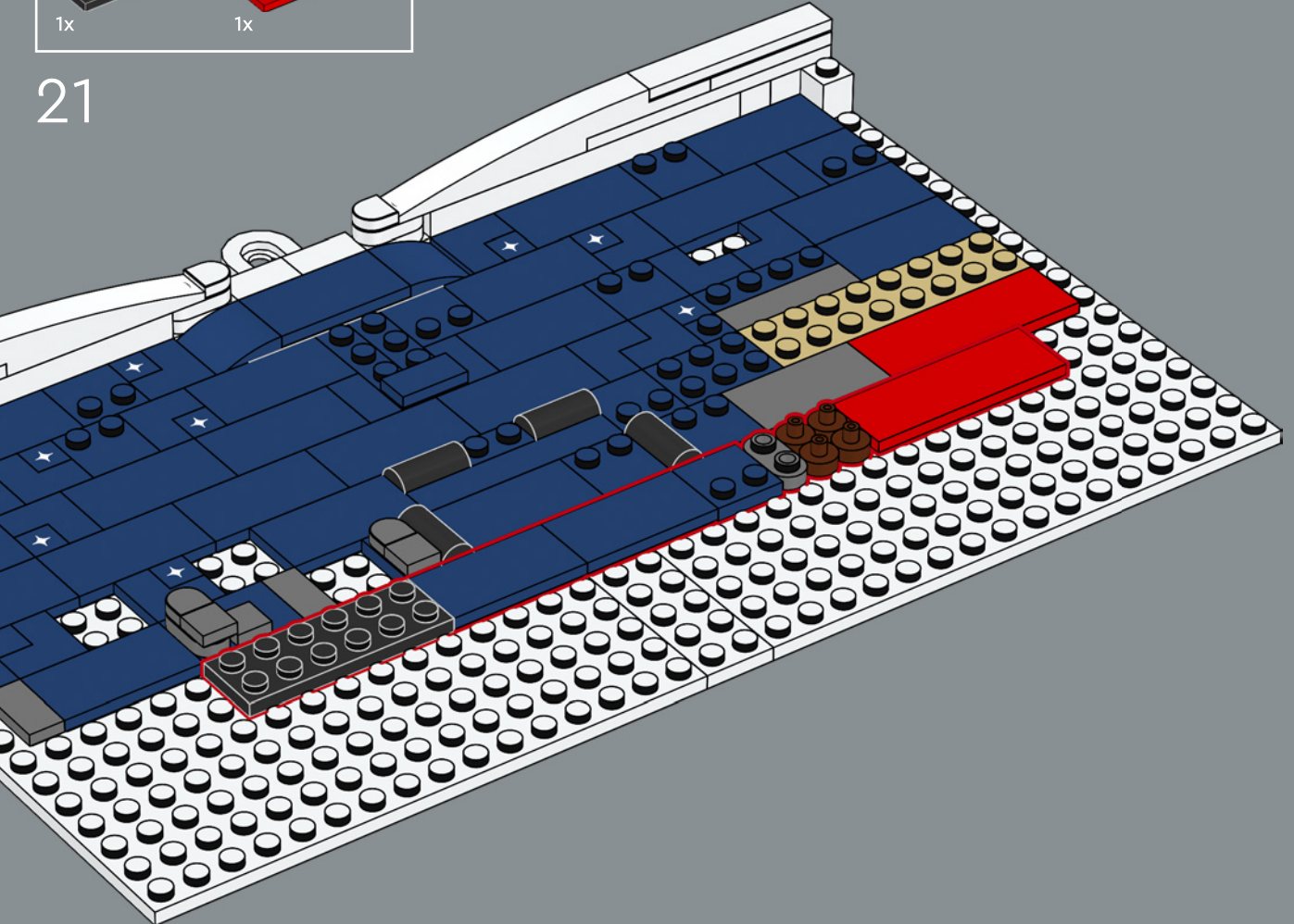

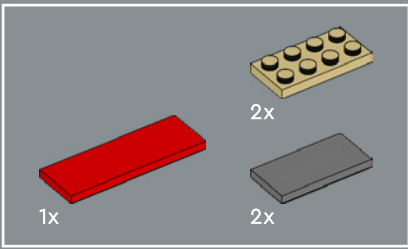

22

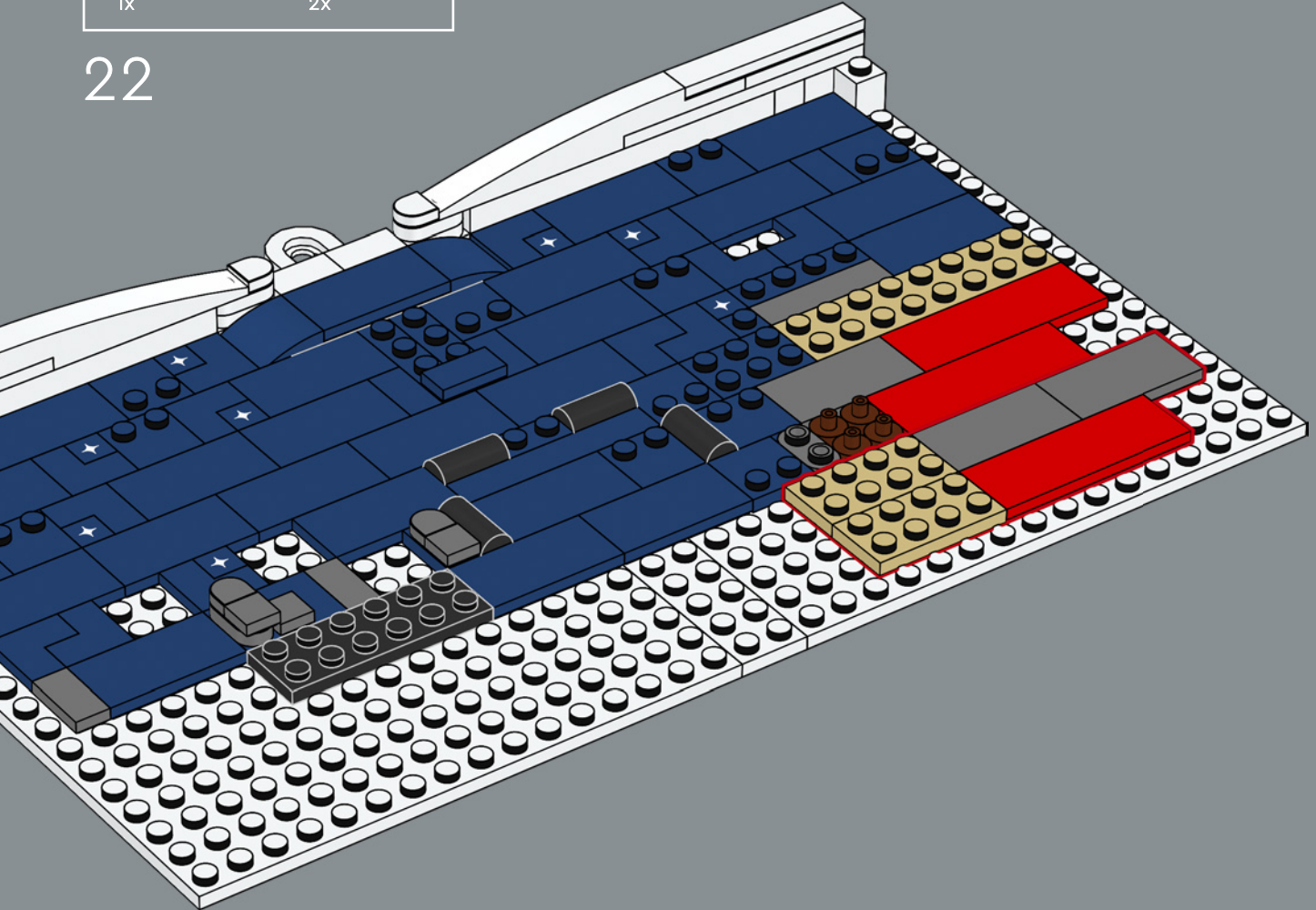

La ricca storia architettonica della città è testimoniata da edifici che risalgono all'epoca romana.

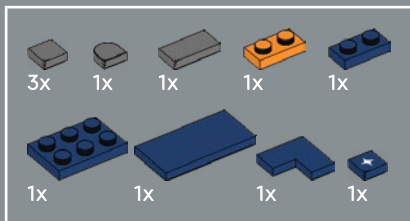

23

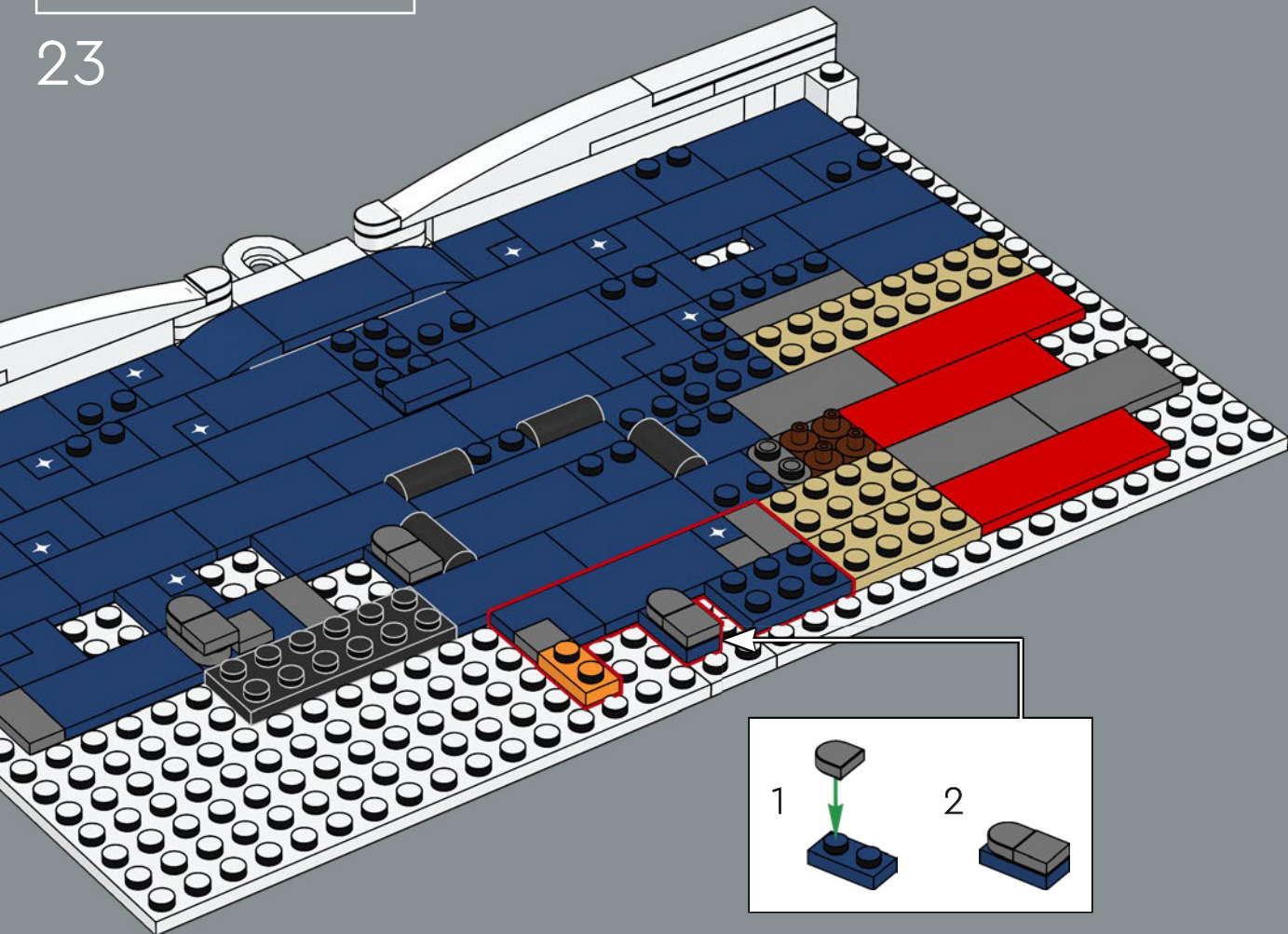

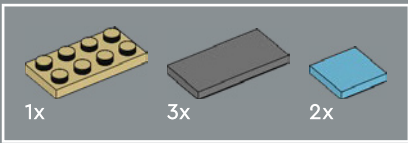

24

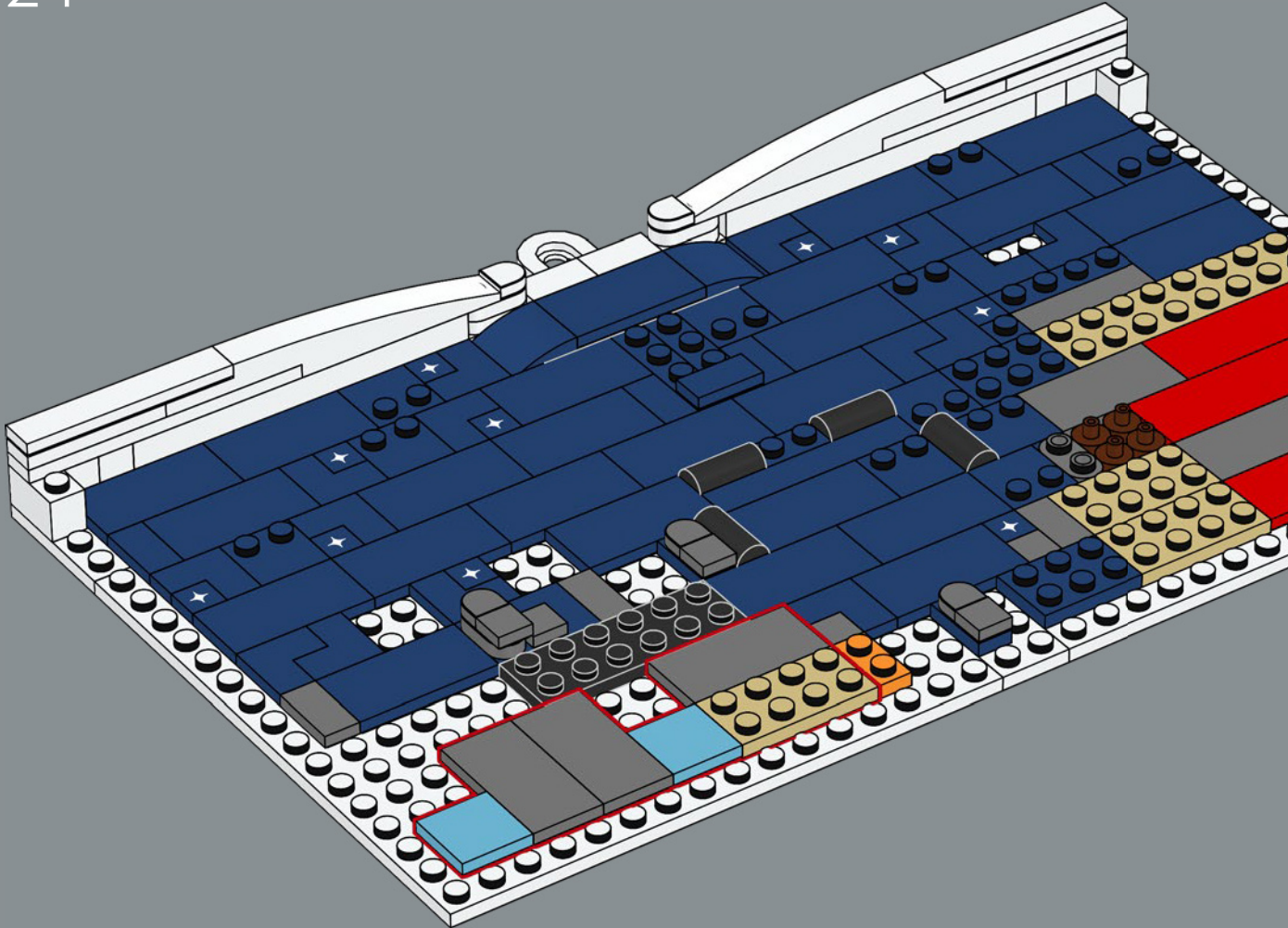

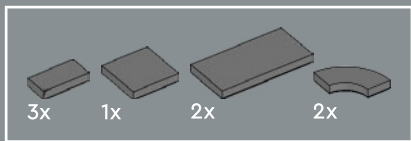

25

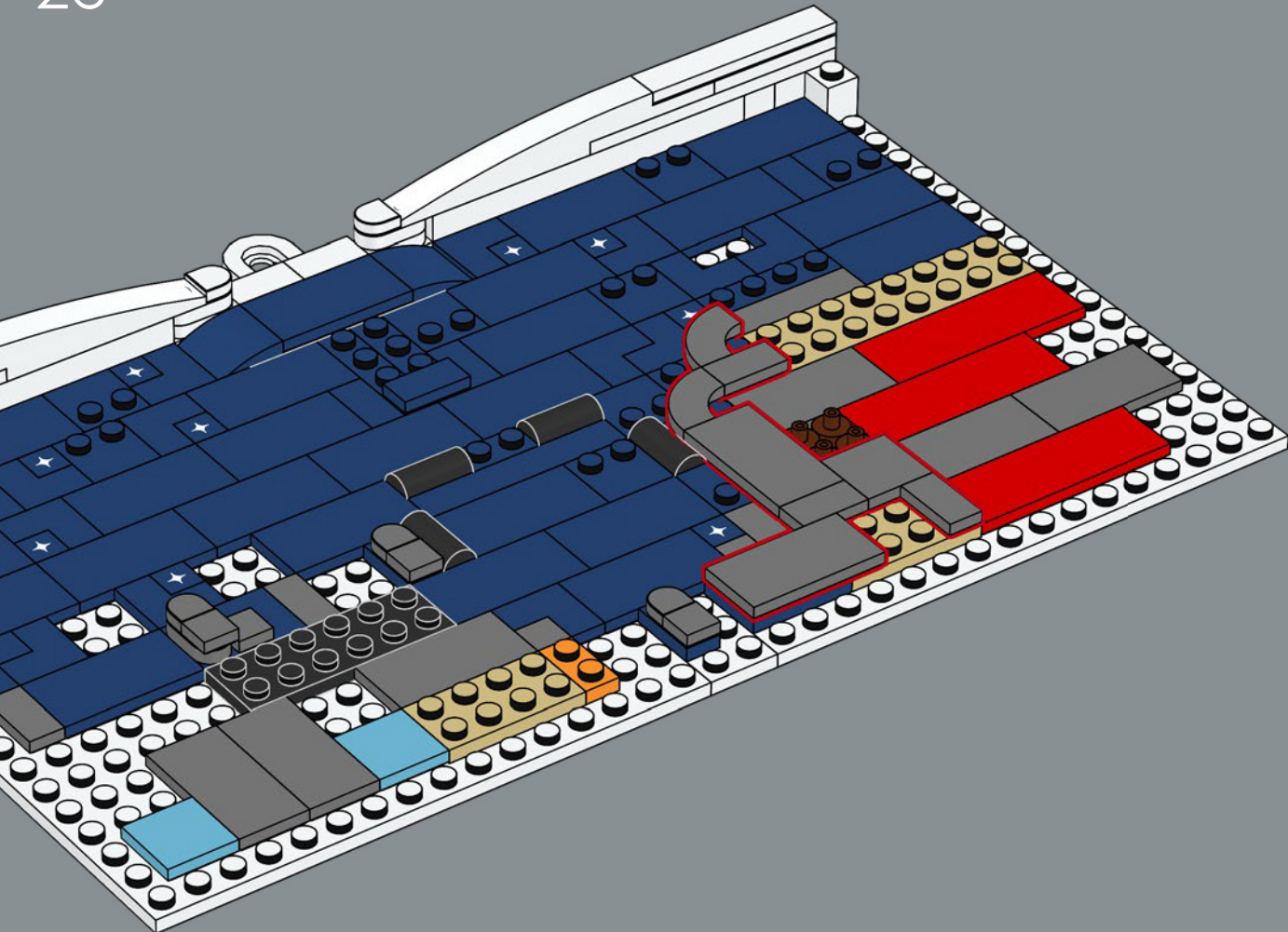

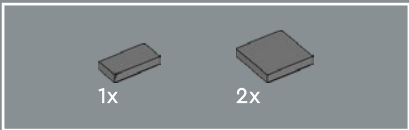

26

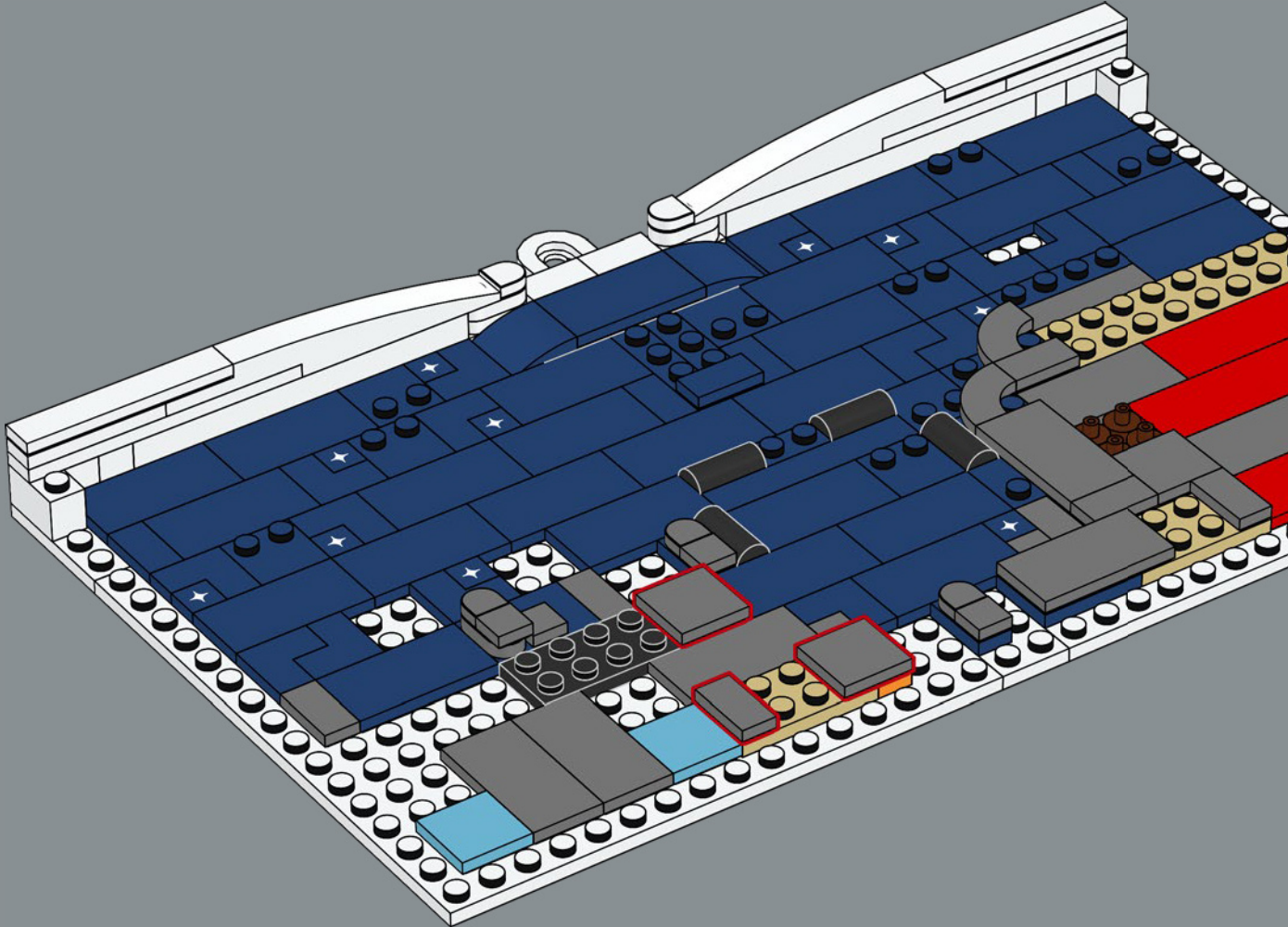

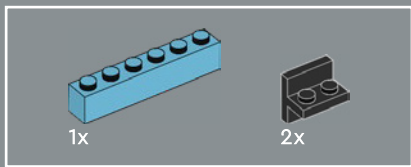

27

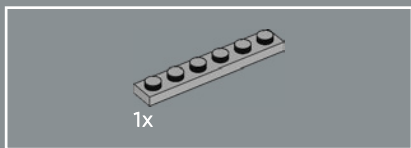
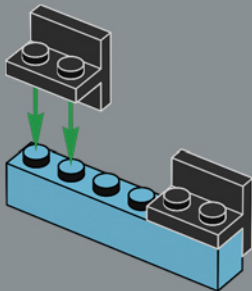

28

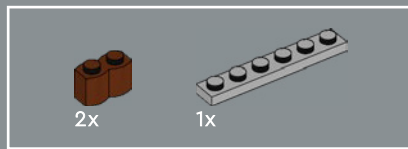
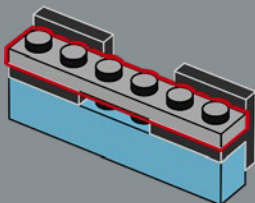

29

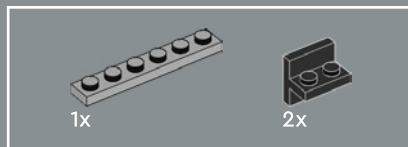
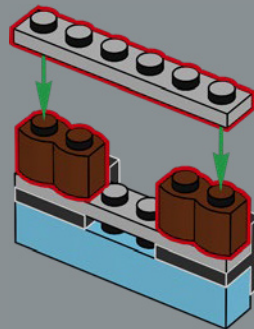

30

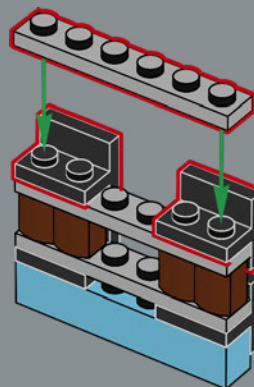

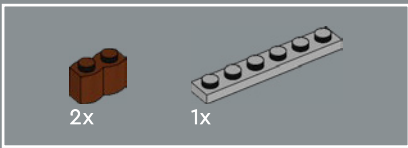

31

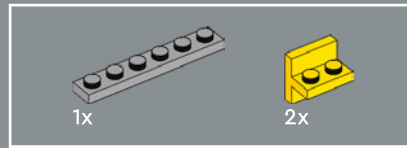
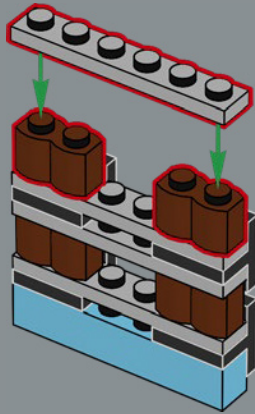

33

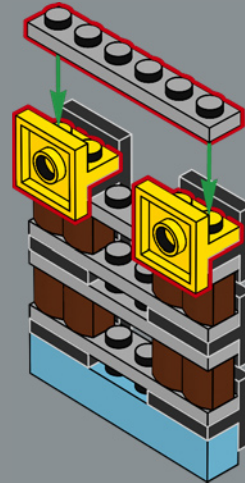

32

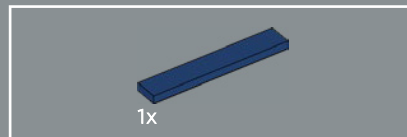
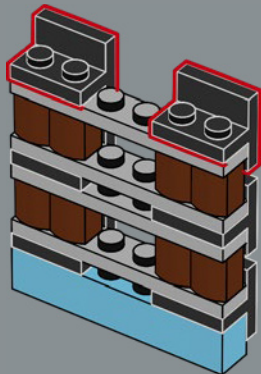

34

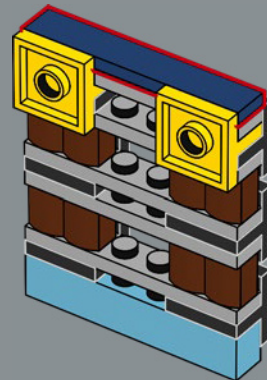

35

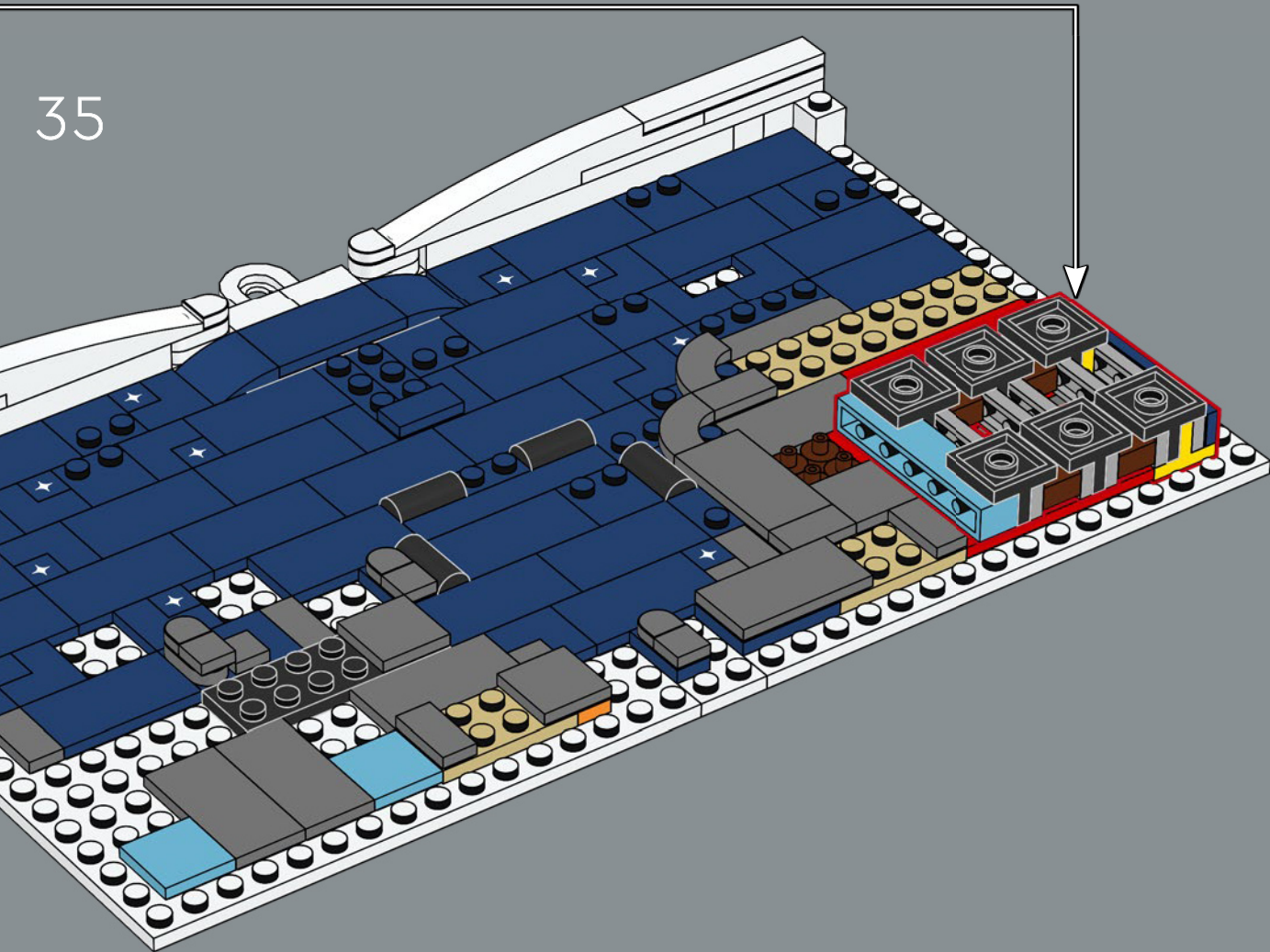

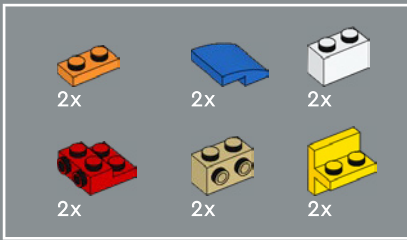

36

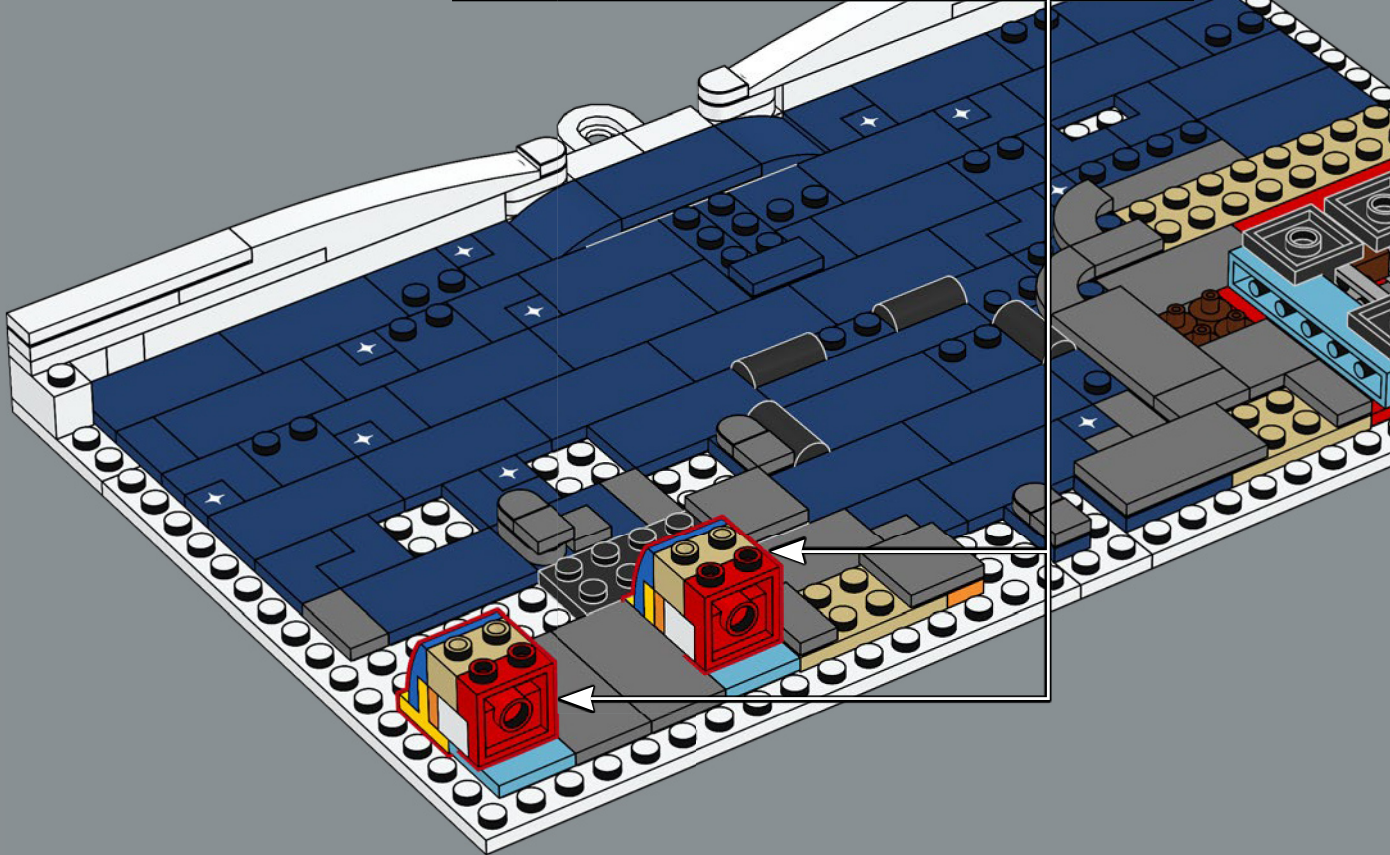
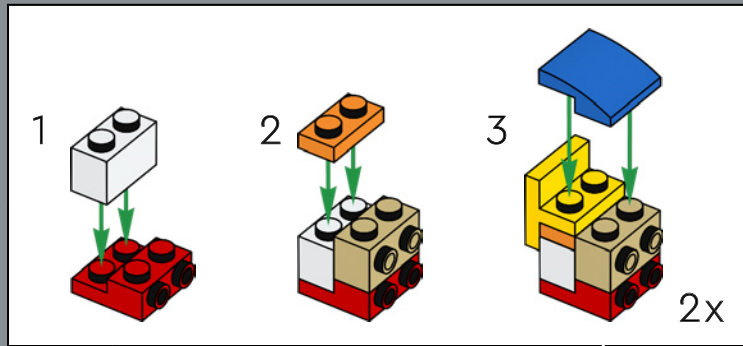

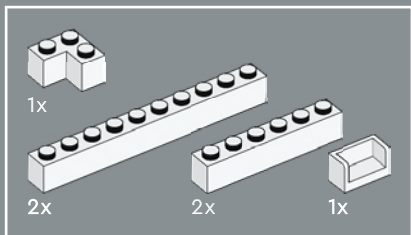

37

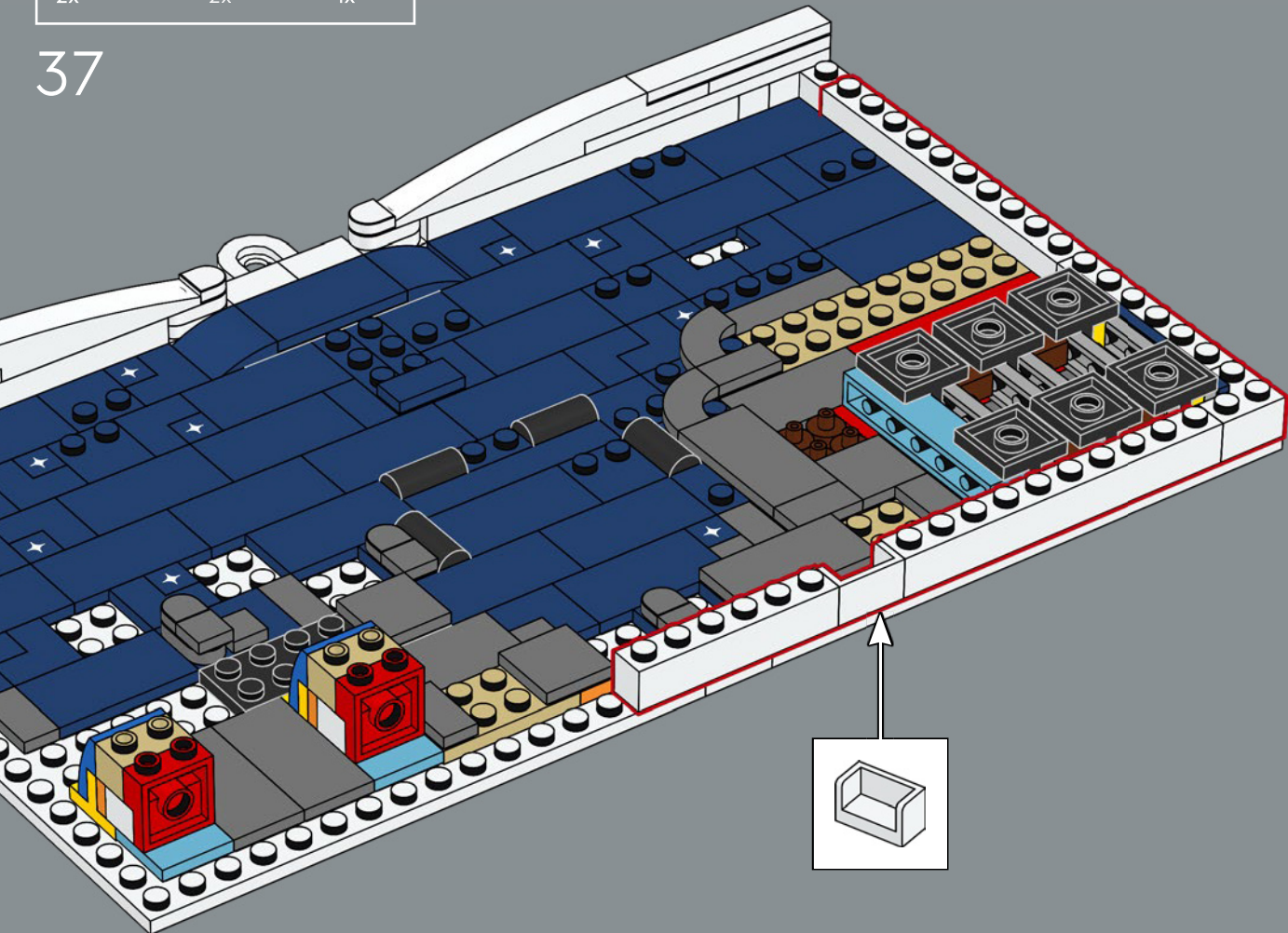

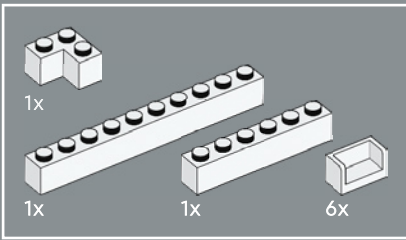

38

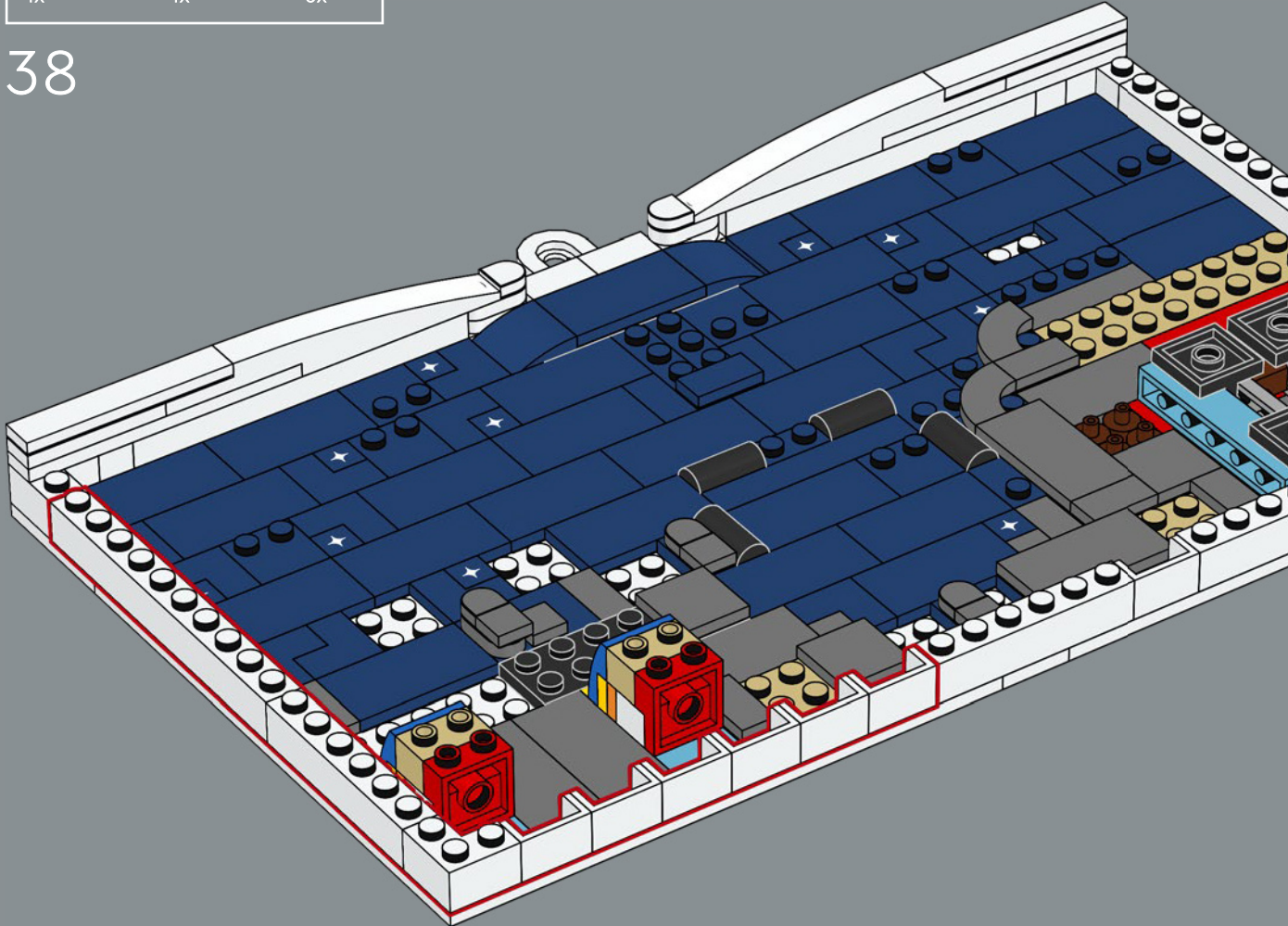

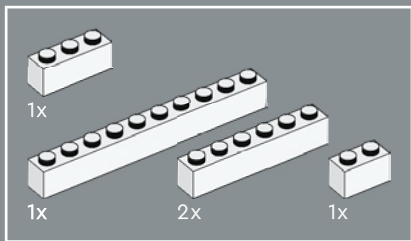

39

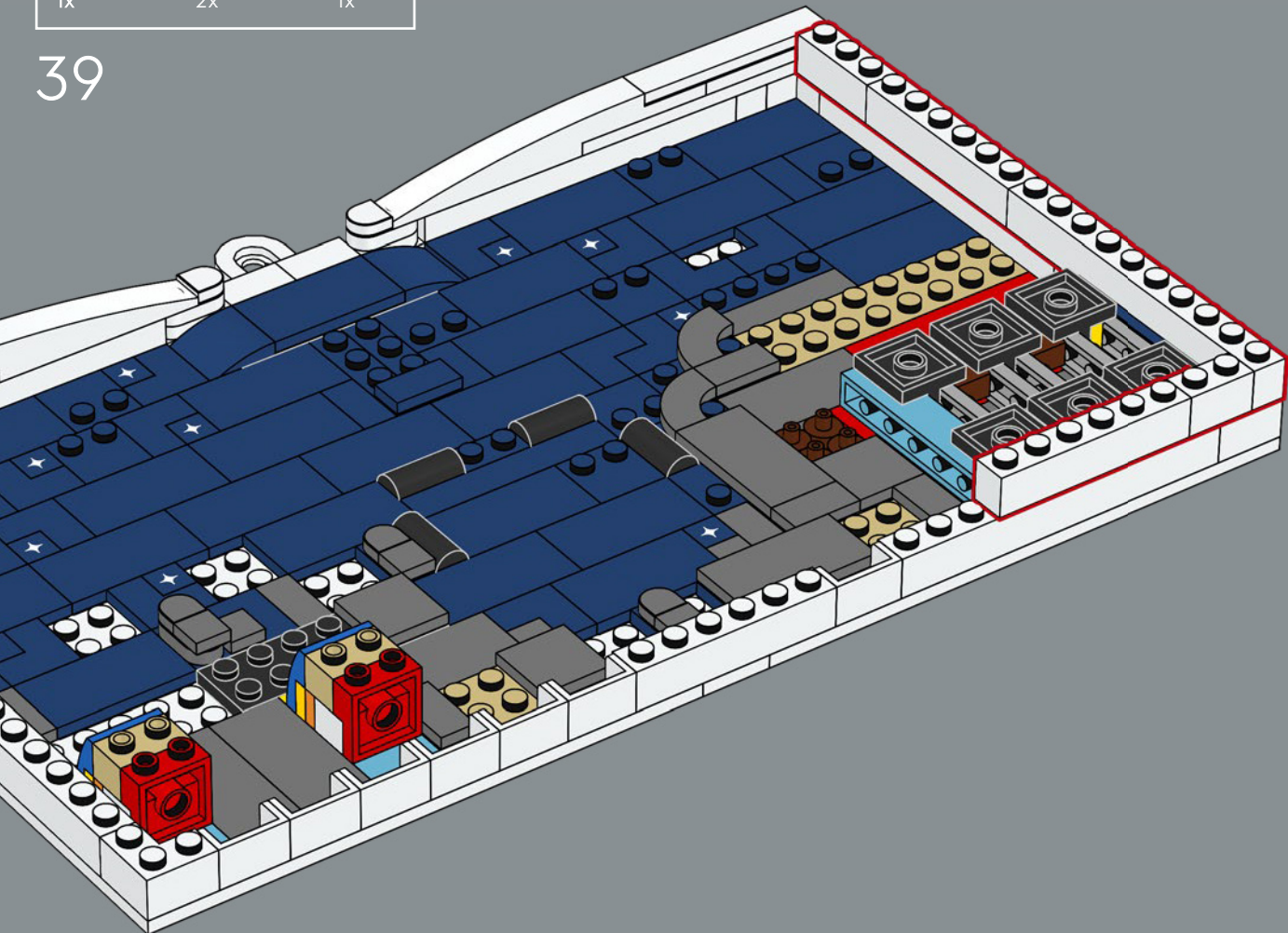

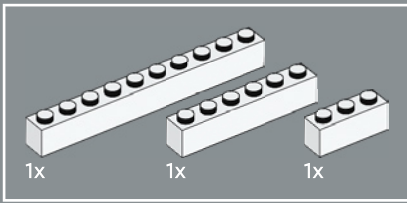

40

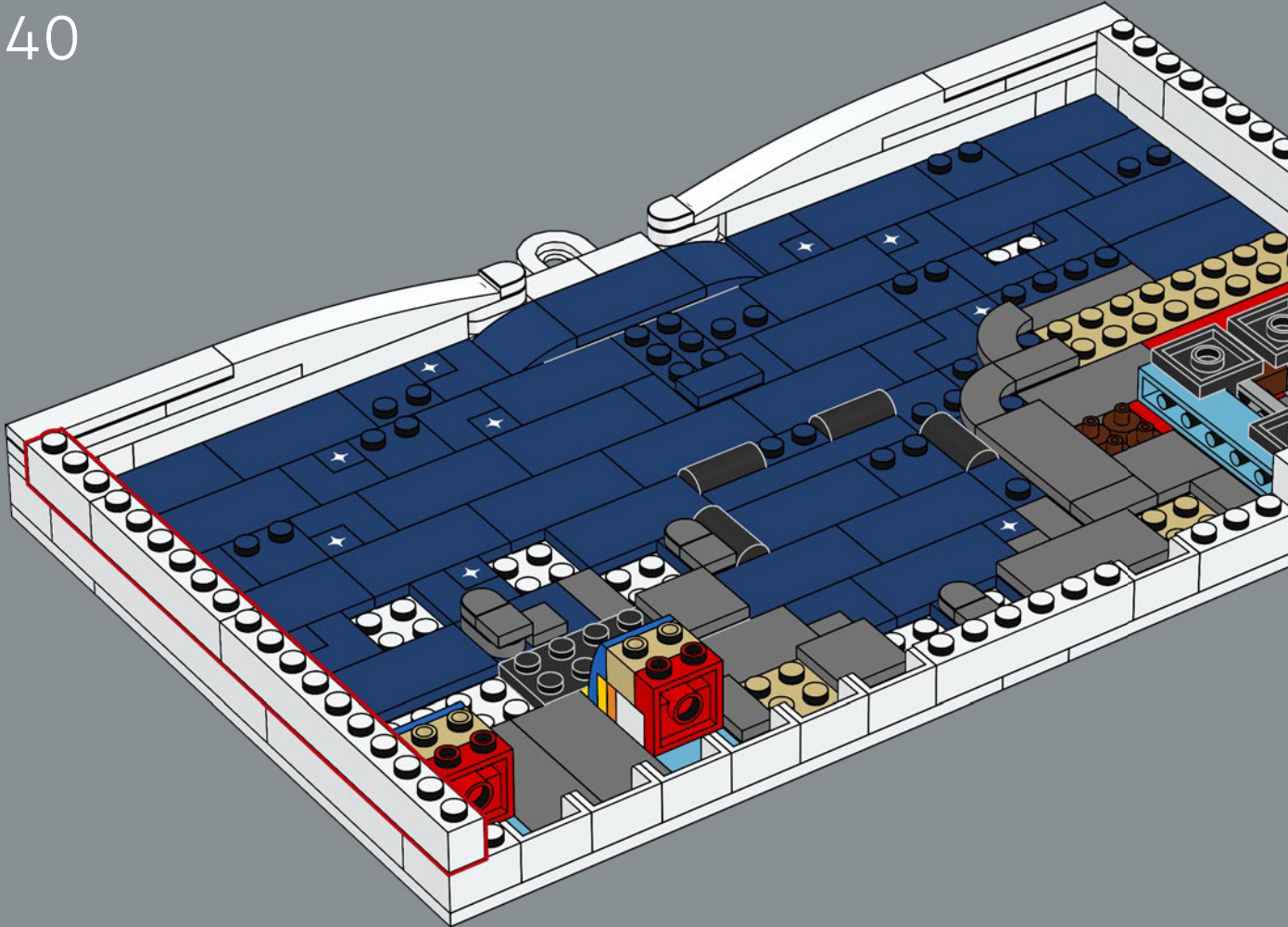

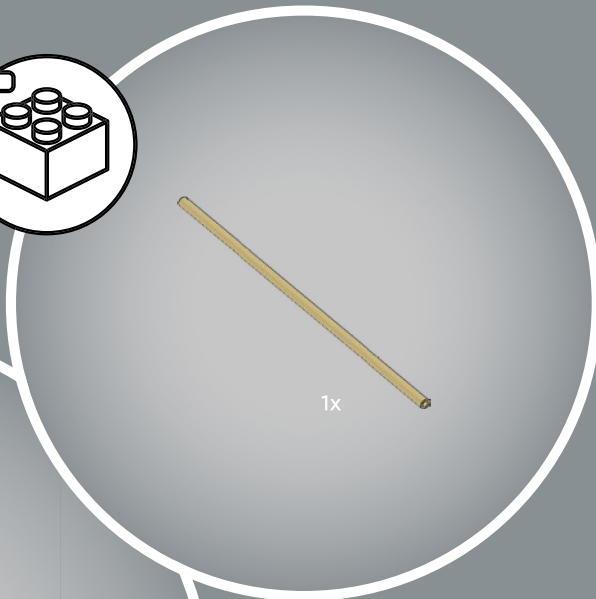
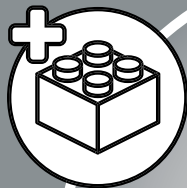

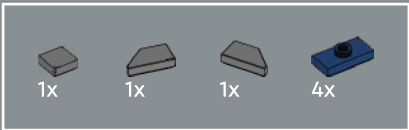

41

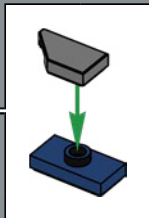
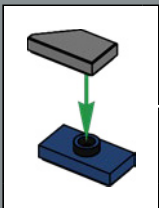
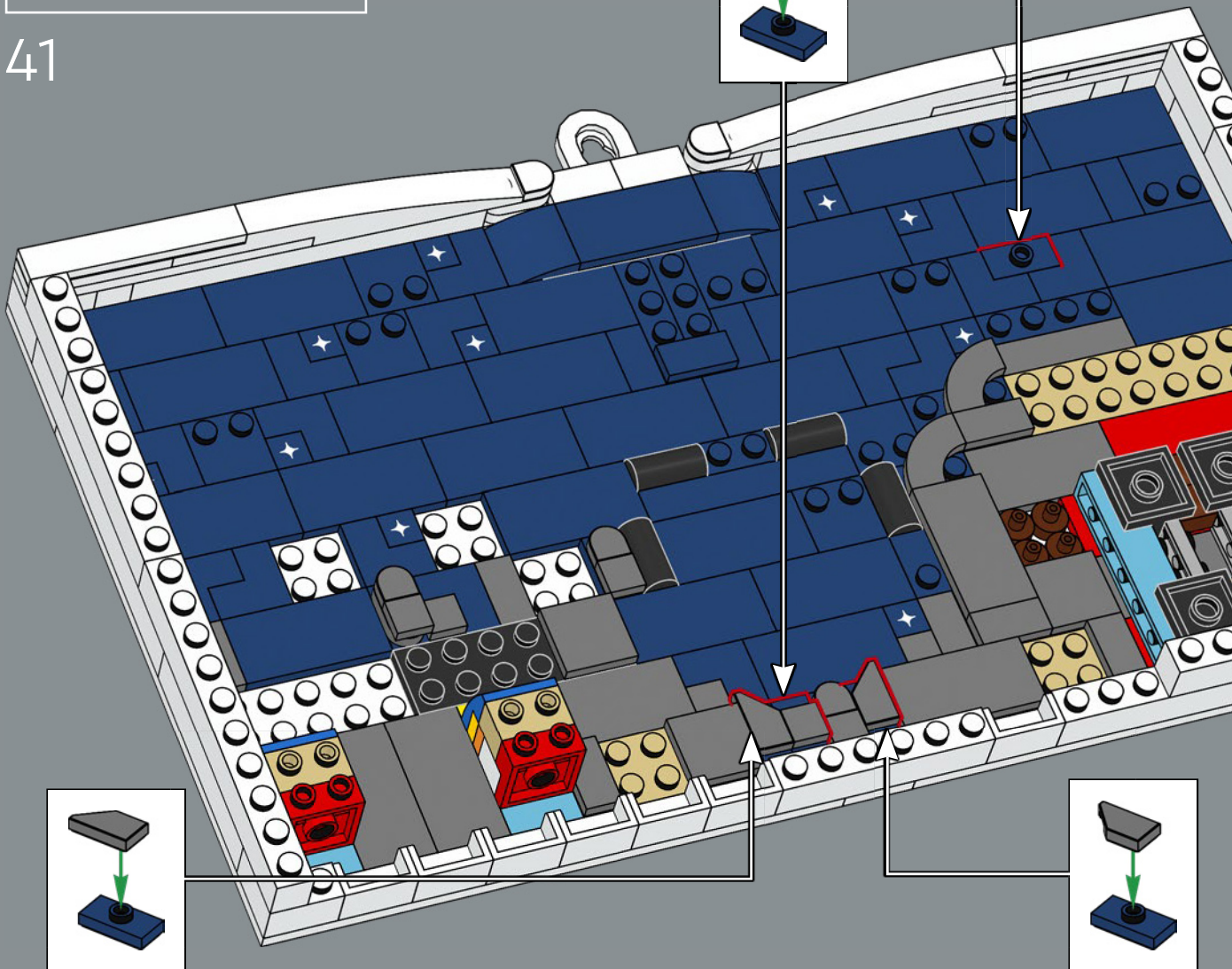
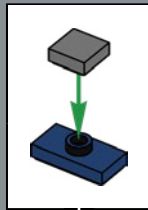

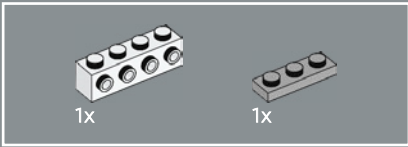
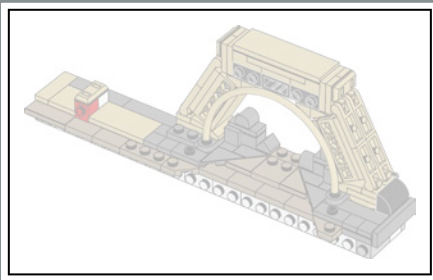

42

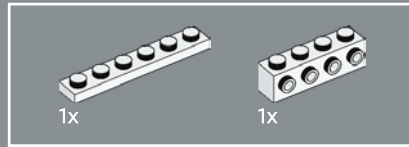
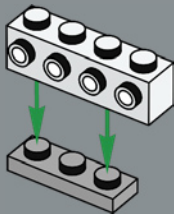

43

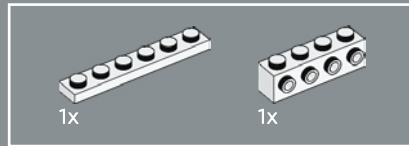
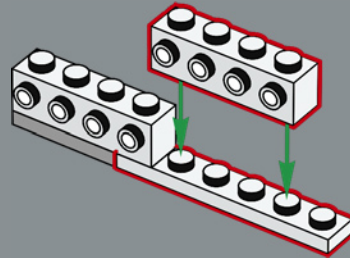

44

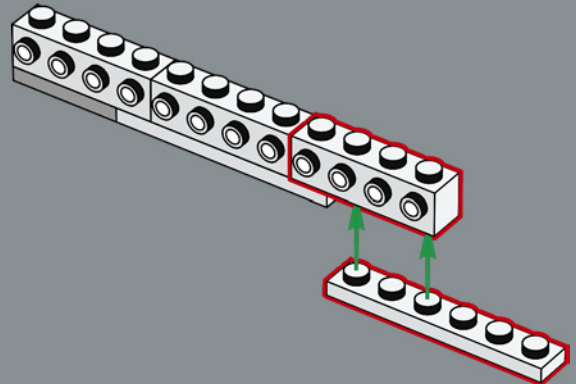

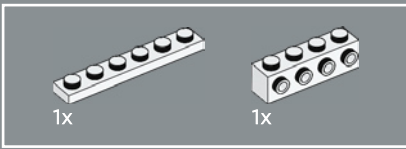

45

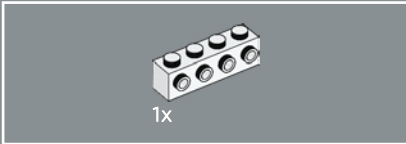
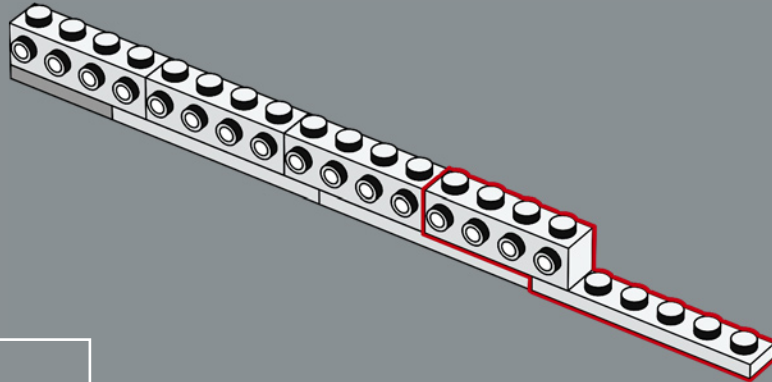

46

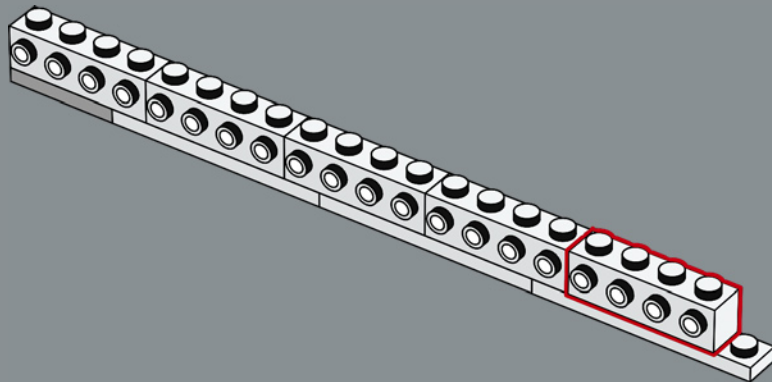

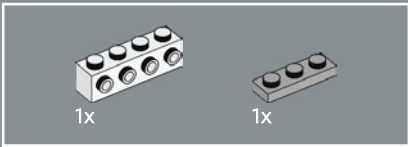

47

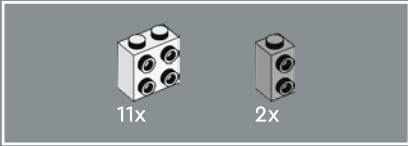
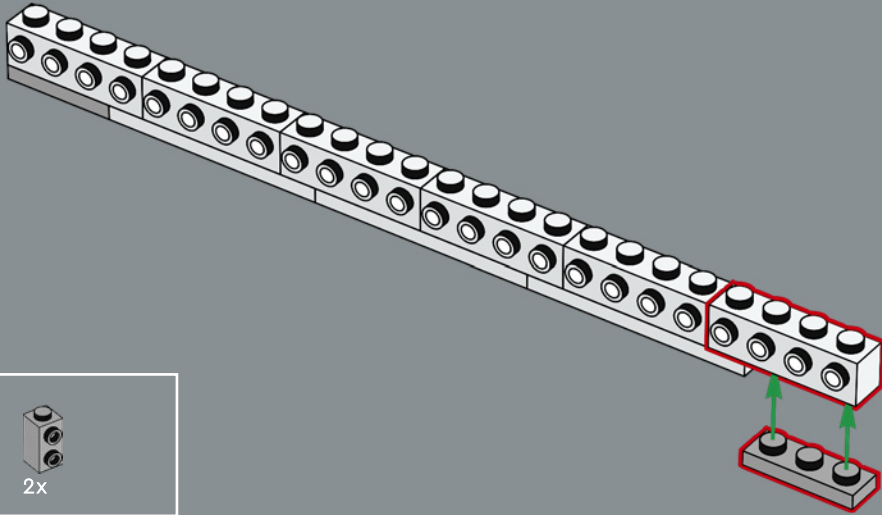

48

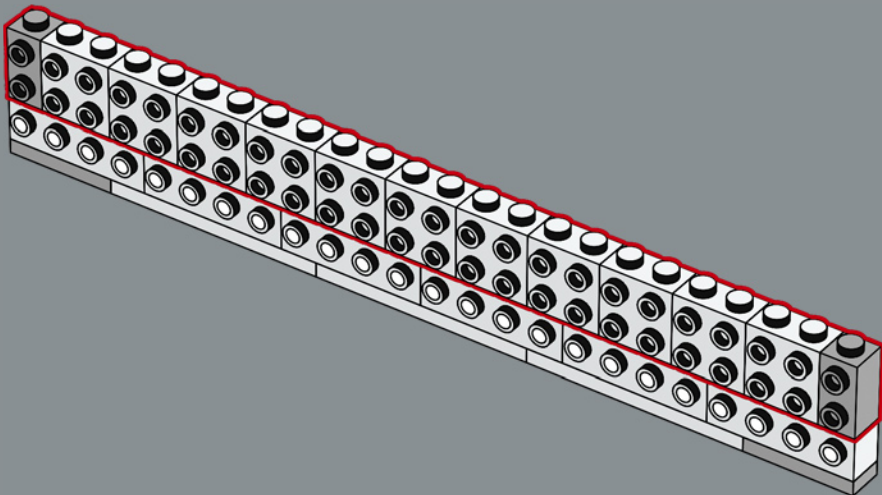

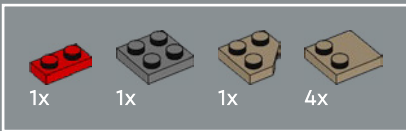

49

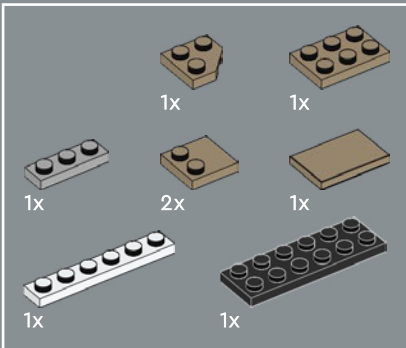
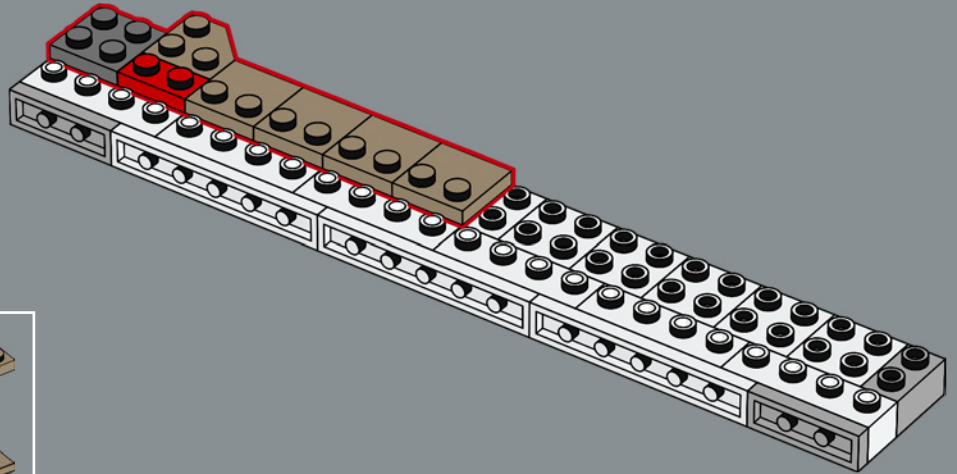

50

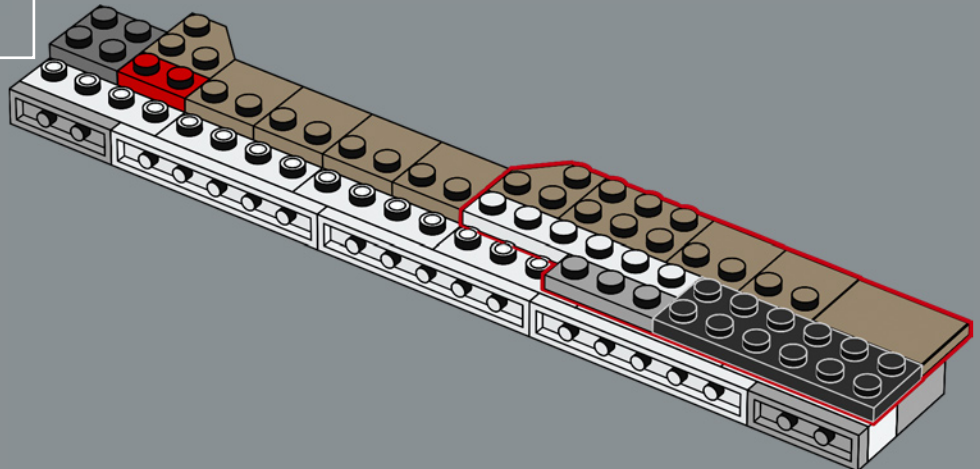

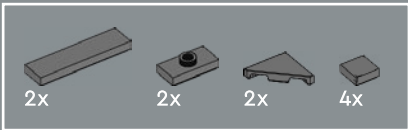

51

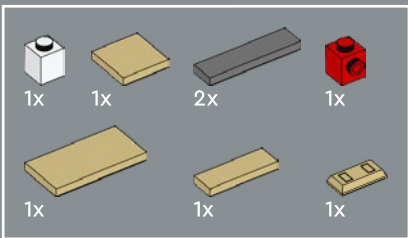
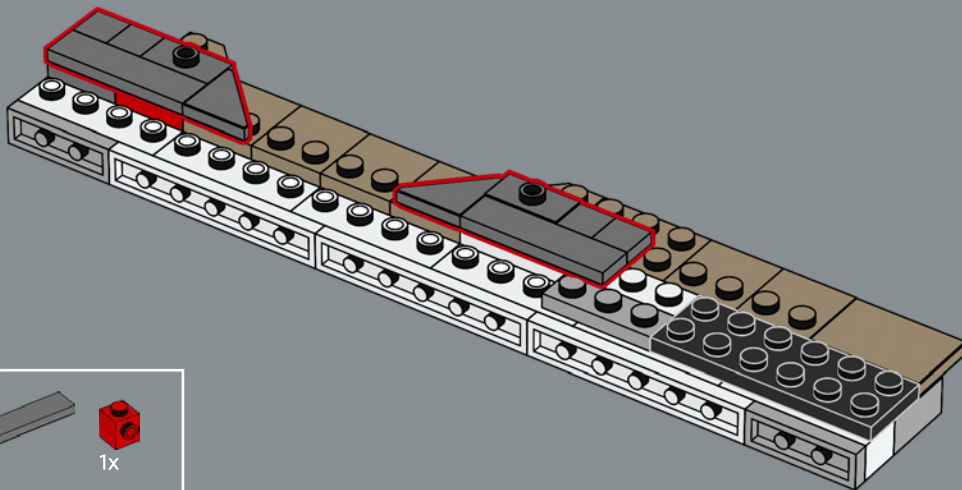

52

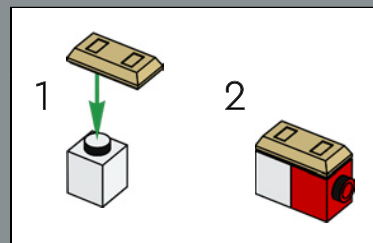
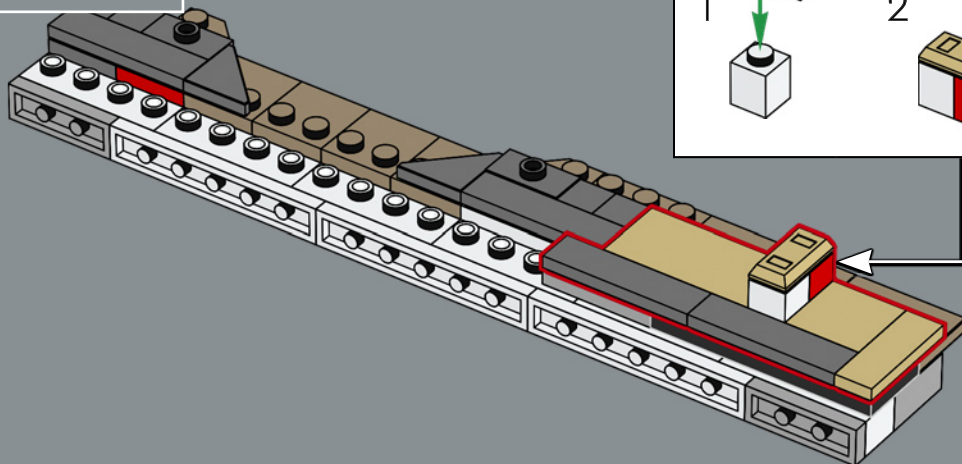

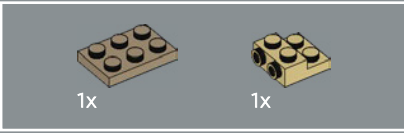
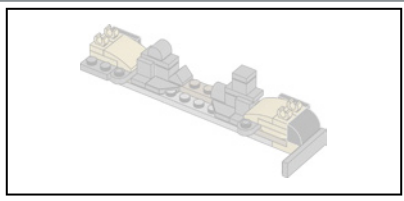

53

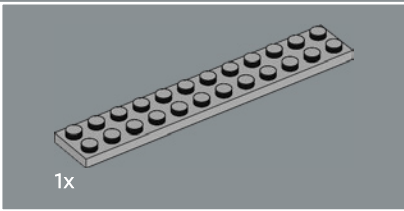
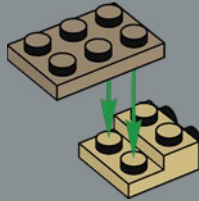

54

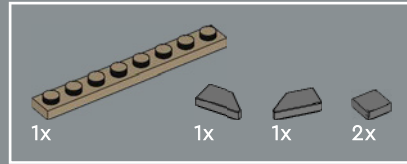
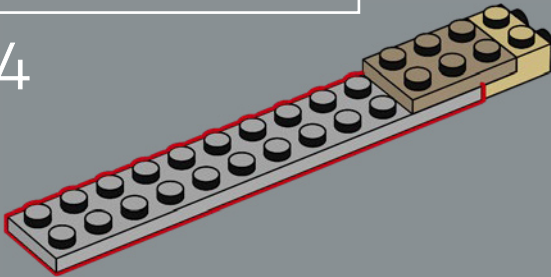

55

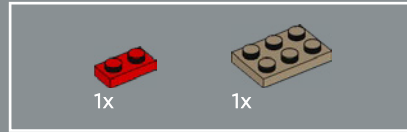
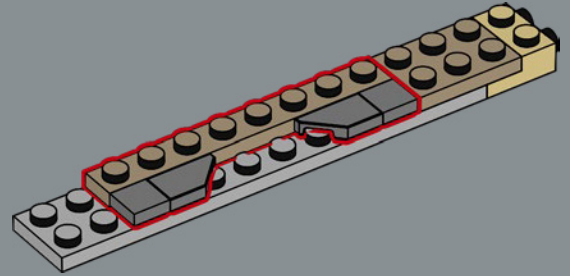

56

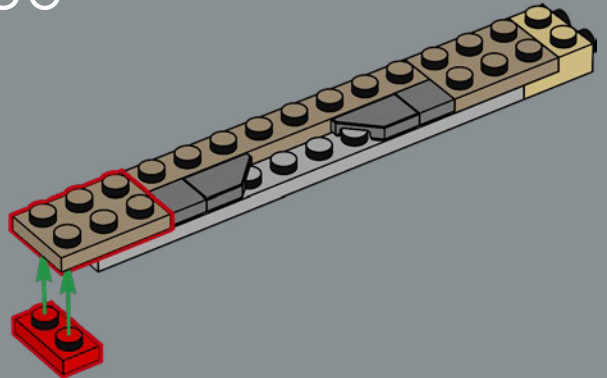

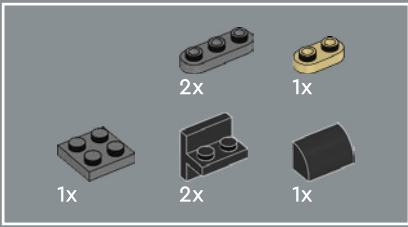

57

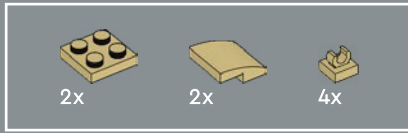
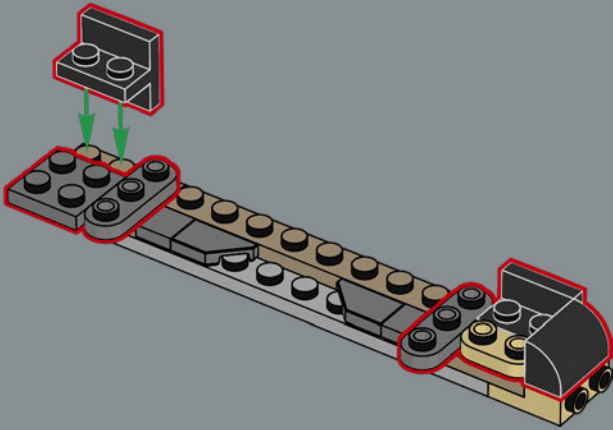

58

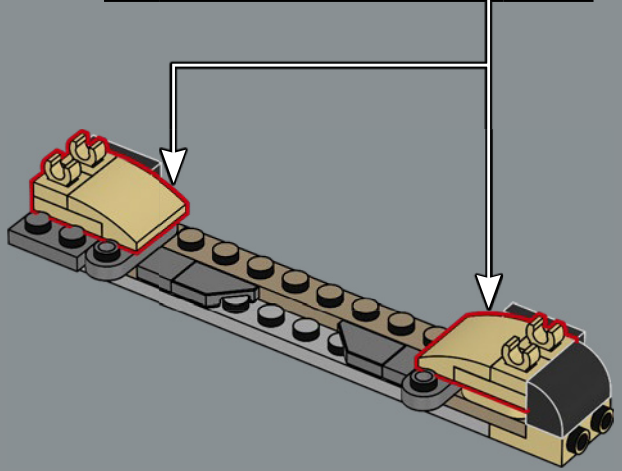
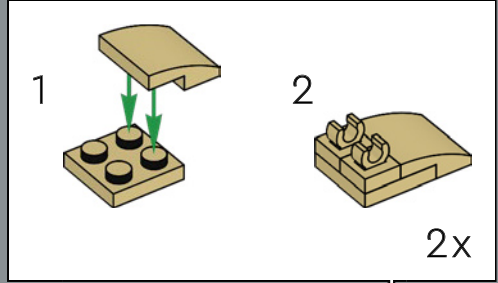

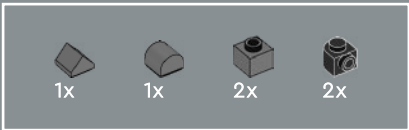

59

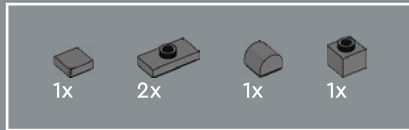
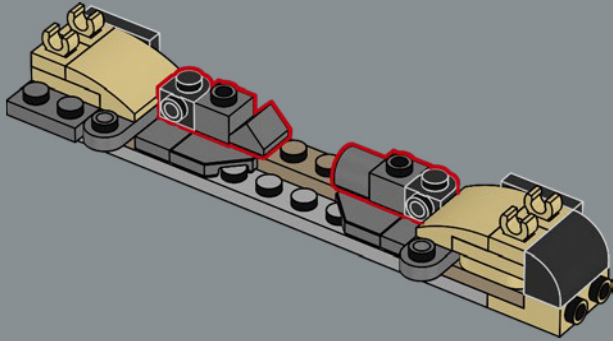

60

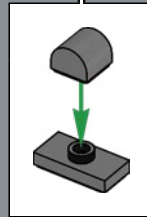
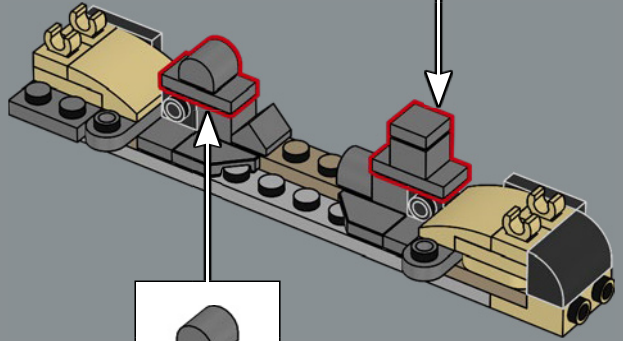
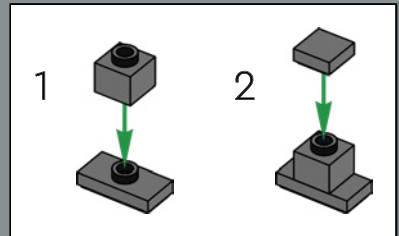

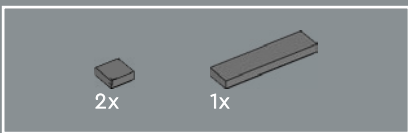

61

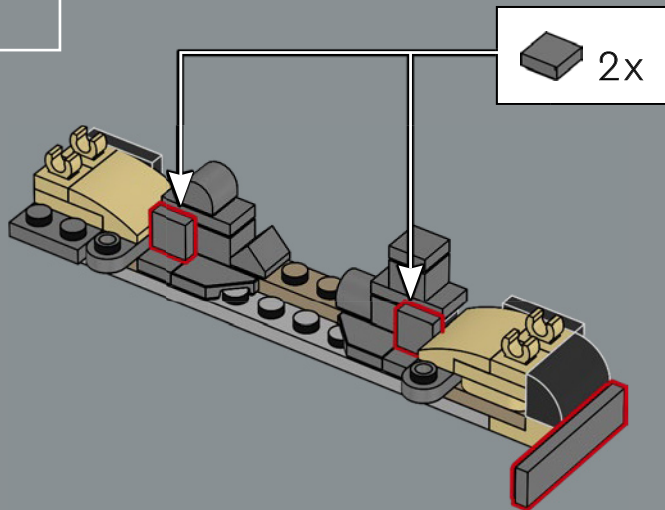

62

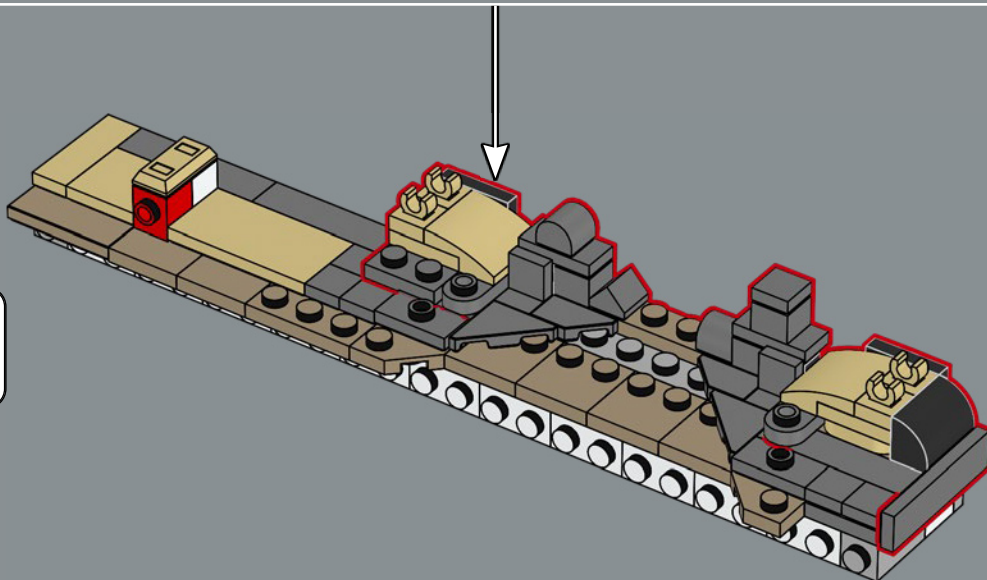

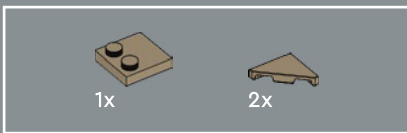

63

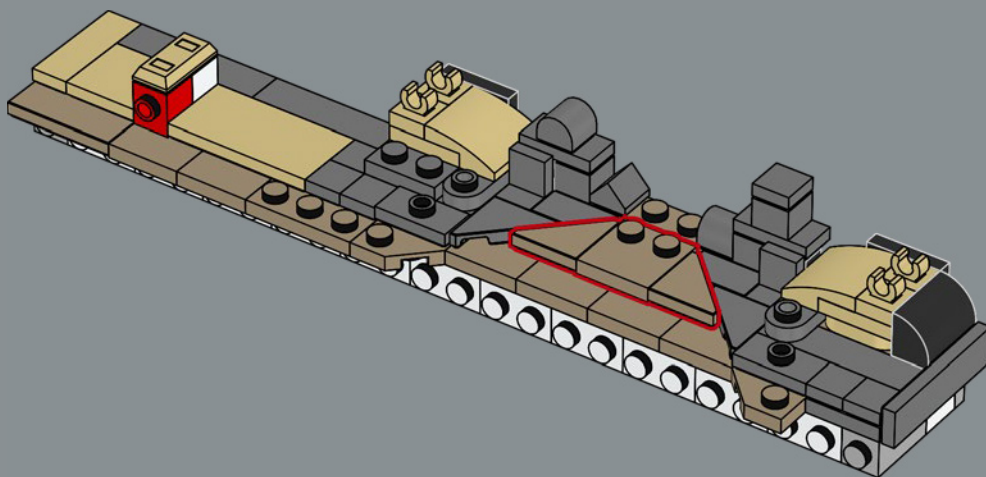

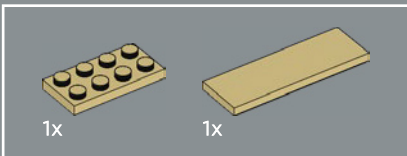
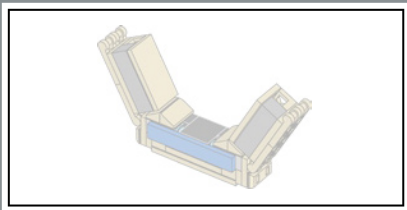

64

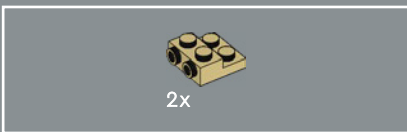
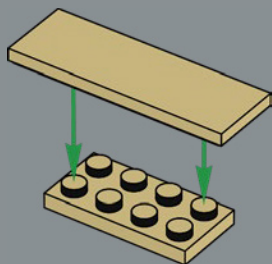

65

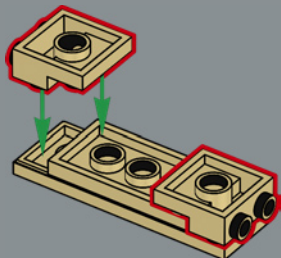

66

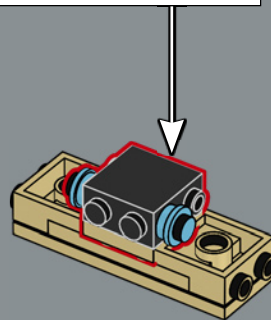
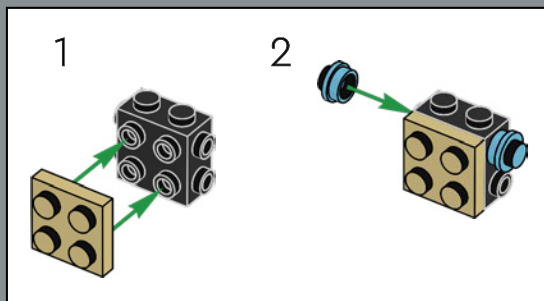

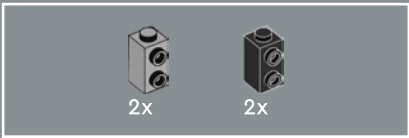

67

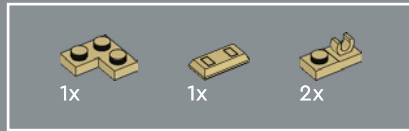
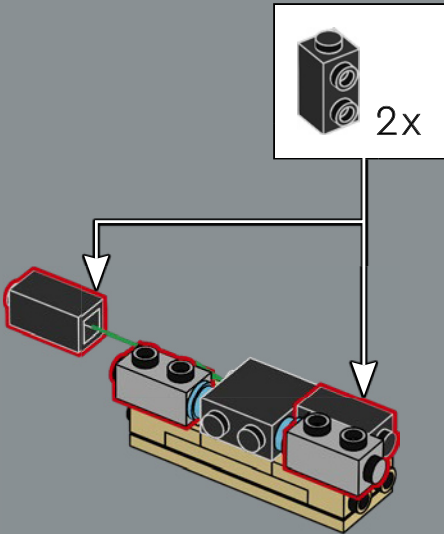

68

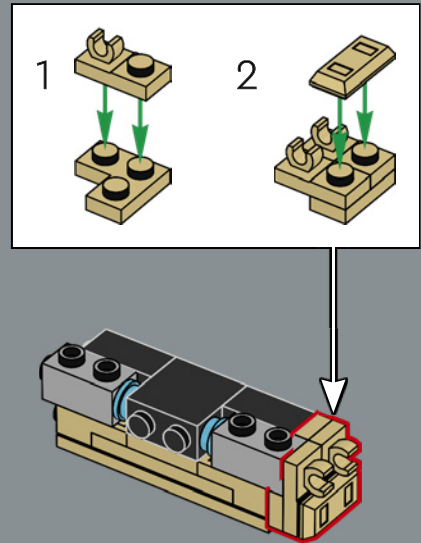

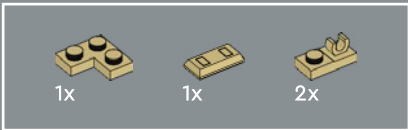

69

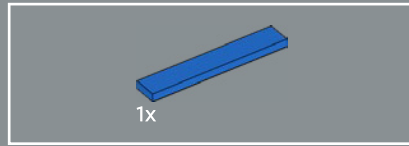
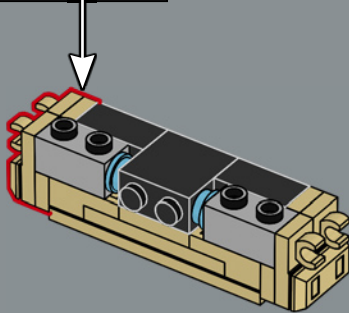
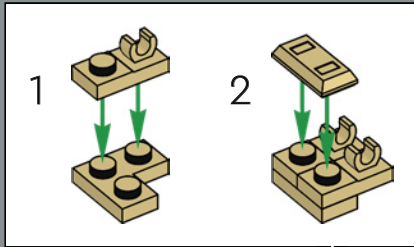

70

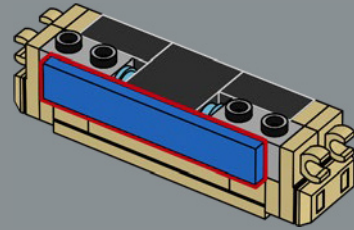

71

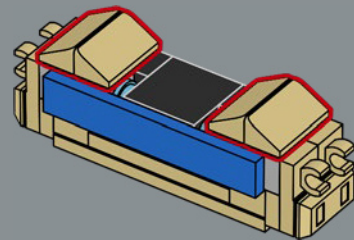

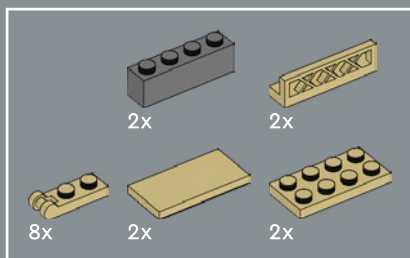

72

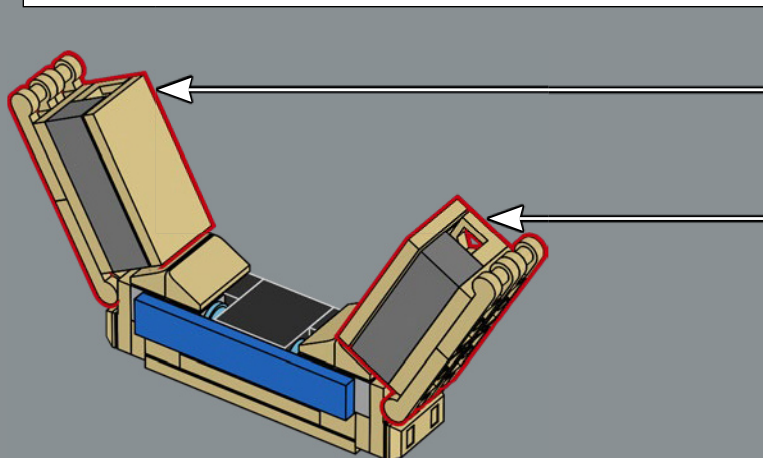
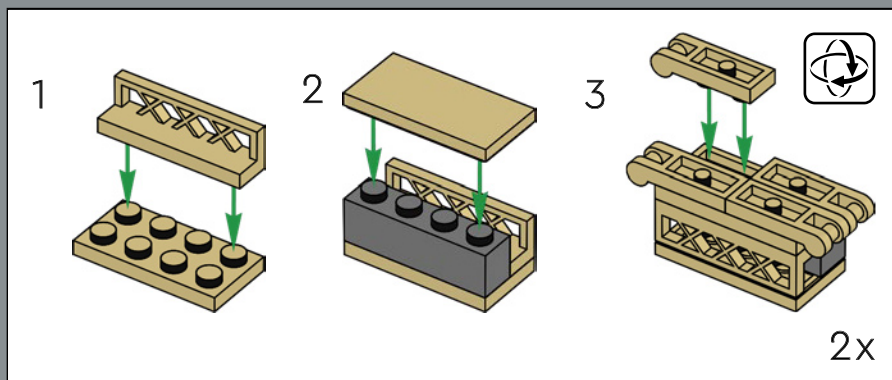

L'elemento recinto 1x4, introdotto per la prima volta nel 1976, rappresenta un classico esempio di architettura del ferro.

73

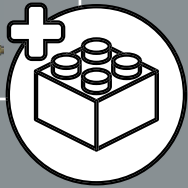
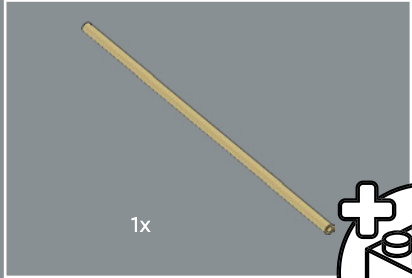
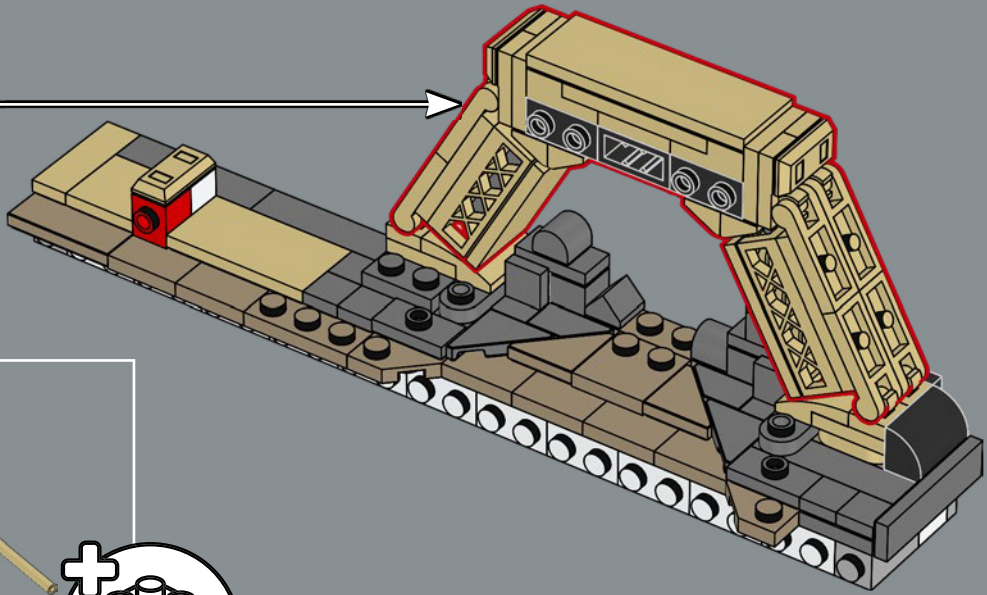

74

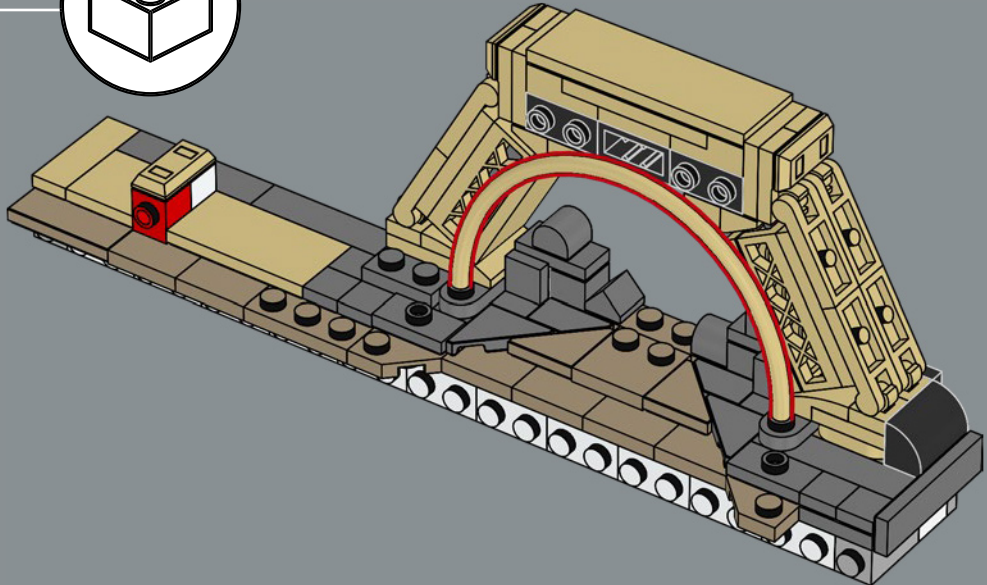

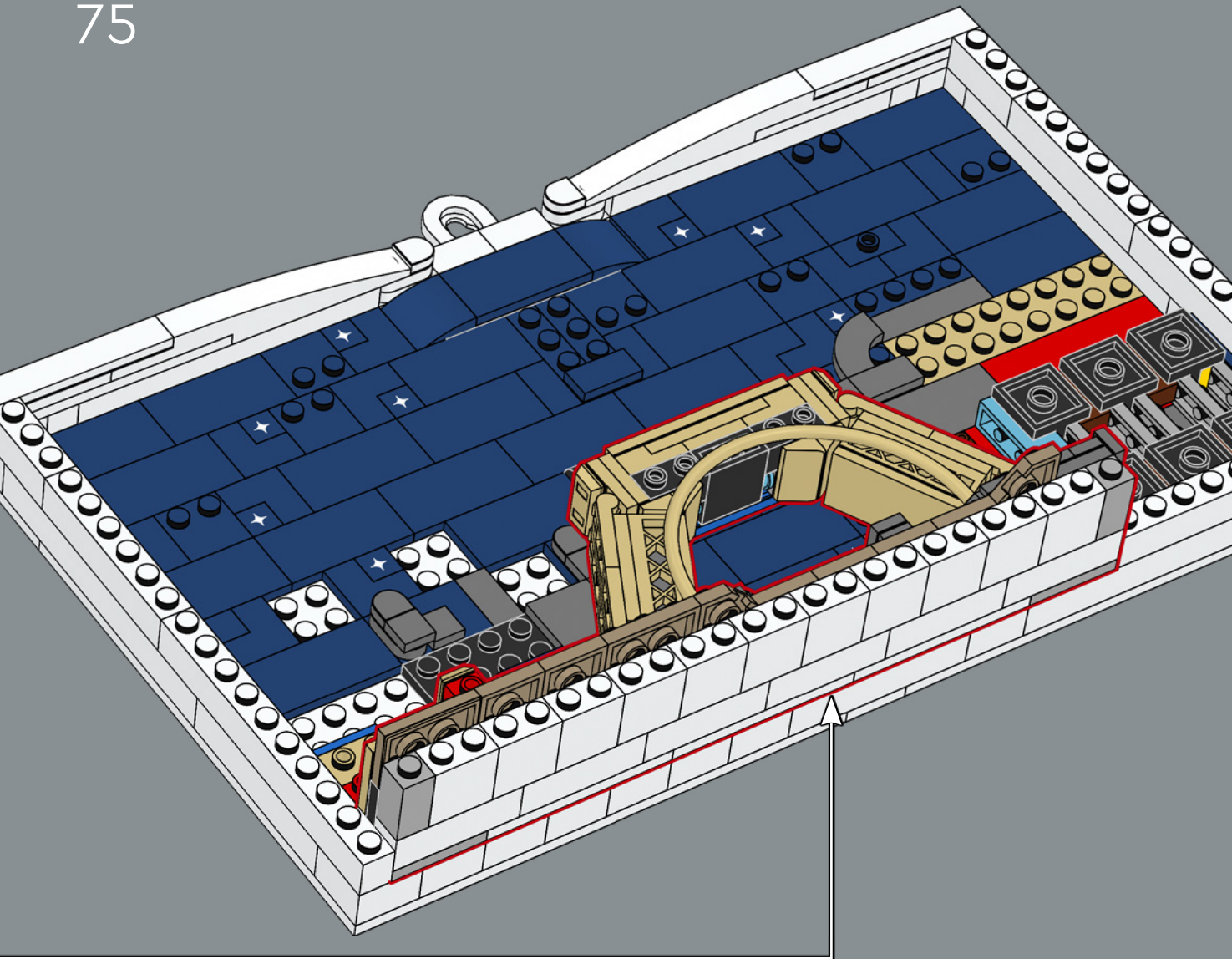



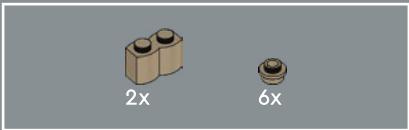

76

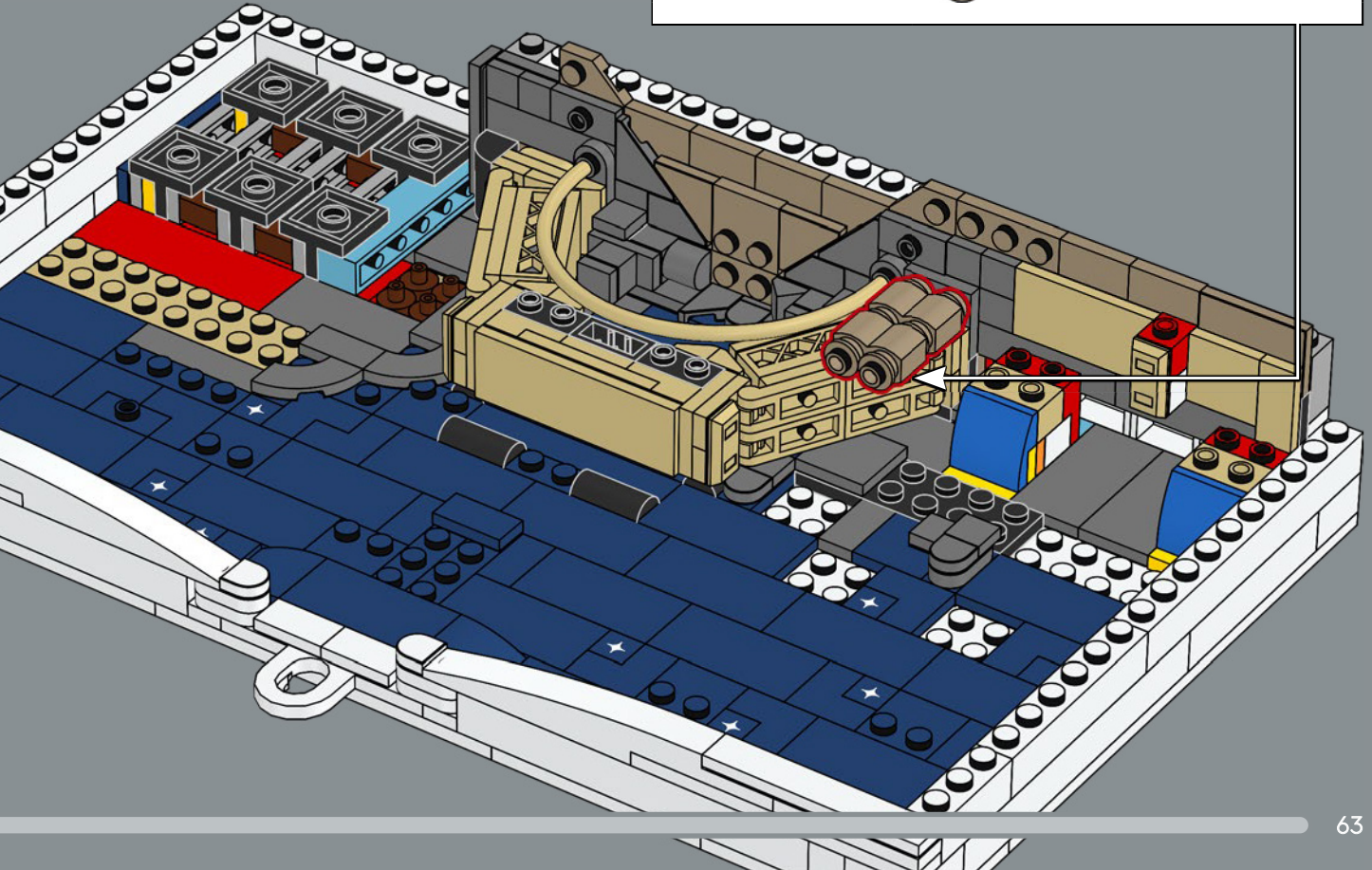
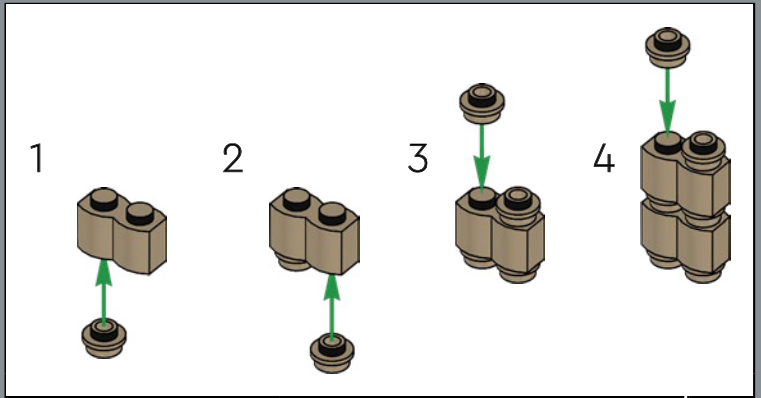

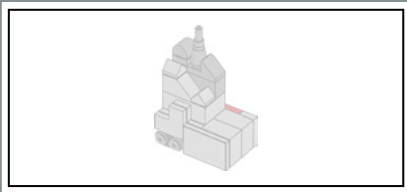

77

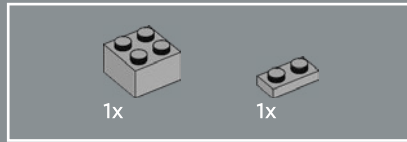
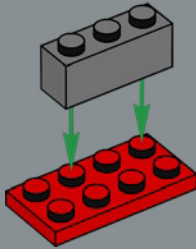

78

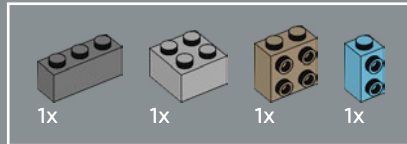
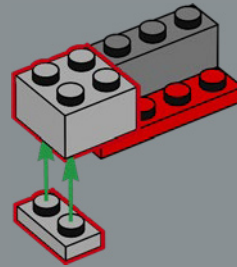

79

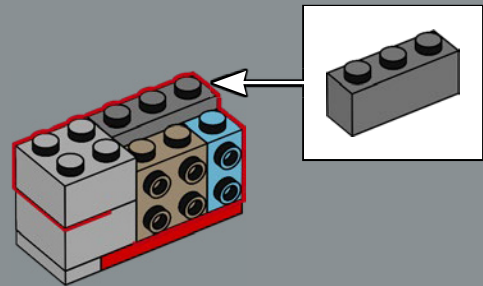

I classici mattoncini LEGO® e gli elementi slope si combinano accuratamente per formare una micro-skyline.



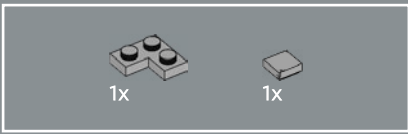

80

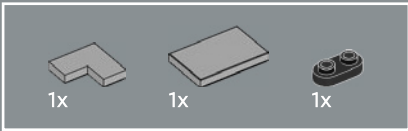
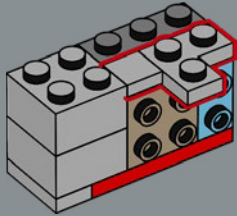

81

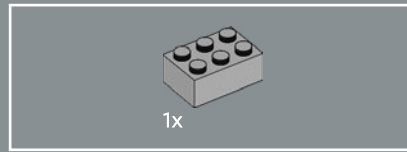
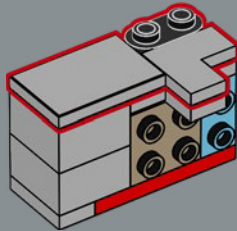

82

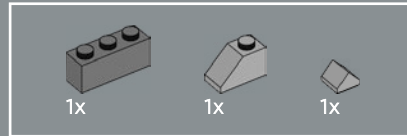
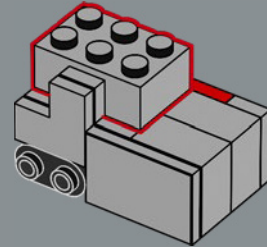

83

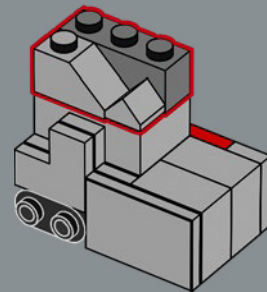

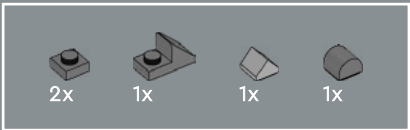

84

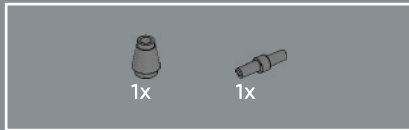
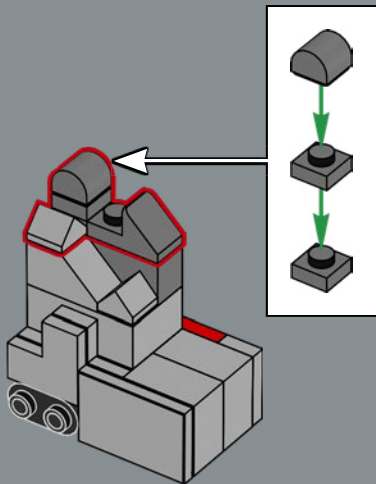

85

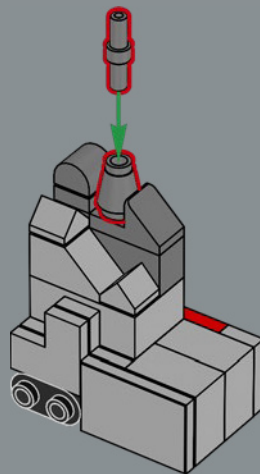

86

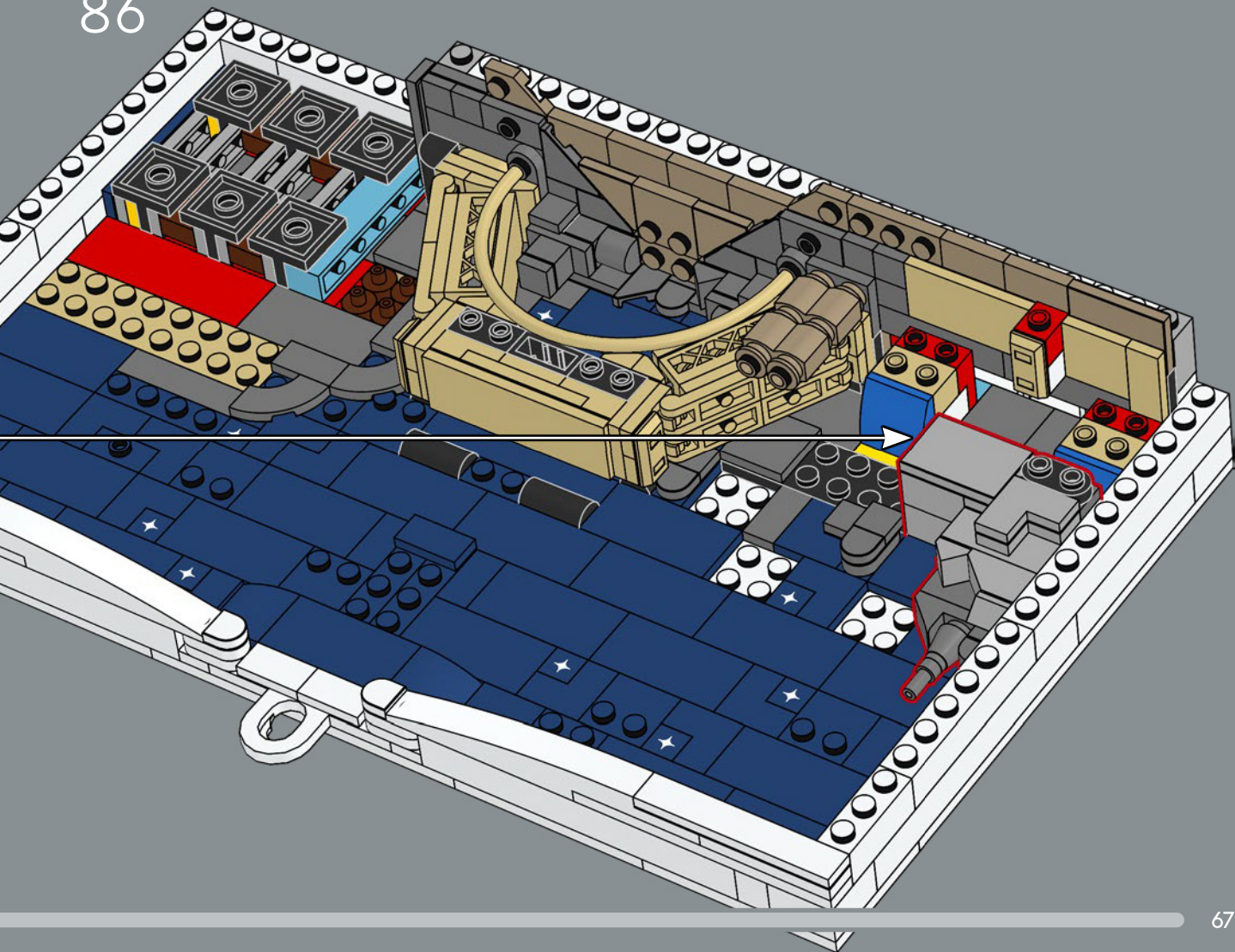

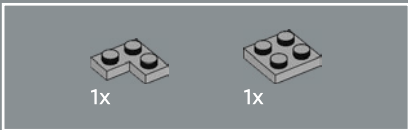
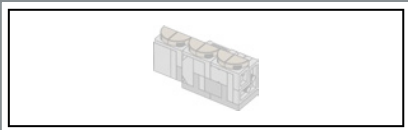

87

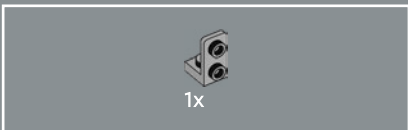
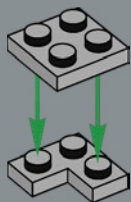

88

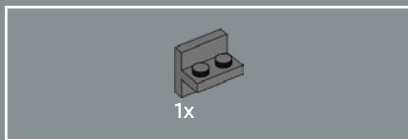

89

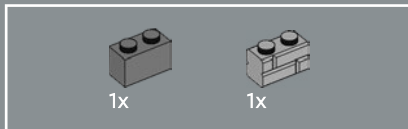
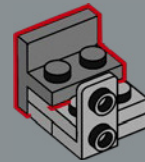

90

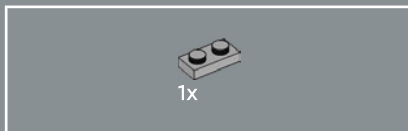
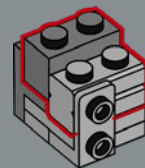

91

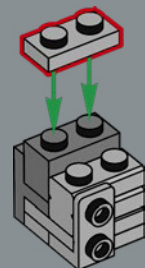

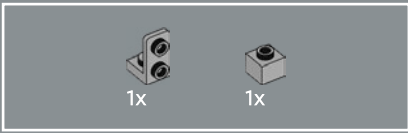

92

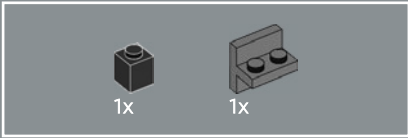
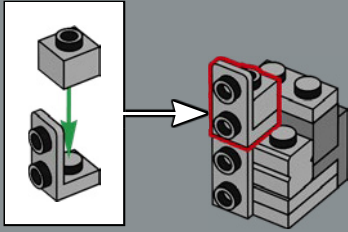

93

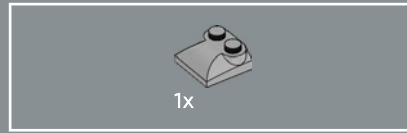
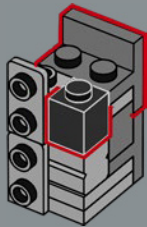

94

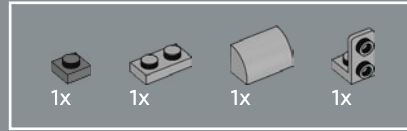
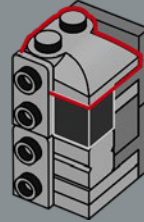

95

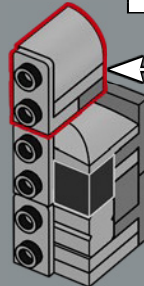
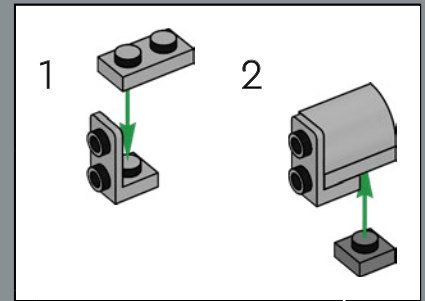



96

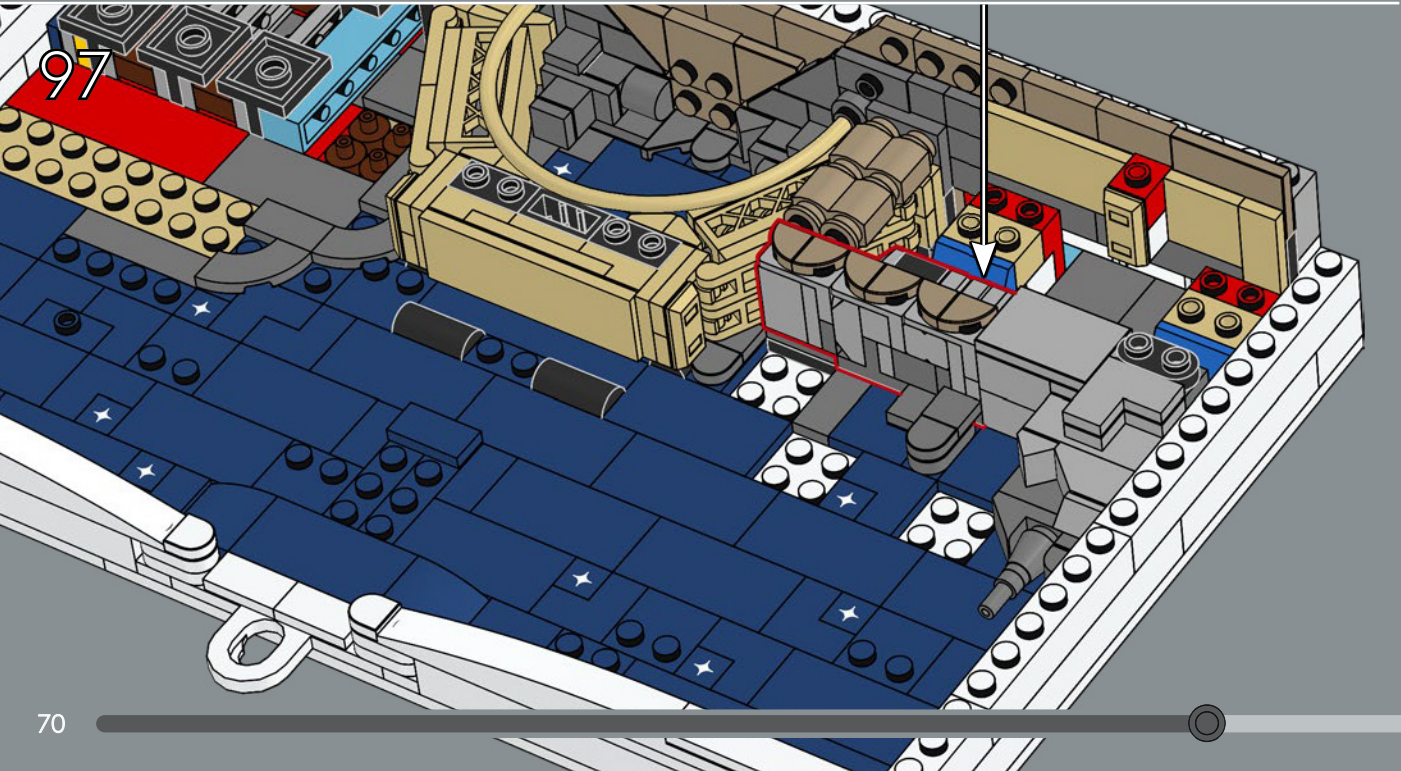
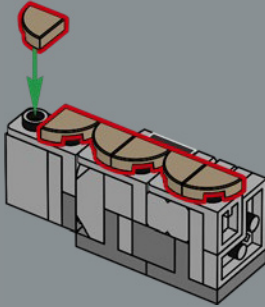

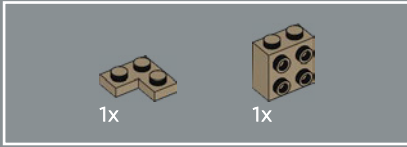
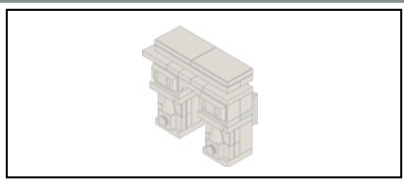

98

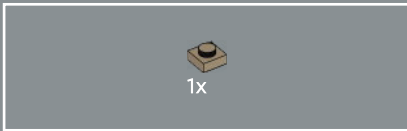
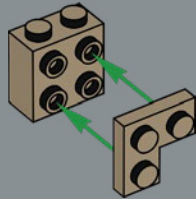

99

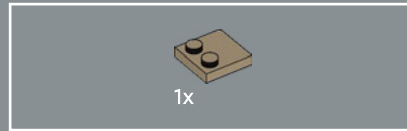
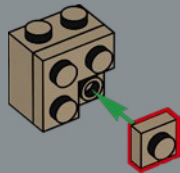

100

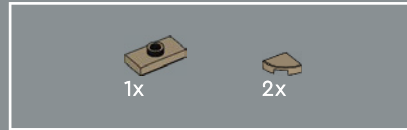
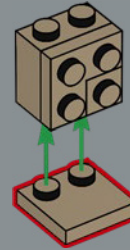

101

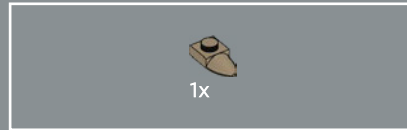
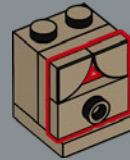

102

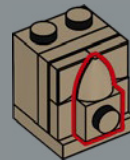

La costruzione dell'Arco di Trionfo ha richiesto 30 anni.

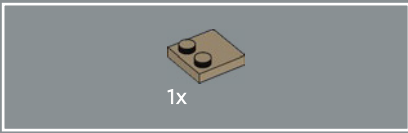

103

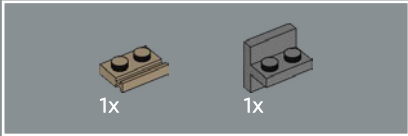
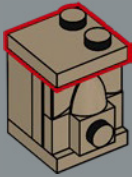

104

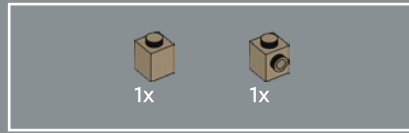
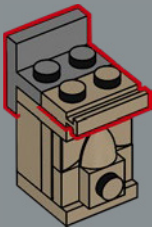

105

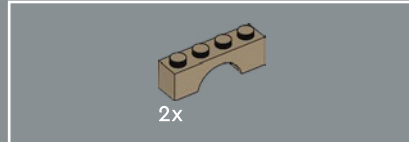
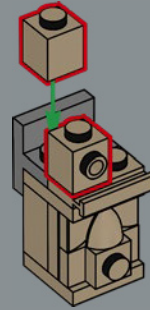

106

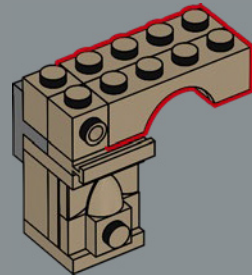

5

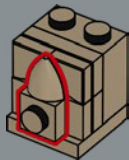

7

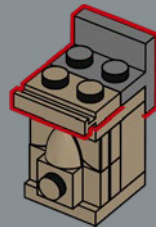

6

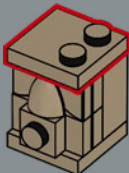

8

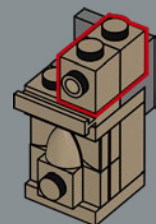

Un elemento lingotto color oro è stato utilizzato per catturare alcuni dettagli del fregio scultoreo dell'Arco di Trionfo. Questa è la sua prima apparizione in giallo sabbia.

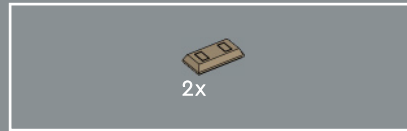
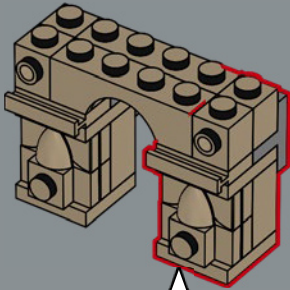

108

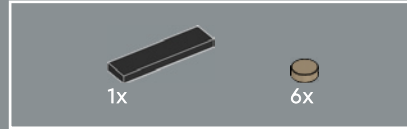
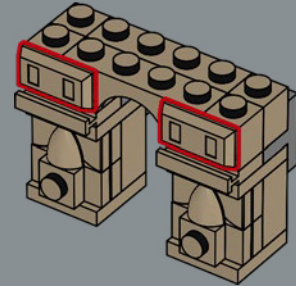

109

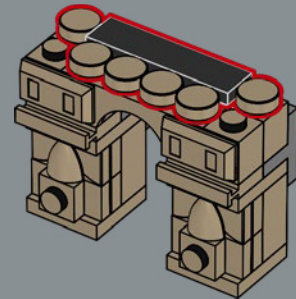

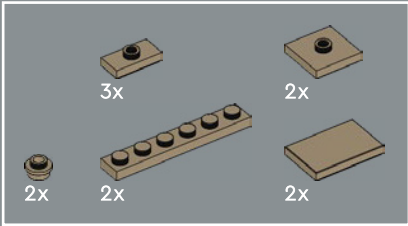

110

1

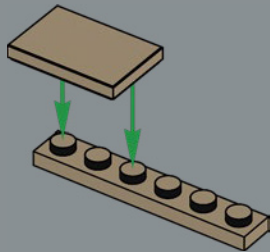

2

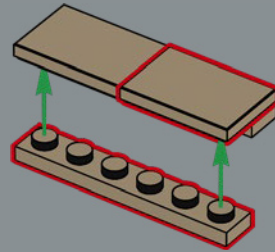

3

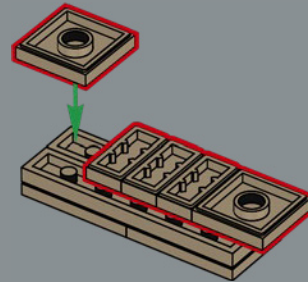

4

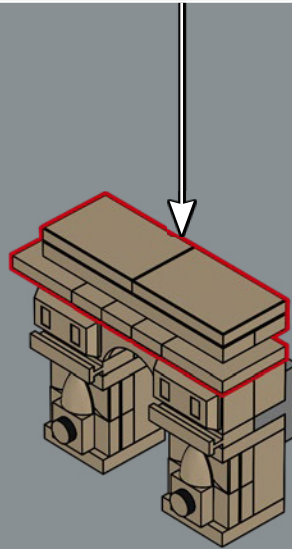
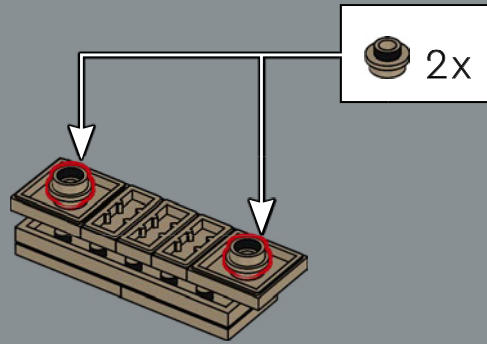

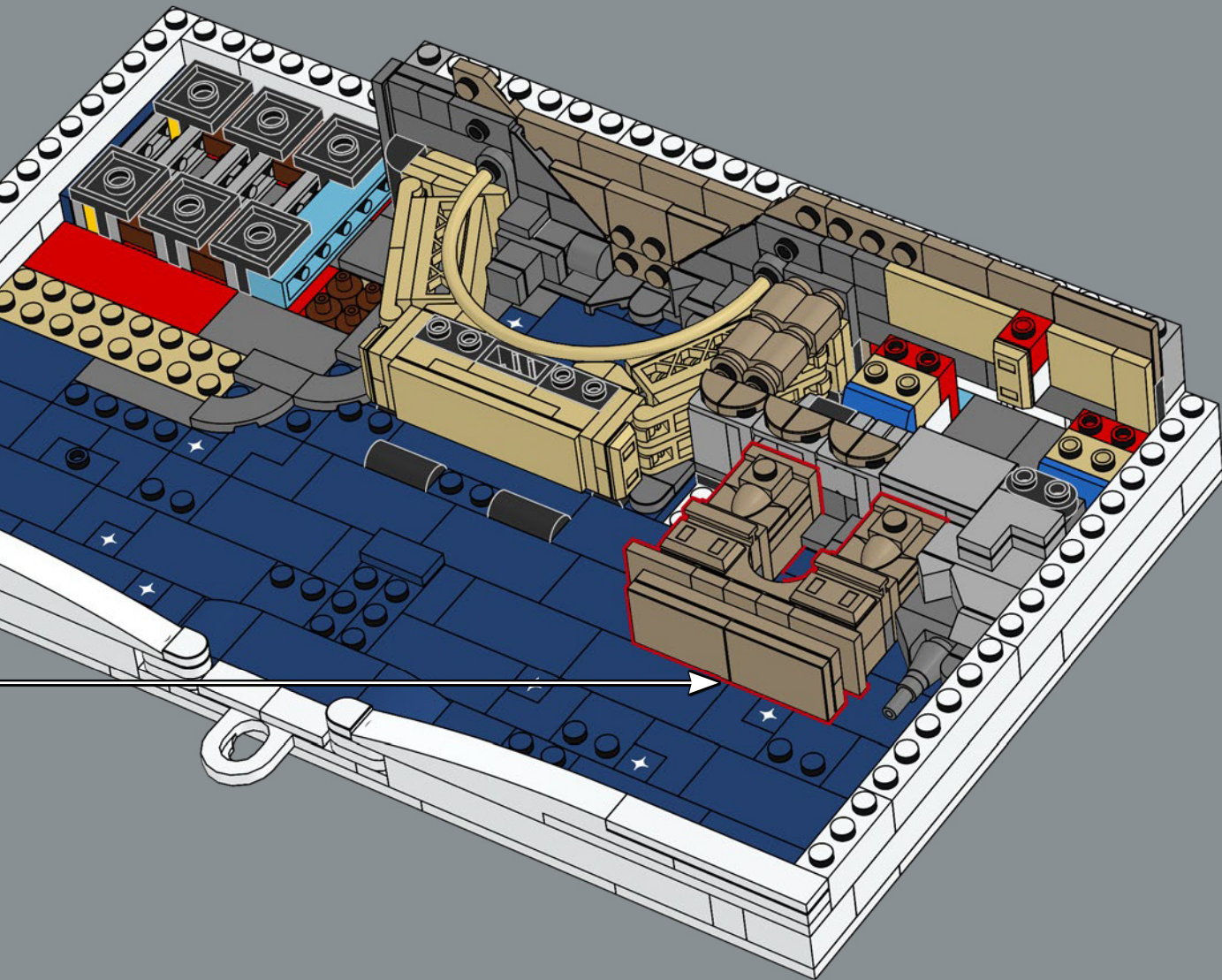

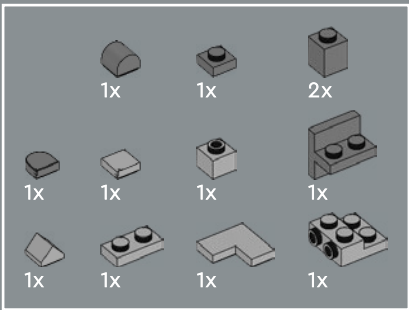

112

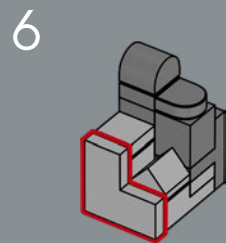
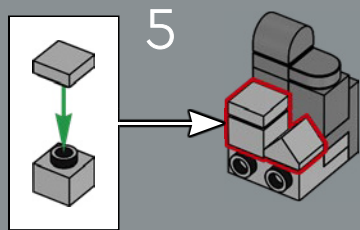
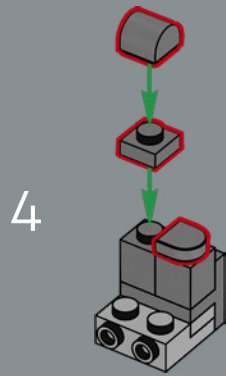
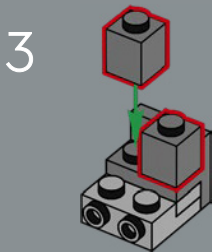
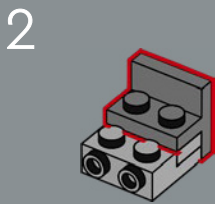
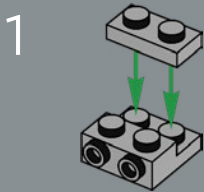

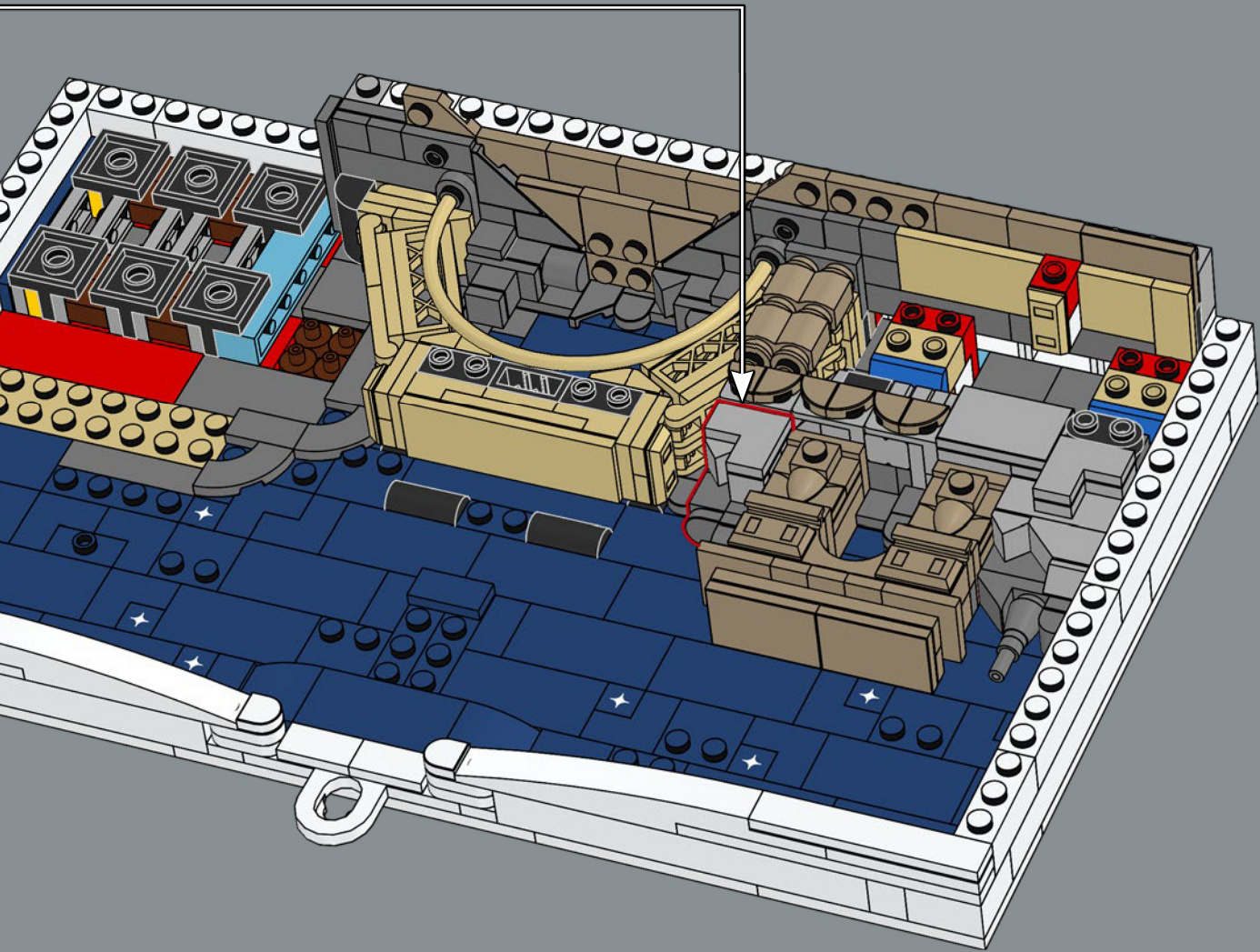

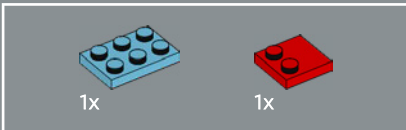

1x

1x

113

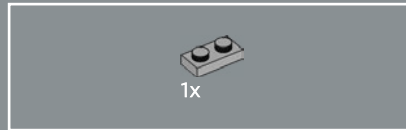
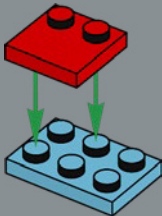

1x

114

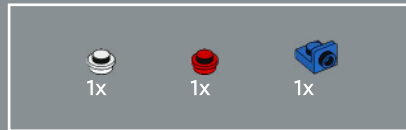
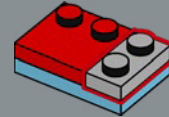

1x

1x

1x

115

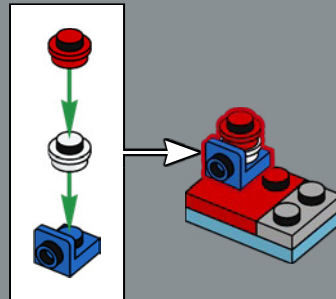

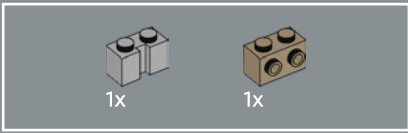

116

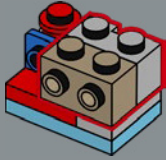

117

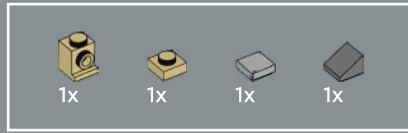
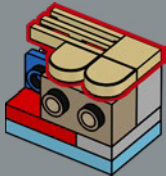

118

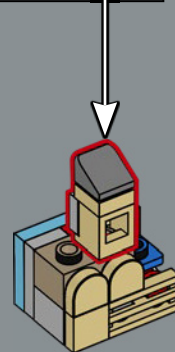
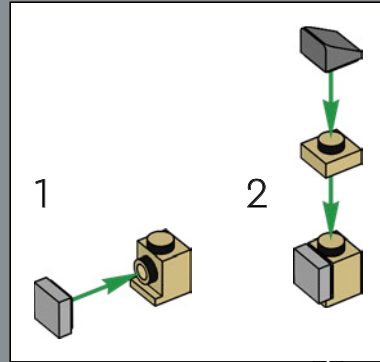

Il Louvre è il più grande museo d'arte del mondo, con una superficie di oltre 70.000 m²!

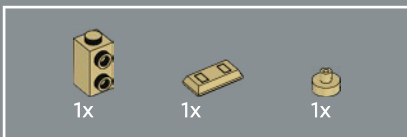

119

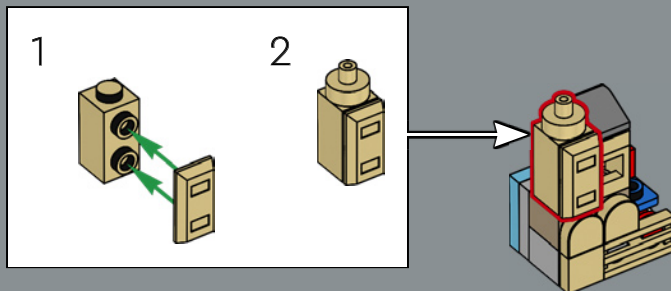

120

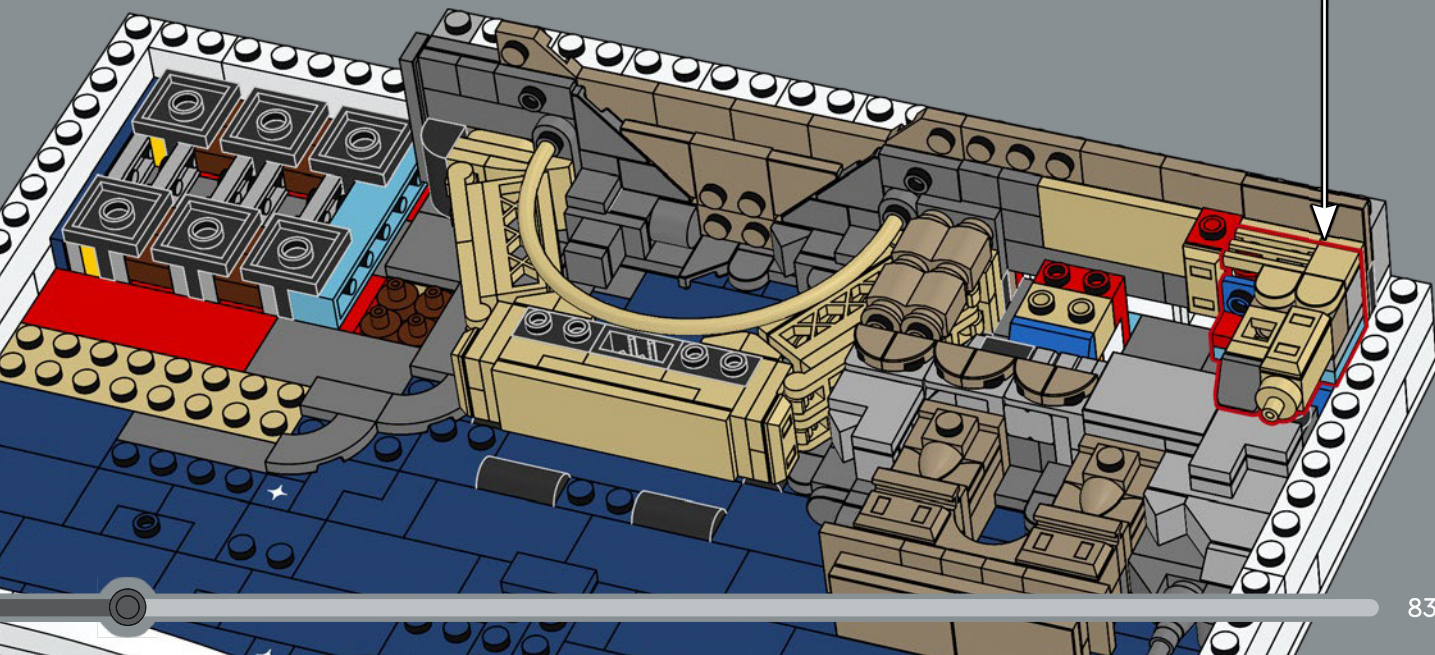

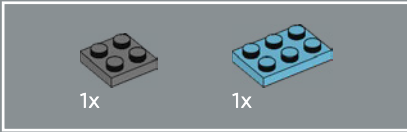
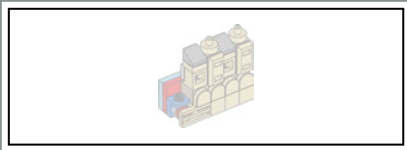

121

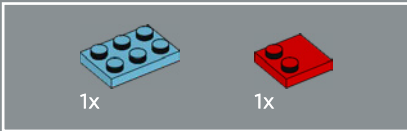
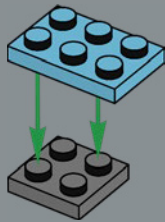

122

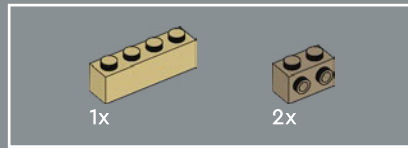
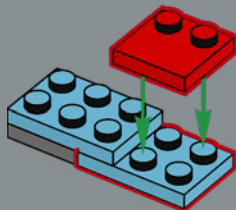

123

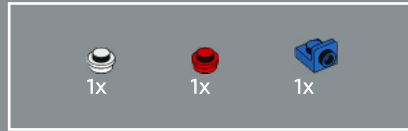
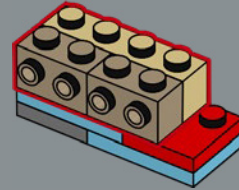

124

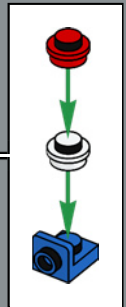
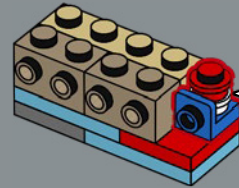

125

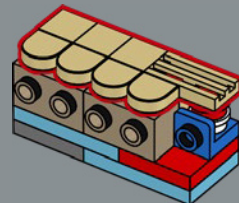

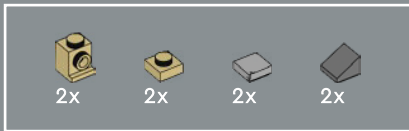

126

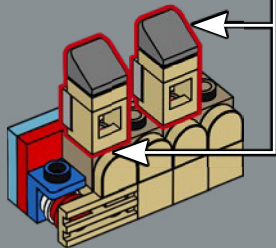
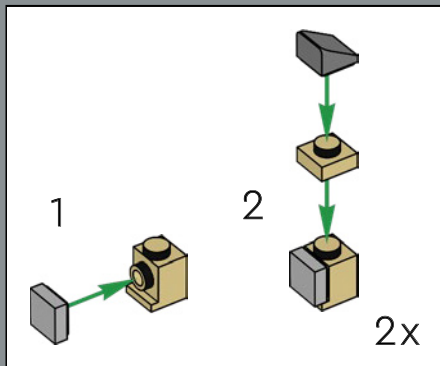

Il retro dei mattoncini 1x1 angolari consente di creare finestre in microscala perfette.

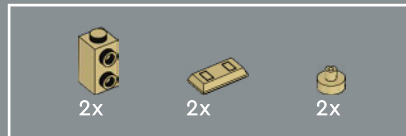

127

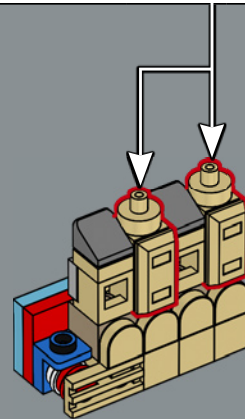
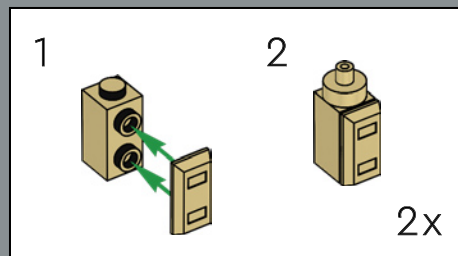

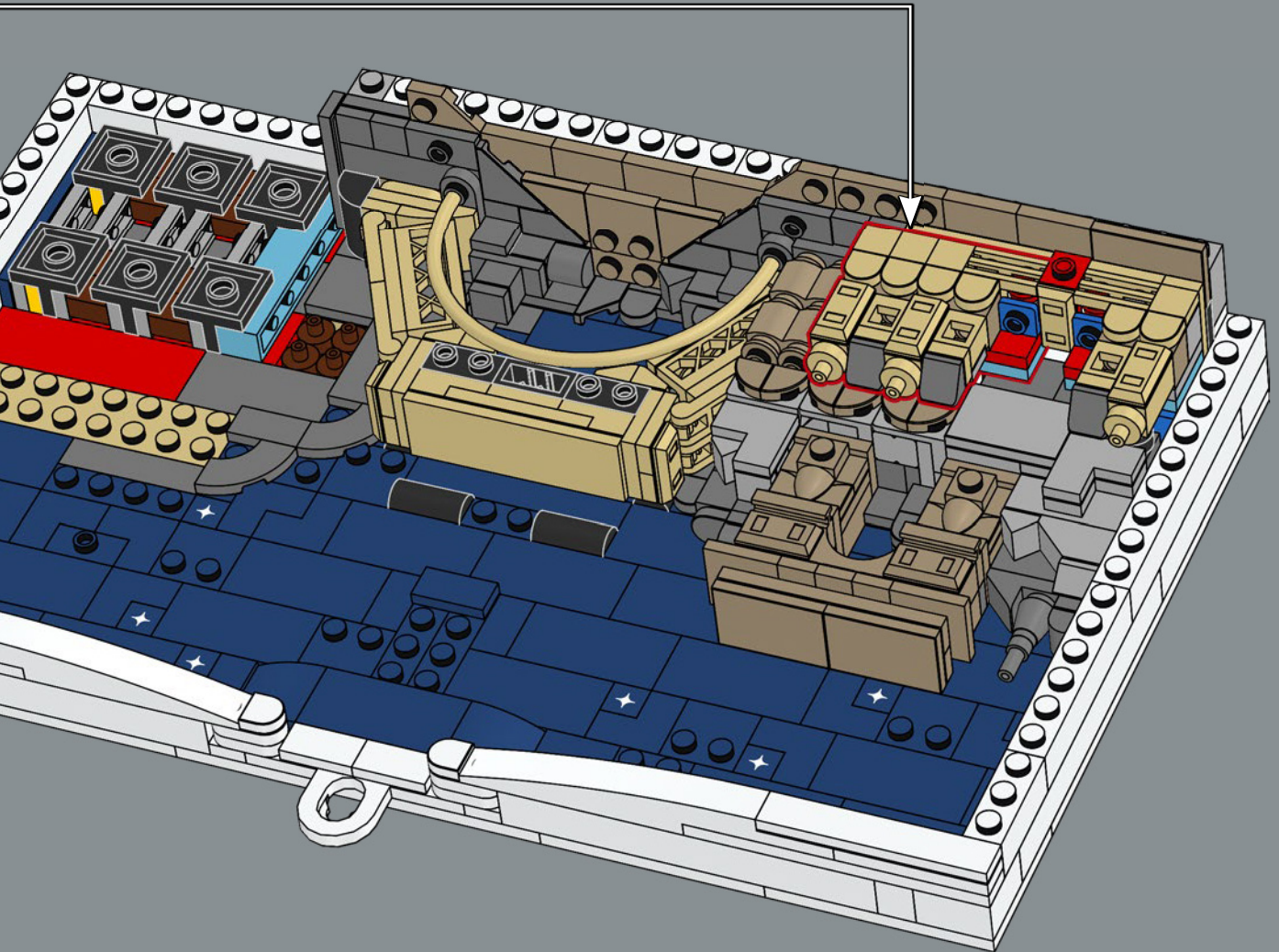

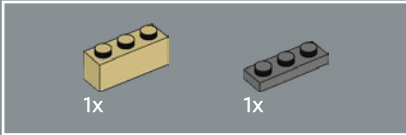

129

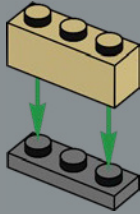

130

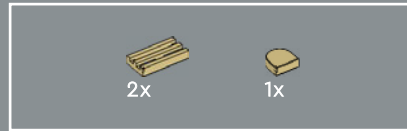
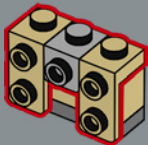

131

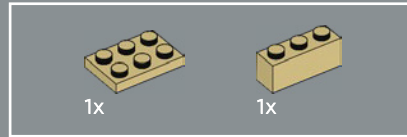
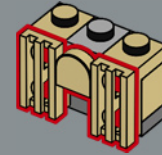

132

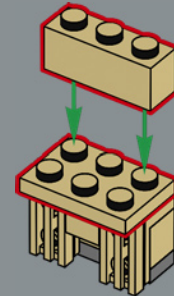



3x



3x

133

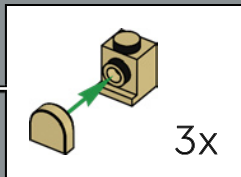
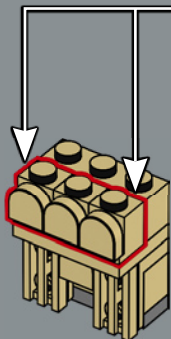

1x



1x

134

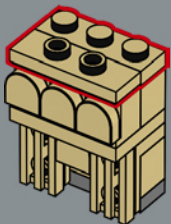

1x



2x

135

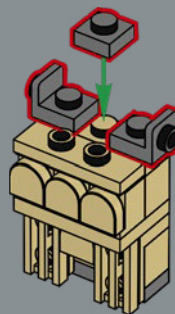

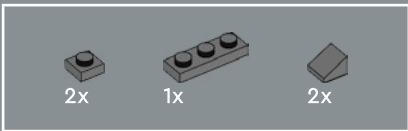

136

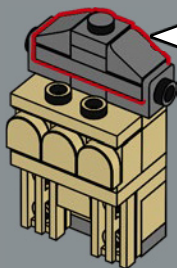
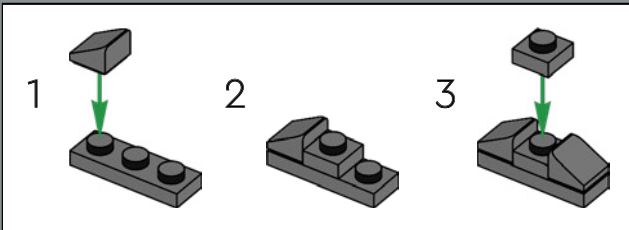

137

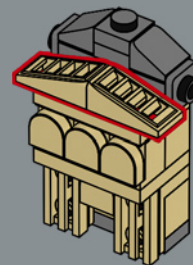

138

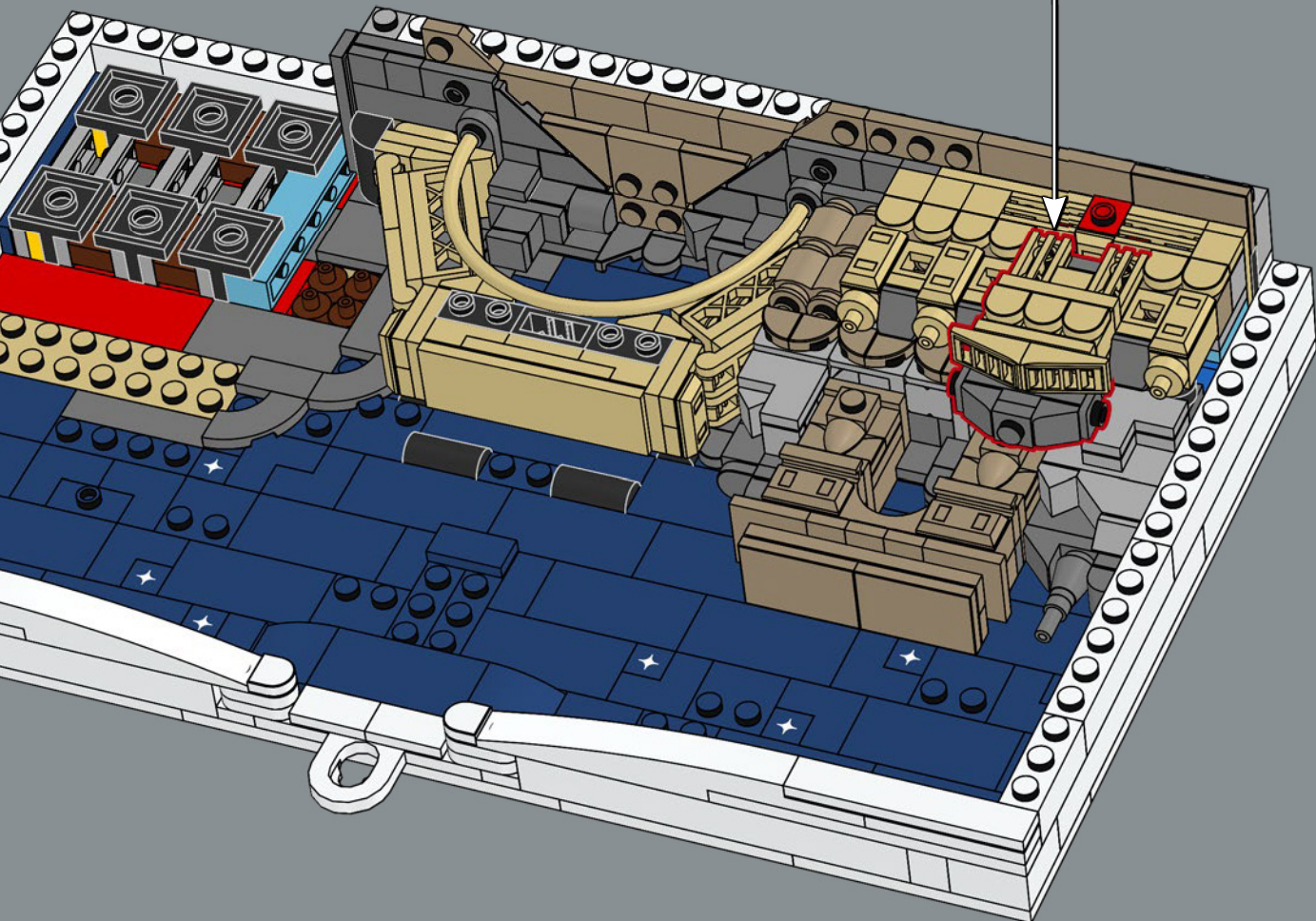

Le tessere 1x1, ruotate di 45 gradi, creano le lastre a forma di diamante della sorprendente piramide di vetro.

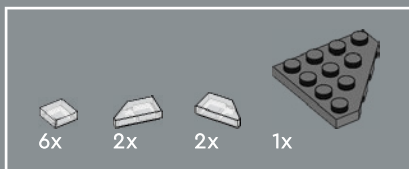

139

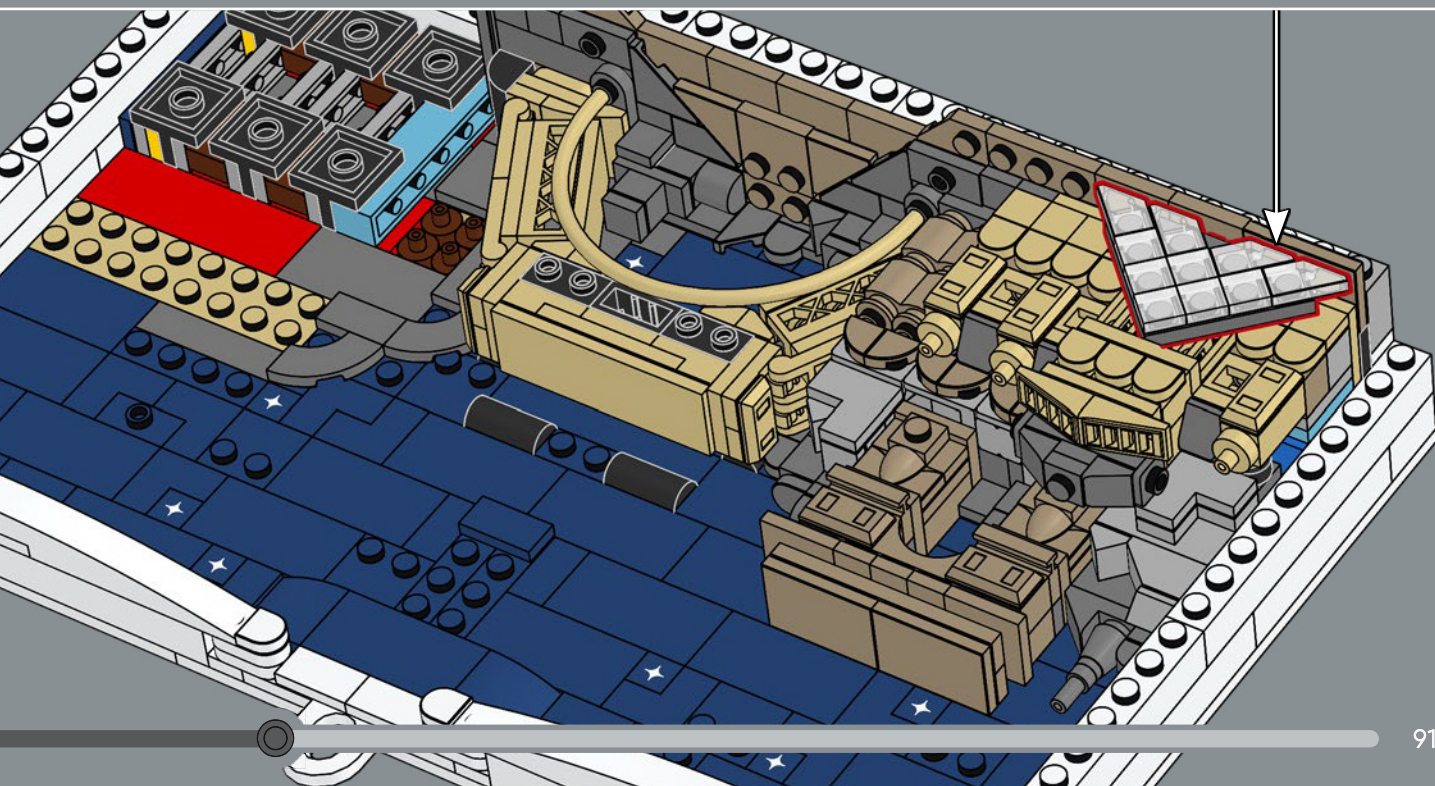
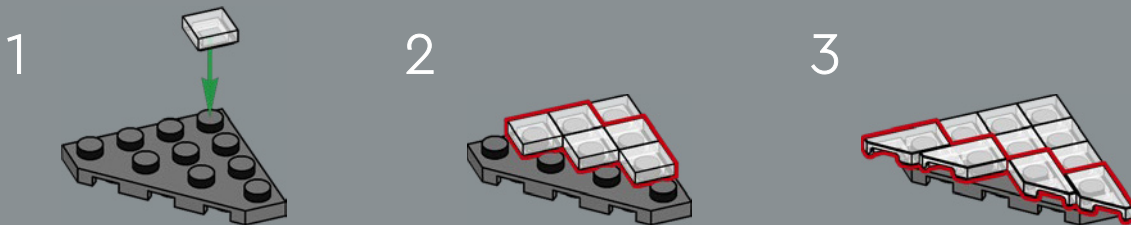

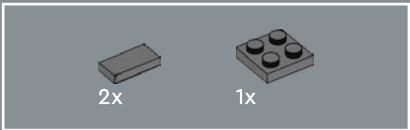

140

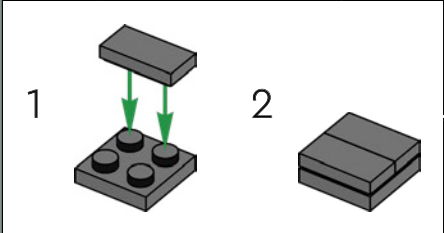
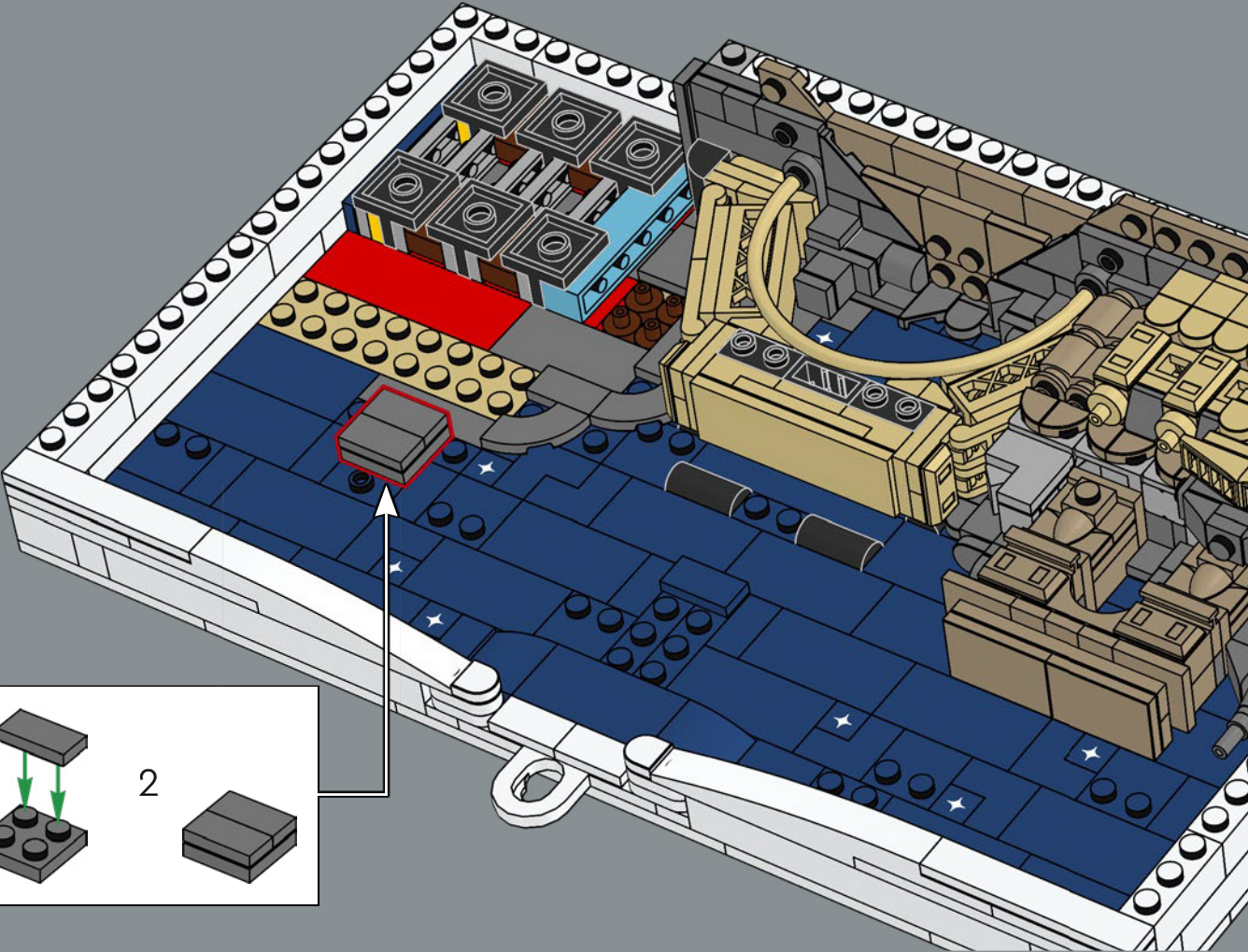



141

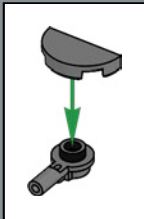
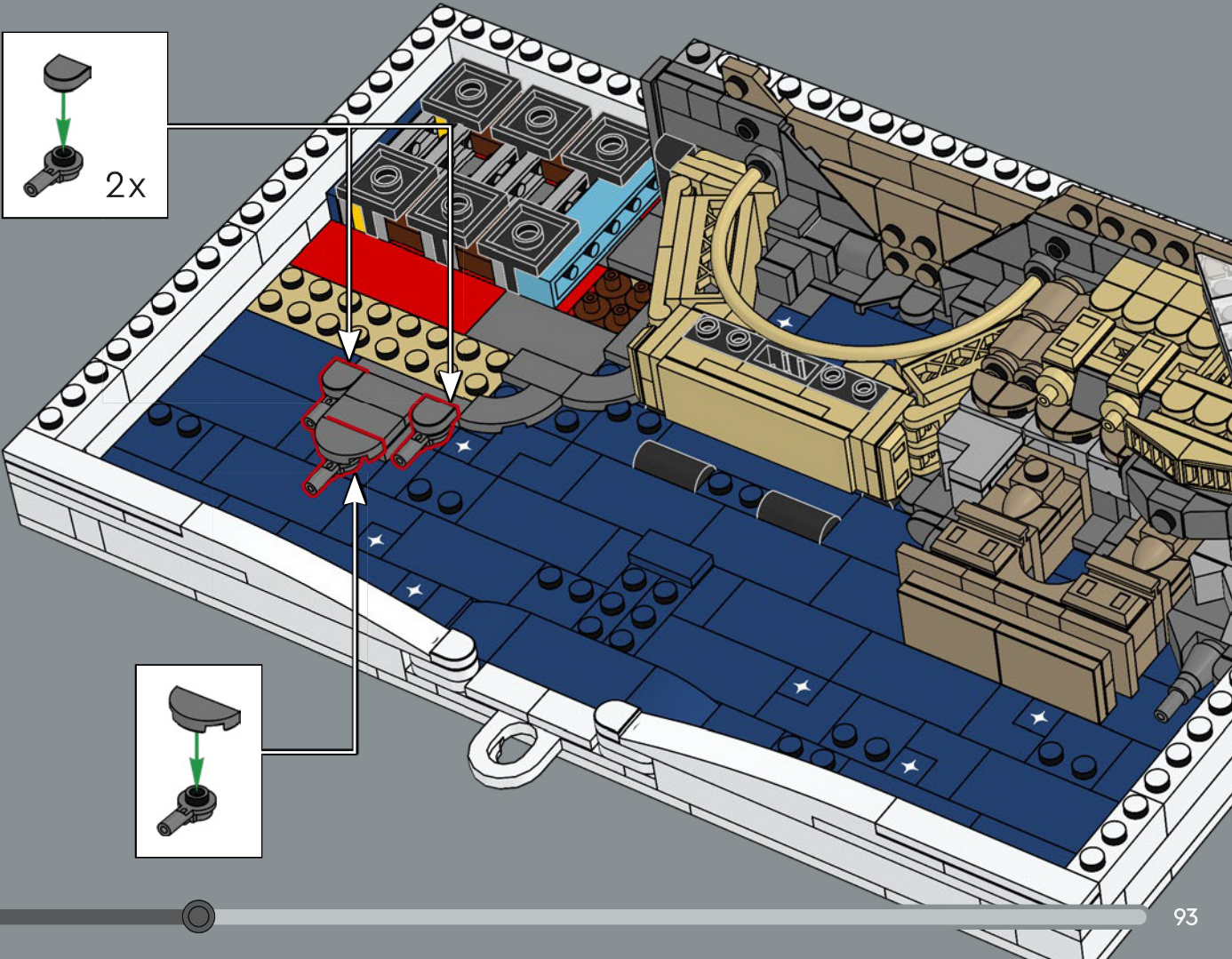
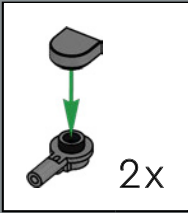

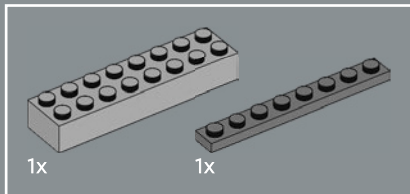
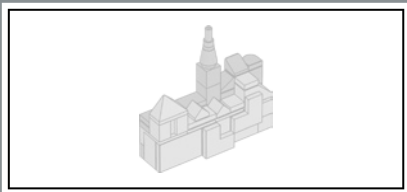

142

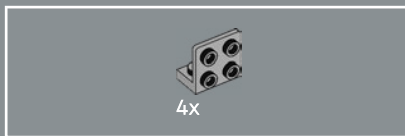
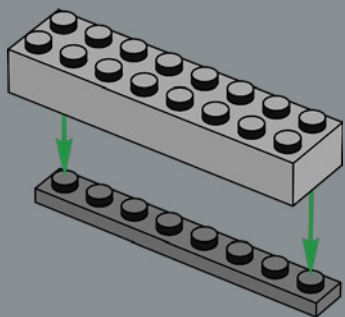

143

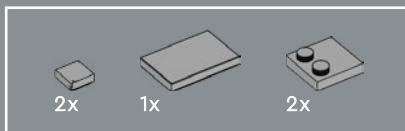
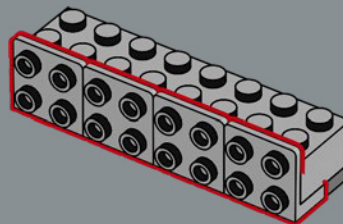

144

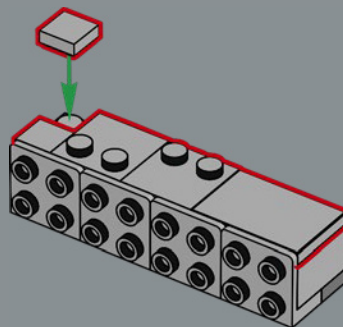

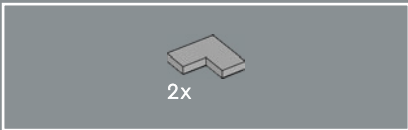

145

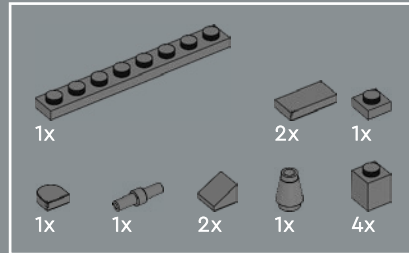
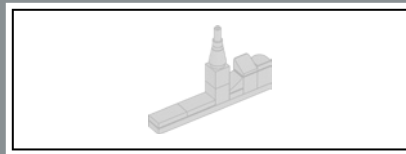
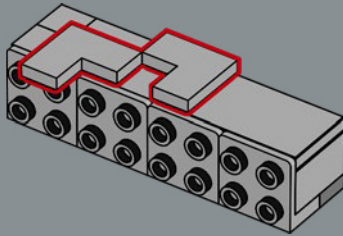

146

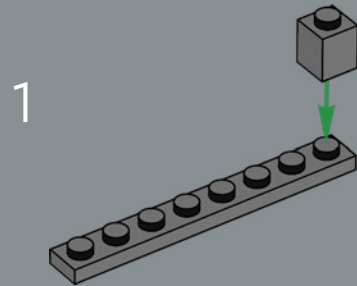

2

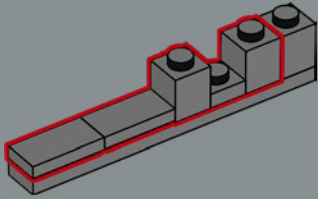

3

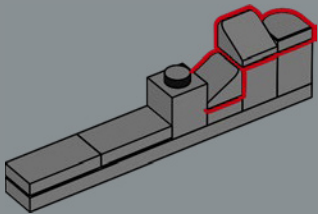

4

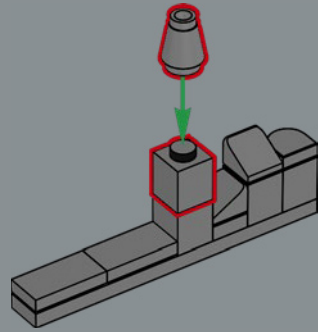

5

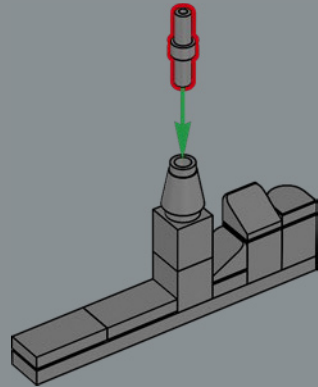

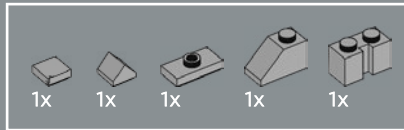
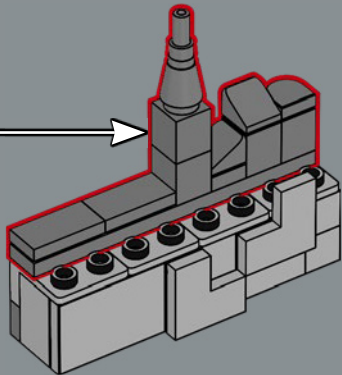

147

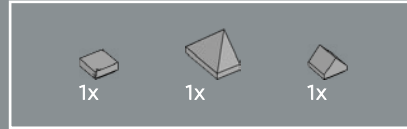
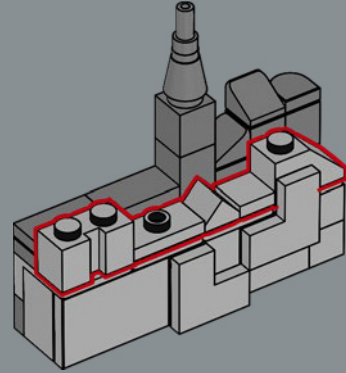

148

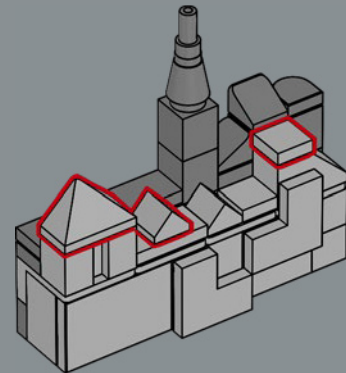

149

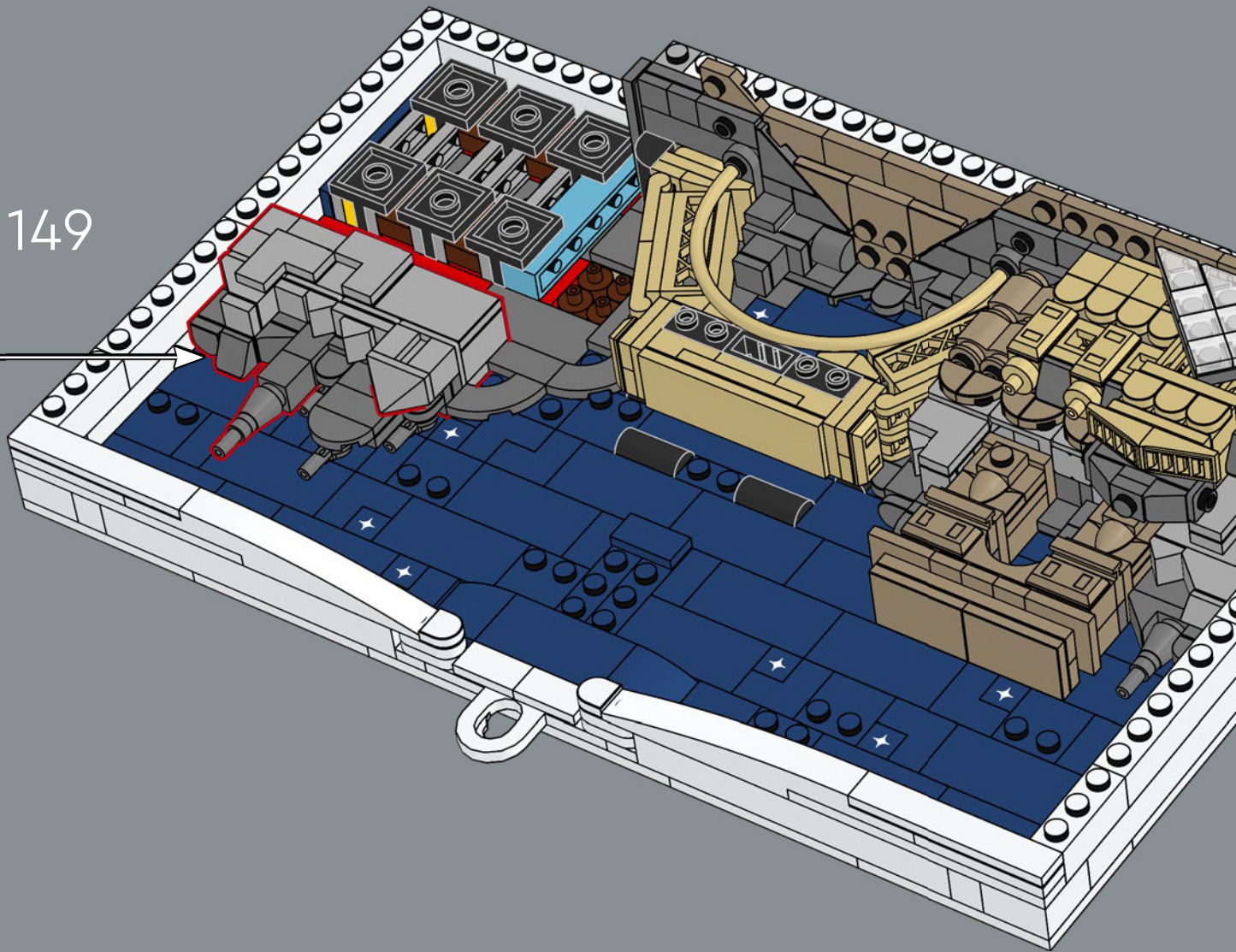

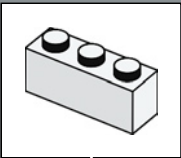
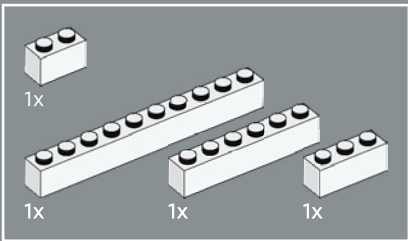

150

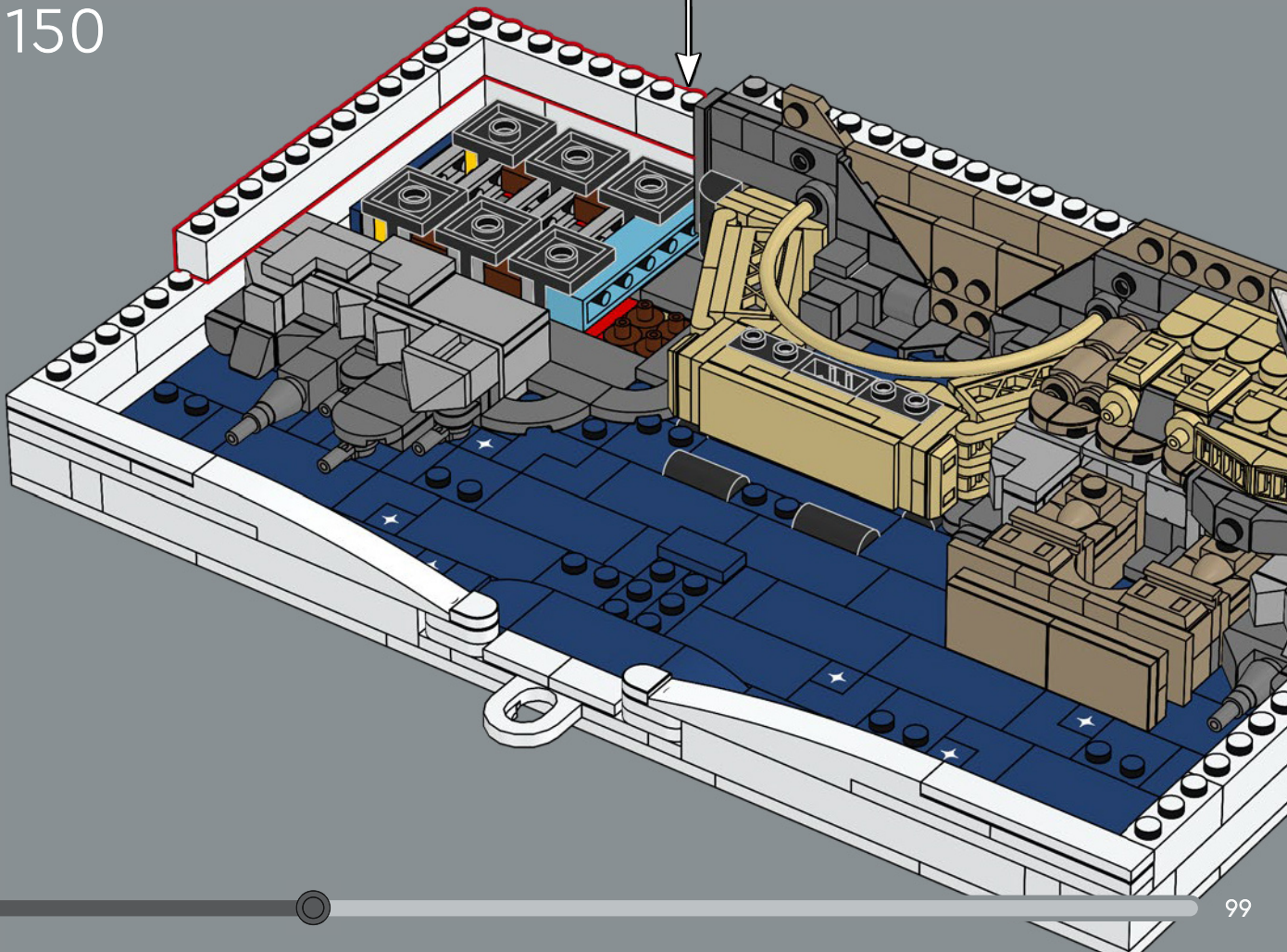

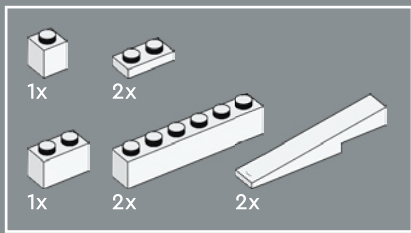

151

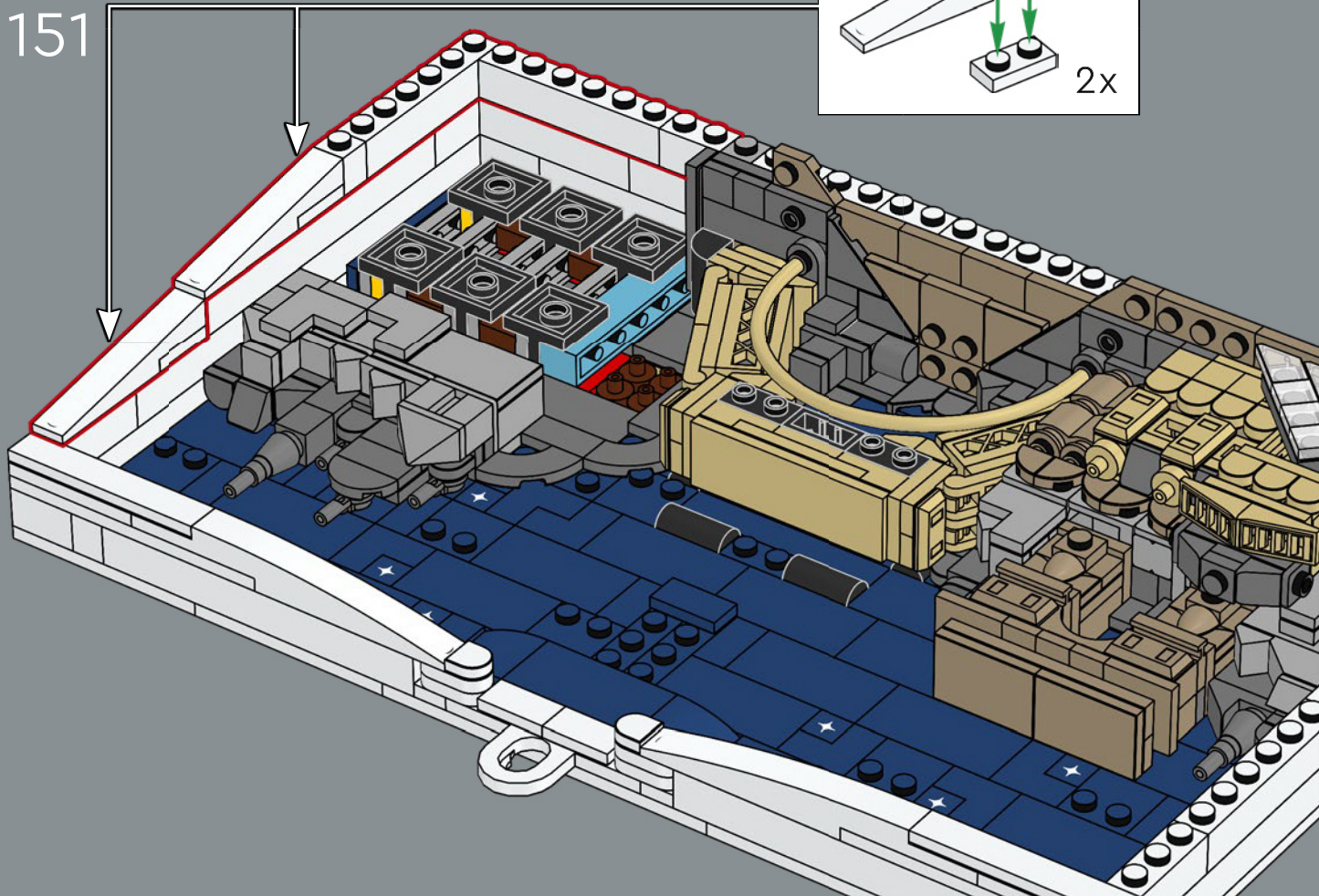
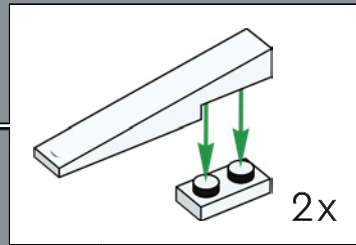

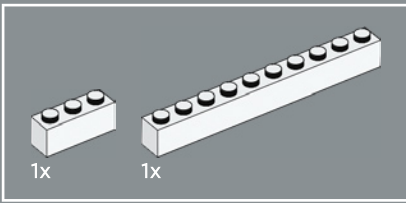

152

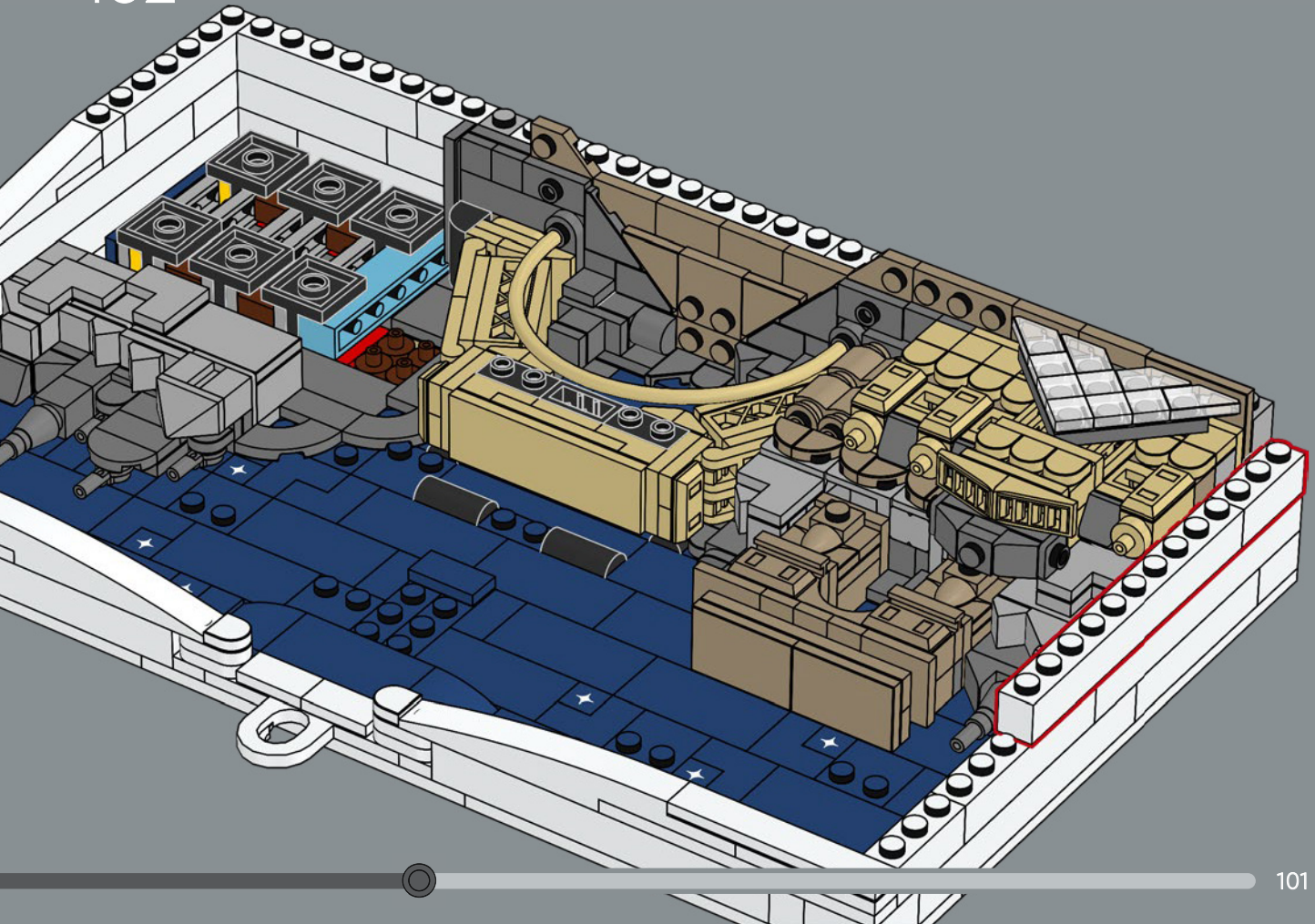

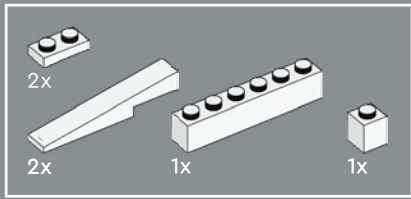

153

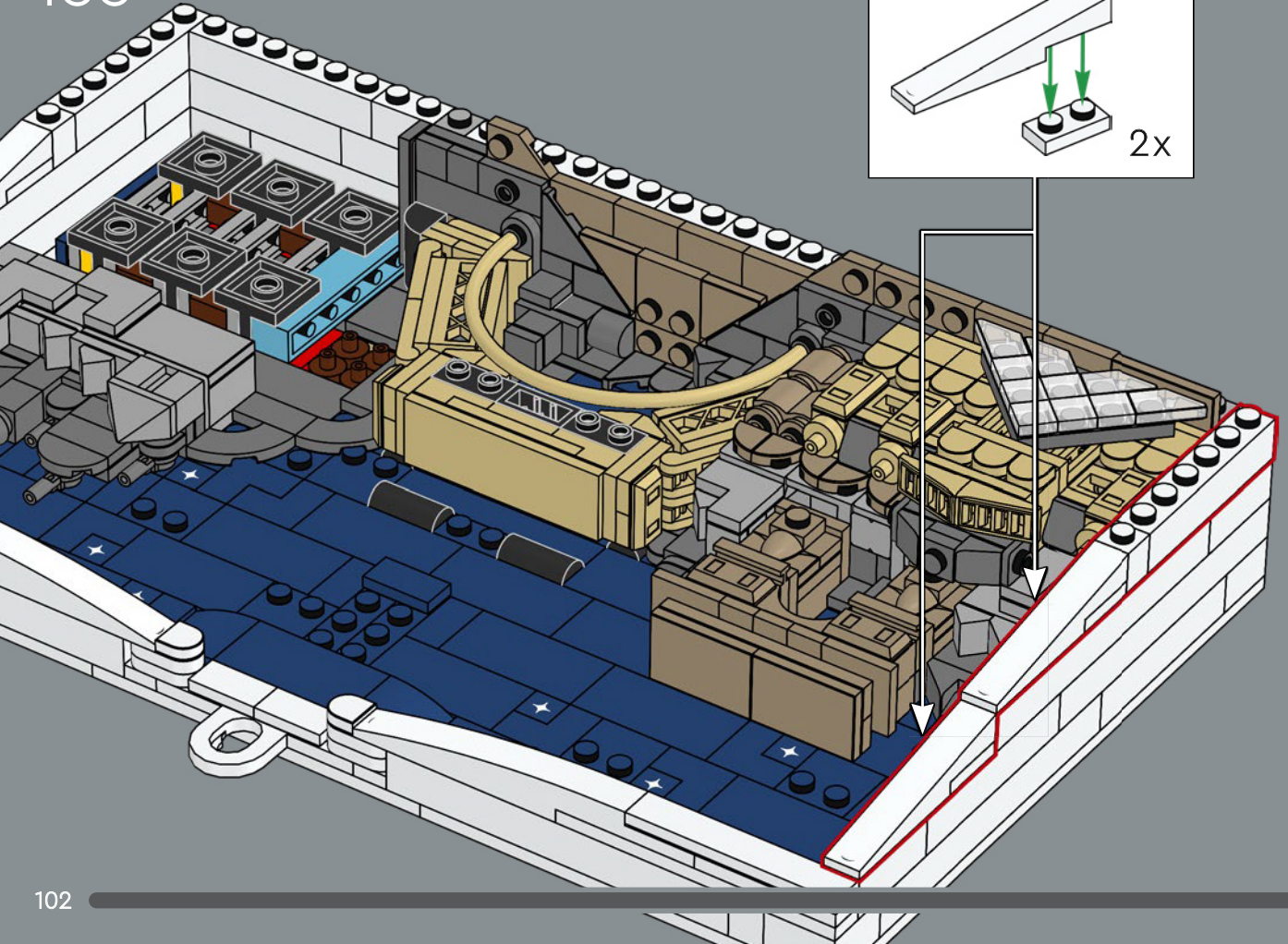
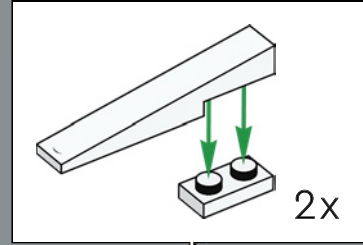

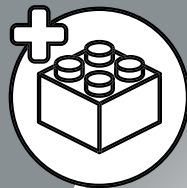

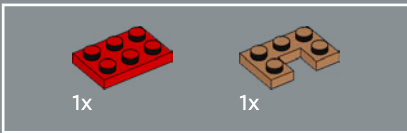
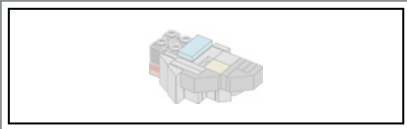

154

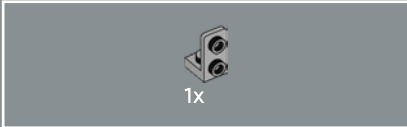
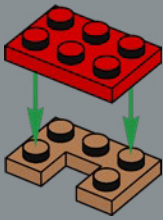

155

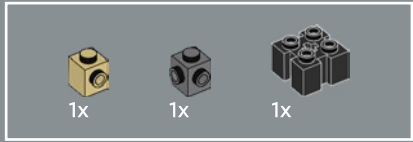
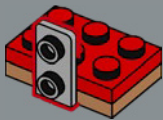

156

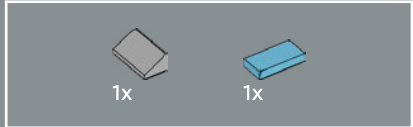
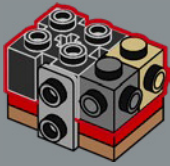

157

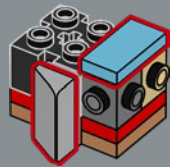

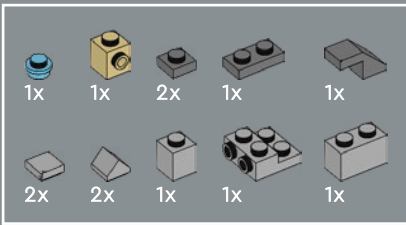

158

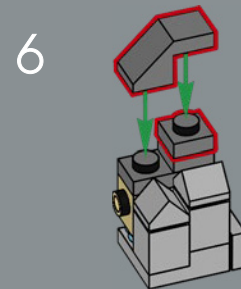
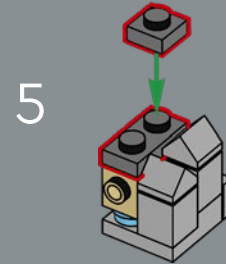
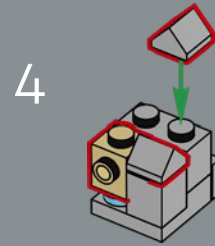
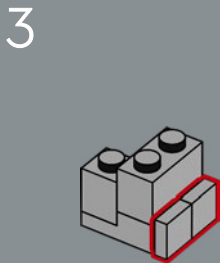
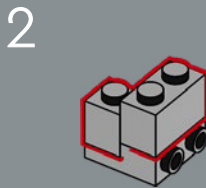
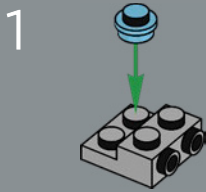

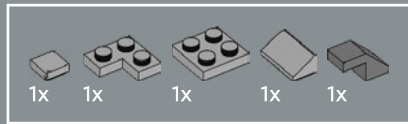

159

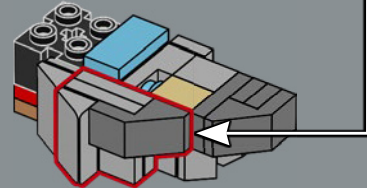
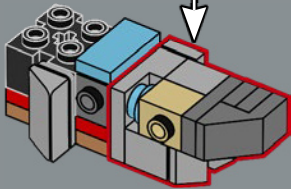
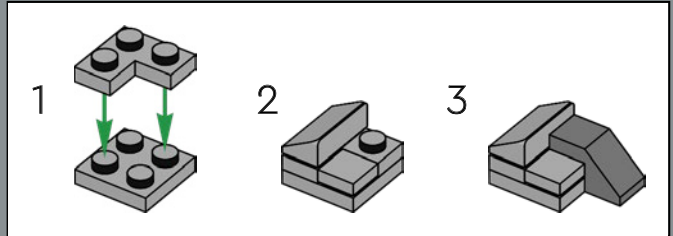

160

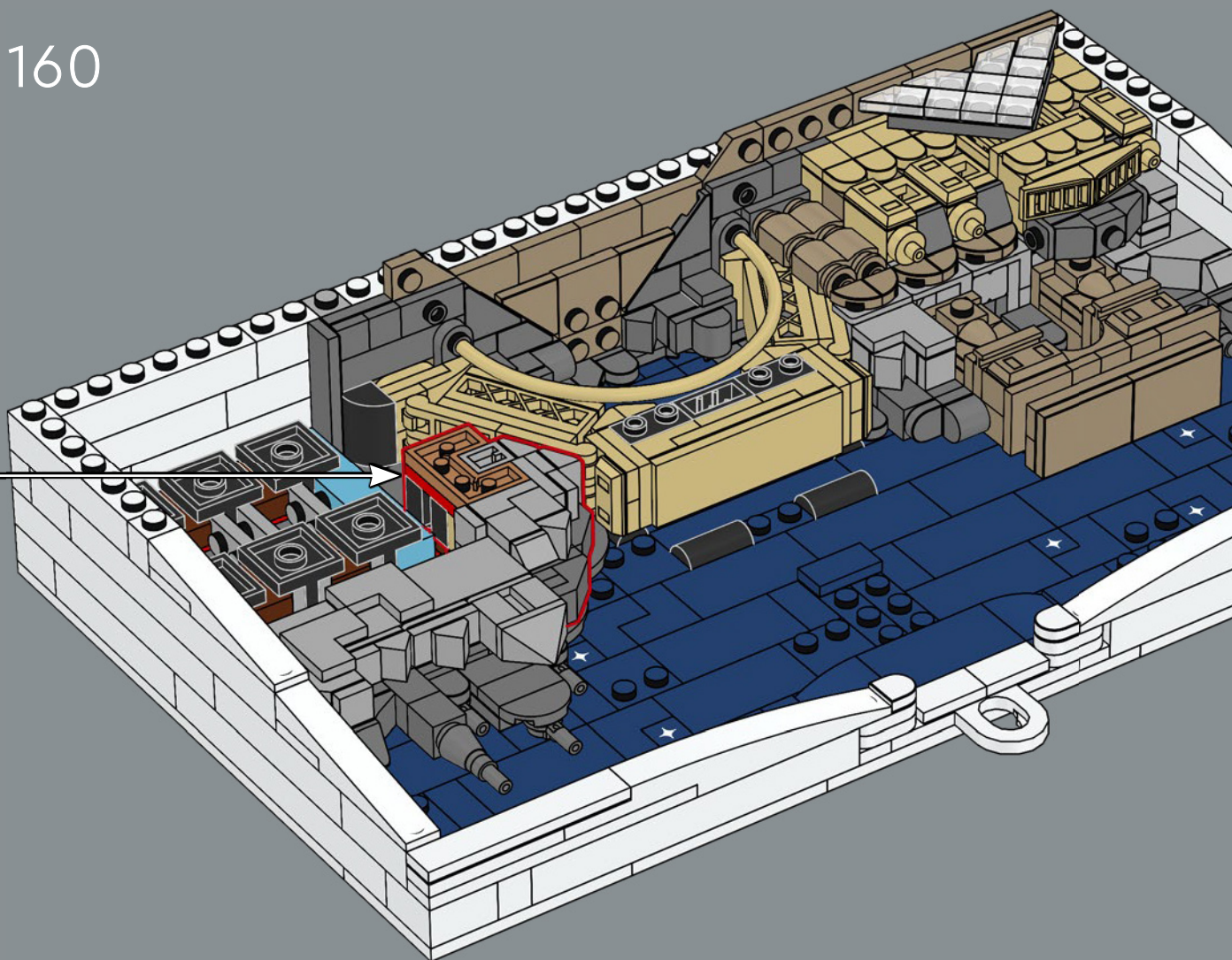

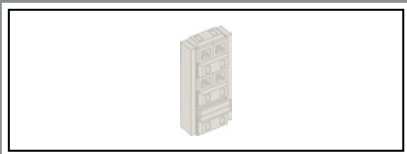

161

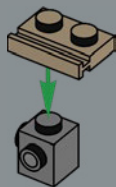

162

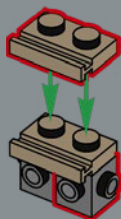

163

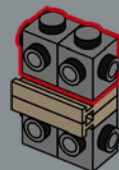

164

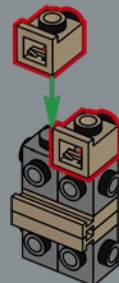

Il mattoncino angolare 1x1 viene utilizzato anche per le finestre qui. Questa volta, la parte inferiore rappresenta una finestra dotata di cornice quadrata.



165

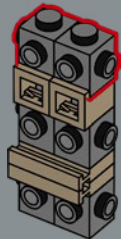

166

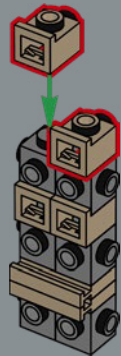

167

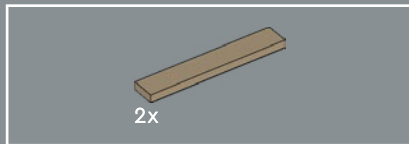
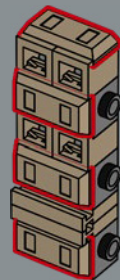

168

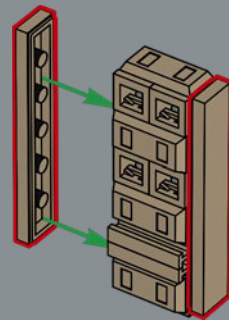

169

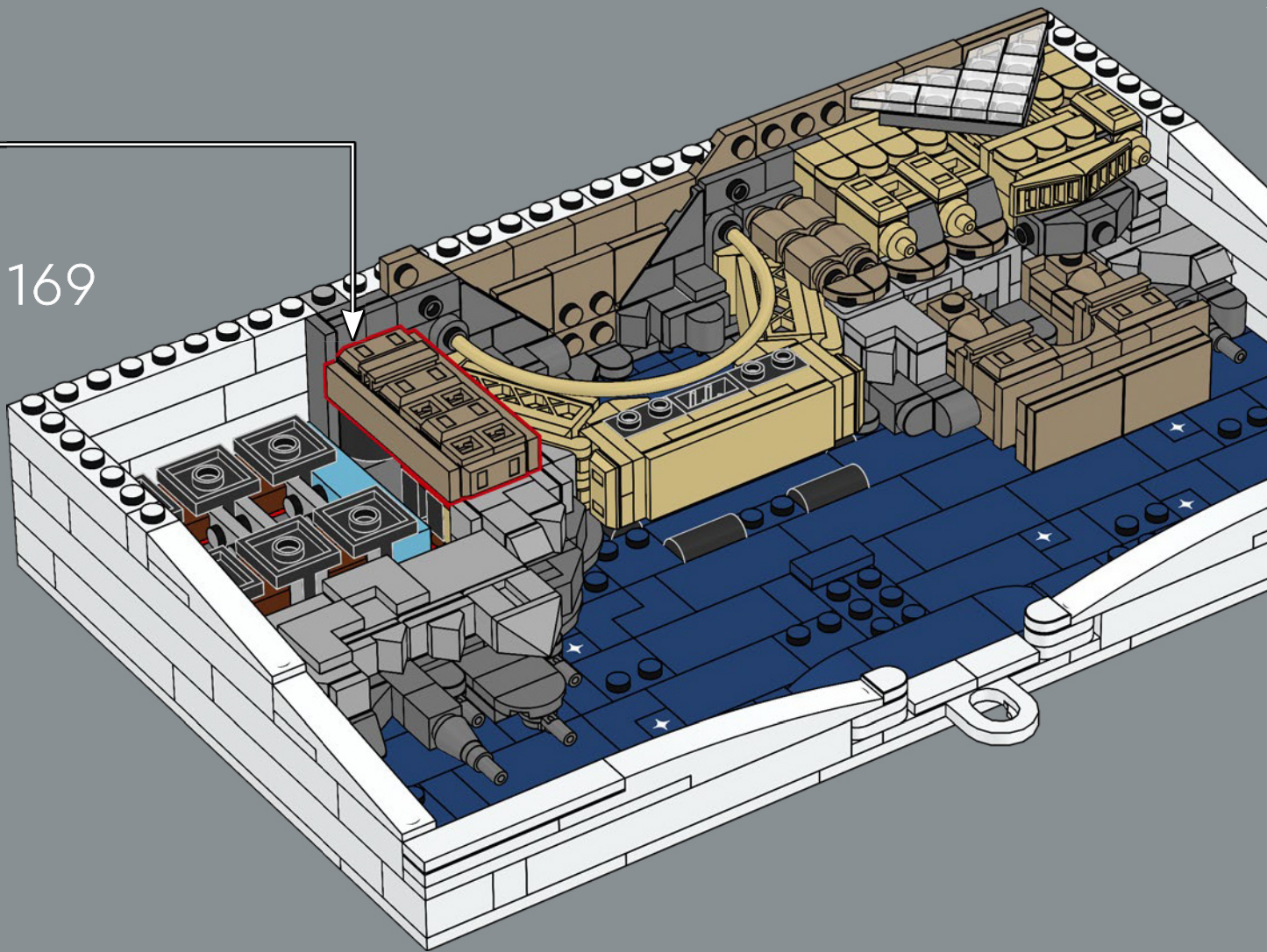

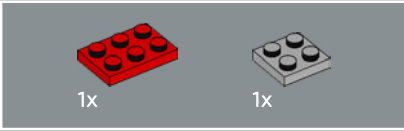
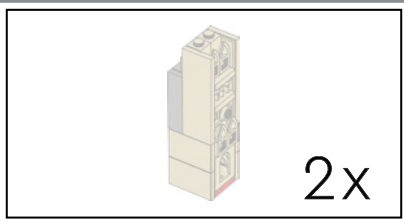

170

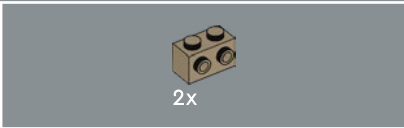
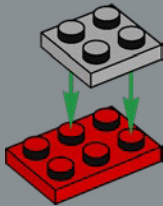

171

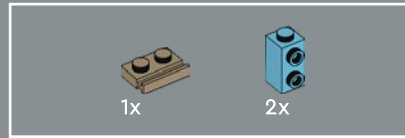
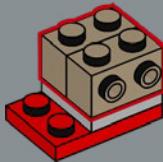

172

L'incoronazione di Napoleone si svolse
nella cattedrale di Notre-Dame de Paris.

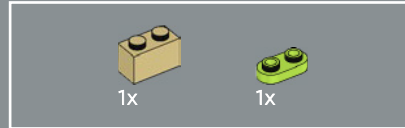
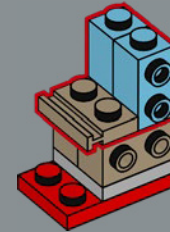

173

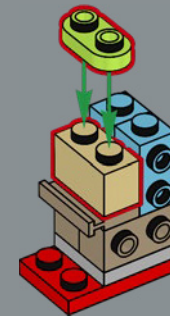

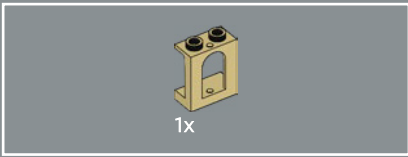

174

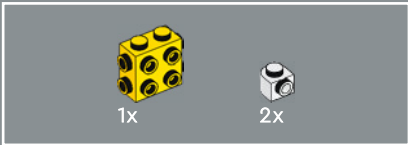
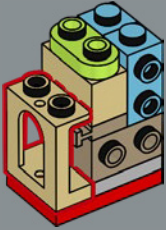

175

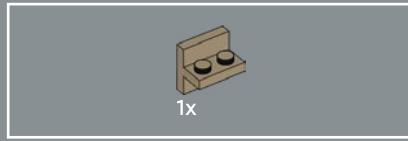
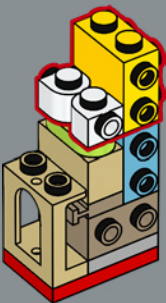

176

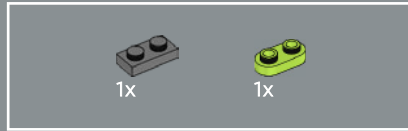
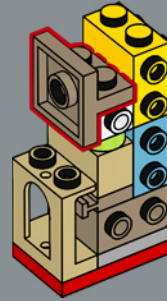

177

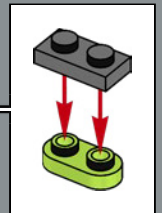
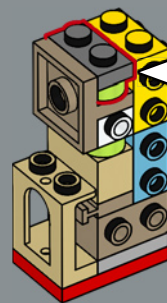

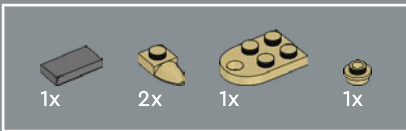

178

Gli archi gotici appuntiti sono stati catturati utilizzando il fondo di basi dotate di denti.

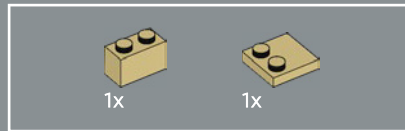
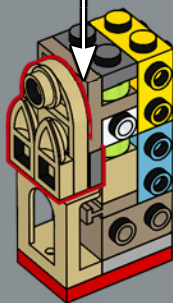
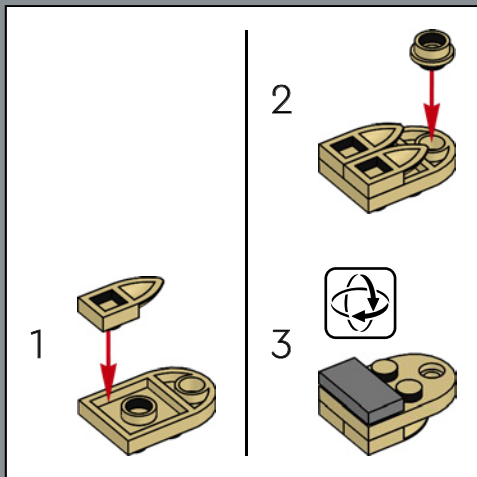

179



180

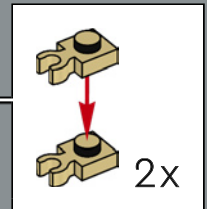
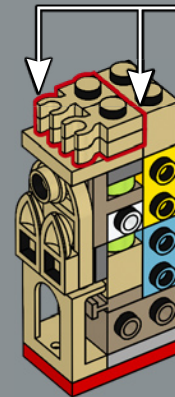

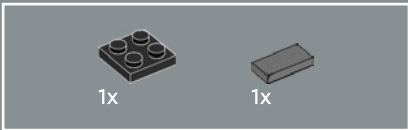

181



182

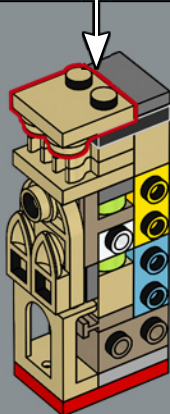
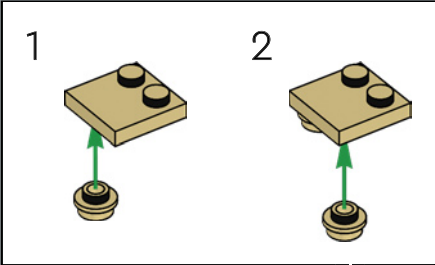



183

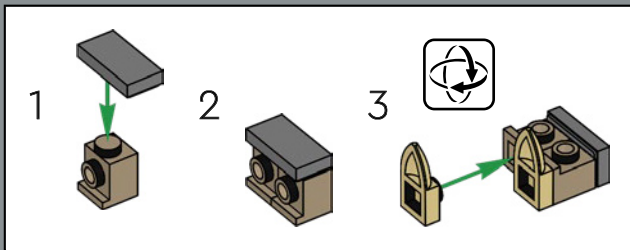

184



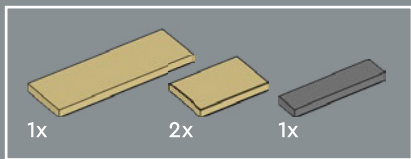

185

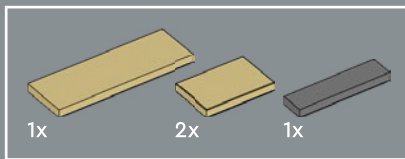
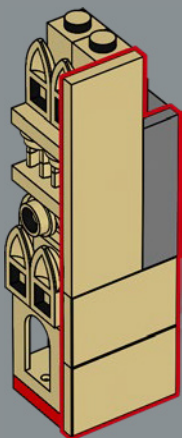

186

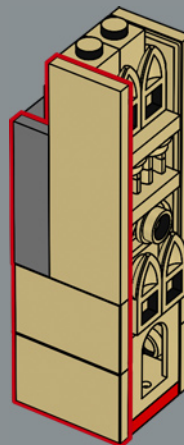

2x

187

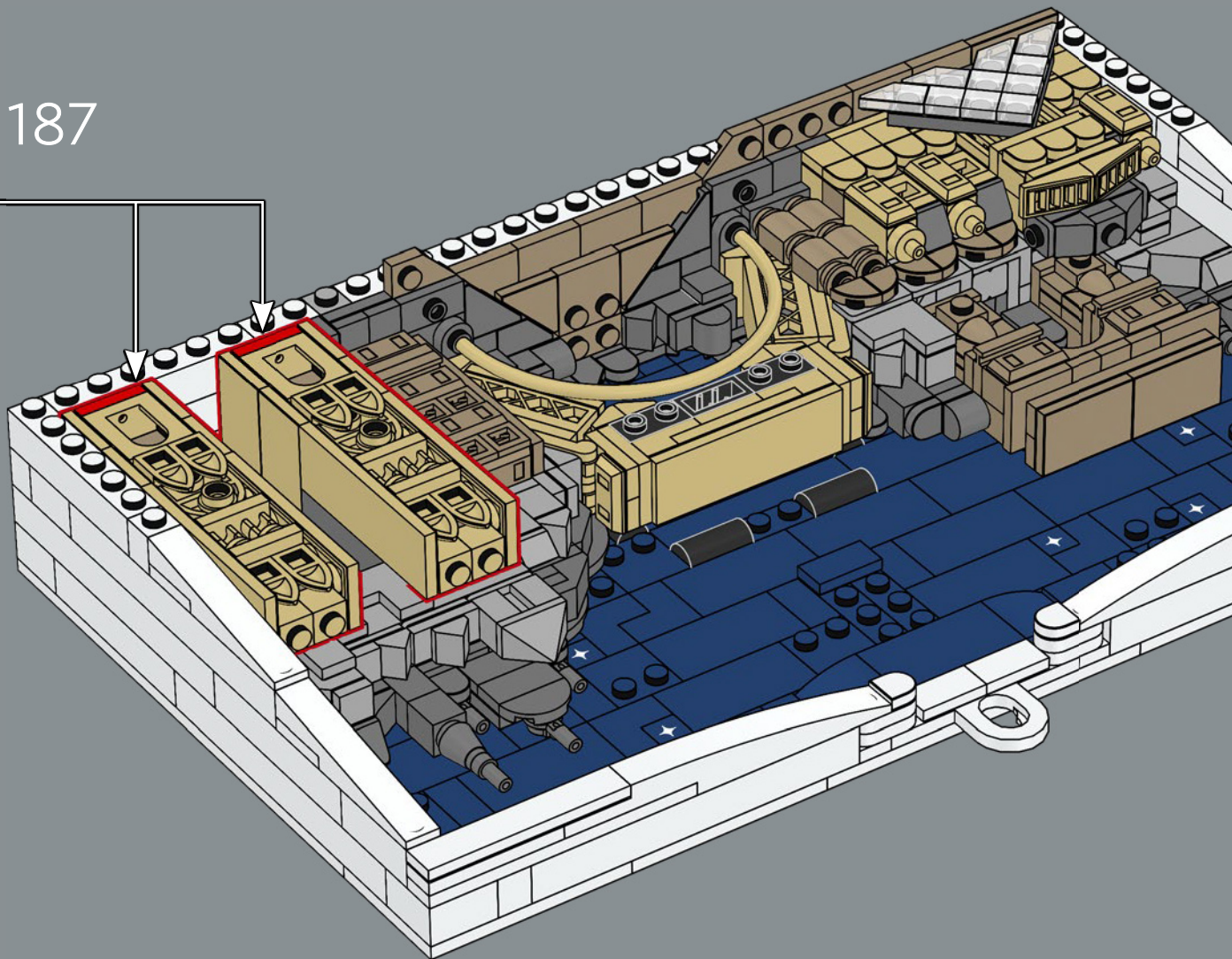

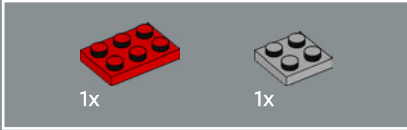
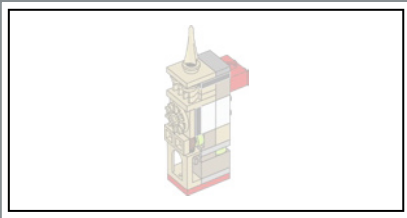

188

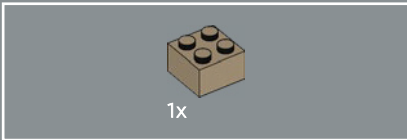
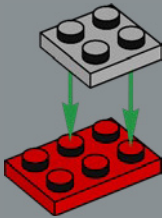

189

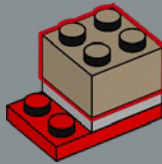

190

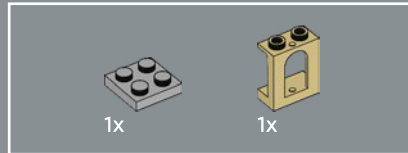
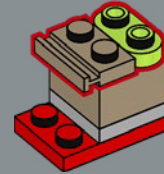

191

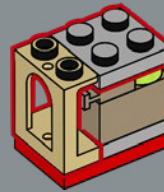

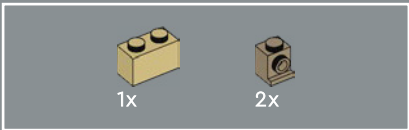

192

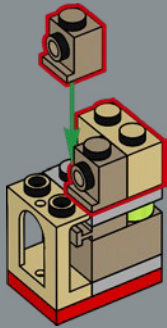

193

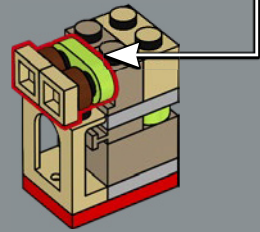
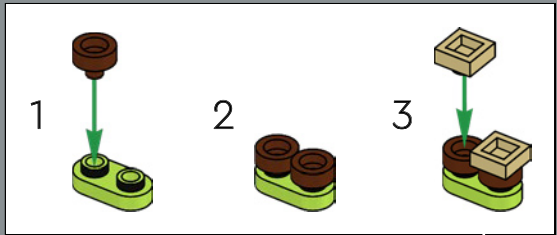

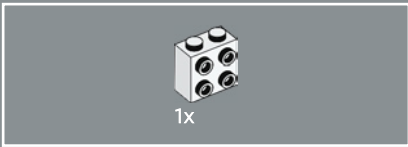

194

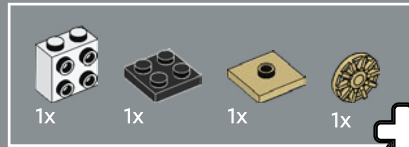
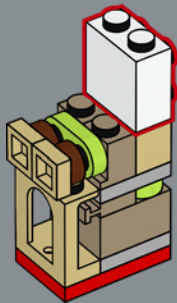

195

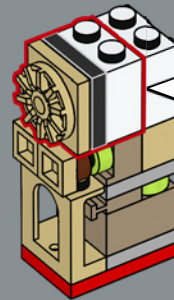
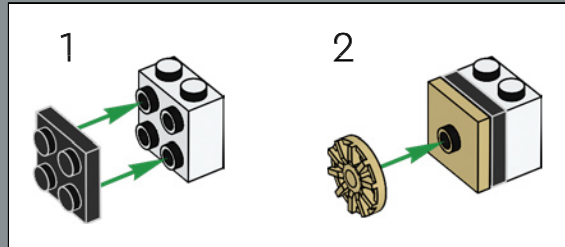
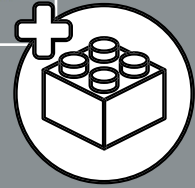

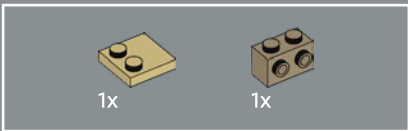

196

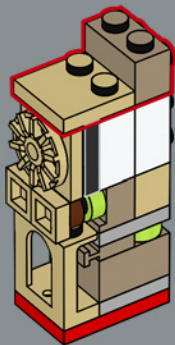

197

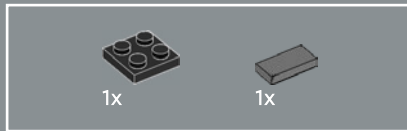
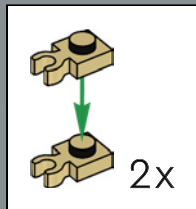
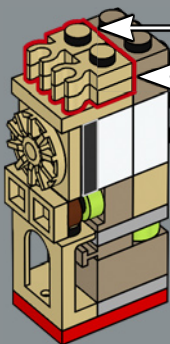

198

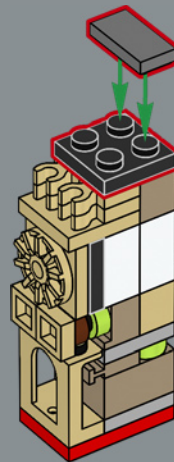

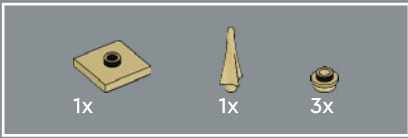

199

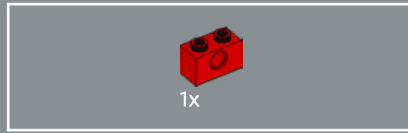
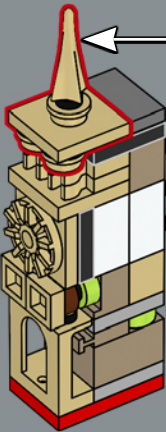
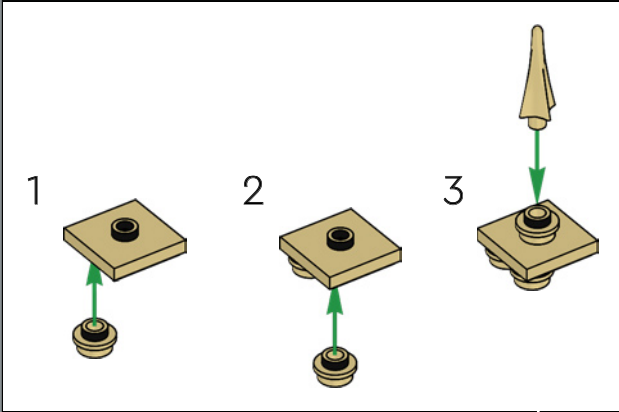

200

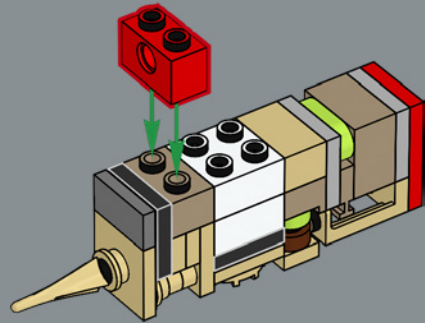

201

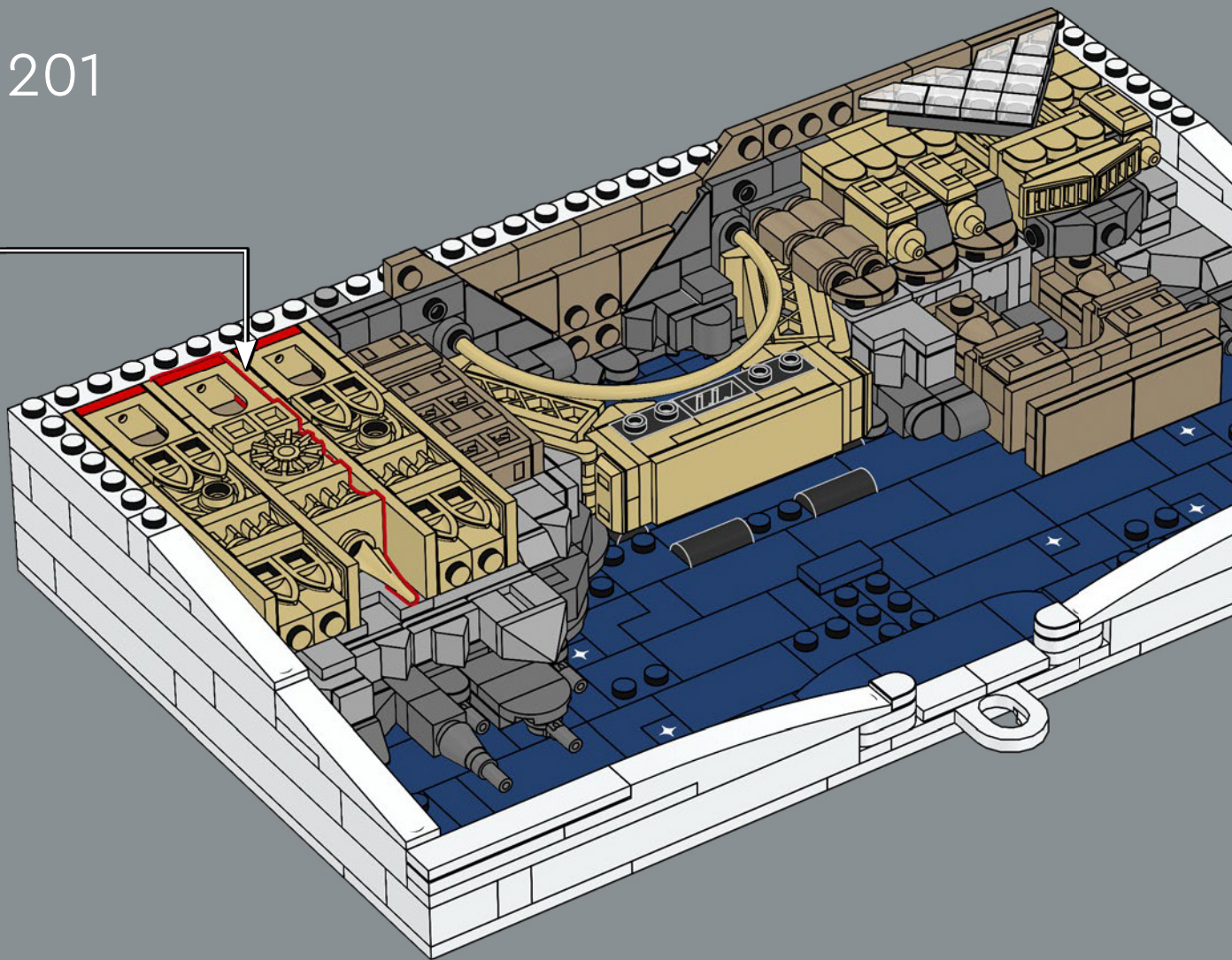

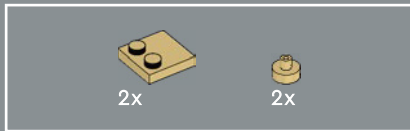

202

Il rosone di 9,6 m della cattedrale di Notre-Dame è rappresentato qui da un elemento coprimozzo LEGO®.

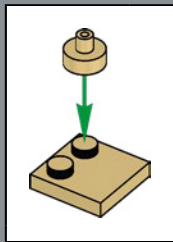
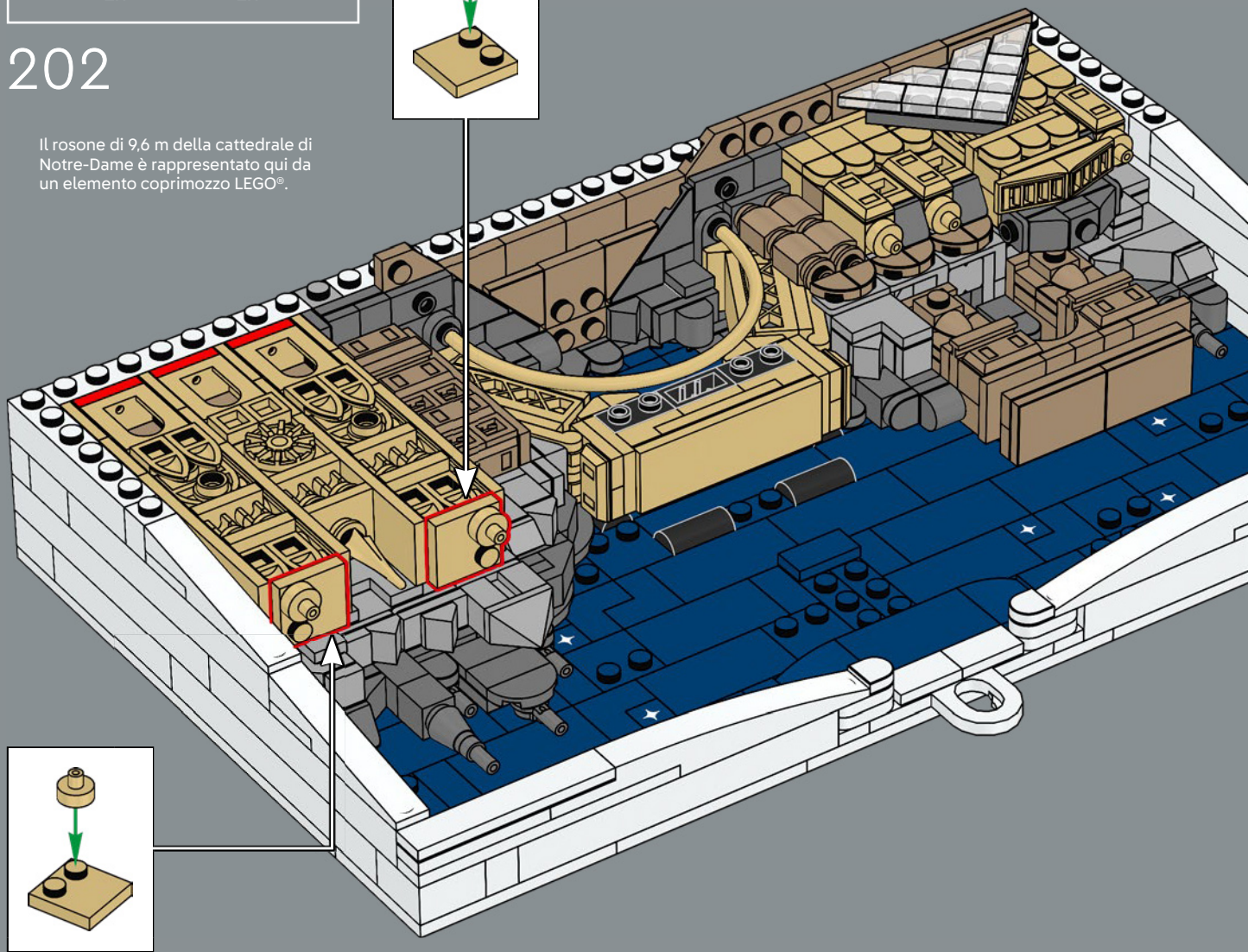
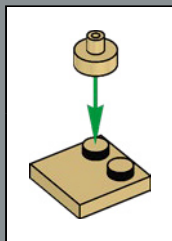



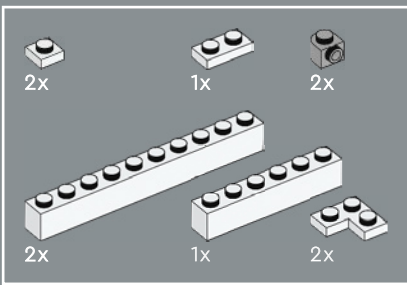

203

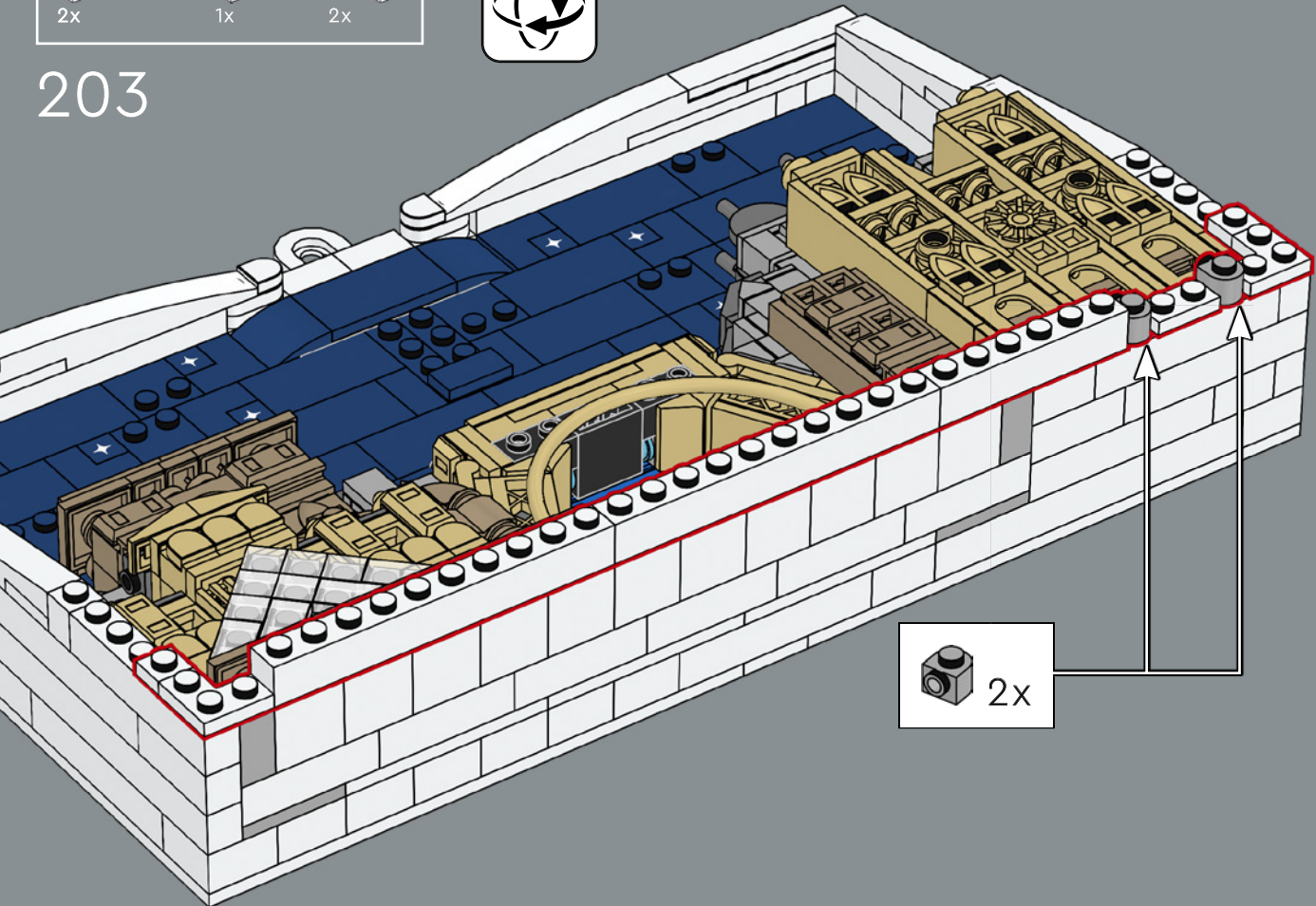

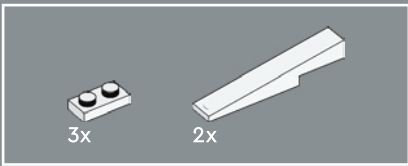

204

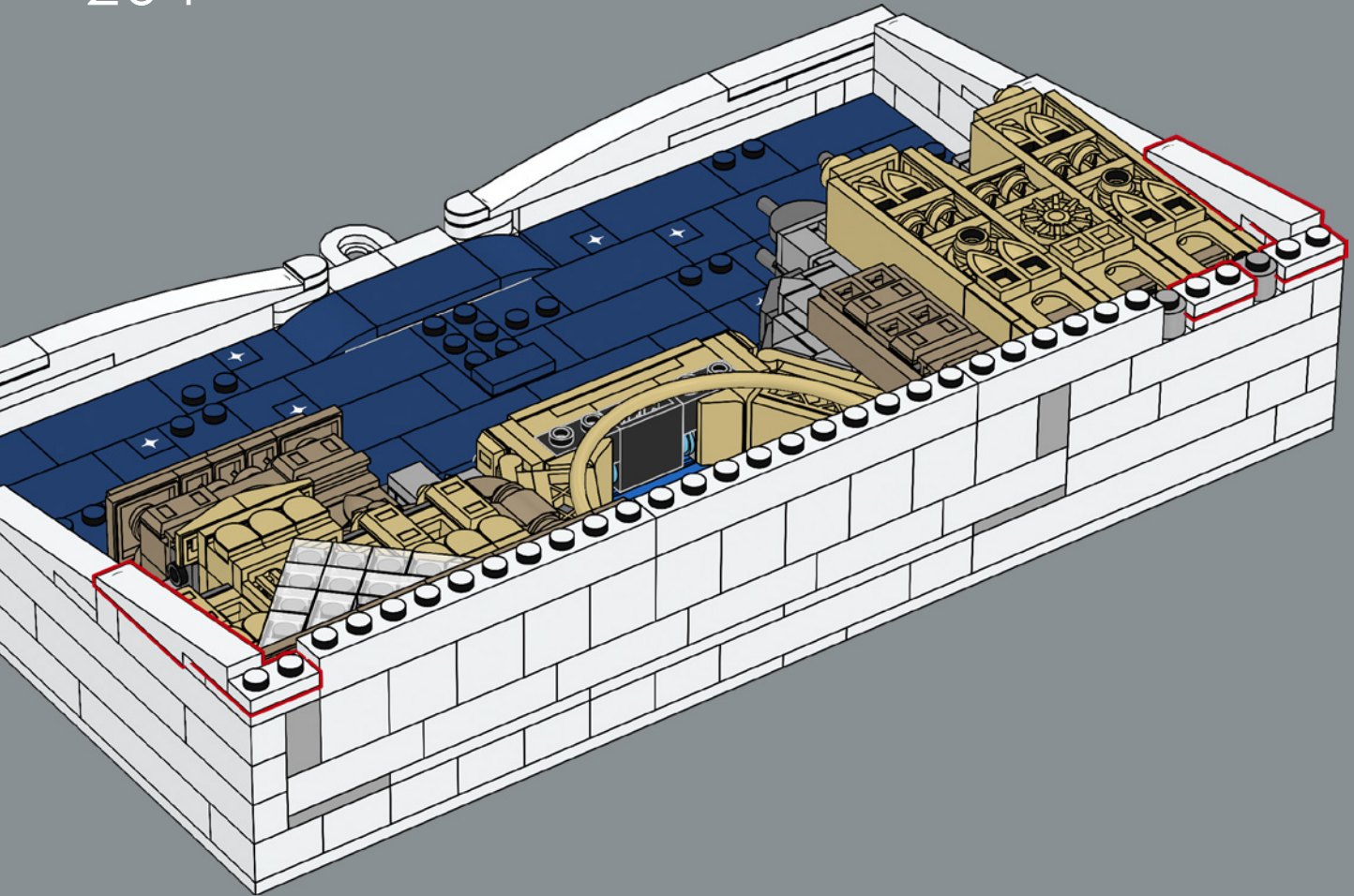

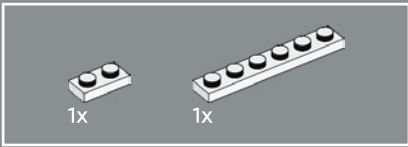

205

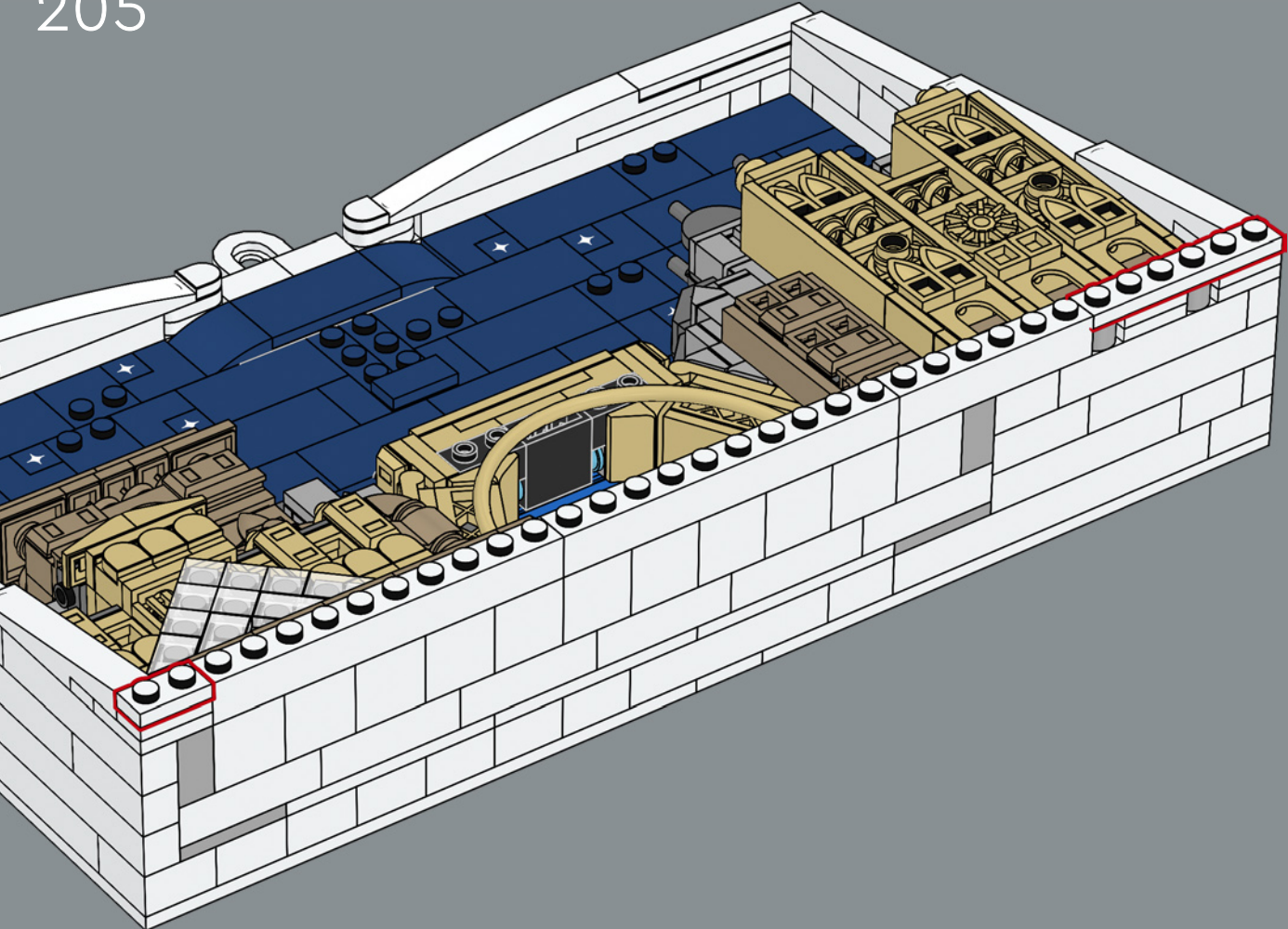

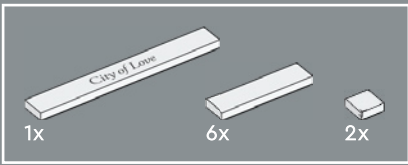

206

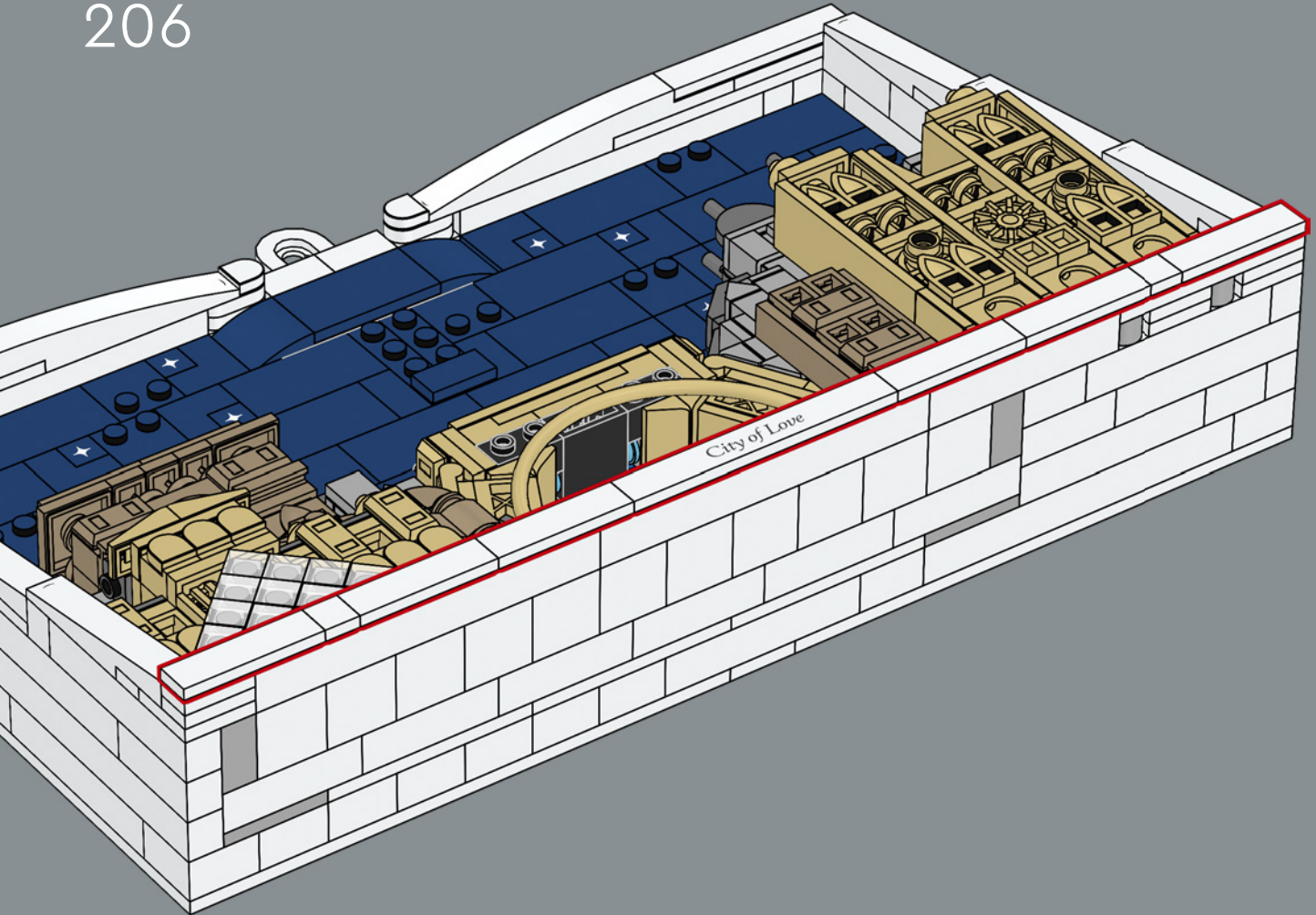

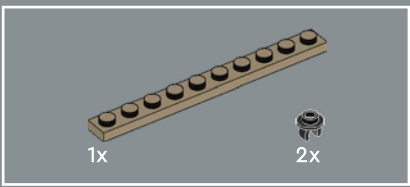

207

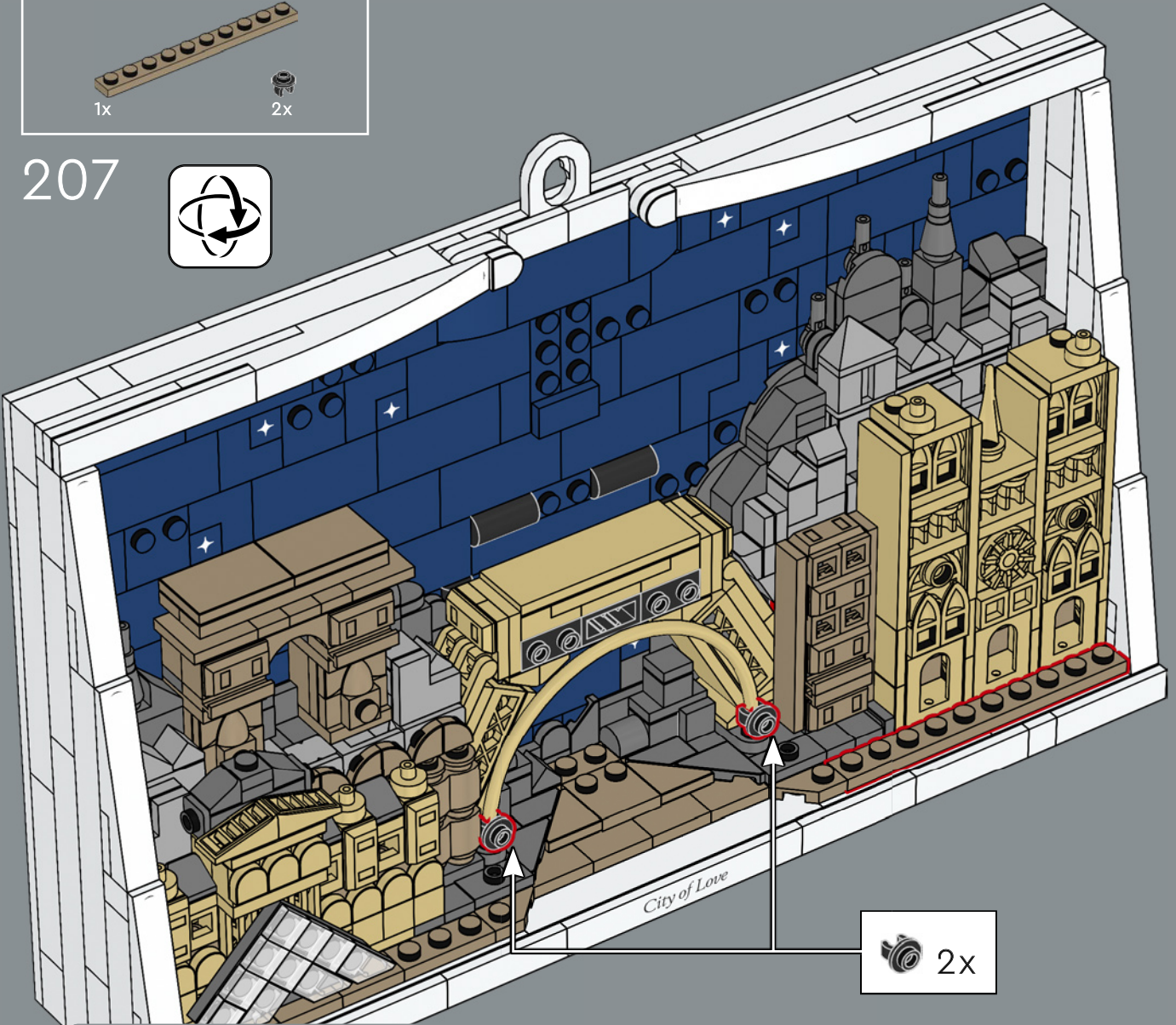

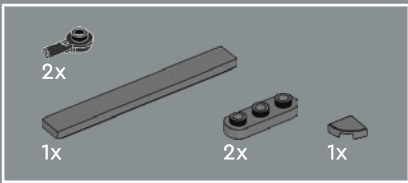

208

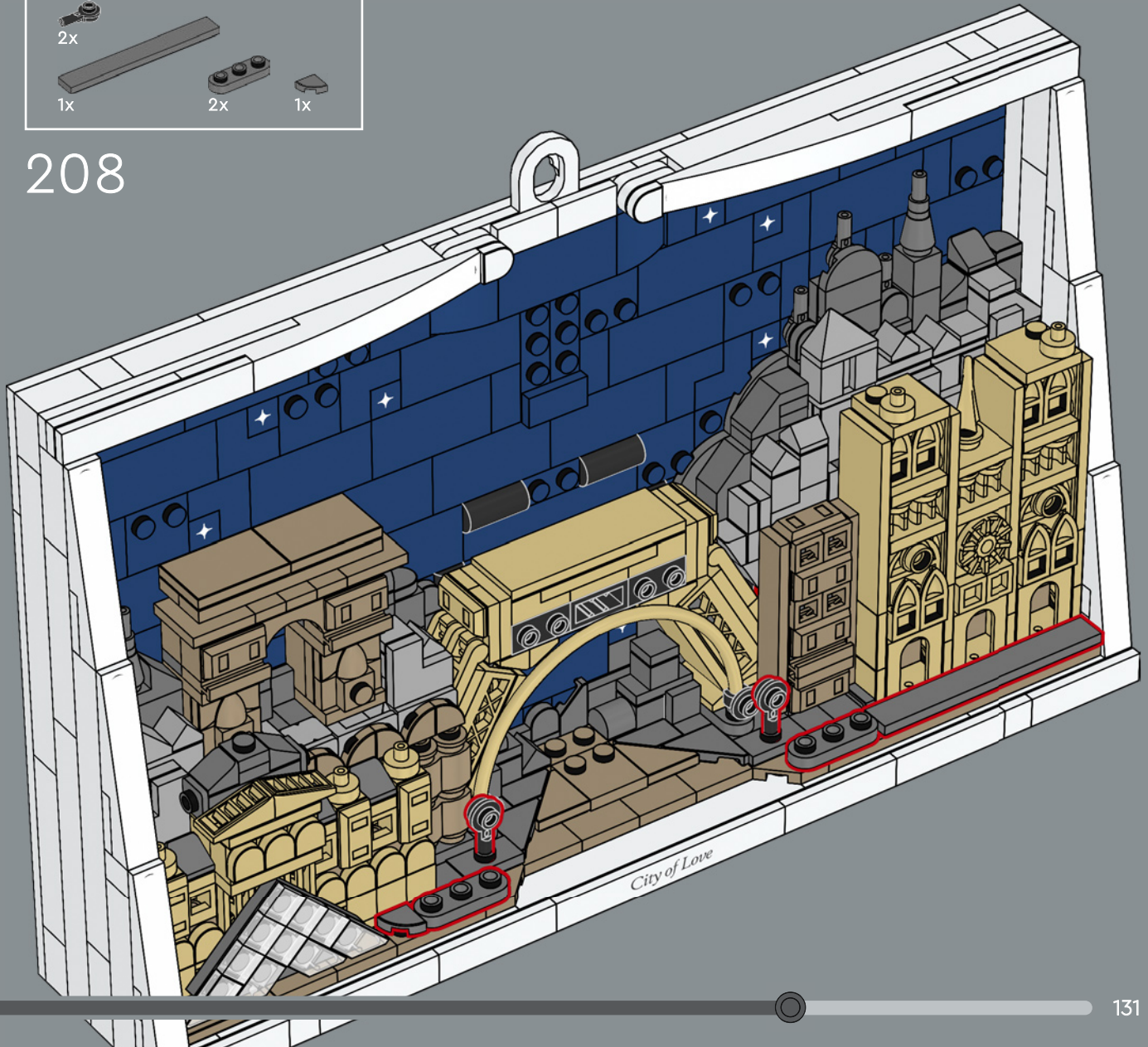

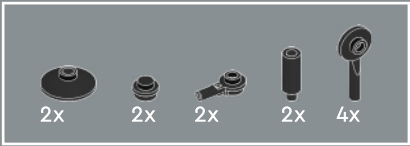

209

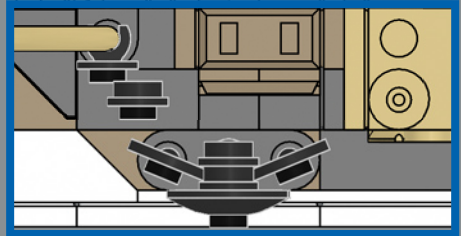
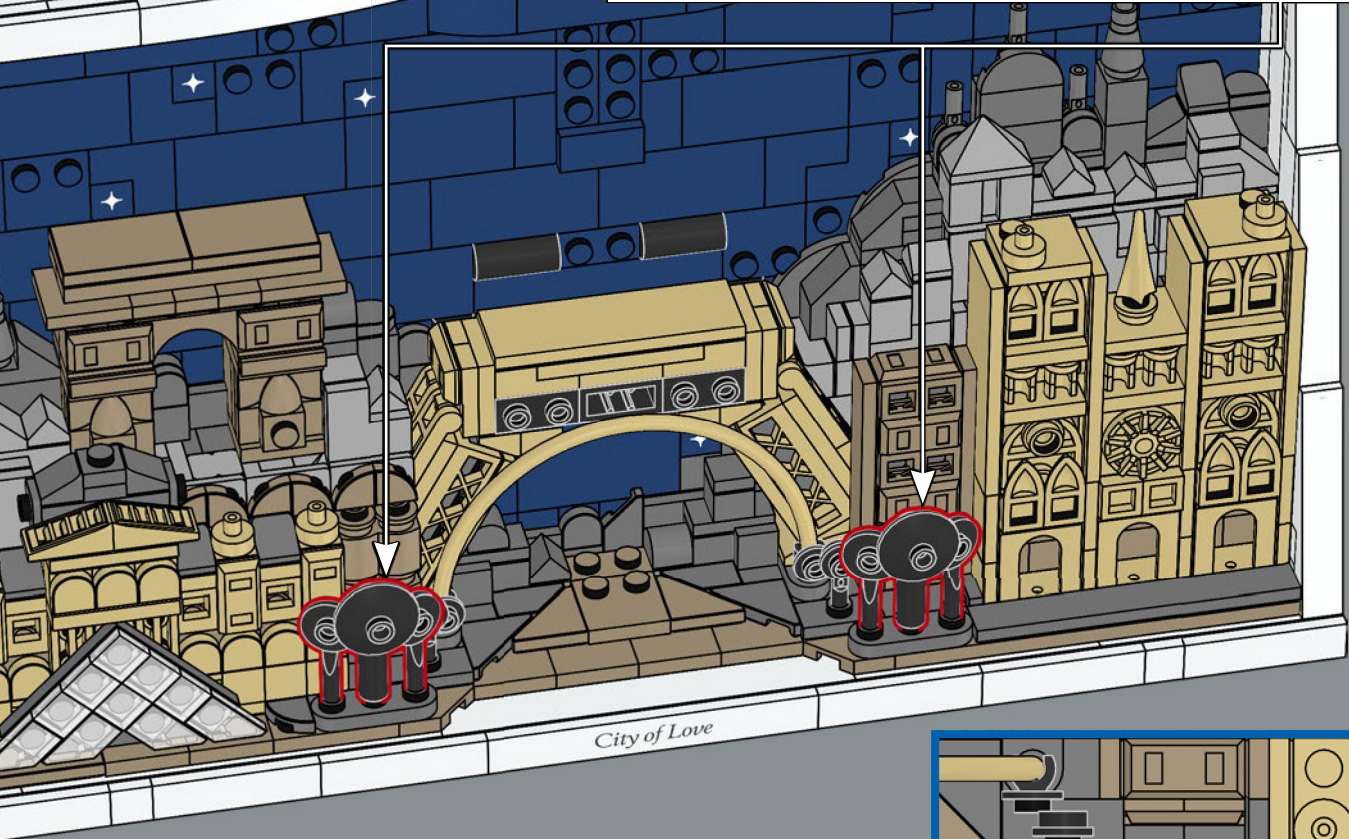
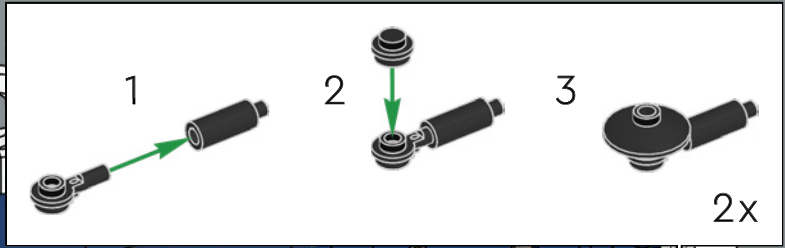

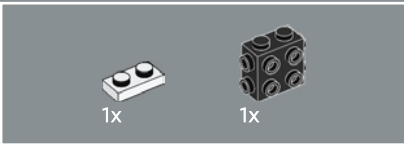
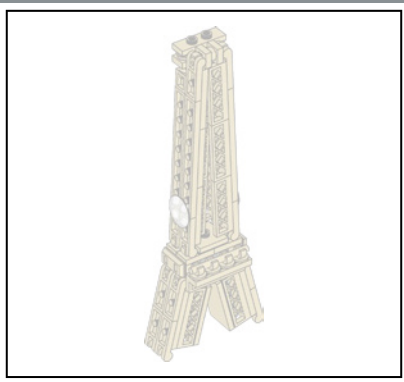

210

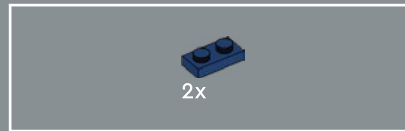
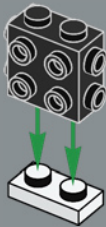

211

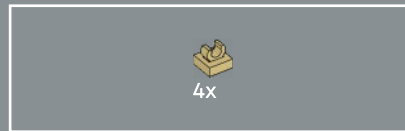
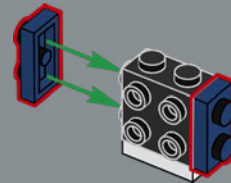

212

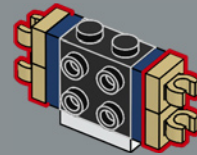

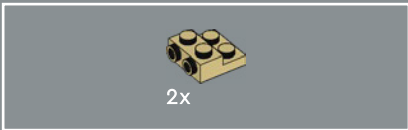

213

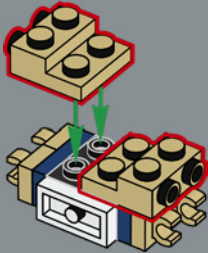

214

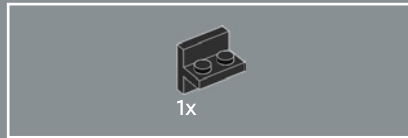
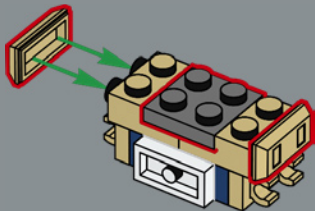

215

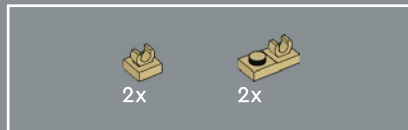
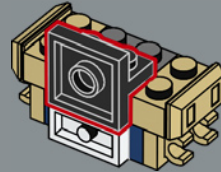

216

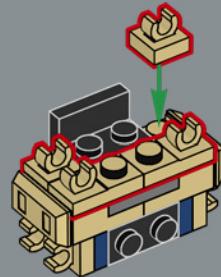

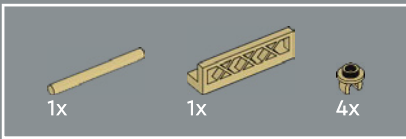

217

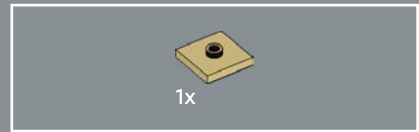
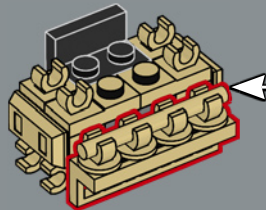
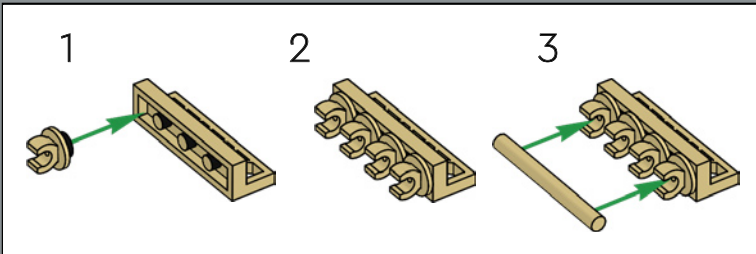

218

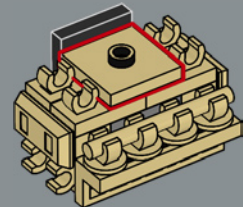

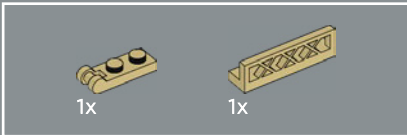
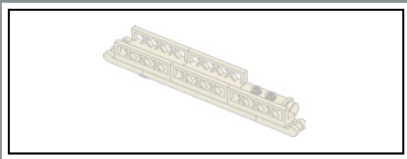

219

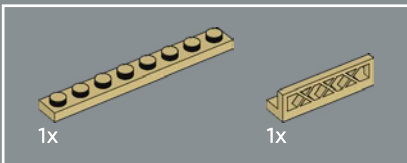
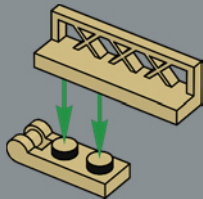

220

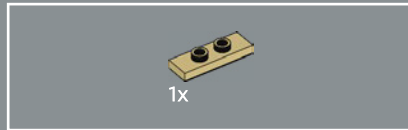
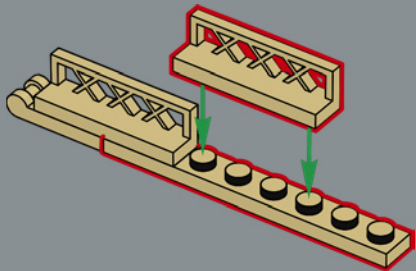

221

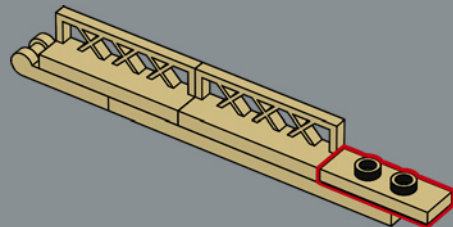

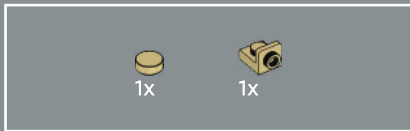

222

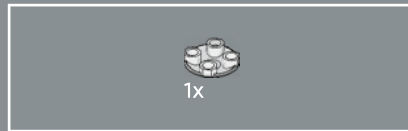
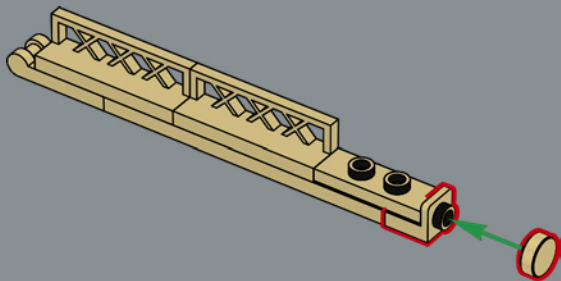

223

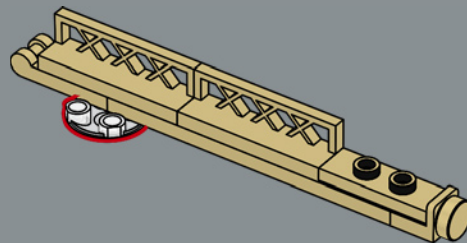

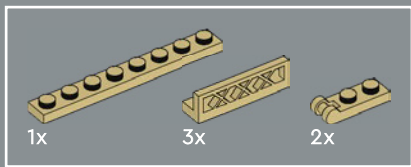

224

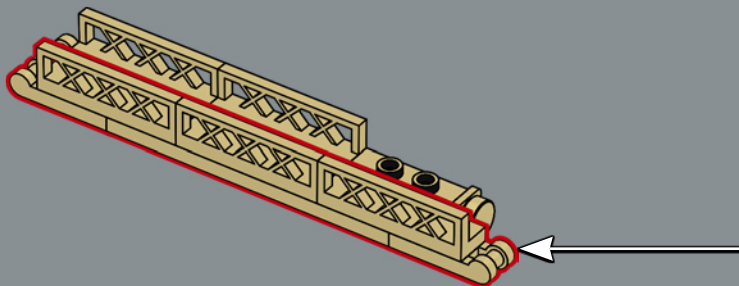
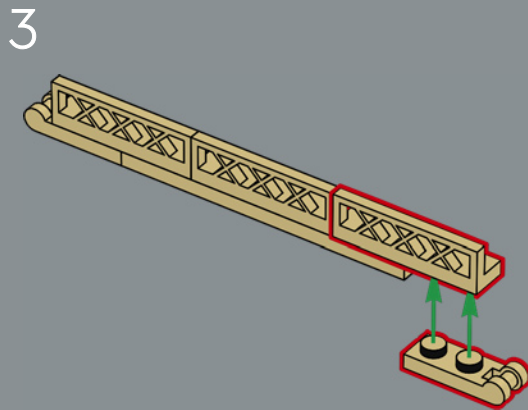
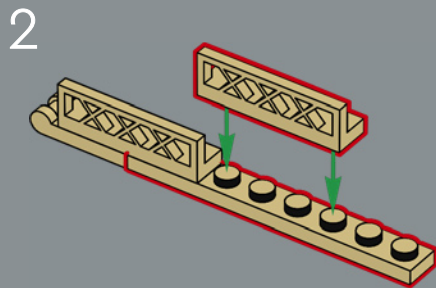
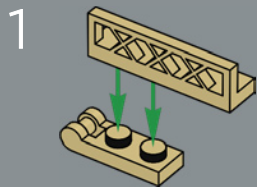

Oltre 2,5 milioni di rivetti tengono insieme la torre Eiffel! Sono rappresentati qui sotto forma LEGO® tramite il lato tubolare delle basi.

225



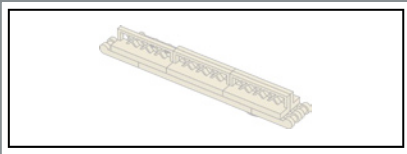

226

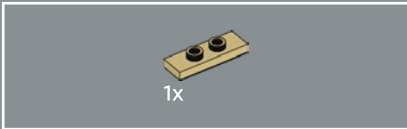
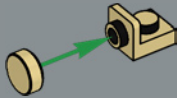

227

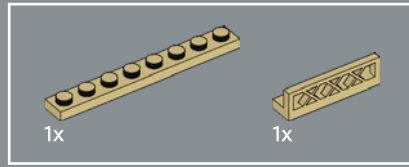
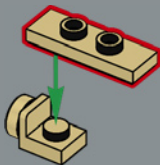

228

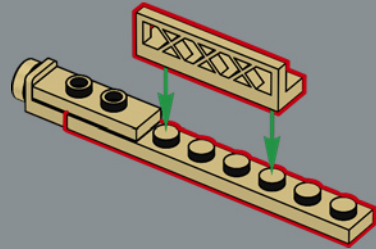

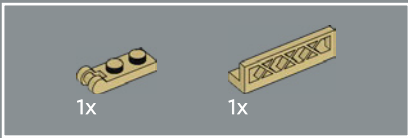

229

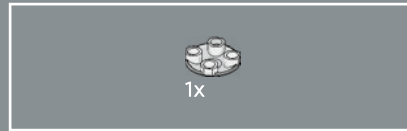
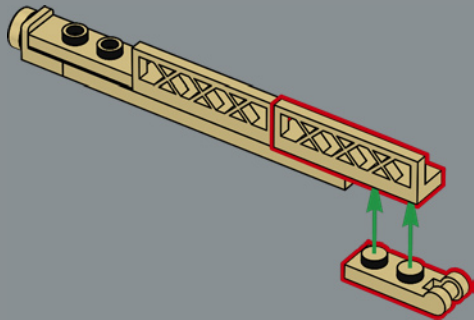

230

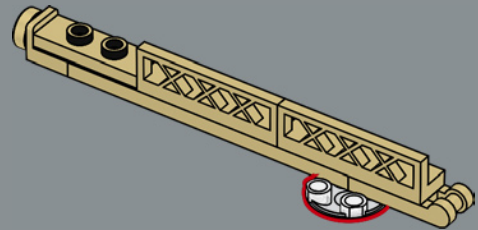

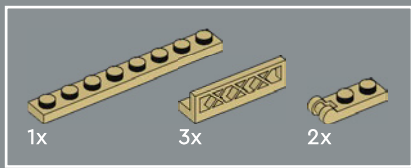

231

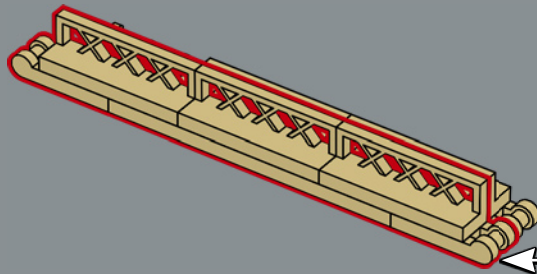
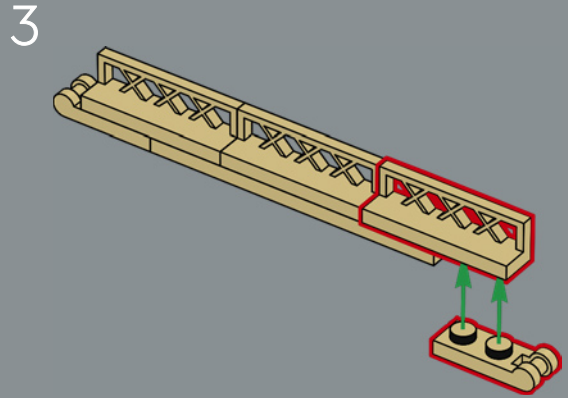
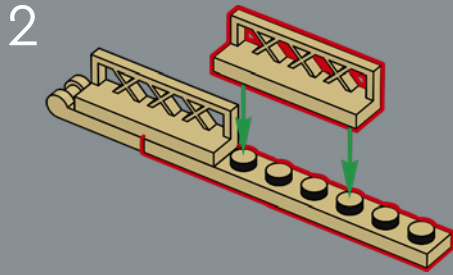
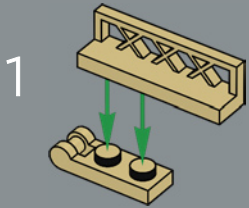

232

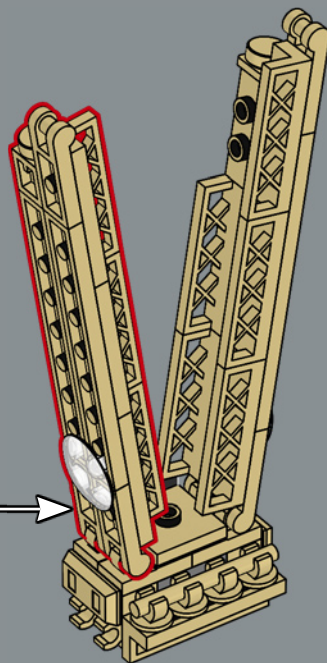

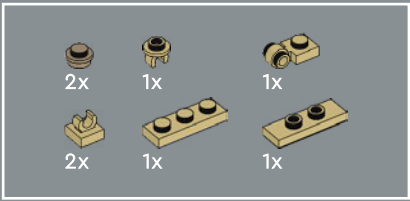

233

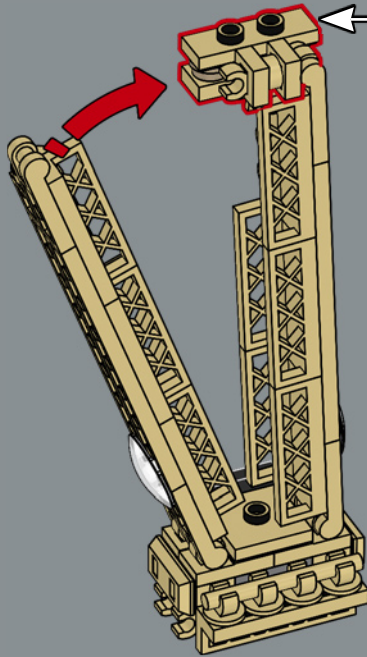
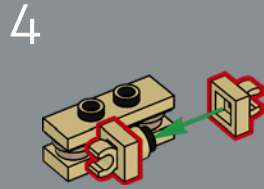
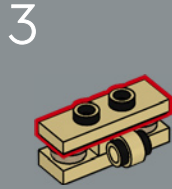
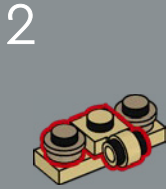
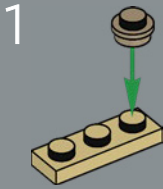

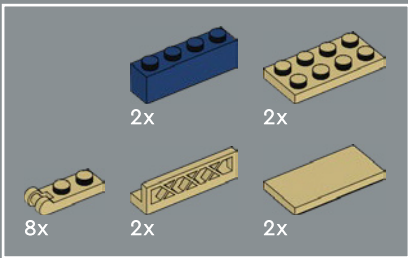

234

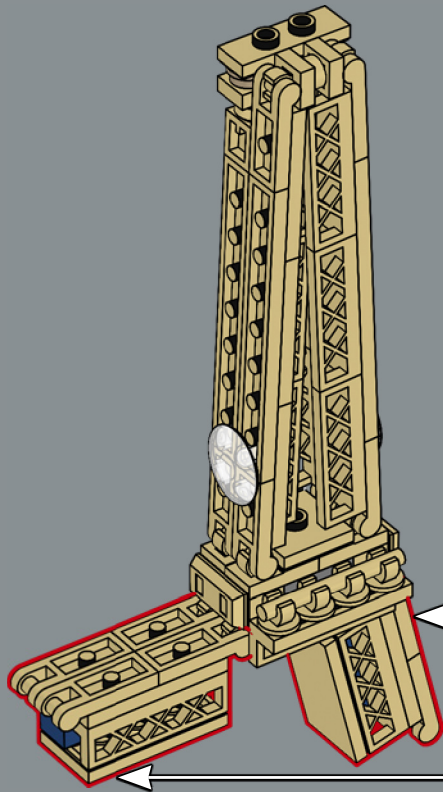
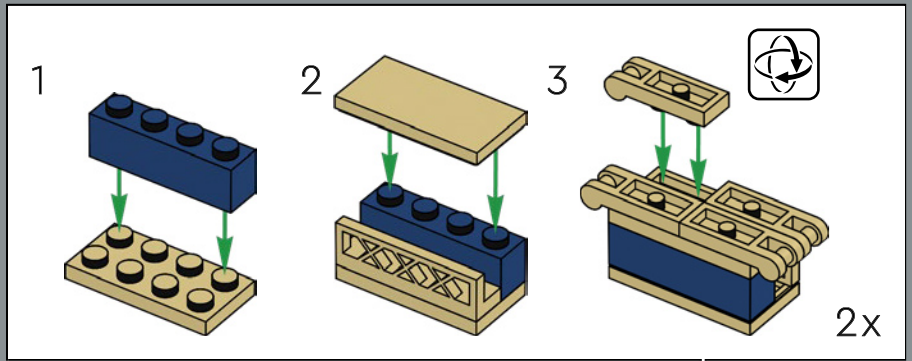

235

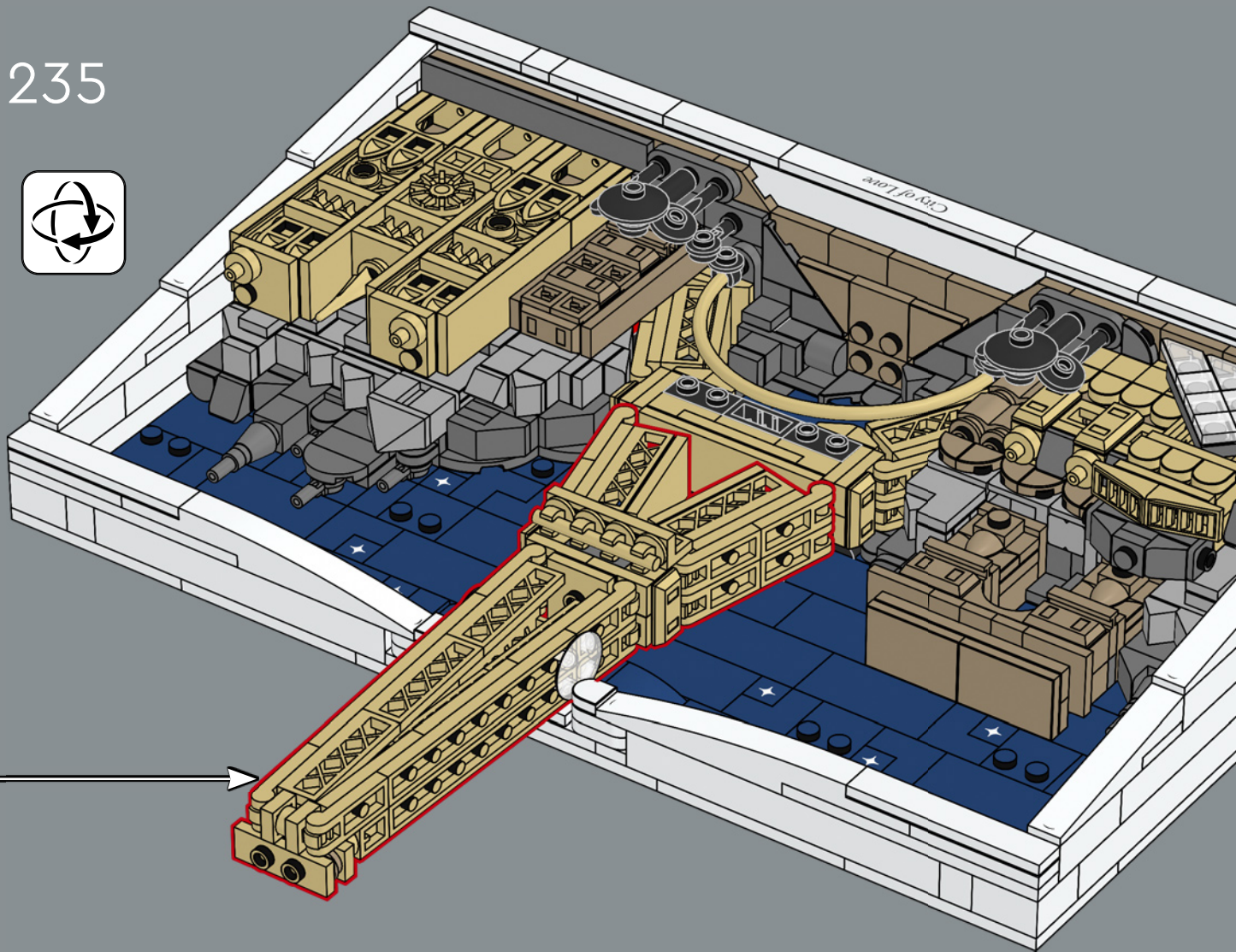



236

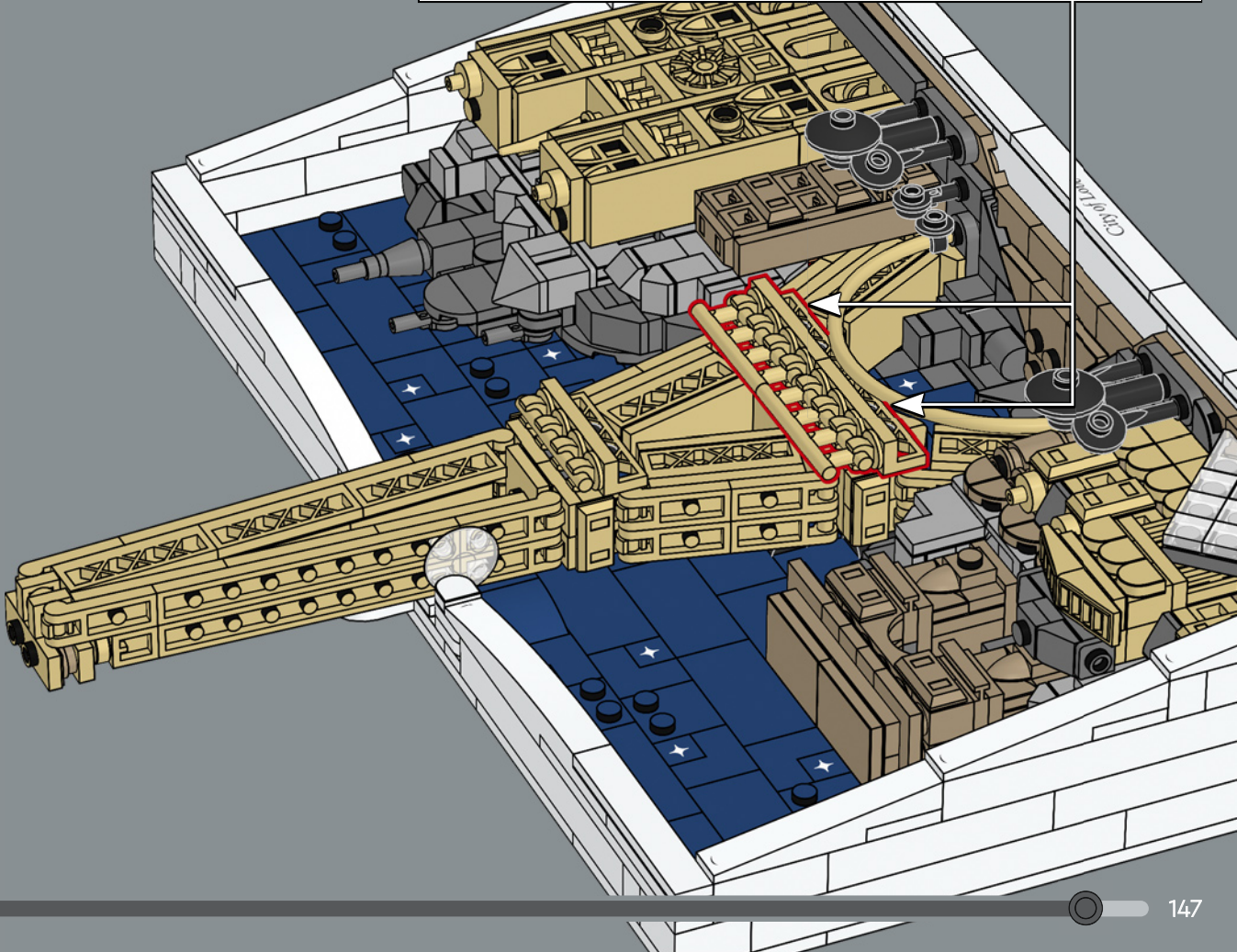
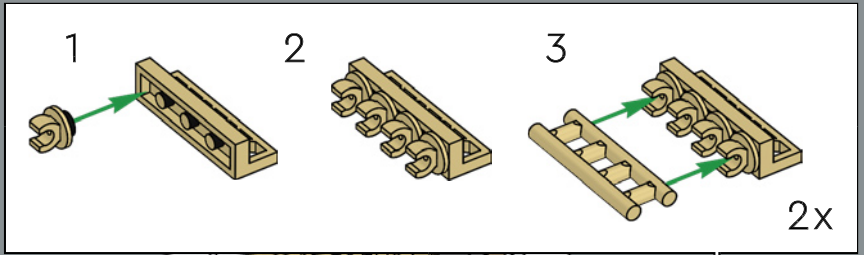

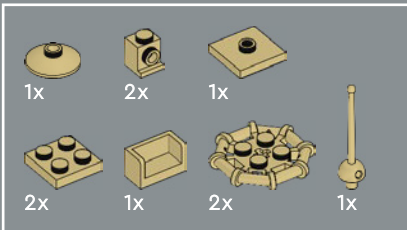
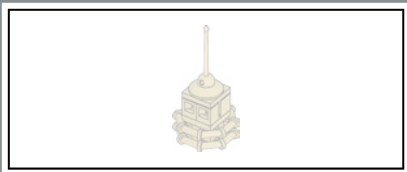

237

1

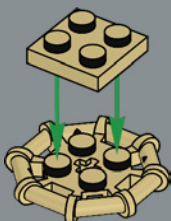

2



3

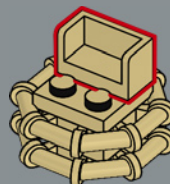

En garde! La guglia di questa Torre Eiffel
LEGO® Architecture è realizzata con la
spada da scherma di una minifigure.

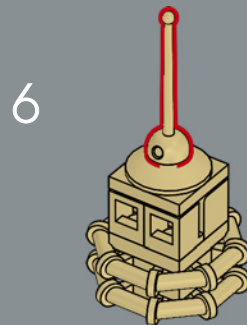
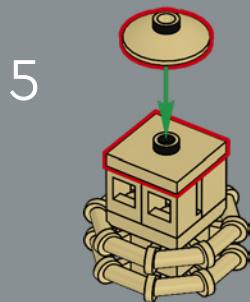
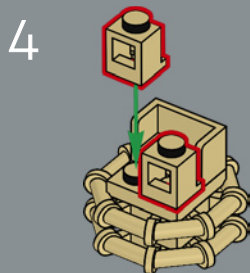

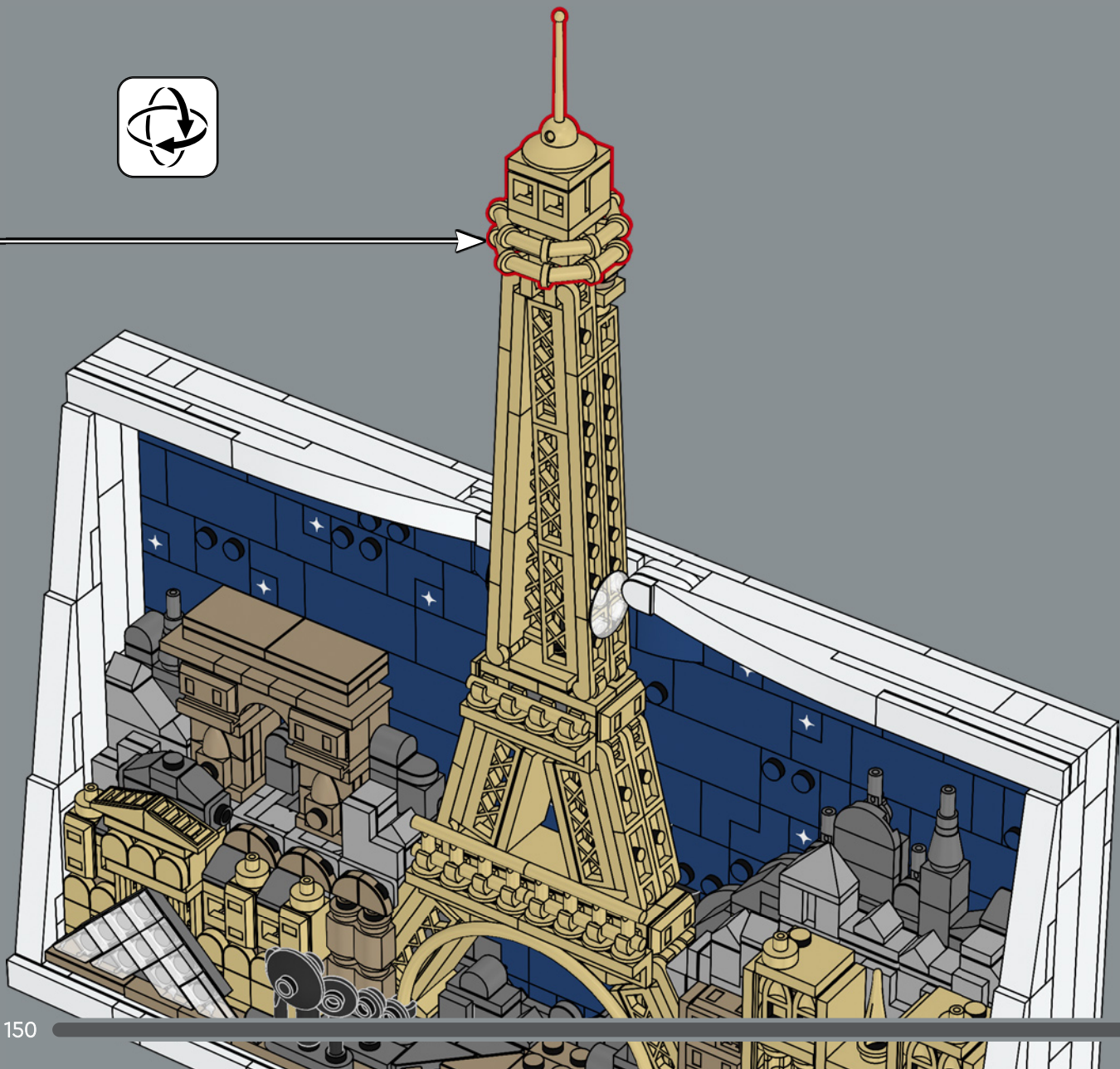

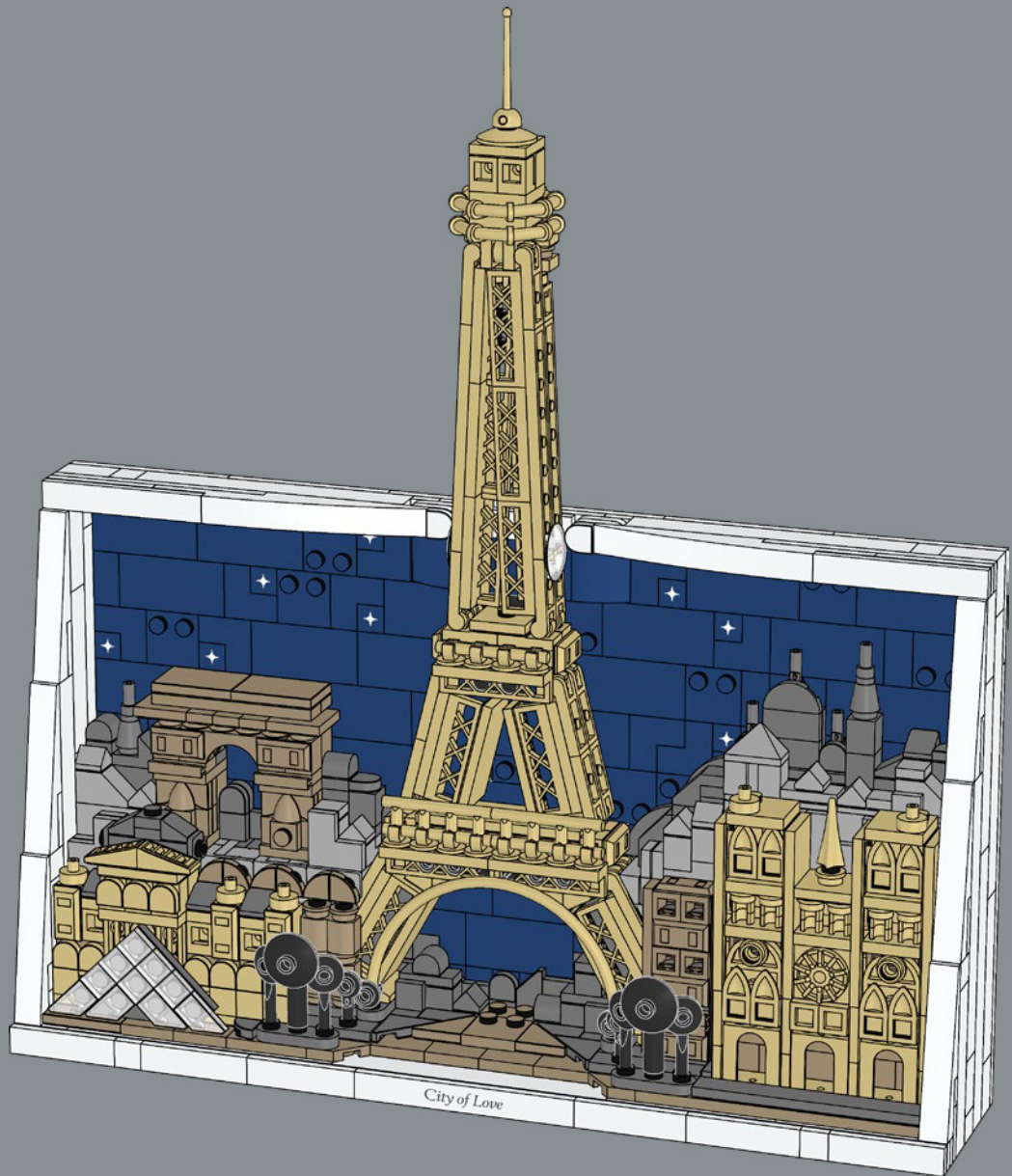

2x 614101
 2x 6250591
 4x 6446788
 5x 300501
 2x 307001
 4x 302401
 4x 6210272
 10x 302301
 5x 300401
 13x 6218823
 7x 6248490
 2x 306901
 4x 235701
 2x 242001
 4x 362201

2x 371001

6x 243101

6x 4143254

1x 6378415

2x 663601

6x 6507991

11x 300901

5x 366601

2x 346001

1x 6576392

4x 303201

2x 6035405

11x 611101

1x 4503008

1x 4119227

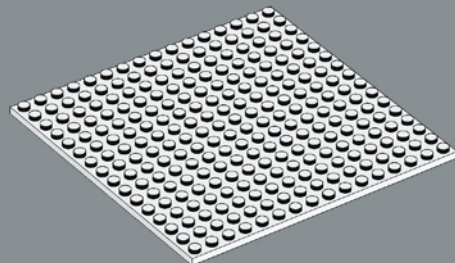

2x 4618526

1x 6269968

9x 6443061

13x 6559240

2x 6284573

1x 6486889

5x 6463667

10x 6353196

6x 4579260

4x 4125253

3x 6232135

8x 4118793

5x 4159553

12x 6360078

2x 6374151

2x 6365720

8x 4224793

1x 6212758

12x 6352222

4x 4624086

1x 6281995

1x 4617765

8x 6271228

5x 4109995

3x 4642933

2x 6024495

4x 4124456

6x 6575079

2x 6294481

1x 6248495

1x 4185177

4x 4565387

5x 4114084

2x 6046924

7x 6221467

2x 4114077

5x 6469454

22x 6211975

1x 6131896

2x 4162465

4x 6211966

2x 4121921

2x 6170776

1x 6116614

8x 6175367

1x 4118790

2x 6575077

17x 6458386

1x
4113916

2x
6575080

5x
6122047

8x
4114309

5x
6331158

4x
4114324

1x
4113988

1x
6575083

1x
6575084

2x
614121

1x
4558886

2x
302321

1x
370021

2x
6219819

2x
6469446

4x
302121

1x
302021

3x
6335578

6x
6264062

2x
6307926

2x
6116786

1x
4118785

2x
6310247

4x
6253273

2x
6290456

2x
614126

2x
6534180

2x
6424674

4x
6575081

1x
300526

2x
6228987

1x
6210270

4x
6196548

2x
474026

1x
6275732

4x
6472004

2x
6308883

9x
6250020

1x
6430547

4x
302226

1x
243126

1x
366626

2x
379526

6x
6581822

2x
6515310

2x
6515311

2x
6581772

1x
6336665

3x
4177932

1x
6240515

6x
6322841

8x
6300322

2x
6315781

10x
6362967

10x
6273590

2x
6001824

2x
4549436

2x
6536855

2x
6553752

2x
4520257

6x
6575078

8x
6310835

3x
6449563

2x
6228921

5x
6092591

7x
4616711

2x
6328183

2x
6480380

11x
6396392

1x
4255416

2x
4550168

2x
6126075

3x
6035540

3x
6328307

2x
6310832

2x
4507047

2x
6015424

1x
6156492

1x
6232137

10x
6576391

2x
4184108

6x
4528981

4x
6092588

5x
4528488

2x
6061569

11x
6214810

16x
6103392

2x
4530028

3x
4502089

2x
4264569

25x
4569836

2x
4252437

6x
6186673

4x
4211180

2x 6448793	1x 6066097	4x 6065824	1x 6075075	2x 6510145	2x 6350724	2x 4529240
4x 6225242	5x 4211398	2x 4211387	1x 6000066	1x 6510078	2x 6225494	7x 6362252
1x 4211389	1x 6227184	2x 6469440	1x 4211388	2x 6221607	2x 6510131	16x 4210848
7x 6253436	4x 4654580	3x 4211429	2x 4617170	3x 6388118	1x 6262021	1x 6199549
12x 4211415	1x 4494475	2x 6171894	2x 4617170	2x 6168776	4x 6333129	2x 4211133
2x 6401023	6x 4211397	5x 4211438	1x 4211386	18x 4211052	6x 4211098	5x 6250018
4x 6345639	3x 4211353	1x 6037399	3x 6102986	3x 4211055	7x 4504378	2x 6262025
1x 6248078	2x 6212077	1x 4211360	5x 6465292	5x 4211094	10x 4210719	4x 6543014
2x 4568637			1x 4649741	2x 6265306	3x 6388133	2x 4211103
			2x 6060857	3x 4211094	7x 6332045	2x 4211103
			3x 4619513	2x 6265306	1x 6069164	8x 4560184
			1x 4619653	3x 4211104	1x 4211088	2x 4210998
				1x 4210728	4x 6092572	1x 4211008
				10x 4211053	3x 4211063	

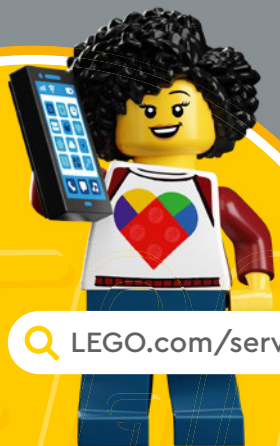

[LEGO.com/service](https://www.LEGO.com/service)



YOU COULD WIN



YOU COULD WIN

Your feedback will help shape the future development of this product series.

Visit:

DU KÖNNTEST GEWINNEN

Dein Feedback trägt zur Weiterentwicklung dieser Produktreihe bei.

Geh auf:

VOUS POURRIEZ GAGNER

Vos commentaires nous aideront à concevoir les futurs produits de cette gamme.

Visitez :

POTRESTI VINCERE TU

La tua opinione ci aiuterà a migliorare la creazione futura di questa linea di prodotti.

Visita:

PUEDES GANAR

Tu opinión contribuirá al futuro de esta serie de productos.

Visita:

轻松获奖

您的反馈将有助于我们在今后改进本产品系列。

请访问:

LEGO.com/productfeedback

You also have the chance to win a LEGO® set.

Terms and conditions apply.*

Außerdem hast du die Chance, ein LEGO® Set zu gewinnen.

Es gelten die Teilnahmebedingungen.*

Vous pourriez également gagner un ensemble LEGO®.

Des conditions s'appliquent.*

Hai anche la possibilità di vincere un set LEGO®.

Termini e condizioni sono applicabili.*

También tienes la oportunidad de ganar un set LEGO®.

Aplican términos y condiciones.*

您还有机会赢取乐高®套装。

条款和条件适用。*

*LEGO.com/productfeedback-terms

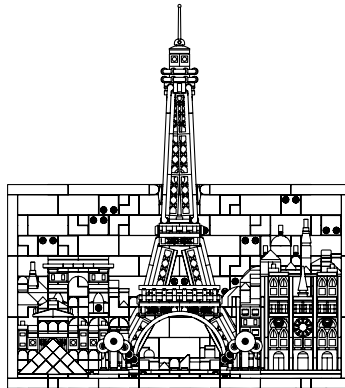

LEGO and the LEGO logo are trademarks of the LEGO Group. ©2026 The LEGO Group.
LOUVRE and MUSEE DU LOUVRE are protected trademarks of
Etablissement public du musée du Louvre. Pyramide du Louvre © arch. I.M. Pei.
Adam Reed Tucker is the co-developer of the LEGO® Architecture product line.