



# BOTANICALS™

11506



1



LEGO.com/sustainable-packaging



**FR**  
**DONNEZ**  
OU  
**RECYCLEZ**

 OU  OU 

ASSOCIATION    MAGASIN    DÉCHÈTERIE

Adresses sur [quefairedemesdechets.fr](http://quefairedemesdechets.fr)



LEGO® Builder

# BUILDER



Apple and the Apple logo are trademarks of Apple Inc., registered in the U.S. and other countries and regions. App Store is a service mark of Apple Inc. Google Play and the Google Play logo are trademarks of Google LLC. Tencent and the Tencent logo are trademarks of Tencent Inc.

**[LEGO.com/devicecheck](https://www.lego.com/devicecheck)**

**EN** Ask parents' permission before going online | **DE** Eltern um Erlaubnis bitten, bevor du online gehst | **FR** Demande l'autorisation d'un parent avant d'aller en ligne | **IT** Chiedi il permesso ai tuoi genitori prima di andare online | **ES** Pídeles permiso a tus papás antes de conectarte a Internet | **PT** Pede autorização aos teus pais antes de ficares online | **ZH** 上网前应先征得父母的同意 | **PL** Poproś rodziców o zgodę, zanim wejdiesz do Internetu | **CS** Než půjdeš na internet, požádej rodiče o svolení | **SK** Skôr než pôjdeš na internet, vypýtaj si povolenie od rodičov | **HU** Kérj szülői engedélyt, mielőtt online csatlakoznál! | **UA** Запитуйте дозволу батьків, перш ніж користуватися інтернетом | **RO** Cere permisiunea părinților înainte de a te conecta online | **BG** Поискайте разрешение от родител, преди да влезете онлайн | **LV** Pirms došanās tiešsaistē palūdz atļauju vecākiem | **ET** Enne Interneti kasutamist küsi vanematelt luba | **LT** Prieš prisijungdami prie interneto, atsiklauskite tėvų | **TR** İnternete girmeden önce anne babandan izin iste



Cześć, tu Lumi. Jestem  
słonecznicą Coopera, ale zwa-  
mnie też lodową rośliną!

Jednak ten fajny, błyszczący sukulent wcale nie jest lodowaty. Jego ksywka pochodzi od drobnych włosków na todydze i liściach, które odbijają światło i wyglądają zupełnie jak kryształki lodu. Ekstra! Ta odważna, urocza i lubiąca zabawę roślina LEGO® przybyła aż z Republiki Południowej Afryki i jest gotowa do zabawy w każdym miejscu.





## *Cześć, mam na imię Ellie i jestem eszewerią elegans!*

Ten pochodzący z Ameryki Środkowej klasyczny sukulent jest tak lubiany, ponieważ jest łatwy w uprawie. Jest sztywny, ale potrafi się przystosować, a jeśli na jego widok przychodzi Ci na myśl słowo „elegancki”, nie mamy Ci tego za złe – przecież ma je w nazwie! Nie brakuje mu też jednak dzikiego oblicza. Wersja tej rośliny z klocków LEGO® ma efektowne kwiaty w żywych kolorach i doskonale przypomina, że życie jest pełne niespodzianek.



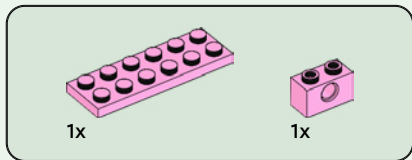

1

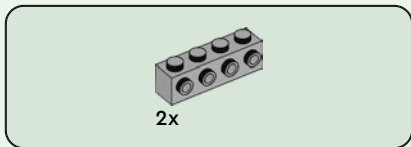
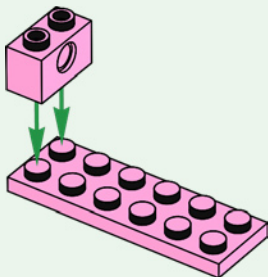

2

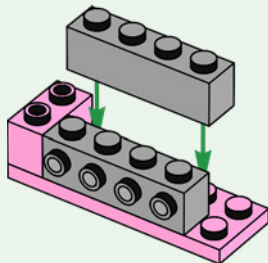



1x

3

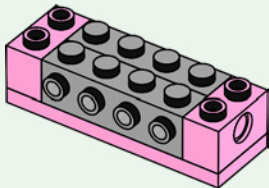

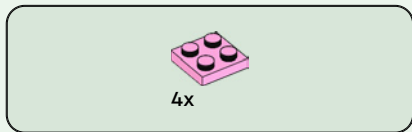

4

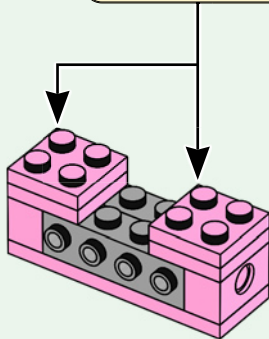
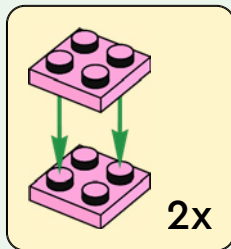

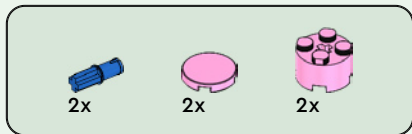

5

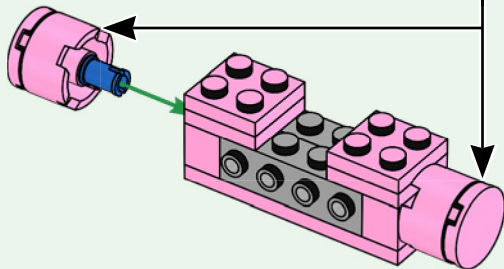
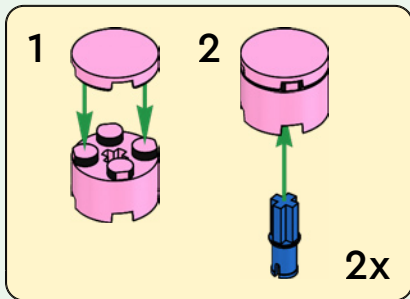



2x

6

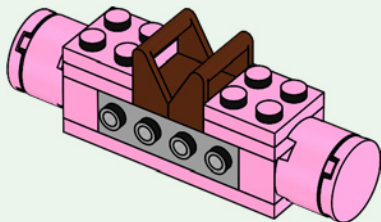



2x

7

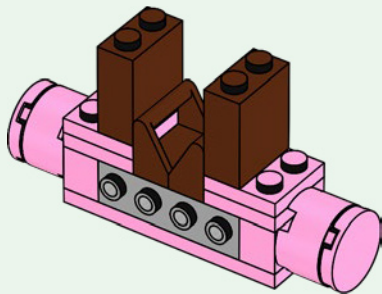



4x



4x



2x

# 8

1

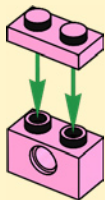

2

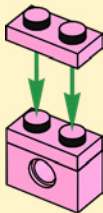

3

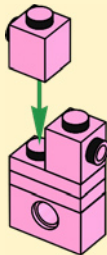

2x

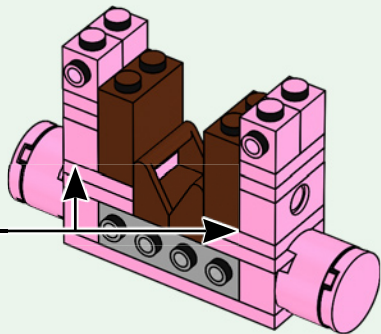

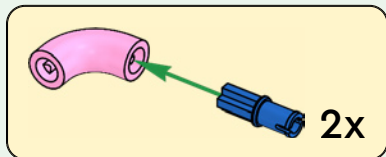
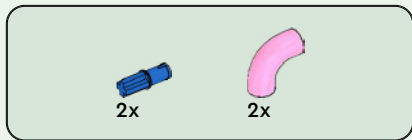

9

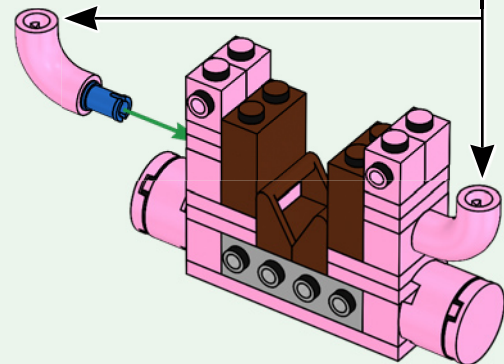

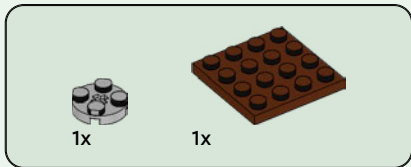

10

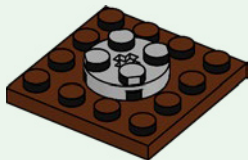



2x



2x

# 11

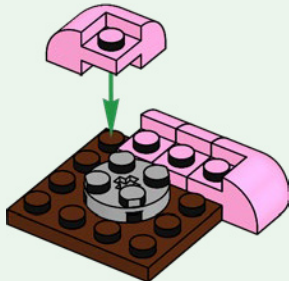

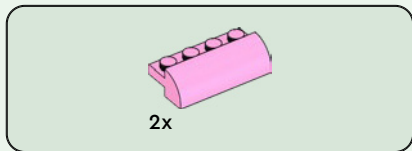

12

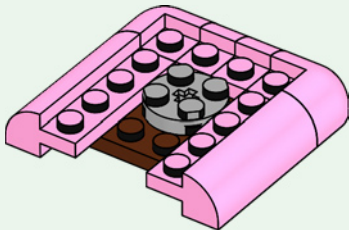



1x

13

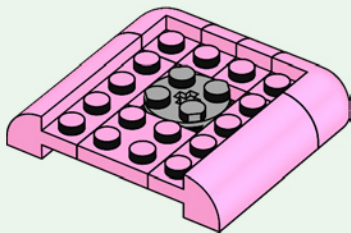

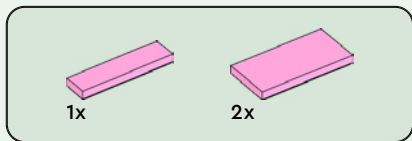

14

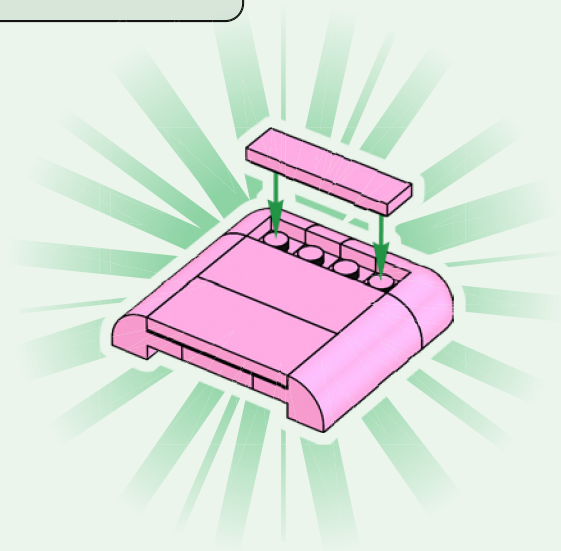

15

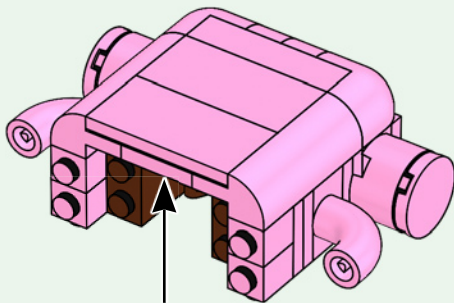
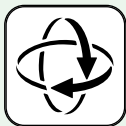

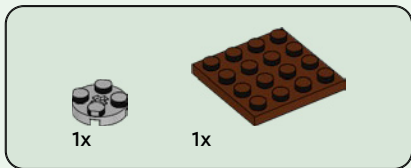

16

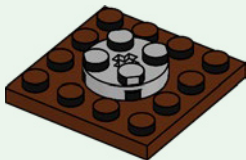



2x



2x

17

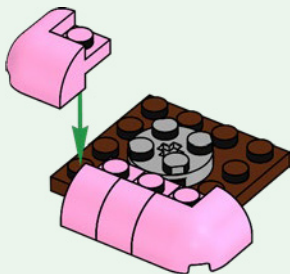

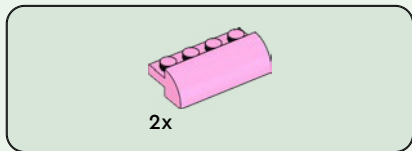

18

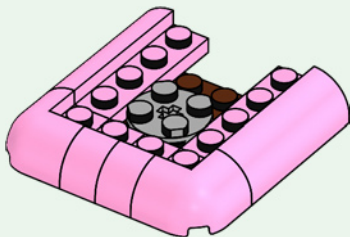



1x

19

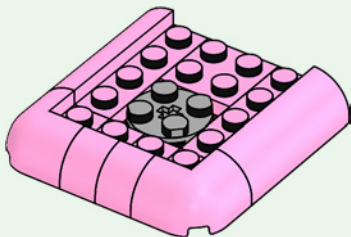

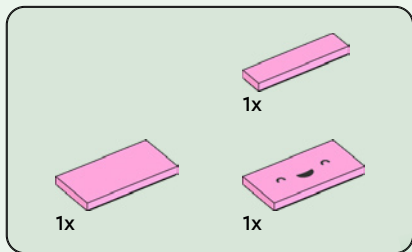

20

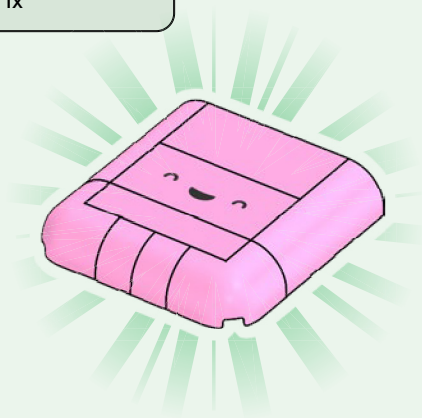

21

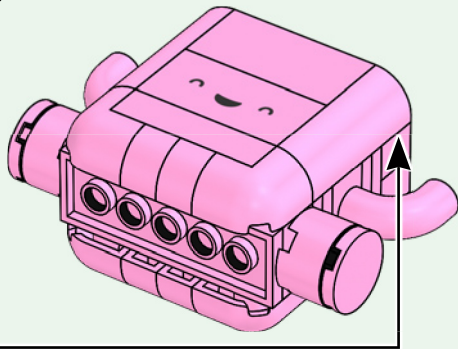
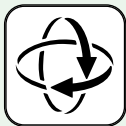



1x



2x

# 22

1

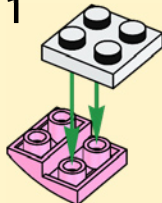

2

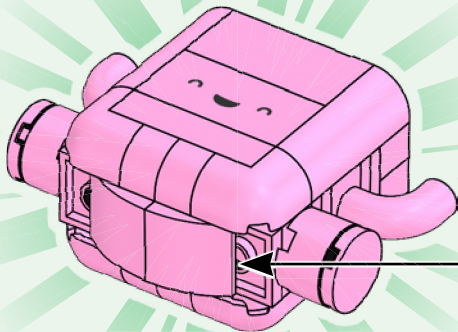
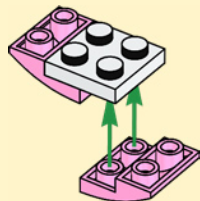

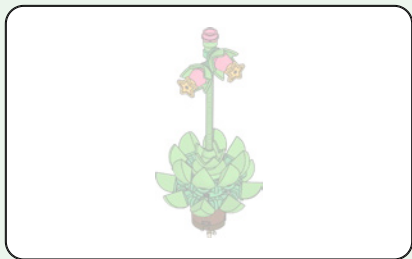

1x



1x

23

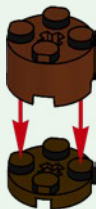



1x

24



1x

25



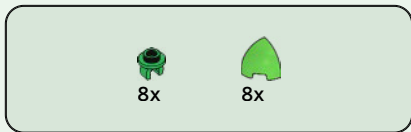

26

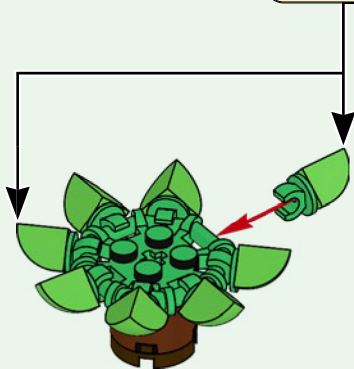
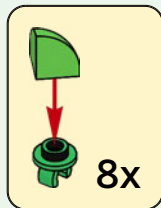

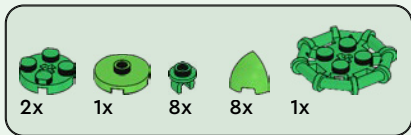
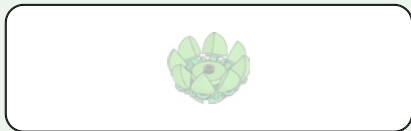

27

1

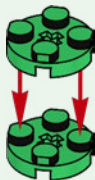

2

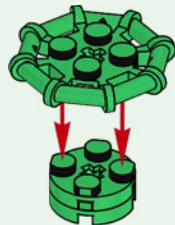

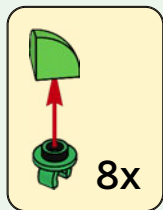

3

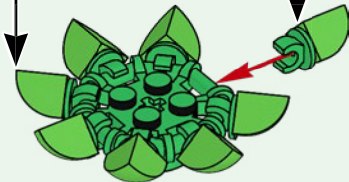

4

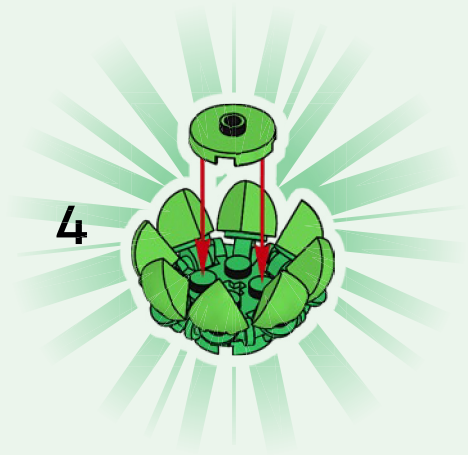



1x

28

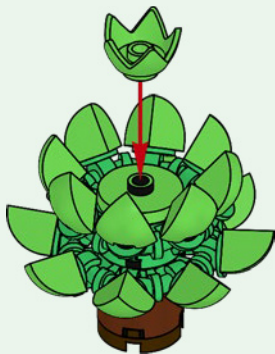
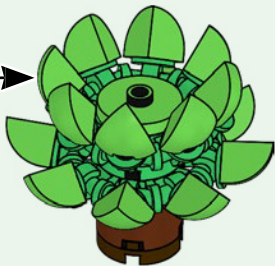

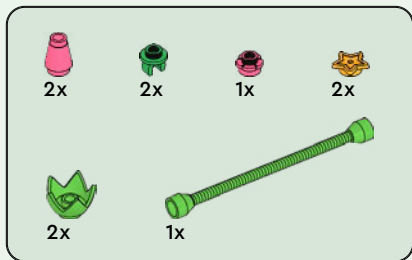

29

1



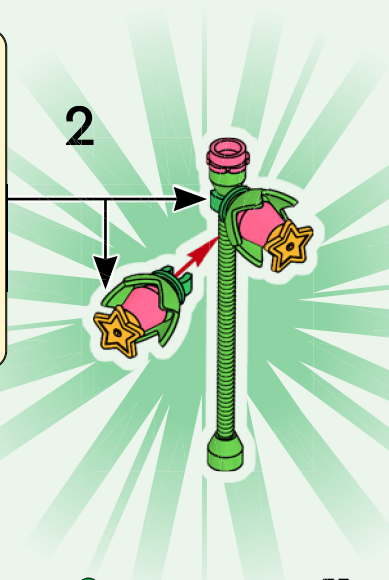
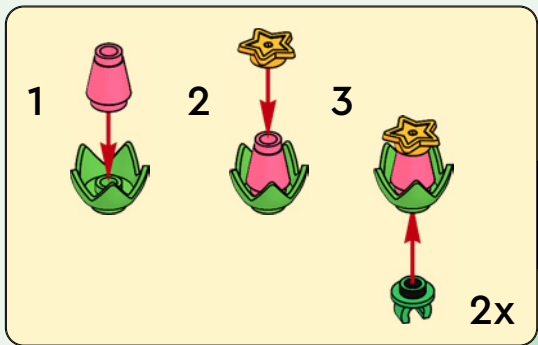

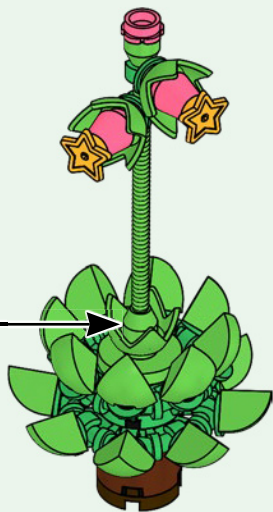



1x



1x

30

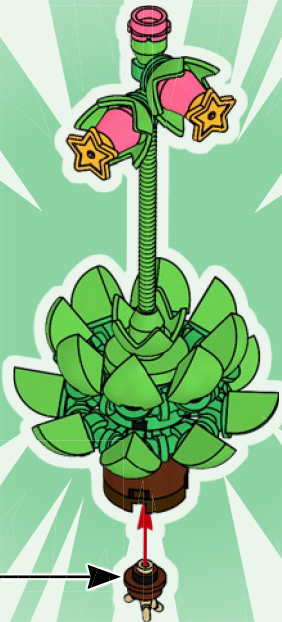

31

