



11505





LEGO.com/sustainable-packaging



FR
**DONNEZ
OU
RECYCLEZ**



ASSOCIATION

OU



MAGASIN

OU



DÉCHÈTERIE

Adresses sur quefairedemesdechets.fr



BUILDER



Apple and the Apple logo are trademarks of Apple Inc., registered in the U.S. and other countries and regions. App Store is a service mark of Apple Inc. Google Play and the Google Play logo are trademarks of Google LLC. Tencent and the Tencent logo are trademarks of Tencent Inc.

LEGO.com/devicecheck



LEGO® Builder



ESISTENZA SEMPLICE E SELVAGGIA

Quando esploriamo la natura con una mentalità curiosa, inevitabilmente avvertiamo un senso di dualità nel cambio delle stagioni. La decomposizione coesiste in perfetta armonia con la nuova vita. Questo ecosistema LEGO® cattura una magica sezione di terreno boschivo ai margini di un bosco del Nord Europa, nel periodo di transizione tra l'estate e l'autunno. Immagina una fruttuosa escursione alla ricerca di cibo, durante la quale potrai esplorare una ricca varietà di funghi e colchidi autunnali. Sebbene una collezione di specie così densa possa sembrare improbabile in natura, volevamo creare una scena visivamente accattivante e teoricamente plausibile. Ogni elemento è progettato con cura per bilanciare il realismo con un fascino estroso.

Il LEGO® Botanicals Design Team





Colchicum autumnale

COLCHICO D'AUTUNNO

Questa pianta rosa e viola appartiene alla famiglia delle Colchicaceae e fiorisce in autunno. Elegante e aggraziata, ma tossica, prospera nelle praterie e nei boschi in Europa e Asia.



Pteridium aquilinum

FELCE

Una delle piante più comuni al mondo, prospera sotto il sole o all'ombra, nelle praterie o nelle aree più trafficate. Con fronde che raggiungono un'altezza di 1 m, è una pianta da giardino molto apprezzata e decorativa.



Mycena galericulata

BONNET COMUNE

Questo delicato fungo a grappolo con tipico cappello a campana è reperibile sui tronchi e sui ceppi caduti nelle zone umide e nei boschi misti. Noto per il suo aspetto meraviglioso e incantevole, ha ispirato artisti di tutte le epoche.



Pleurotus ostreatus

ORECCHIONE

Cerca questo fungo con cappello a forma di conchiglia con lamelle decorrenti e stelo corto o assente sul legno in decomposizione nelle foreste o persino nelle aree urbane. Tipicamente bianco o grigio, può crescere fino a 25 cm di larghezza.



Amanita muscaria

OVOLO MALEFICO

Con il suo cappello rosso-arancio lucido punteggiato di bianco, l'ovolo malefico aggiunge un tocco di colore vivace agli inverni europei, ed è spesso presente sotto betulle, pini e abeti rossi. Se avvistato in natura, maneggialo con cura!



Cantharellus cibarius

GALLINACCIO

I gallinacci presentano trombe dorate con creste smussate e biforcute al posto delle lamelle. Di non facile reperimento, i fungaioli spesso tendono a non rivelare i luoghi in cui abbondano in quanto li considerano una squisita prelibatezza.



INOCYBE HIRTELLA

Nonostante il suo cappello fibroso emani un bel profumo di mandorla, è meglio ammirare questo fungo da una distanza di sicurezza! Presente nelle zone erbose, fornisce zuccheri e sostanze nutritive agli alberi circostanti.



Geastrum triplex

STELLA DI TERRA A COLLARE

Cerca questo spettacolare fungo nei boschi e nelle praterie. Dal corpo rotondo e pieno di spore, apre le sue braccia a forma di stella per rilasciare le spore in un vero e proprio spettacolo pirotecnico in miniatura!



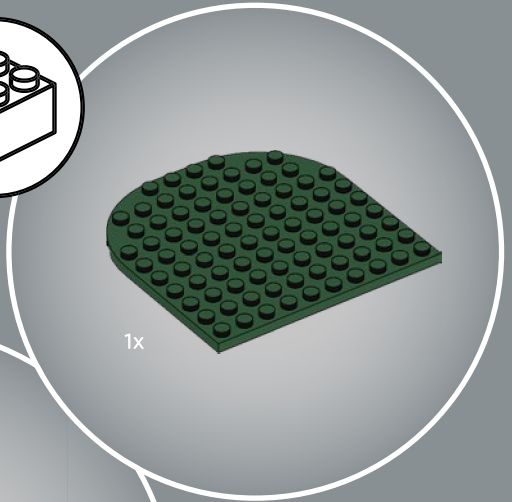
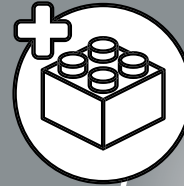
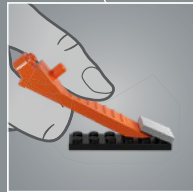
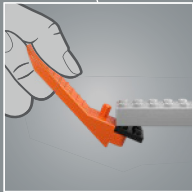
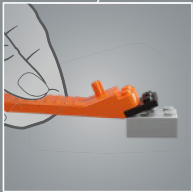
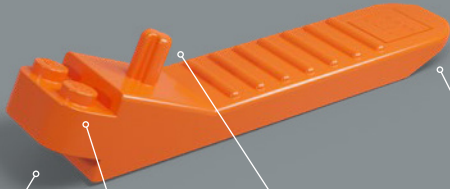

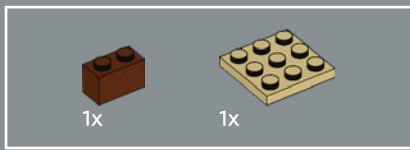

1

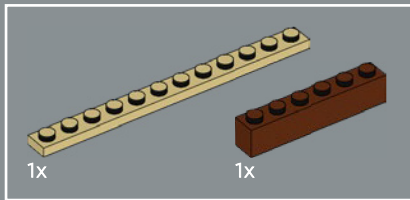
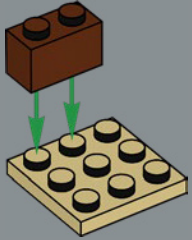

2

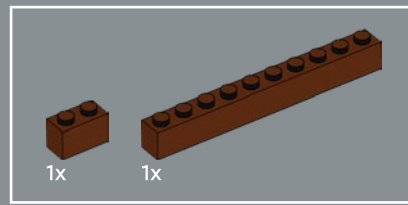
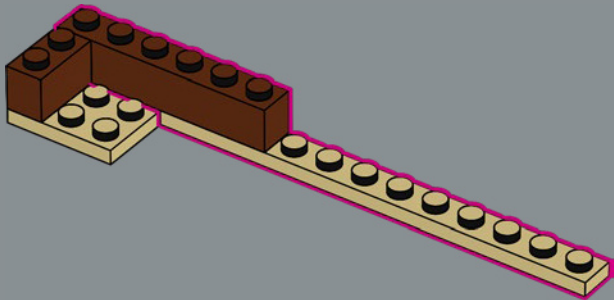

3

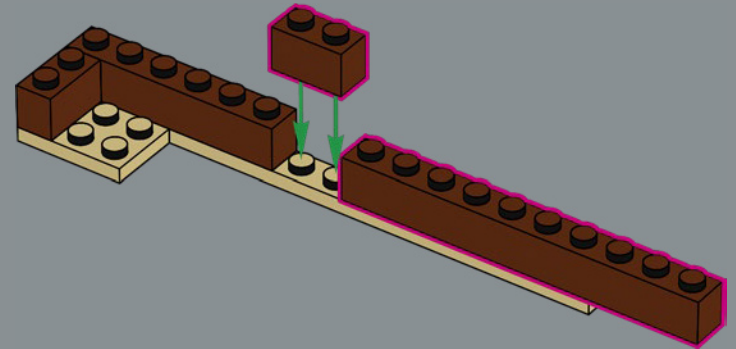

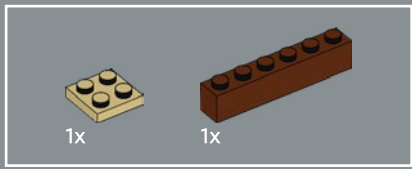

4

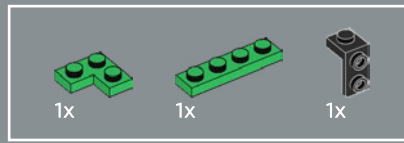
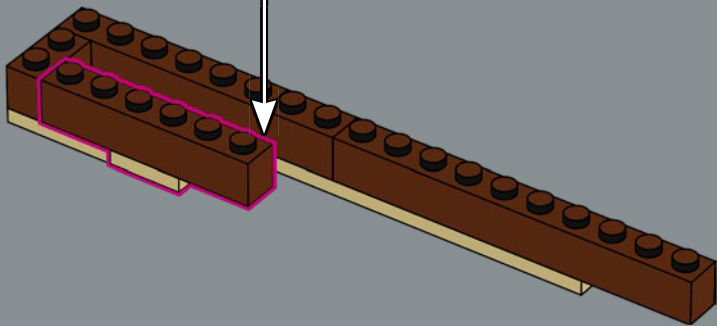
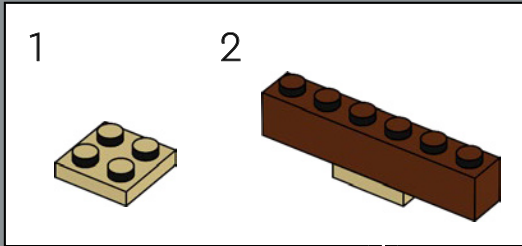

5

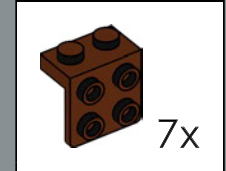
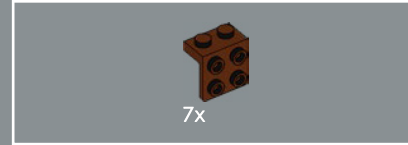
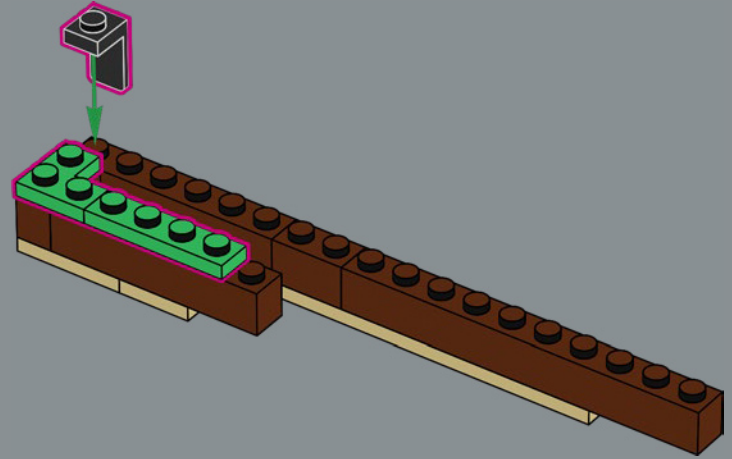

6

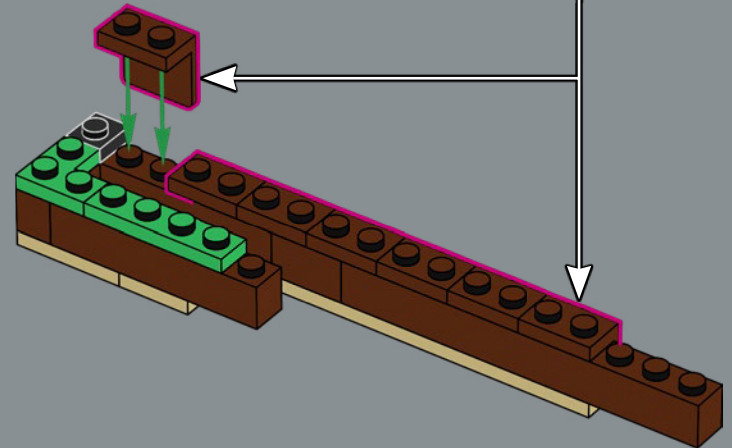

5

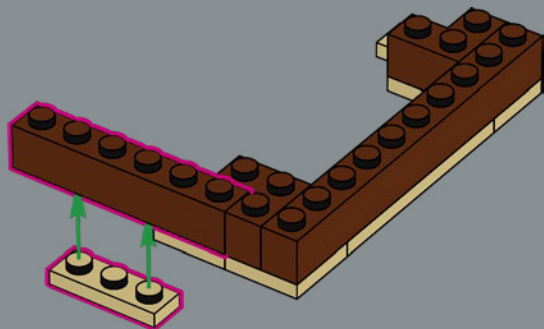

6

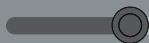
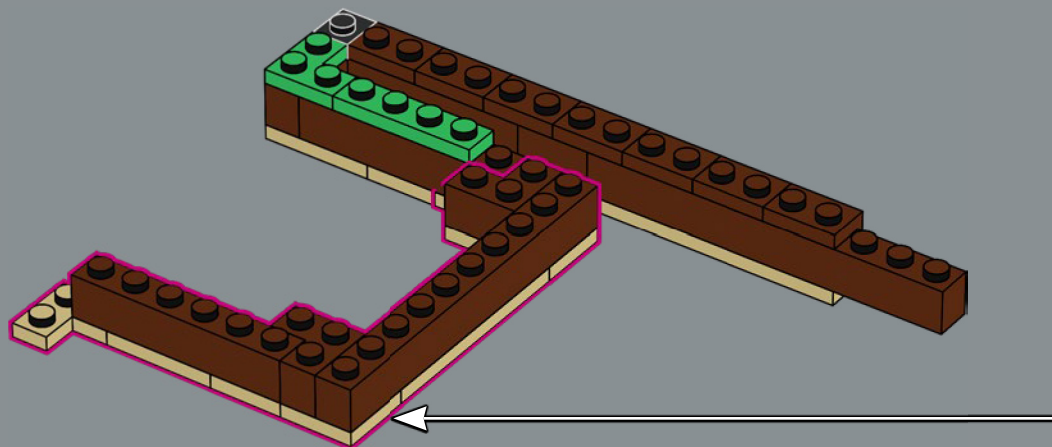
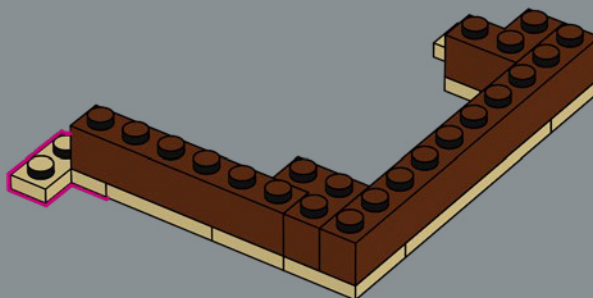

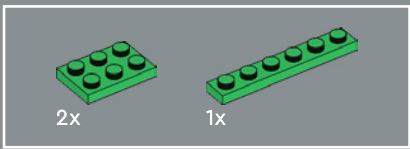

8

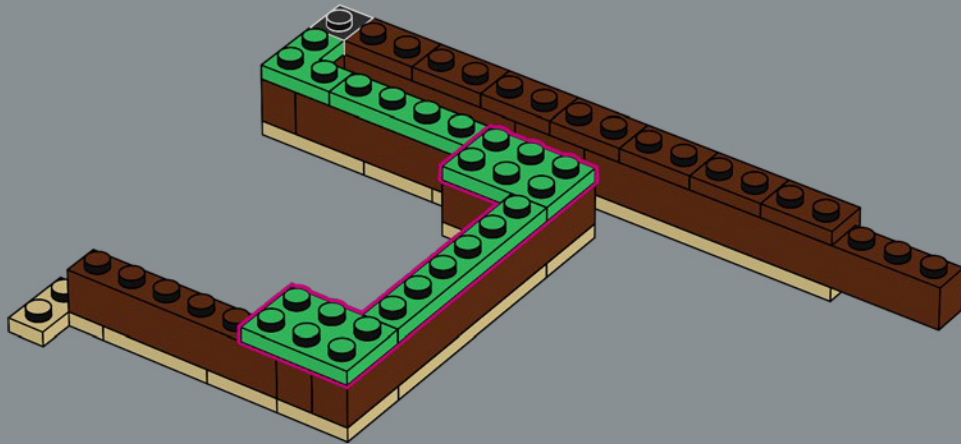

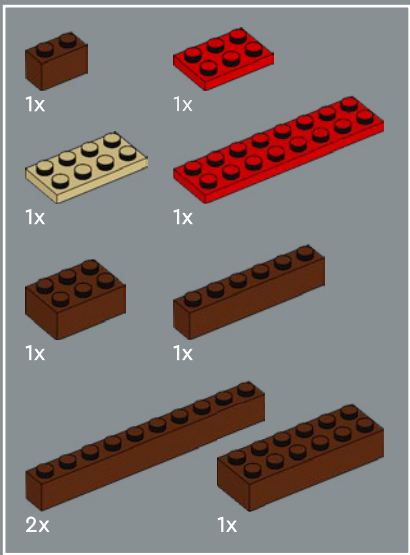

9

1

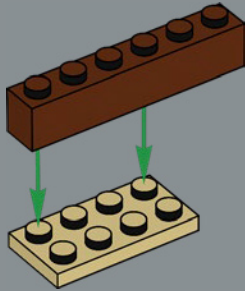

2

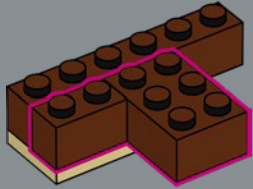

3

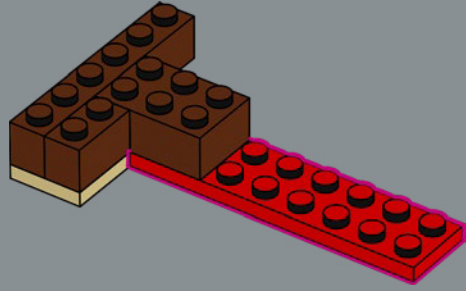

4

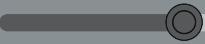
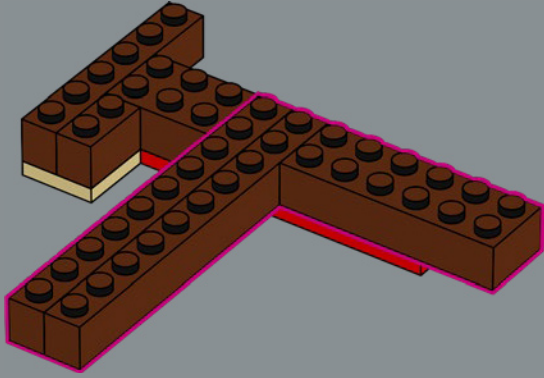

5

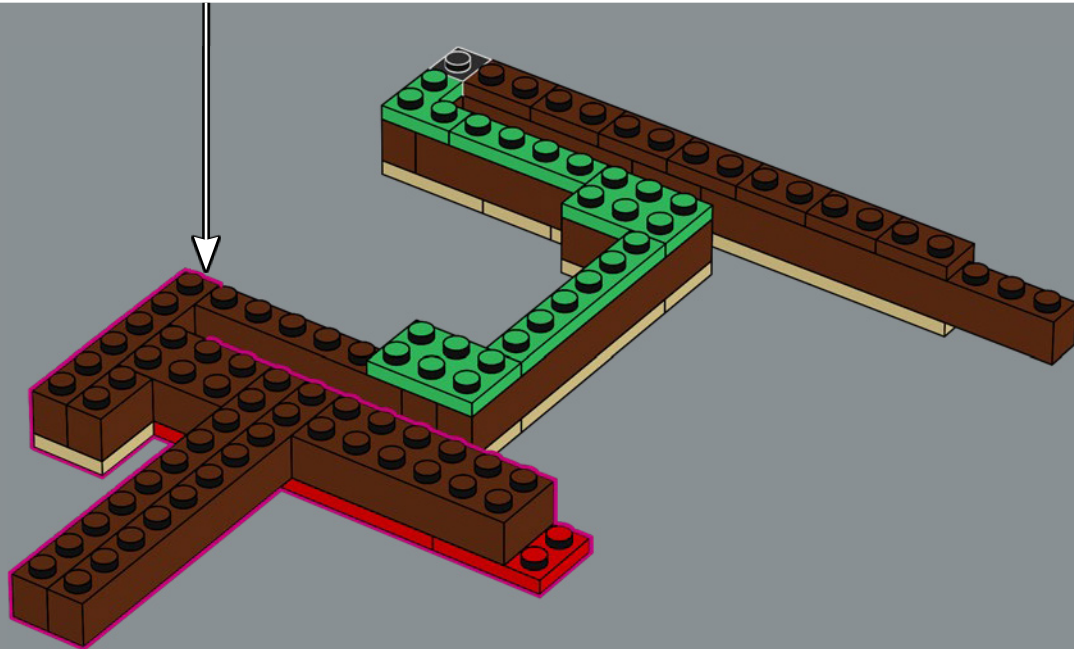
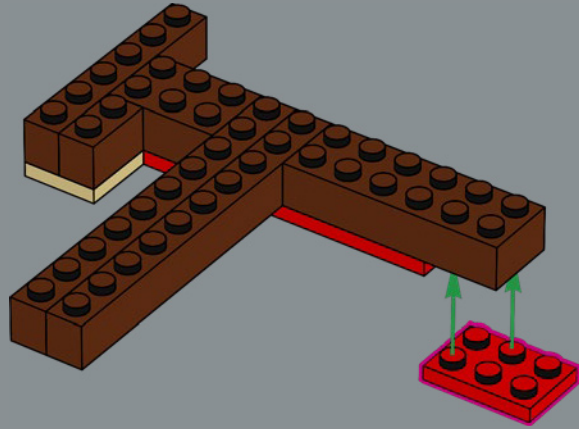

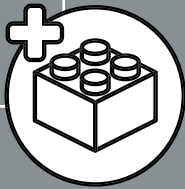
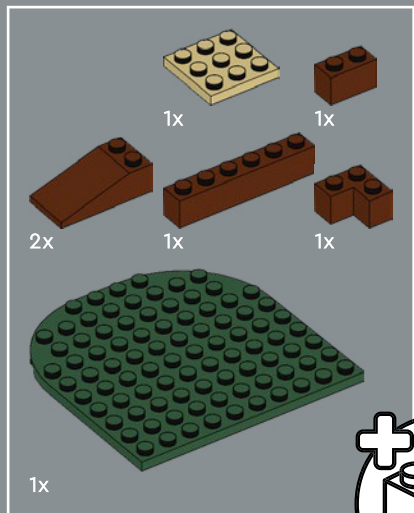

10

1

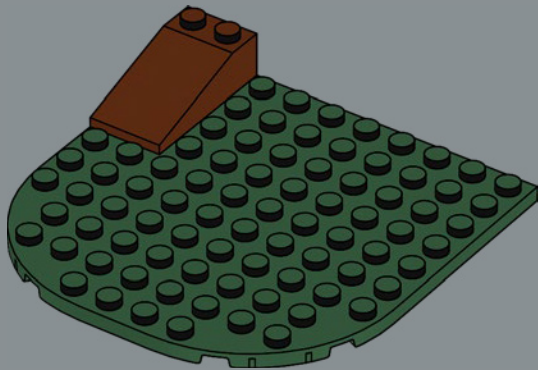

2

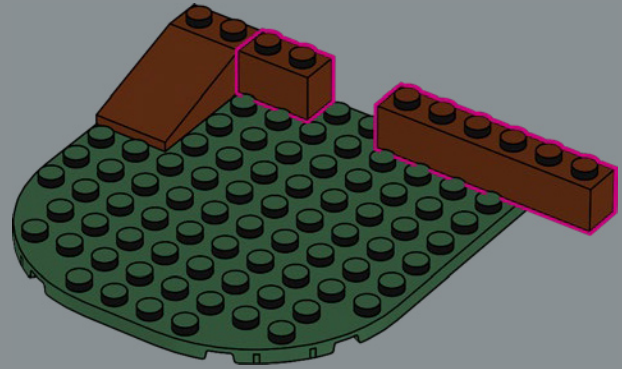

3

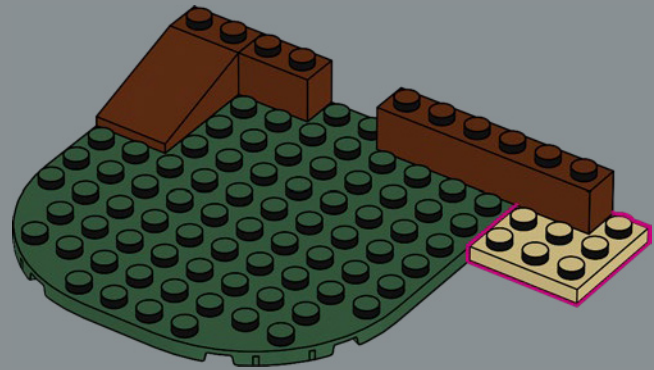

4

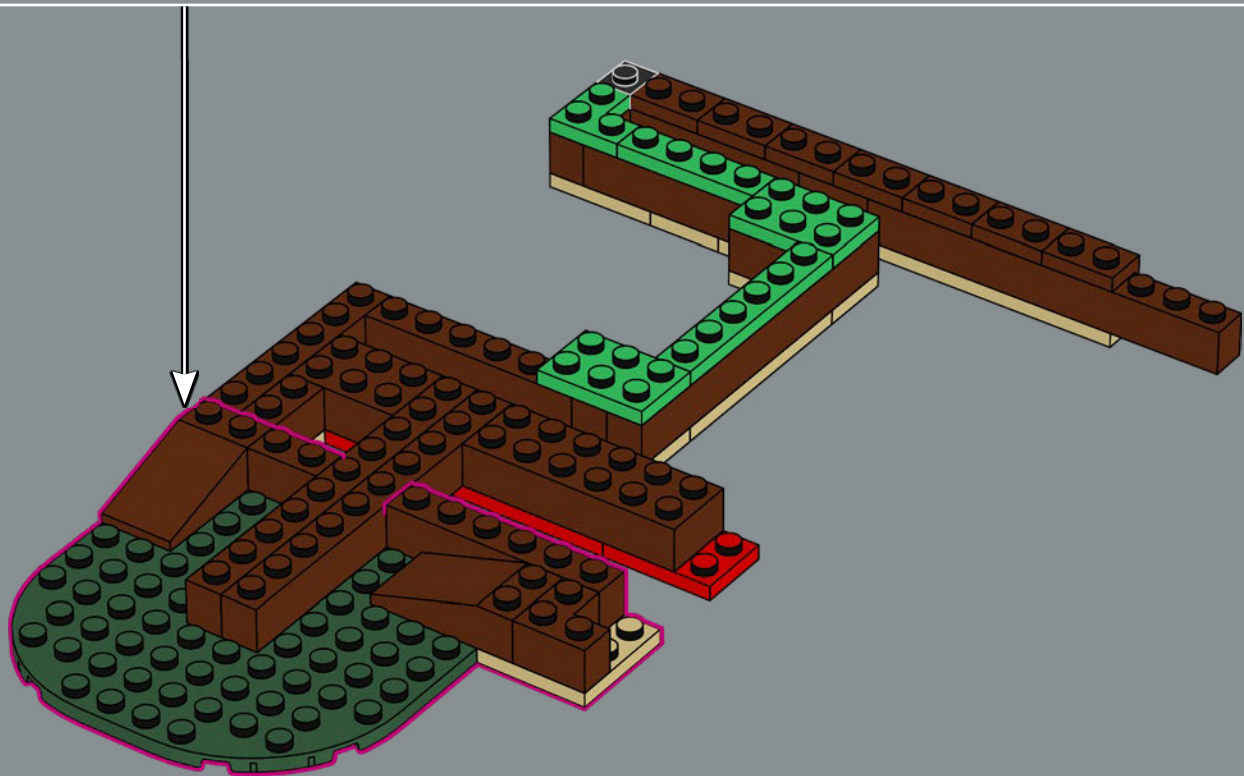
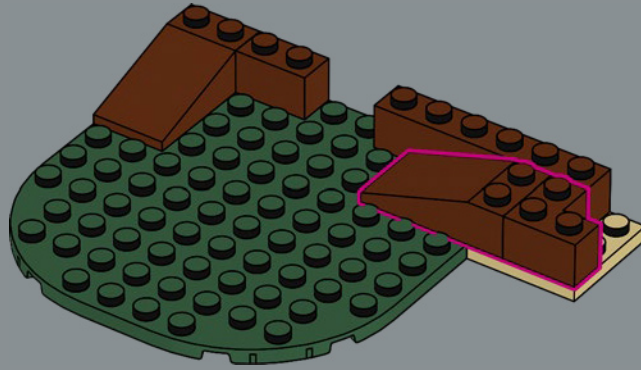

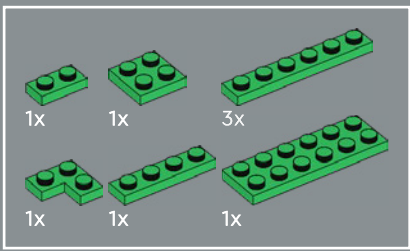

11

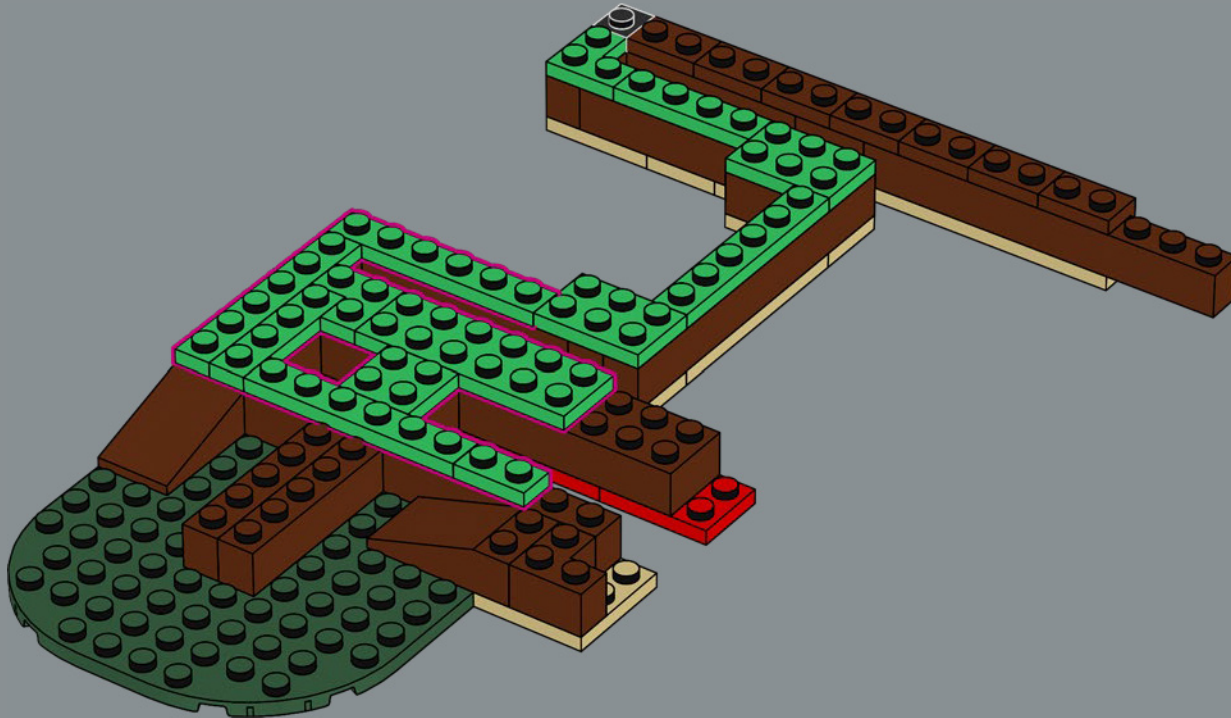

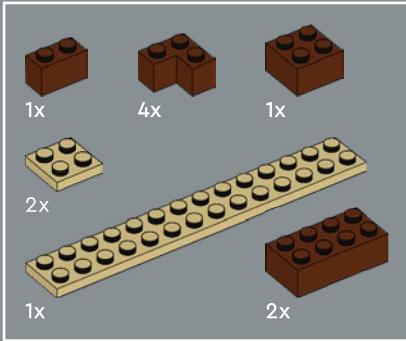
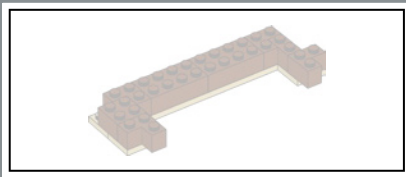

12

1

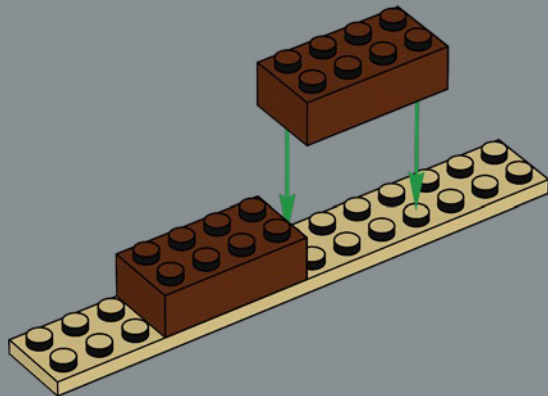

2

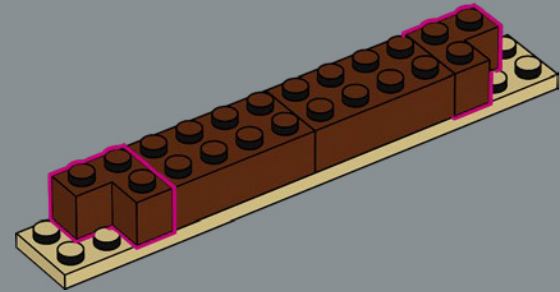

3

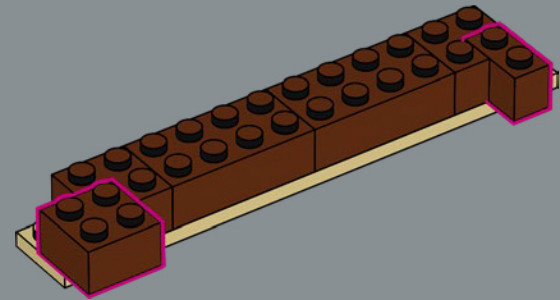

4

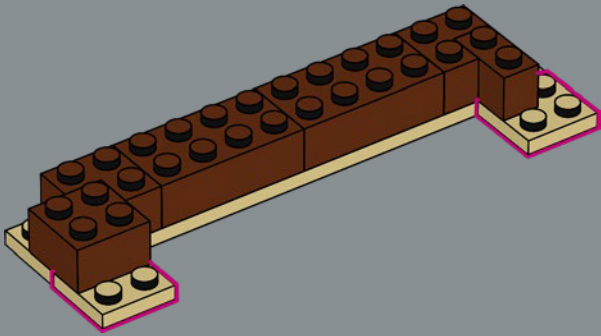

5

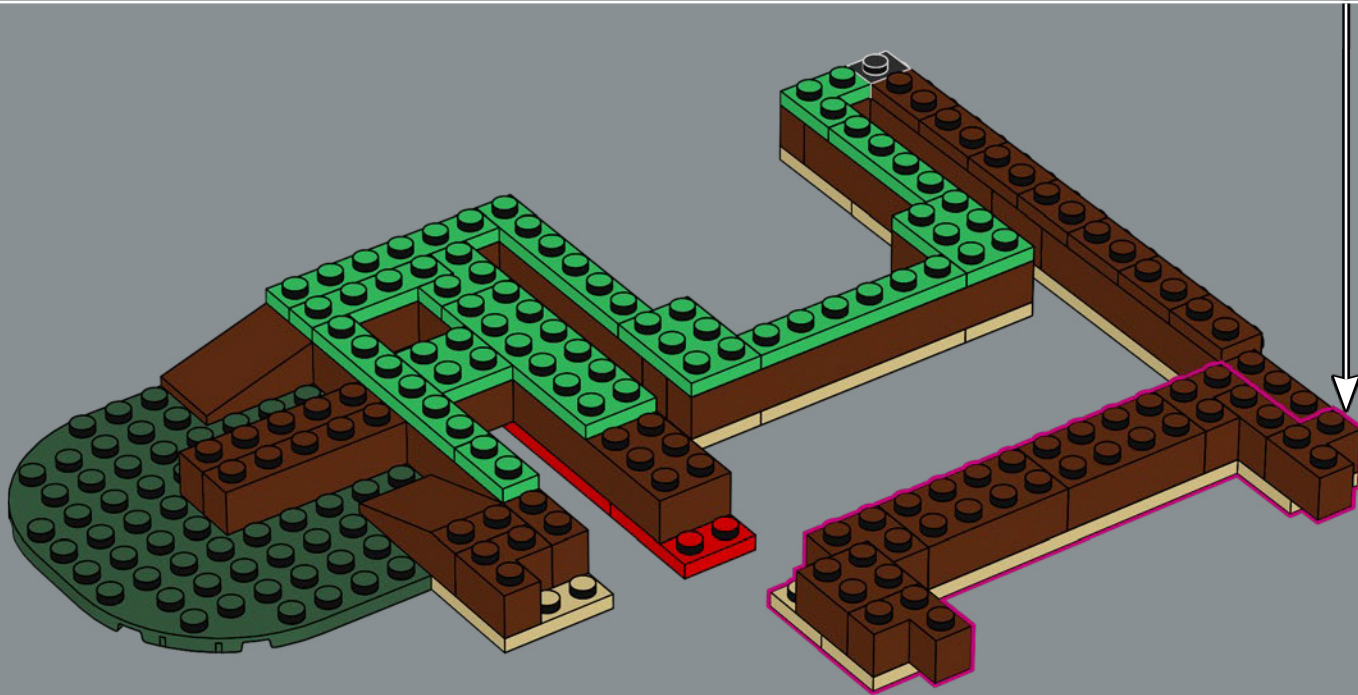
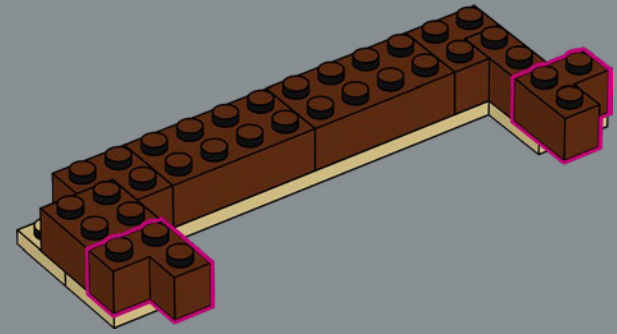

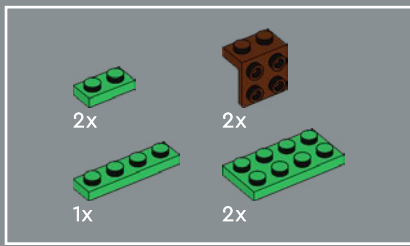

13

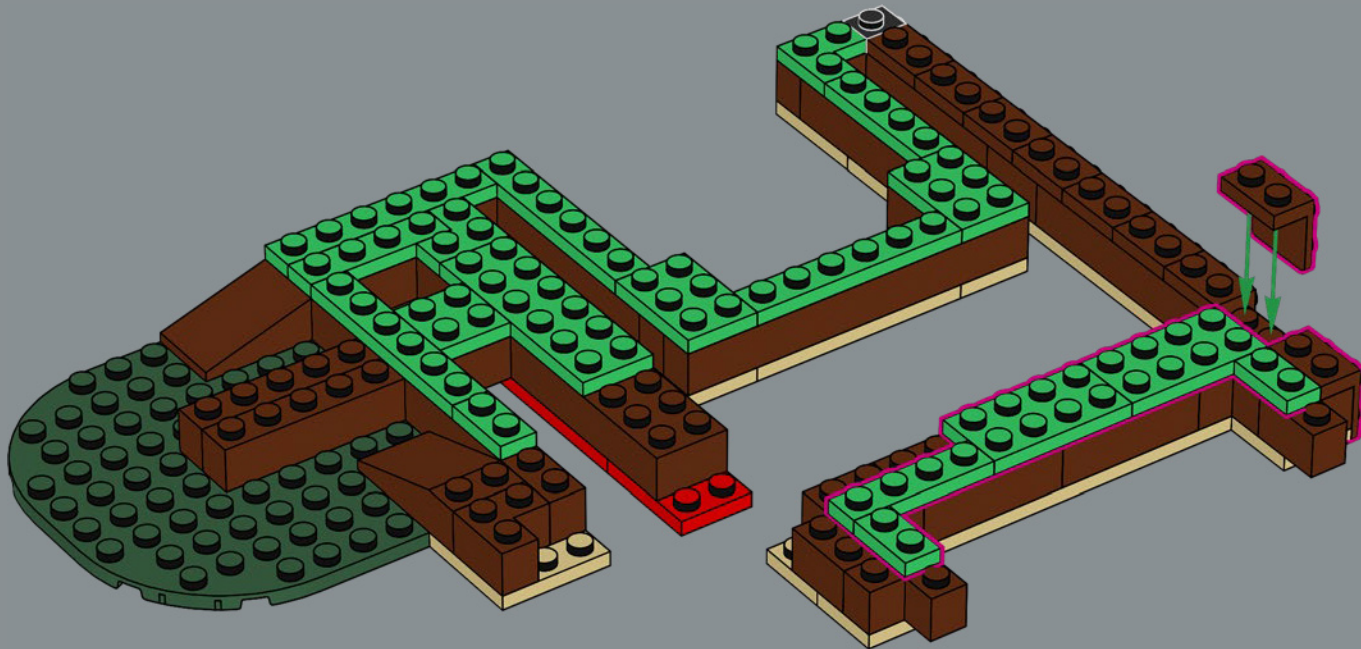

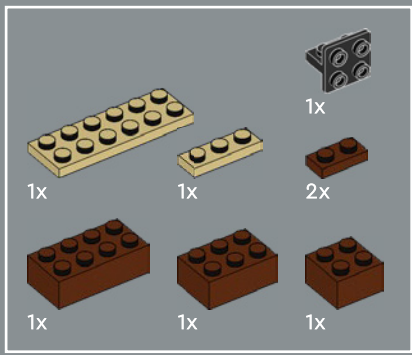

14

1

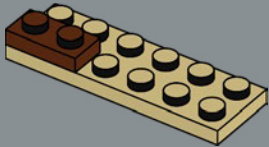

2

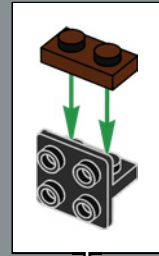
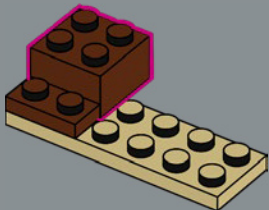

3

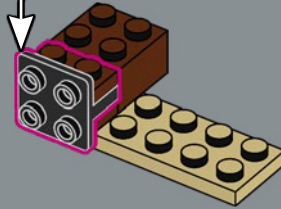

4

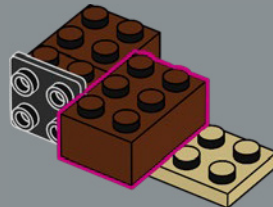

5

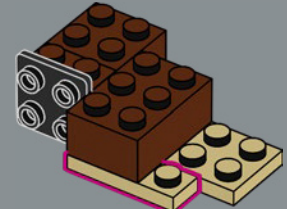

6

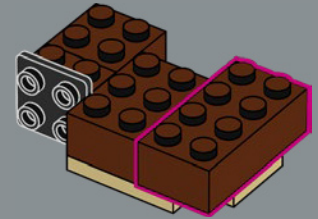

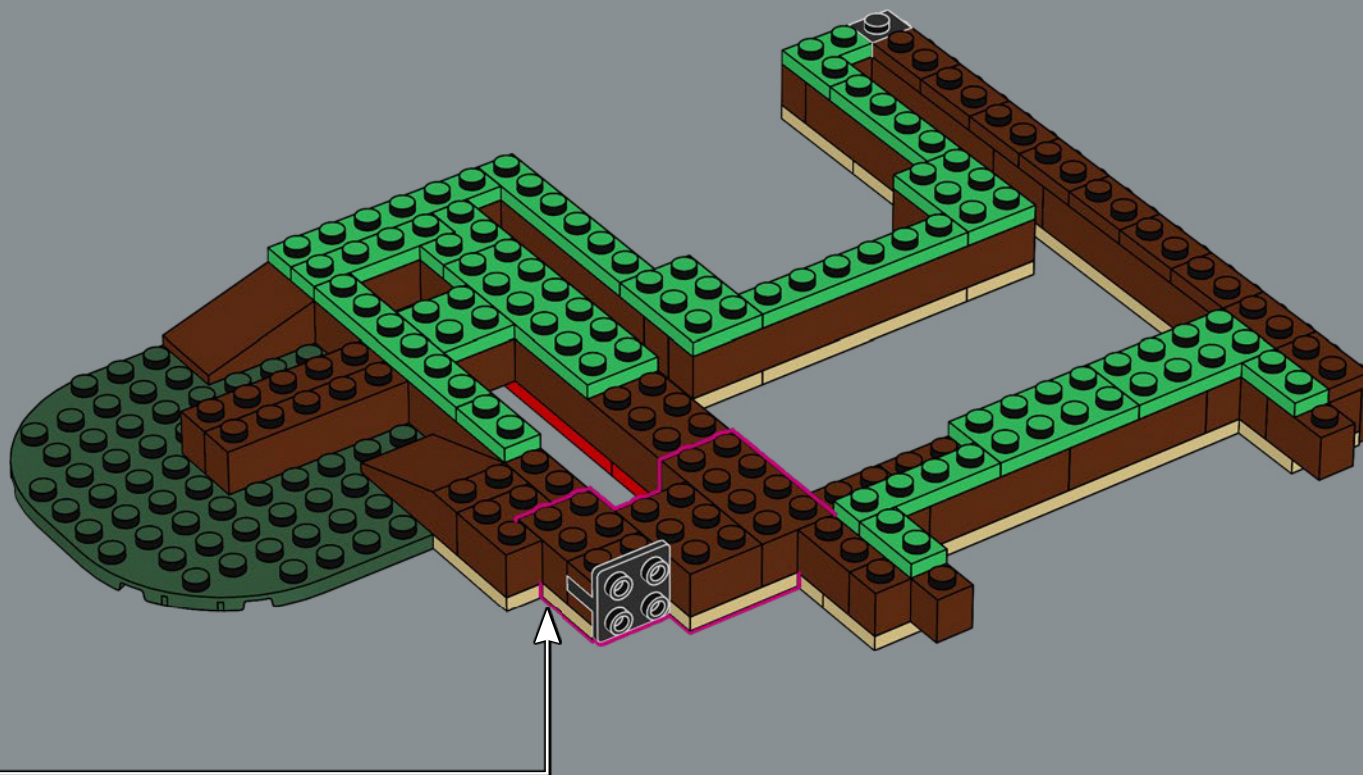

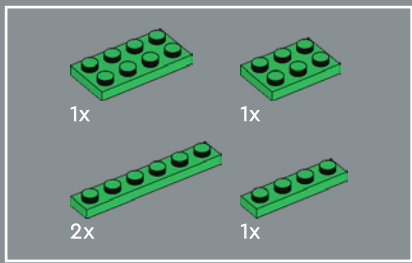

15

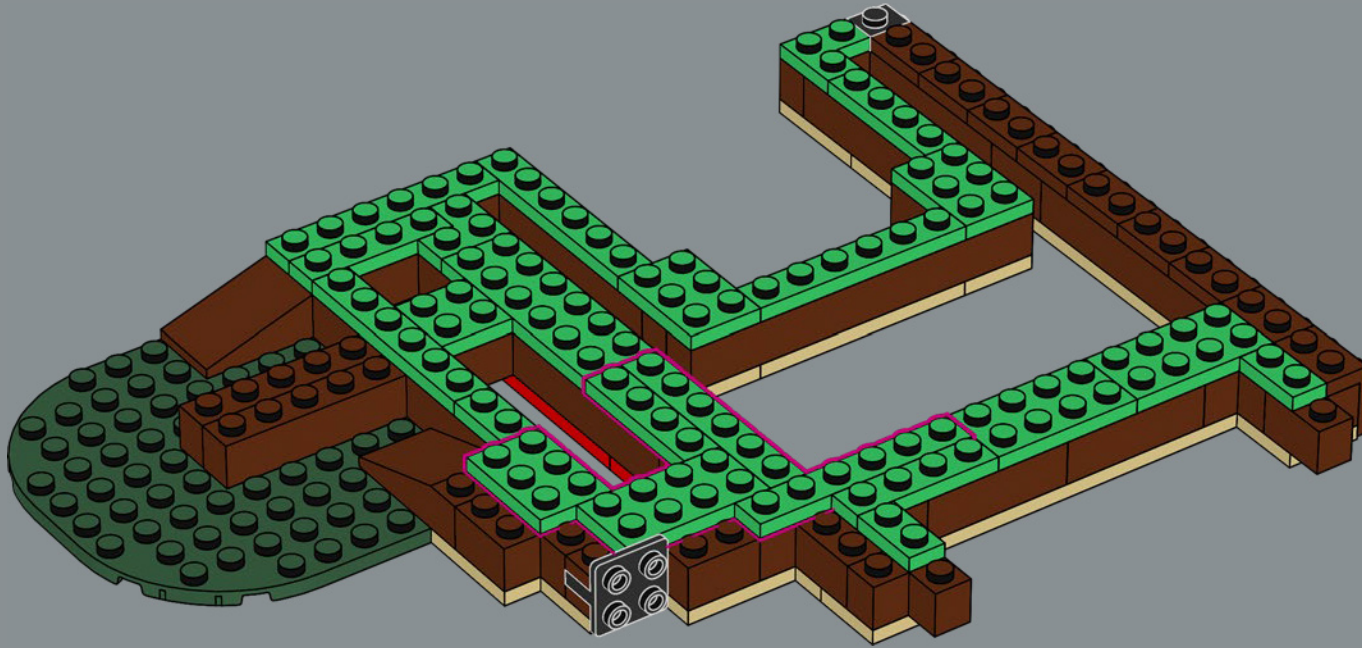

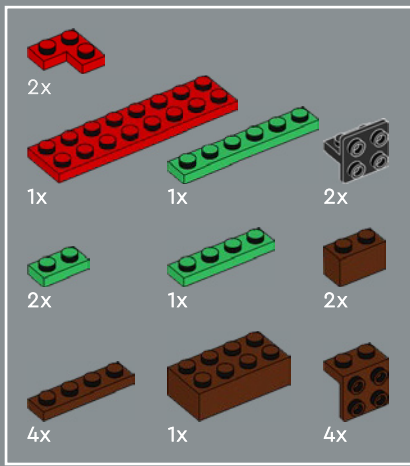

16

1

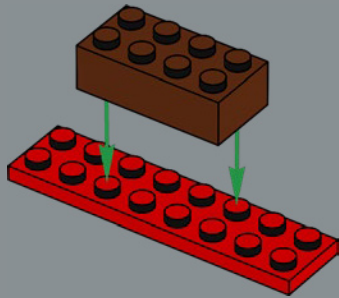

2

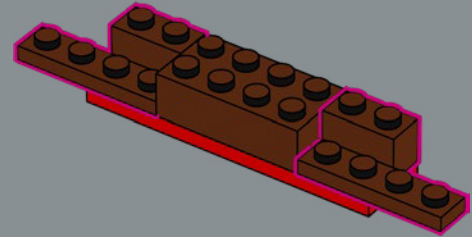

3

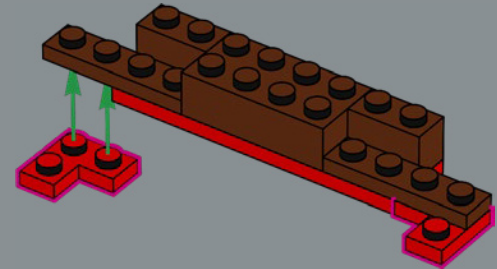

4

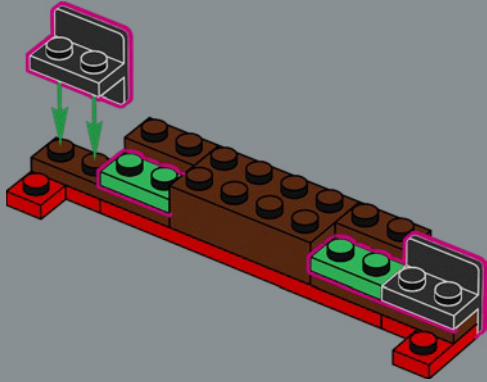

5

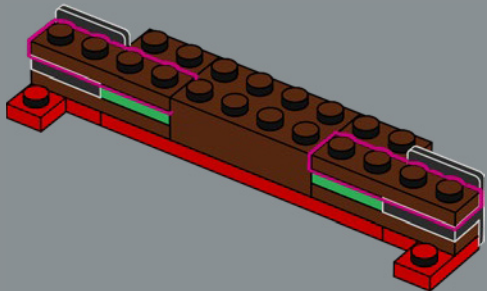

6

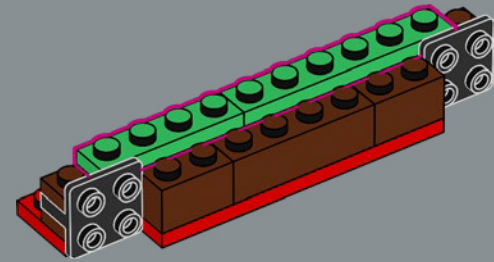

7

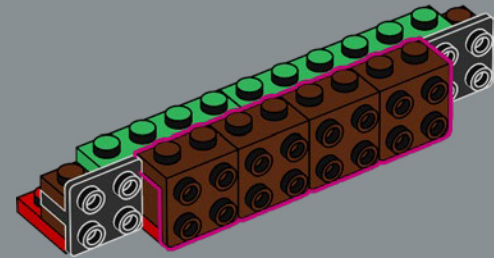





17

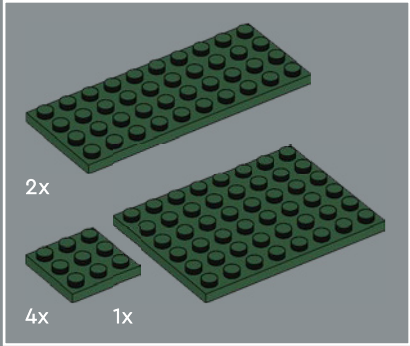
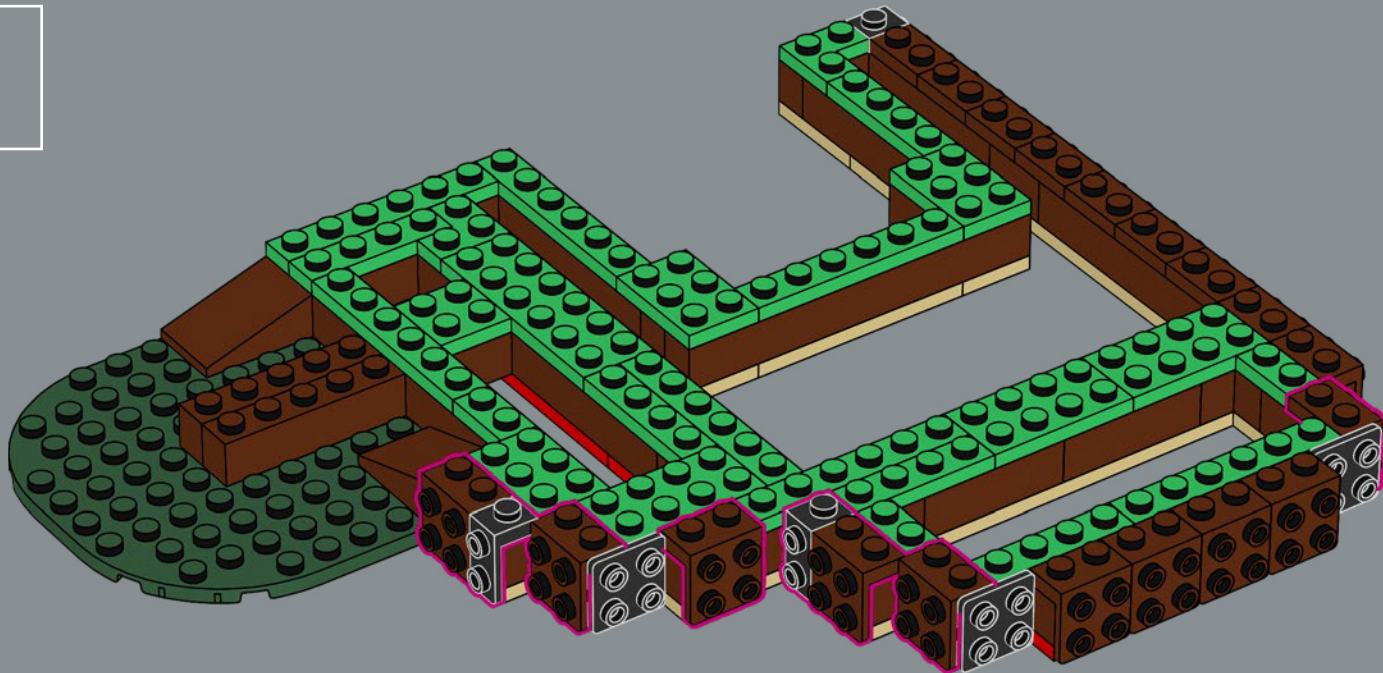

18

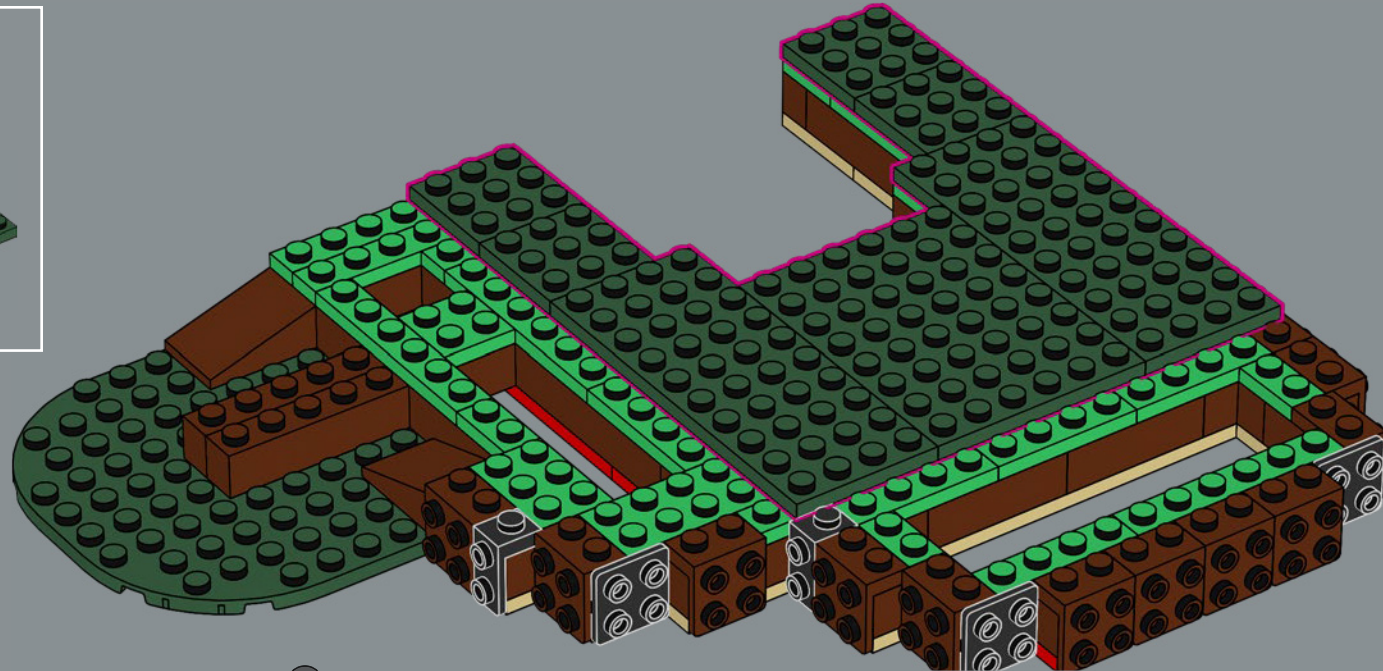

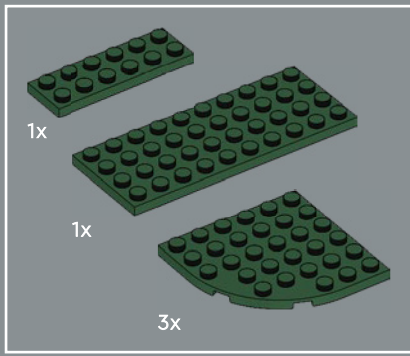

19

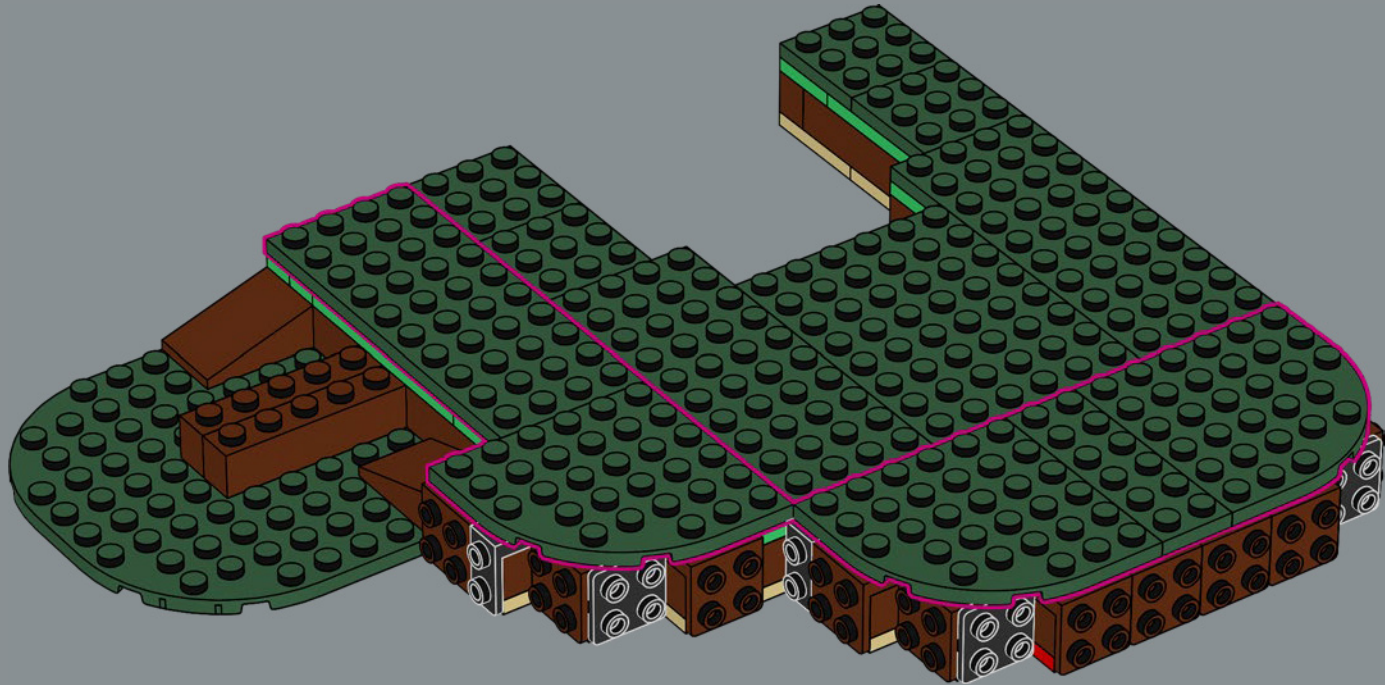

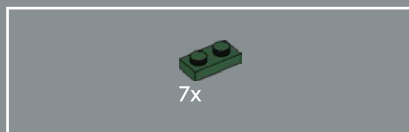

20

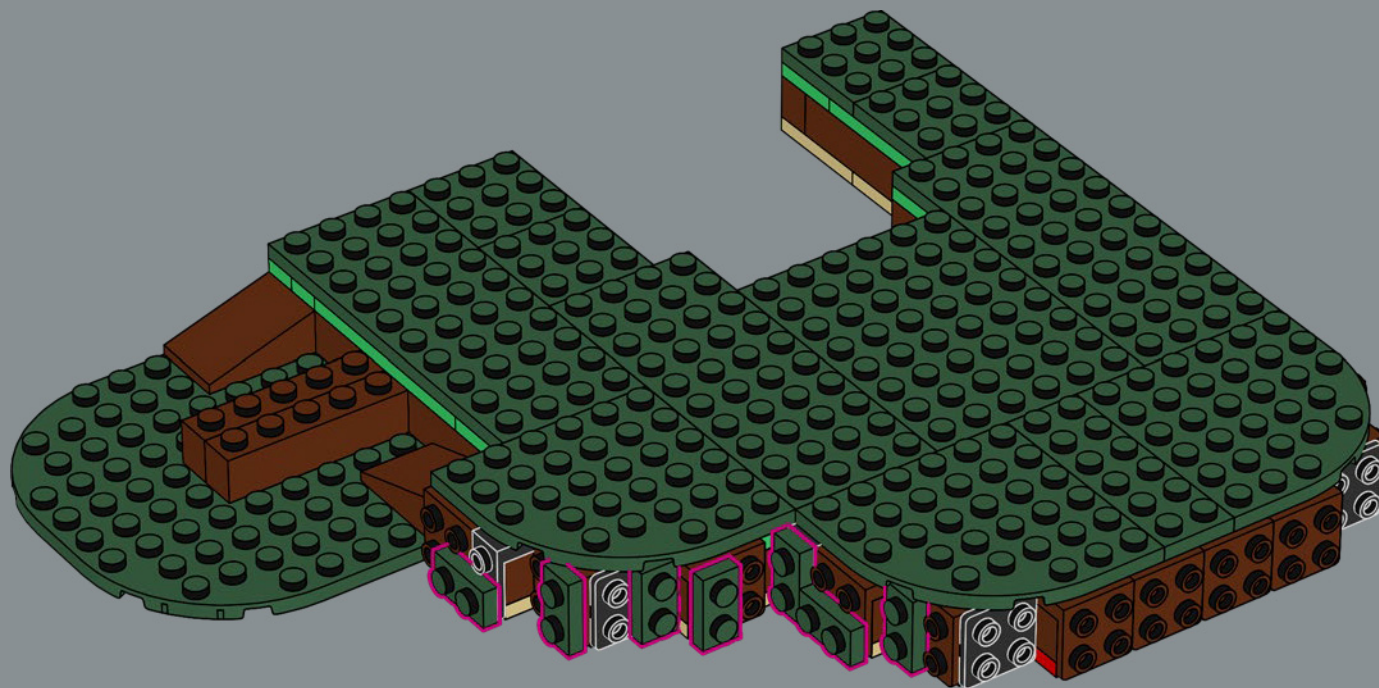



21

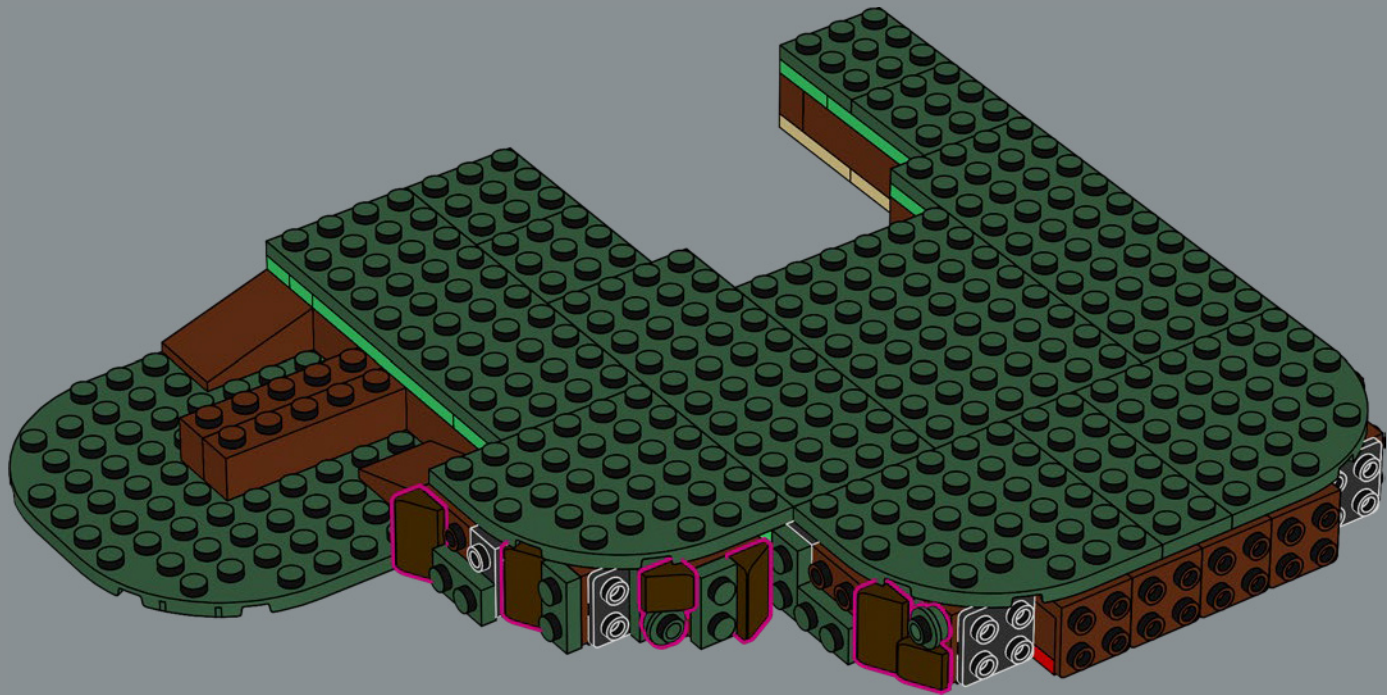



22

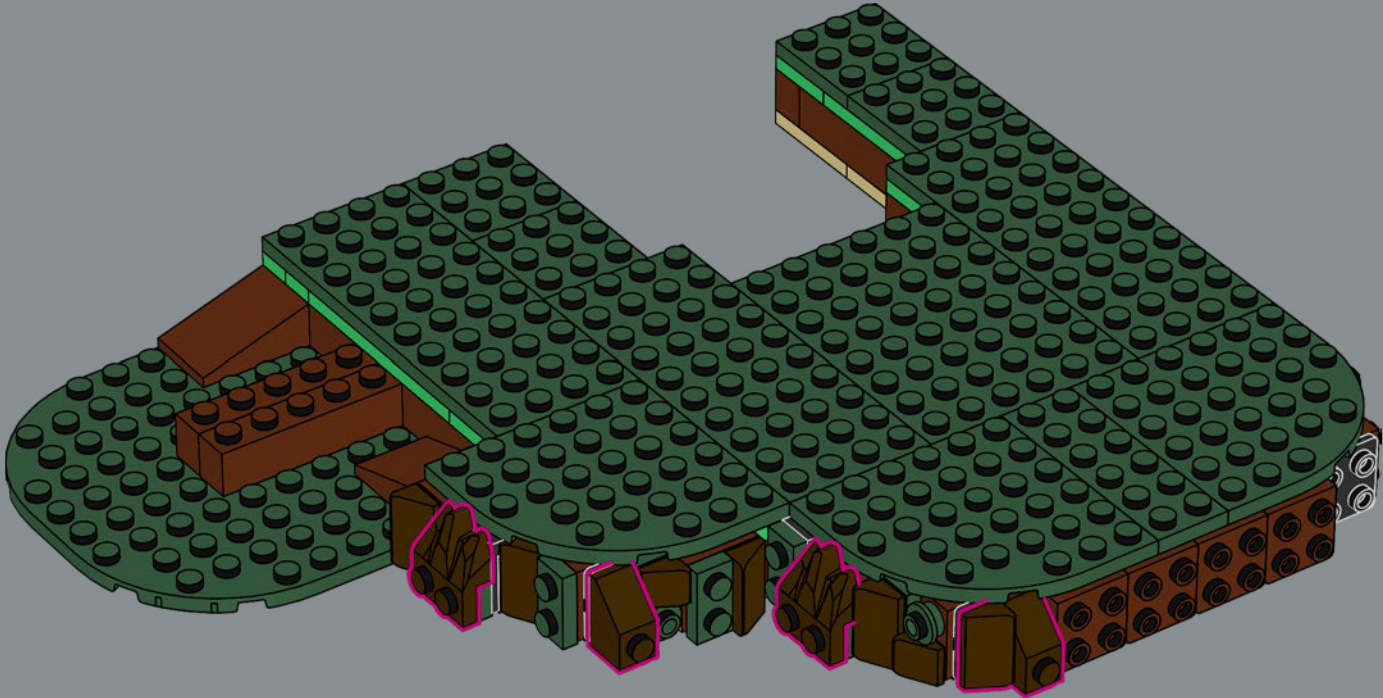

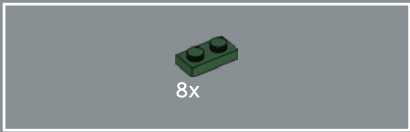

23

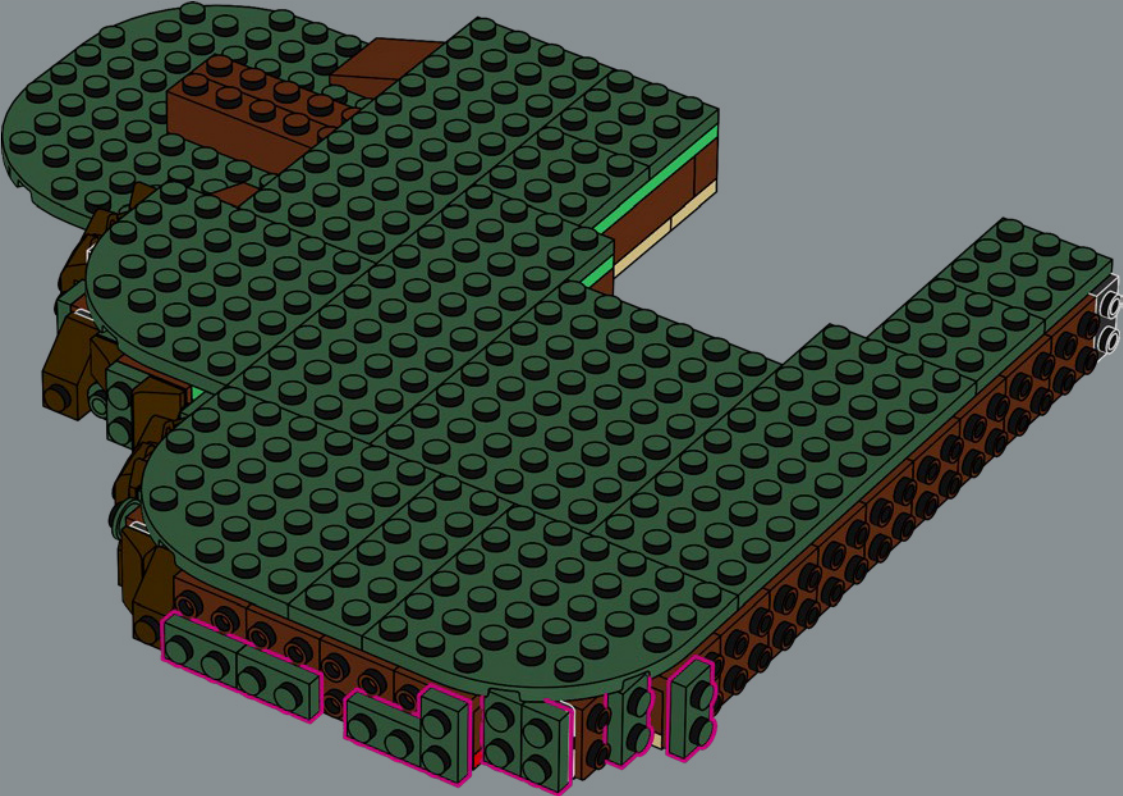

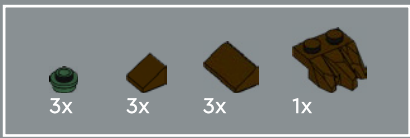

24

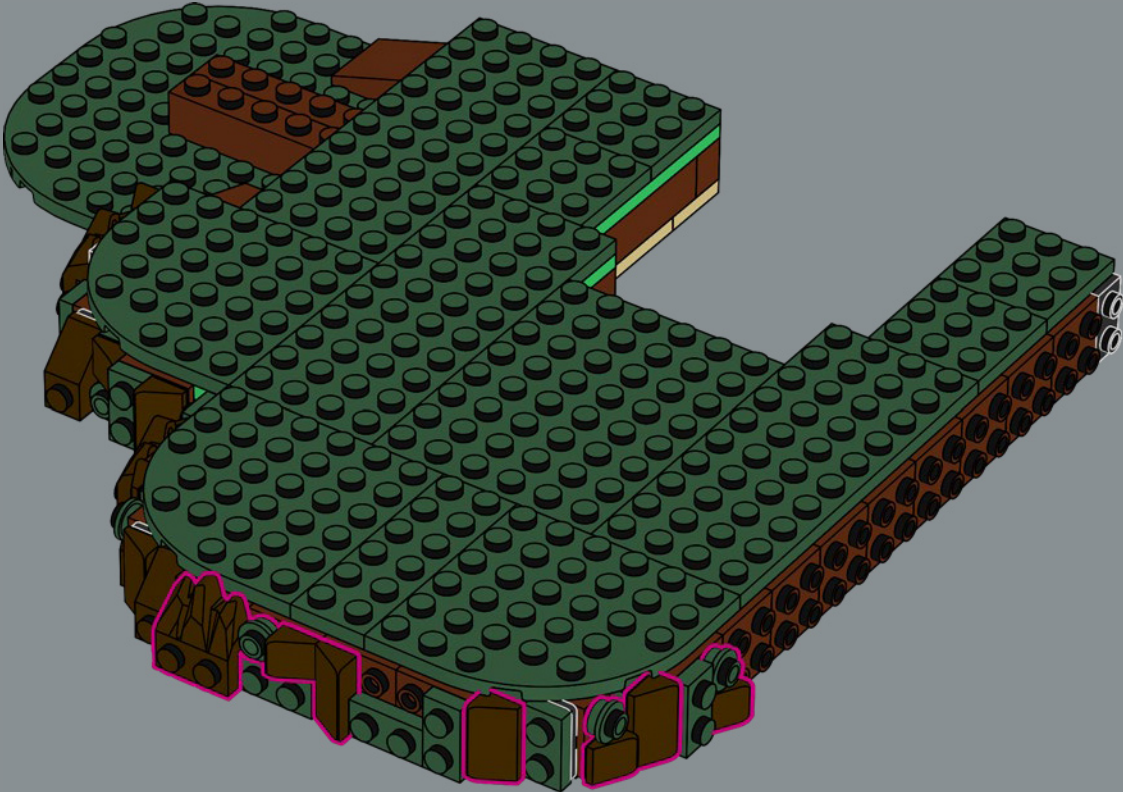



25

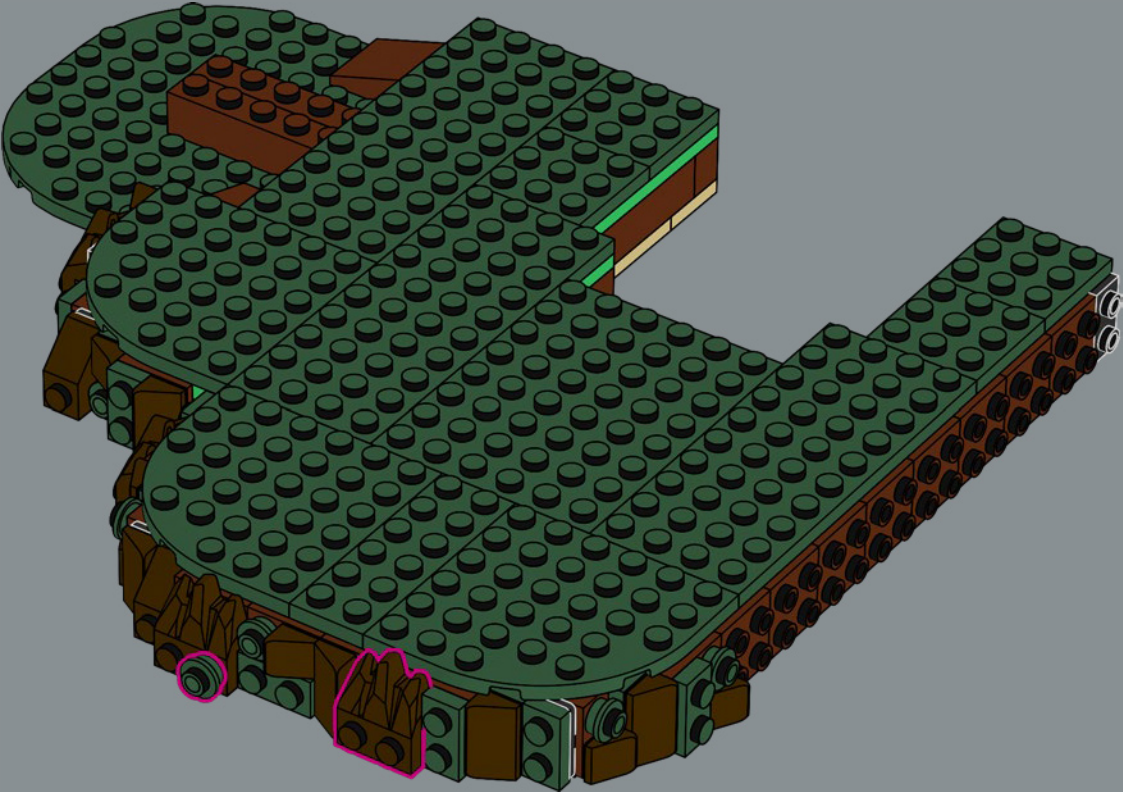

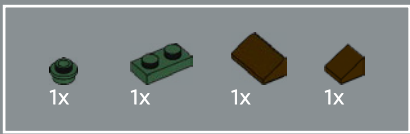

26

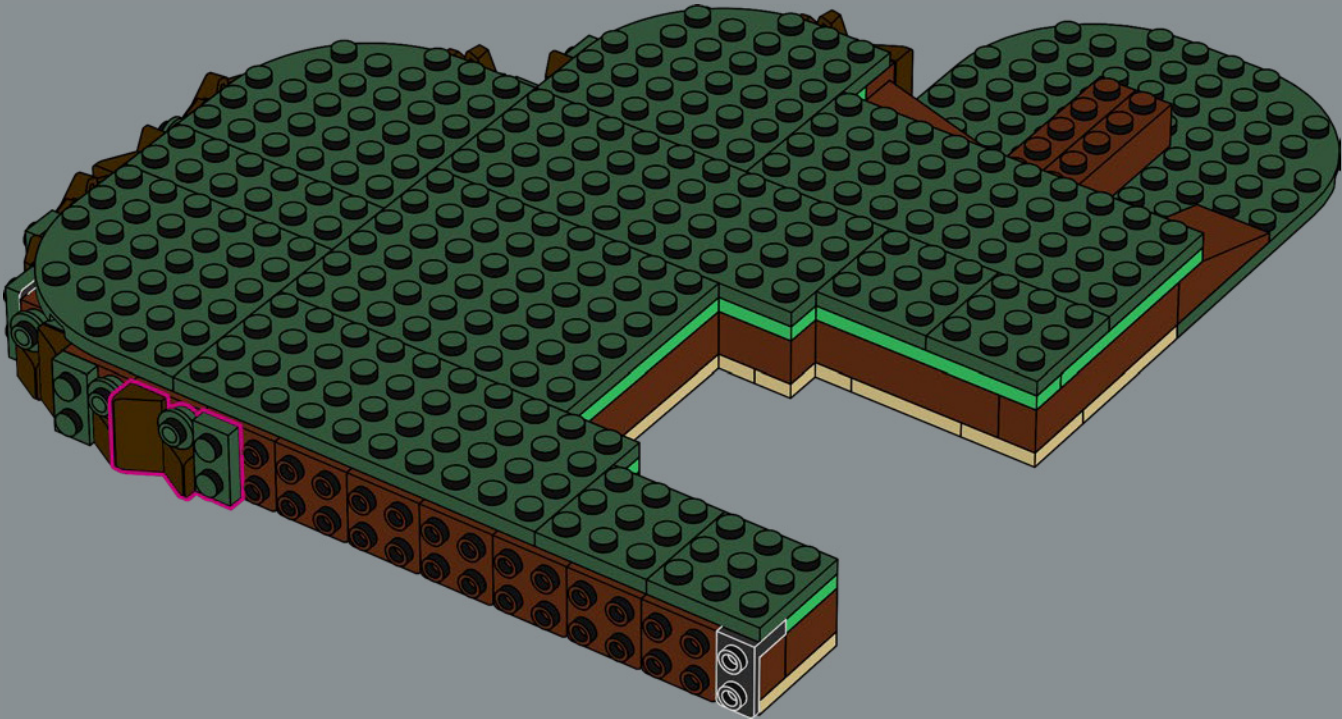

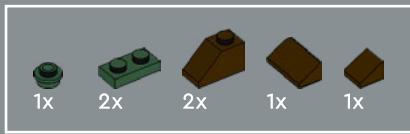

27



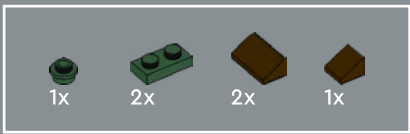

28

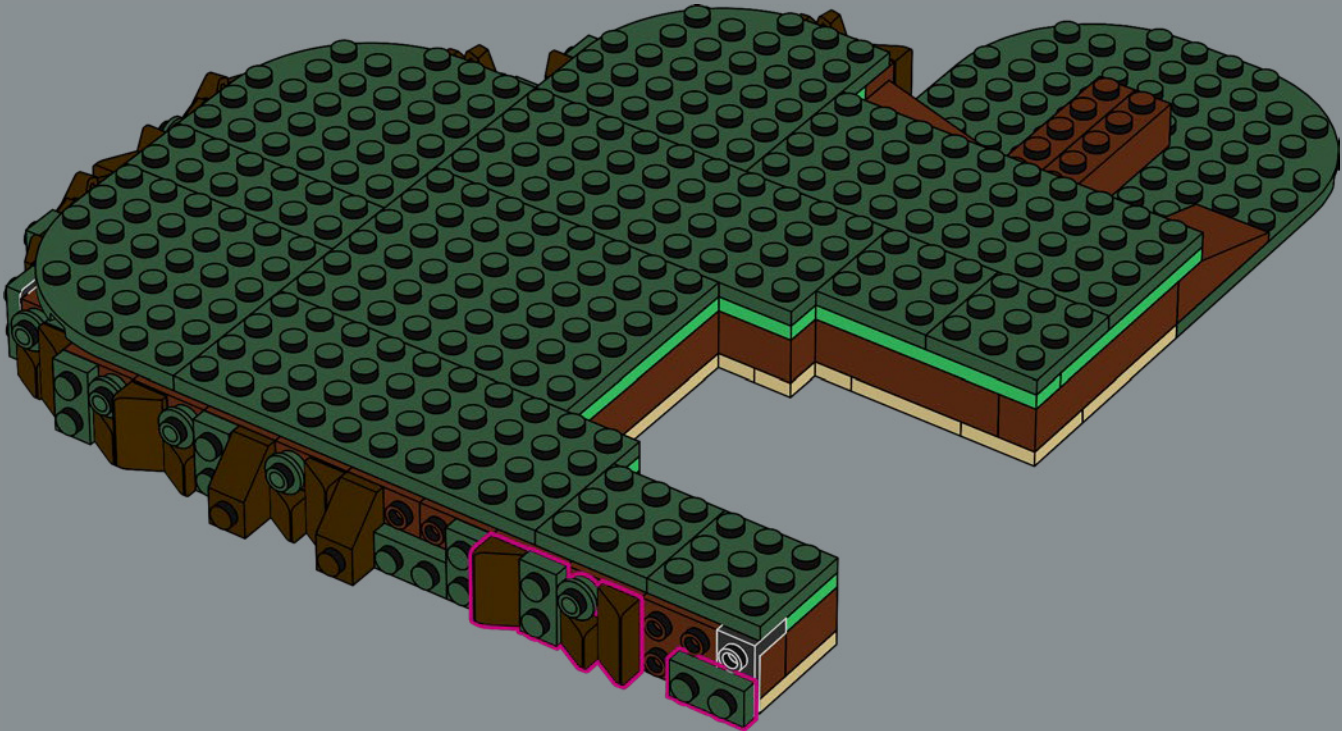

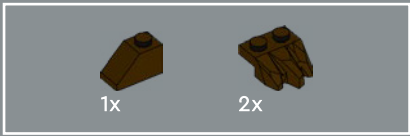

29

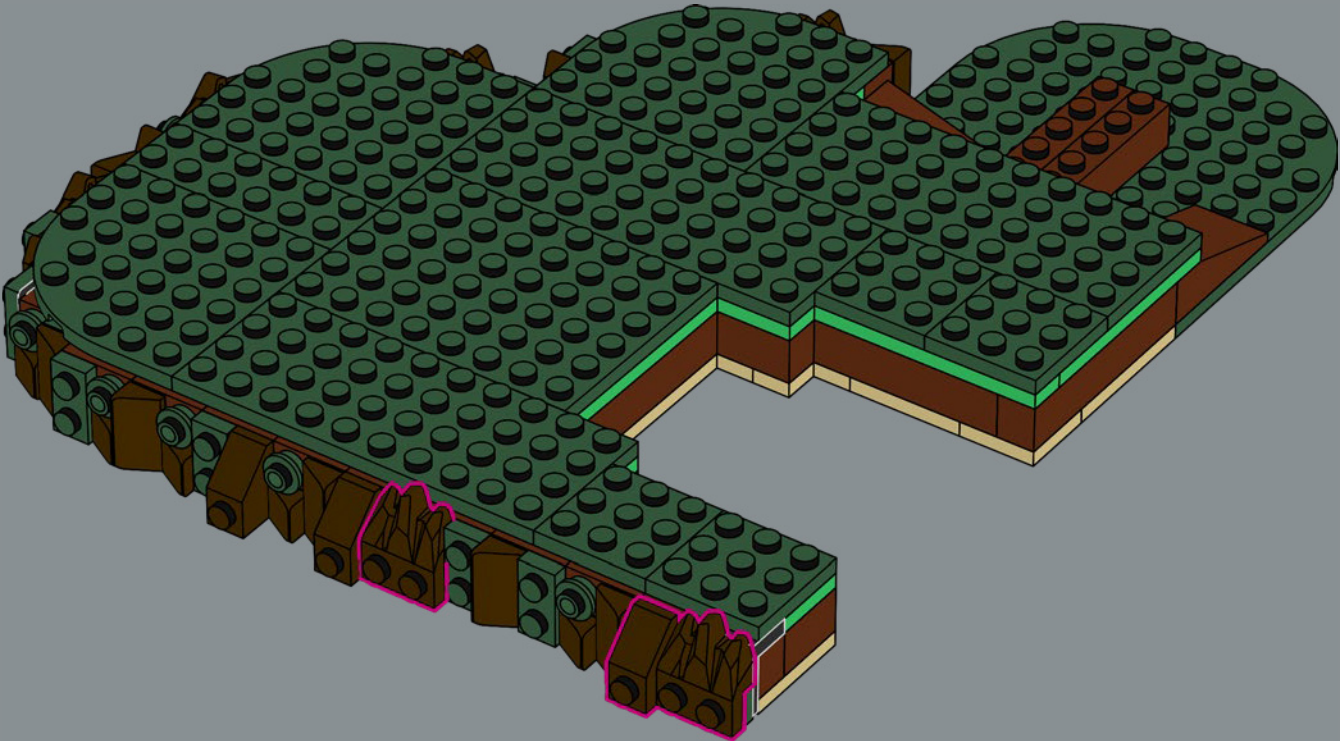

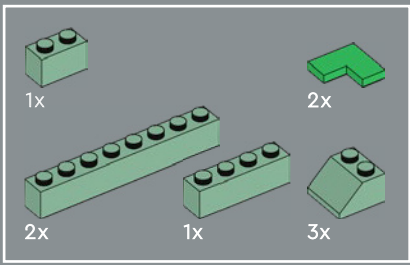

30

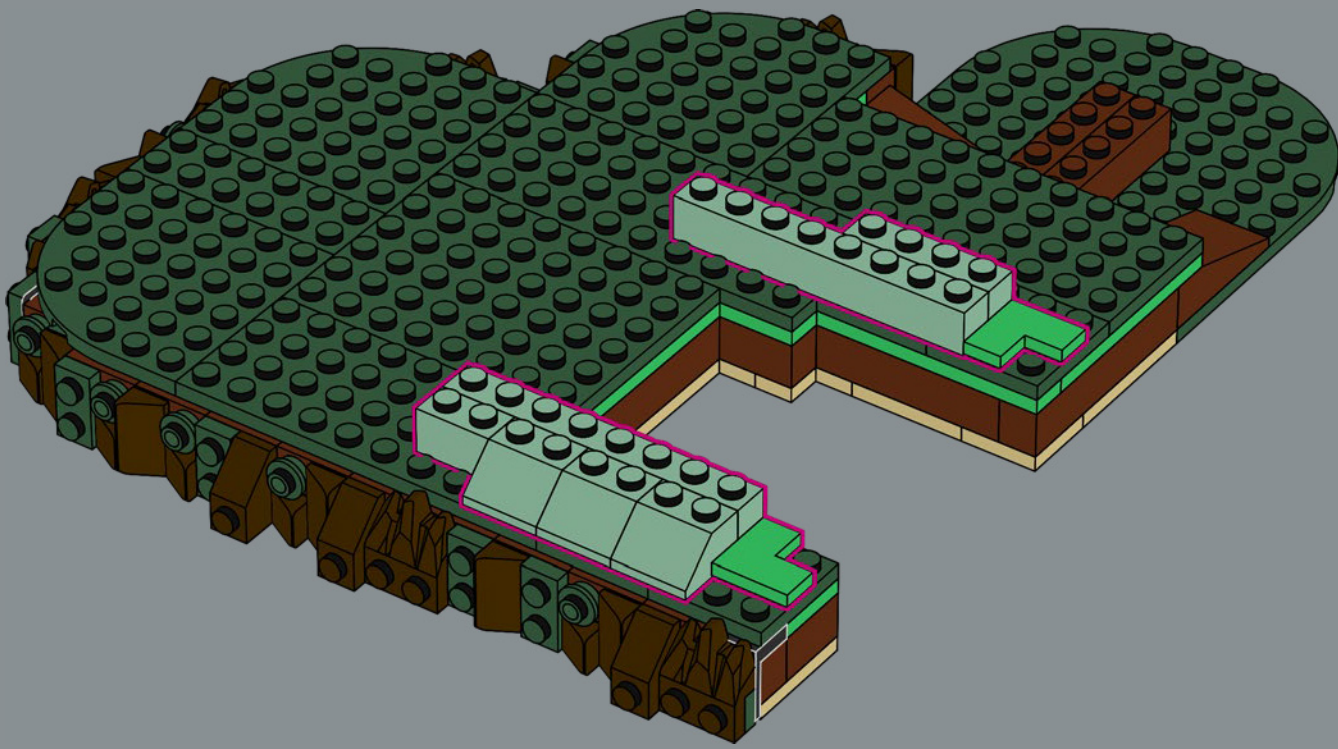

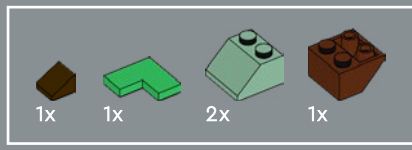

31

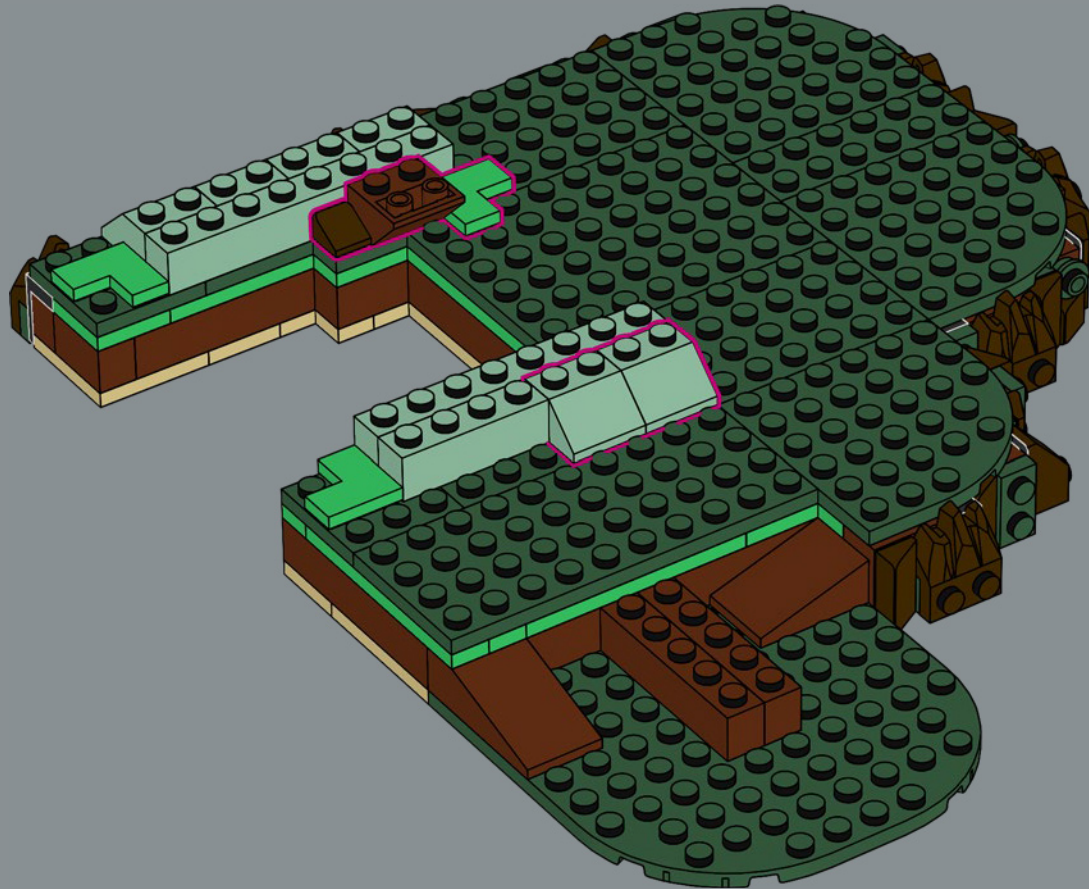

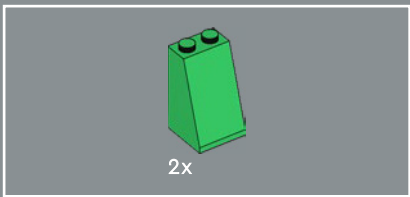

32

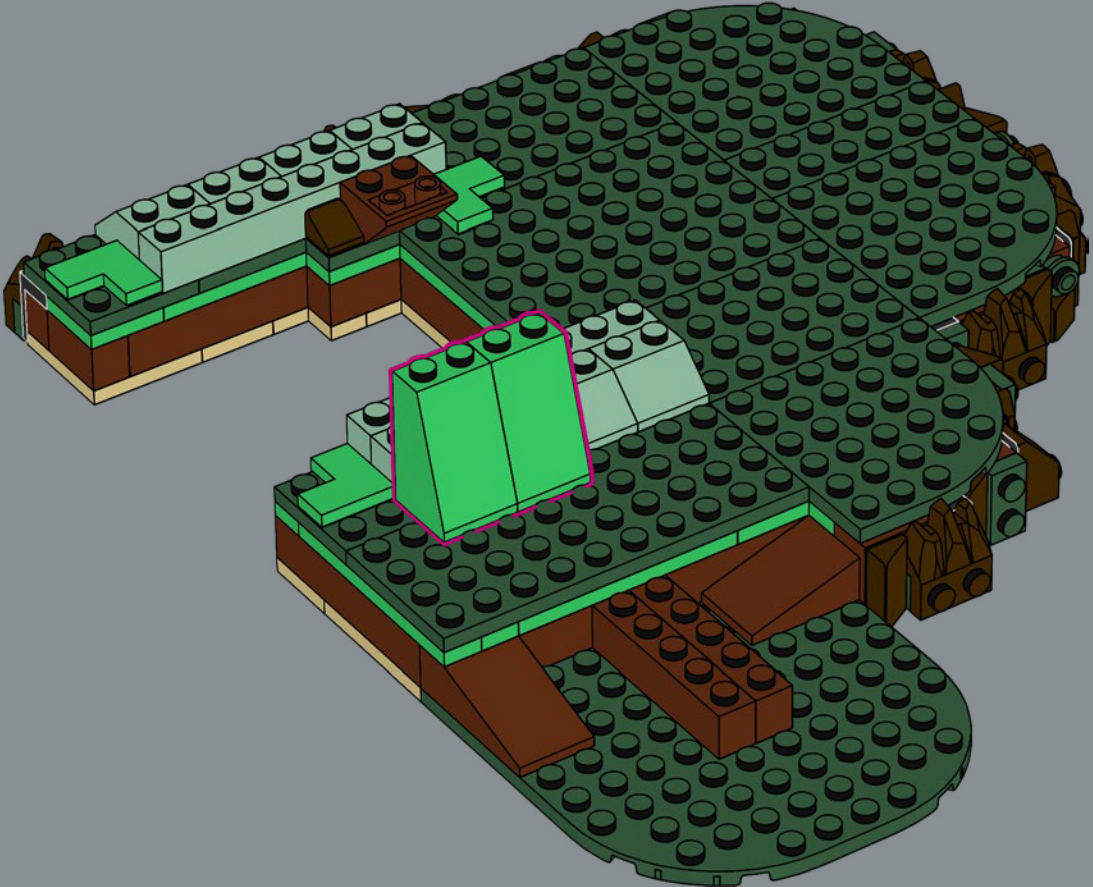

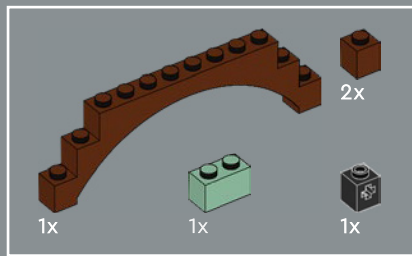

33

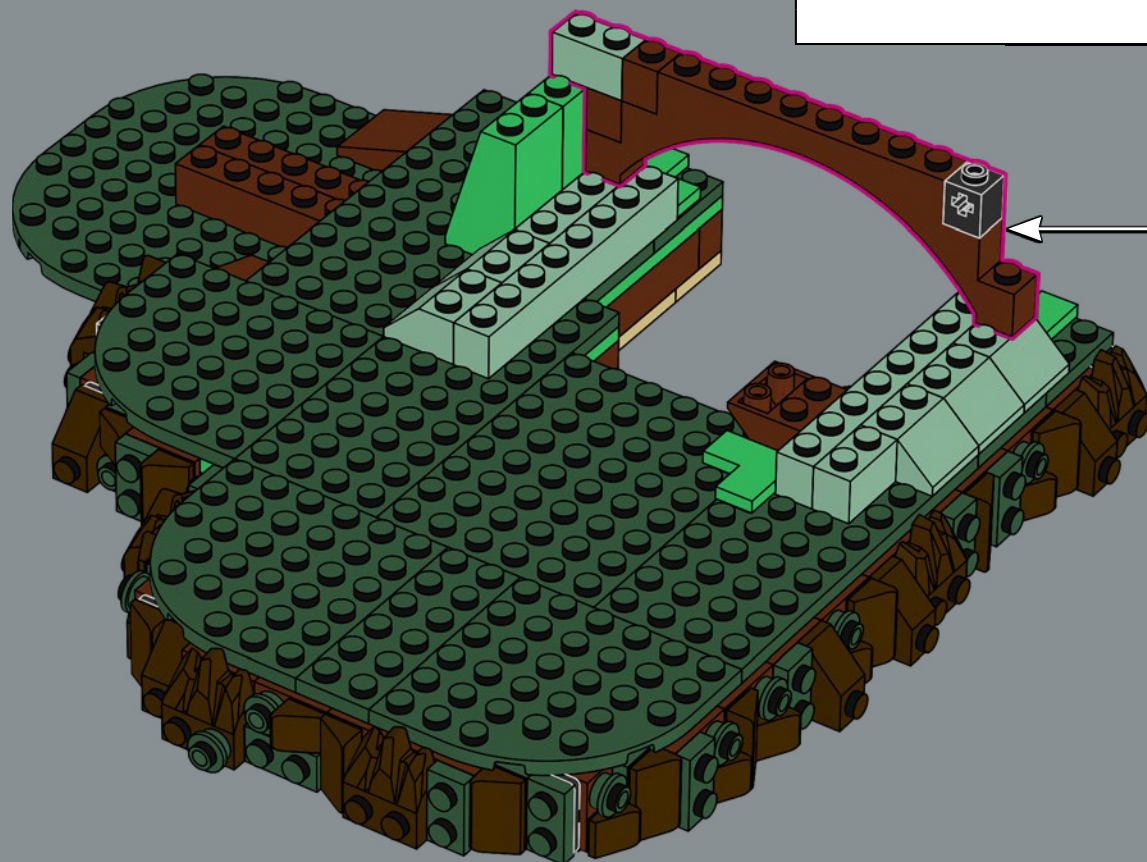
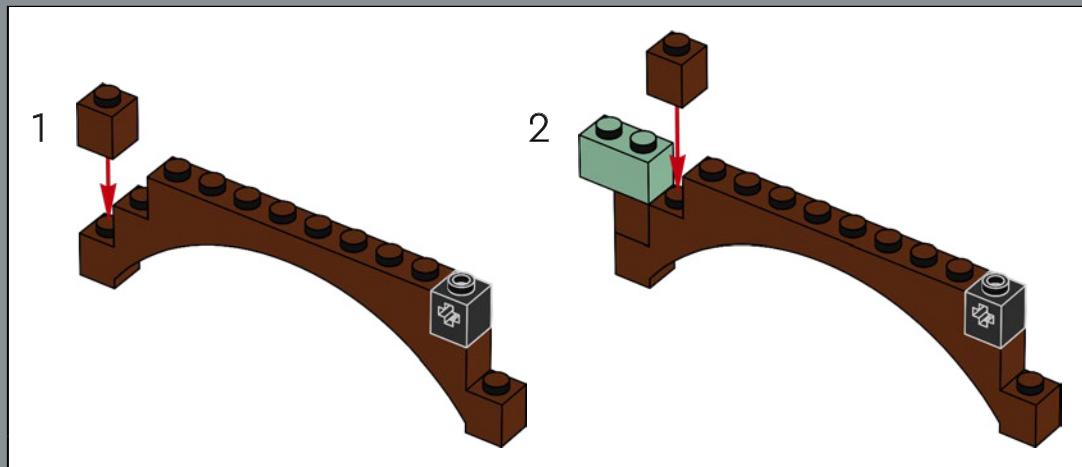

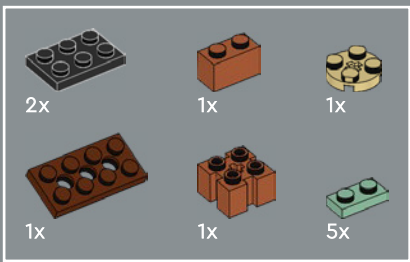

34

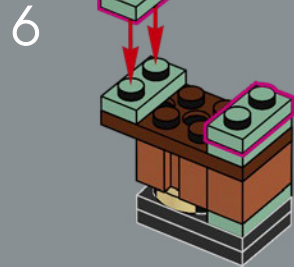
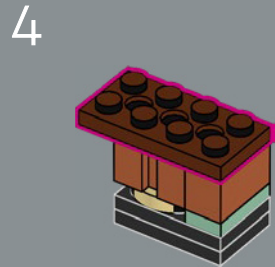
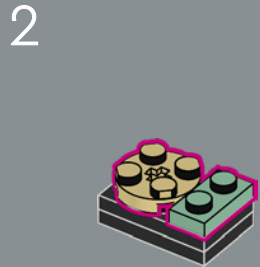
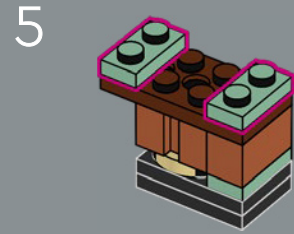
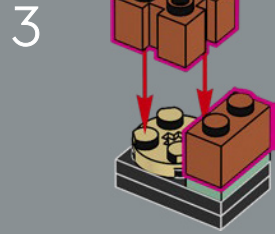
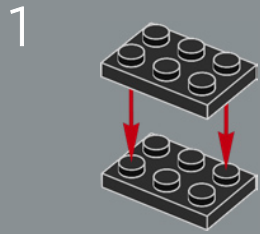



35

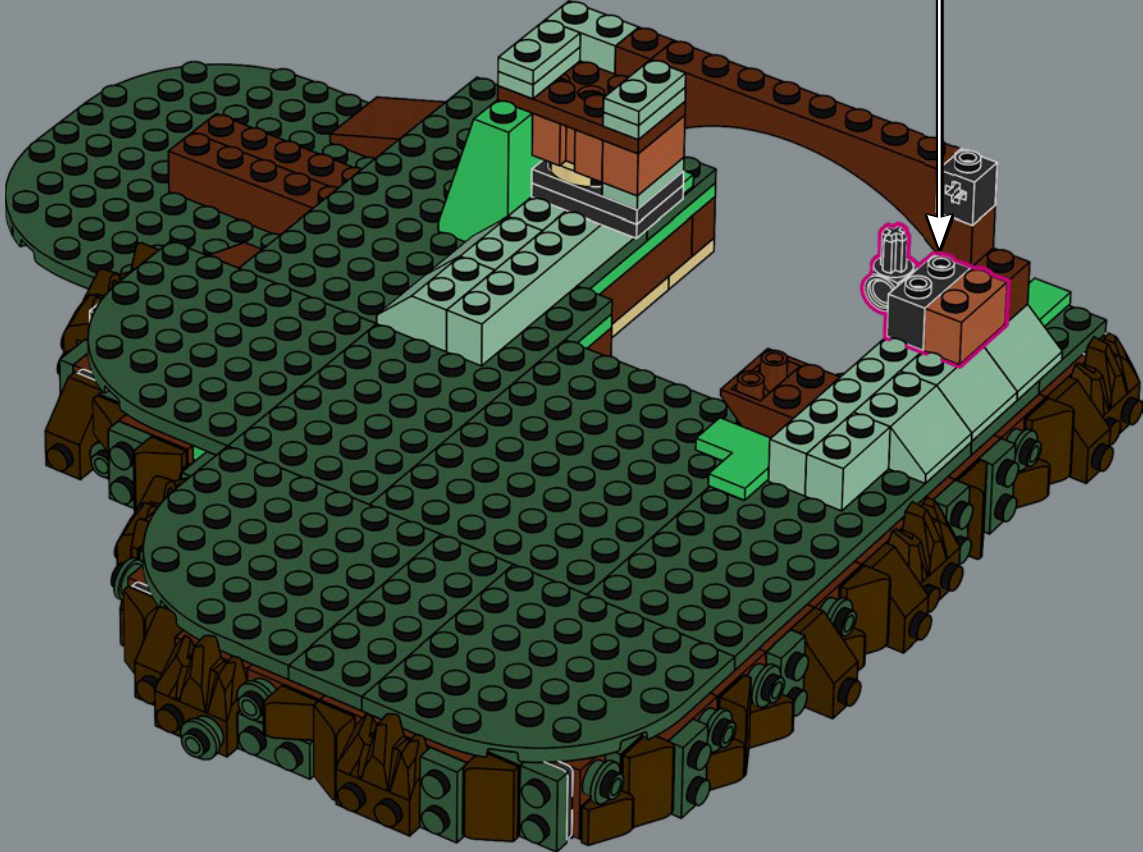
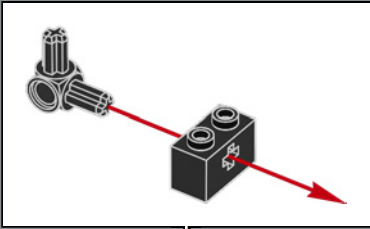



36

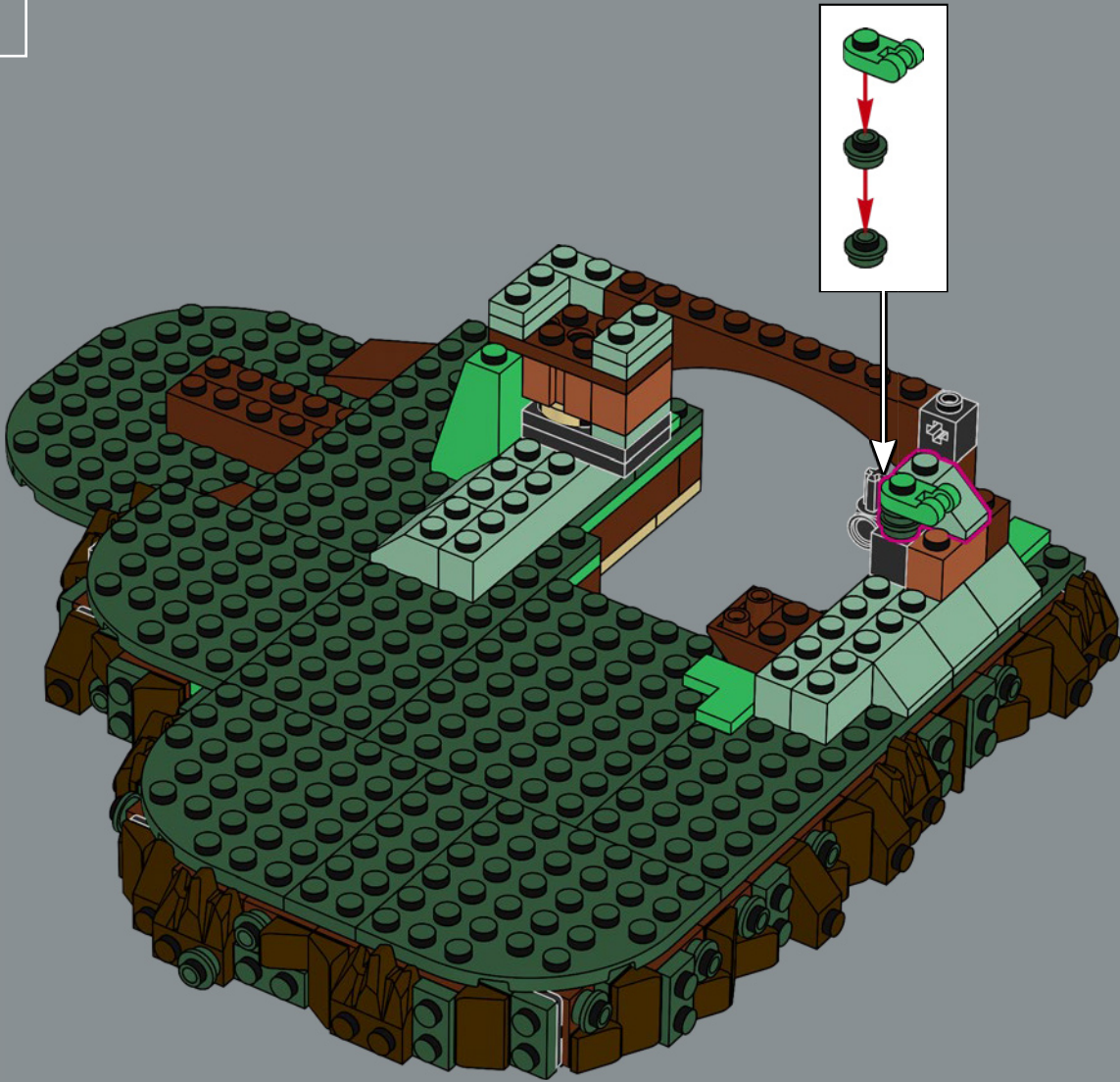

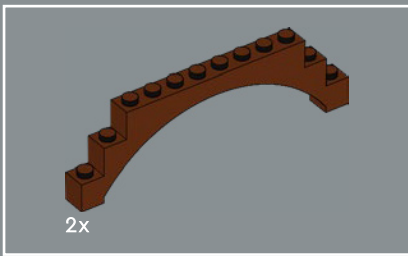

37

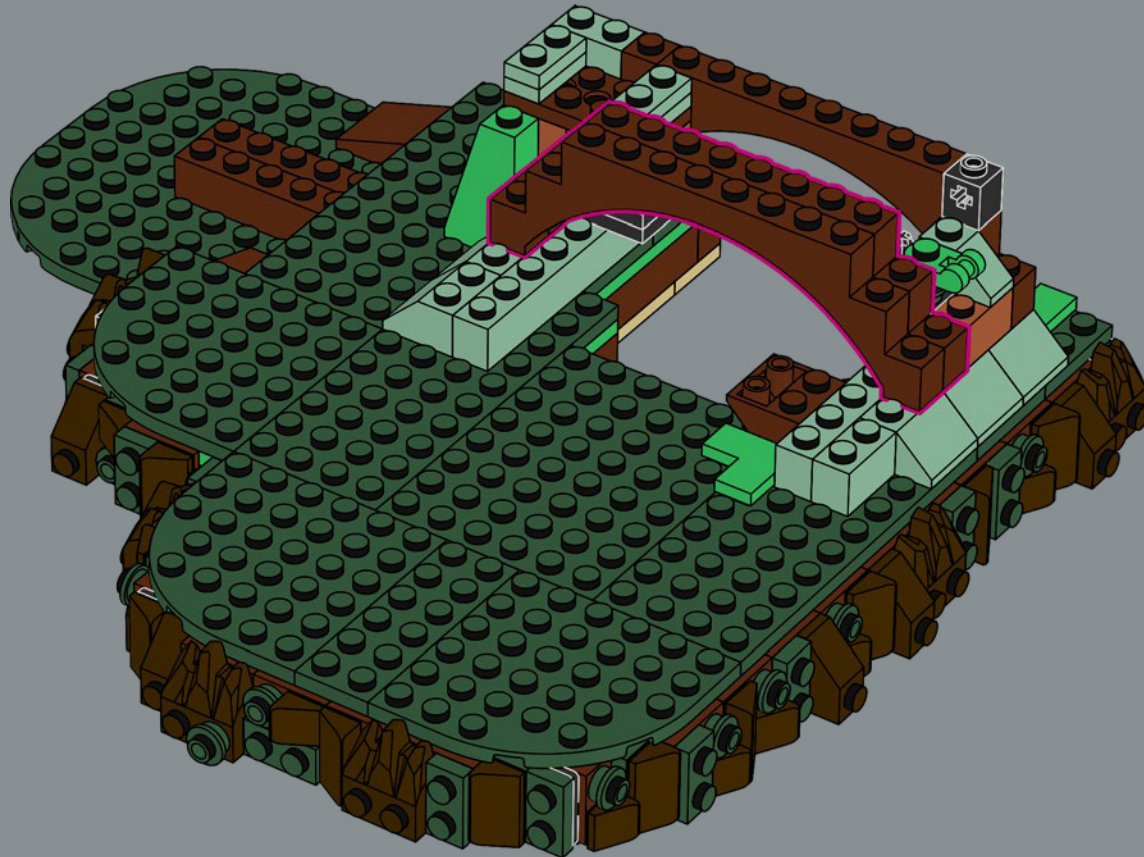



2x

38

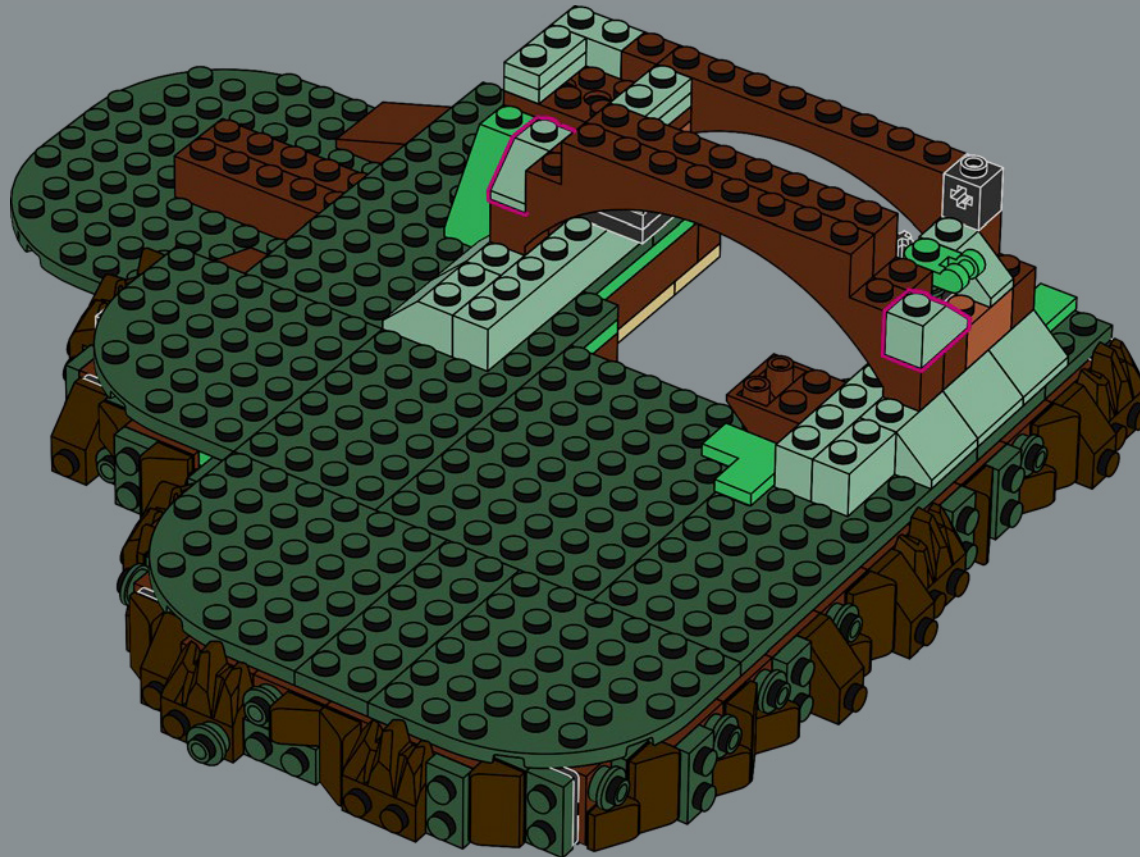

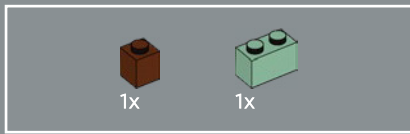

39

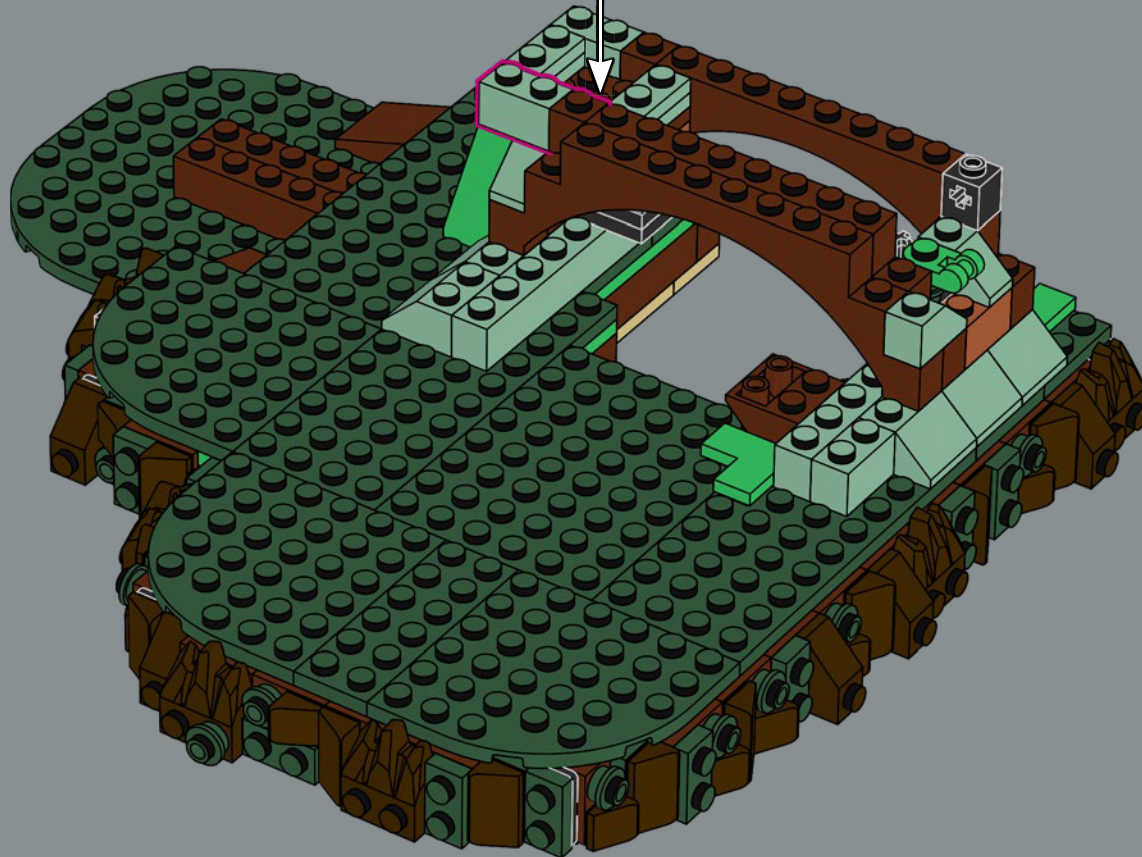
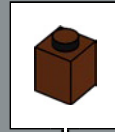

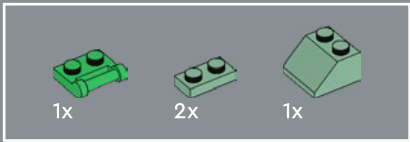

40

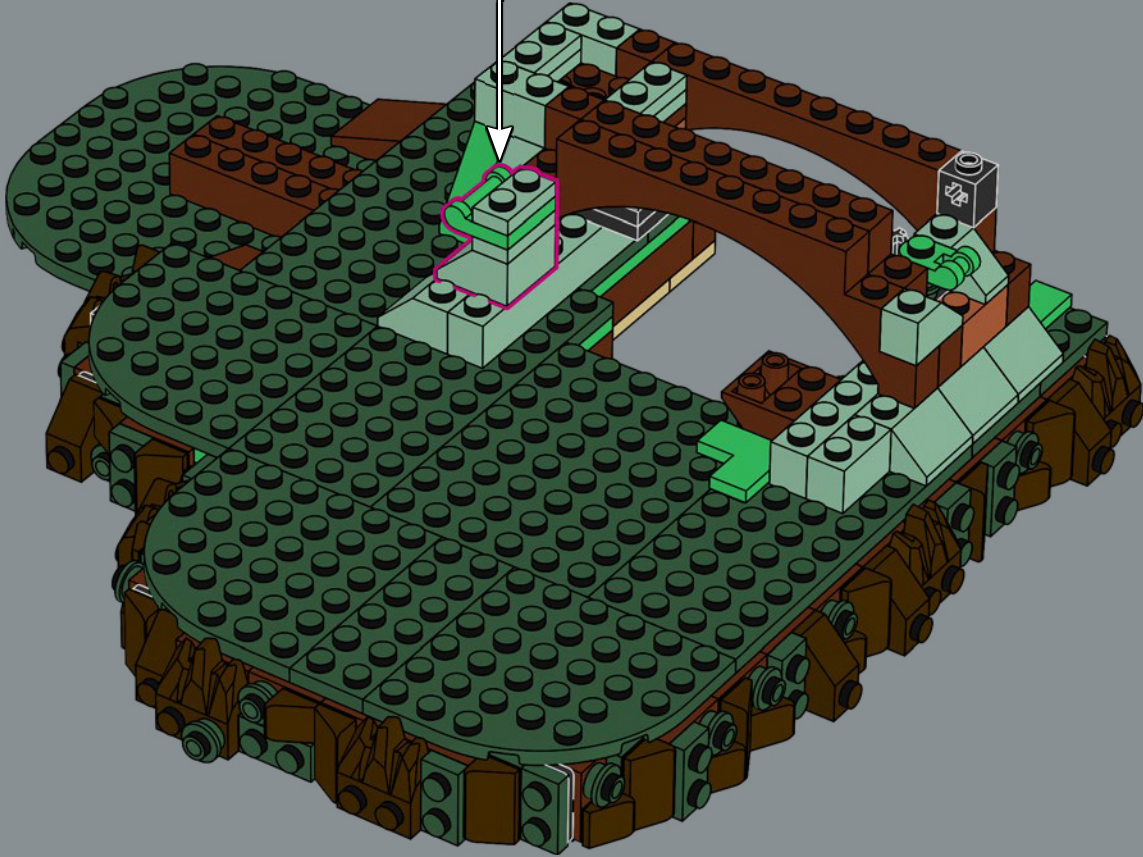
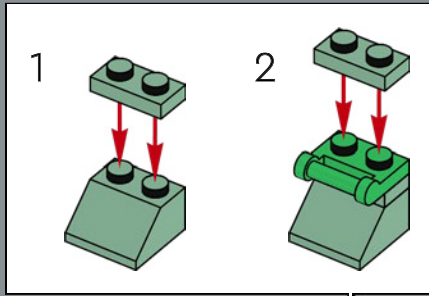

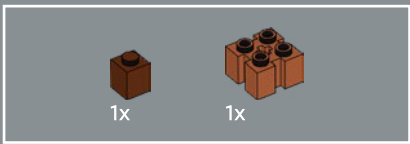

41

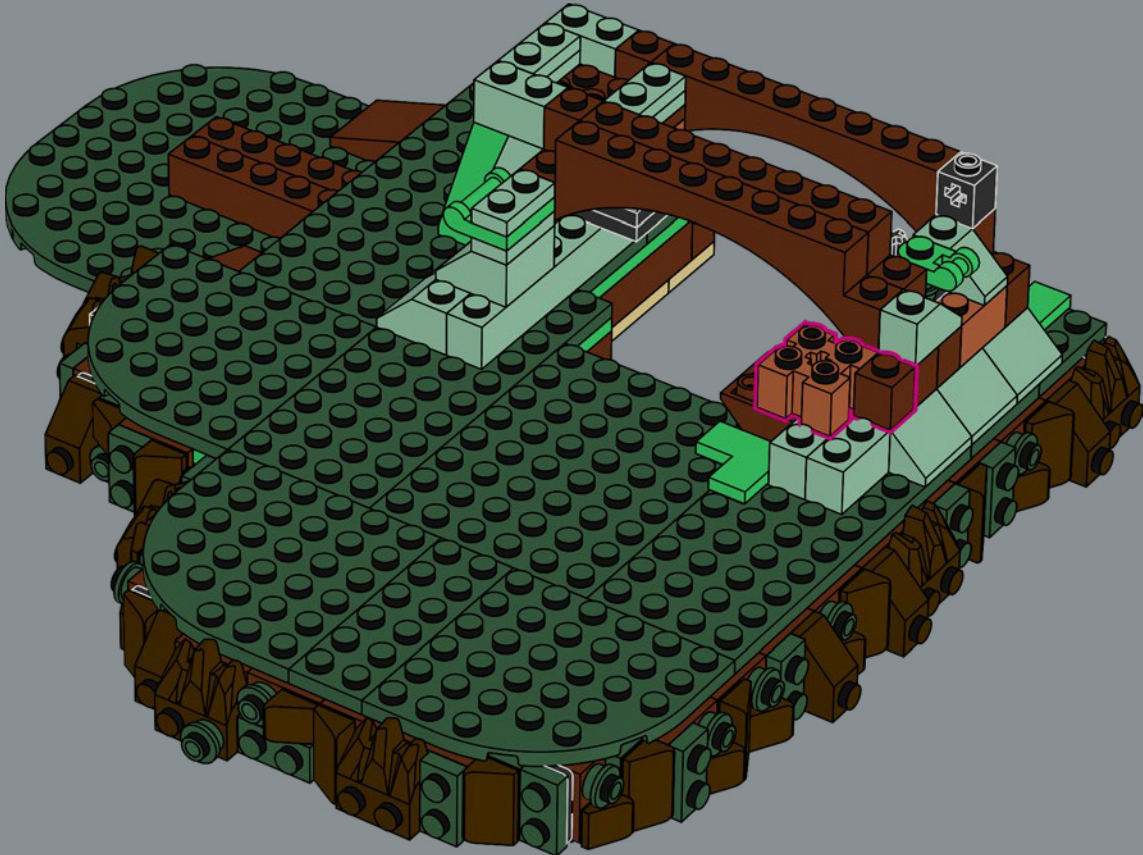

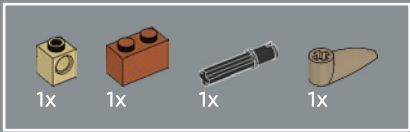

42

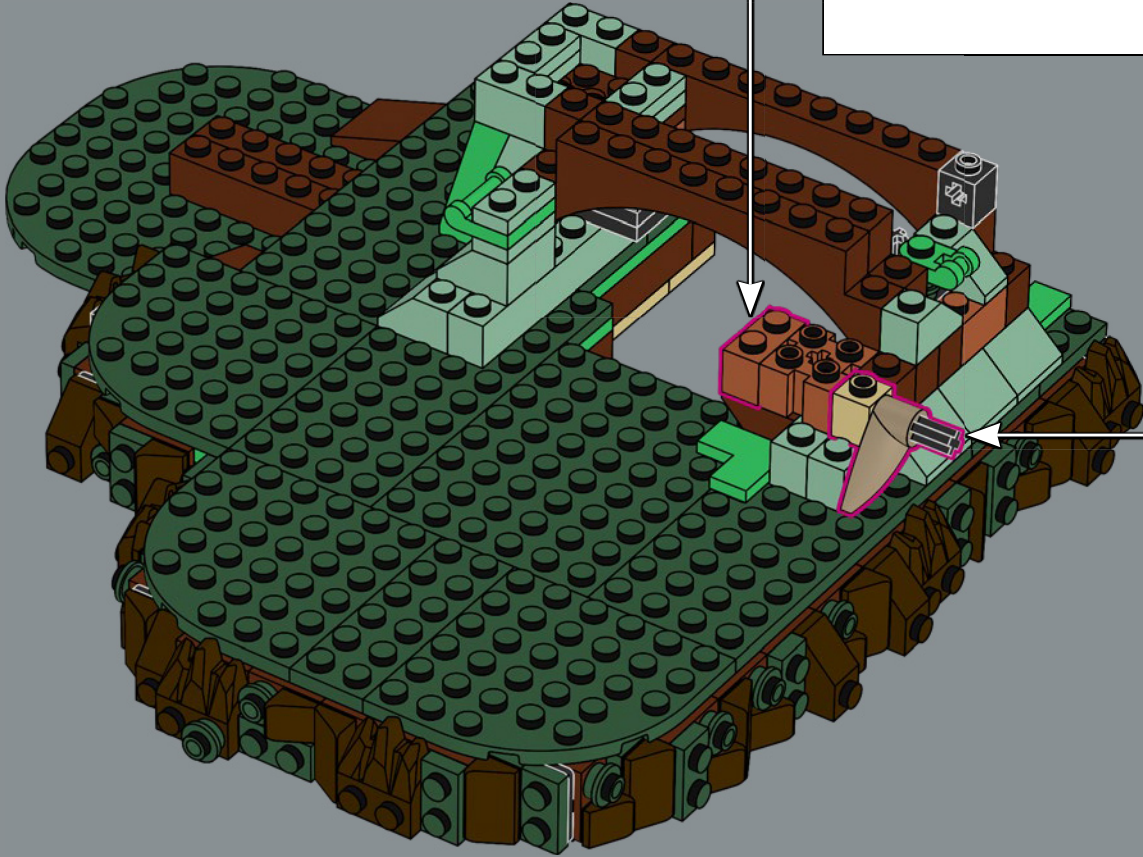
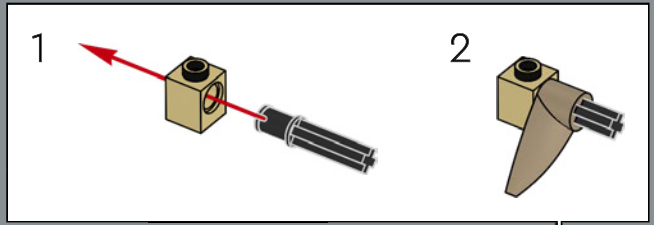
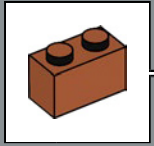

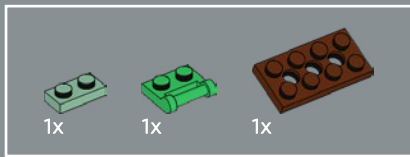

43

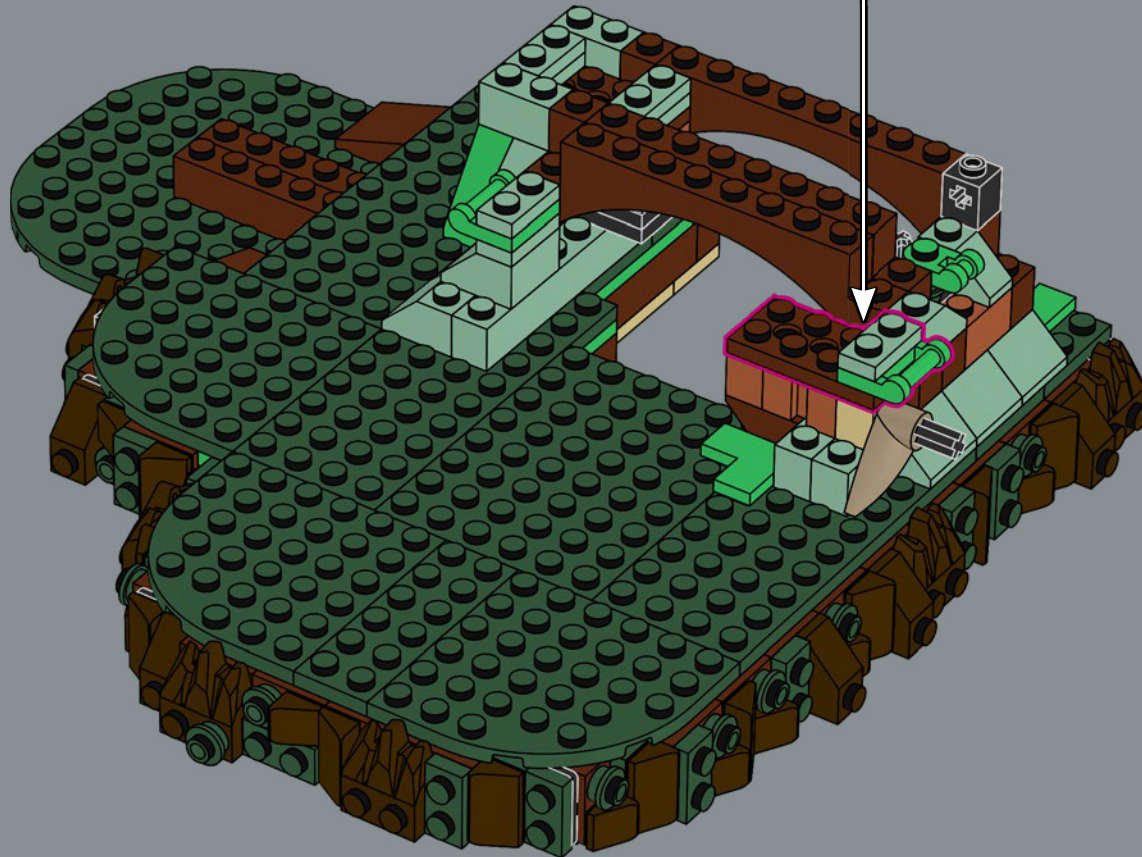
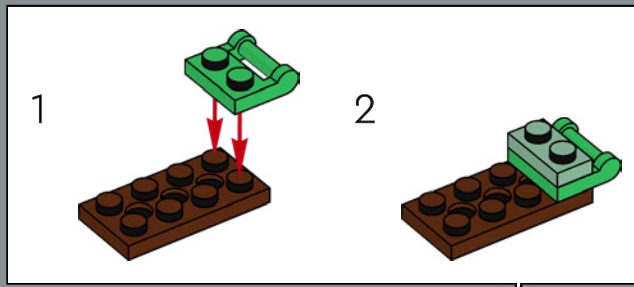

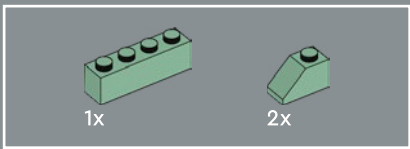

44

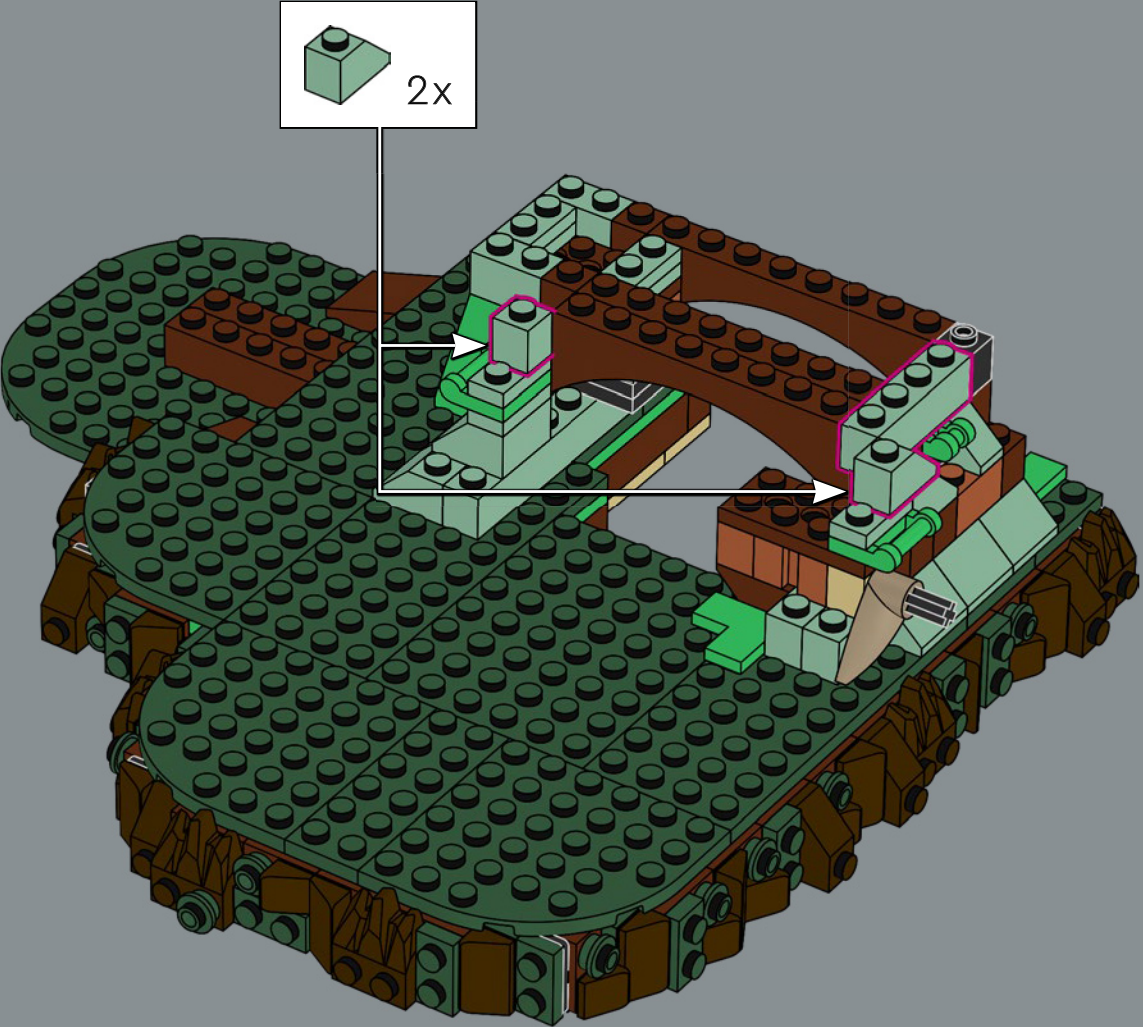

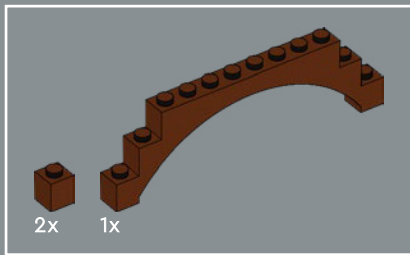

45

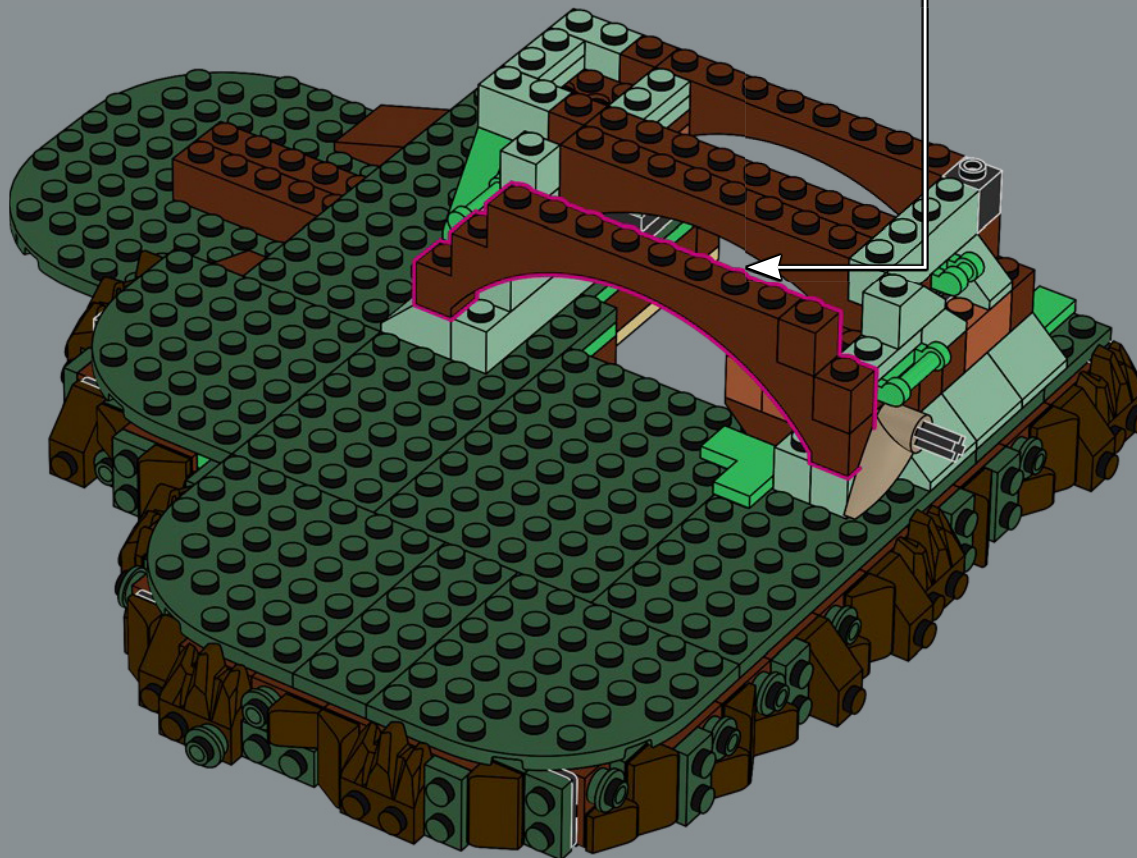
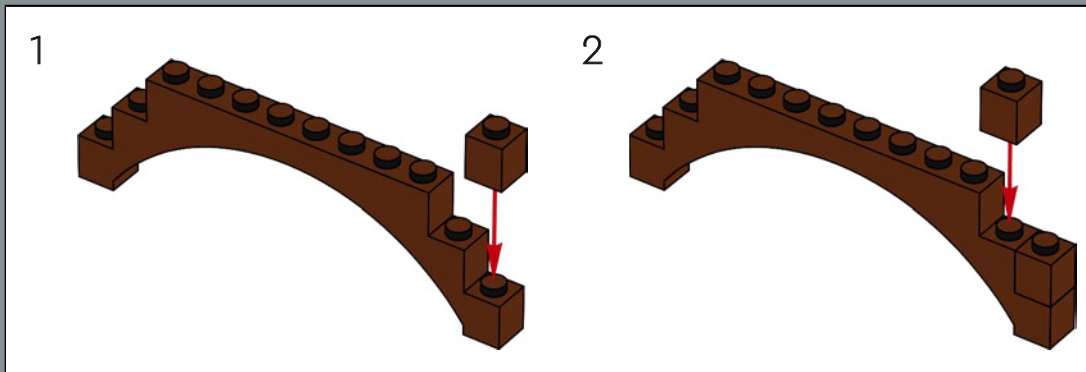



2x

46

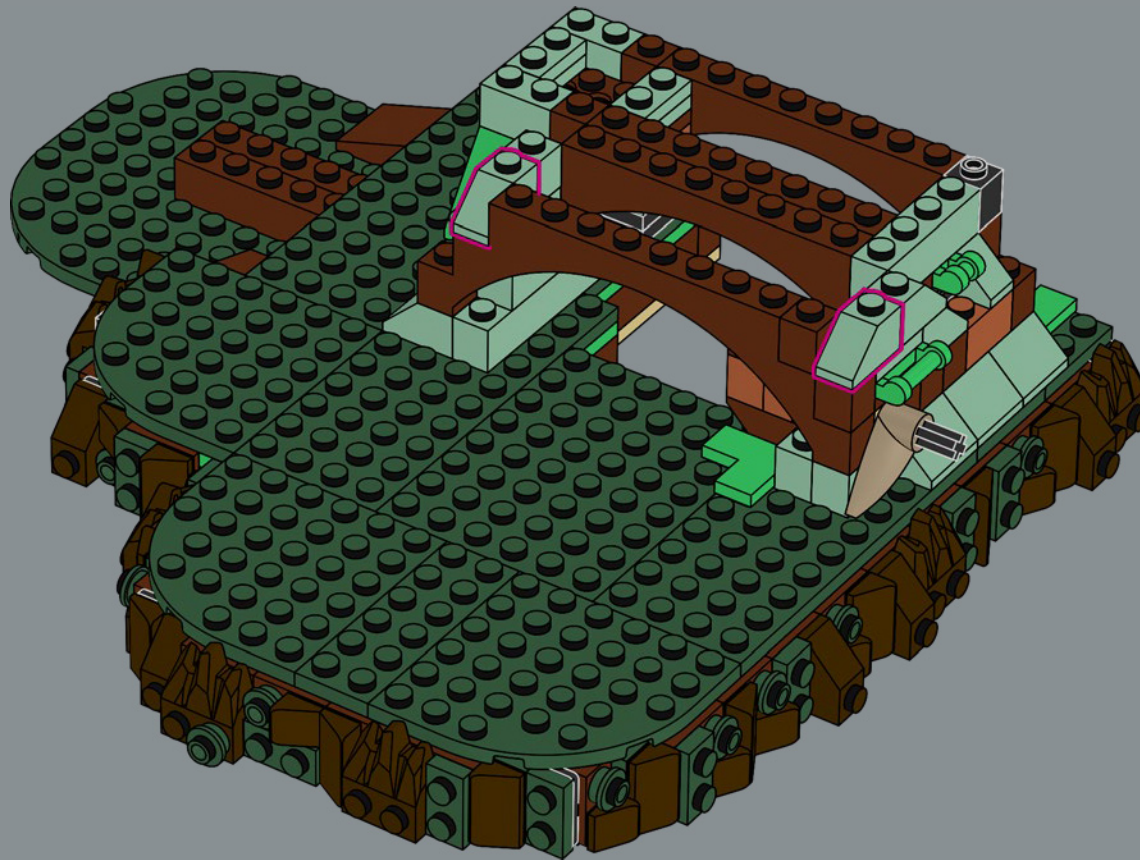

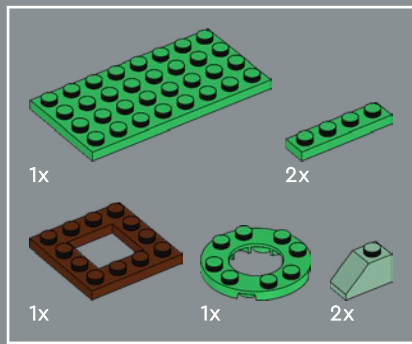

47

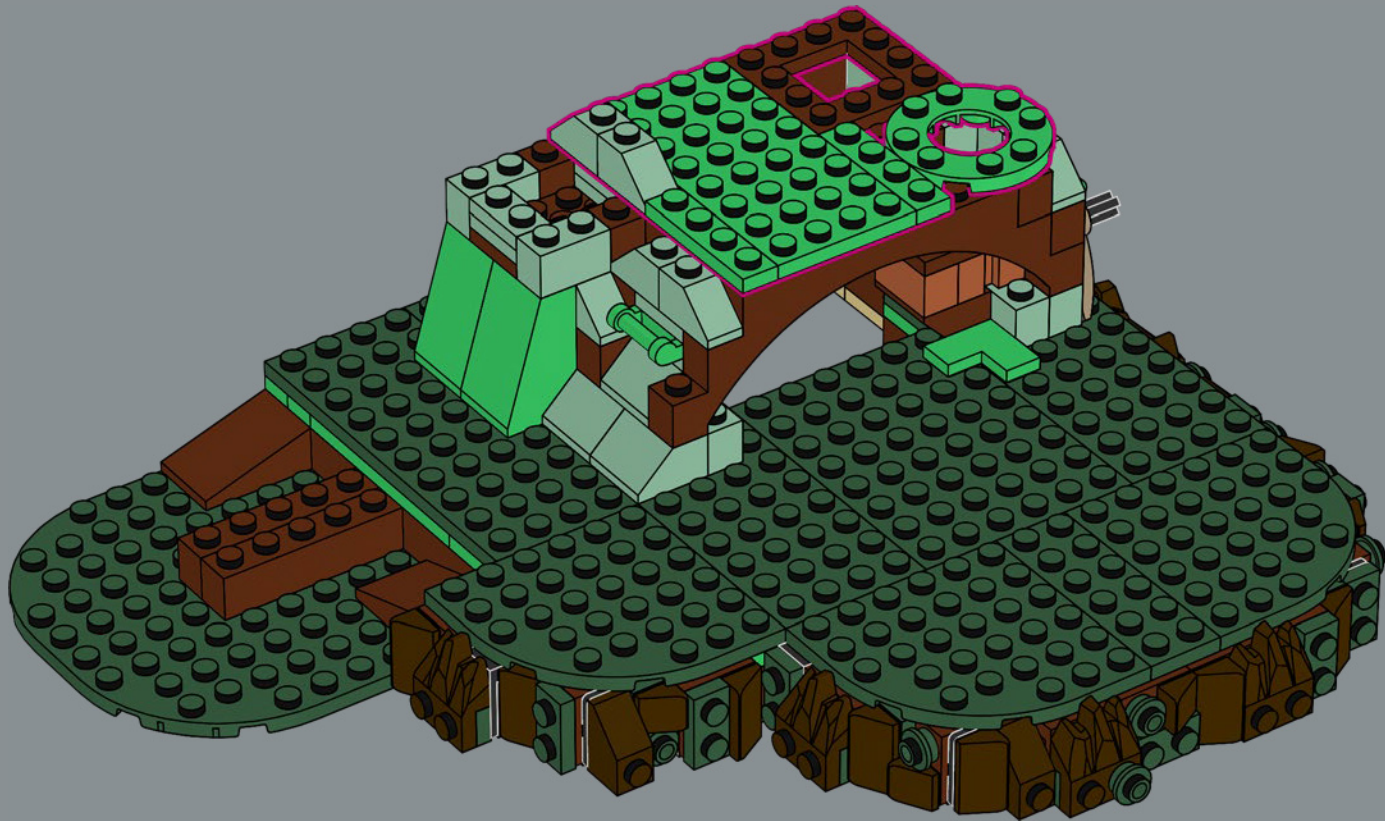

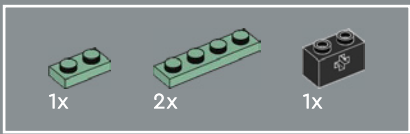

48



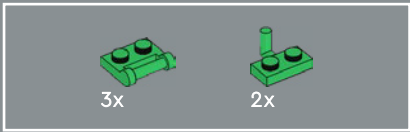

49



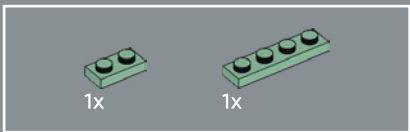

50



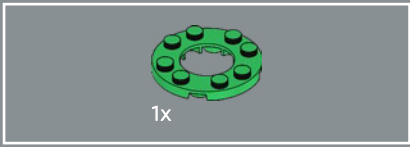

51



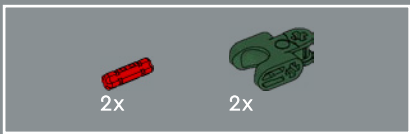

52

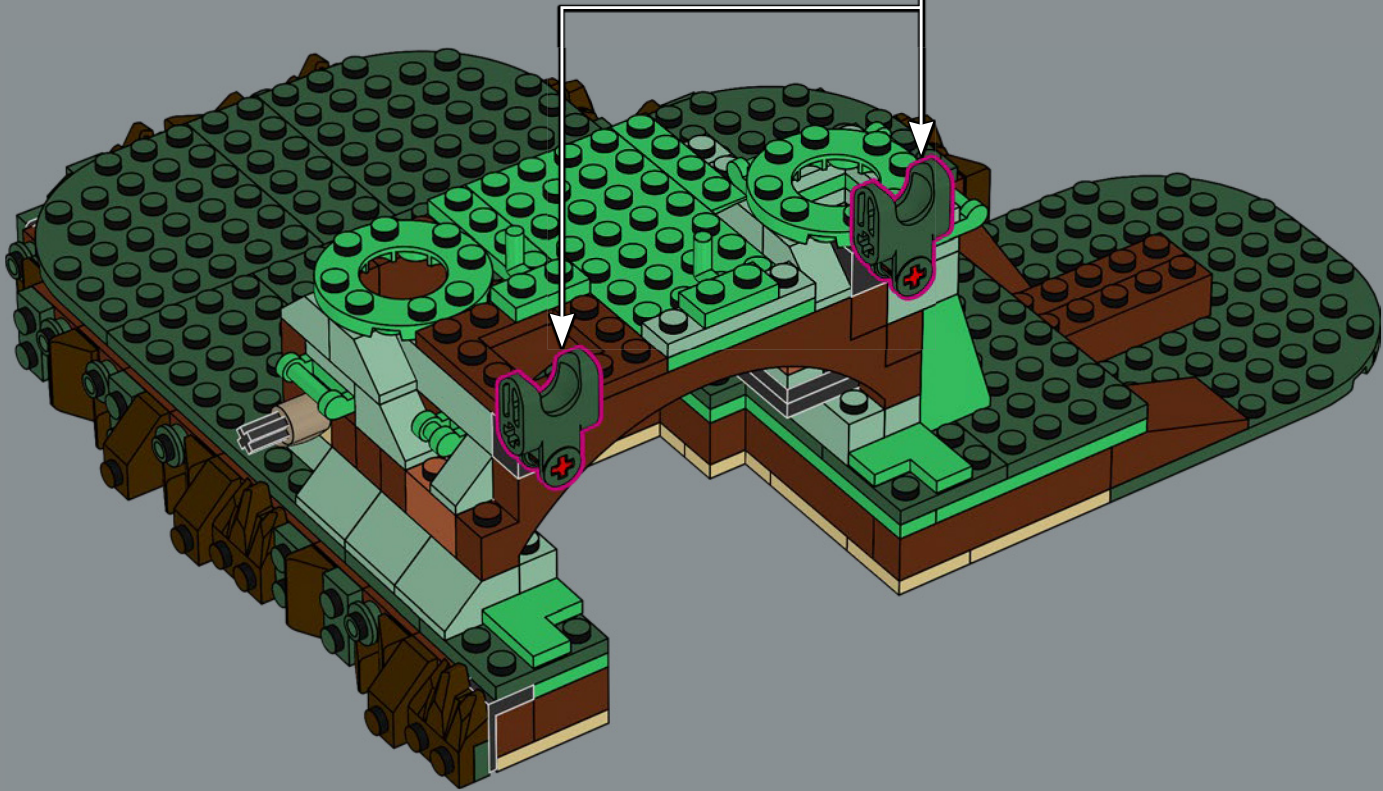
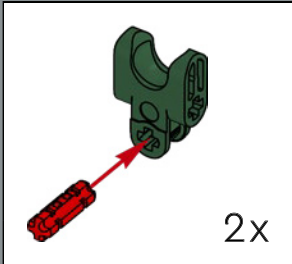

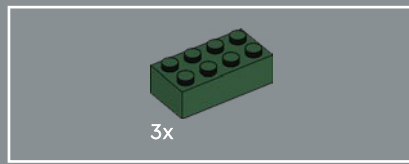

53

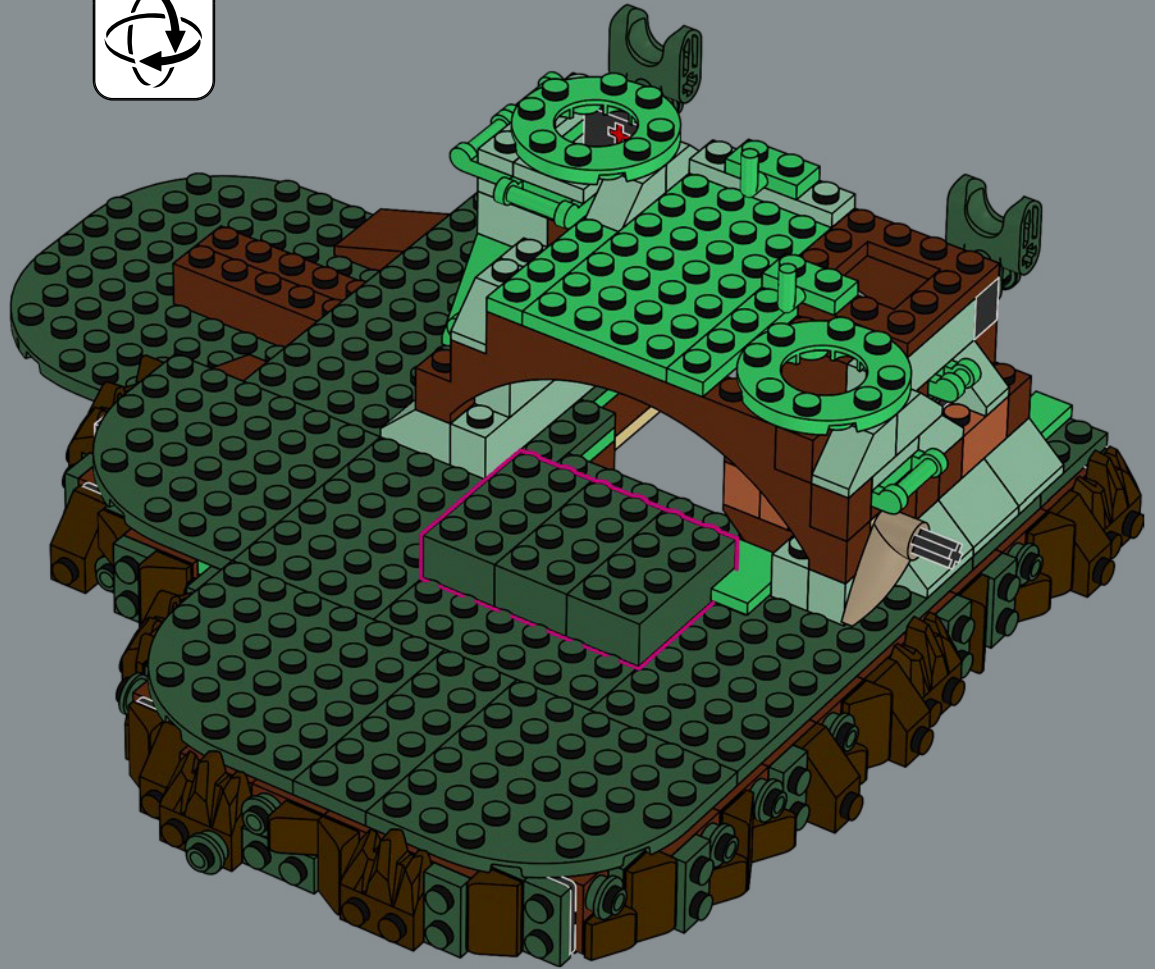

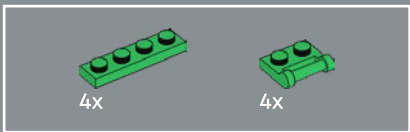

54





1x



5x

55

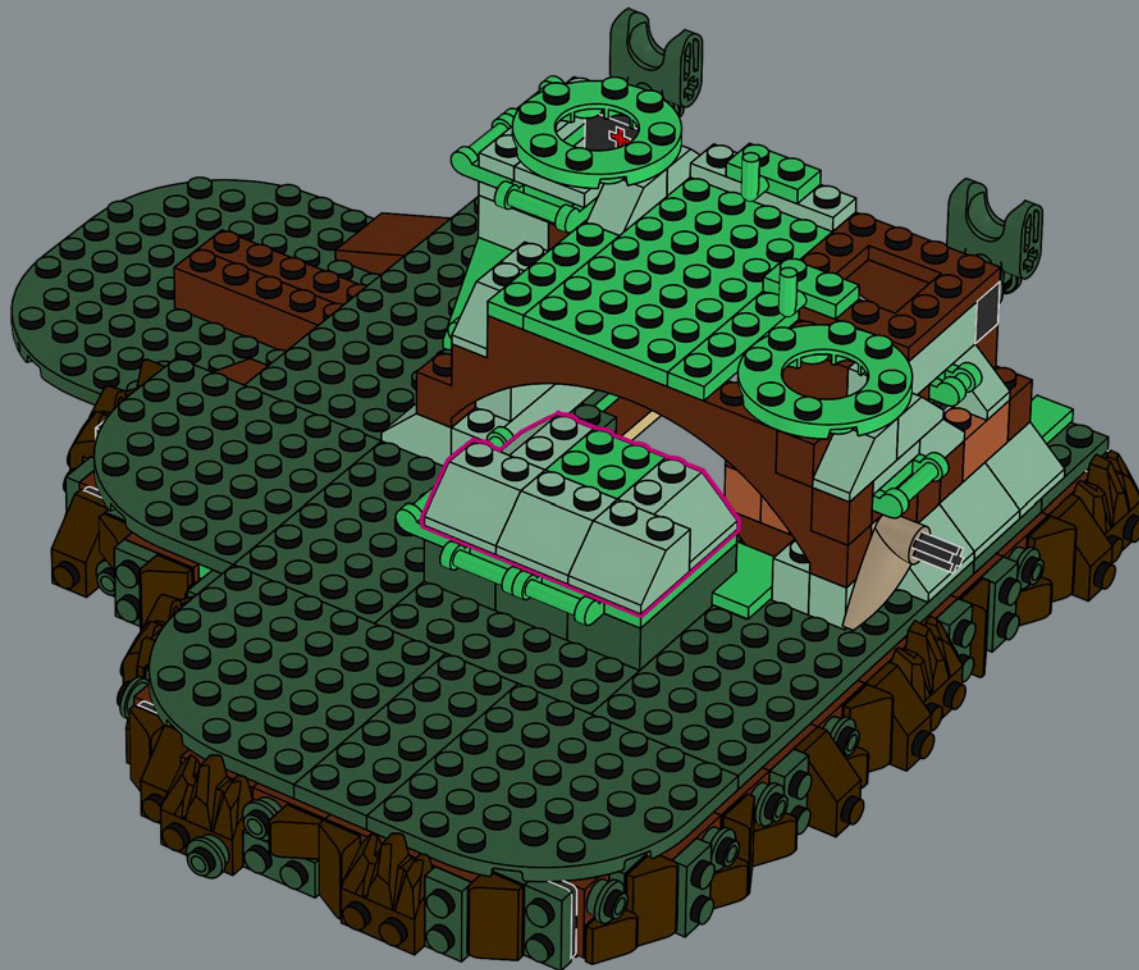

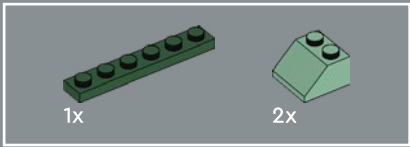

56

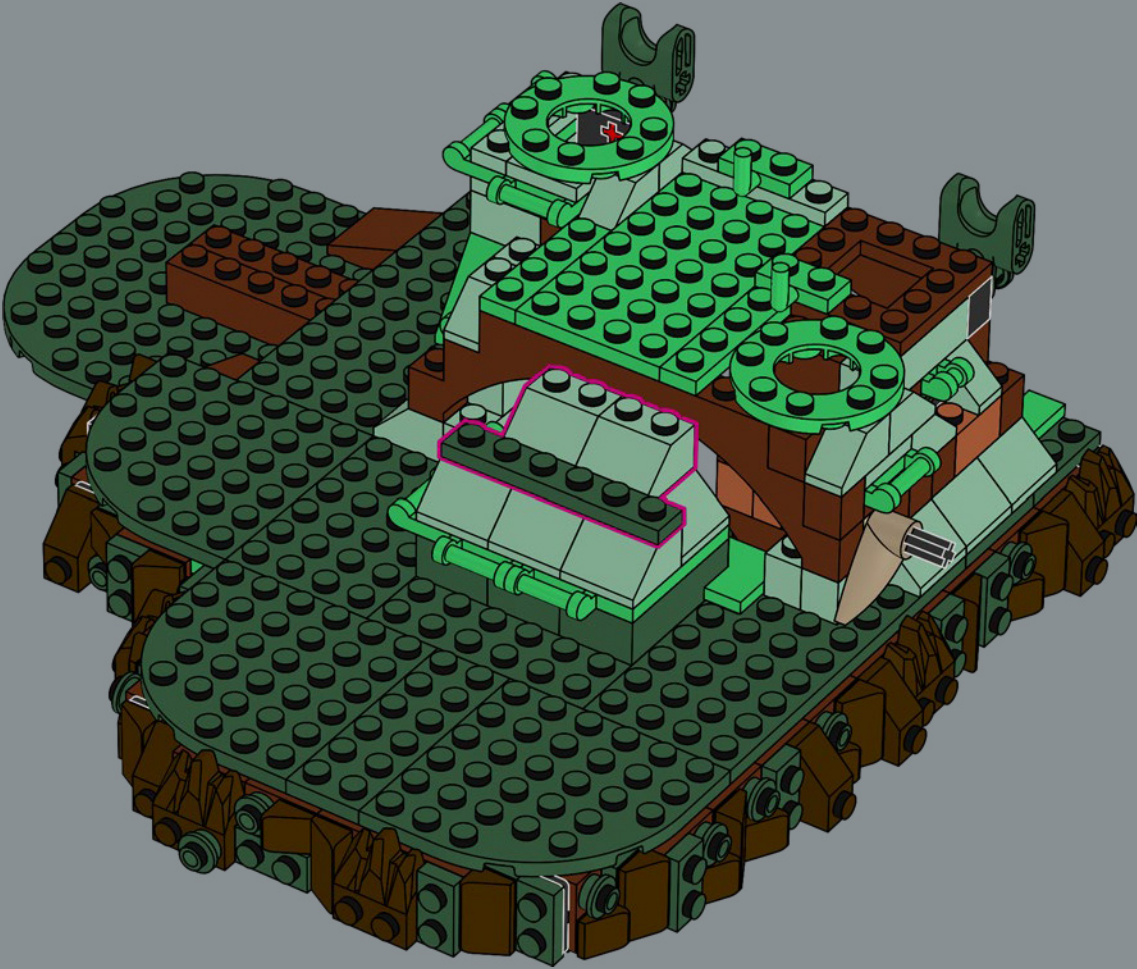

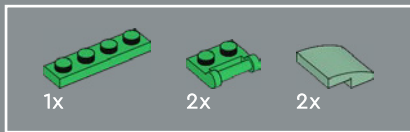

57

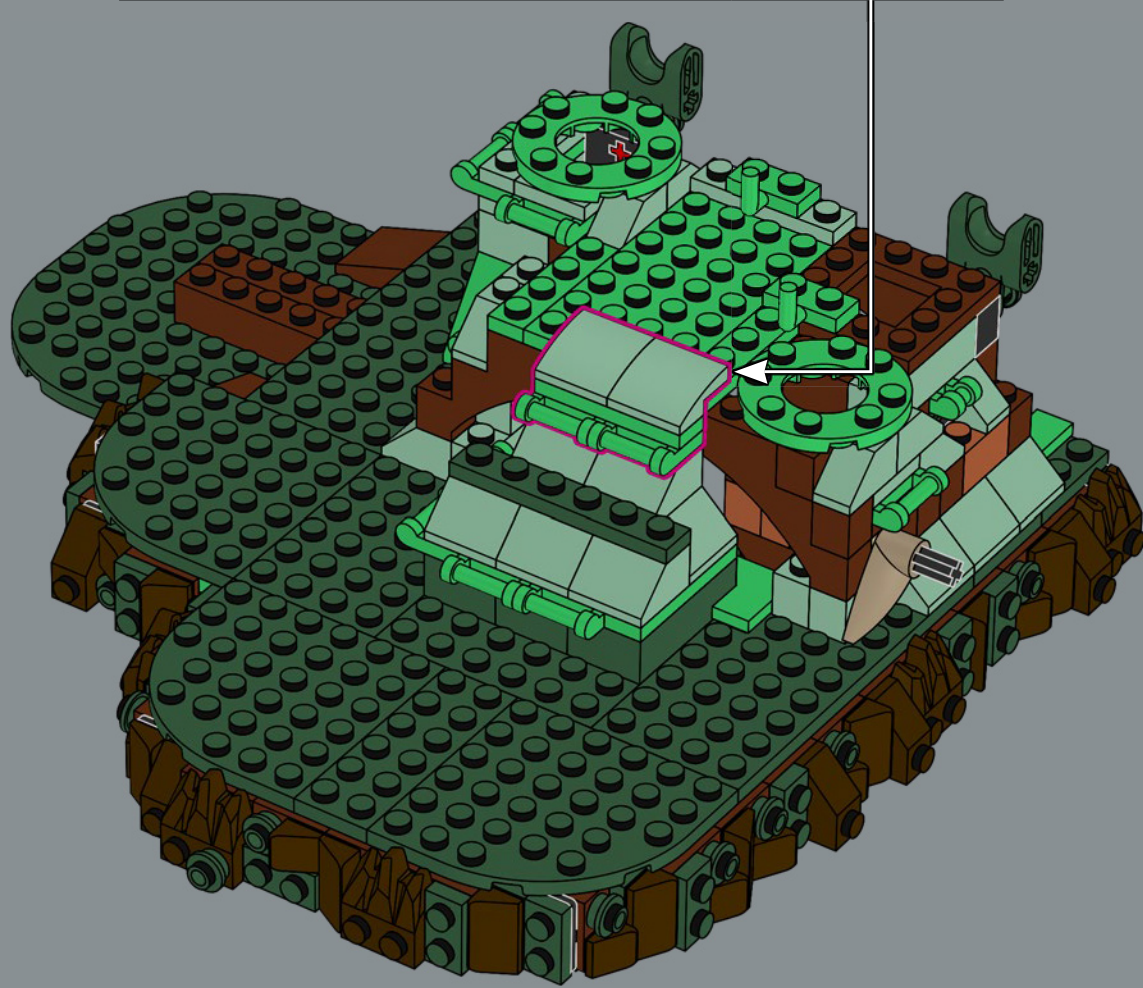
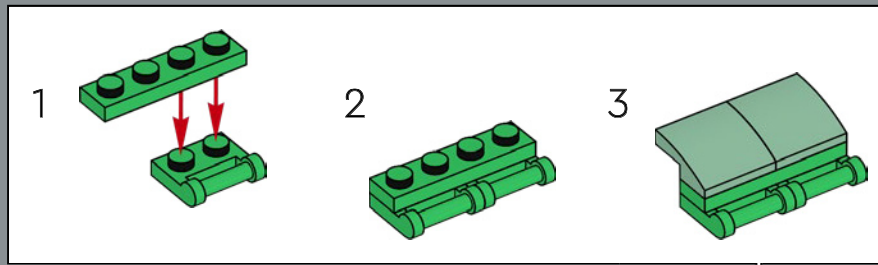



5x

58

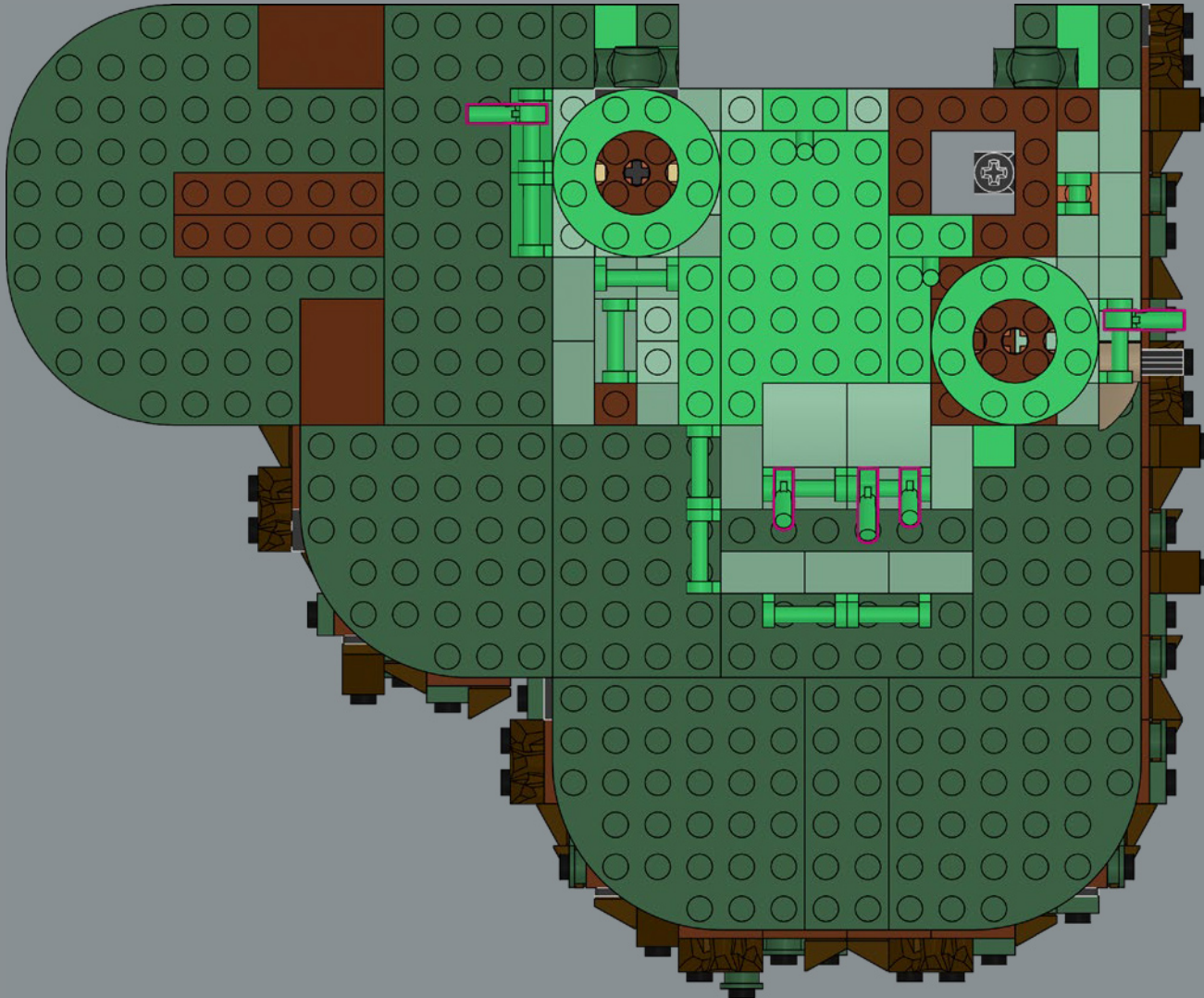



59

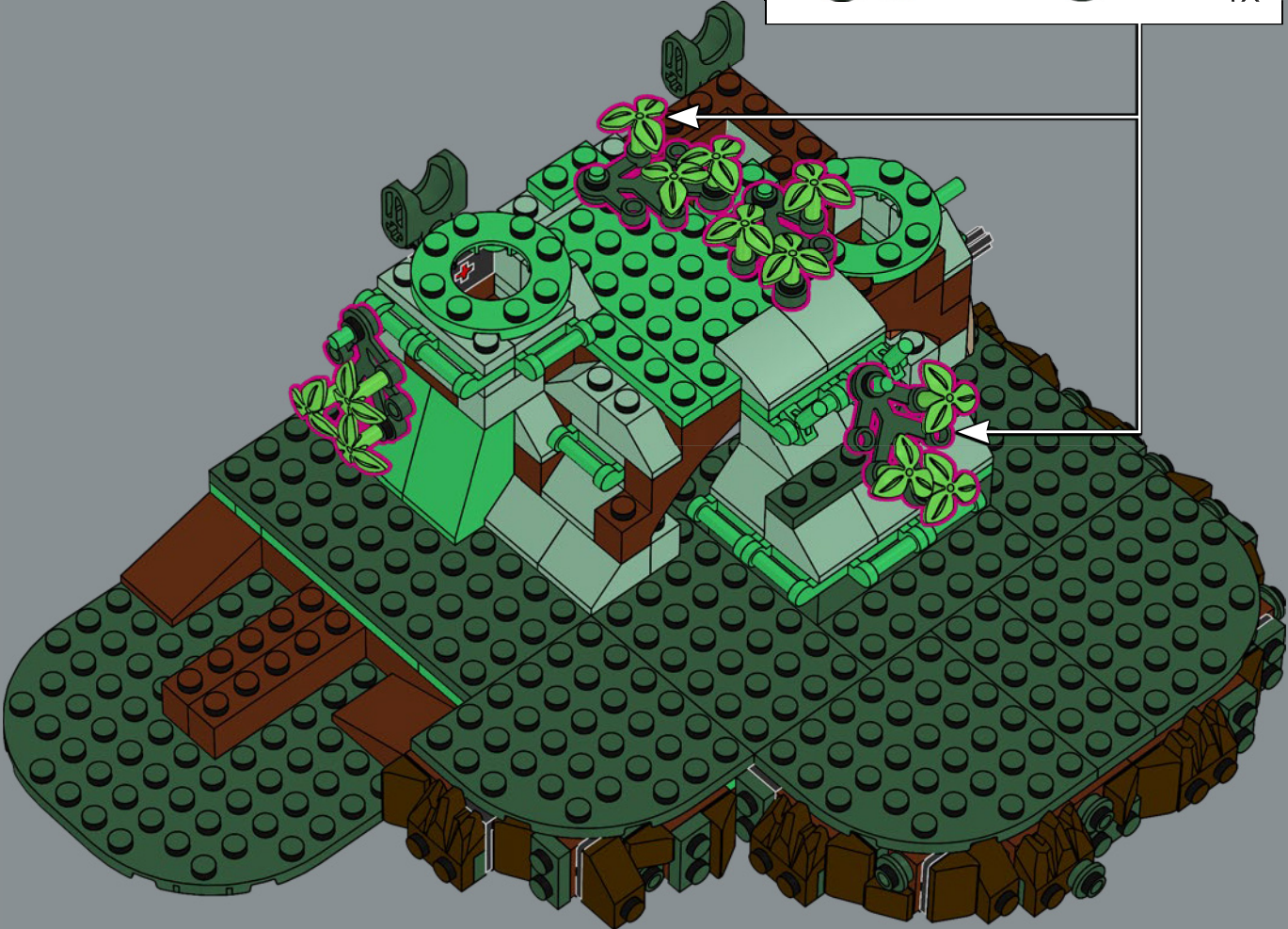
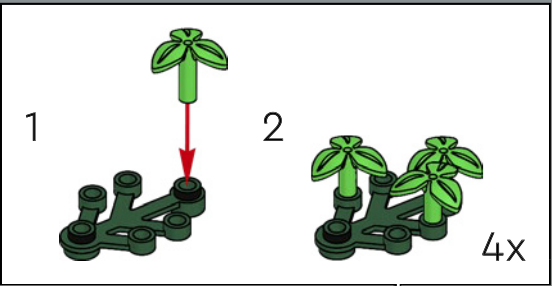



60

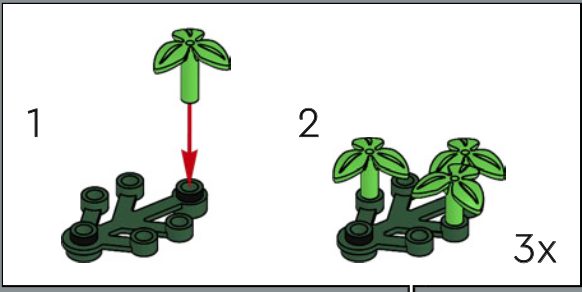



61

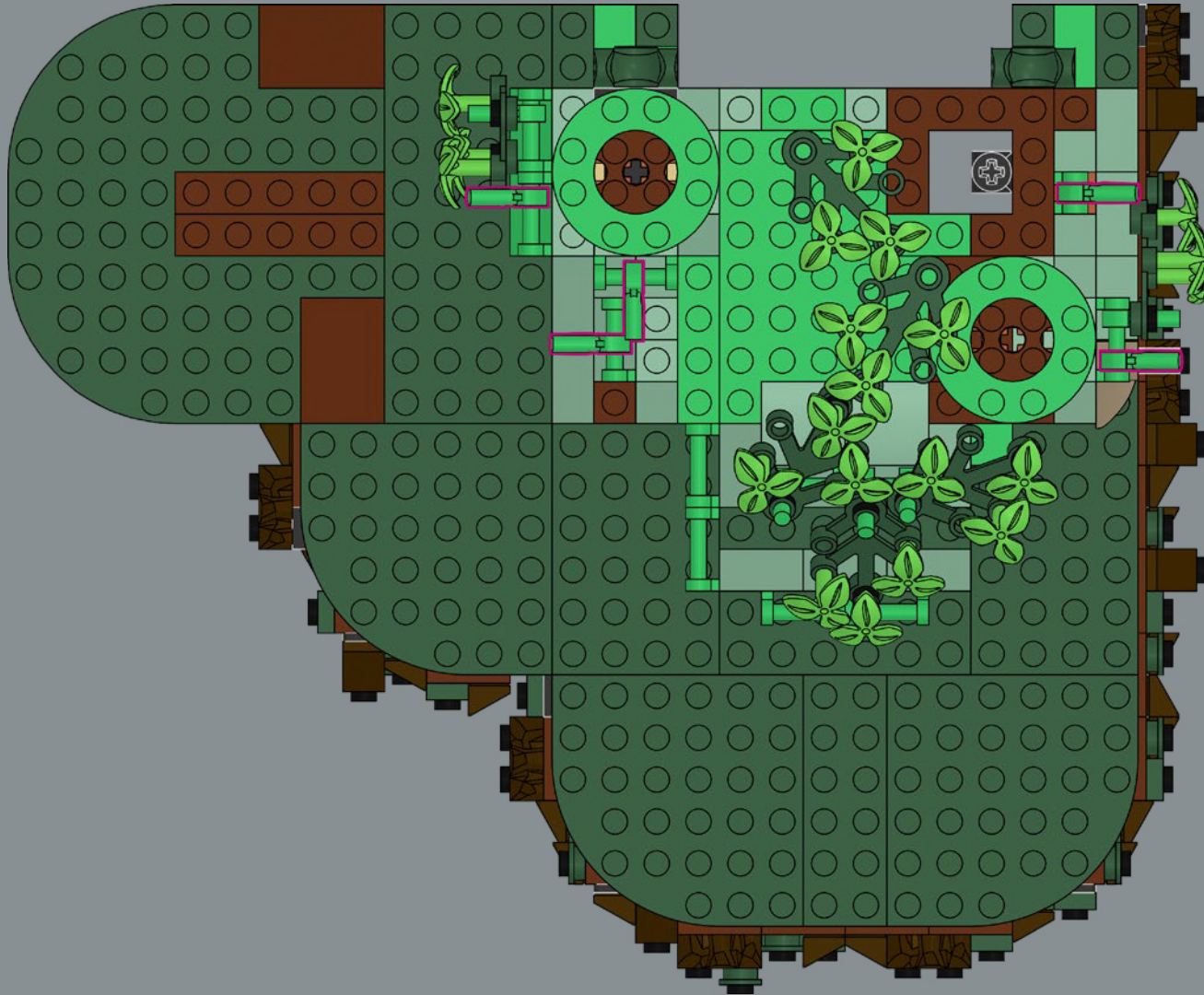



62

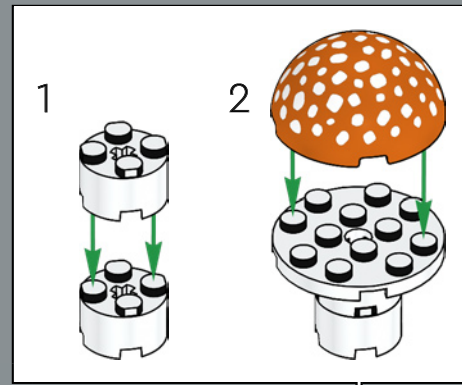

Una nuova decorazione fa risplendere il cappello dell'ovolo malefico con vivaci esplosioni di colore.



63



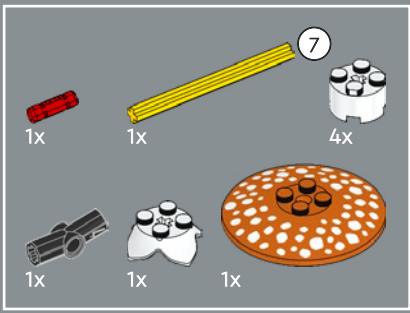

64

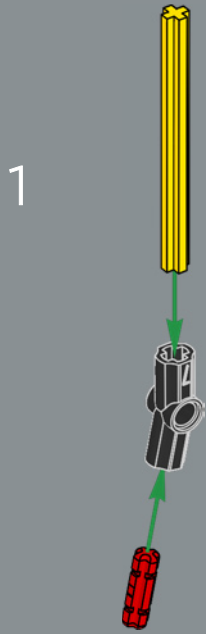

2



3

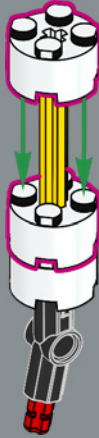

4



5





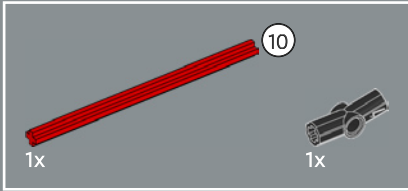
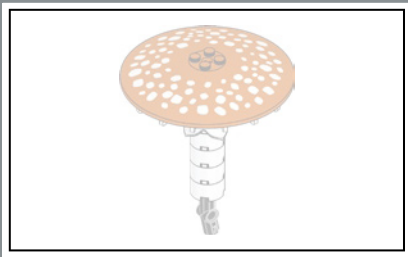

65

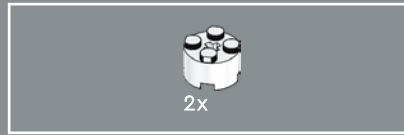

66

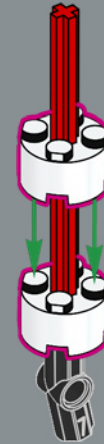

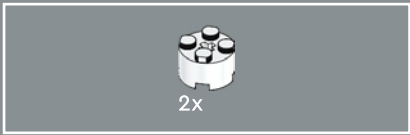

67

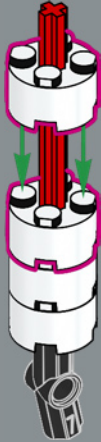

68

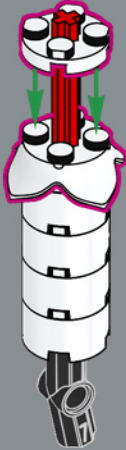

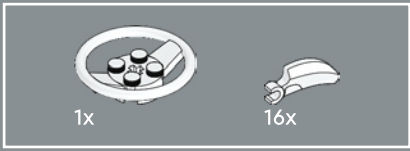

69

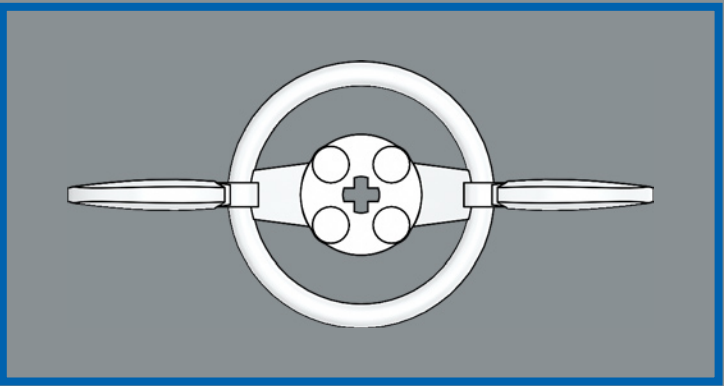

1

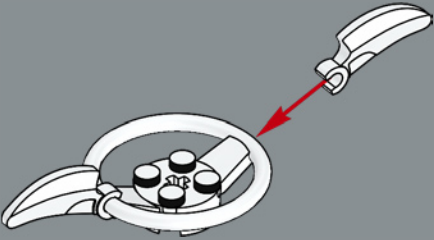

2

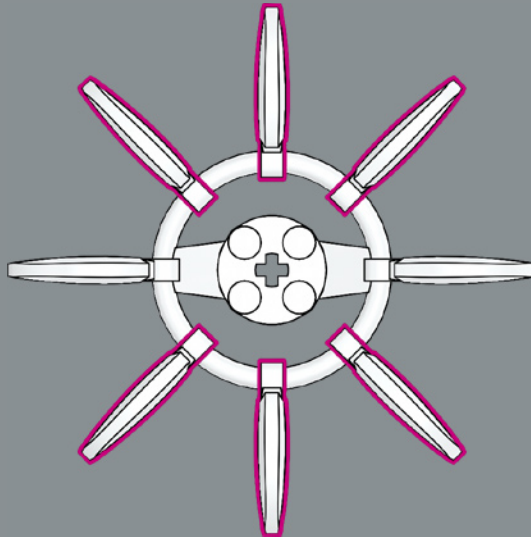

3

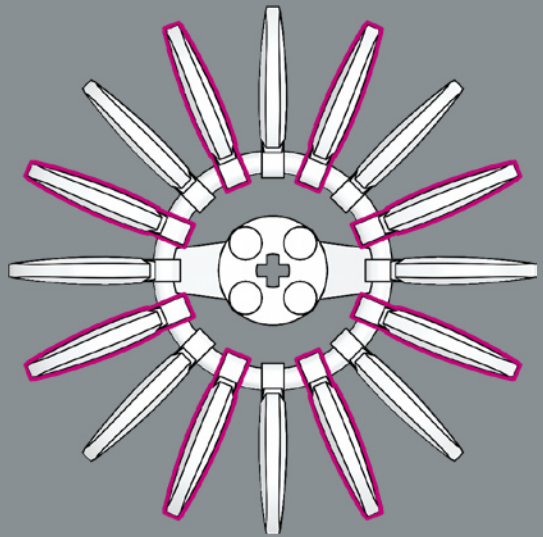

Gli elementi artiglio possono essere utilizzati per molto più che semplici animali e creature LEGO®. Qui sono utilizzati per le lamelle sotto i grandi cappelli degli ovoli malefici.

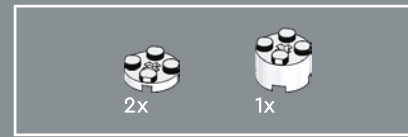
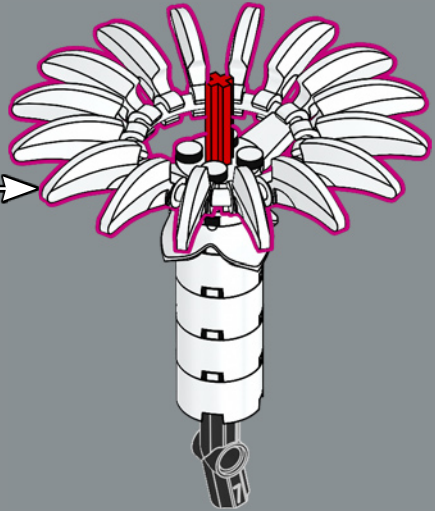

70

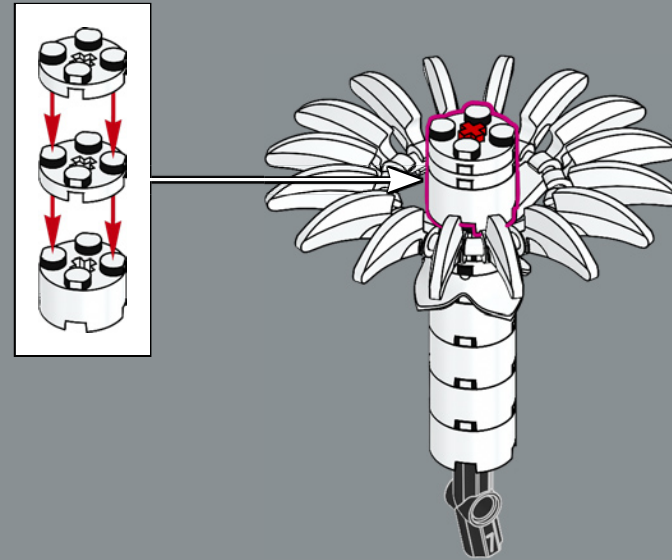

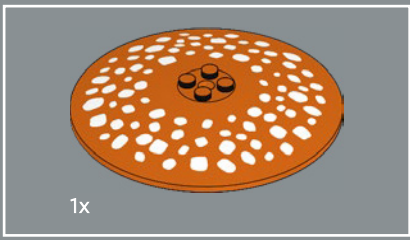

71



72





73



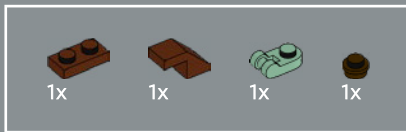

74

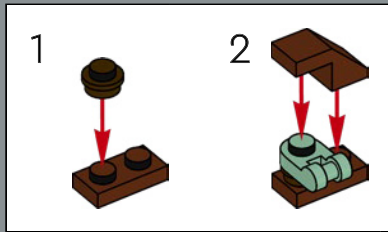



4x

75





76

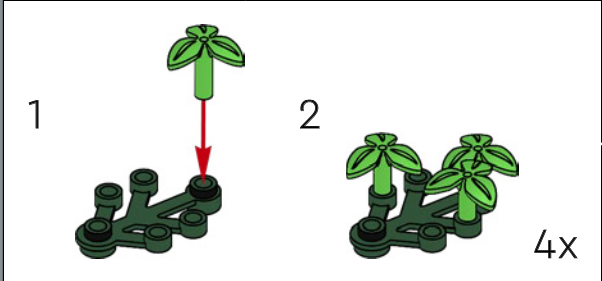



77



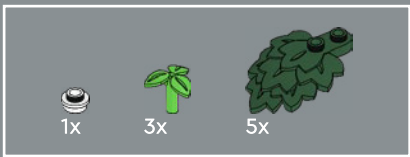

78



3x  2x 

79



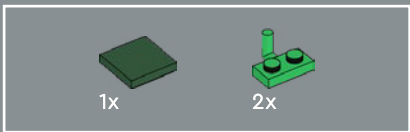

80

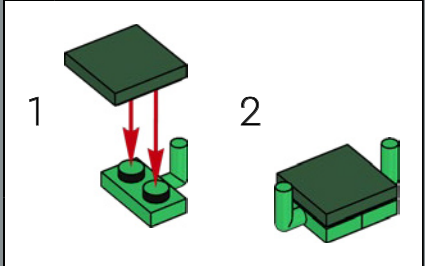

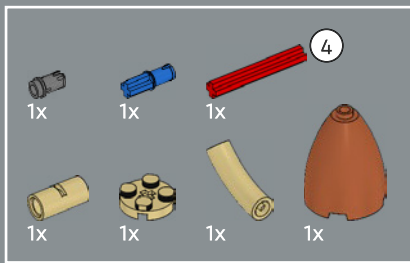

81

1



2

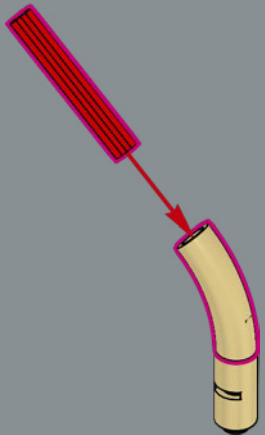

3

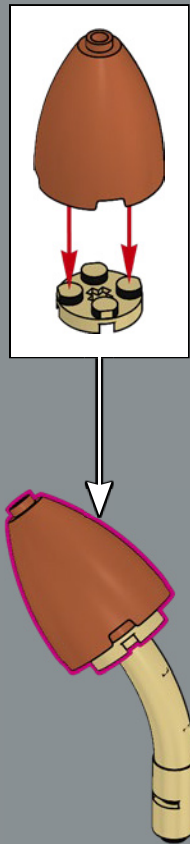

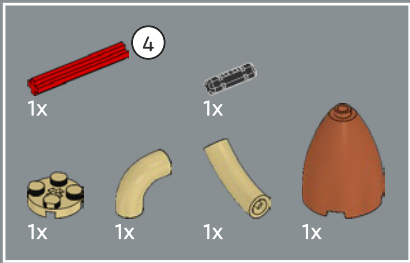

82

1

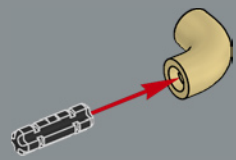

2

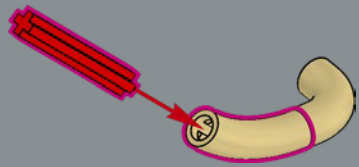

3

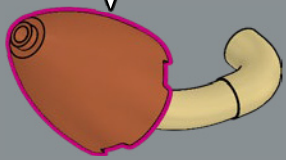
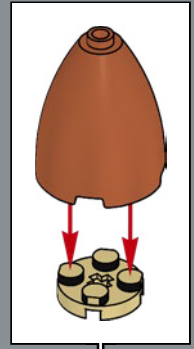

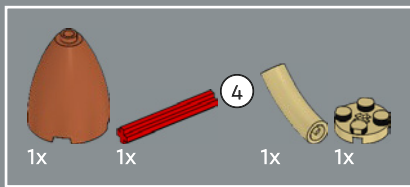

83

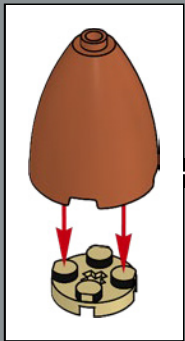
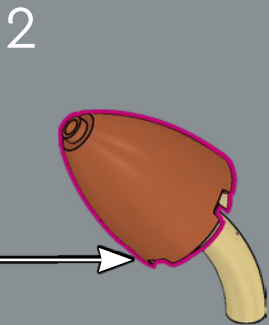
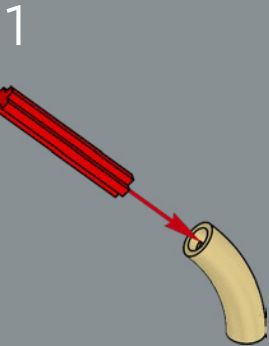

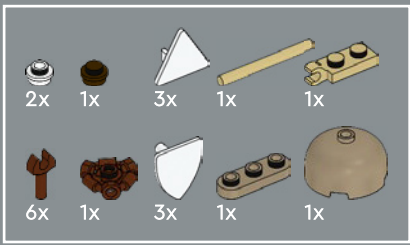

84

1

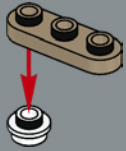

2

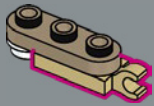

3

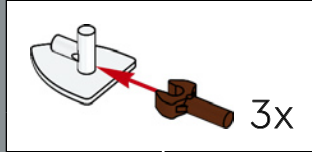
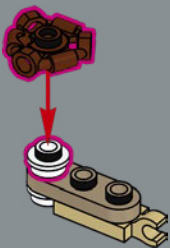

4

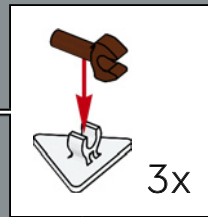
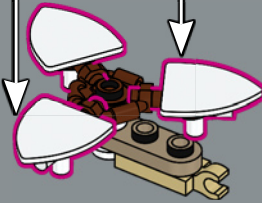

5

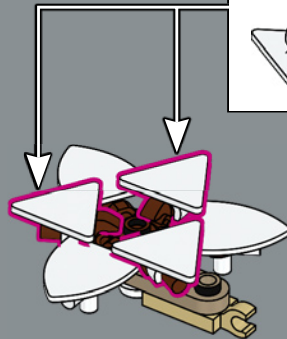

Quando si ricreano forme un po' insolite, ogni tipo di elemento LEGO® entra in gioco. Per la forma caratteristica della stella di terra a collare, abbiamo combinato cartelli stradali triangolari con elementi scudo per minifigure.

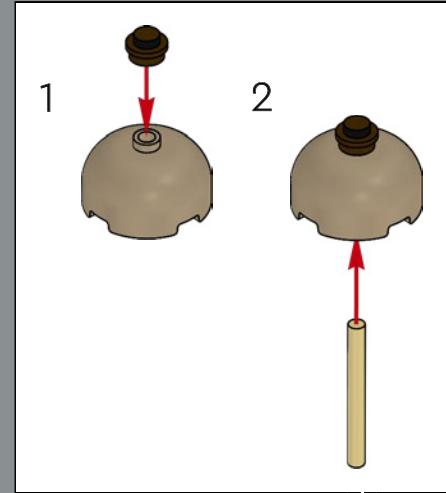

6

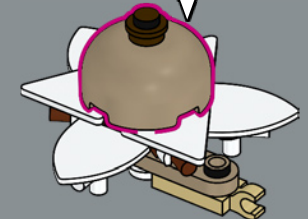





85

1

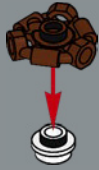

2

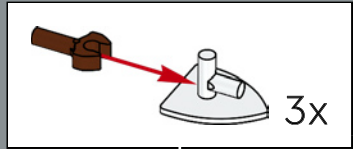

3

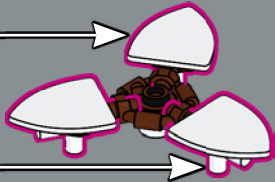
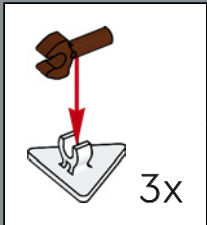



86

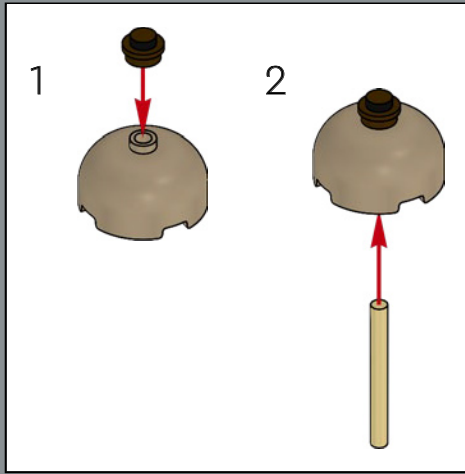

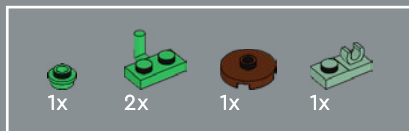

87



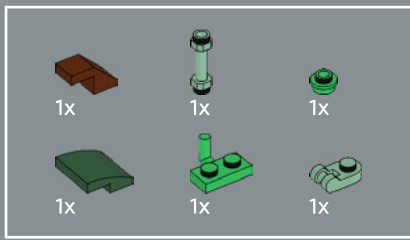

88

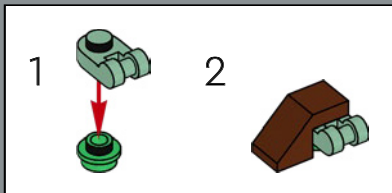
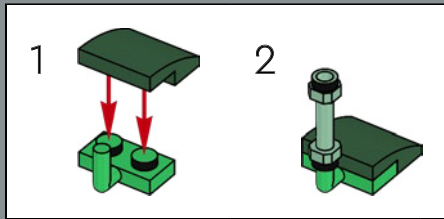

Con queste corone per minifigure LEGO®, gli stami del colchico si illuminano quasi in modo regale.

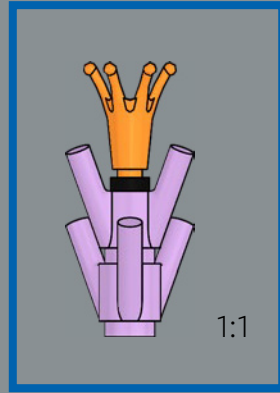
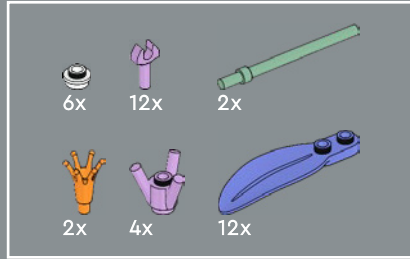
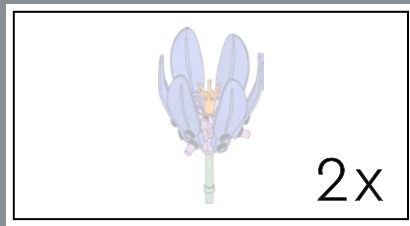

89

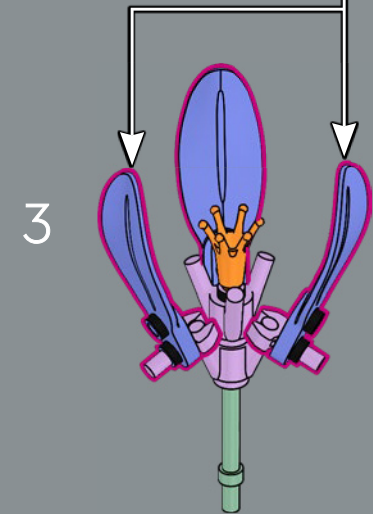
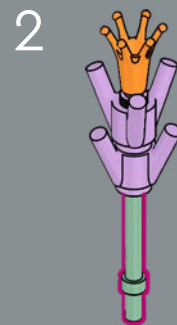
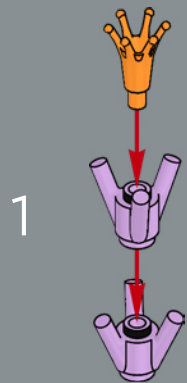
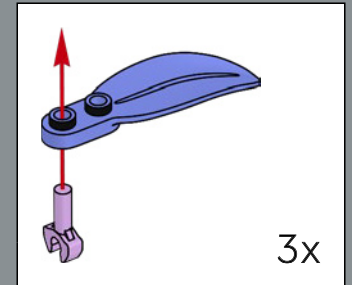

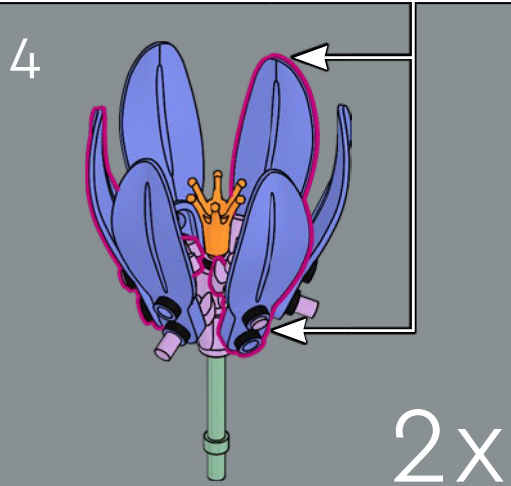
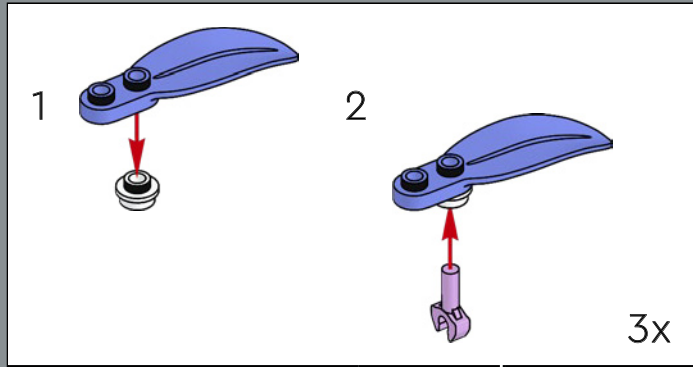

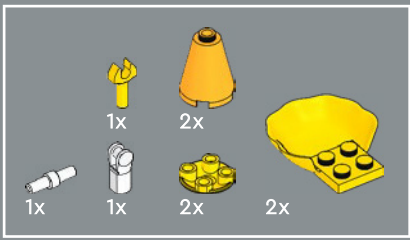

90

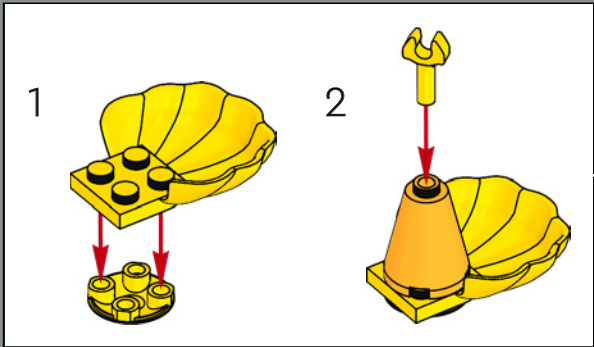
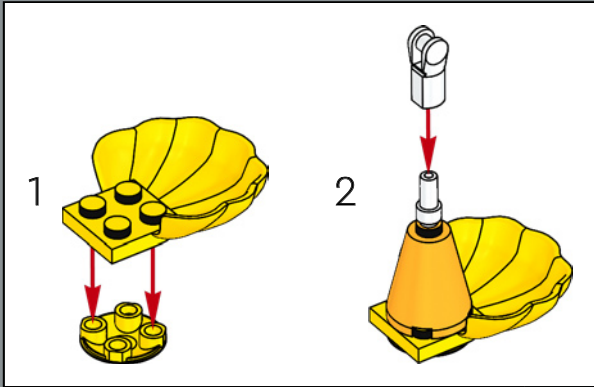

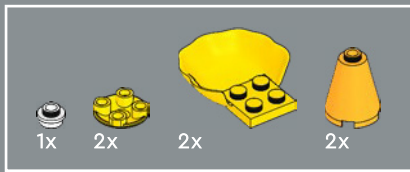

91

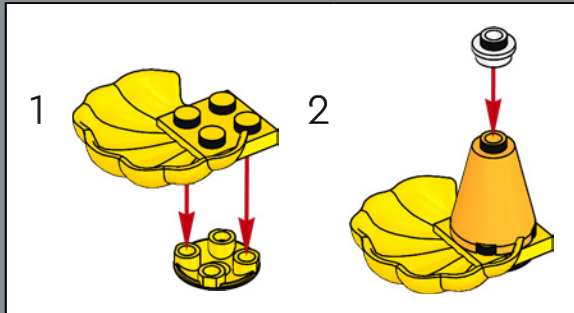
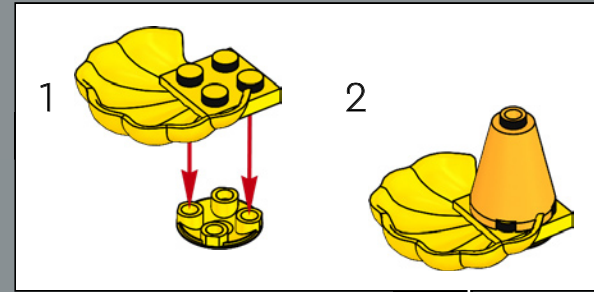

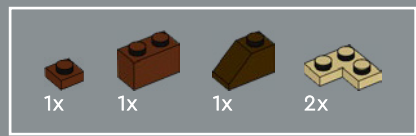

92





93





94



1x  2x 

95





96



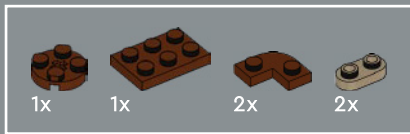

97



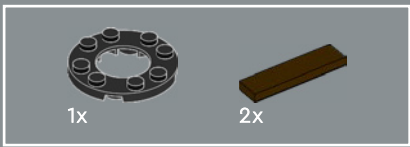

98



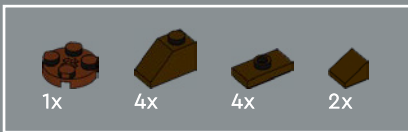

99

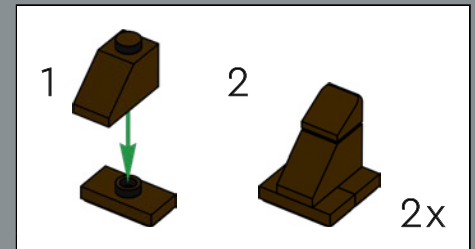



1x

100



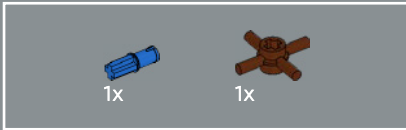

101

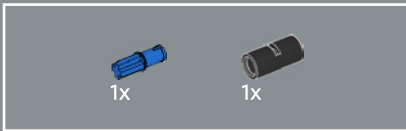
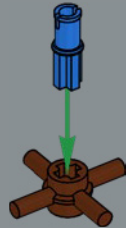

102

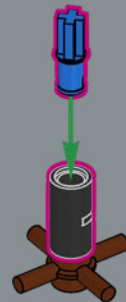

103

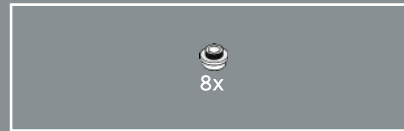
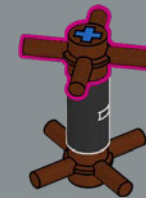

104

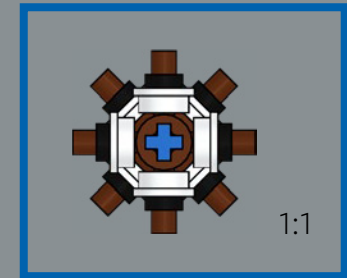



105

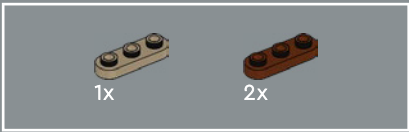
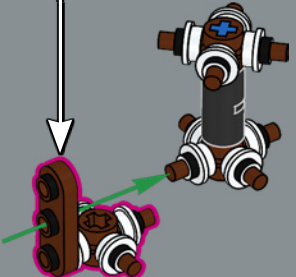
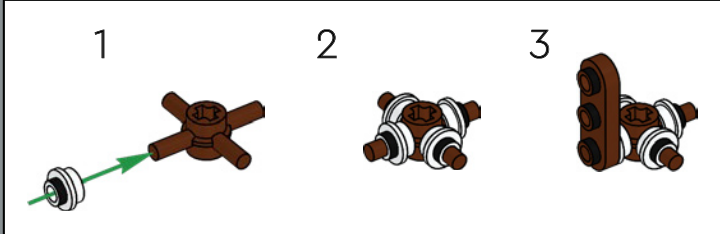

106

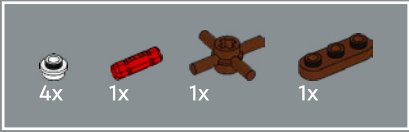
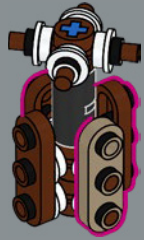

107

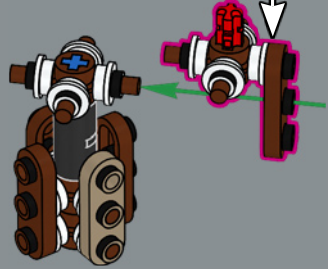
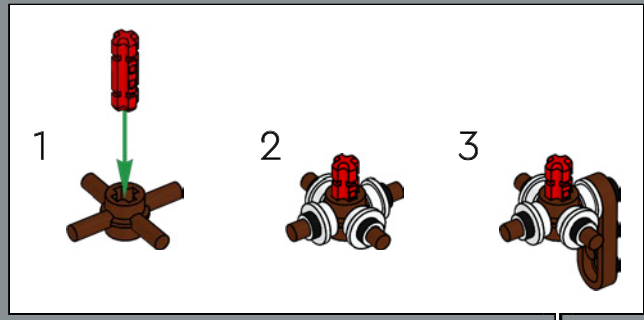



108

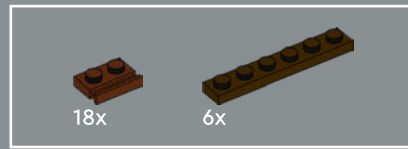
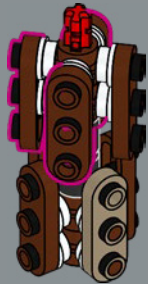

109

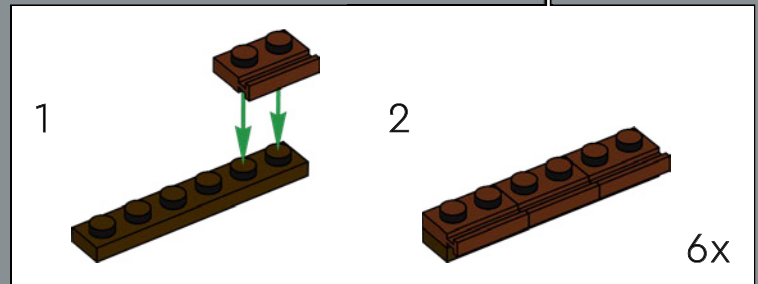
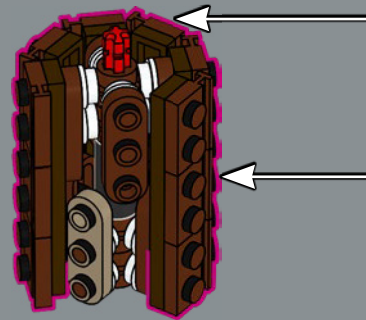
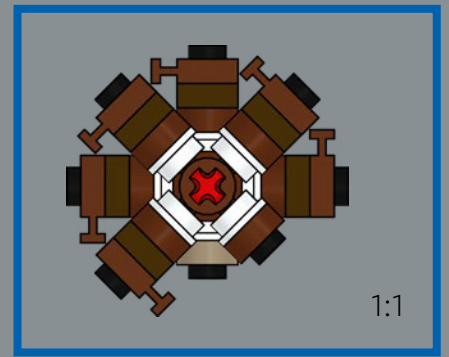

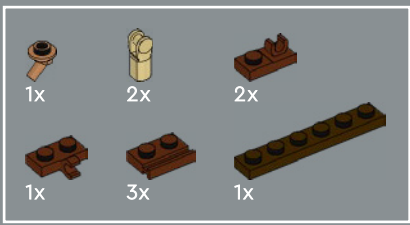

110

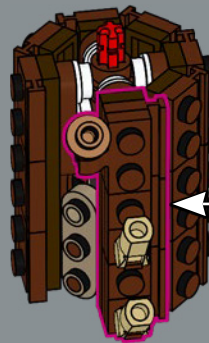
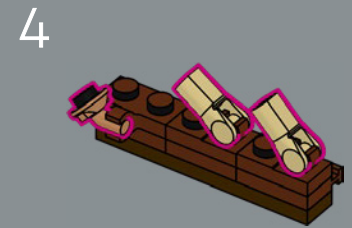
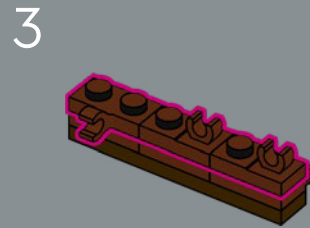
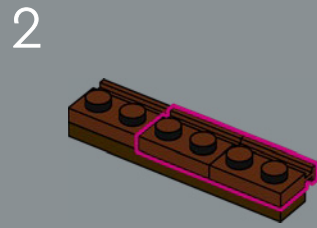
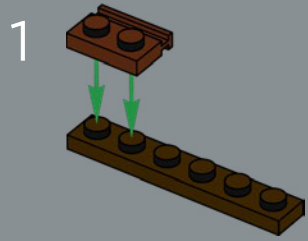

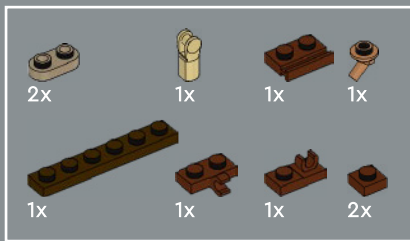

111

1

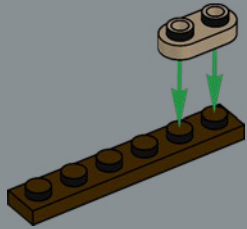

2

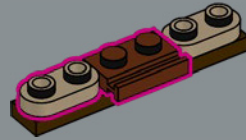

3

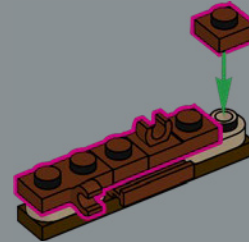

4

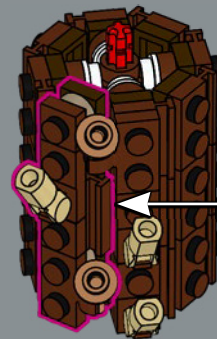
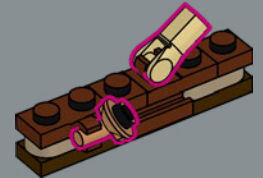

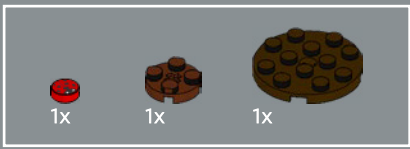

112

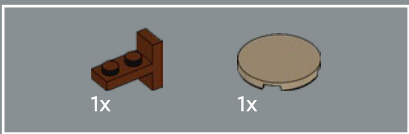
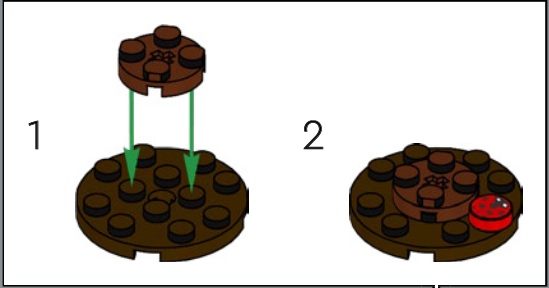

113

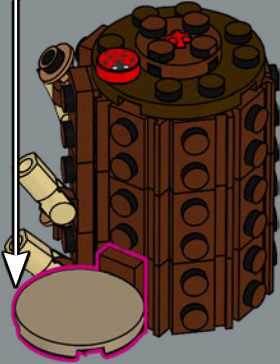
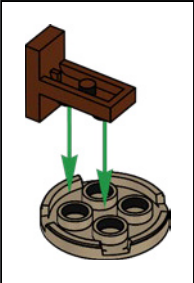



114

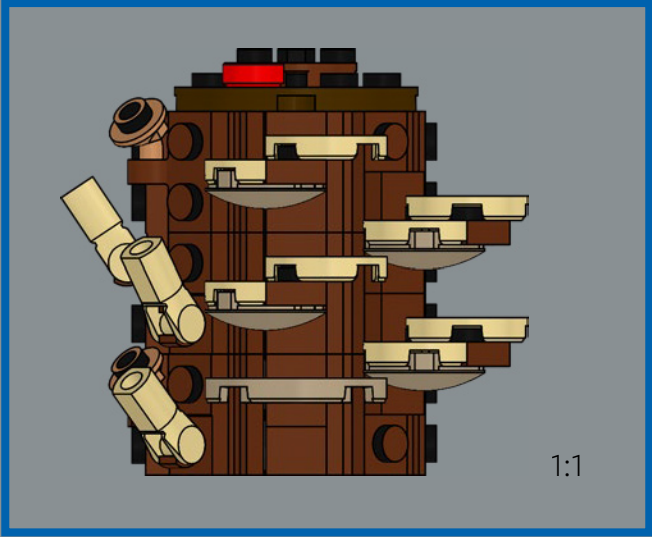
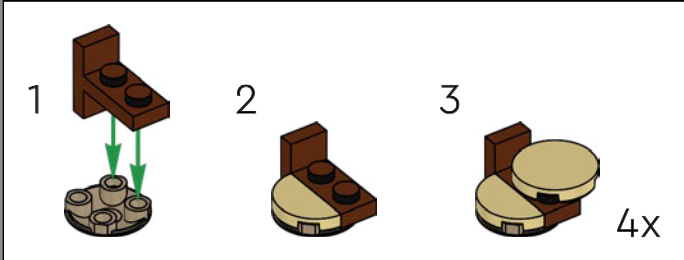





116

Il fungo *Mycena galericulata*, con il suo delicato cappello e il gambo sottile, sembra uscito direttamente dalle pagine di una fiaba: la parte superiore è realizzata con i cappelli di minifigure di nani LEGO®.

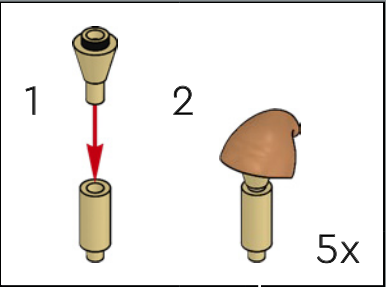

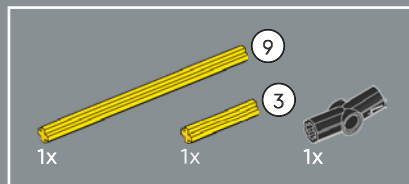
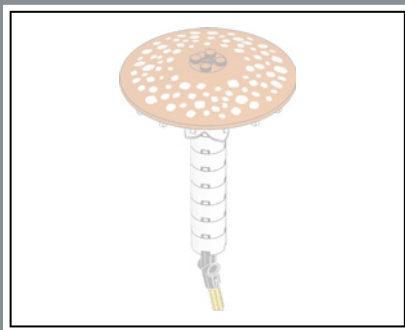

117

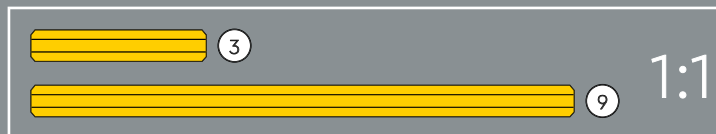
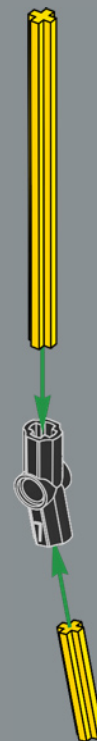

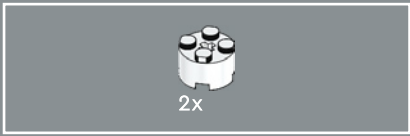

118

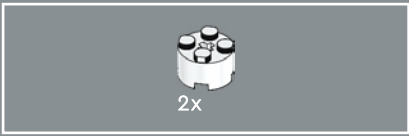
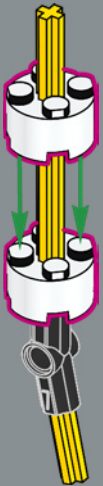

119

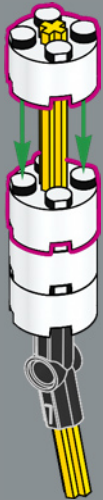



2x

120

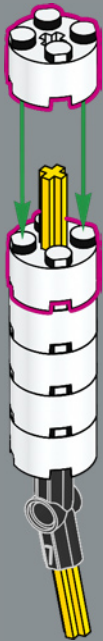

1x



1x



1x

121

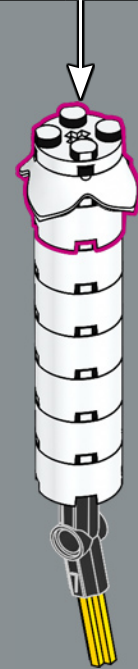
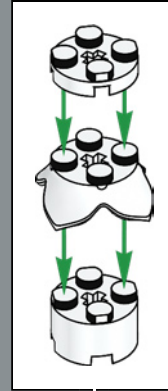

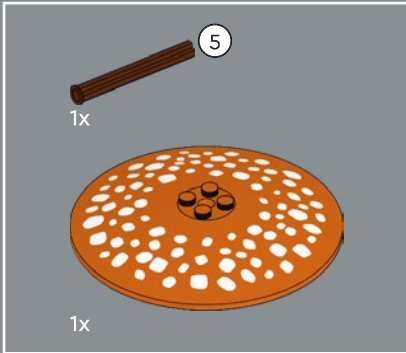
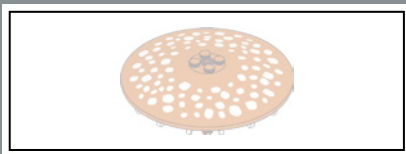

122

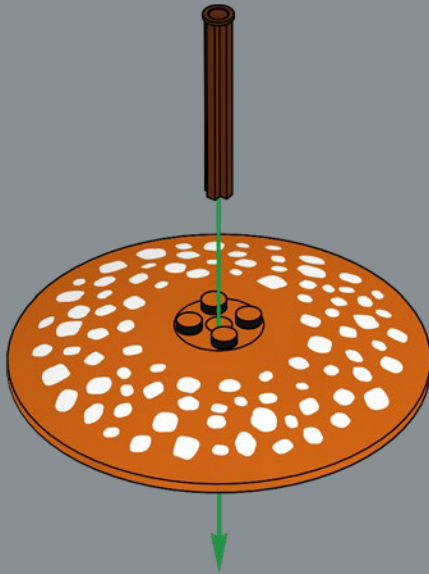

123

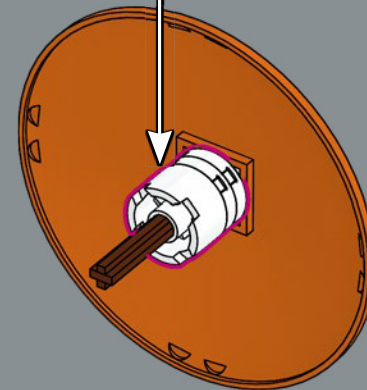
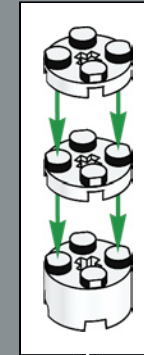

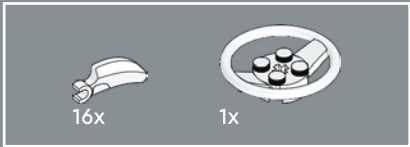
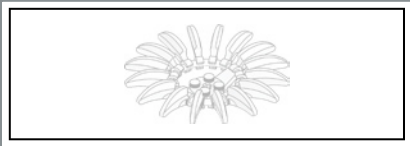

124

1

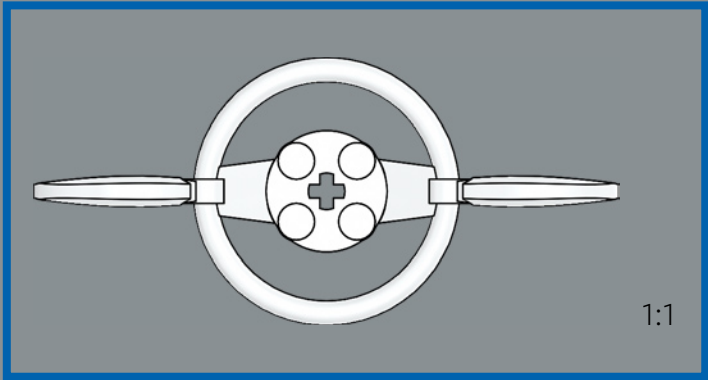
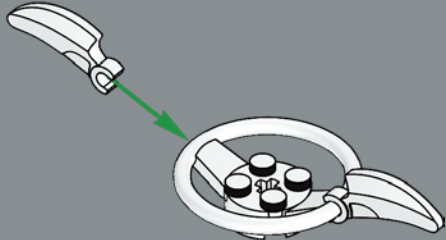

1:1

2

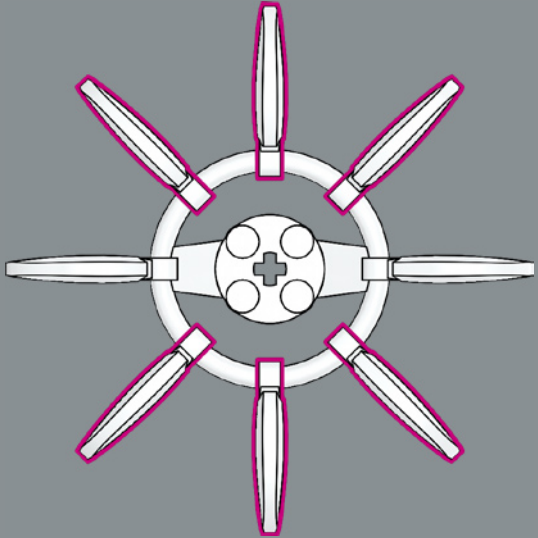

3

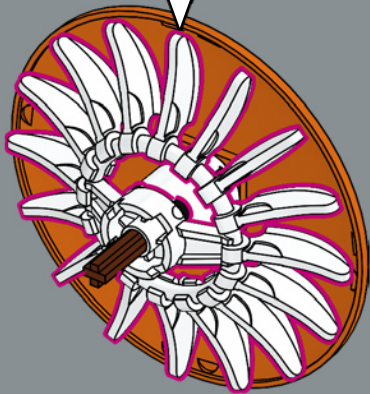
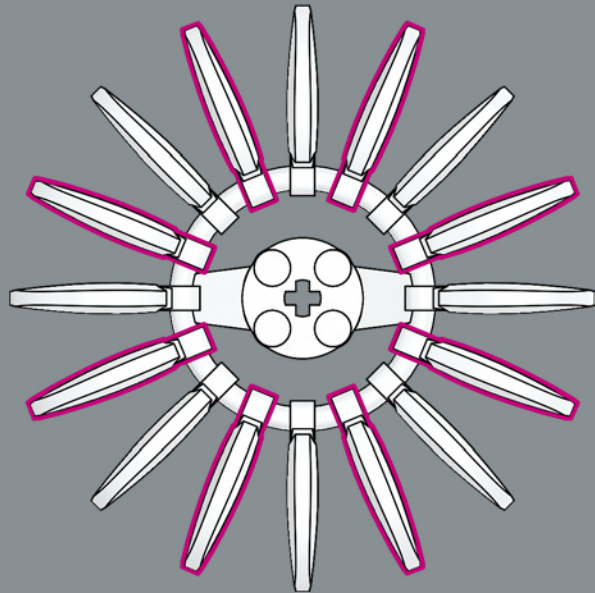

125

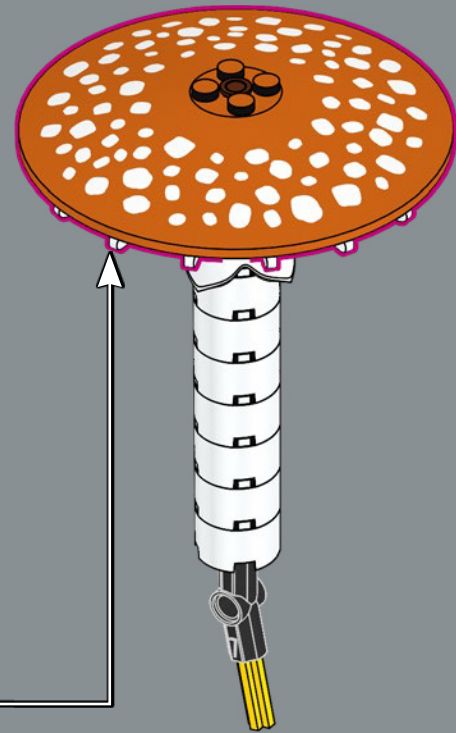



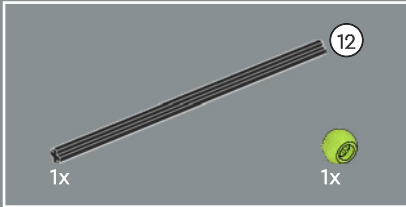
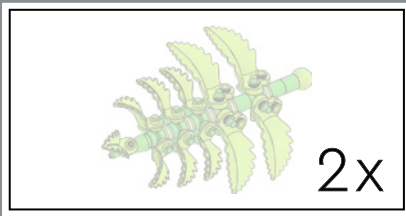

127

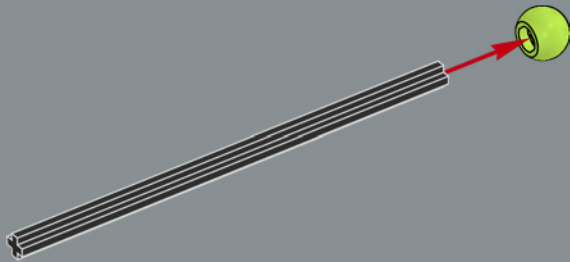

128

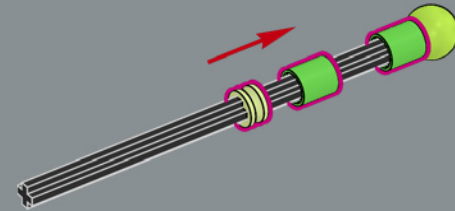

129

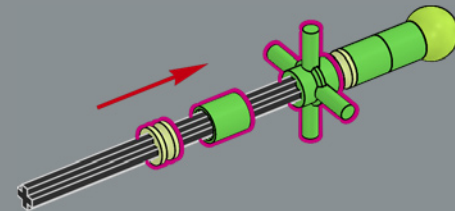



130

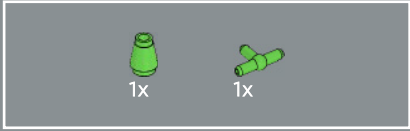
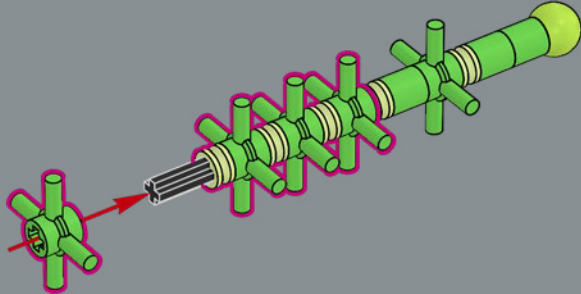

131

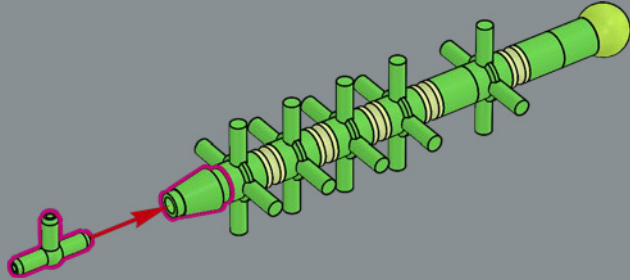

132

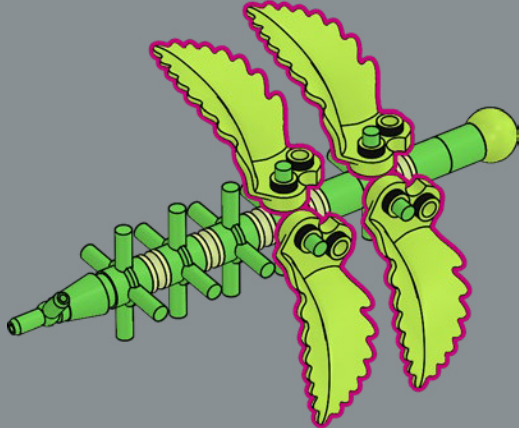

133

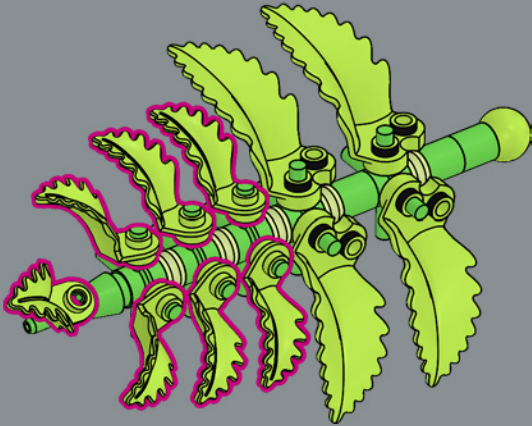

2x





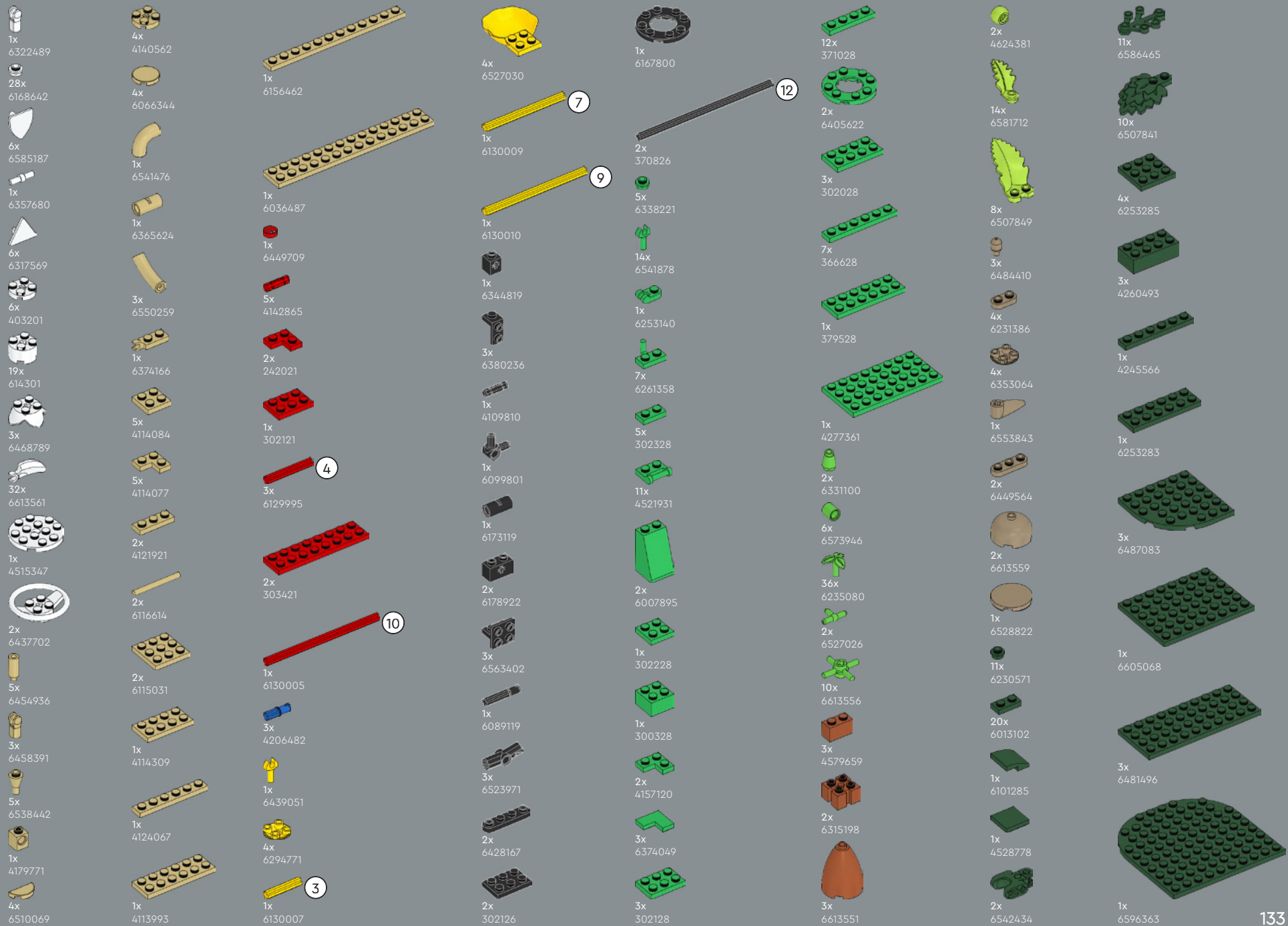



2x
6527031

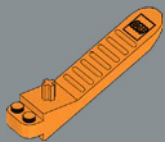

1x
6240515



2x
6510192



5x
6613562



4x
6613560



10x
6553342



1x
6474604



2x
6278550



1x
6360075



10x
4655080



12x
6614067



3x
4616581



13x
6083972



2x
4521947



2x
6080431



3x
6100234

3x
6083972

2x
4521947

2x
6080431

3x
6100234

2x
6474602

2x
6577789

12x
6614067

2x
6577789

2x
6577789

2x
6577789

2x
6577789

2x
6577789

2x
6577789

2x
6577789

2x
6577789

2x
6577789

2x
6577789

2x
6577789

2x
6577789

2x
6577789

2x
6577789

2x
6577789

2x
6577789

2x
6577789

2x
6577789

2x
6577789

2x
6577789

2x
6577789

2x
6577789

2x
6577789

2x
6577789

2x
6577789

2x
6577789

2x
6577789

2x
6577789

2x
6577789

2x
6577789

2x
6577789

2x
6577789

2x
6577789

2x
6577789

2x
6577789

2x
6577789

2x
6577789

2x
6577789

2x
6577789

2x
6577789

2x
6577789

2x
6577789

2x
6577789

2x
6577789

2x
6577789

2x
6577789

2x
6577789

2x
6577789

2x
6577789

2x
6577789

2x
6577789

2x
6577789

2x
6577789

2x
6577789

2x
6577789

2x
6577789

2x
6577789

2x
6577789

2x
6577789

2x
6577789

2x
6577789

2x
6577789

2x
6577789

2x
6577789

2x
6577789

2x
6577789

2x
6577789

2x
6577789

2x
6577789

2x
6577789

2x
6577789

2x
6577789

2x
6577789

2x
6577789

2x
6577789

2x
6577789

2x
6577789

2x
6577789

2x
6577789

2x
6577789

2x
6577789

2x
6577789

2x
6577789

2x
6577789

2x
6577789

2x
6577789

2x
6577789

2x
6577789

2x
6577789

2x
6577789

2x
6577789

2x
6577789

2x
6577789

2x
6577789

2x
6577789

2x
6577789

2x
6577789

2x
6577789

2x
6577789

2x
6577789

2x
6577789

2x
6577789

2x
6577789

2x
6577789

2x
6577789

2x
6577789

2x
6577789

2x
6577789

2x
6577789

2x
6577789

2x
6577789

2x
6577789

2x
6577789

2x
6577789

2x
6577789

2x
6577789

2x
6577789

2x
6577789

2x
6577789

2x
6577789

2x
6577789

2x
6577789

2x
6577789

2x
6577789

2x
6577789

2x
6577789

2x
6577789

2x
6577789



YOU COULD
WIN



**YOU COULD
WIN**

Your feedback will help shape the future development of this product series.

Visit:

**DU KÖNNTEST
GEWINNEN**

Dein Feedback trägt zur Weiterentwicklung dieser Produktreihe bei.

Geh auf:

**VOUS POURRIEZ
GAGNER**

Vos commentaires nous aideront à concevoir les futurs produits de cette gamme.

Visitez :

**POTRESTI
VINCERE TU**

La tua opinione ci aiuterà a migliorare la creazione futura di questa linea di prodotti.

Visita:

**PUEDES
GANAR**

Tu opinión contribuirá al futuro de esta serie de productos.

Visita:

轻松获奖

您的反馈将有助于我们在今后改进本产品系列。

请访问:

LEGO.com/productfeedback

You also have the chance to win a LEGO® set.

Terms and conditions apply.*

Außerdem hast du die Chance, ein LEGO® Set zu gewinnen.

Es gelten die Teilnahmebedingungen.*

Vous pourriez également gagner un ensemble LEGO®.

Des conditions s'appliquent.*

Hai anche la possibilità di vincere un set LEGO®.

Termini e condizioni sono applicabili.*

También tienes la oportunidad de ganar un set LEGO®.

Aplican términos y condiciones.*

您还有机会赢取乐高®套装。

条款和条件适用。*

*LEGO.com/productfeedback-terms

LEGO and the LEGO logo are trademarks of the LEGO Group.
©2026 The LEGO Group.

