



11505





LEGO.com/sustainable-packaging



FR  
**DONNEZ  
OU  
RECYCLEZ**



ASSOCIATION

OU



MAGASIN

OU



DÉCHÈTERIE

Adresses sur [quefairedemesdechets.fr](http://quefairedemesdechets.fr)



# BUILDER



Apple and the Apple logo are trademarks of Apple Inc., registered in the U.S. and other countries and regions. App Store is a service mark of Apple Inc. Google Play and the Google Play logo are trademarks of Google LLC. Tencent and the Tencent logo are trademarks of Tencent Inc.

[LEGO.com/devicecheck](https://LEGO.com/devicecheck)



LEGO® Builder



# UNE EXISTENCE SIMPLE ET SAUVAGE

Quand vous explorez la nature avec un regard curieux, vous ressentez inévitablement une forme de dualité au fil des saisons. La décomposition cohabite en parfaite harmonie avec la naissance de nouvelles formes de vie. Cet écosystème en briques LEGO® reproduit un instant magique du sol forestier, à la lisière d'un bois d'Europe du Nord, entre l'été et l'automne. Imaginez une cueillette fructueuse, où vous découvrirez une grande diversité de champignons et de colchiques d'automne. Une concentration aussi dense d'espèces serait sans doute peu probable dans la nature. Mais notre objectif était de créer une scène visuellement captivante – et théoriquement plausible. Chaque élément a été soigneusement conçu pour allier réalisme et charme un peu féerique.

L'équipe de design LEGO® Botanicals





*Colchicum autumnale*

## COLCHIQUE D'AUTOMNE

Contrairement à son cousin printanier, cette fleur rose et violette appartient à la famille des Colchicacées et fleurit à l'automne. Élegante et gracieuse, mais toxique, elle s'épanouit dans les prairies et les forêts d'Europe et d'Asie.



*Pteridium aquilinum*

## FOUGÈRE AIGLE

Cette plante, parmi les plus répandues au monde, peut prospérer aussi bien au soleil qu'à l'ombre, dans les prairies comme dans les zones très fréquentées. Avec des frondes pouvant atteindre 1 mètre, elle est très appréciée comme plante décorative au jardin.



*Mycena galericulata*

## MYCÈNE EN CASQUE

Ce champignon délicat, reconnaissable à son chapeau en forme de cloche, pousse en groupes sur les troncs tombés et les souches dans les zones humides et les forêts mixtes. Célèbre pour son apparence élégante et presque envoûtante, il a inspiré des artistes à travers les siècles.



*Pleurotus ostreatus*

## PLEUROTE EN HUÎTRE

Vous pouvez observer ces célèbres chapeaux en forme de coquille, dotés de lames décurrentes et de pieds courts – voire absents – sur le bois en décomposition dans les forêts et même en milieu urbain. Généralement blancs ou gris, ils peuvent atteindre jusqu'à 25 cm de large.



*Cantharellus cibarius*

## GIROLLE

Les girolles dressent leurs trompettes dorées ornées de plis épais et fourchus à la place des lames. Réputées pour leur discrétion, elles incitent souvent les cueilleurs à garder leurs coins secrets et sont considérées comme un mets délicat.



*Amanita muscaria*

## AMANITE TUE-MOUCHES

Avec son chapeau rouge orangé brillant tacheté de blanc, l'amanite tue-mouches apporte une touche de couleur vive aux hivers européens. On la trouve fréquemment sous les bouleaux, pins et épicéas. Dans la nature, mieux vaut la manipuler avec prudence !



*Inocybe hirtella*

## INOCYBE À ODEUR D'AMANDES AMÈRES

Malgré son nom et son chapeau fibreux dégageant une odeur qui rappelle l'amande, ce champignon est à apprécier uniquement avec les yeux, et à bonne distance ! Présent dans les zones herbeuses, il fournit sucres et nutriments aux arbres environnants.



*Geastrum triplex*

## GÉASTRE À TROIS ENVELOPPES

Ouvrez l'œil dans les bois et les prairies pour apercevoir ce champignon spectaculaire. Depuis son corps sphérique rempli de spores, il déploie ses bras en forme d'étoile pour libérer ces derniers dans un véritable feu d'artifice miniature !



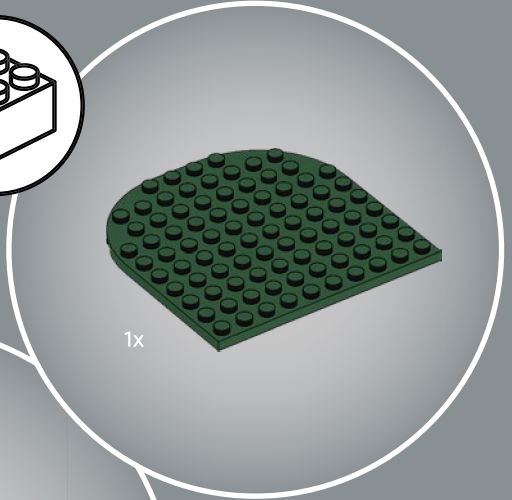
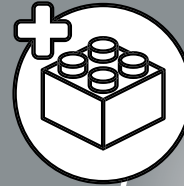
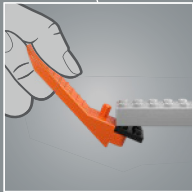
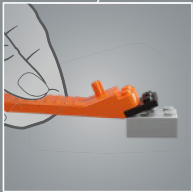
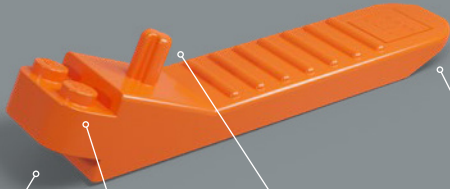

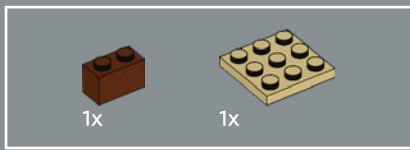

1

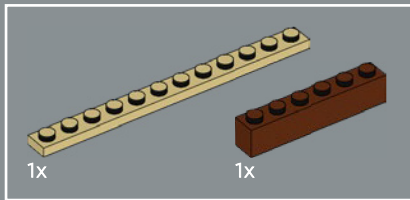
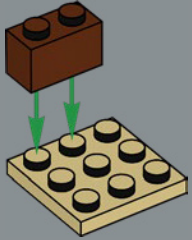

2

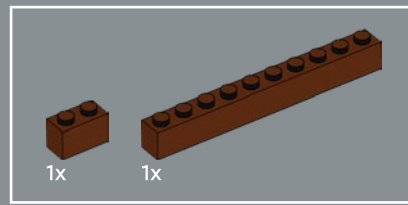
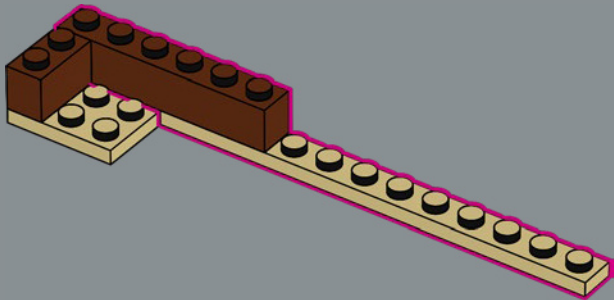

3

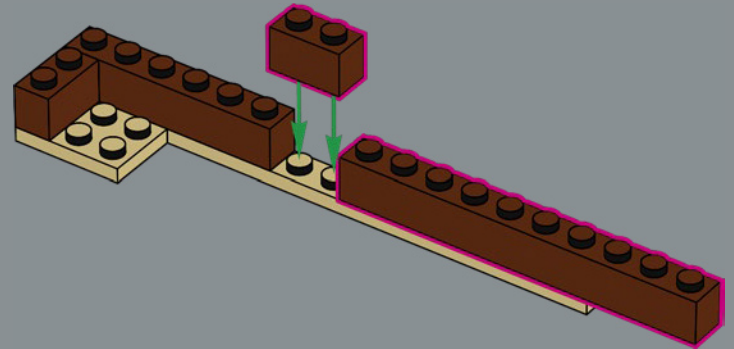

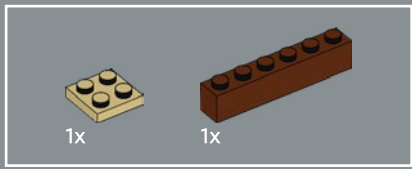

4

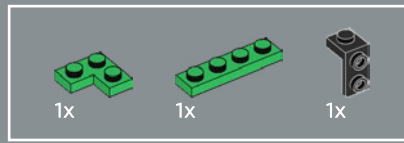
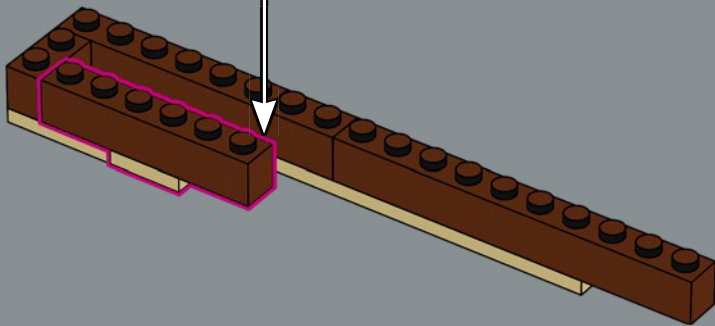
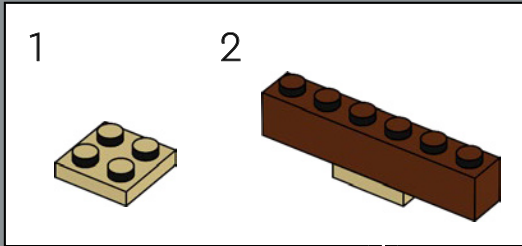

5

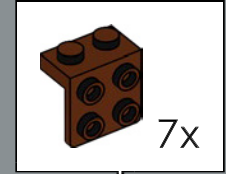
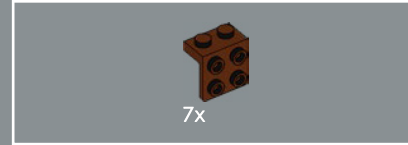
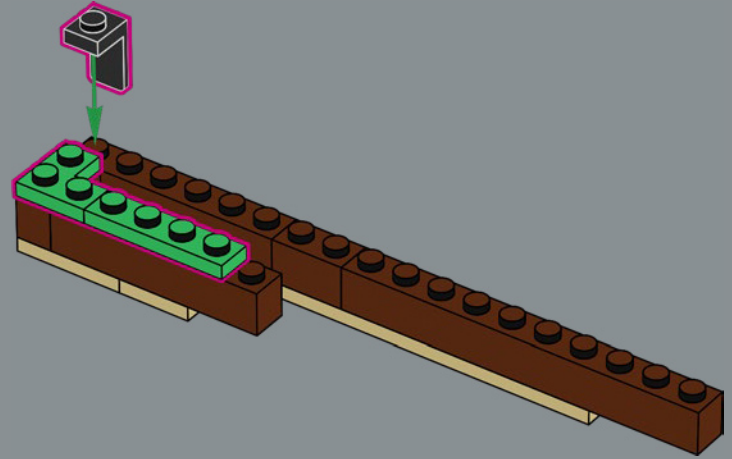

6

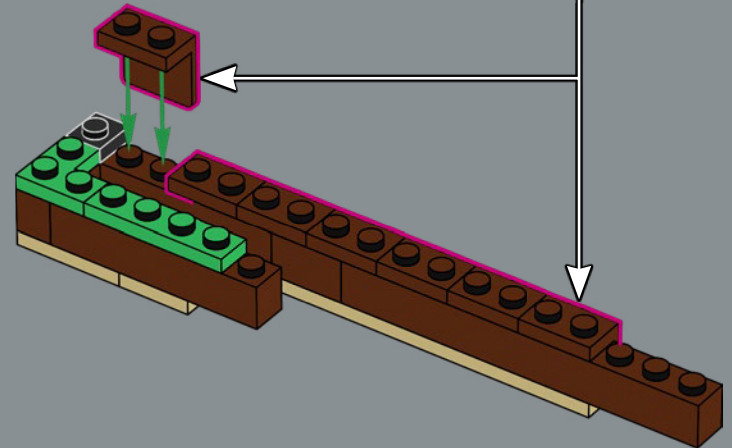

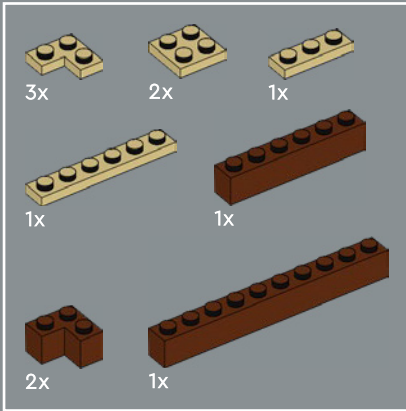
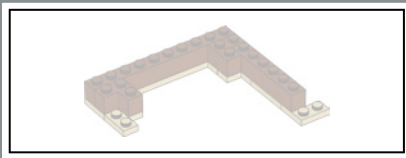

7

1

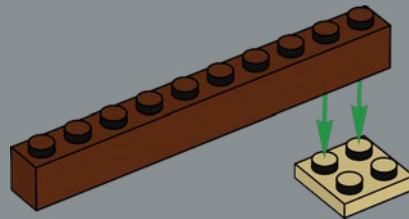

2

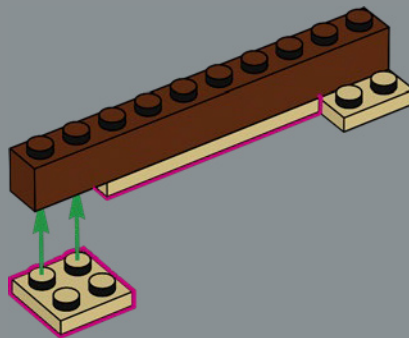

3

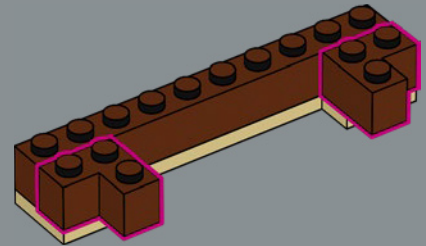

4

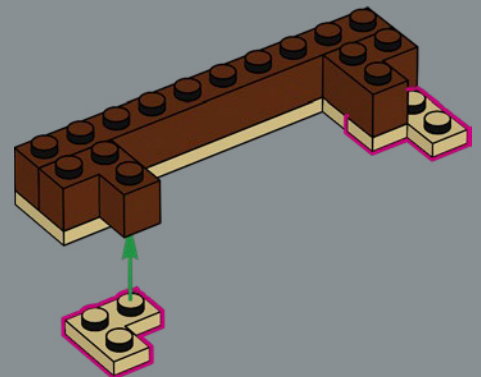

5

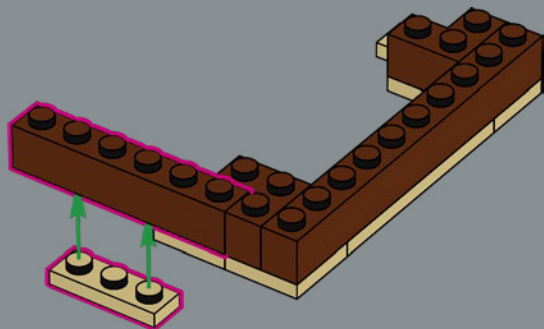

6

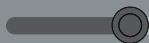
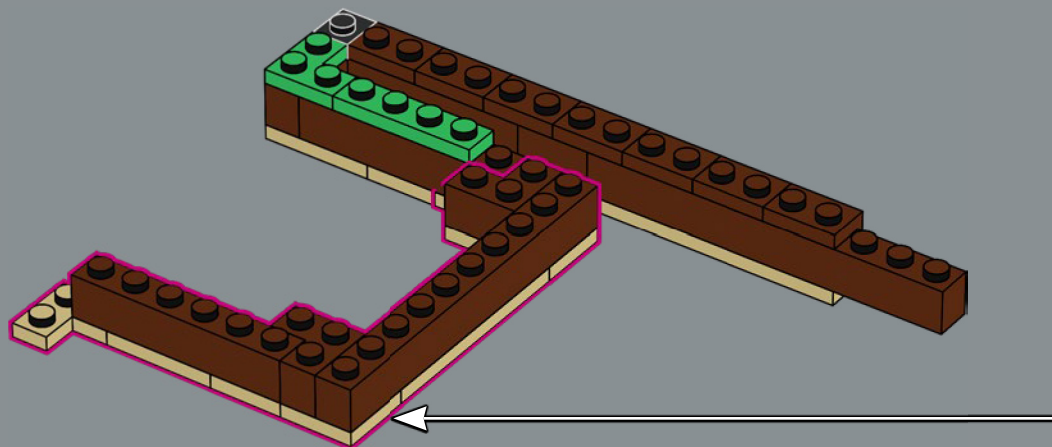
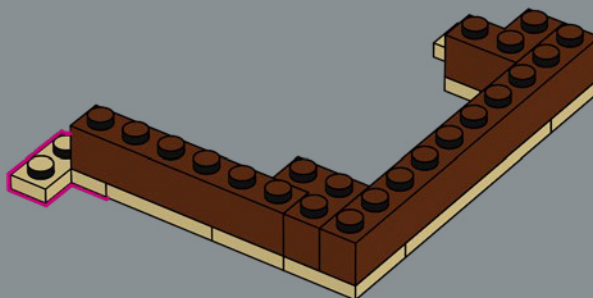

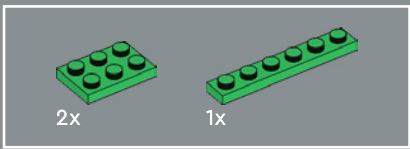

8

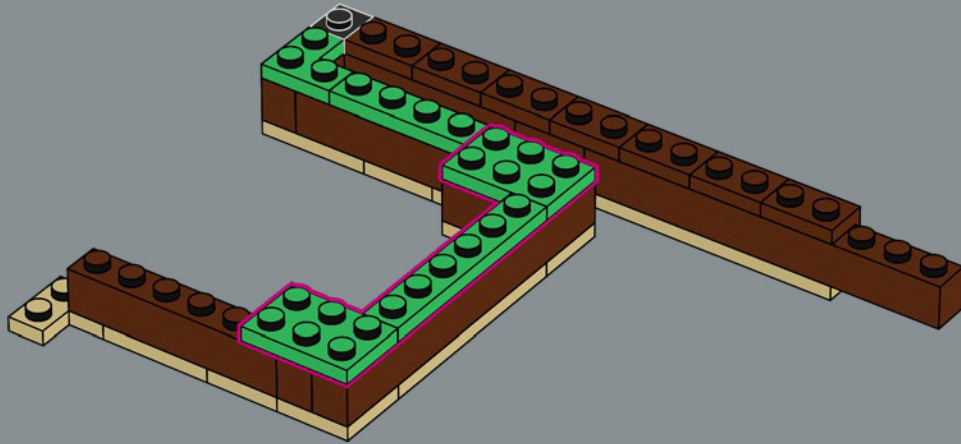

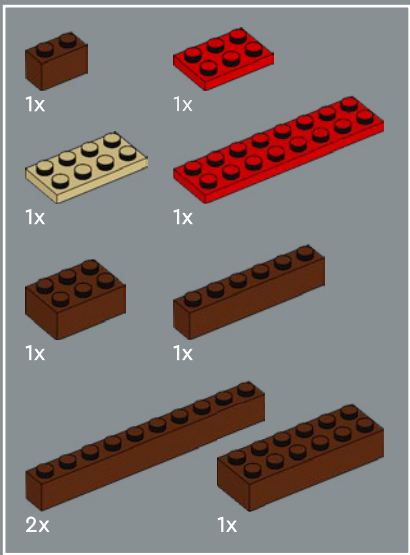

9

1

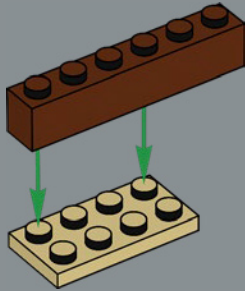

2

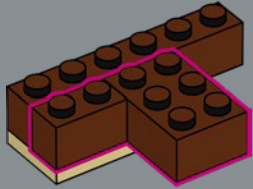

3

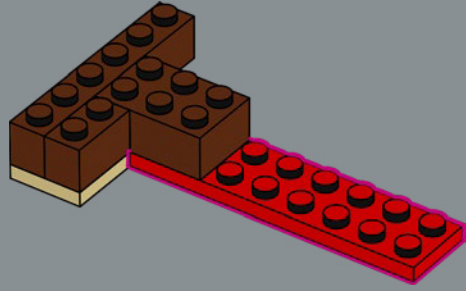

4

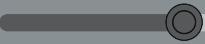
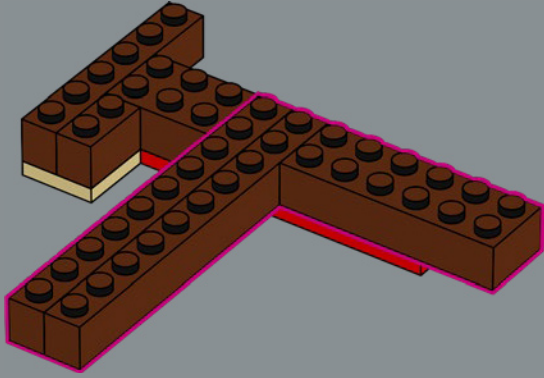

5

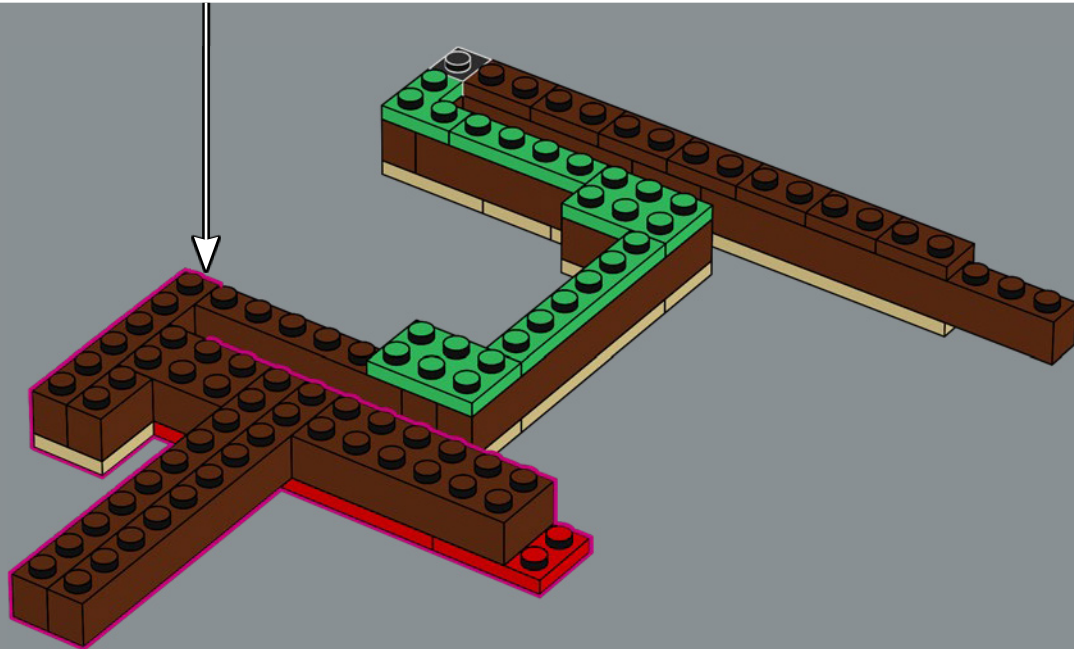
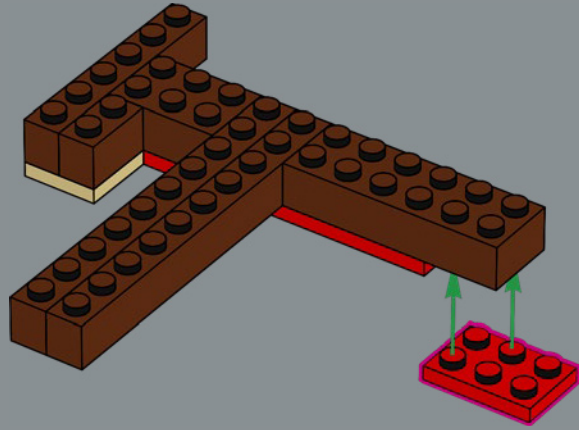

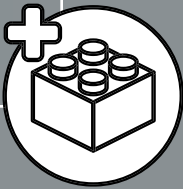
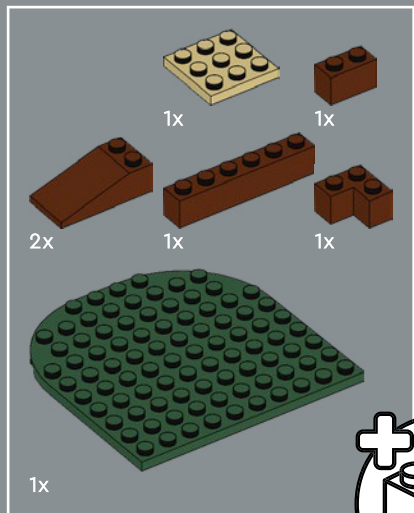

10

1

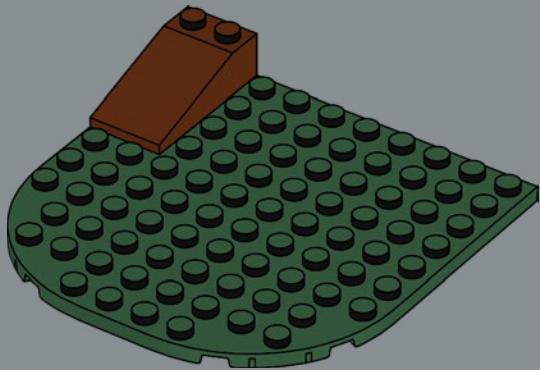

2

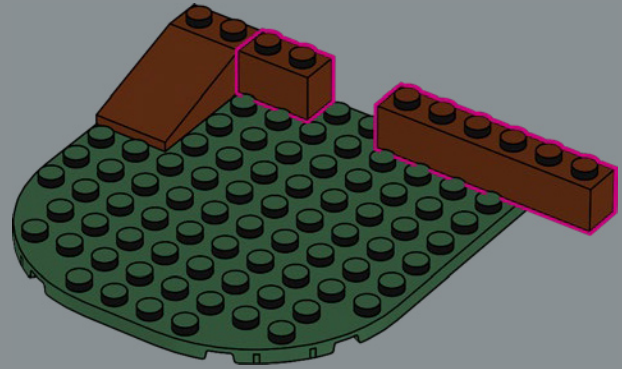

3

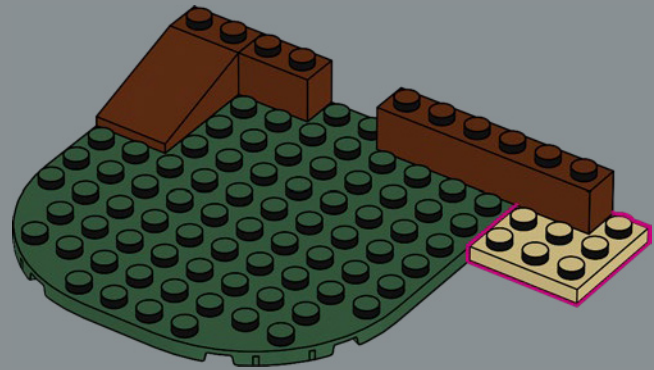

4

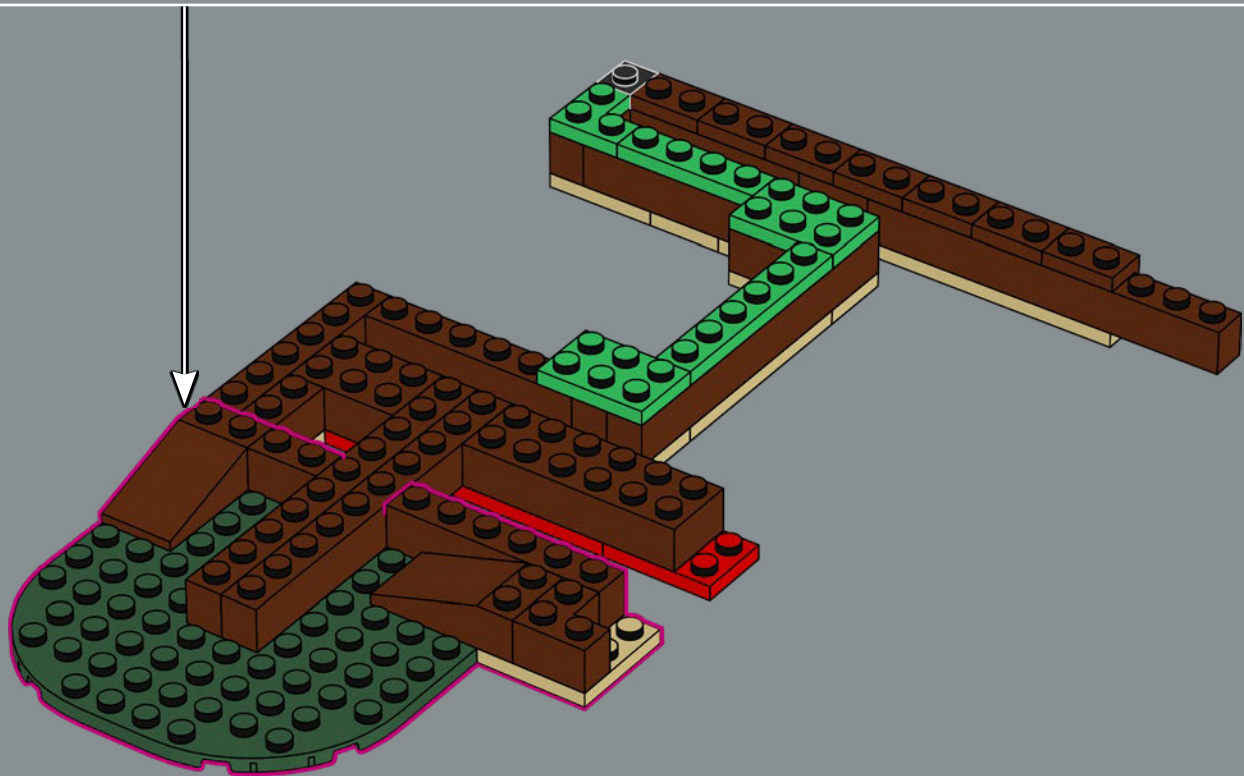
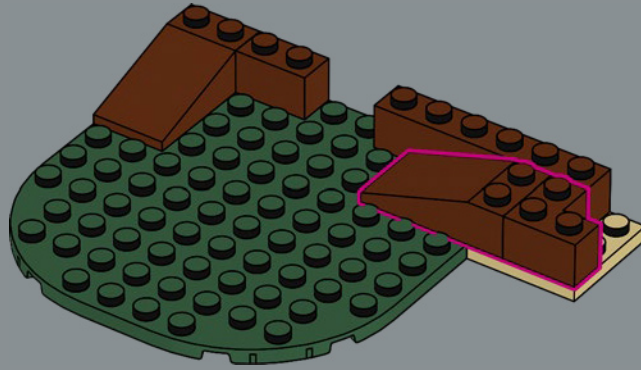

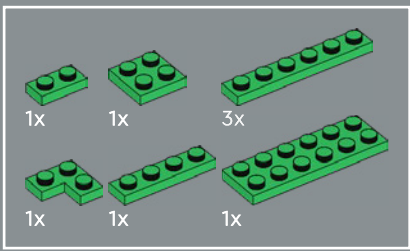

11

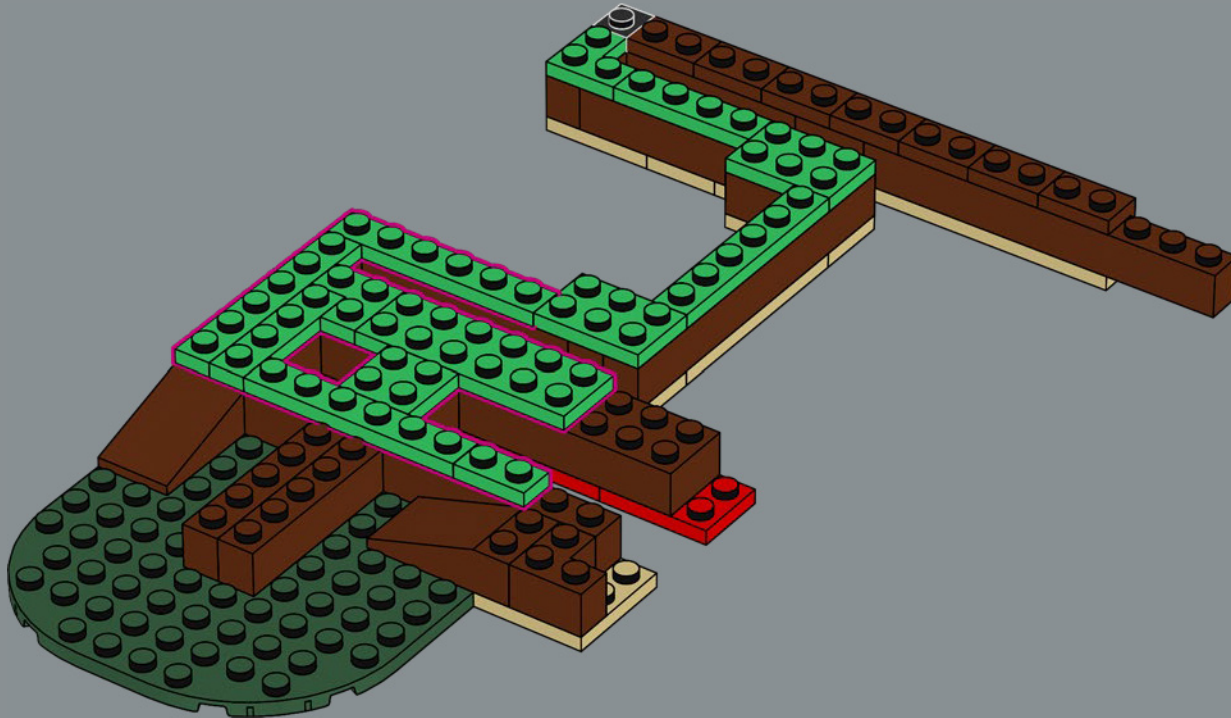

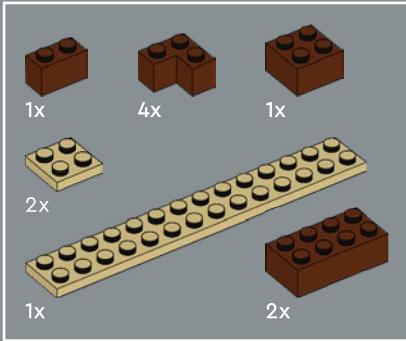
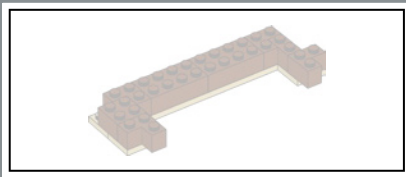

12

1

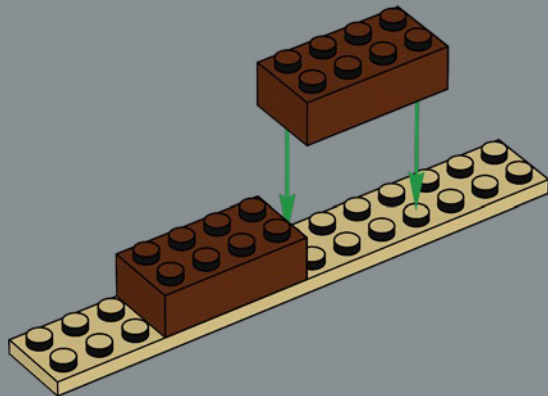

2

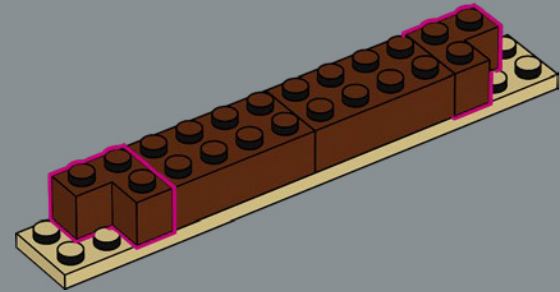

3

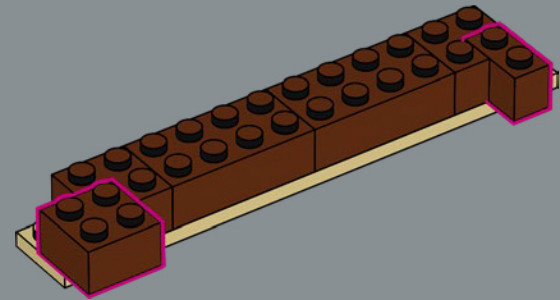

4

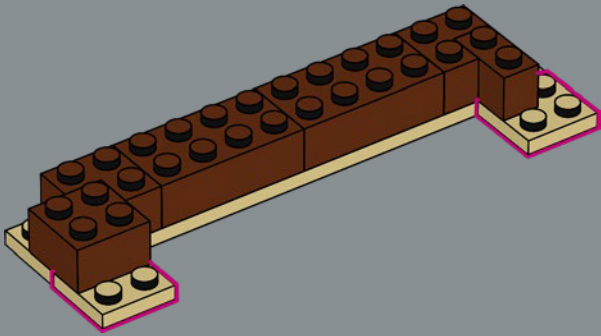

5

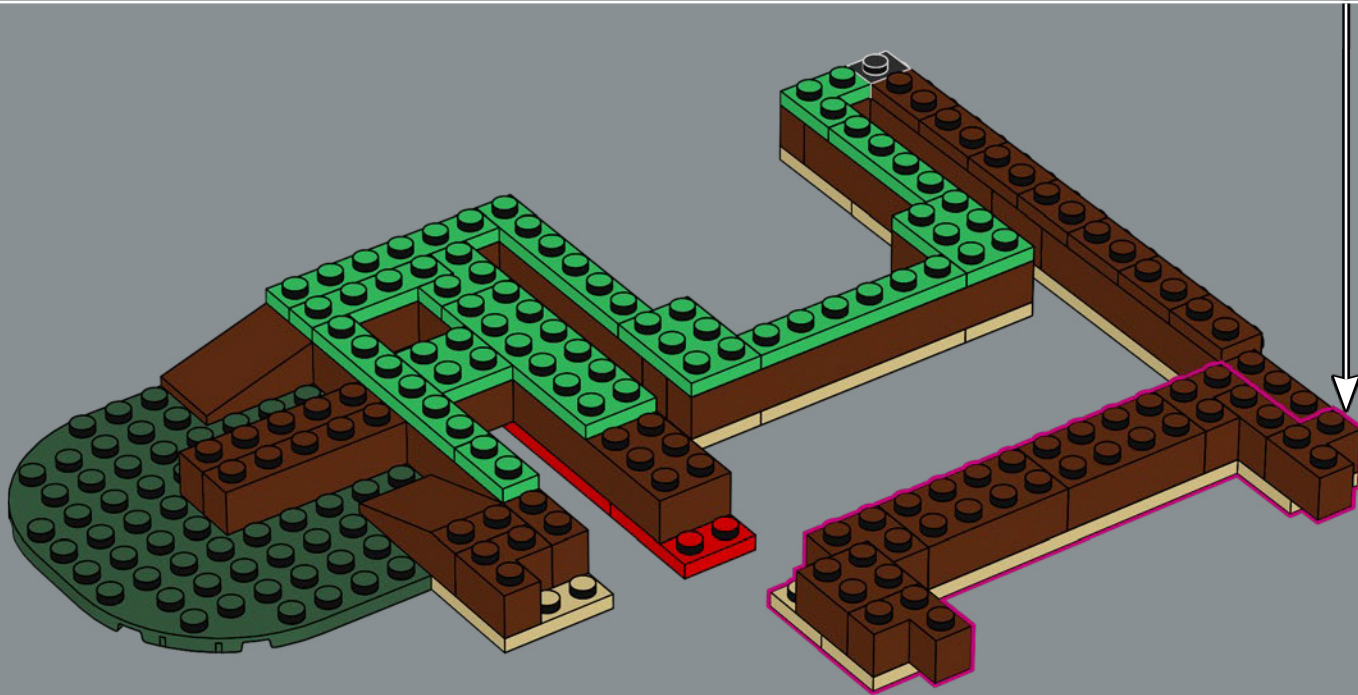
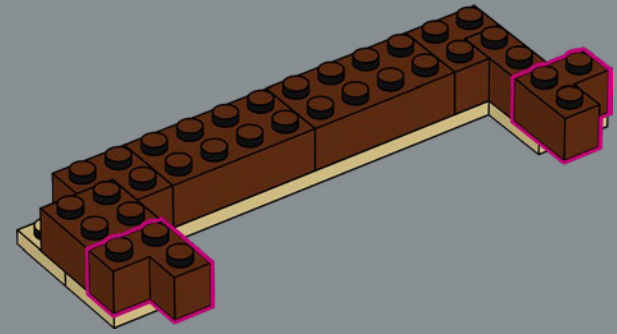

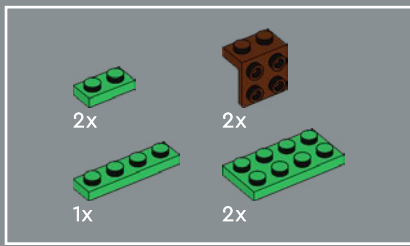

13

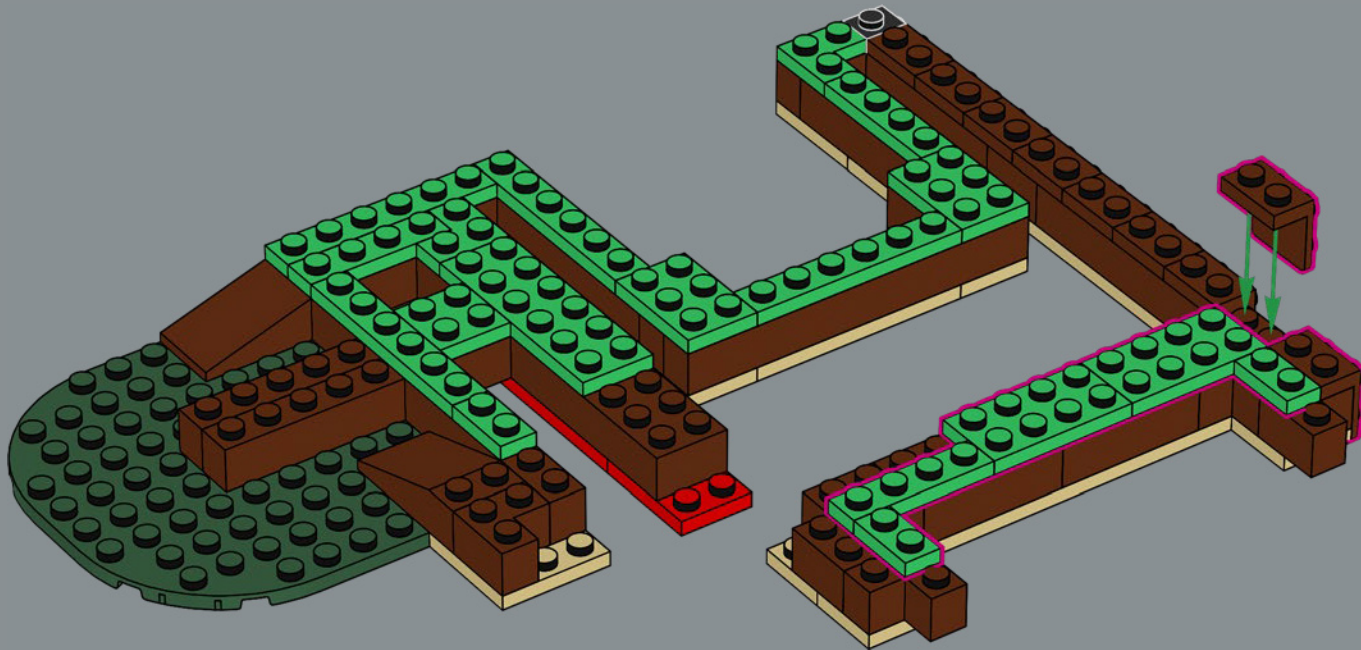

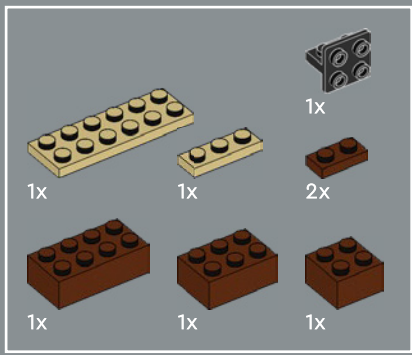

14

1

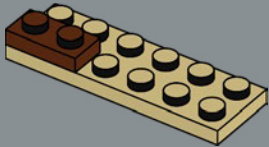

2

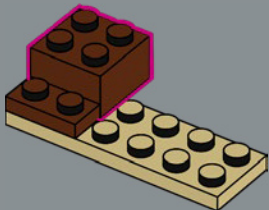

3

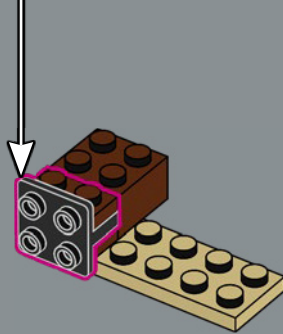
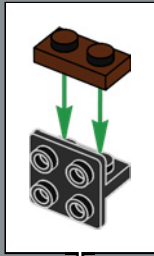

4

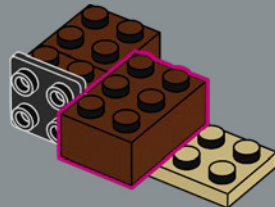

5

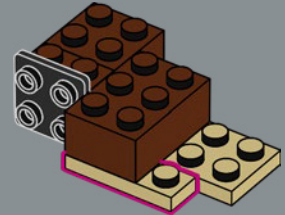

6

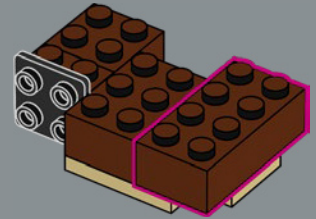

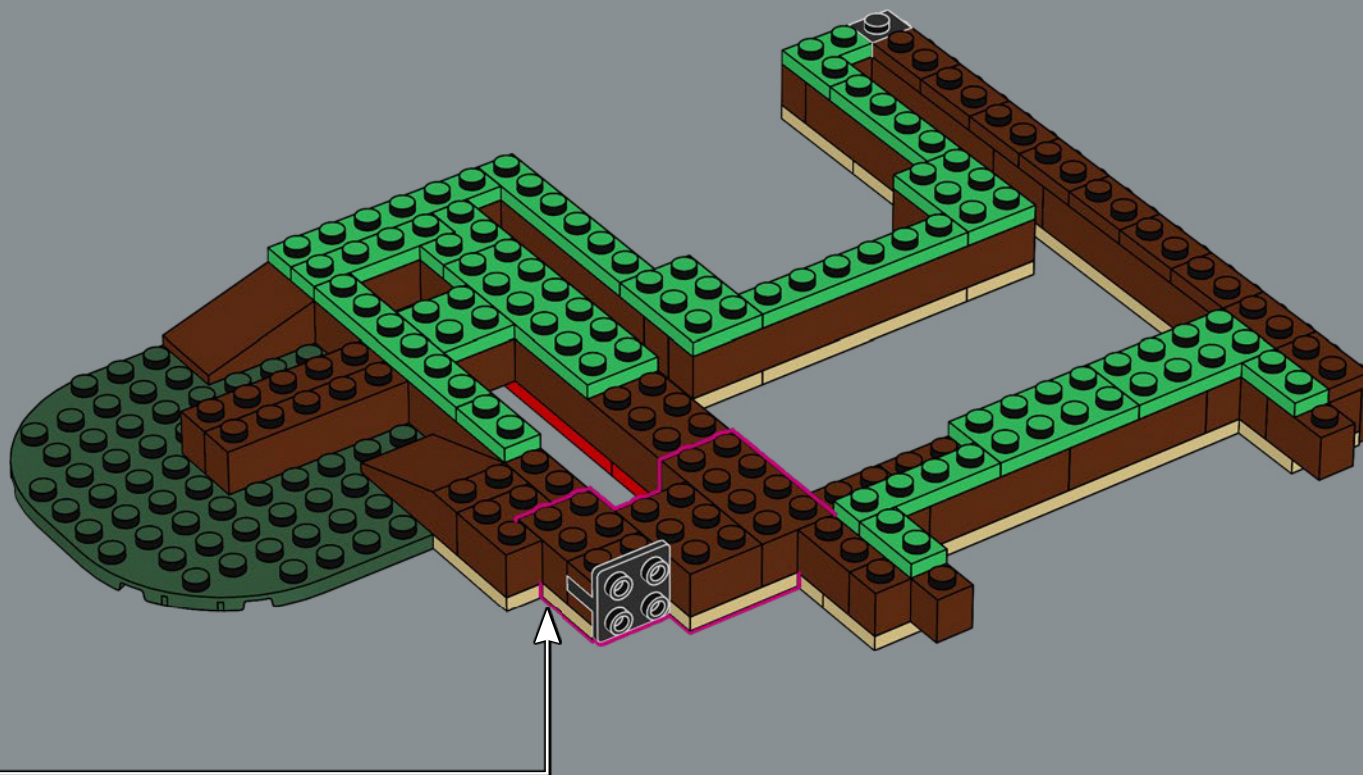

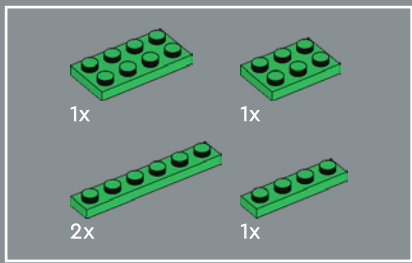

15

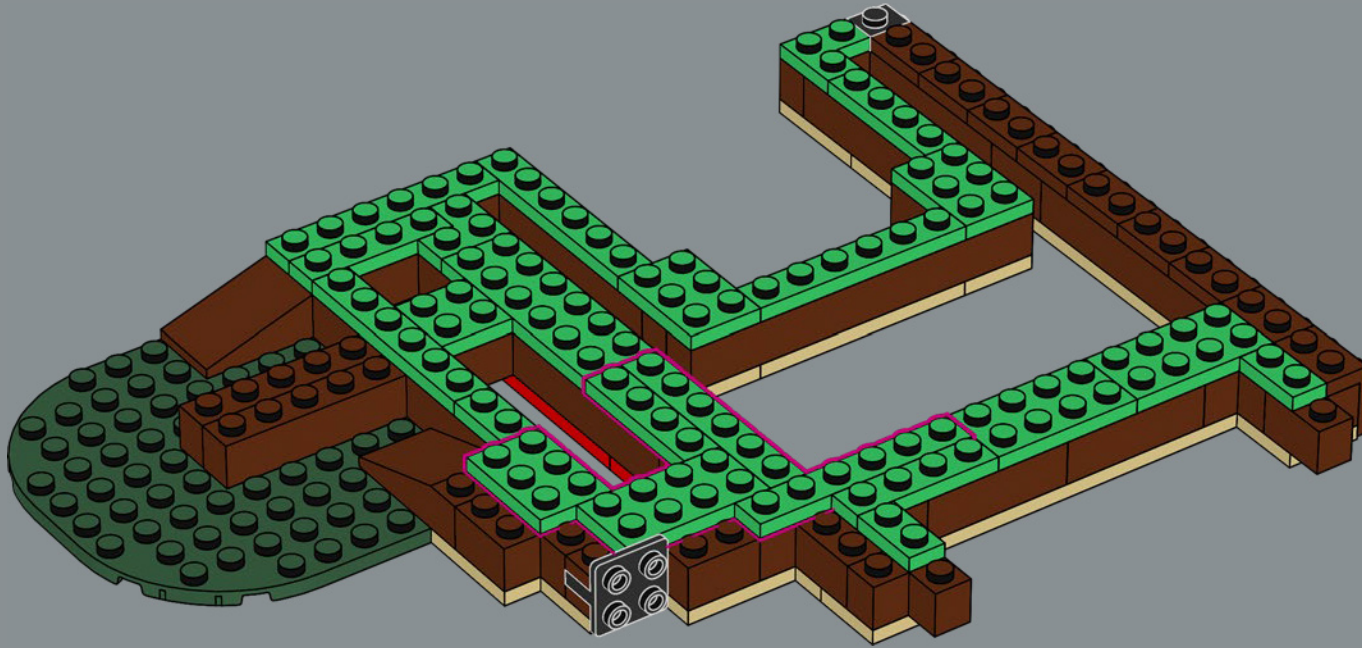

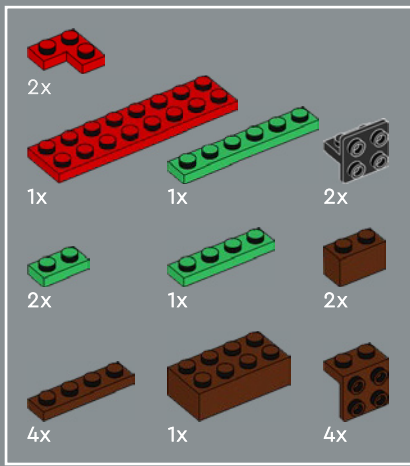

16

1

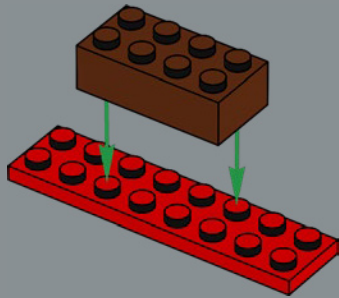

2

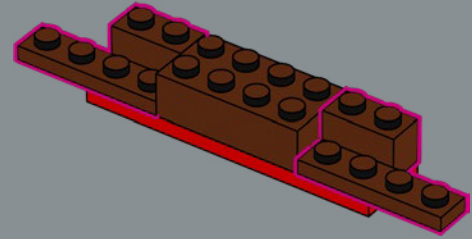

3

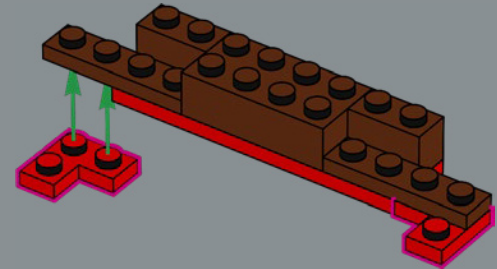

4

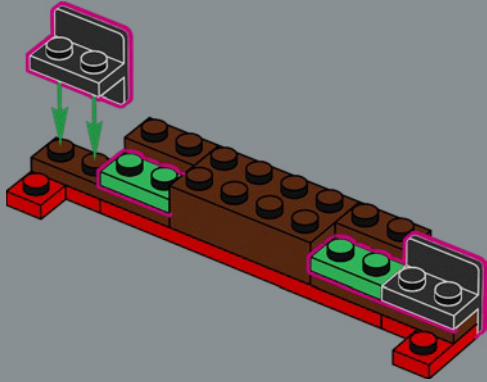

5

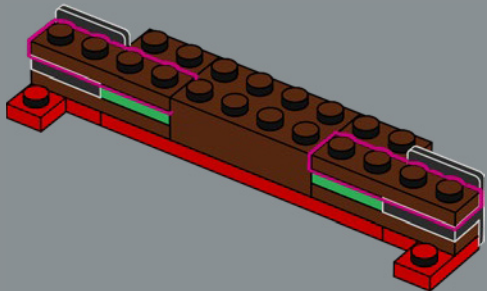

6

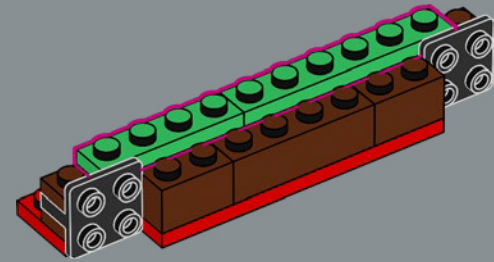

7

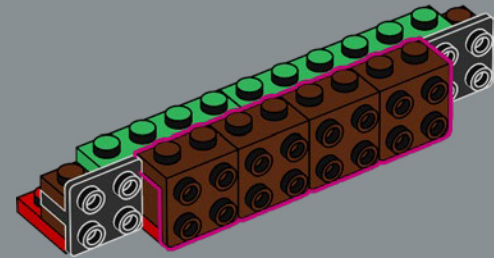

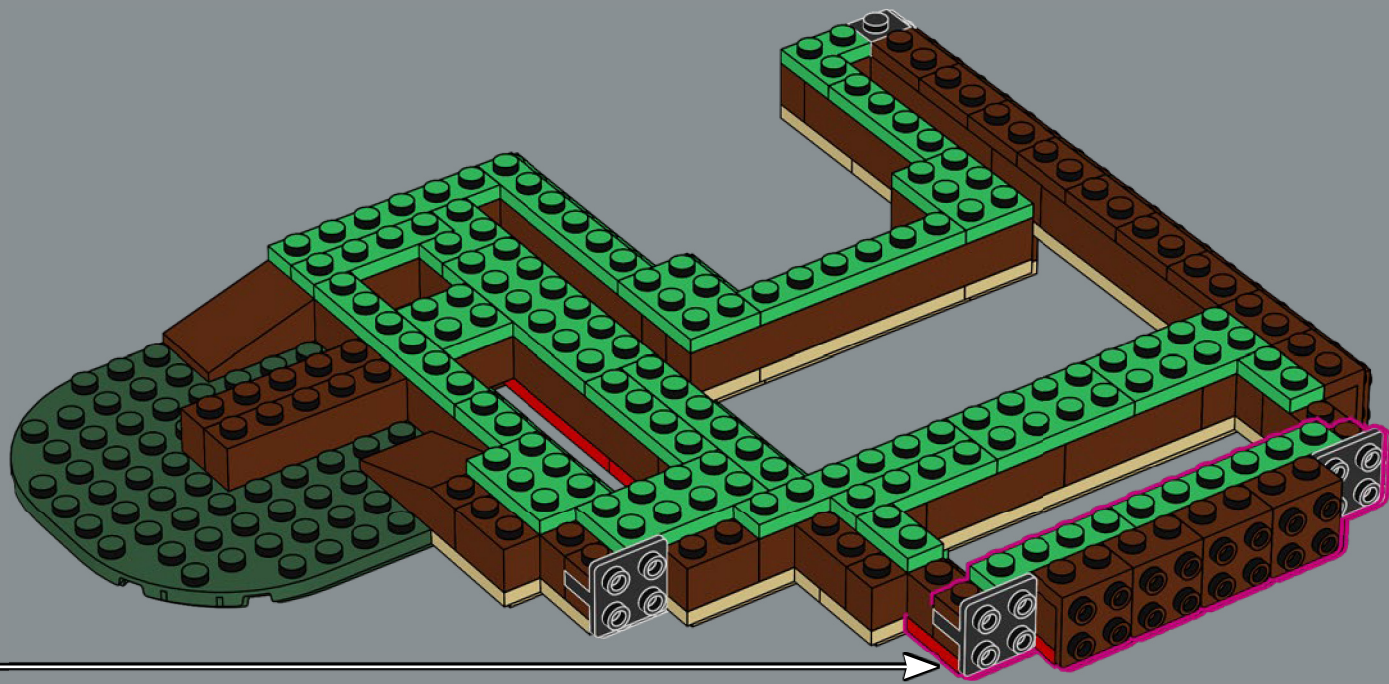



17

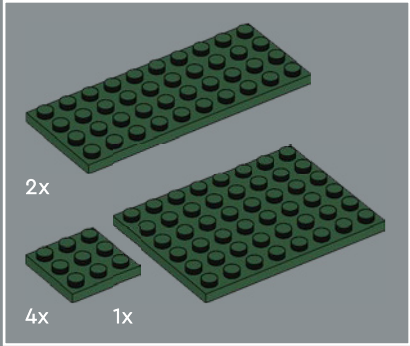
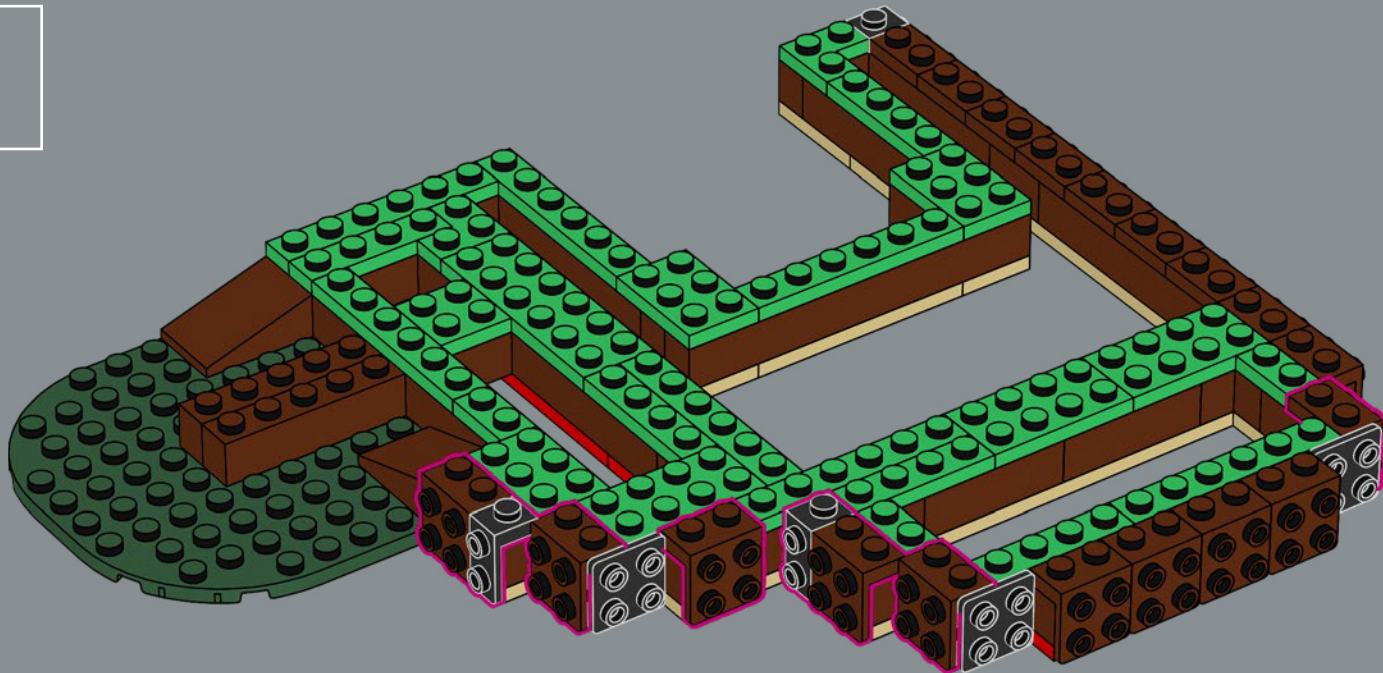

18

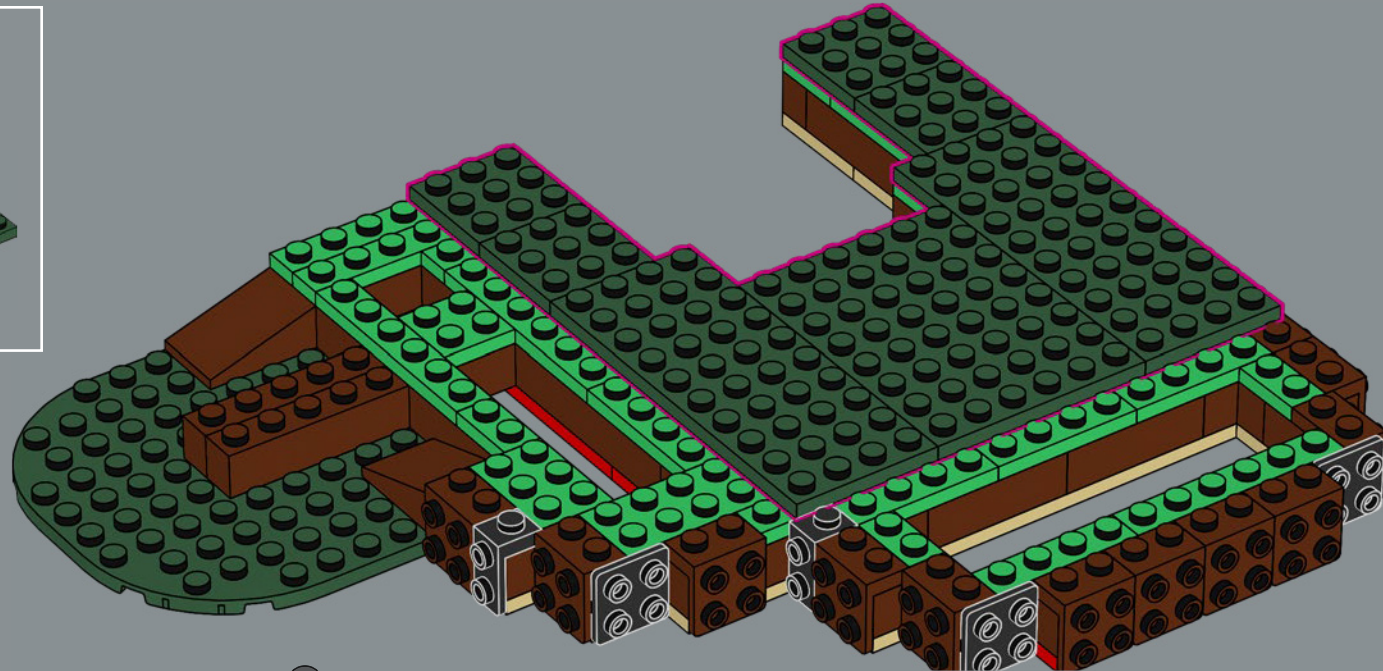

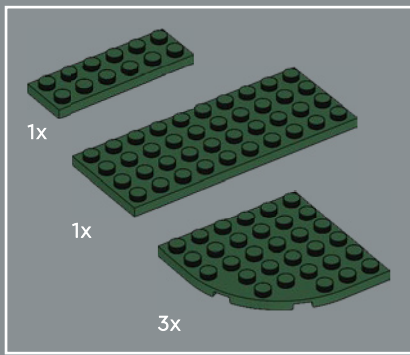

19

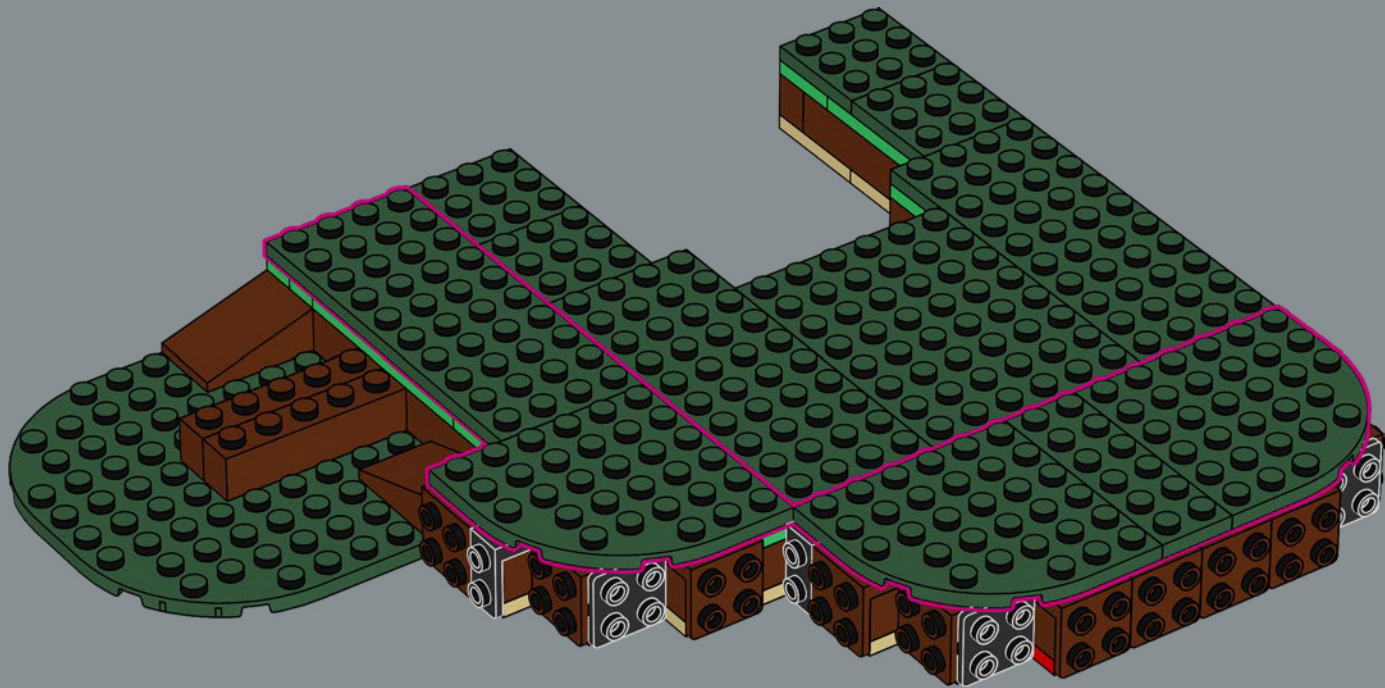

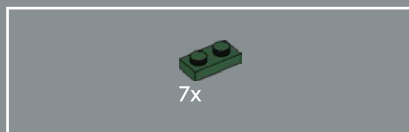

20

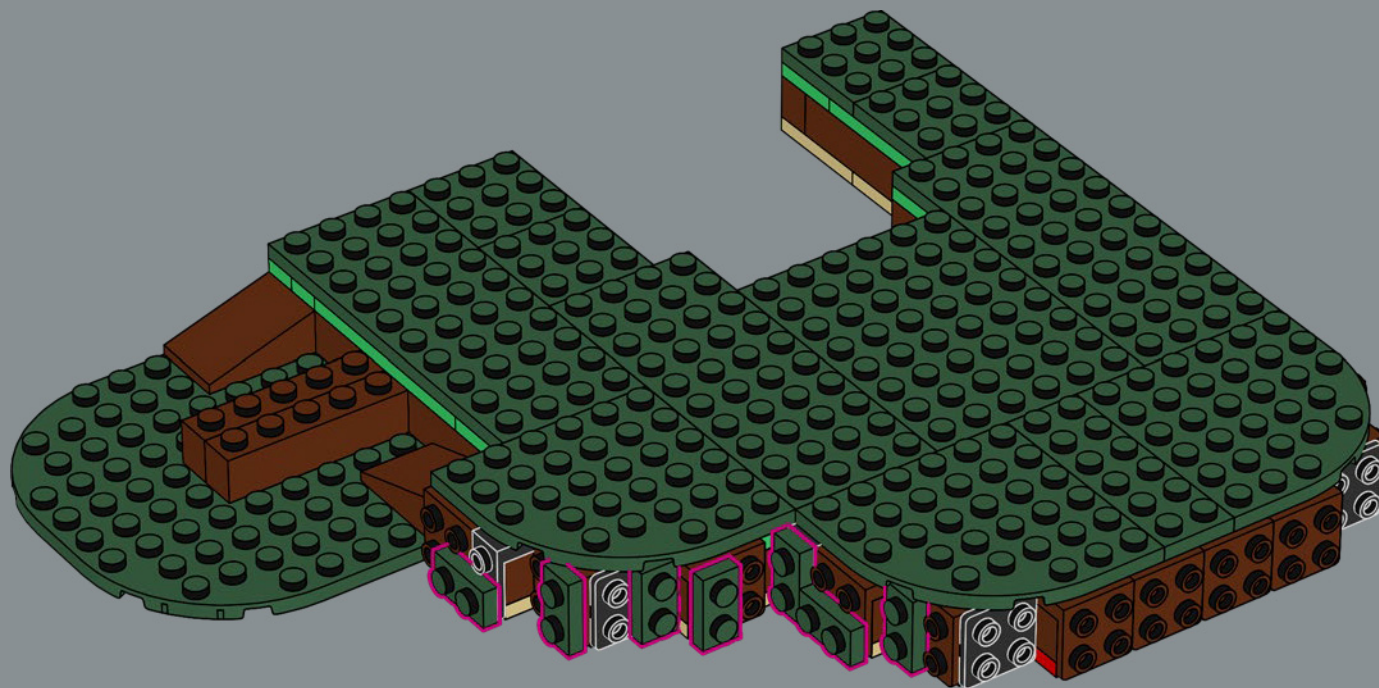



21

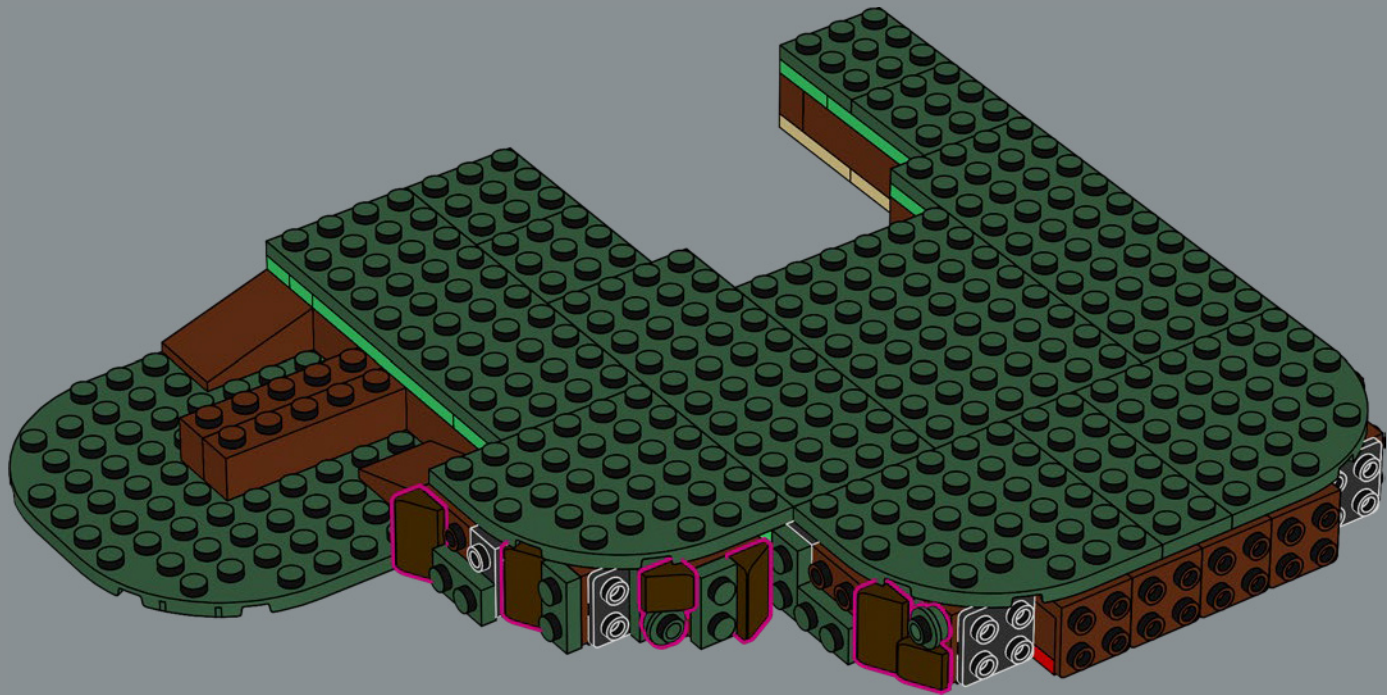



22

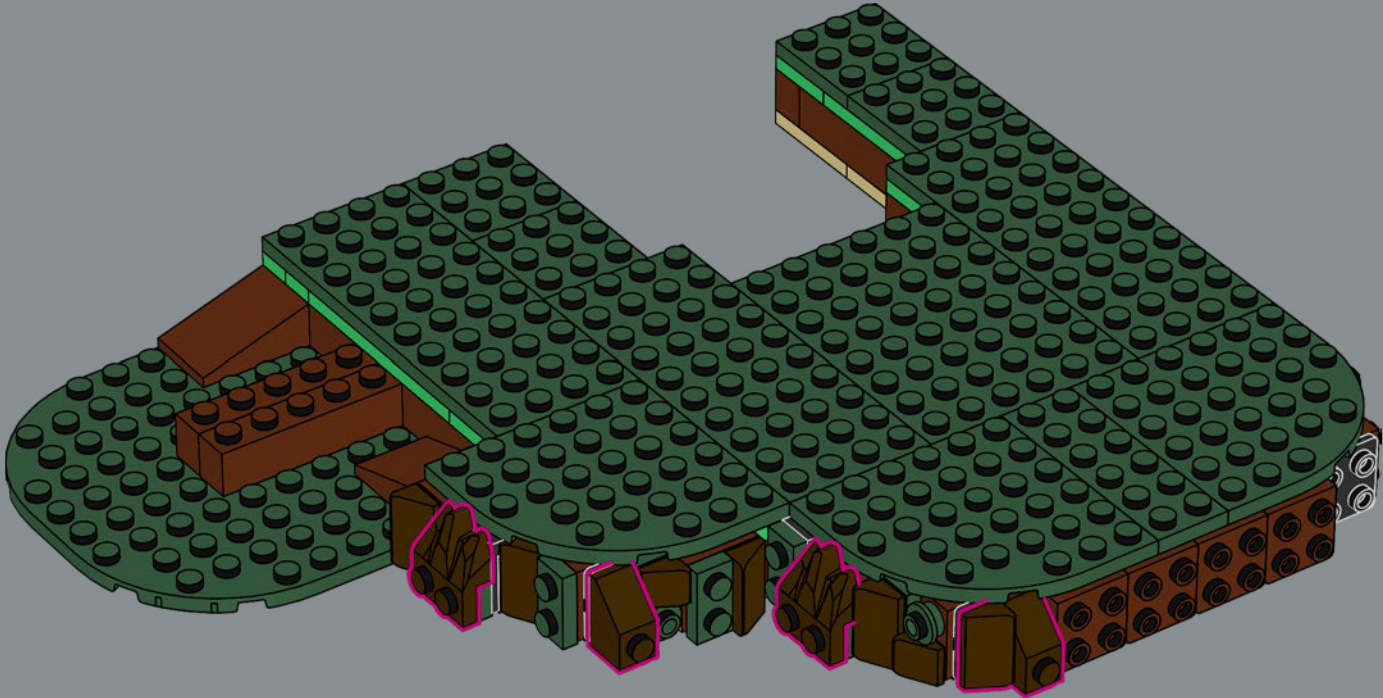

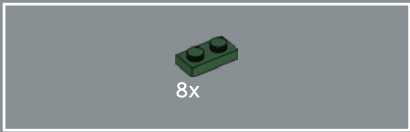

23

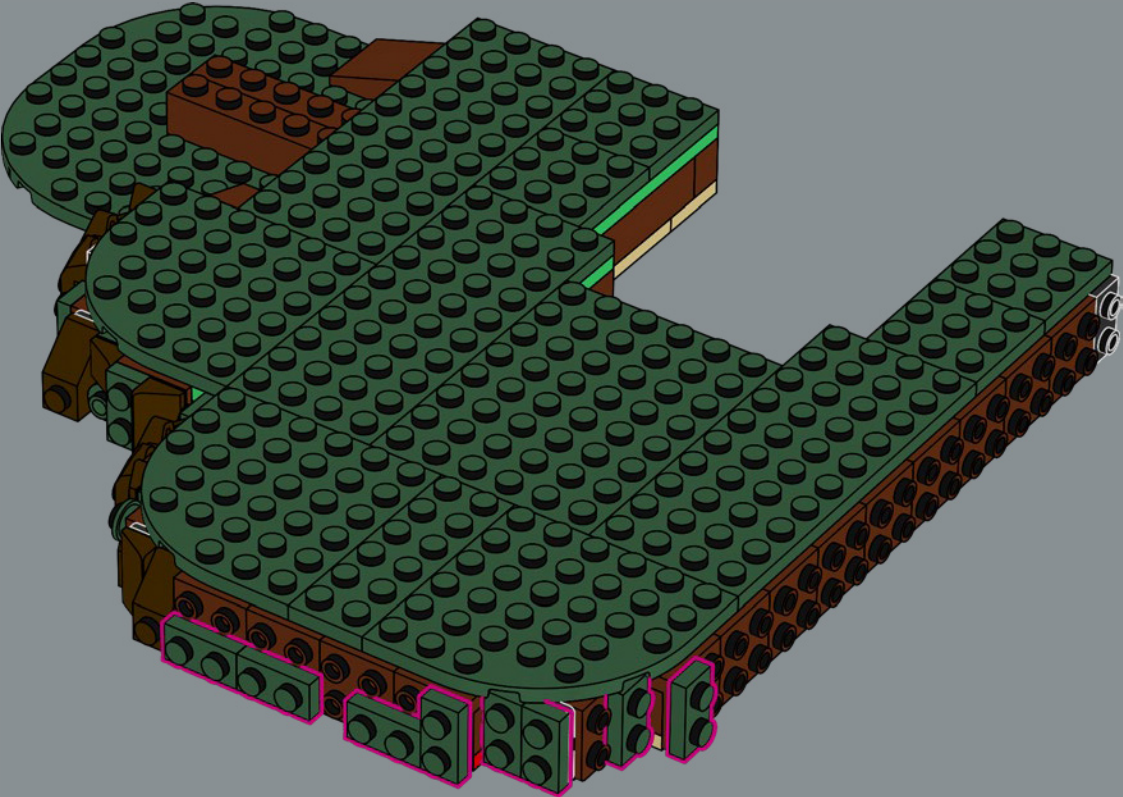

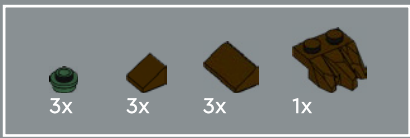

24

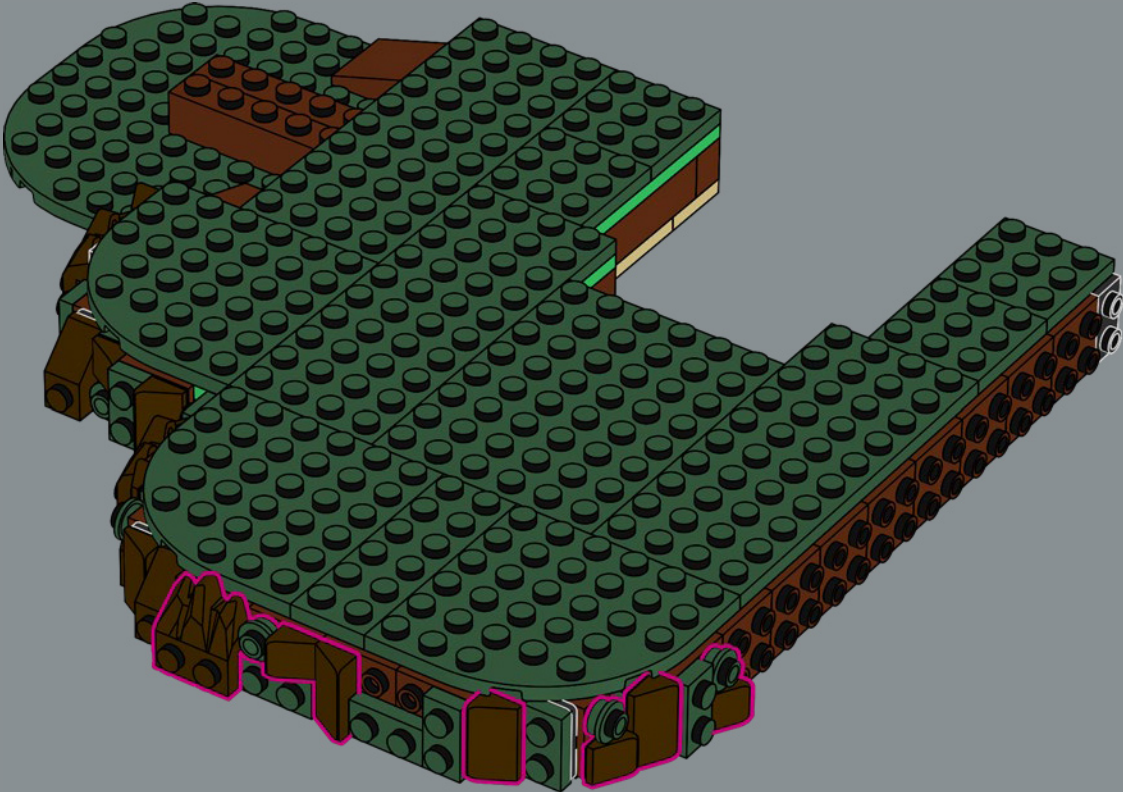



25

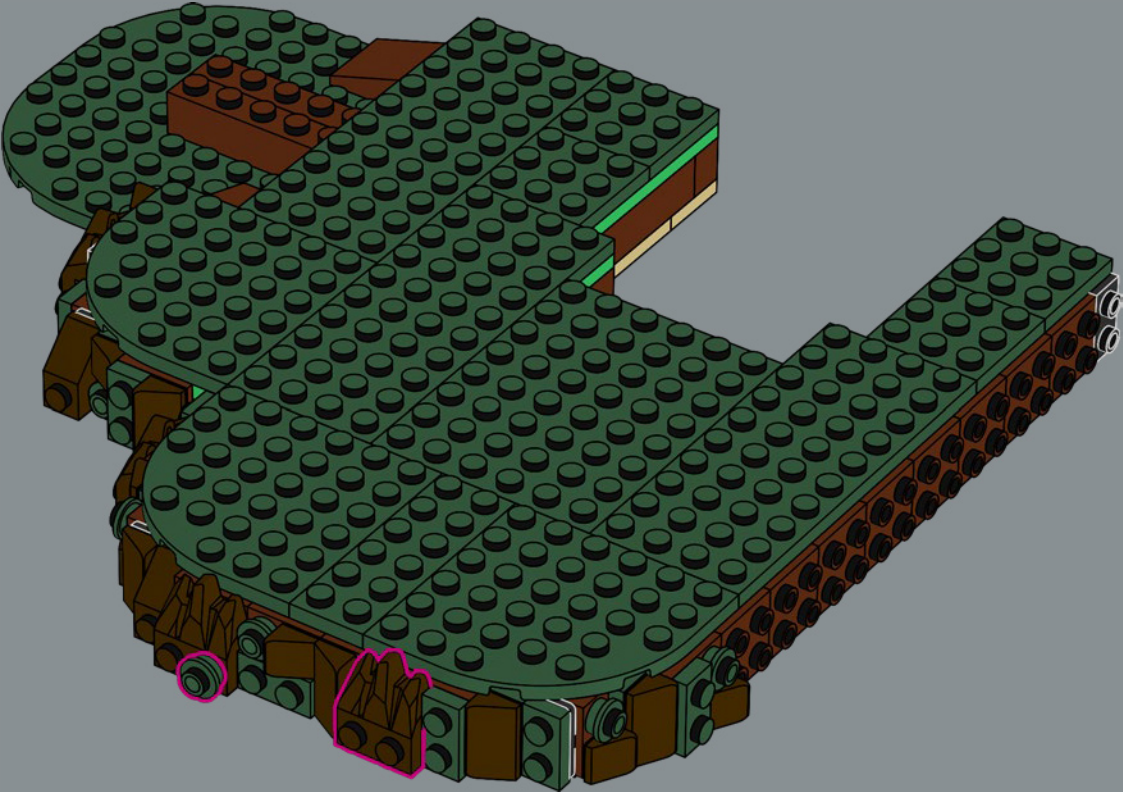

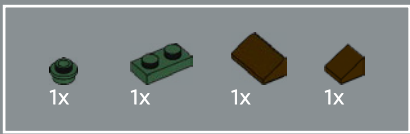

26

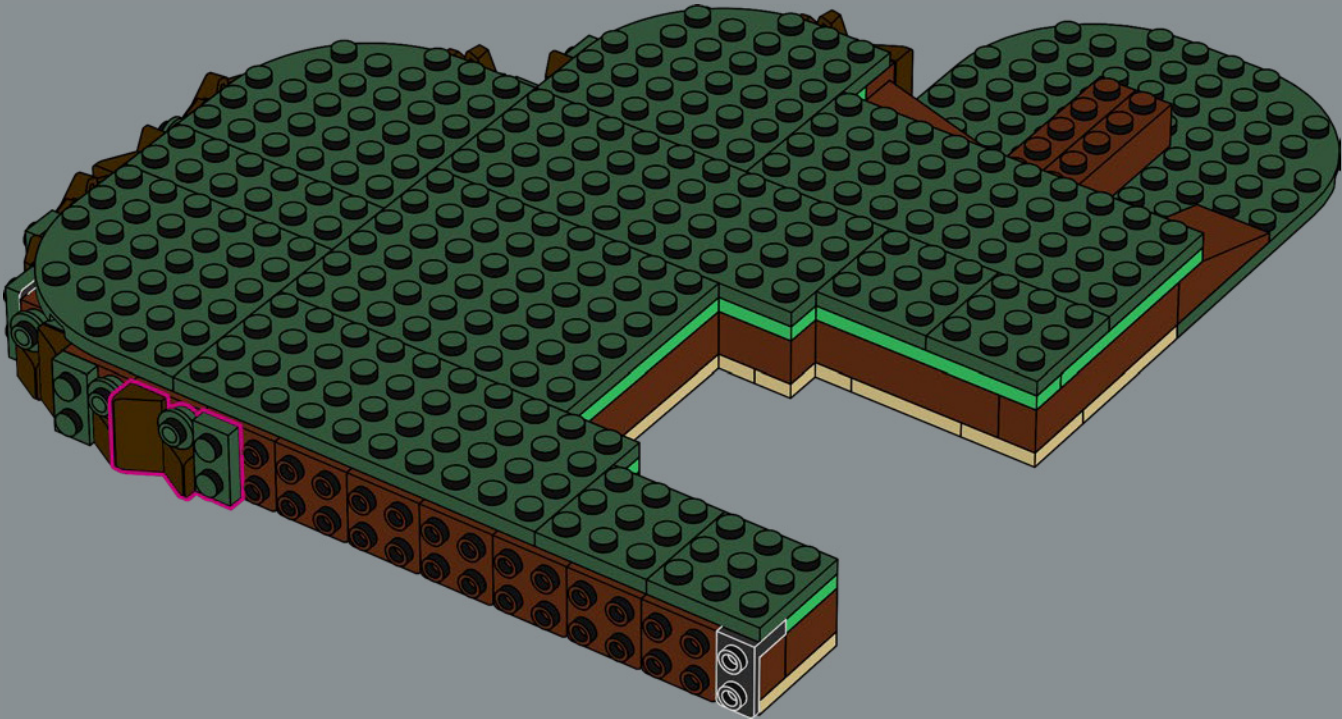



27



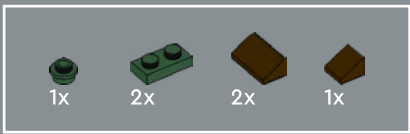

28

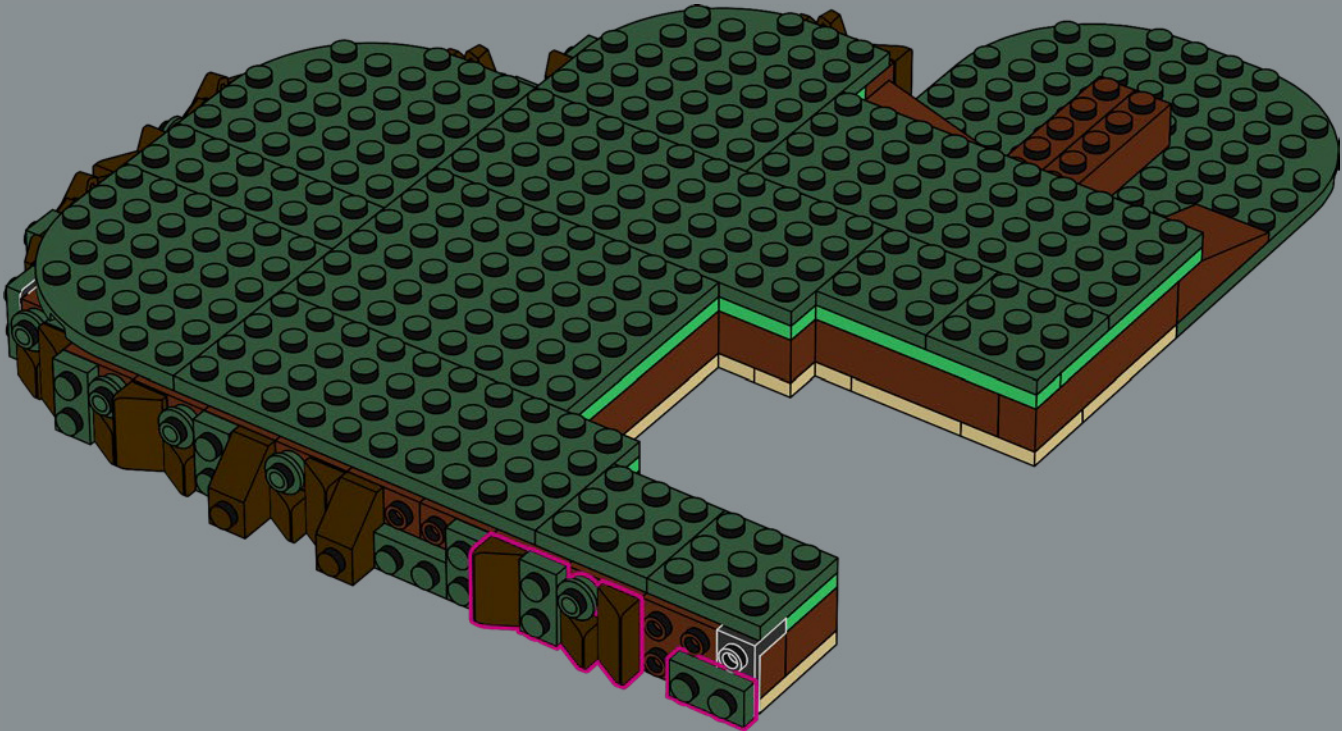

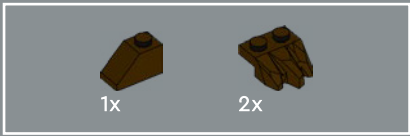

29

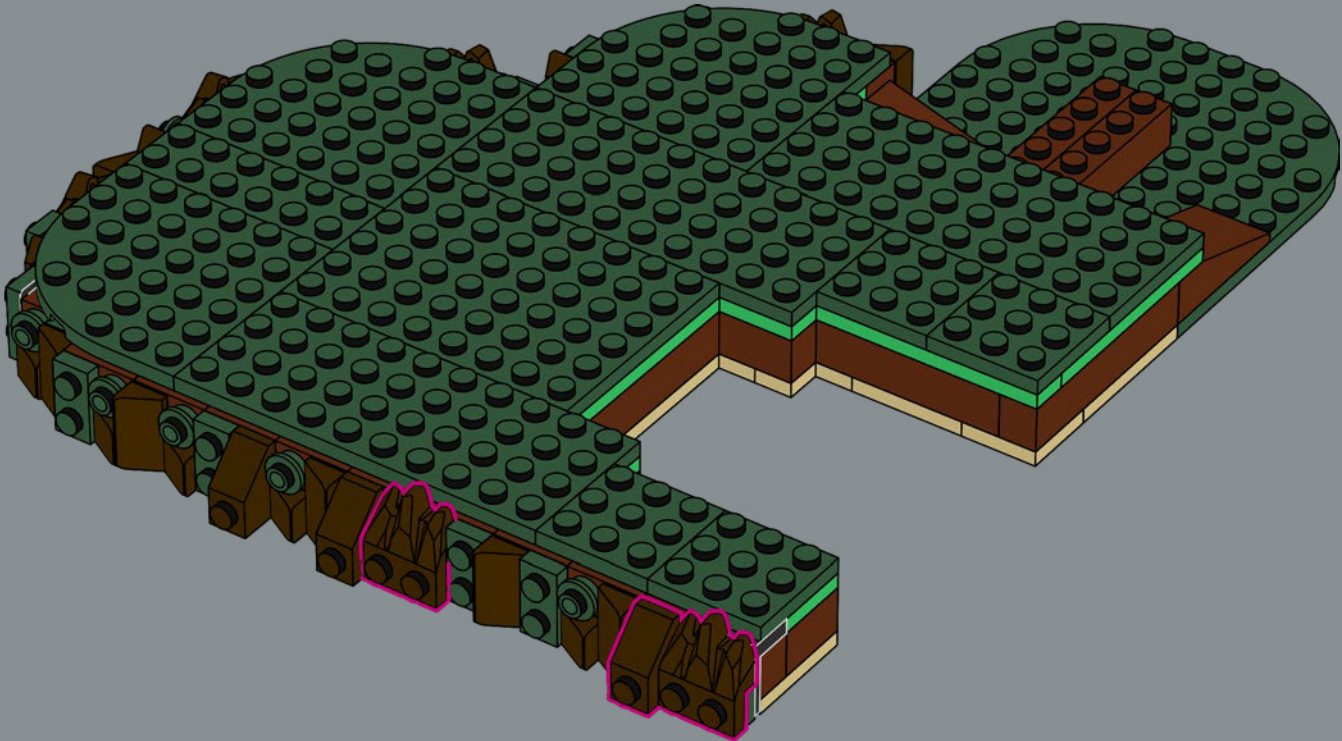

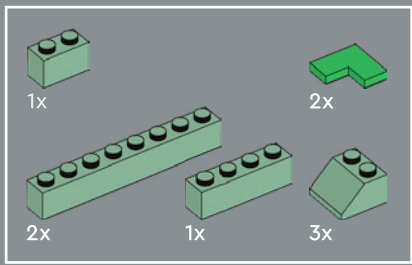

30

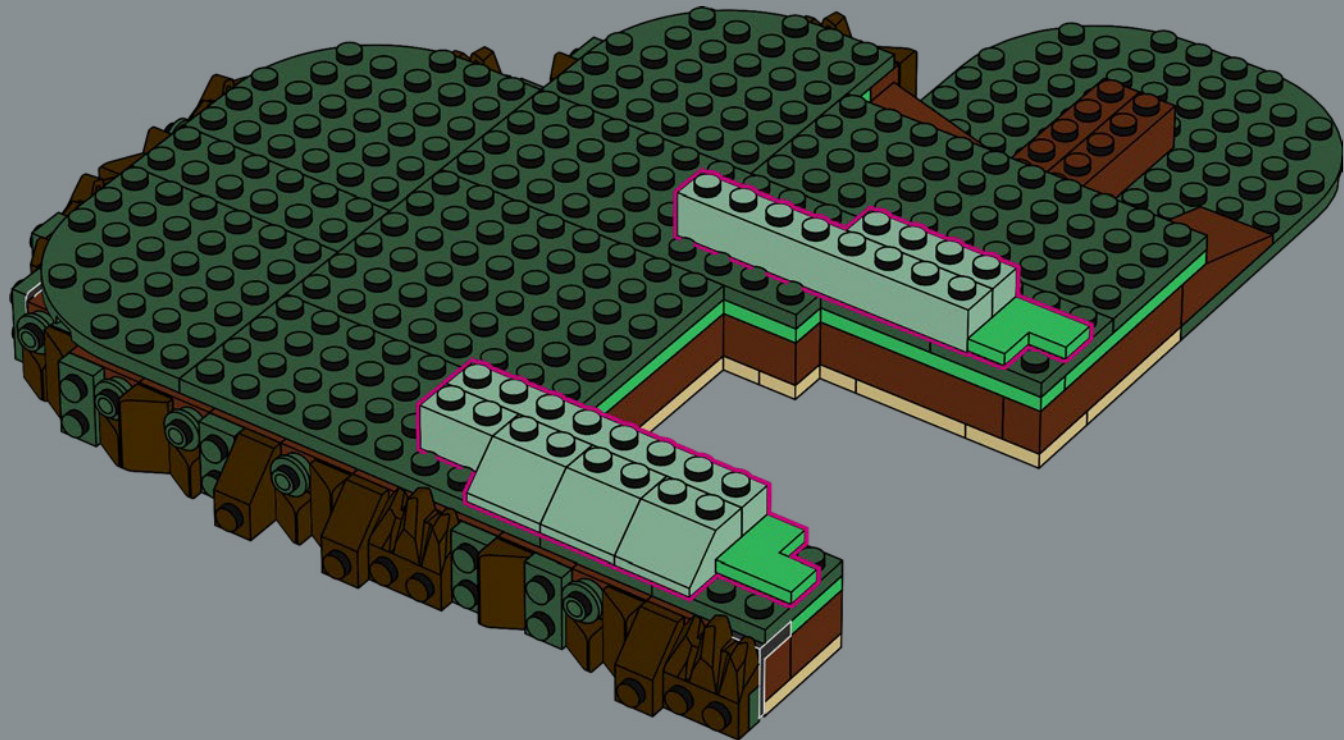



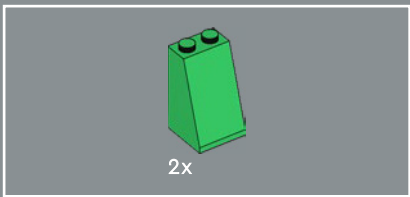

32

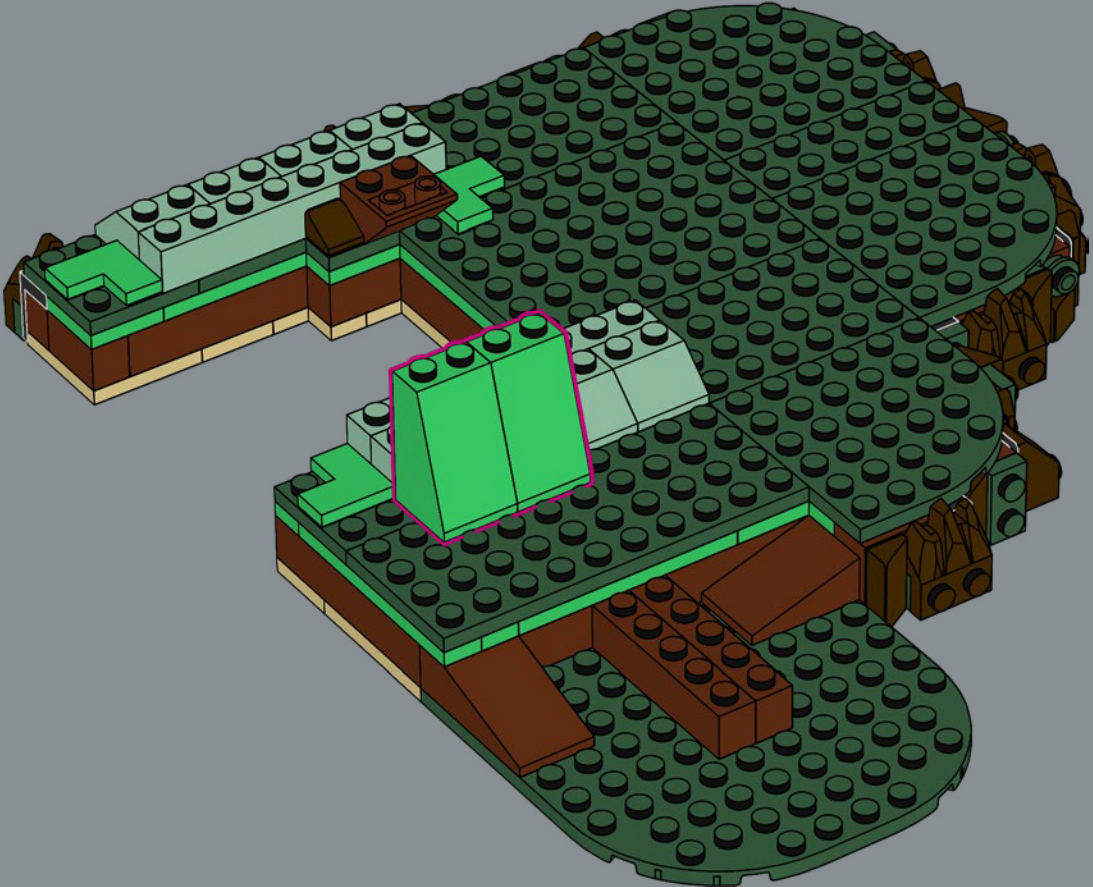

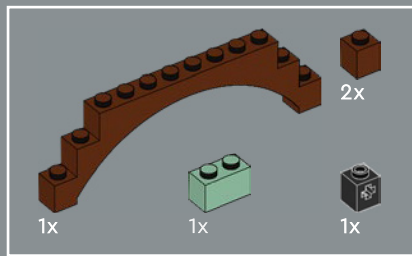

33

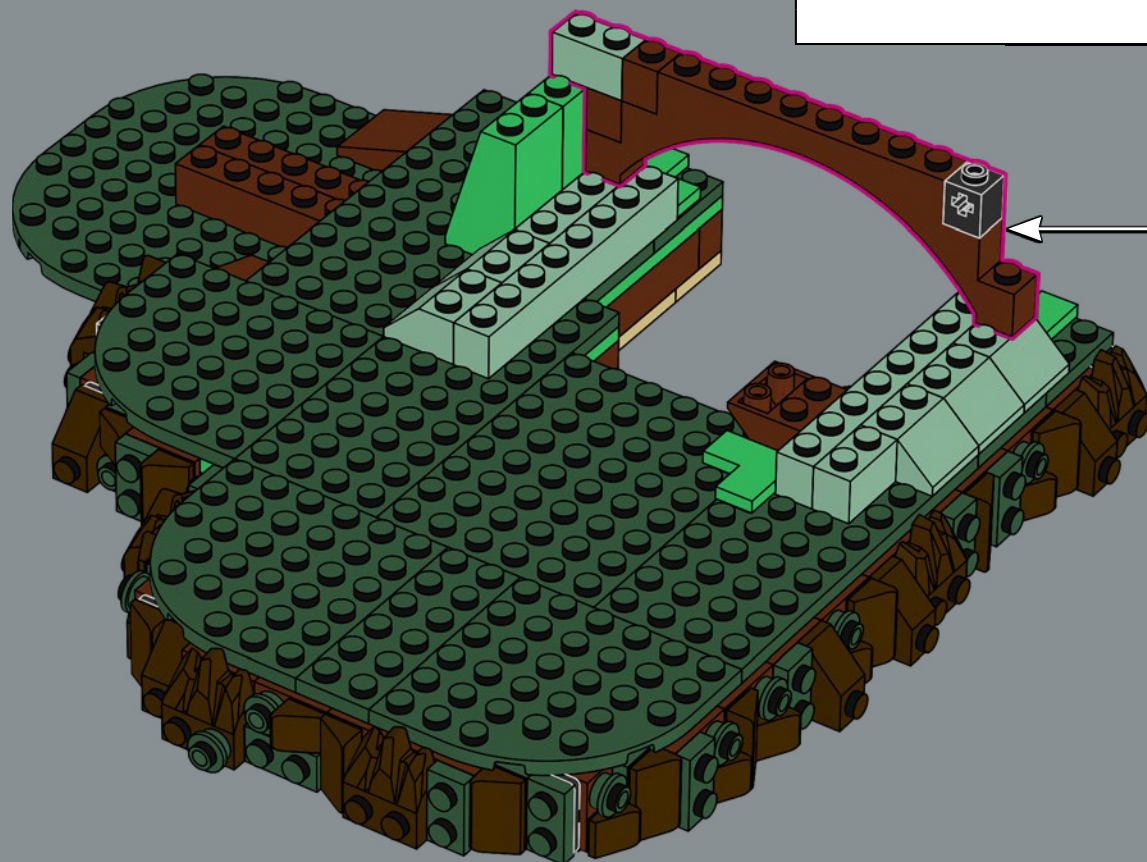
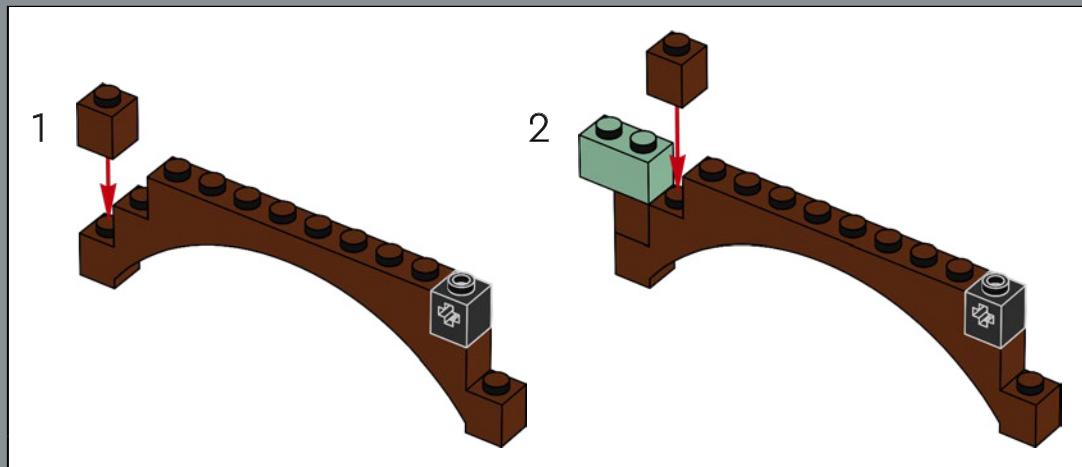

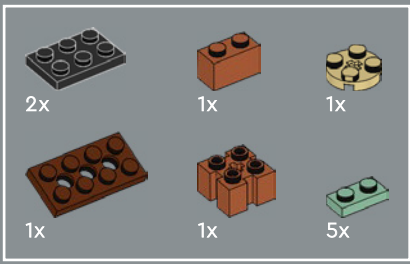

34

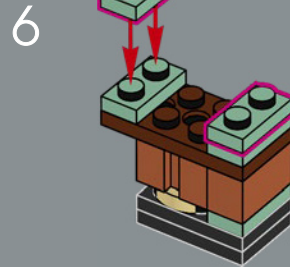
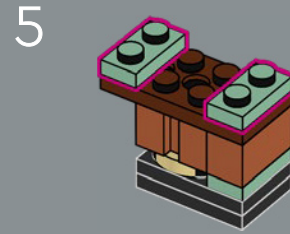
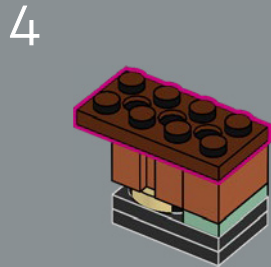
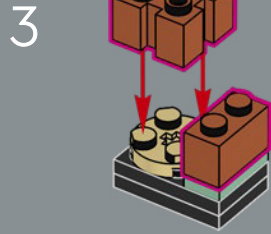
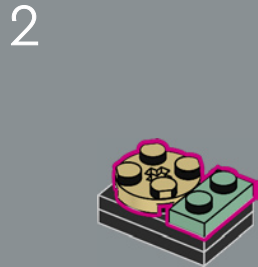
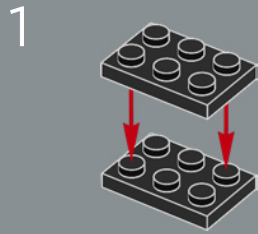



35

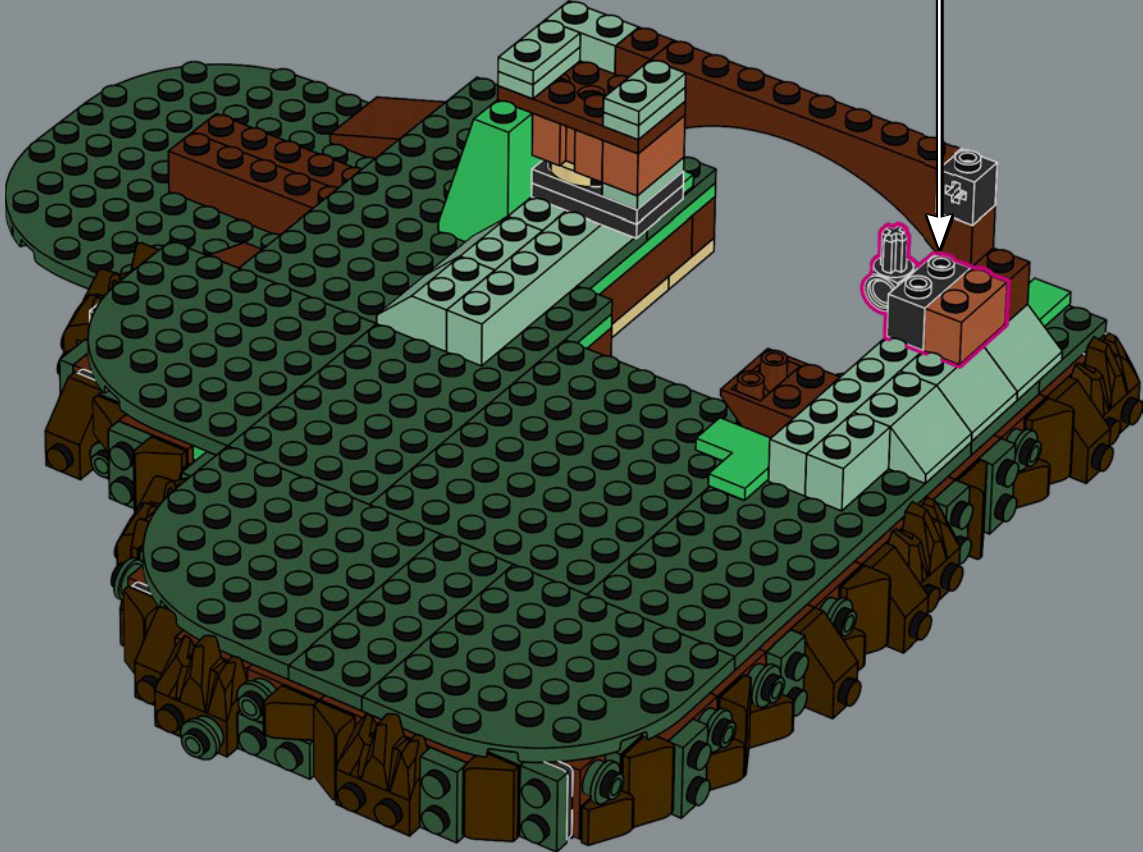
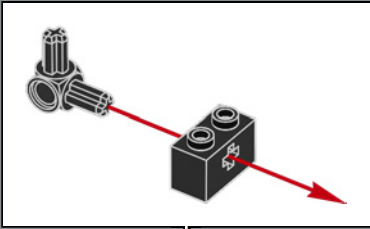



36

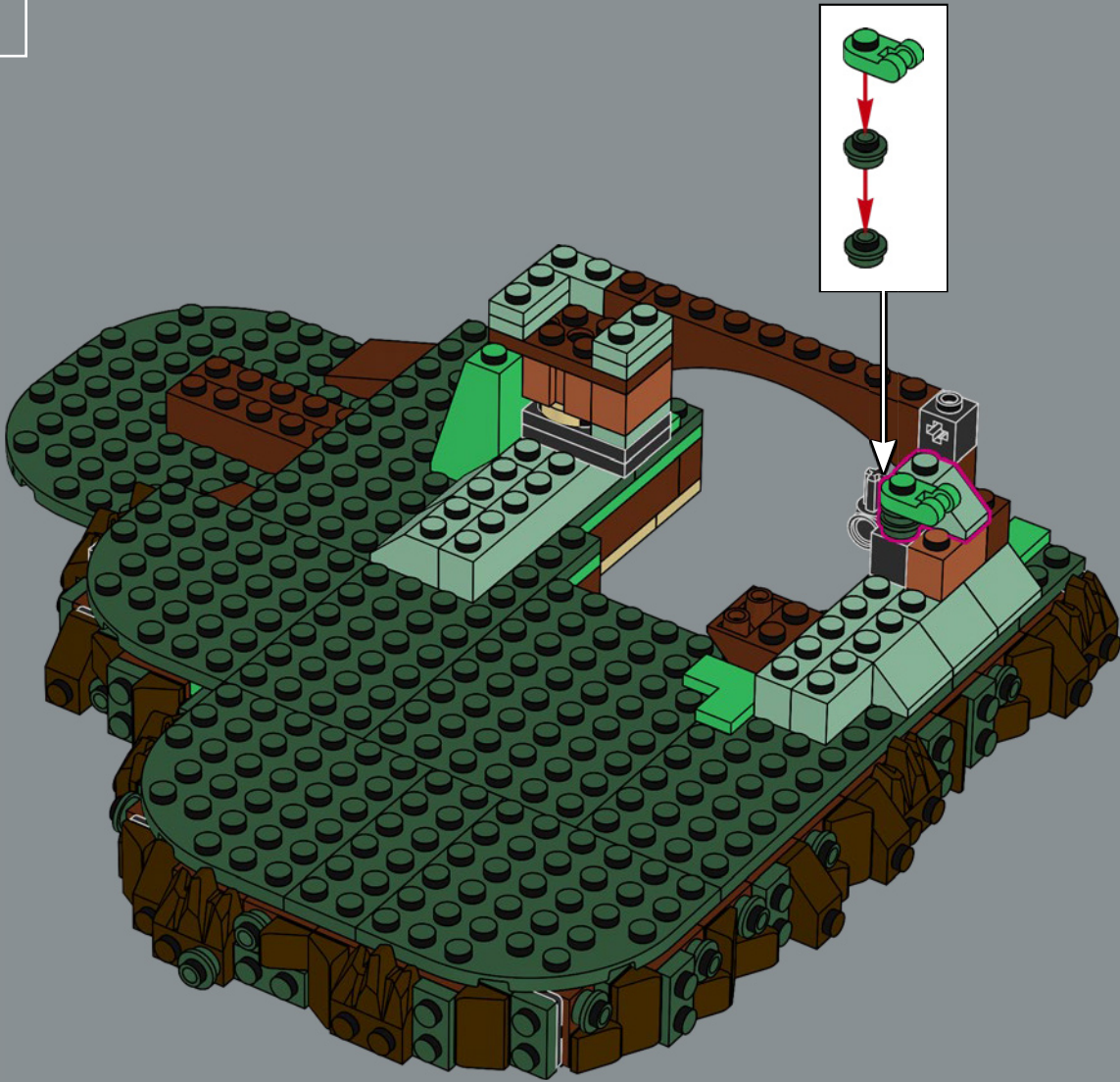

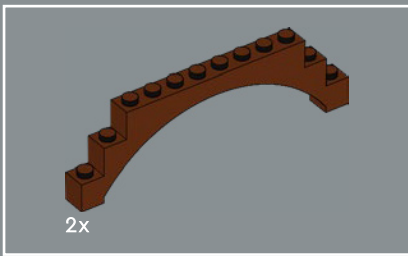

37

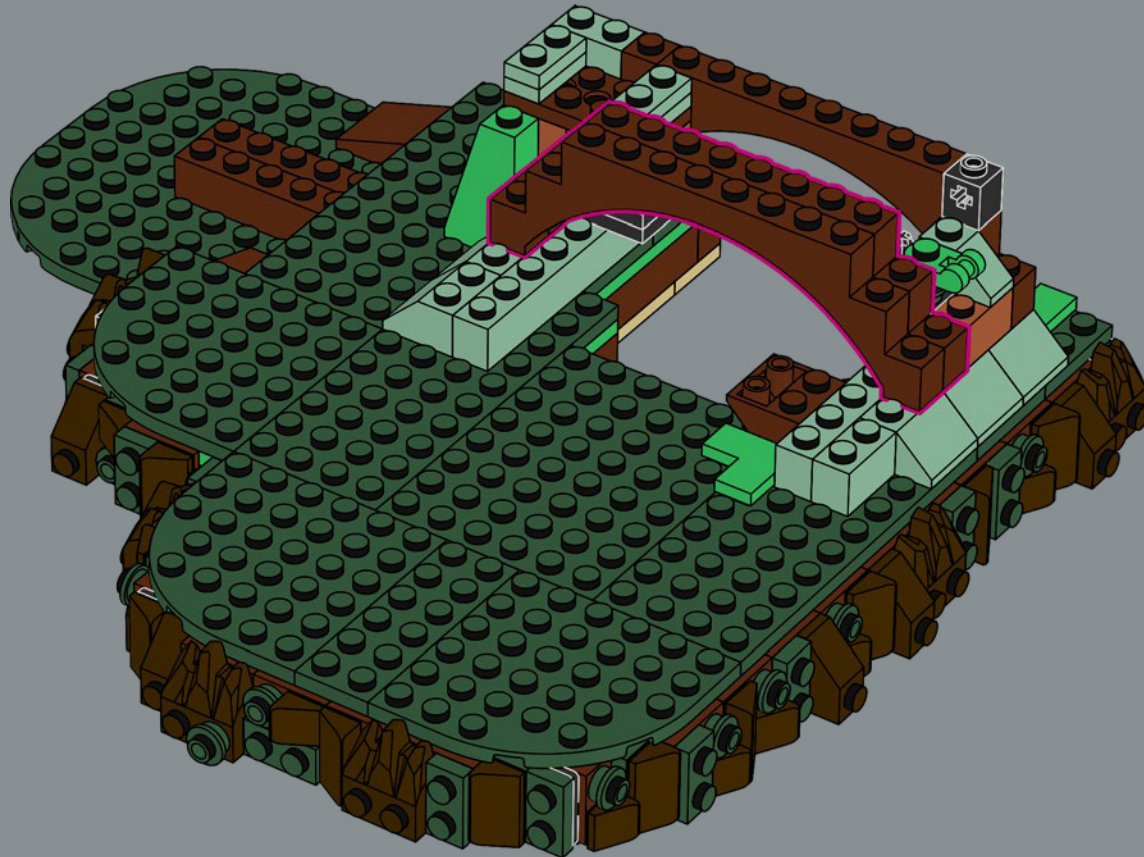



2x

38

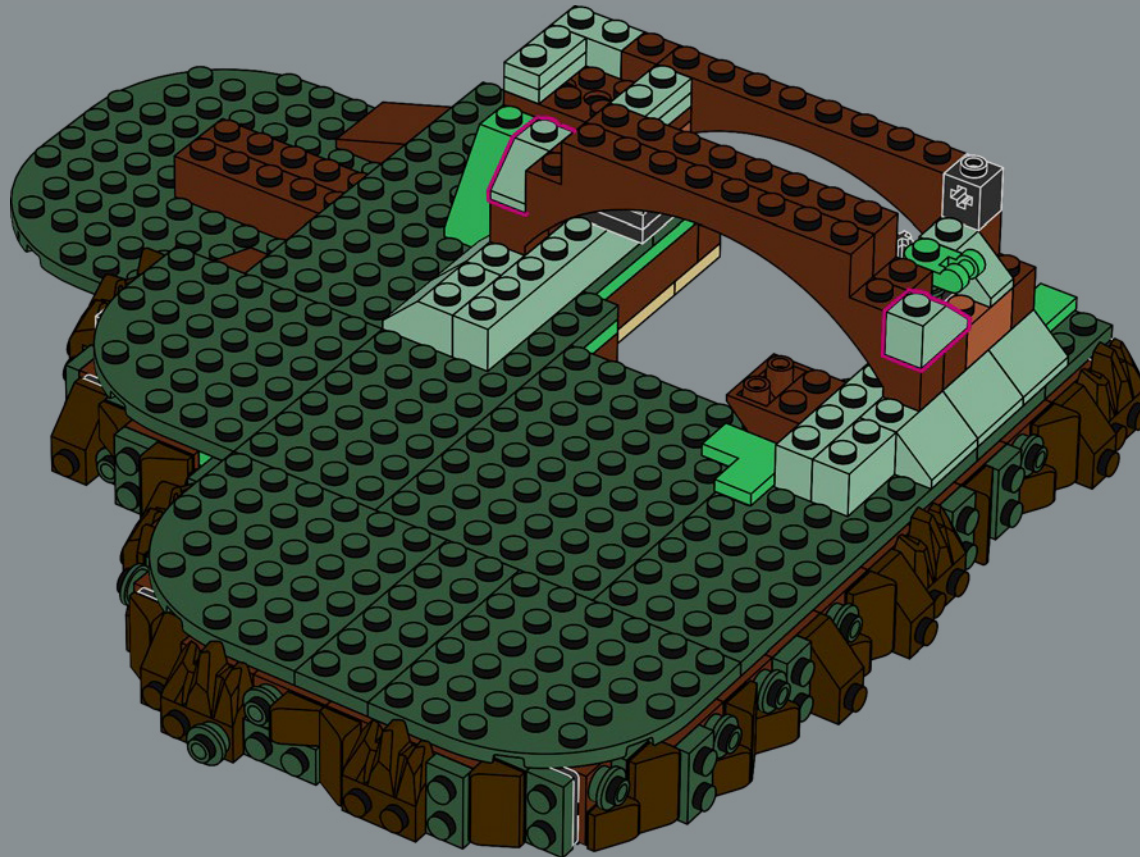

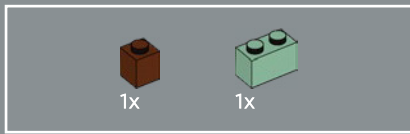

39

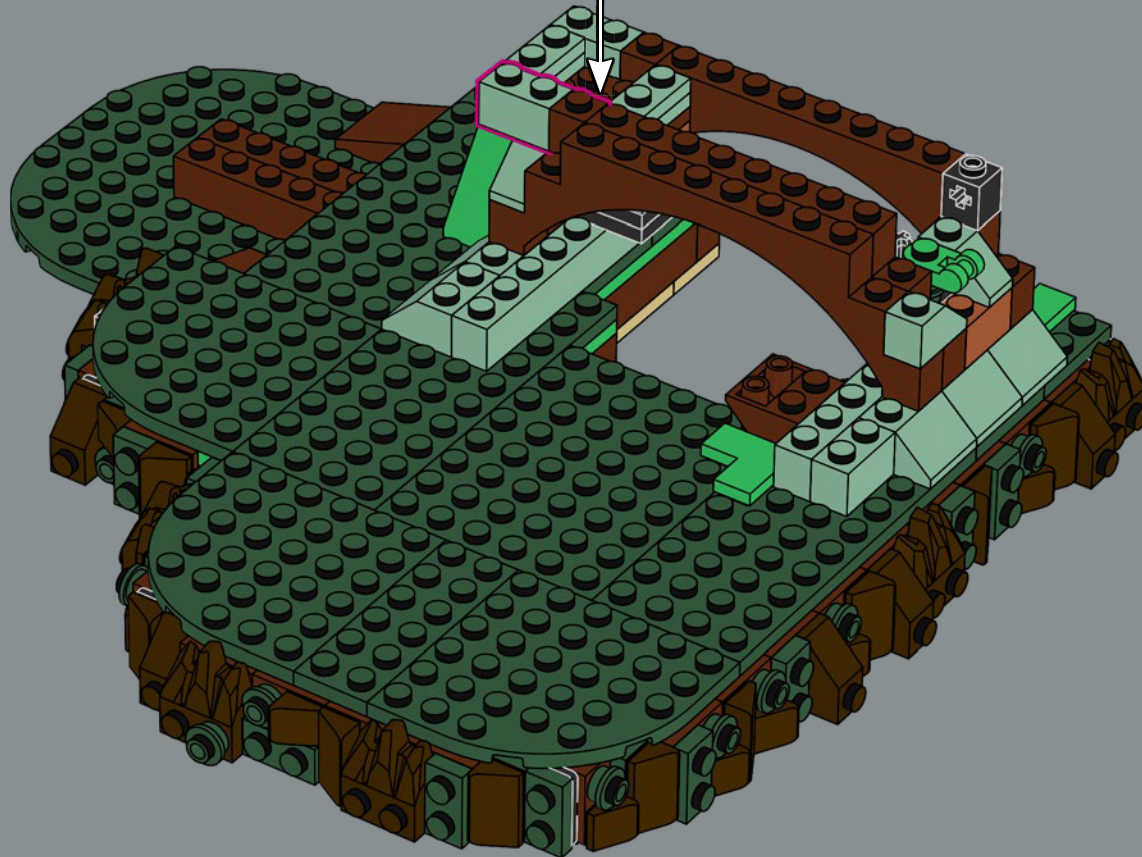
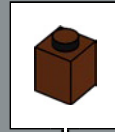

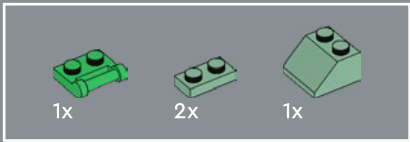

40

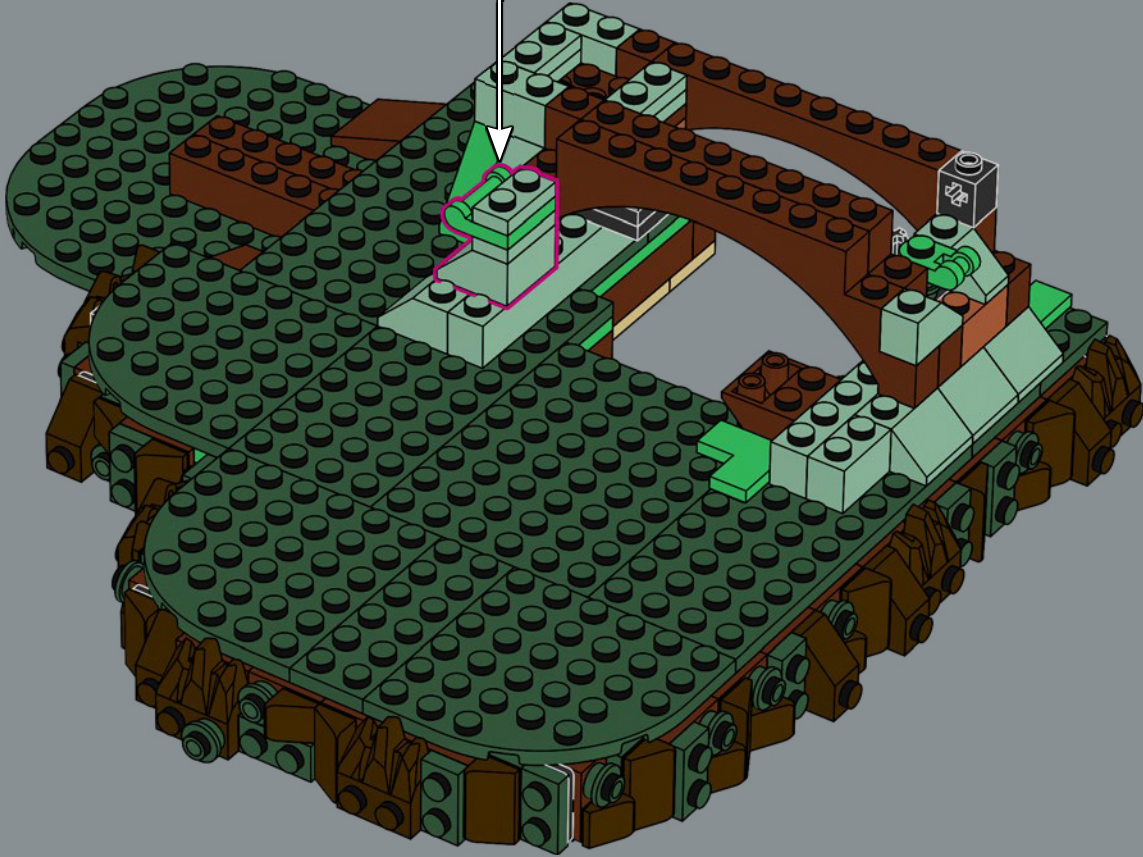
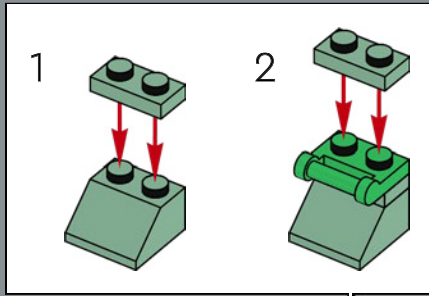

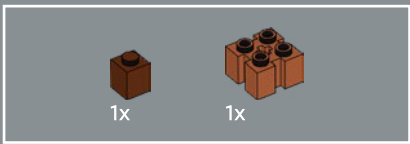

41

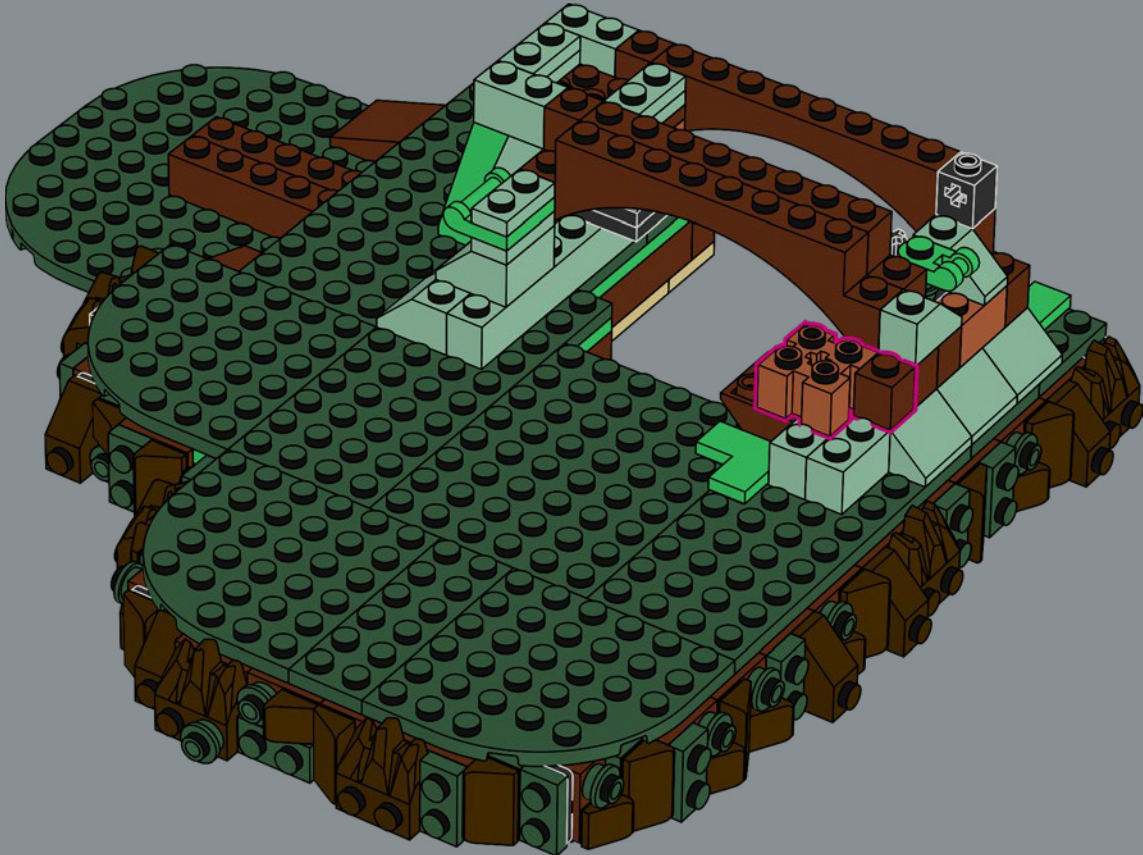

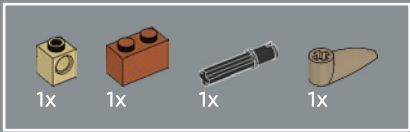

42

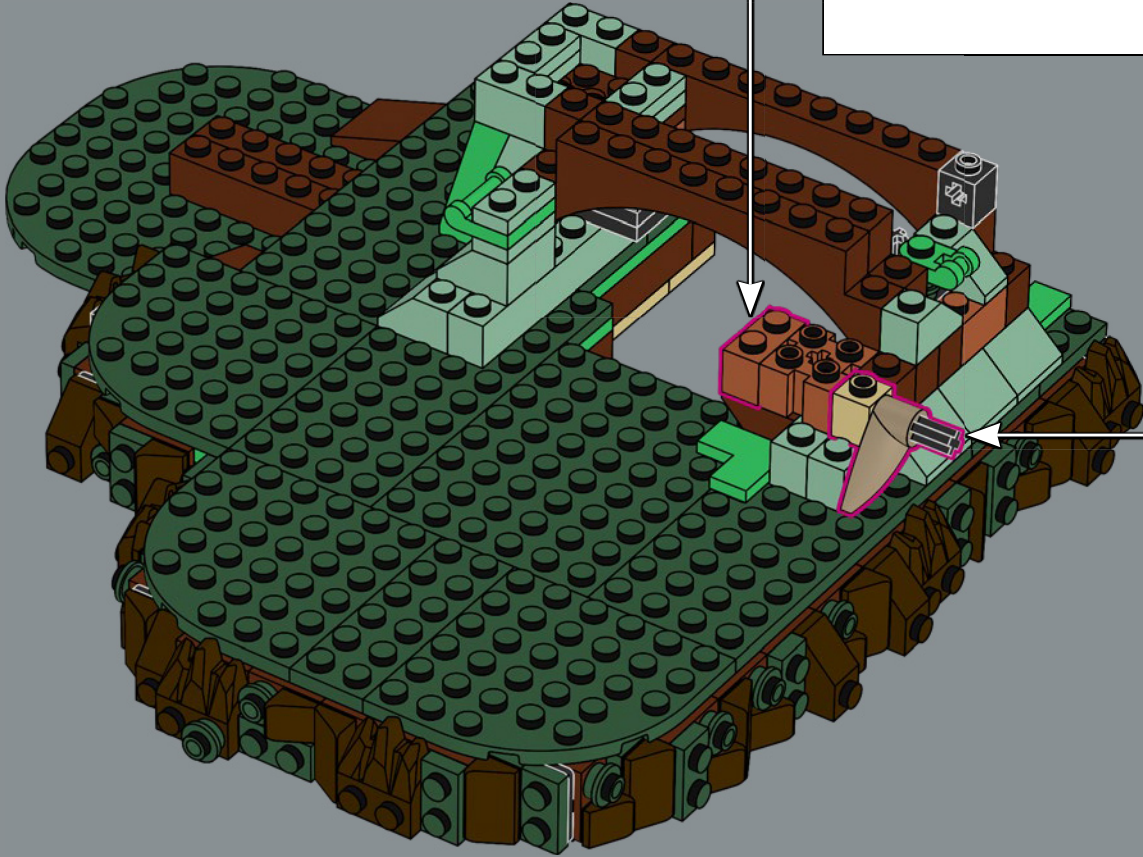
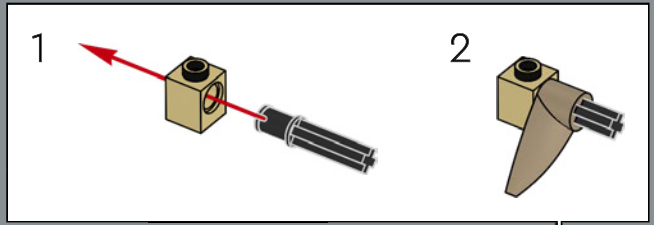
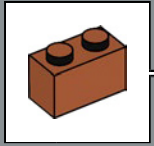

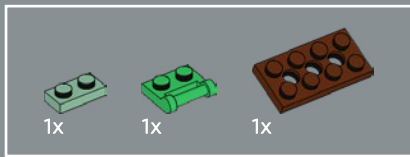

43

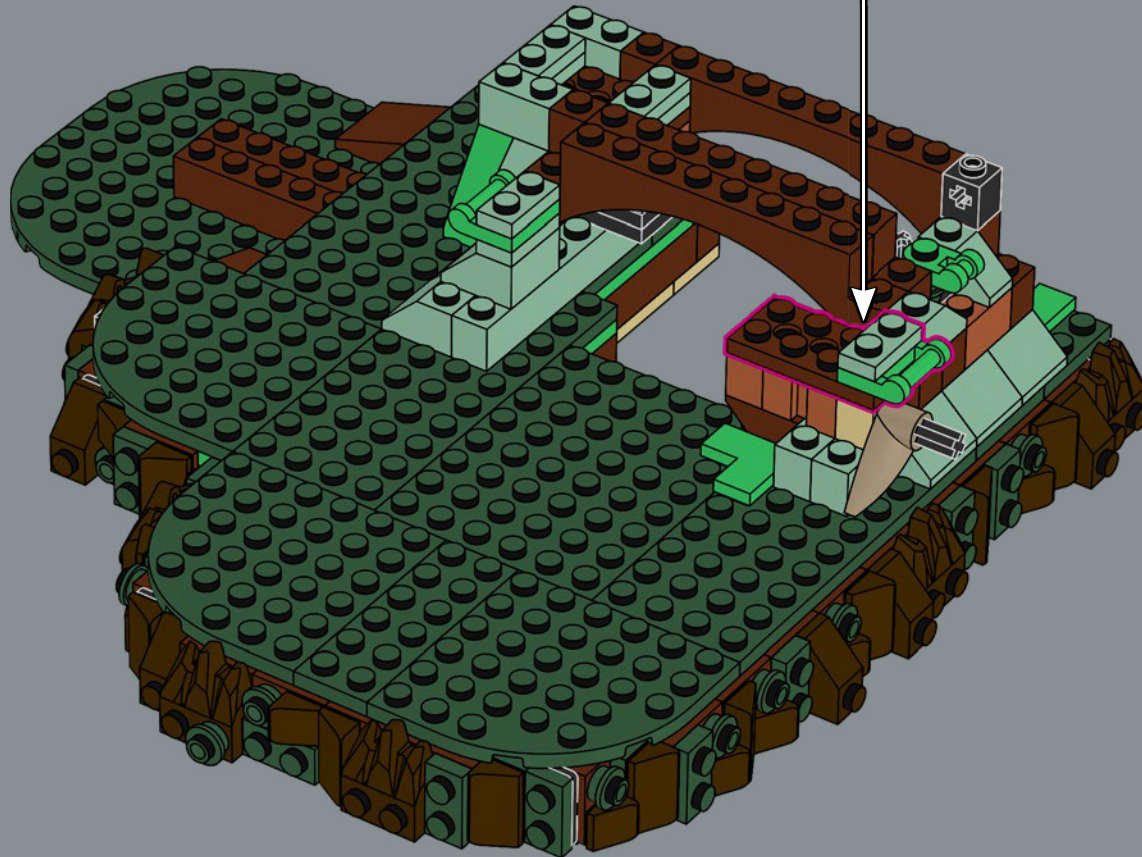
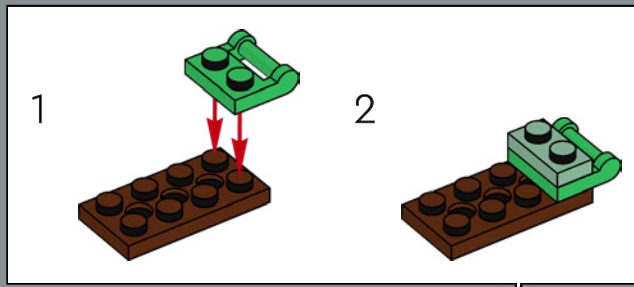

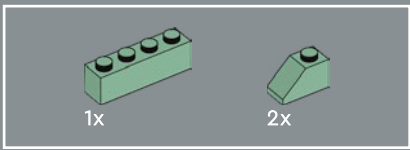

44

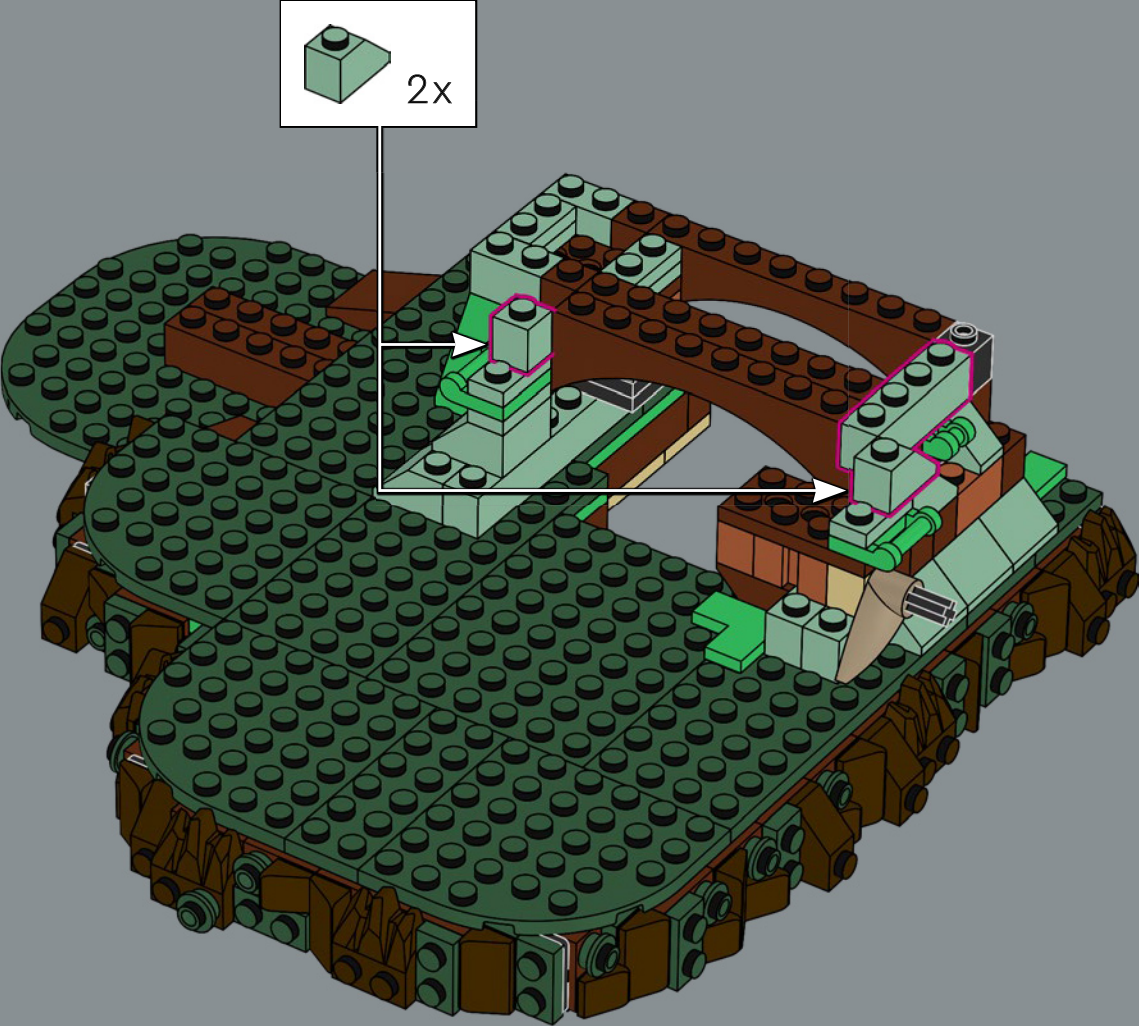

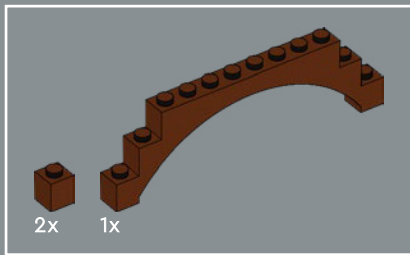

45

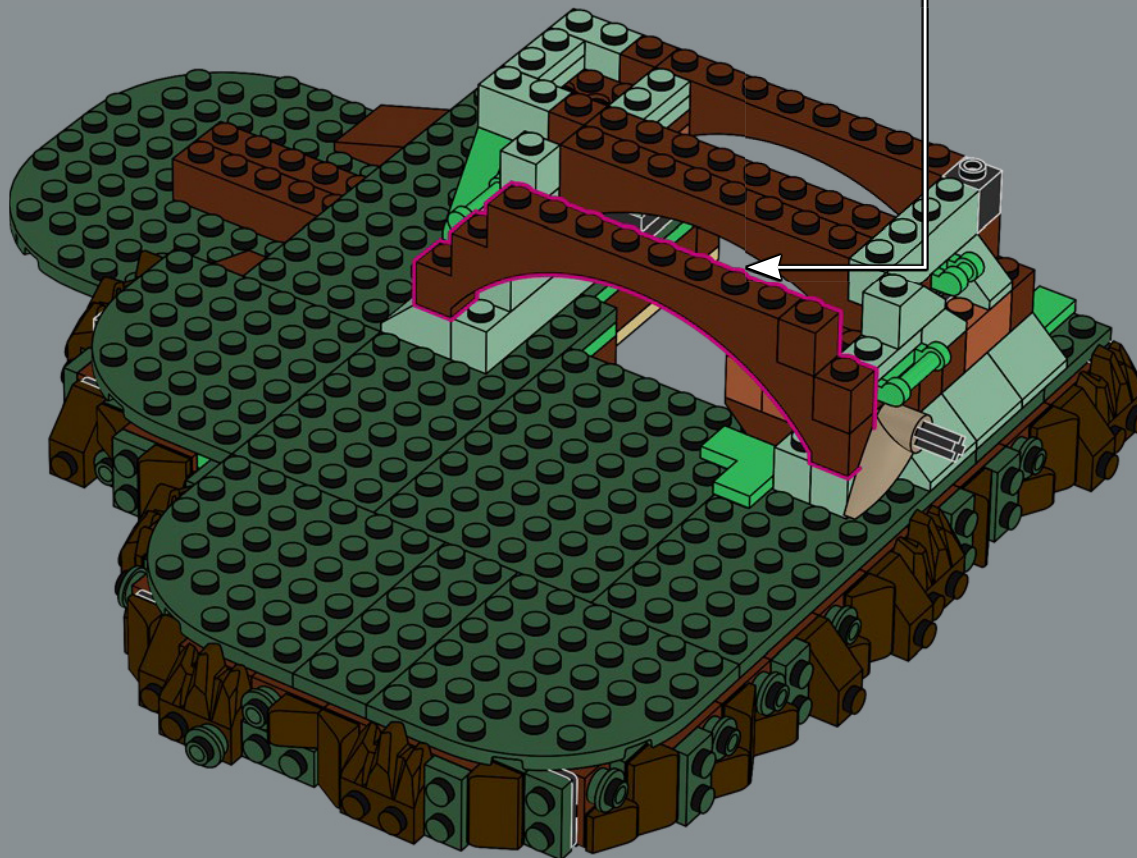
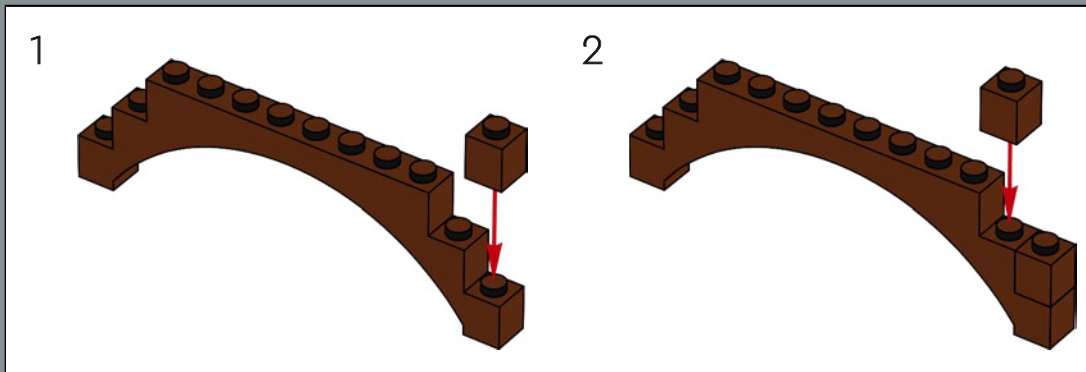



2x

46

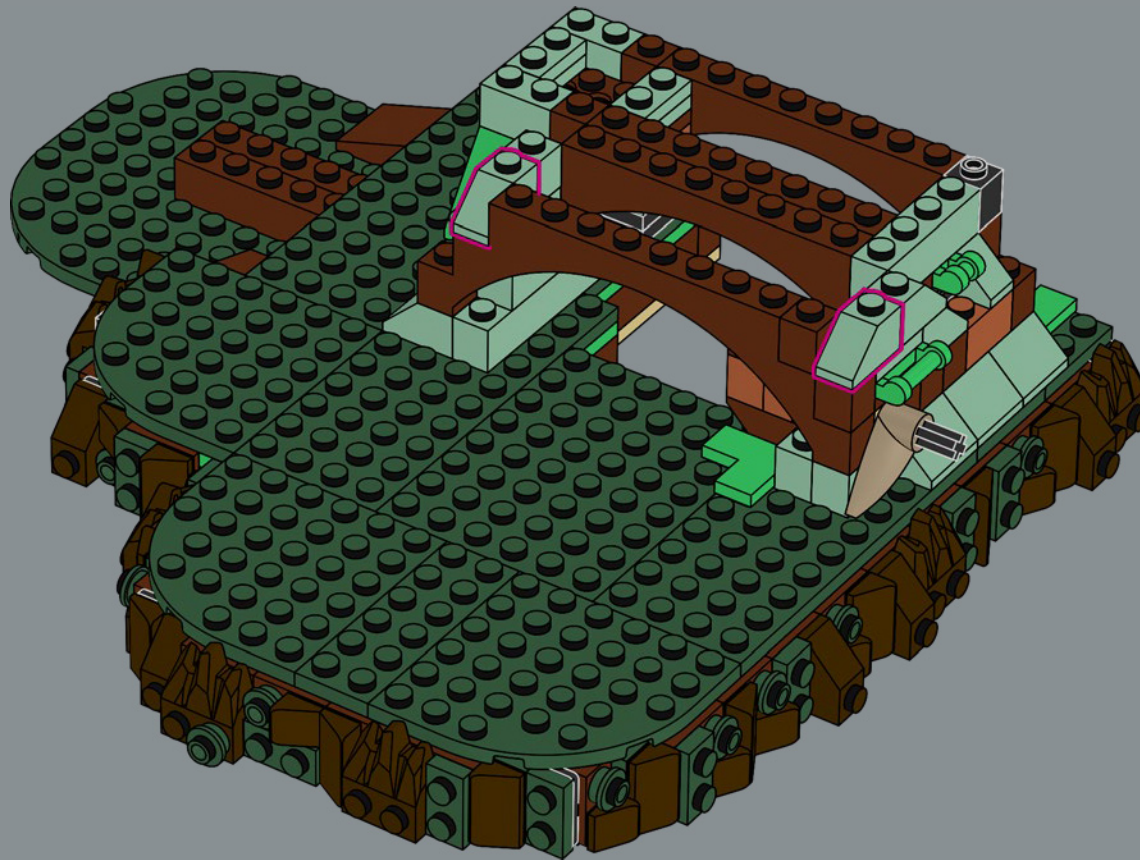

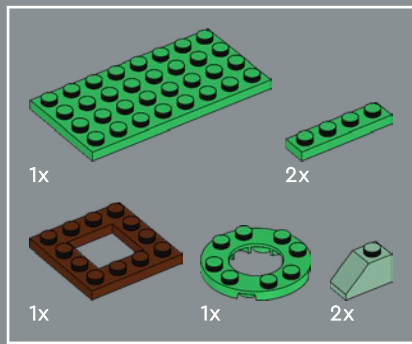

47

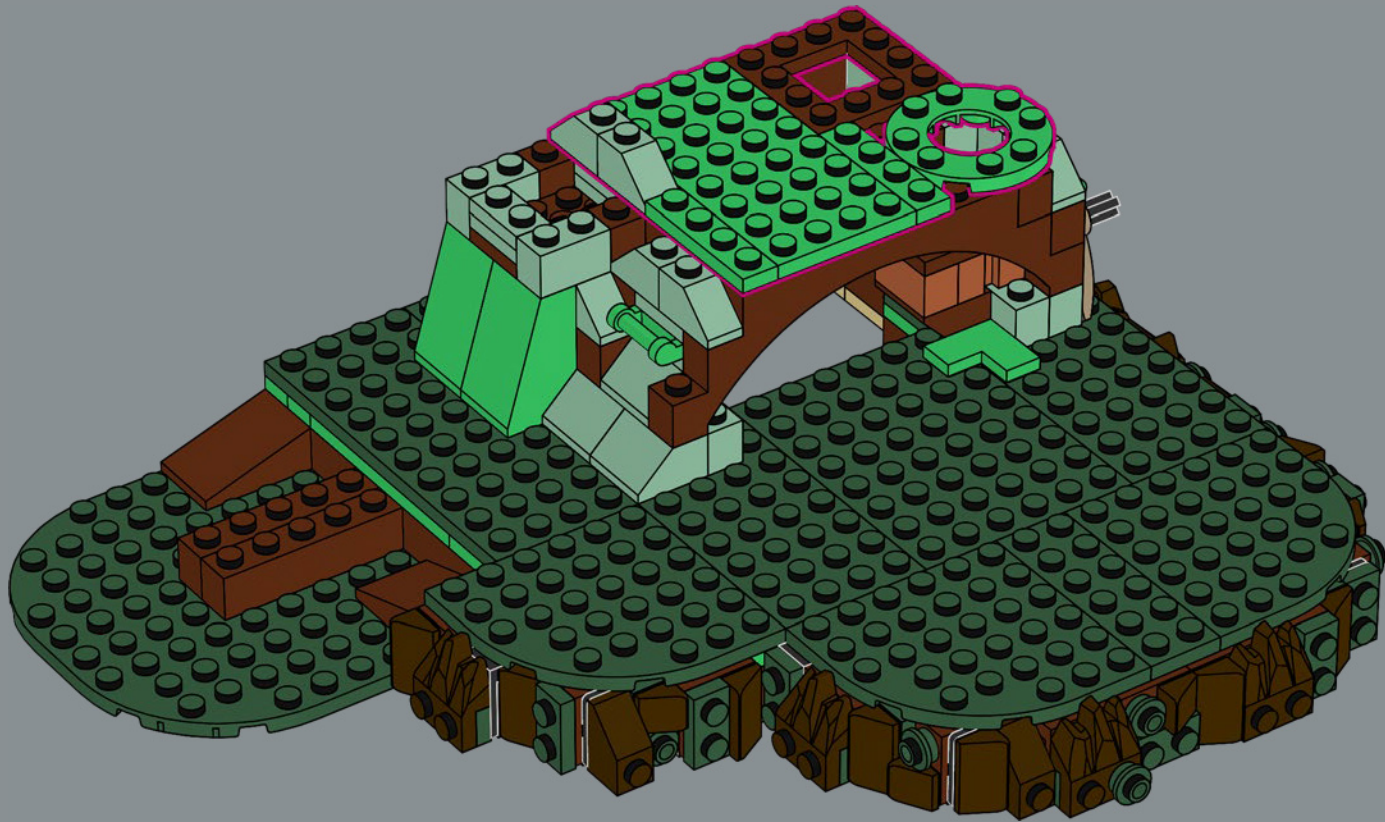

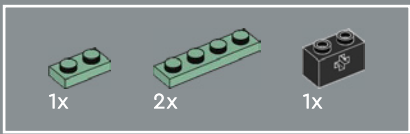

48



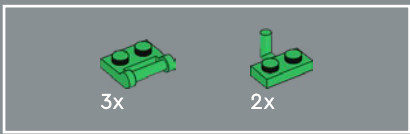

49



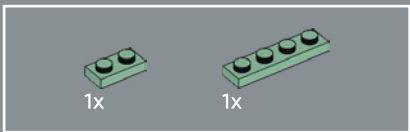

50



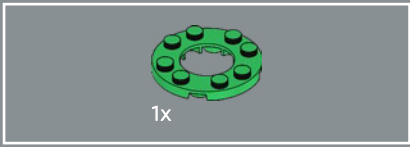

51



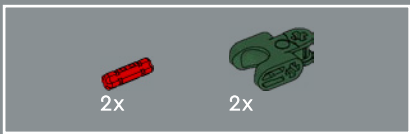

52

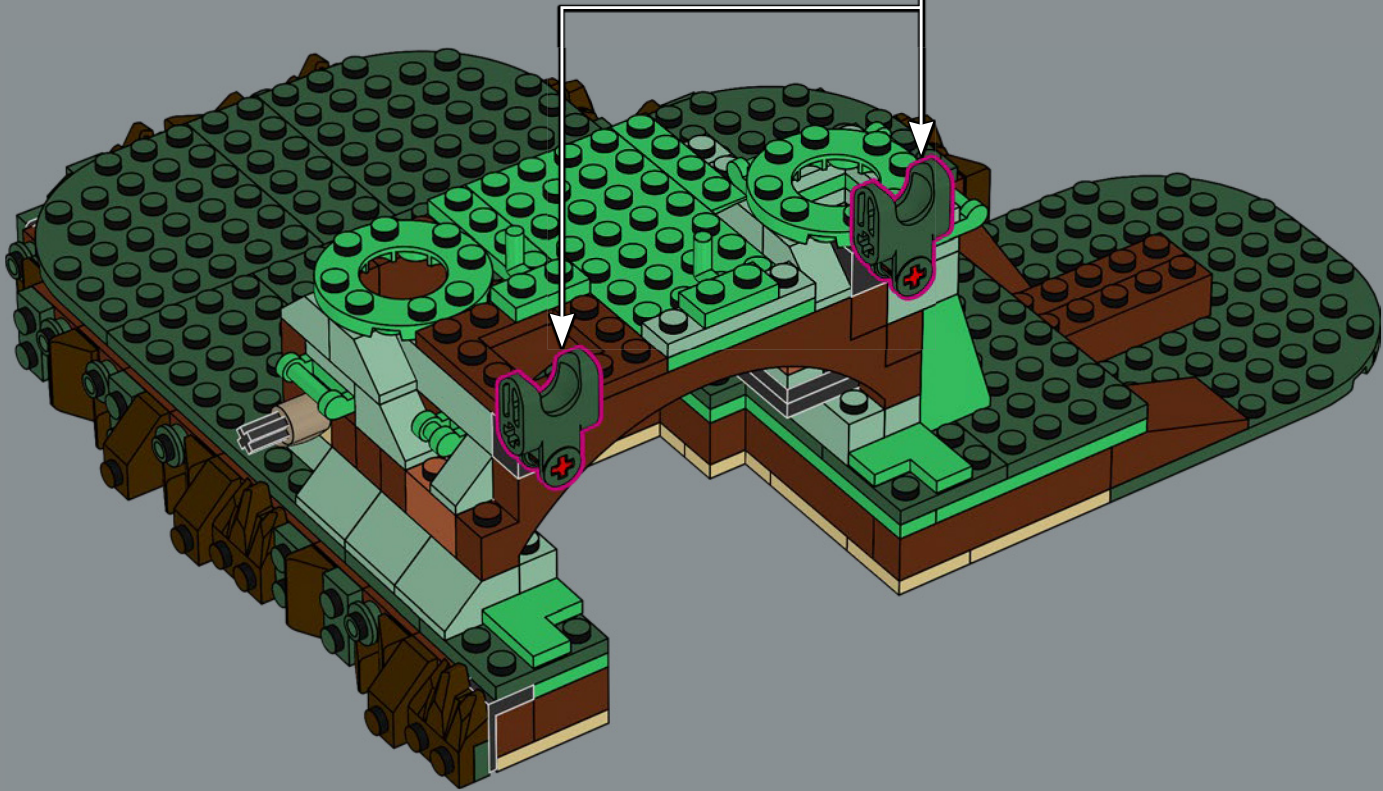
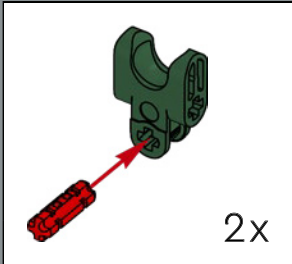

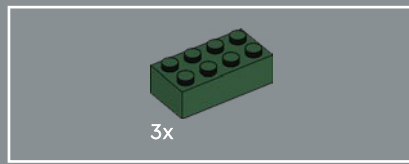

53

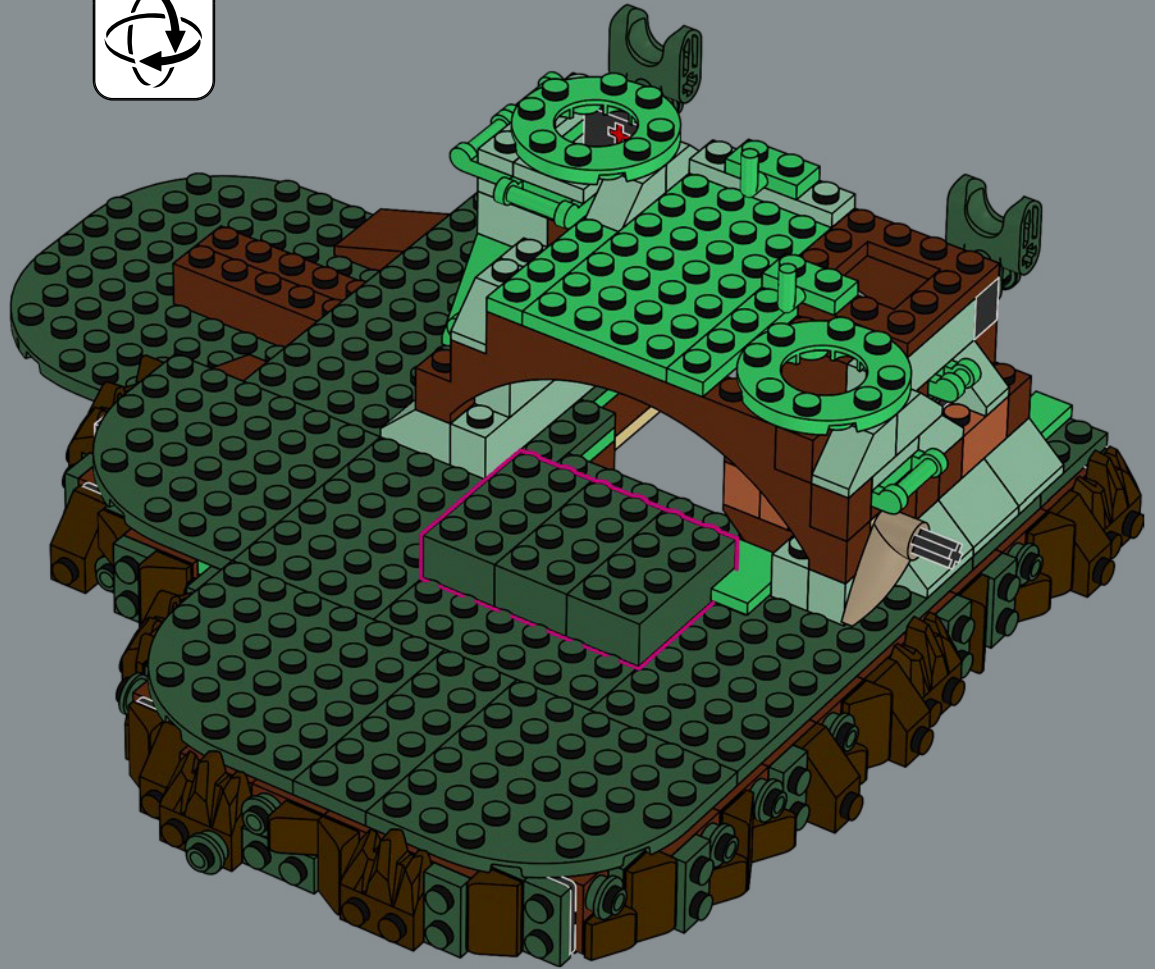

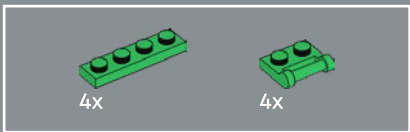

54





1x



5x

55

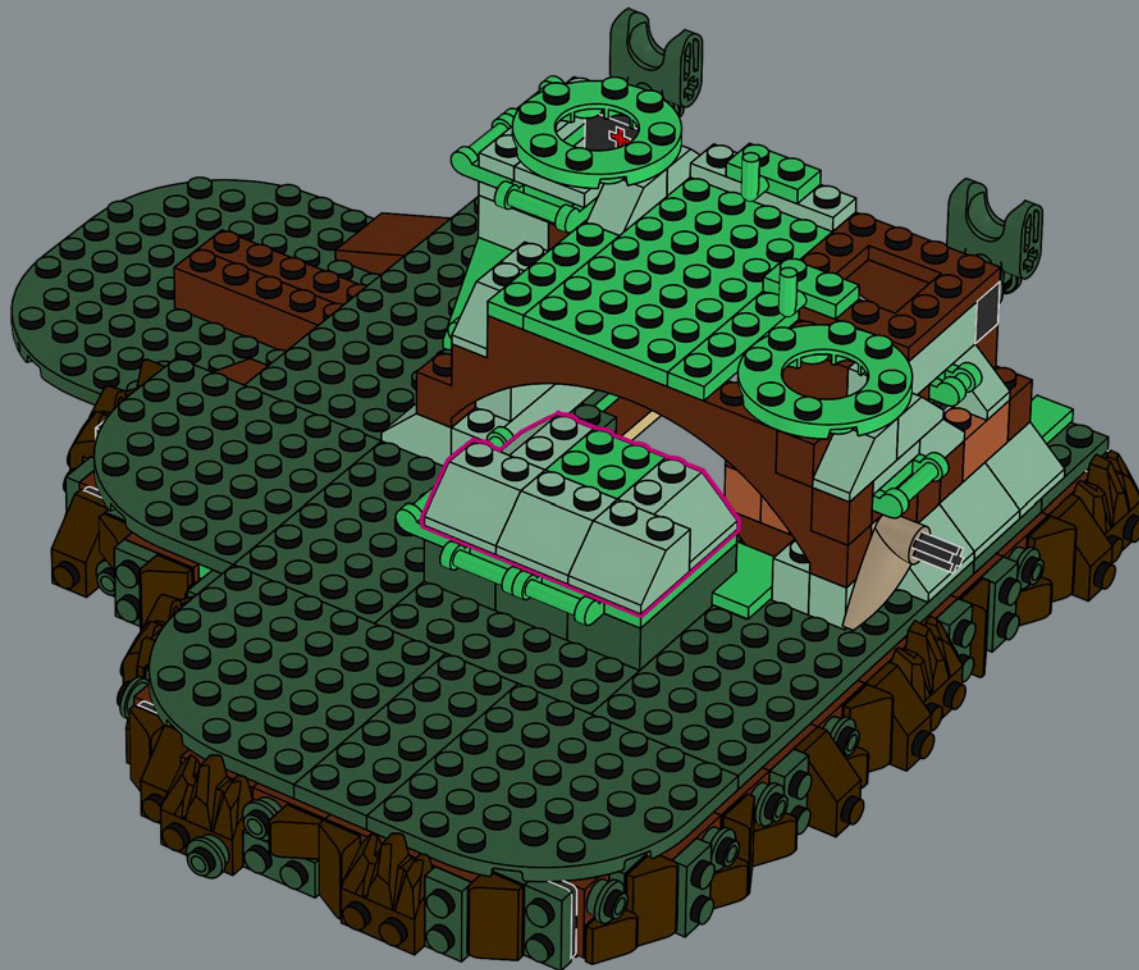

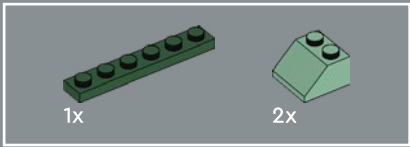

56

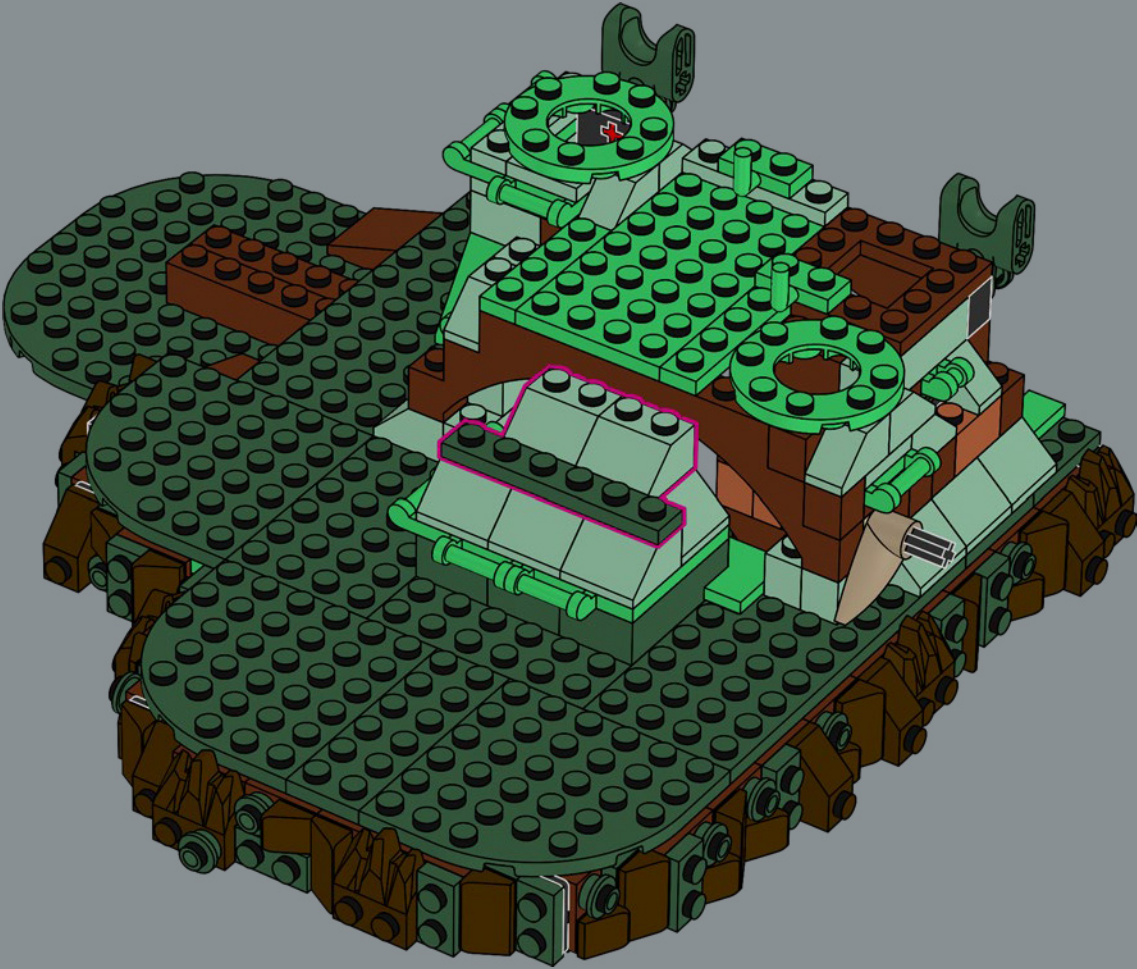

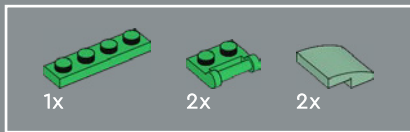

57

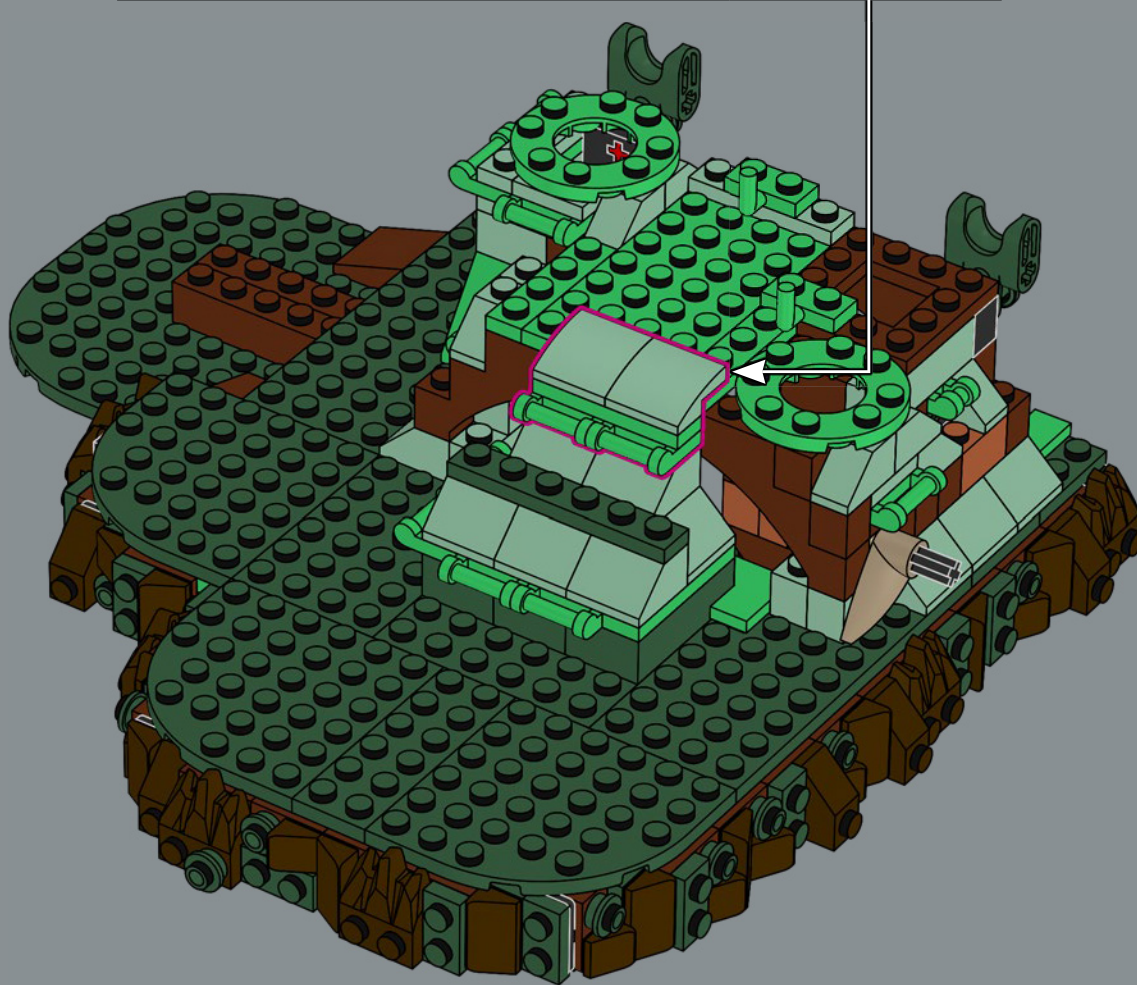
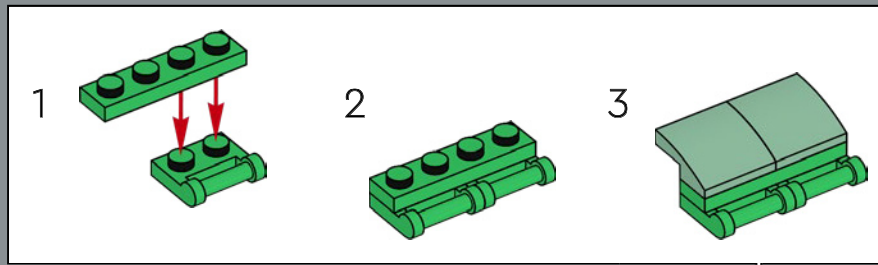



5x

58

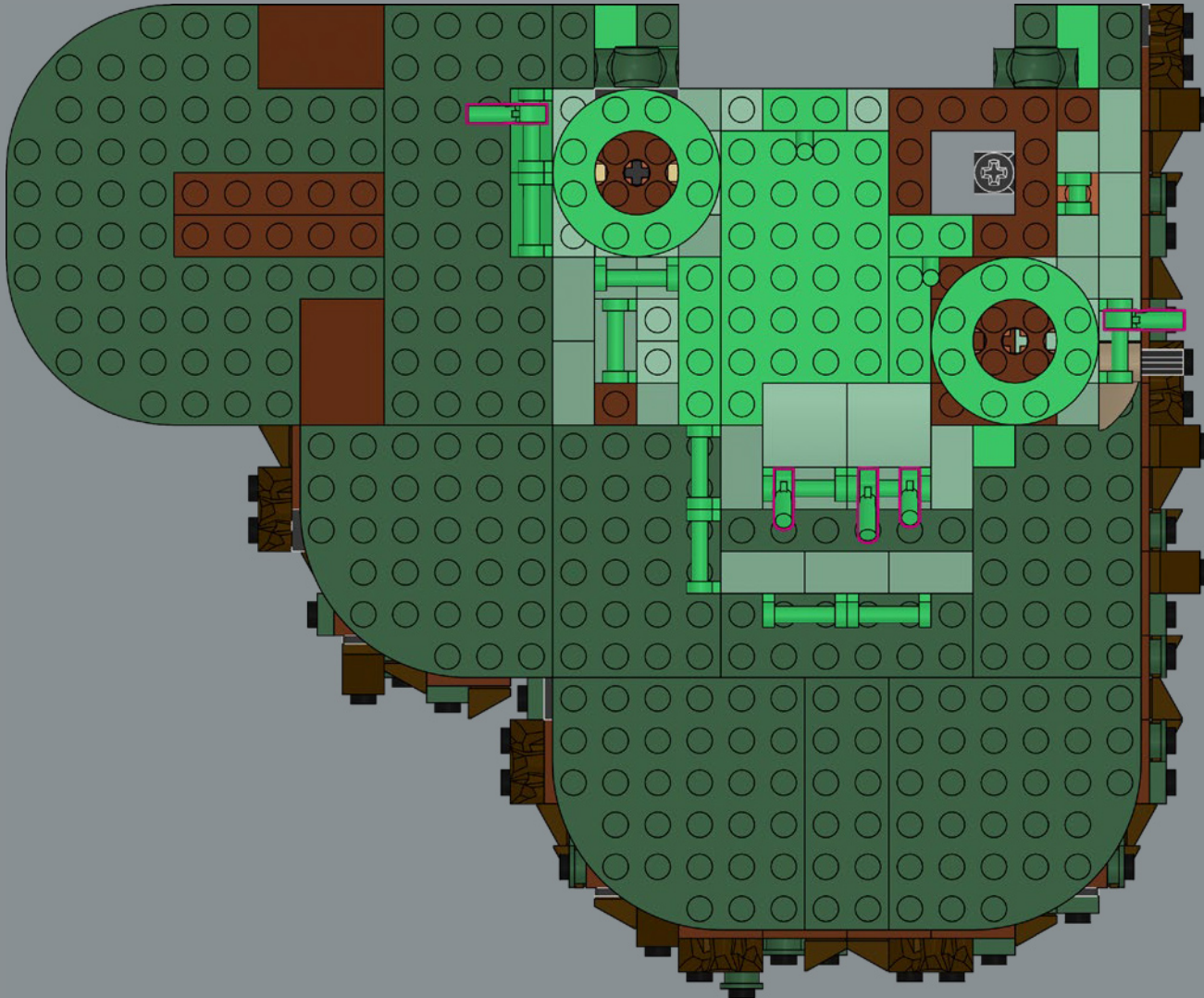



59

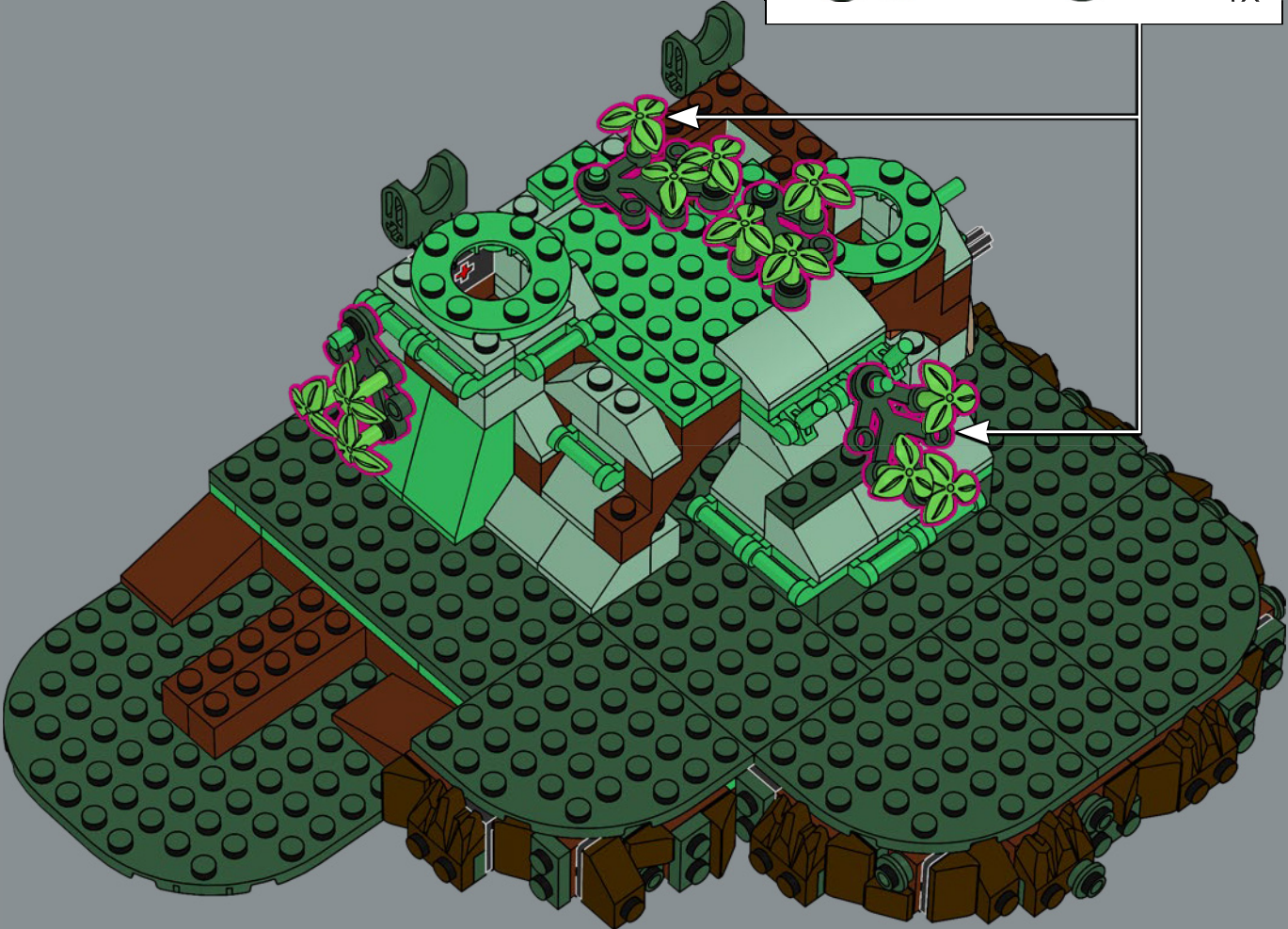
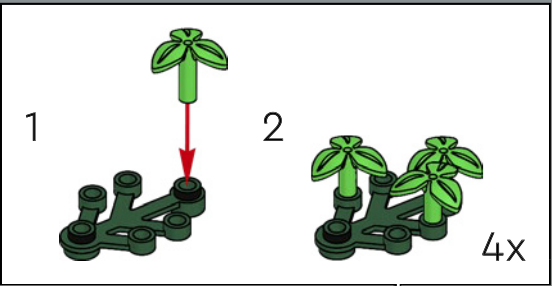



60

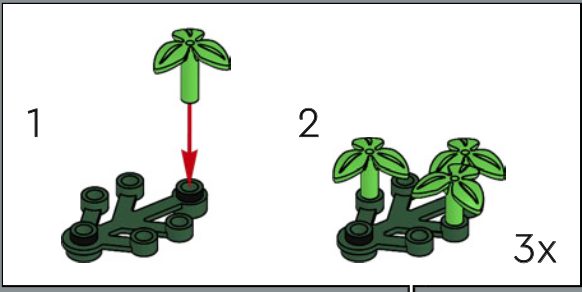



61

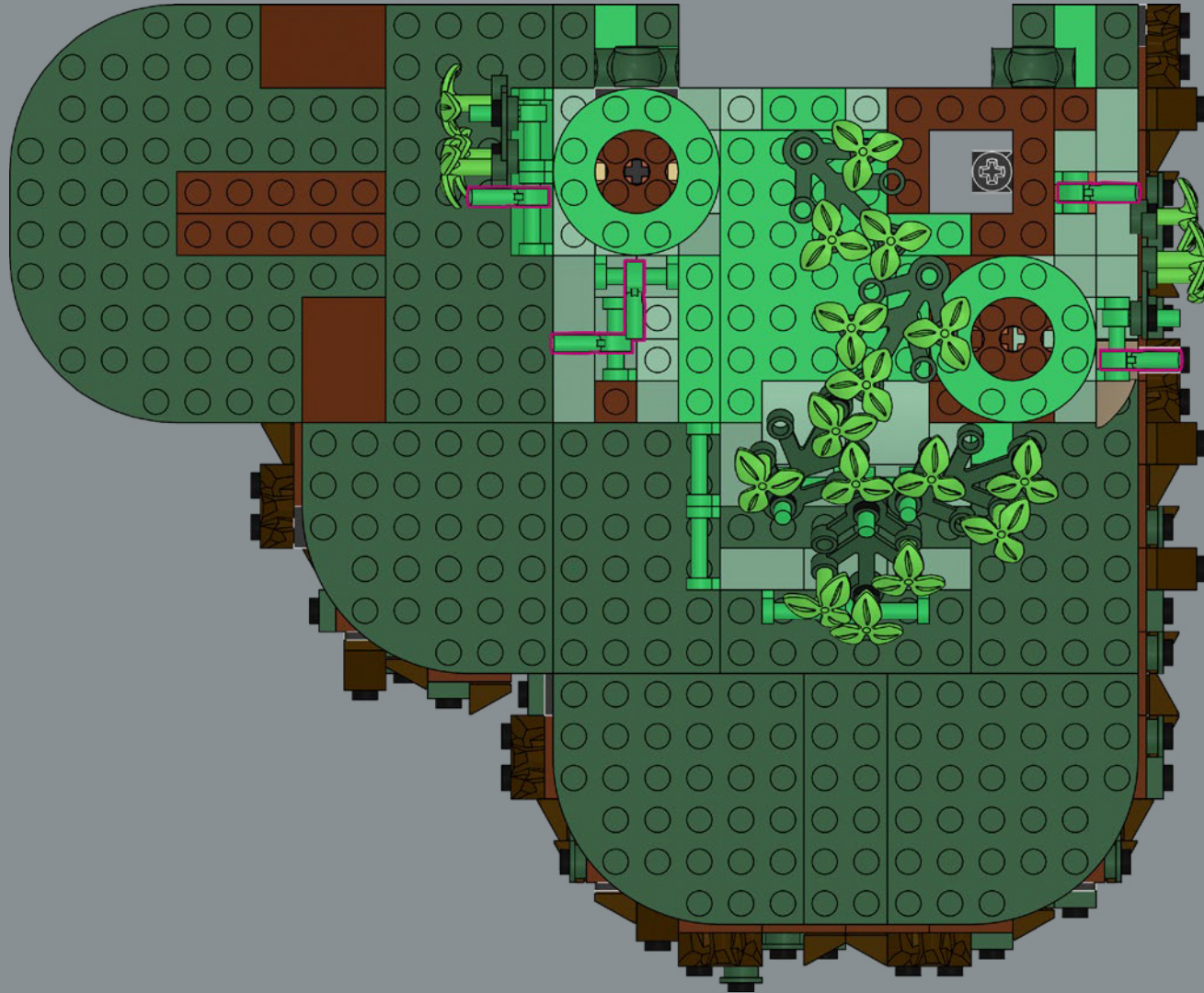



62

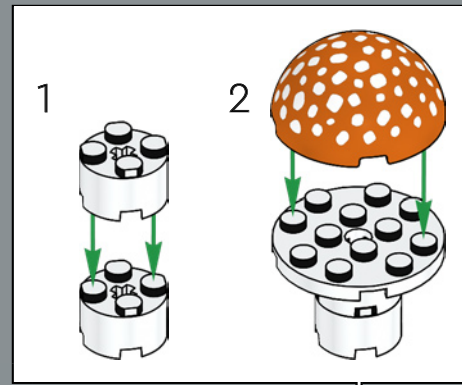

Une nouvelle décoration fait scintiller les chapeaux des amanites tue-mouches de touches de couleur éclatantes.



63



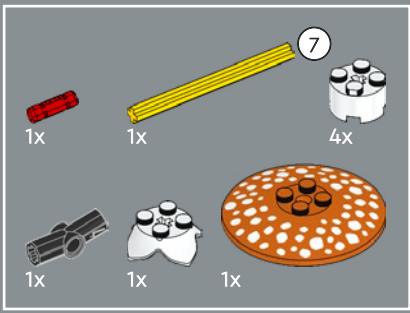

64

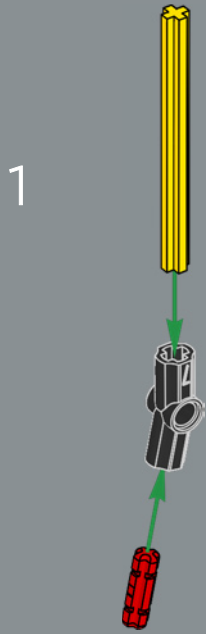

2



3

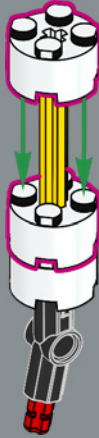

4



5





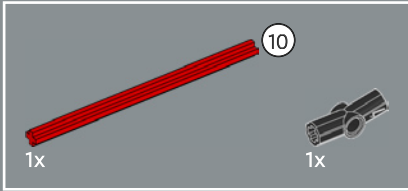
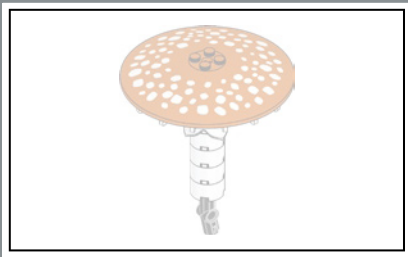

65

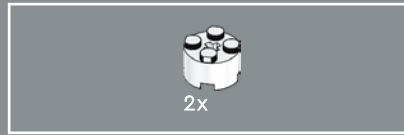

66

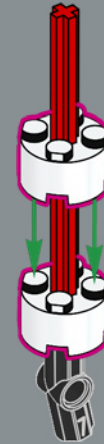

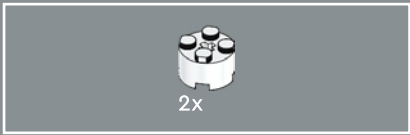

67

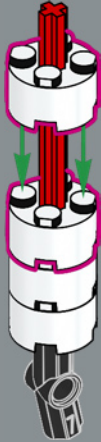

68

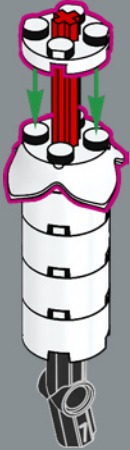

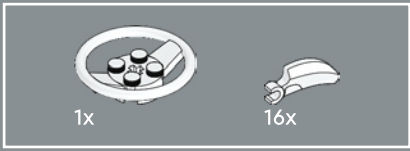

69

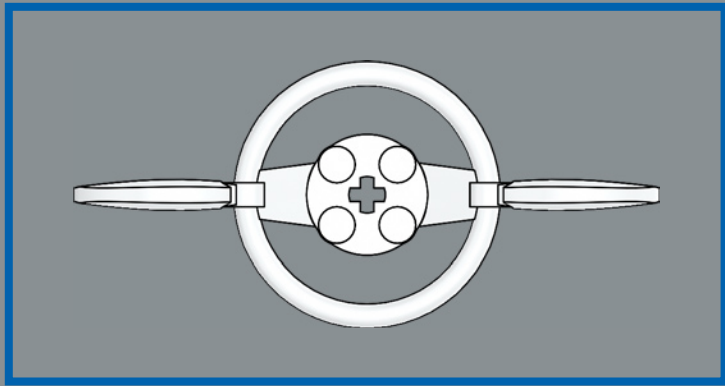

1

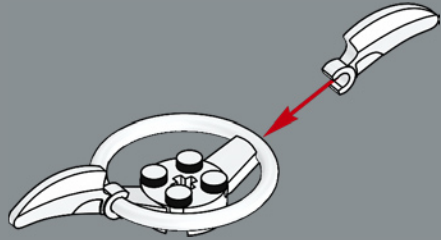

2

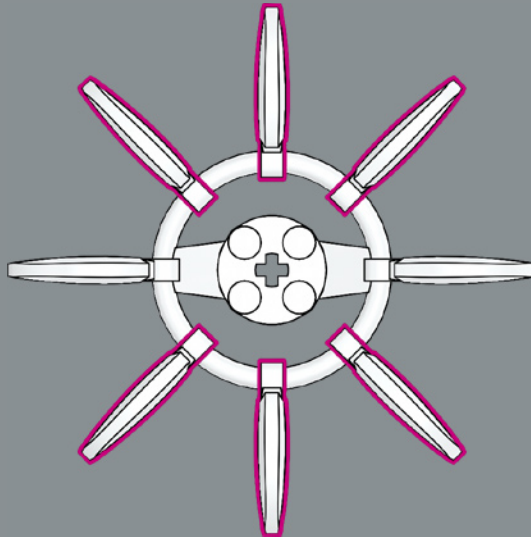

3

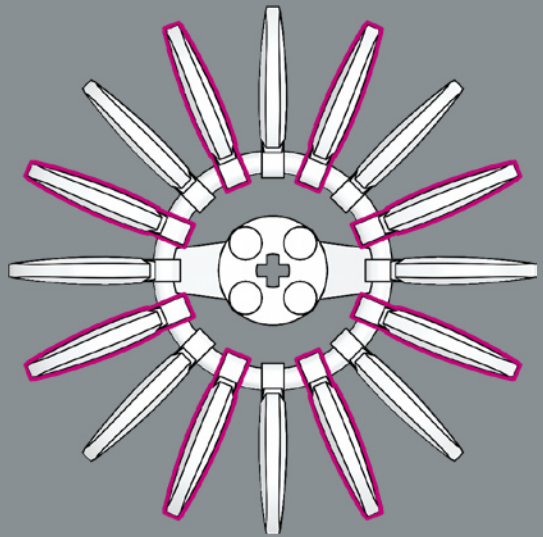

Les éléments en forme de griffes peuvent servir à bien d'autres choses que créer des animaux ou des créatures LEGO®. Ici, ils composent les lames sous les grandes amanites tue-mouches.

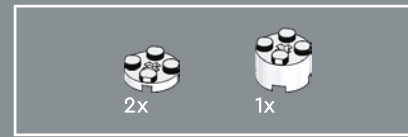
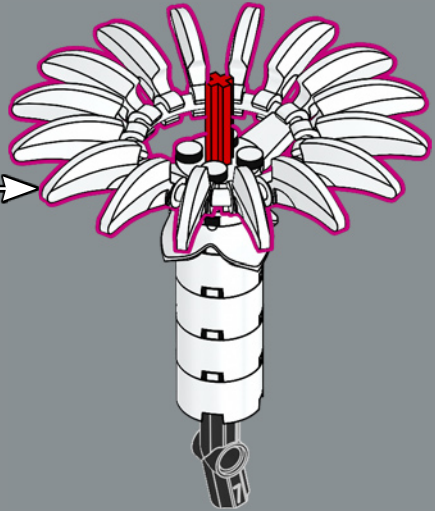

70

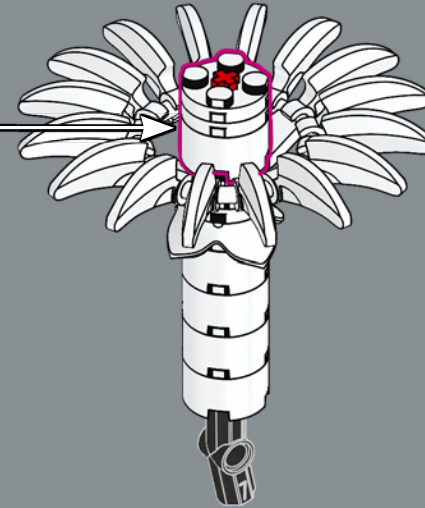
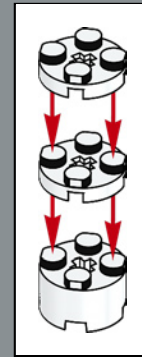

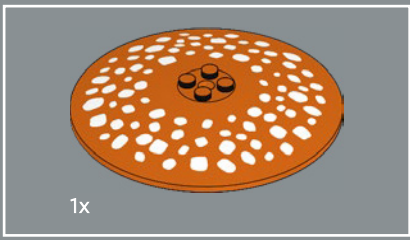

71



72





73



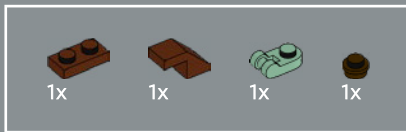

74

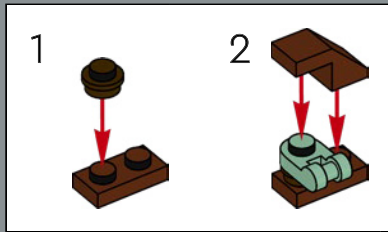



4x

75





76

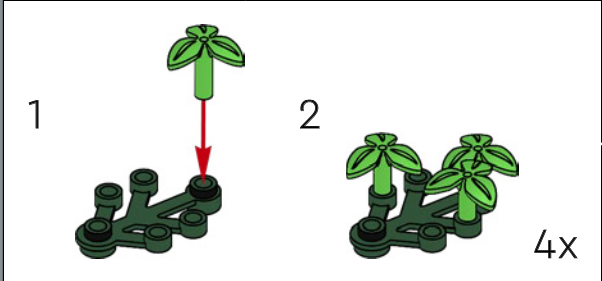



77



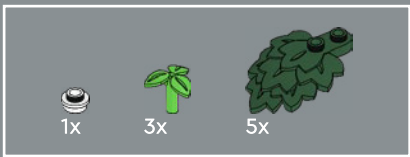

78



3x  2x 

79



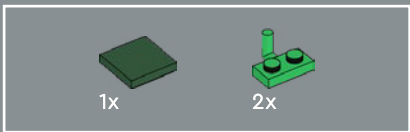

80

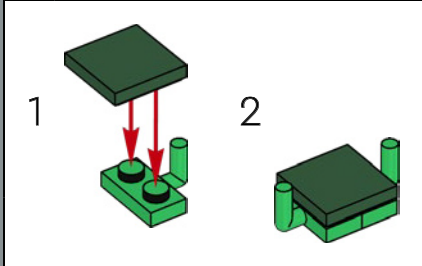

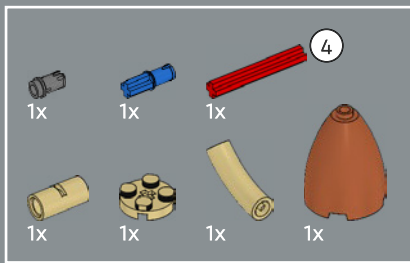

81

1



2

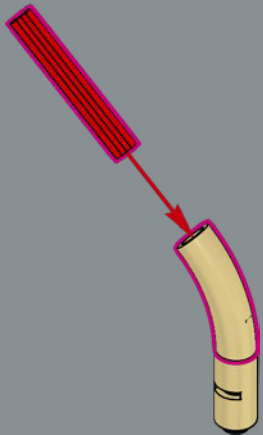

3

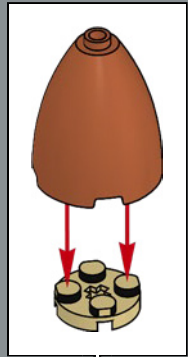

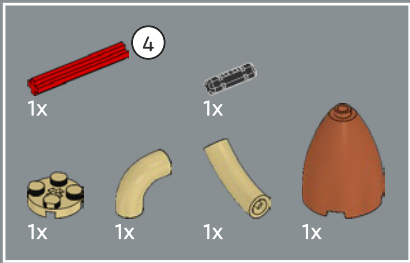

82

1

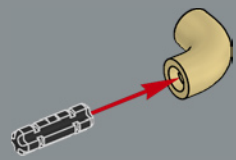

2

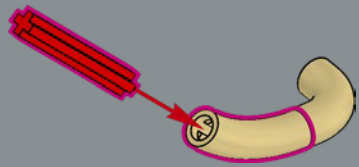

3

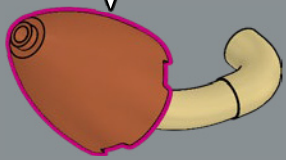
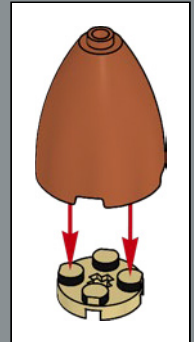

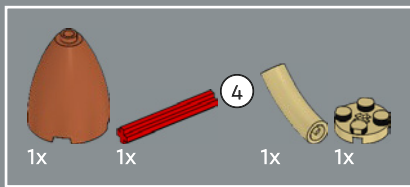

83

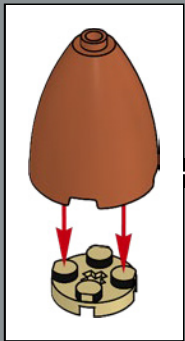
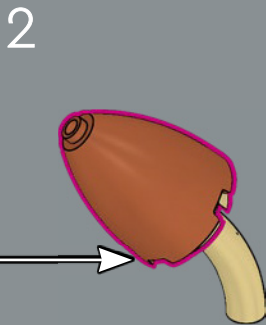
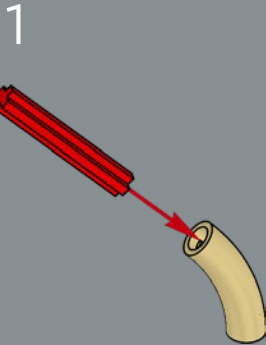

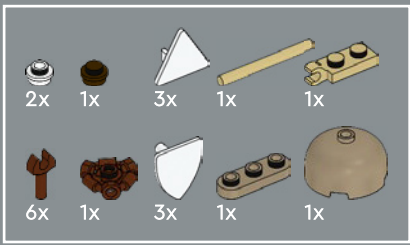

84

1

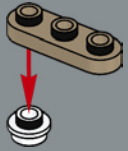

2

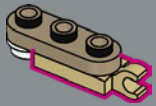

3

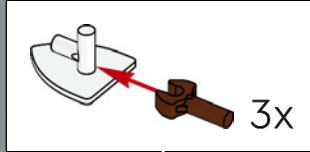
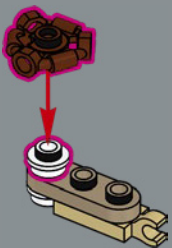

4

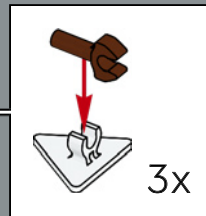
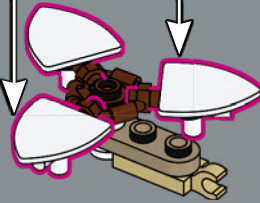

5

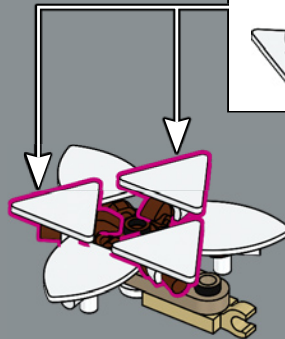

Pour recréer des formes fantaisistes, toutes sortes d'éléments LEGO® entrent en jeu. Pour obtenir la forme caractéristique du géastre, nous avons combiné des panneaux de signalisation triangulaires avec des boucliers de minifigures.

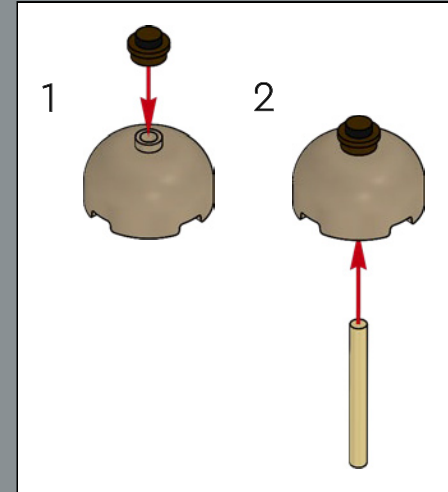

6

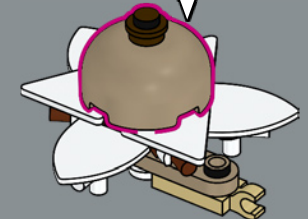





85

1

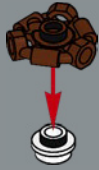

2

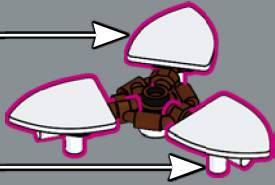
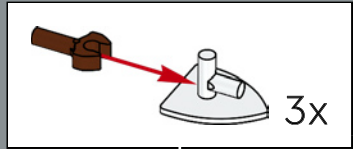

3

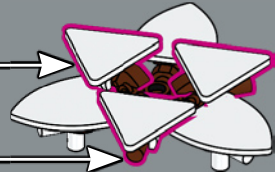
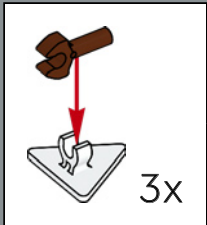



86

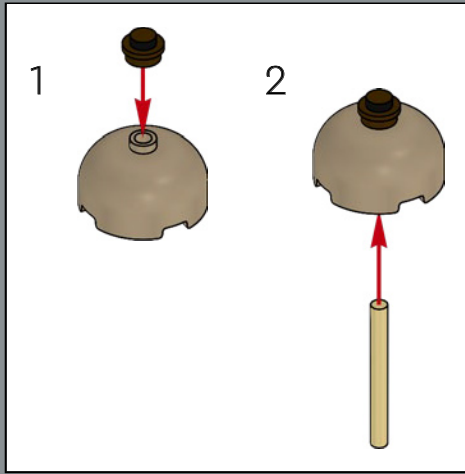

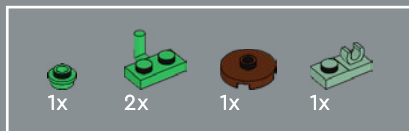

87



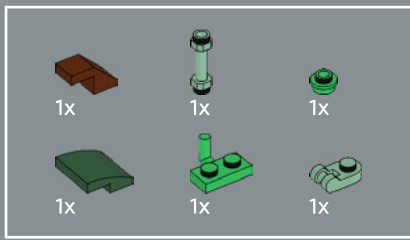

88

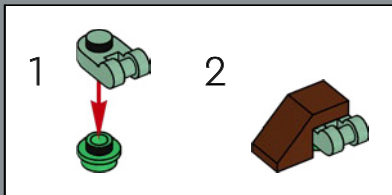
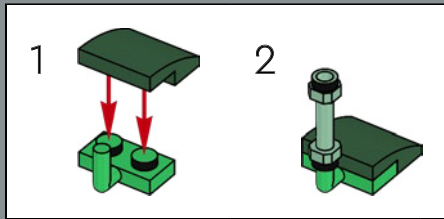

Les étamines des colchiques prennent un éclat presque royal grâce à ces couronnes de minifigurine LEGO®.

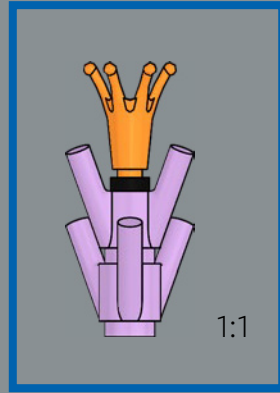
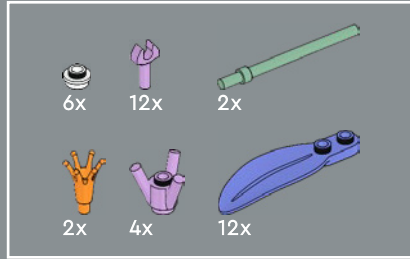
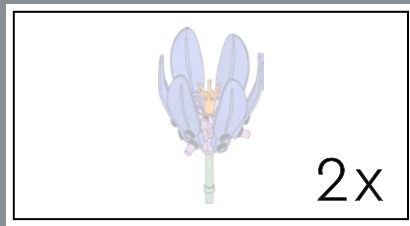

89

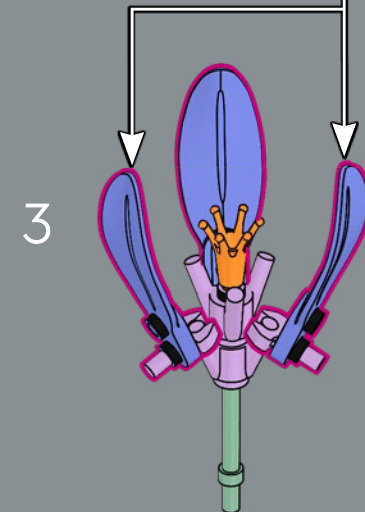
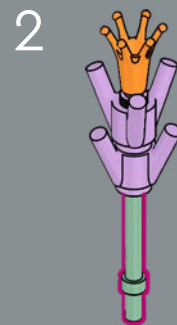
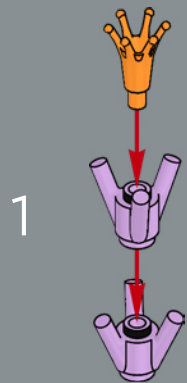
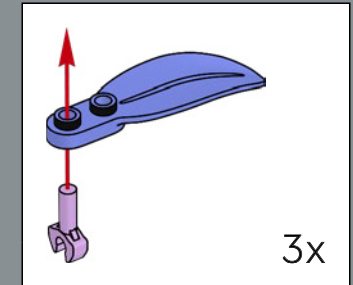

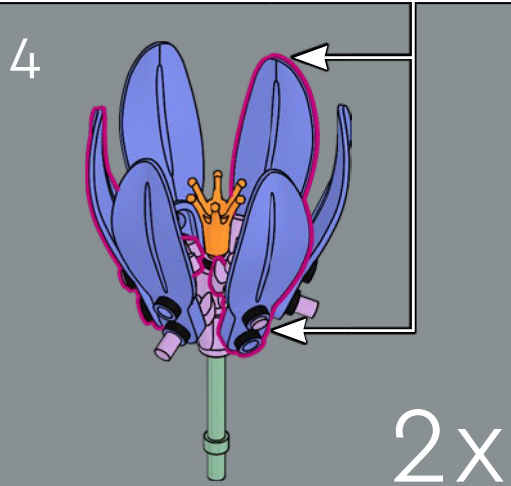
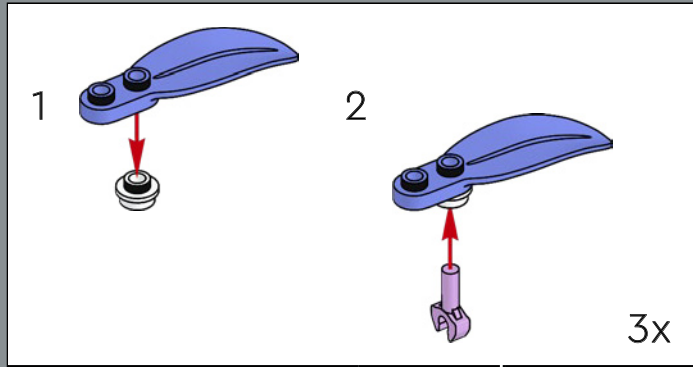

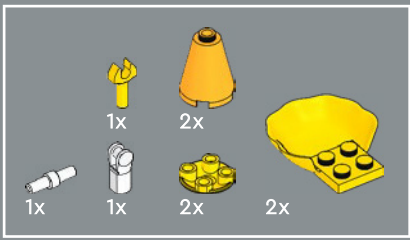

90

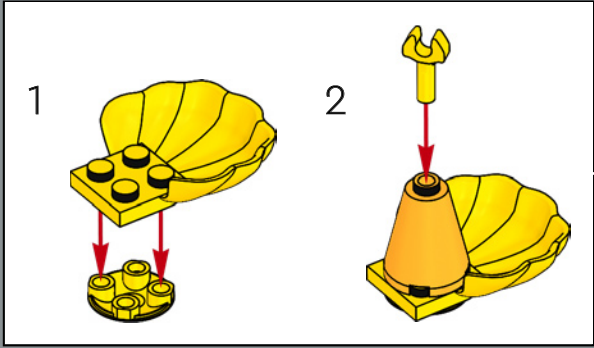
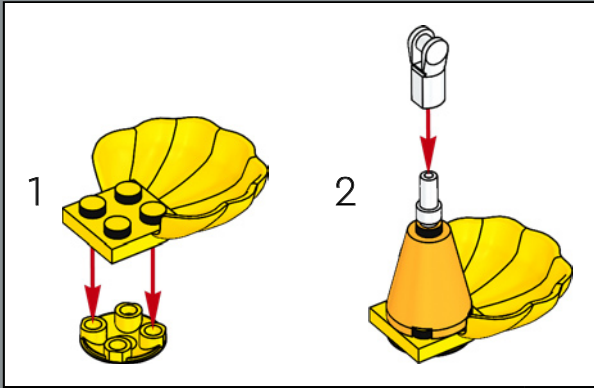

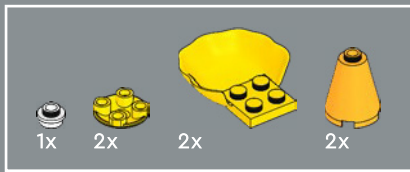

91

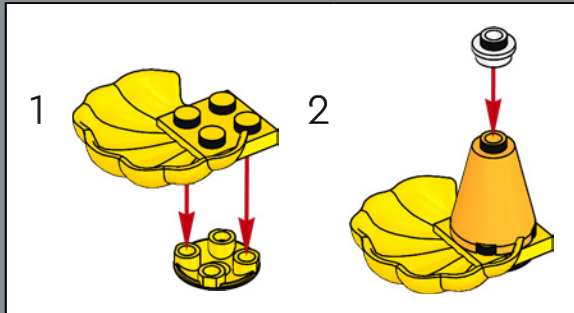
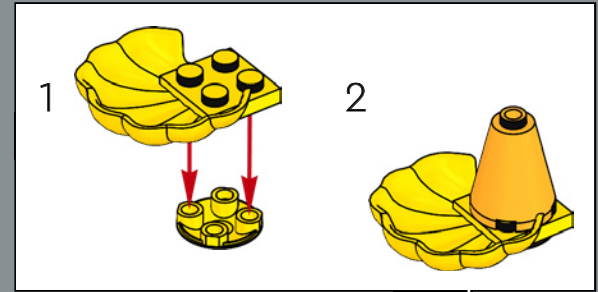

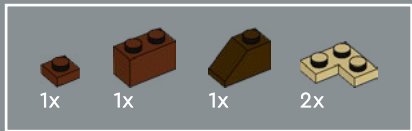

92





93





94



1x  2x 

95





96



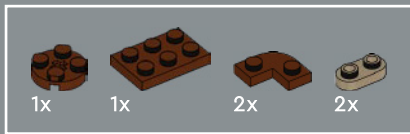

97



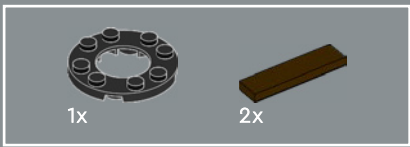

98



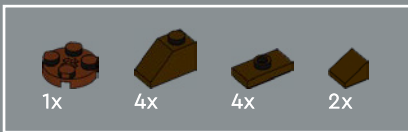

99

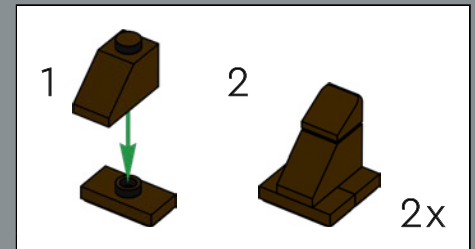



1x

100



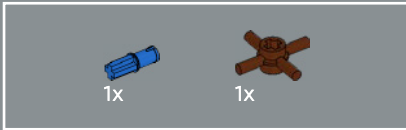

101

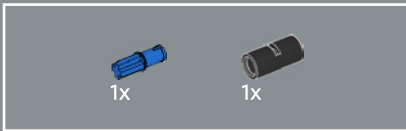
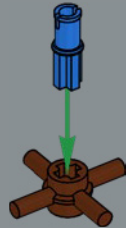

102

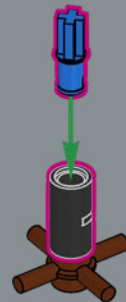

103

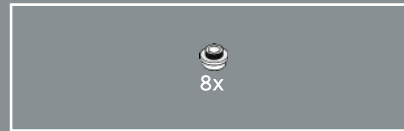

104

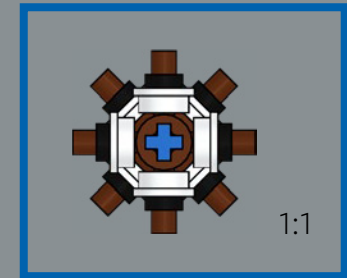



105

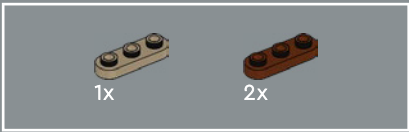
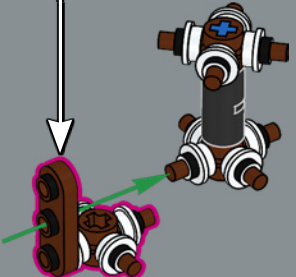
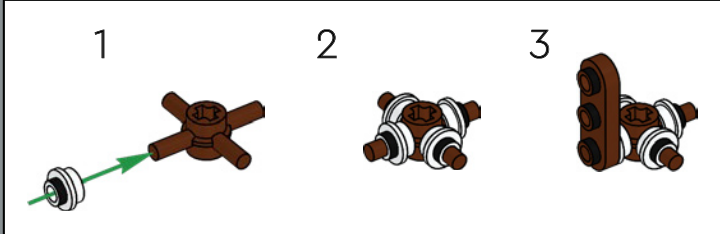

106

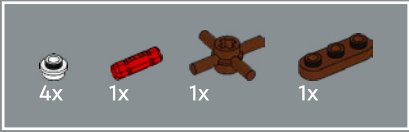
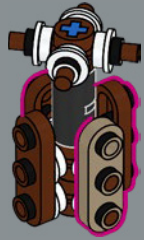

107

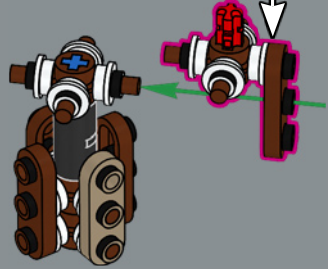
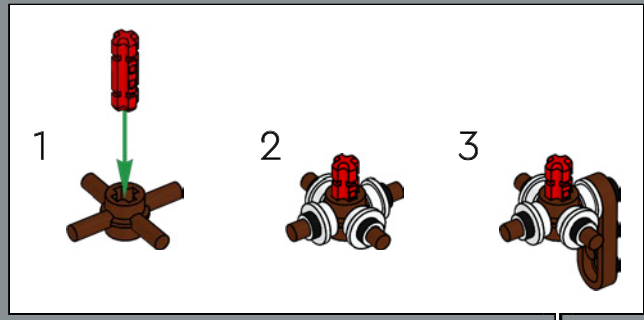



108

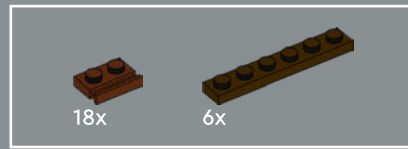

109

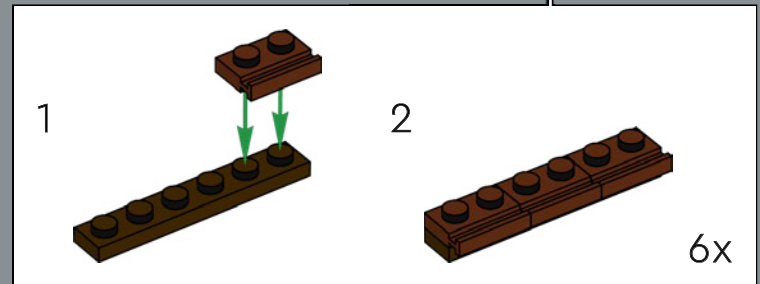
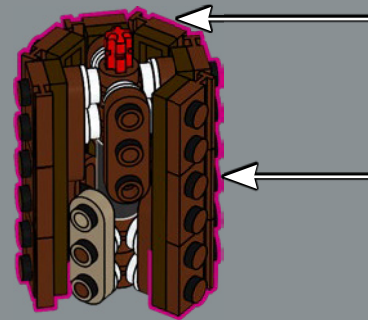
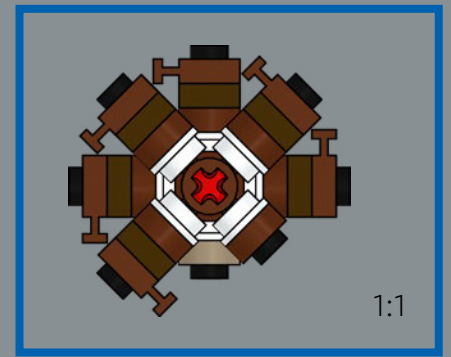

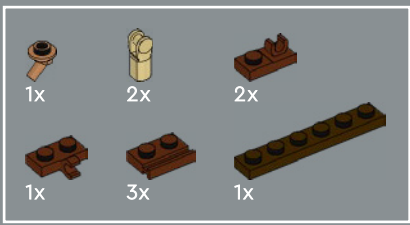

110

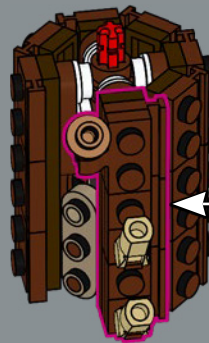
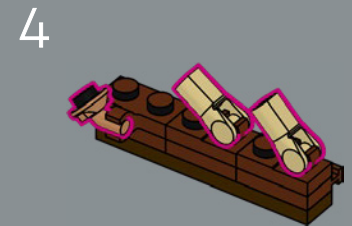
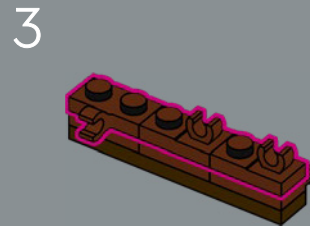
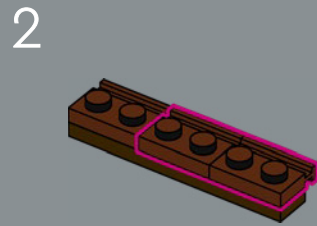
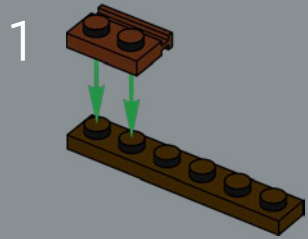

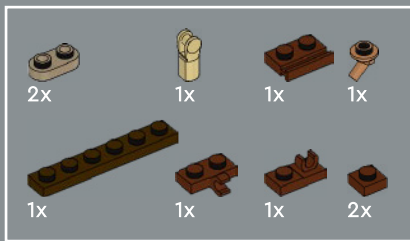

111

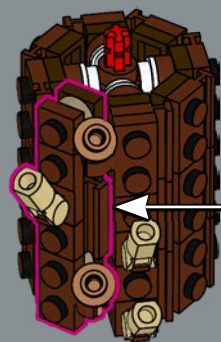
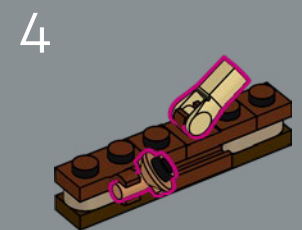
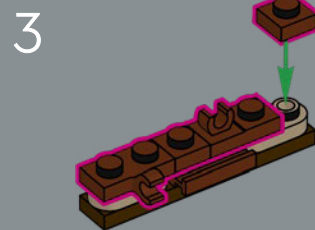
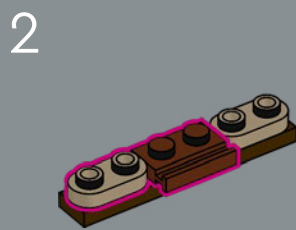
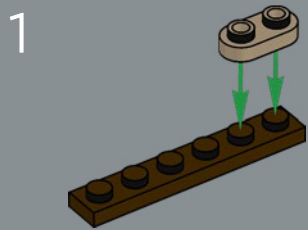

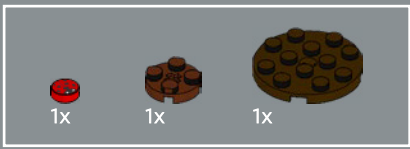

112

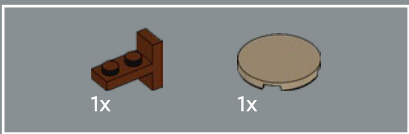
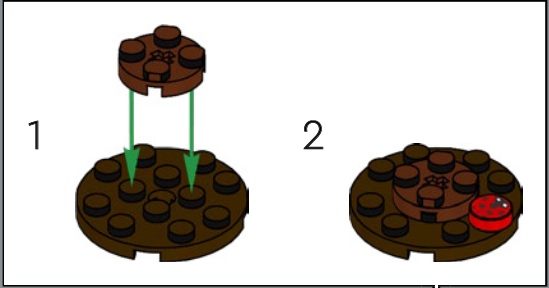

113

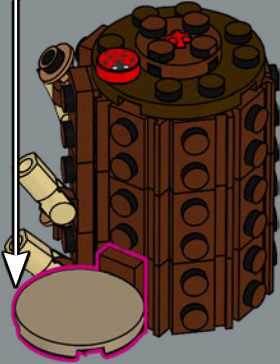
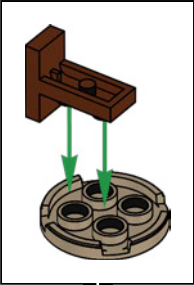



114

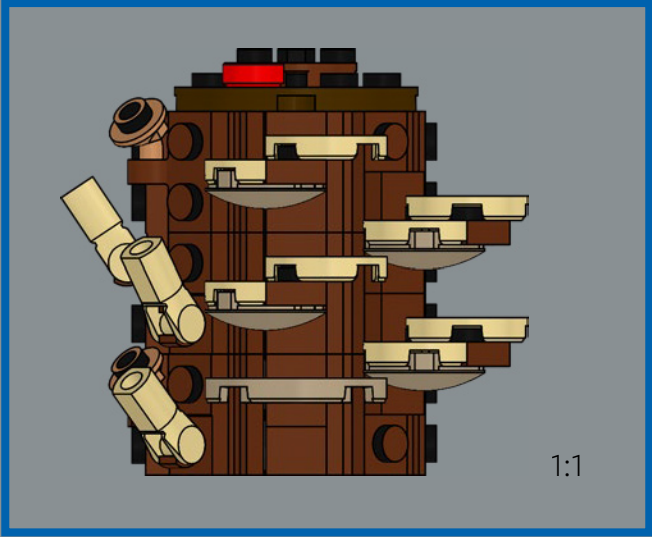
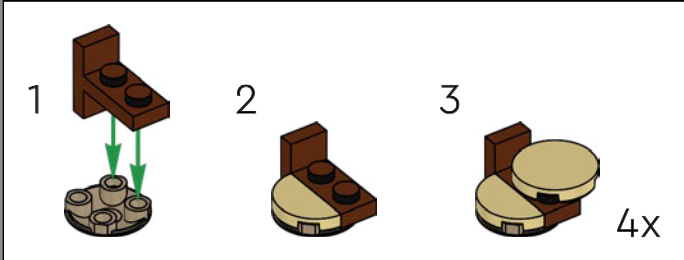



La mycène en casque, avec son chapeau délicat et son pied élancé, semble tout droit sortie d'un conte de fées – le dessus est réalisé avec des chapeaux de minifigurines de nains LEGO®.



116

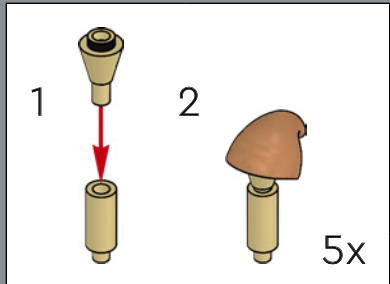

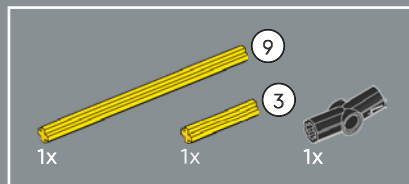
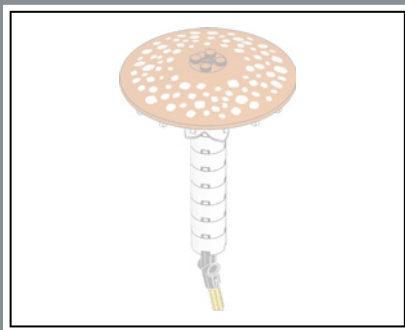

117

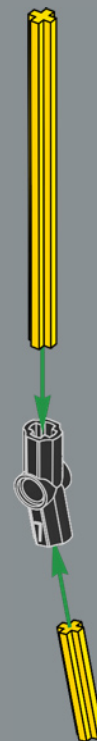

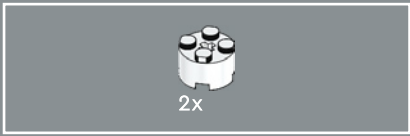

118

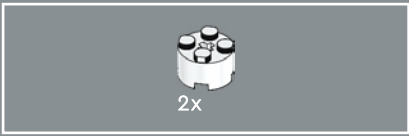
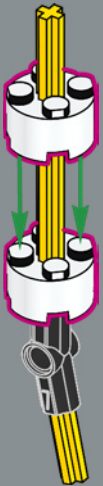

119

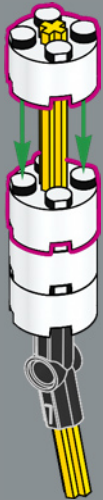



2x

120

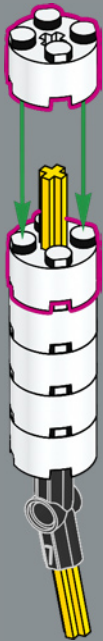

1x



1x



1x

121

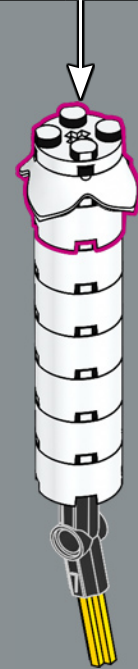
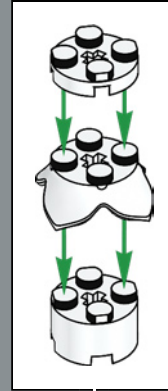

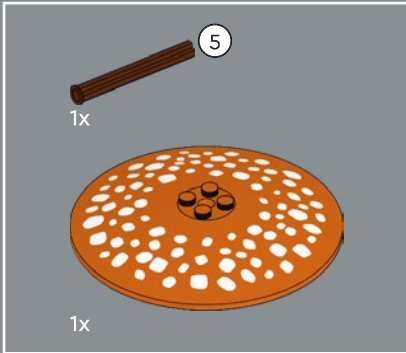
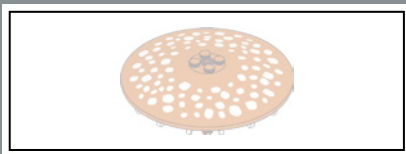

122

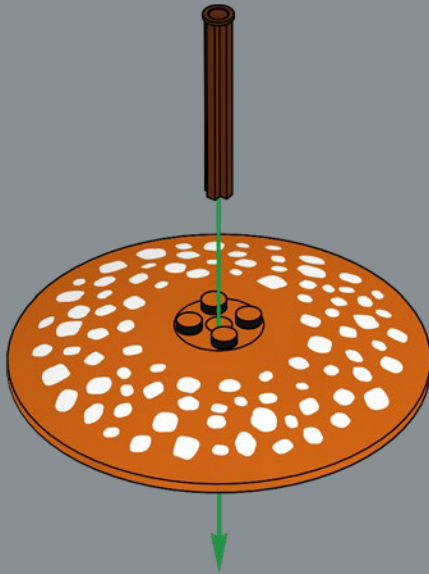

123

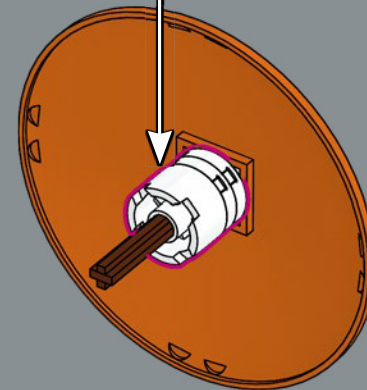
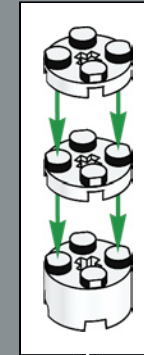

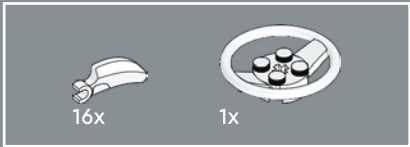
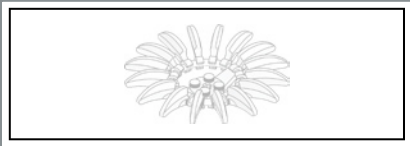

124

1

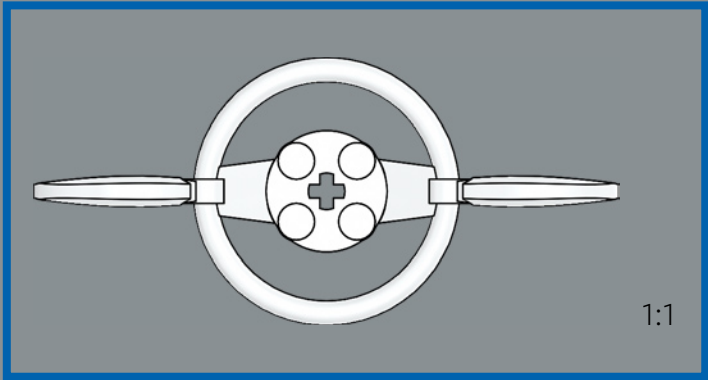
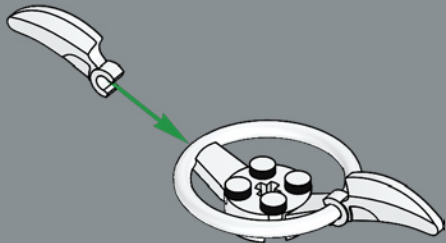

2

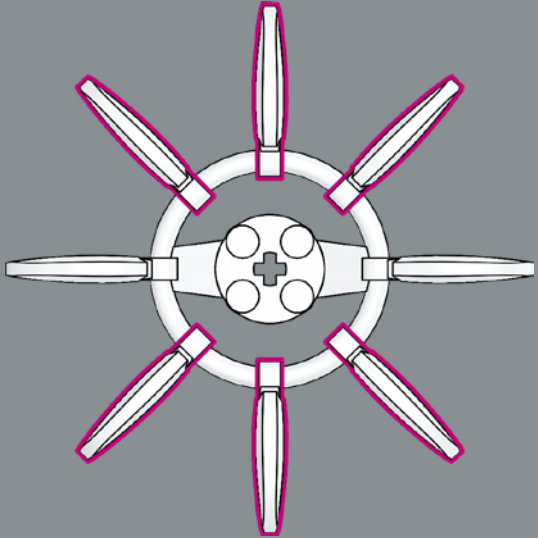

3

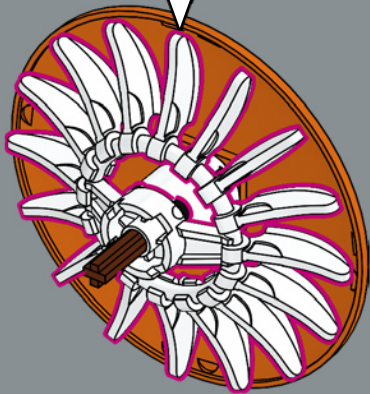
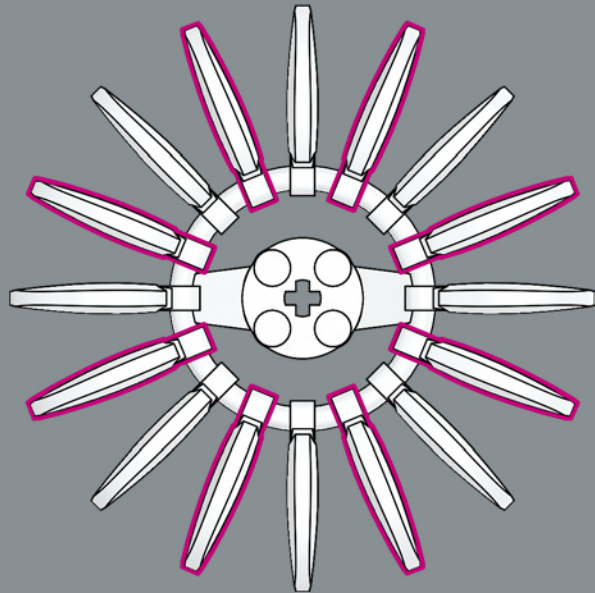

125

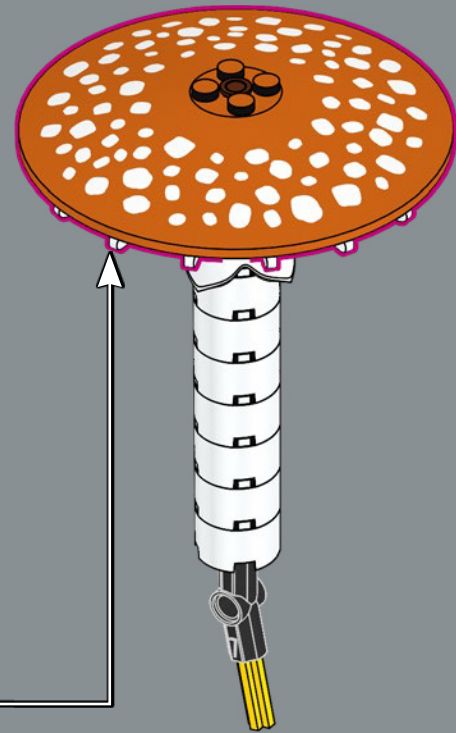



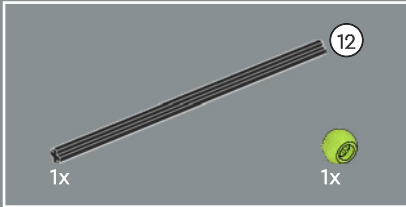
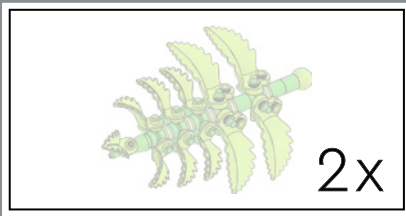

127

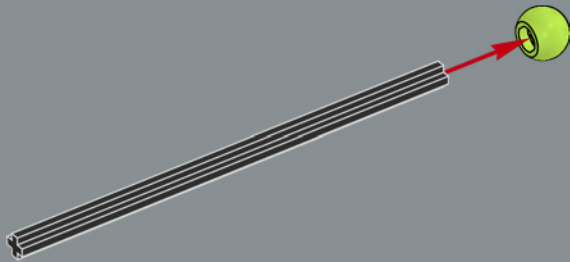

128

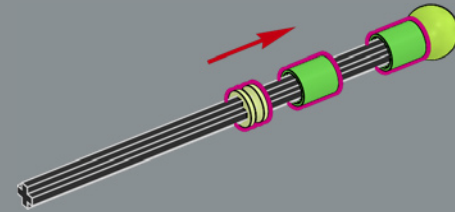

129

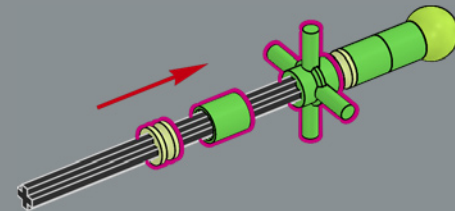



130

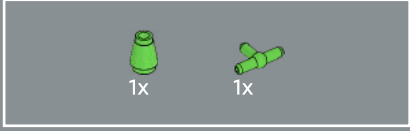
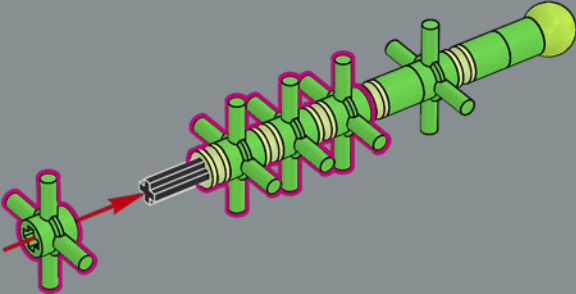

131

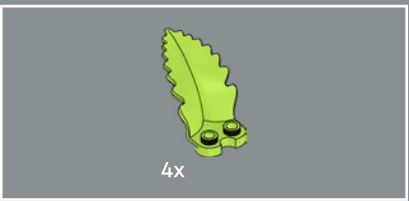
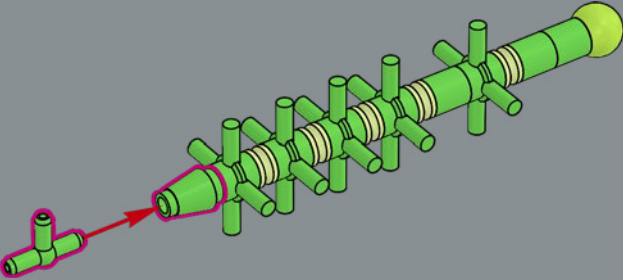

132

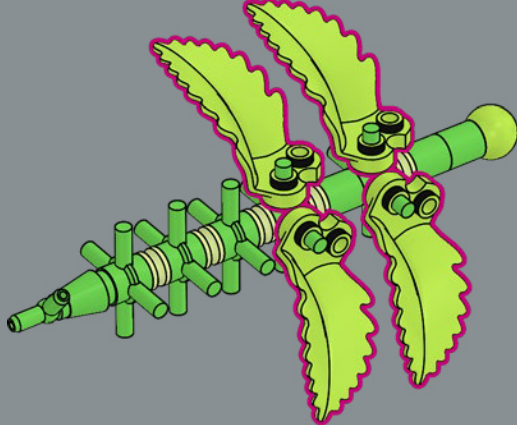

133

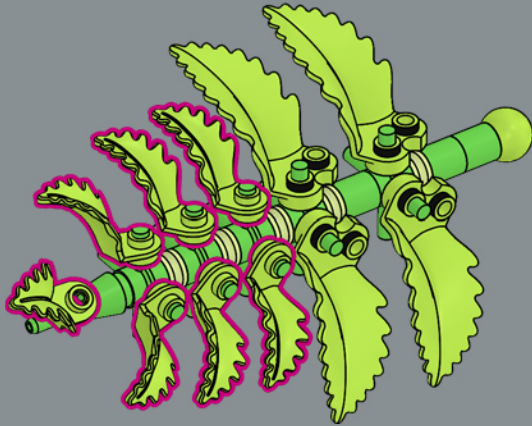

2x





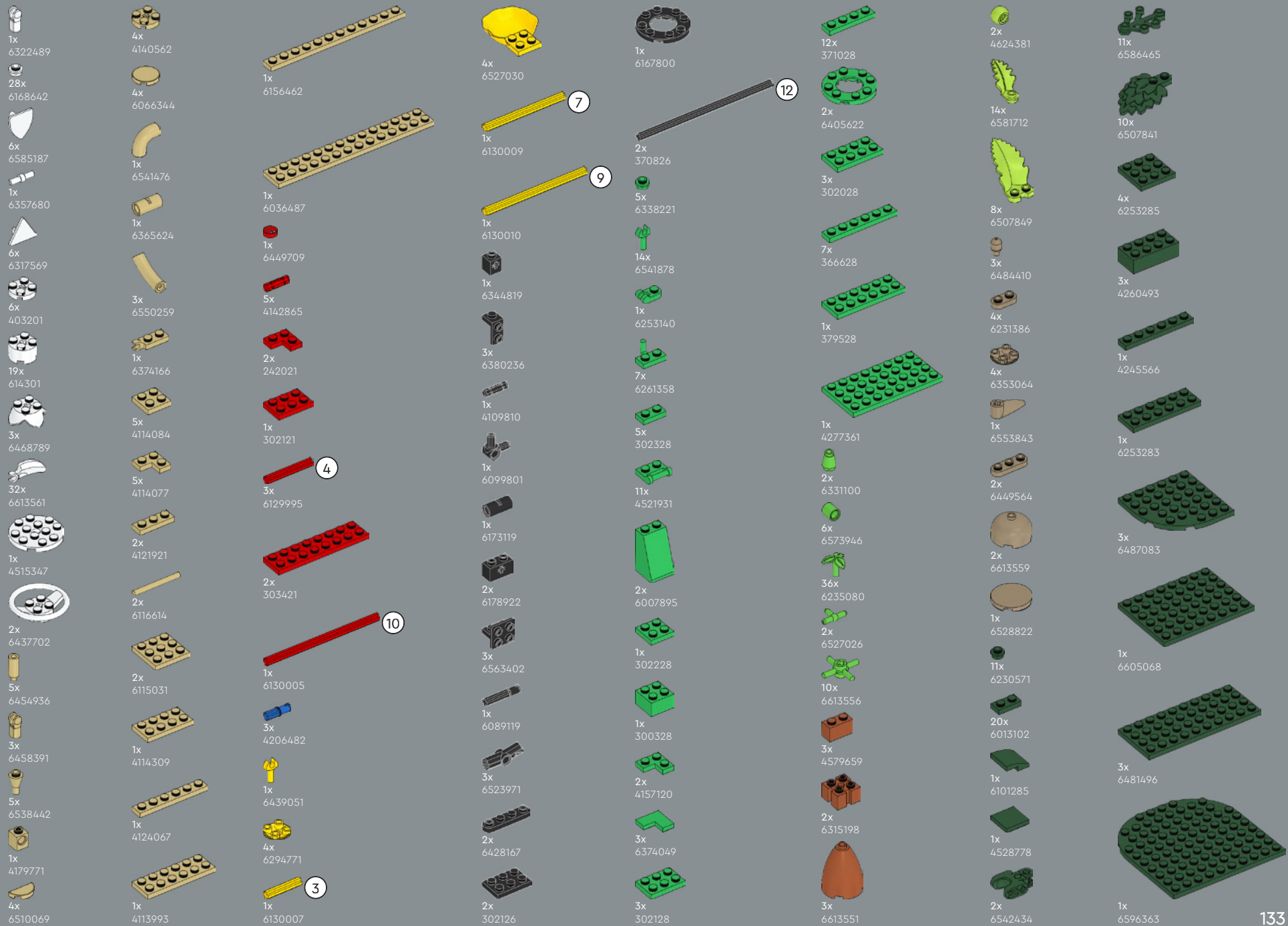



2x  
6527031

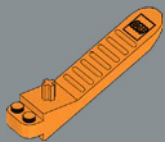

1x  
6240515



2x  
6510192



5x  
6613562



4x  
6613560



10x  
6553342



1x  
6474604



2x  
6278550



1x  
6360075



10x  
4655080



[LEGO.com/service](https://www.LEGO.com/service)



9x  
6083976



3x  
4616581



13x  
6083972



2x  
4521947



2x  
6080431



3x  
6100234



2x  
6474602



2x  
6577789

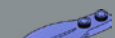

12x  
6614067



2x  
6551408



4x  
6559515



12x  
6439053



6x  
4211242



4x  
4221744



3x  
4211159



7x  
6102360



3x  
4211150



2x  
6313124



3x  
6608792



19x  
6117976



2x  
6226436



22x  
4645103



2x  
6273865



5x  
6502370



9x  
6551600



4x  
6316697



7x  
4211200



2x  
4211210



1x  
6425510



2x  
6492629



2x  
6248854



4x  
6526059



8x  
4211149



2x  
4216668



3x  
4211189



4x  
4211190



2x  
6574769



4x  
4211201



2x  
4225869



1x  
6159763



5x  
4211193



1x  
6070442



1x  
4216615



4x  
6469351



4x  
6246843



1x  
6395635



3x  
6315780



11x  
6259071



6x  
6568024



12x  
6127366



10x  
4518557



4x  
6404033



6x  
6353396



2x  
6179803



2x  
6313874



1x  
6005030



8x  
6223039



12x  
6439052



1x  
6623718



1x  
6623717



2x  
6623716



**YOU** COULD  
**WIN**



**YOU COULD  
WIN**

Your feedback will help shape the future development of this product series.

Visit:

**DU KÖNNTEST  
GEWINNEN**

Dein Feedback trägt zur Weiterentwicklung dieser Produktreihe bei.

Geh auf:

**VOUS POURRIEZ  
GAGNER**

Vos commentaires nous aideront à concevoir les futurs produits de cette gamme.

Visitez :

**POTRESTI  
VINCERE TU**

La tua opinione ci aiuterà a migliorare la creazione futura di questa linea di prodotti.

Visita:

**PUEDES  
GANAR**

Tu opinión contribuirá al futuro de esta serie de productos.

Visita:

**轻松获奖**

您的反馈将有助于我们在今后改进本产品系列。

请访问:

---

**[LEGO.com/productfeedback](https://LEGO.com/productfeedback)**

---

You also have the chance to win a LEGO® set.

Terms and conditions apply.\*

Außerdem hast du die Chance, ein LEGO® Set zu gewinnen.

Es gelten die Teilnahmebedingungen.\*

Vous pourriez également gagner un ensemble LEGO®.

Des conditions s'appliquent.\*

Hai anche la possibilità di vincere un set LEGO®.

Termini e condizioni sono applicabili.\*

También tienes la oportunidad de ganar un set LEGO®.

Aplican términos y condiciones.\*

您还有机会赢取乐高®套装。

条款和条件适用。\*

\*[LEGO.com/productfeedback-terms](https://LEGO.com/productfeedback-terms)

LEGO and the LEGO logo are trademarks of the LEGO Group.  
©2026 The LEGO Group.

