



11505





LEGO.com/sustainable-packaging



FR  
**DONNEZ**  
OU  
**RECYCLEZ**



OU



OU



ASSOCIATION    MAGASIN    DÉCHÈTERIE

Adresses sur [quefairedemesdechets.fr](http://quefairedemesdechets.fr)



# BUILDER



Apple and the Apple logo are trademarks of Apple Inc., registered in the U.S. and other countries and regions. App Store is a service mark of Apple Inc. Google Play and the Google Play logo are trademarks of Google LLC. Tencent and the Tencent logo are trademarks of Tencent Inc.

[LEGO.com/devicecheck](https://LEGO.com/devicecheck)



LEGO® Builder



# UNA EXISTENCIA SENCILLA Y SALVAJE

Si exploras la naturaleza con una mentalidad curiosa, es inevitable que acabes percibiendo una sensación de dualidad durante el cambio de estaciones. La vida en declive coexiste en perfecta armonía con la que renace. Este ecosistema construido con LEGO® captura un mágico fragmento de suelo de la linde de un bosque del norte de Europa cuando tiene lugar la transición del verano al otoño. Imagina una fructífera excursión de recolección que te permita explorar una amplia variedad de hongos y azafranes silvestres. Aunque una concentración tan densa de especies podría ser improbable en la naturaleza, queríamos dar forma a una escena visualmente cautivadora y, al menos en teoría, plausible. Cada elemento está diseñado con todo cuidado para equilibrar el realismo con un encanto caprichoso.

El equipo de diseño de LEGO® Botanicals





*Colchicum autumnale*

## AZAFRÁN SILVESTRE

A diferencia de su primo primaveral, este azafrán silvestre rosa y morado pertenece a la familia de las colquicáceas y florece en otoño. Elegante y grácil, aunque también tóxico, crece en praderas y bosques de Europa y Asia.



*Pteridium aquilinum*

## HELECHO COMÚN

Una de las especies vegetales más comunes del mundo, crece tanto al sol como a la sombra y tanto en praderas como en áreas concurridas. Con frondes que se extienden hasta 1 m, es una planta muy popular para decorar jardines.



*Mycena galericulata*

## MICENA EN FORMA DE SACO

Esta delicada seta acampanada se encuentra en zonas húmedas y bosques mixtos, donde forma pequeños grupos sobre troncos caídos y tocones. Conocida por su belleza encantadora, ha inspirado a artistas durante siglos.



*Pleurotus ostreatus*

## SETA DE OSTRA

Estas populares setas con sombrero semejante a una concha, láminas decurrentes y pie corto (o carentes de pie) crecen sobre la madera en descomposición en bosques o incluso en zonas urbanas. Acostumbran a ser blancas o grises y pueden alcanzar una anchura de hasta 25 cm.



*Cantharellus cibarius*

## REBOZUELO

Los rebozuelos exhiben unas trompetas doradas con pliegues gruesos y ramificados en lugar de láminas. Con justificada fama de esquivos, los recolectores los consideran un manjar exquisito y suelen proteger celosamente sus ubicaciones.



*Amanita muscaria*

## SETA MATAMOSCAS

Con su brillante sombrero bermellón salpicado de puntos blancos, la matamoscas aporta una vibrante pincelada de color a los inviernos europeos y se encuentra normalmente bajo abedules, pinos y píceas. Si la ves en la naturaleza, ¡manéjala con cuidado!



*Inocybe hirtella*

## SETAS DE SOMBRERO FIBROSO

A pesar de que su sombrero fibroso despiden un irresistible aroma parecido al de las almendras, ¡es mejor admirar esta seta desde una distancia segura! Podrás encontrarla en zonas cubiertas de hierba, donde proporciona azúcares y nutrientes a los árboles circundantes.



*Geastrum triplex*

## ESTRELLA DE TIERRA

Busca esta espectacular seta en bosques y praderas. Desde un cuerpo redondo lleno de esporas, ¡extiende sus brazos formando una estrella para liberarlas en lo que podría considerarse un auténtico espectáculo de pirotecnia en miniatura!



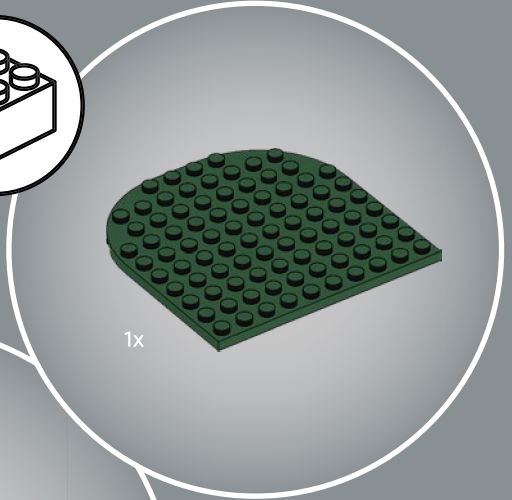
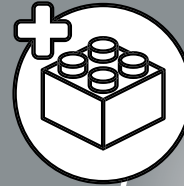
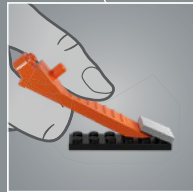
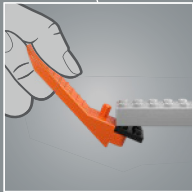
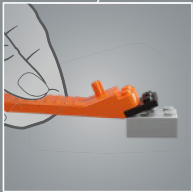
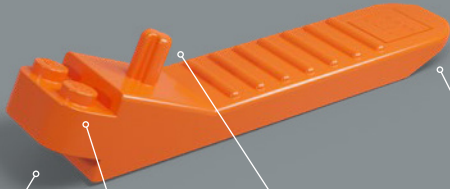

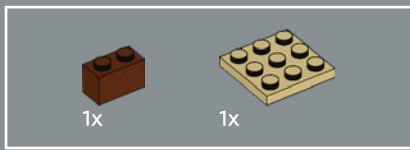

1

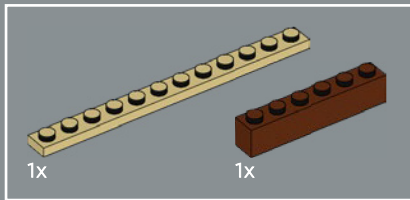
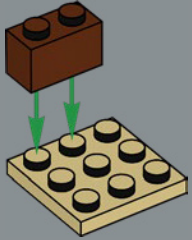

2

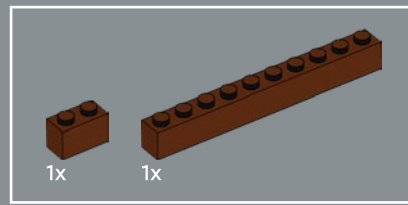
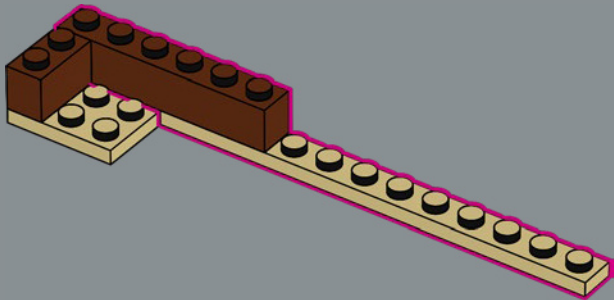

3

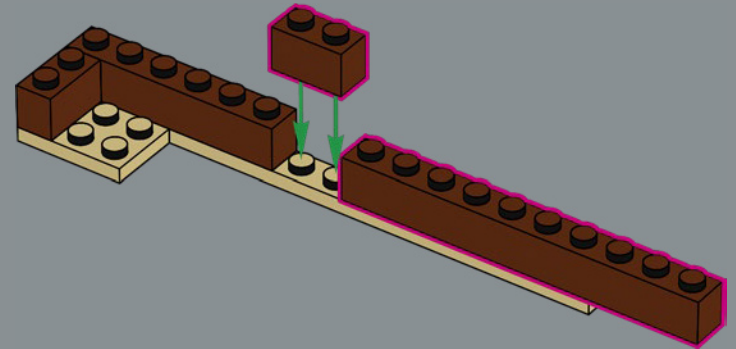

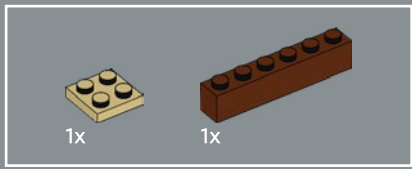

4

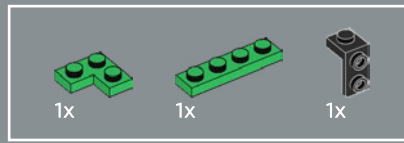
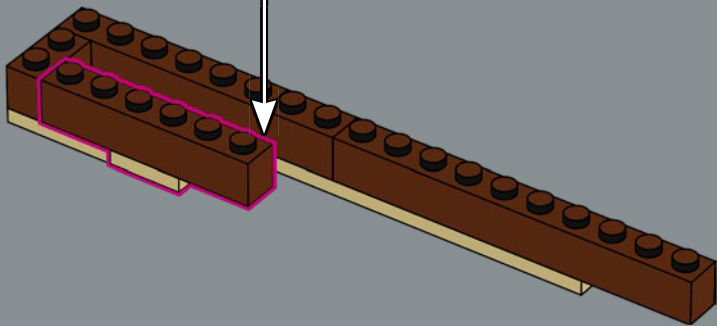
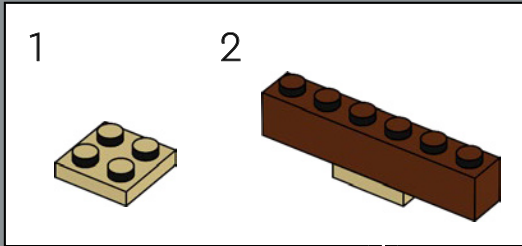

5

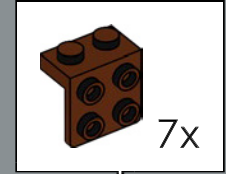
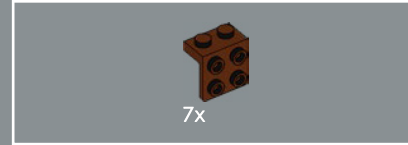
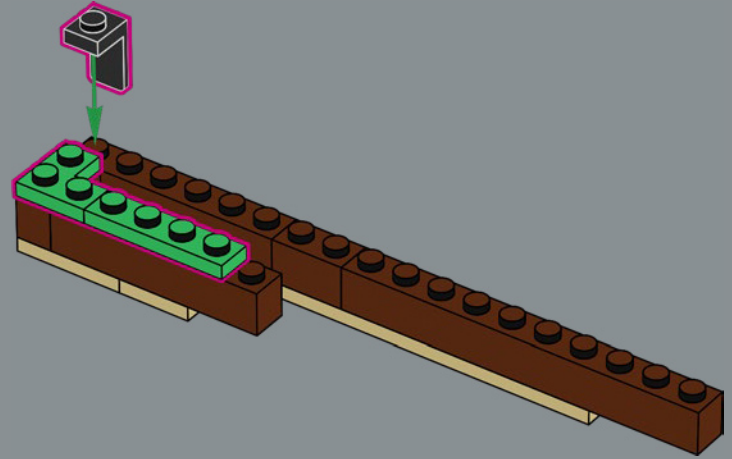

6

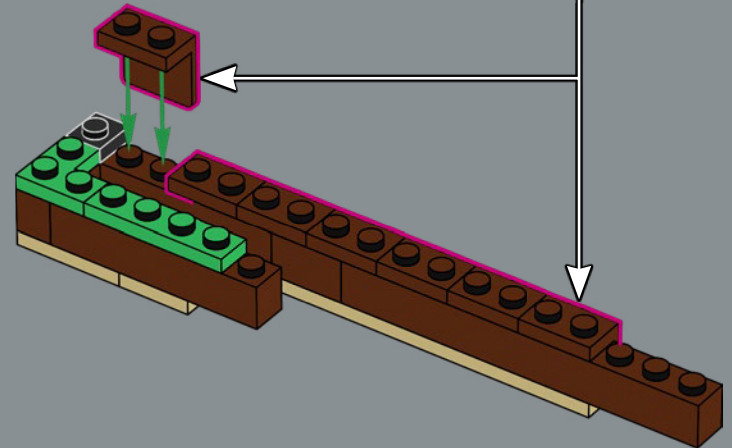



5

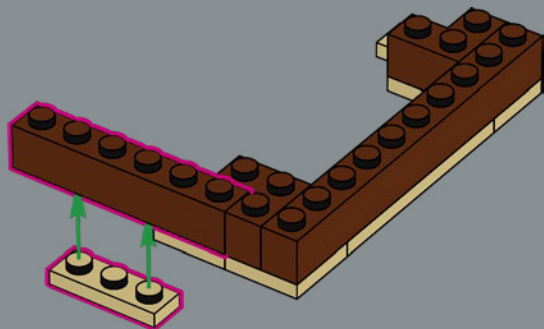

6

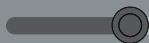
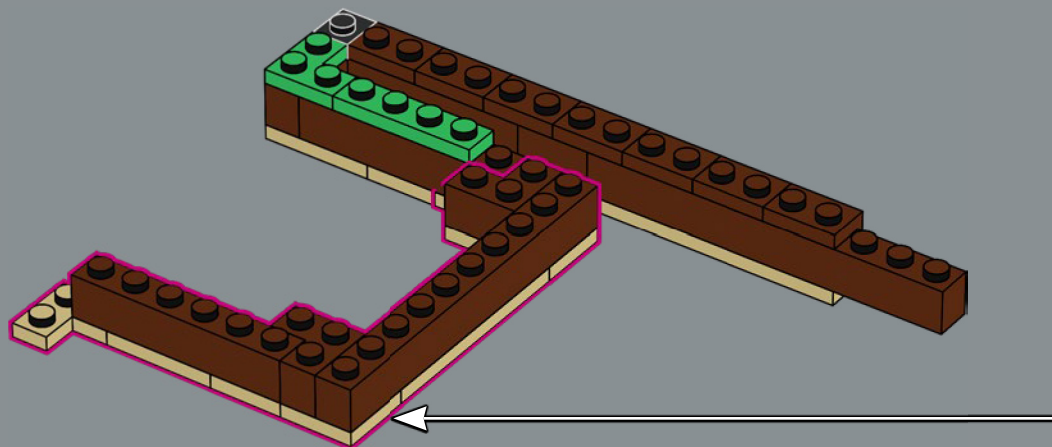
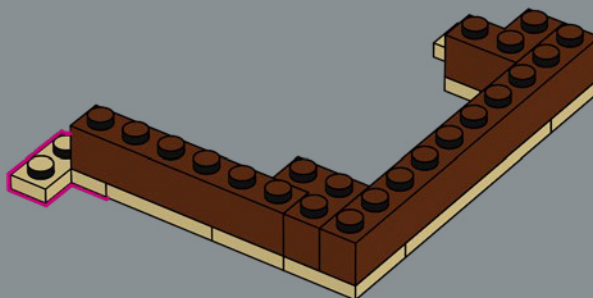

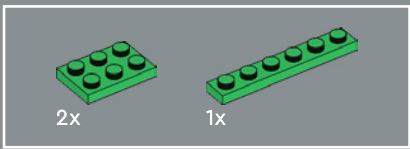

8

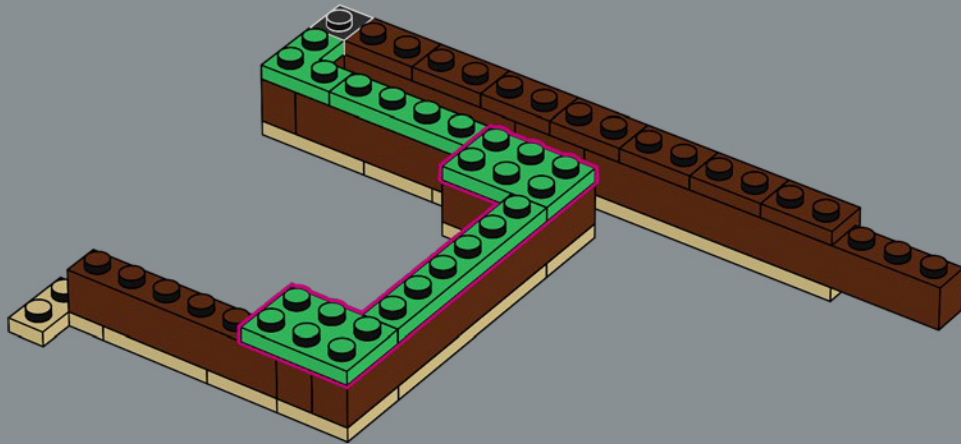

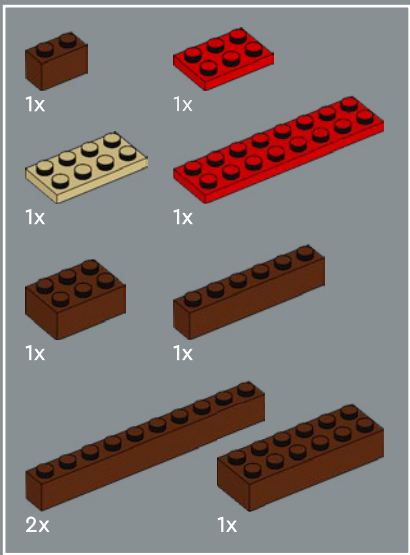

9

1

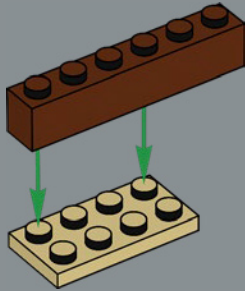

2

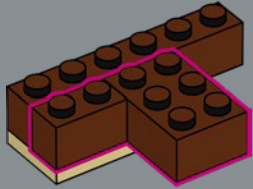

3

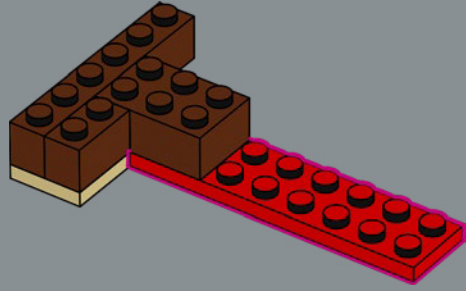

4

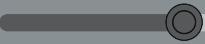
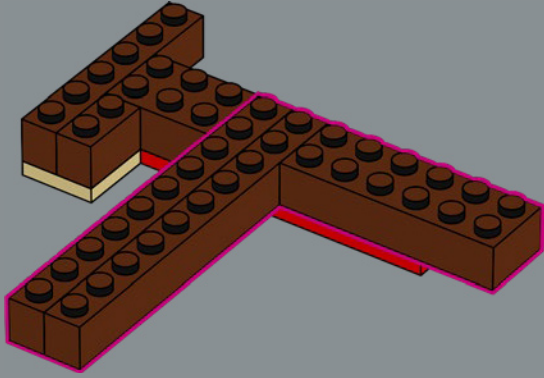

5

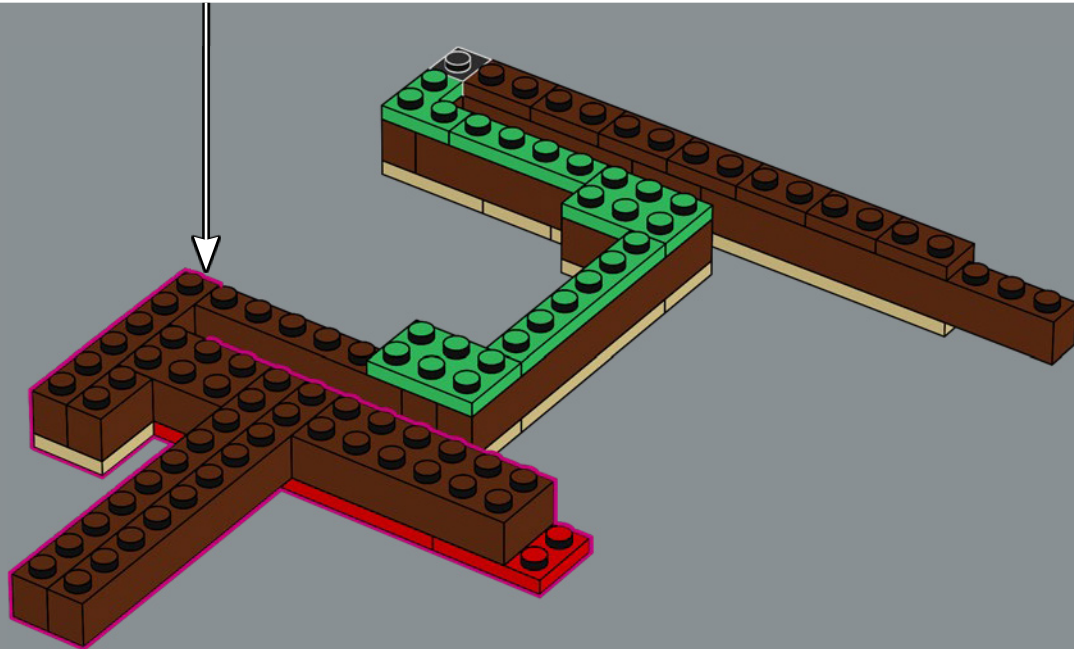
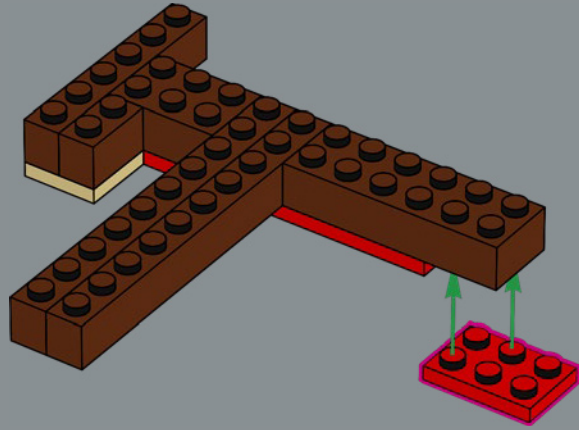

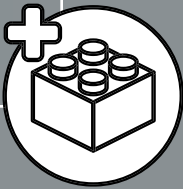
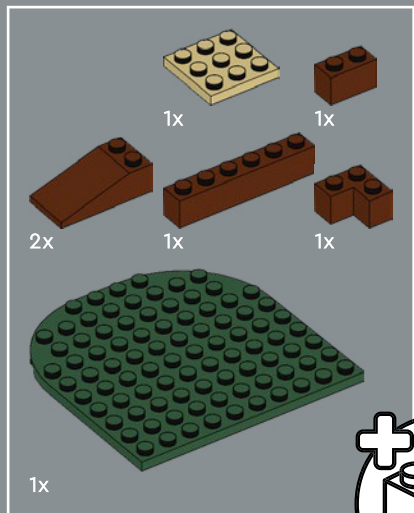

10

1

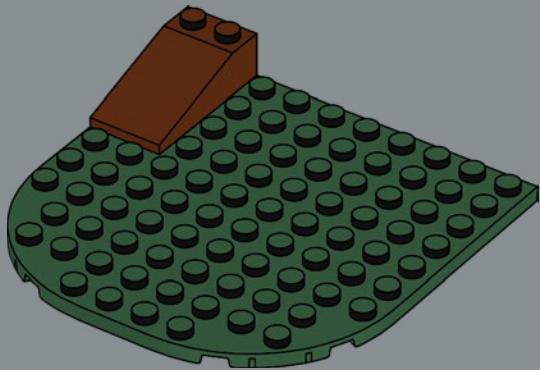

2

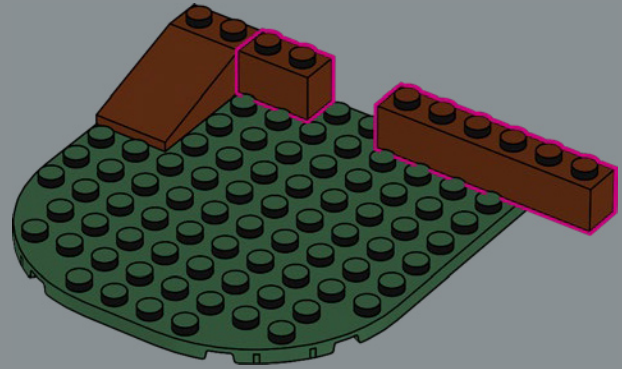

3

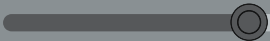
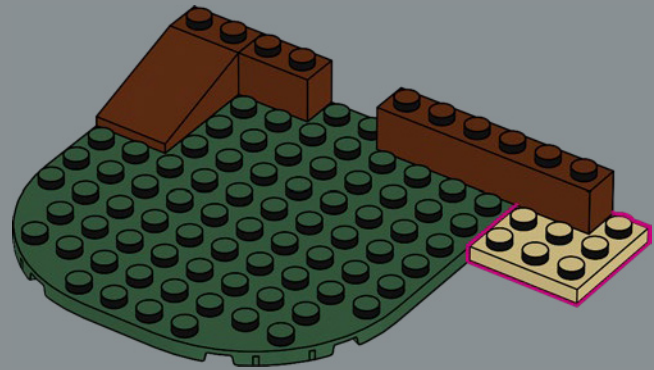

4

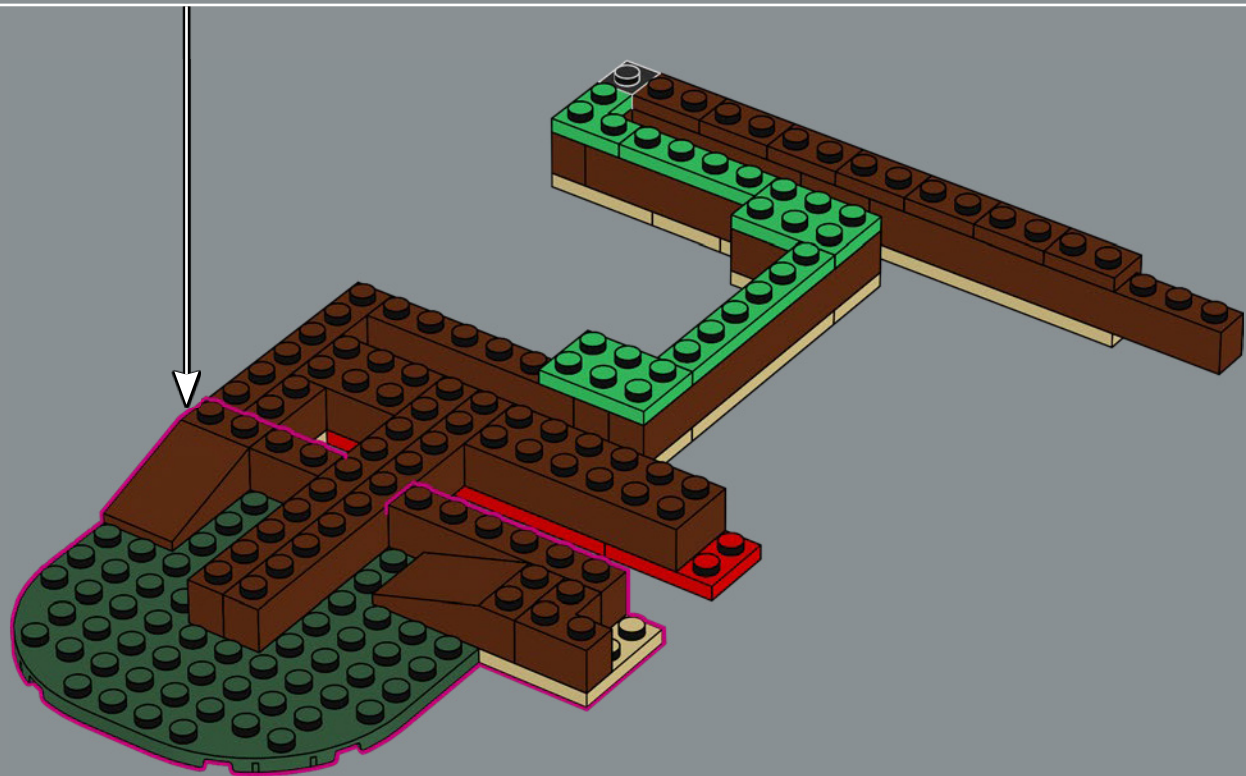
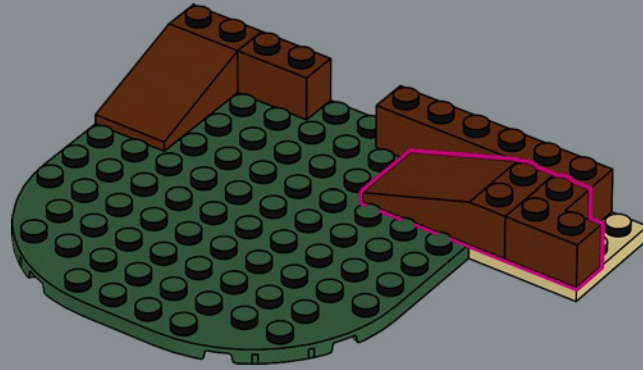

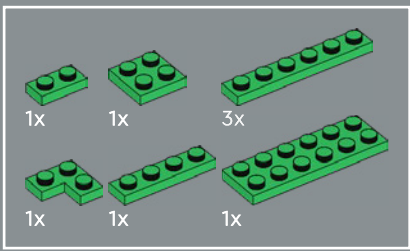

11

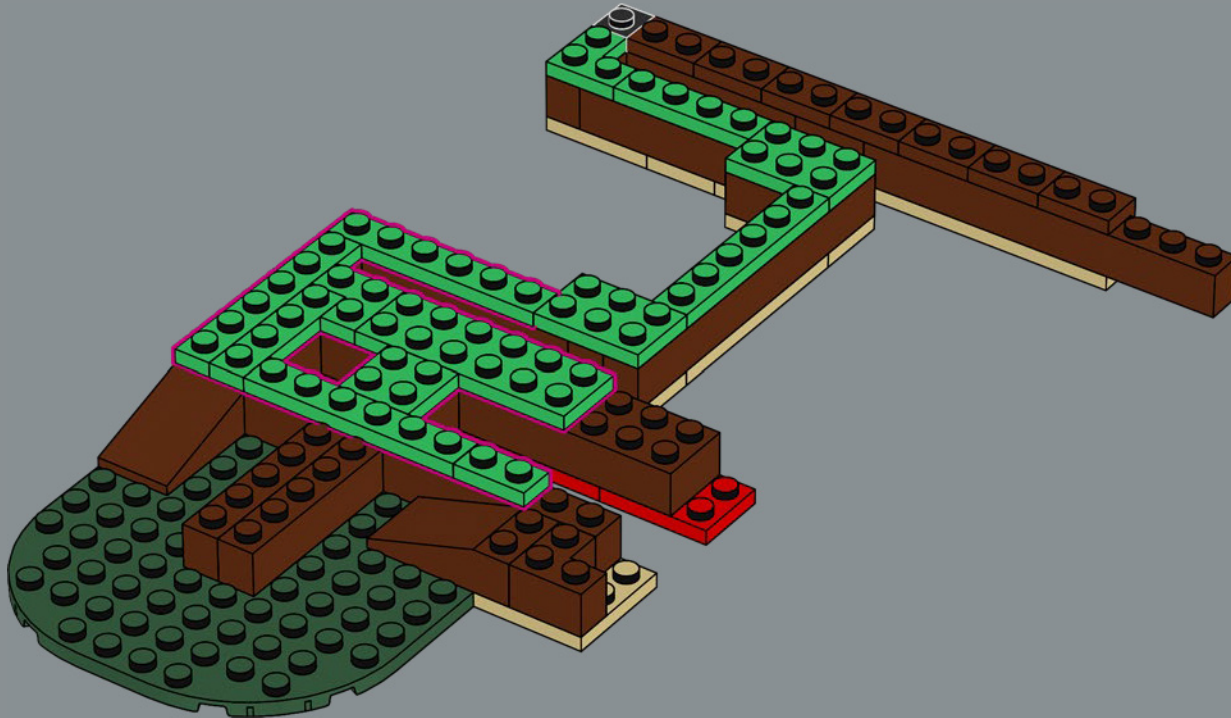

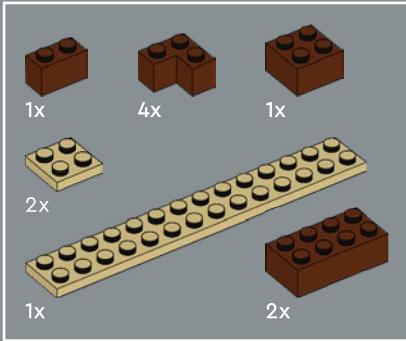
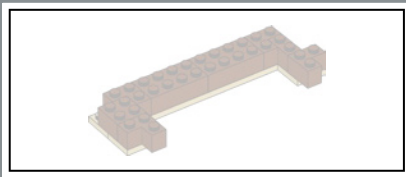

12

1

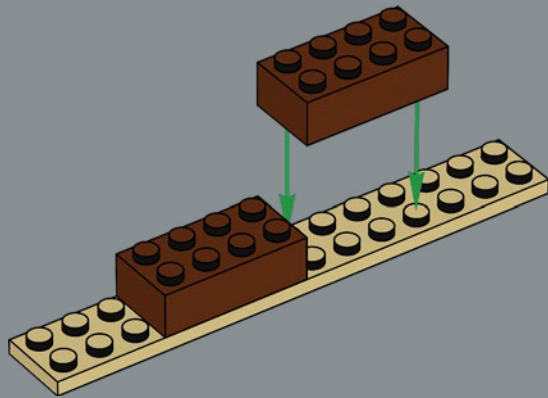

2

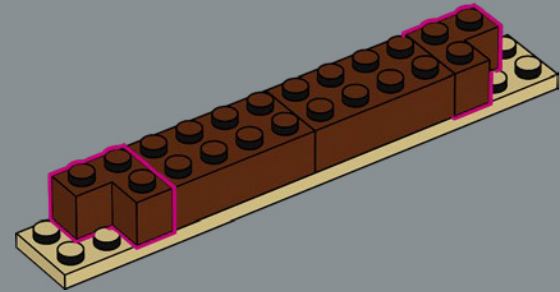

3

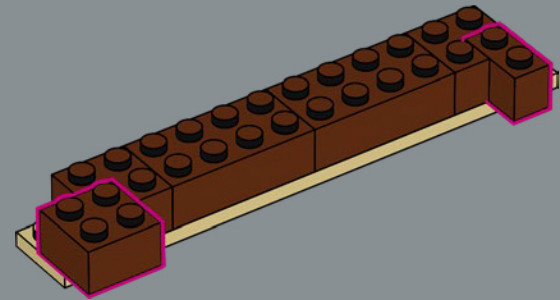

4

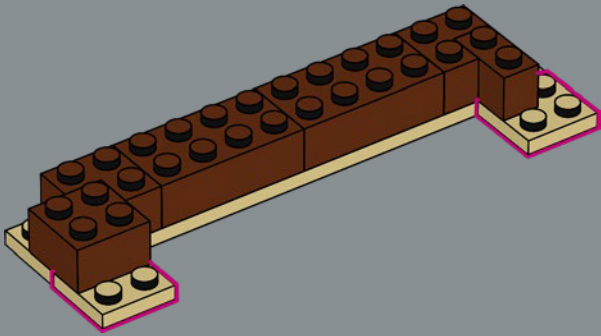

5

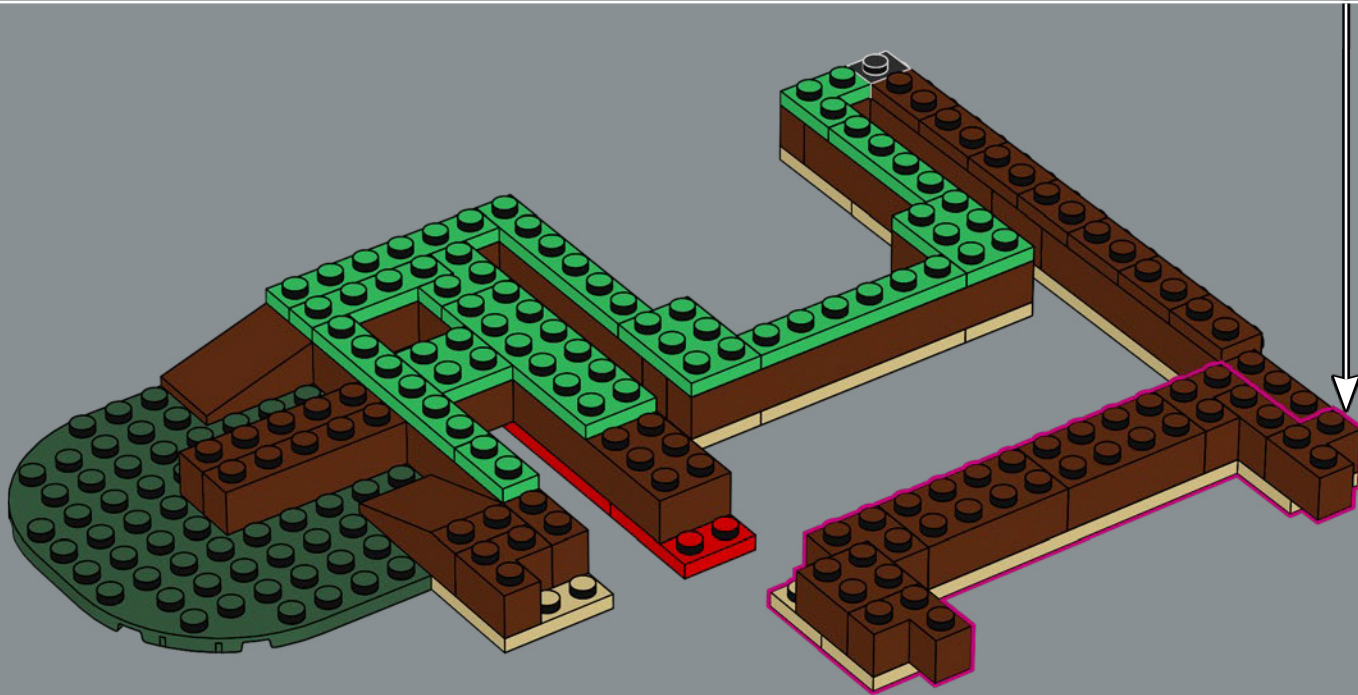
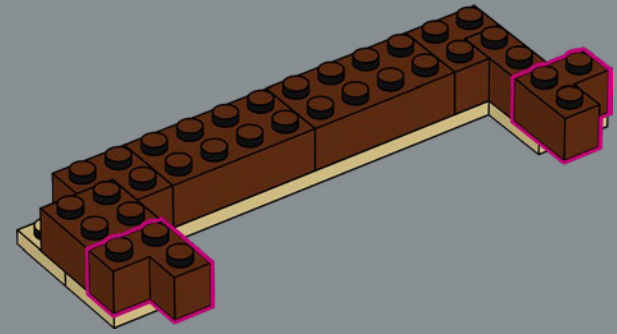

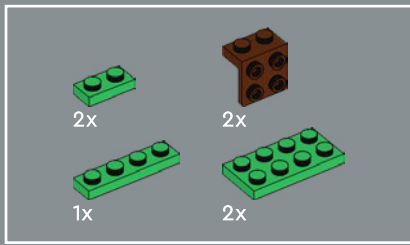

13

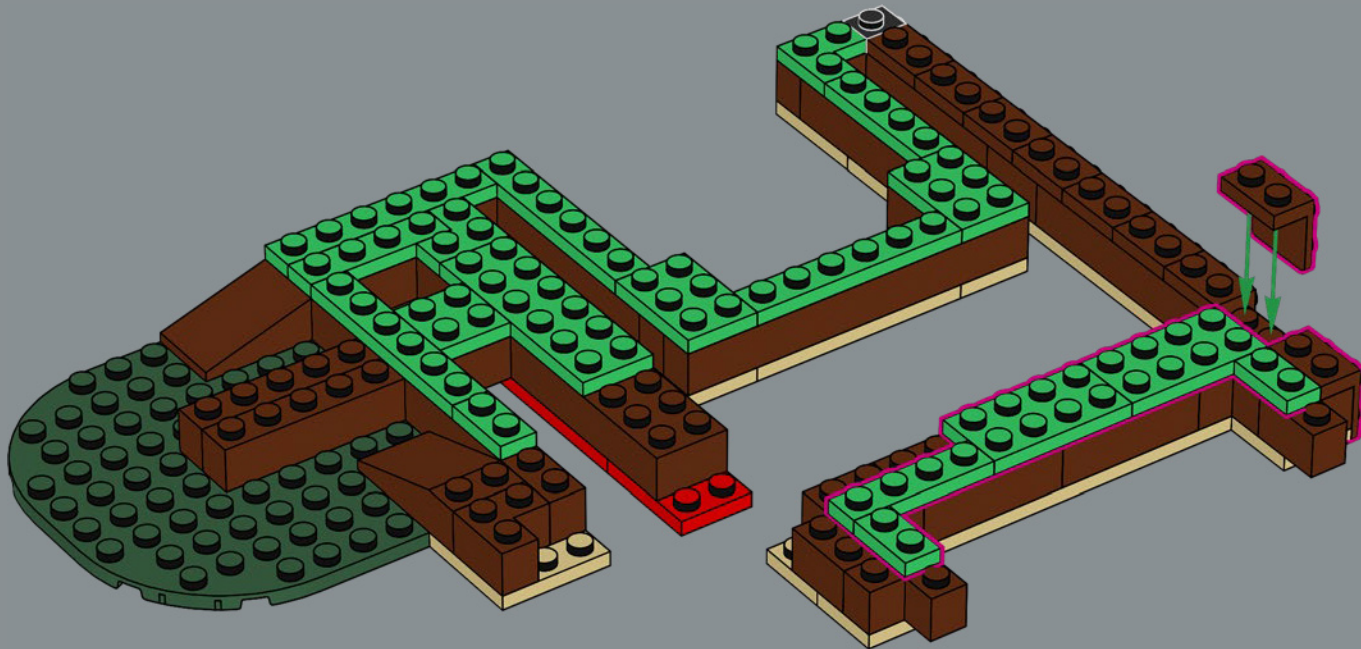

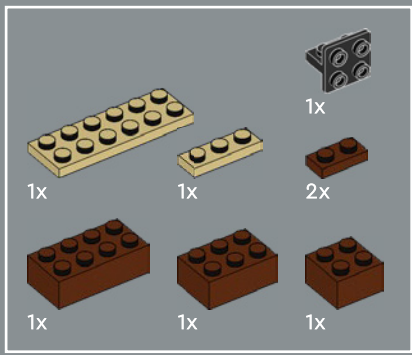

14

1

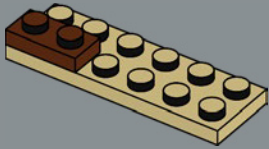

2

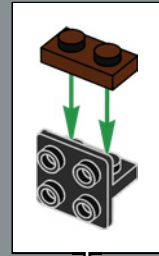
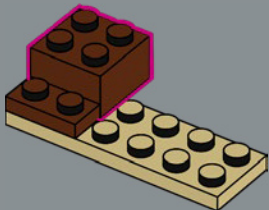

3

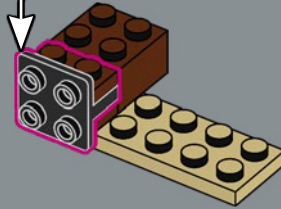

4

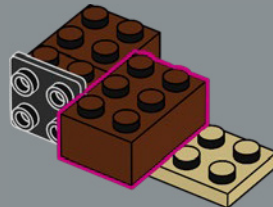

5

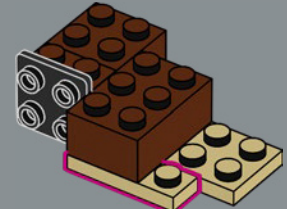

6

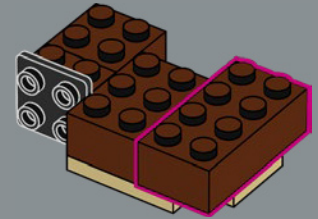

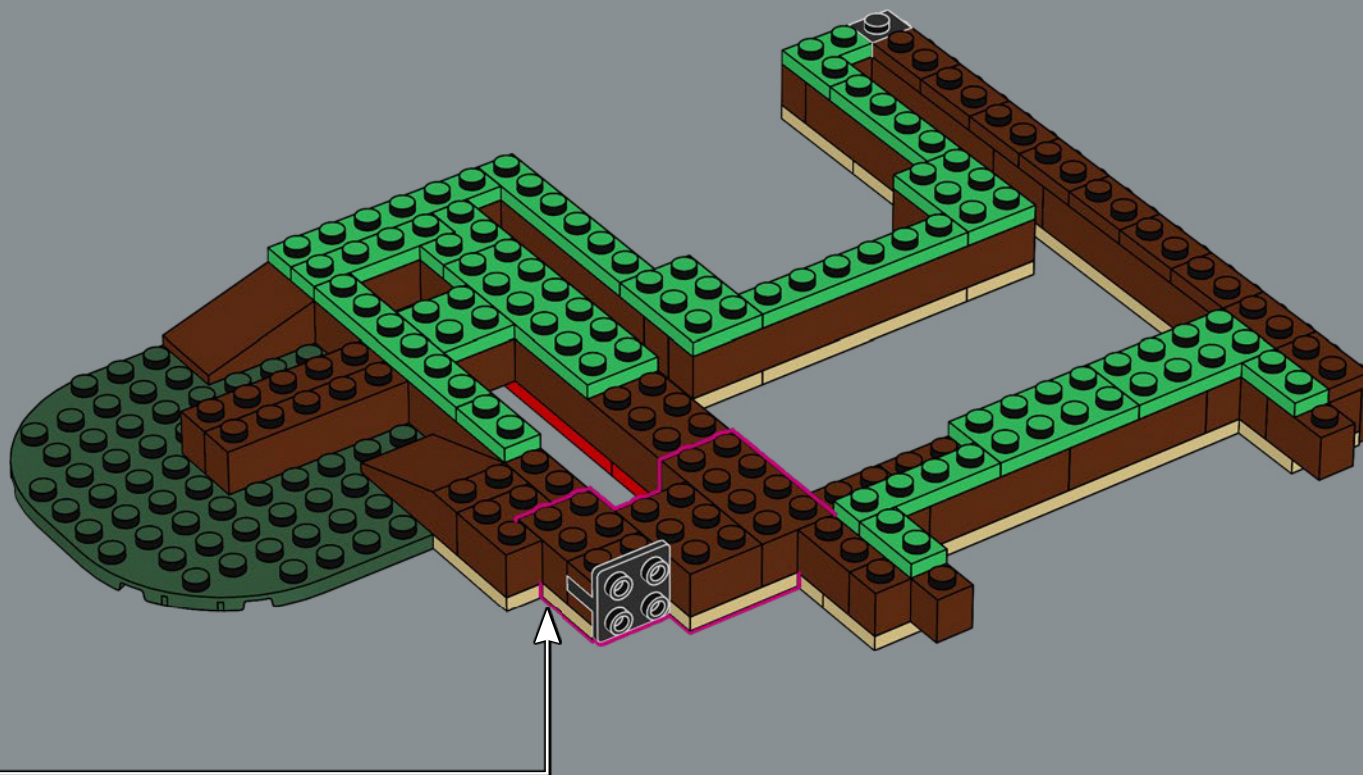

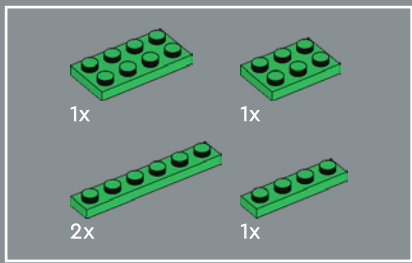

15

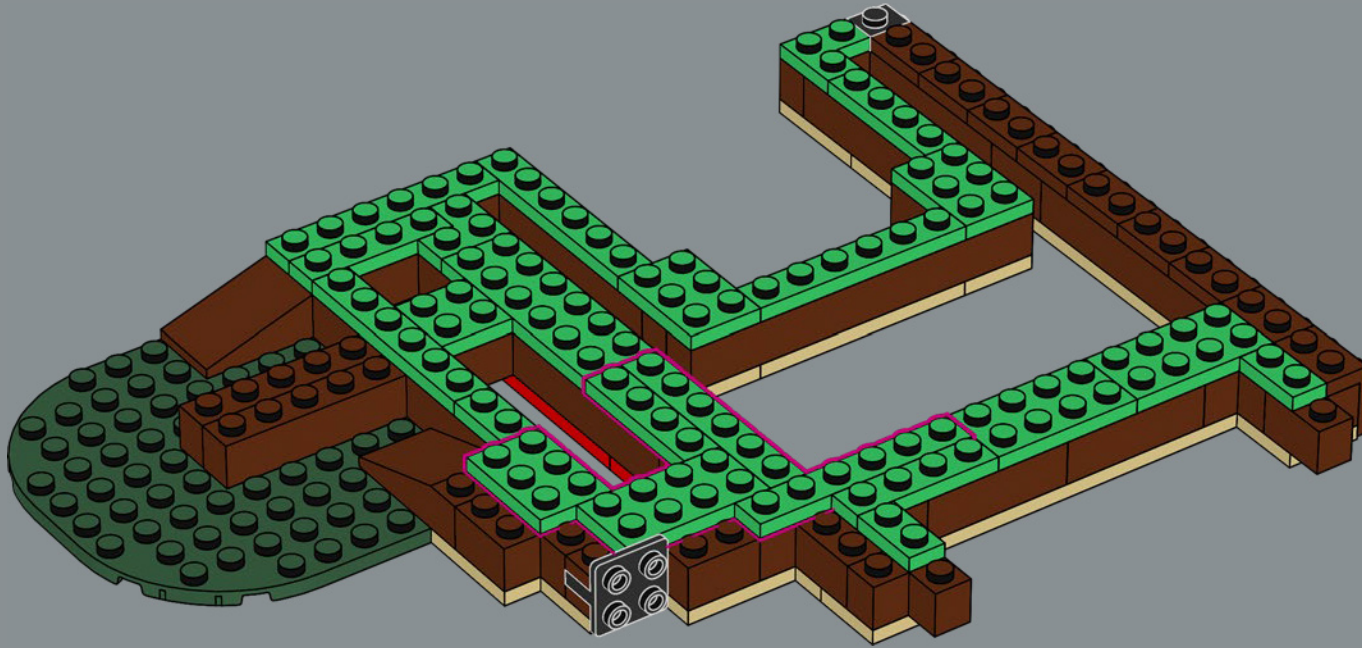

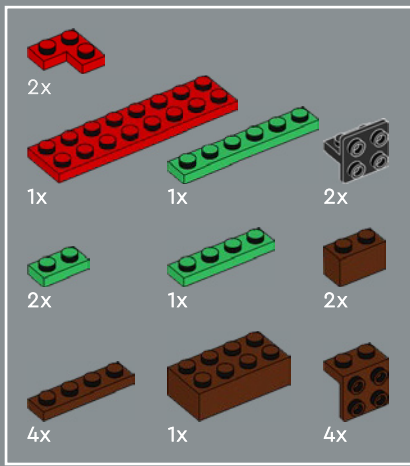

16

1

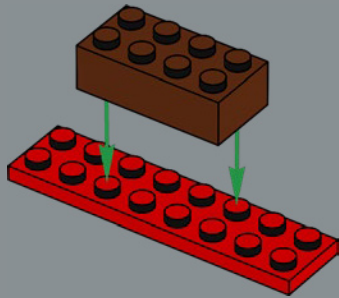

2

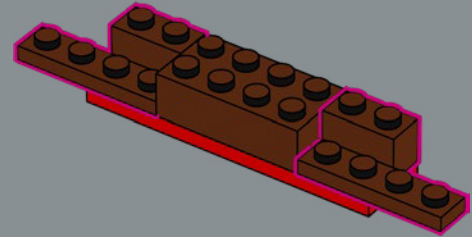

3

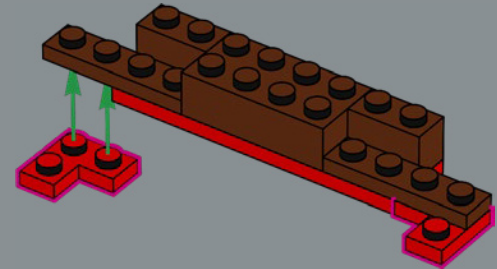

4

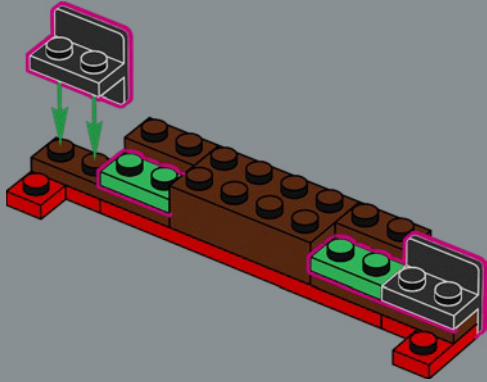

5

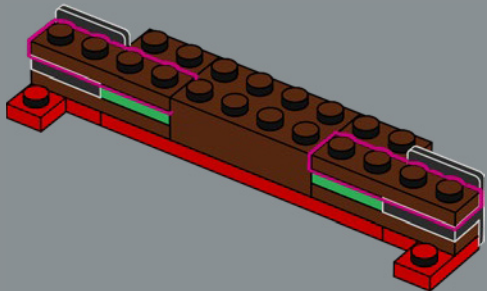

6

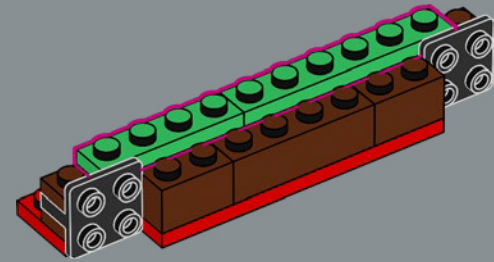

7

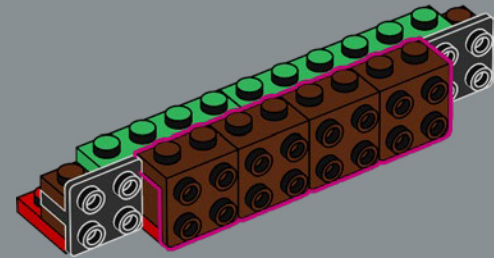

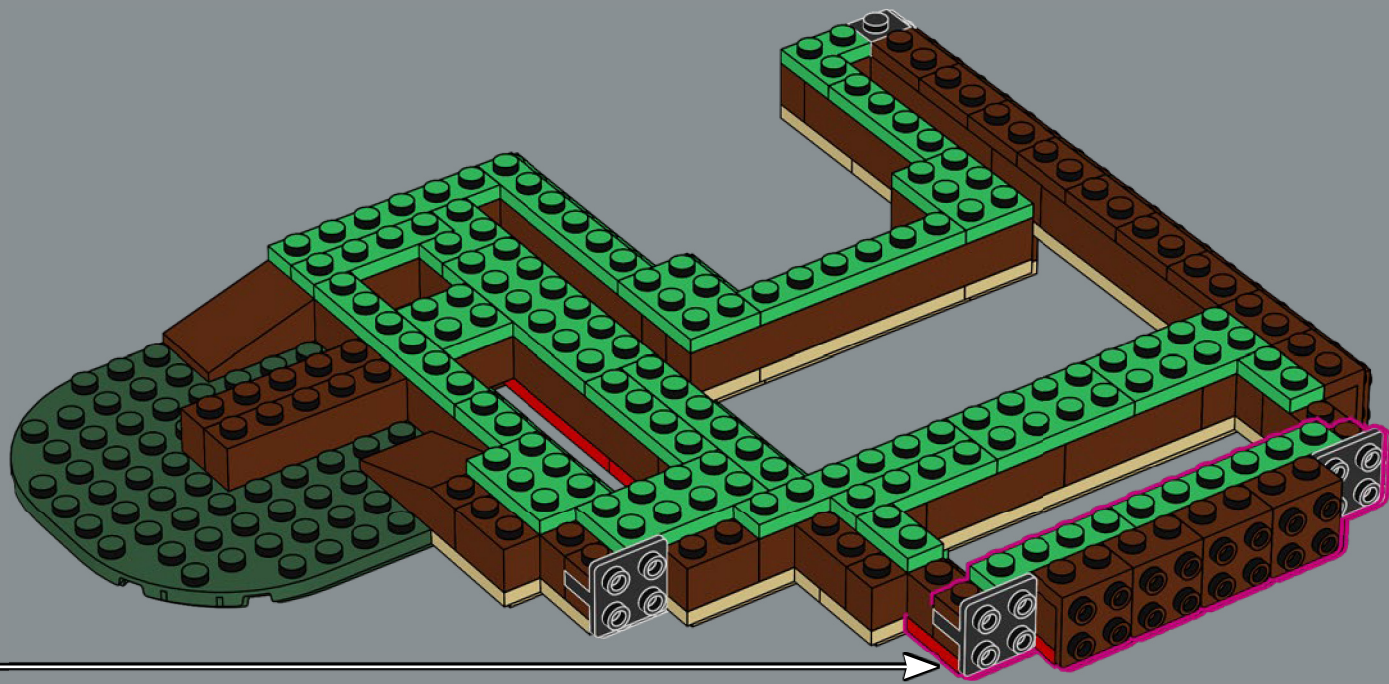



17

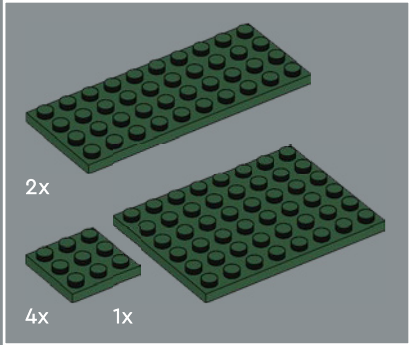
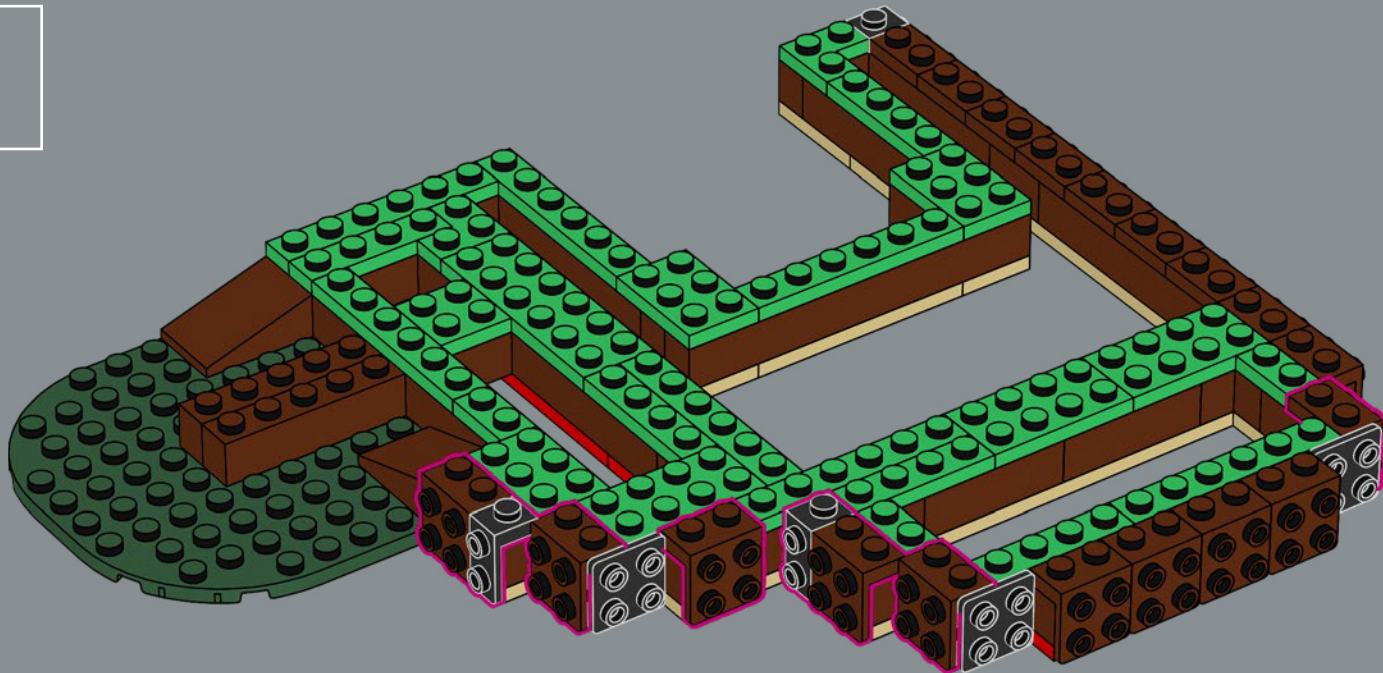

18

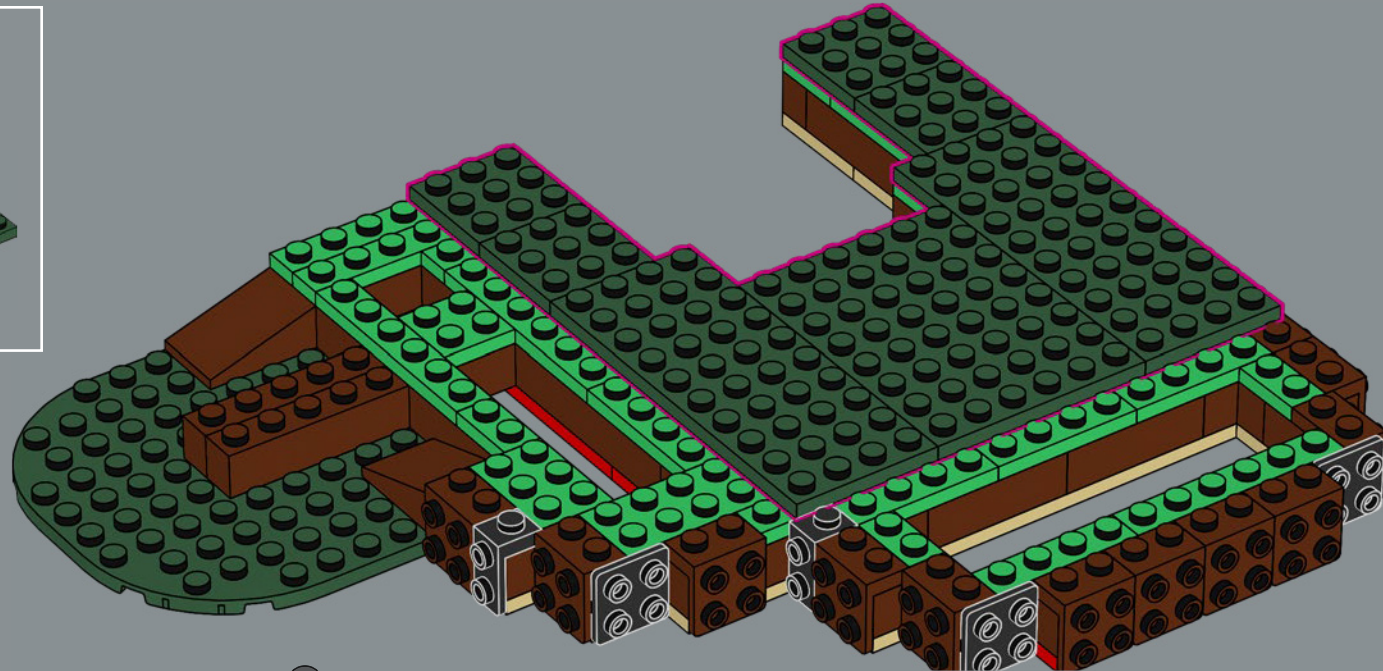

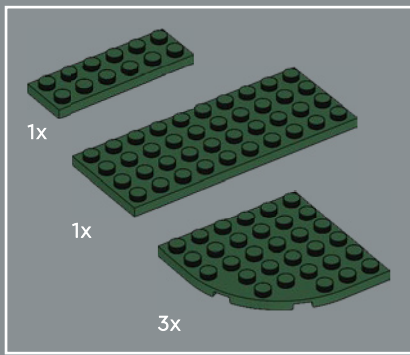

19

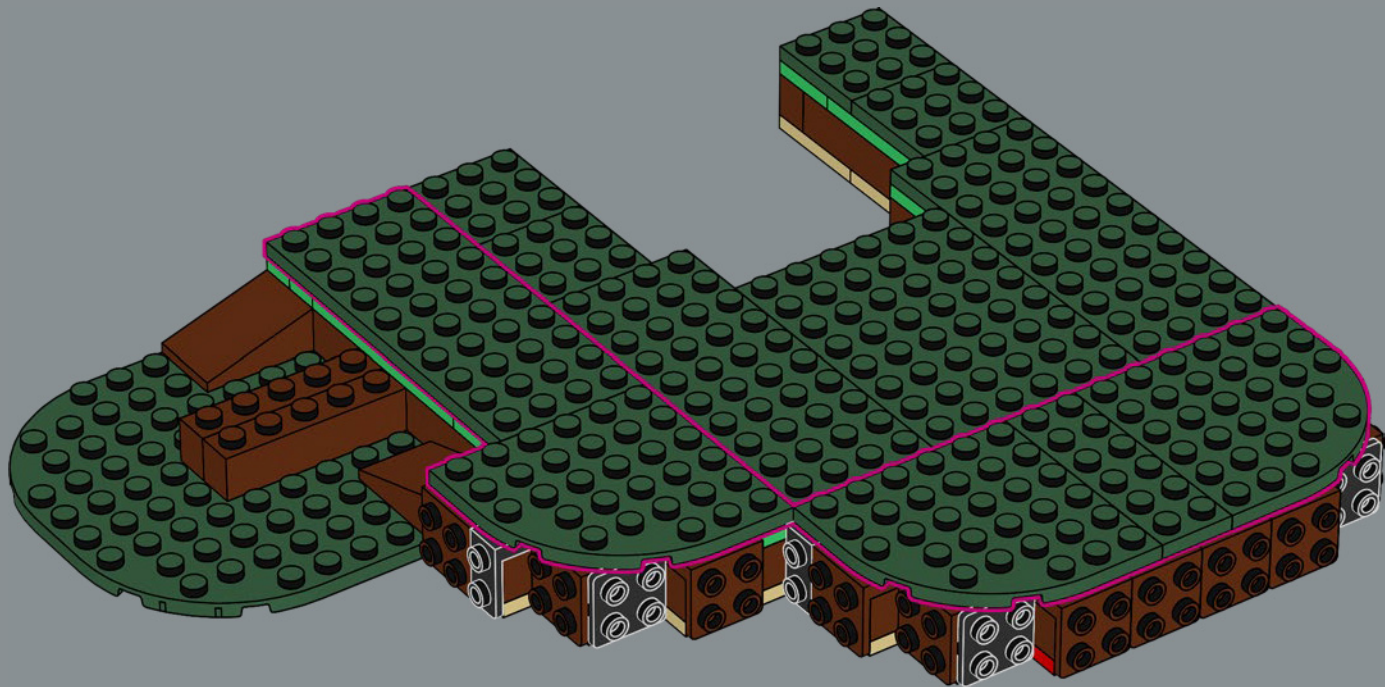

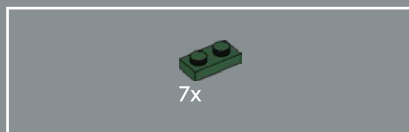

20

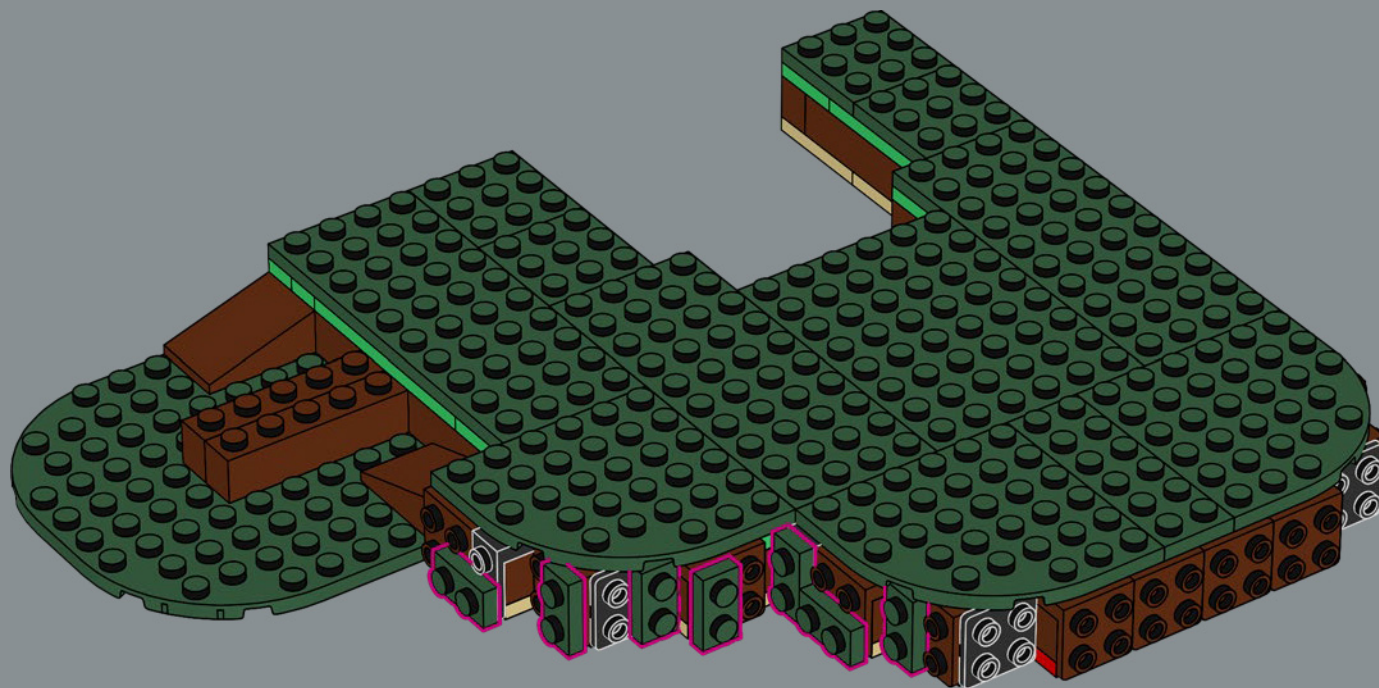



21

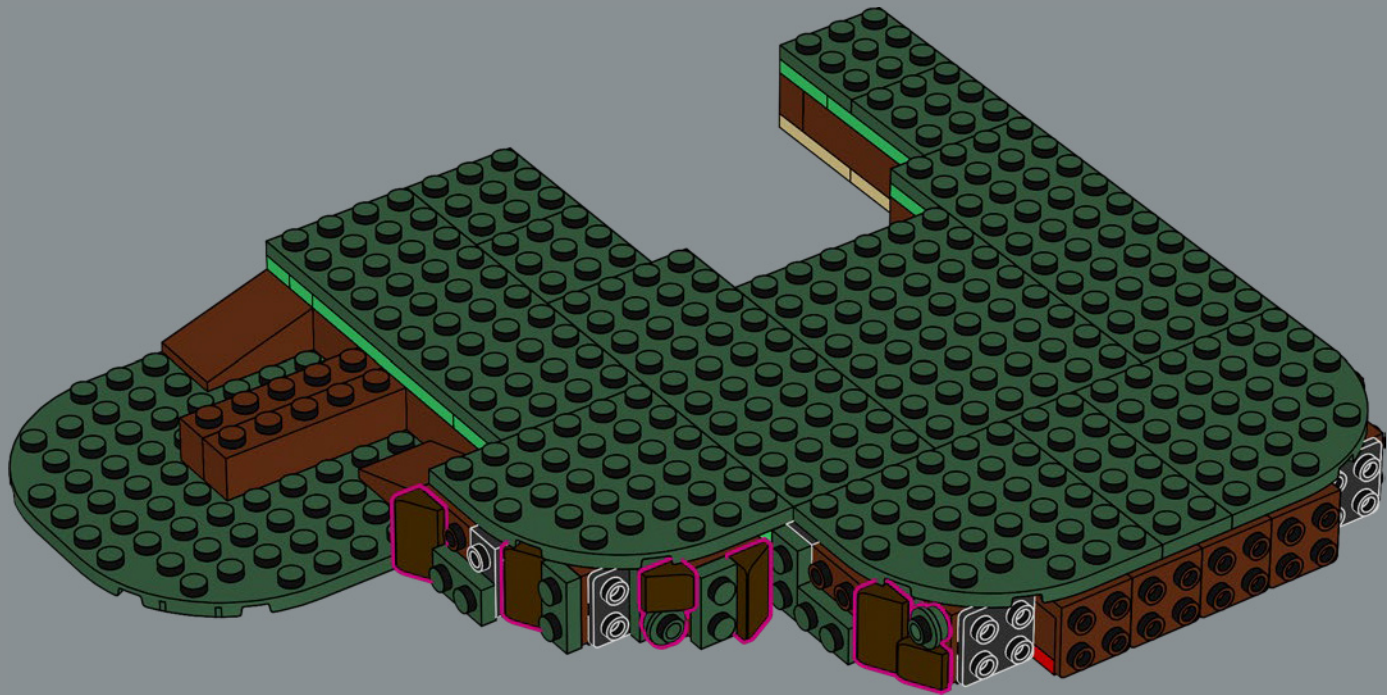



22

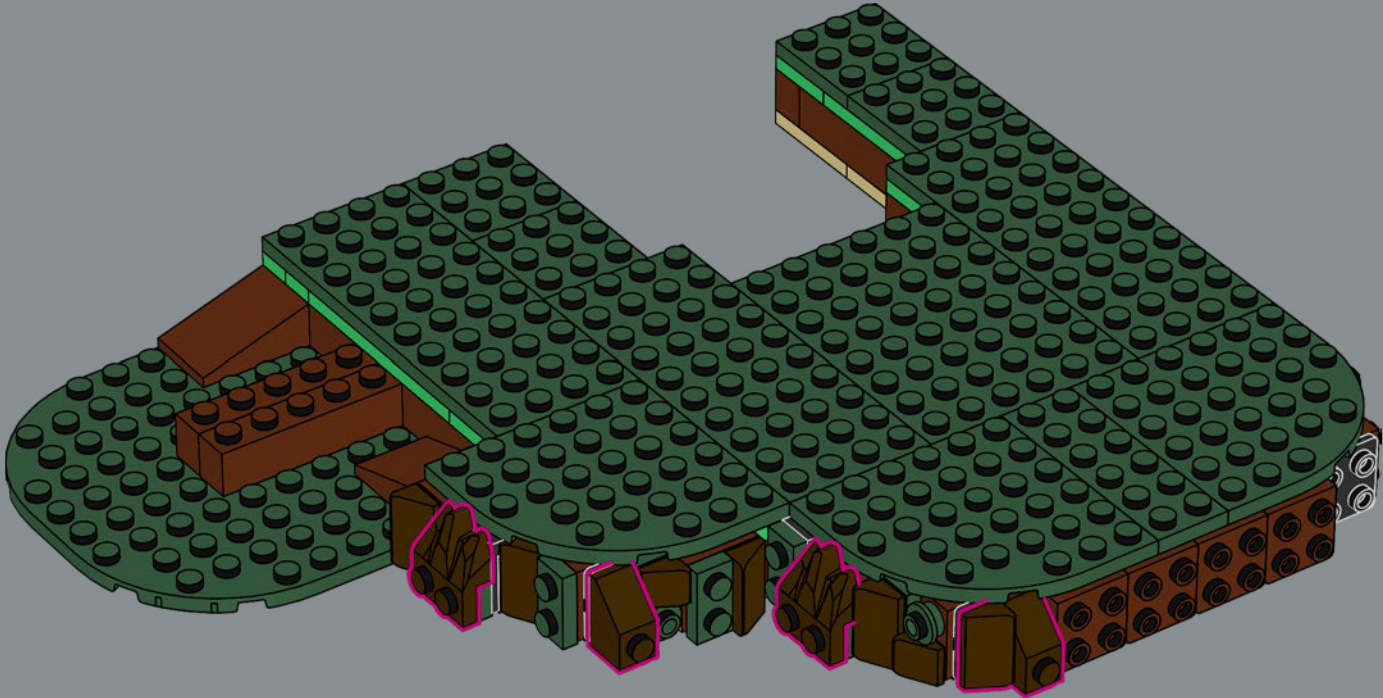

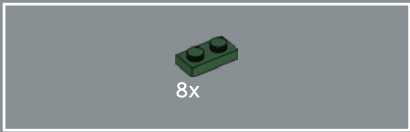

23

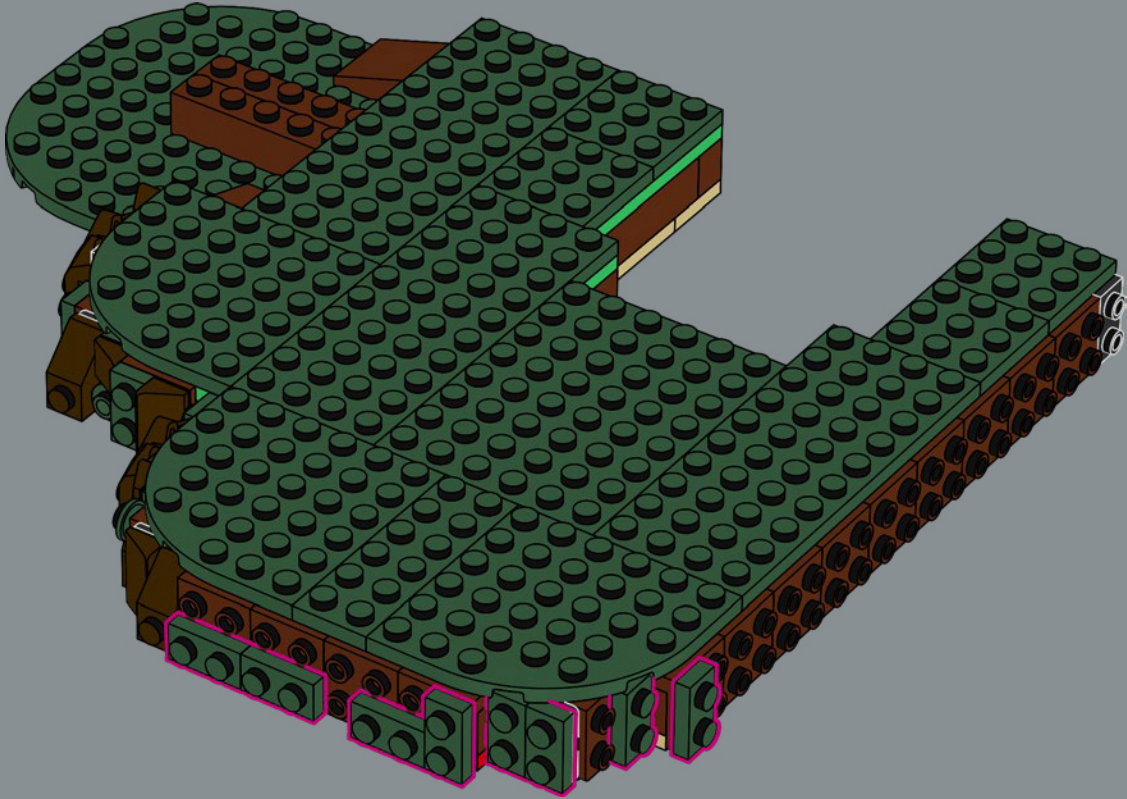

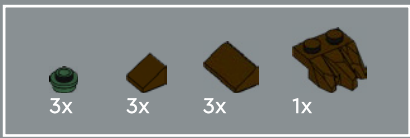

24

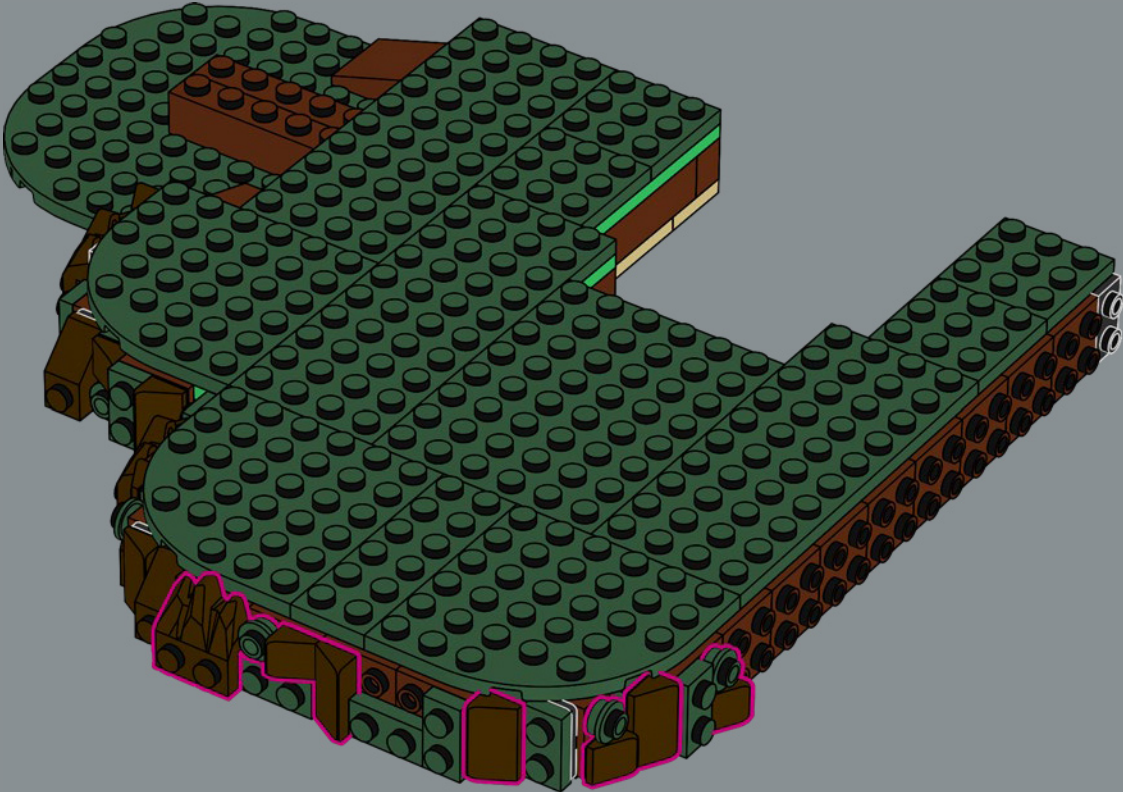



25

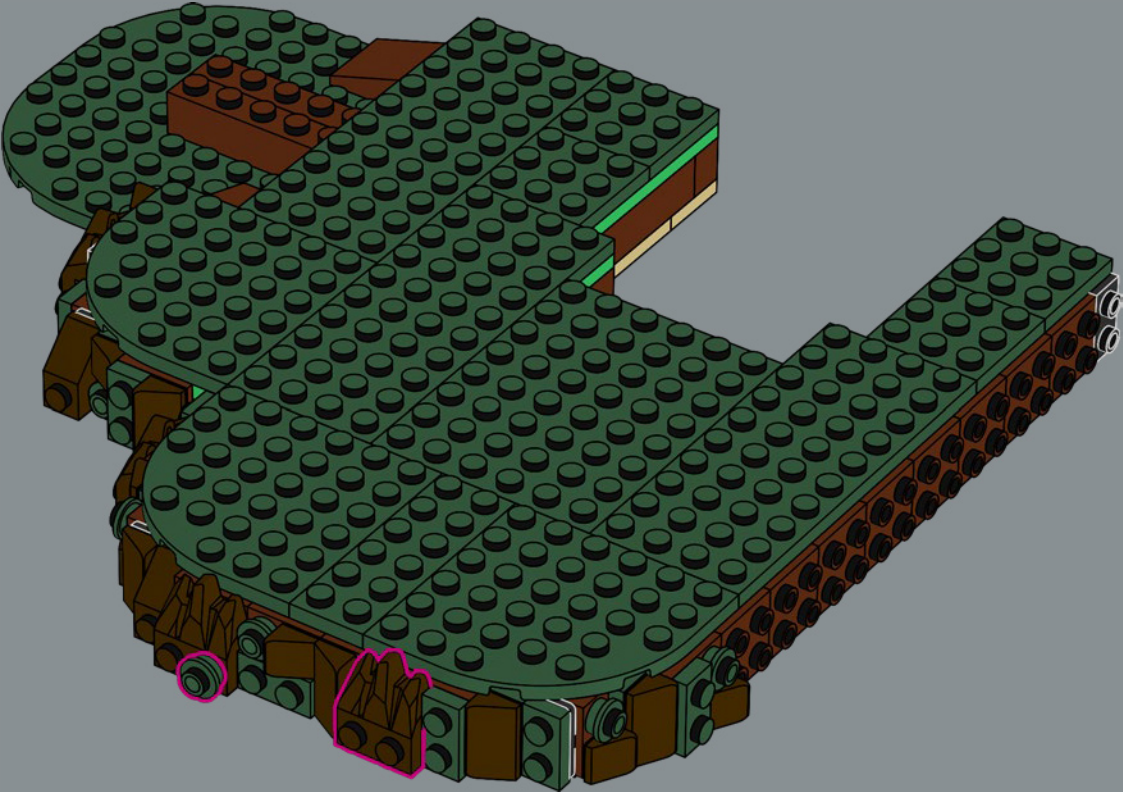

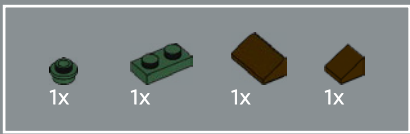

26

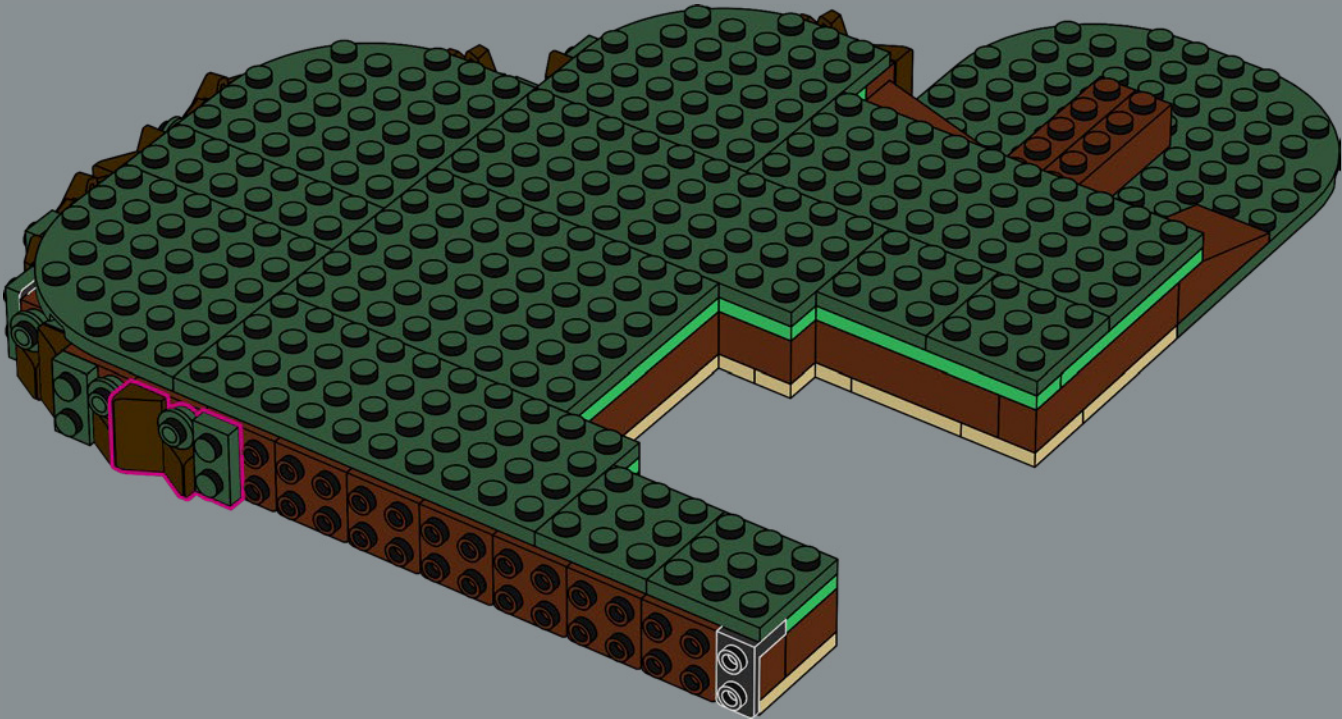



27



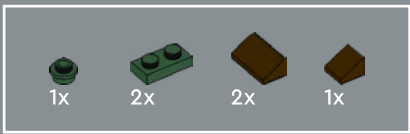

28

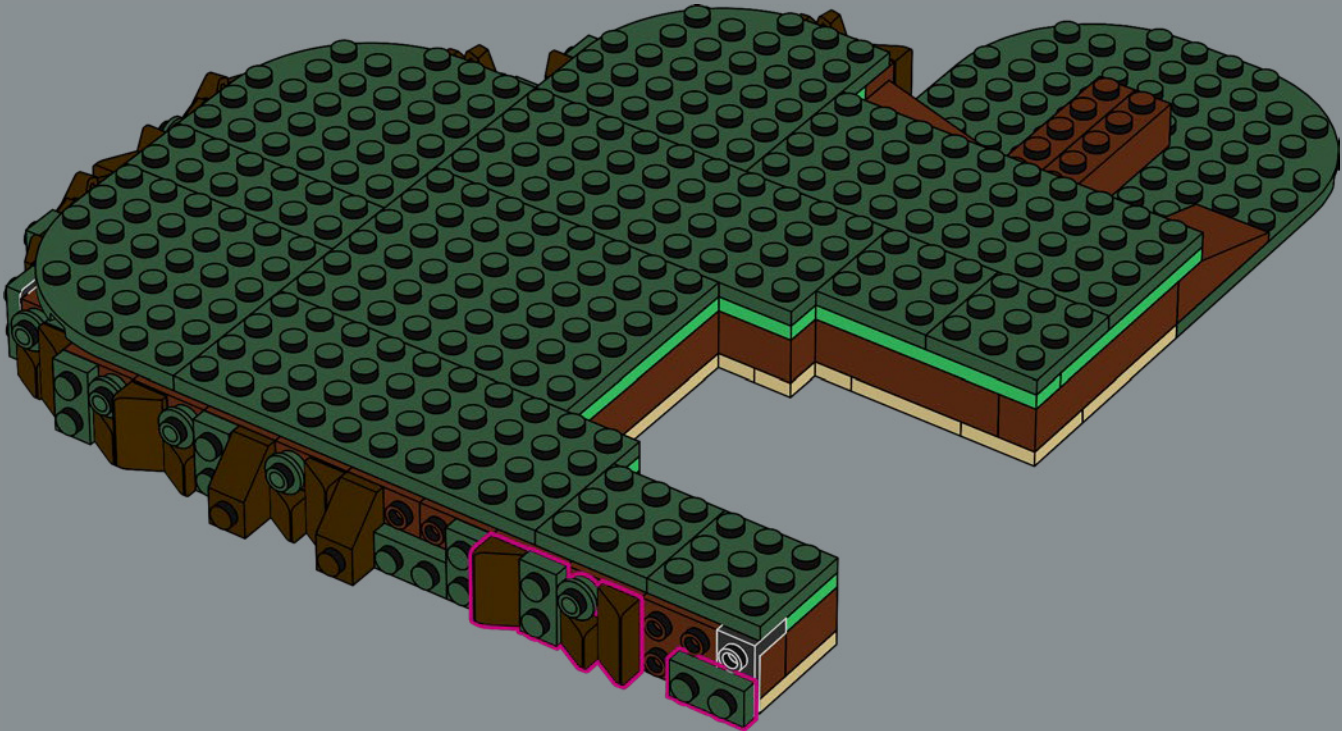

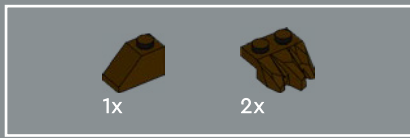

29

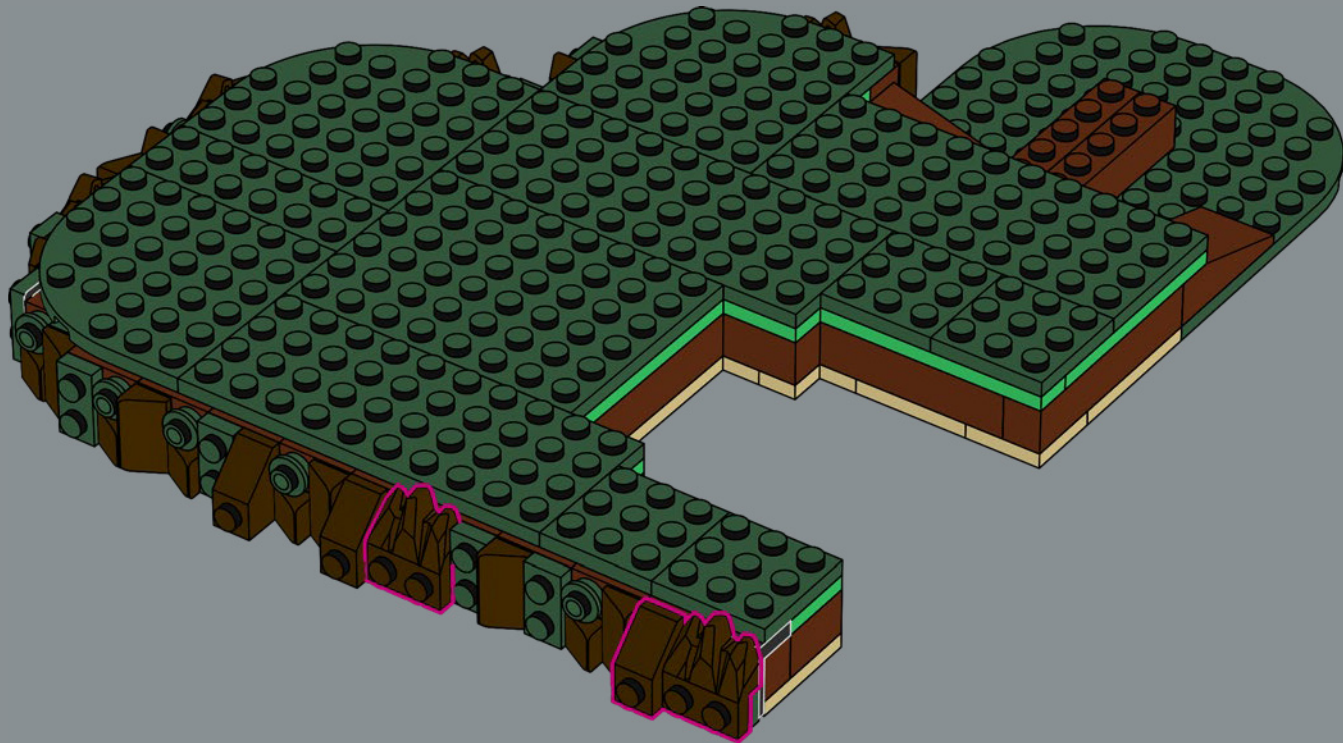

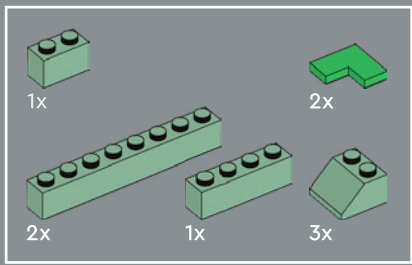

30

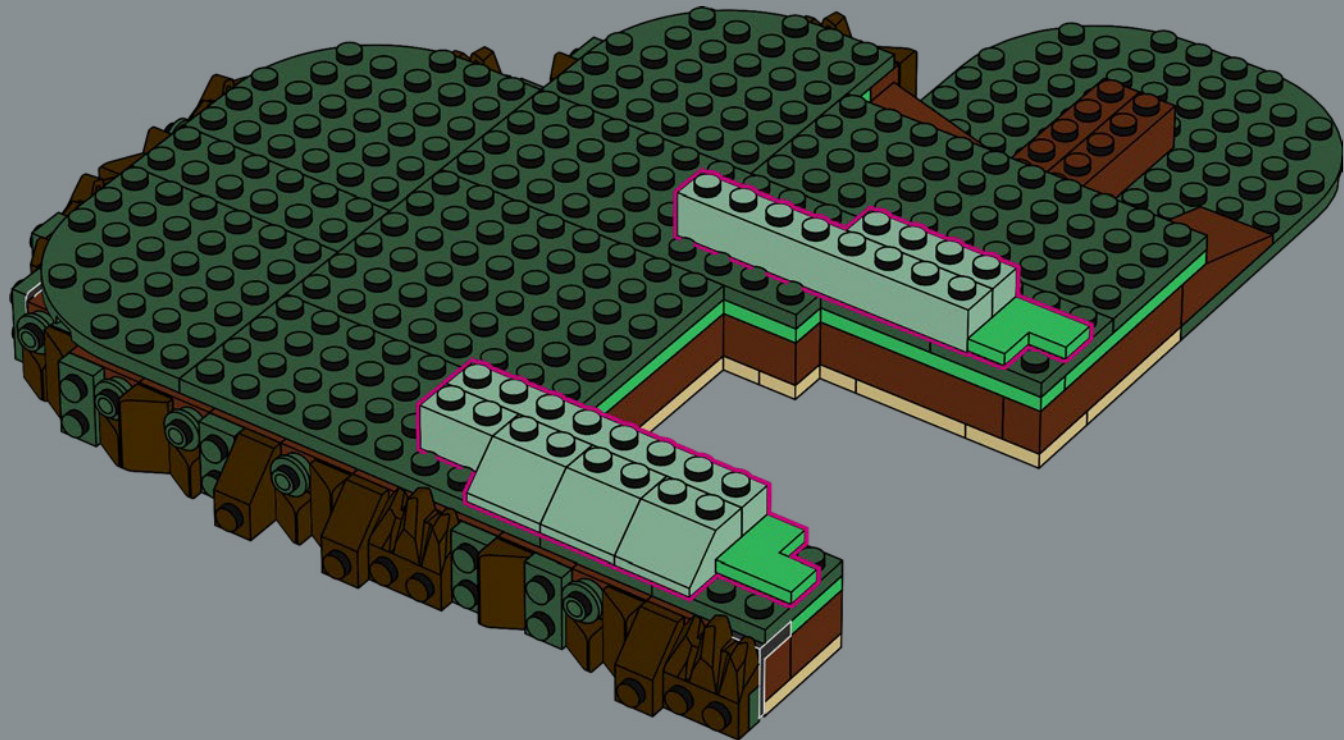

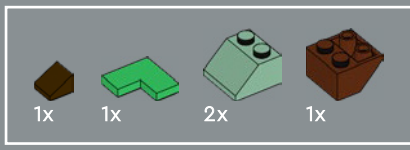

31

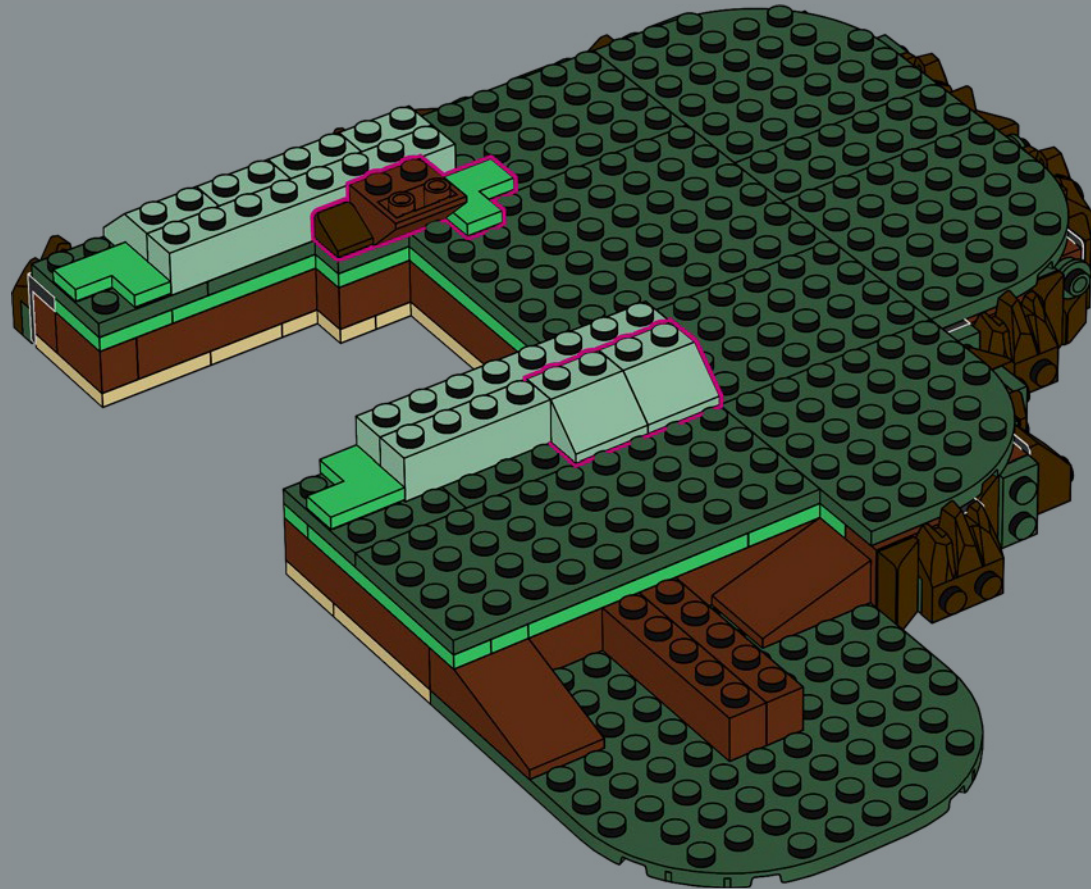

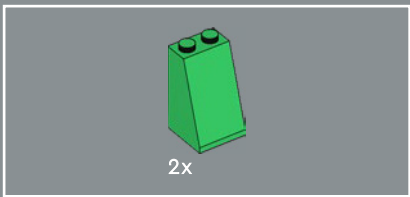

32

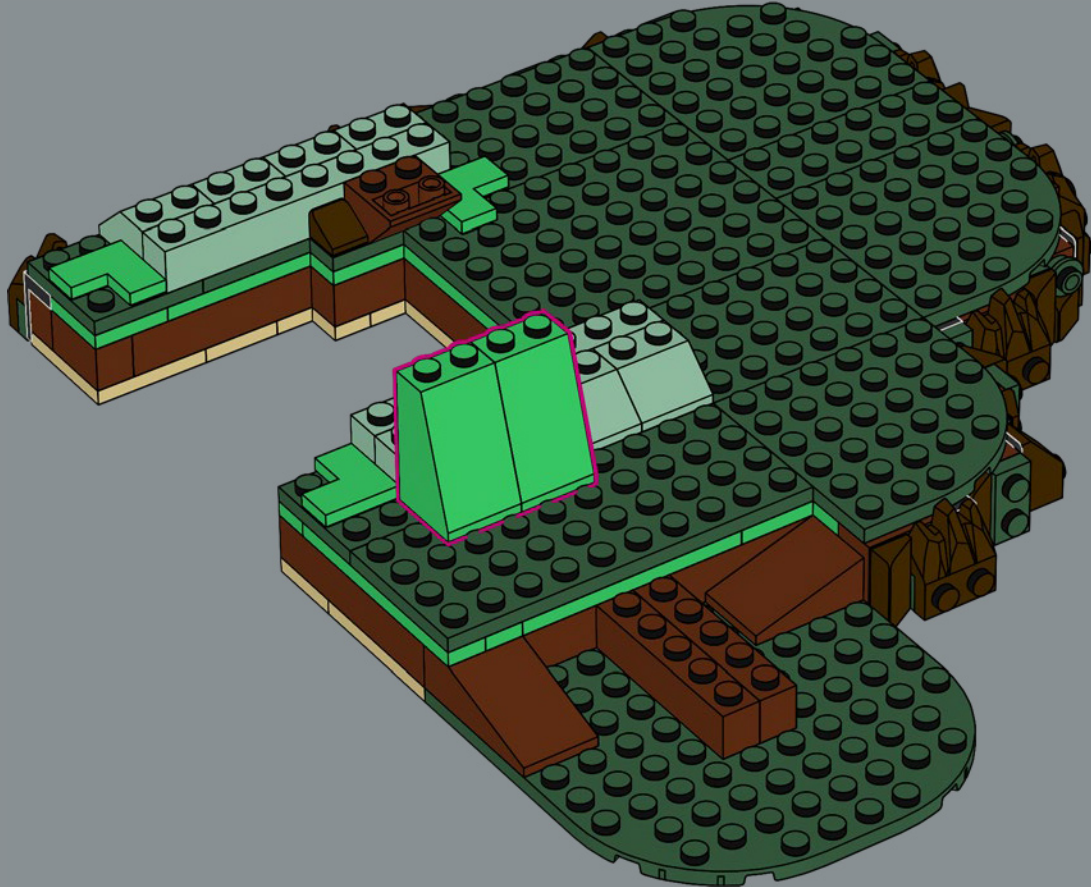

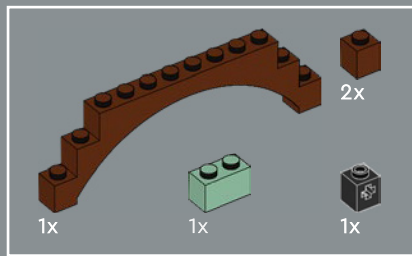

33

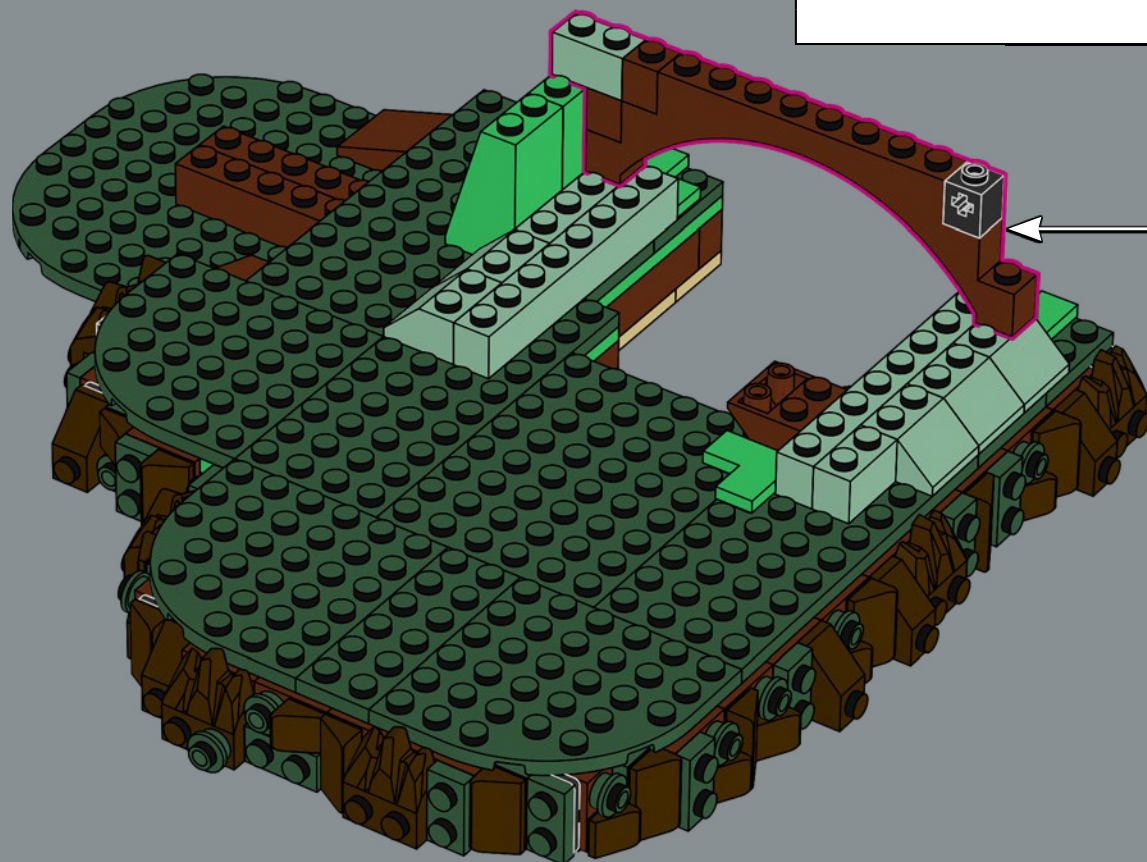
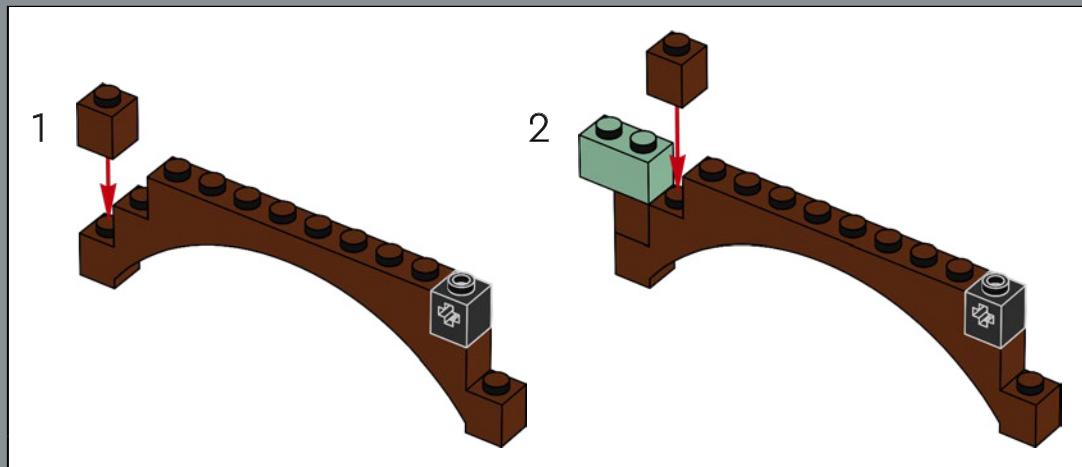

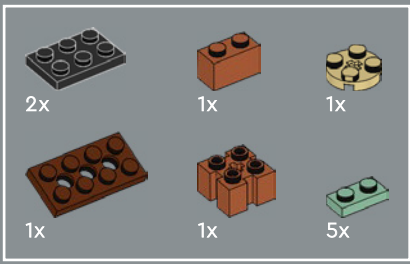

34

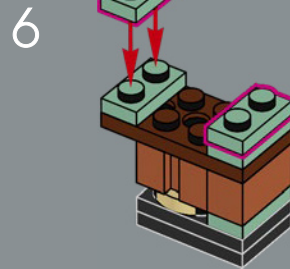
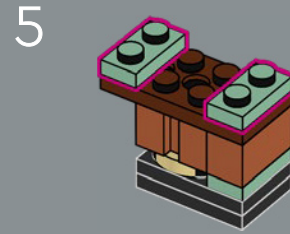
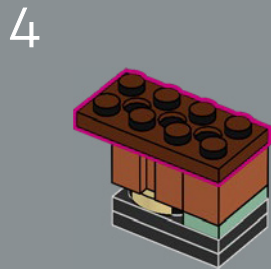
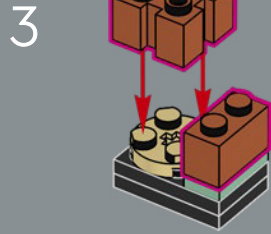
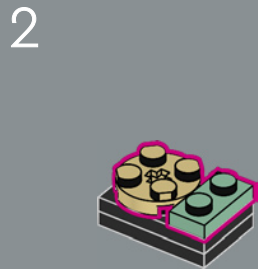
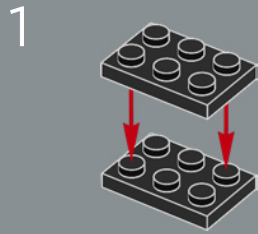



35

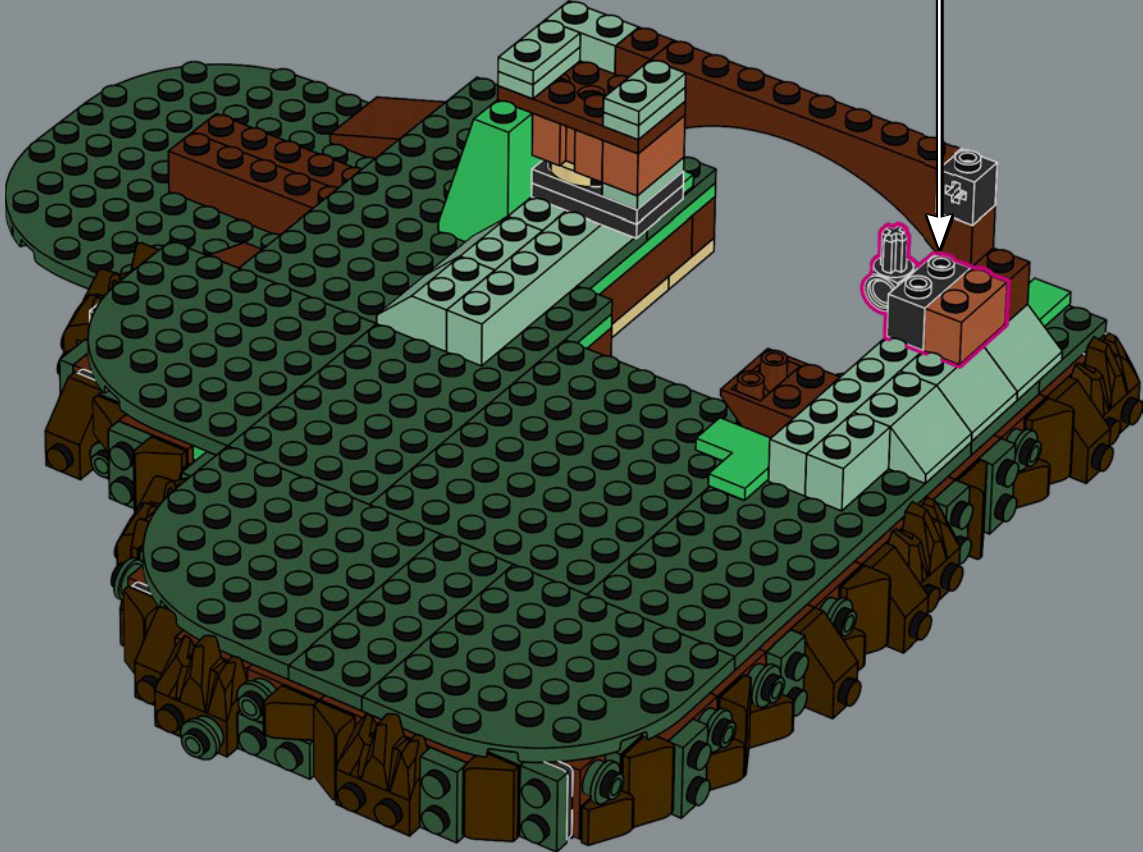
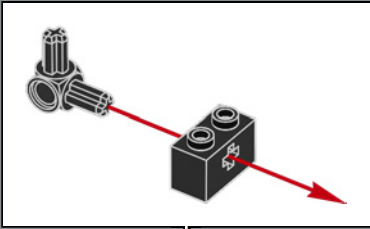



36

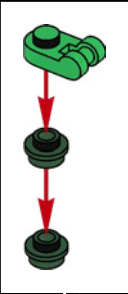

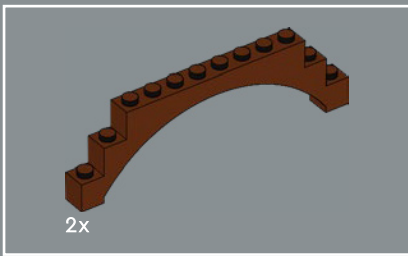

37

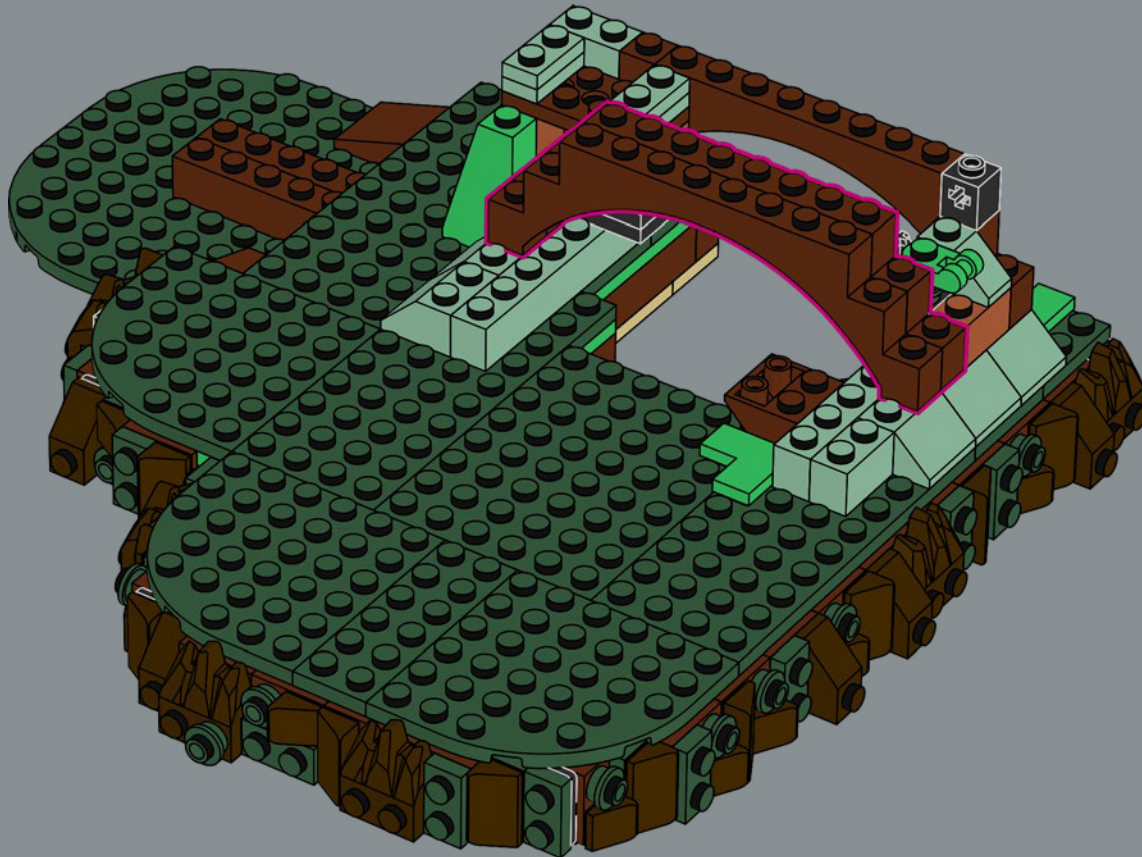



2x

38

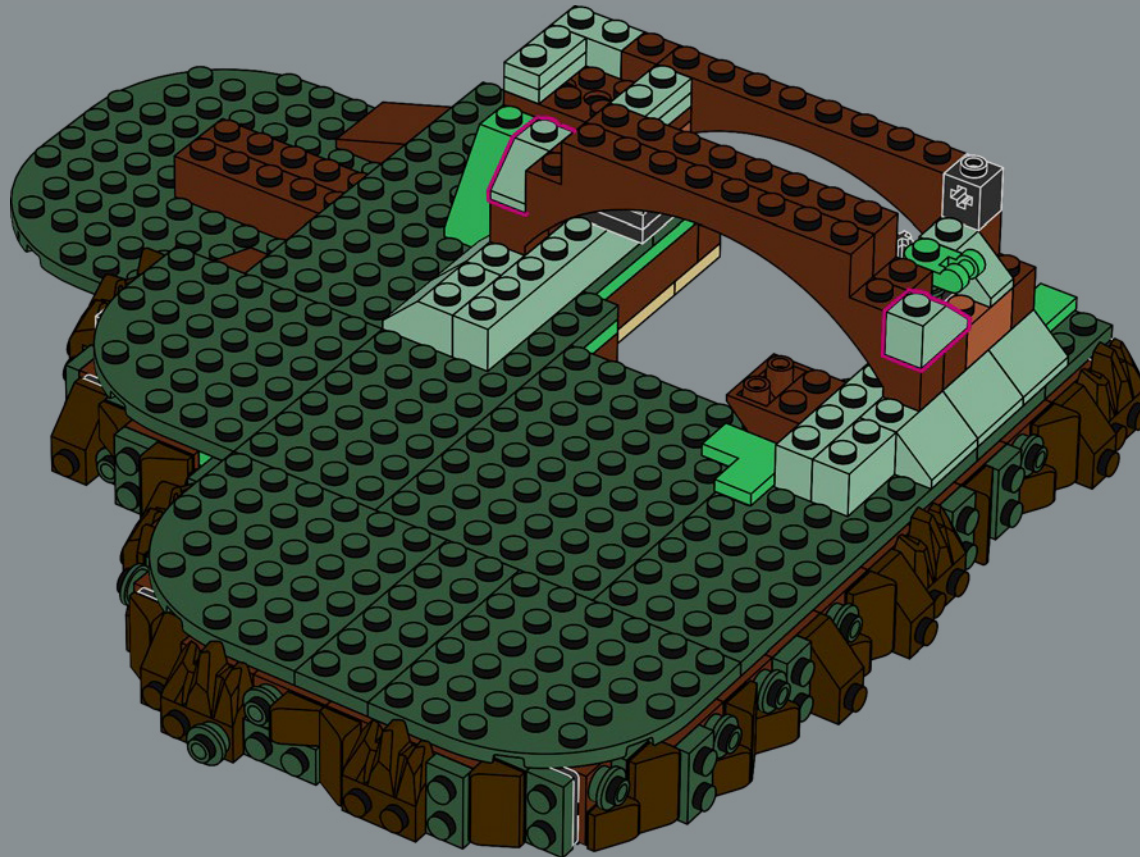

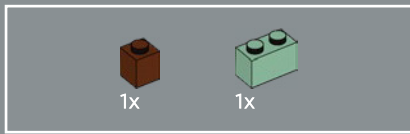

39

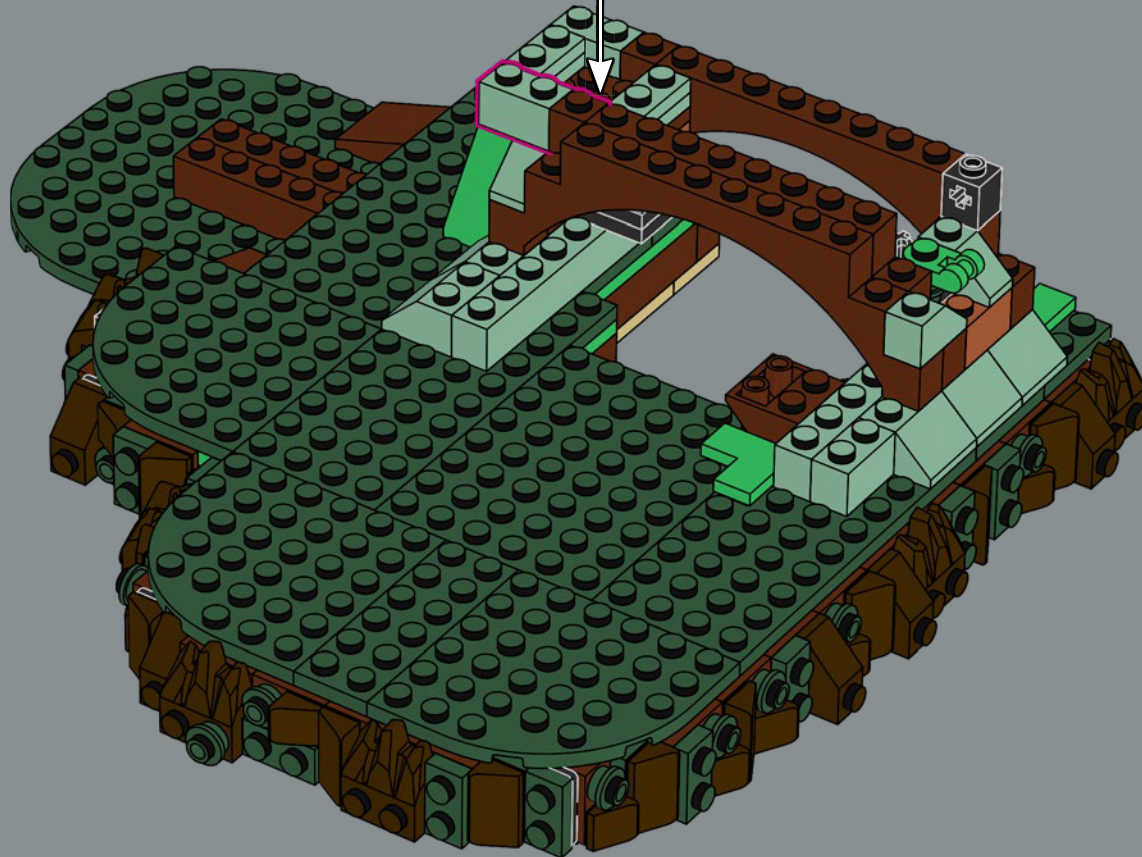
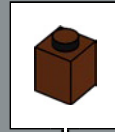

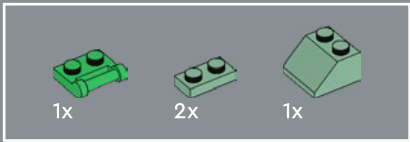

40

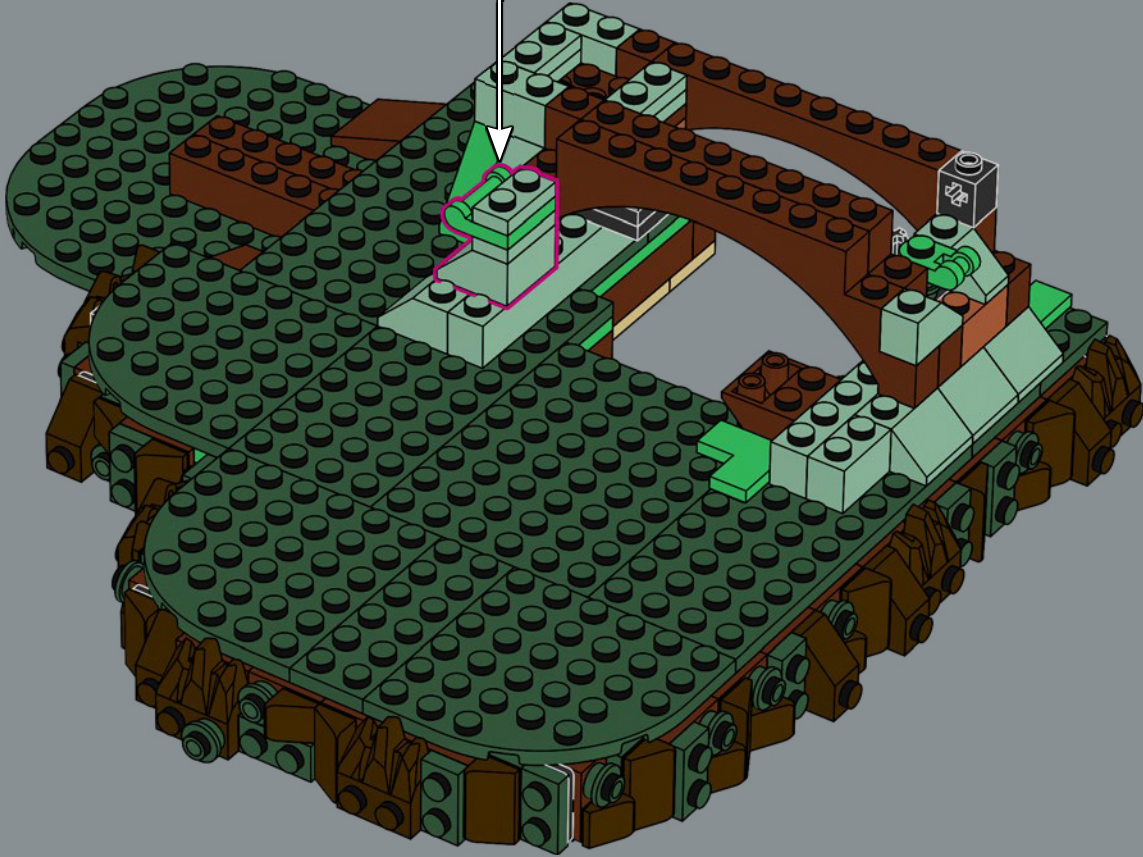
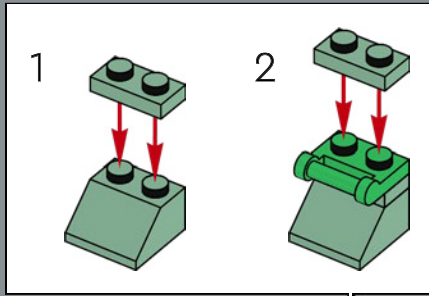

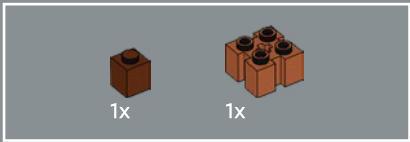

41

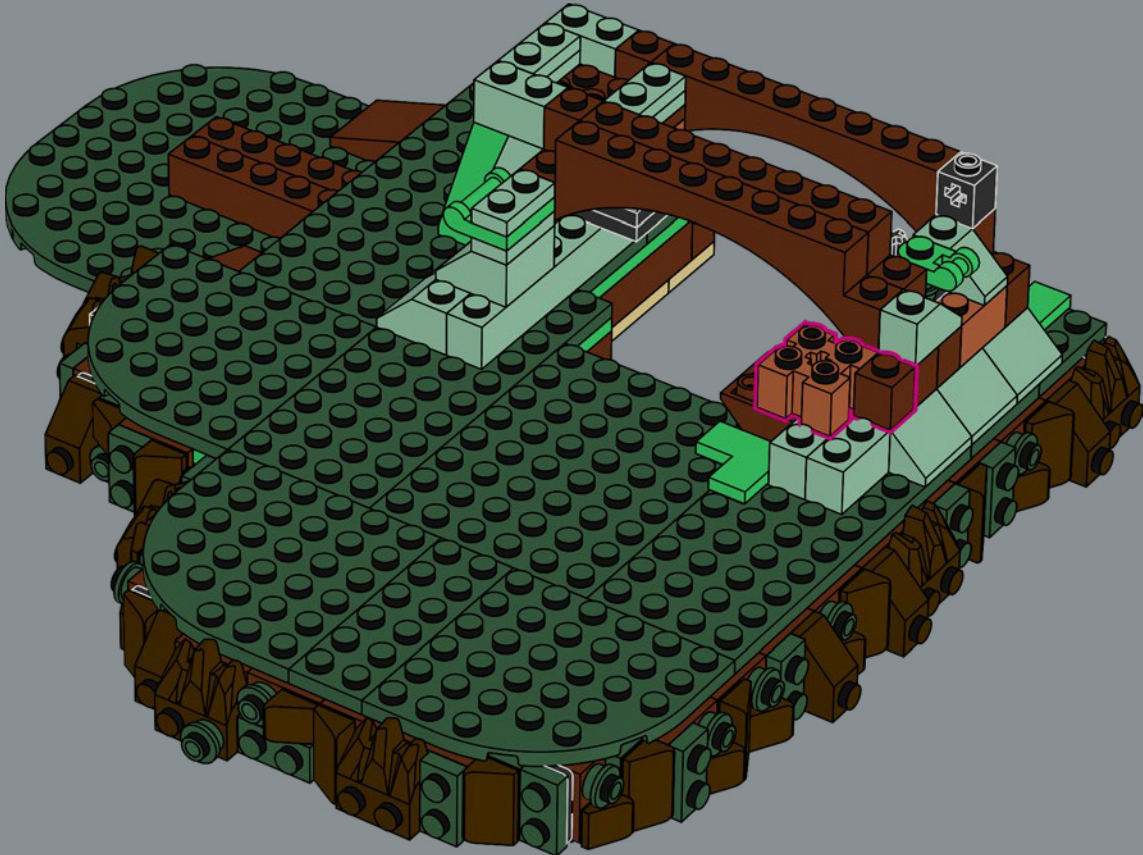

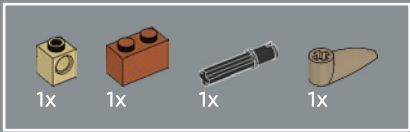

42

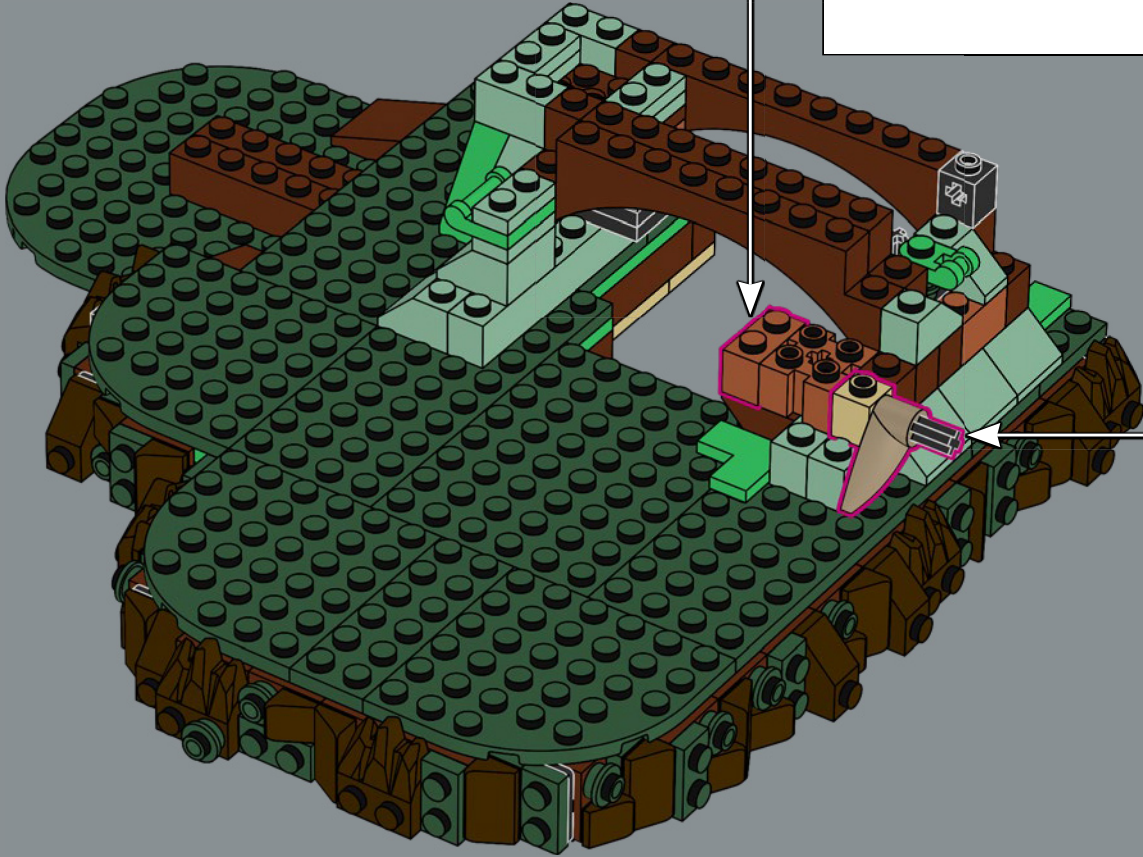
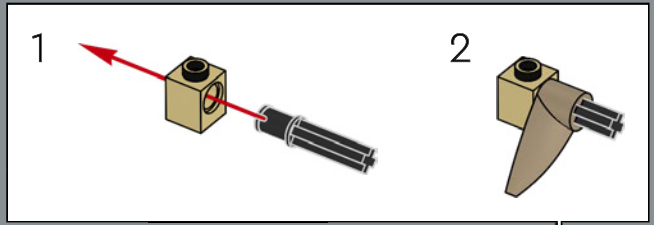
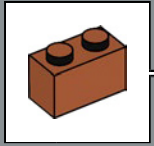

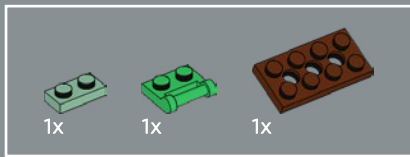

43

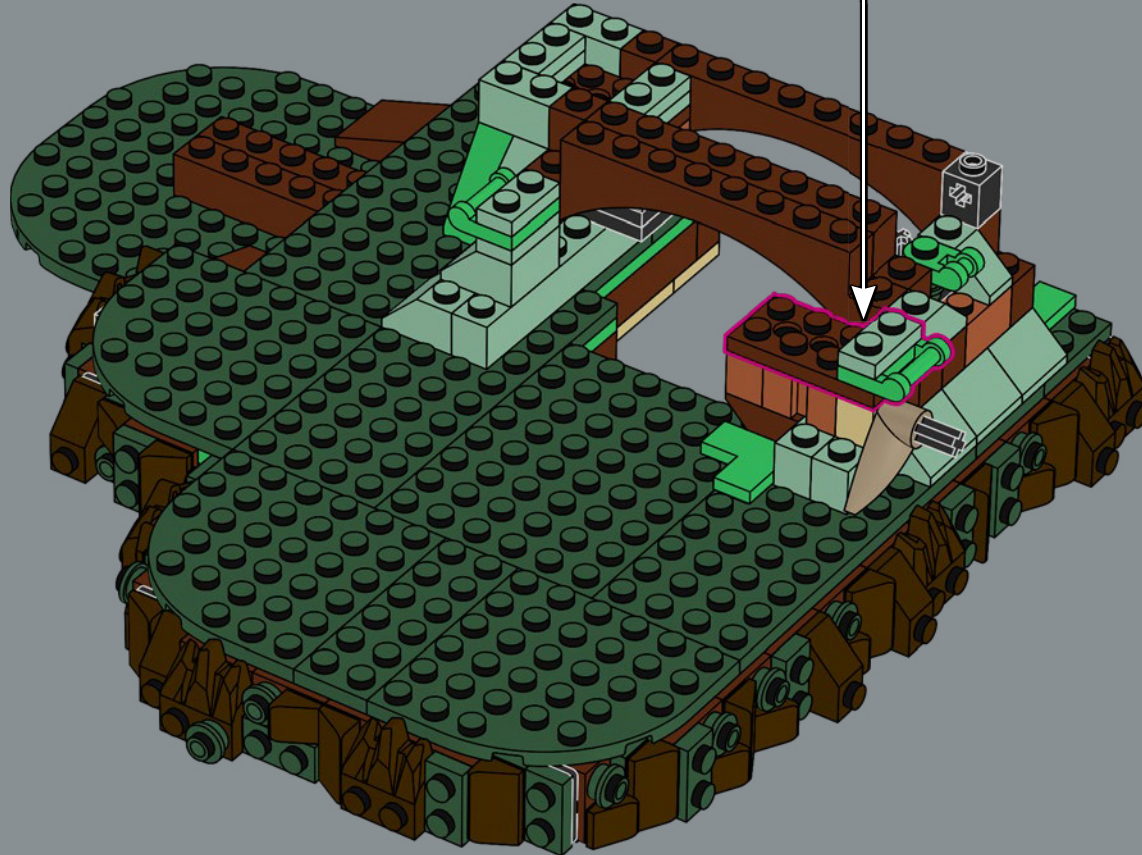
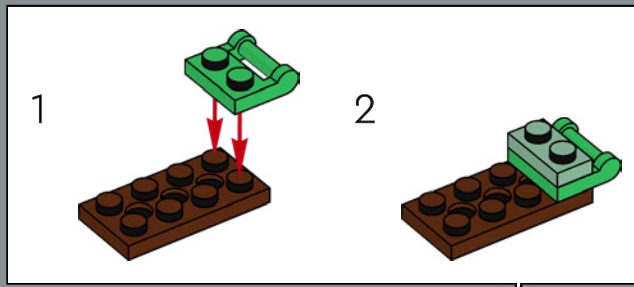

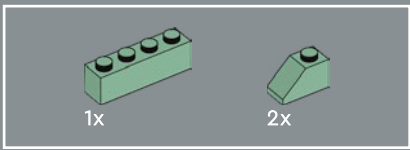

44

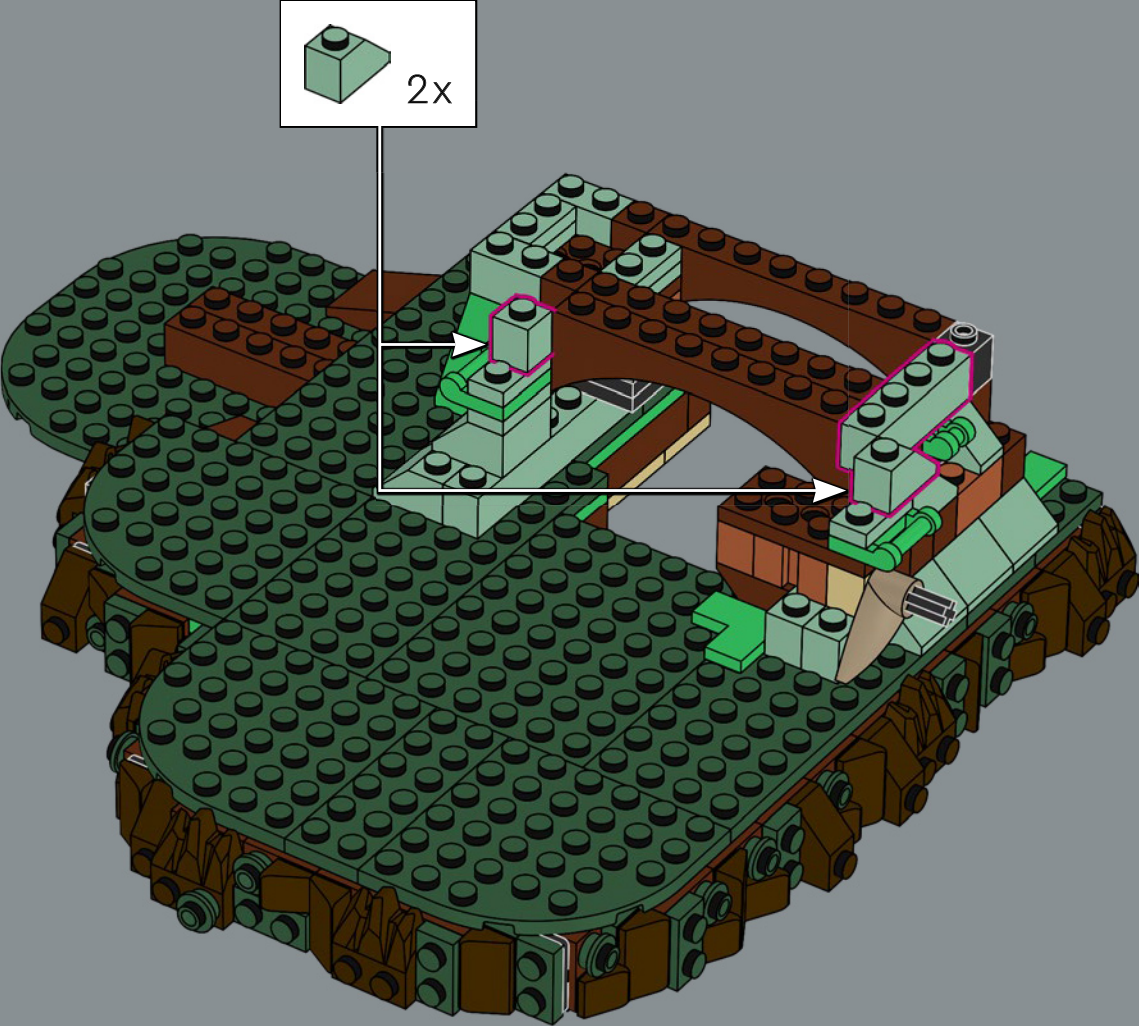

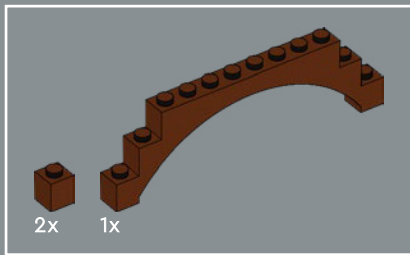

45

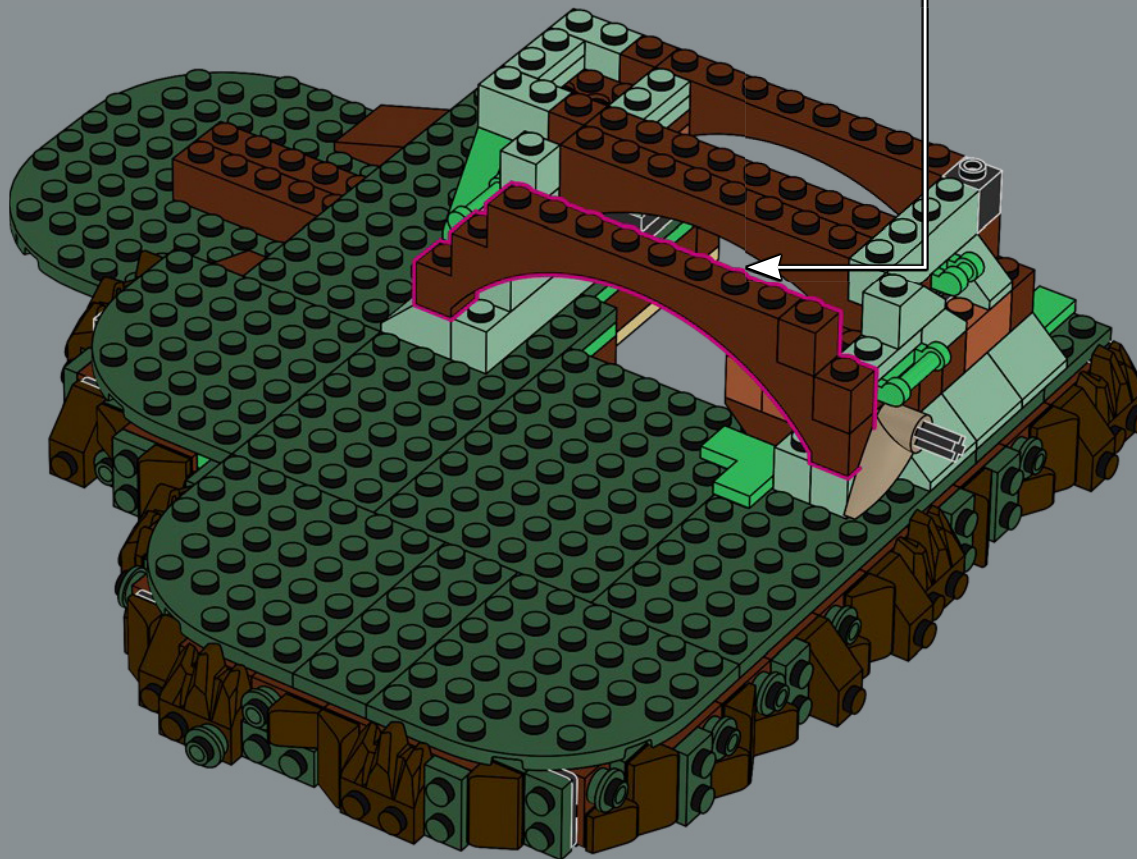
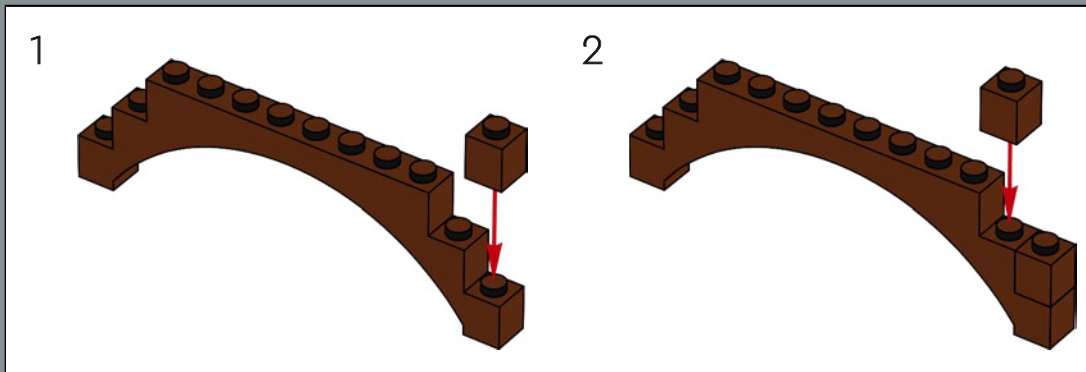



2x

46

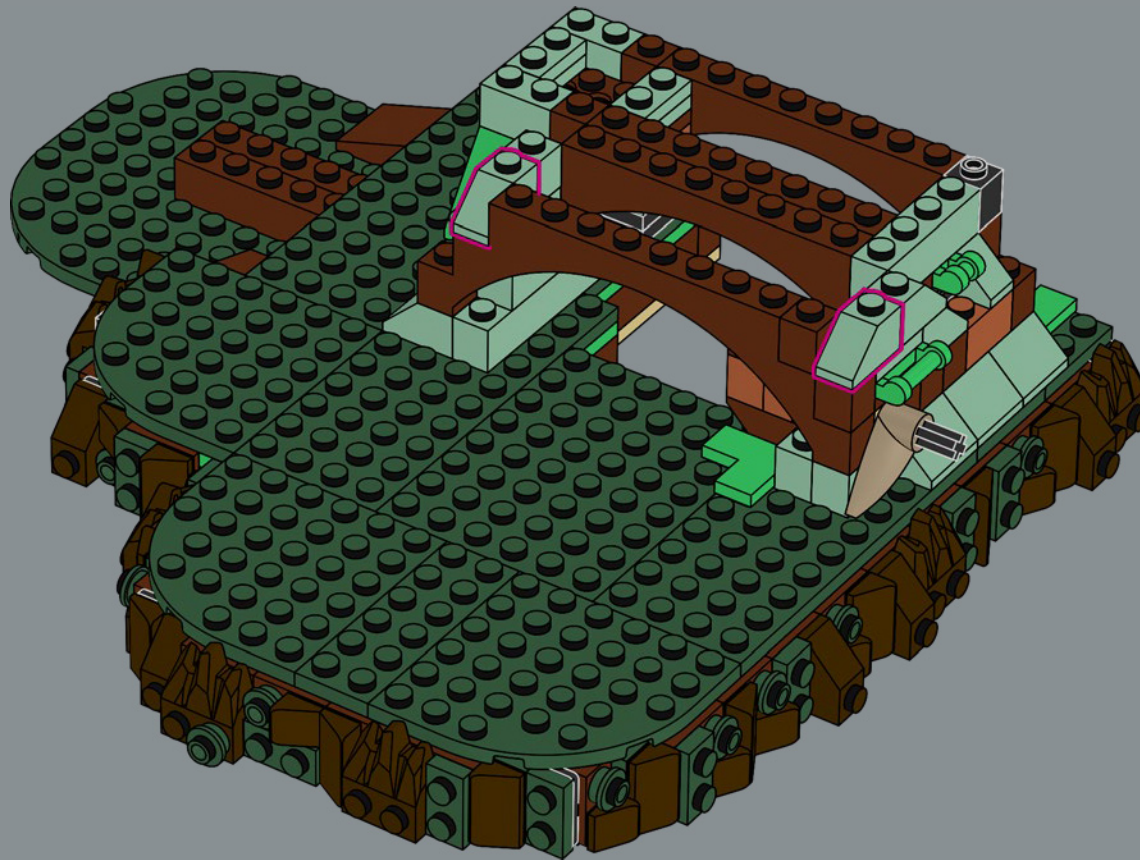

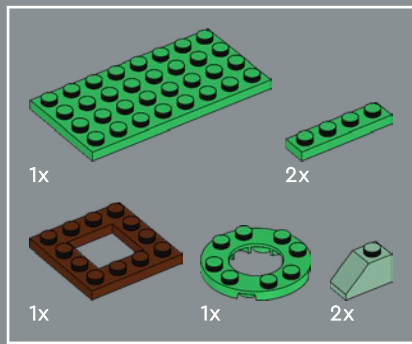

47

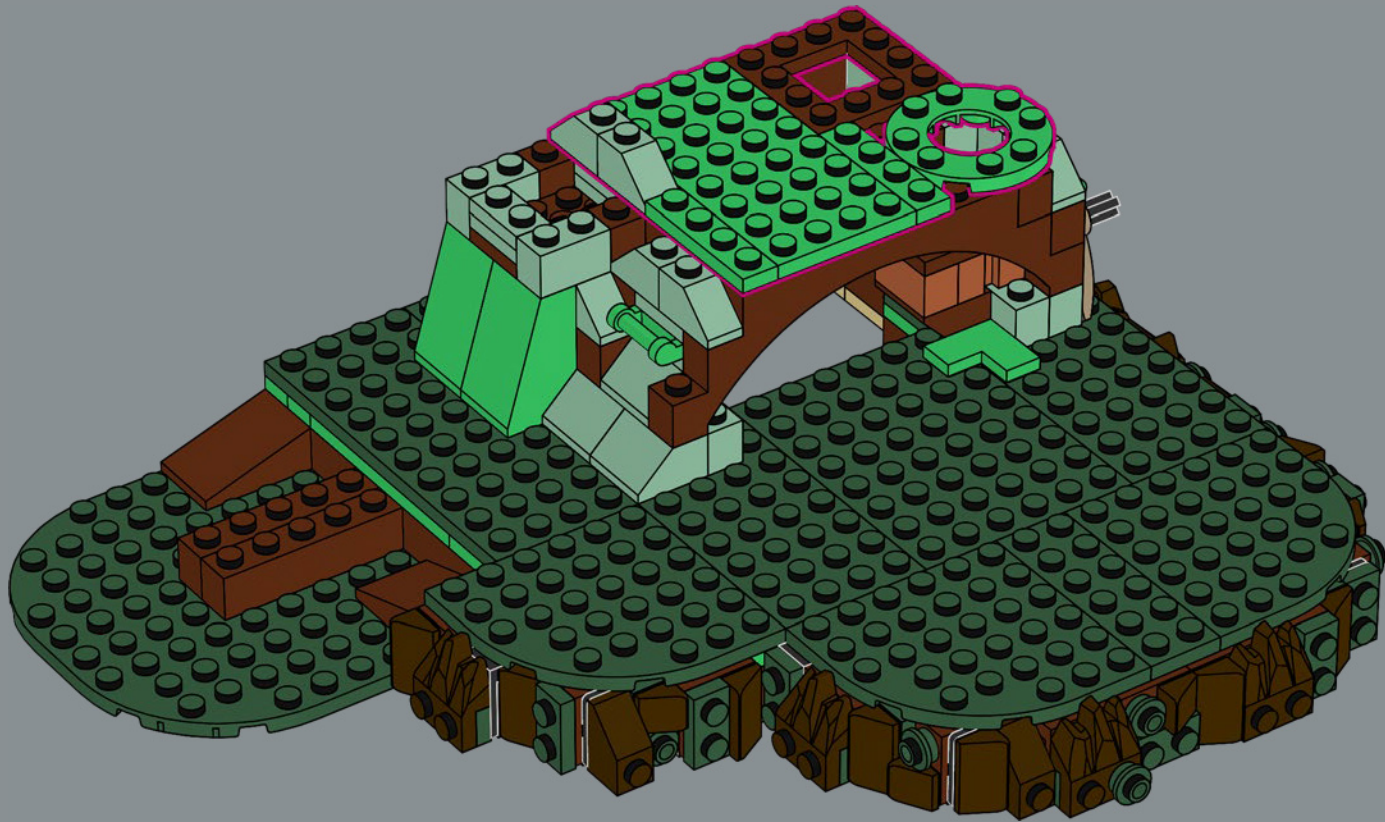

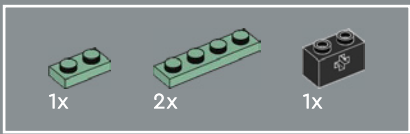

48



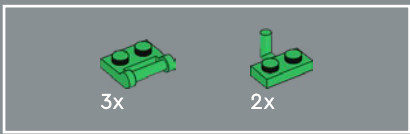

49



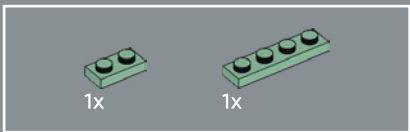

50



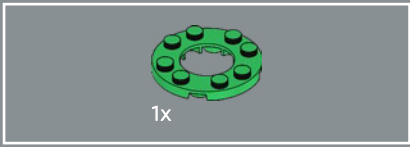

51



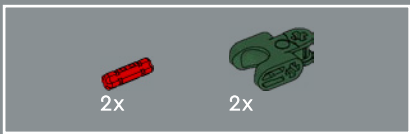

52

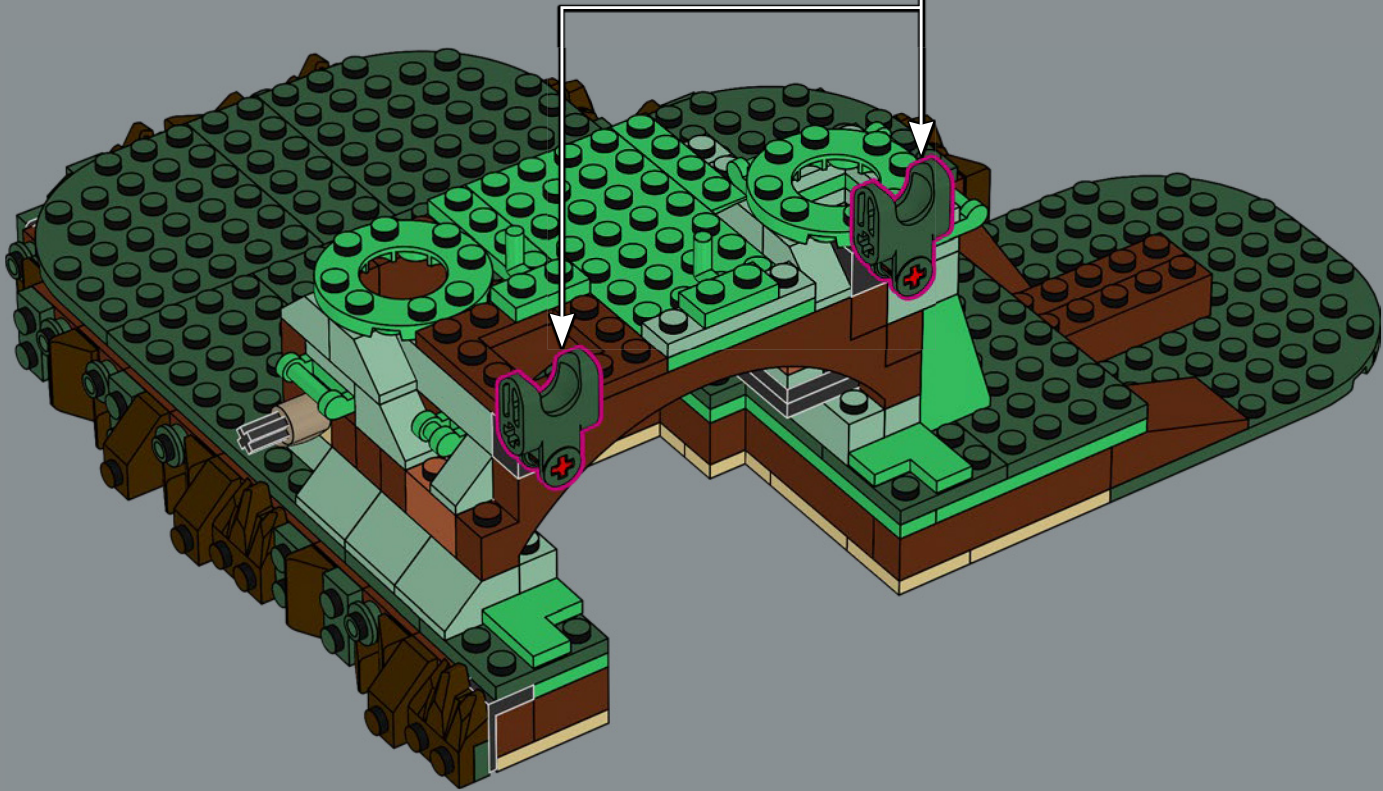
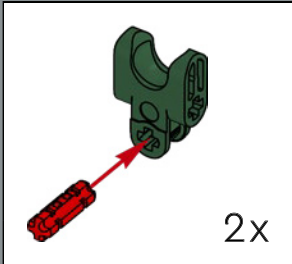

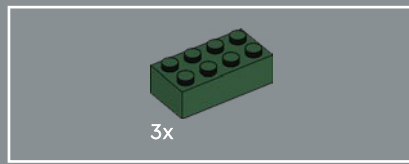

53

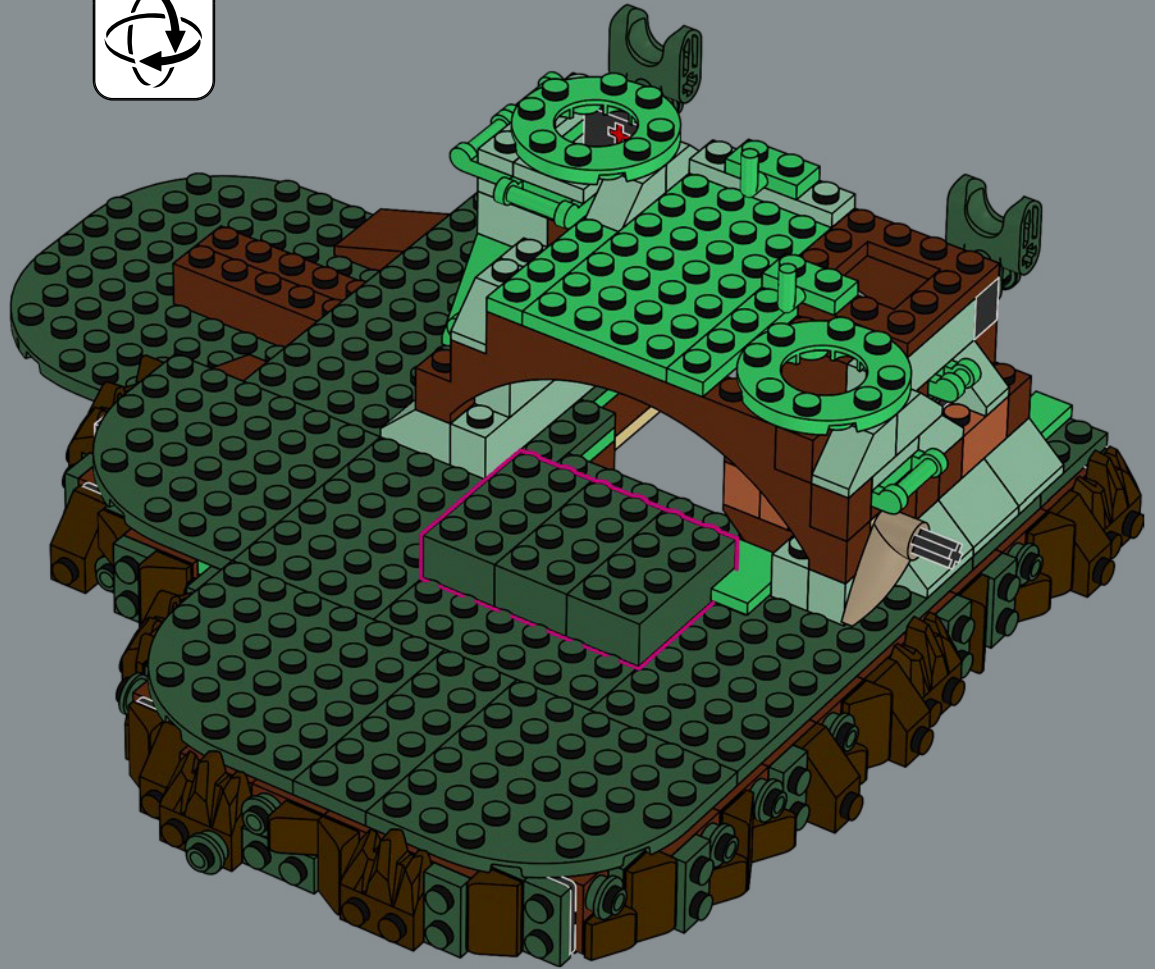

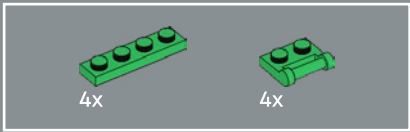

54



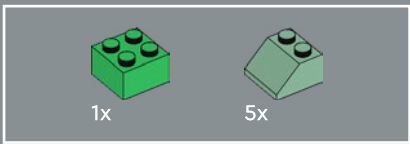

55



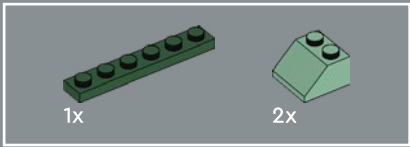

56

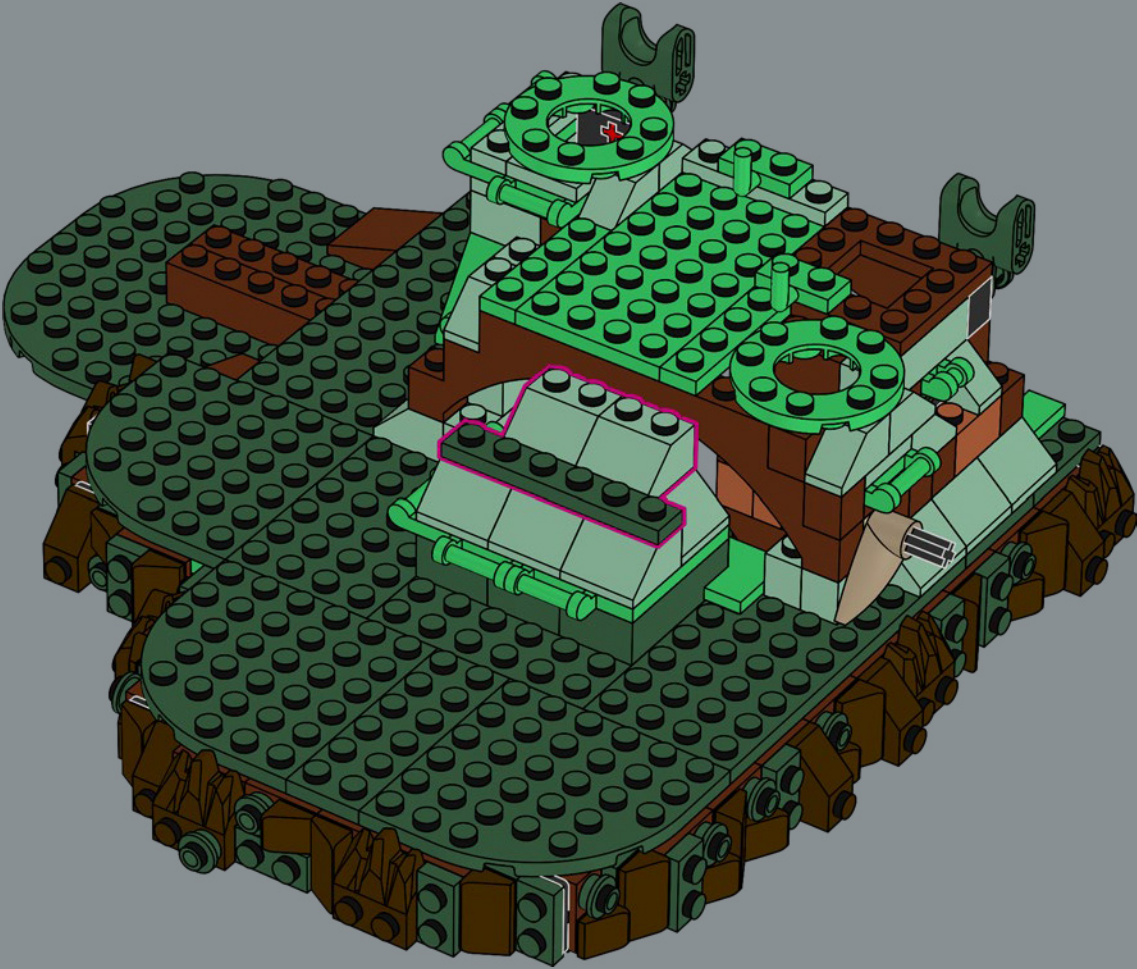

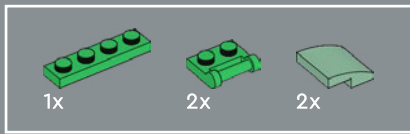

57

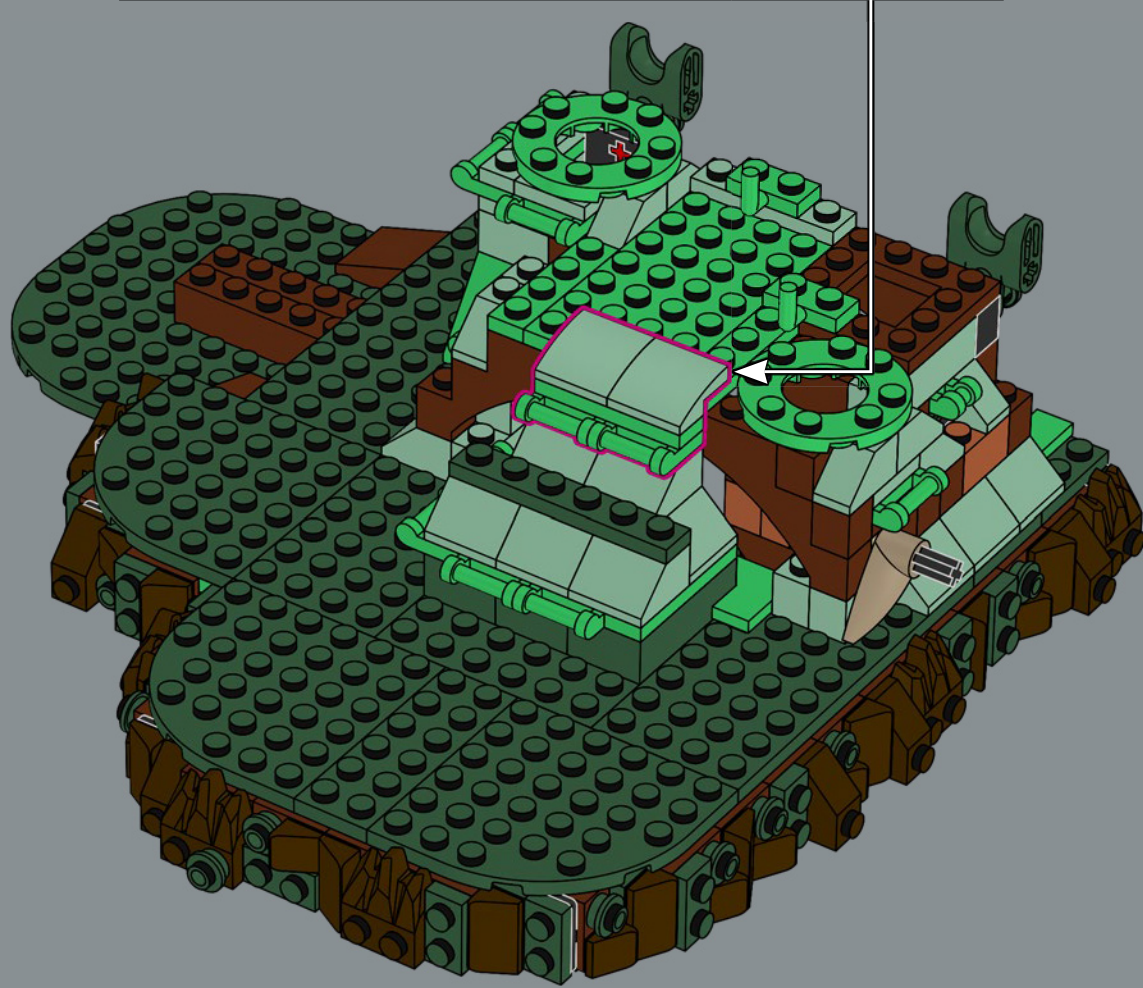
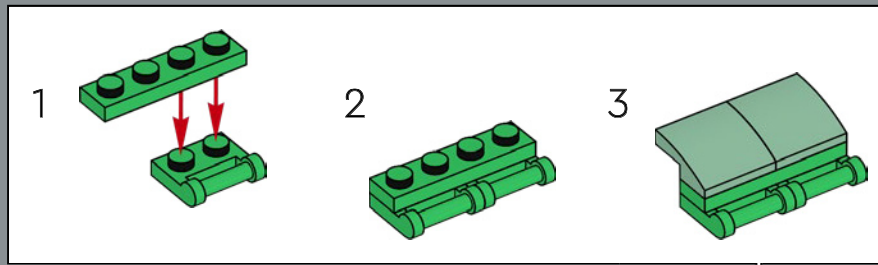



5x

58

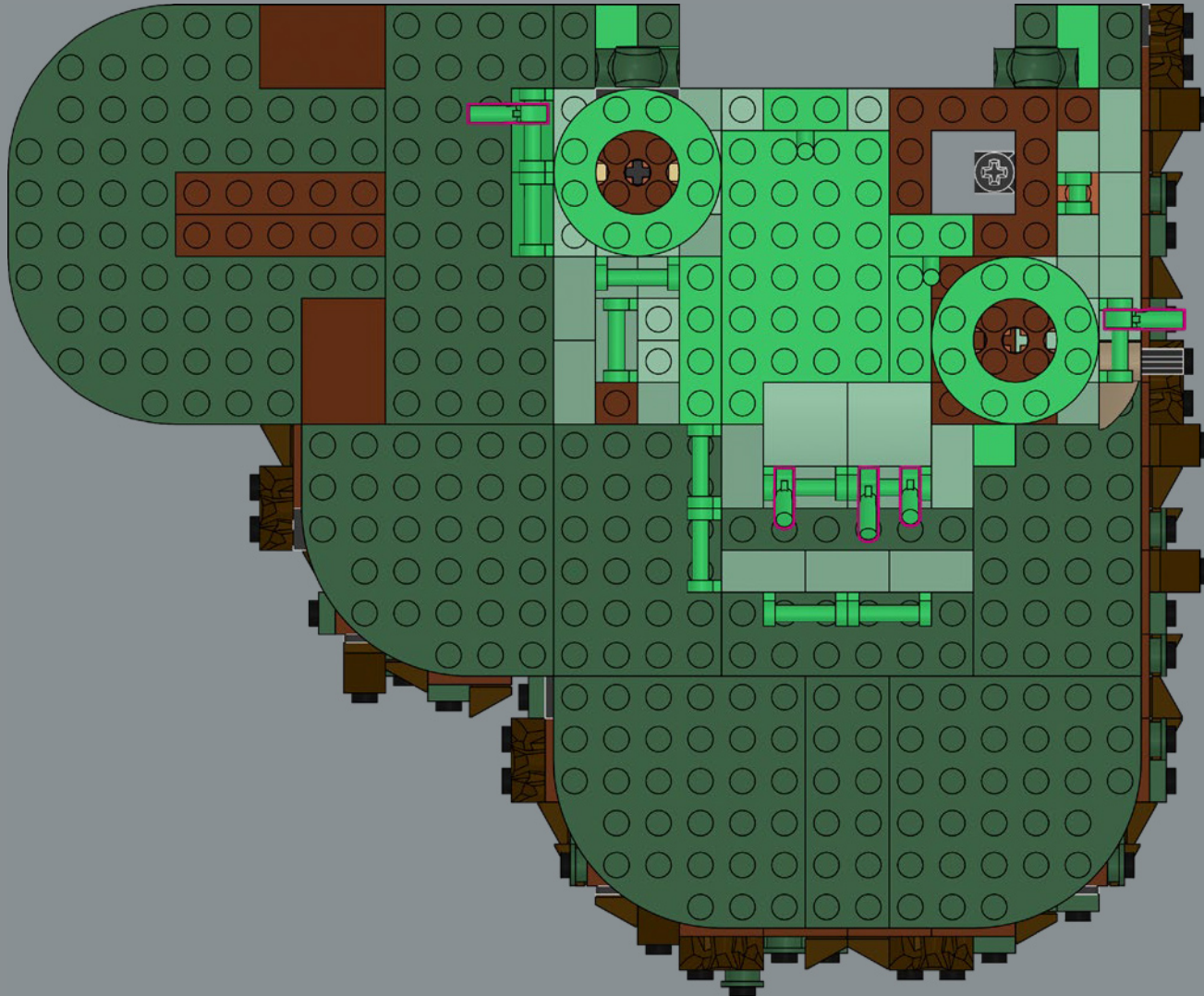



59

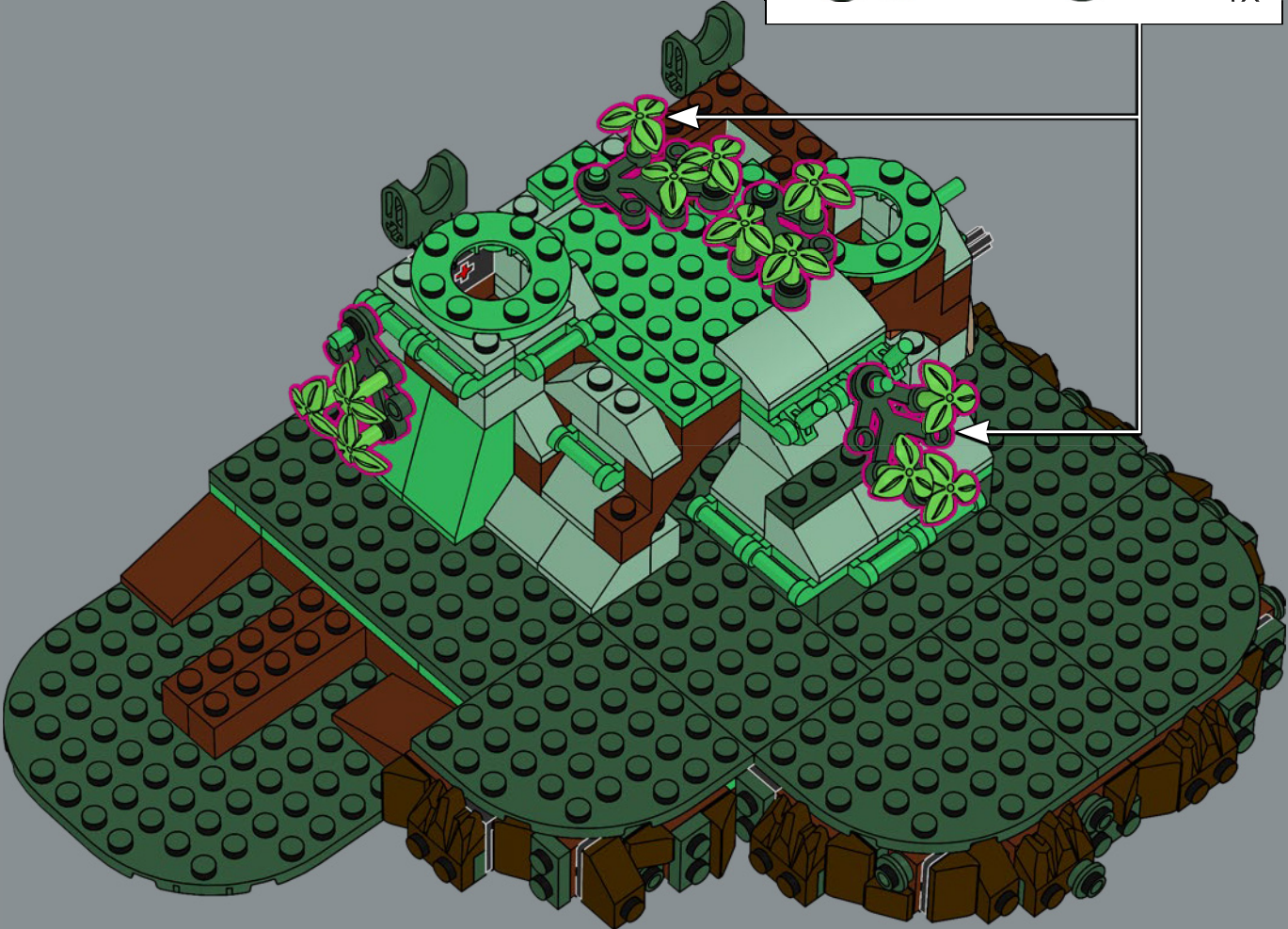
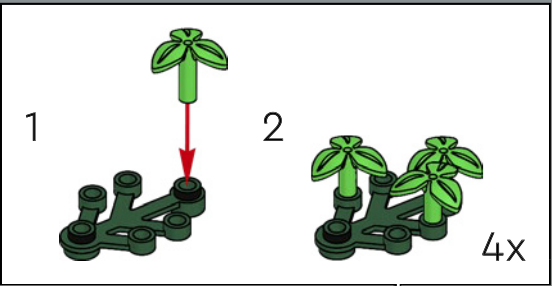



60

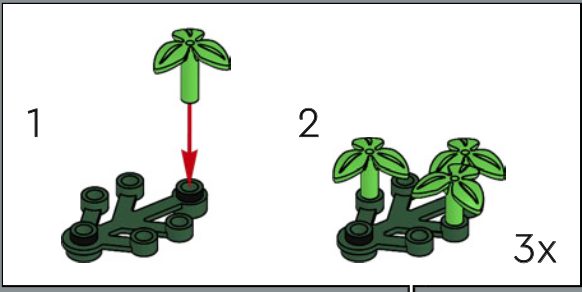



61

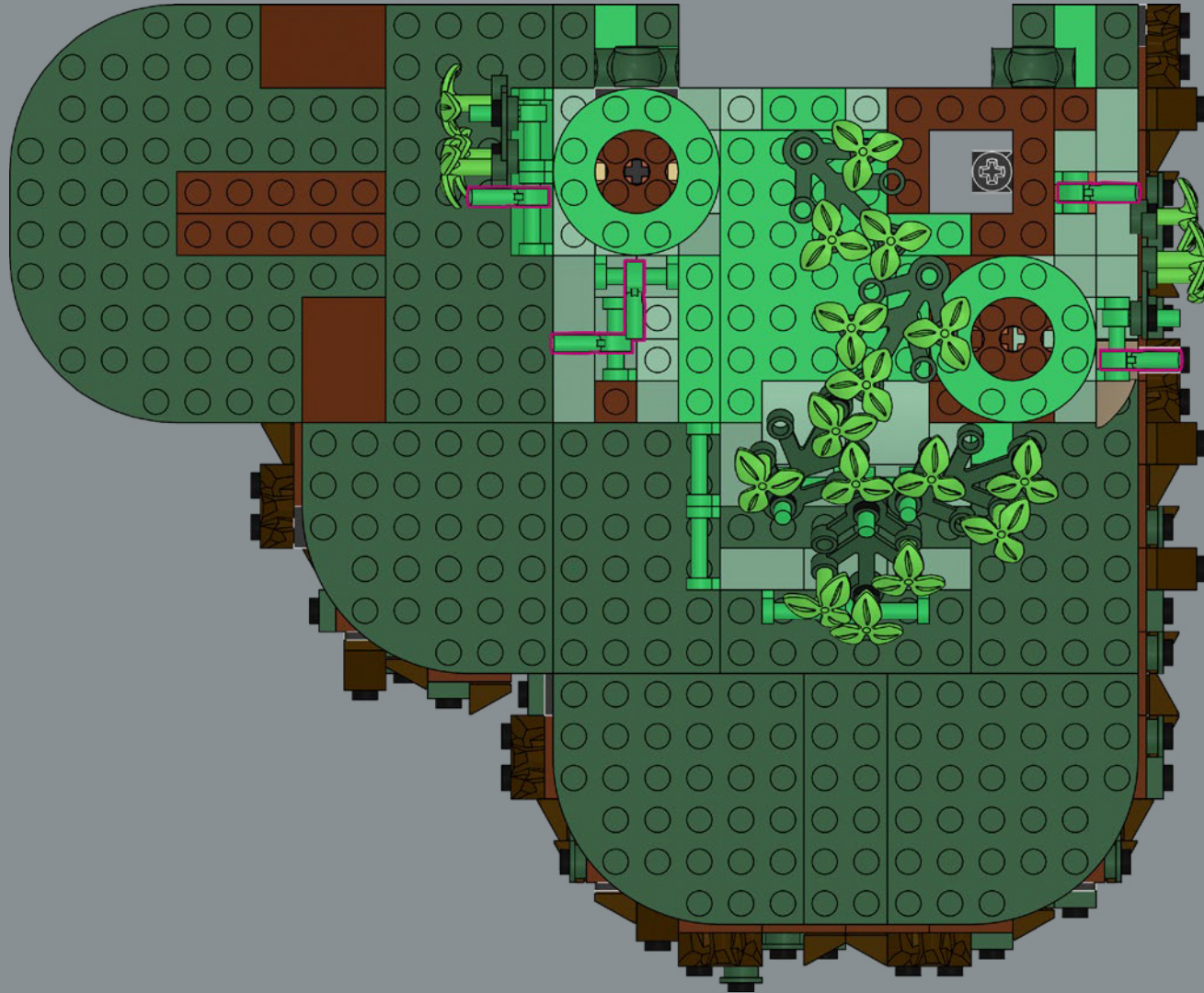



62

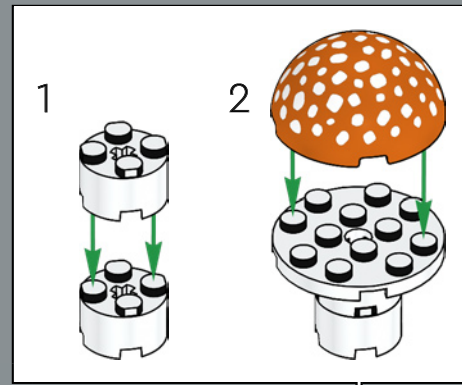



63



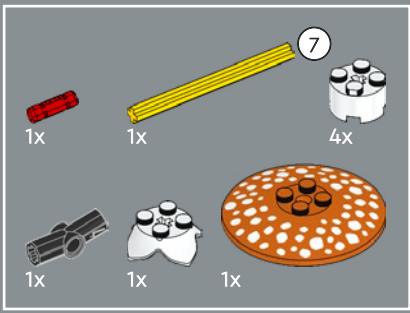

64

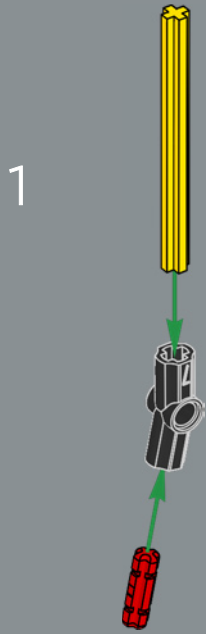

2



3

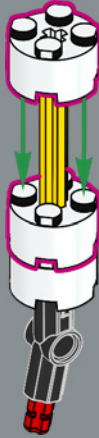

4



5





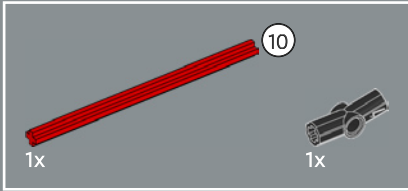
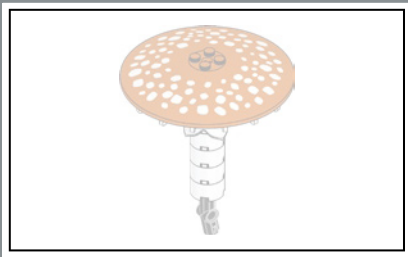

65

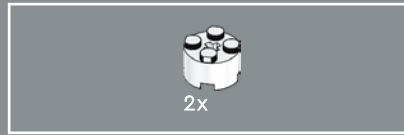

66

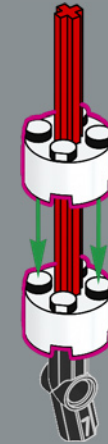

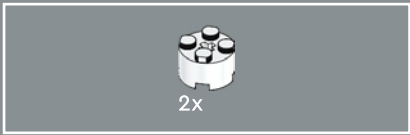

67

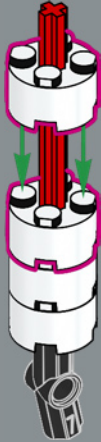

68

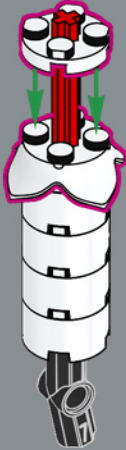

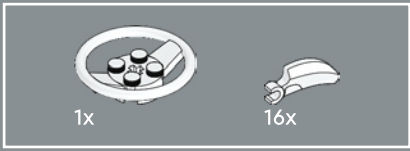

69

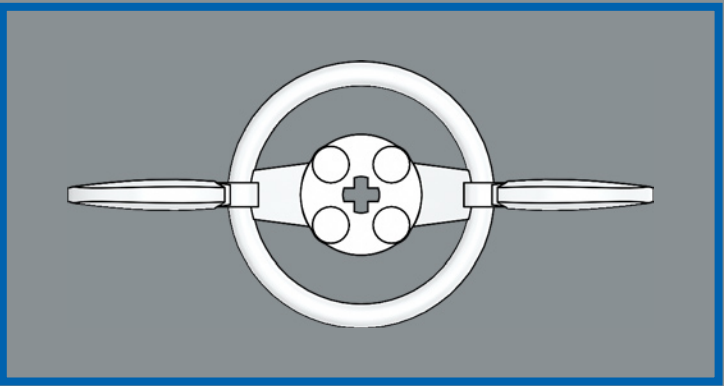

1

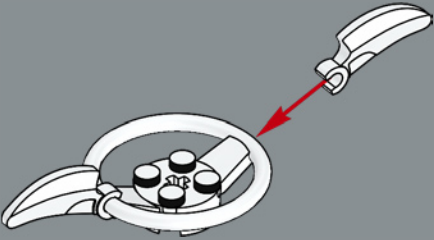

2

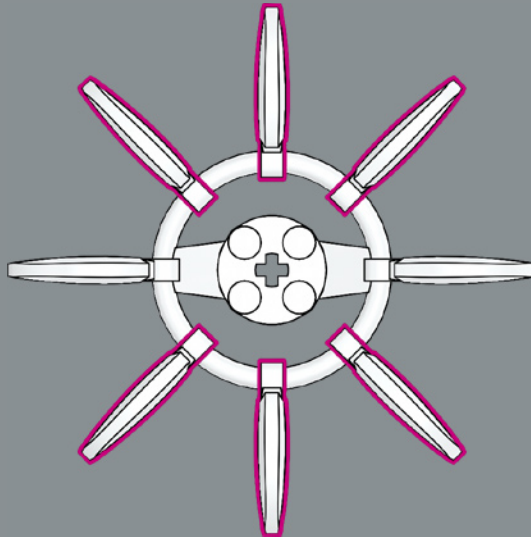

3

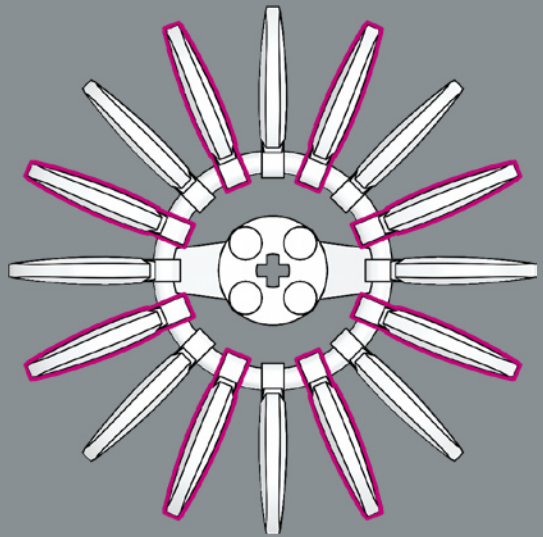

Los elementos que representan garras pueden usarse para mucho más que animales y criaturas LEGO®. Aquí, forman las láminas bajo las grandes setas matamoscas.

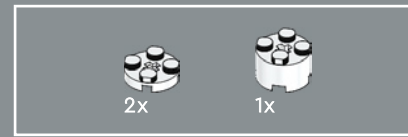

70

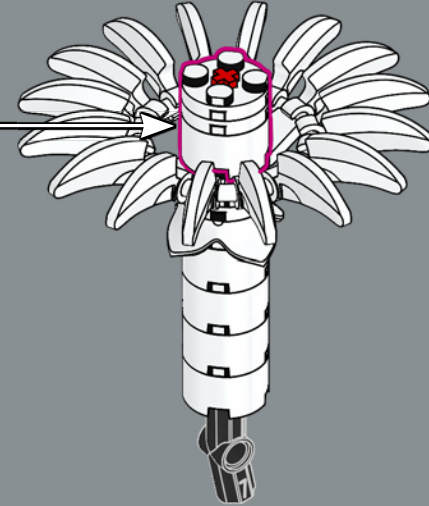
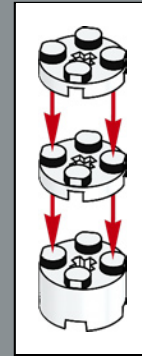
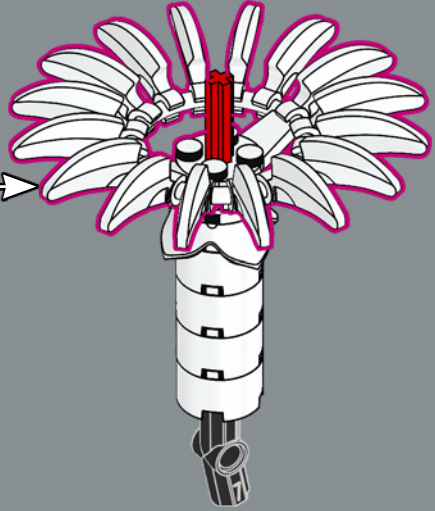

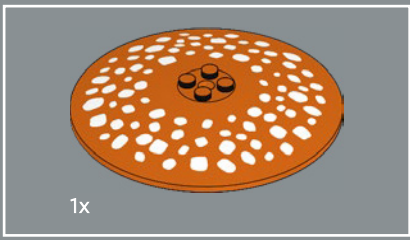

71



72





73



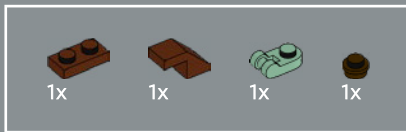

74

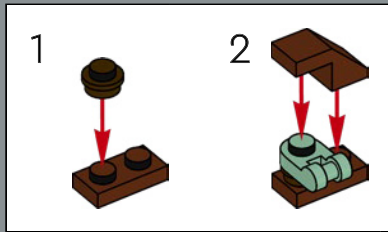



4x

75





76

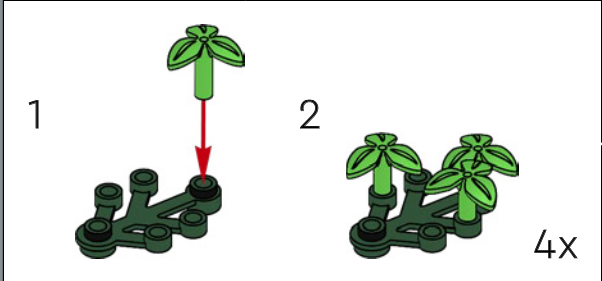



77



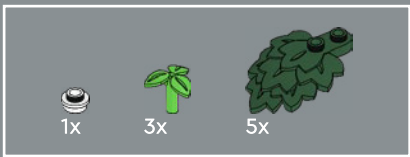

78





3x



2x

79



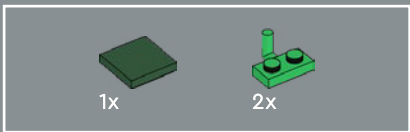

80

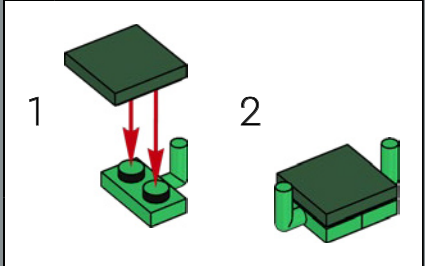

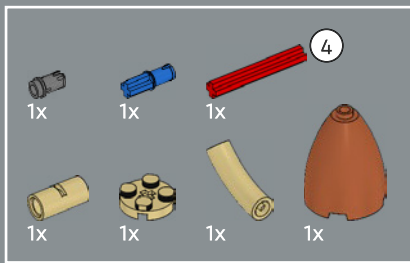

81

1



2

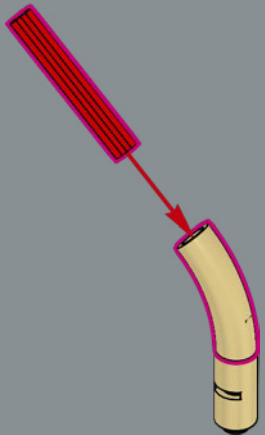

3

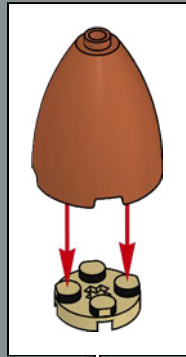

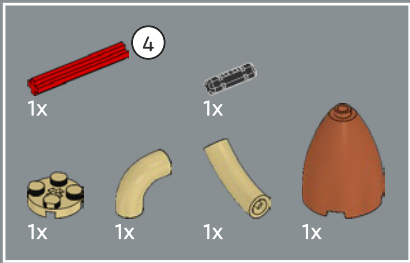

82

1

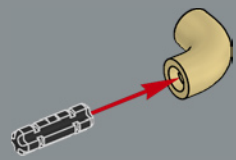

2

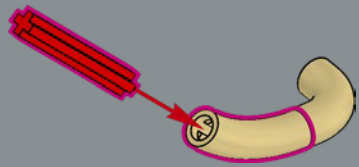

3

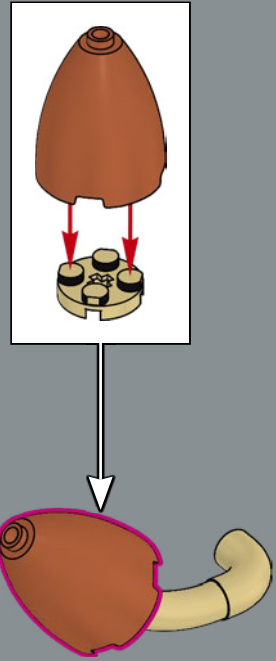

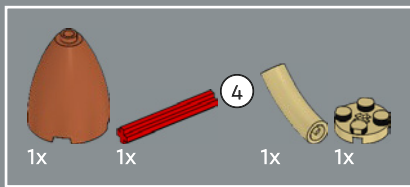

83

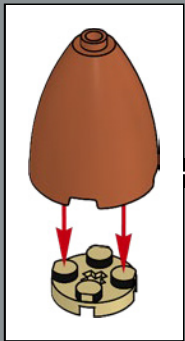
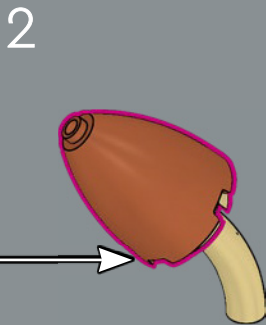
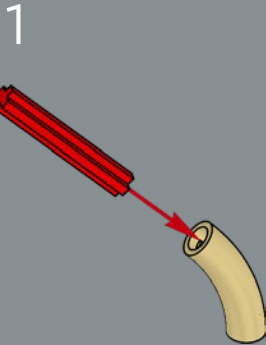

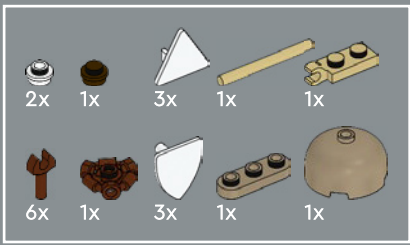

84

1

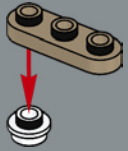

2

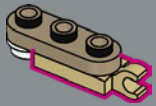

3

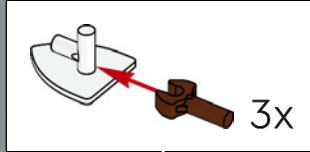
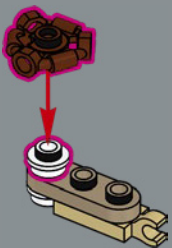

4

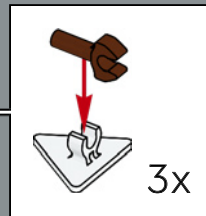
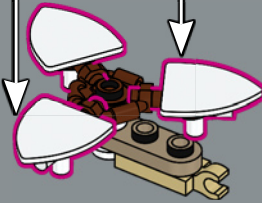

5

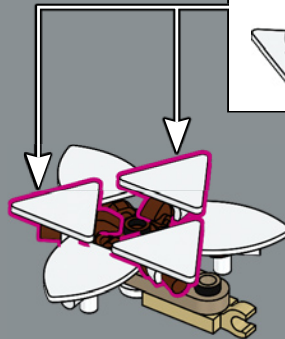

A la hora de recrear figuras caprichosas, entran en juego todo tipo de elementos LEGO®. Para conseguir la forma característica de la estrella de tierra con collar, combinamos señales de tráfico triangulares con escudos de minifiguras.

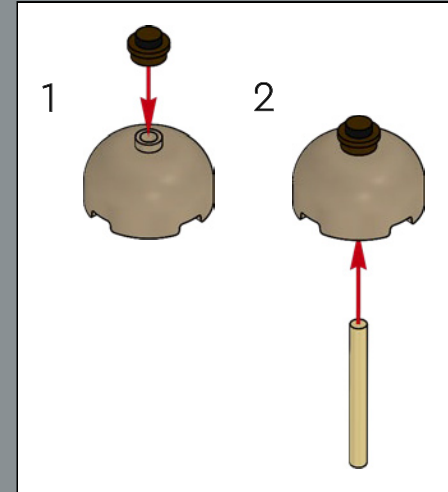

6

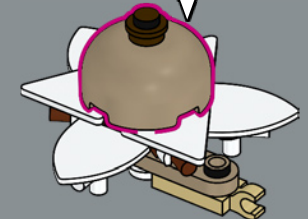





85

1

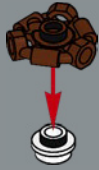

2

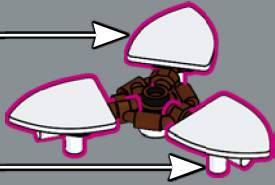
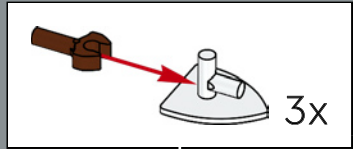

3

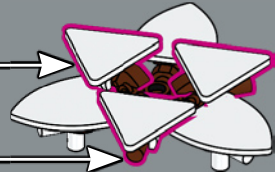
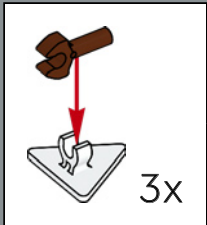



86

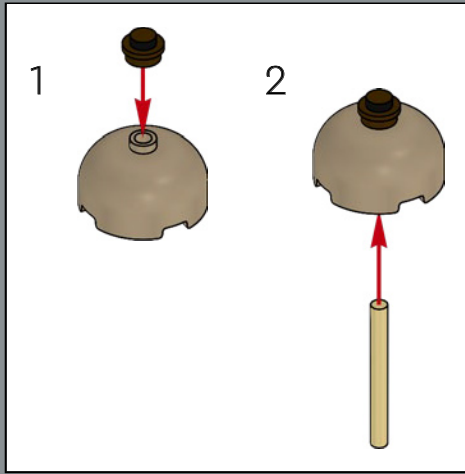

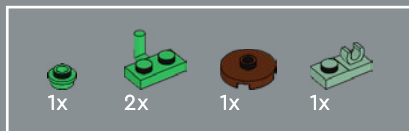

87



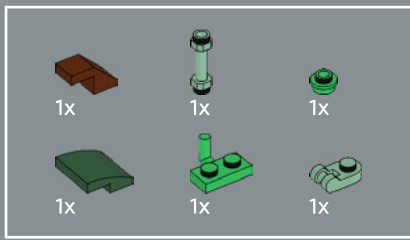

88

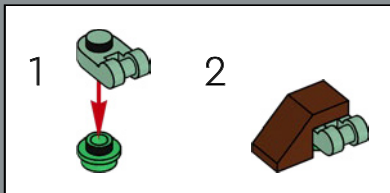
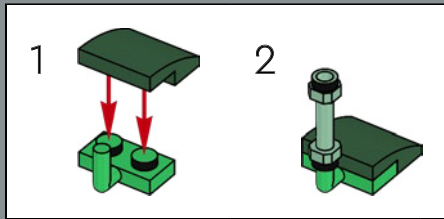

Los estambres de los azafrares silvestres adquieren un brillo casi regio con estas coronas de minifiguras LEGO®.

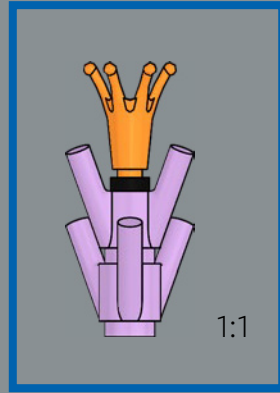
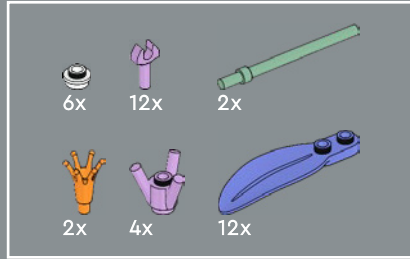
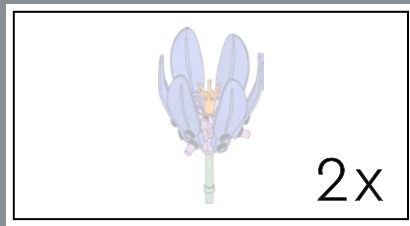

89

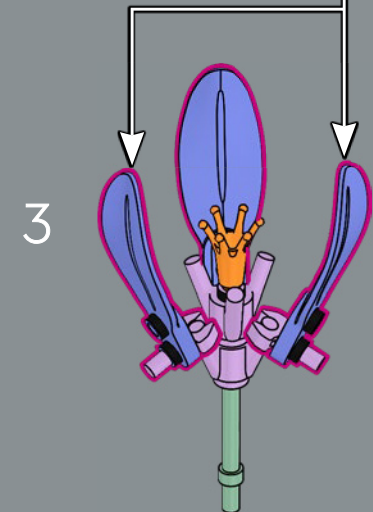
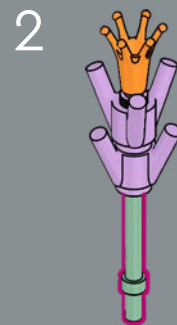
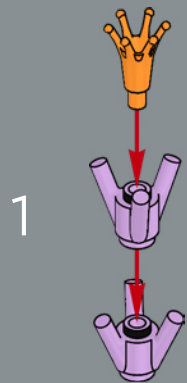
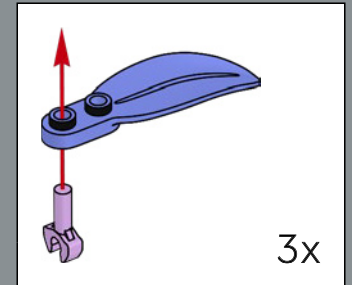

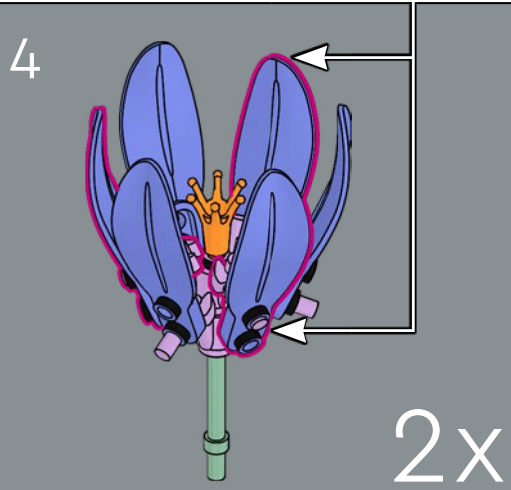
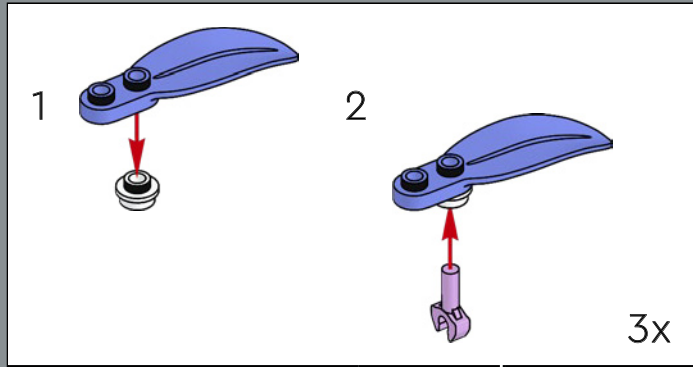

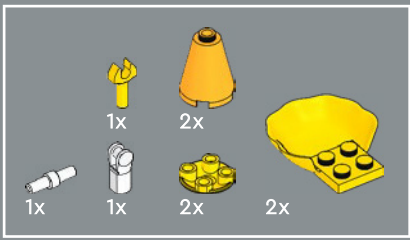

90

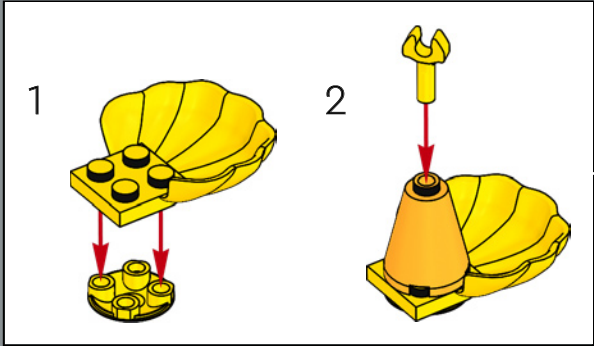
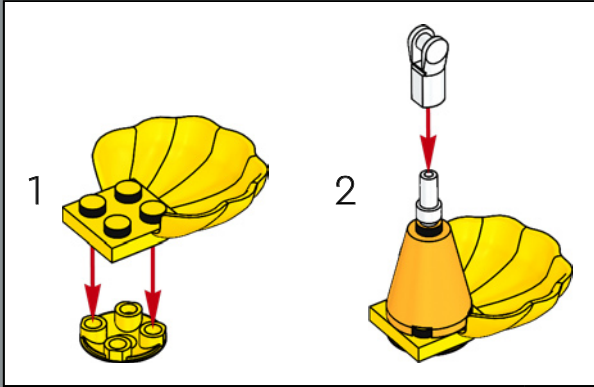

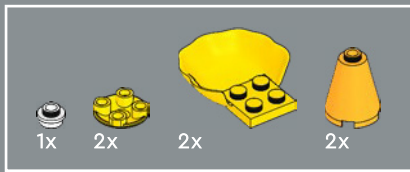

91

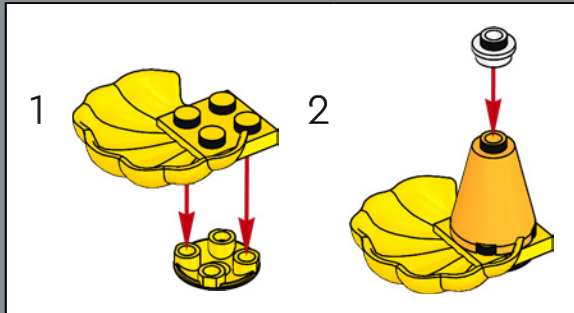
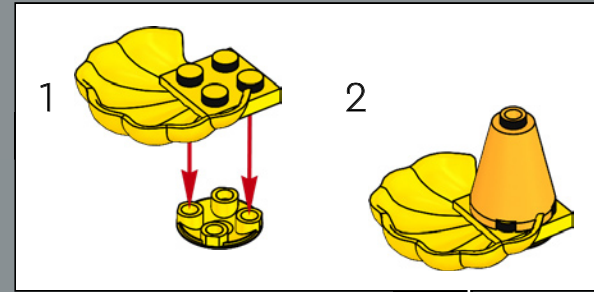

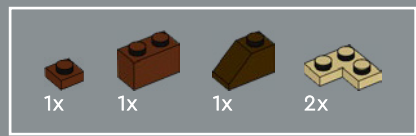

92





93





94



1x  2x 

95





96



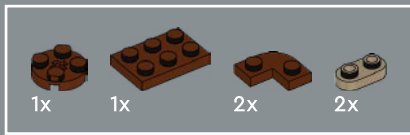

97



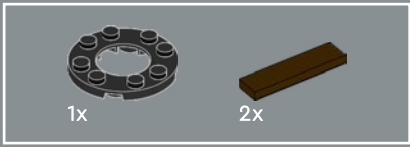

98



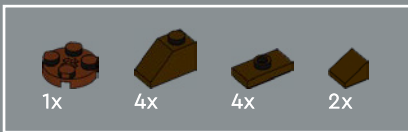

99

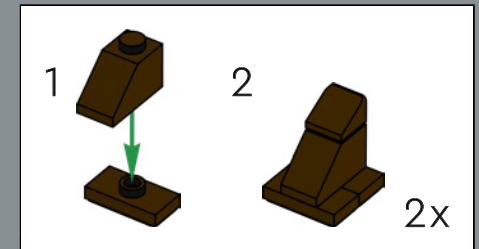



1x

100



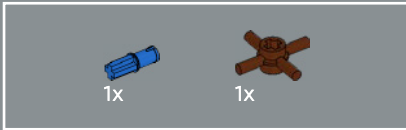

101

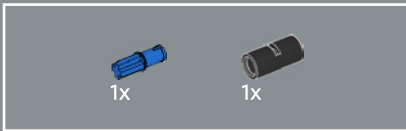
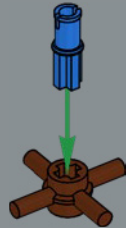

102

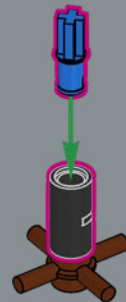

103

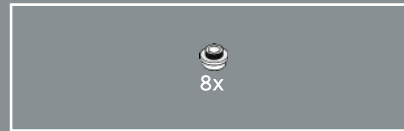

104

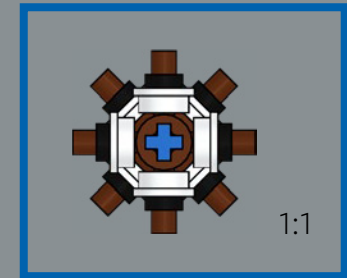



105

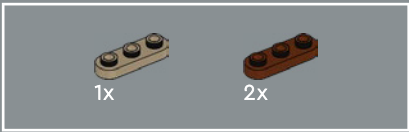
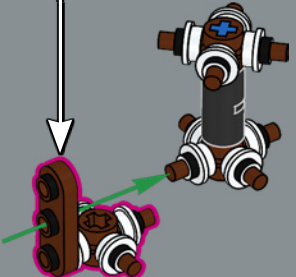
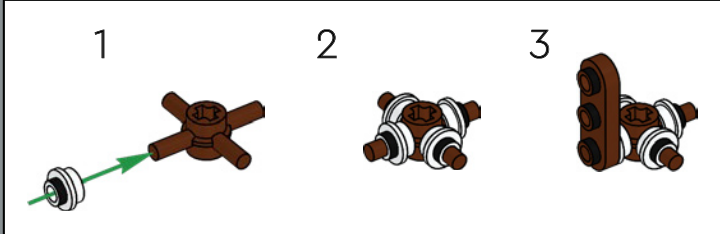

106

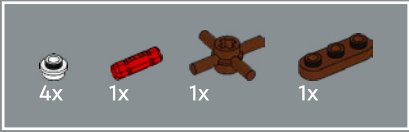
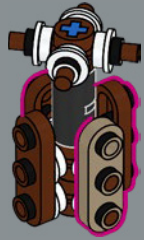

107

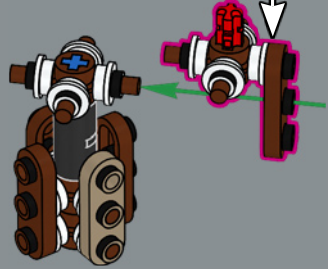
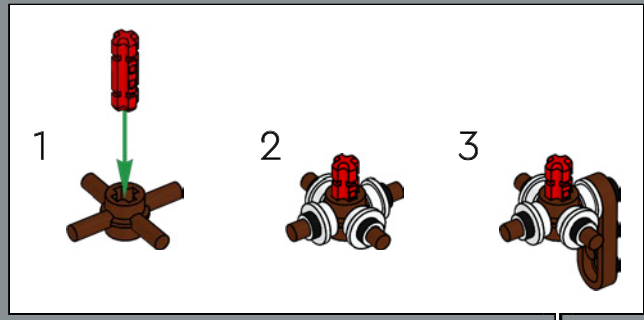



108

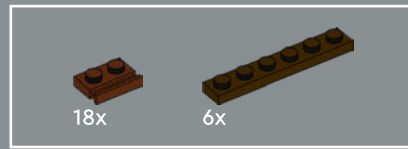
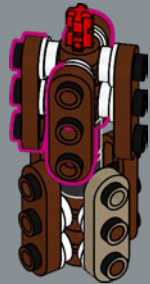

109

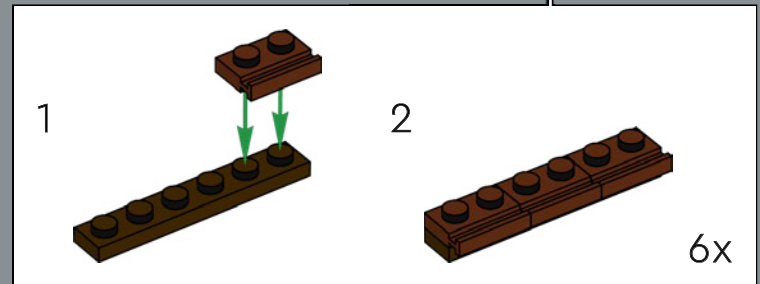
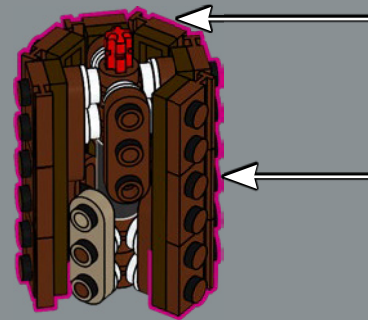
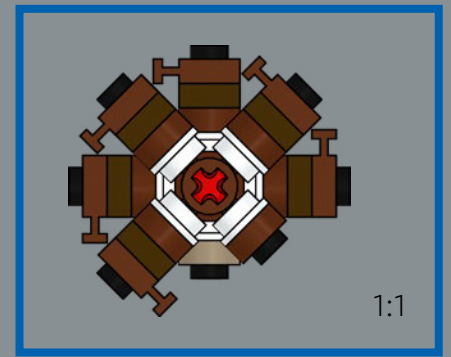

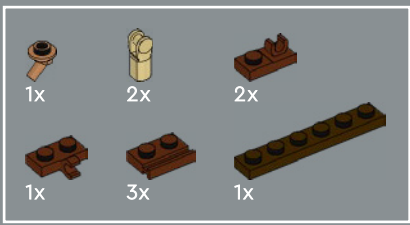

110

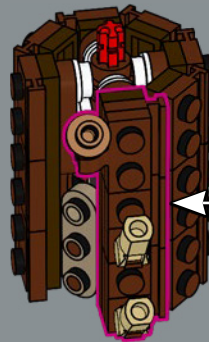
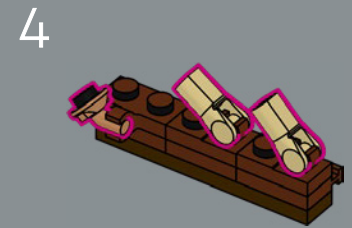
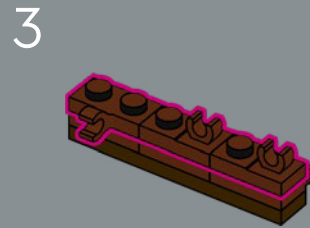
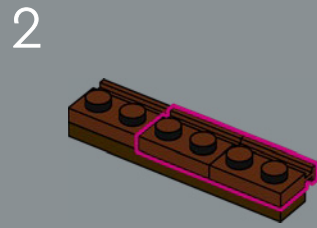
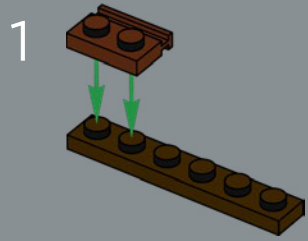

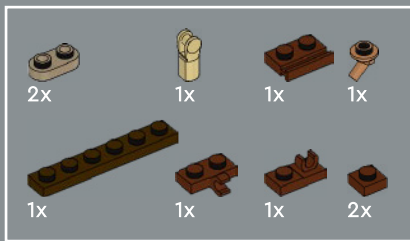

111

1

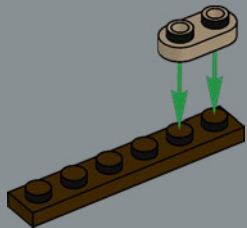

2

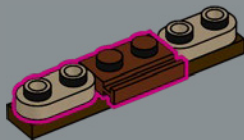

3

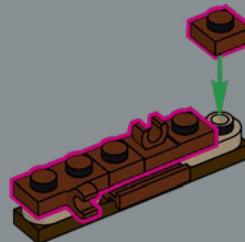

4

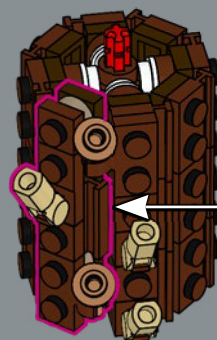
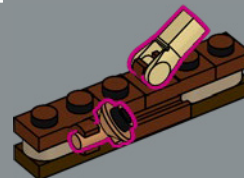

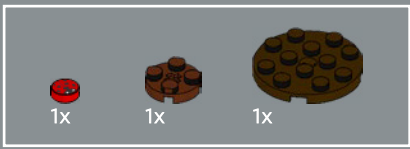

112

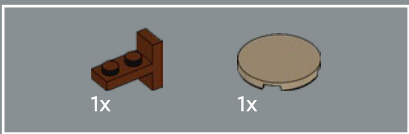
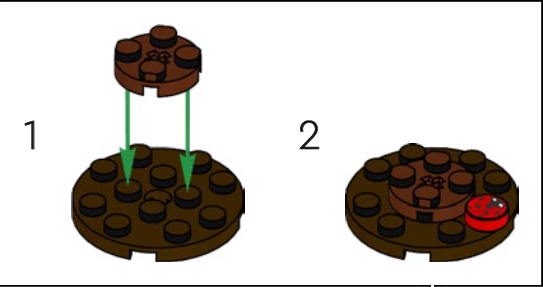

113

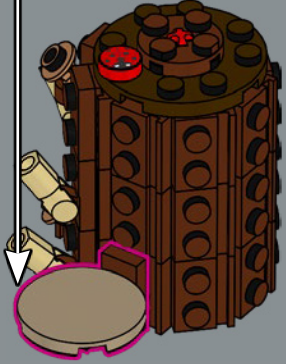
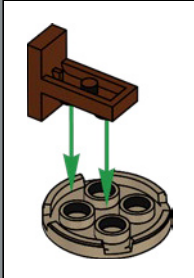



114

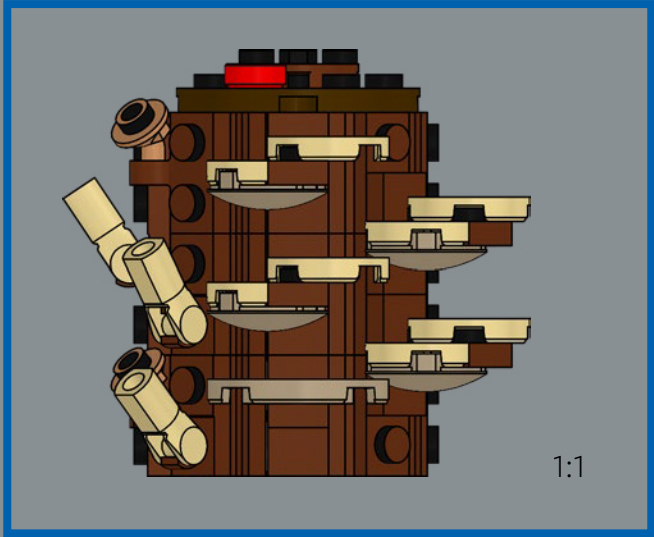
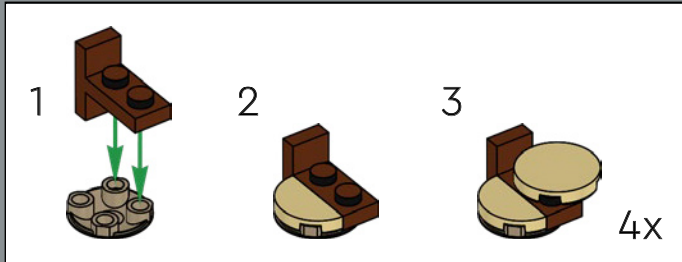



La micena, con su delicado sombrero y su esbelto pie, parece sacada directamente de las páginas de un cuento de hadas. La parte superior de esta versión es, en realidad, un sombrero de minifiguras LEGO® de enanos.



116

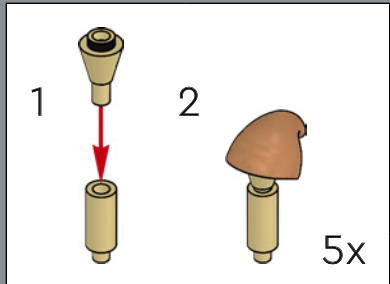

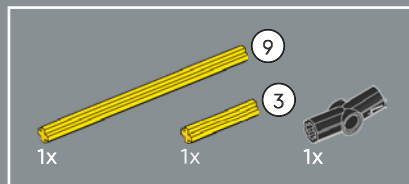
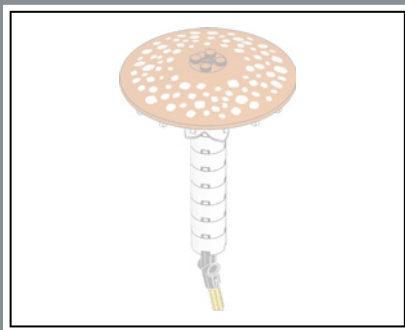

117

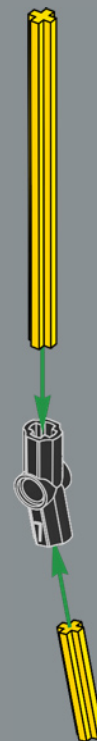

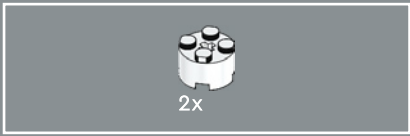

118

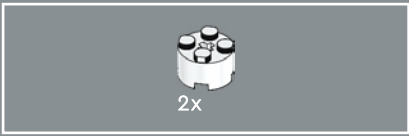
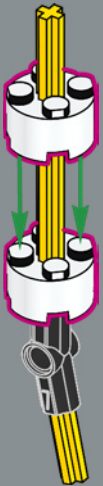

119

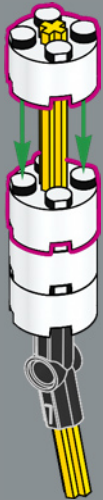



2x

120

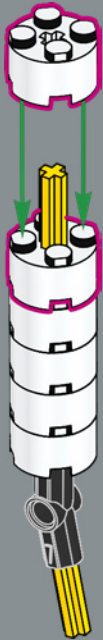

1x



1x



1x

121

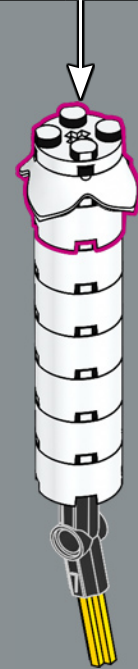
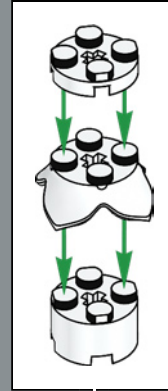

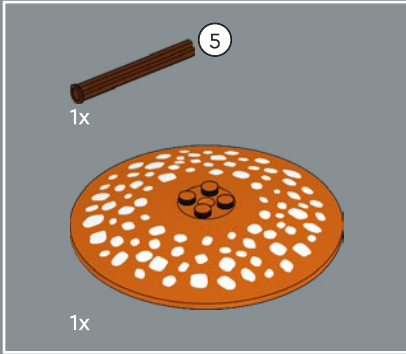
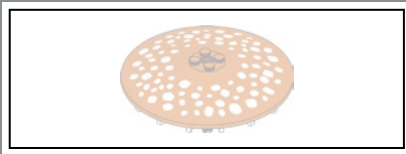

122

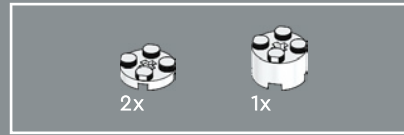
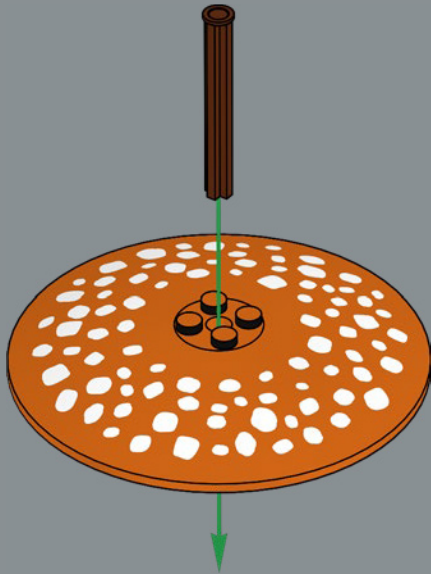

123

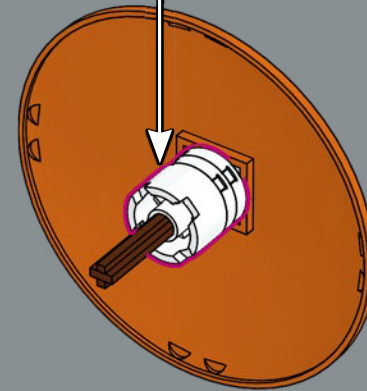
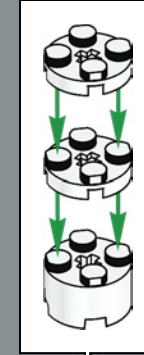

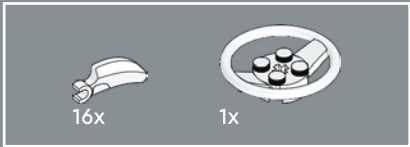
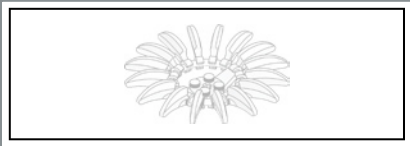

124

1

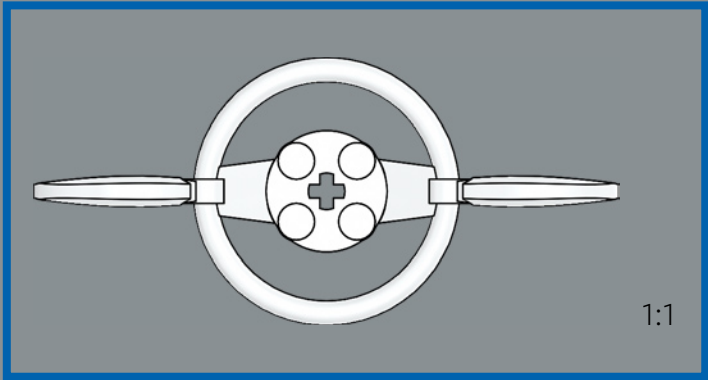
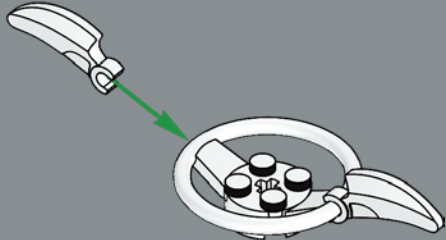

1:1

2

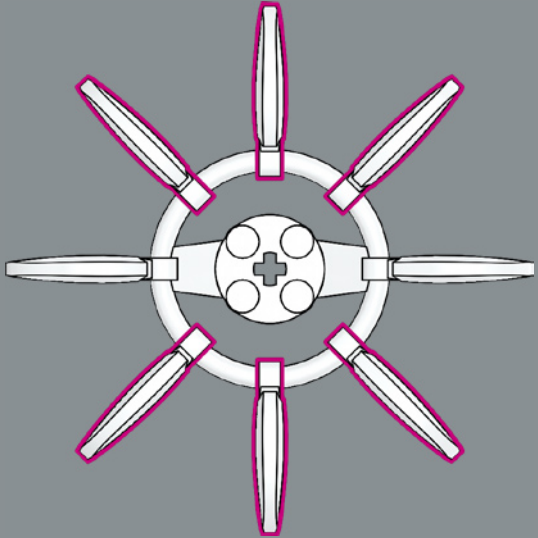

3

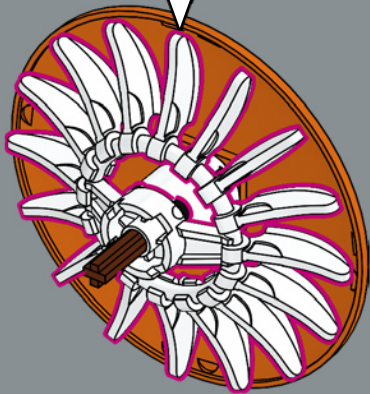
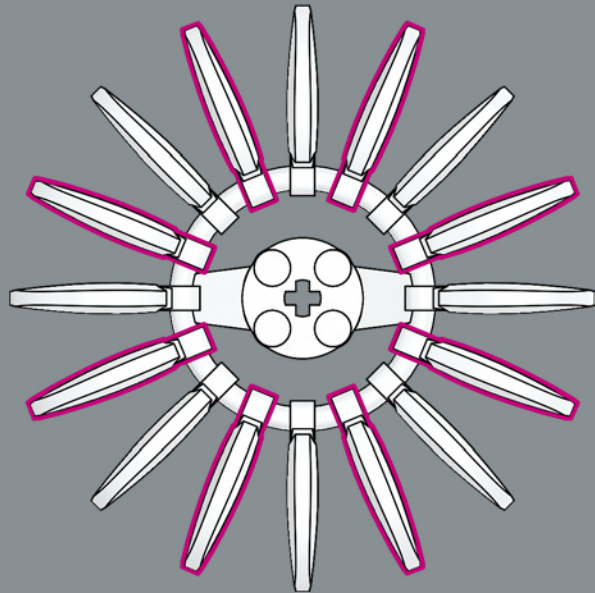

125

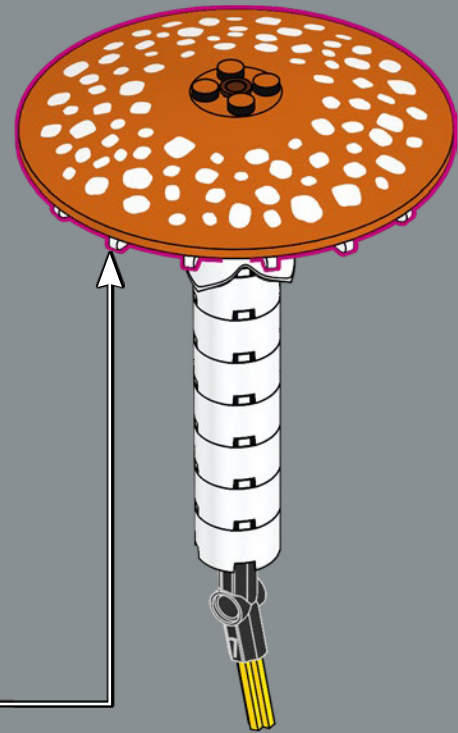



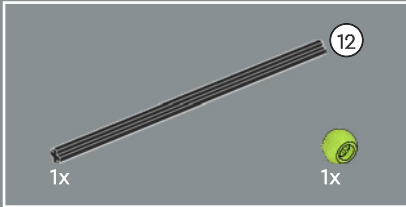
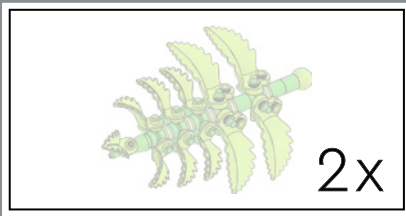

127

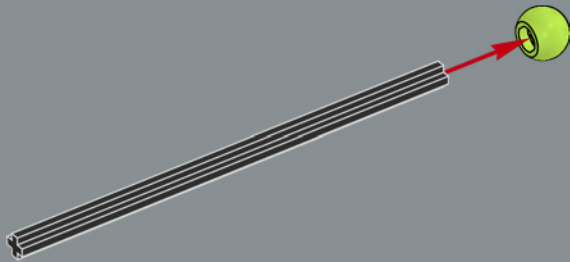

128

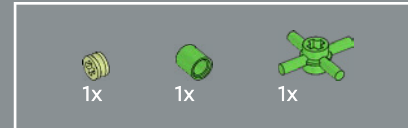
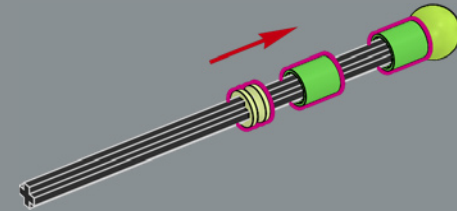

129

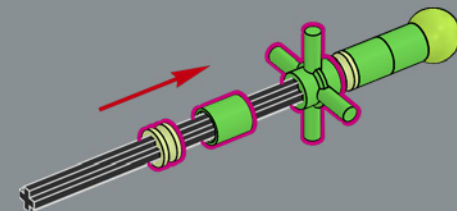



130

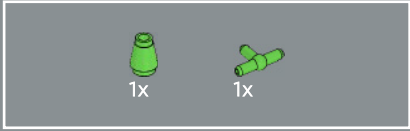
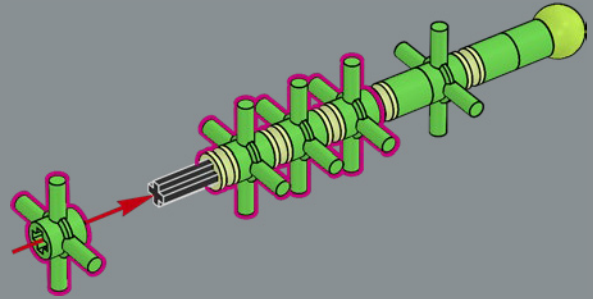

131

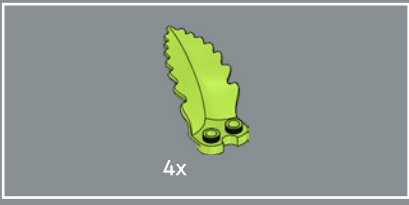
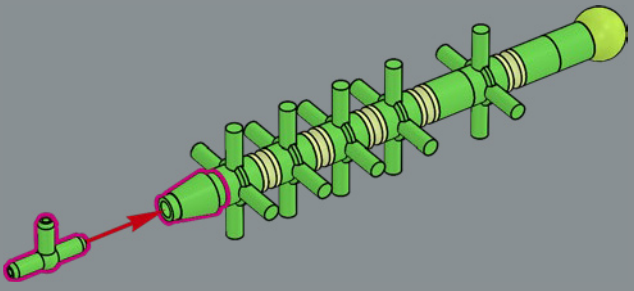

132

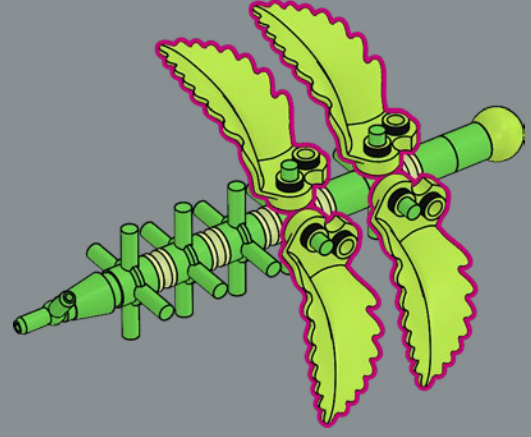

133

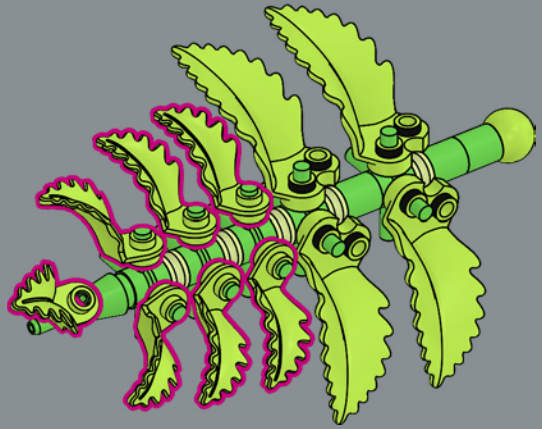

2x





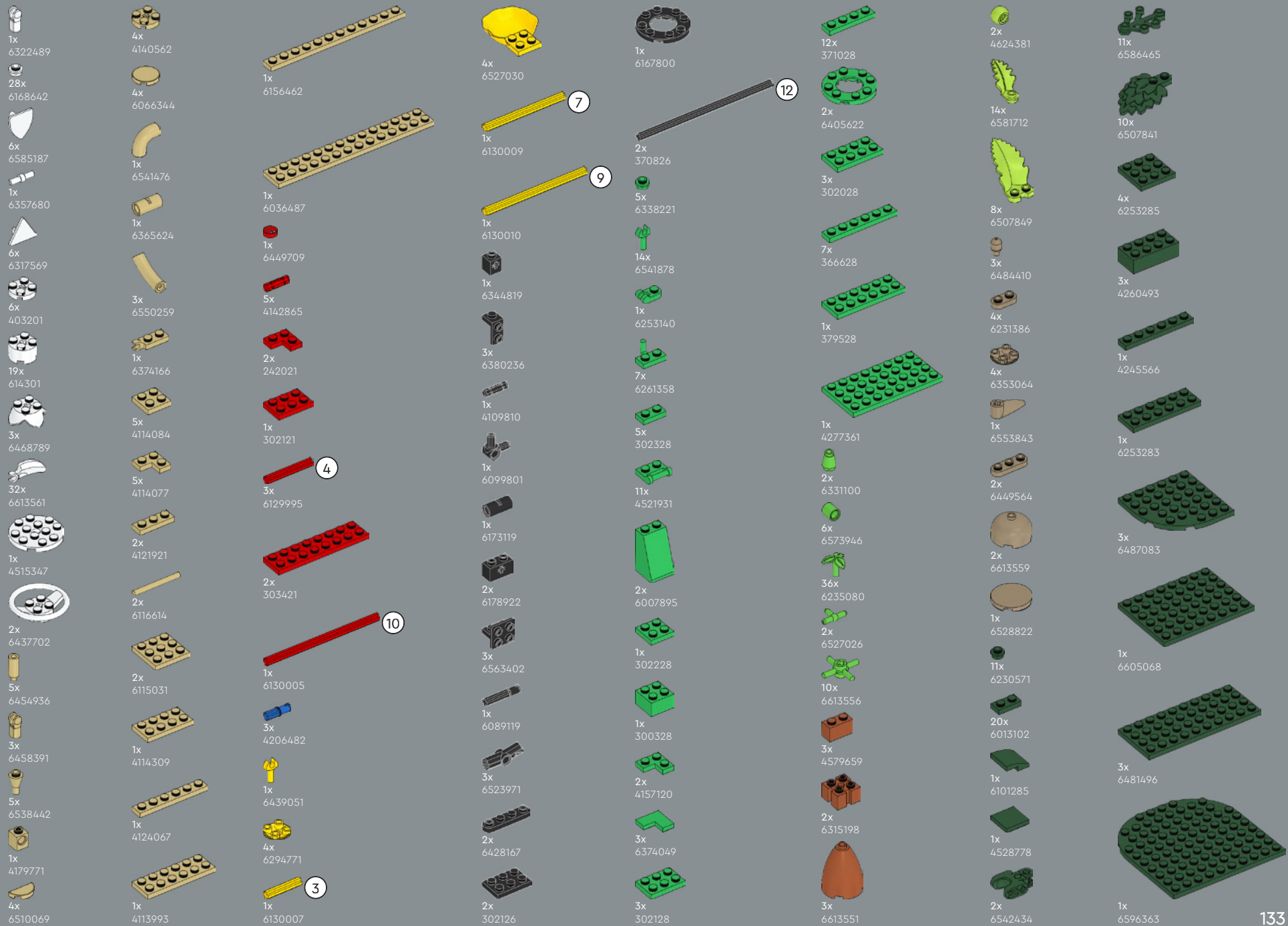



2x  
6527031

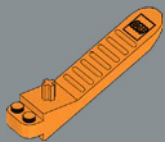

1x  
6240515



2x  
6510192



5x  
6613562



4x  
6613560



10x  
6553342



1x  
6474604



2x  
6278550



1x  
6360075



10x  
4655080



[LEGO.com/service](https://www.LEGO.com/service)



9x  
6083976



3x  
4616581



13x  
6083972



2x  
4521947



2x  
6080431



3x  
6100234



2x  
6474602



2x  
6577789

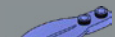

12x  
6614067



2x  
6551408



4x  
6559515



12x  
6439053



6x  
4211242



4x  
4221744



3x  
4211159



7x  
6102360



3x  
4211150



2x  
6313124



3x  
6608792



19x  
6117976



2x  
6226436



22x  
4645103



2x  
6273865



5x  
6502370



9x  
6551600



4x  
6316697



7x  
4211200



2x  
4211210



1x  
6425510



2x  
6492629



2x  
6248854



4x  
6526059



8x  
4211149



2x  
4216668



3x  
4211189



4x  
4211190



2x  
6574769



4x  
4211201



2x  
4225869



1x  
6159763



5x  
4211193



1x  
6070442



1x  
4216615



4x  
6469351



4x  
6246843



1x  
6395635



3x  
6315780



11x  
6259071



6x  
6568024



12x  
6127366



5



10x  
4518557



4x  
6404033



6x  
6353396



2x  
6179803



2x  
6313874



1x  
6005030



8x  
6223039



12x  
6439052



1x  
6623718



1x  
6623717



2x  
6623716



**YOU COULD  
WIN**



**YOU COULD  
WIN**

Your feedback will help shape the future development of this product series.

Visit:

**DU KÖNNTEST  
GEWINNEN**

Dein Feedback trägt zur Weiterentwicklung dieser Produktreihe bei.

Geh auf:

**VOUS POURRIEZ  
GAGNER**

Vos commentaires nous aideront à concevoir les futurs produits de cette gamme.

Visitez :

**POTRESTI  
VINCERE TU**

La tua opinione ci aiuterà a migliorare la creazione futura di questa linea di prodotti.

Visita:

**PUEDES  
GANAR**

Tu opinión contribuirá al futuro de esta serie de productos.

Visita:

**轻松获奖**

您的反馈将有助于我们在今后改进本产品系列。

请访问:

---

**[LEGO.com/productfeedback](https://LEGO.com/productfeedback)**

---

You also have the chance to win a LEGO® set.

Terms and conditions apply.\*

Außerdem hast du die Chance, ein LEGO® Set zu gewinnen.

Es gelten die Teilnahmebedingungen.\*

Vous pourriez également gagner un ensemble LEGO®.

Des conditions s'appliquent.\*

Hai anche la possibilità di vincere un set LEGO®.

Termini e condizioni sono applicabili.\*

También tienes la oportunidad de ganar un set LEGO®.

Aplican términos y condiciones.\*

您还有机会赢取乐高®套装。

条款和条件适用。\*

\*[LEGO.com/productfeedback-terms](https://LEGO.com/productfeedback-terms)

LEGO and the LEGO logo are trademarks of the LEGO Group.  
©2026 The LEGO Group.

