



11505





LEGO.com/sustainable-packaging



FR
**DONNEZ
OU
RECYCLEZ**



OU



OU



ASSOCIATION MAGASIN DÉCHÈTERIE

Adresses sur quefairedemesdechets.fr



BUILDER



Apple and the Apple logo are trademarks of Apple Inc., registered in the U.S. and other countries and regions. App Store is a service mark of Apple Inc. Google Play and the Google Play logo are trademarks of Google LLC. Tencent and the Tencent logo are trademarks of Tencent Inc.

LEGO.com/devicecheck



LEGO® Builder



DAS EINFACHE LEBEN IN DER NATUR

Wenn du die Natur mit Neugierde erkundest, spürst du unweigerlich eine Gegensätzlichkeit im Wechsel der Jahreszeiten. Neues Leben und Vergänglichkeit existieren in perfekter Harmonie. Dieses aus LEGO® Steinen gebaute Ökosystem zeigt einen Ausschnitt des Waldbodens aus dem Randgebiet eines nordeuropäischen Waldes zwischen Sommer und Herbst. Stell dir eine erfolgreiche Pilzsuche vor, bei der du jede Menge Pilze und Herbstzeitlose entdecken kannst. Auch wenn so viele Arten auf einmal in der Natur eher selten anzutreffen sind, wollten wir eine besonders eindrucksvolle Szene kreieren, die theoretisch möglich wäre. Jedes Element ist sorgfältig gestaltet, um eine Balance zwischen Natürlichkeit und verspielter Magie zu schaffen.

Das LEGO® Botanicals Design Team





Colchicum autumnale

HERBSTZEITLOSE

Im Gegensatz zu seinem Frühlingsverwandten gehört dieser rosa und violette Krokus zur Familie der Colchicaceae und blüht im Herbst. Diese elegante, anmutige, aber giftige Pflanze gedeiht in Gras- und Waldlandschaften in Europa und Asien.



Pteridium aquilinum

ADLERFARN

Eine der häufigsten Pflanzen der Welt, die sowohl in der Sonne als auch im Schatten, auf Wiesen oder in belebten Gegenden gut wächst. Mit bis zu 1 m langen Blättern ist sie eine beliebte, dekorative Gartenpflanze.



Mycena galericulata

GEMEINER HUTLING

Dieser zarte, glockenförmige Pilz wächst auf umgestürzten Baumstämmen und Stümpfen in feuchten Gebieten und Mischwäldern. Bekannt für sein wunderschönes, zauberhaftes Aussehen, hat er Künstler aller Epochen inspiriert.



Pleurotus ostreatus

AUSTERNPILZ

Halte Ausschau nach diesen beliebten, muschelartigen Kappen mit herablaufenden Lamellen und kurzen – oder fehlenden – Stielen auf vermoderndem Holz in Wäldern oder sogar in städtischen Gebieten. Sie sind in der Regel weiß oder grau und können bis zu 25 cm breit werden.



Cantharellus cibarius

ECHTER PFIFFERLING

Pfifferlinge blähen ihre goldenen Trompeten auf, die anstelle von Lamellen stumpfe, gegabelte Rippen aufweisen. Sammler sind bekannt dafür, dass sie ihre Fundorte sorgfältig geheim halten.



Amanita muscaria

FLIEGENPILZ

Mit seinem glänzenden rot-orangefarbenen Hut mit weißen Flecken sorgt der Fliegenpilz für einen lebhaften Farbtupfer im europäischen Winter und ist häufig unter Birken, Kiefern und Fichten zu finden. Wenn du ihn in freier Wildbahn siehst, sei vorsichtig damit.



Inocybe hirtella

BITTERMANDELRISSPILZ

Trotz seines Namens und seines mandelähnlichen Dufts sollte man diesen Pilz mit seiner faserigen Kappe nur aus sicherer Entfernung bewundern. Er kommt auf Grasflächen vor und versorgt die umliegenden Bäume mit Zucker und Nährstoffen.



Geastrum triplex

HALSKRAUSEN- ERDSTERN

Halte Ausschau nach diesem spektakulären Pilz in Wäldern und Wiesen. Aus einem runden, mit Sporen gefüllten Körper öffnet er seine sternförmigen Arme, um seine Sporen in einem wahren Miniatur-Feuerwerk abzugeben.



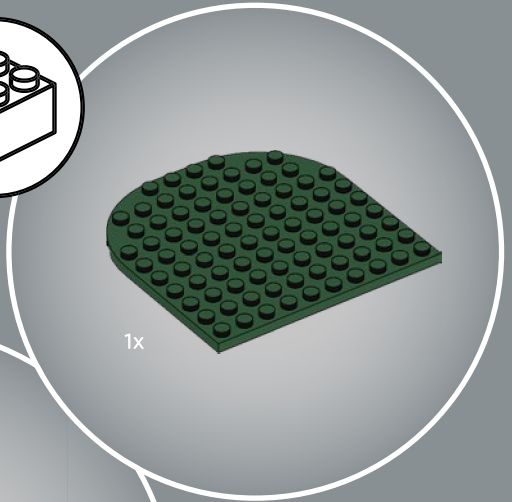
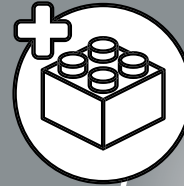
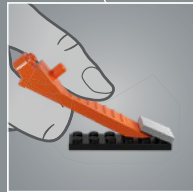
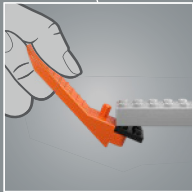
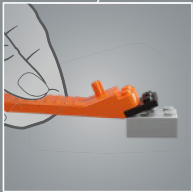
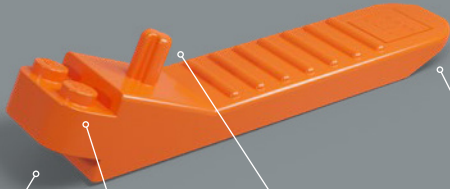

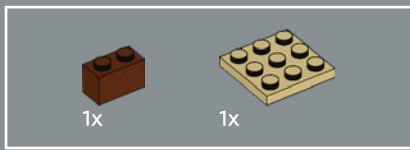

1

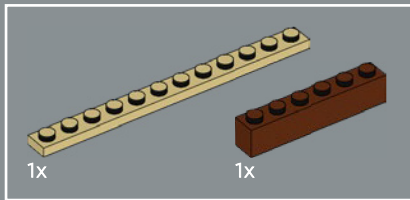
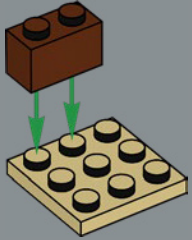

2

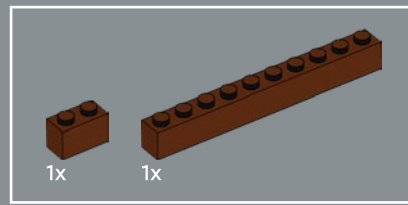
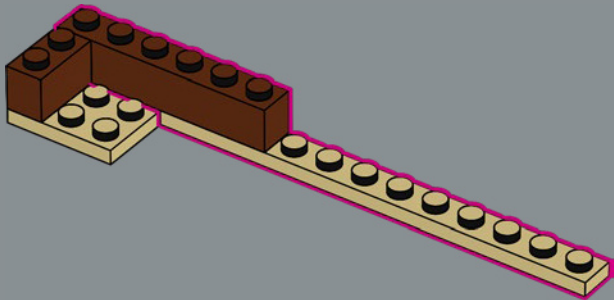

3

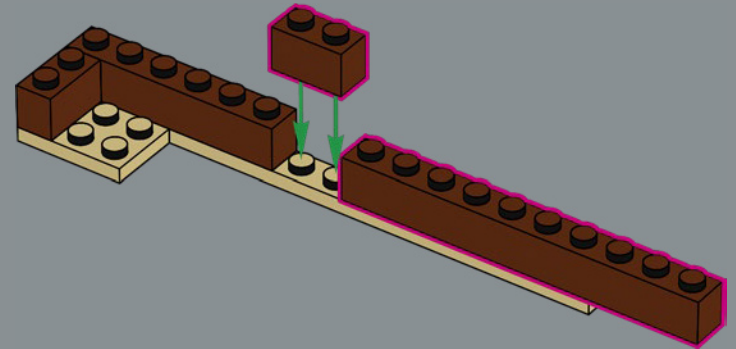

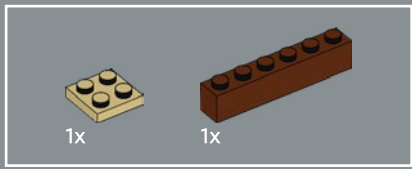

4

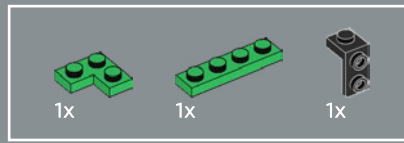
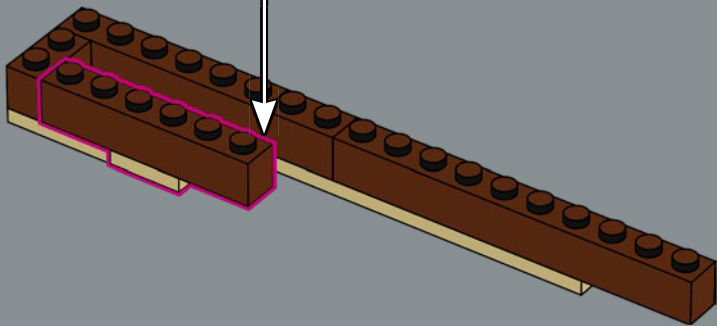
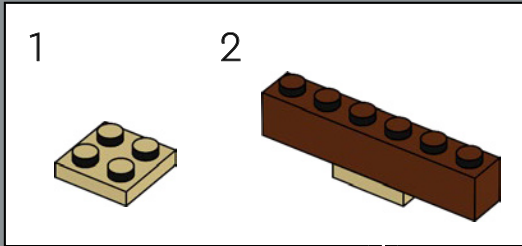

5

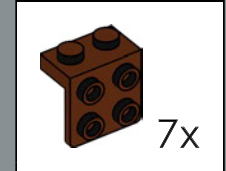
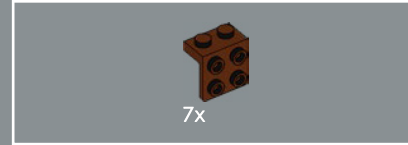
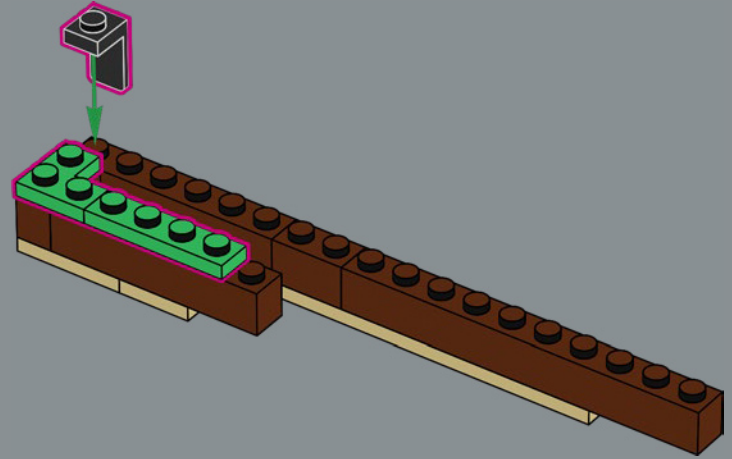

6

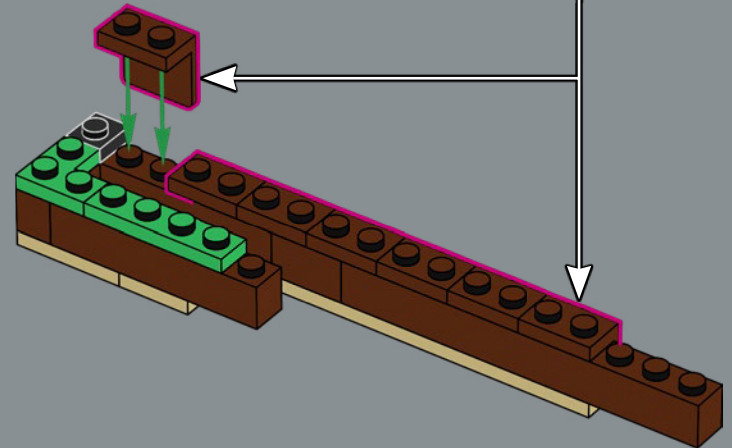

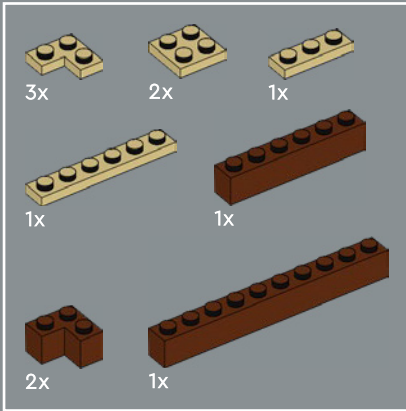
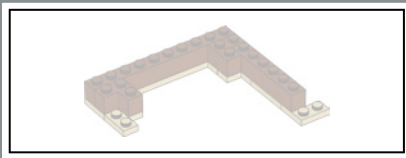

7

1

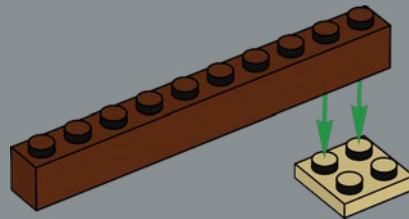

2

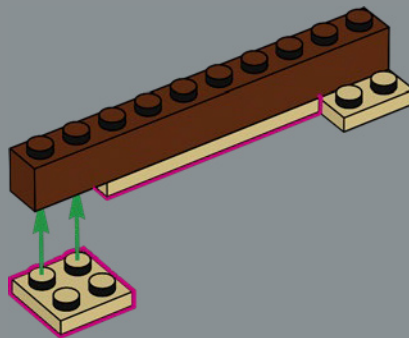

3

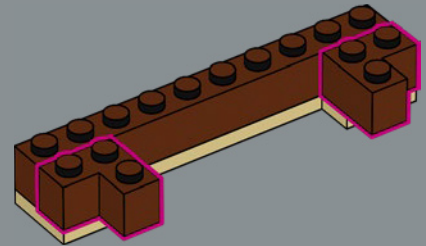

4

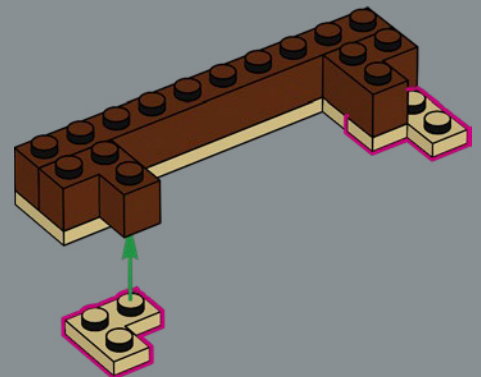

5

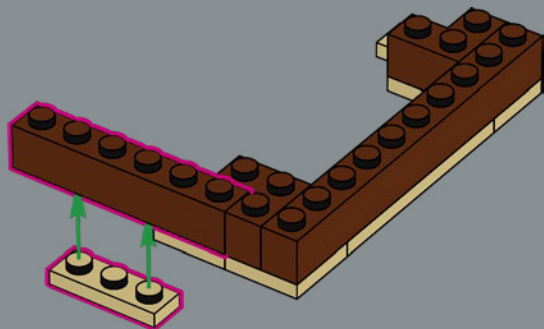

6

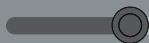
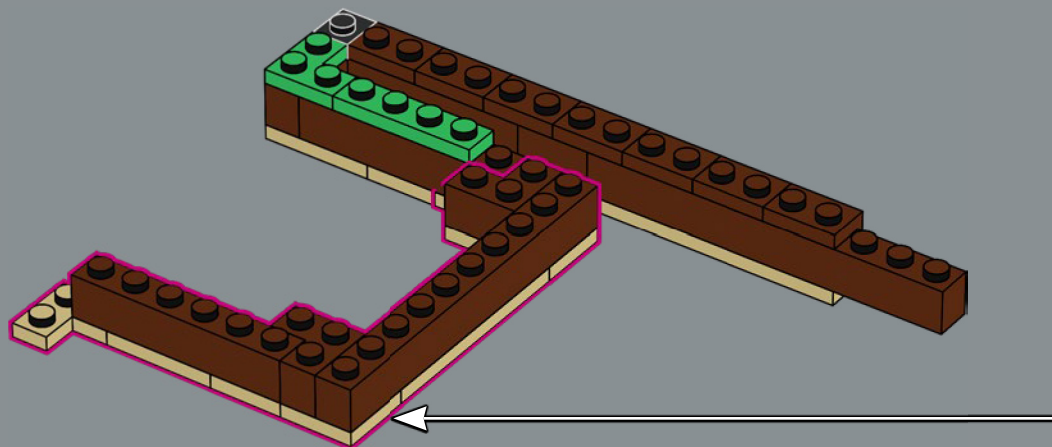
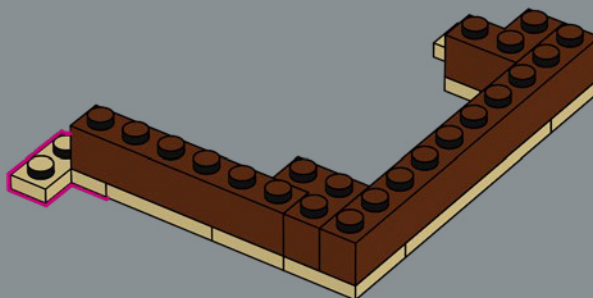

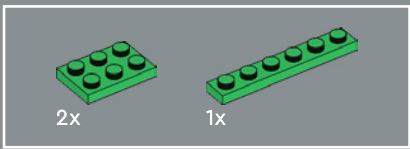

8

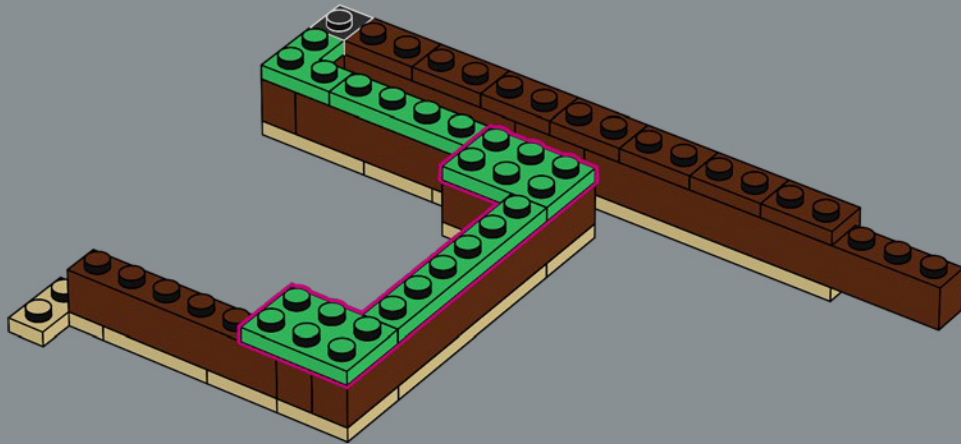

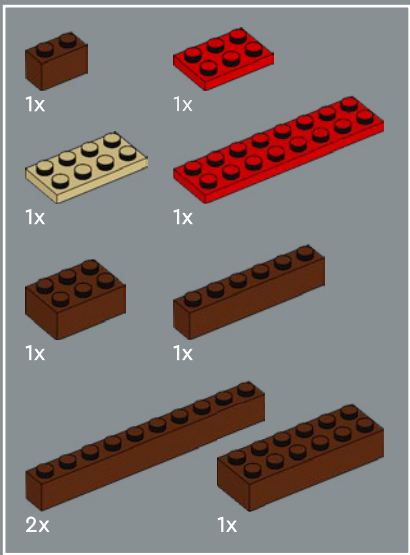

9

1

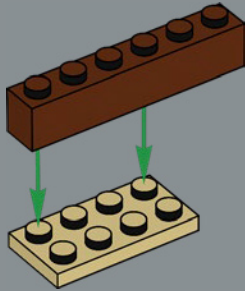

2

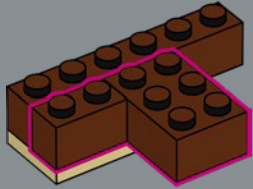

3

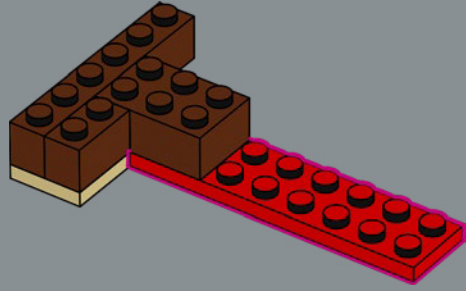

4

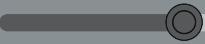
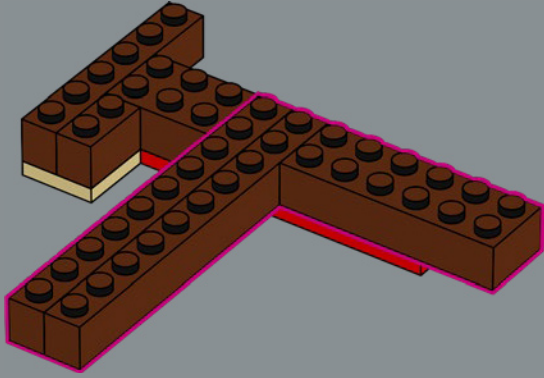

5

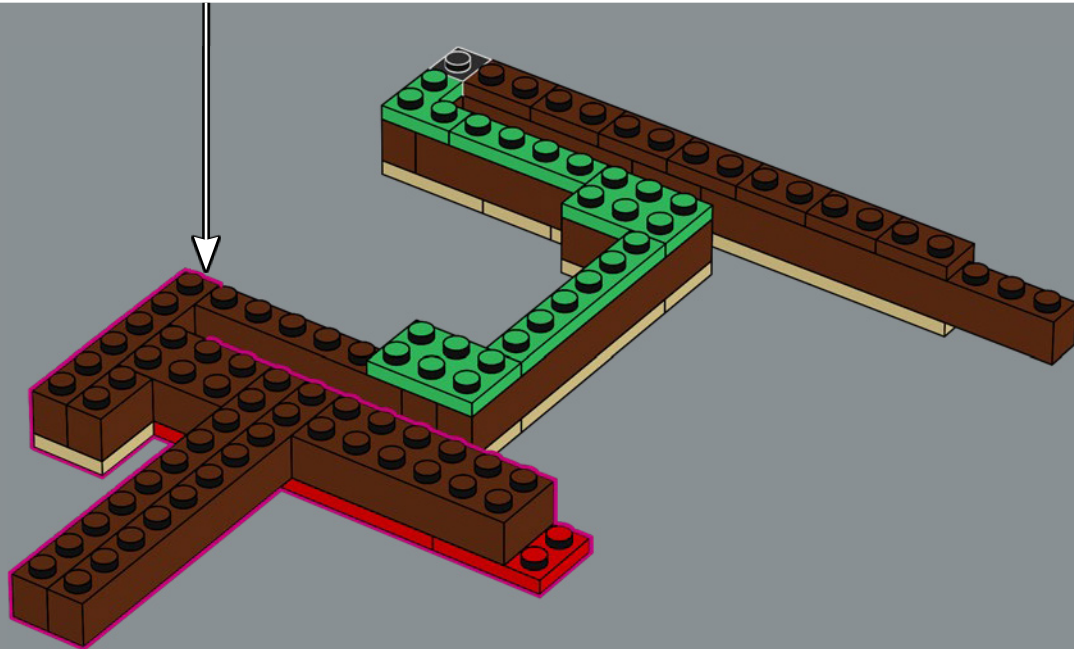
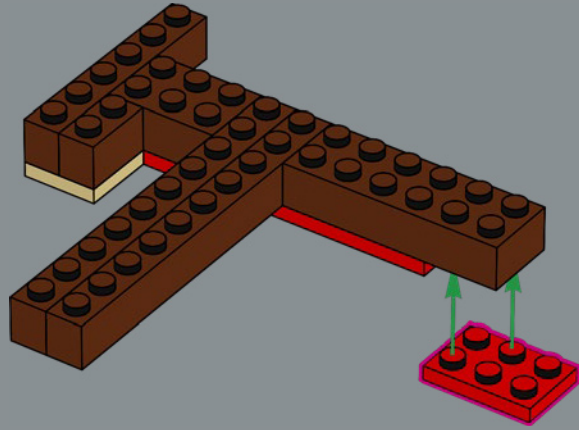

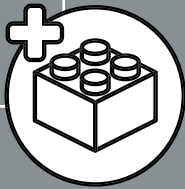
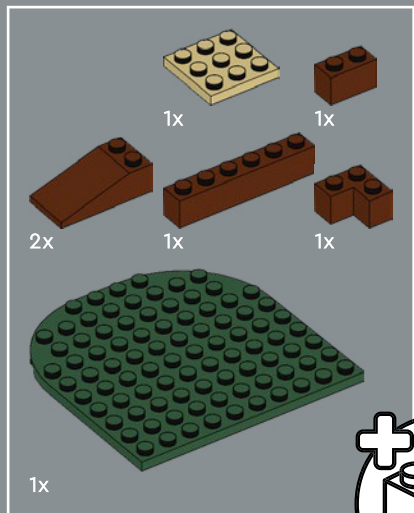

10

1

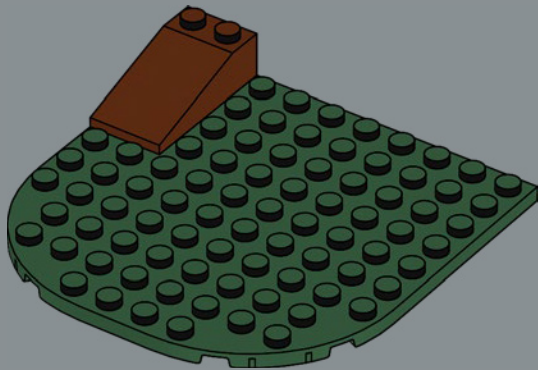

2

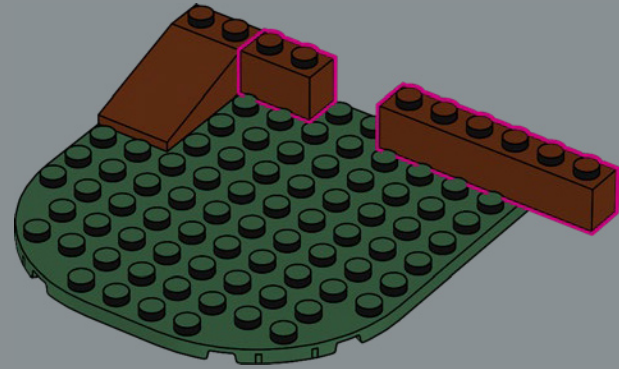

3

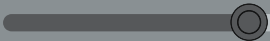
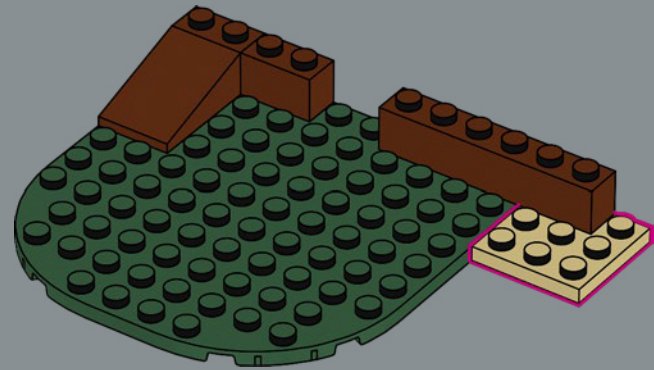

4

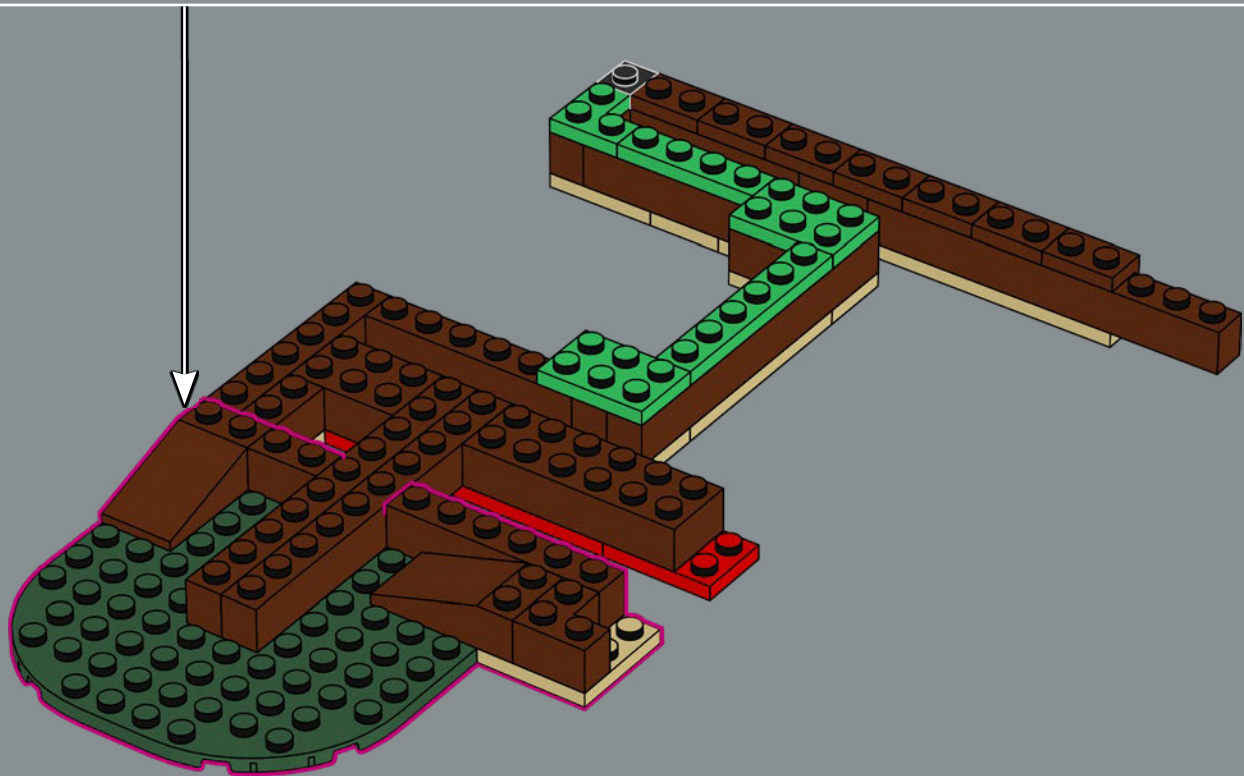
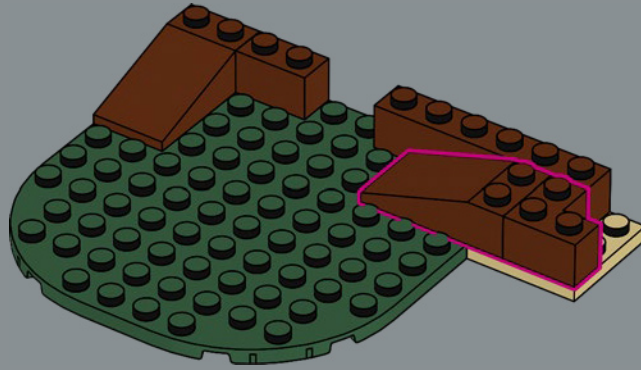

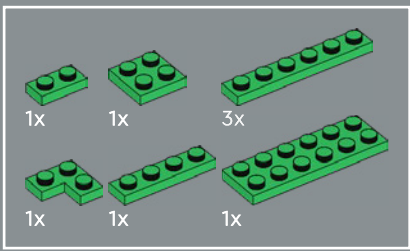

11

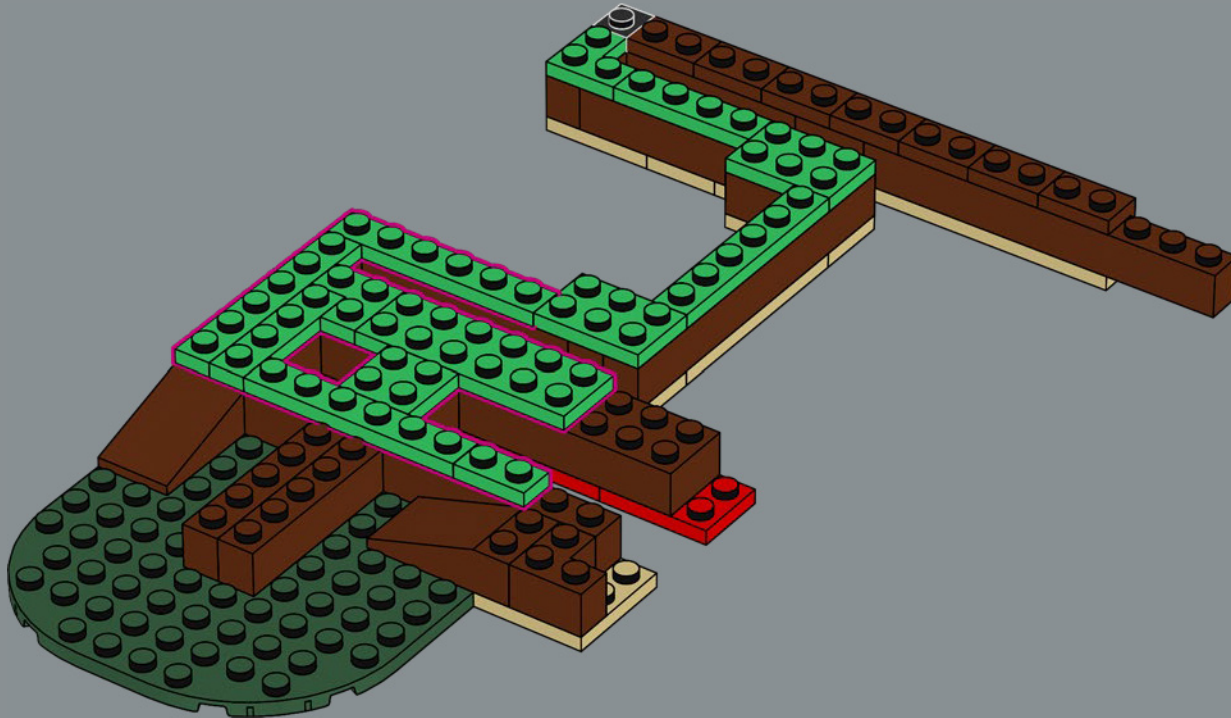

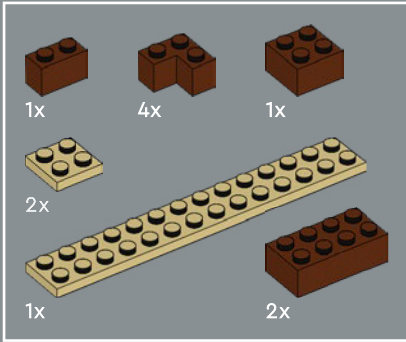
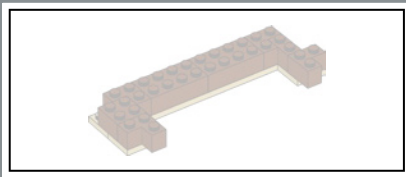

12

1

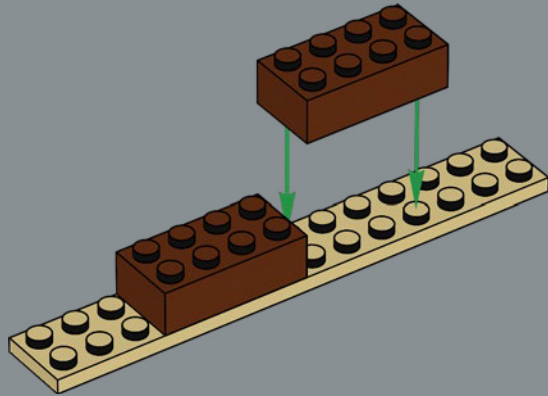

2

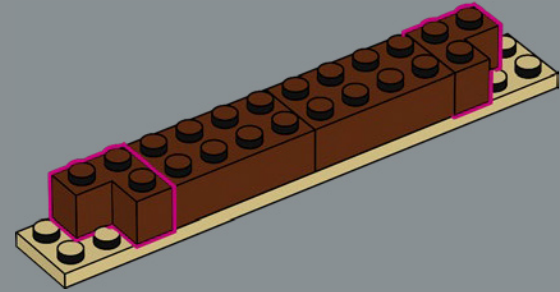

3

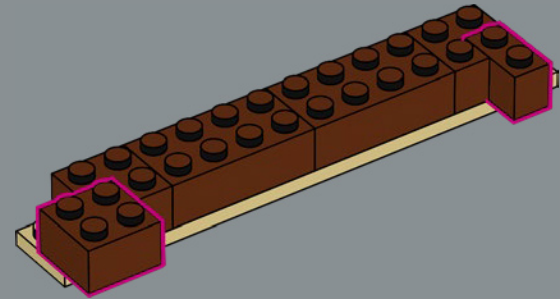

4

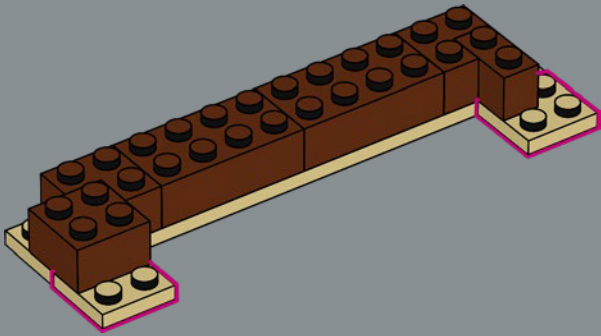

5

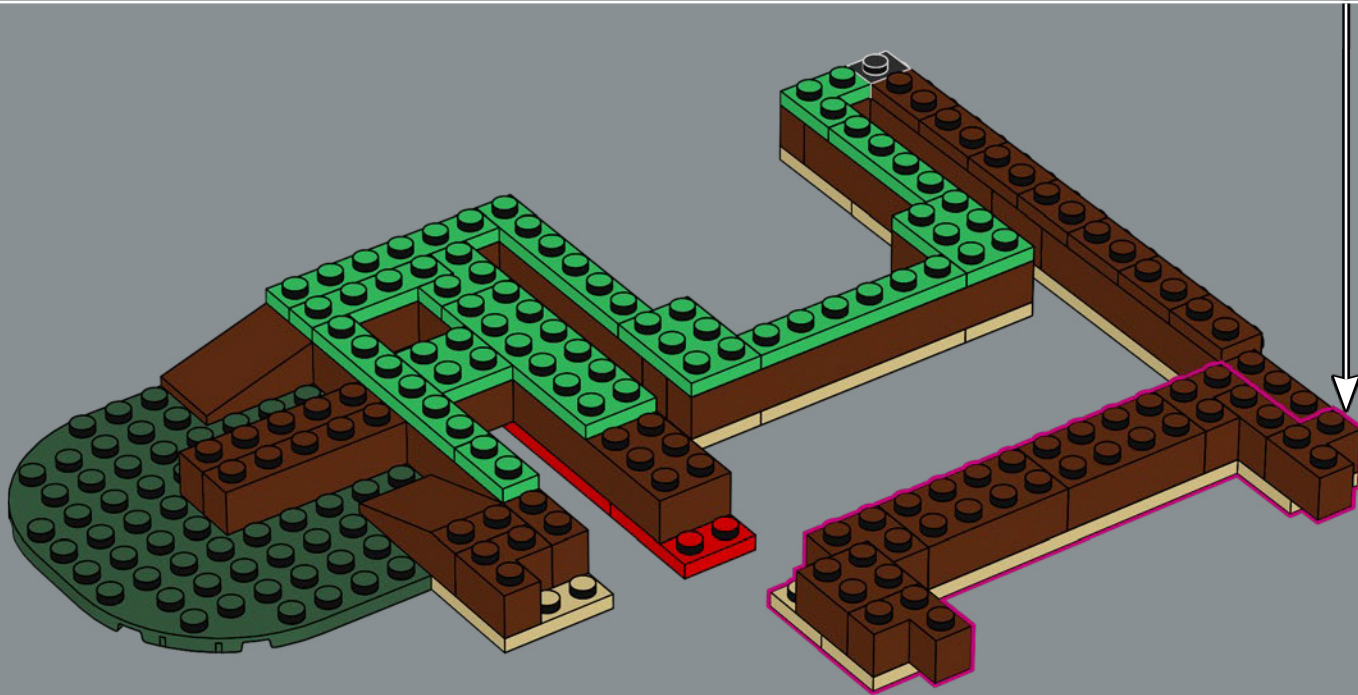
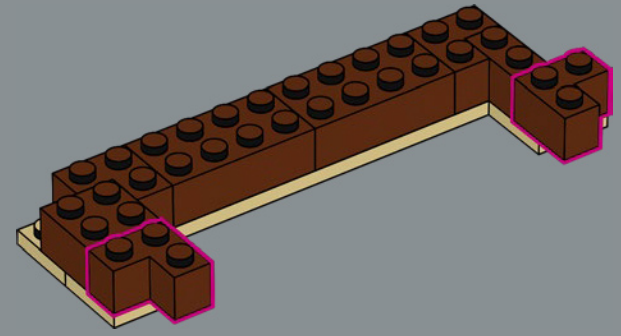

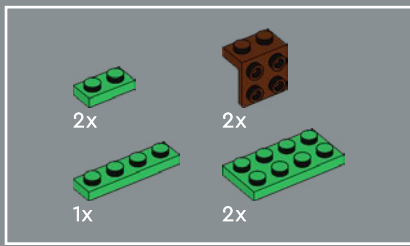

13

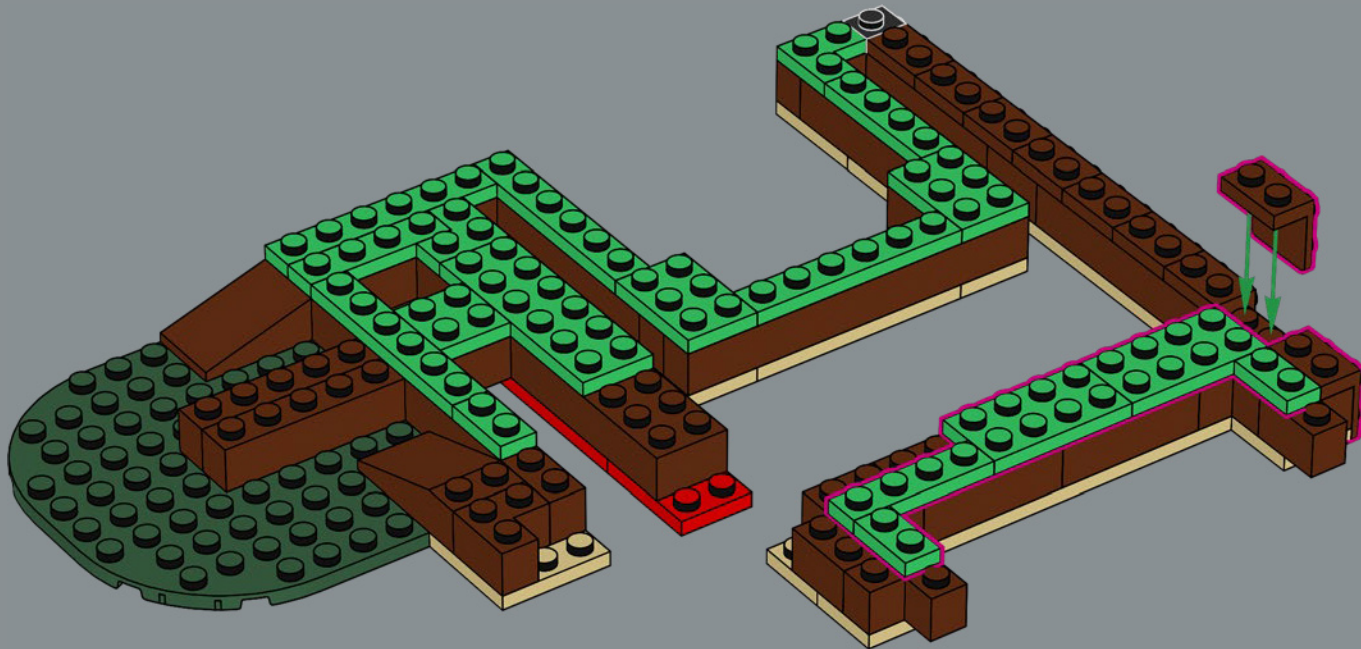

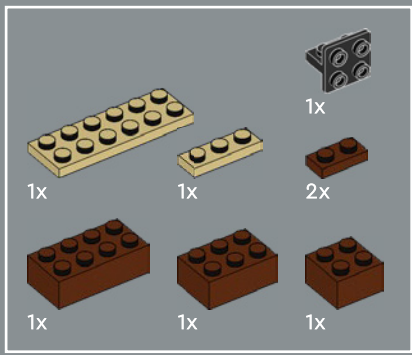

14

1

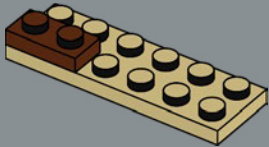

2

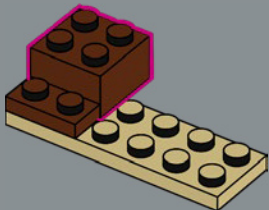

3

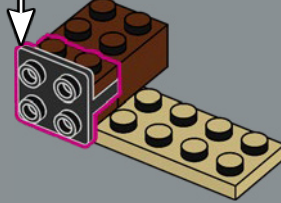
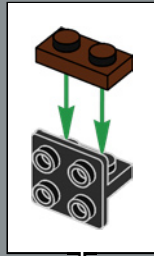

4

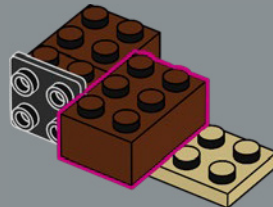

5

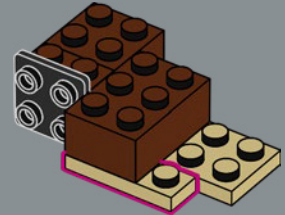

6

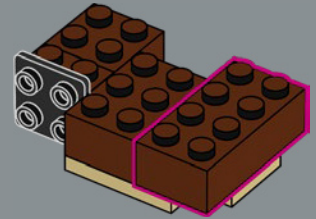

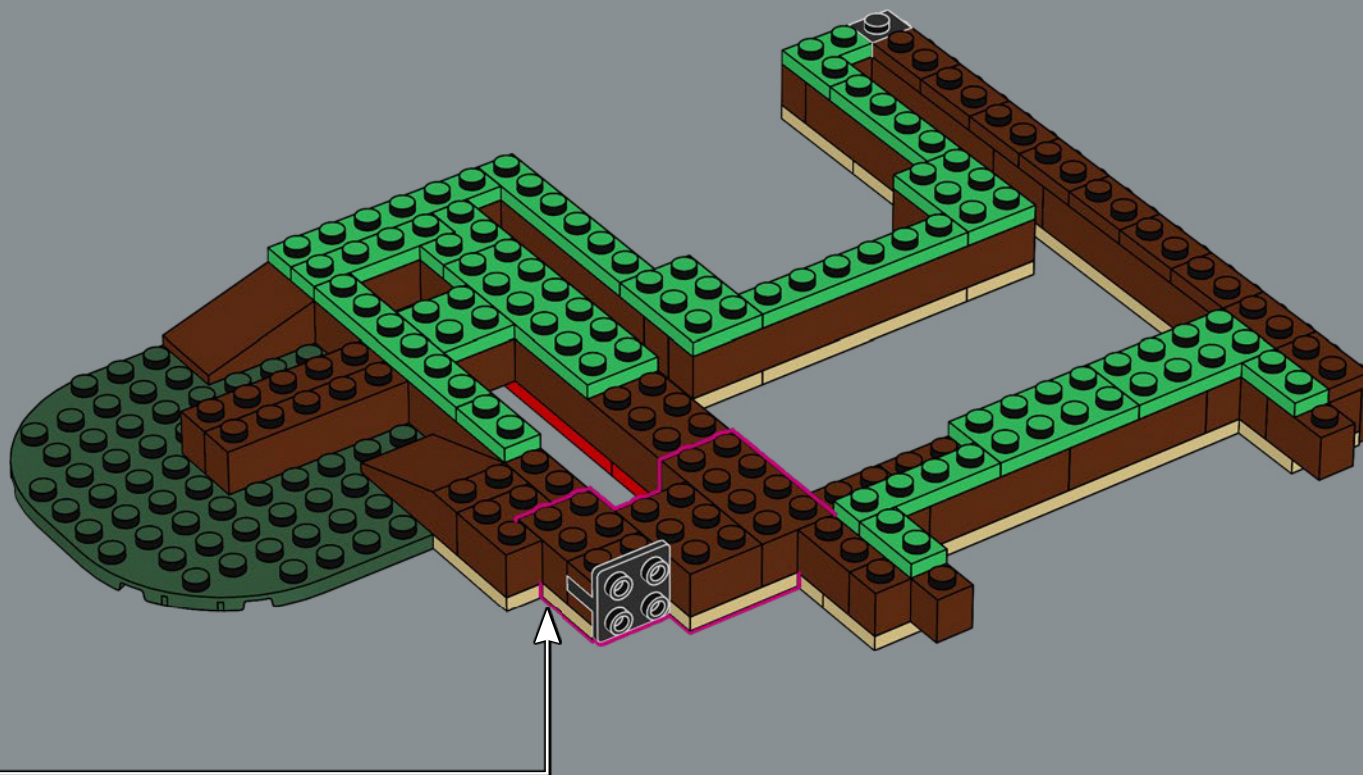

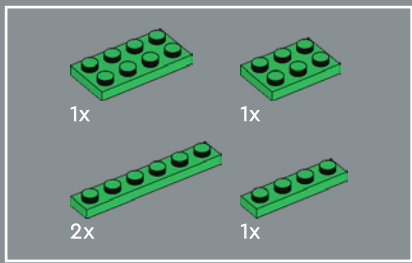

15

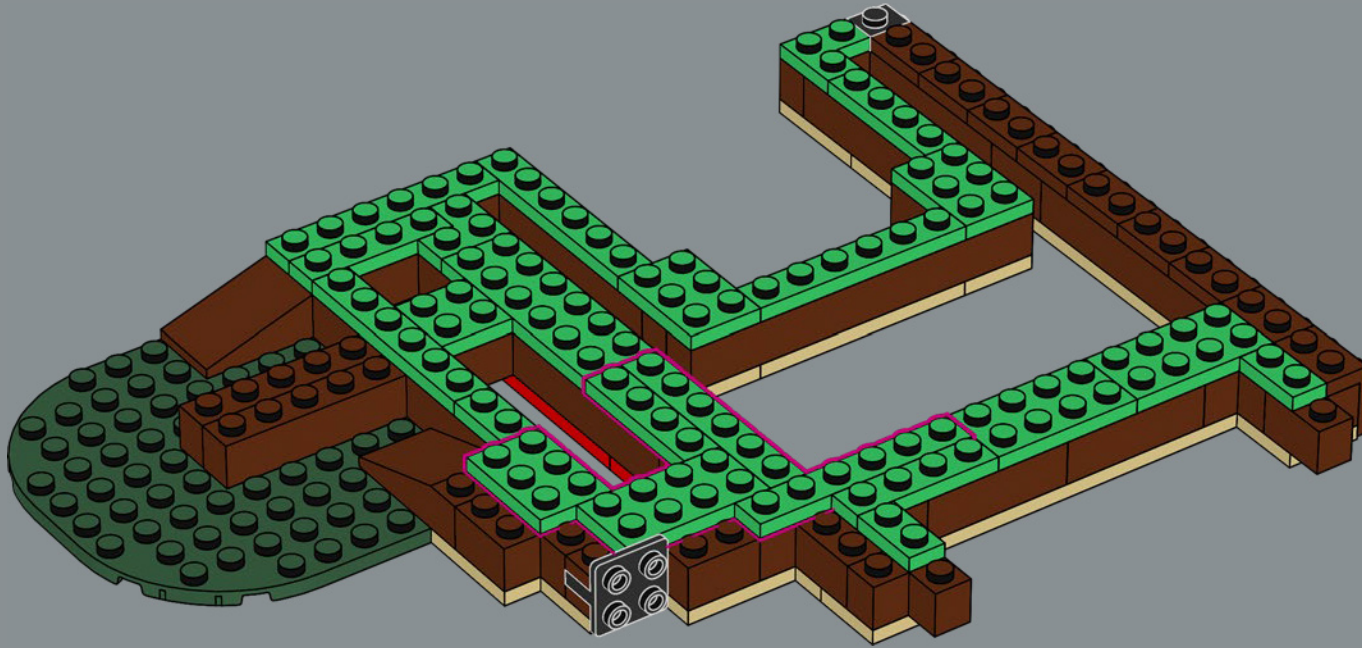

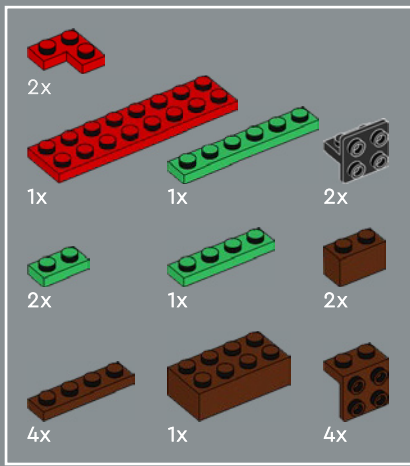

16

1

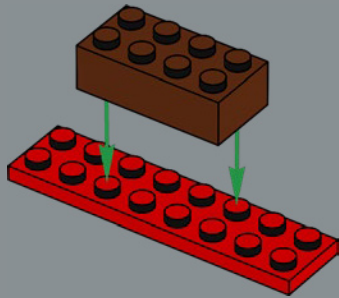

2

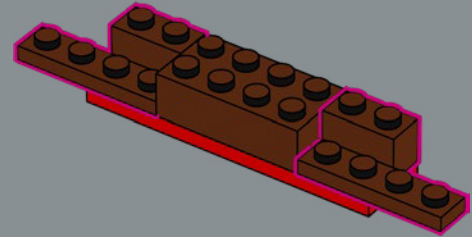

3

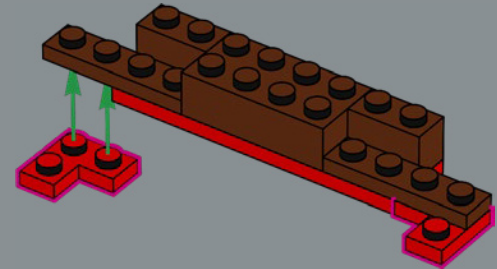

4

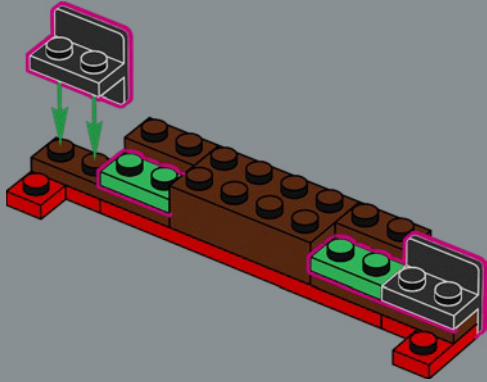

5

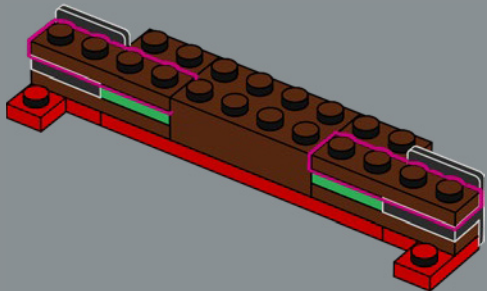

6

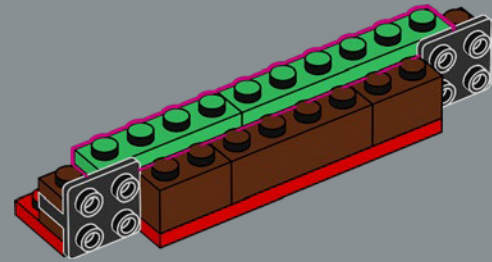

7

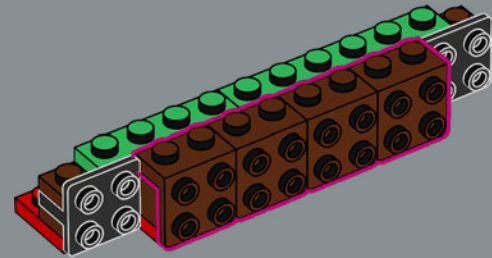

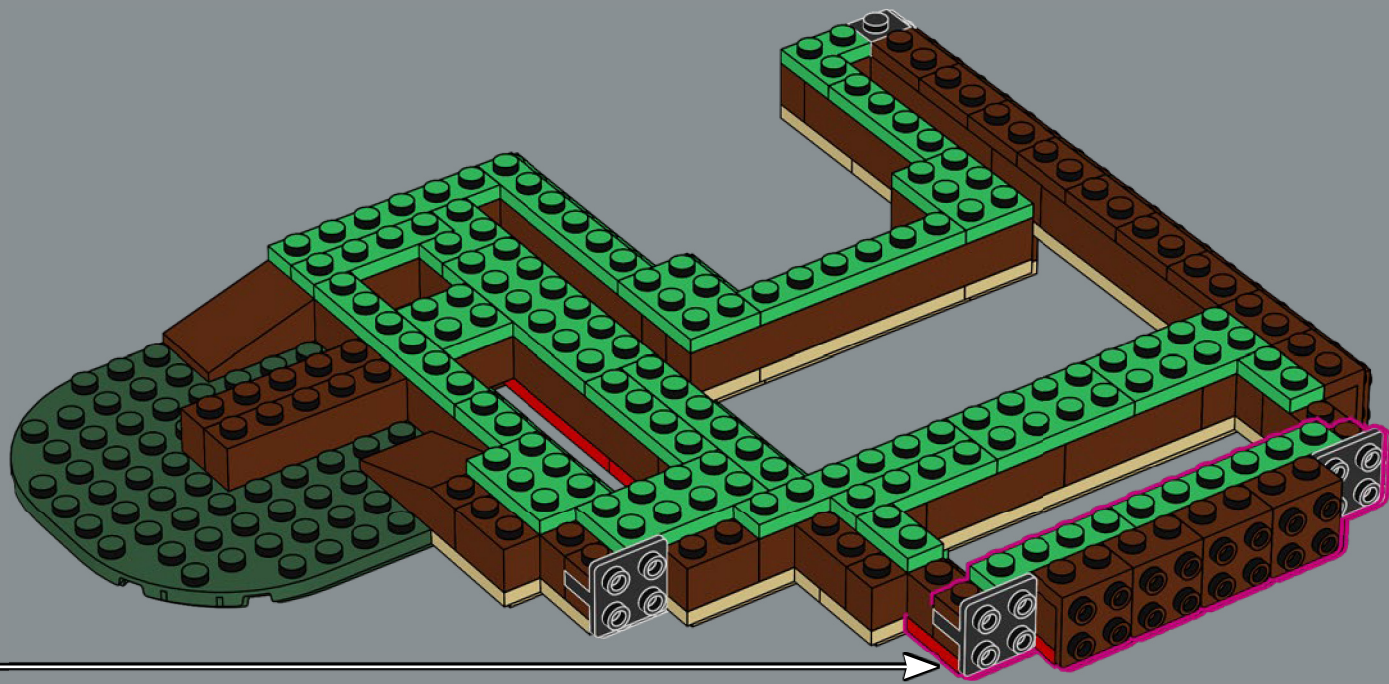



17

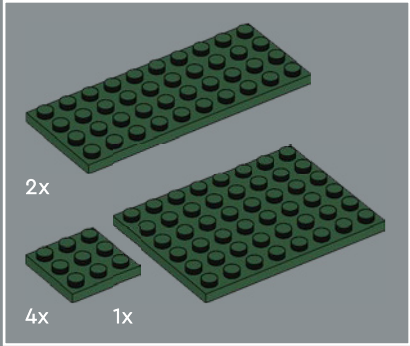
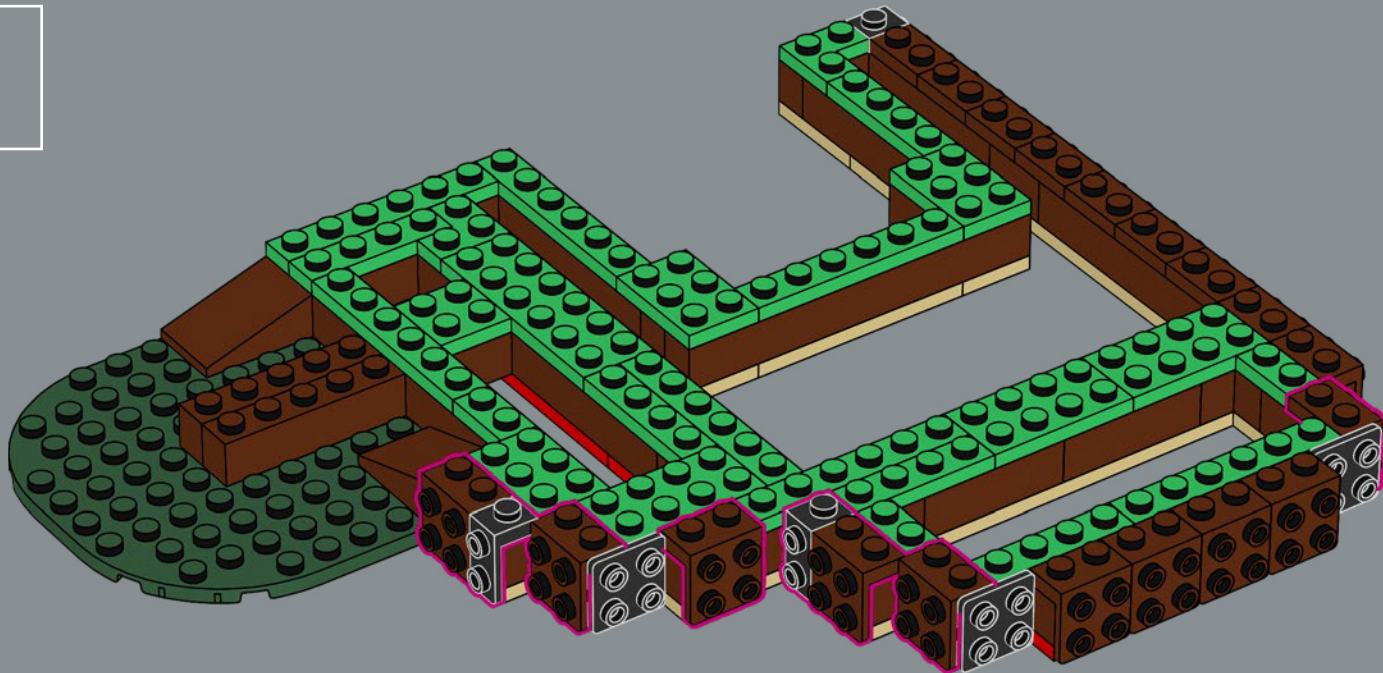

18

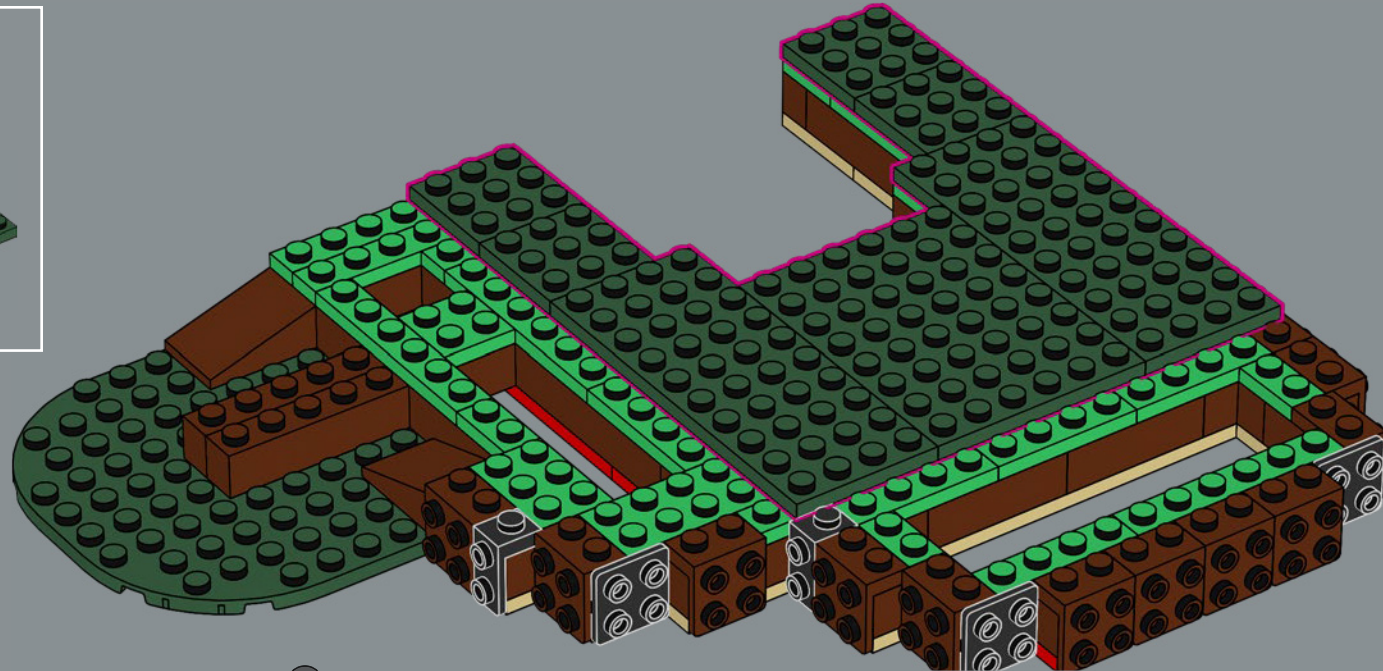

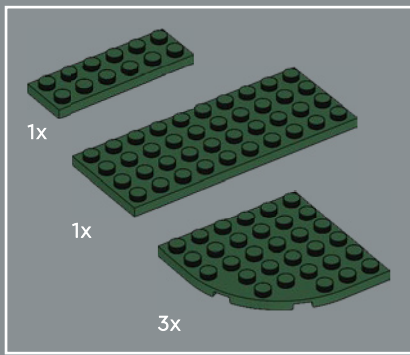

19

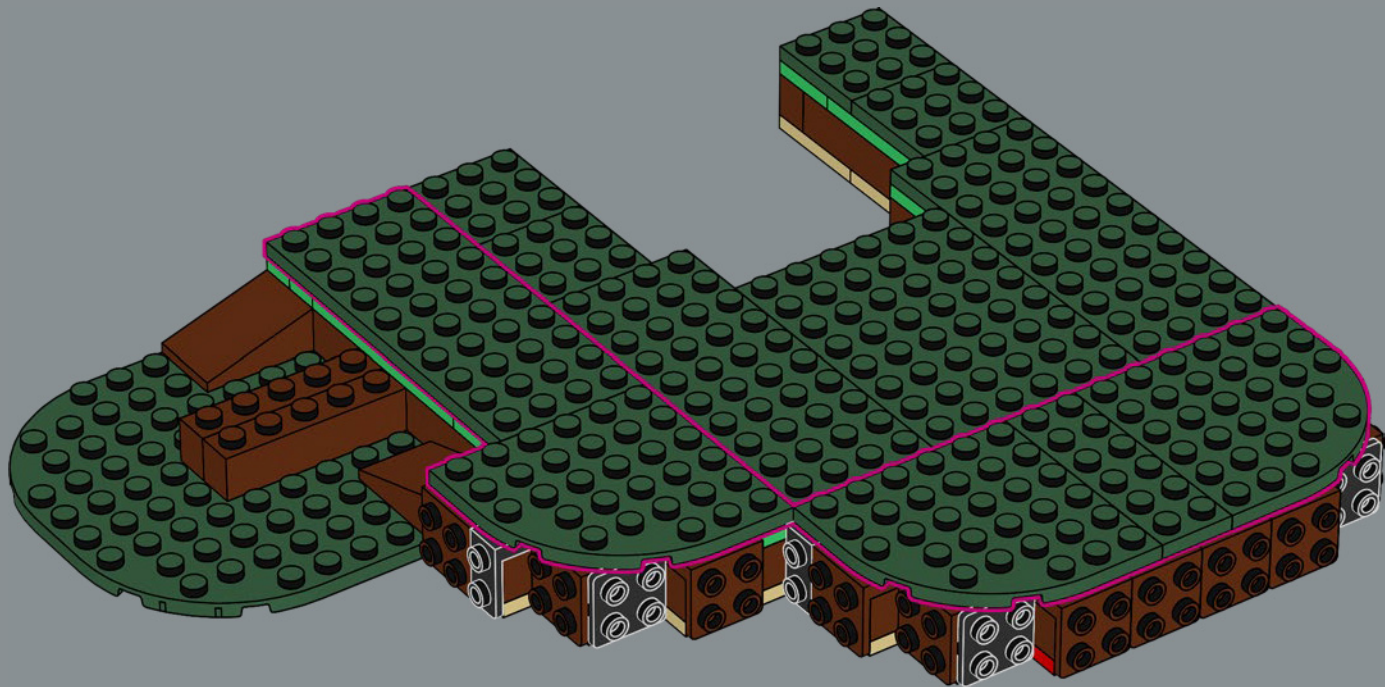

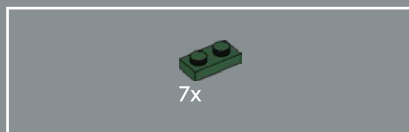

20

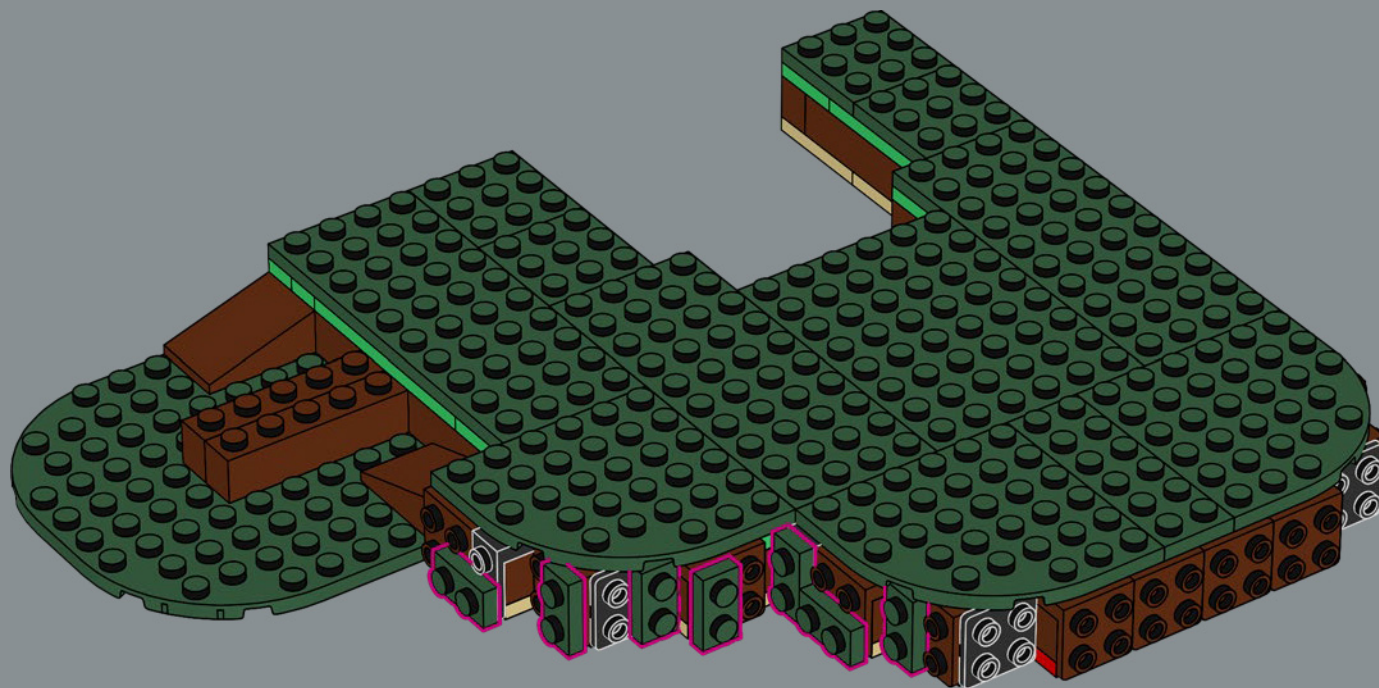



21

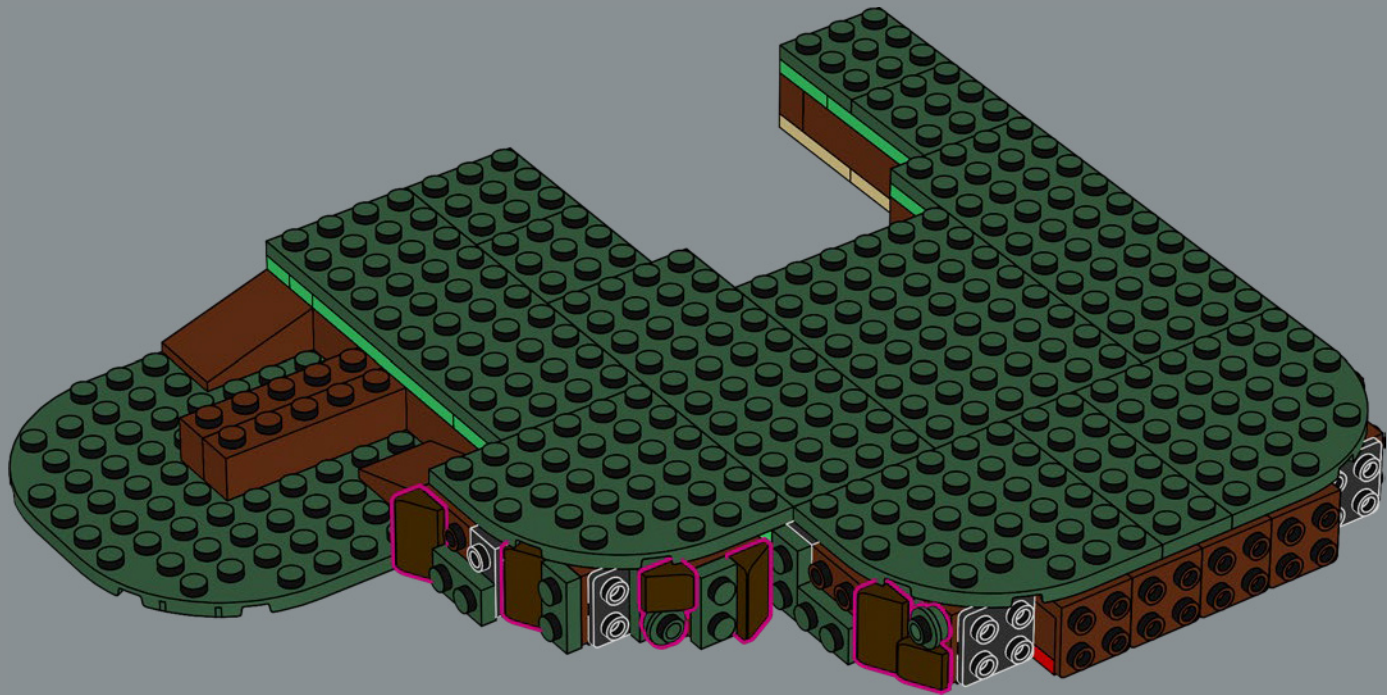



22

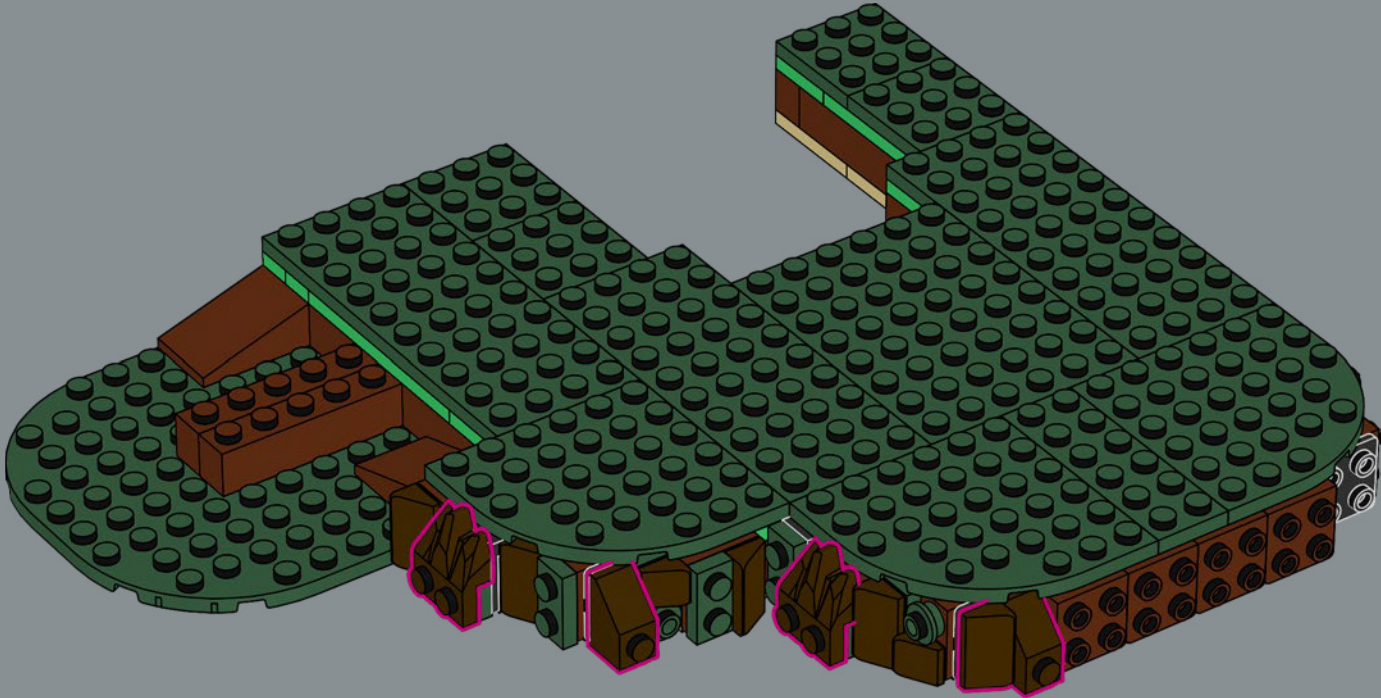

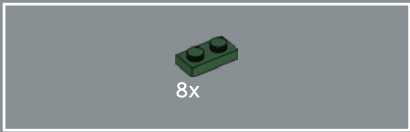

23

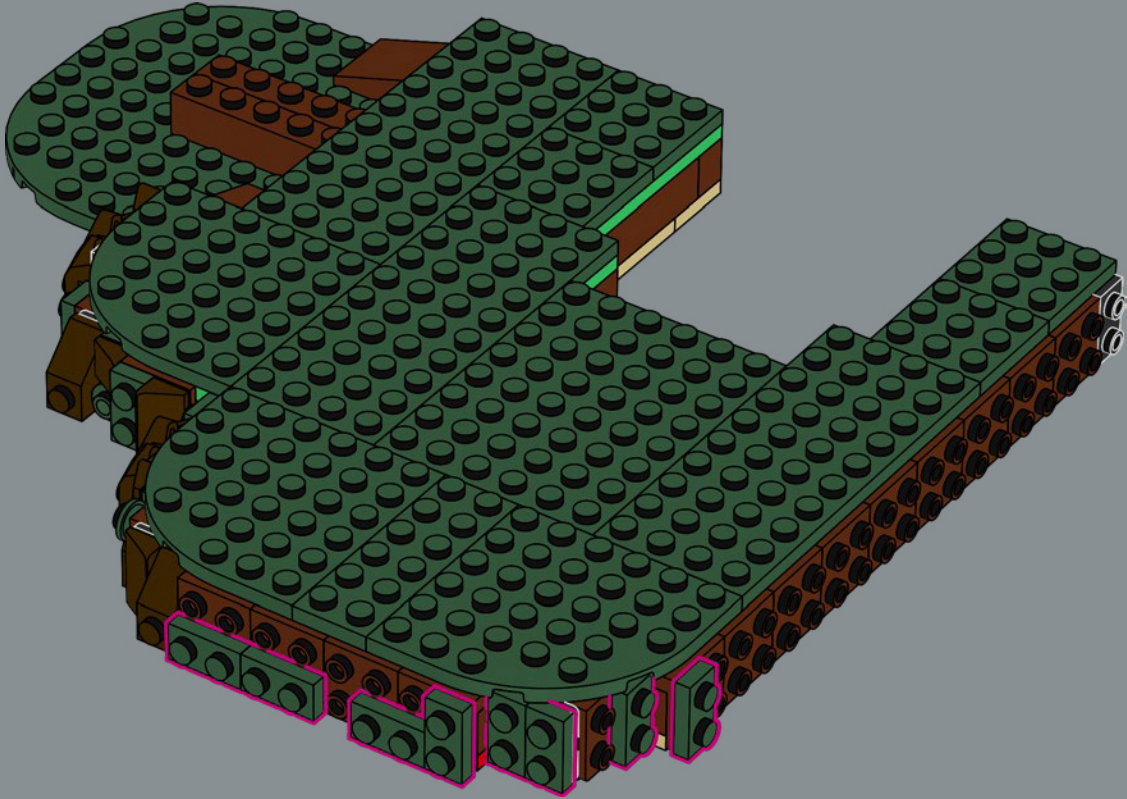

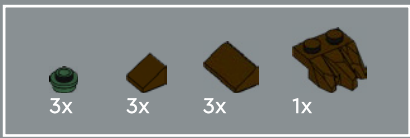

24

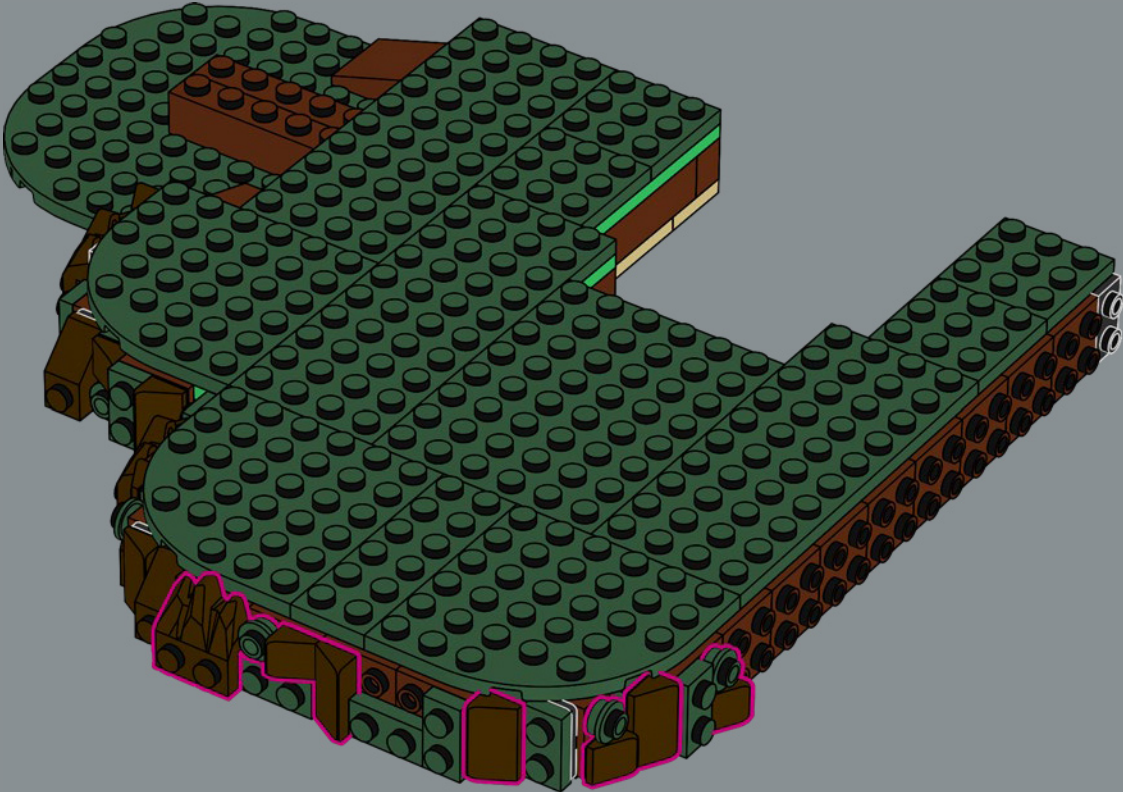



25

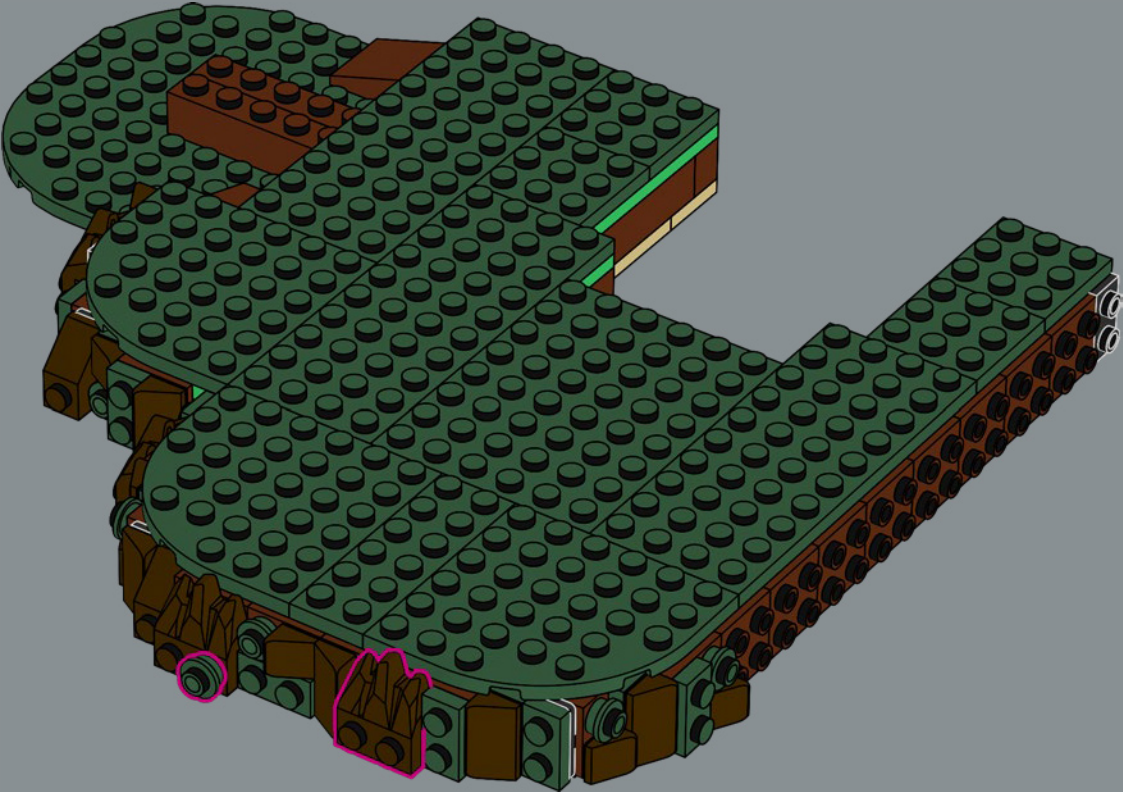

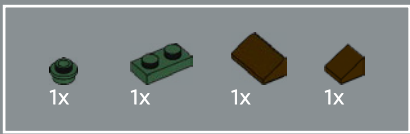

26

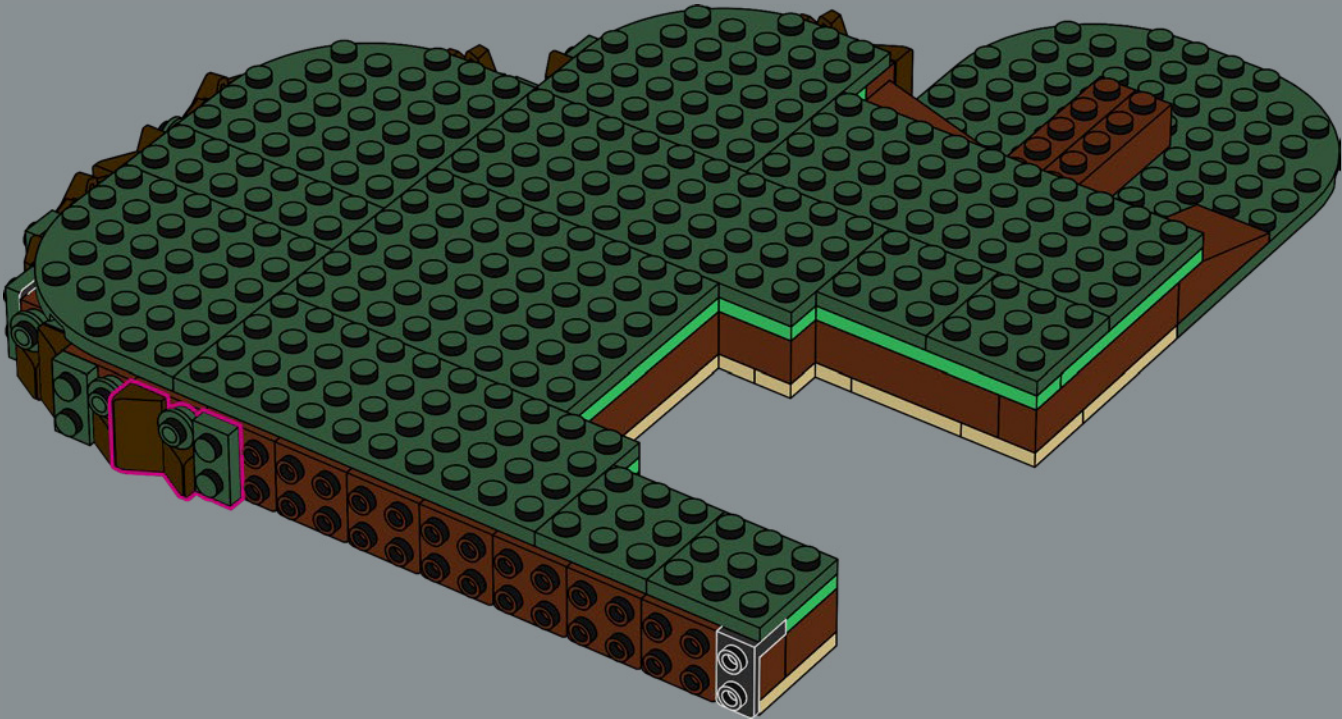



27



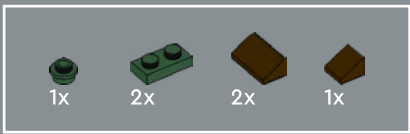

28

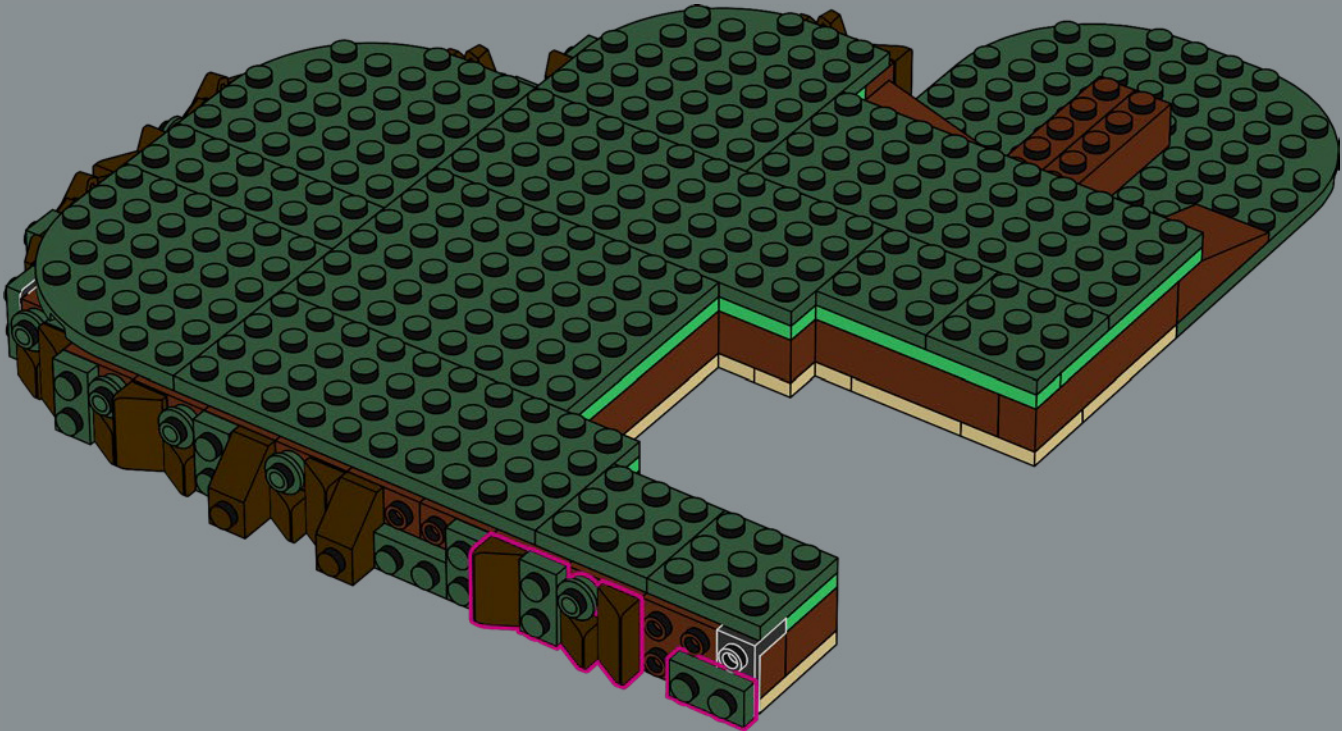

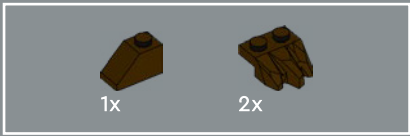

29

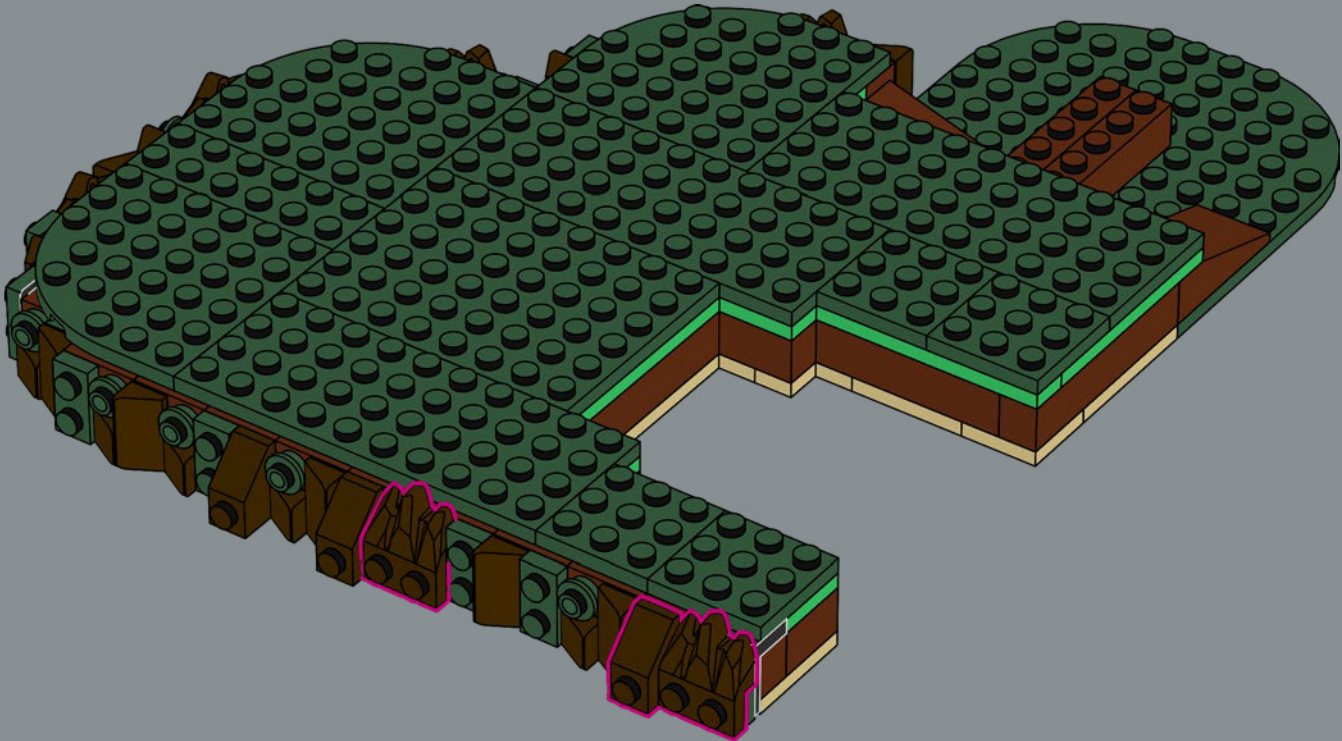

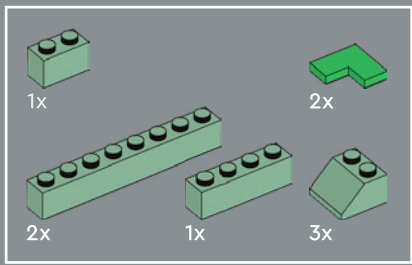

30

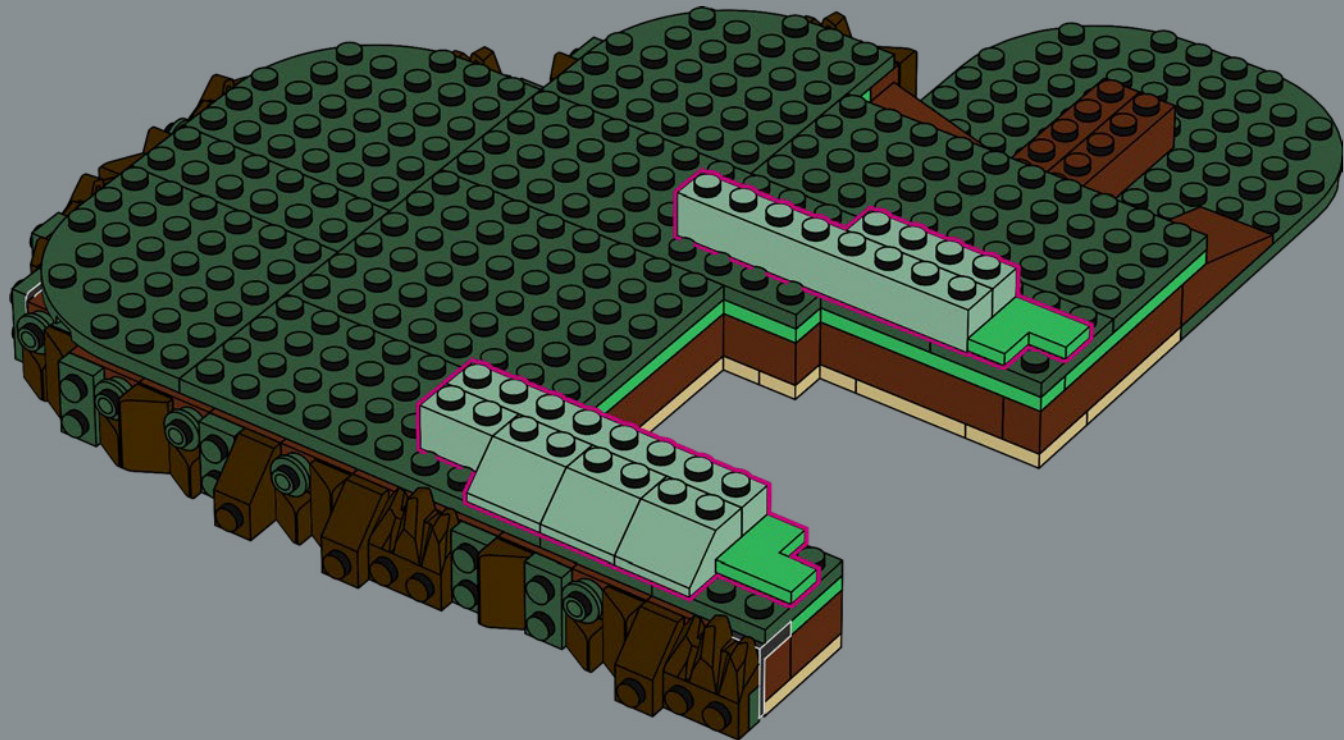

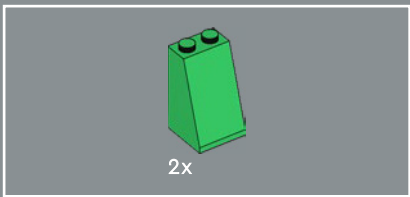

32

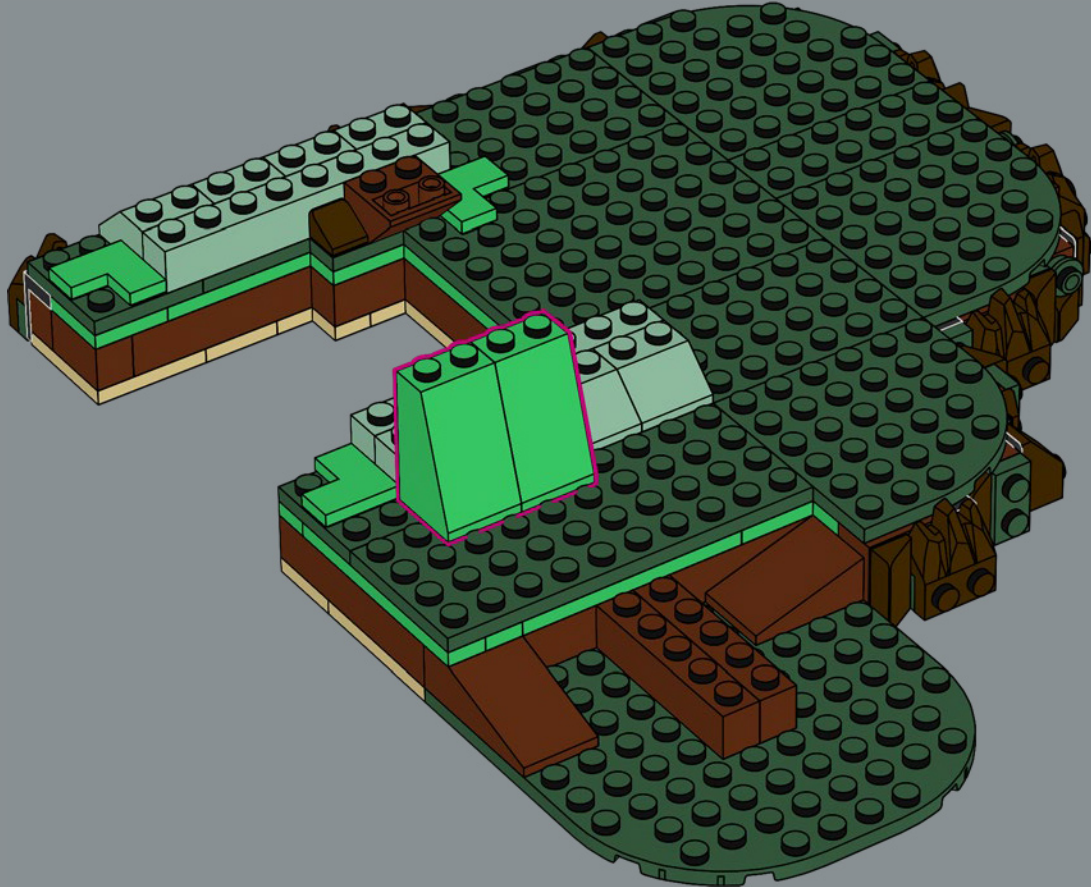

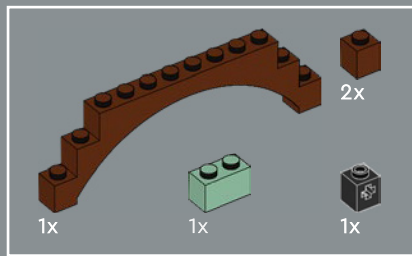

33

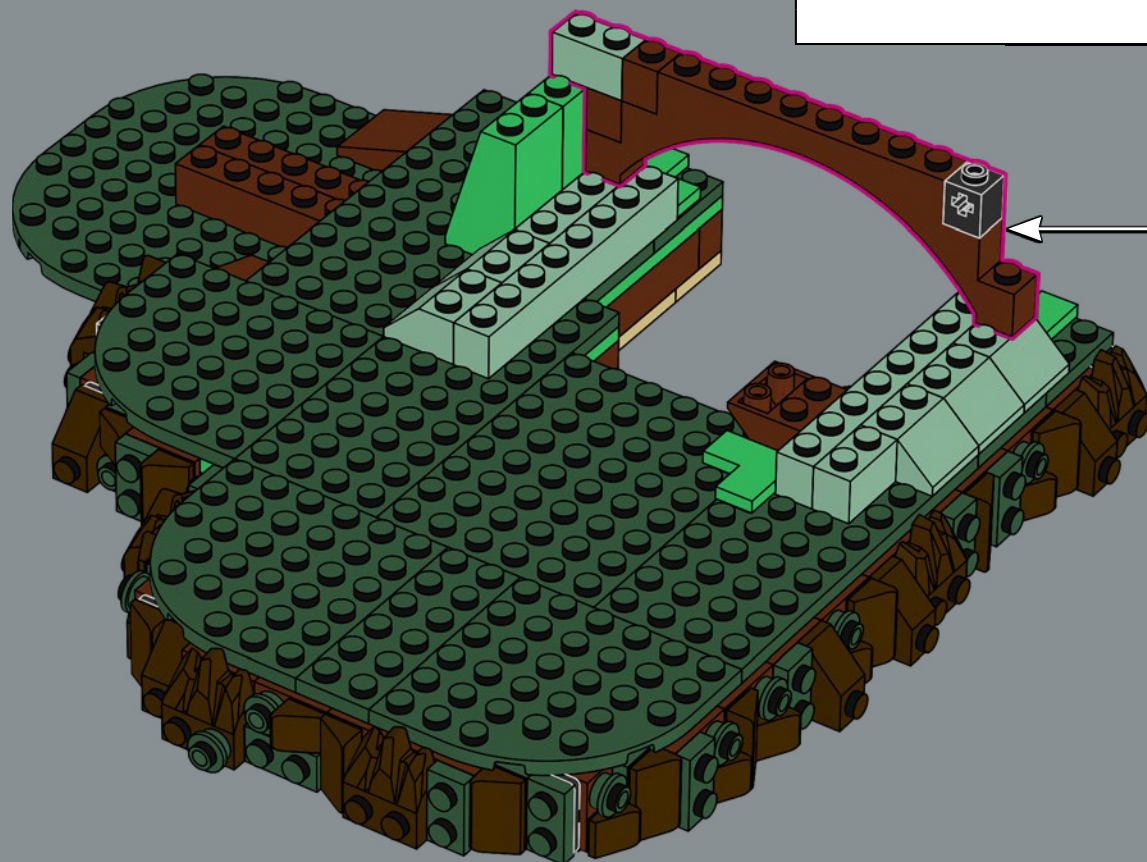
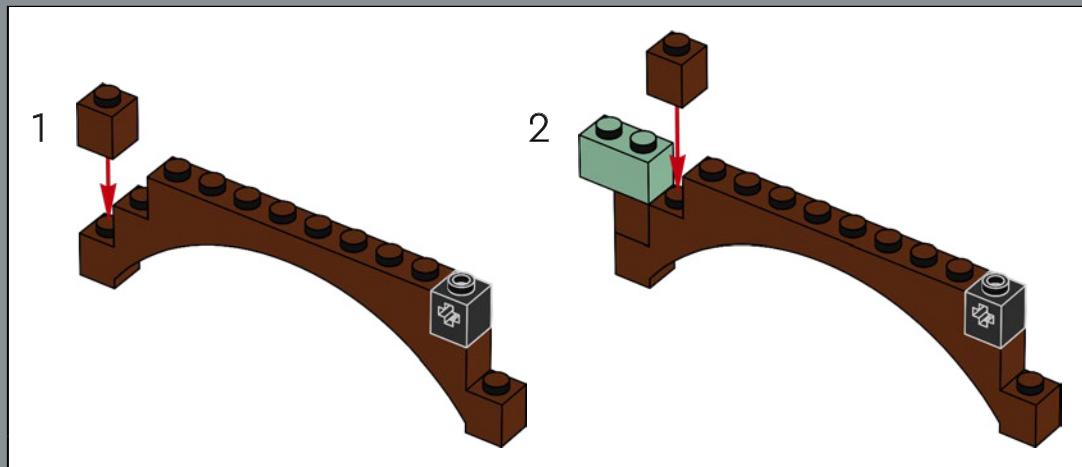



35

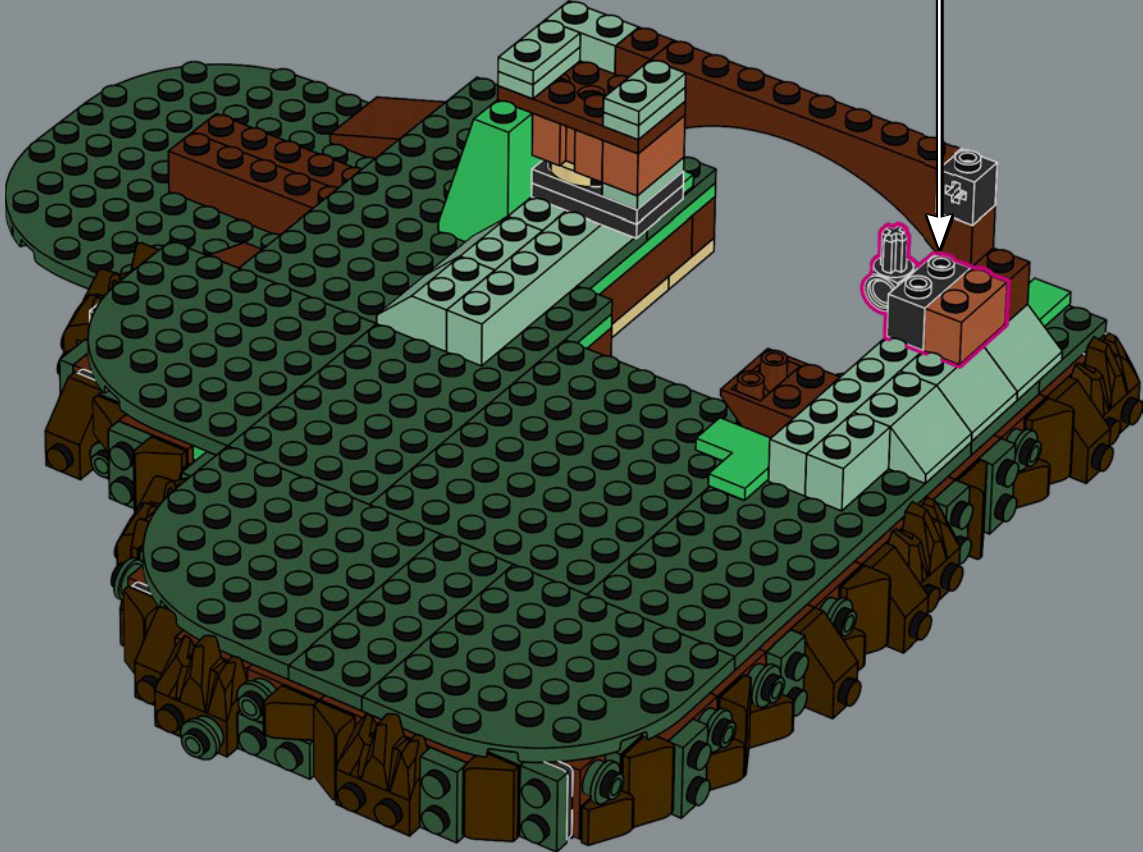
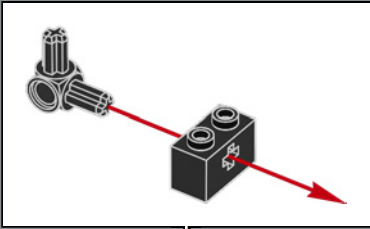



36

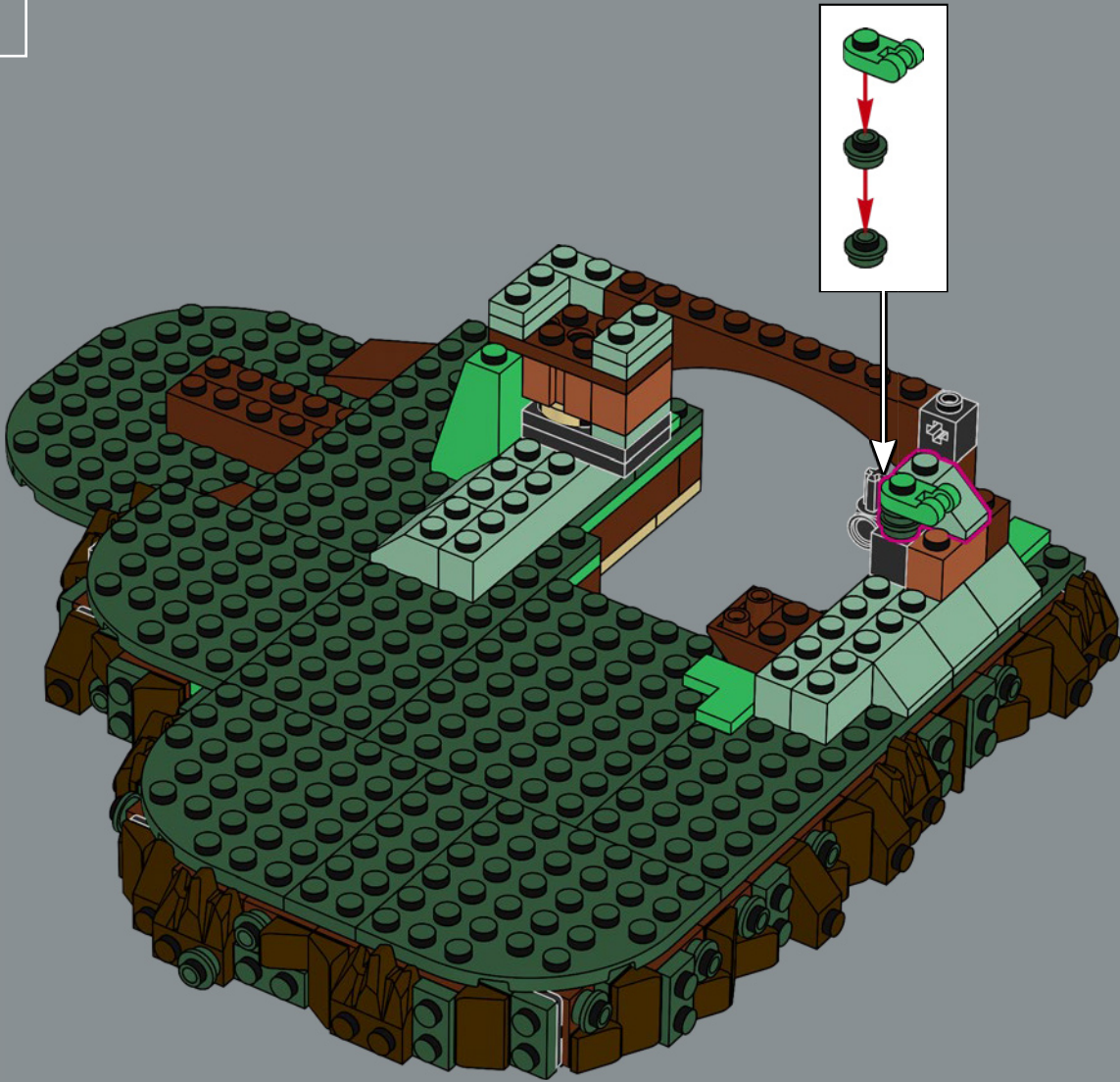

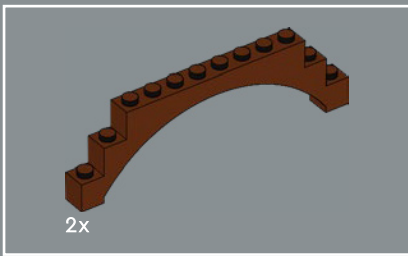

37

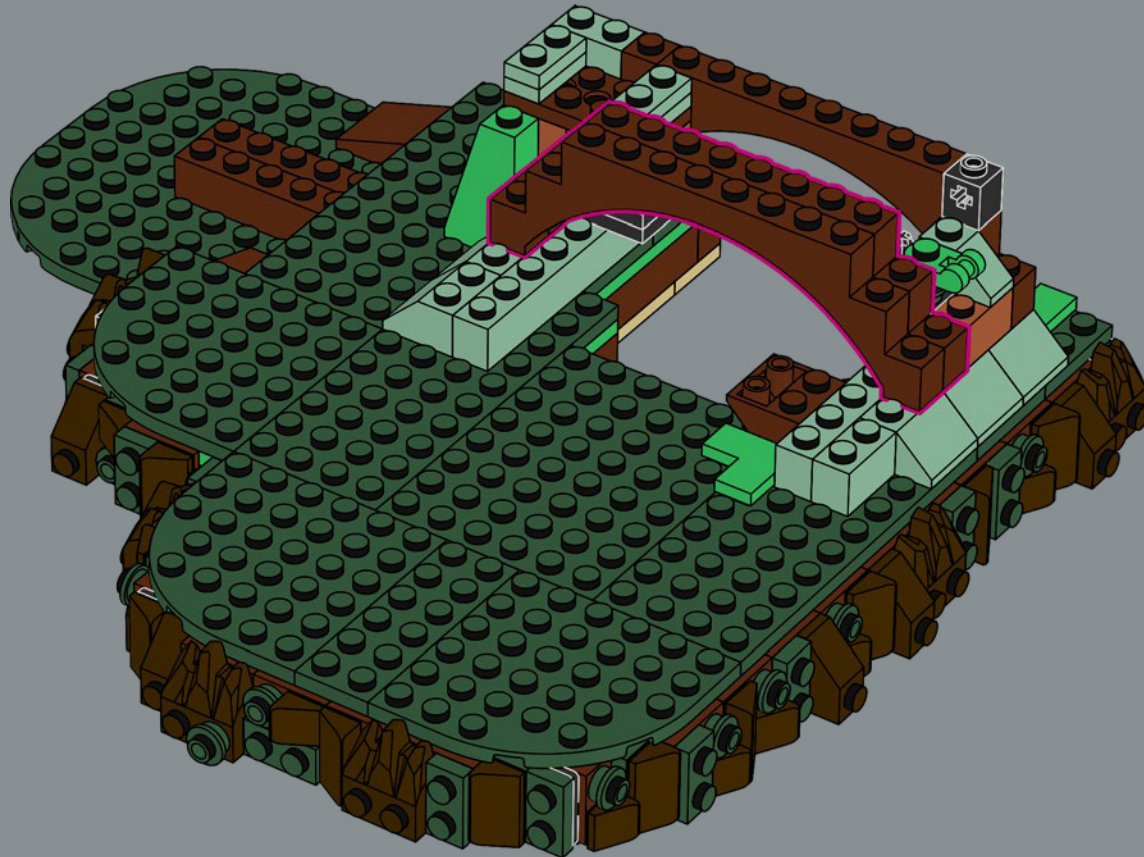



2x

38

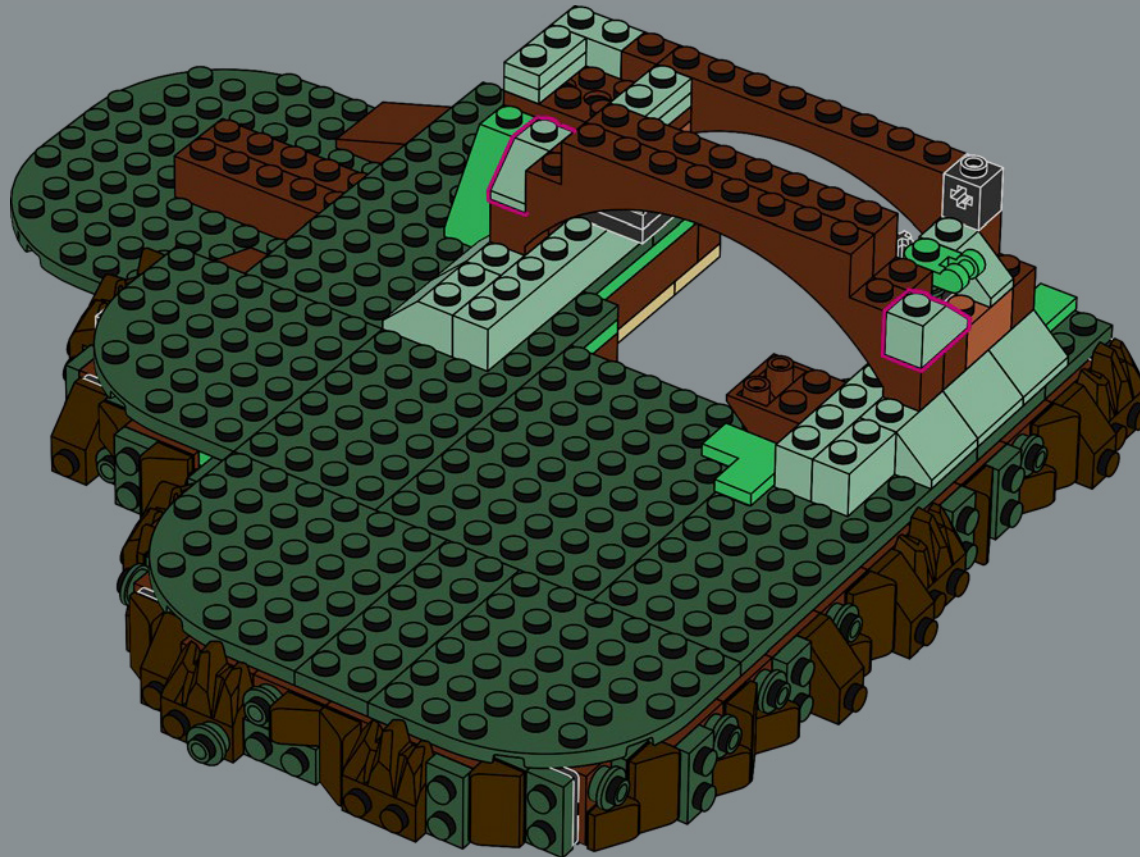

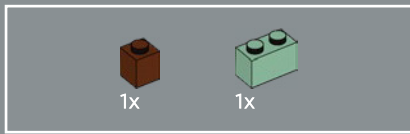

39

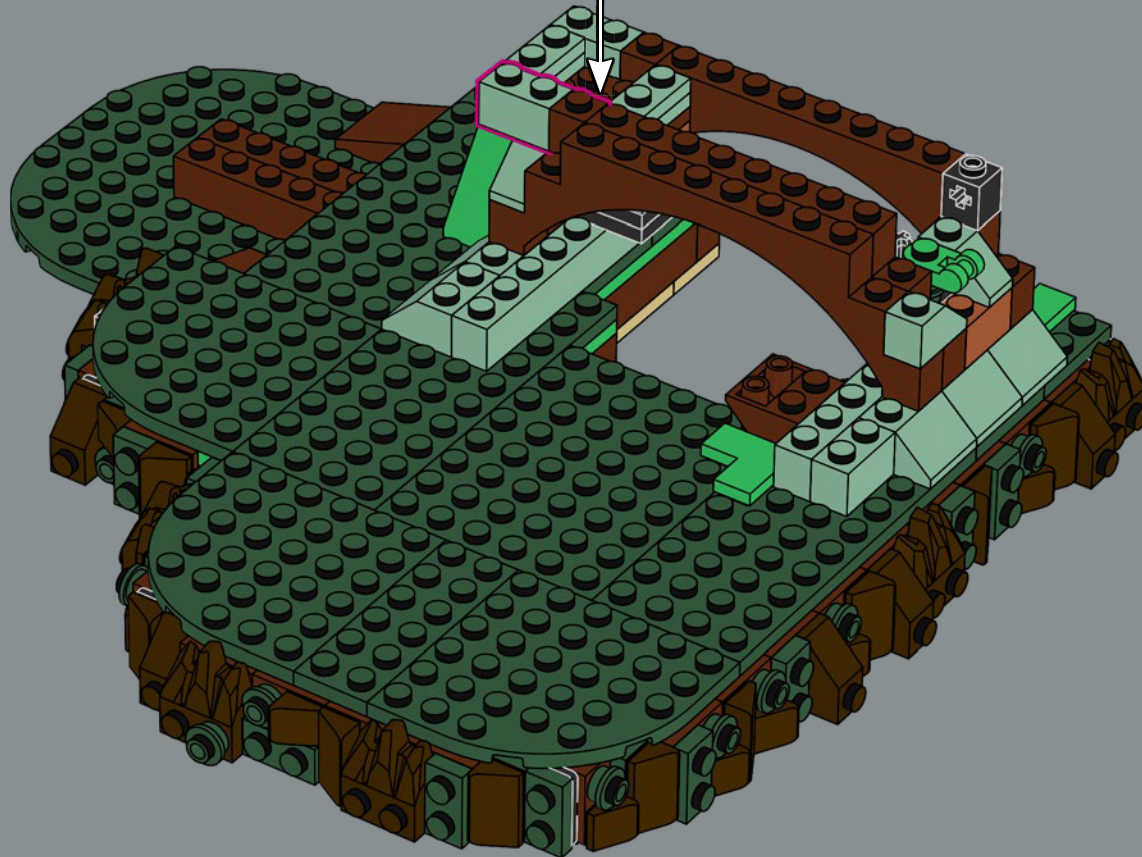
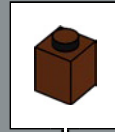

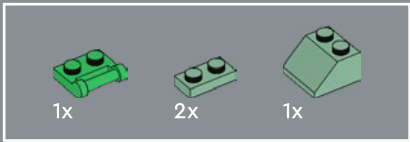

40

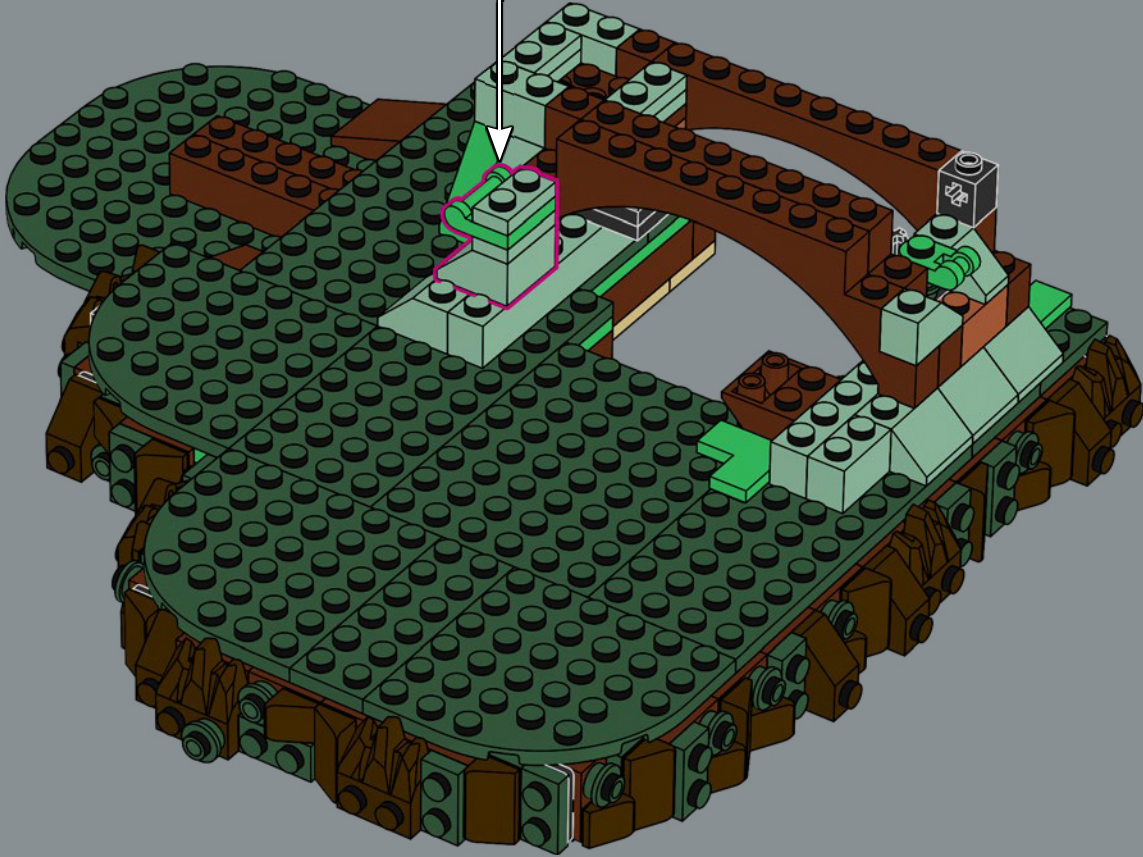
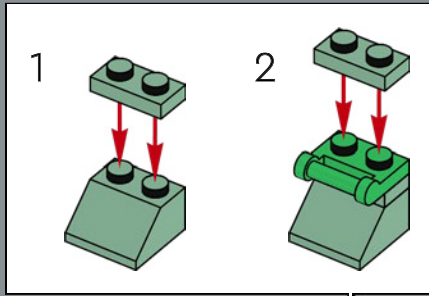

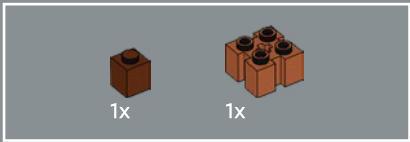

41

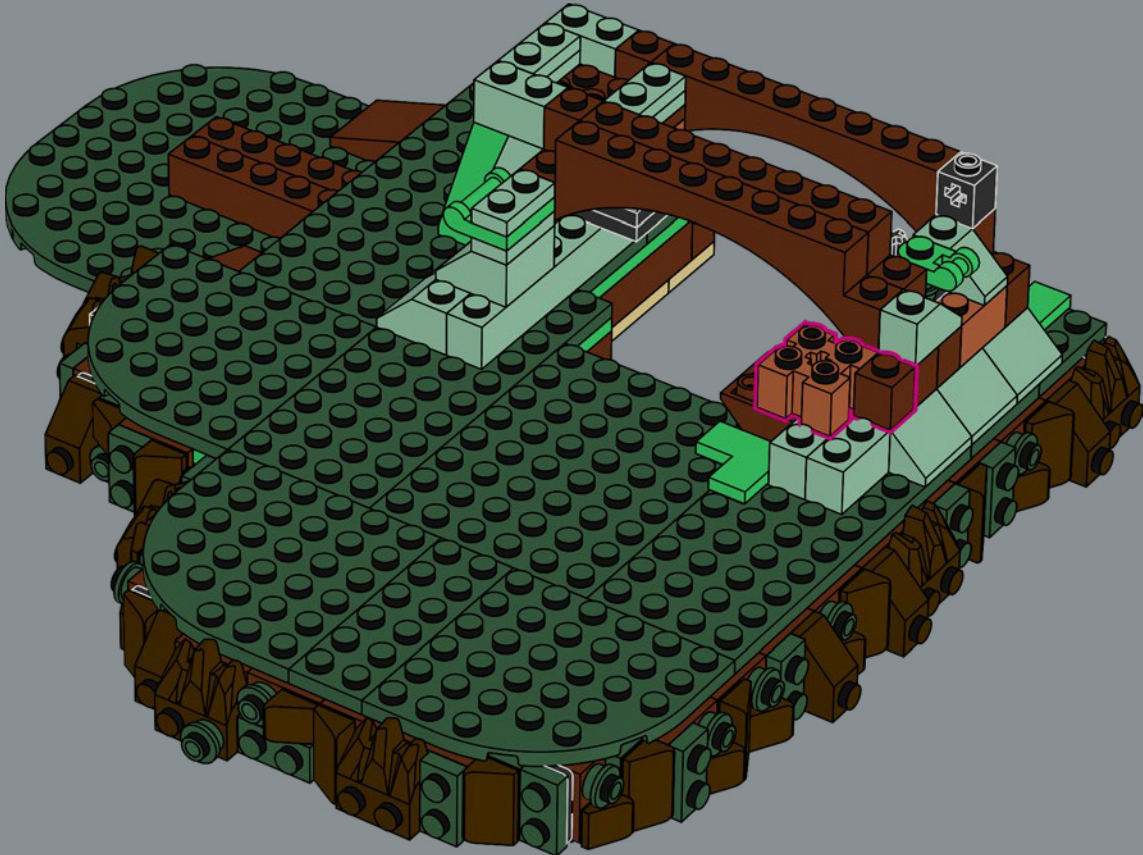

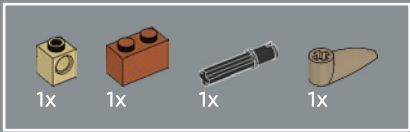

42

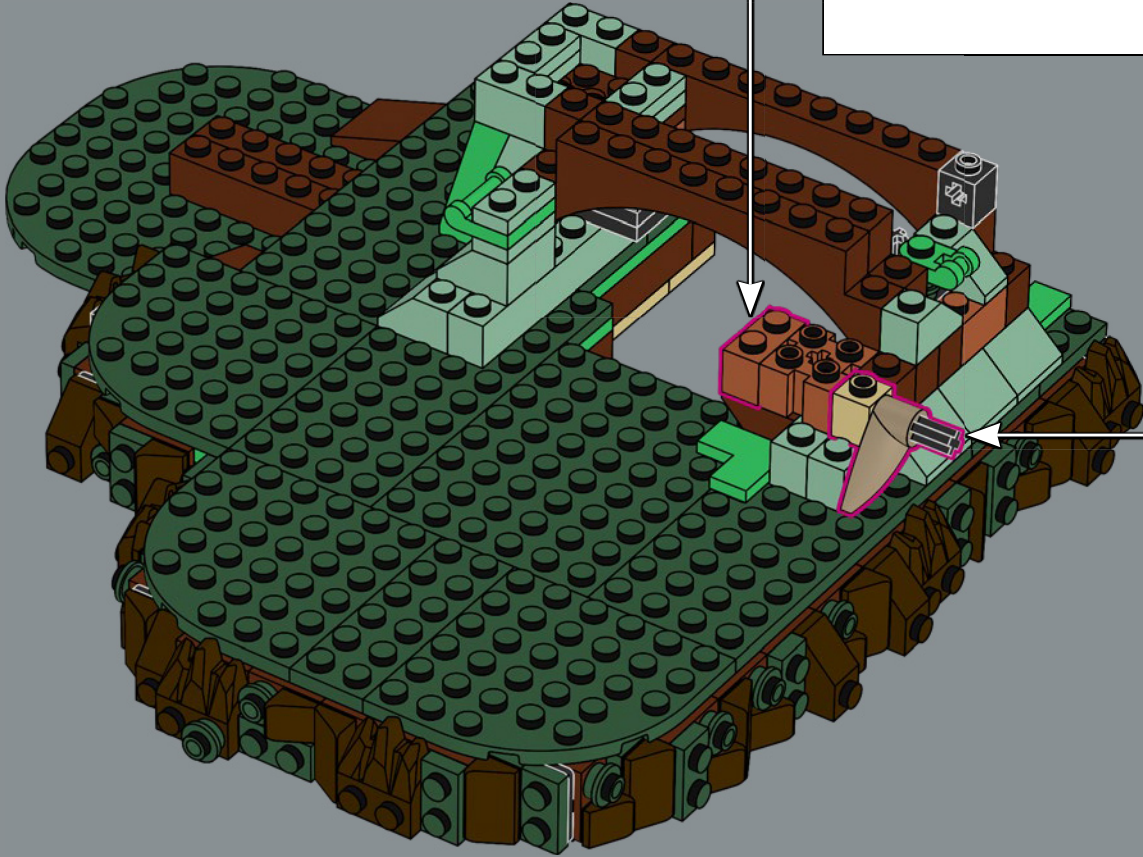
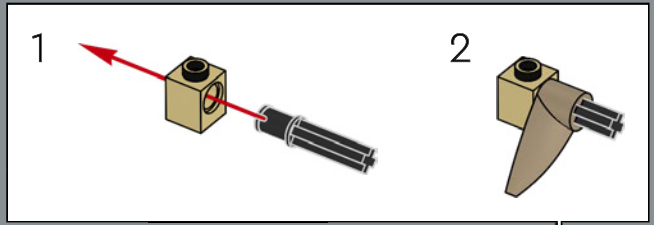
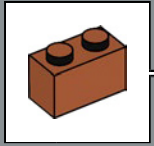

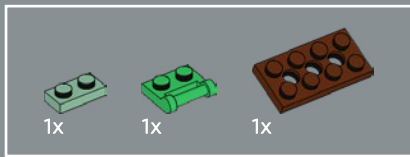

43

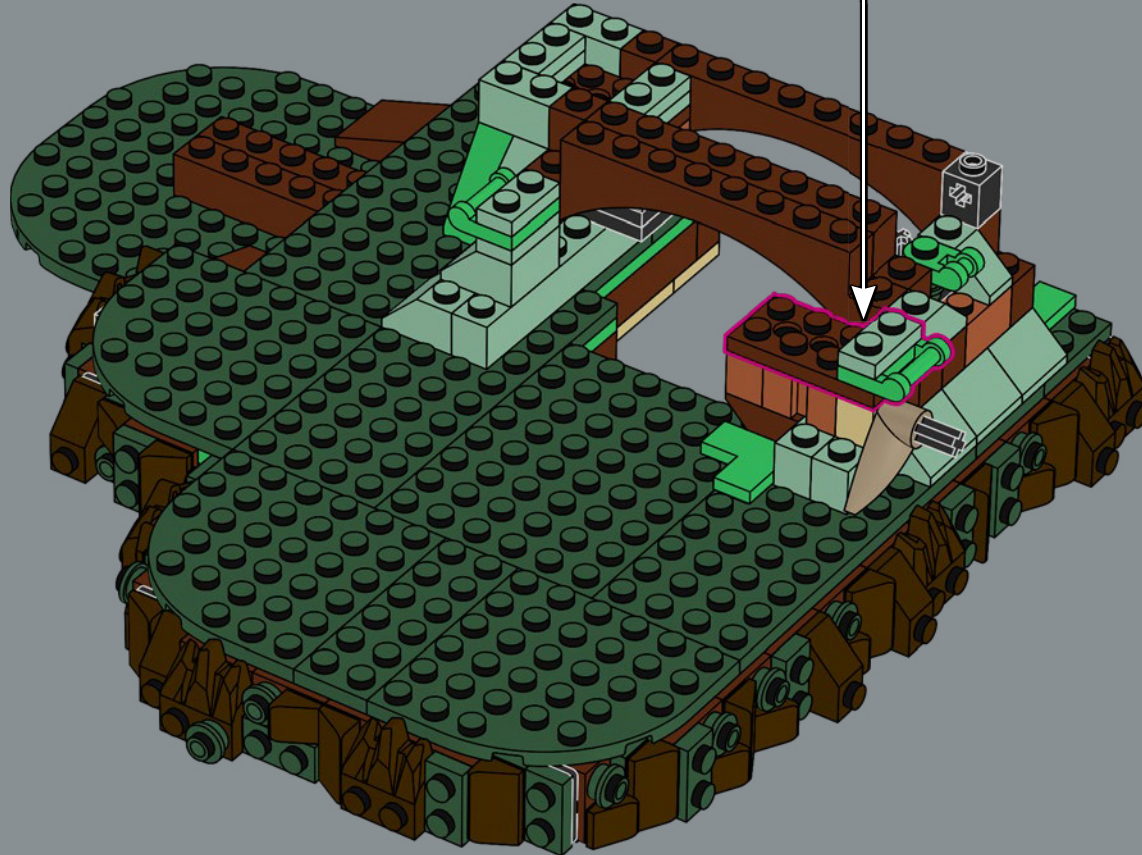
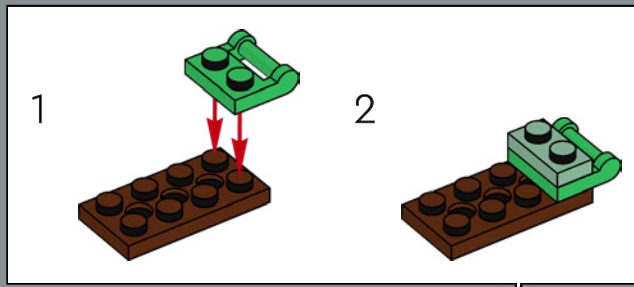

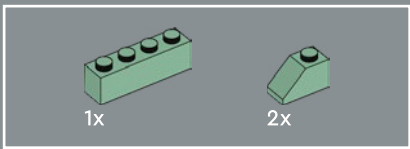

44

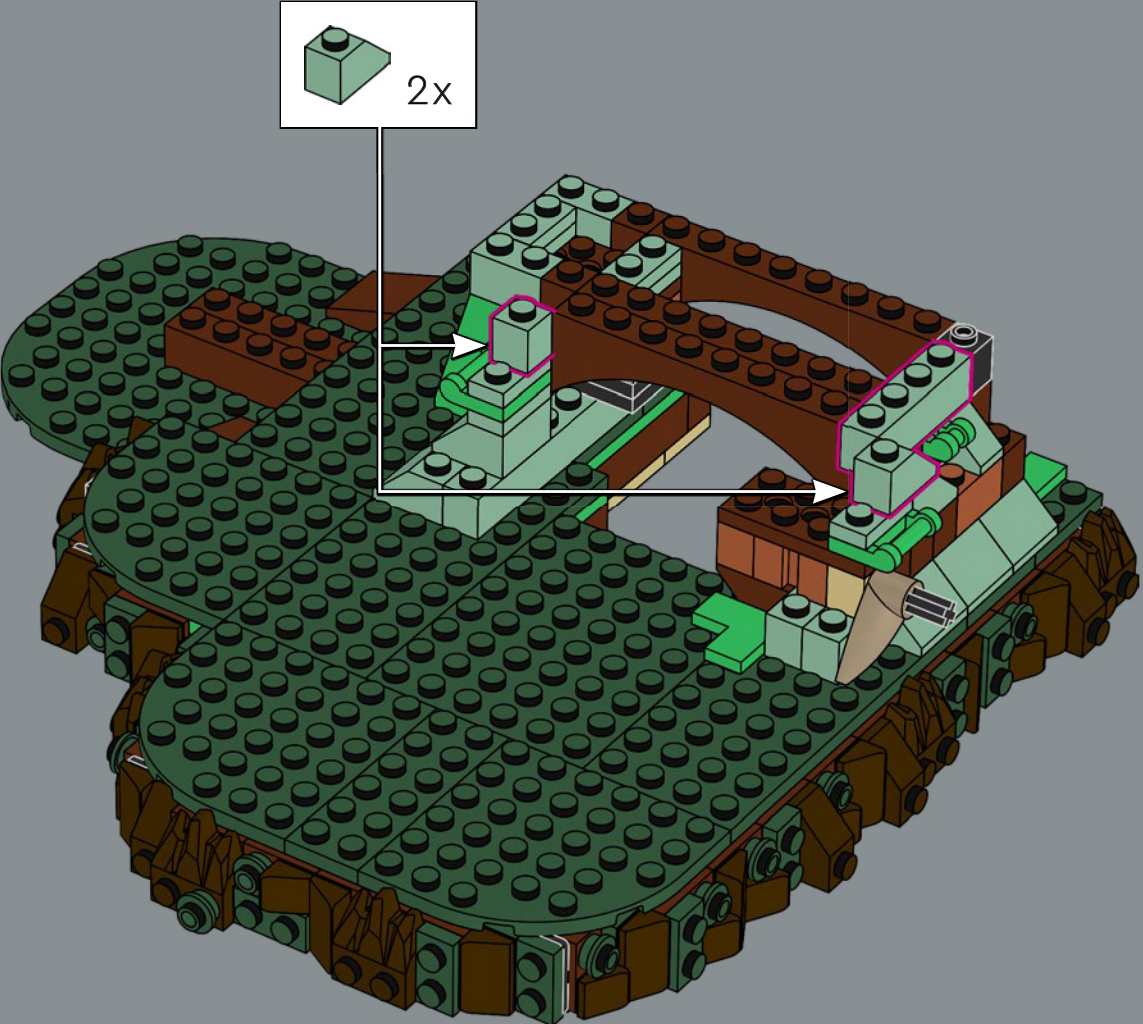

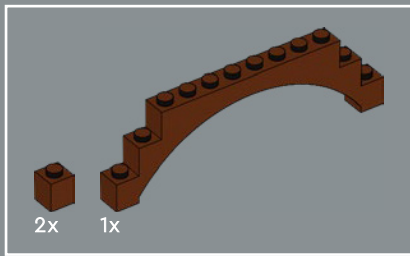

45

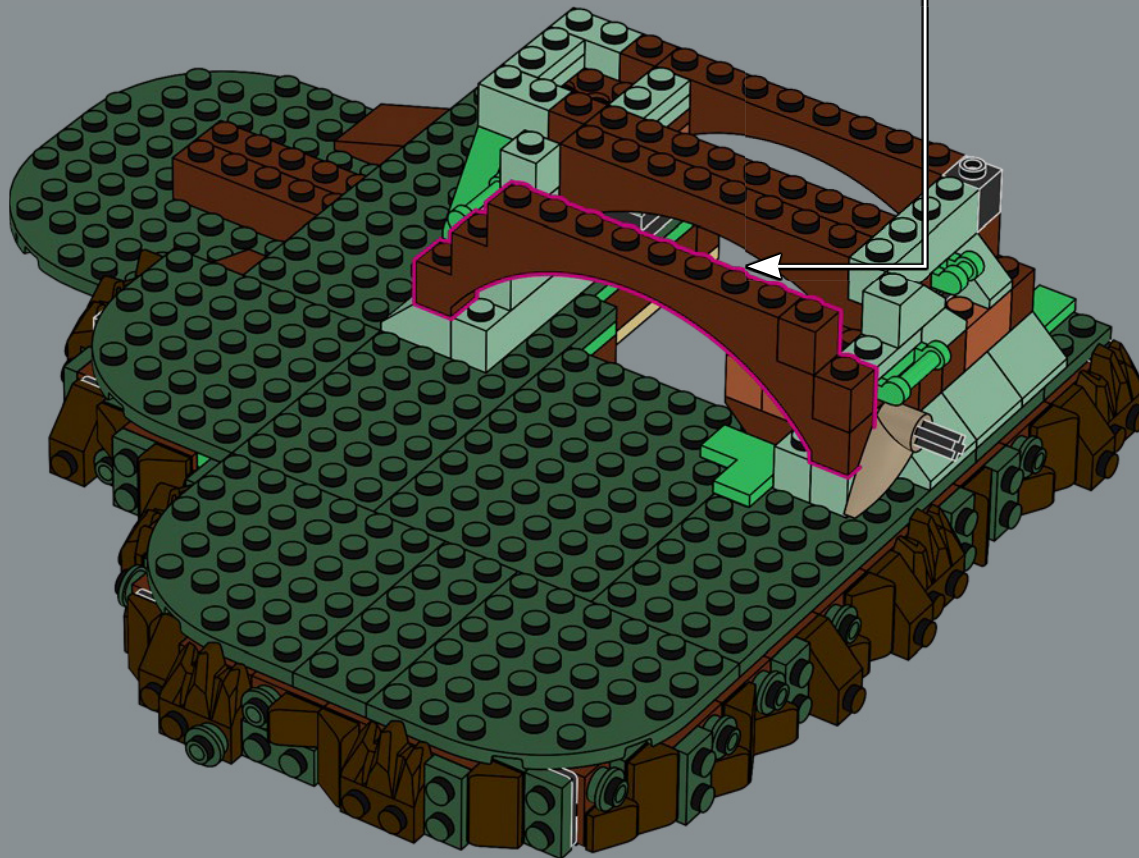
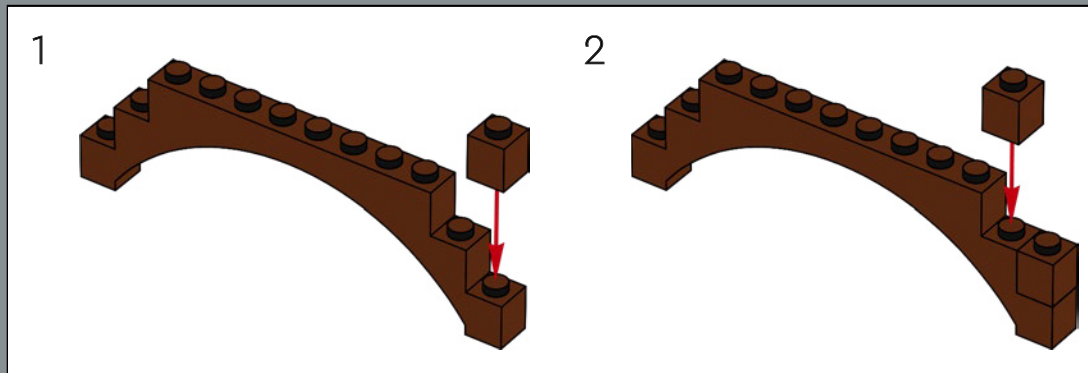



2x

46

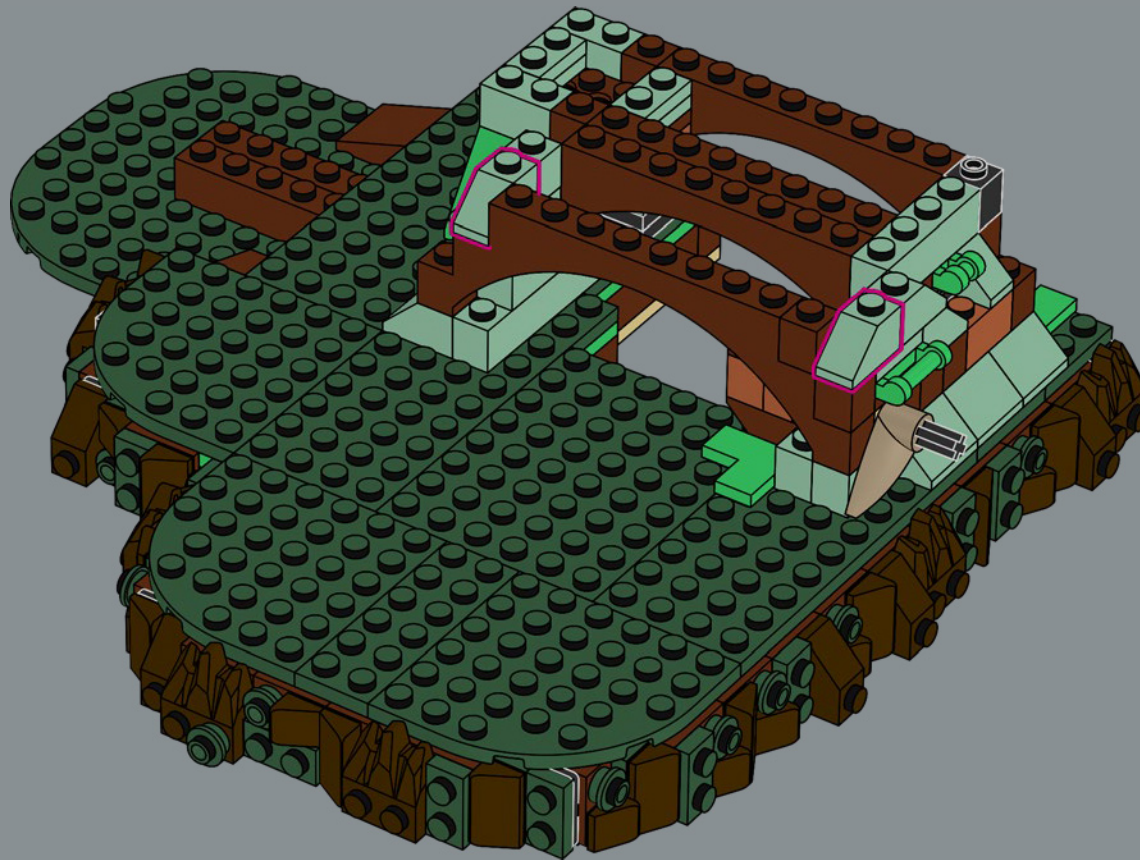

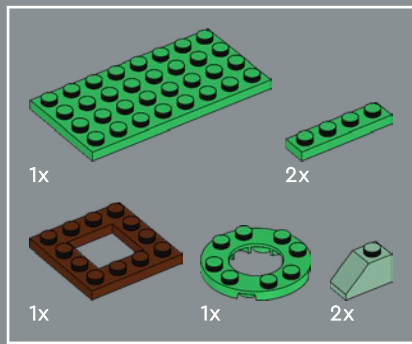

47

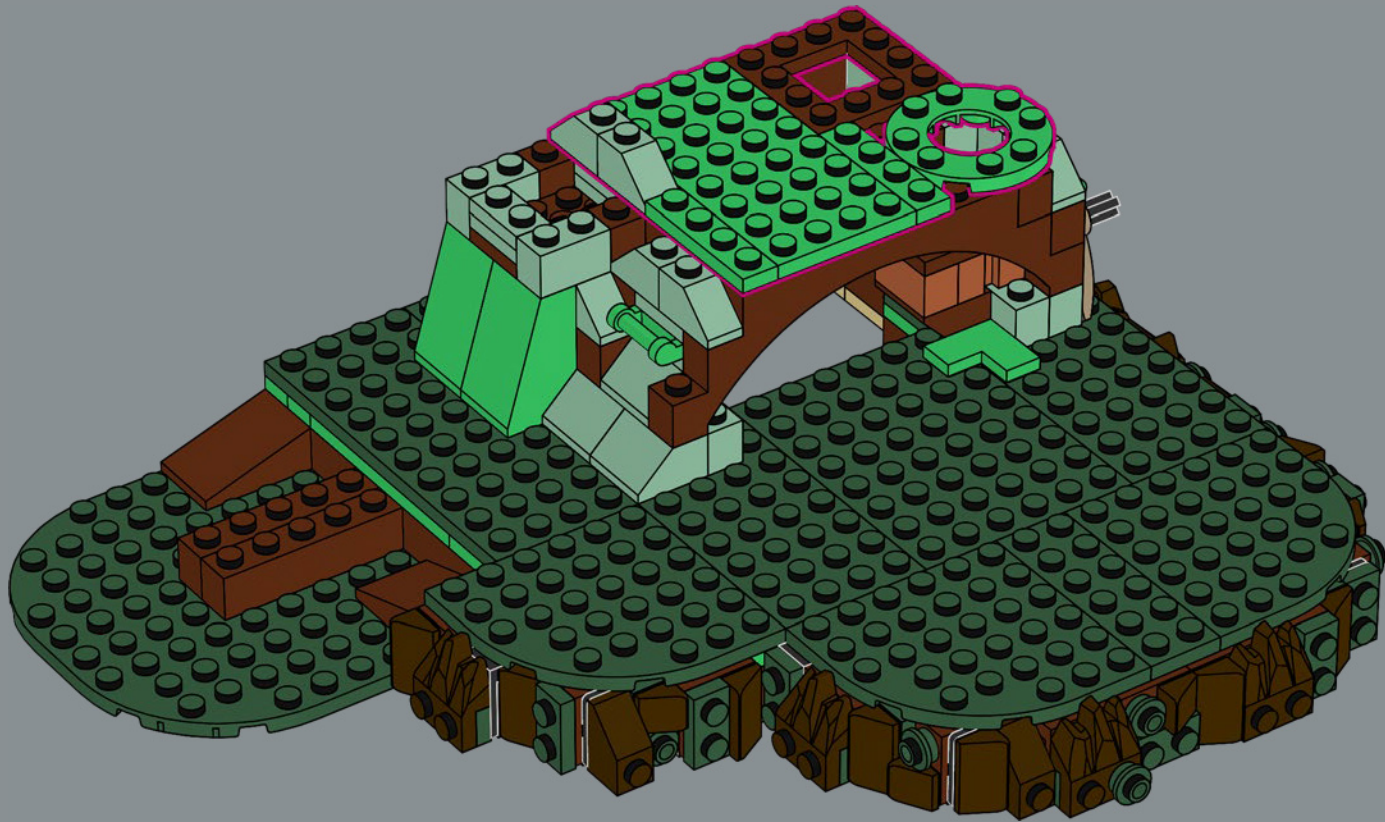

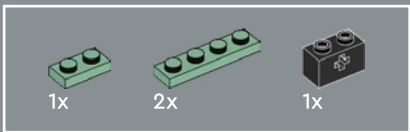

48



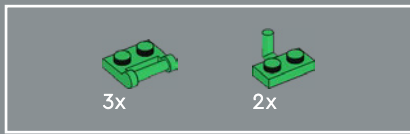

49



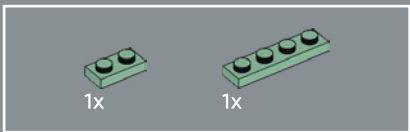

50



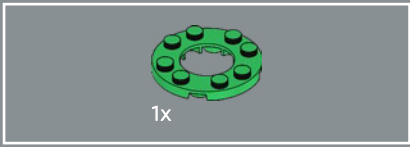

51



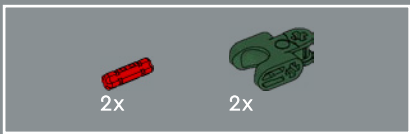

52

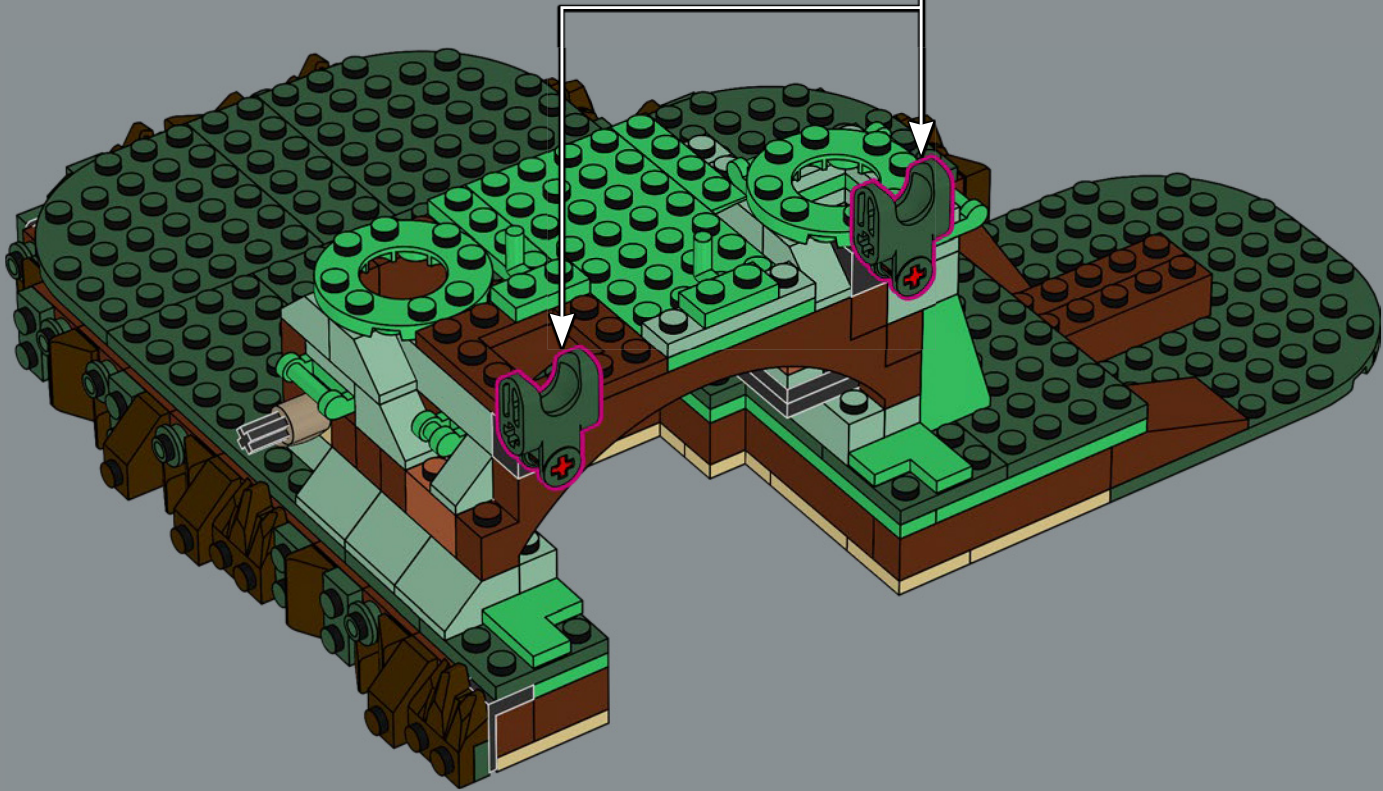
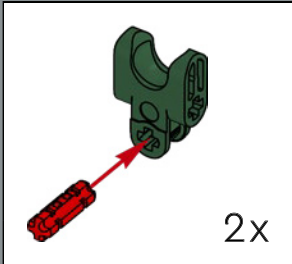

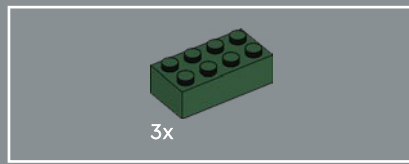

53

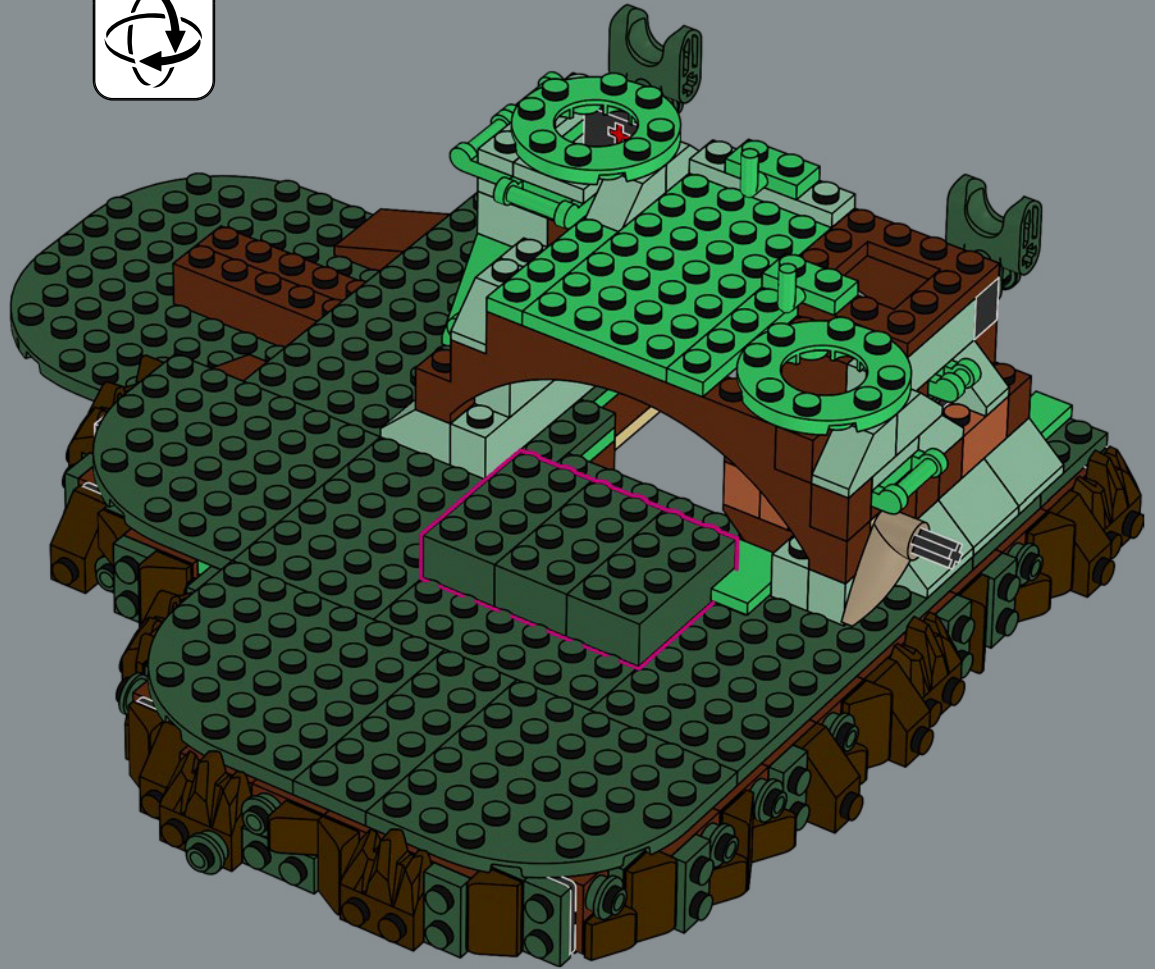

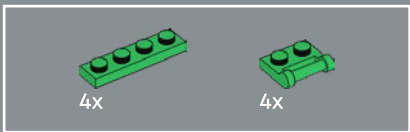

54





1x



5x

55

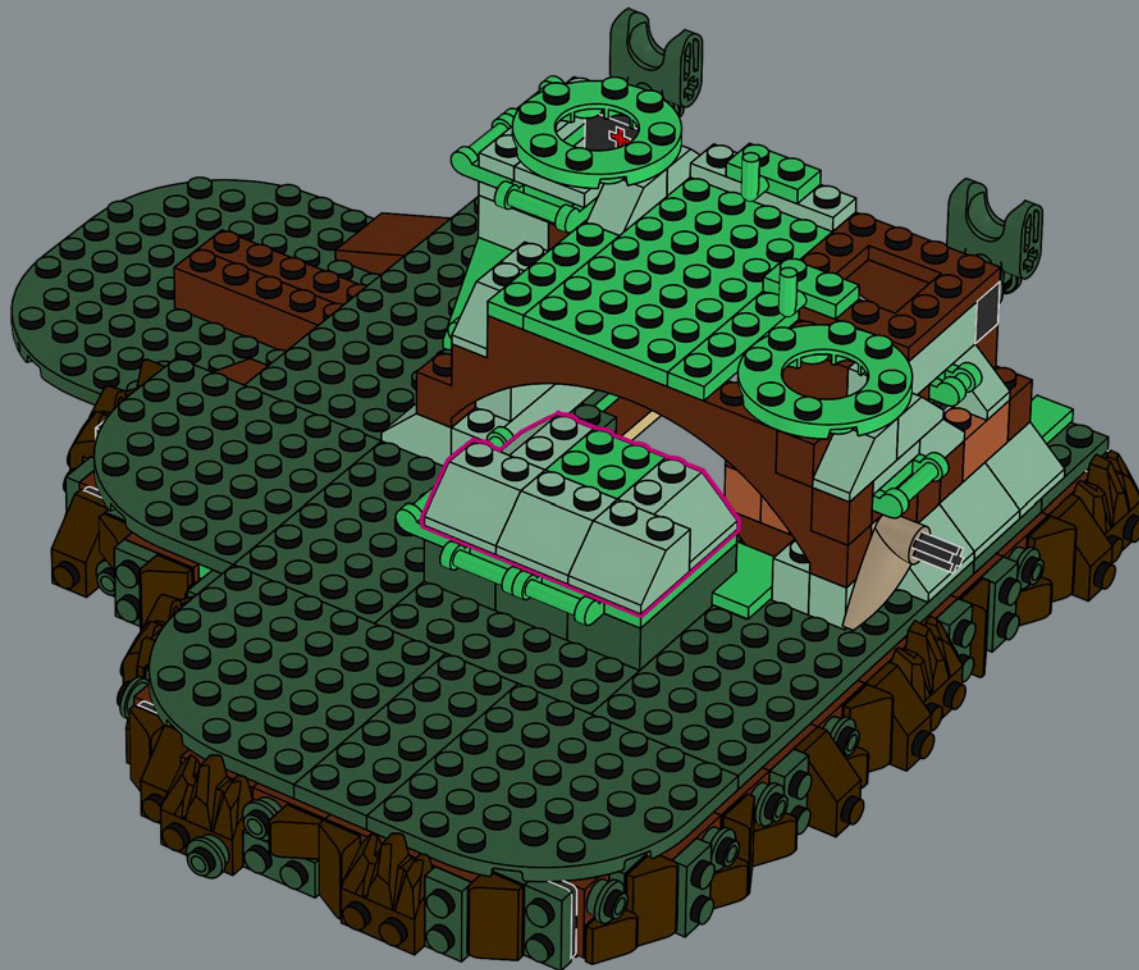

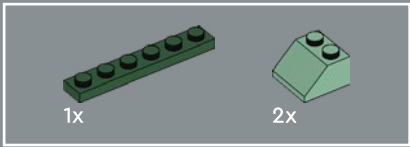

56

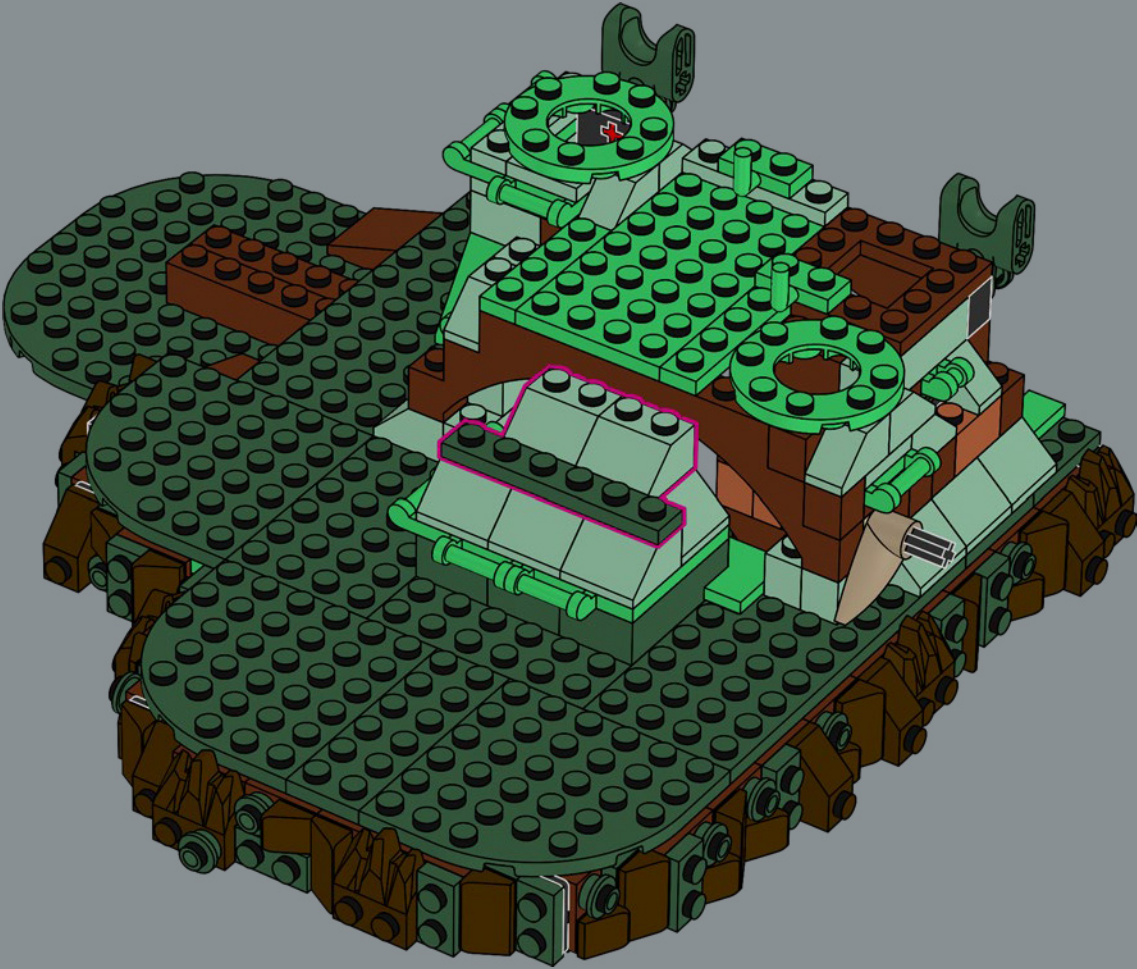

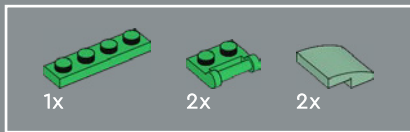

57

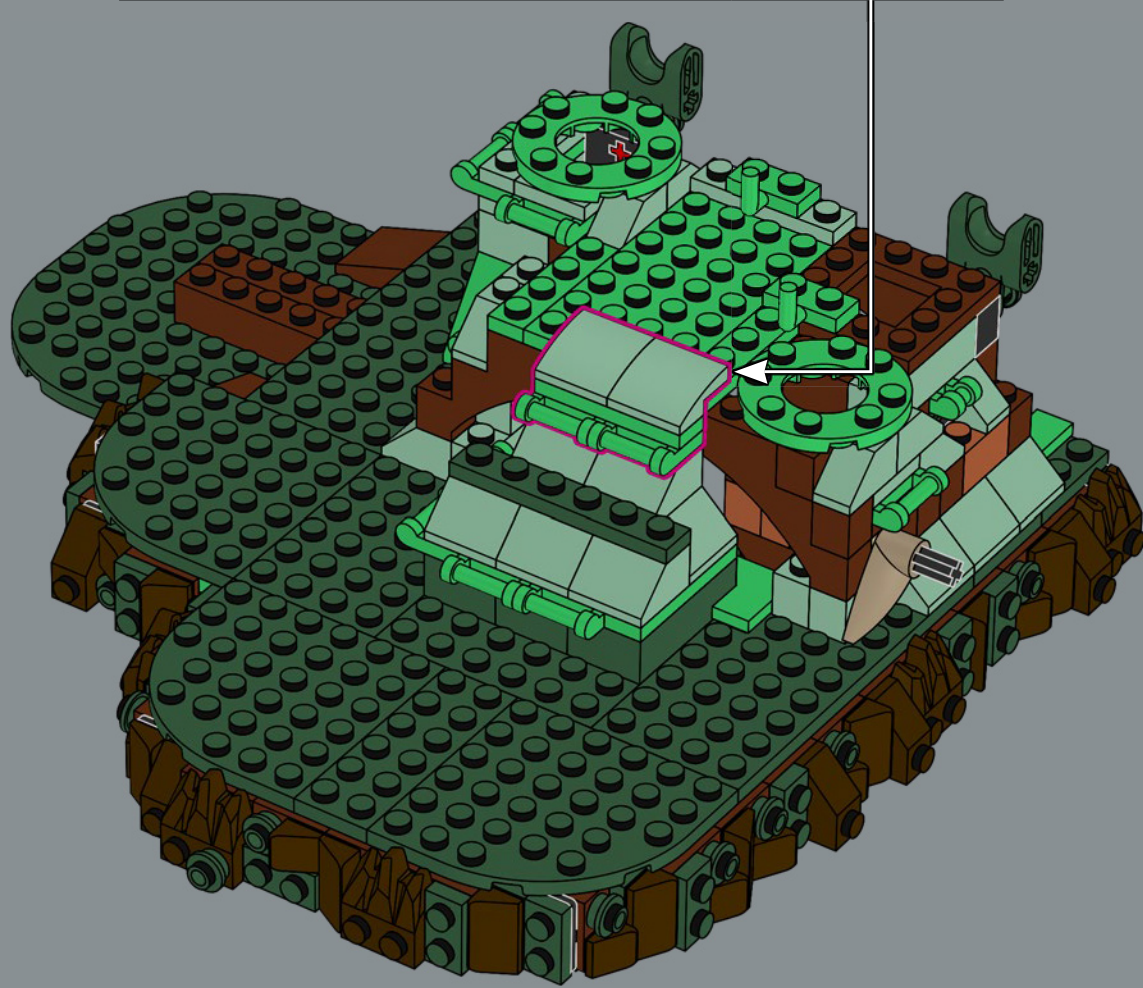
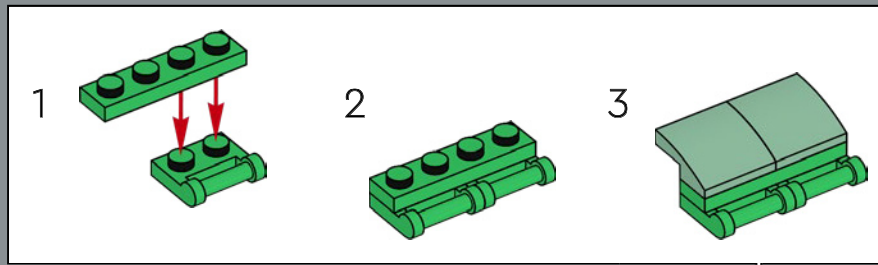



5x

58

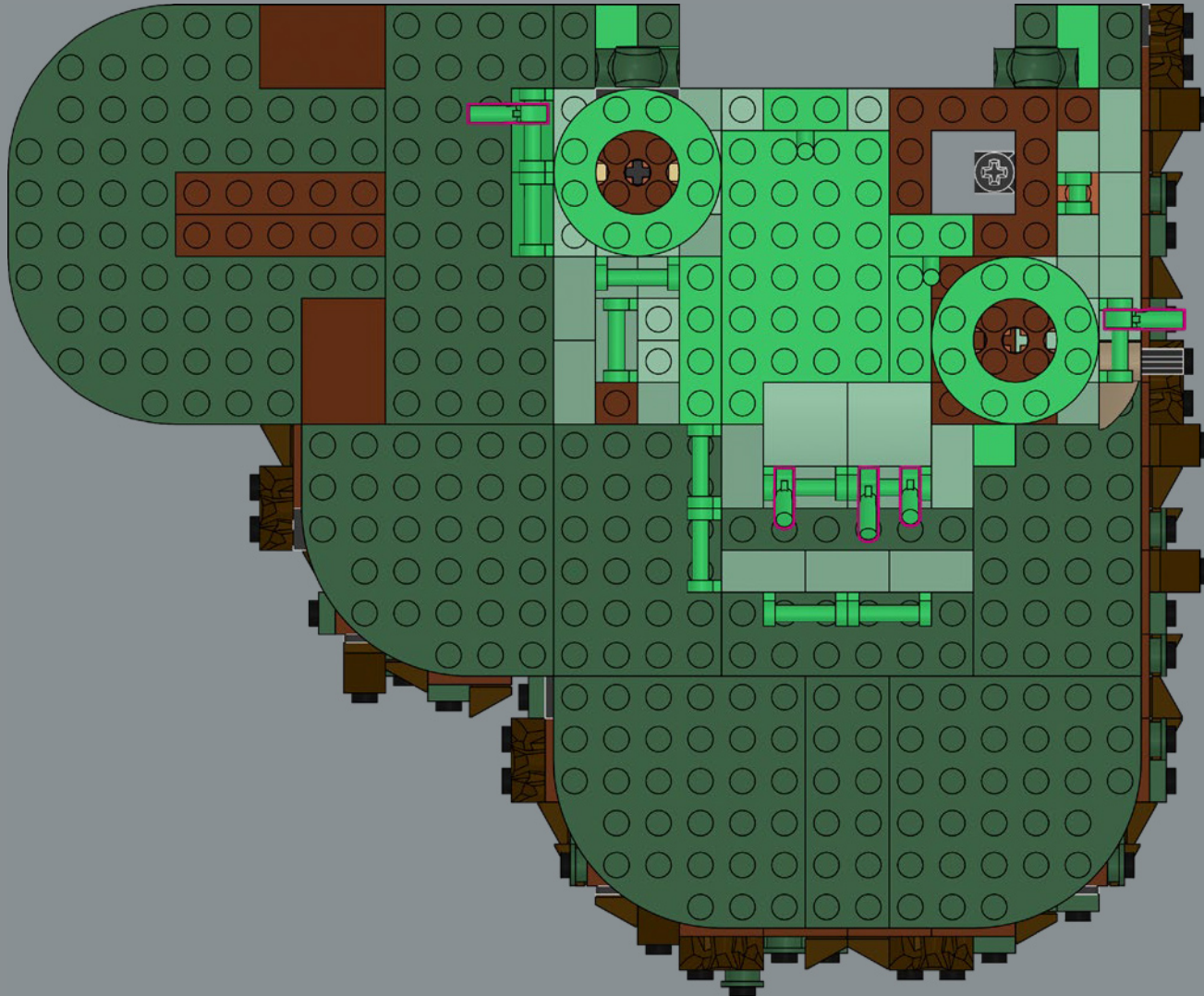



59

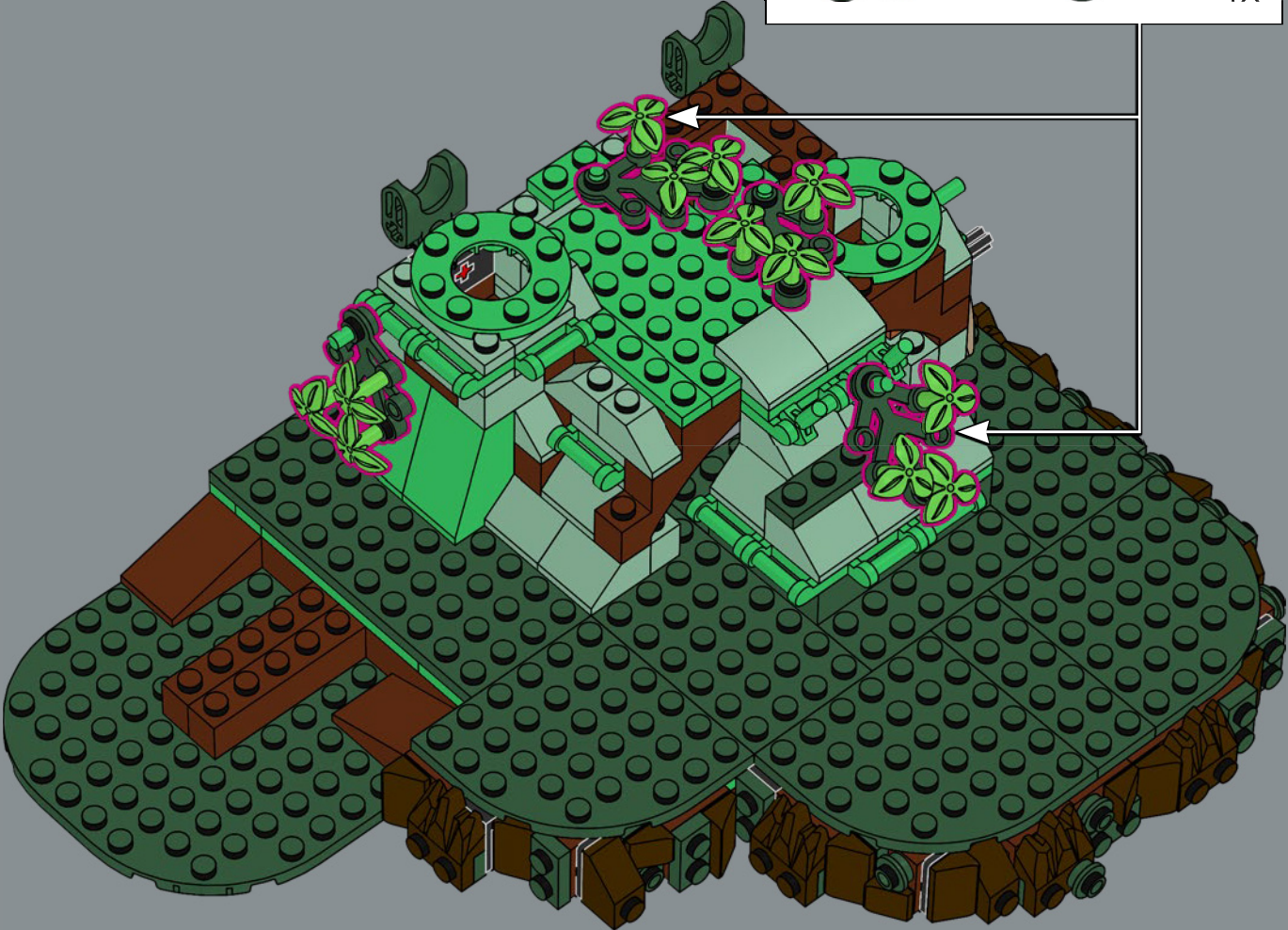
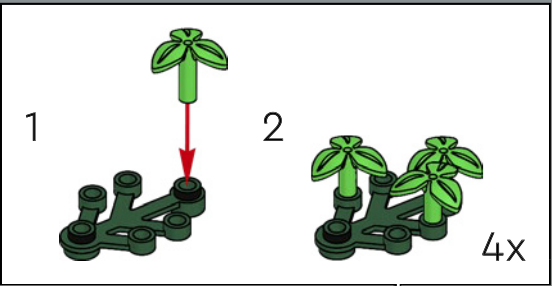



60

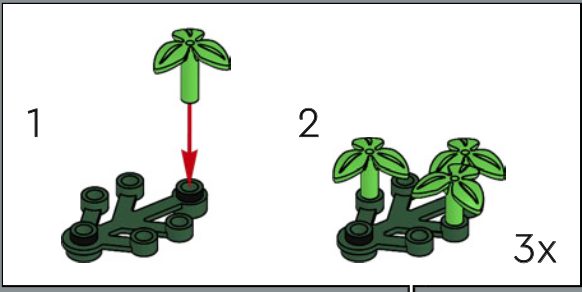



61

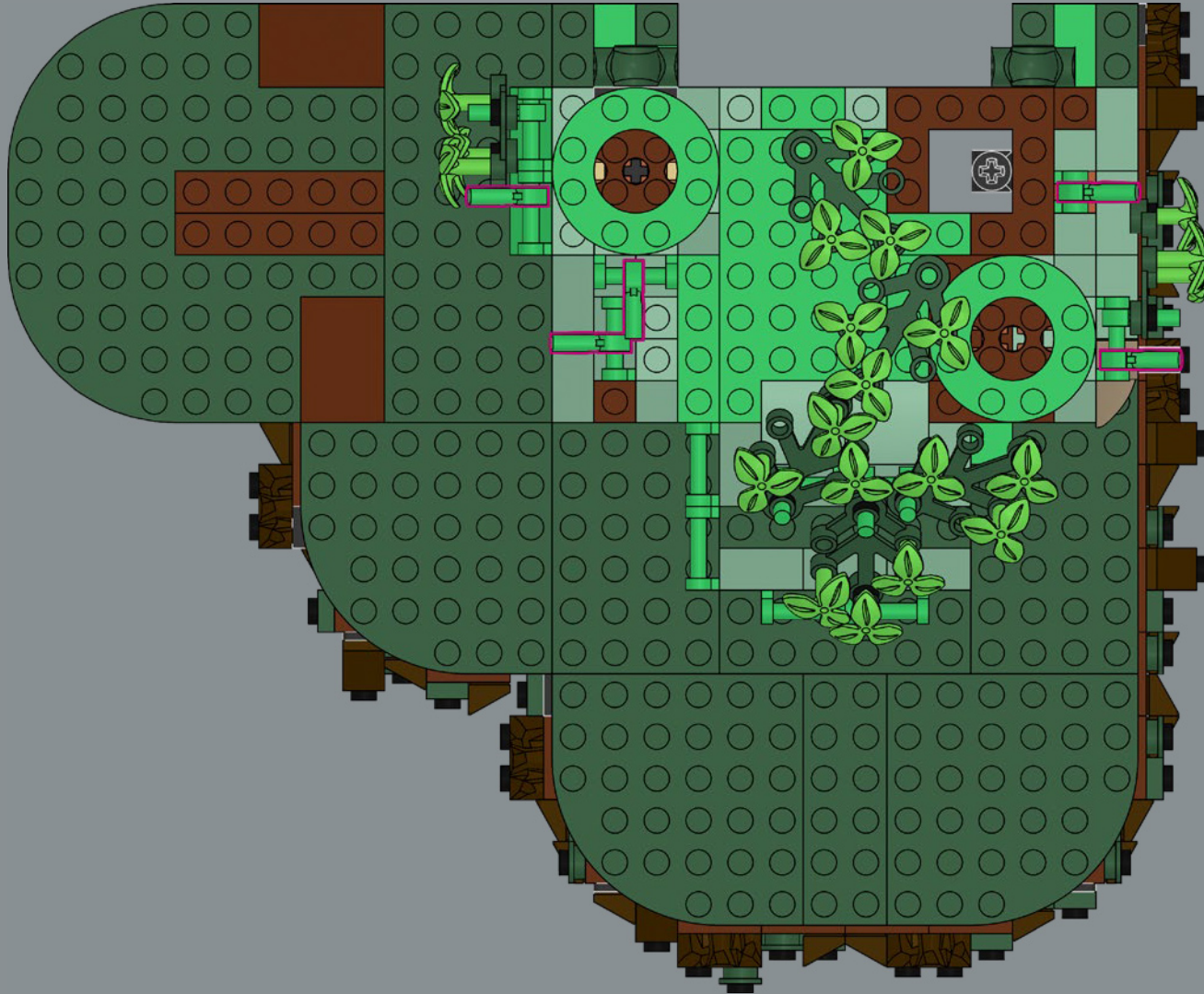



62

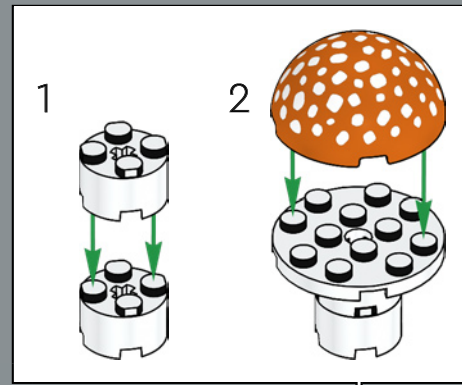



63



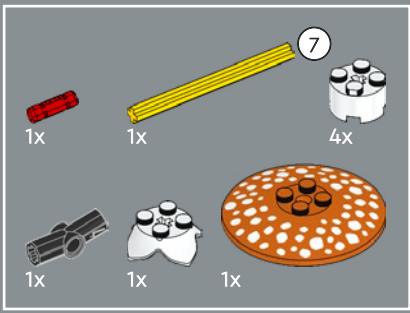

64

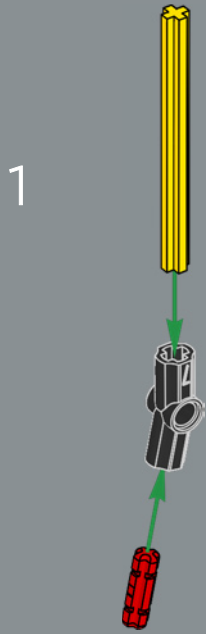

2



3

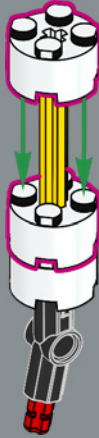

4



5





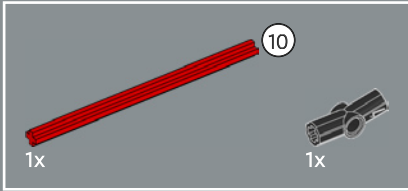
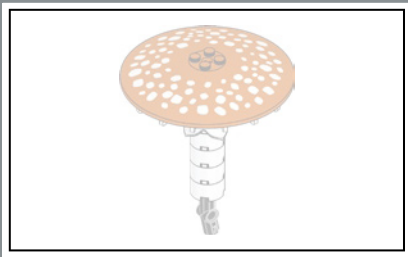

65

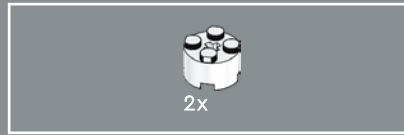

66

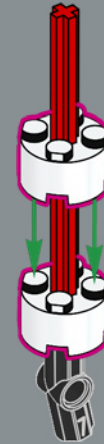

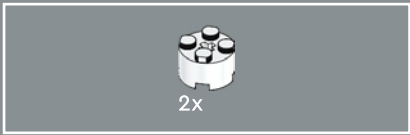

67

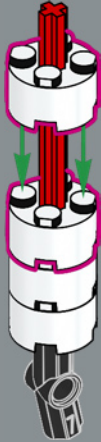

68

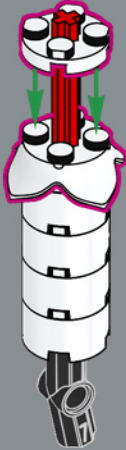

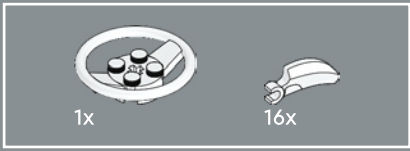

69

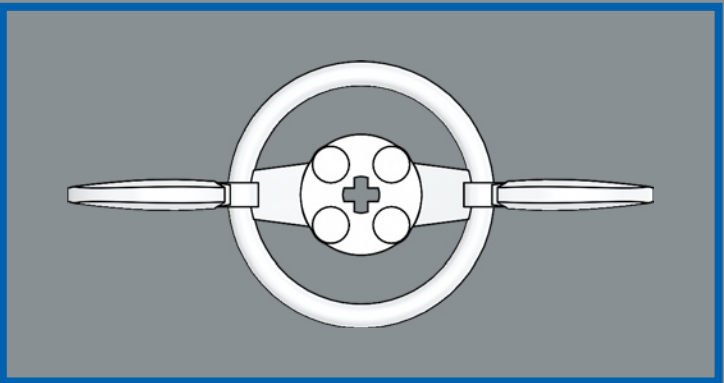

1

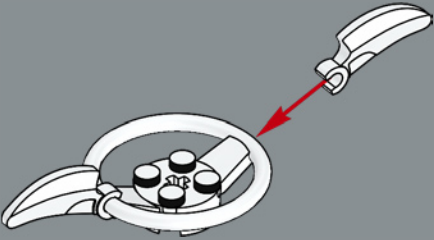

2

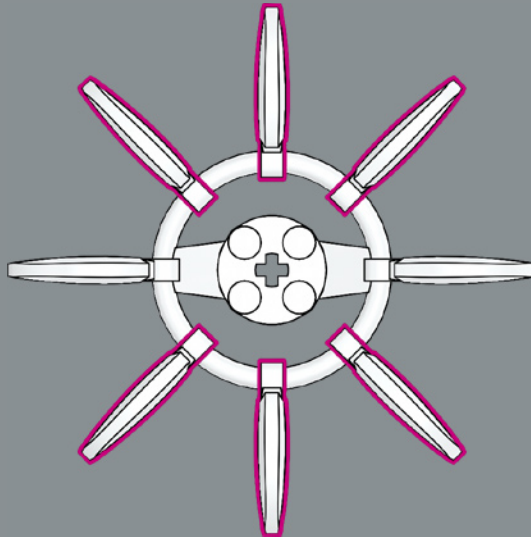

3

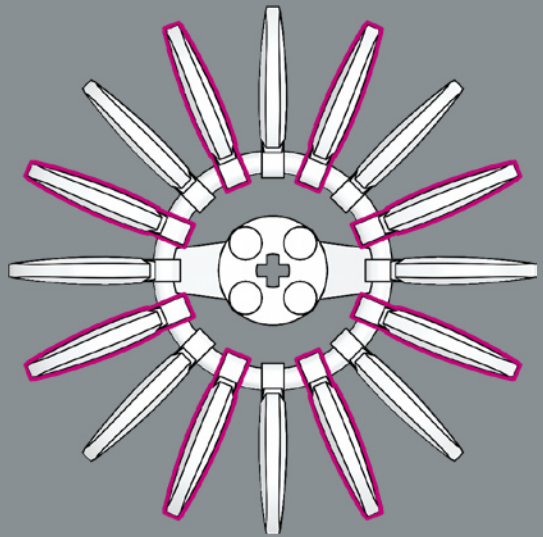

Klauenelemente können für viel mehr als nur LEGO® Tiere und Kreaturen genutzt werden. Hier bilden sie die Lamellen unter den großen Fliegenpilzen.

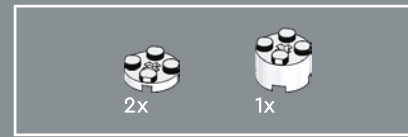
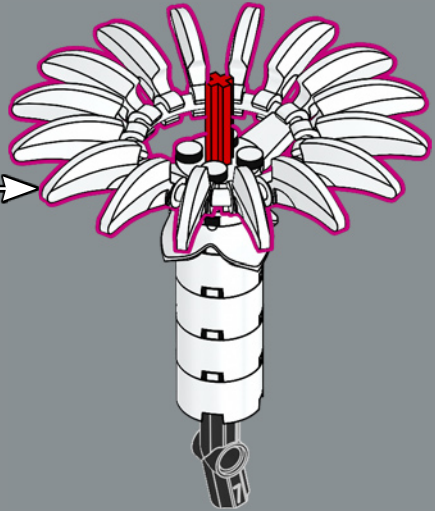

70

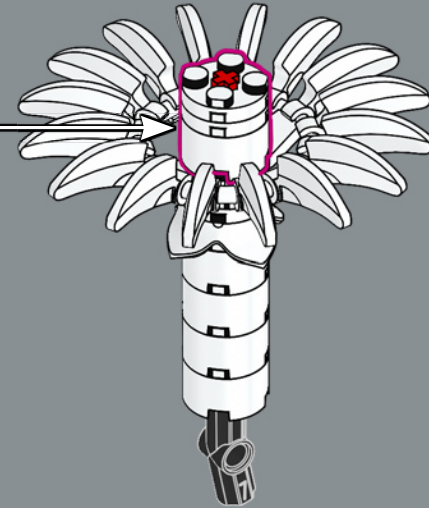
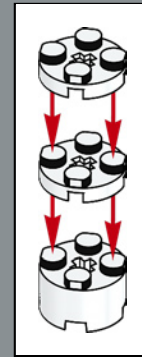

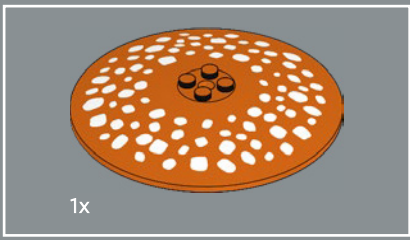

71



72





73



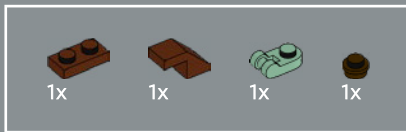

74

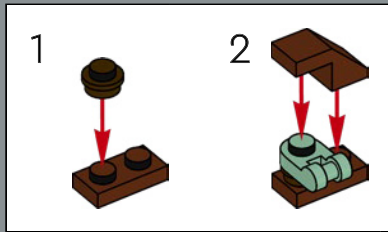



4x

75





76

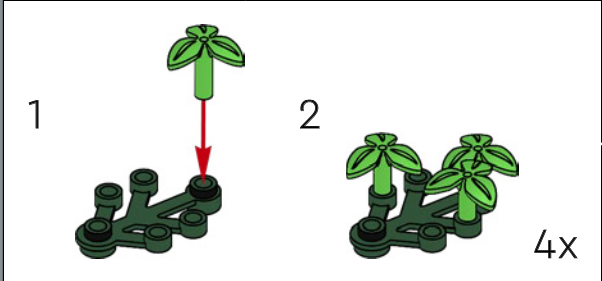



77



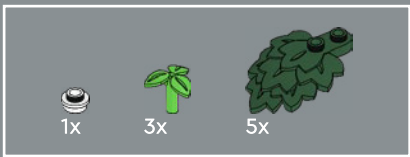

78



3x  2x 

79



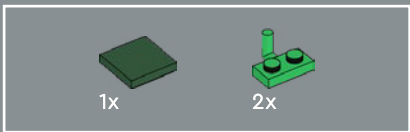

80

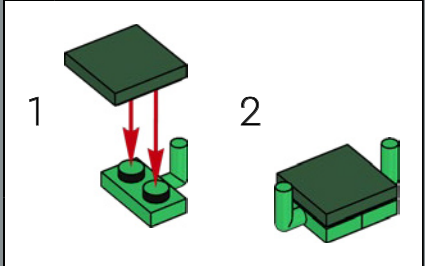

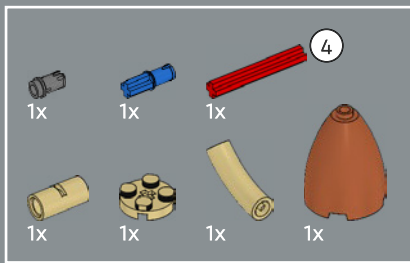

81

1



2

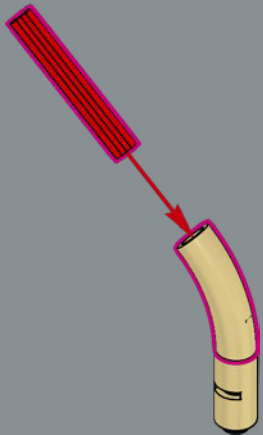

3

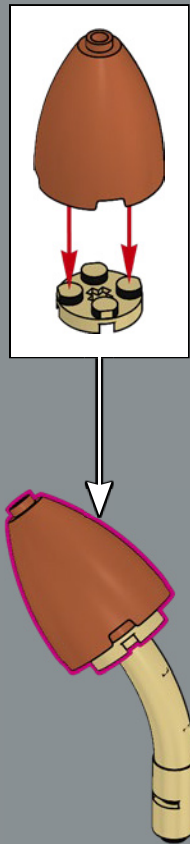

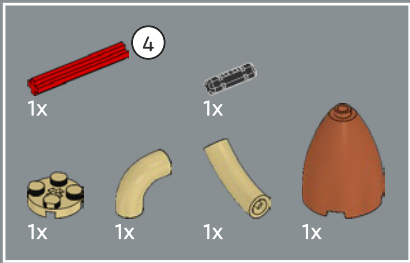

82

1

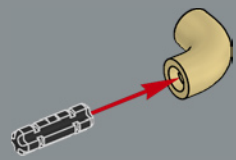

2

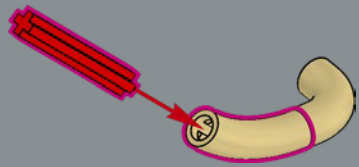

3

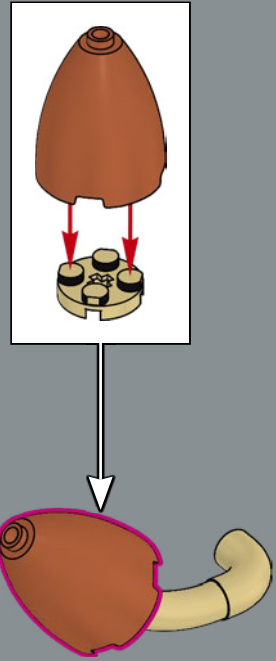

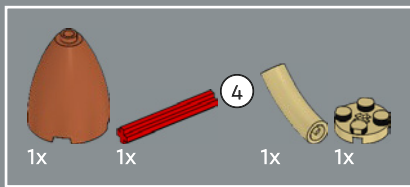

83

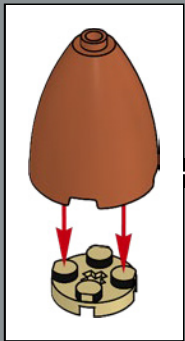
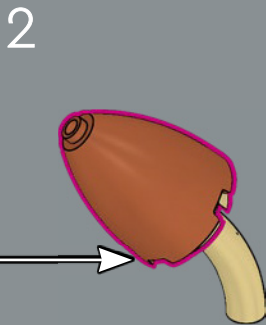
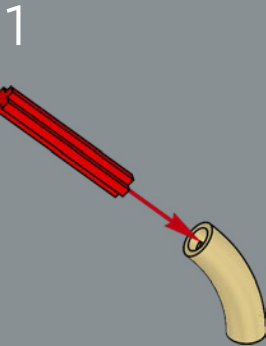

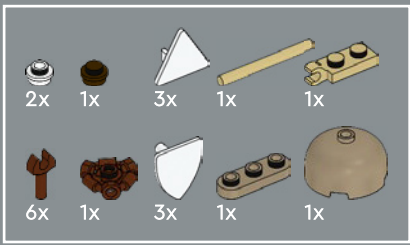

84

1

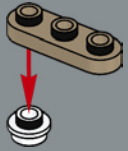

2

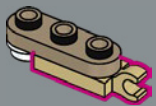

3

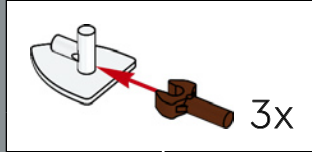
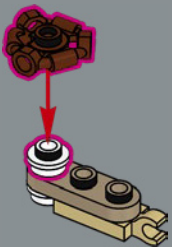

4

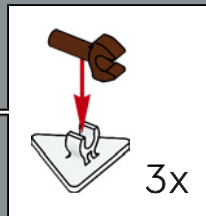
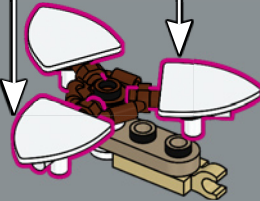

5

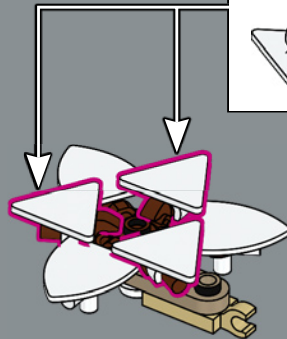

Bei der Nachbildung besonderer Formen kommen alle möglichen LEGO® Elemente ins Spiel. Für die charakteristische Form des Halskrausen-Erdsterns haben wir dreieckige Straßenschilder mit Minifiguren-Schildelementen kombiniert.

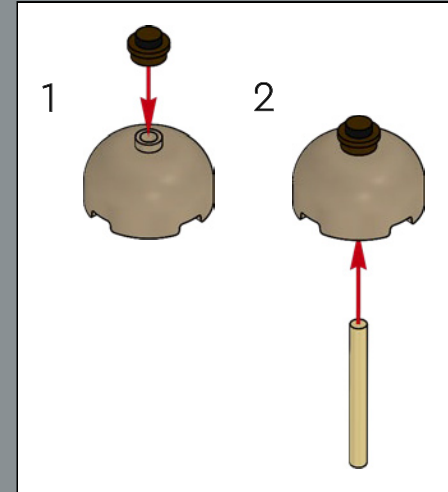

6

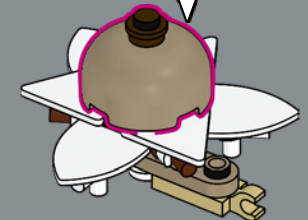





85

1

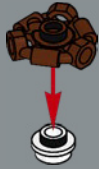

2

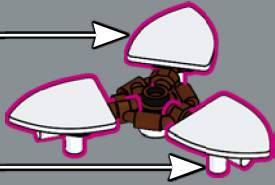
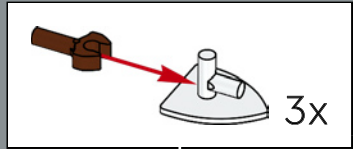

3

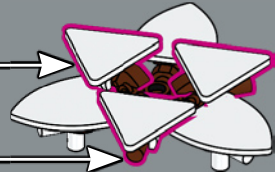
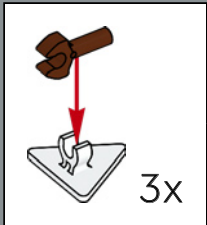



86

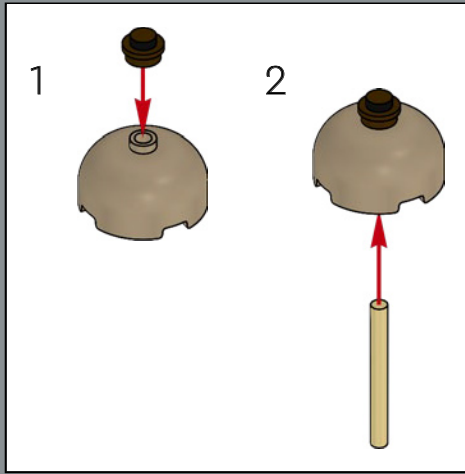

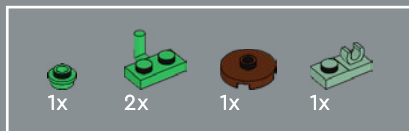

87



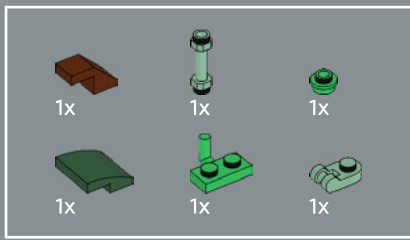

88

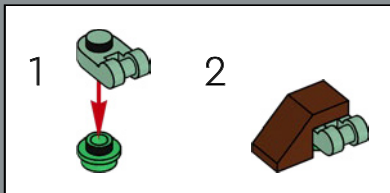
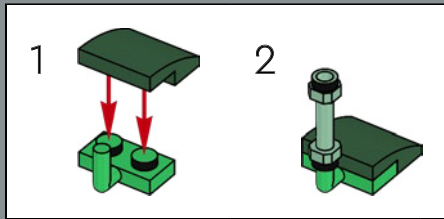

Die Staubblätter der Krokusse erhalten durch diese LEGO® Minifiguren-Kronen einen fast königlichen Glanz.

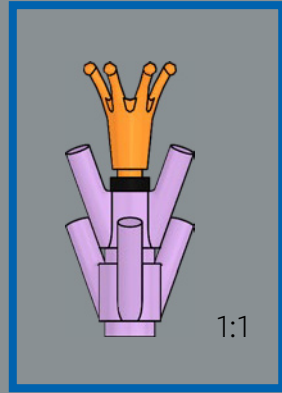
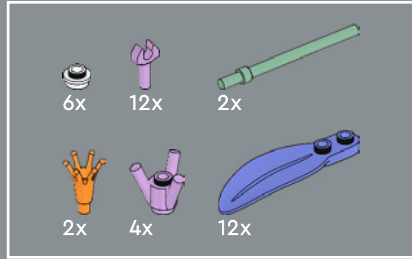
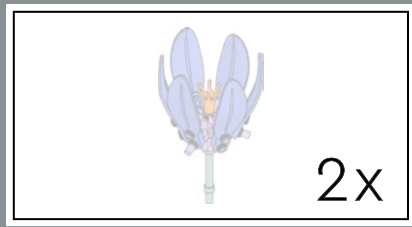

89

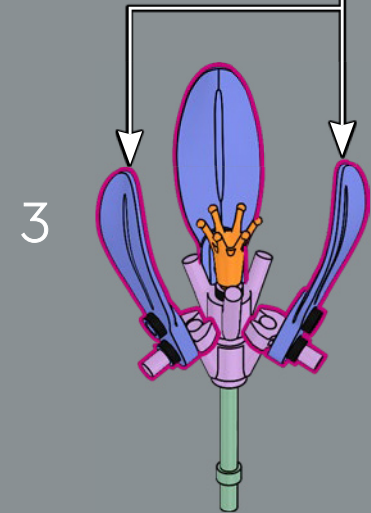
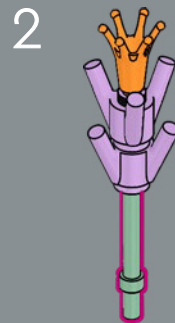
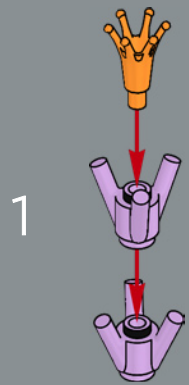
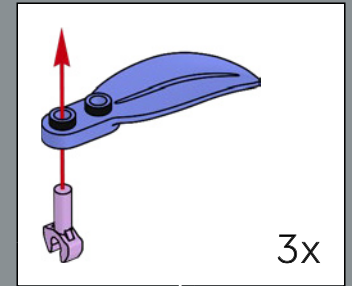

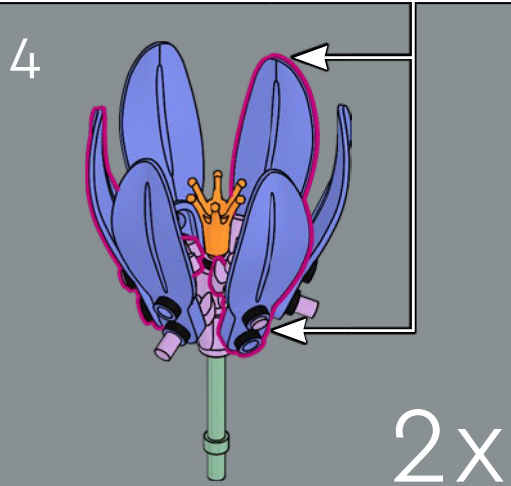
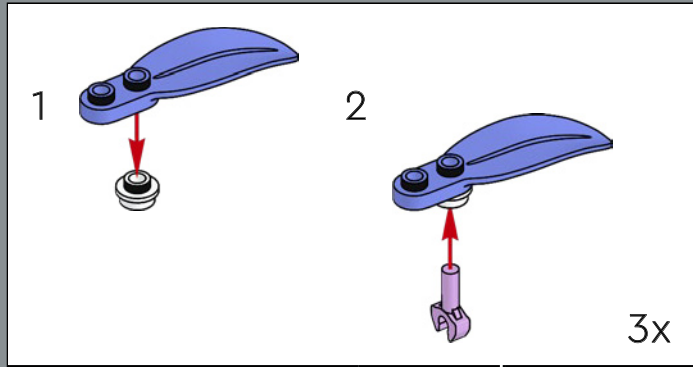

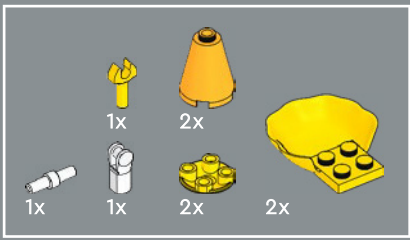

90

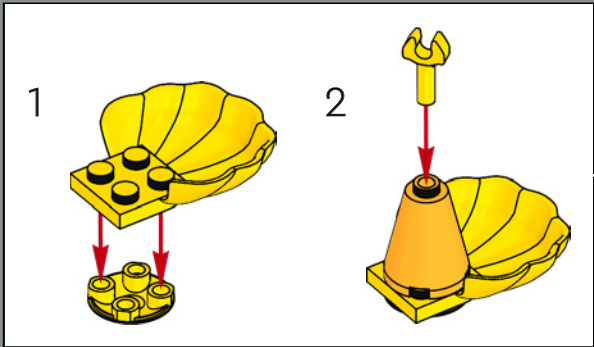
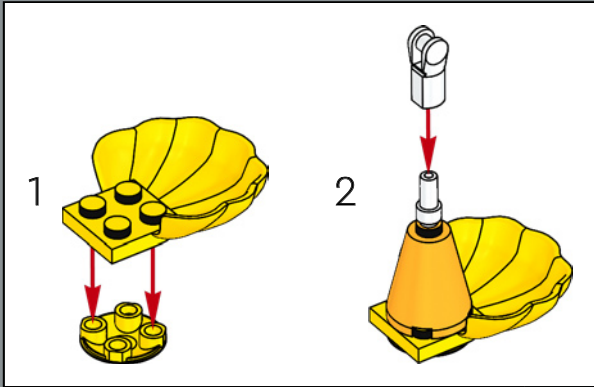

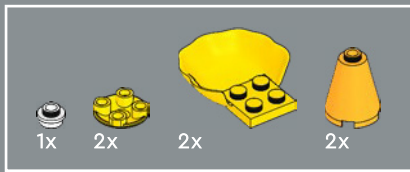

91

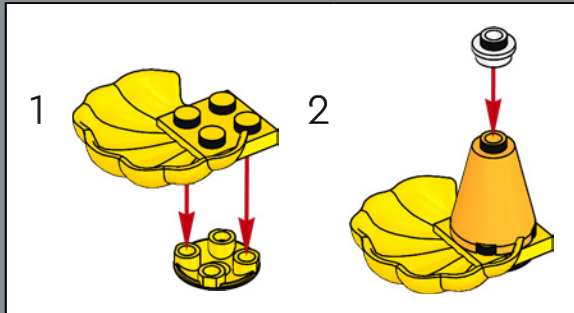
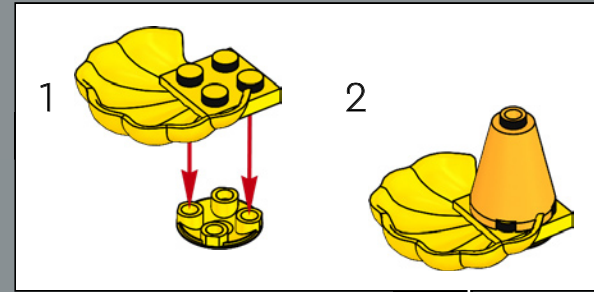

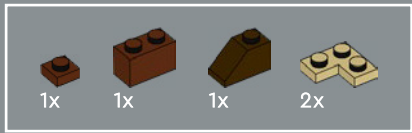

92





93





94



1x  2x 

95





96



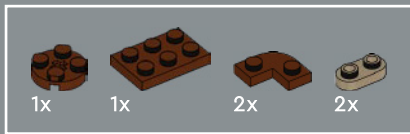

97



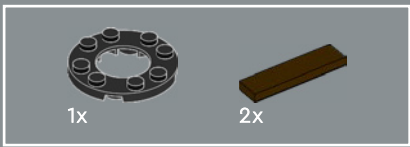

98



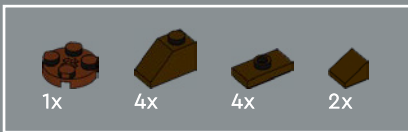

99

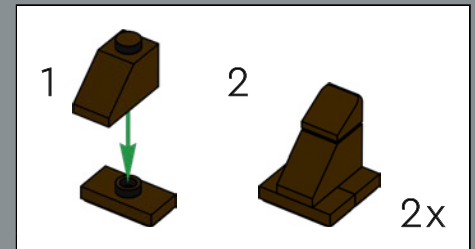



1x

100



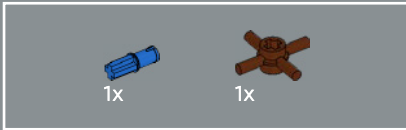

101

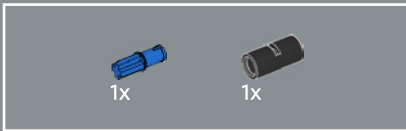
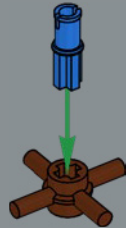

102

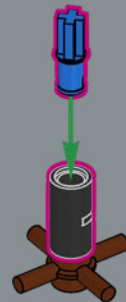

103

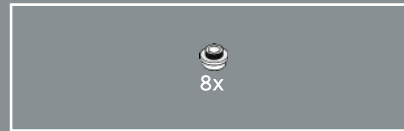
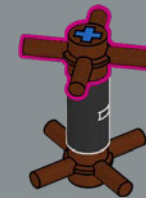

104

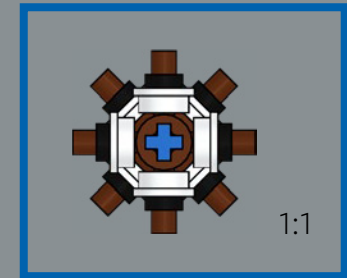



105

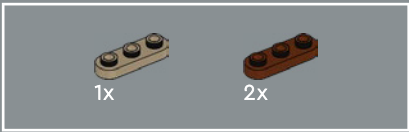
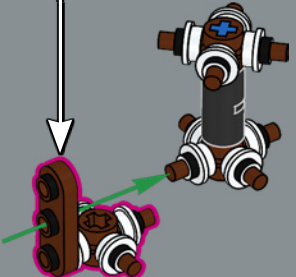
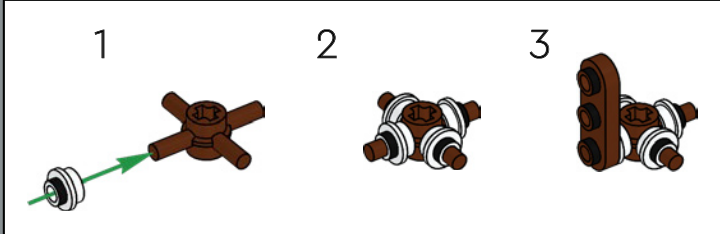

106

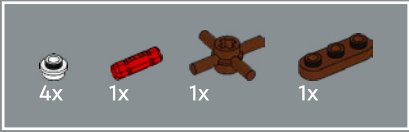
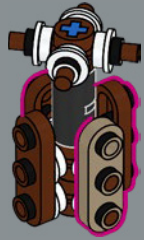

107

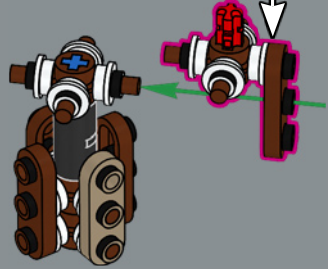
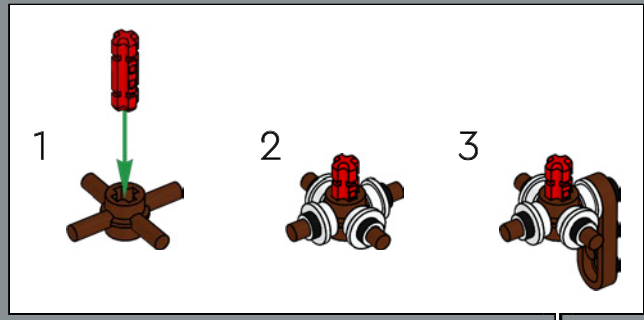



108

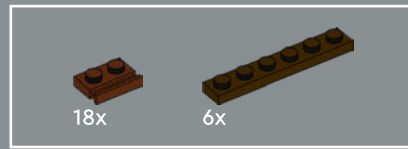
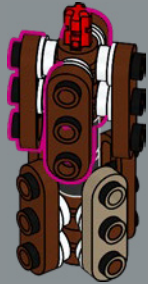

109

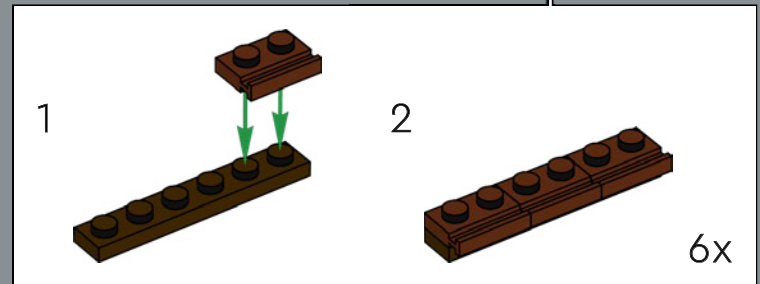
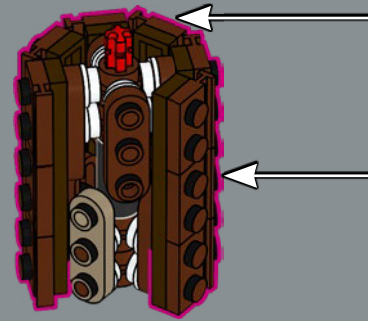
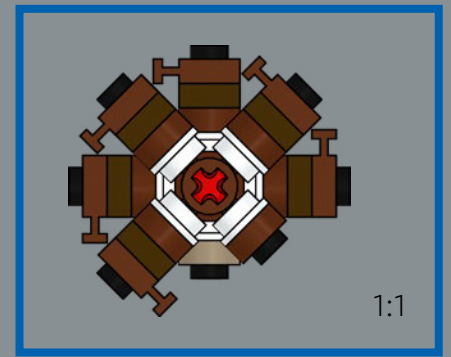

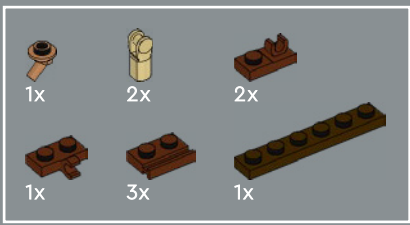

110

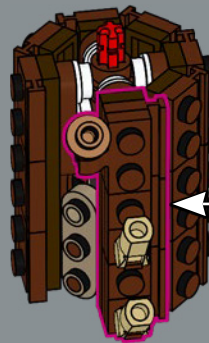
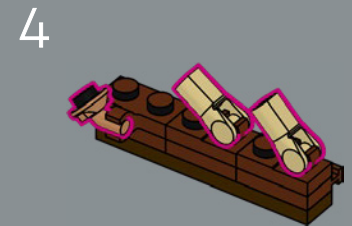
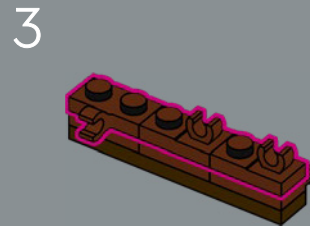
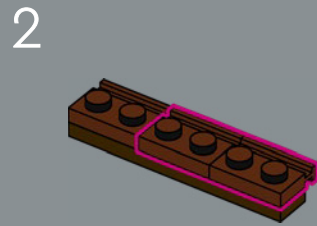
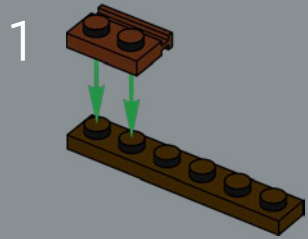

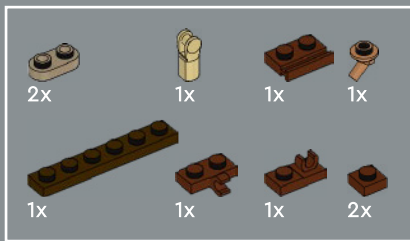

111

1

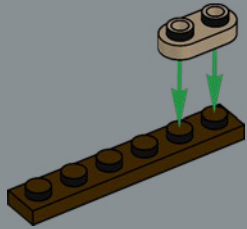

2

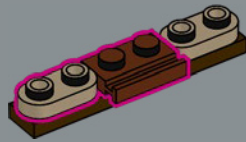

3

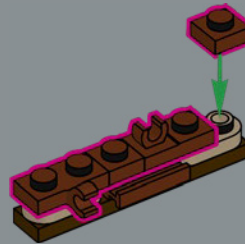

4

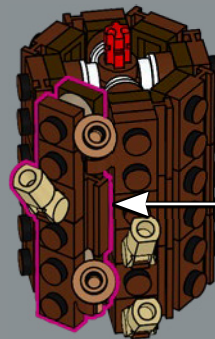
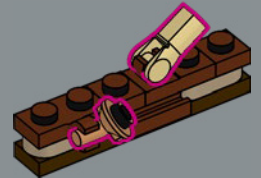

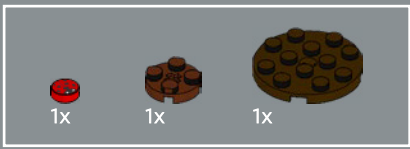

112

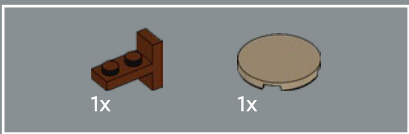
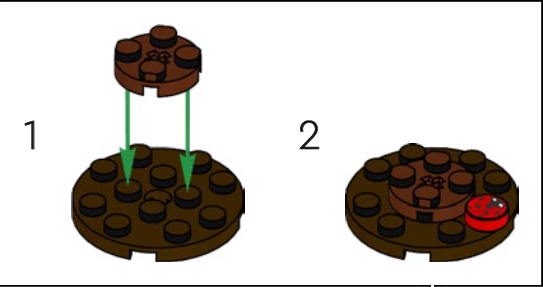

113

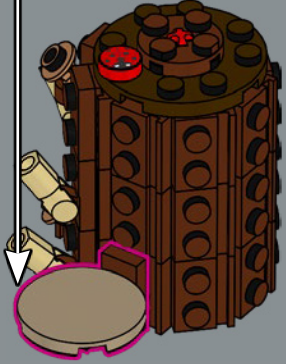
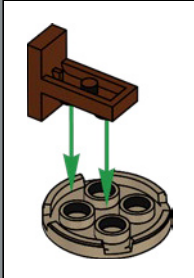



114

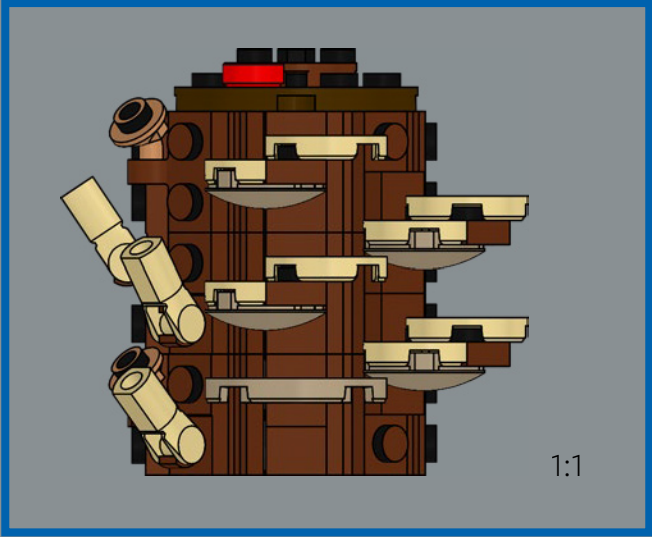
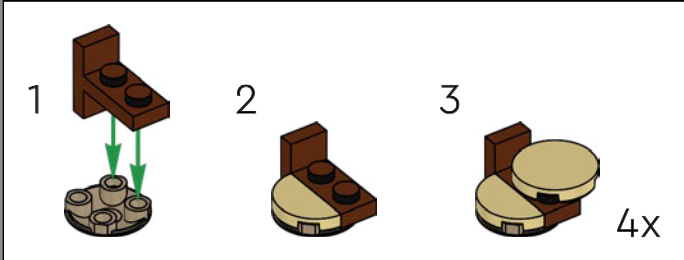





Der gemeine Hutling mit seiner zarten Kappe und dem schlanken Stiel sieht aus, als stamme er direkt aus einem Märchen – die Oberteile sind aus LEGO® Zwergen-Minifiguren-Hüten gebildet.

116

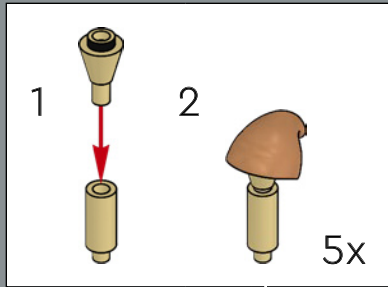

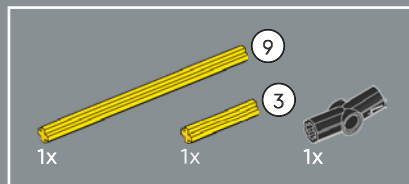
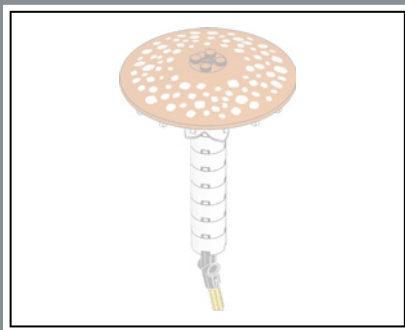

117

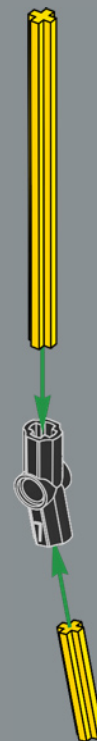

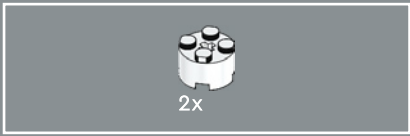

118

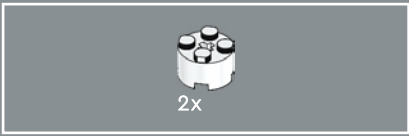
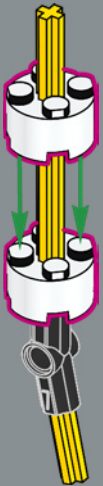

119

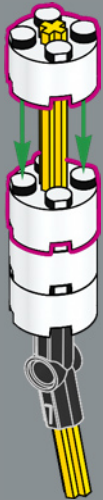



2x

120

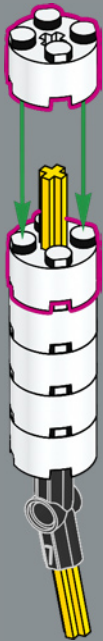

1x



1x



1x

121

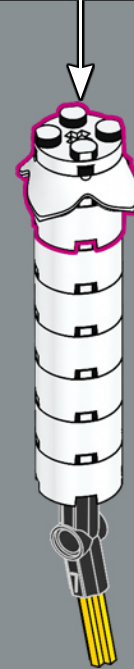
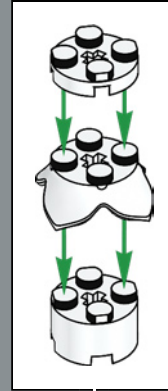

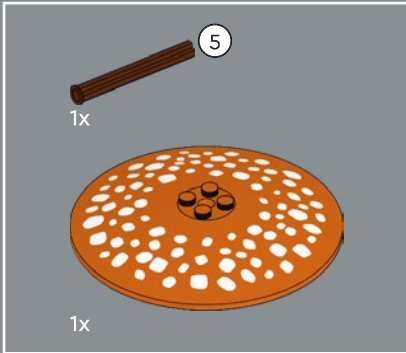
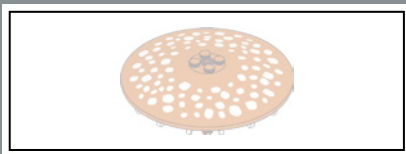

122

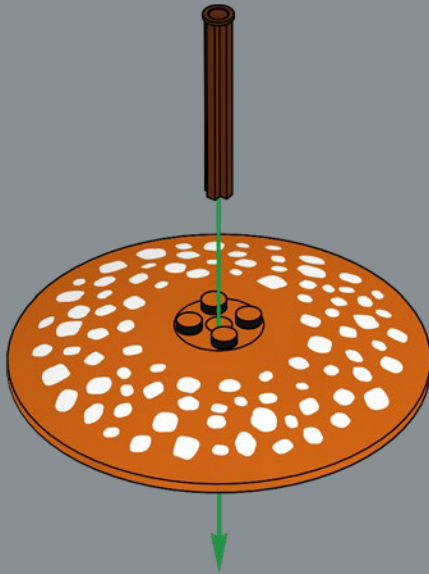

123

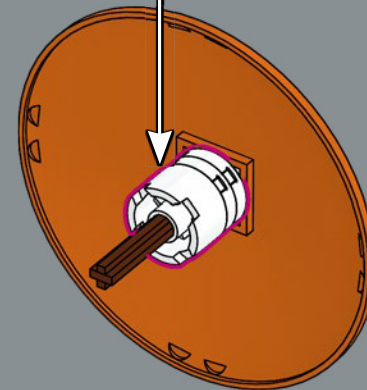
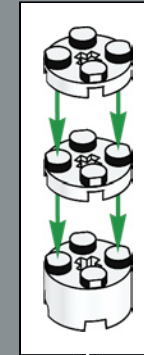

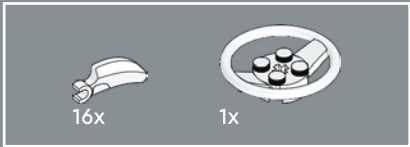
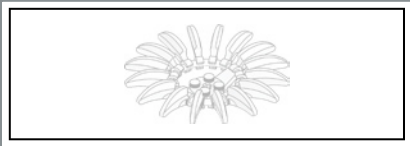

124

1

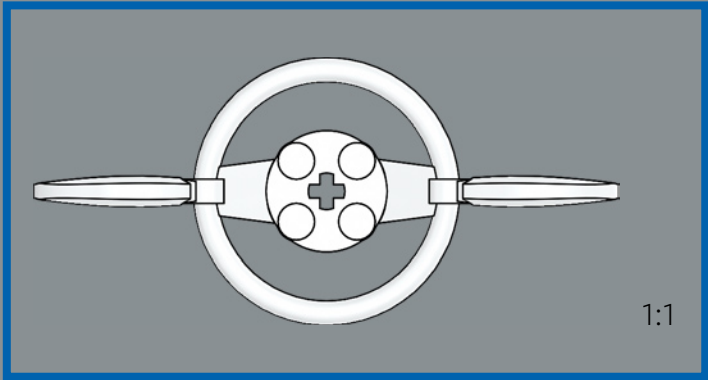
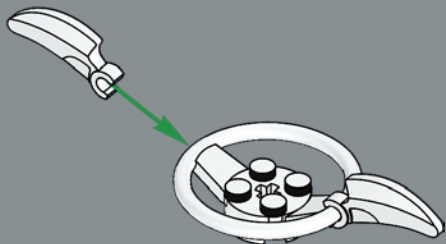

1:1

2

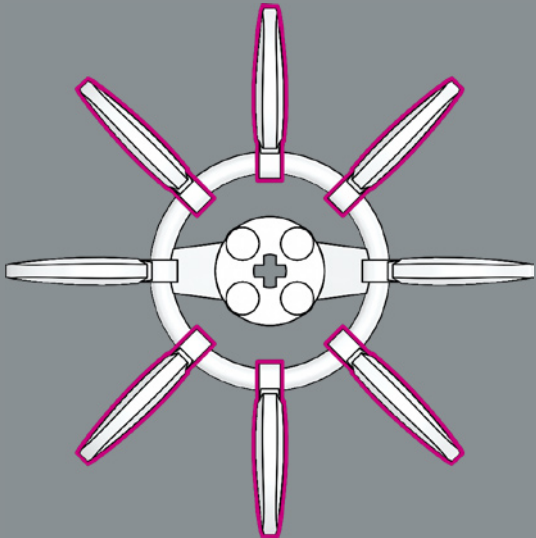

3

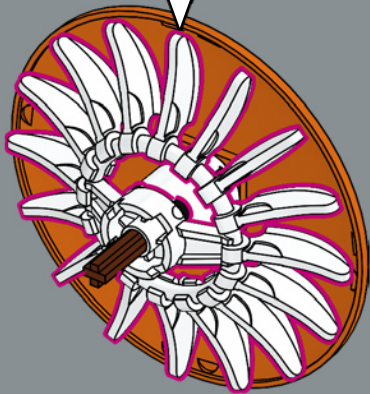
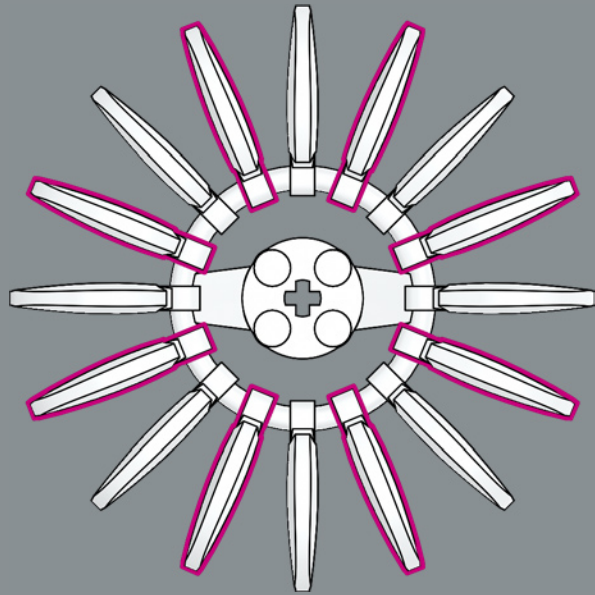

125

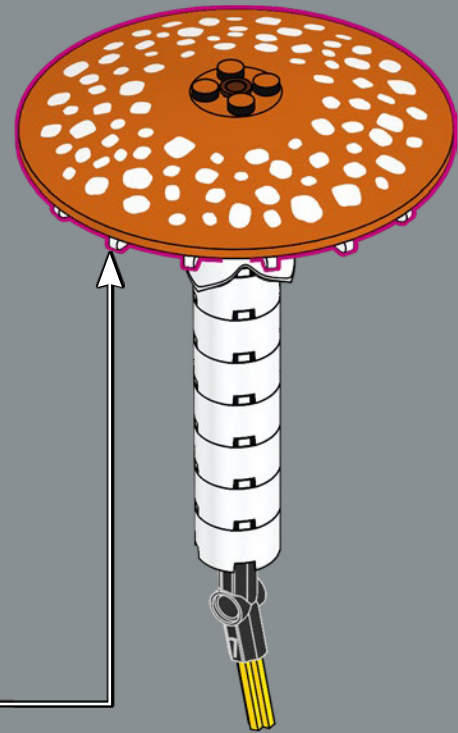



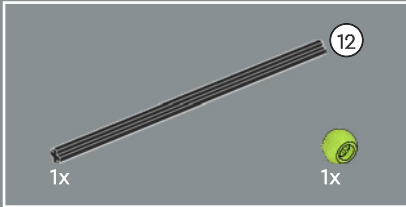
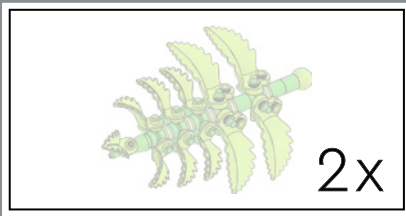

127

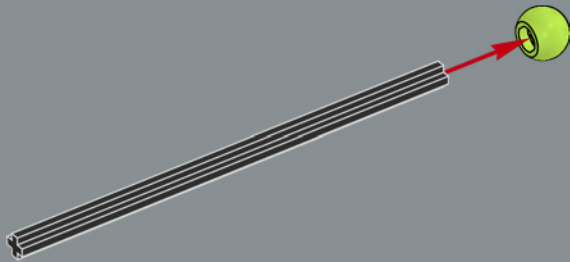

128

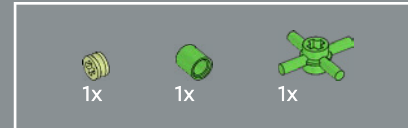
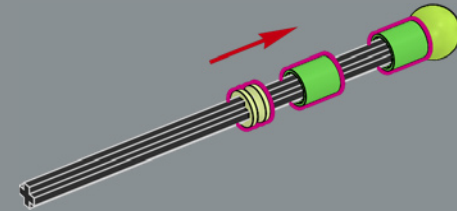

129

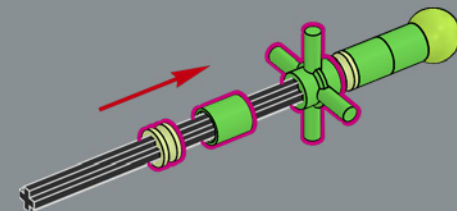



130

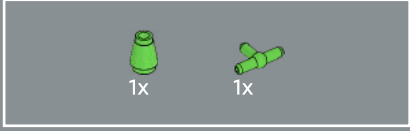
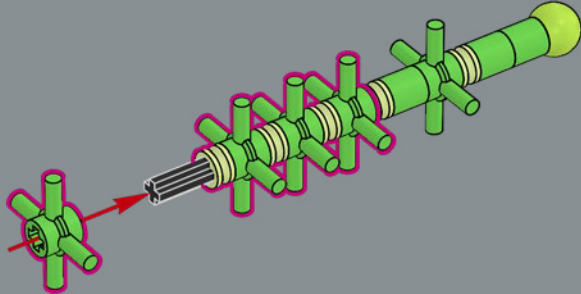

131

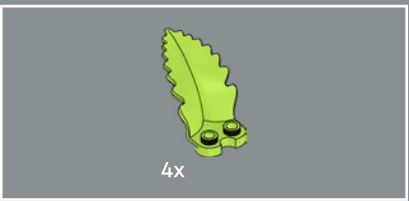
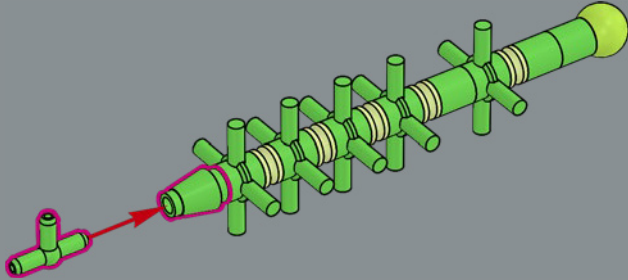

132

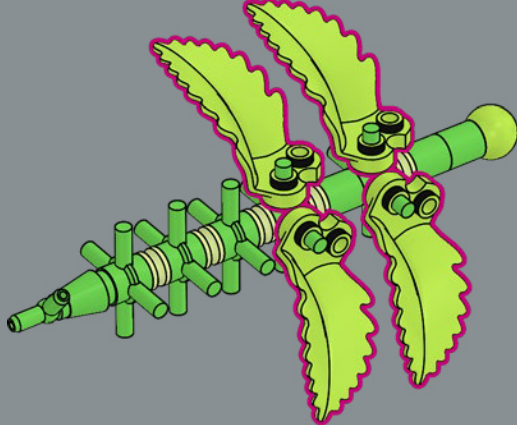

133

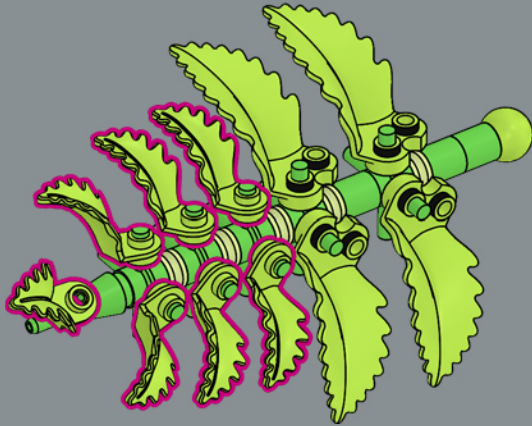

2x





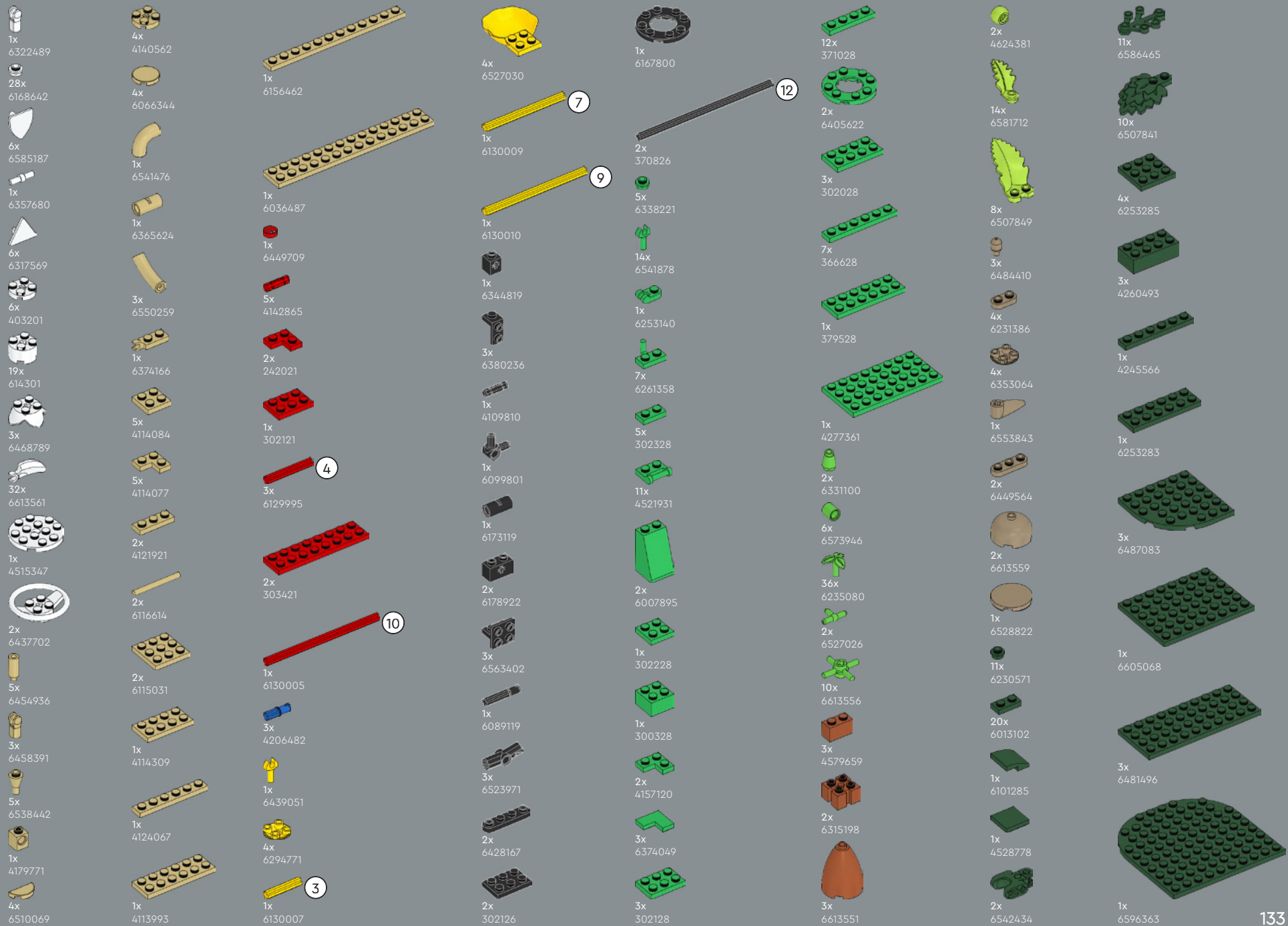



2x
6527031

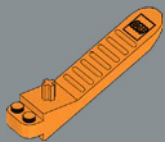

1x
6240515



2x
6510192



5x
6613562



4x
6613560



10x
6553342



1x
6474604



2x
6278550



1x
6360075



10x
4655080



12x
6614067



3x
4616581



13x
6083972



2x
4521947



2x
6080431



3x
6100234

2x
6083972

2x
4521947

2x
6080431

3x
6100234

2x
6080431

3x
6100234

2x
6080431

3x
6100234

2x
6080431

3x
6100234

2x
6080431

3x
6100234

2x
6080431

3x
6100234

2x
6080431

3x
6100234

2x
6080431

3x
6100234

2x
6080431

3x
6100234

2x
6080431

3x
6100234

2x
6080431

3x
6100234

2x
6080431

3x
6100234

2x
6080431

3x
6100234

2x
6080431

3x
6100234

2x
6080431

3x
6100234

2x
6080431

3x
6100234

2x
6080431

3x
6100234

2x
6080431

3x
6100234

2x
6080431

3x
6100234

2x
6080431

3x
6100234

2x
6080431

3x
6100234

2x
6080431

3x
6100234

2x
6080431

3x
6100234

2x
6080431

3x
6100234

2x
6080431

3x
6100234

2x
6080431

3x
6100234

2x
6080431

3x
6100234

2x
6080431

3x
6100234

2x
6080431

3x
6100234

2x
6080431

3x
6100234

2x
6080431

3x
6100234

2x
6080431

3x
6100234

2x
6080431

3x
6100234

2x
6080431

3x
6100234

2x
6080431

3x
6100234

2x
6080431

3x
6100234

2x
6080431

3x
6100234

2x
6080431

3x
6100234

2x
6080431

3x
6100234

2x
6080431

3x
6100234

2x
6080431

3x
6100234

2x
6080431

3x
6100234

2x
6080431

3x
6100234

2x
6080431

3x
6100234

2x
6080431

3x
6100234

2x
6080431

3x
6100234

2x
6080431

3x
6100234

2x
6080431

3x
6100234

2x
6080431

3x
6100234

2x
6080431

3x
6100234

2x
6080431

3x
6100234

2x
6080431

3x
6100234

2x
6080431

3x
6100234

2x
6080431

3x
6100234

2x
6080431

3x
6100234

2x
6080431

3x
6100234

2x
6080431

3x
6100234

2x
6080431

3x
6100234

2x
6080431

3x
6100234

2x
6080431

3x
6100234

2x
6080431

3x
6100234

2x
6080431

3x
6100234

2x
6080431

3x
6100234

2x
6080431

3x
6100234

2x
6080431

3x
6100234

2x
6080431

3x
6100234

2x
6080431



YOU COULD
WIN



**YOU COULD
WIN**

Your feedback will help shape the future development of this product series.

Visit:

**DU KÖNNTEST
GEWINNEN**

Dein Feedback trägt zur Weiterentwicklung dieser Produktreihe bei.

Geh auf:

**VOUS POURRIEZ
GAGNER**

Vos commentaires nous aideront à concevoir les futurs produits de cette gamme.

Visitez :

**POTRESTI
VINCERE TU**

La tua opinione ci aiuterà a migliorare la creazione futura di questa linea di prodotti.

Visita:

**PUEDES
GANAR**

Tu opinión contribuirá al futuro de esta serie de productos.

Visita:

轻松获奖

您的反馈将有助于我们在今后改进本产品系列。

请访问:

LEGO.com/productfeedback

You also have the chance to win a LEGO® set.

Terms and conditions apply.*

Außerdem hast du die Chance, ein LEGO® Set zu gewinnen.

Es gelten die Teilnahmebedingungen.*

Vous pourriez également gagner un ensemble LEGO®.

Des conditions s'appliquent.*

Hai anche la possibilità di vincere un set LEGO®.

Termini e condizioni sono applicabili.*

También tienes la oportunidad de ganar un set LEGO®.

Aplican términos y condiciones.*

您还有机会赢取乐高®套装。

条款和条件适用。*

*LEGO.com/productfeedback-terms

LEGO and the LEGO logo are trademarks of the LEGO Group.
©2026 The LEGO Group.

