



11380





LEGO.com/sustainable-packaging



FR
**DONNEZ
OU
RECYCLEZ**



OU



OU



ASSOCIATION MAGASIN DÉCHÈTERIE

Adresses sur quefairedemesdechets.fr



BUILDER



Apple and the Apple logo are trademarks of Apple Inc., registered in the U.S. and other countries and regions. App Store is a service mark of Apple Inc. Google Play and the Google Play logo are trademarks of Google LLC. Tencent and the Tencent logo are trademarks of Tencent Inc.

LEGO.com/devicecheck

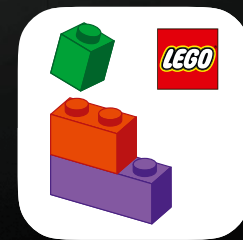

LEGO® Builder





简约中的巧妙



自行车是工业革命中最巧妙的技术发明之一。自19世纪末首批简单且价格亲民的本普及以来，自行车为个人自由与独立铺平了道路。如今的公路车与竞速车延续这一传统：流线型、极简主义，并针对速度与耐力进行了精细调校。对于追求更健康、更可持续生活方式的人们，自行车已成为文化与环保的标志，融合美学、性能与巧思。





乐高® ICONS 设计团队寄语

▶ 骑行是全球许多人的热情所在，包括乐高集团的故乡丹麦！但我们能用（大多是方形的）乐高®积木造出一辆吗？打造一个稳定的设计是一项极具挑战的工程任务。尤其是前管部分，上管与下管在此交汇，形成前叉的插口。选择大比例是确保比例准确的关键，而展示支架则在陈列与操作时提供额外稳定性。





1
↓

2
↓

3
↓

8
↓

4
↓

5
↓

6
↓

9
▶

7
▶

动态功能

1 ▶ 新轮胎元件——首个安装在积木拼搭的车轮上的轮胎

2 ▶ 新分段轮圈元件

3 ▶ 新辐条元件

4 ▶ 新大型64齿齿轮，为链条驱动系统不可或缺的组件

5 ▶ 曲柄与链条机构驱动后轮

6 ▶ 新单向齿轮，实现真实的滑行效果

7 ▶ 可拆卸训练支架

8 ▶ 可拆卸水瓶

9 ▶ 可拆卸尾灯

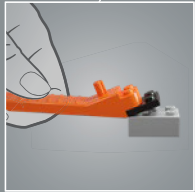
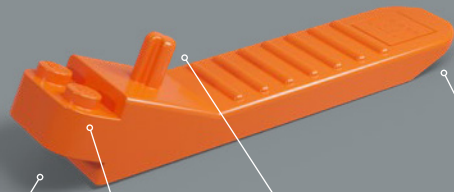

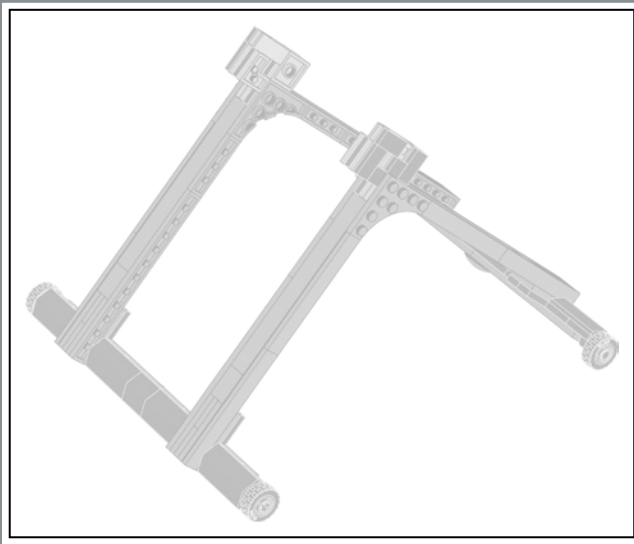

1

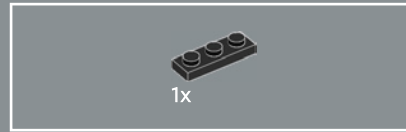
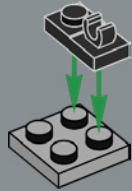

2

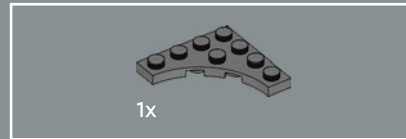
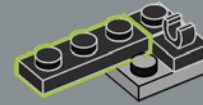

3

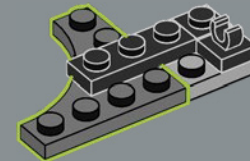

谁说室内不能骑自行车?



1x

4

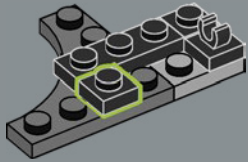

1x

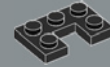

1x

5

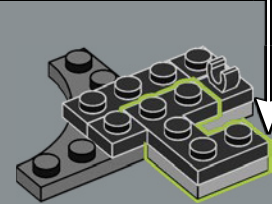
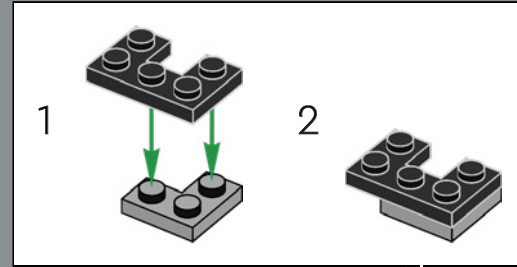

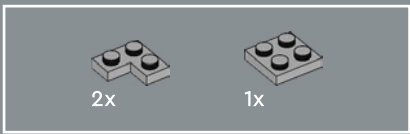

6

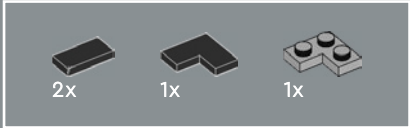
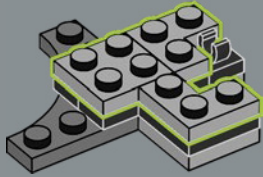

7

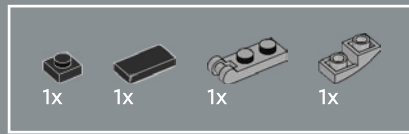
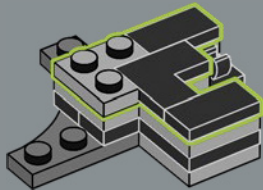

8

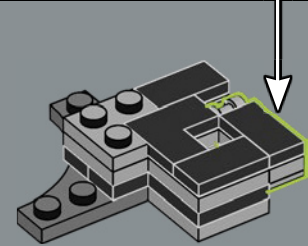
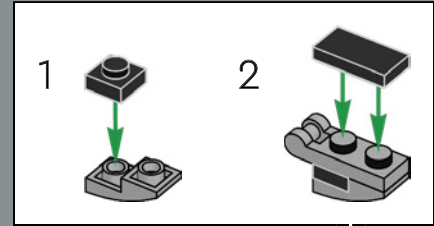

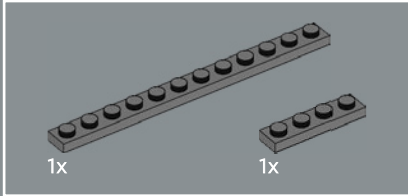
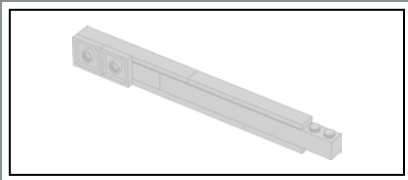

9

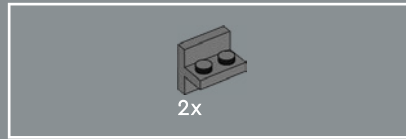
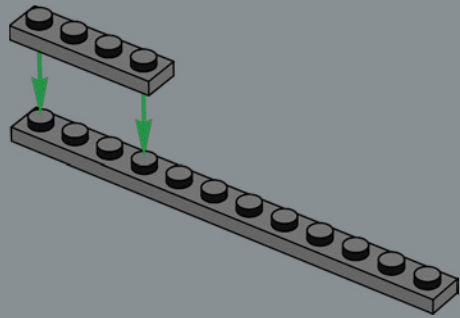

10

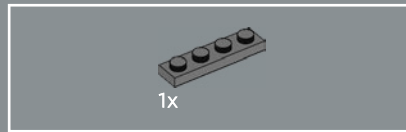
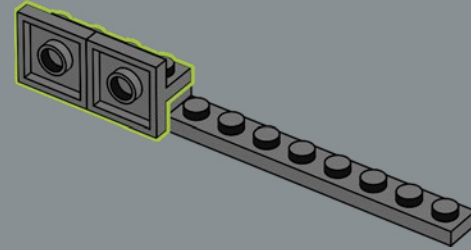

11

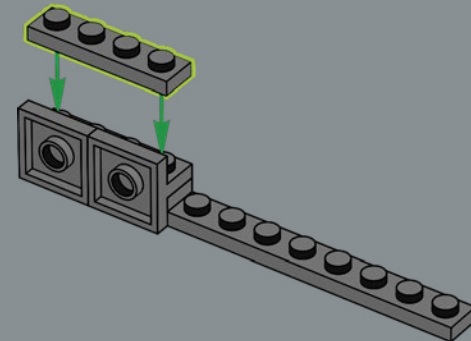

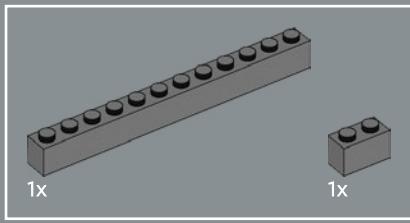

12

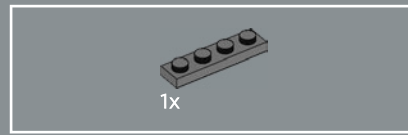
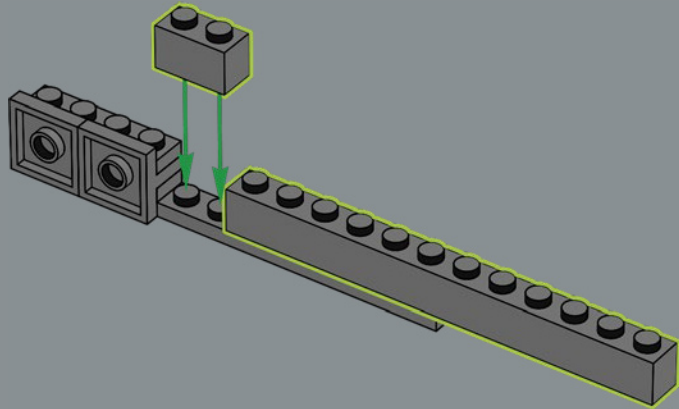

13

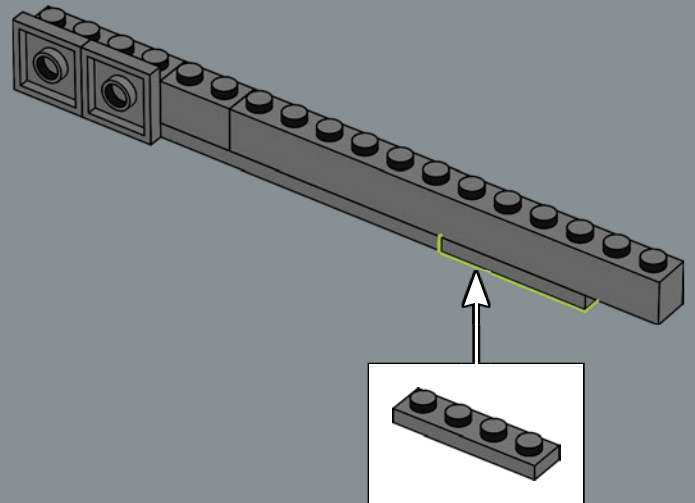

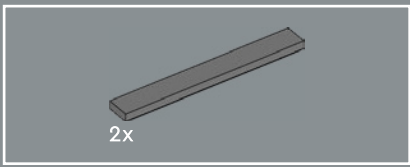

14

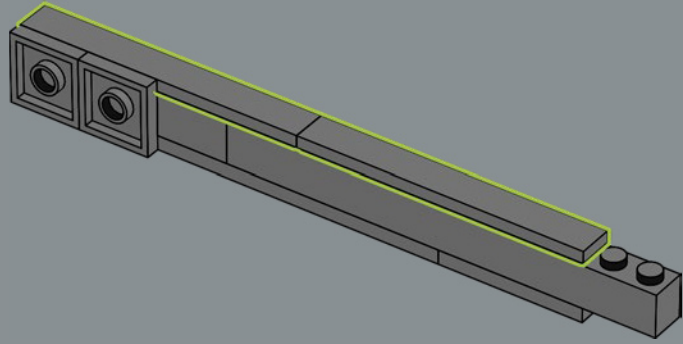

15

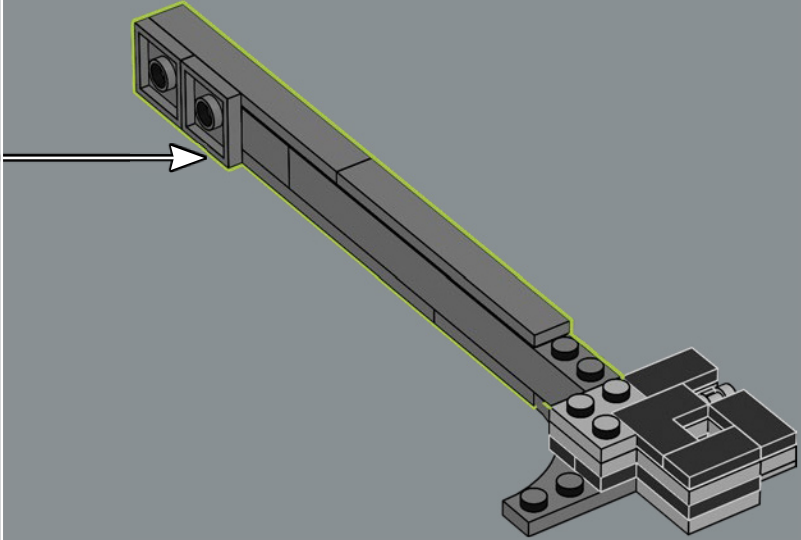

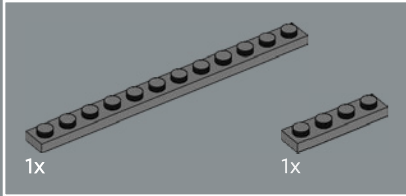
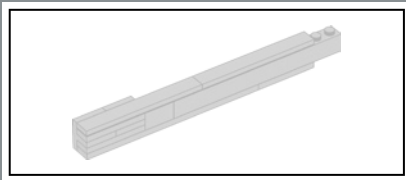

16

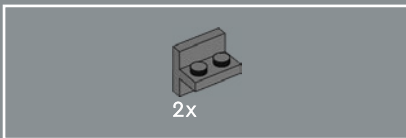
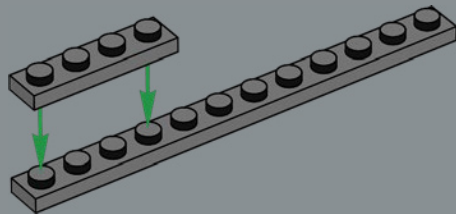

17

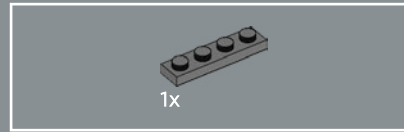
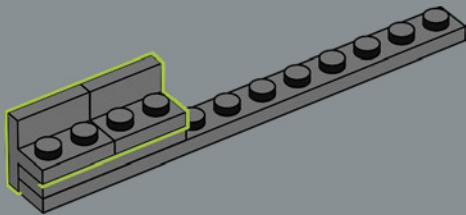

18

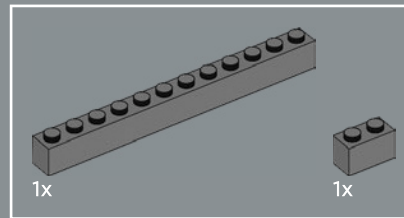
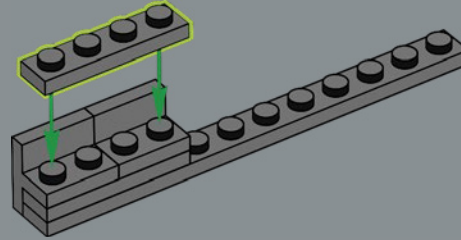

19

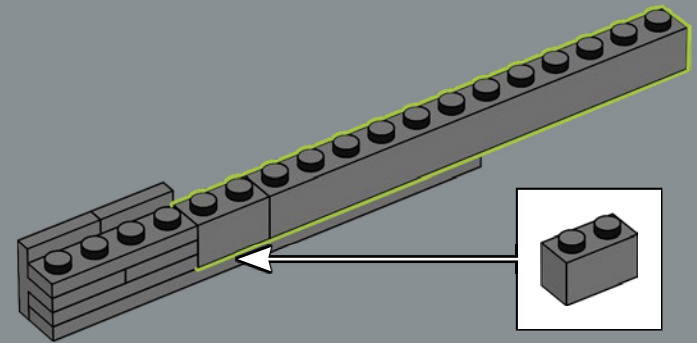

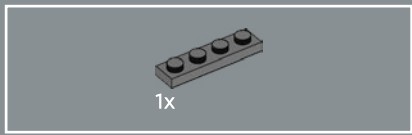

20

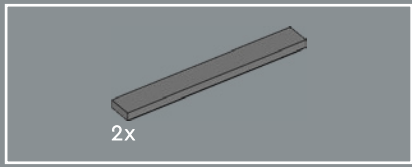
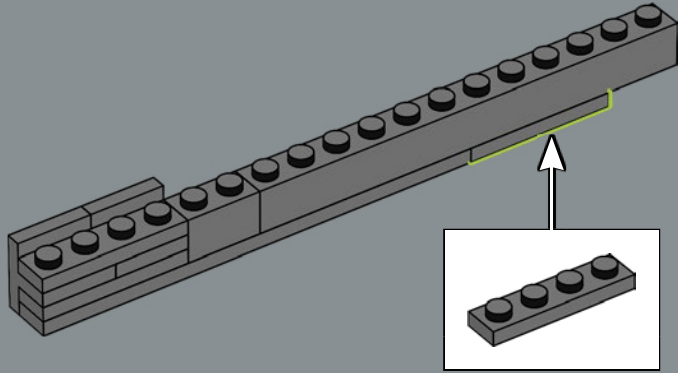

21

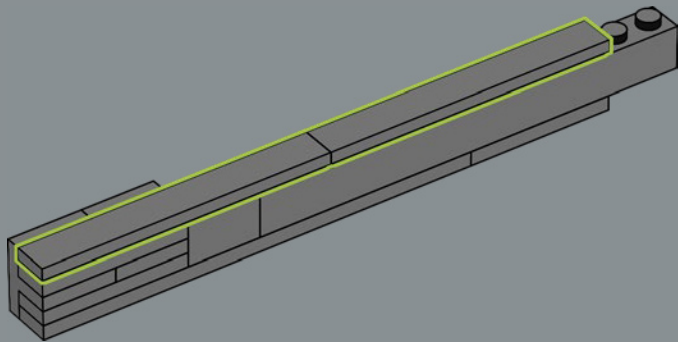

22

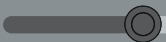
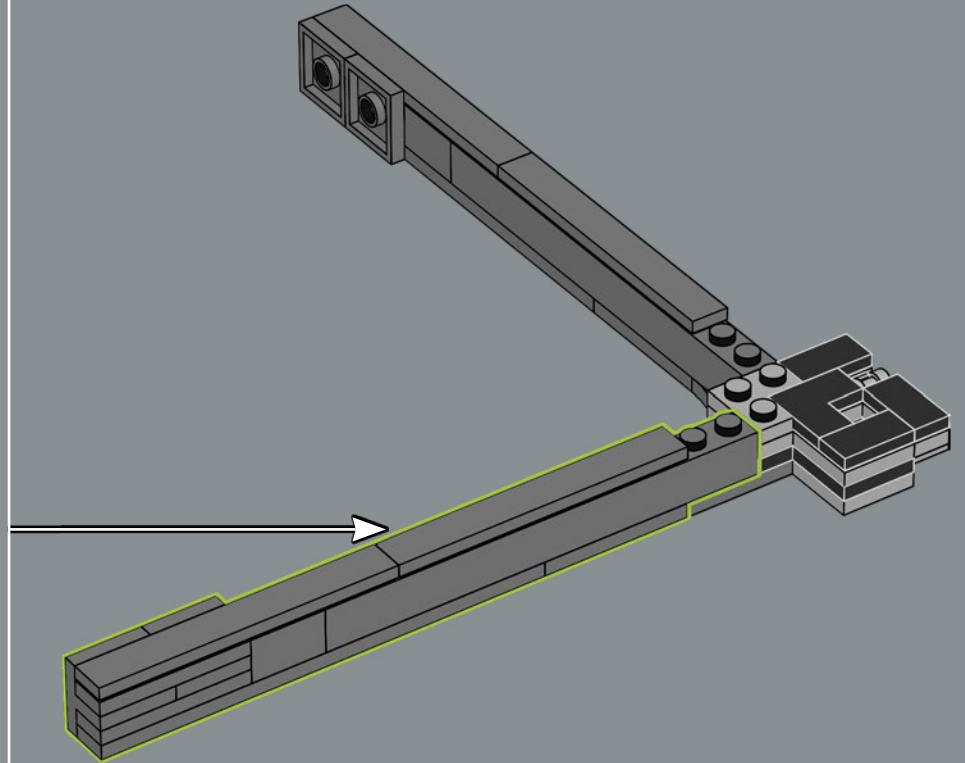

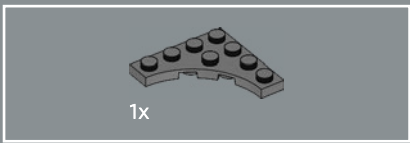

23

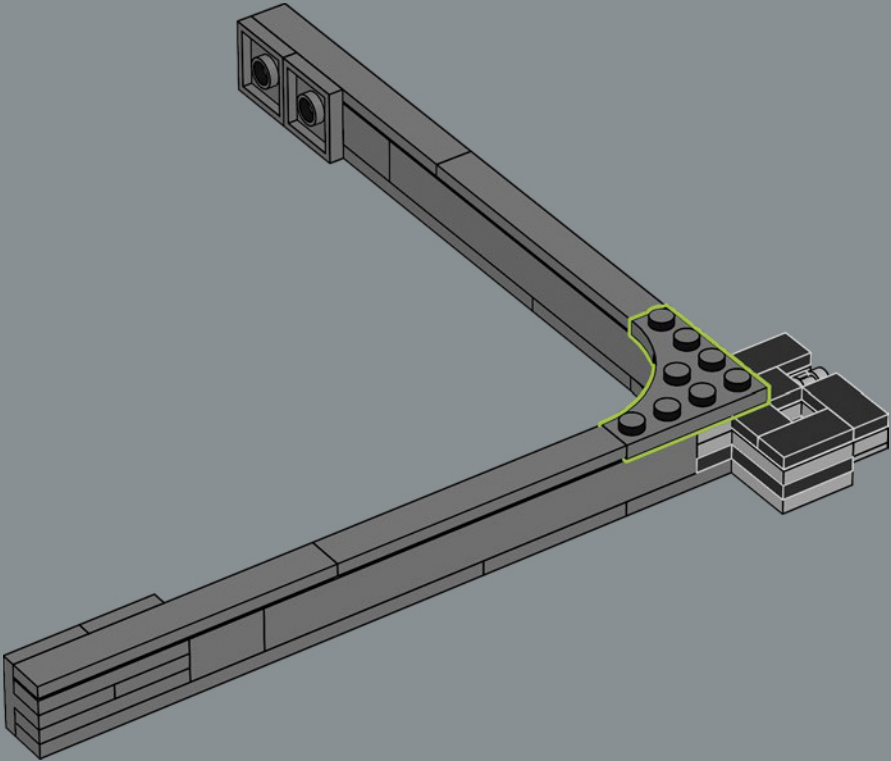

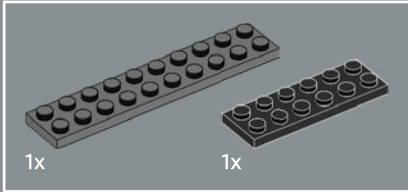
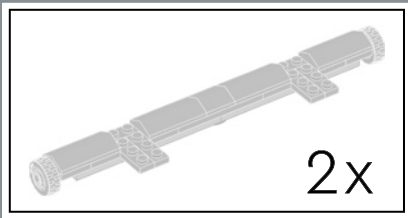

24

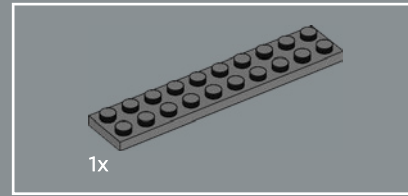
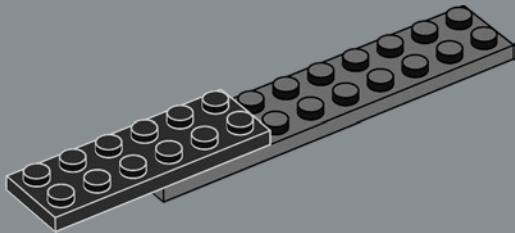

25

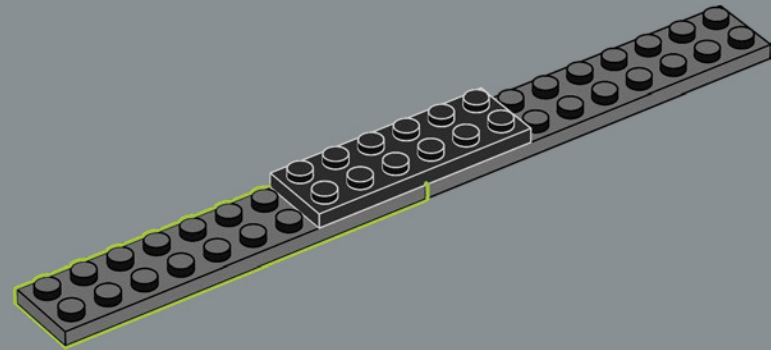

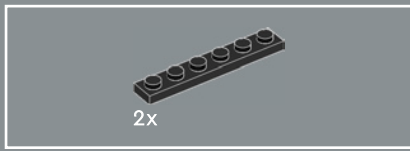

26

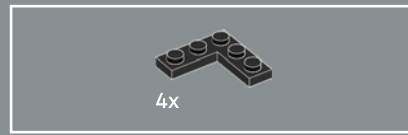
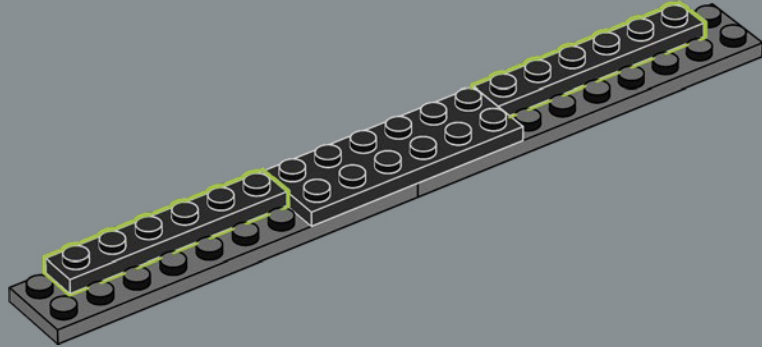

27

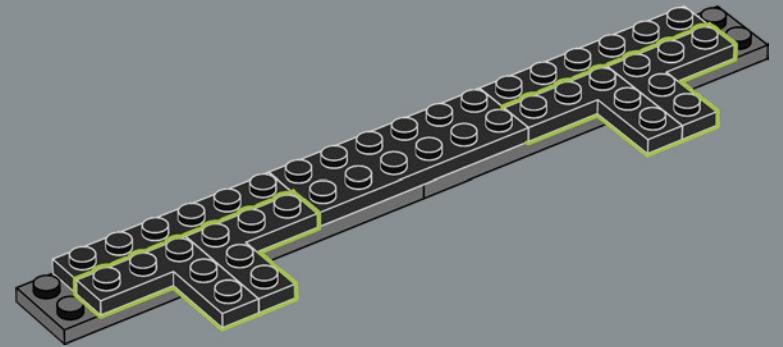



28

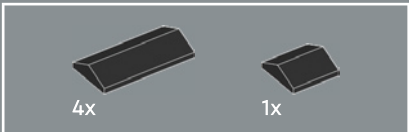
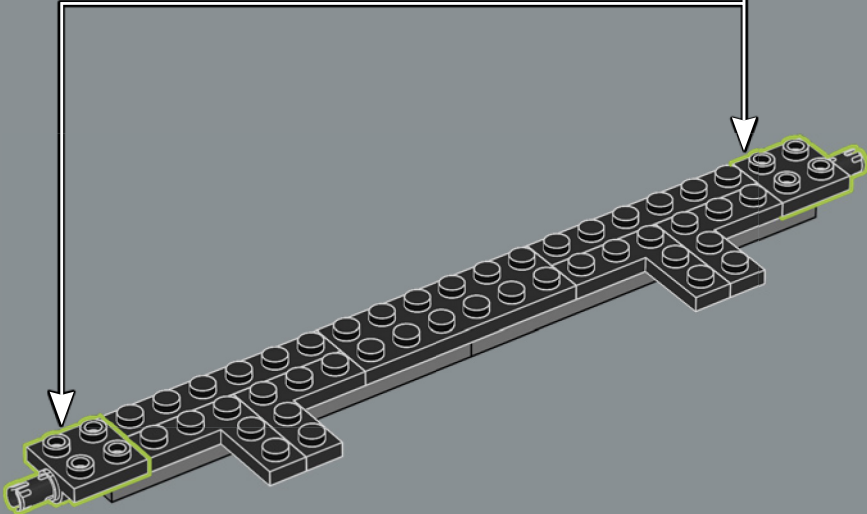
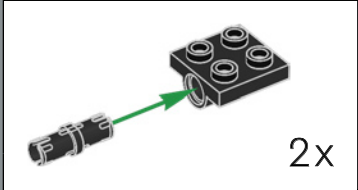

29

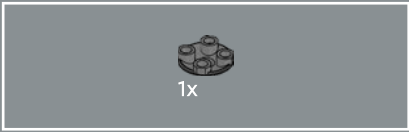
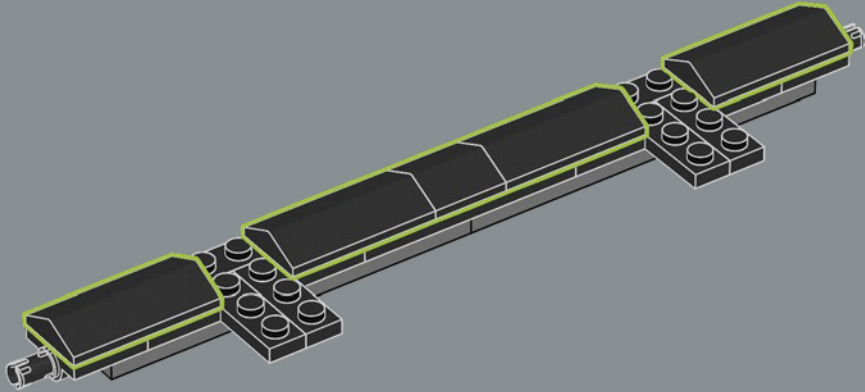

30

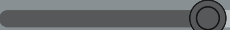
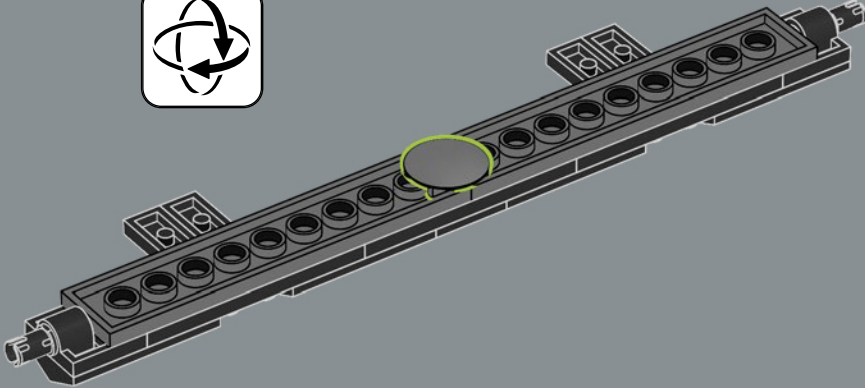

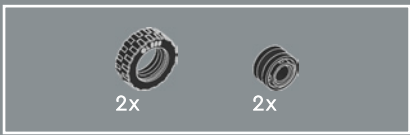

31

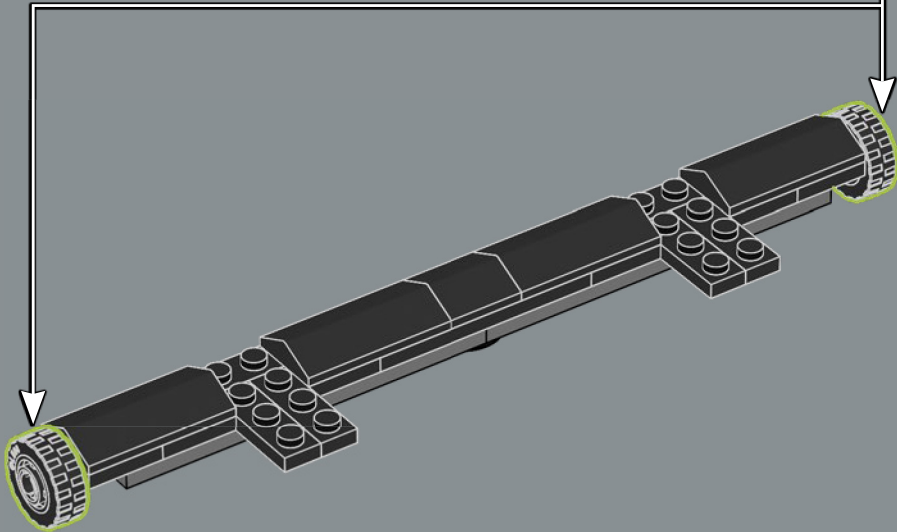
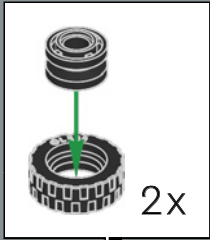

2x

32

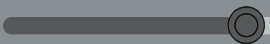
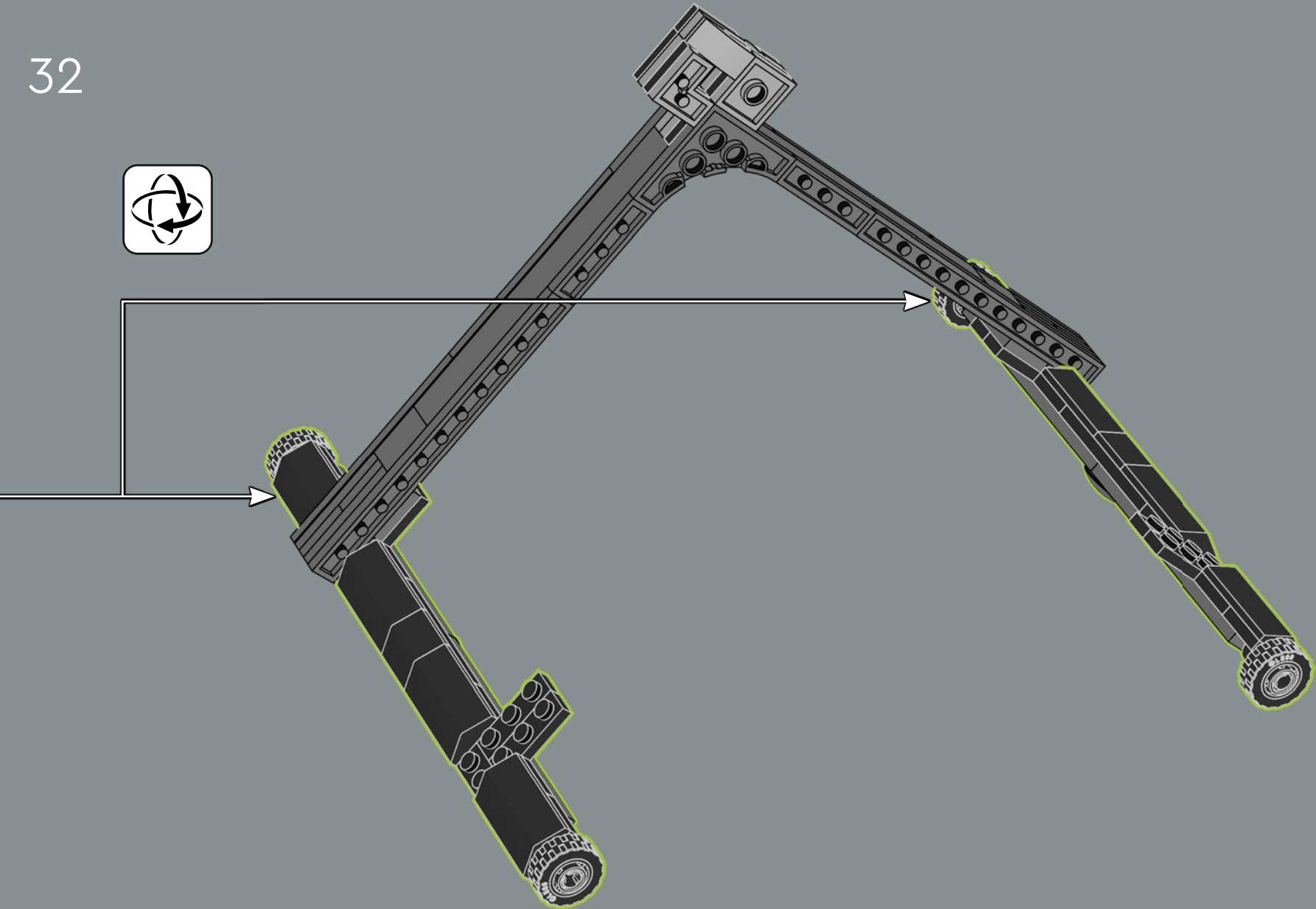

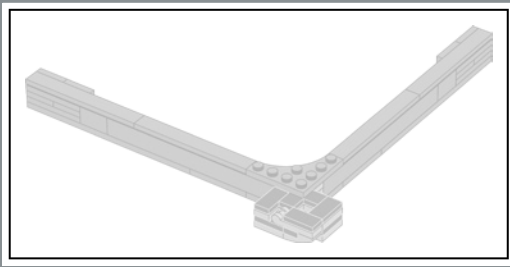

33

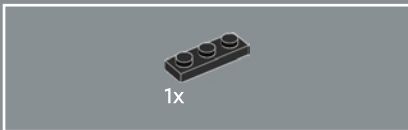
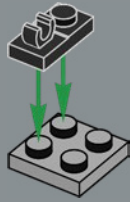

34

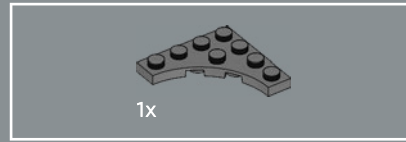
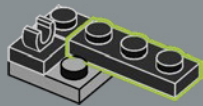

35

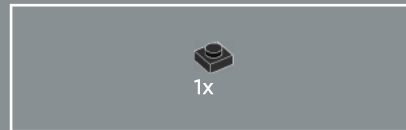
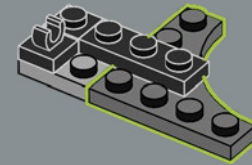

36

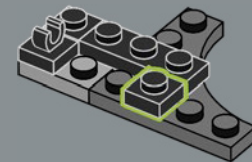

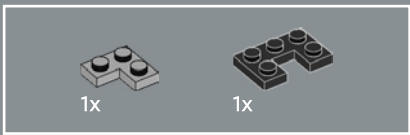

37

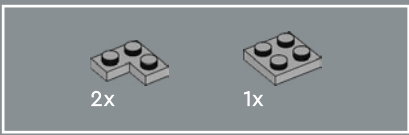
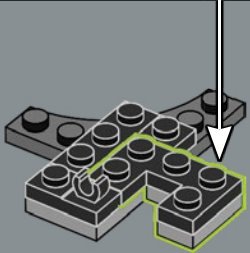
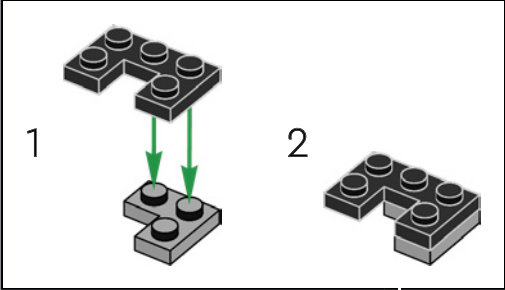

38

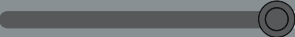
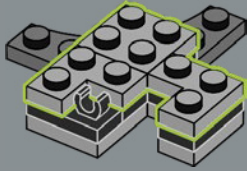

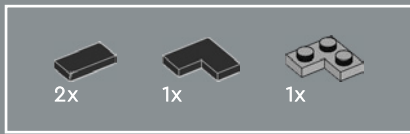

39

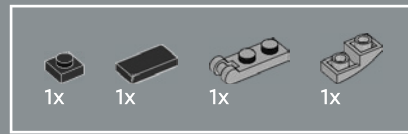
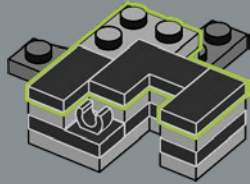

40

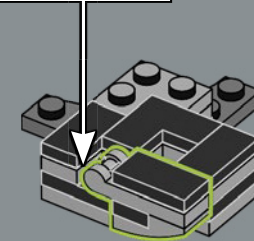
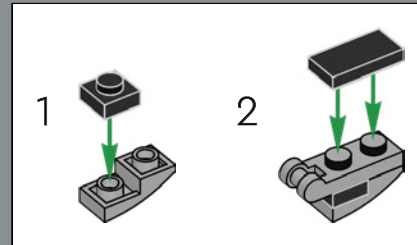

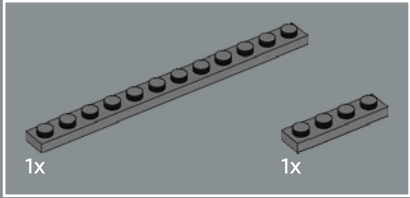
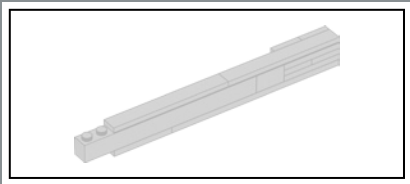

41

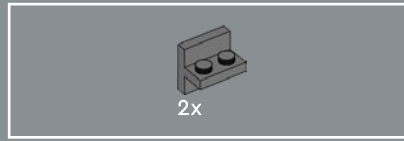
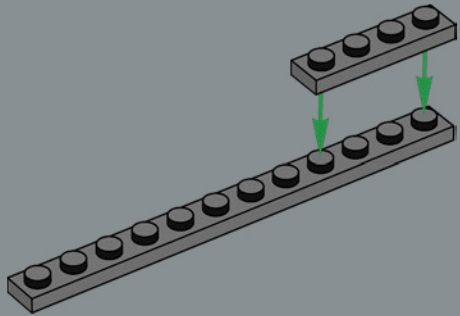

42

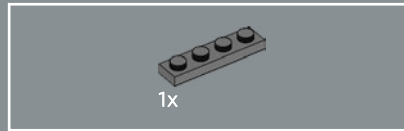
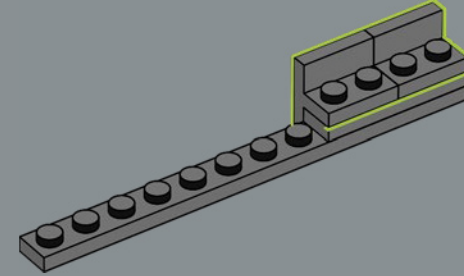

43

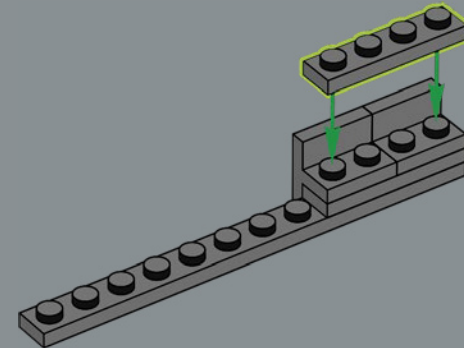

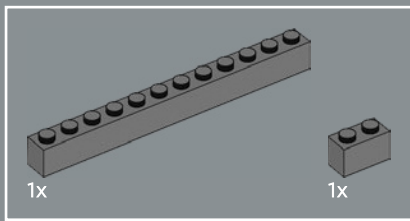

44

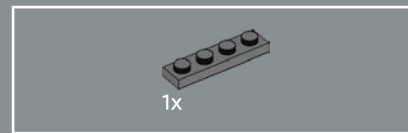
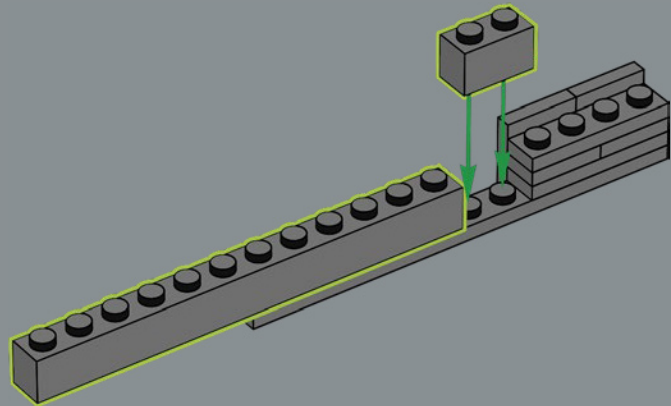

45

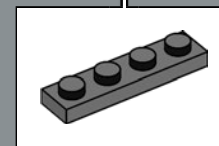
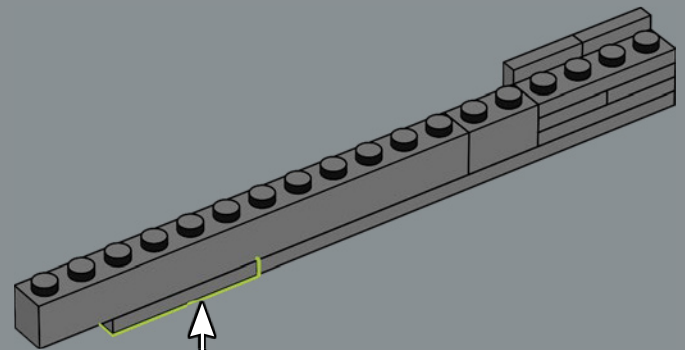

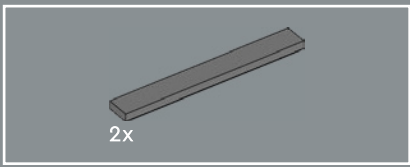

46

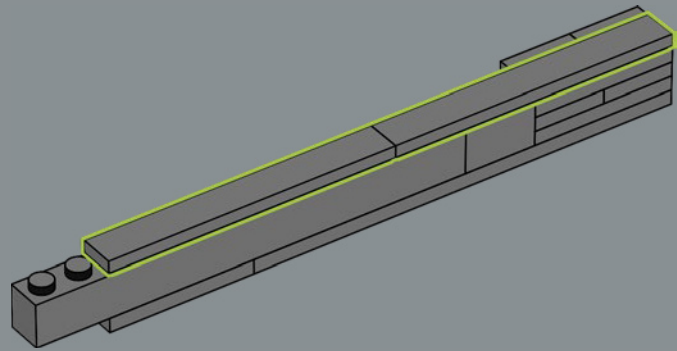

47

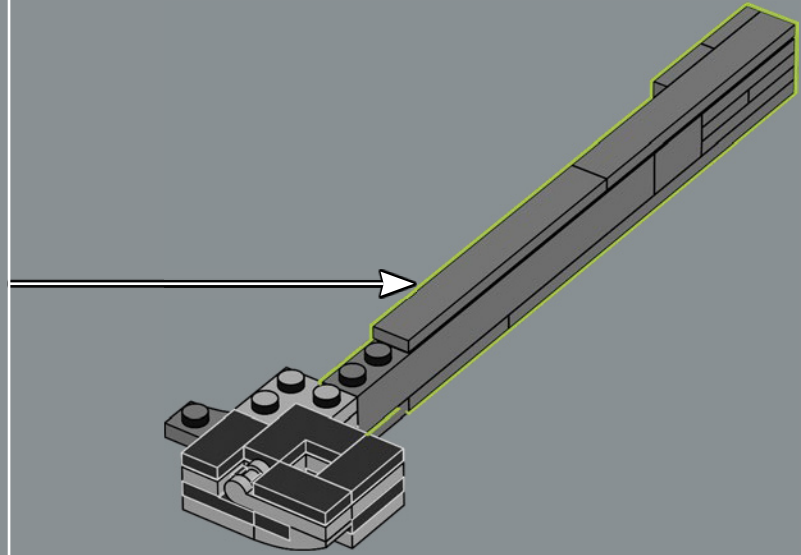

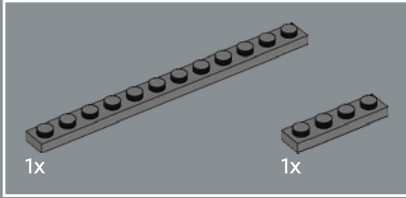
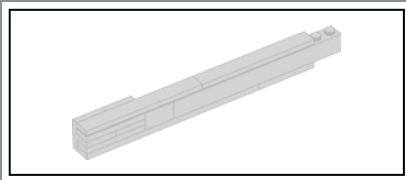

48

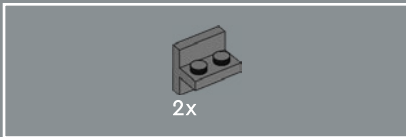
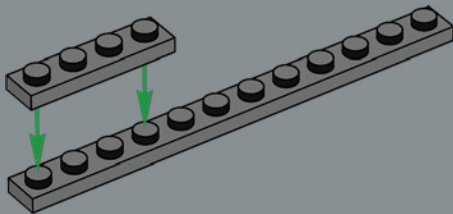

49

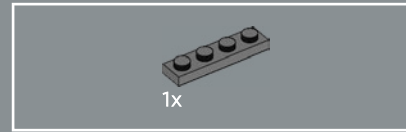
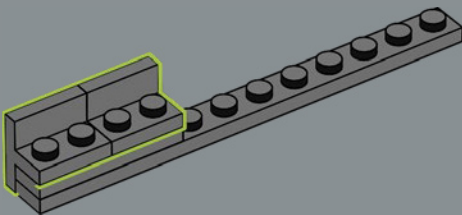

50

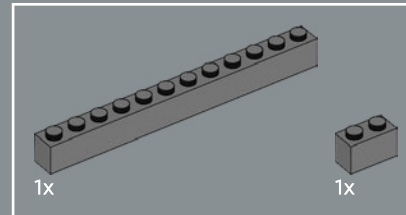
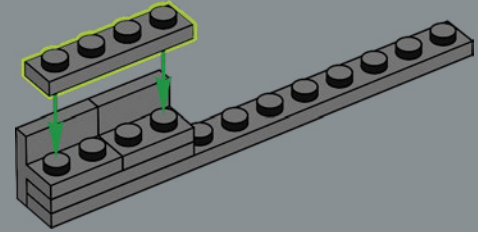

51

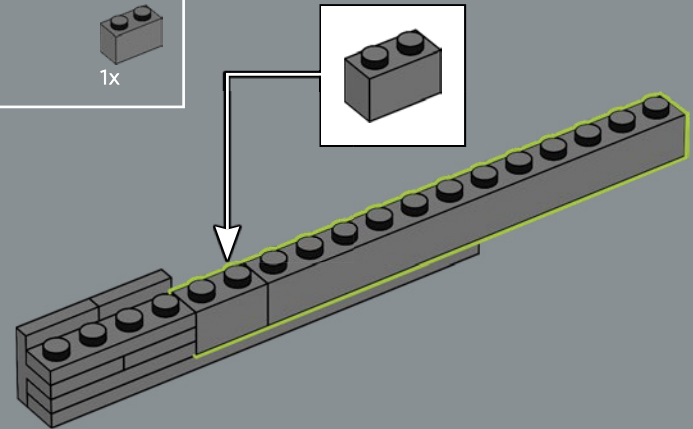

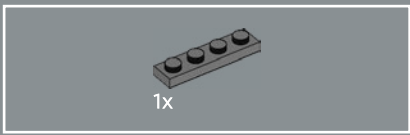

52

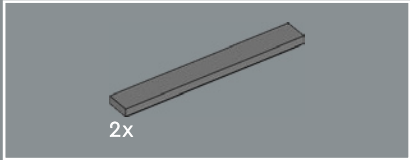
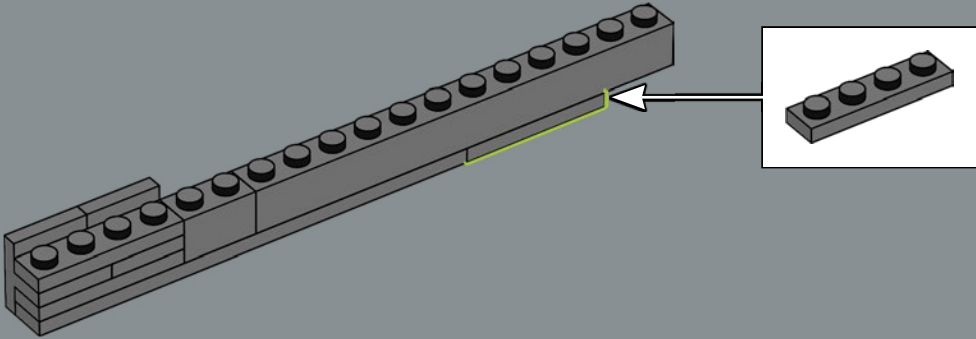

53

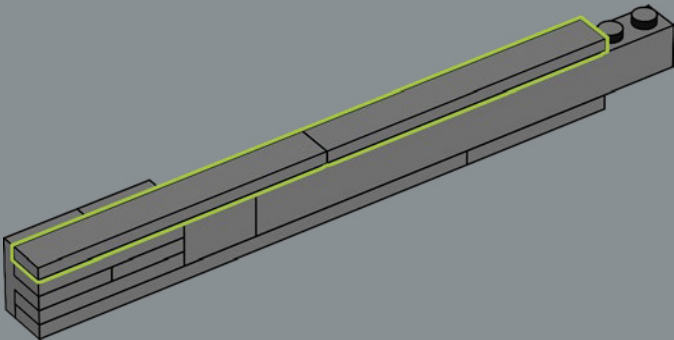

54

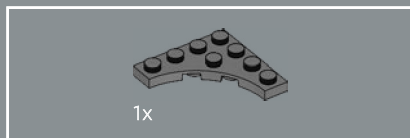
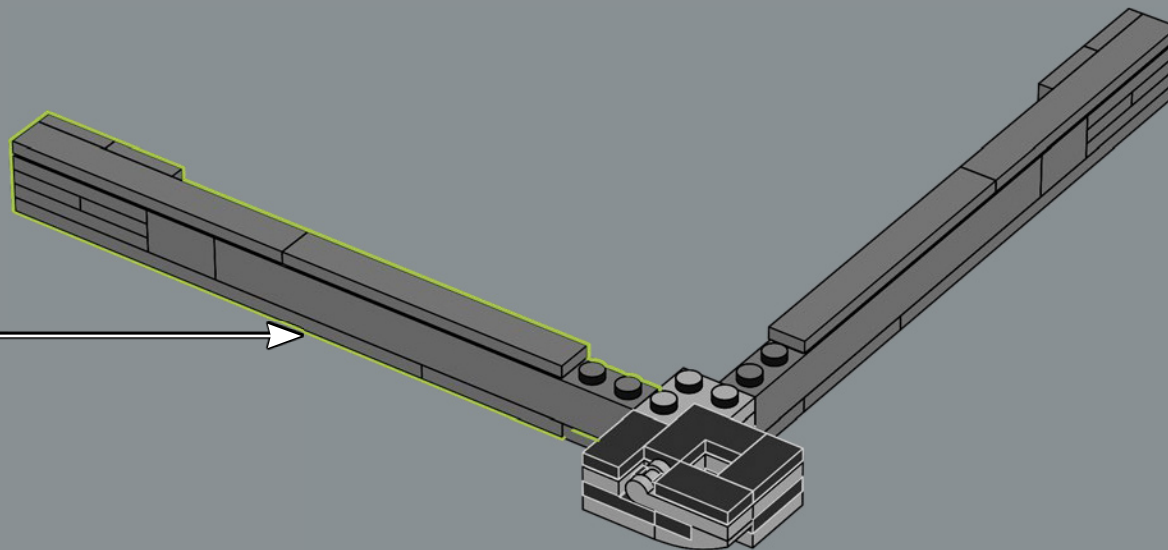

55

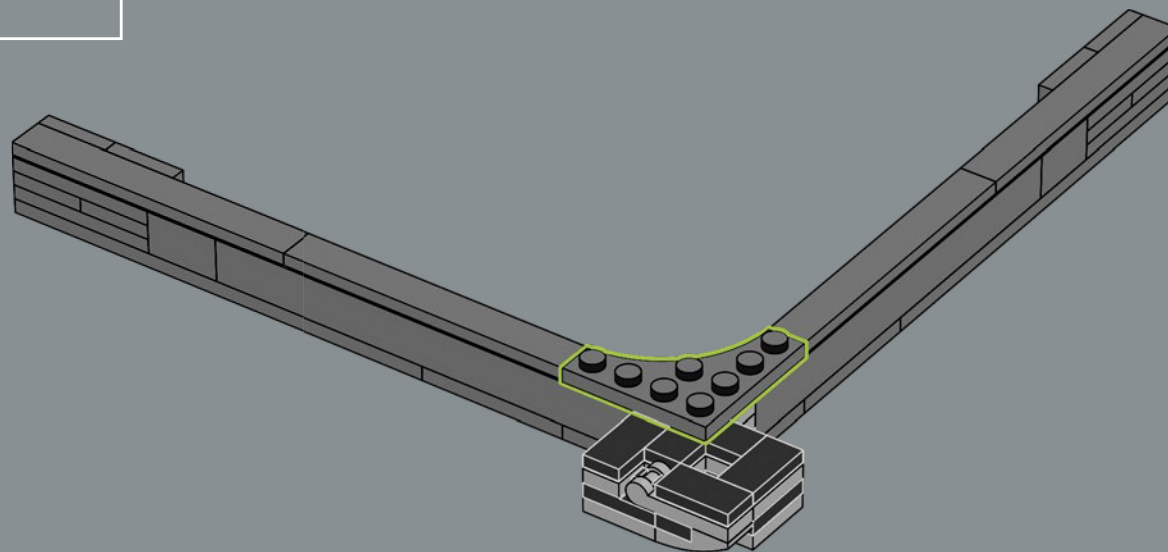

56

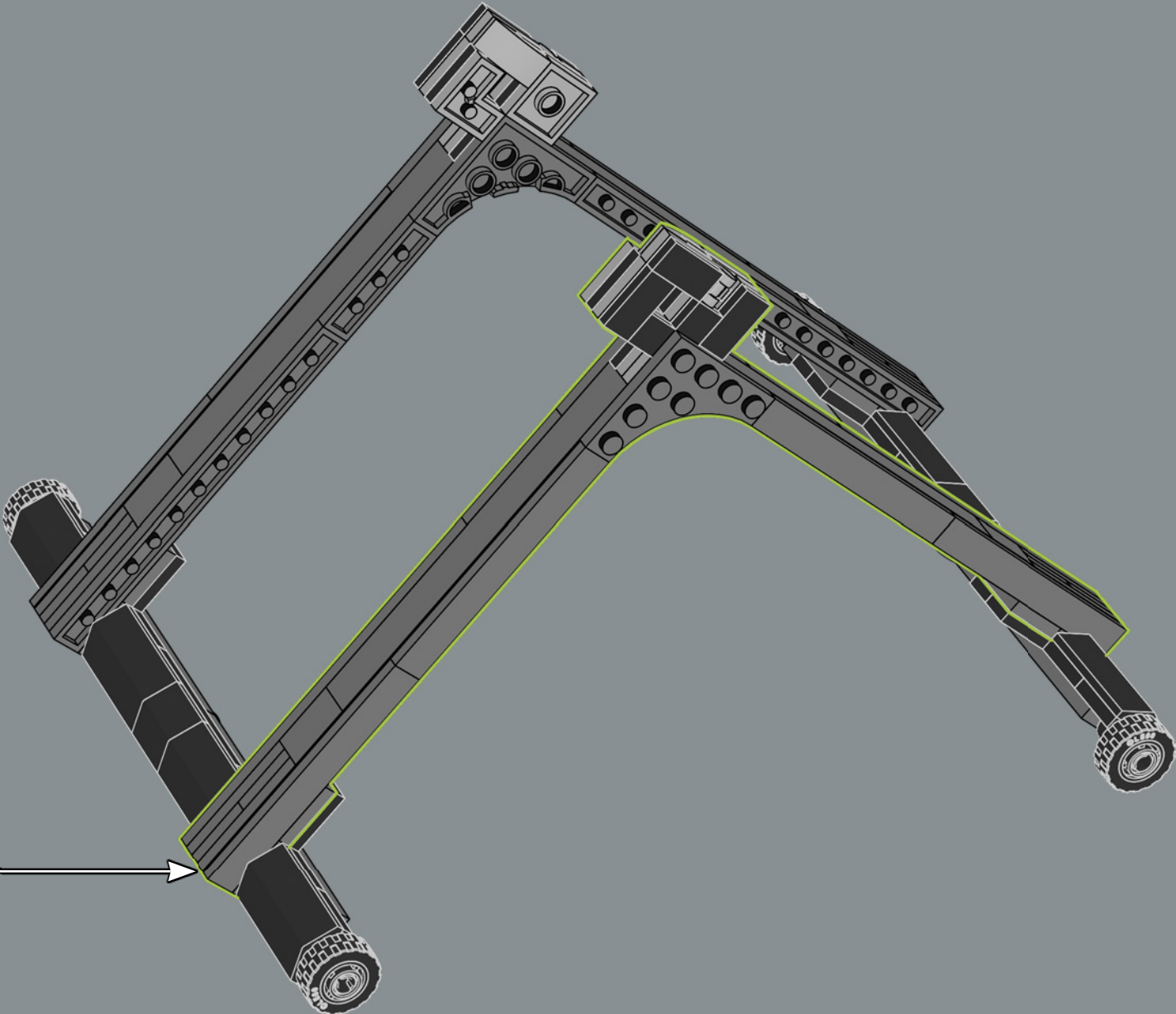

57

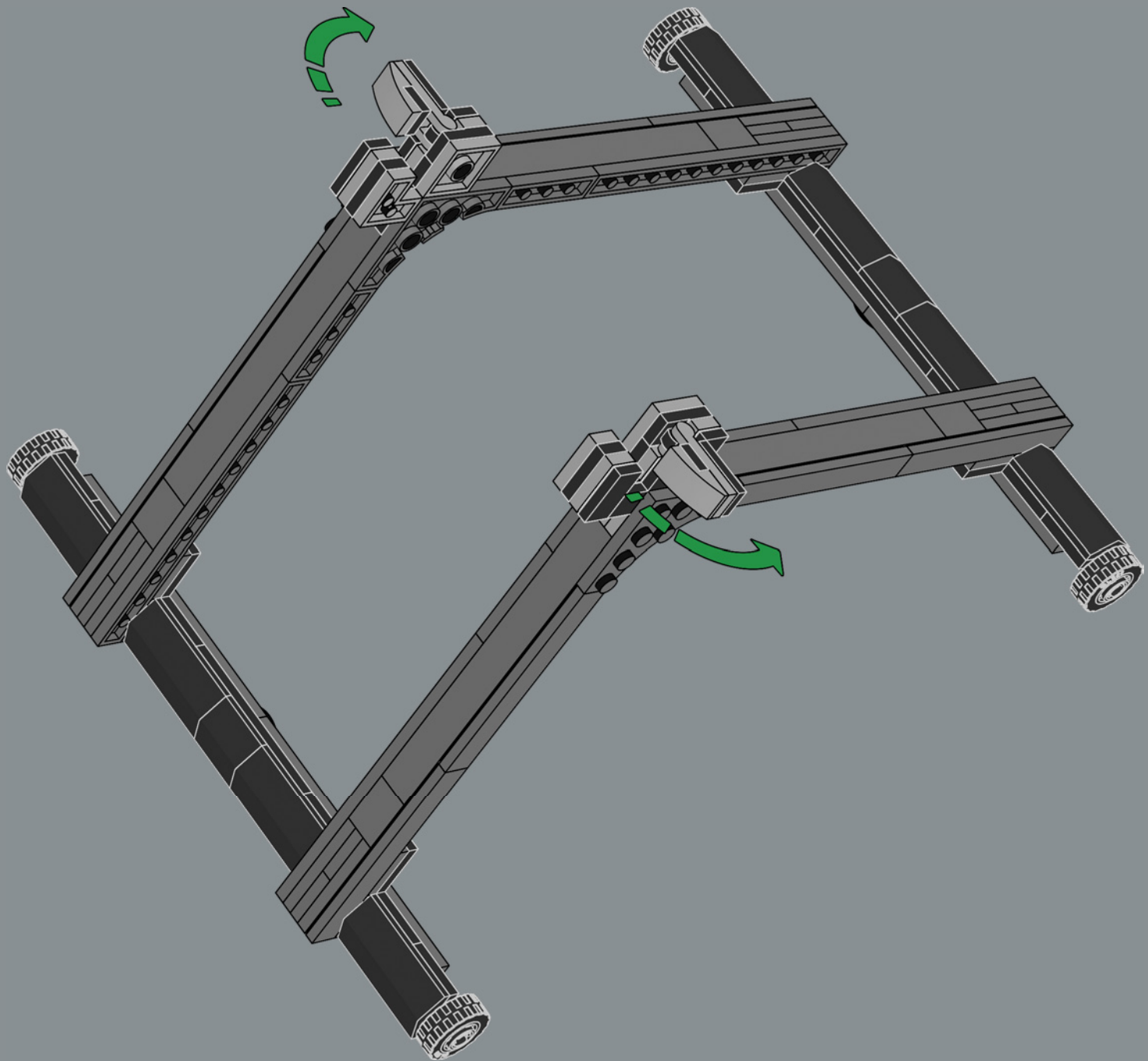

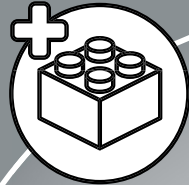

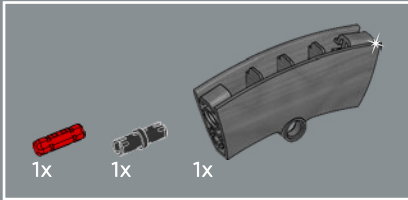
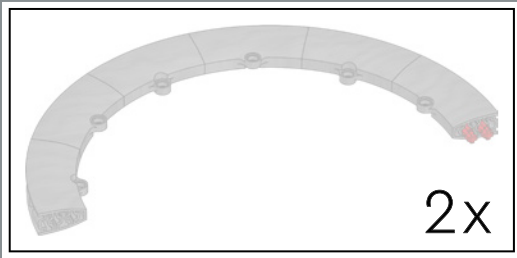
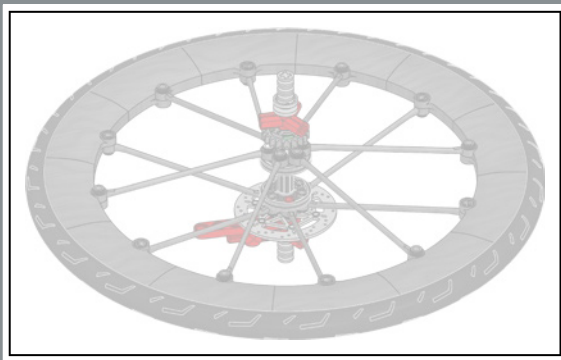

58



乐高®轮胎通常安装在单一车轮元件上。这是首个作为模型一部分的可建造乐高车轮。

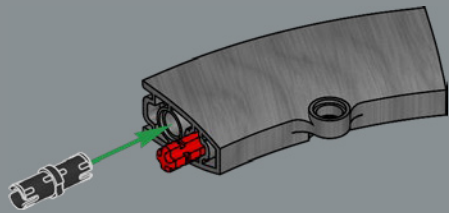

59

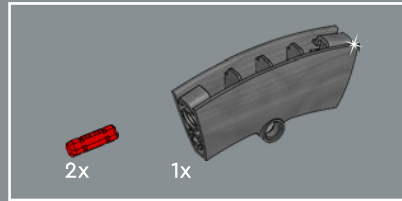
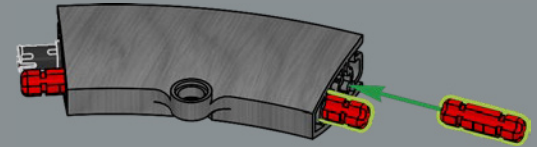

60

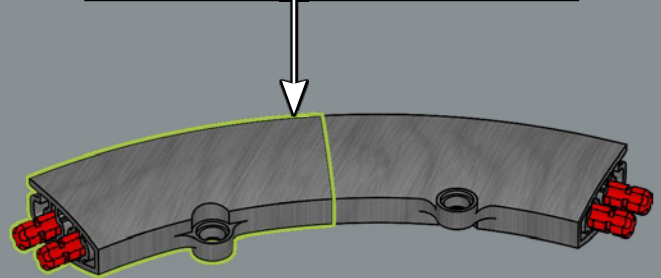
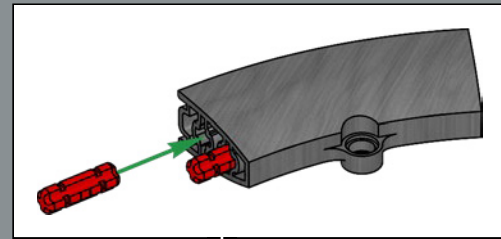

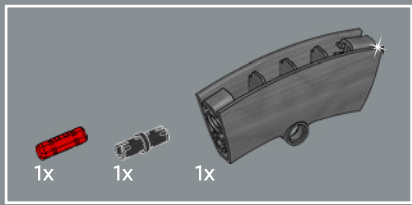

61

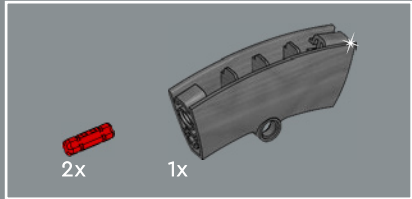
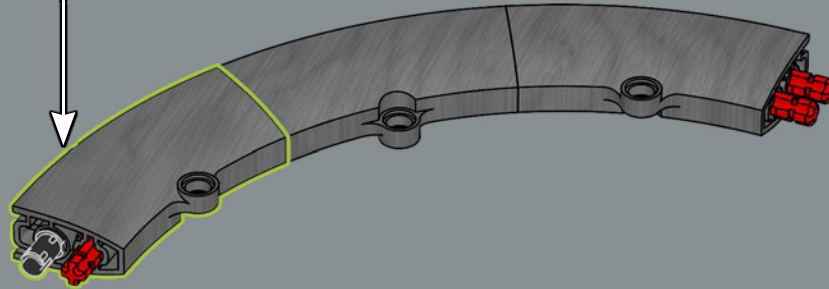
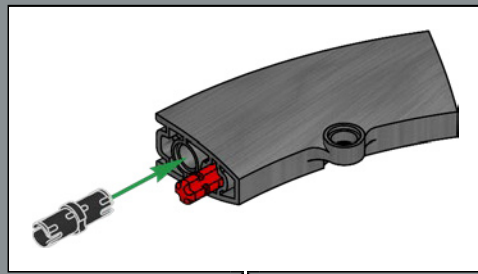

62

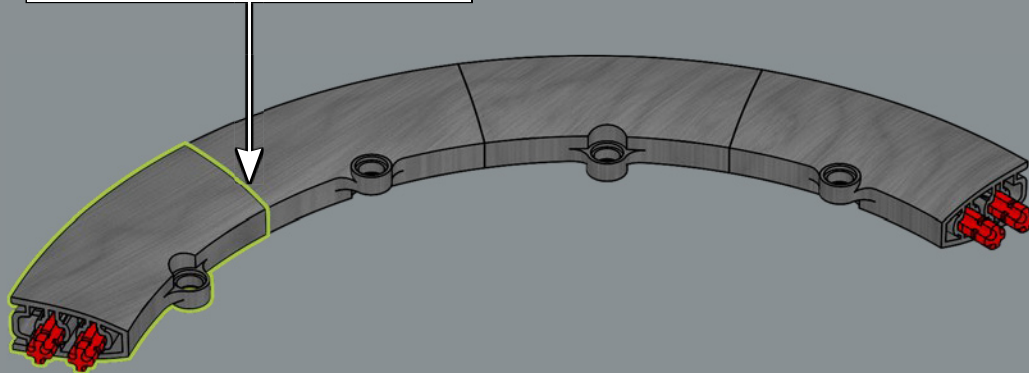
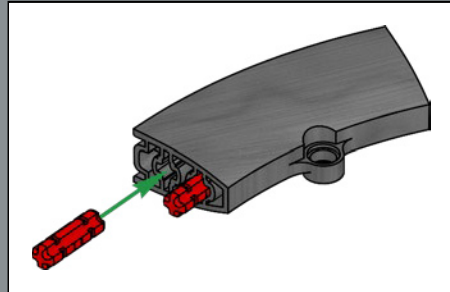

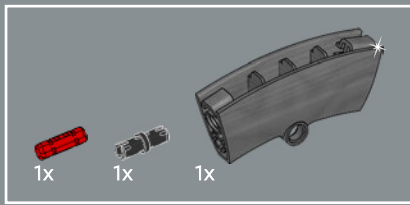

63

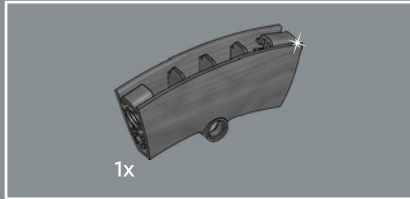
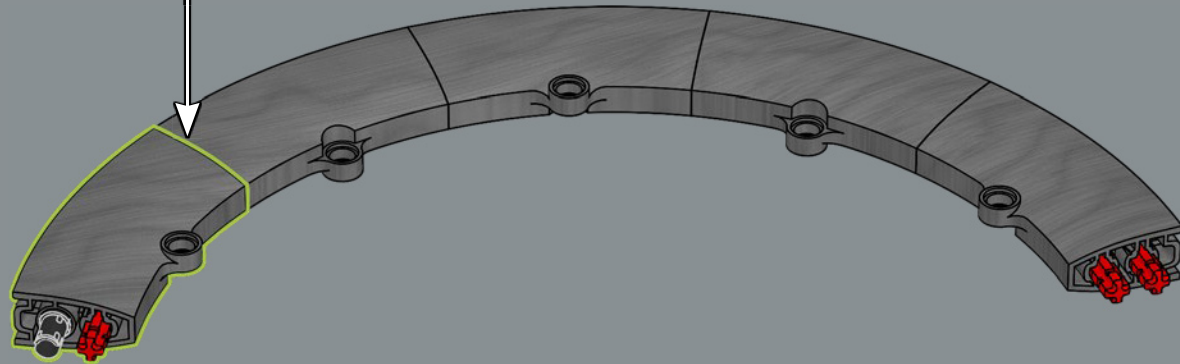
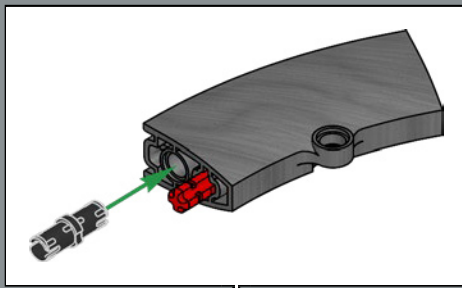

64

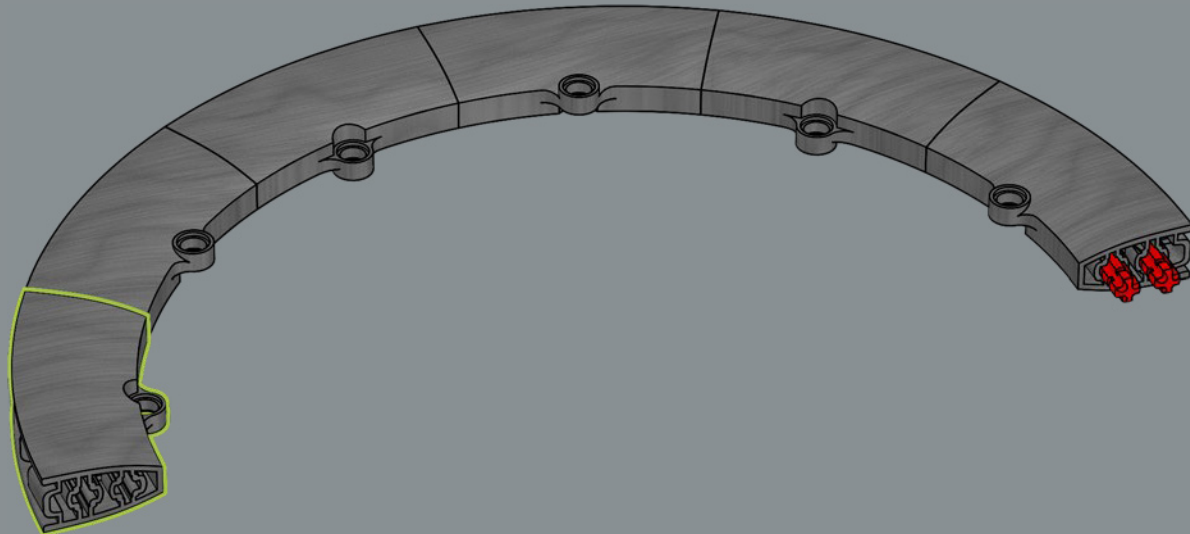

2x

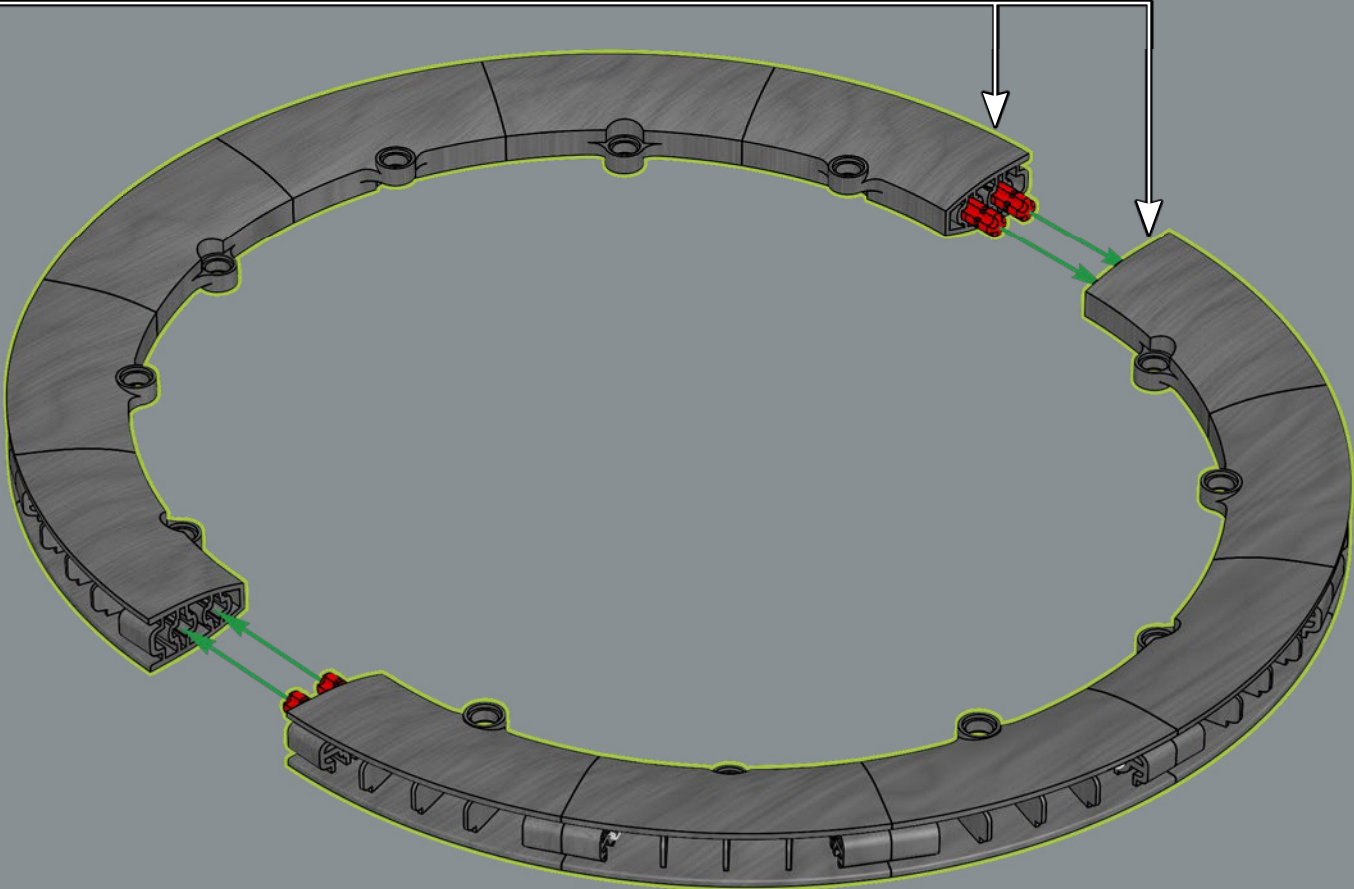

66

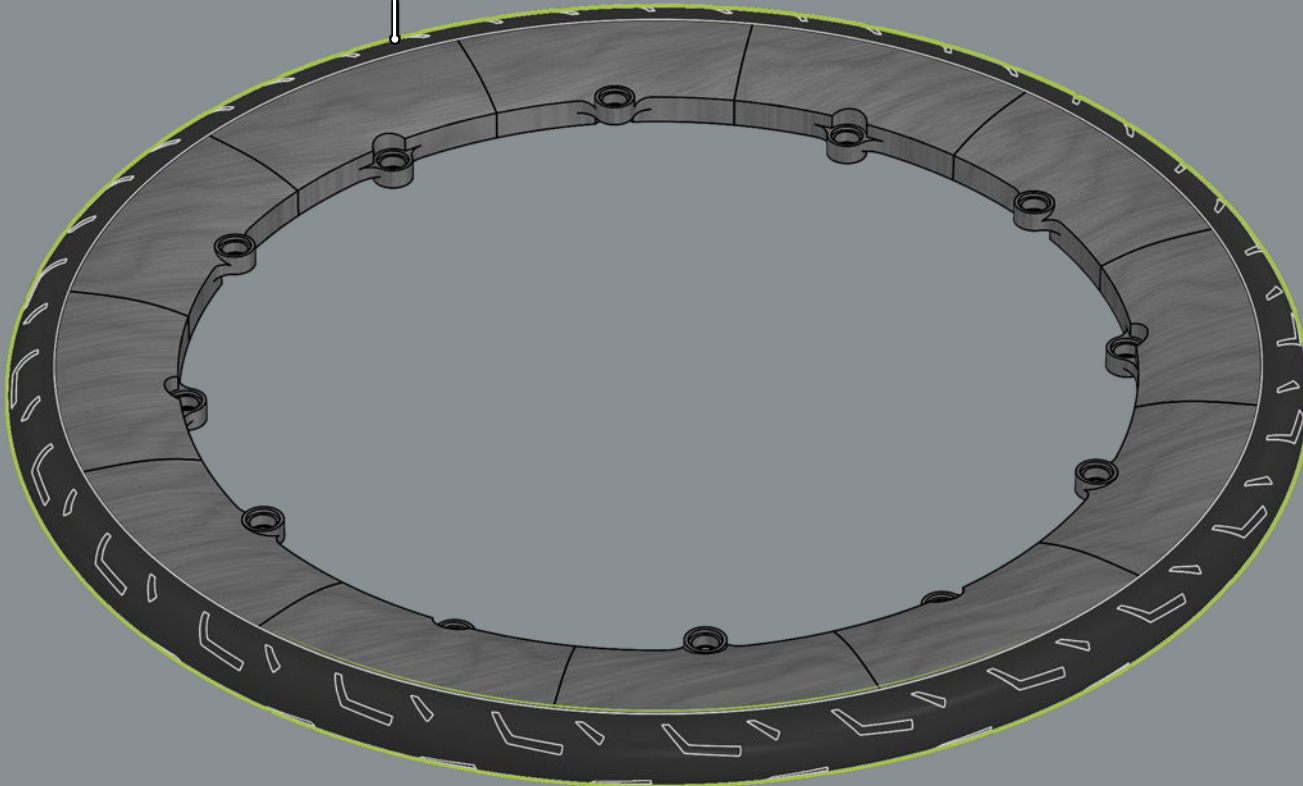
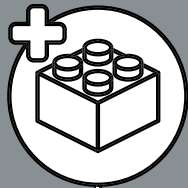

这是迄今为止最大的乐高®轮胎。

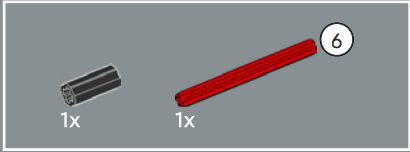
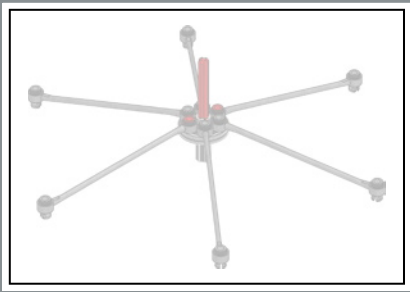

67

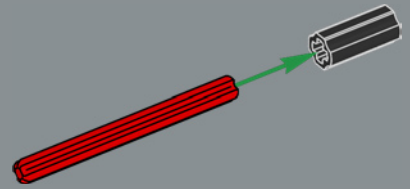

68

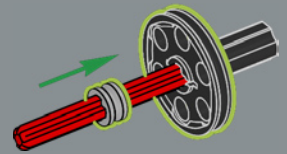

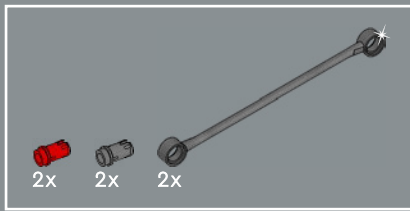

69

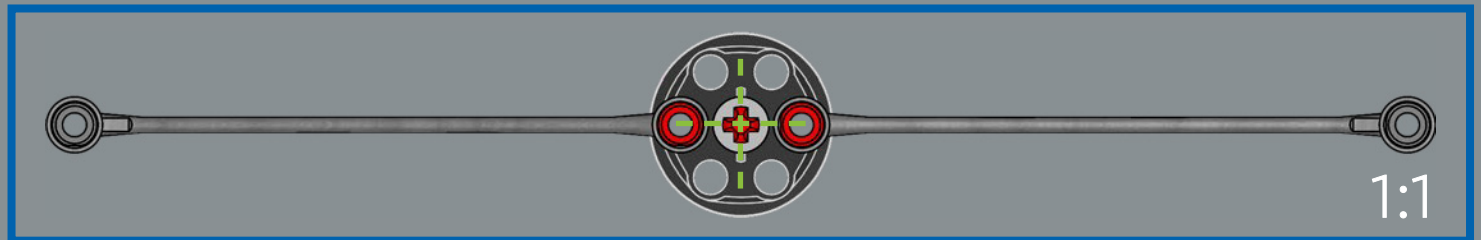
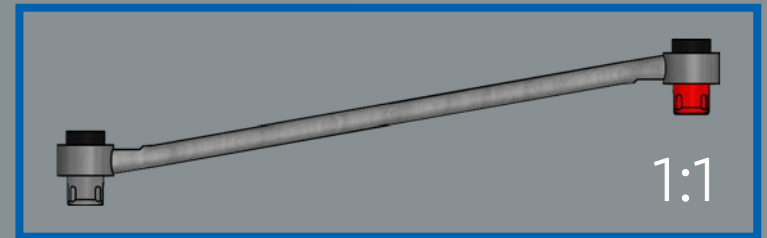
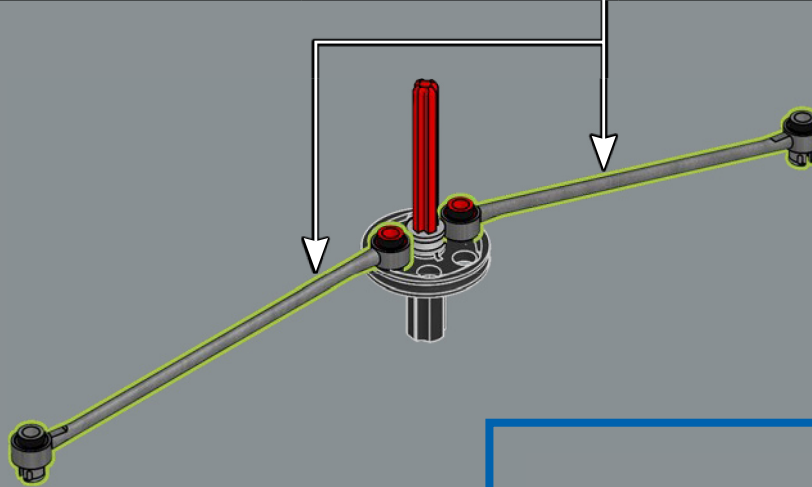
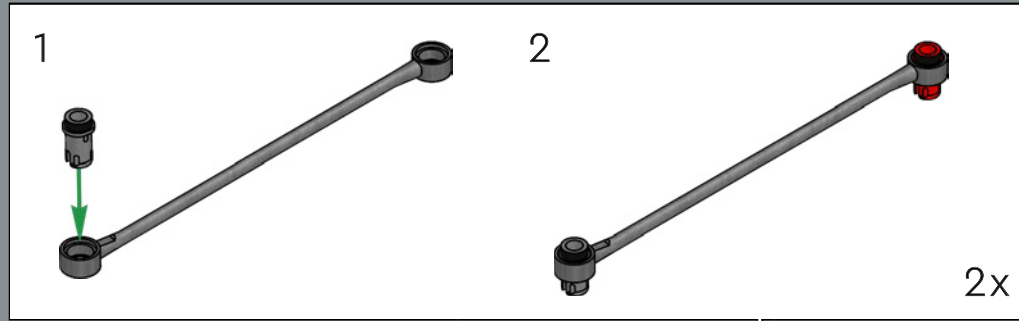

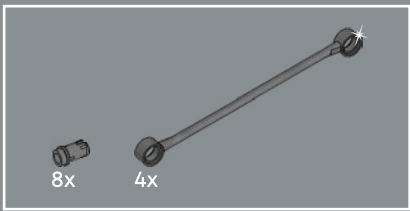

70

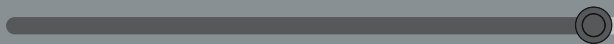
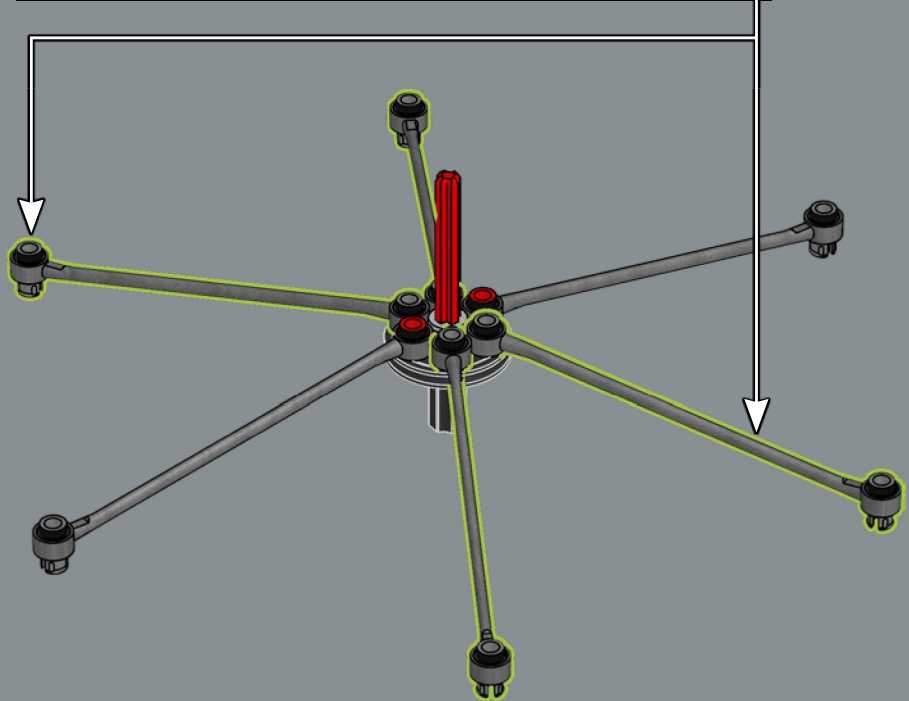
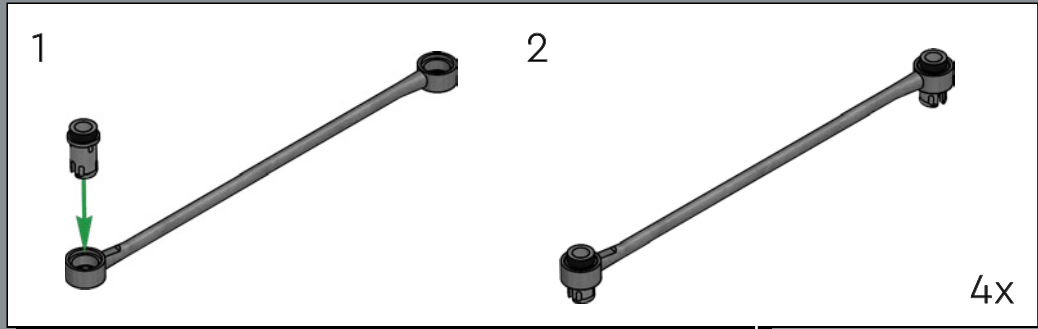

71

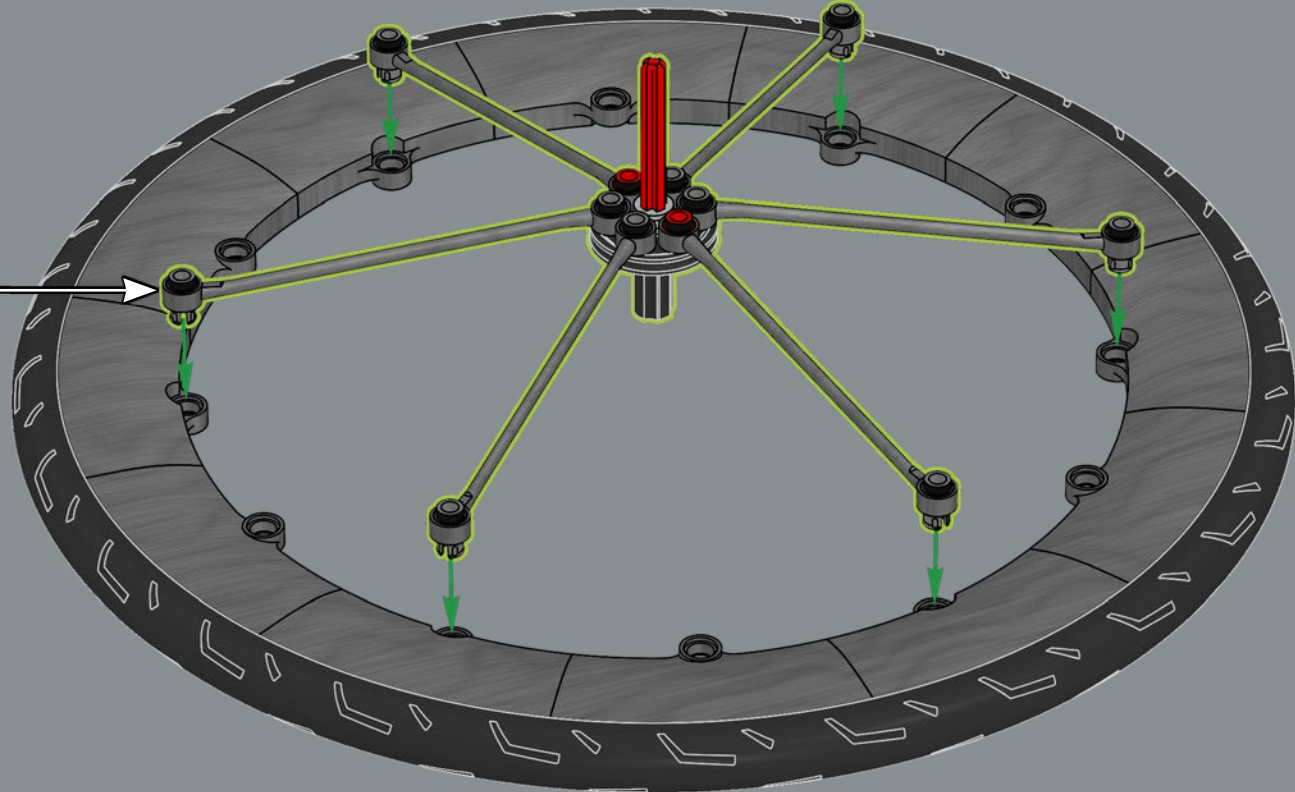
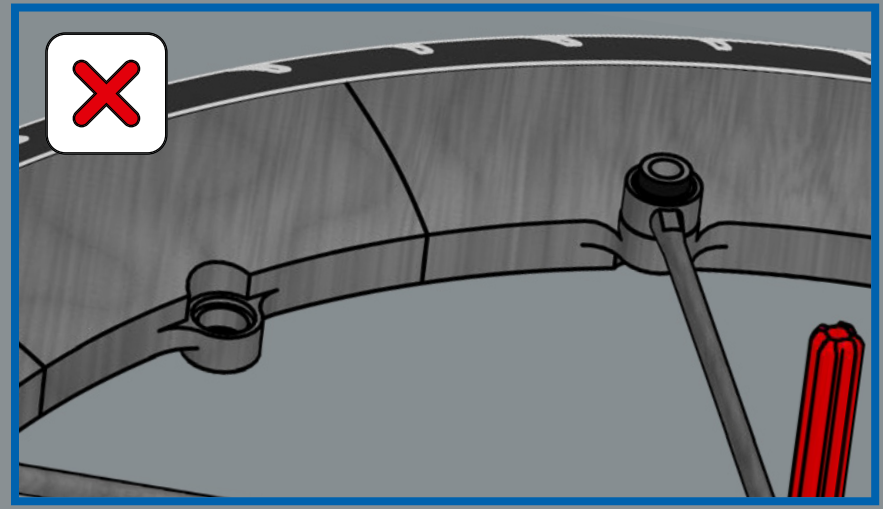
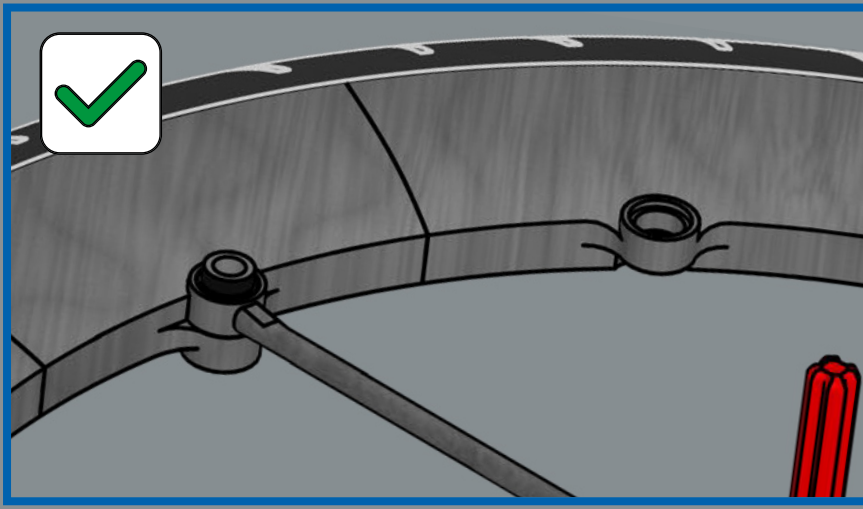

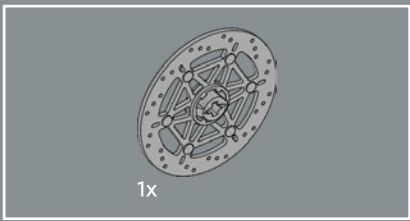

72

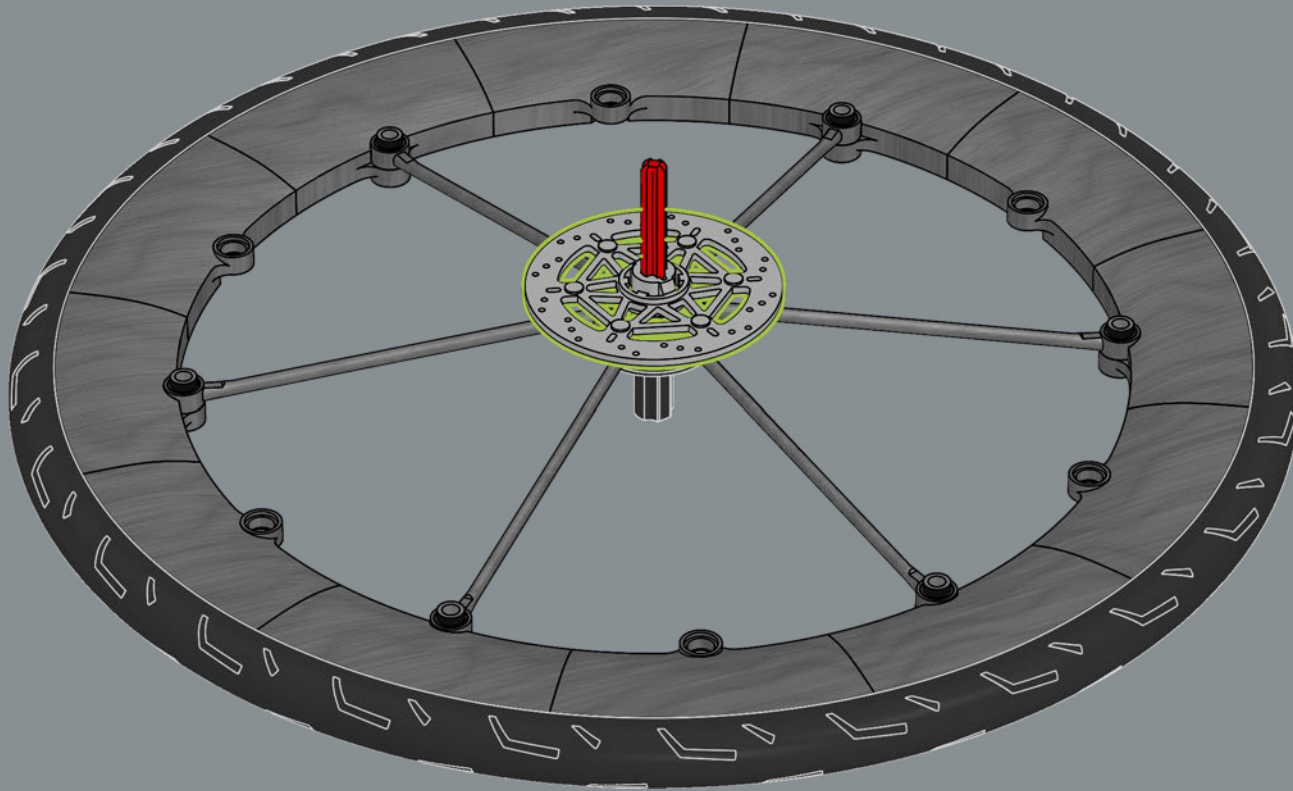

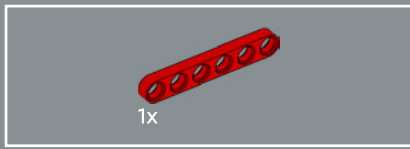

73

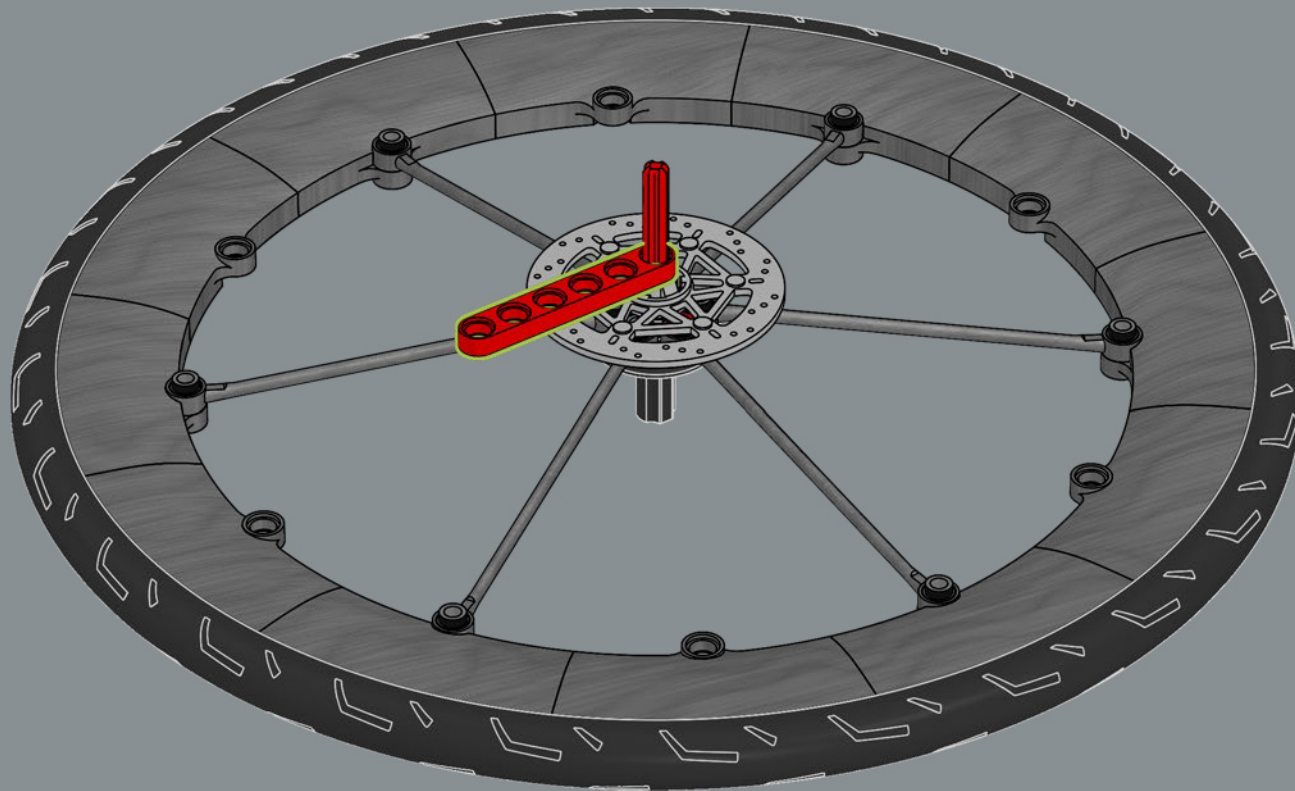

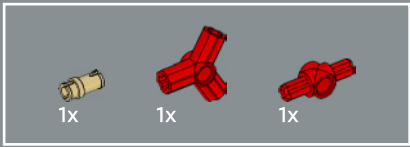

74

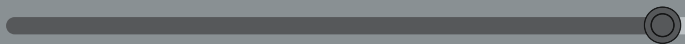
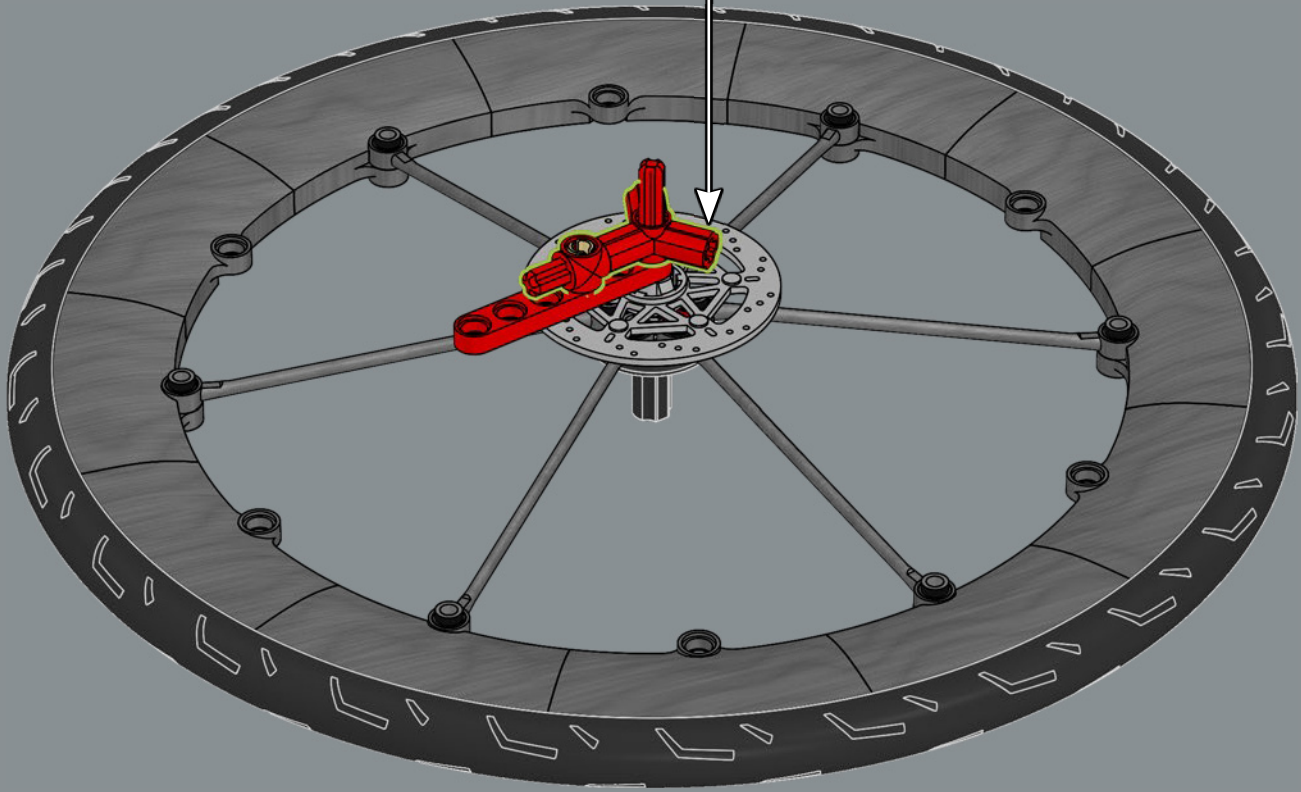
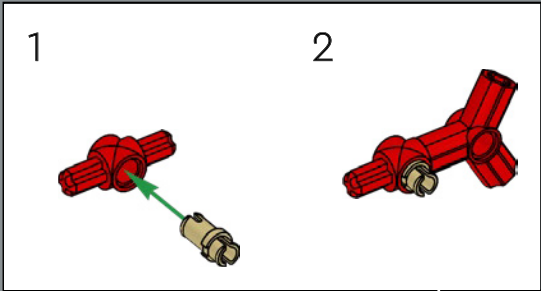



75

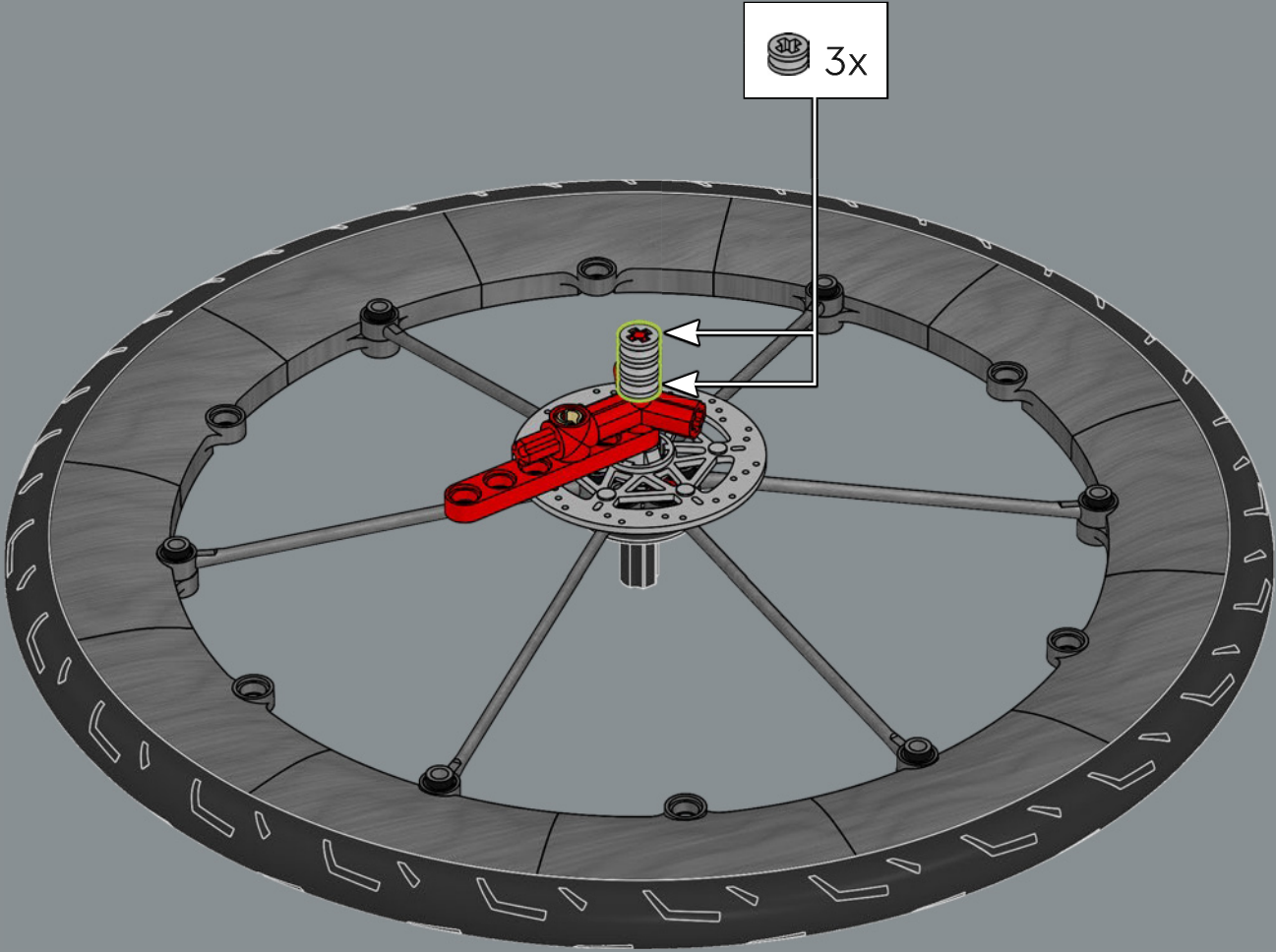

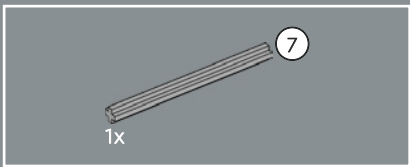

76

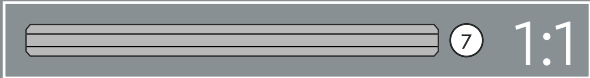
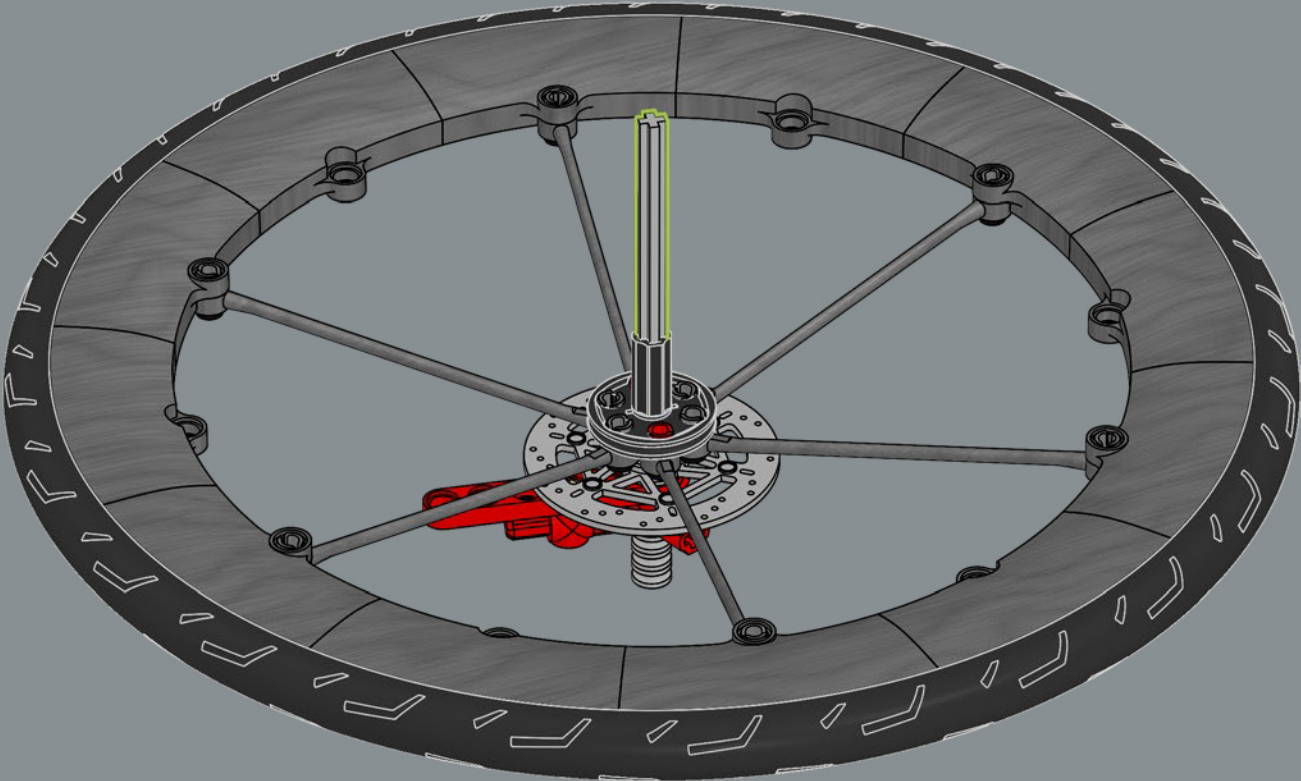



77

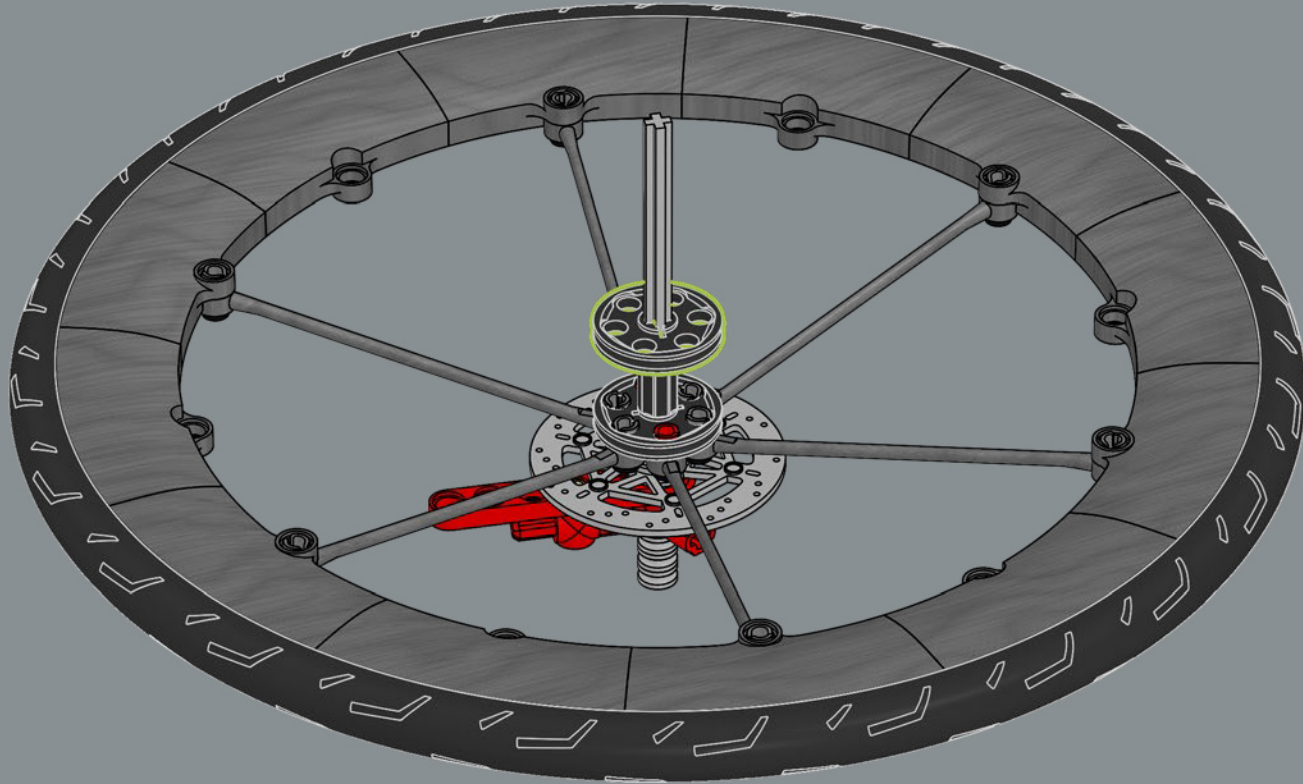
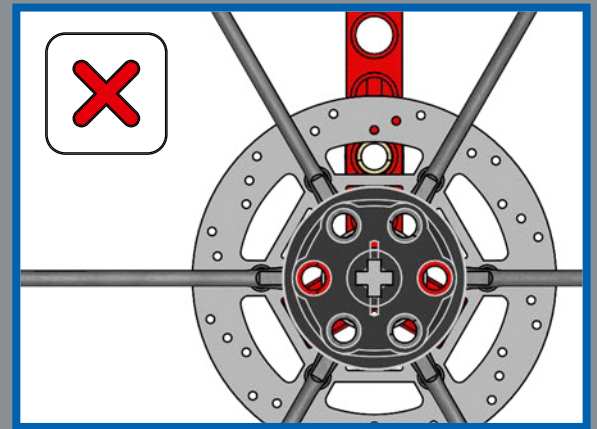
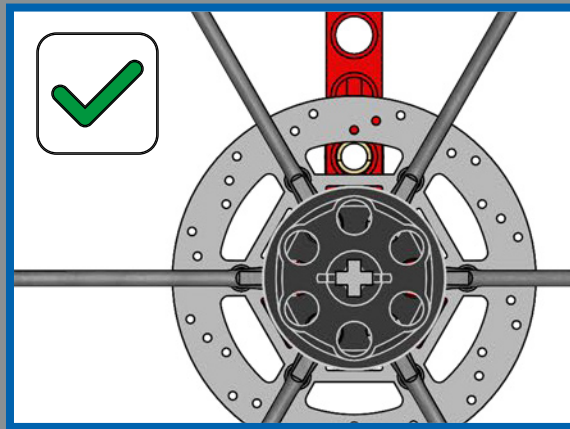

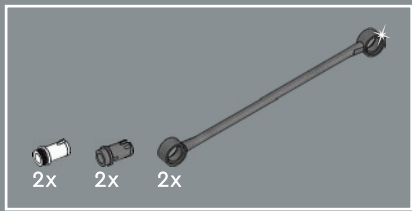

78

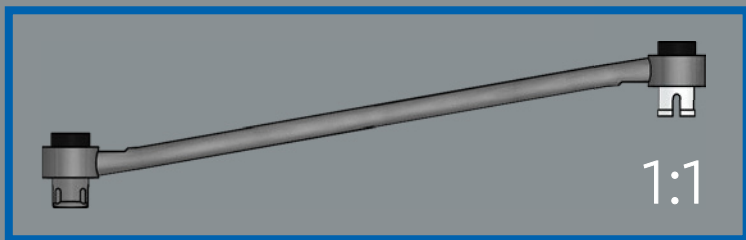
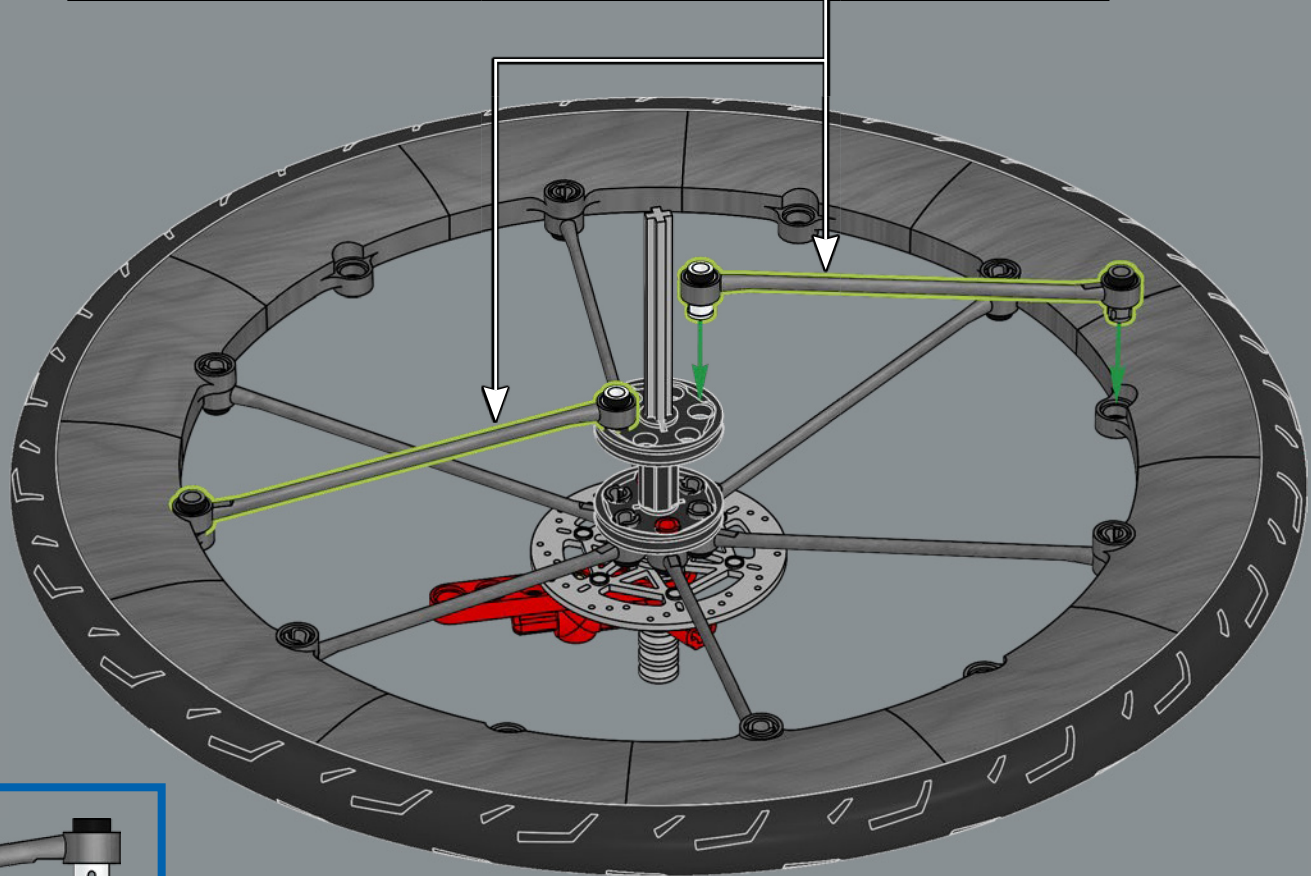
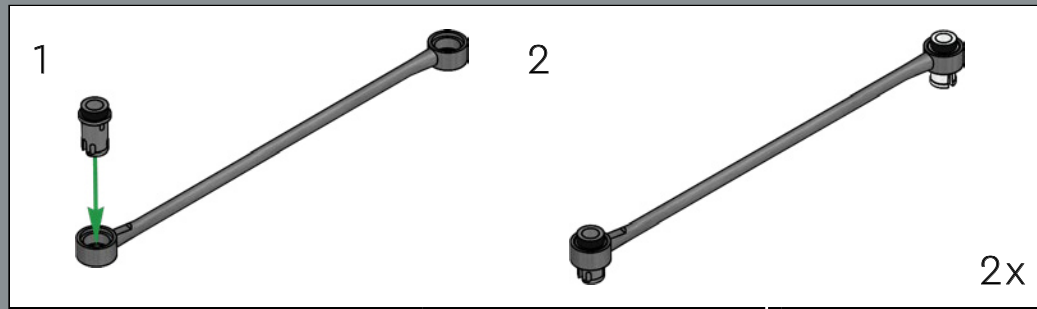

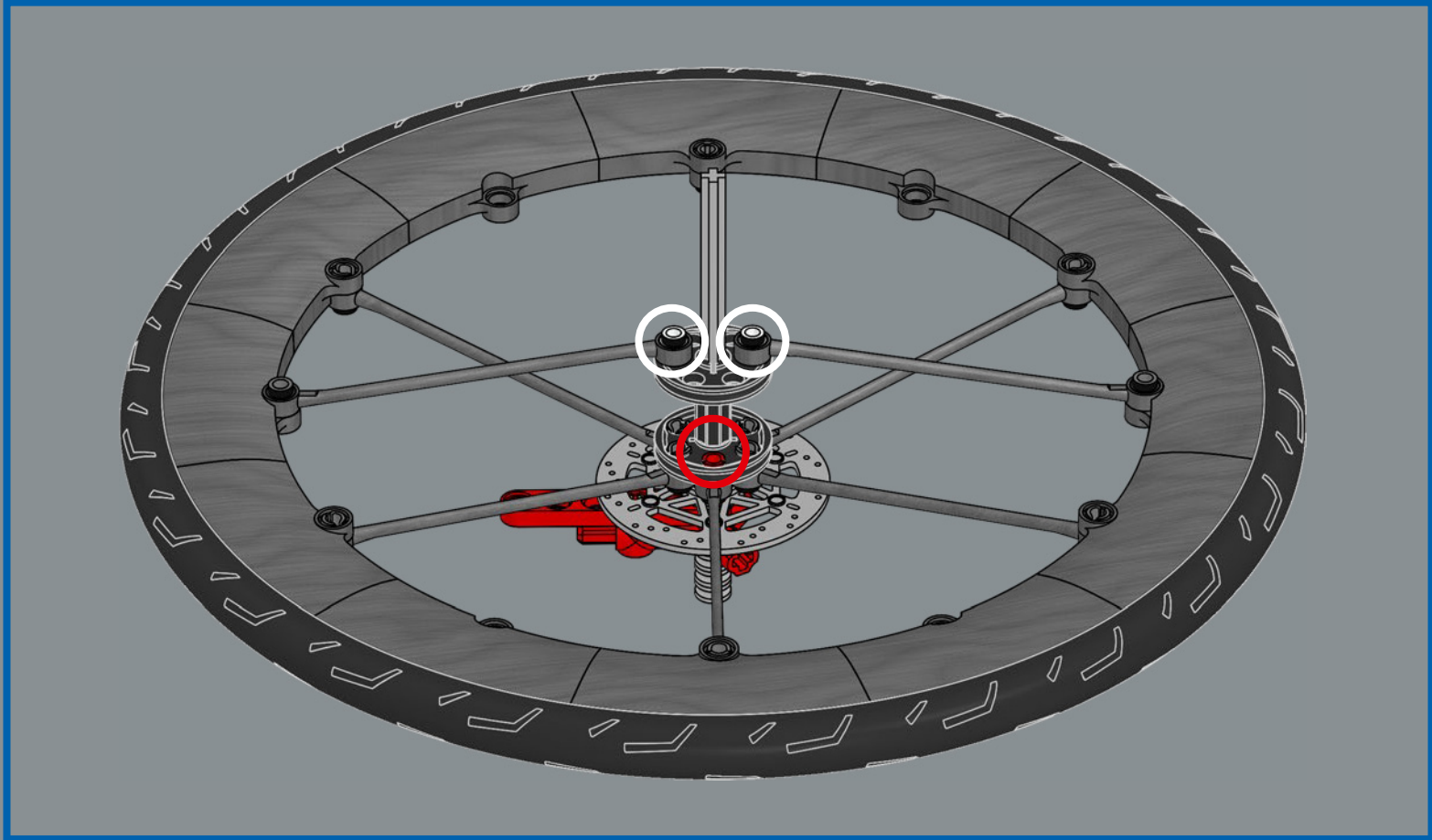

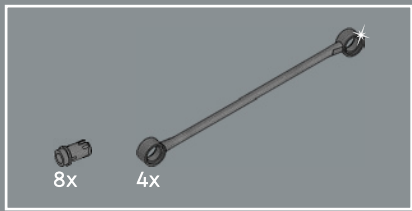

79

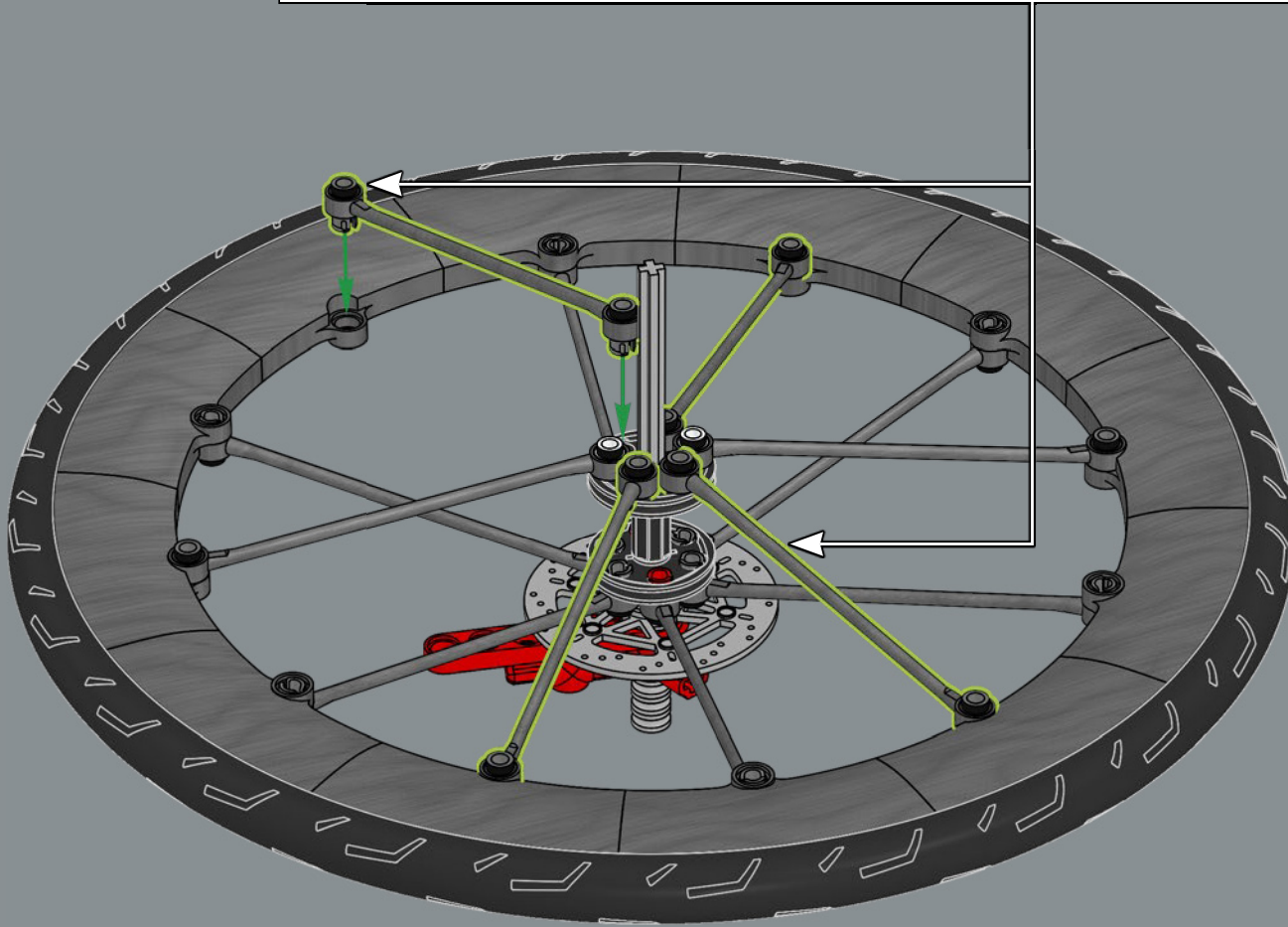
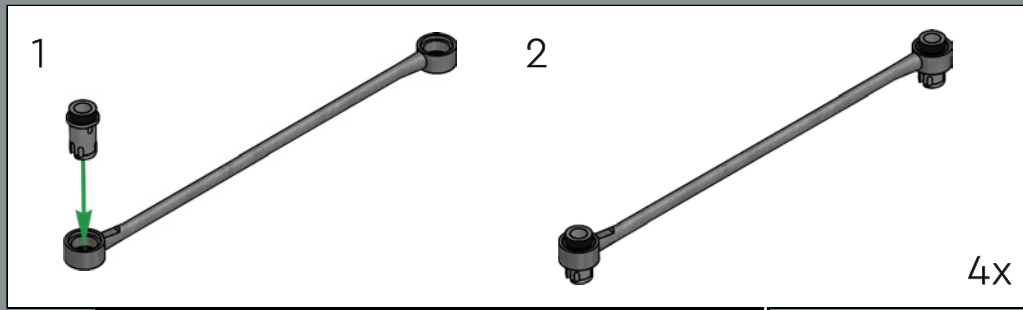



80

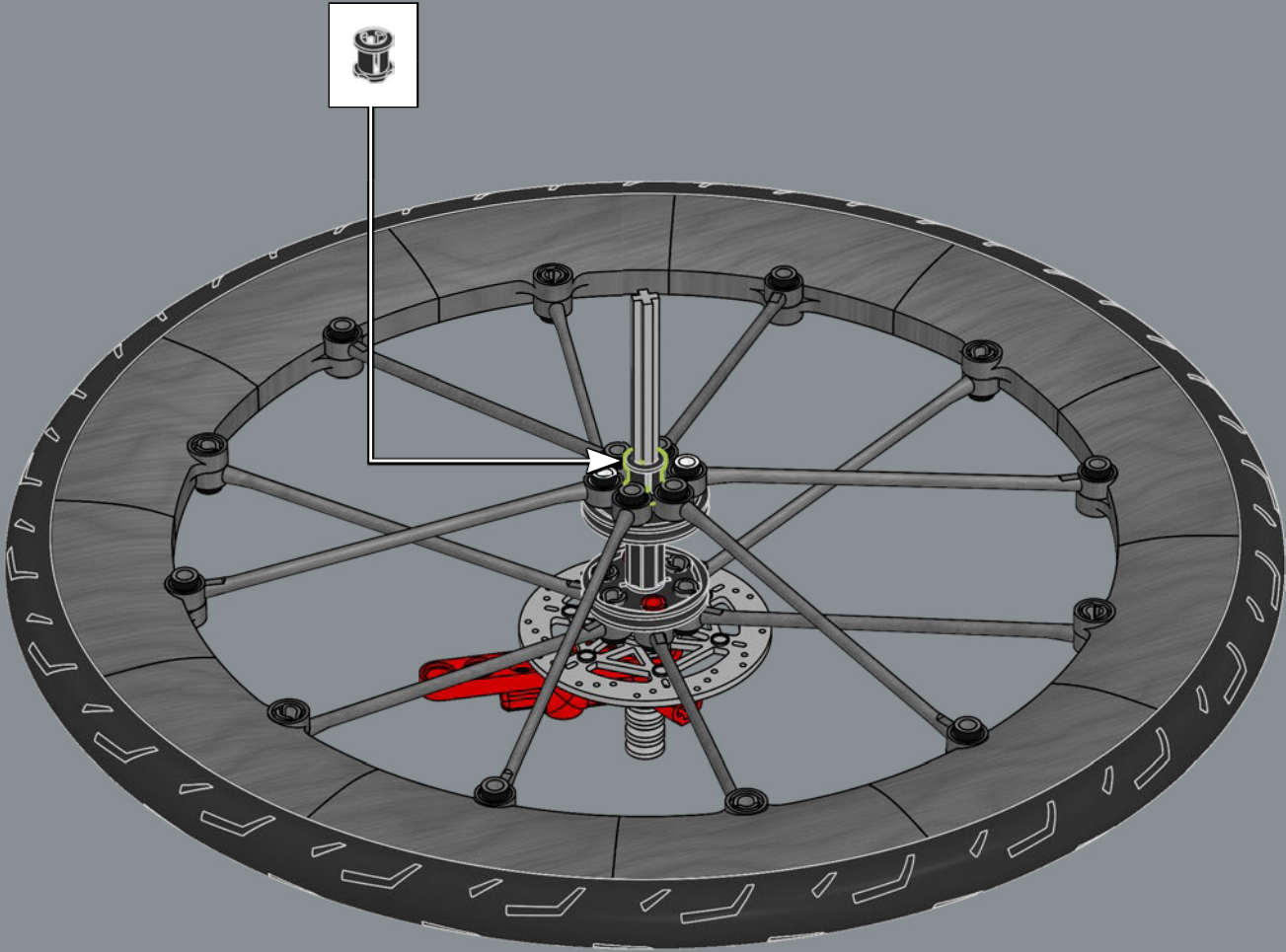



1x

81

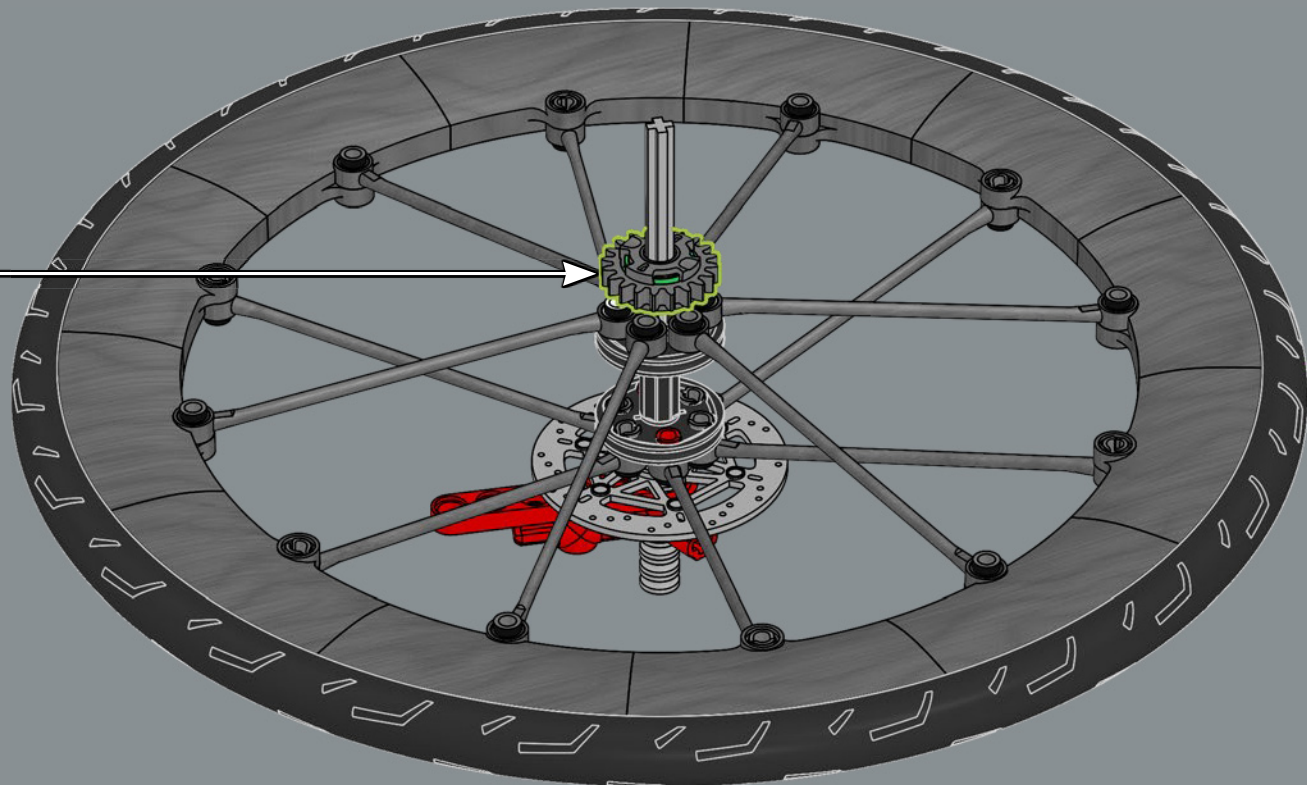
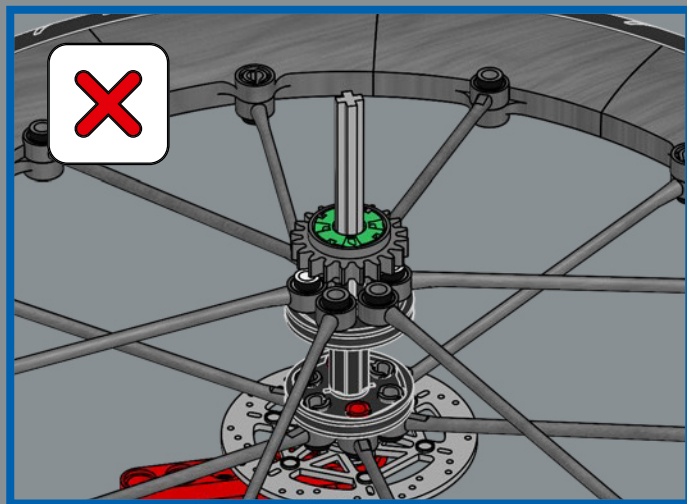
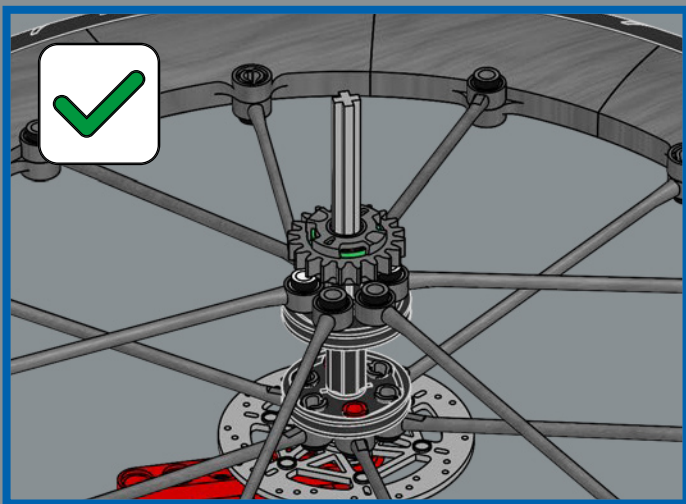

这个全新单向正齿轮让自行车能自由滑行，就像真车一样。



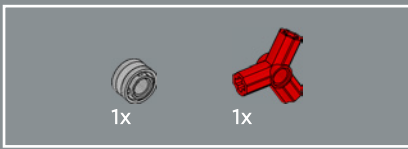

82

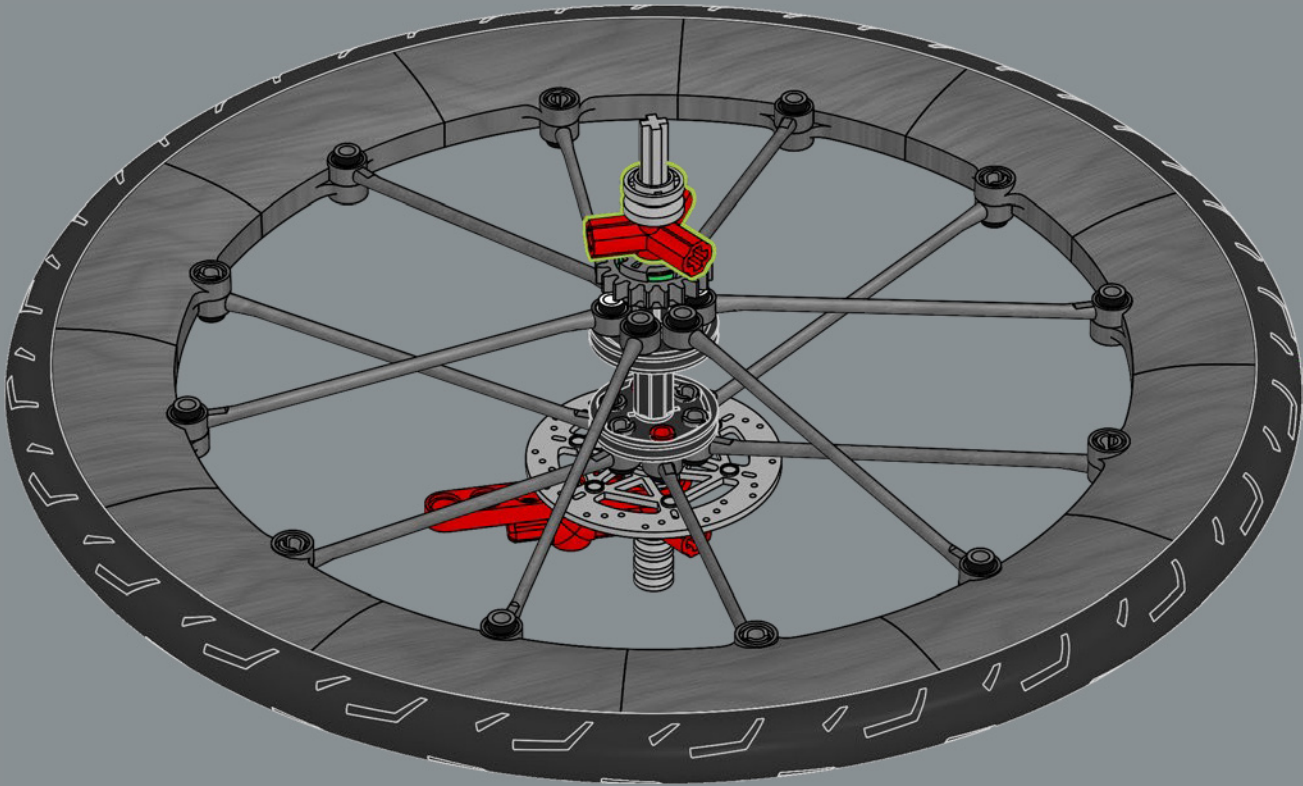



3x

83

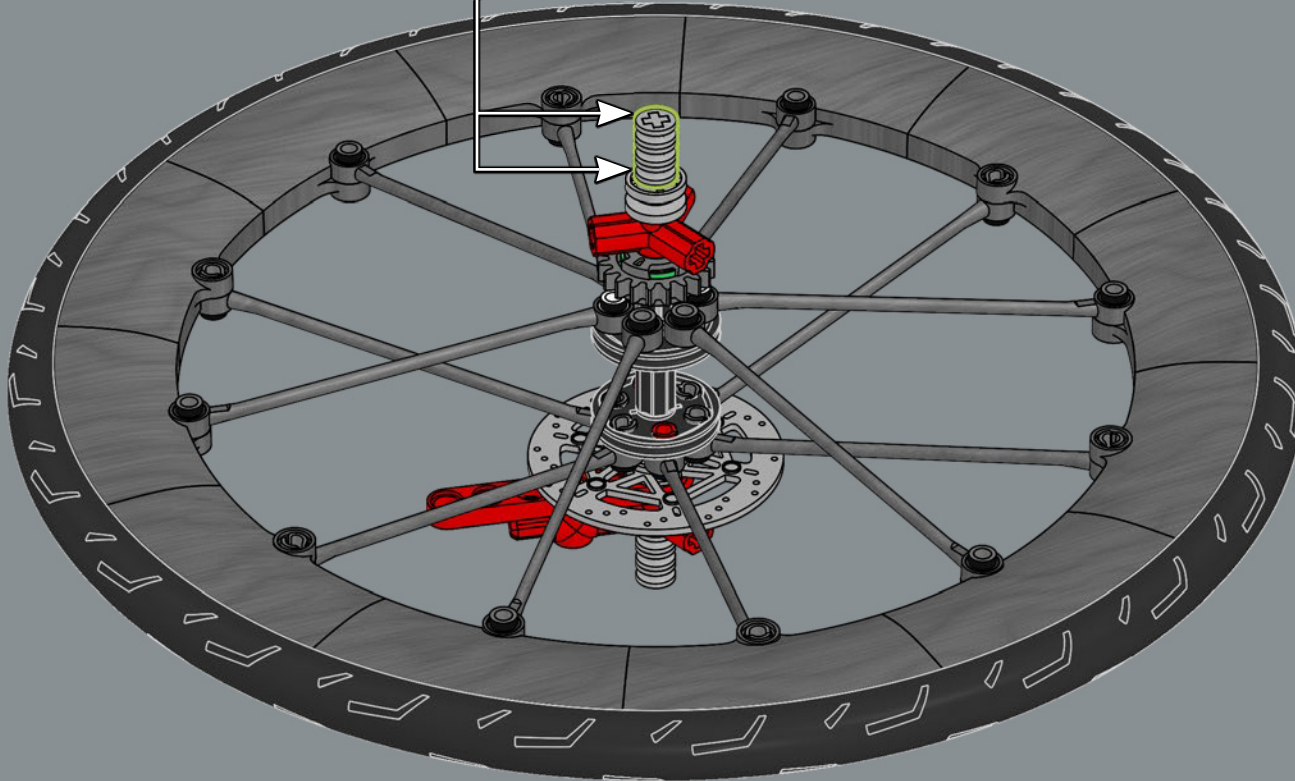
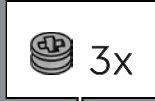

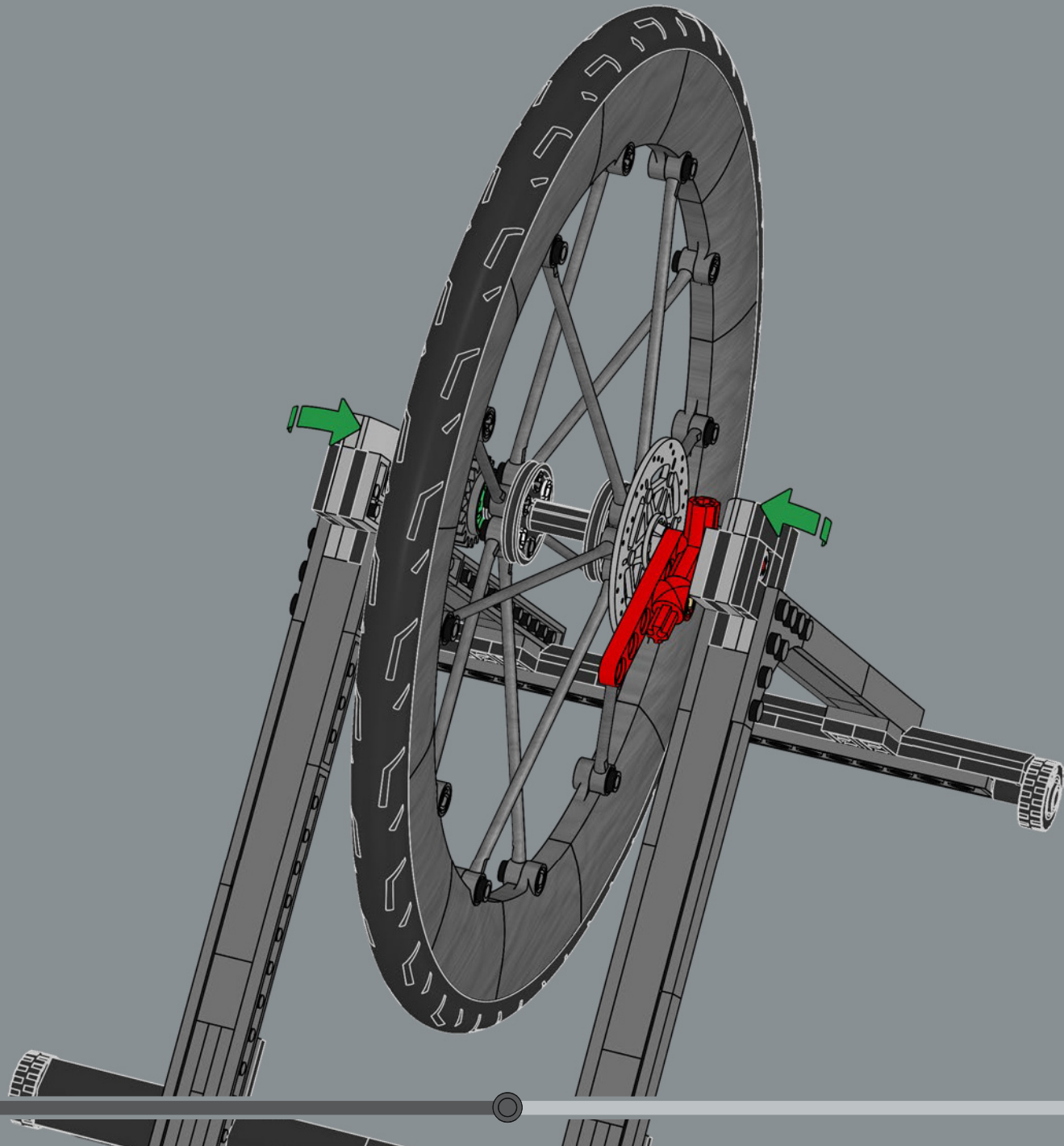

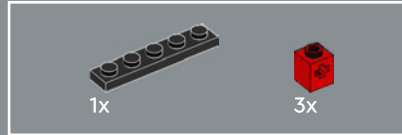
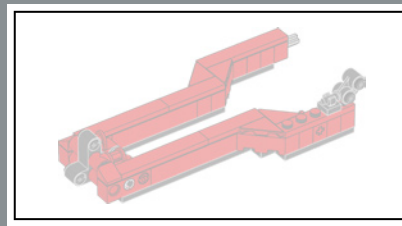

86

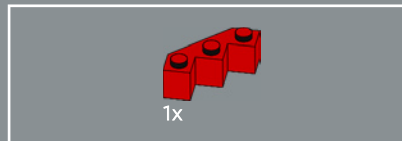
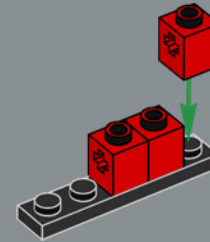

87

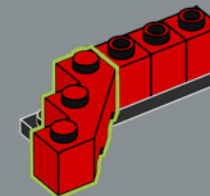

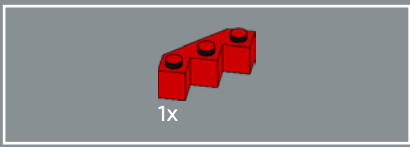

88

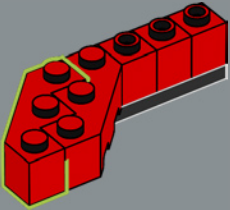

89

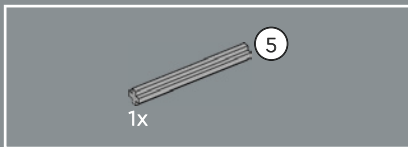
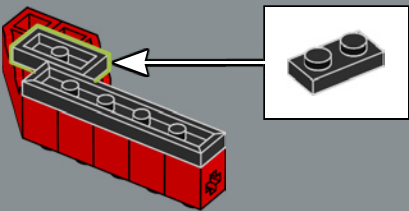

90

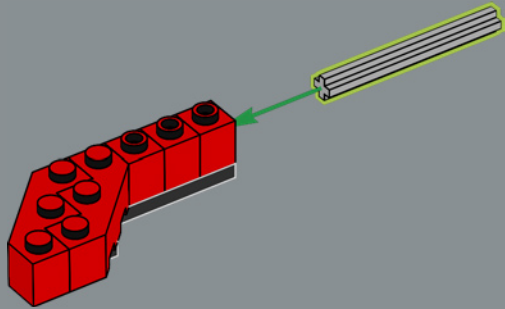

91

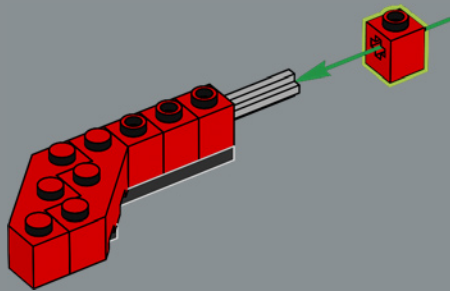

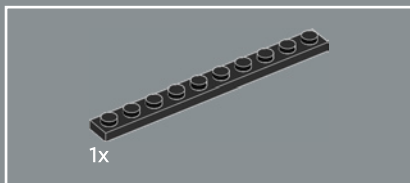

92

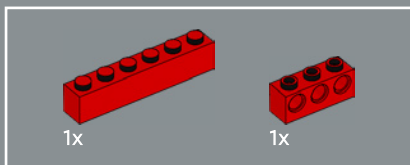
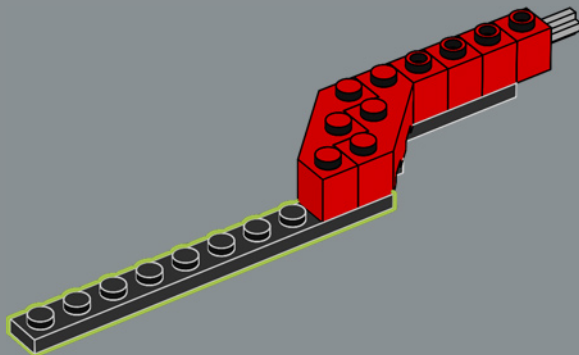

93

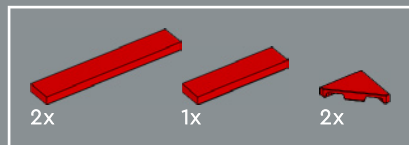
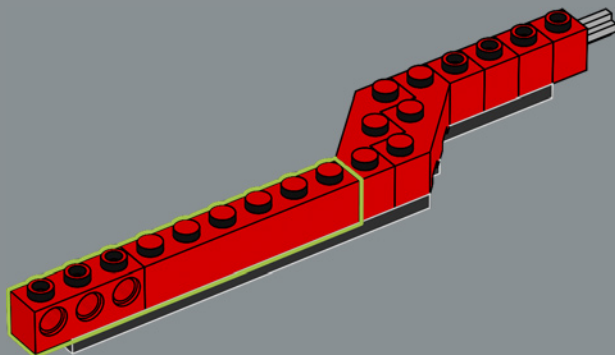

94

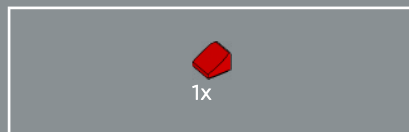
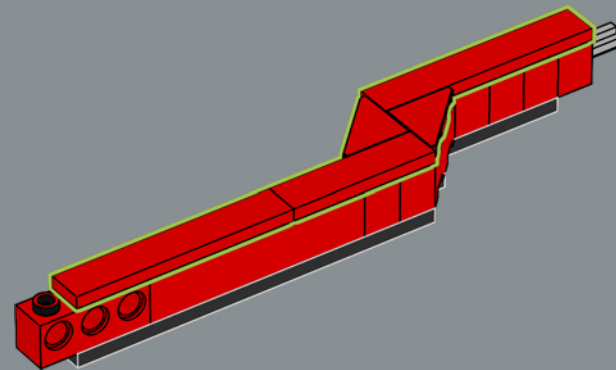

95

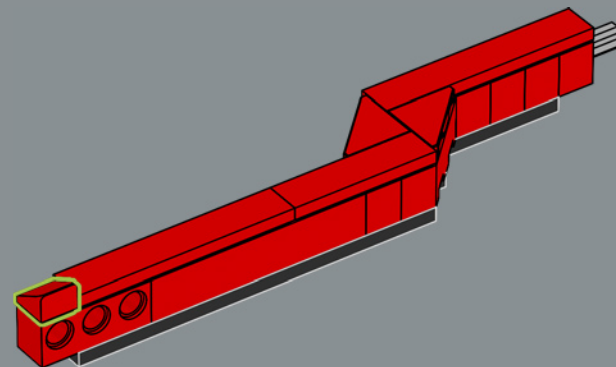

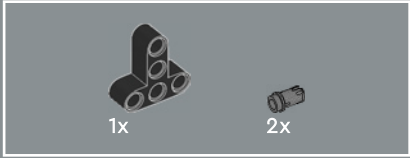
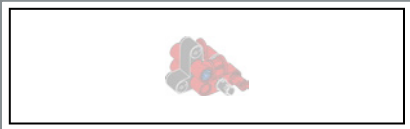

96

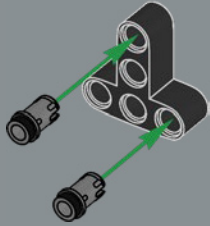

97

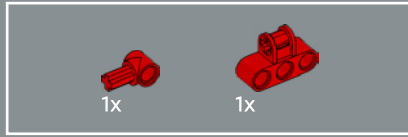
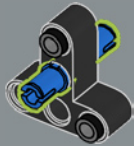

98

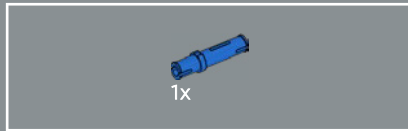
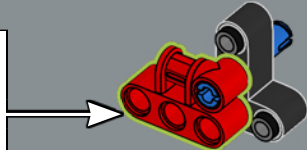
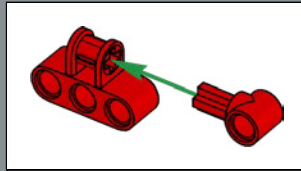

99

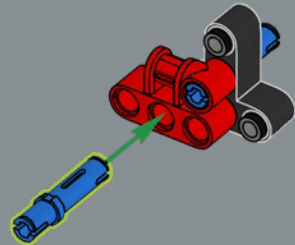



100

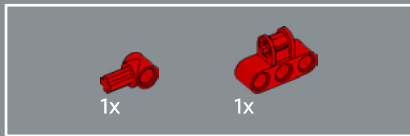
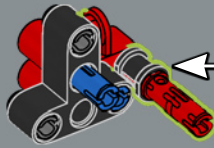
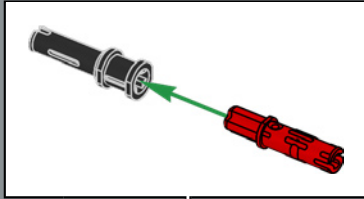

101

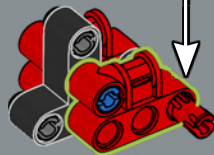
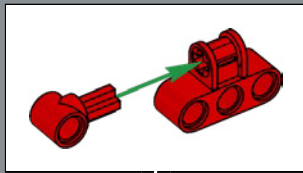

102

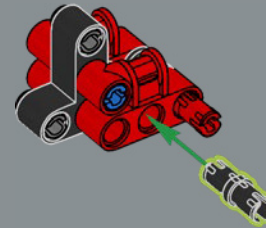

103

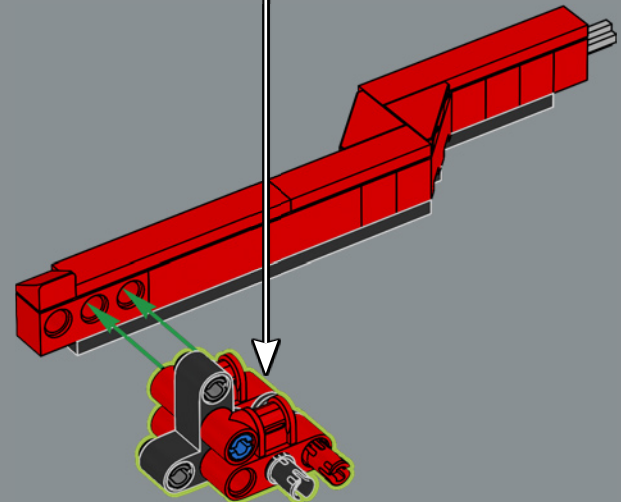

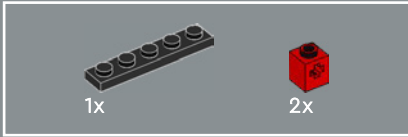
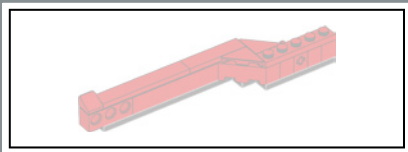

104

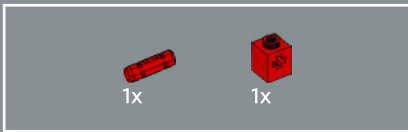
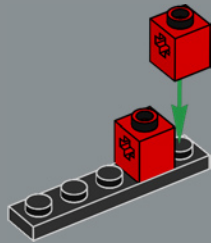

105

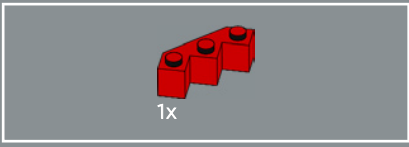
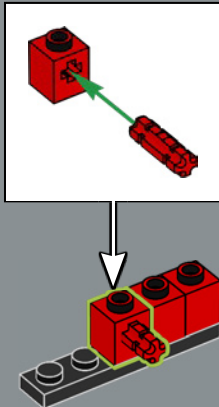

106

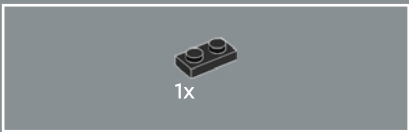
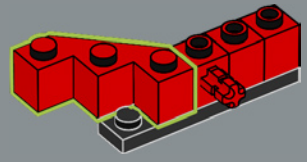

107

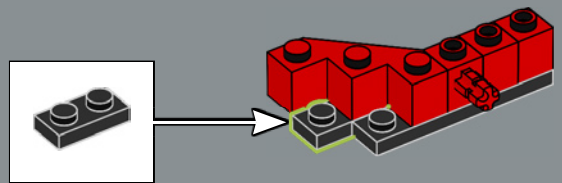

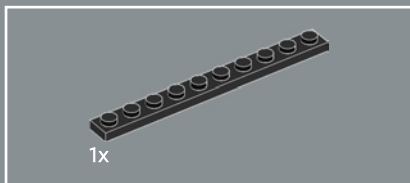

108

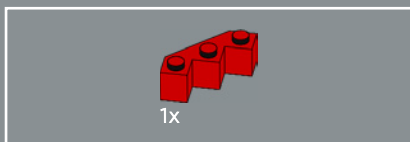
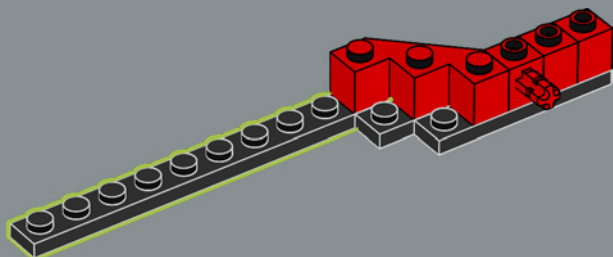

109

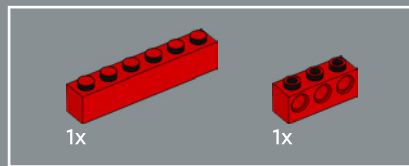
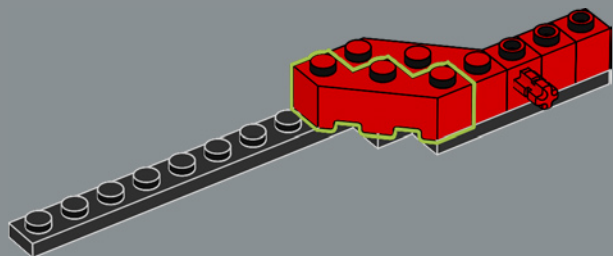

110

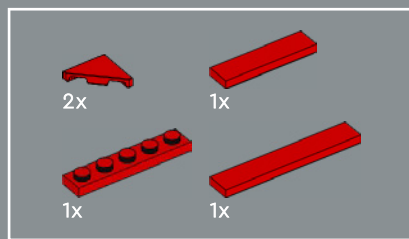
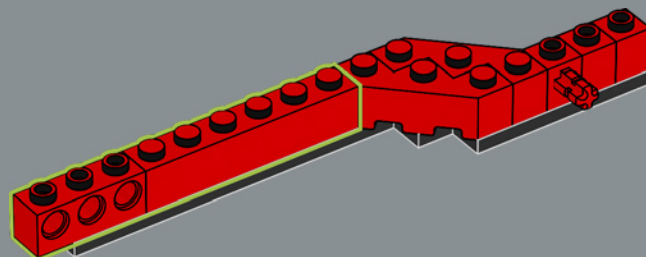

111

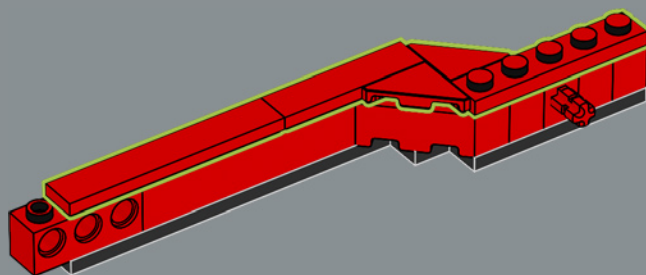



1x

112

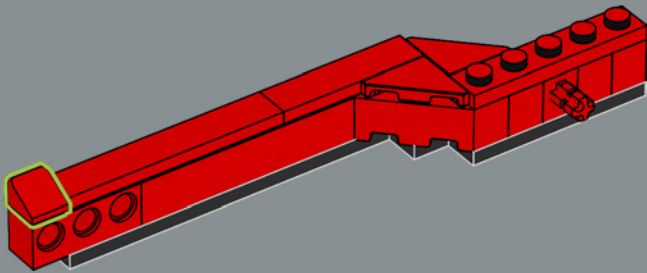

113

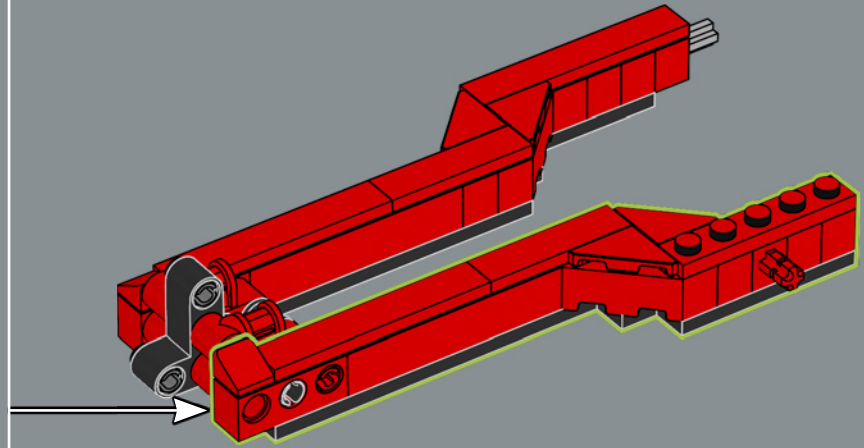



1x

114

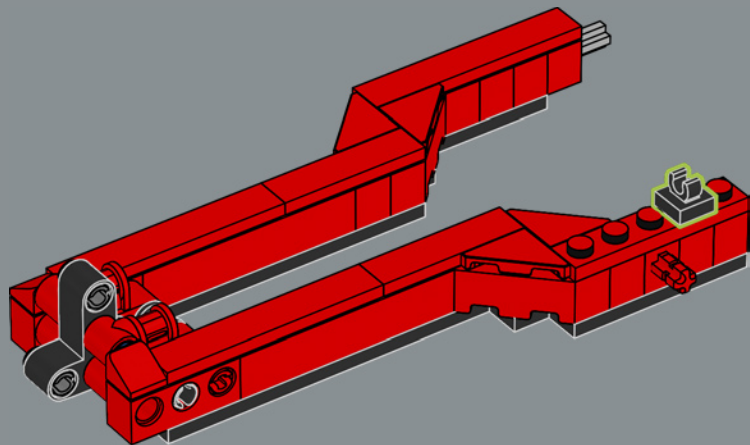

1x



2x

115



这个元件最初是为2009年乐高®太空警察系列的弹射导弹发射器设计的。在这里，它完美地模拟了盘刹卡钳。

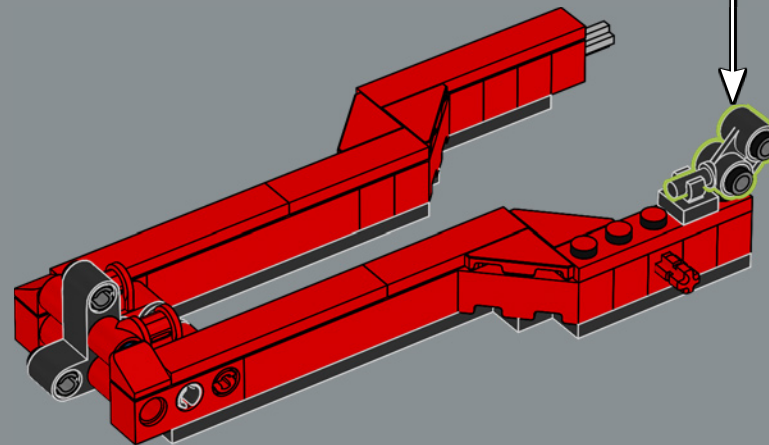
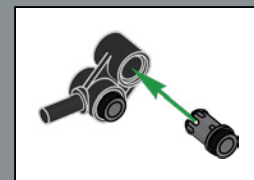

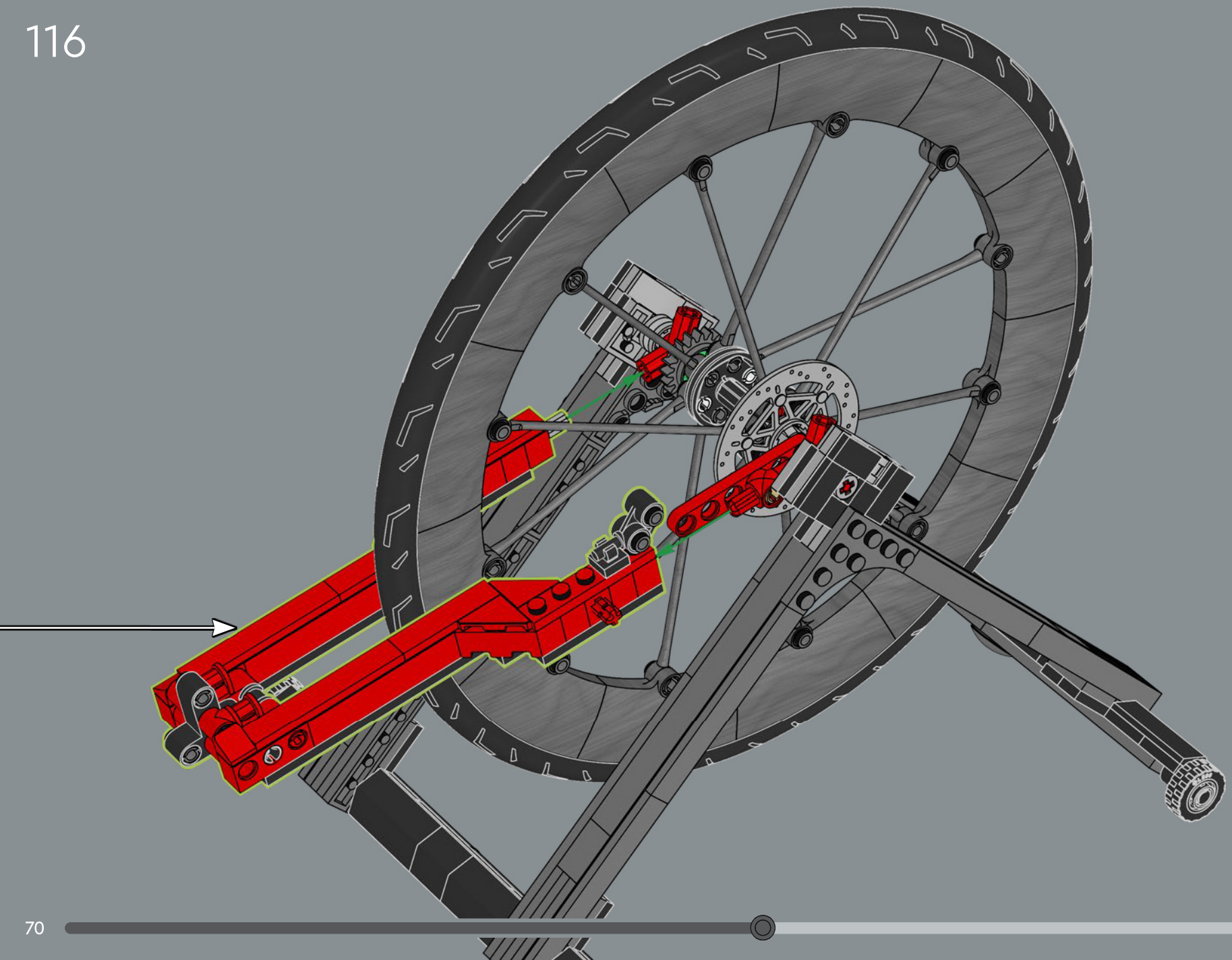

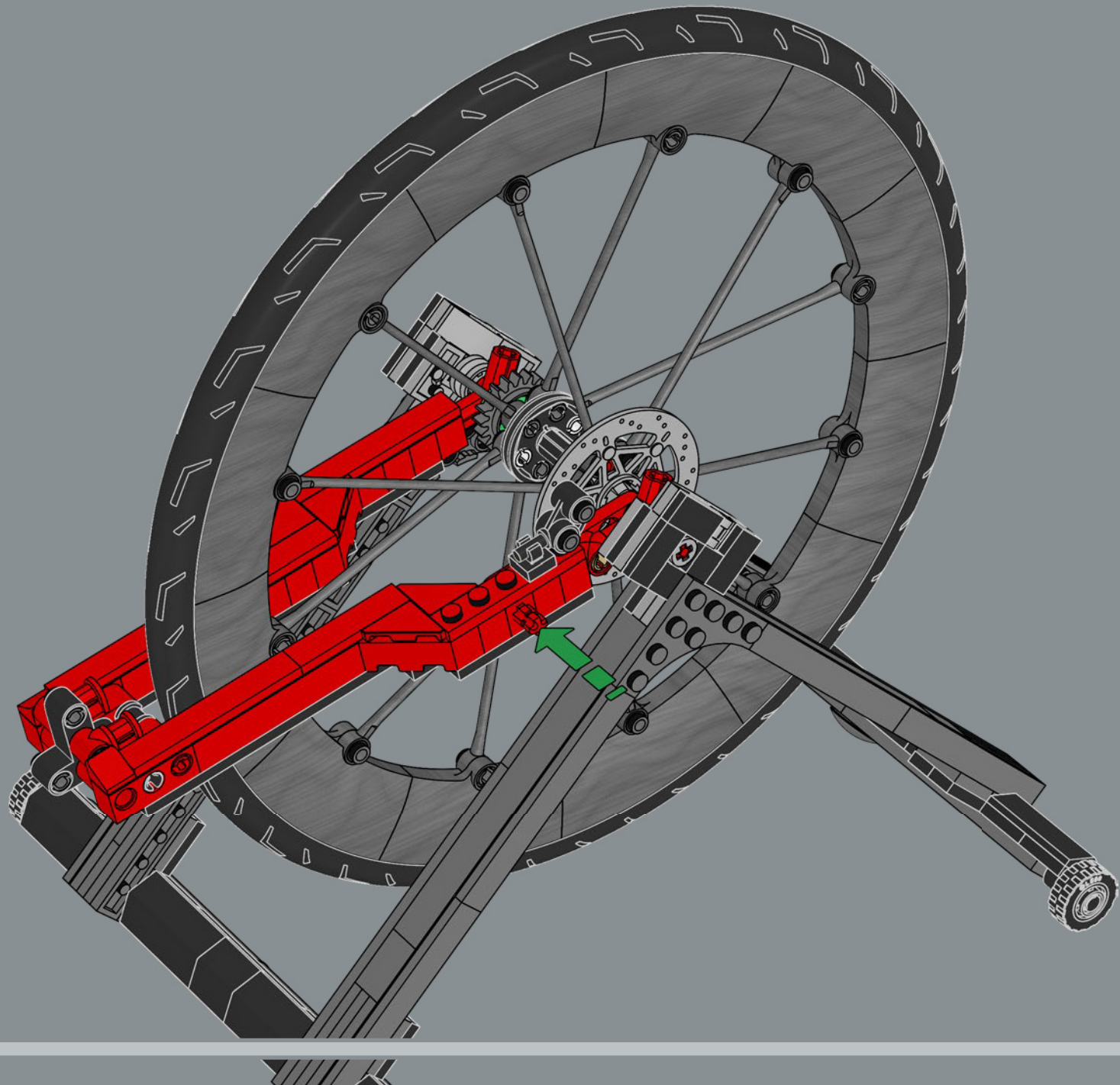

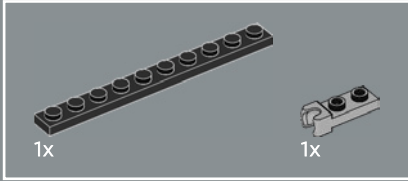
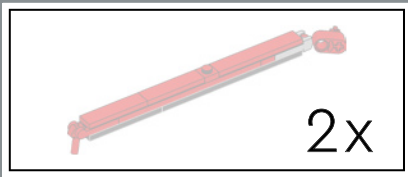

118

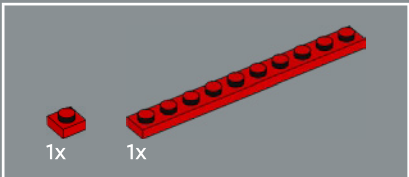
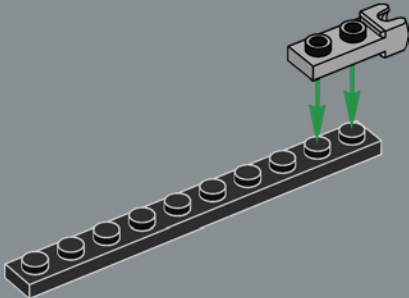

119

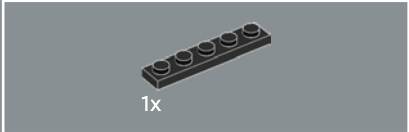
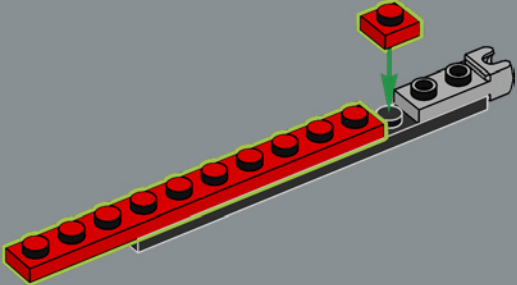

120

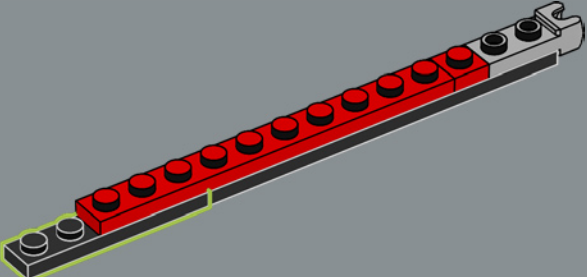

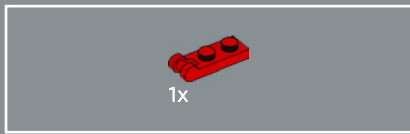

121

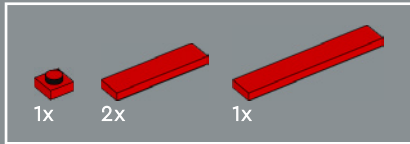
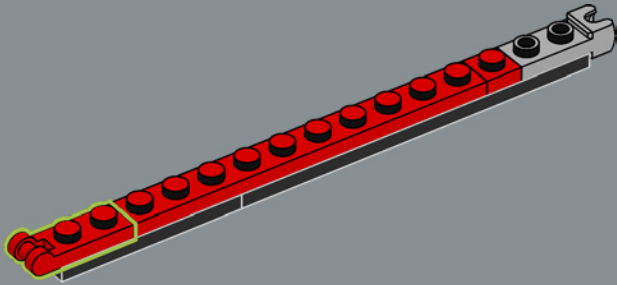

122

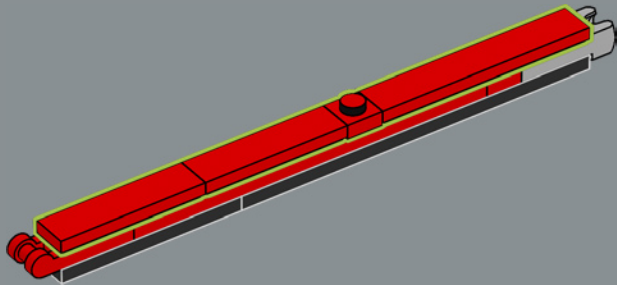

123

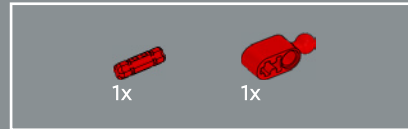
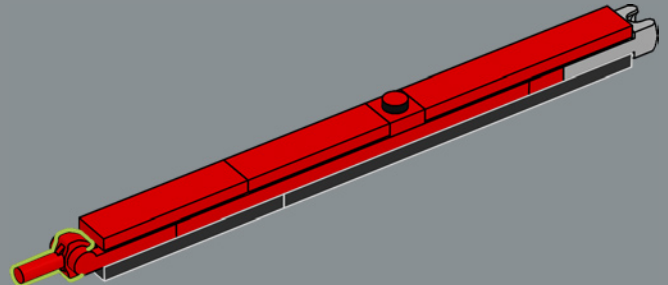

124

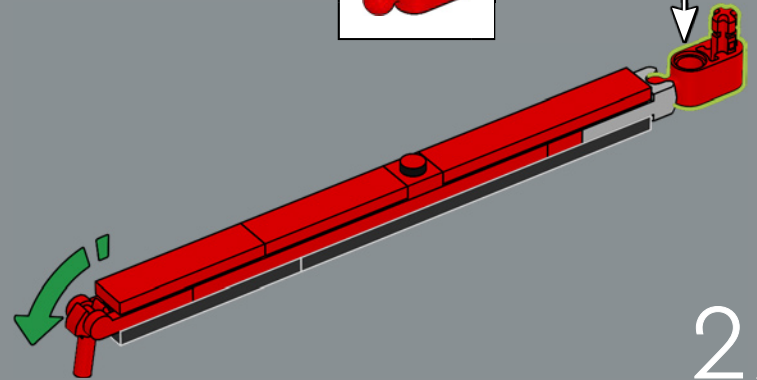
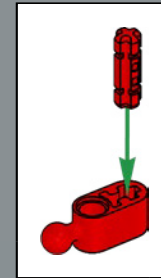

2x

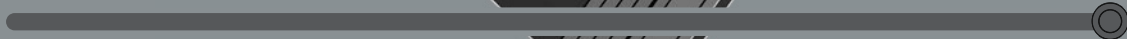
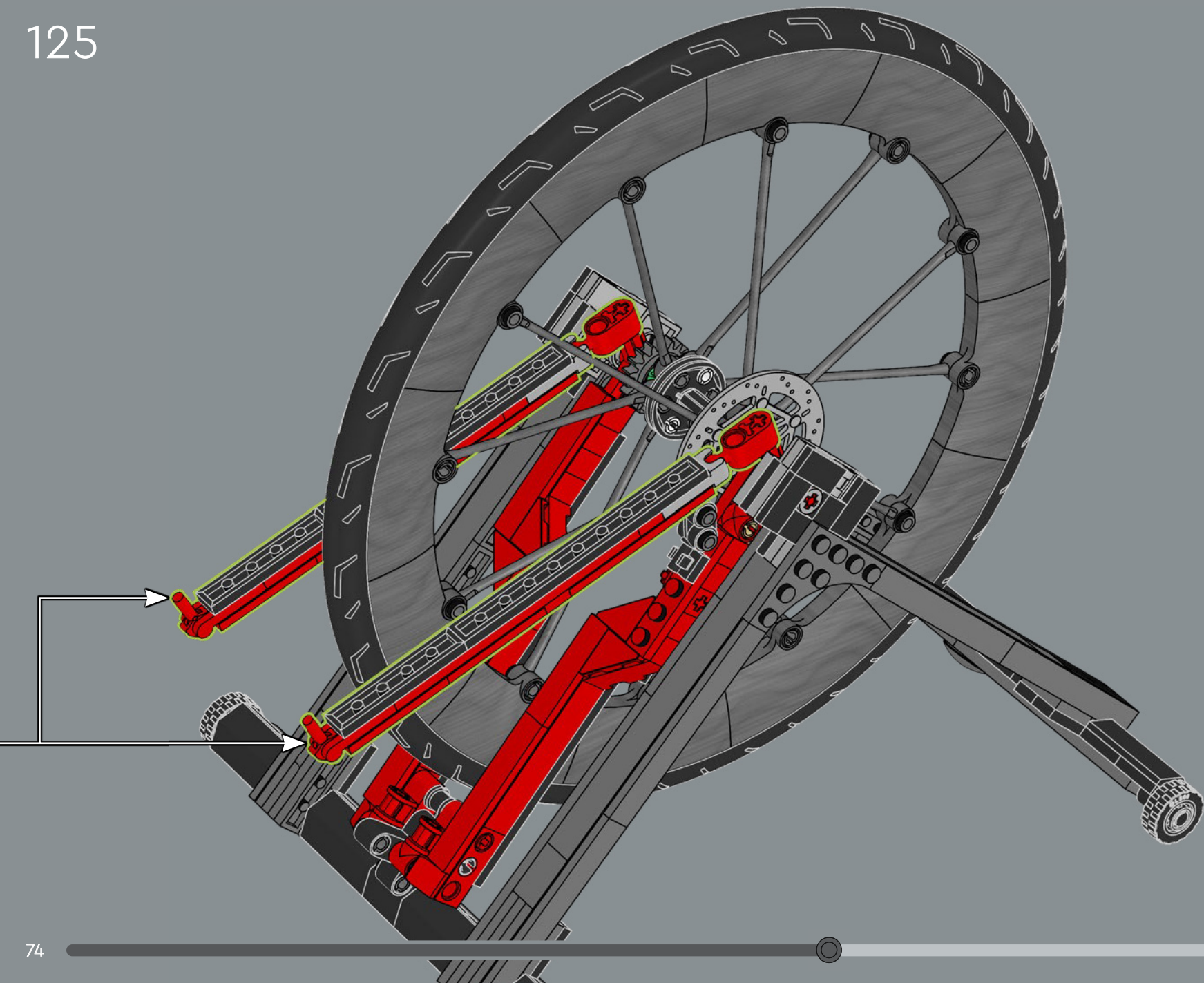

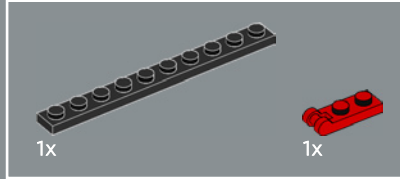
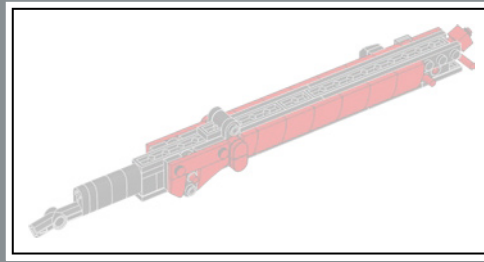

126

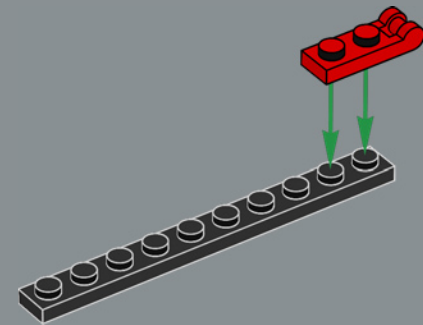

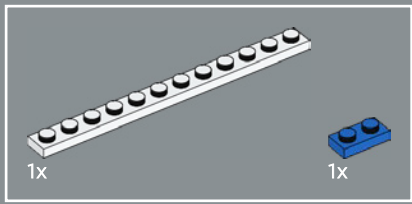

127

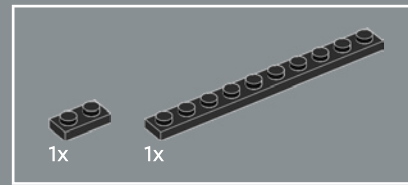
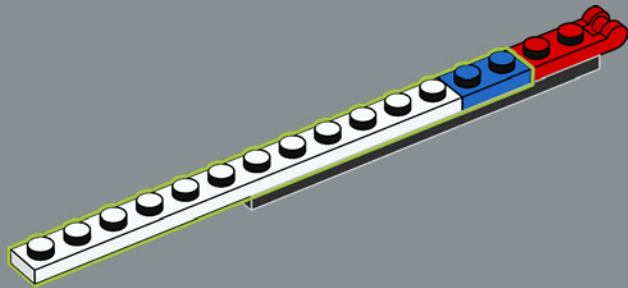

128

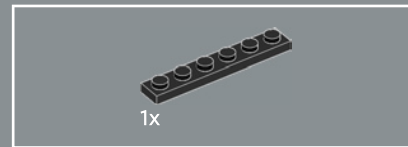
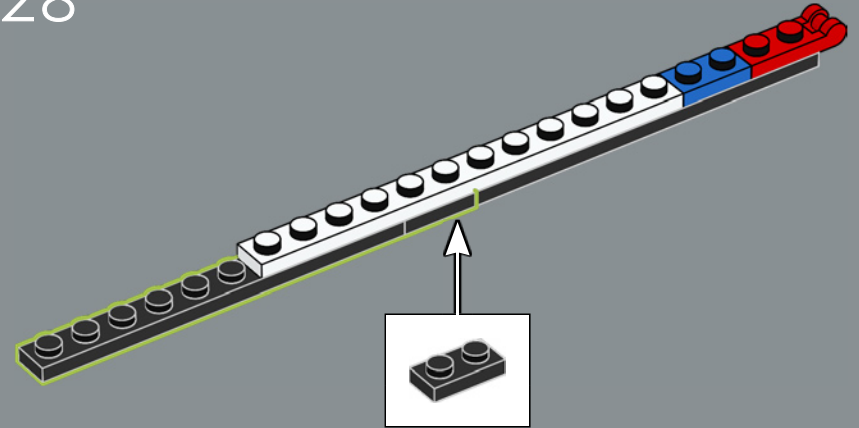

129

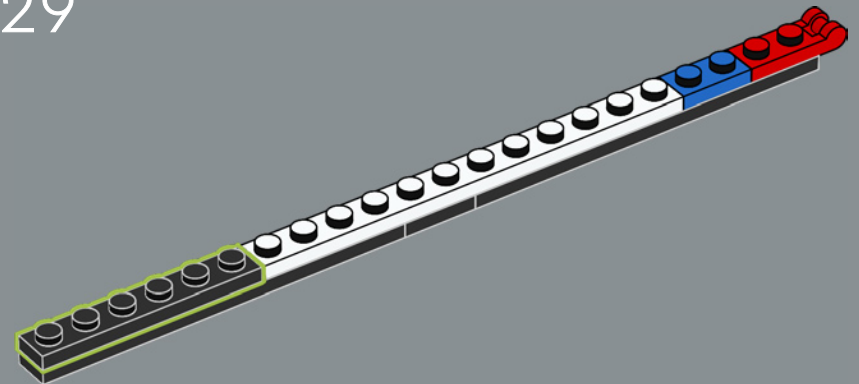

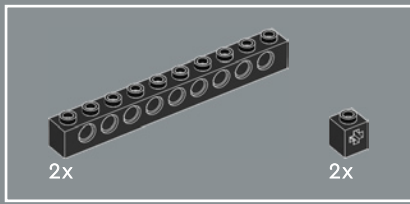

130

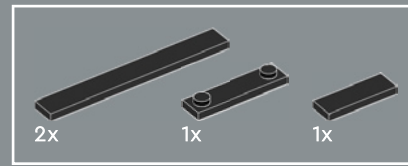
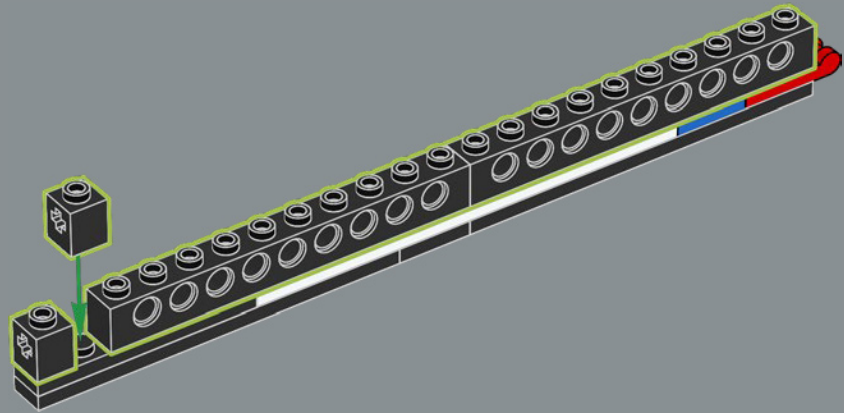

131

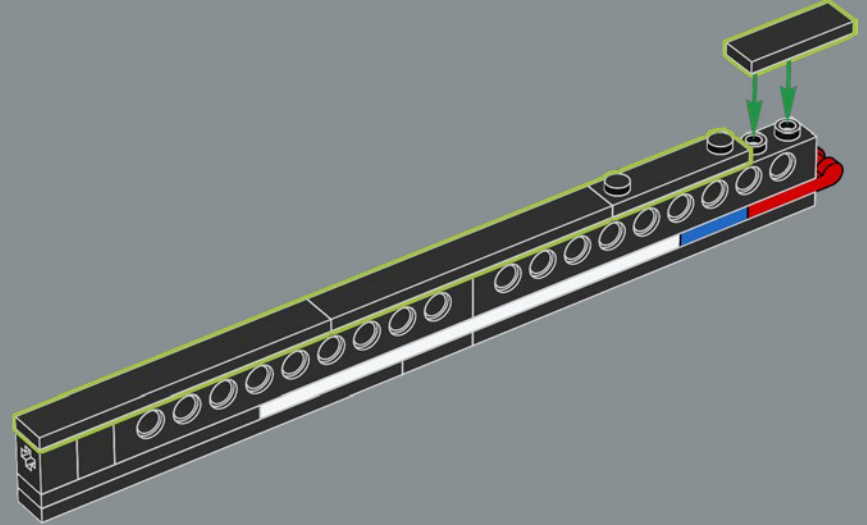

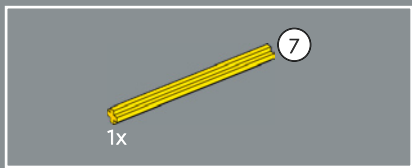

132

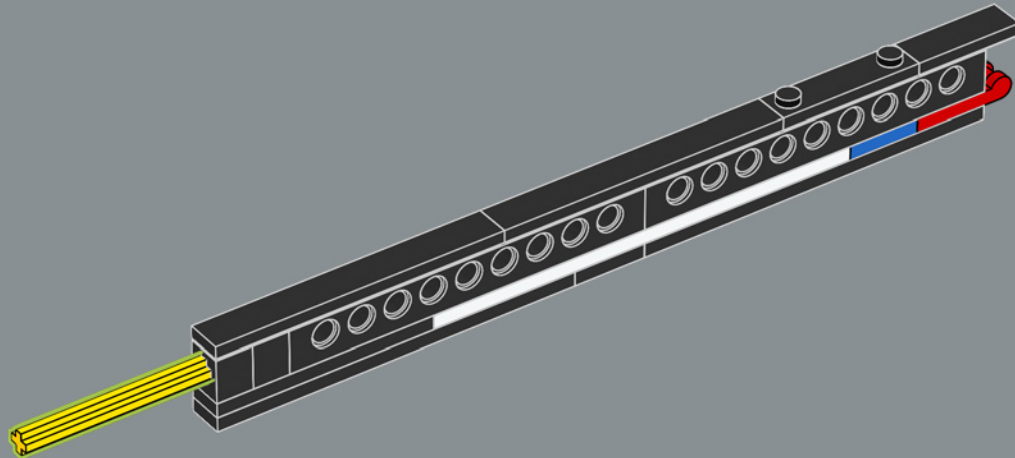

133

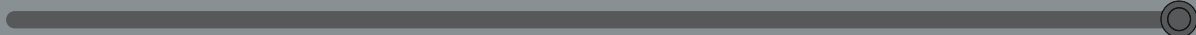
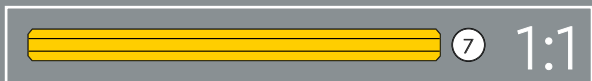
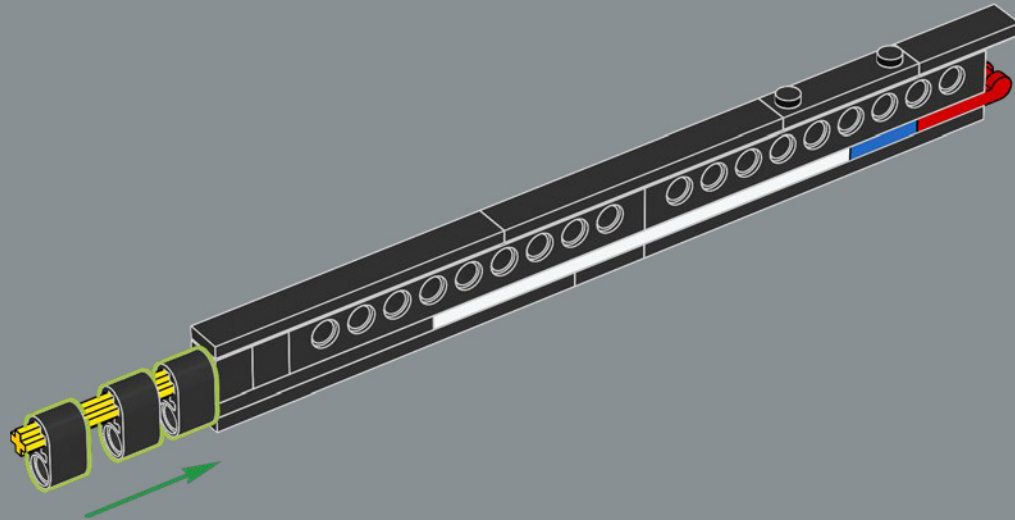



134

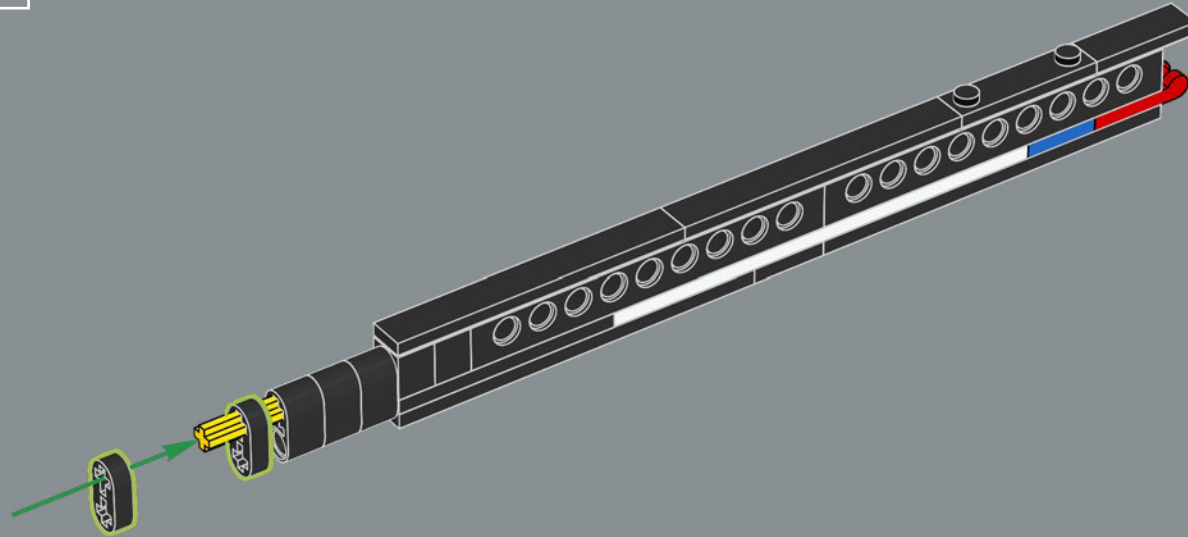

135

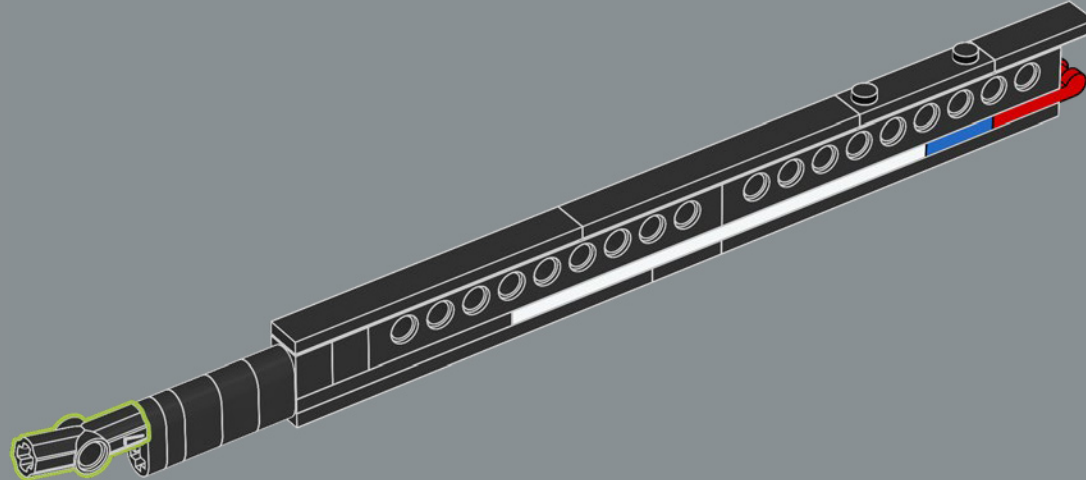

10x

136

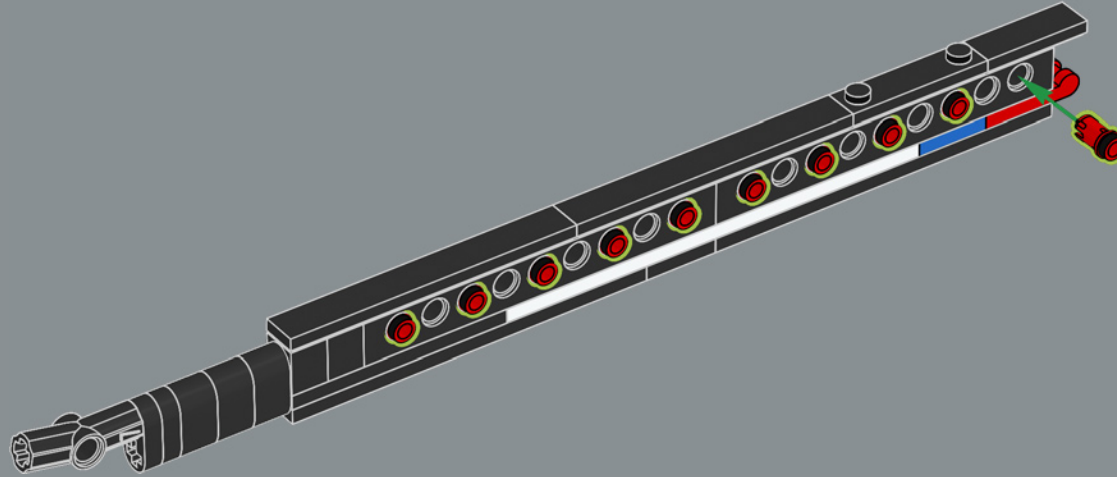

1x

137

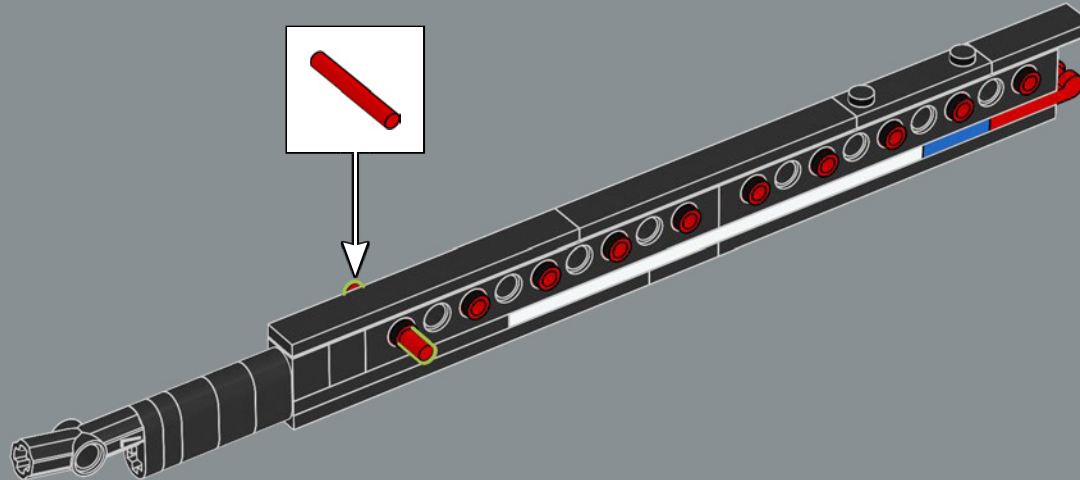
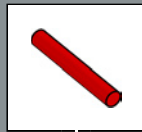



138

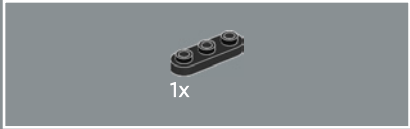
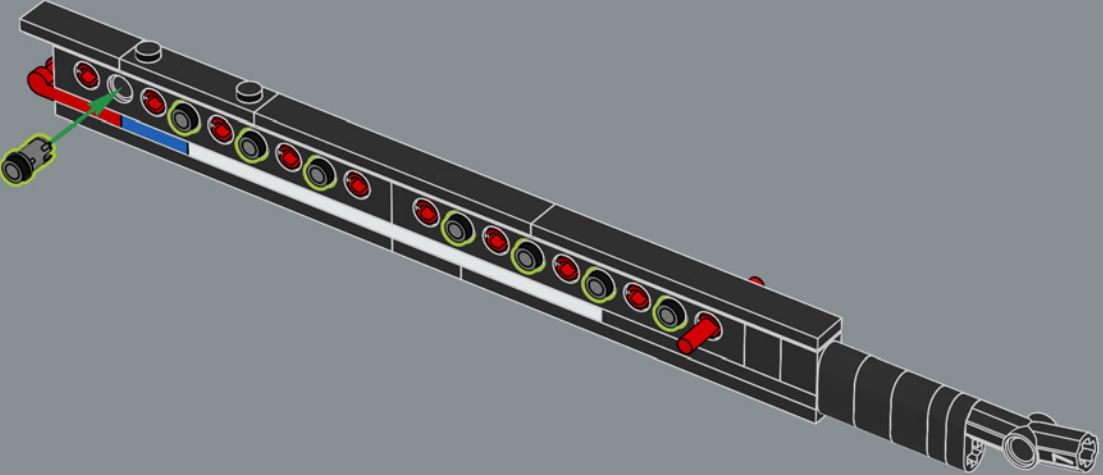

139

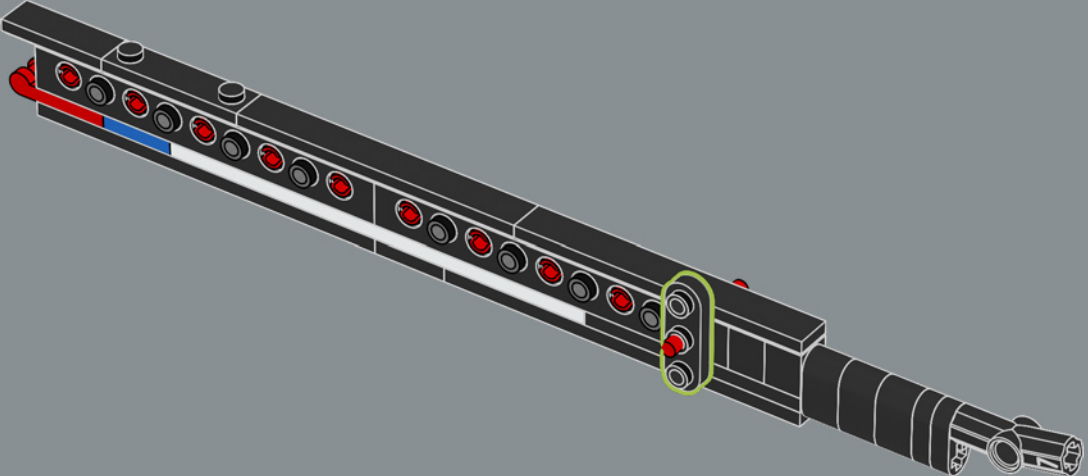

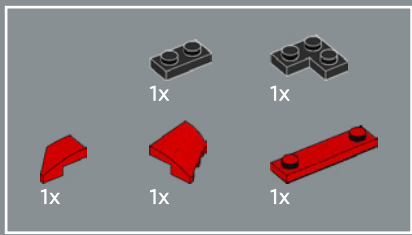

140

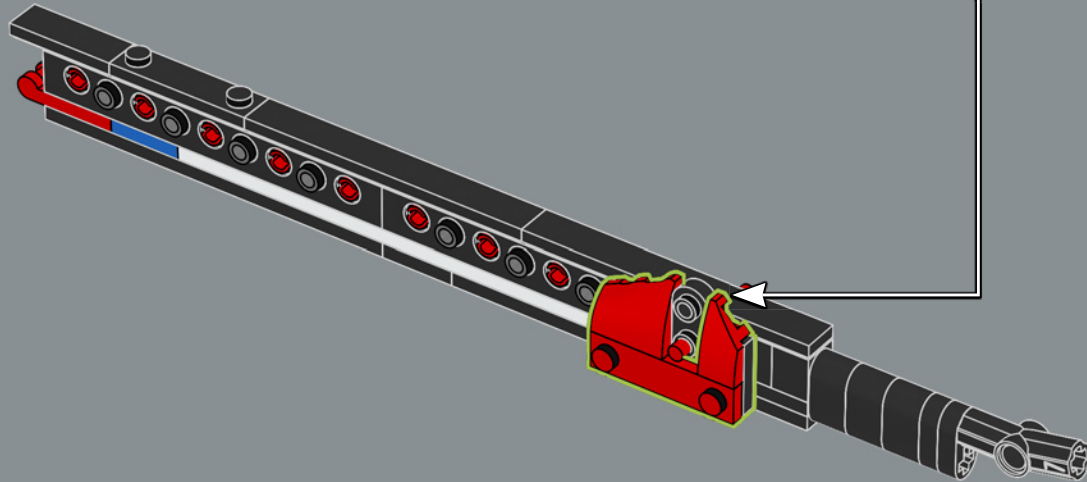
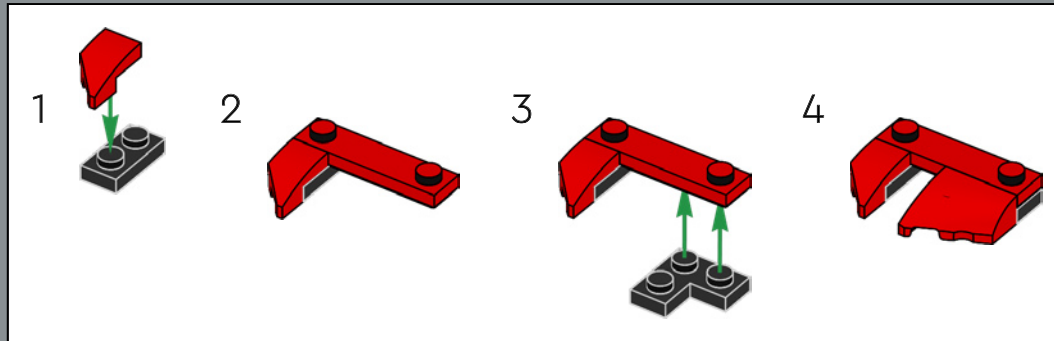



141

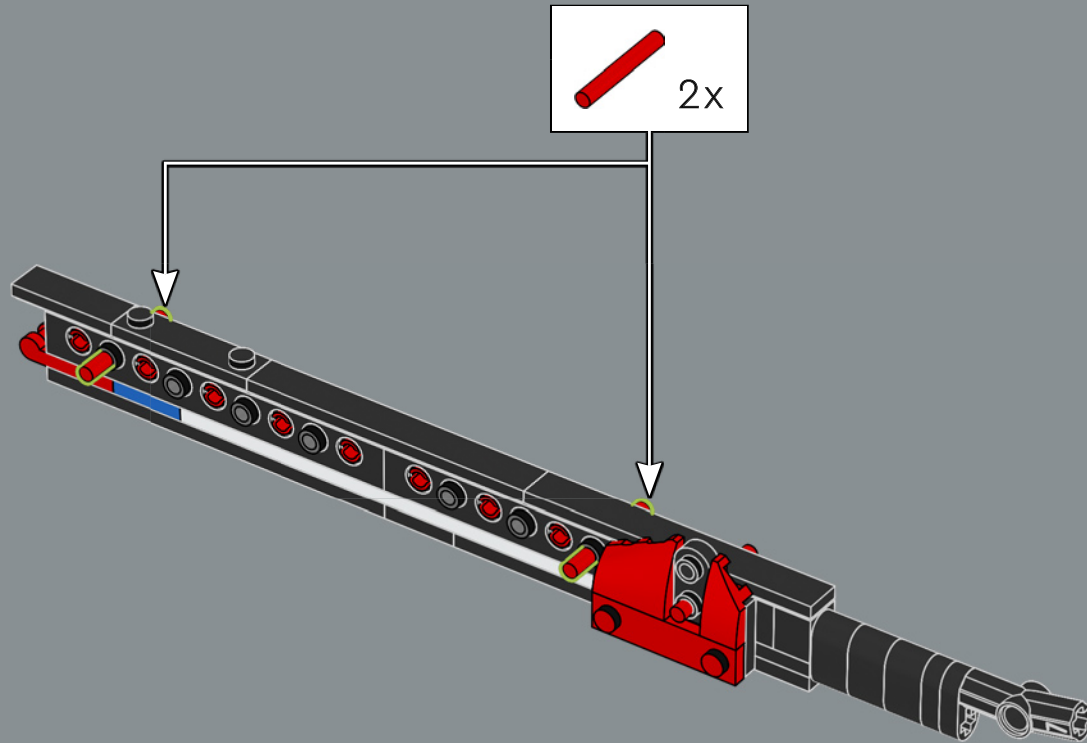

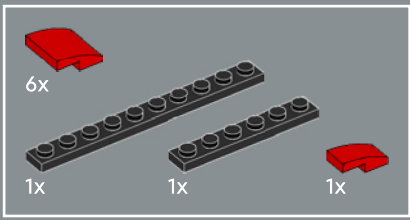

142

1

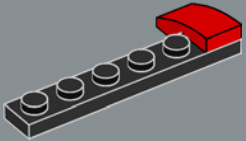

2

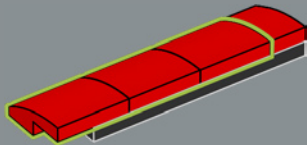

3

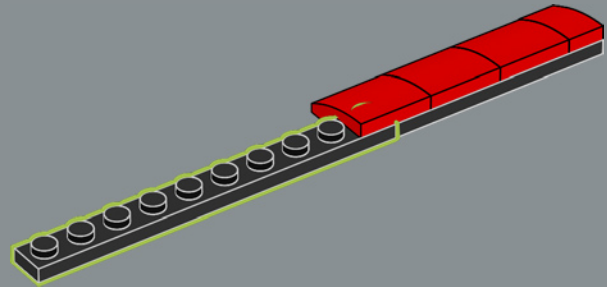

4

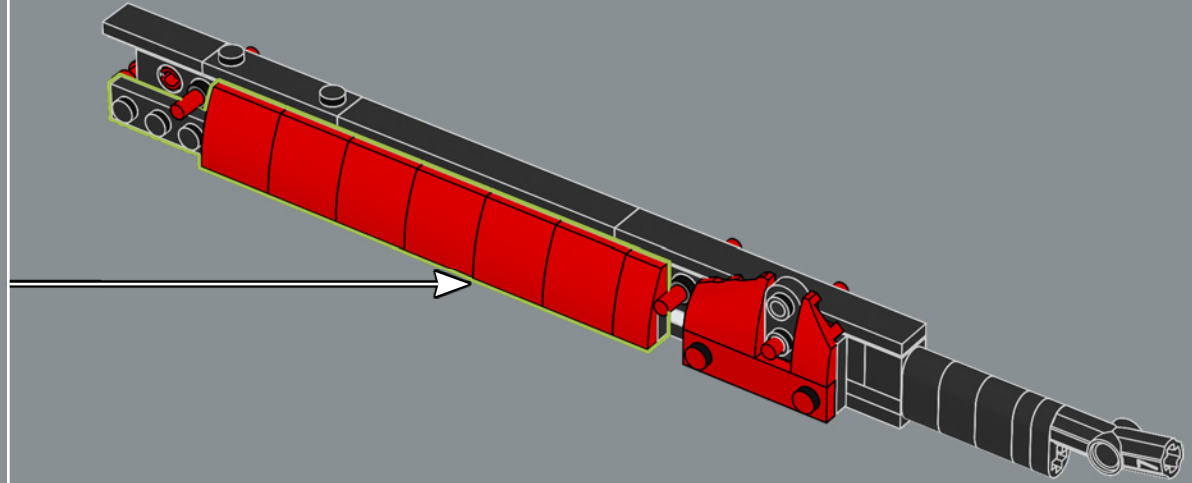
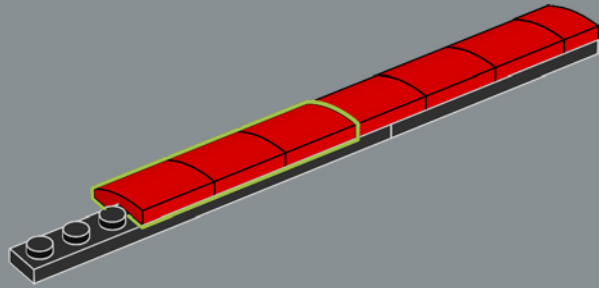

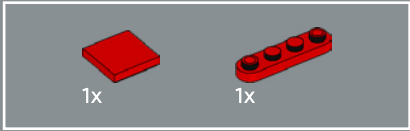
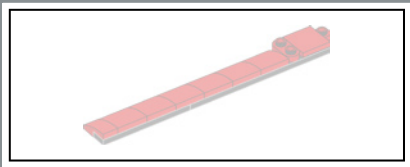

143

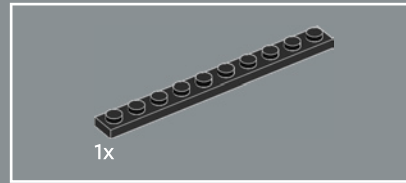
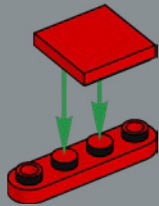

144

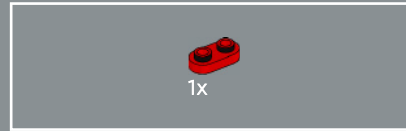
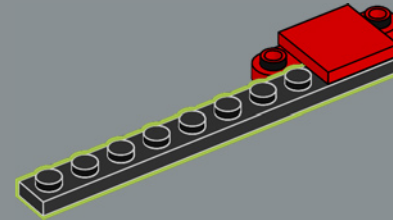

145

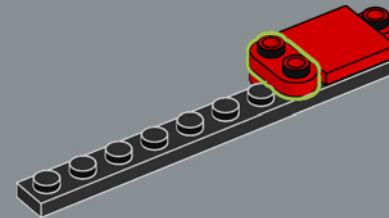

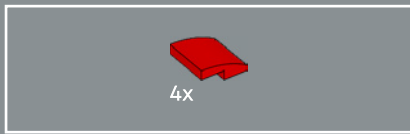

146

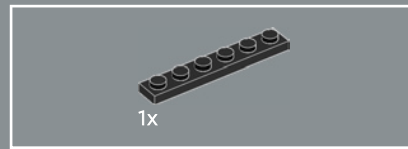
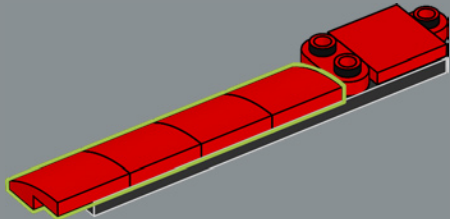

147

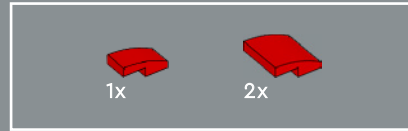
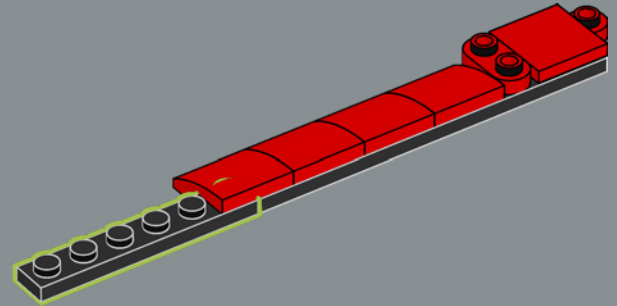

148

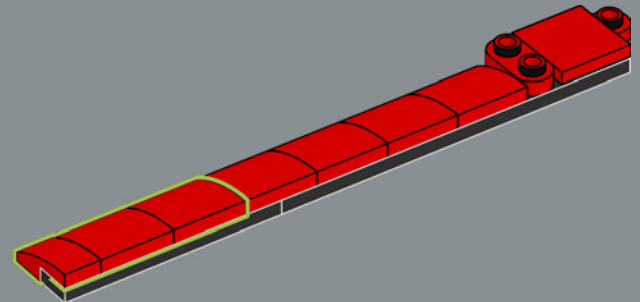

149

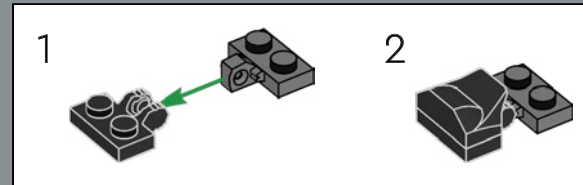
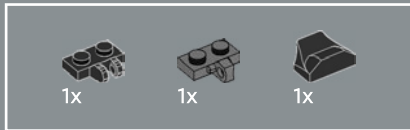
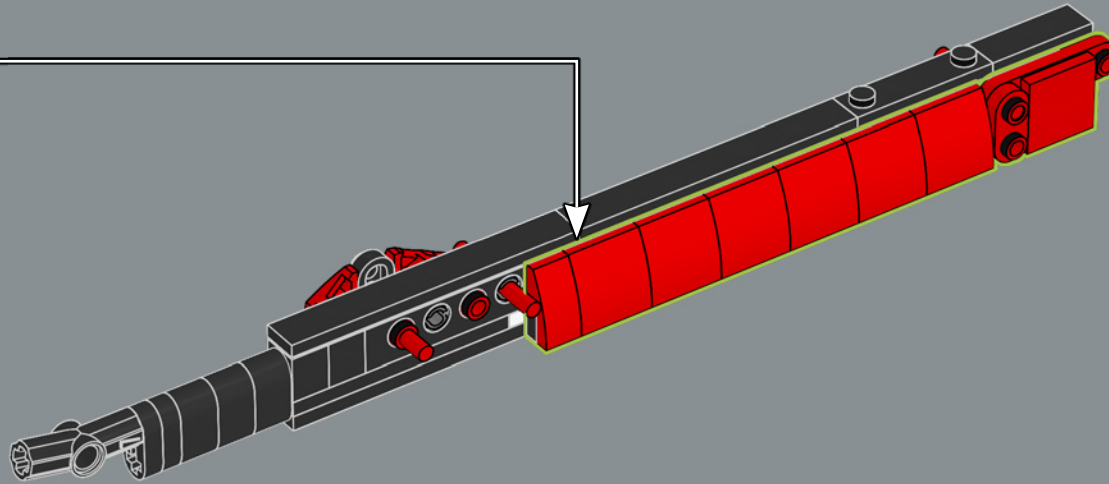

150

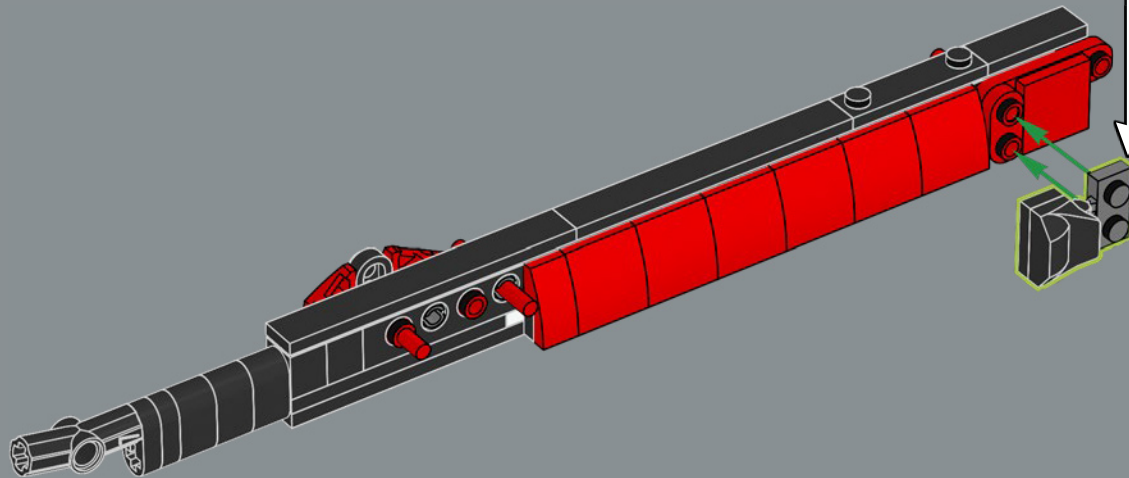



151

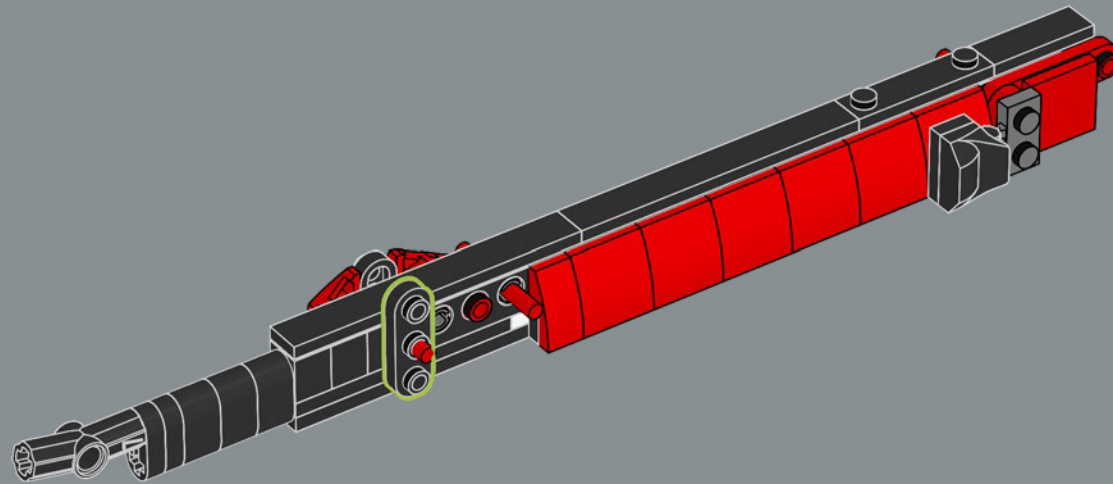

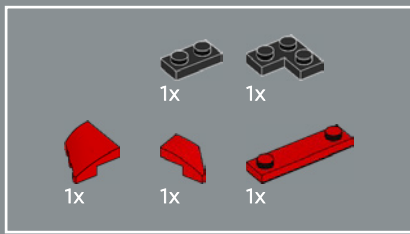

152

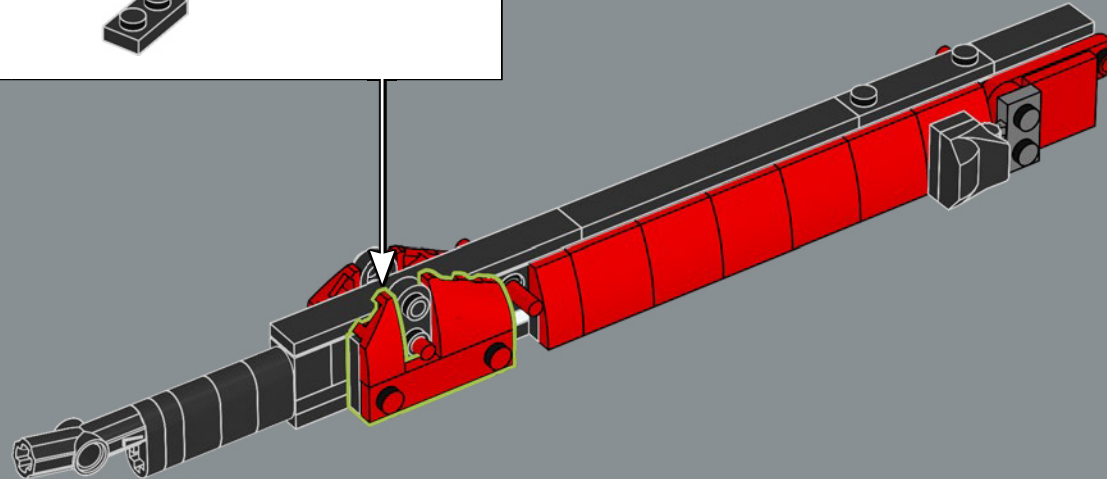
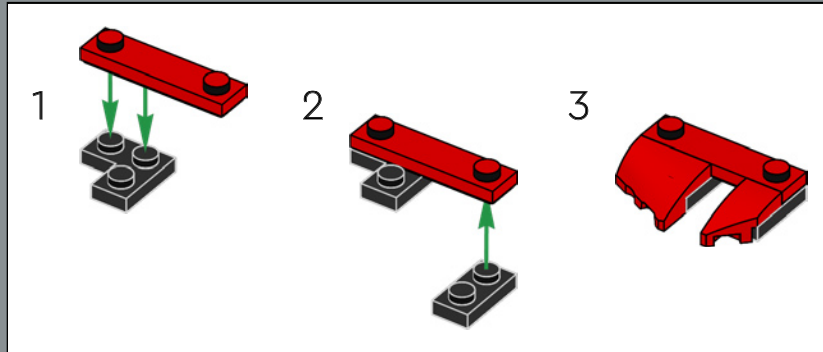

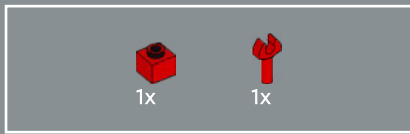

153

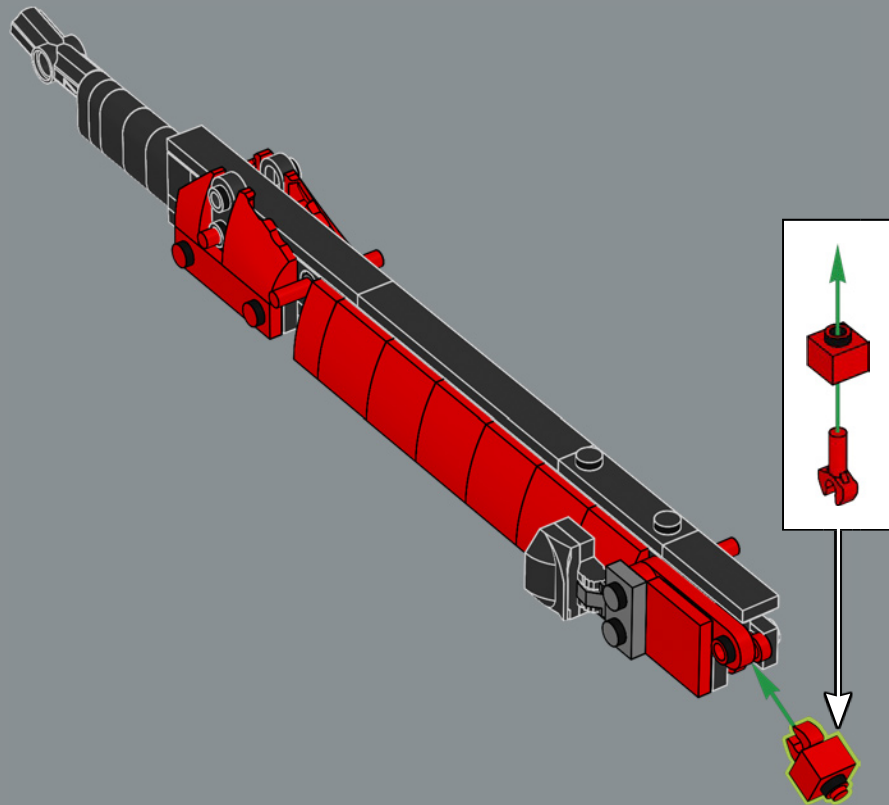

154

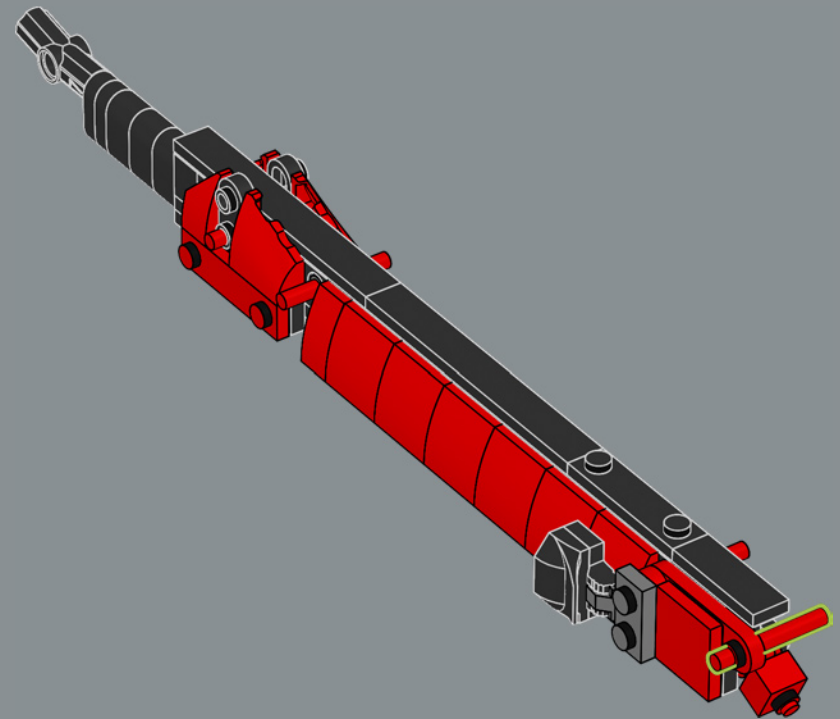



155

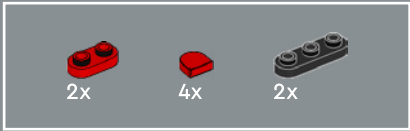
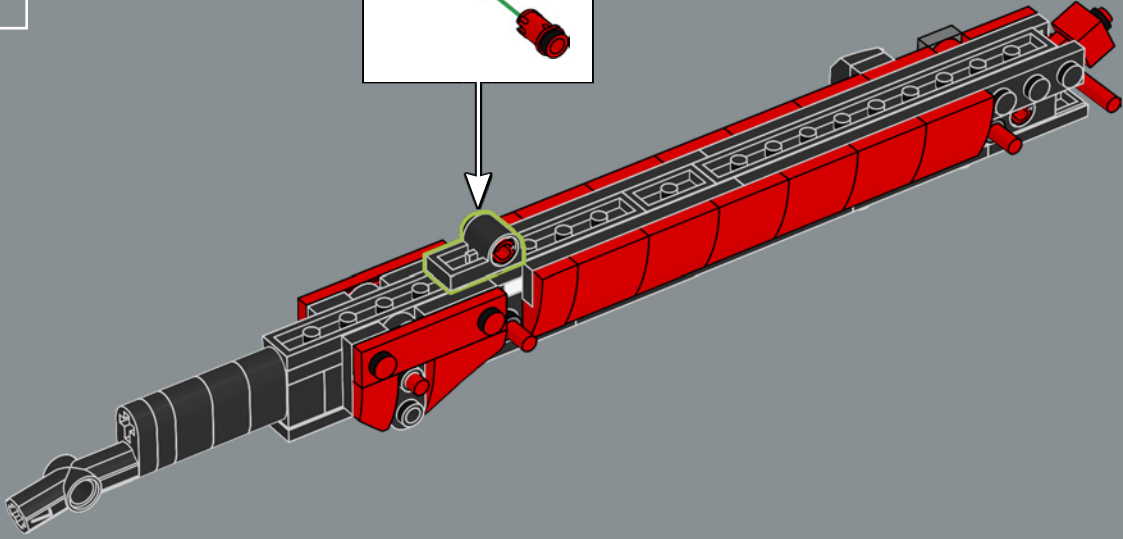
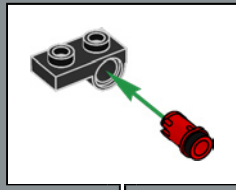

156

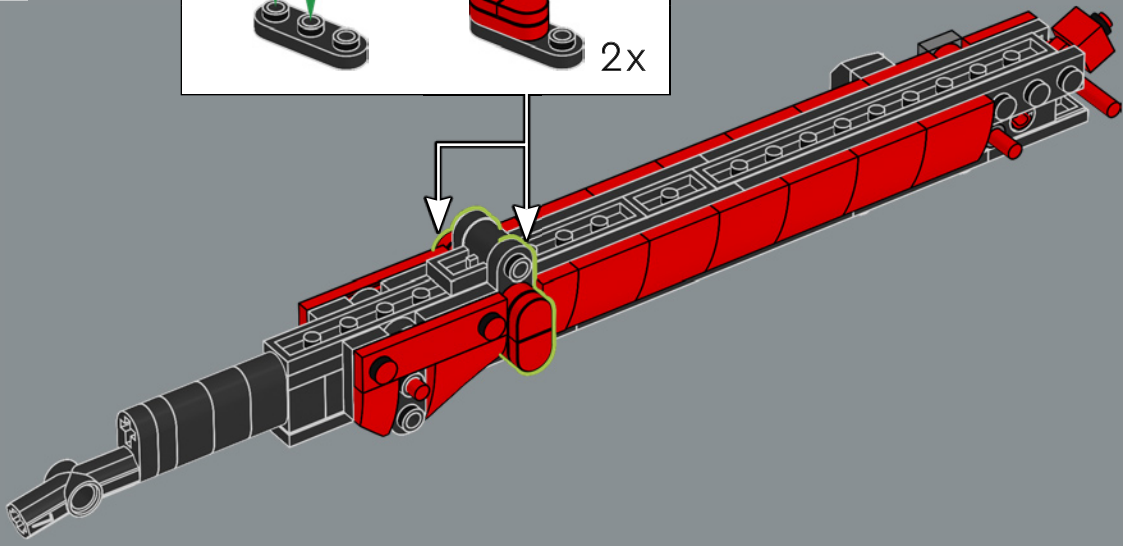
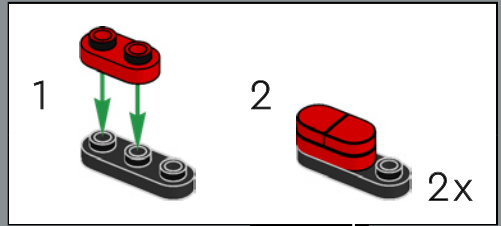

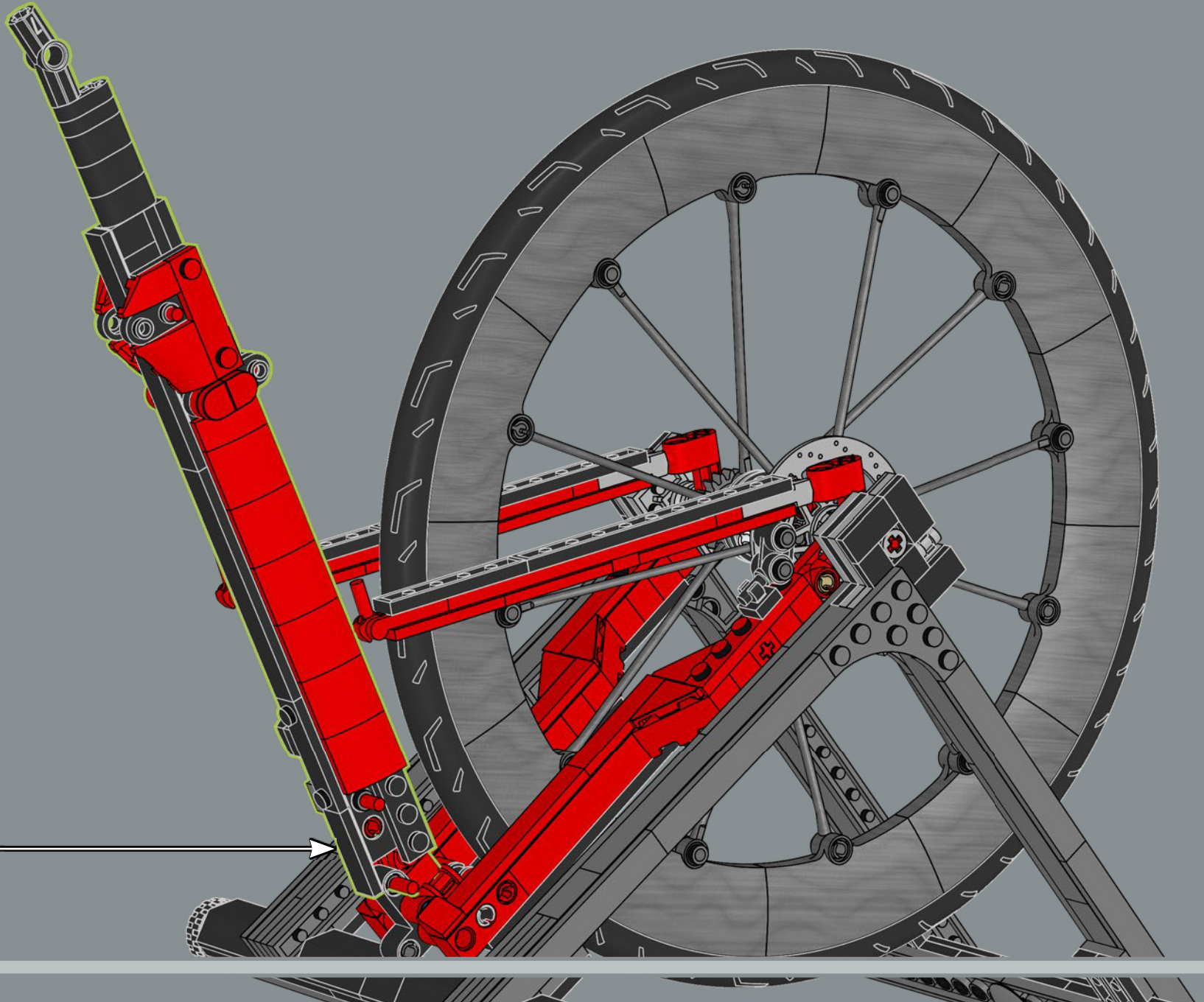



158

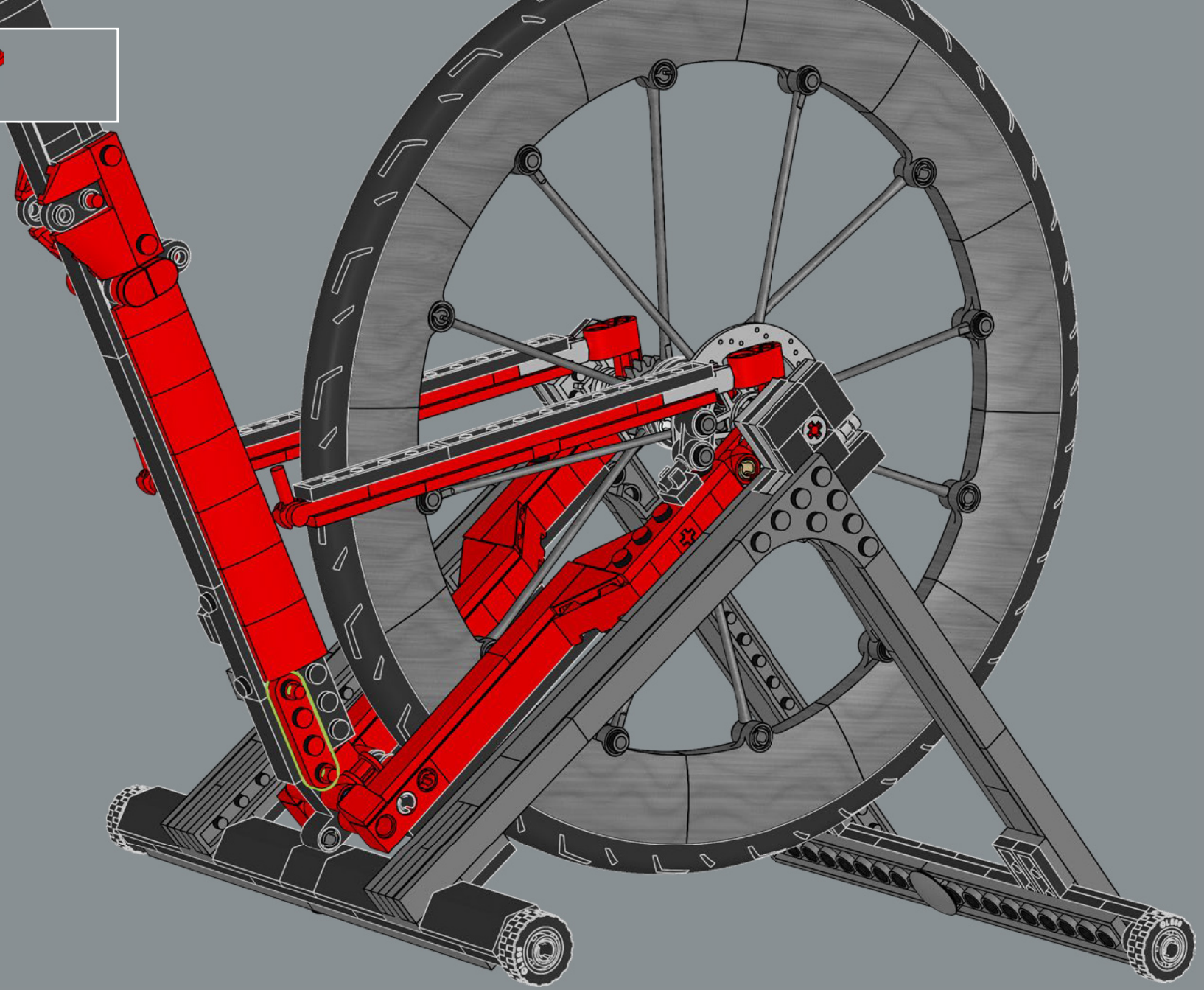



159

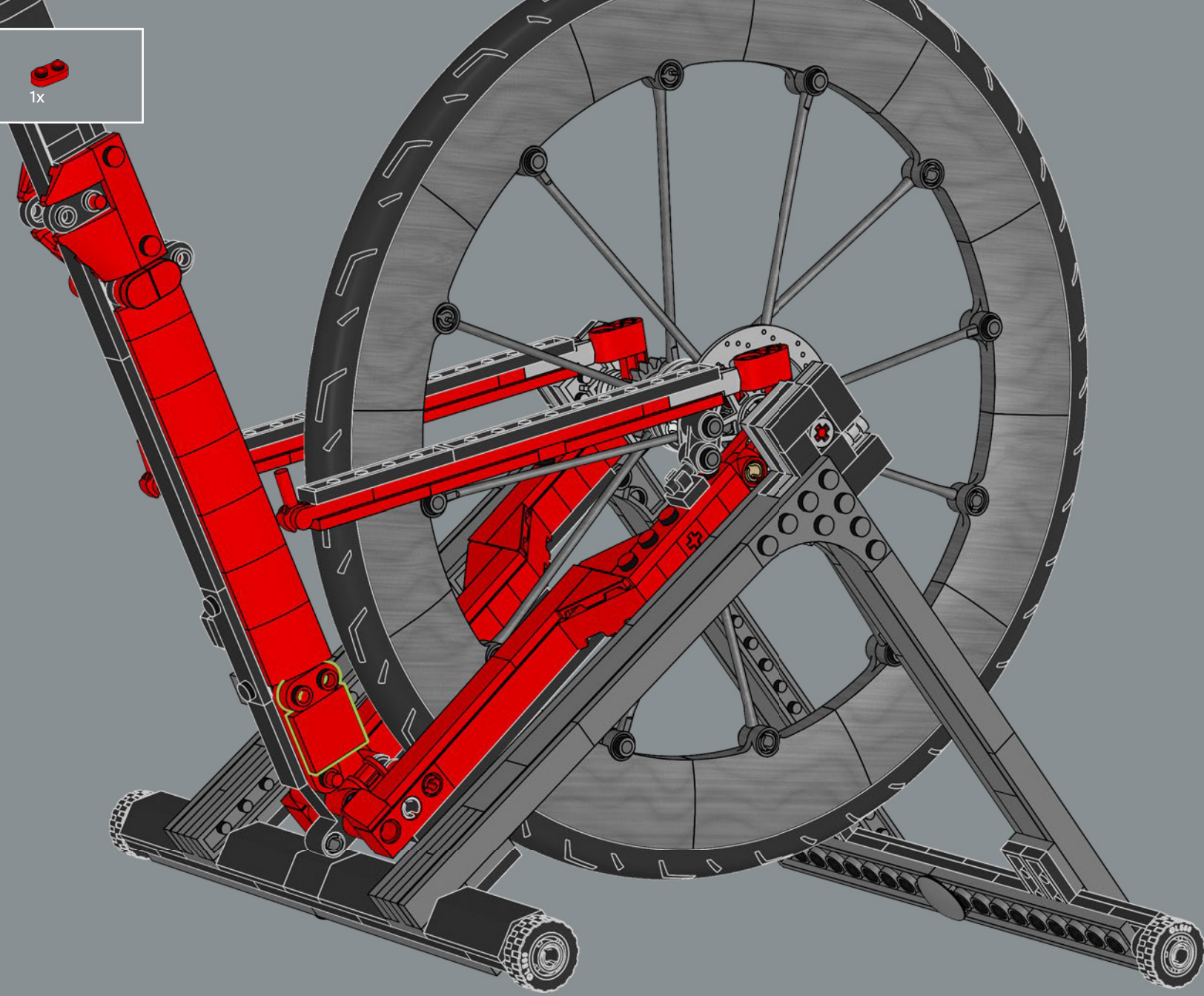

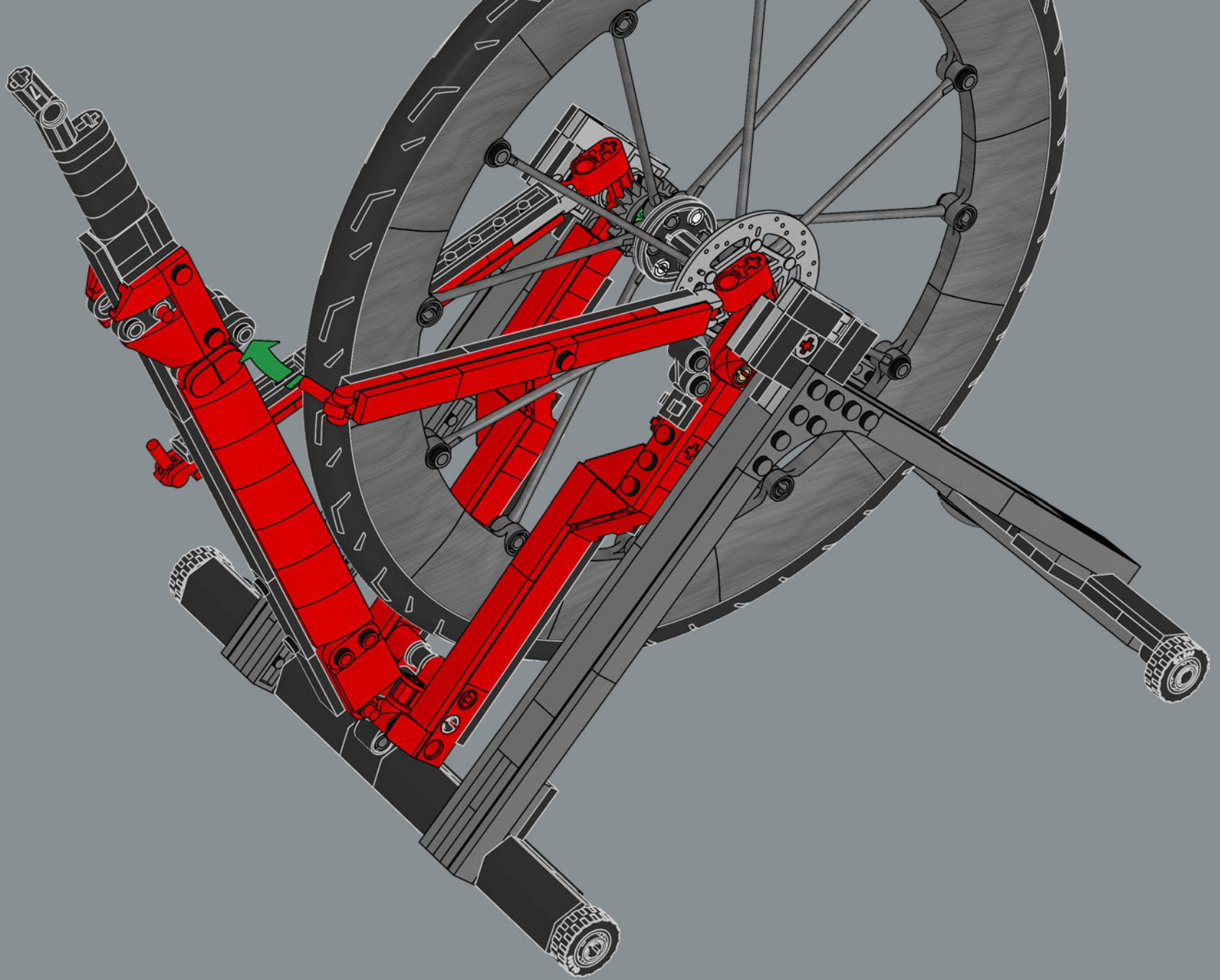

161

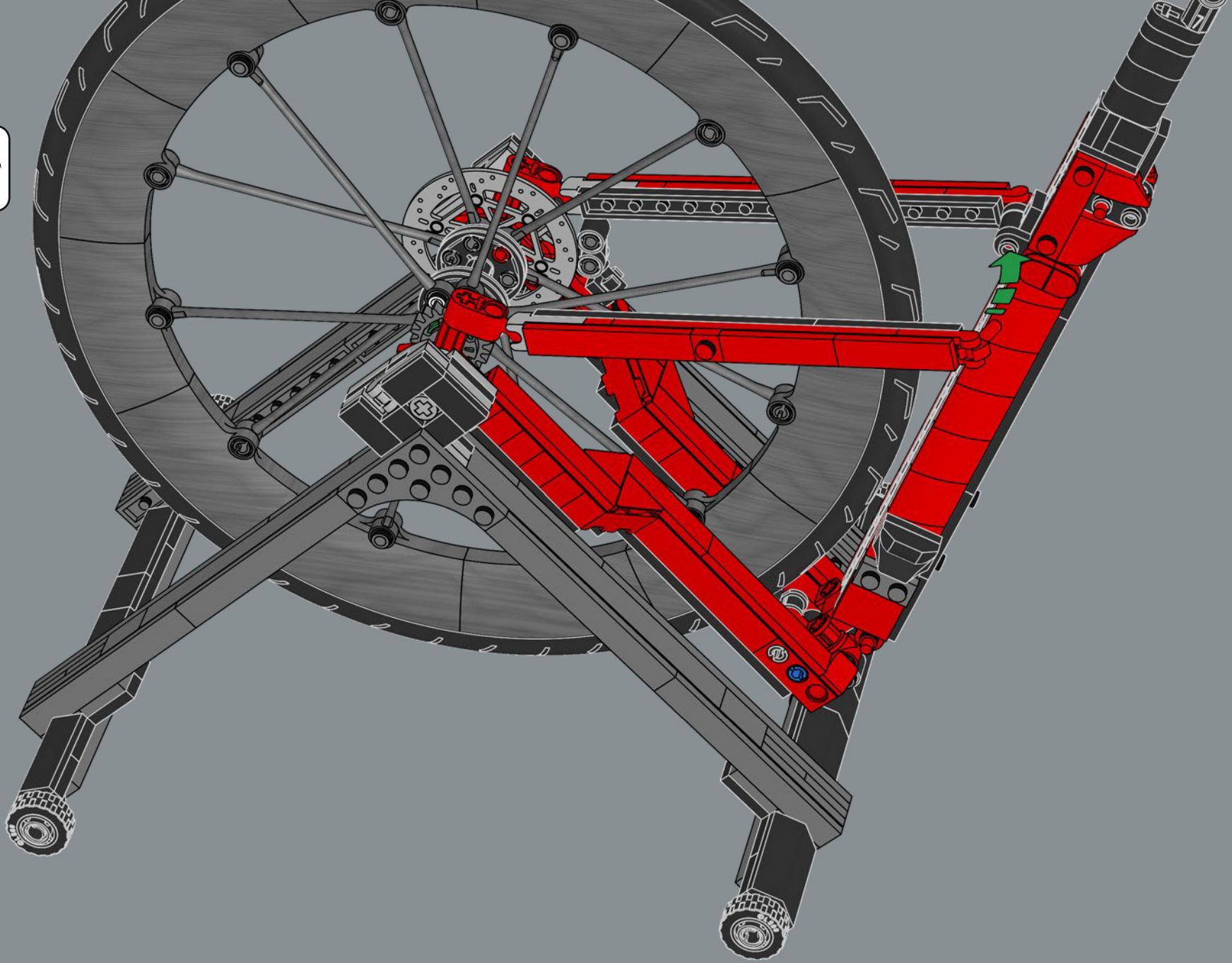

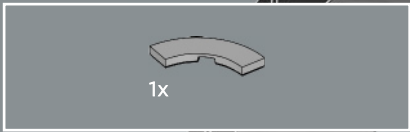

162

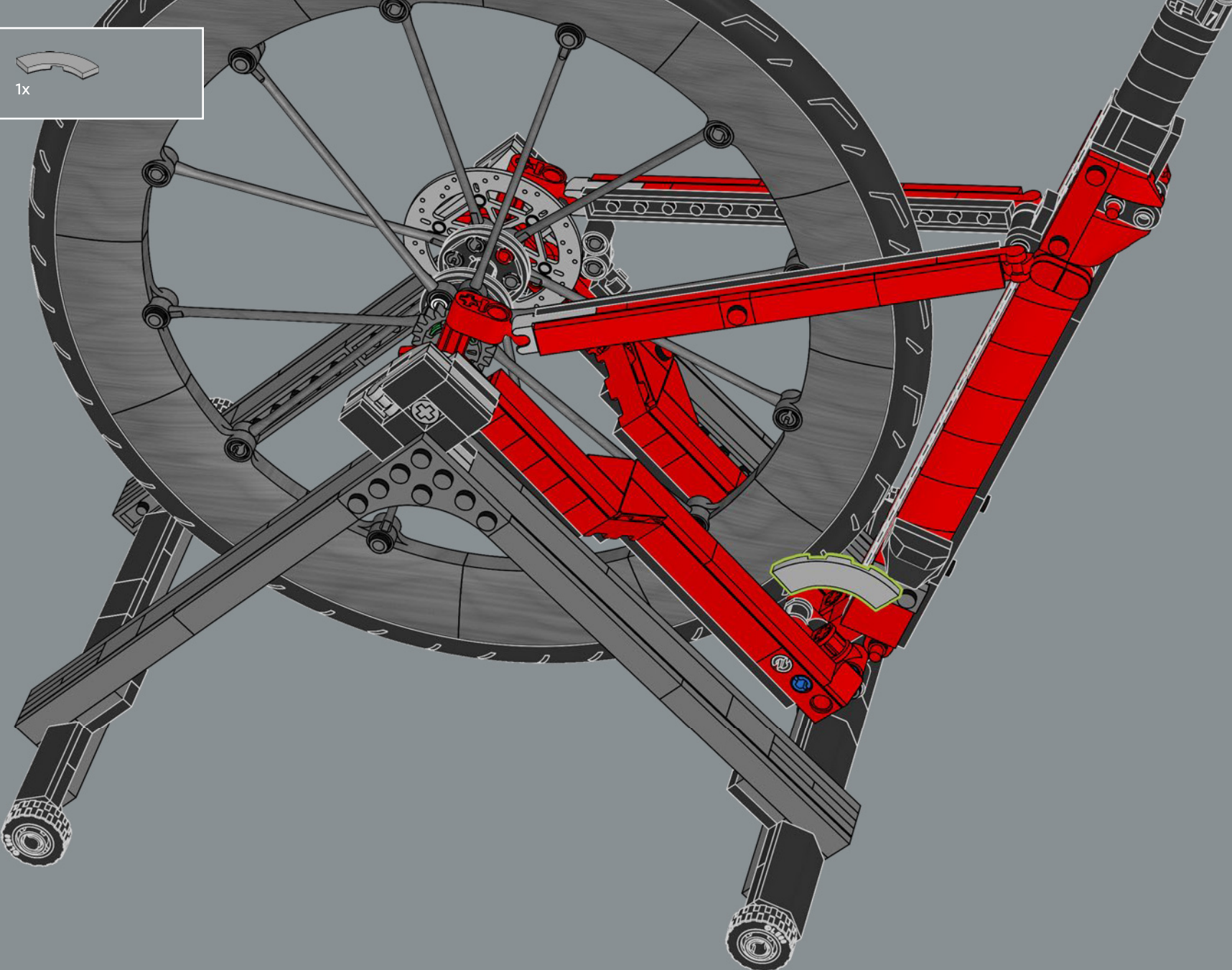

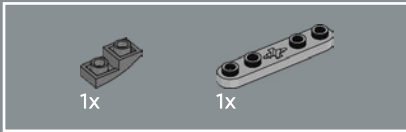
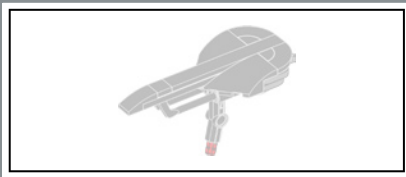

163

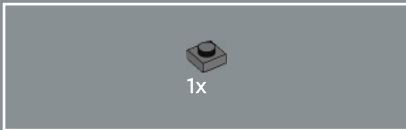
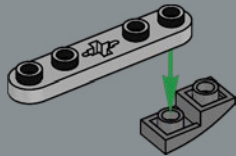

164

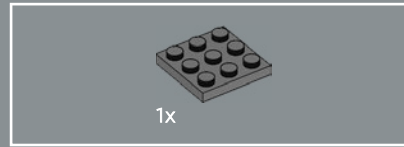
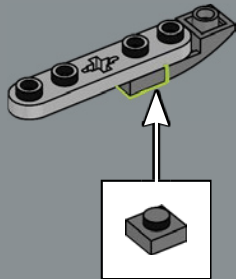

165

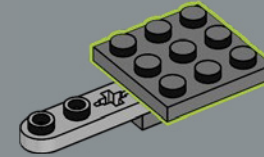

166

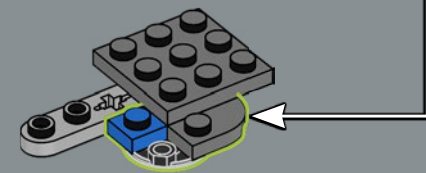
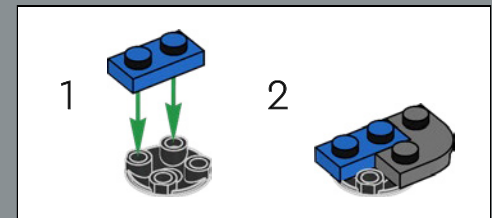

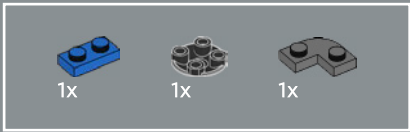

167

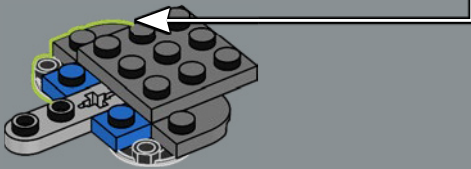
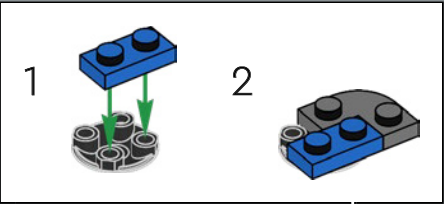

168

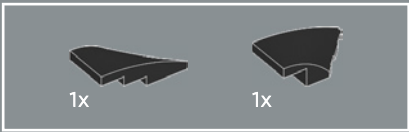
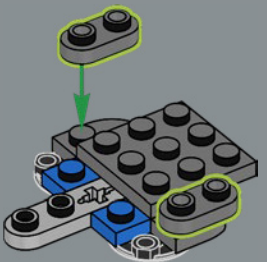

169

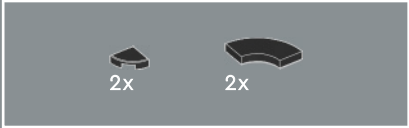
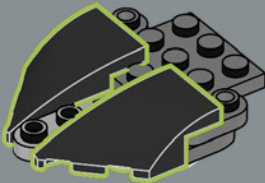

170

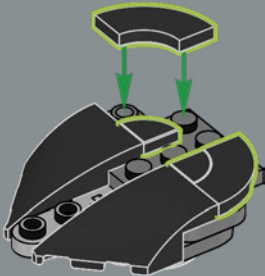

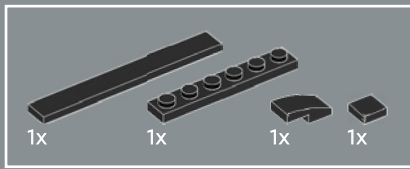

171

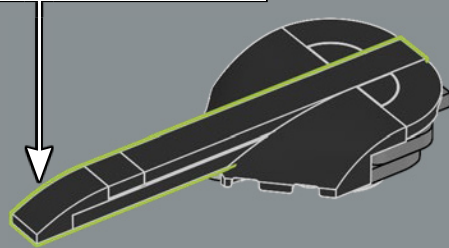
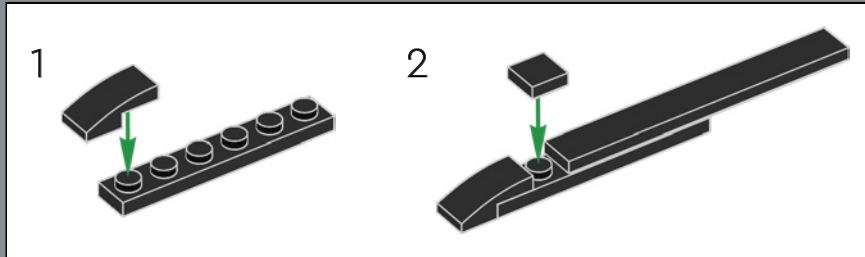

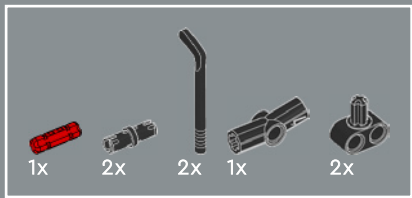

172

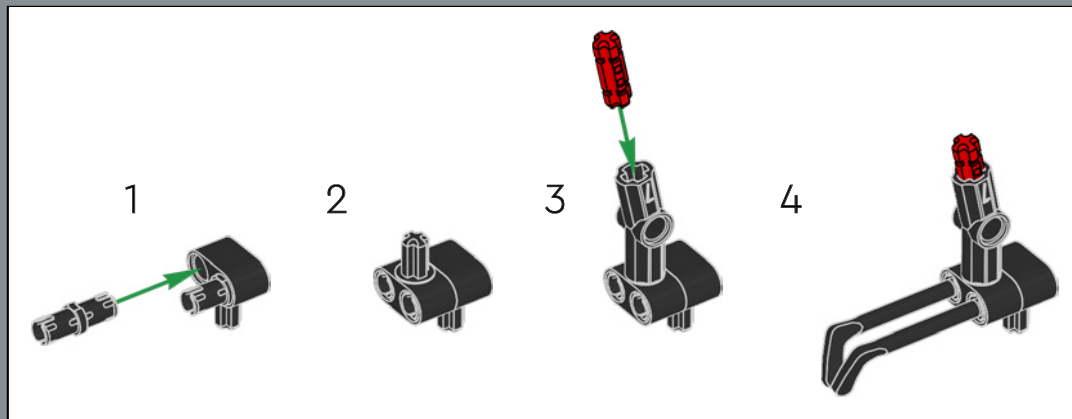

乐高®小人仔曲棍球杆被用来形成鞍座的护栏。

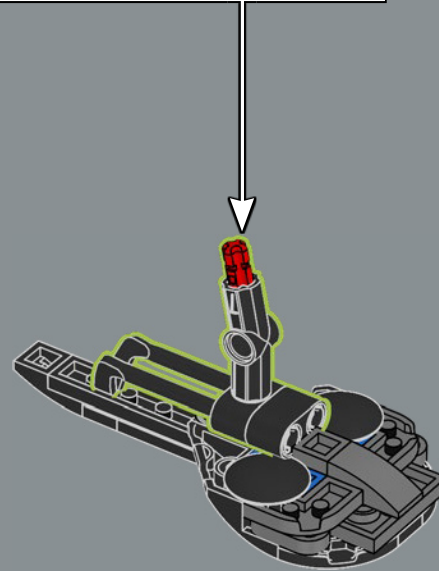

173

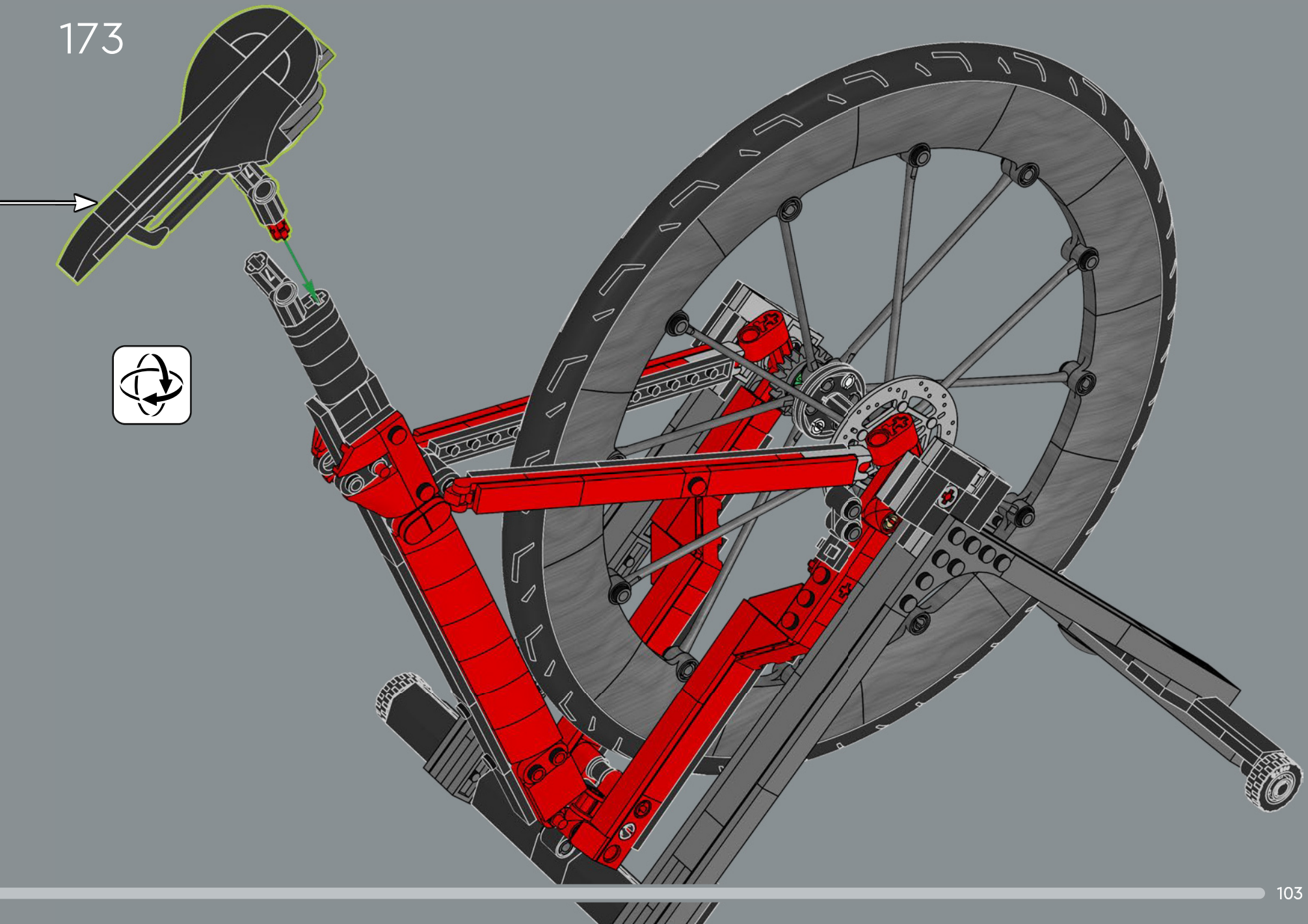

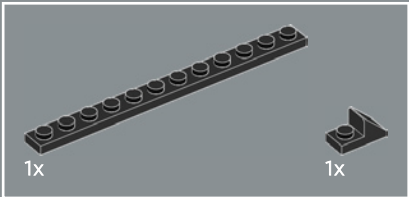
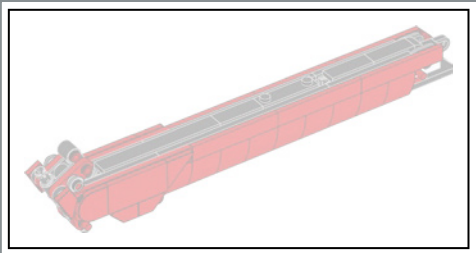

174

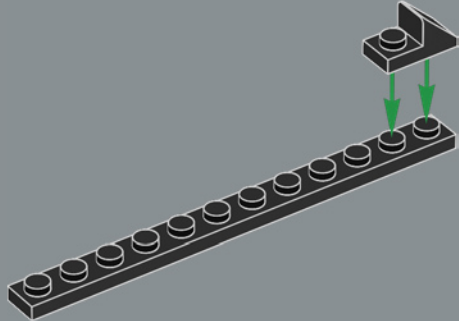

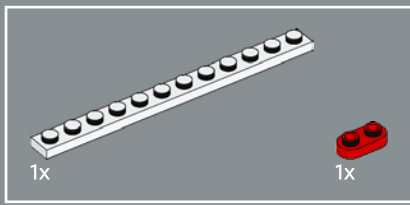

175

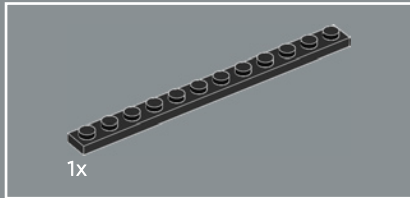
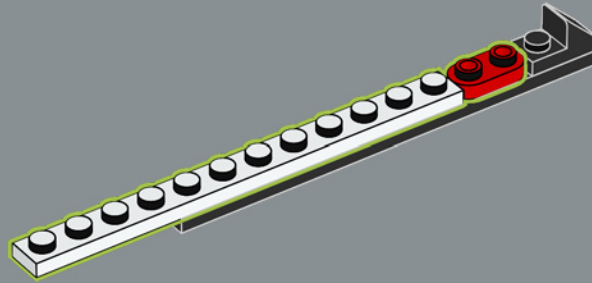

176

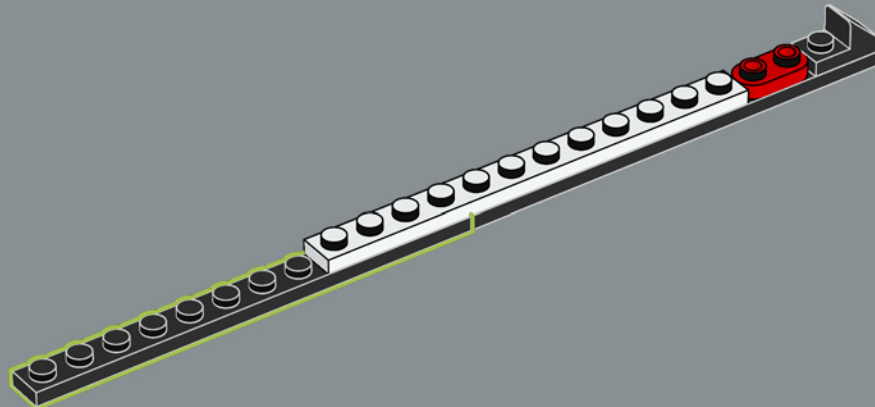

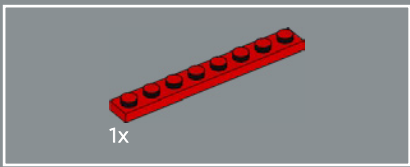

177

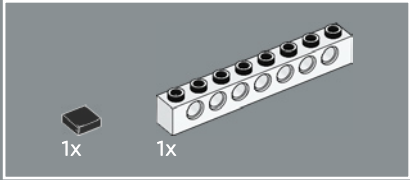
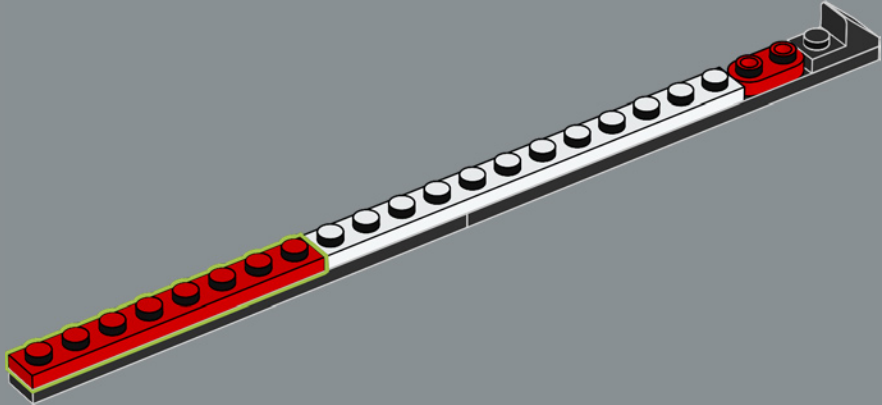

178

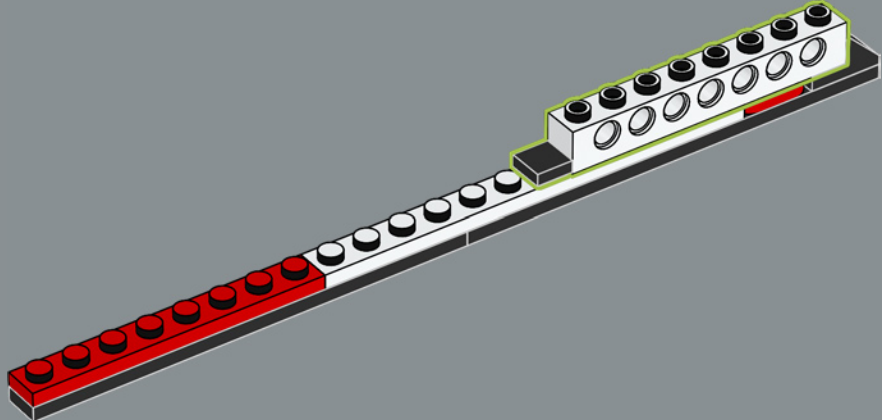

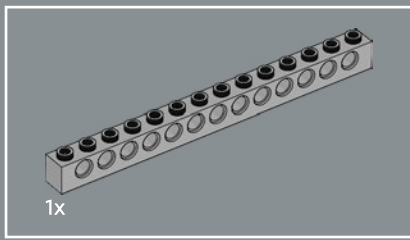

179

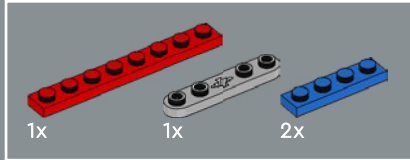
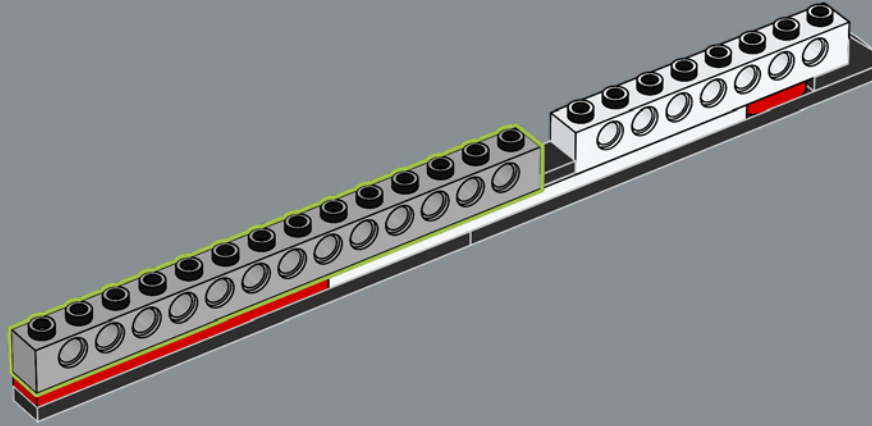

180

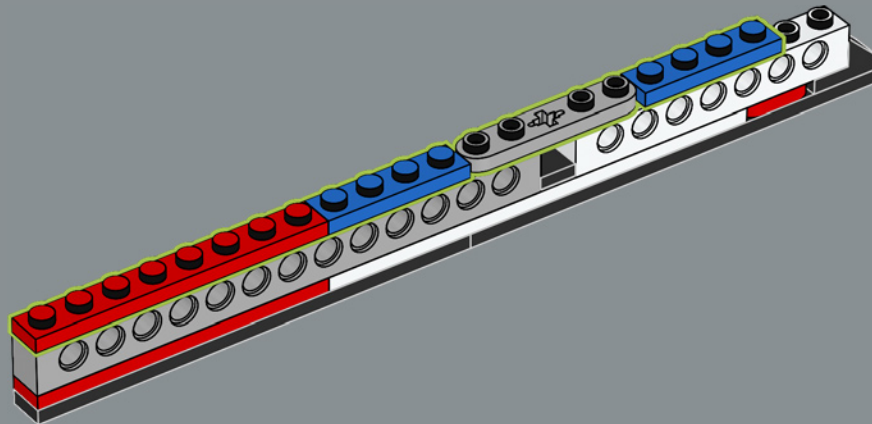

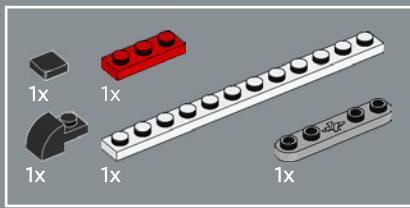

181

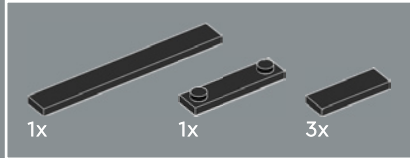
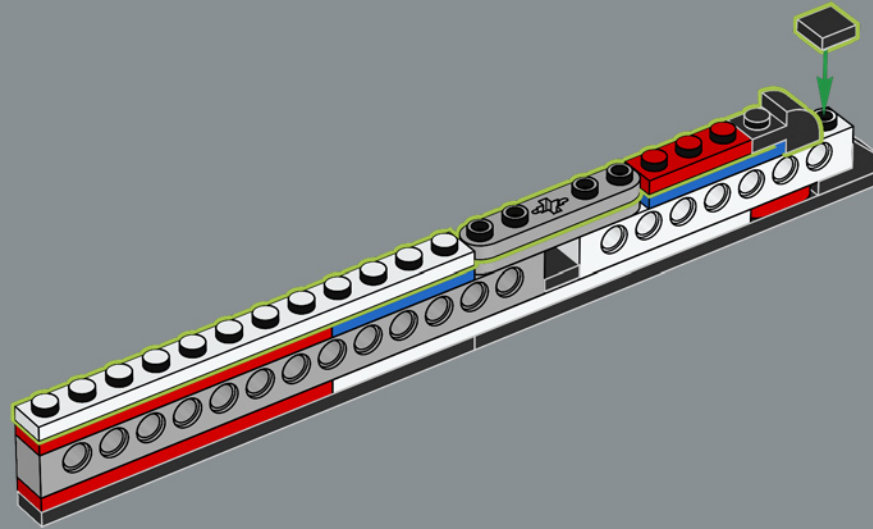

182

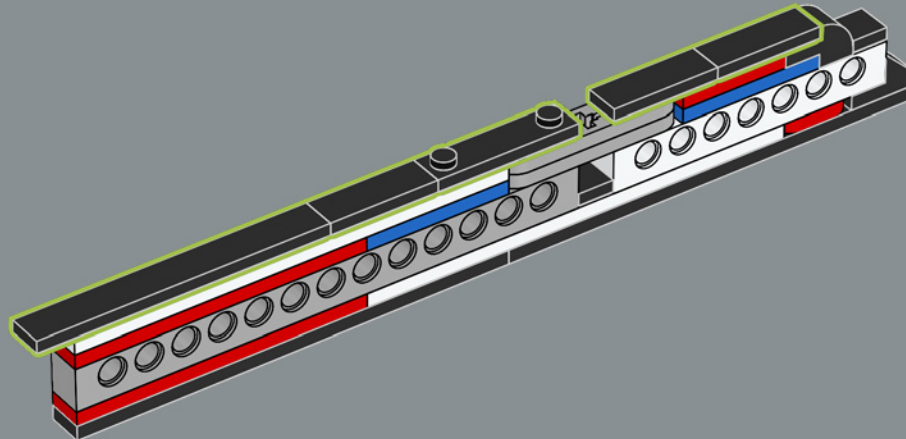



183

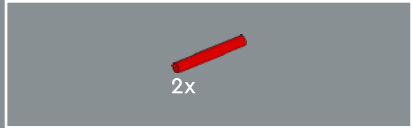
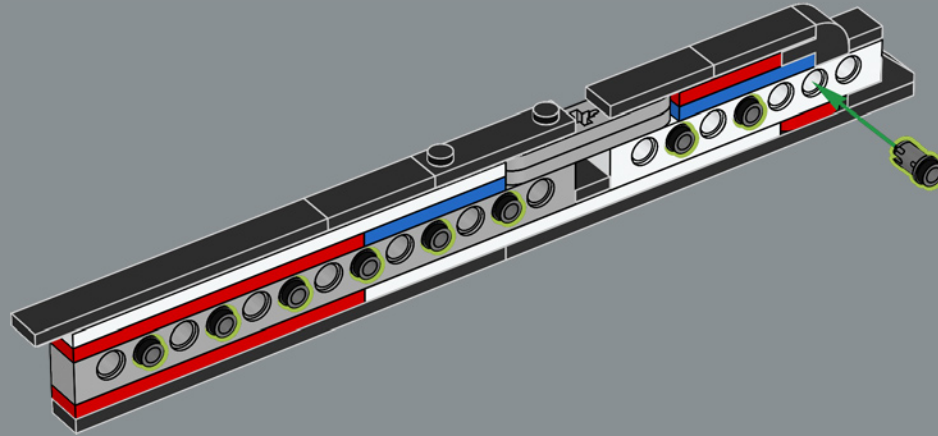

184

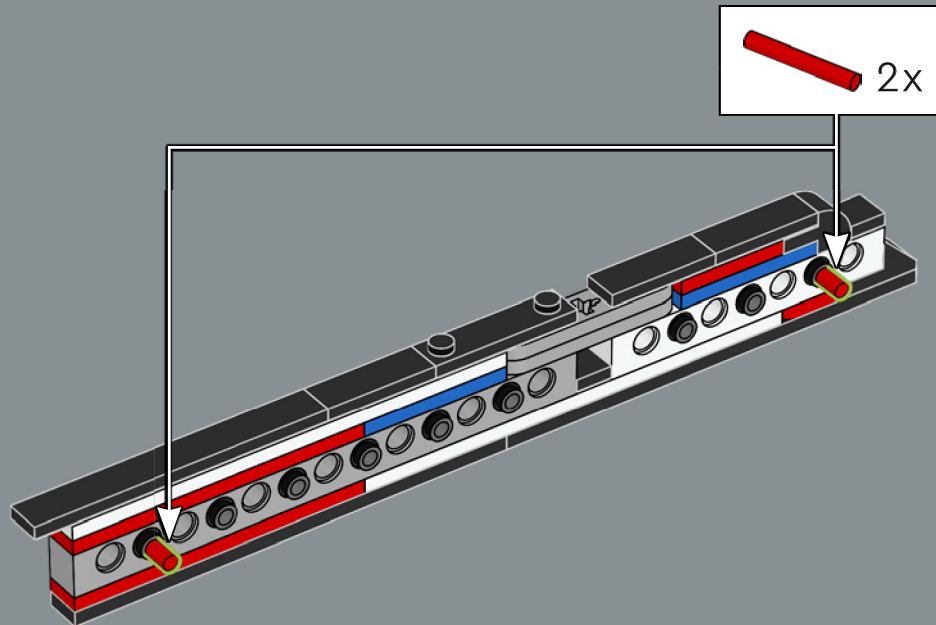

11x

185

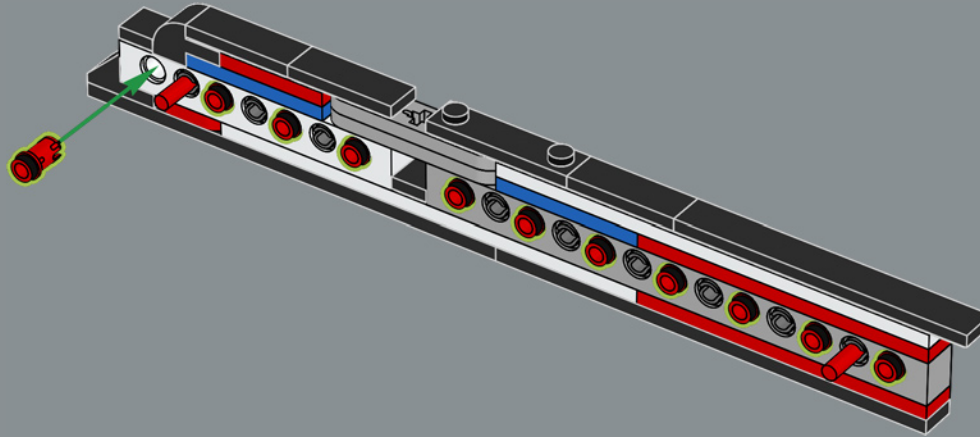

1x

186

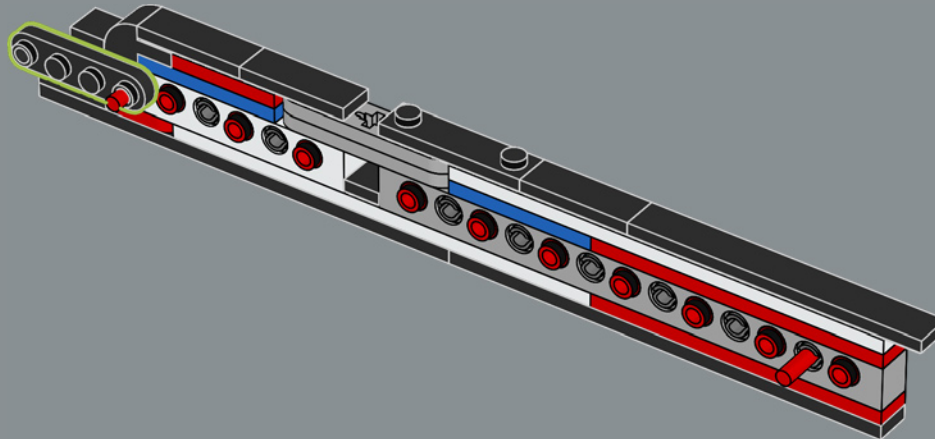

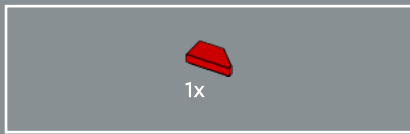

187

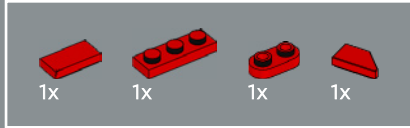
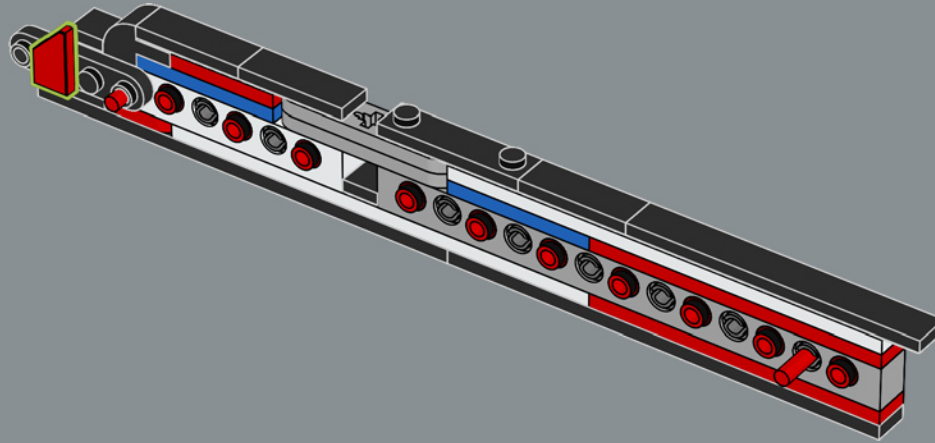

188

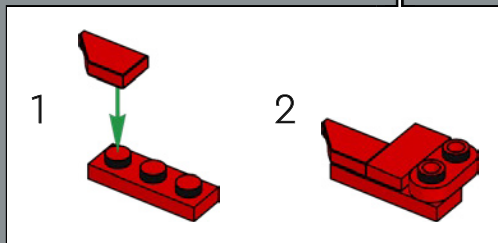
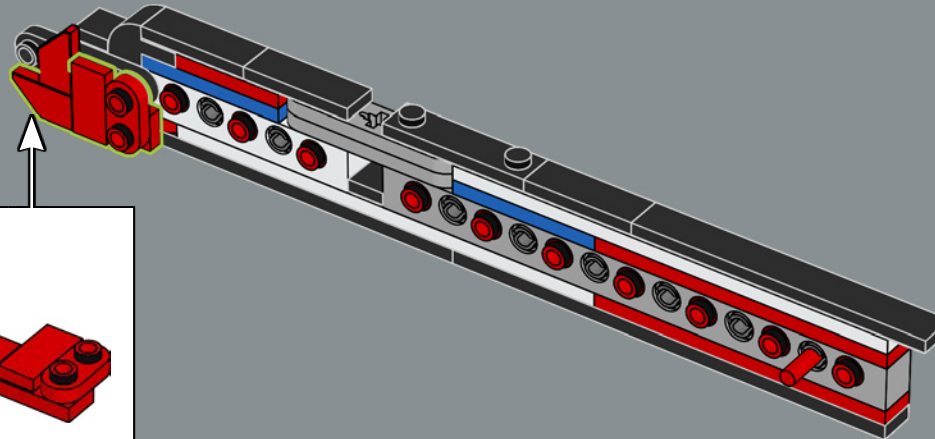

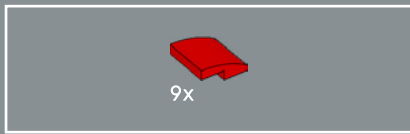

191

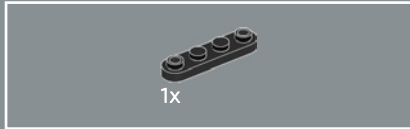
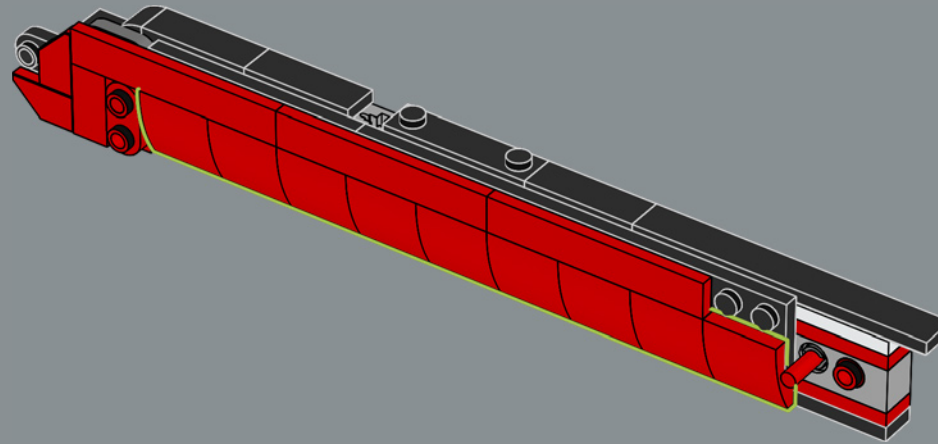

192

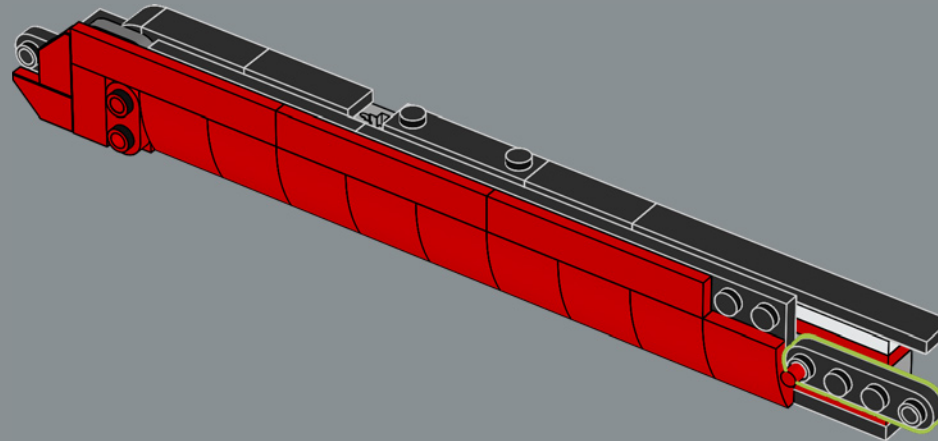

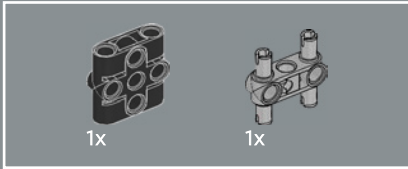
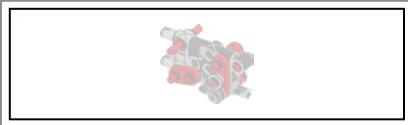

193

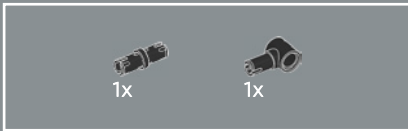
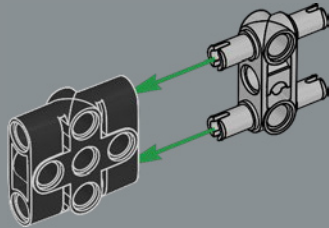

194

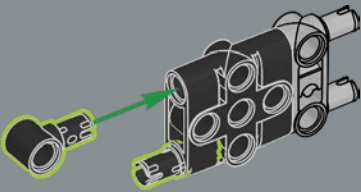

195

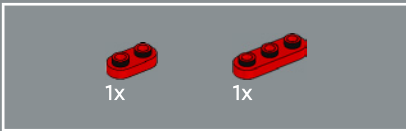
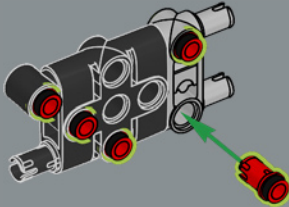

196

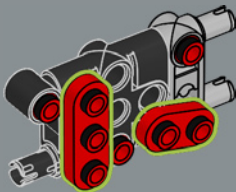



197

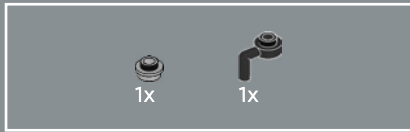
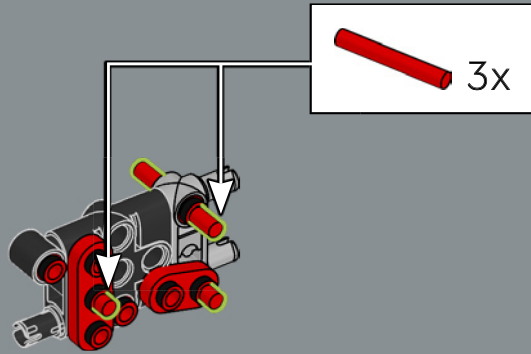

198

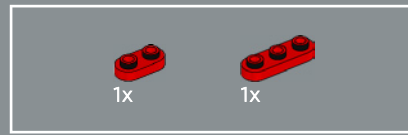
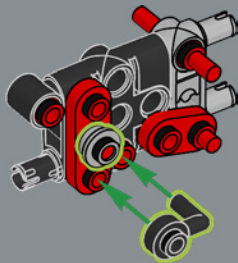

199

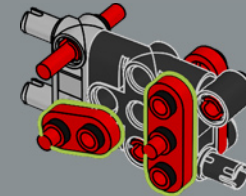

200

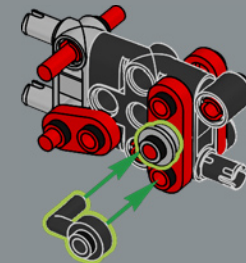

201

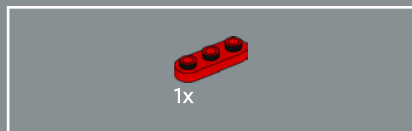
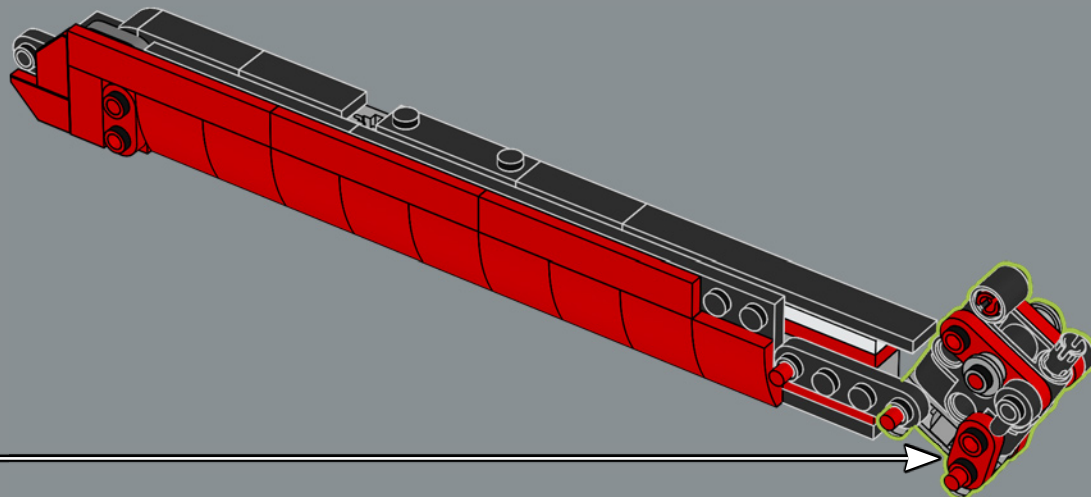

202

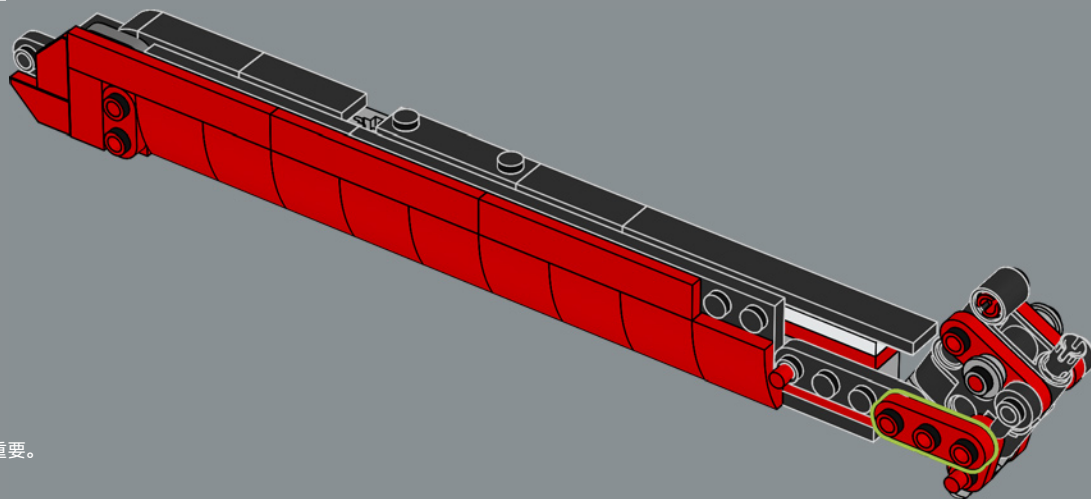

1x3和1x4圆角板在自行车车架的复杂结构中至关重要。

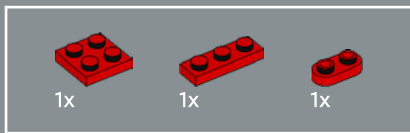

203

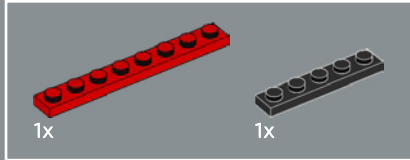
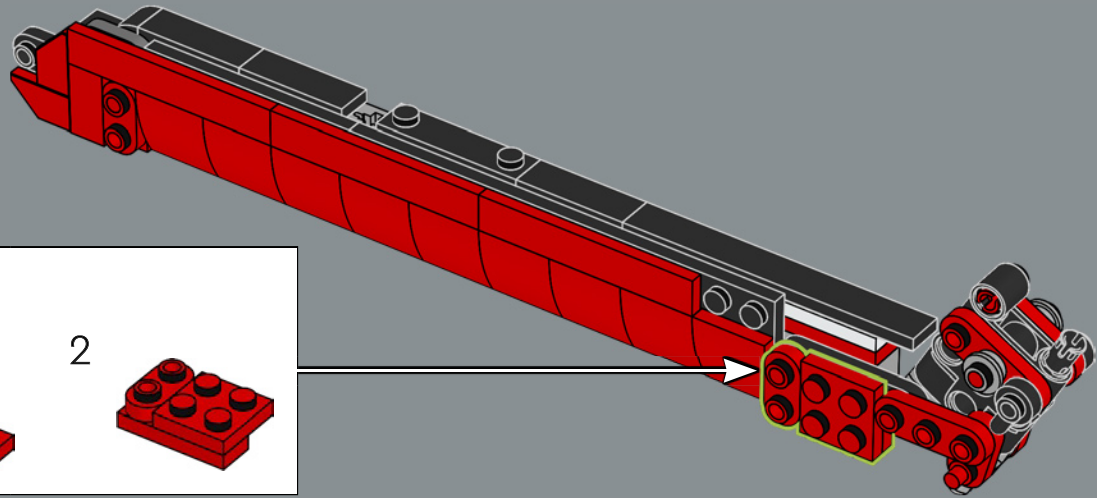
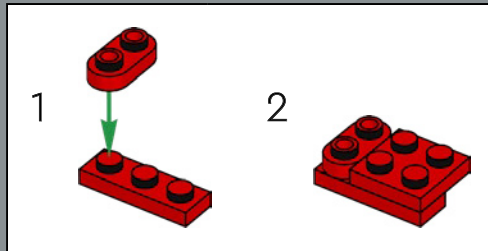

204

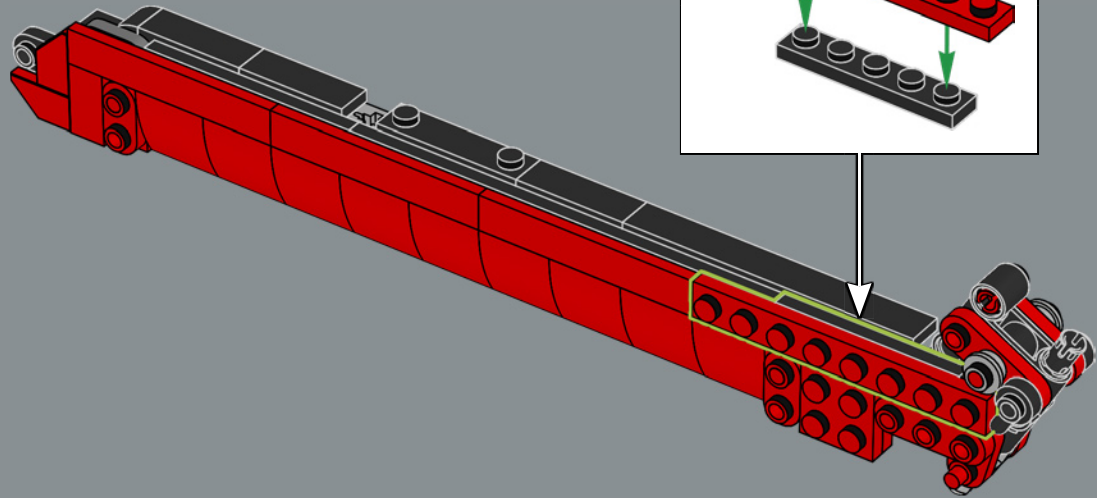
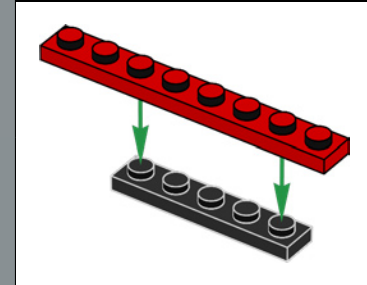

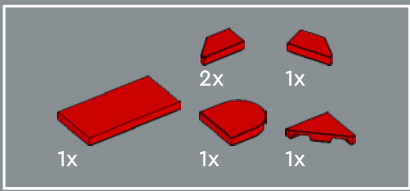

205

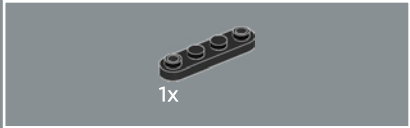
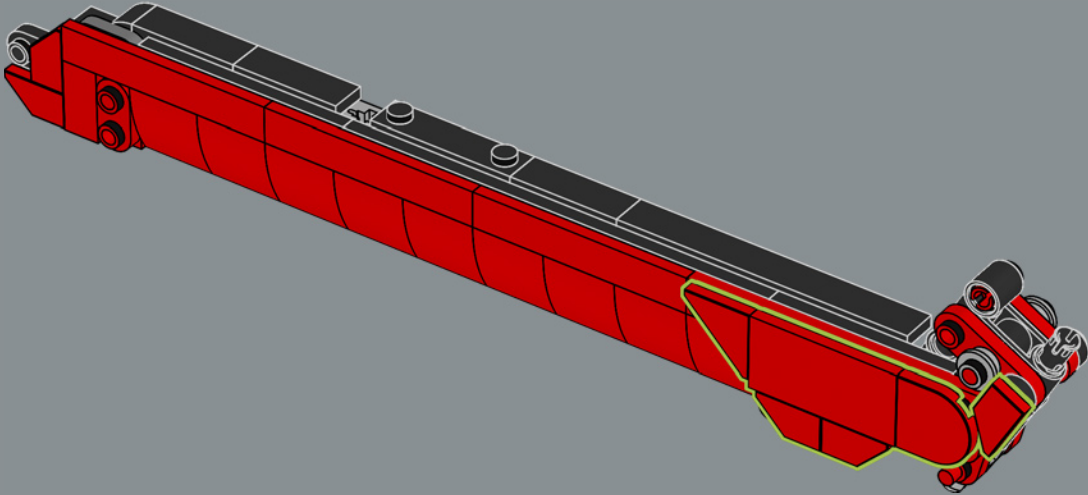

206

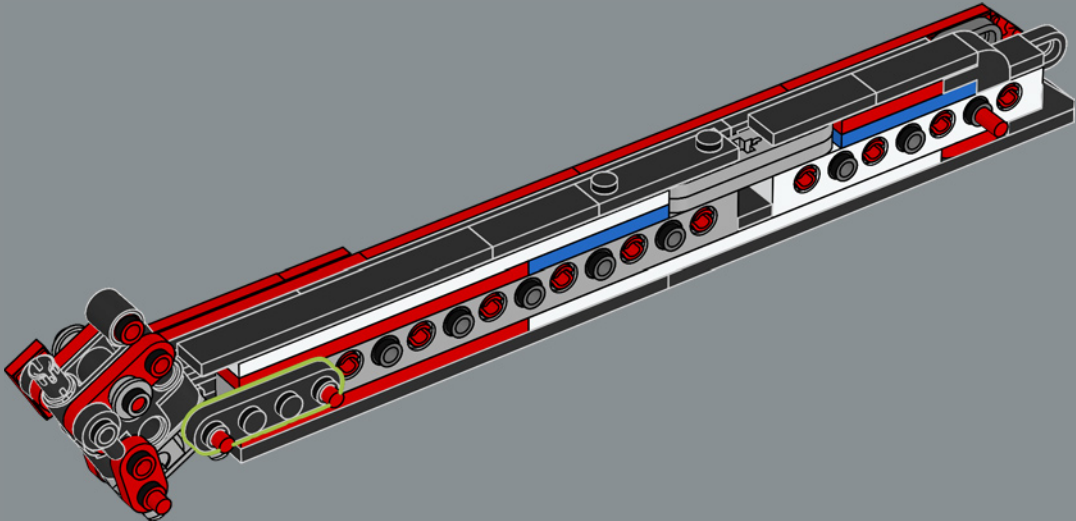

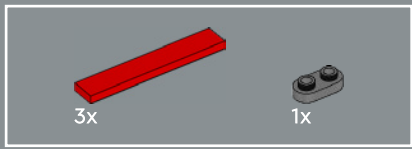

209

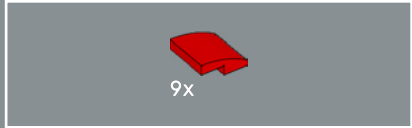
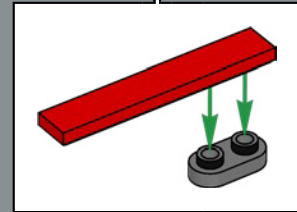
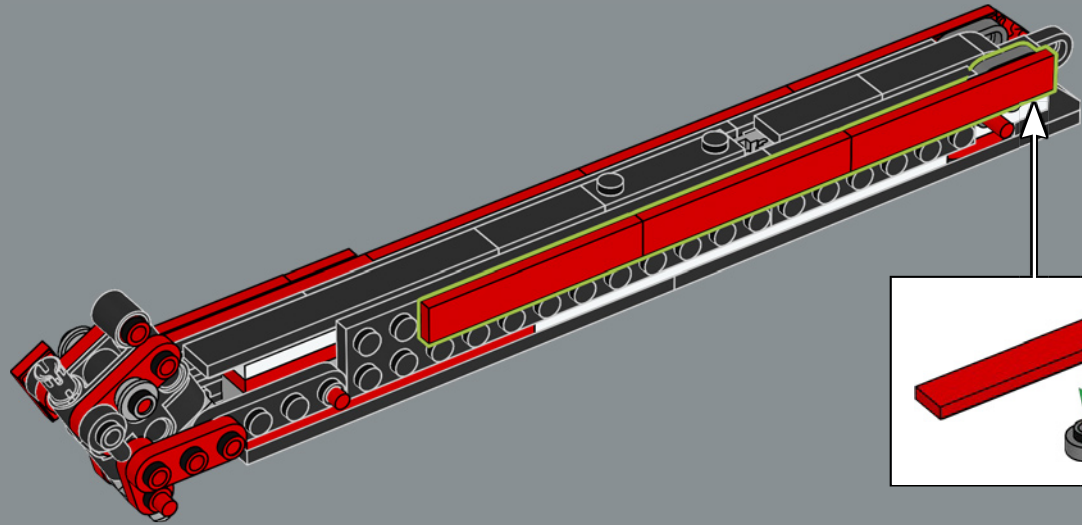

210

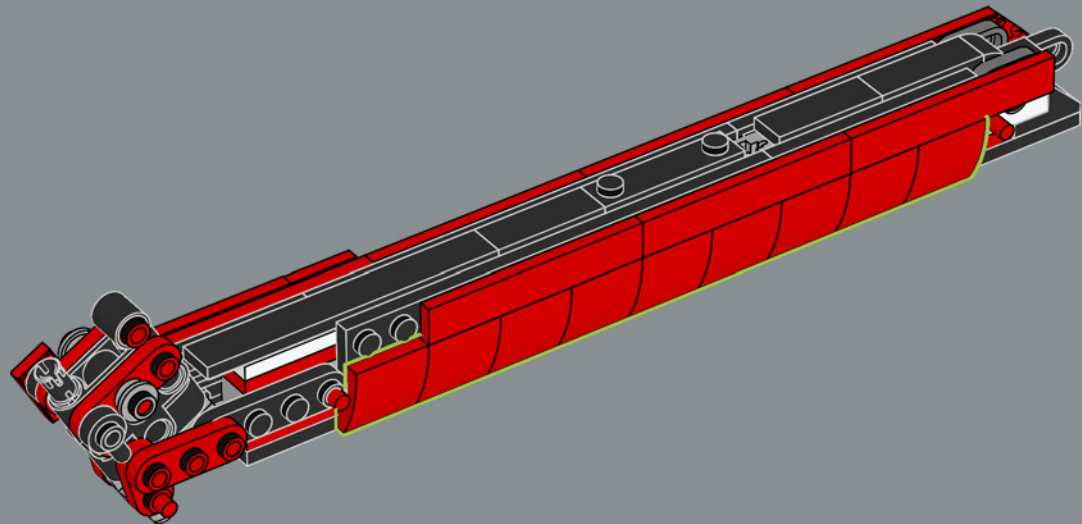

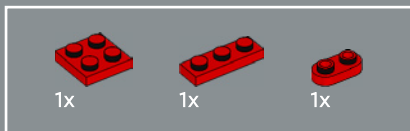

211

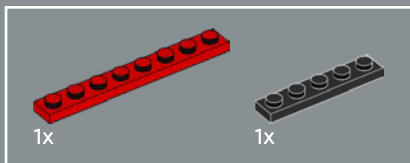
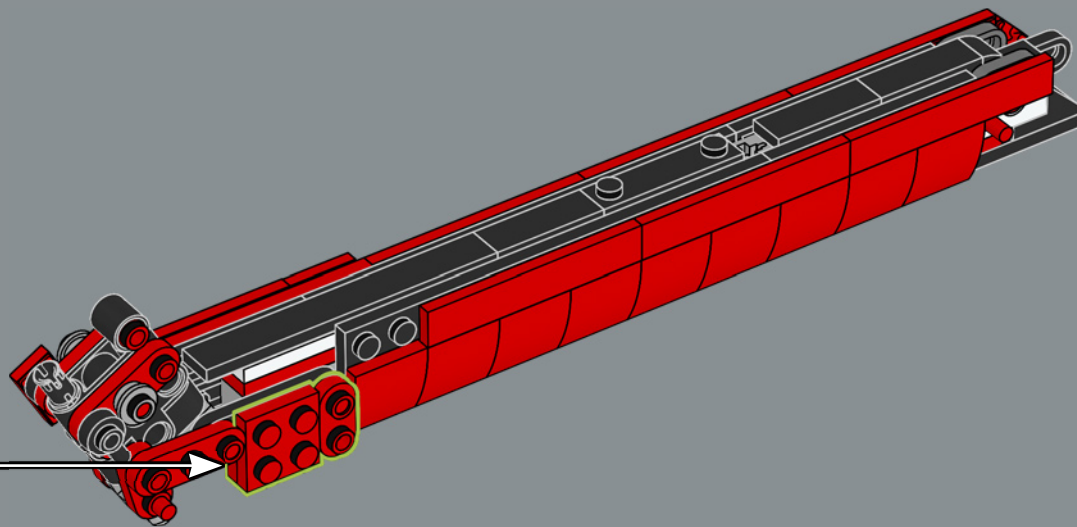
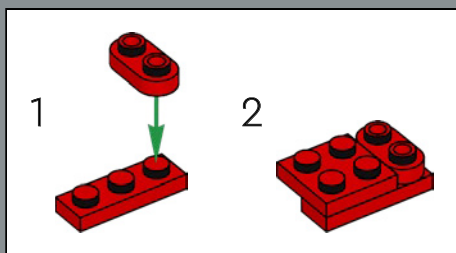

212

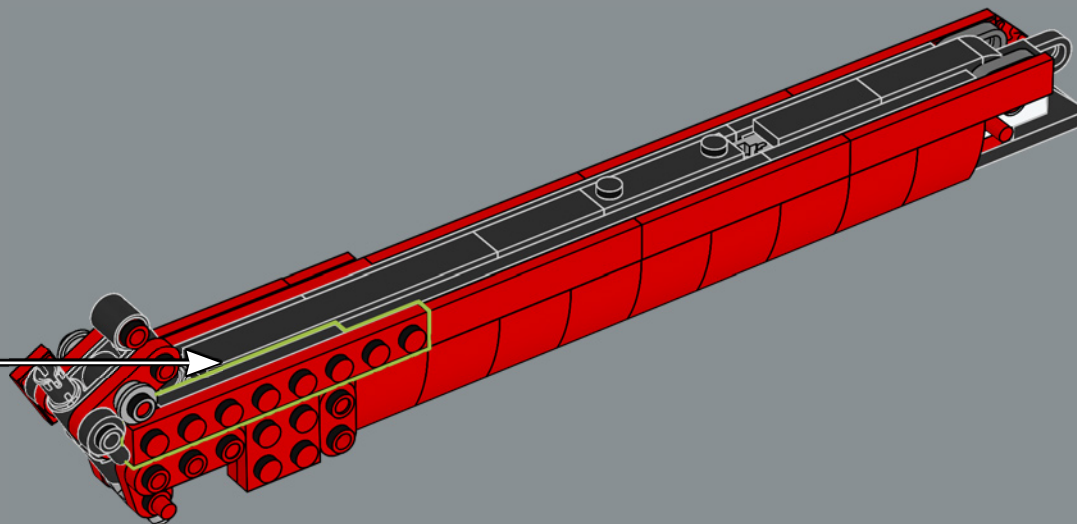
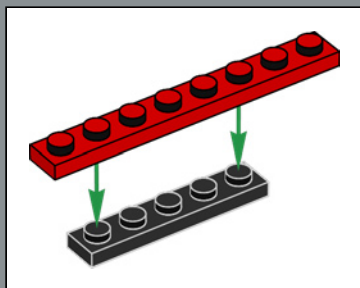

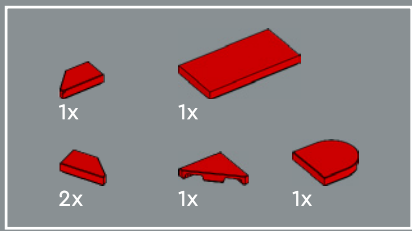

213

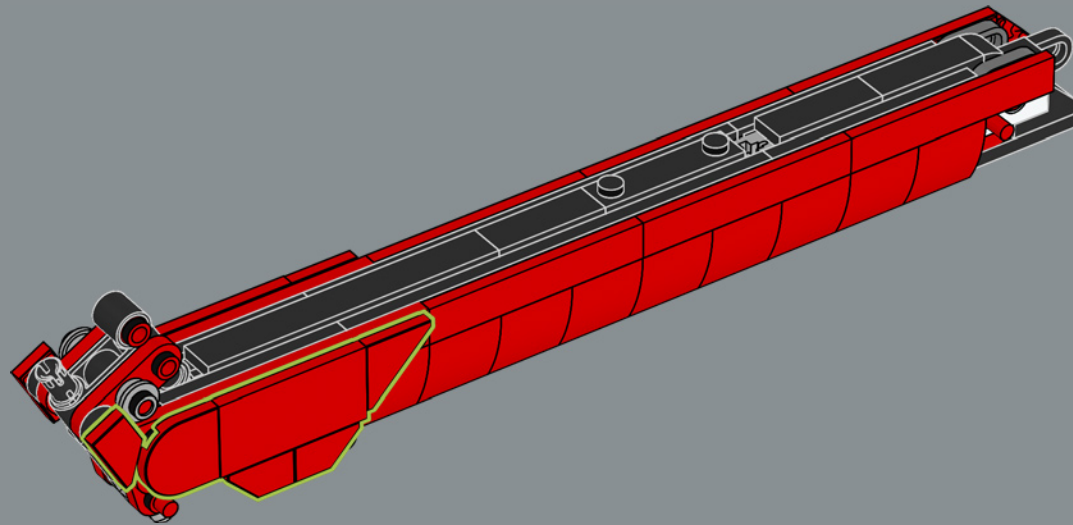

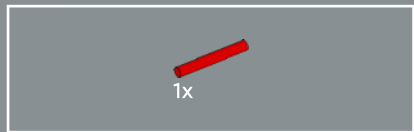

214

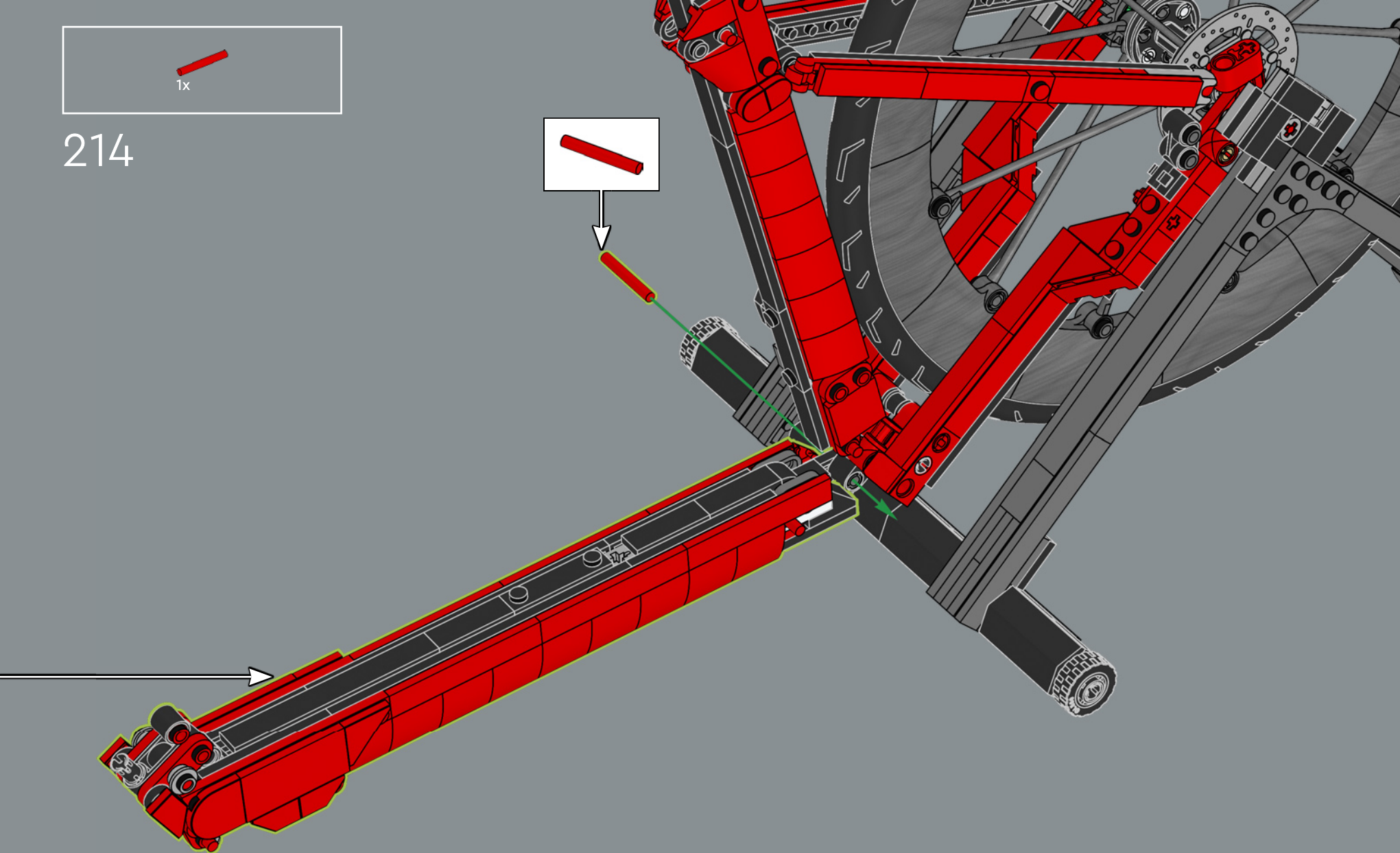
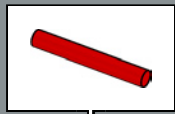



215

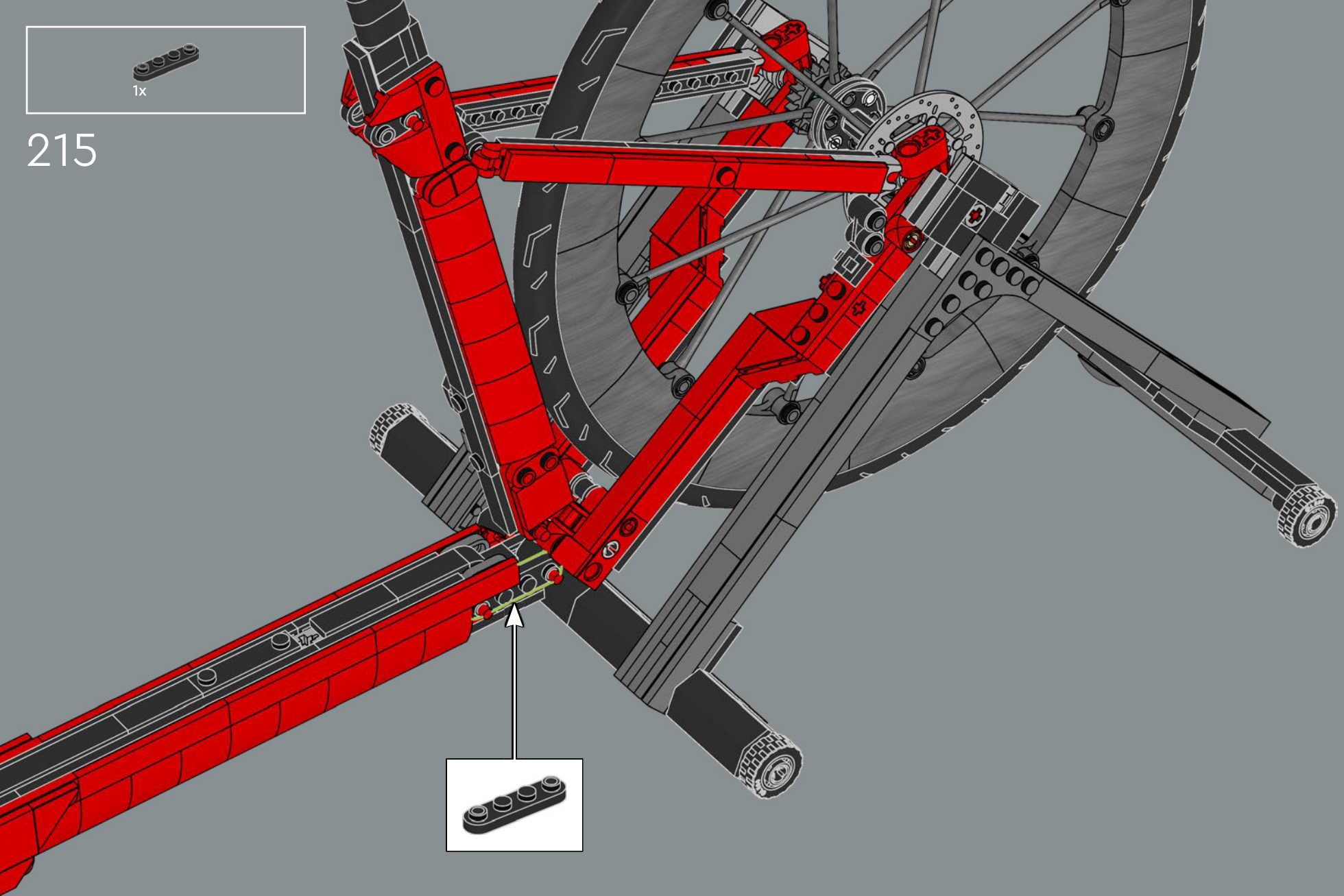



216

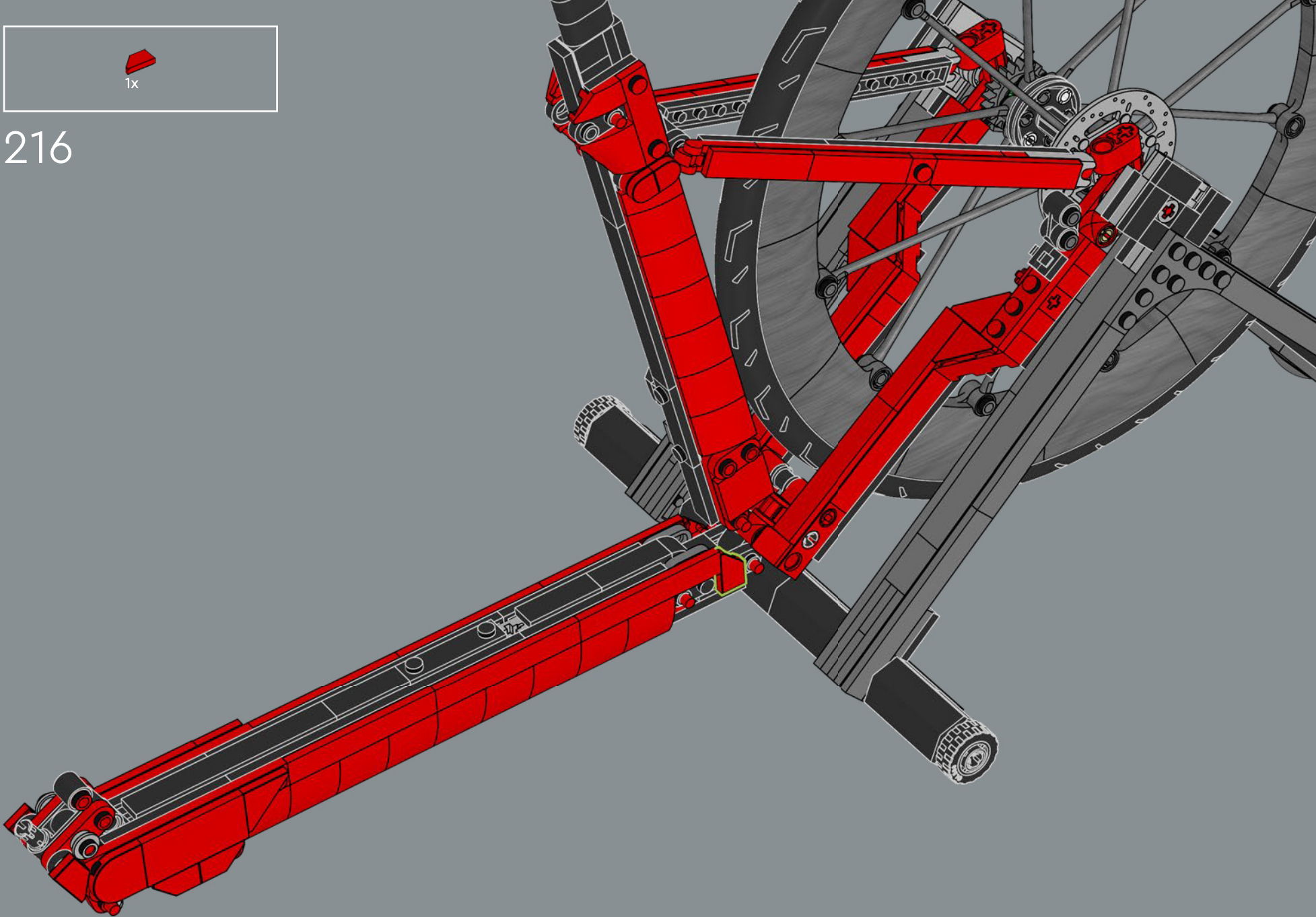

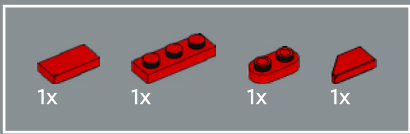

217

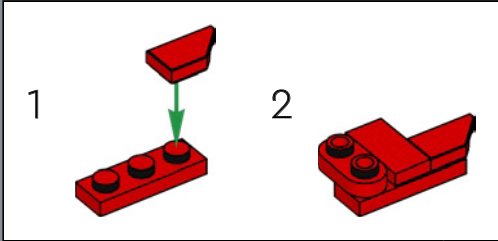



218

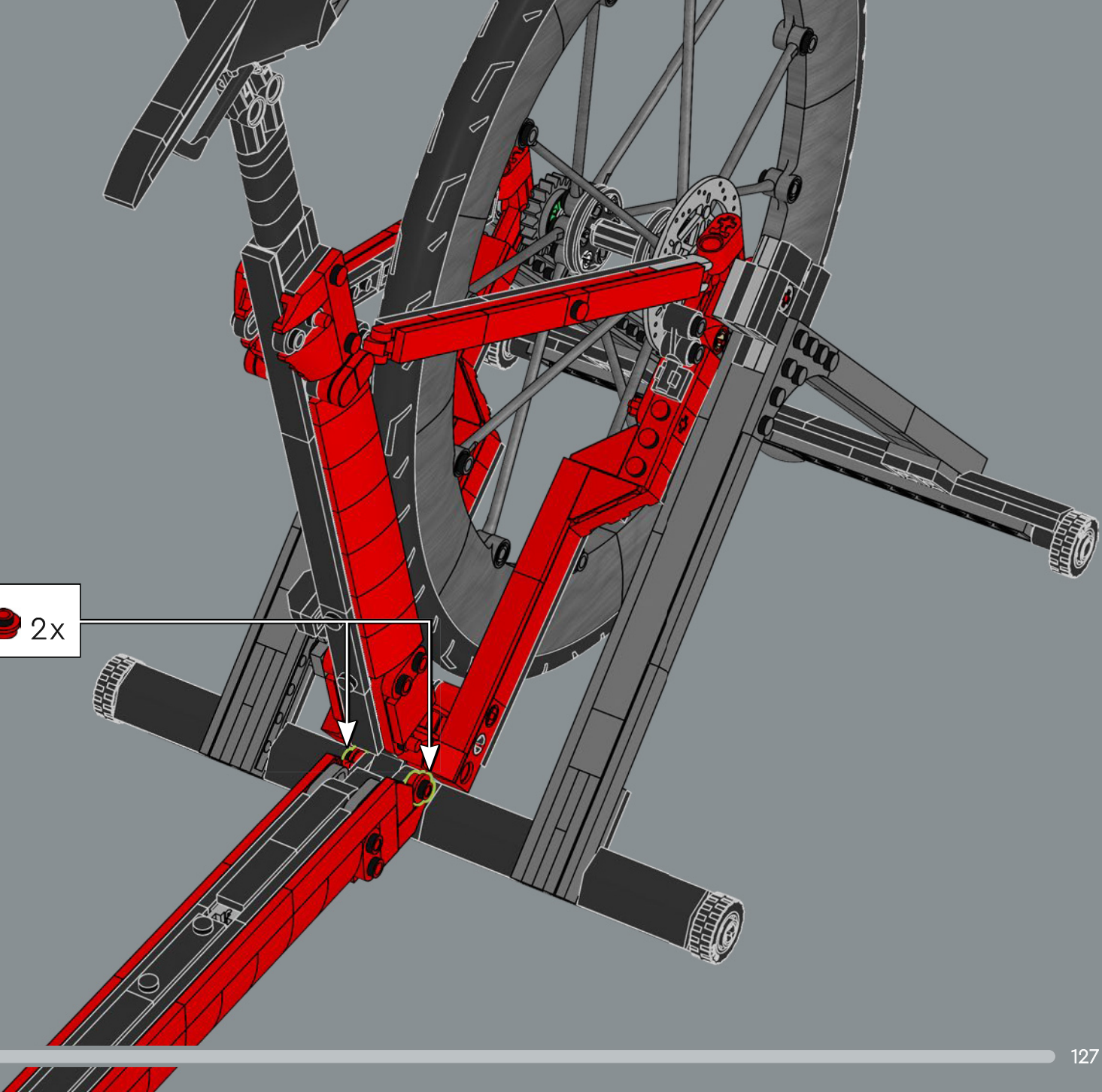

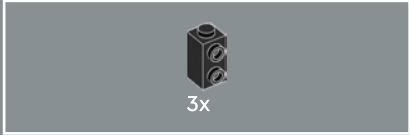
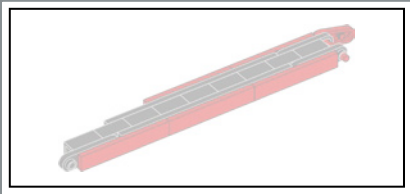

219

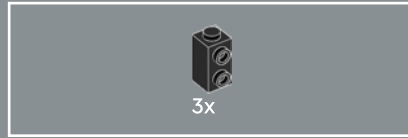

220





221

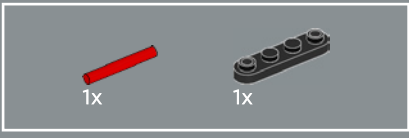

222

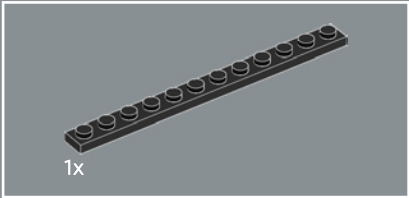
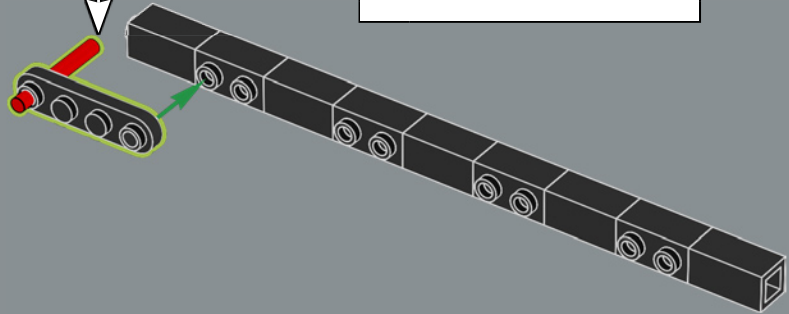
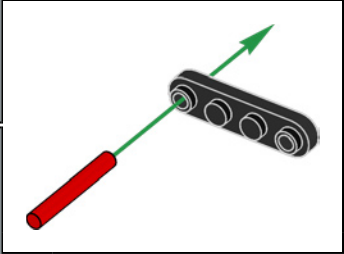
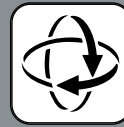

223

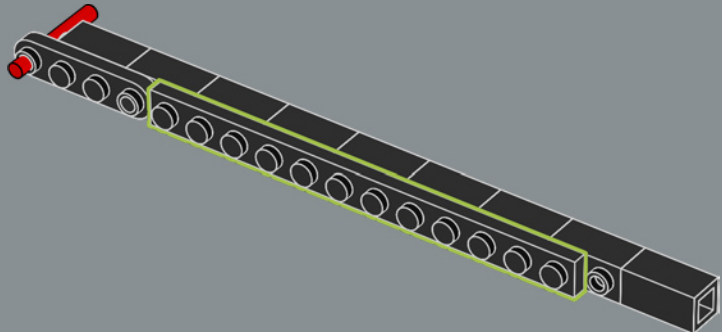

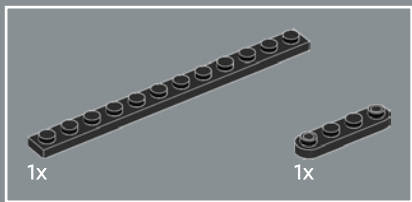

224

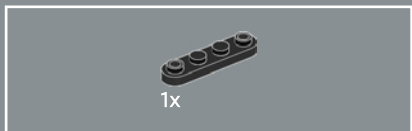
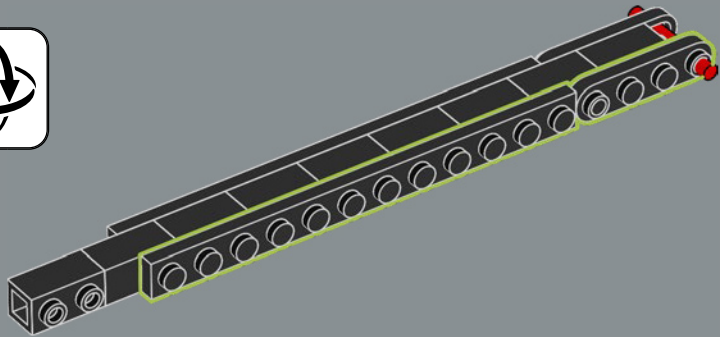

225

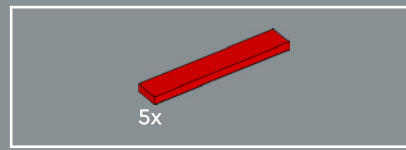
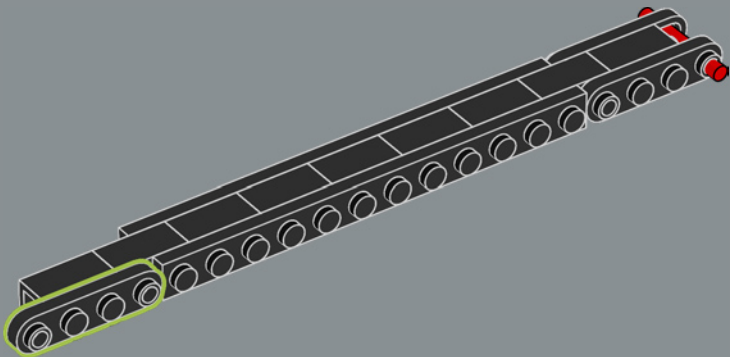

226

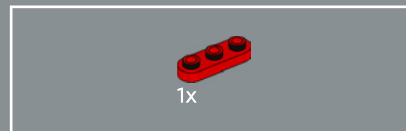
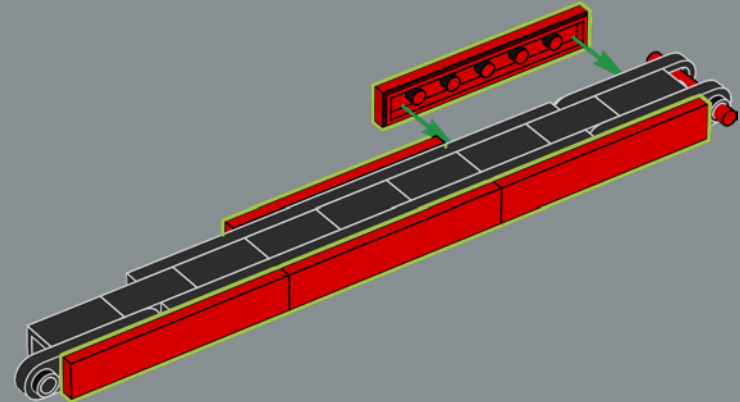

227

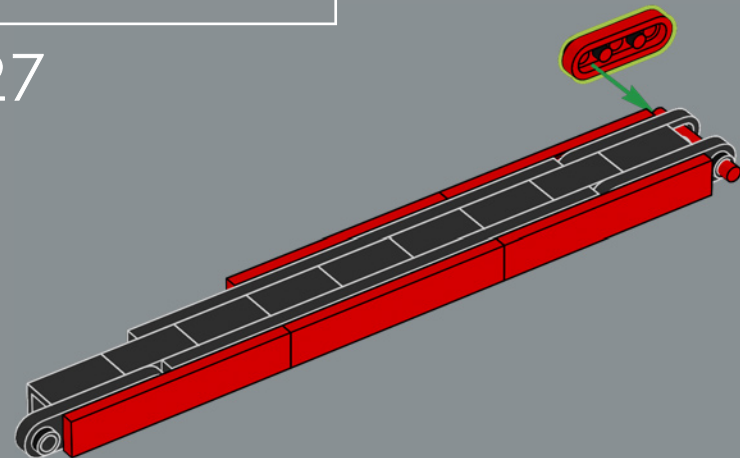

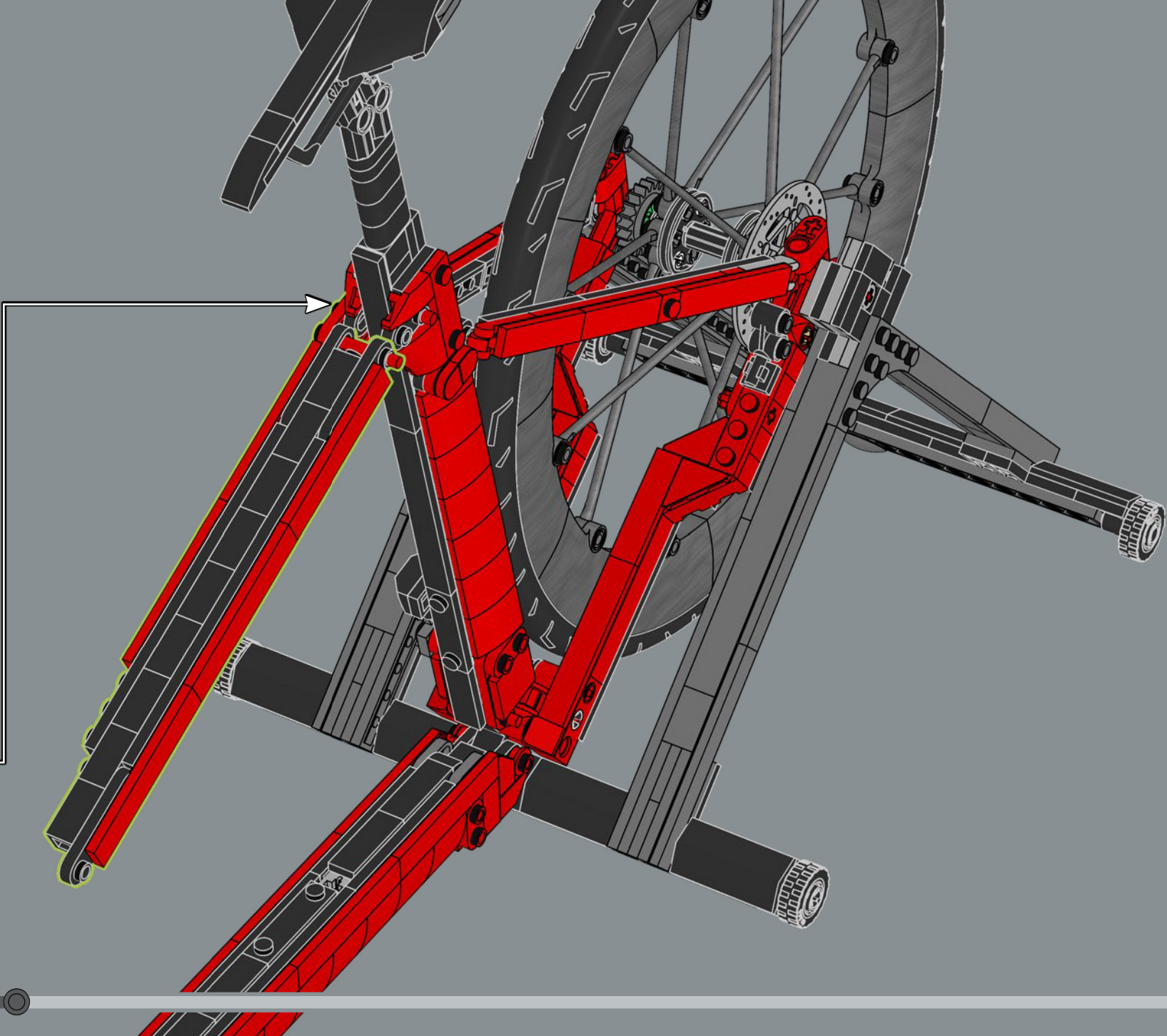

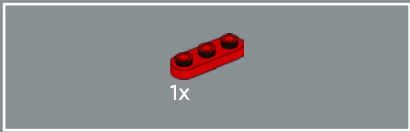

229

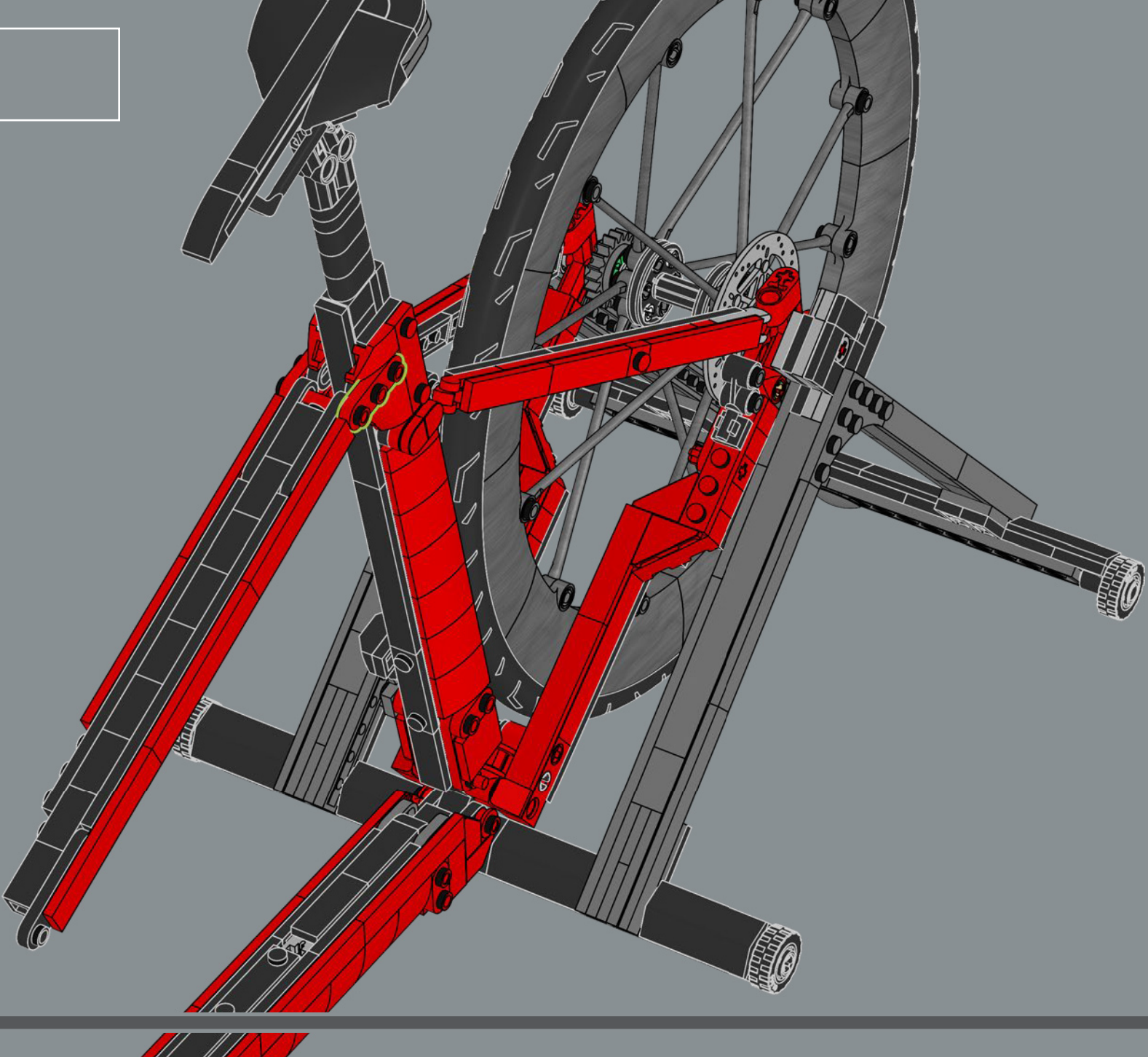

230

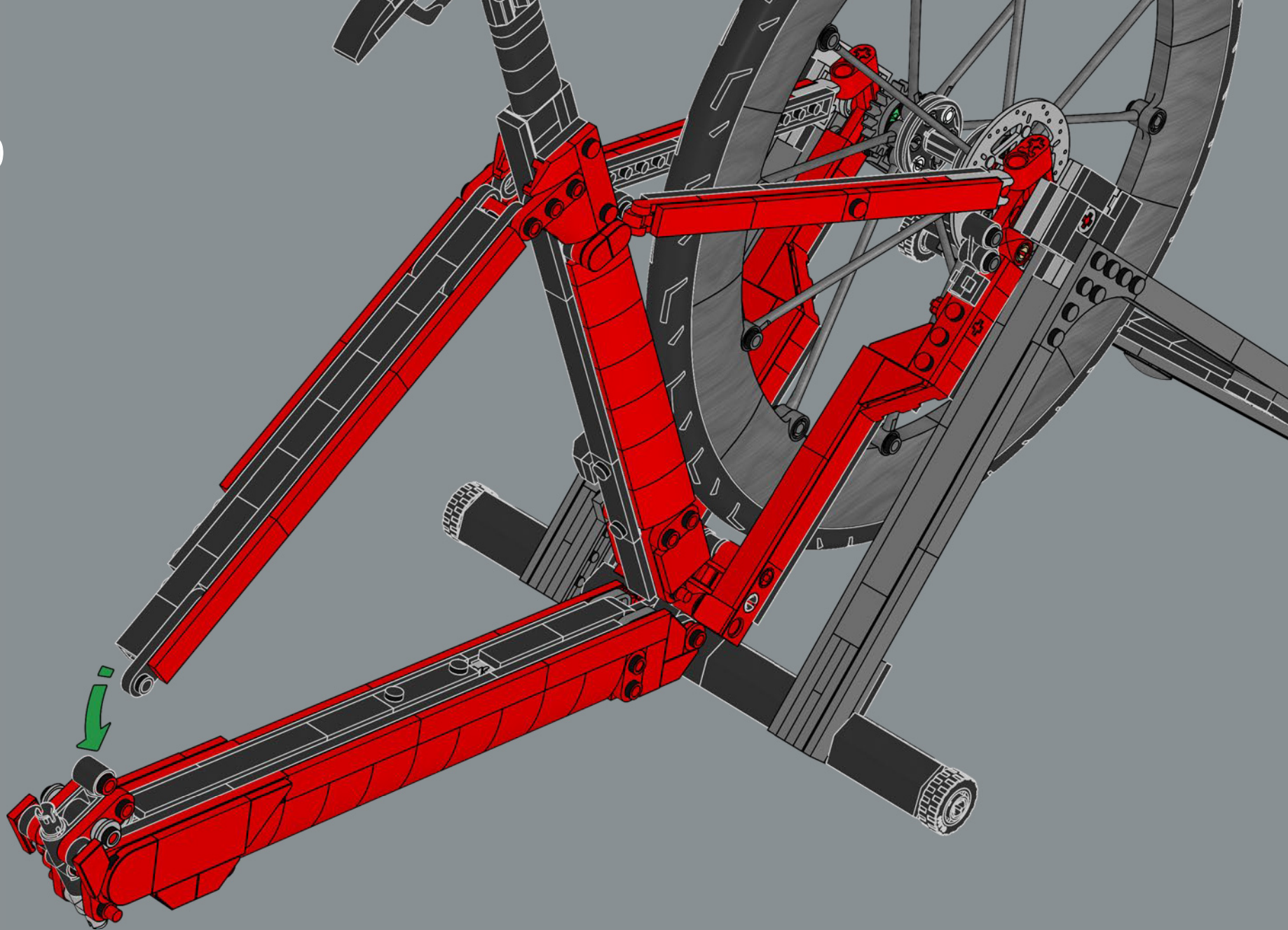

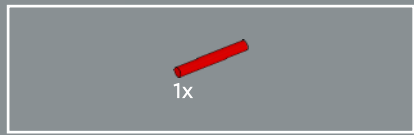

231

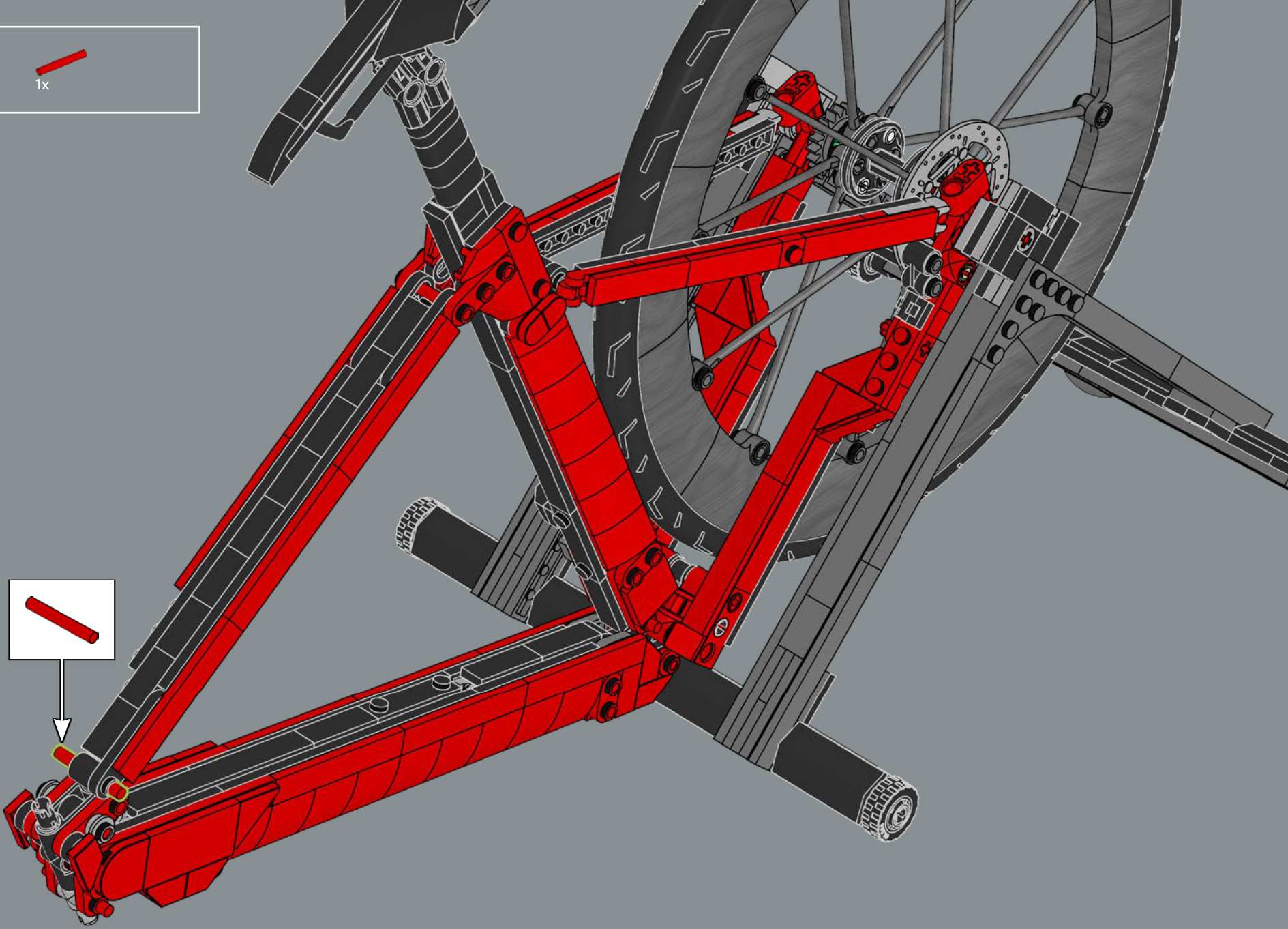

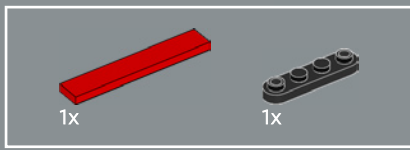

232

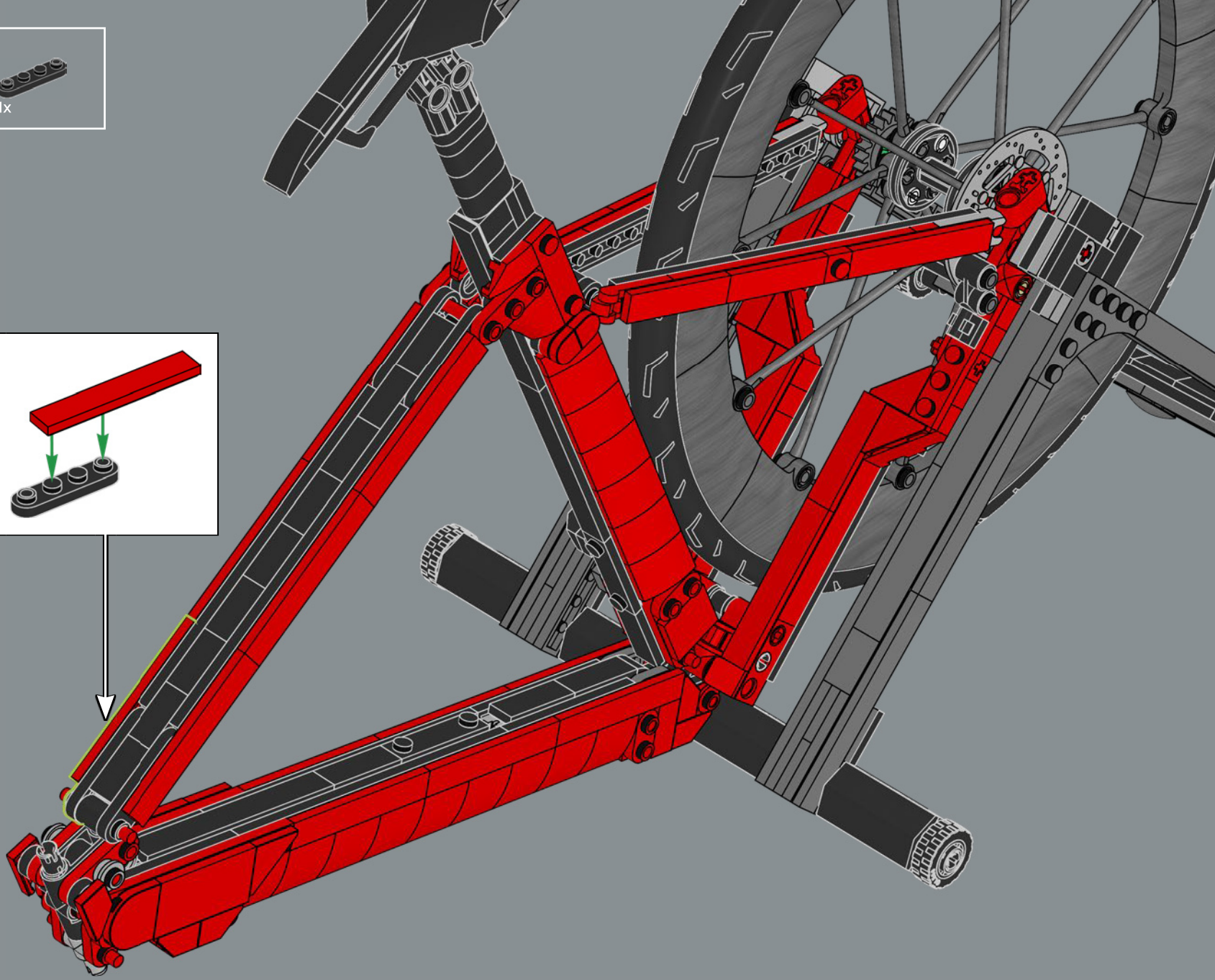
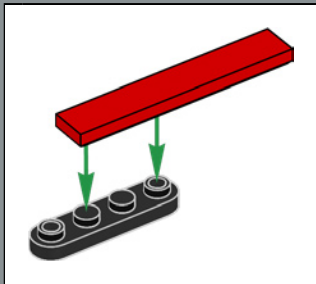

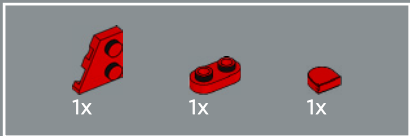

233

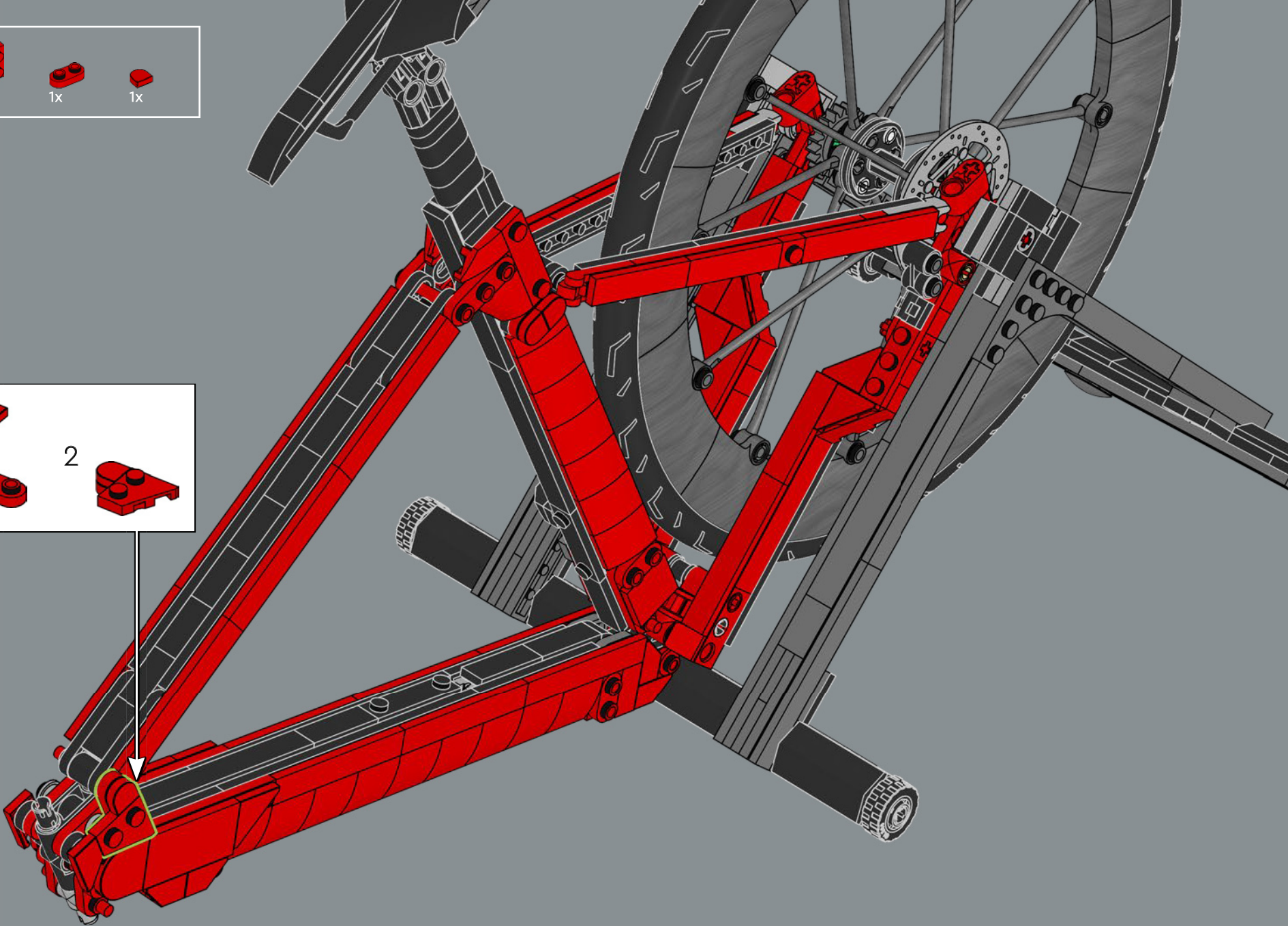
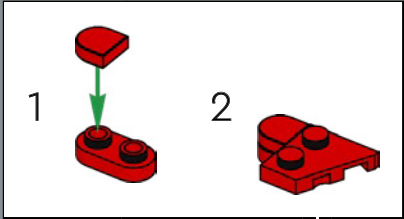



234

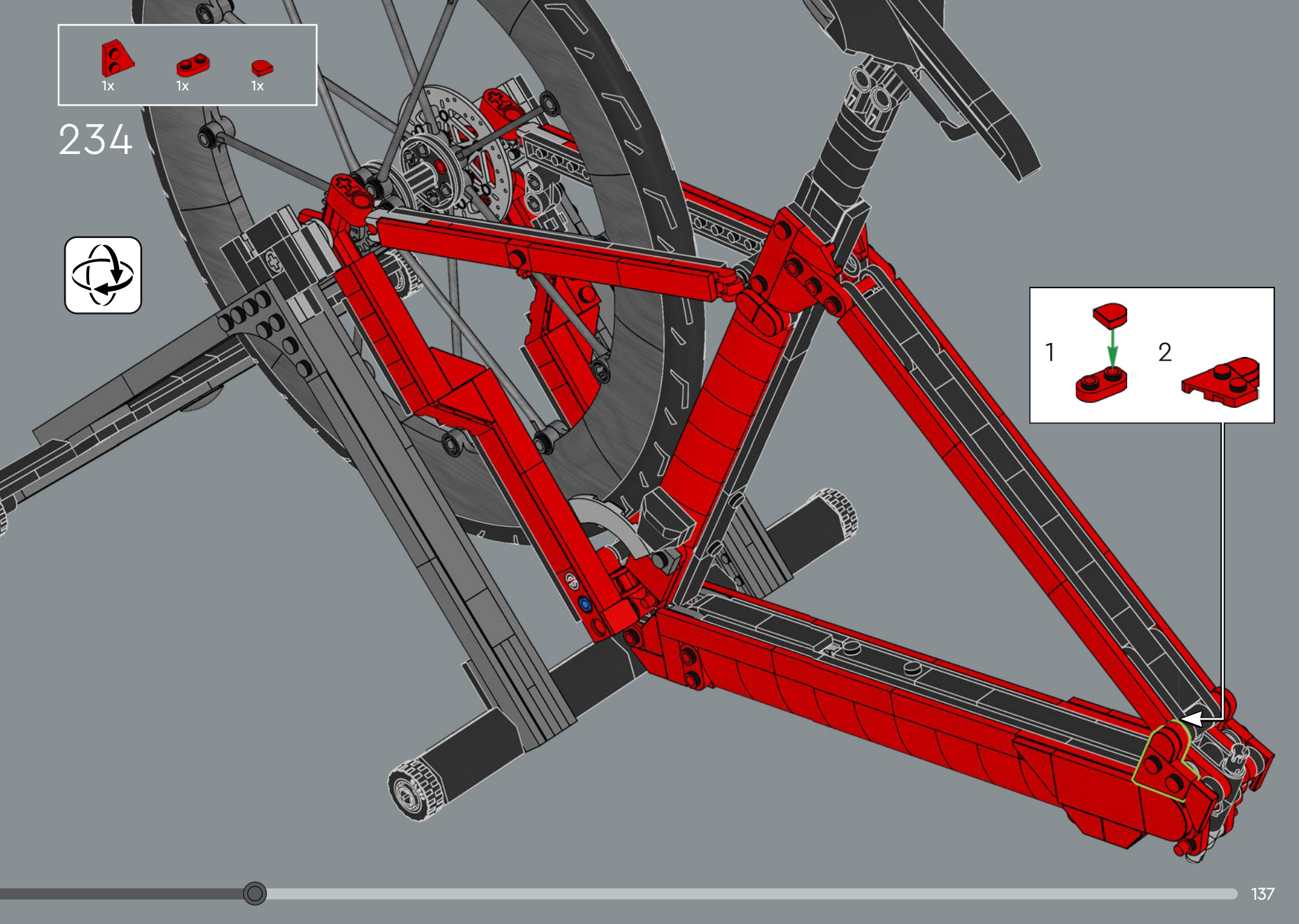
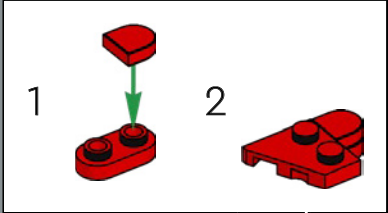

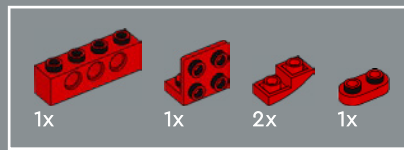

235



1

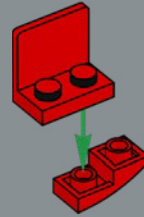

2

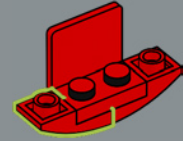

3

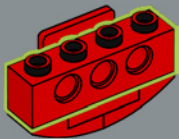

4

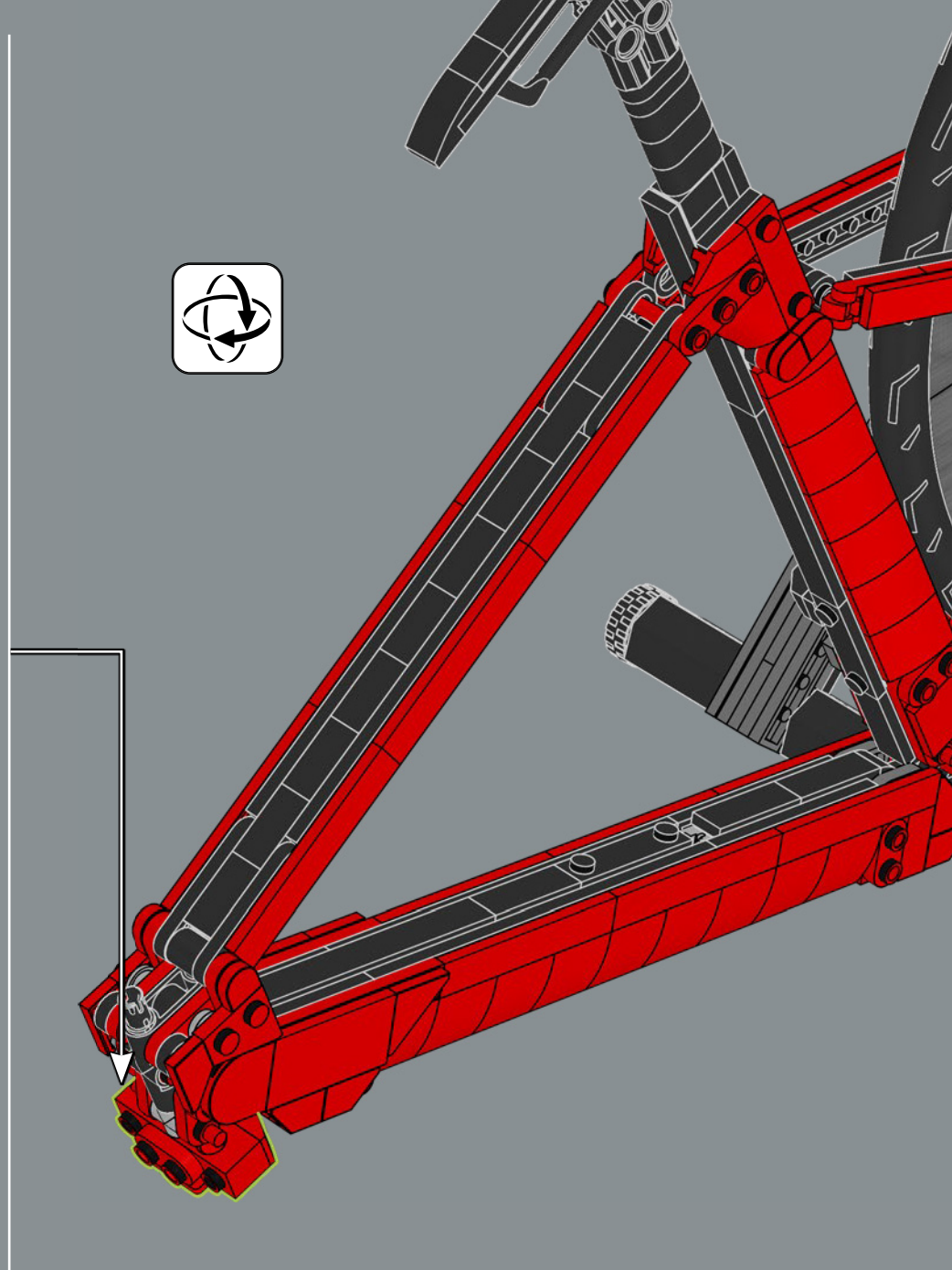
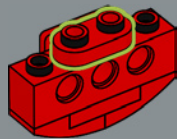

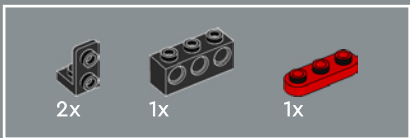

236

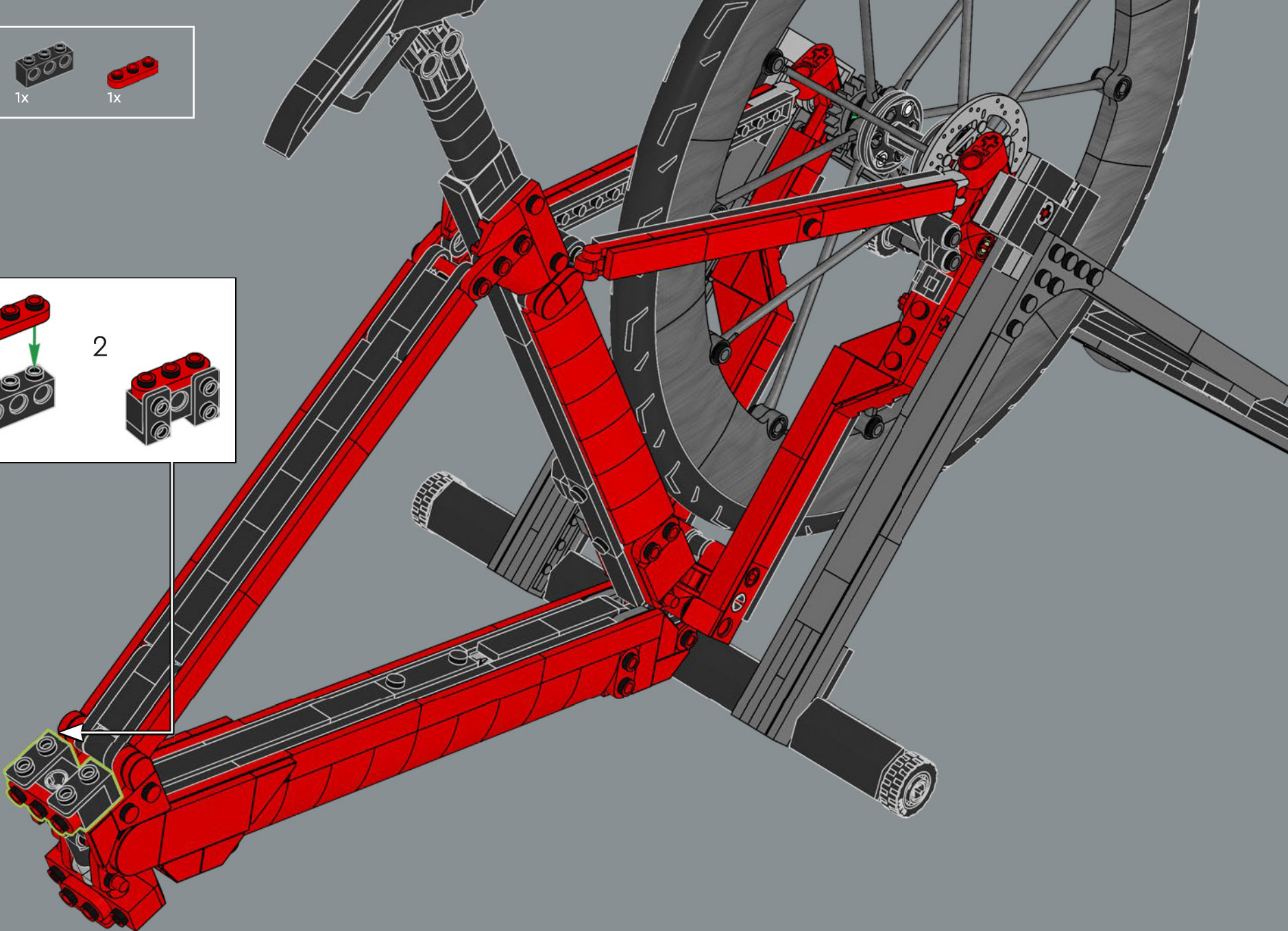
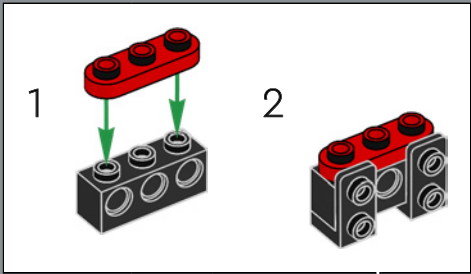

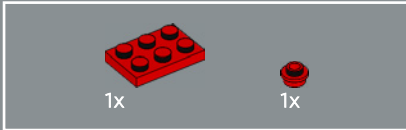
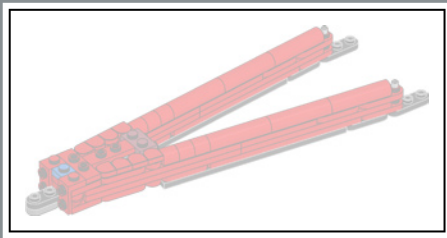

237

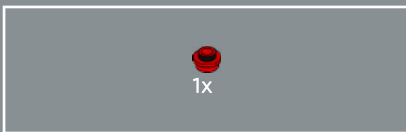
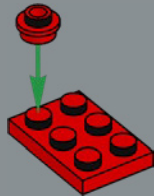

238

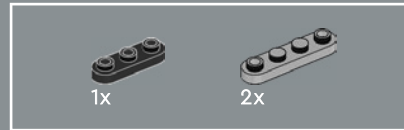
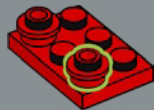

239

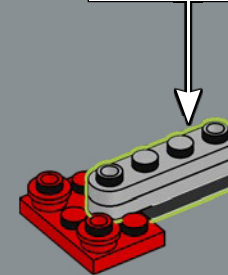
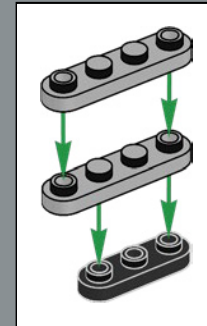

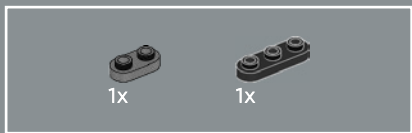

240

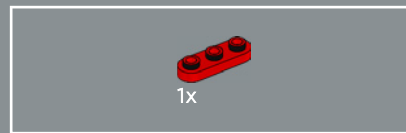
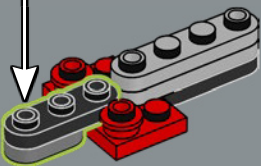
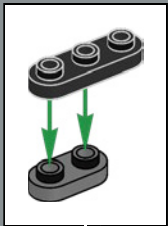

241

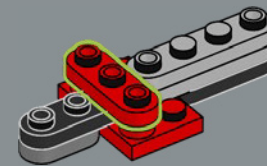

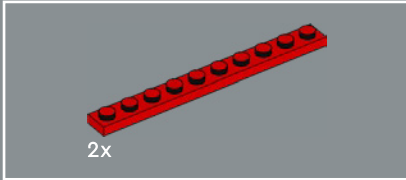
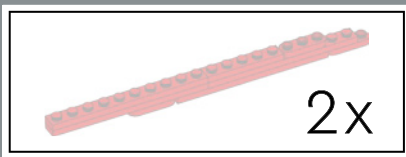

242

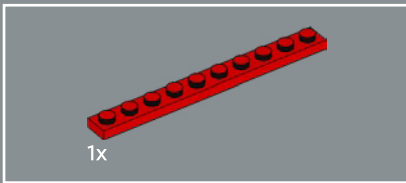
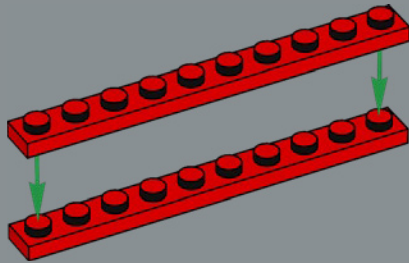

243

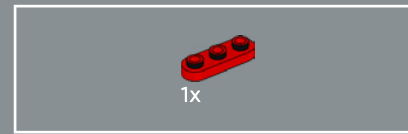
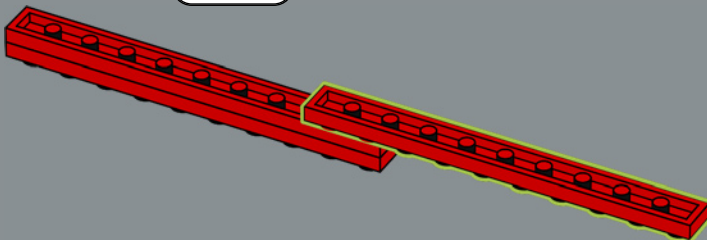

244

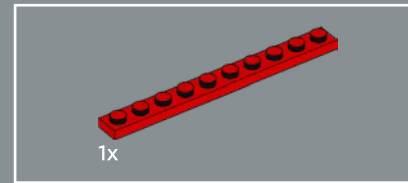
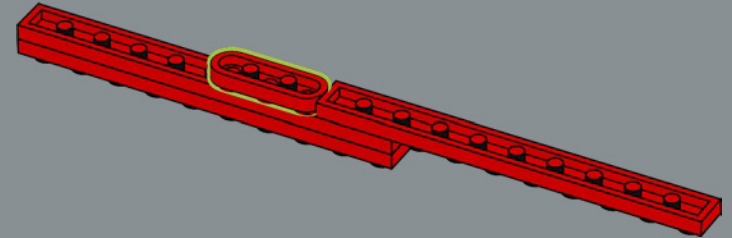

245

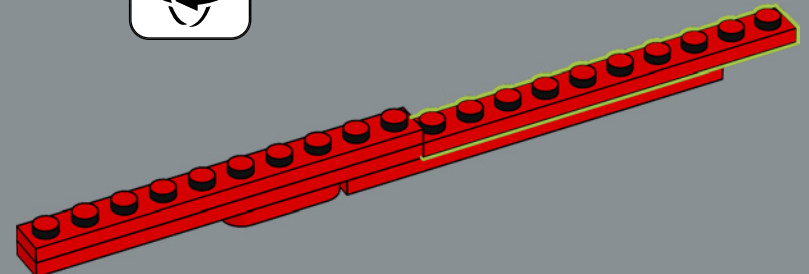

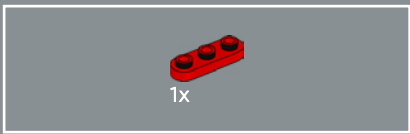

246

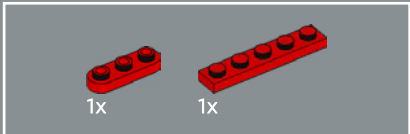
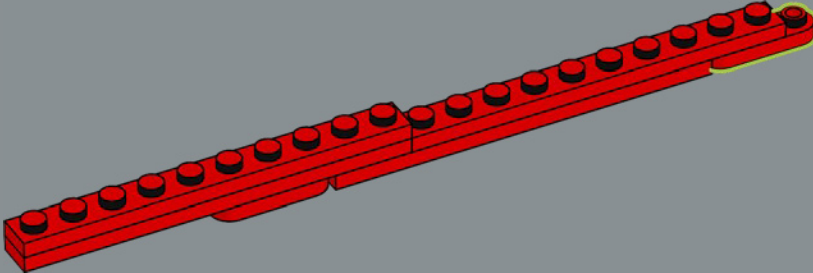

247

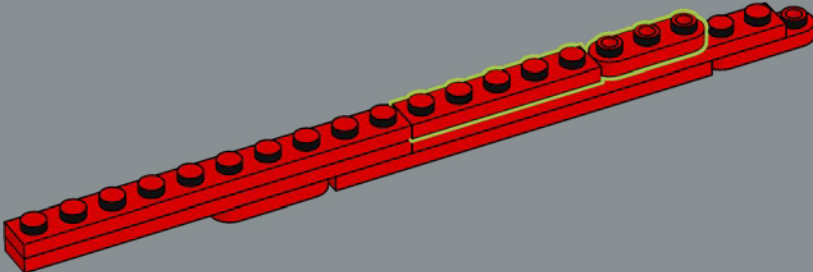

2x

248

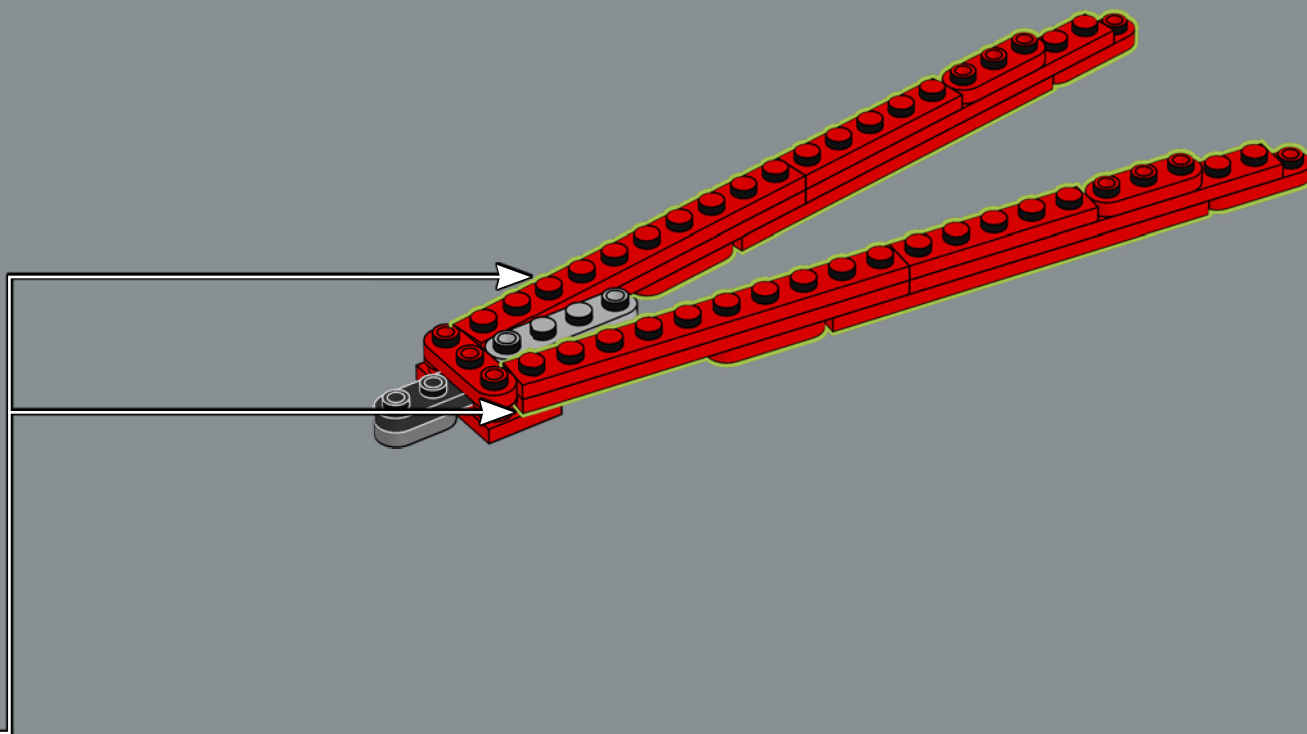

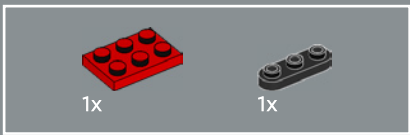

249

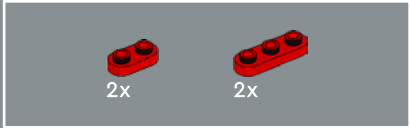
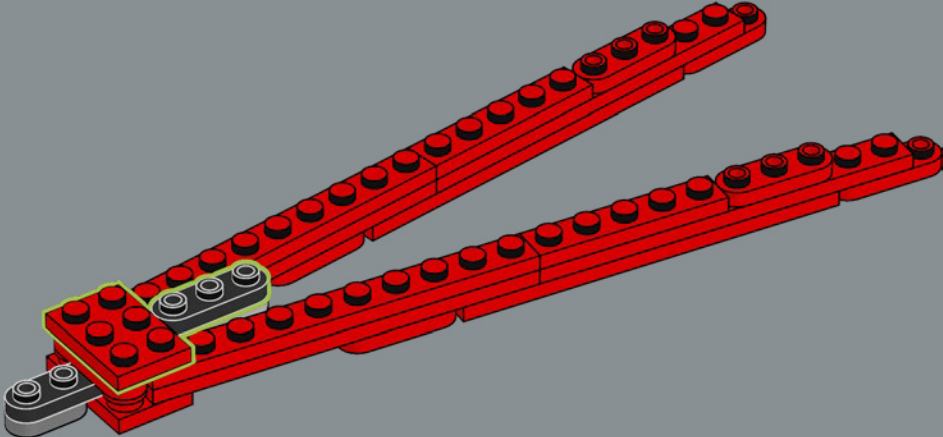

250

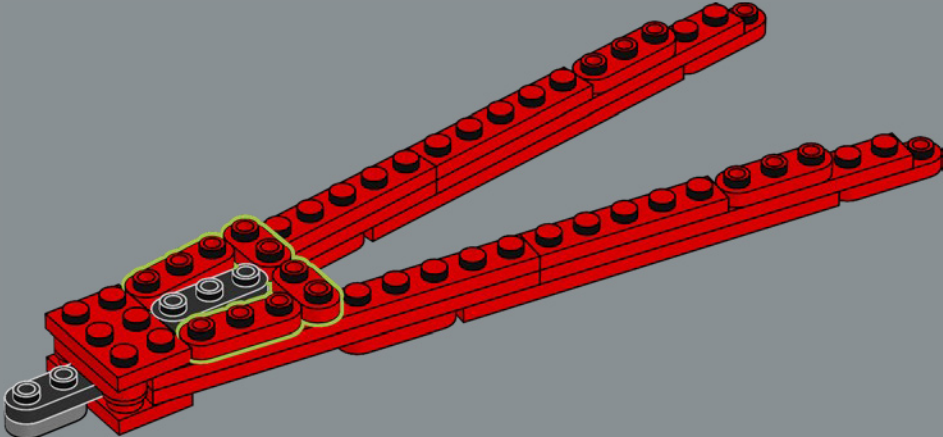



251

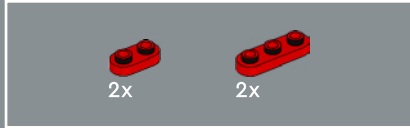
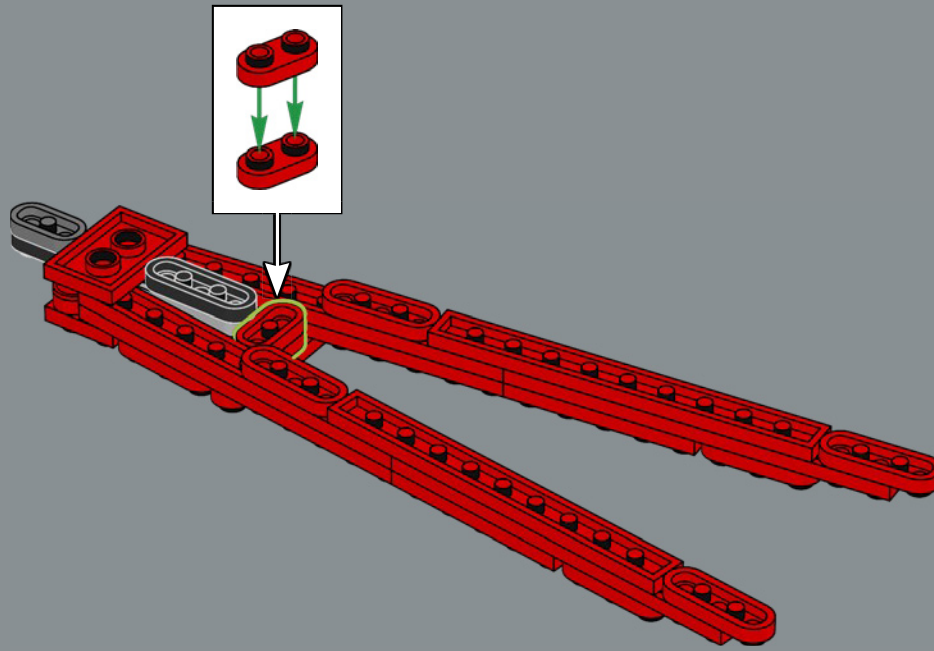

252

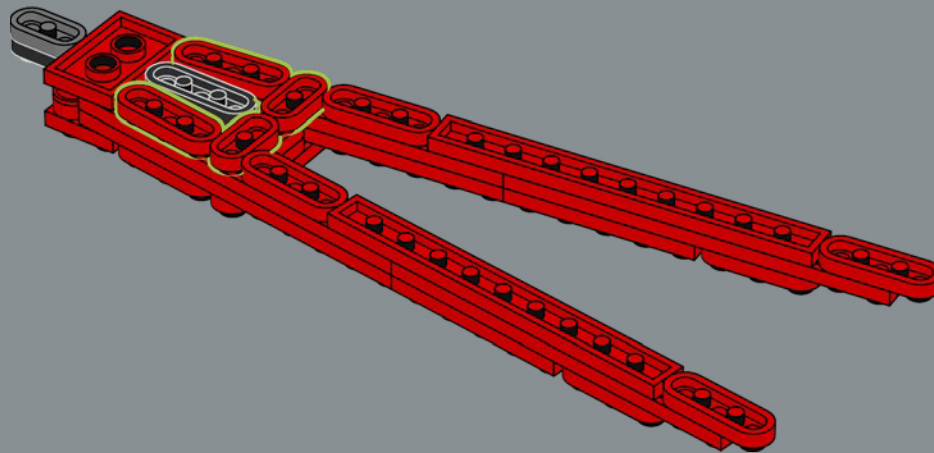

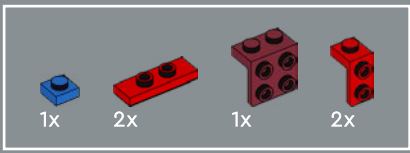

253

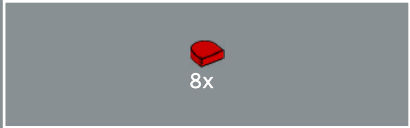
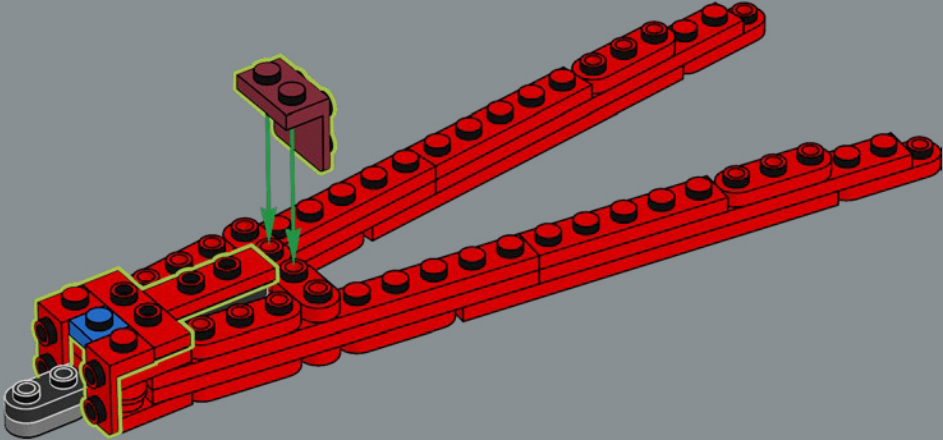

254

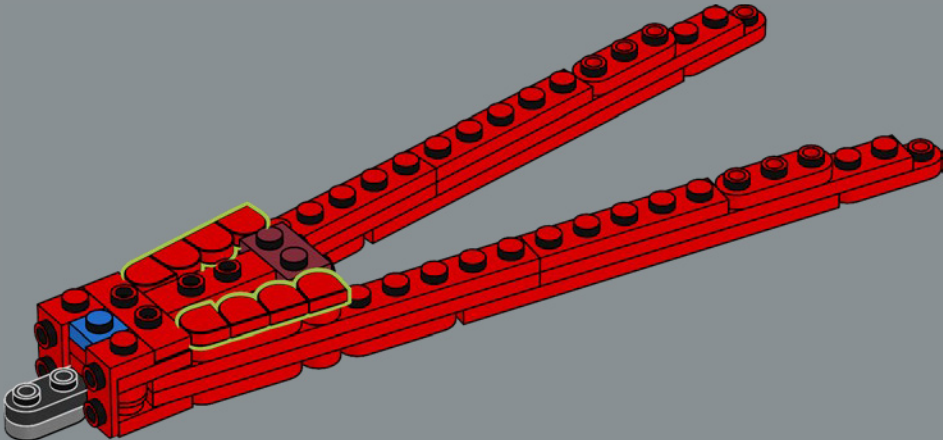

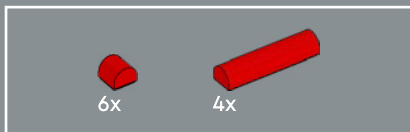

255

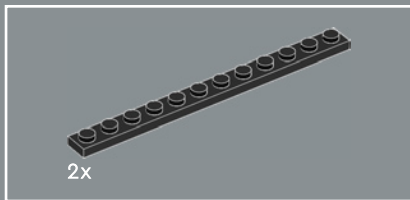
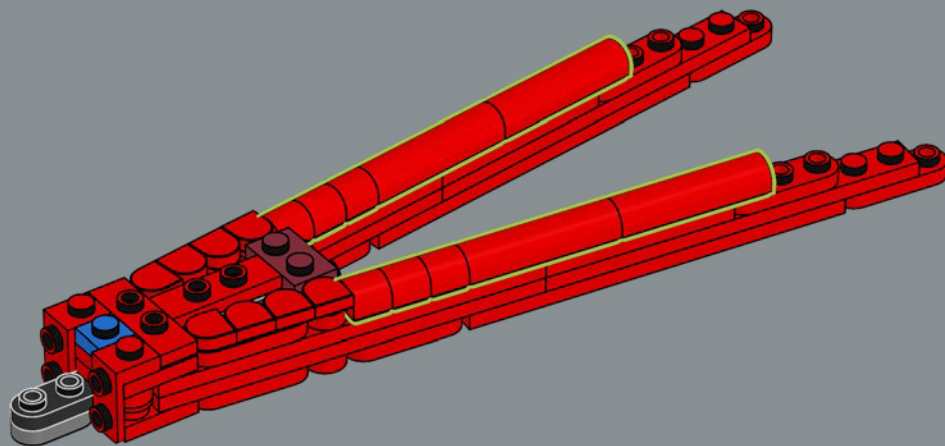

256

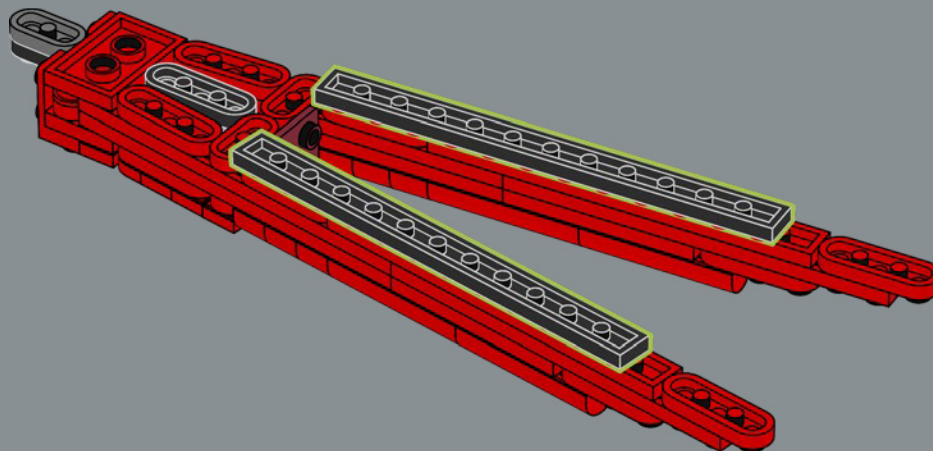



257

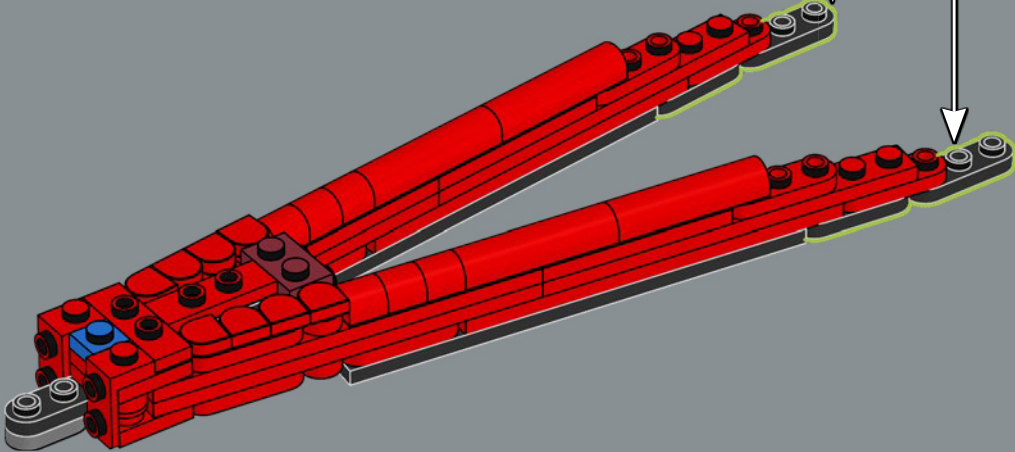
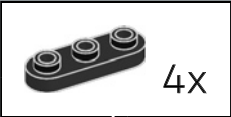

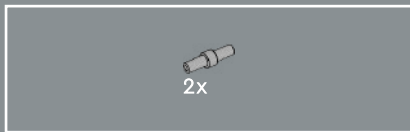

258

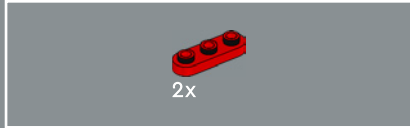
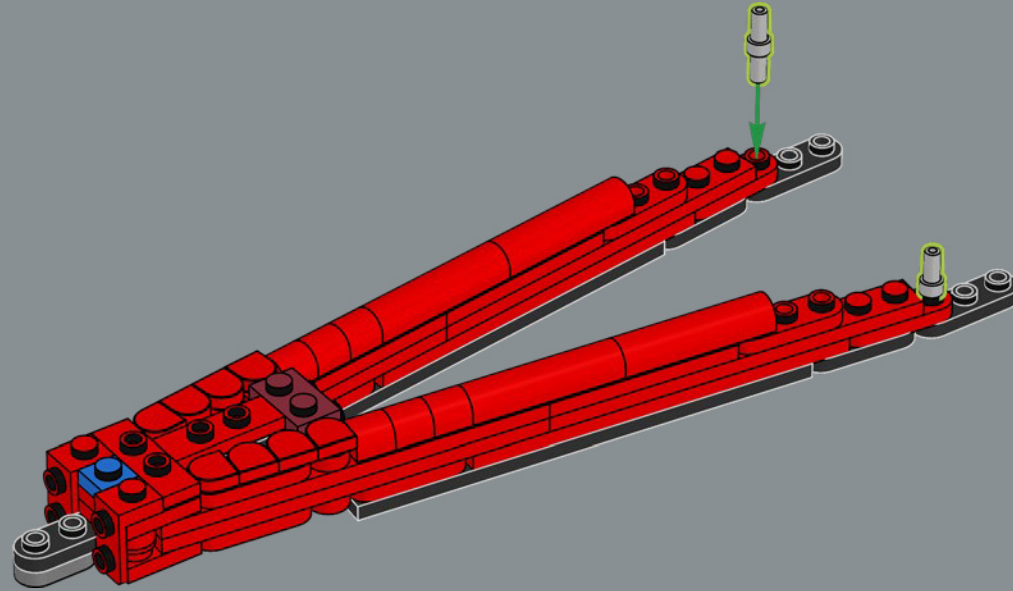

259

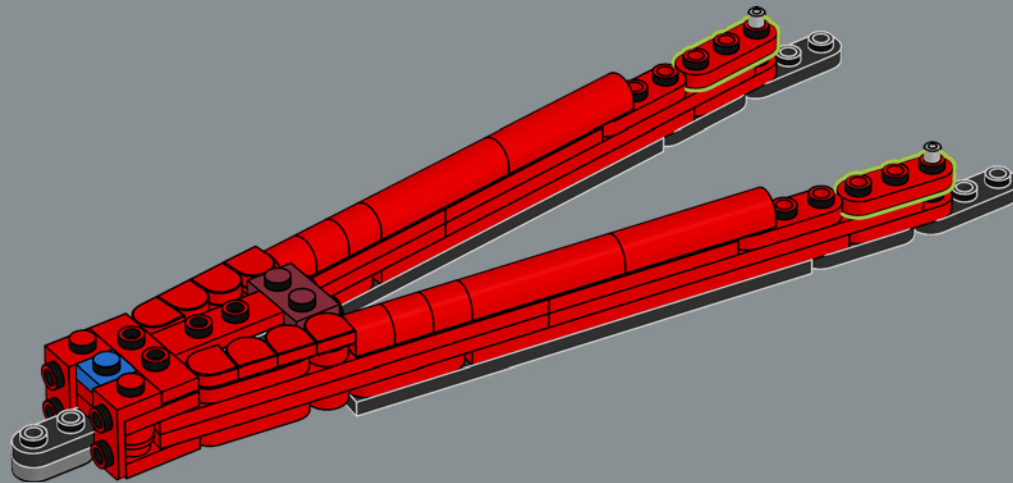



260

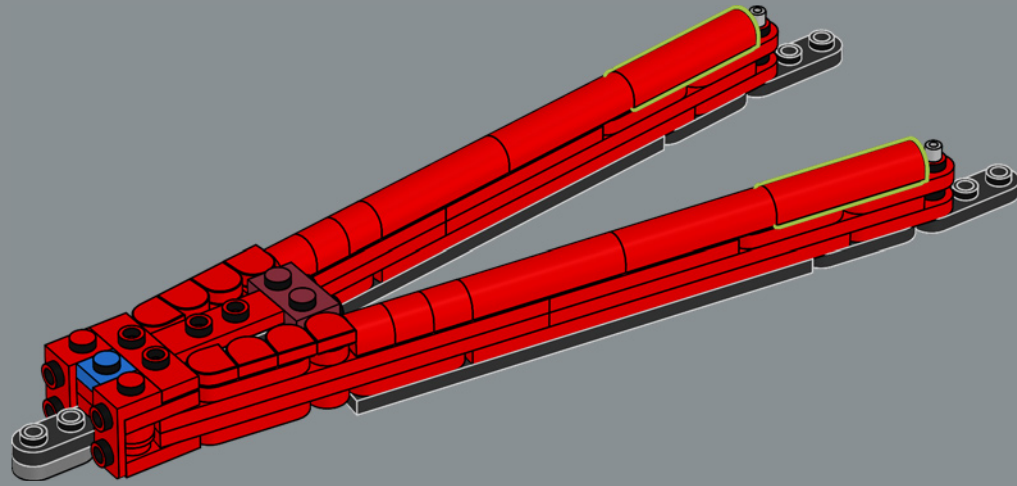

261

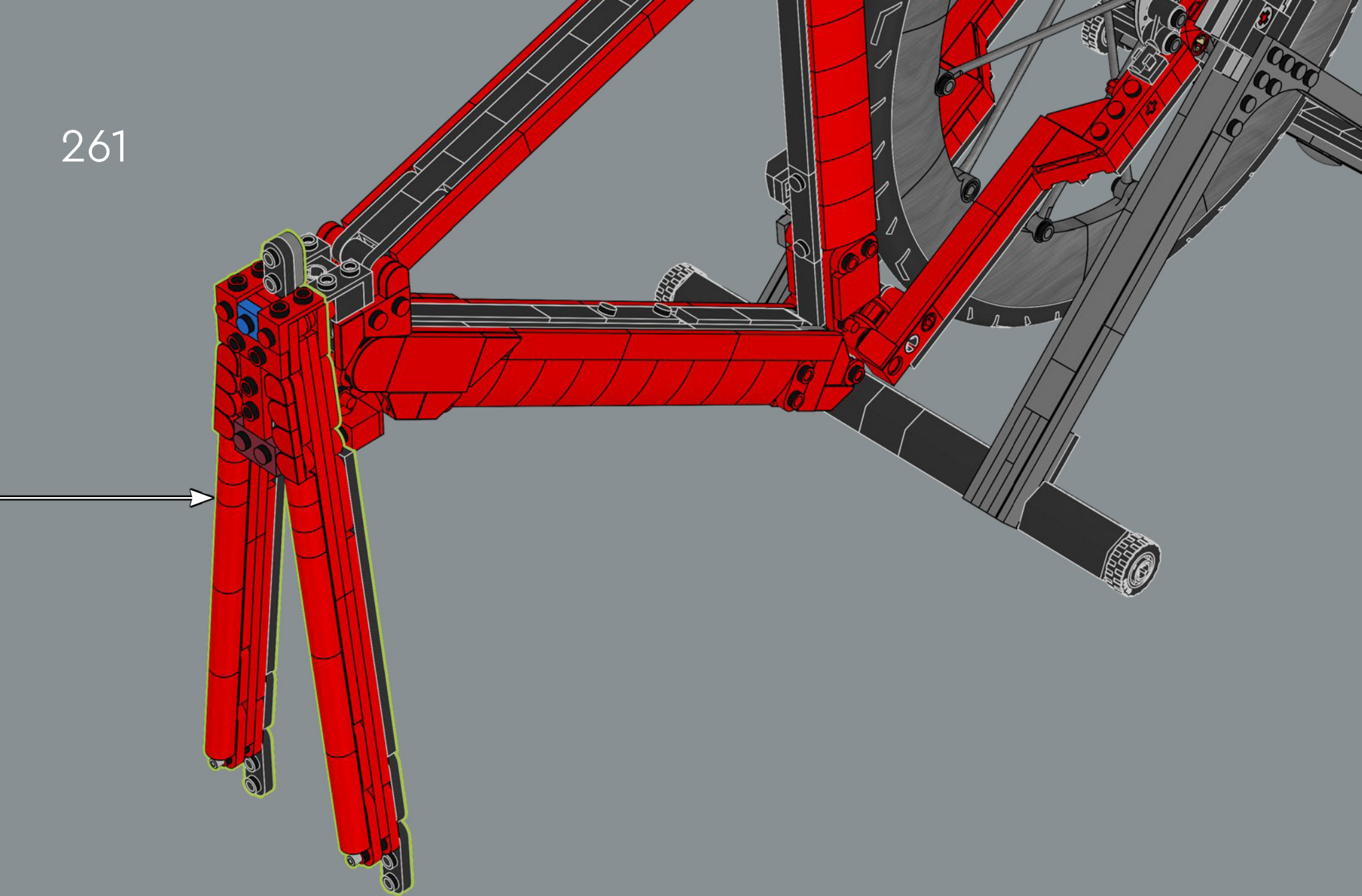

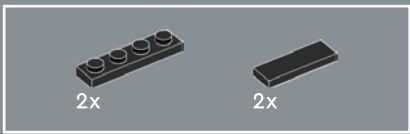

262

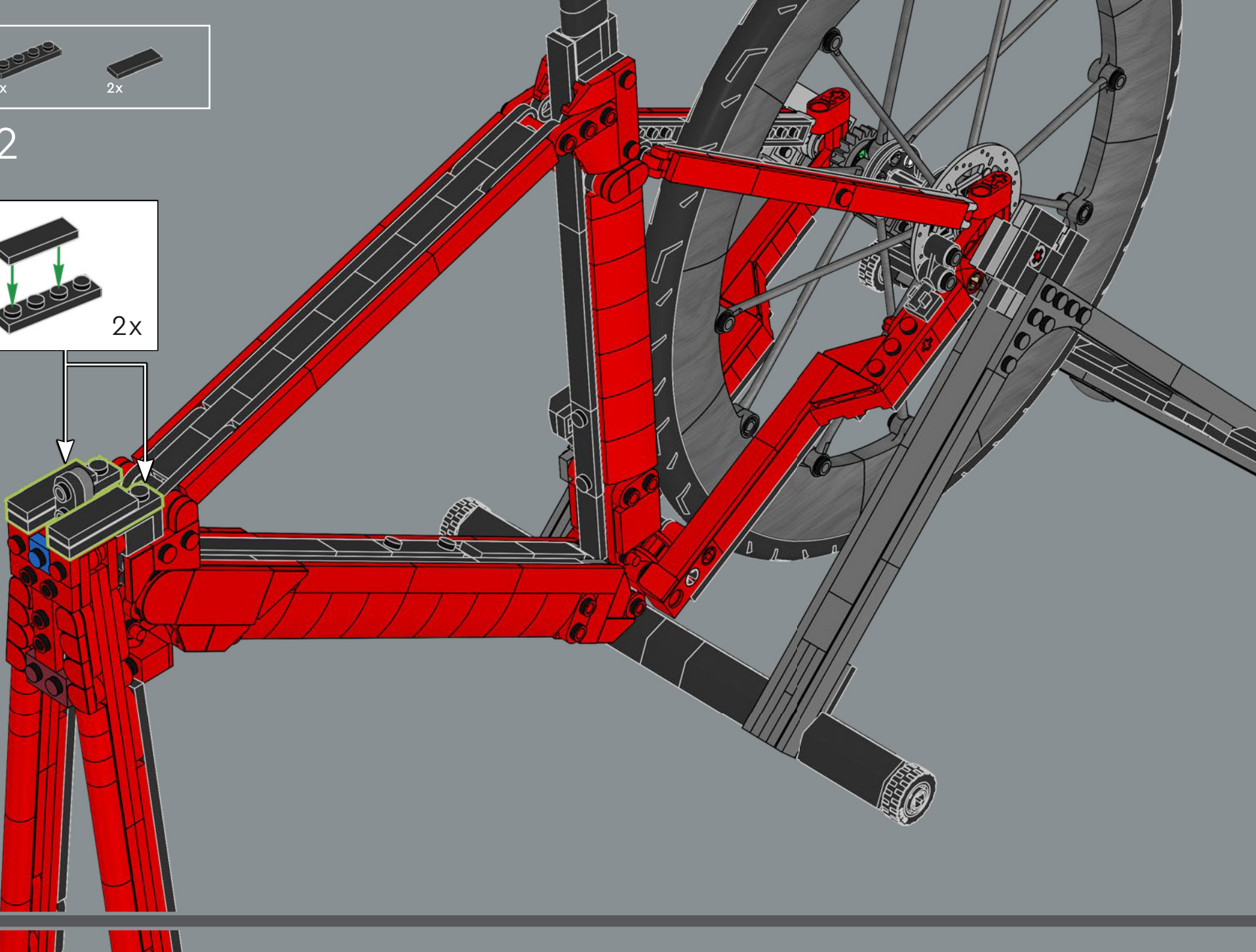
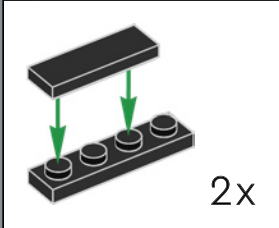

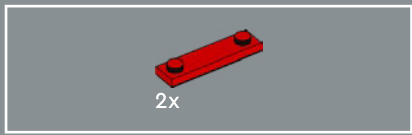

263

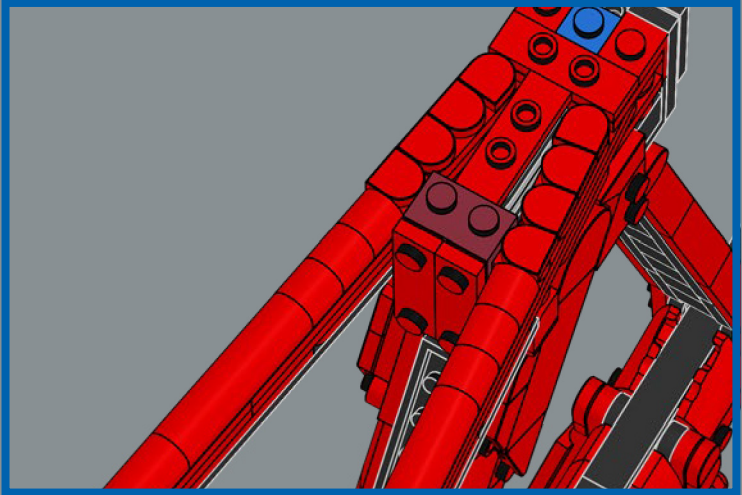
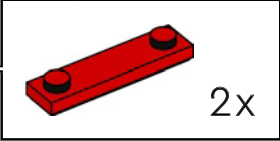
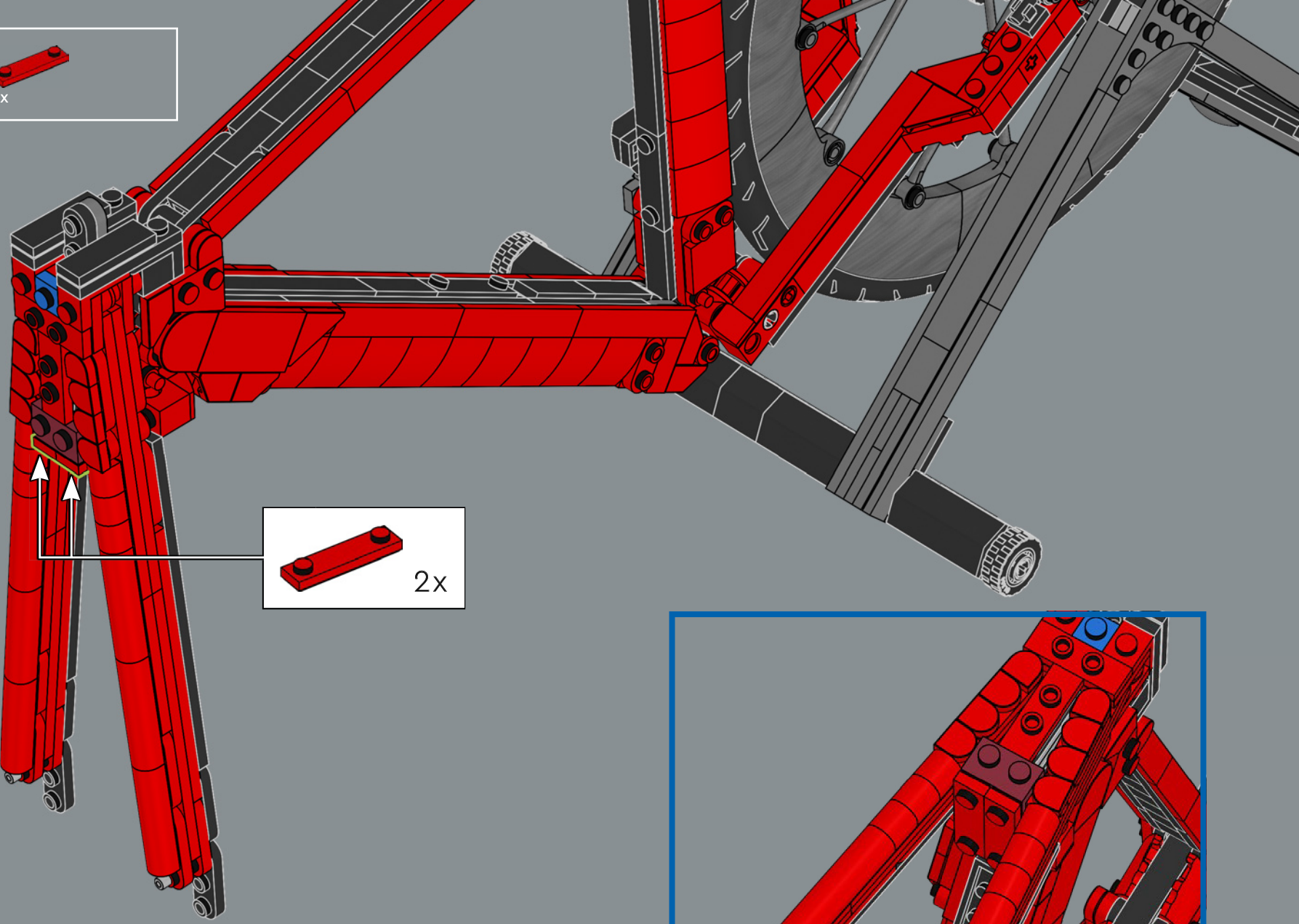

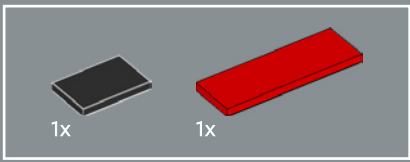

264

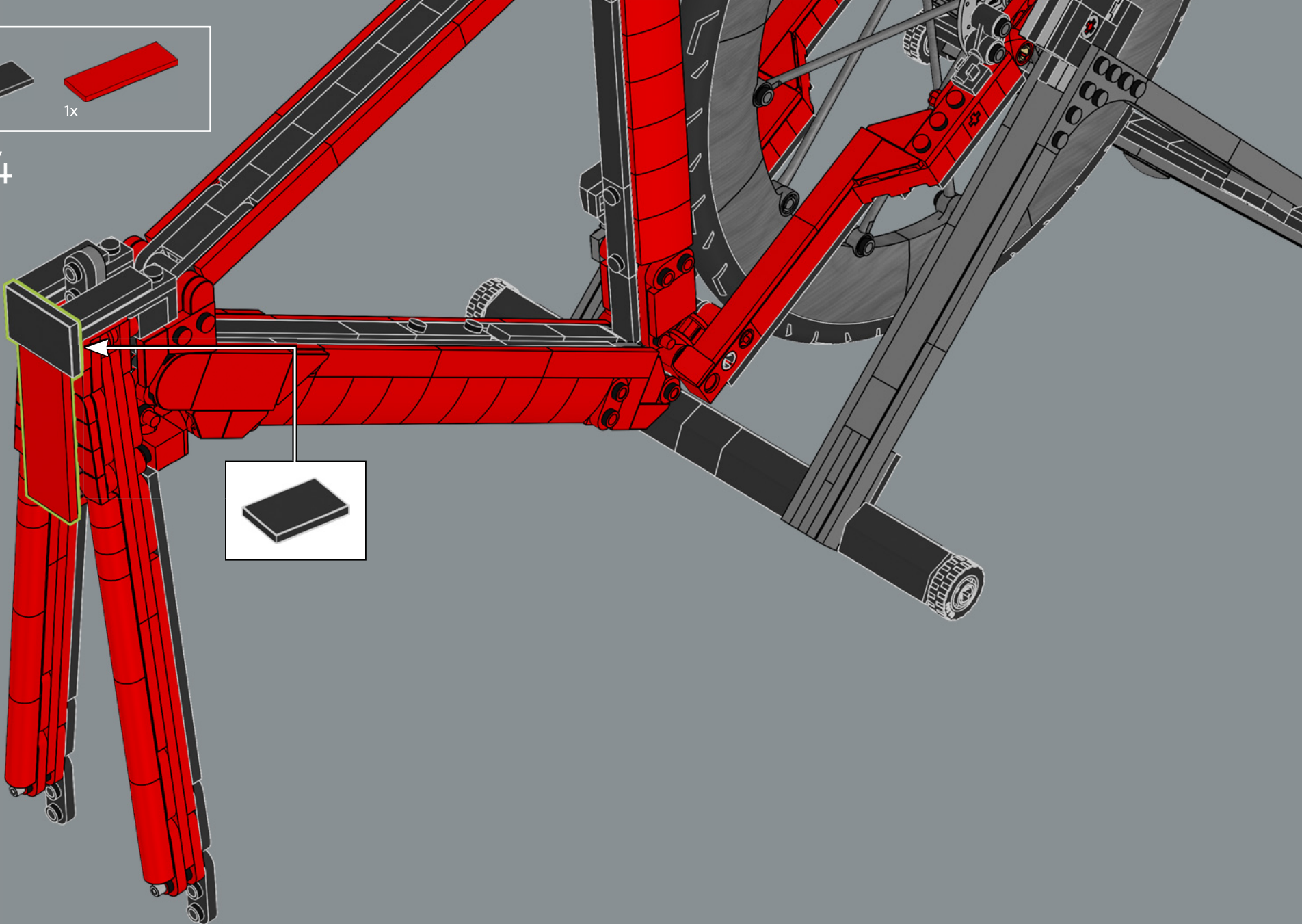



265

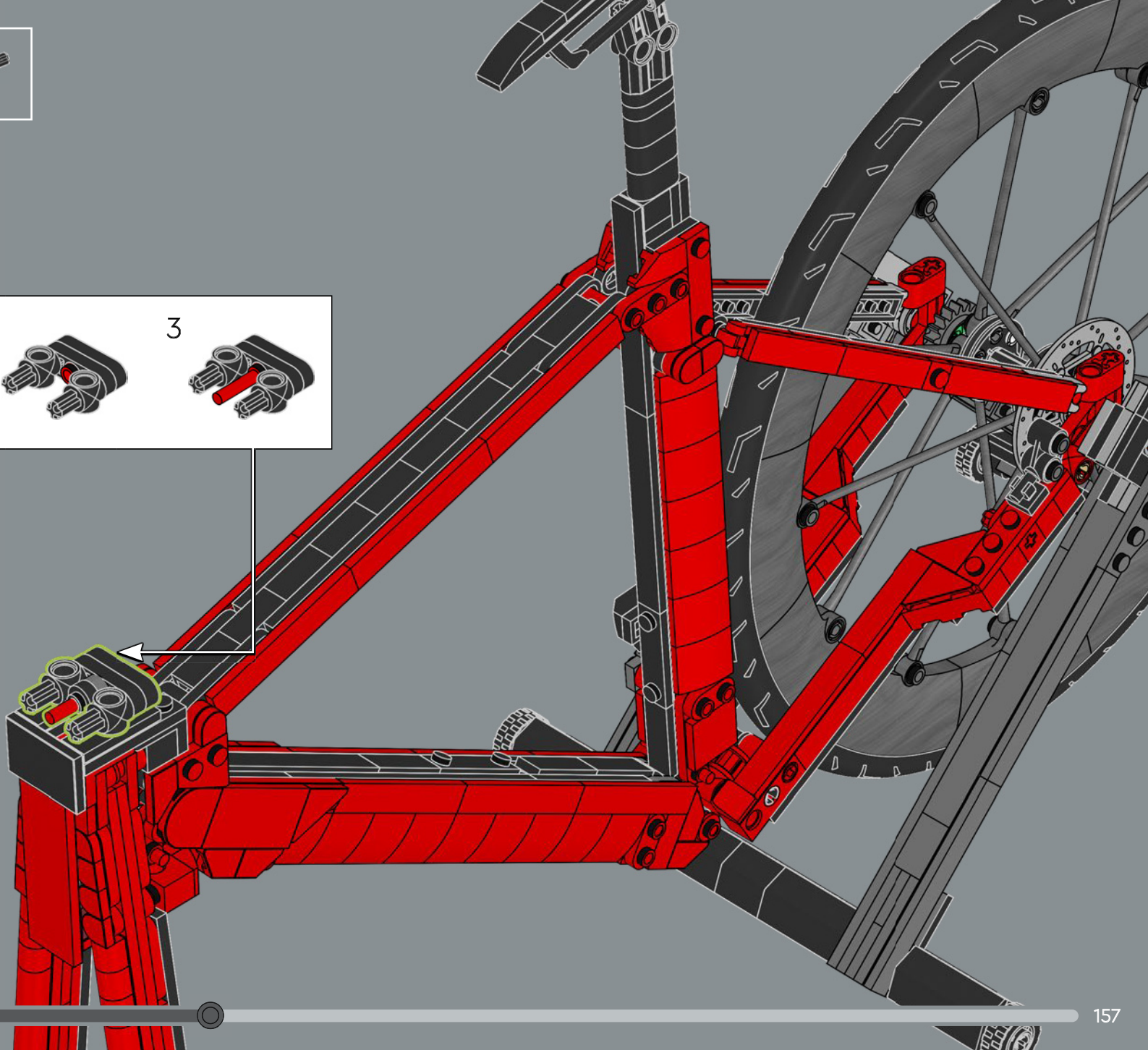
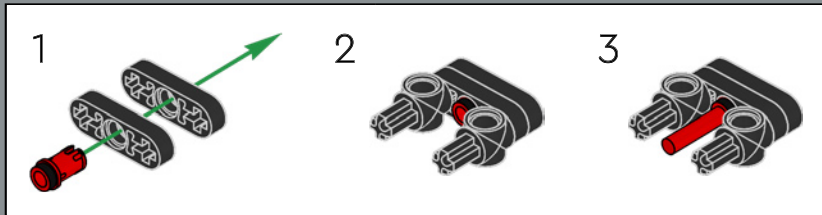



2x

266

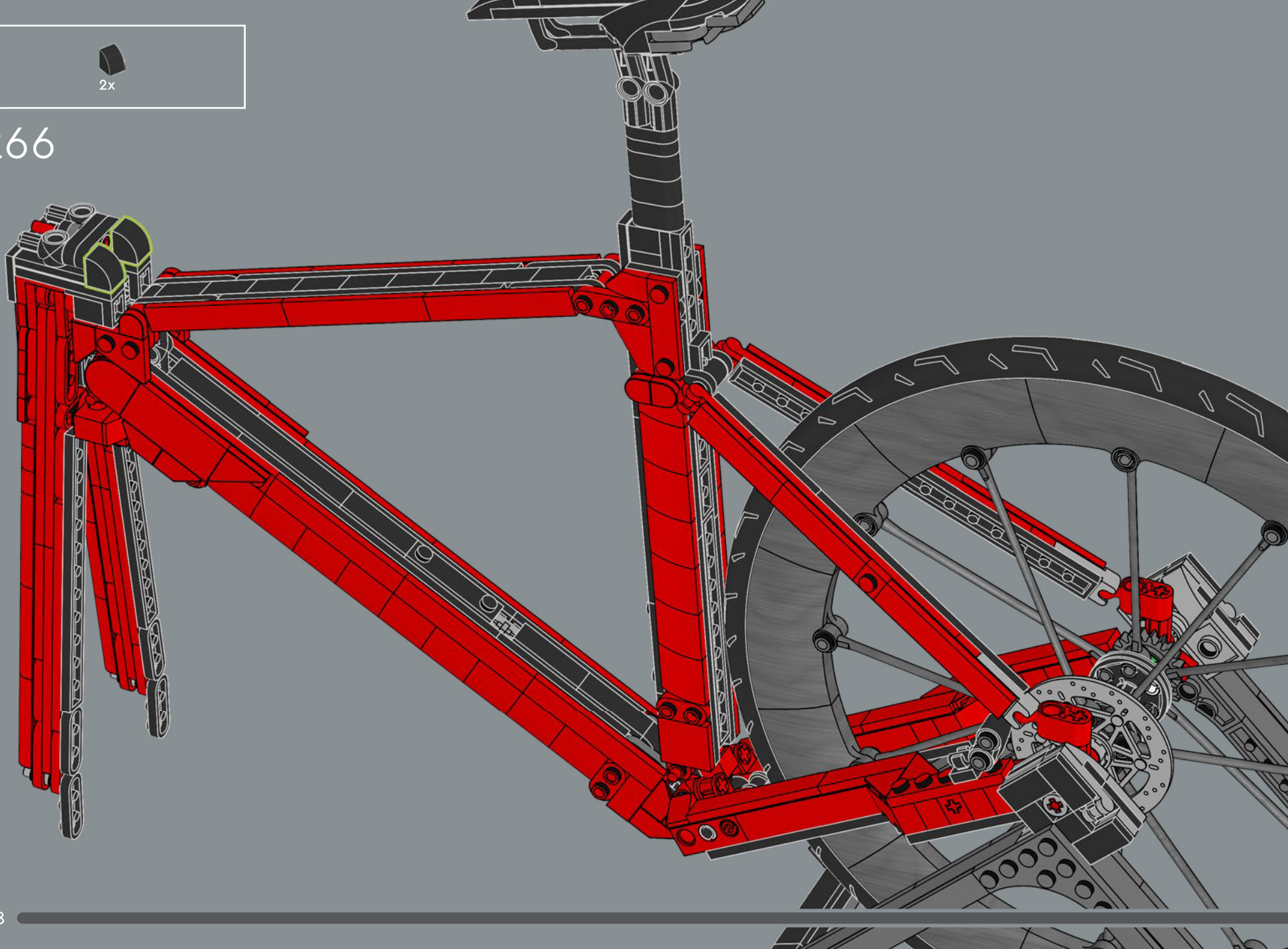



267

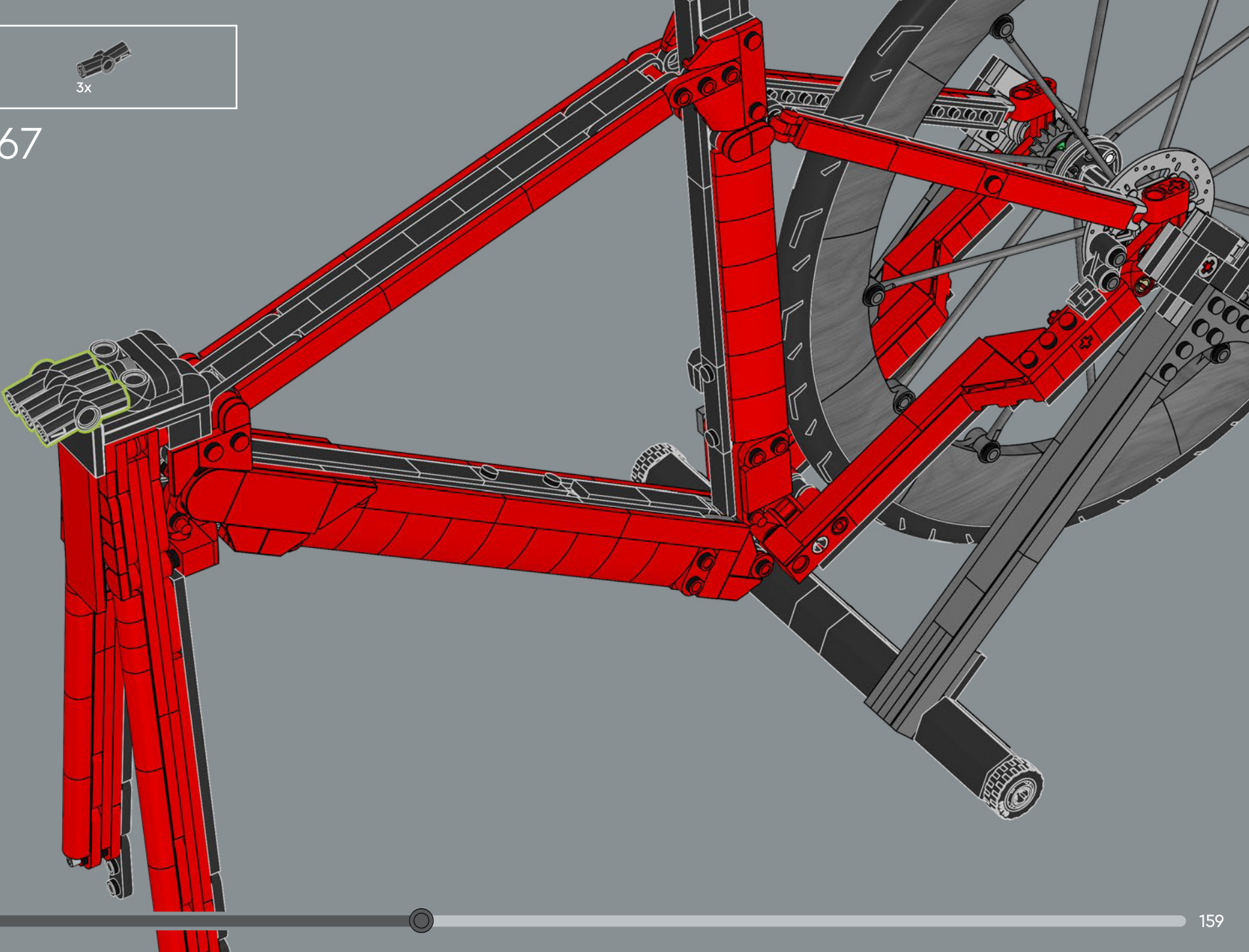

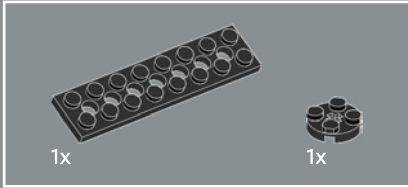
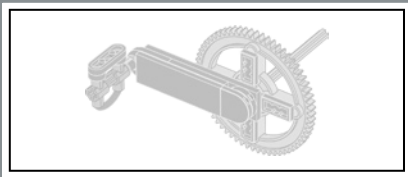

268

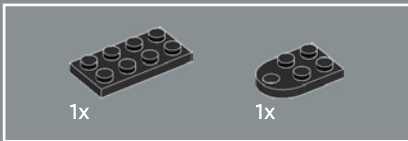
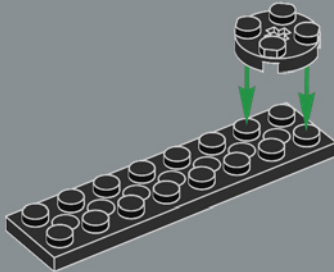

269

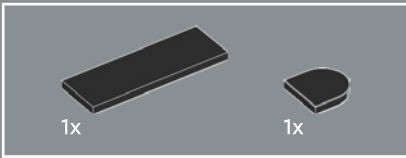
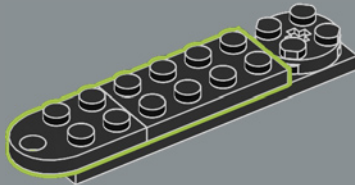

270

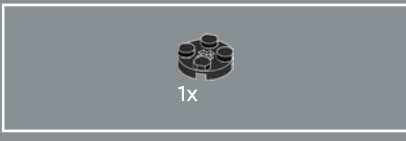
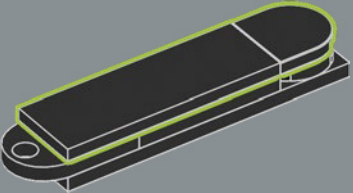

271

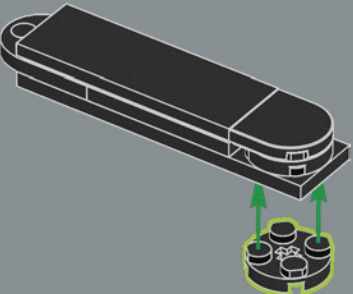

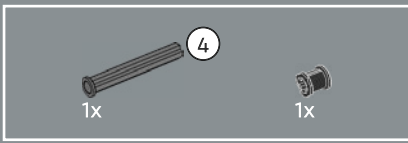

272

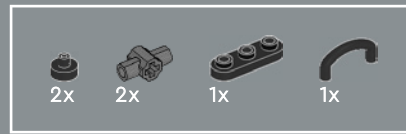
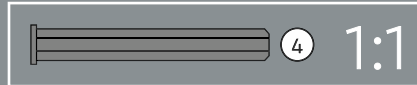
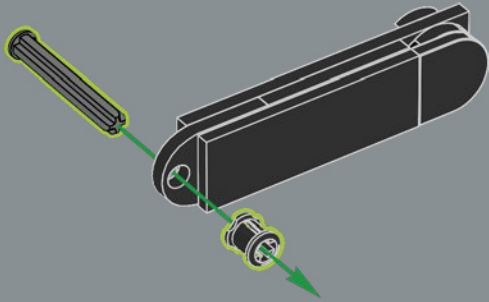

273

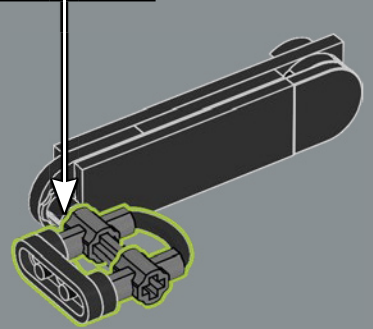
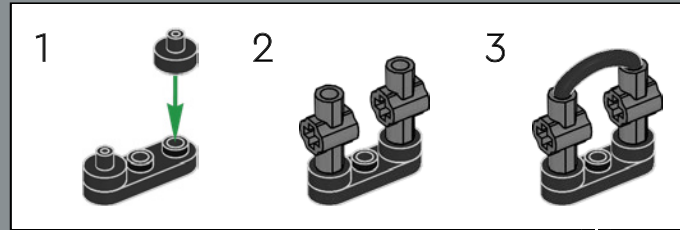

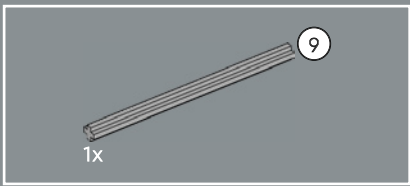

274

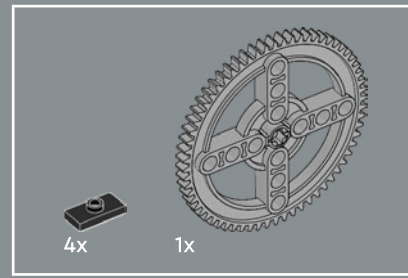
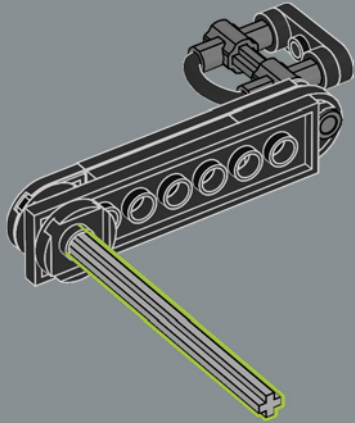

275

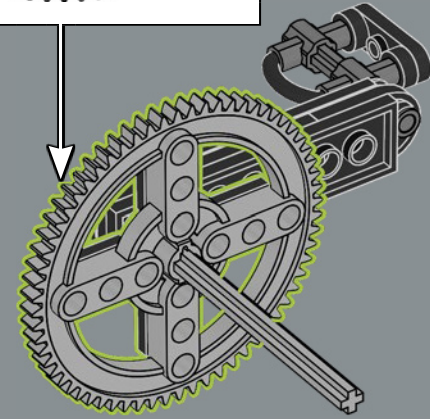
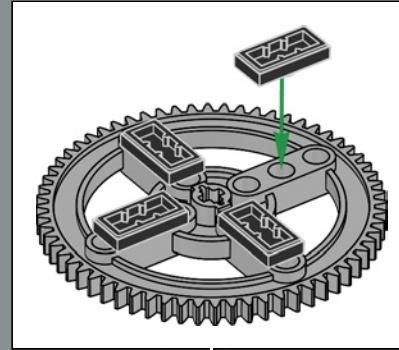

这是目前最大的乐高®正齿轮，专为此模型打造。

276

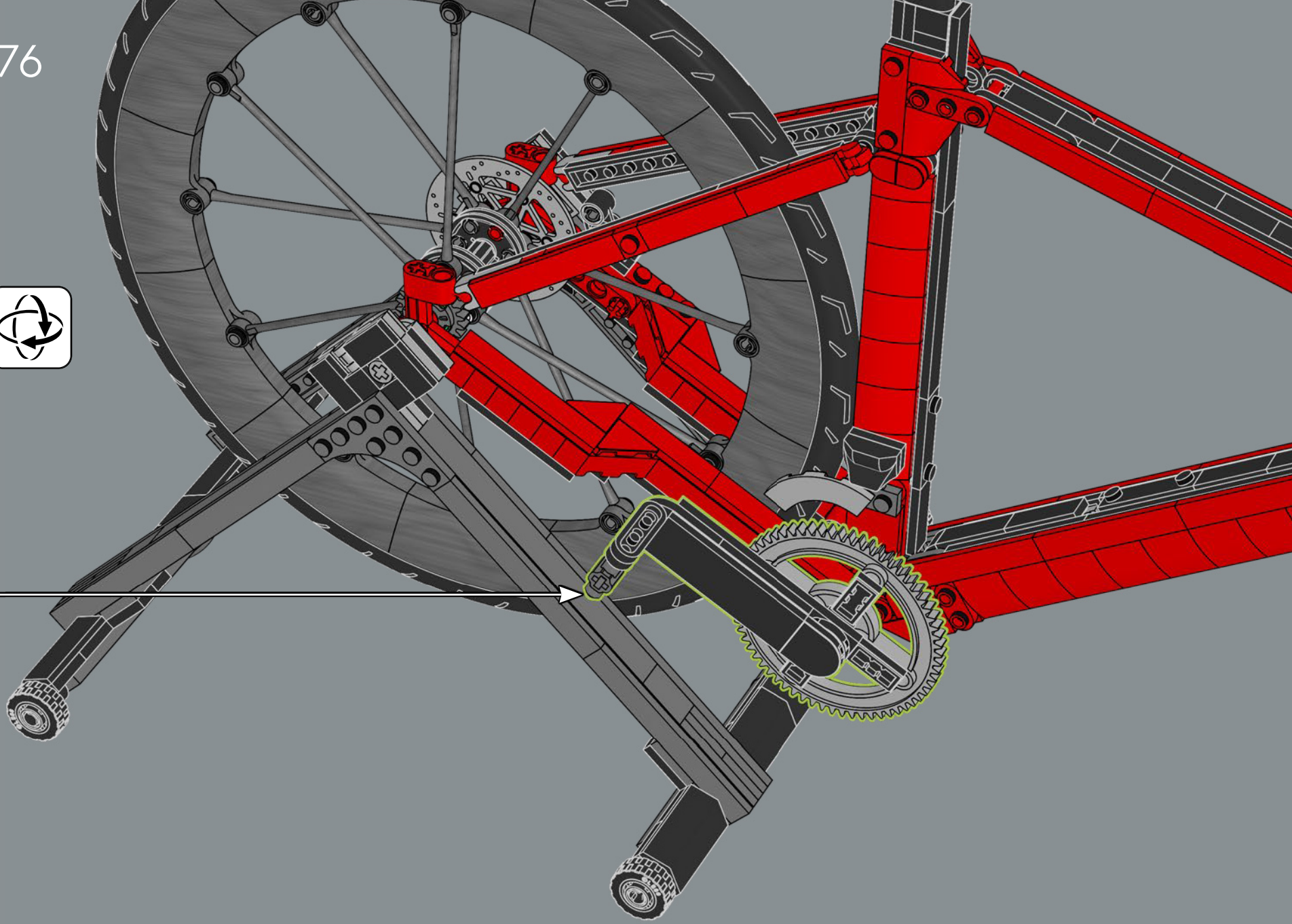

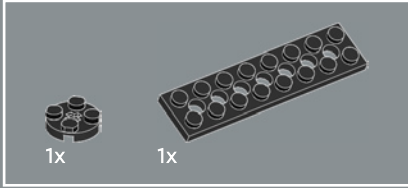
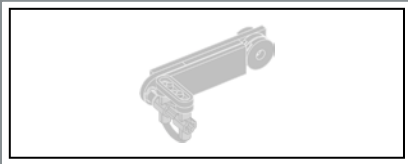

277

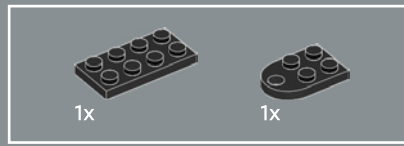
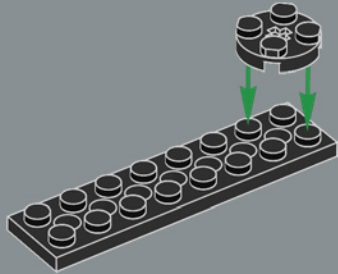

278

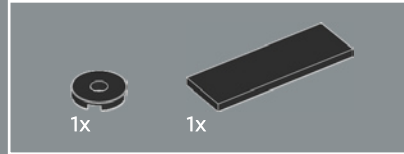
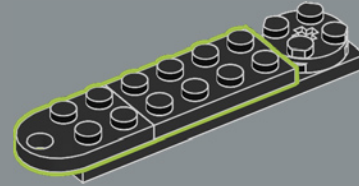

279

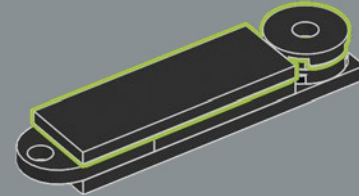



280

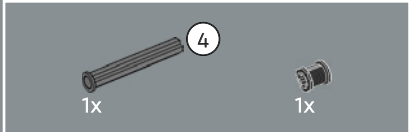
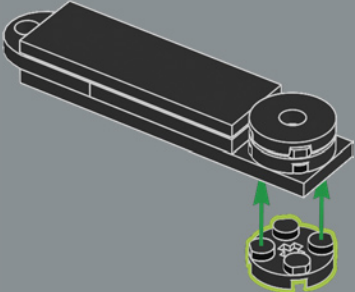

281

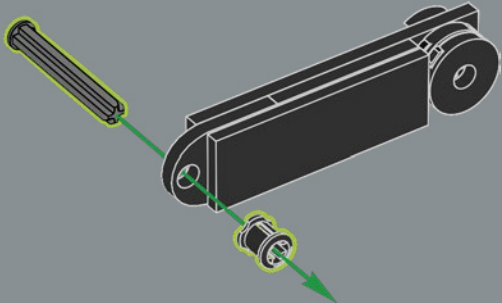

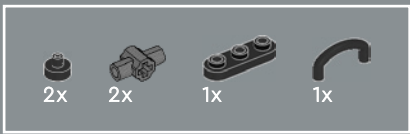

282

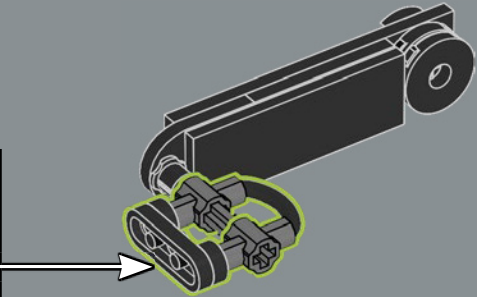
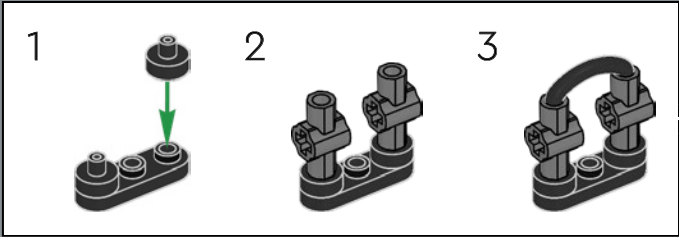

283

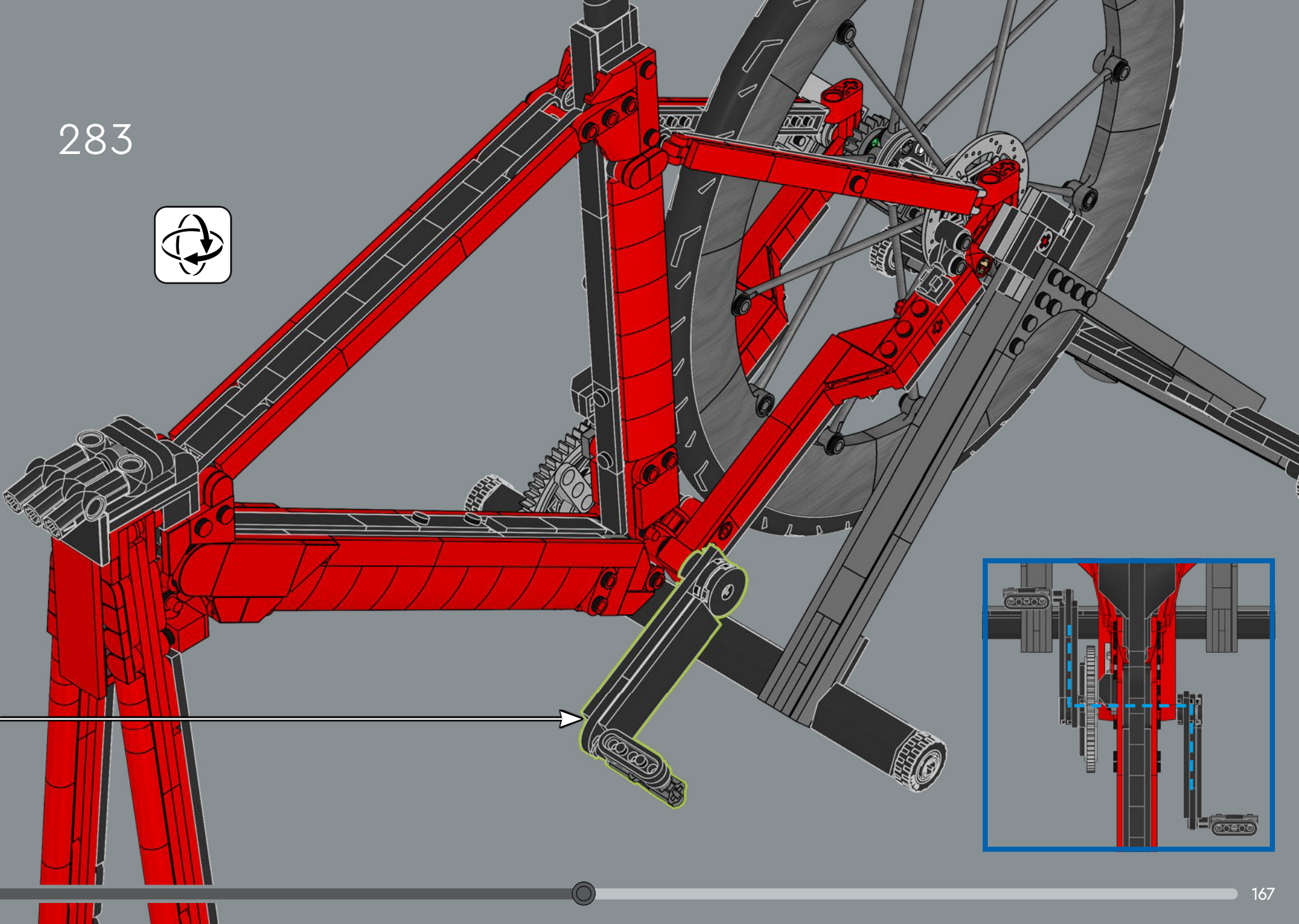

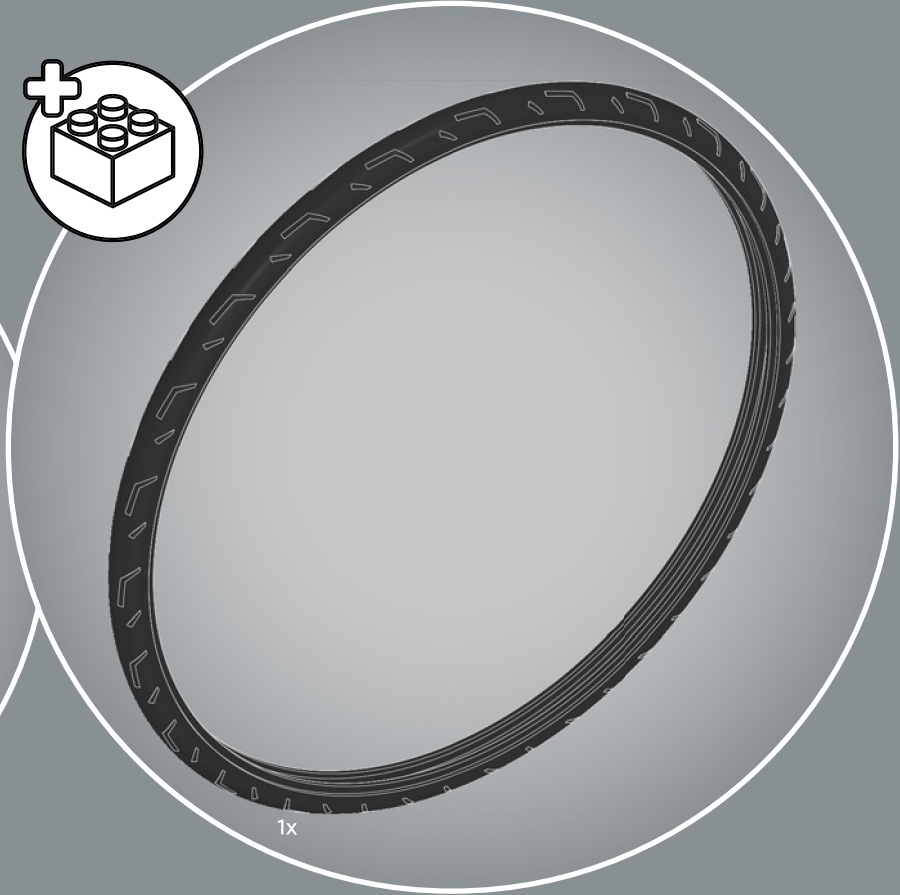
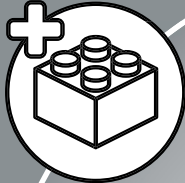

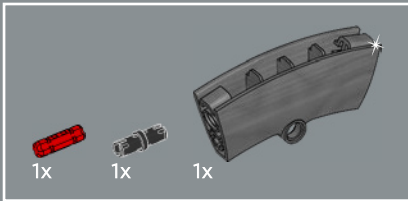
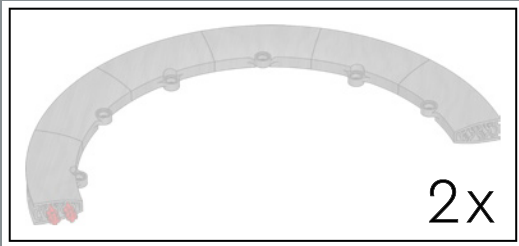
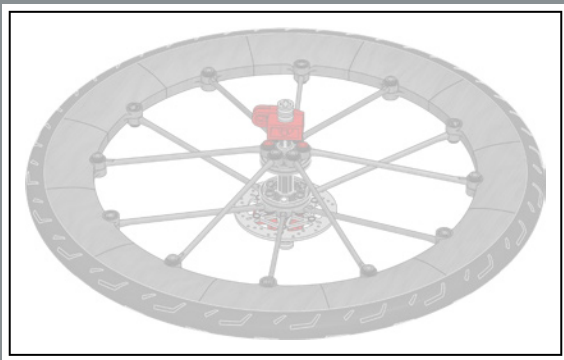

284

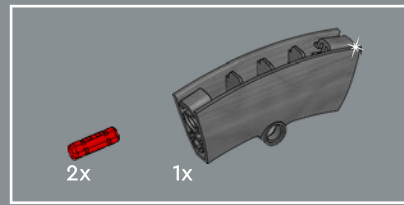
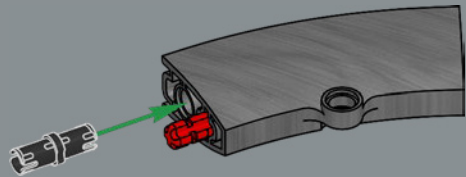

285

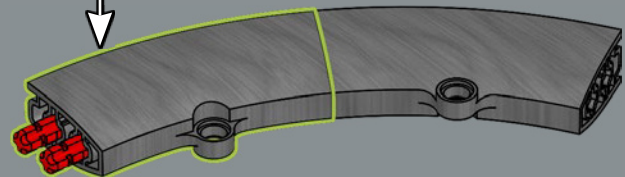
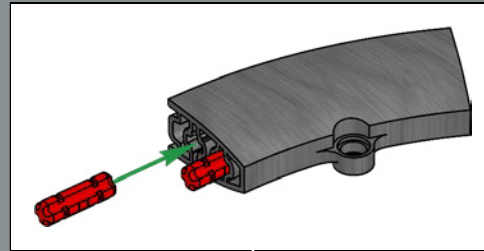

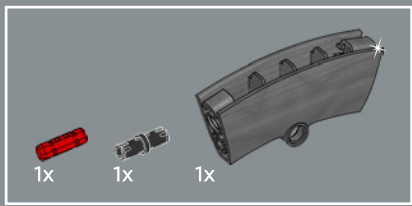

286

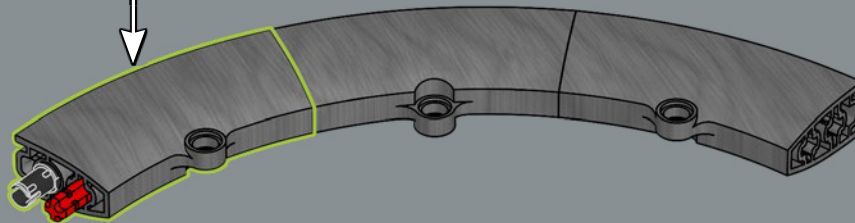
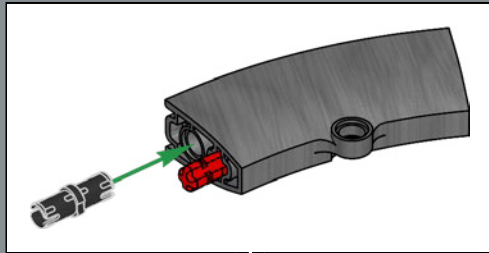

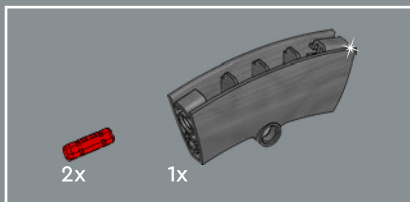

287

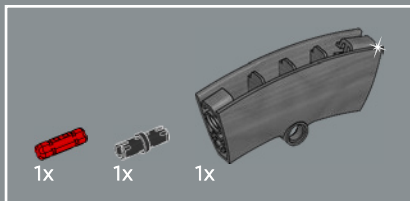
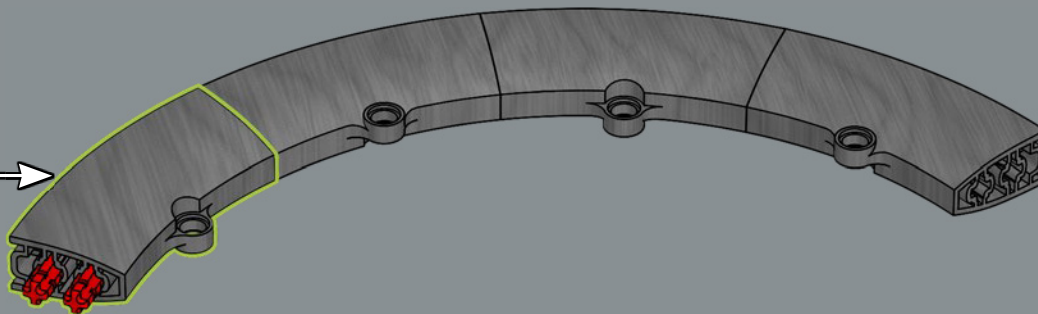
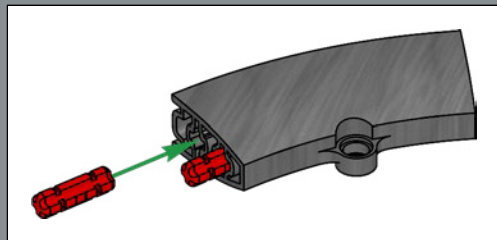

288

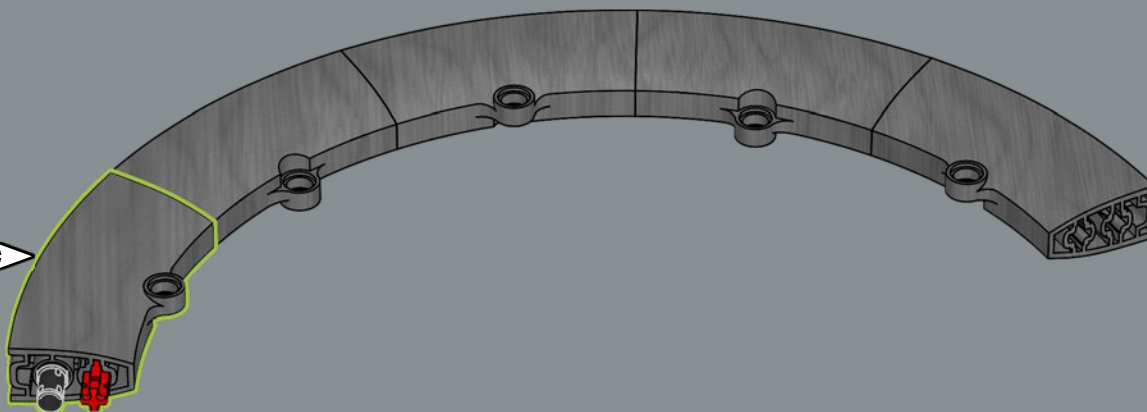
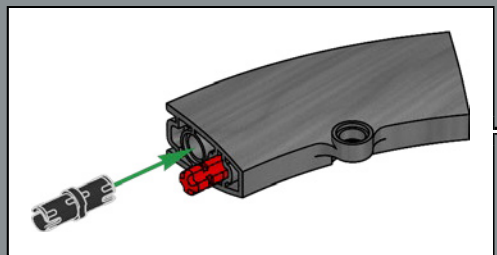

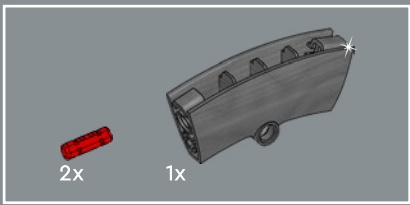

289

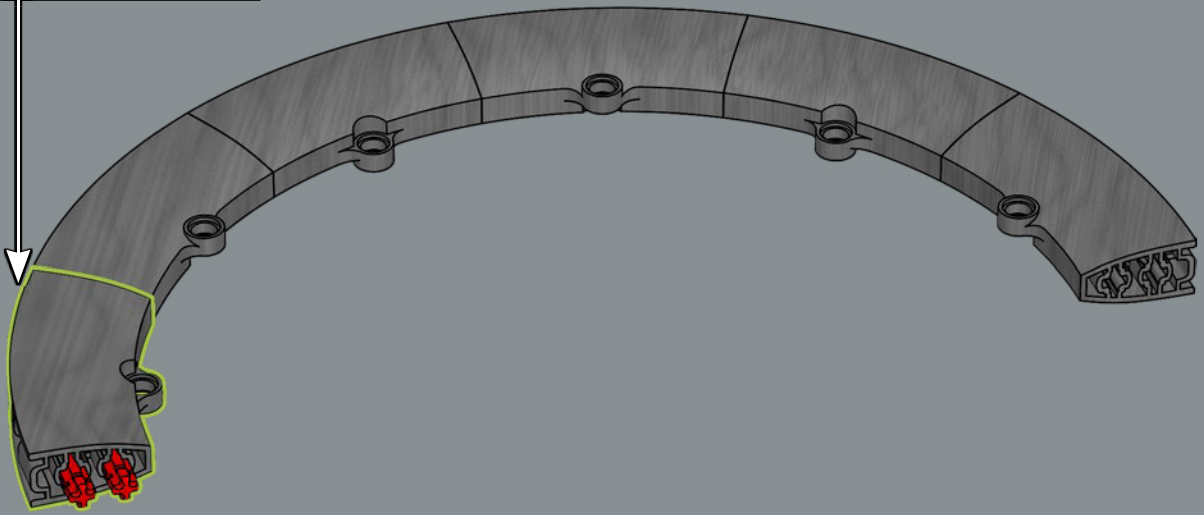
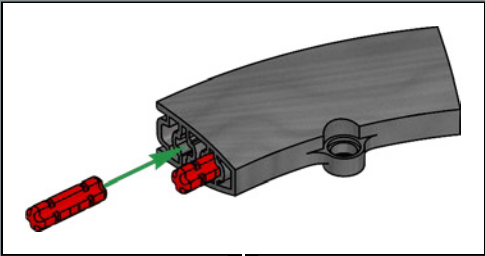

2x

290

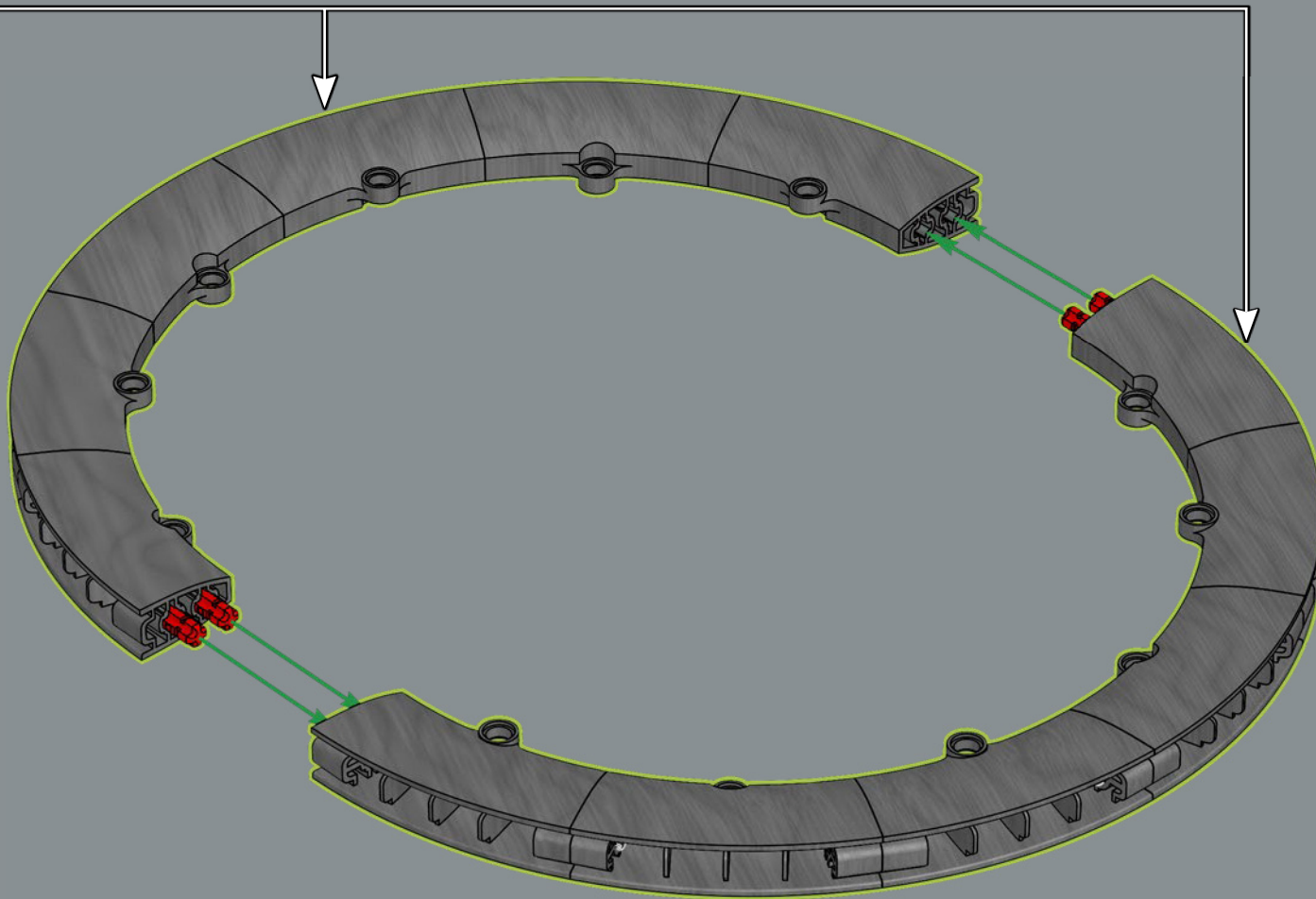

291

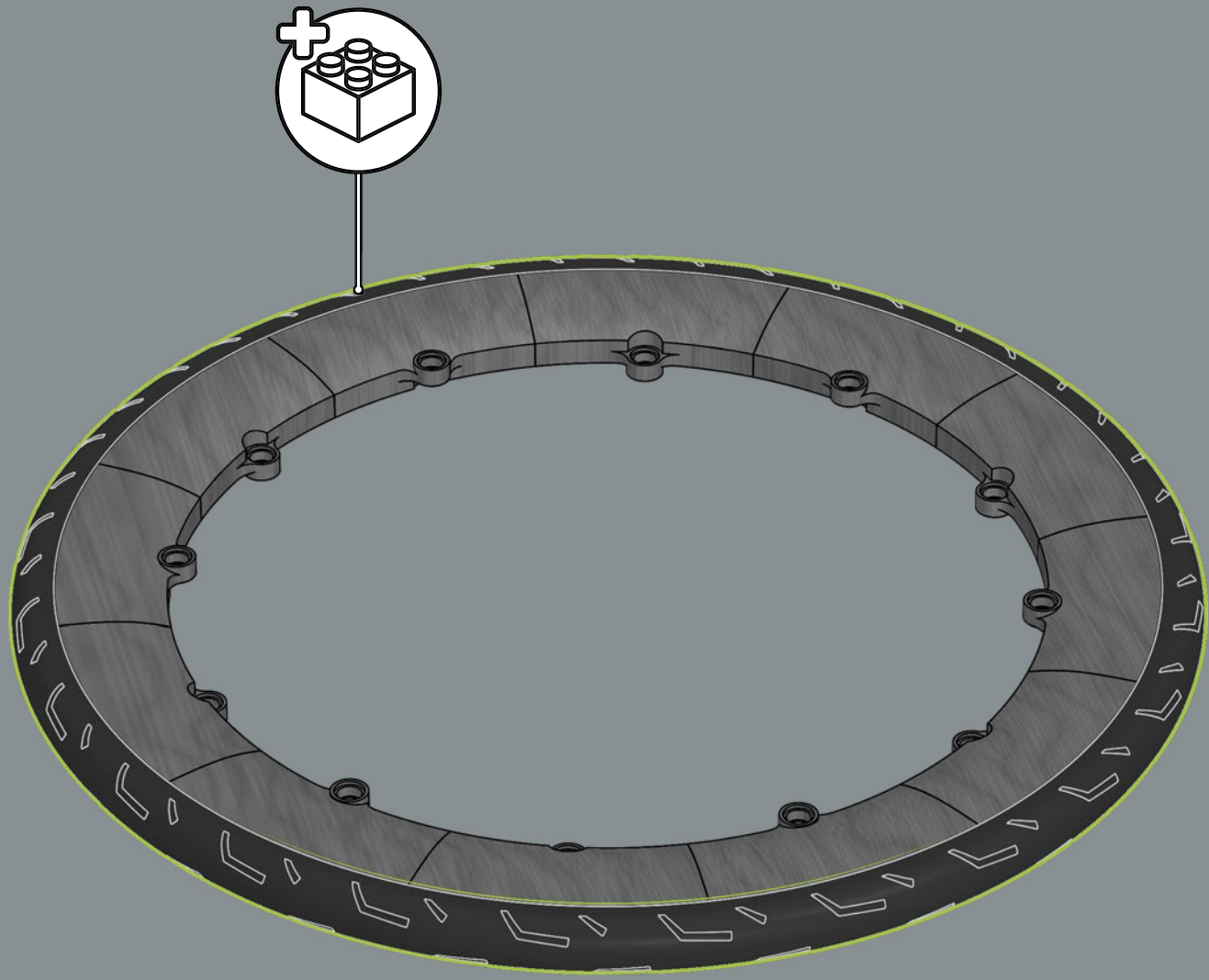

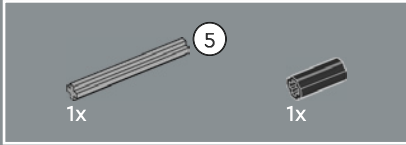
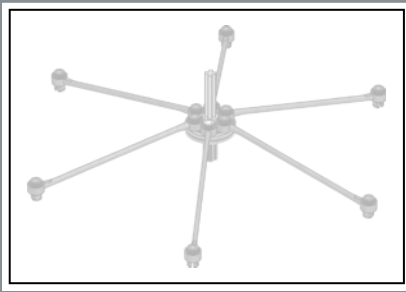

292

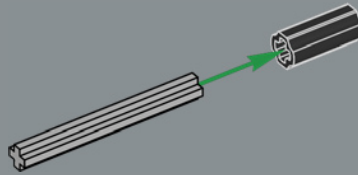

293

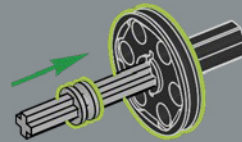

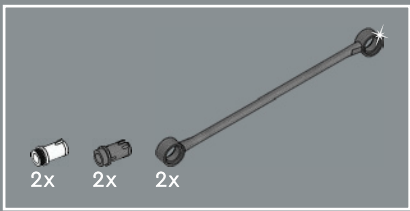

294

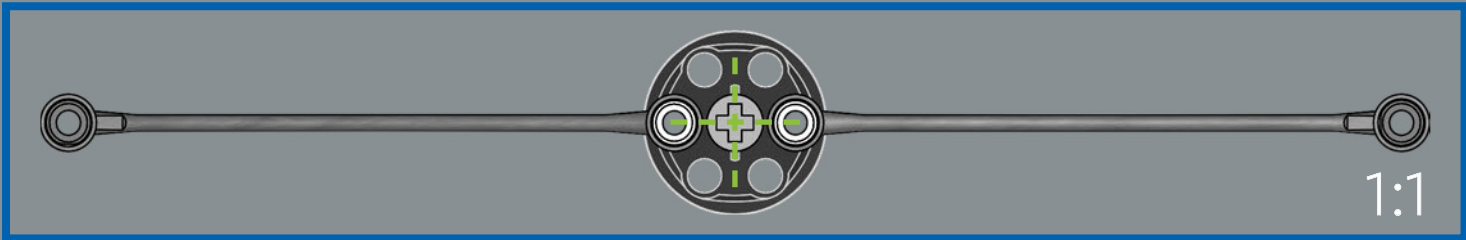
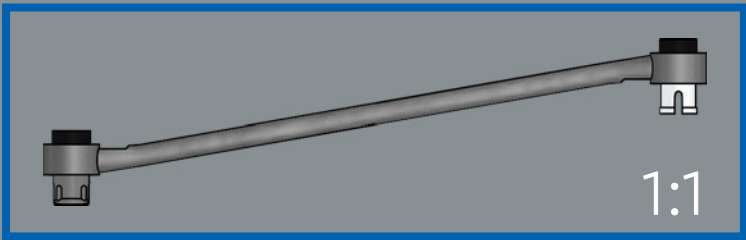
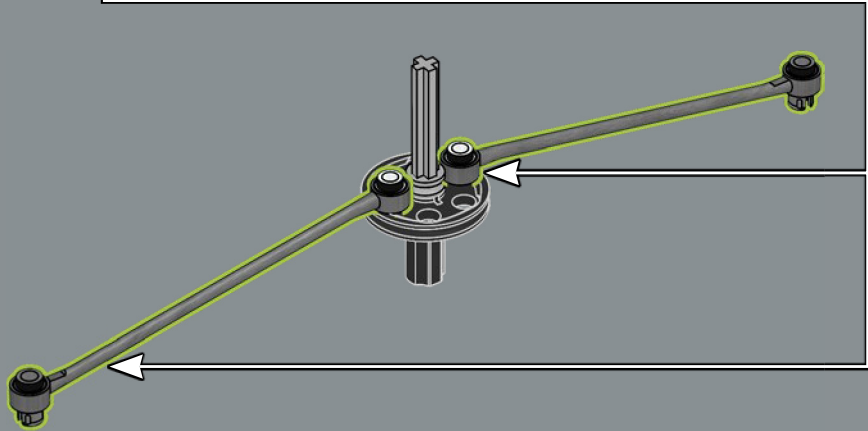
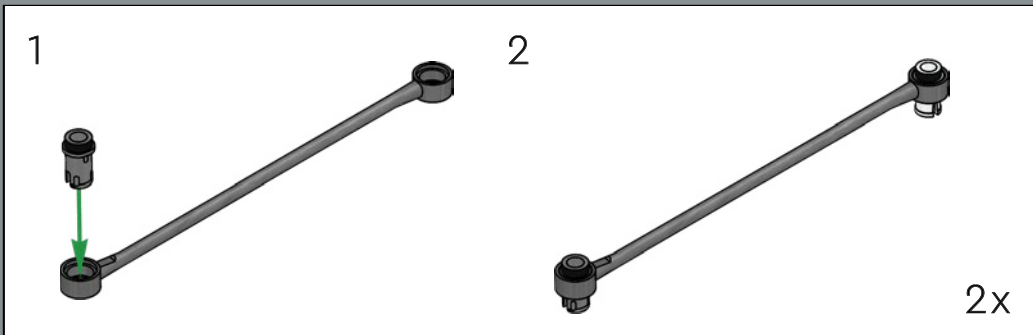

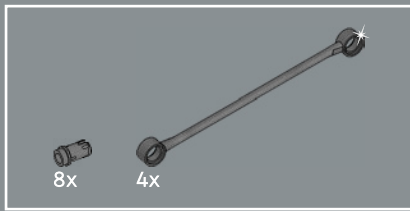

295

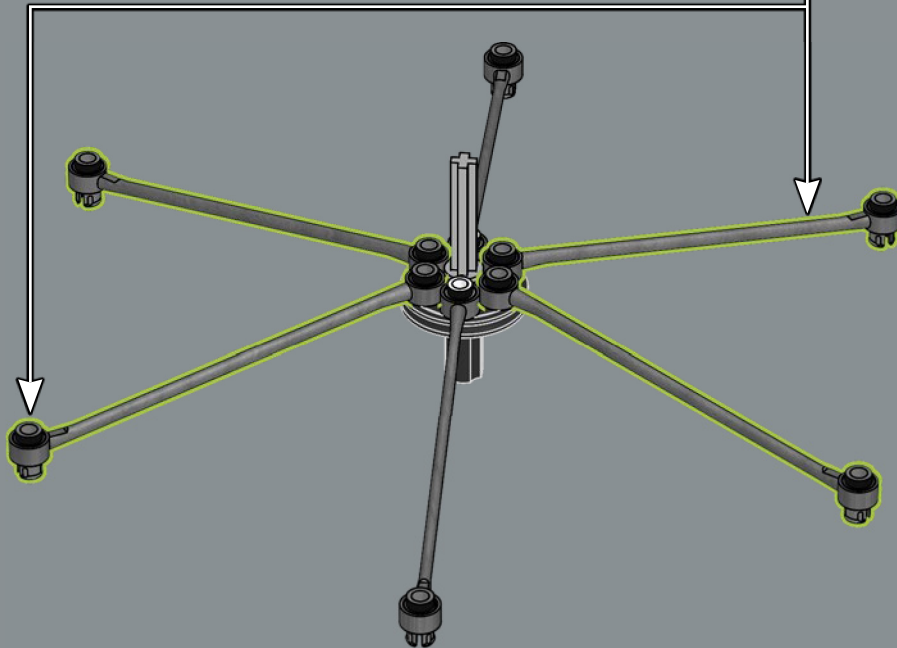
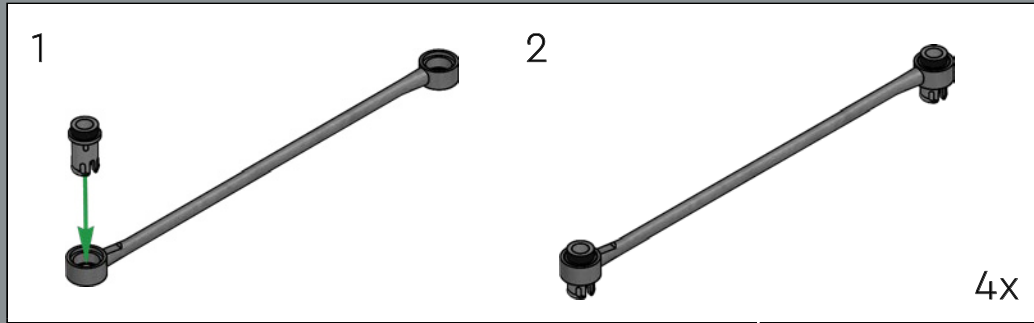

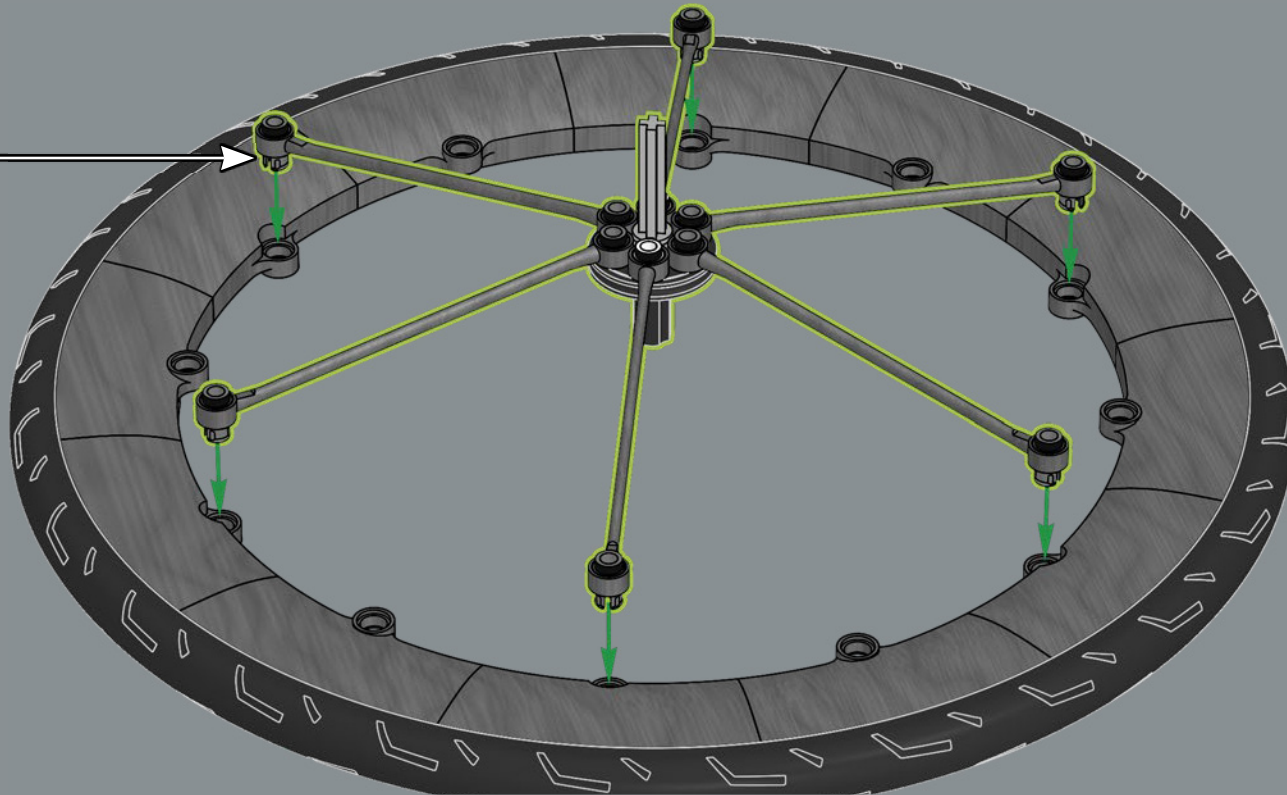
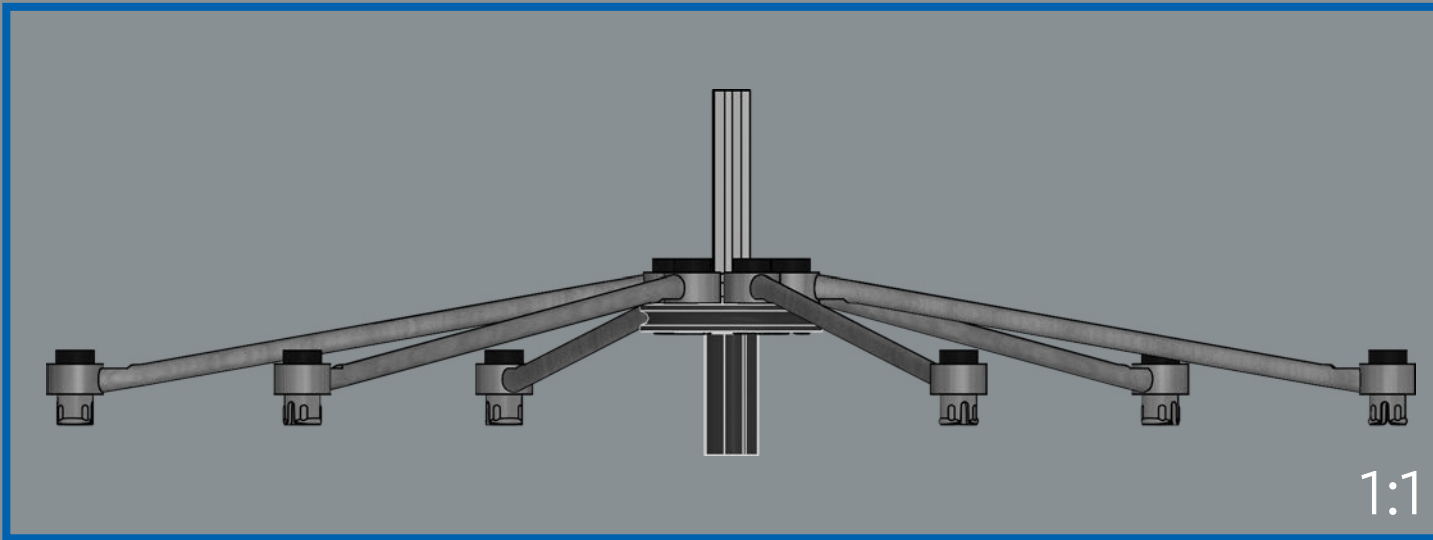

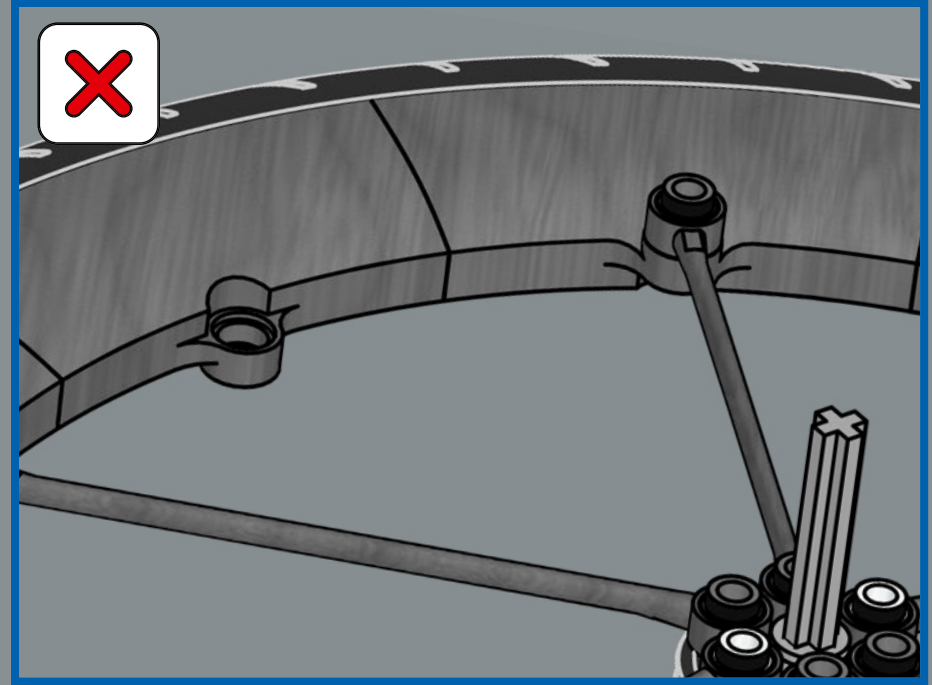
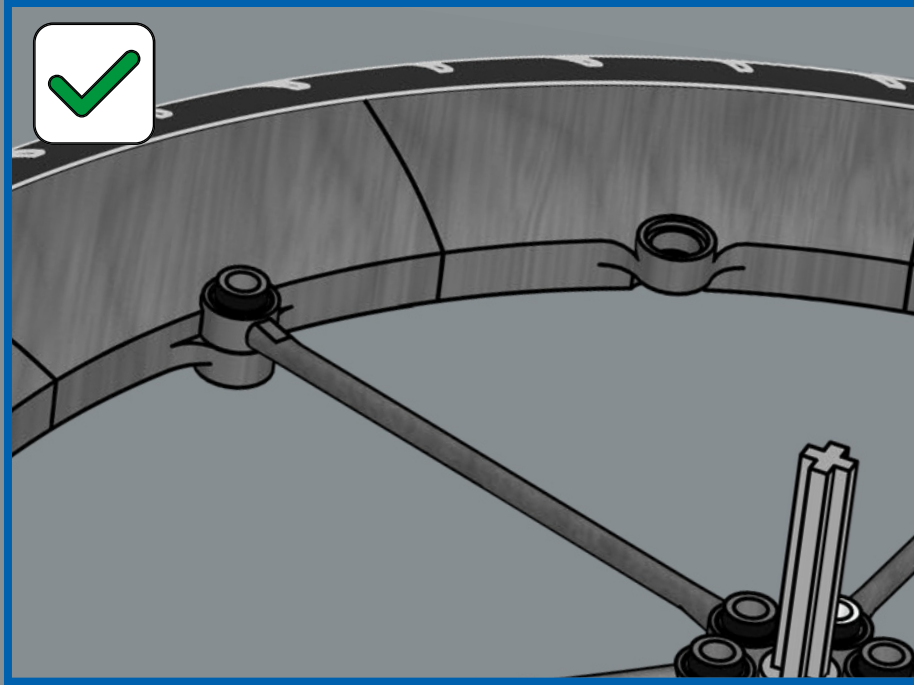

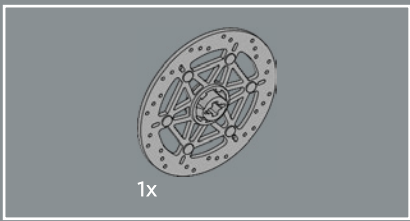

297

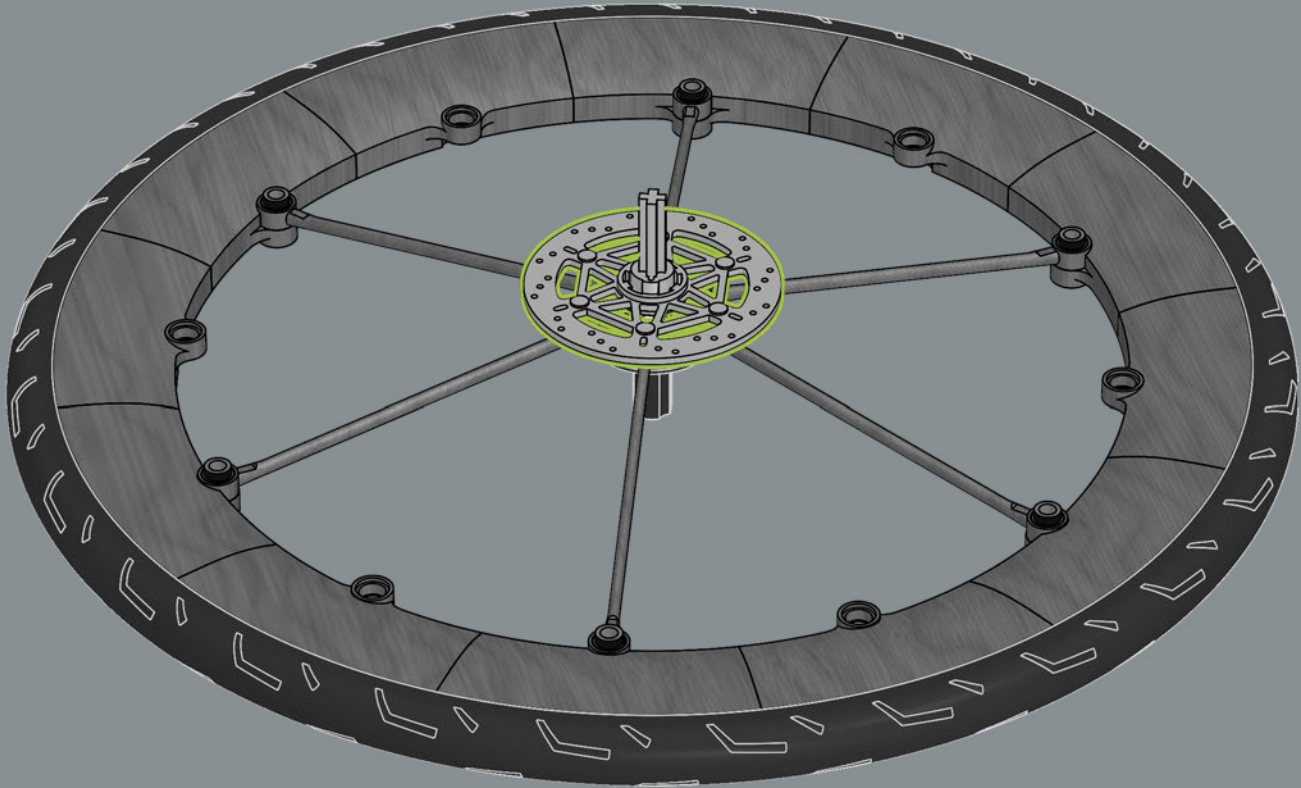

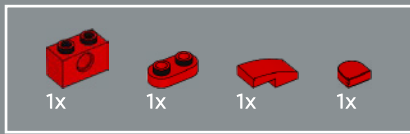

298

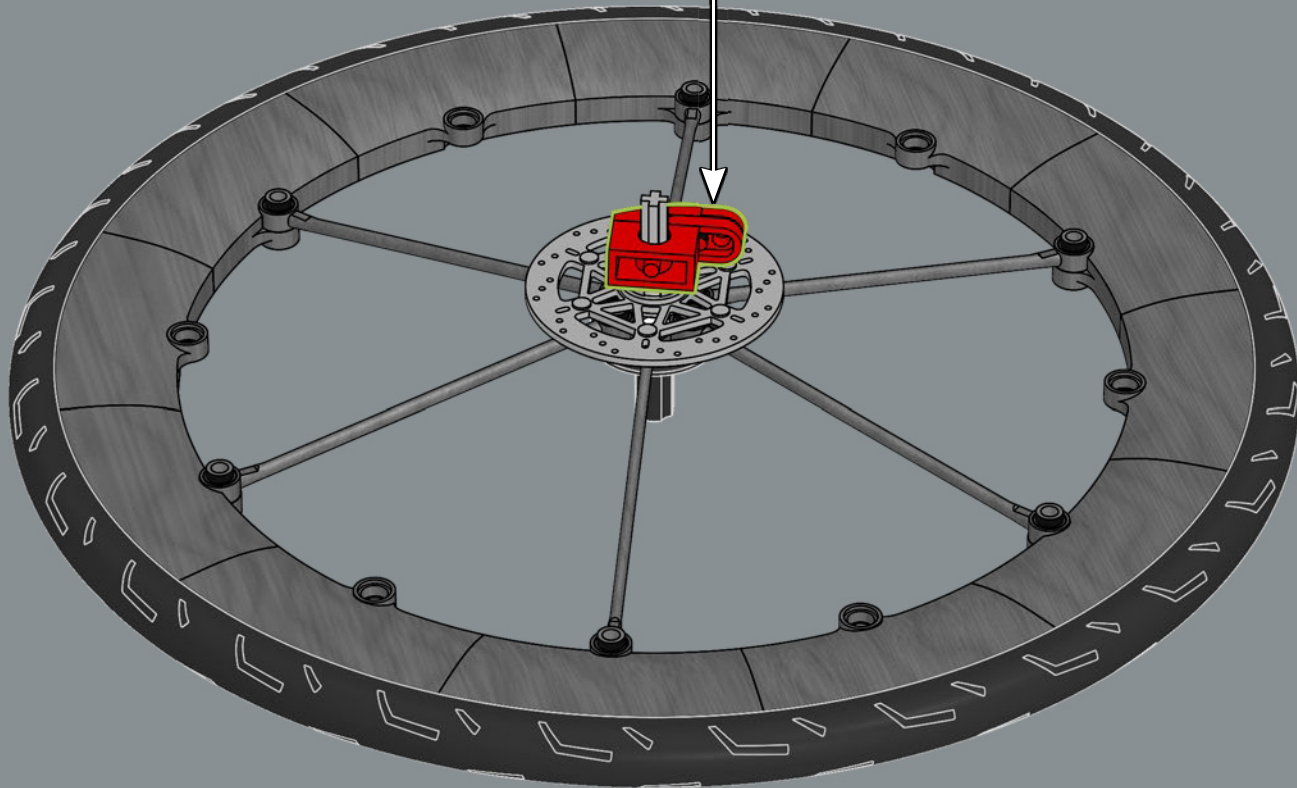
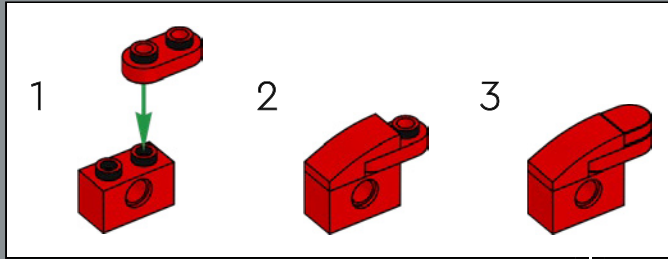



2x

299

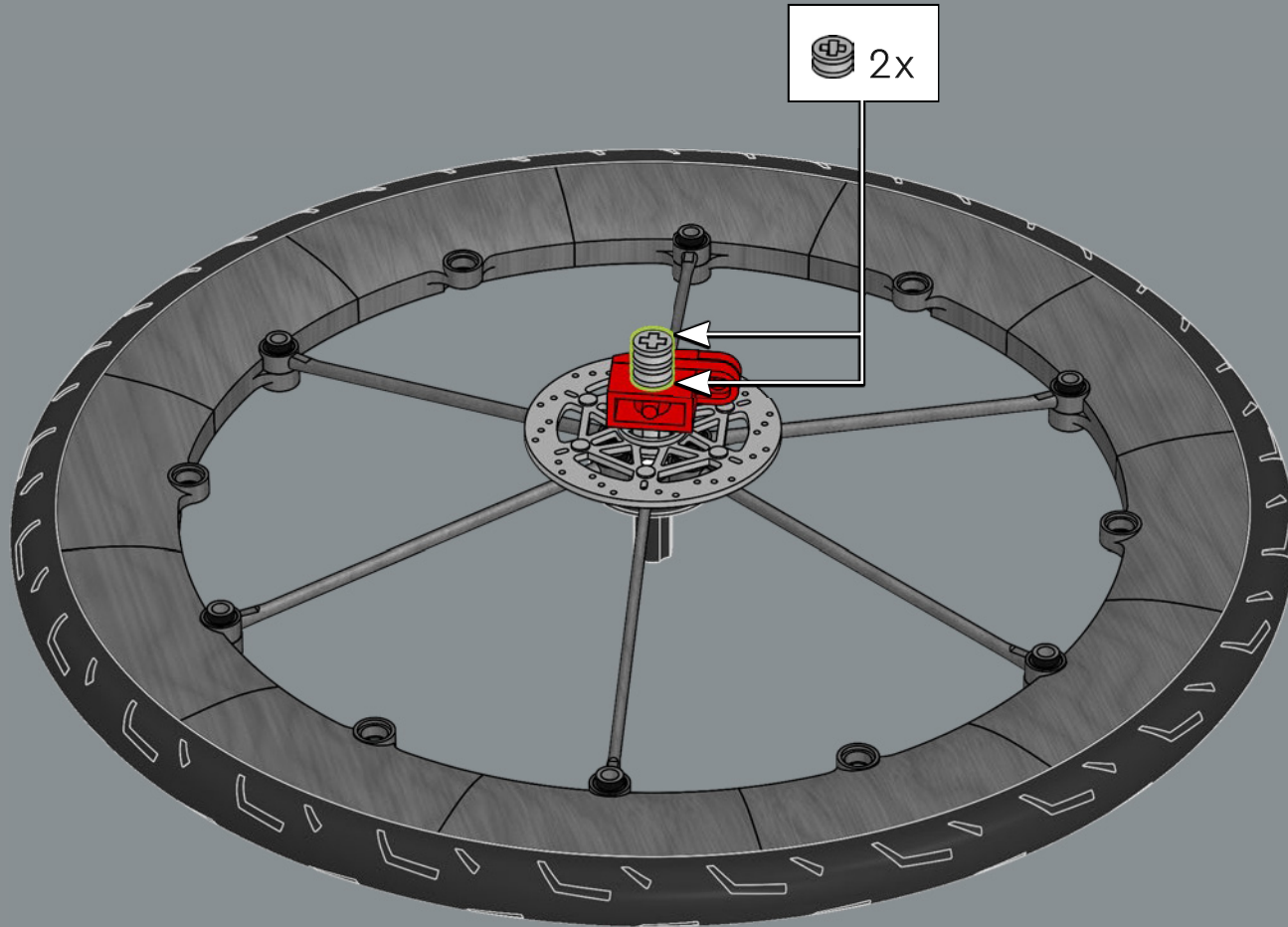

2x

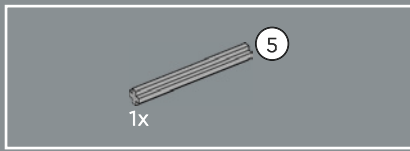

300

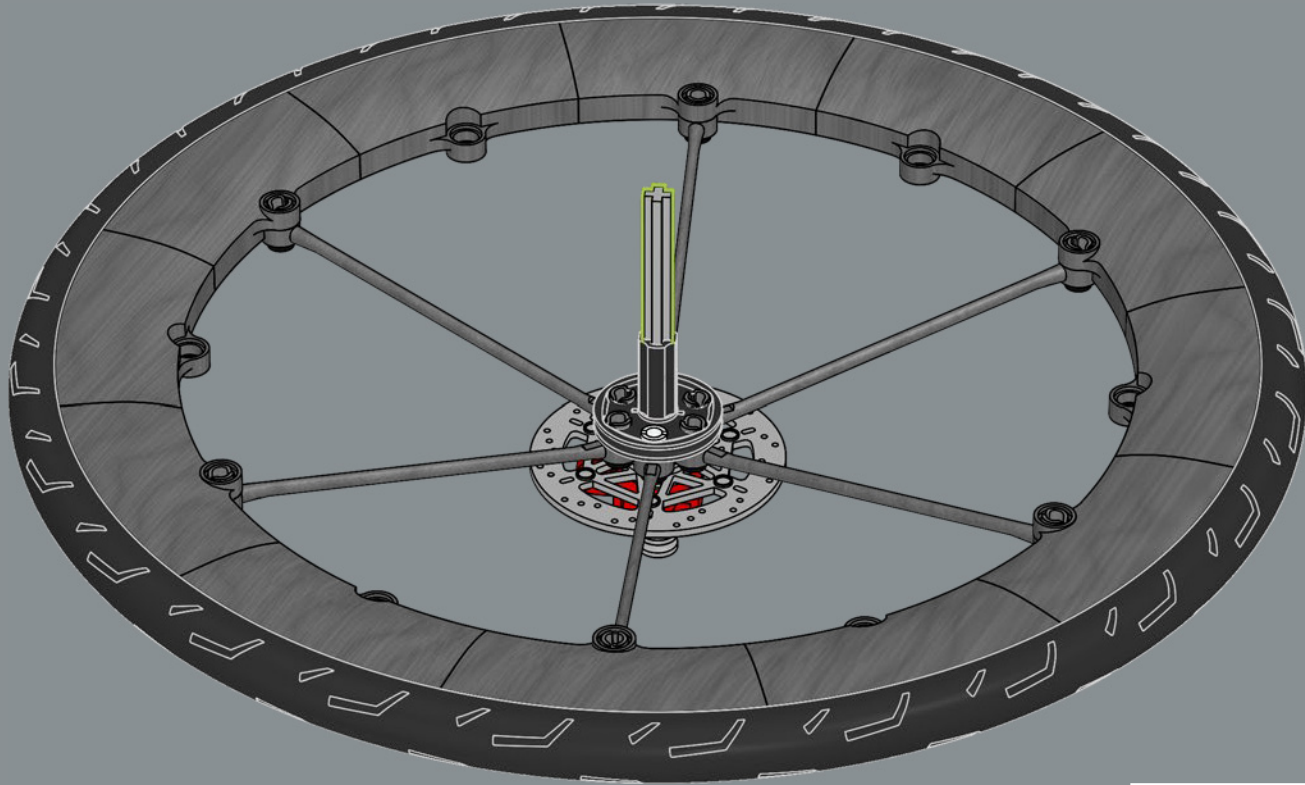



301

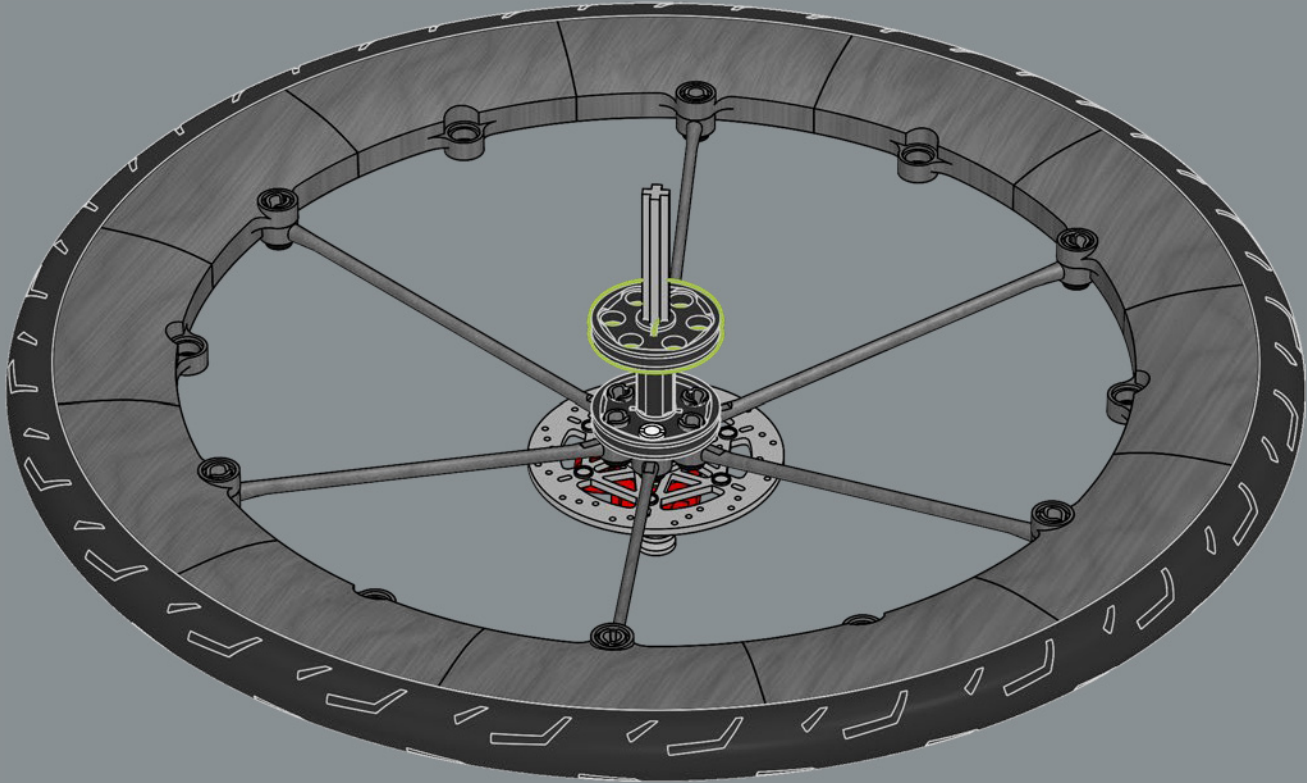

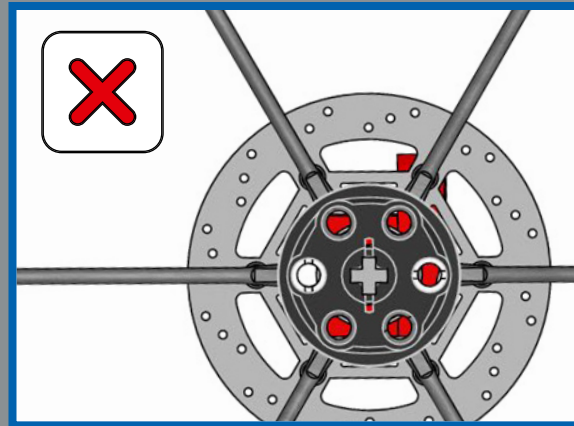
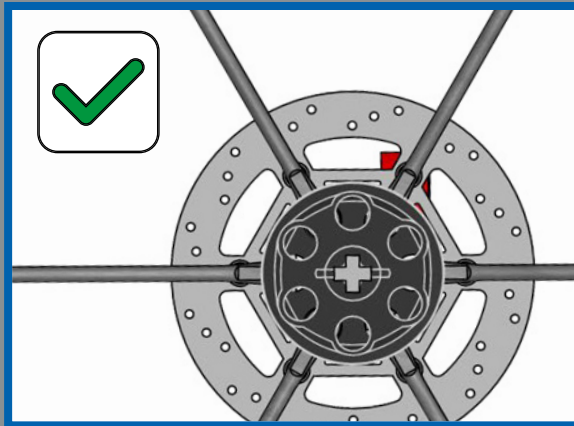



1x

302

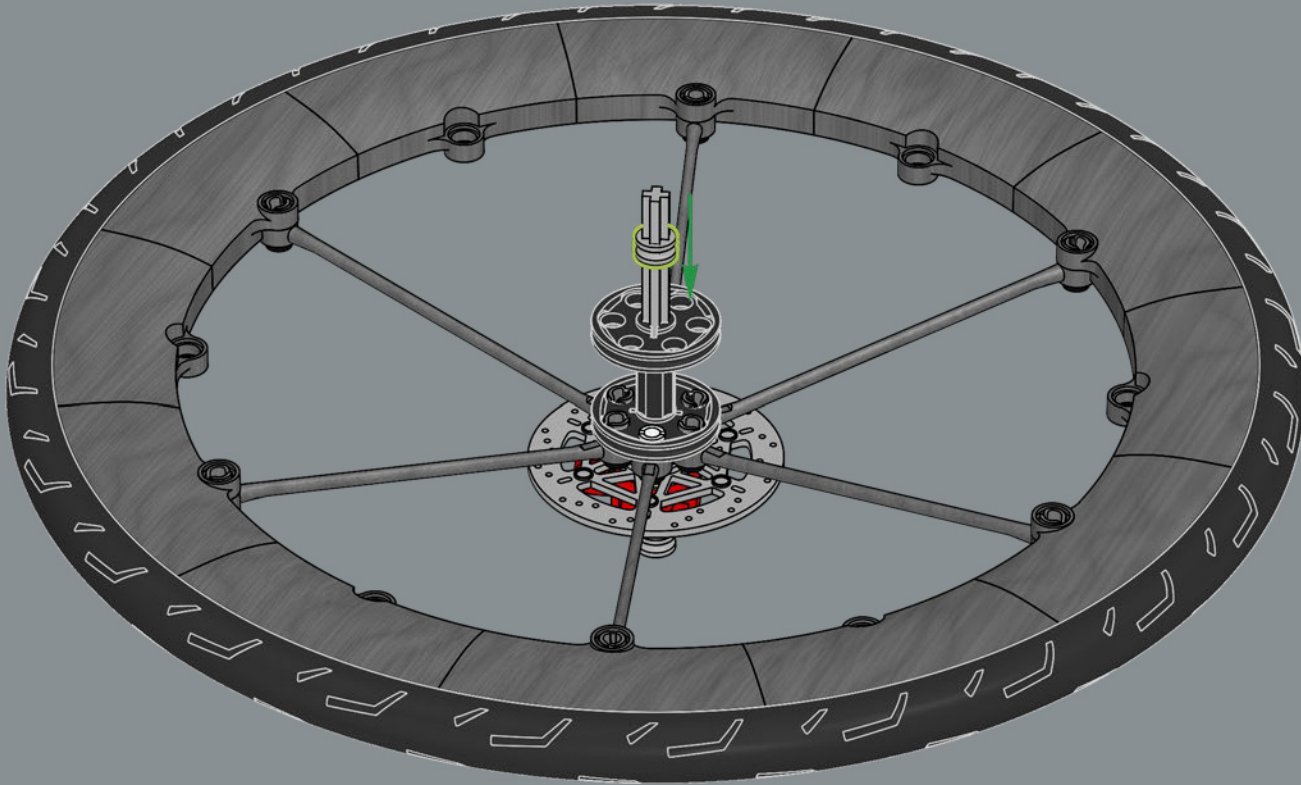



303

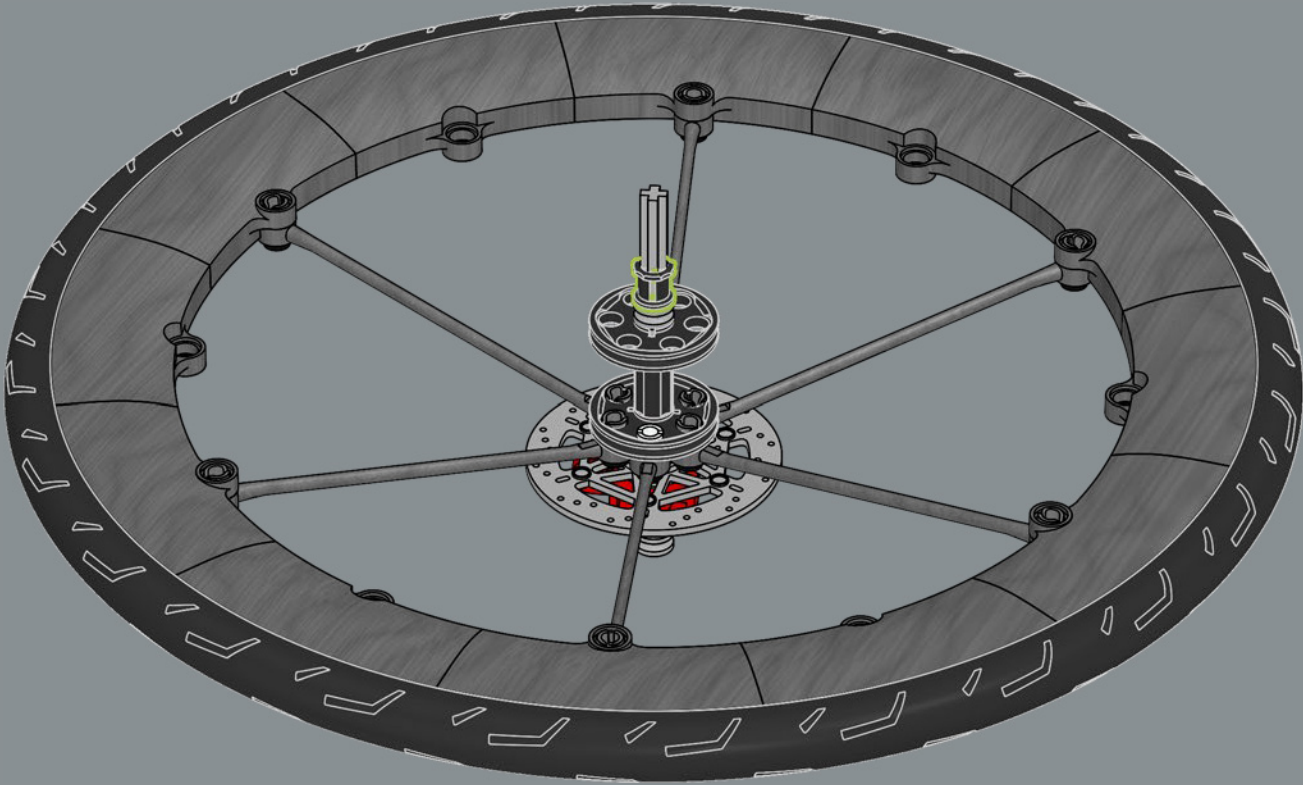

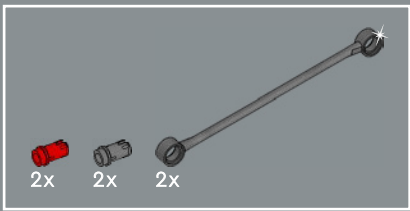

304

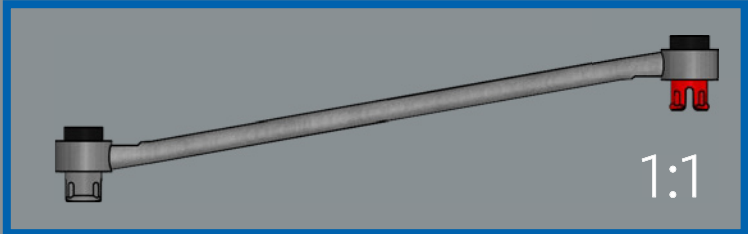
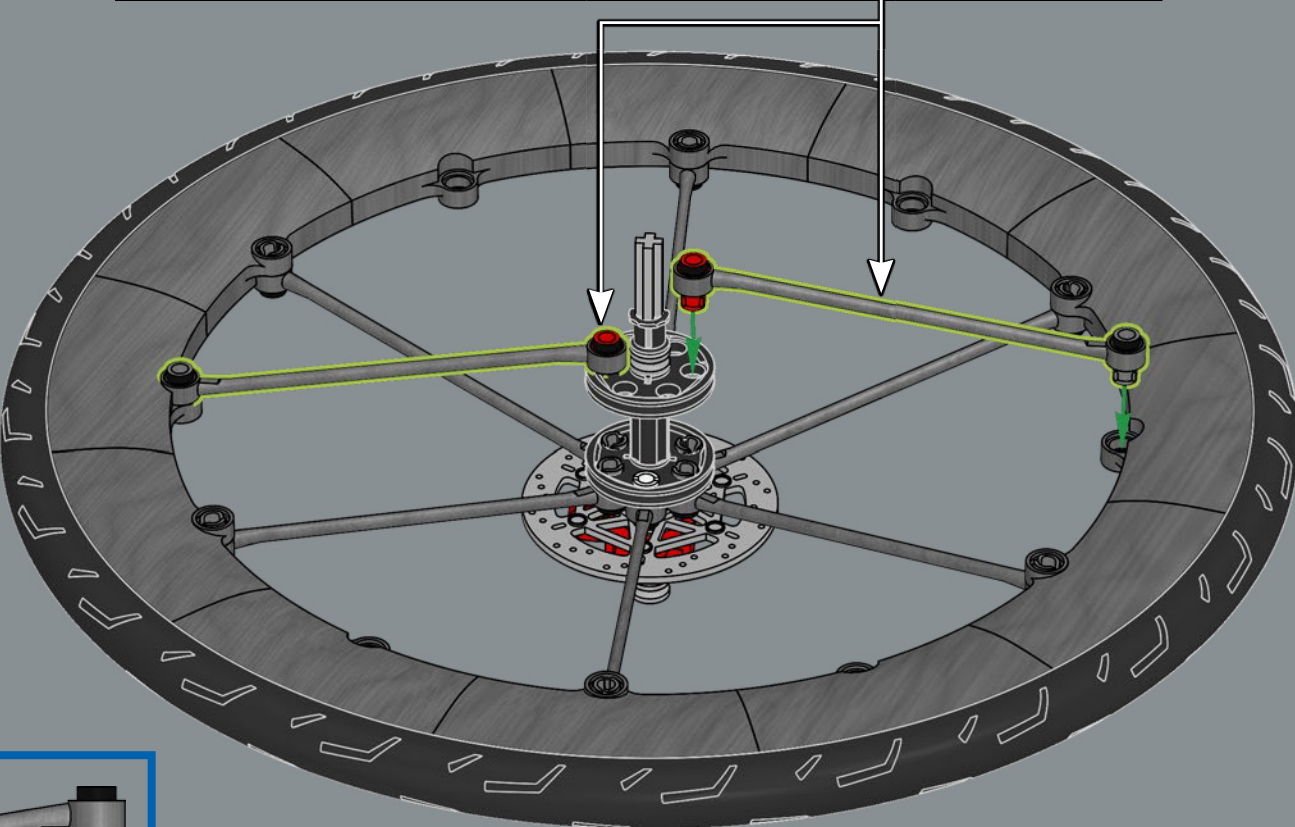
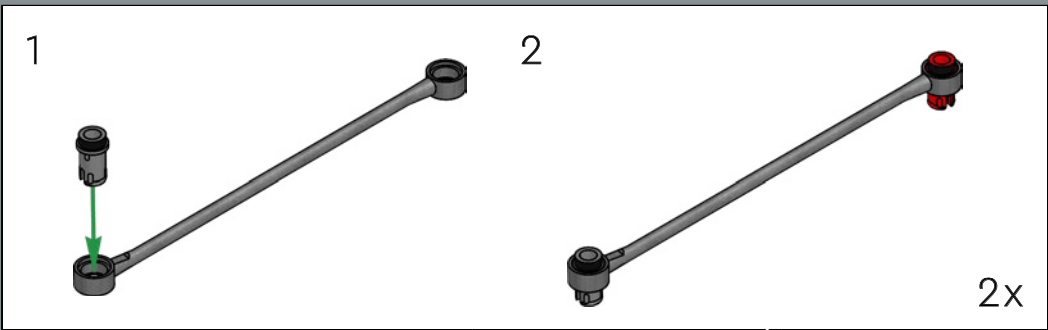

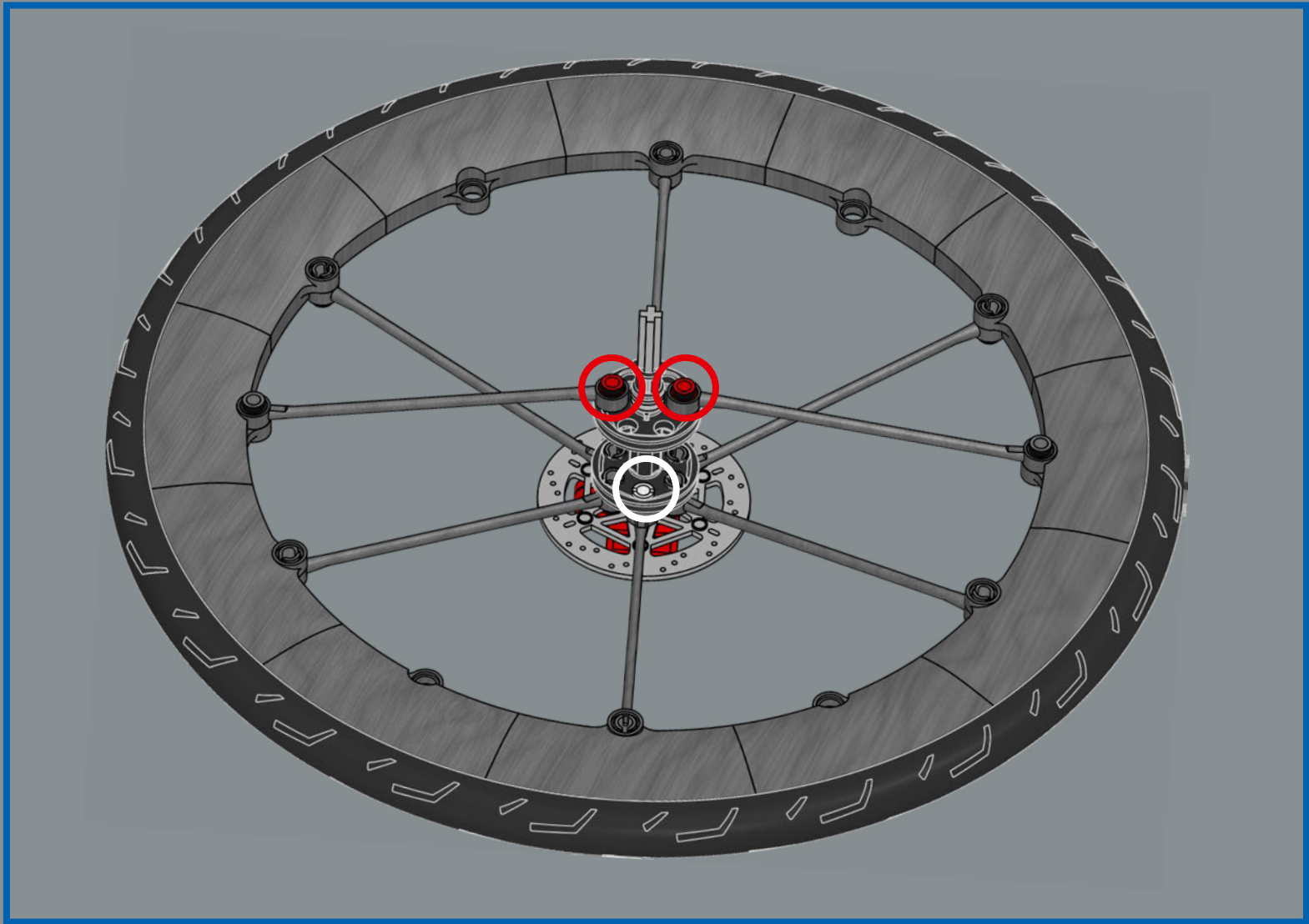

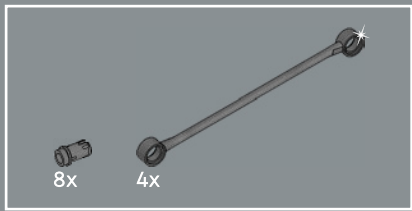

305

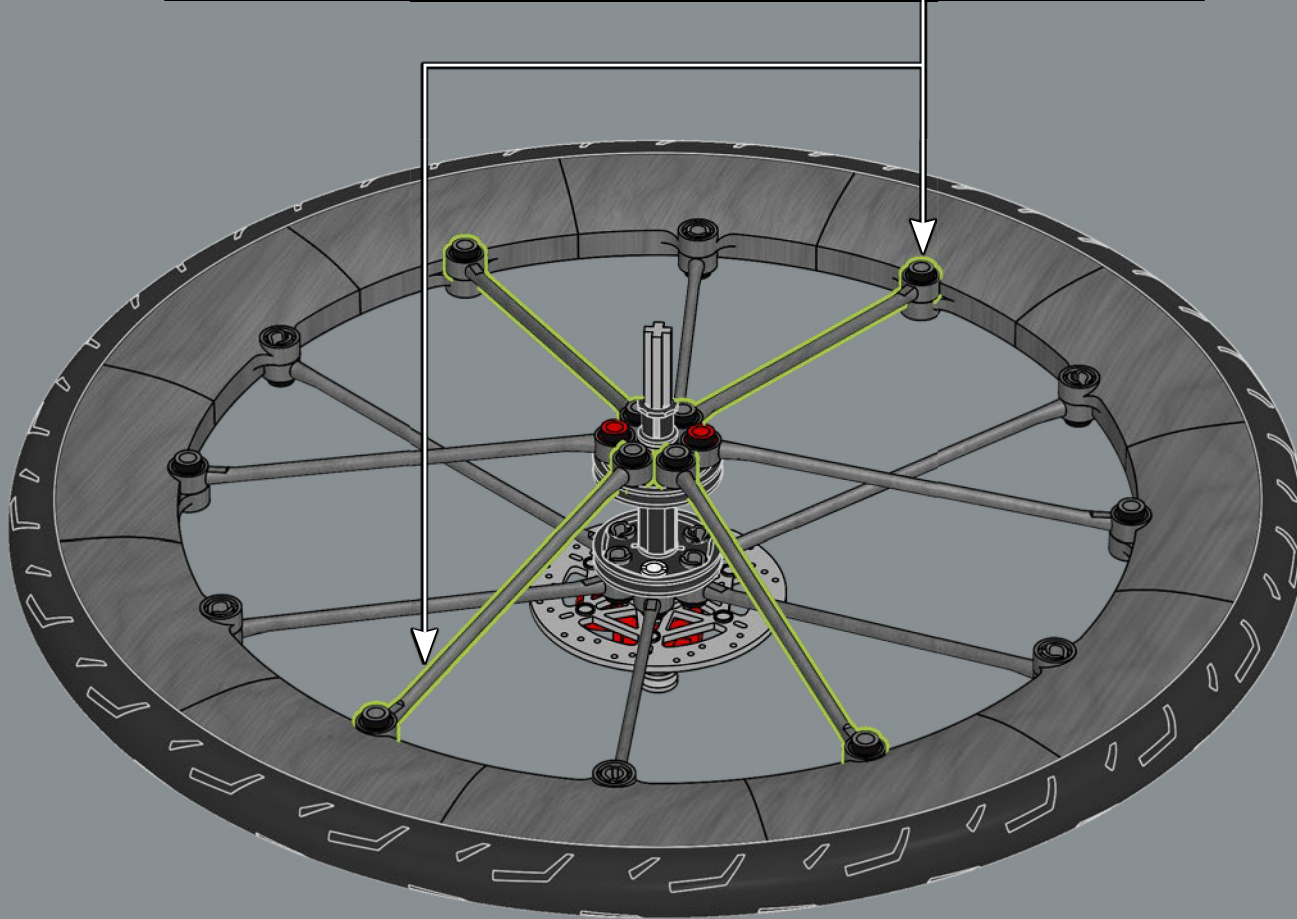
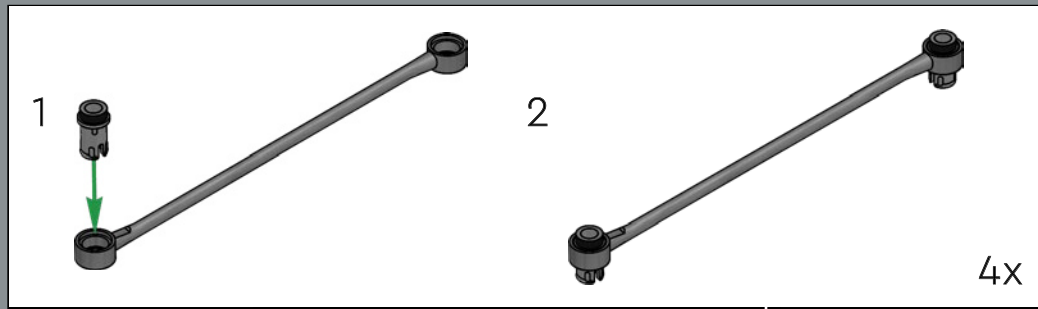

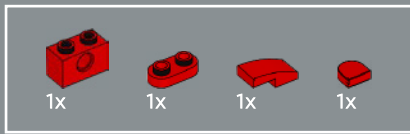

306

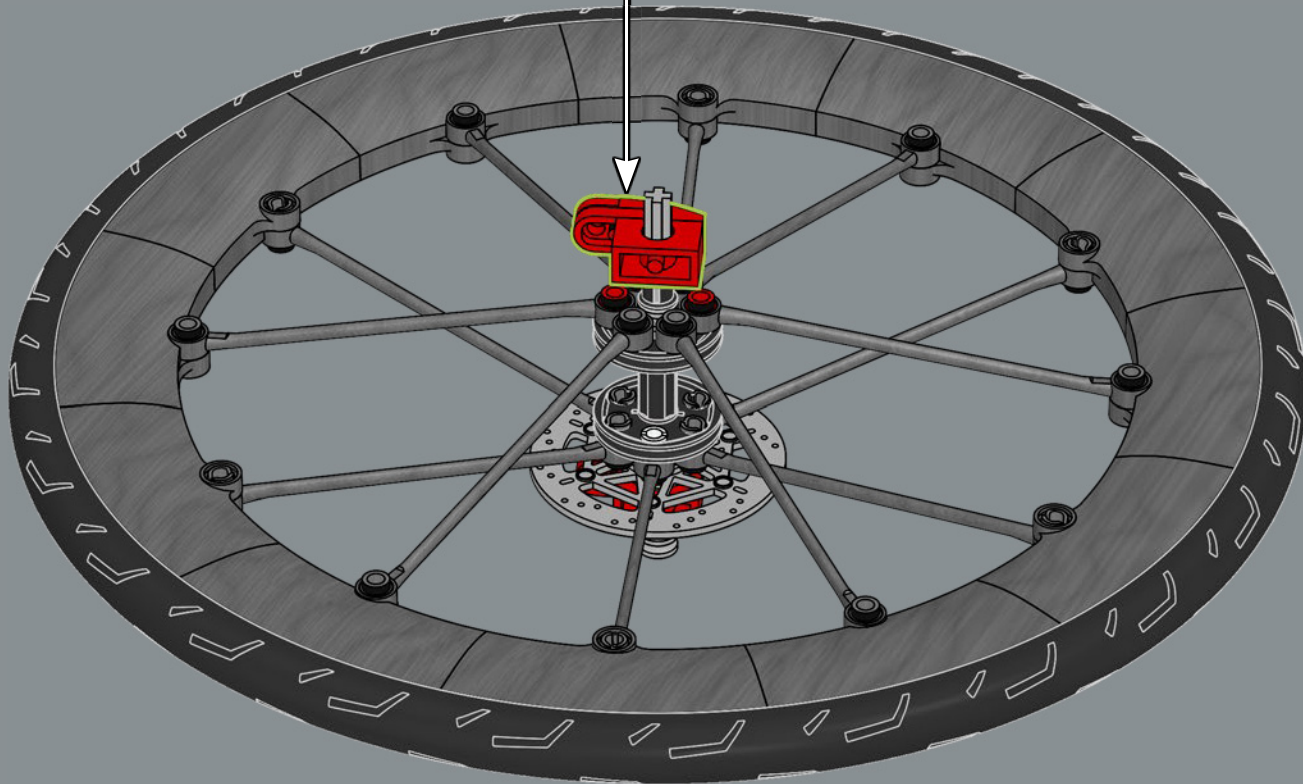
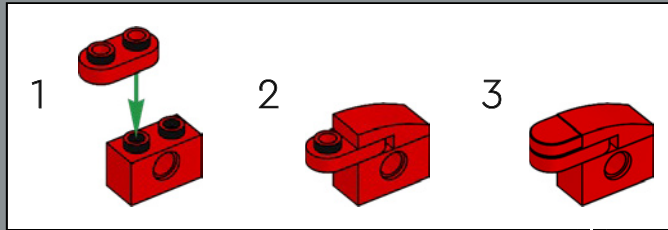



2x

307



2x

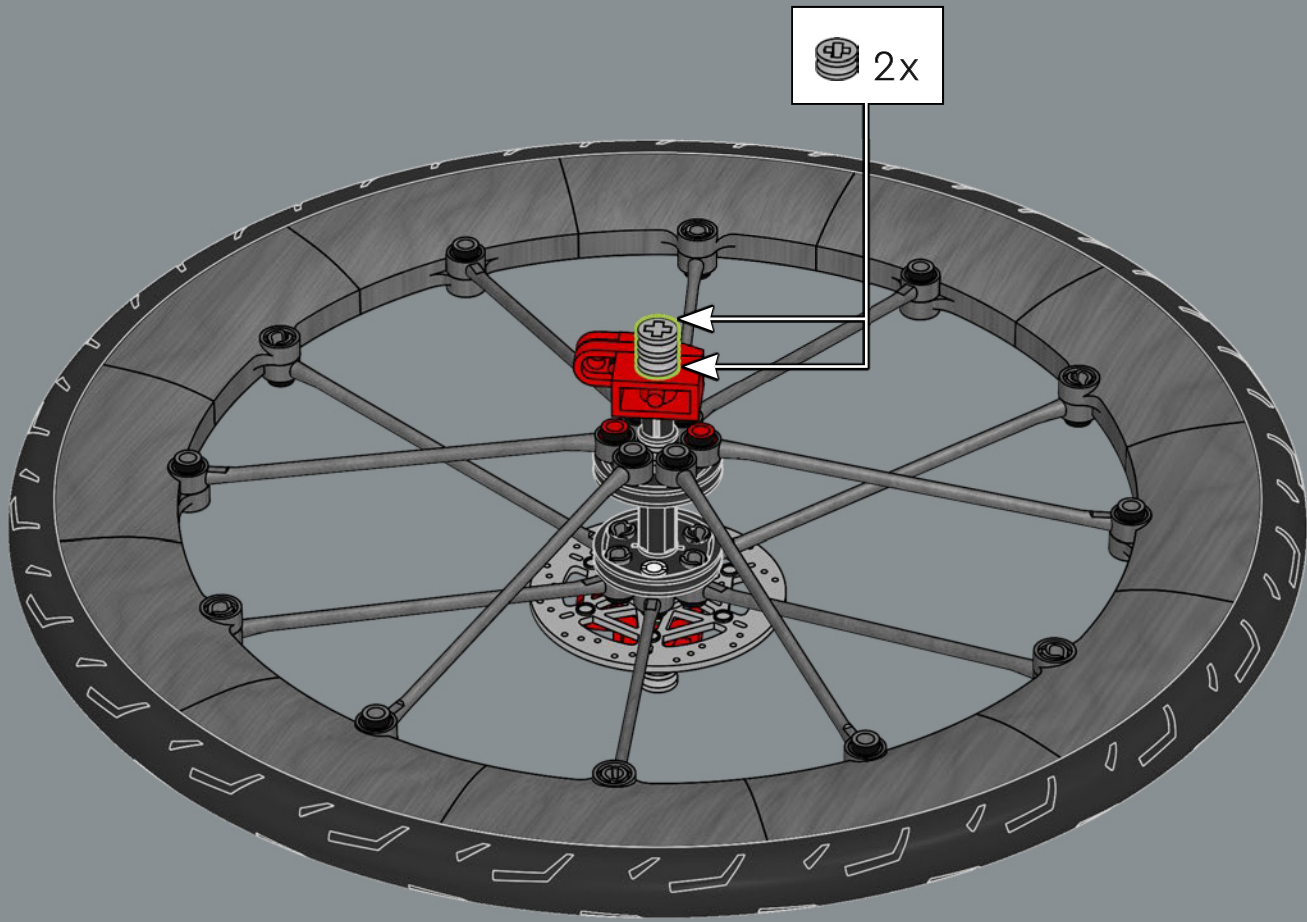

308

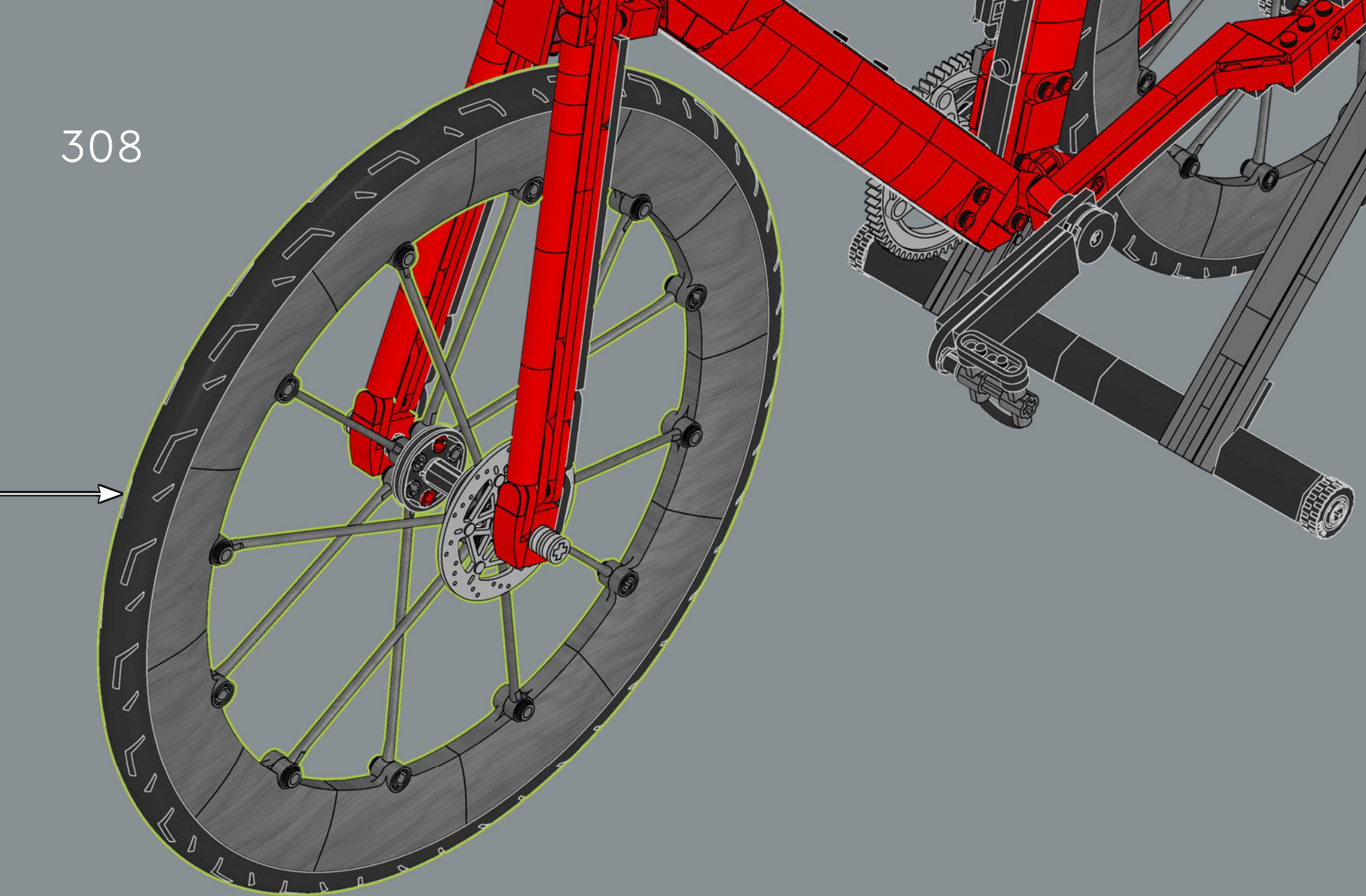

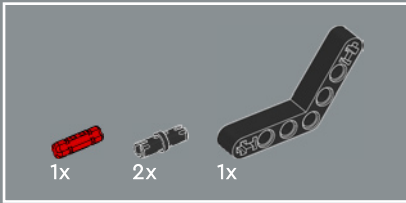

310

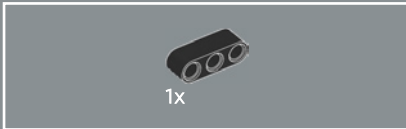
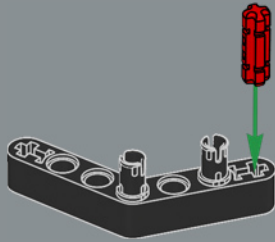

311

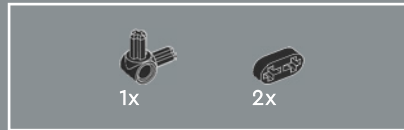
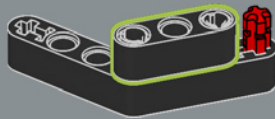

312

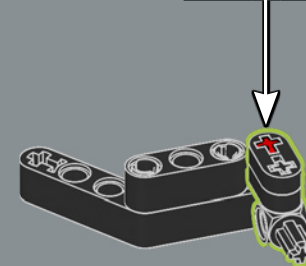
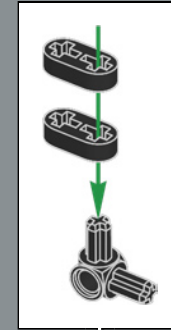



2x

313

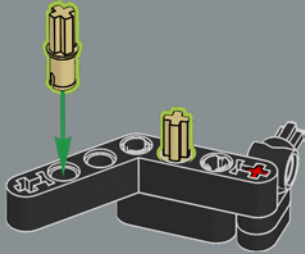

2x

314

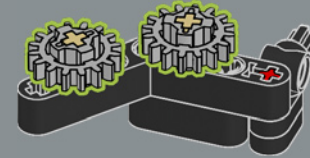

315

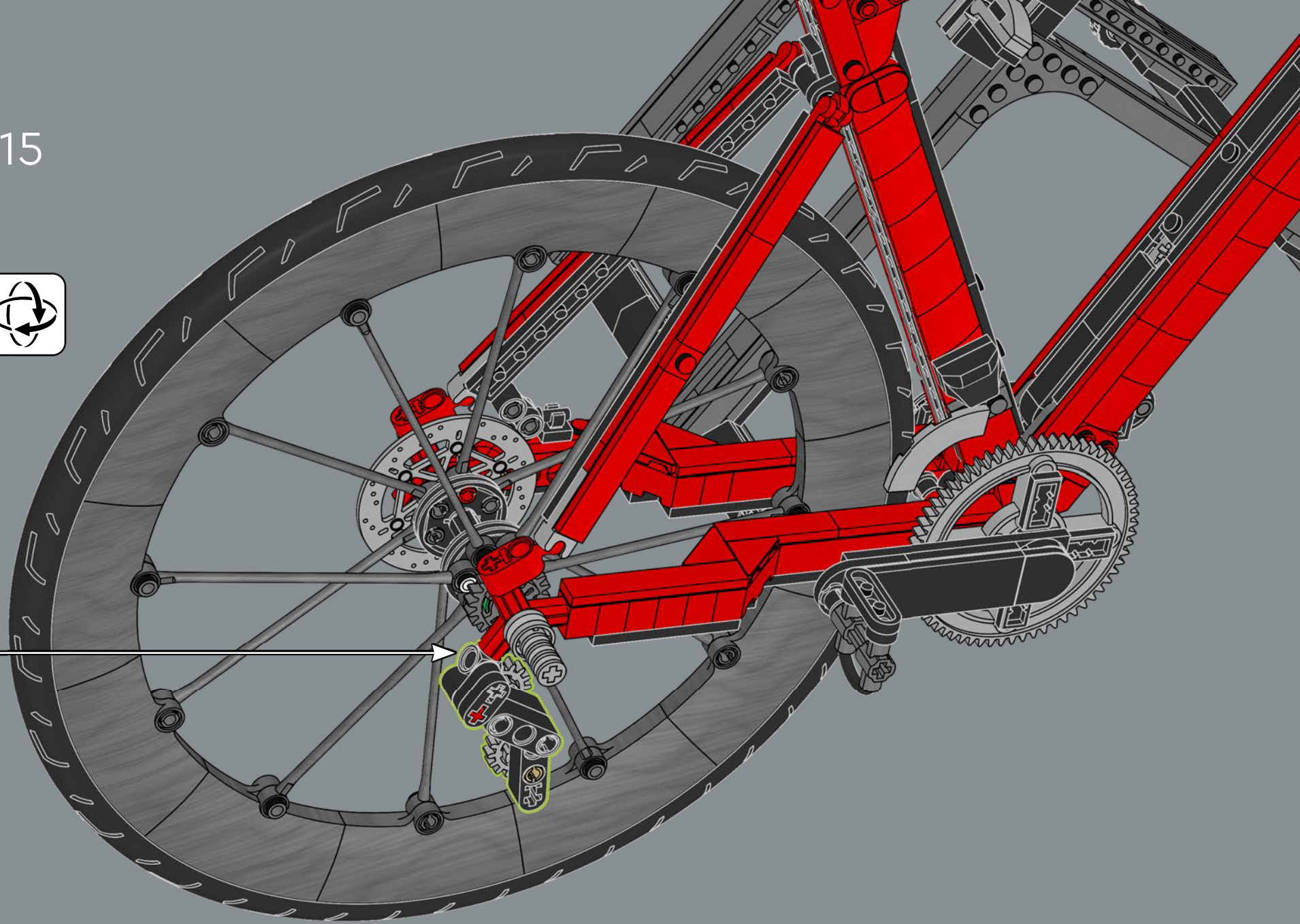



72x



这个链条元件首次以银色金属色出现。

316

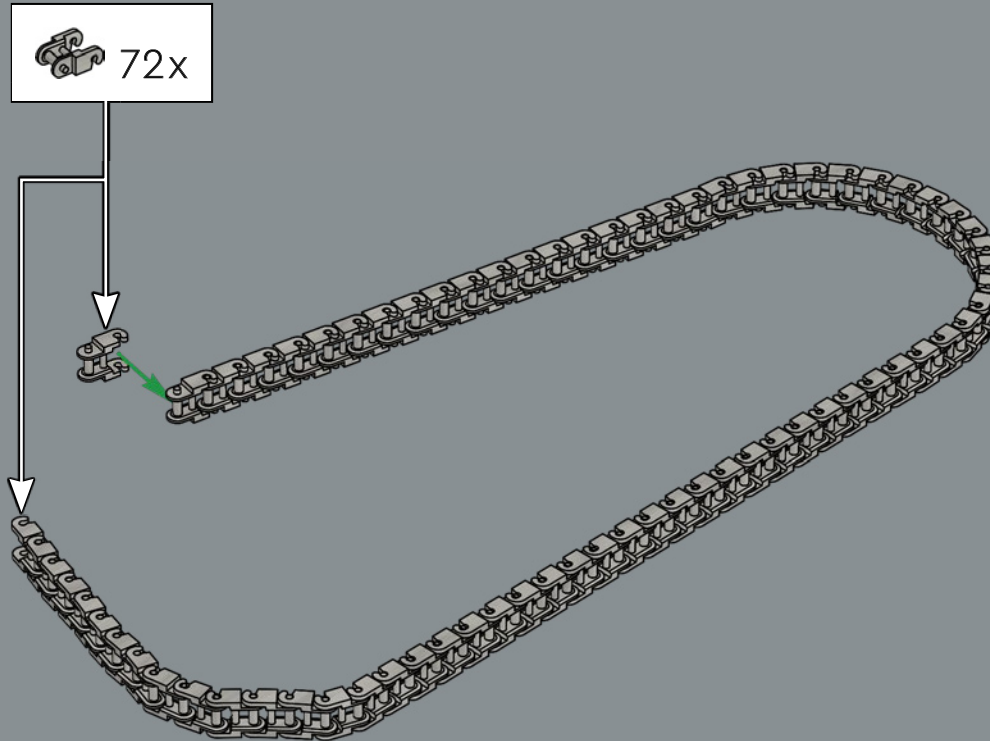

317

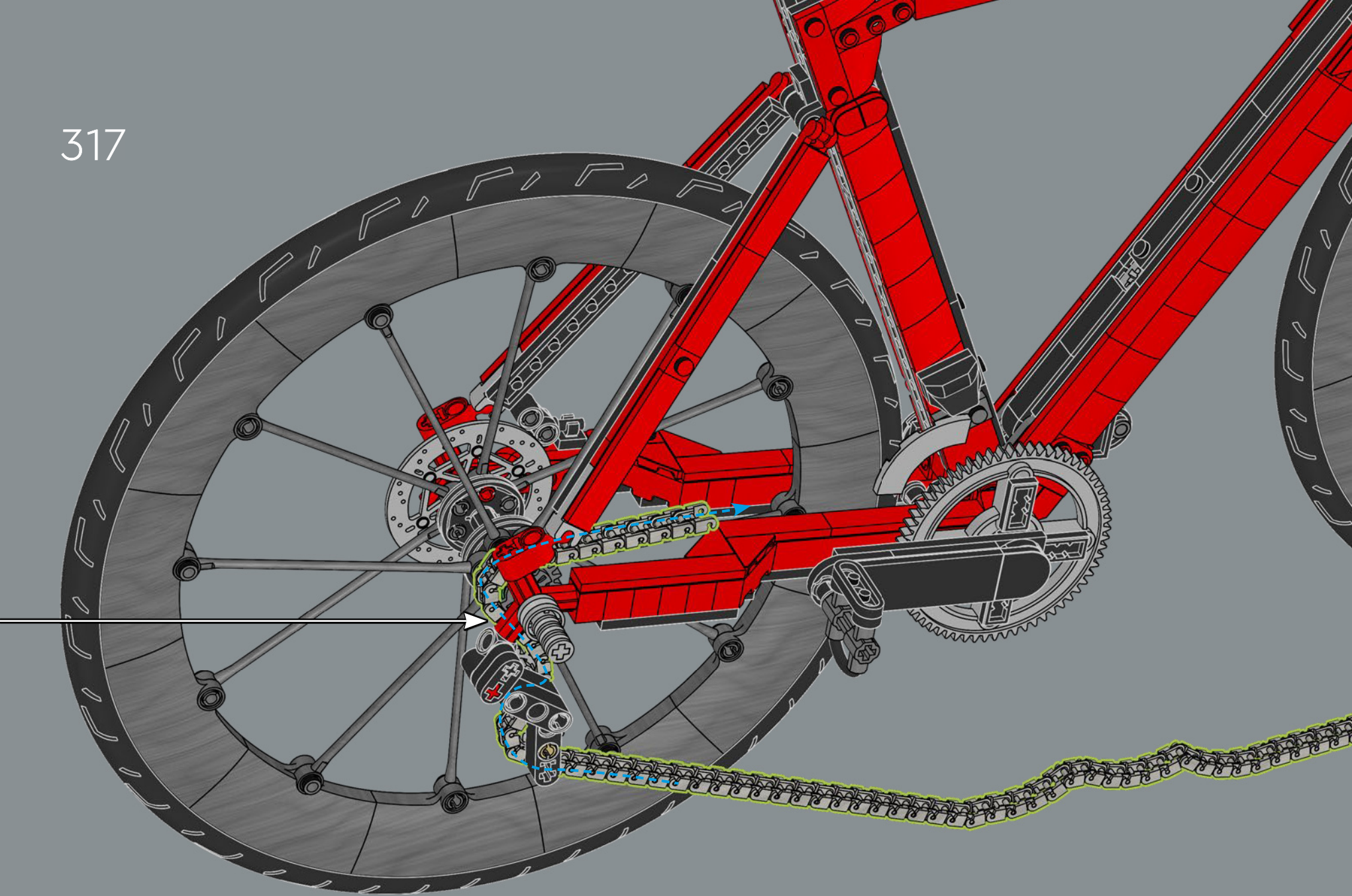

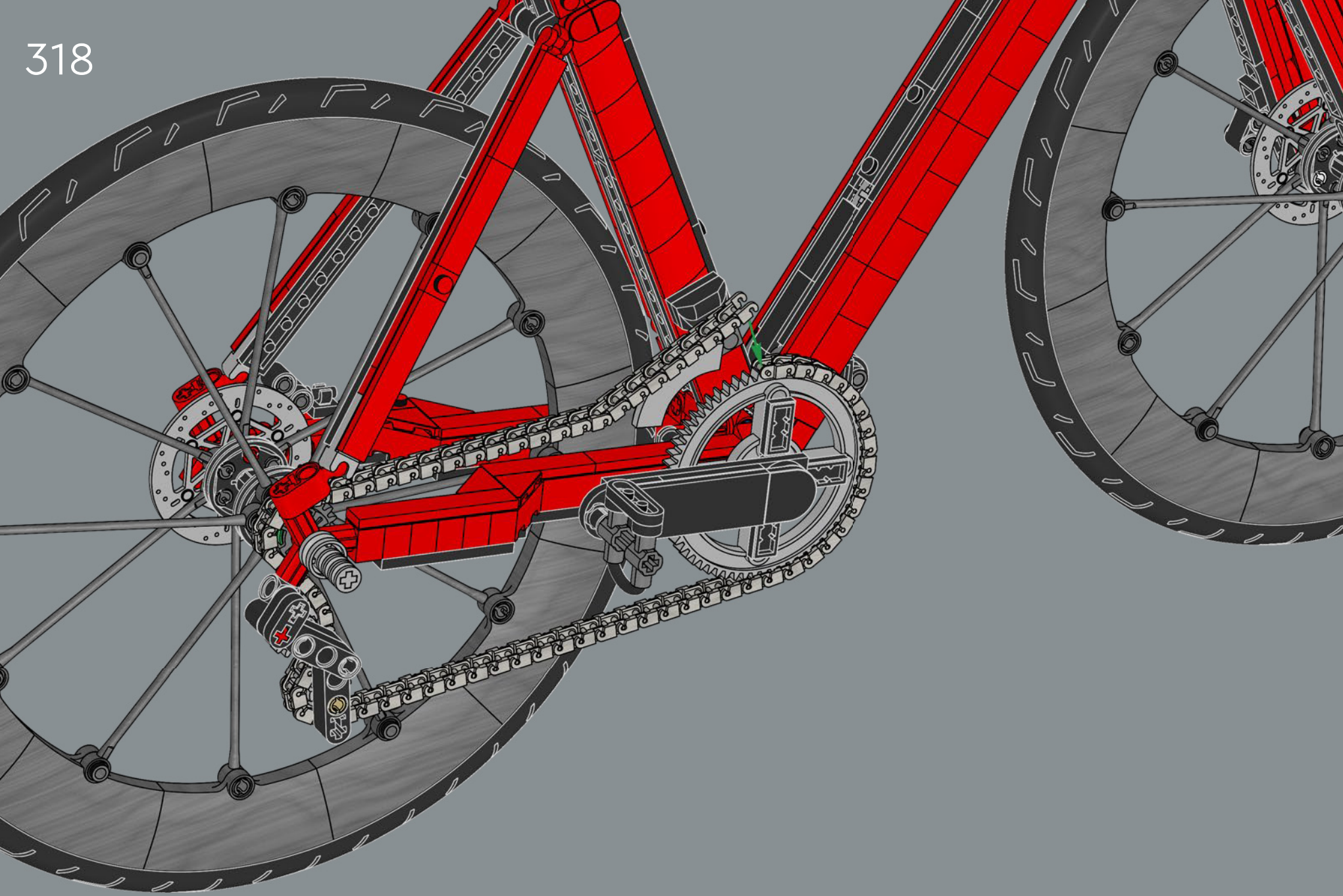

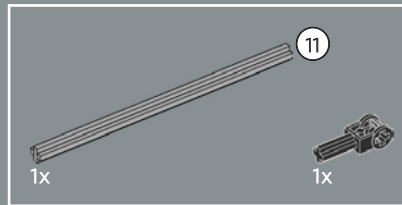
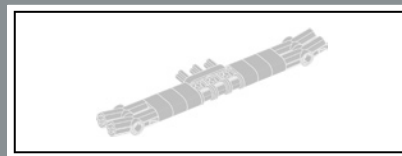

319

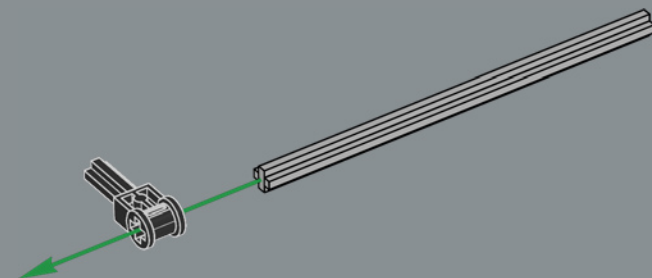

320

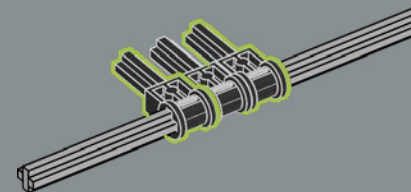



321

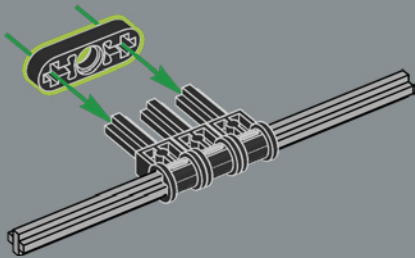

322

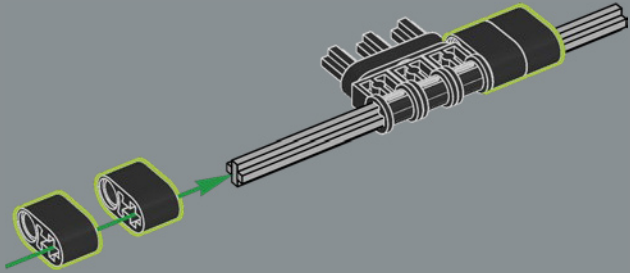

323

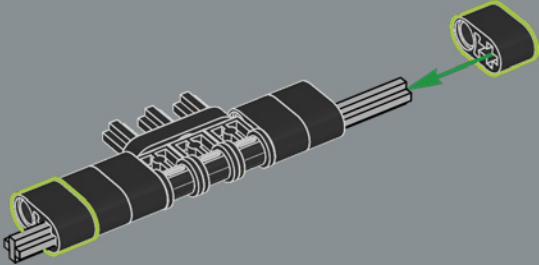



324

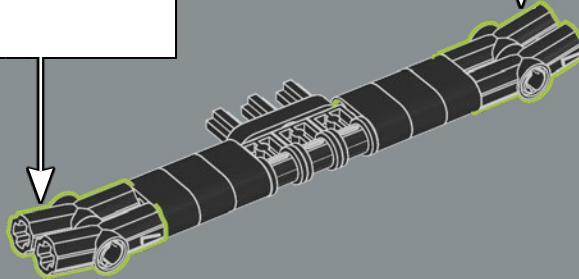
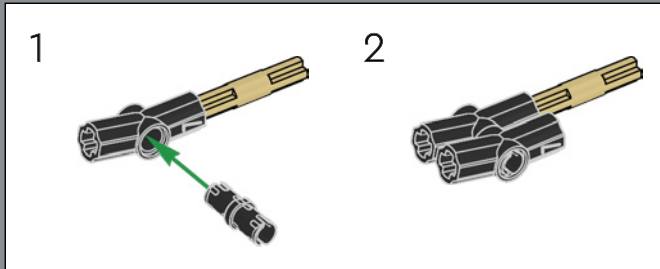
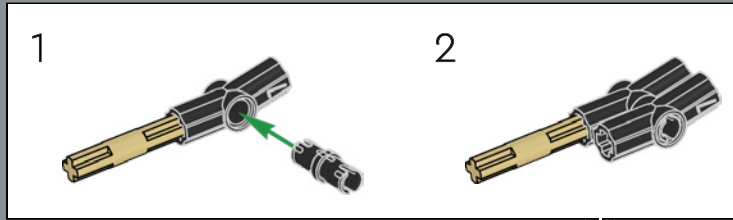

325

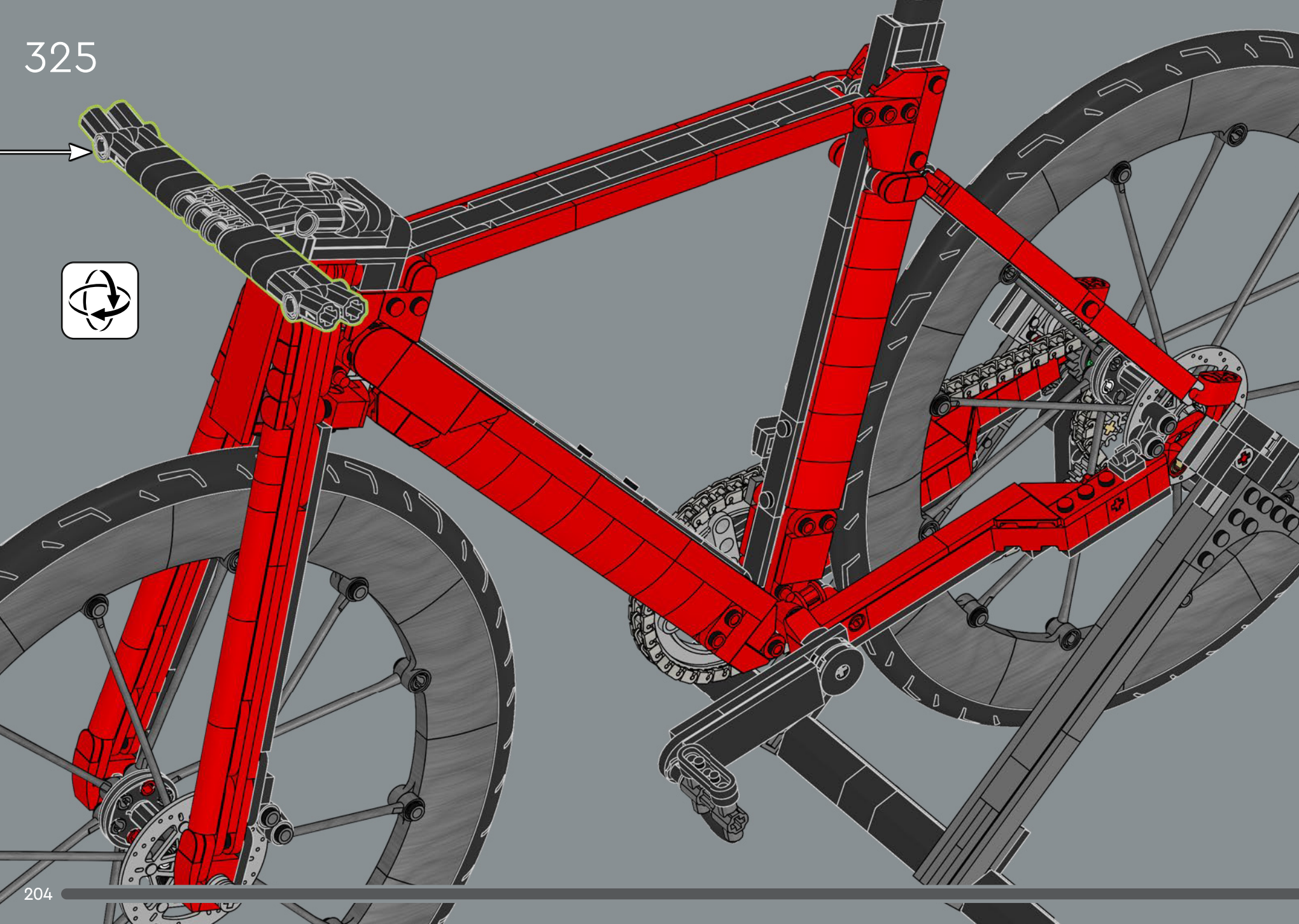

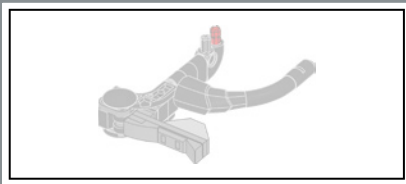

1x

1x

326

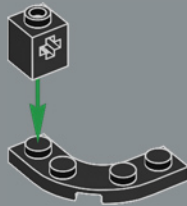

1x

327

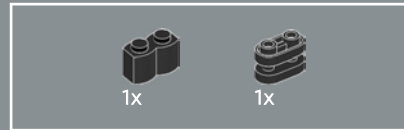

1x

1x

328

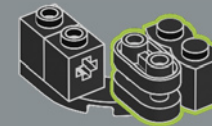

1x

329

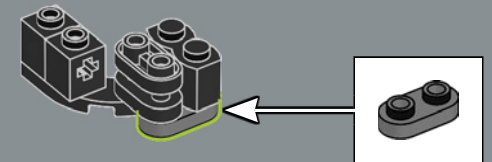



330

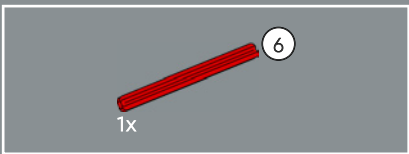
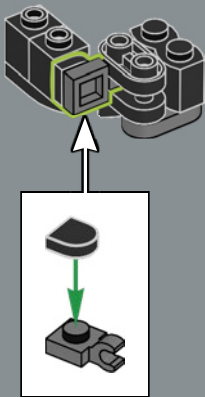

331

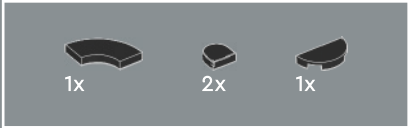
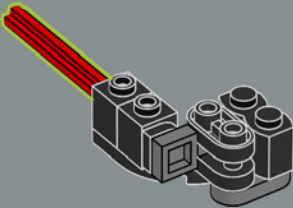

332

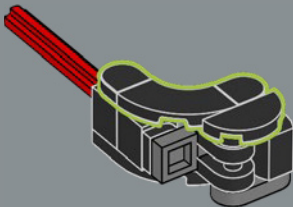



333

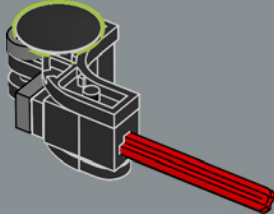

334

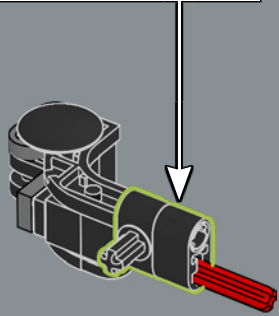
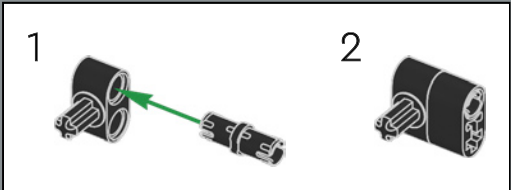

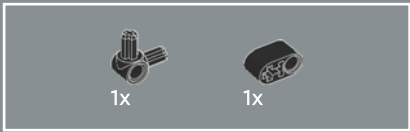

335

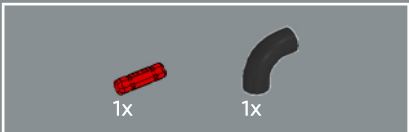
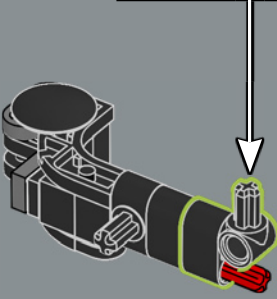
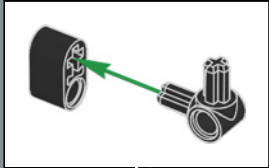

336

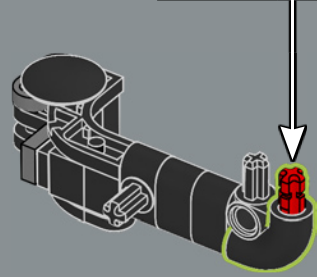
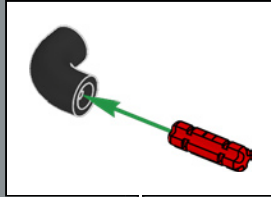

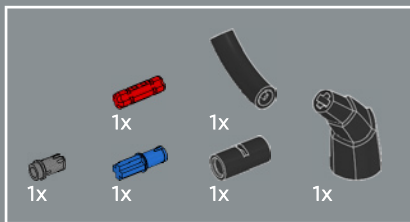

这个元件原本是为幻影忍者系列代表龙角设计的——结果，它也非常适合公路车把手！

337

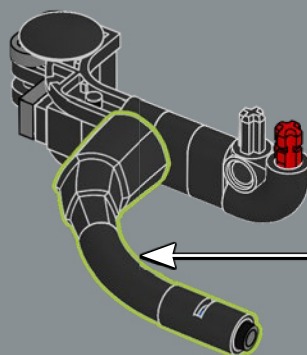
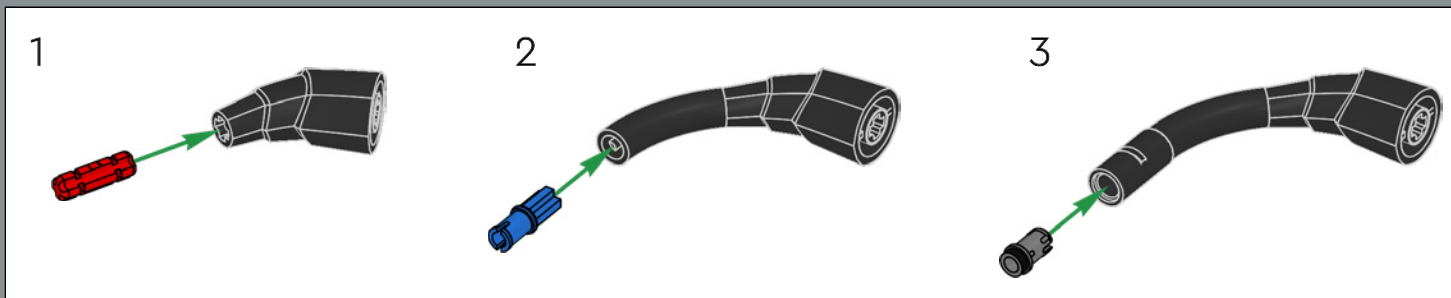

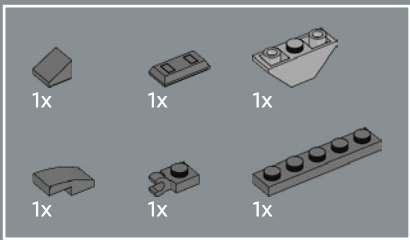

338

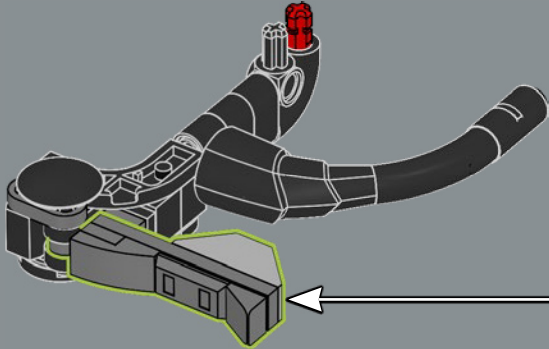
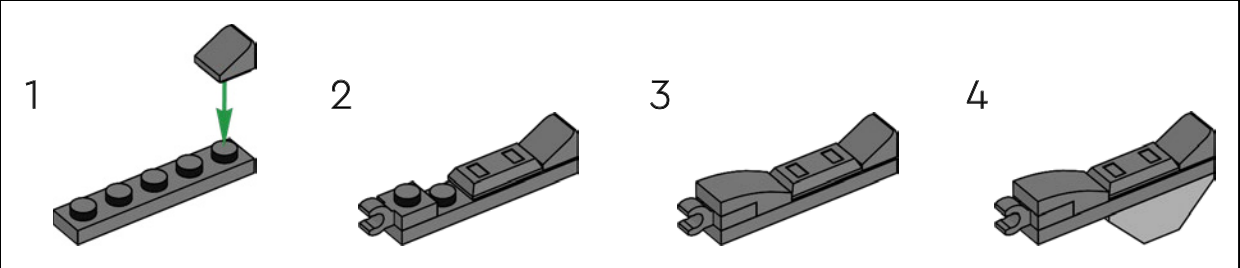

339

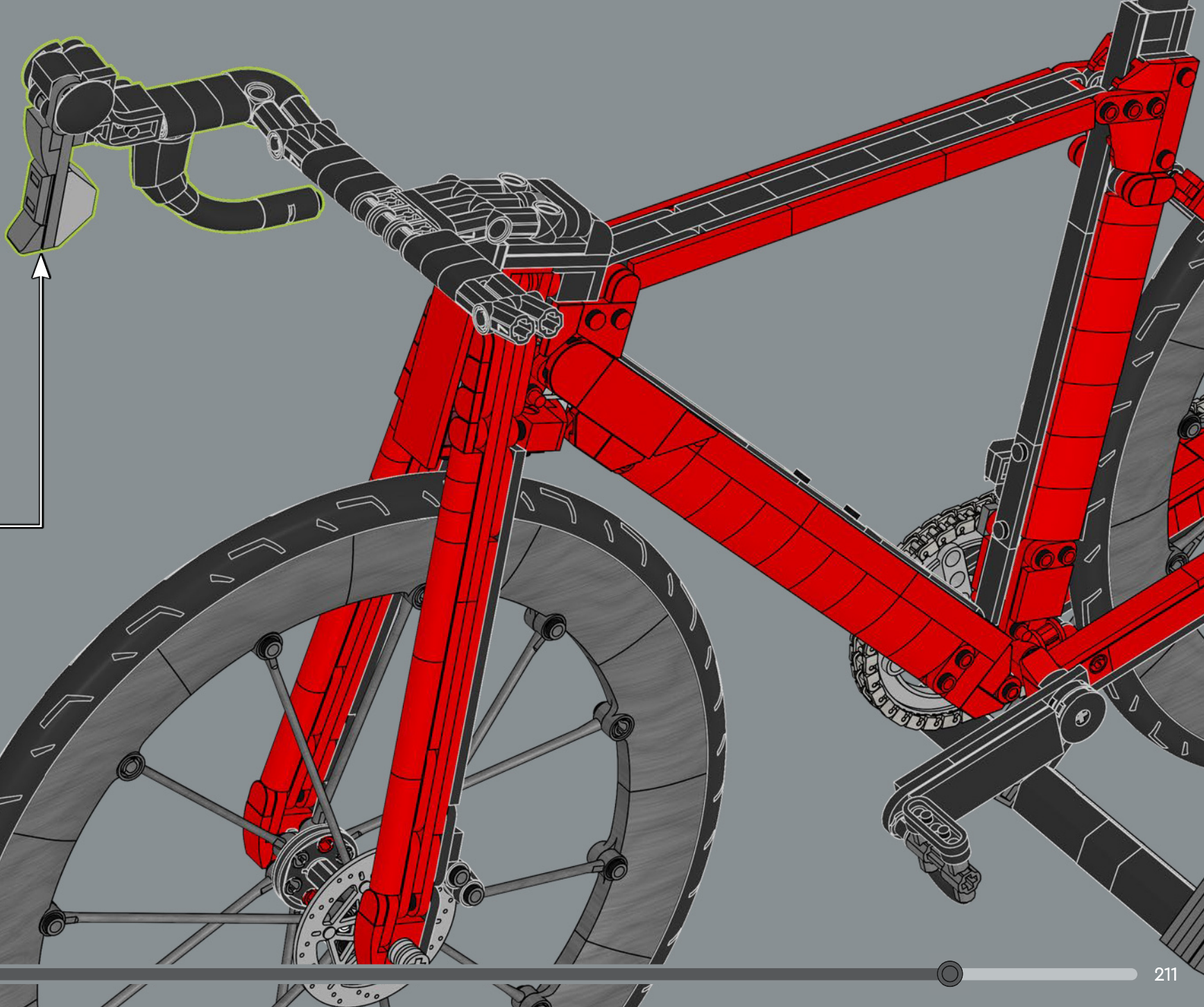

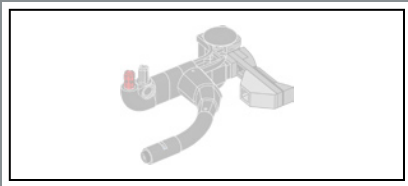

340

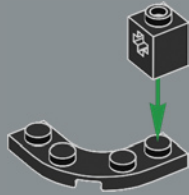

341

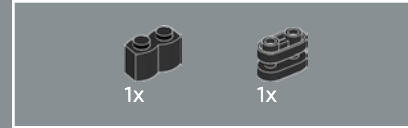

342





343

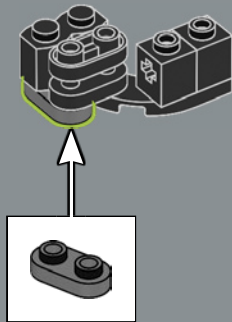

344

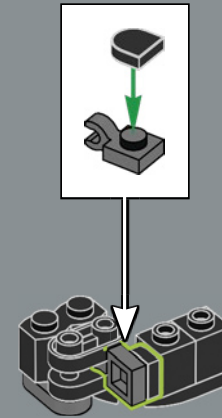

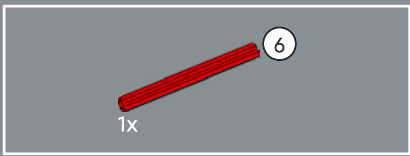

345

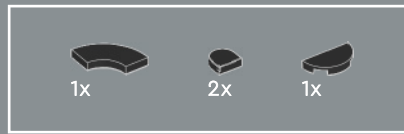
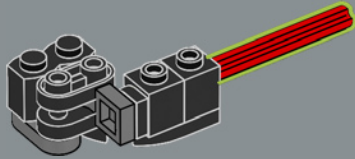

346

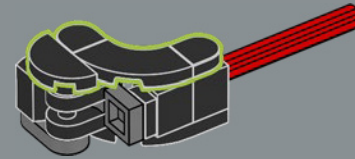



347

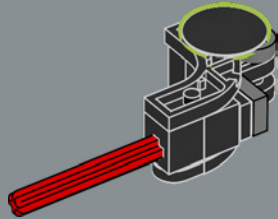

348

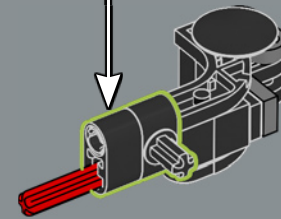
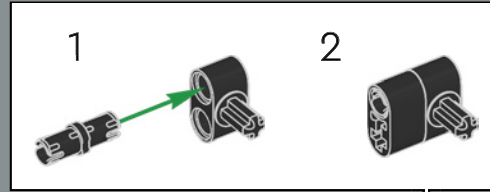

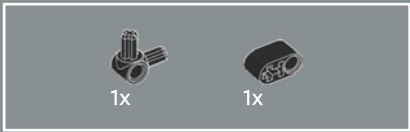

349

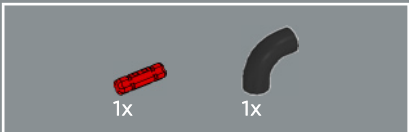
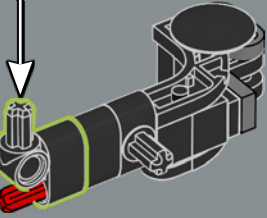
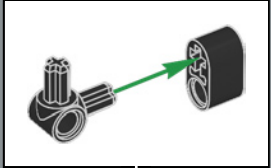

350

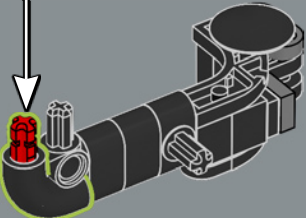
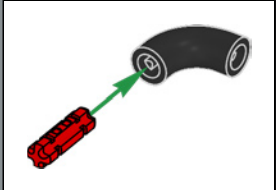

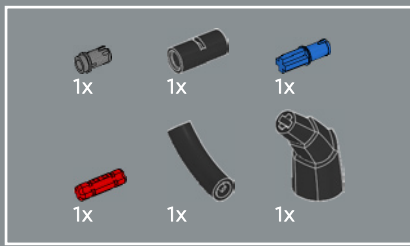

351

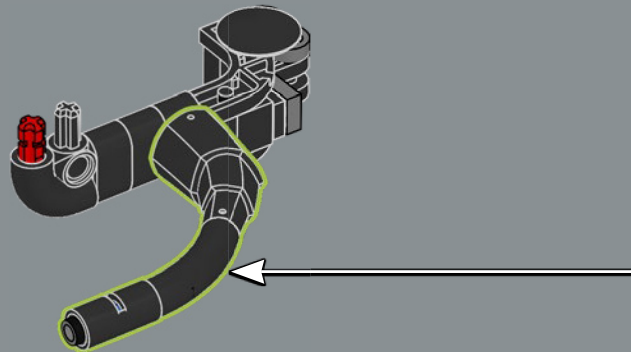
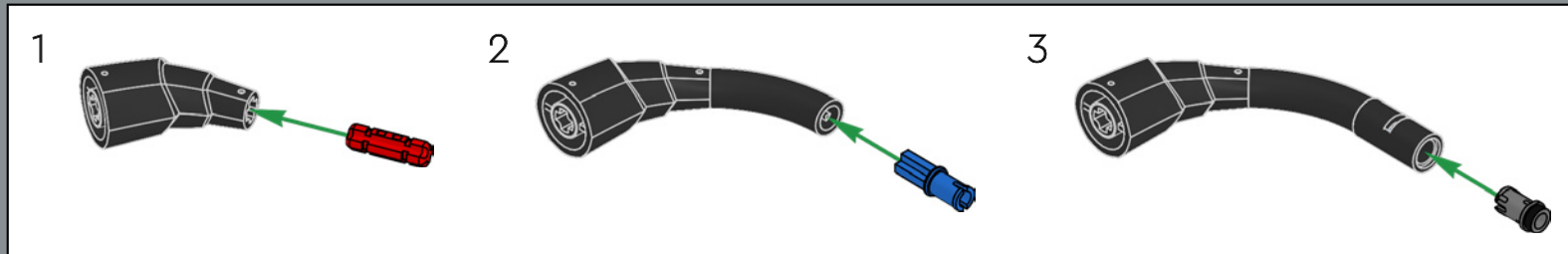

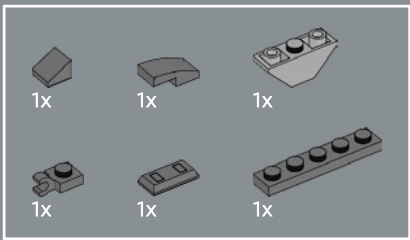

352

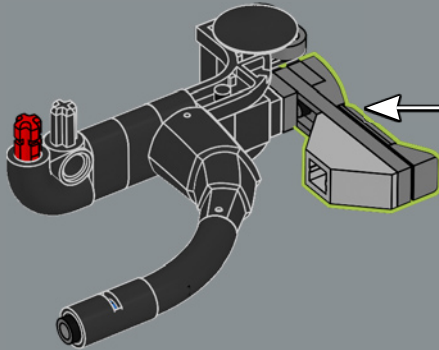
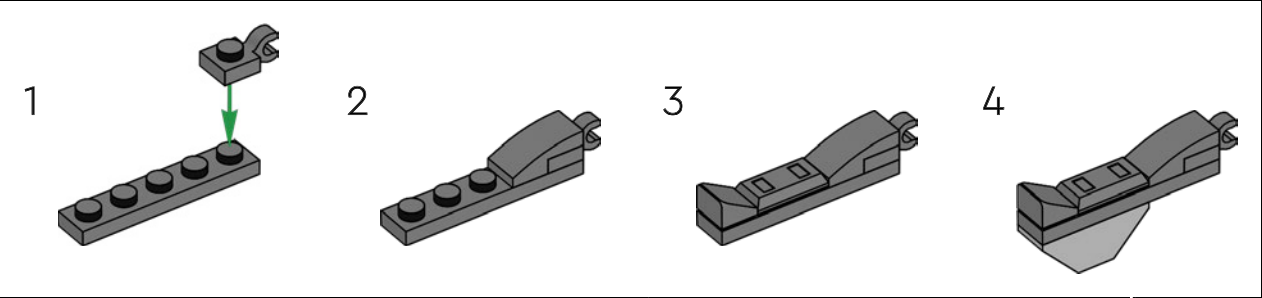

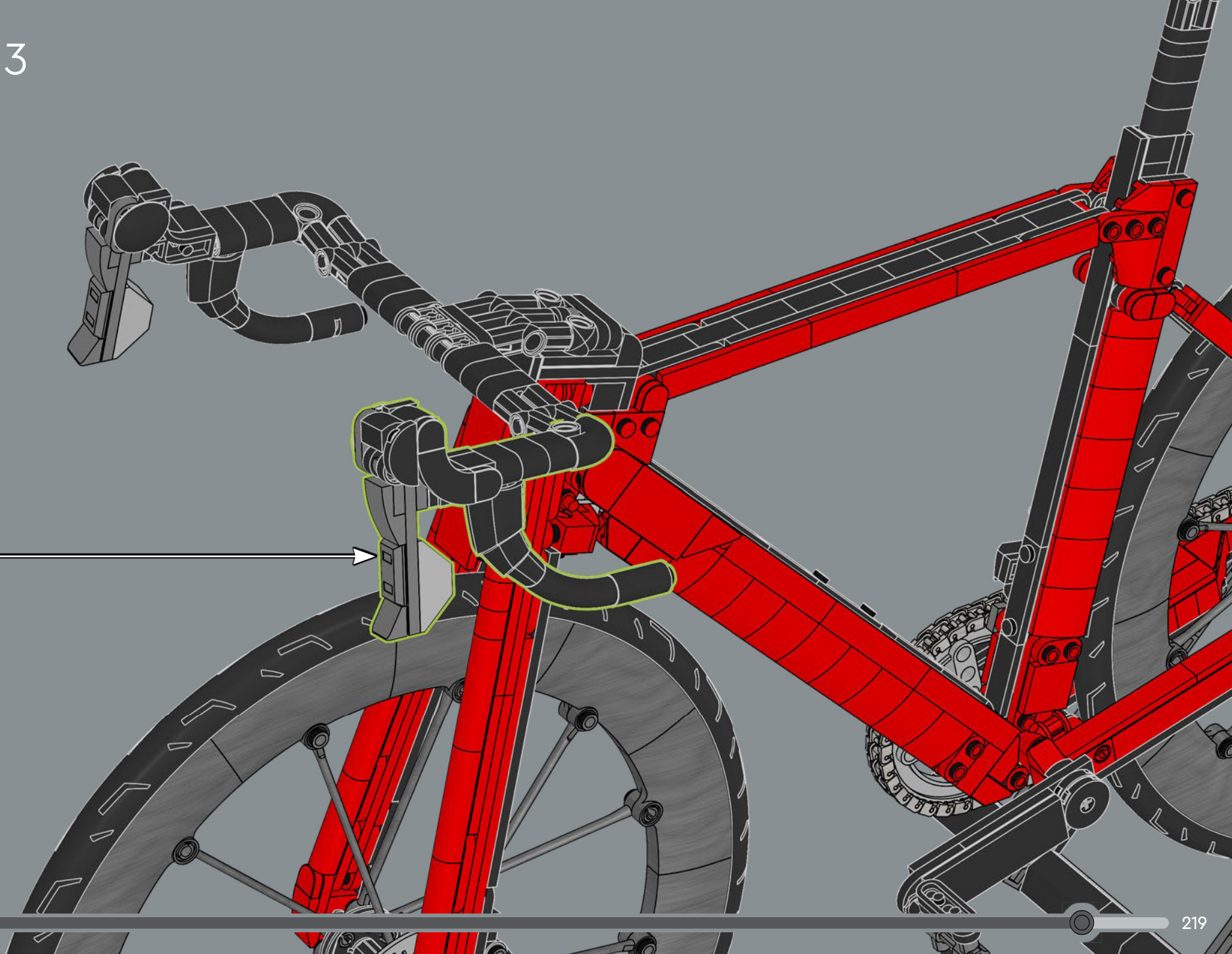

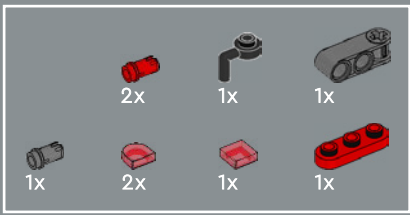

354

1

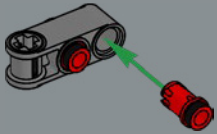

2

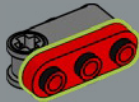

3

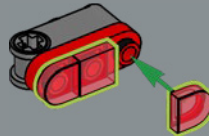

4

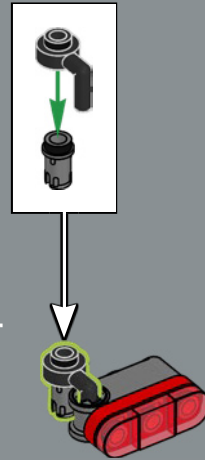

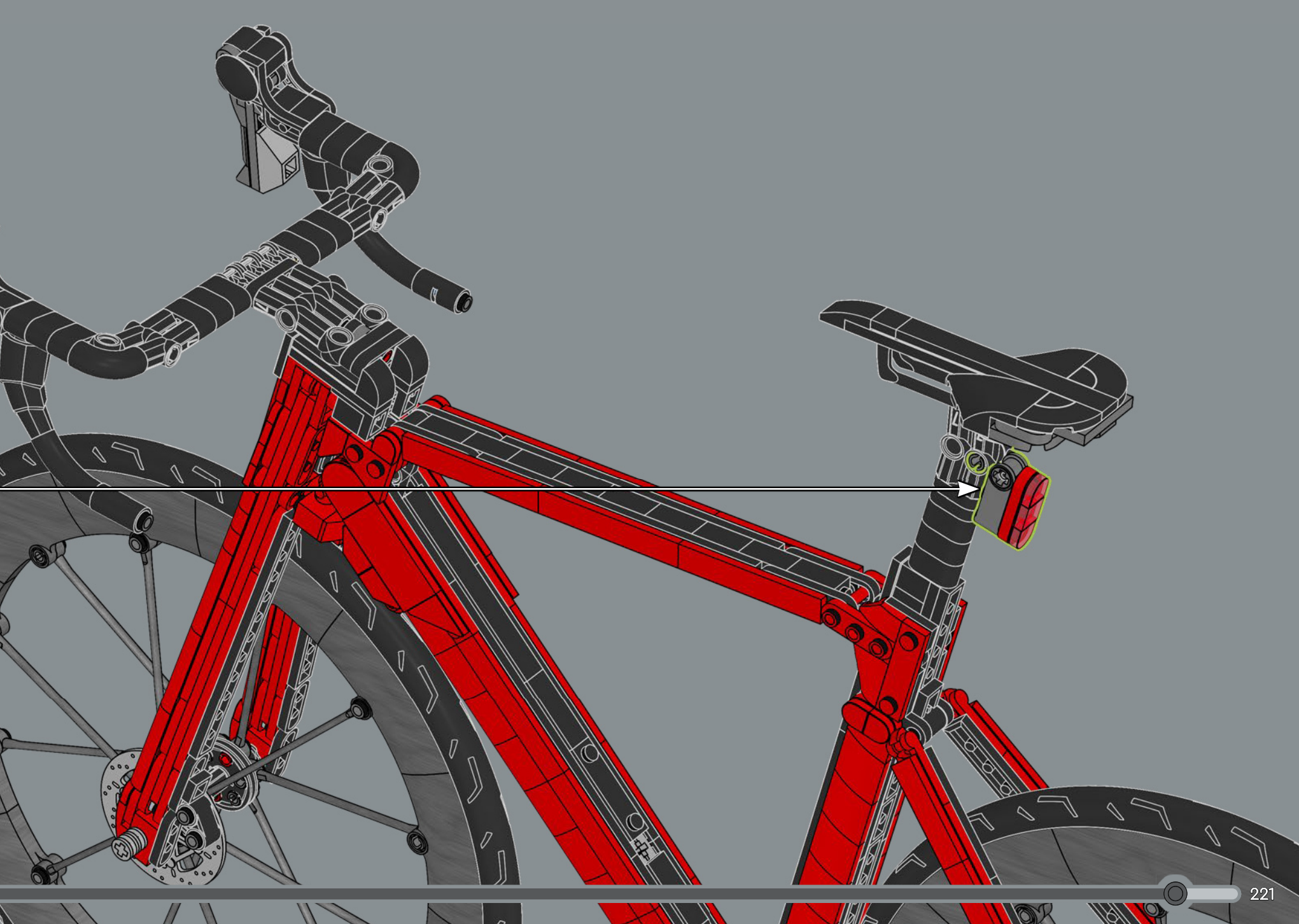

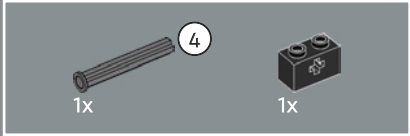
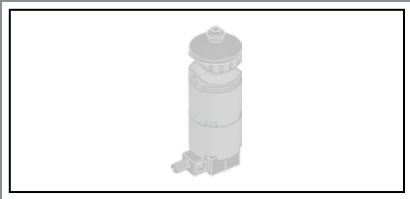

355

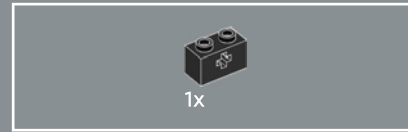
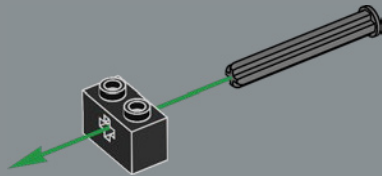

356

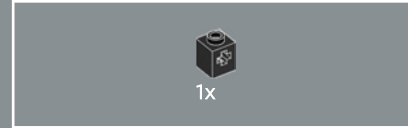
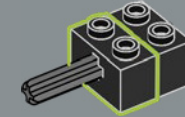

357

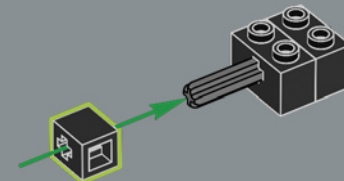

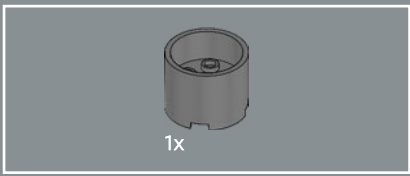

358

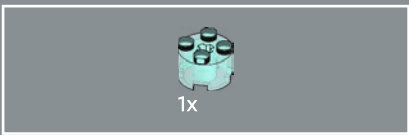
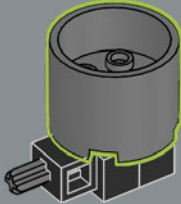

359

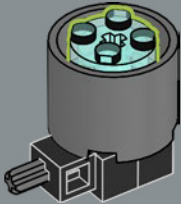

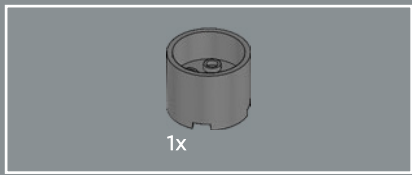

360



361

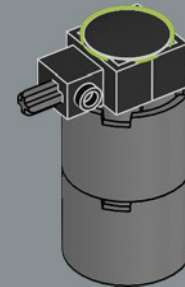

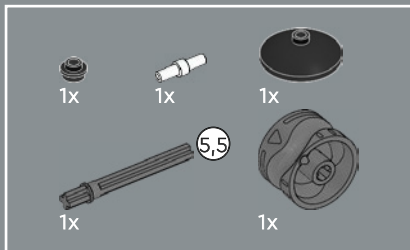

362

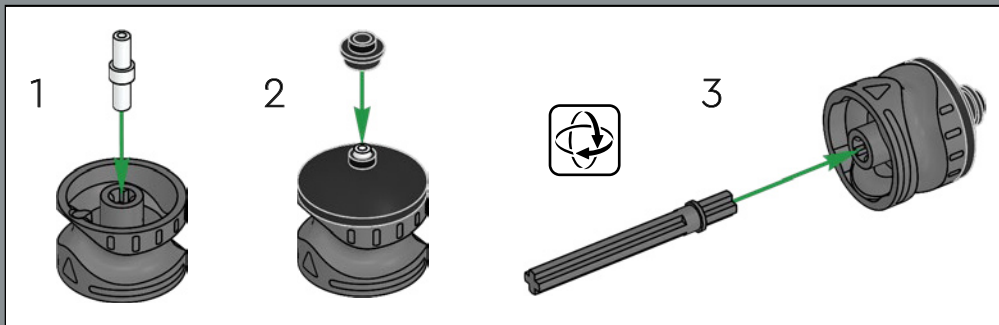

水瓶上的这个元件是乐高®机械组变速箱中常用的换挡杆。

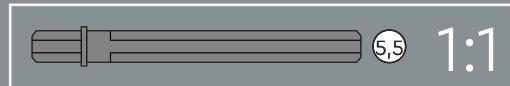
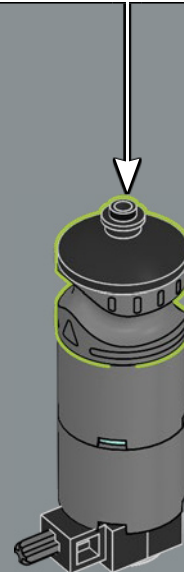

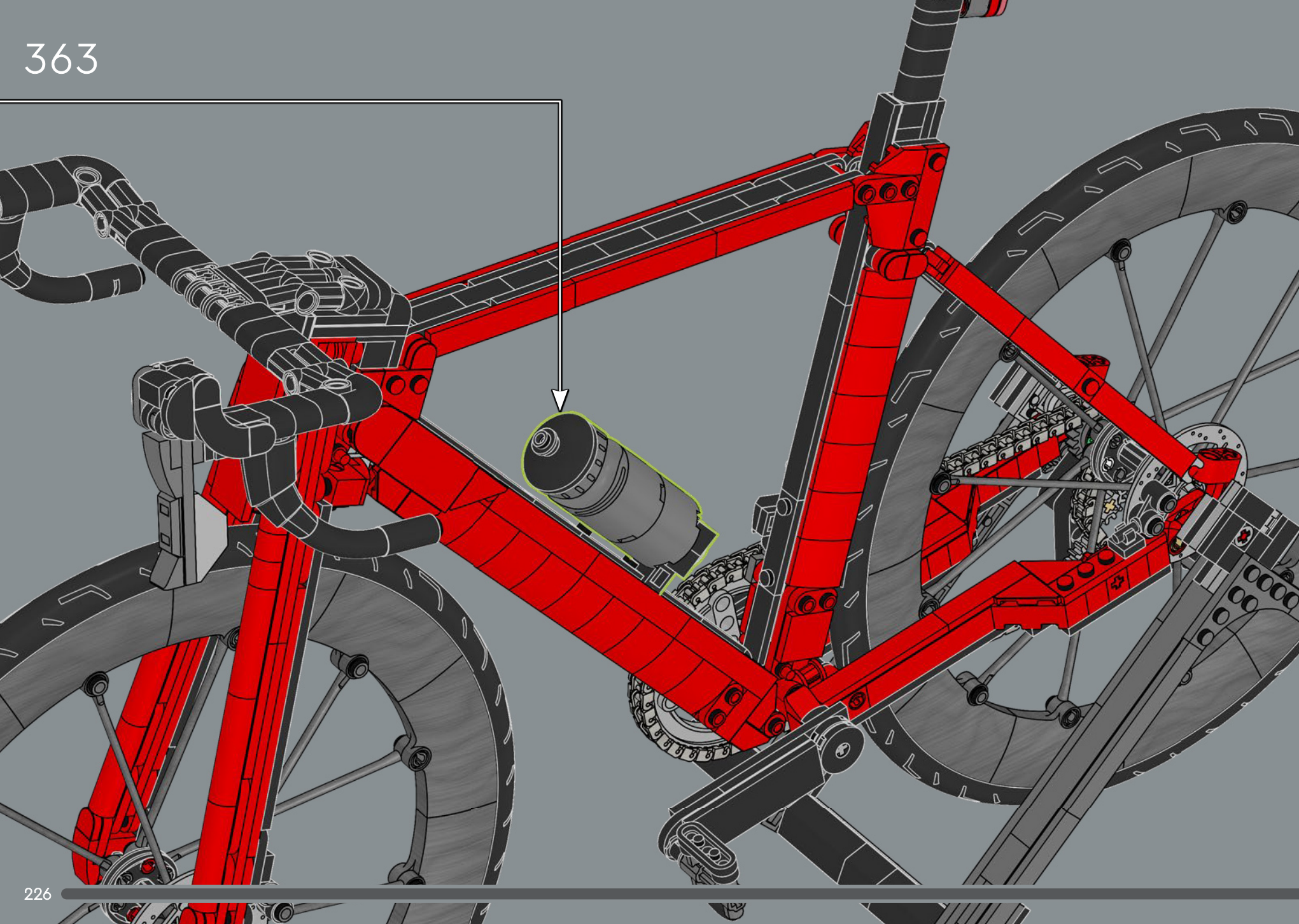

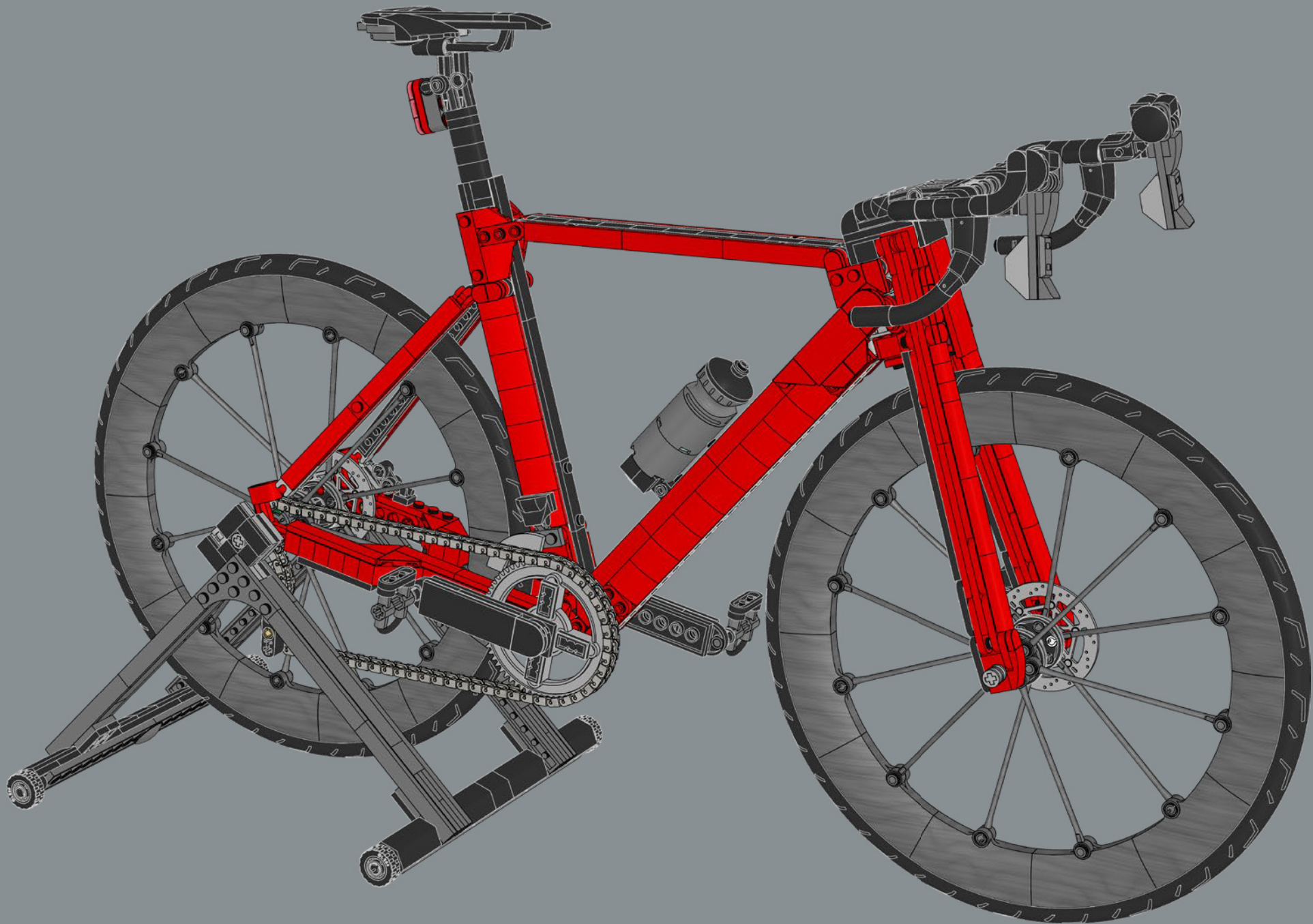

4x
6388018
1x
6357680



1x
4582543

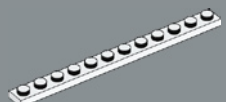

3x
4514842



1x
6013938



2x
4666579



2x
4666999



4x
6223427



3x
6439048



16x
6258973



34x
6378120



6x
6278441



7x
6473604



2x
4504379



4x
302421



1x
6397571

228

2x
6435047

5x
6510141

1x
6177505

1x
6177507

5x
6510127

1x
6141552

1x
6141553

22x
6210269

45x
4142865

1x
6513907

1x
6507845

2x
6167939

2x
6186398

2x
370021

4x
6029946

2x
306921

1x
6001806

2x
6545843

2x
6532099

6x
6351892

21x
6598629

2x
6540722

13x
6275080

1x
6209519

1x
6555339

30x
6105976

2x
302221

2x
306821

3x
4515365

2x
6362998

2x
6251410

5x
362321

2x
6494104

2x
6480856

4x
6598628

2x
302121

6x
6534946

4x
6256923

1x
370121

6x
243121

2x
4560179

3x
6371582

3x
6130002

1x
6398773

17x
4113858

2x
300921

1x
6335578

4x
346021

10x
447721

1x
302423

2x
4206482

3x
302323

2x
6299413

2x
371023

1x
6130009

1x
6168646

4x
6186675

2x
6473449

6x
6256435

4x
6332148

5x
302426

2x
6539387

7x
6344819

3x
307026

2x
6172383

9x
6228987

1x
6335388

2x
6335317

3x
6508269

4x
6291068

2x
6510214

2x
6510071

4x
6338428

2x
6173124

26x
6279875

5x
4278359

4x
403226
1x
6143850

4

7

6

3x
6099801

2x
6179182

2x
4644456

1x
6282140

2x
6535446

4x
6542617

13x
6265091

2x
4512363

4x
4617848

2x
6173119

6x
306926

2x
6347310

2x
6178922

1x
6069000

1x
6192309

5x
302326

1x
6542614

1x
6047276

1x
6375706

1x
6266207

4x
6092585

1x
6517779

2x
6586225

2x
6422988

13x
6428168

3x
6331723

4x
6323668

2x
6396457

2x
6470264

4x
6061032

2x
6133722

4x
6191630

2x
242026

1x
6321745

3x
4107765

1x
4552347

9x
6523971

1x
4142822

1x
6265644

1x
4180087

2x
362326

6x
4558170

1x
6572774

2x
317626

1x
6522834

8x
6428167

2x
6493691

1x
6162892

2x
371026

2x
6254045

8x
6439175

2x
6325190

1x
6522832

8x
4529155

2x
302026

6x
6350415

1x
6278125

8x
366626

4x
379526

2x
6318582

4x
416226

2x
373826

8x
447726

2x
273026

6x
4514845

2x
244526

2x
6507960

1x
6581817

1x
6514282

1x
6240515

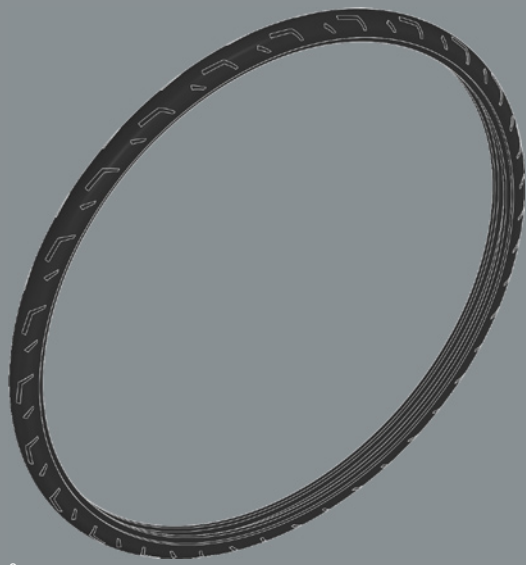

2x
6584779

1x
6267486

13x
6271165

2x
6168647

1x
4211758



 [LEGO.com/service](https://www.LEGO.com/service)

2x
6436419

8x
4211353

4x
4211397

2x
6043639

2x
4515369

1x
6282158

2x
6088708

2x
6456718

1x
6385740

3x
6549304

2x
6285654

1x
6576953

2x
4640536

2x
6144138

3x
4211639

1x
4211805

1x
4535768

1x
6178172

1x
4211705

66x
6395635

2x
4504378

1x
4210719

4x
6360111

7x
6221607

2x
4278274

4x
4211088

2x
6331866

2x
6029948

1x
6266248

1x
6215212

8x
6250018

1x
6576527

1x
6273715

2x
6411395

2x
6473422

1x
6598627

12x
4211001

1x
6039176

2x
6413109

4x
6310174

3x
6083620

1x
4508553

4x
6389443

8x
4211008

4x
4210678

4x
4210798

4x
6133611

72x
6576937

24x
6585275

24x
6584089

4

5,5

5

7

9

11



YOU COULD
WIN



**YOU COULD
WIN**

Your feedback will help shape the future development of this product series.

Visit:

**DU KÖNNTEST
GEWINNEN**

Dein Feedback trägt zur Weiterentwicklung dieser Produktreihe bei.

Geh auf:

**VOUS POURRIEZ
GAGNER**

Vos commentaires nous aideront à concevoir les futurs produits de cette gamme.

Visitez :

**POTRESTI
VINCERE TU**

La tua opinione ci aiuterà a migliorare la creazione futura di questa linea di prodotti.

Visita:

**PUEDES
GANAR**

Tu opinión contribuirá al futuro de esta serie de productos.

Visita:

轻松获奖

您的反馈将有助于我们在今后改进本产品系列。

请访问:

LEGO.com/productfeedback

You also have the chance to win a LEGO® set.

Terms and conditions apply.*

Außerdem hast du die Chance, ein LEGO® Set zu gewinnen.

Es gelten die Teilnahmebedingungen.*

Vous pourriez également gagner un ensemble LEGO®.

Des conditions s'appliquent.*

Hai anche la possibilità di vincere un set LEGO®.

Termini e condizioni sono applicabili.*

También tienes la oportunidad de ganar un set LEGO®.

Aplican términos y condiciones.*

您还有机会赢取乐高®套装。

条款和条件适用。*

*LEGO.com/productfeedback-terms



LEGO and the LEGO logo are trademarks of the LEGO Group. ©2026 The LEGO Group.