



11378





LEGO.com/sustainable-packaging



FR  
**DONNEZ  
OU  
RECYCLEZ**



ASSOCIATION

OU



MAGASIN

OU



DÉCHÈTERIE

Adresses sur [quefairedemesdechets.fr](http://quefairedemesdechets.fr)



# BUILDER



Apple and the Apple logo are trademarks of Apple Inc., registered in the U.S. and other countries and regions. App Store is a service mark of Apple Inc. Google Play and the Google Play logo are trademarks of Google LLC. Tencent and the Tencent logo are trademarks of Tencent Inc.

[LEGO.com/devicecheck](https://LEGO.com/devicecheck)

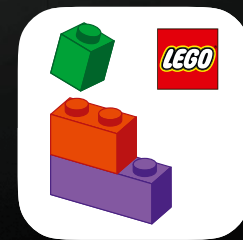

LEGO® Builder



# Enjoying the ride since 1927™

Fondata nel 1927 e operativa fino al 1991, Pan American World Airways – Pan Am® – entrò nella sua era più glamour con la messa in servizio del venerabile PAA® Douglas™ DC-3™ a metà degli anni '30. La prima compagnia aerea a volare a livello mondiale, Pan Am, così come il DC-3, sono ancora considerati icone che hanno trasformato il viaggio aereo e l'esplorazione del mondo in uno stile di vita. Attraversare i continenti significava molto di più che semplice trasporto, era un segno di prestigio e raffinatezza. Il DC-3 della PAA offriva un'affidabilità impareggiabile sia sulle rotte interne sia su quelle transatlantiche. Il servizio della Pan Am, rinomato per le uniformi impeccabili ed eleganti dell'equipaggio, le cabine raffinate e l'ospitalità senza pari, è ancora oggi l'emblema dell'età d'oro del volo, stabilendo lo standard globale di raffinatezza, lusso ed eleganza nei cieli.







## Il mondo è tuo

Il Douglas™ DC-3™ prese il volo per la prima volta il 17 dicembre 1935, con la consegna del primo velivolo commerciale nel giugno 1936; l'aeromobile arrivò a dominare le flotte delle compagnie aeree negli anni '40, con 455 DC-3 costruiti, sempre per uso commerciale, fino all'inizio del 1946. Un monoplano monomotore ad ala bassa, poteva decollare da piste corte e atterrare comodamente in spazi ristretti, ed era quindi ideale per quasi tutte le destinazioni e terreni. I piloti prediligevano il DC-3 per la sua affidabilità e manovrabilità, mentre i passeggeri apprezzavano il suo immacolato comfort e, naturalmente, le avventure di viaggio nei paesi esotici di tutto il mondo! Oggi, se sai dove cercare, potresti ancora vederne alcuni solcare i cieli.

Sebbene il nome Douglas sia stato ritirato, la sua storia e i suoi design vivono ancora all'interno della divisione Commercial Airplanes di Boeing, che continua a custodire con orgoglio l'eredità del DC-3.



DOUGLAS DC-3

 **BOEING**

## SPECIFICHE

**LUNGHEZZA:**  
19,7 M

**APERTURA ALARE:**  
29 M

**CAPACITÀ:**  
UN EQUIPAGGIO DI TRE PERSONE,  
21-28 PASSEGGERI PER I VOLI DIURNI  
(14 PASSEGGERI IN CUCCETTA PER I  
VOLI NOTTURNI) O 2.041 KG DI CARICO

**VELOCITÀ DI CROCIERA:**  
333 KM/H FINO A 3.420 KM

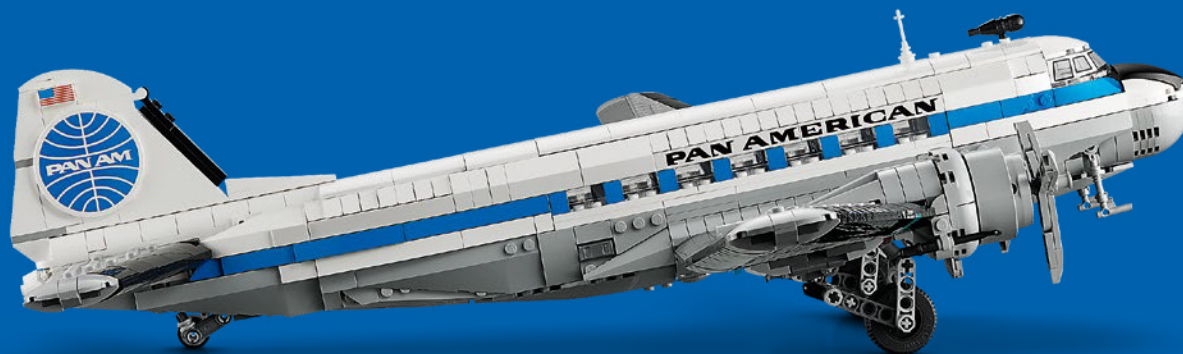



## Il commento dell'equipaggio dei designer di LEGO® Icons

Il Douglas™ DC-3™ era un fantastico candidato per la nostra collezione di veicoli LEGO® Icons a tema viaggio. Volevamo creare un modello altamente dettagliato, un omaggio nostalgico a un'epoca emozionante, abbastanza robusto da poter essere rimosso dal supporto e studiato in dettaglio. Le parti superiori della cabina di pilotaggio e della cabina passeggeri sono rimovibili per poter sbirciare all'interno. Con l'aiuto dei nostri partner di Pan Am® e Boeing, che hanno recuperato una rara illustrazione a colori della cabina dai loro archivi da condividere con noi, abbiamo costruito il modello quasi in scala LEGO minifigure, con carrello di atterraggio retrattile e un'impressionante apertura alare. All'inizio del processo di progettazione, abbiamo deciso di replicare quella che è probabilmente la livrea Pan Am del 1959 più iconica, vista solo su pochi DC-3, come omaggio all'epoca in cui questo aereo era la spina dorsale del trasporto aereo. (È molto probabile che l'abbiate visto in film usciti o ambientati proprio in quel periodo!) Le decorazioni stampate sul modello includono un nuovo parabrezza e l'iconico logo Pan Am Globe® su una nuova tessera LEGO 6x6. Per completare la scena, abbiamo progettato un equipaggio di minifigure LEGO in con uniformi vintage, incluso un nuovo elemento cappello storicamente accurato, e abbiamo integrato la caratteristica striscia blu sulla fusoliera.



*"Speriamo che vi divertirete a bordo ed  
esplorerete un mondo di divertimento costruibile!"*

*- Il LEGO® Icons Design Team*



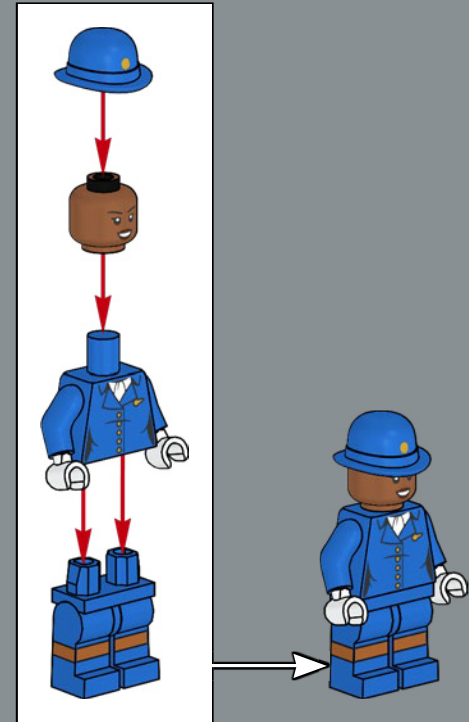
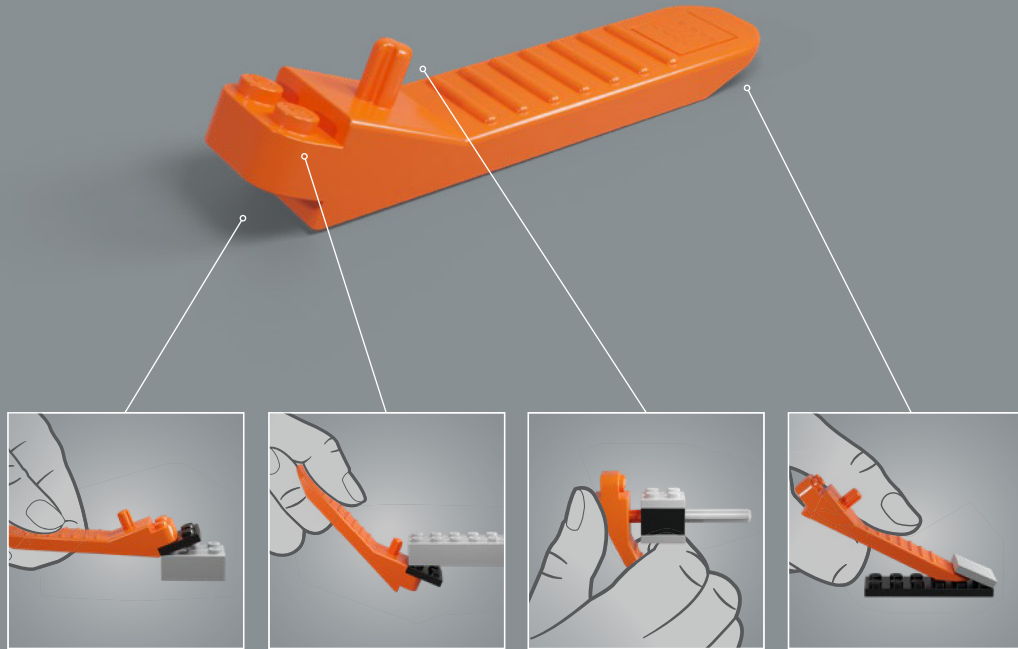

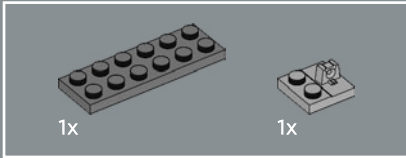
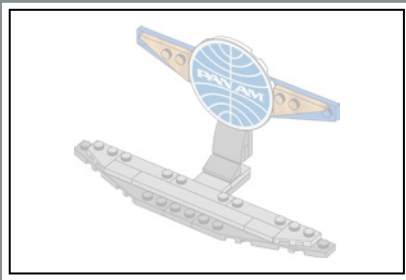

1

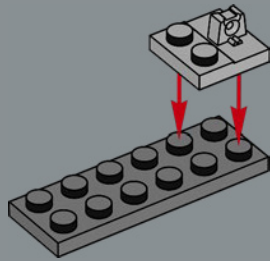

Il cappello dell'uniforme introdotto nel 1970 era talvolta chiamato "derby hat" (nome americano della bombetta), ma all'interno dell'azienda era comunemente chiamato "bowler hat" (nome inglese della bombetta).

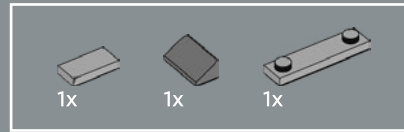

2

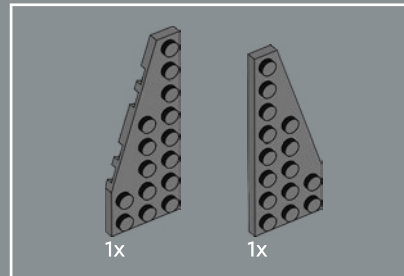
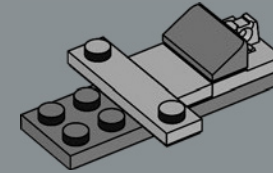

3

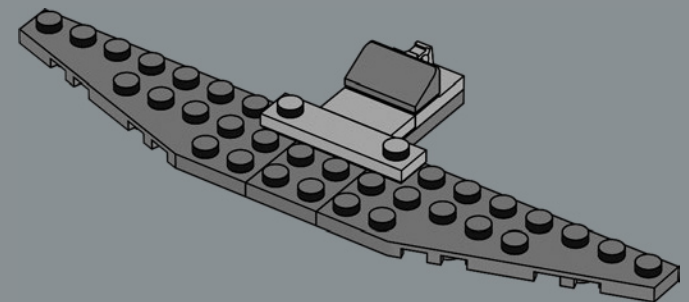

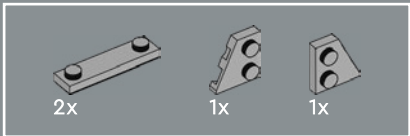

4

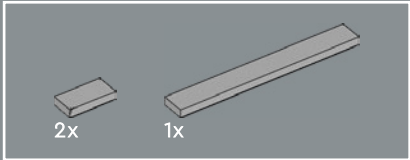
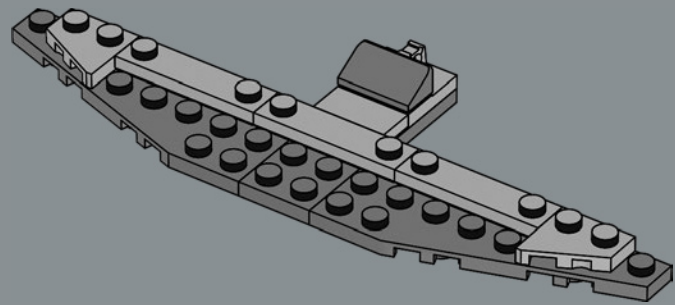

5

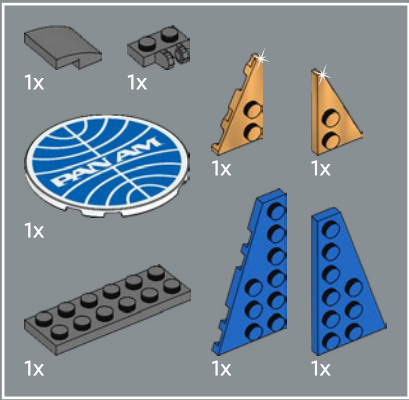
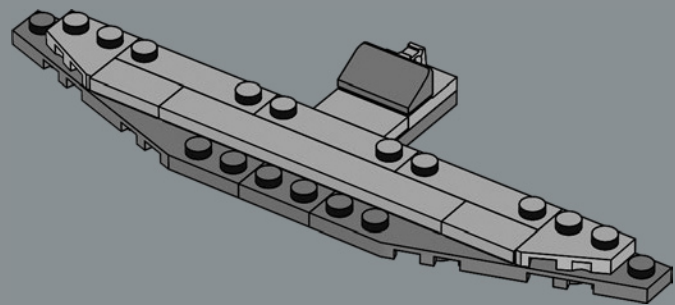

6

1

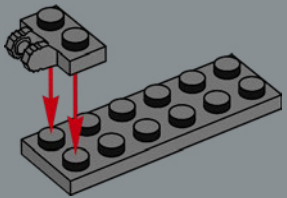

2

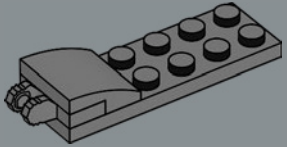

3



4

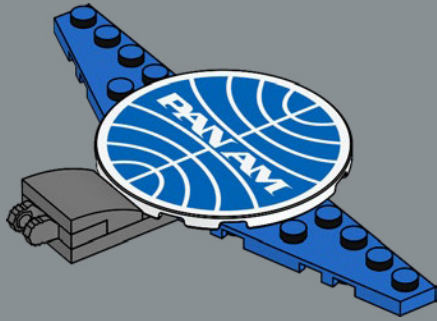

5

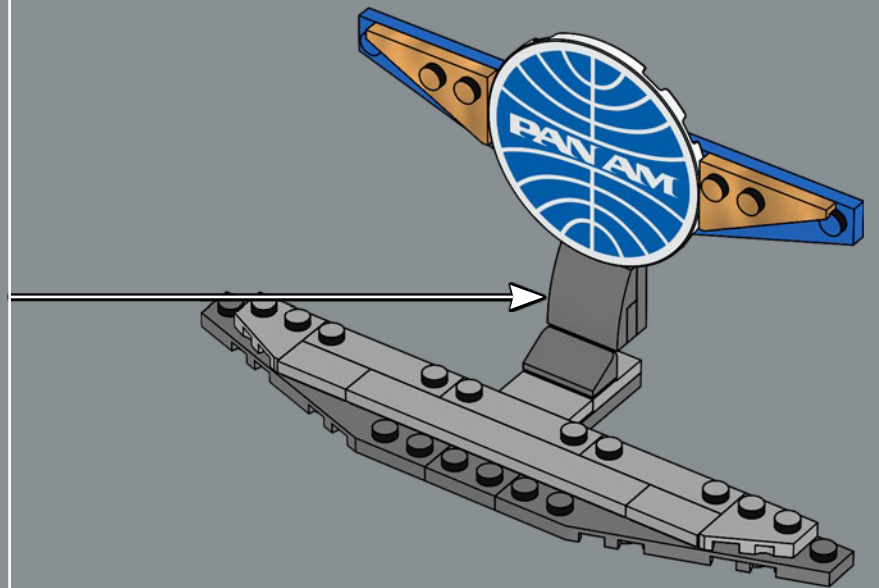

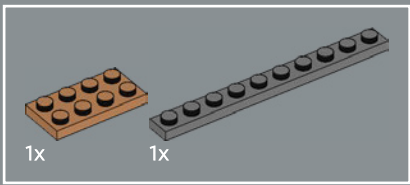

7

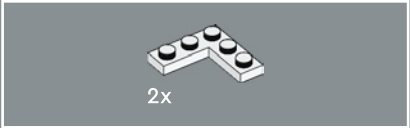
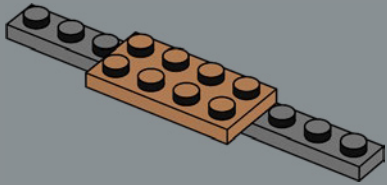

8

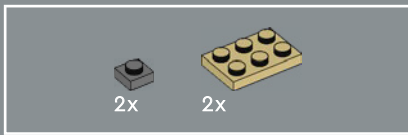
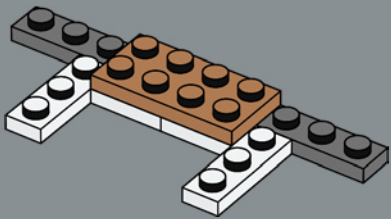

9

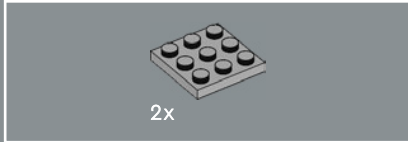
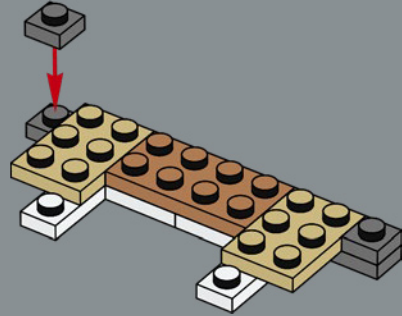

10

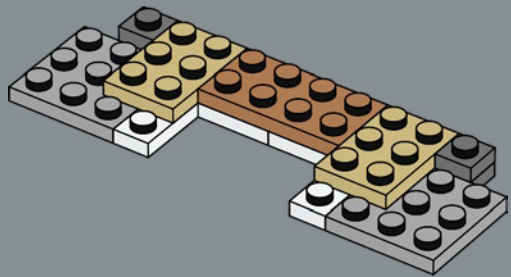

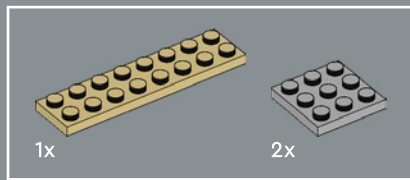

11

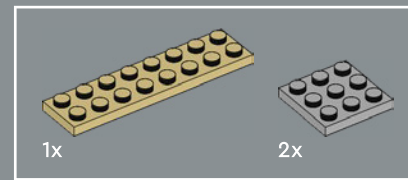
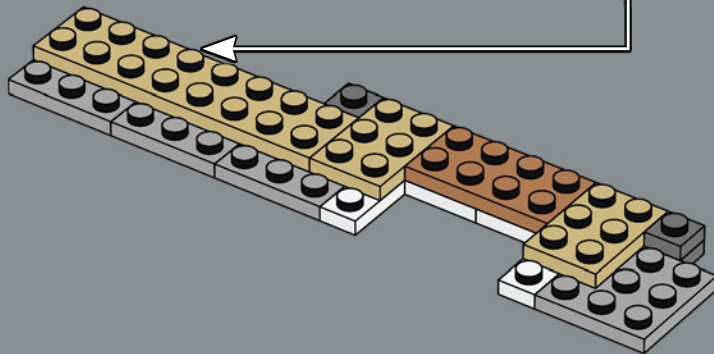
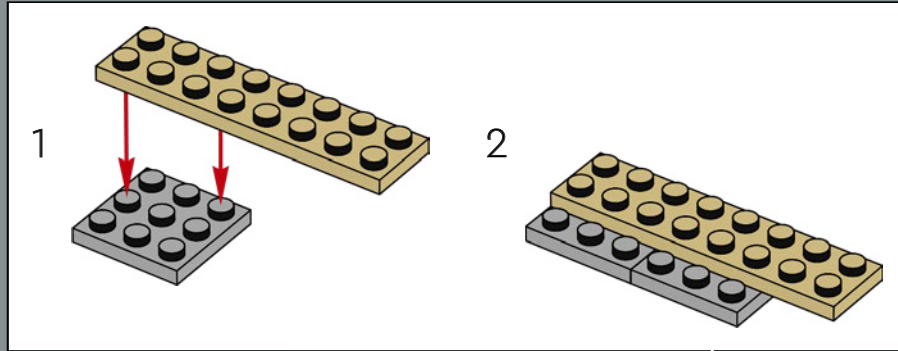

12

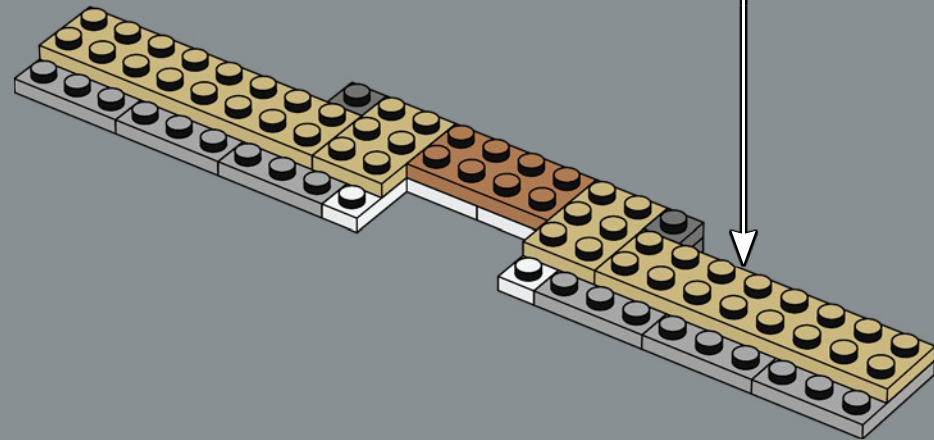
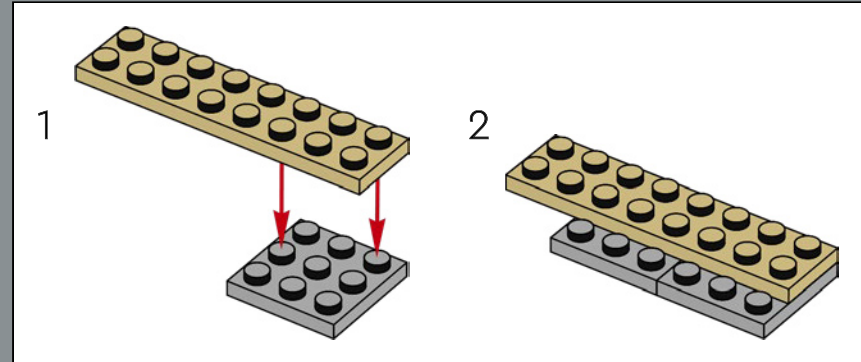

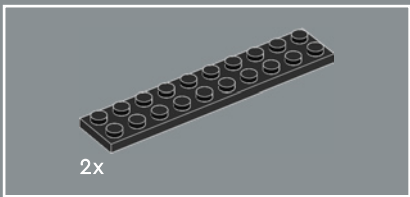

13

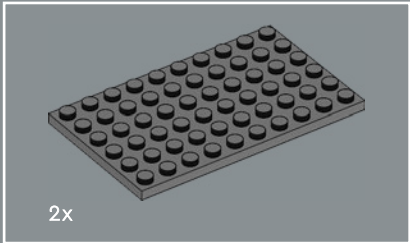
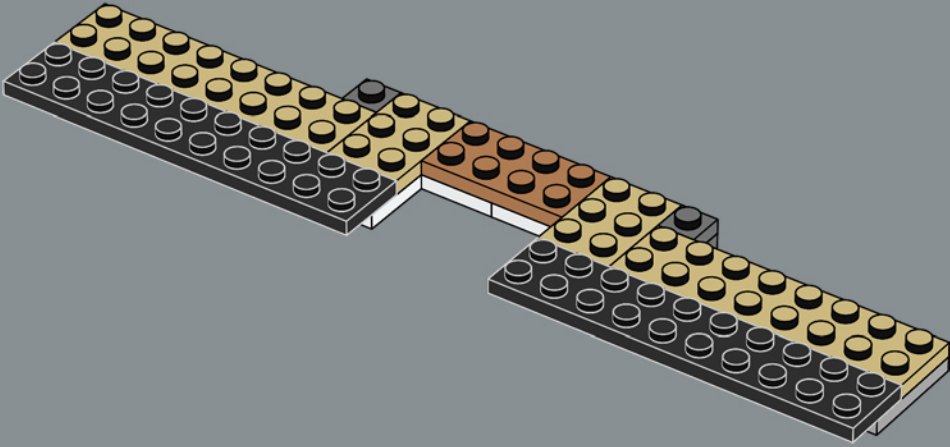

14

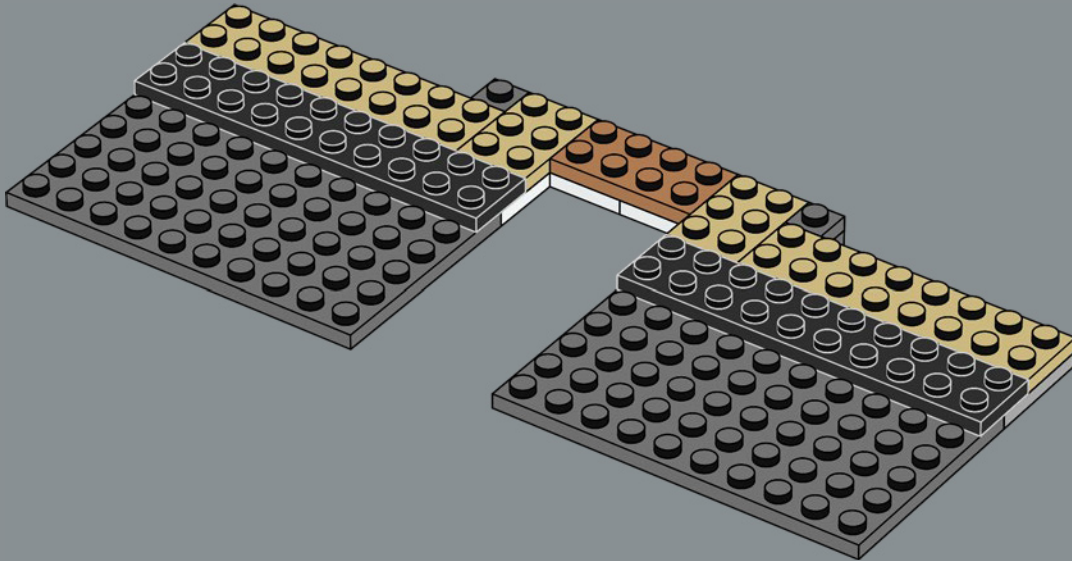

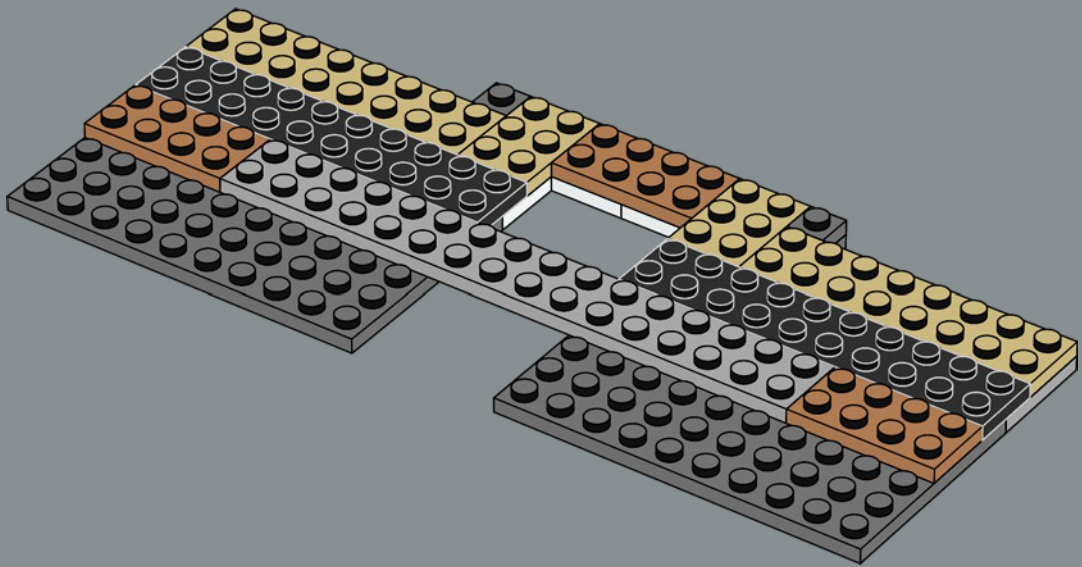
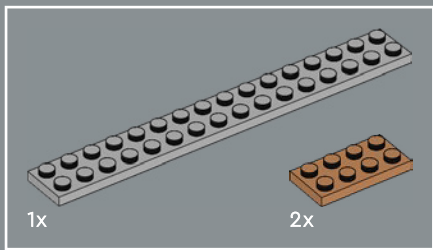

15

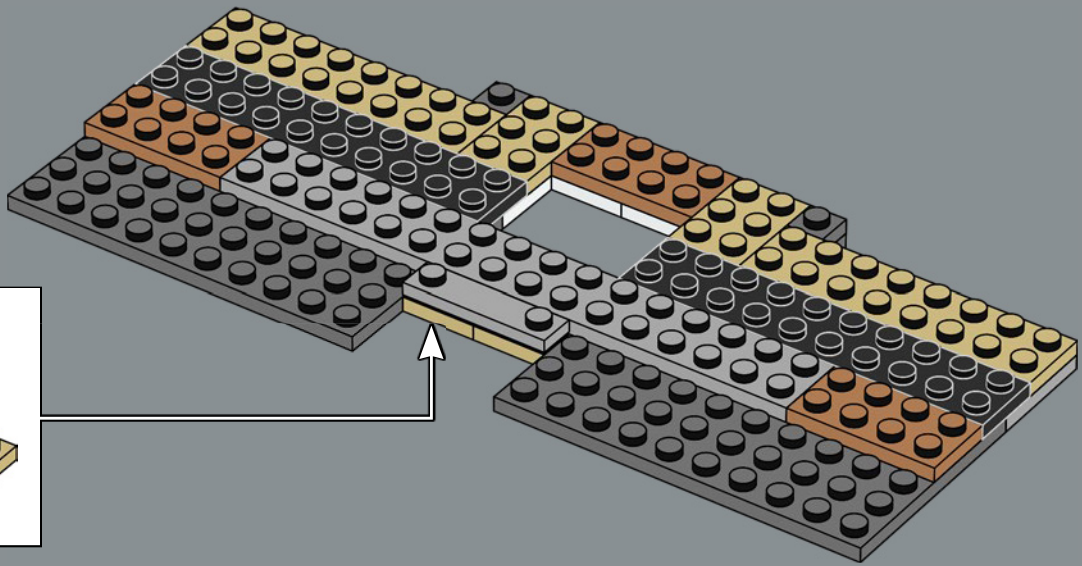
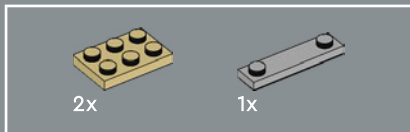

16

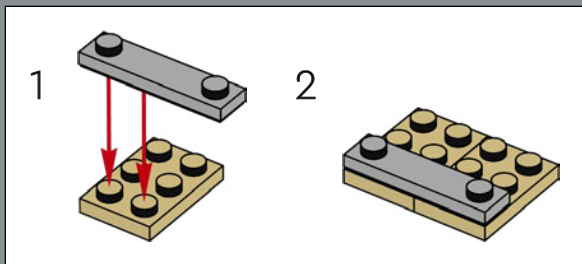



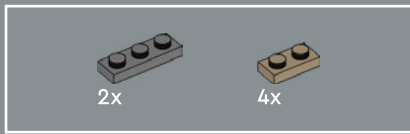

19

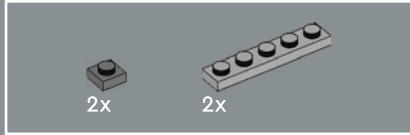
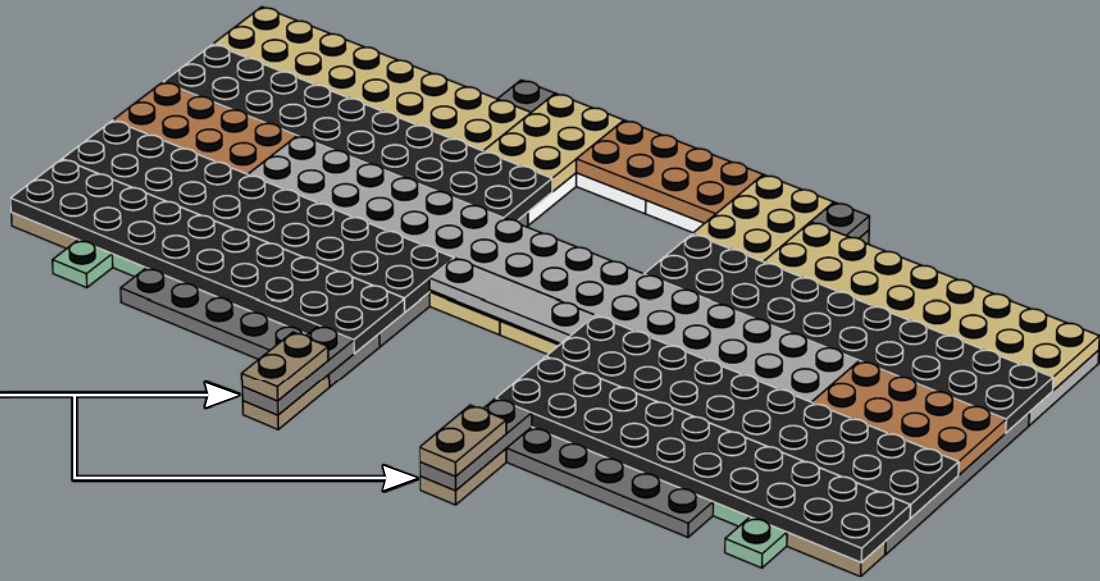
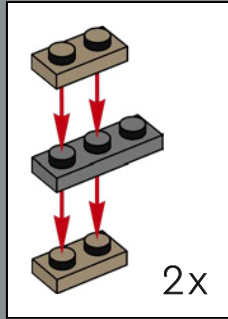

20



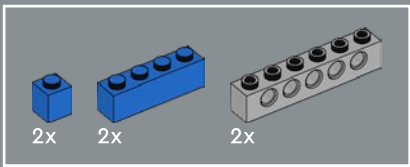

21

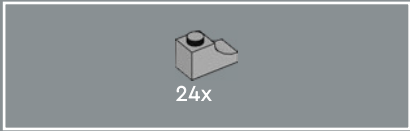
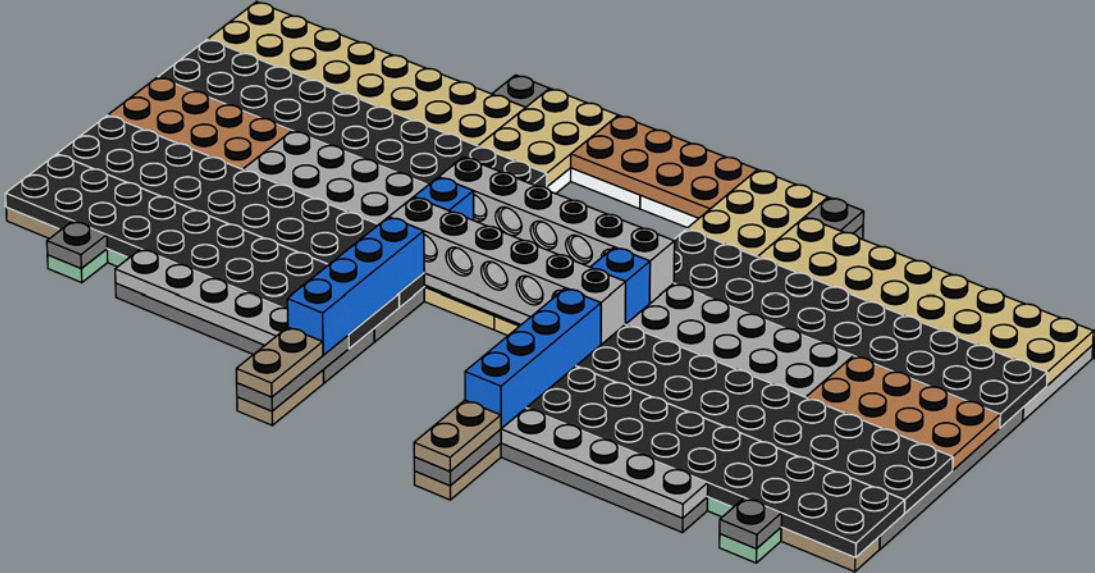

22

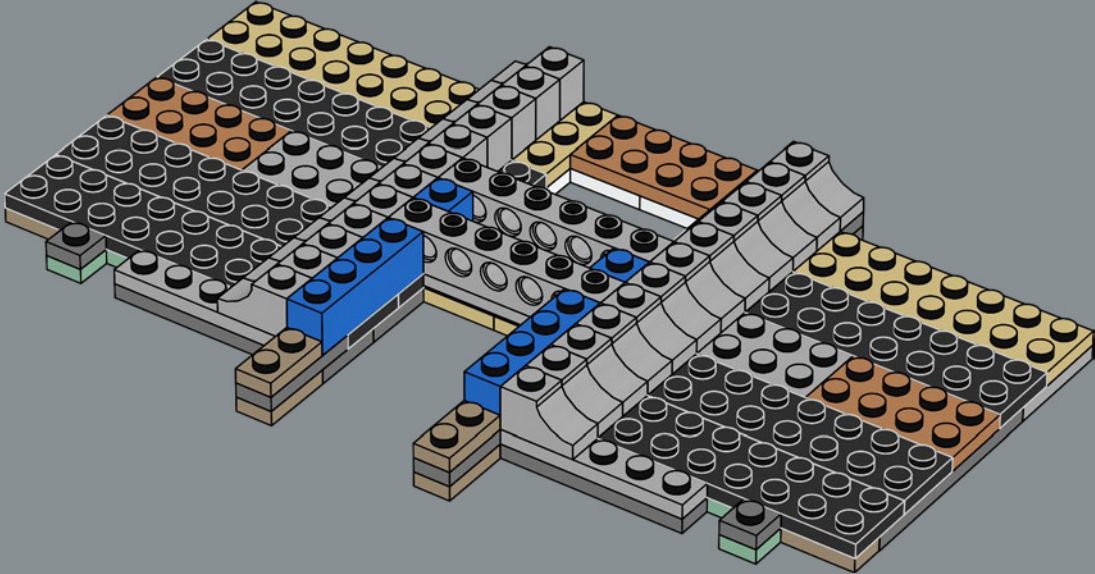

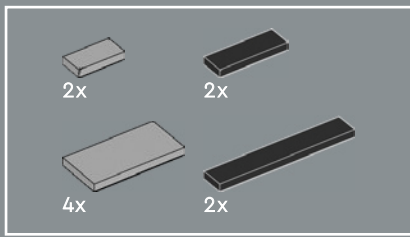

23

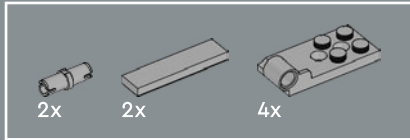
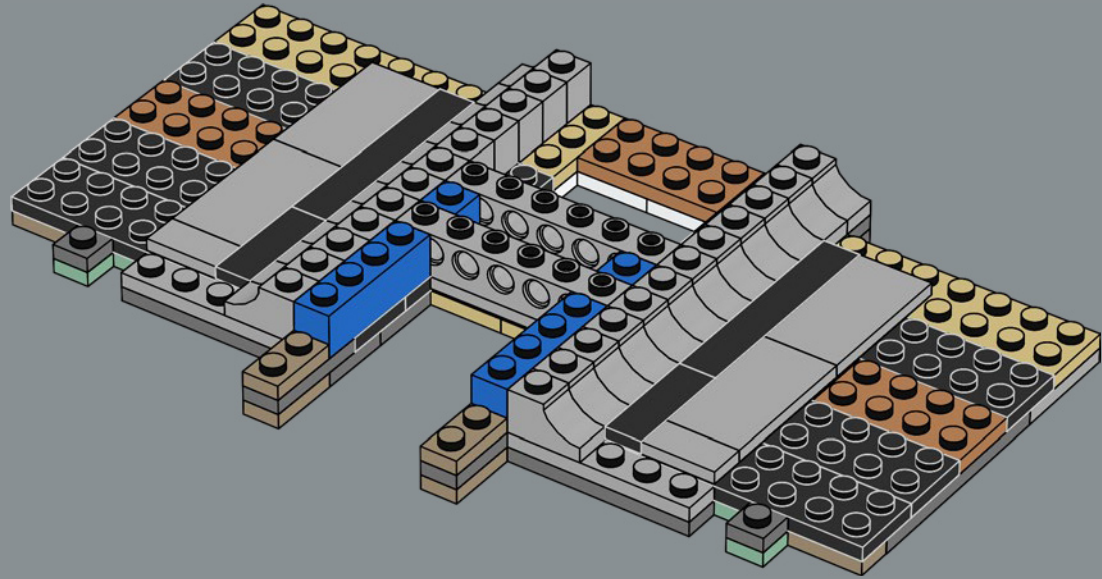

24

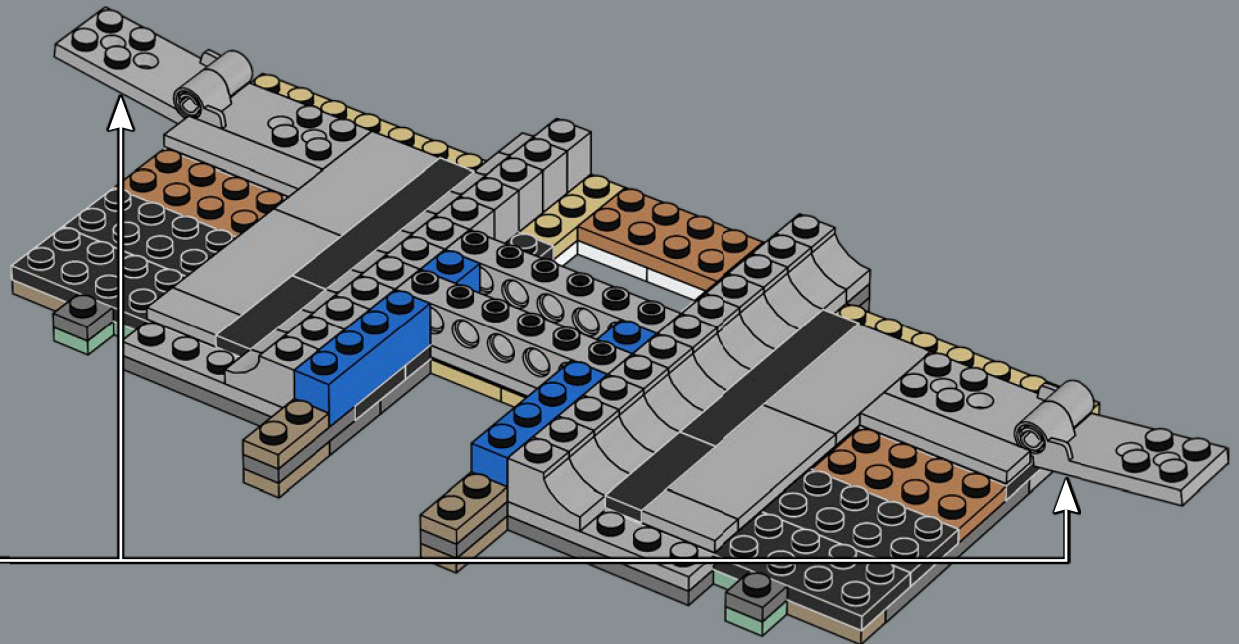
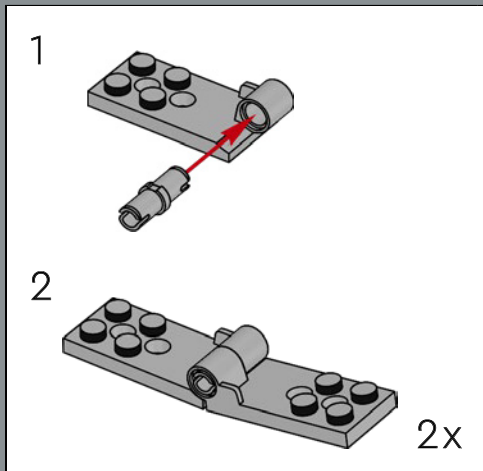

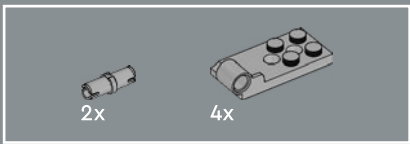

25

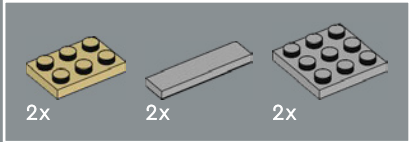
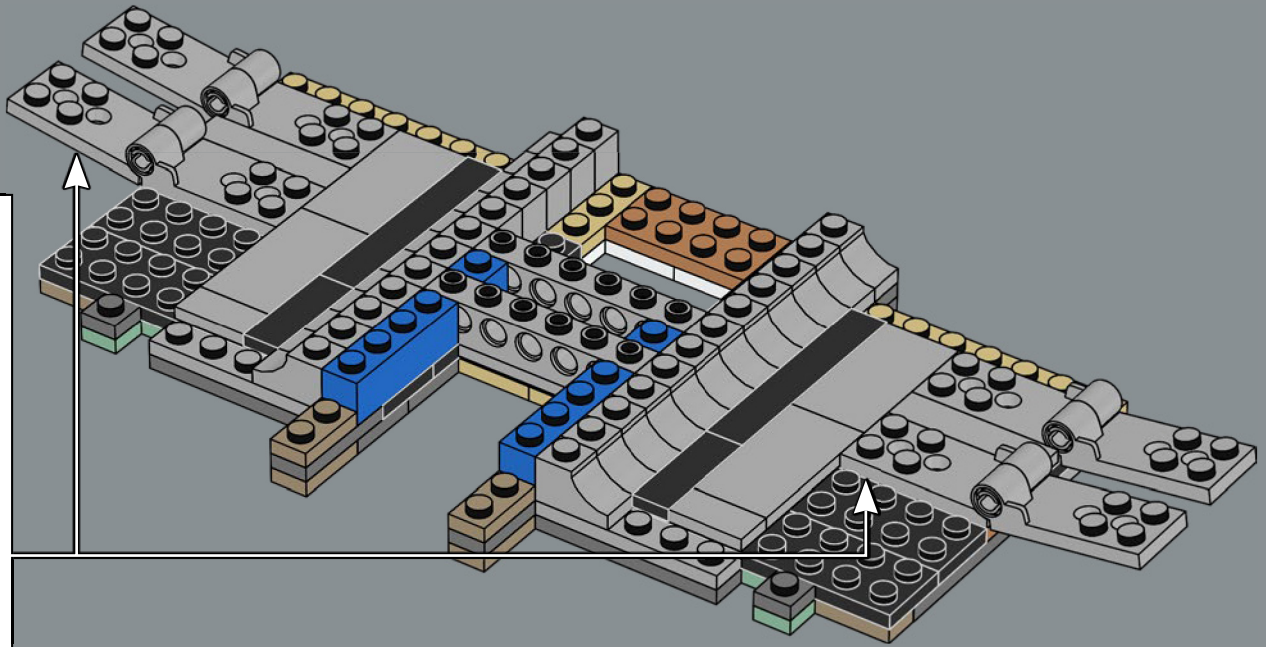
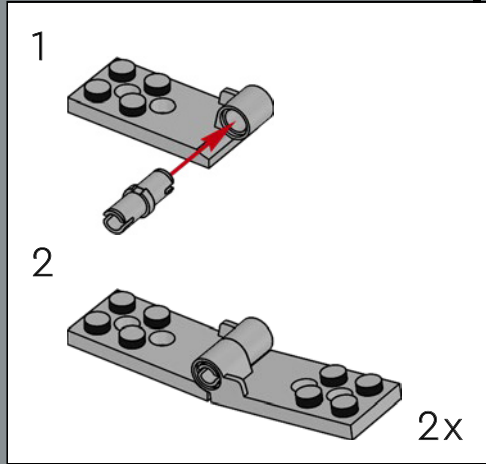

26

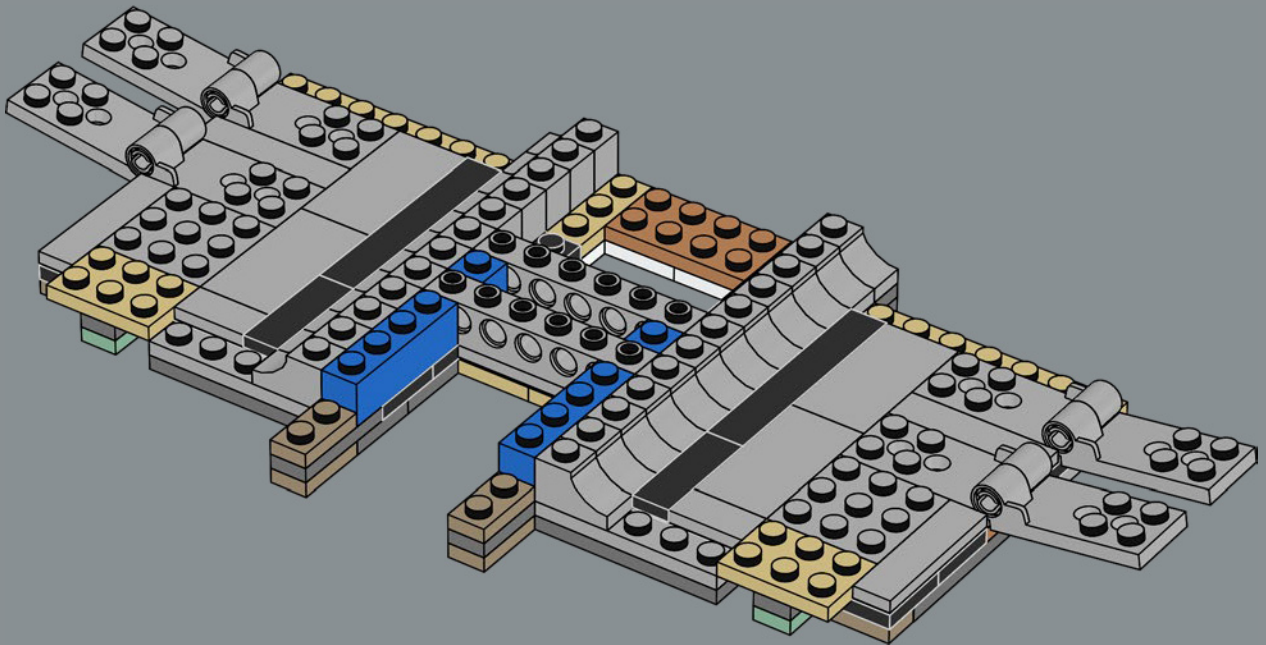

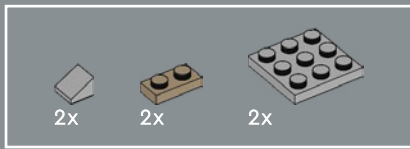

27

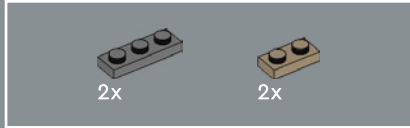
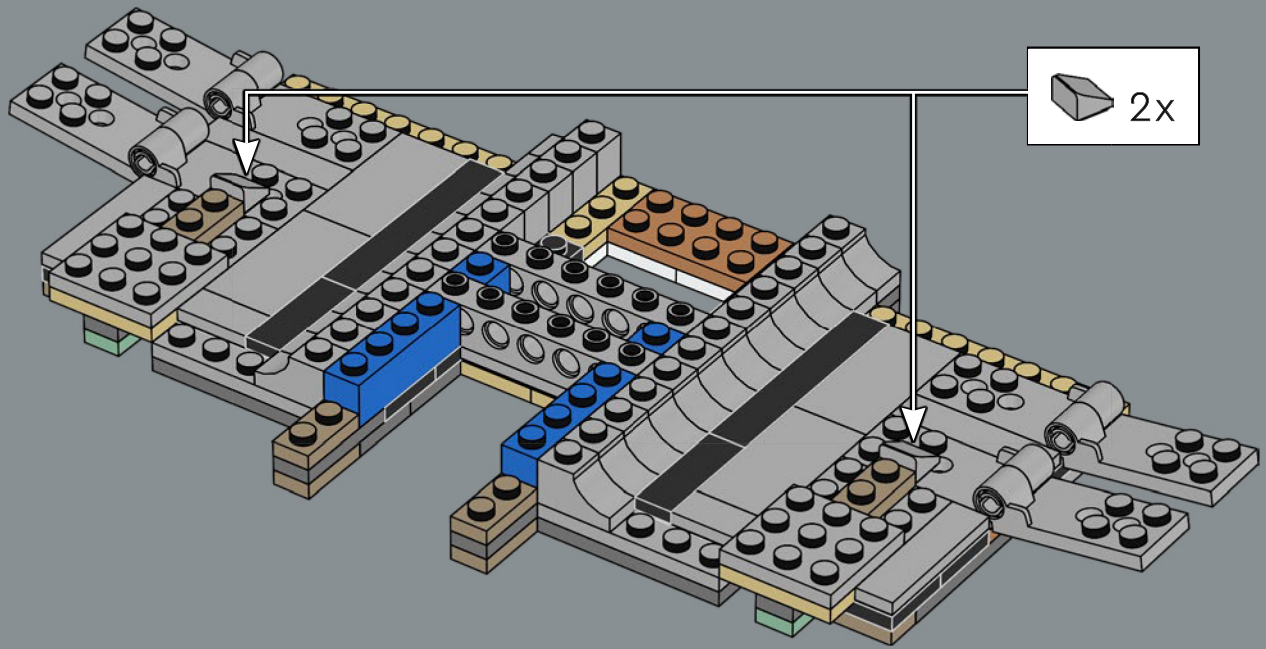

28

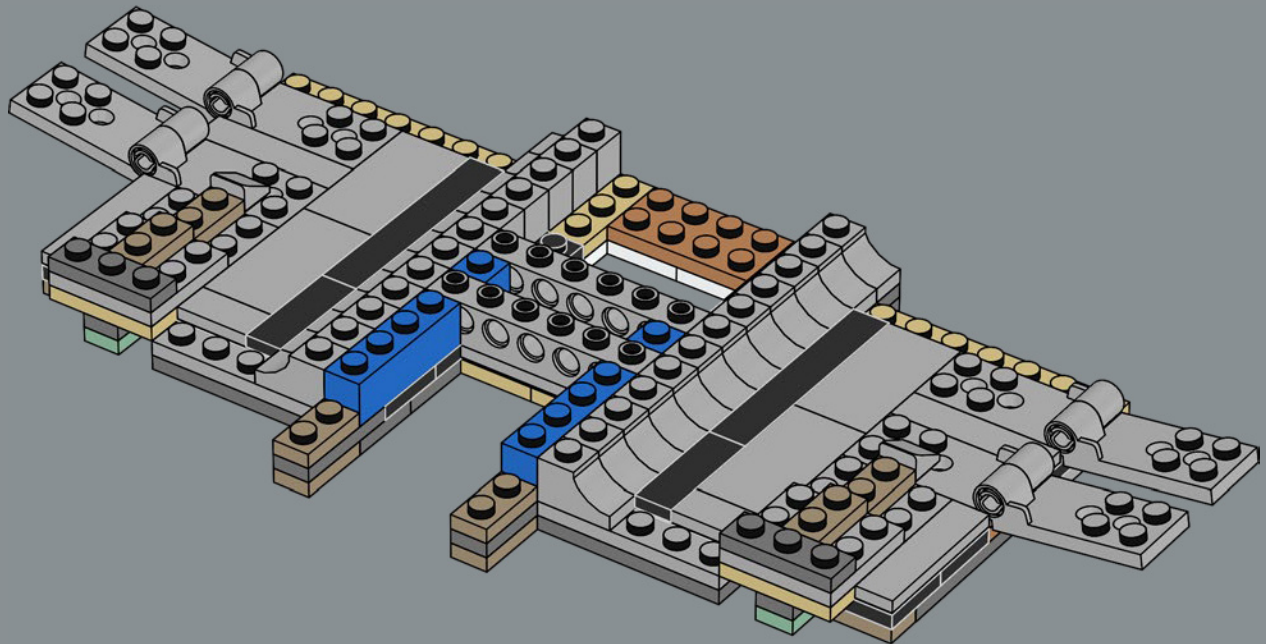

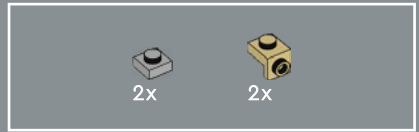

29

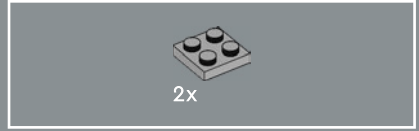
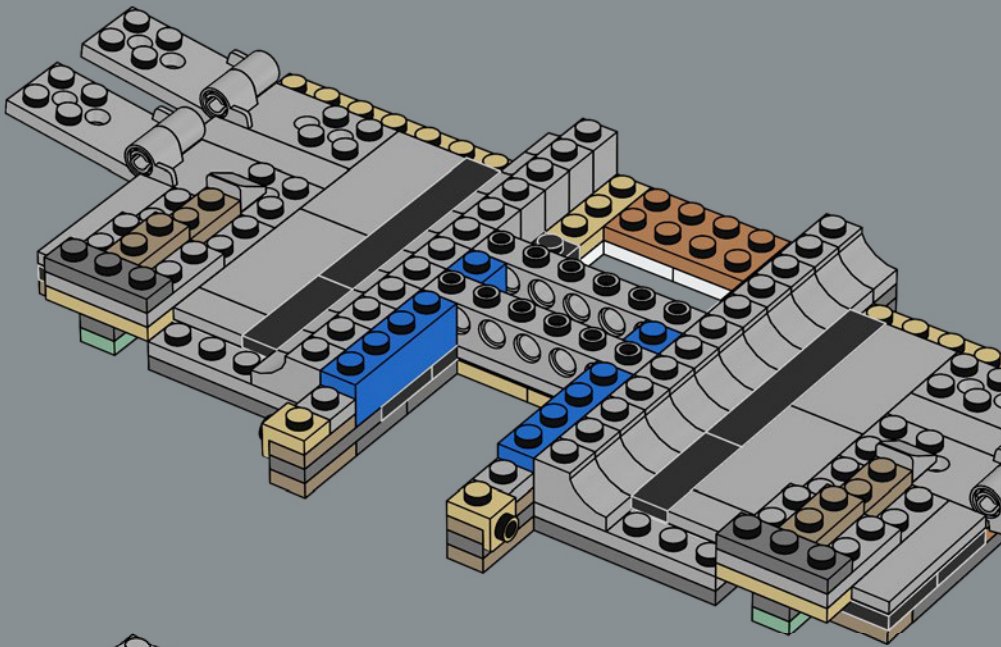

30

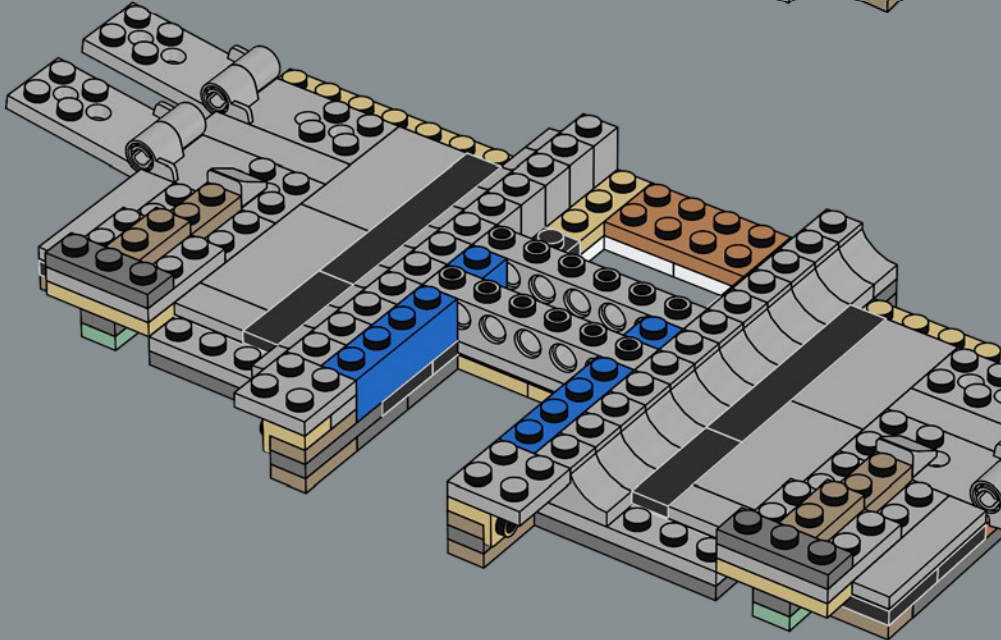

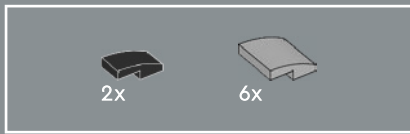

31

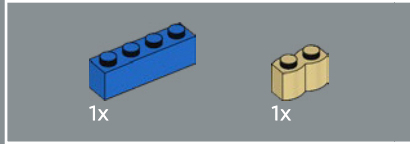
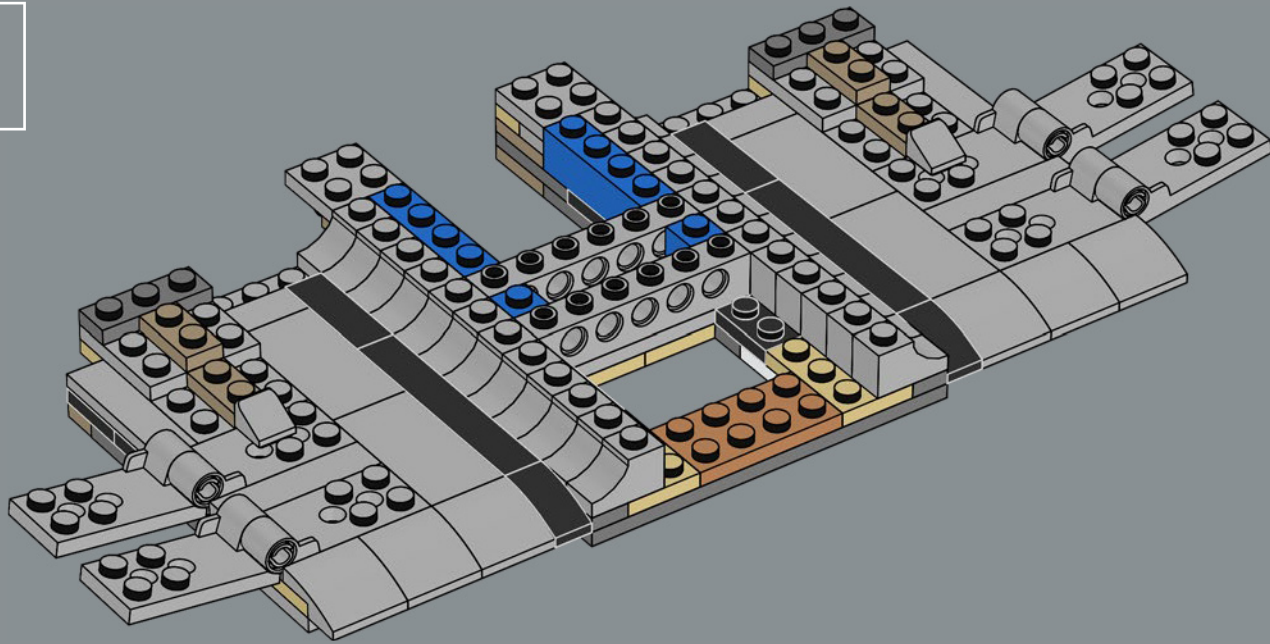

32

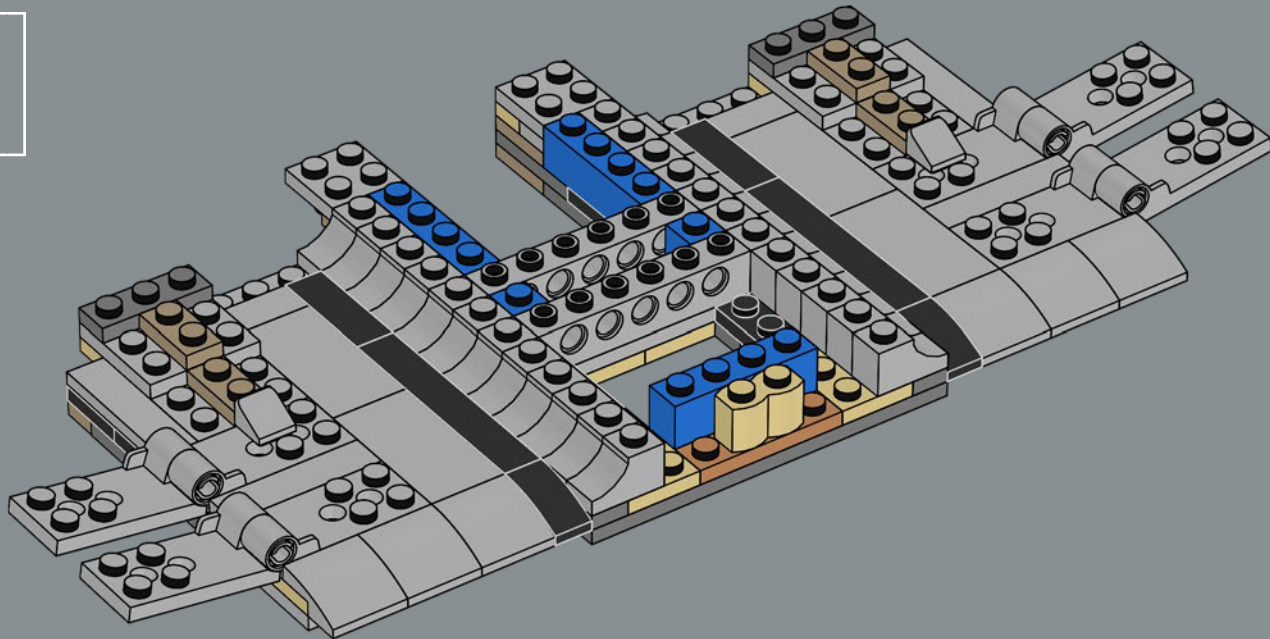

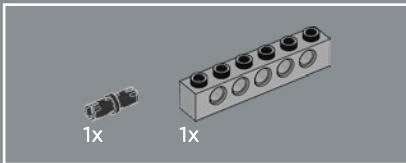
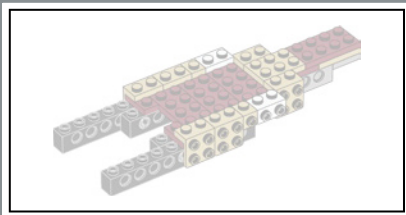

33

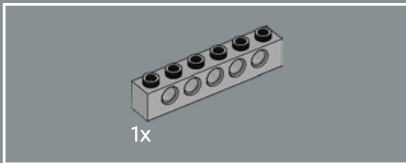
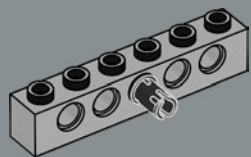

34

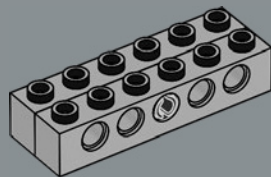

35

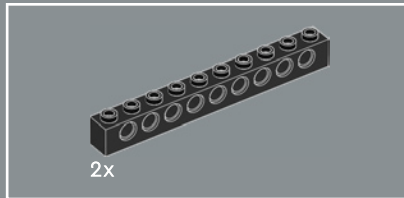
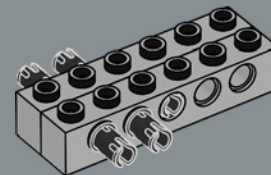

36

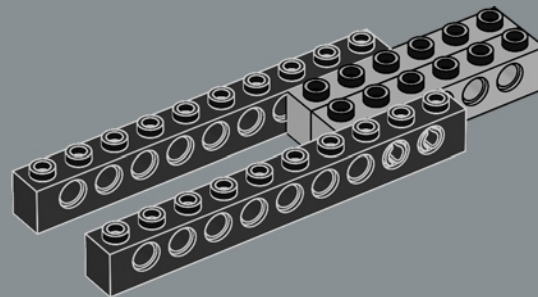

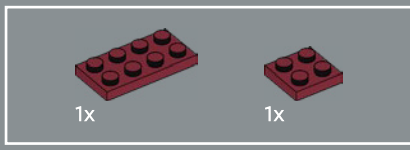

37

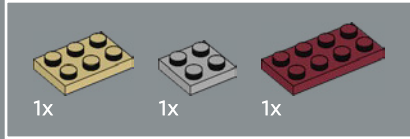
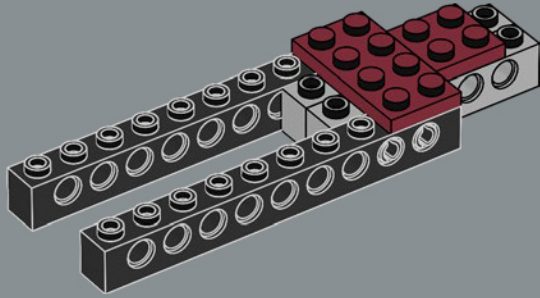

38

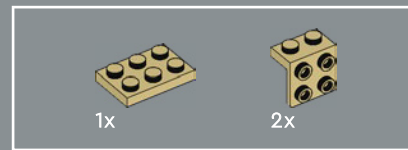
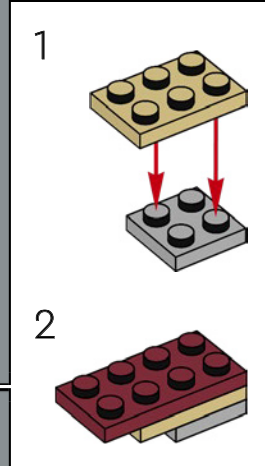
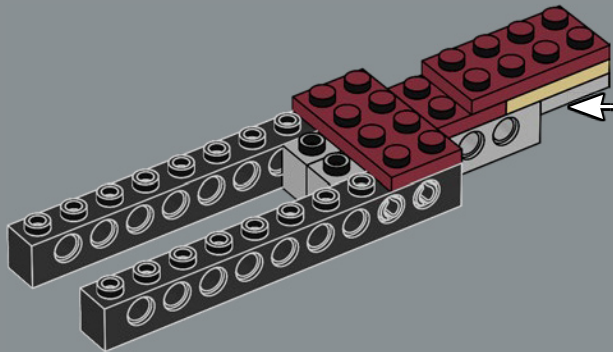

39

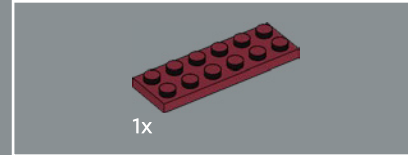
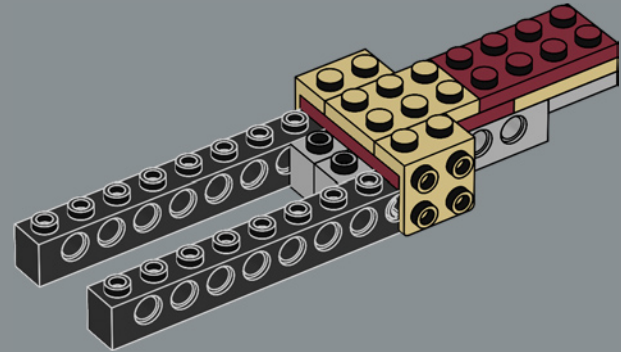

40

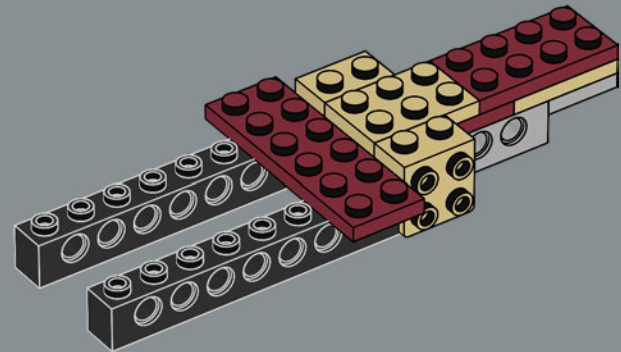

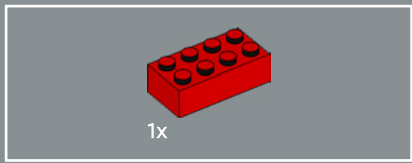

41

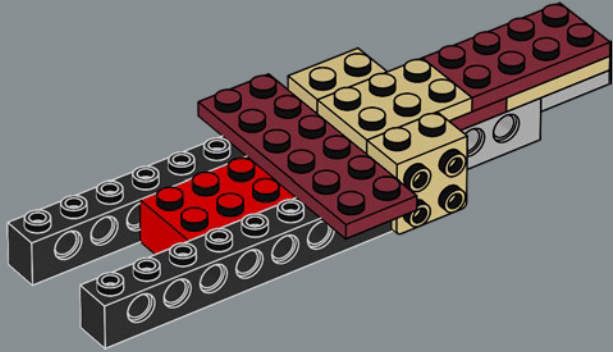

42

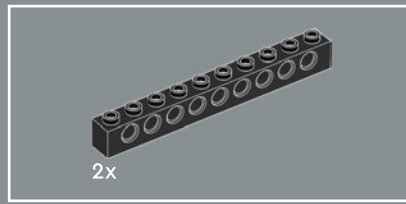
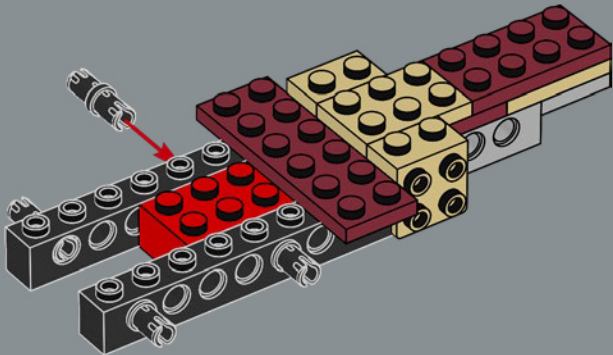

43

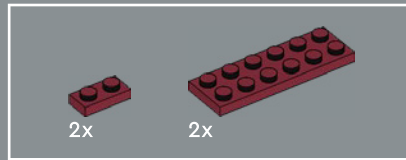
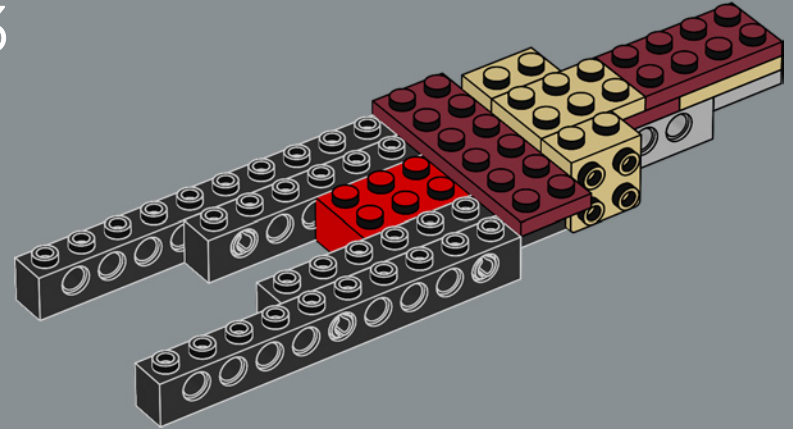

44

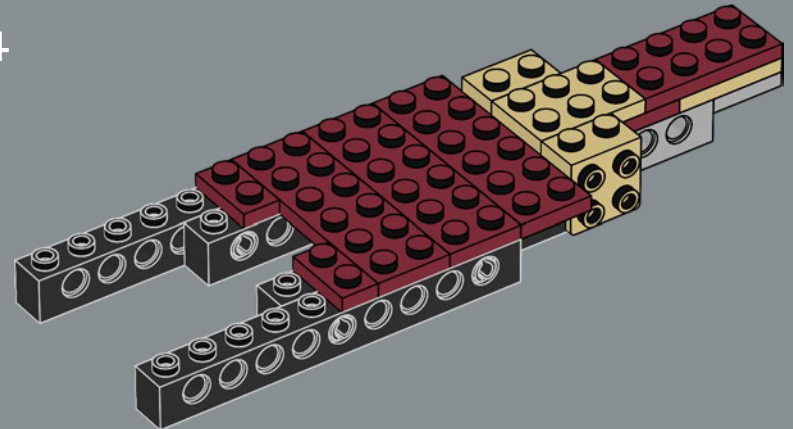

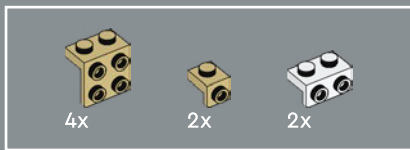

45

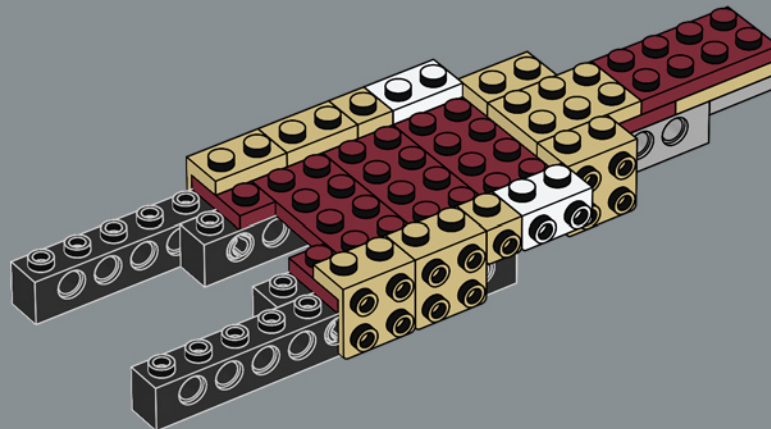

46

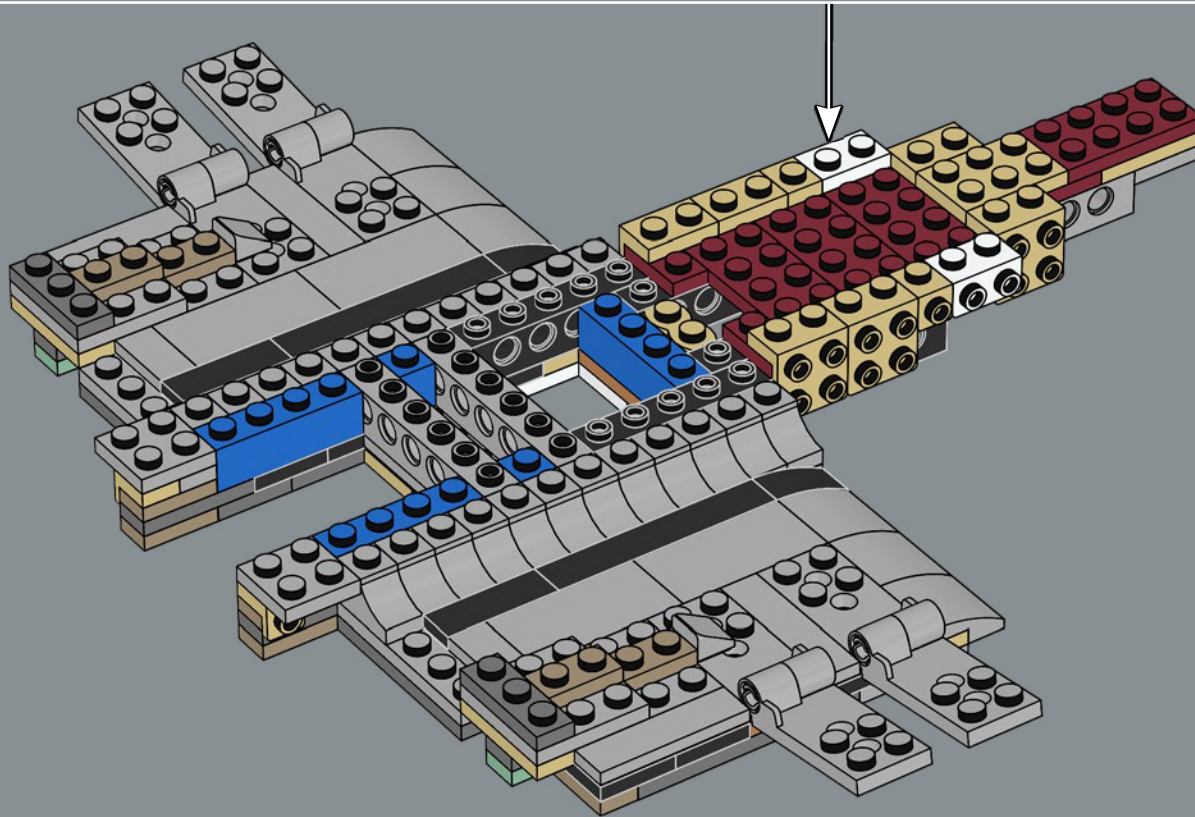

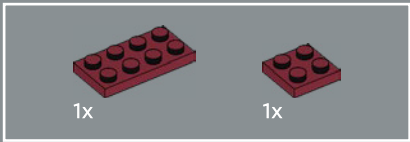

47

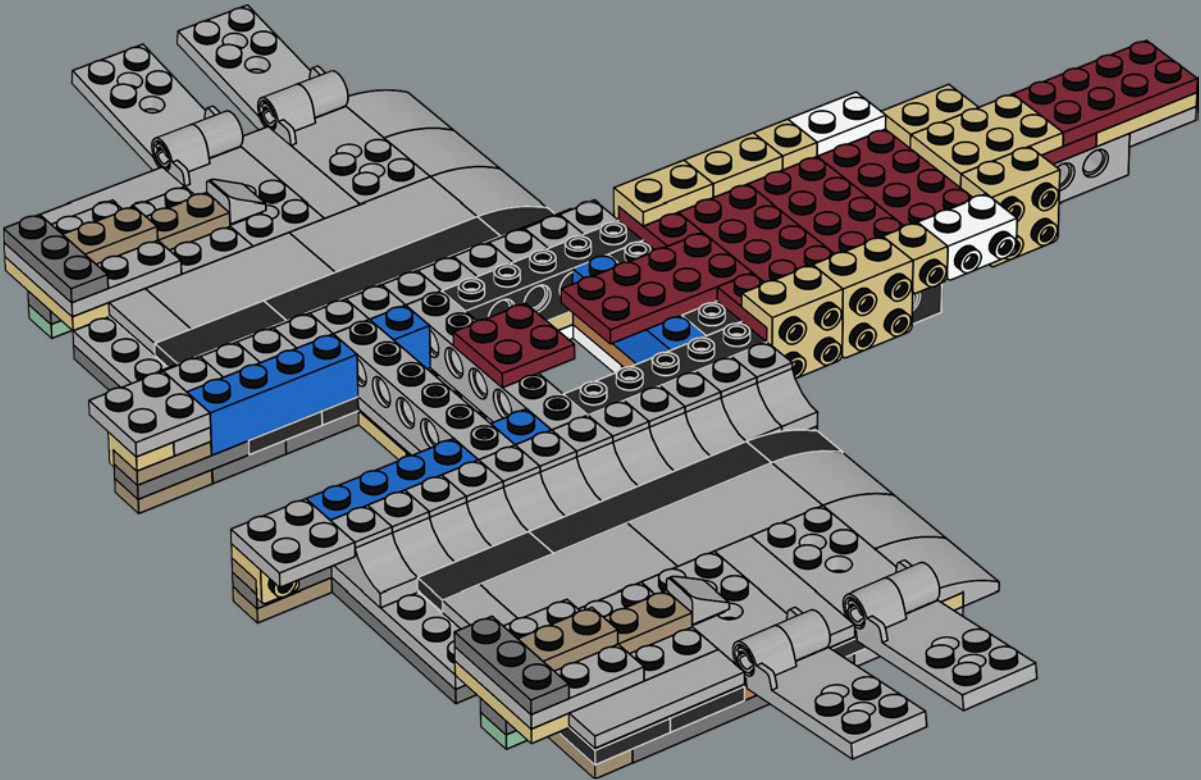

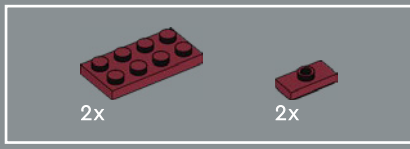

48

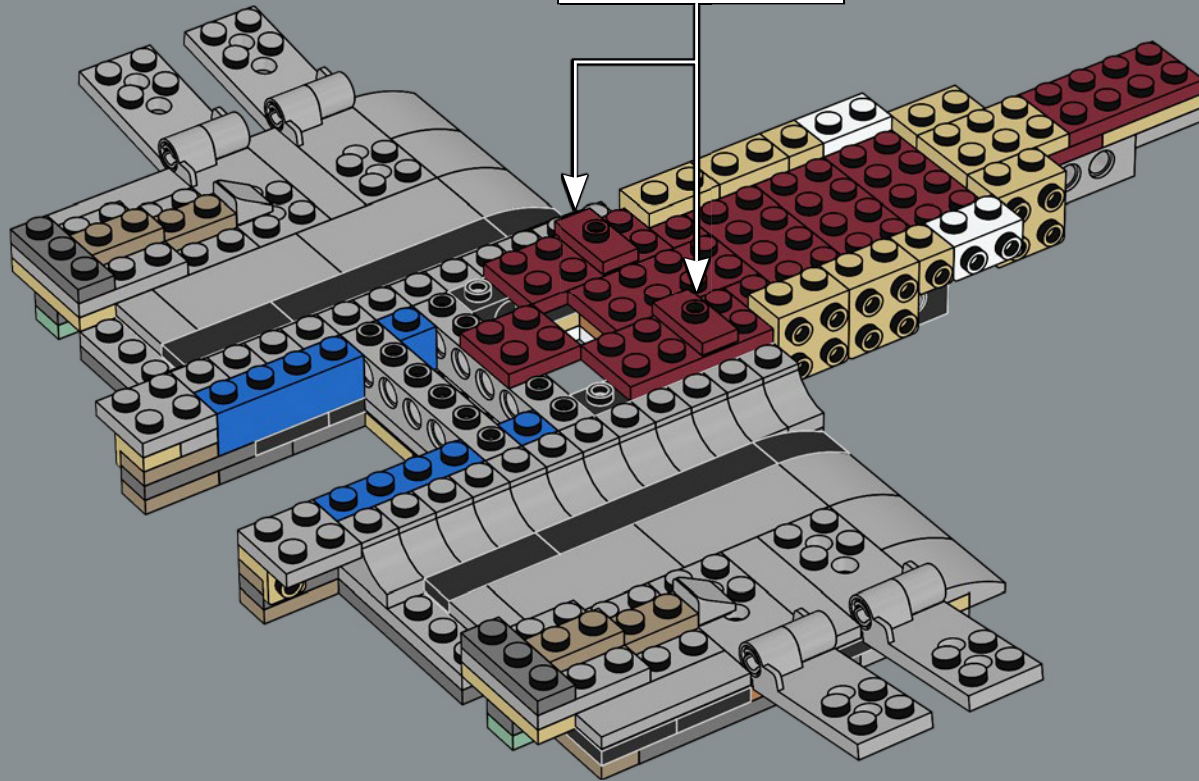
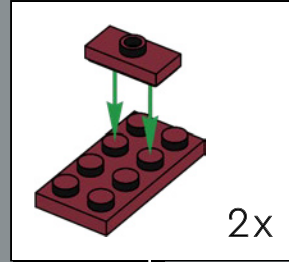

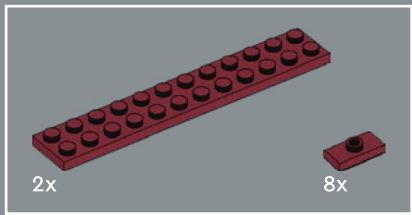

49

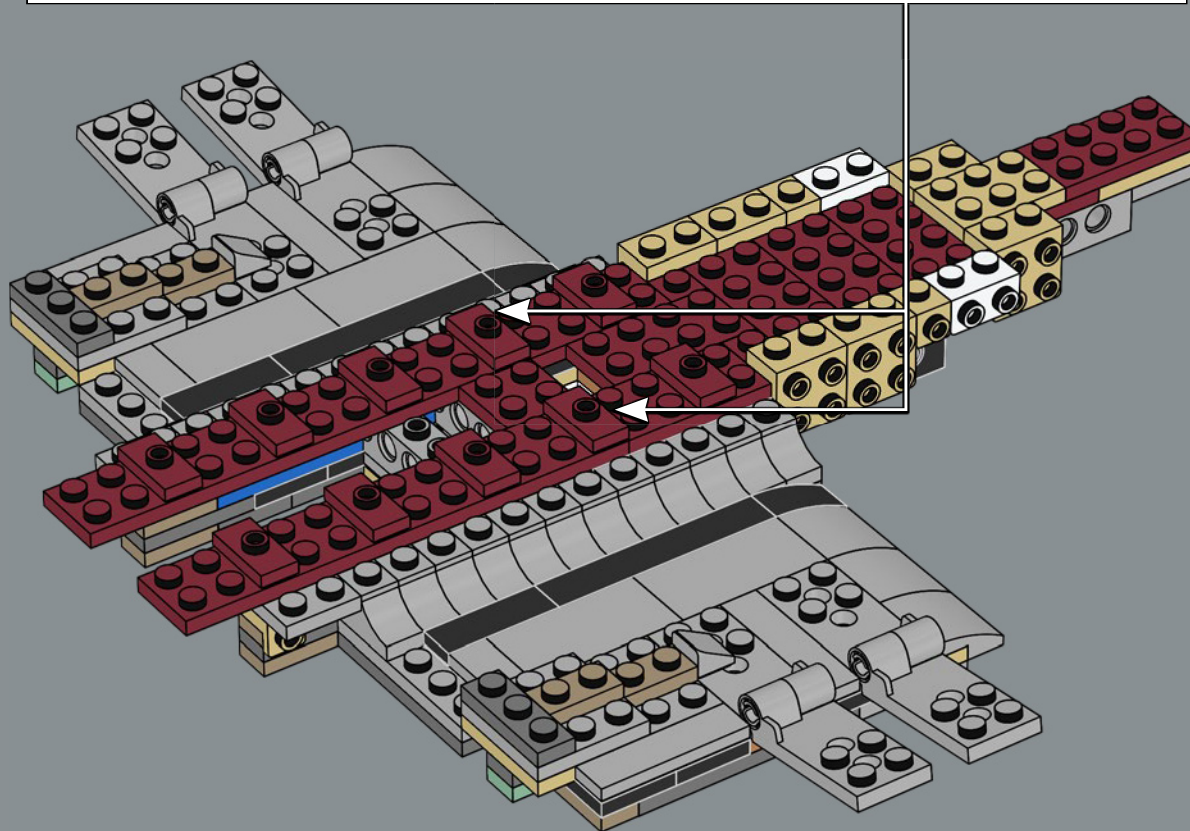
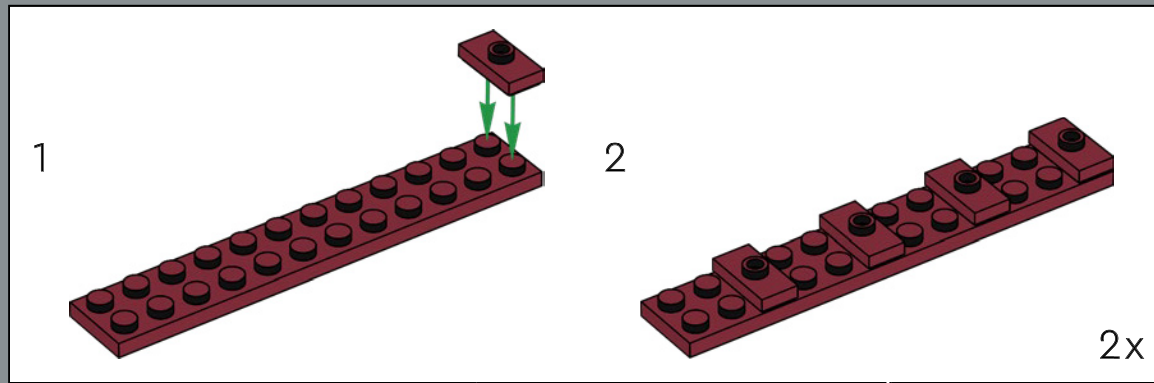

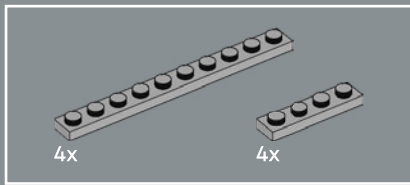

50

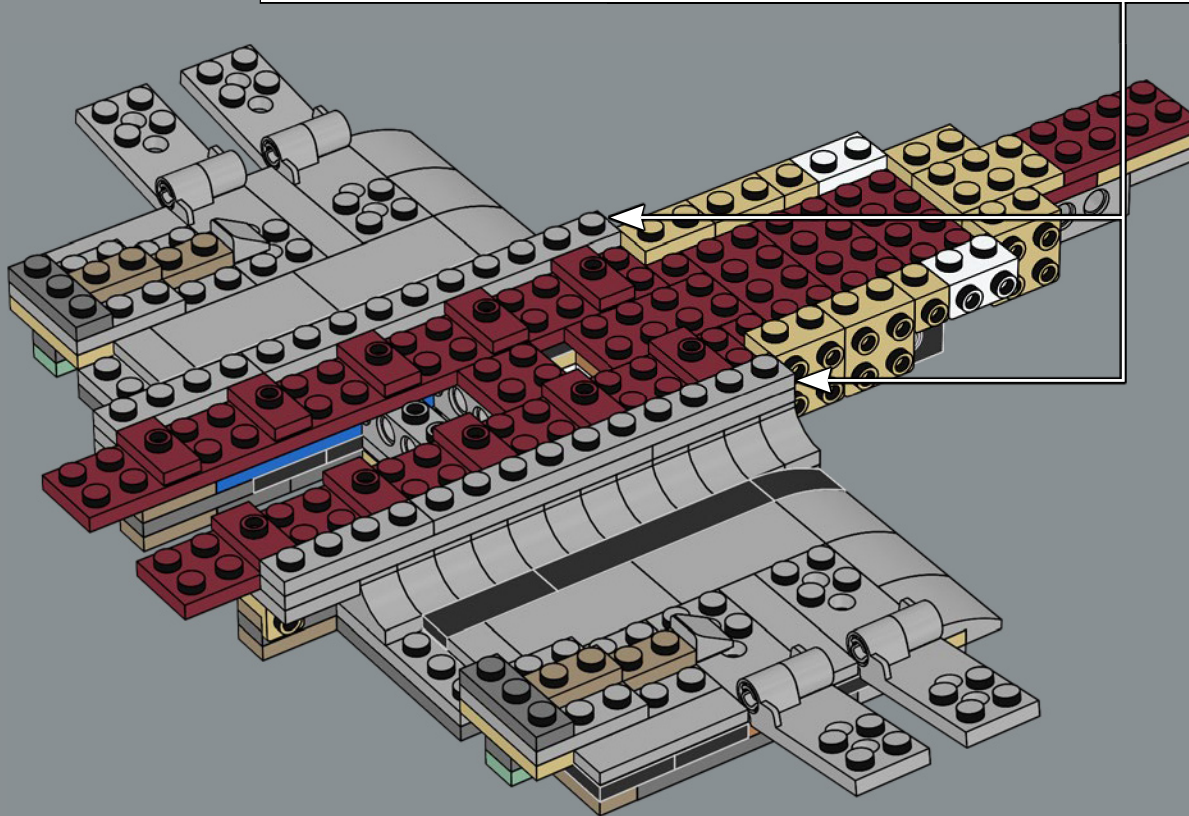
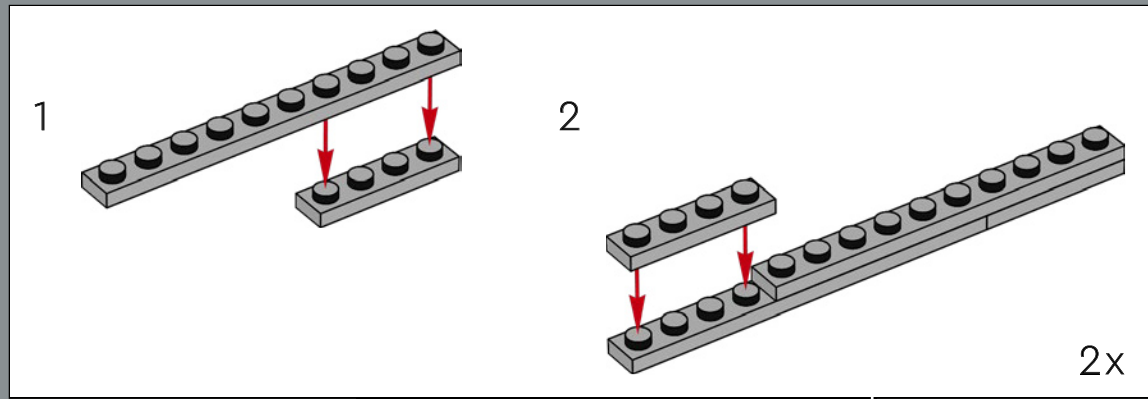



2x

51

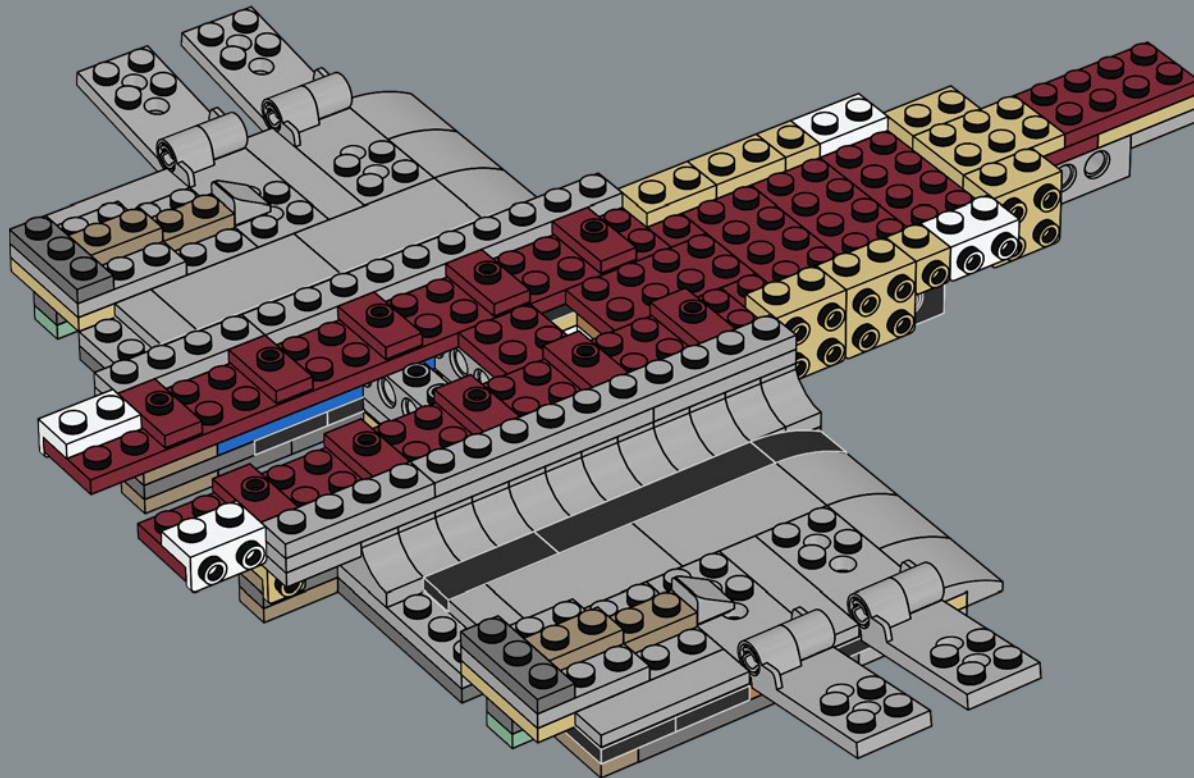

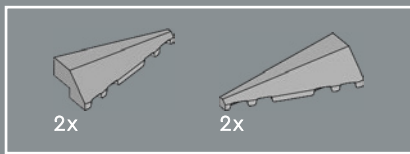

52

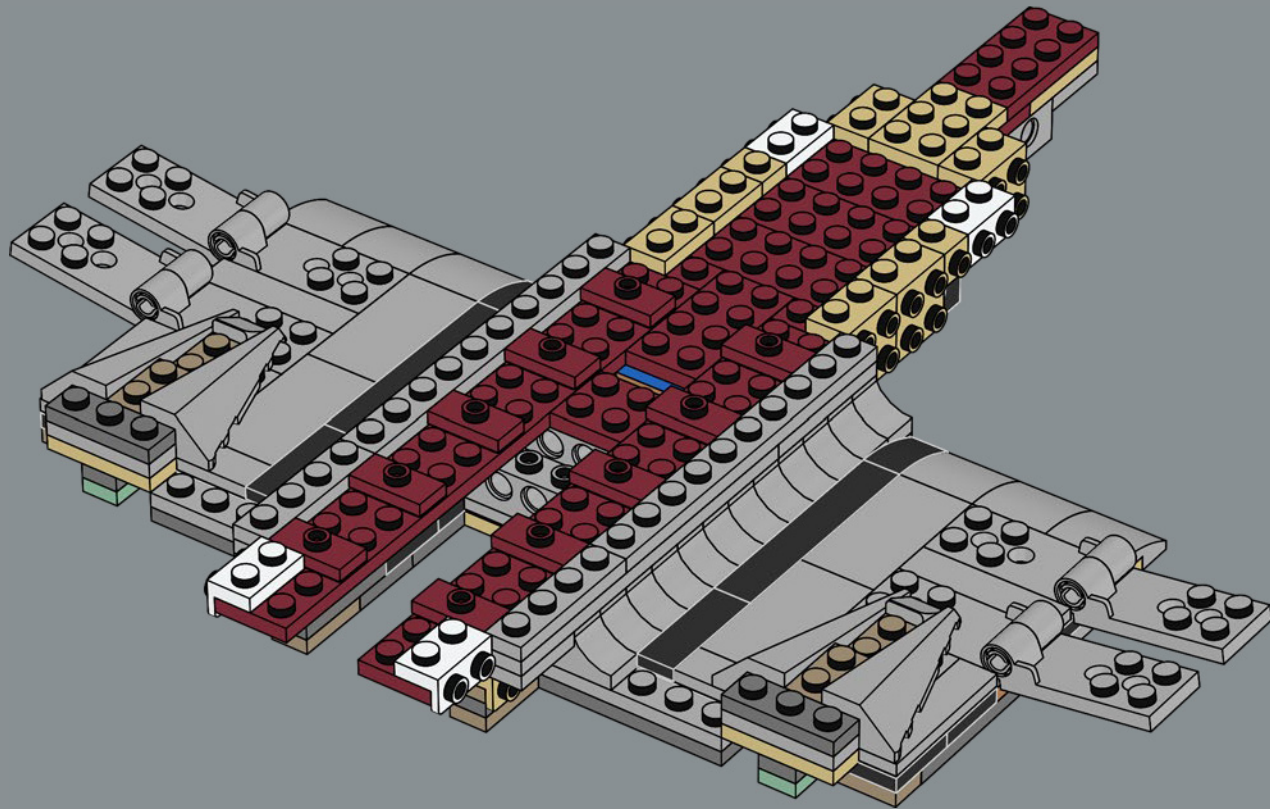

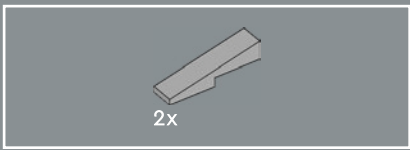

53

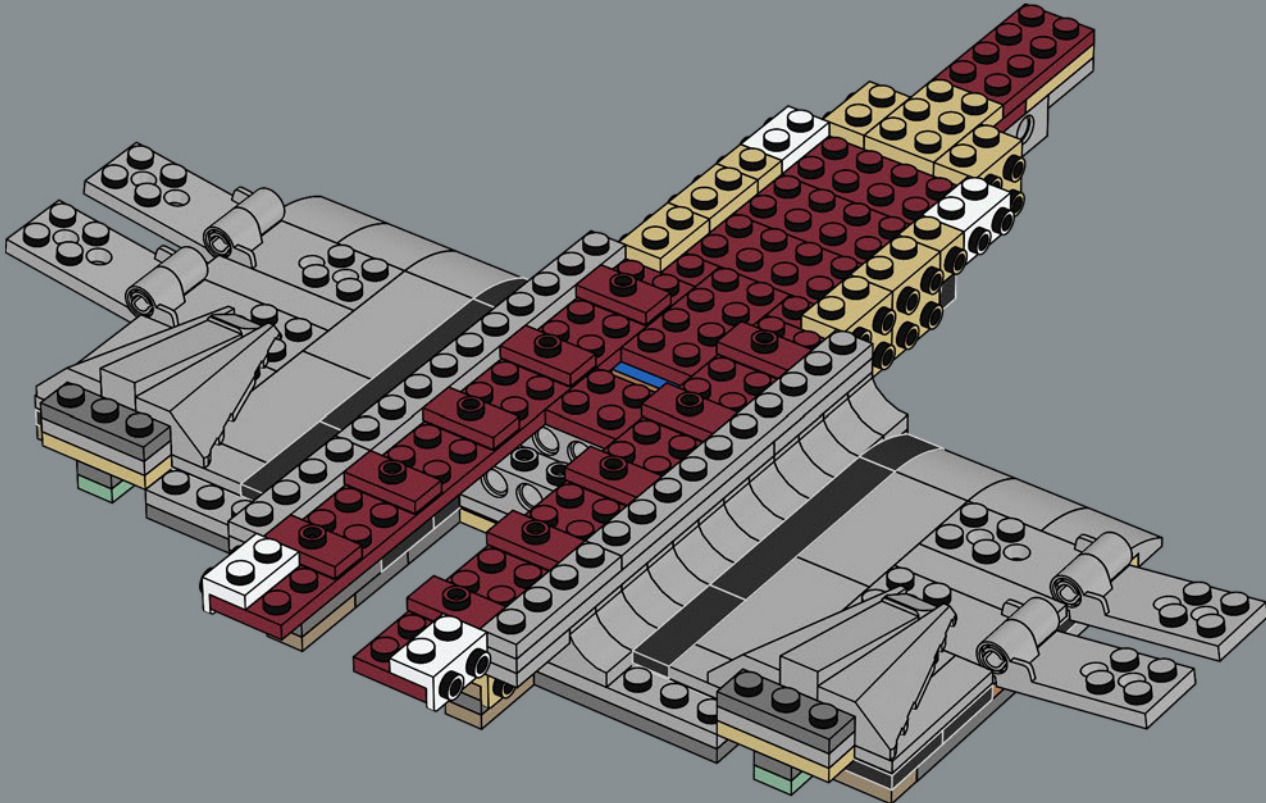

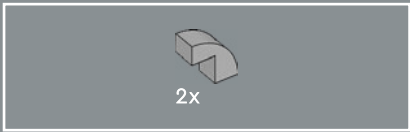

54

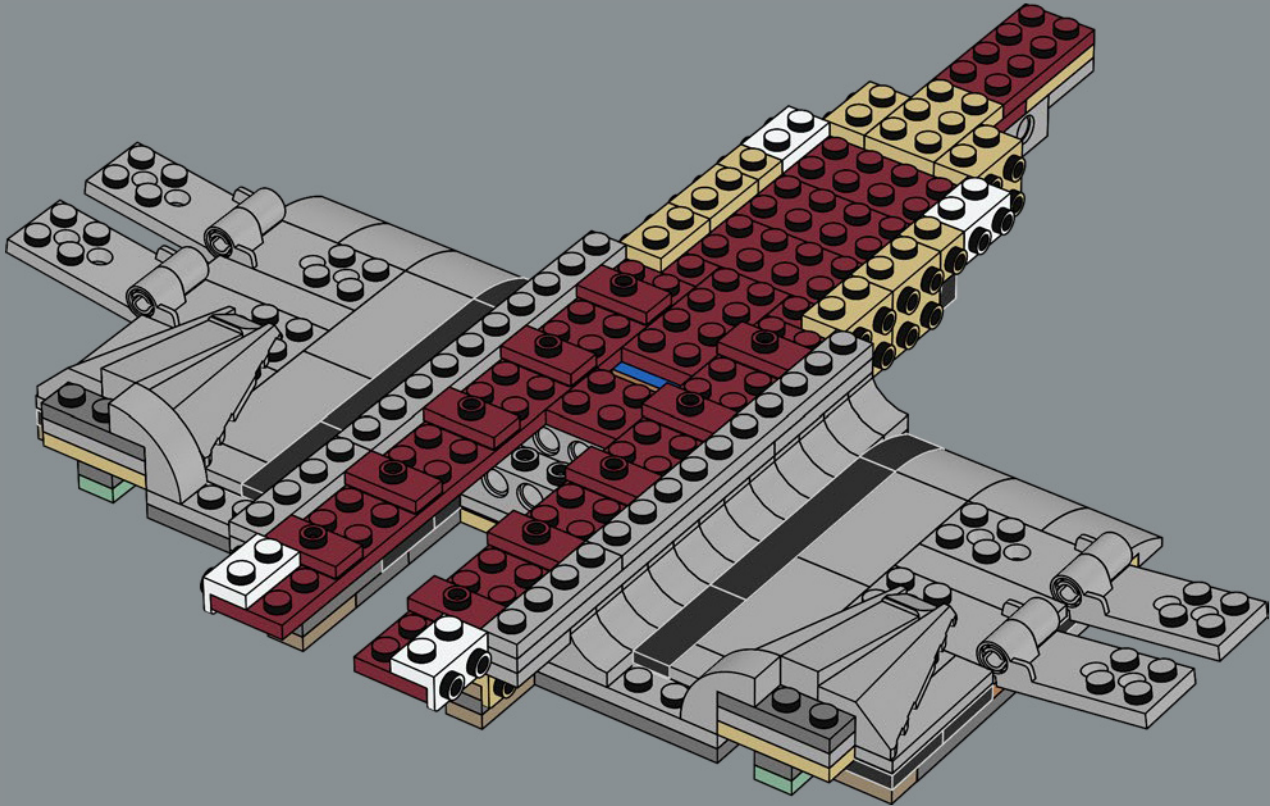



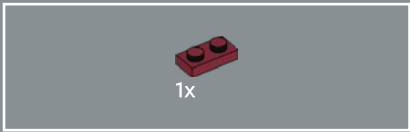

56

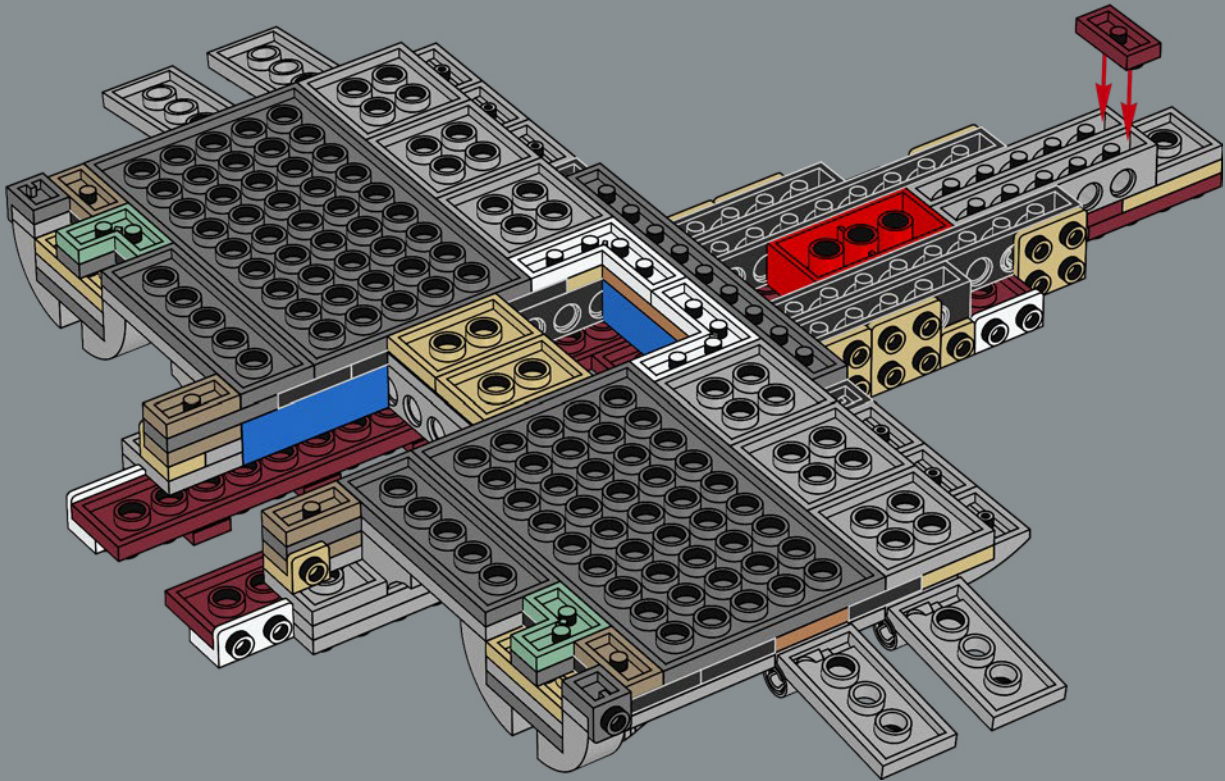

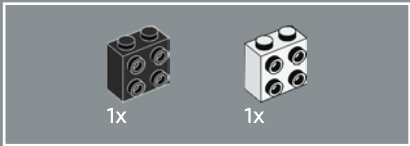
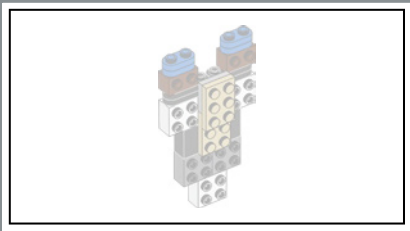

57

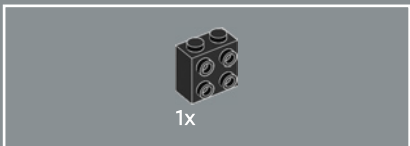
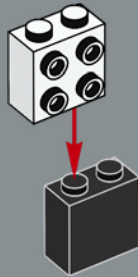

58

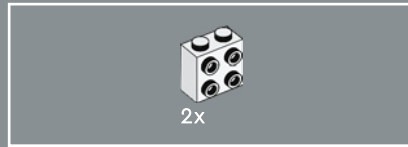
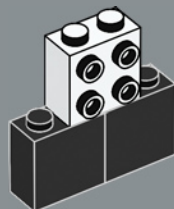

59

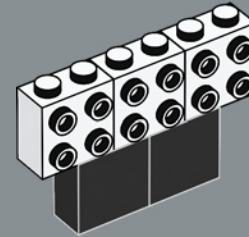

60

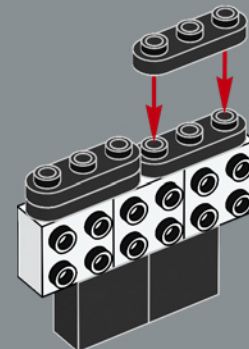

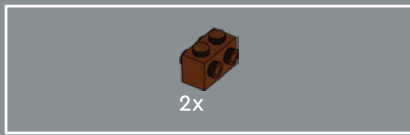

61

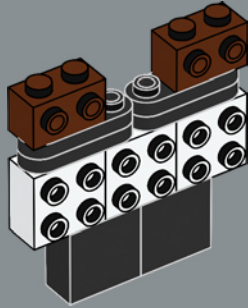

62

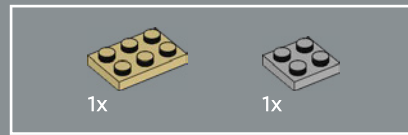
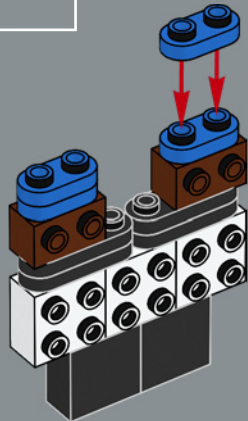

63

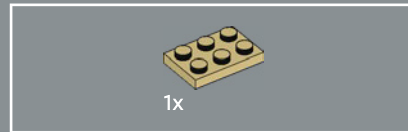
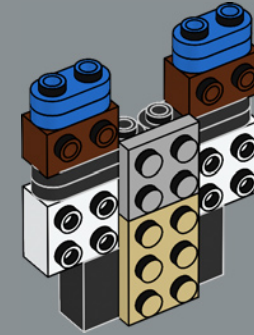

64

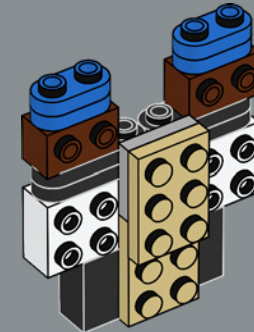



2x

65

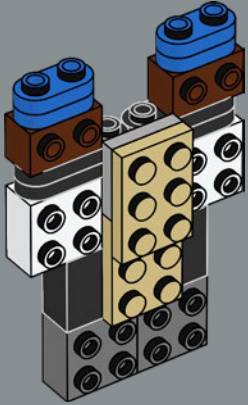

1x

66

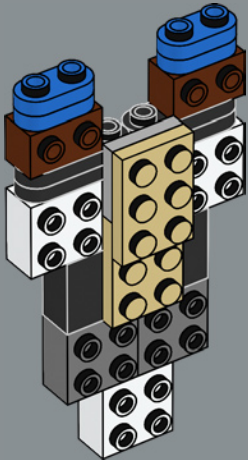

67

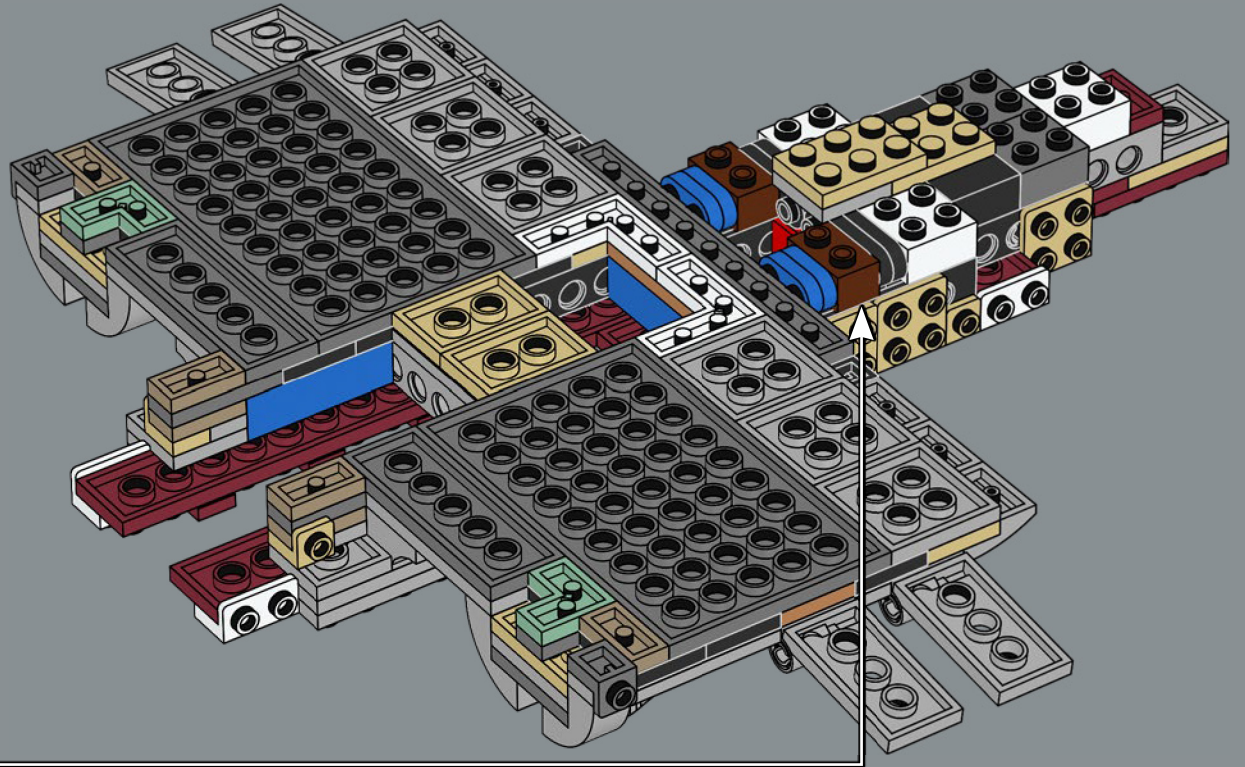

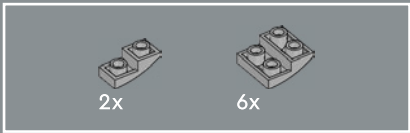

68

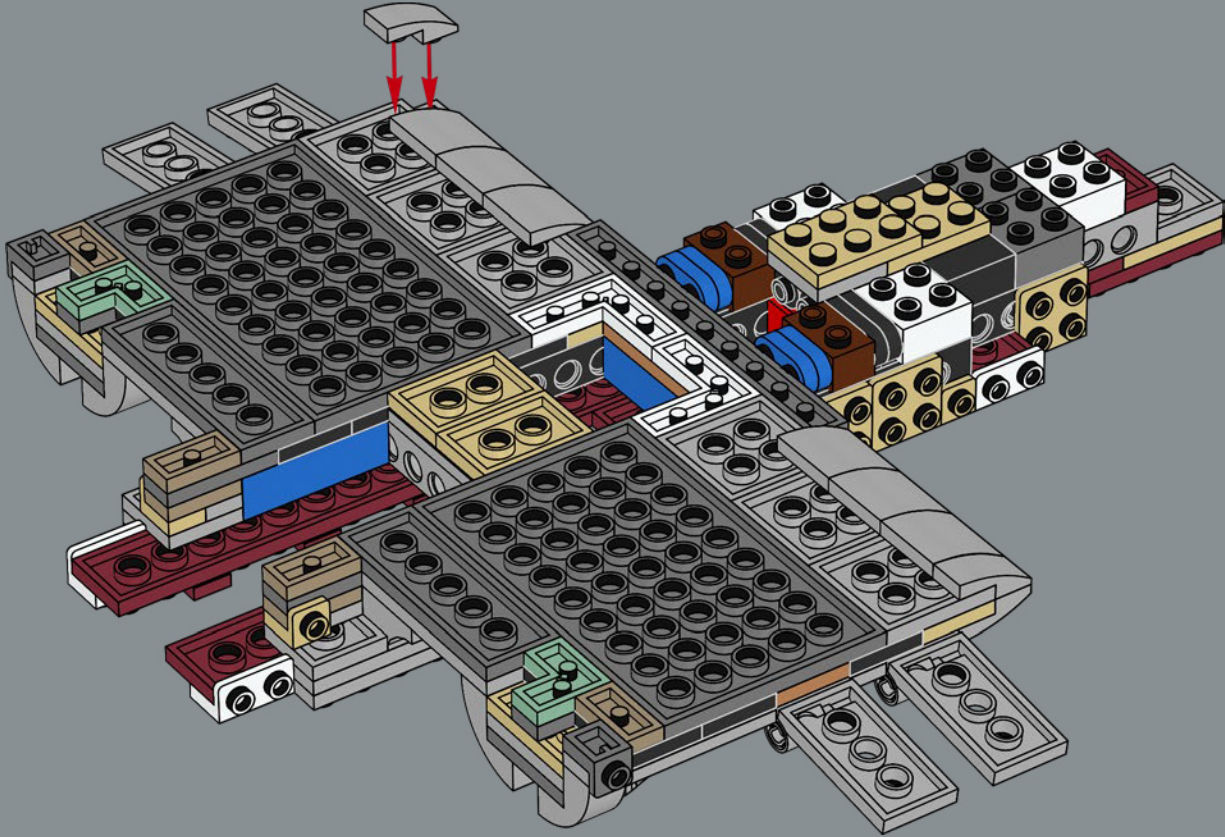

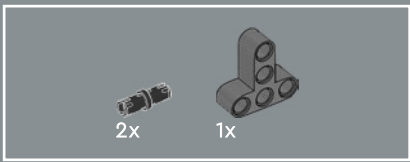

69

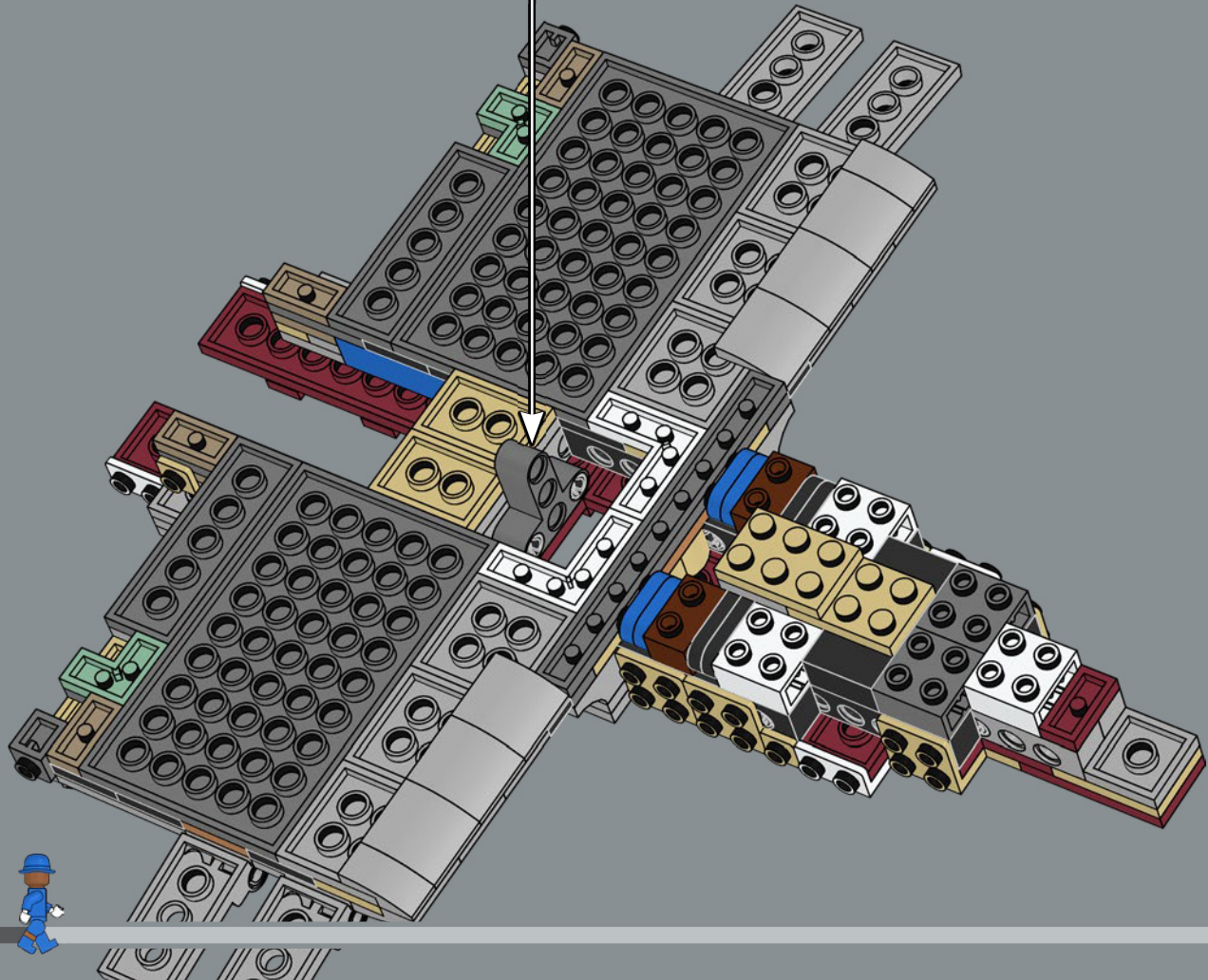
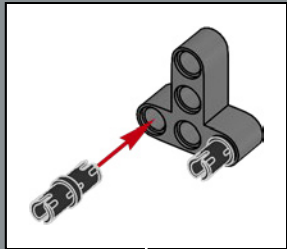

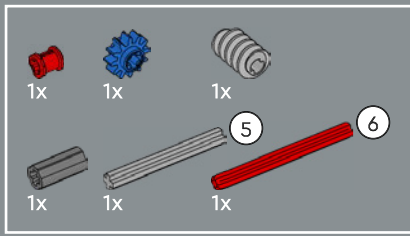

70

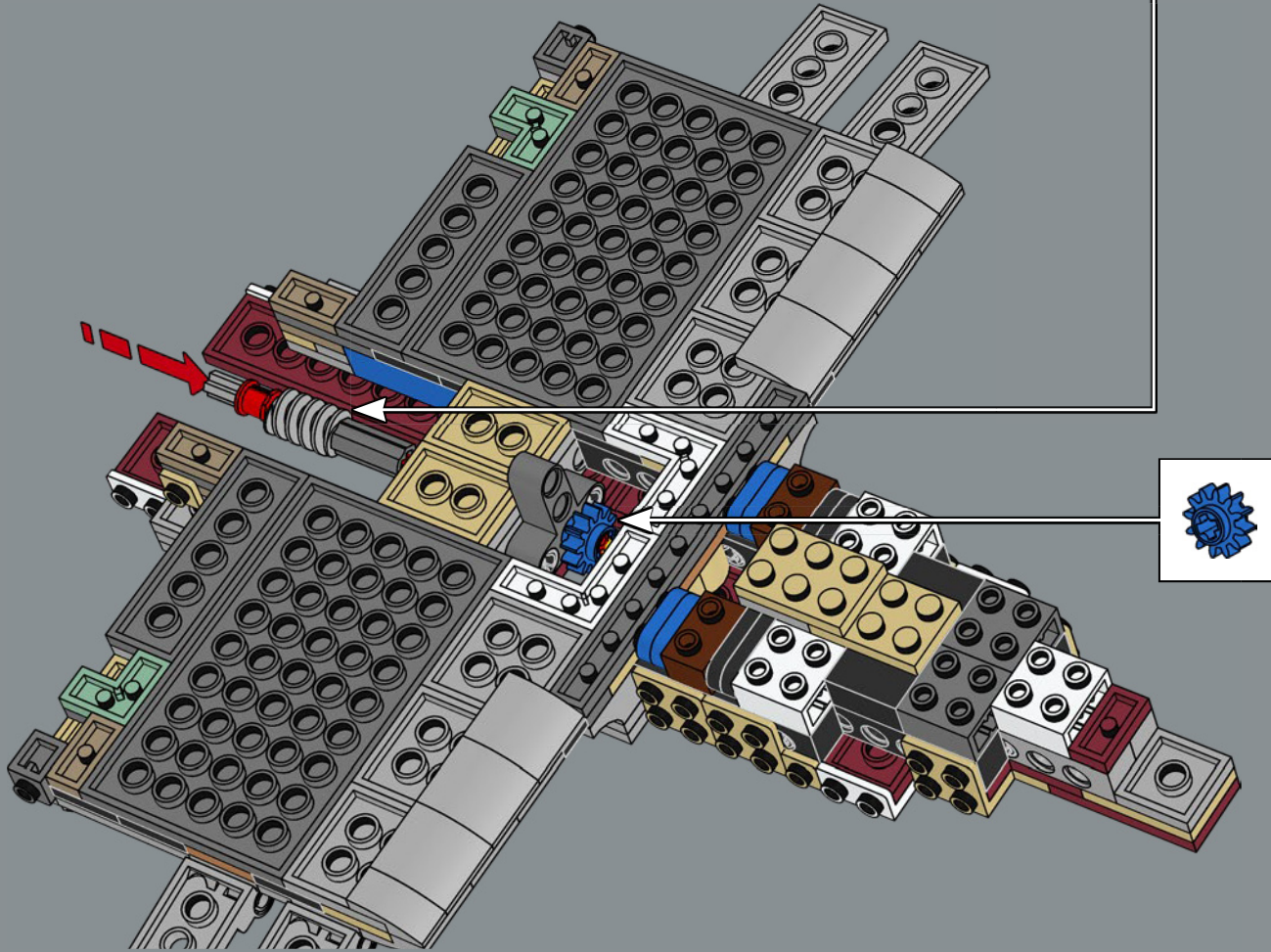
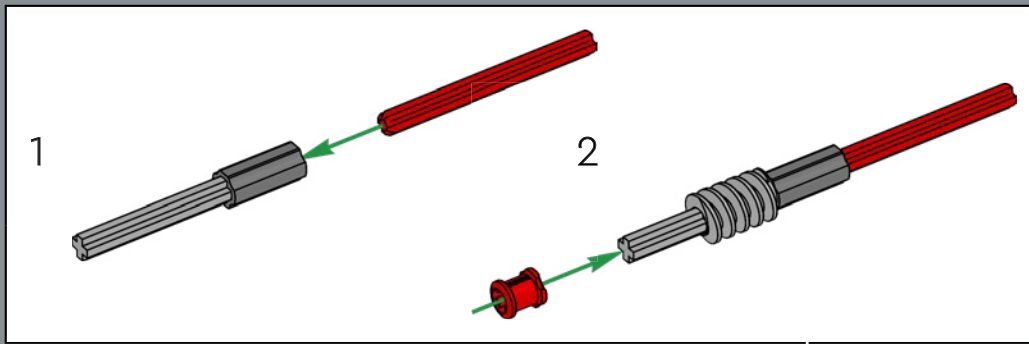

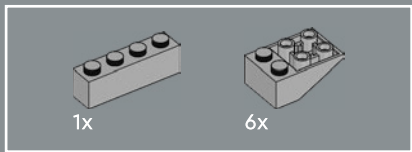

71

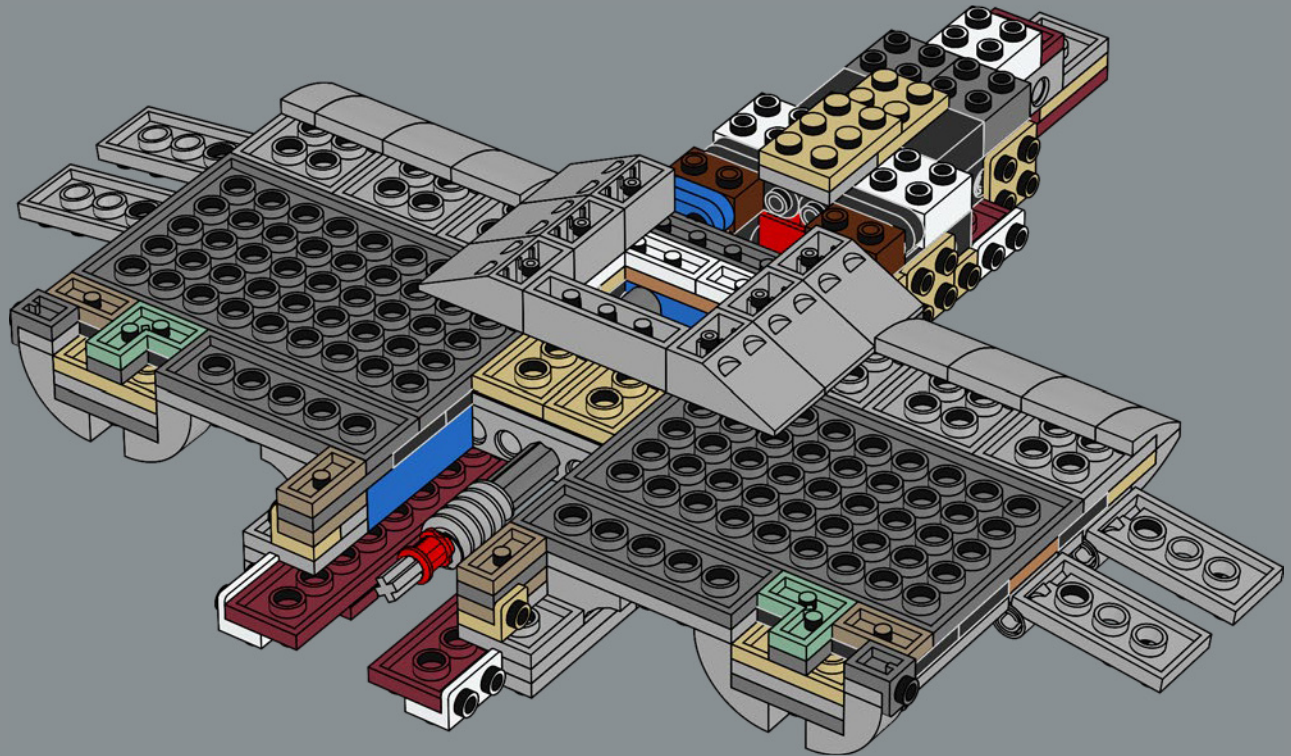

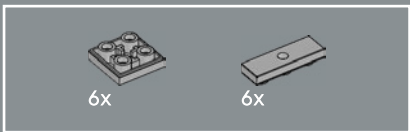

72

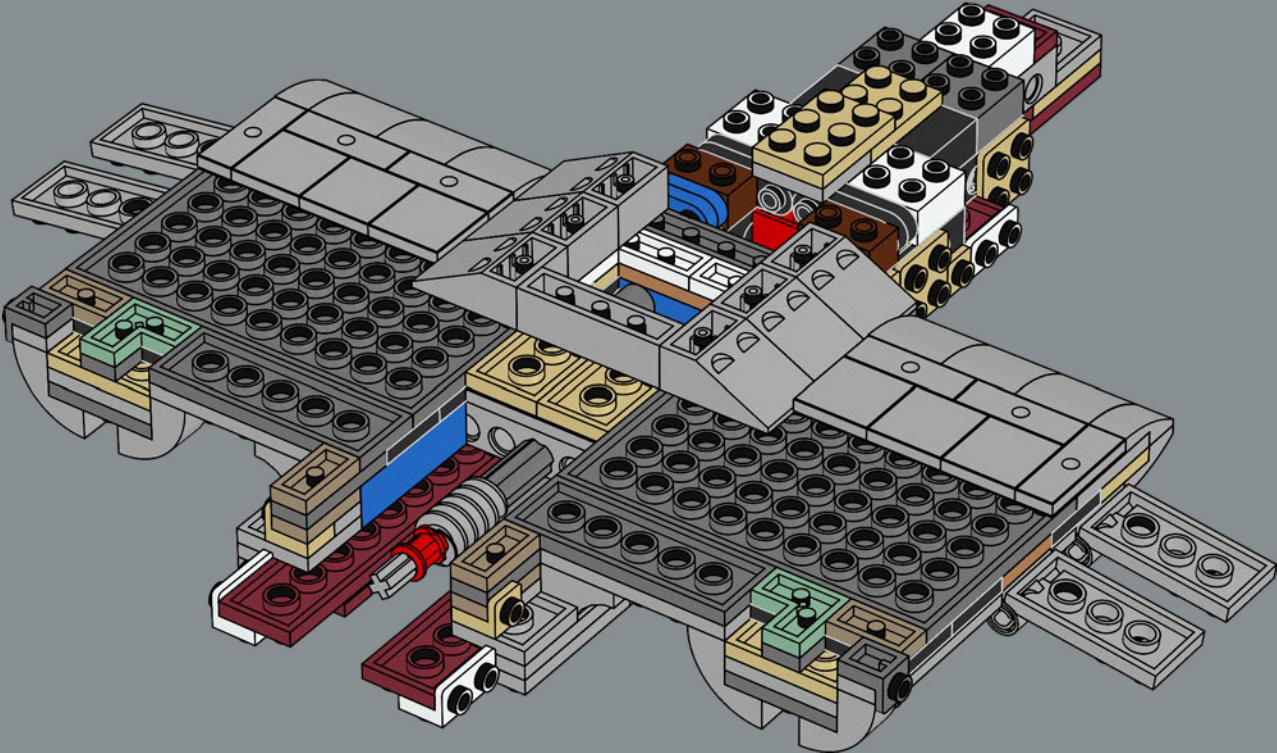

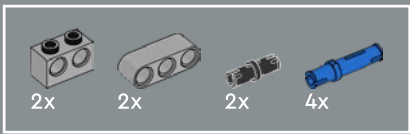

73

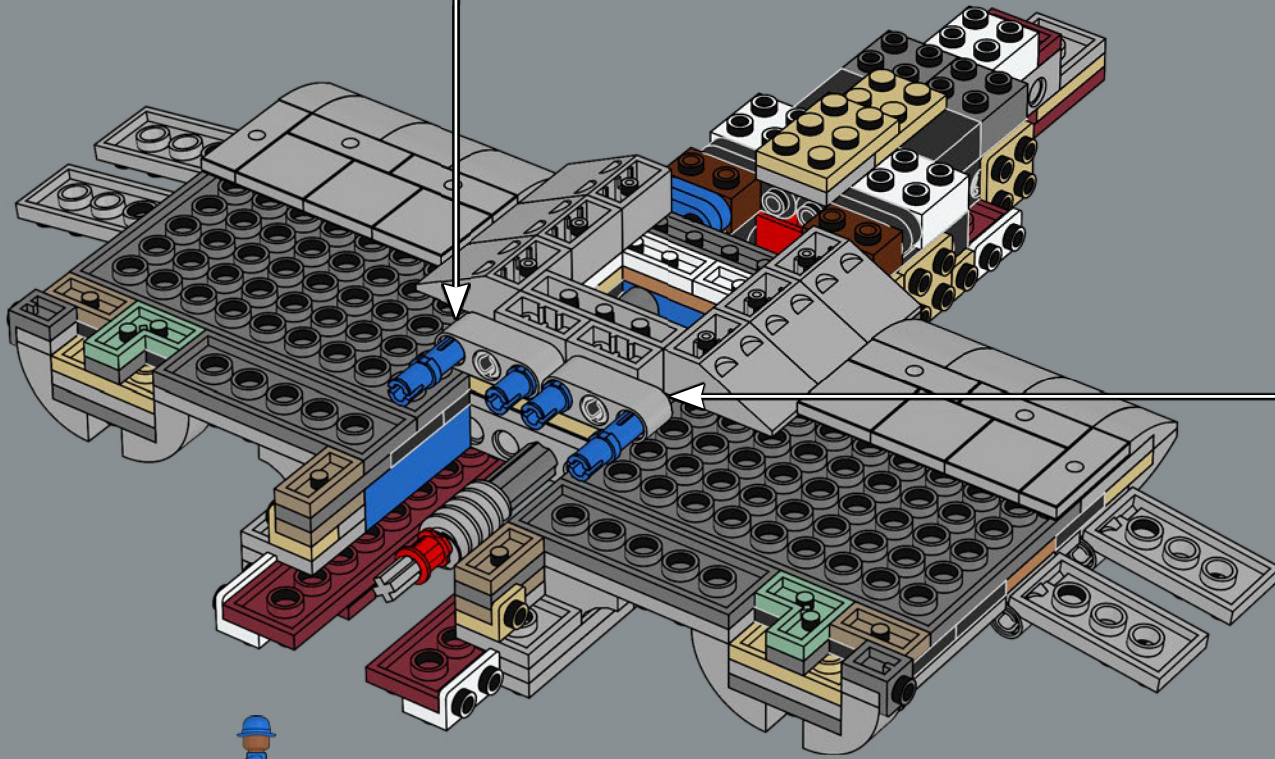
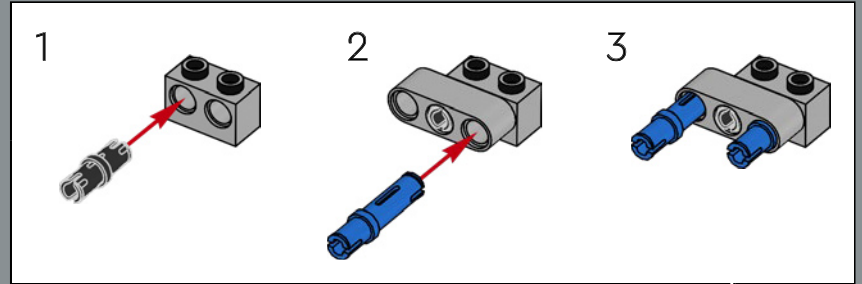
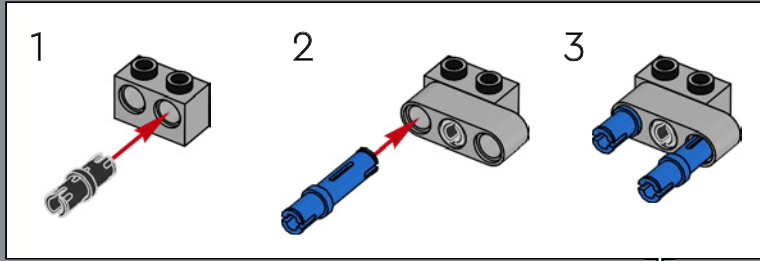

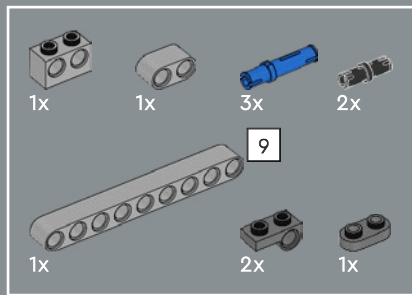

74

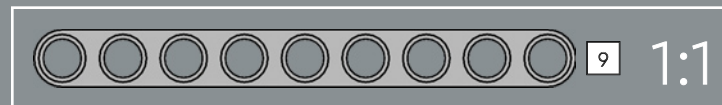
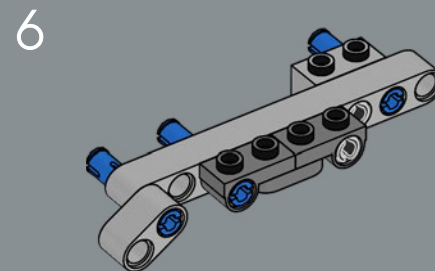
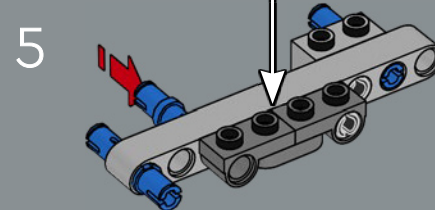
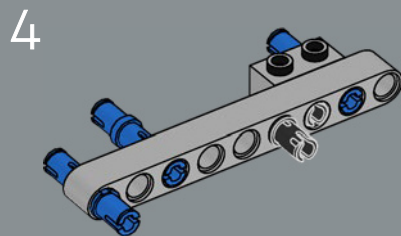
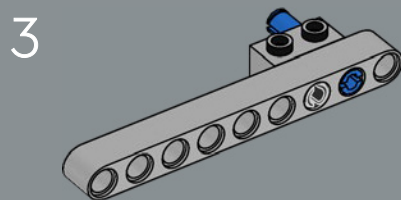
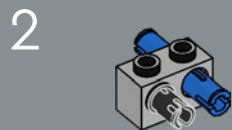
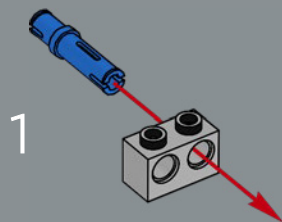
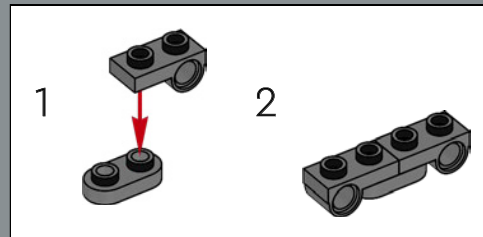

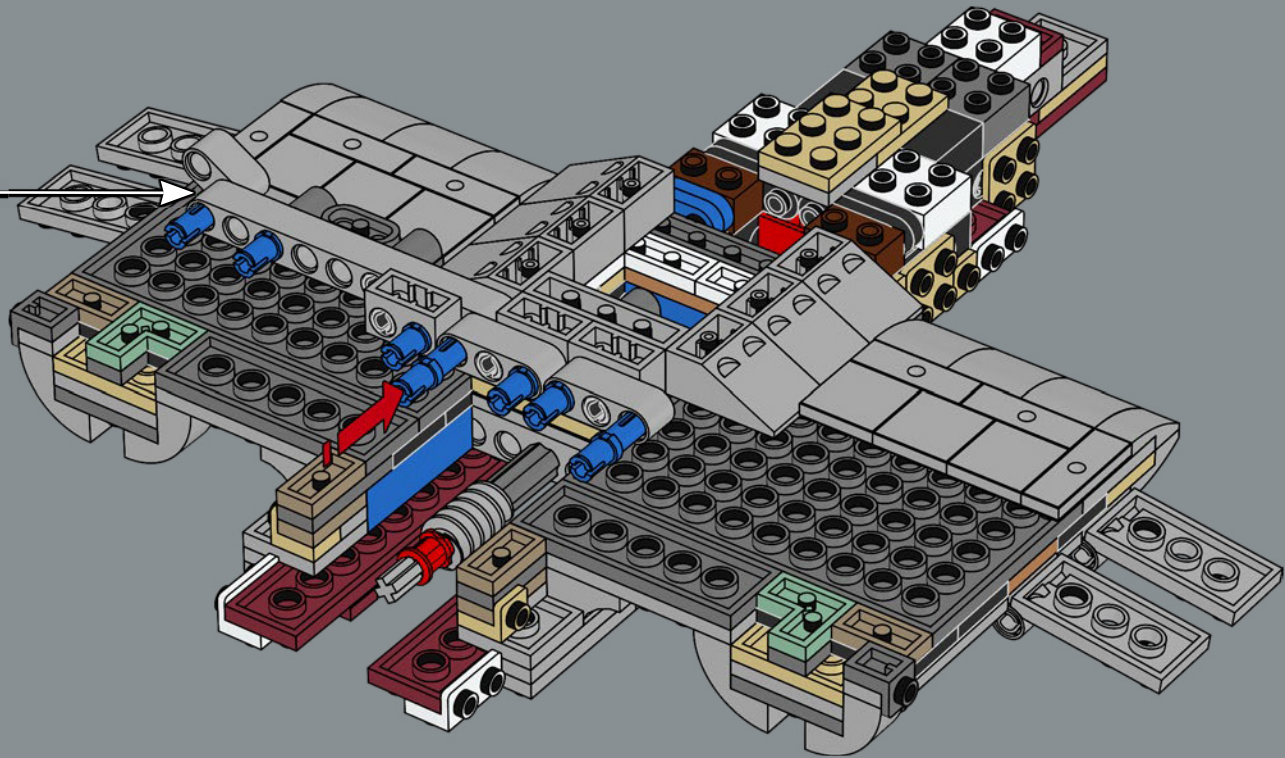

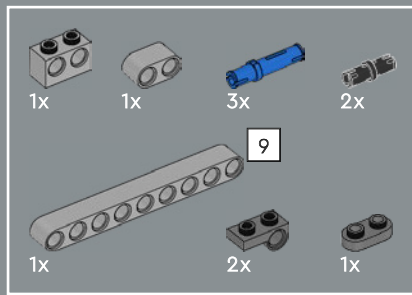

75

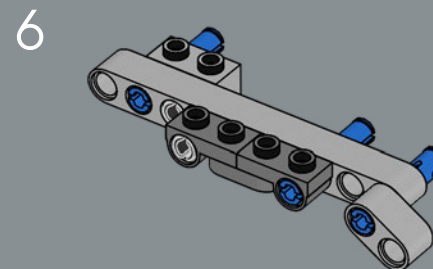
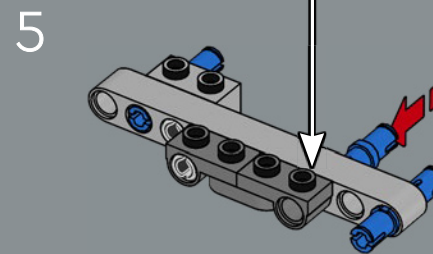
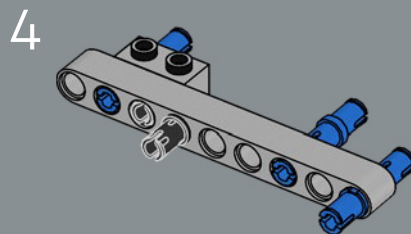
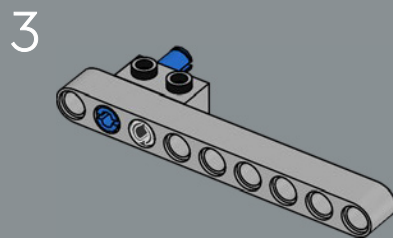
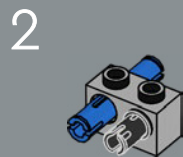
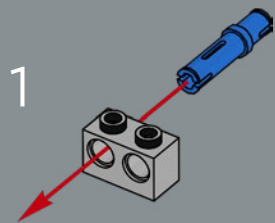
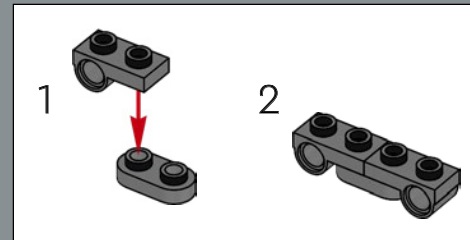

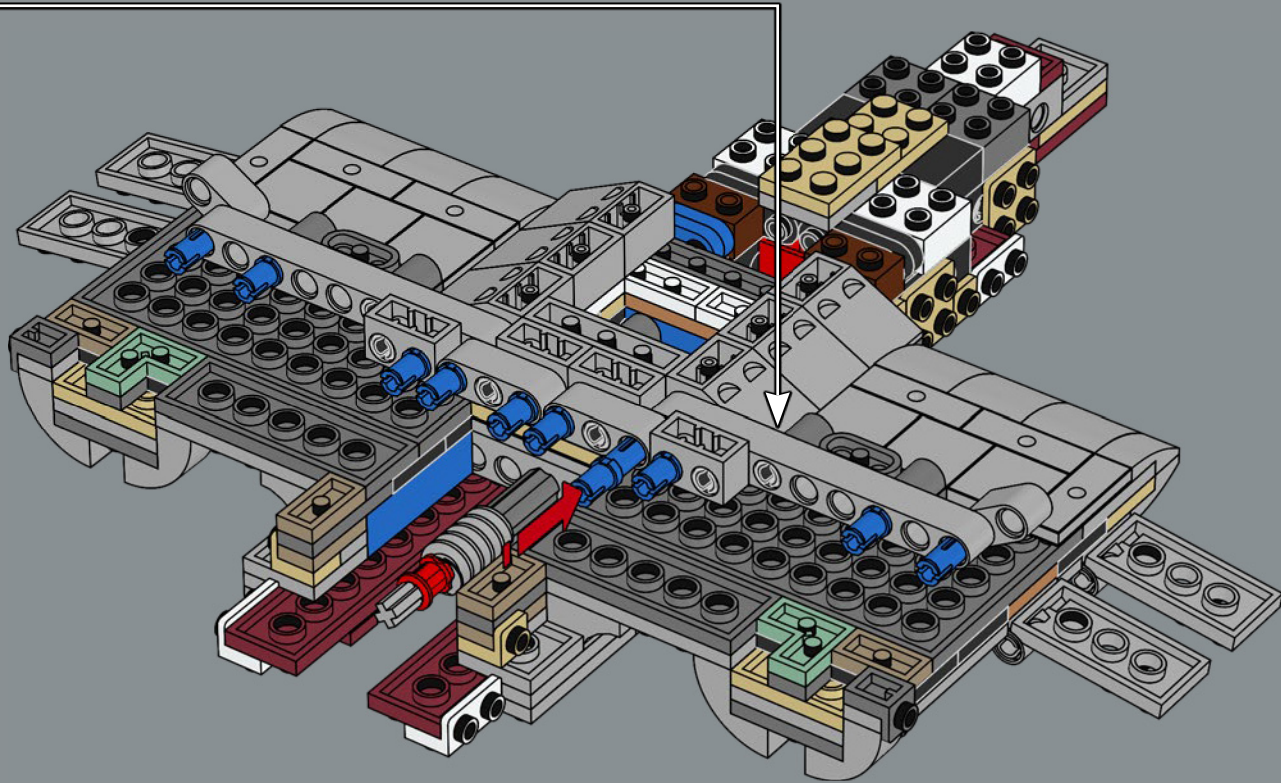

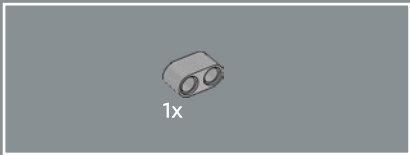

76

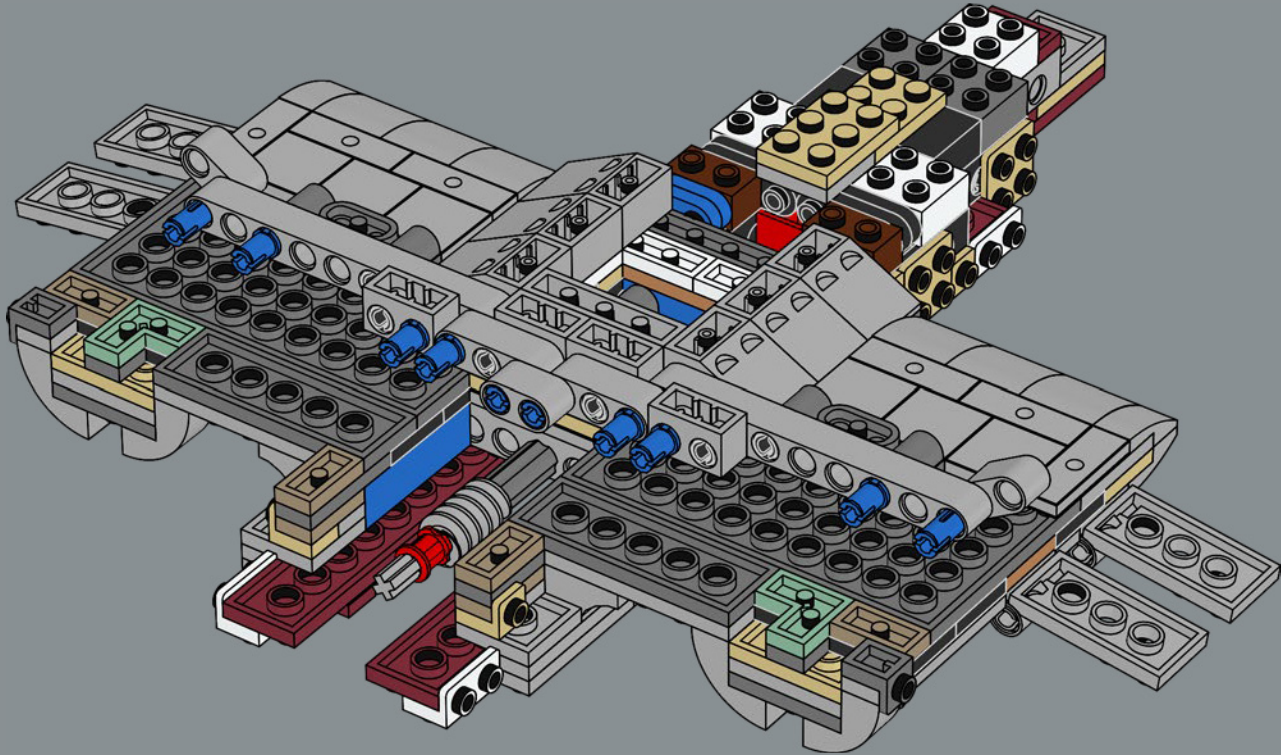

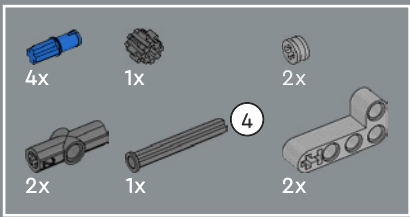

77

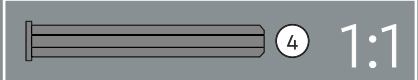
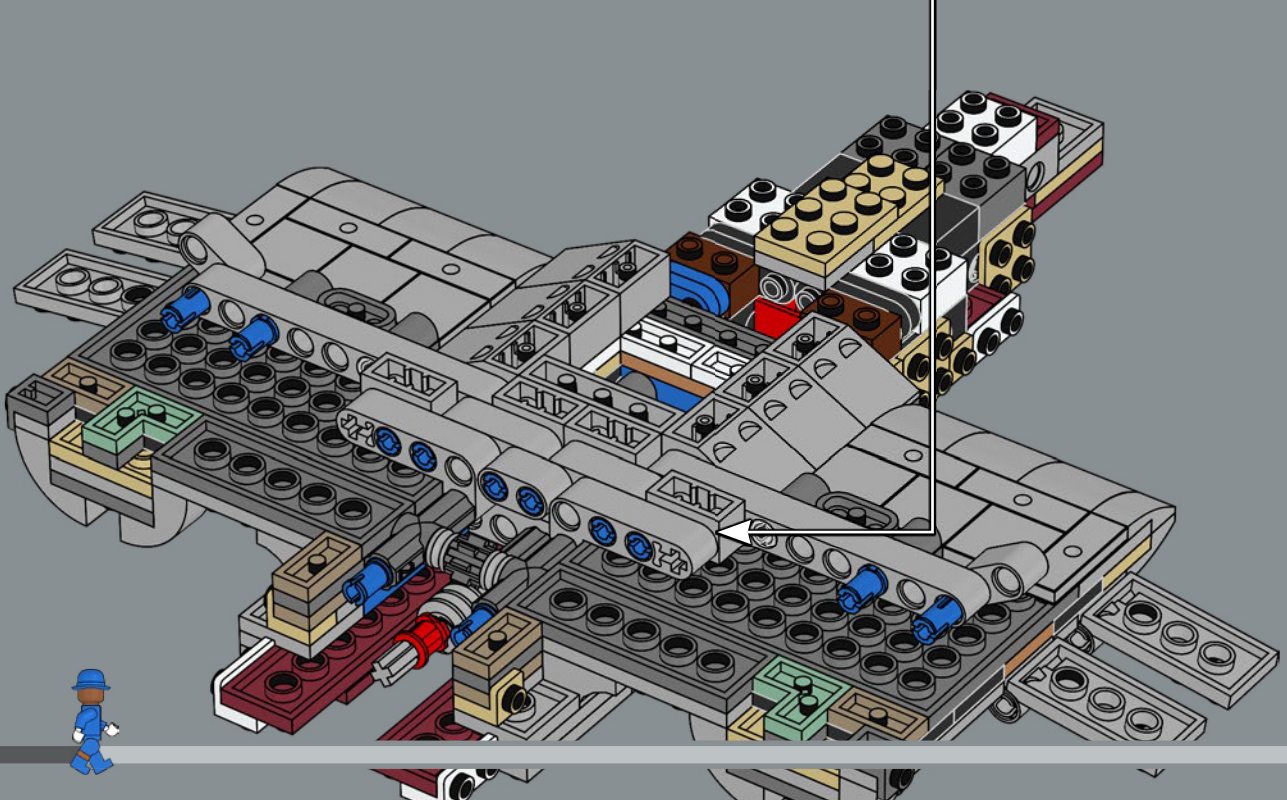
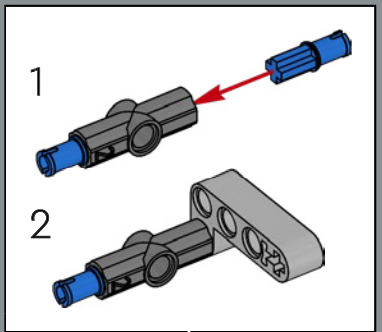
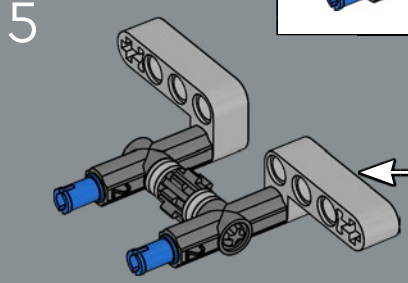
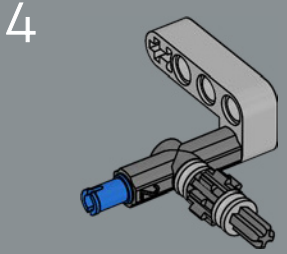
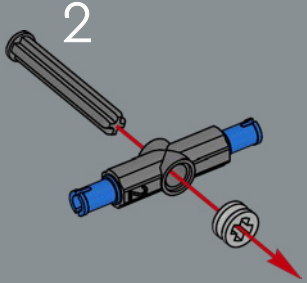
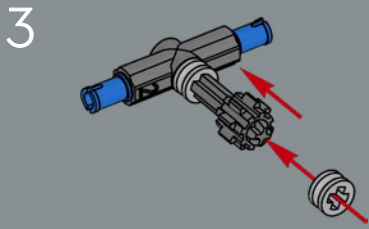
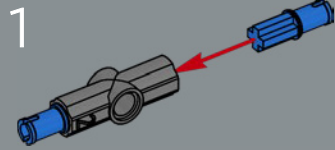



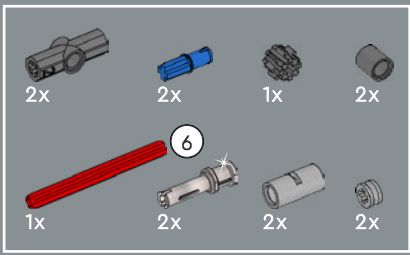

79

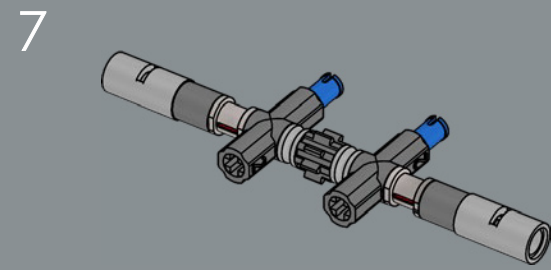
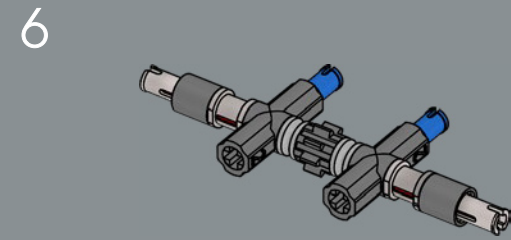
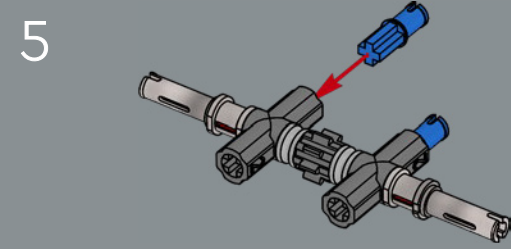
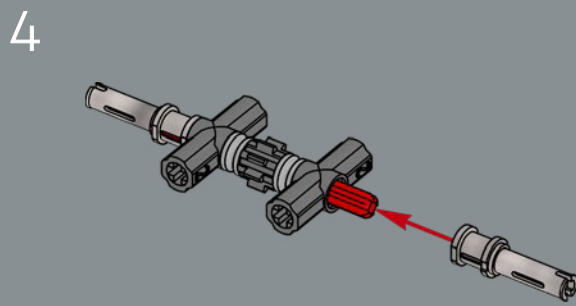
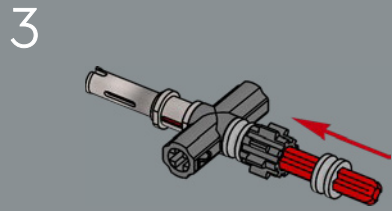
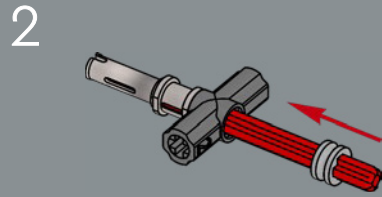
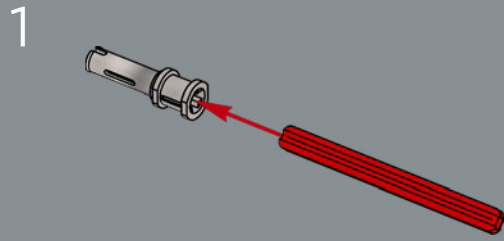

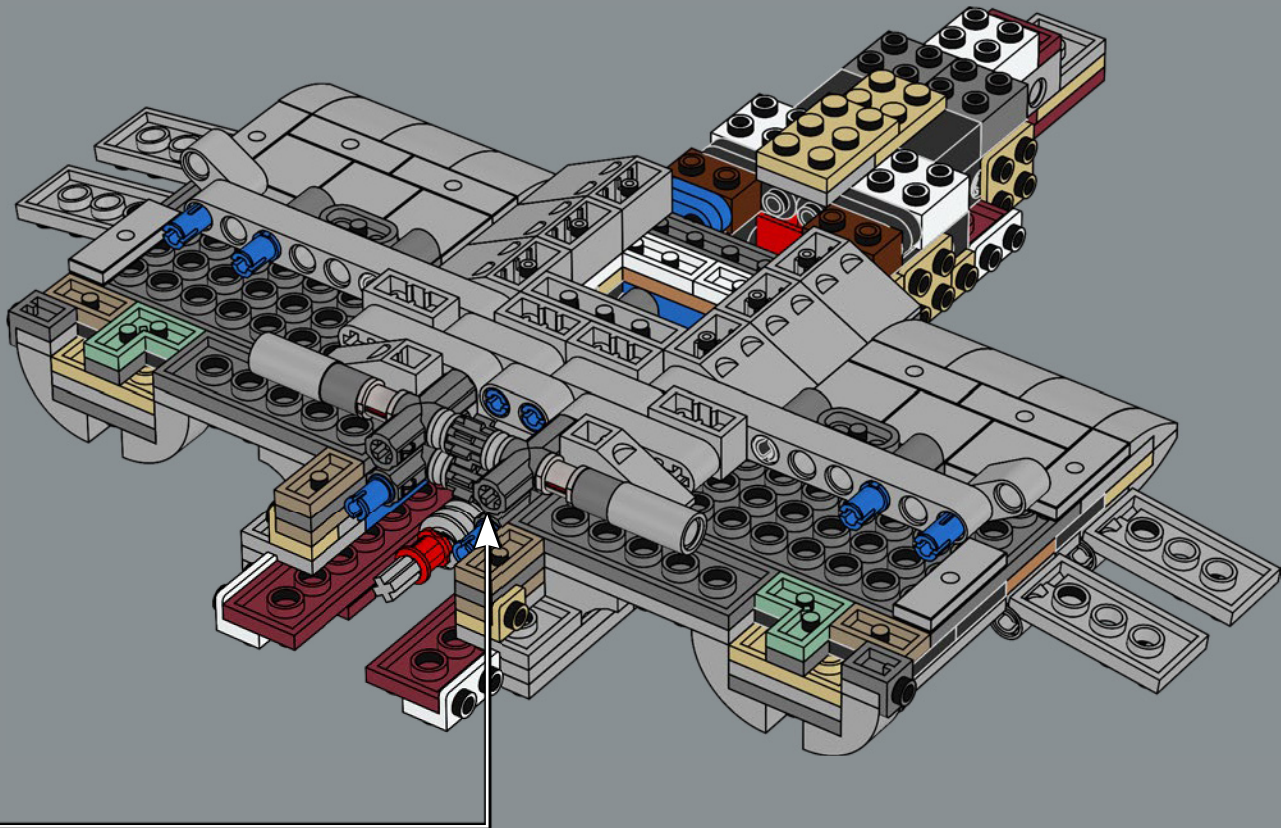



2x

80

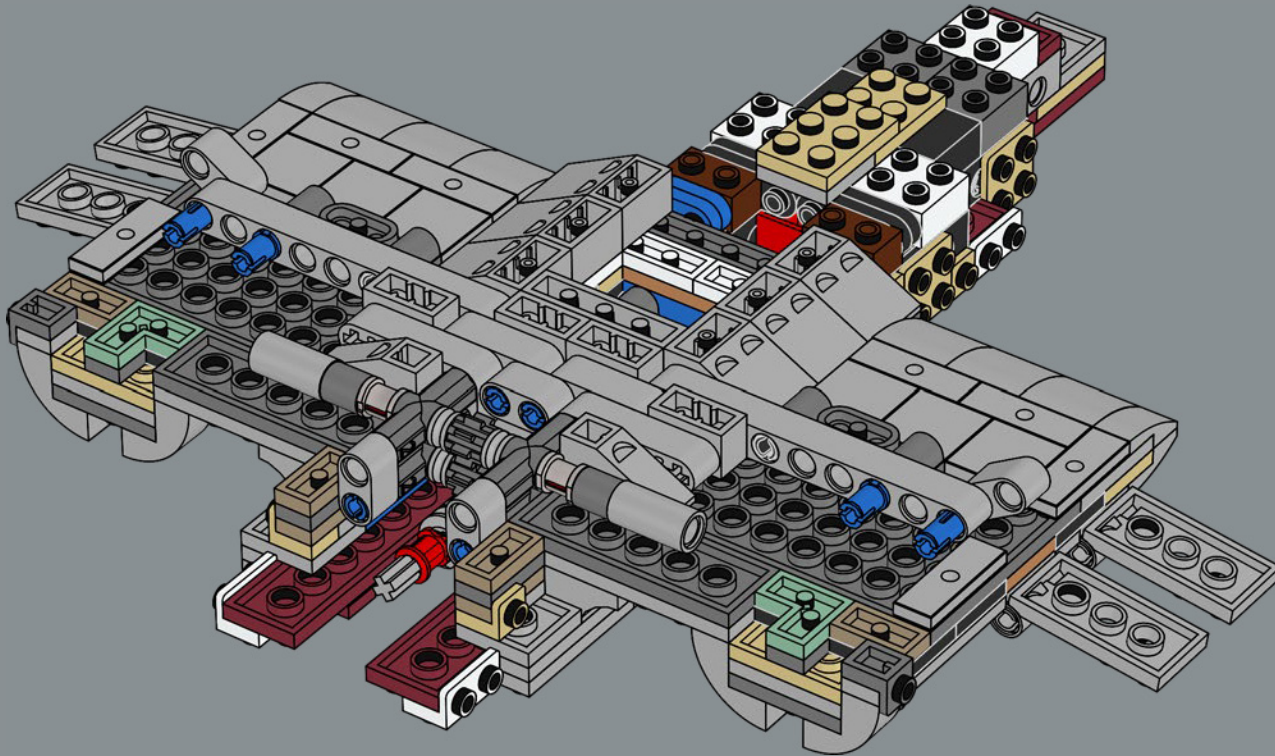

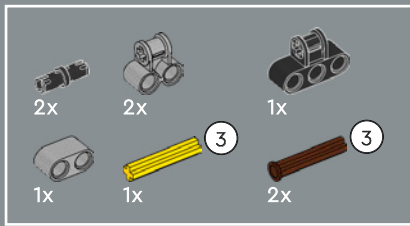

81

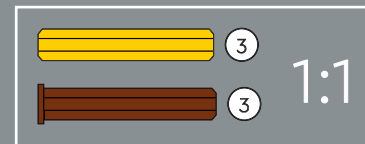
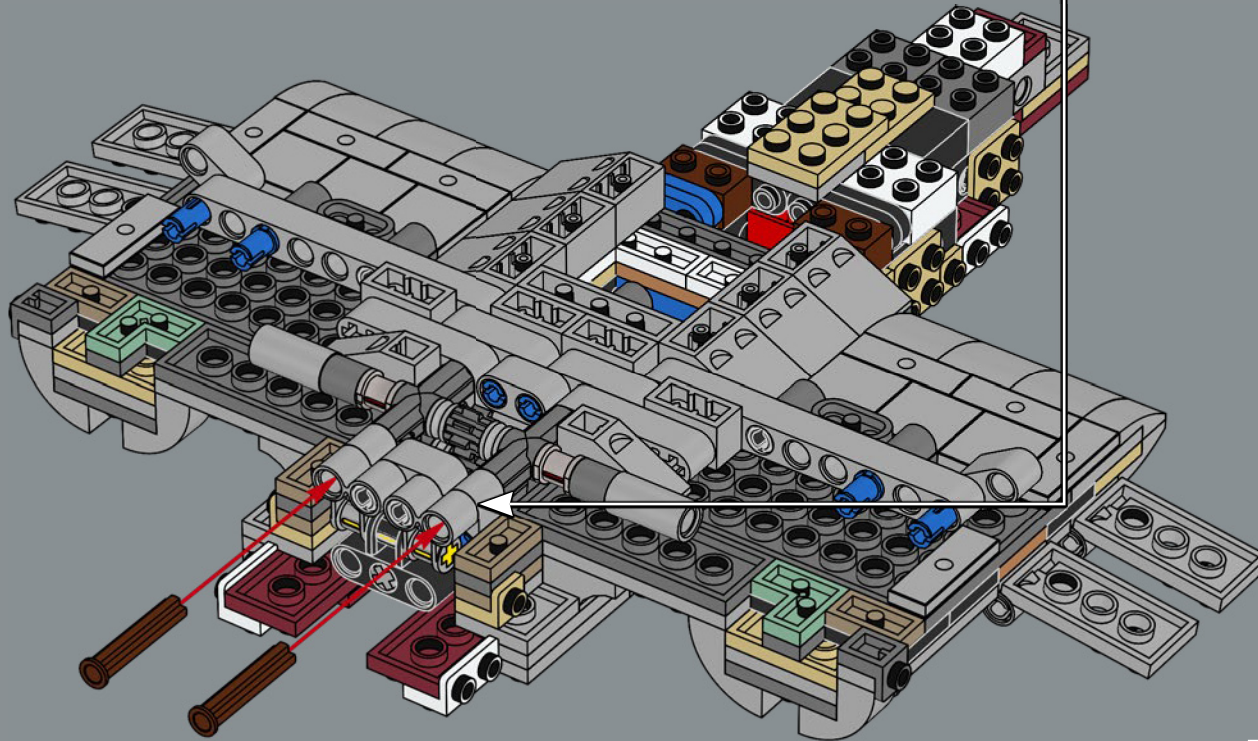
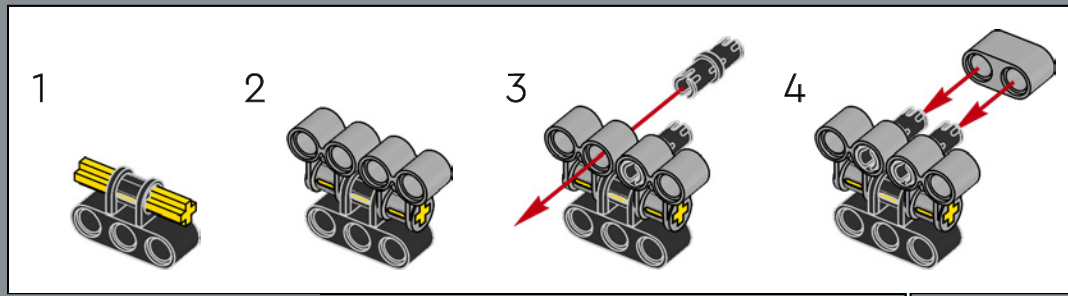



2x



1x

82

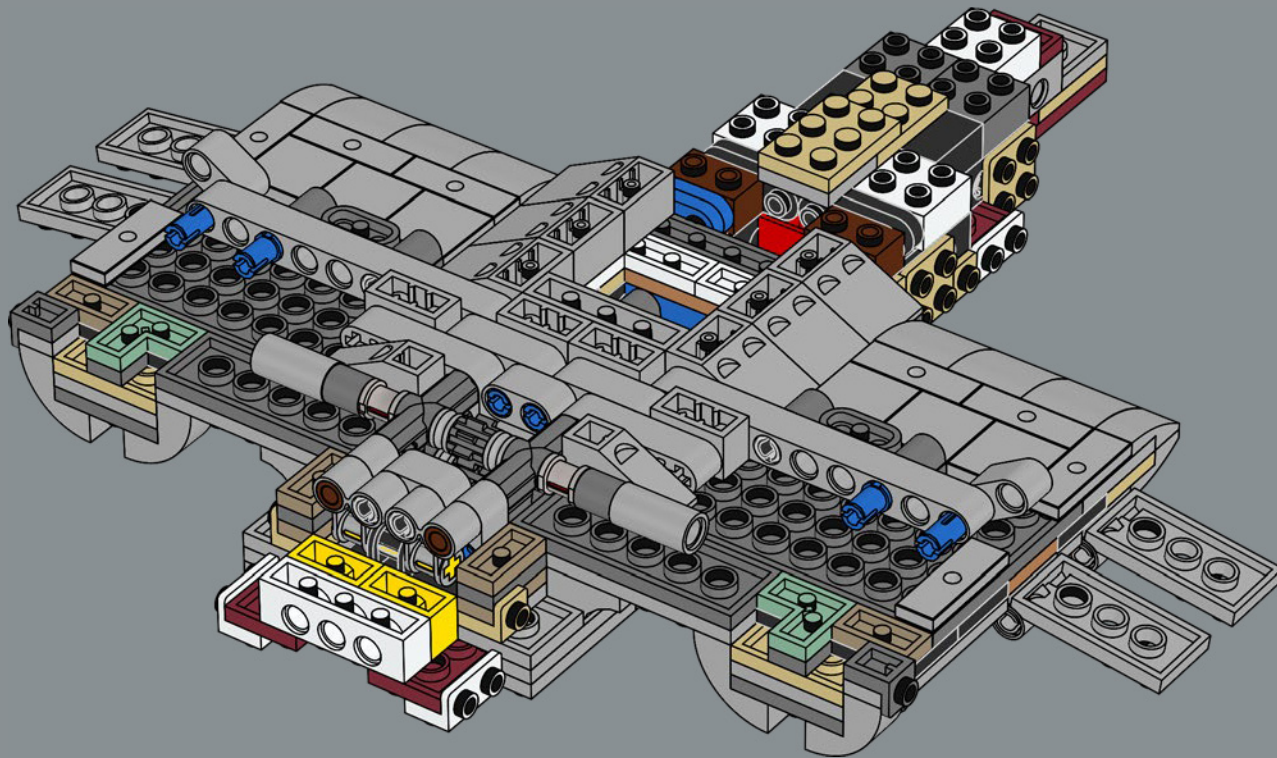

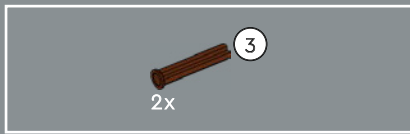

83

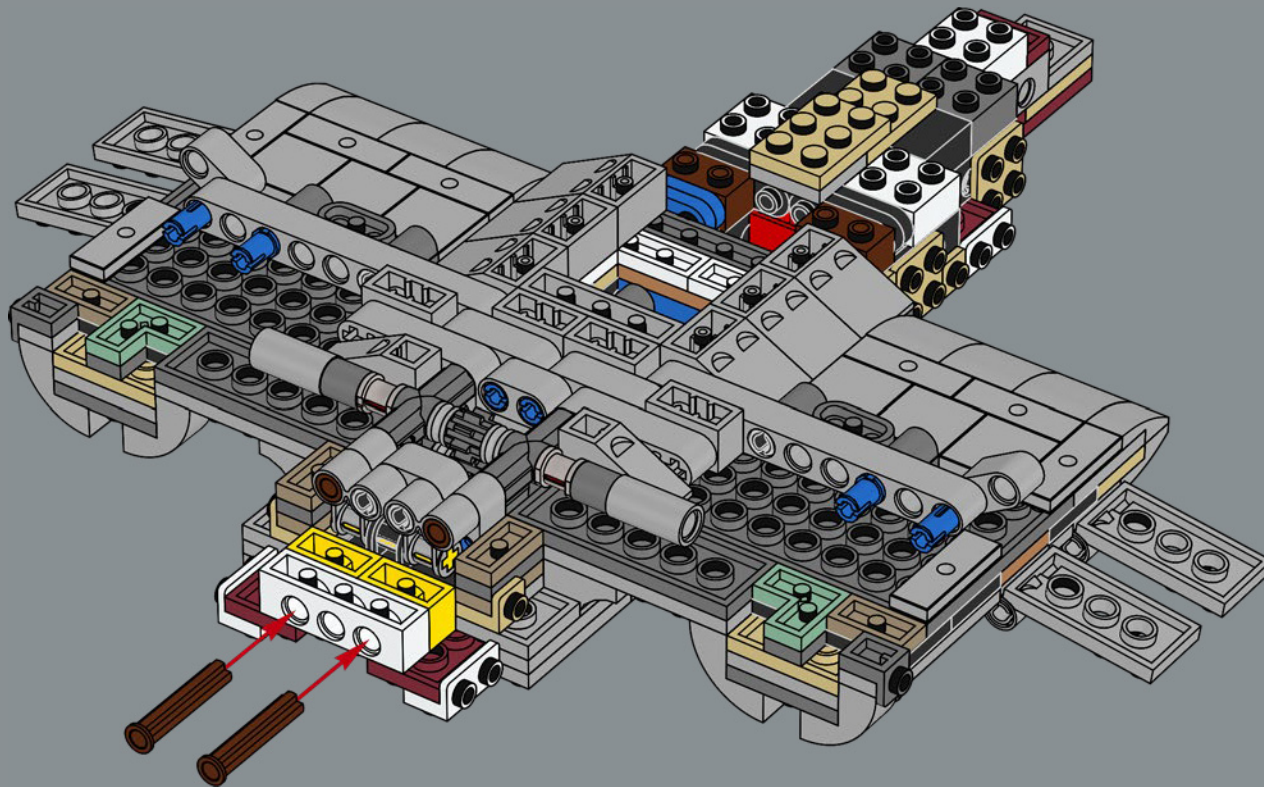

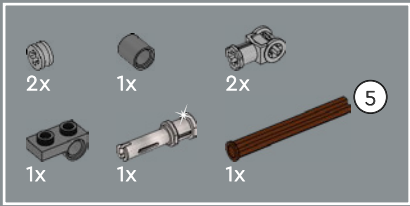

84

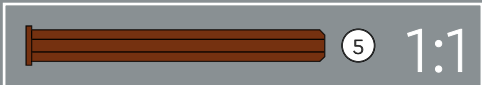
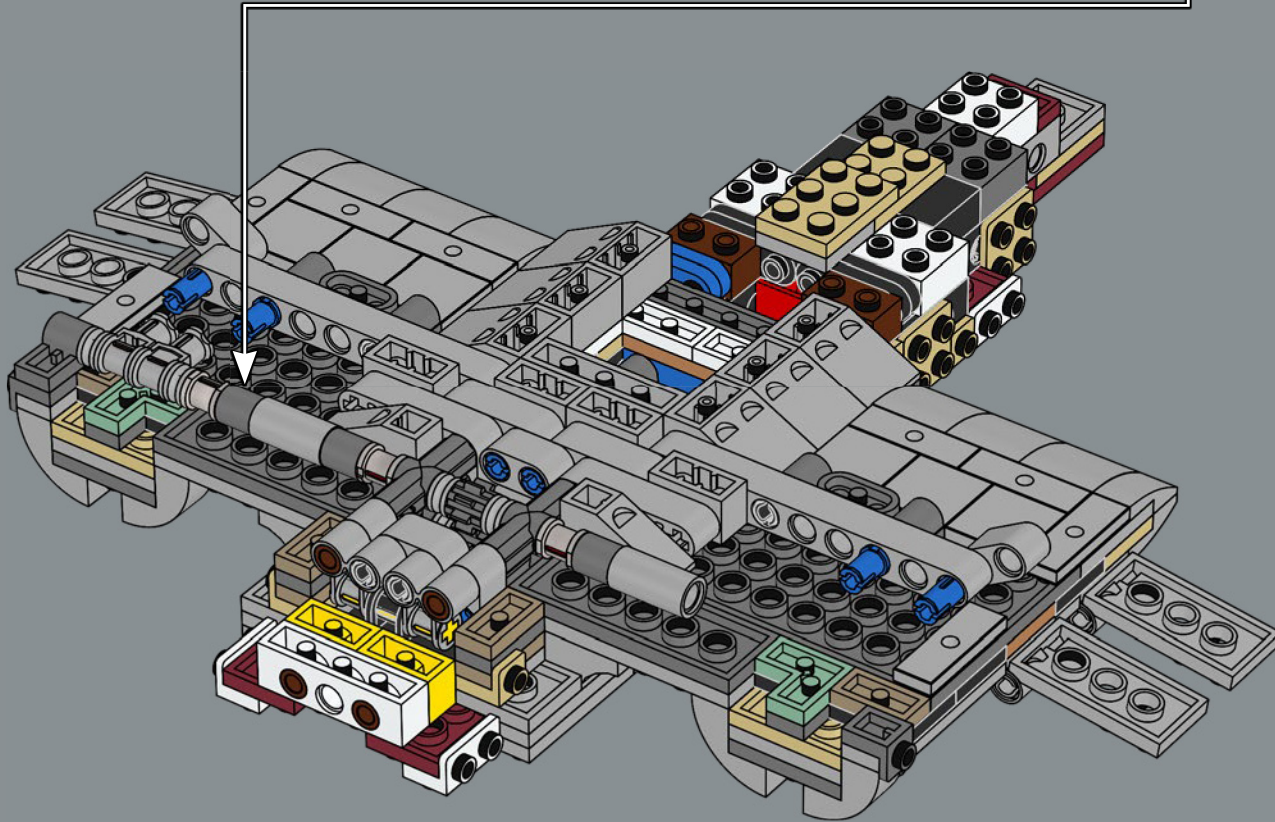
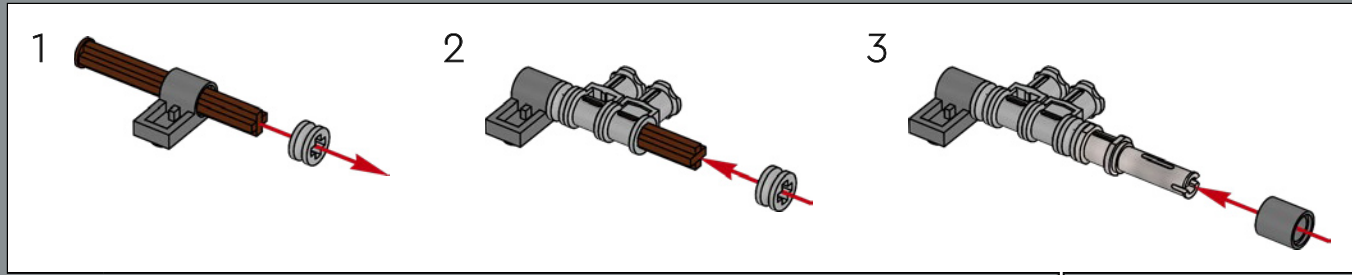

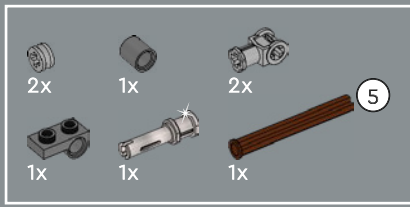

85

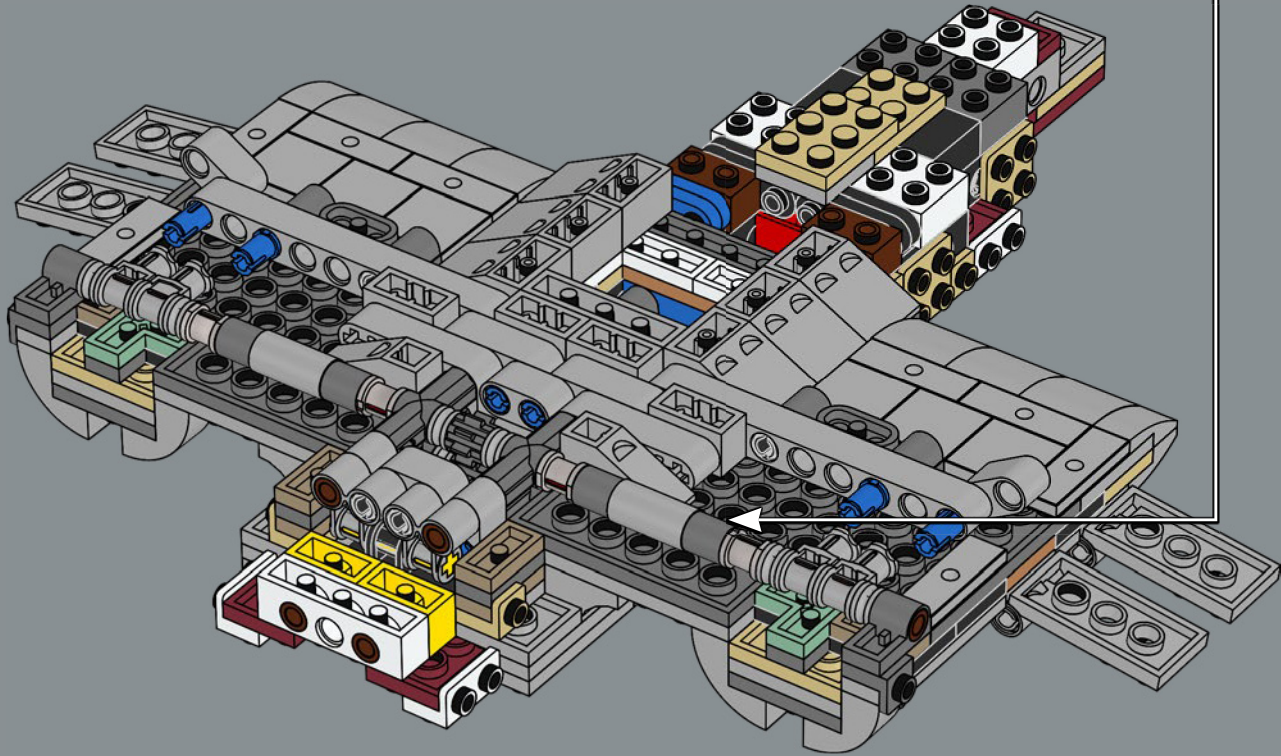
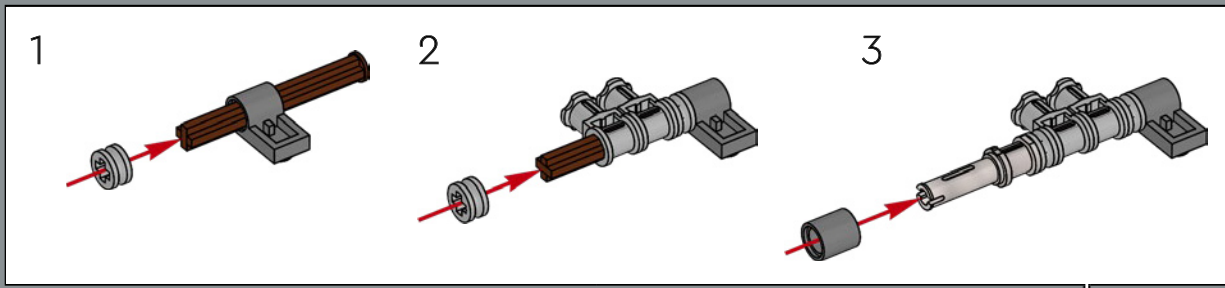

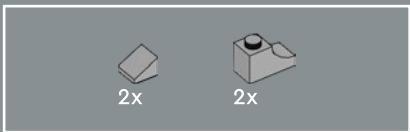

86

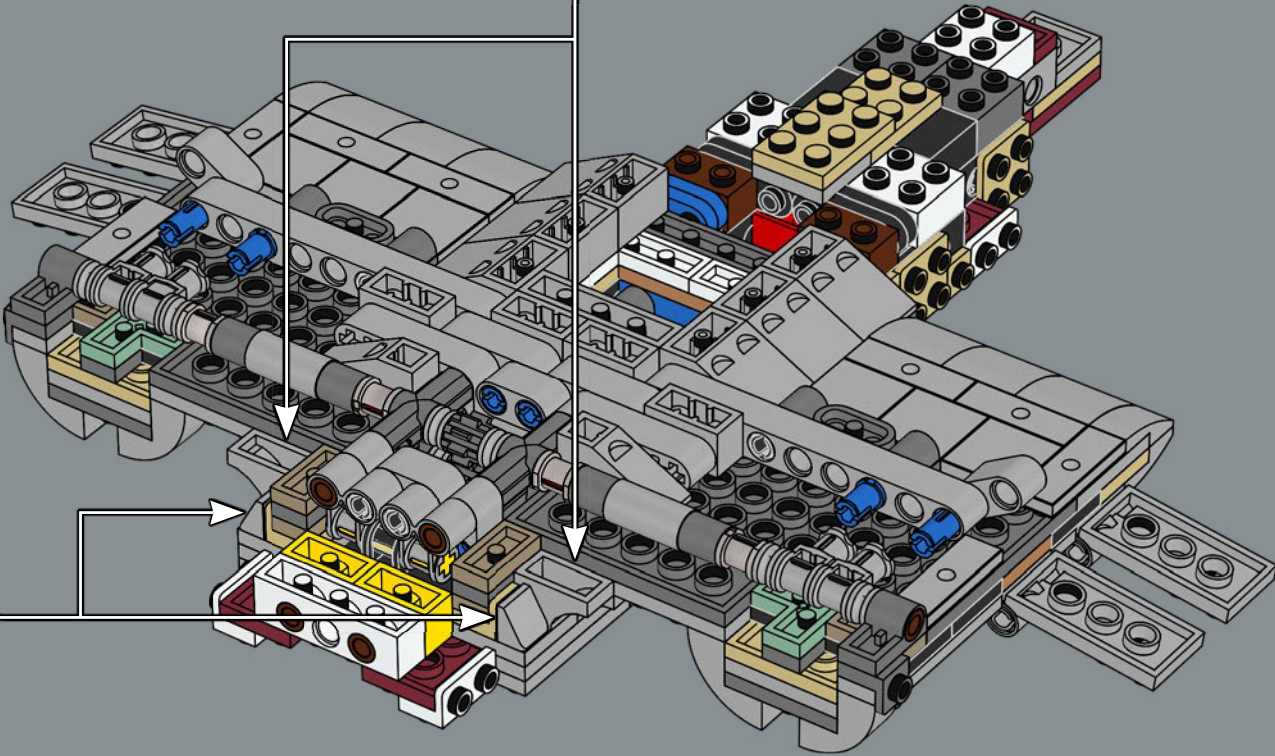
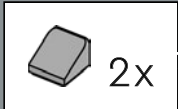
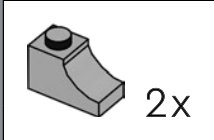



87

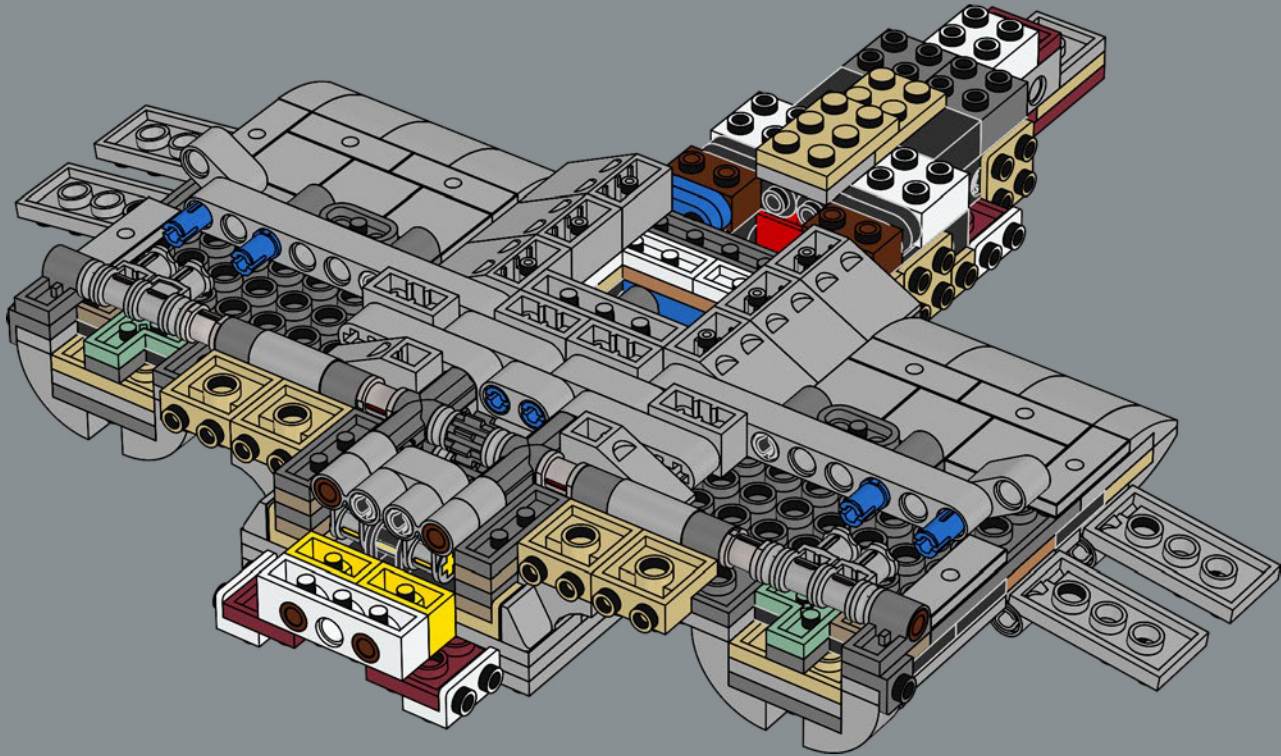



88

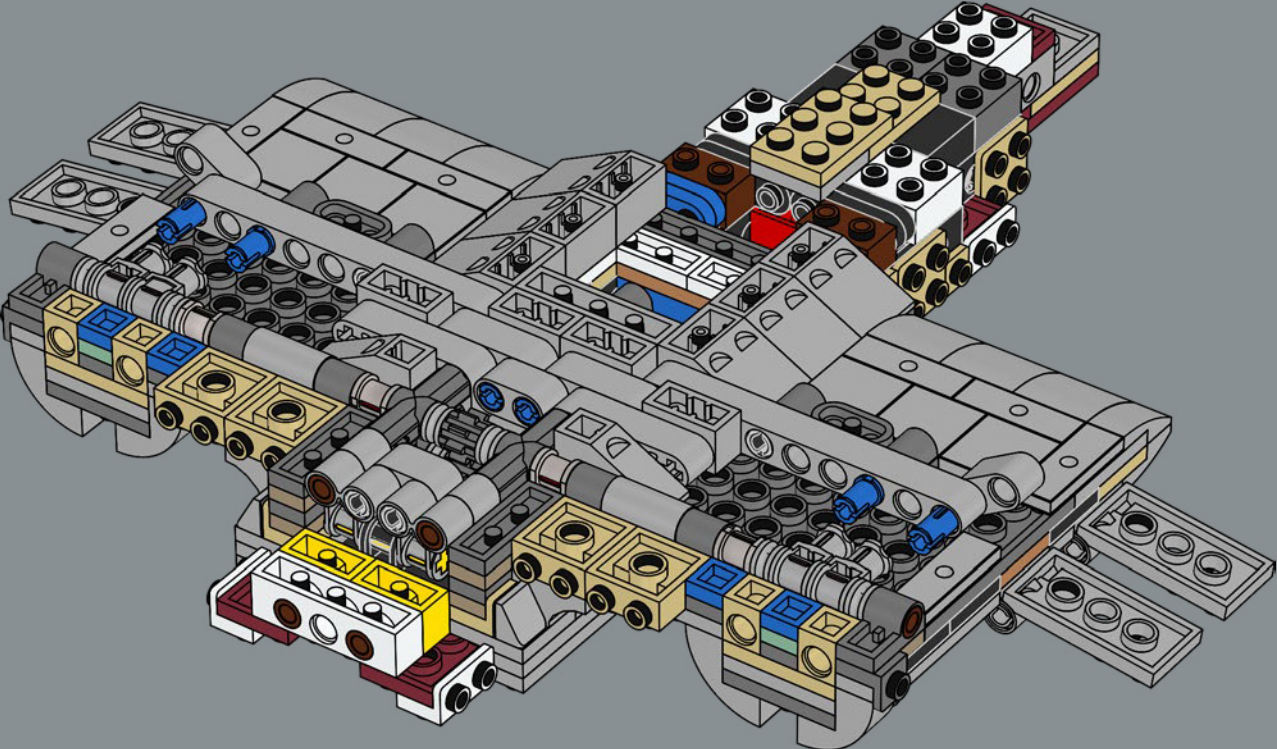

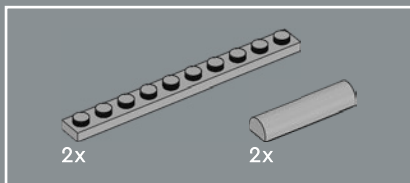

89

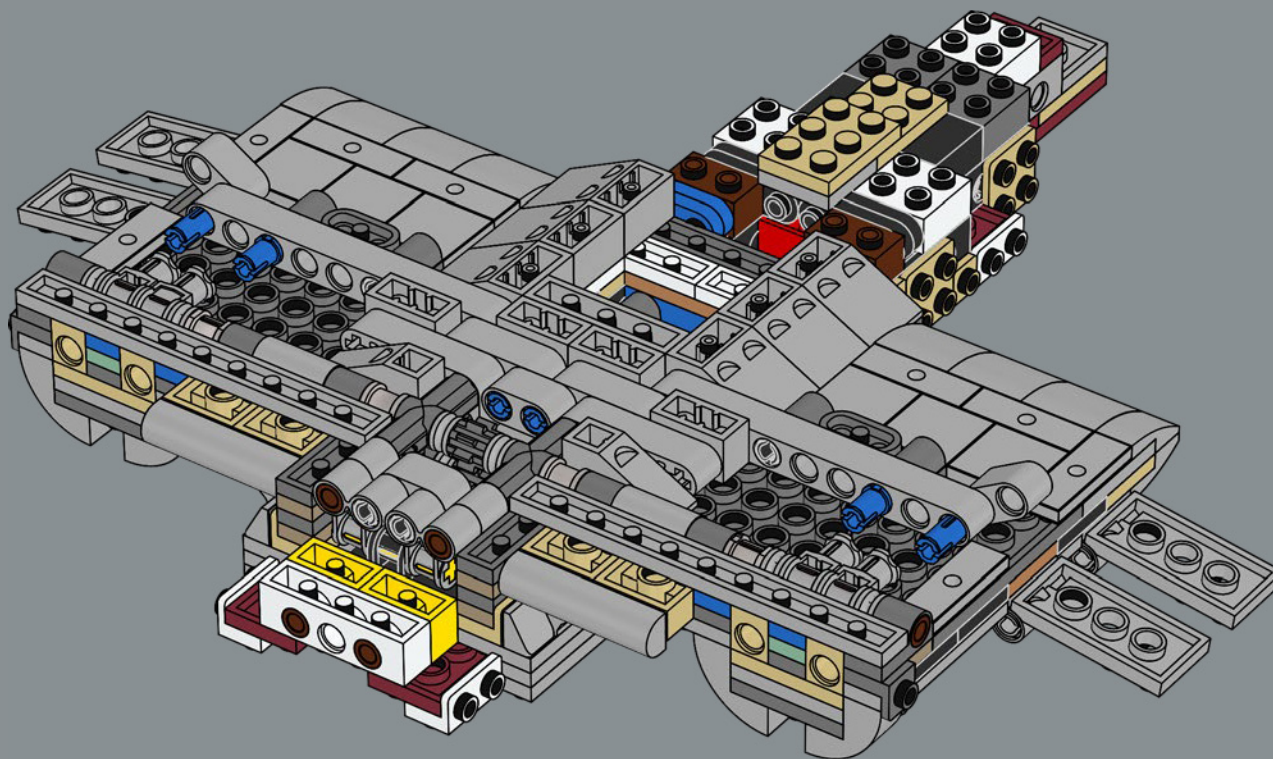

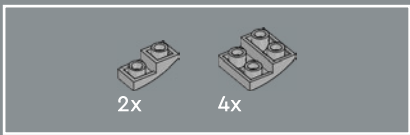

90

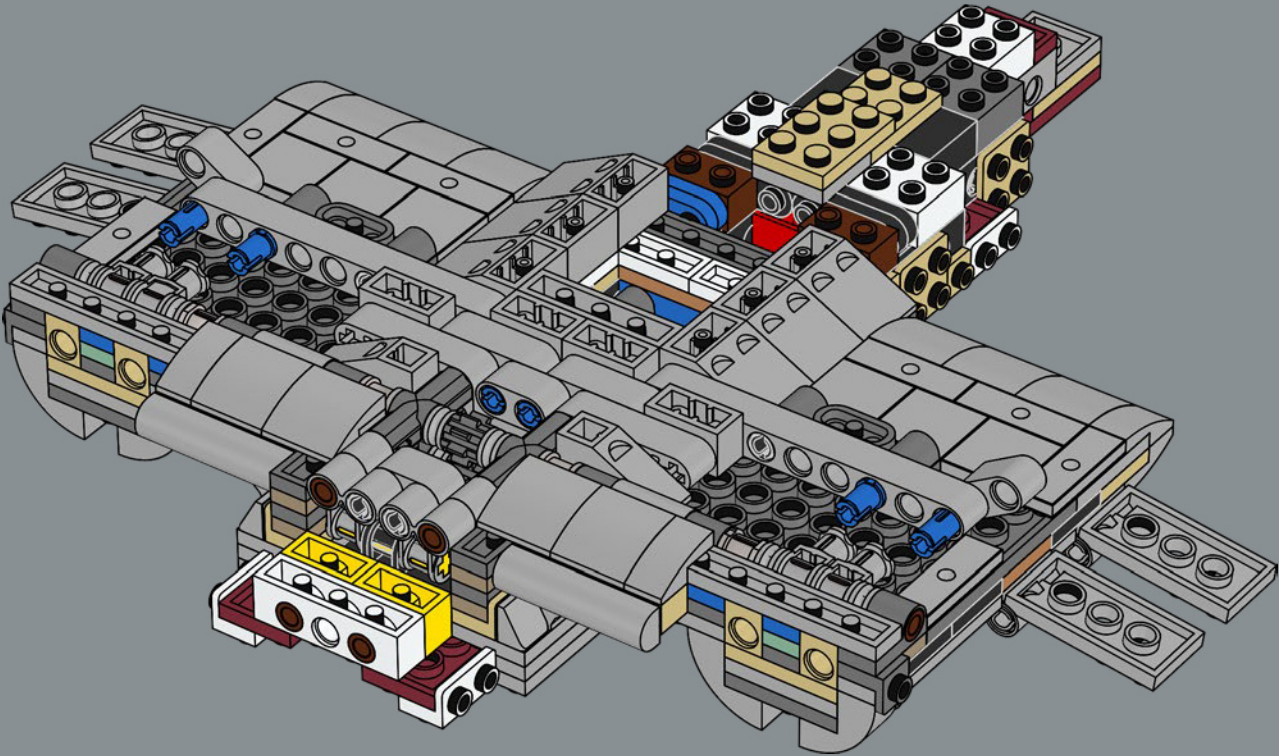

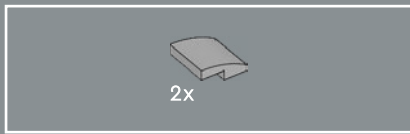

91

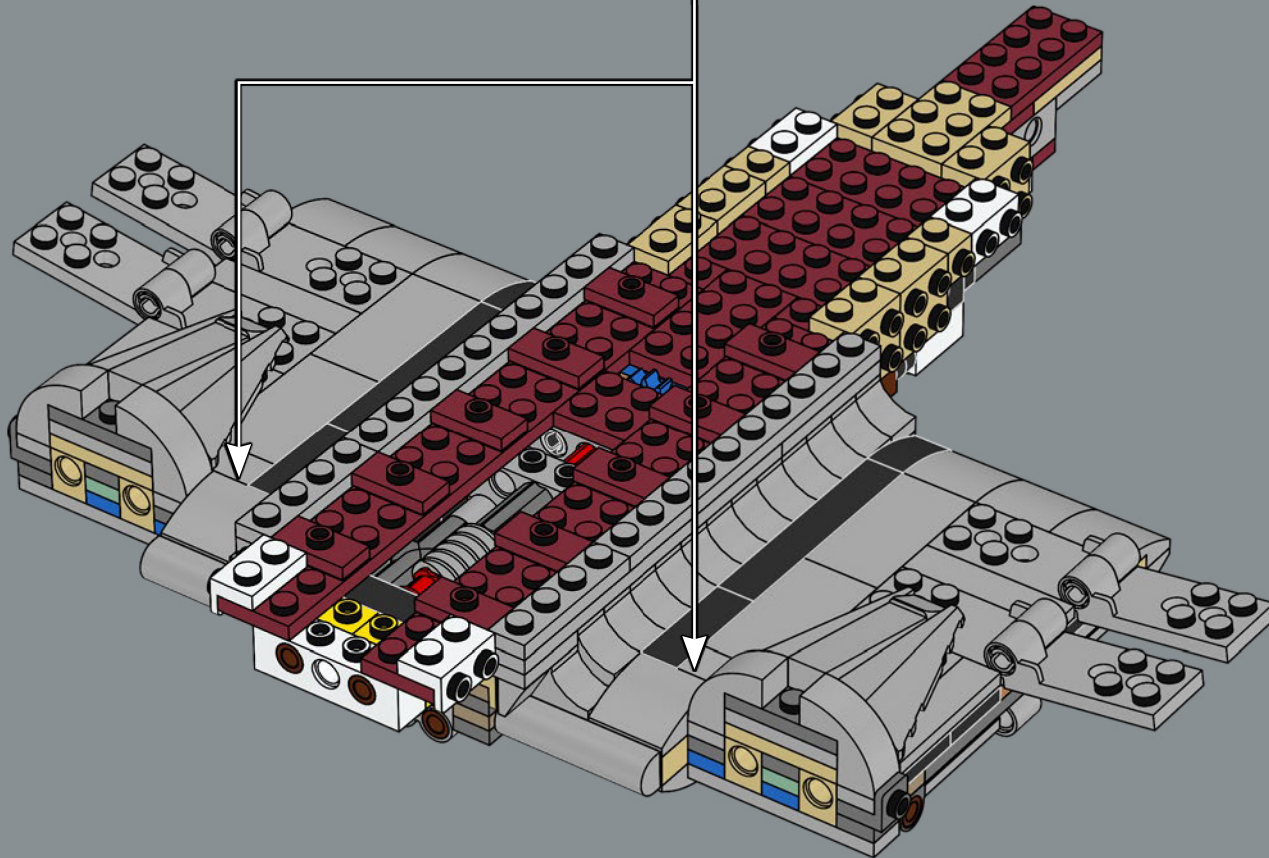
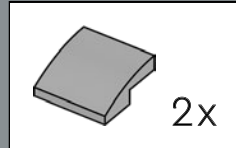



Illustrazioni a colori del DC-3™ sono difficili da trovare, quindi siamo stati molto felici che Boeing abbia deciso di condividere con noi un'illustrazione della cabina a colori, prelevata direttamente dai loro archivi! L'illustrazione ha rivelato che l'interno presentava un tappeto rosso scuro e sedili blu sabbia.

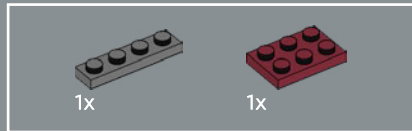

92

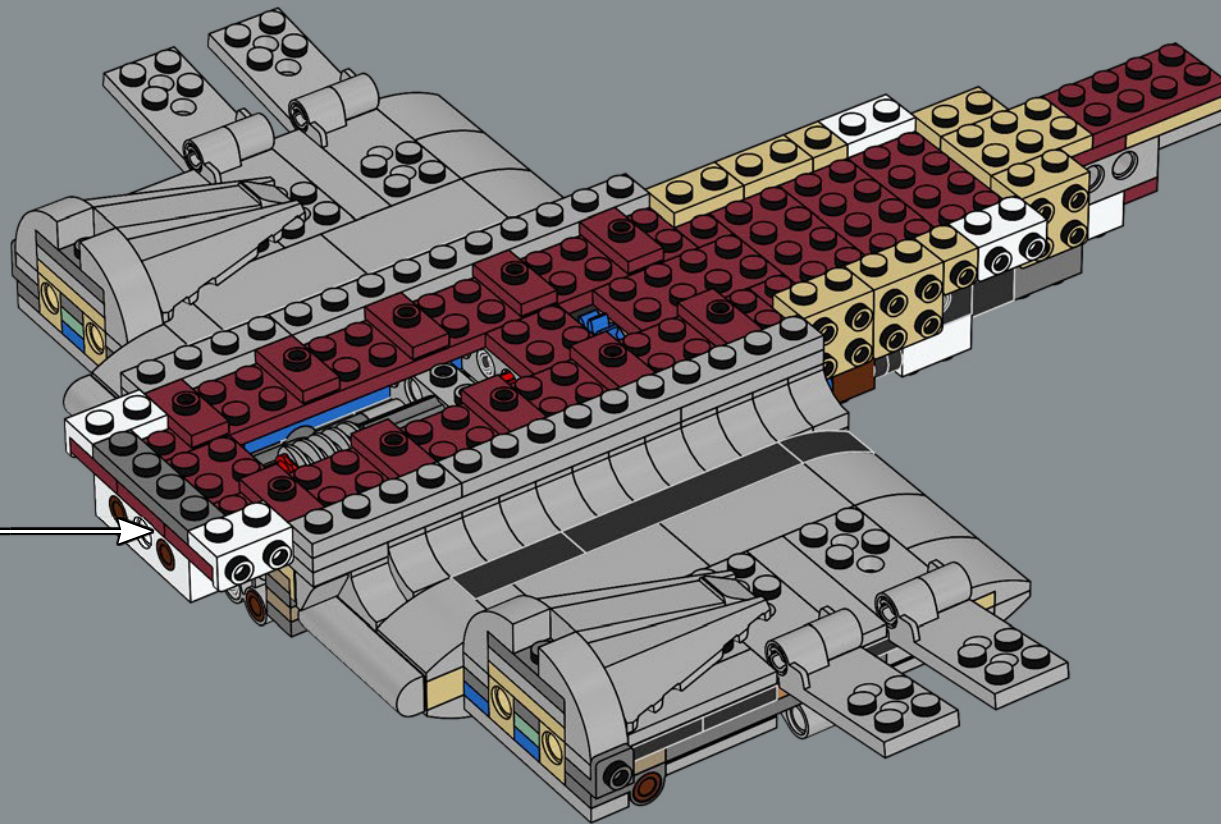
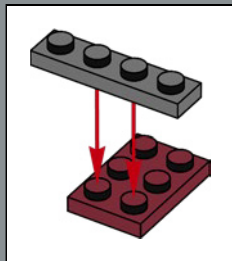

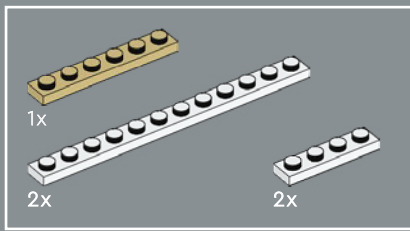

93

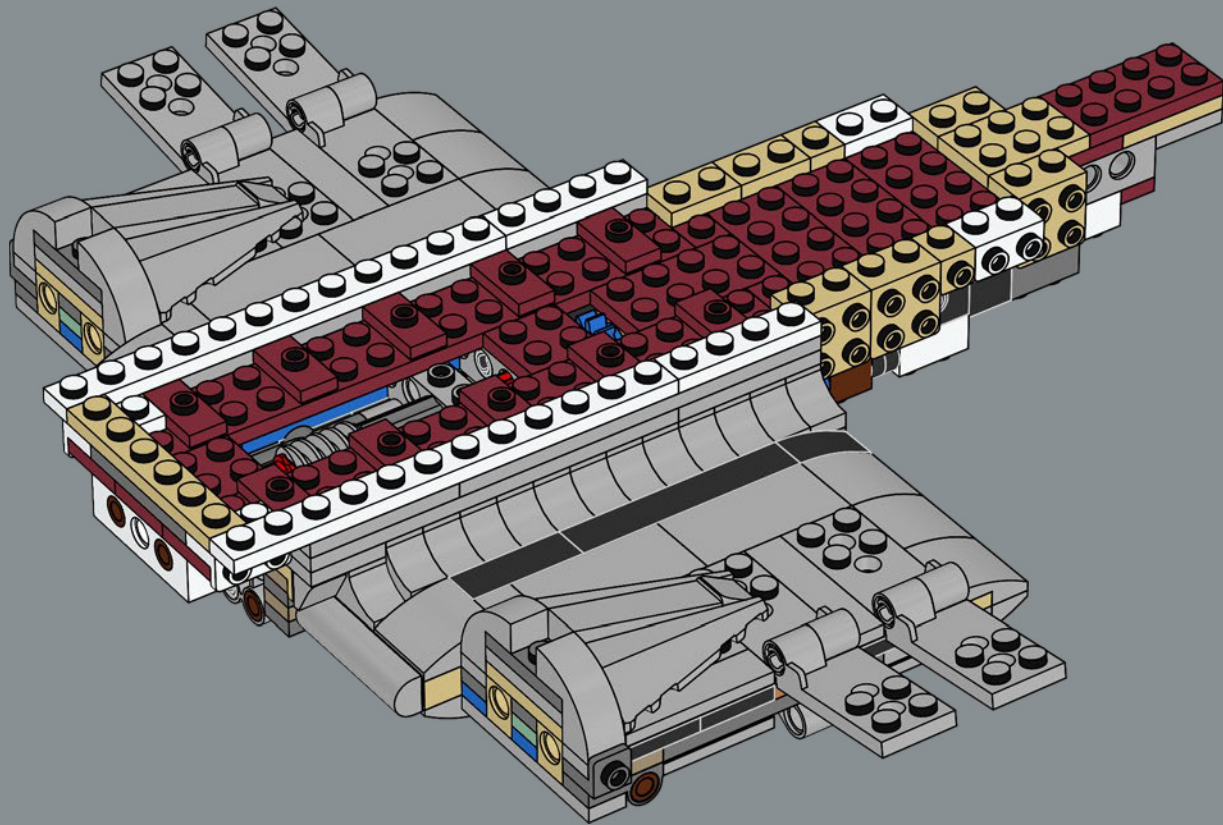

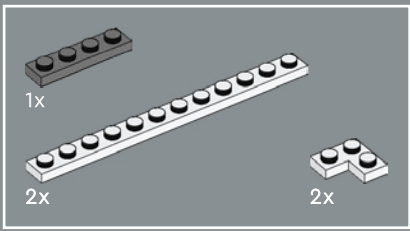

94

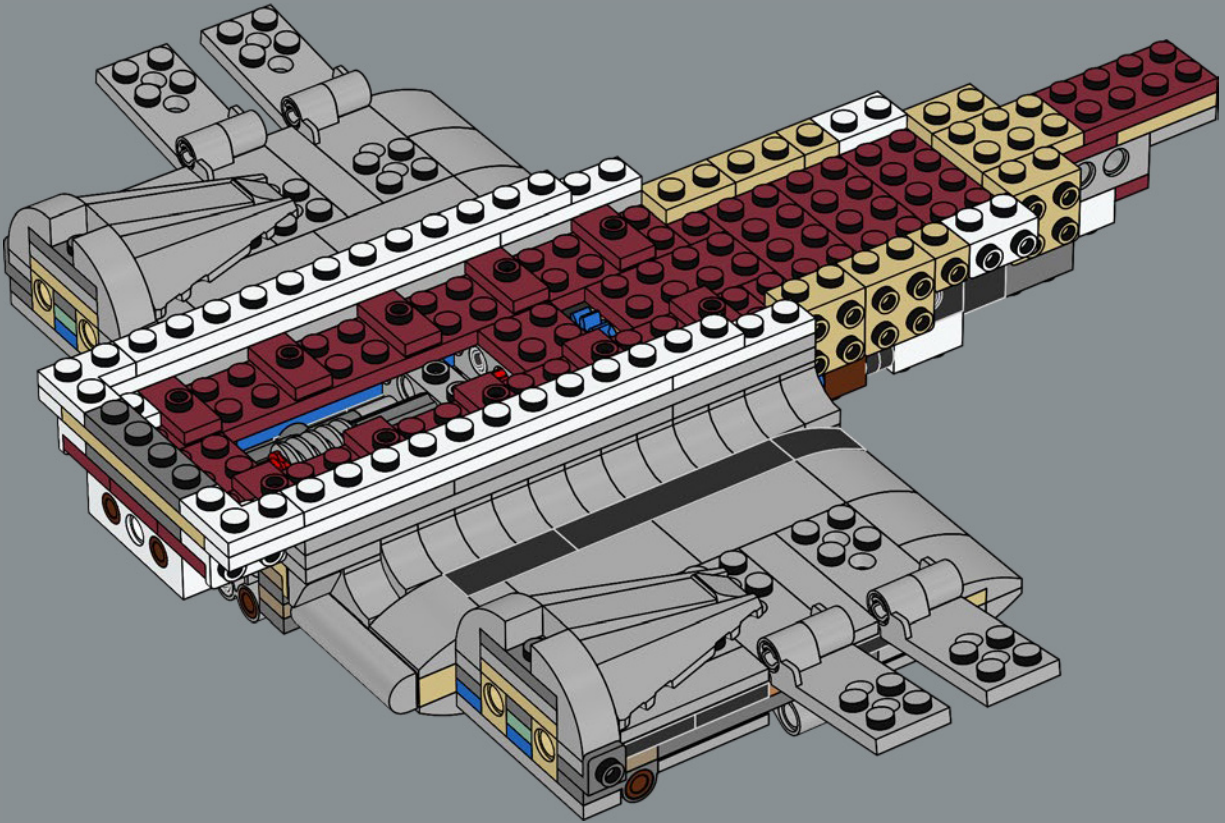

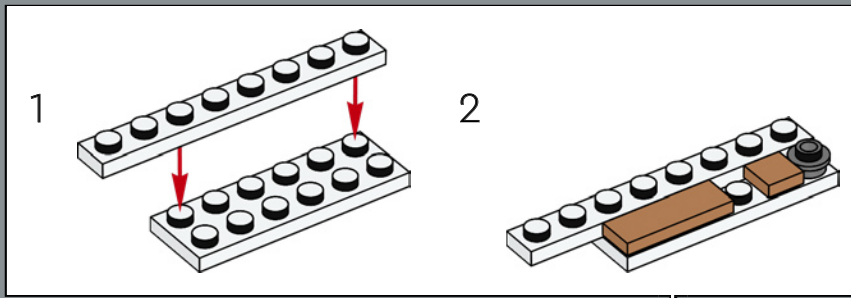
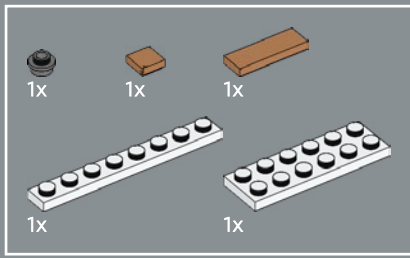

95

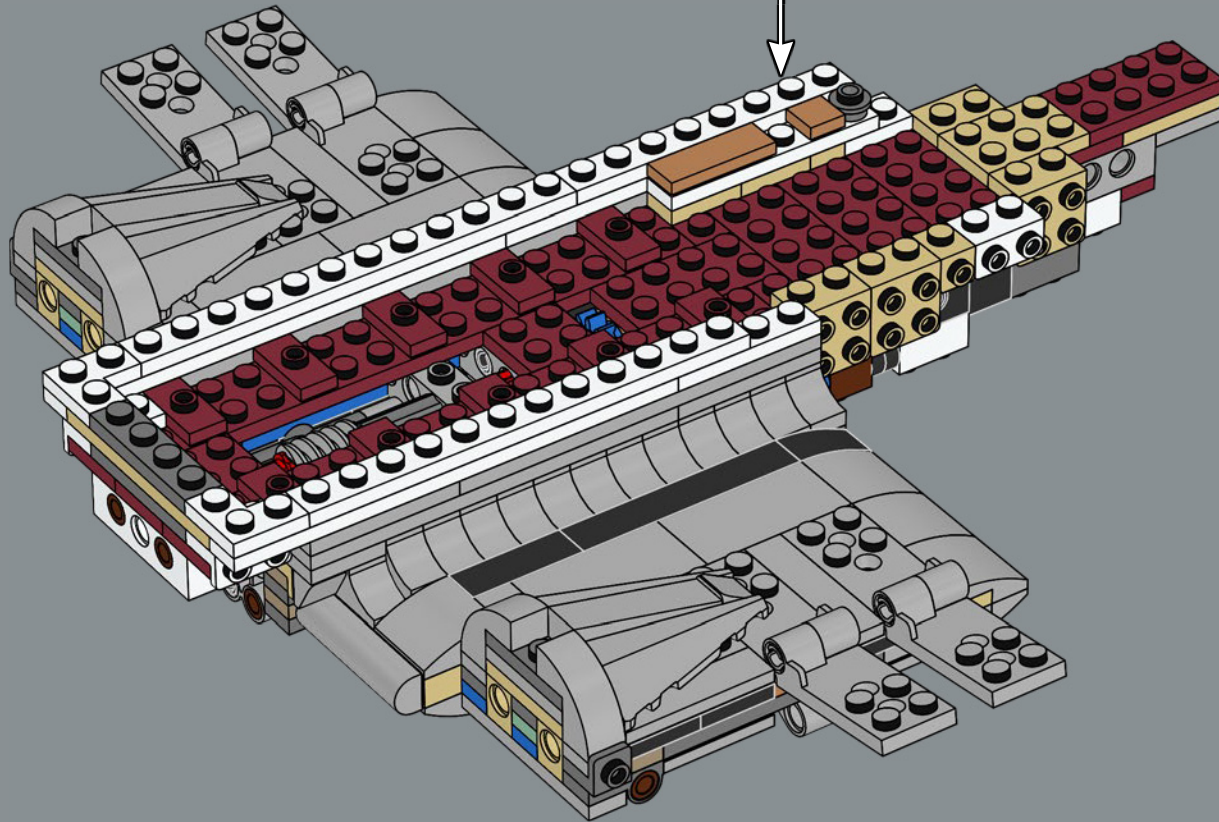

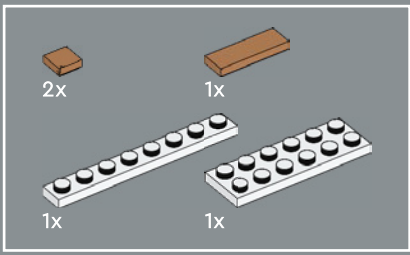

96

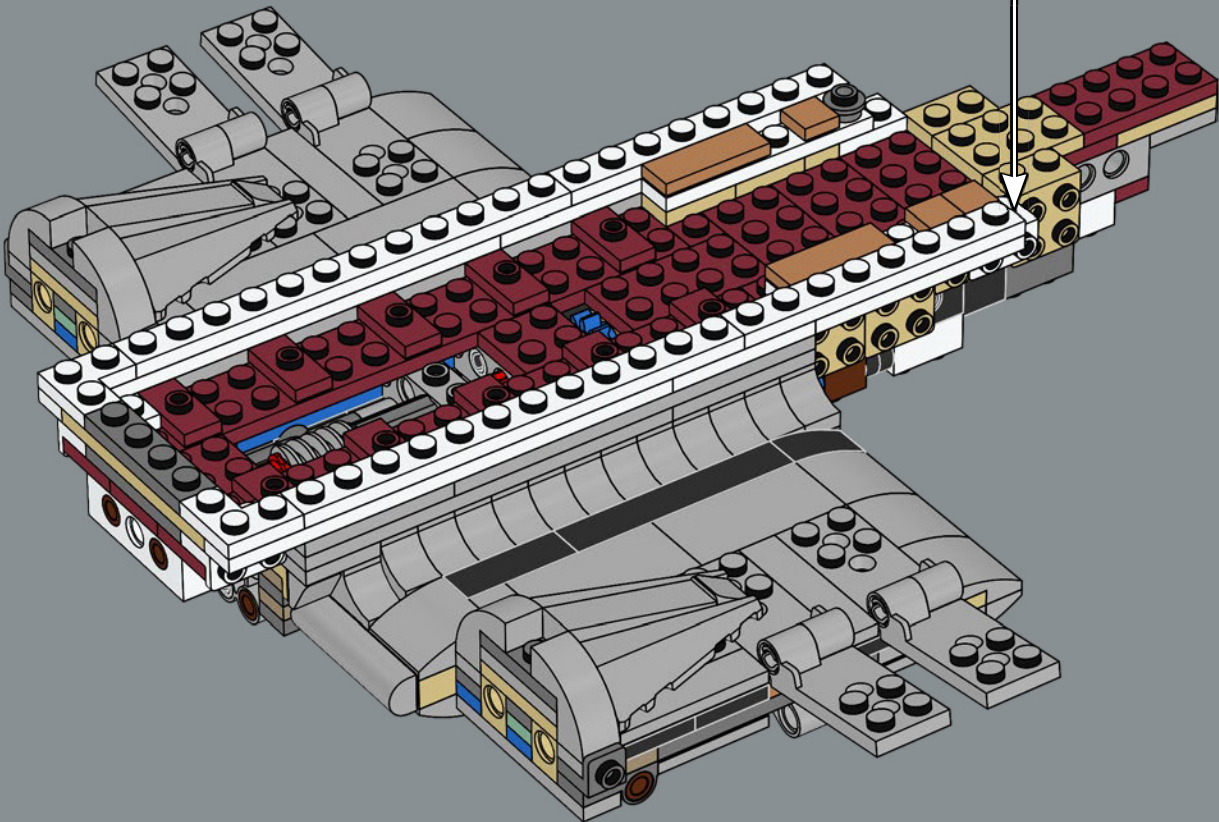
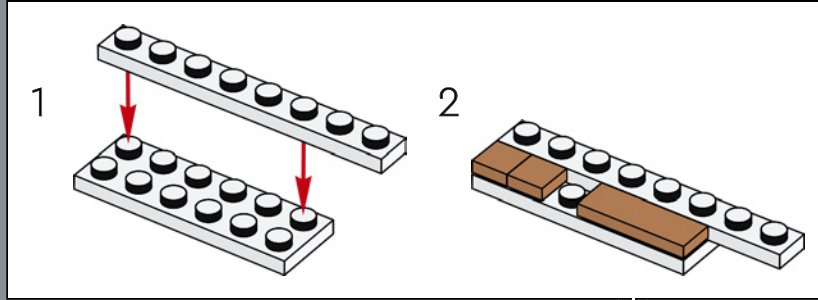

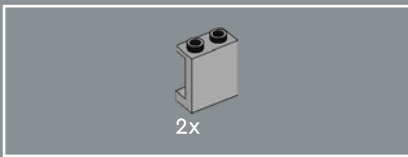

97

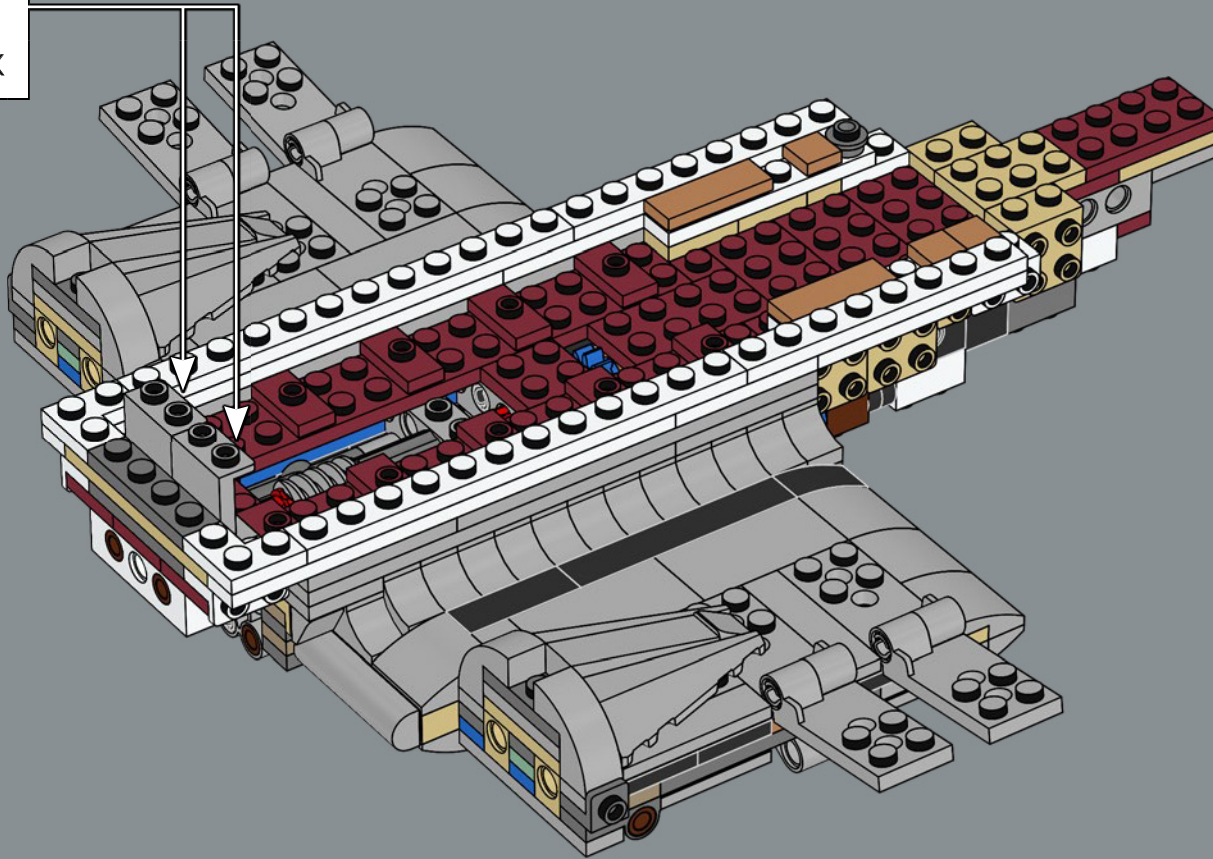
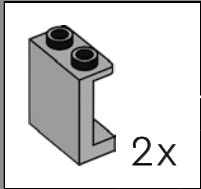

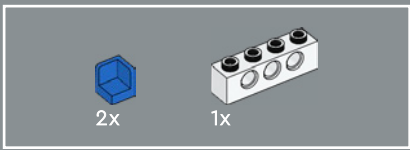



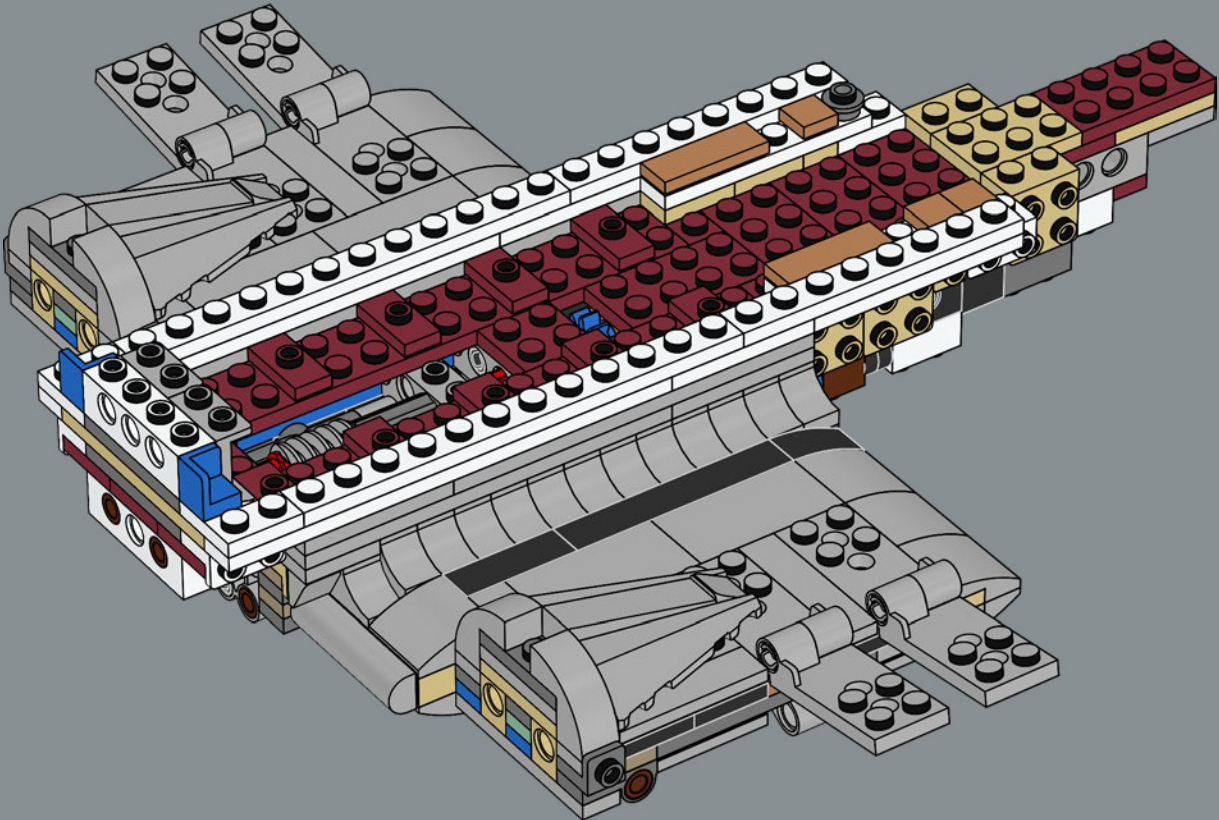

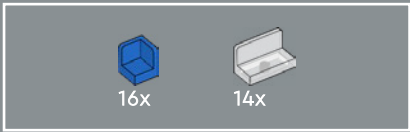
98



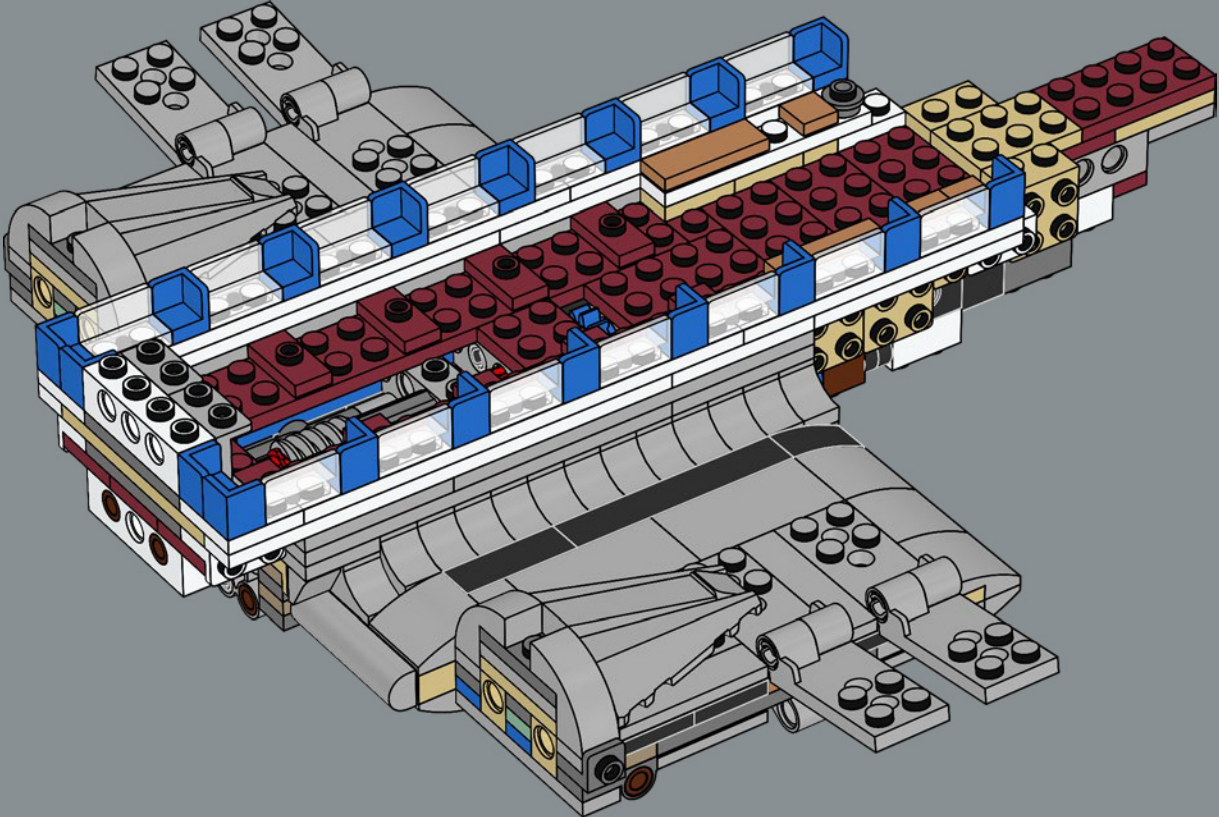

99



- 1x 
- 1x 
- 1x 
- 1x 

100

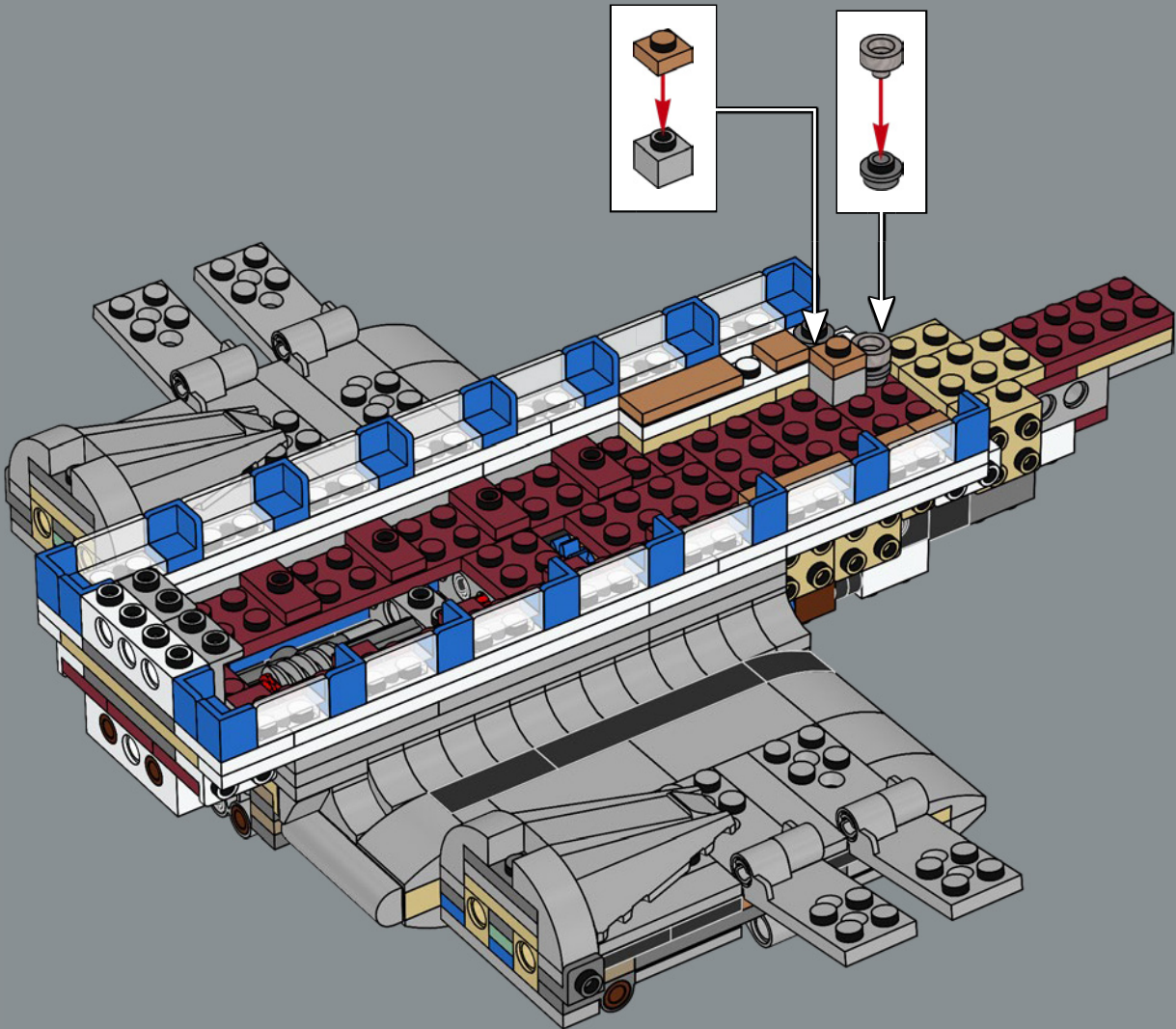

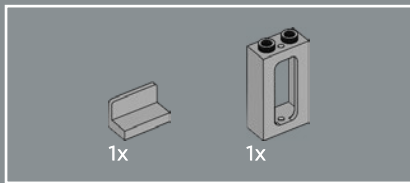

101

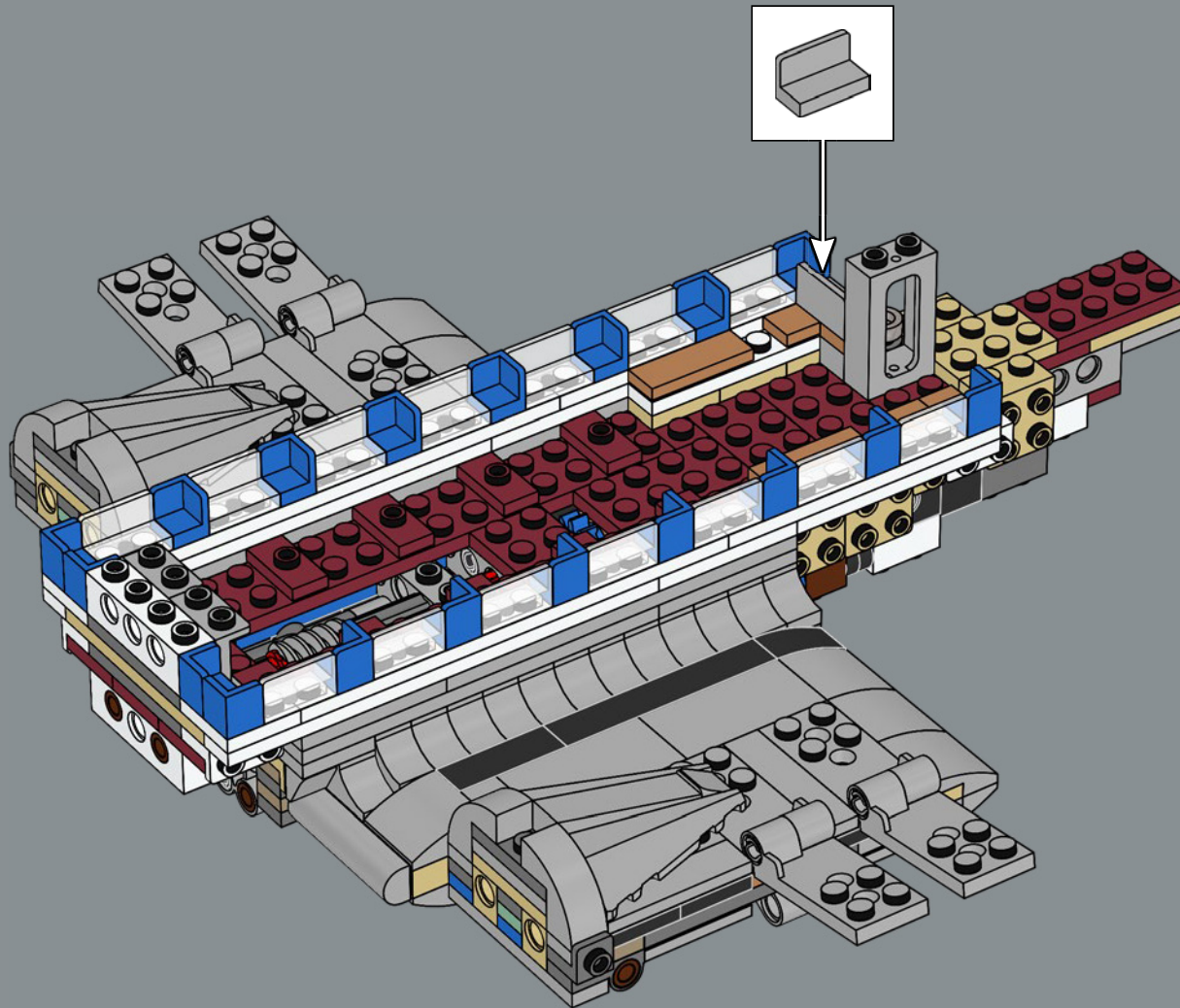

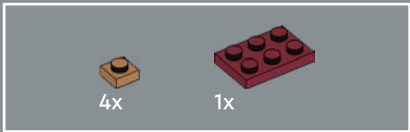

102

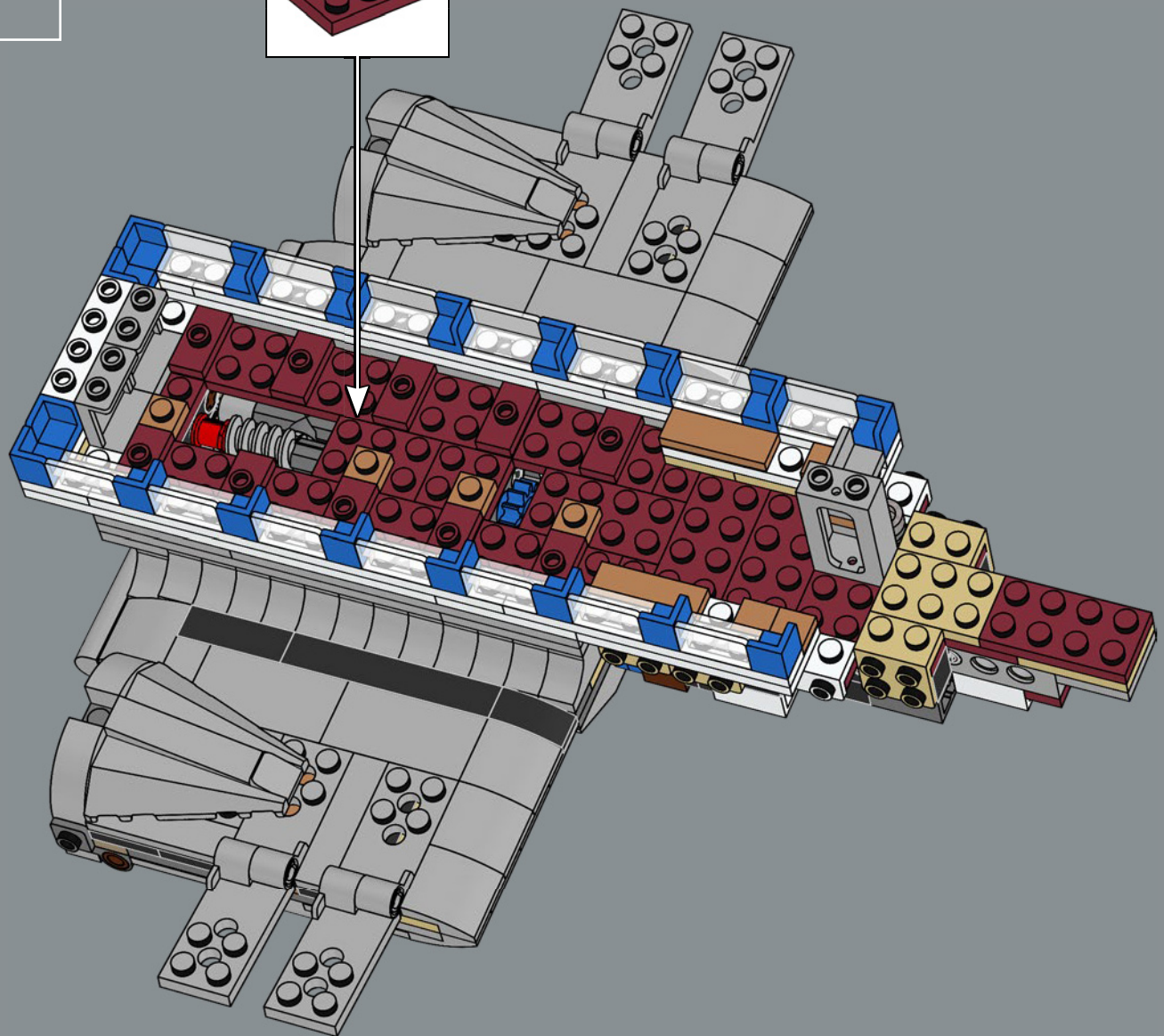
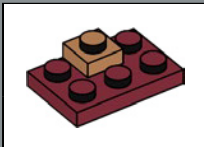

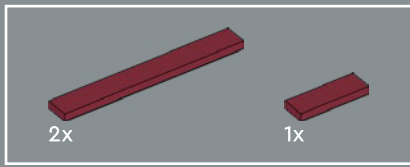

103

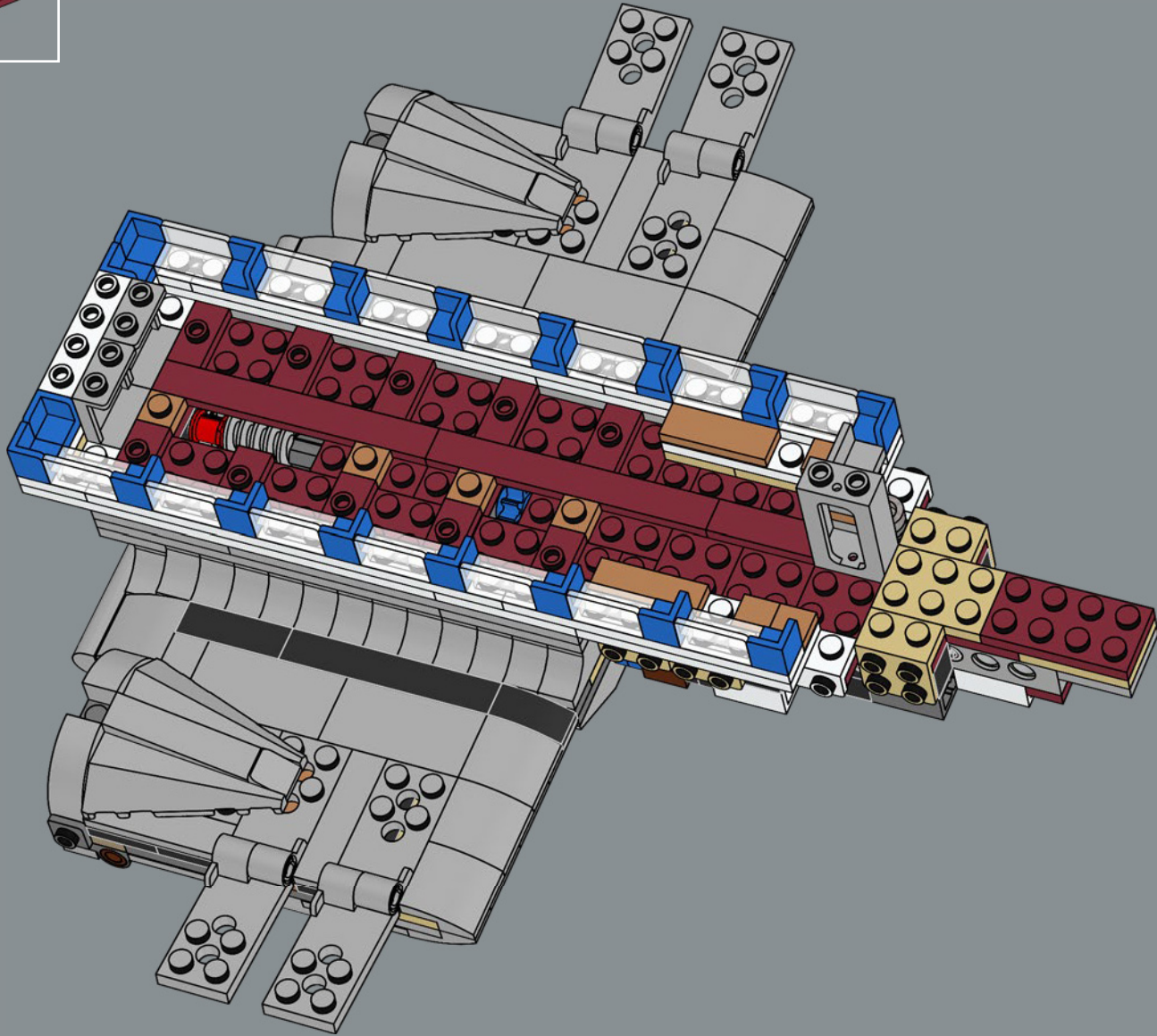



2x

104

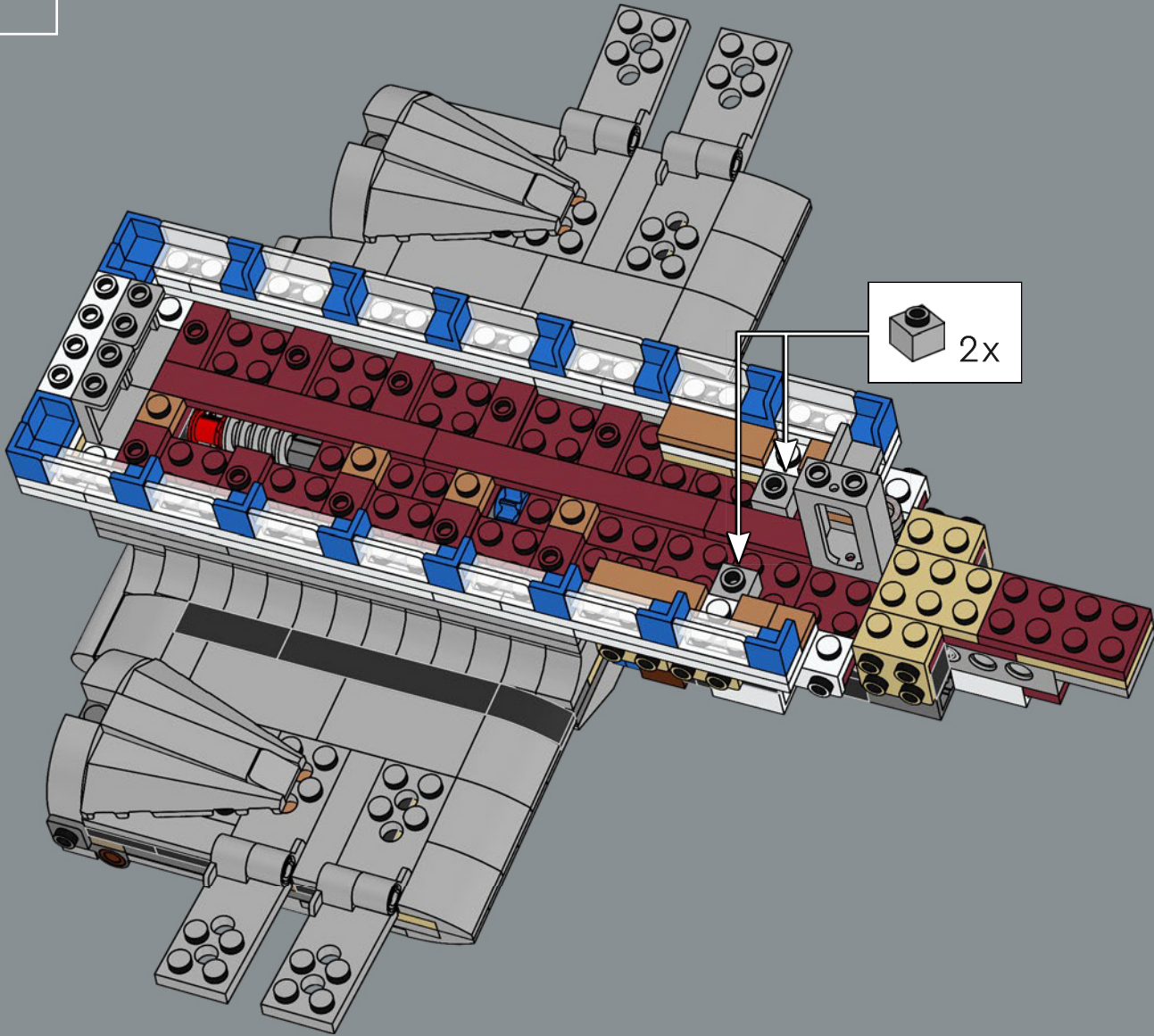

2x



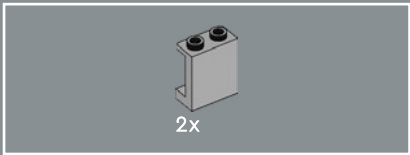

105

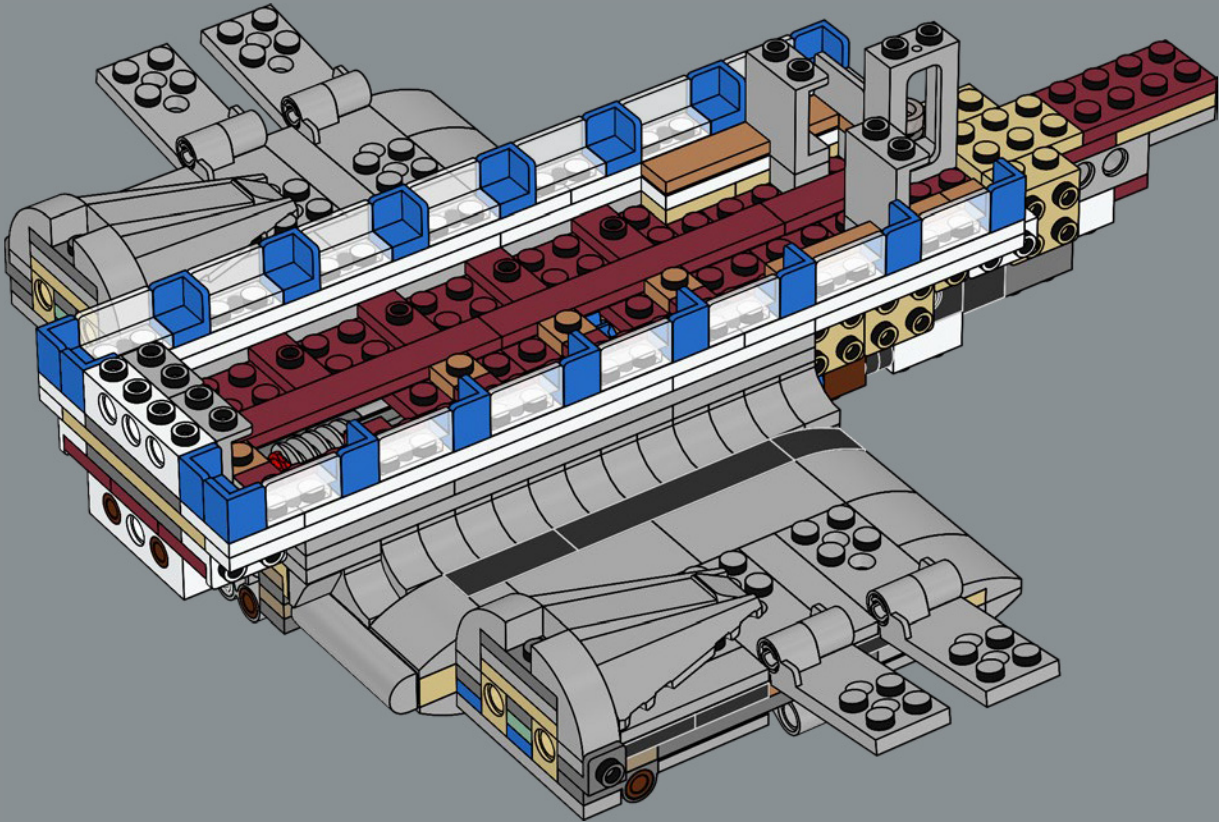

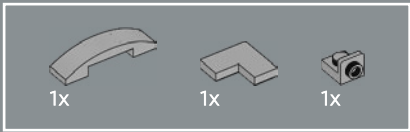

106

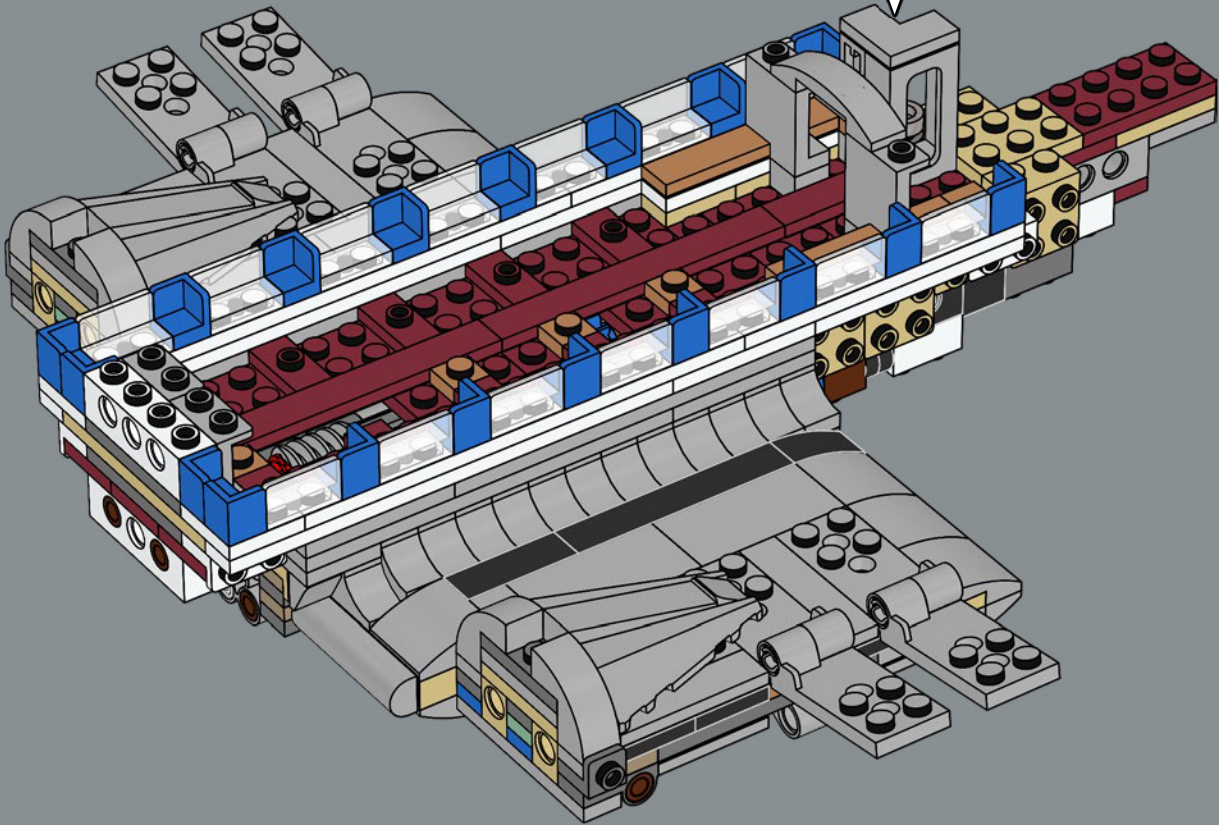
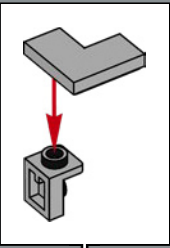

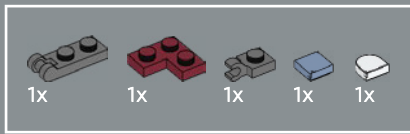

107

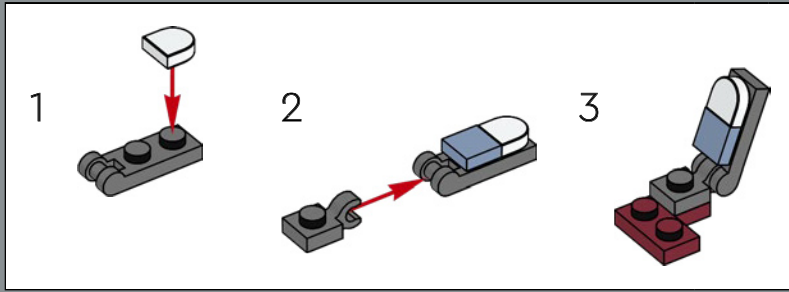
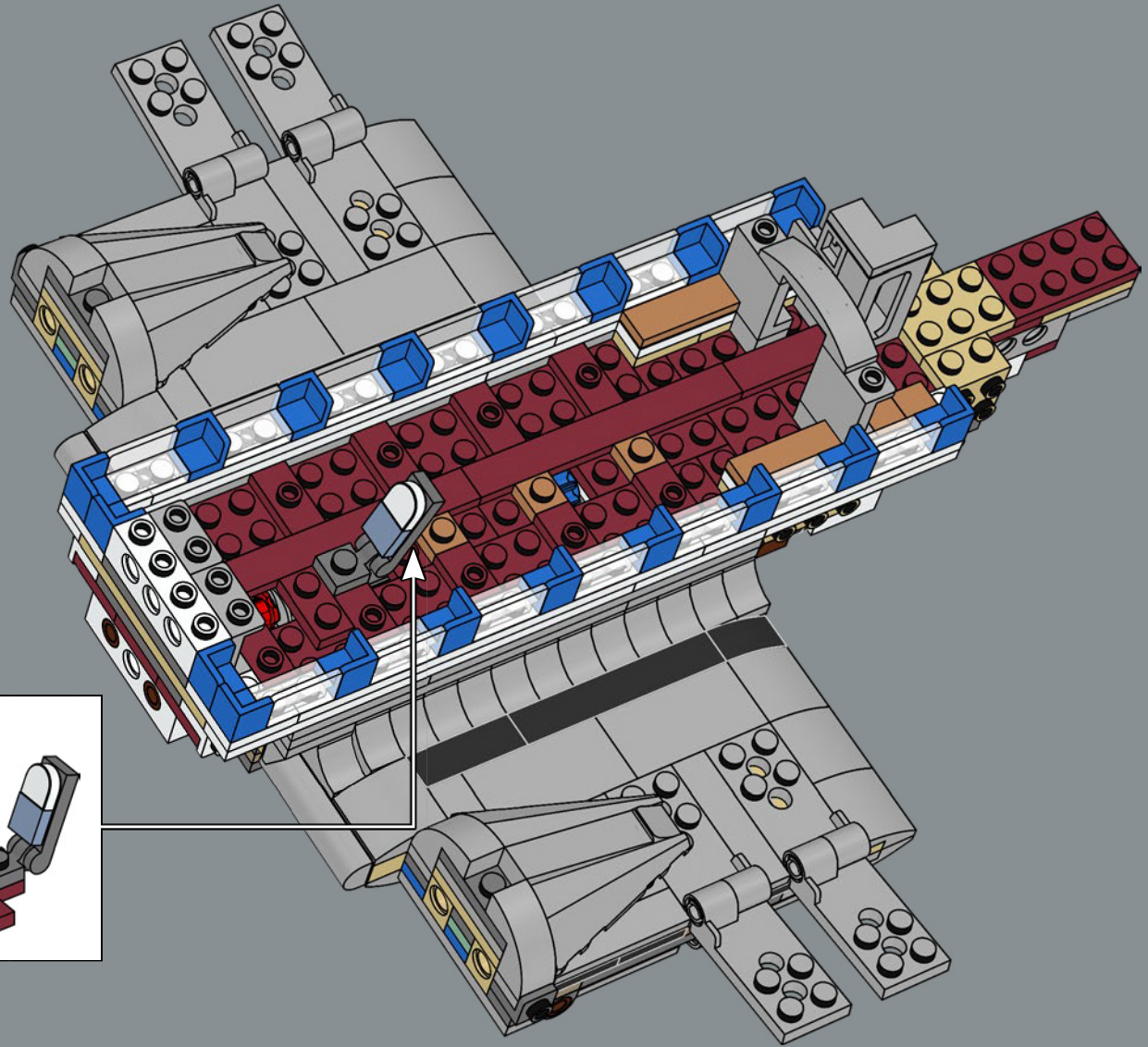

- 14x
- 14x
- 14x
- 14x

108

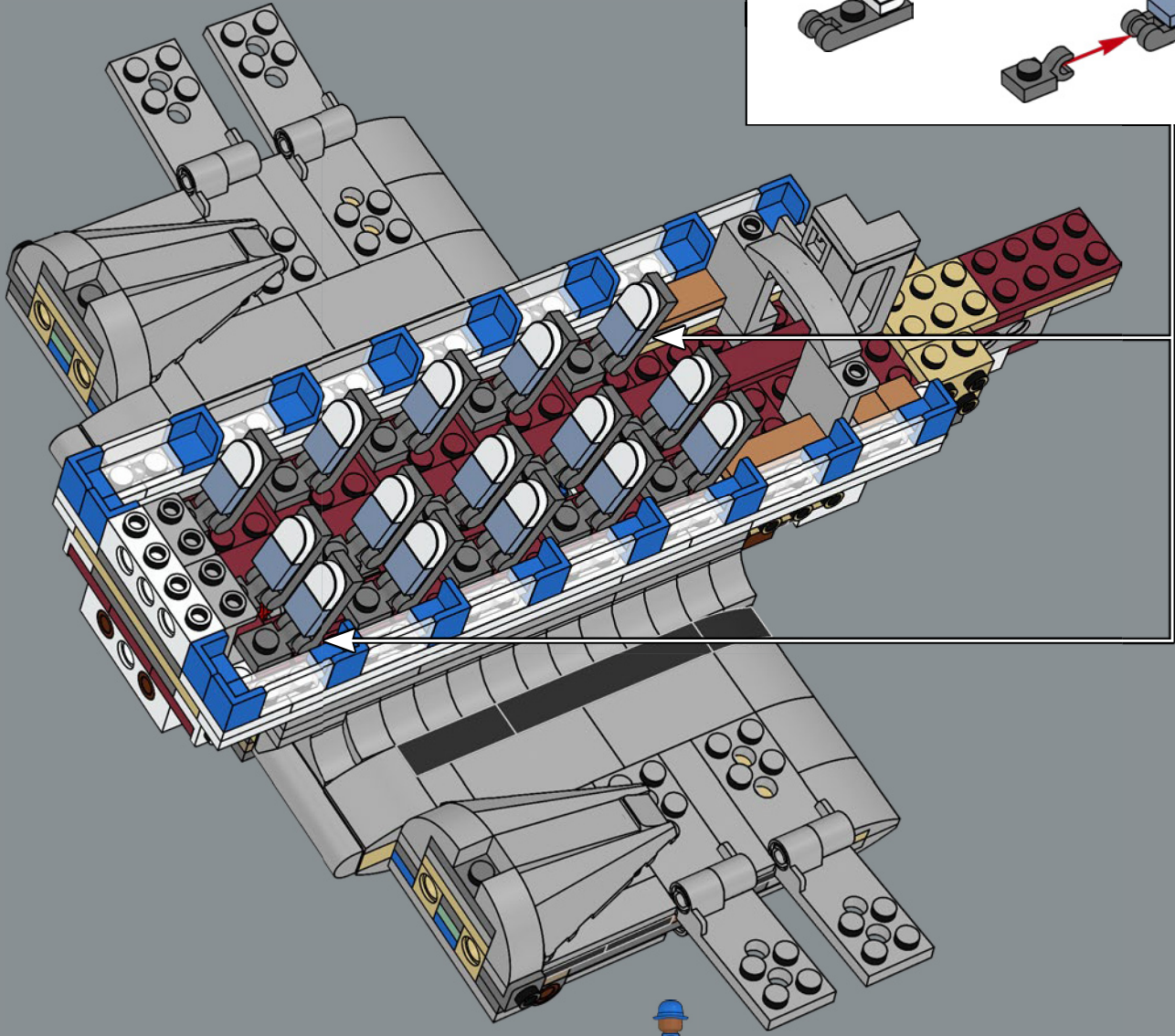
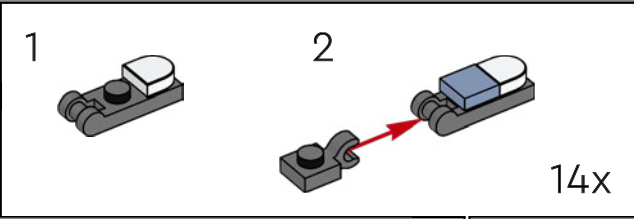

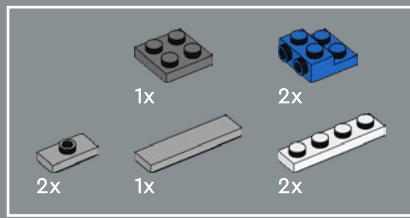

109

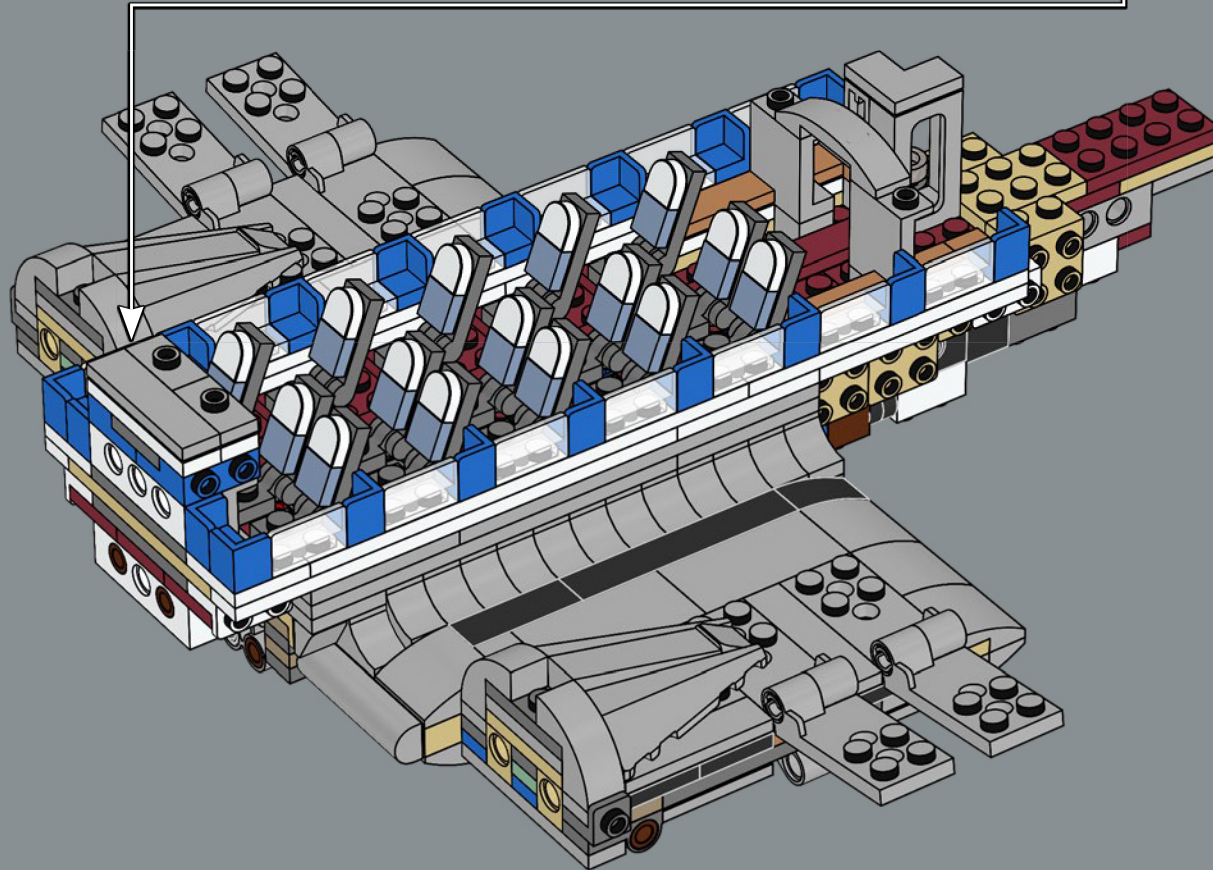
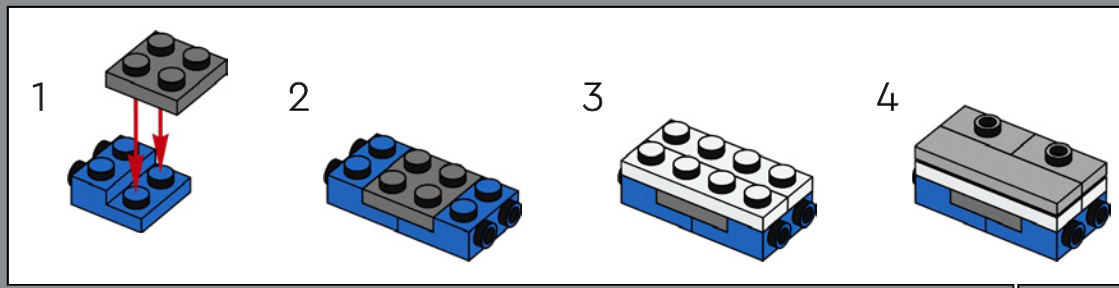

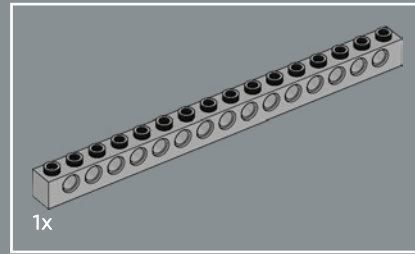
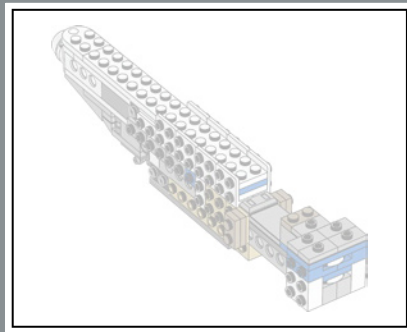

111

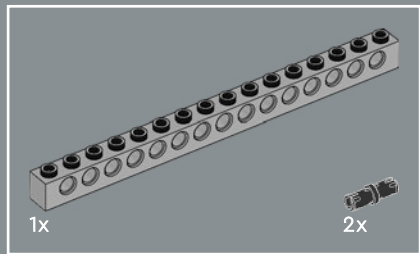
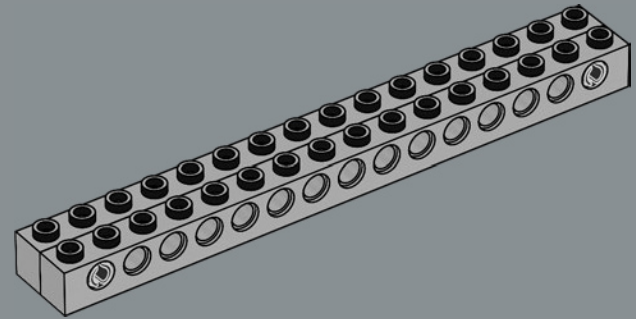

110

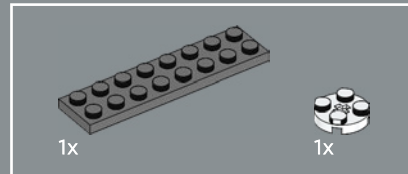
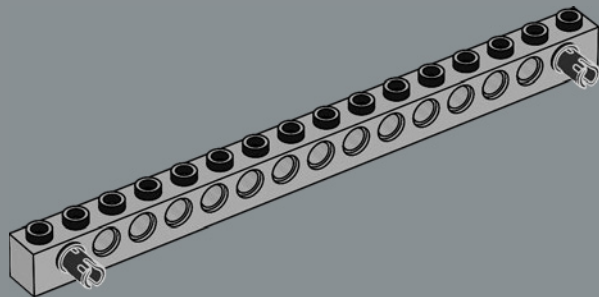

112

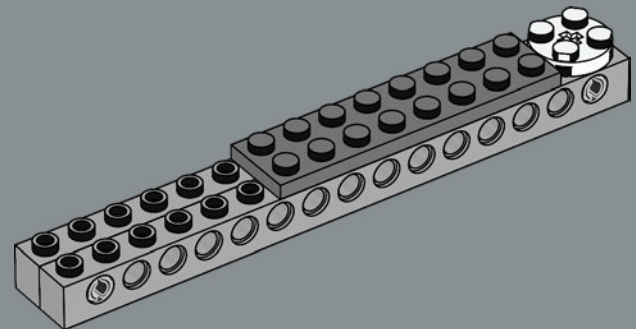

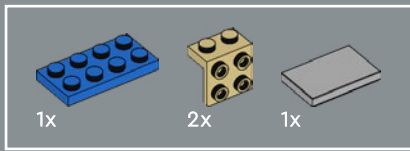

113

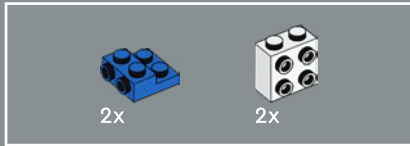
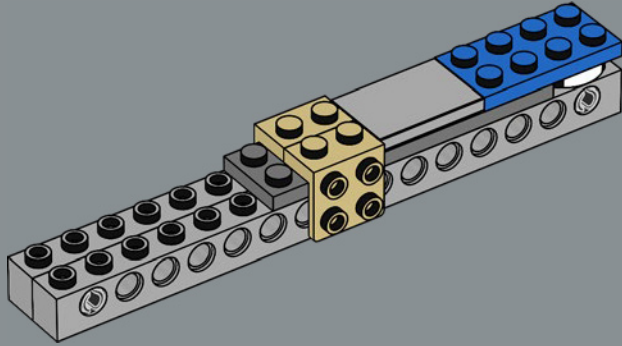

114

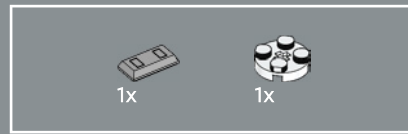
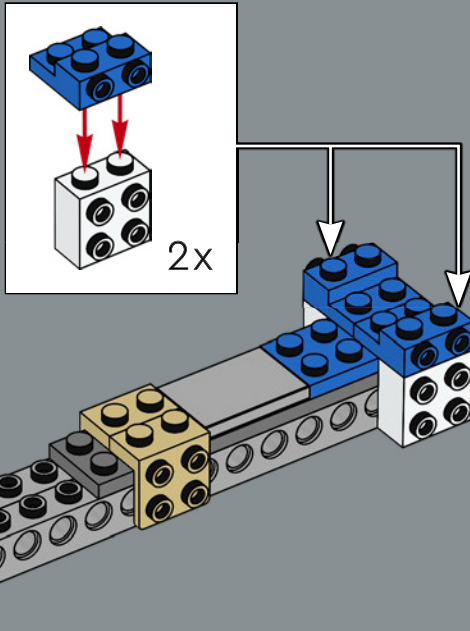

115

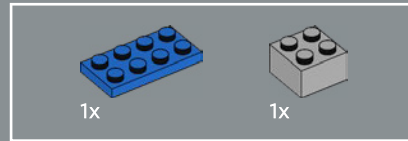
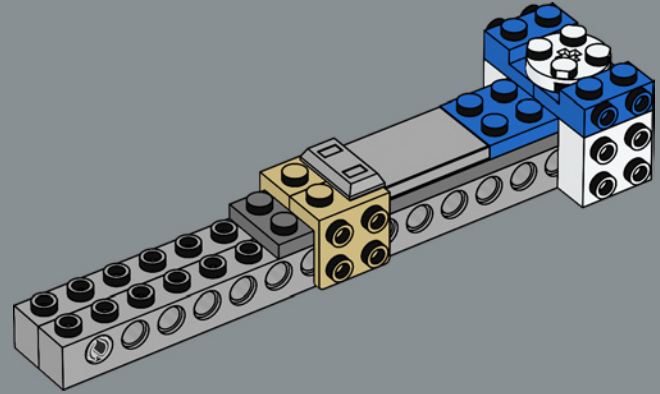

116

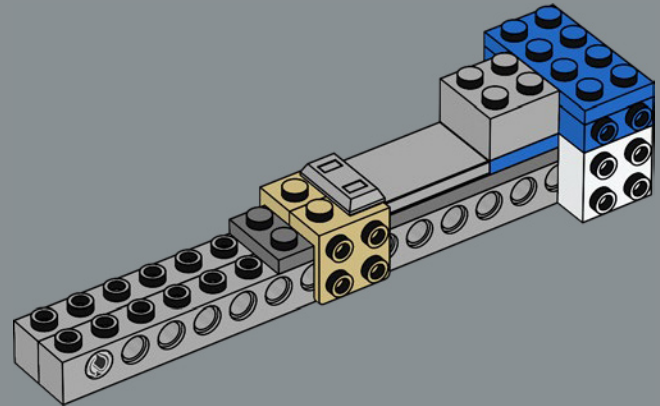

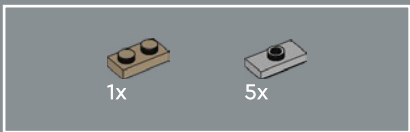

117

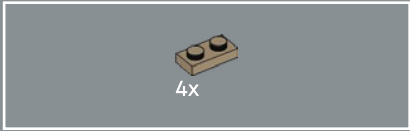
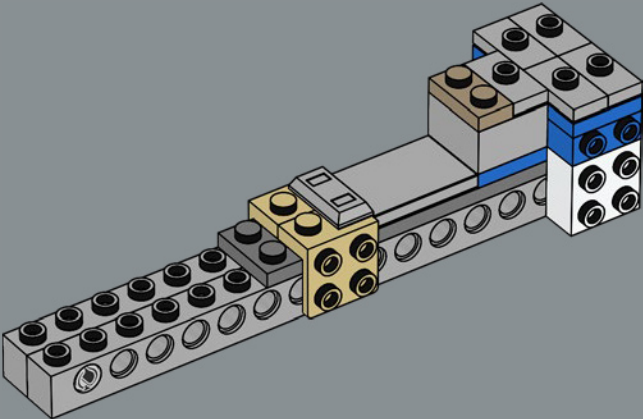

118

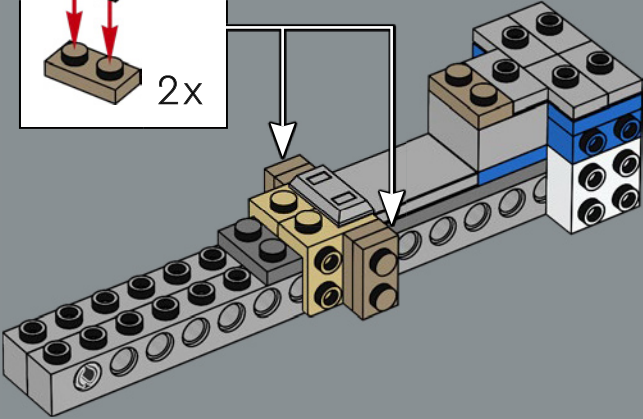
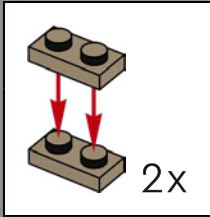

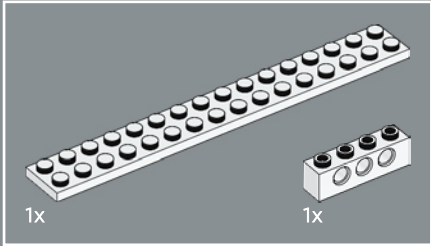
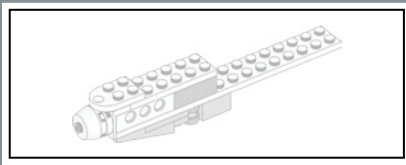

119

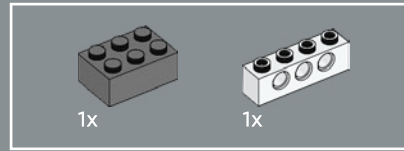
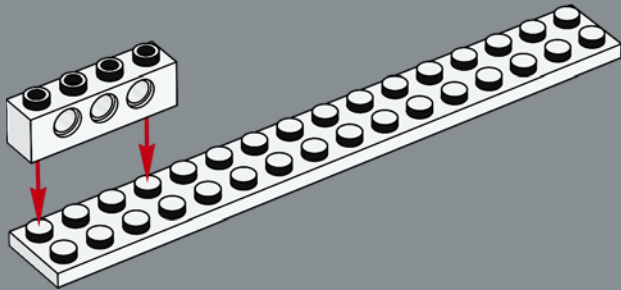

120

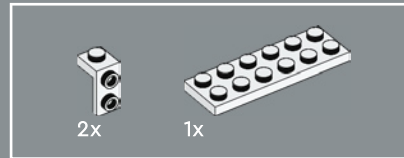
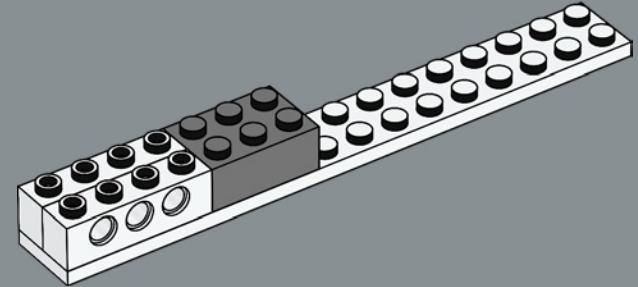

121

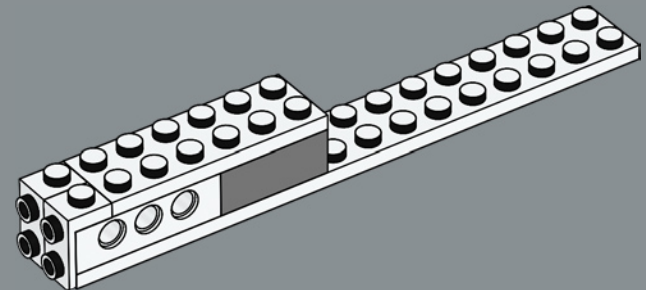

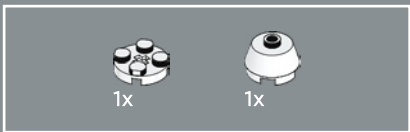

122

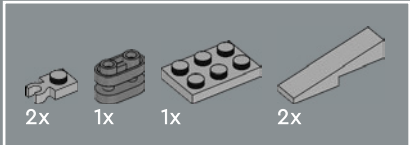
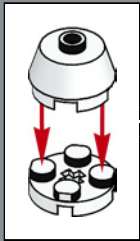
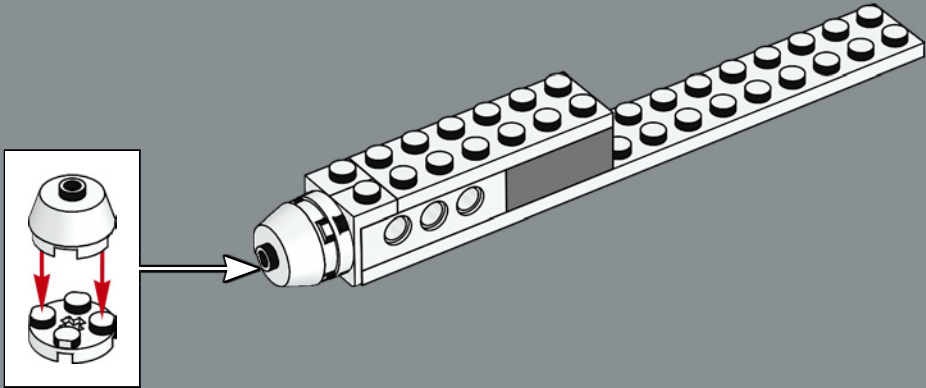

123

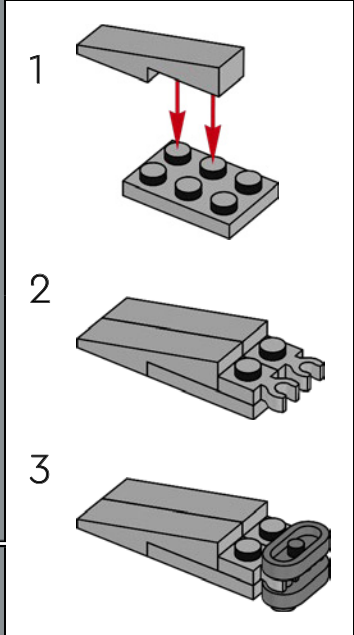
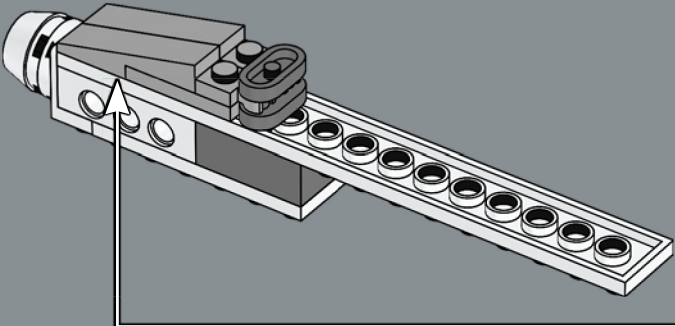
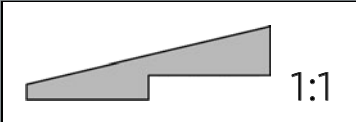

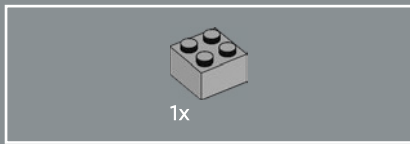

124

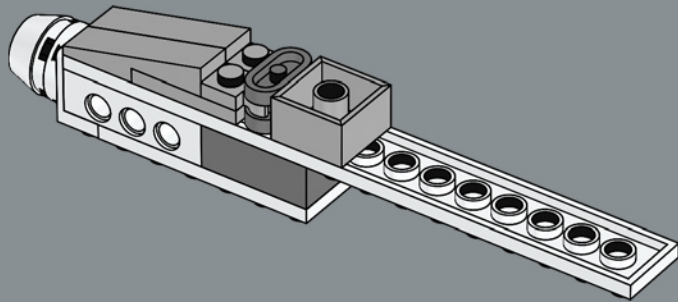

125

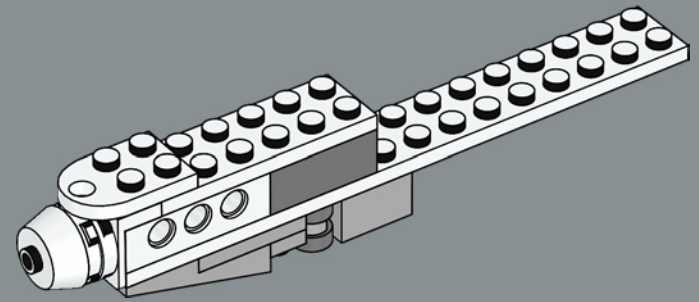

126

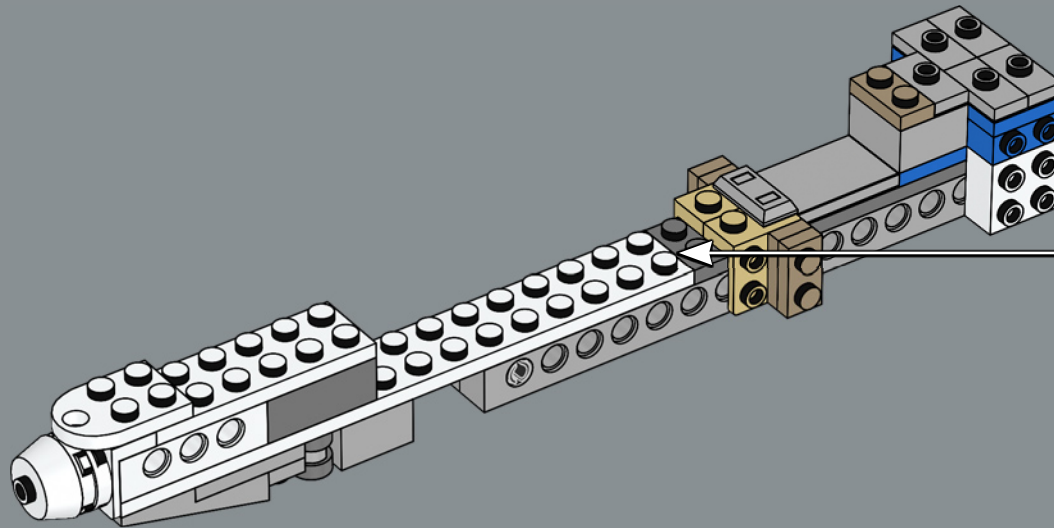

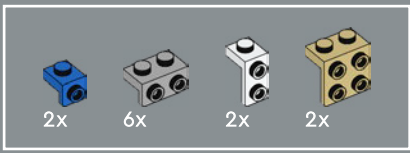

127

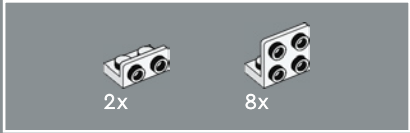
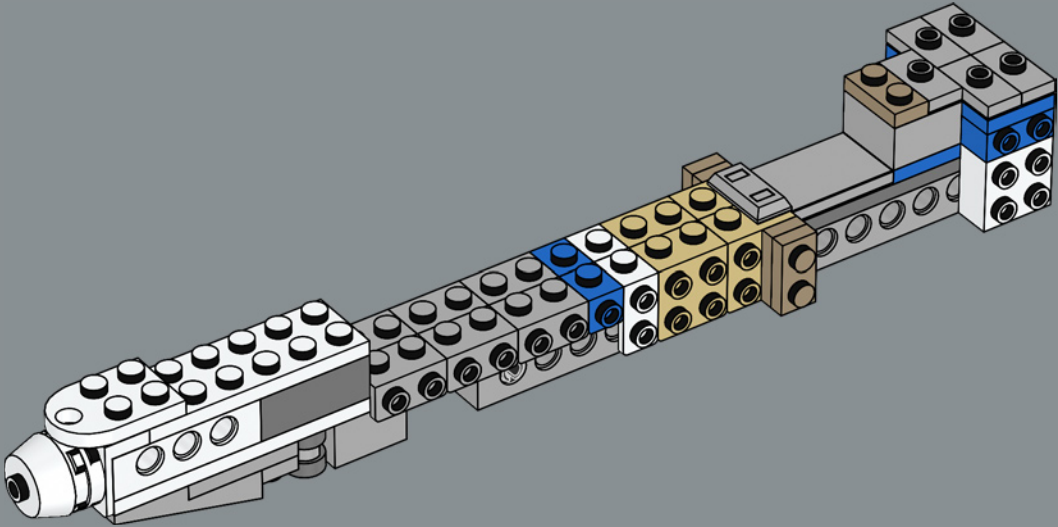

128

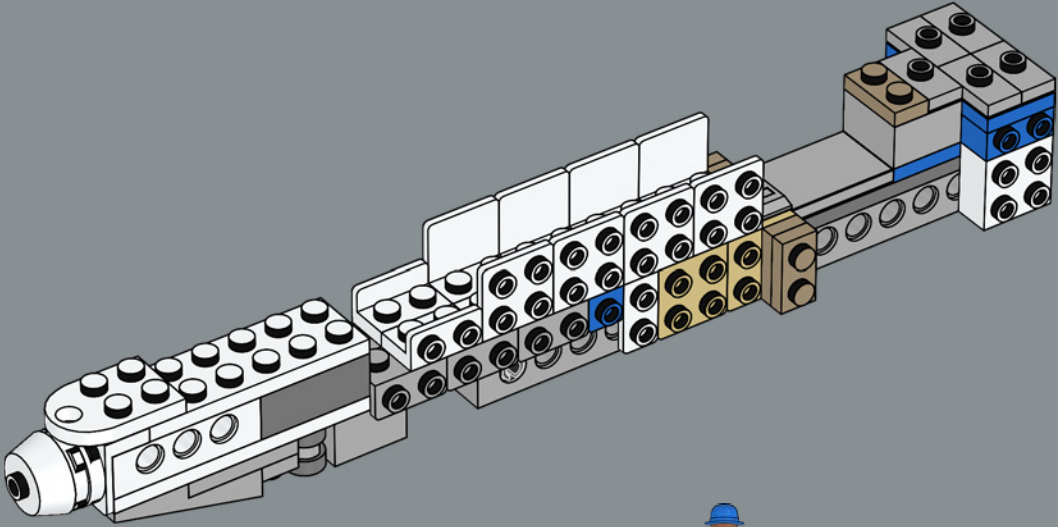

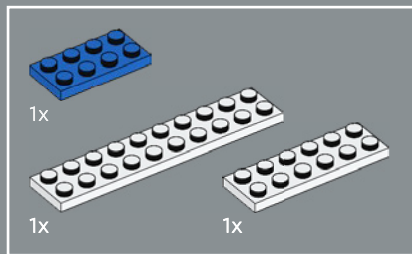

129

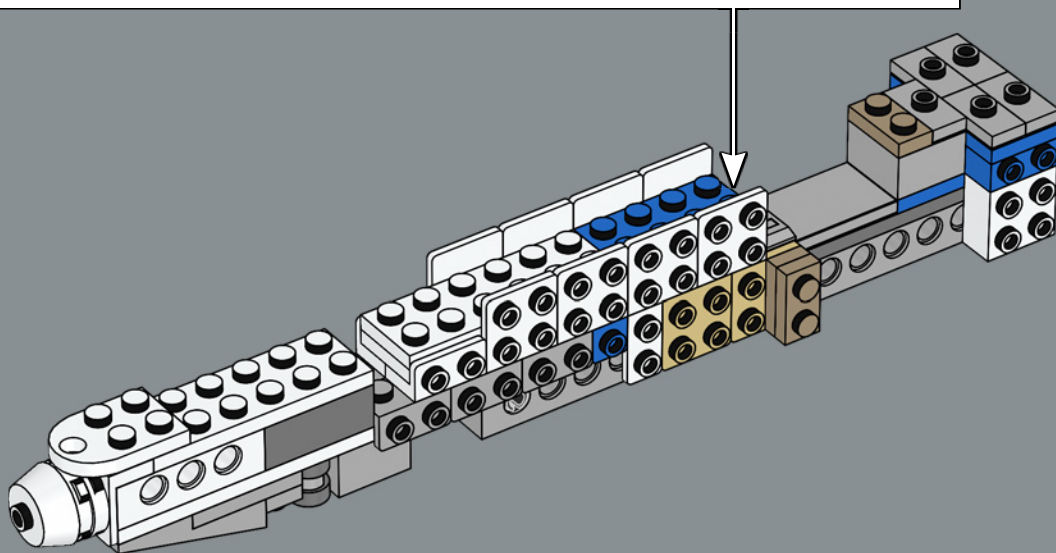
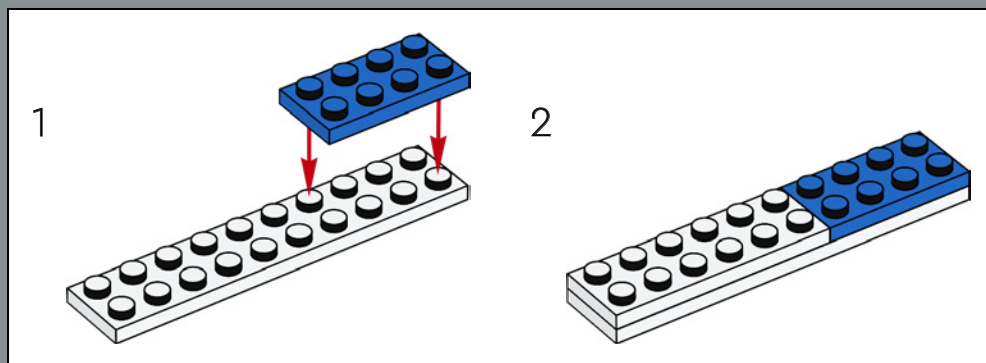



2x

130

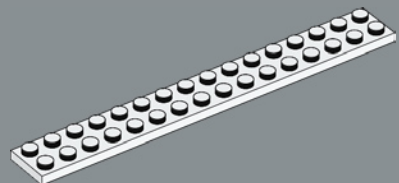
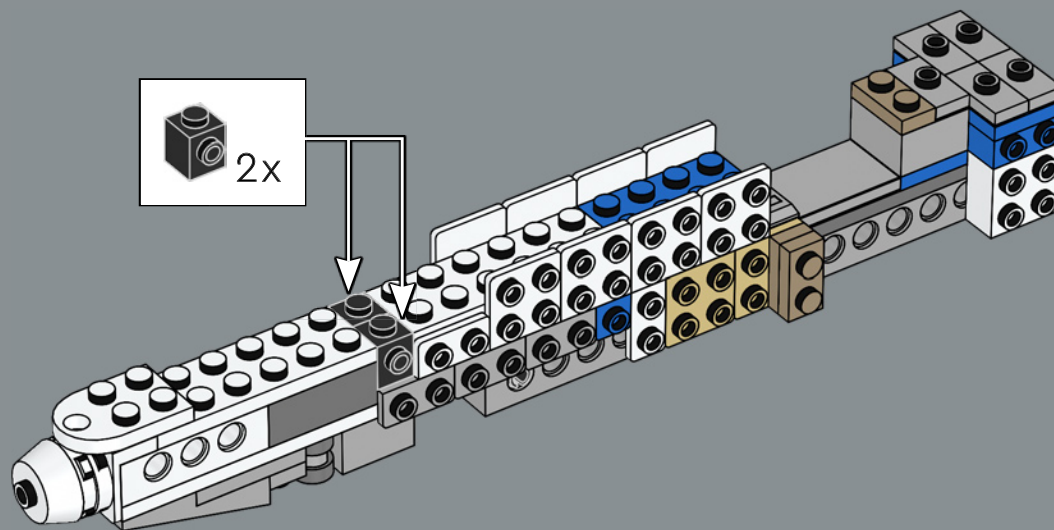

1x

131

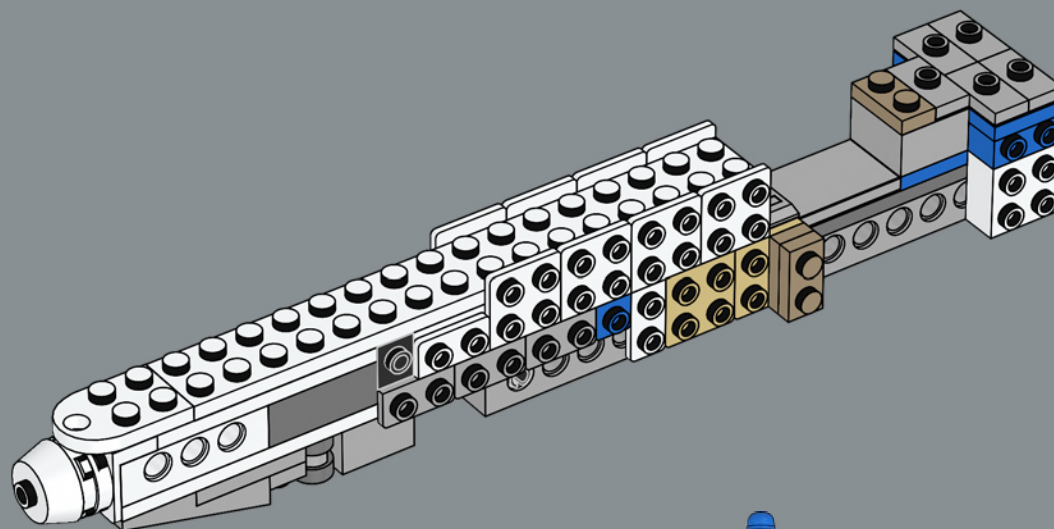

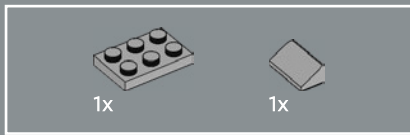

132

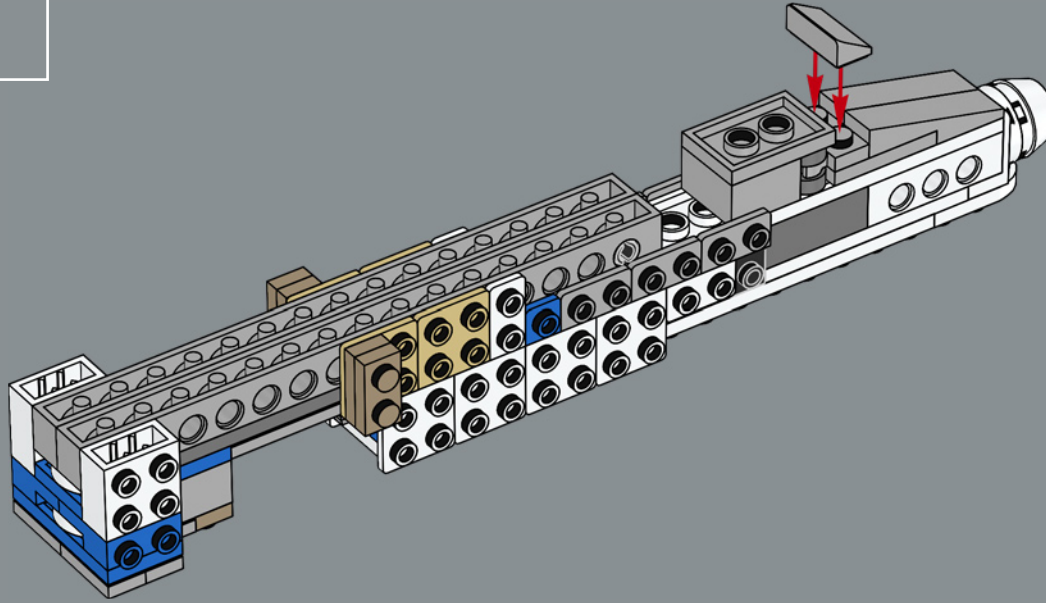

133

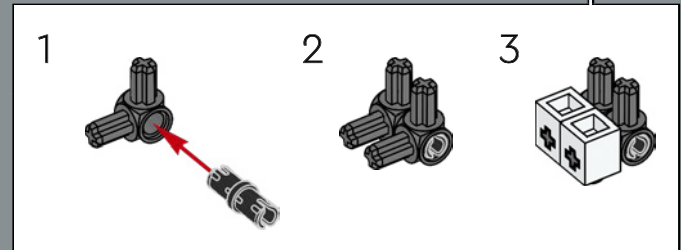
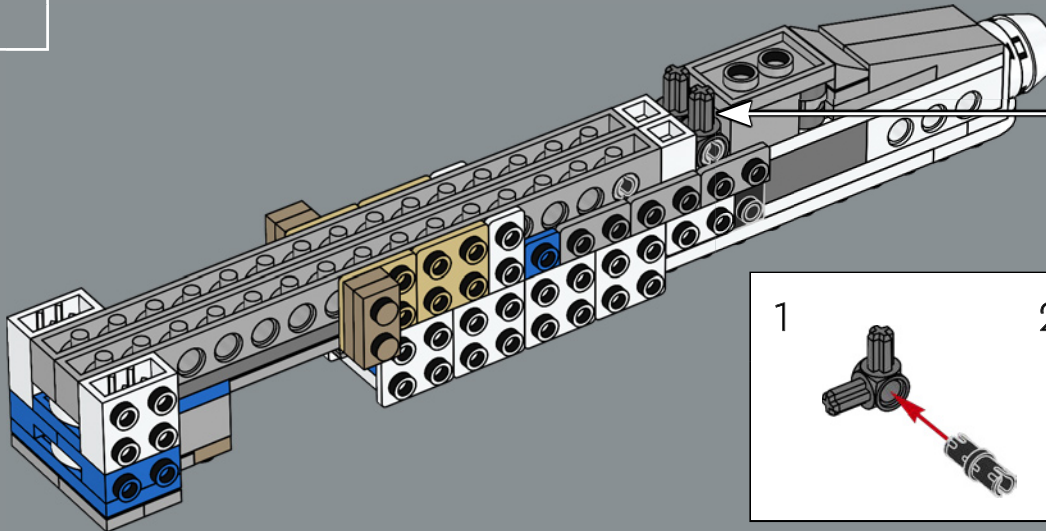

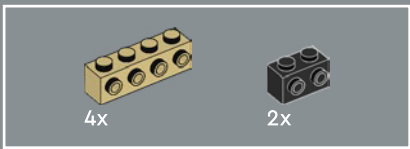

134

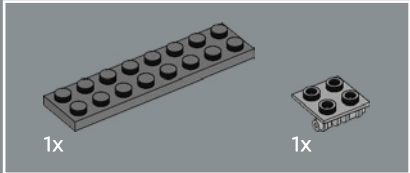
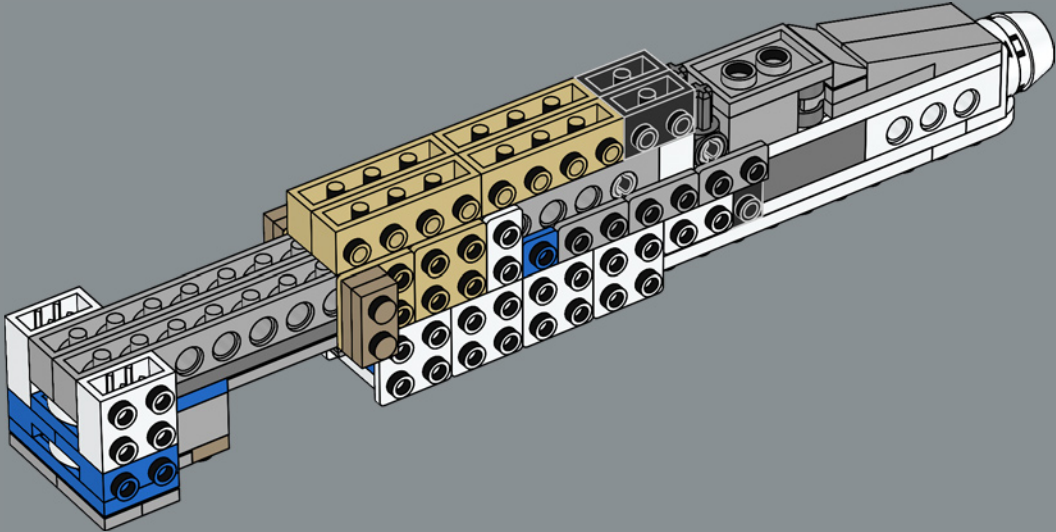

135

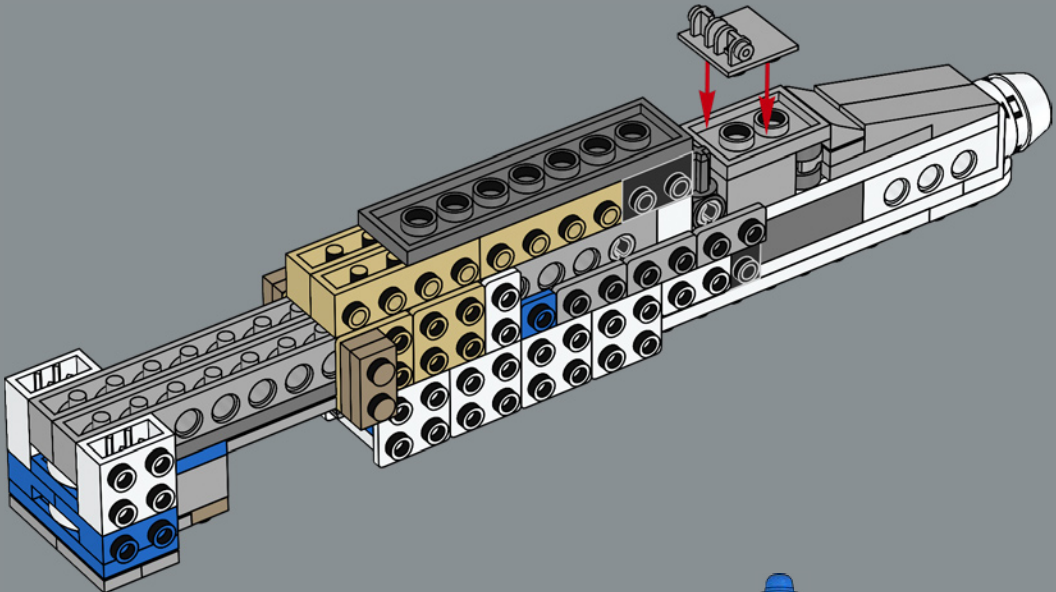

136

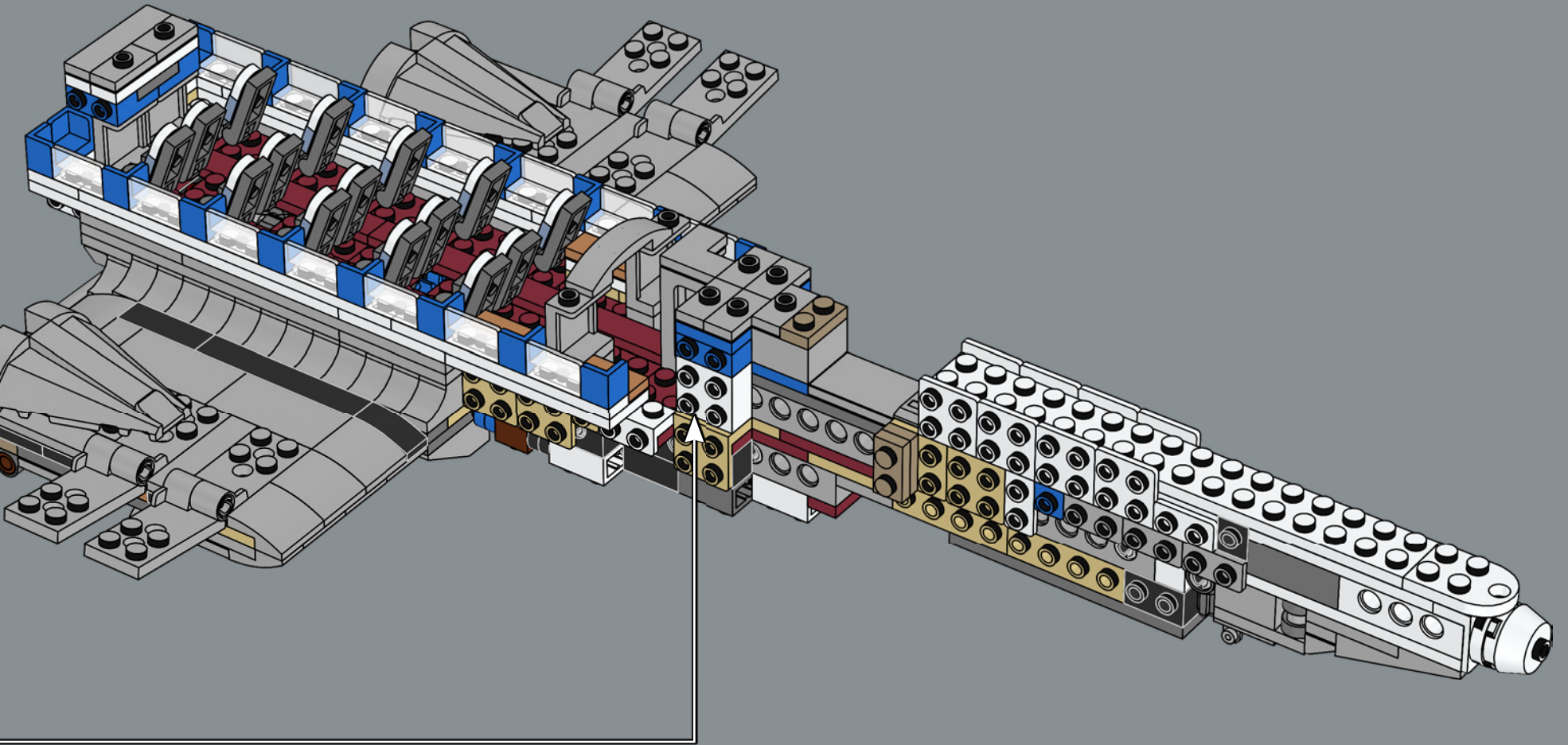



1x

137

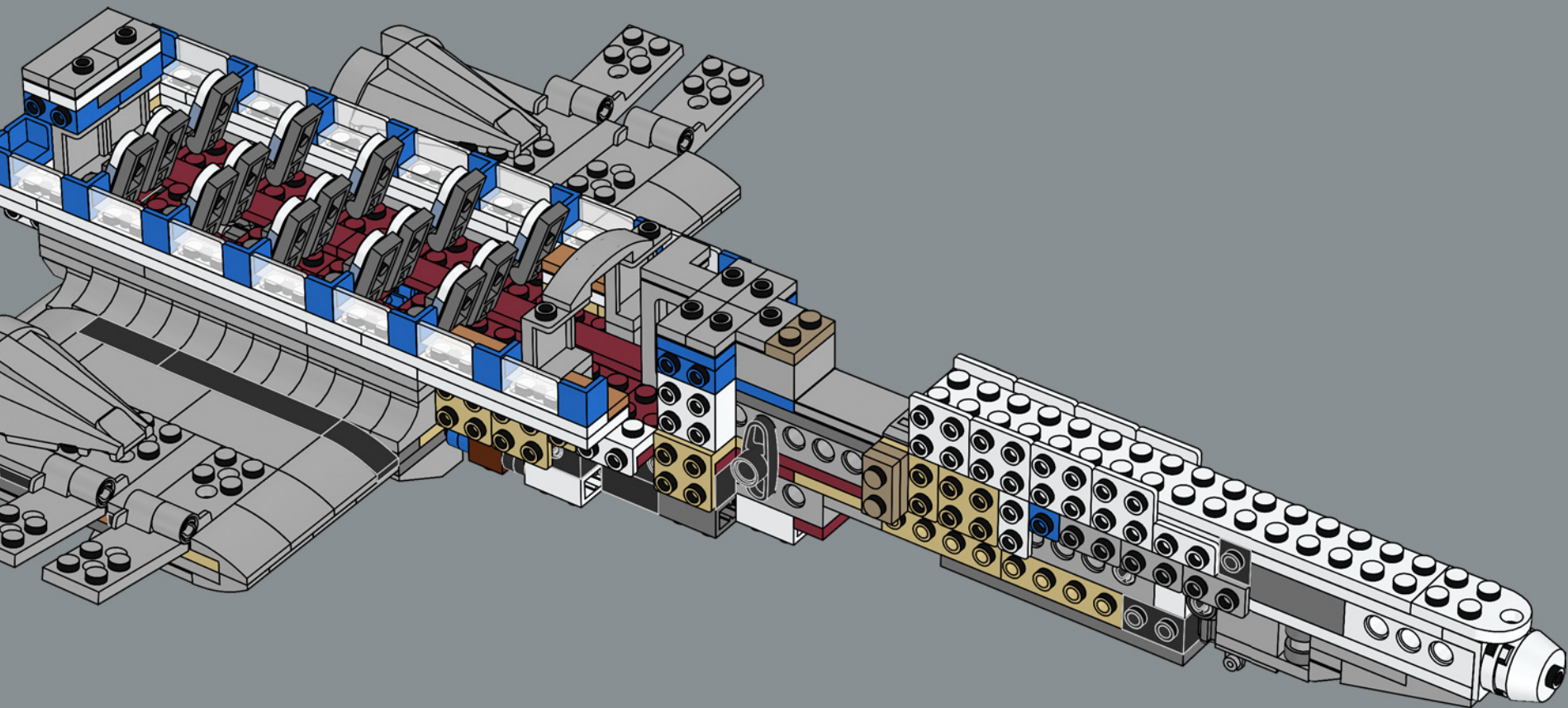

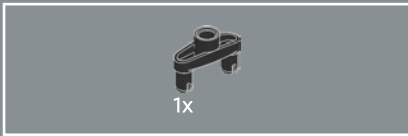

138

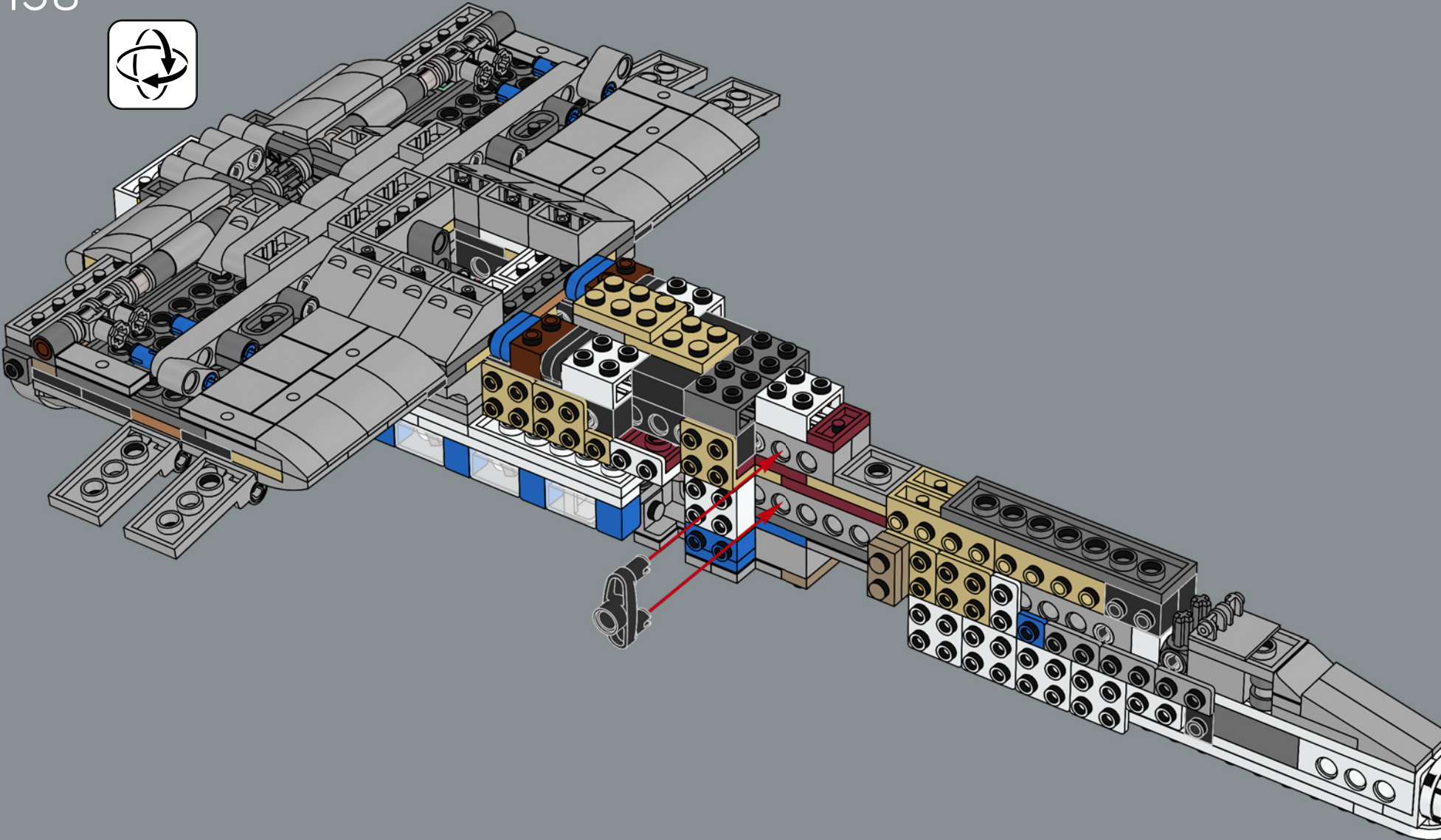

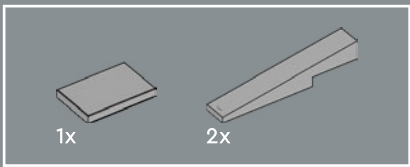

139

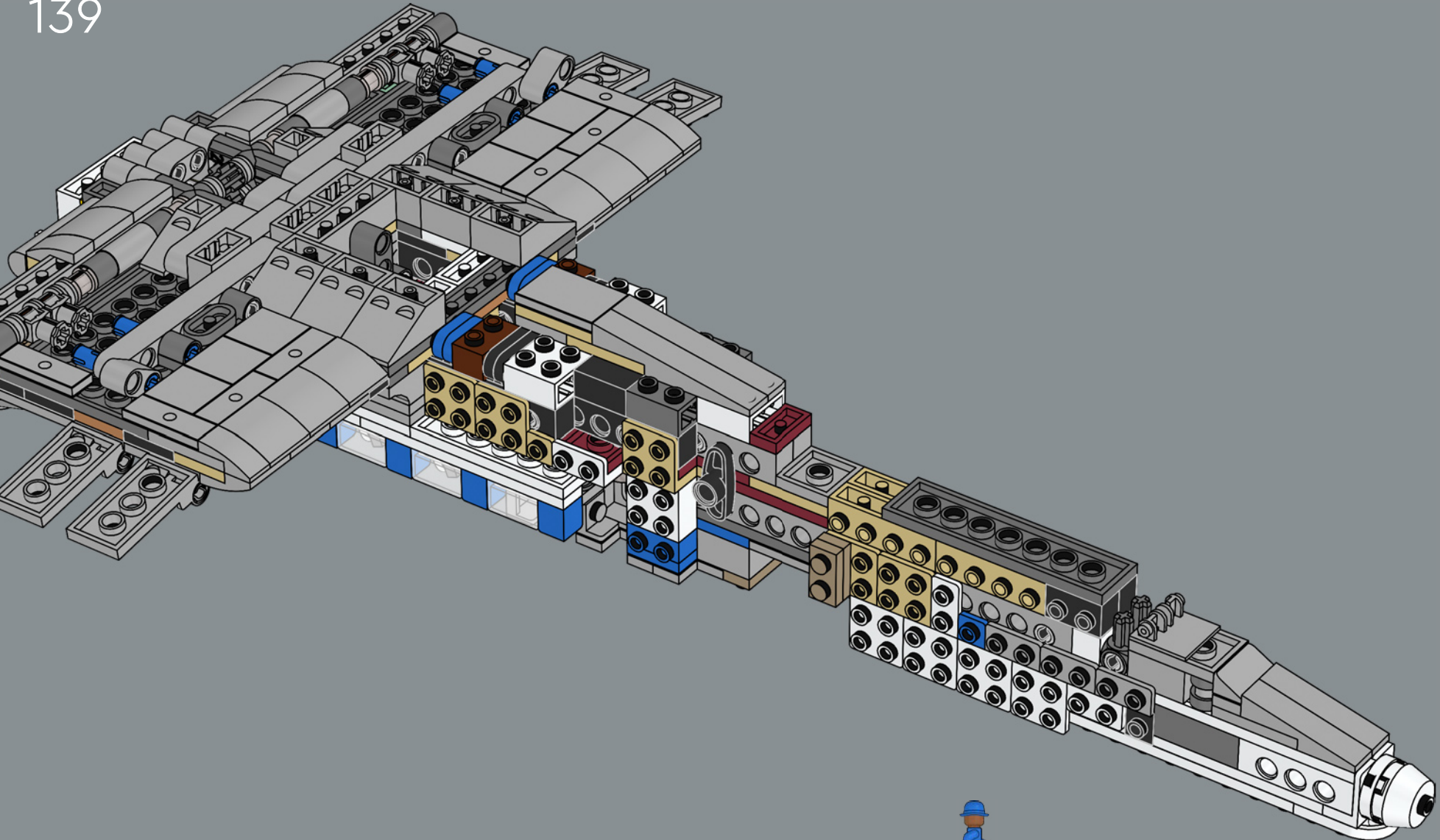

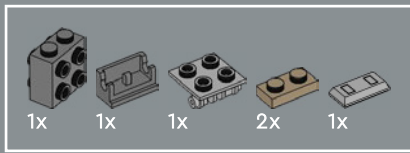

140

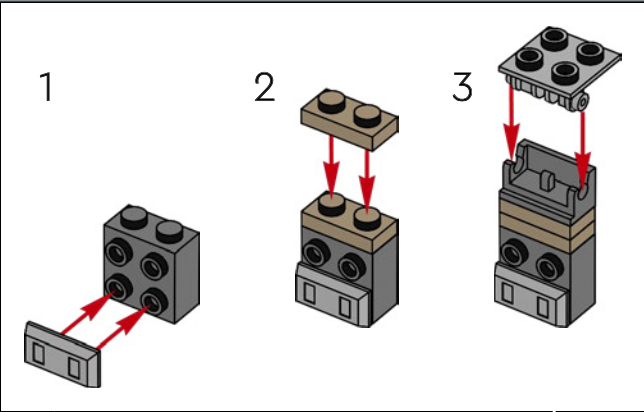
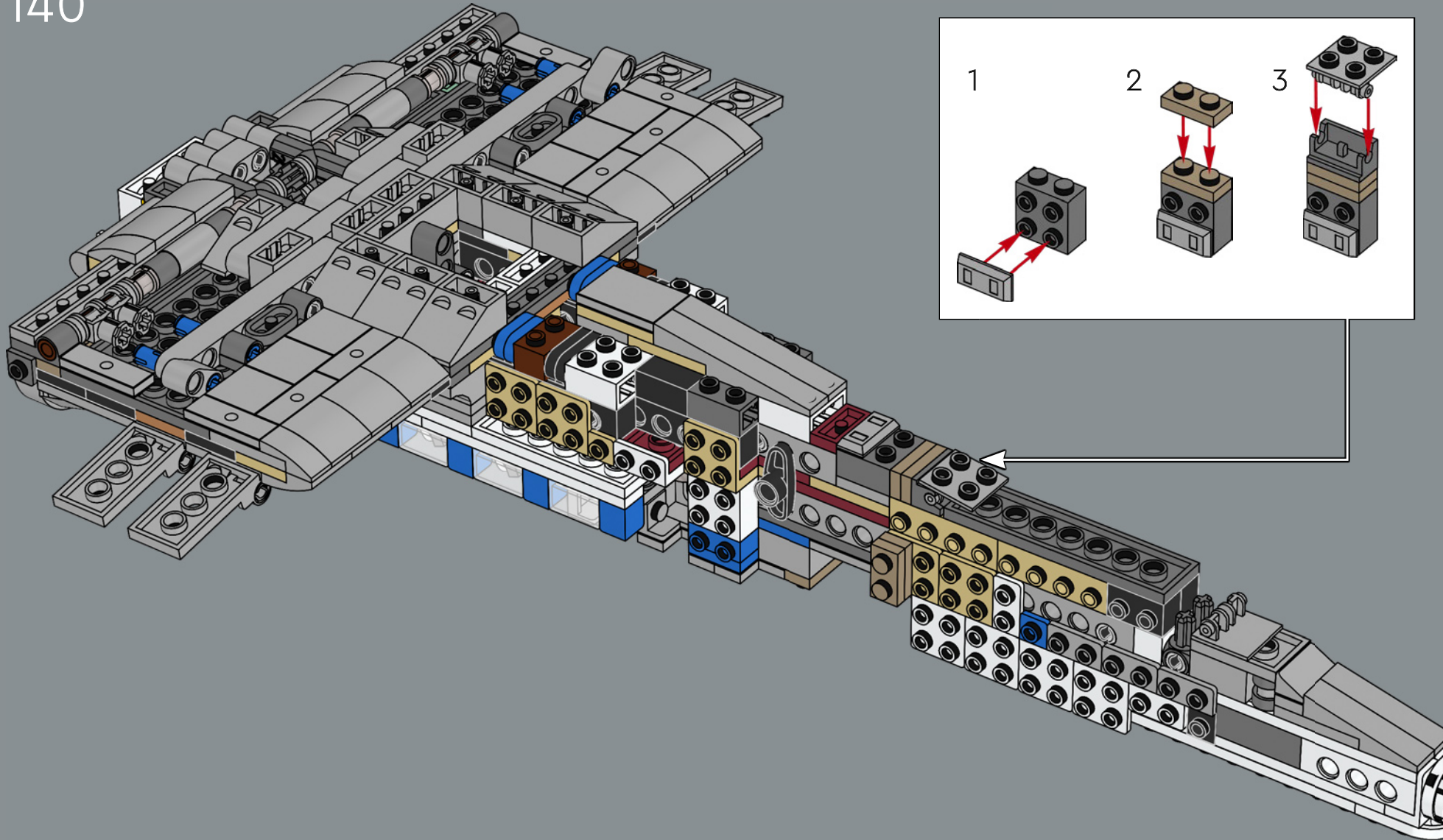

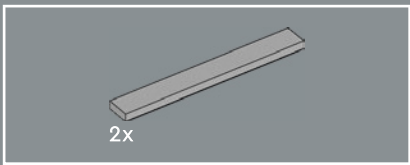

141

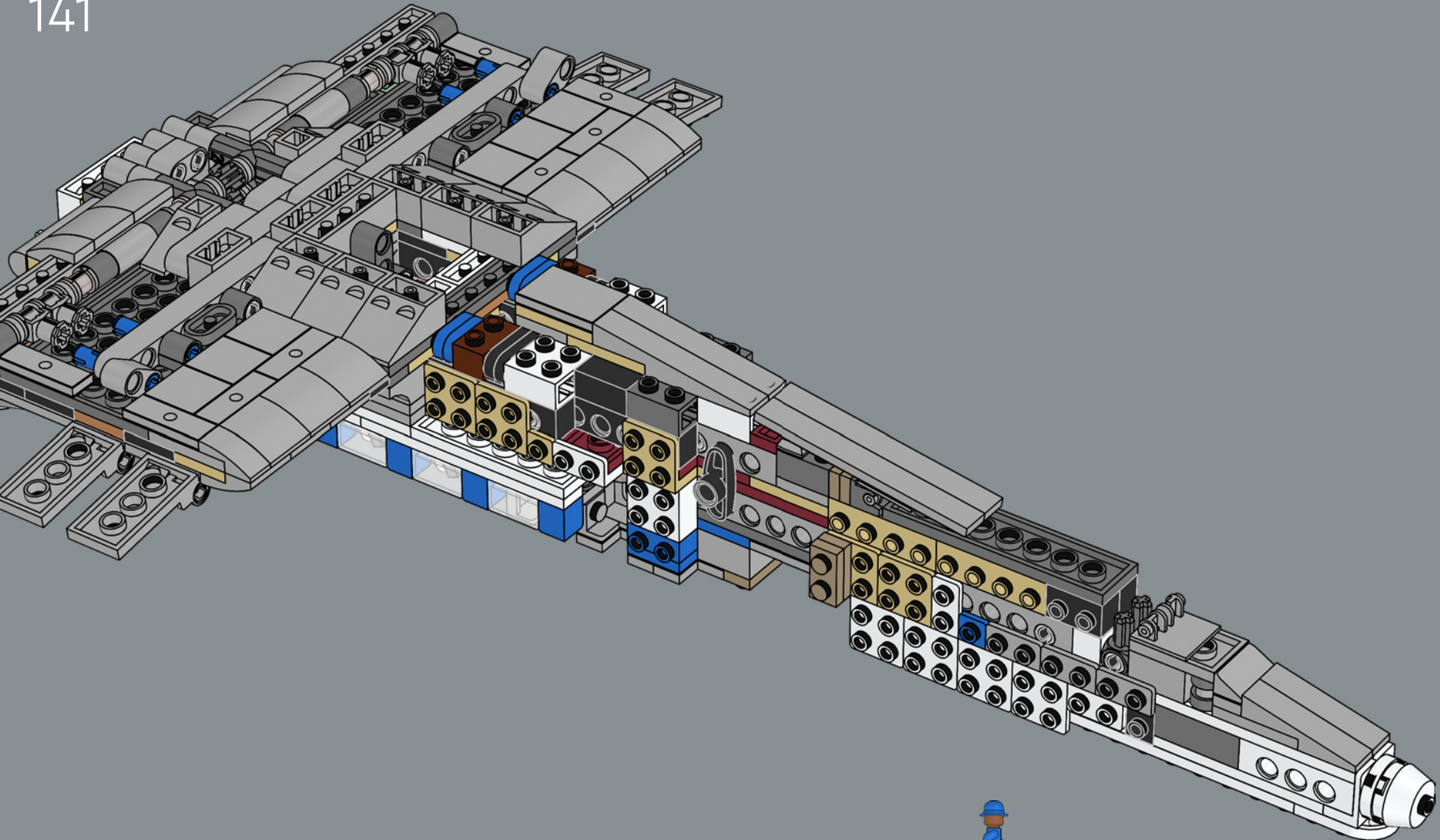

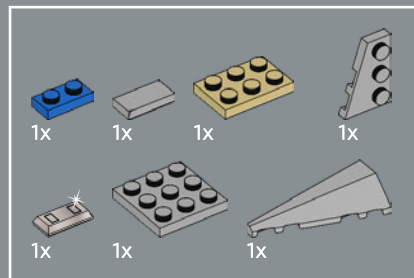
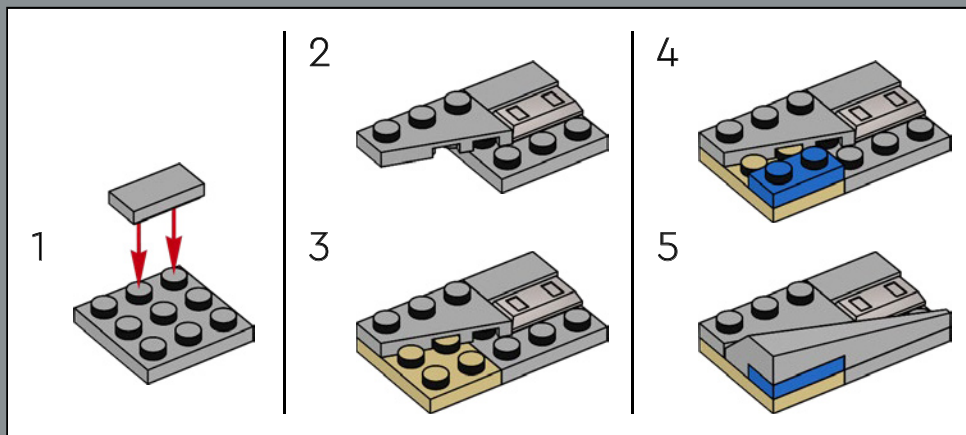

142

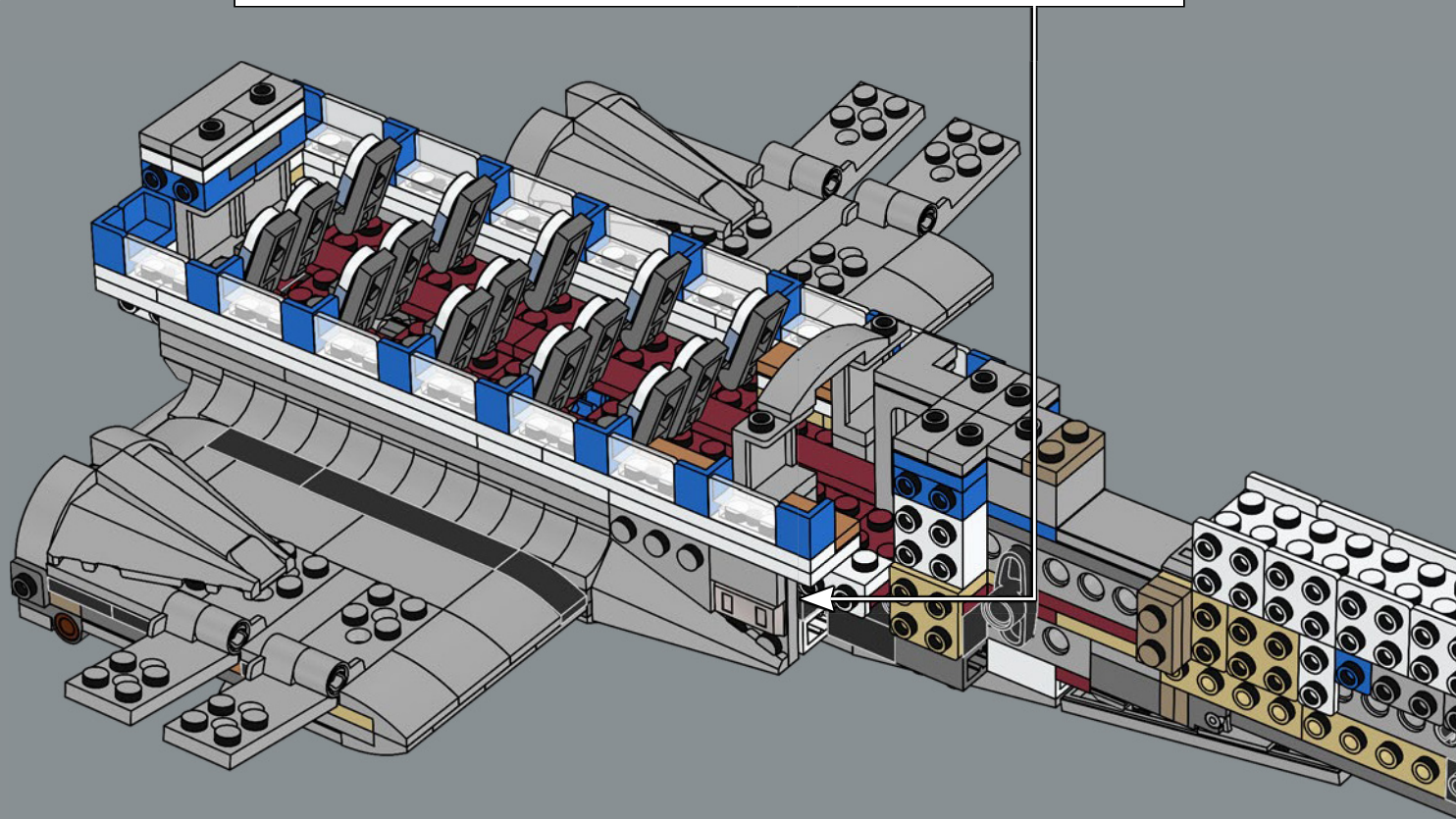

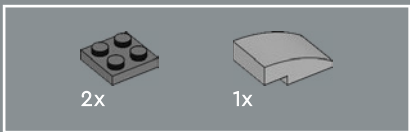

143

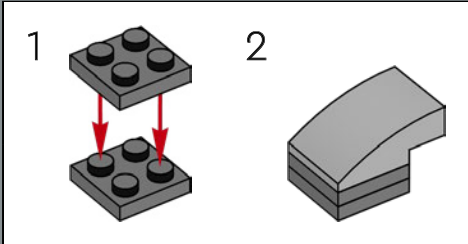
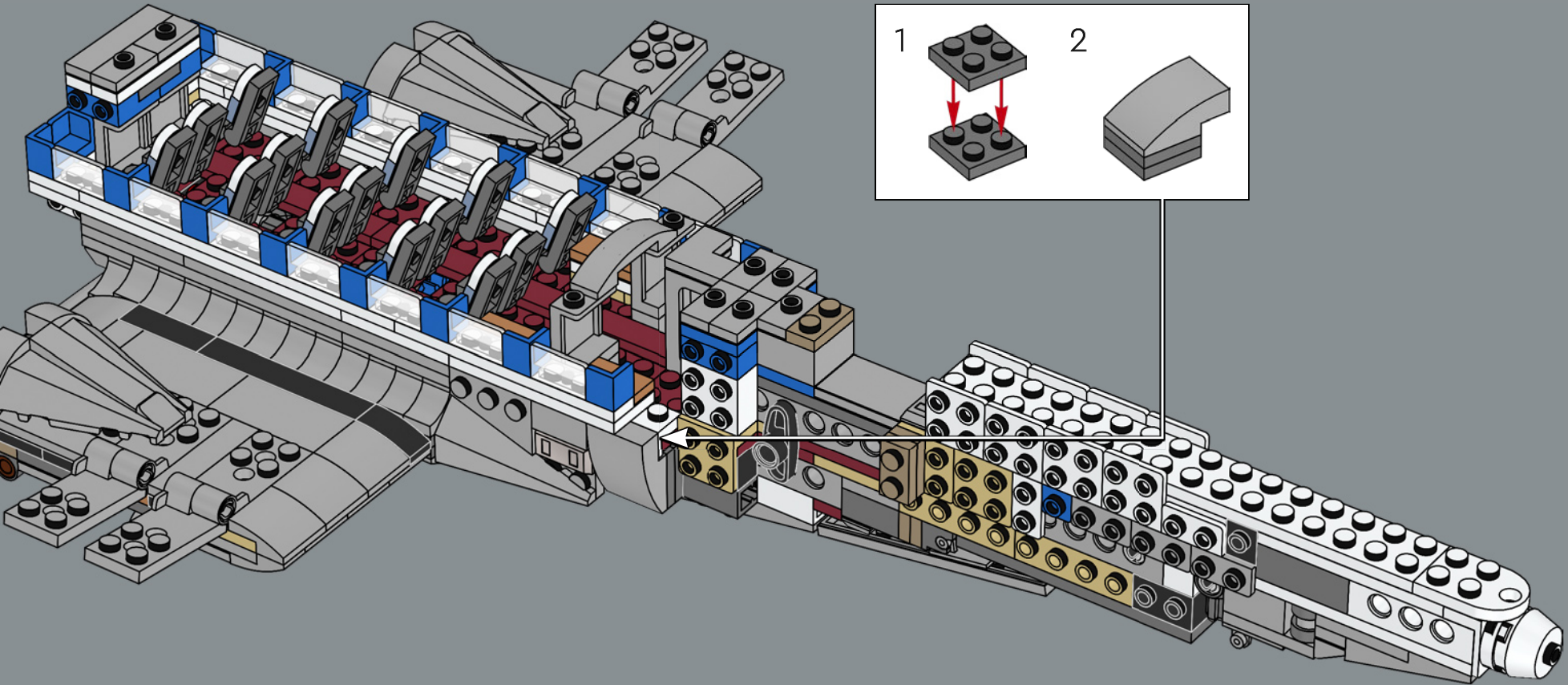

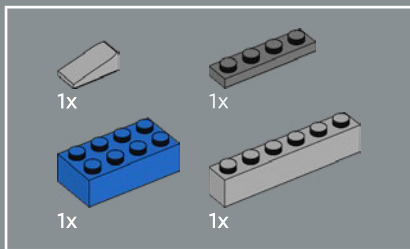

144

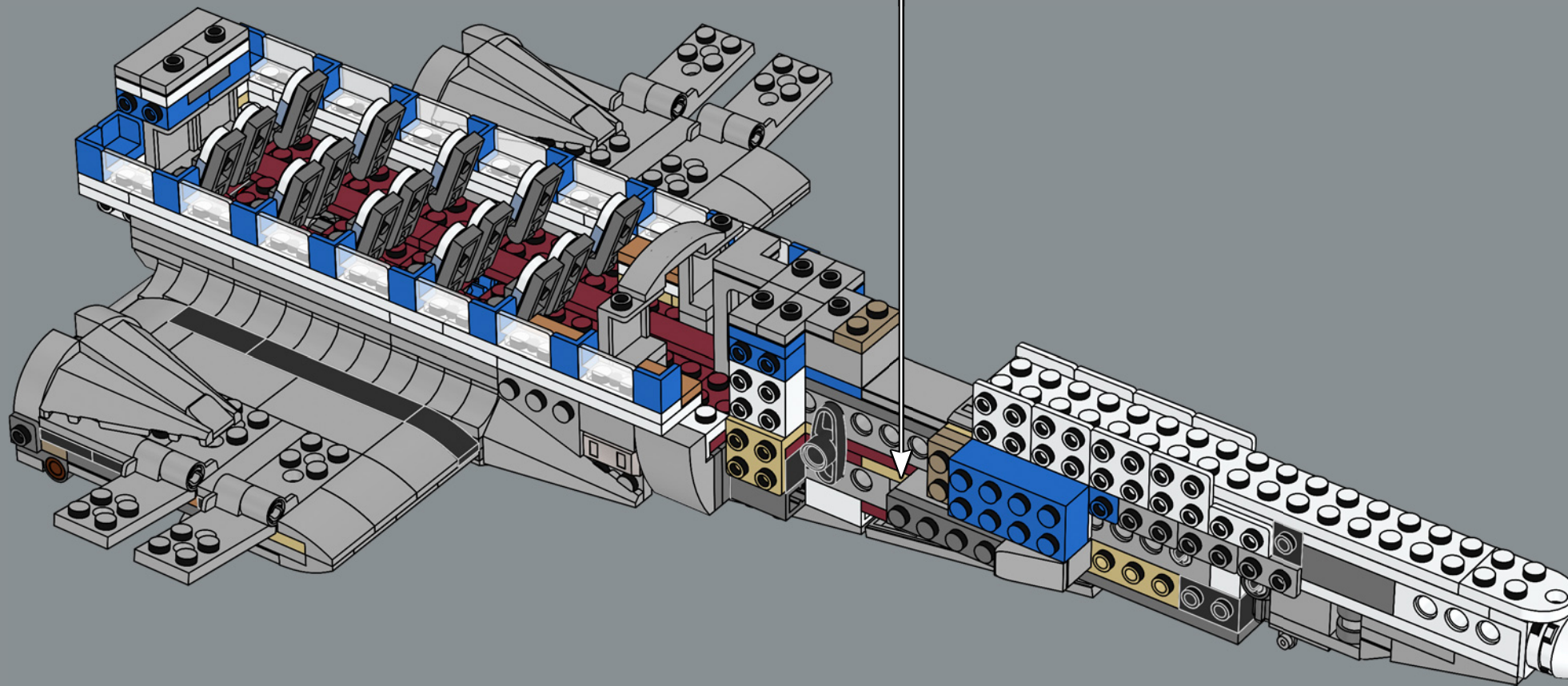
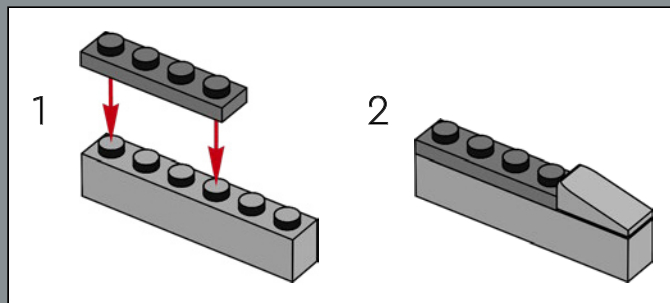

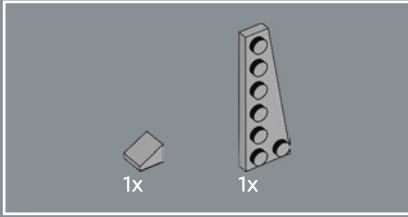
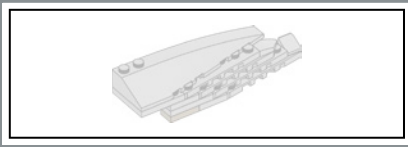

145

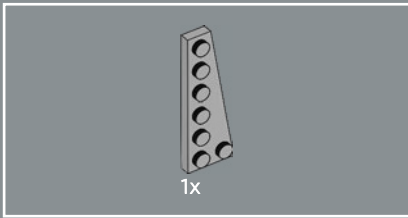
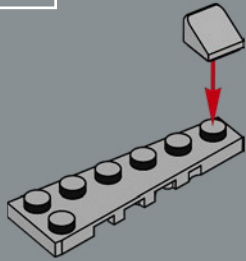

146

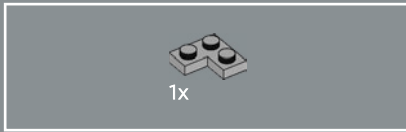
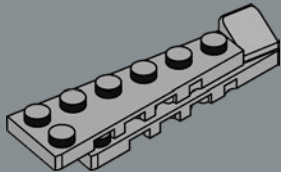

147

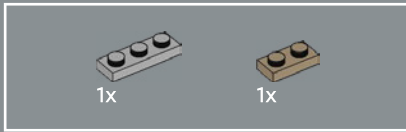
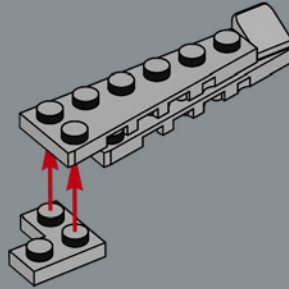

148

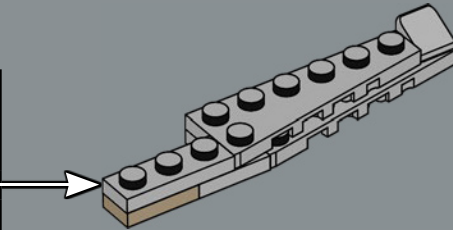
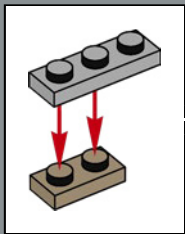

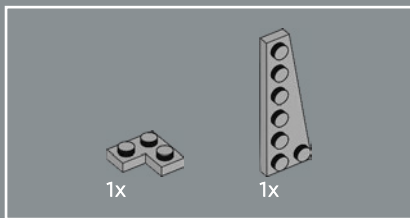

149

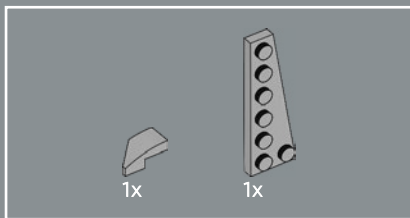
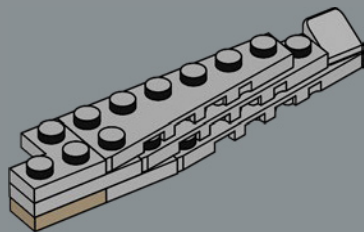

150

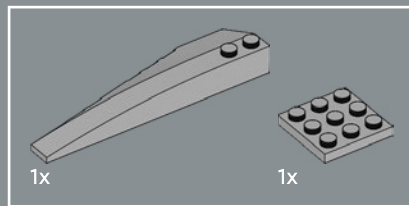
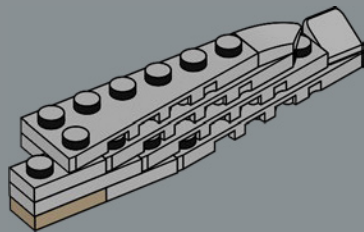

151

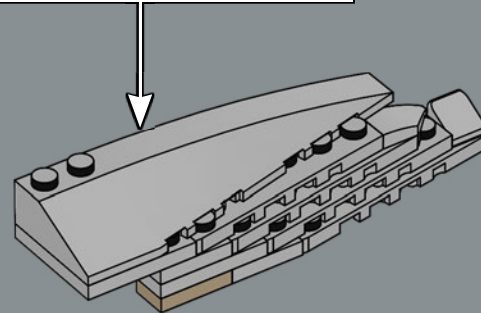
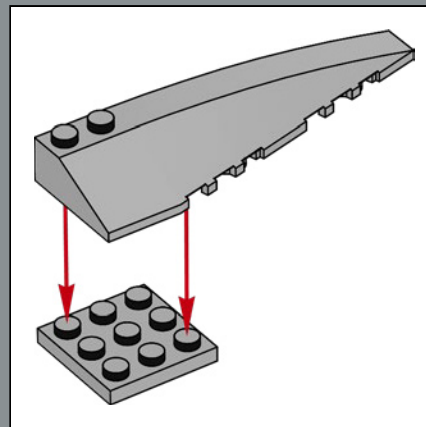

152

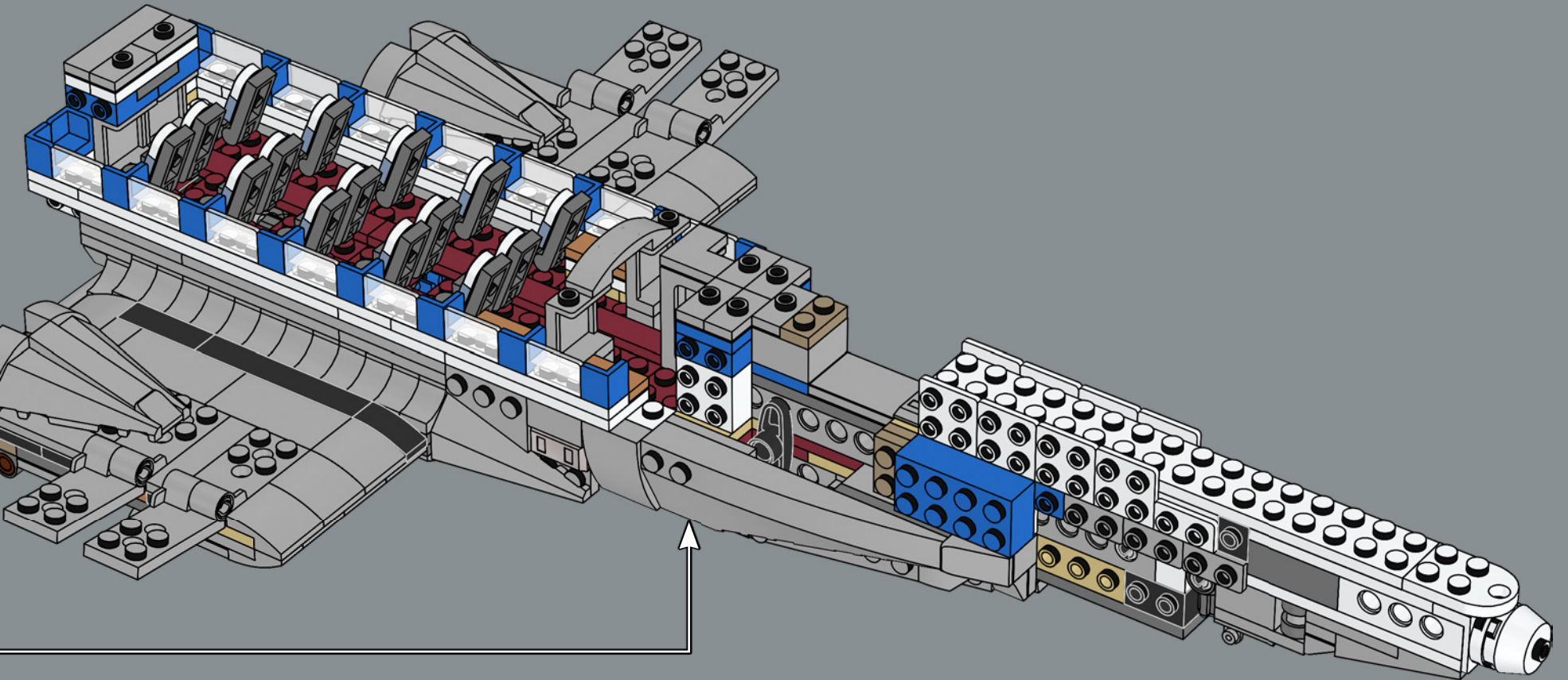

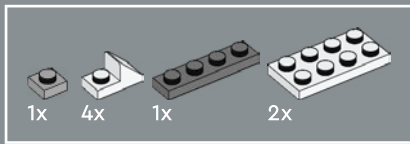

153

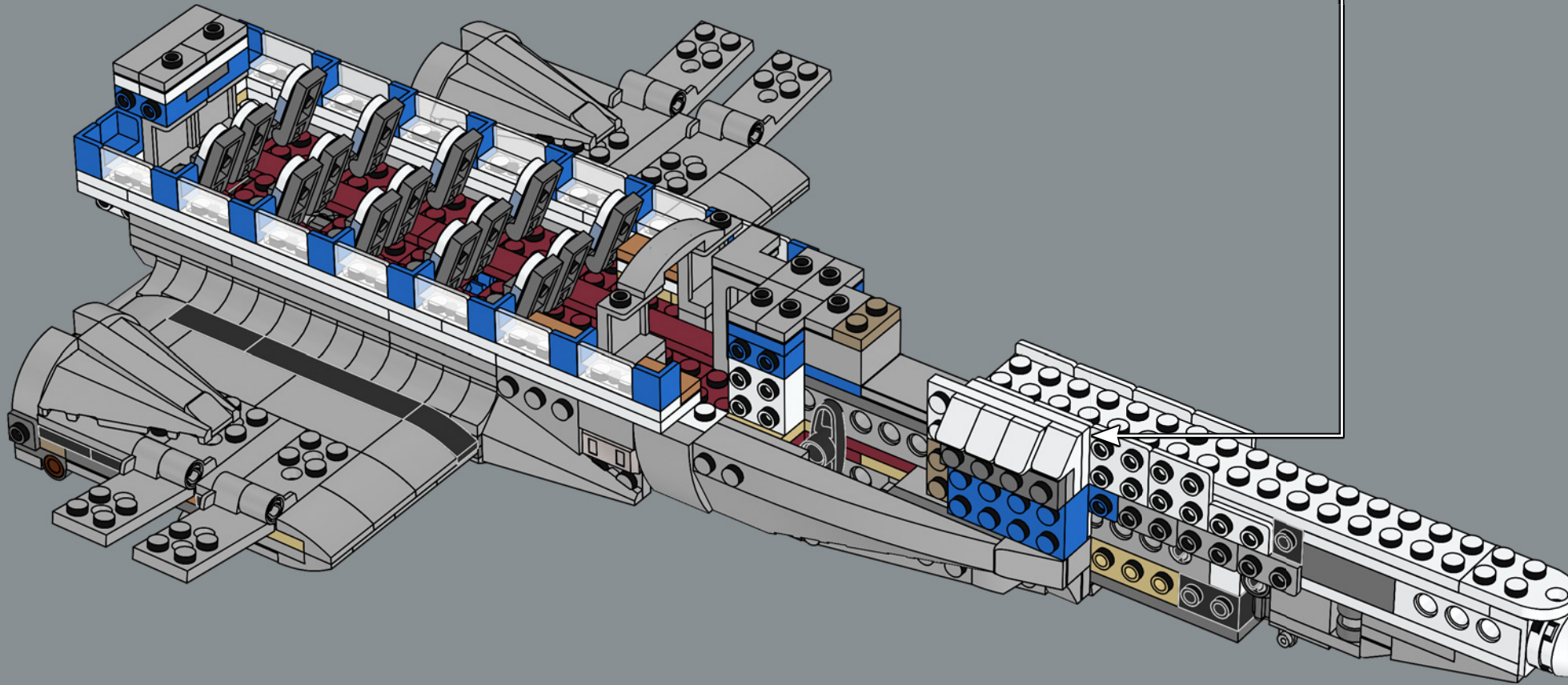
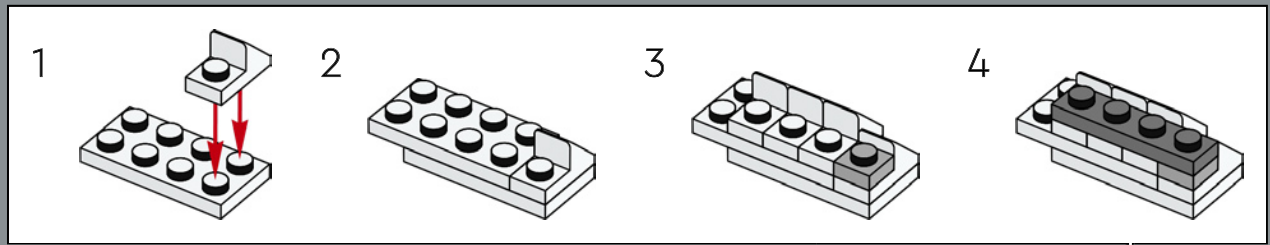

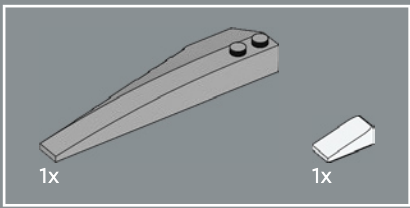

154

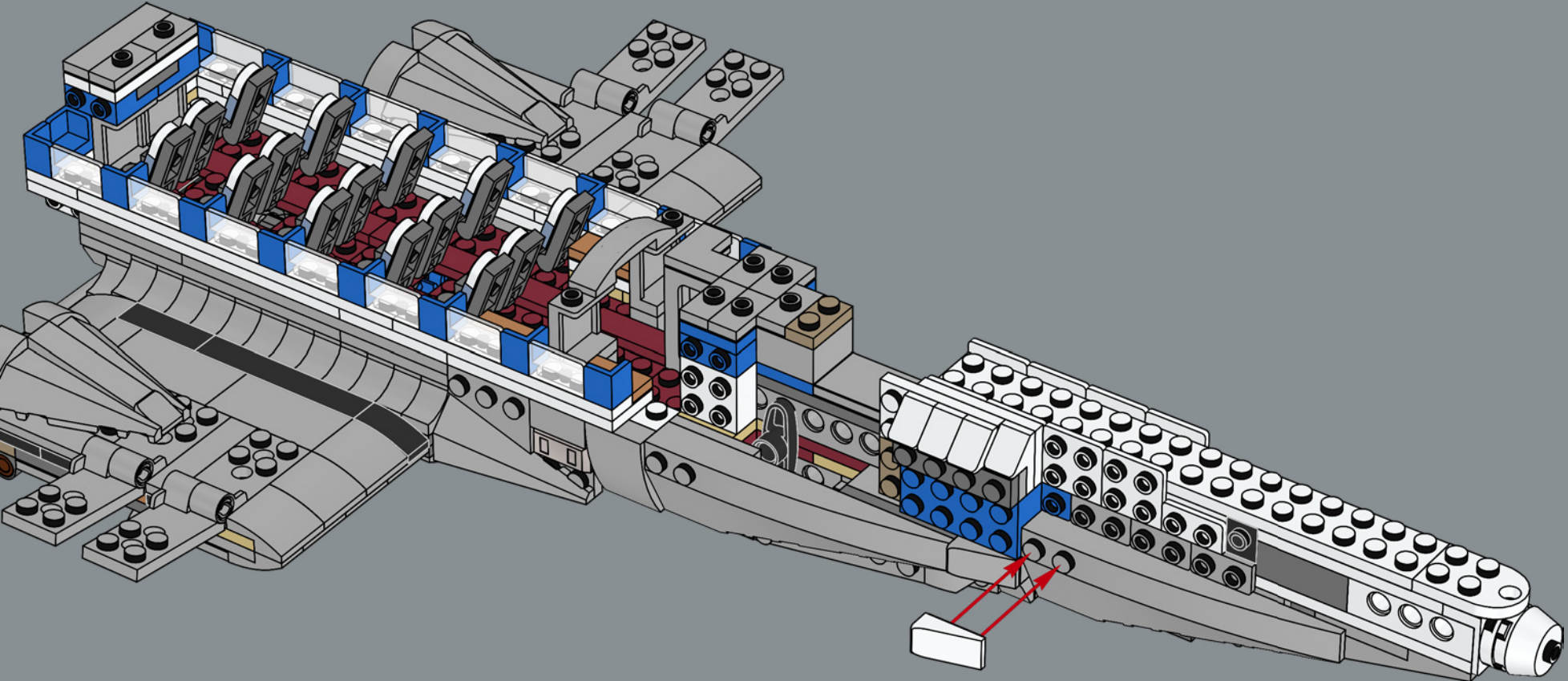

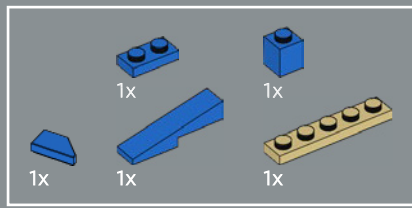

155

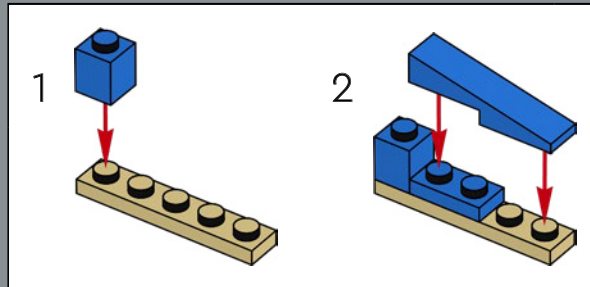
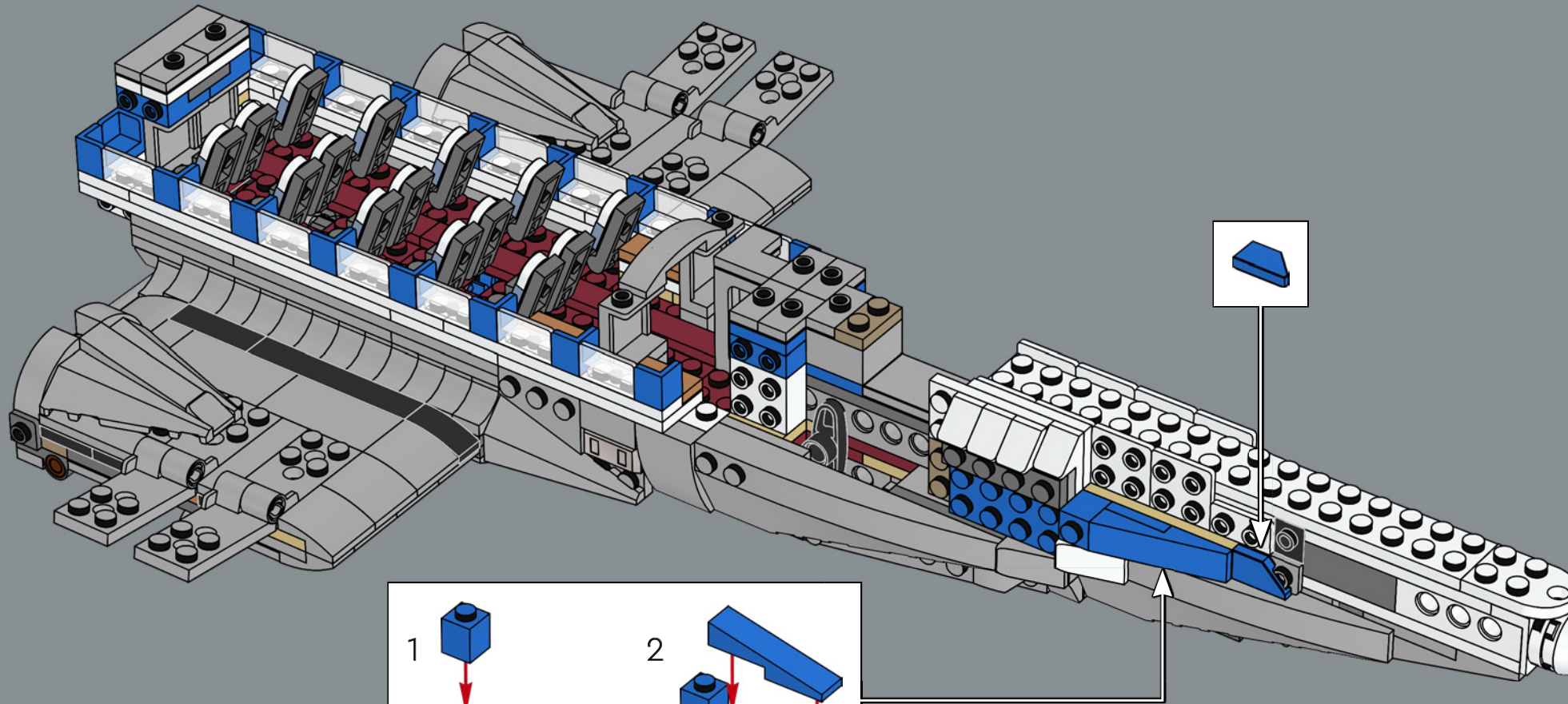

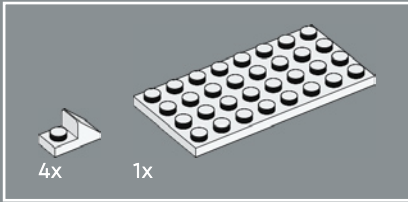
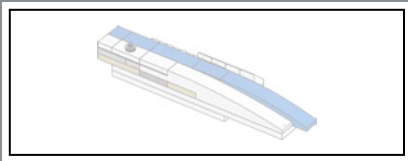

156

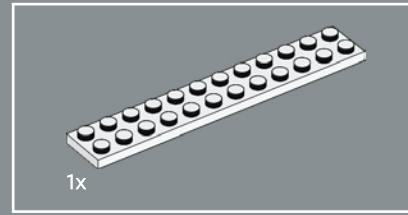
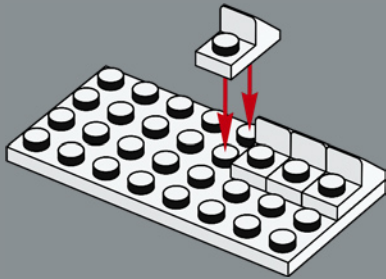

157

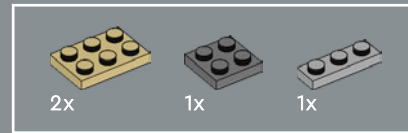
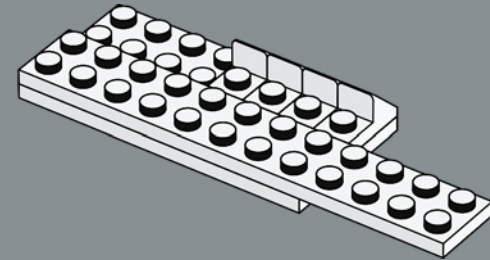

158

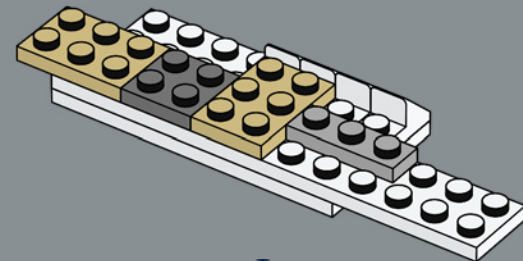

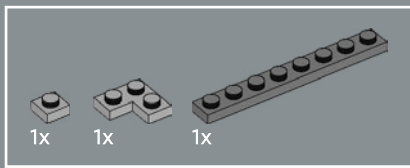

159

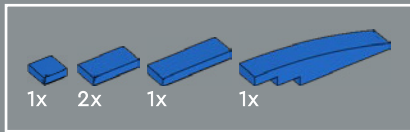
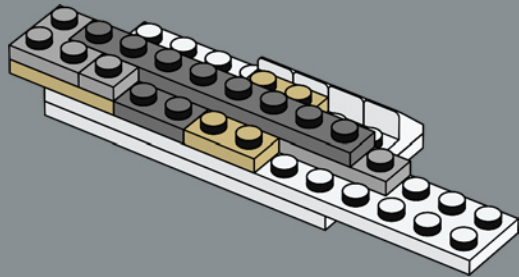

160

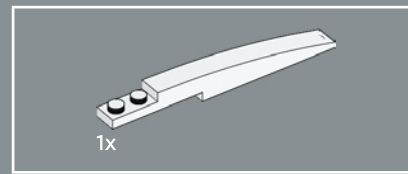
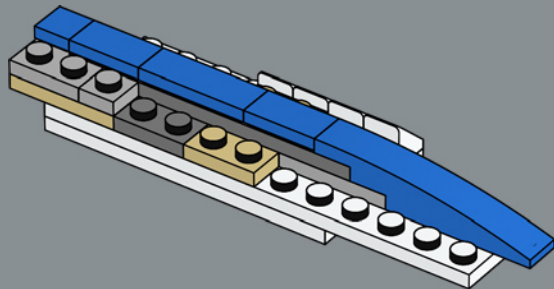

161

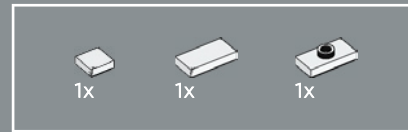
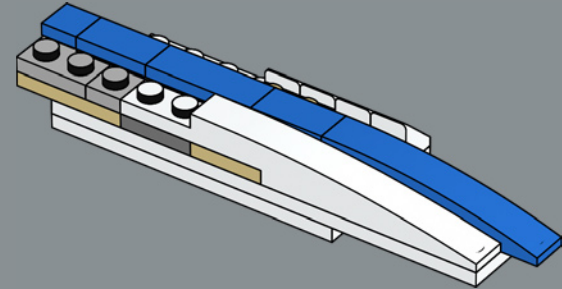

162

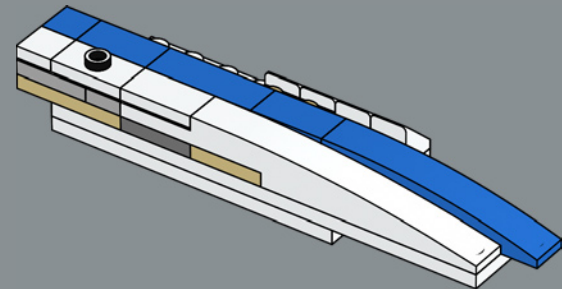

163

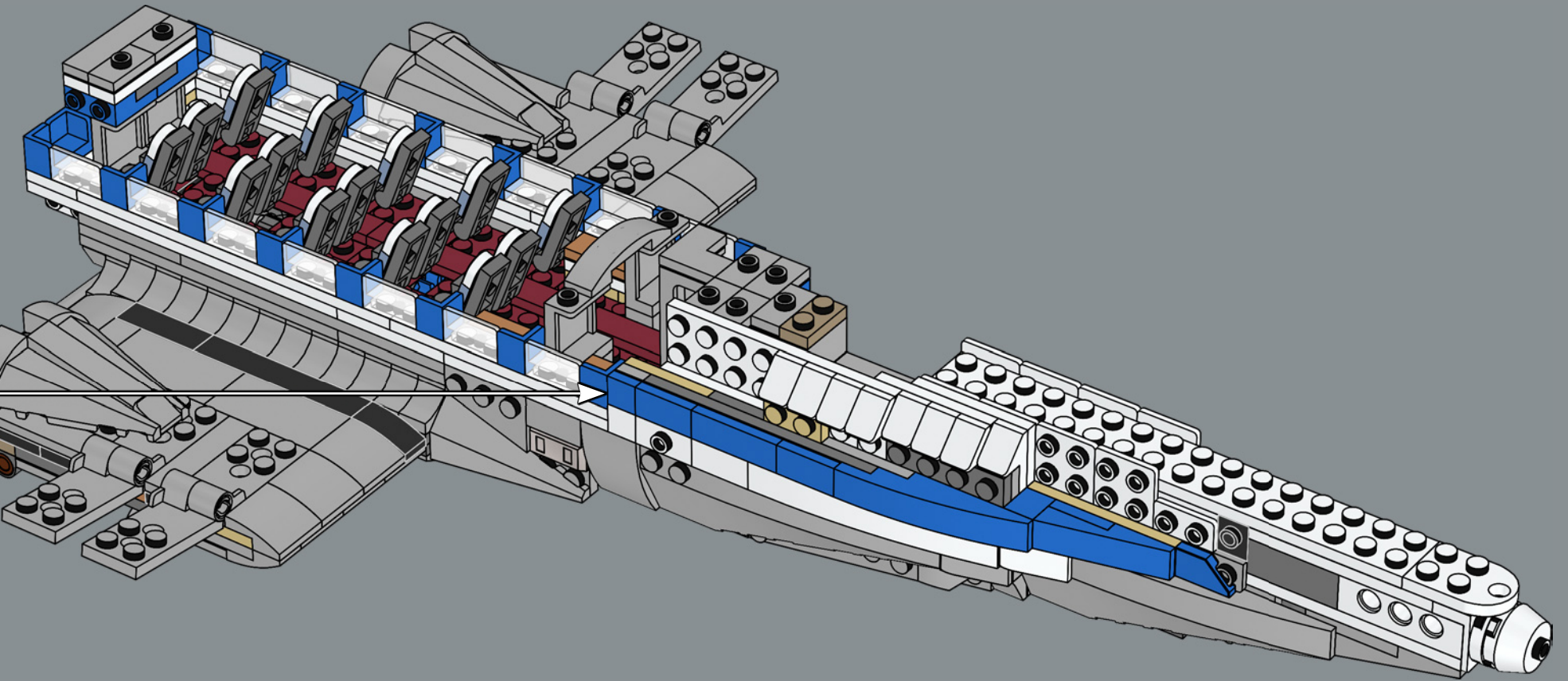

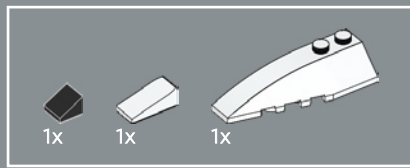

164

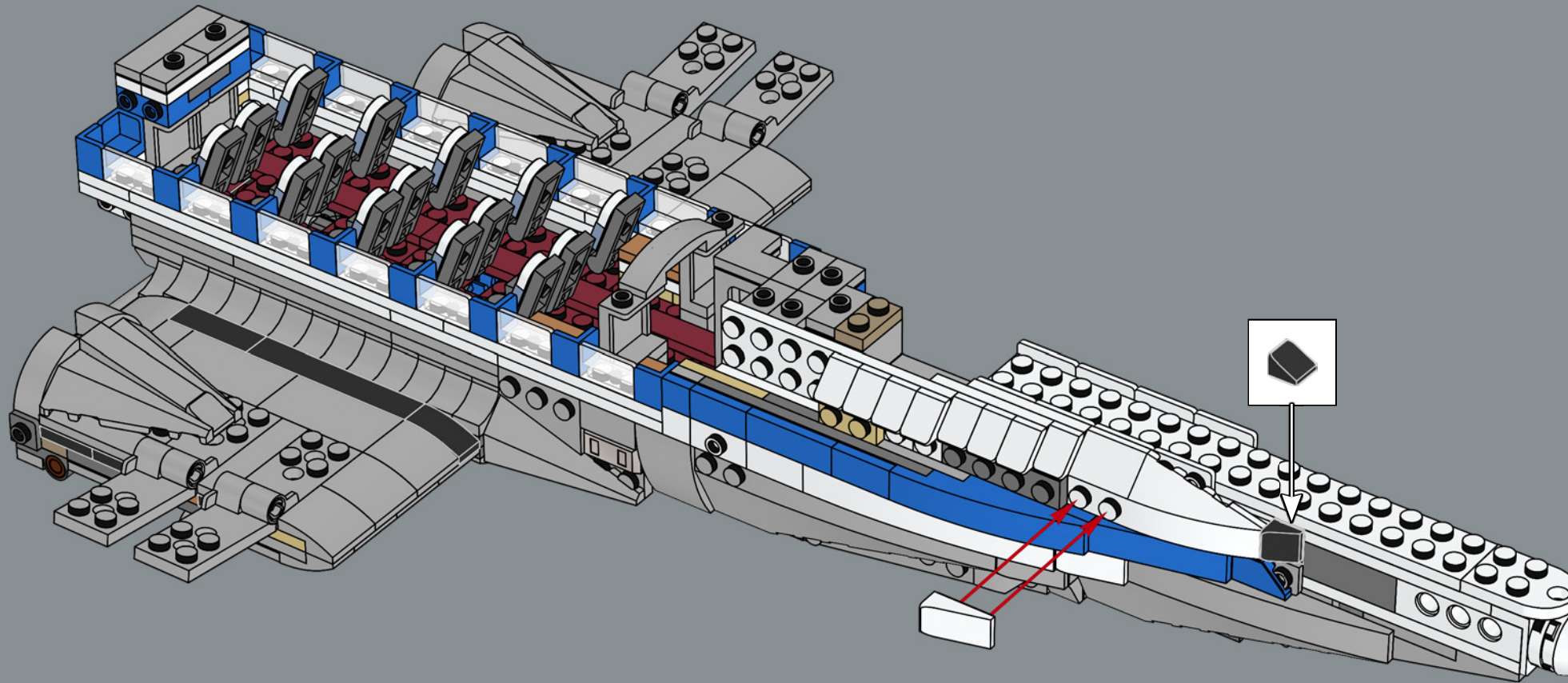

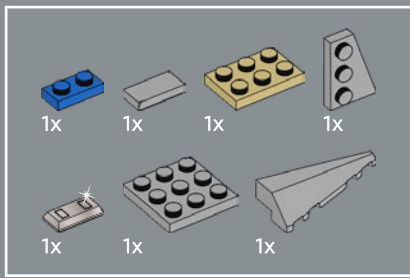

165

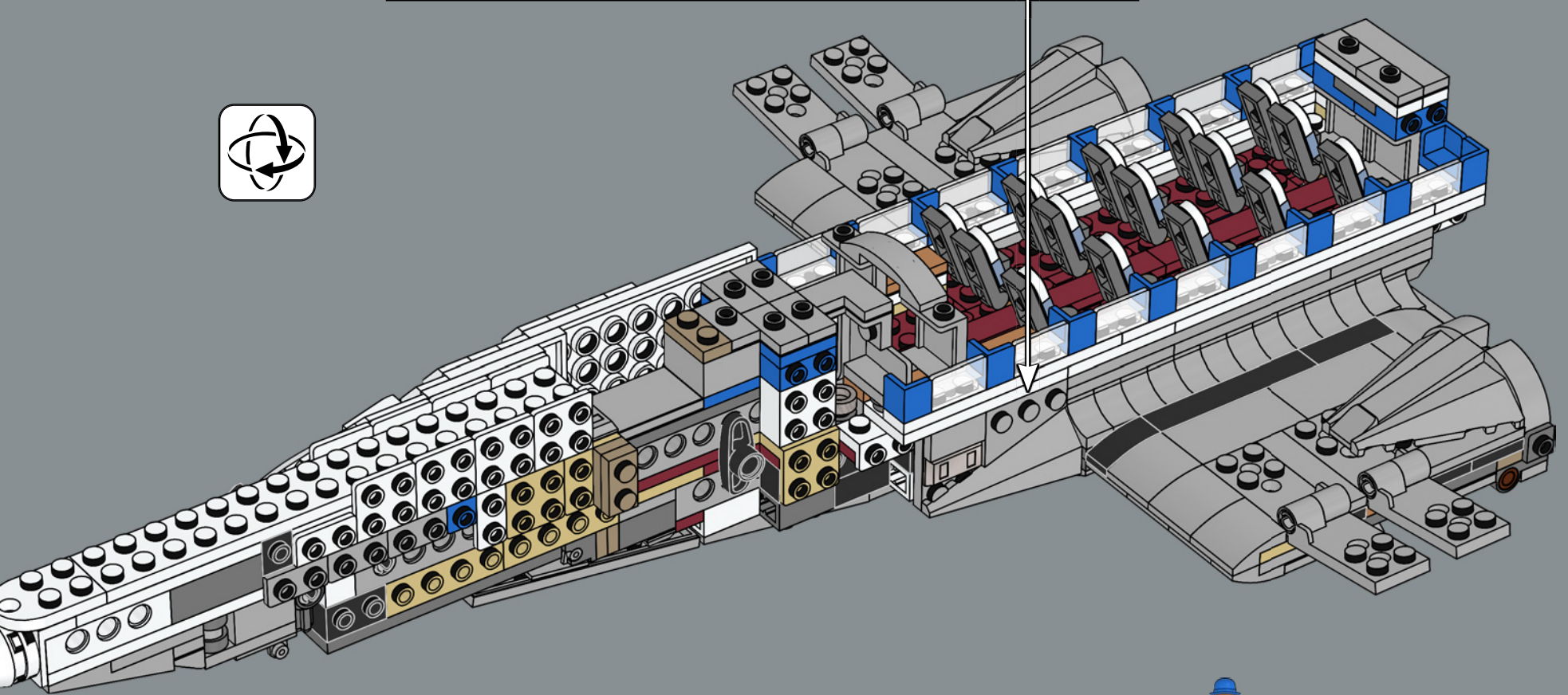
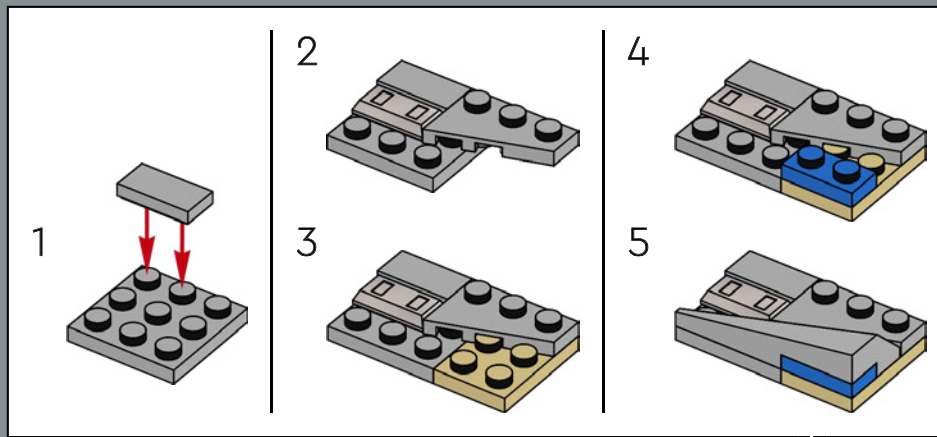

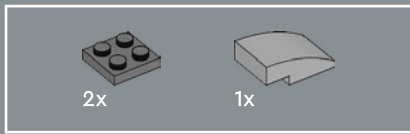

166

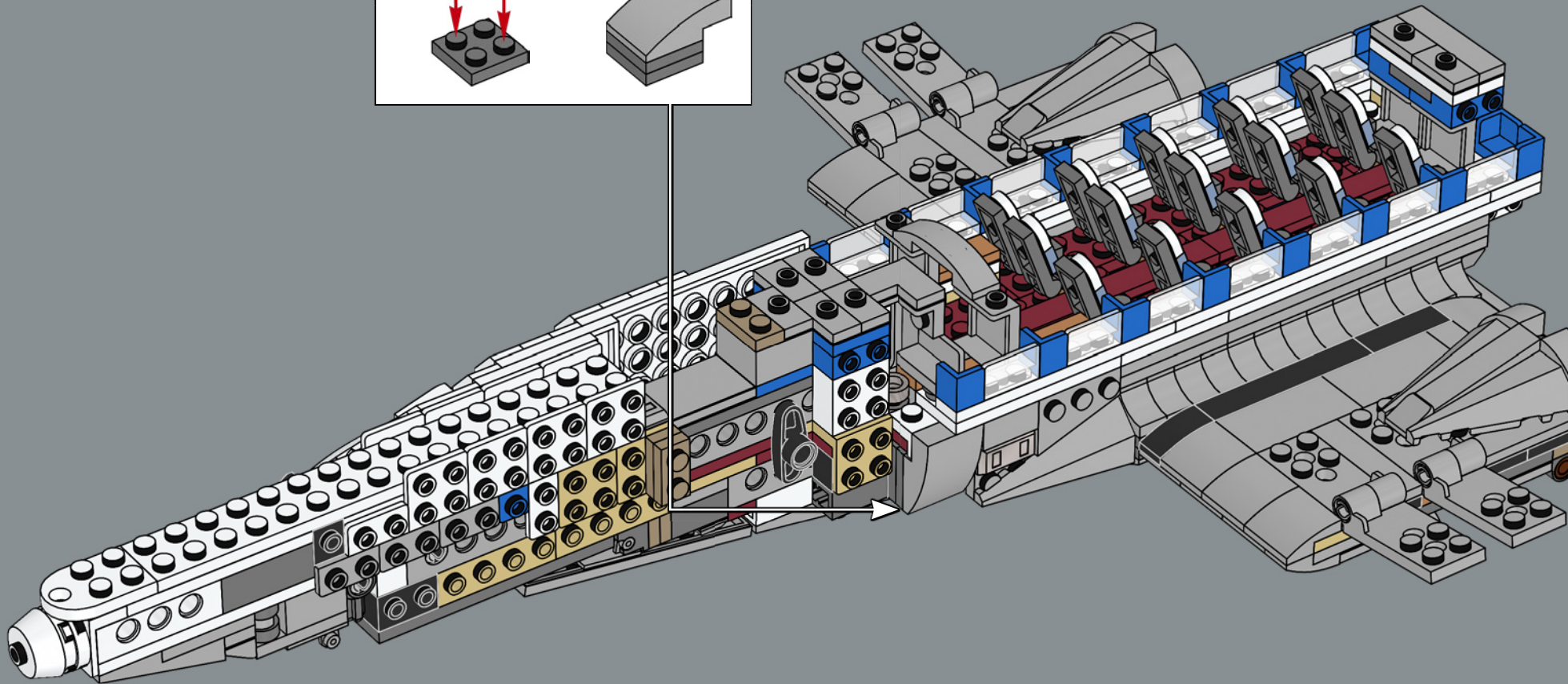
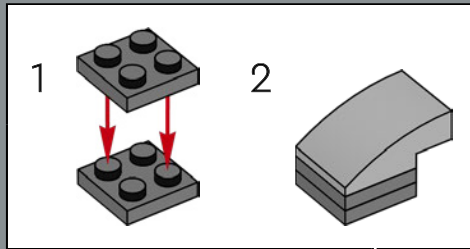

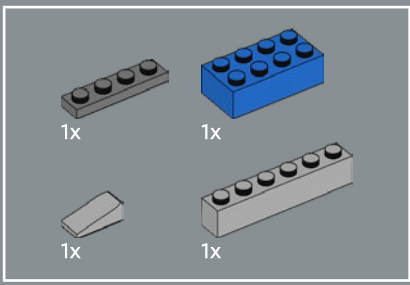

167

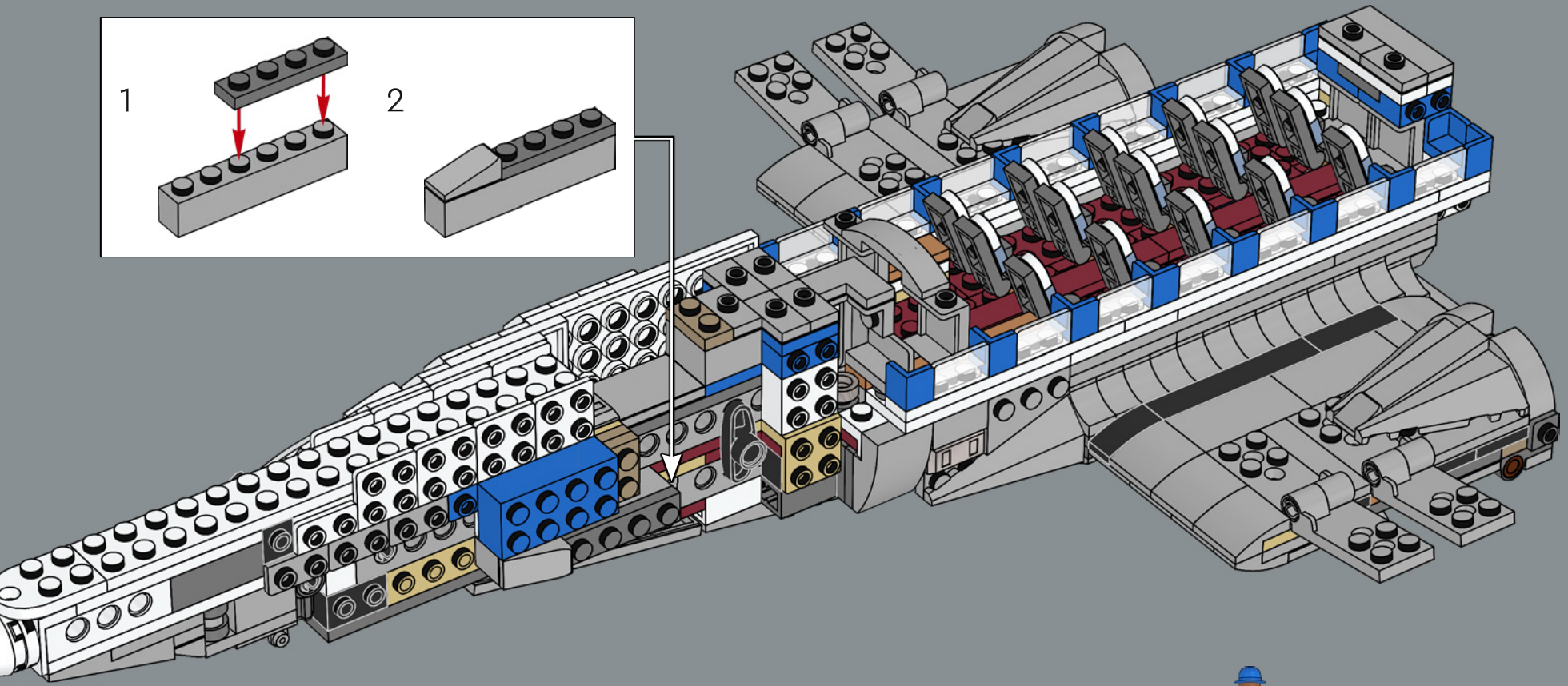
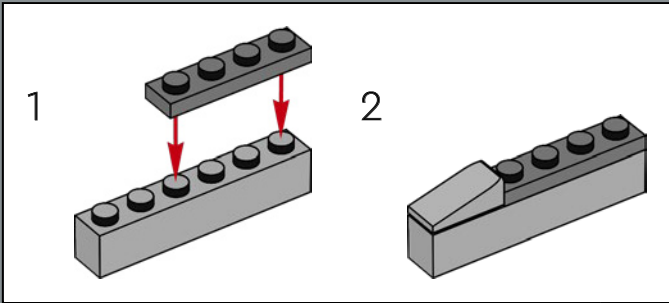

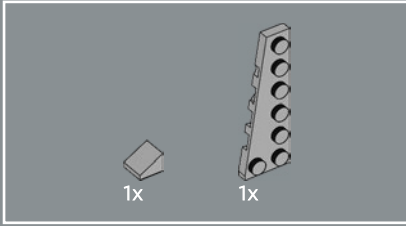
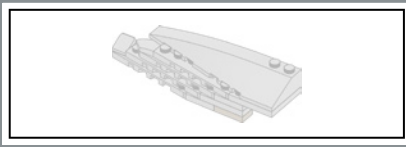

168

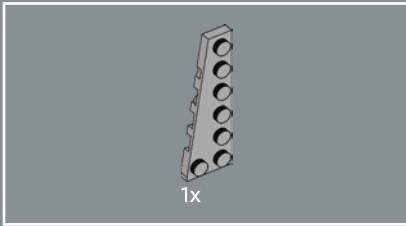
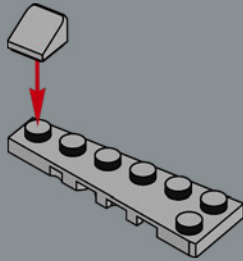

169

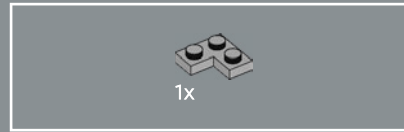
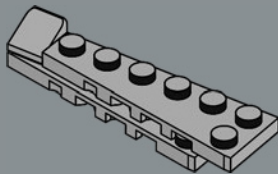

170

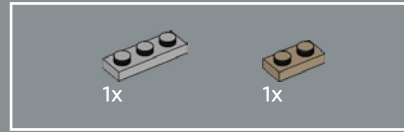
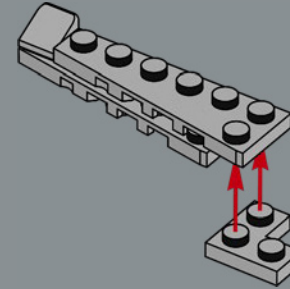

171

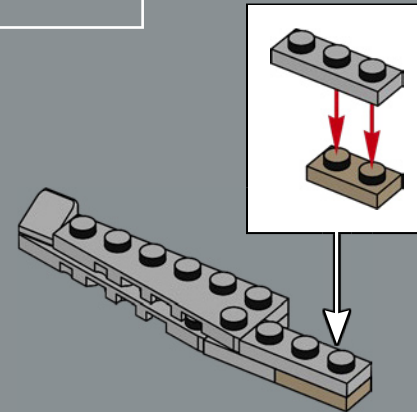

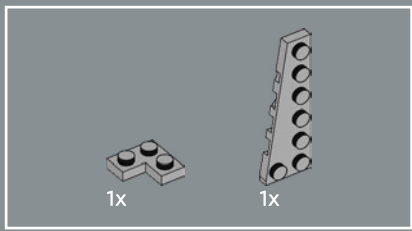

172

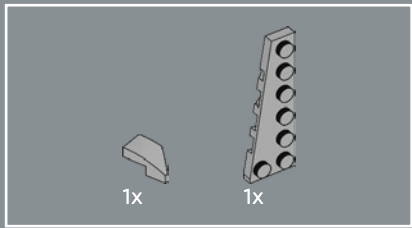
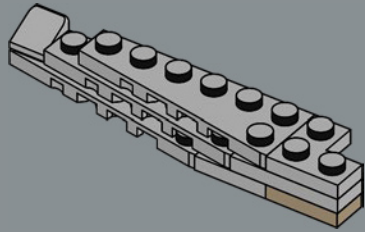

173

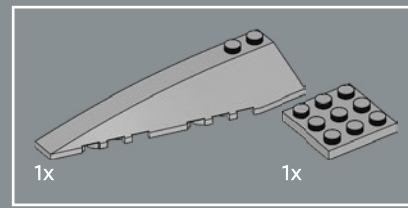
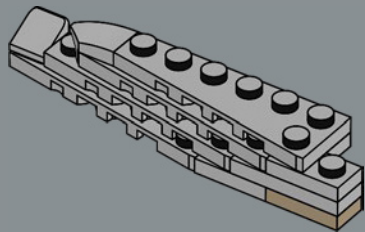

174

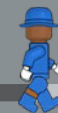
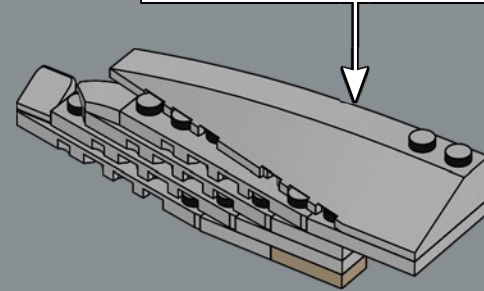
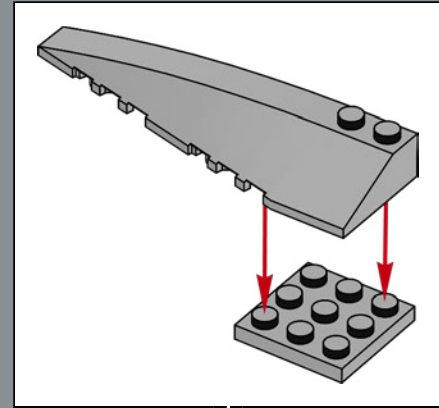

175

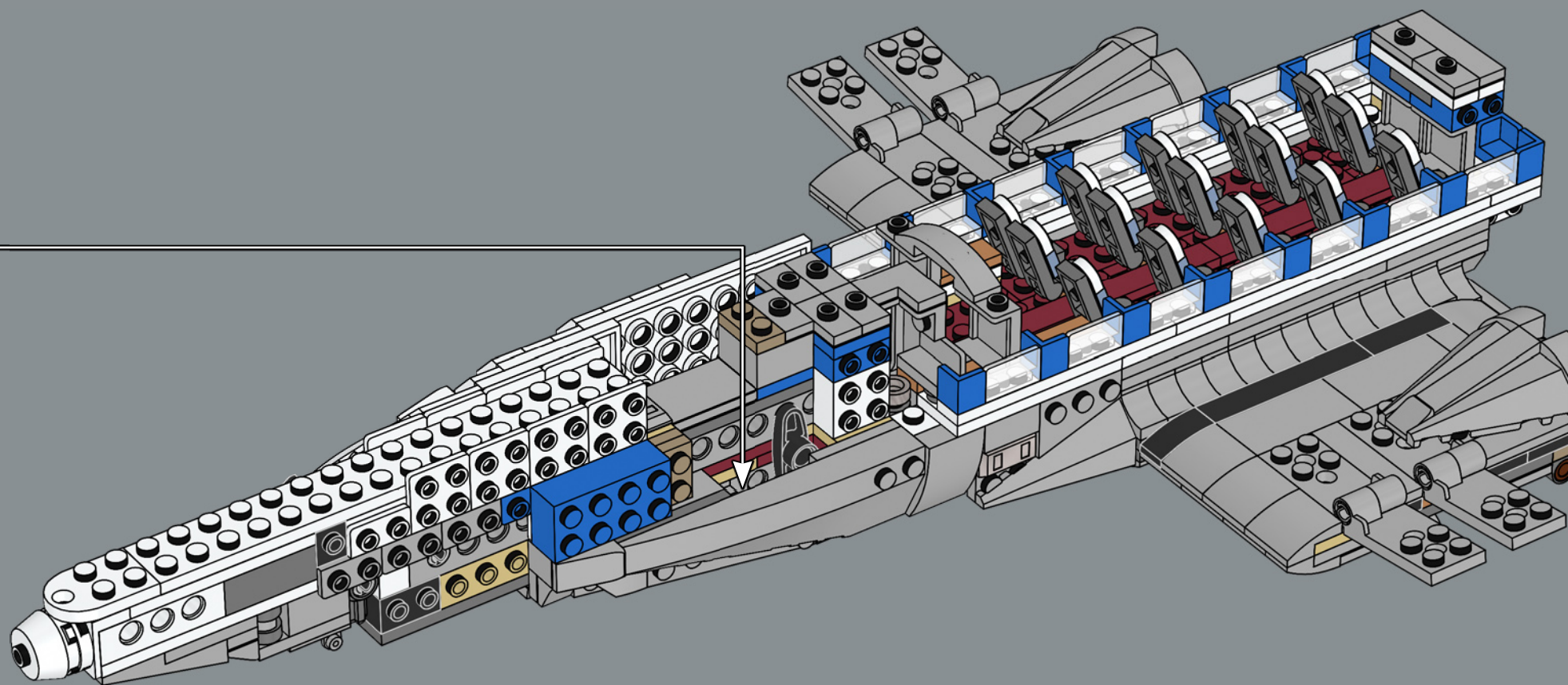

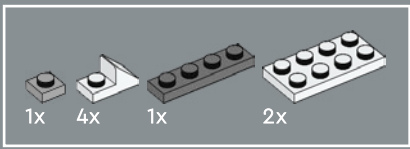

176

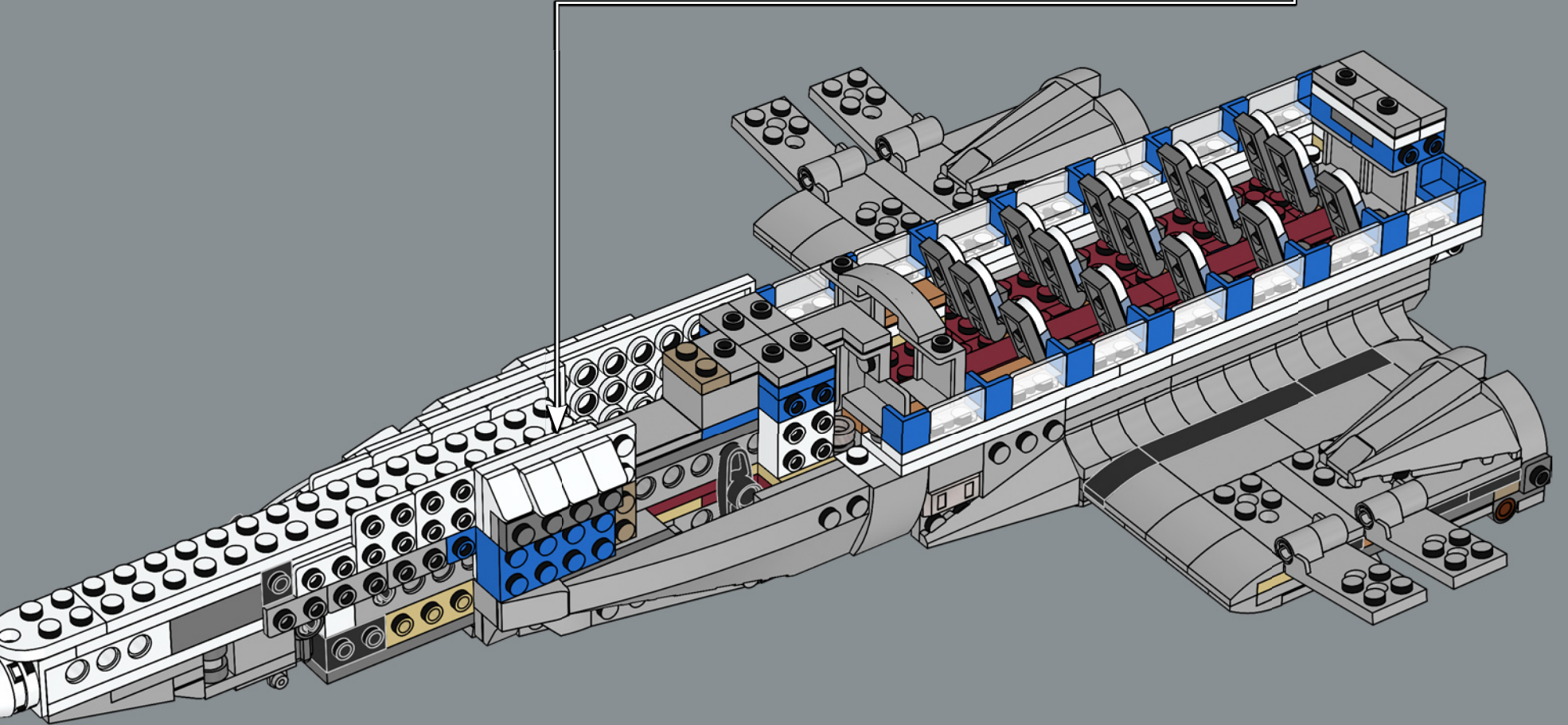
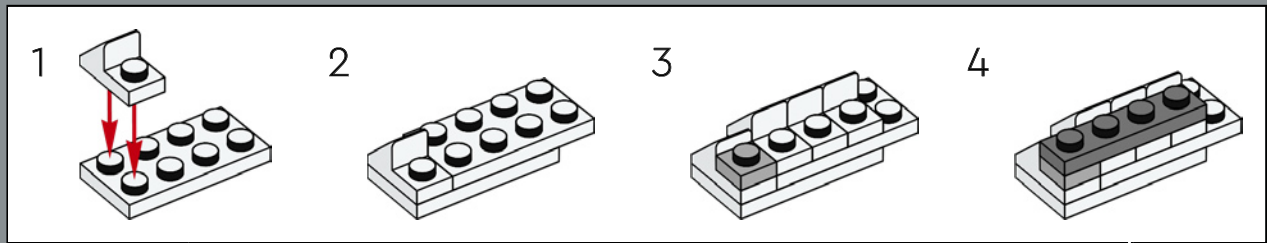

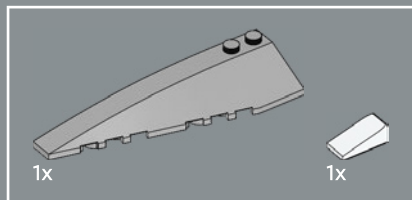

177

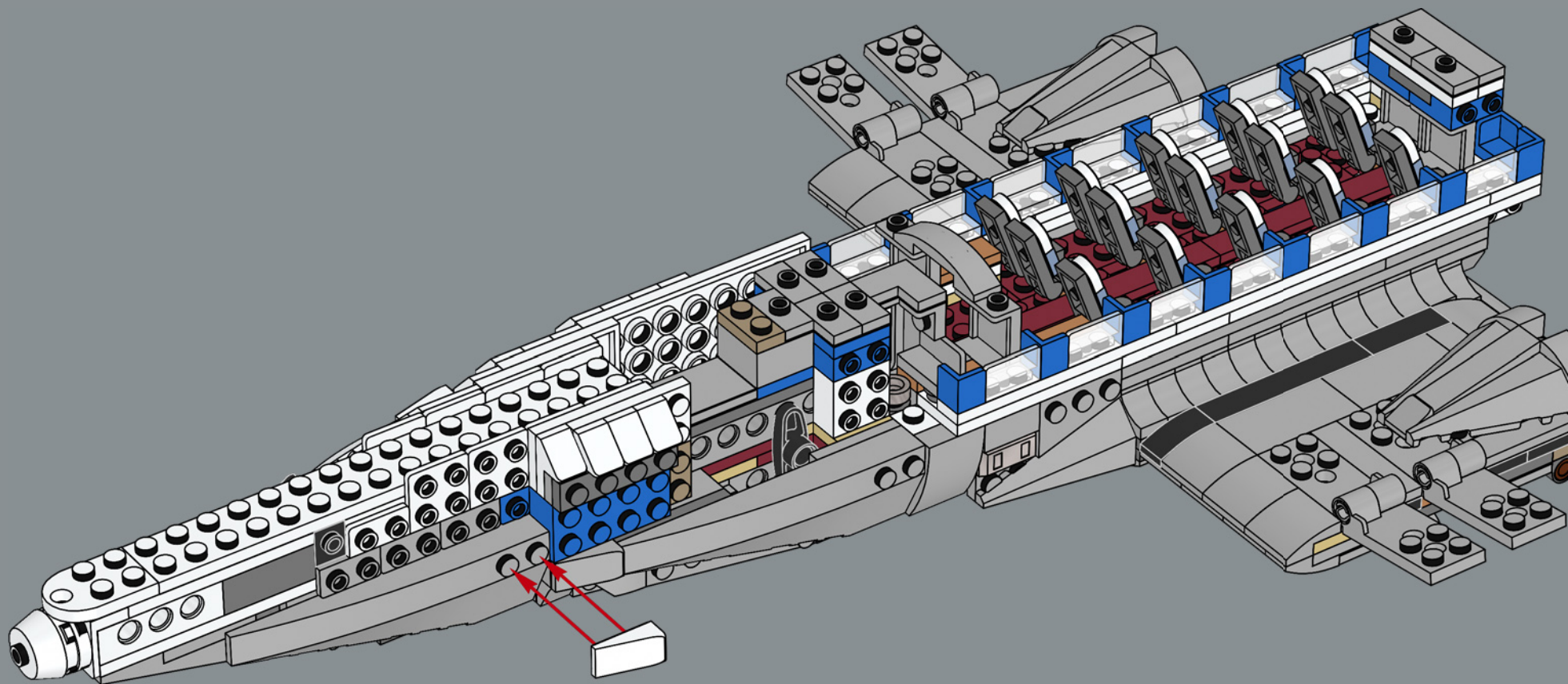

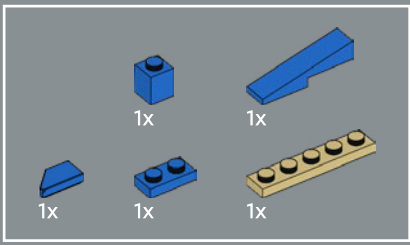

178

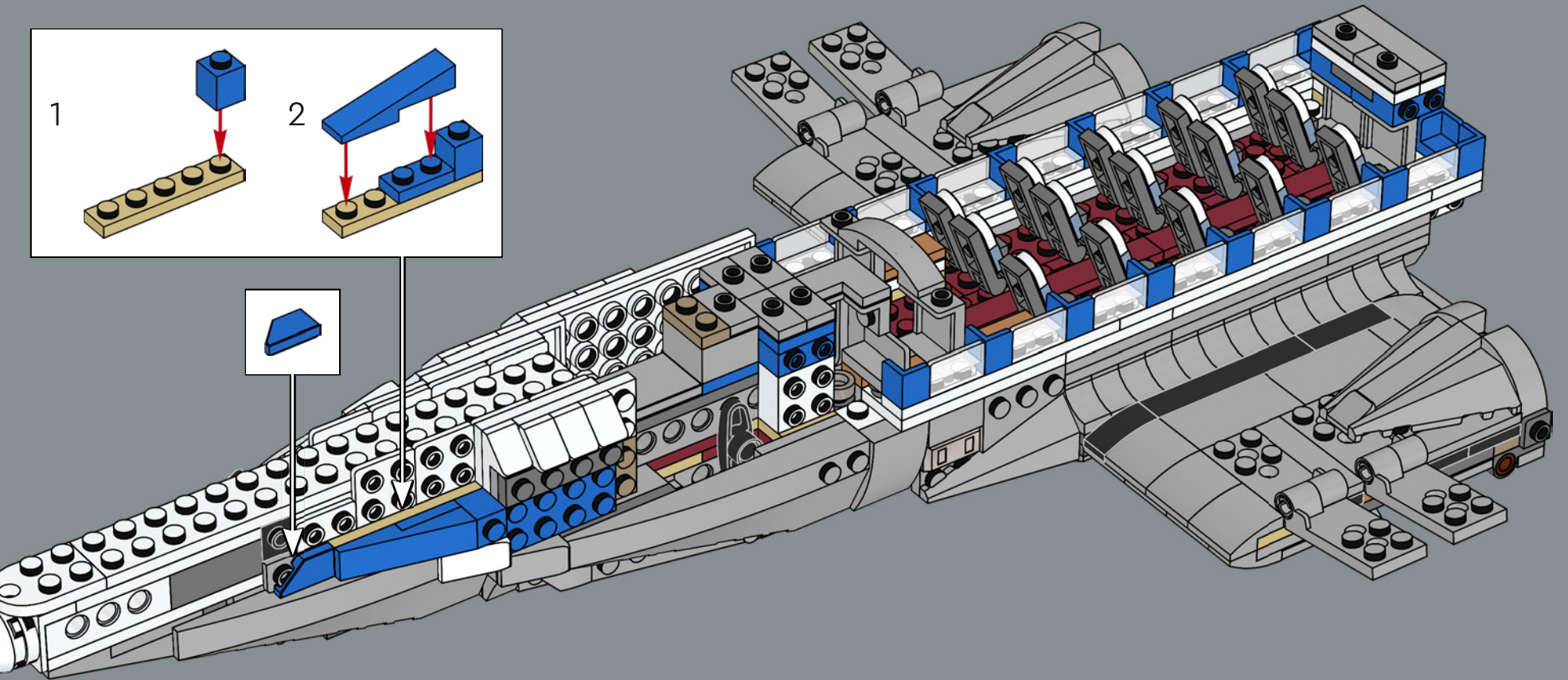
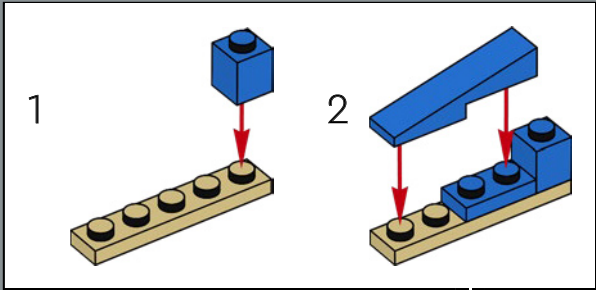

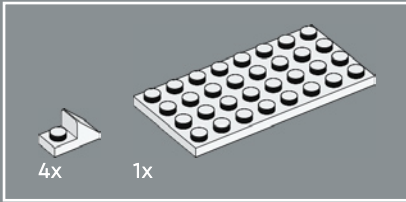
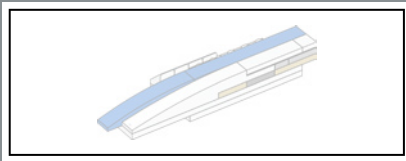

179

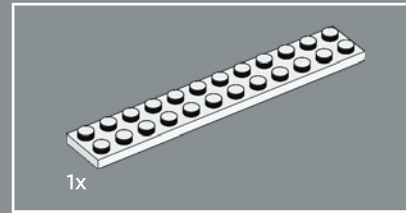
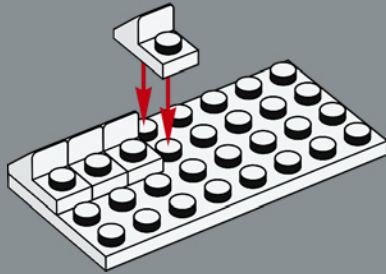

180

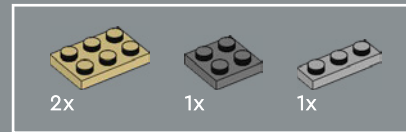
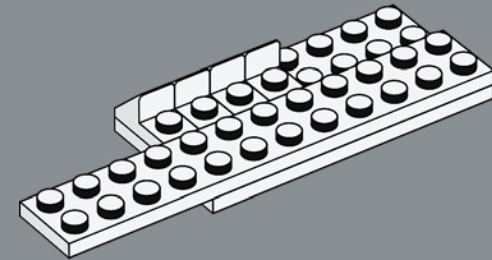

181

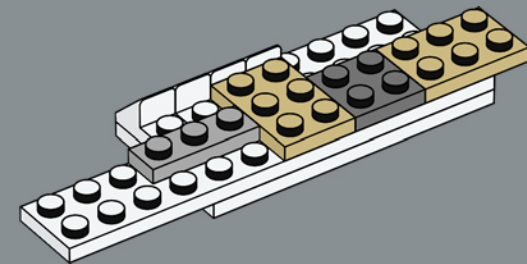

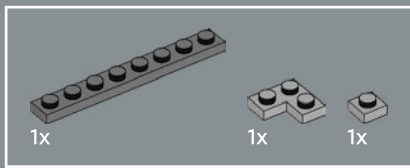

182

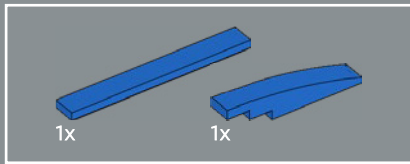
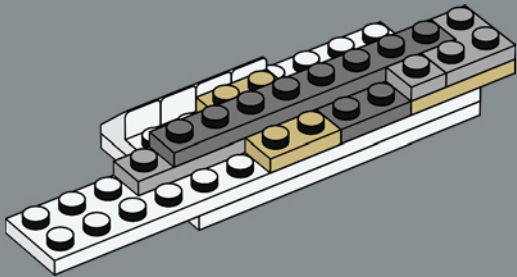

183

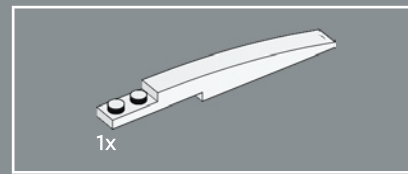
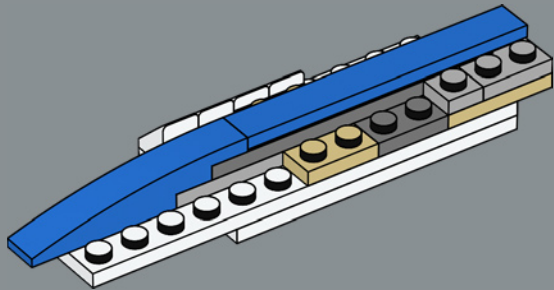

184

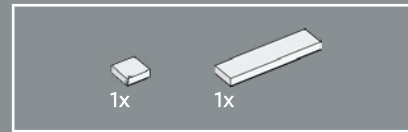
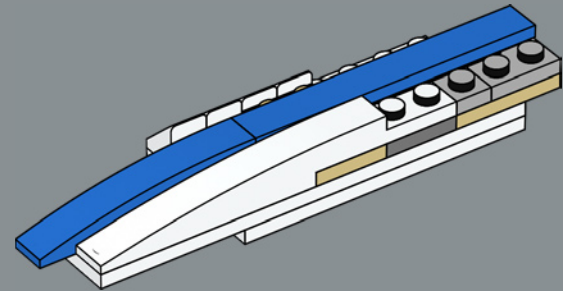

185

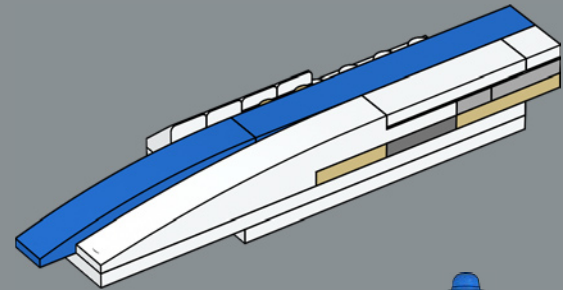

186

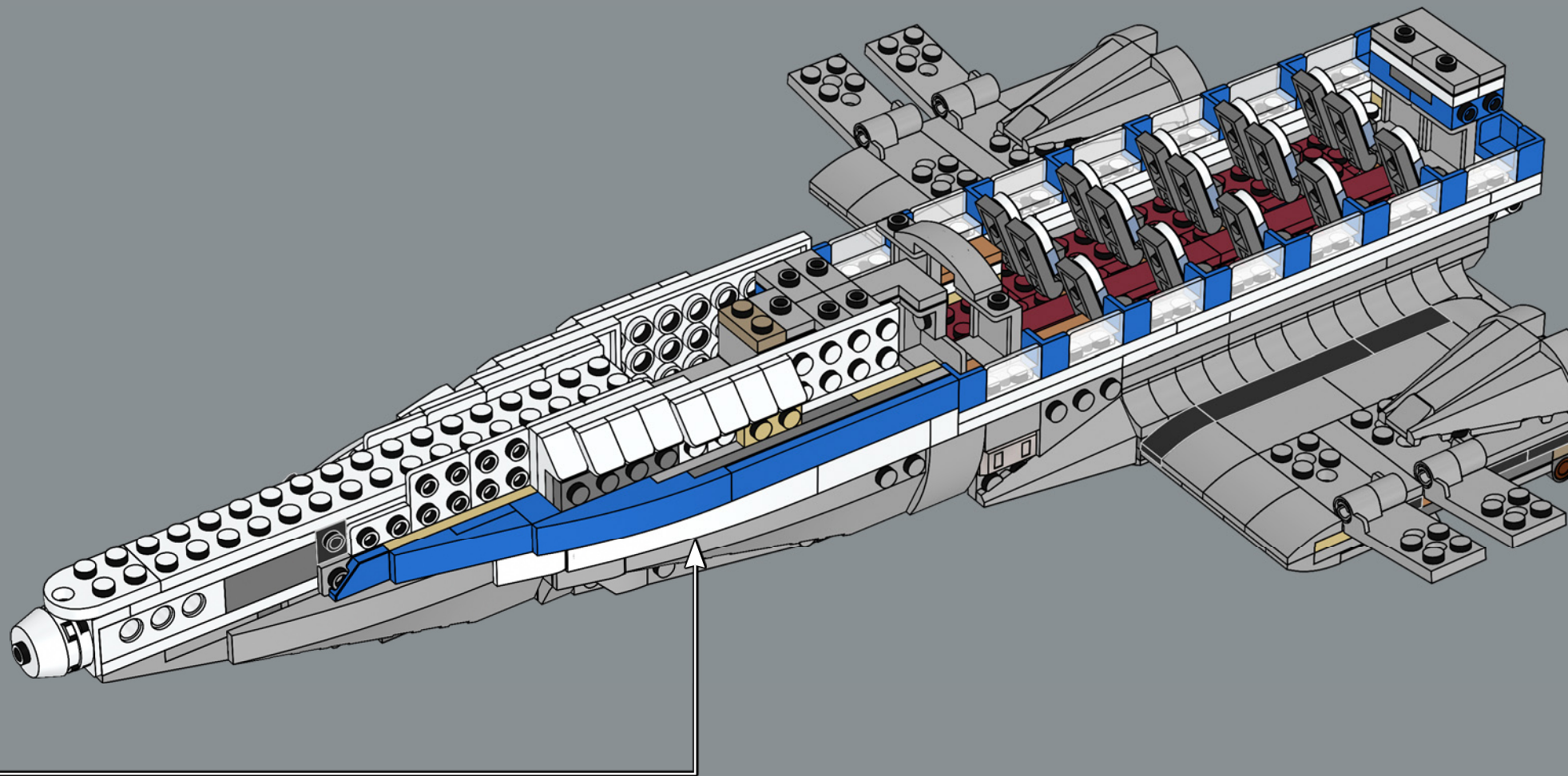

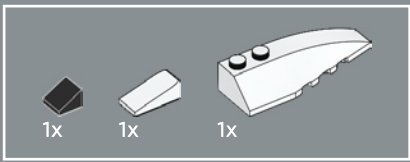

187

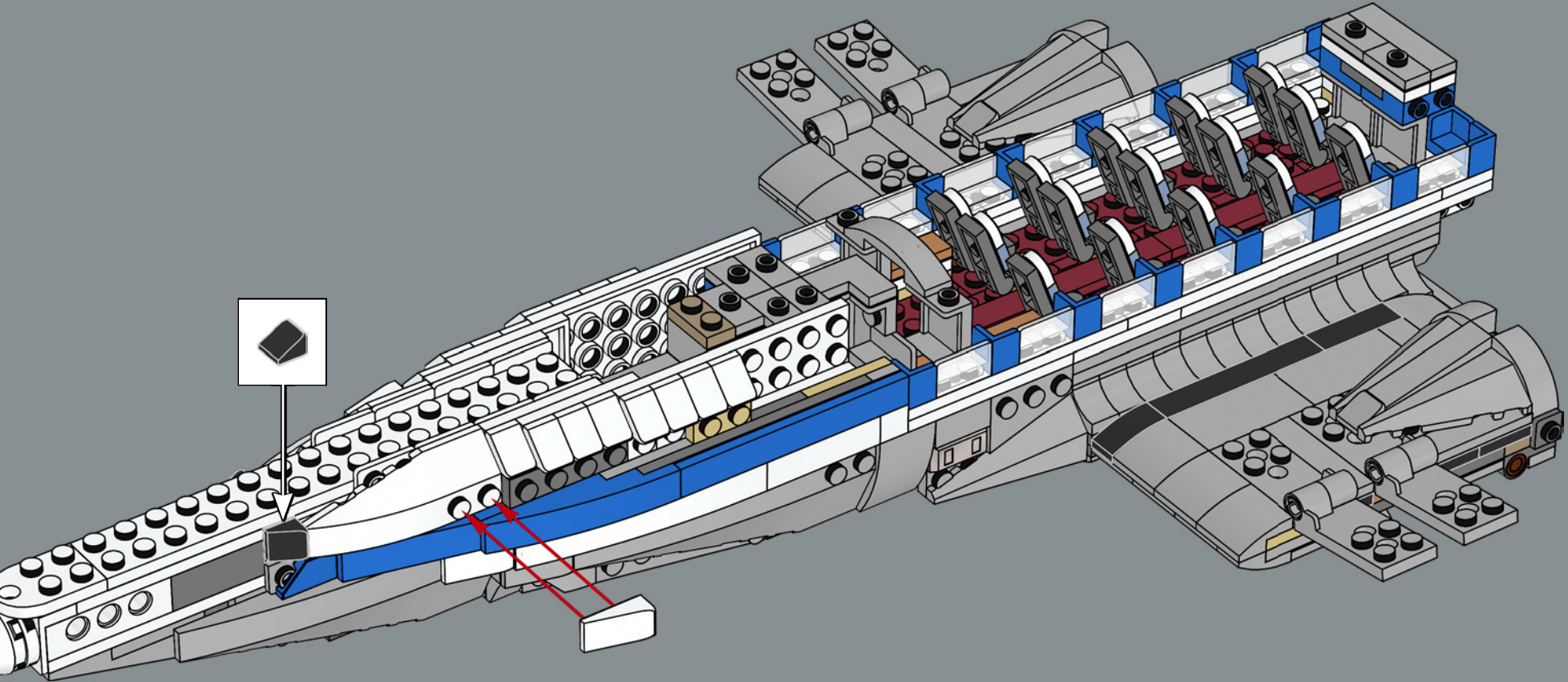



Pan Am® è stata la prima compagnia aerea a introdurre uniformi standardizzate di ispirazione navale per i piloti.

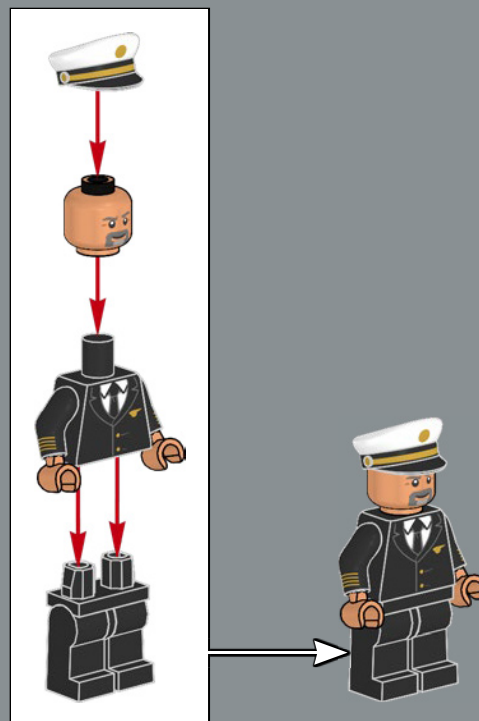

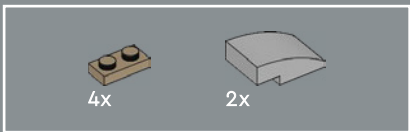

188

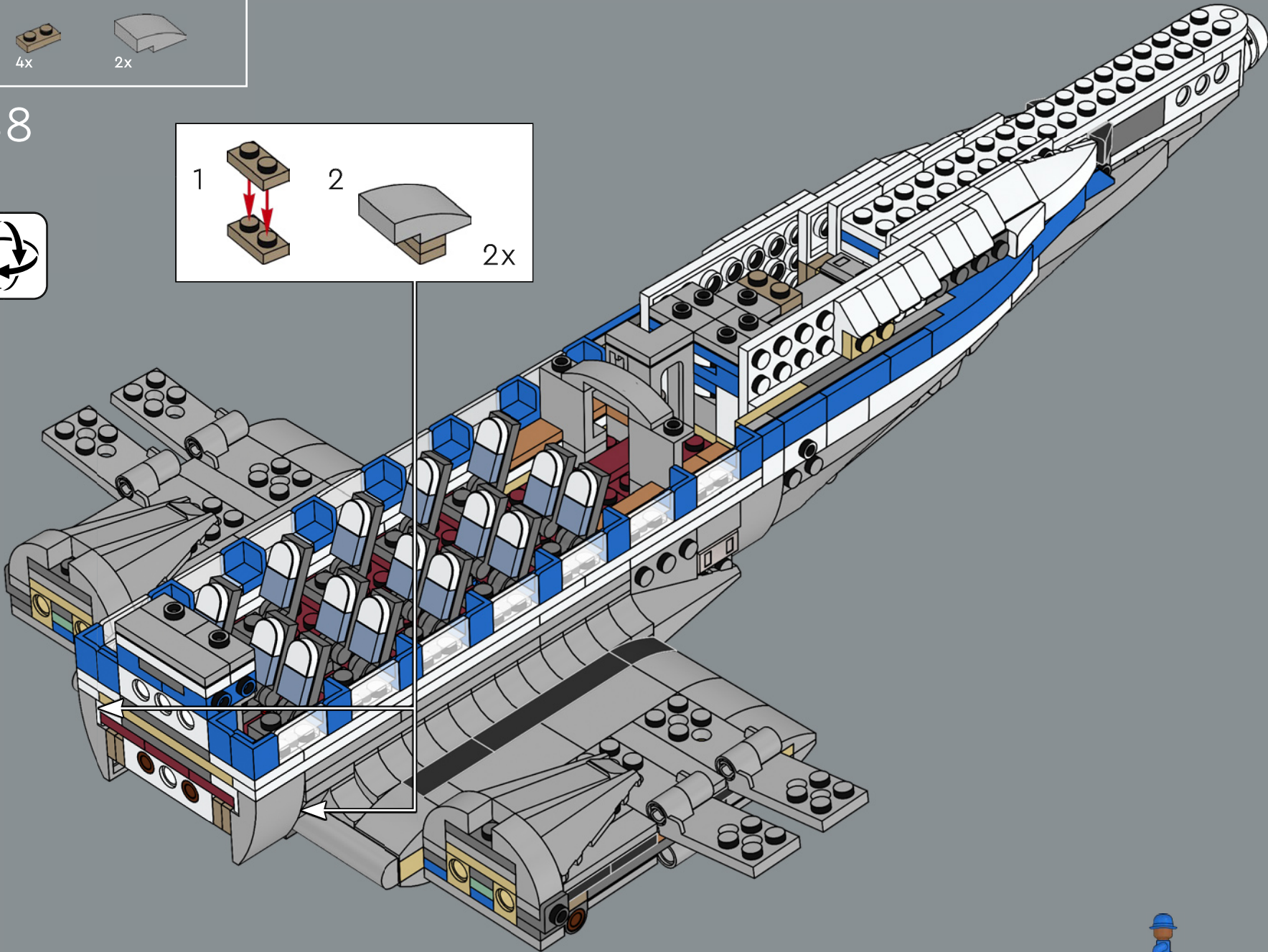
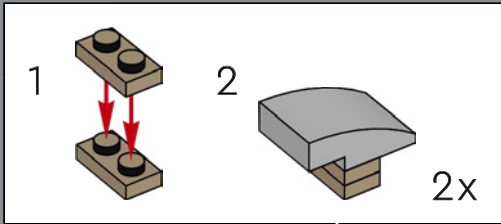

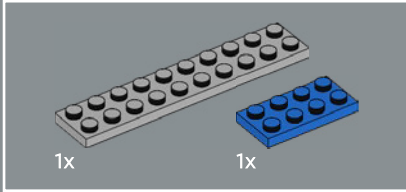
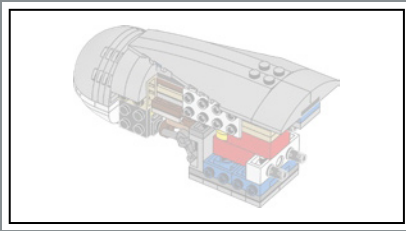

189

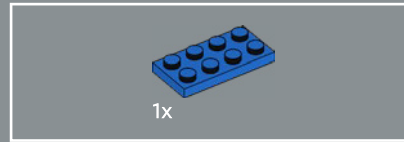
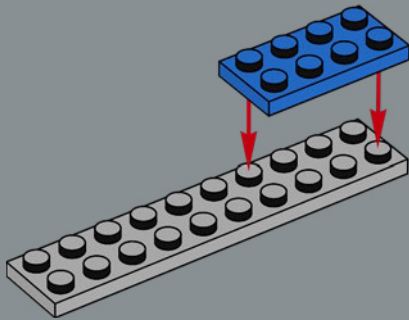

190

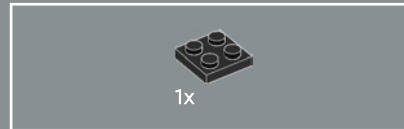
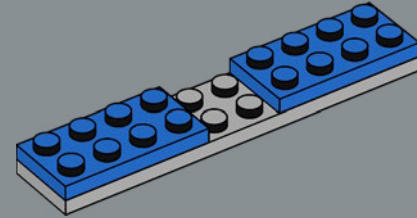

191

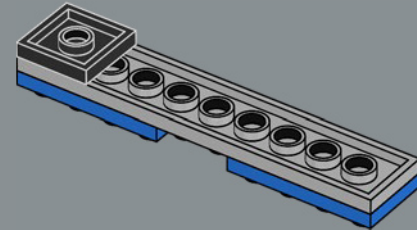



192

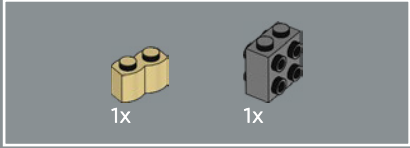
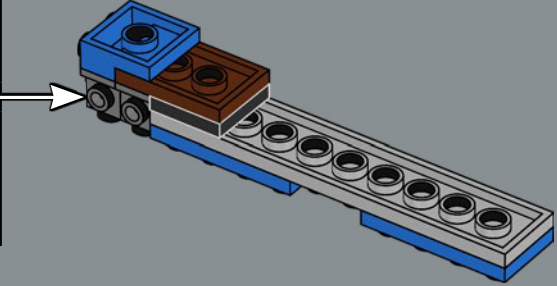
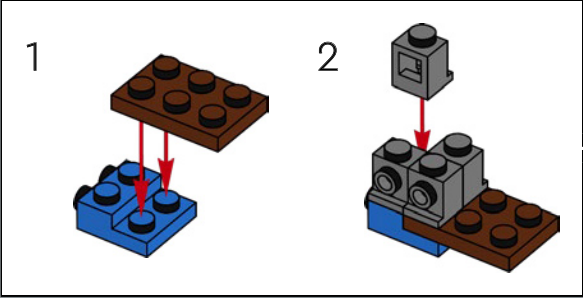

193

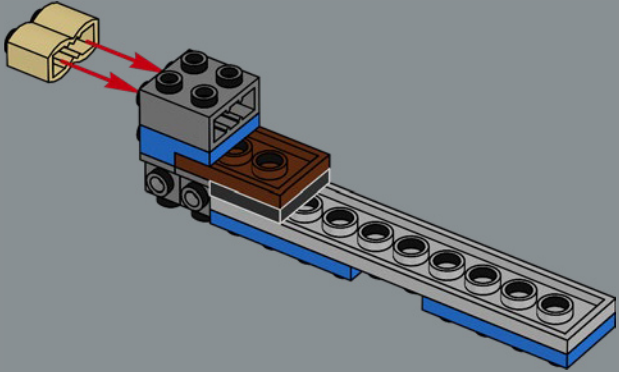

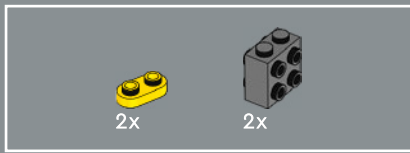

194

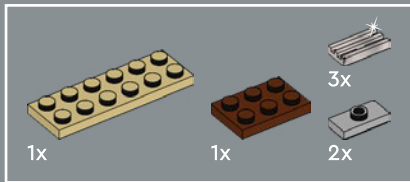
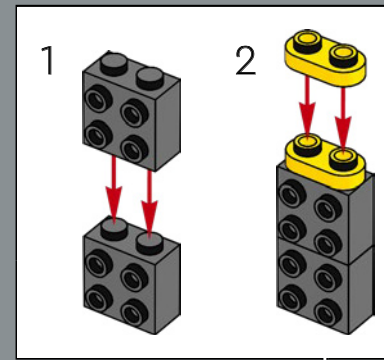
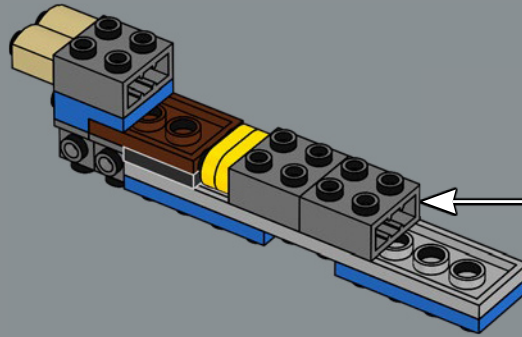

195

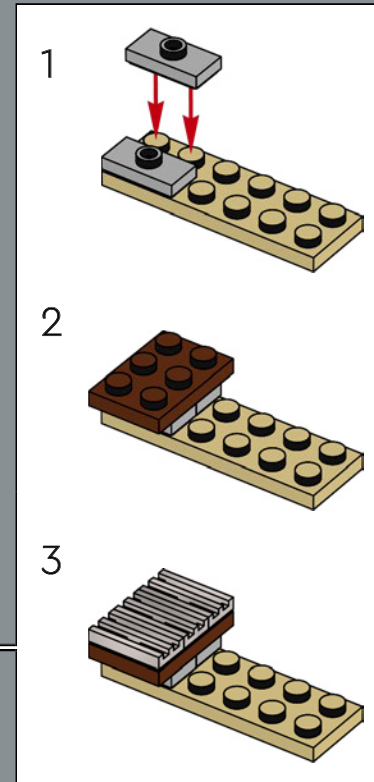
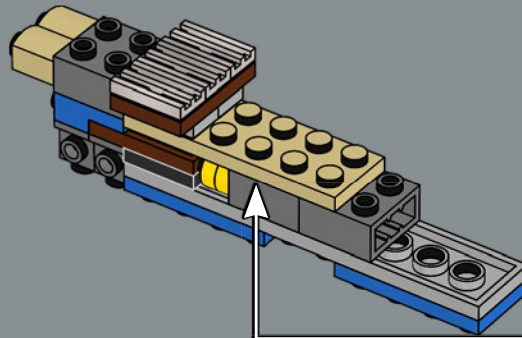



196

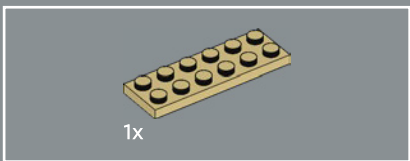
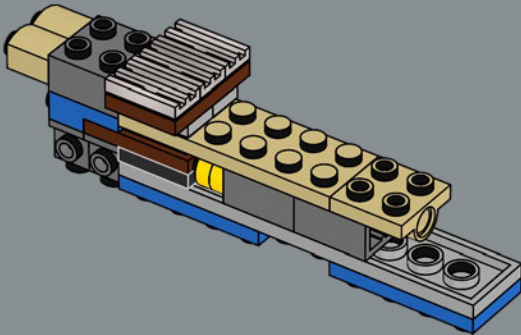

197

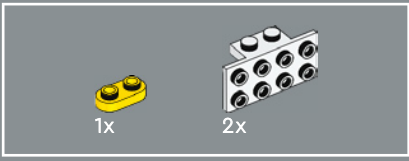
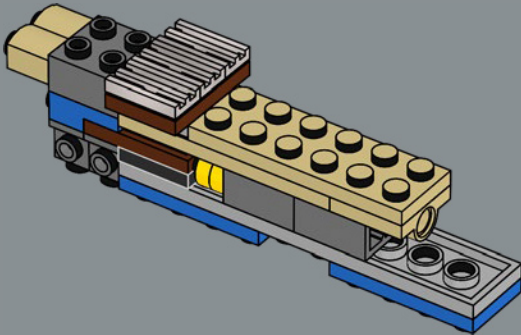

198

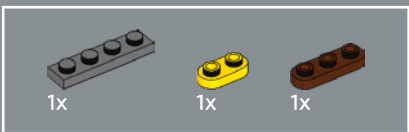
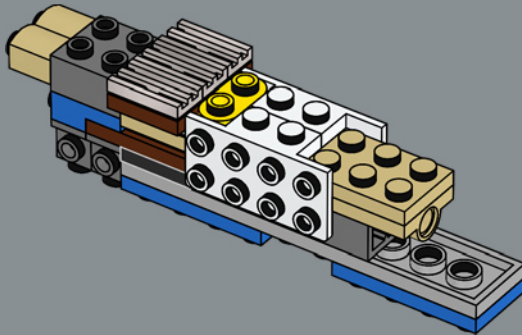

199

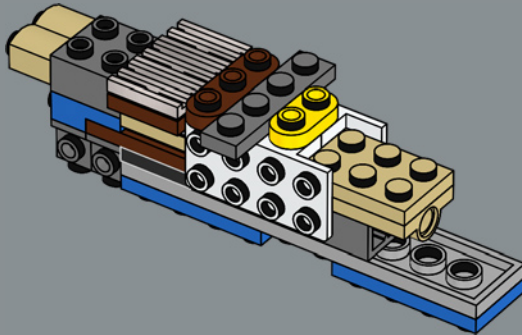

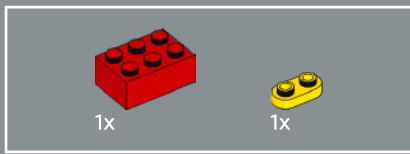

200

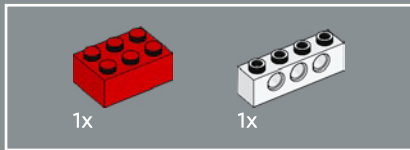
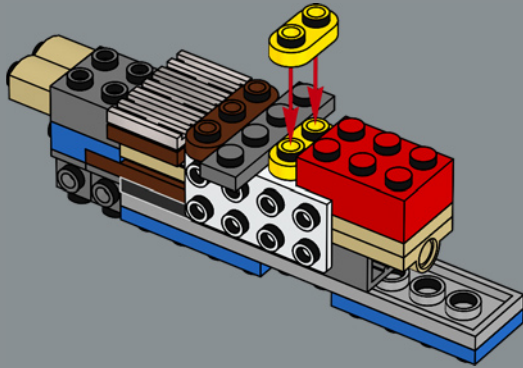

201

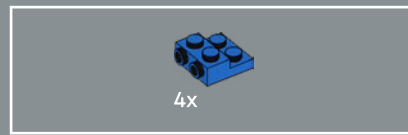
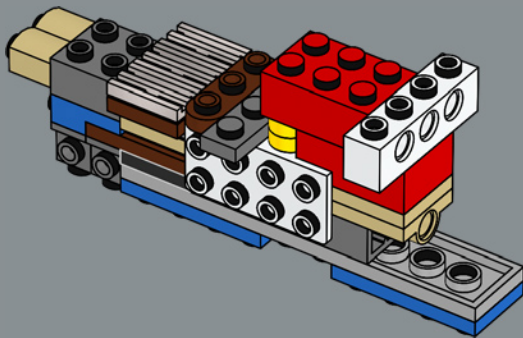

202

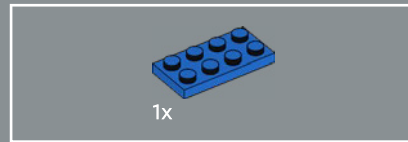
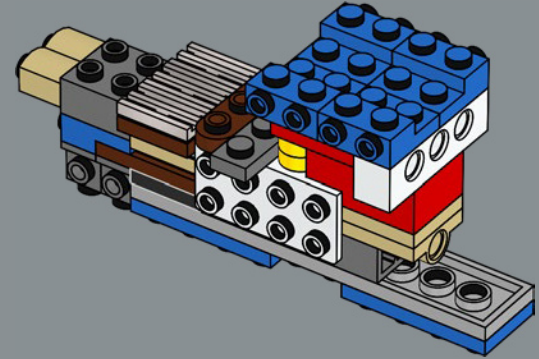

203

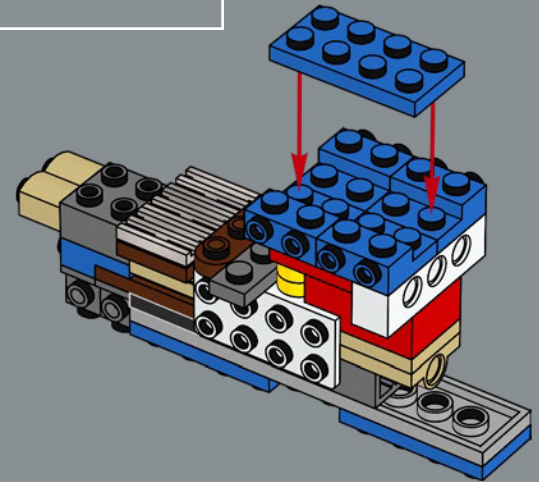

3x

204

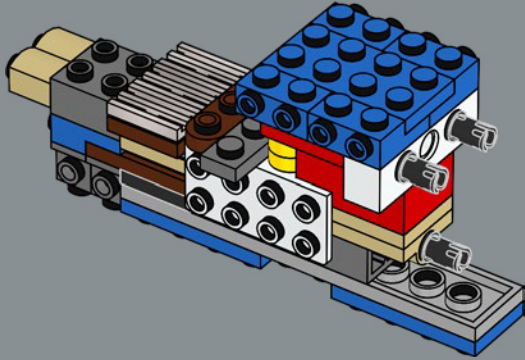

2x

205

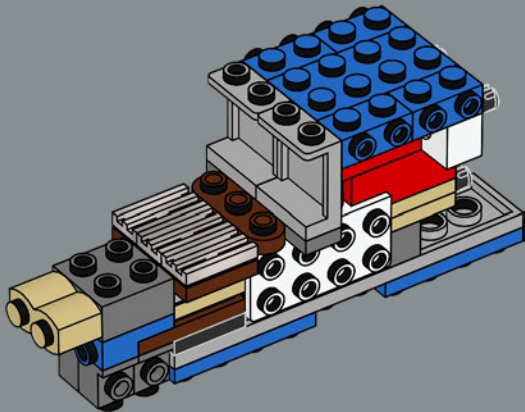

1x

1x

206

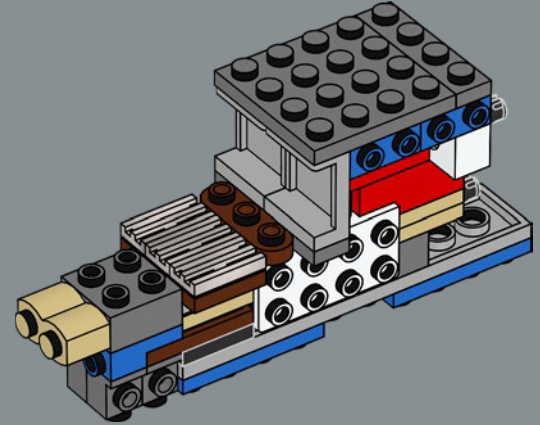

10x

207

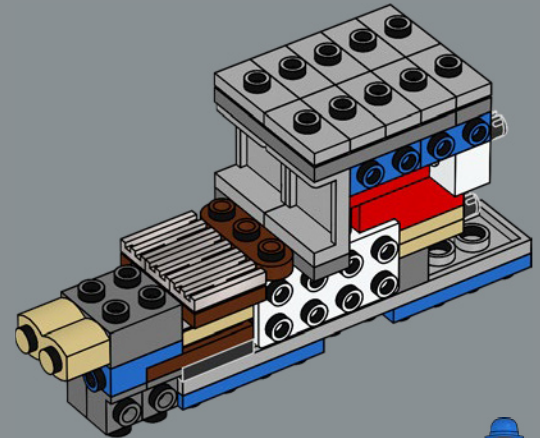

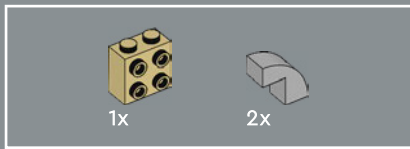

208

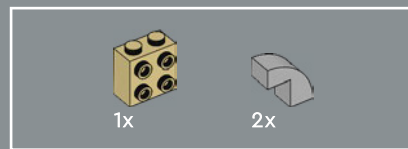
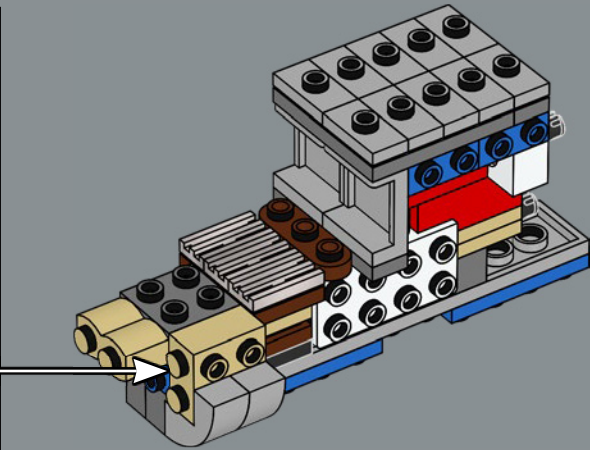
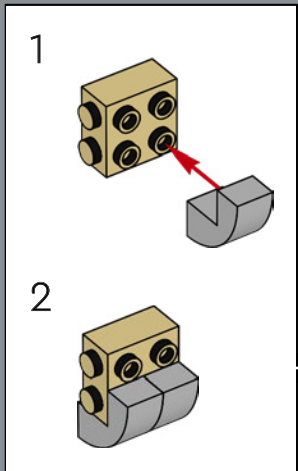

209

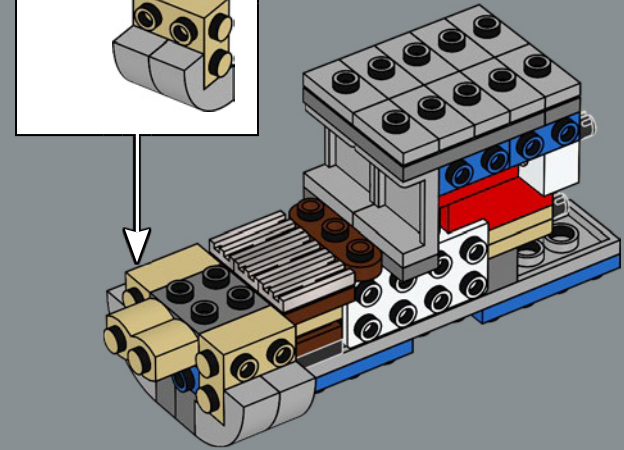
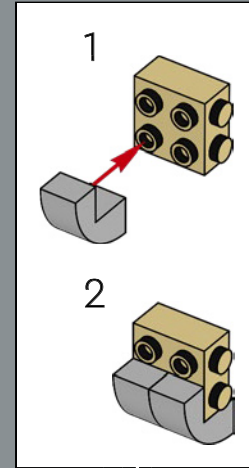



2x

# 210

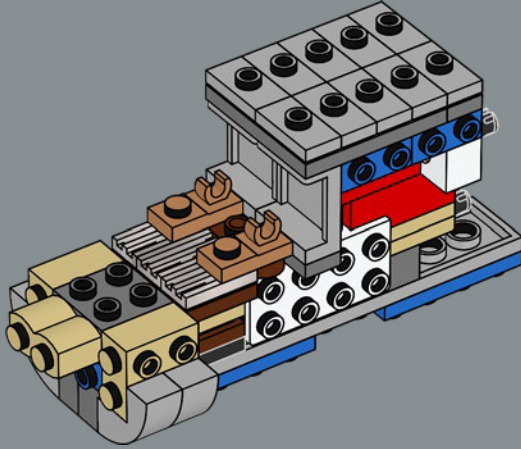

2x



4x

# 211

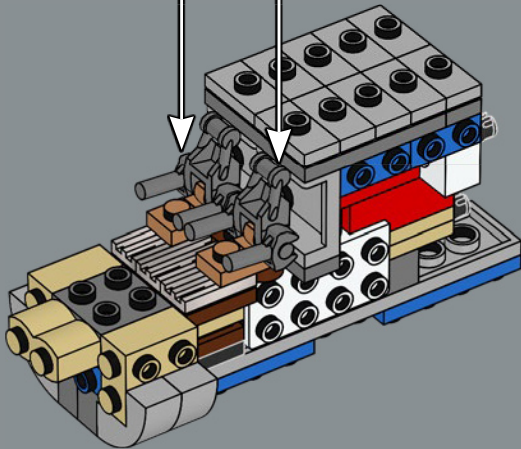
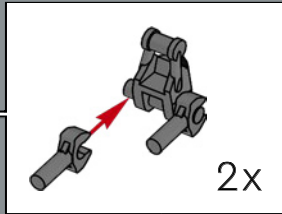

1x



1x



1x



1x



1x



1x

# 212

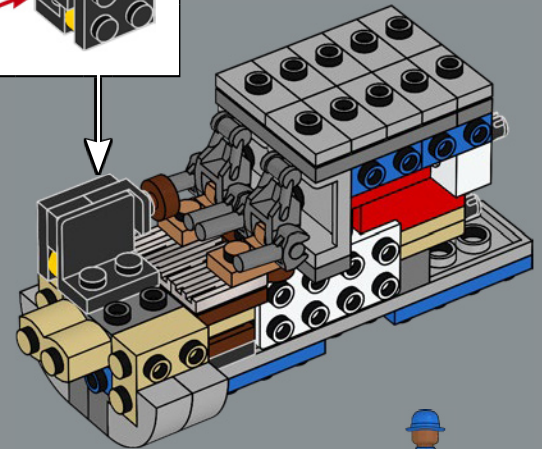
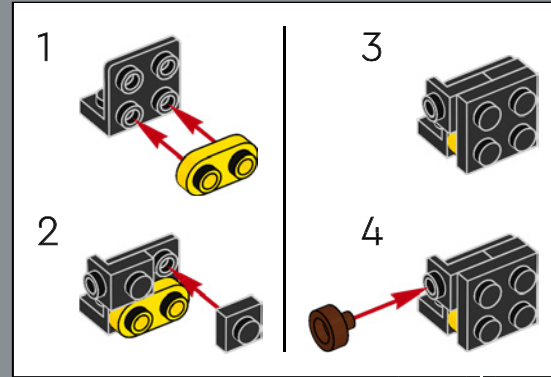

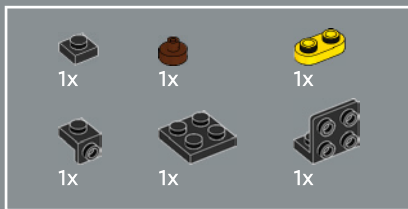

213

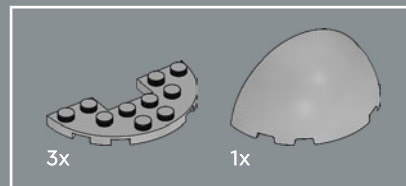
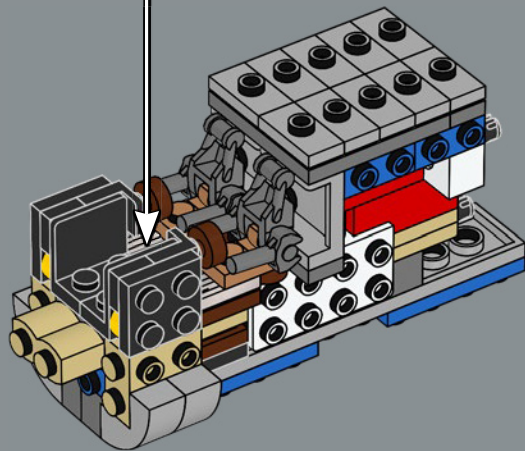
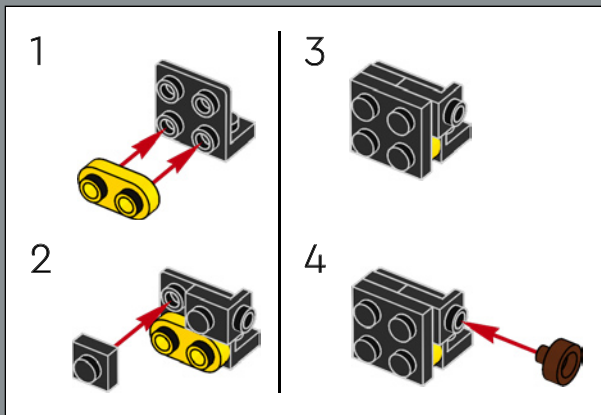

214

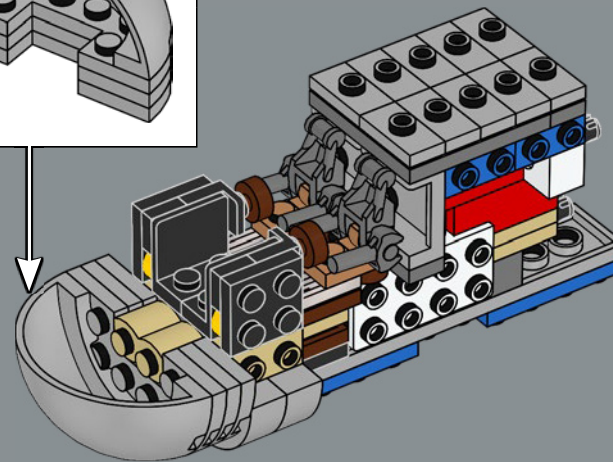
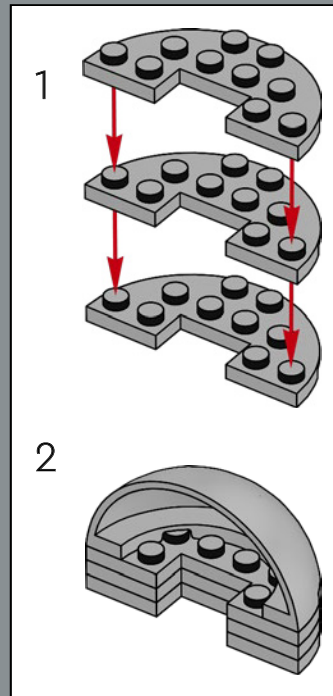

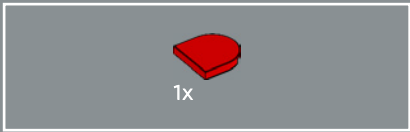

215

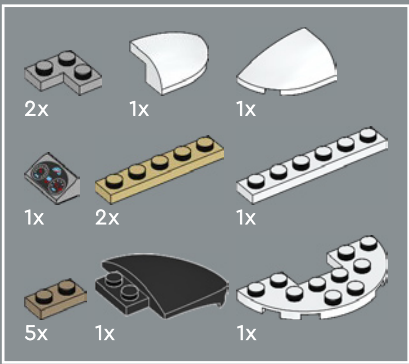
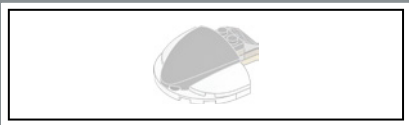
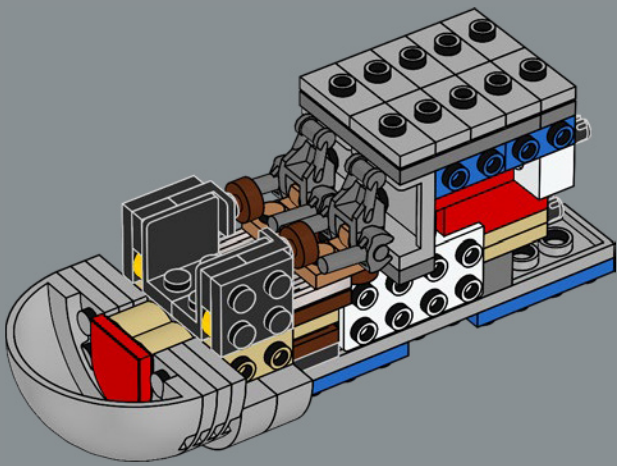

216

1



2

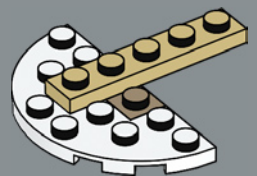

3

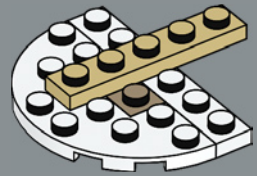



Il pezzo del muso nero è un elemento LEGO® originariamente creato come petalo per i tulipani.

4

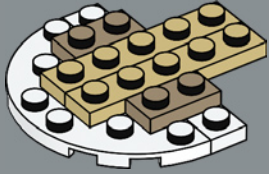

5

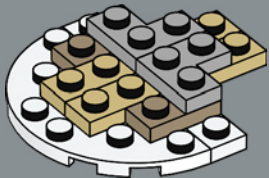

6

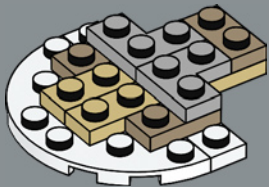

7

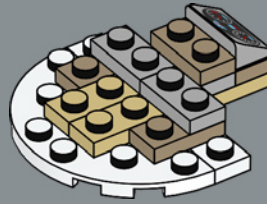

8

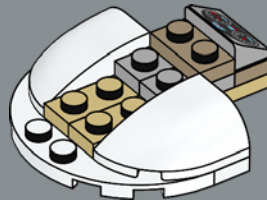

9

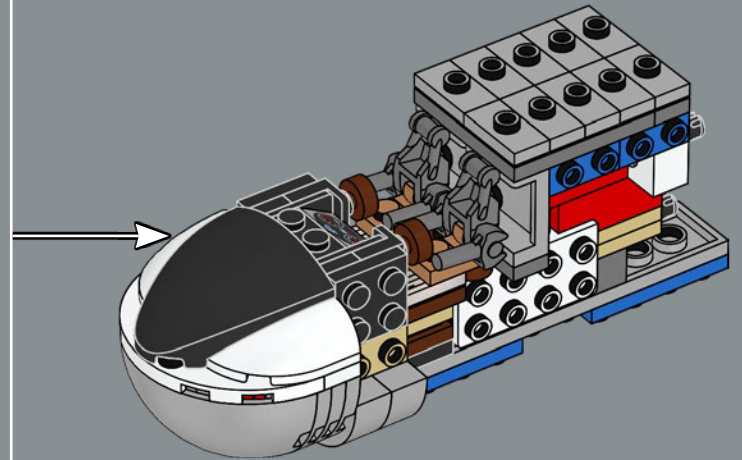
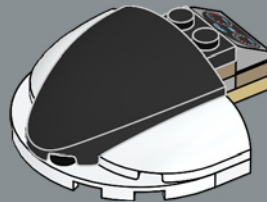

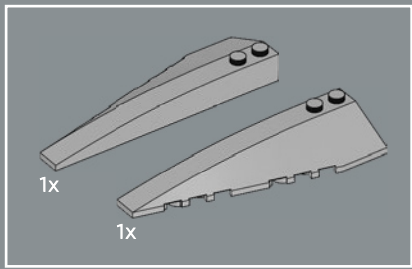

217

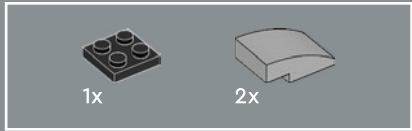
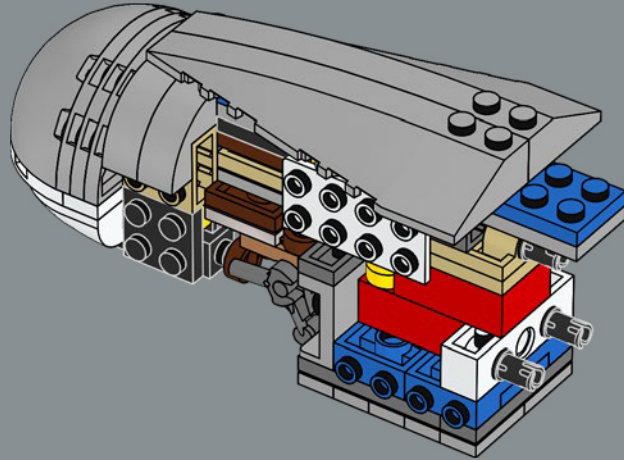

218

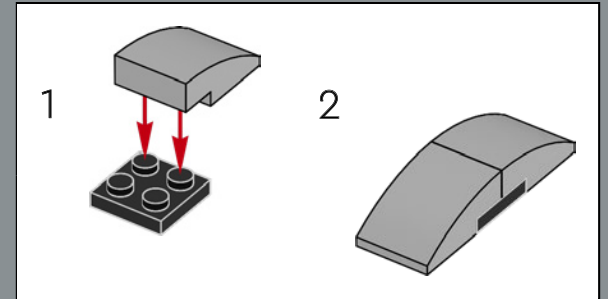
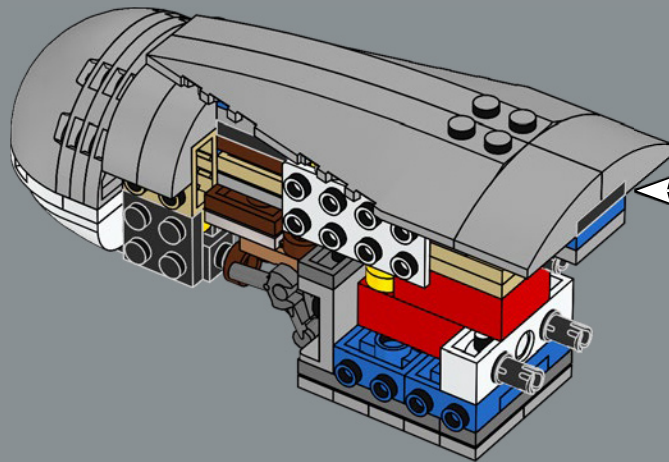

219

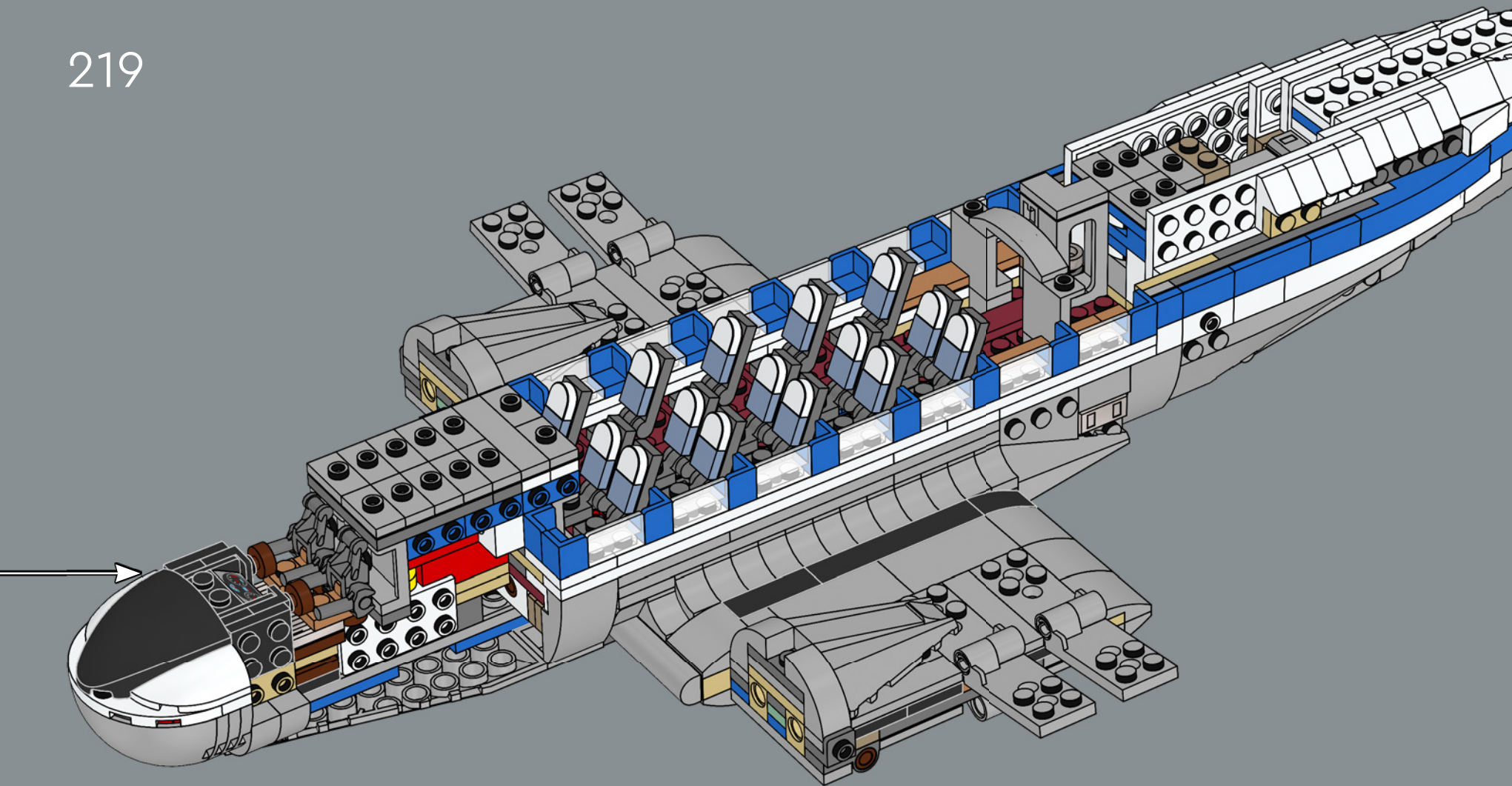

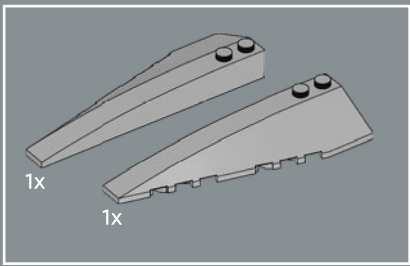

220

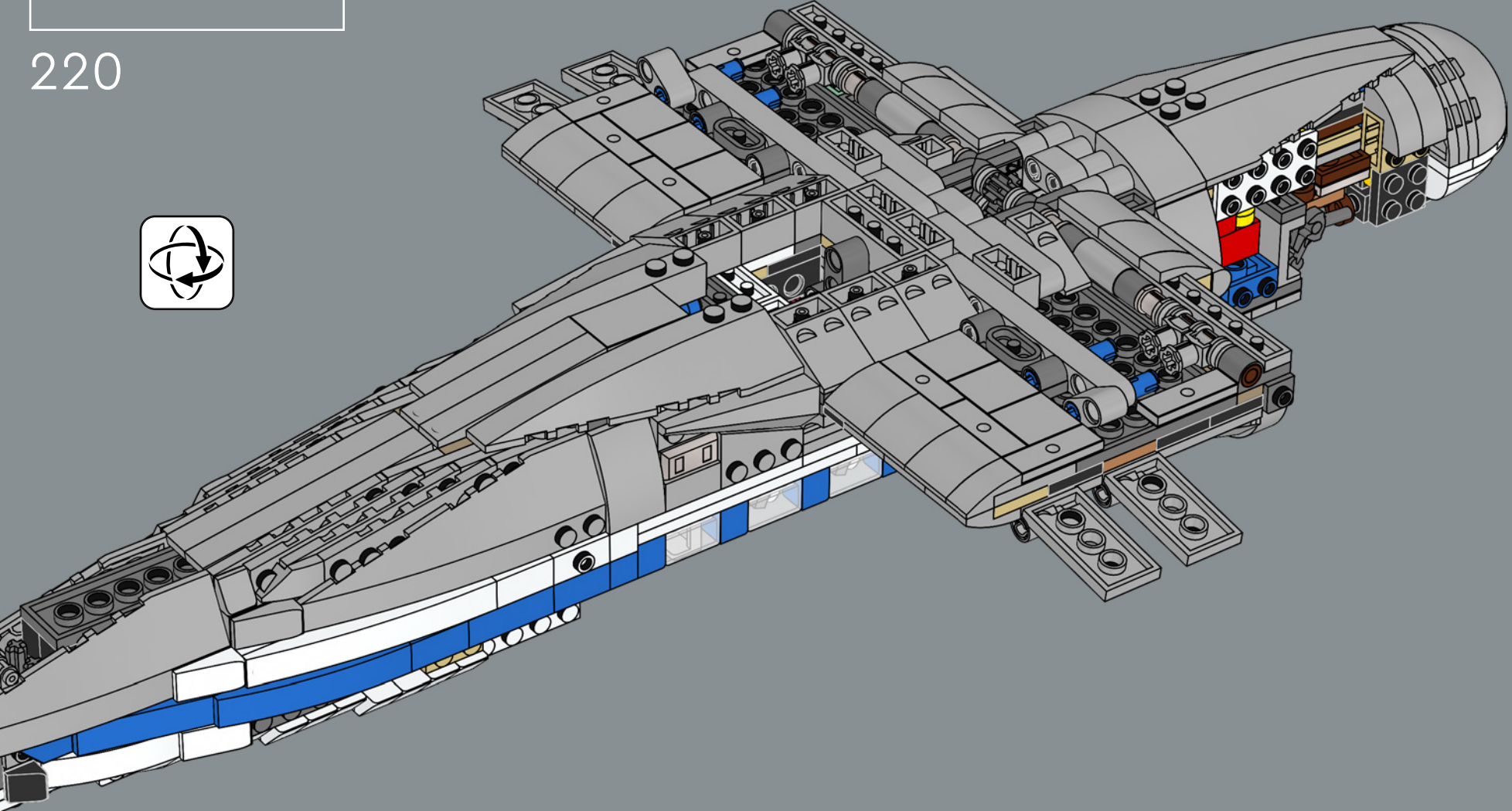

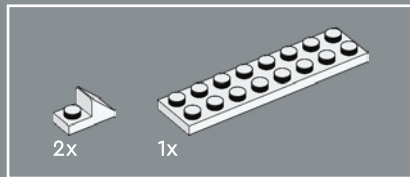
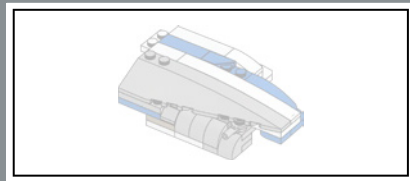

221

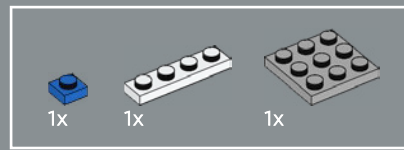
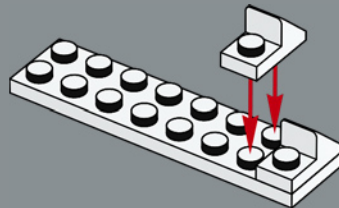

222

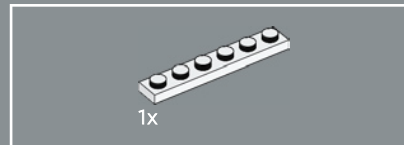
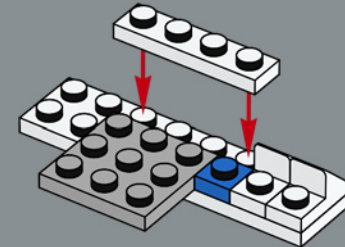

223

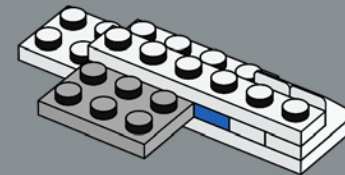

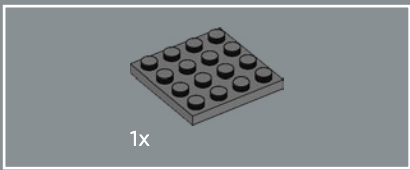

224

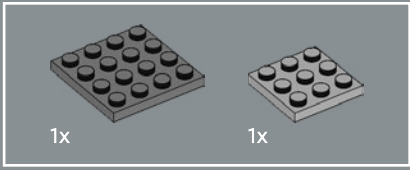
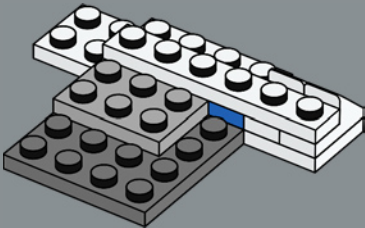

225

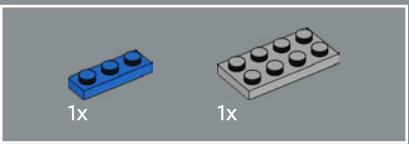
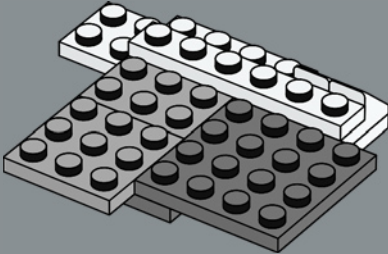

226

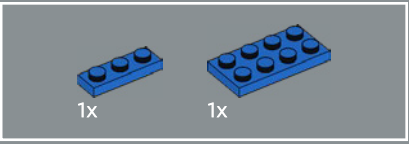
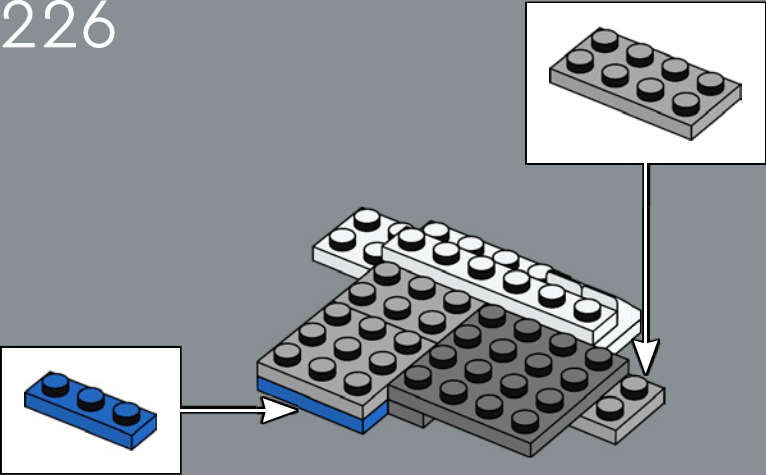

227

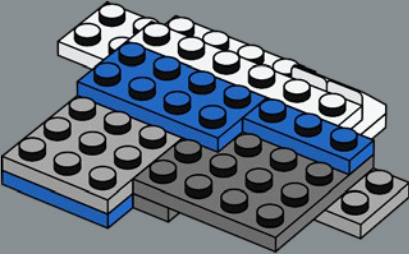

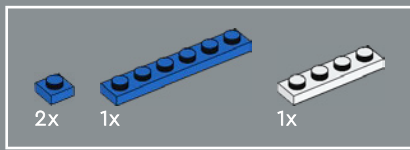

228

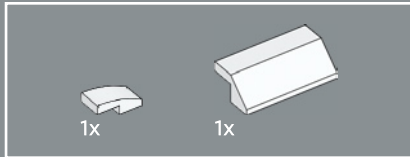
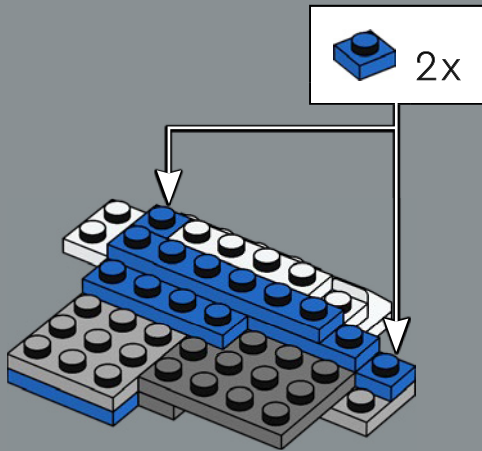

229

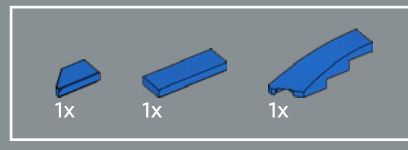
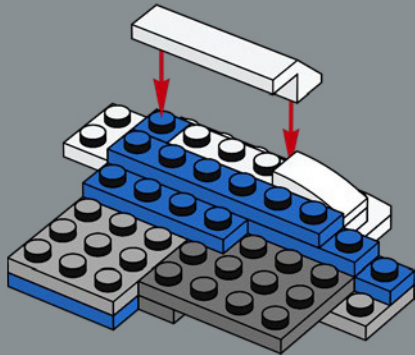

230

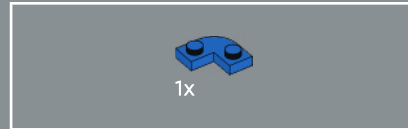
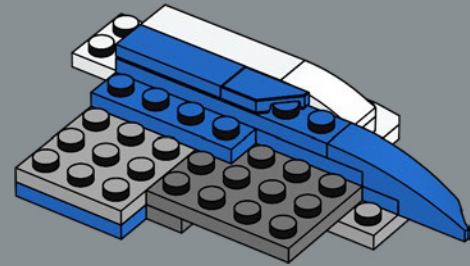

231

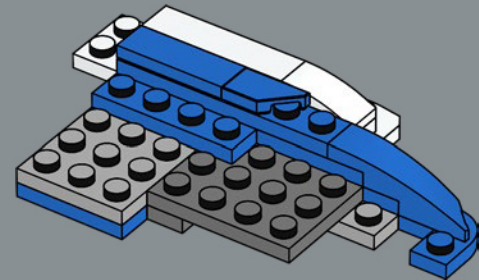

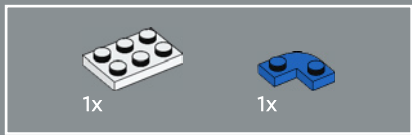

232

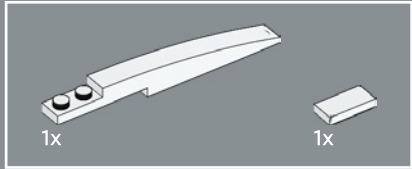
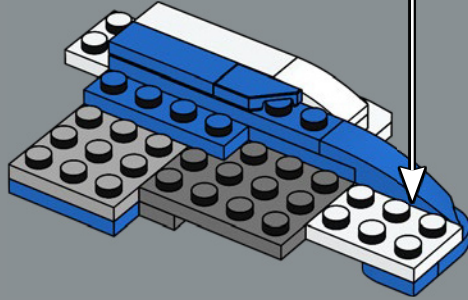
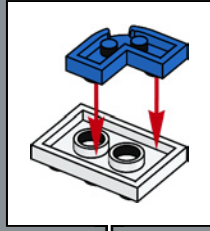

233

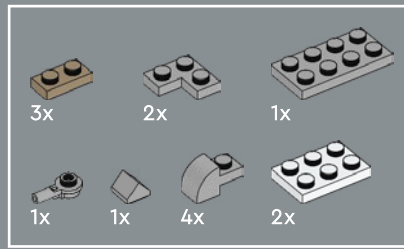
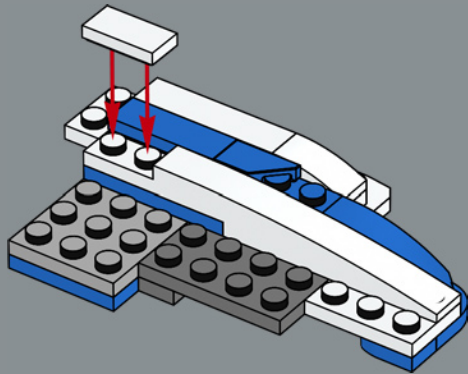

234

1

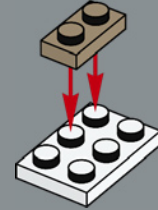

2

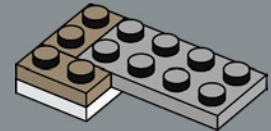

3

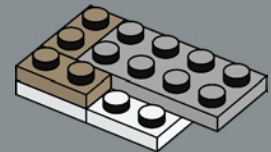

4

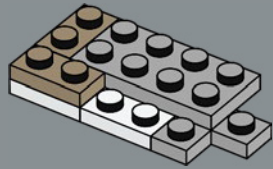

5

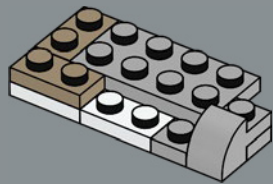

6

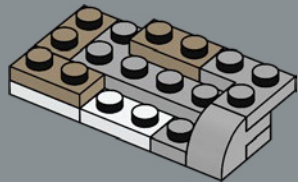

7

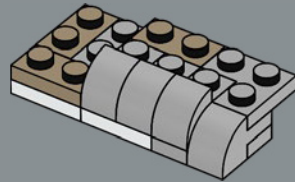

8

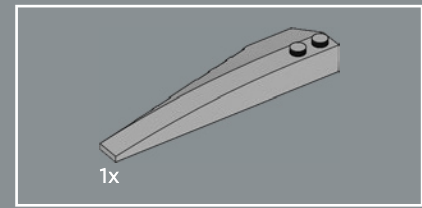
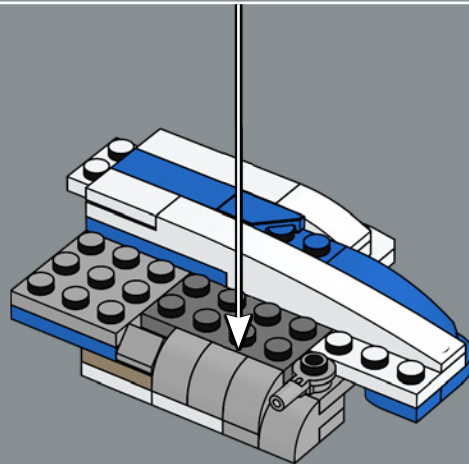
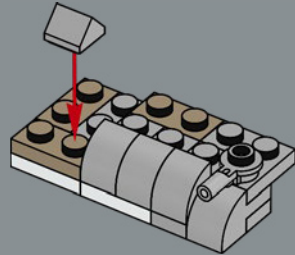

1x

235

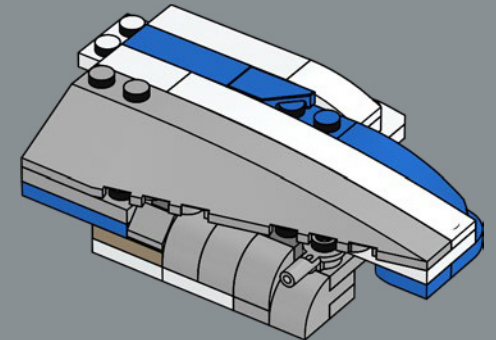

236

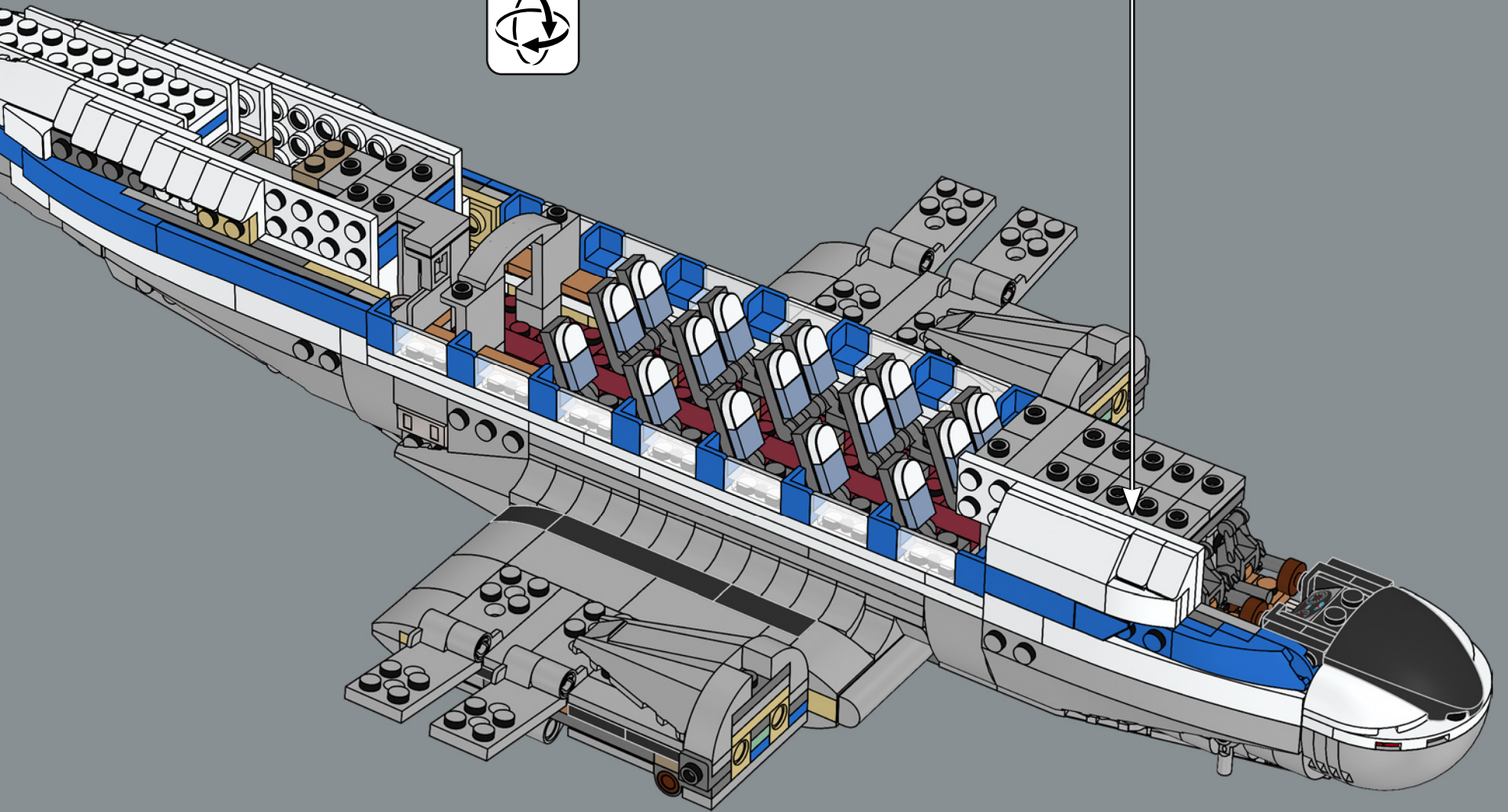

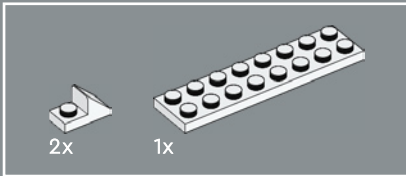
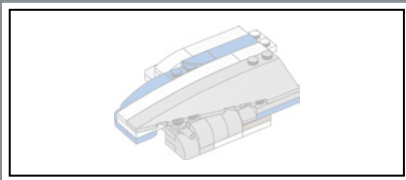

237

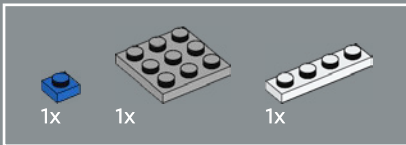
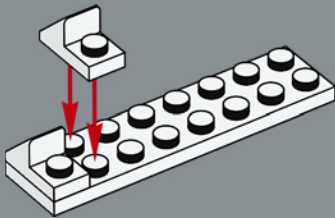

238

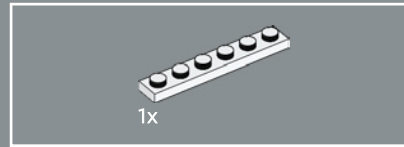
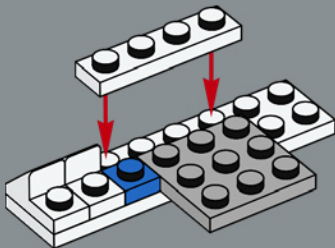

239

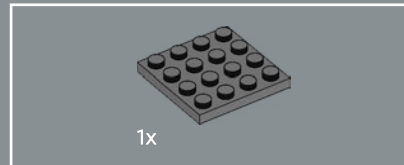
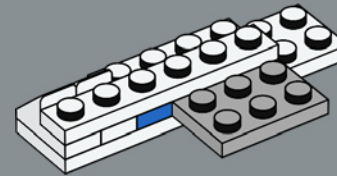

240

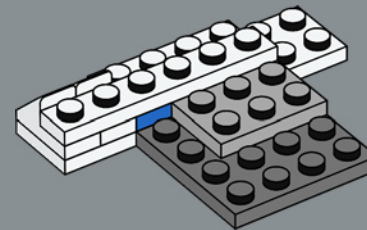

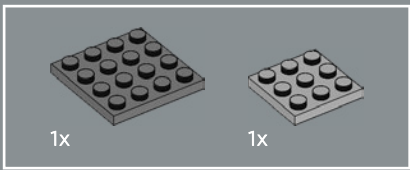

241

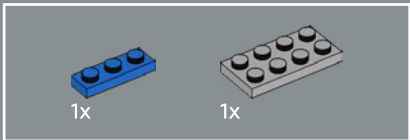
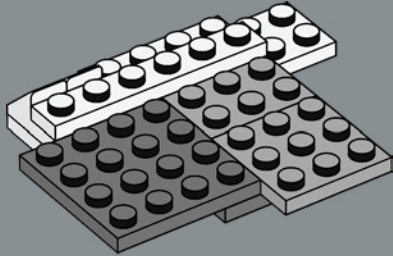

242

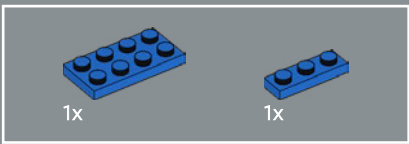
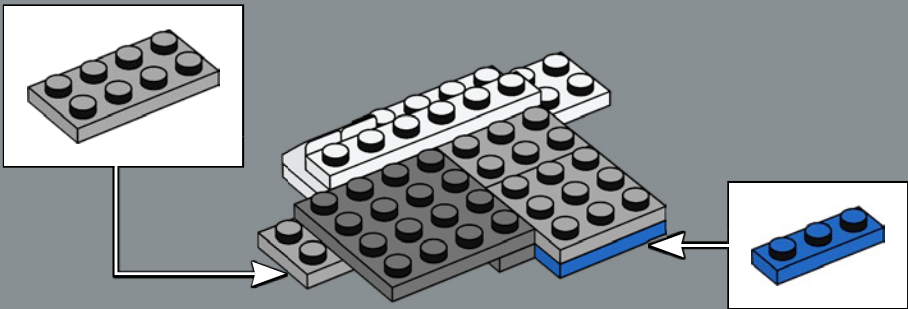

243

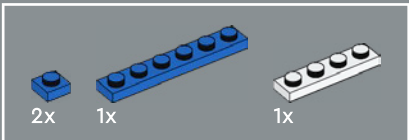
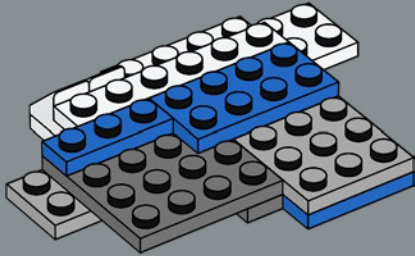

244

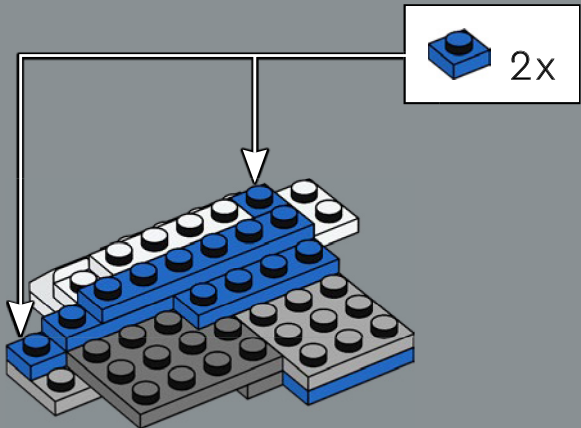

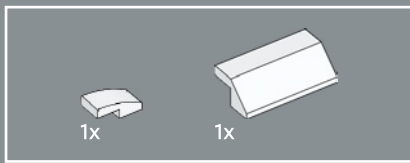

245

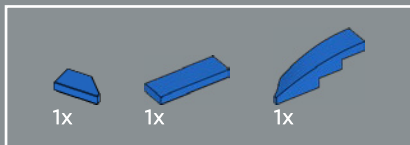
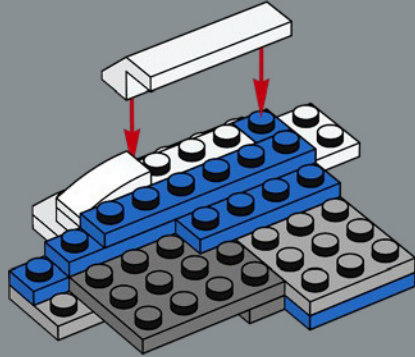

246

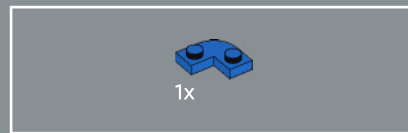
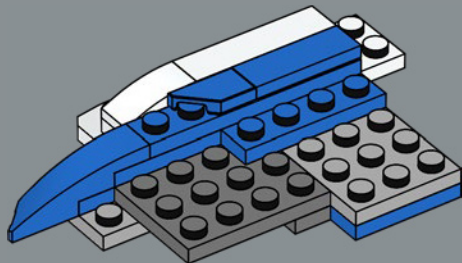

247

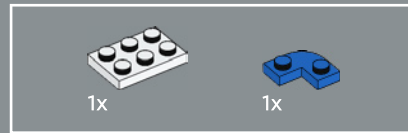
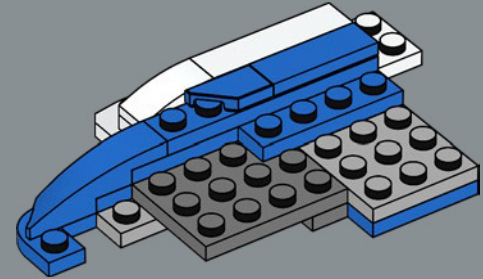

248

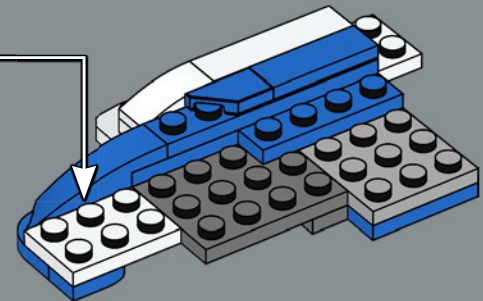
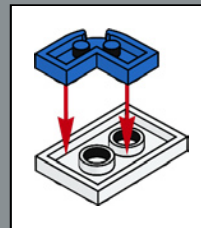

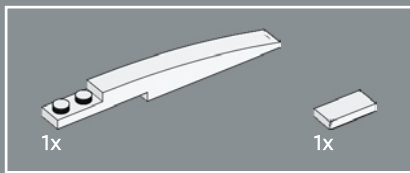

249

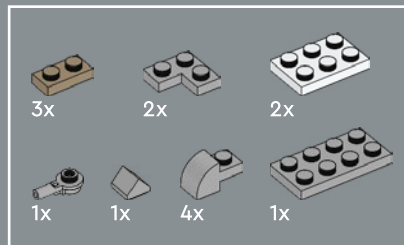
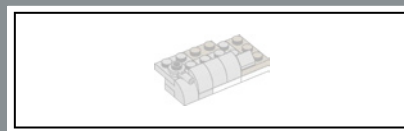
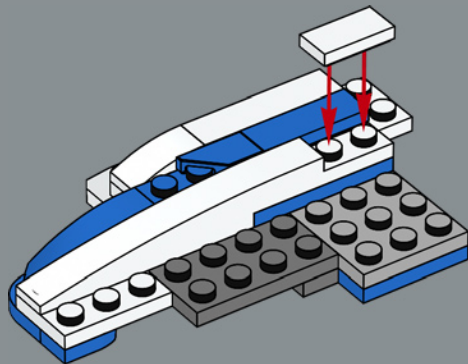

250

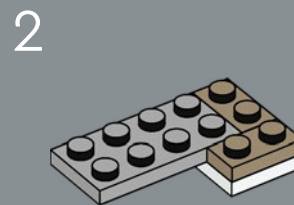
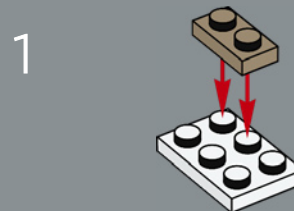



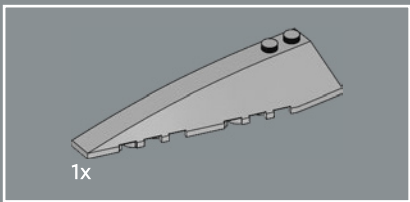

251

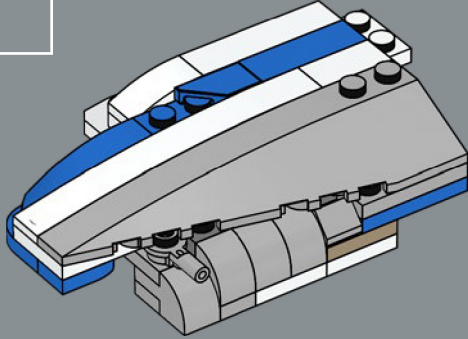

L'iconica livrea "Globo" di Pan Am®, con una linea blu a livello dei finestrini e scritte nere su sfondo bianco, fu introdotta nel 1958 e utilizzata fino al 1984.

252

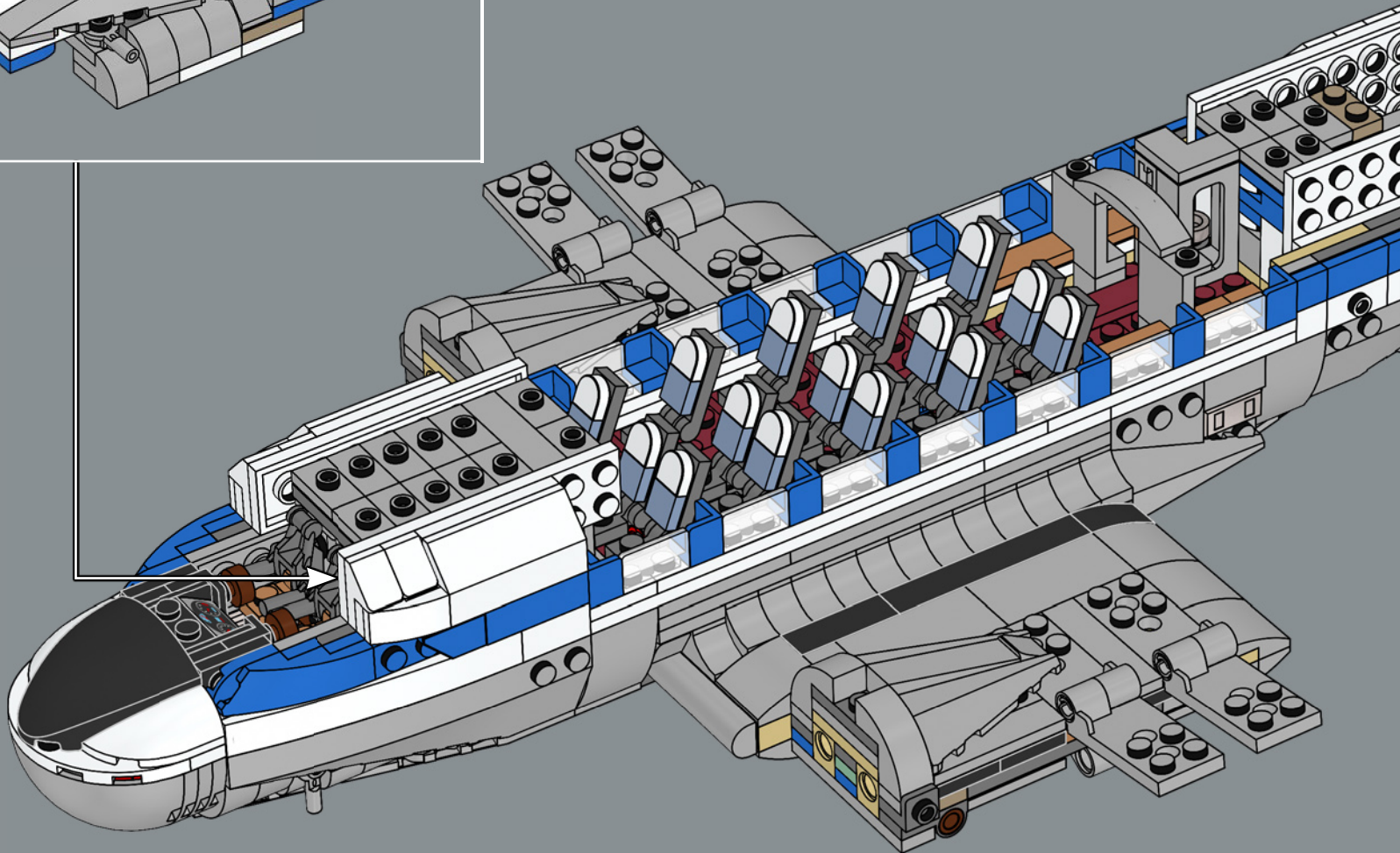

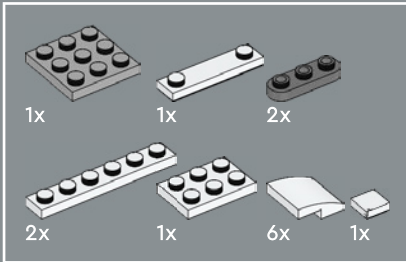
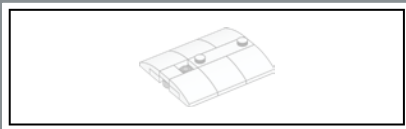

253

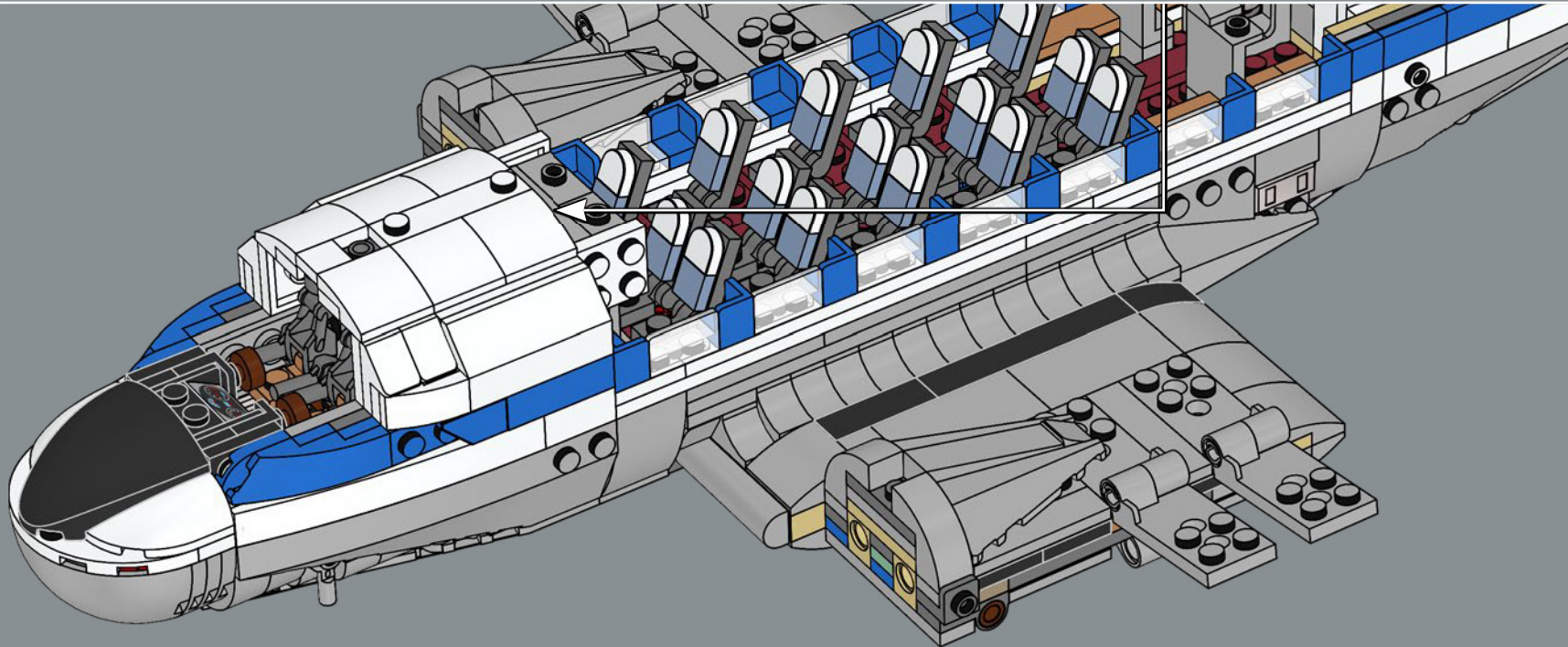
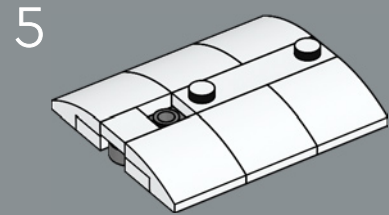
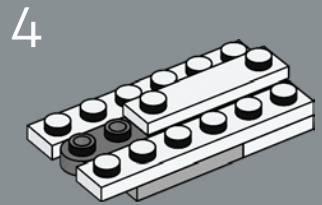
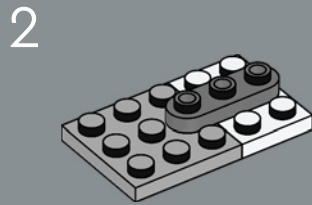
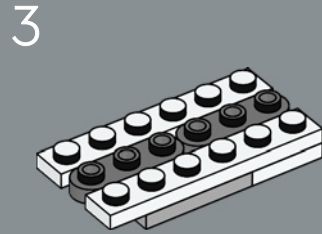
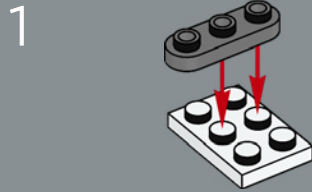

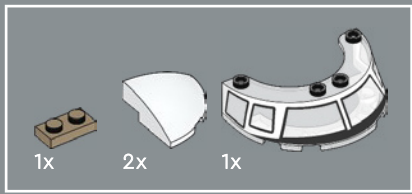

254

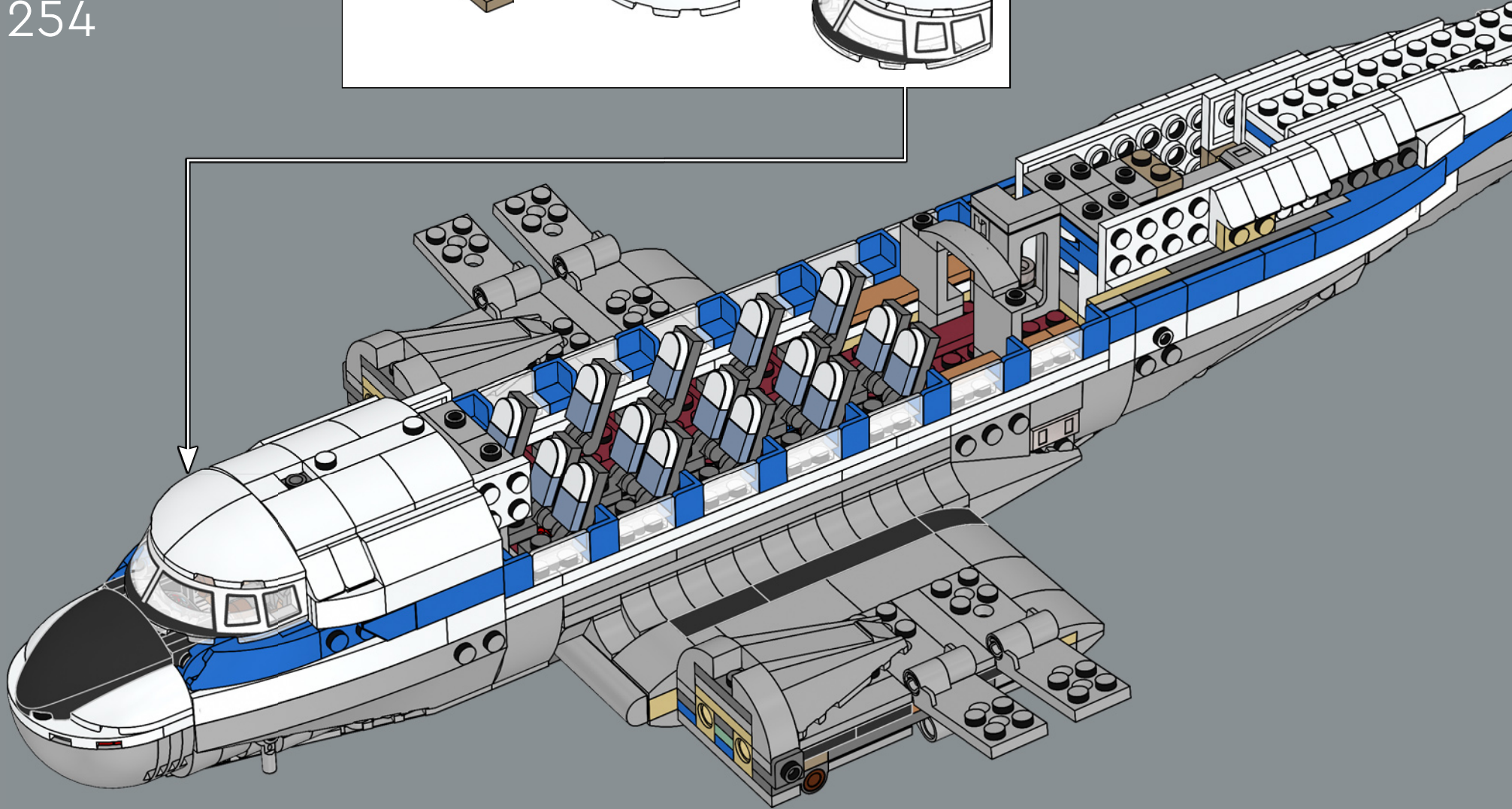
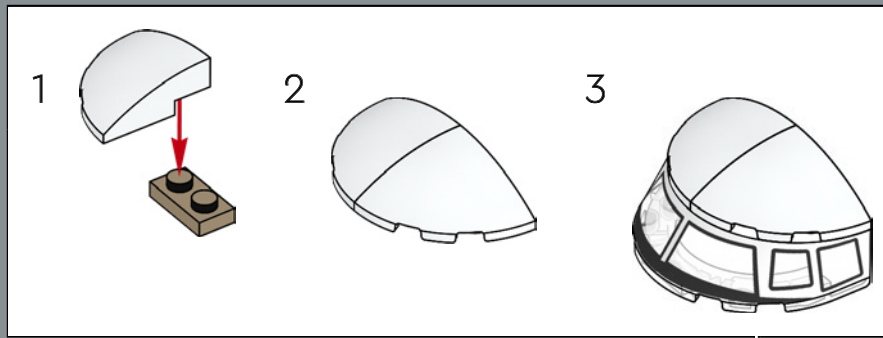

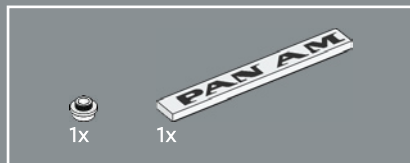
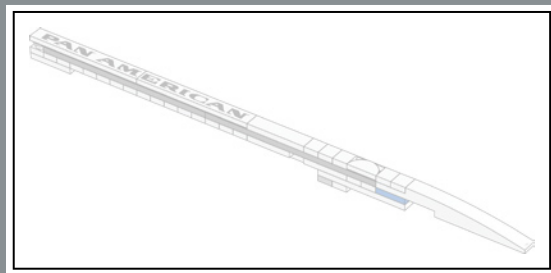

255

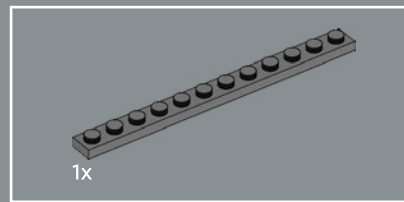
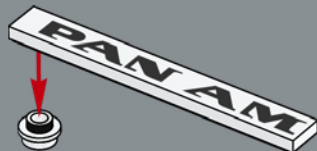

256

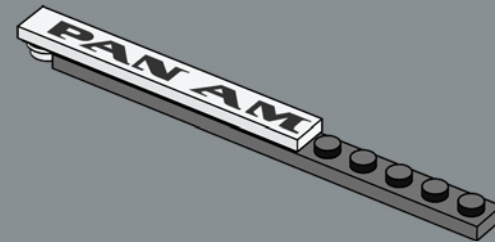

257

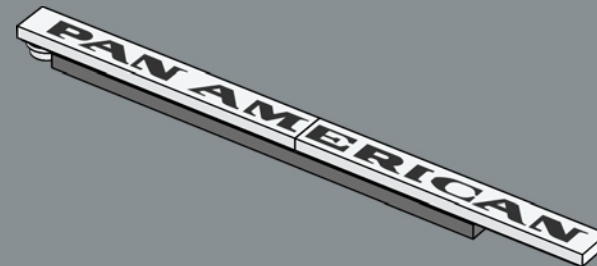

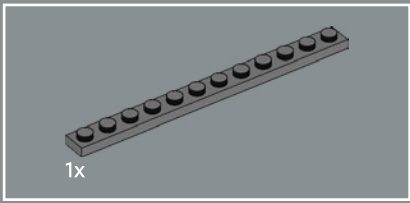

258

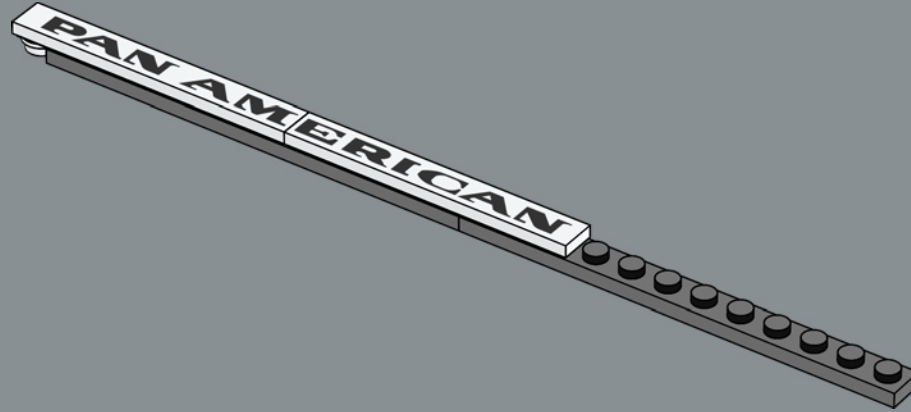

259

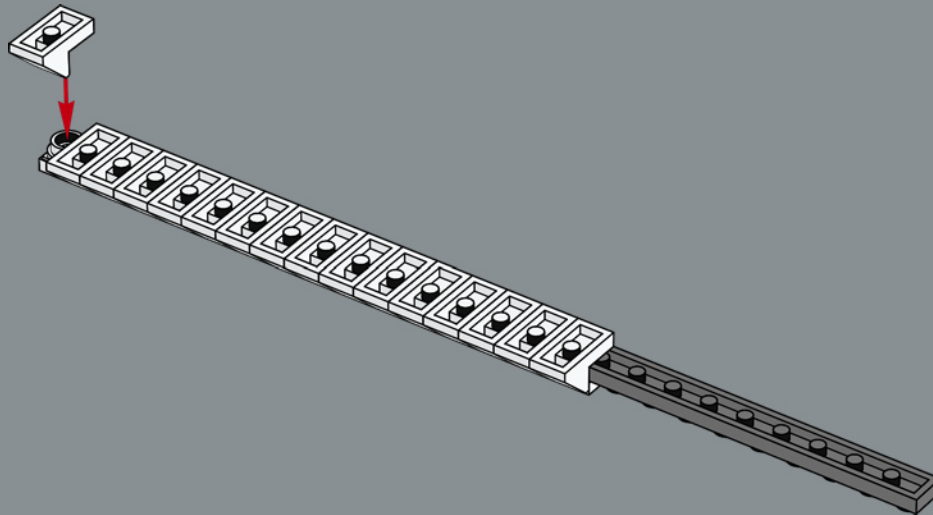

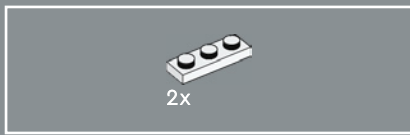

260

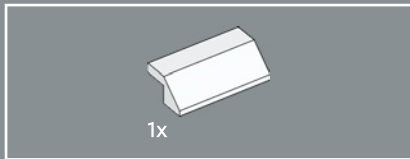
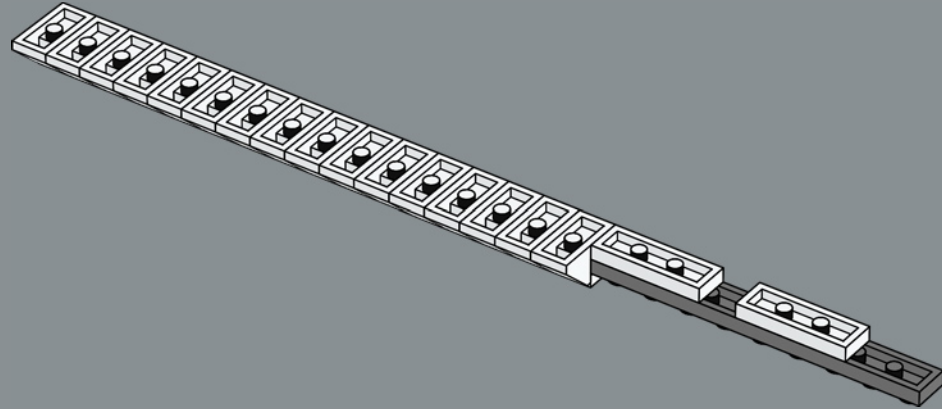

261

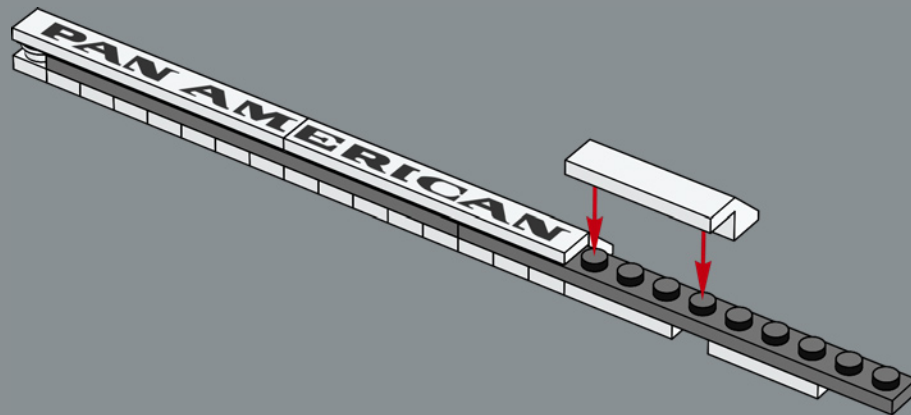

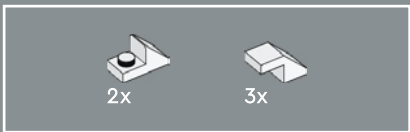

262

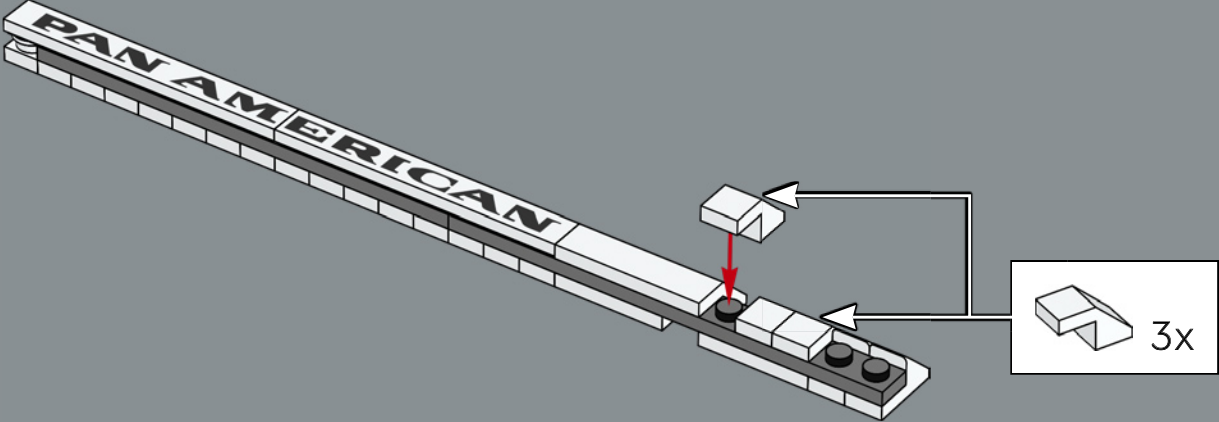

263

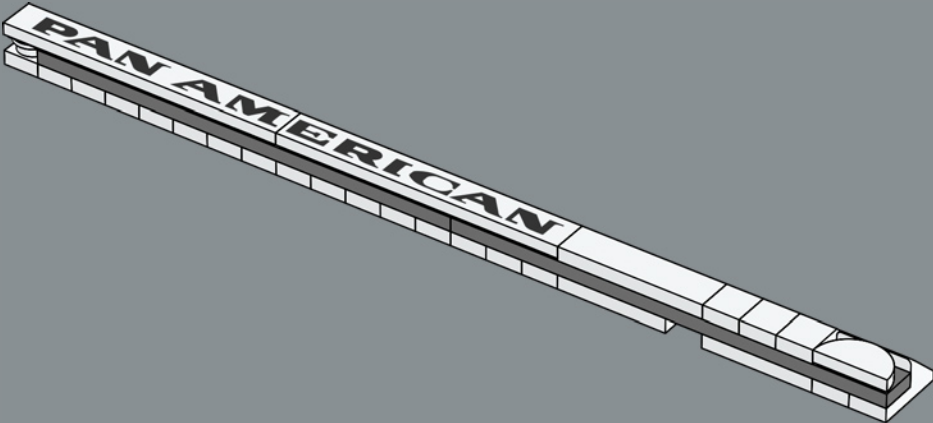

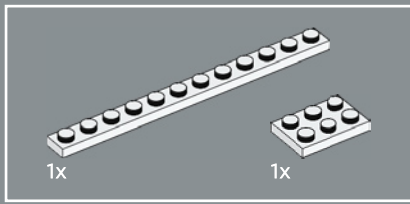

264

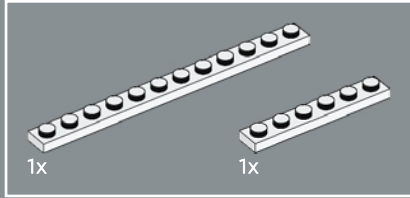
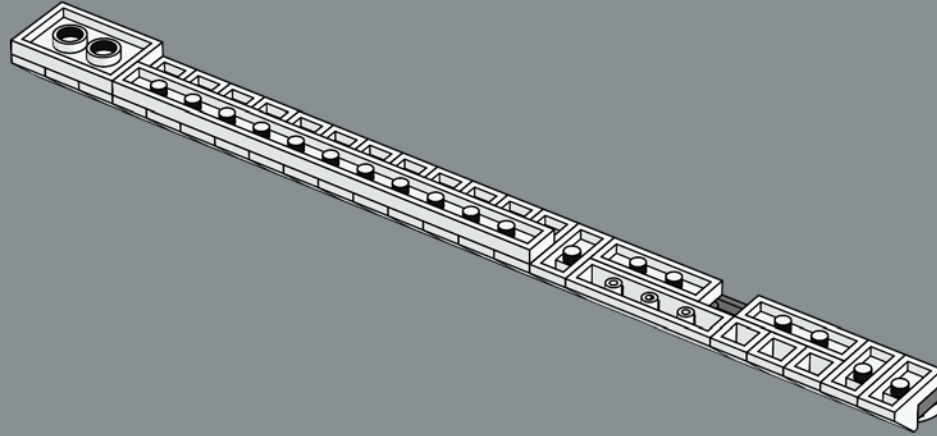

265

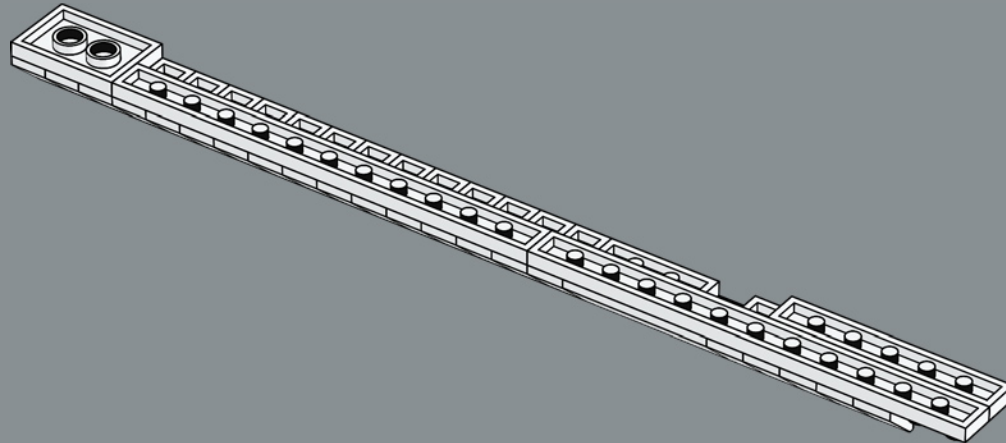

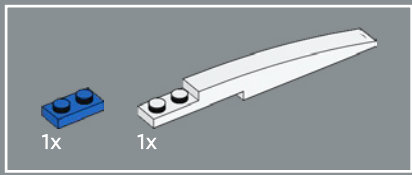

266

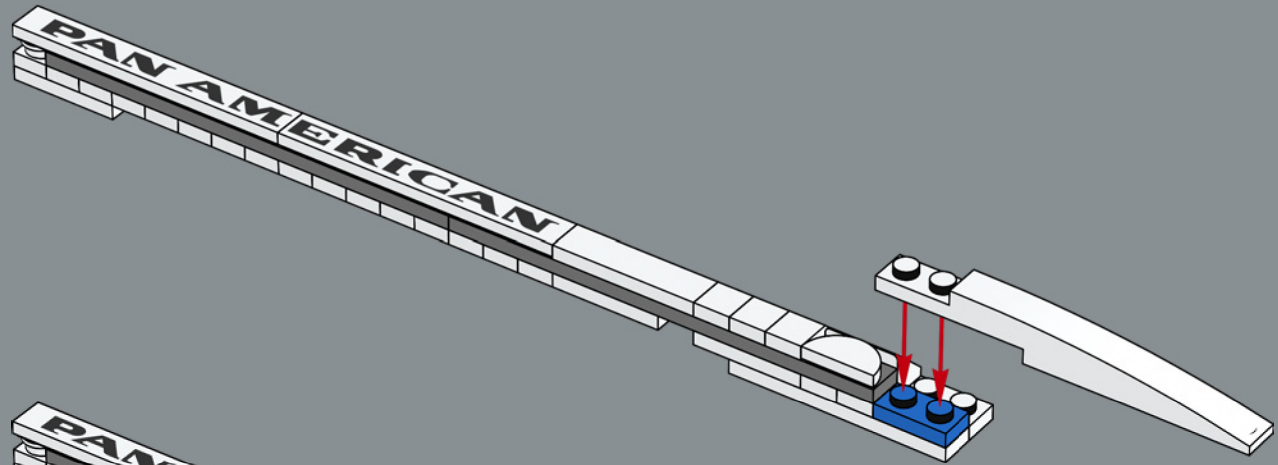

267

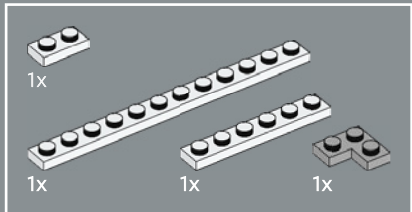
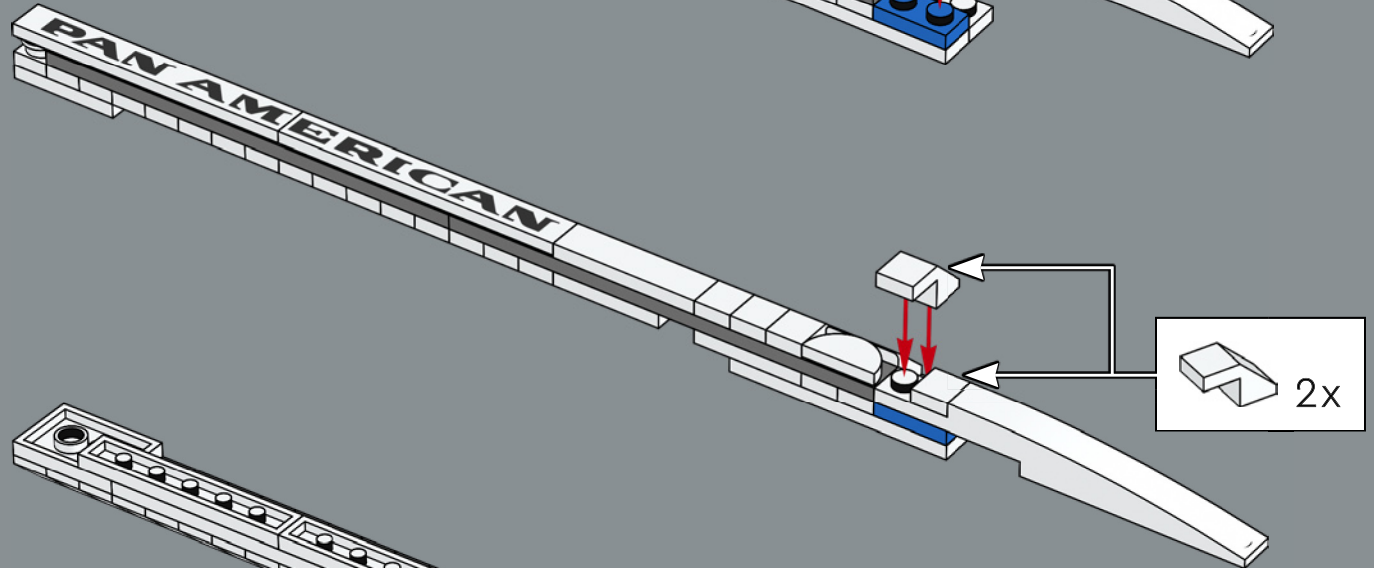

268

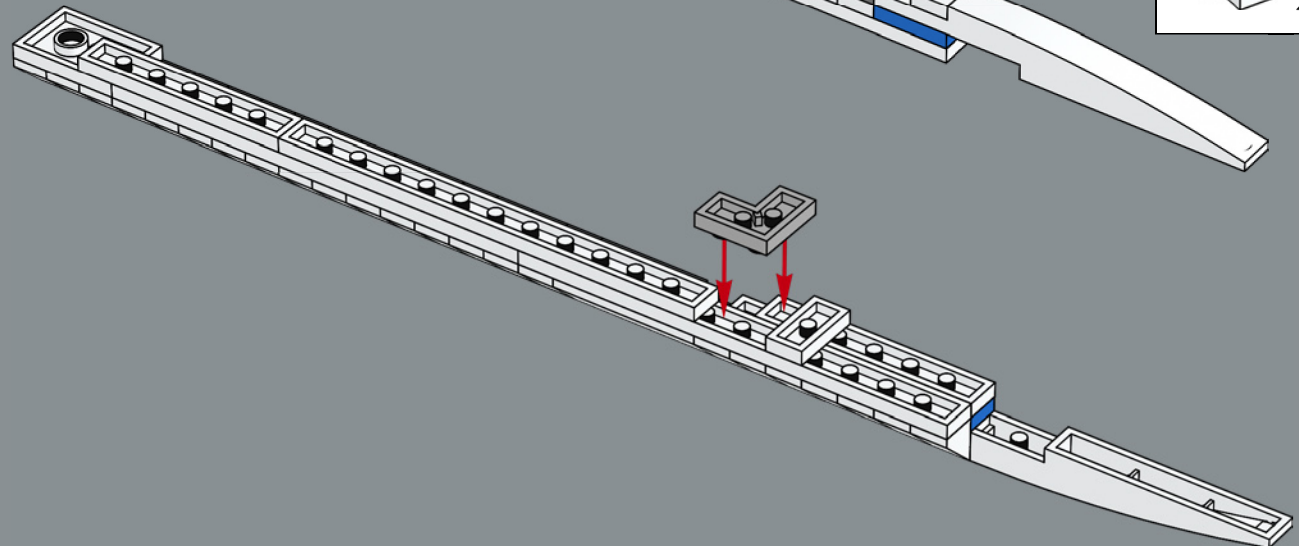

269

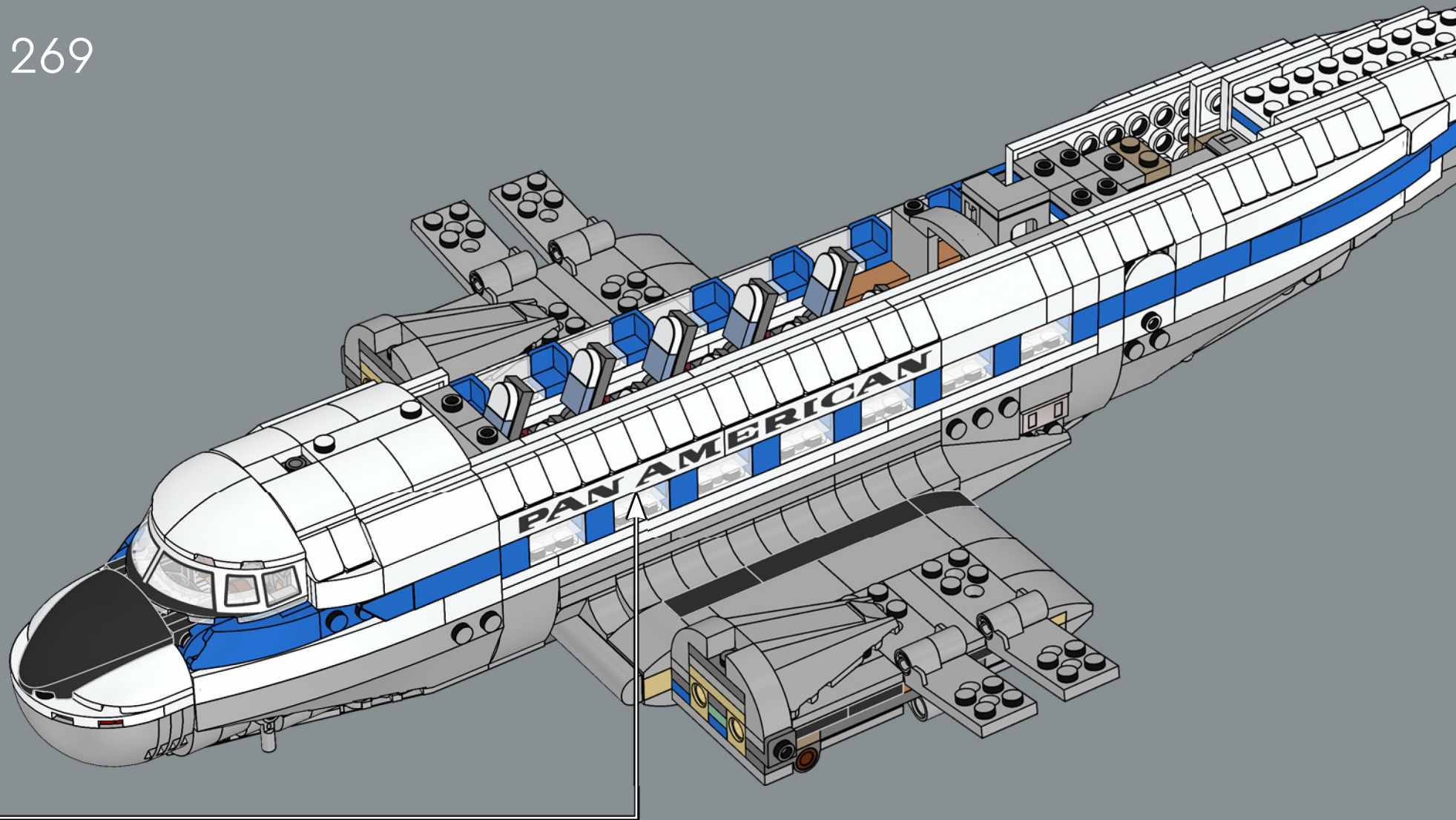

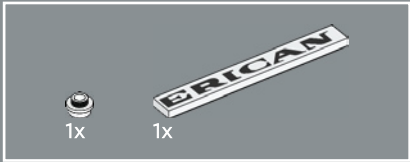
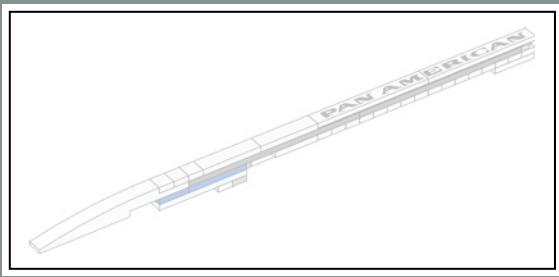

270

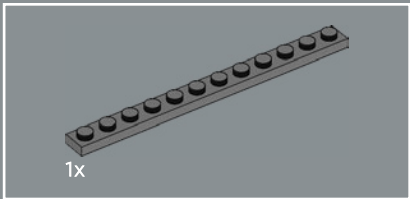

271

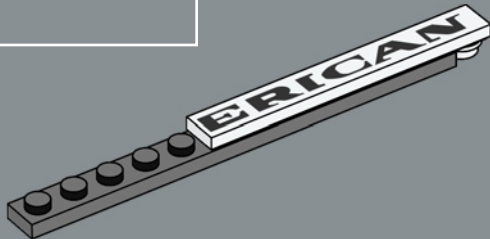

272

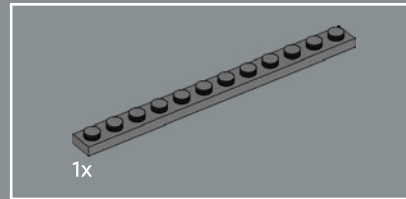
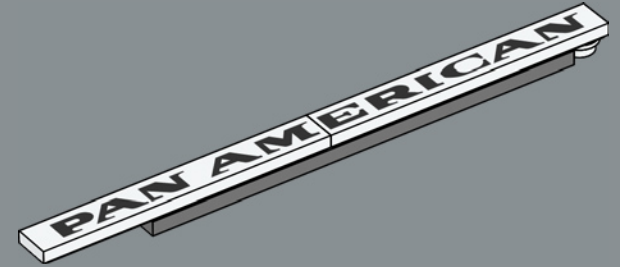

273

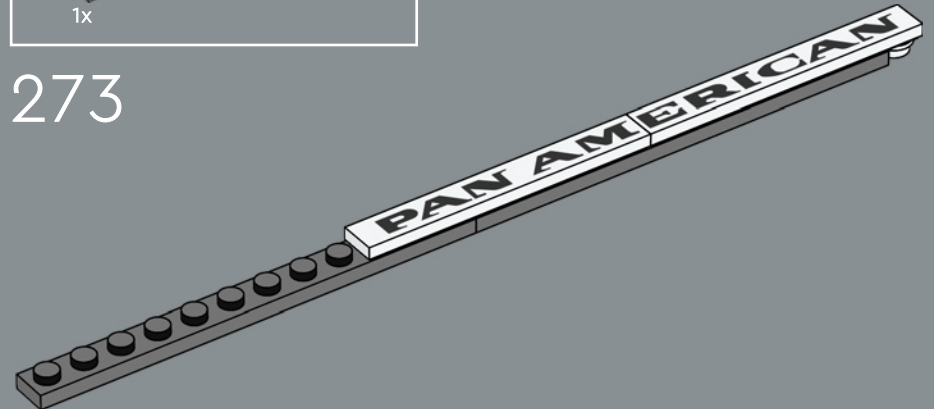



274

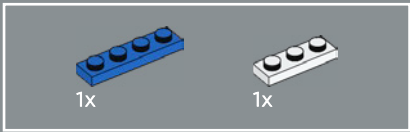
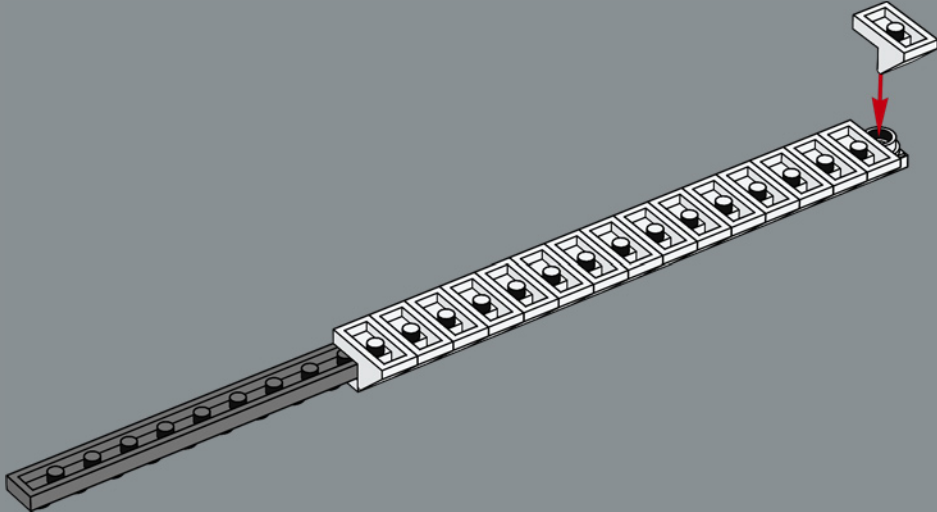

275

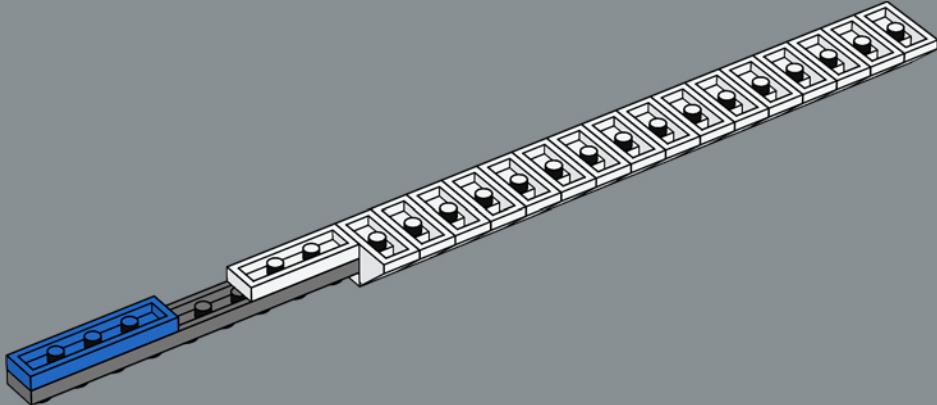

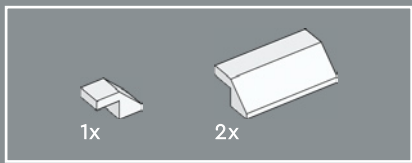

276

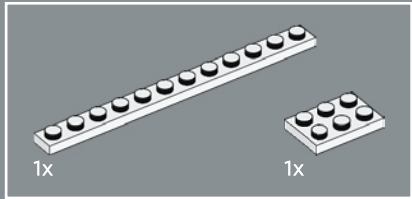
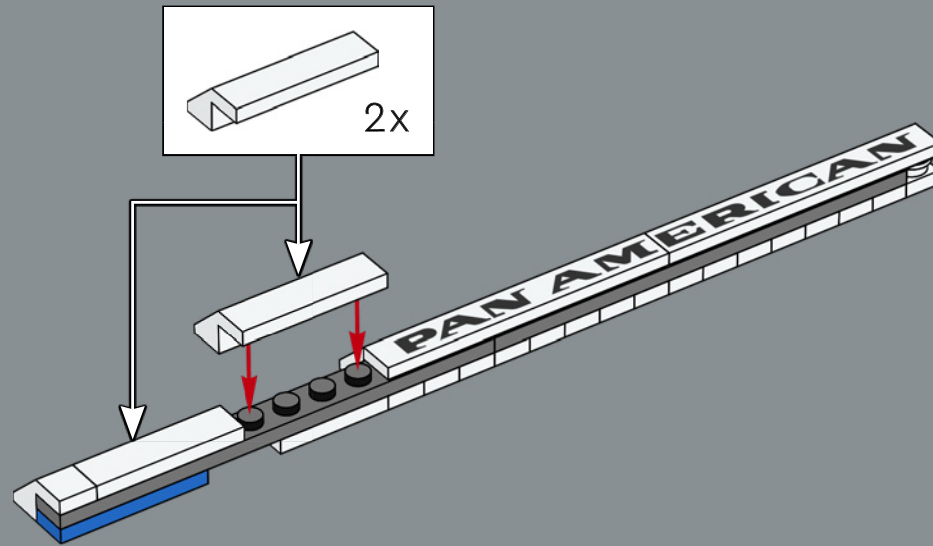

277

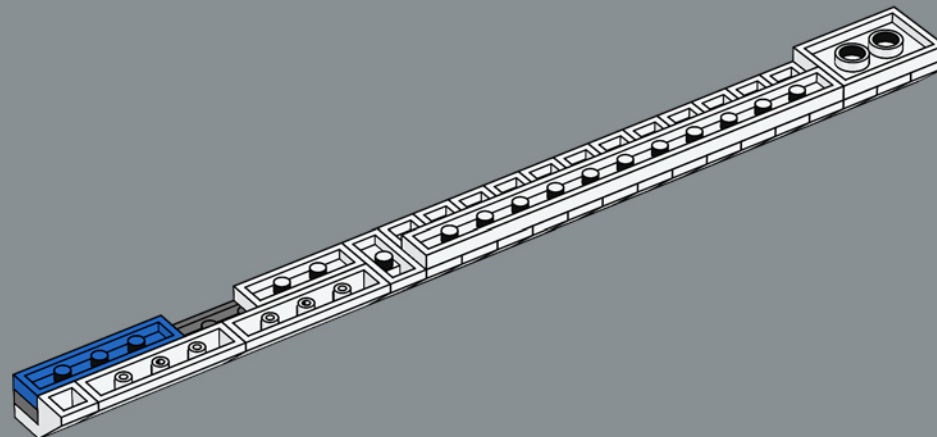

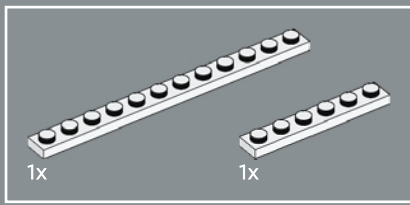

278

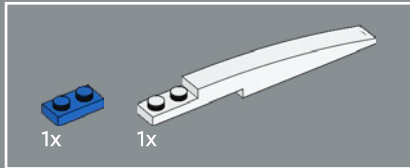
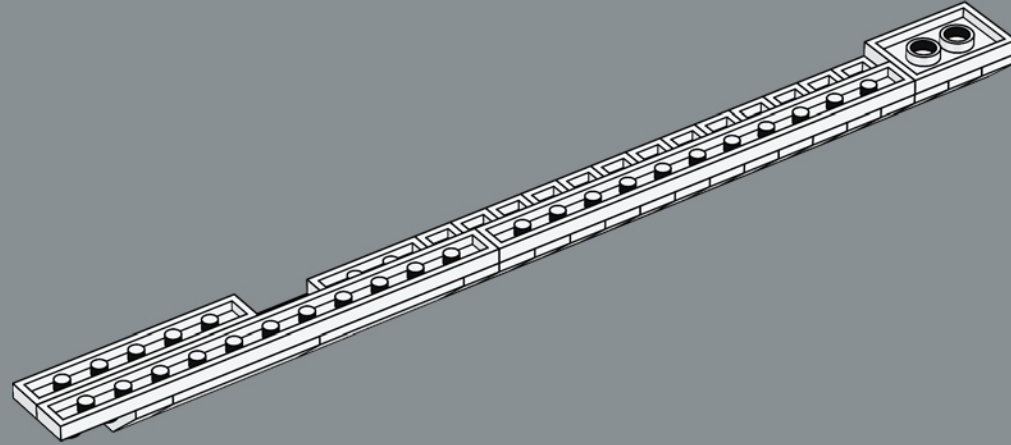

279

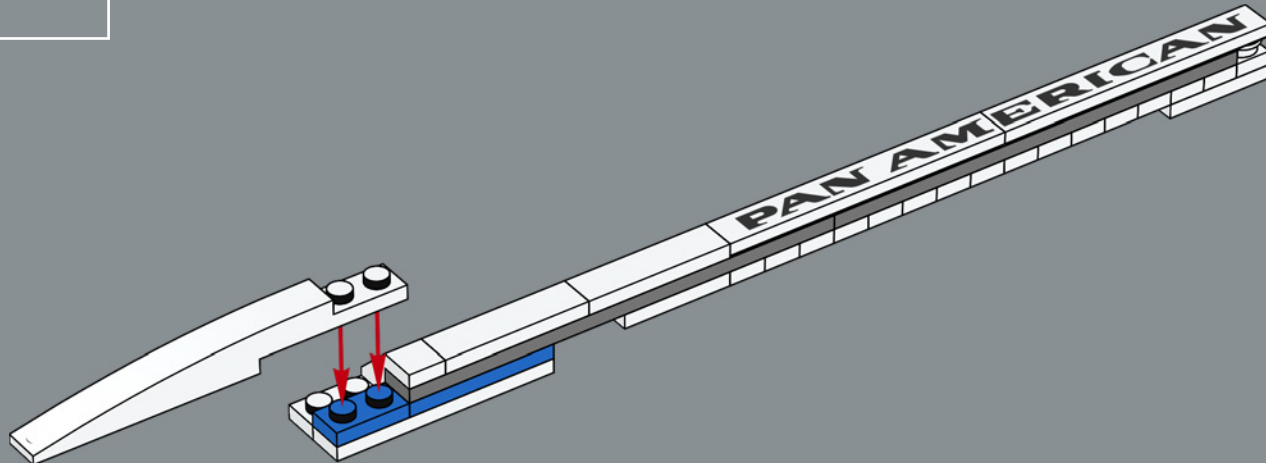



2x

280



2x

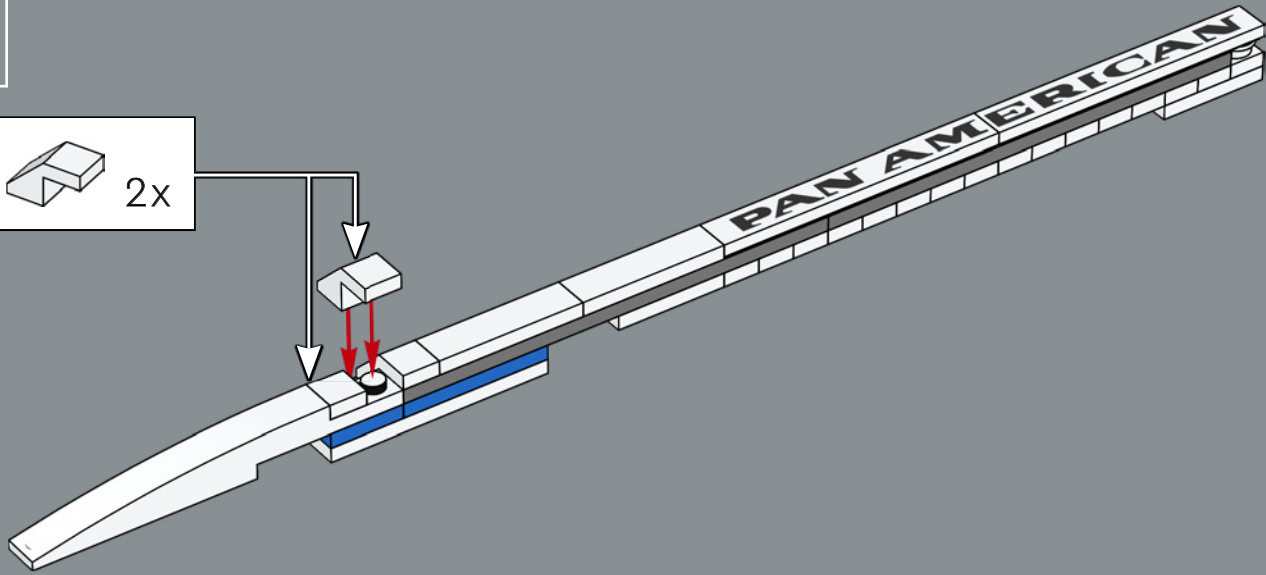

1x



1x

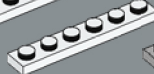

1x



1x

281

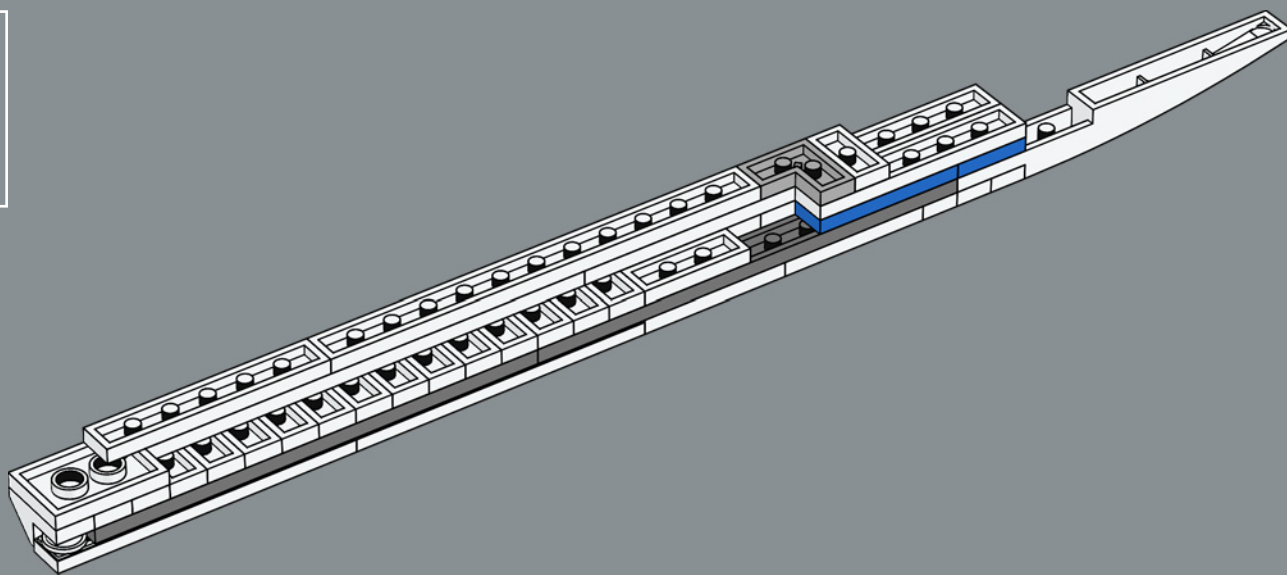

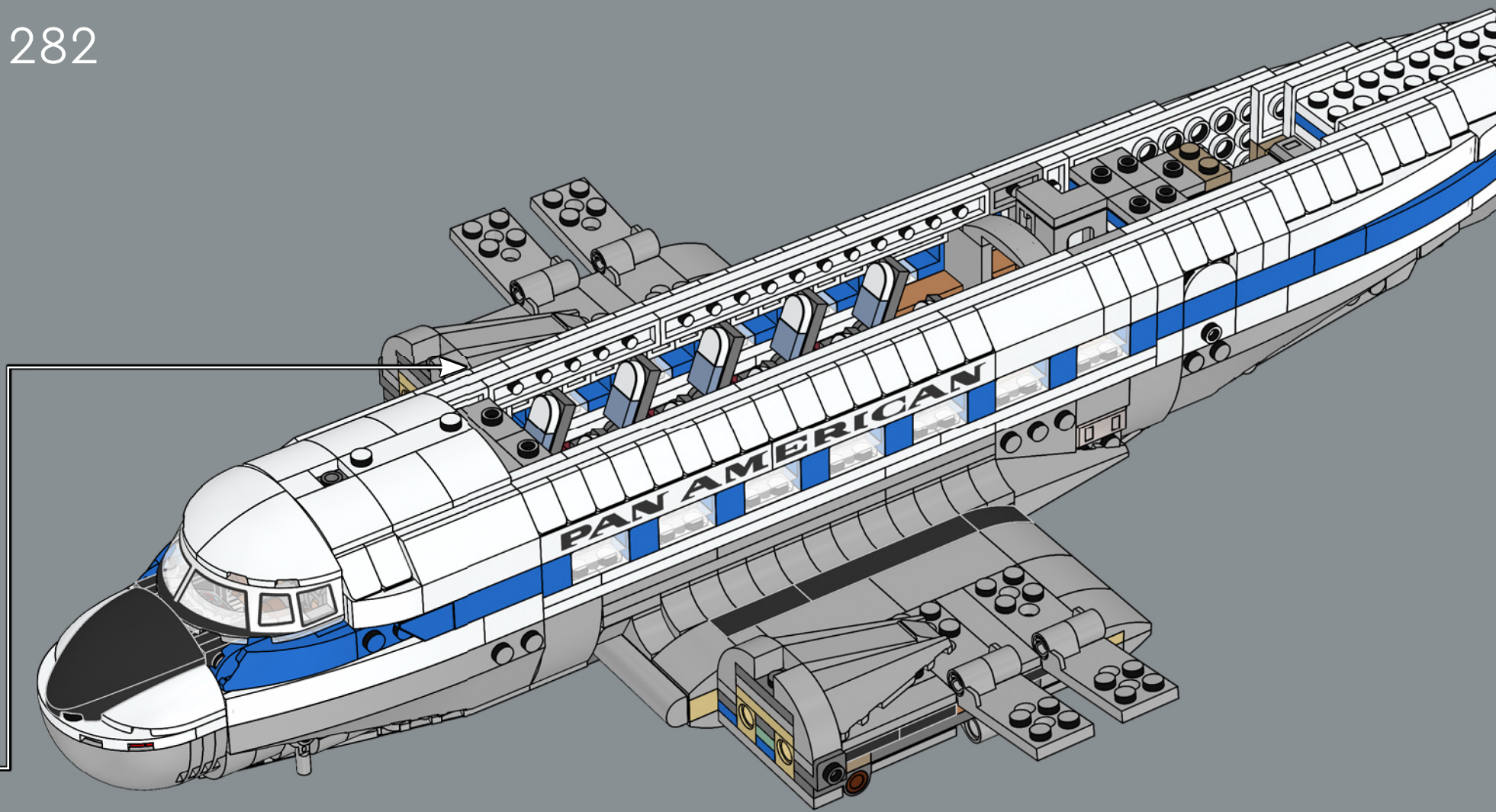

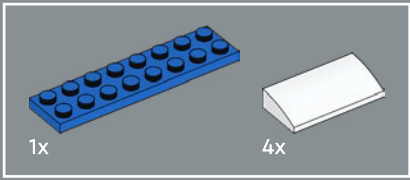

283

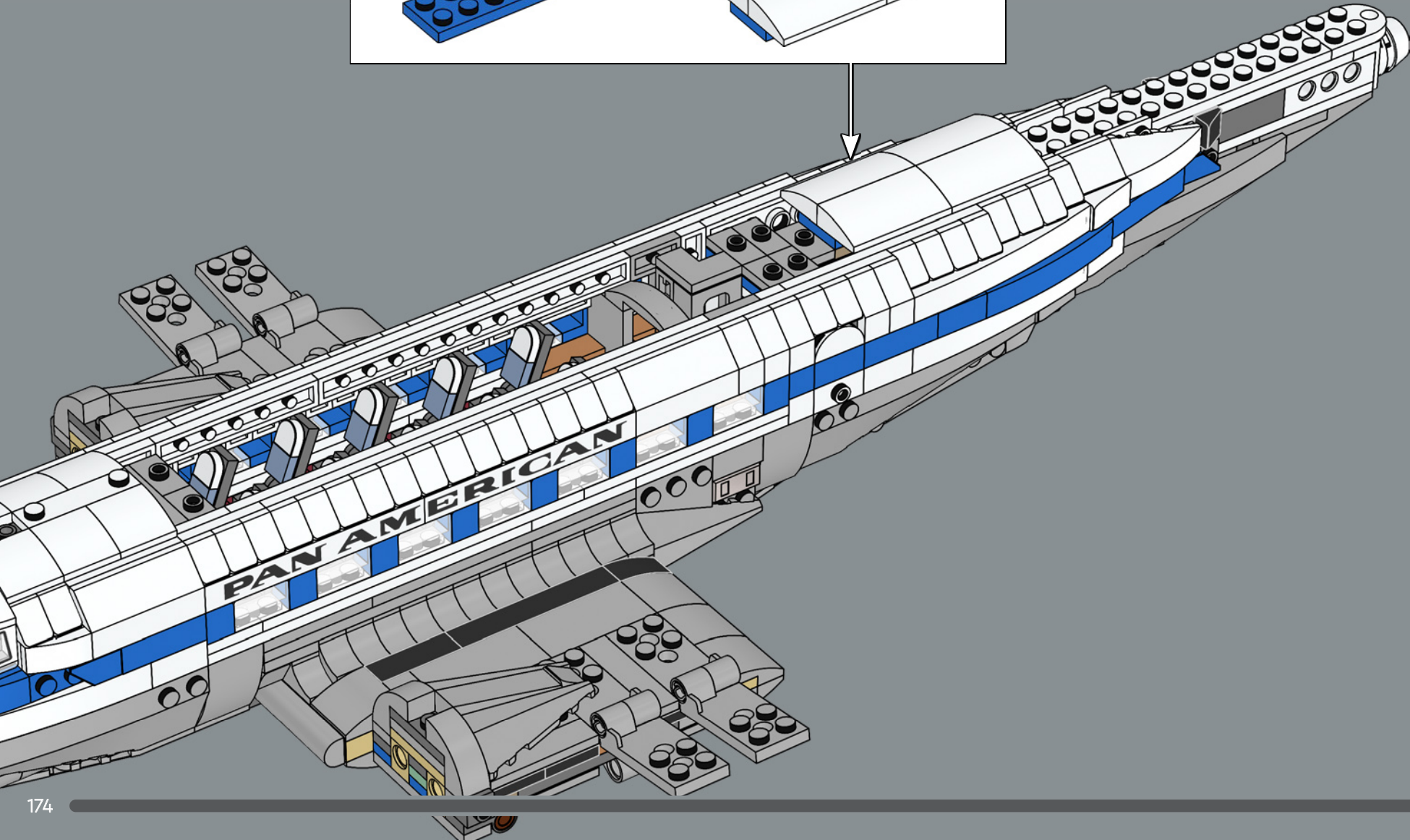
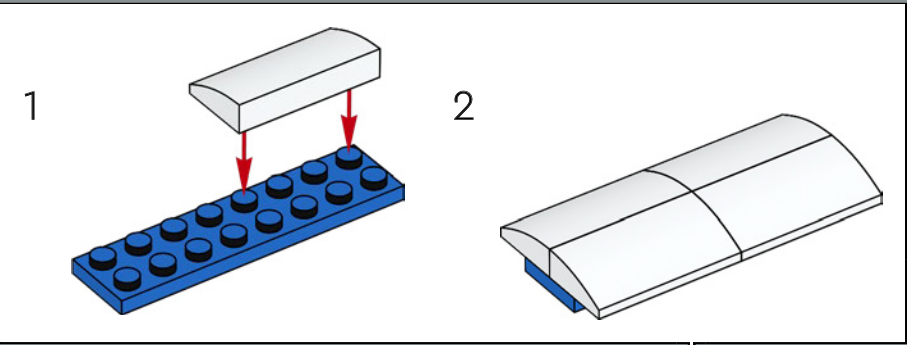

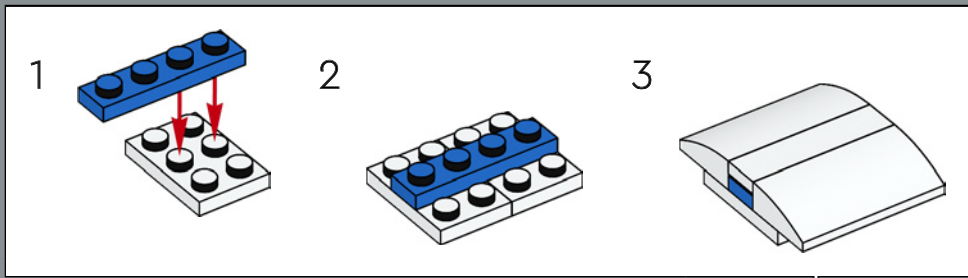
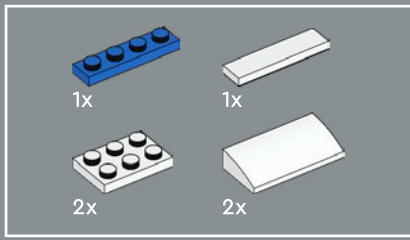

284

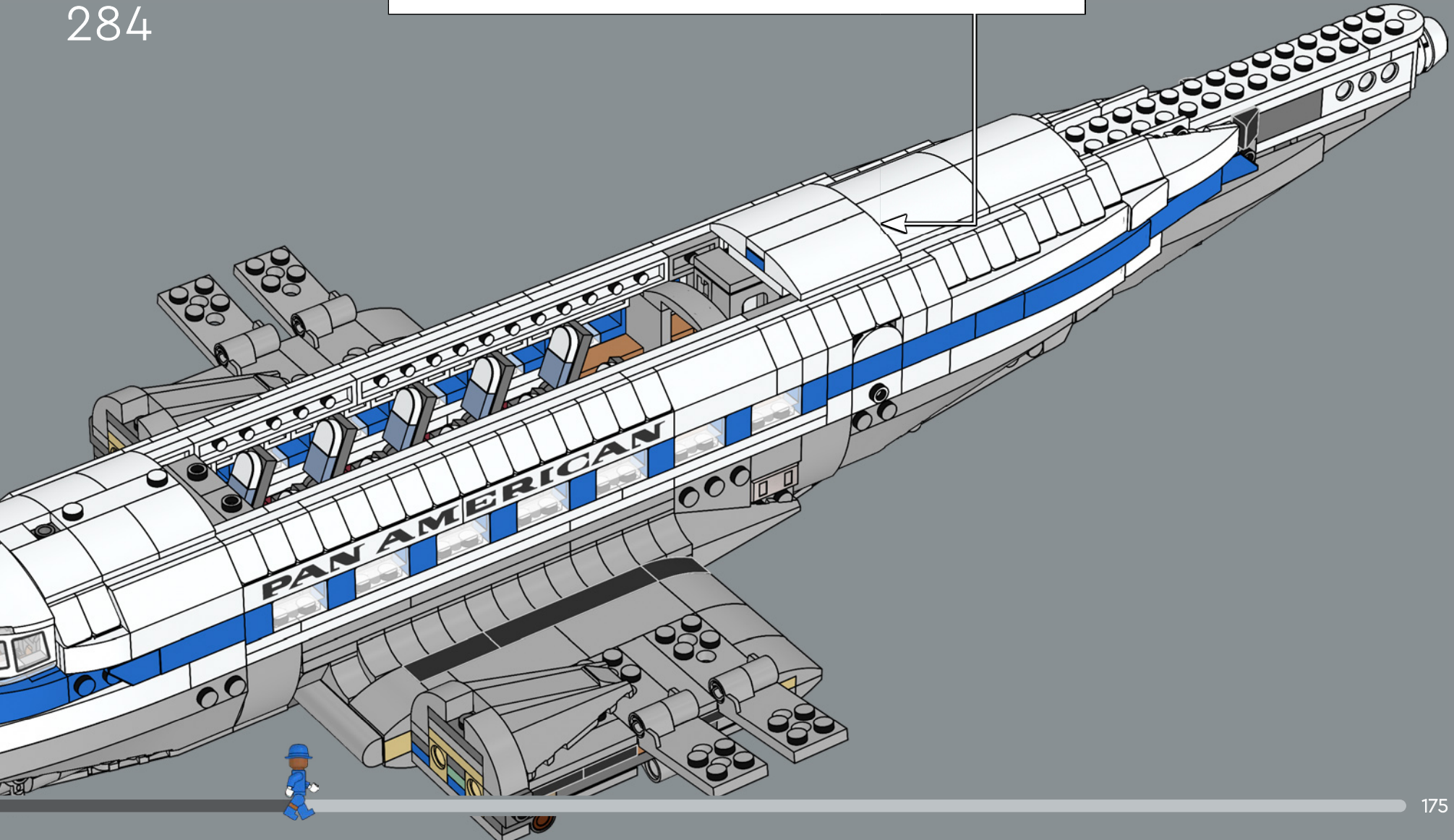

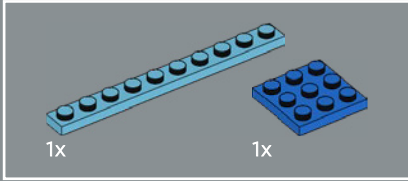
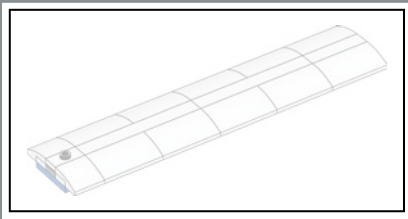

285

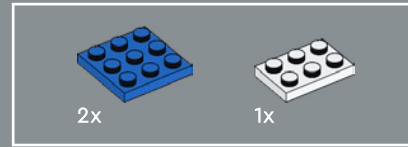
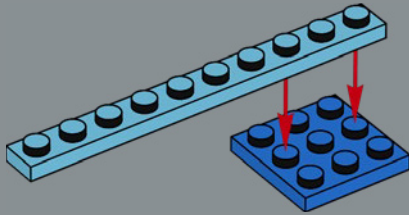

286

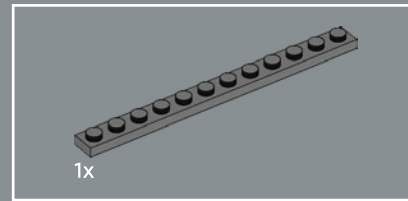
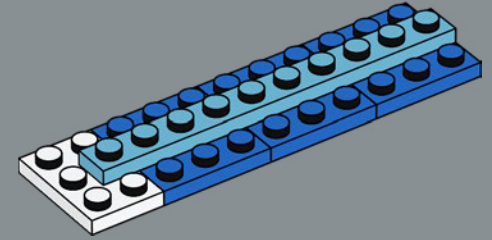

287

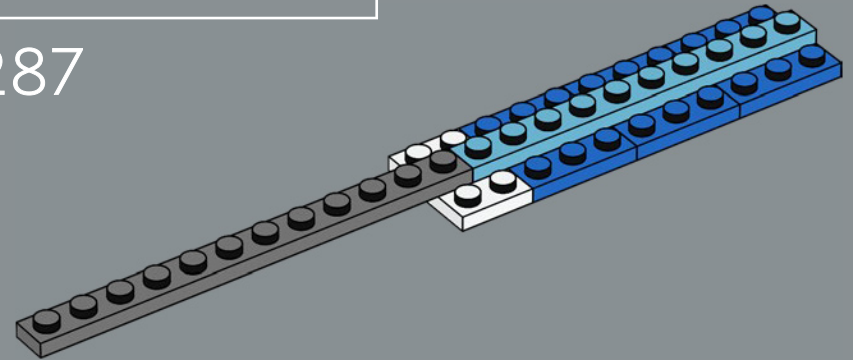

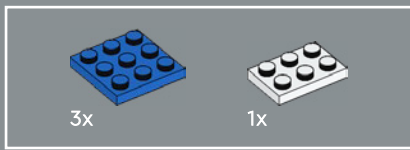

288

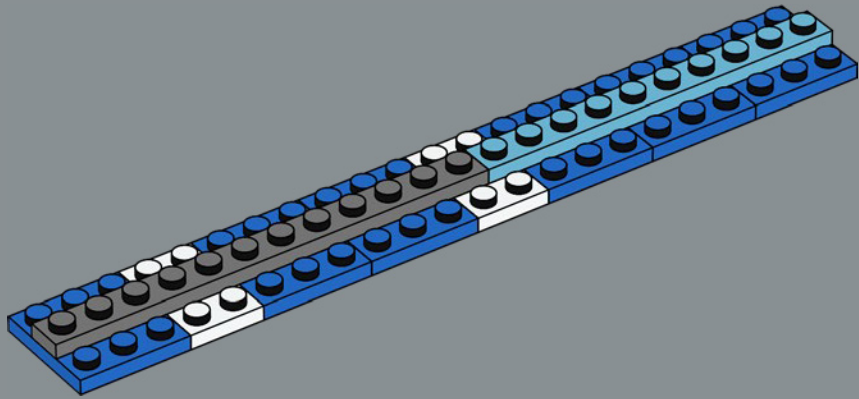

289

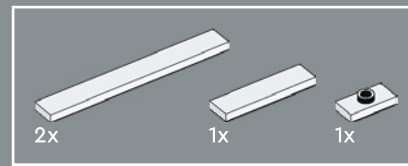
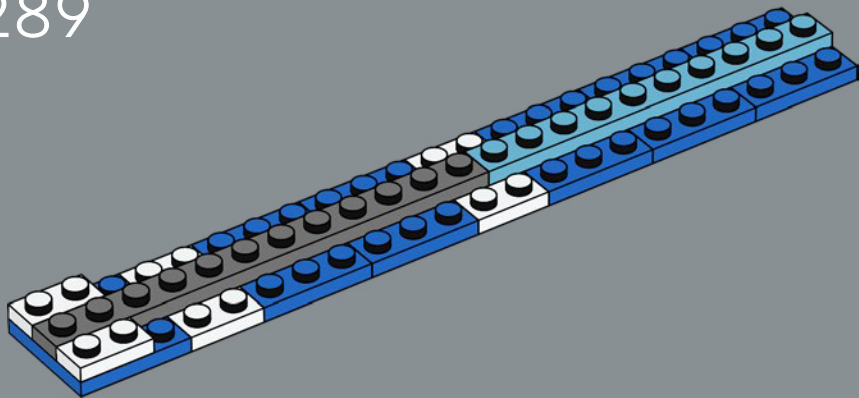

290

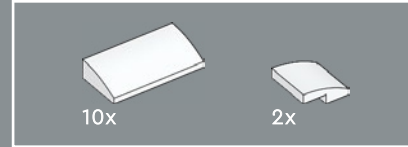
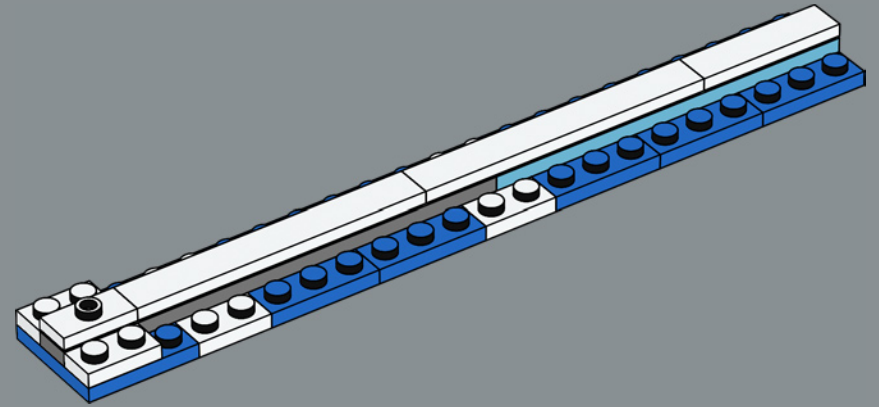

291

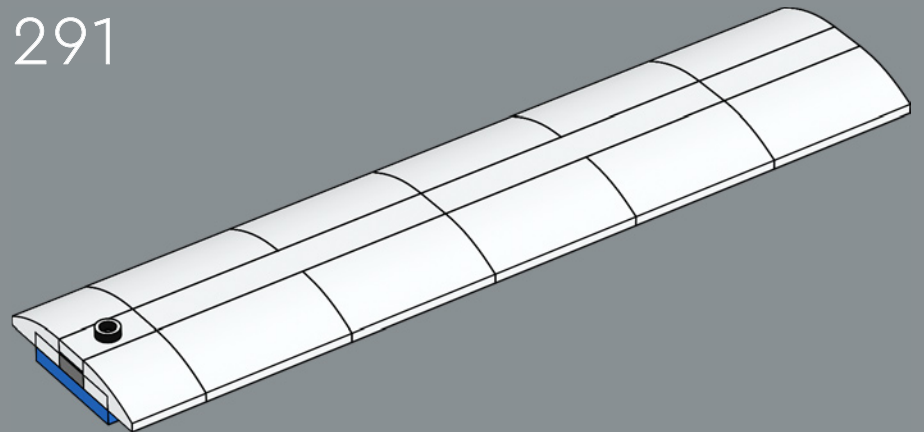

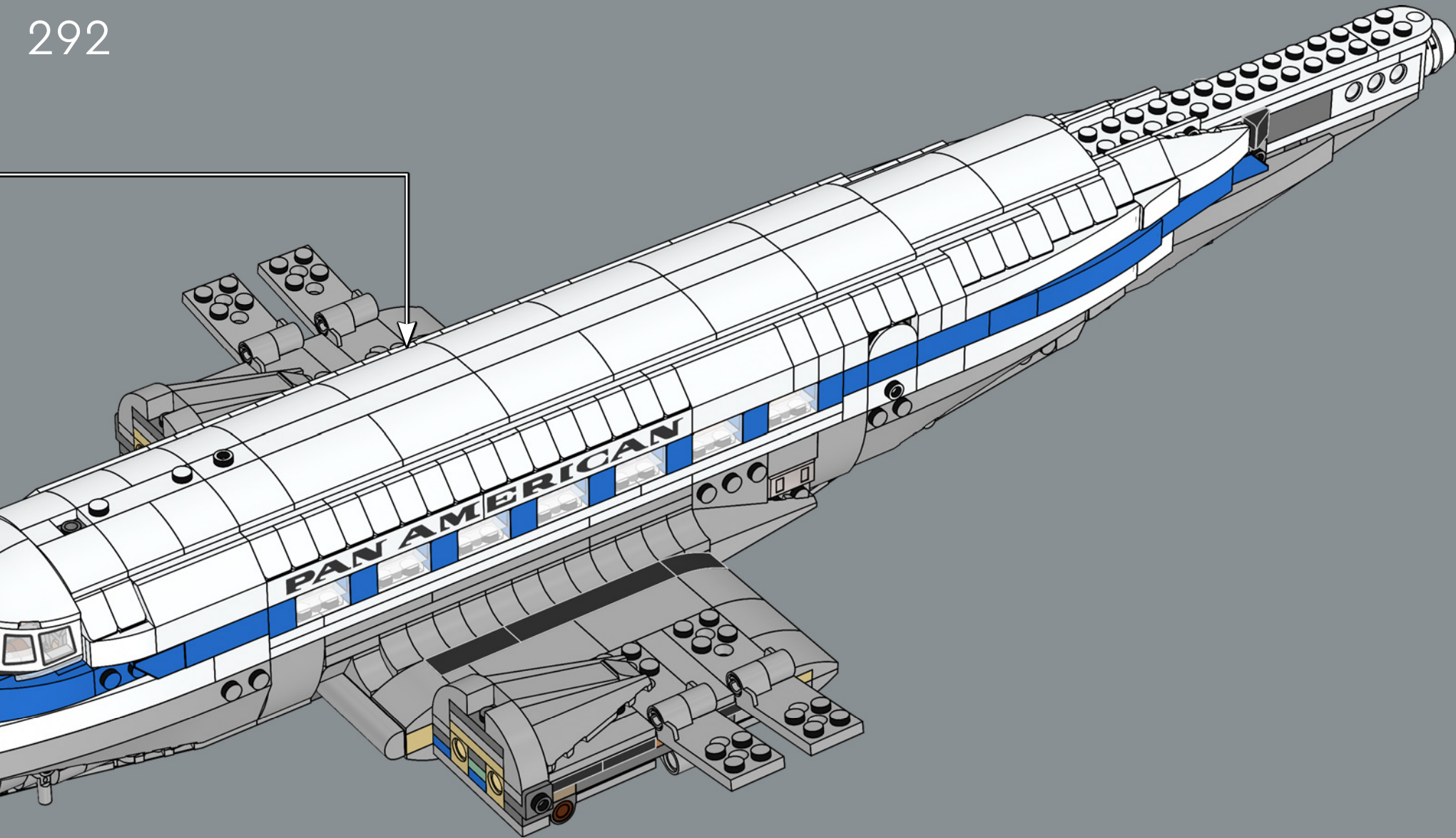

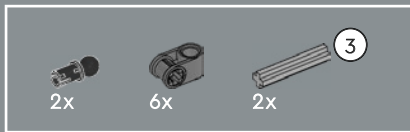

293

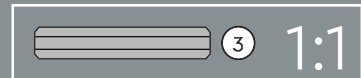
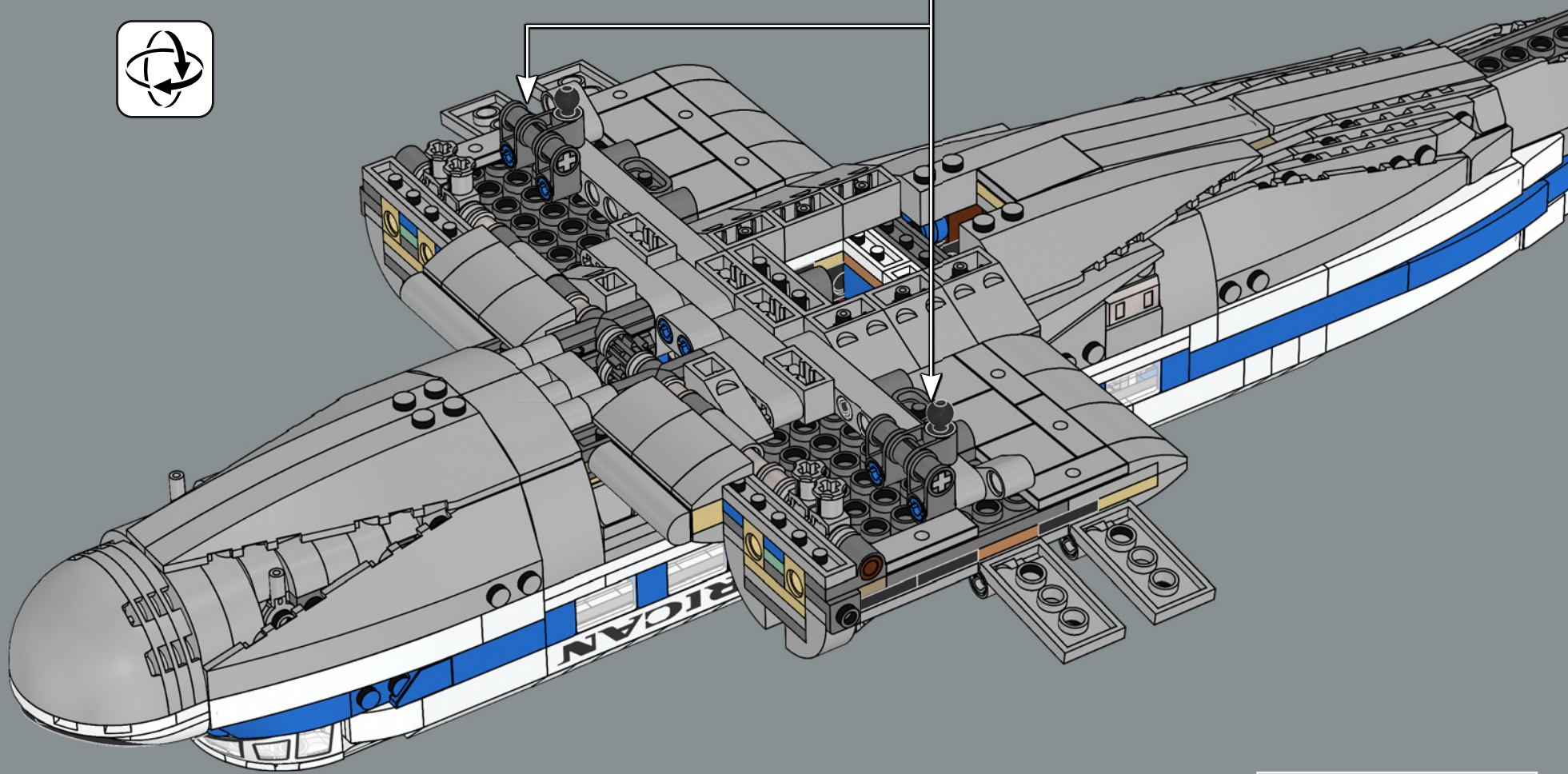
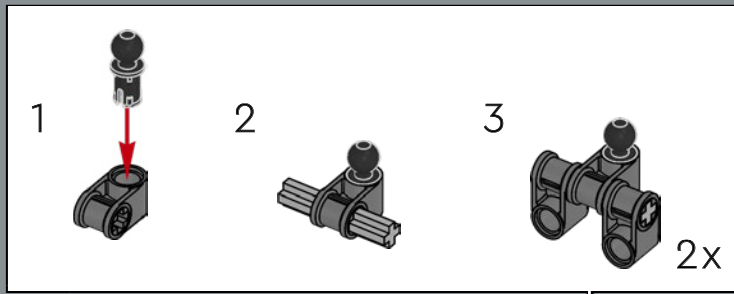

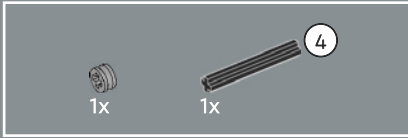
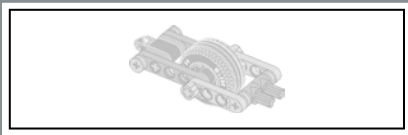

294

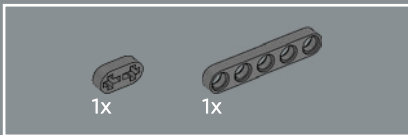

295

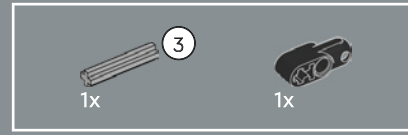
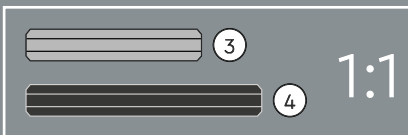
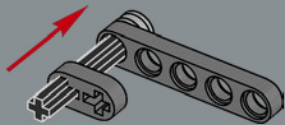

296

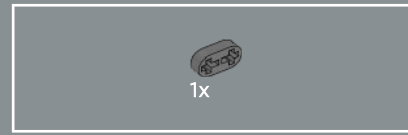
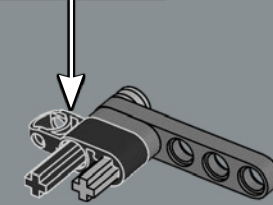
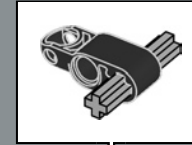

297

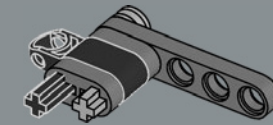

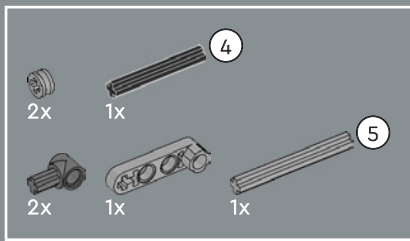

298

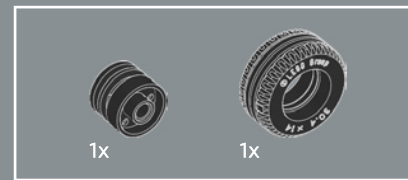
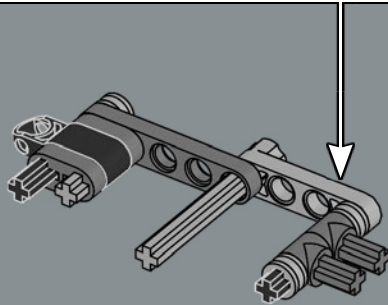
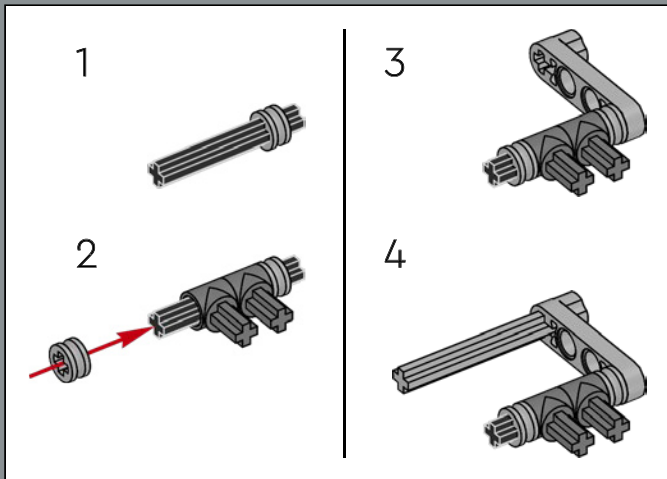

299

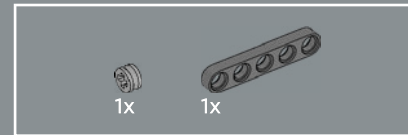
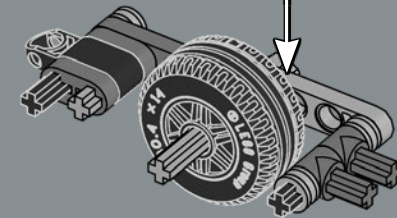
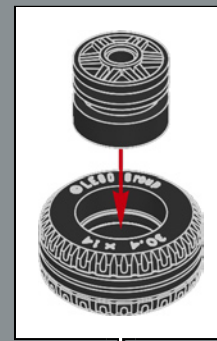

300

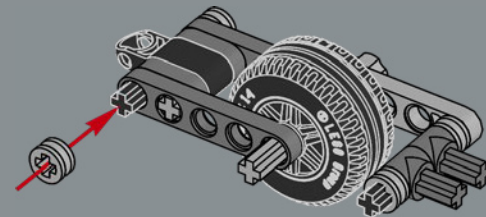



301

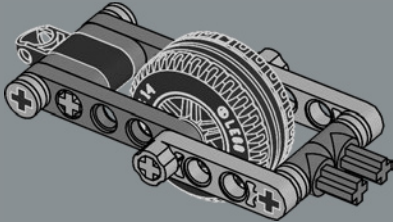

302

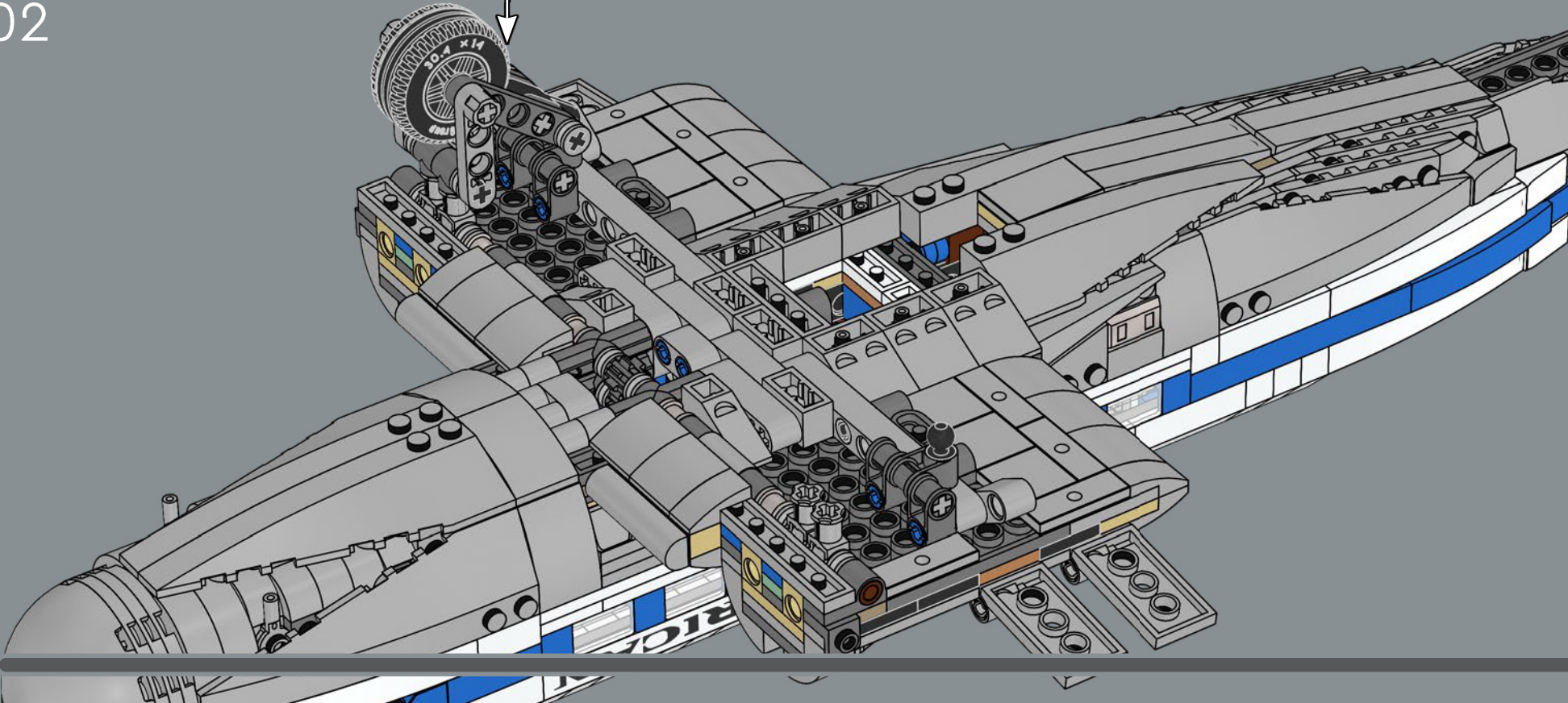

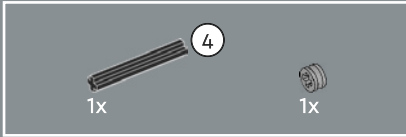
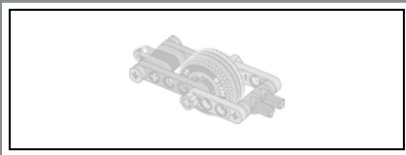

303

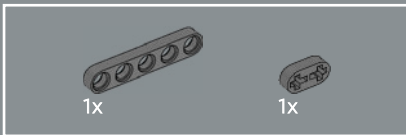

304

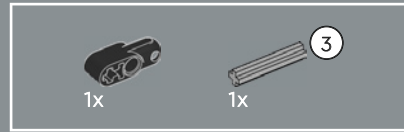
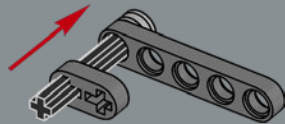

305

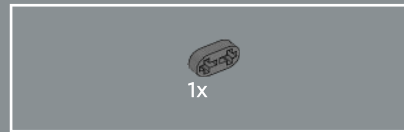
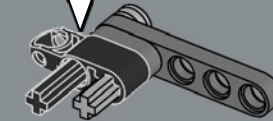
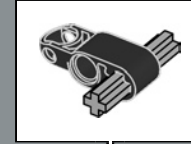

306

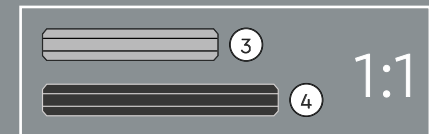
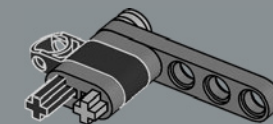

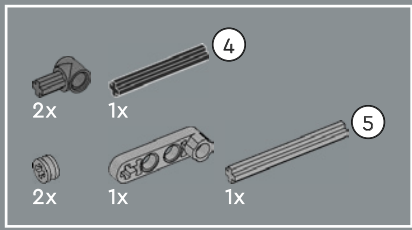

307

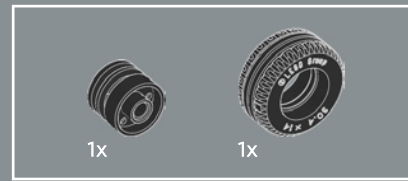
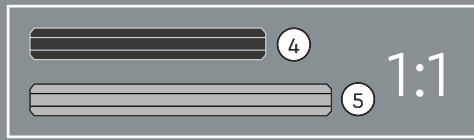
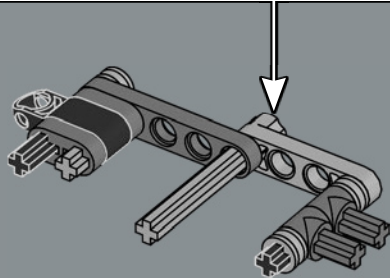
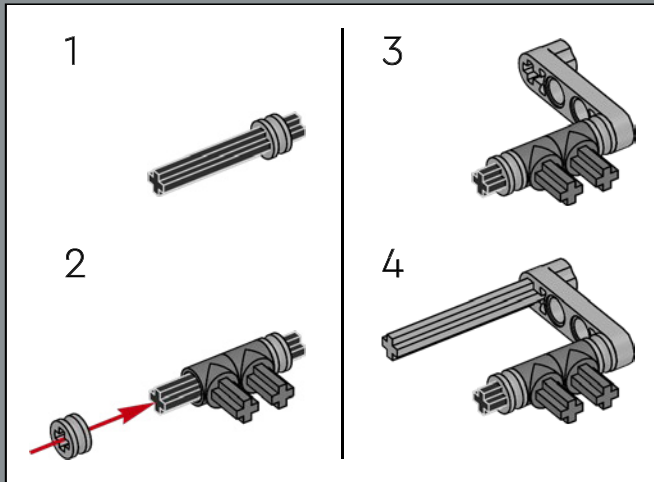

308

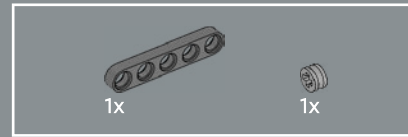
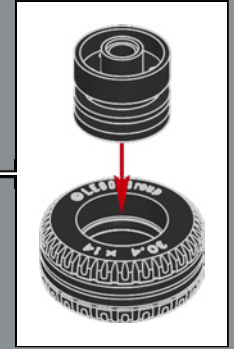
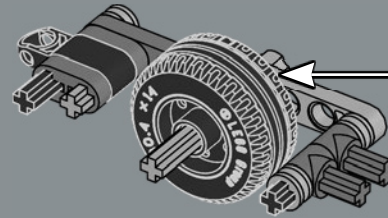

309

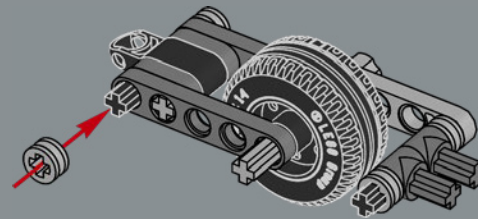



310

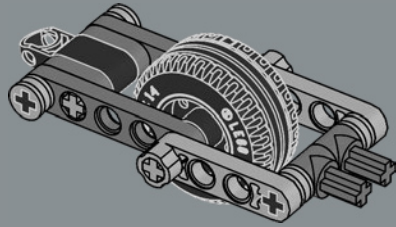

311

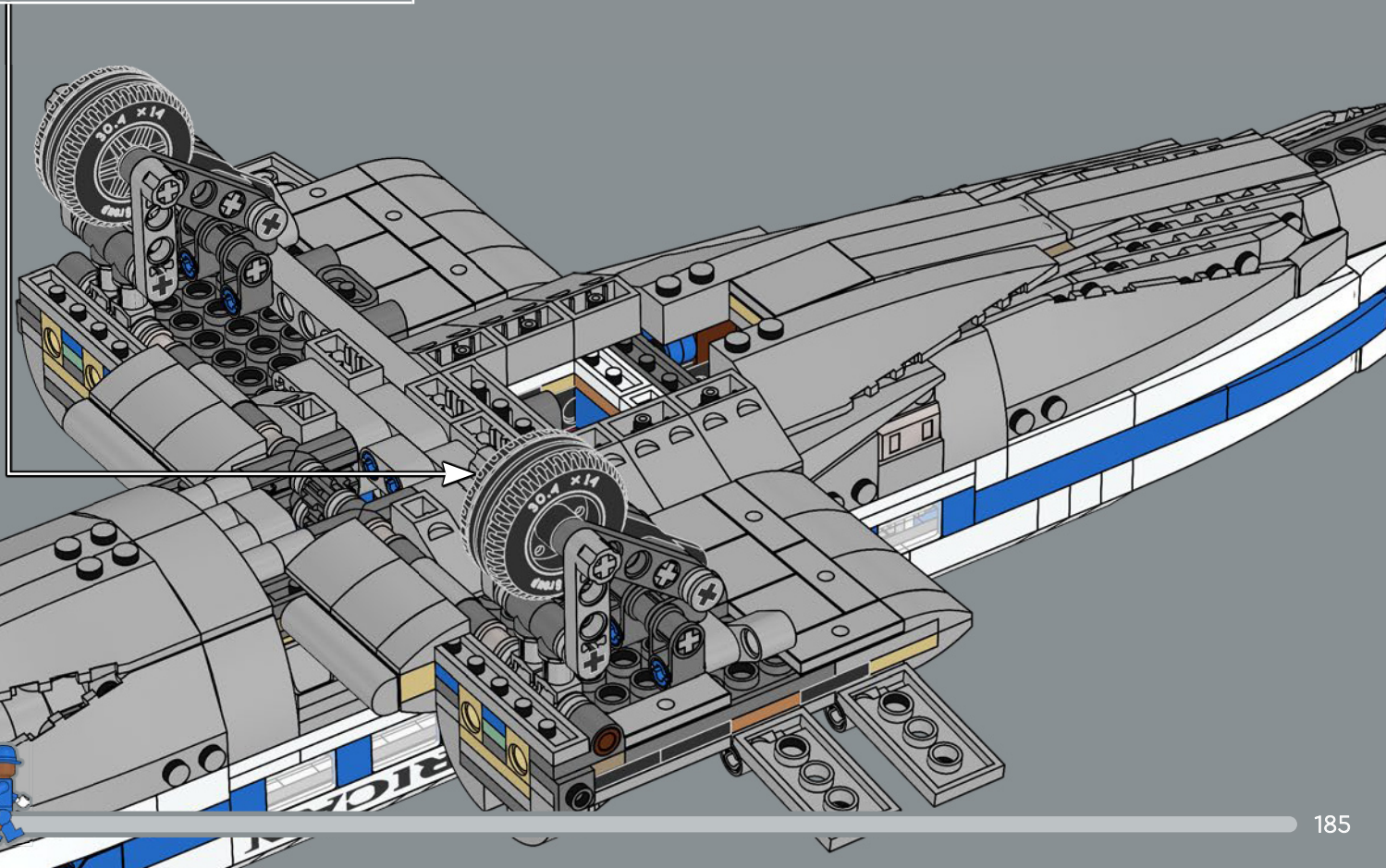

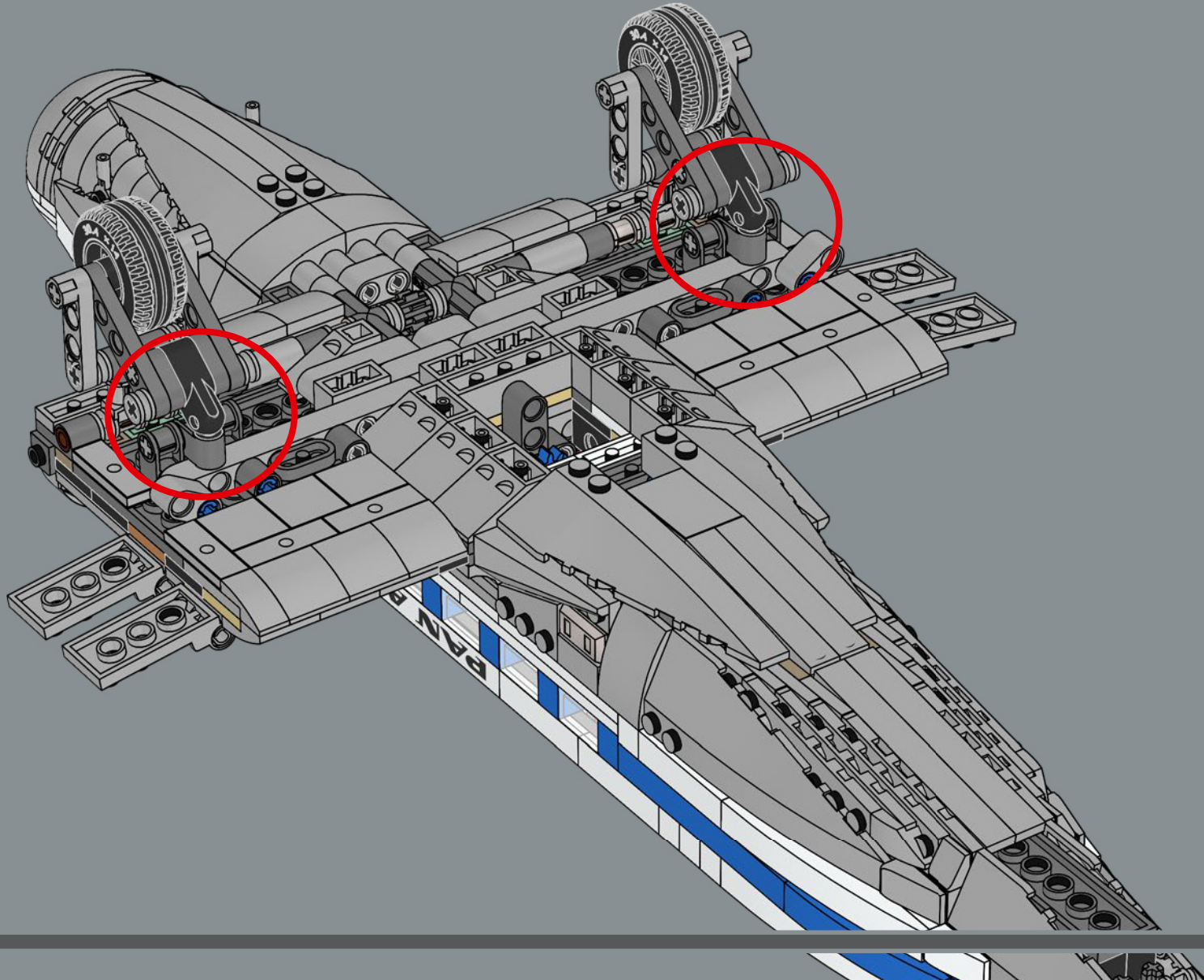

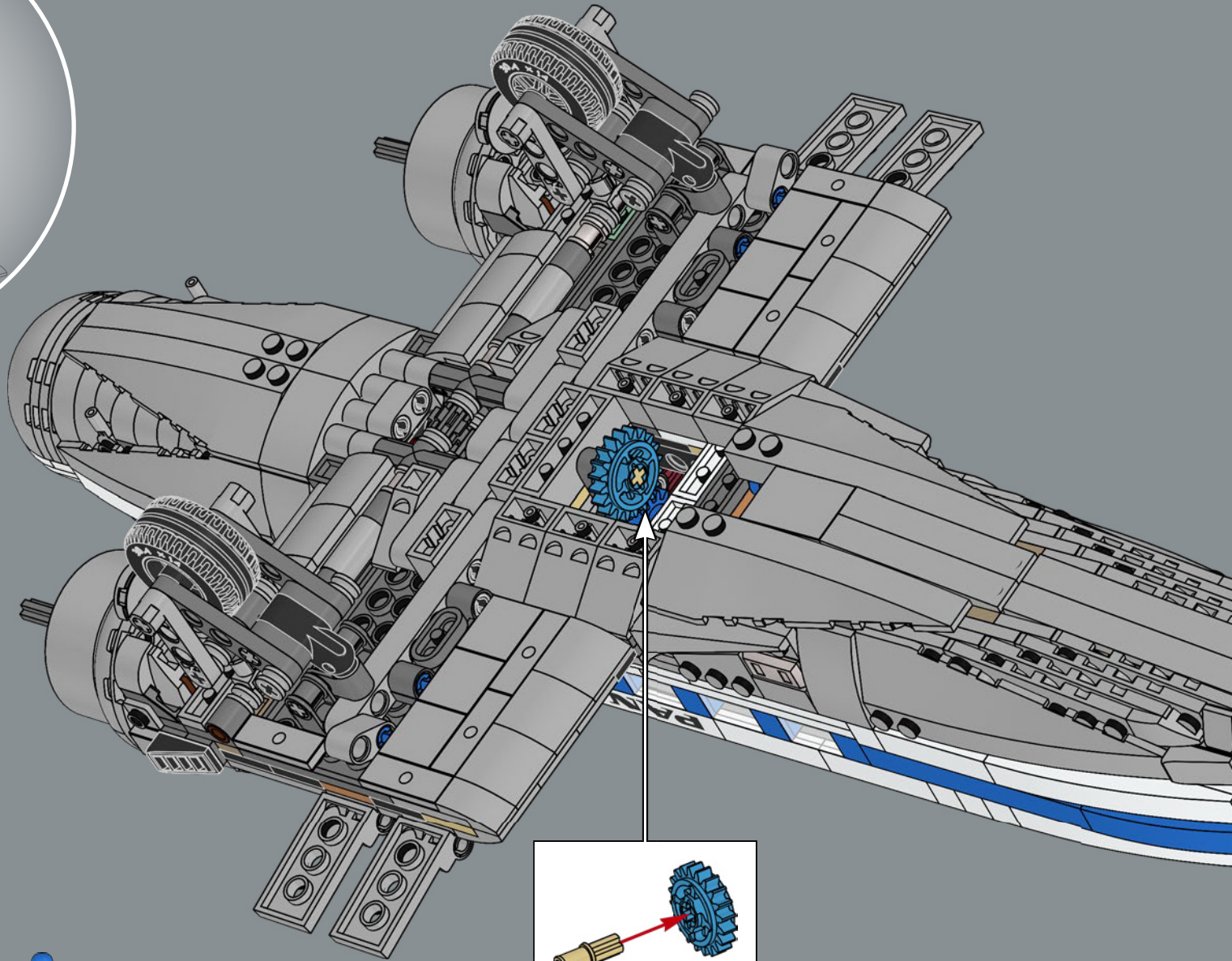

313

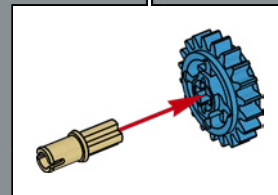

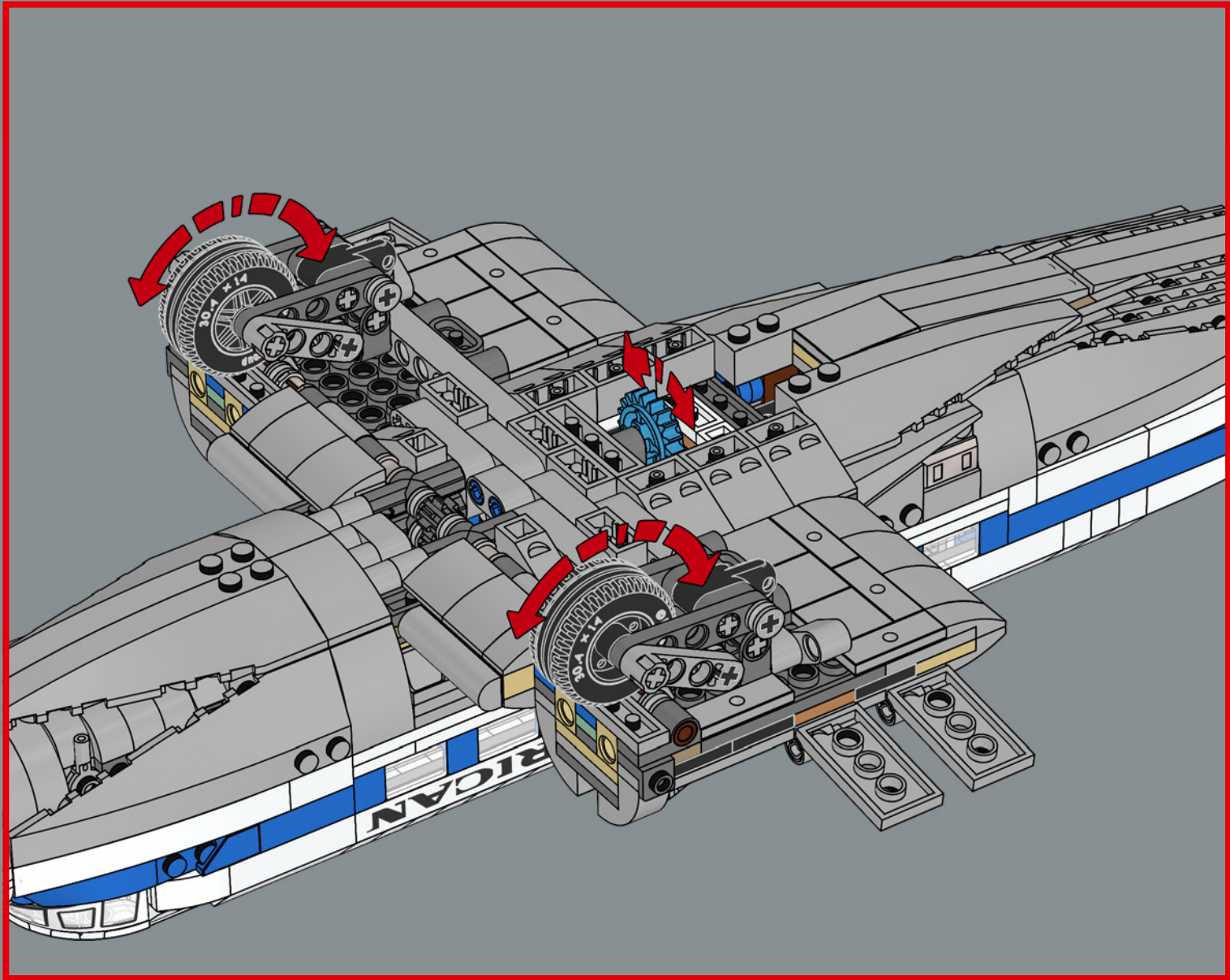

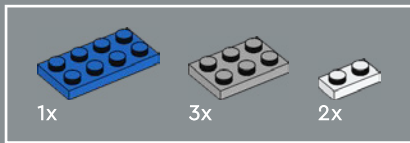

314

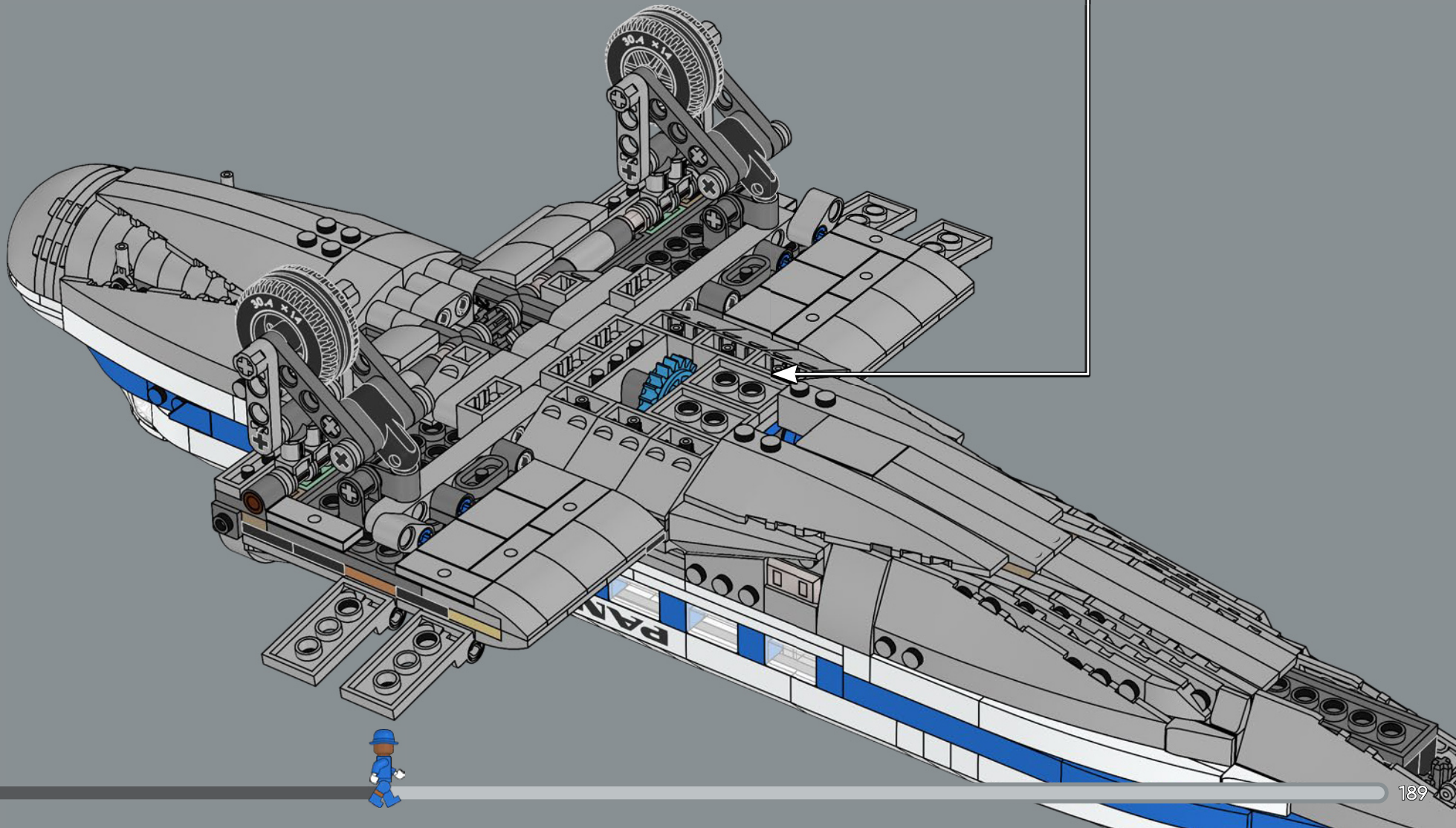
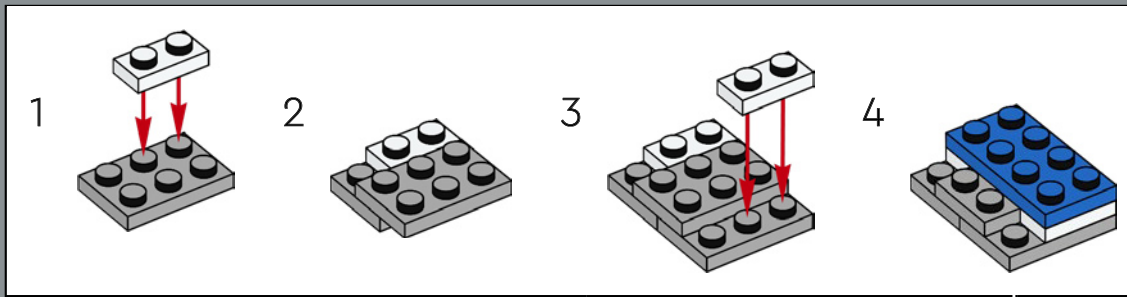



4x

315

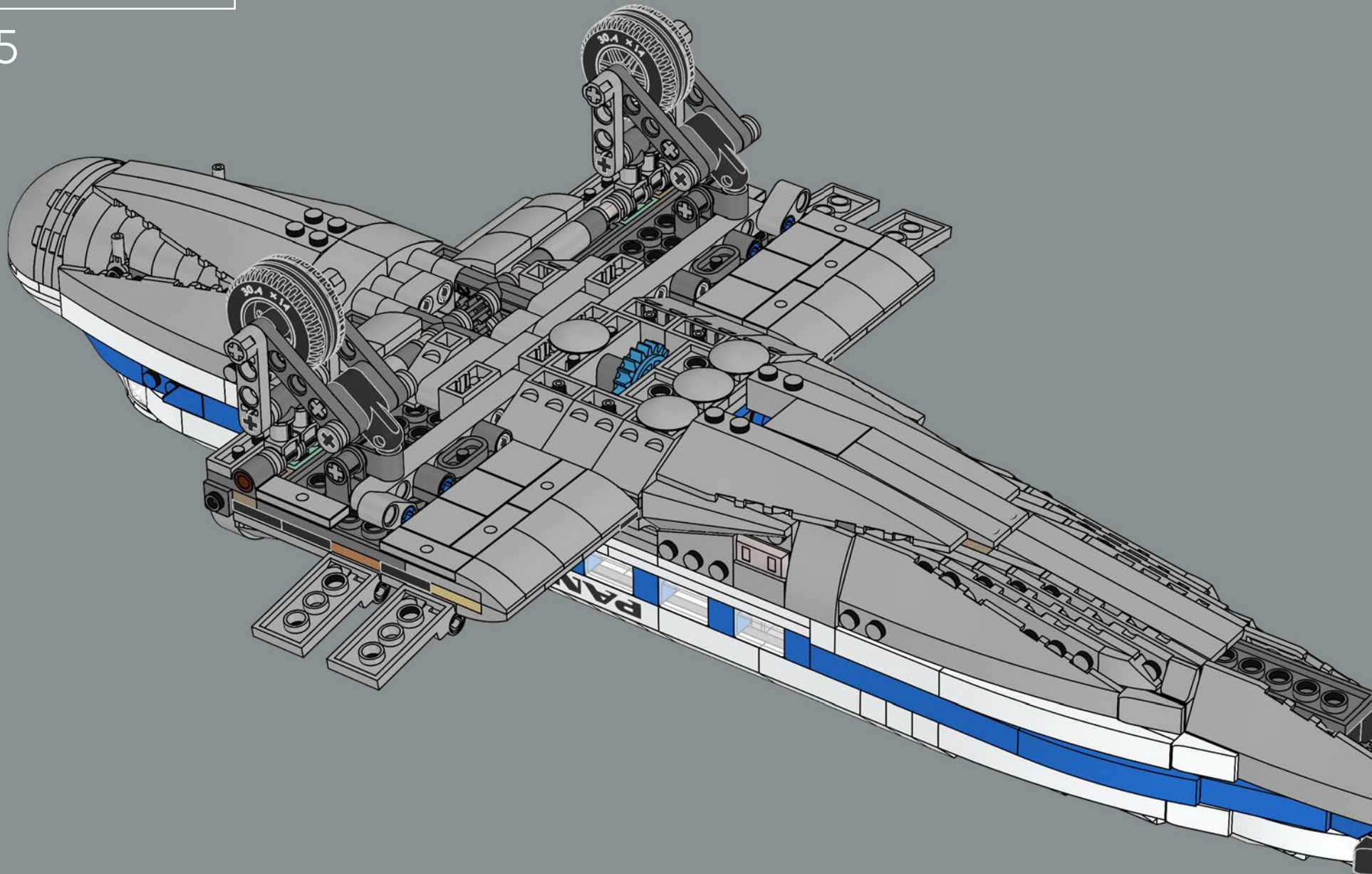

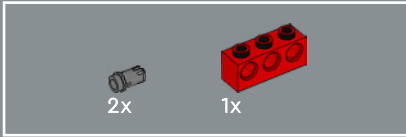
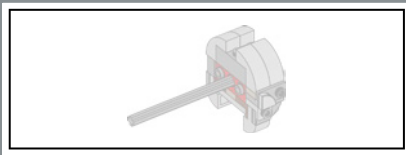

316

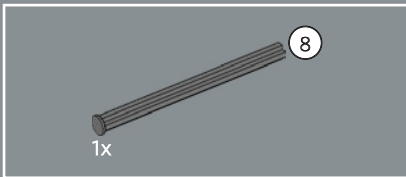
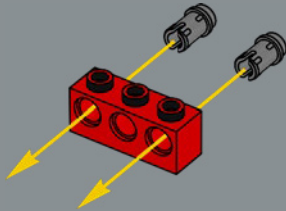

317

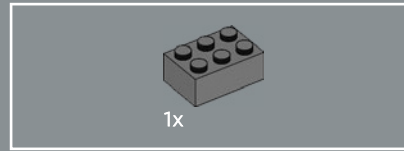
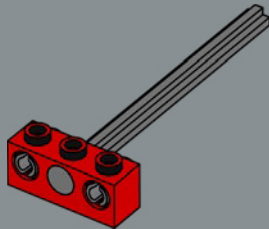

318

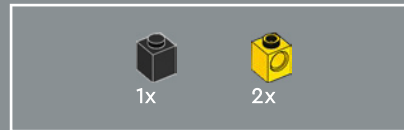
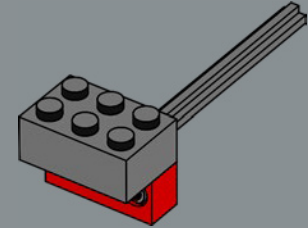

319

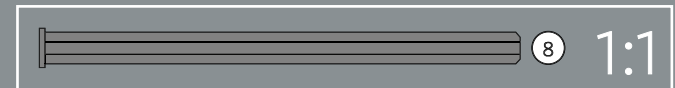
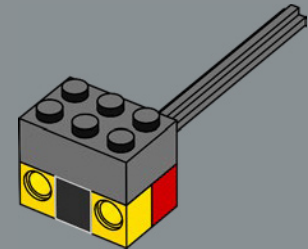

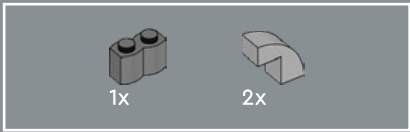

320

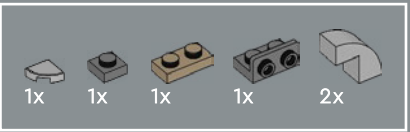
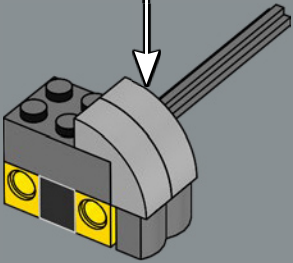
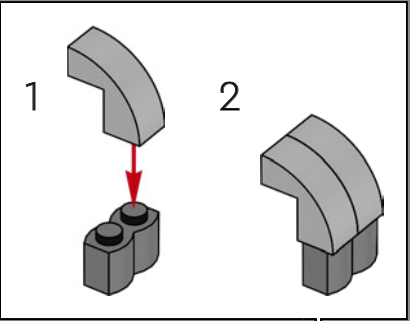

321

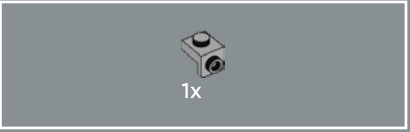
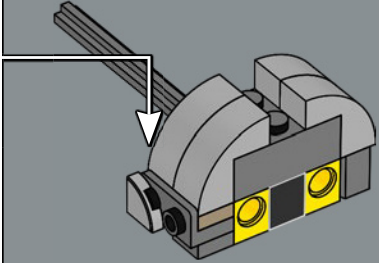
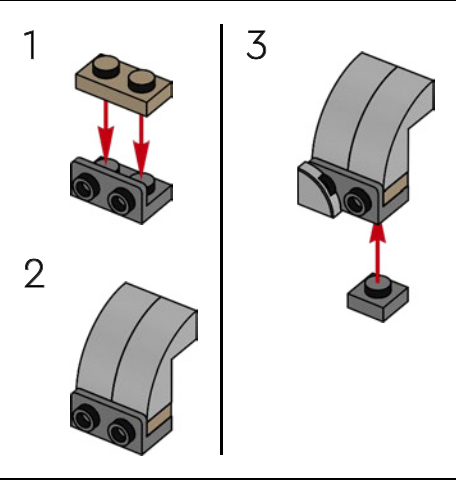

322

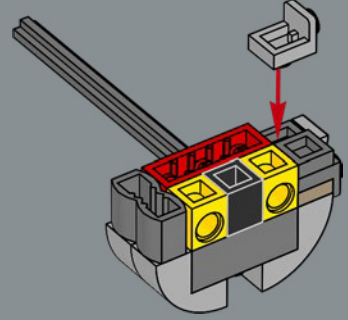

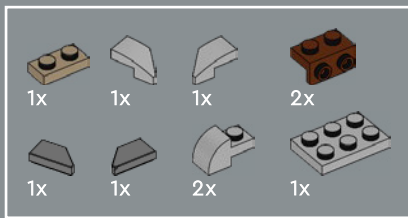

323

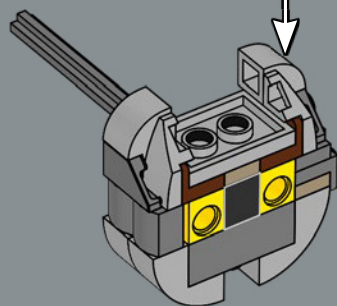
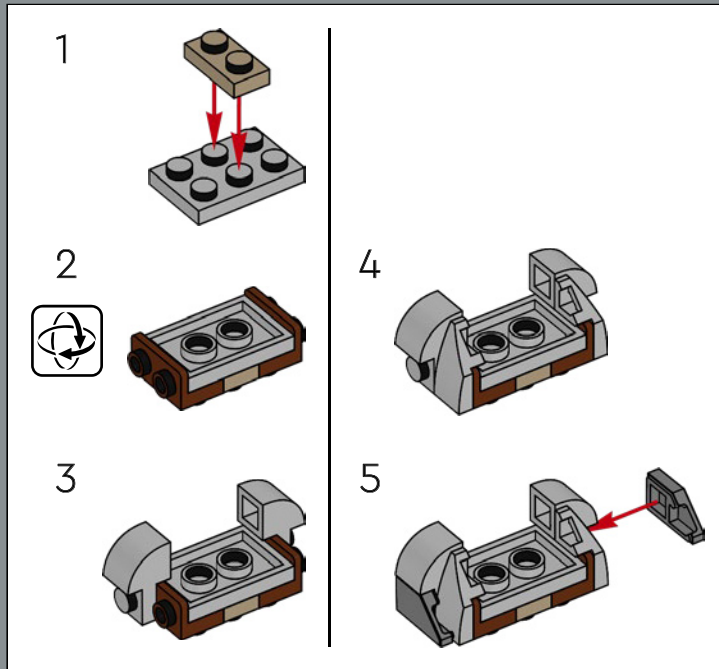

324

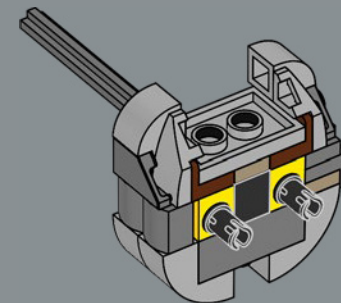



1x

325

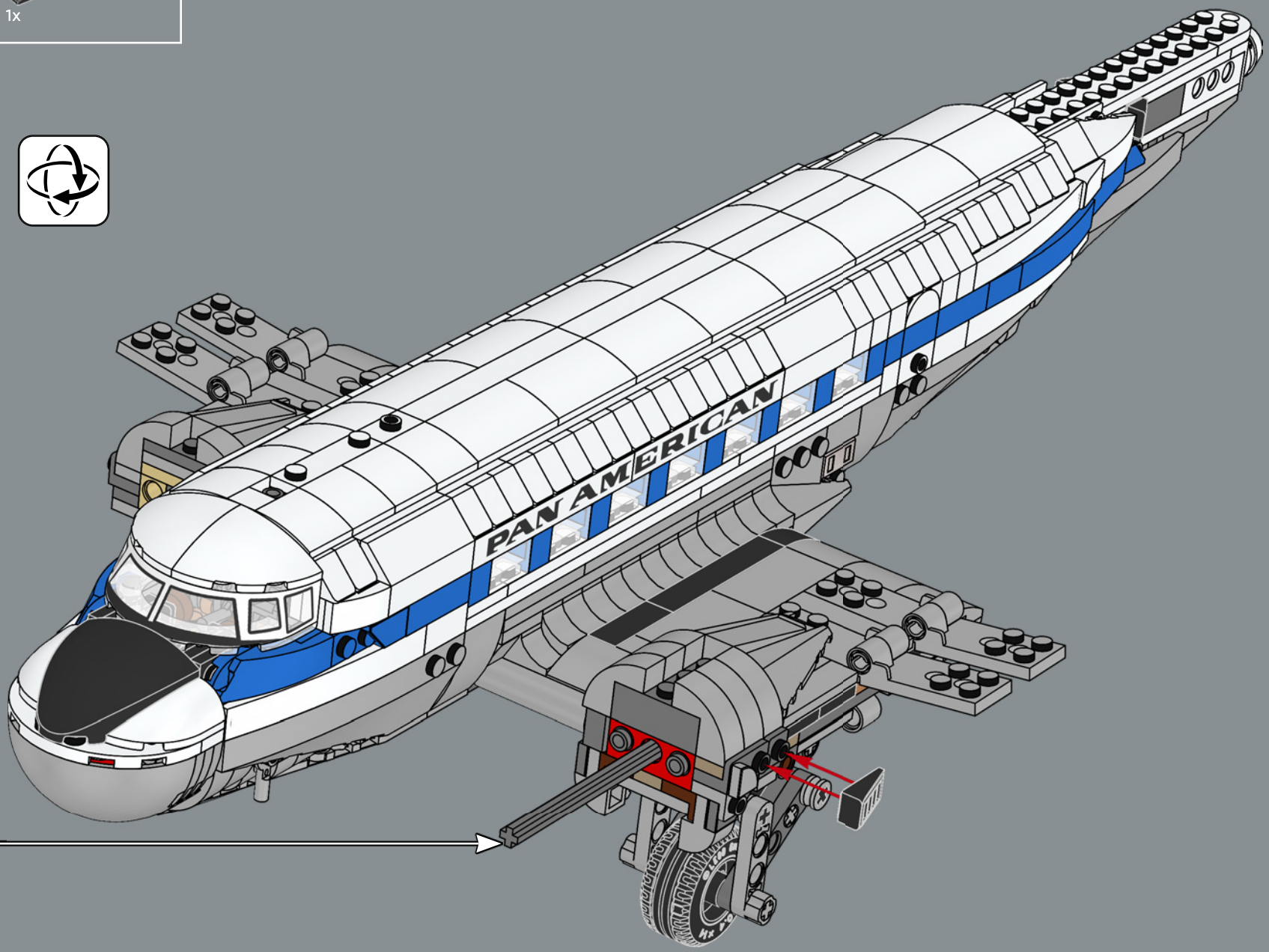

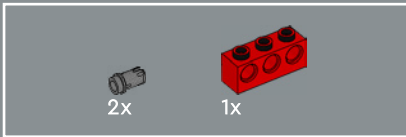
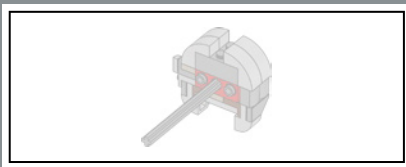

326

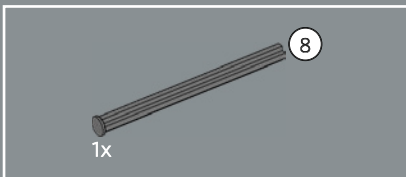
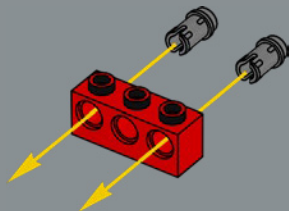

327

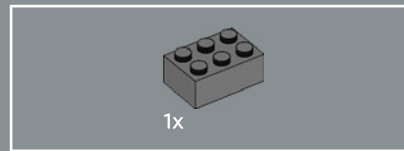
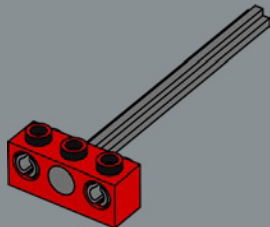

328

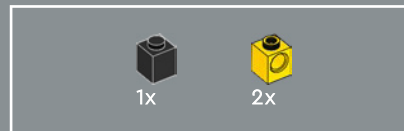
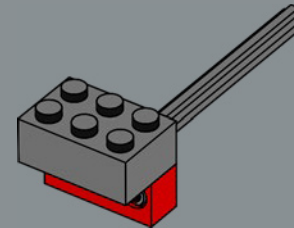

329

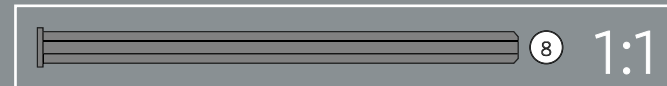
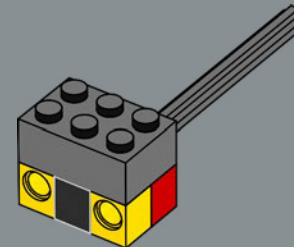

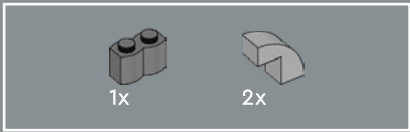

330

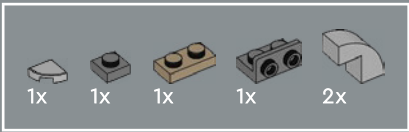
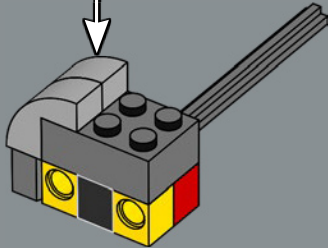
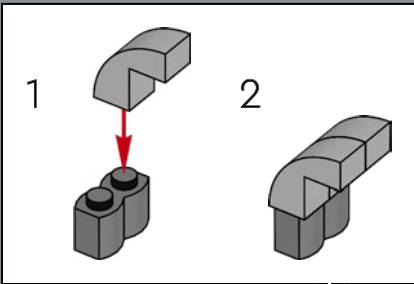

331

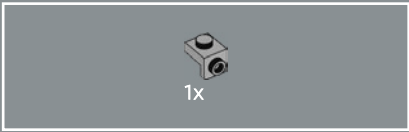
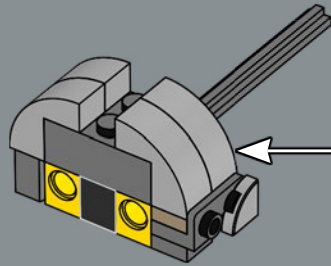
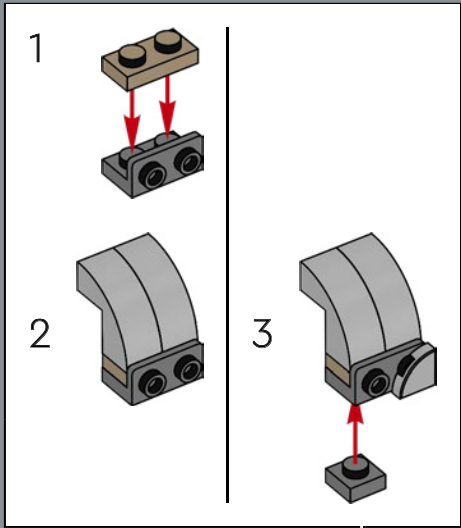

332

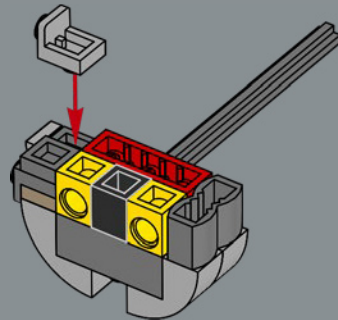



333

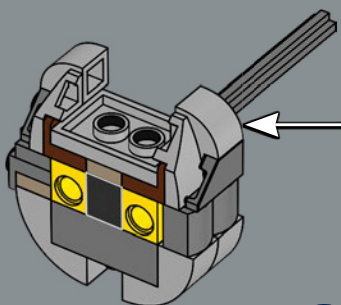
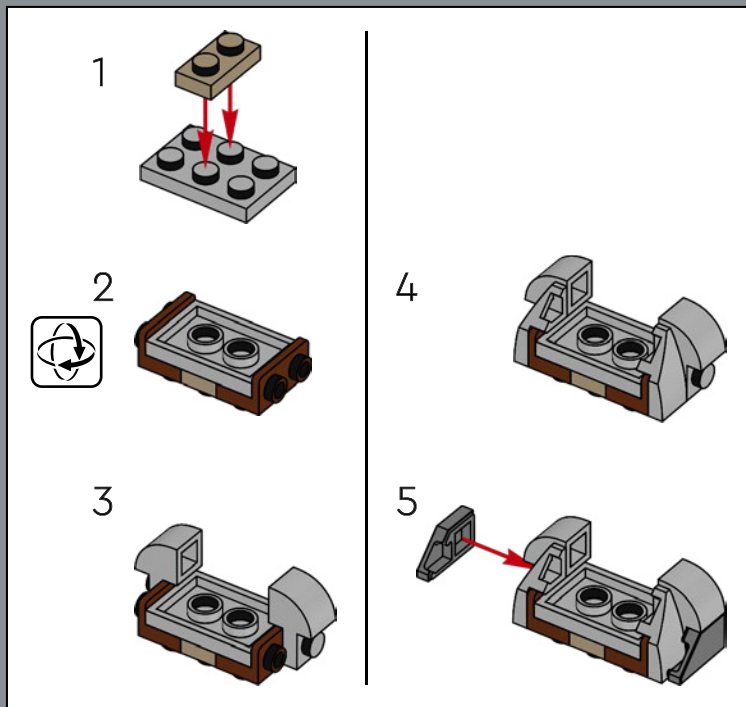

334

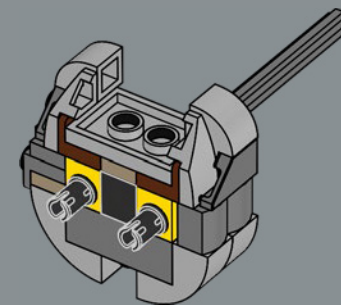



1x

335

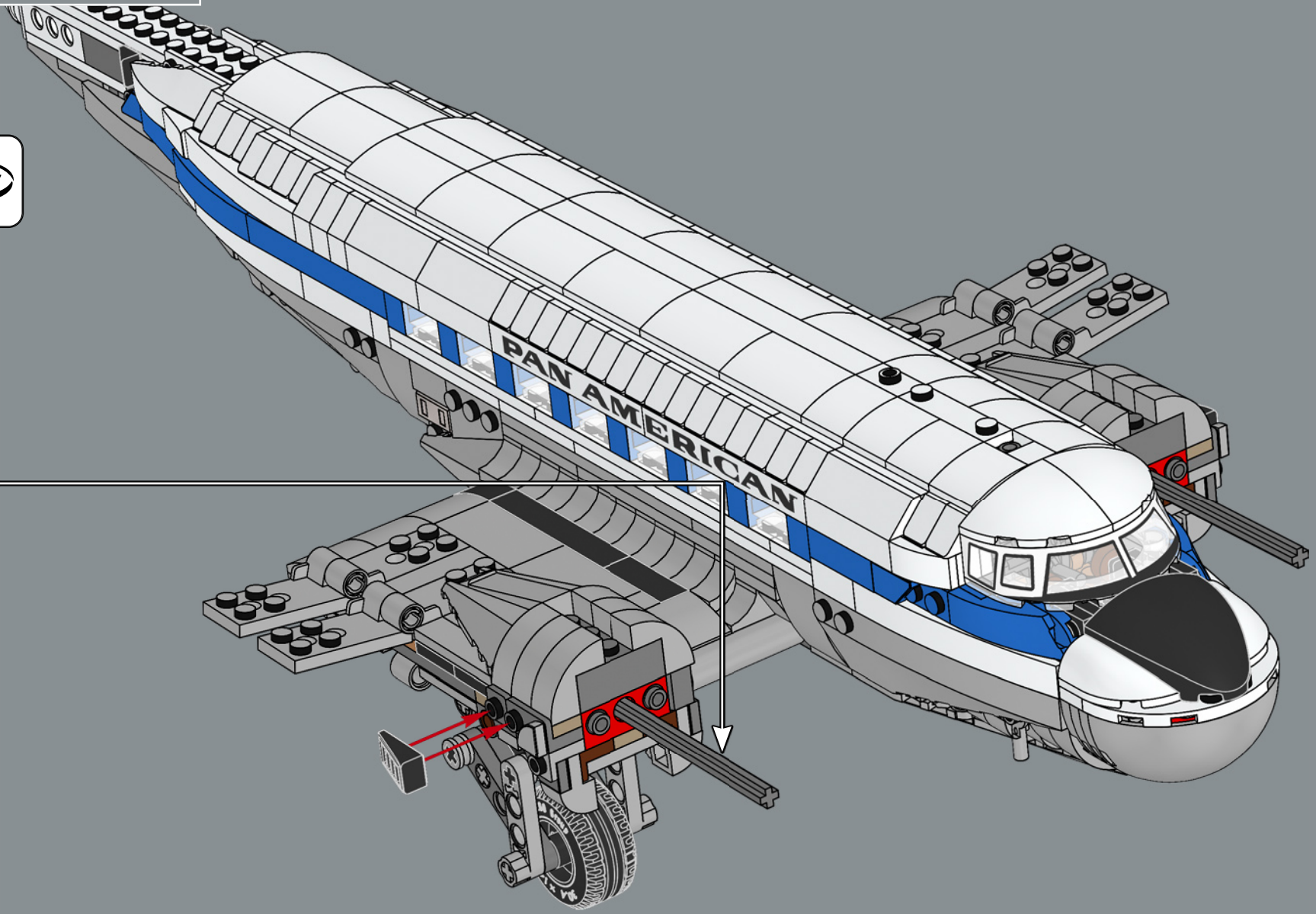



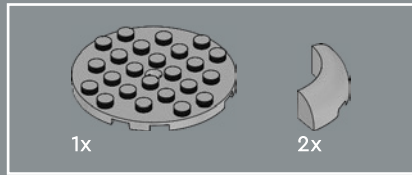

337

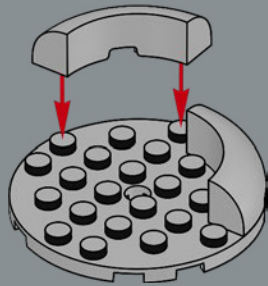

338

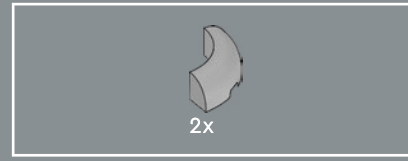
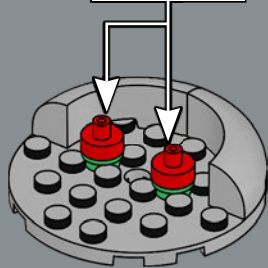
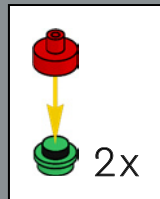

339

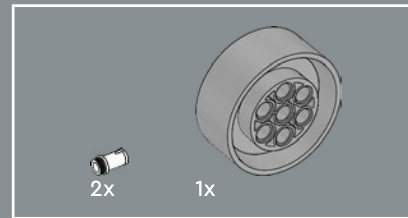
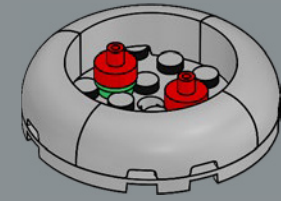

340

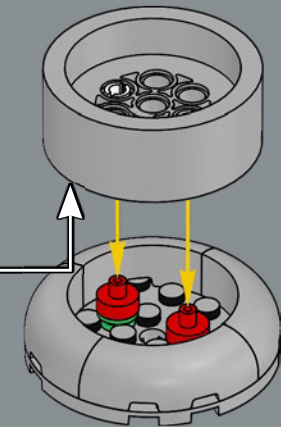
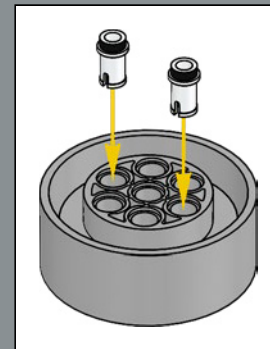

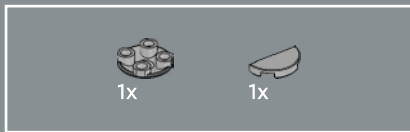

341

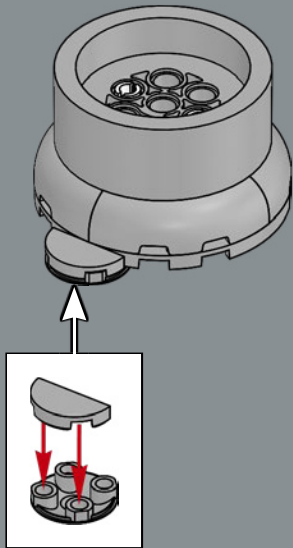

2x

342

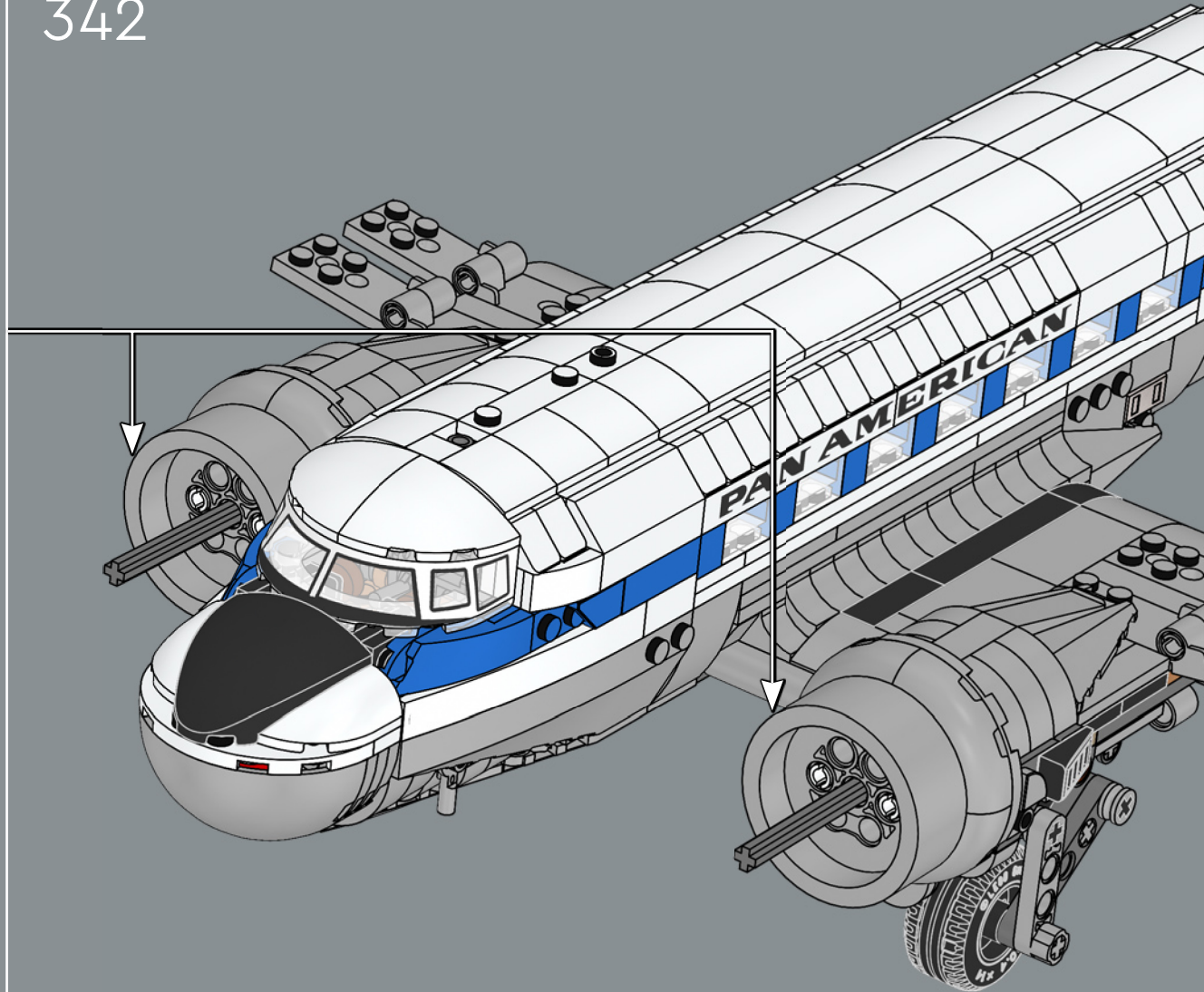

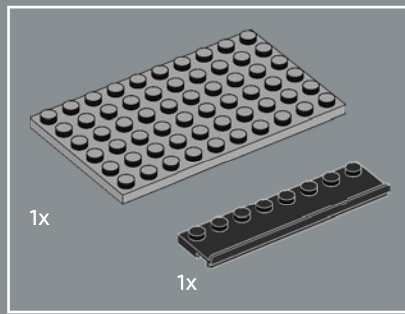
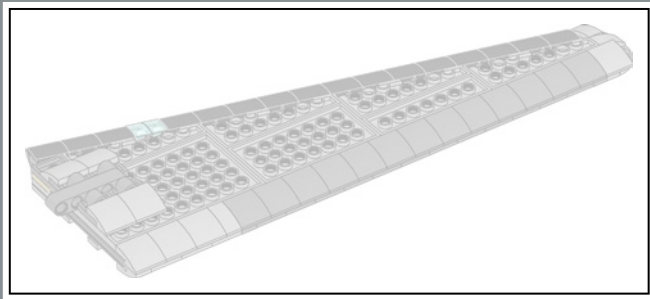

343

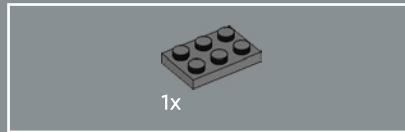
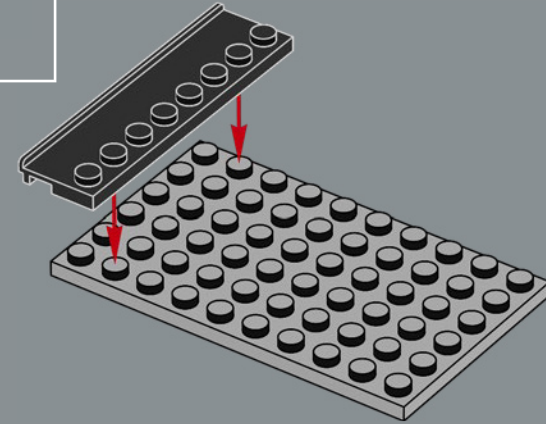

344

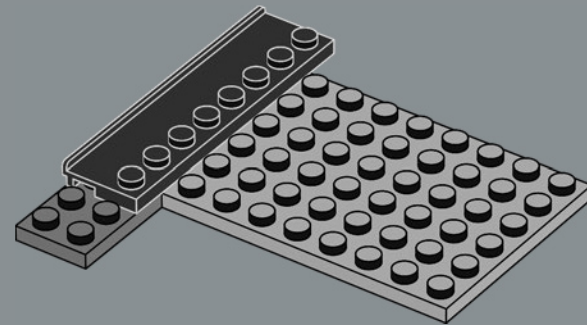

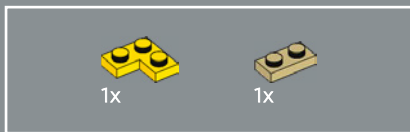

345

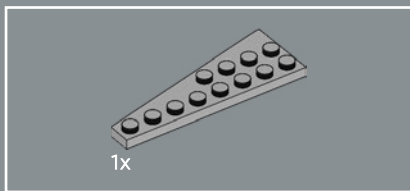
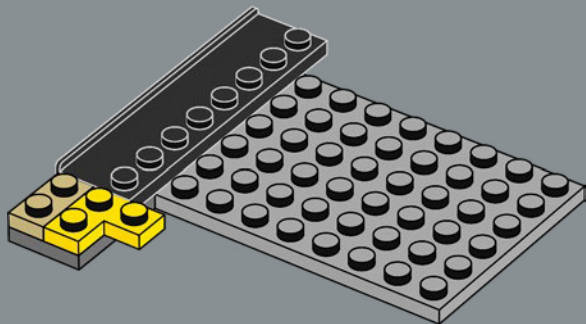

346

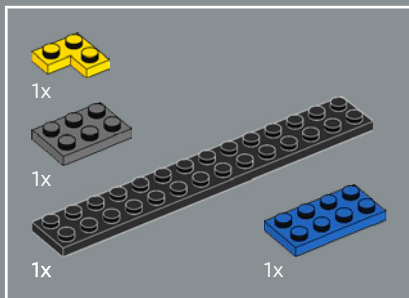
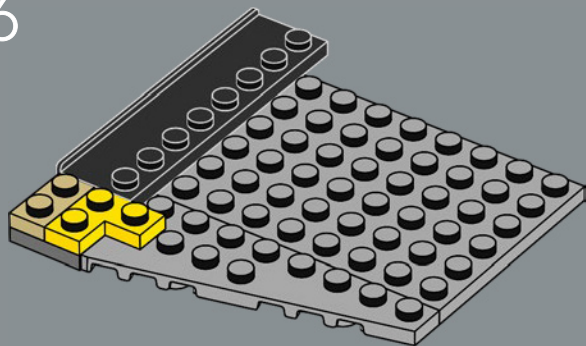

347

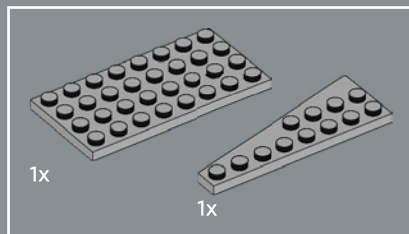
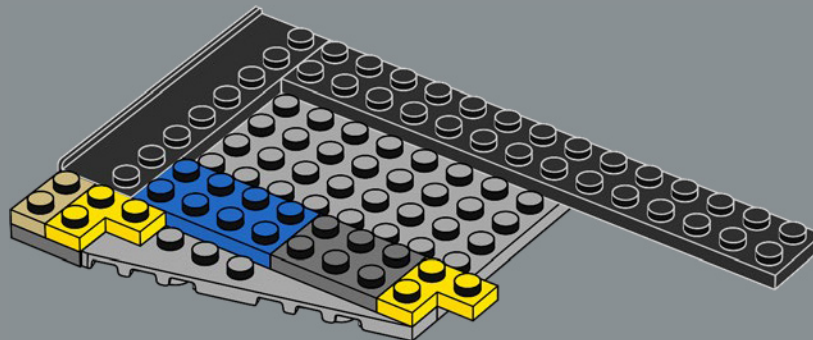

348

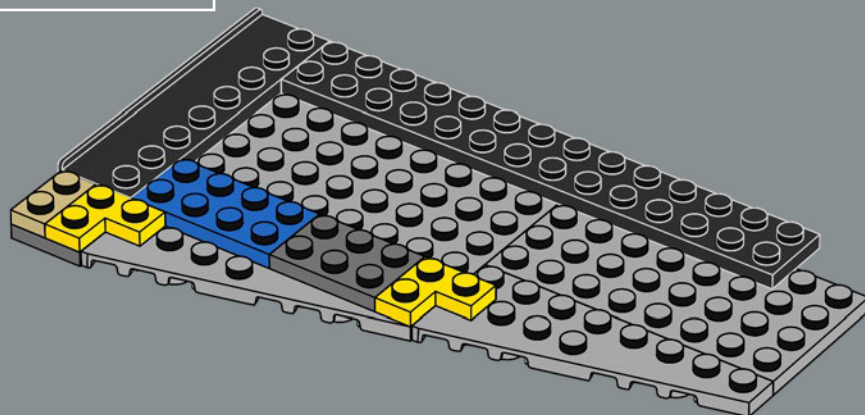

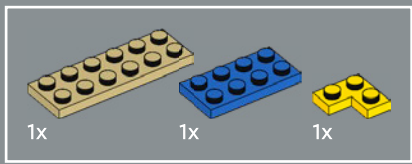

349

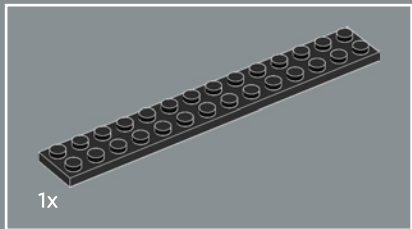
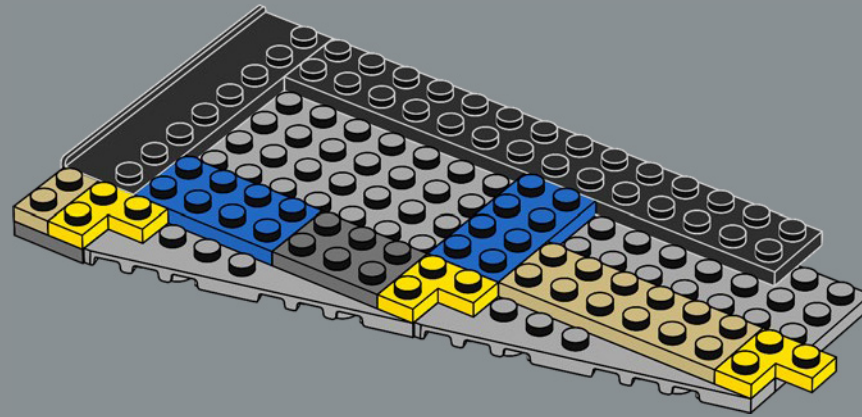

350

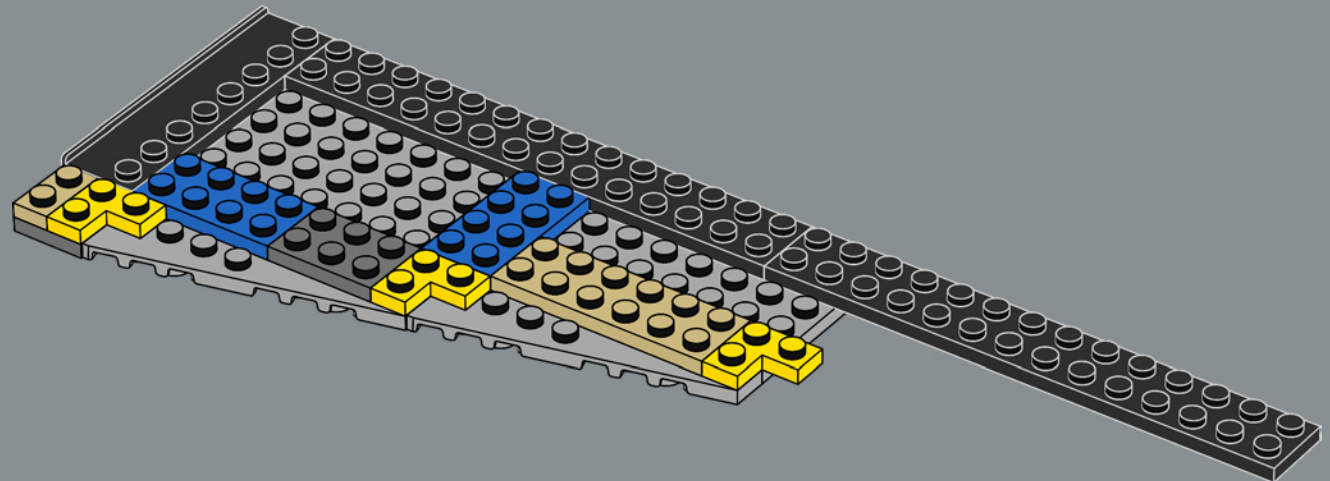

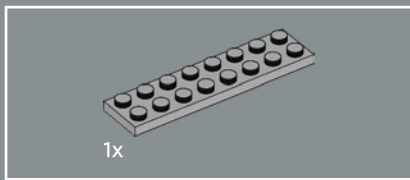

351

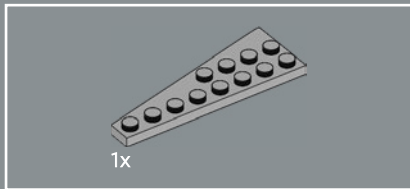
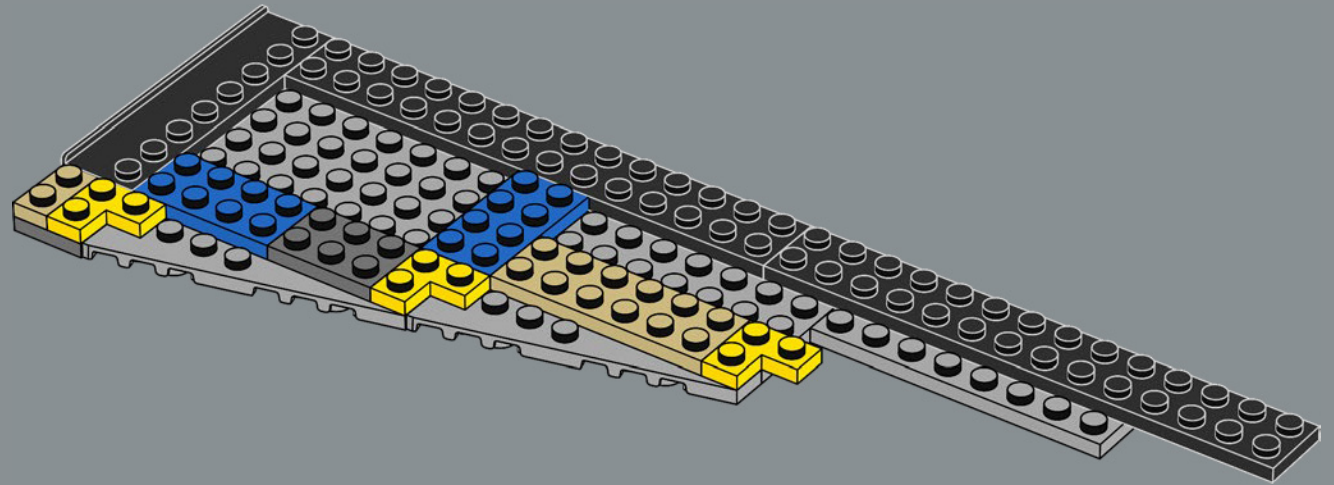

352

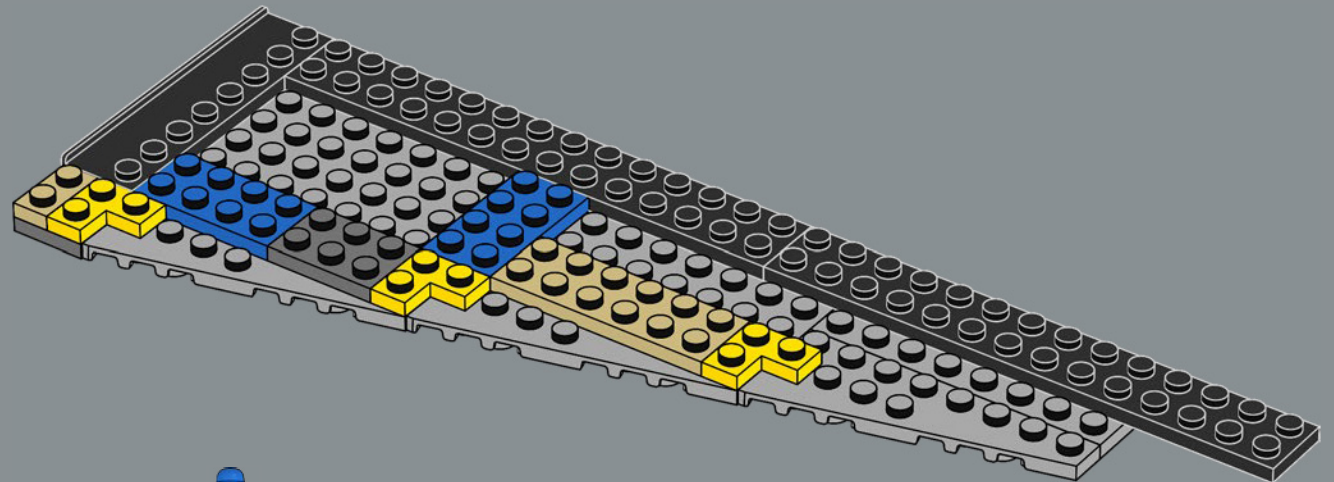

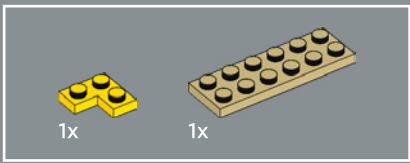

353

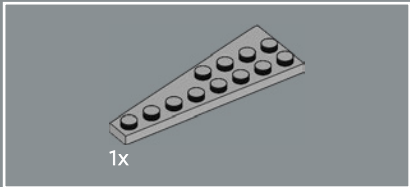
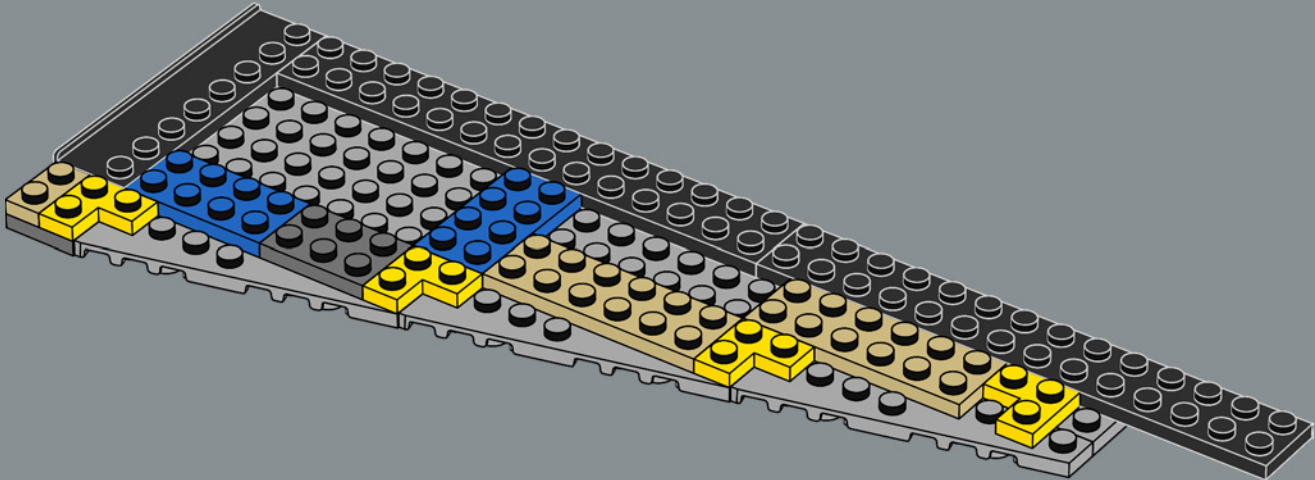

354

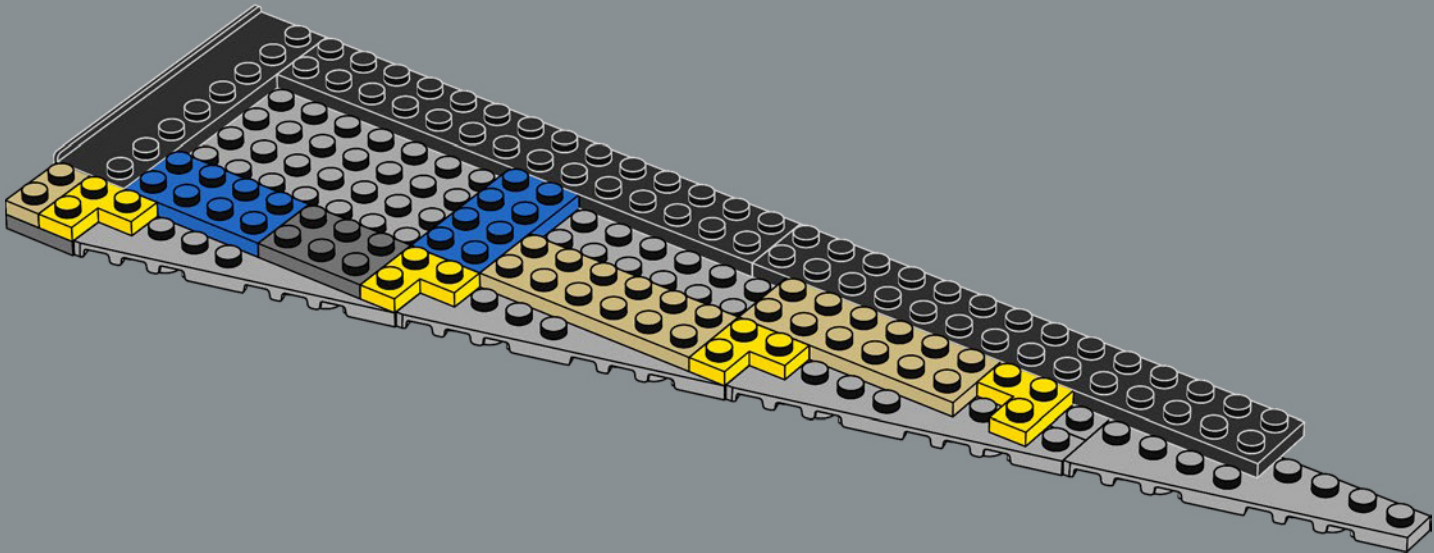

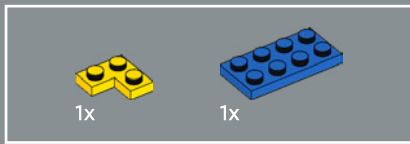

355

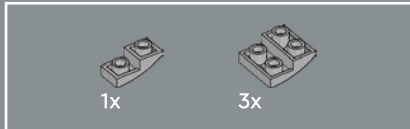
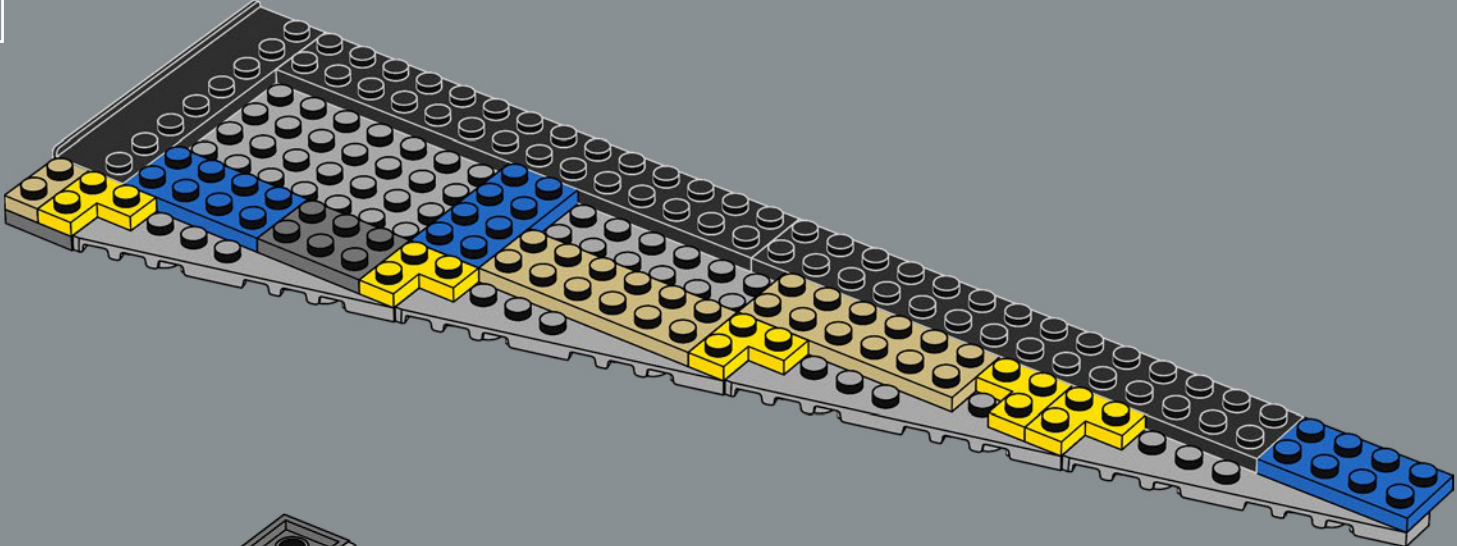

356

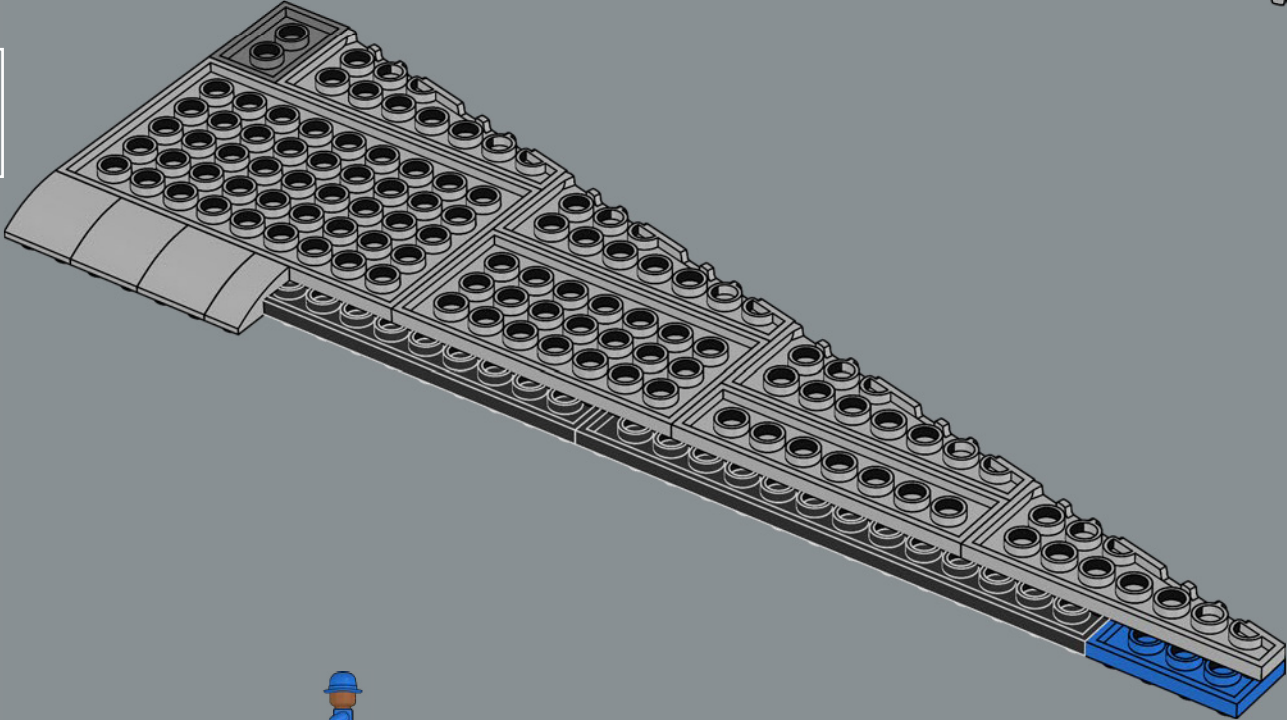



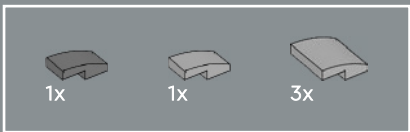

359

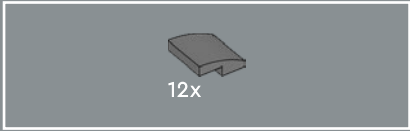
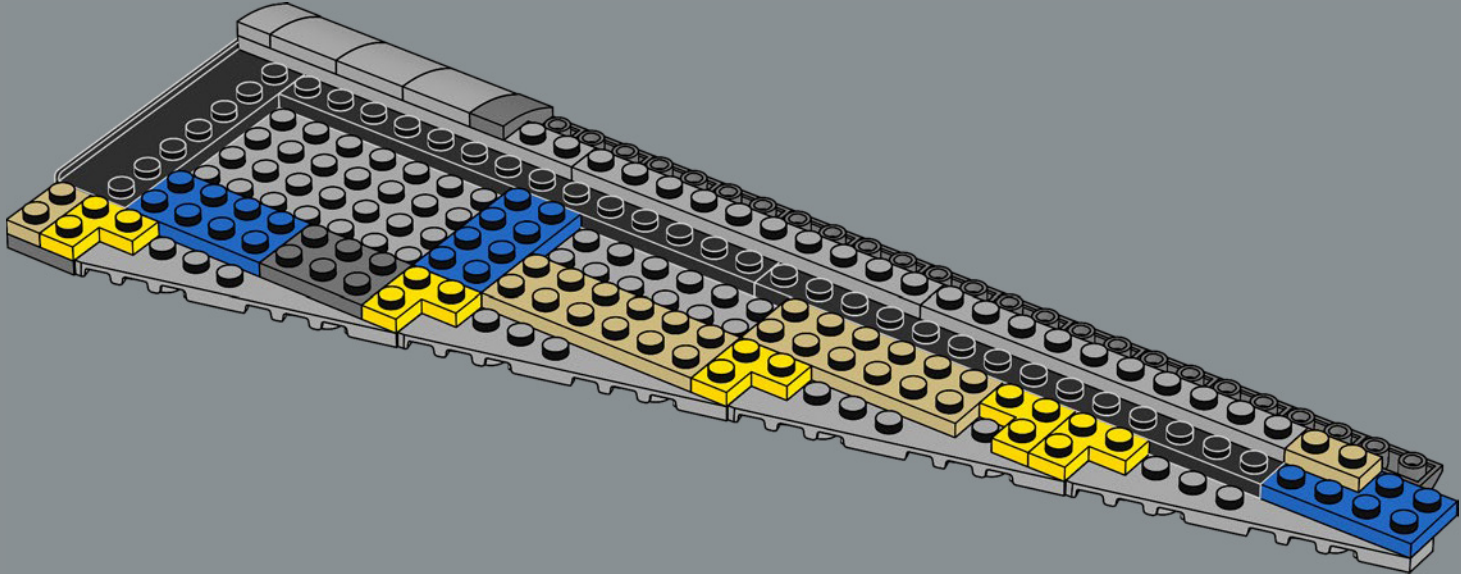

360

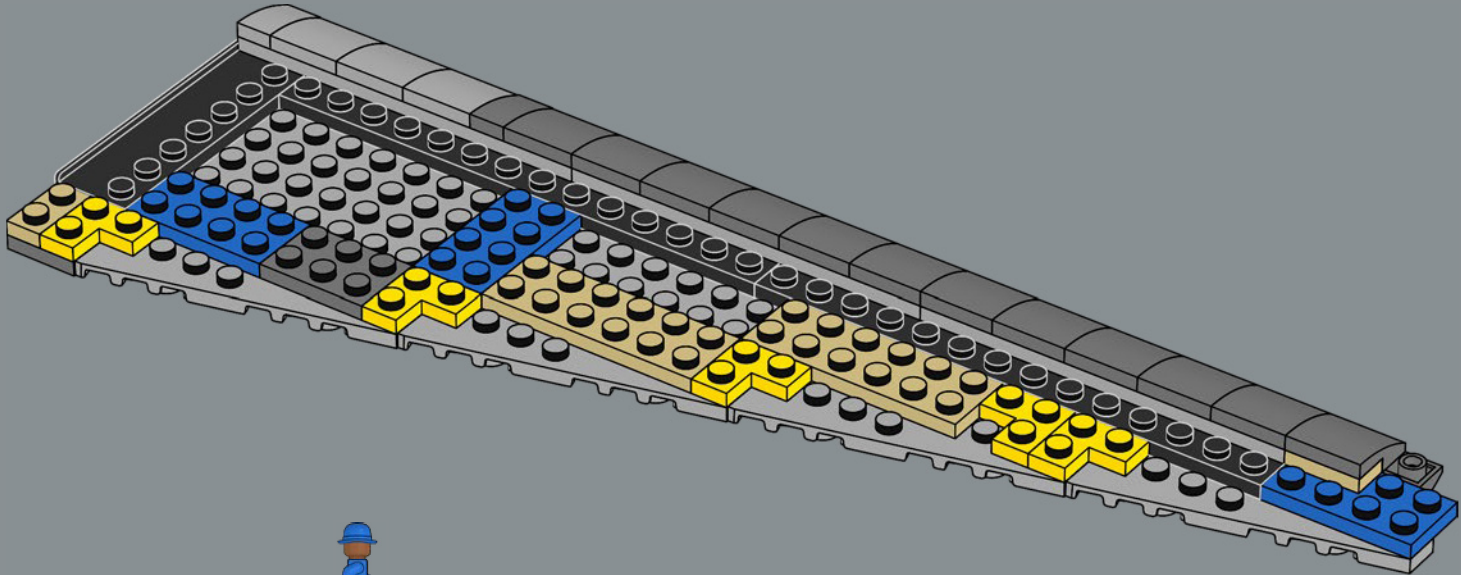

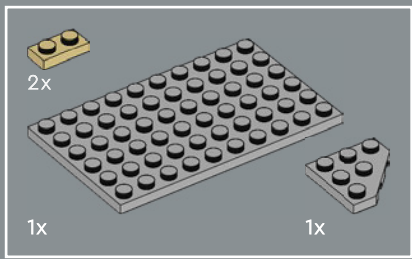

361

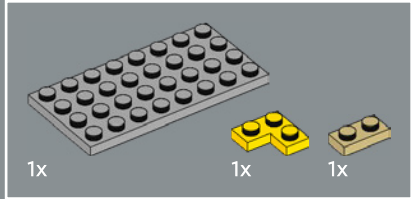
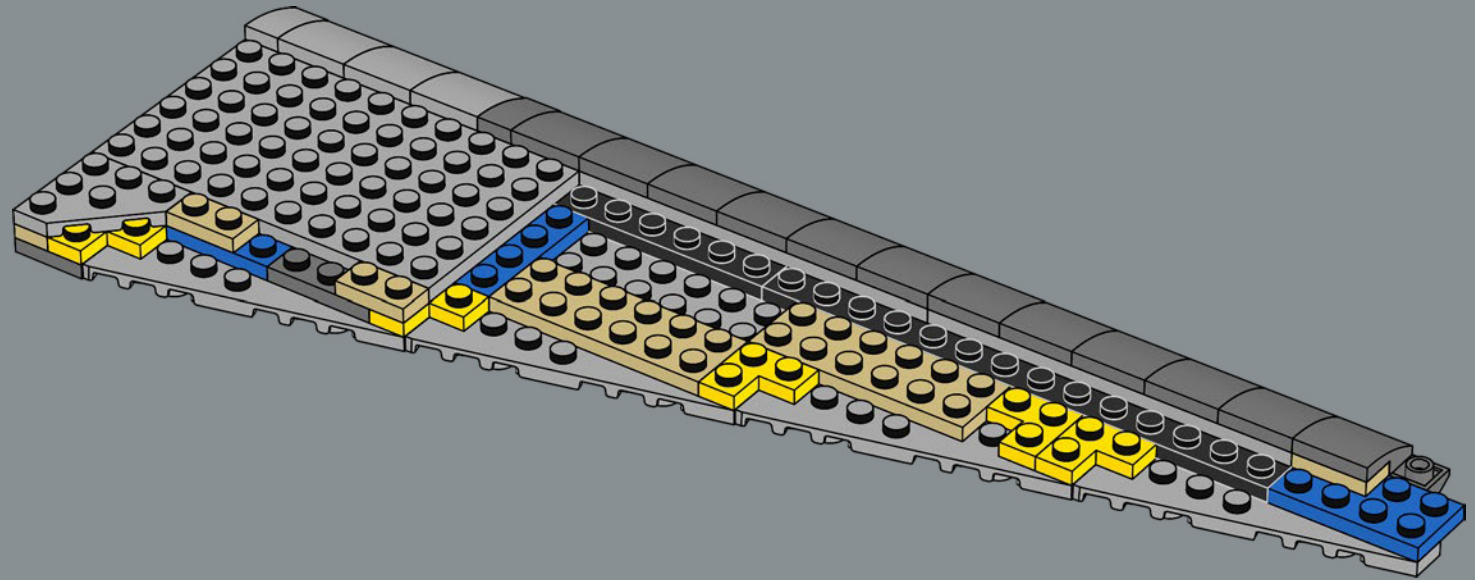

362

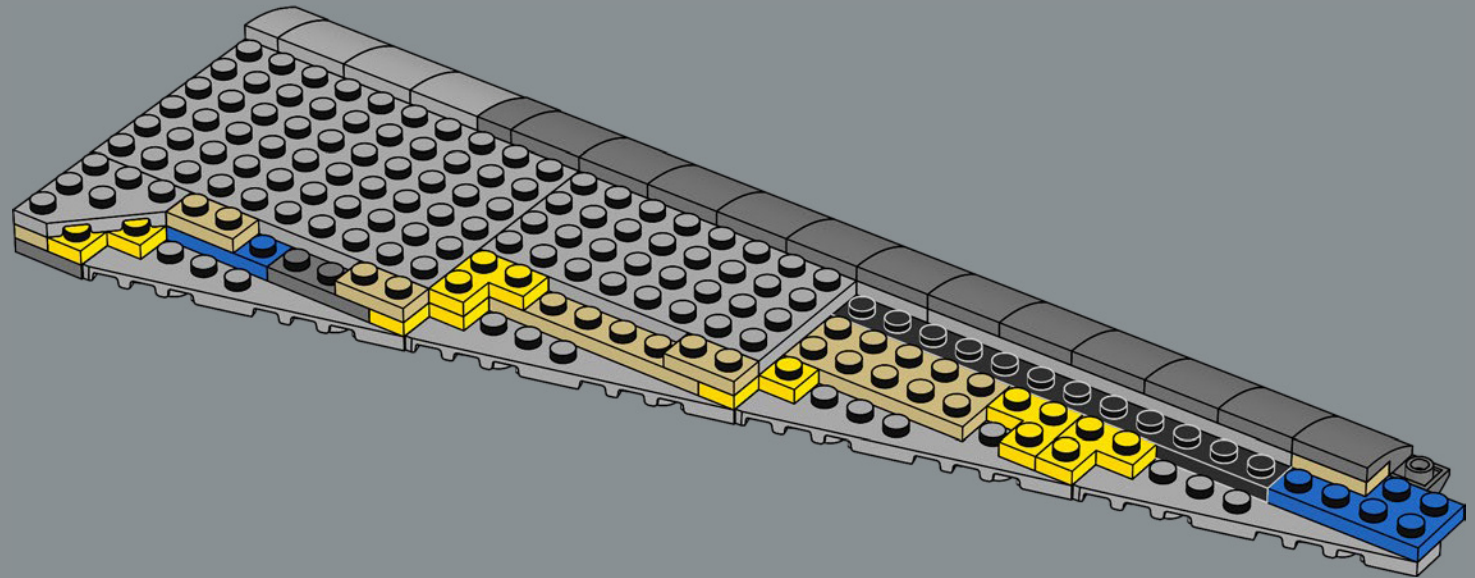

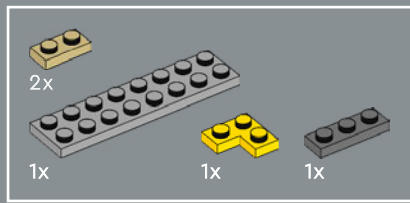

363

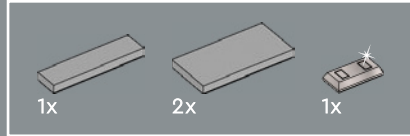
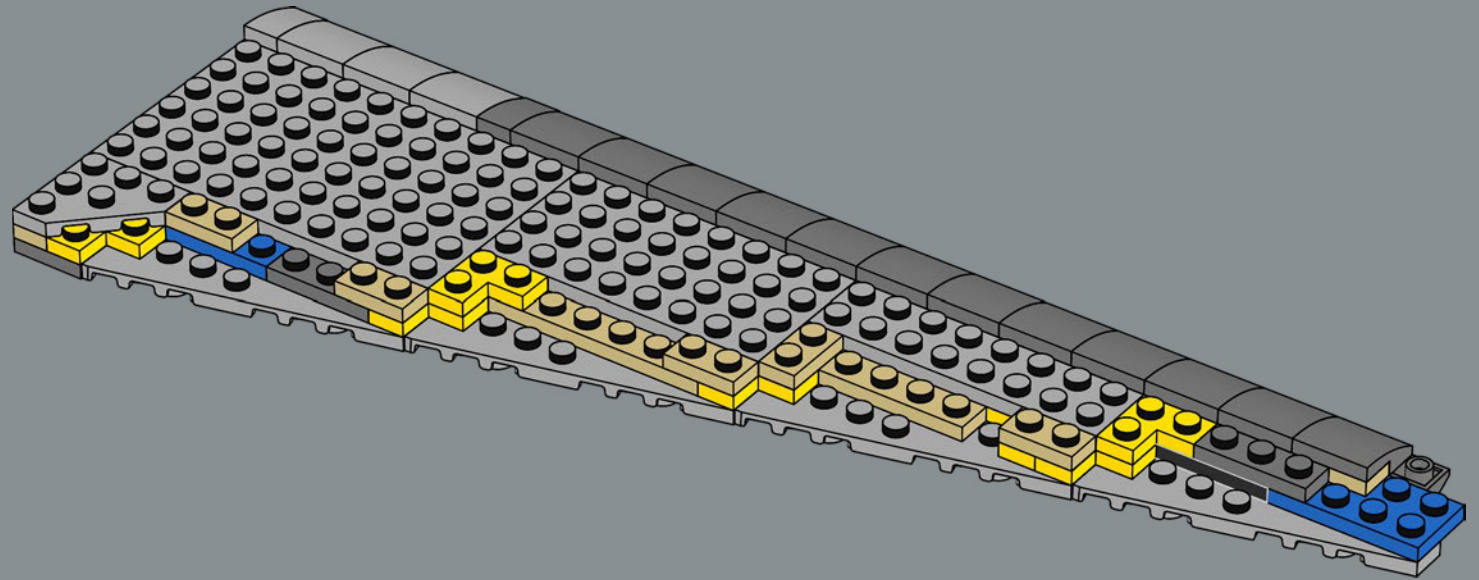

364

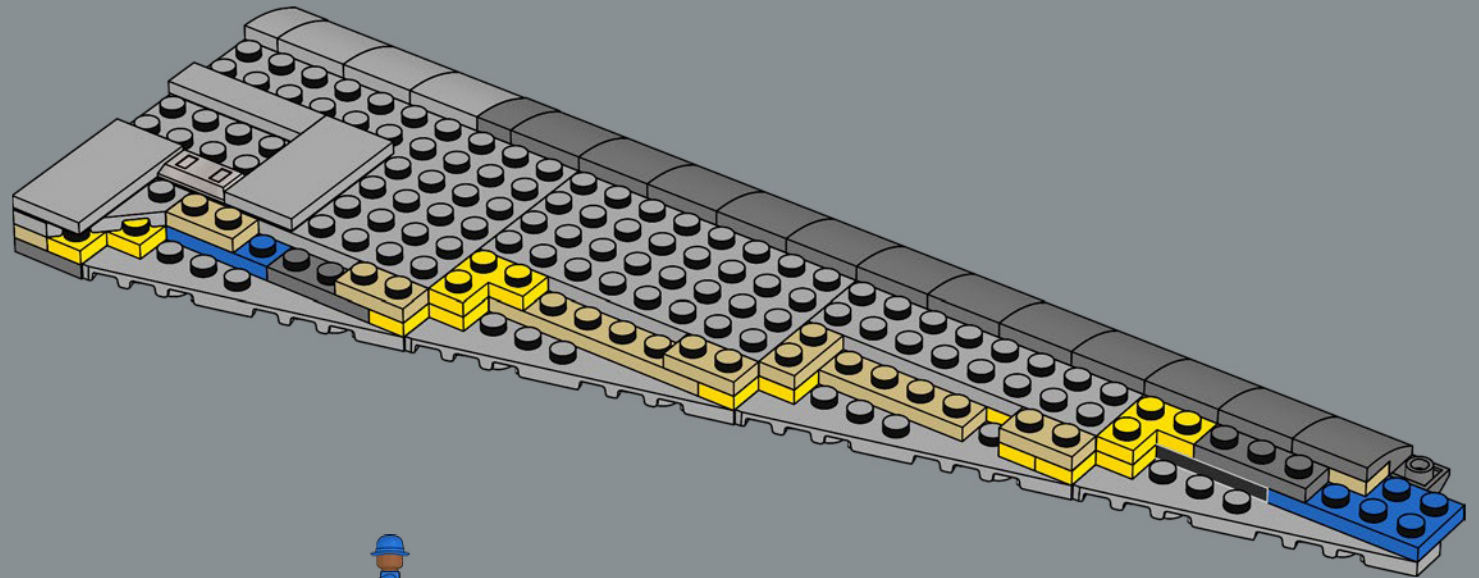

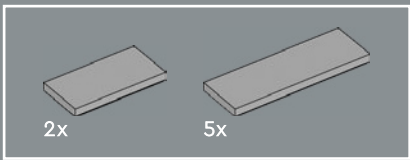

365

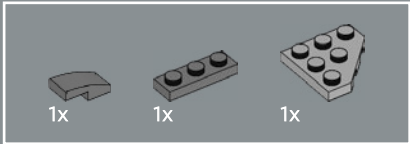
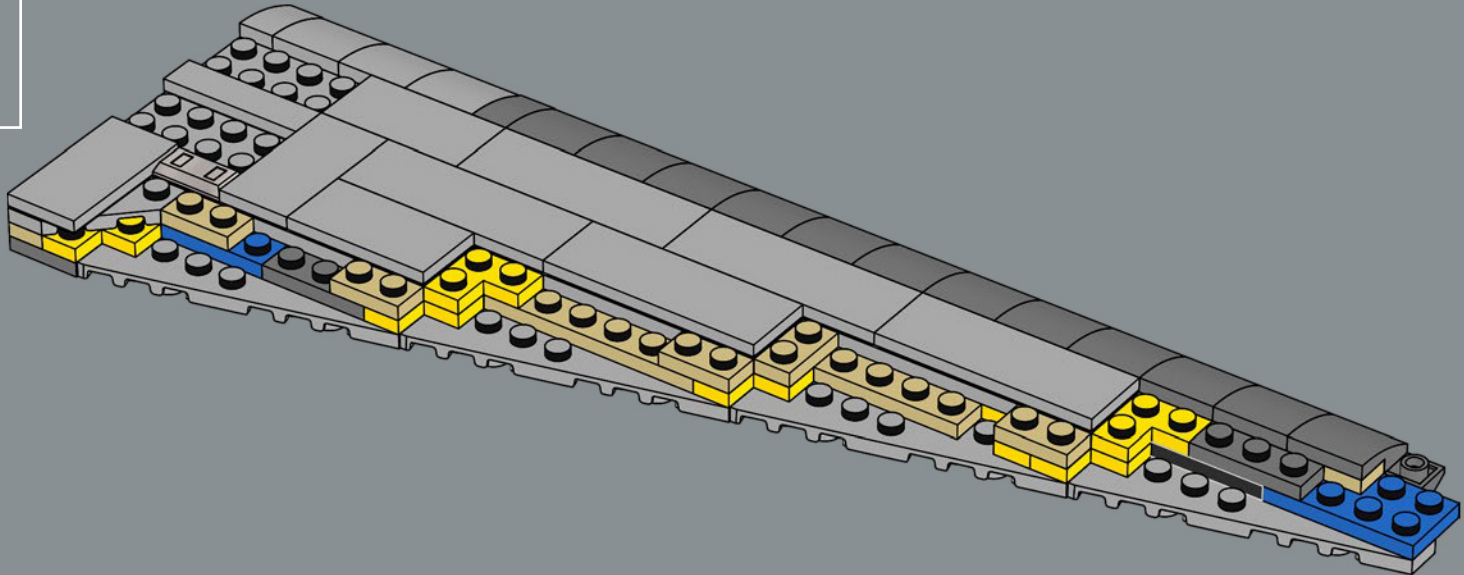

366

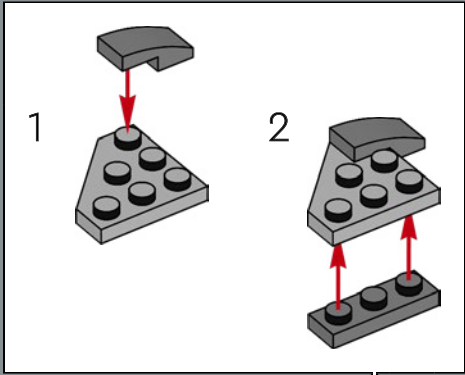
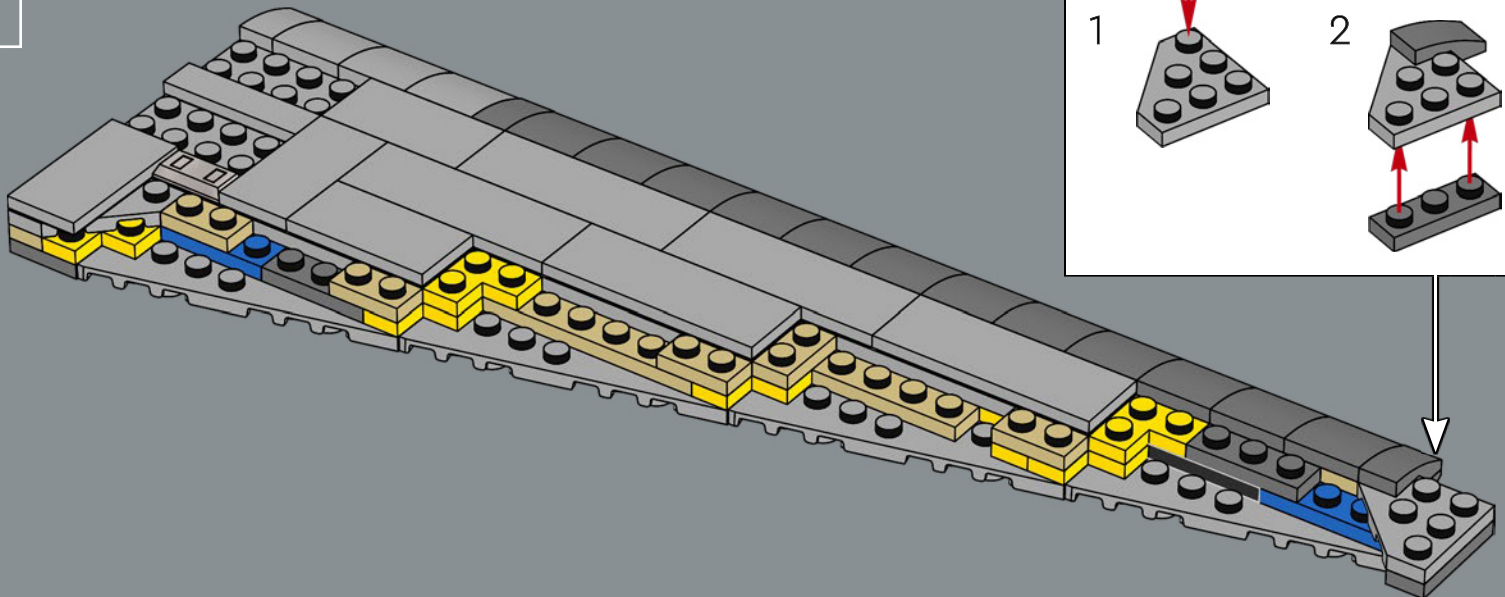

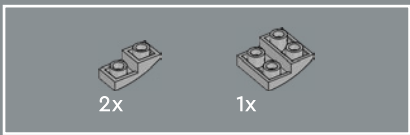

367

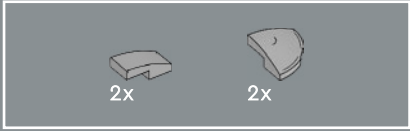
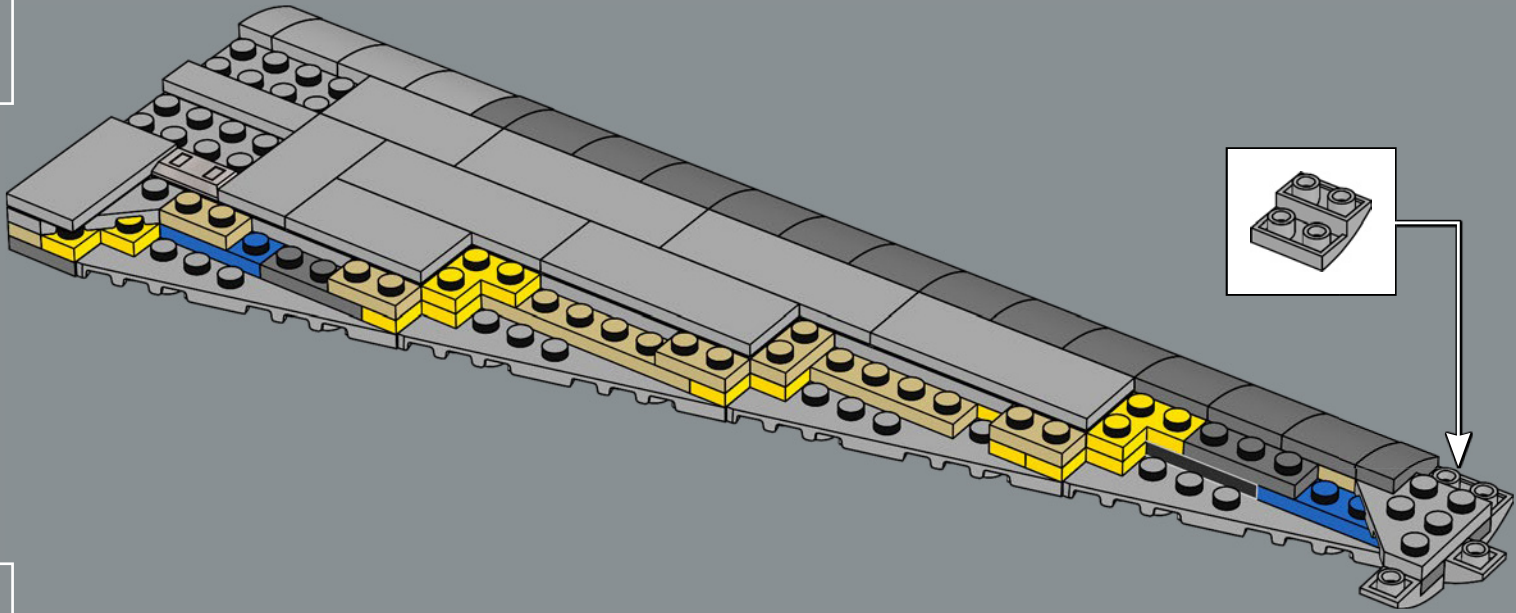

368

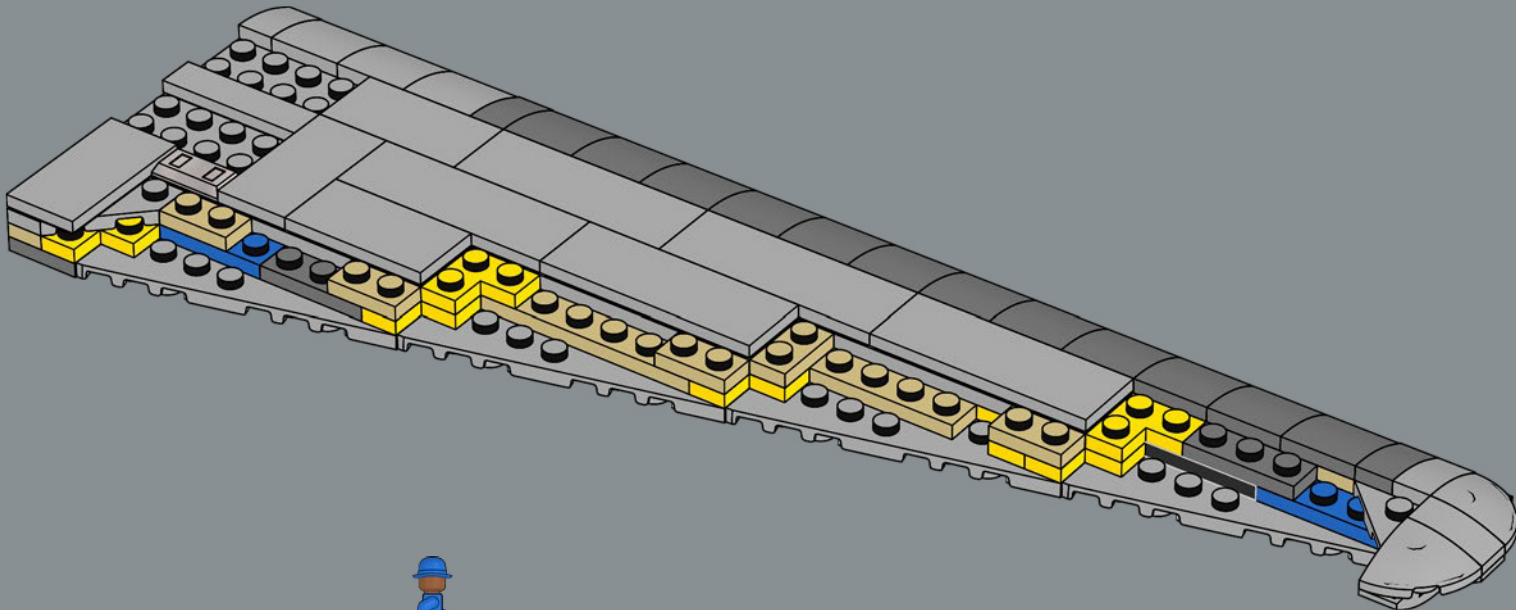

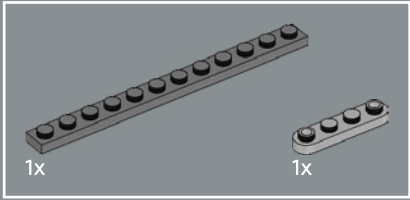
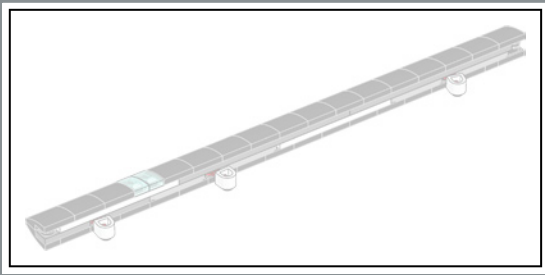

369

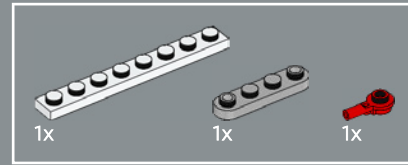
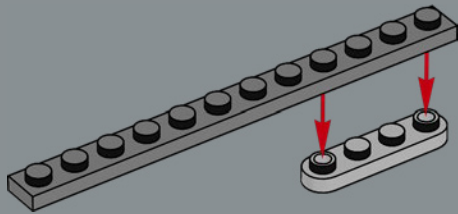

370

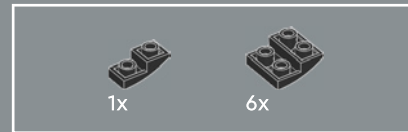
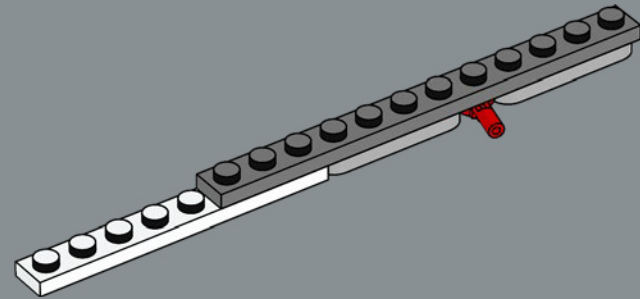

371

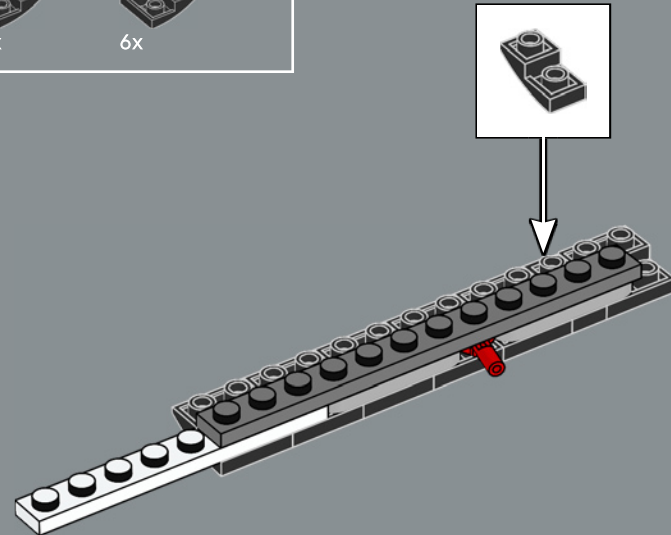



372

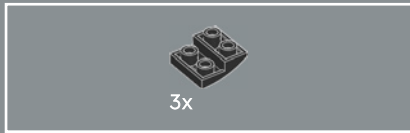
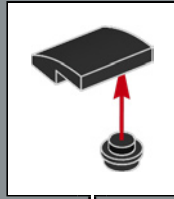
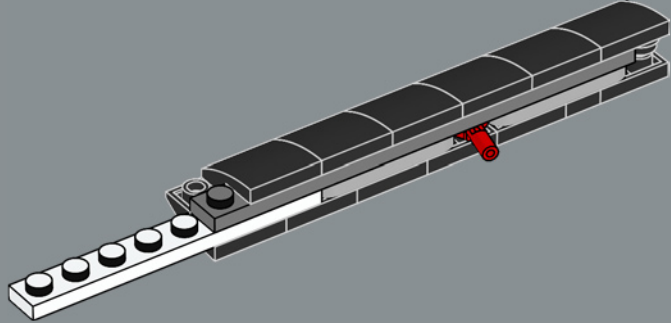

373

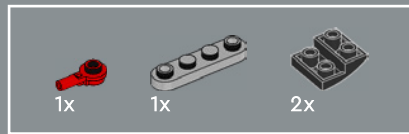
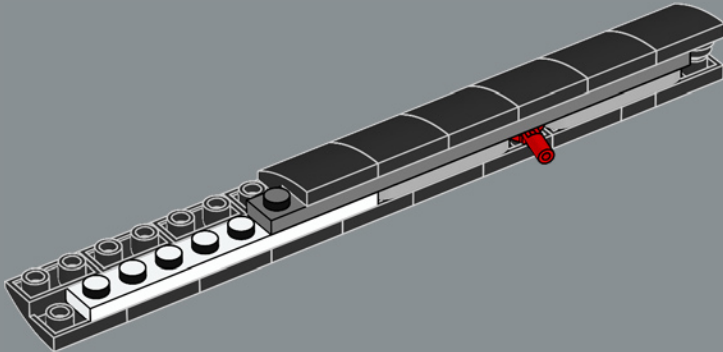

374

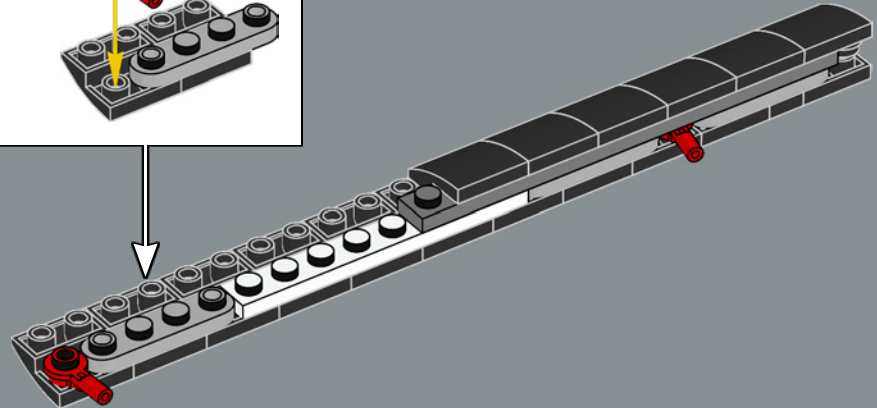
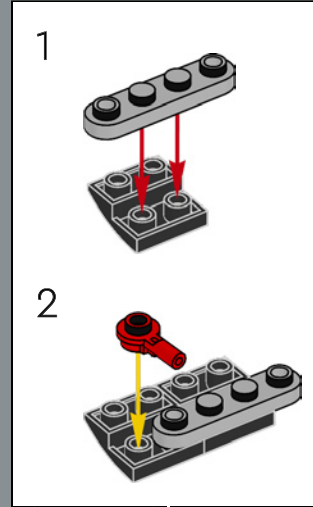

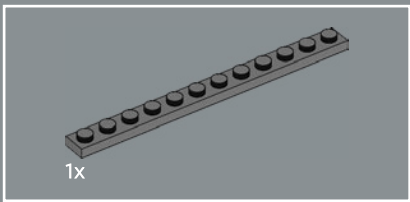

375

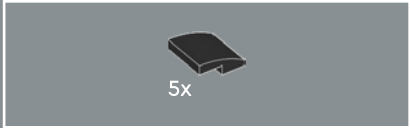
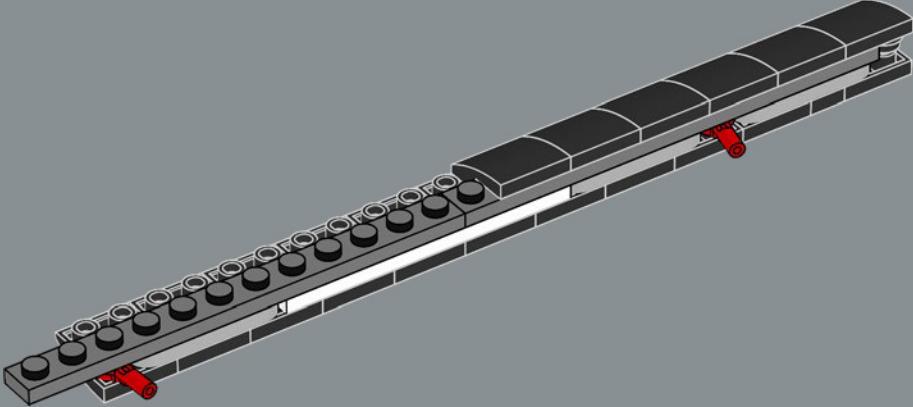

376

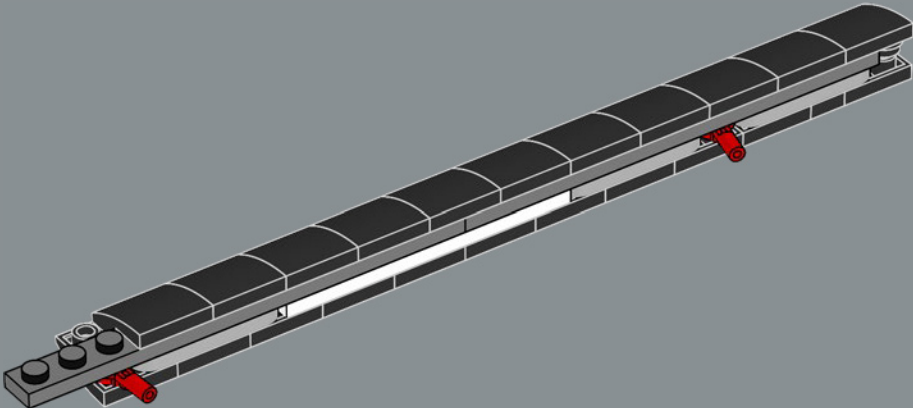

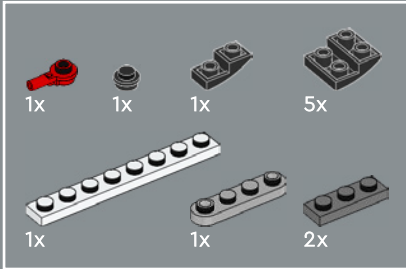
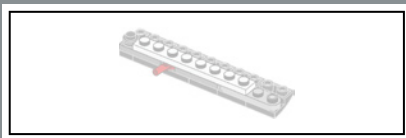

377

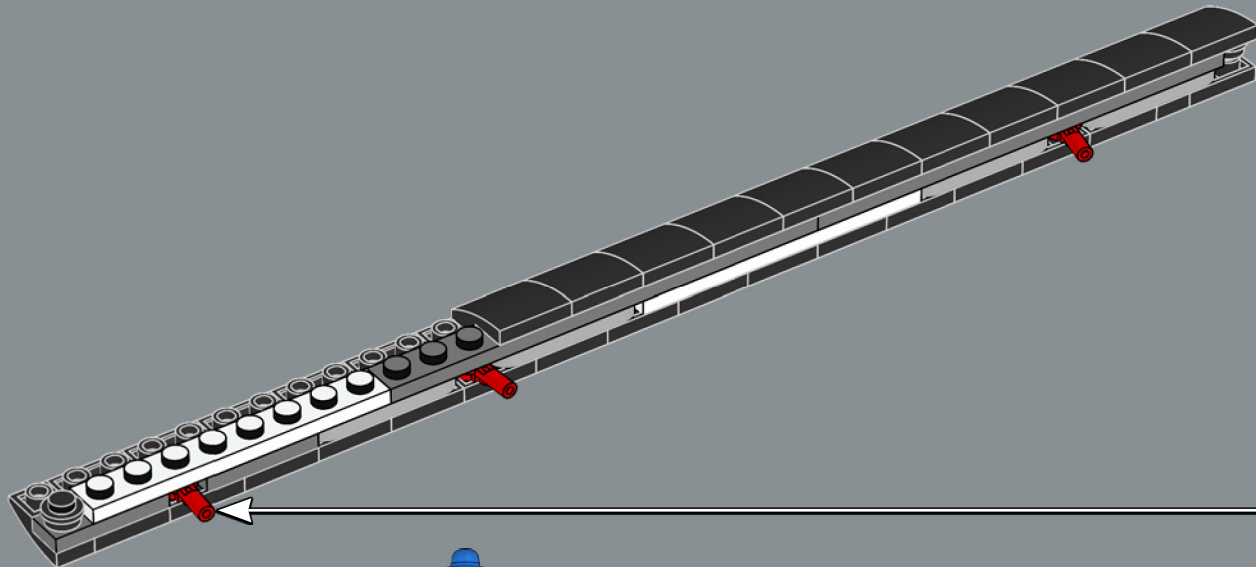
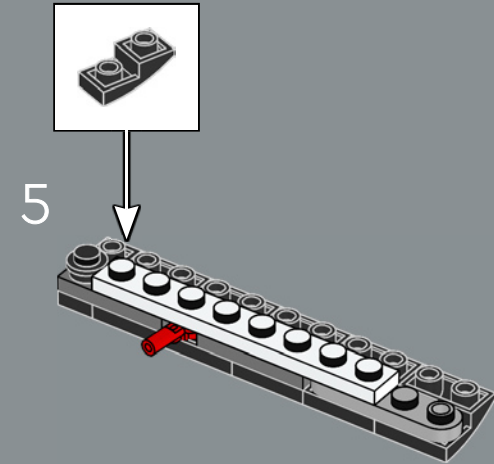
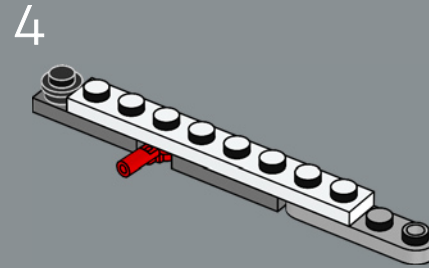
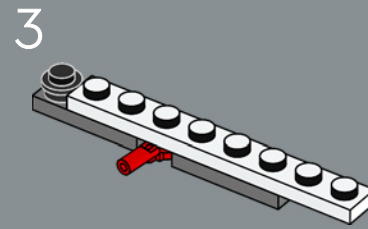
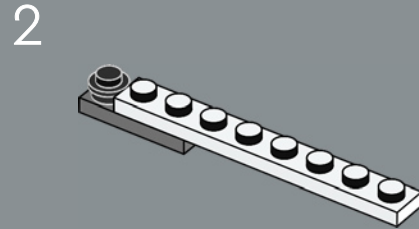
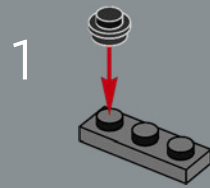



378

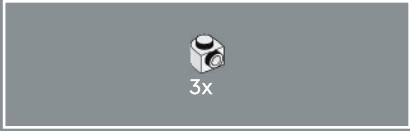
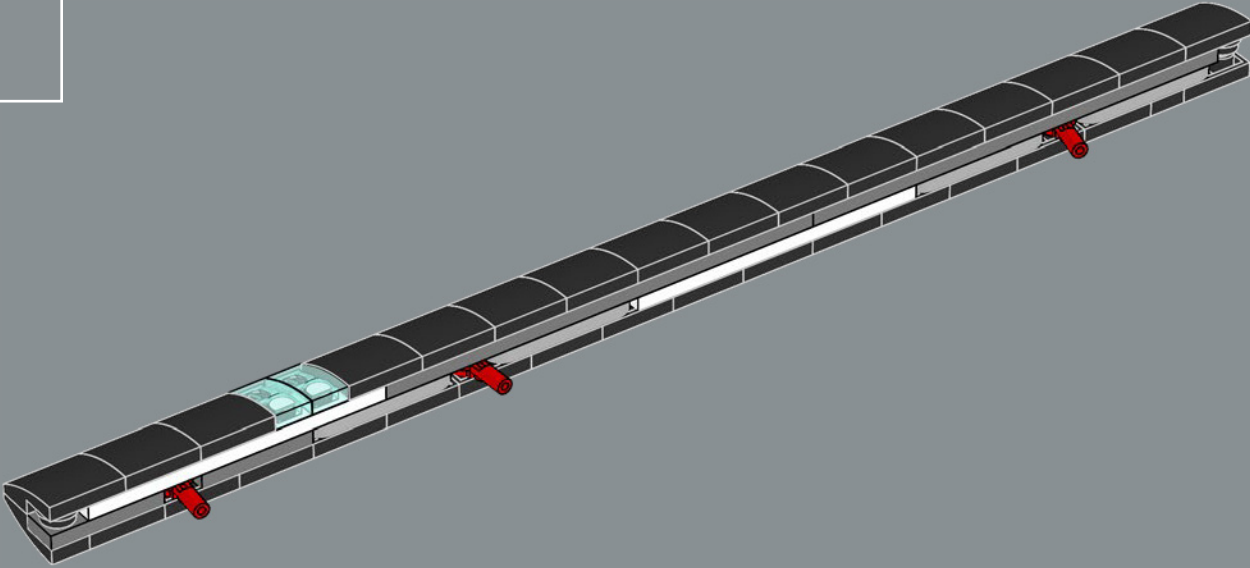

379

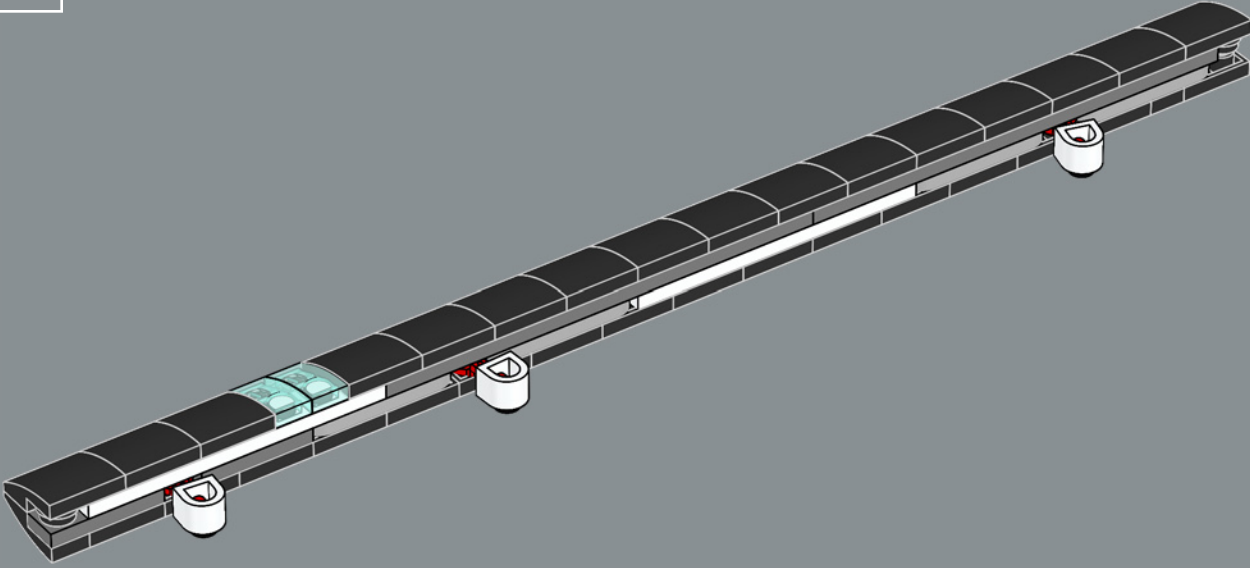

380

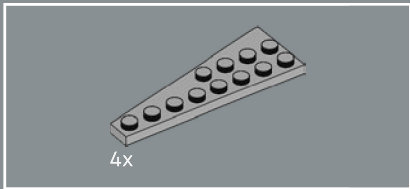
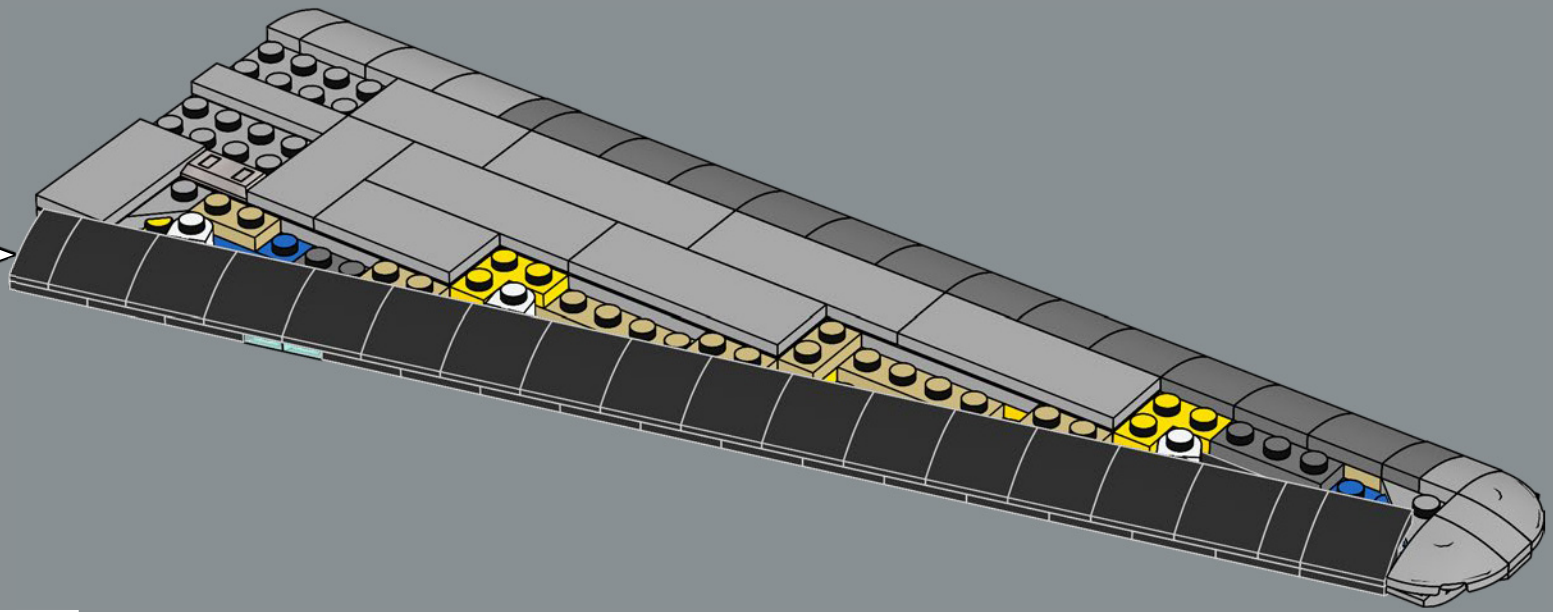

381

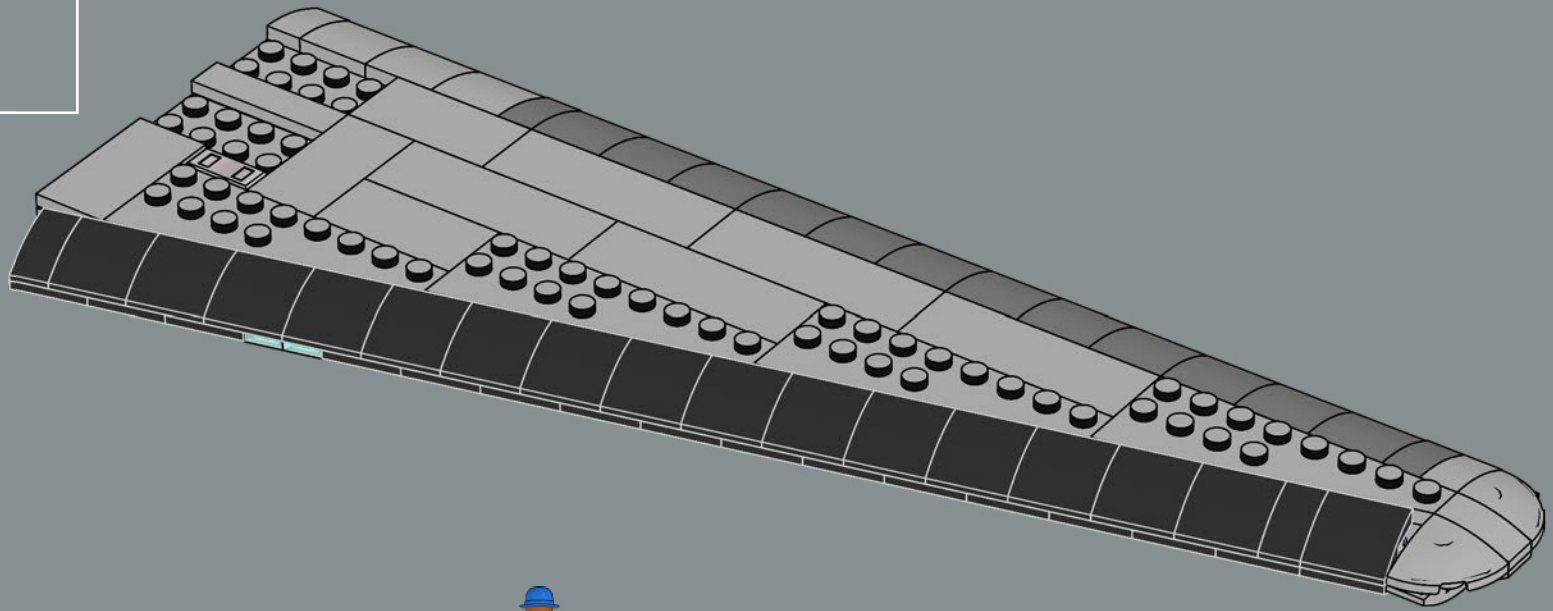

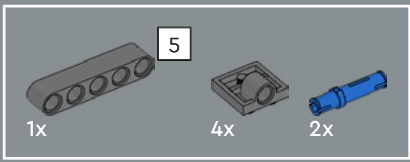

382

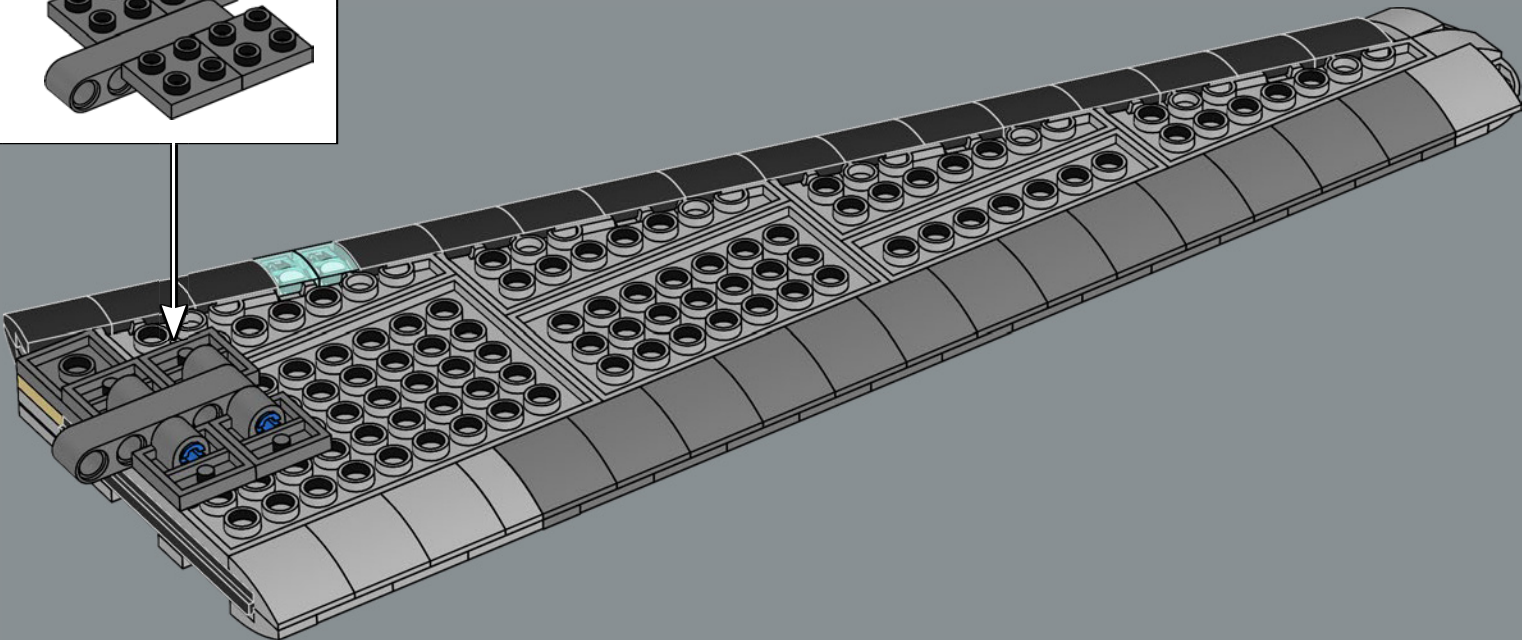
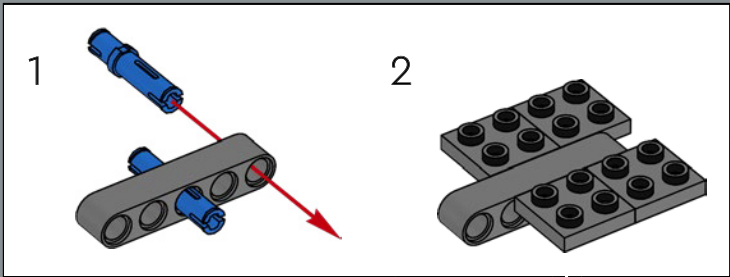



4x

383

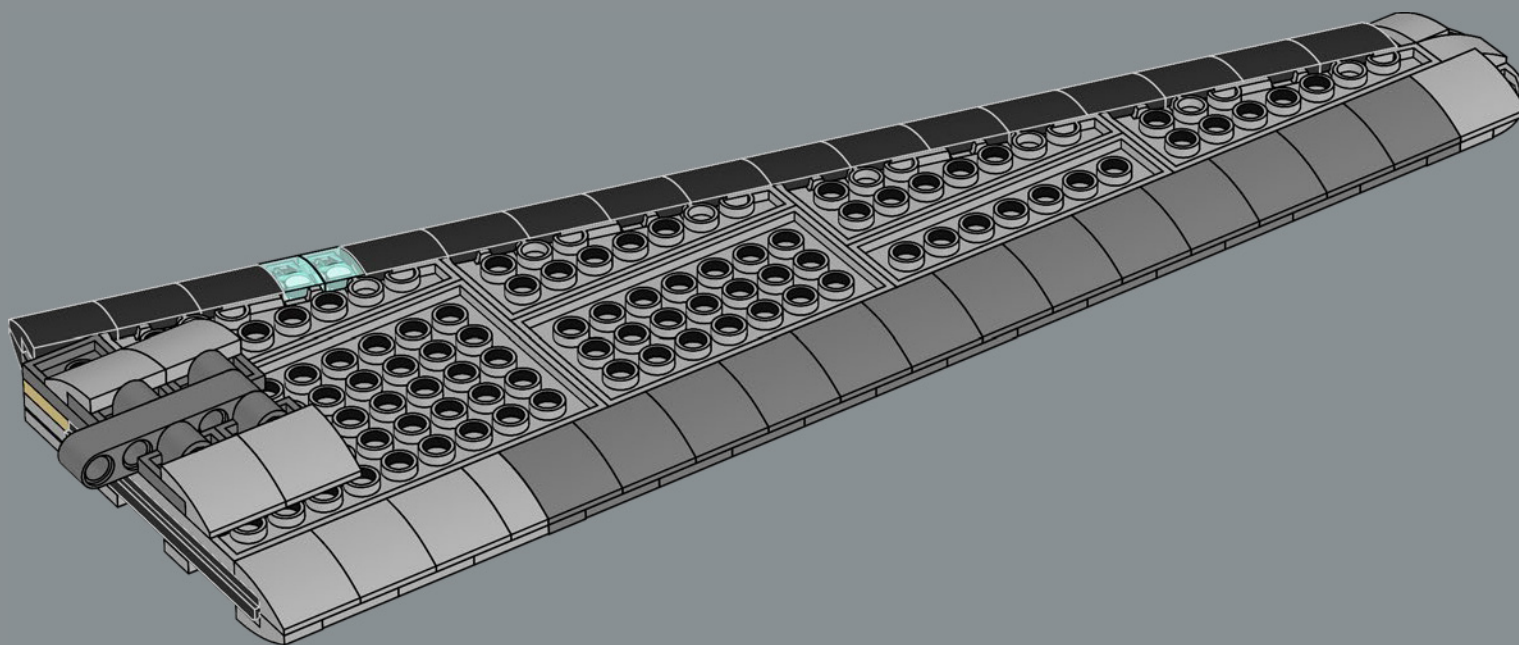

384

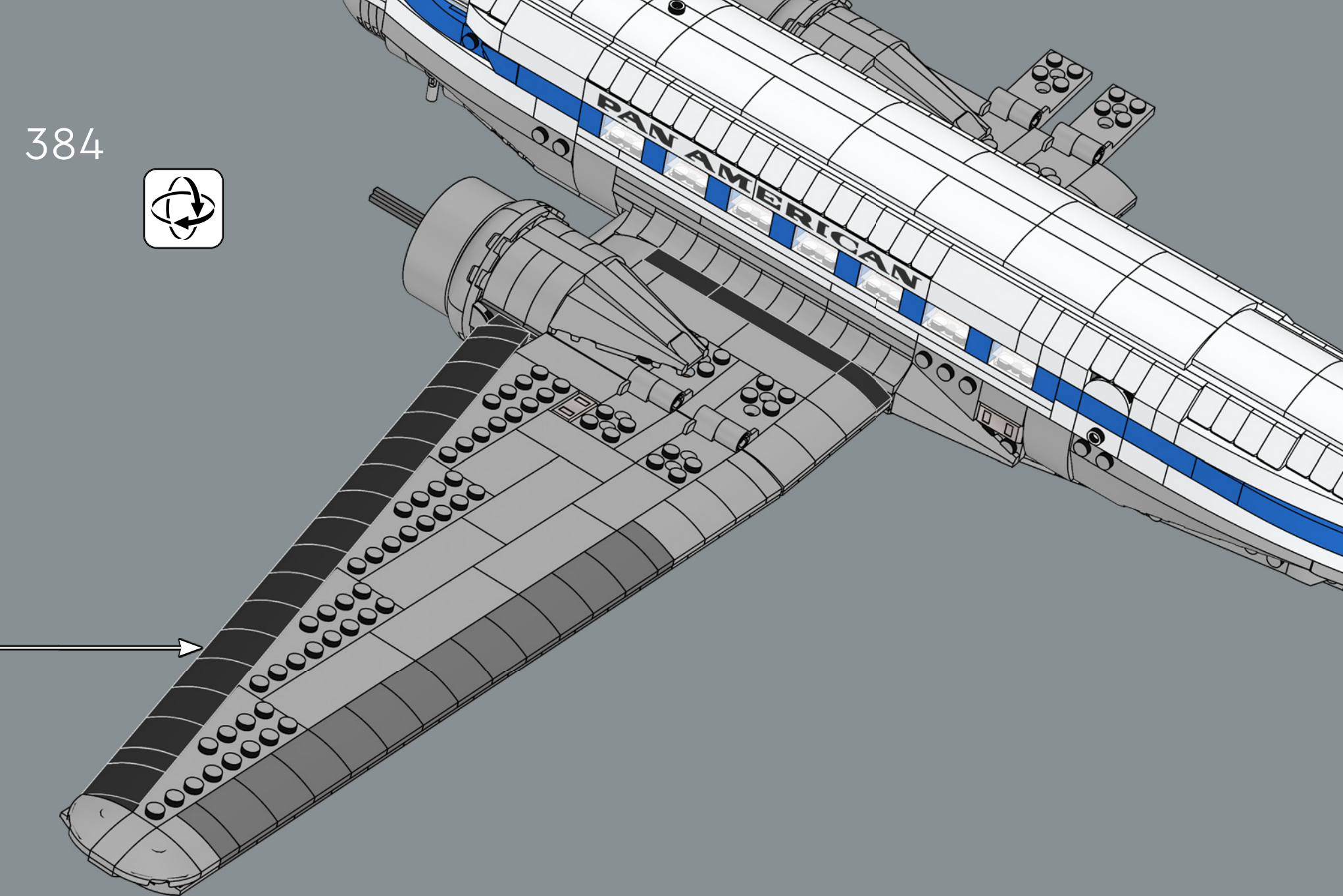

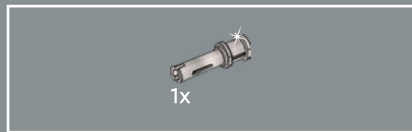

Un perno LEGO® Technic sul lato inferiore fissa l'ala in posizione.  
I designer LEGO chiamano questo pezzo "valvola di bicicletta".

385

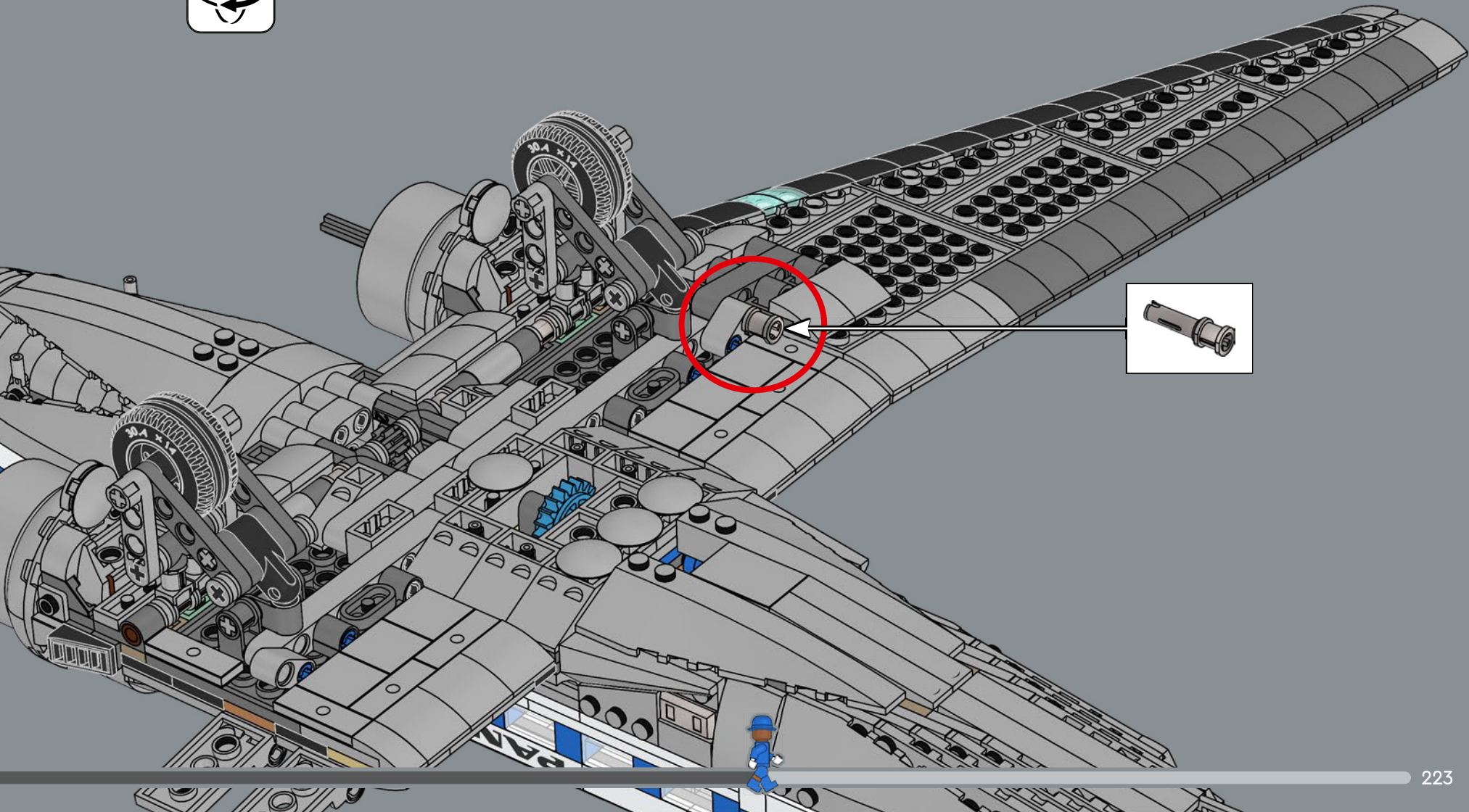

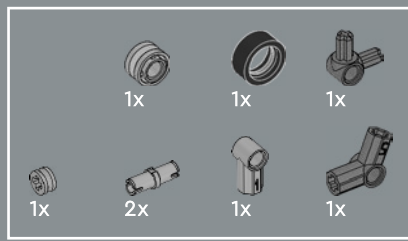

386



Le celebri uniformi apparvero per la prima volta solo nel 1958 con il lancio del B-707. Lo stilista hollywoodiano Don Loper disegnò le uniformi per le hostess Pan Am® in occasione dell'avvento della cosiddetta Jet Age.

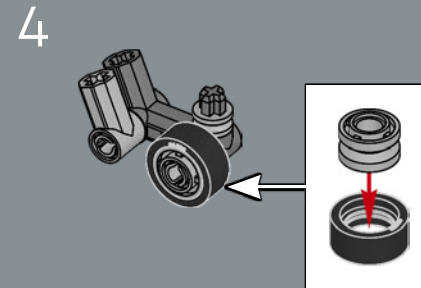
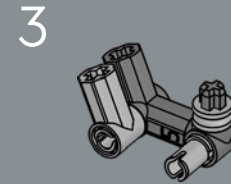
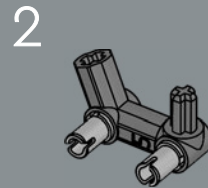
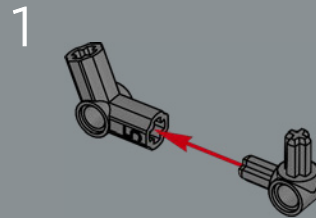
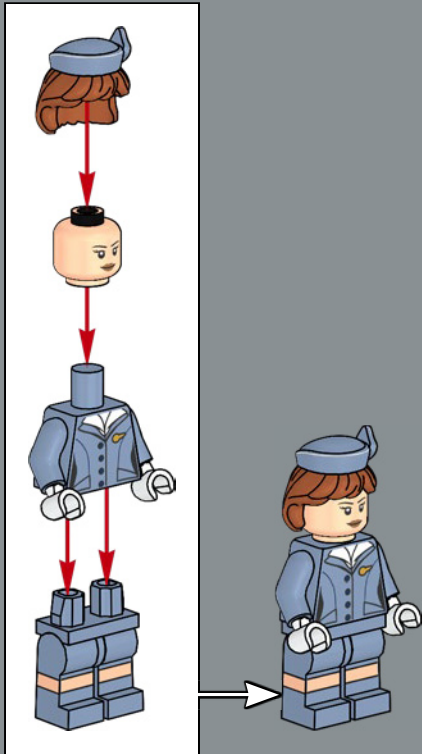



Sia gli assistenti di volo uomini che donne potevano essere promossi alla posizione di "purser" (capocabina) sull'aeromobile. A partire dagli anni '60, le donne hanno ricoperto sempre più questo ruolo.

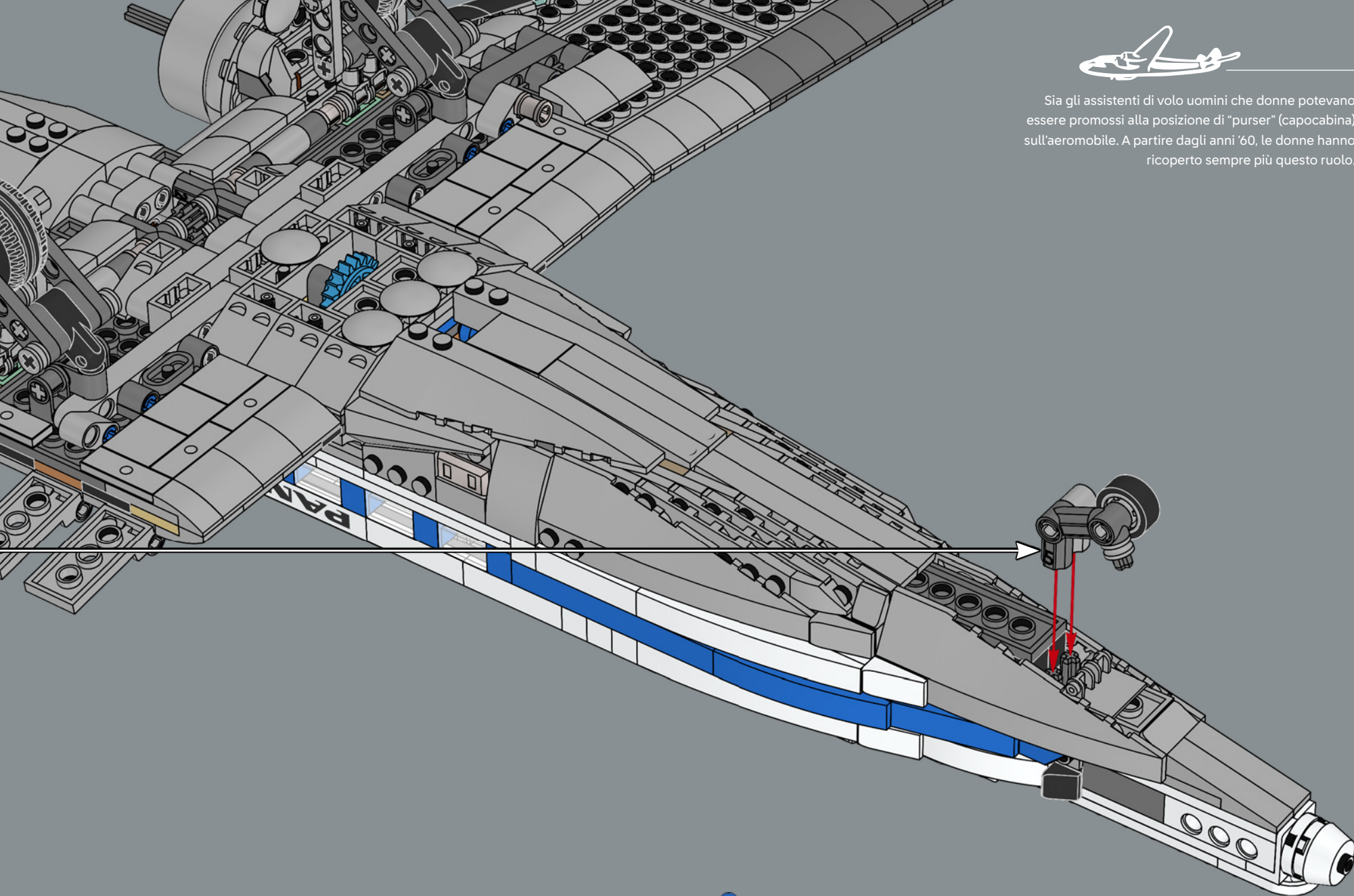

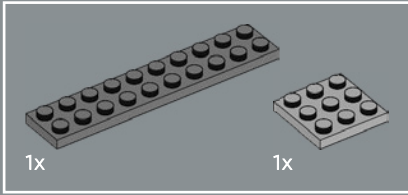
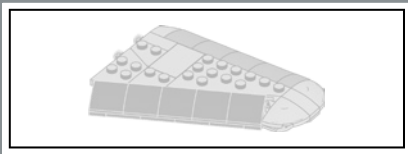

387

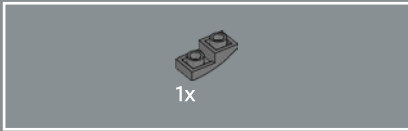
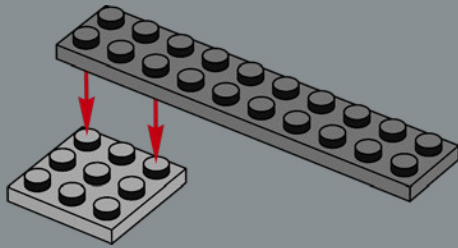

388

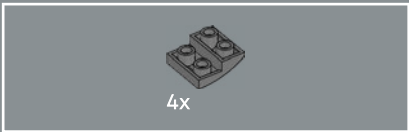
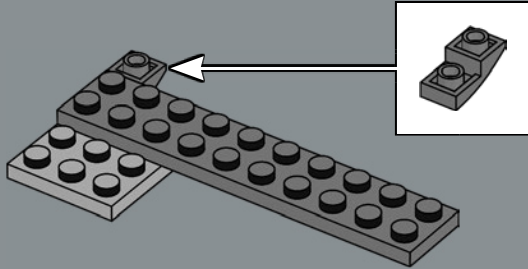

389

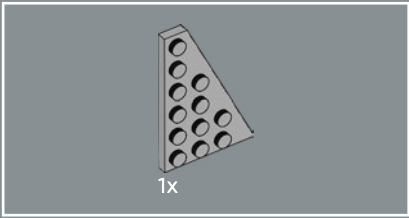
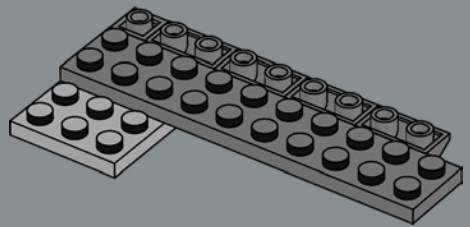

390

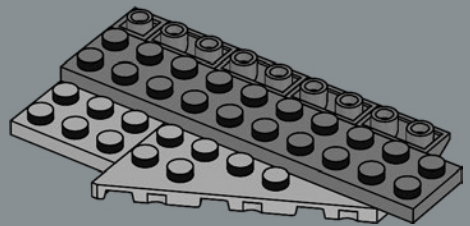

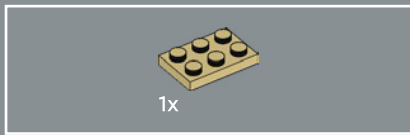

391

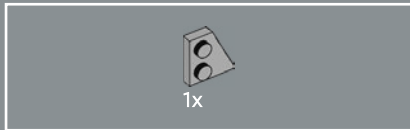
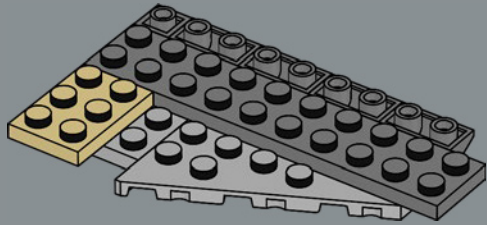

392

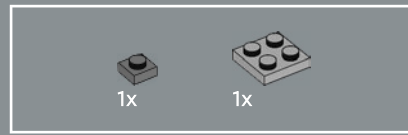
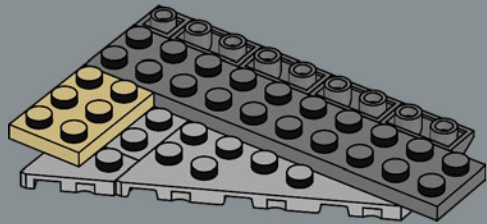

393

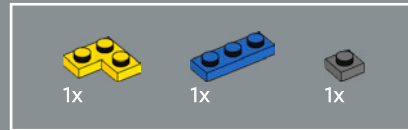
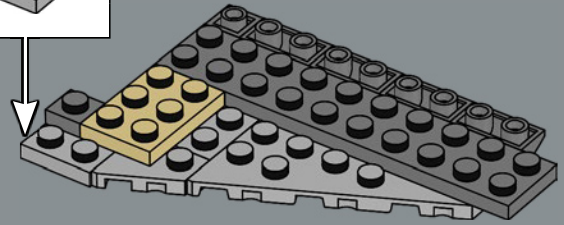
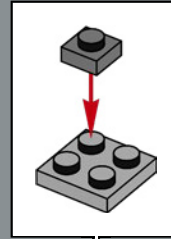

394

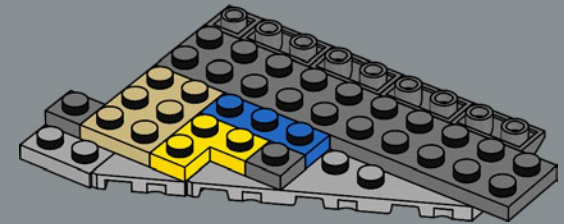





399

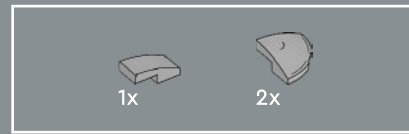
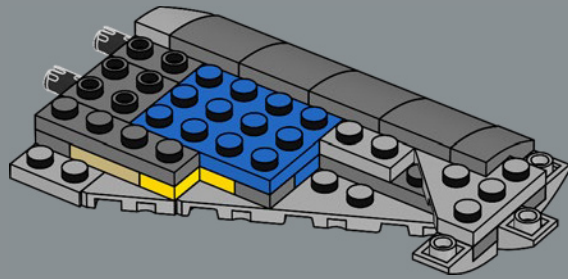

400

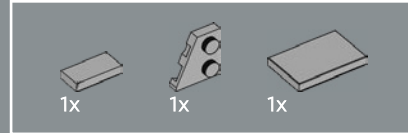
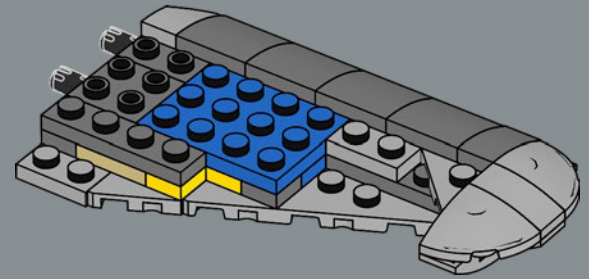

401

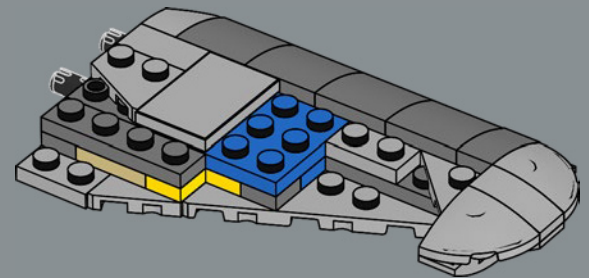

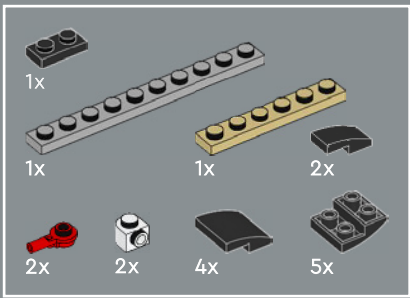

402

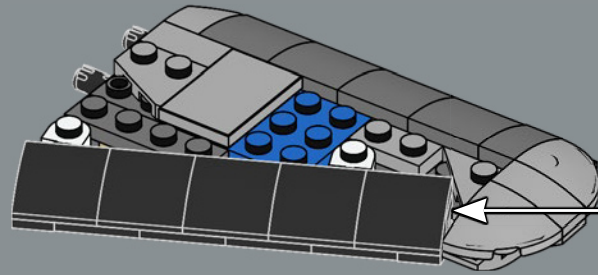
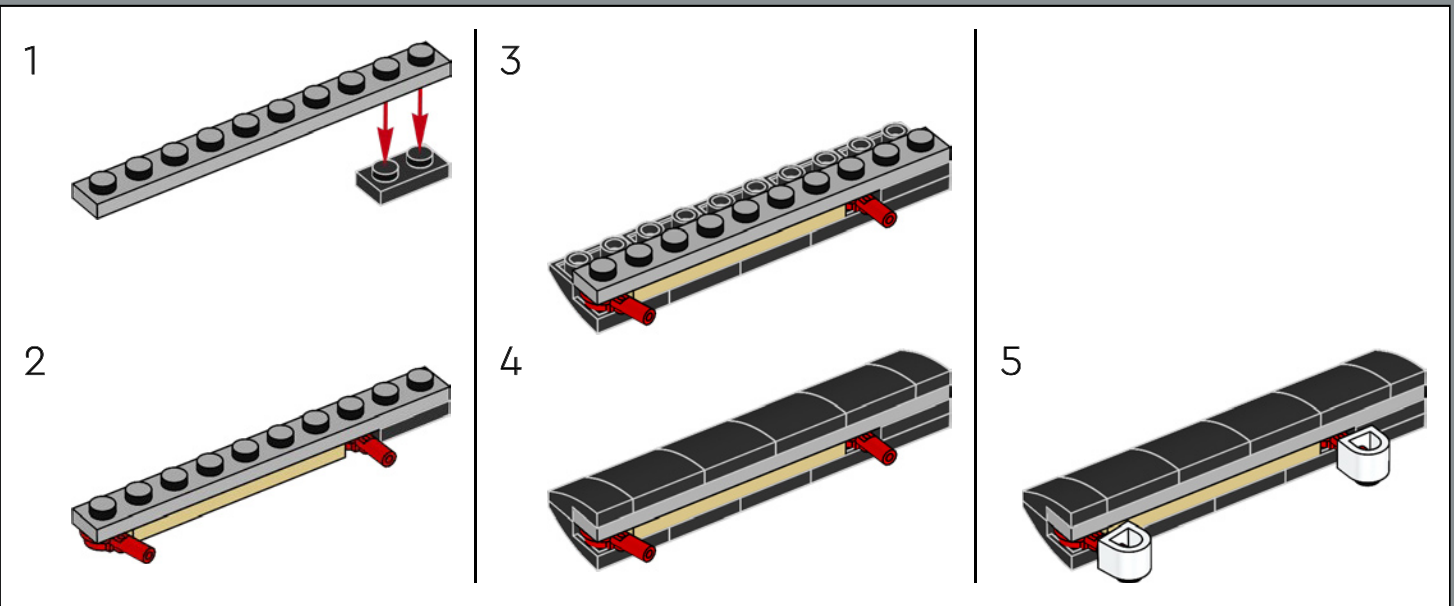

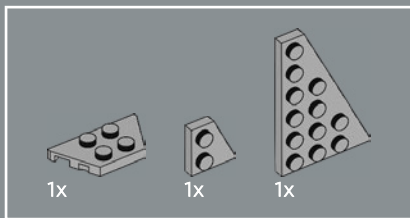

403

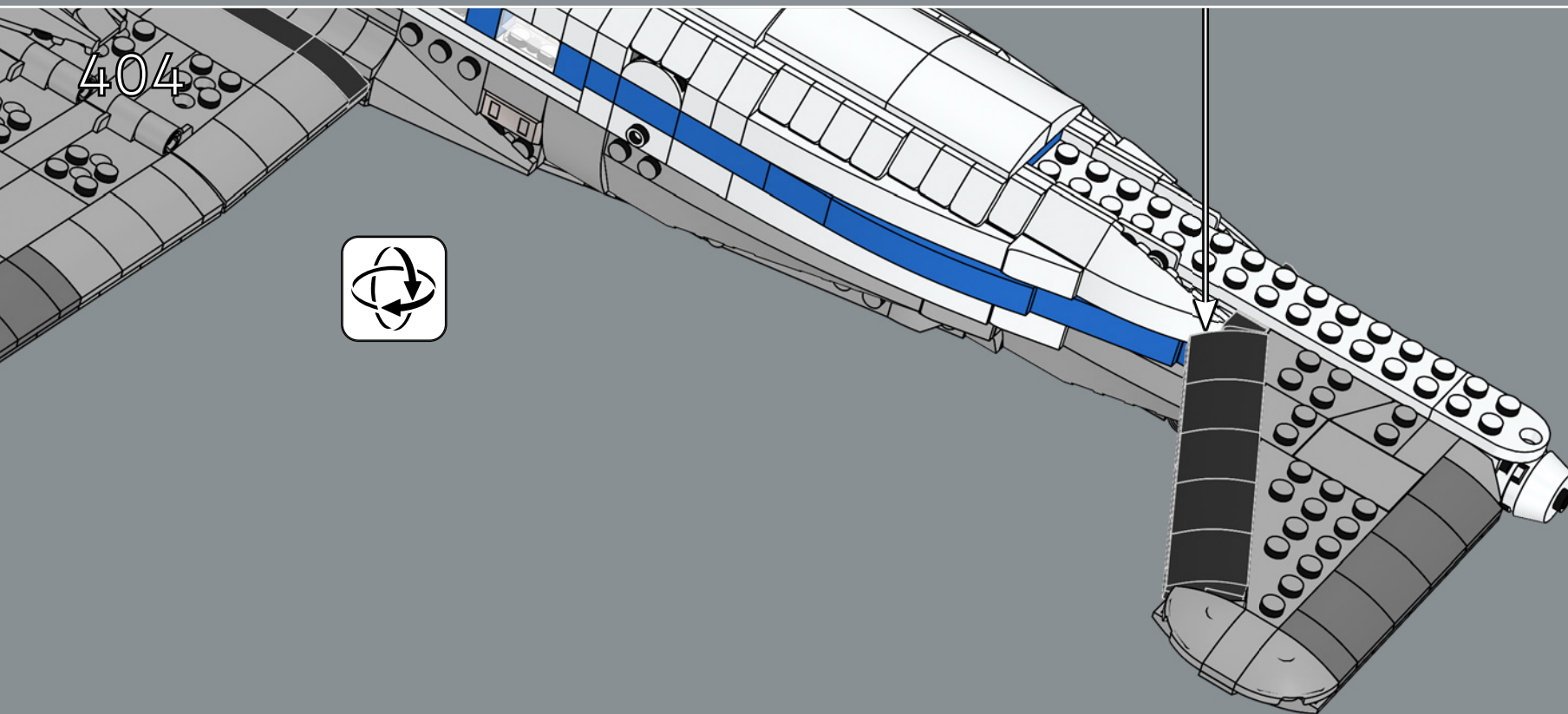
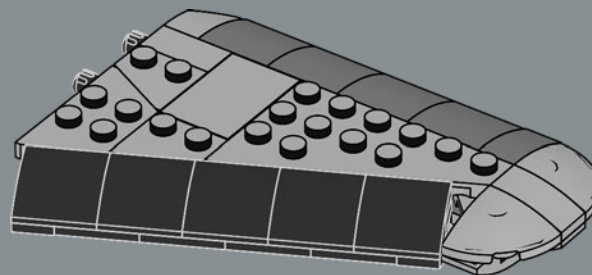

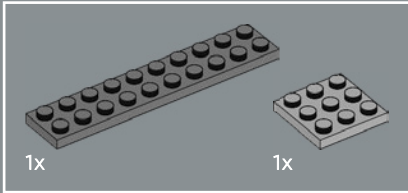
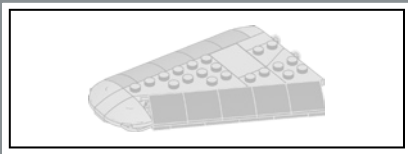

405

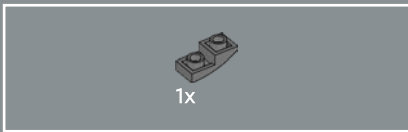
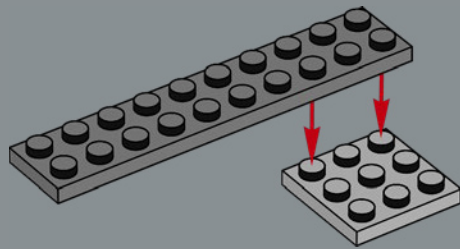

406

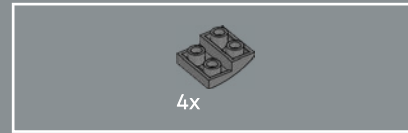
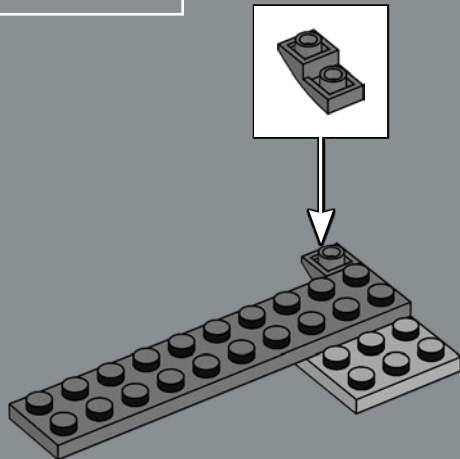

407

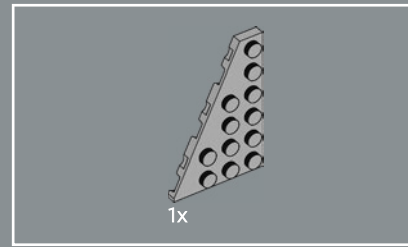
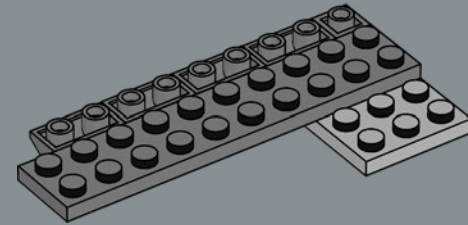

408

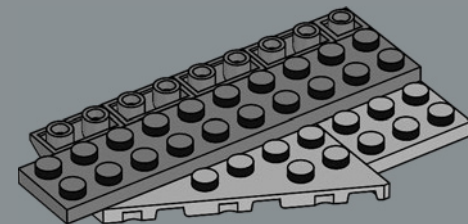

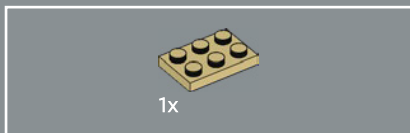

409

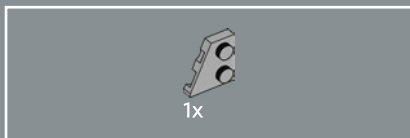
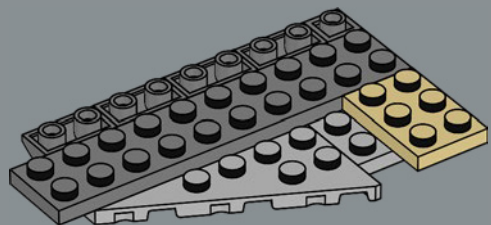

410

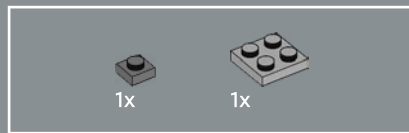
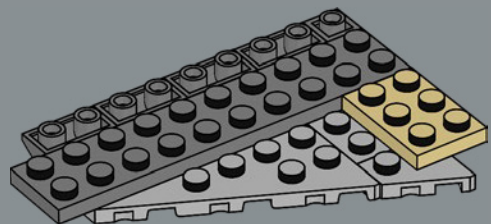

411

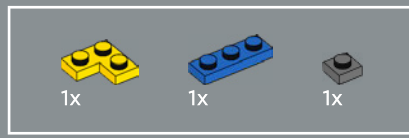
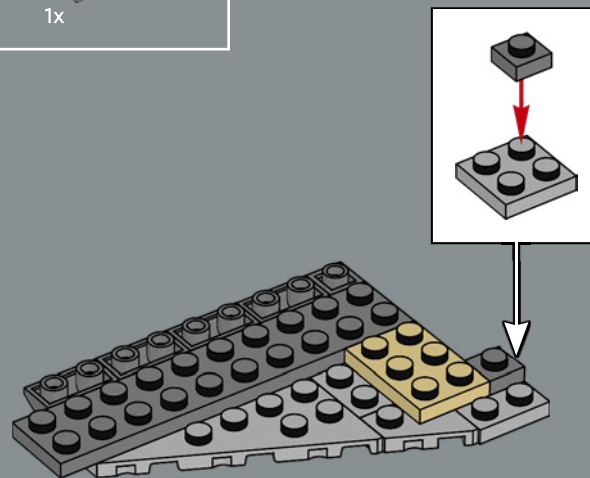

412

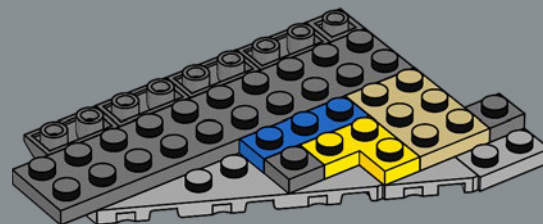



413

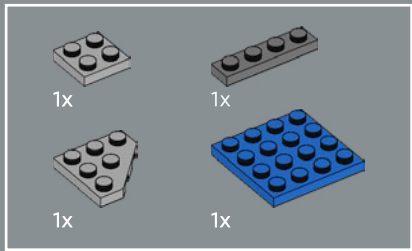
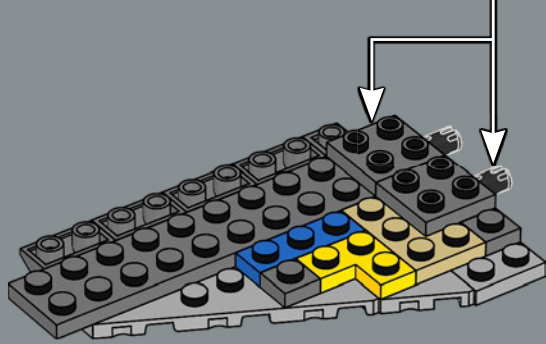
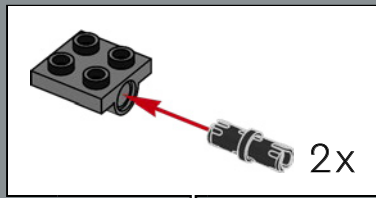

414

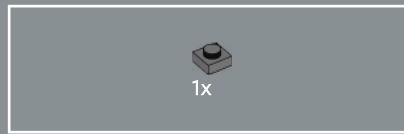
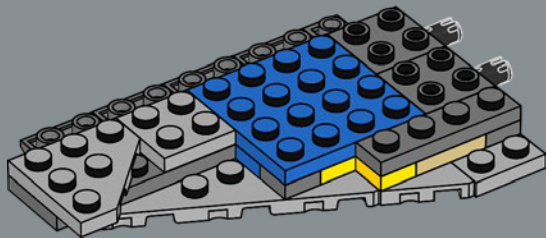

415

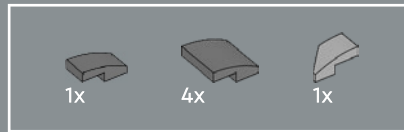
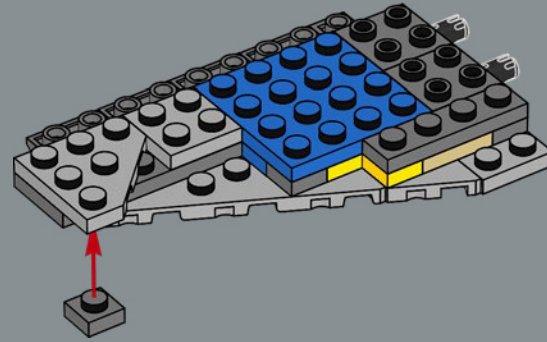

416

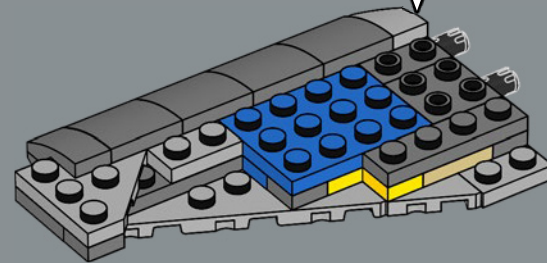
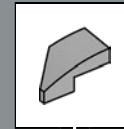

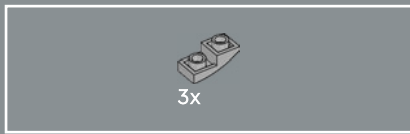

417

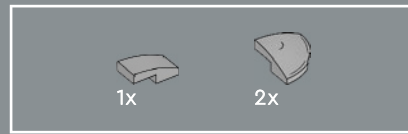
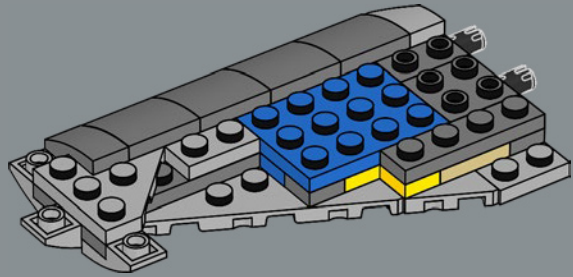

418

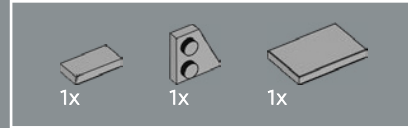
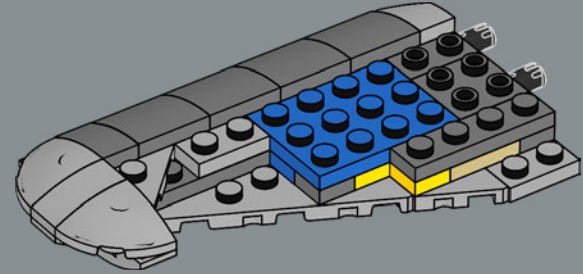

419

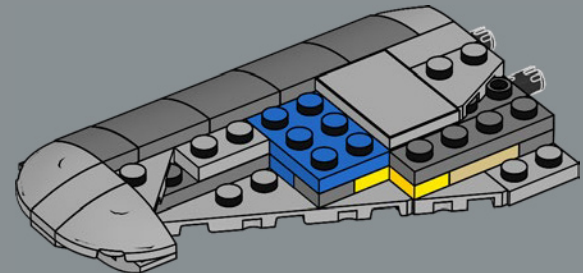

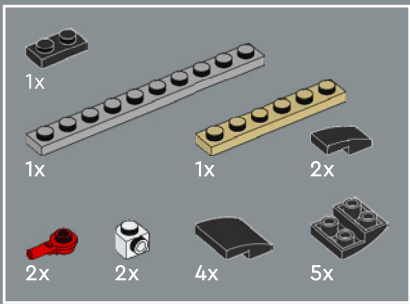

420

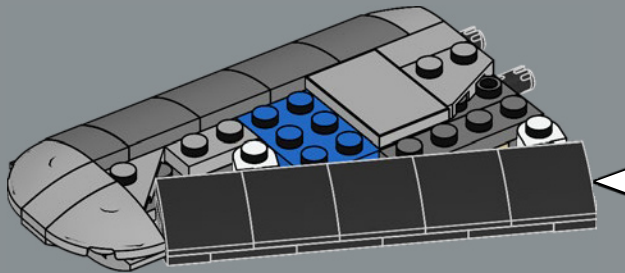
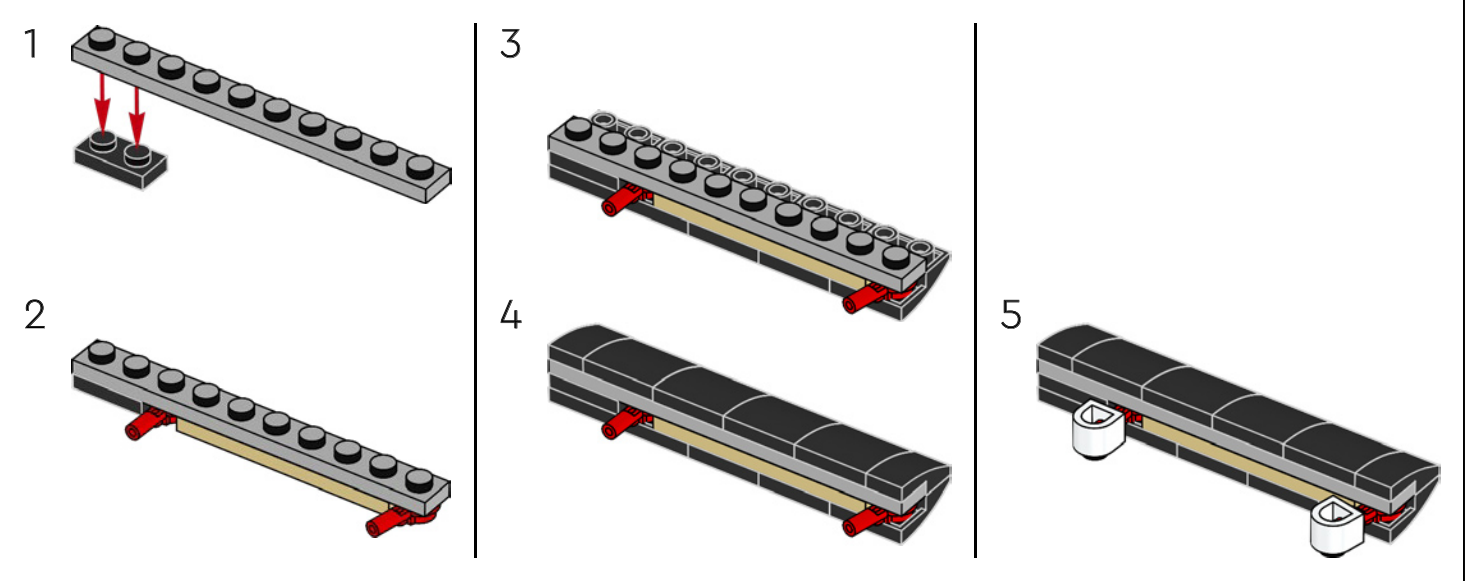

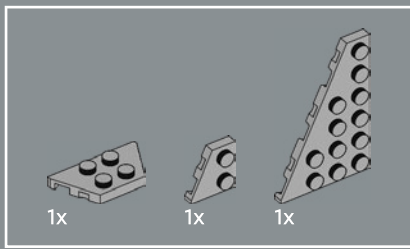

421

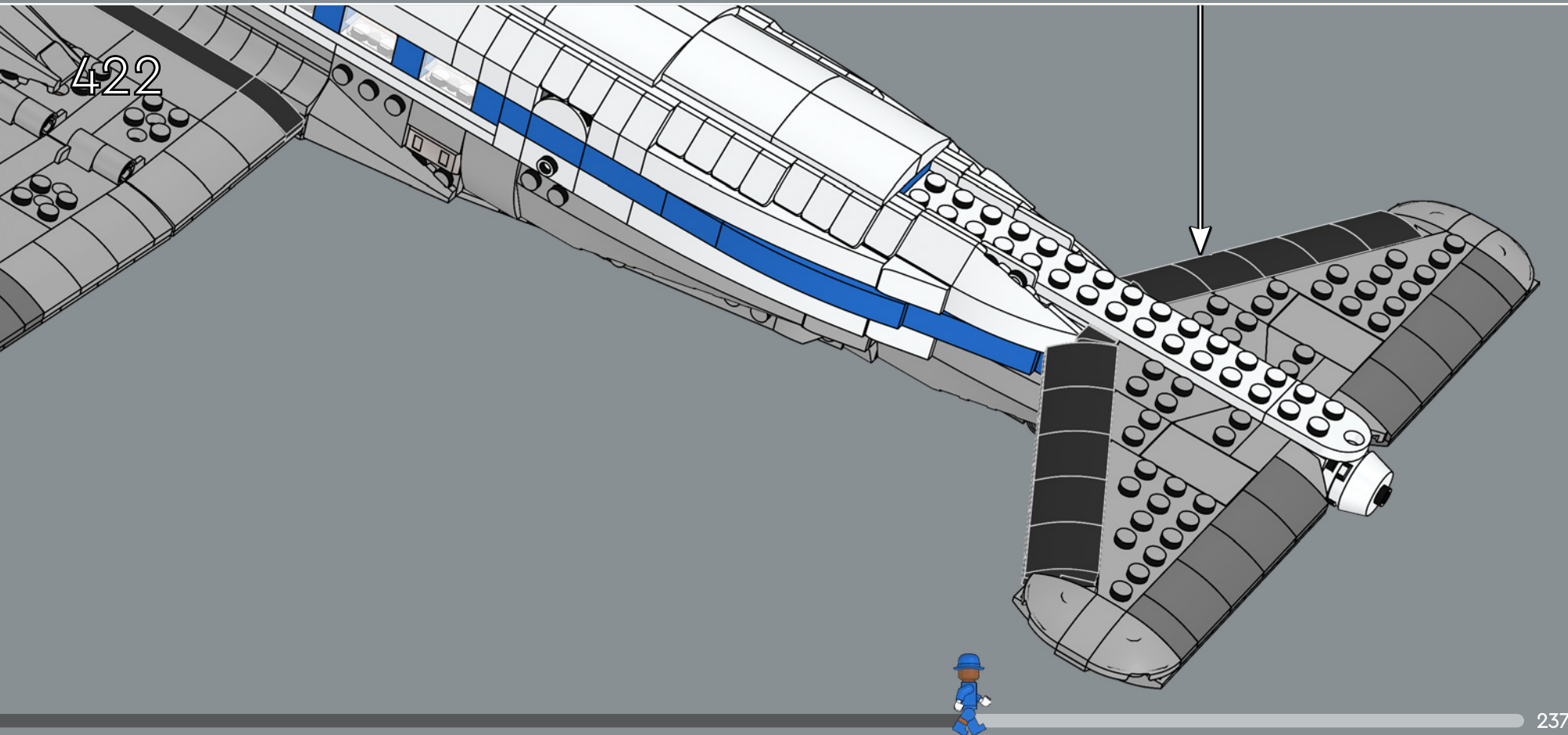
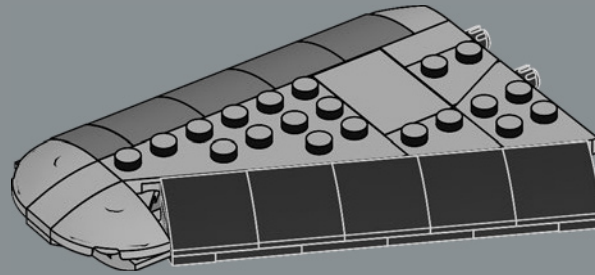





425

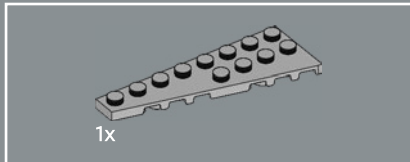
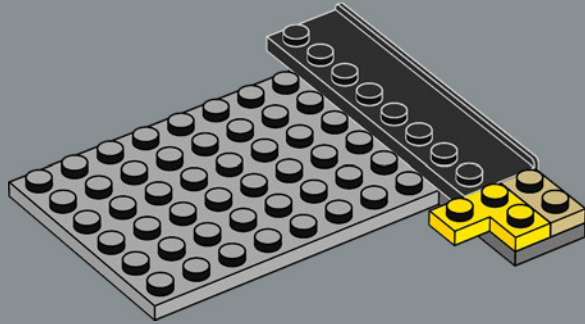

426

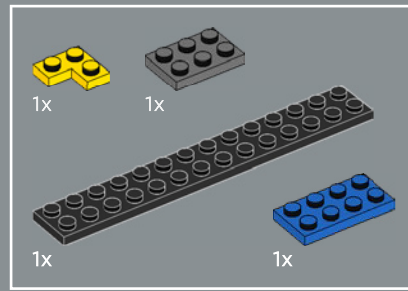
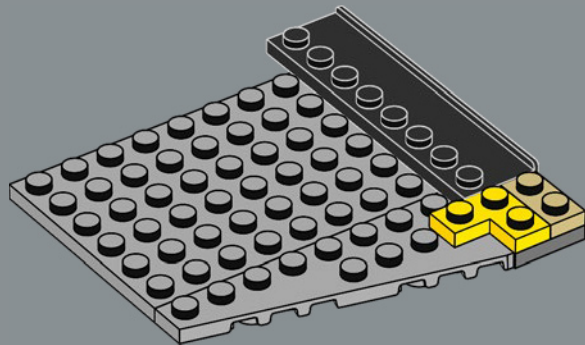

427

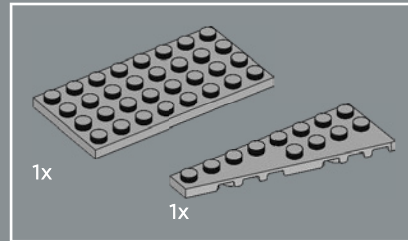
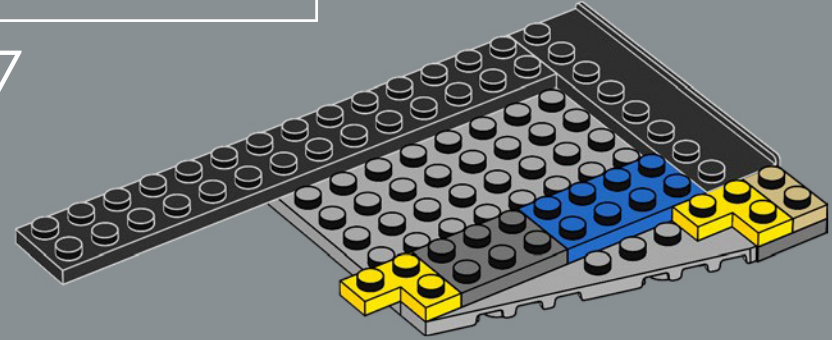

428

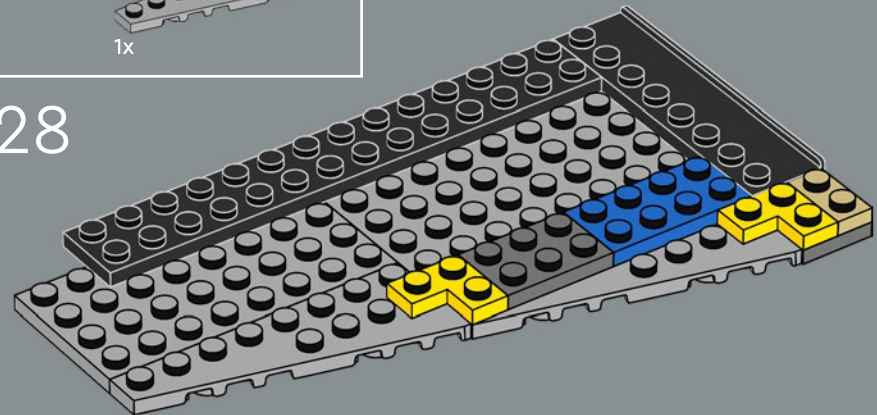

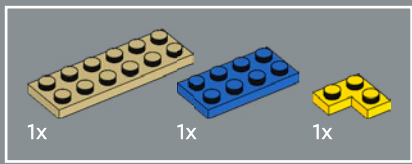

429

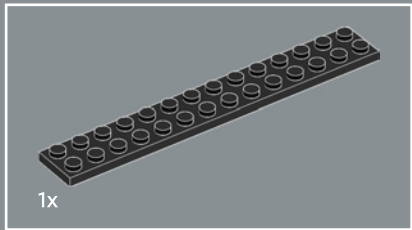
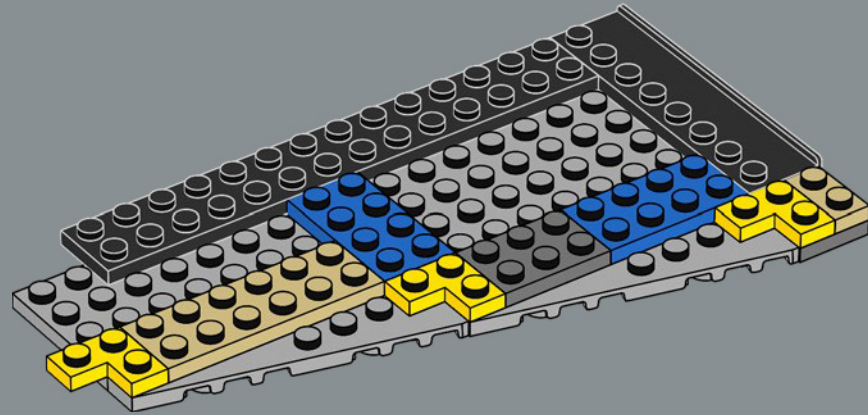

430

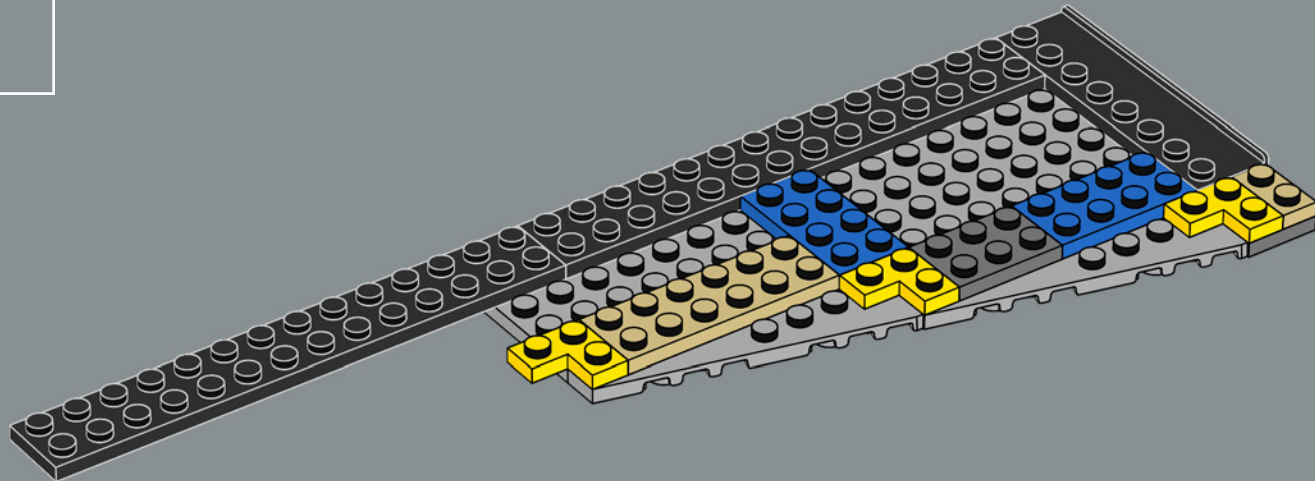

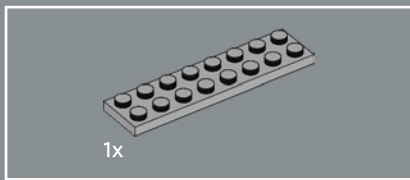

431

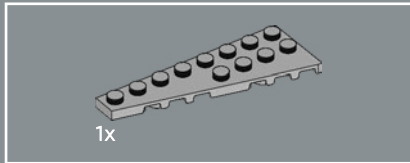
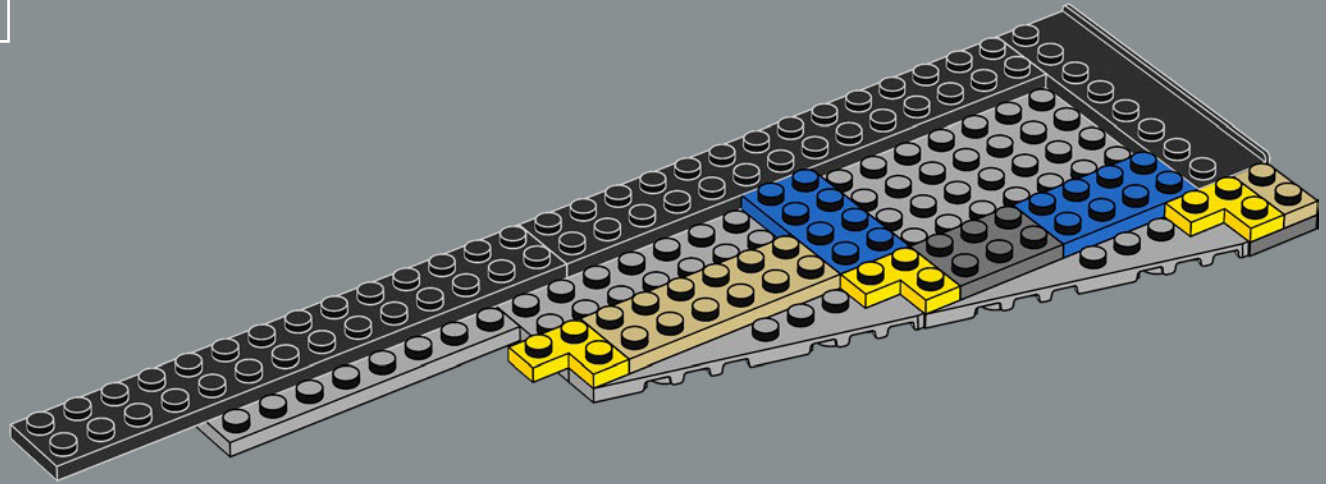

432

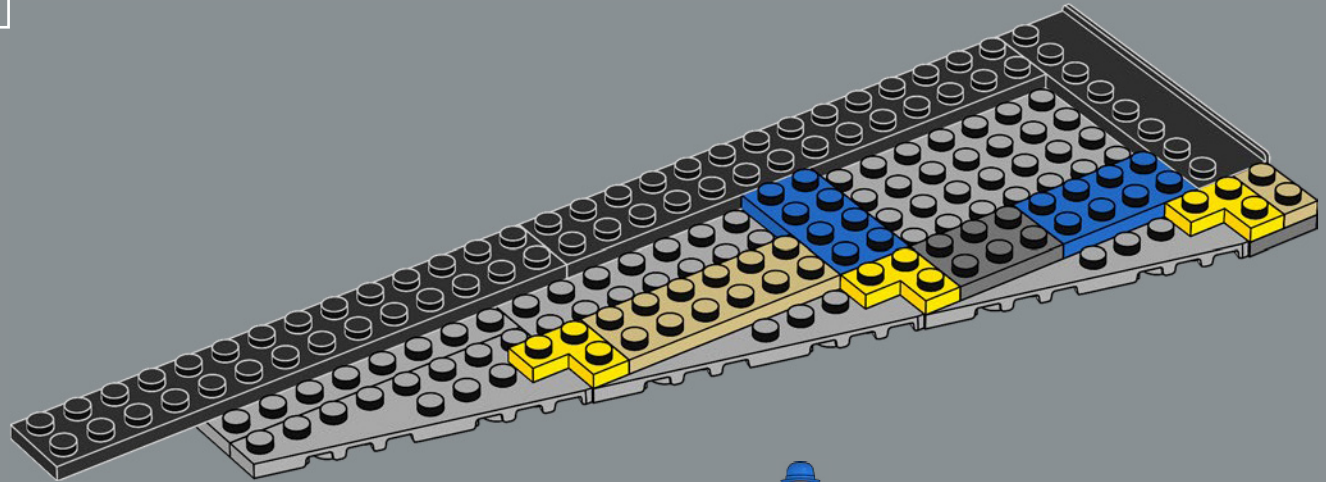

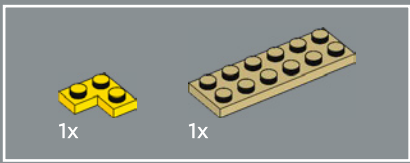

433

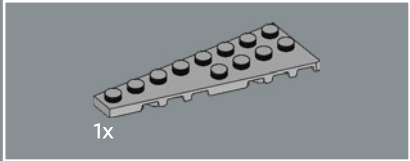
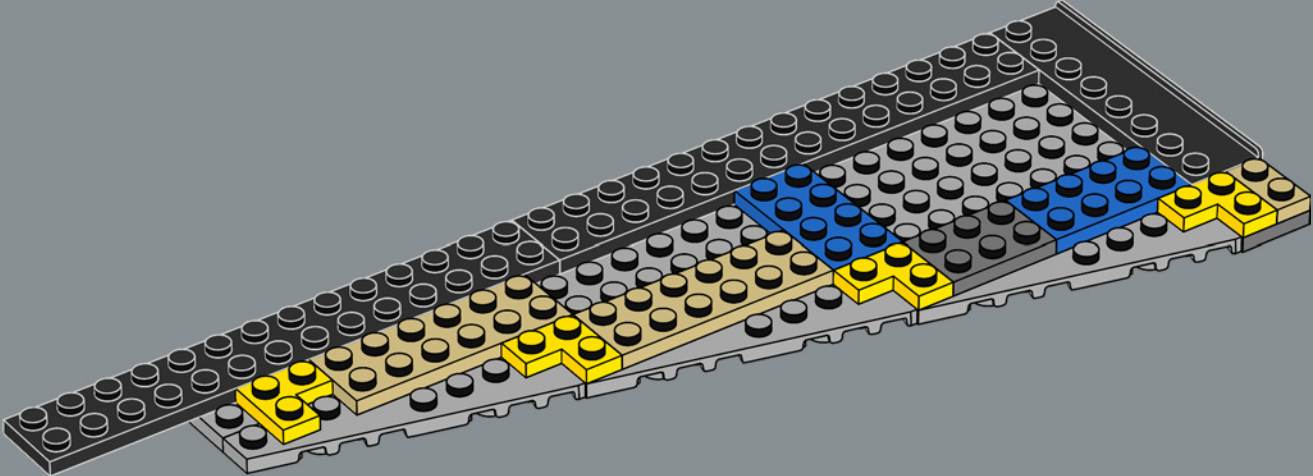

434

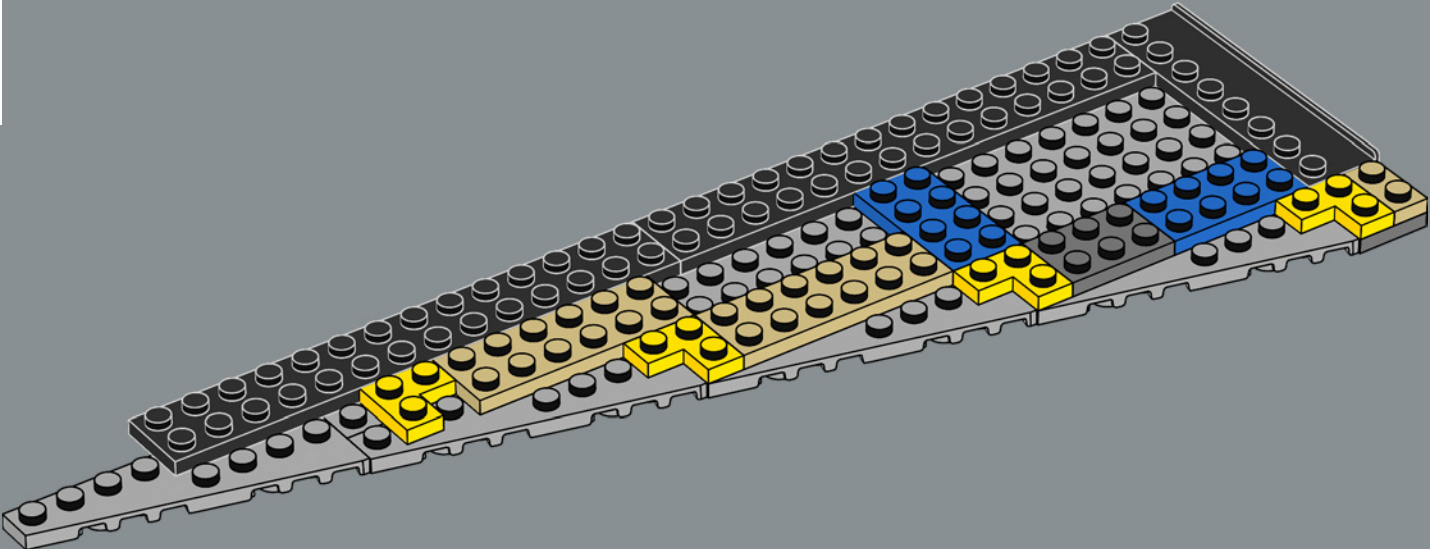

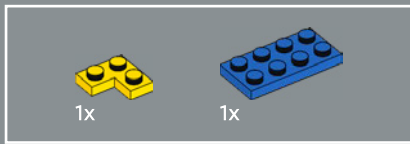

435

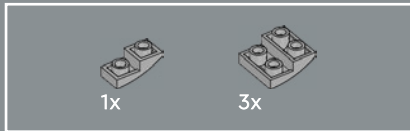
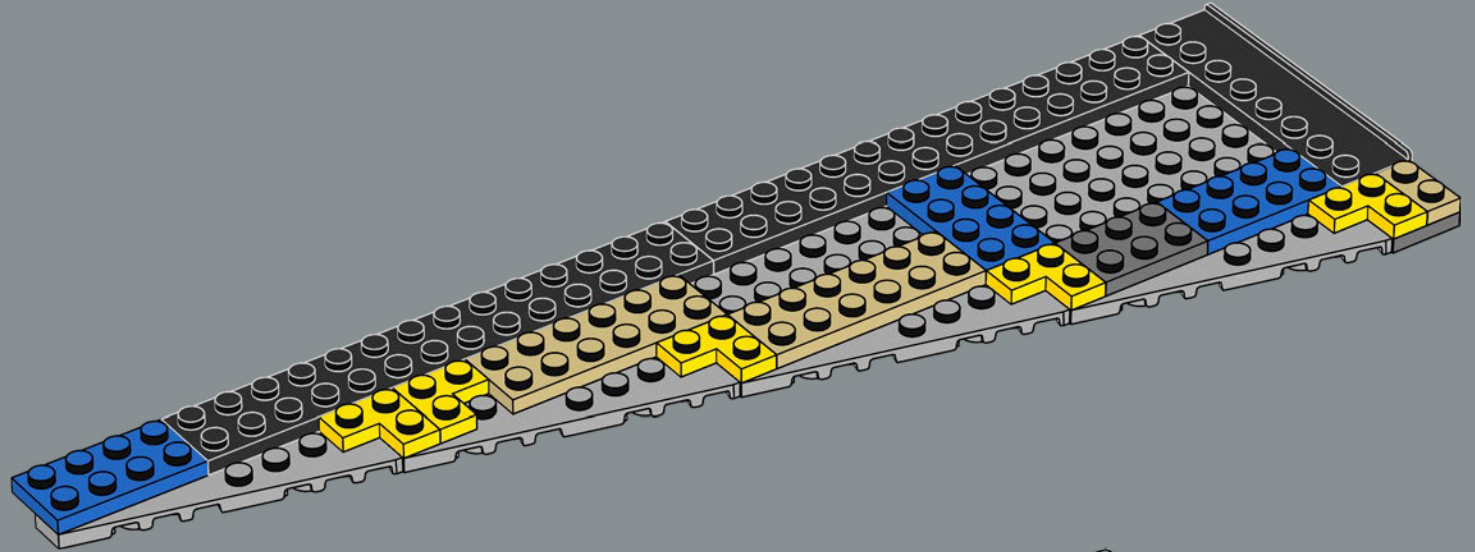

436

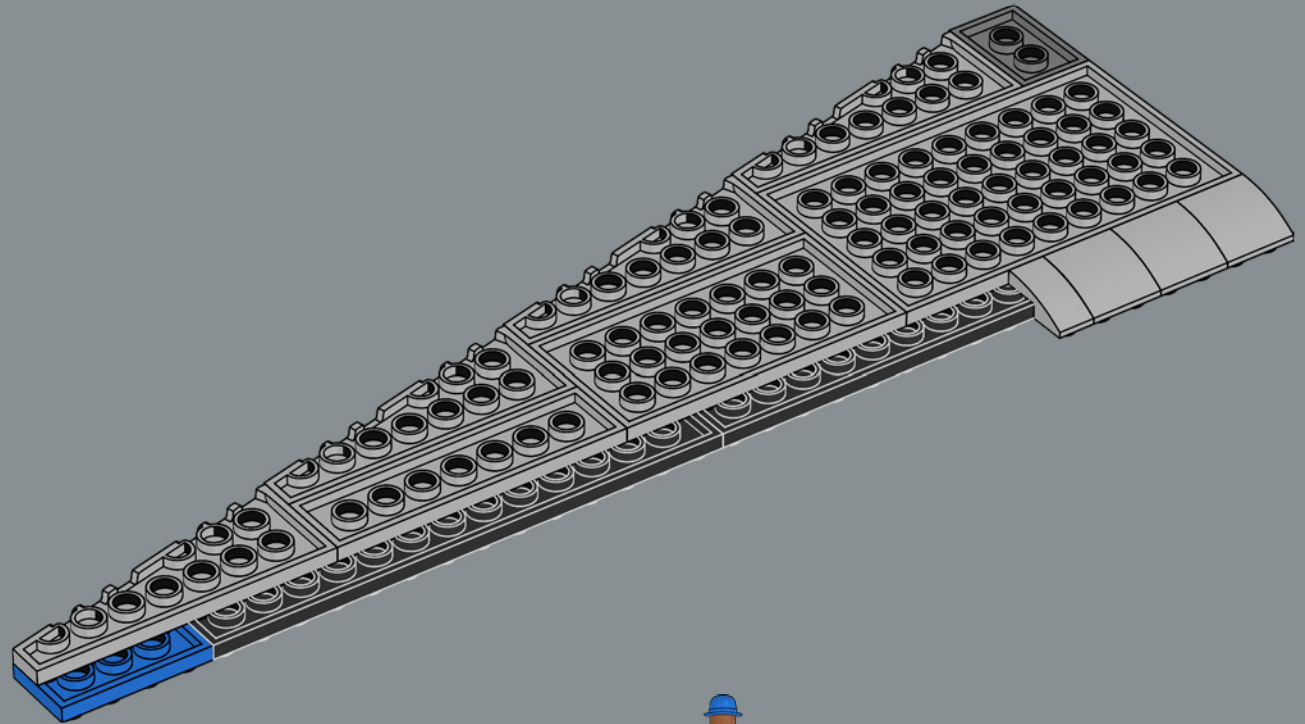

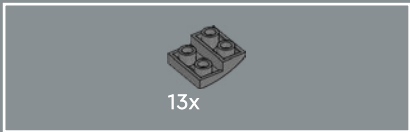

437

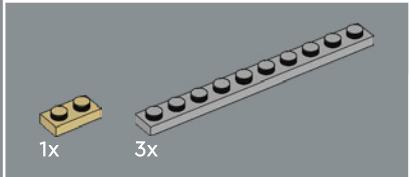
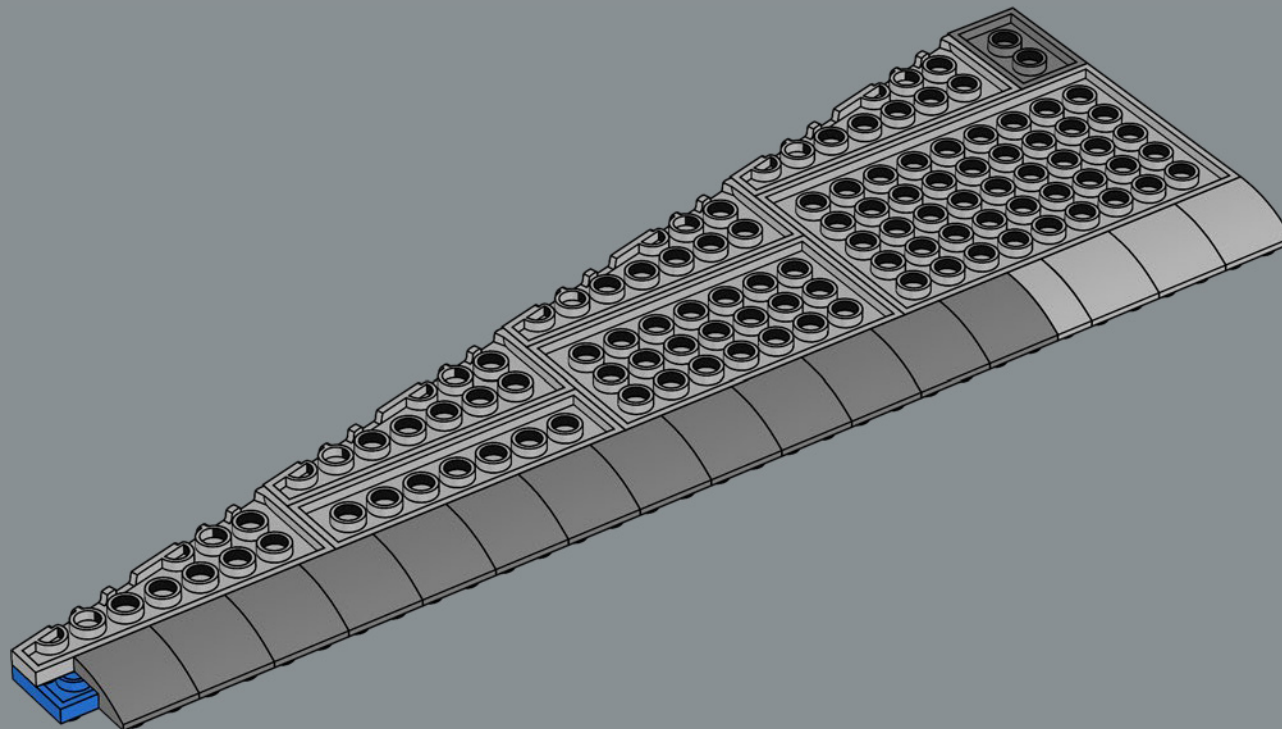

438

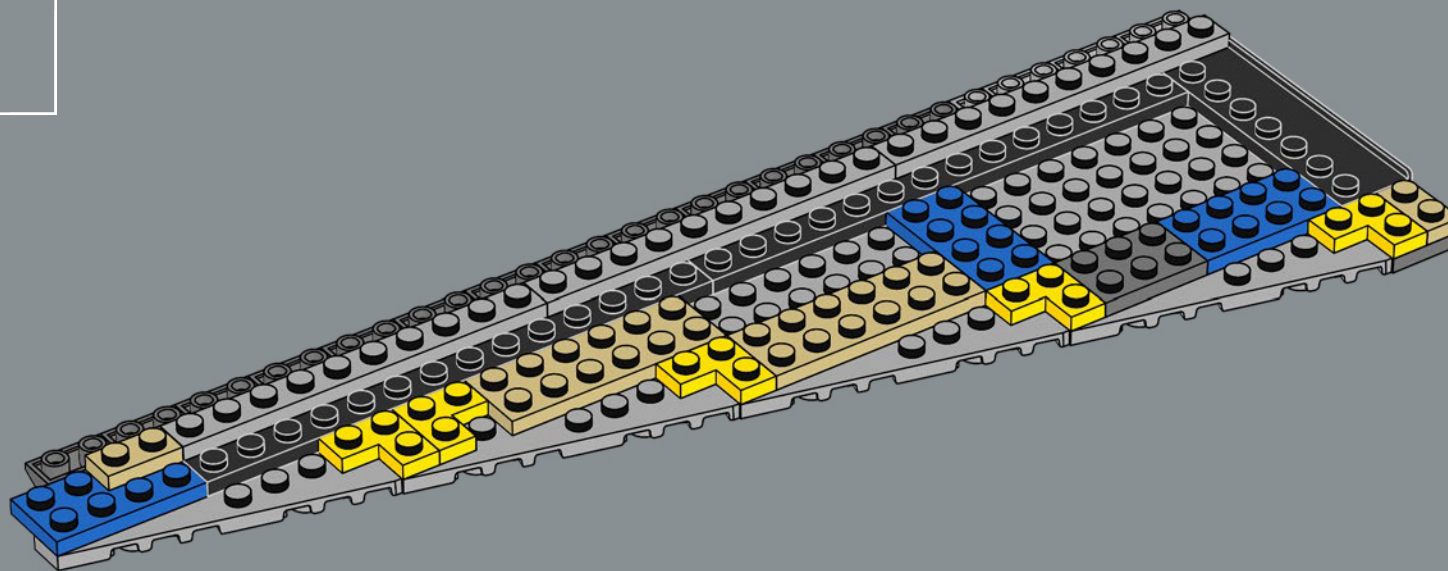

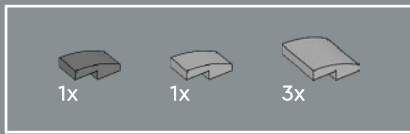

439

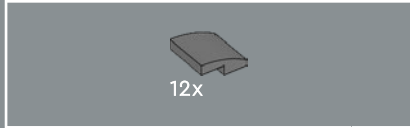
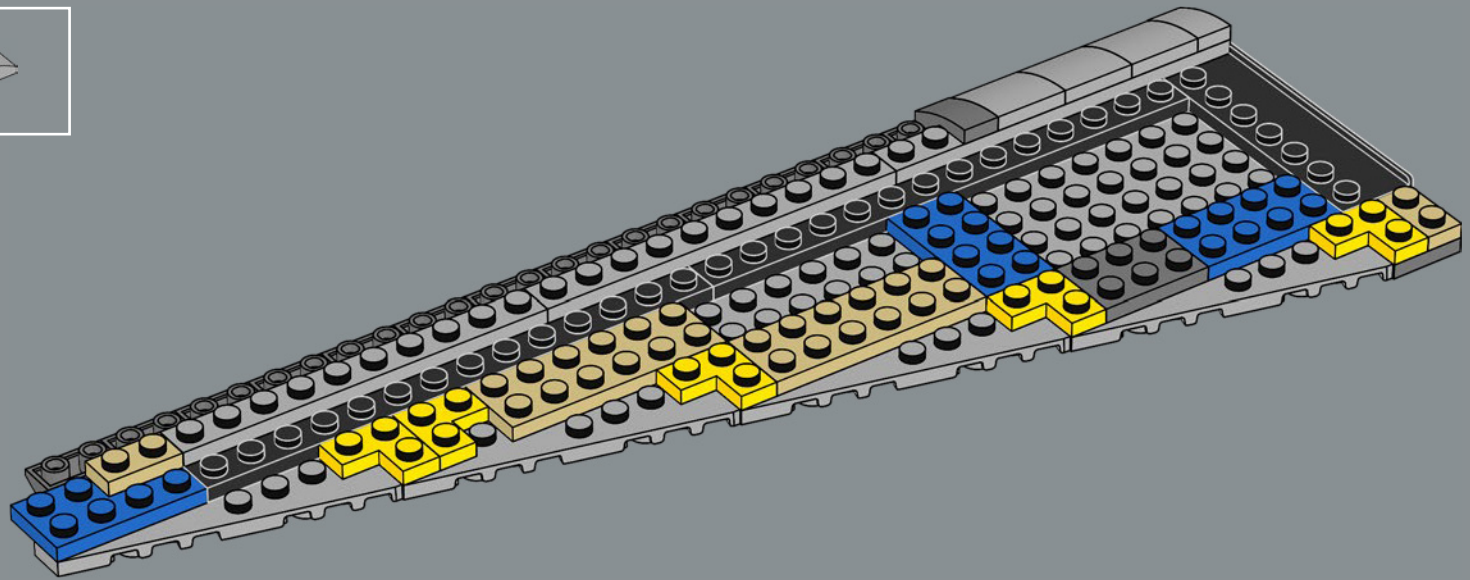

440

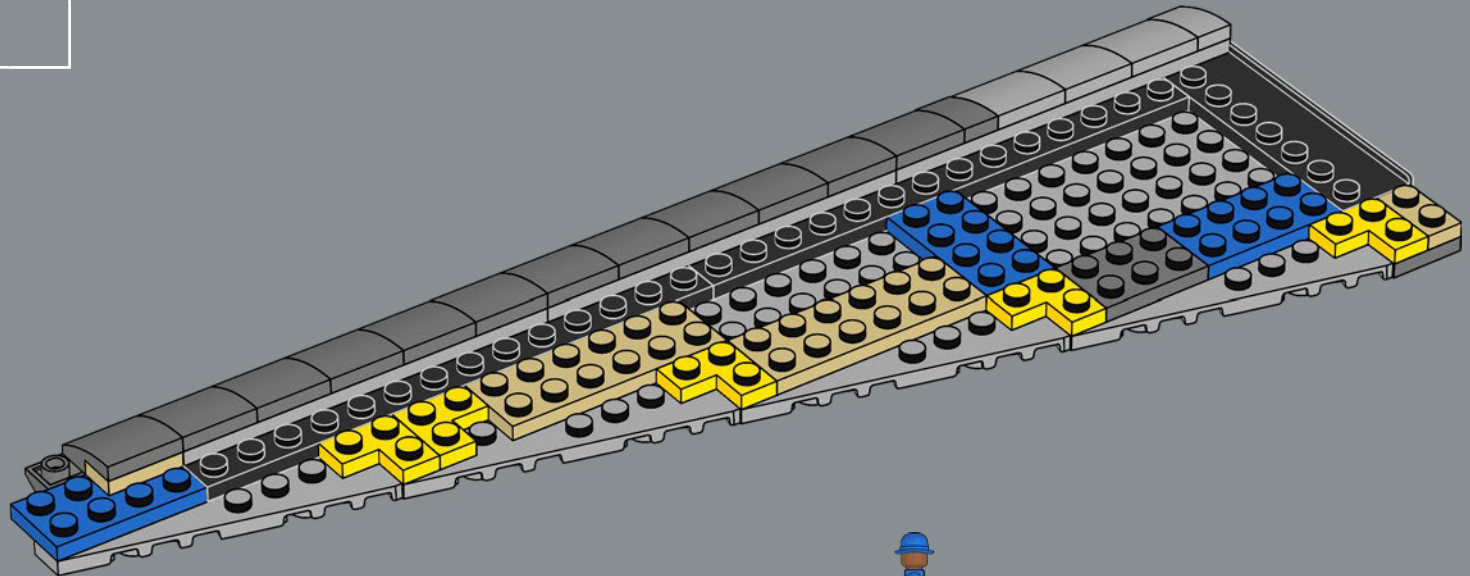

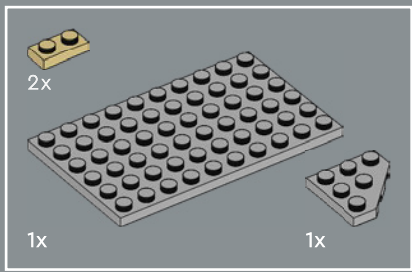

441

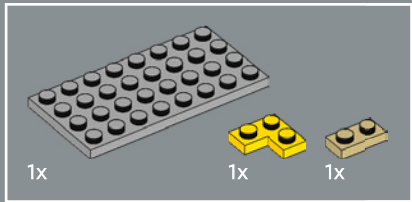
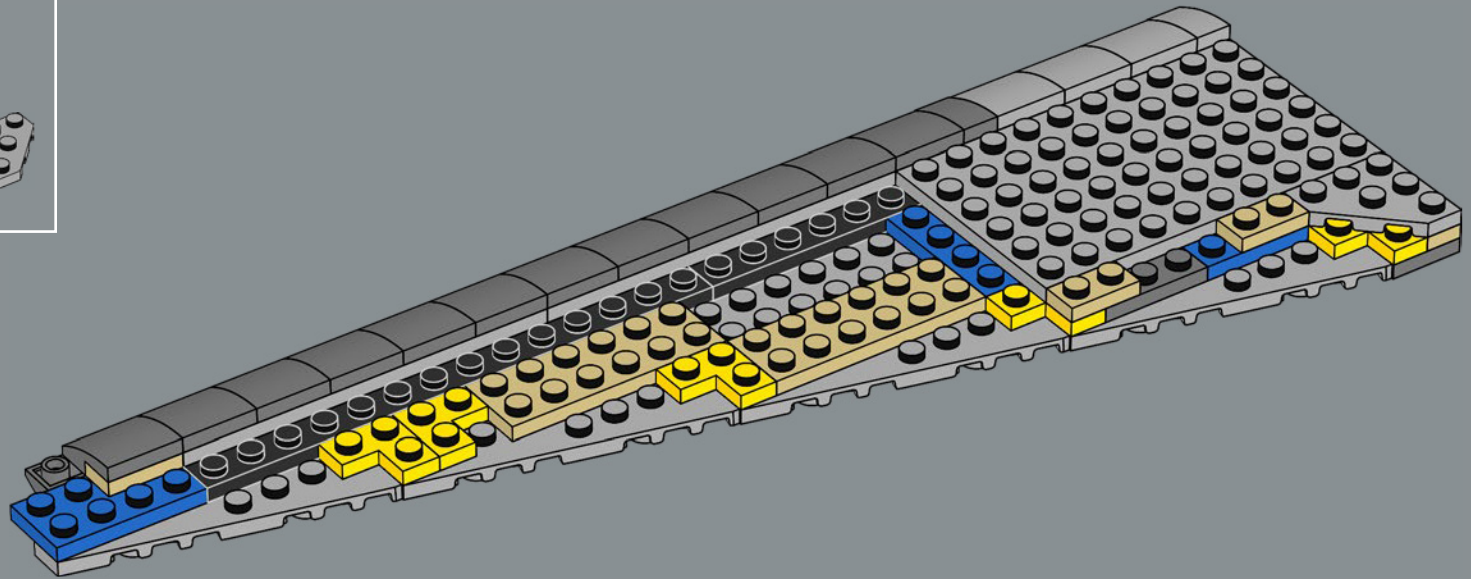

442

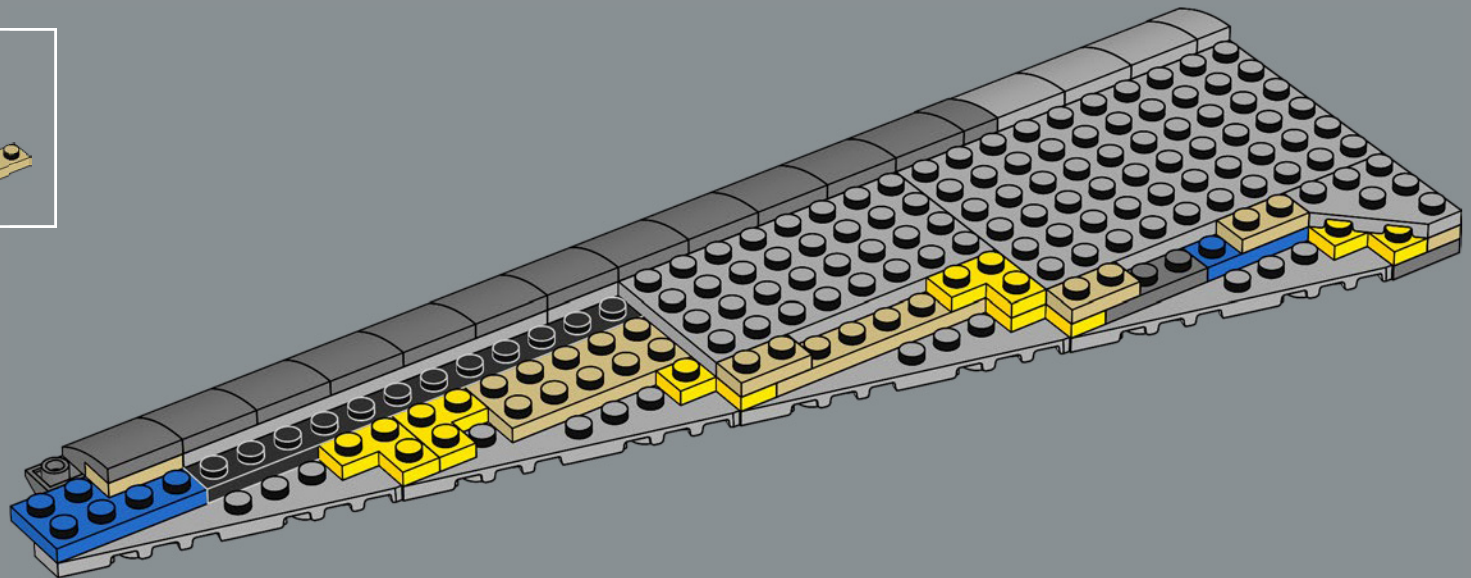

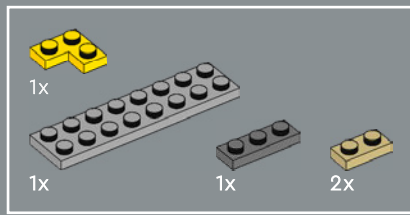

443

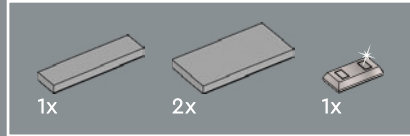
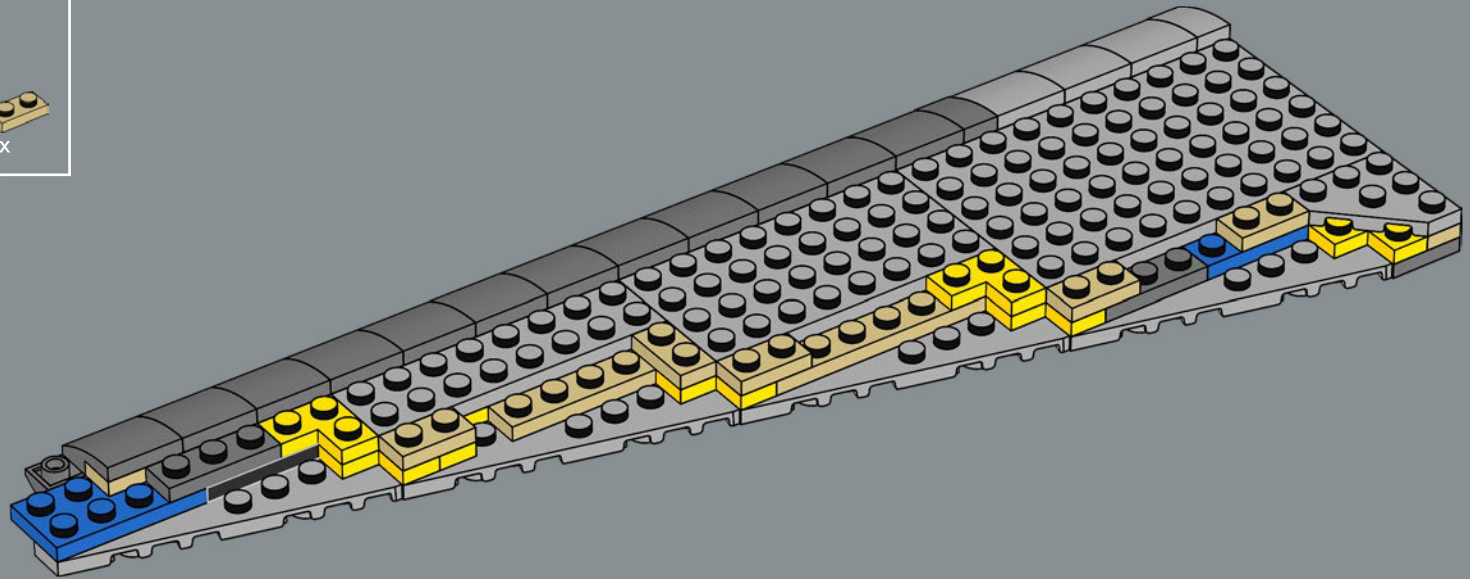

444

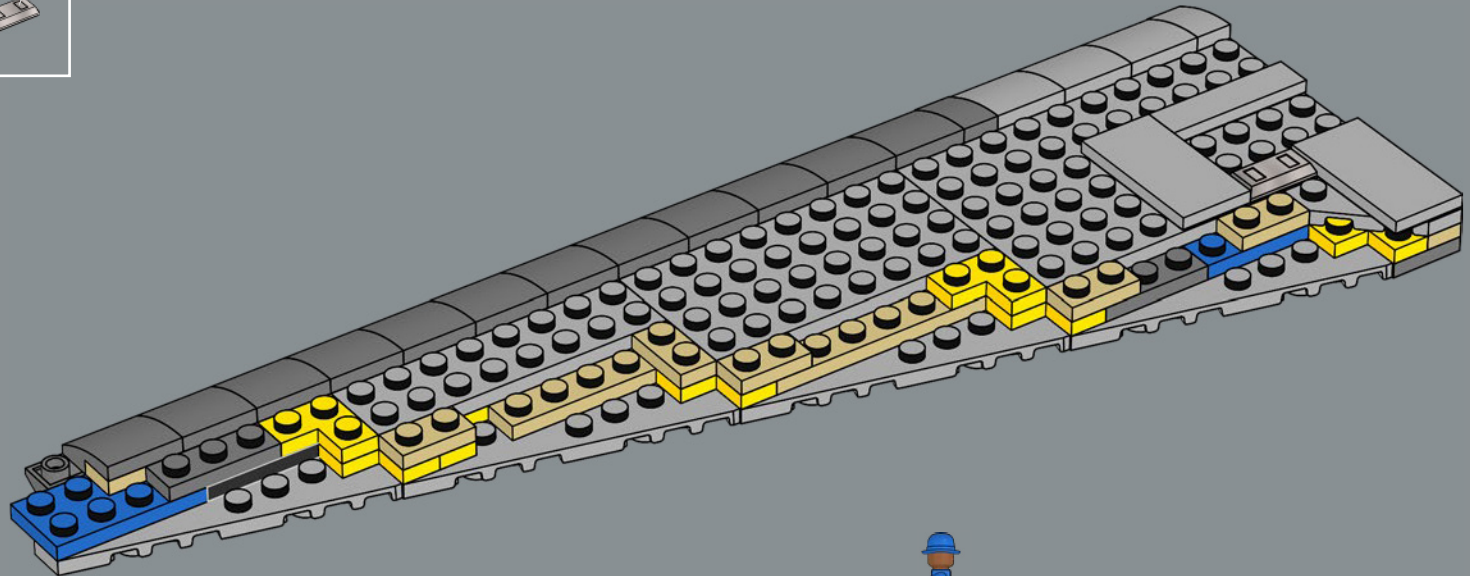

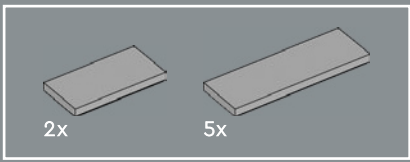

445

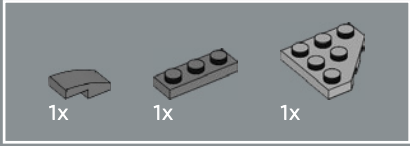
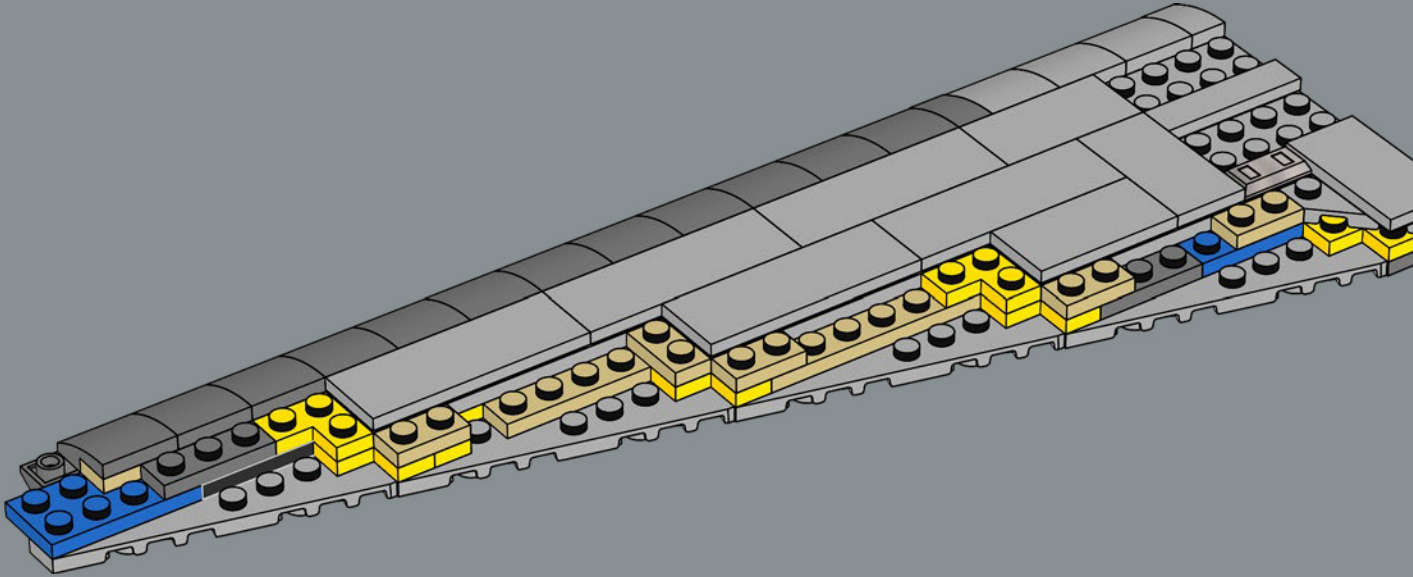

446

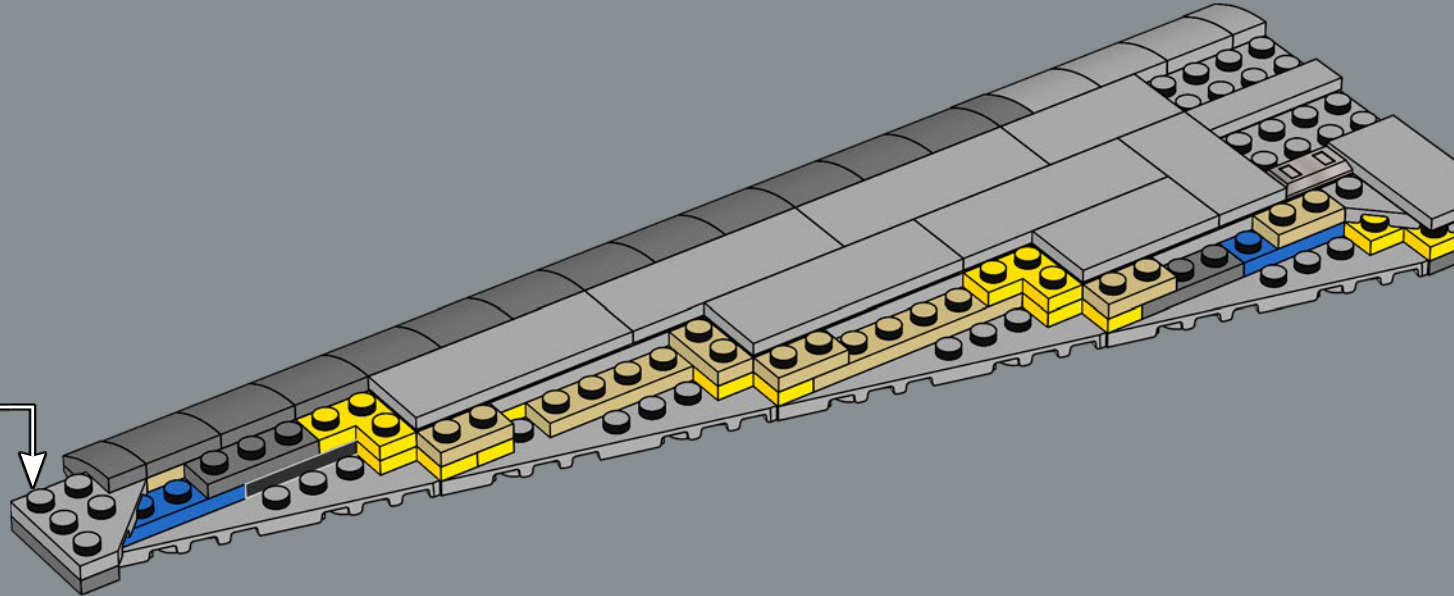
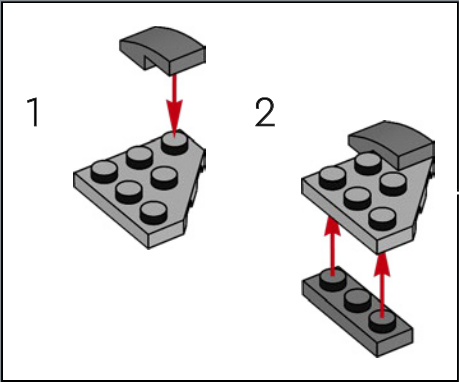

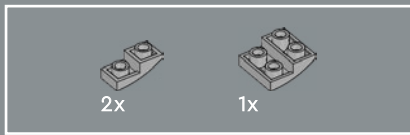

447

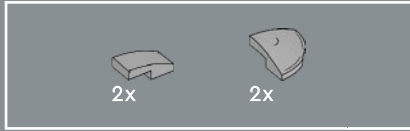
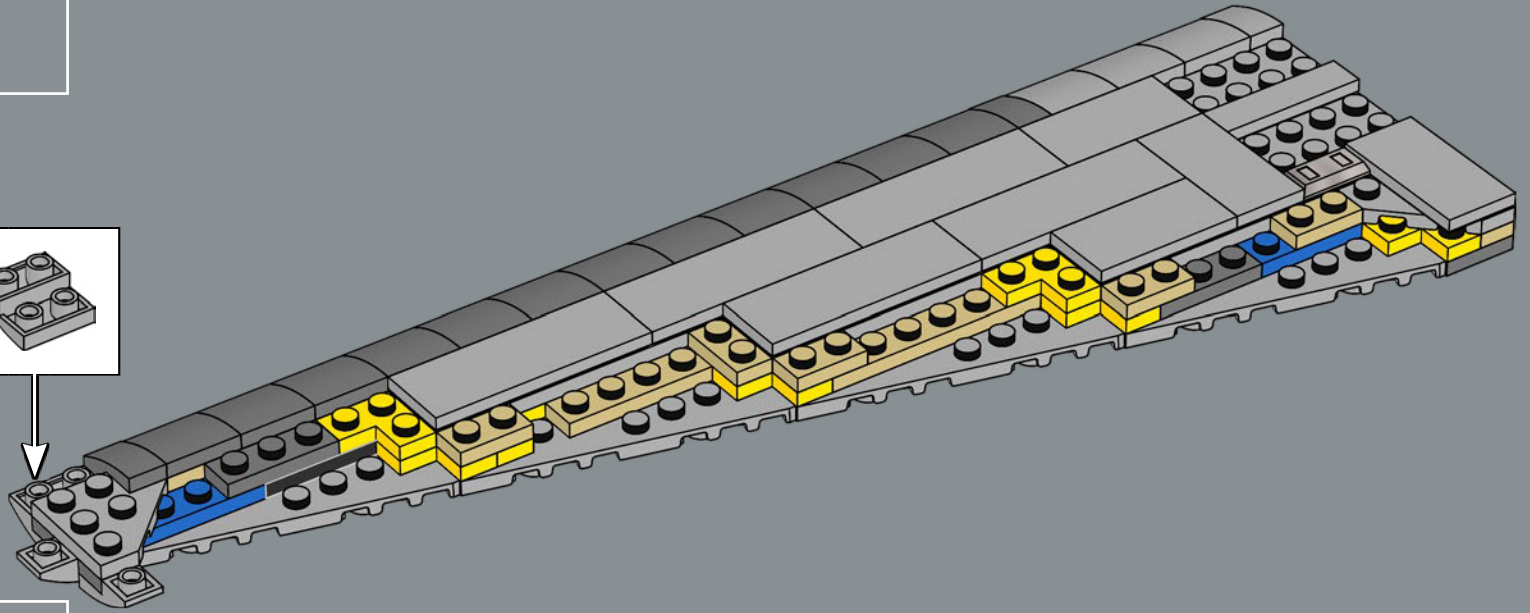
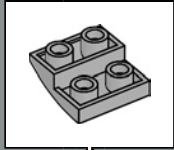

448

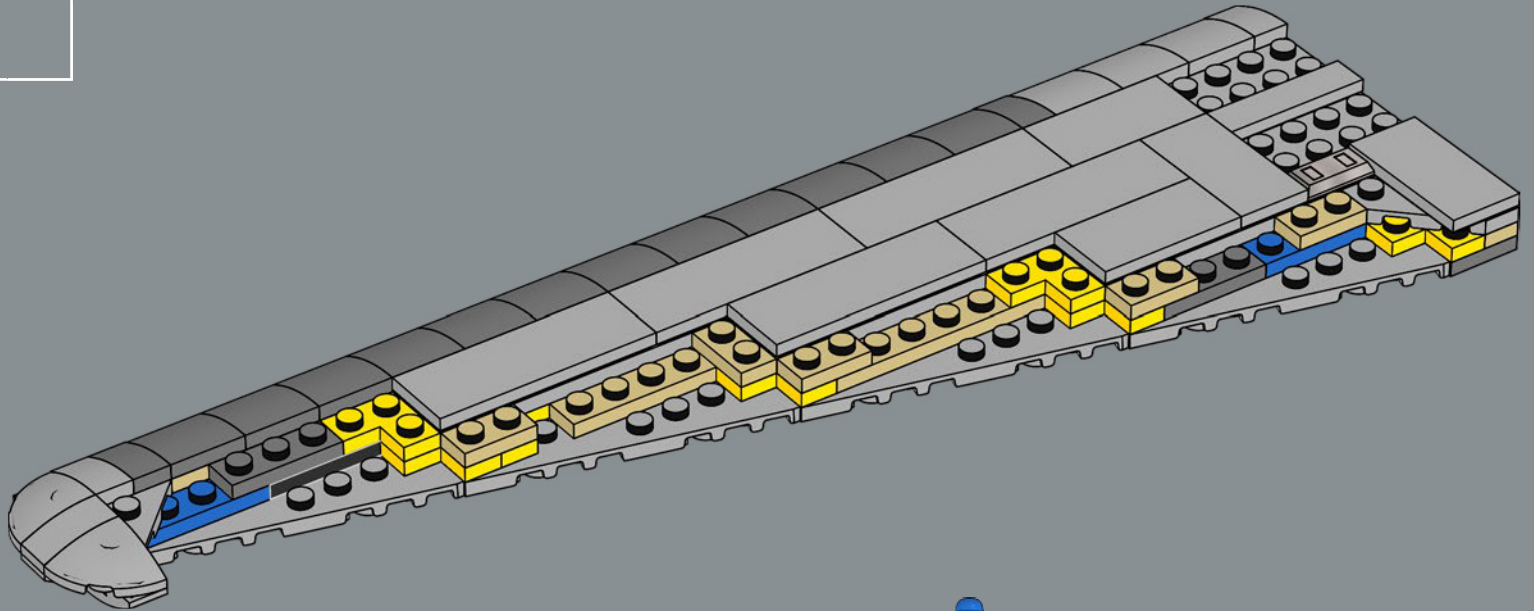

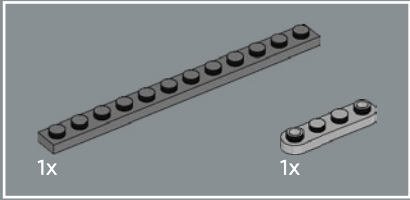
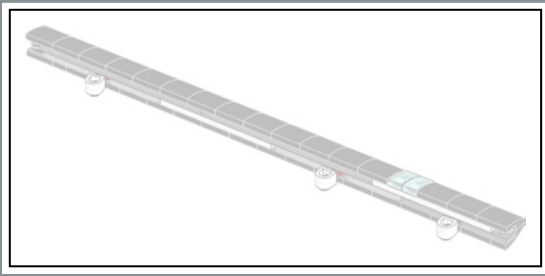

449

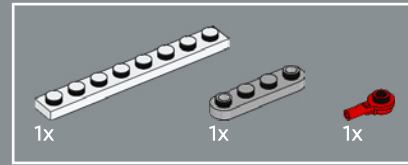
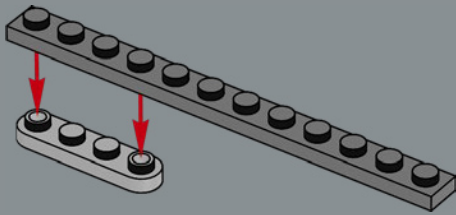

450

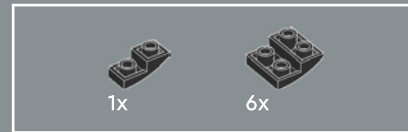
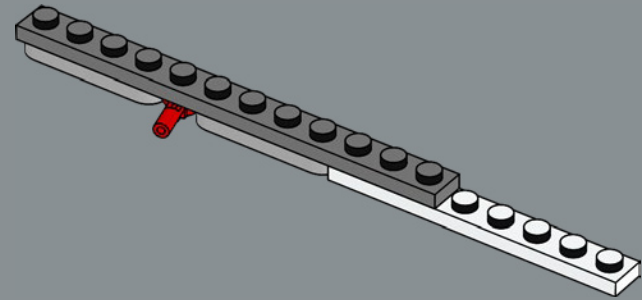

451

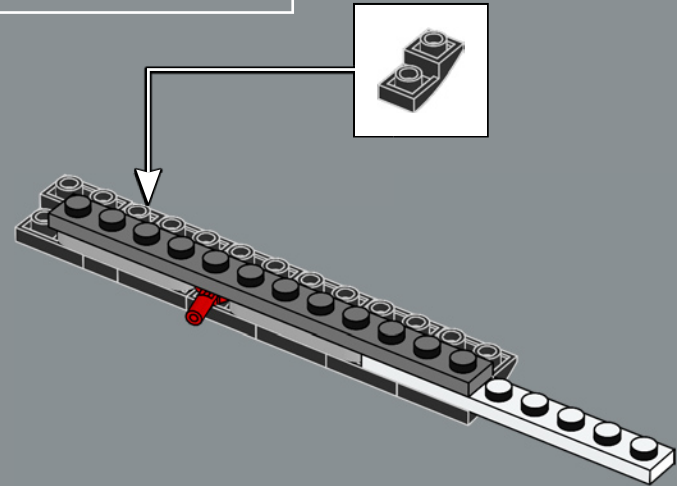



452

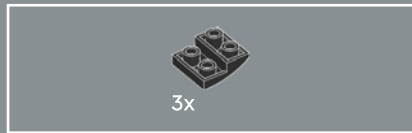
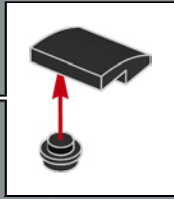
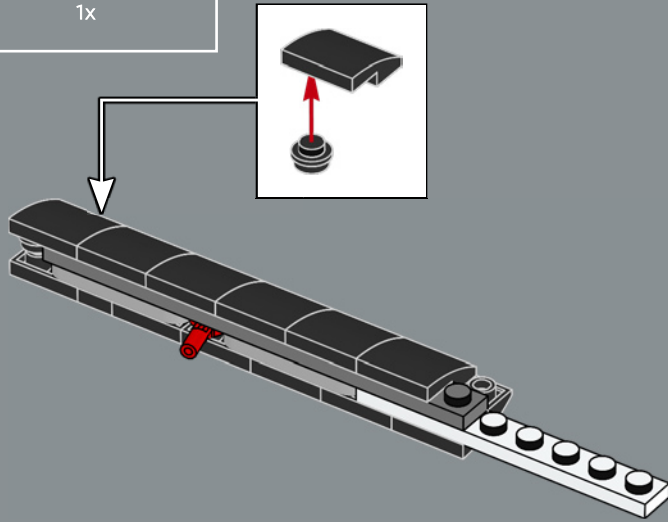

453

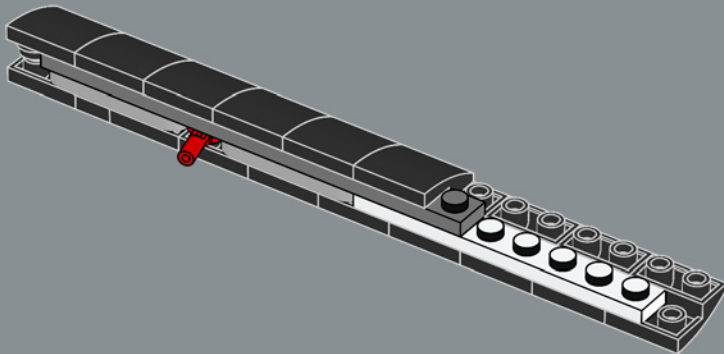

454

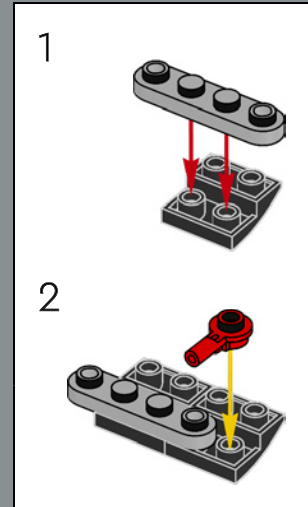
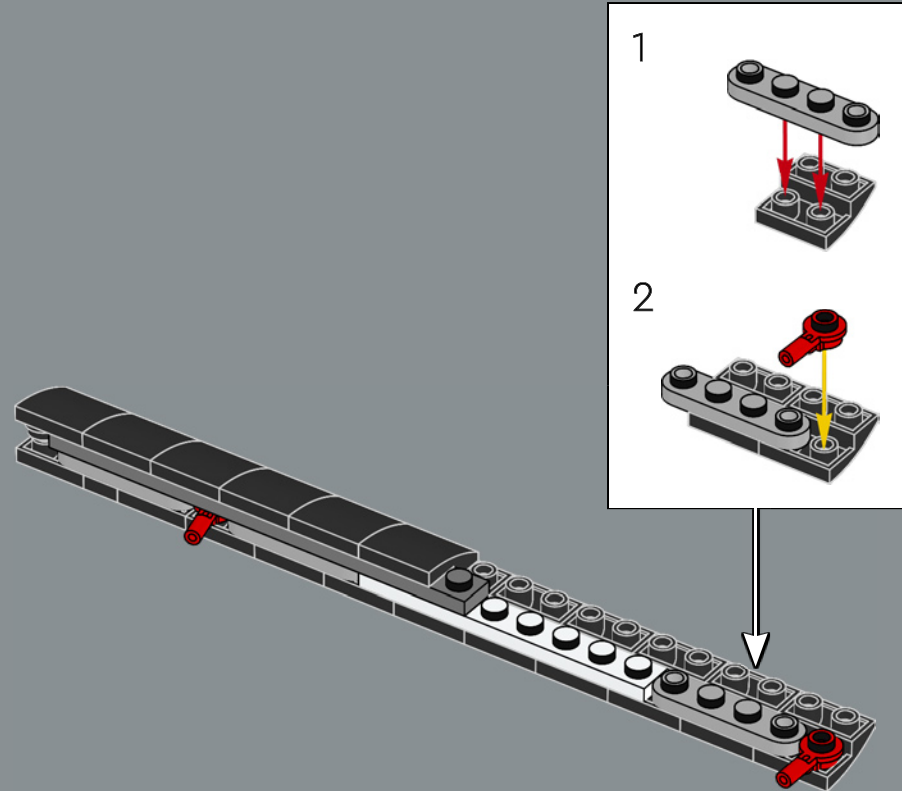

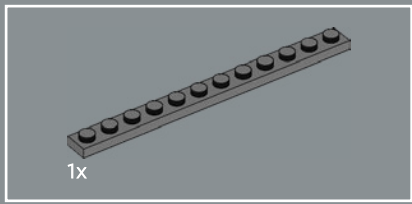

1x

455

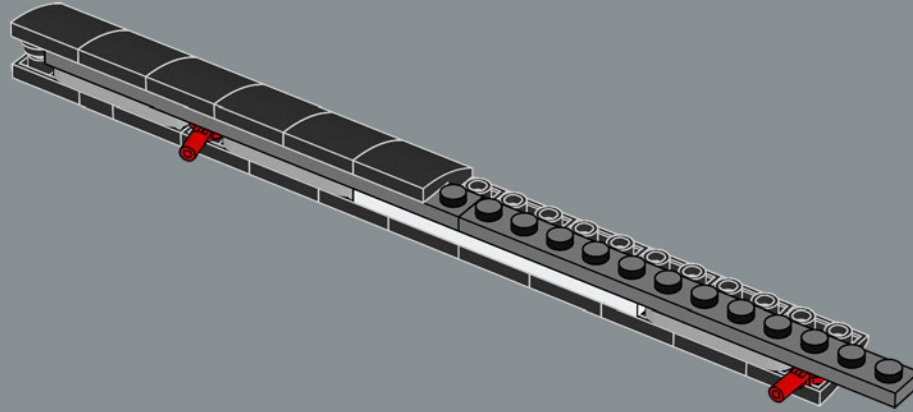

5x

456

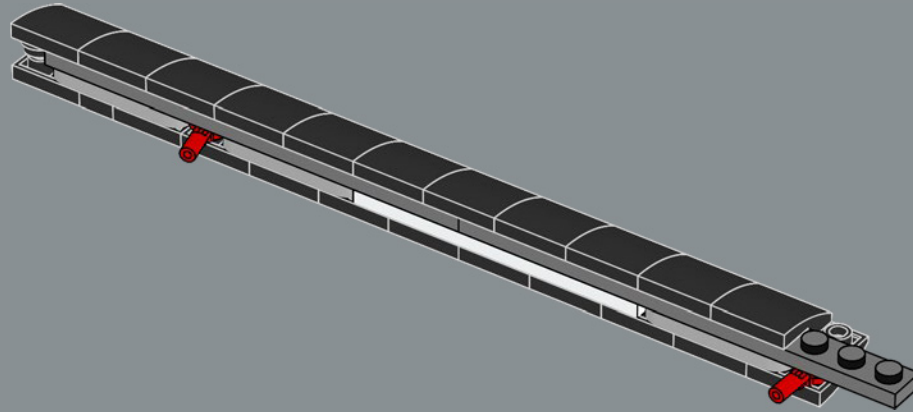

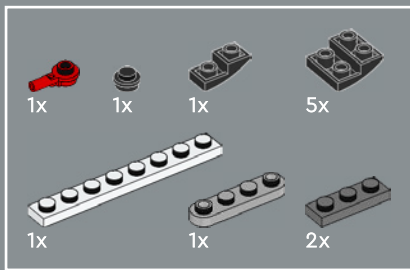

457

1

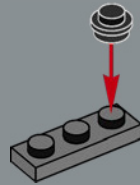

2

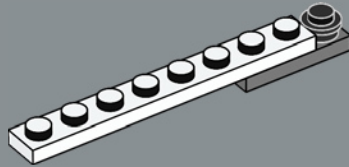

3

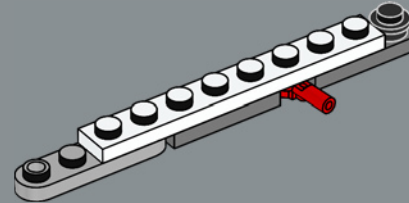

4

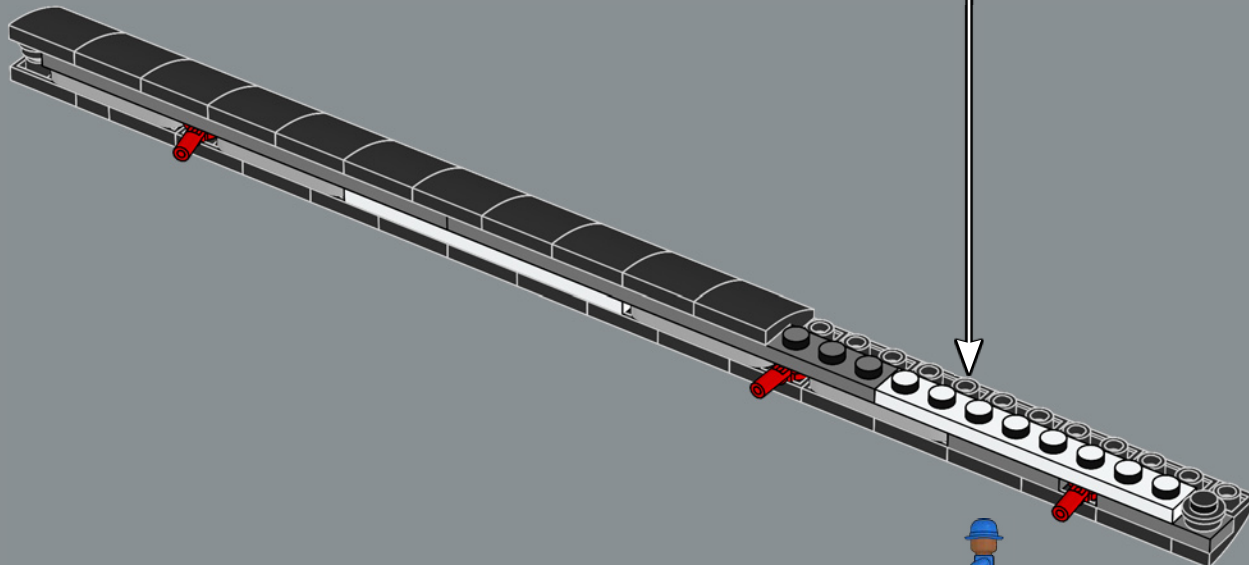
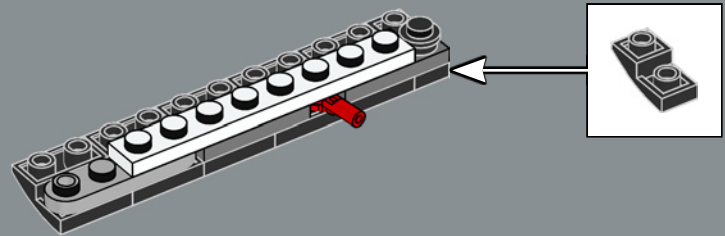



458

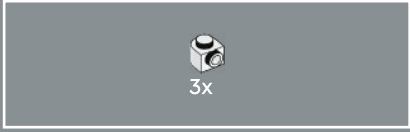
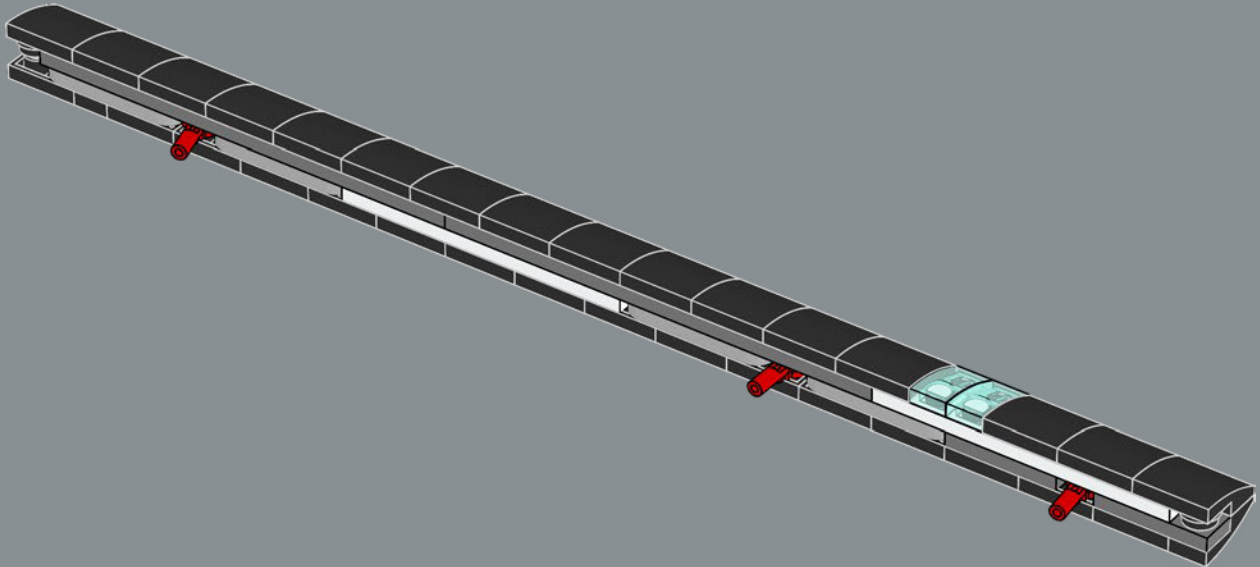

459

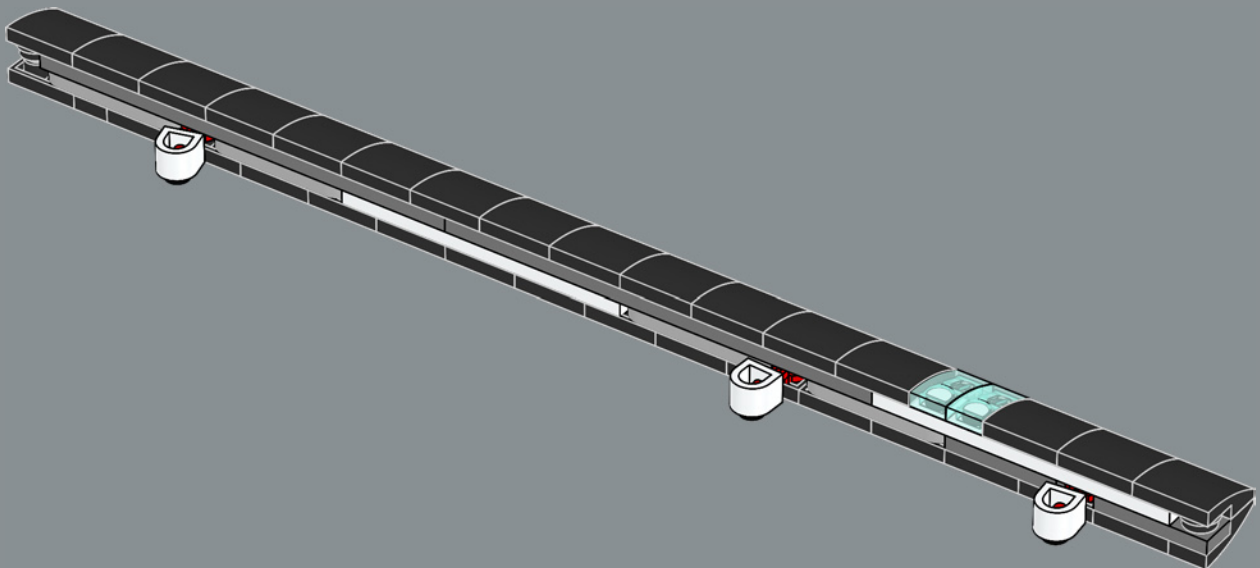

460

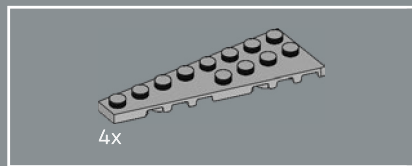
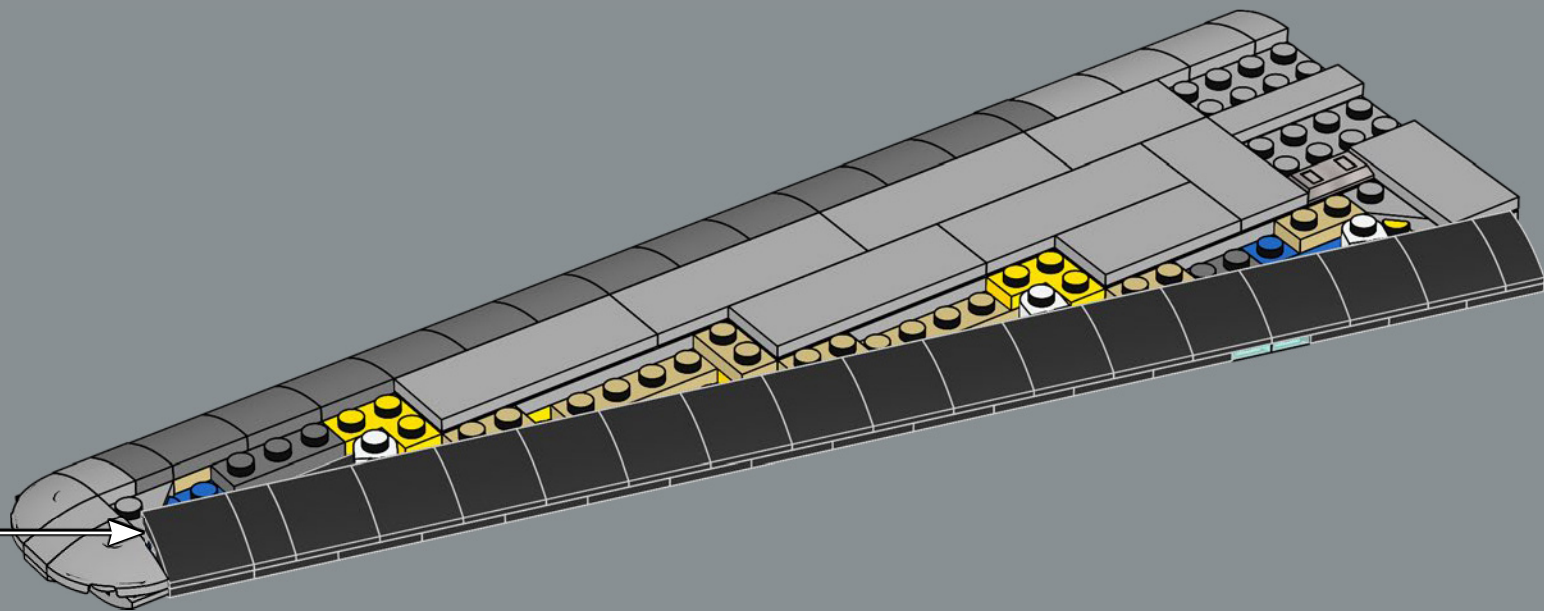

461

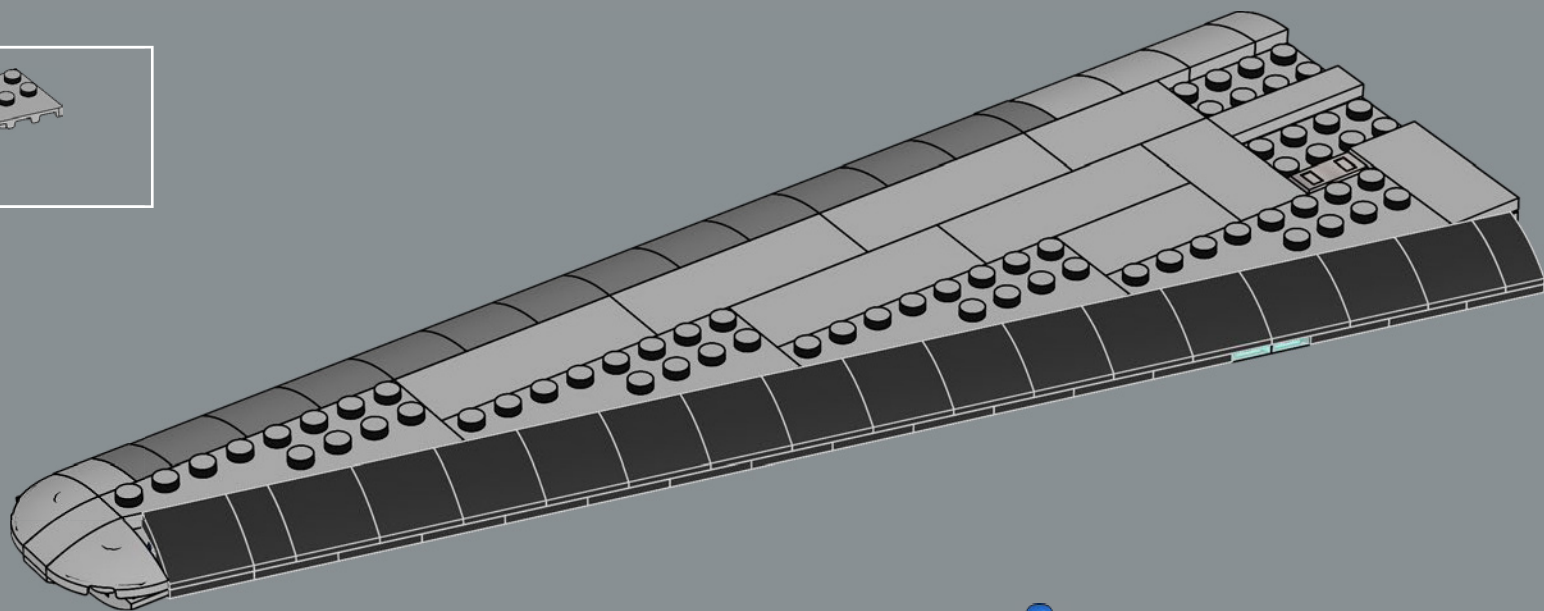

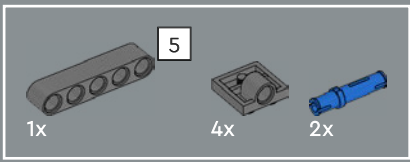

462

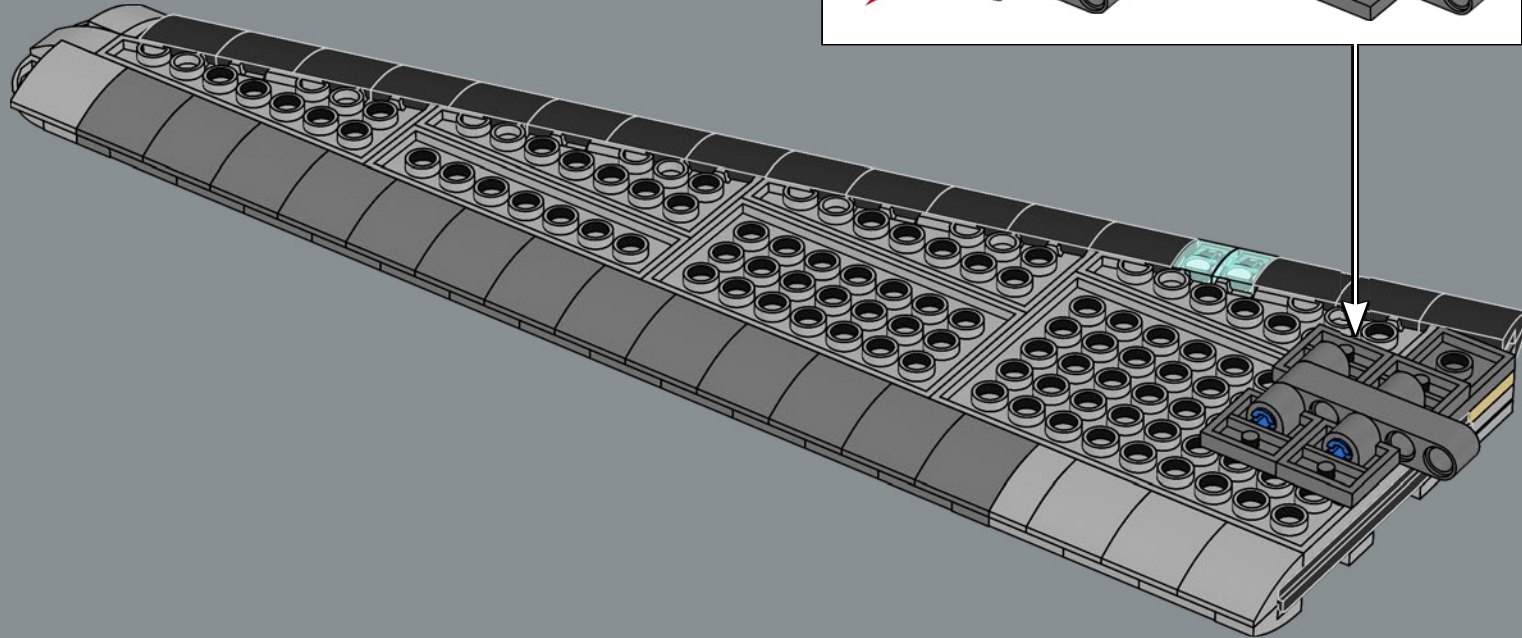
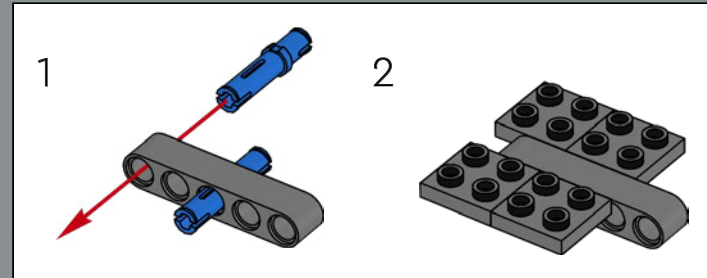



4x

463

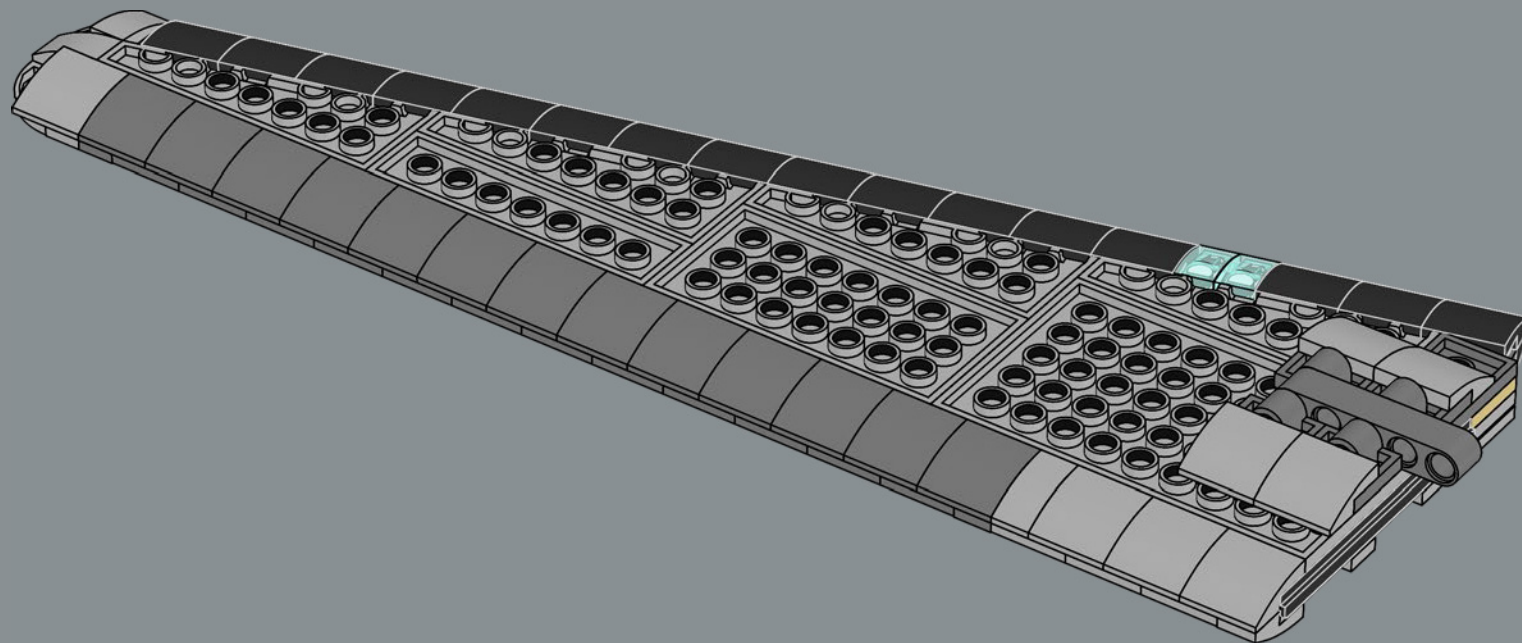

464

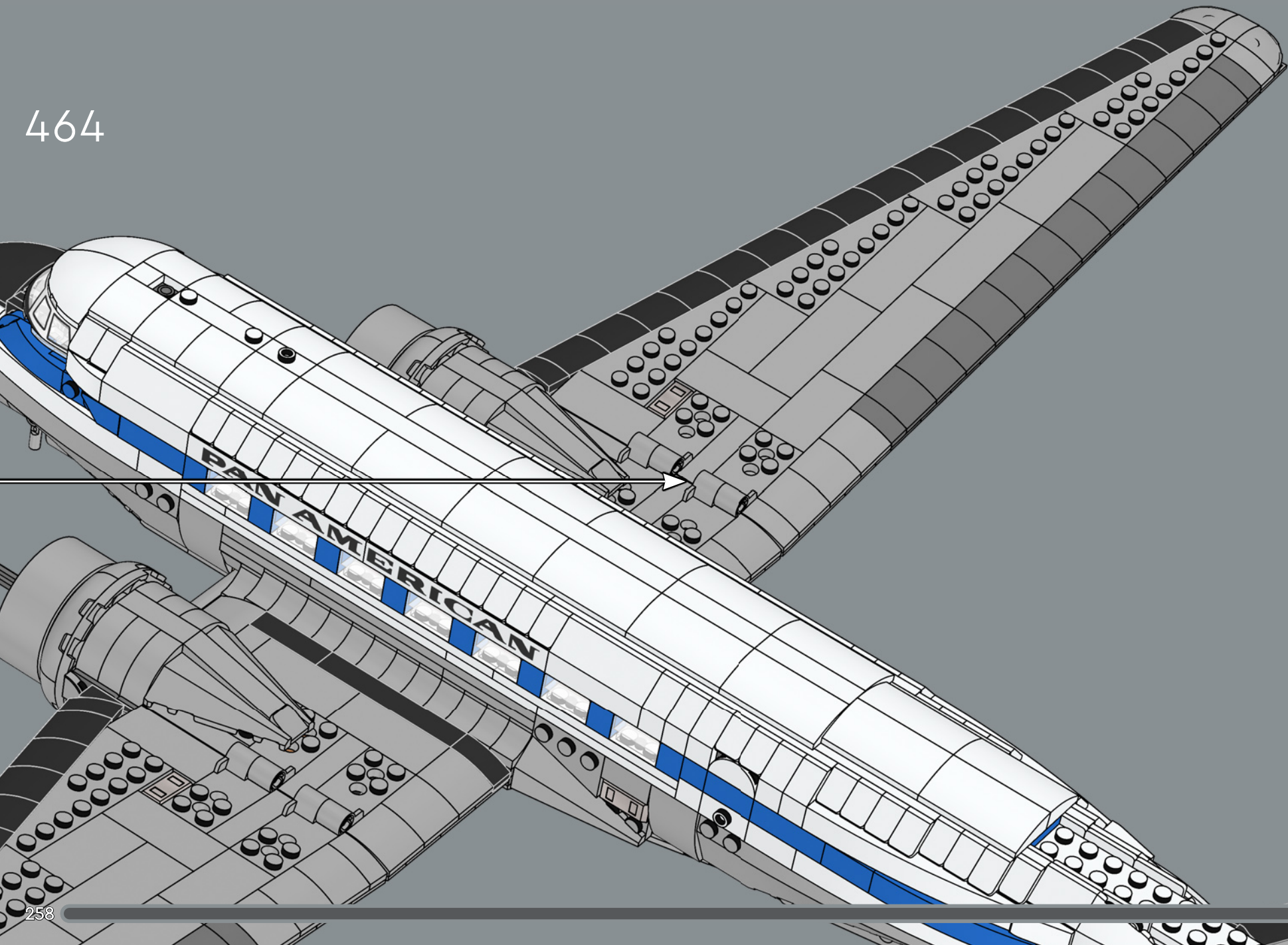



465

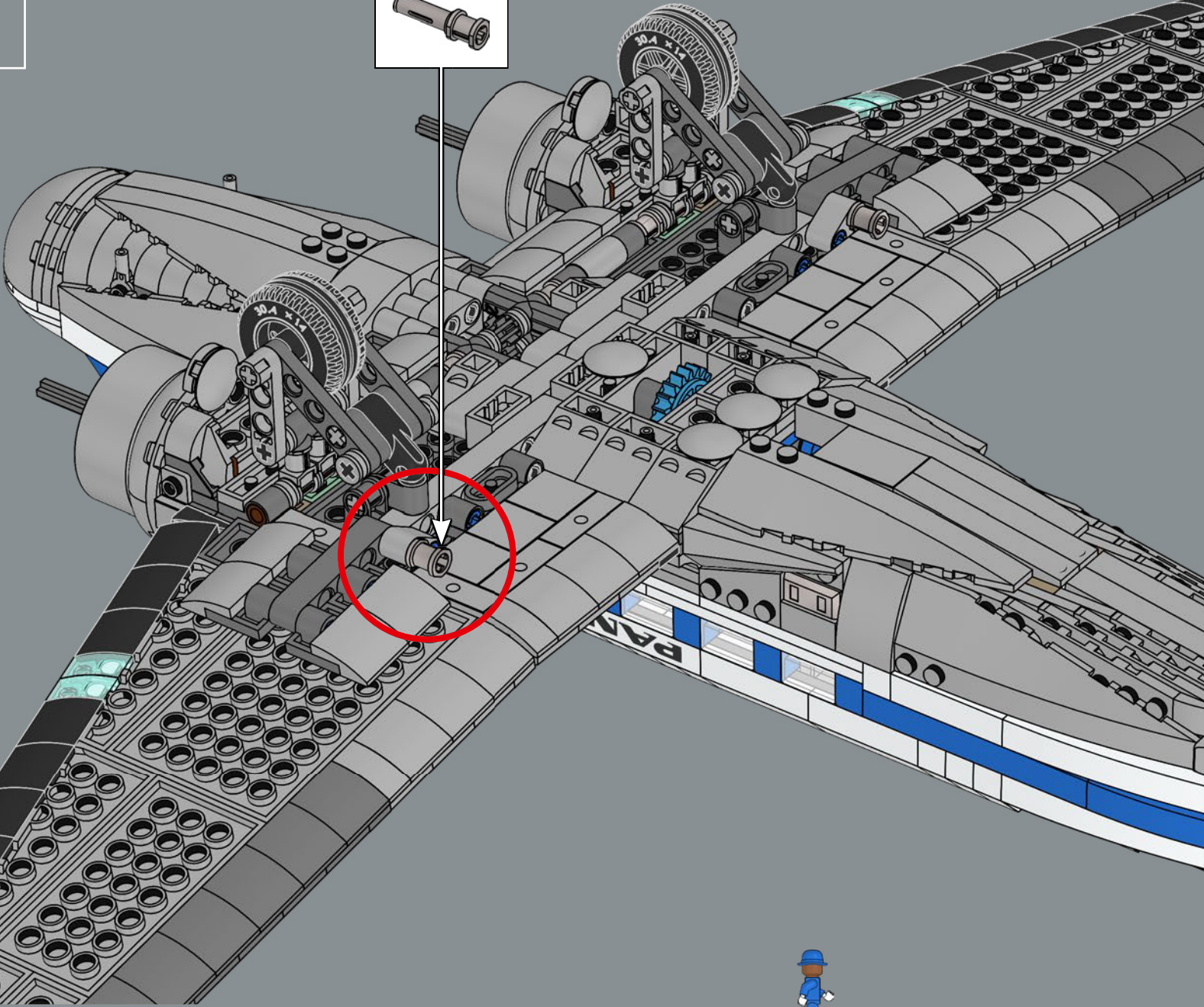



Le nuove uniformi, disegnate da una casa di moda americana, furono introdotte nel 1980. Gli assistenti di volo di sesso maschile erano chiamati "purser".

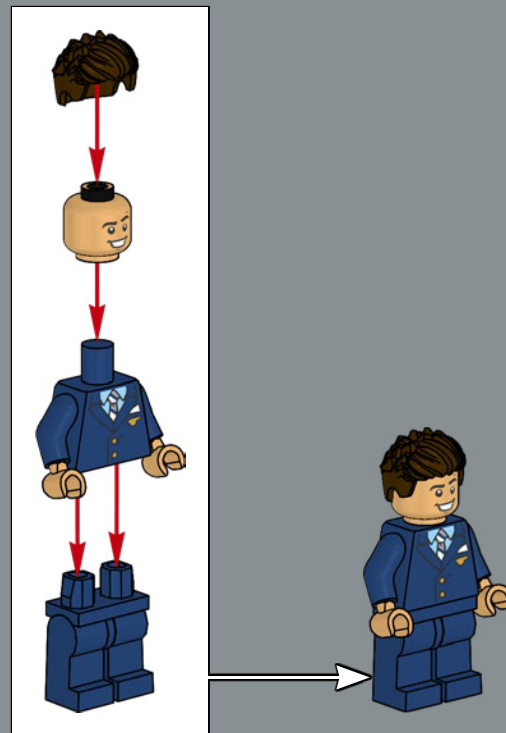

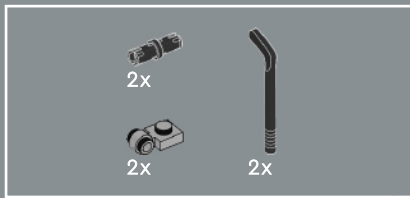

466

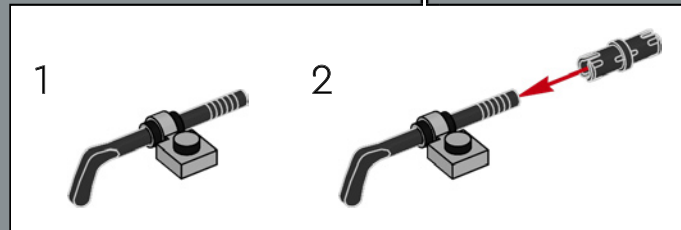
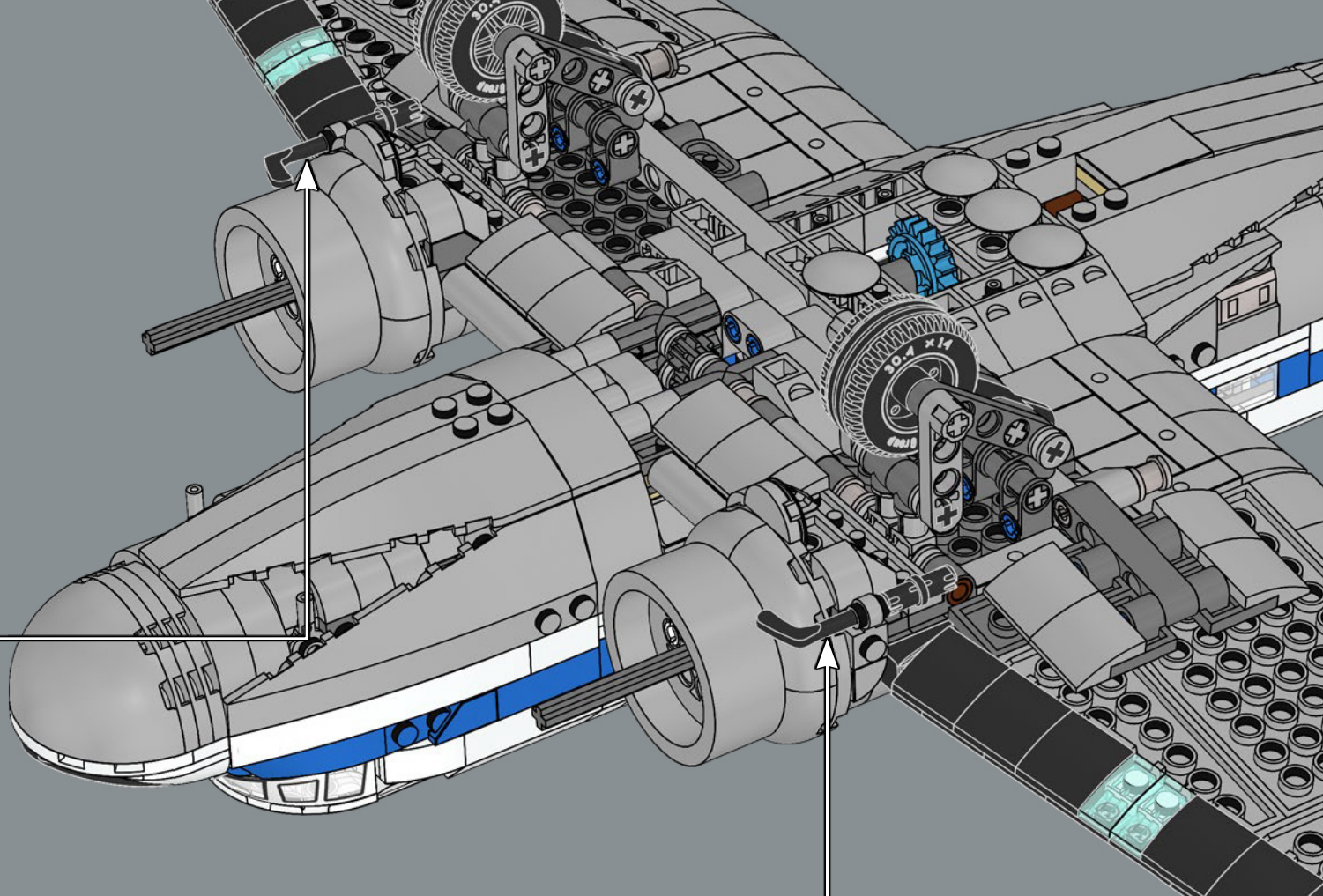
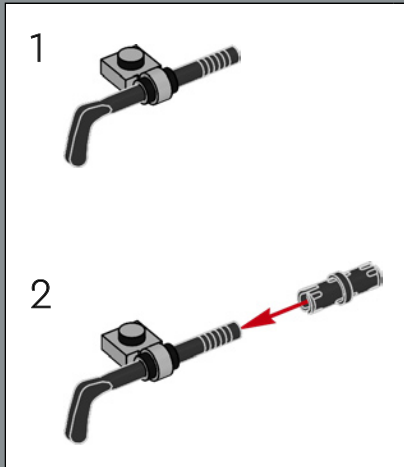



Le sporgenze sotto l'area della cabina di pilotaggio rappresentano i sensori di velocità dell'aria.

467

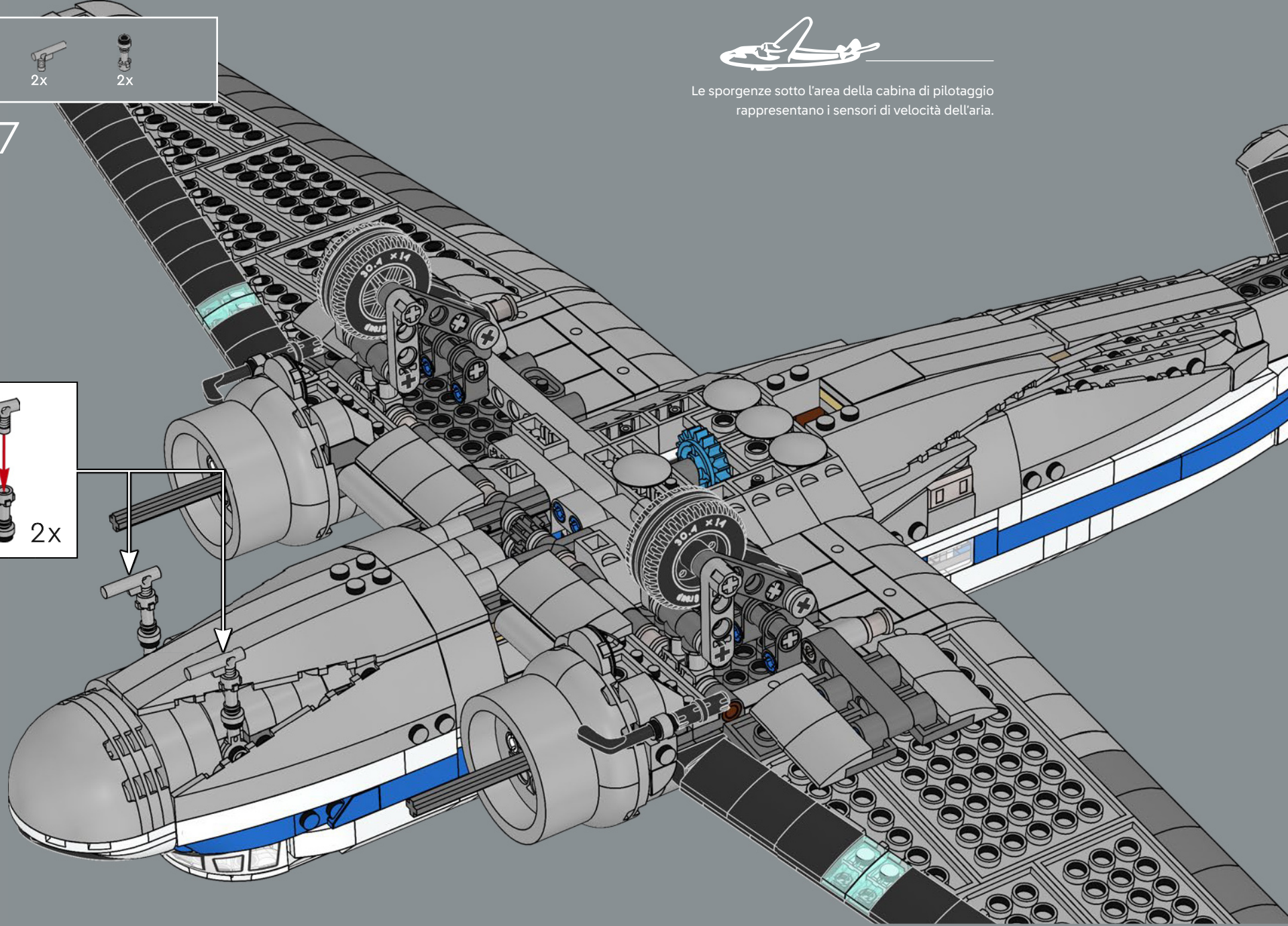
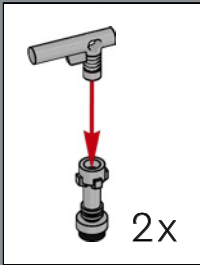

2x

468

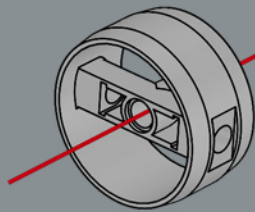

2x 2x



469

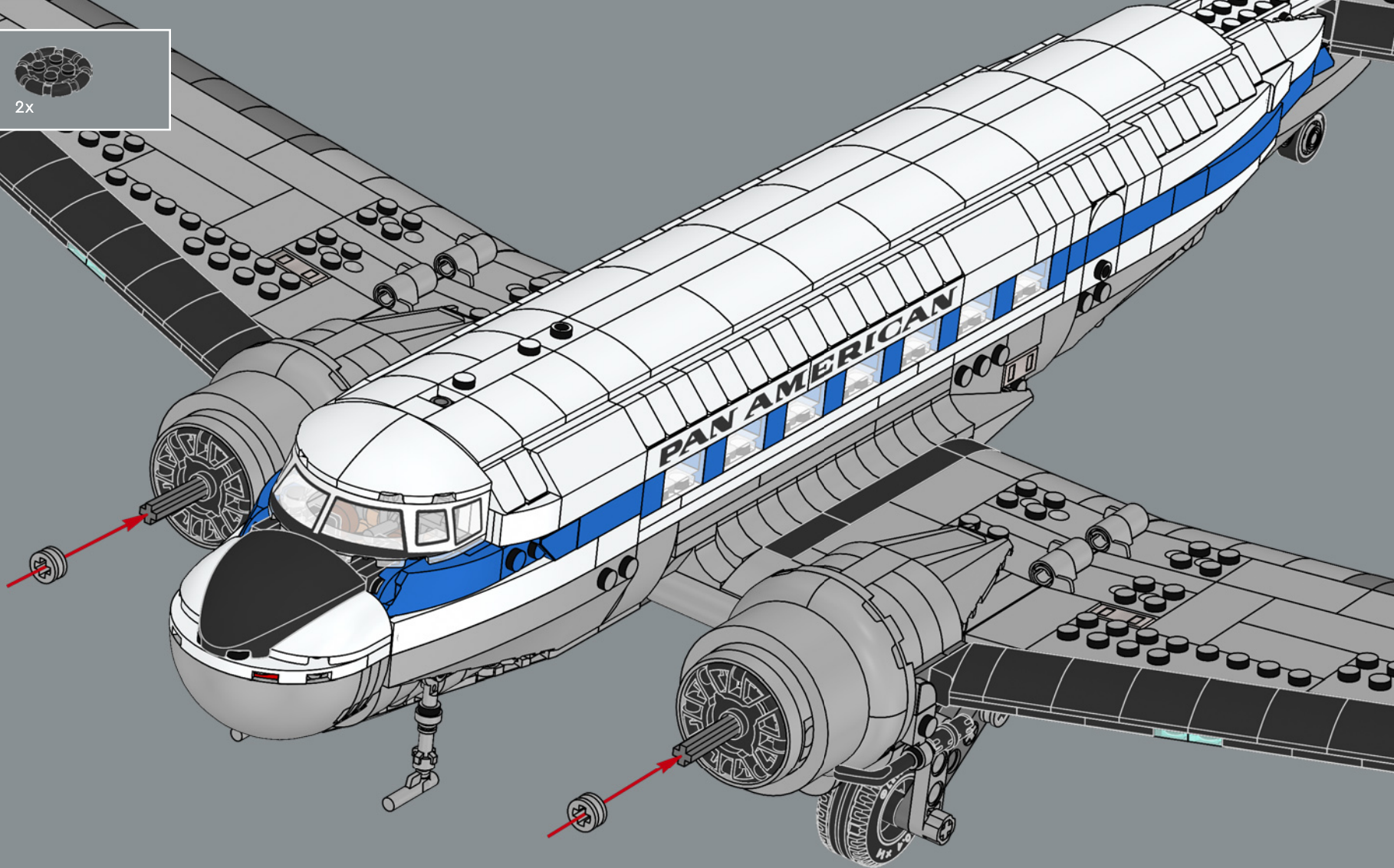

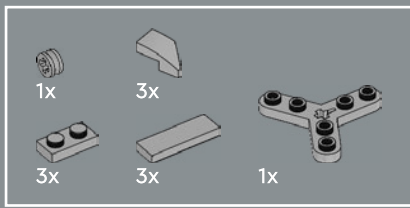

470

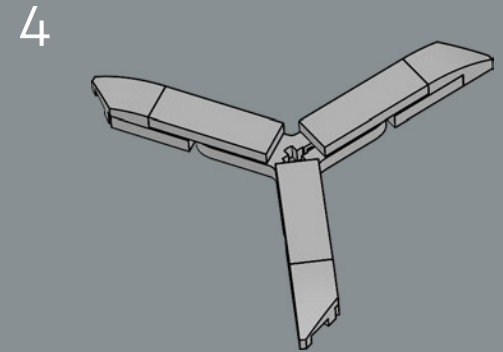
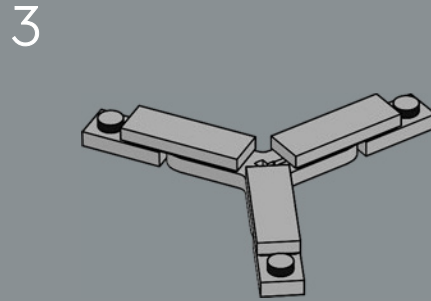
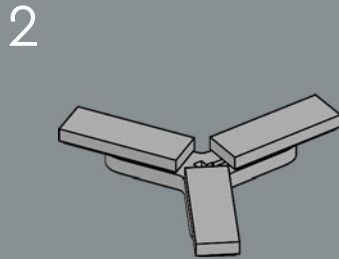
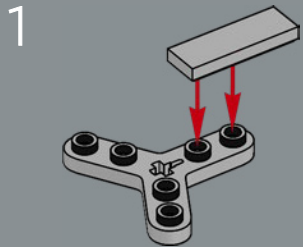

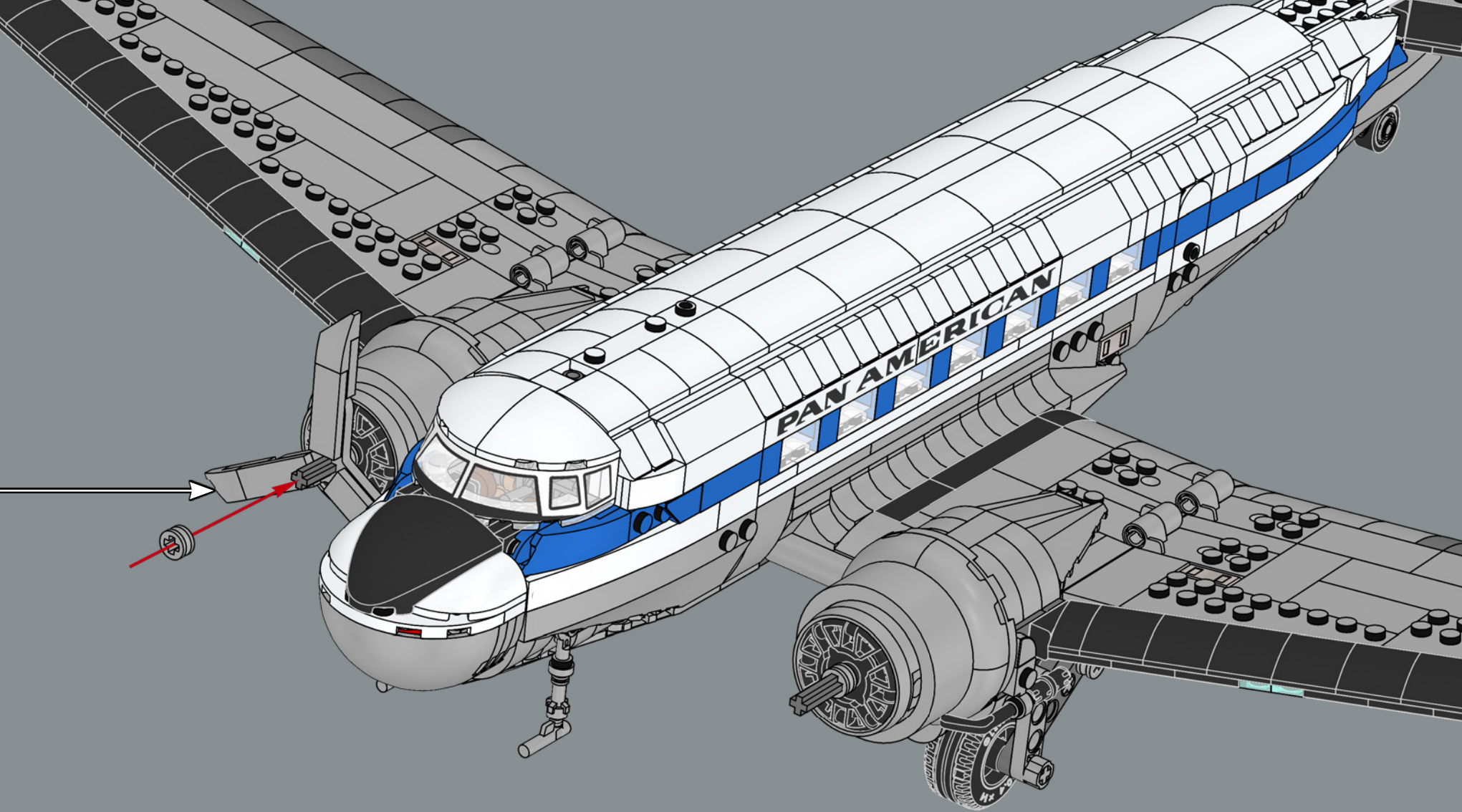

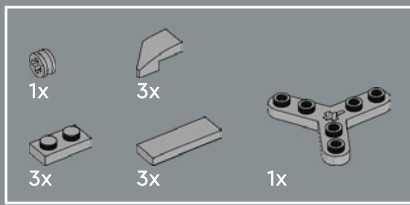

471

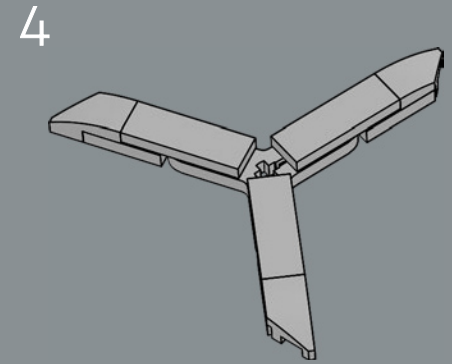
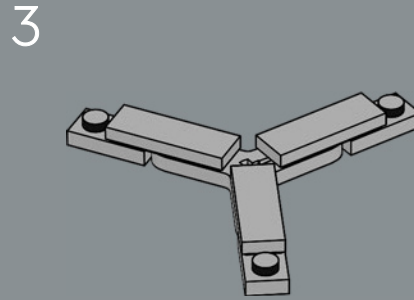
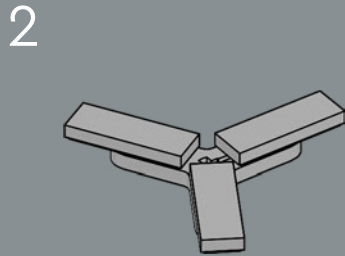
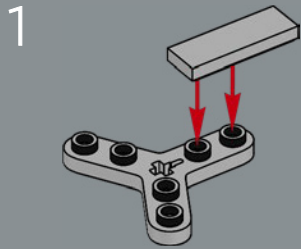

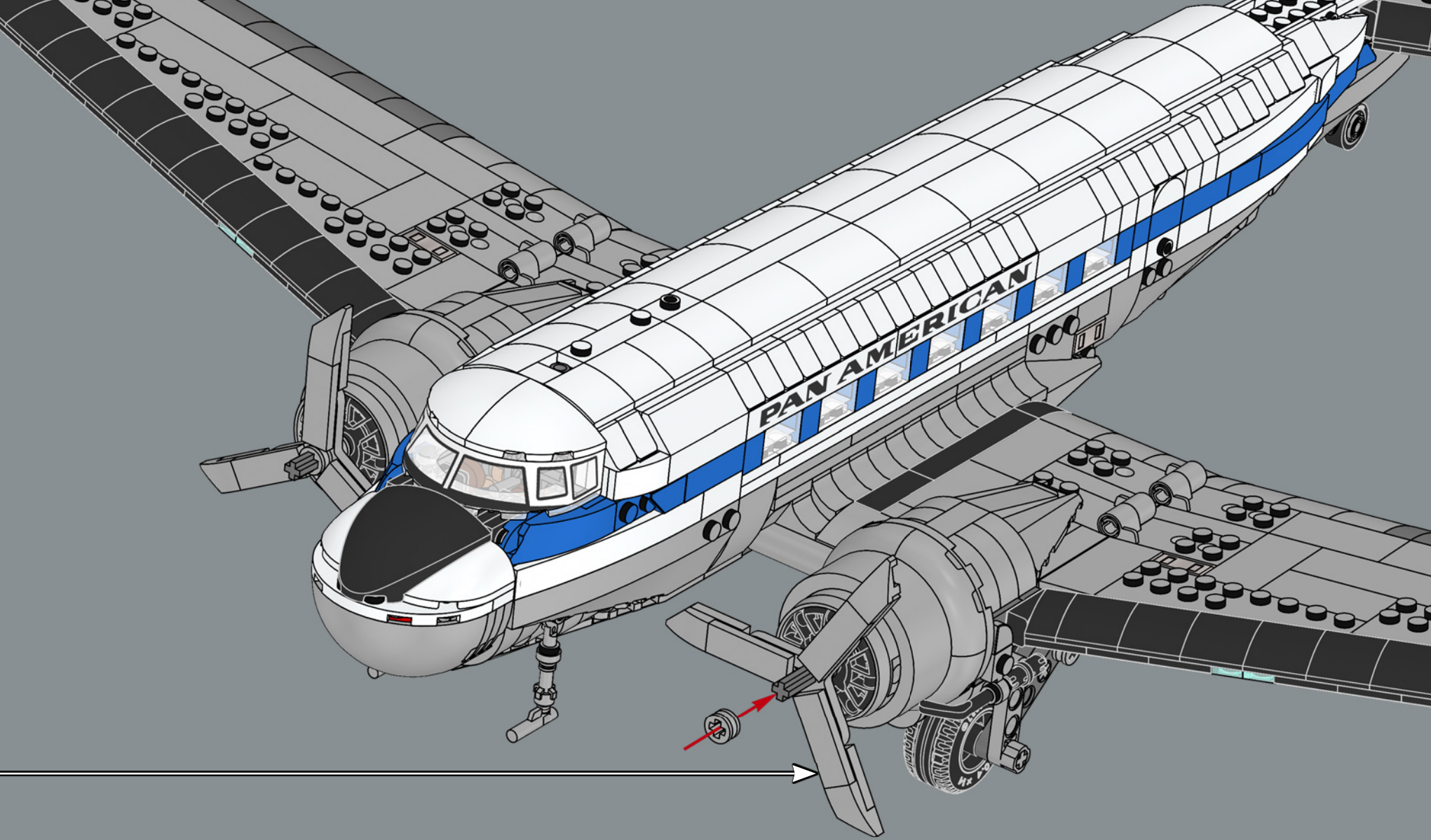



2x

472

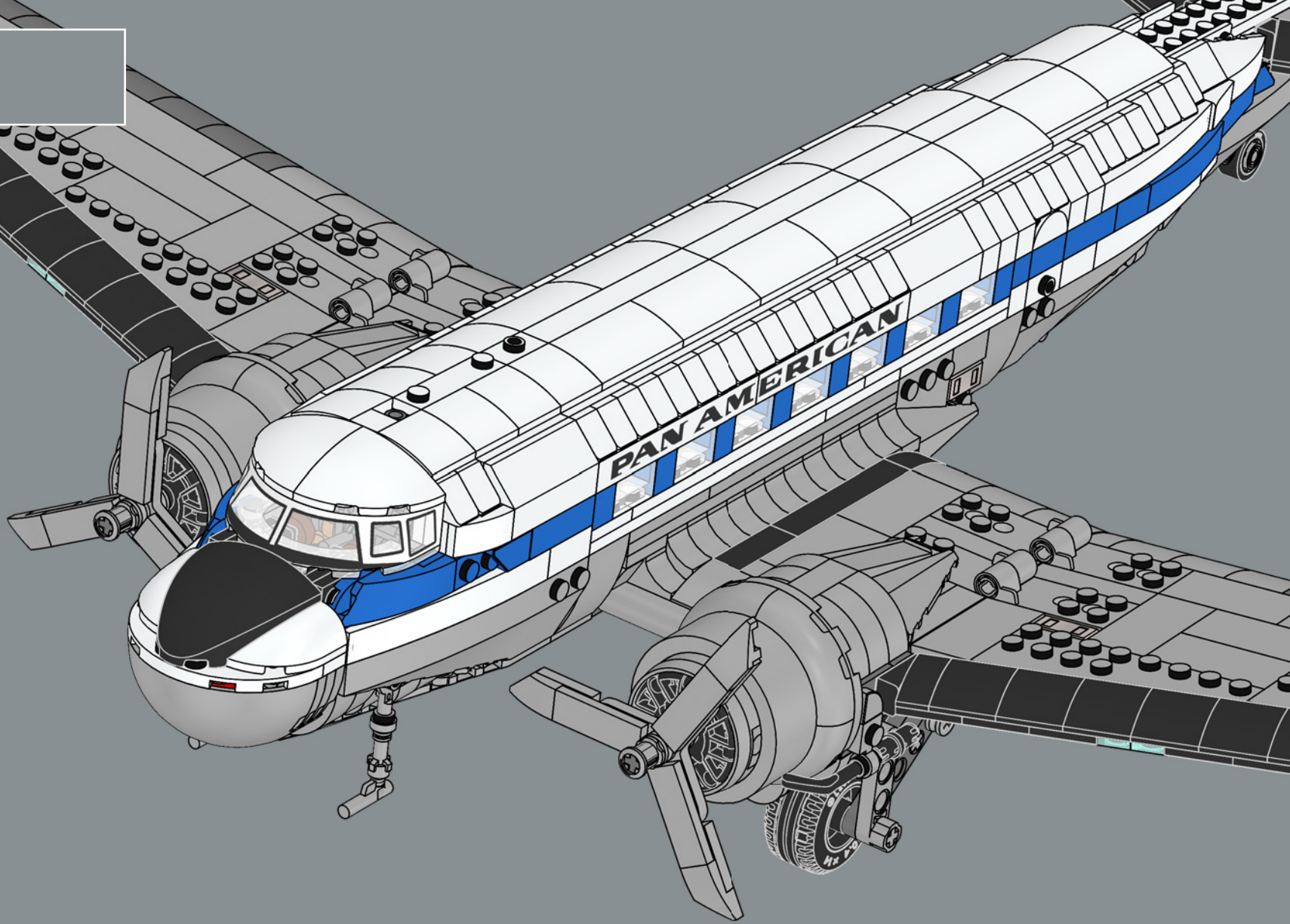

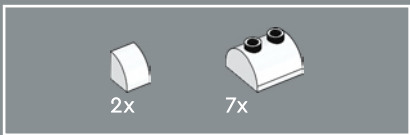

473

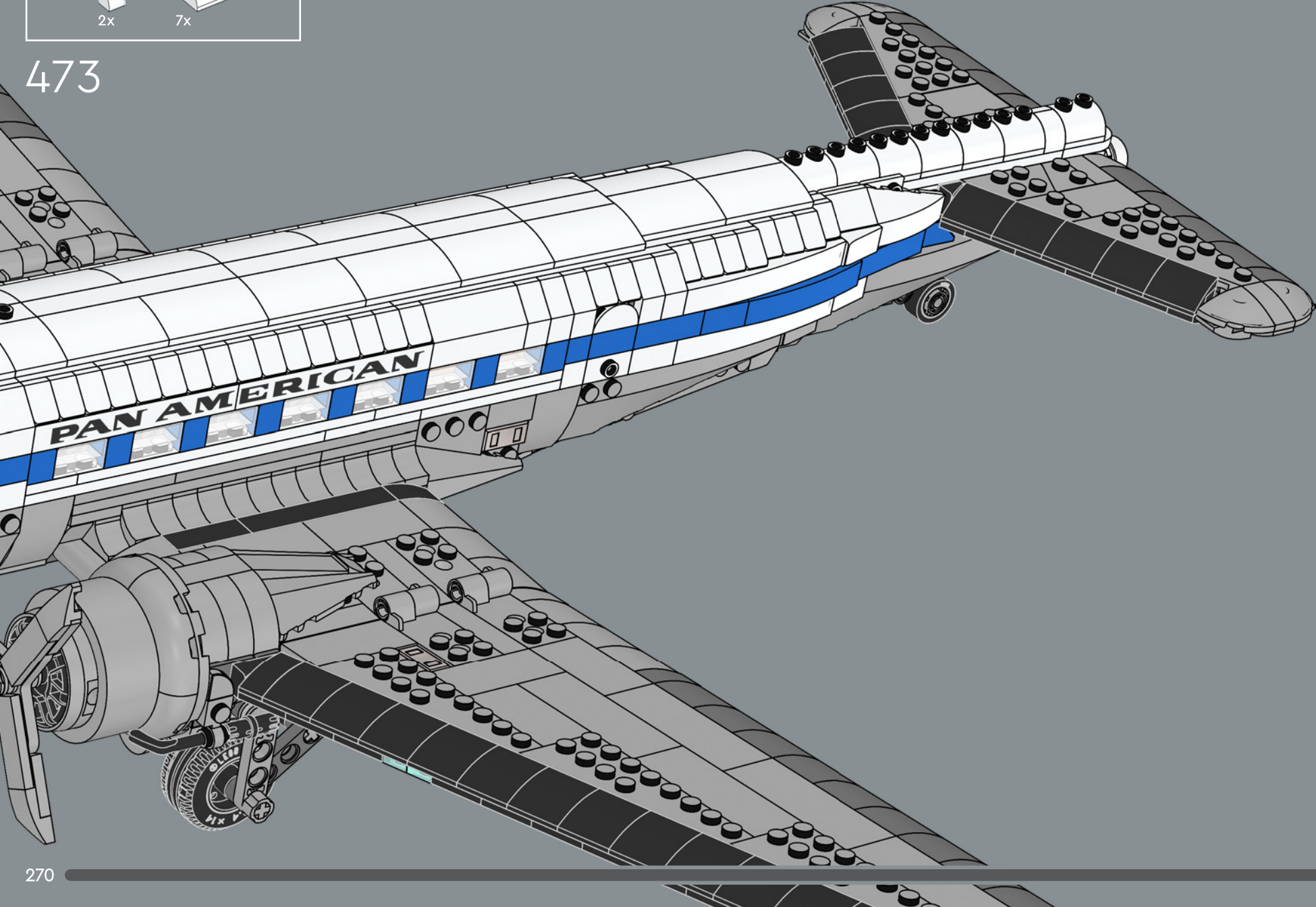

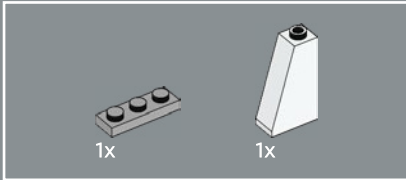
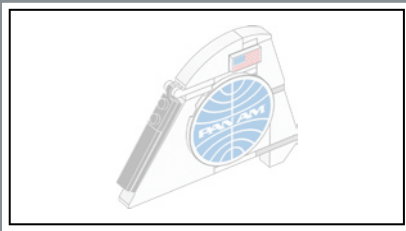

474

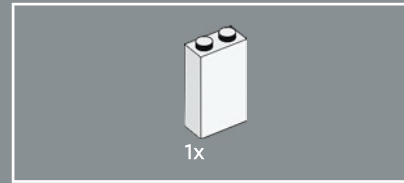
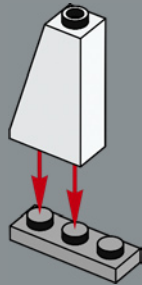

475

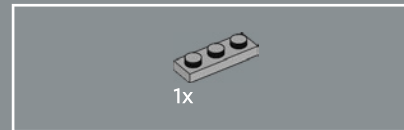
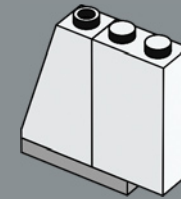

476

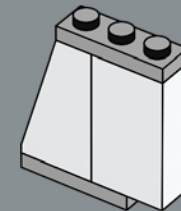

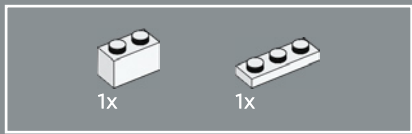

477

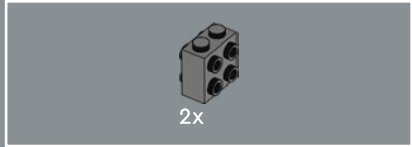
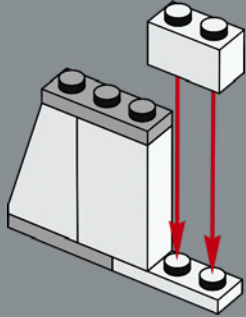

478

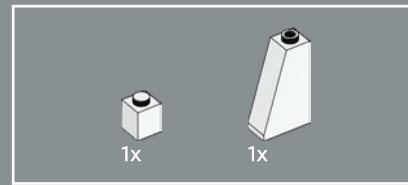
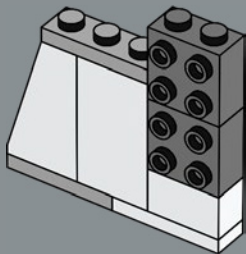

479

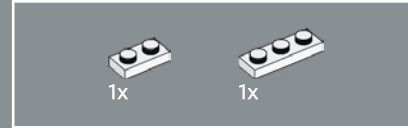
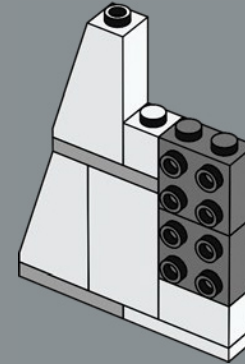

480

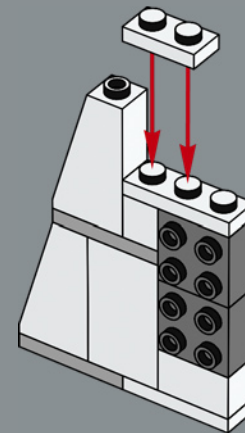

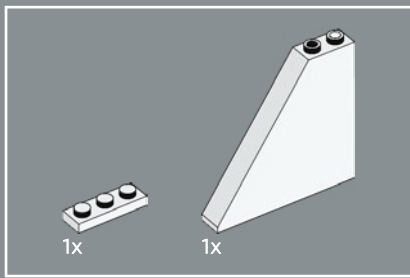

481

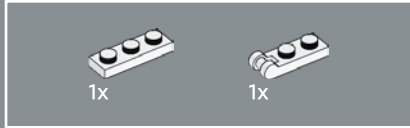
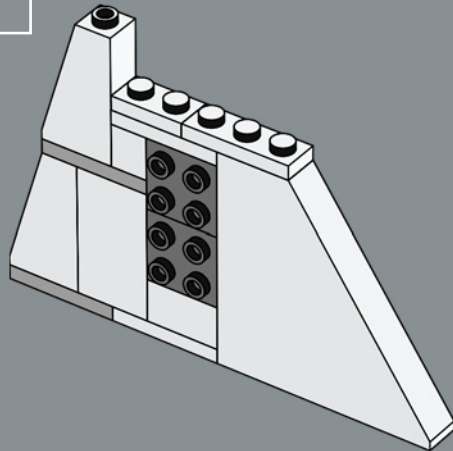

482

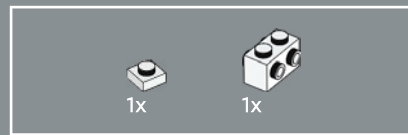
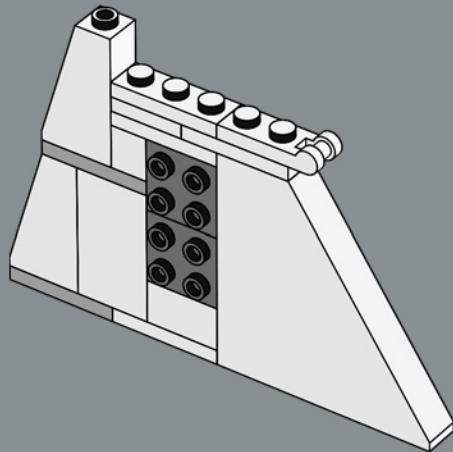

483

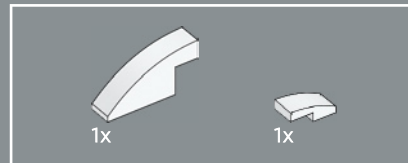
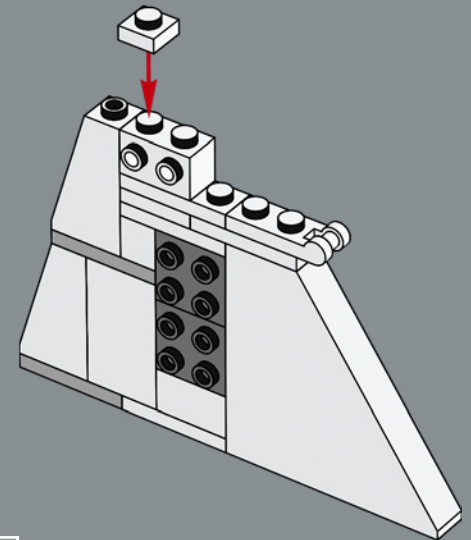

484

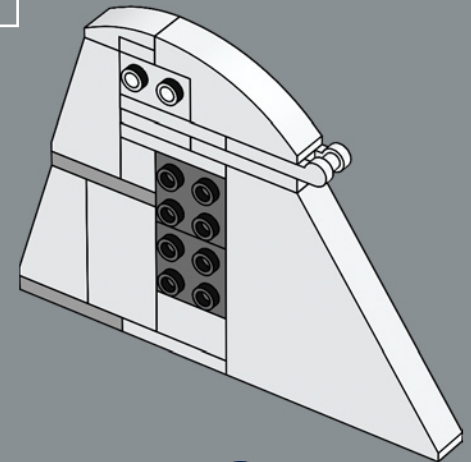

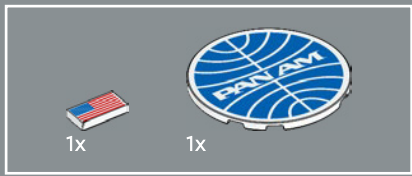

485

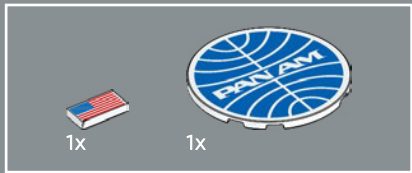
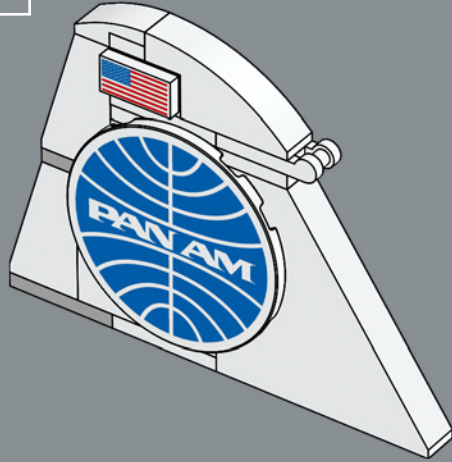

486

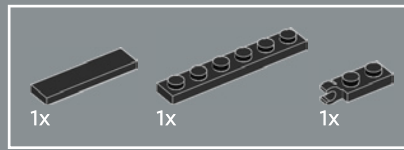
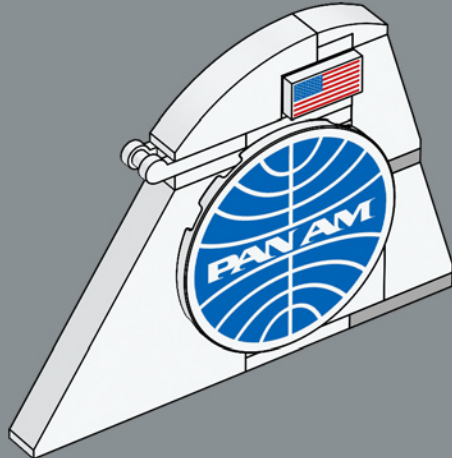

487

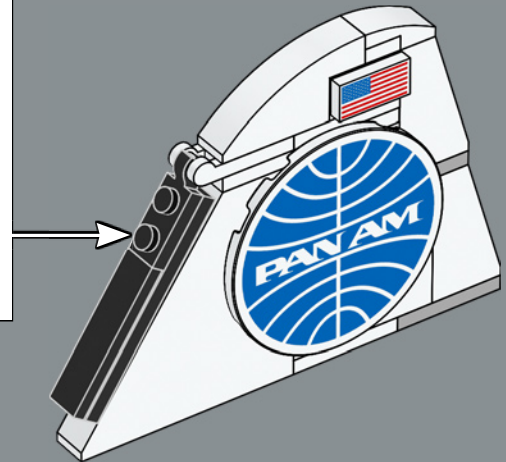
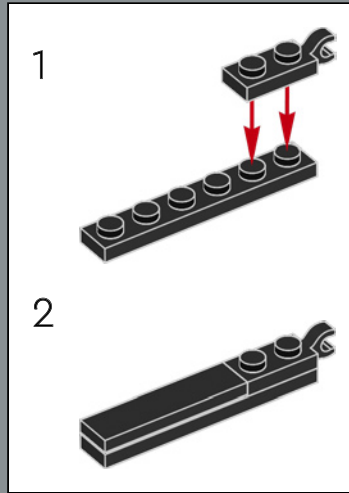



1x

488

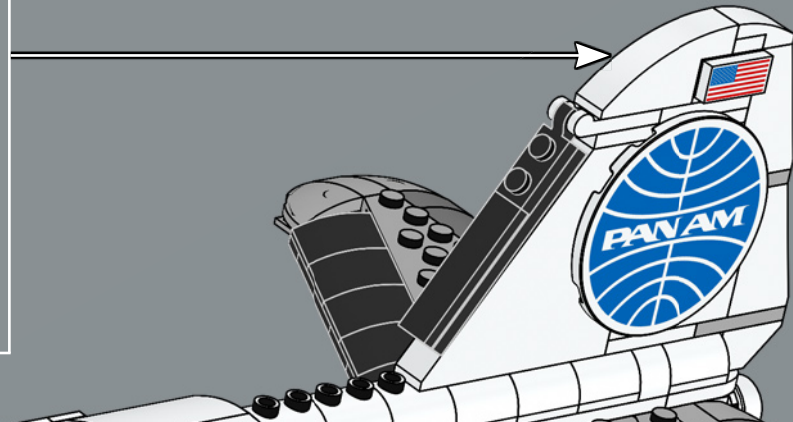
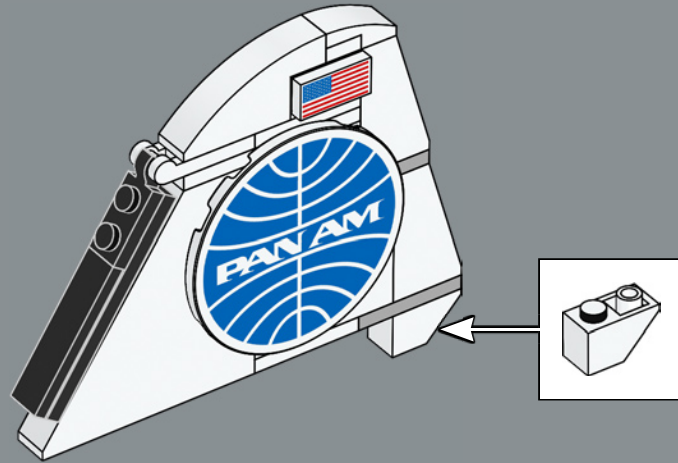

489

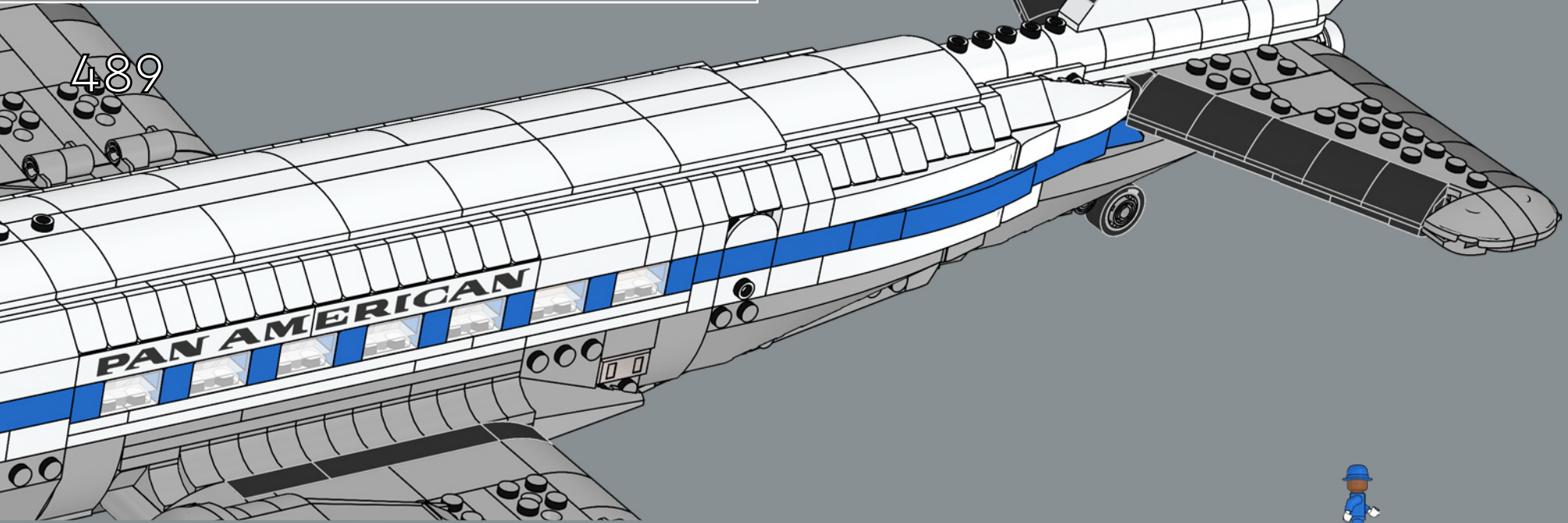

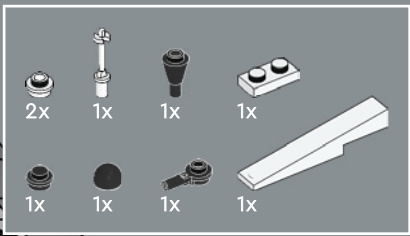

La gondola nera fa parte dell'Automatic Direction Finder (ADF), uno strumento di radionavigazione che visualizza il rilevamento relativo dall'aeromobile a una stazione radio idonea.

490

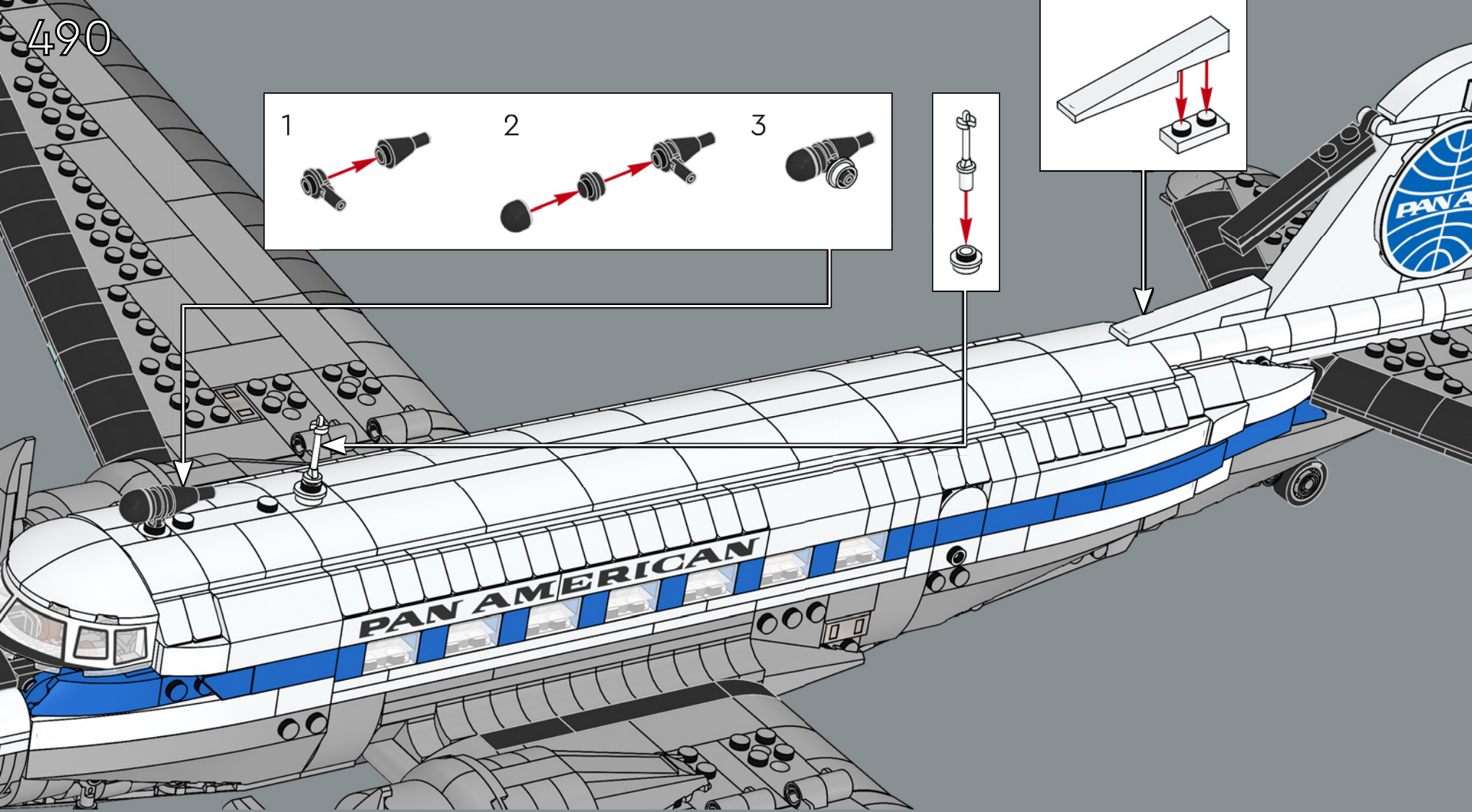
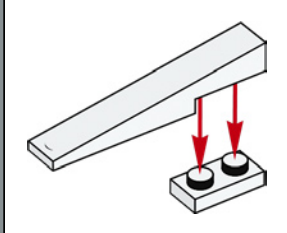
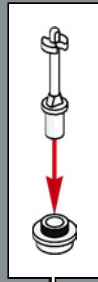
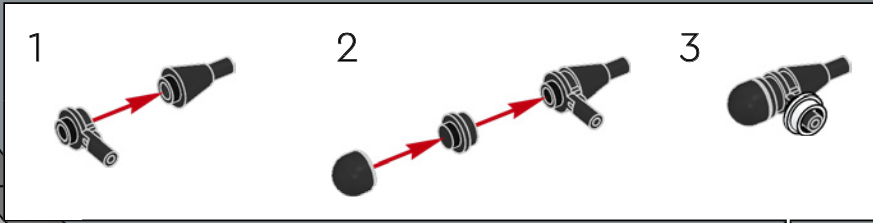

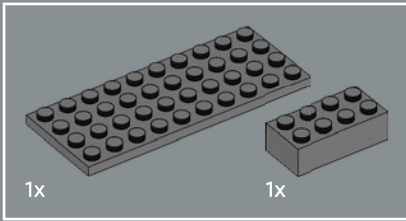
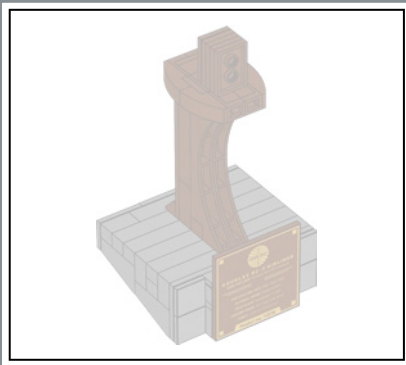

491

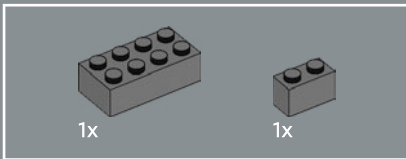
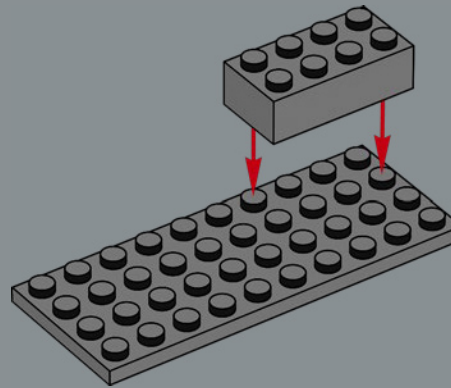

492

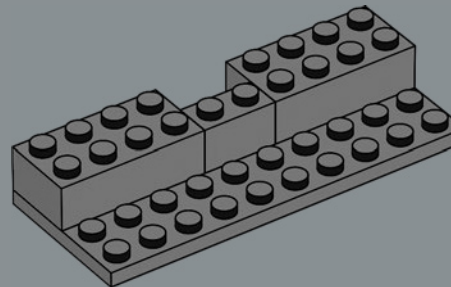

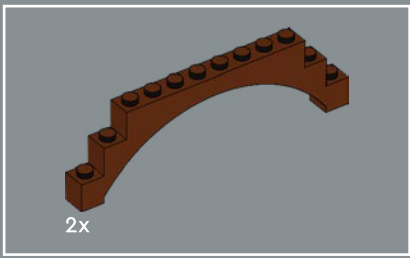

493

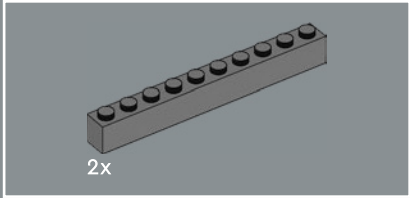
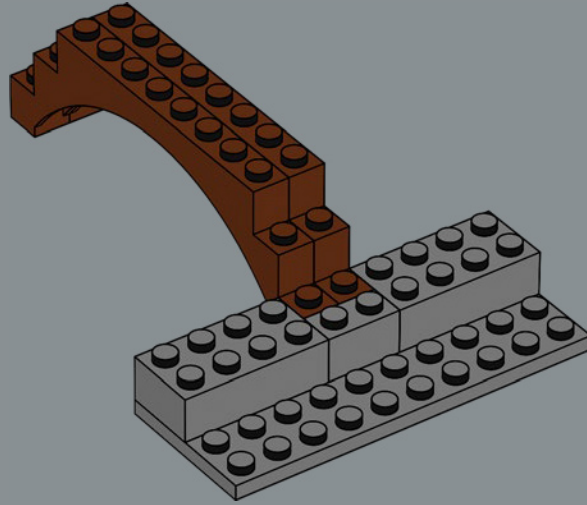

494

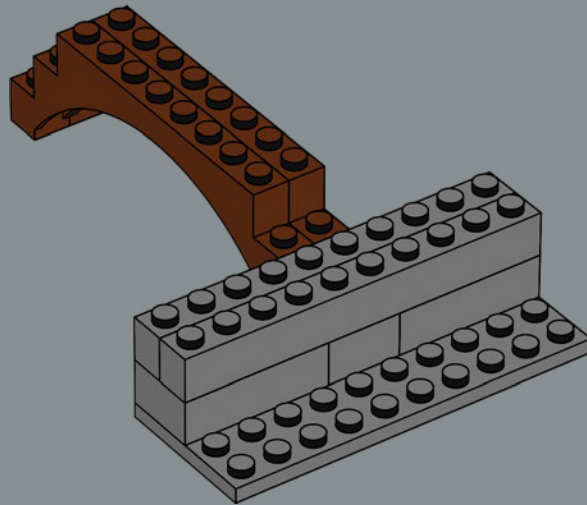

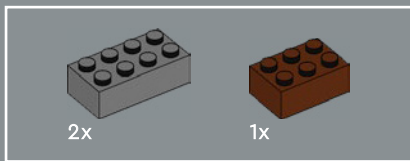

495

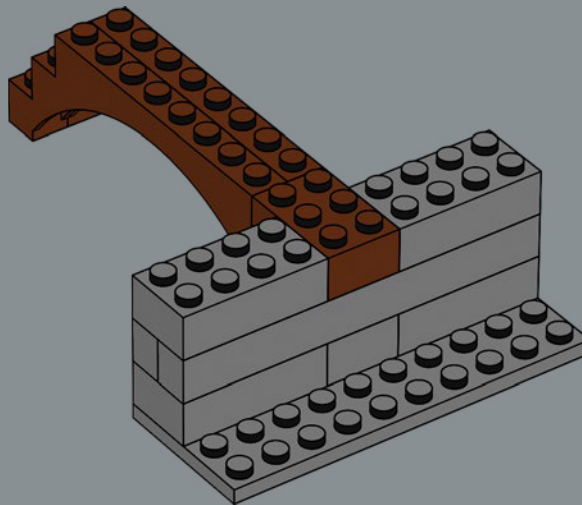

496

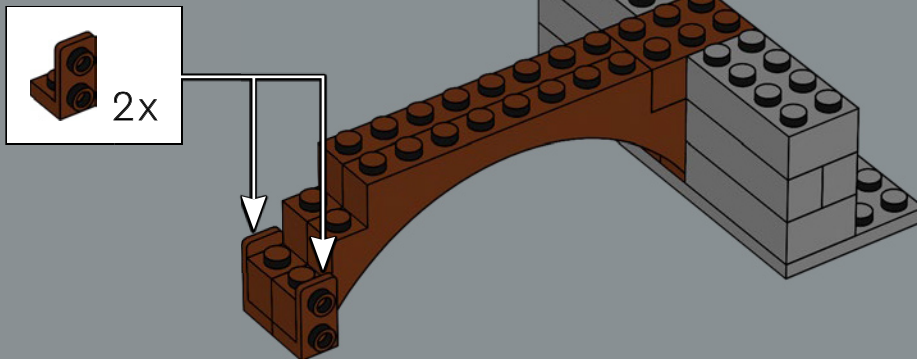

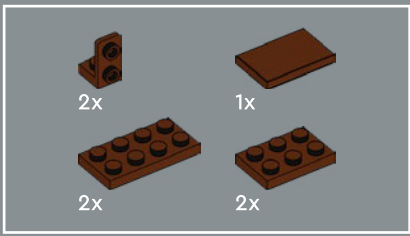

497

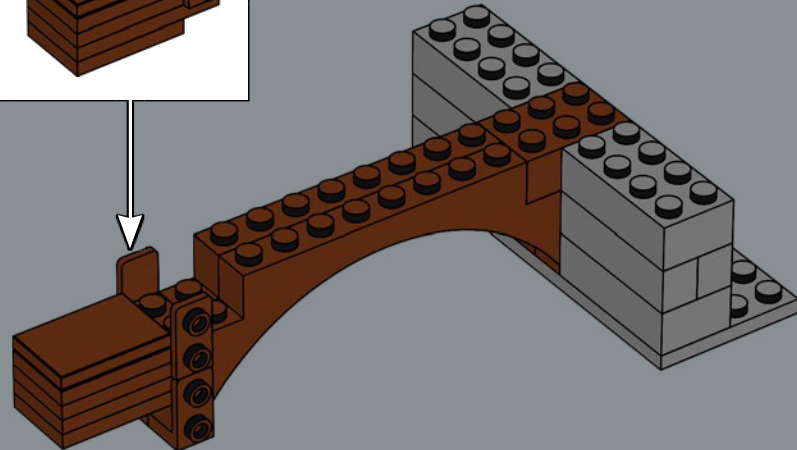
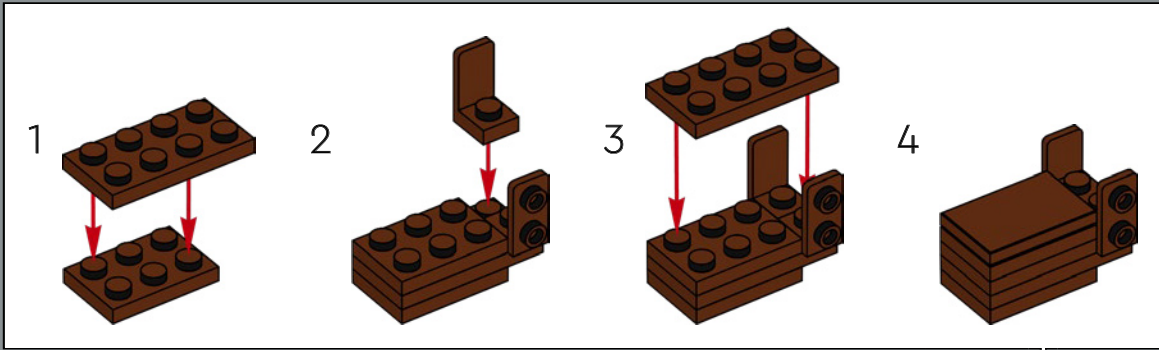

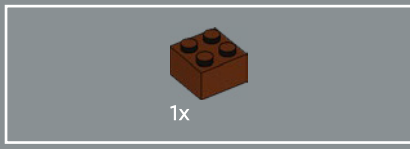

498

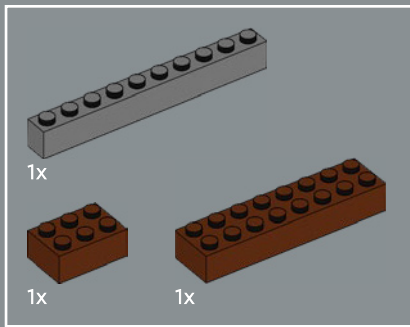
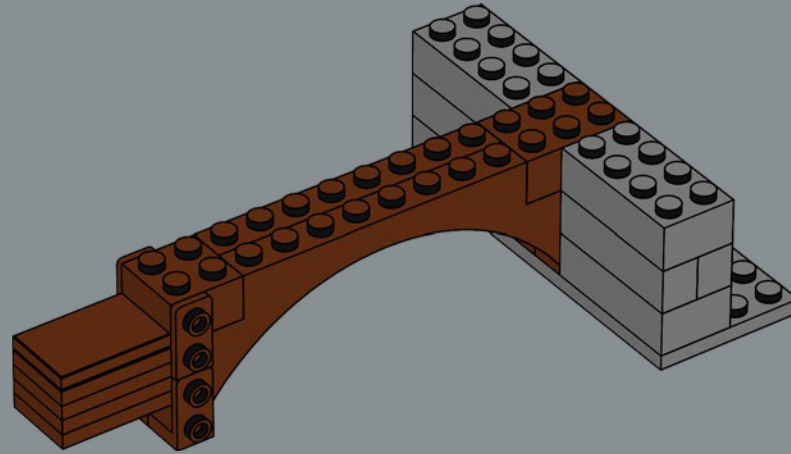

499

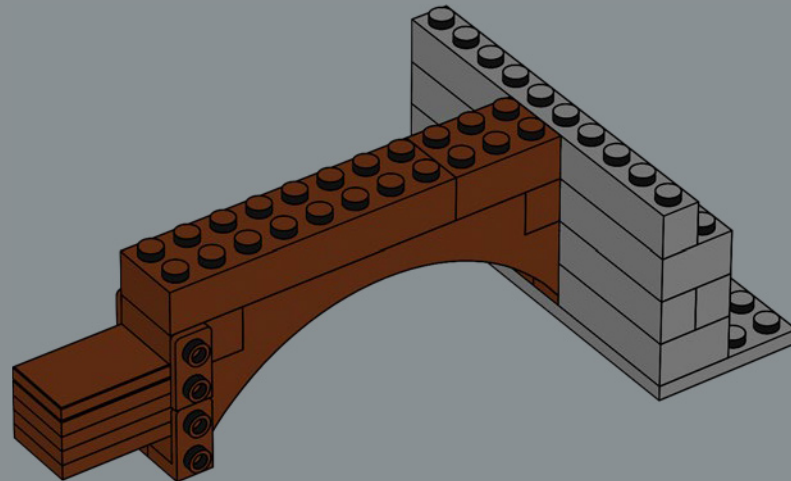

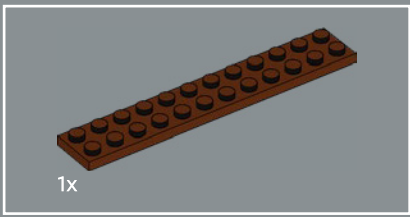

500

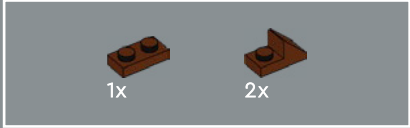
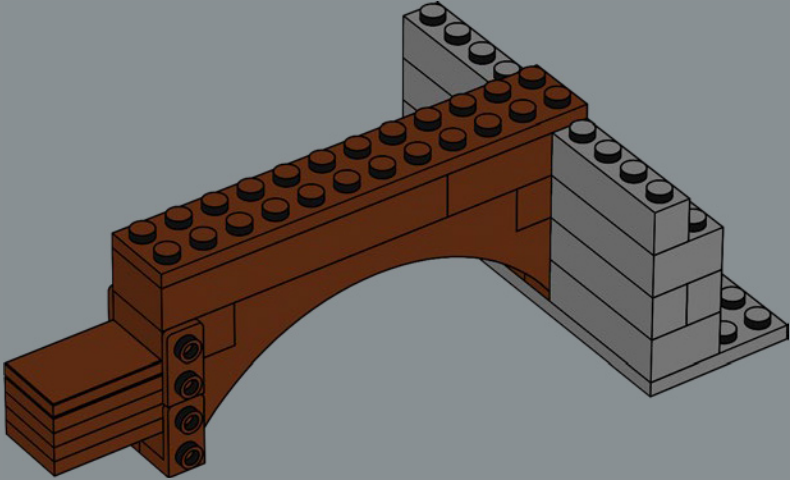

501

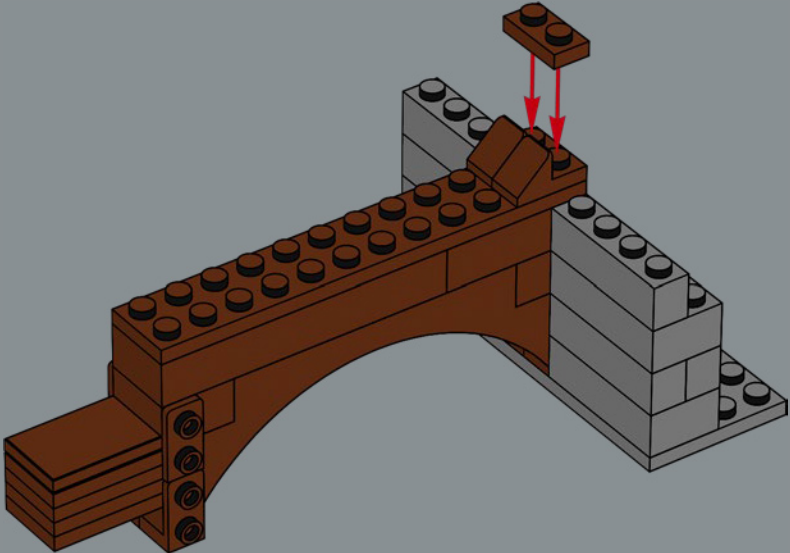



502

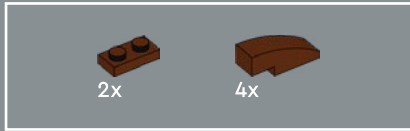
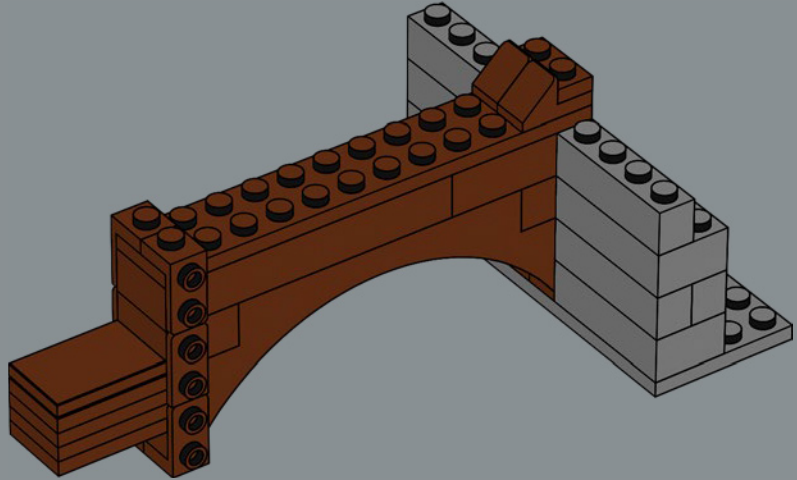

503

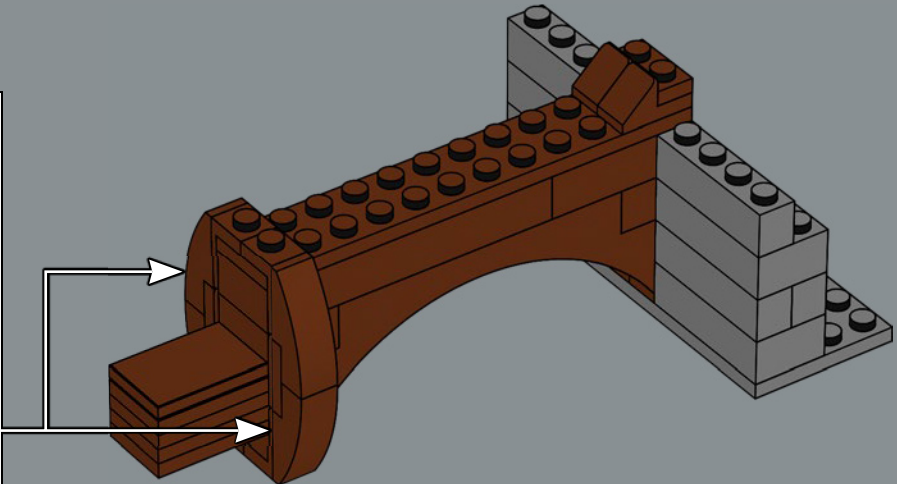
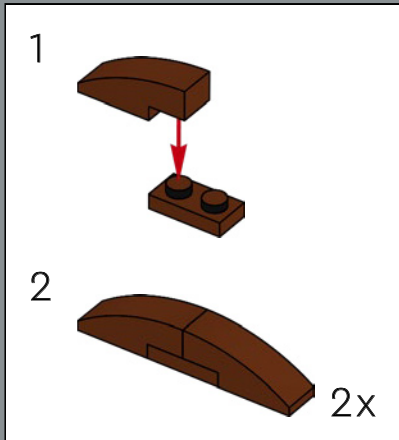



2x

504

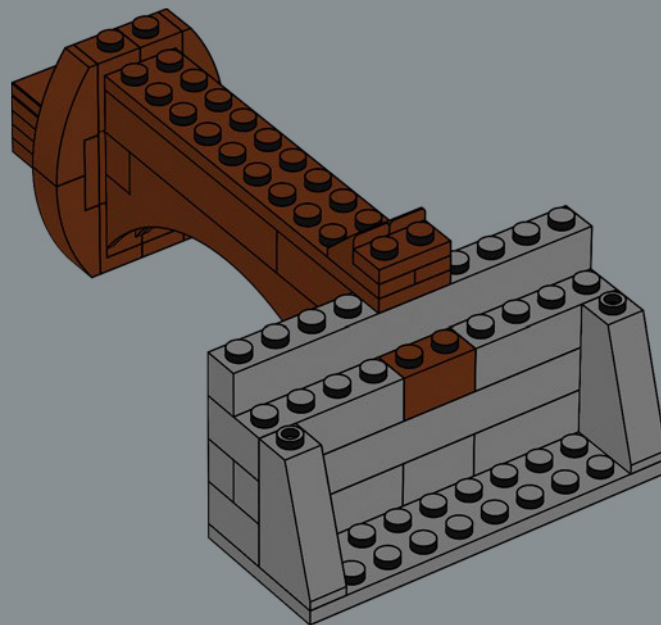

2x

505

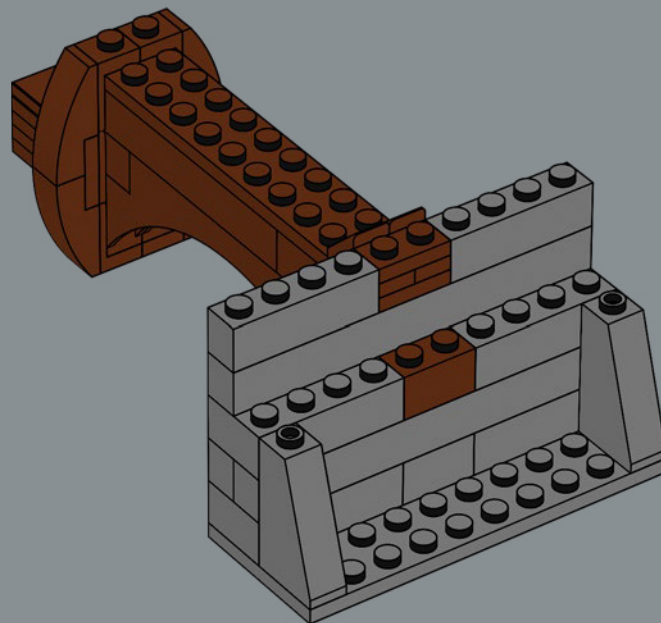

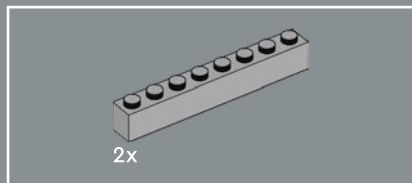

506

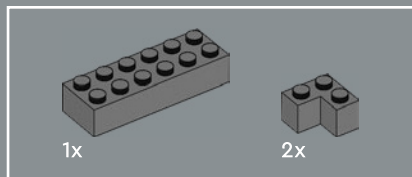
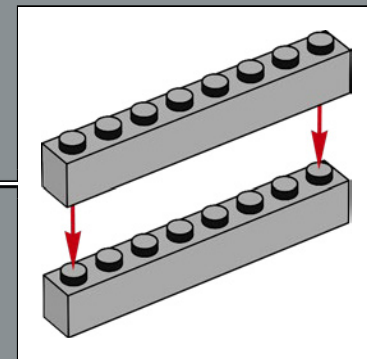
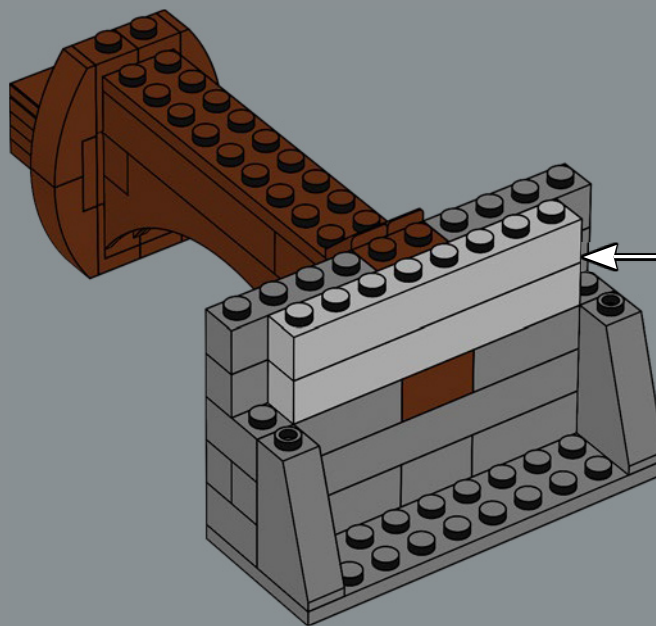

507

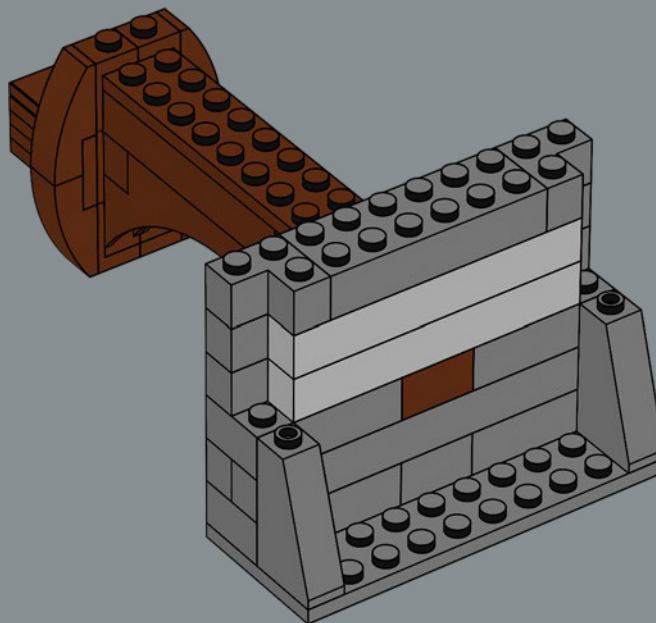

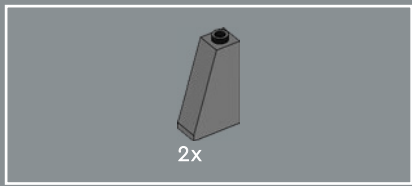

508

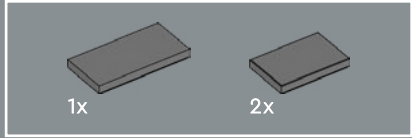
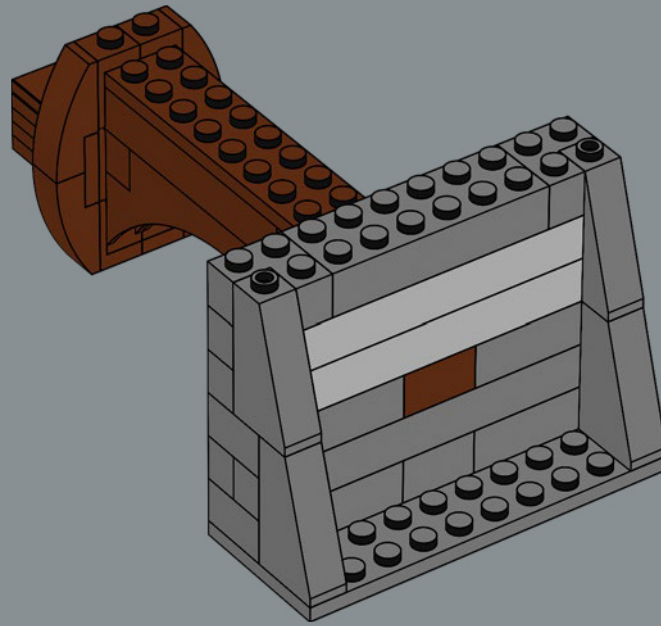

509

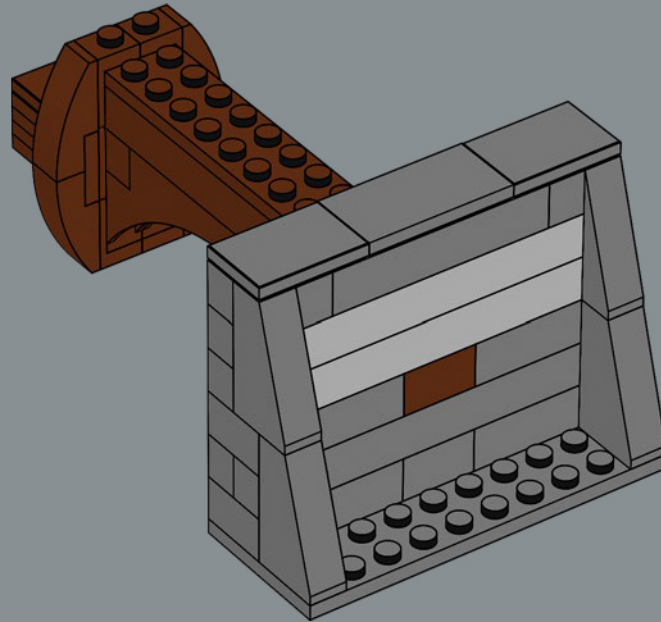



510

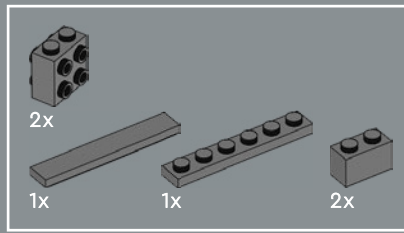
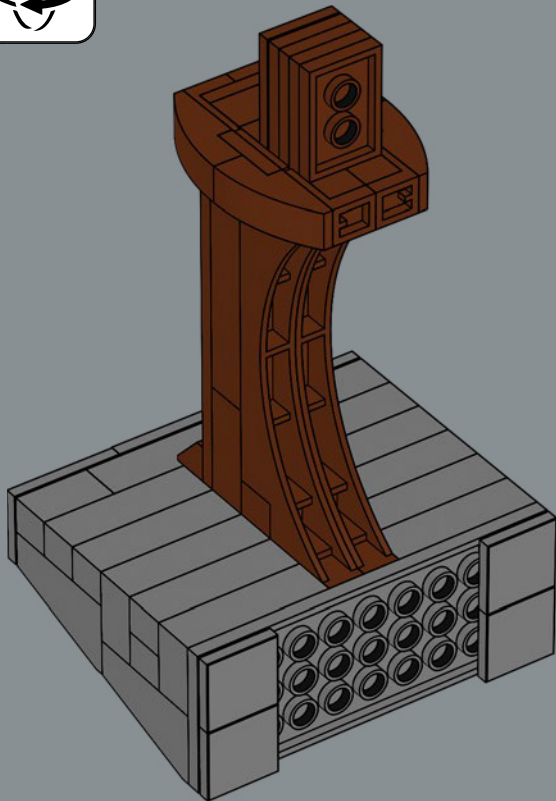

511

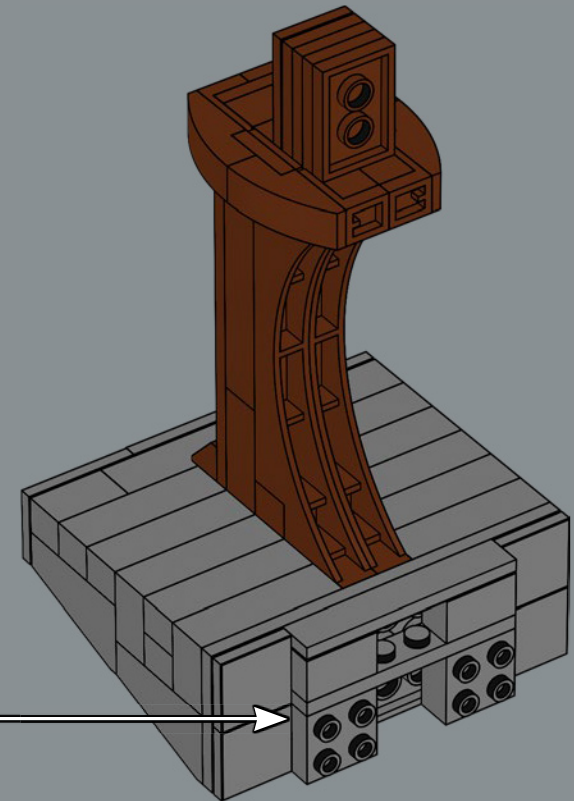
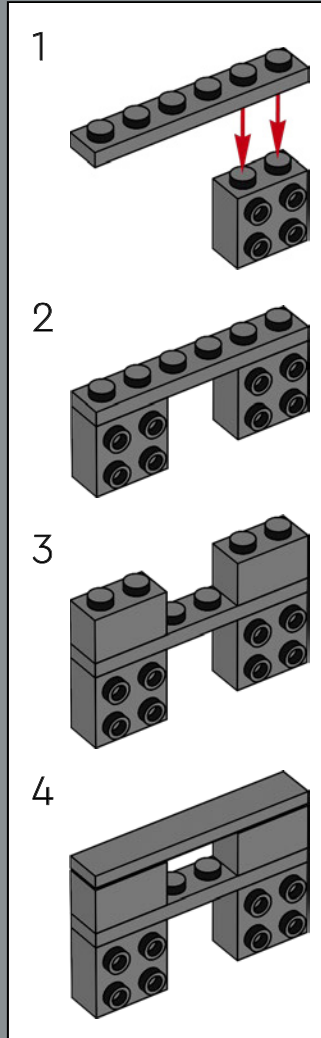



1x

512



513

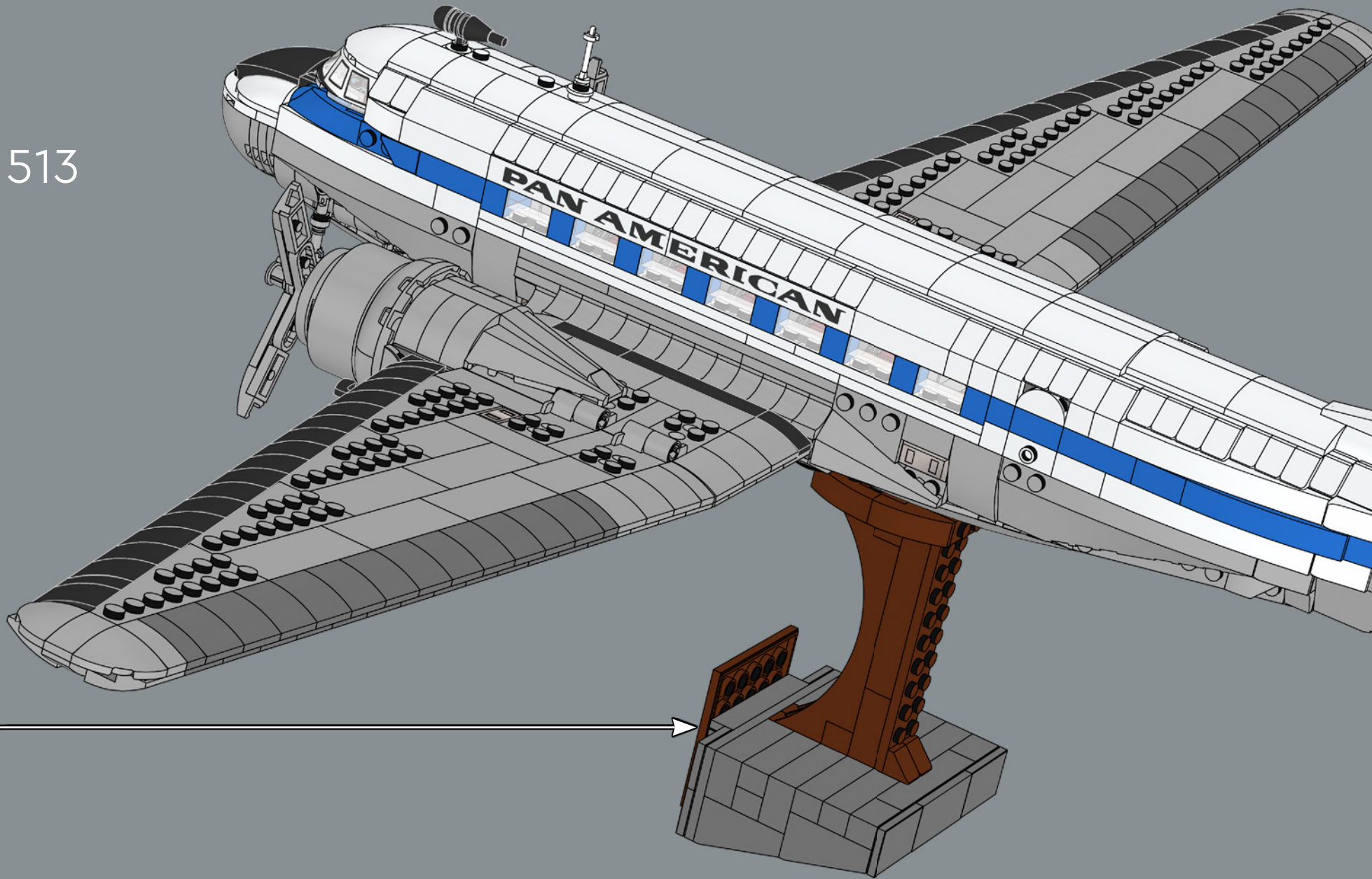



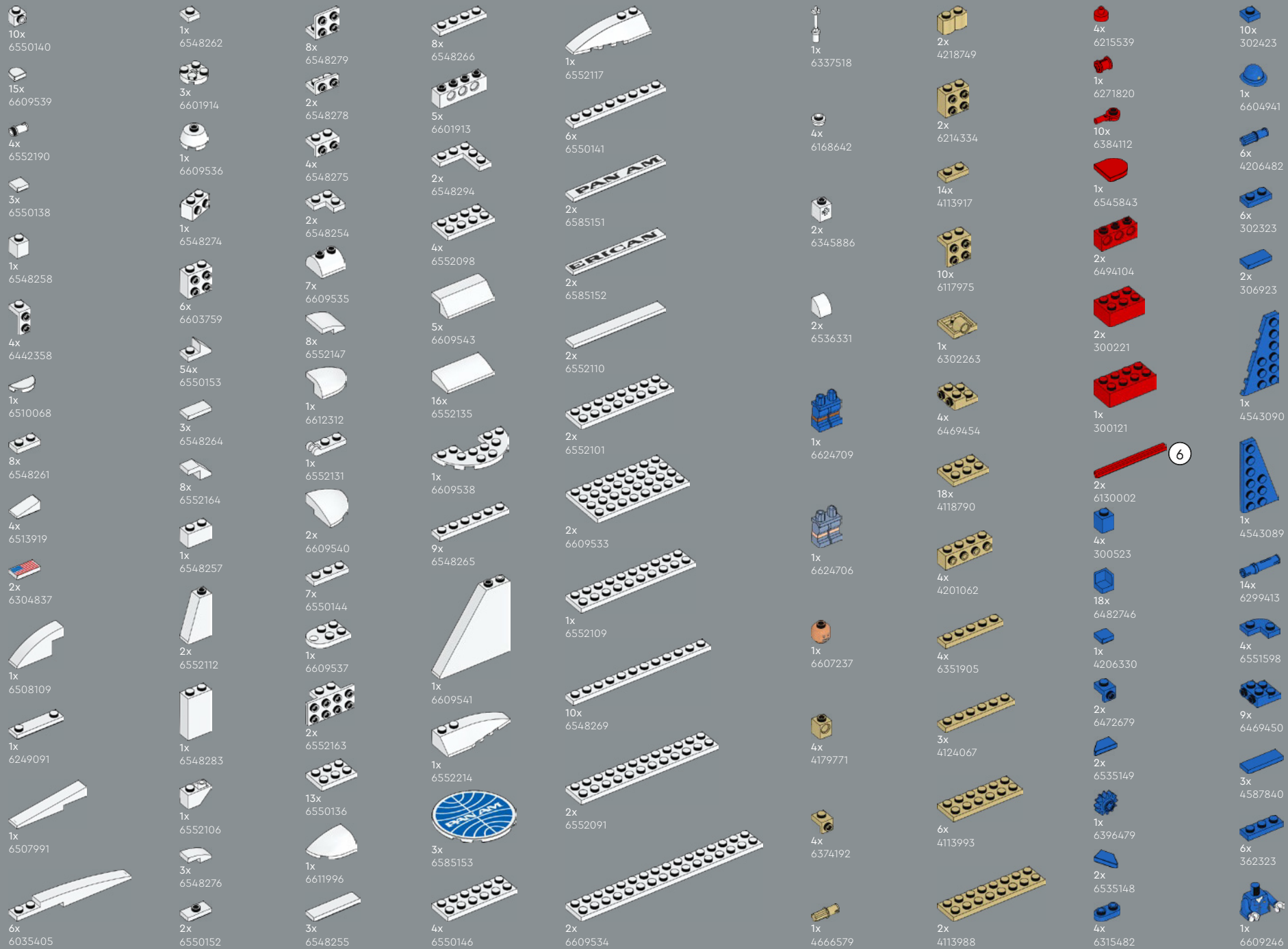

6

- 1x 6558857
- 1x 6558916
- 2x 371023
- 3x 301023
- 2x 6555137
- 6x 6307275
- 15x 302023
- 2x 300123
- 2x 6535145
- 2x 366623
- 2x 4243815
- 1x 416223
- 1x 303423
- 4x 654124
- 7x 6248971
- 2x 6206240
- 16x 242024
- 1x 6130007
- 5x 614126
- 1x 6538443
- 2x 6473449
- 2x 4558954
- 2x 4504382
- 2x 300526
- 2x 302426
- 2x 6299338
- 2x 6344752
- 1x 6585195
- 1x 6196548
- 1x 4246901
- 35x 6279875
- 1x 9339
- 4x 6147050
- 2x 6275806
- 2x 6138173
- 6x 6047276
- 2x 4541191
- 2x 302326
- 2x 6000650
- 2x 6325521
- 4x 6428168
- 1x 6336989
- 2x 6506201
- 40x 6053077
- 4x 302226
- 42x 6211476
- 2x 6109682
- 1x 6362991
- 2x 4558170
- 1x 6609279
- 2x 6537354
- 4x 370526
- 2x 6601610
- 1x 243126
- 1x 6597398
- 1x 366626
- 1x 6560654
- 2x 663626
- 2x 6161298
- 4x 273026
- 6x 383226
- 4x 6001494
- 4x 4569058
- 1x 6604940
- 14x 6514121
- 1x 6585145
- 4x 6508249
- 1x 6240515
- 1x 6486027
- 1x 6609230
- 39x 4528604
- 1x 4162916
- 1x 6609257
- 2x 6282619
- 10x 6092597
- 3x 4539097
- 2x 4585479
- 1x 4585751
- 1x 4583299
- 2x 6264030
- 5x 4539071
- 3x 4618986
- 1x 6604944
- 2x 6347304
- 2x 6365746
- 3x 6093494
- 4x 6208446
- 3x 4619636
- 6x 6287673
- 1x 6396480
- 1x 6423273
- 1x 6410056
- 1x 6404026
- 1x 6527824
- 1x 6508103
- 1x 6537328
- 3x 6177146
- 5x 6215606
- 2x 4539083
- 2x 6544174
- 15x 6138232
- 2x 6186673
- 4x 6341553
- 2x 6472546
- 2x 6223599
- 3x 4211150
- 2x 6075287
- 4x 6443654
- 1x 6551600
- 1x 4211210
- 4x 6135494
- 4x 6325975
- 4x 4211189

3

4

3



2x  
4216668



1x  
6311441



2x  
4211186



2x  
6159763

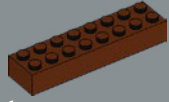

1x  
6096701



1x  
6609285

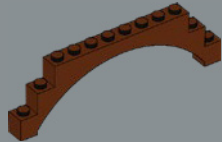

2x  
6246843



1x  
4225700



2x  
4539481



21x  
6271165



2x  
6275844



1x  
6296859



6x  
4521921



2x  
6253436



8x  
4211399



2x  
6176433



3x  
6401023



1x  
6335328



2x  
6248078



7x  
6225142



7x  
6225139



1x  
4211758



4x  
6163478



4x  
6163477



4x  
6344702



2x  
6510070



4x  
6344703



2x  
6510070



4x  
6344703



4x  
6344703



2x  
6227897



1x  
4211791



1x  
4211794



8x  
6294038



2x  
6296894



2x  
4514195



6x  
6134378



2x  
6134378



16x  
6144138



16x  
6548933



2x  
6185676



2x  
4211881



4x  
6171894



6x  
6435930



4x  
6171894



2x  
6271831



4x  
6331574



4x  
6257593



2x  
6173127



9x  
4211414



19x  
6066097



2x  
6493586



4x  
4211541



26x  
6396791



2x  
6132886



14x  
6102357



2x  
4211387



26x  
6185676



2x  
4211881



4x  
6171894



2x  
4211655



8x  
4211429



8x  
6251044



2x  
4211489



1x  
6435915



6x  
4654582



1x  
6265742



14x  
4211353



1x  
6065824



8x  
4211397



6x  
632886



14x  
6102357



2x  
4211387



26x  
6185676



2x  
4211881



4x  
6171894



2x  
4211655



8x  
4211429



8x  
6251044



2x  
4211489



6x  
4211361



8x  
4558169



2x  
6262083



2x  
6262082



8x  
6456718



2x  
4507056



6x  
6132207



7x  
4211396



6x  
6435930



4x  
6171894



2x  
6271831



4x  
6331574



4x  
6257593



4x  
4211445



1x  
4211394



7x  
4211356



2x  
6402876



4x  
6558989



1x  
4622803



21x  
6015347



2x  
4507052



3x  
6493587



12x  
4560183



8x  
6258903



4x  
4211395



2x  
6307999



3x  
4211639



2x  
6372029



3x  
6493589



2x  
6303442



3x  
6132983



1x  
6597400



1x  
6597400



1x  
6597400



1x  
6597400



1x  
6597400



1x  
6597400



1x  
6597400



1x  
6597400



1x  
6597400



1x  
6597400



1x  
6597400

5

3

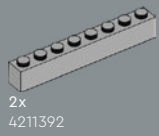

2x  
4211392

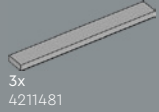

3x  
4211481



8x  
6448327



4x  
4211406

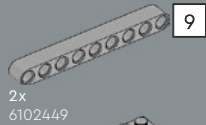

9



8x  
6448326



5x  
4505088

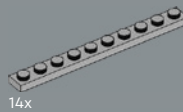

14x  
4251149



LEGO.com/service

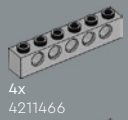

4x  
4211466



2x  
6508016



2x  
6015349



10x  
6318584



2x  
4211393



5x  
4505087

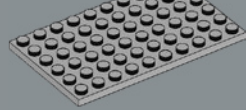

4x  
4211405

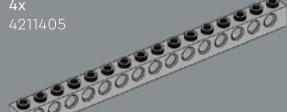

2x  
4211095

2x  
4211443

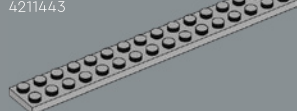

1x  
4211486



2x  
6510131



1x  
6510213



15x  
6360111



2x  
6221607



4x  
6338422



2x  
4521512



6x  
6261374



1x  
4567887



3x  
6005331



4x  
6135014



10x  
6514456



1x  
4516546



3x  
4211088

4x  
4221745



1x  
6342558



6x  
6396058



1x  
4211066



2x  
6215212



6x  
6029948



2x  
6000606



1x  
6271356



2x  
6543014



1x  
4529728



1x  
4529727



4x  
6013082



2x  
4211109



33x  
6071261



7x  
4211094



12x  
6047417



34x  
6344820



15x  
4521187



1x  
4552349



4x  
6271876



14x  
4211133



2x  
6187008



3x  
4211105



4x  
4211043



1x  
6083620



2x  
4211103



10x  
4211001

4x  
6215176



4x  
6395635



2x  
6631413

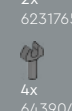

2x  
6231765



4x  
6439040



4x  
6100030



4x  
4211085



1x  
4560184



2x  
4210686



1x  
4211056



1x  
4210651



5x  
4243831



1x  
4210875



4x  
4211002

2x  
4499858



12x  
4210719



2x  
6225494



2x  
6510145

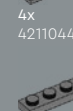

4x  
4211044

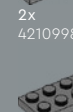

2x  
4210998

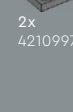

2x  
4210997



1x  
4257526



3x  
4211107



2x  
4210678



9x  
6133611



1x  
4211122



1x  
4211114



2x  
4211114

5

4

8



# YOU COULD WIN



## YOU COULD WIN

Your feedback will help shape the future development of this product series.

Visit:

## DU KÖNNTEST GEWINNEN

Dein Feedback trägt zur Weiterentwicklung dieser Produktreihe bei.

Geh auf:

## VOUS POURRIEZ GAGNER

Vos commentaires nous aideront à concevoir les futurs produits de cette gamme.

Visitez :

## POTRESTI VINCERE TU

La tua opinione ci aiuterà a migliorare la creazione futura di questa linea di prodotti.

Visita:

## PUEDES GANAR

Tu opinión contribuirá al futuro de esta serie de productos.

Visita:

## 轻松获奖

您的反馈将有助于我们在今后改进本产品系列。

请访问:

---

# LEGO.com/productfeedback

---

You also have the chance to win a LEGO® set.

Terms and conditions apply.\*

Außerdem hast du die Chance, ein LEGO® Set zu gewinnen.

Es gelten die Teilnahmebedingungen.\*

Vous pourriez également gagner un ensemble LEGO®.

Des conditions s'appliquent.\*

Hai anche la possibilità di vincere un set LEGO®.

Termini e condizioni sono applicabili.\*

También tienes la oportunidad de ganar un set LEGO®.

Aplican términos y condiciones.\*

您还有机会赢取乐高®套装。

条款和条件适用。\*

\*LEGO.com/productfeedback-terms



LEGO and the LEGO logo are trademarks of the LEGO Group. ©2026 The LEGO Group.

Produced under license from The Boeing Company. BOEING, DOUGLAS and DC-3 and the distinctive Boeing logos, product markings and trade dress are trademarks of The Boeing Company.  
™ All related logos, characters, names, and distinctive likenesses thereof are the exclusive property of Pan American World Airways, LLC. Used under authorization.