



11378





LEGO.com/sustainable-packaging



FR
DONNEZ
OU
RECYCLEZ



OU



OU



ASSOCIATION MAGASIN DÉCHÈTERIE

Adresses sur quefairedemesdechets.fr



BUILDER



Apple and the Apple logo are trademarks of Apple Inc., registered in the U.S. and other countries and regions. App Store is a service mark of Apple Inc. Google Play and the Google Play logo are trademarks of Google LLC. Tencent and the Tencent logo are trademarks of Tencent Inc.

LEGO.com/devicecheck

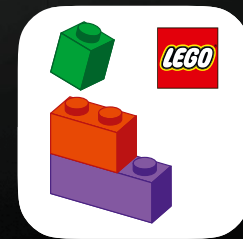

LEGO® Builder



Disfrutando del viaje desde 1927

Fundada en 1927 y operativa hasta 1991, Pan American World Airways, Pan Am®, inició su época más glamurosa con la puesta en servicio del venerable PAA® Douglas™ DC-3™ a mediados de la década de 1930. Al ser la primera aerolínea en volar por todo el mundo, Pan Am, igual que el DC-3, se sigue considerando un icono que transformó los desplazamientos aéreos y fue pionera en convertir los viajes internacionales en un estilo de vida. Cruzar continentes significaba más que usar un medio de transporte: era sinónimo de prestigio y sofisticación. El PAA DC-3 aportó una fiabilidad sin competencia tanto en las rutas nacionales como en las transatlánticas. El servicio de Pan Am, célebre por los impecables y elegantes uniformes de su tripulación, sus refinadas cabinas y su incomparable hospitalidad, continúa siendo el emblema por excelencia de la época dorada de la aviación, marcando para siempre la pauta del refinamiento, el lujo y la distinción en las alturas.





You Can't Beat
the Experience.



...it's Spring now in South America!

St. Señor... and the most luxurious way is by "EL PRESIDENTE", the only double-decker air service between the Americas

El Presidente and the magnificent El Presidente Equal are really something special! You American folks see a Blue Carpet in welcome you aboard one of our luxurious double-decker "President" Clippers and exclusively on the service. In flight you'll enjoy delicious meals with complimentary wine - and, on El Presidente Equal, a "Luscious Dinner with Cocktails, Champagne, Legumes, "La Crosse" and Liqueurs." "Aspigo" for altitude. We'll serve you comfortable berths on all flights with "El Presidente" and "El Presidente Equal" both "one-way" service and "return" for maximum air enjoyment. Travel Right now.

PAN AMERICAN
World's Most Experienced Airline

This is the most comfortable way to go to EUROPE!

... and until March 31st you save over 25% on your round-trip fare!

Save every month of Americans who board in the day the "Clipper" makes an Atlantic crossing. It's the most comfortable double-decker plane for Europe that ever flew - with the smoothest ride and the most attentive service.

The map below shows you that the World's Most Experienced Airline offers you more routes to the Atlantic. For reservations on other routes call your Pan Am Agent.

PAN AMERICAN
World's Most Experienced Airline



El mundo es tuyo

El Douglas™ DC-3™ voló por primera vez el 17 de diciembre de 1935 y, con las primeras unidades entregadas en junio de 1936, pasó a ser el modelo dominante en las flotas aéreas de los años 40, alcanzando 455 DC-3 fabricados para uso comercial en 1946. En términos aeronáuticos, es un monoplano bimotor de ala baja que puede despegar desde pistas cortas y aterrizar cómodamente en espacios reducidos, lo que lo hace ideal para casi cualquier destino y terreno. Su fiabilidad y maniobrabilidad convirtieron al DC-3 en un favorito de los pilotos. Por su parte, sus pasajeros disfrutaban de comodidades de alto nivel y, por supuesto, ¡de exóticas aventuras por todos los rincones del mundo! Hoy en día, si sabes hacia dónde mirar, aún puedes llegar a ver alguno surcando los cielos.

Aunque el nombre Douglas ha pasado a la historia, su legado y diseños permanecen vivos en la división Boeing Commercial Airplanes de The Boeing Company, que preserva con orgullo la memoria del DC-3.

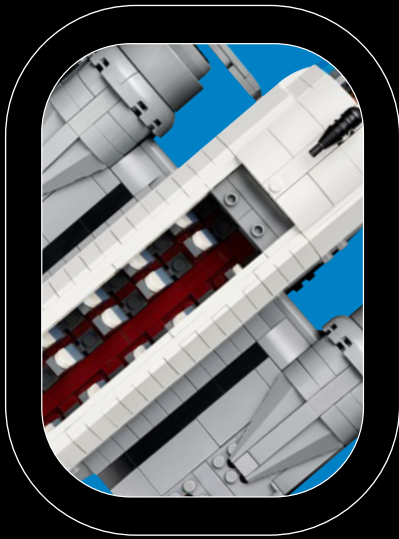

DOUGLAS DC-3



ESPECIFICACIONES

LONGITUD:
19,7 M

ENVERGADURA:
29 M

CAPACIDAD:
UNA TRIPULACIÓN DE TRES PERSONAS
Y 21-28 PASAJEROS SENTADOS (O 14 EN
LITERAS), O 2041 KG DE CARGA

VELOCIDAD DE CRUCERO:
333 KM/H EN TRAYECTOS DE HASTA
3420 KM

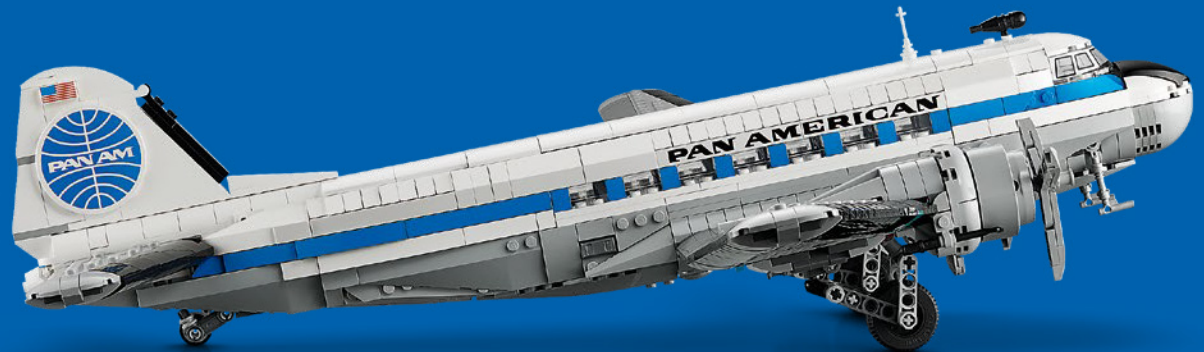



Impresiones de la tripulación de diseño de LEGO® Icons

El Douglas™ DC-3™ era un formidable candidato para nuestra colección de vehículos LEGO® Icons inspirada en los viajes. Queríamos crear un modelo extremadamente detallado, un guiño nostálgico a una emocionante época, que fuera lo suficientemente sólido como para retirarlo del soporte y estudiarlo de cerca. Puedes quitar las partes superiores de la cabina de vuelo y la cabina de pasajeros para echar un vistazo al interior. Con la inestimable ayuda de nuestros socios de Pan Am® y Boeing, que sacaron de sus archivos una rara ilustración a color de la cabina para compartirla con nosotros, logramos dar forma al modelo casi a escala de minifigura LEGO, con una impresionante envergadura y tren de aterrizaje retráctil. Al inicio del proceso de diseño, nos decidimos por la que quizá sea la combinación de colores más emblemática de Pan Am, la de 1959 (vista en solo unos pocos DC-3), como homenaje a la era en la que esta aeronave fue la columna vertebral del transporte aéreo. (¡Seguramente la recuerdas de películas estrenadas o ambientadas alrededor de esa época!). Las decoraciones impresas en el modelo incluyen un nuevo parabrisas y el icónico logotipo del globo estilizado de Pan Am® plasmado en una nueva cubierta LEGO 6x6. Para completar la escena, diseñamos una tripulación de minifiguras LEGO vestidas con uniformes clásicos que incorporan un nuevo sombrero fiel al original. Y, como broche, ¡integramos al fuselaje del avión la característica franja azul!



"¡Esperamos que disfrutes tanto de tu estancia a bordo como de explorar el divertido mundo de la construcción!".

El equipo de diseño de LEGO® Icons



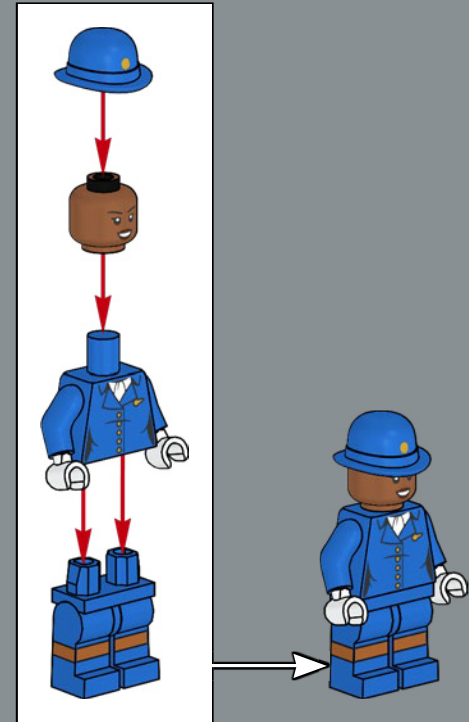
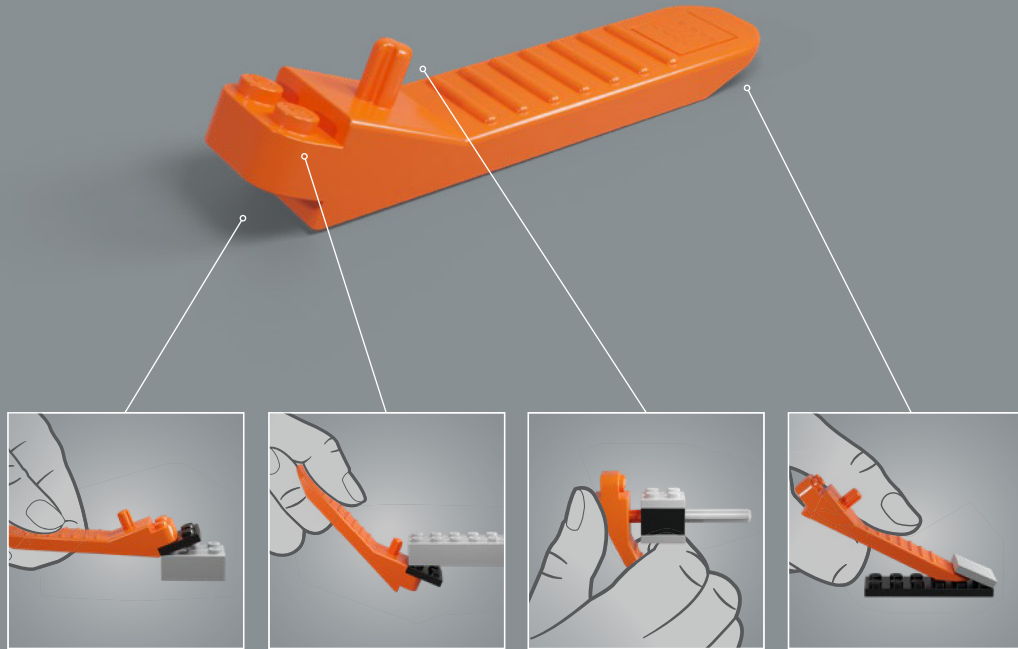

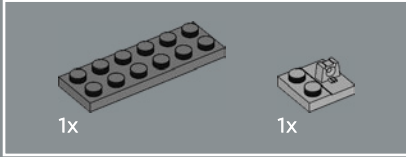
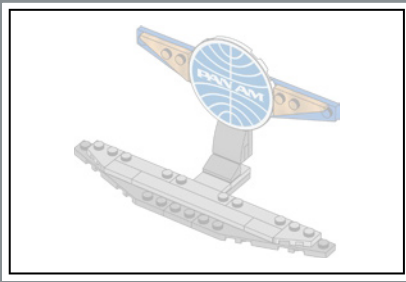

1

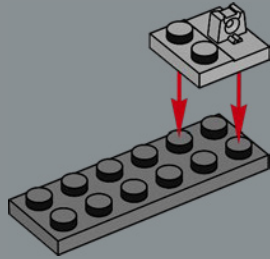

En los años 70, se incorporó al uniforme un bombín, un sombrero conocido en la compañía por su nombre británico, *bowler hat*, si bien a veces se usaba el término estadounidense *derby hat*.

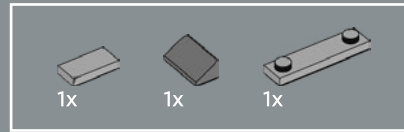

2

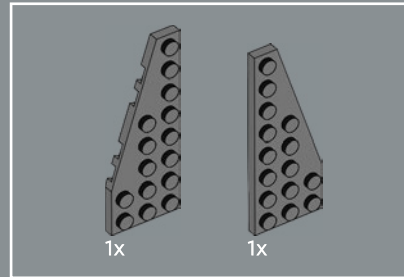
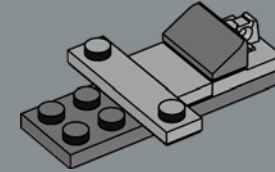

3

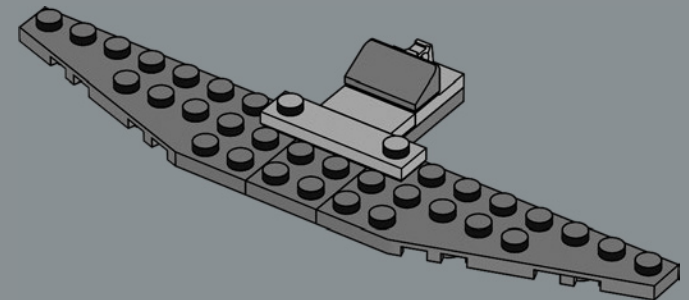

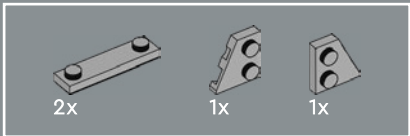

4

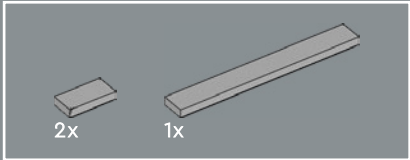
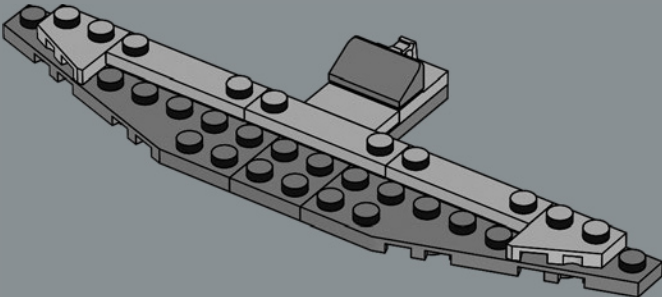

5

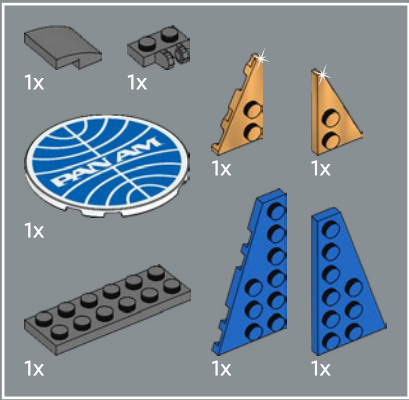
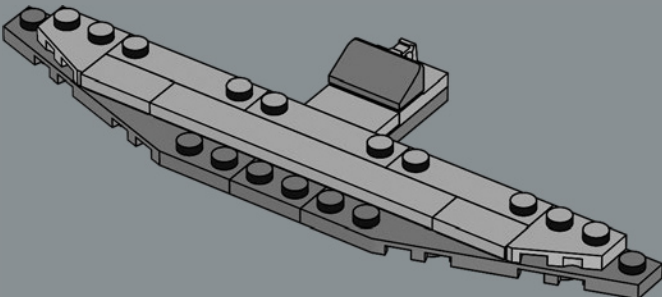

6

1

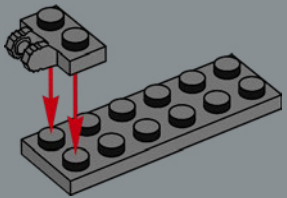

2

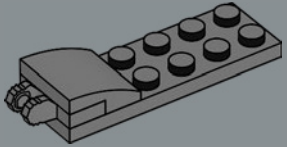

3



4



5

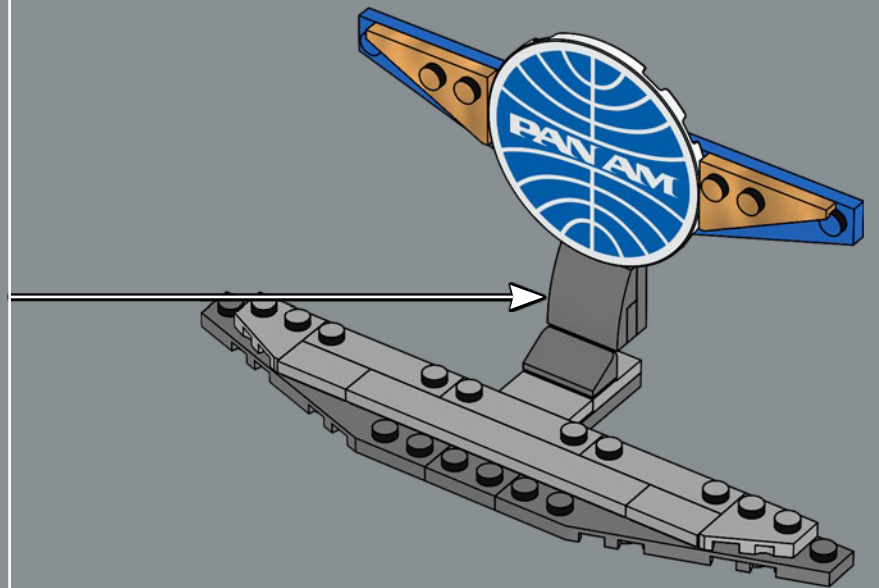

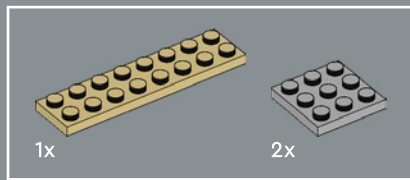

11

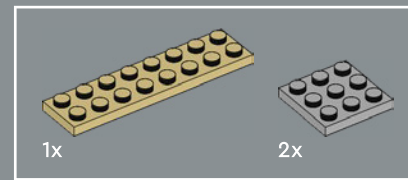
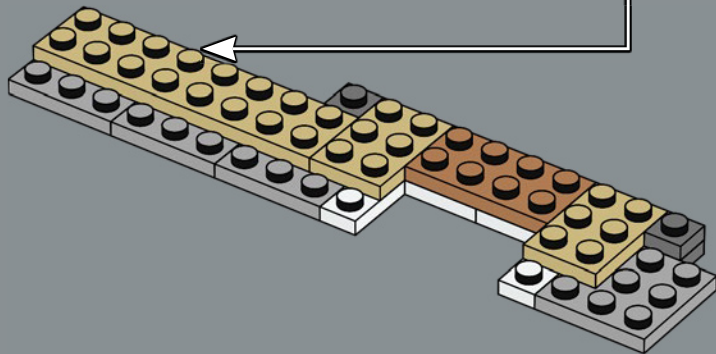
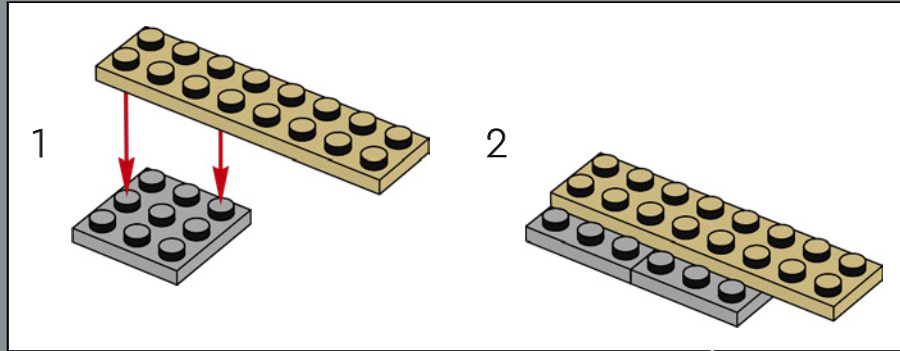

12

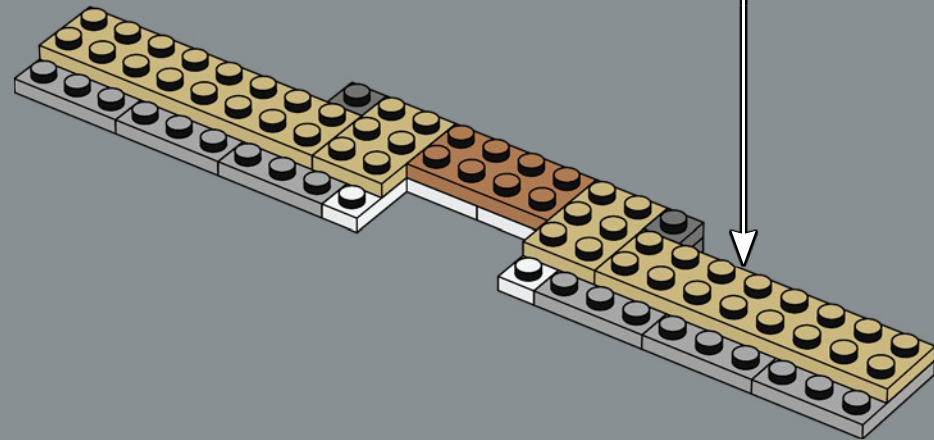
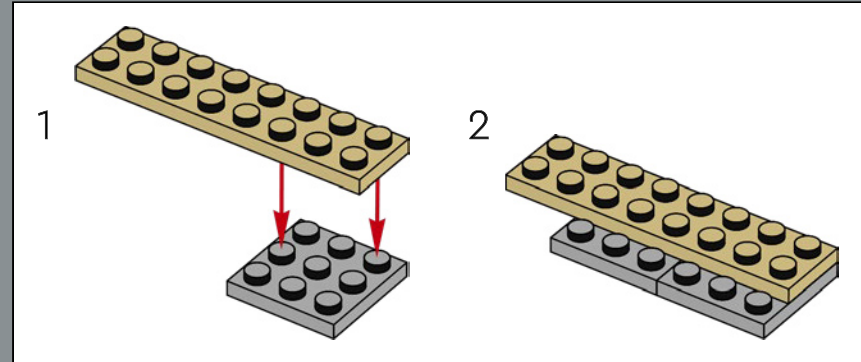

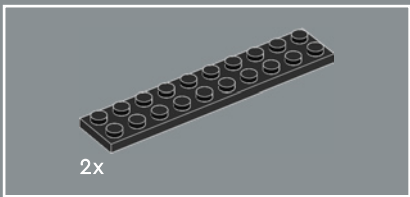

13

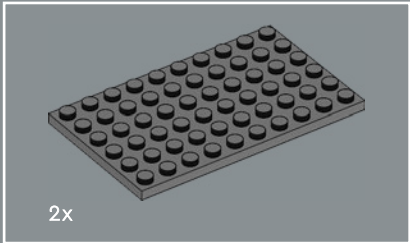
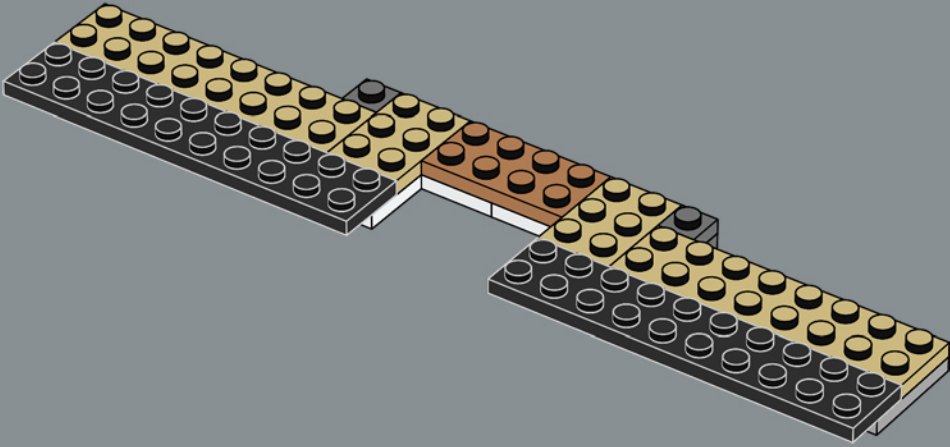

14

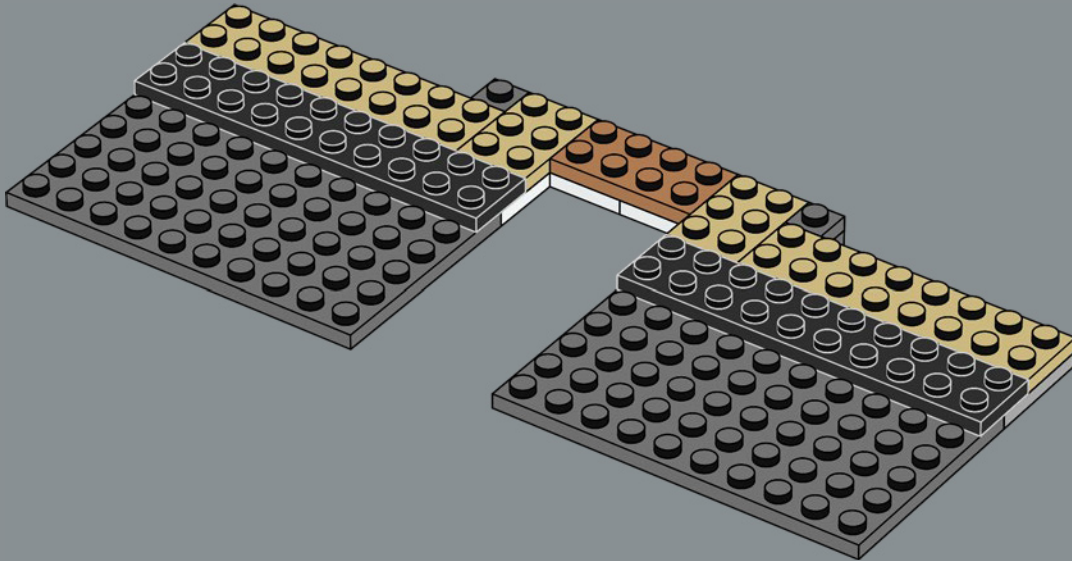

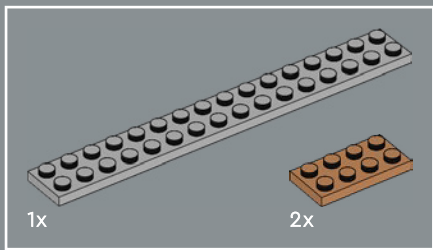

15

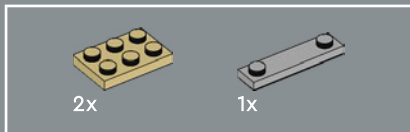
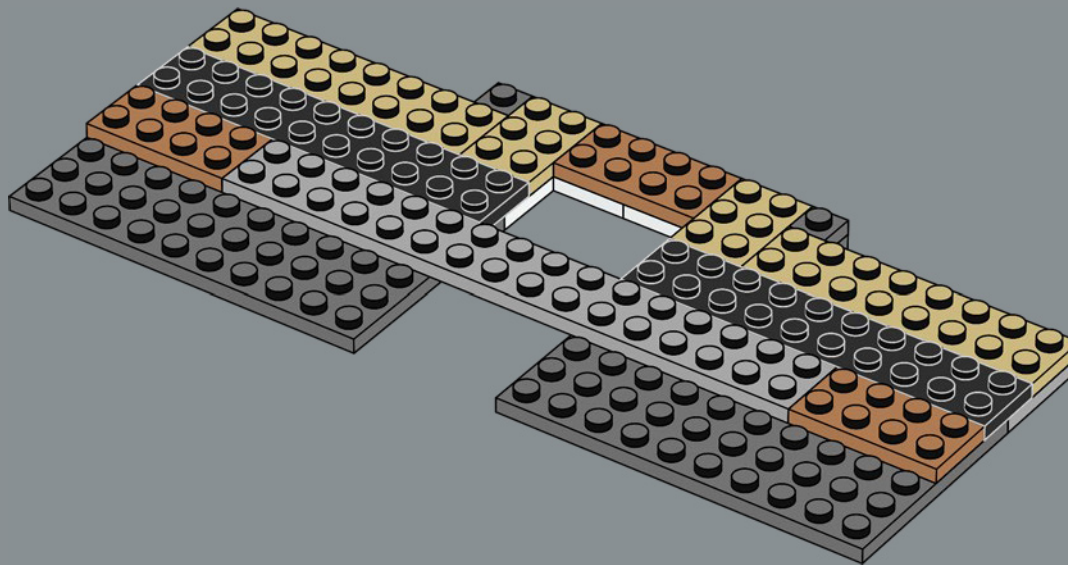

16

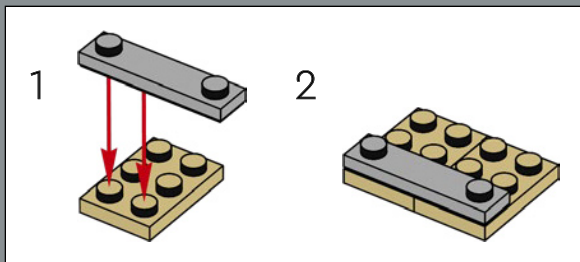
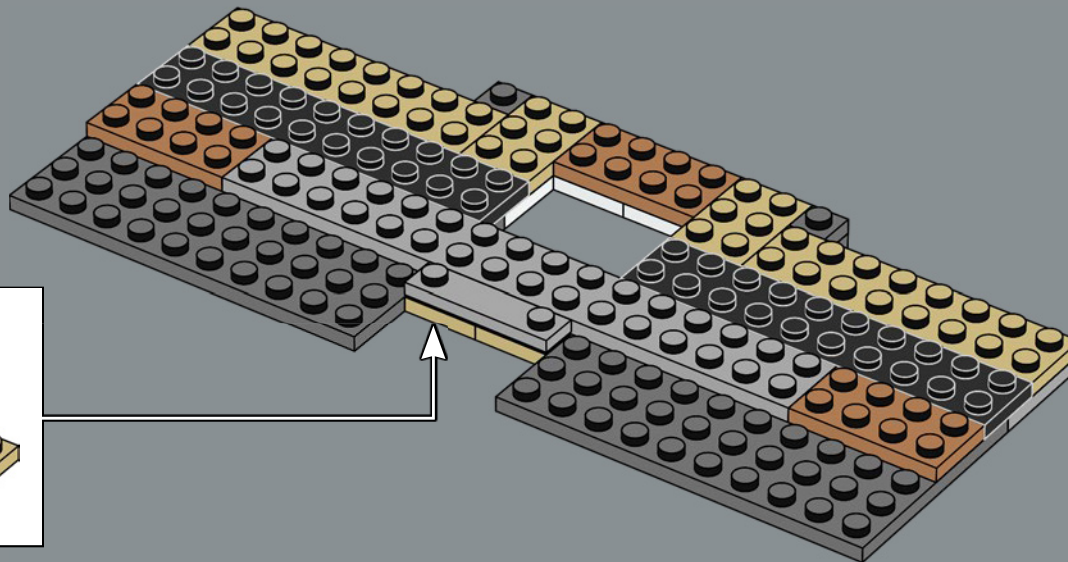

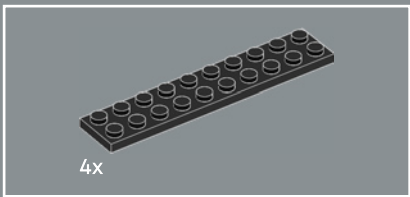

17

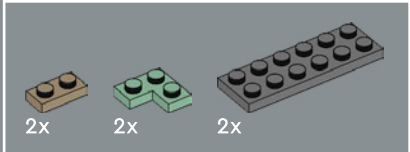
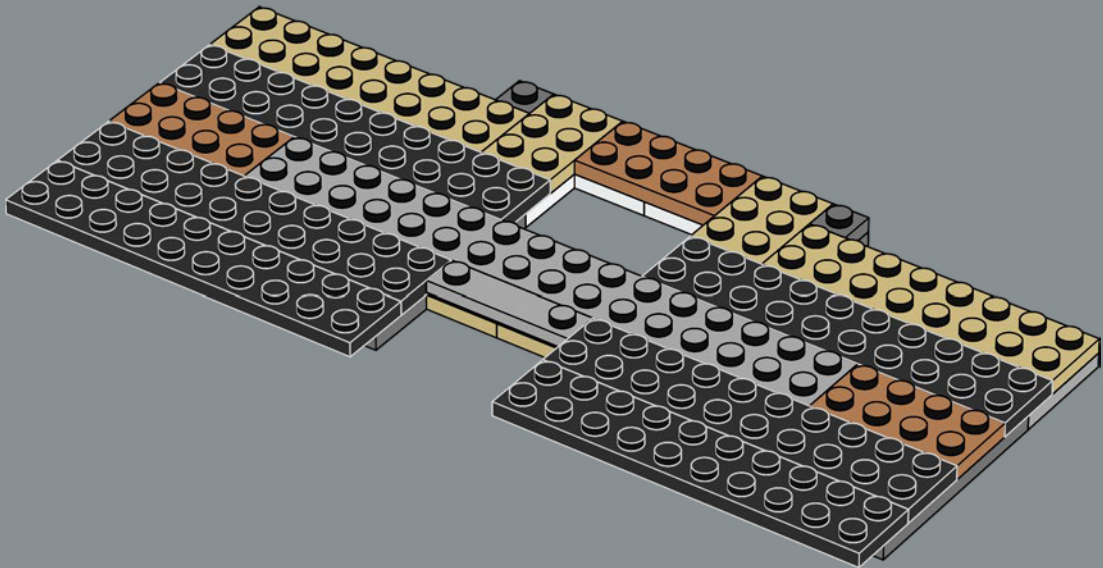

18

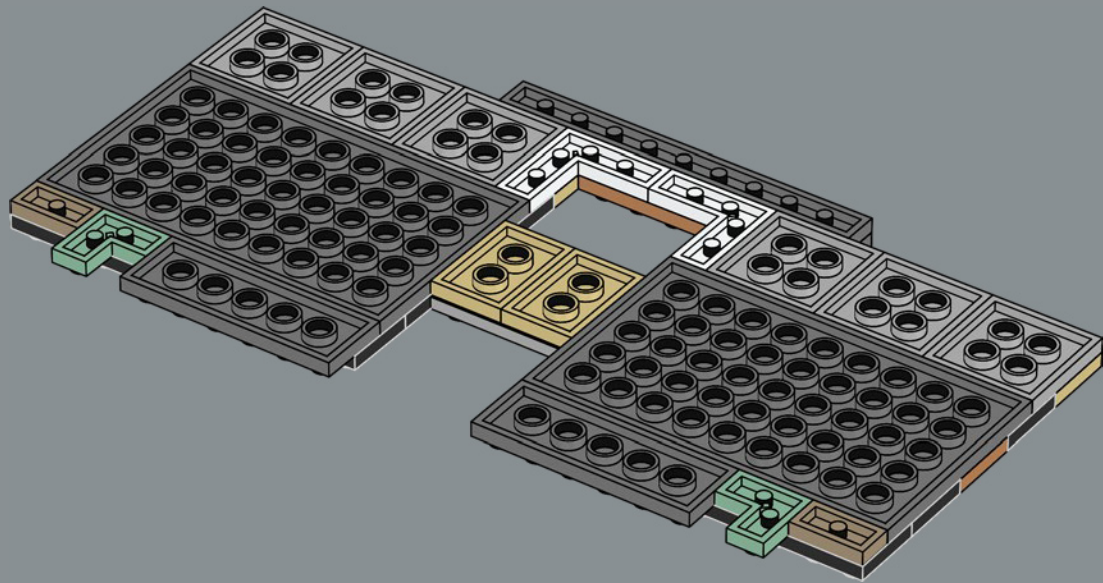

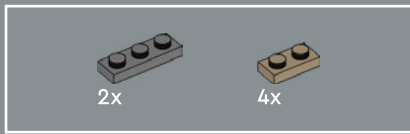

19

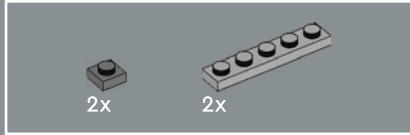
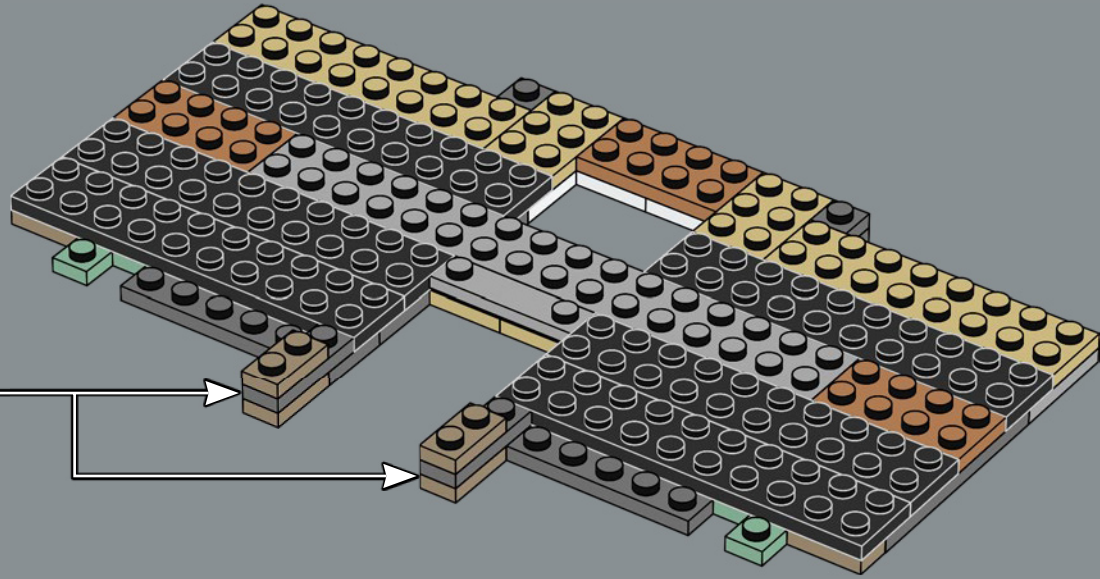
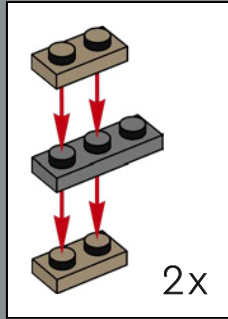

20



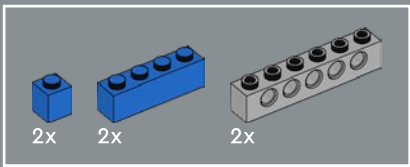

21

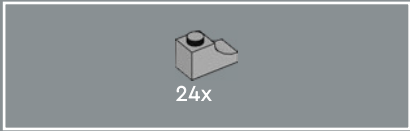
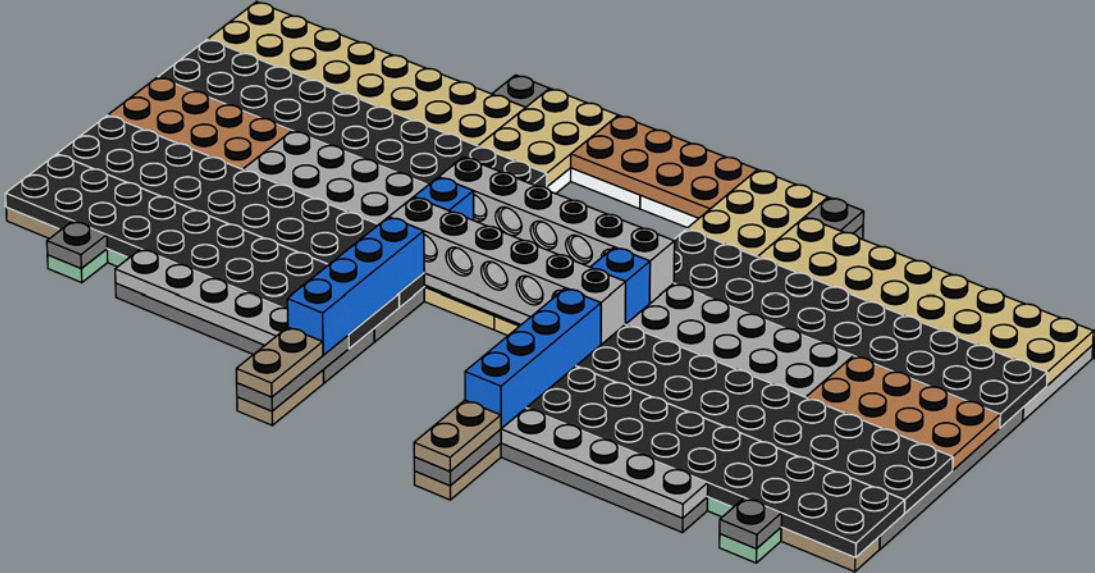

22

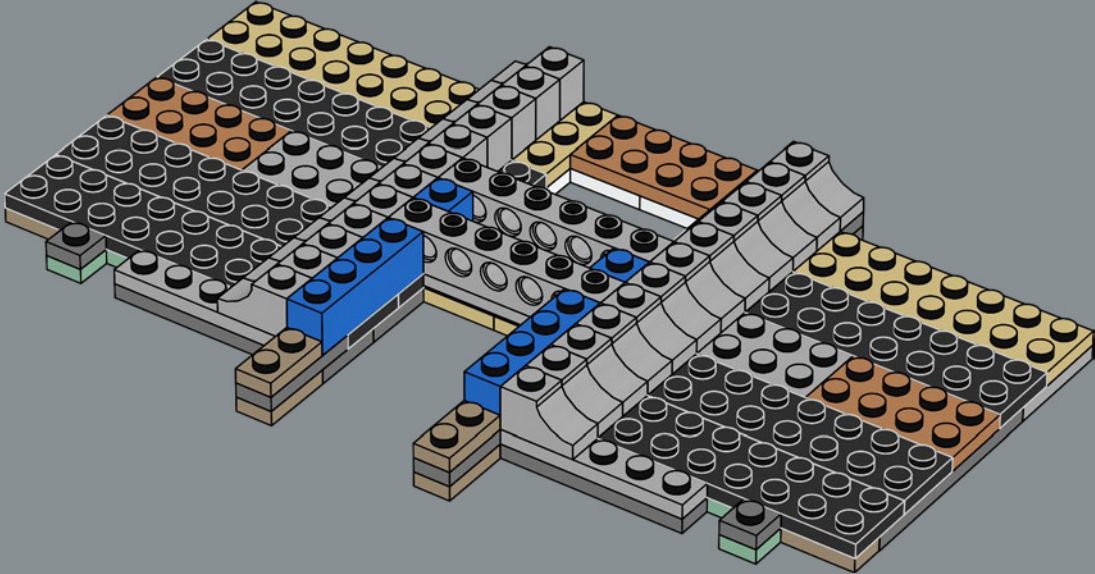

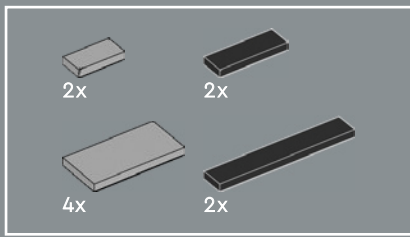

23

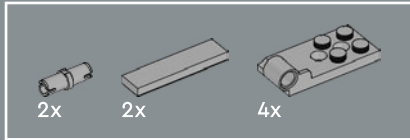
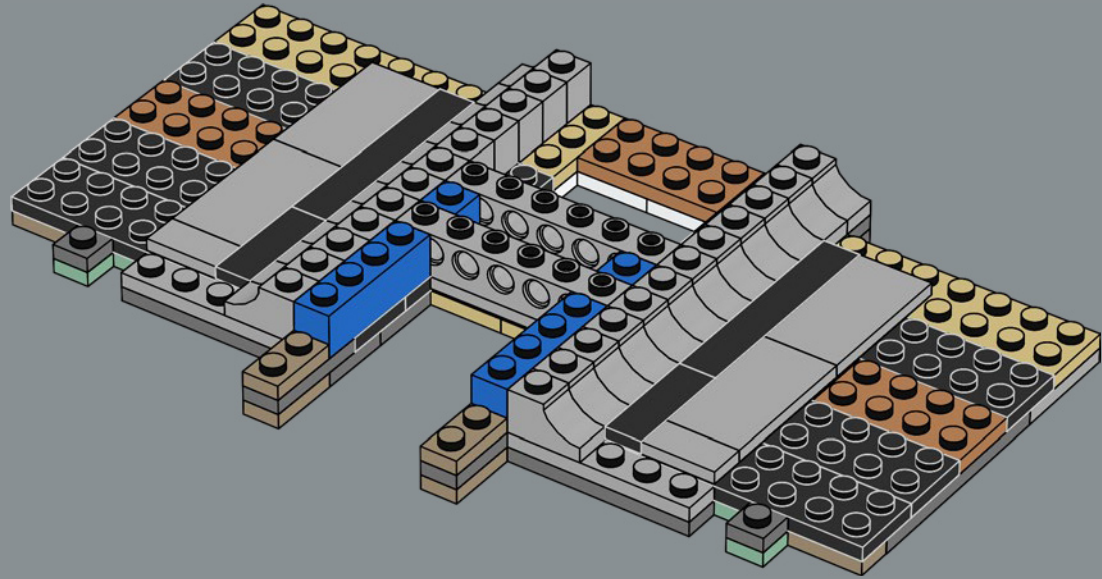

24

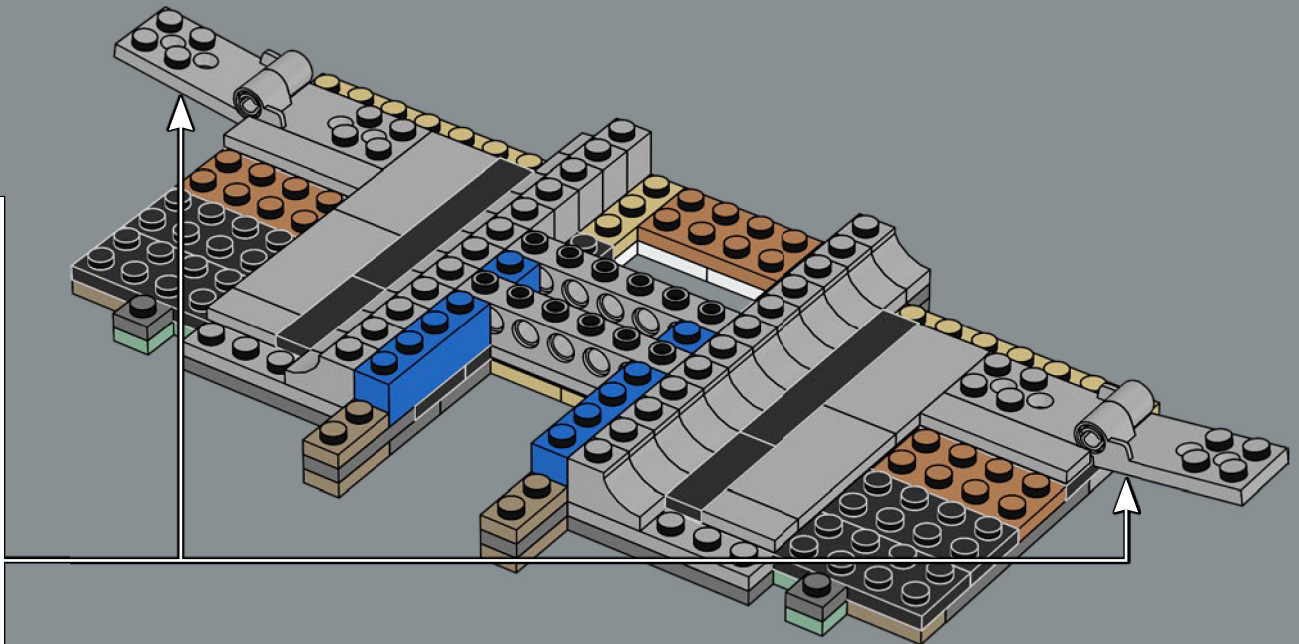
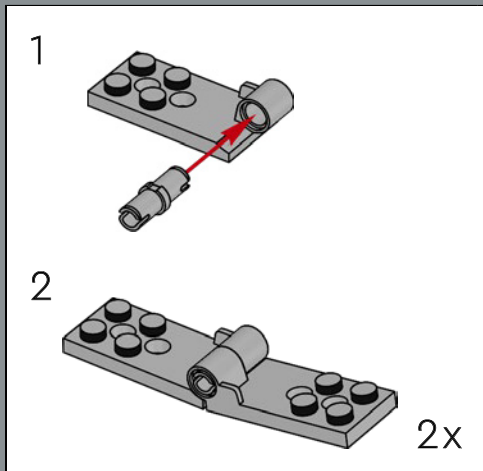

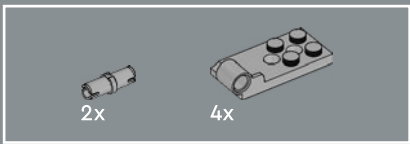

25

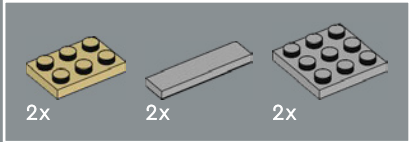
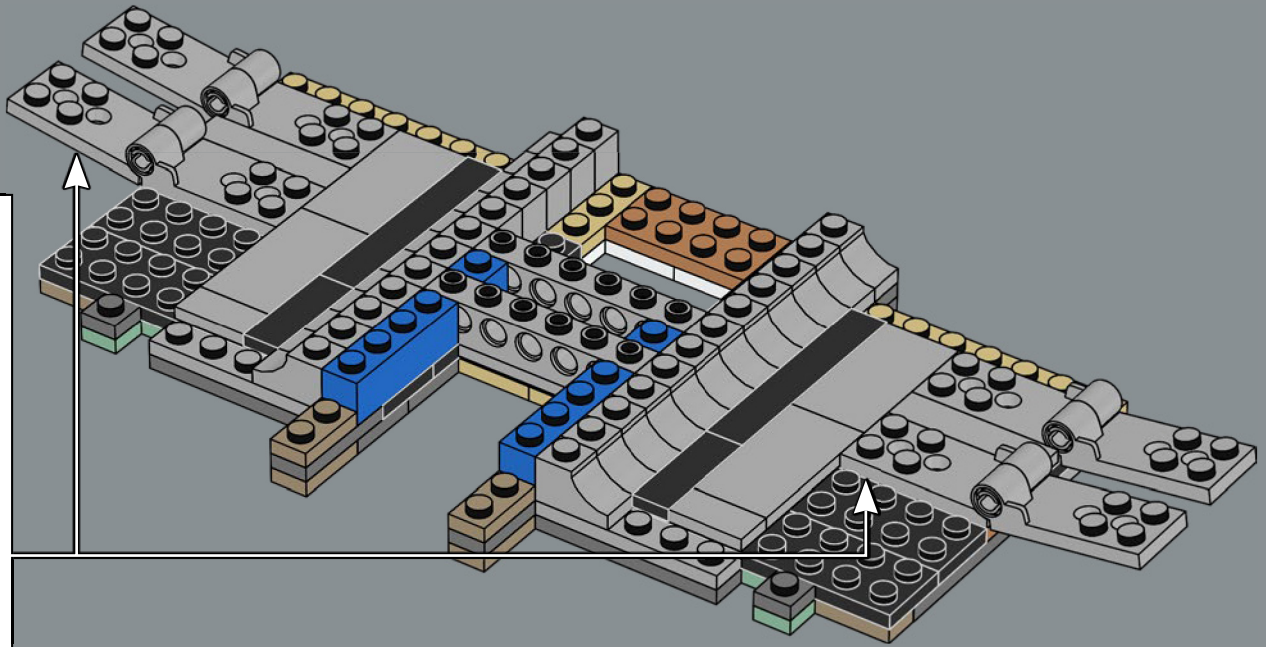
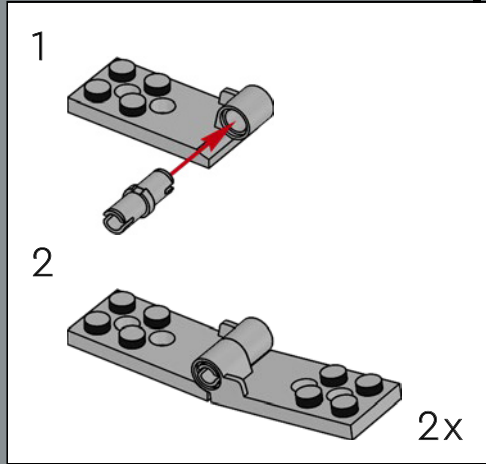

26

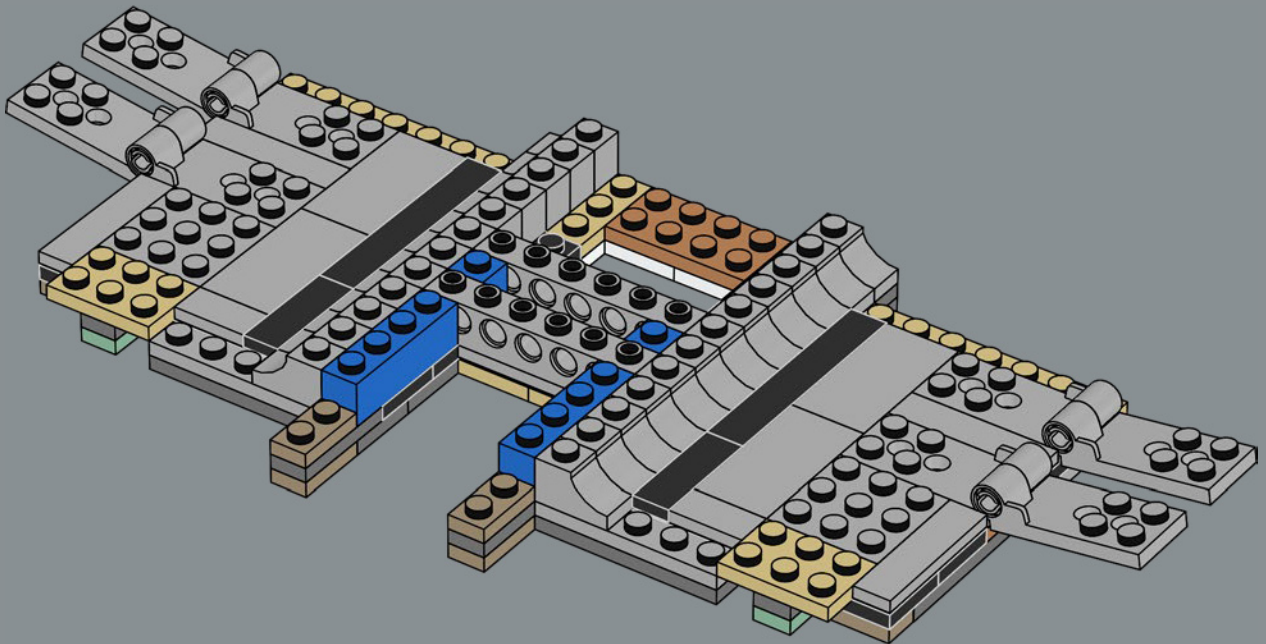

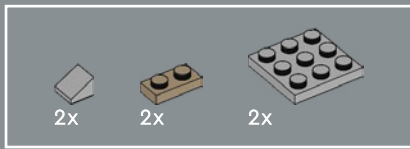

27

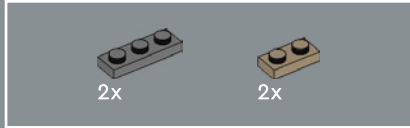
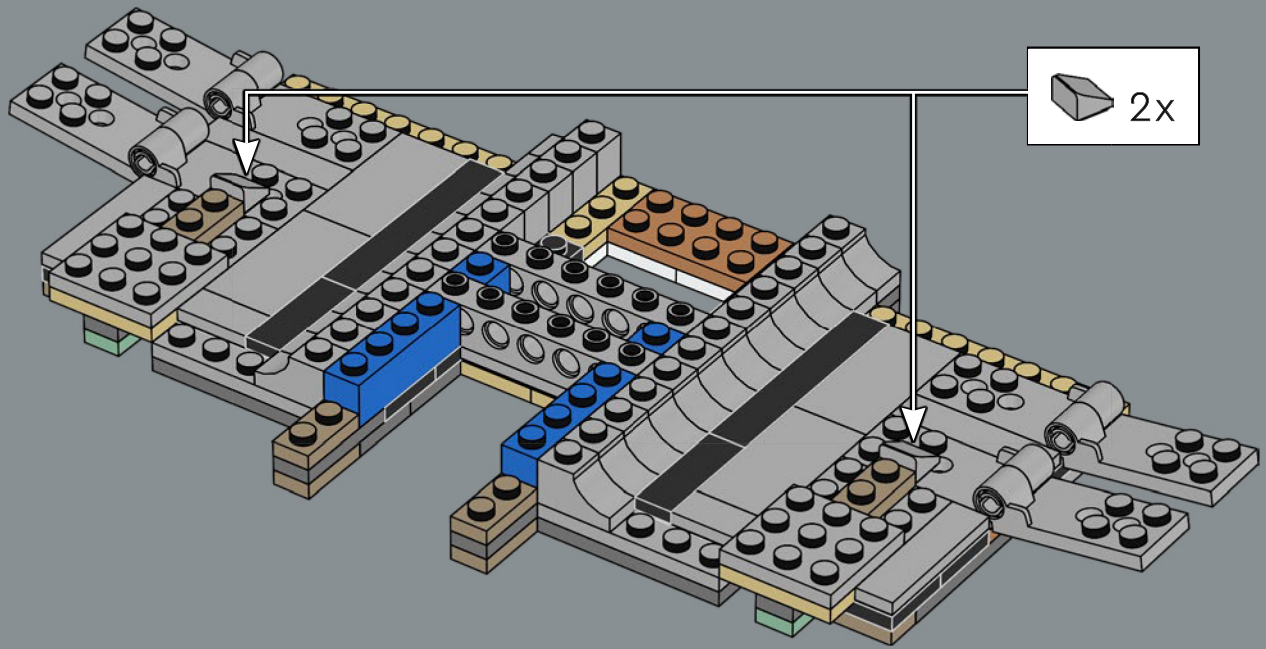

28

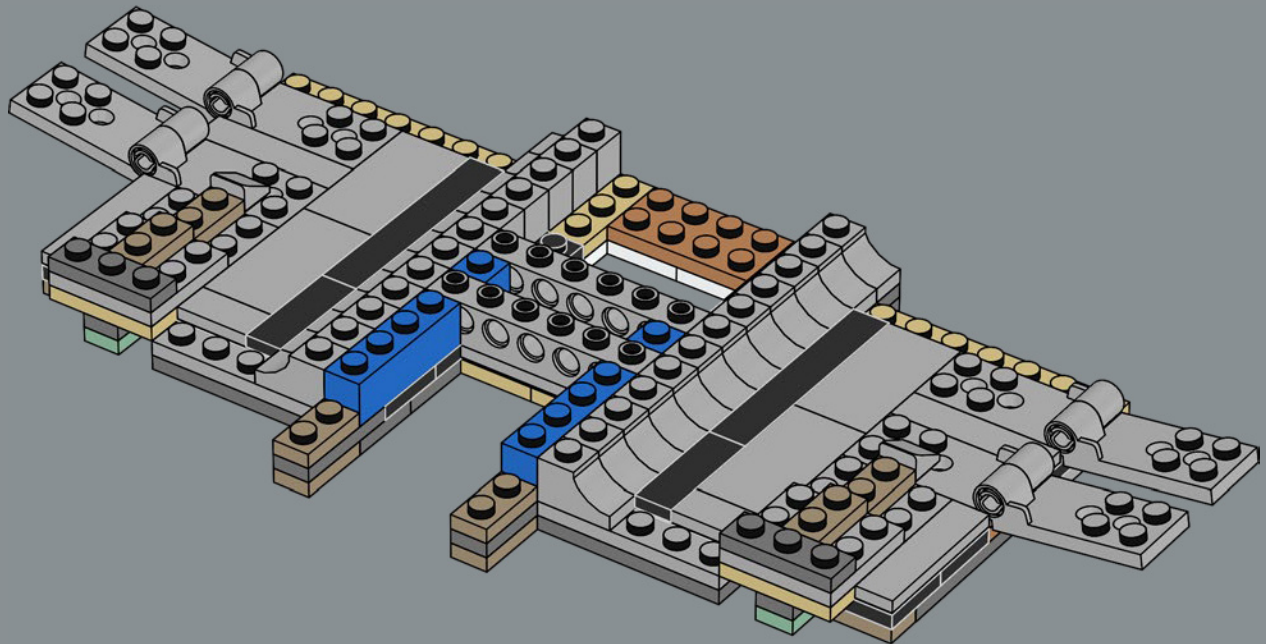

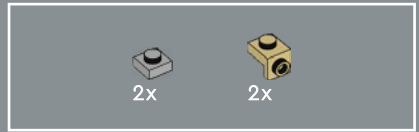

29

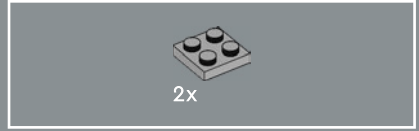
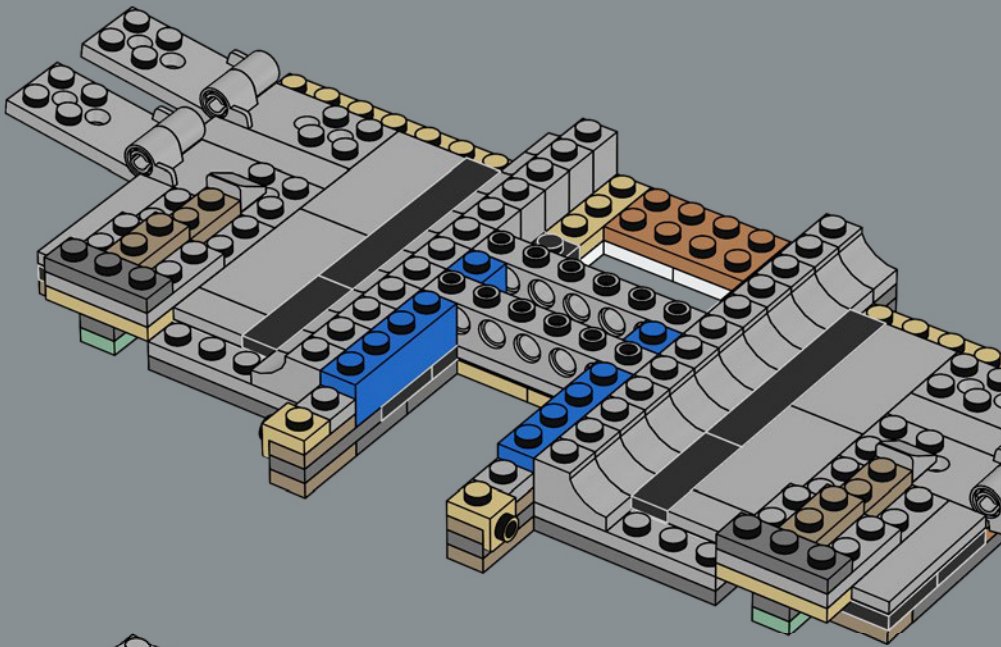

30

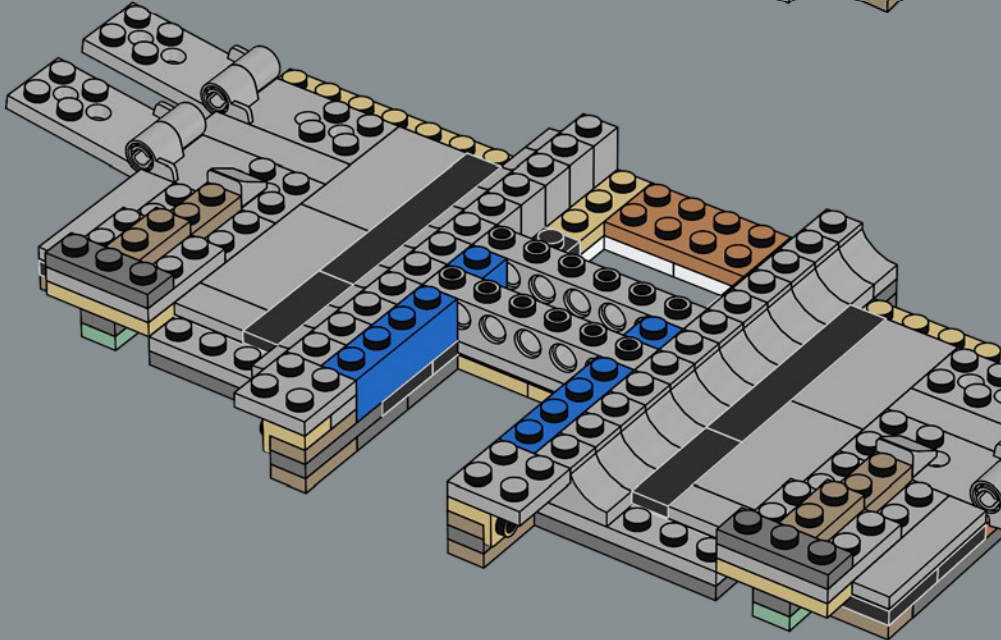

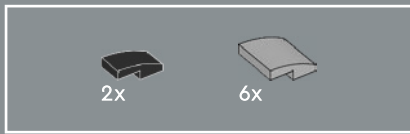

31

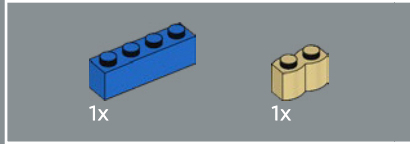
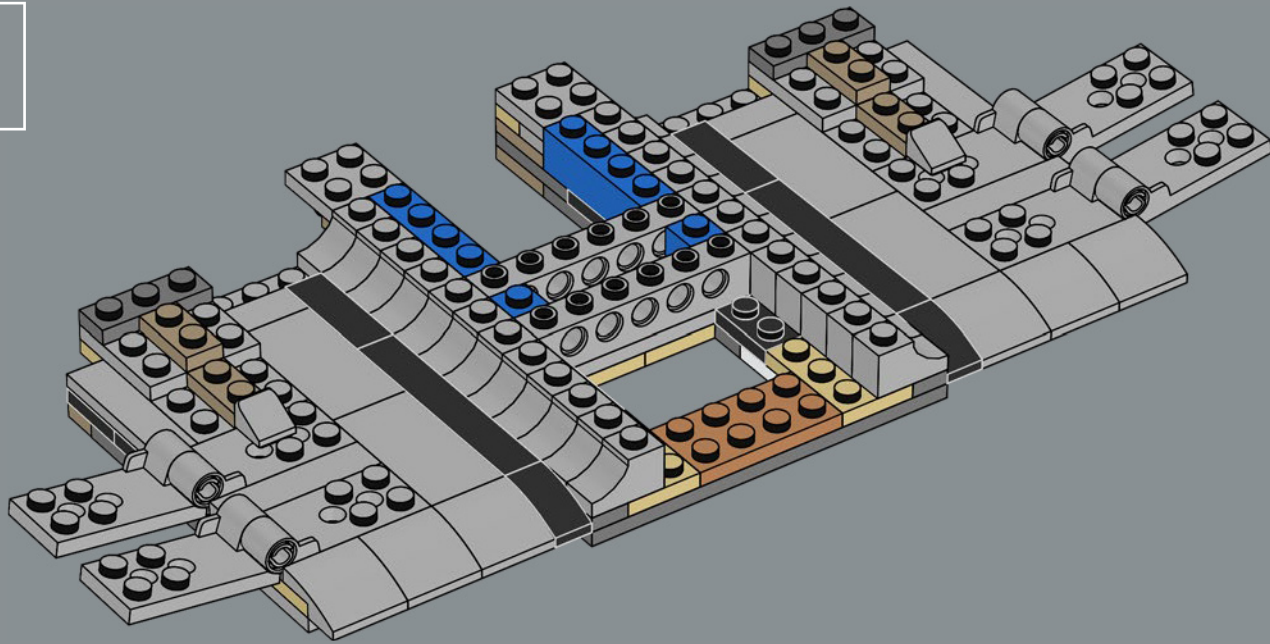

32

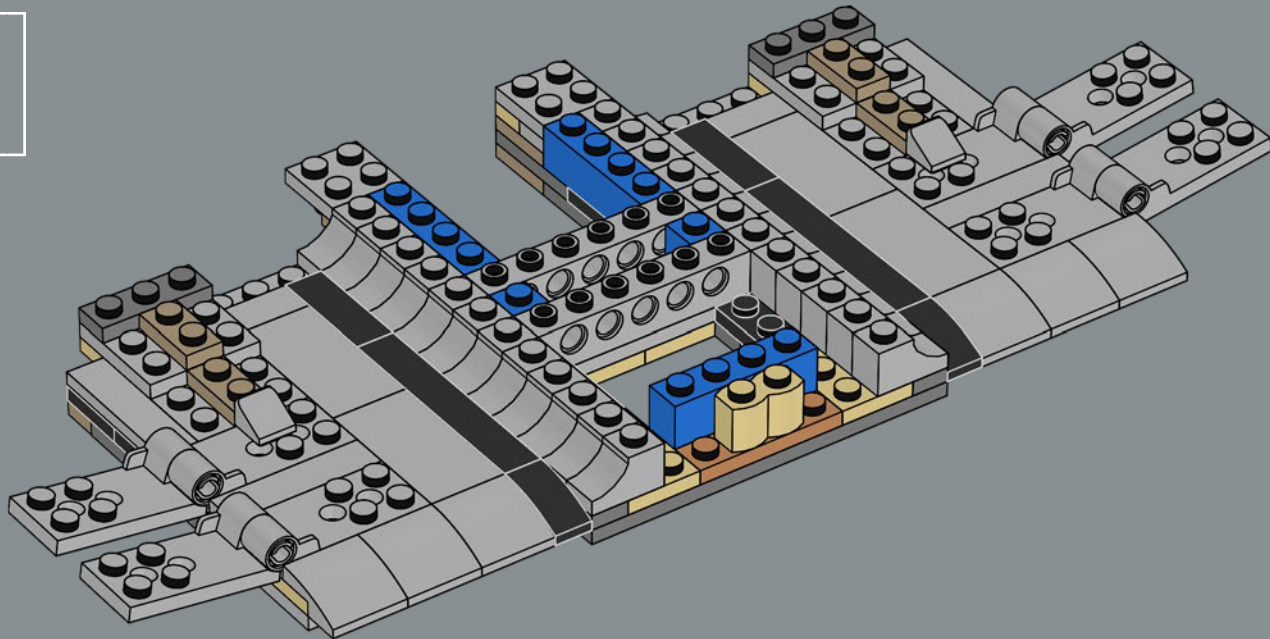

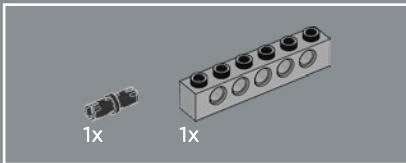
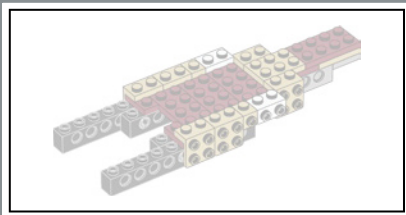

33

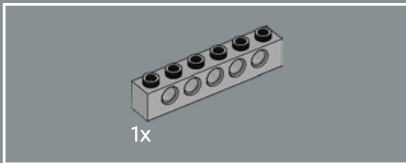
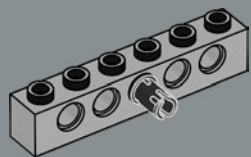

34

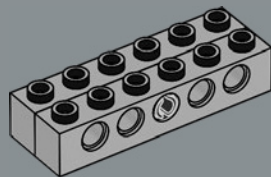

35

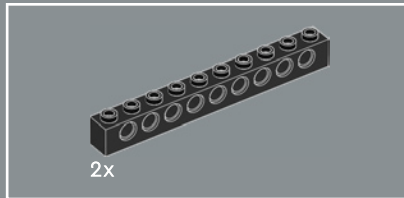
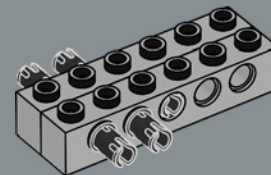

36

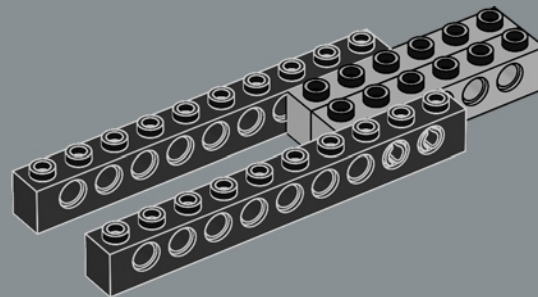

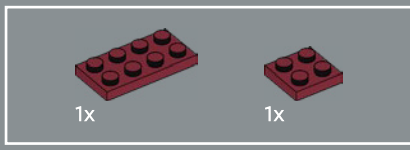

37

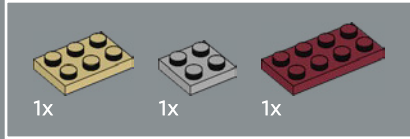
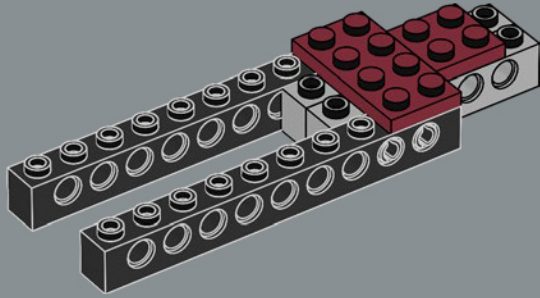

38

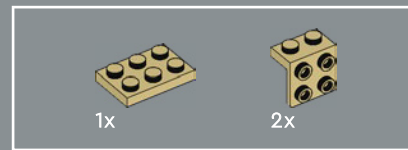
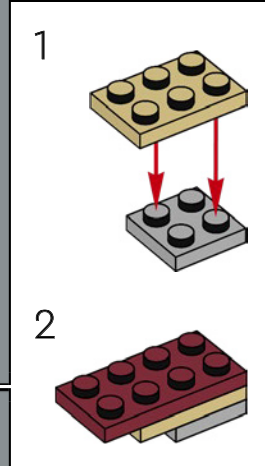
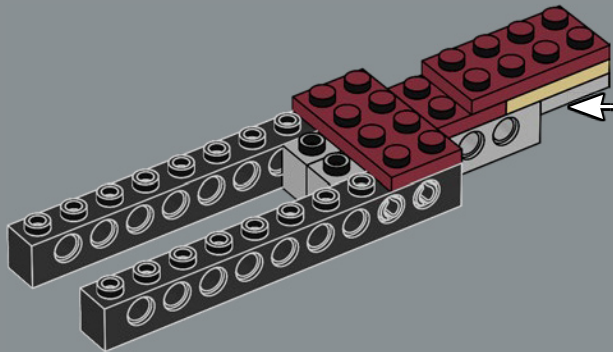

39

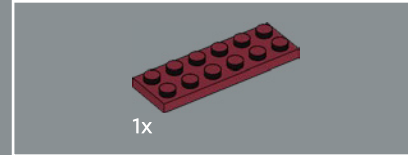
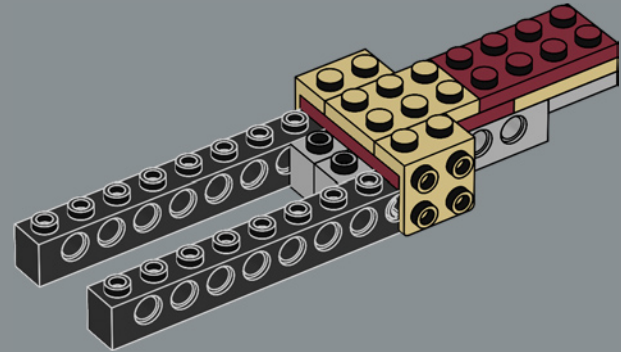

40

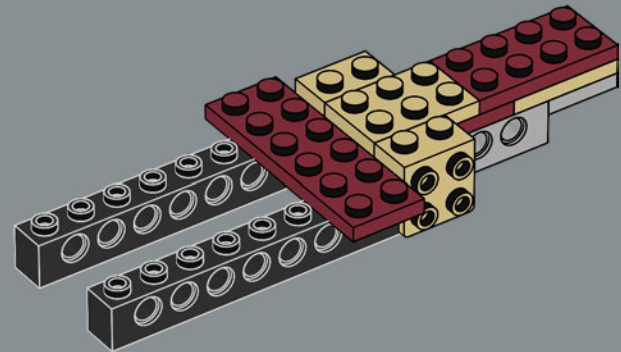

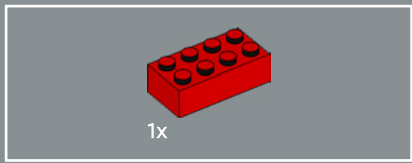

41

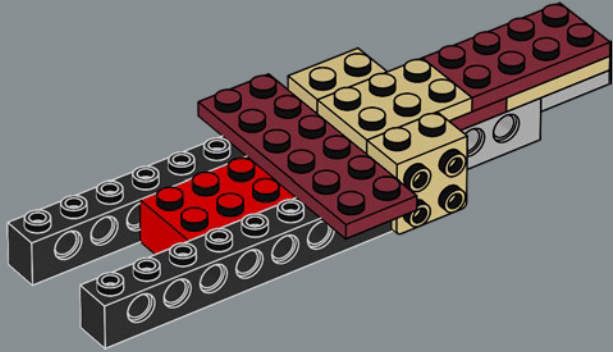

42

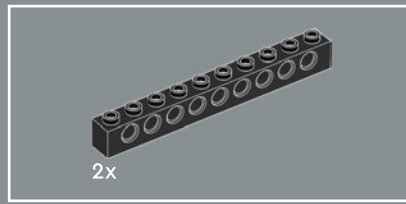
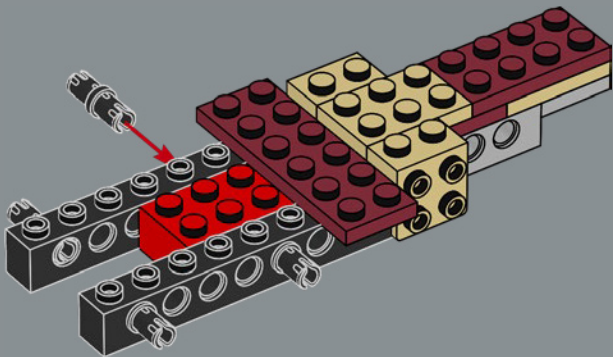

43

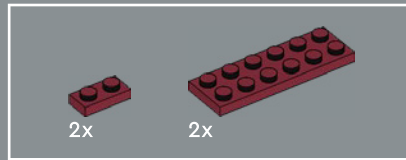
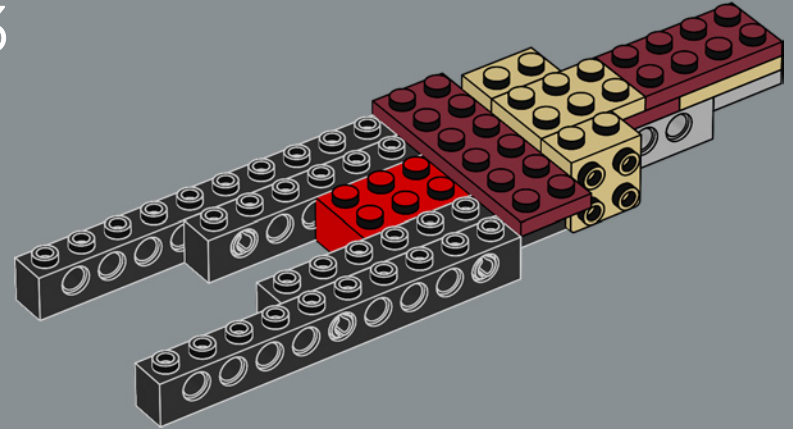

44

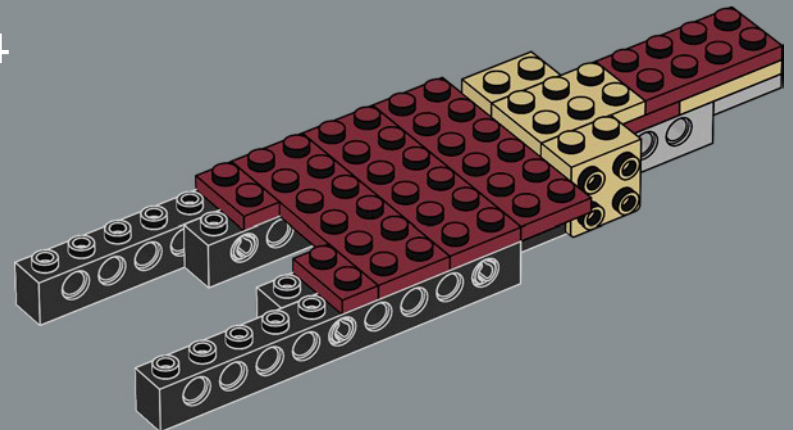

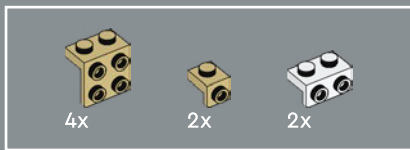

45

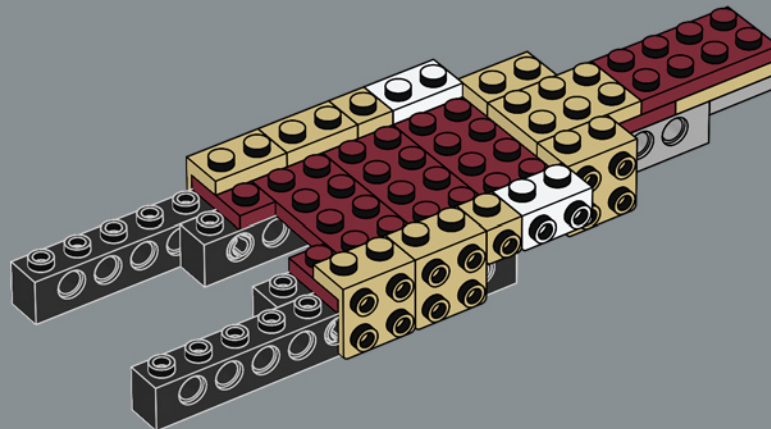

46

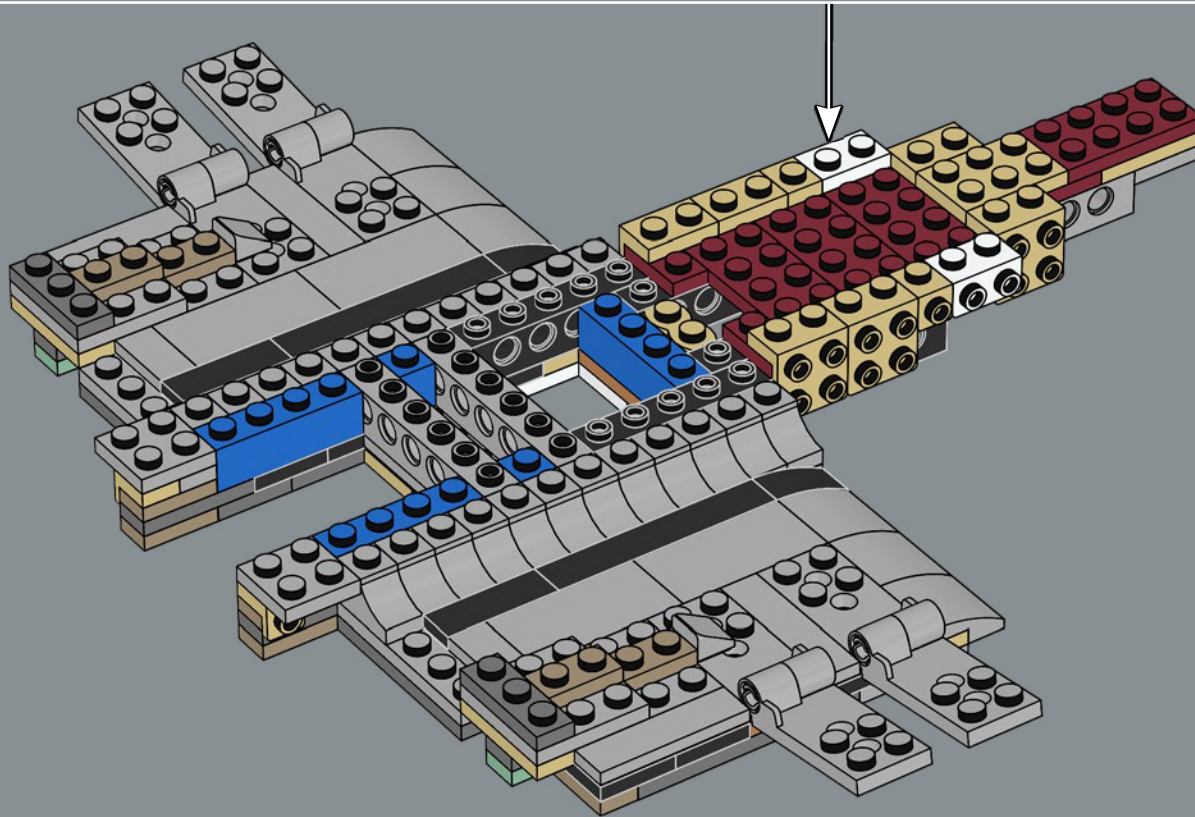

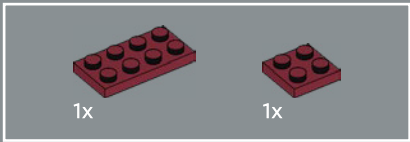

47

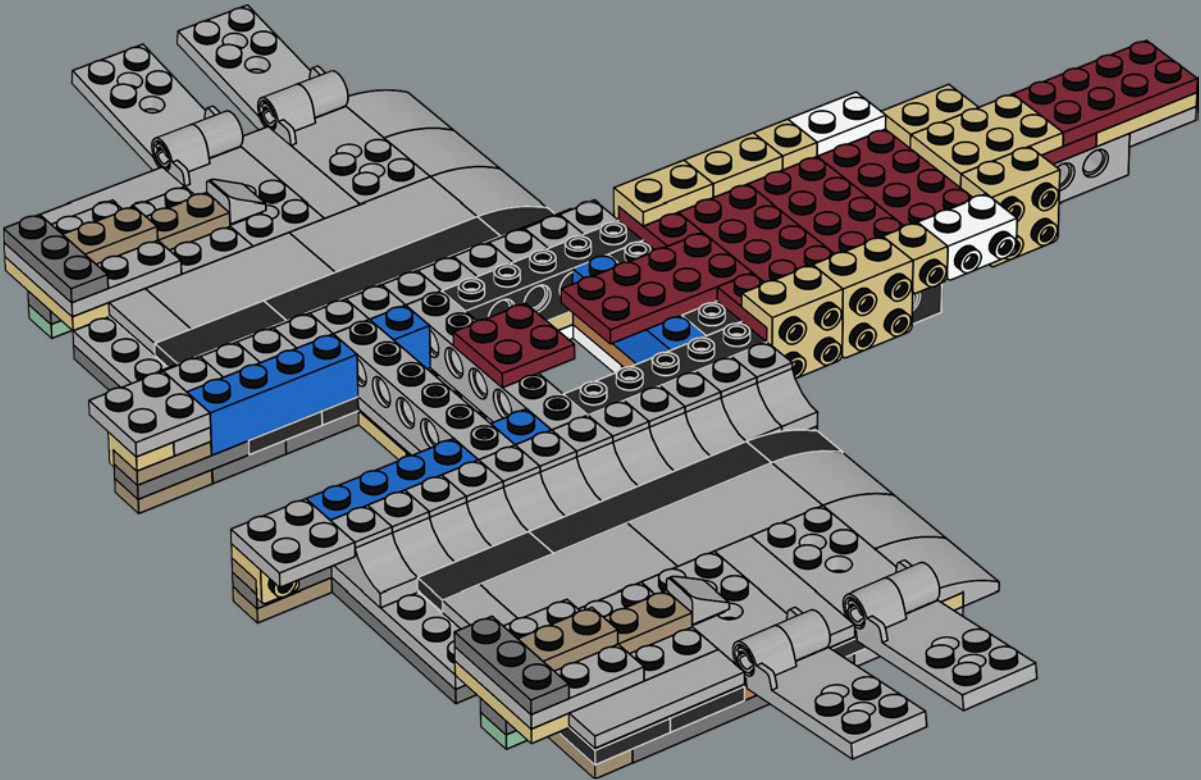

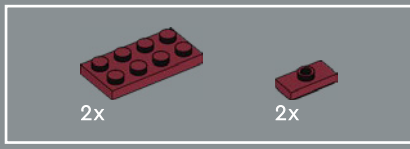

48

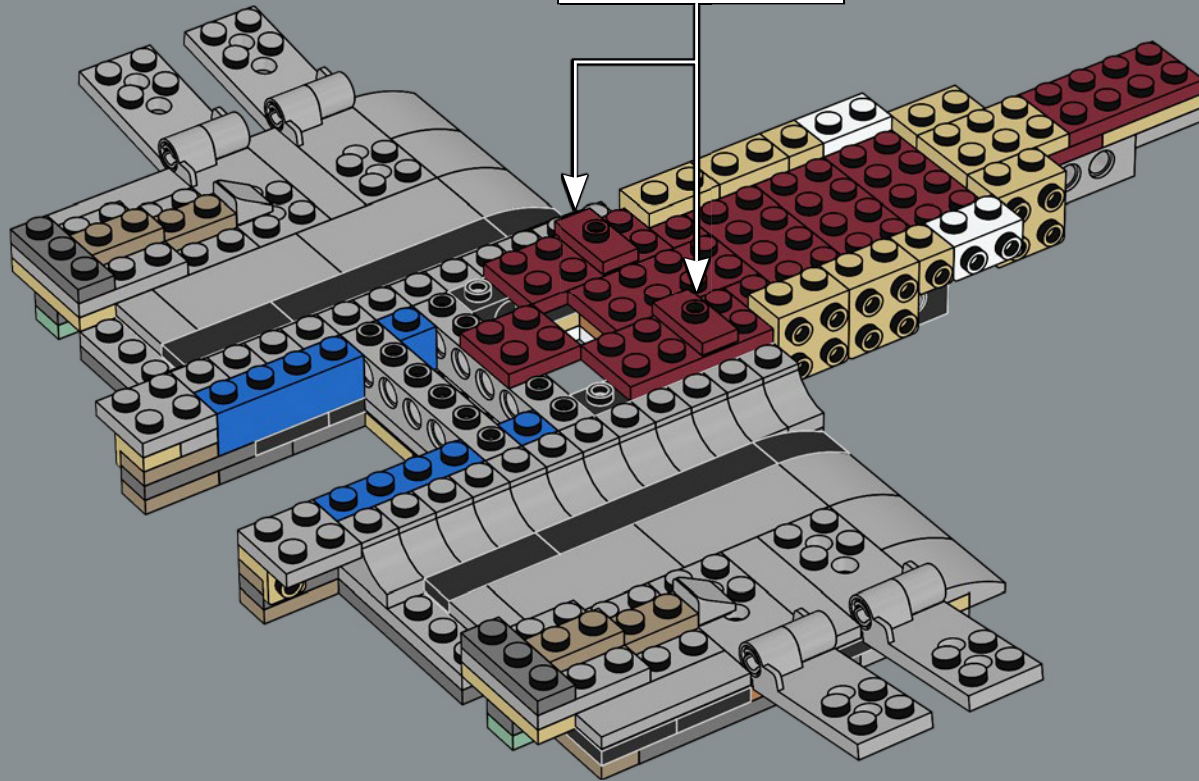
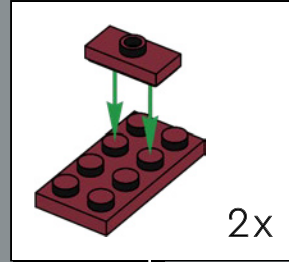

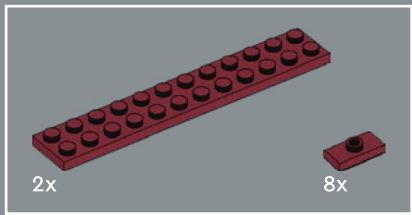

49

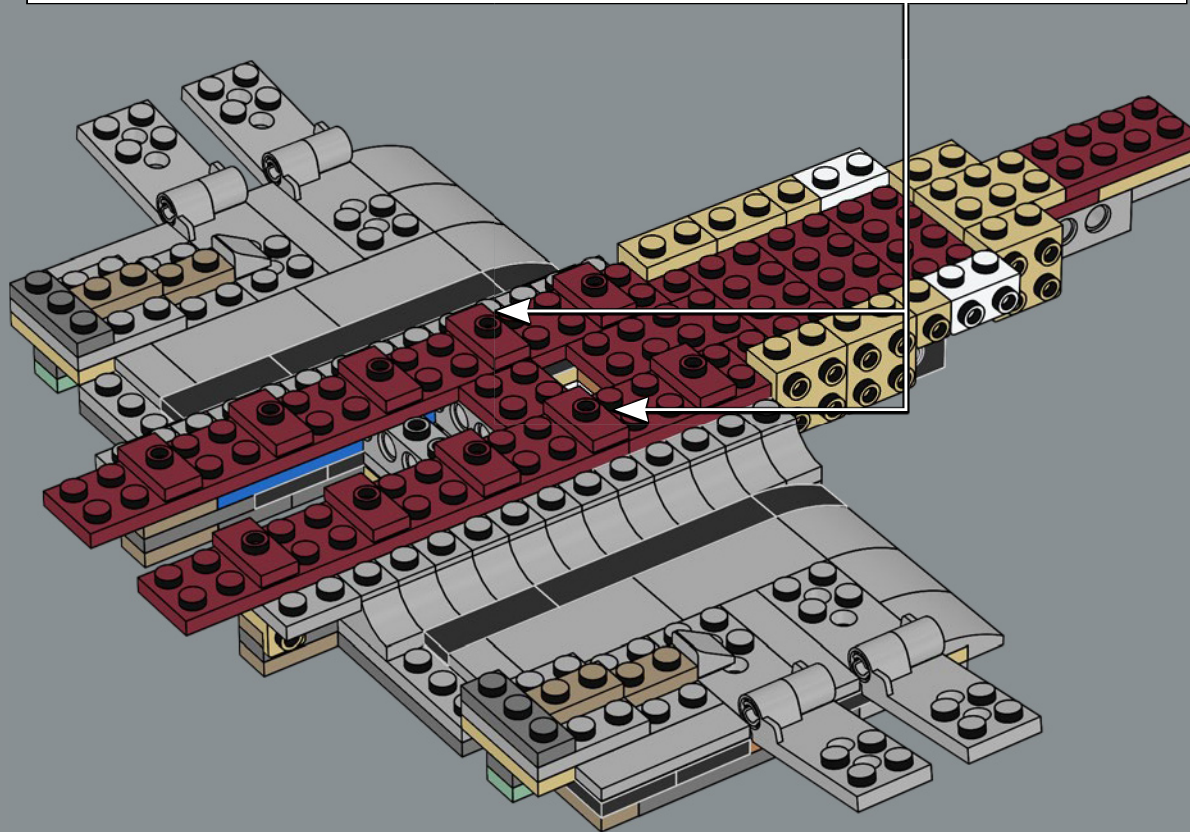
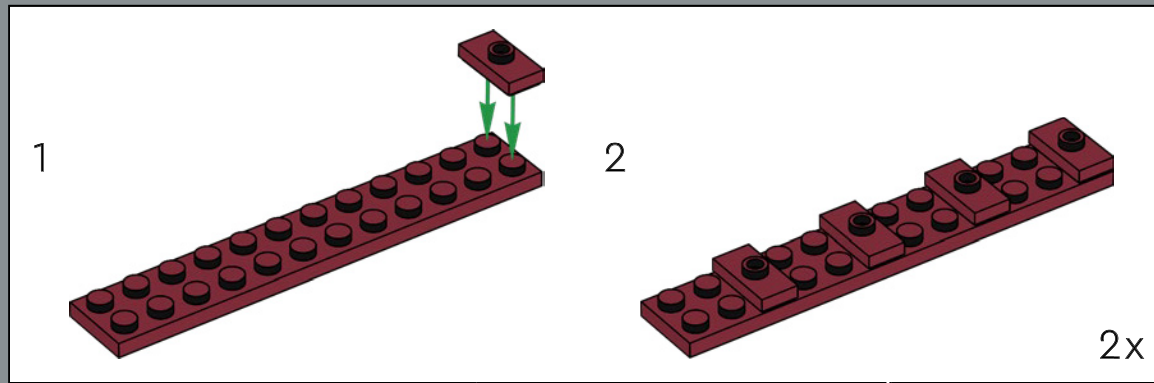

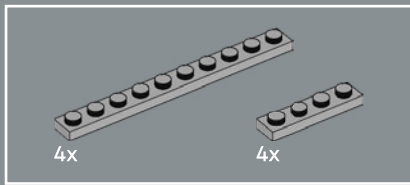

50

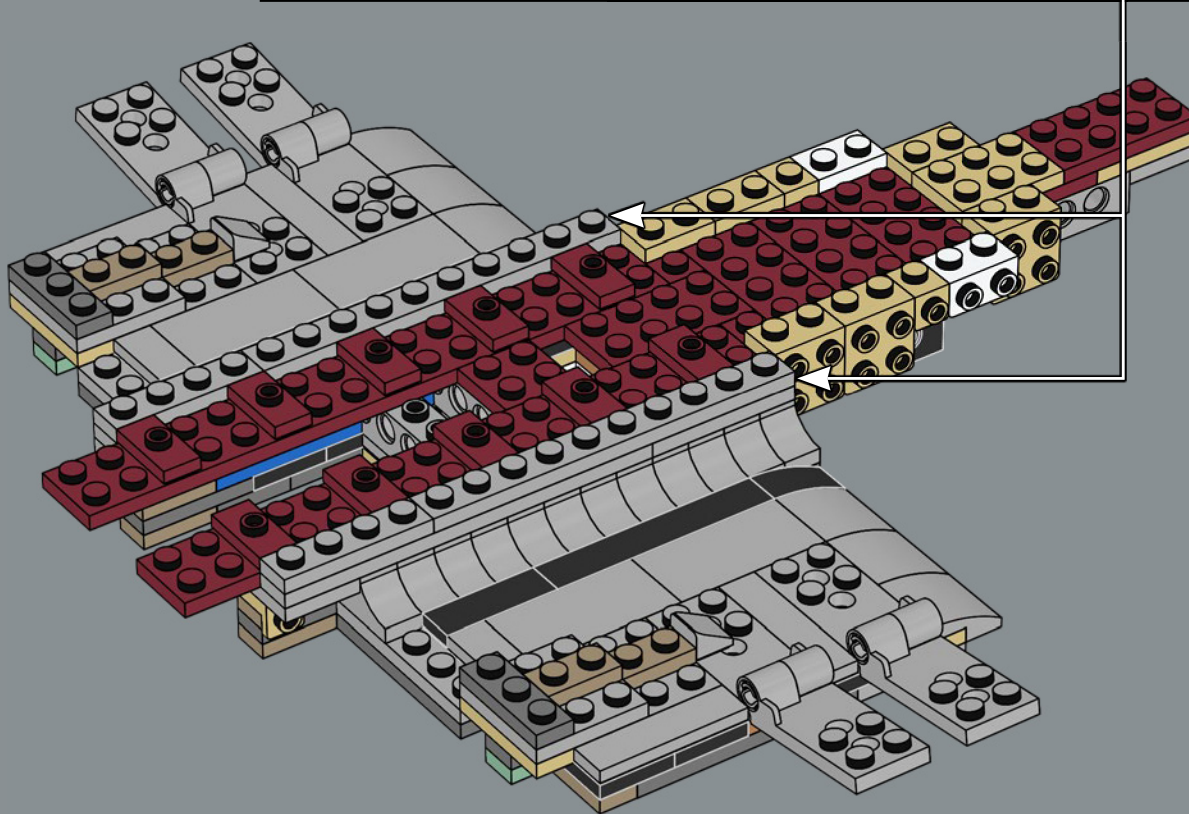
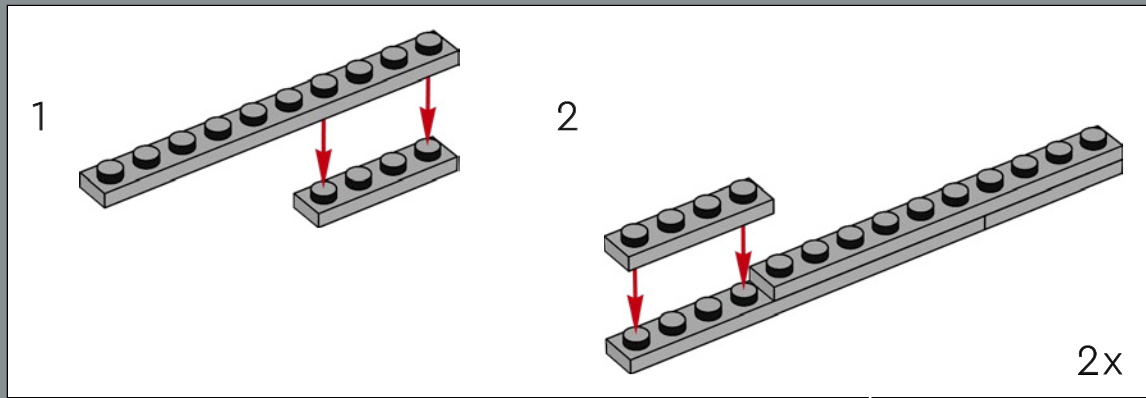



2x

51

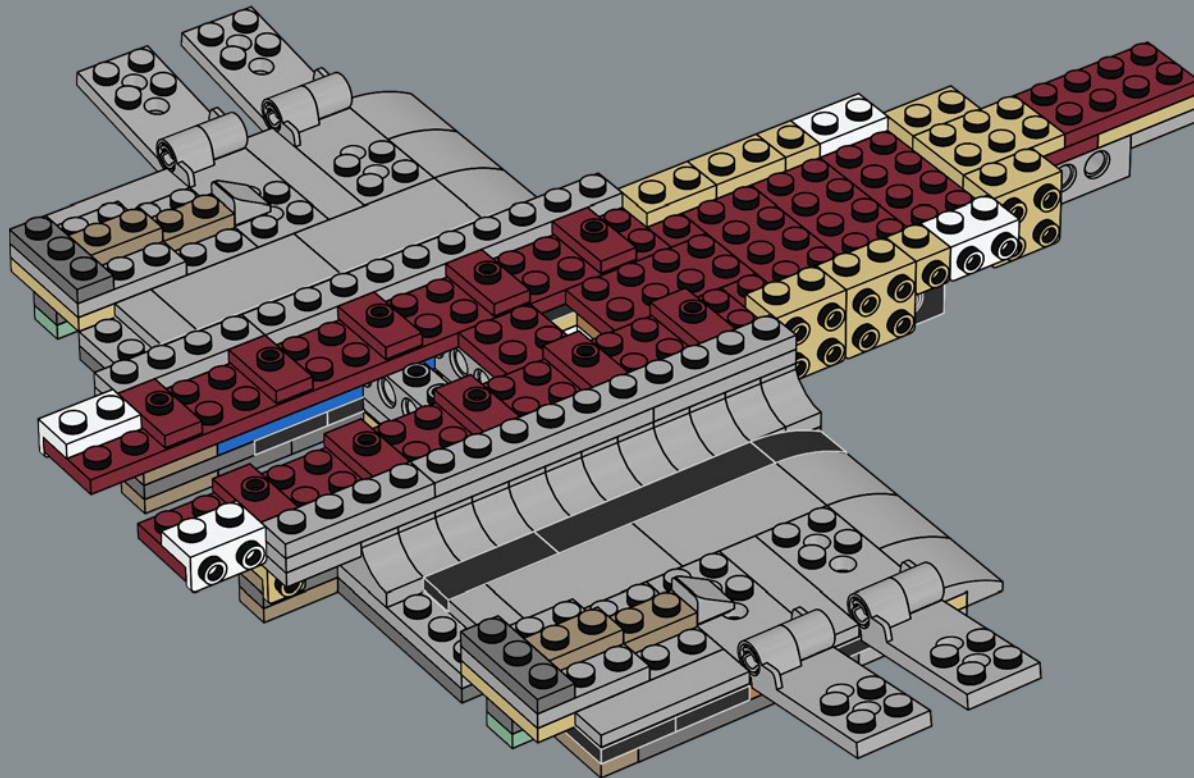

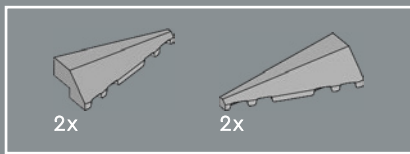

52

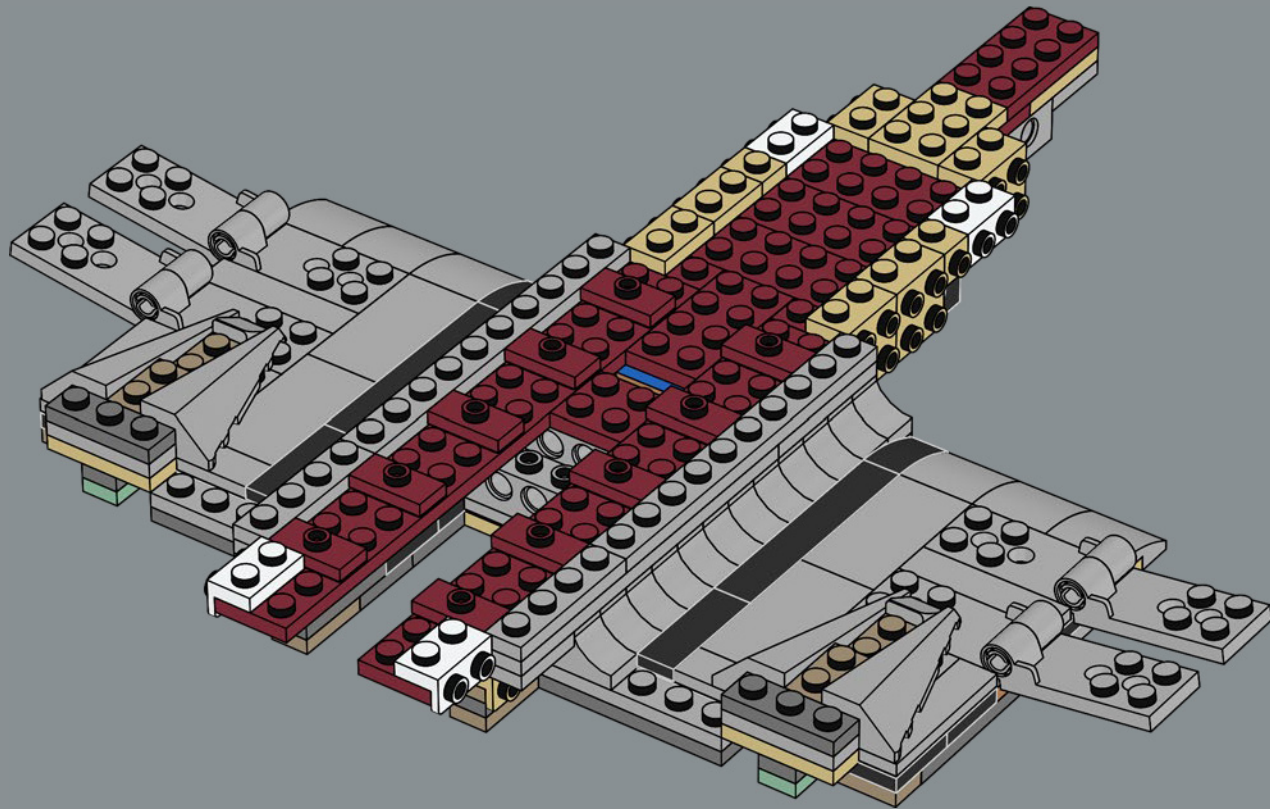

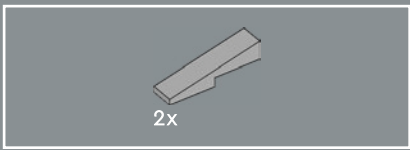

53

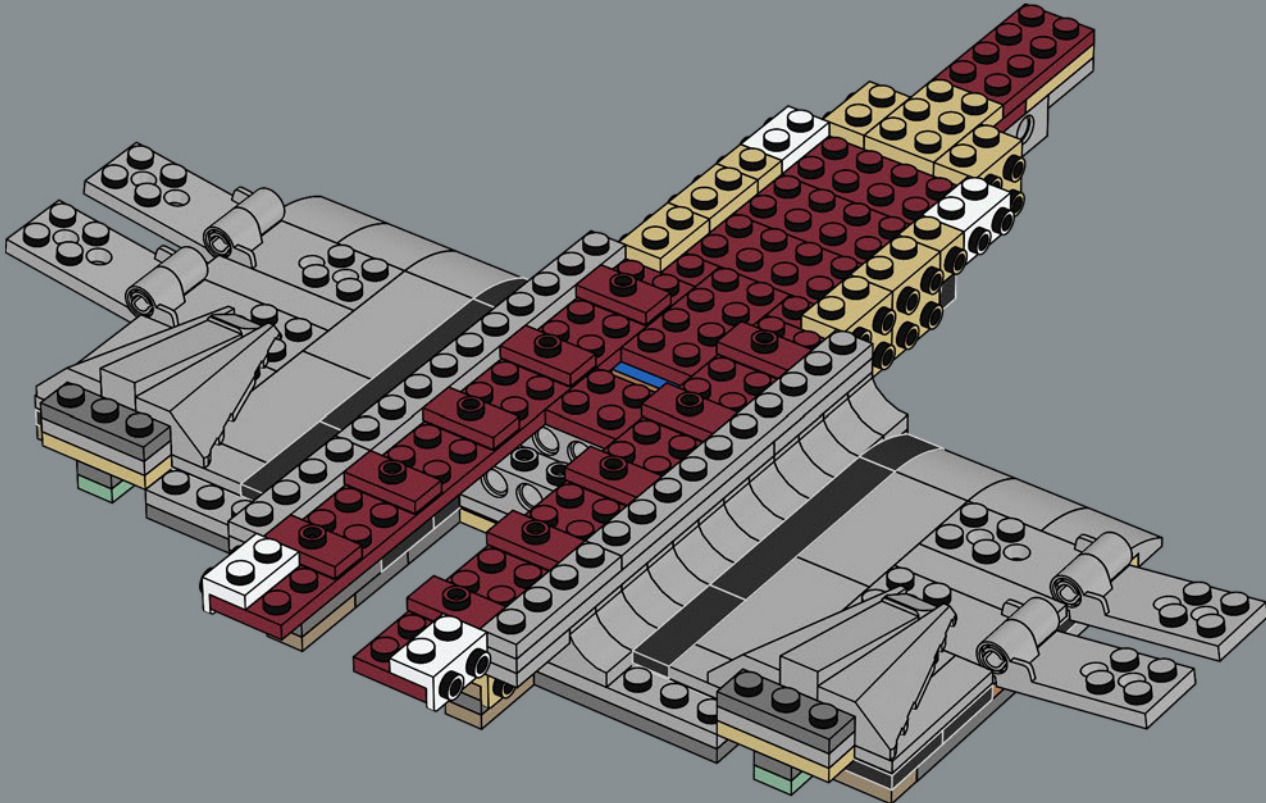

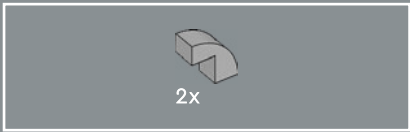

54

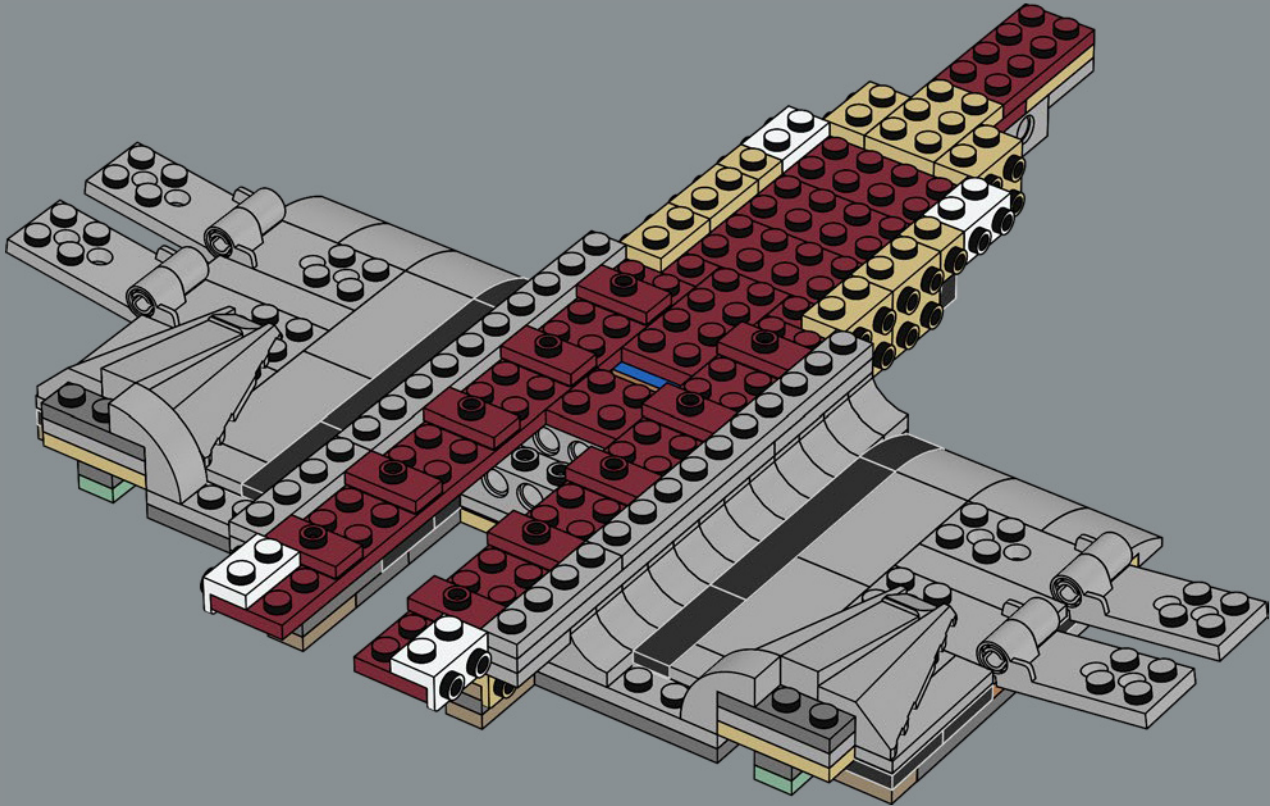



55

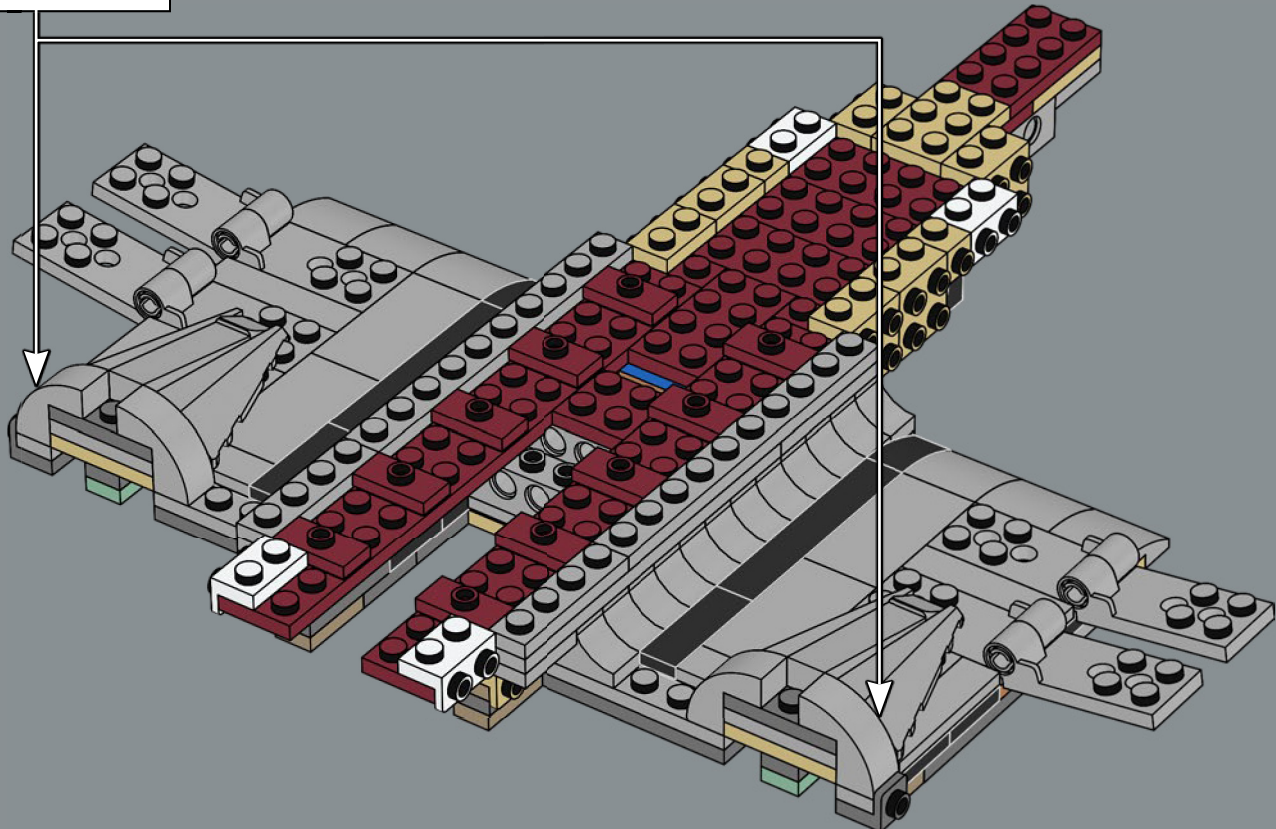
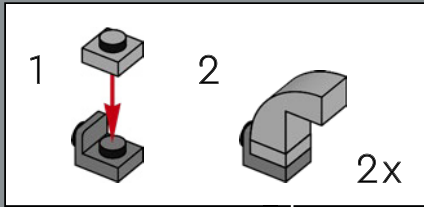

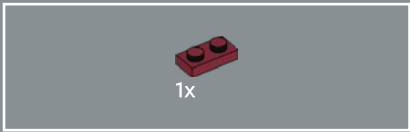

56

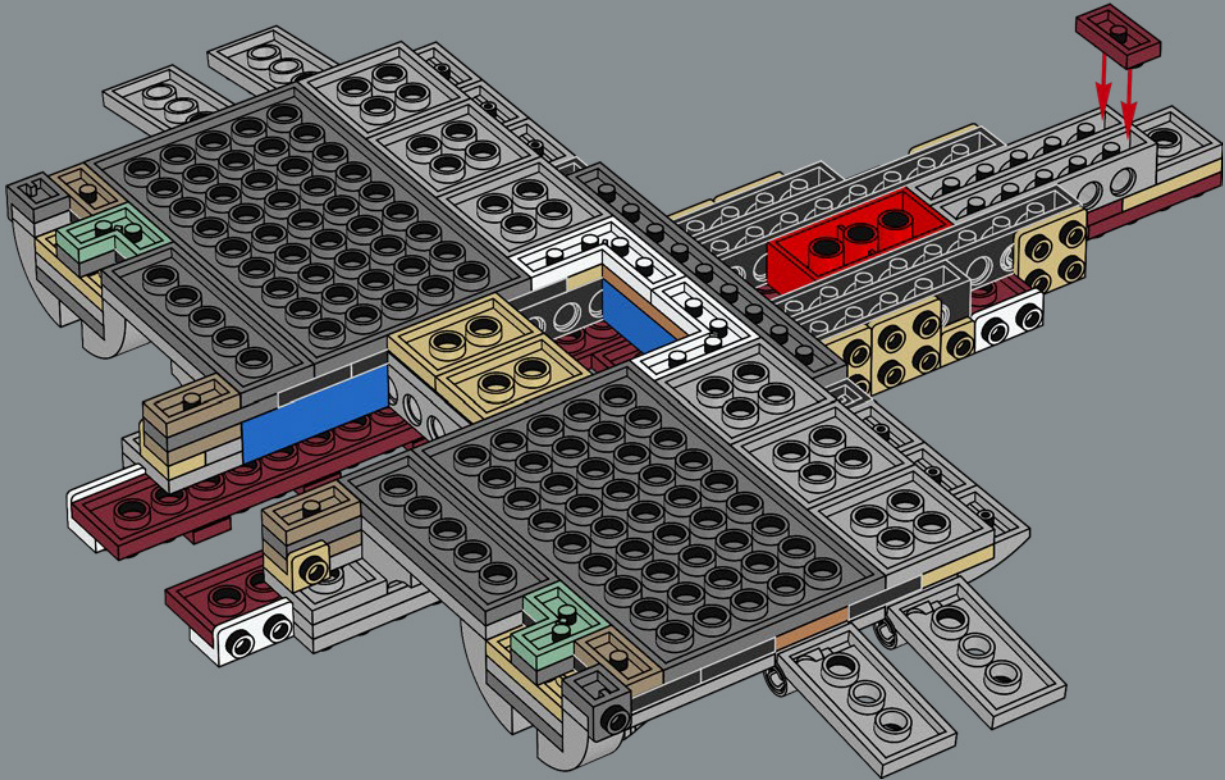

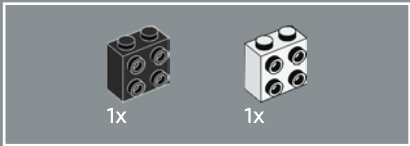
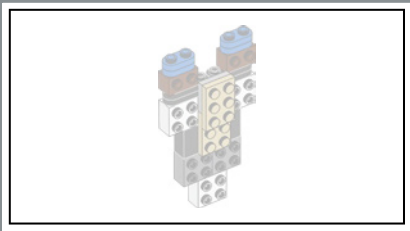

57

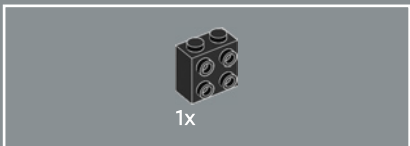
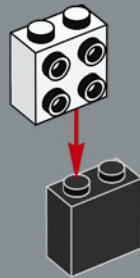

58

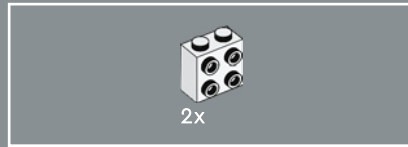
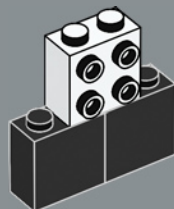

59

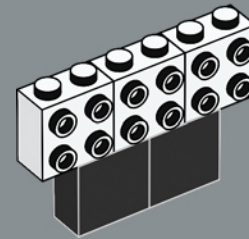

60

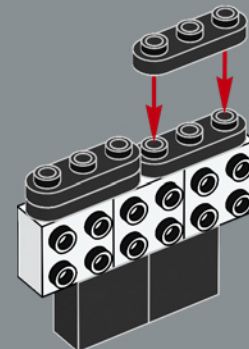

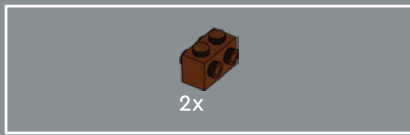

61

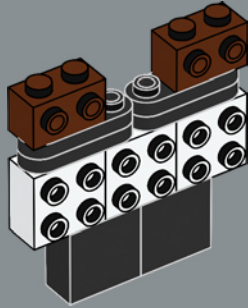

62

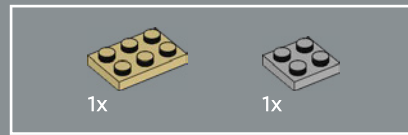
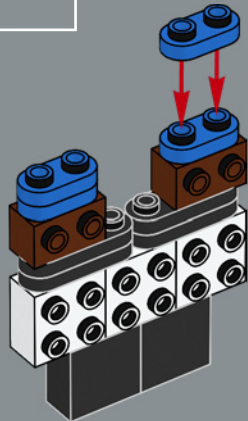

63

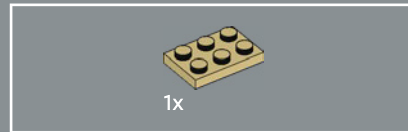
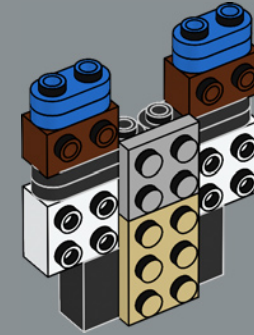

64

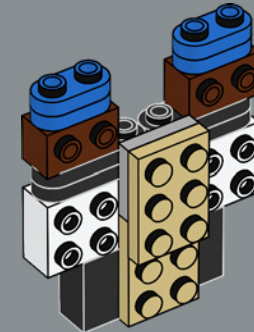



2x

65

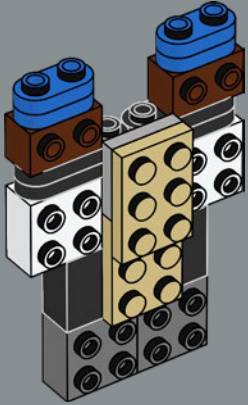

1x

66

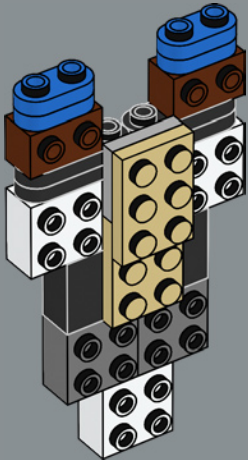

67

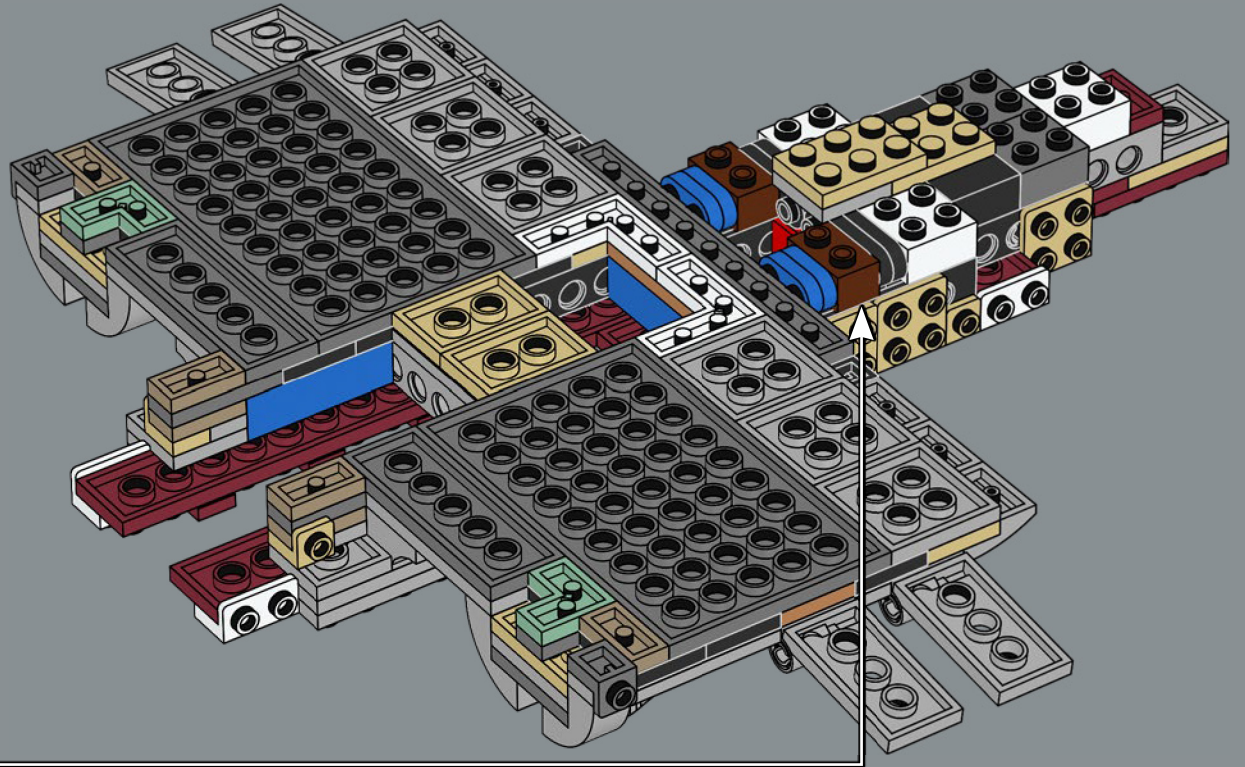

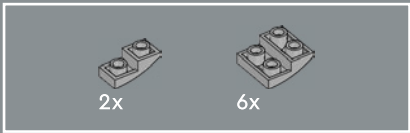

68

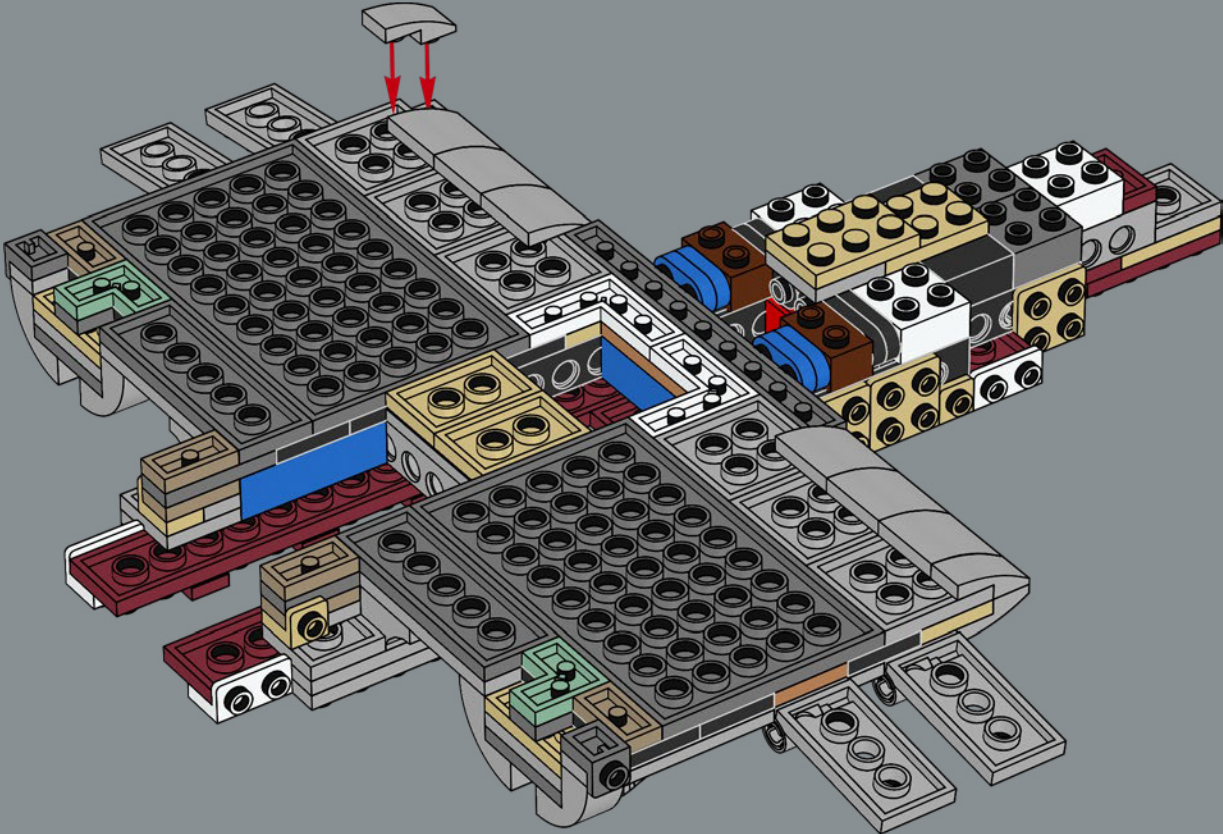

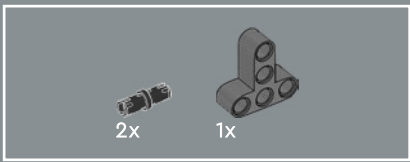

69

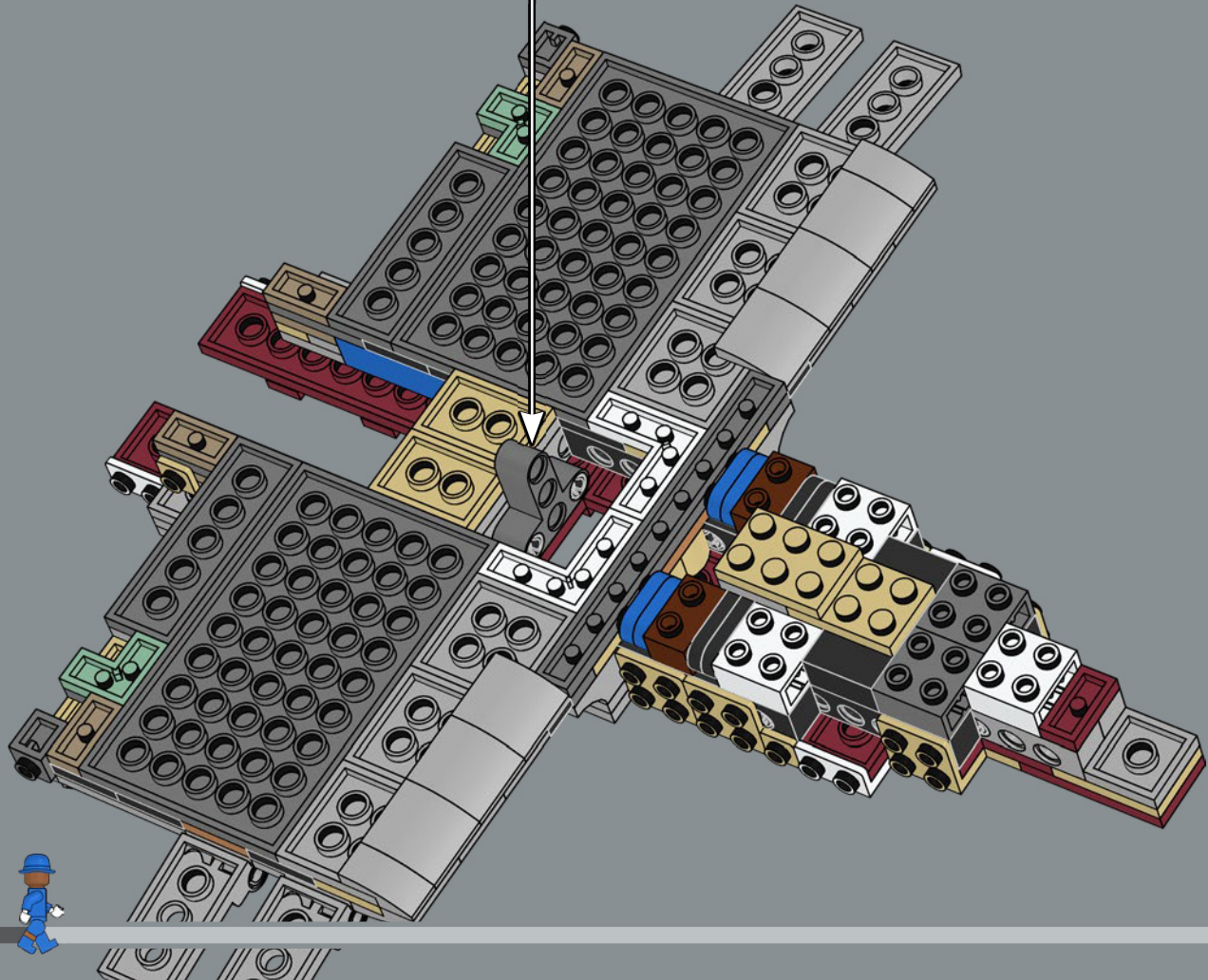
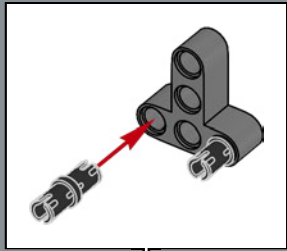

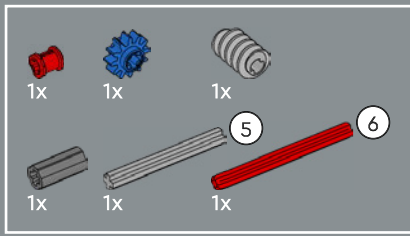

70

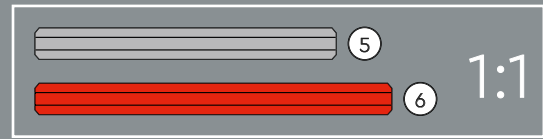
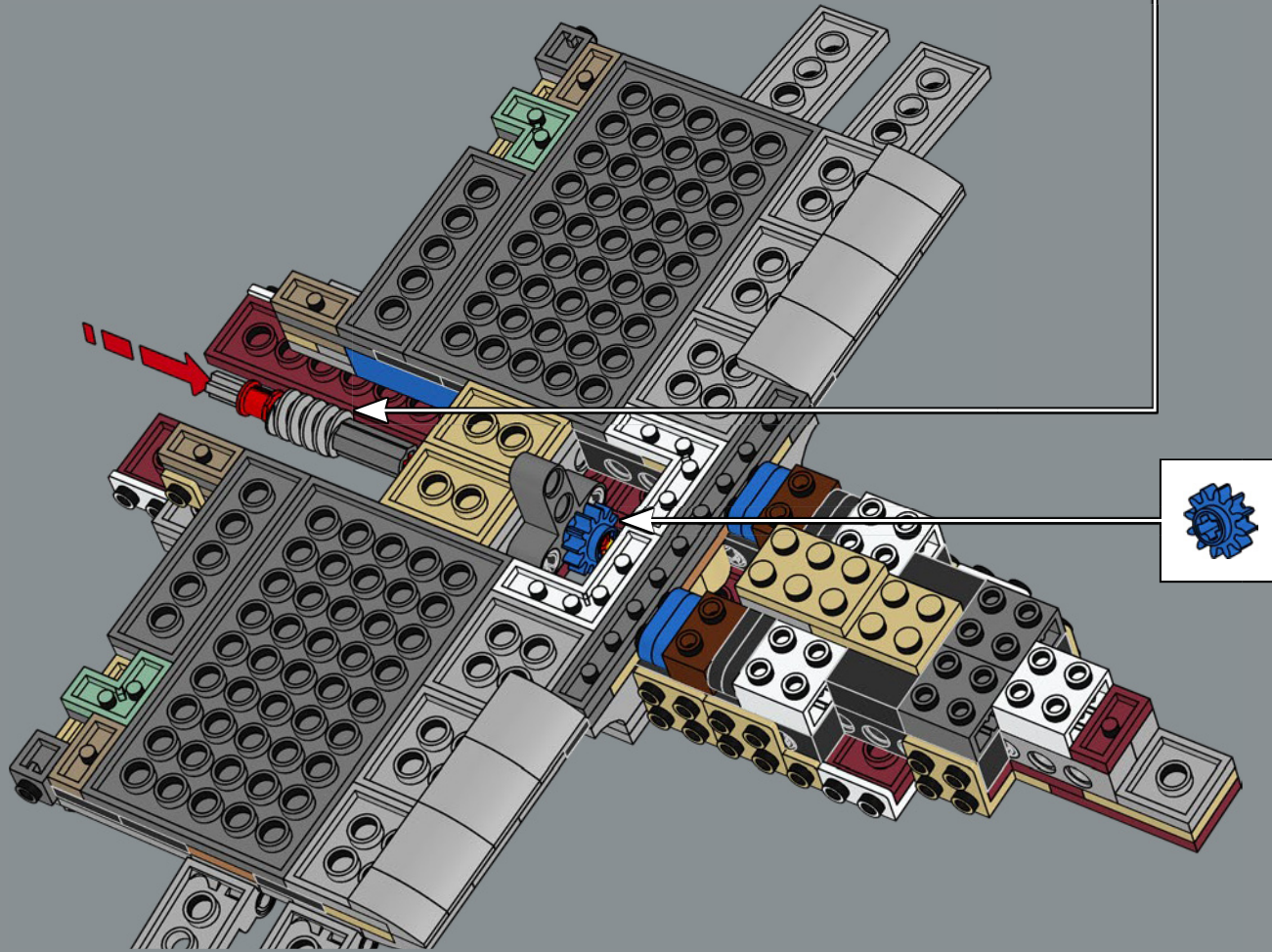
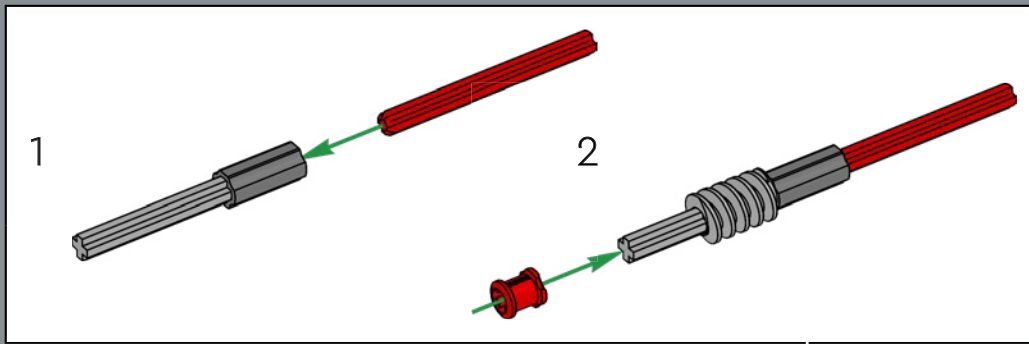

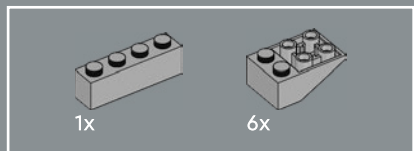

71

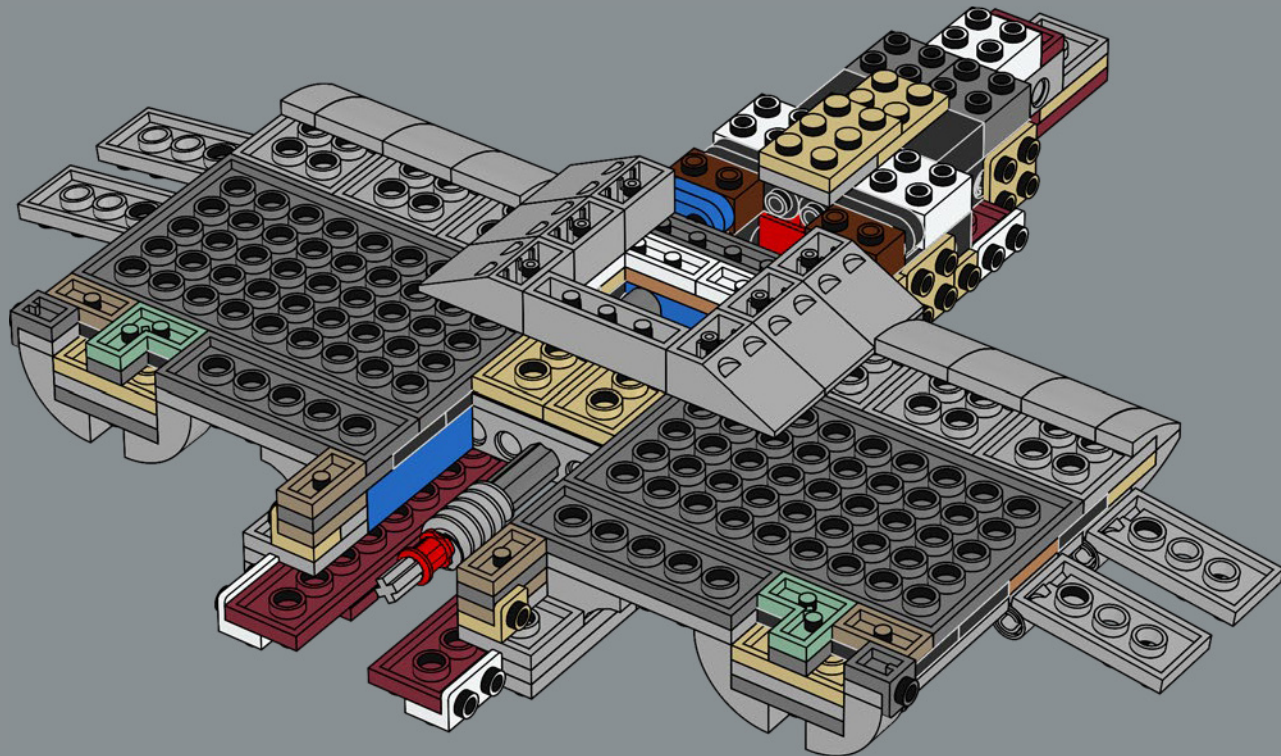

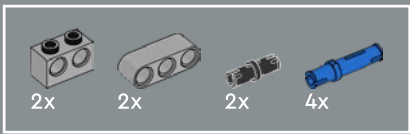

73

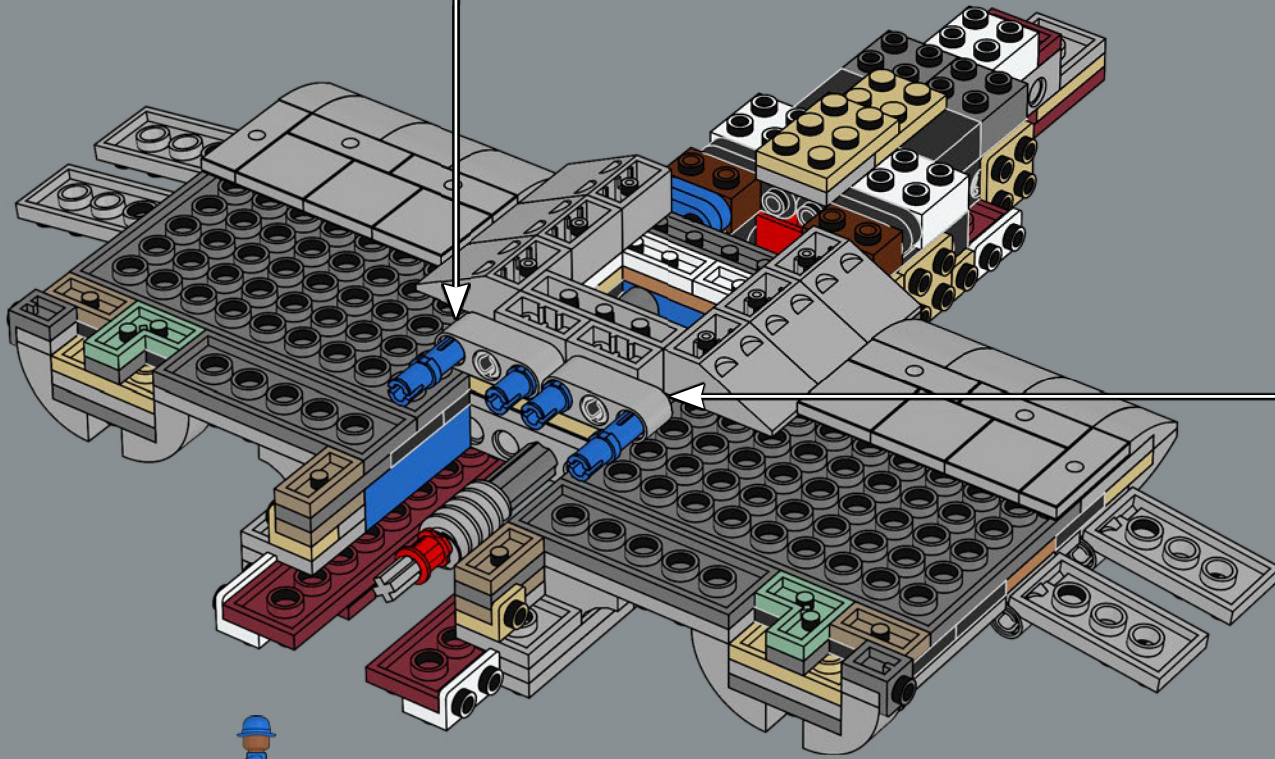
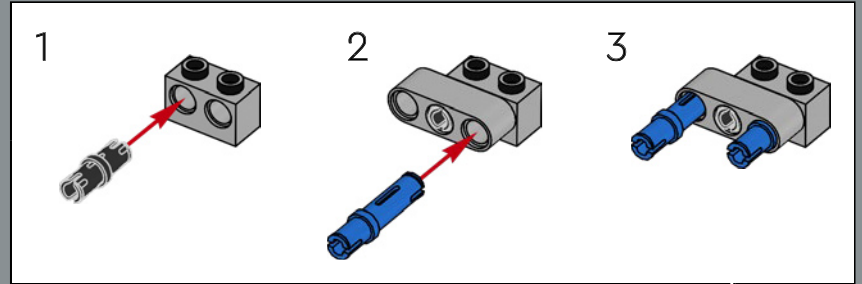
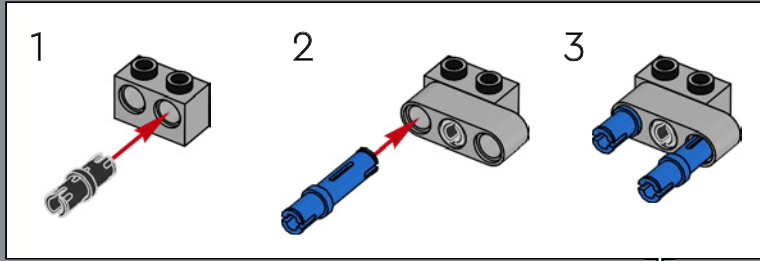

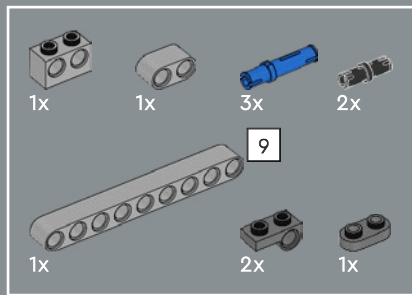

74

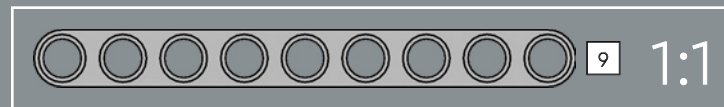
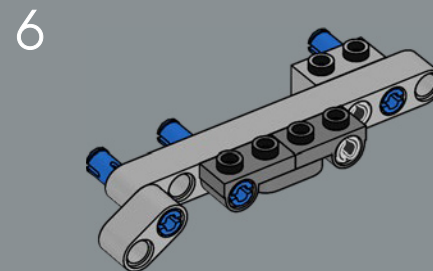
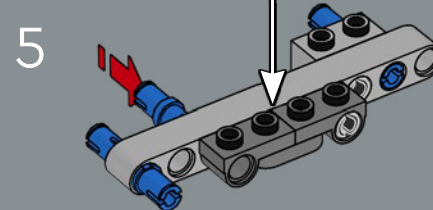
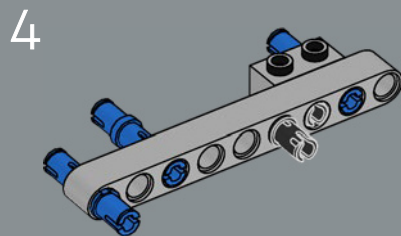
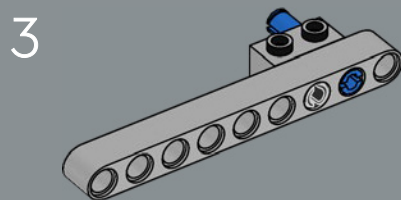
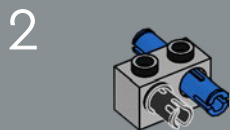
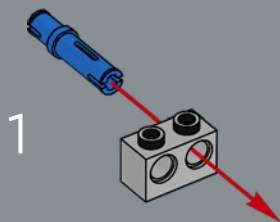
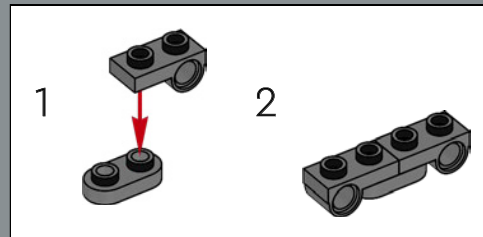

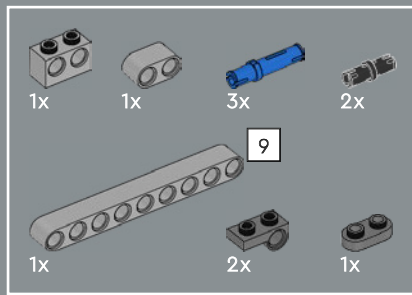

75

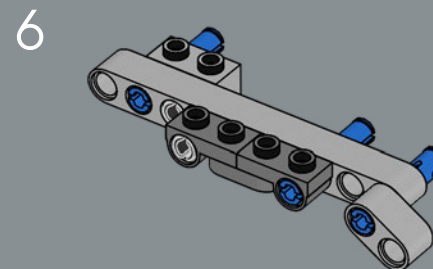
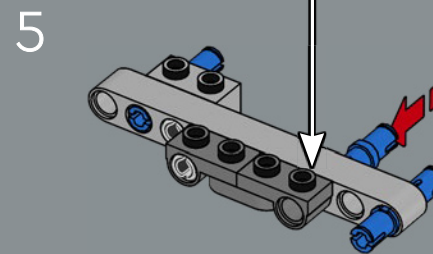
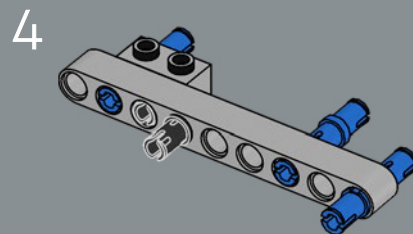
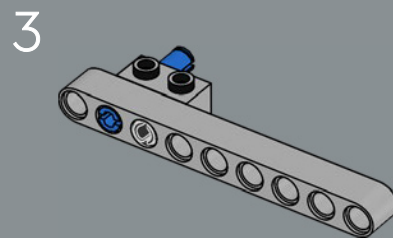
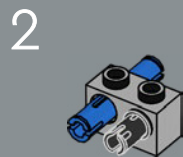
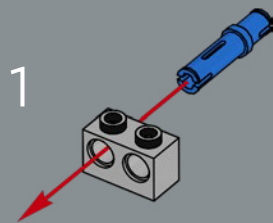
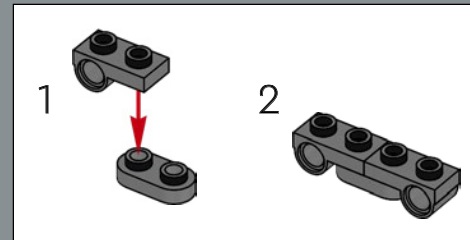

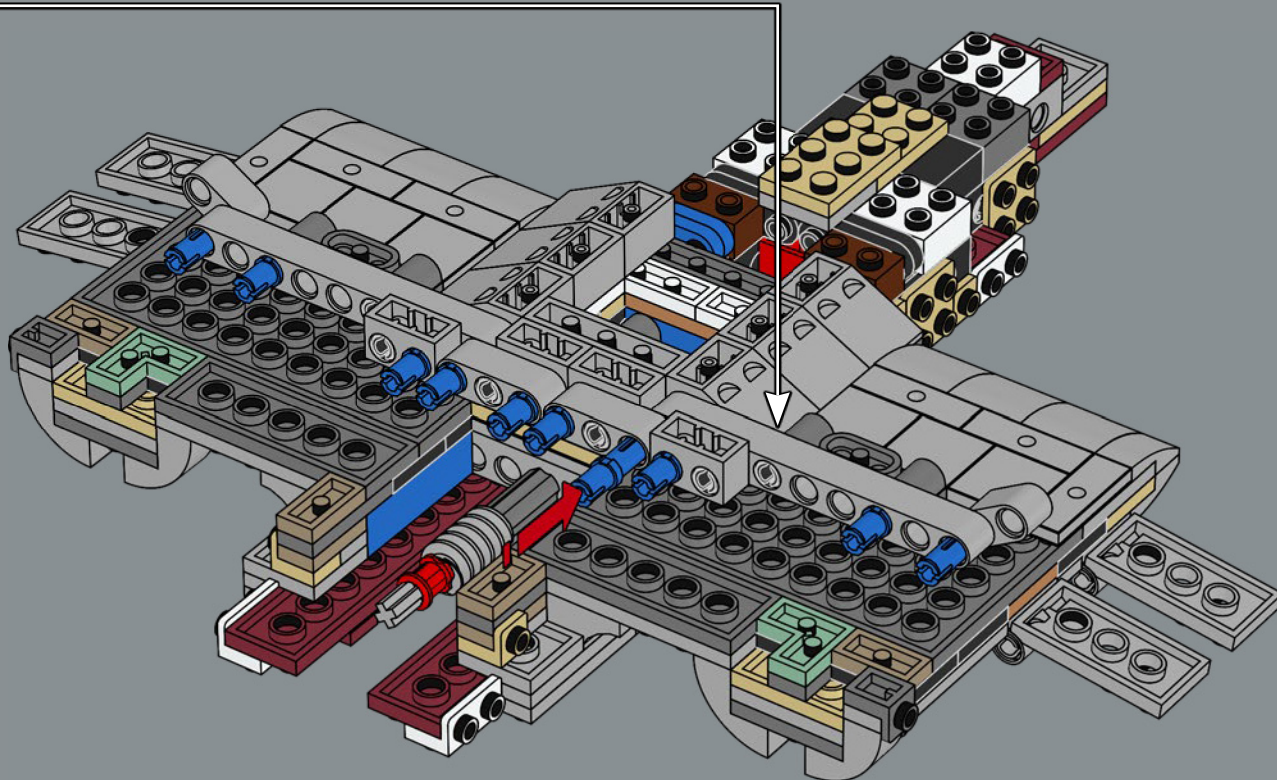

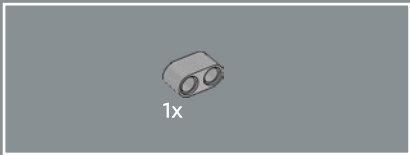

76

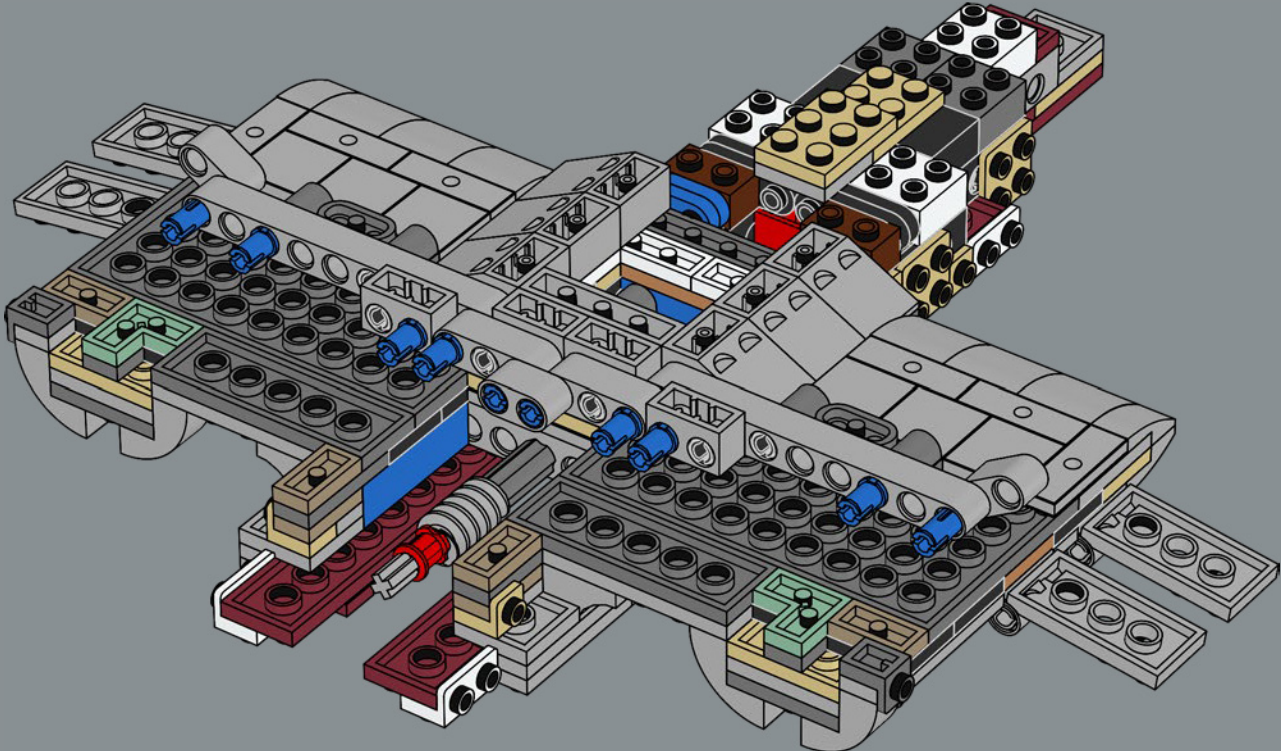

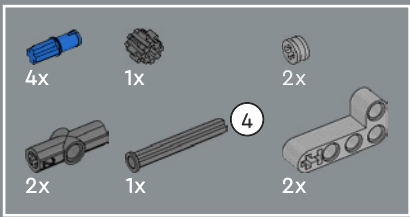

77

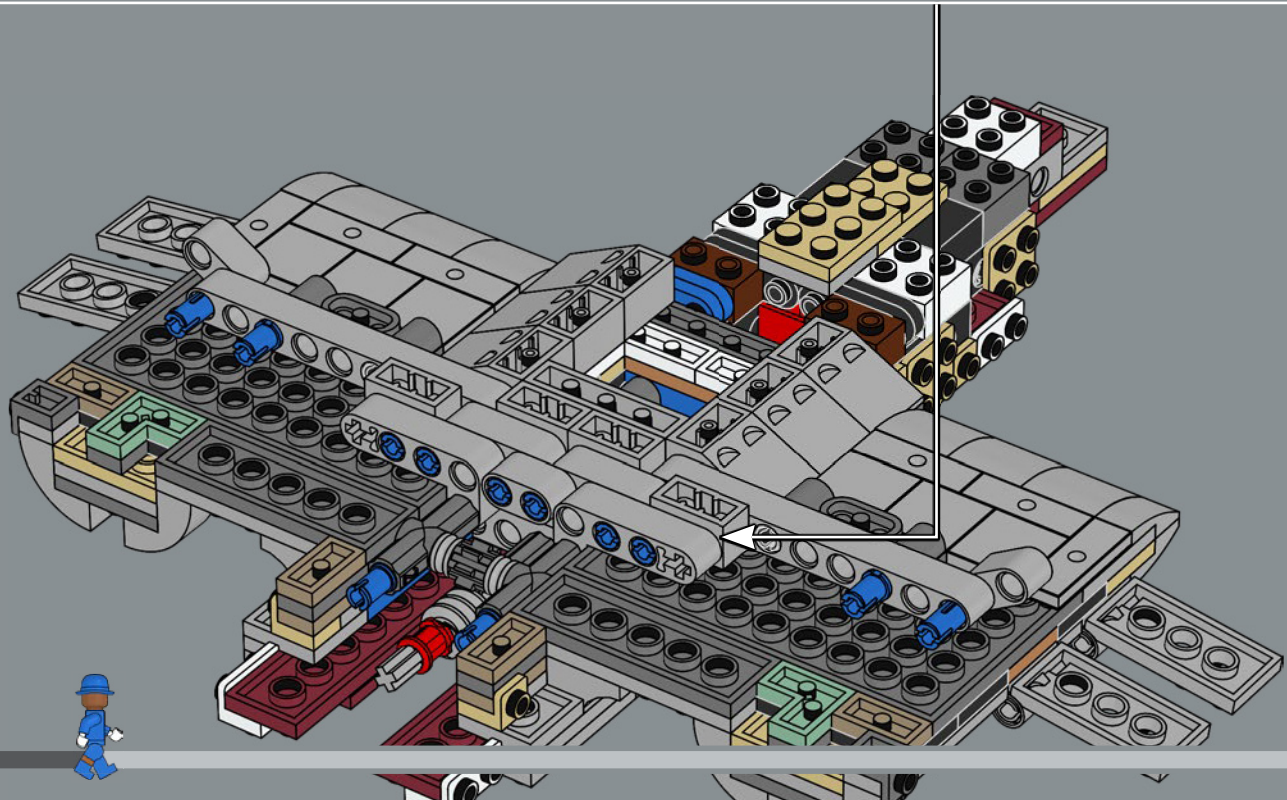
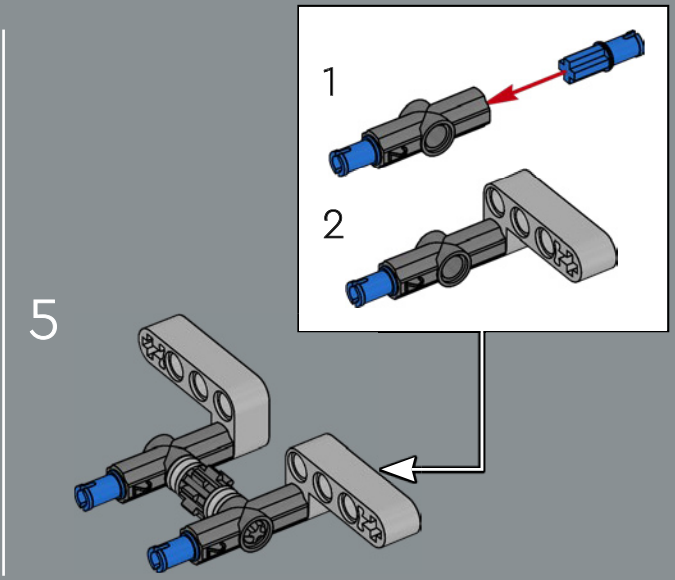
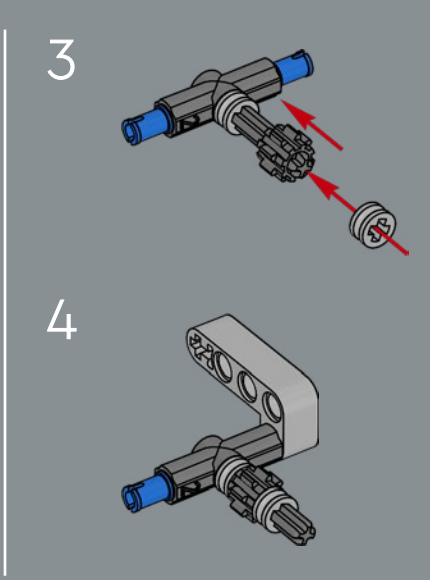
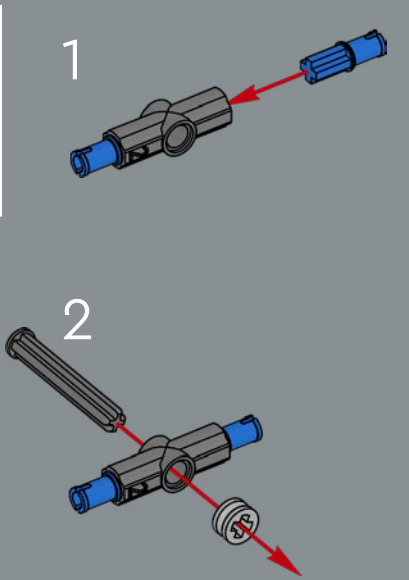

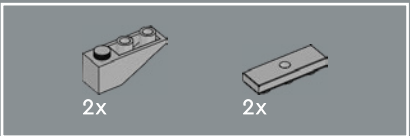

78

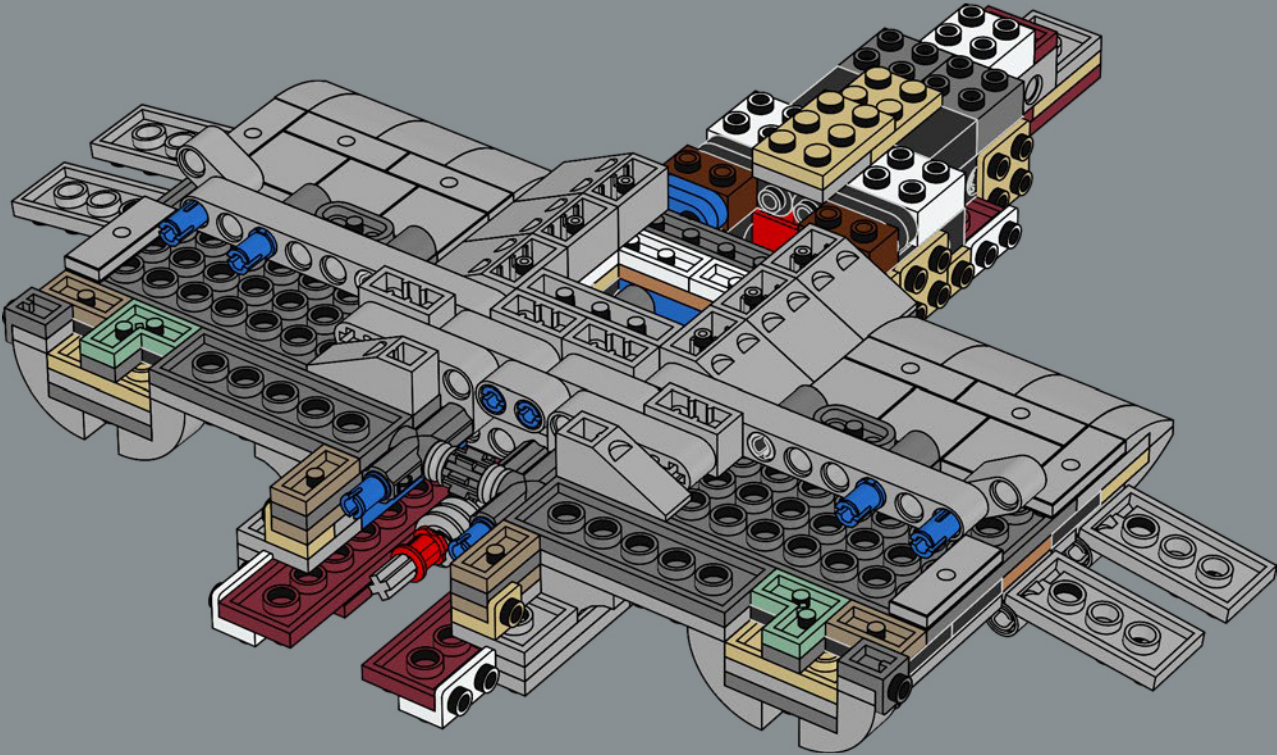

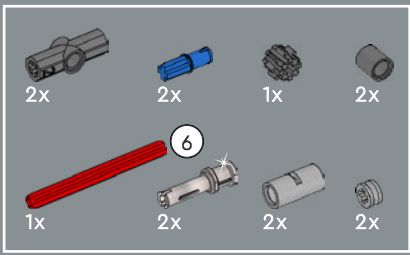

79

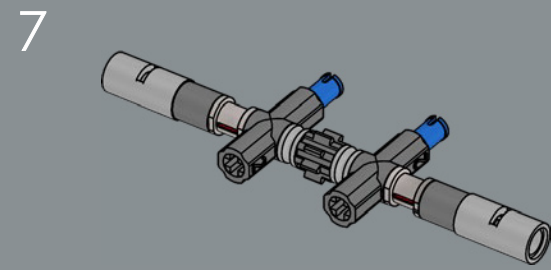
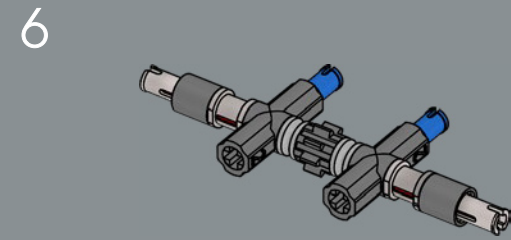
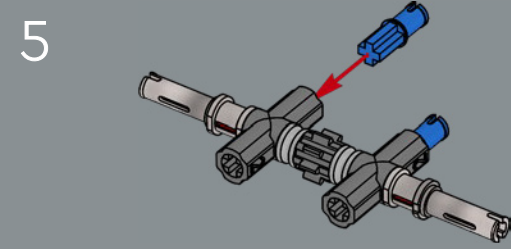
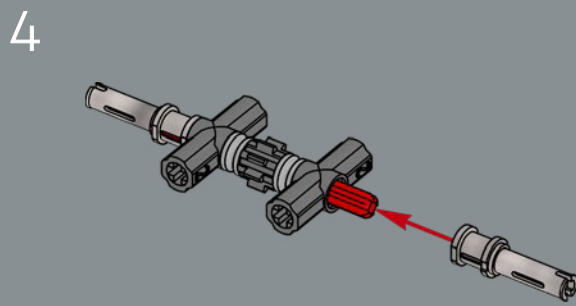
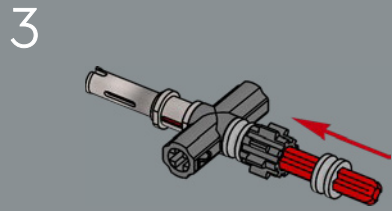
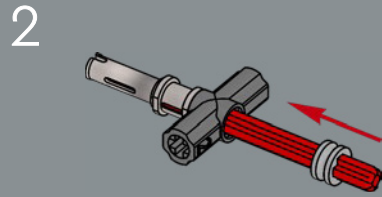
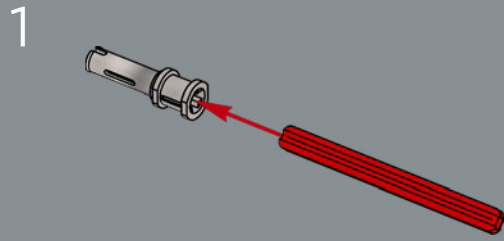

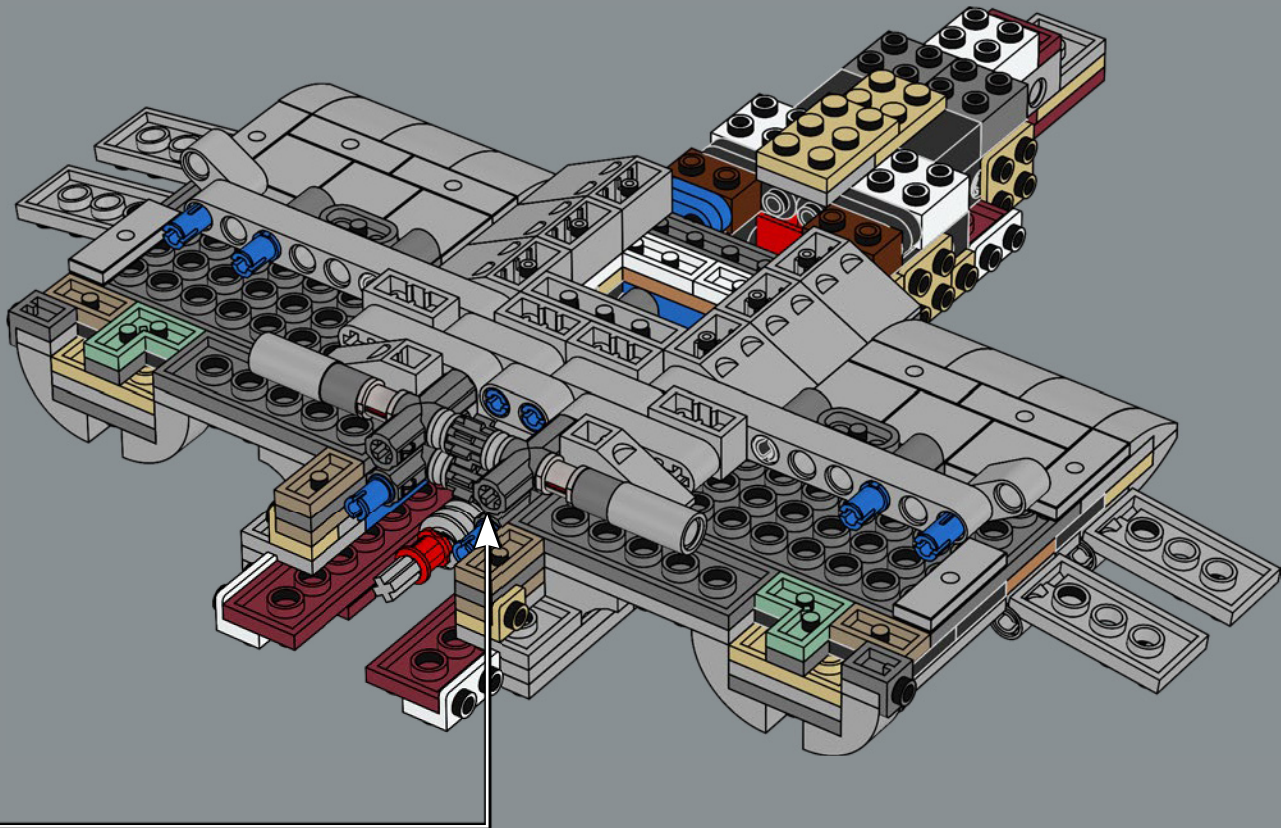



2x

80

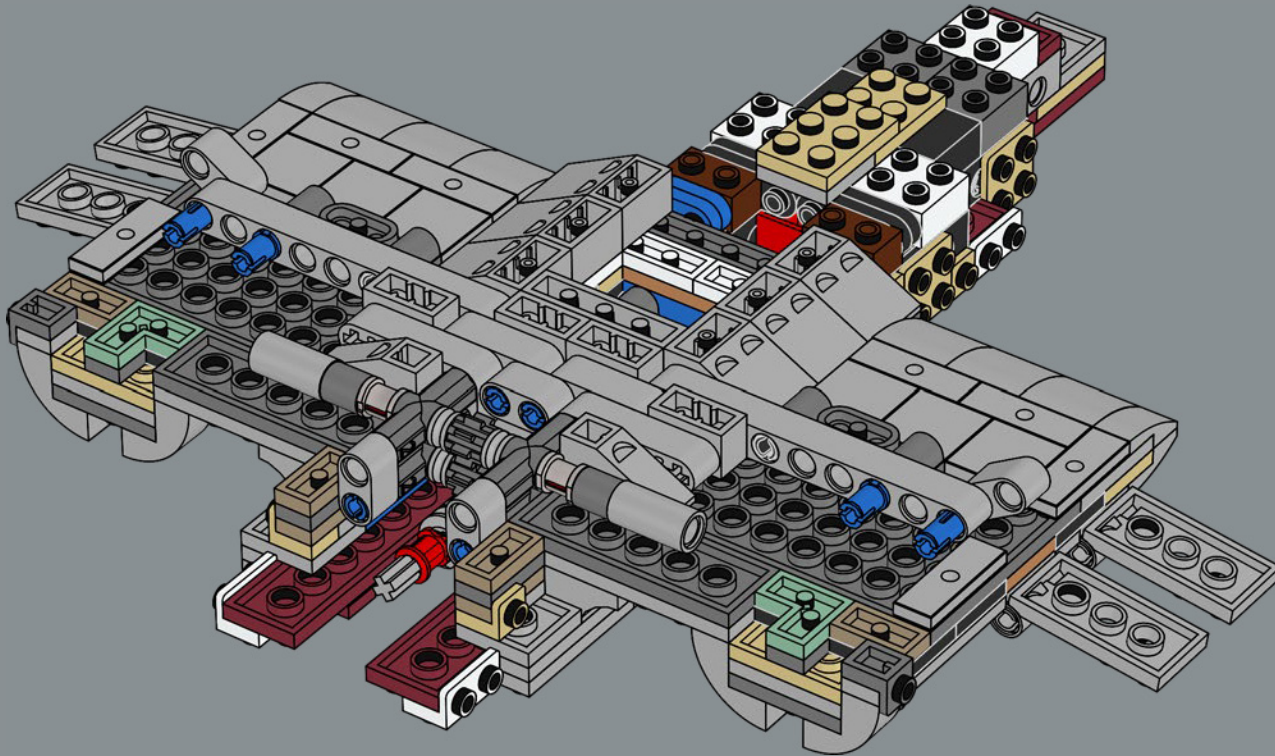

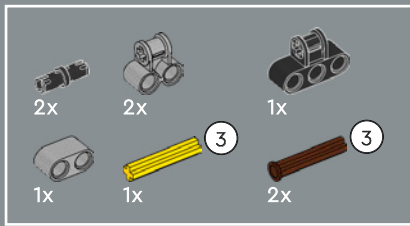

81

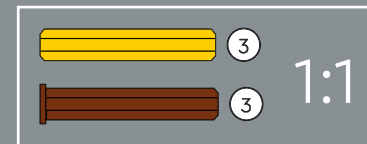
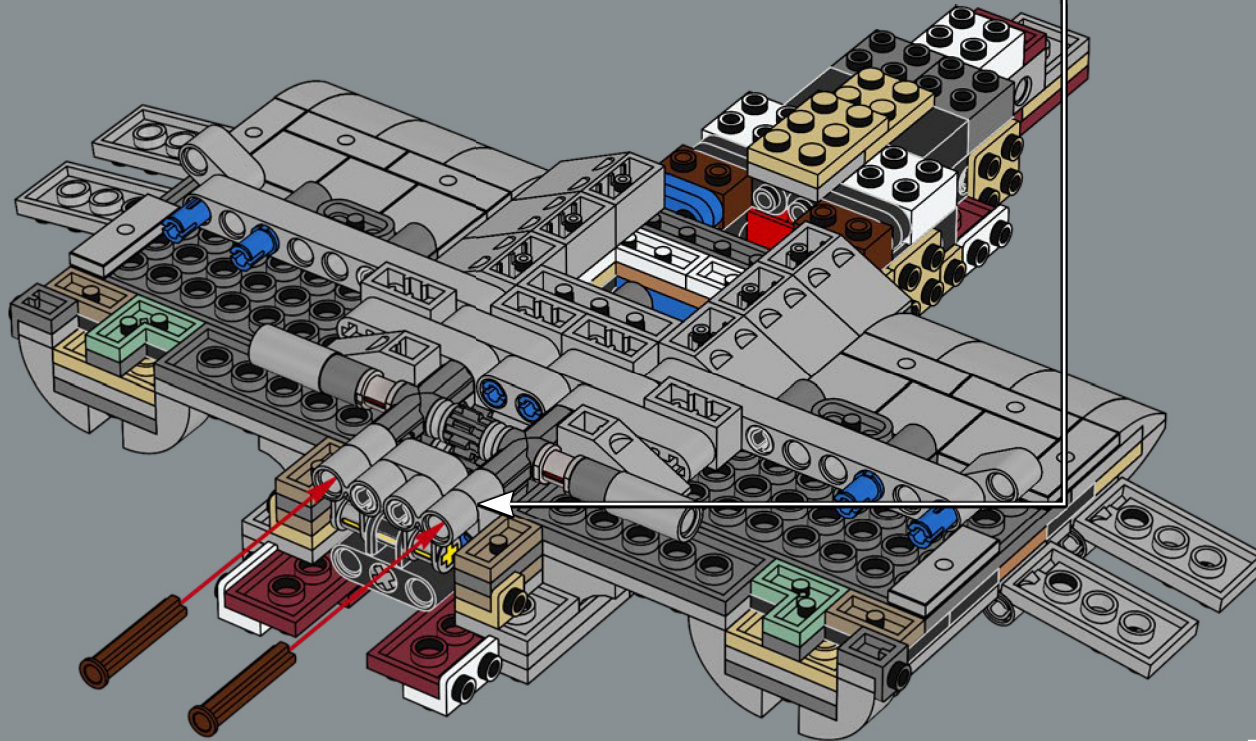
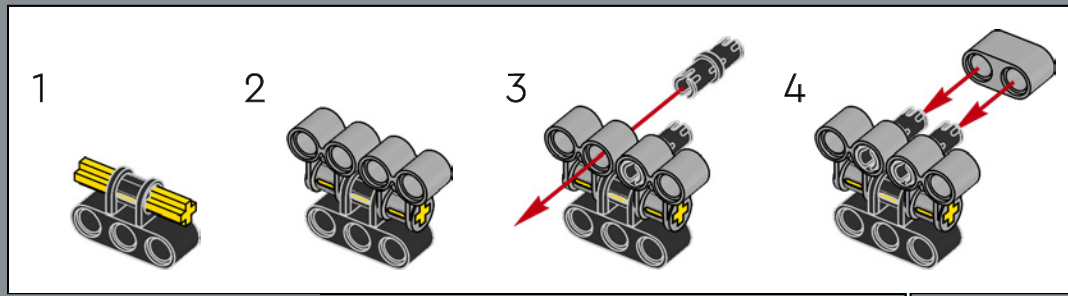



2x



1x

82

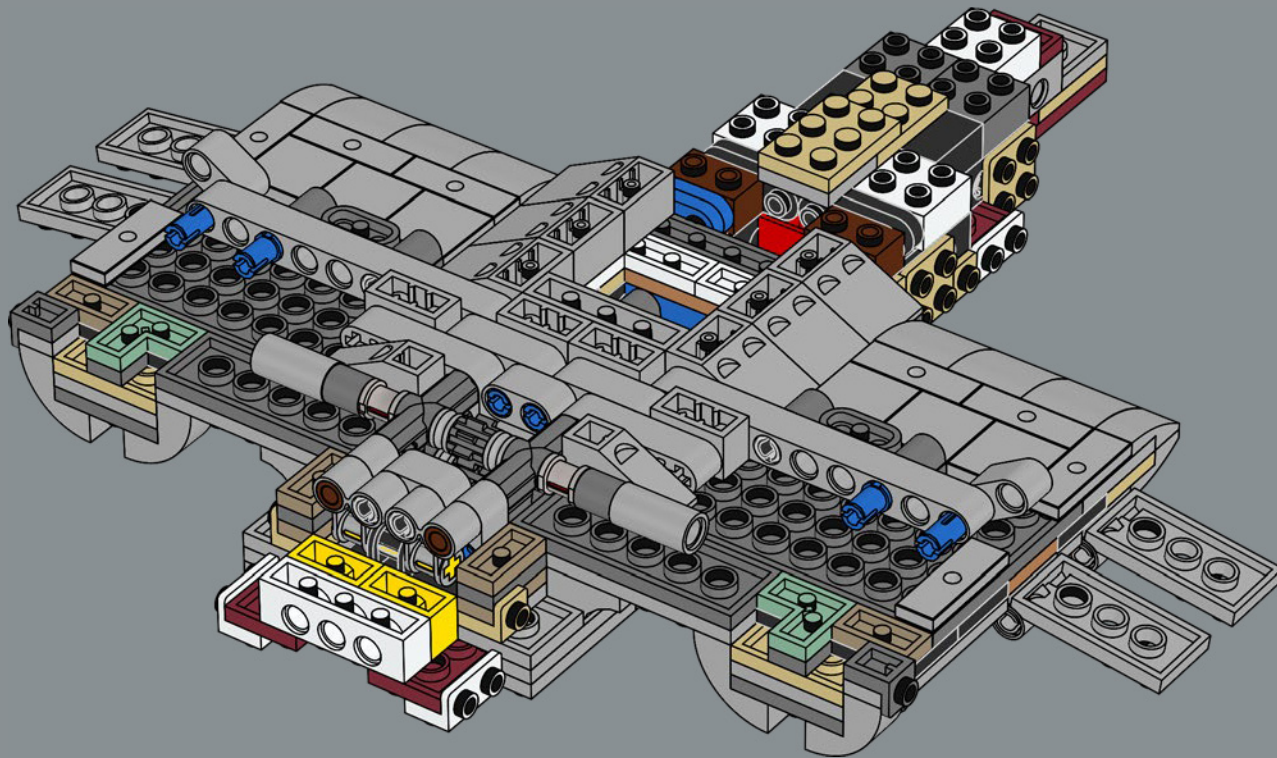

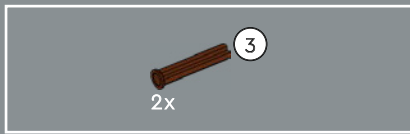

83

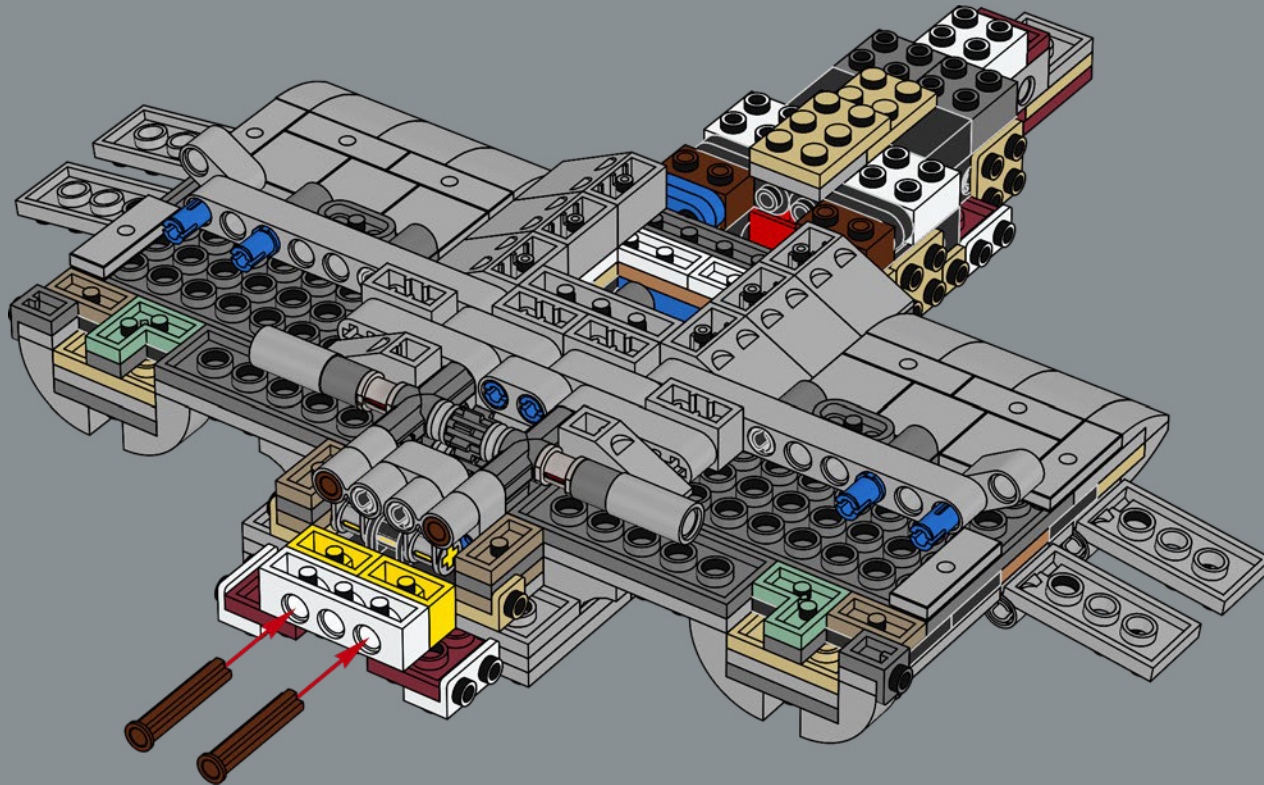

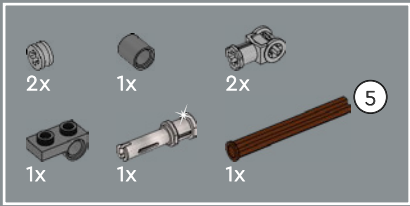

84

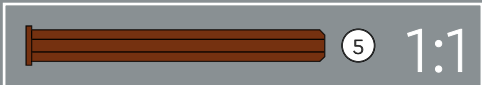
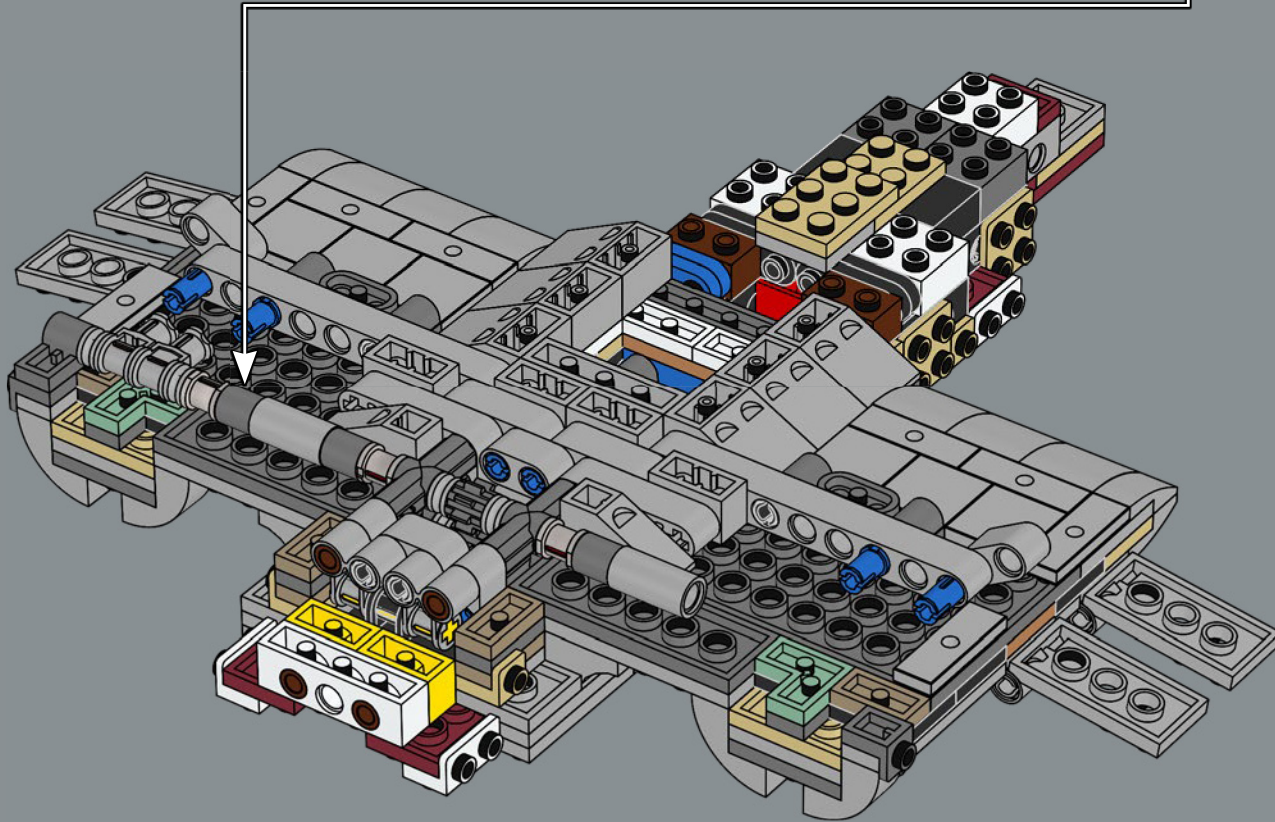
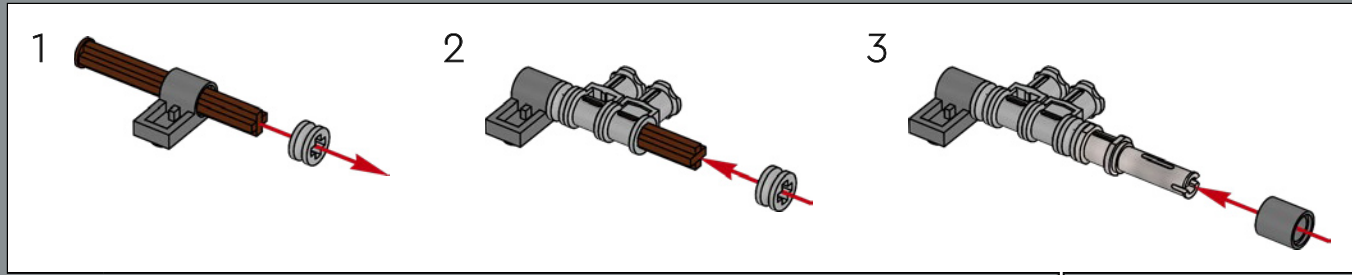

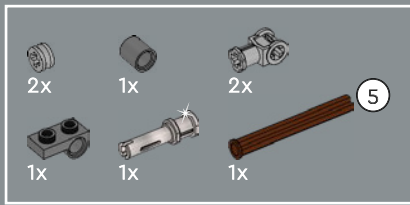

85

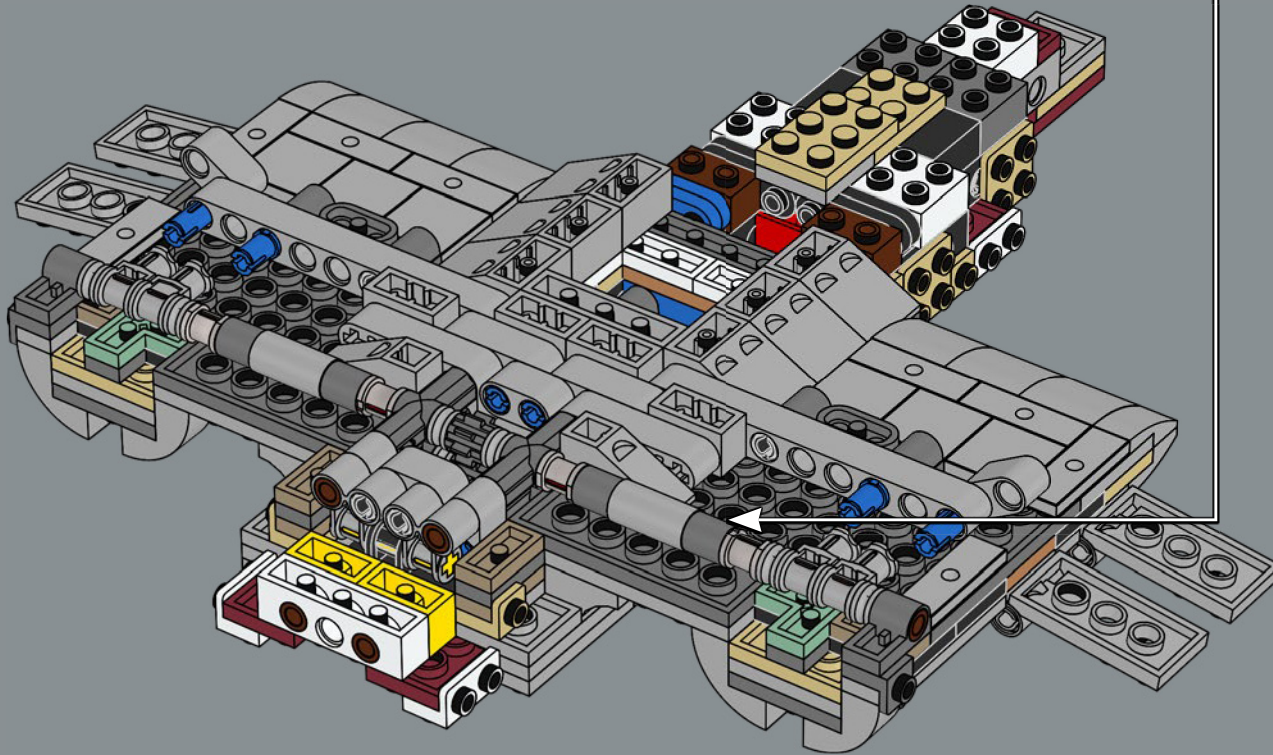
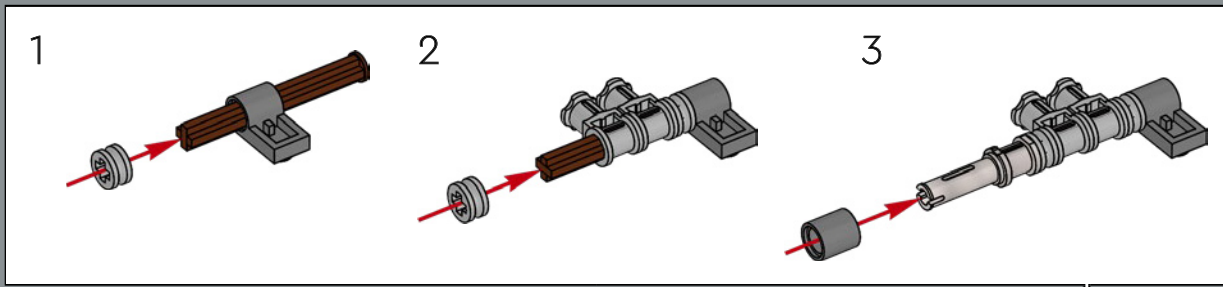

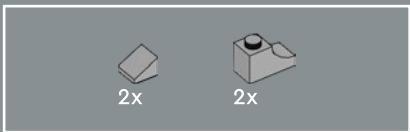

86

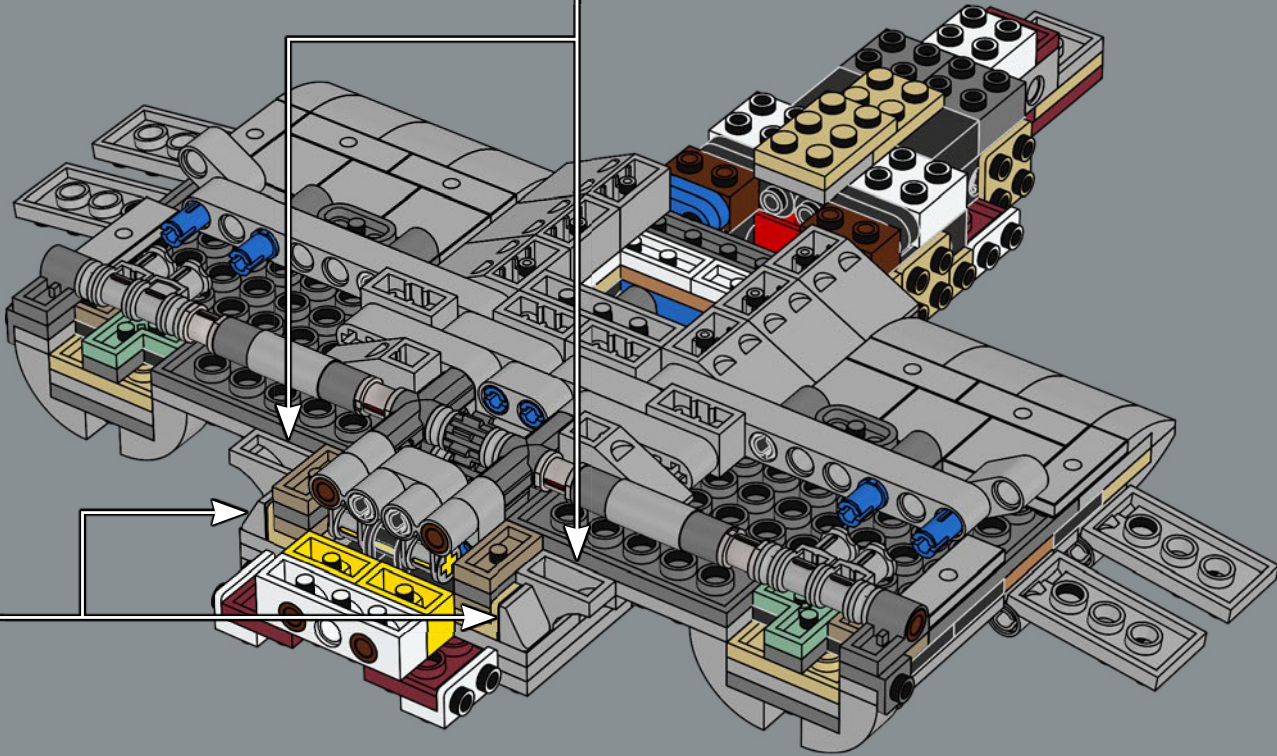
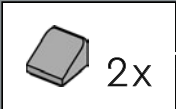
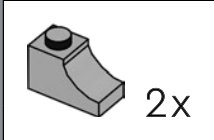



87

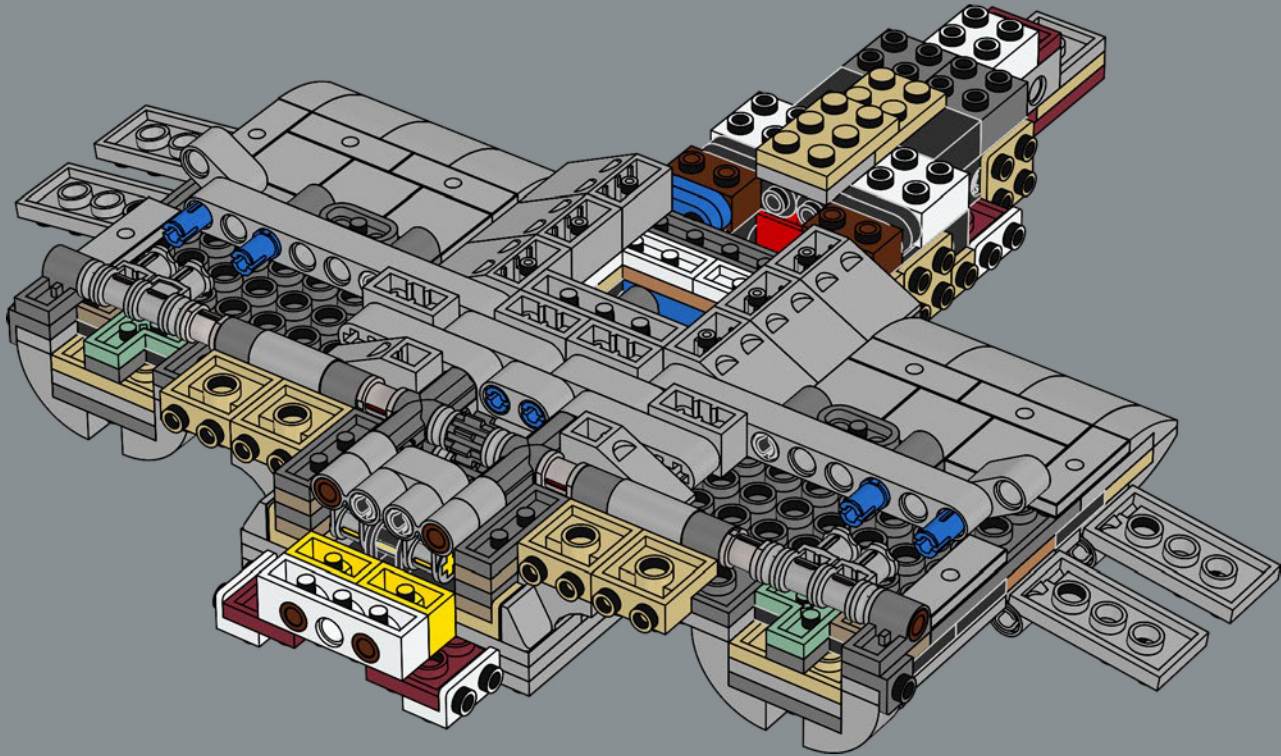

4x  4x 

88

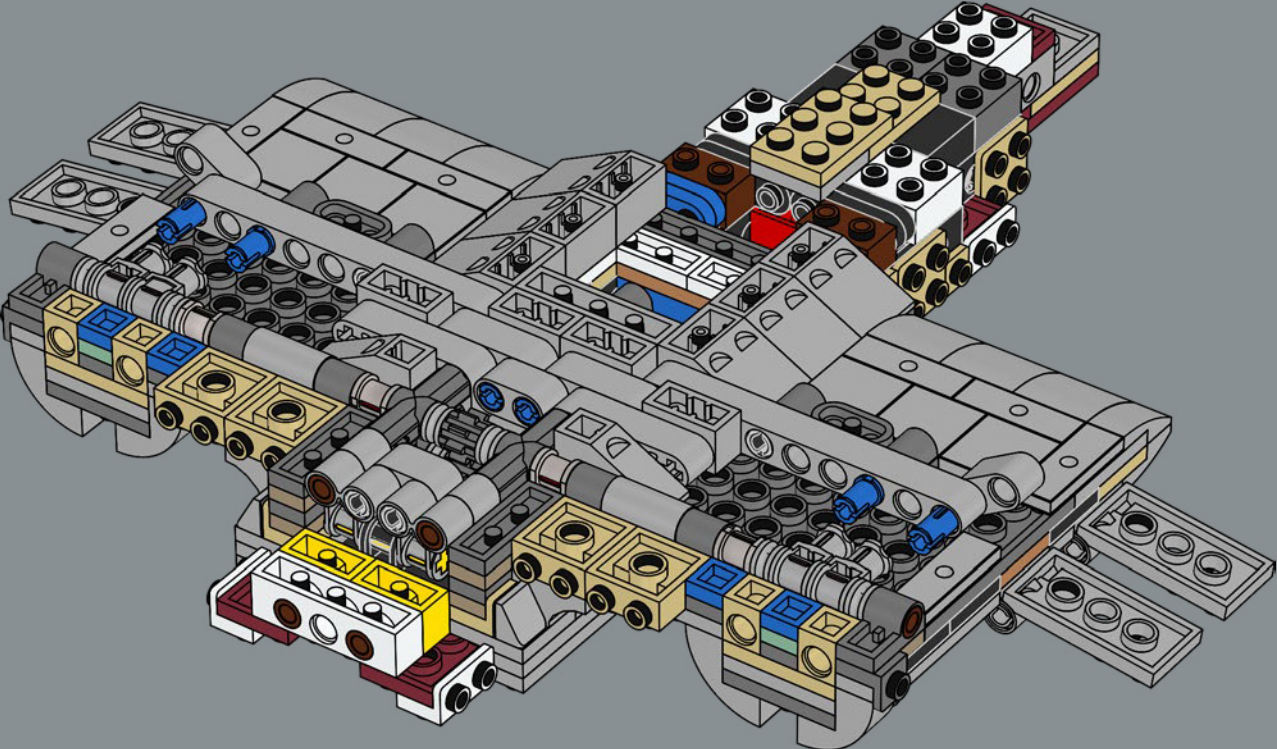

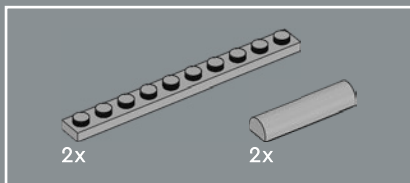

89

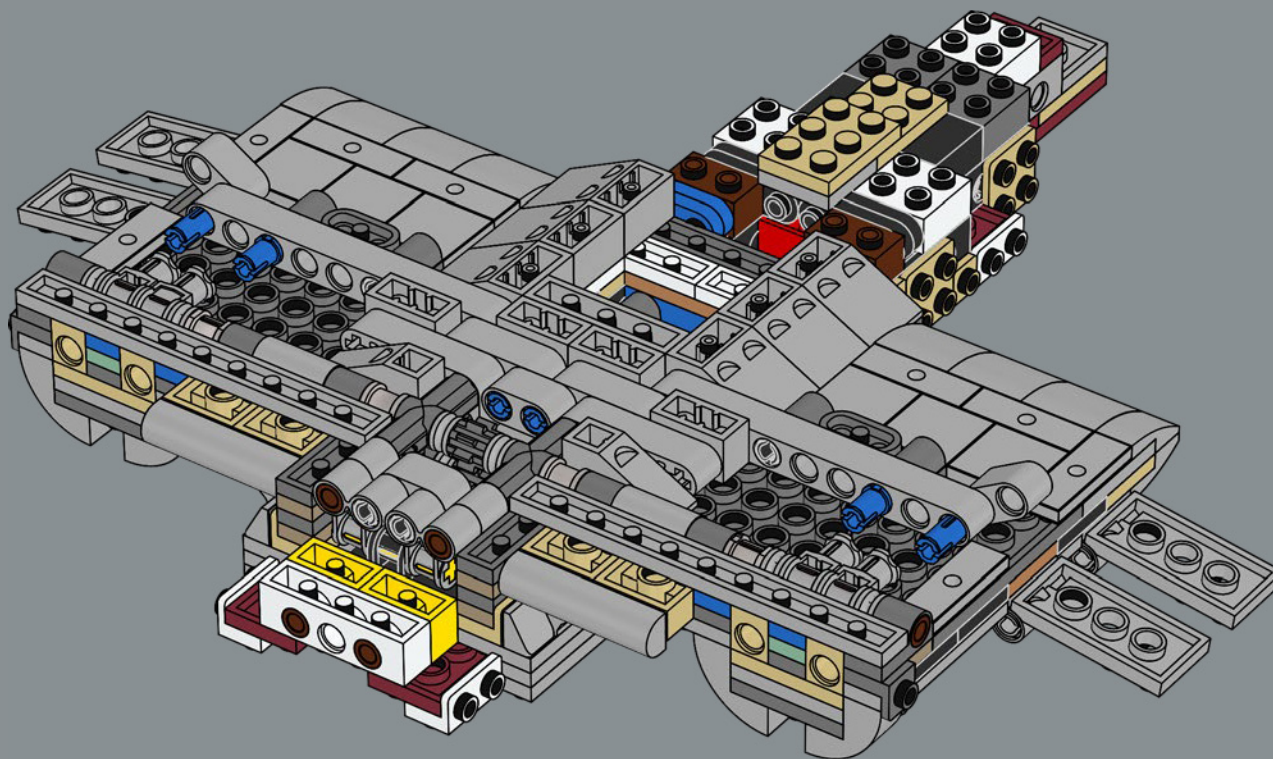

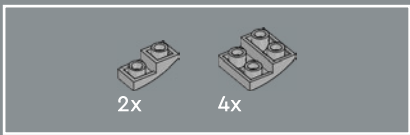

90

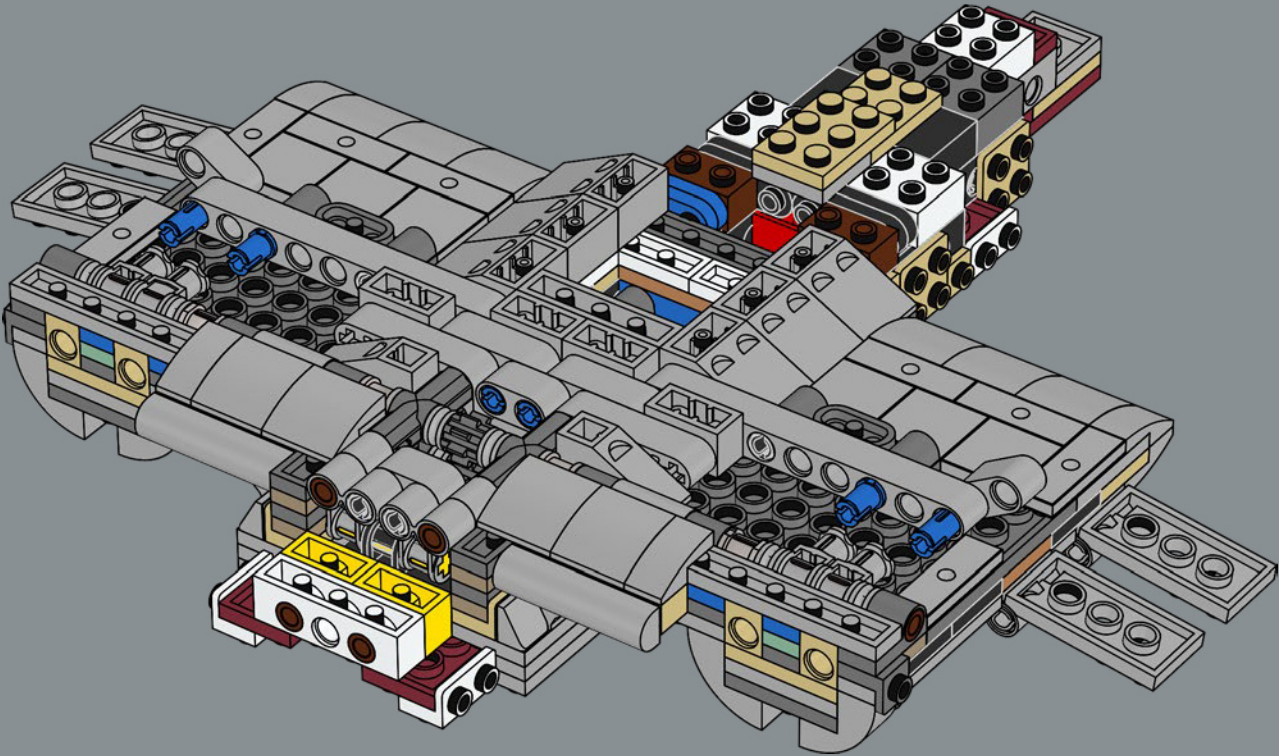

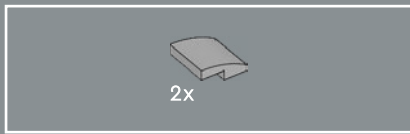

91

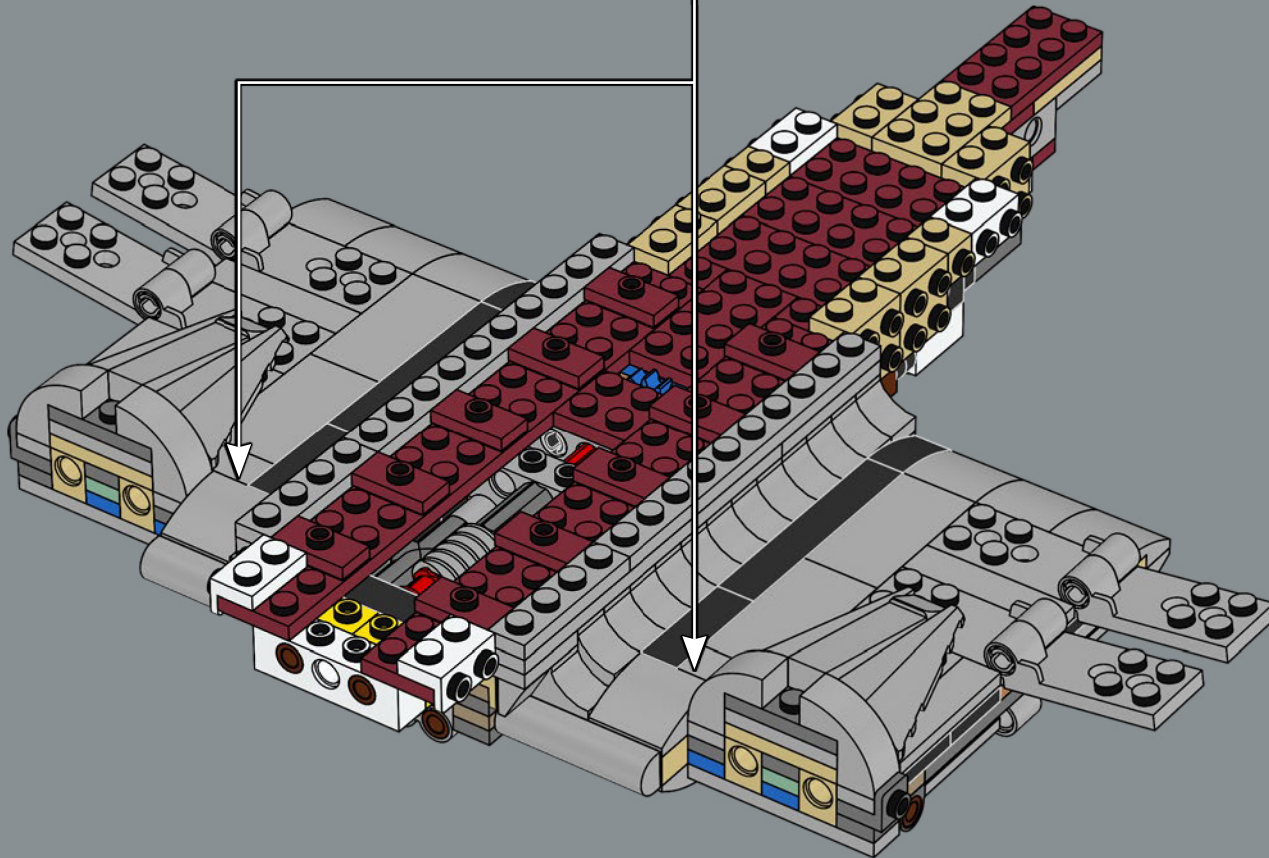
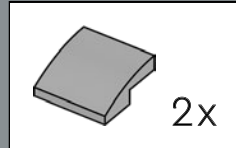



Es difícil encontrar ilustraciones a color del DC-3™, ¡por lo que fue todo un privilegio que Boeing compartiera con nosotros una de la cabina sacada de sus archivos! Nos permitió descubrir que el interior tenía una alfombra en rojo oscuro y asientos en azul arena.

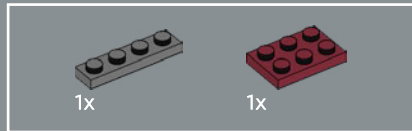

92

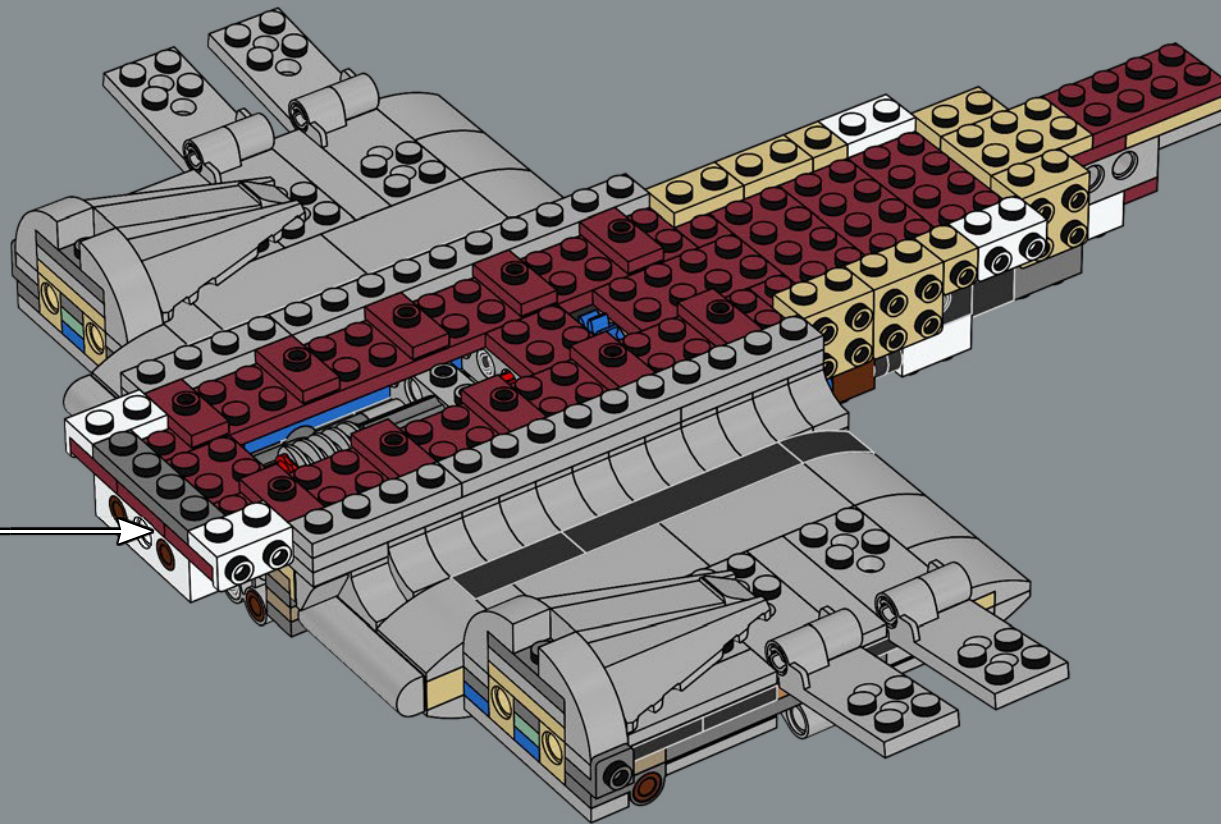
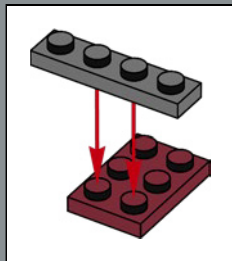

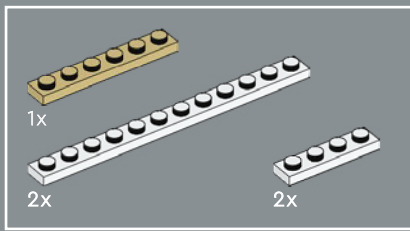

93

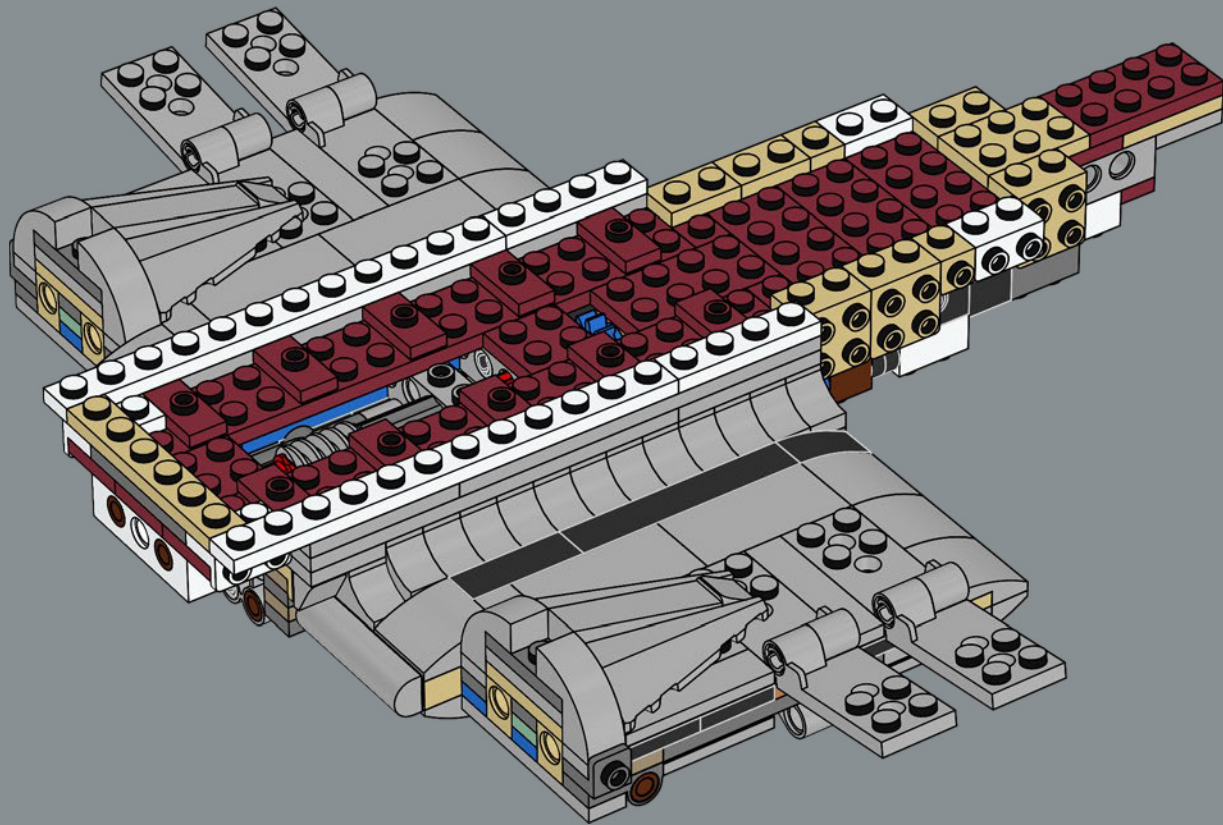

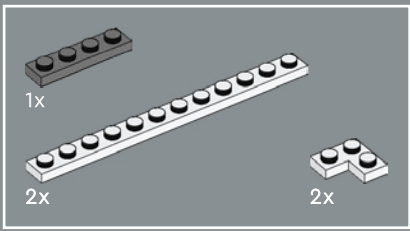

94

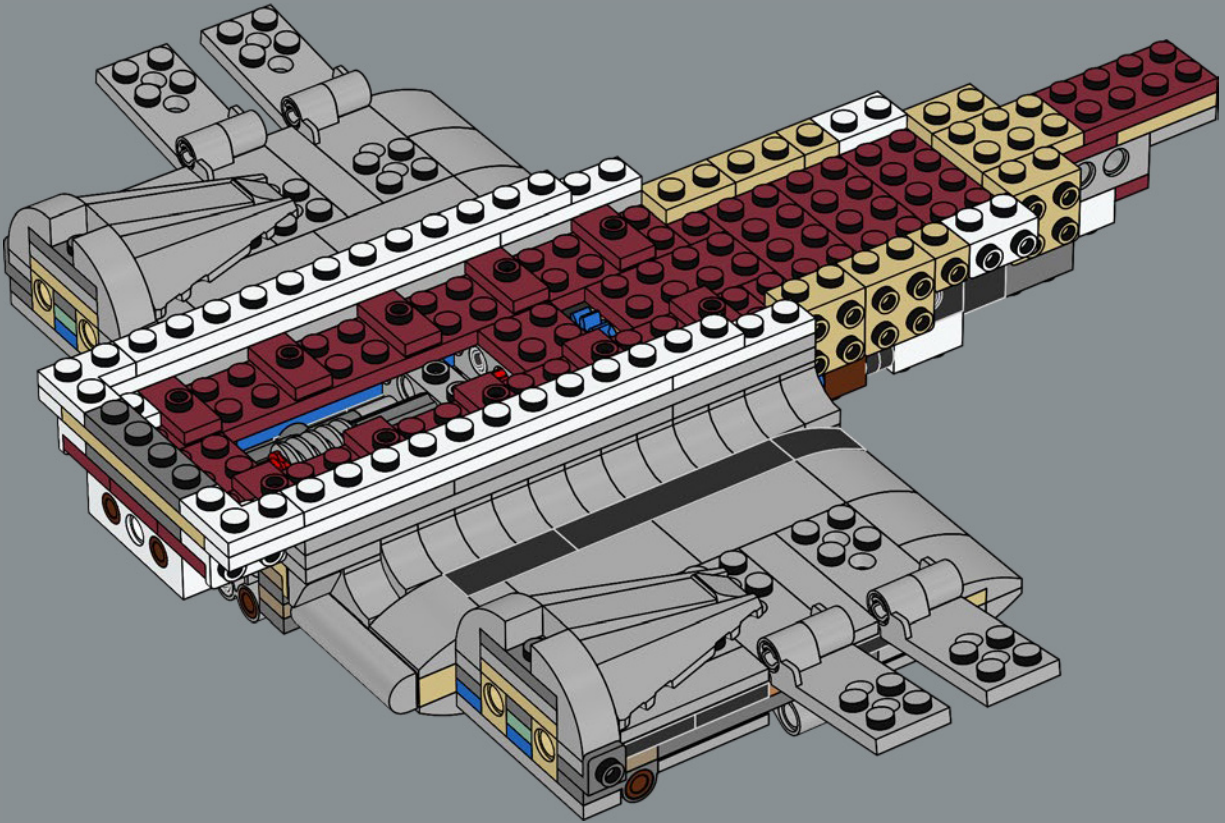

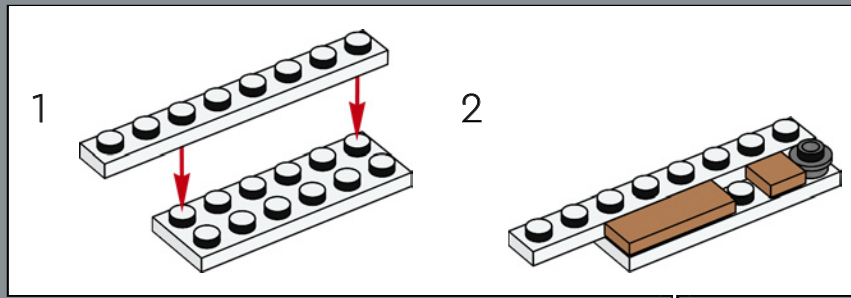
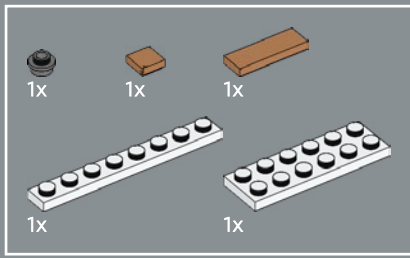

95

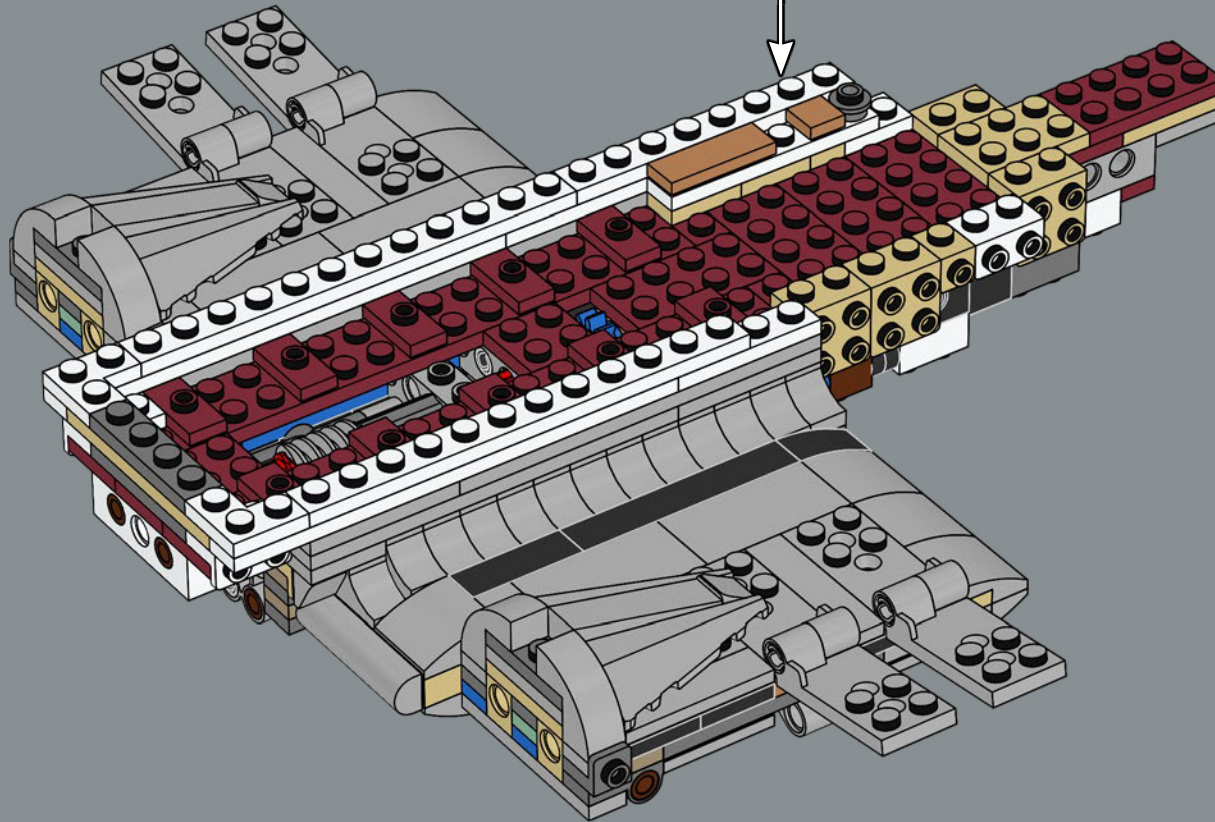

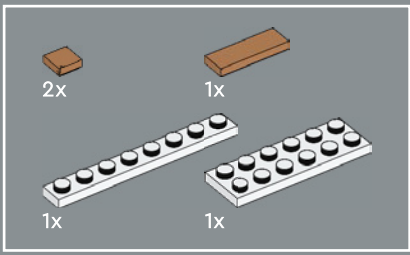

96

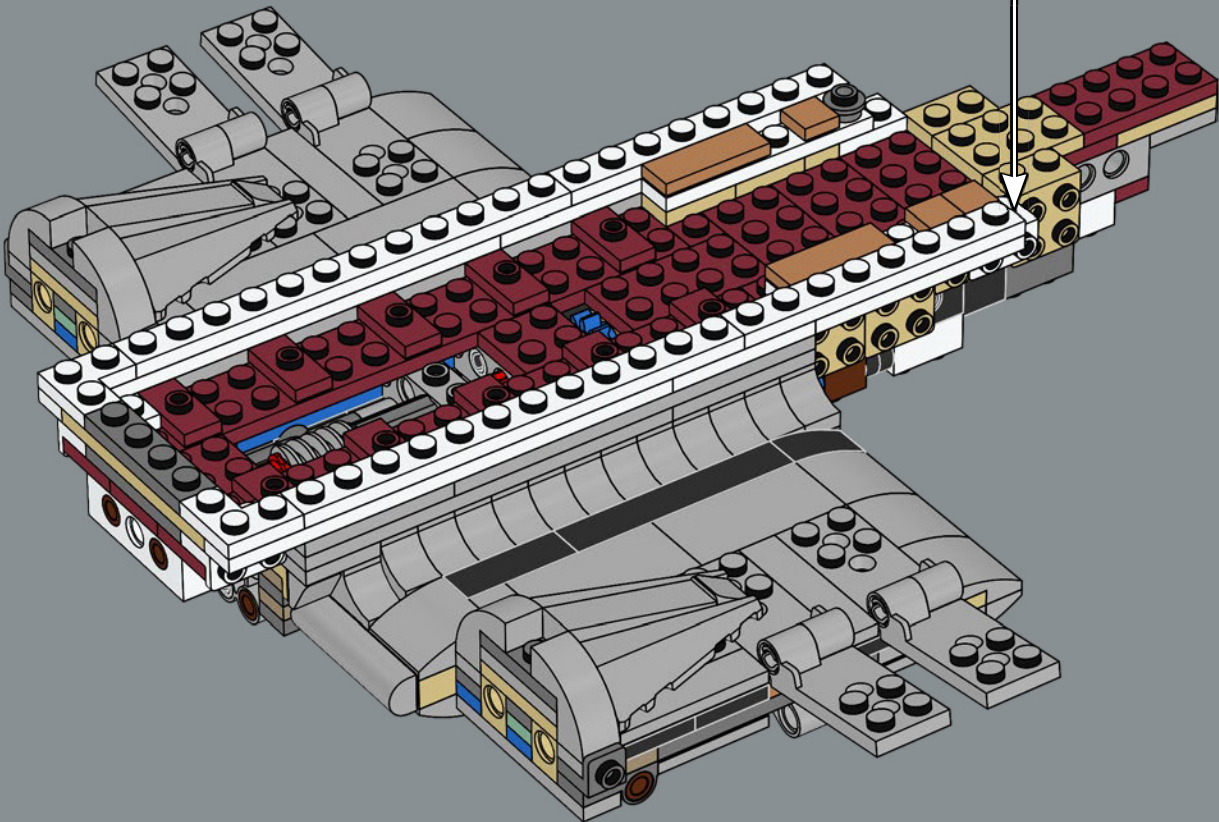
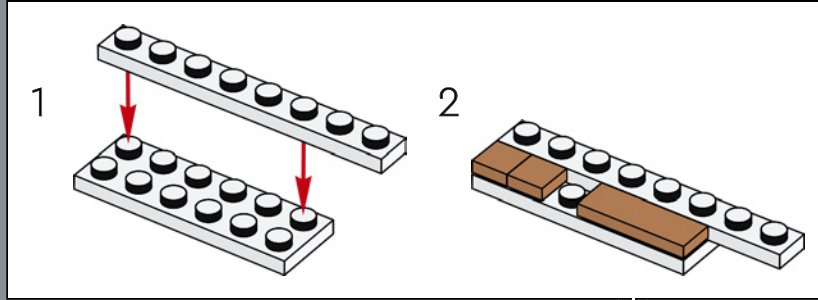

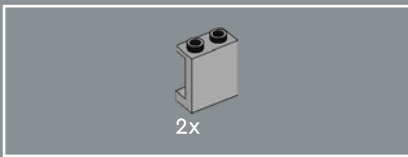

97

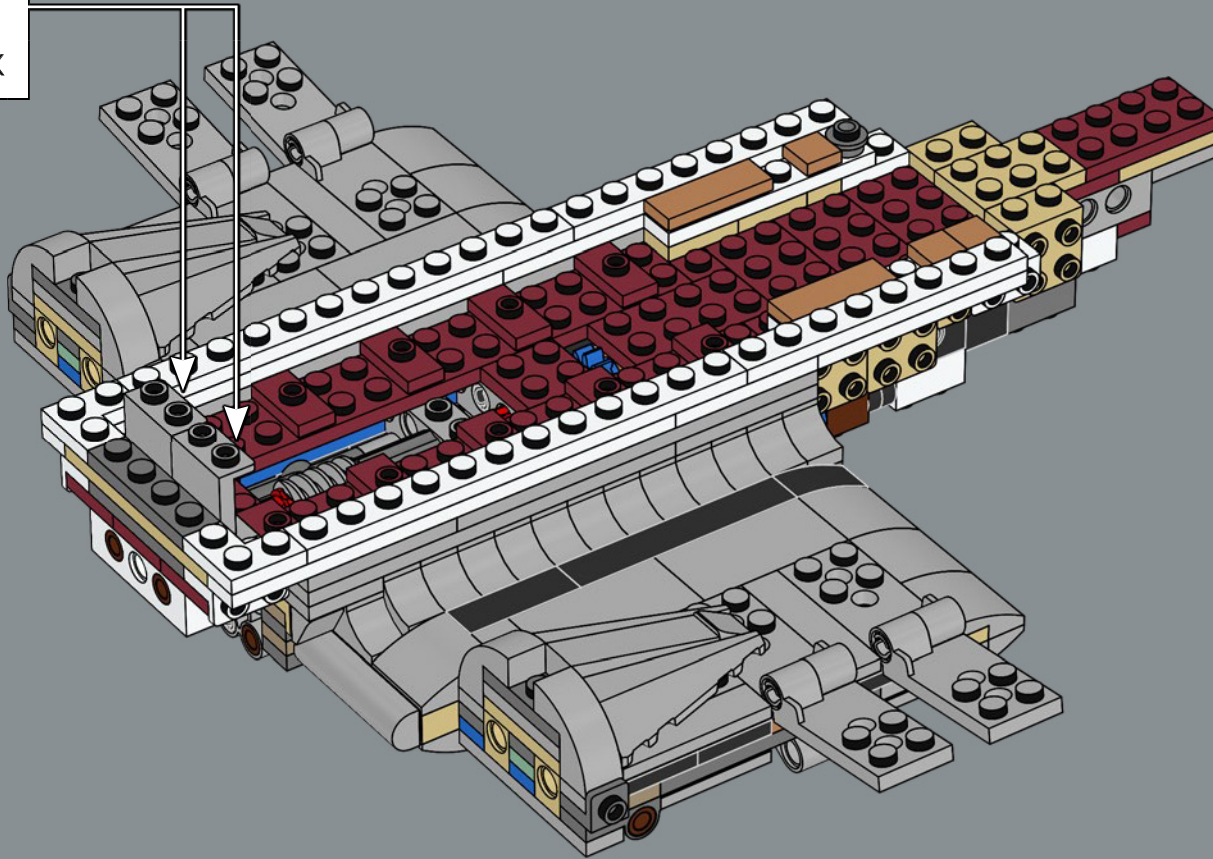
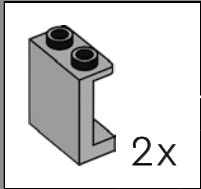

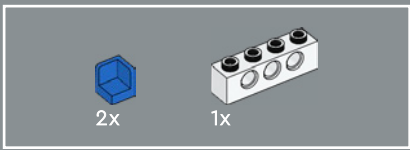



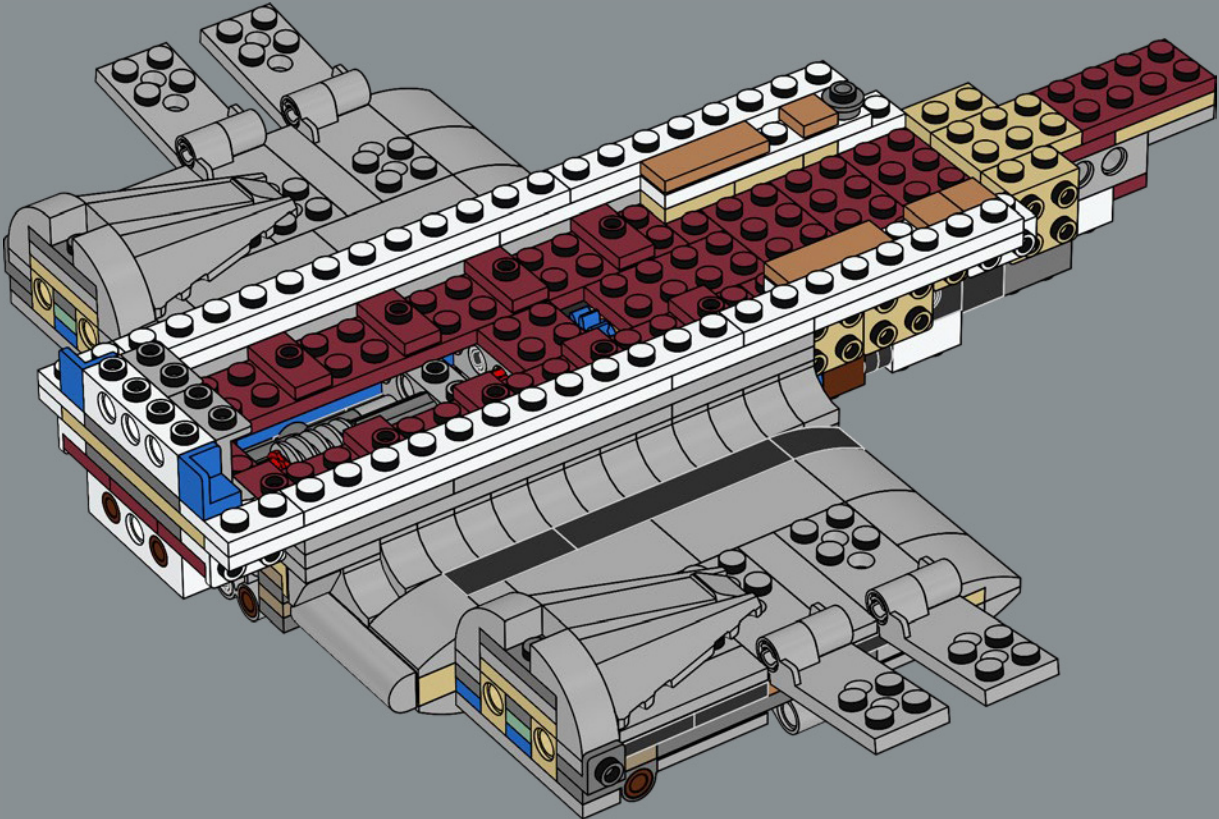

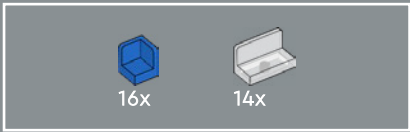
98



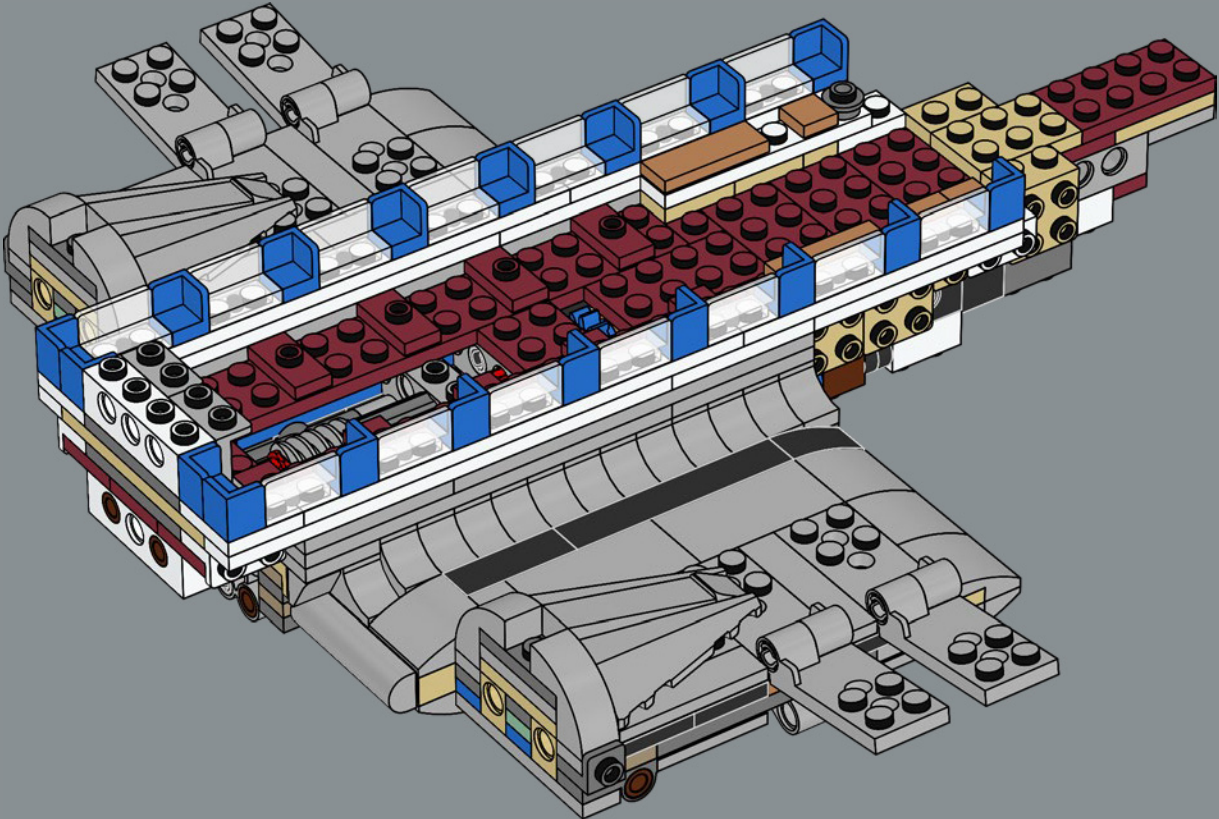

99



- 1x 
- 1x 
- 1x 
- 1x 

100

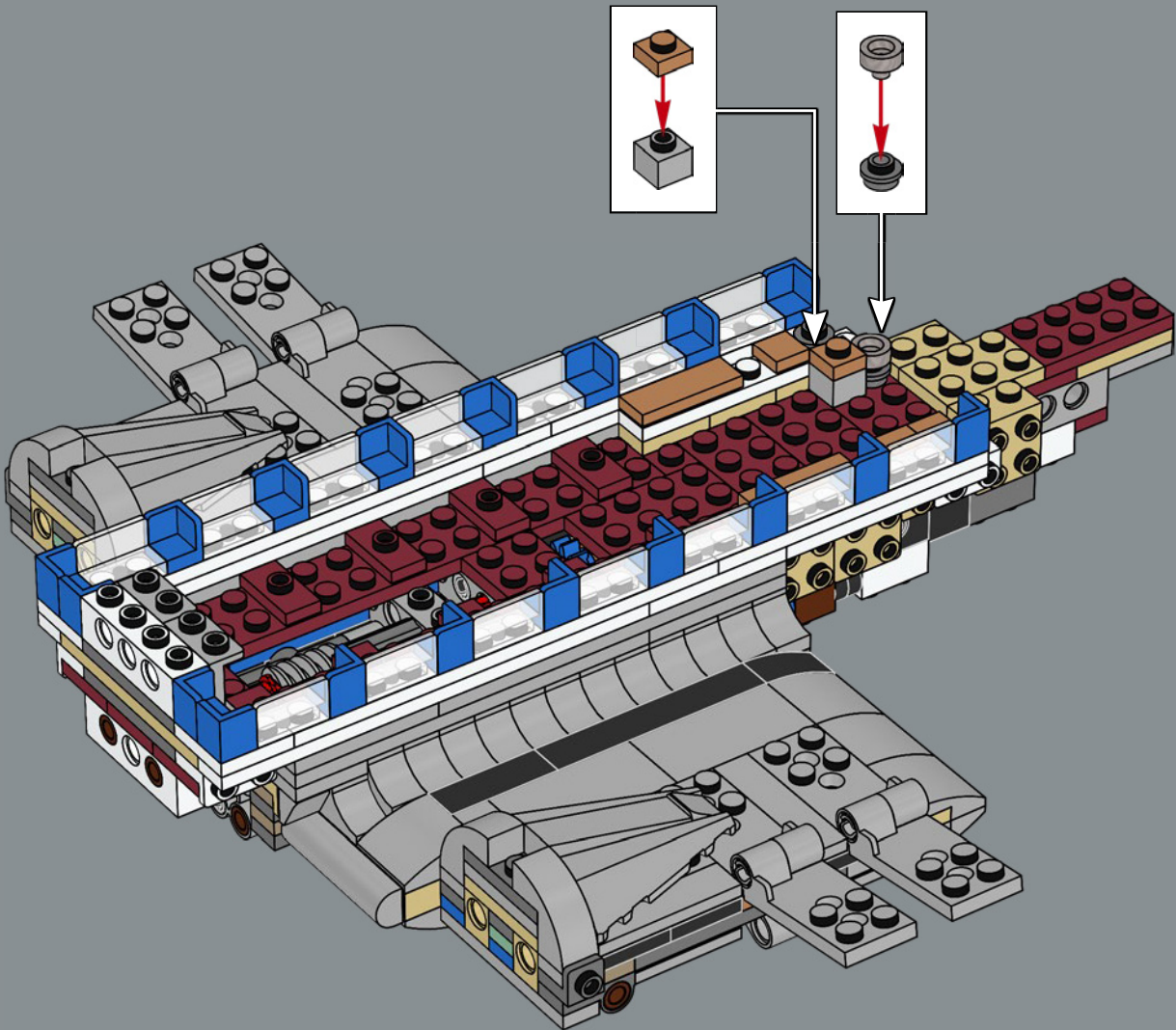

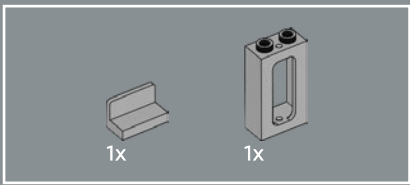

101

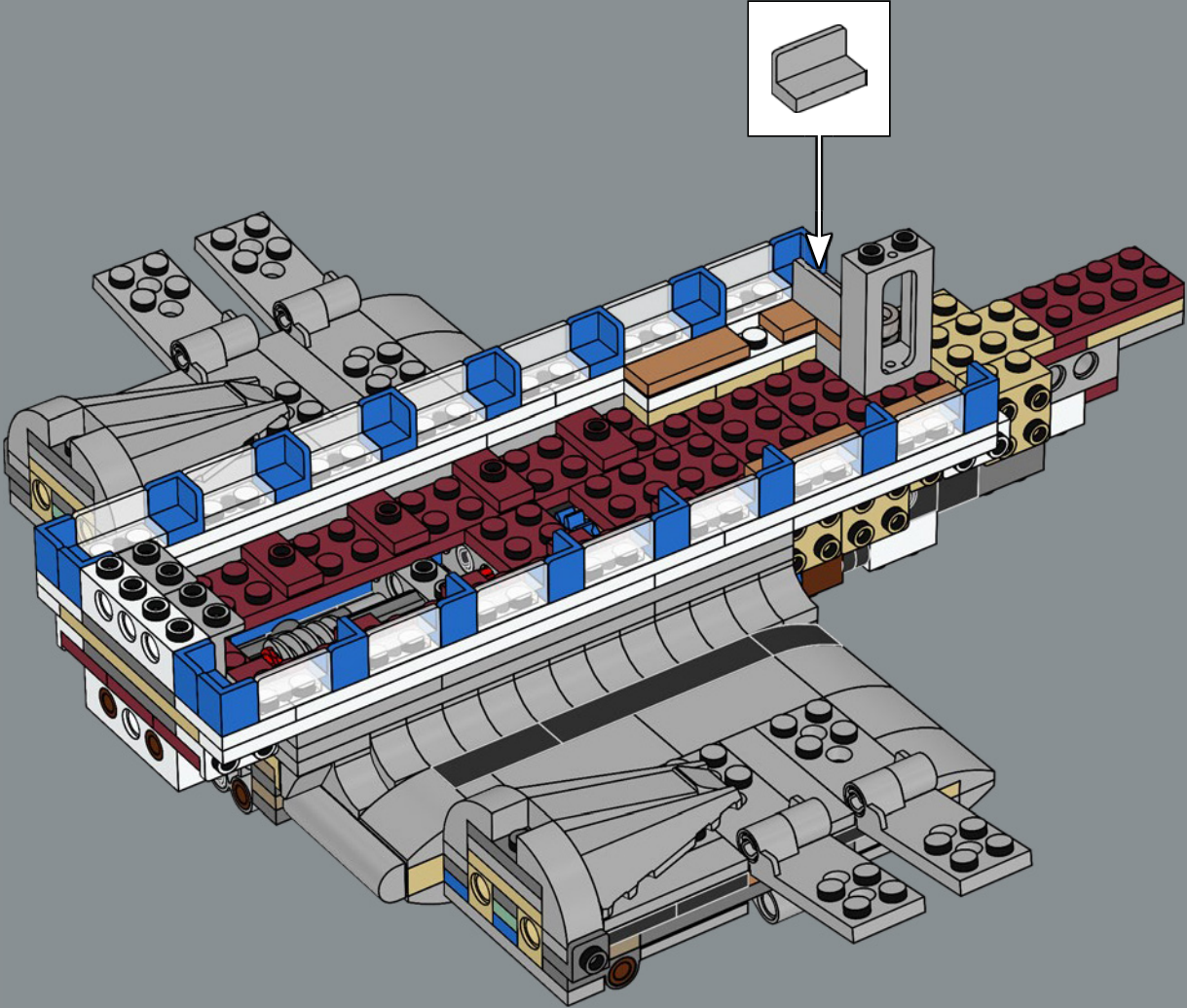

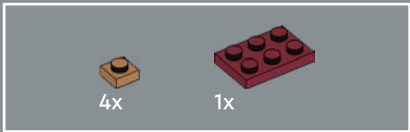

102

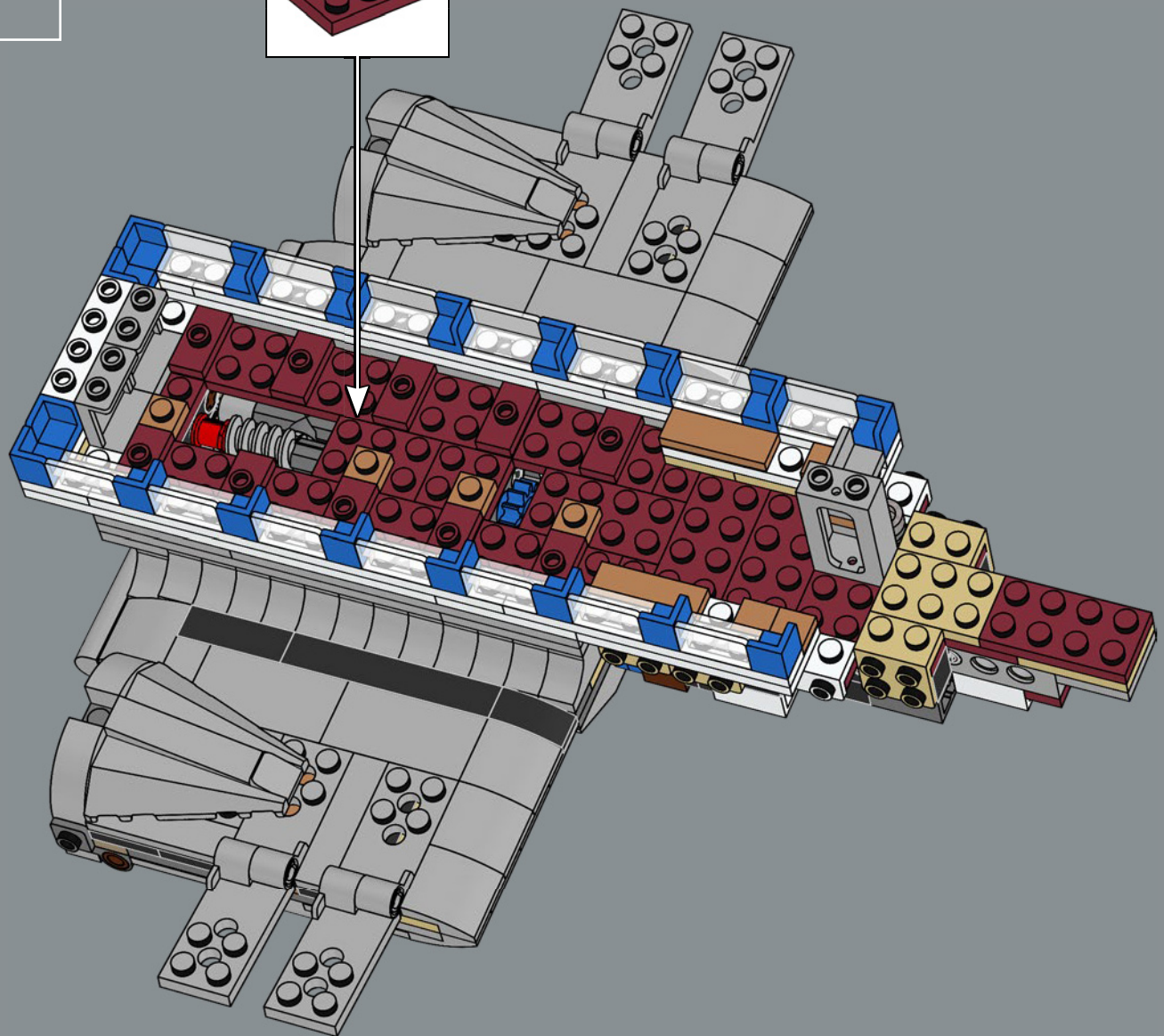
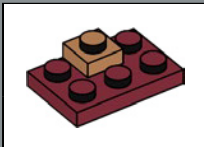

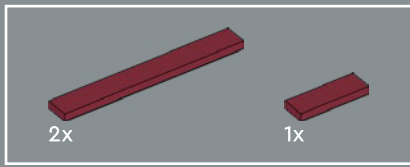

103

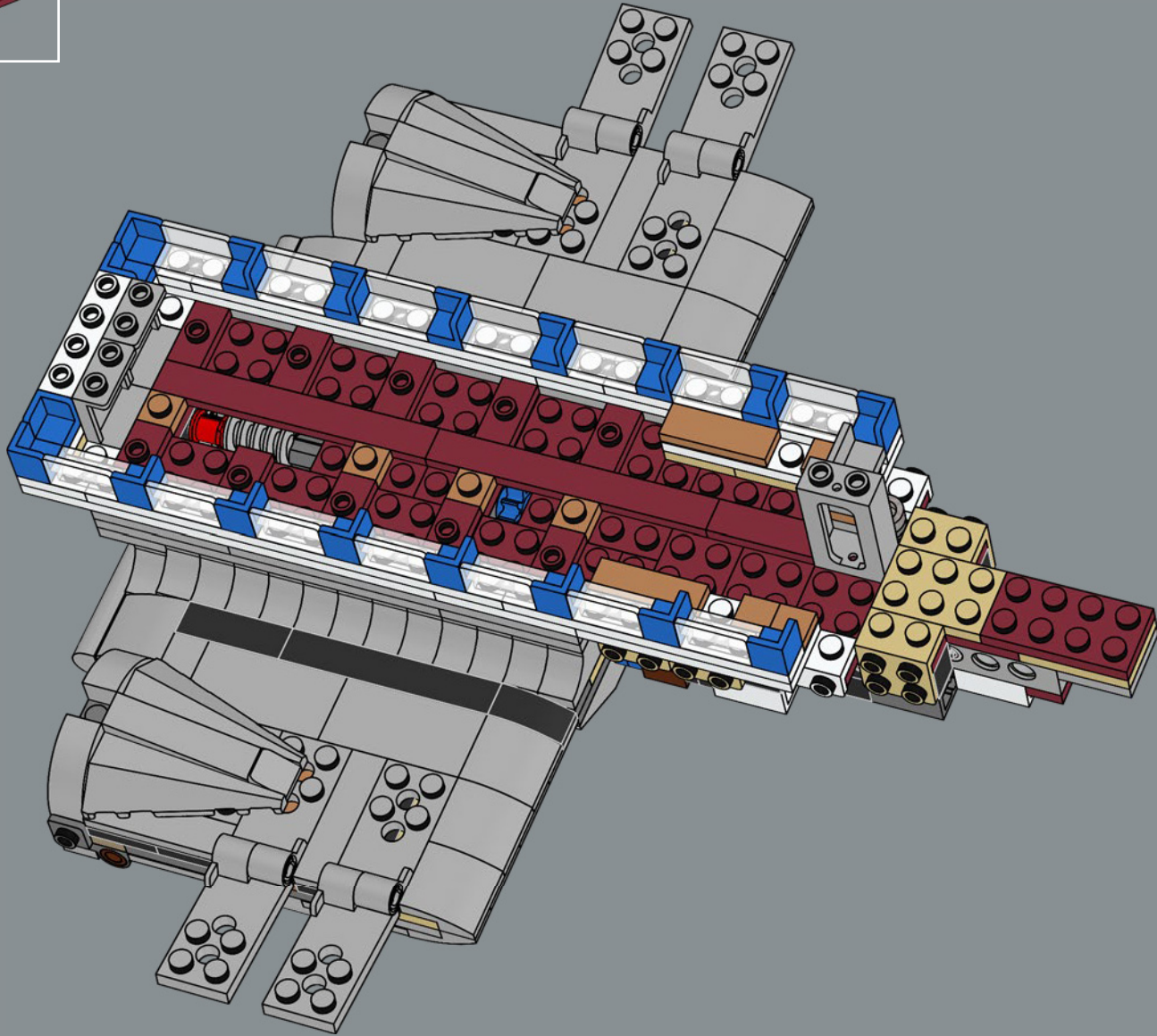



104

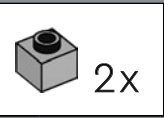
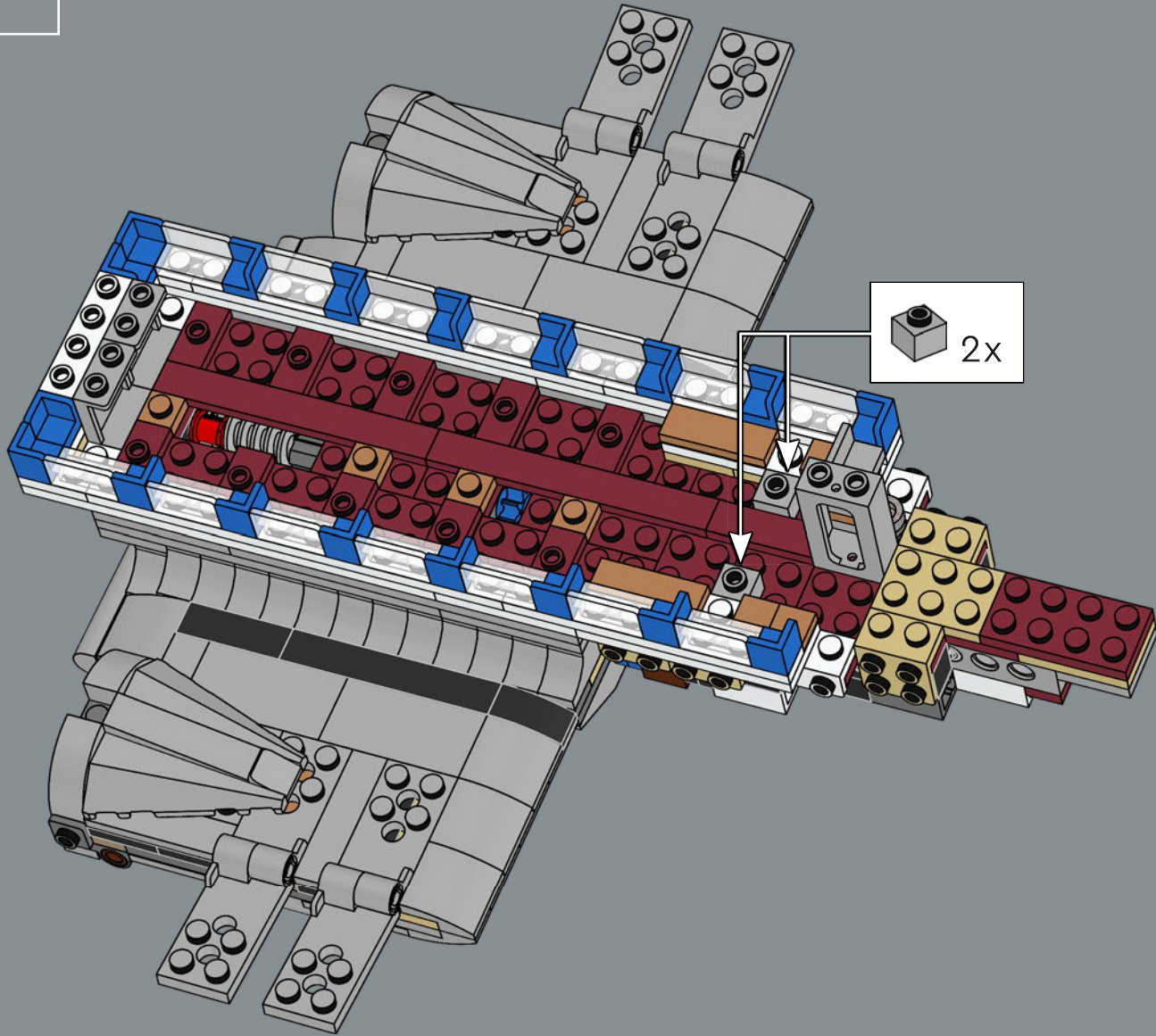

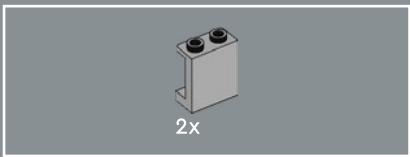

105

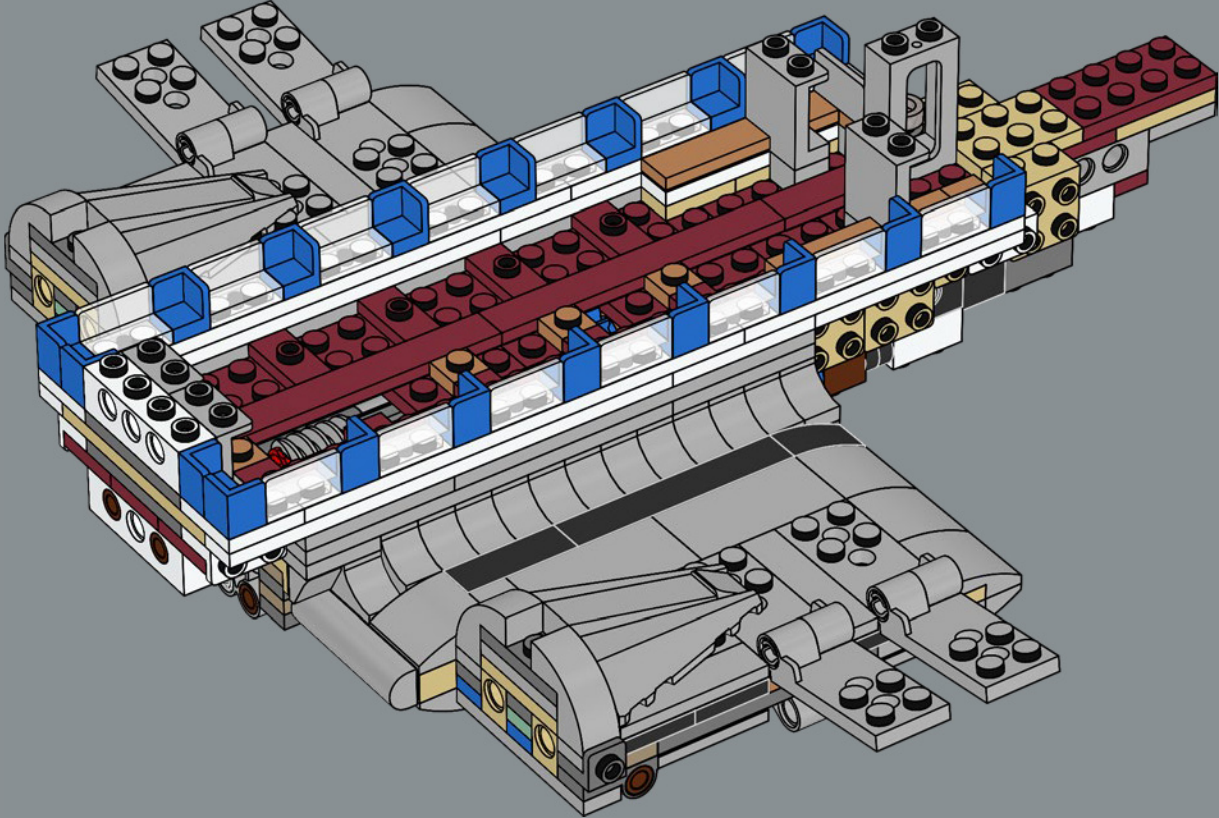

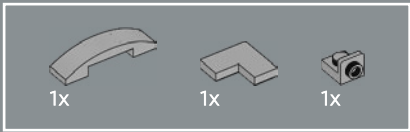

106

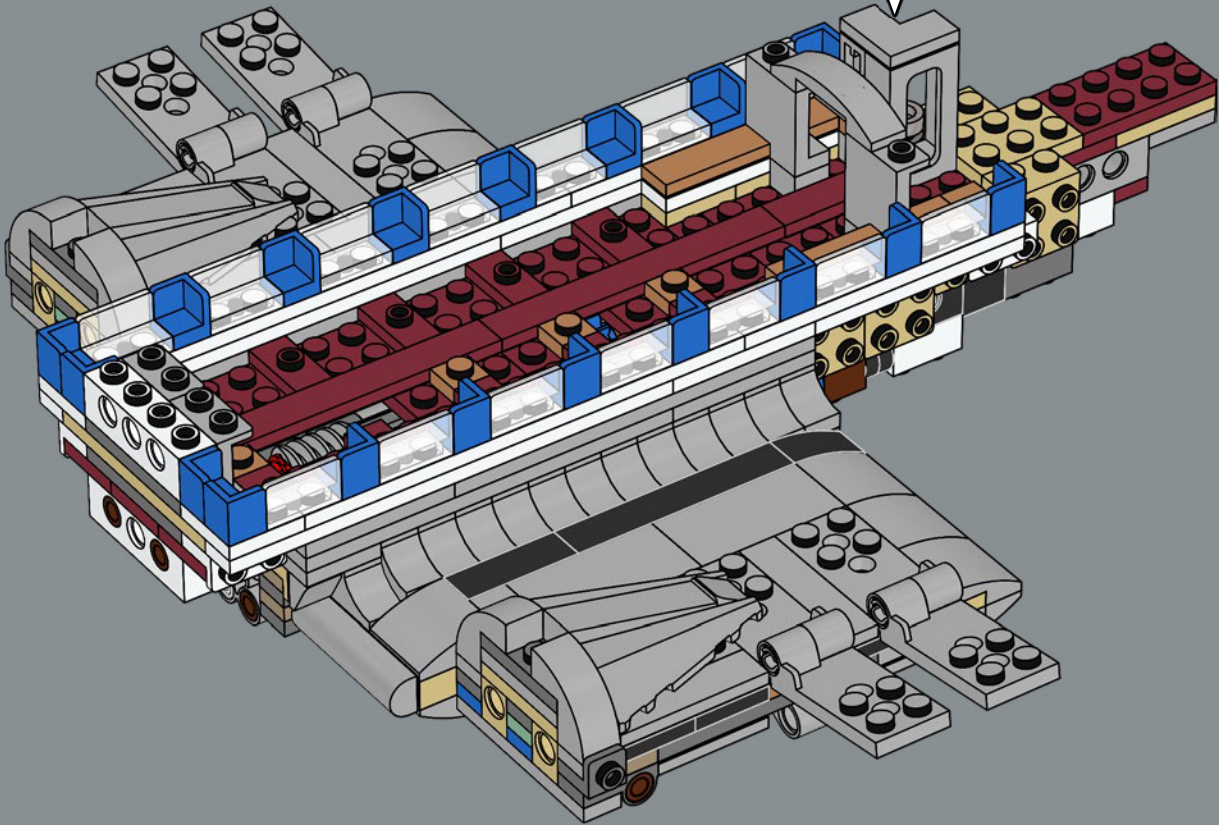
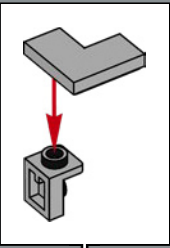

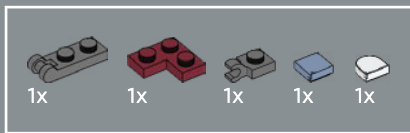

107

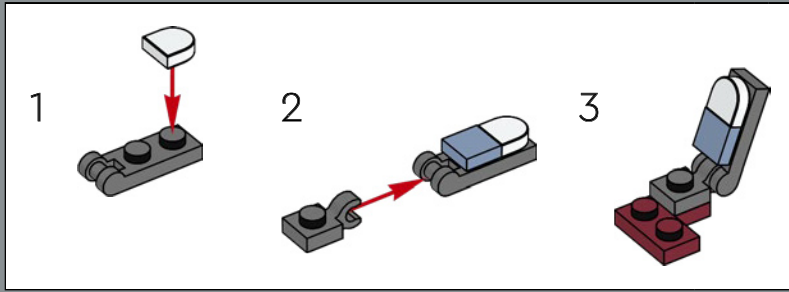
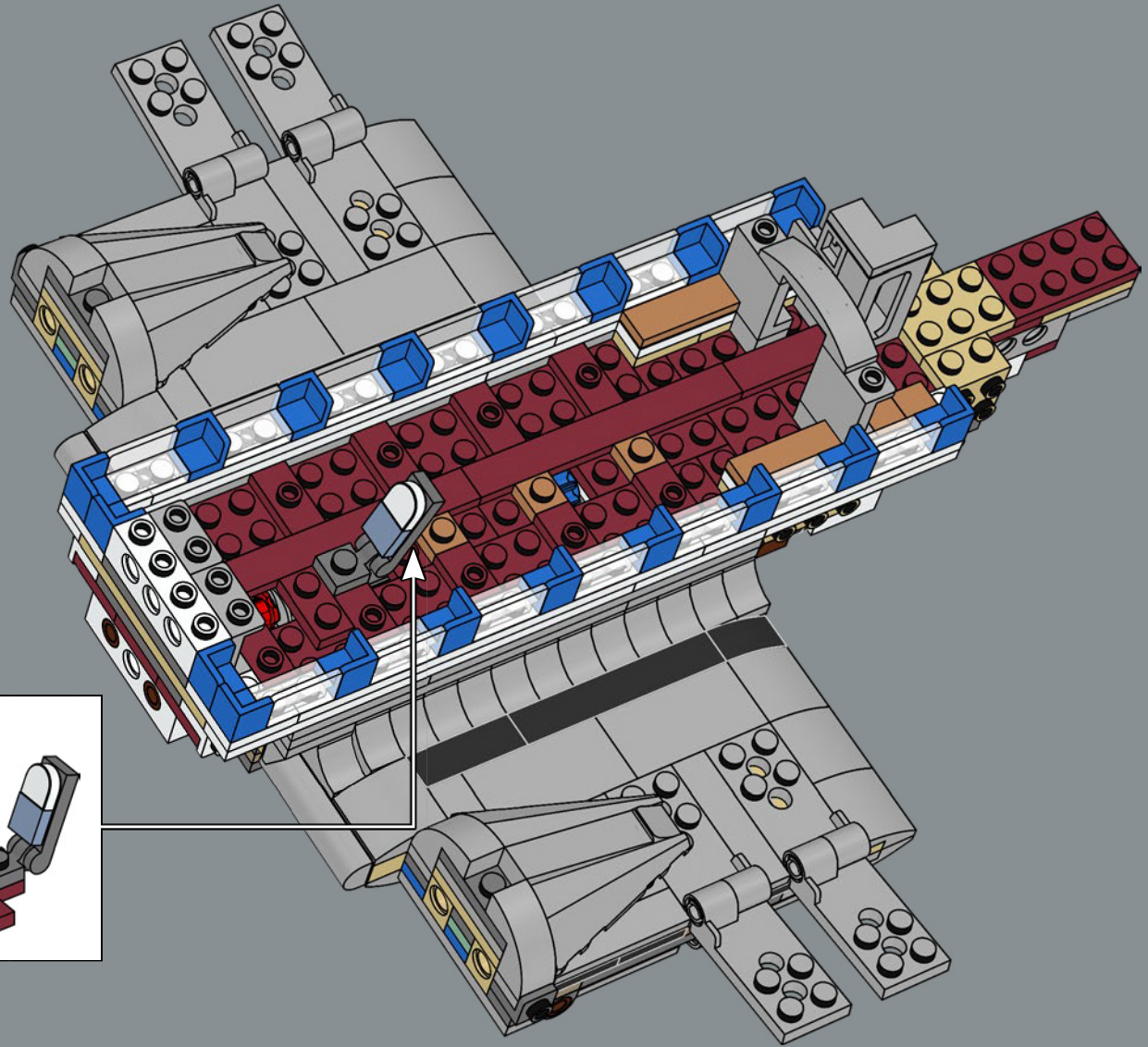

14x 14x 14x 14x

108

1 2 14x

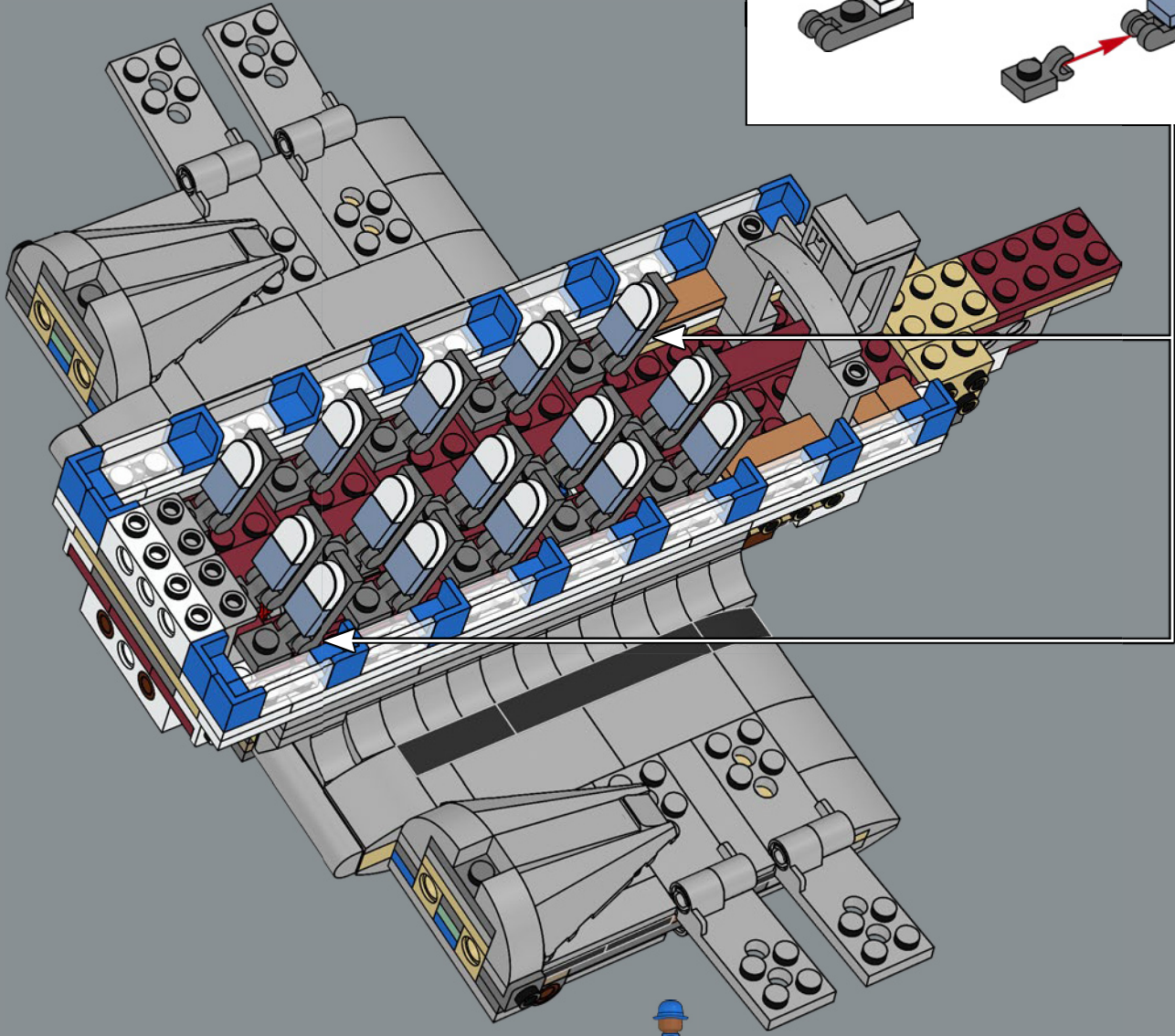

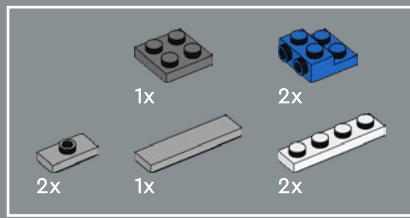

109

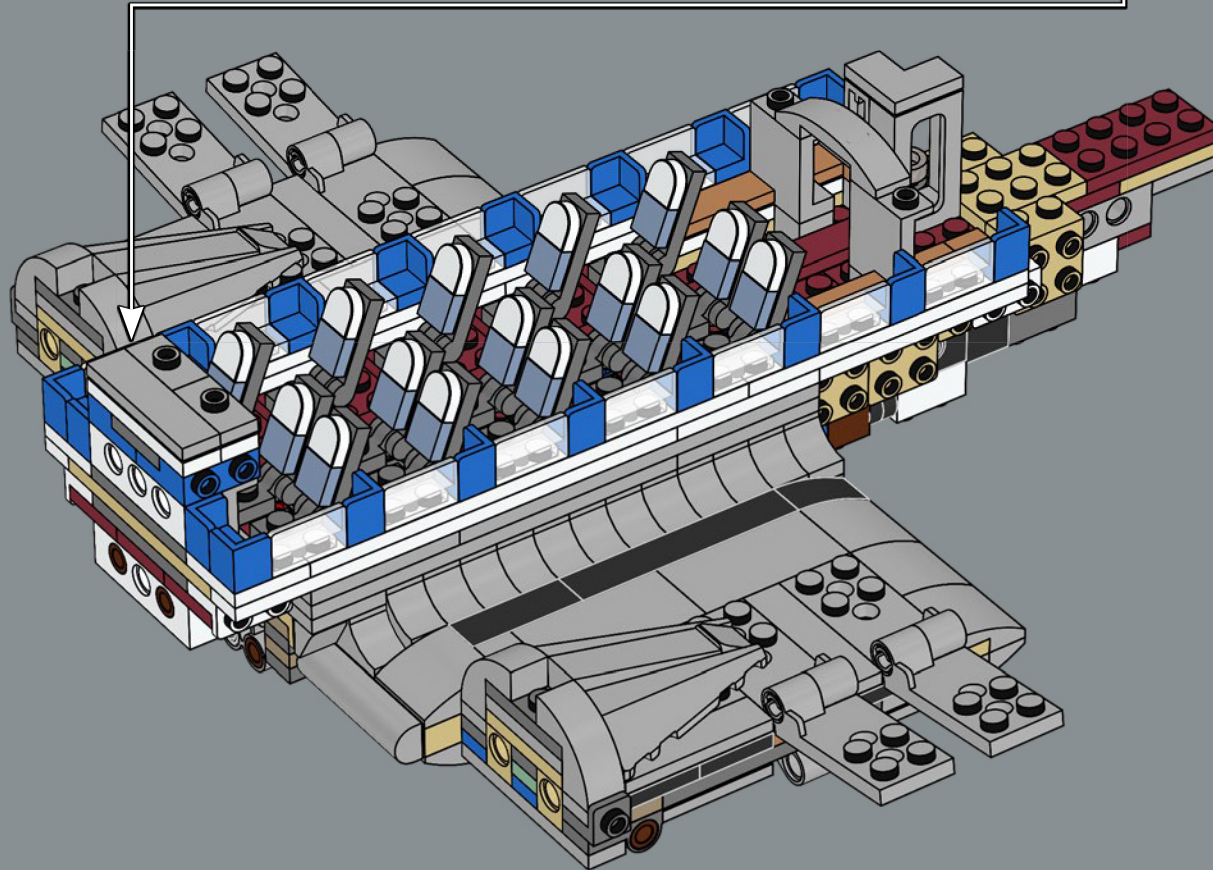
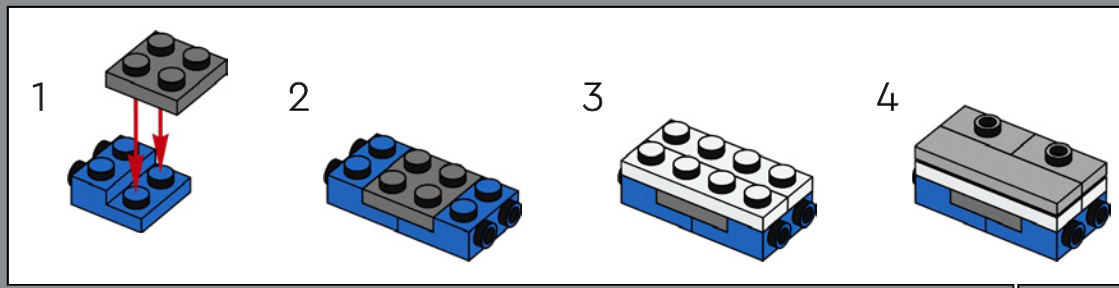

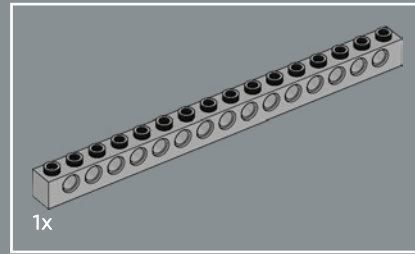
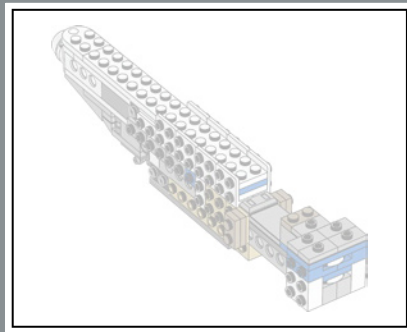

111

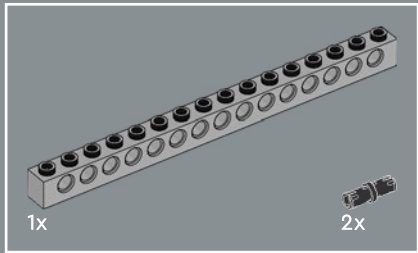
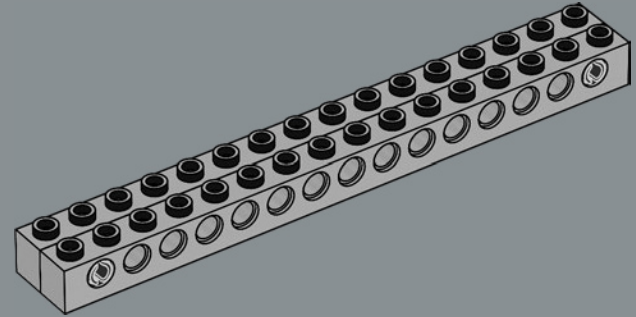

110

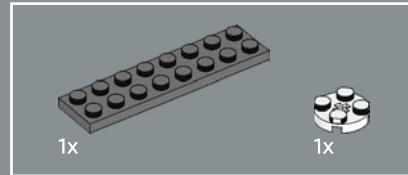
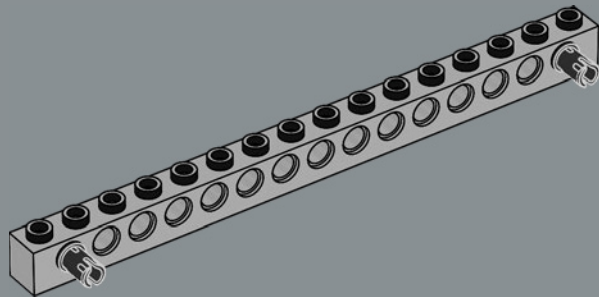

112

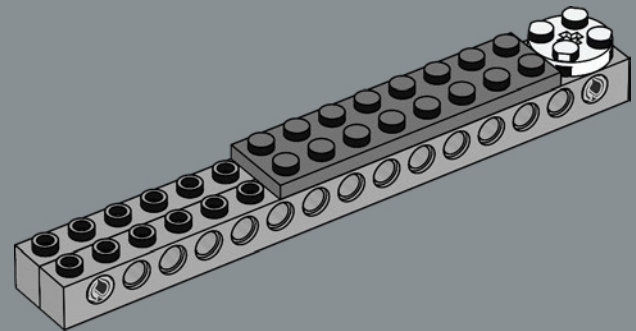

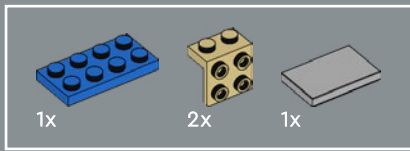

113

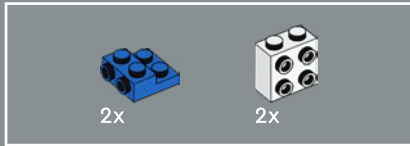
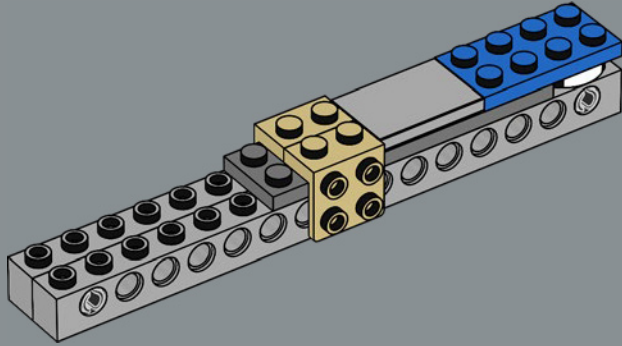

114

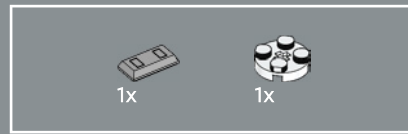
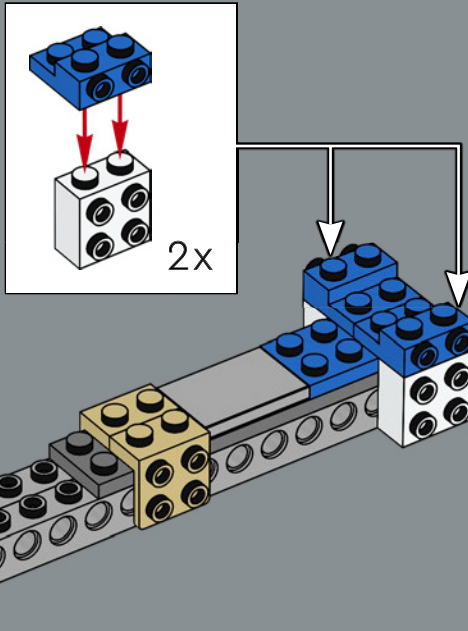

115

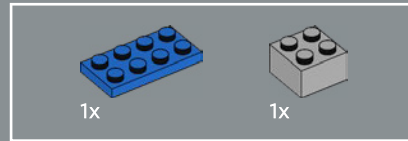
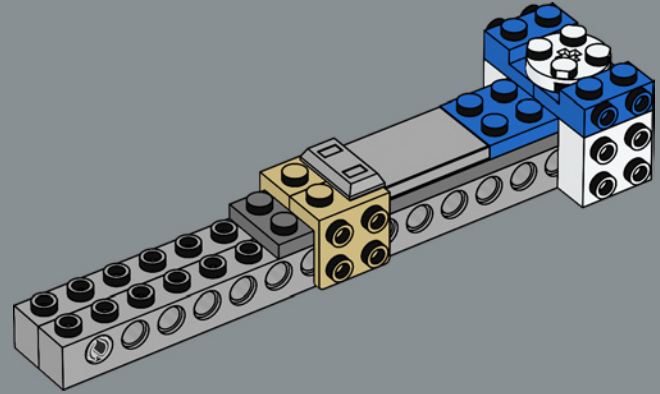

116

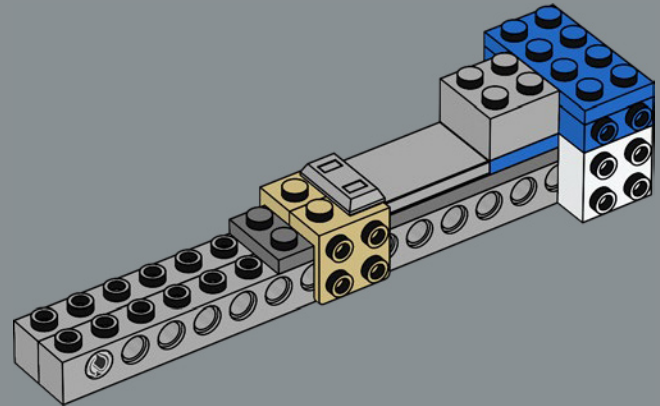

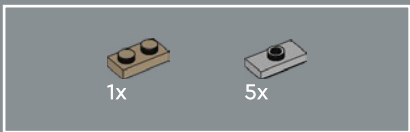

117

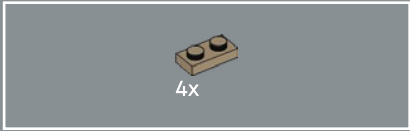
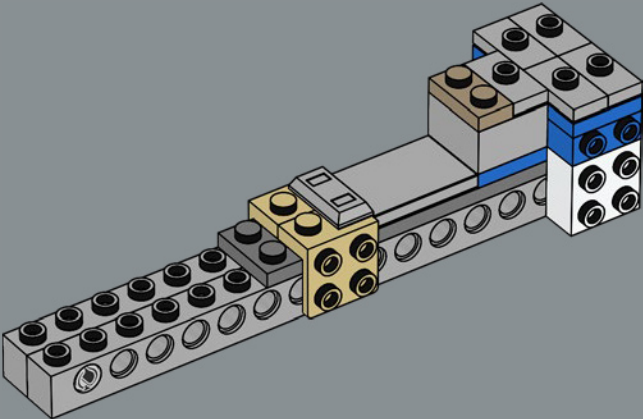

118

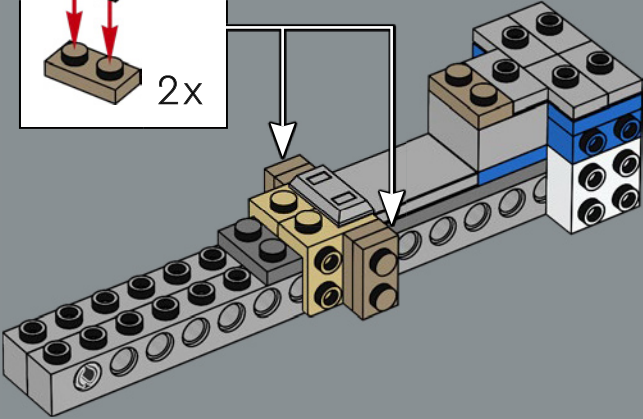
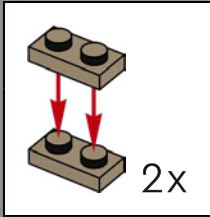

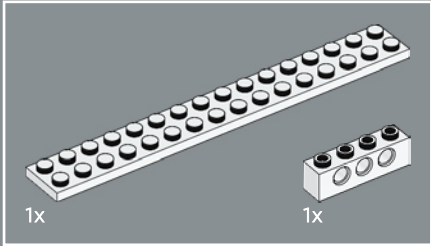
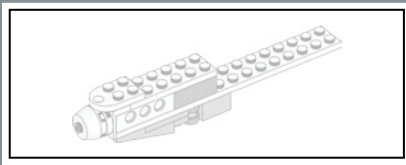

119

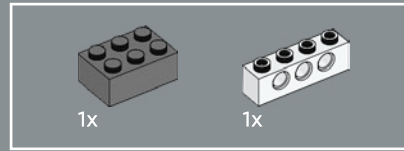
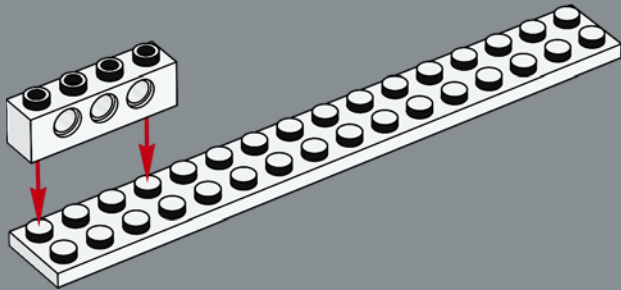

120

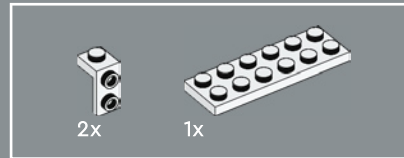
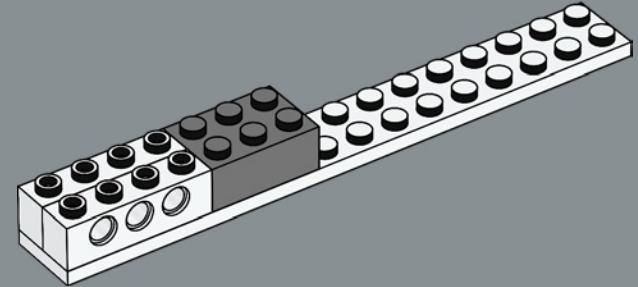

121

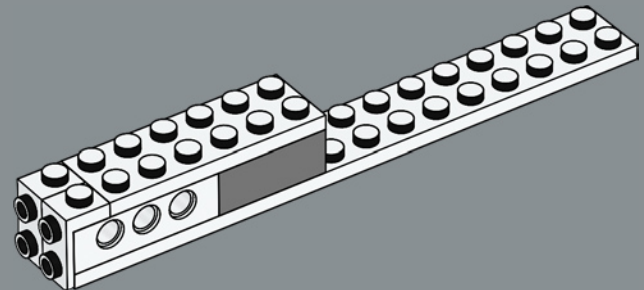

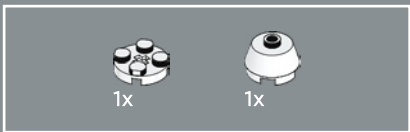

122

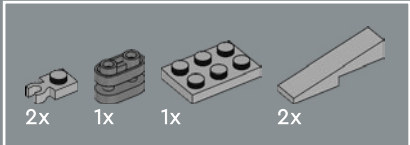
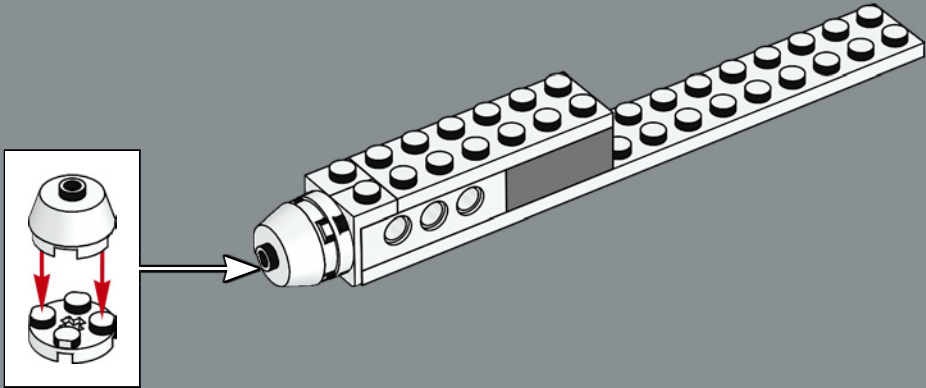

123

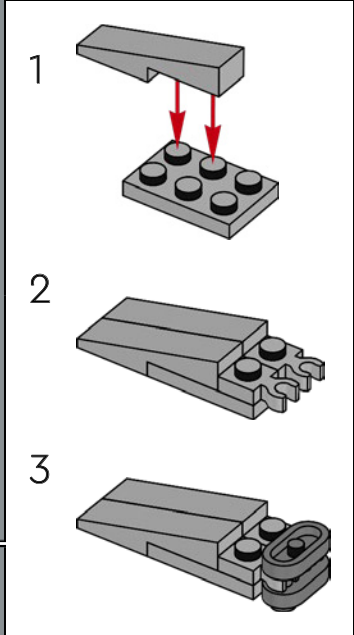
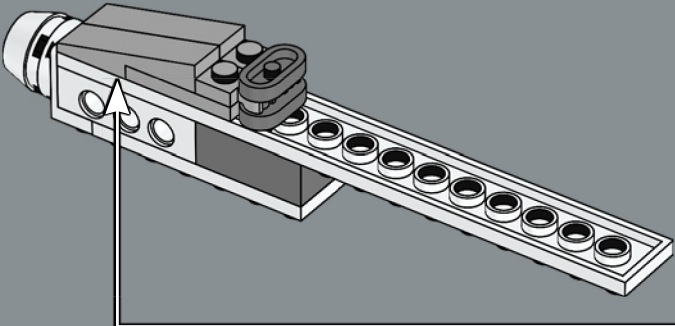
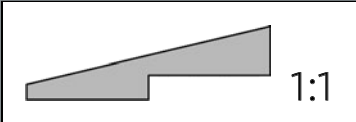

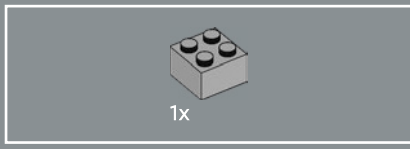

124

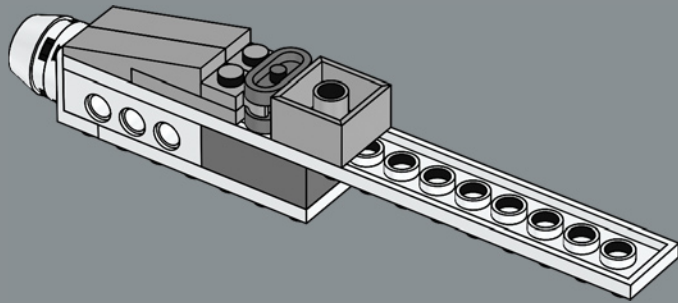

125

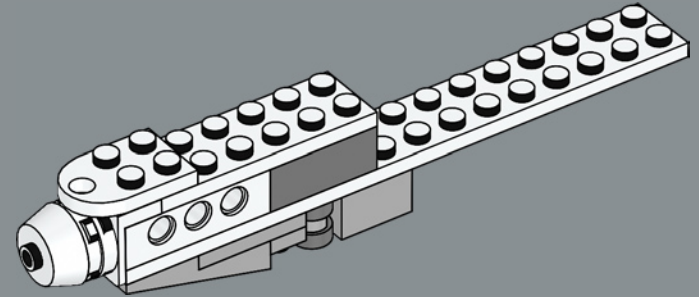

126

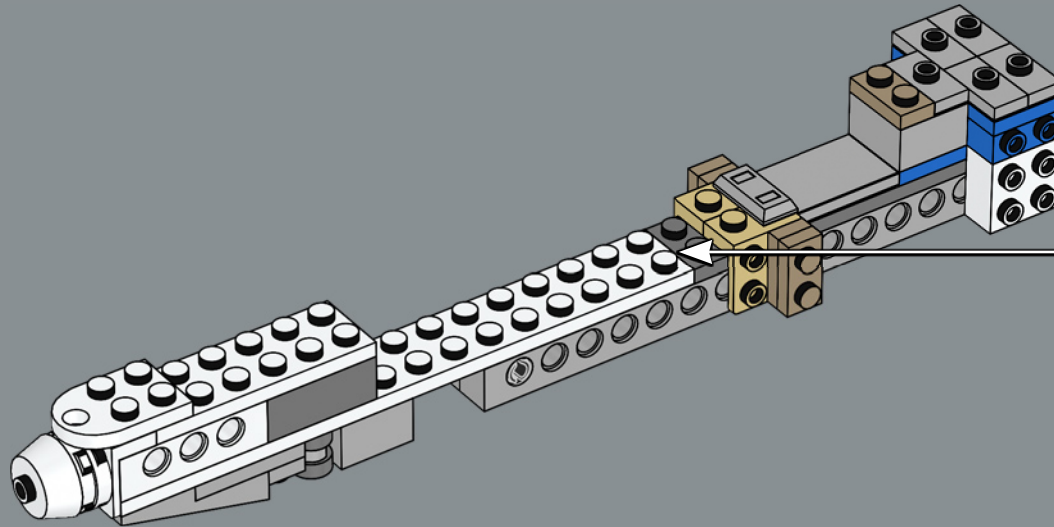

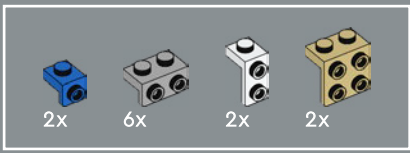

127

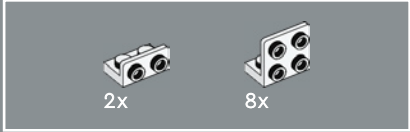
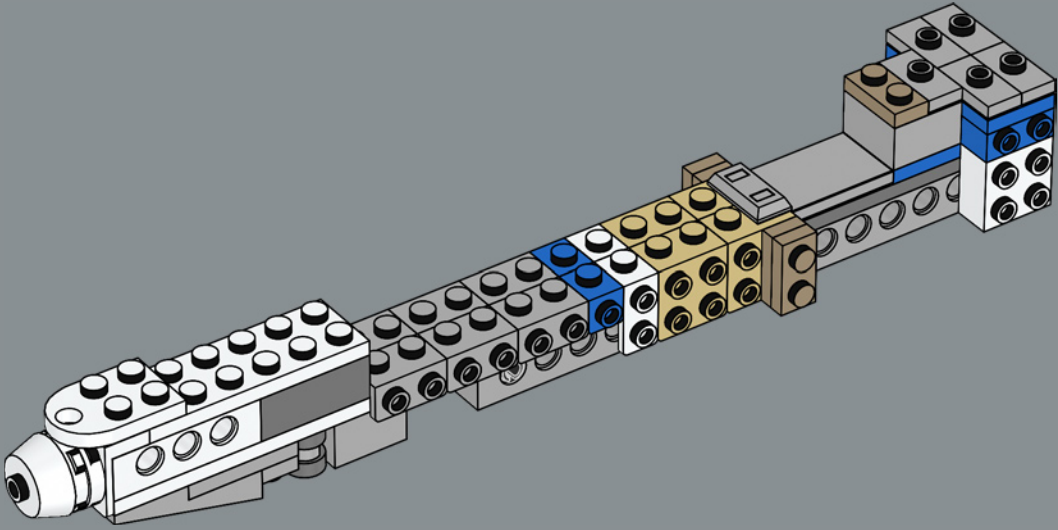

128

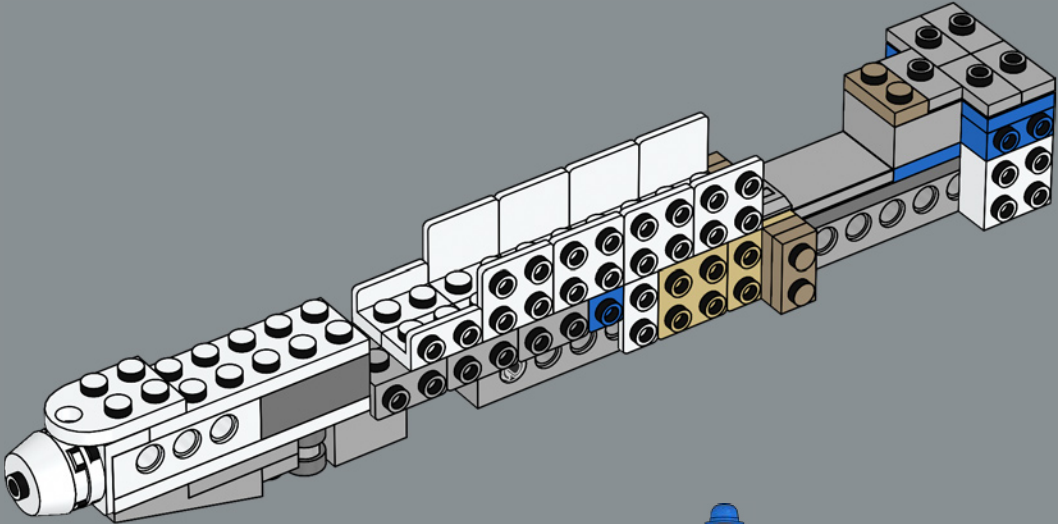

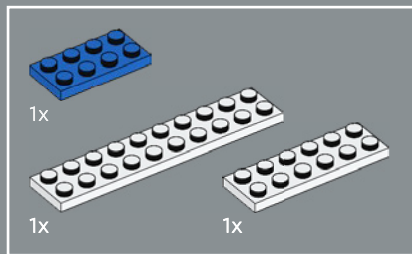

129

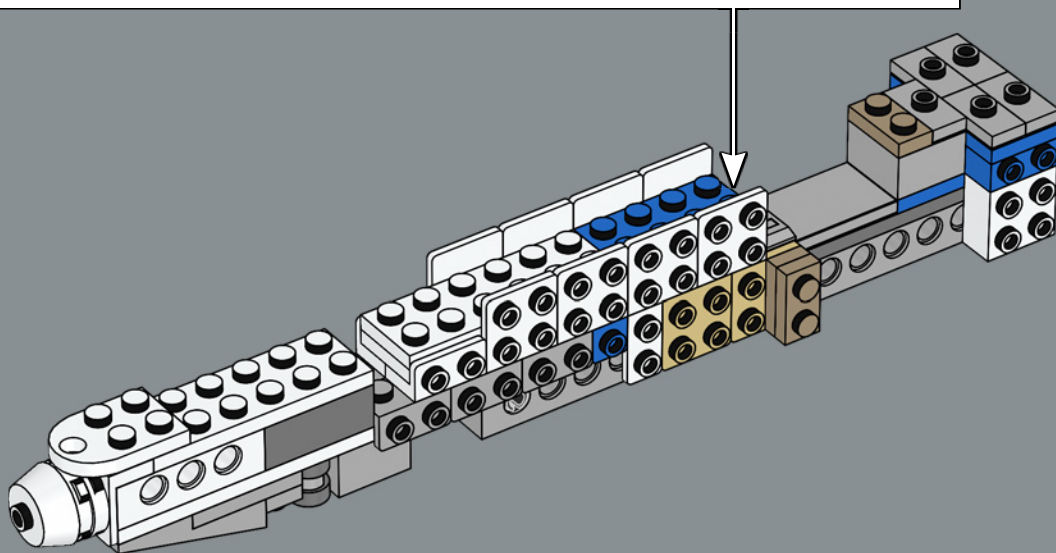
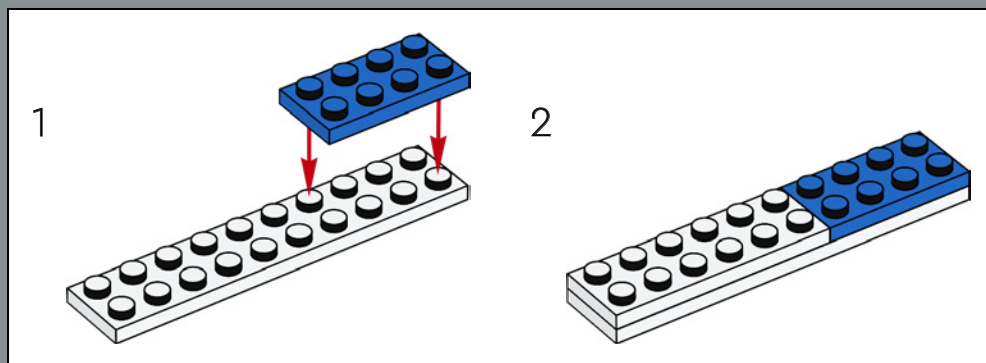



2x

130

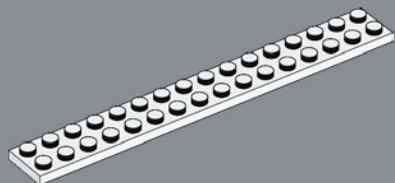
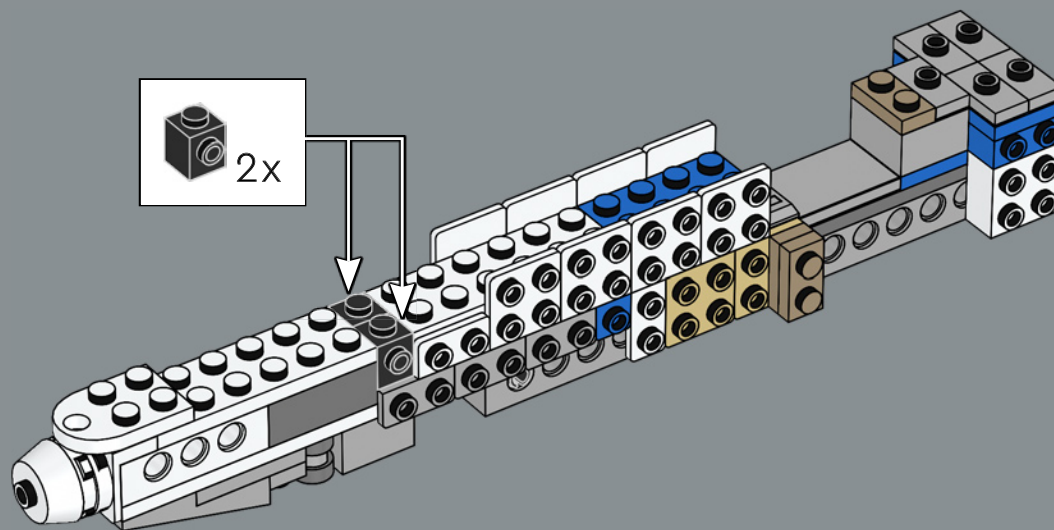

1x

131

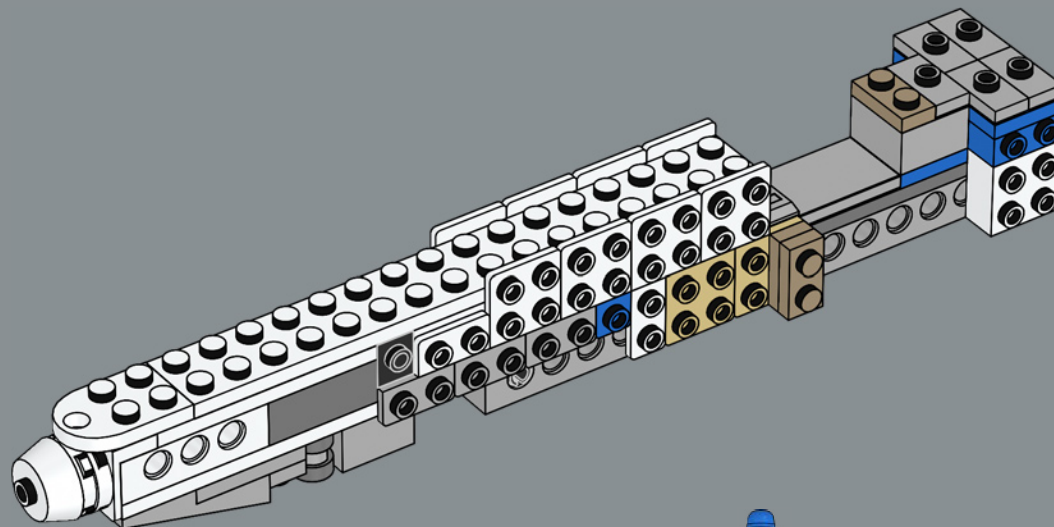

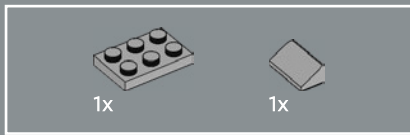

132

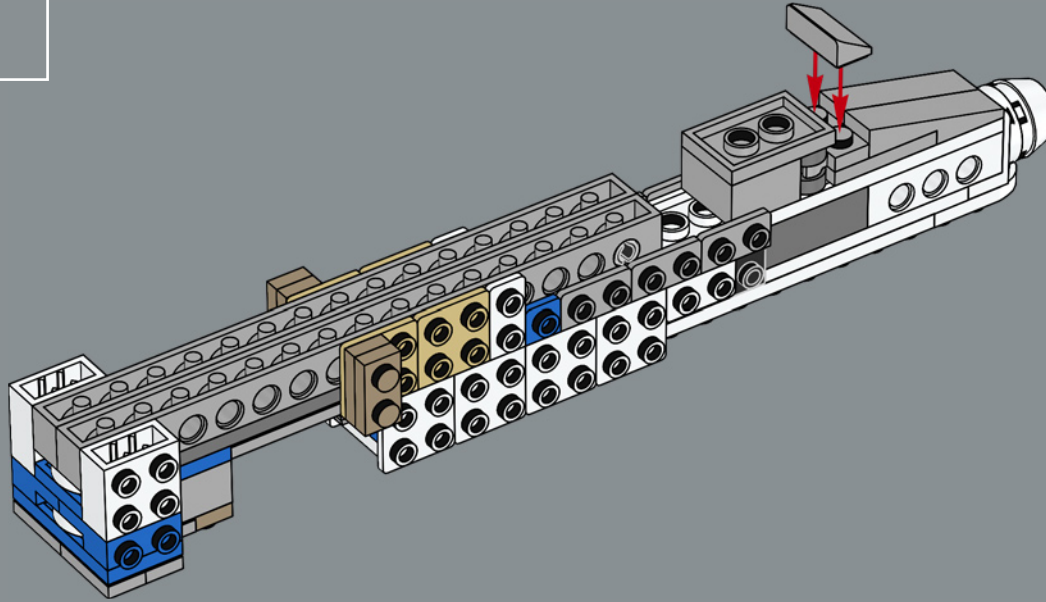

133

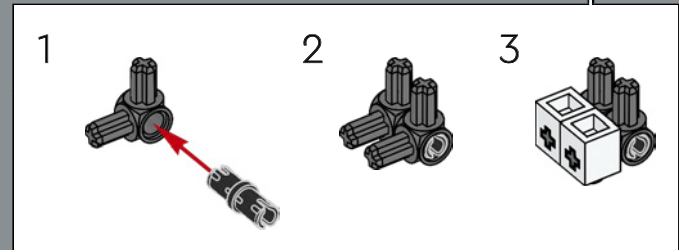
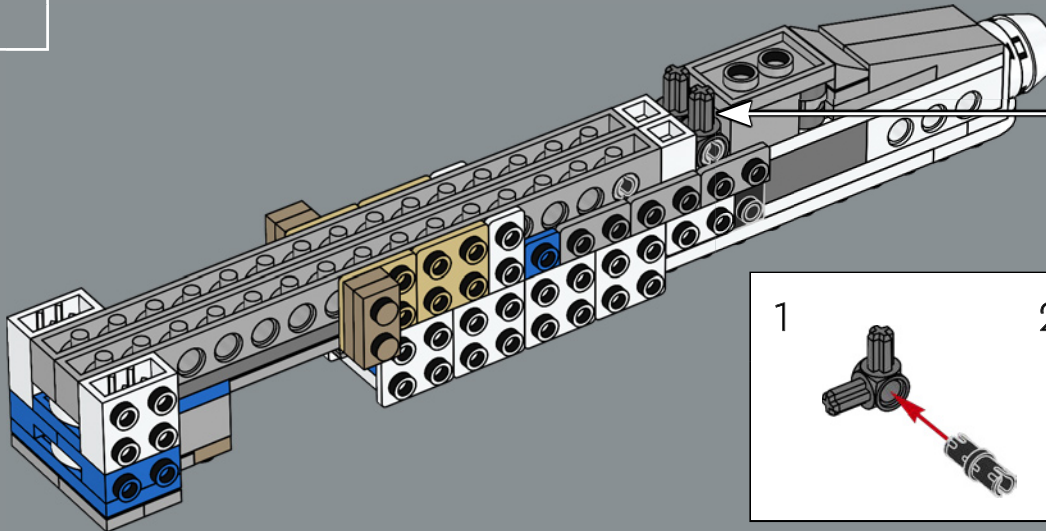

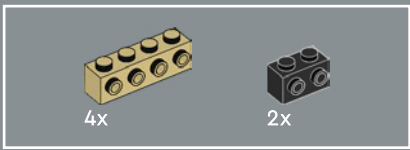

134

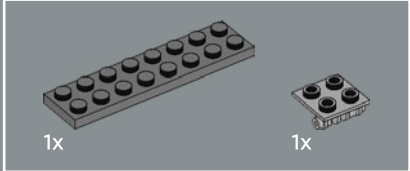
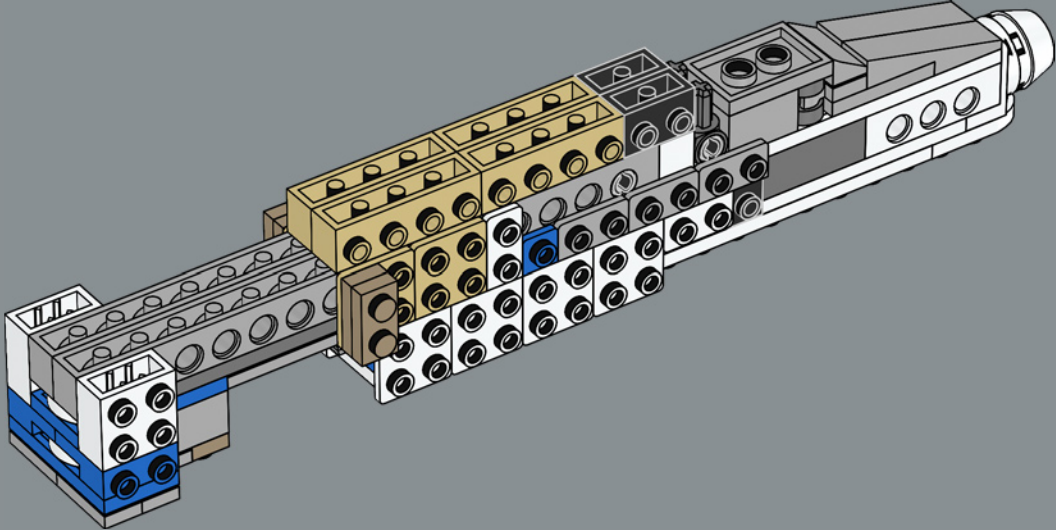

135

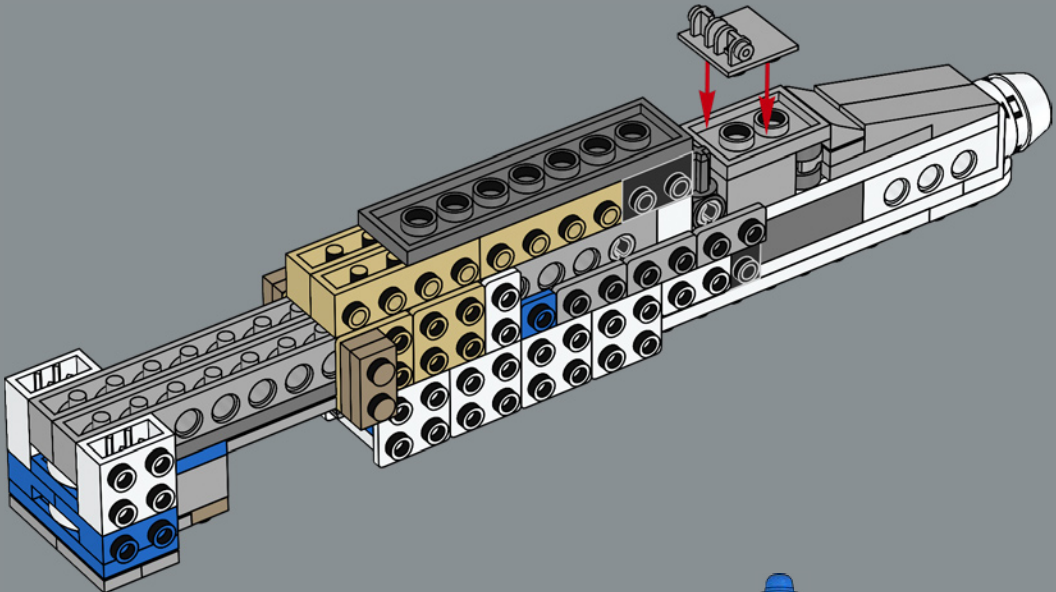

136

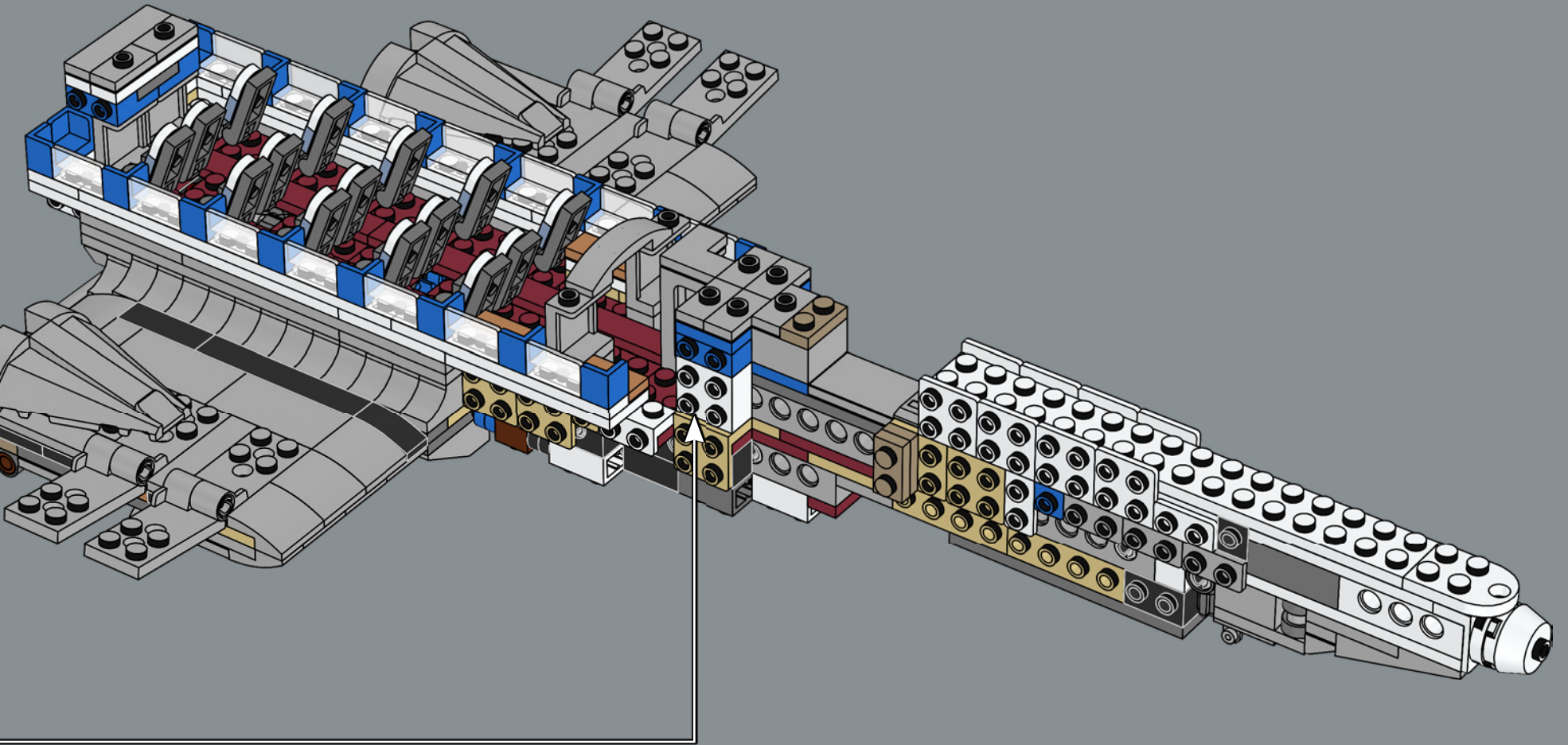



1x

137

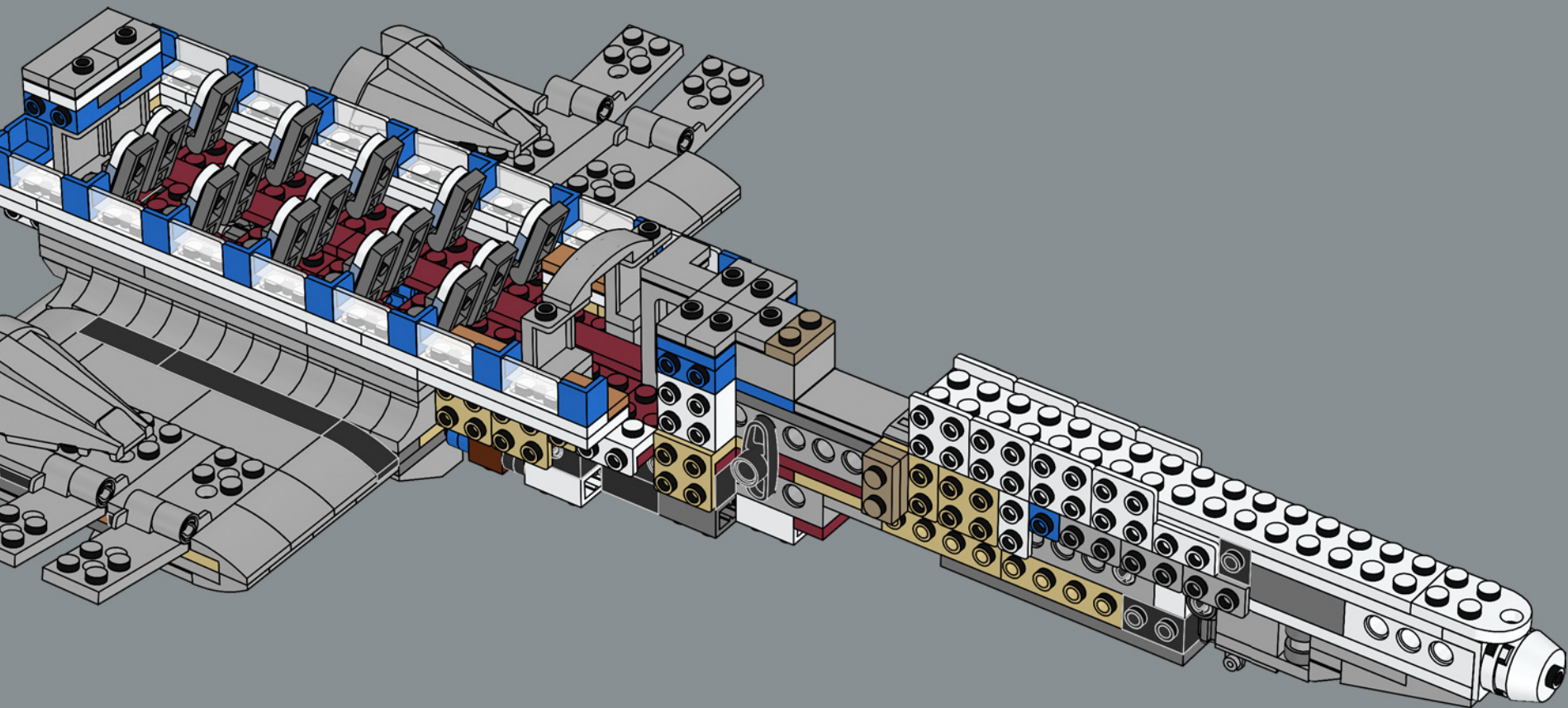

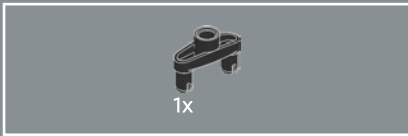

138

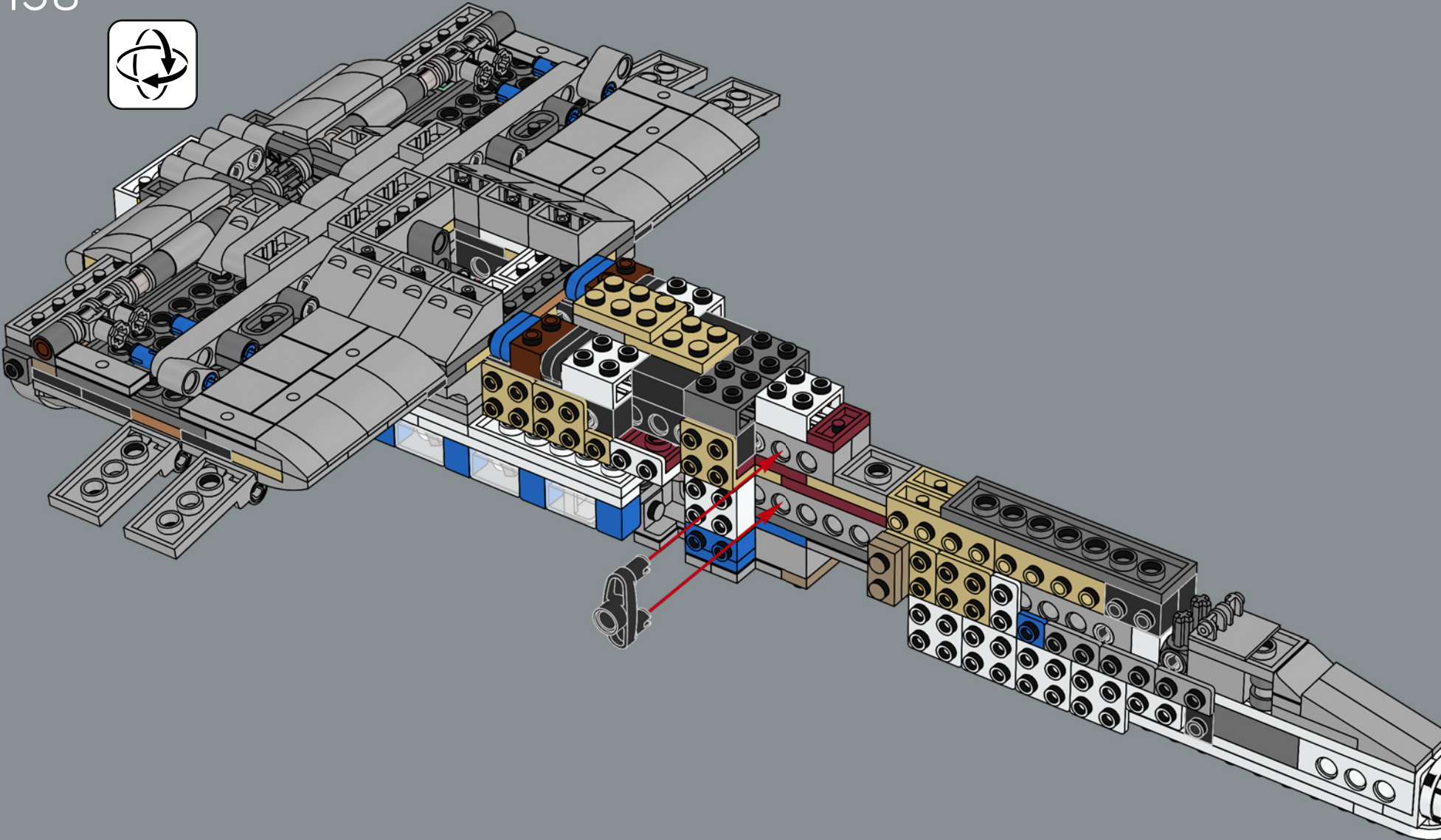

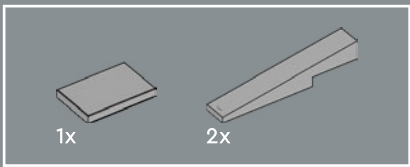

139

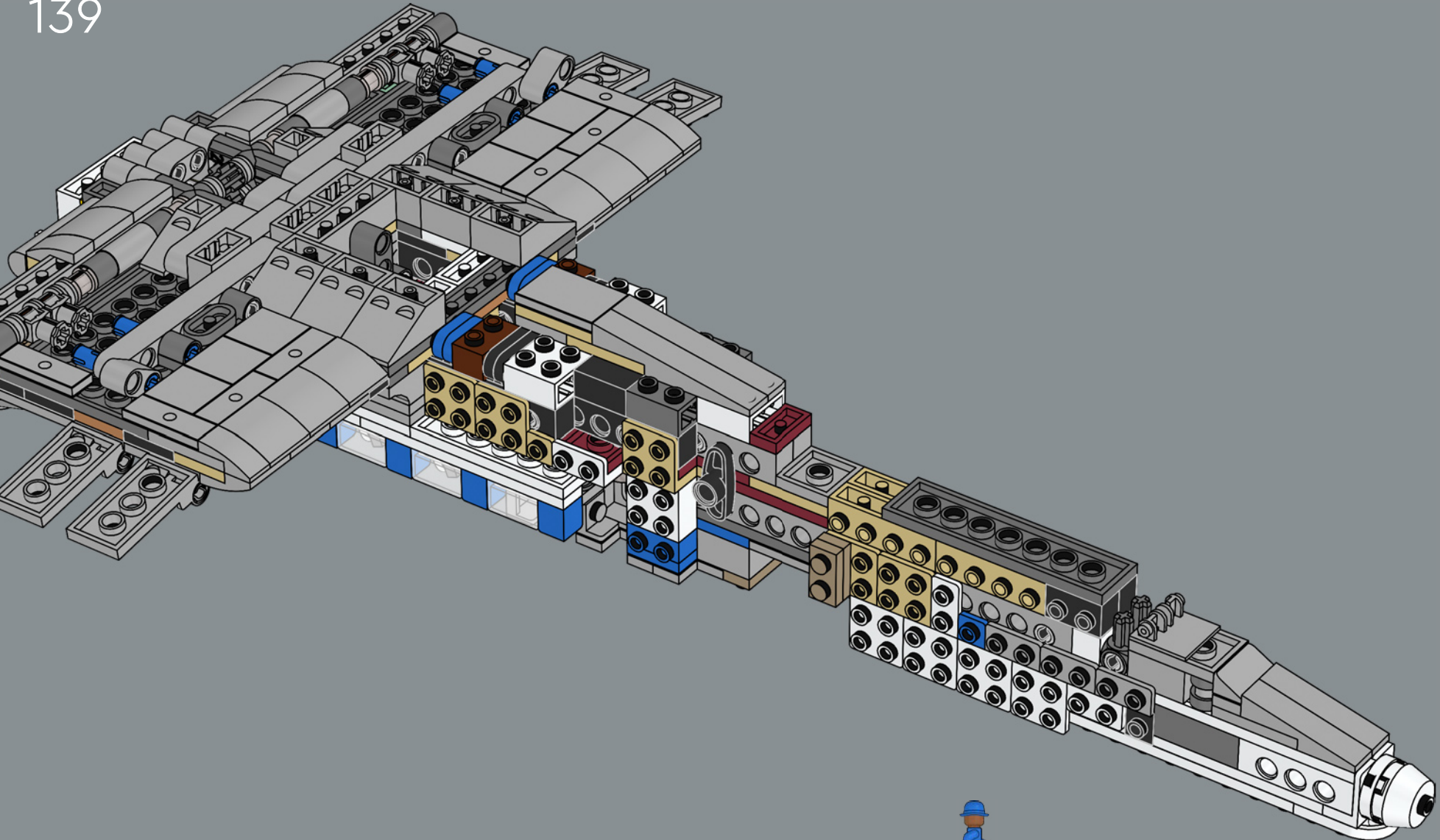

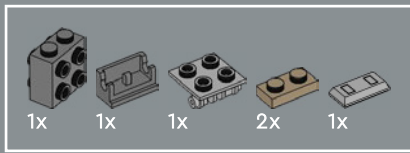

140

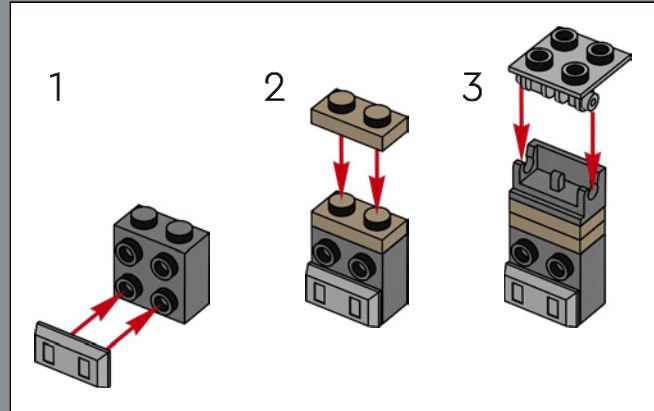
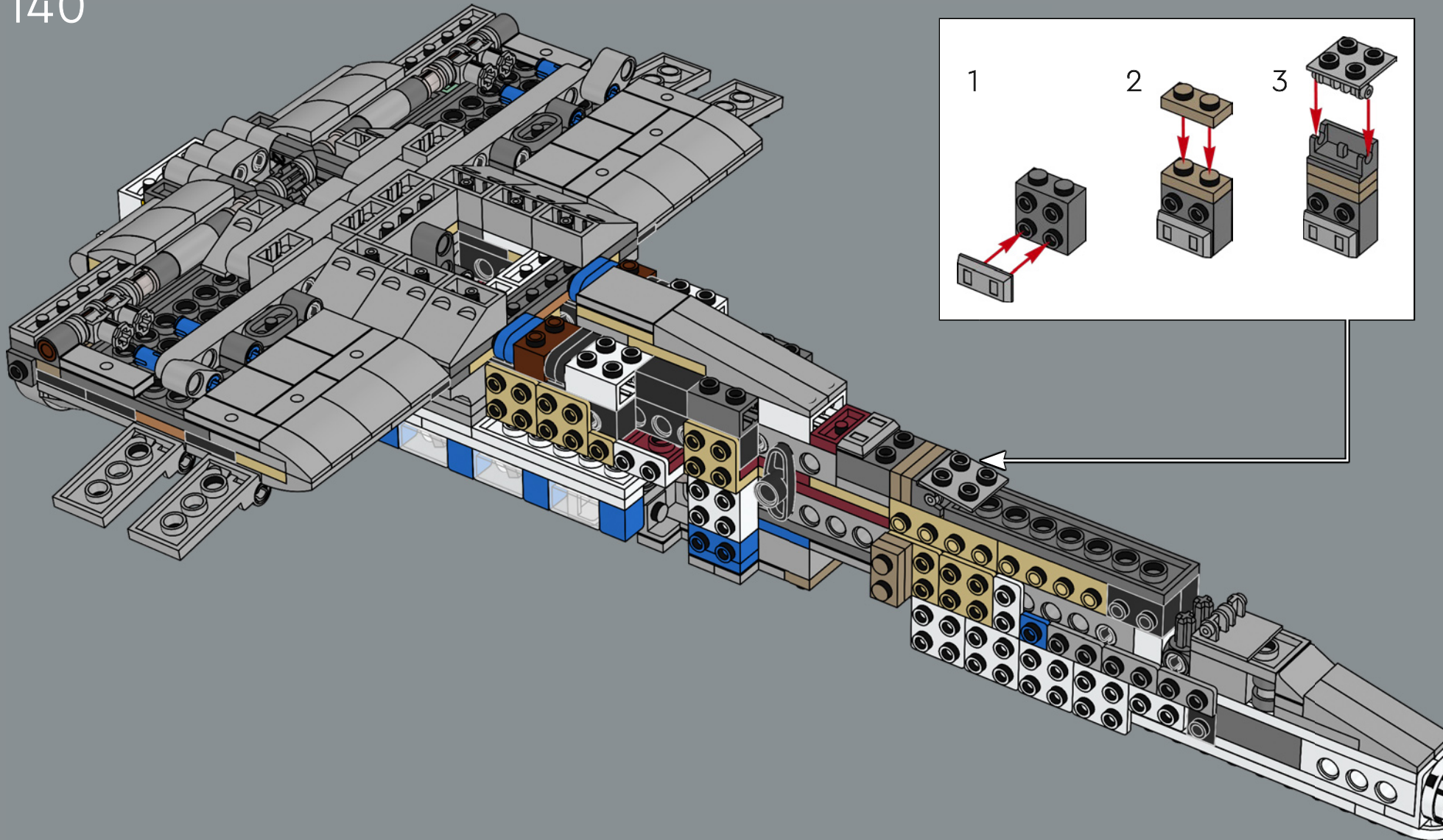

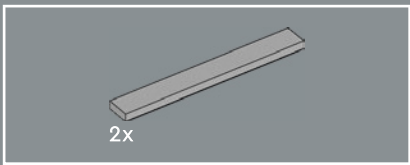

141

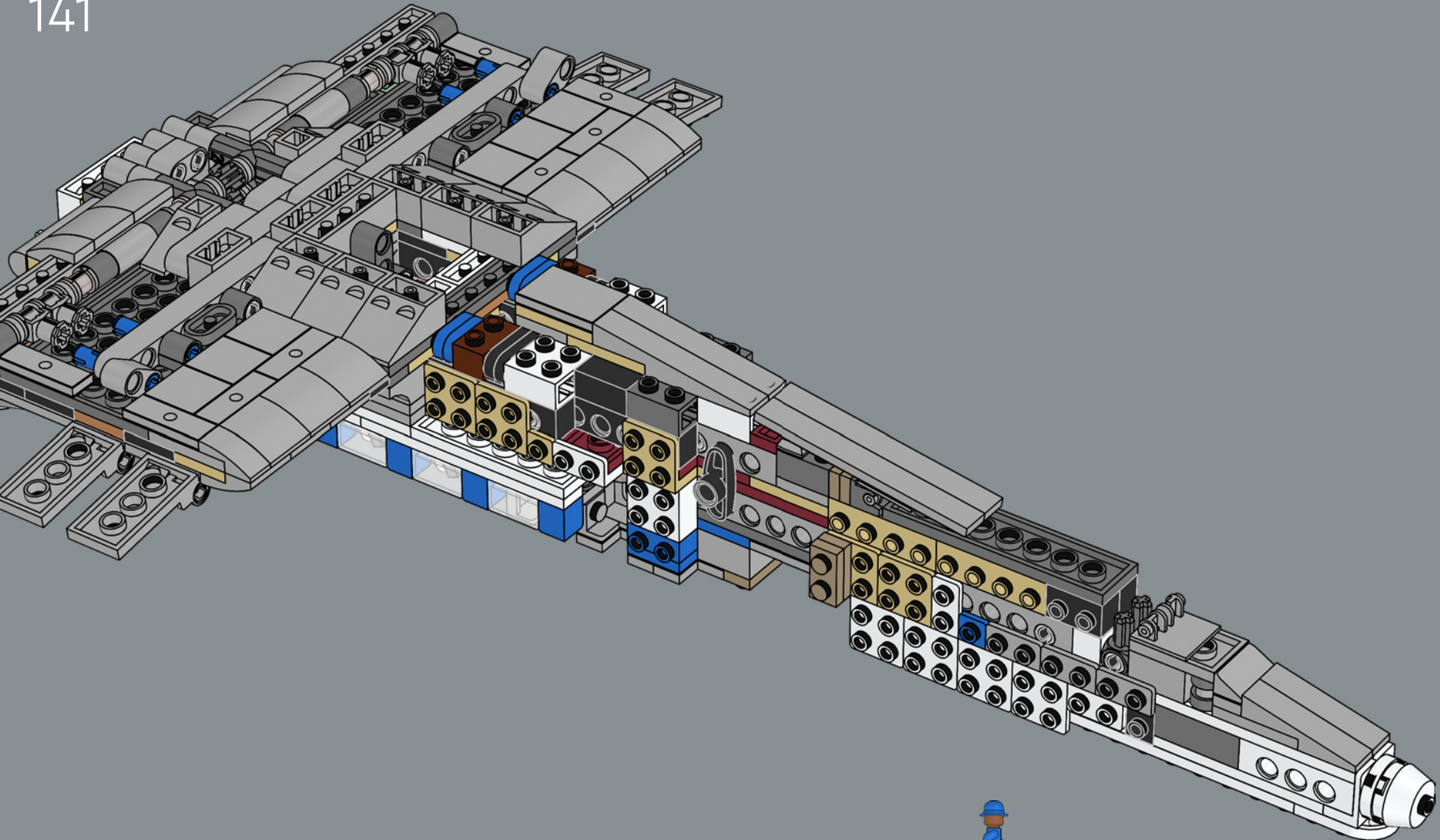

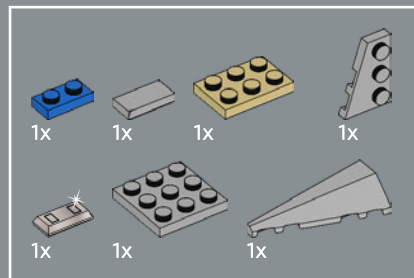
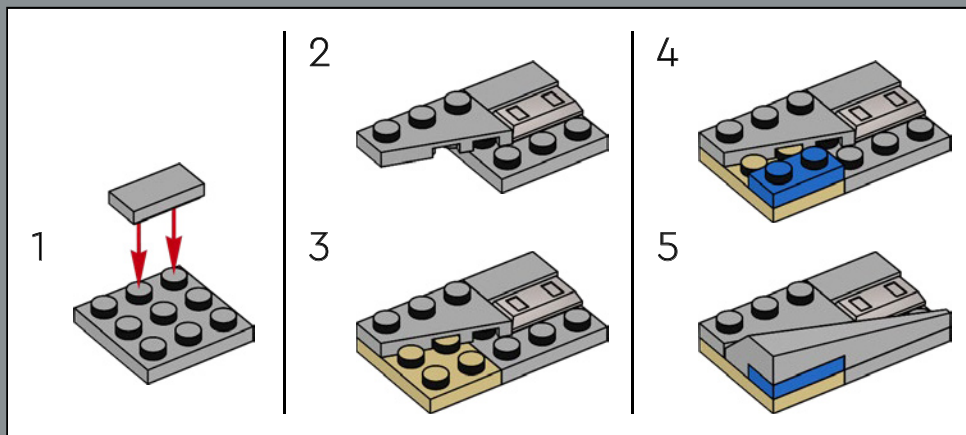

142

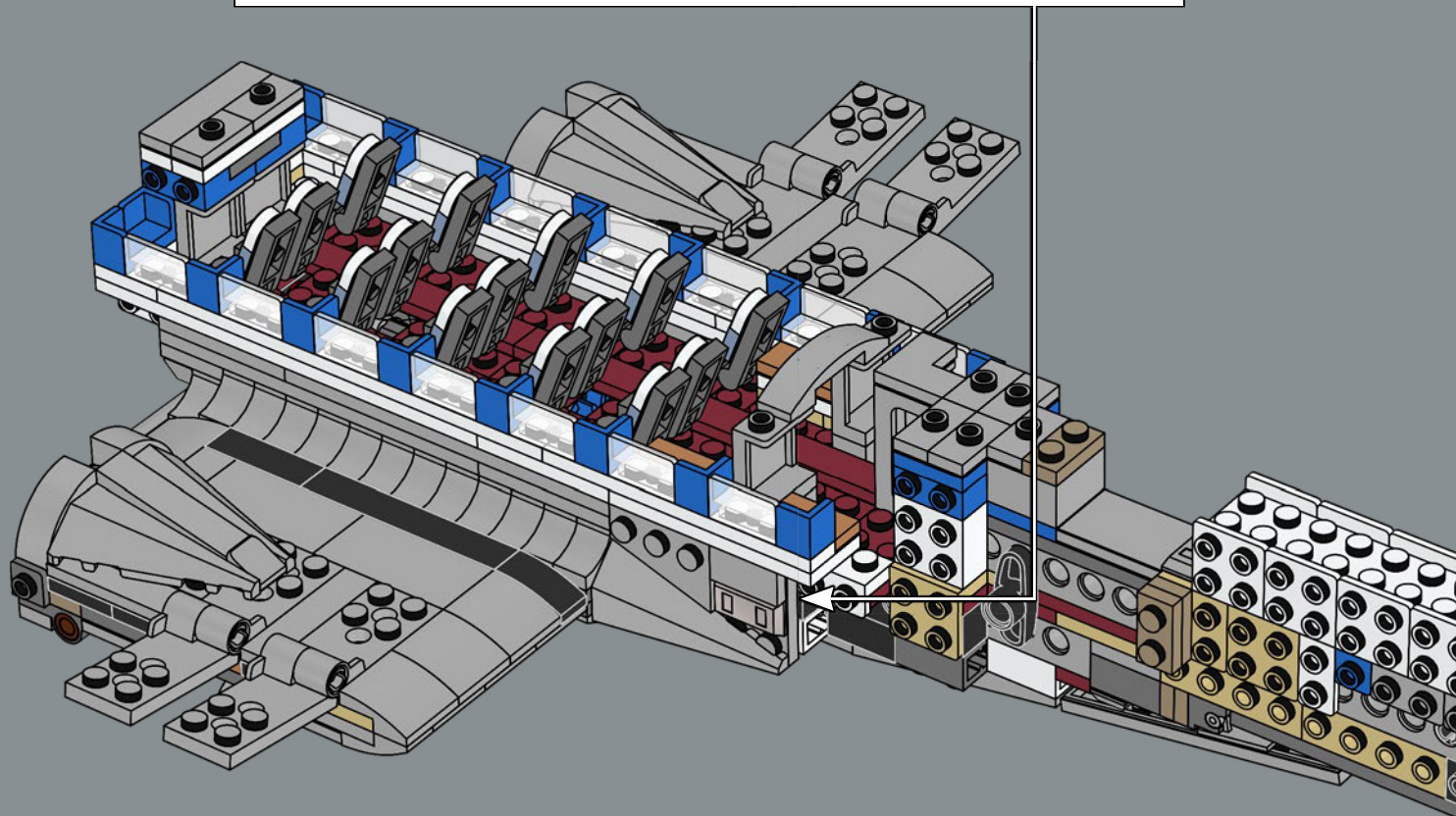

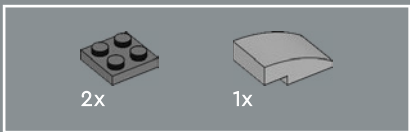

143

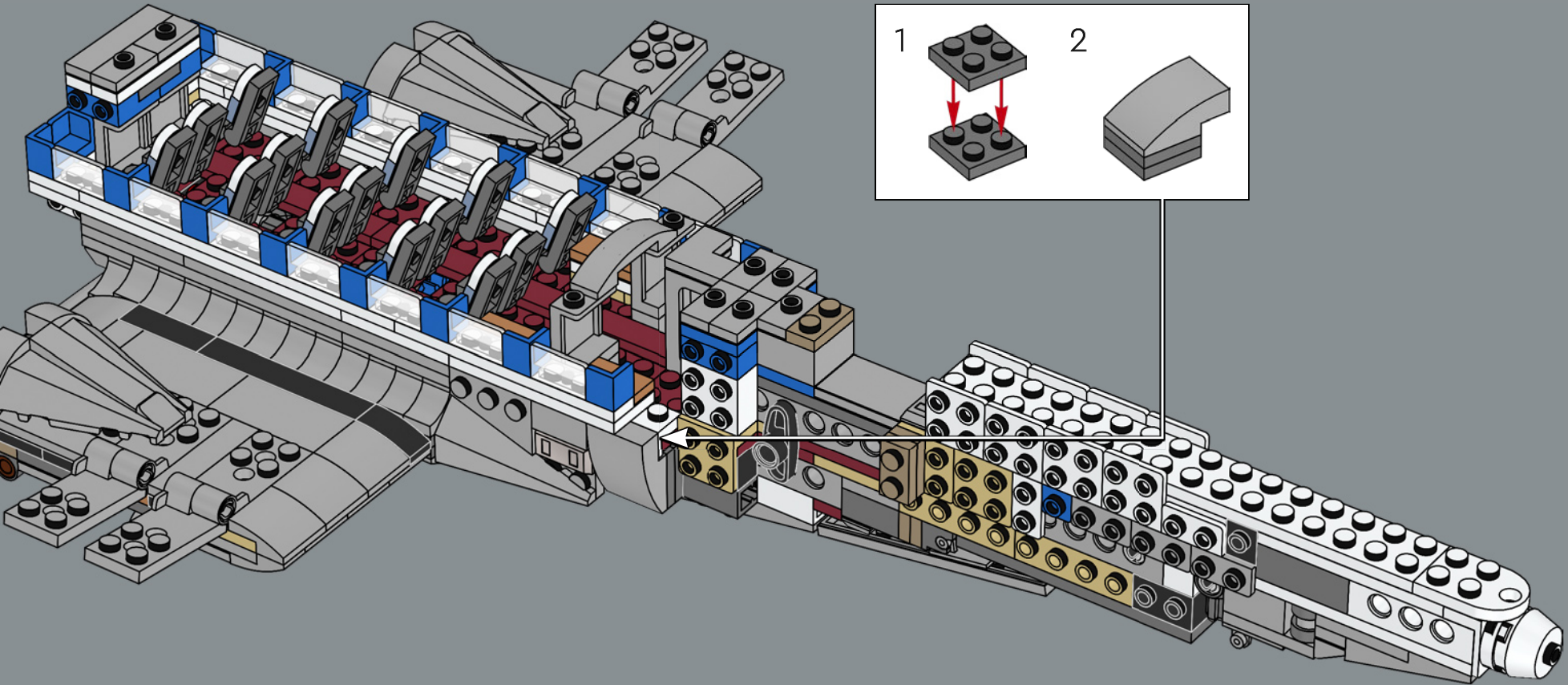

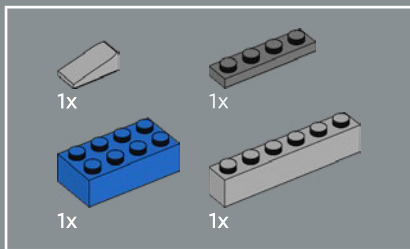

144

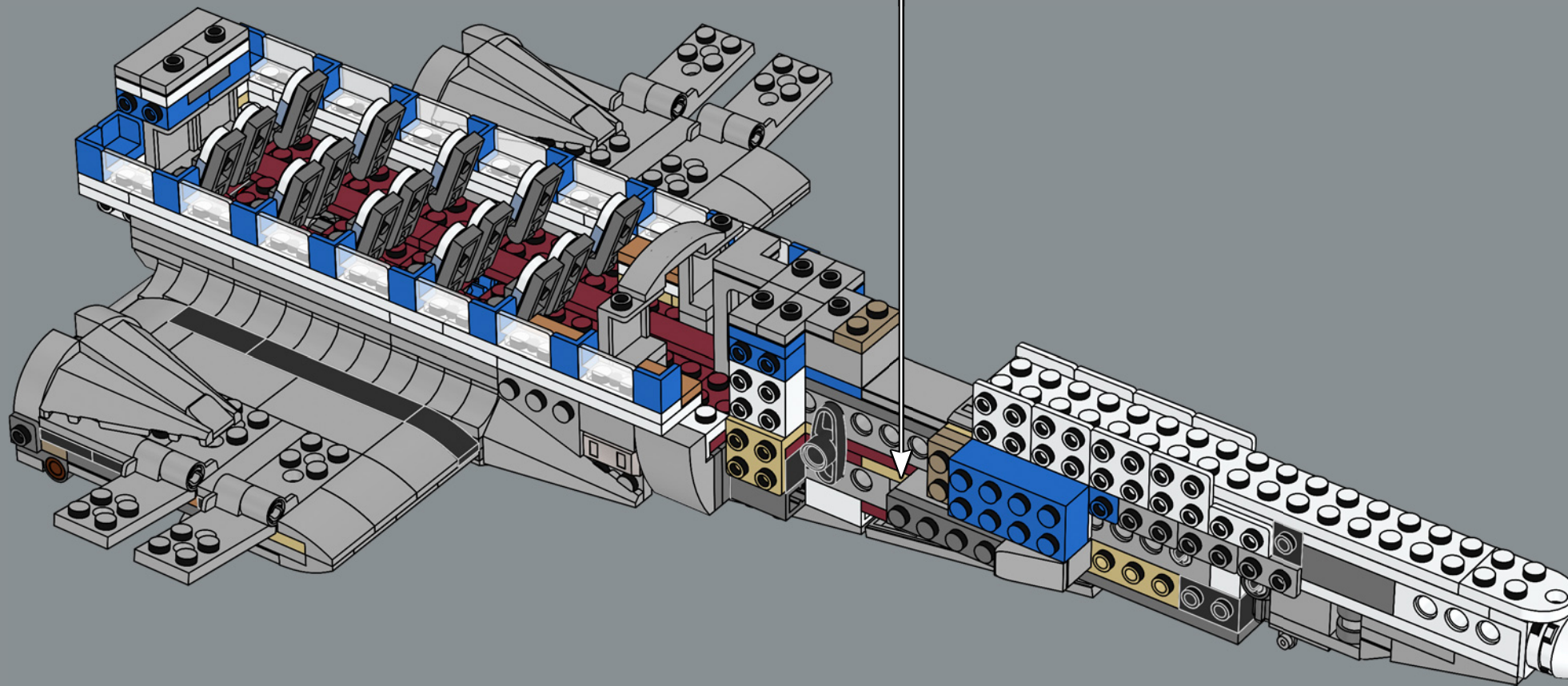
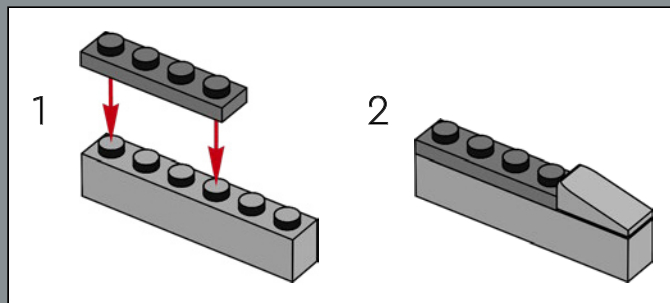

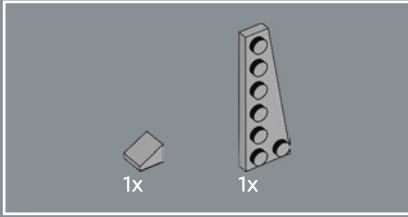
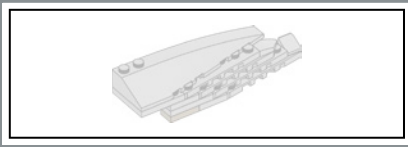

145

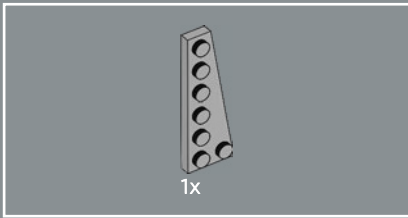
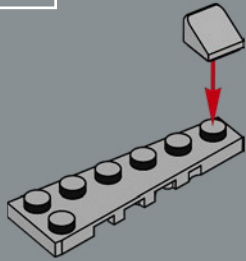

146

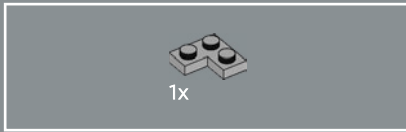
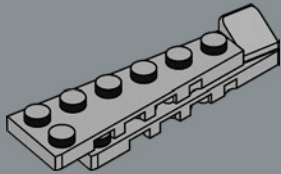

147

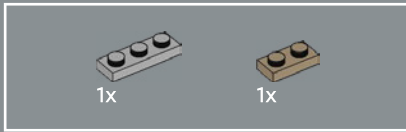
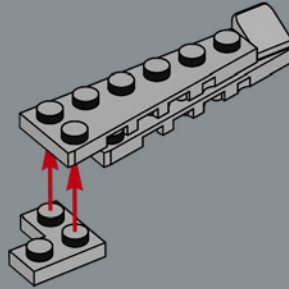

148

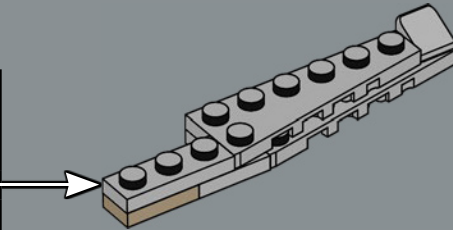
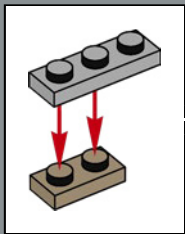

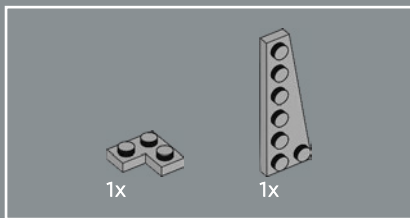

149

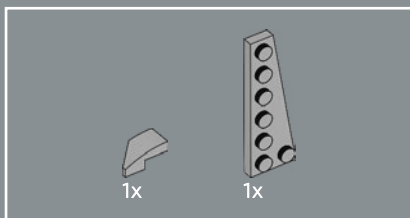
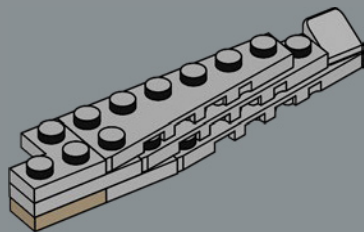

150

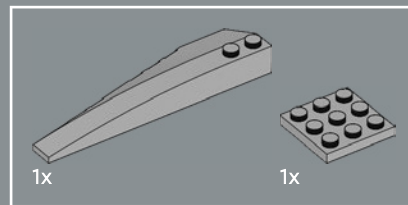
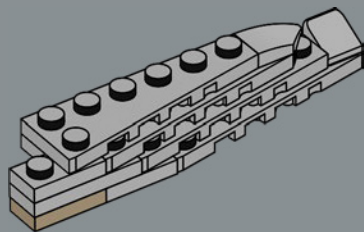

151

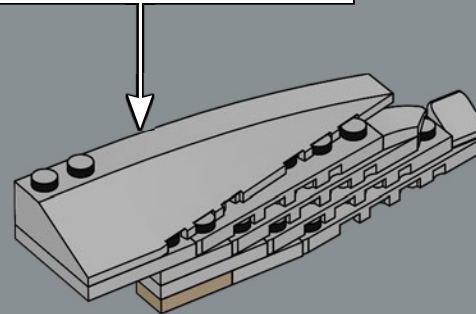
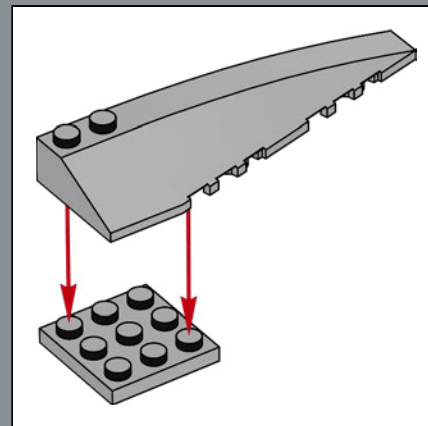

152

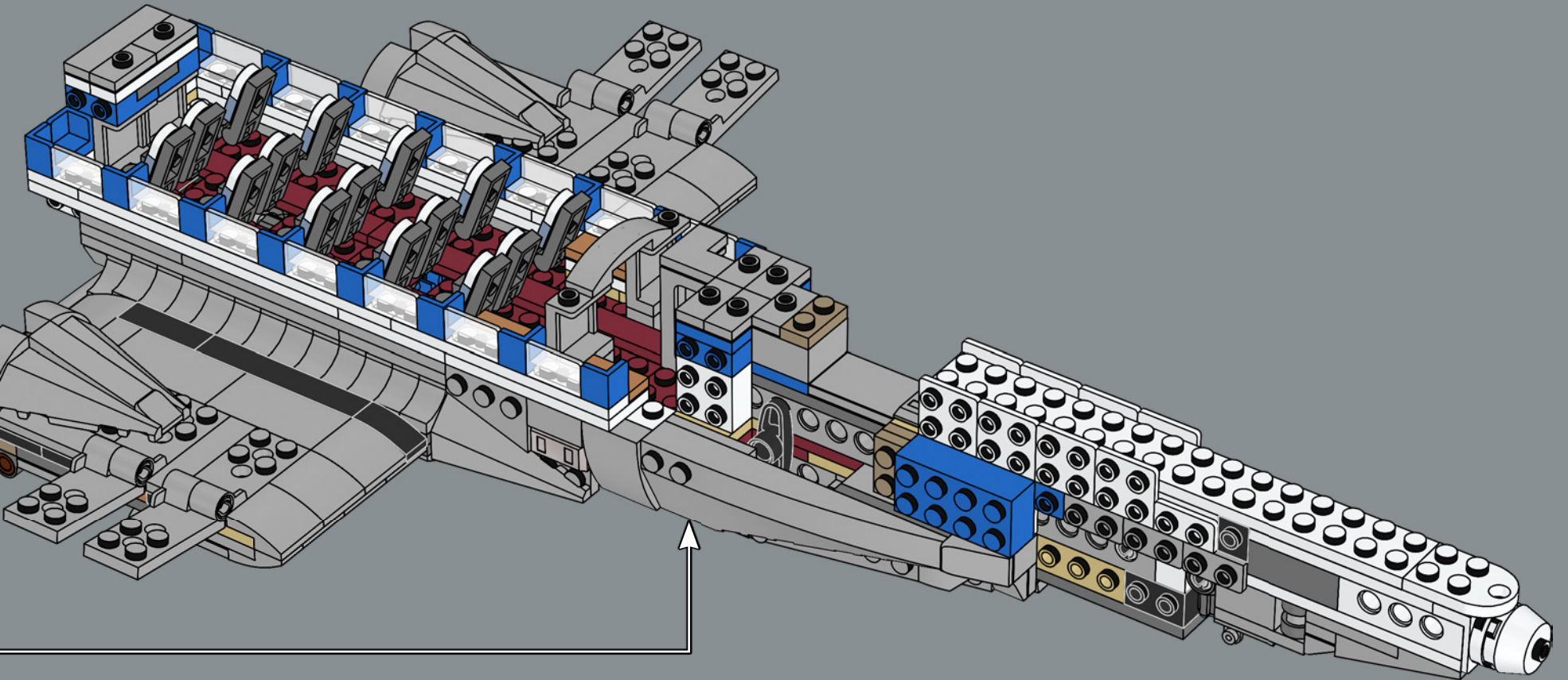

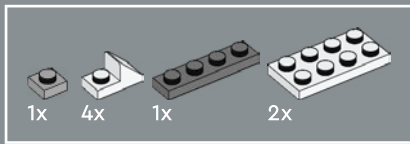

153

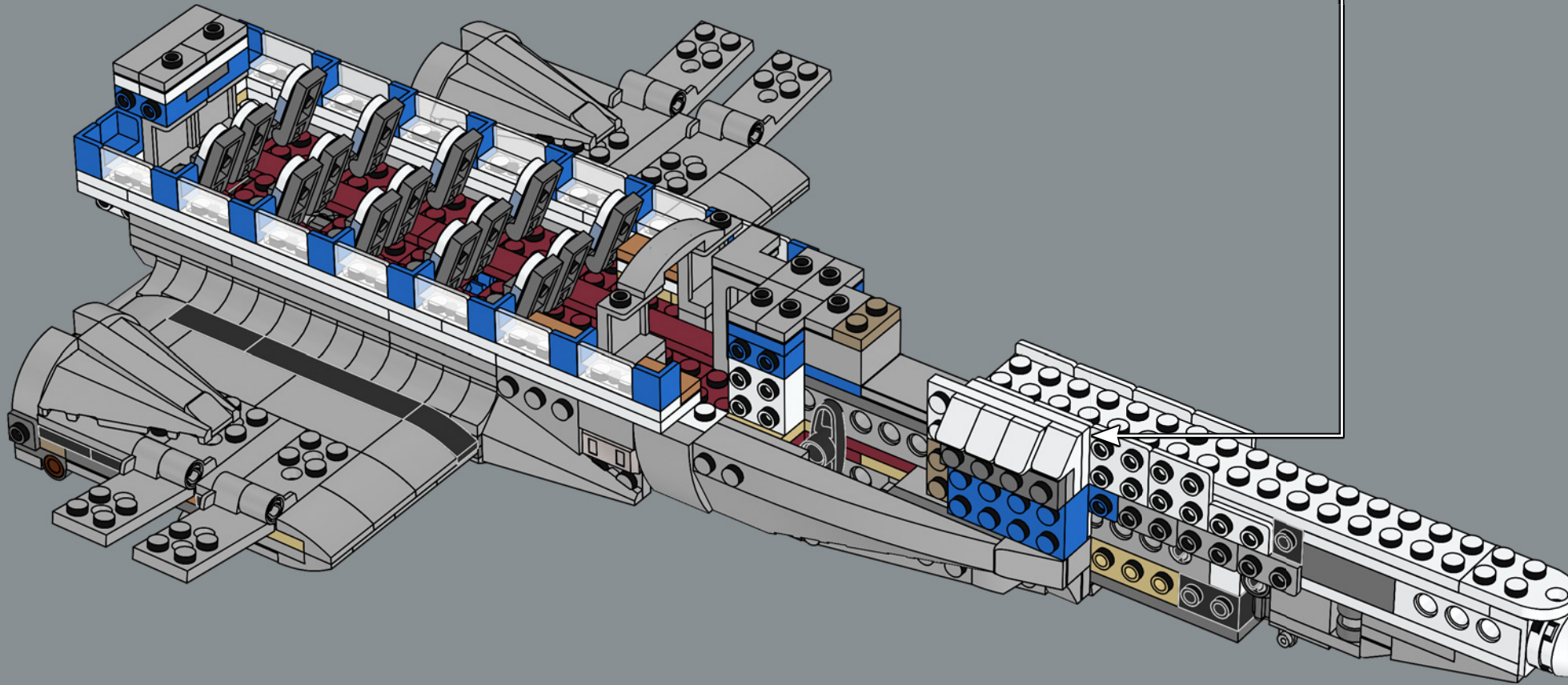
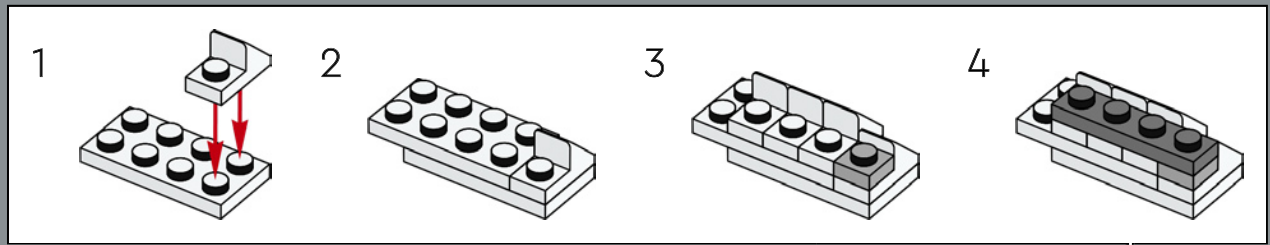

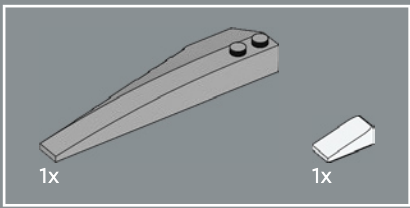

154

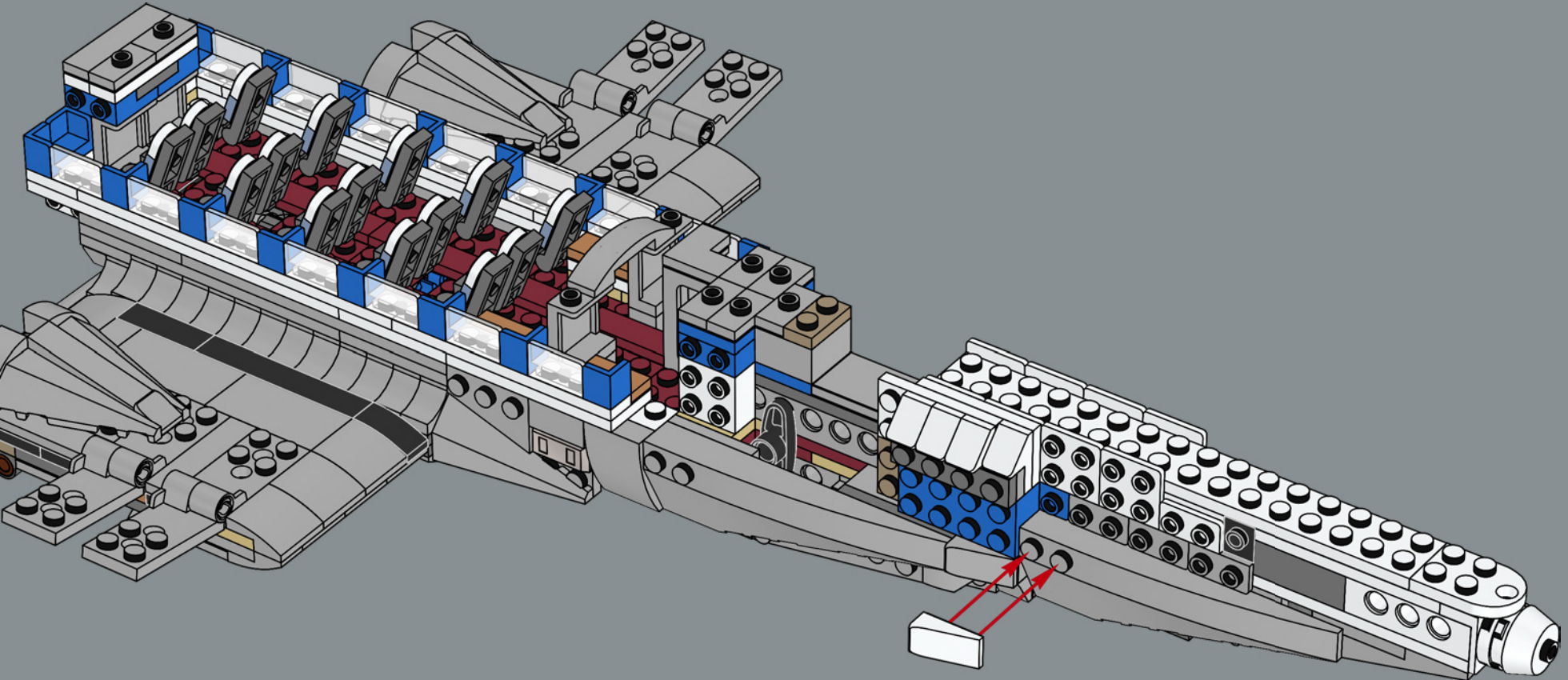

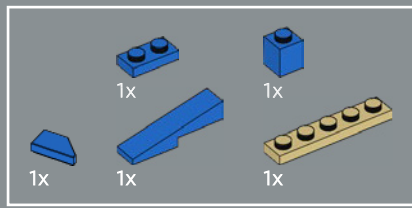

155

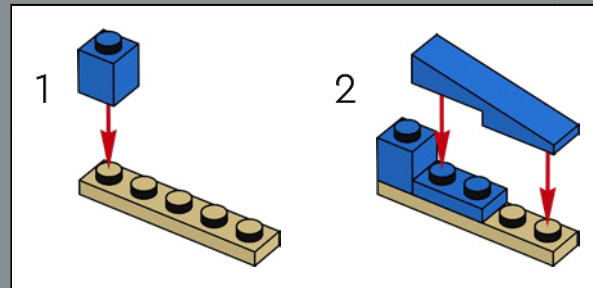
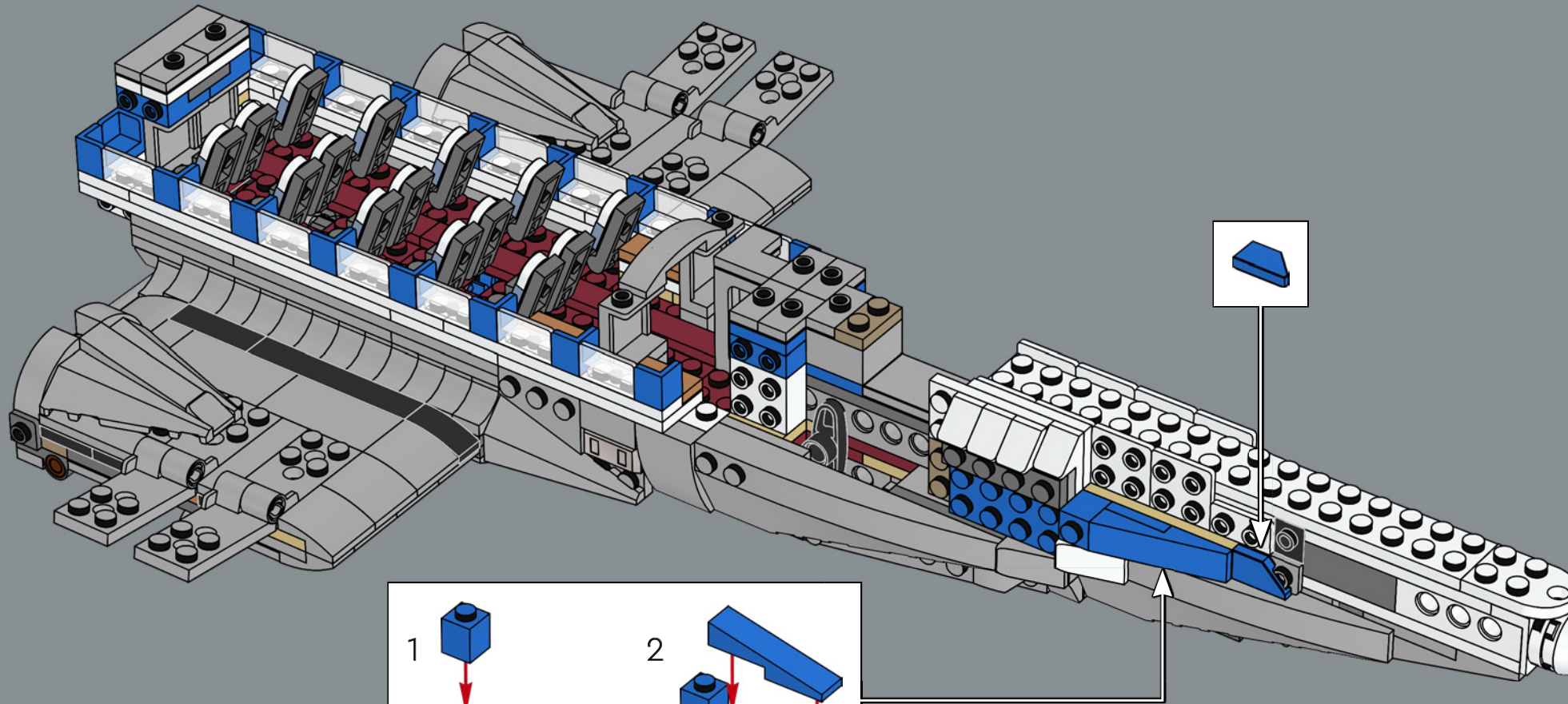

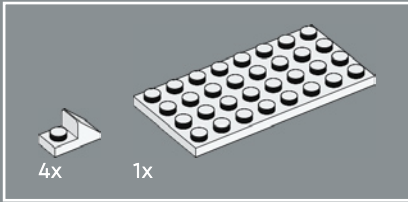
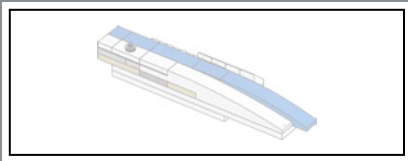

156

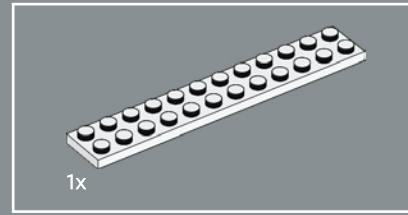
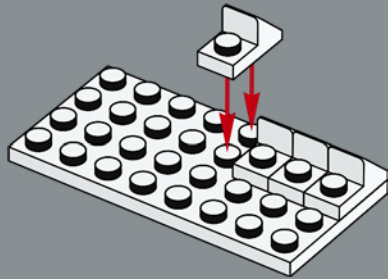

157

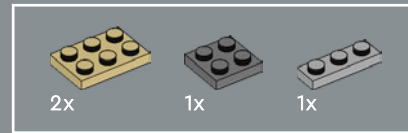
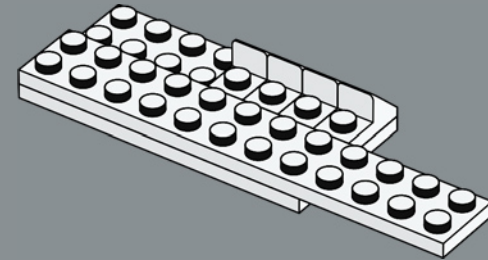

158

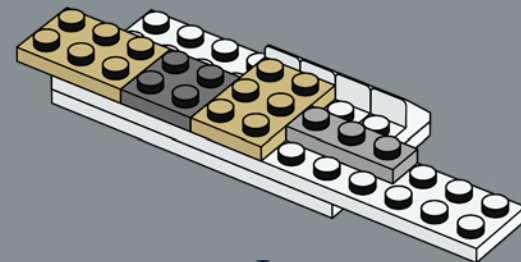

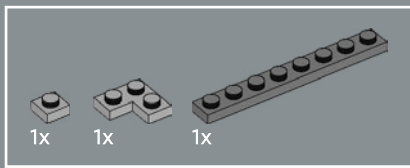

159

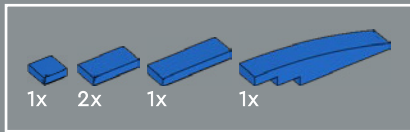
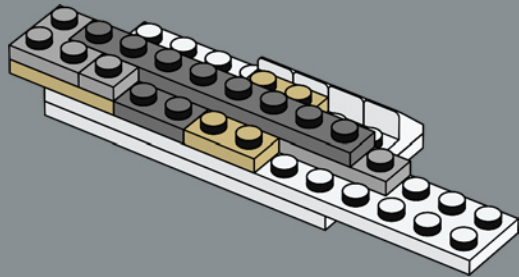

160

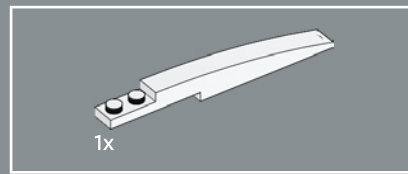
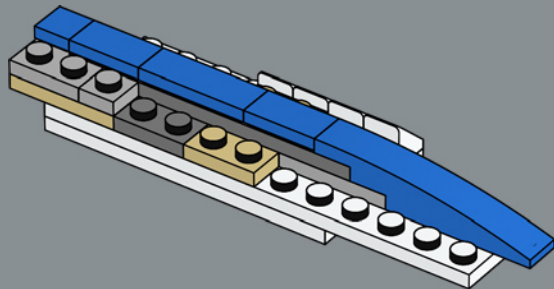

161

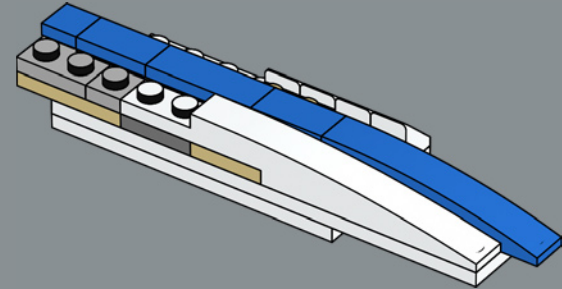

162

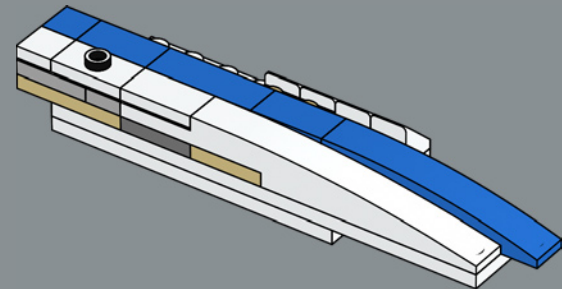

163

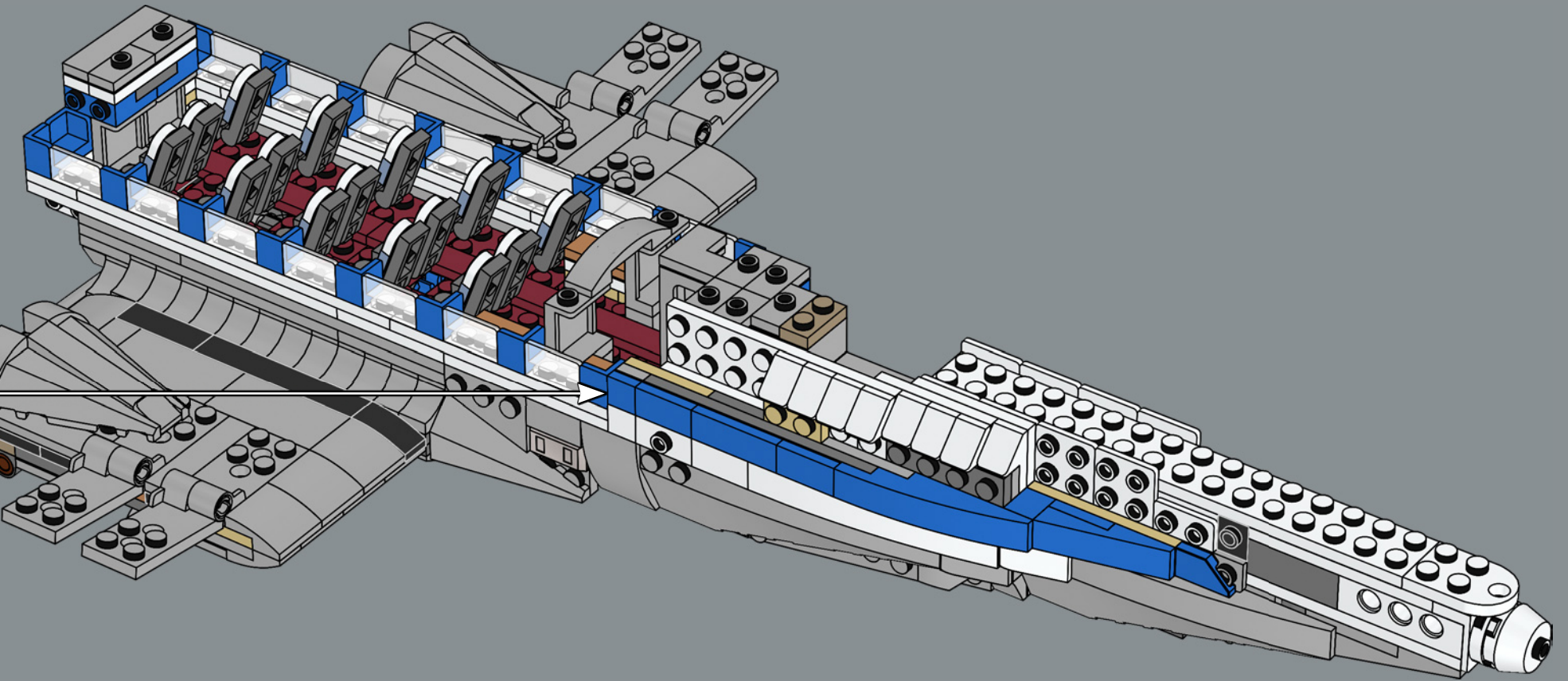

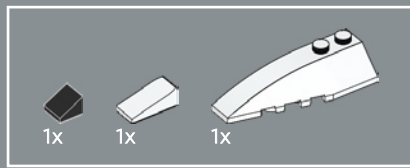

164

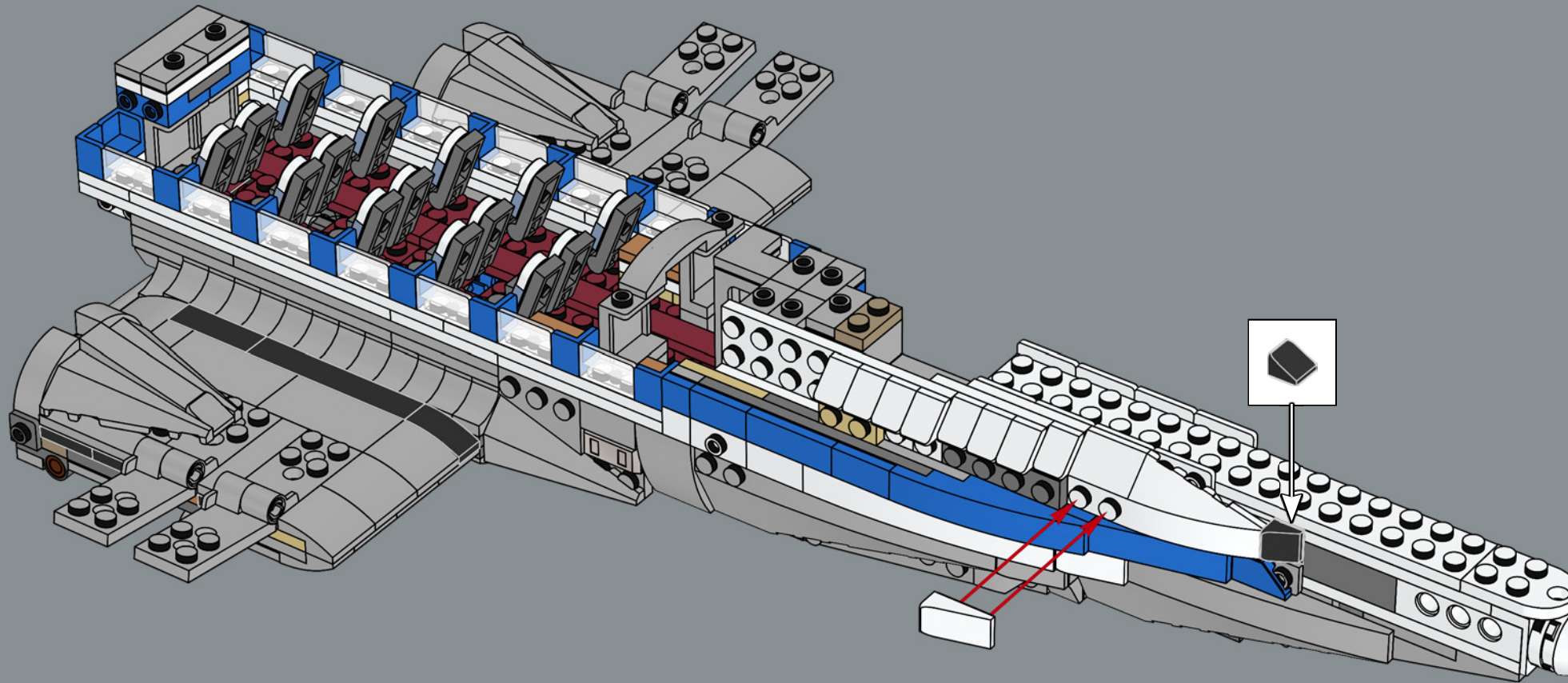

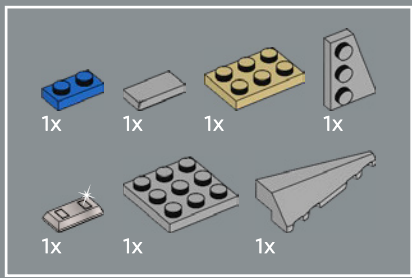

165

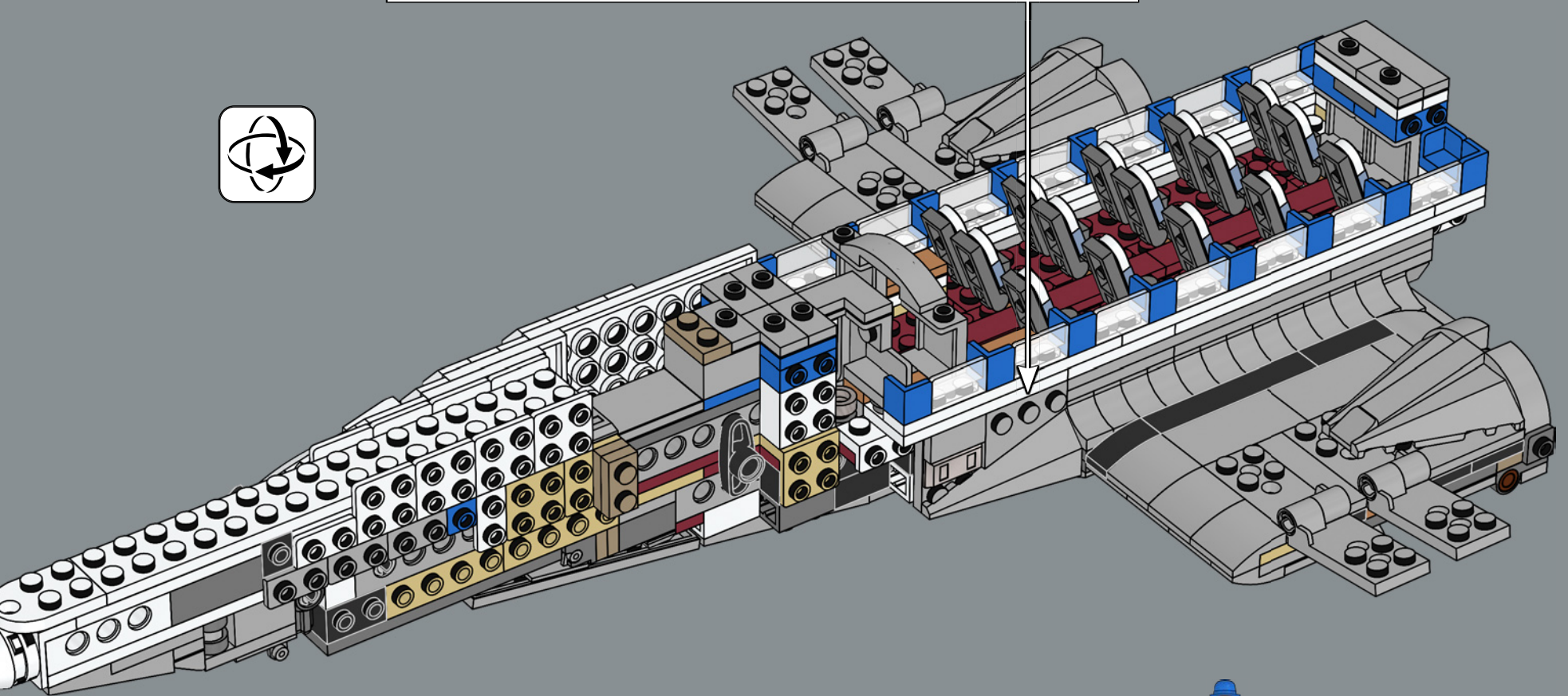
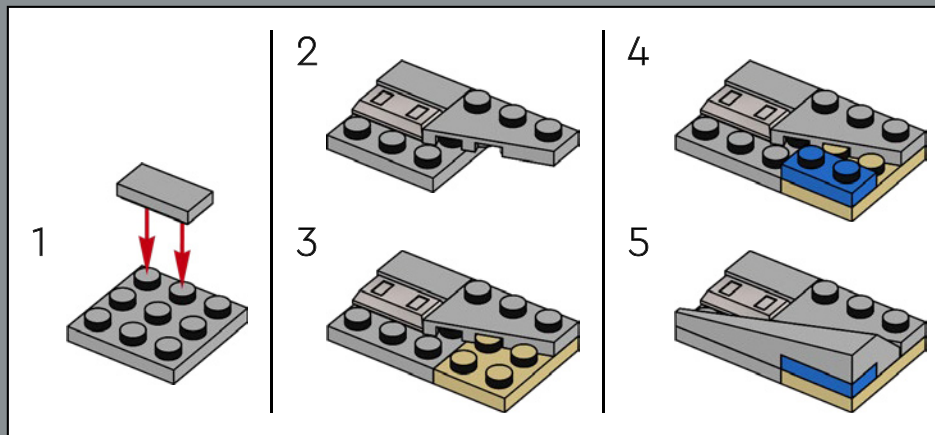

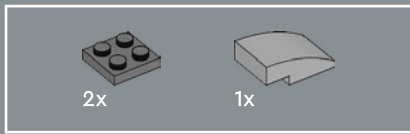

166

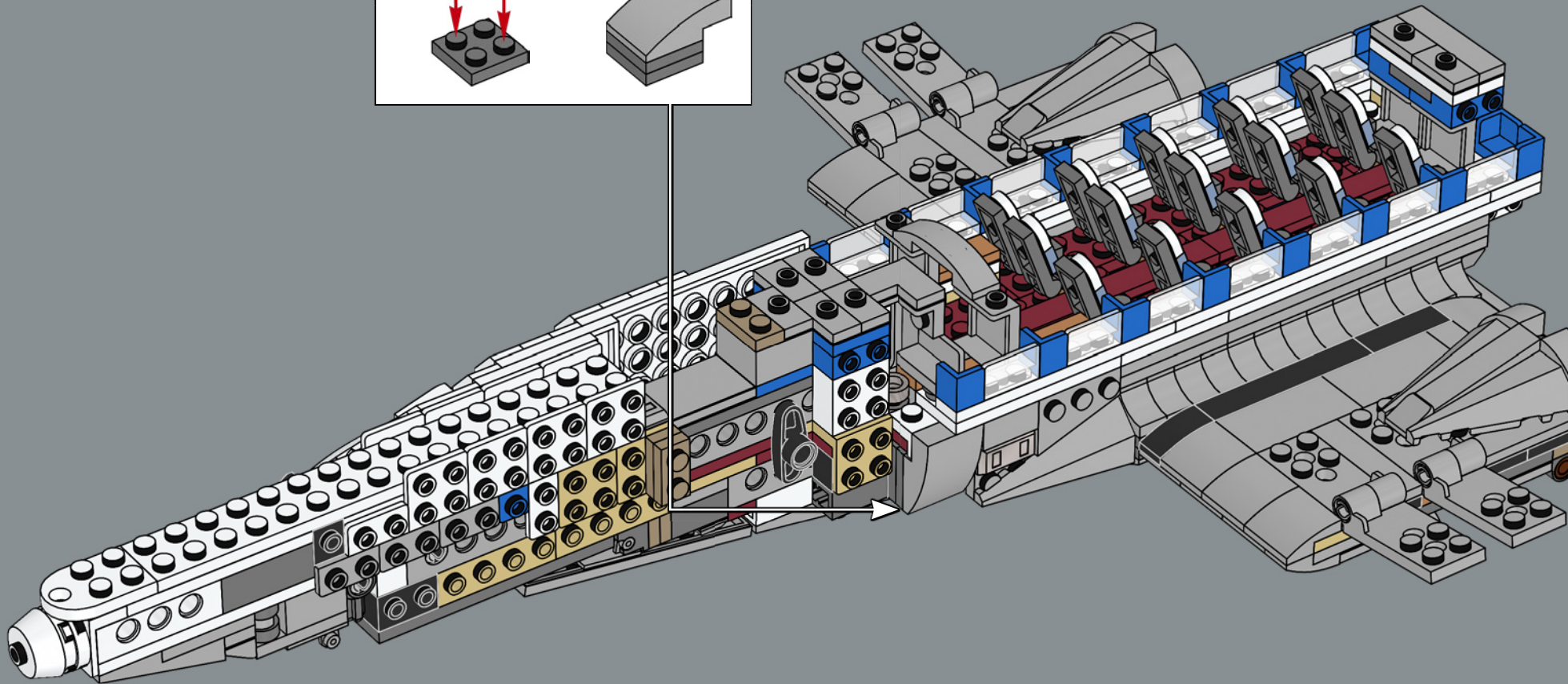
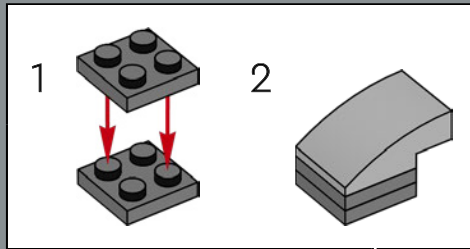

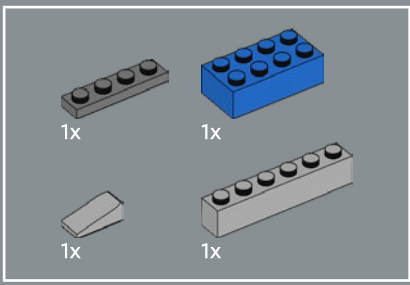

167

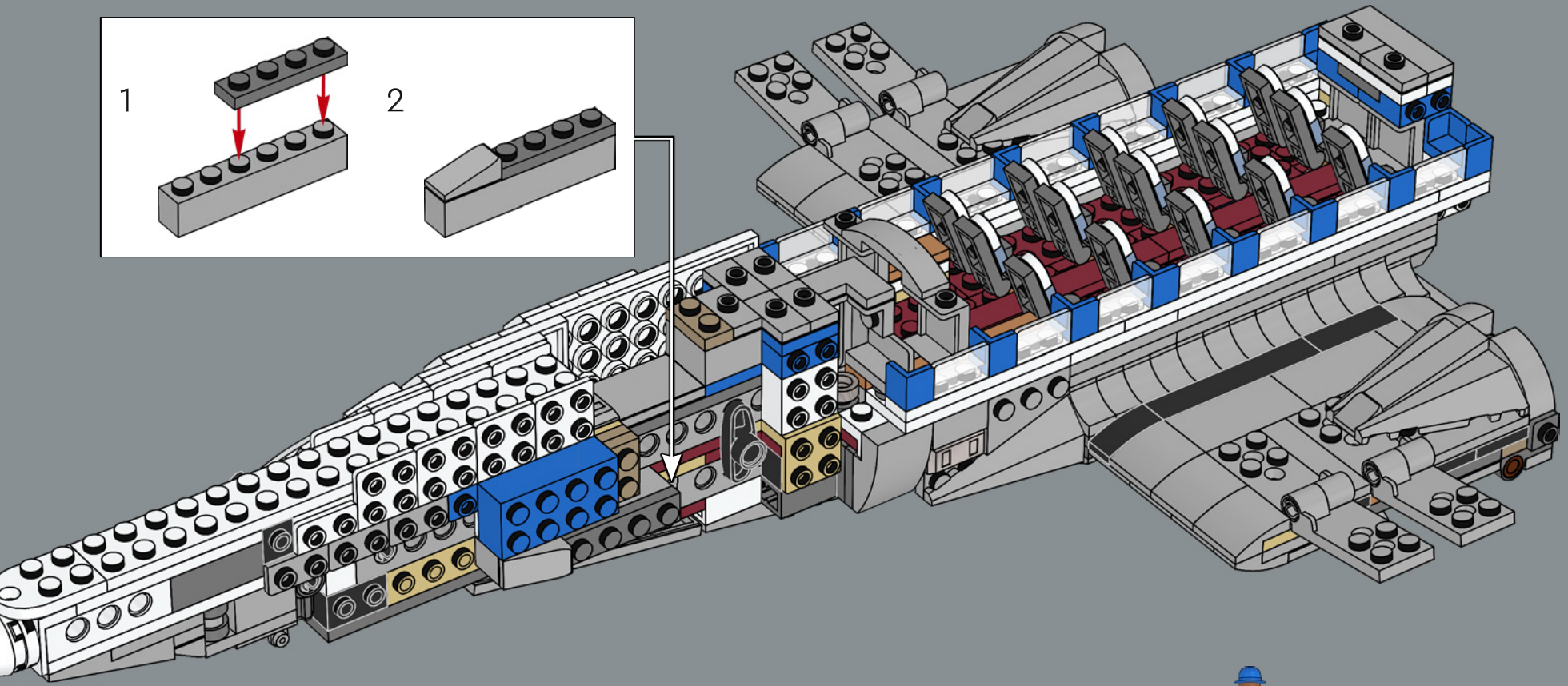
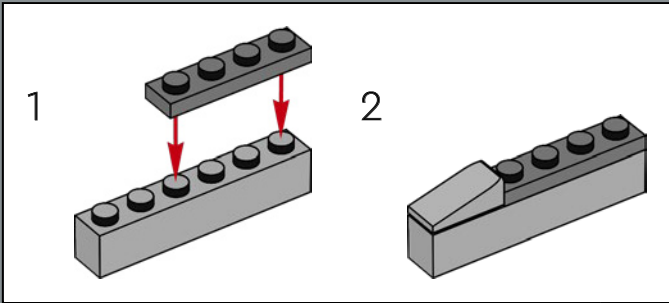

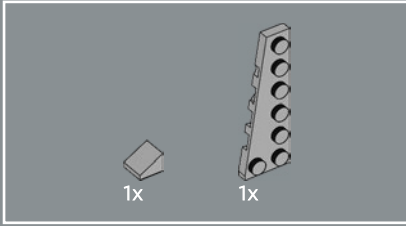
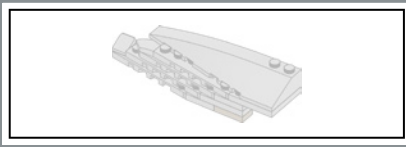

168

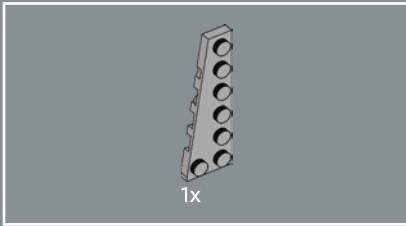
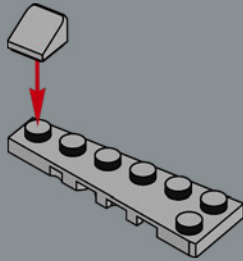

169

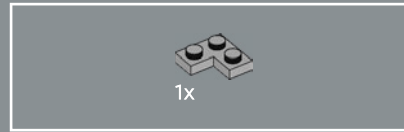
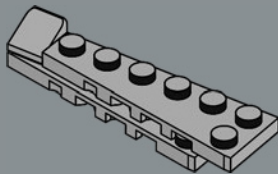

170

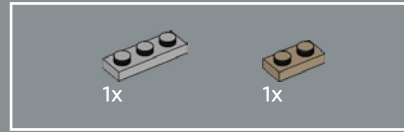
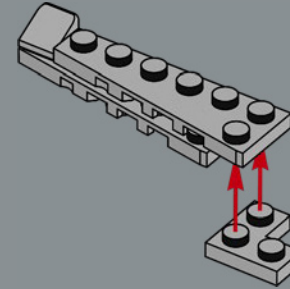

171

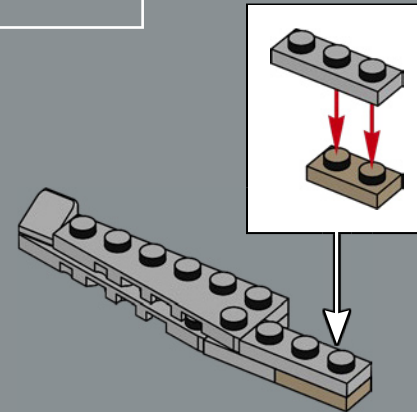

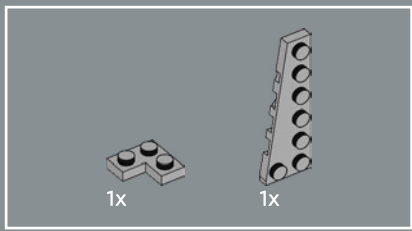

172

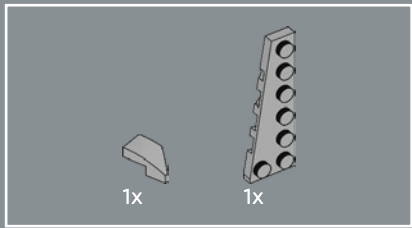
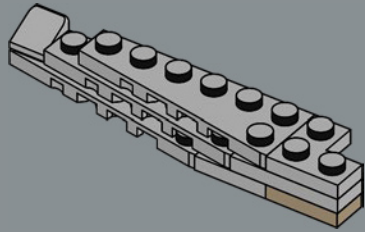

173

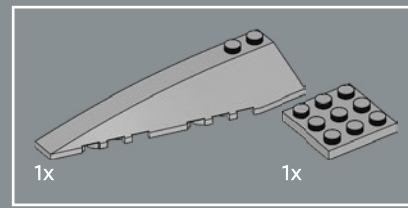
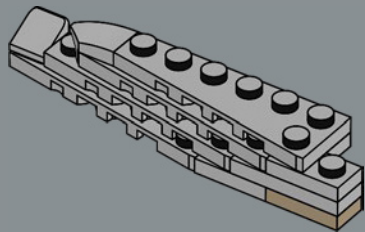

174

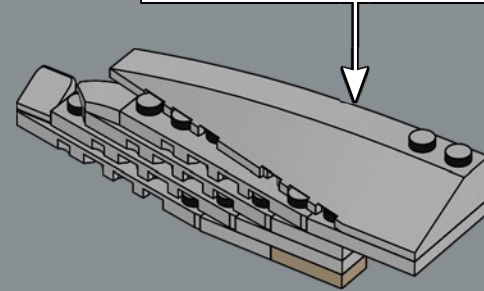
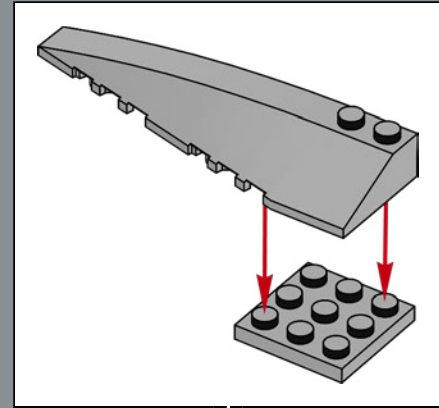

175

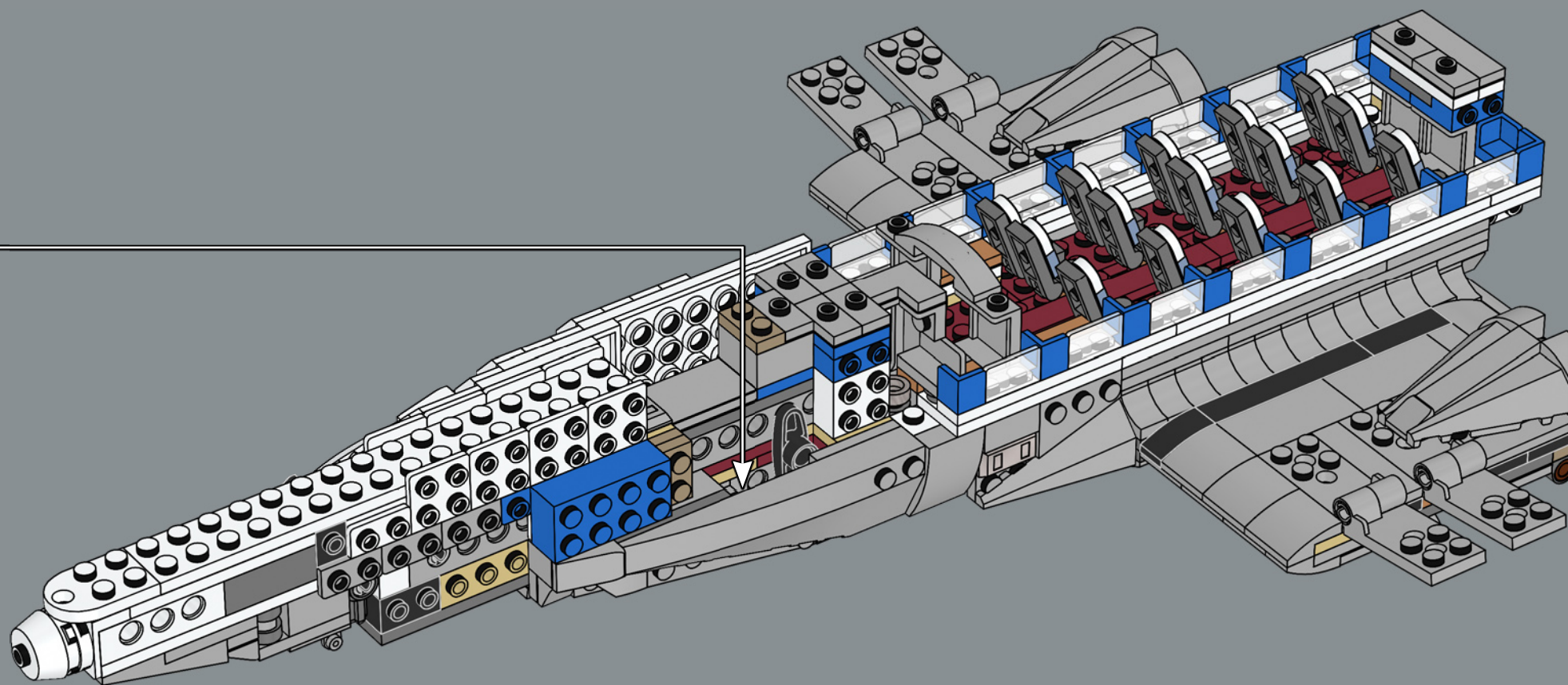

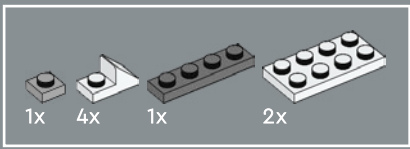

176

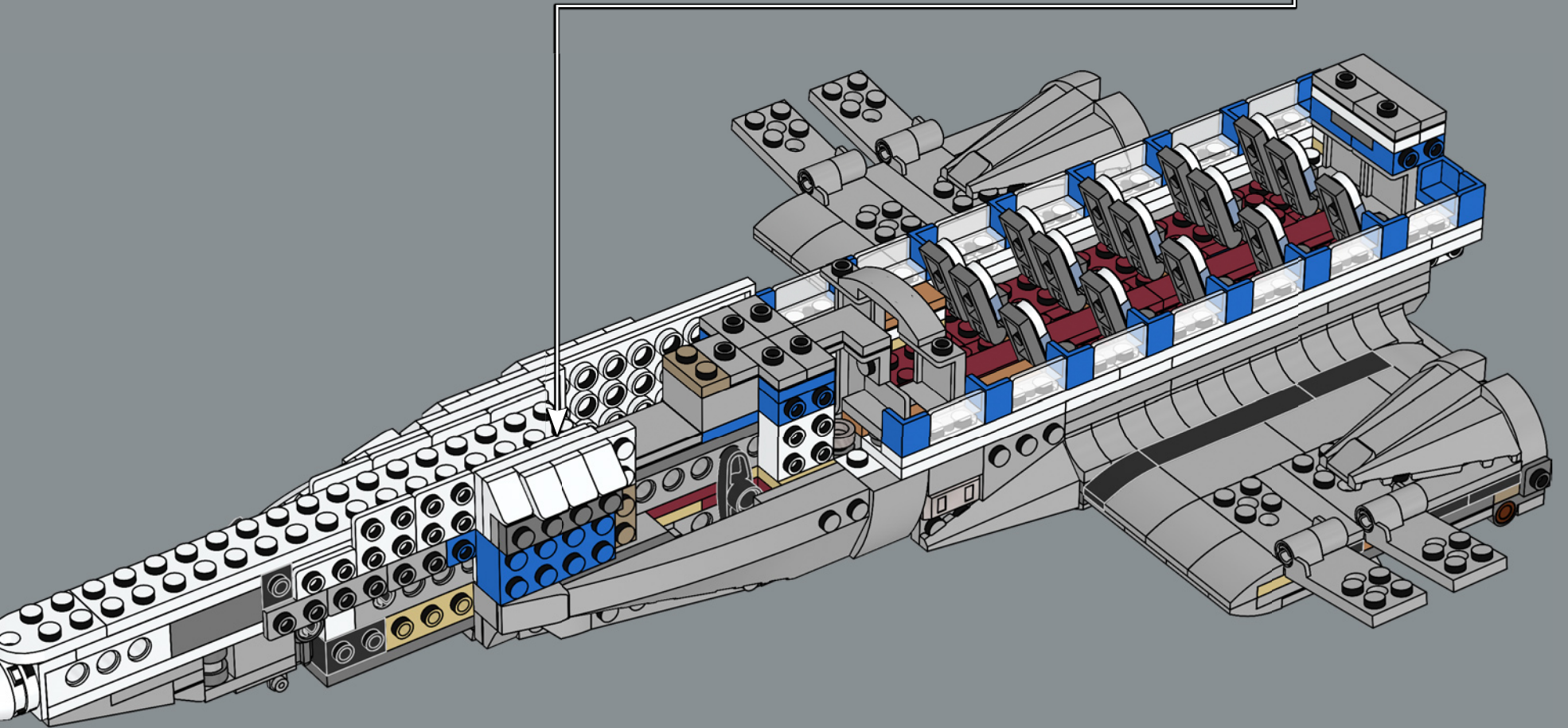
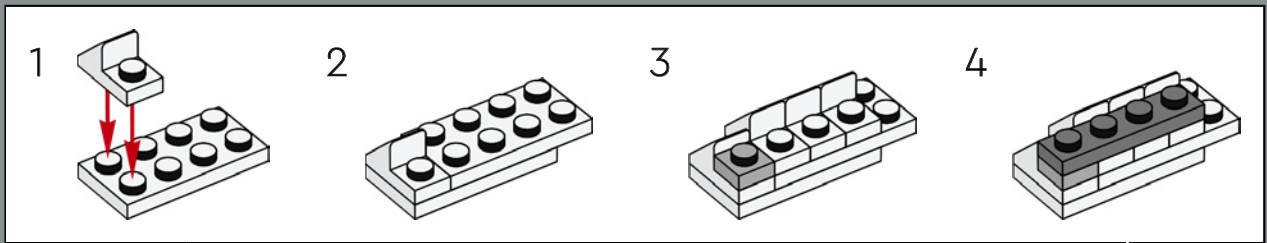

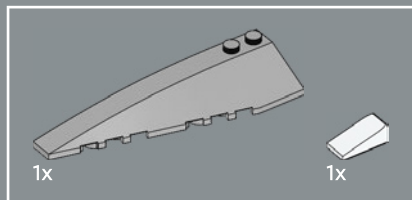

177

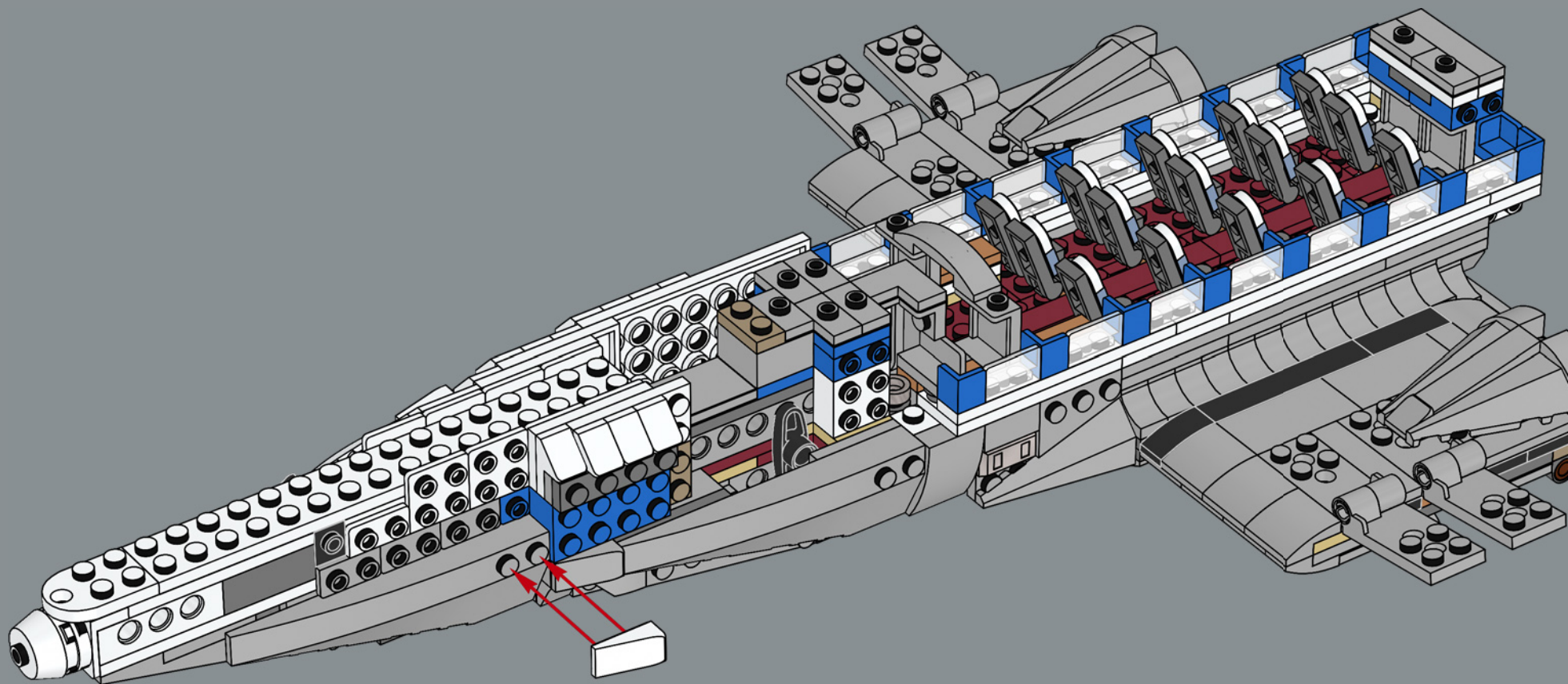

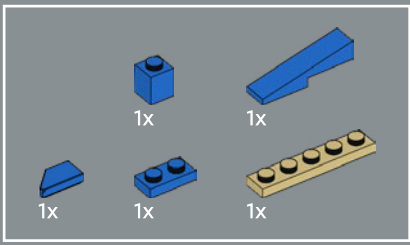

178

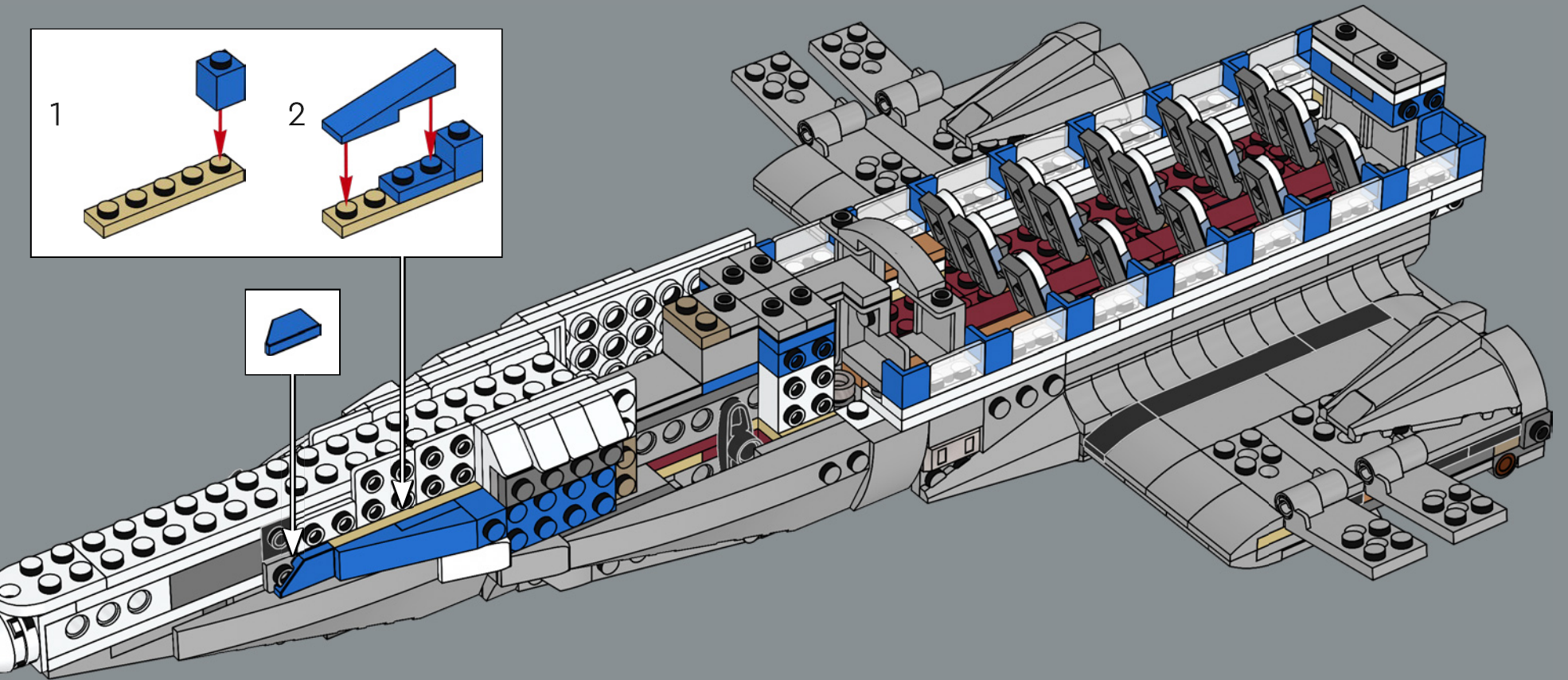
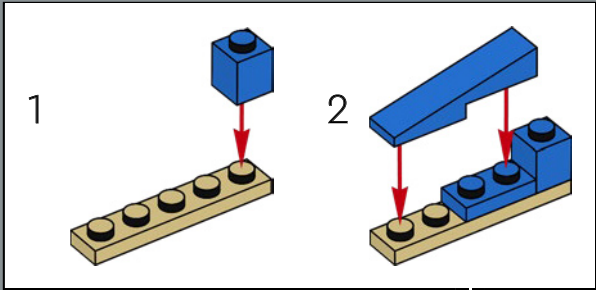

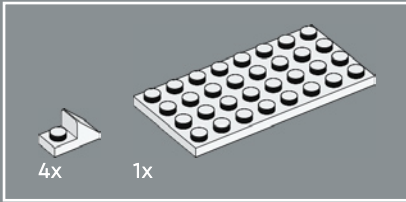
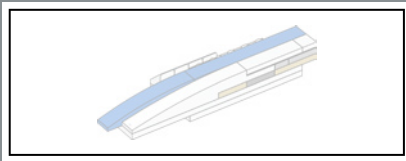

179

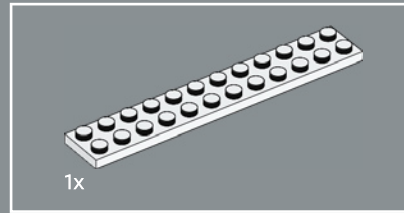
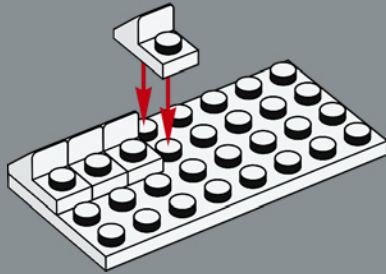

180

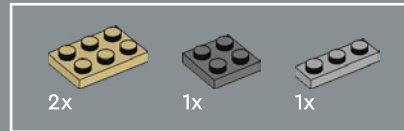
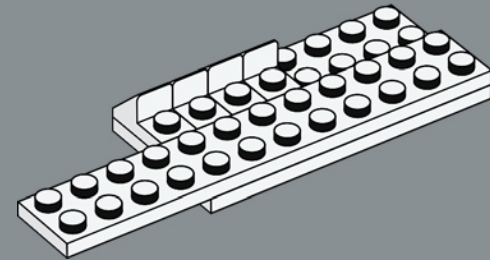

181

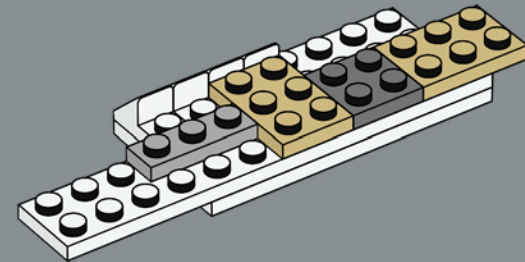

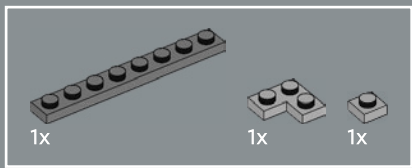

182

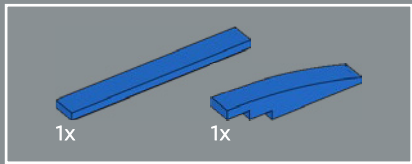
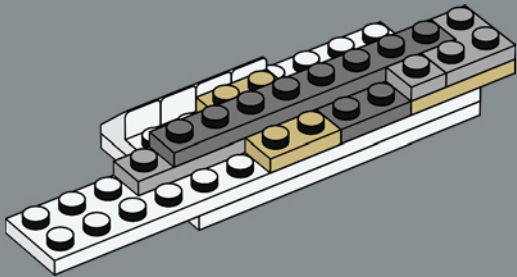

183

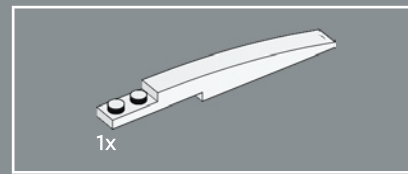
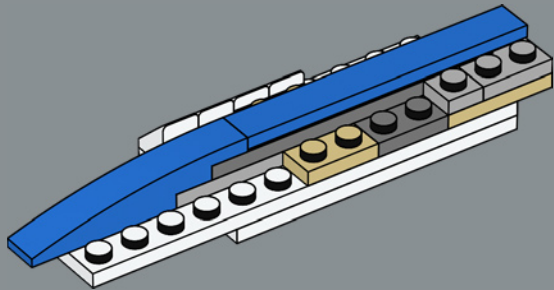

184

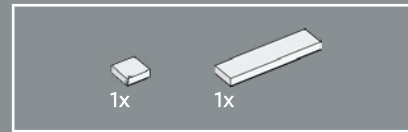
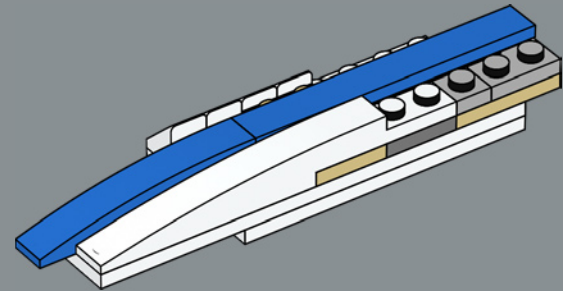

185

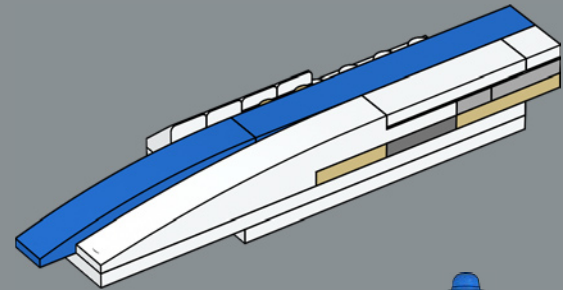

186

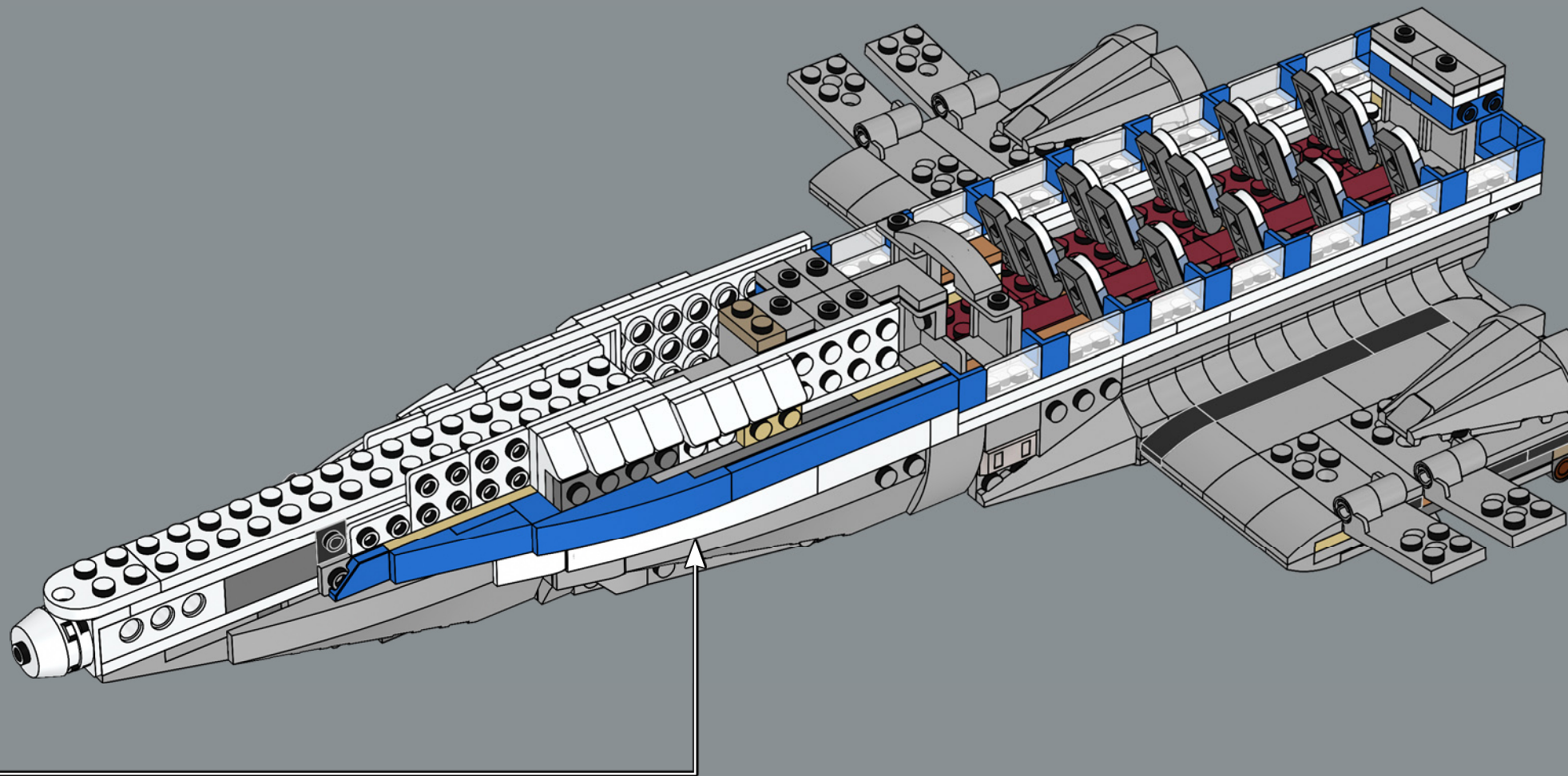

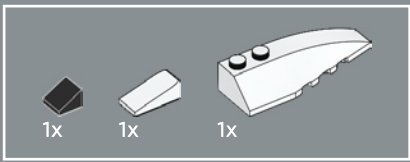

187

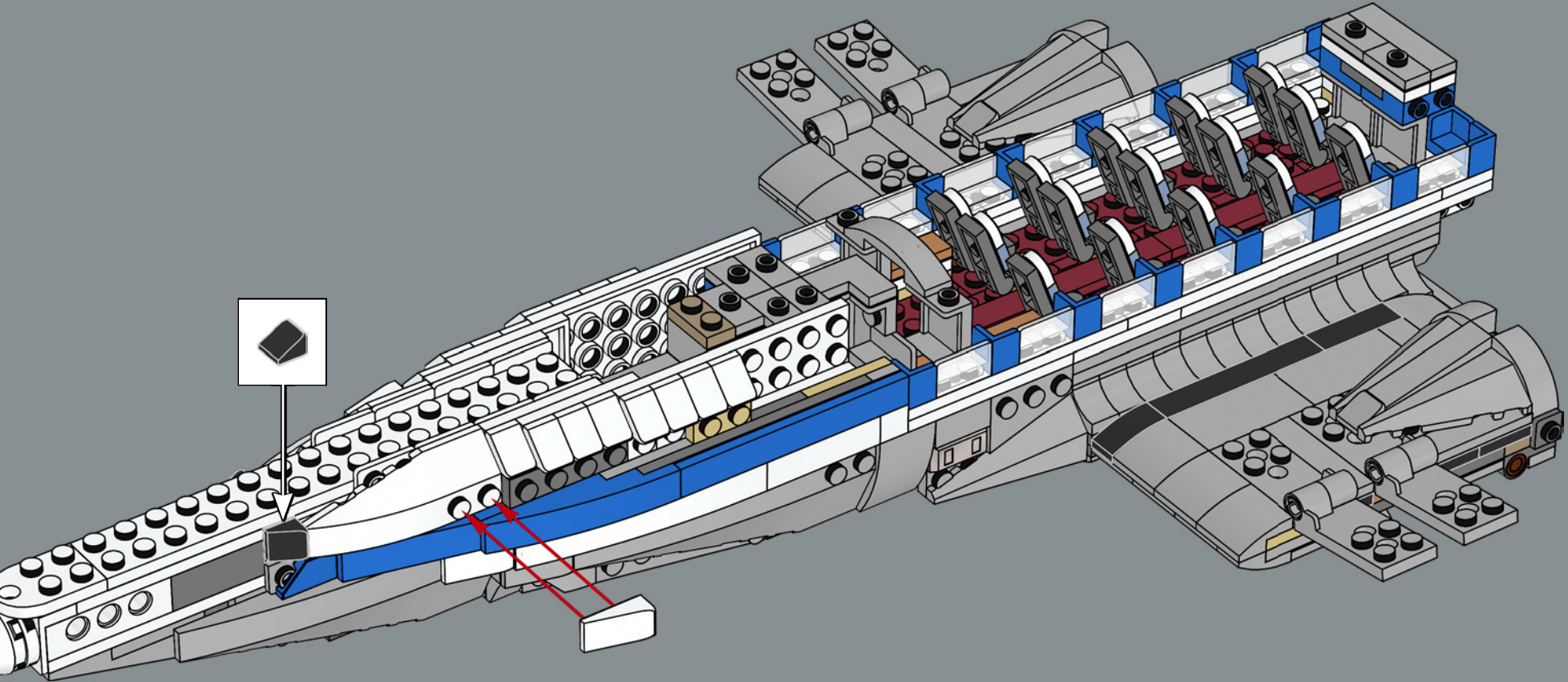



Pan Am® fue la primera aerolínea en introducir uniformes estandarizados de inspiración naval para los pilotos.

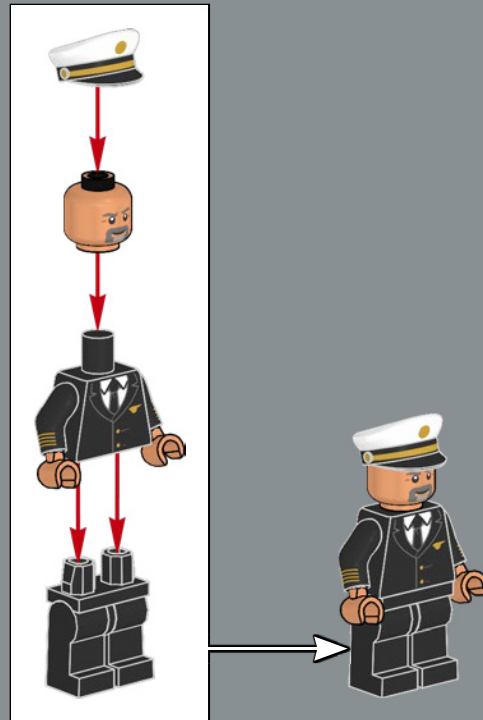

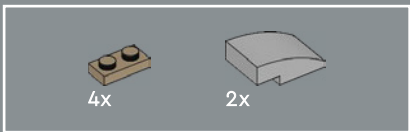

188

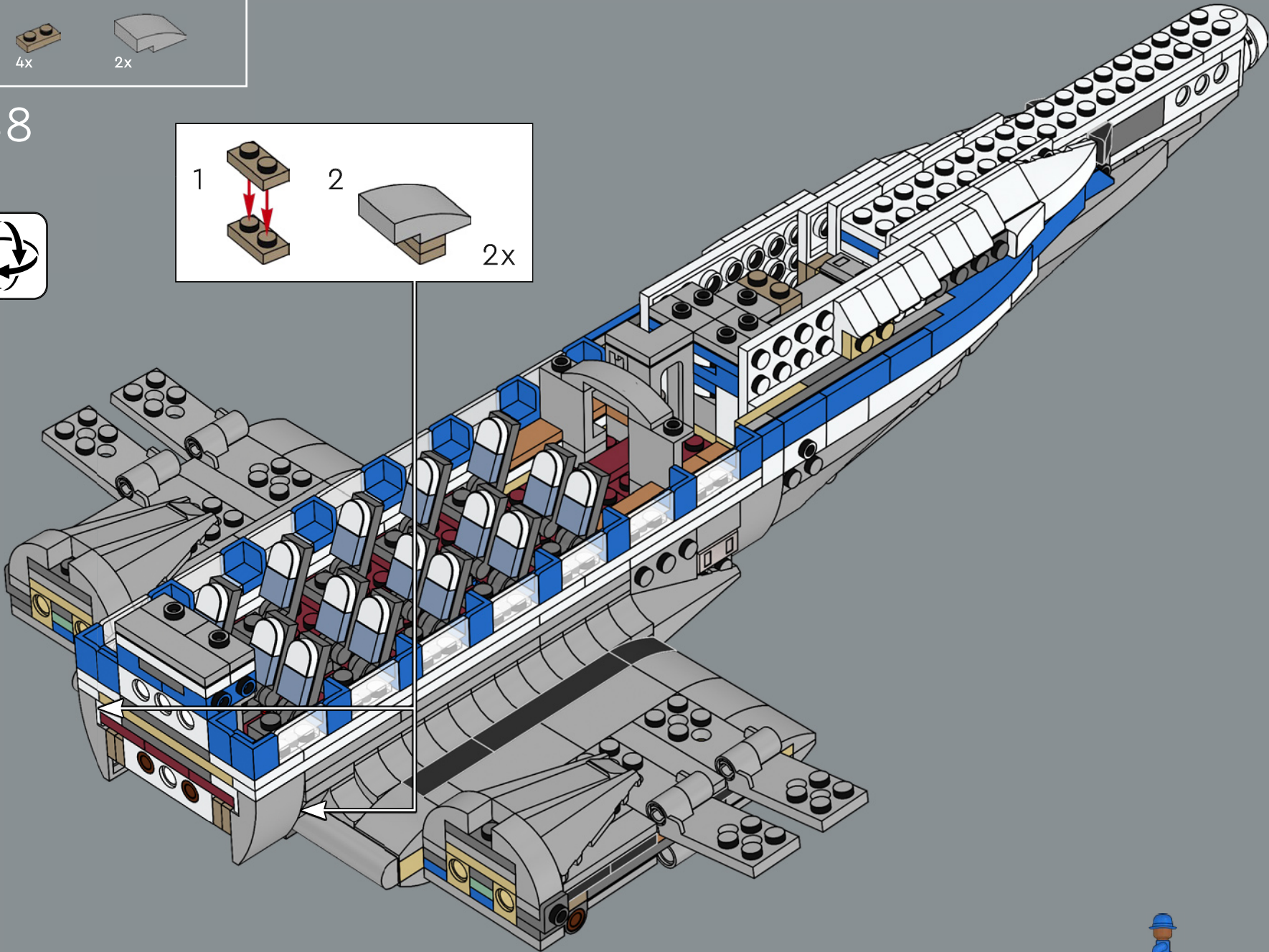
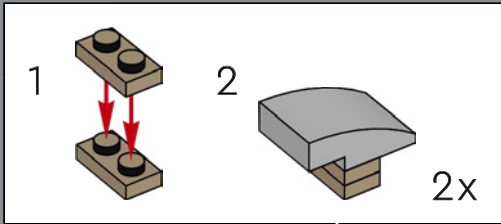

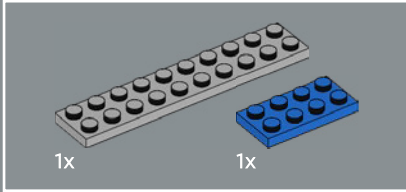
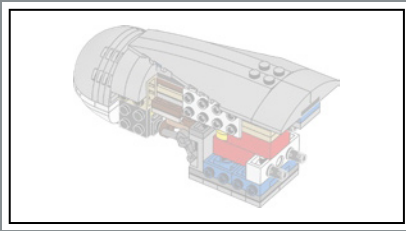

189

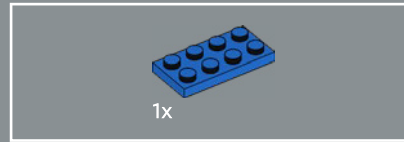
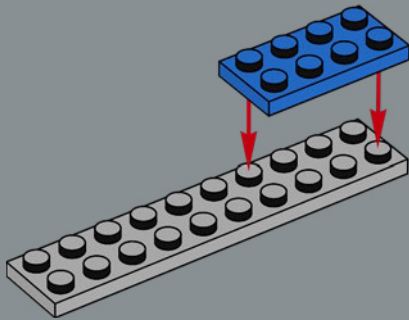

190

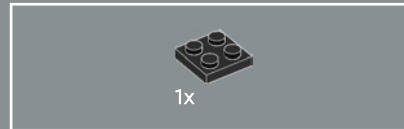
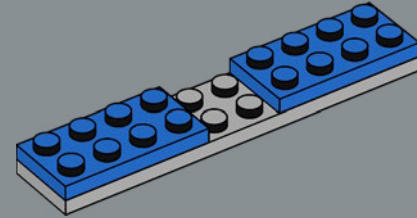

191

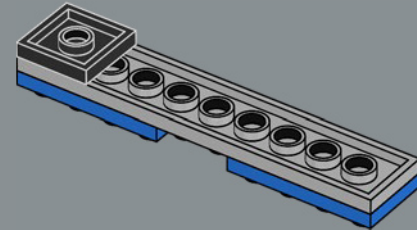



192

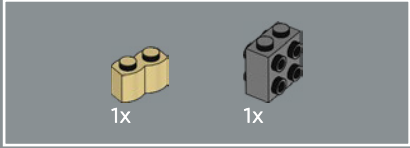
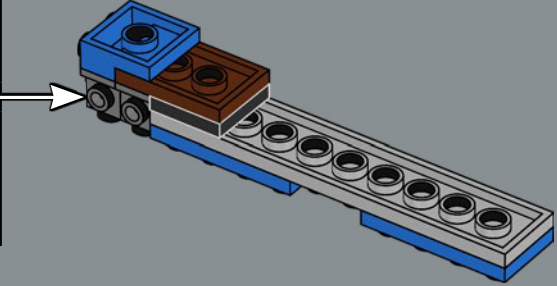
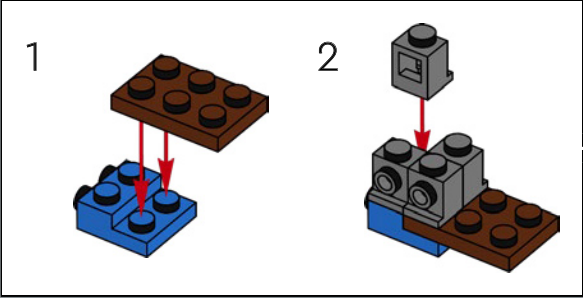

193

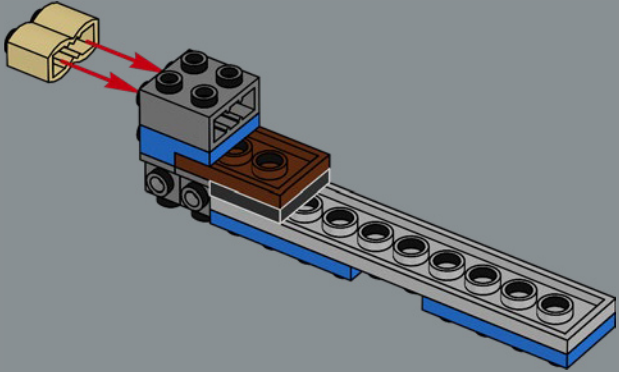

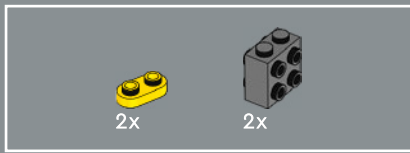

194

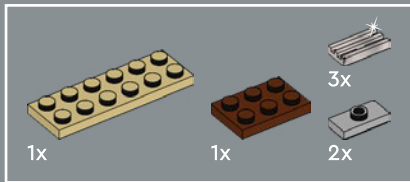
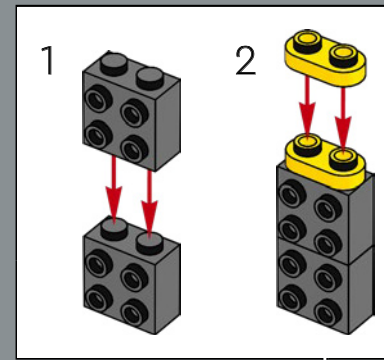
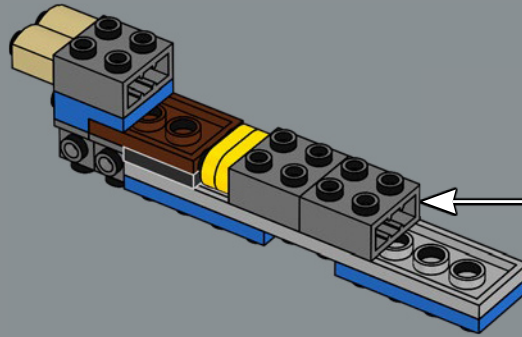

195

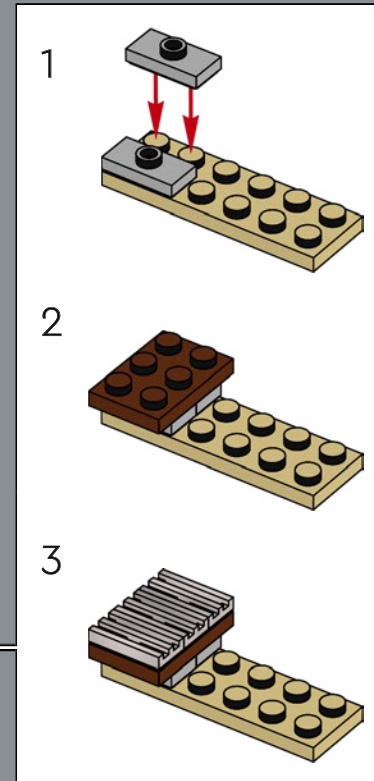
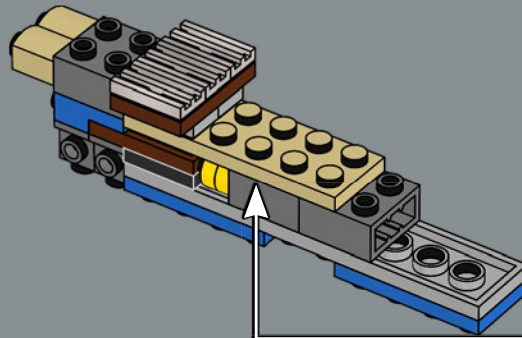



196

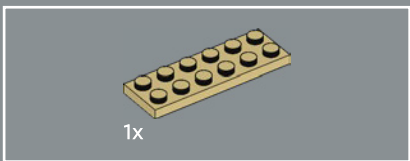
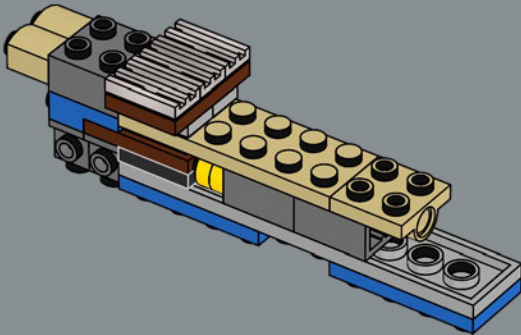

197

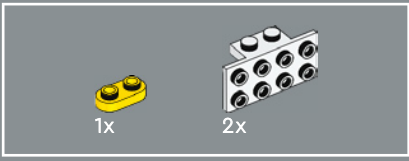
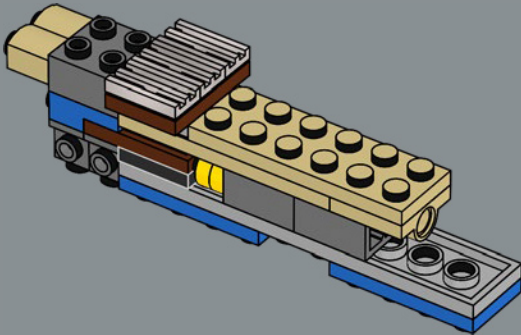

198

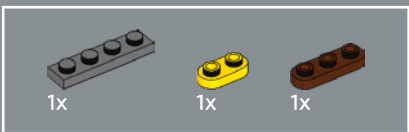
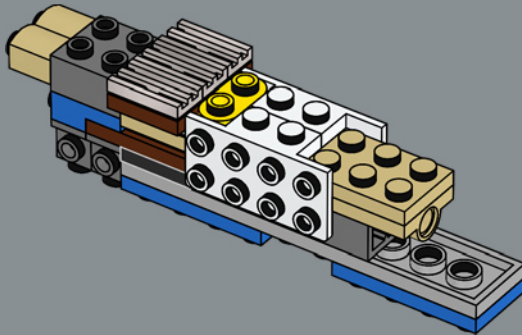

199

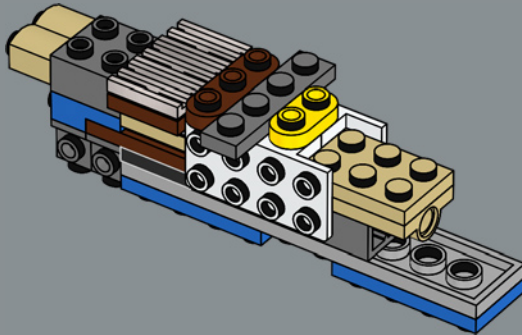

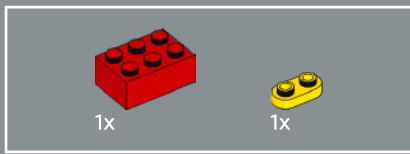

200

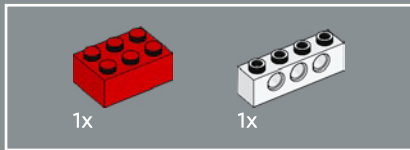
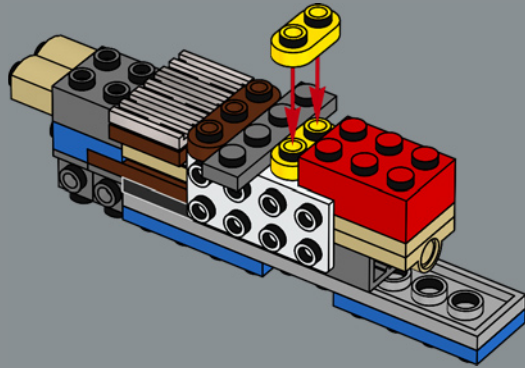

201

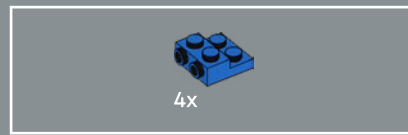
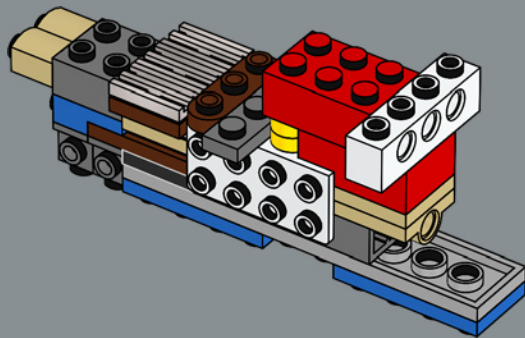

202

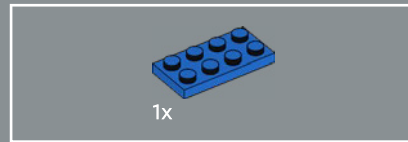
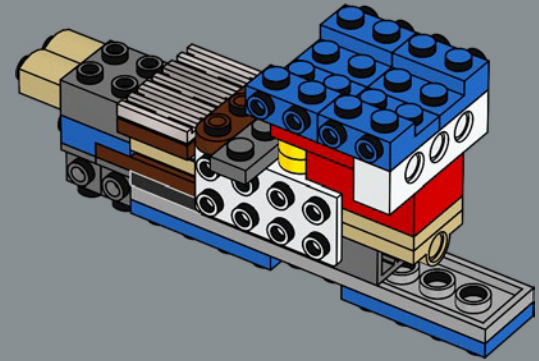

203

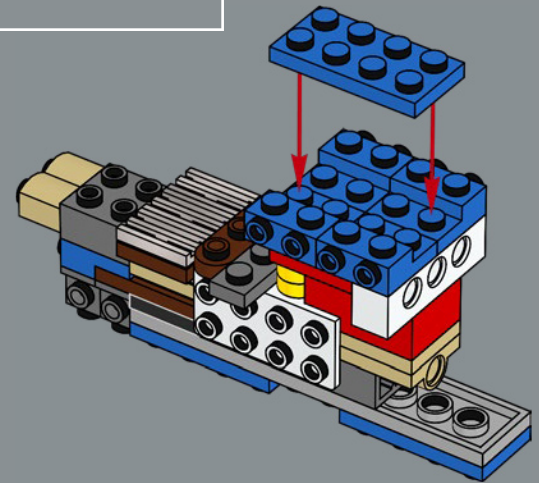

3x

204

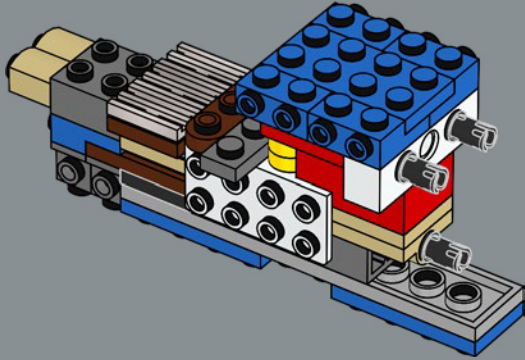

2x

205

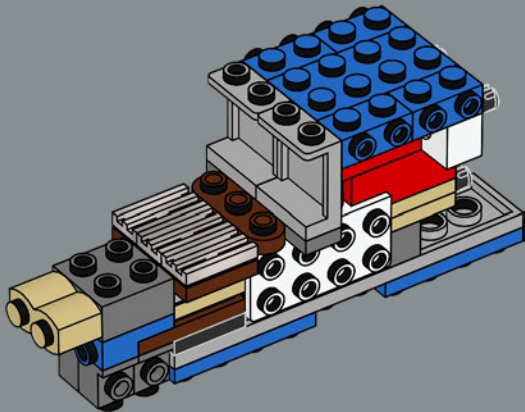

1x

206

1x

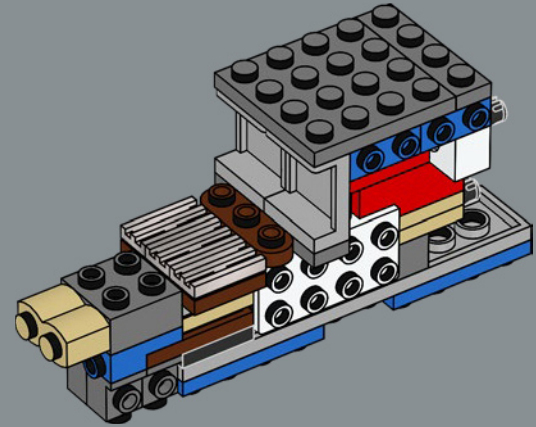

10x

207

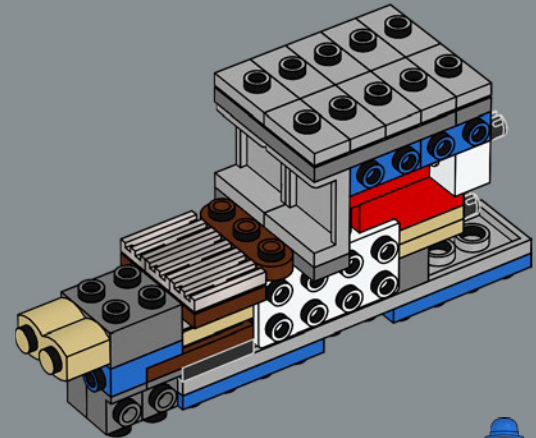

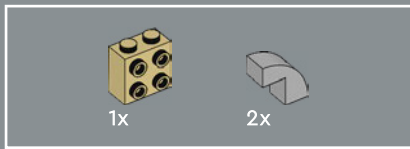

208

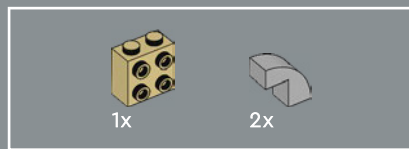
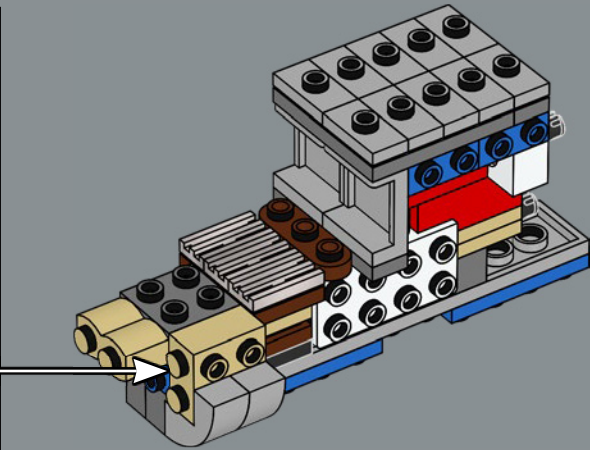
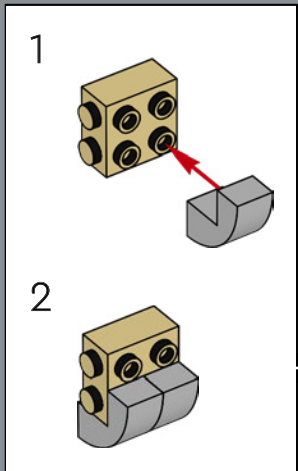

209

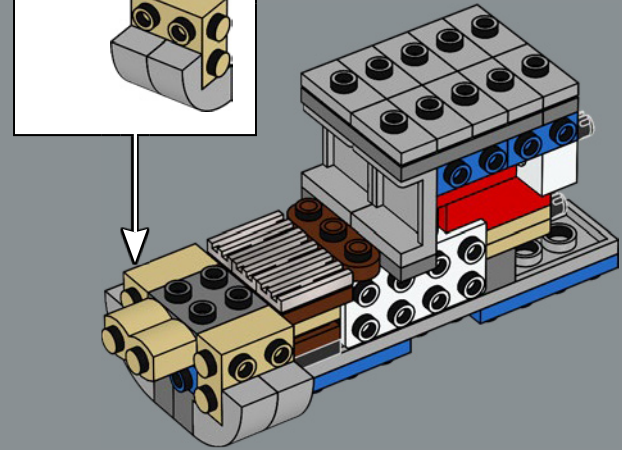
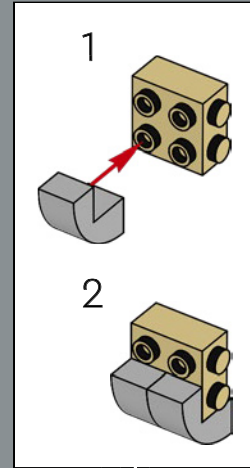



2x

210

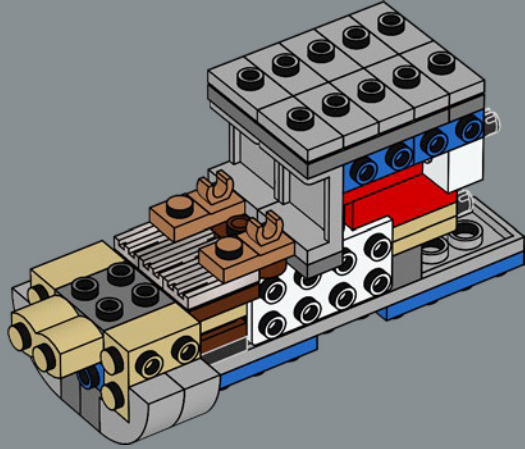

2x



4x

211

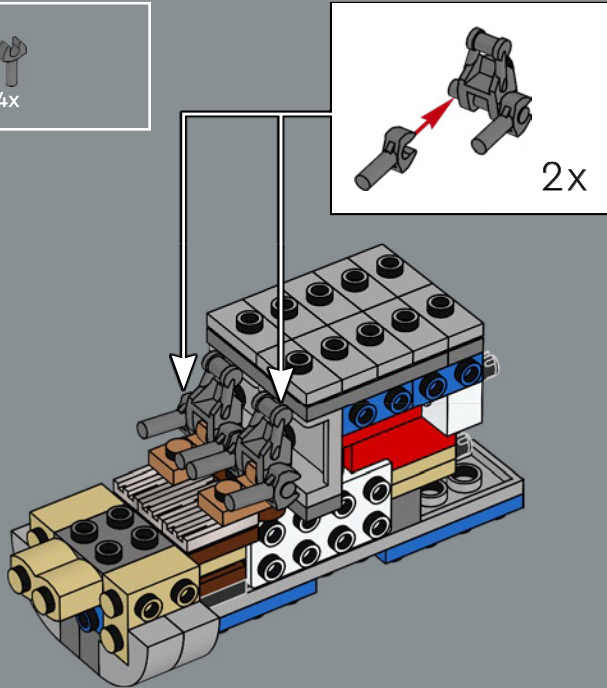

1x



1x



1x



1x



1x



1x

212

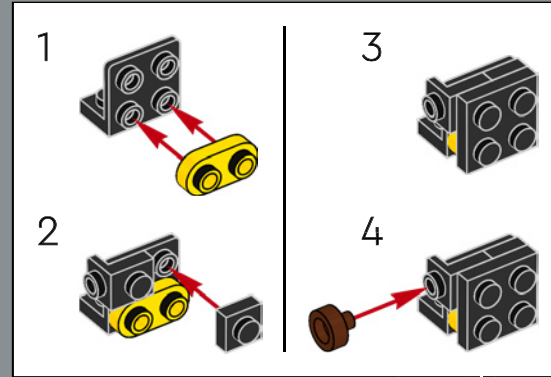

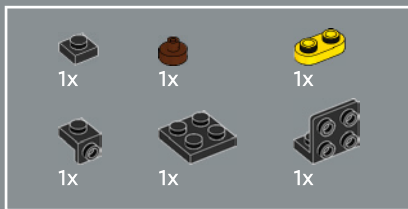

213

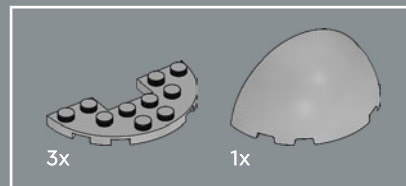
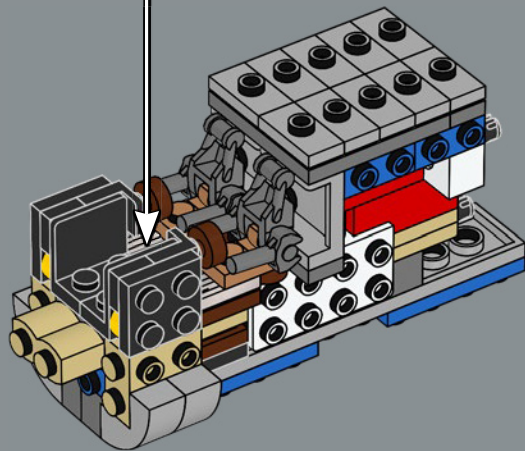
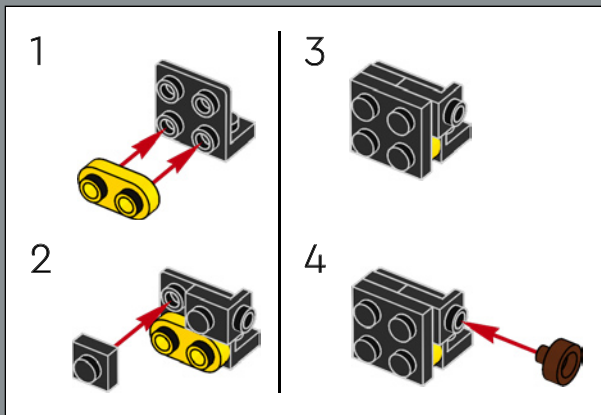

214

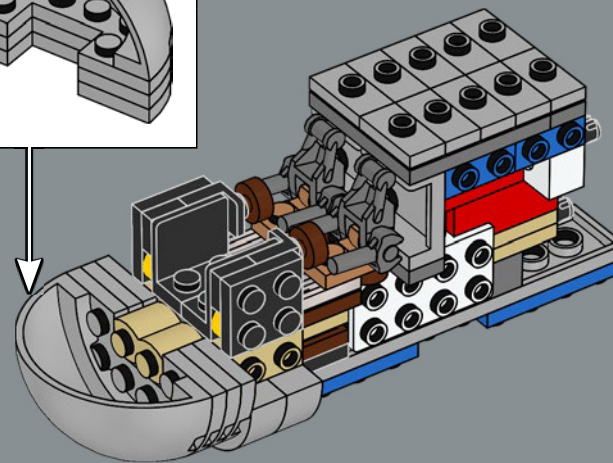
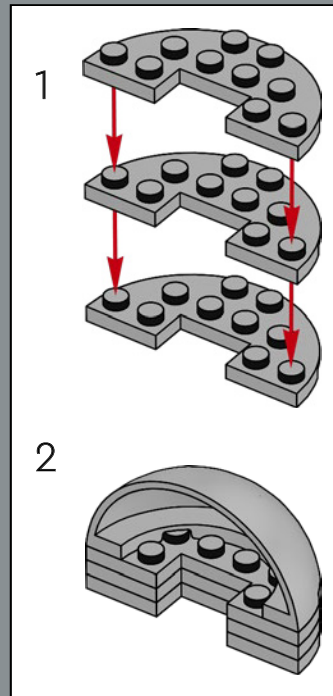

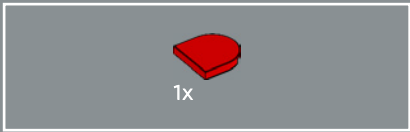

215

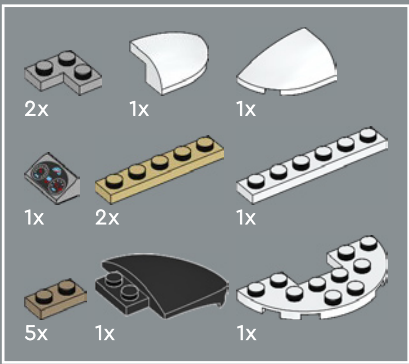
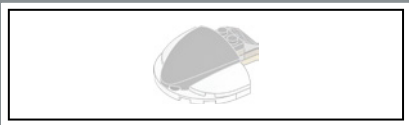
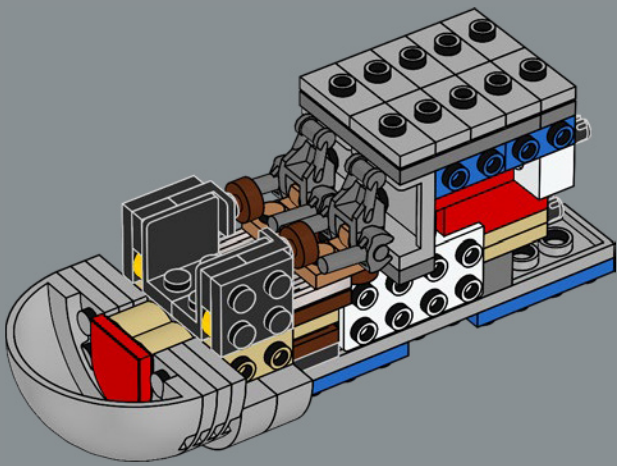

216

1



2

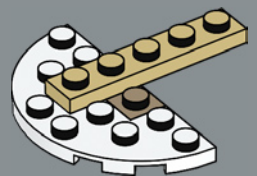

3

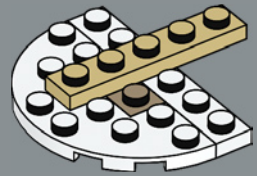



La pieza negra del morro es un elemento LEGO® que se concibió originalmente como pétalo de tulipán.

4

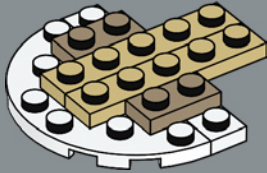

5

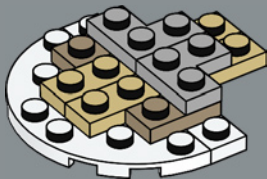

6

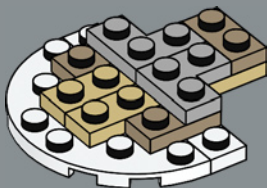

7

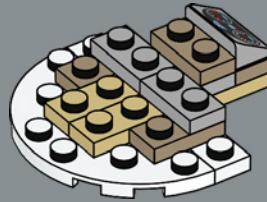

8

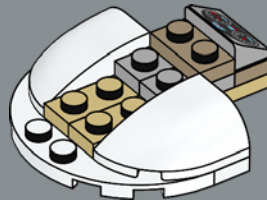

9

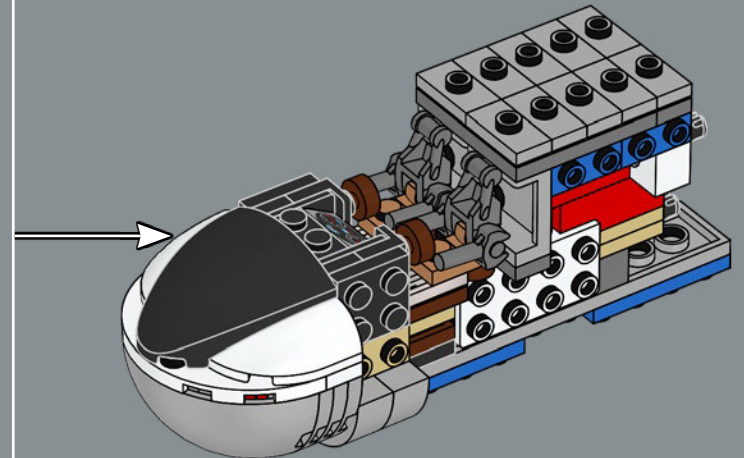
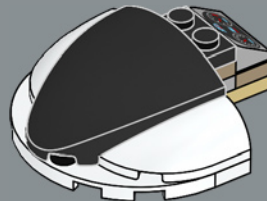

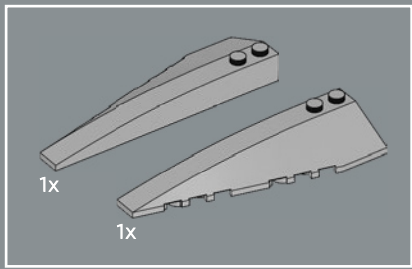

217

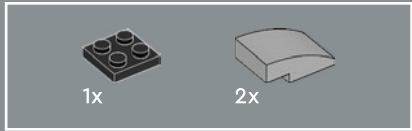
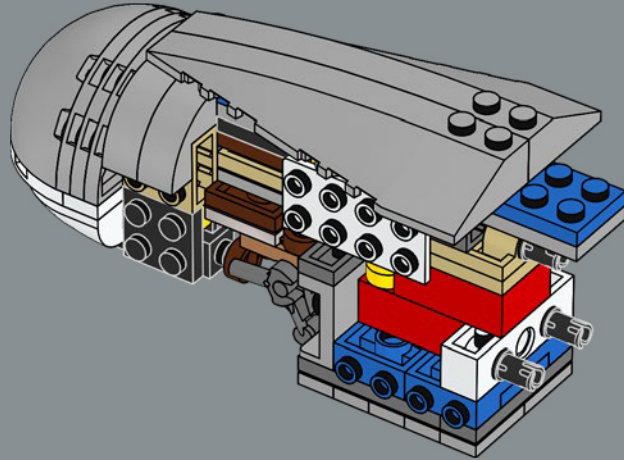

218

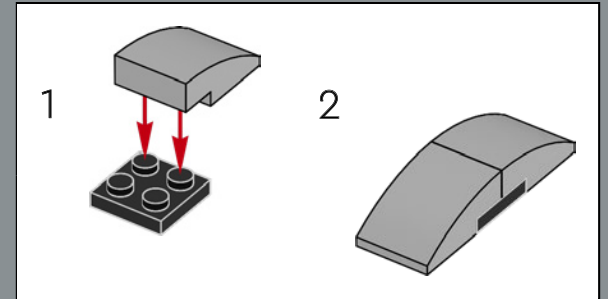
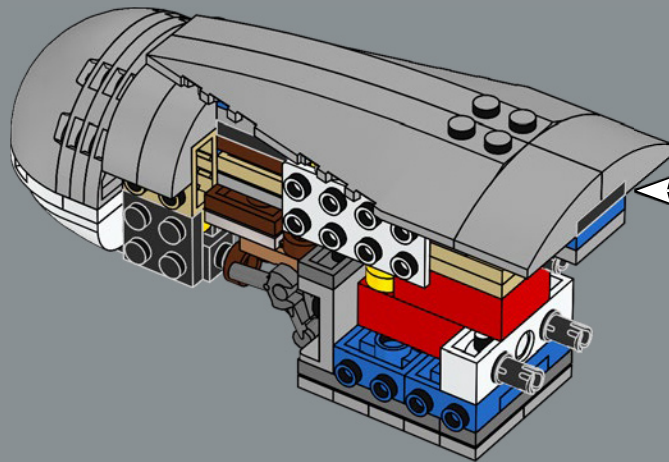

219

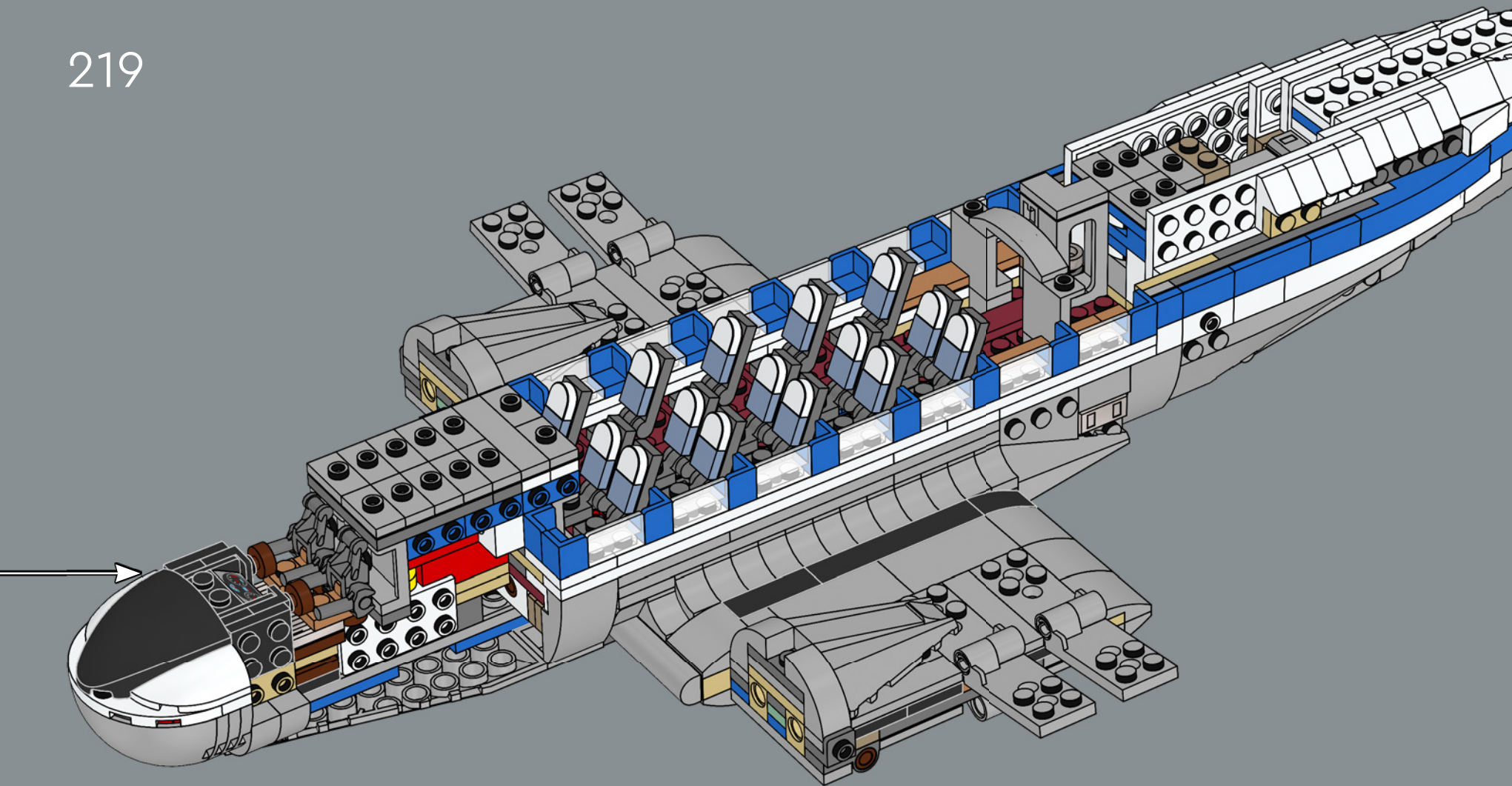

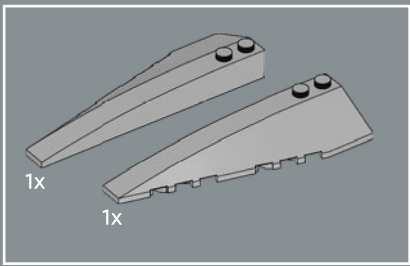

220

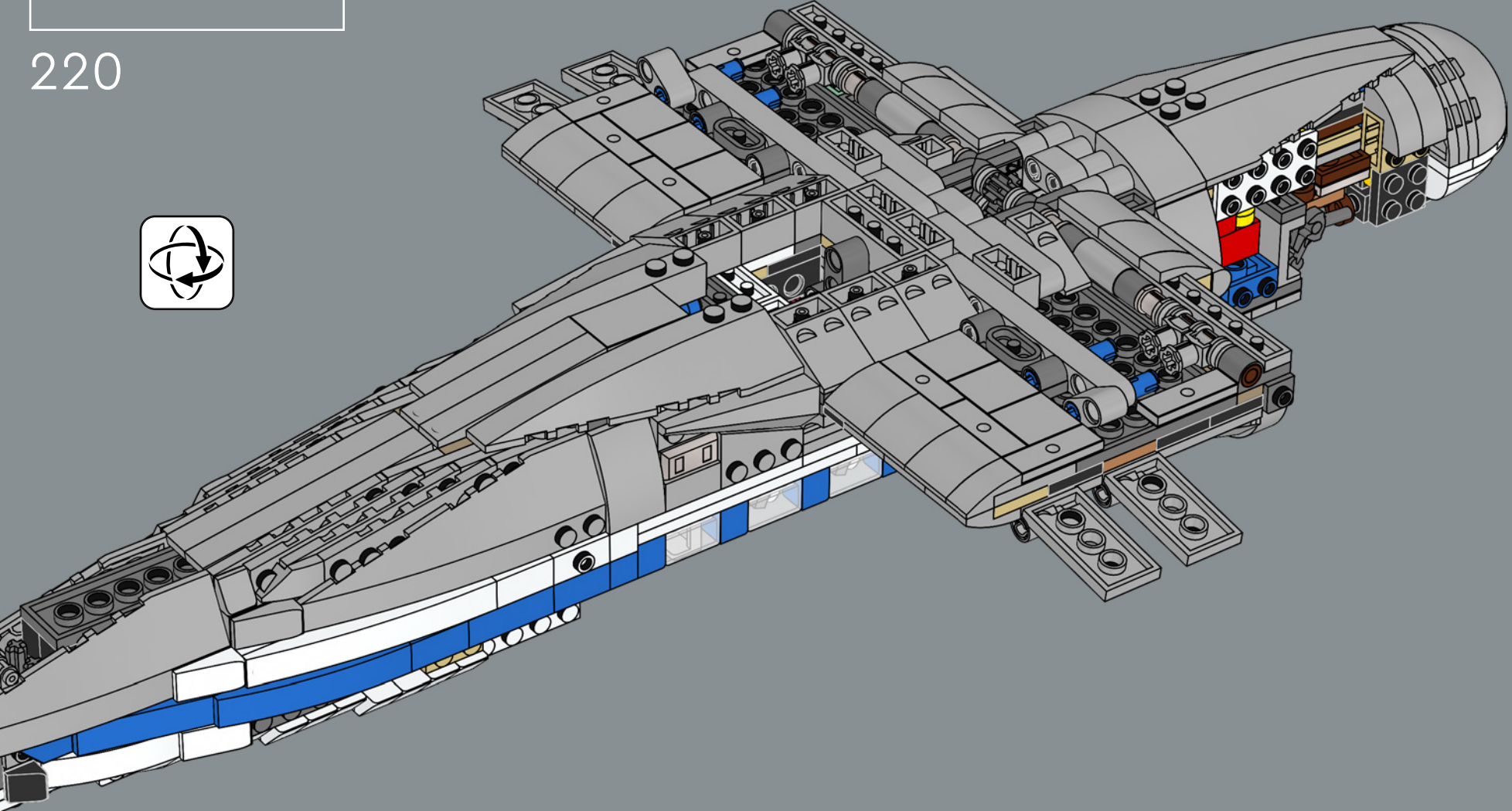

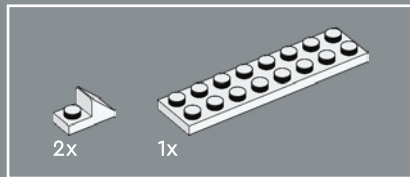
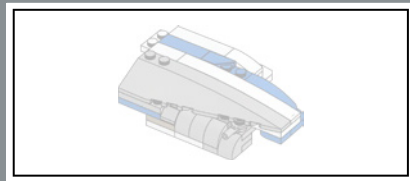

221

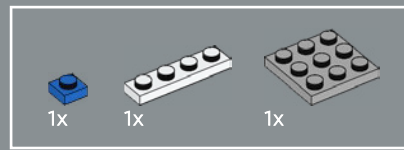
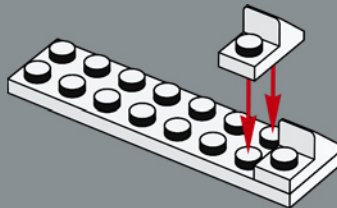

222

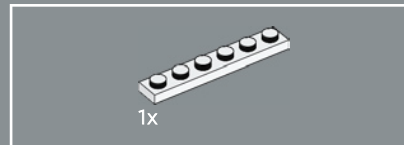
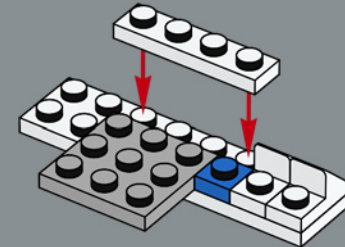

223

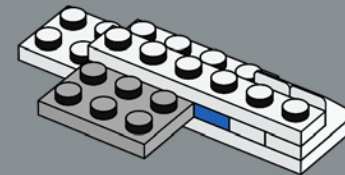

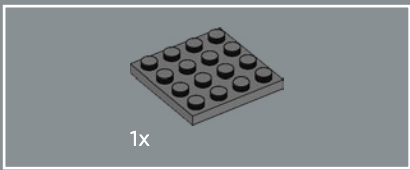

224

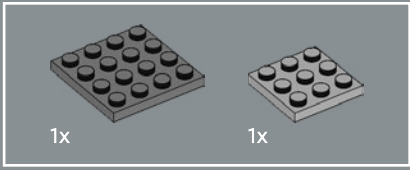
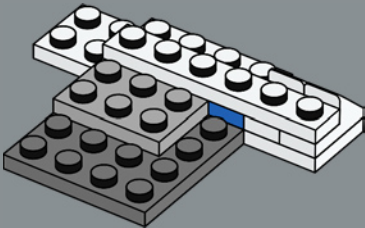

225

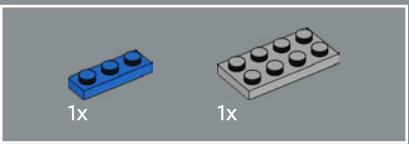
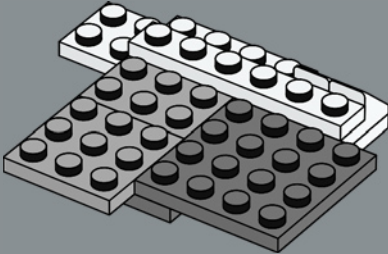

226

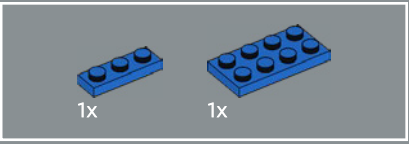
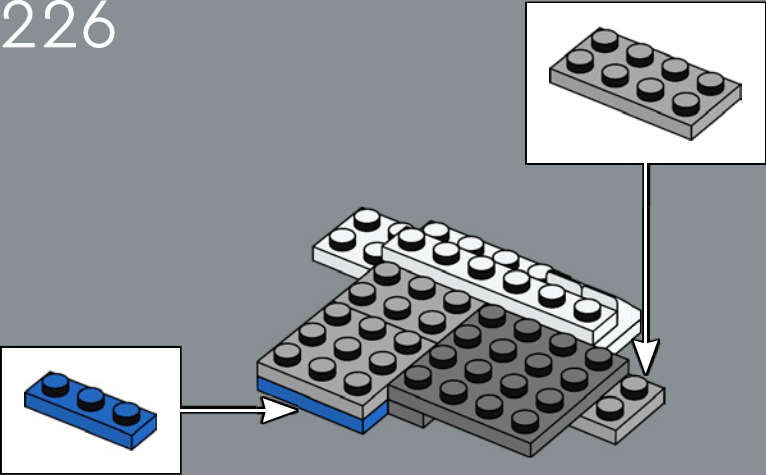

227

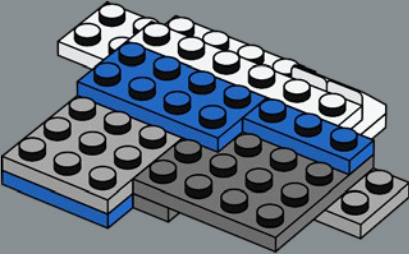

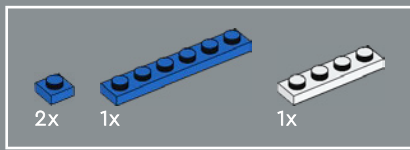

228

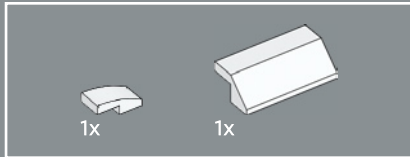
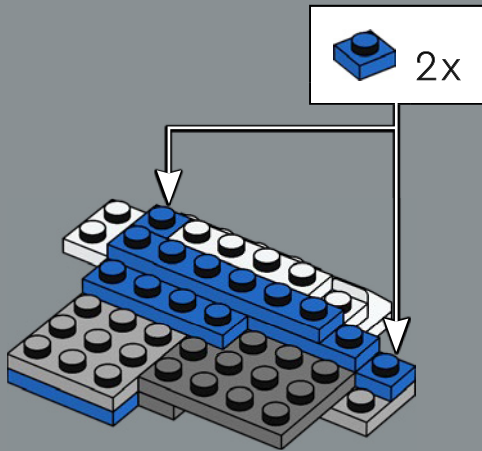

229

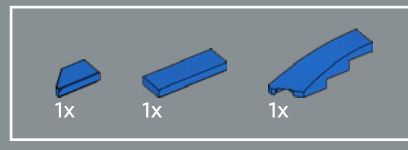
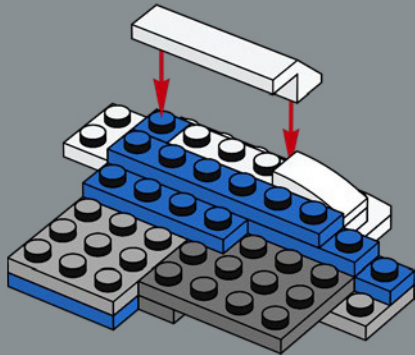

230

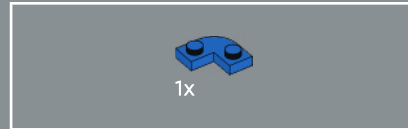
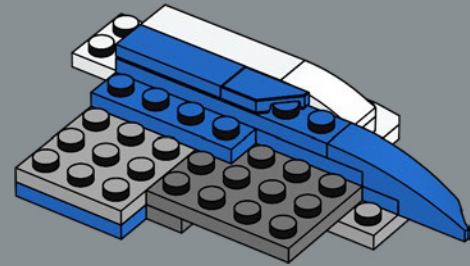

231

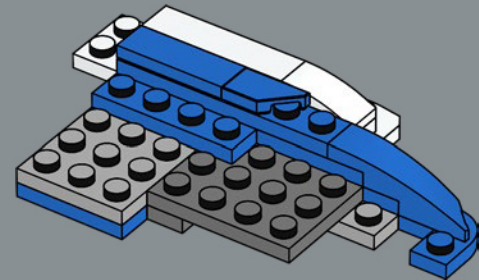

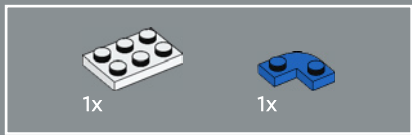

232

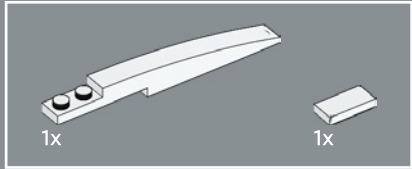
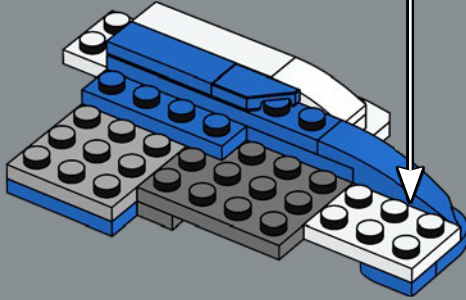
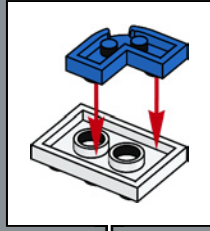

233

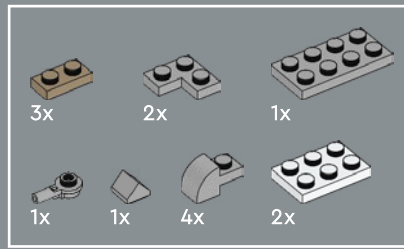
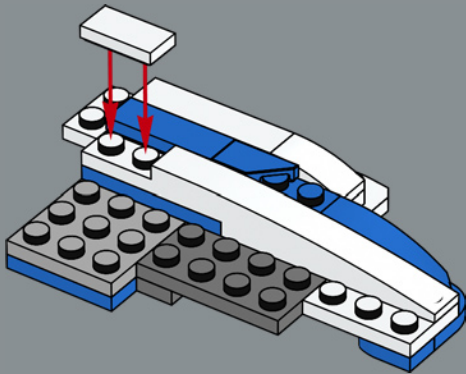

234

1

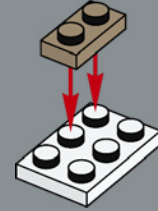

2

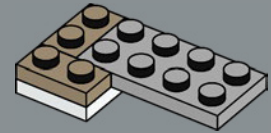

3

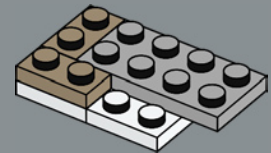

4

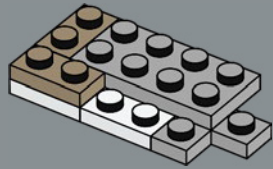

5

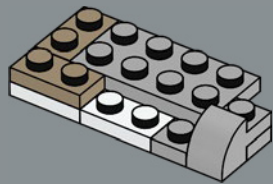

6

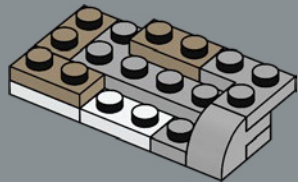

7

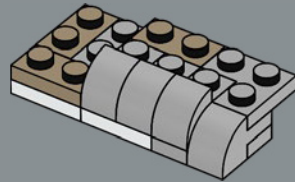

8

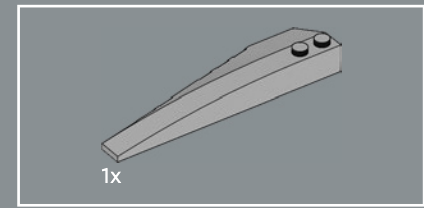
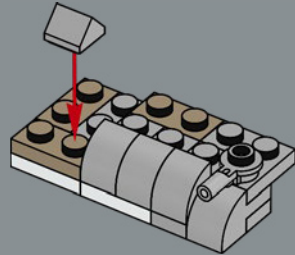

235

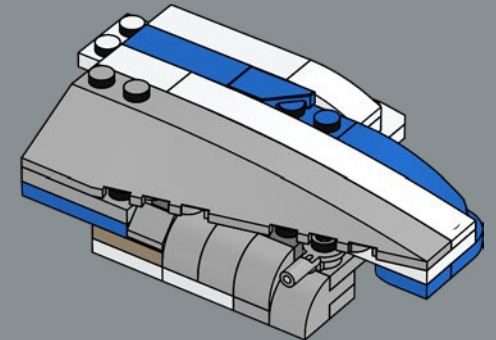
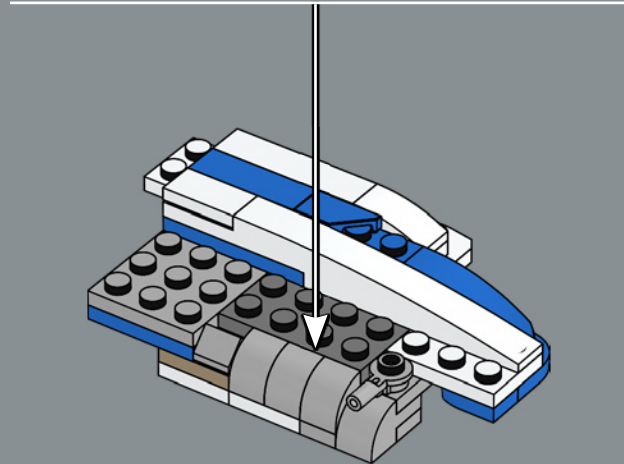

236

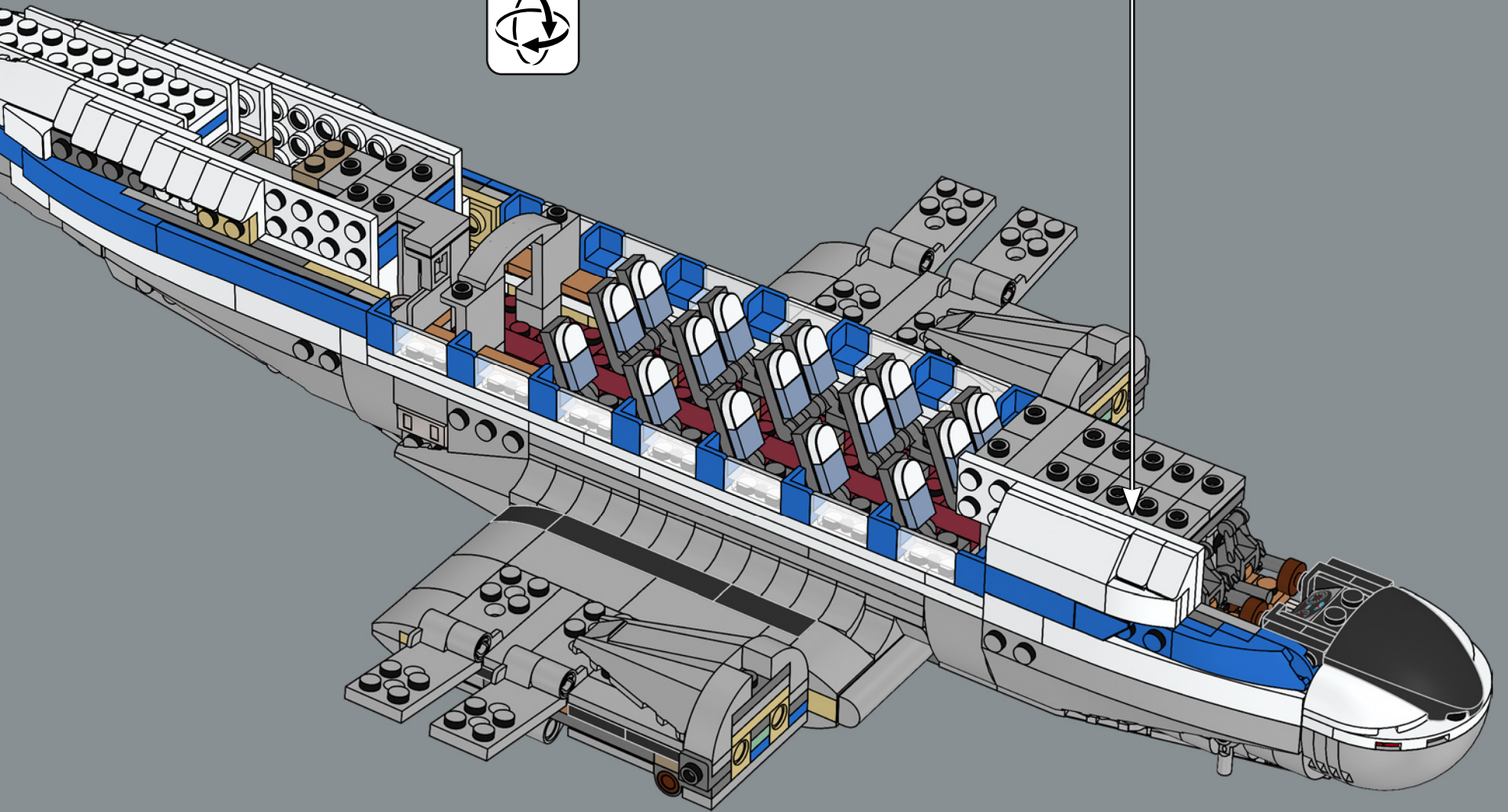

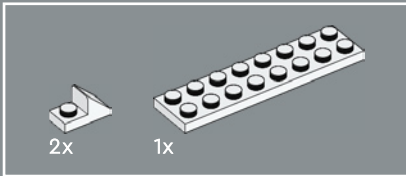
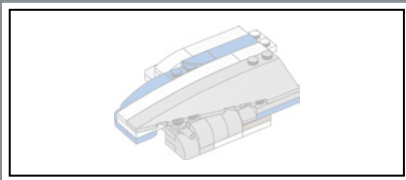

237

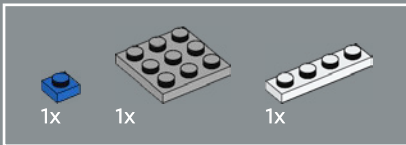
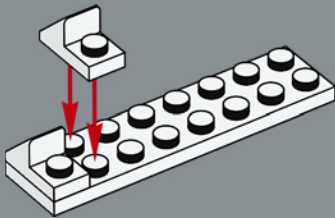

238

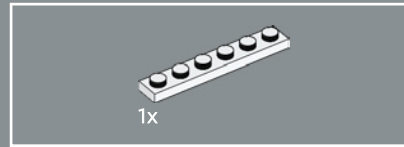
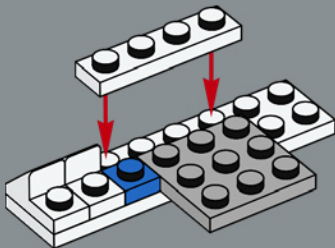

239

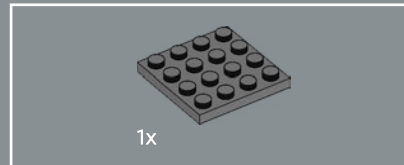
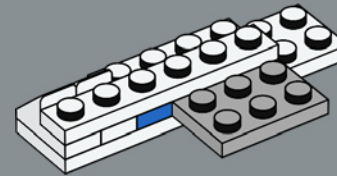

240

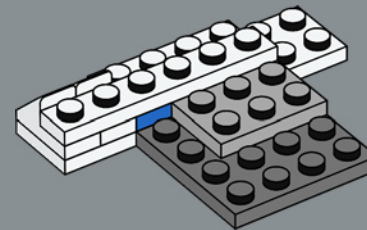

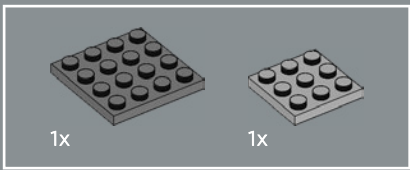

241

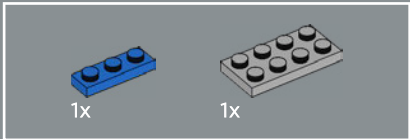
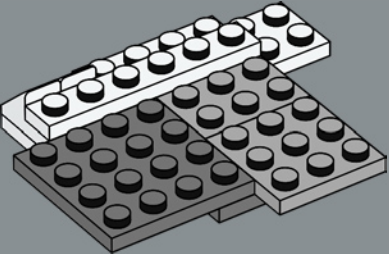

242

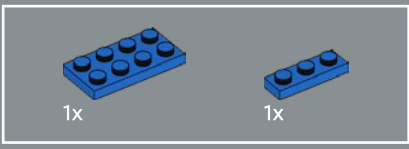
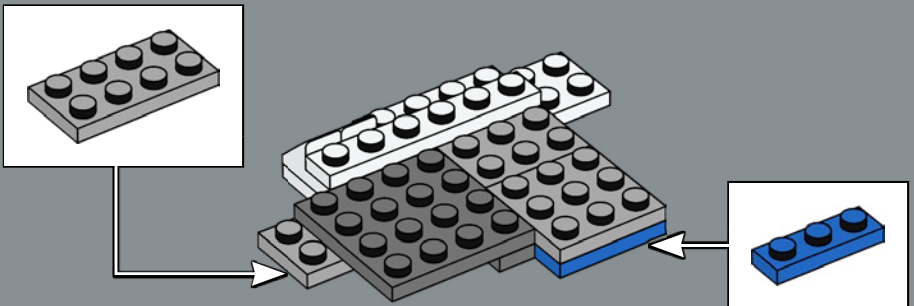

243

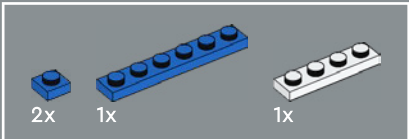
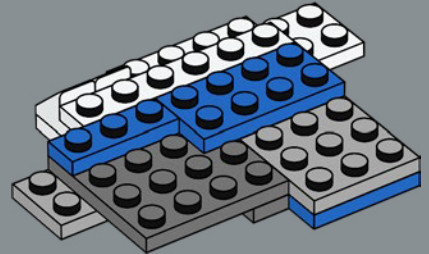

244

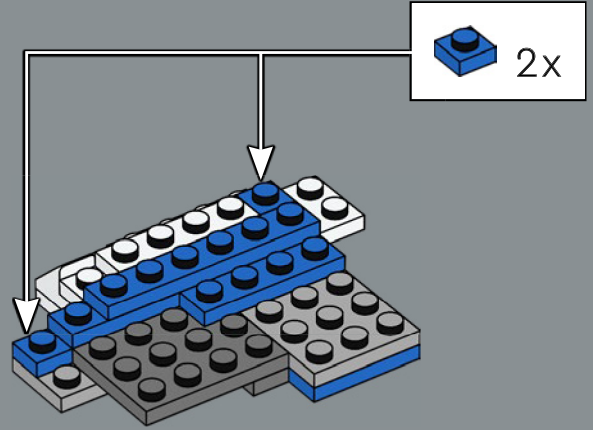

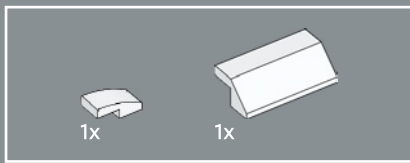

245

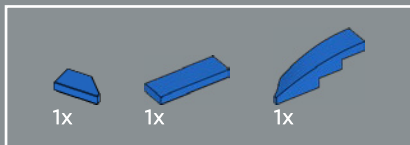
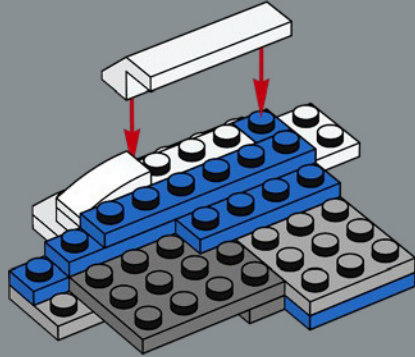

246

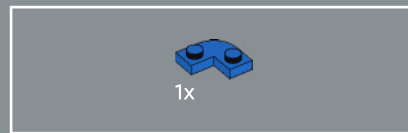
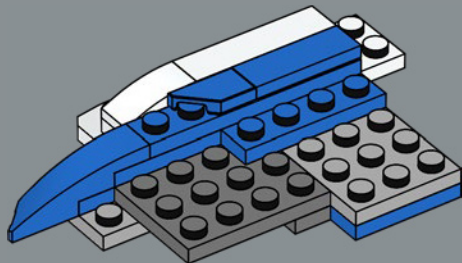

247

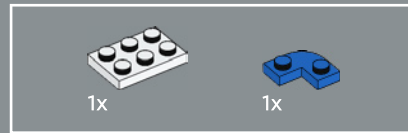
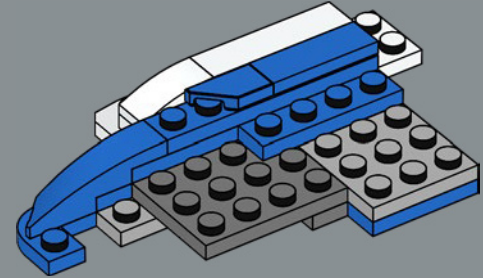

248

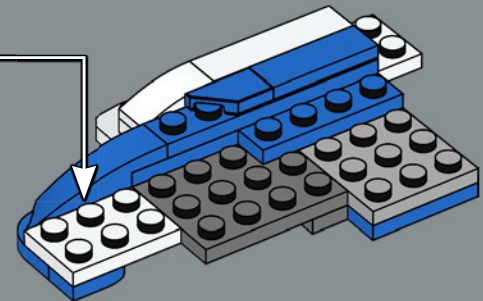
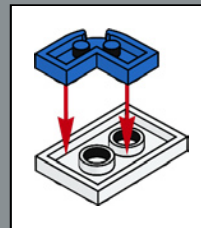

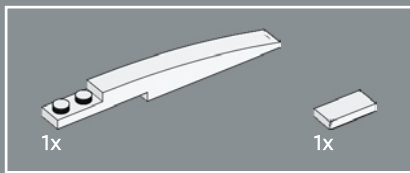

249

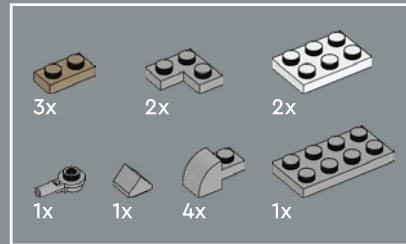
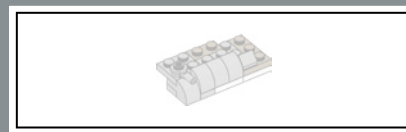
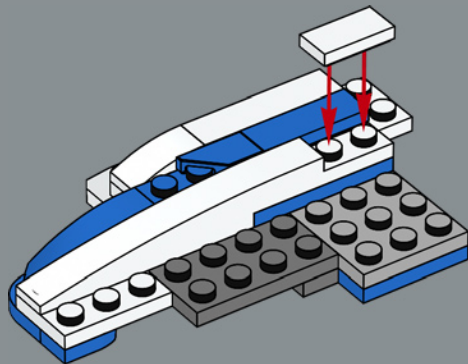

250

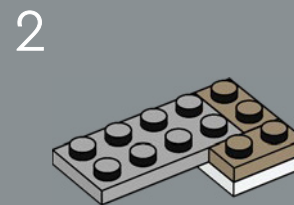
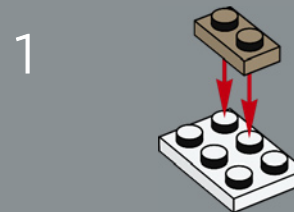

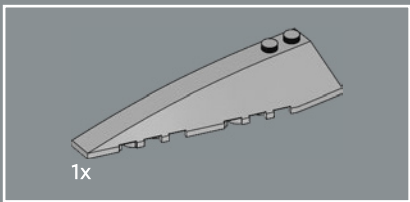

251

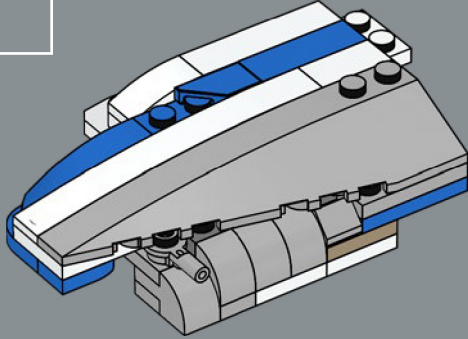

El emblemático esquema cromático Globe de Pan Am®, con el globo estilizado, una franja azul a la altura de las ventanillas y letras en negro sobre un fondo blanco, se introdujo en 1958 y se usó hasta 1984.

252

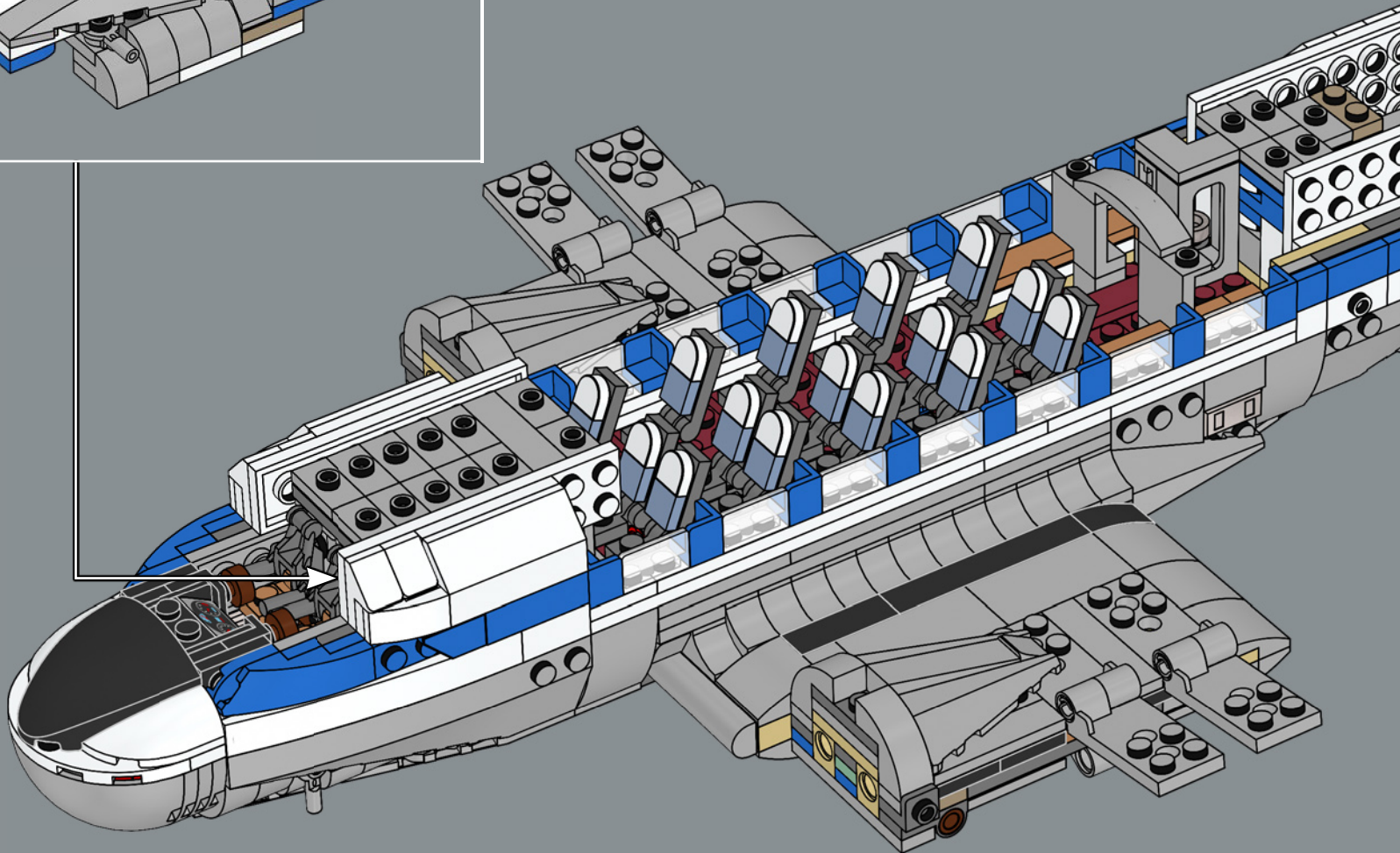

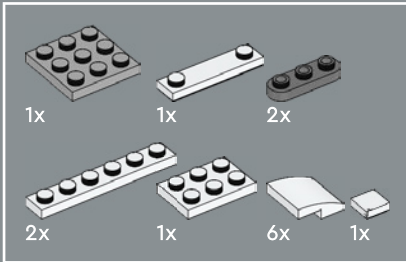
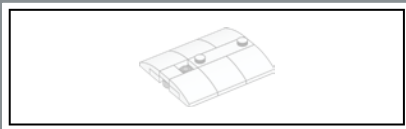

253

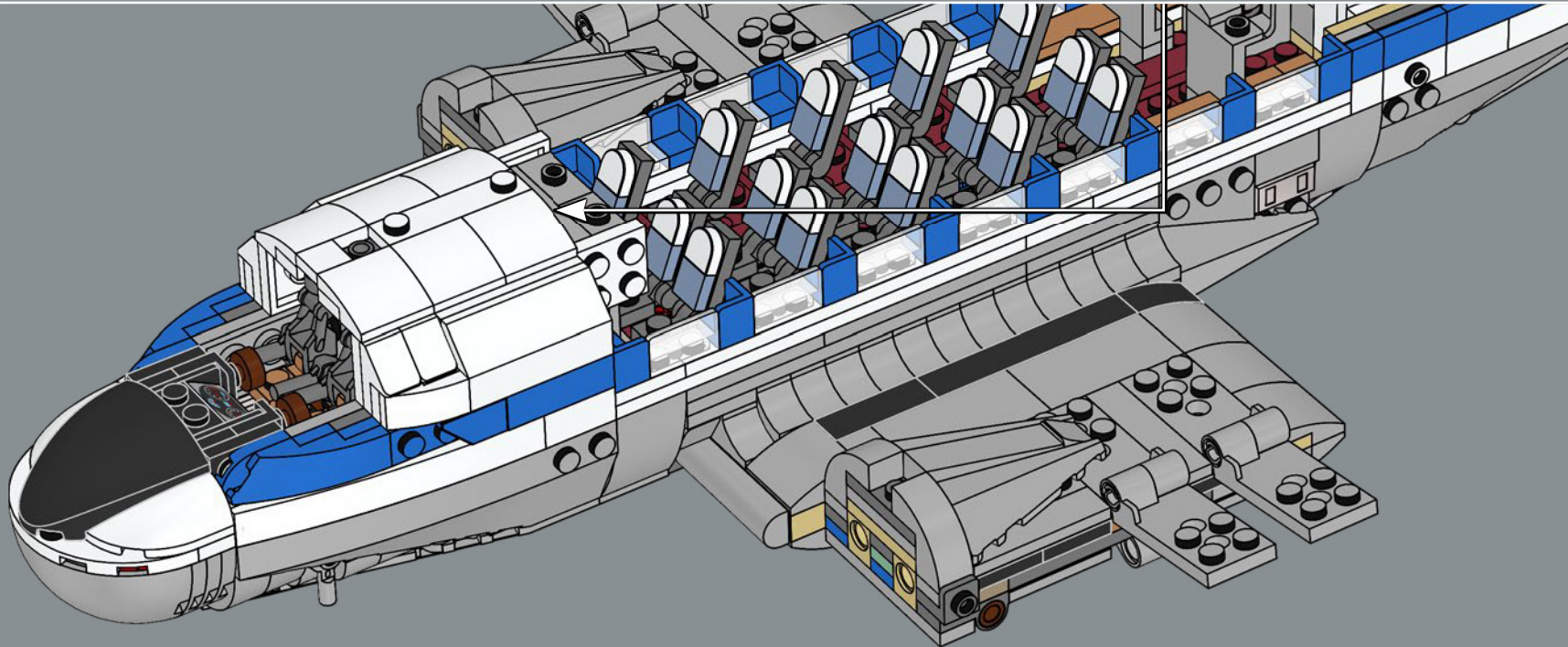
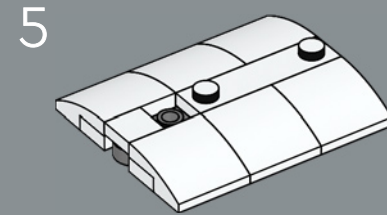
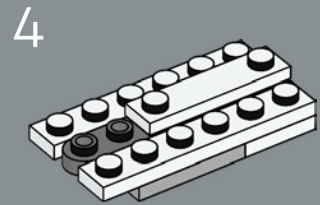
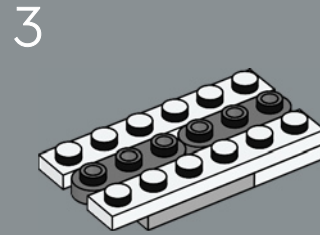
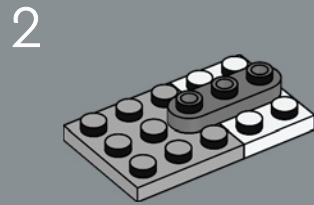
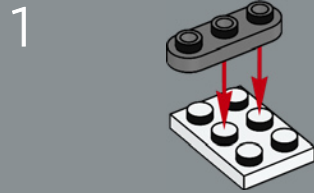

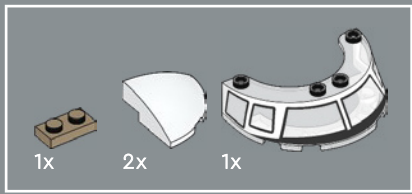

254

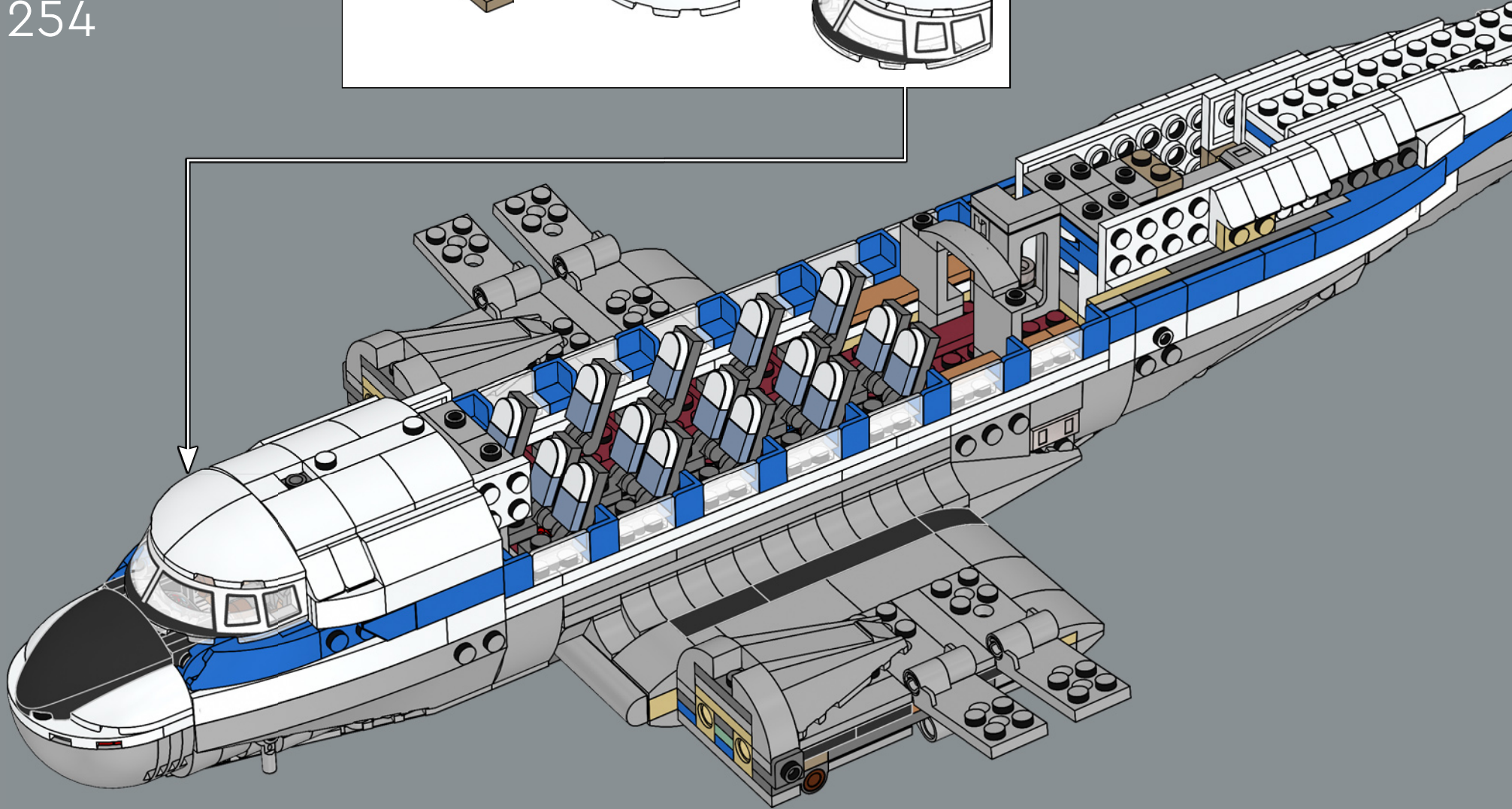
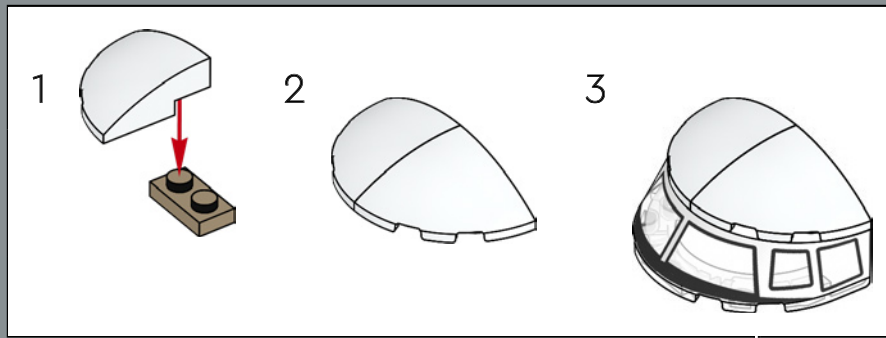

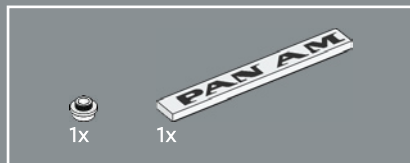
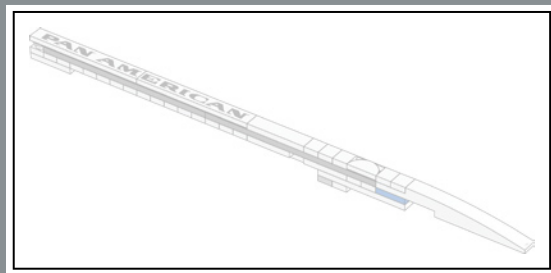

255

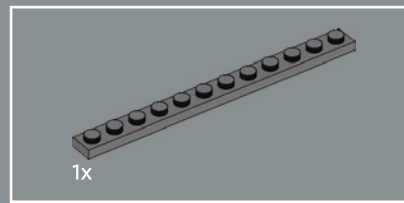

256

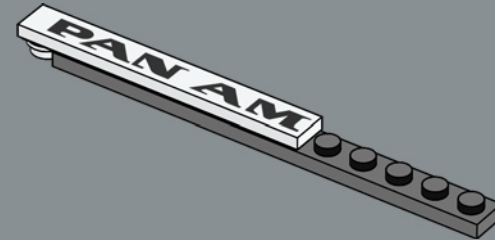

257

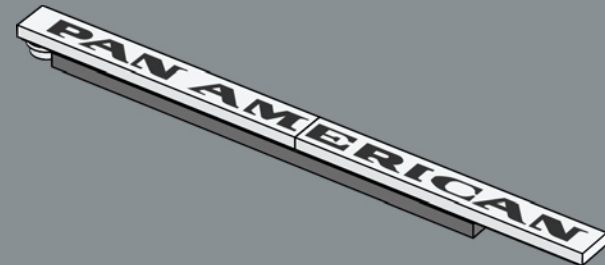

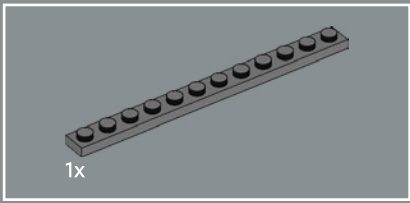

258

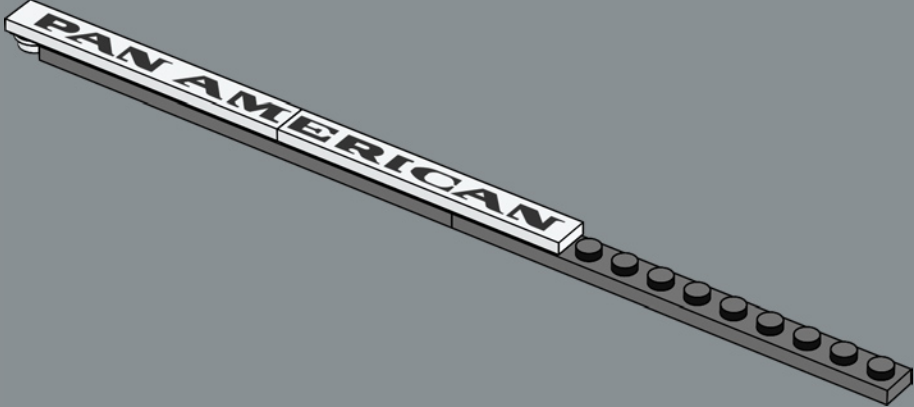

259

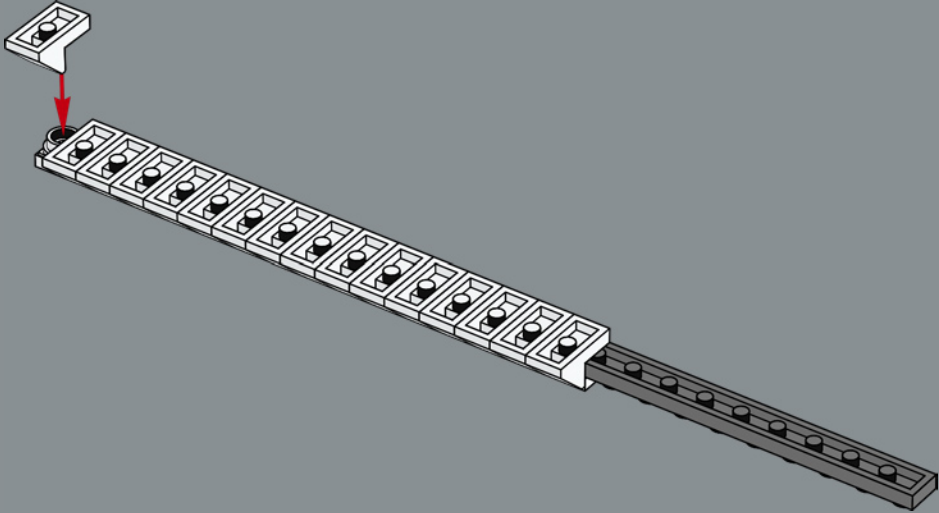

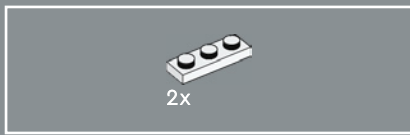

260

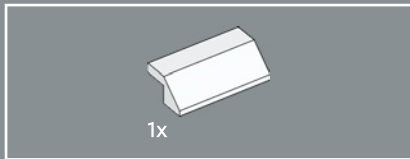
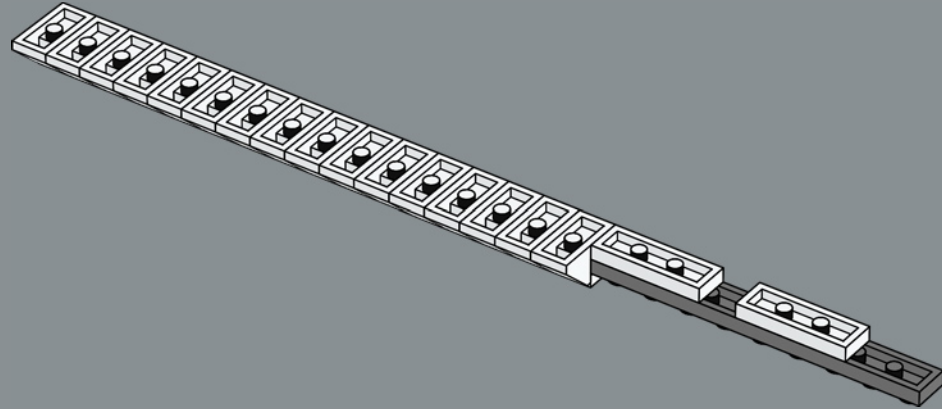

261

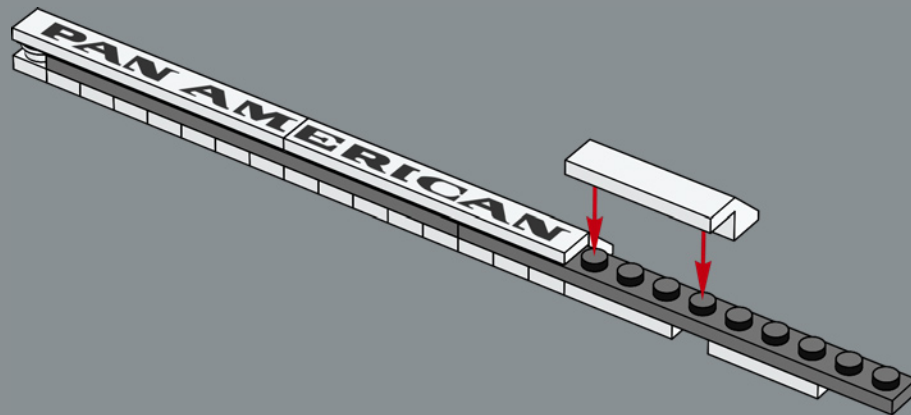

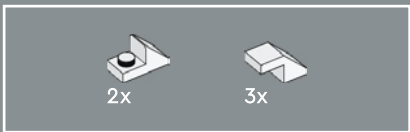

262

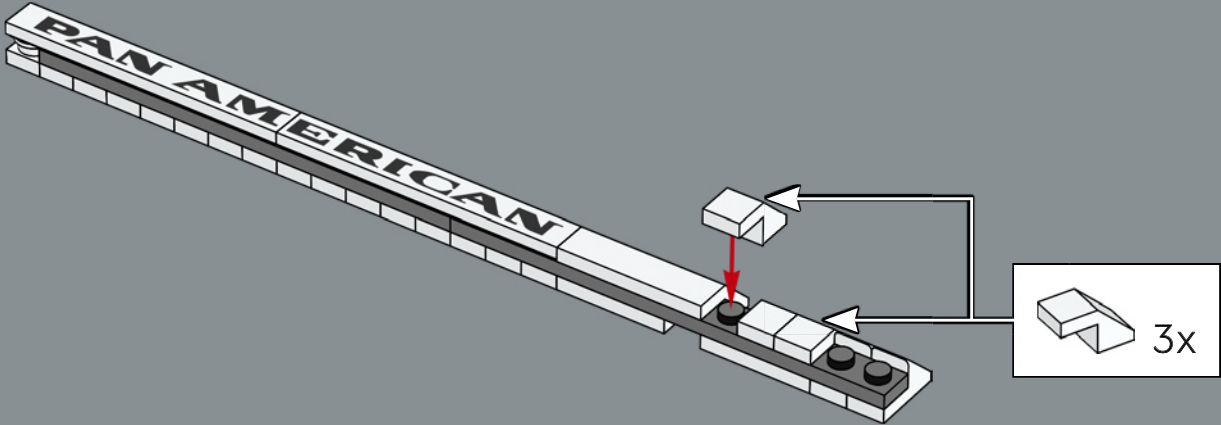

263

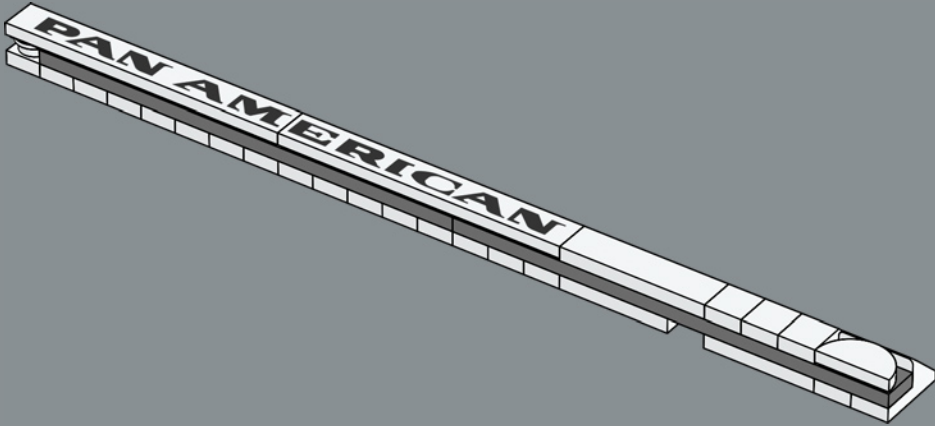

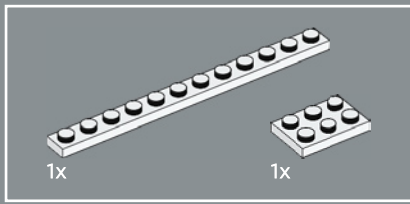

264

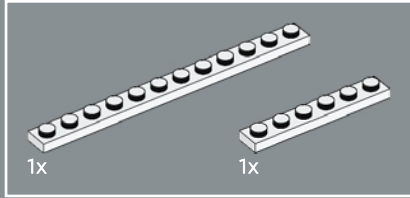
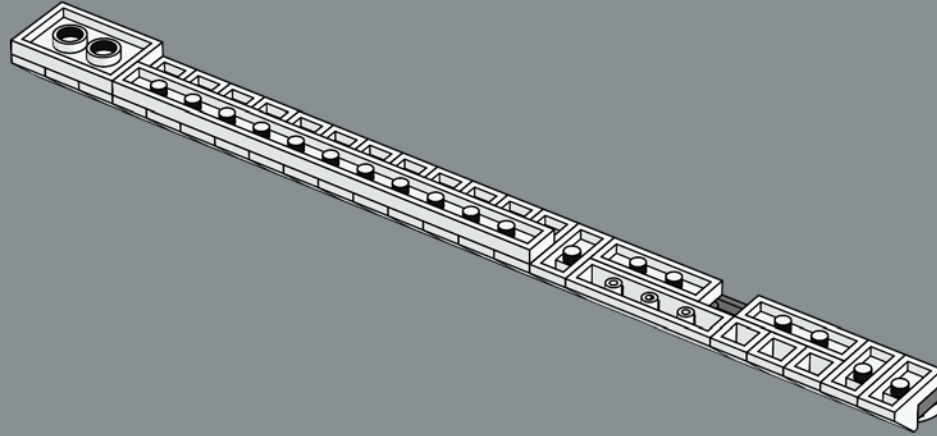

265

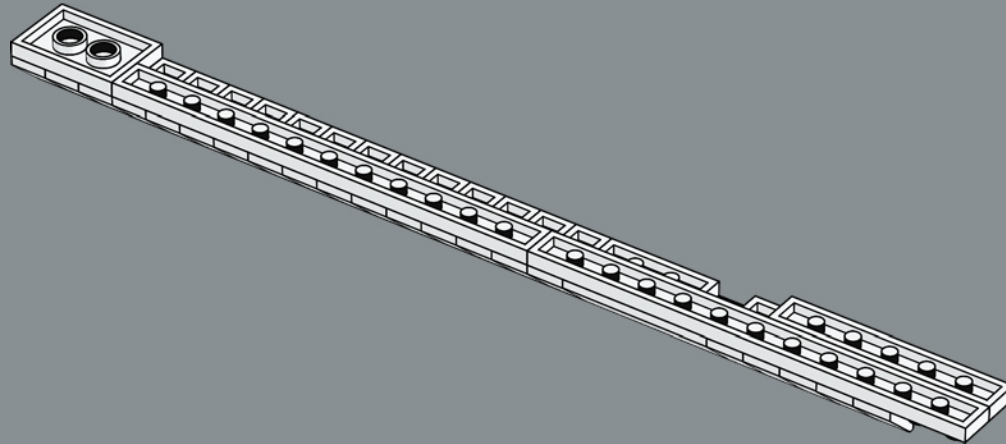

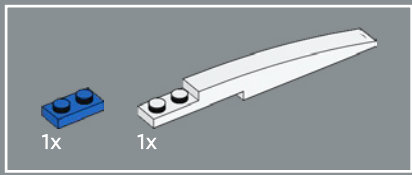

266

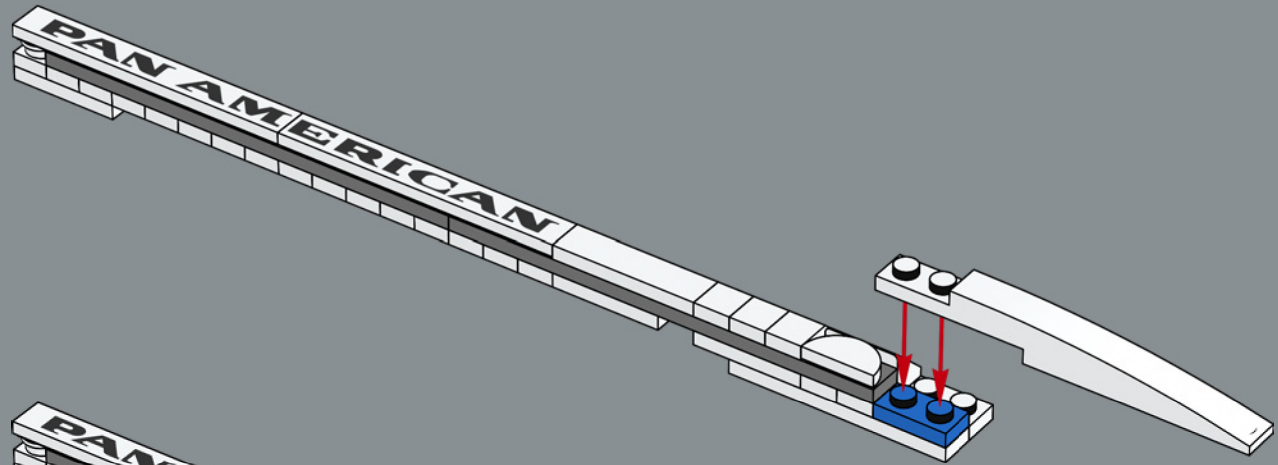

267

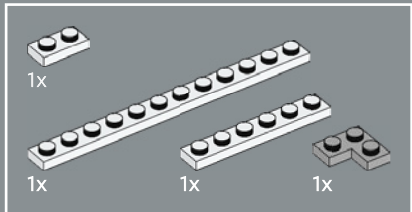
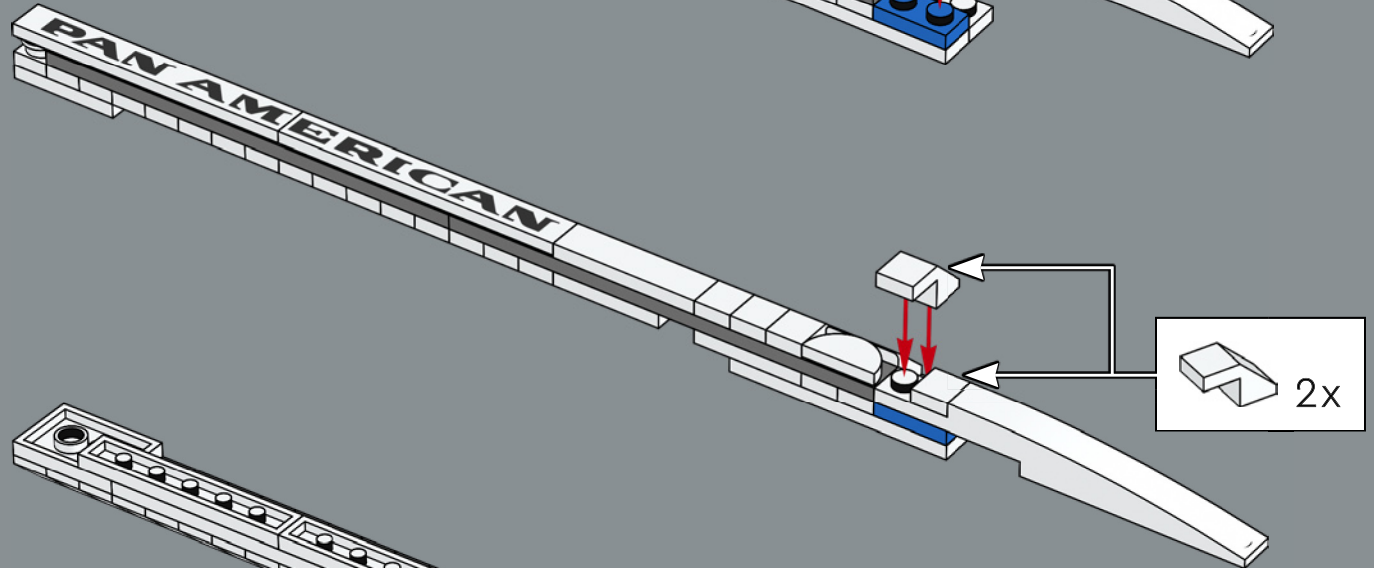

268

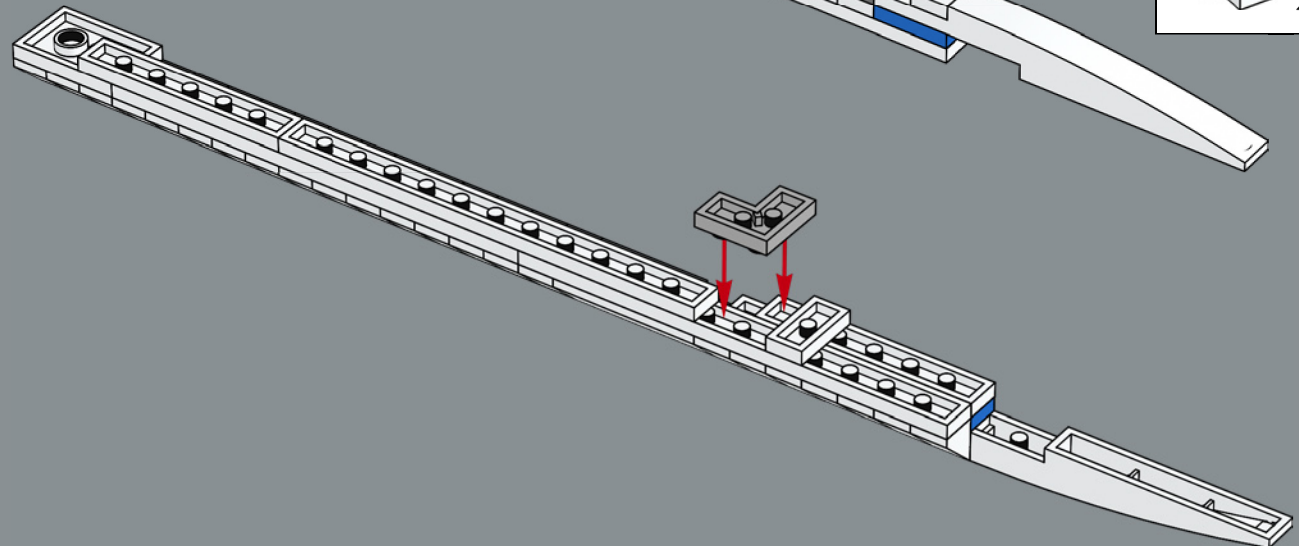

269

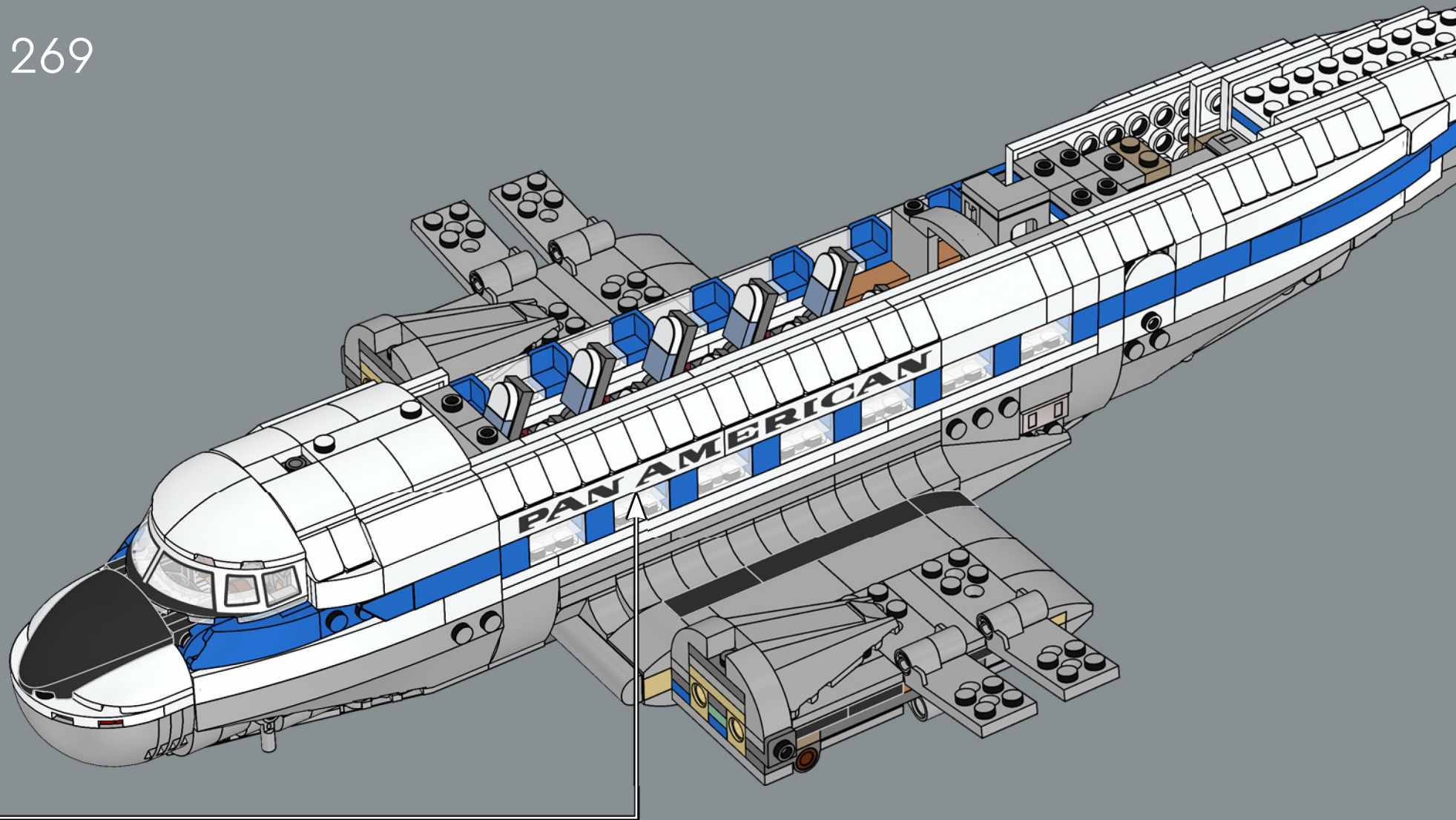

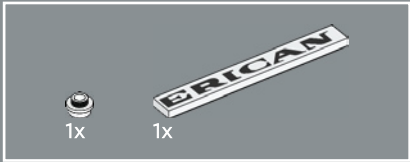
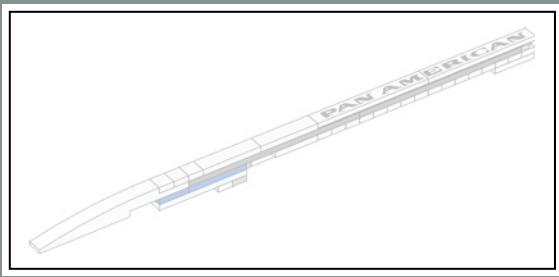

270

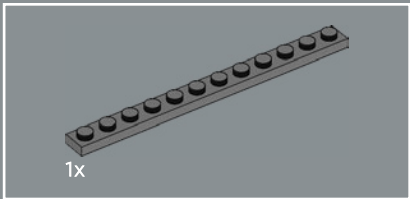

271

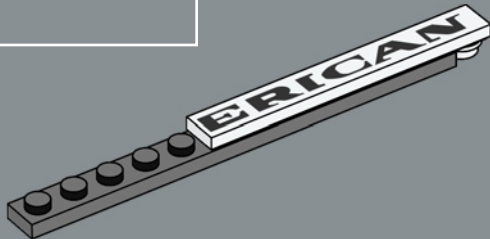

272

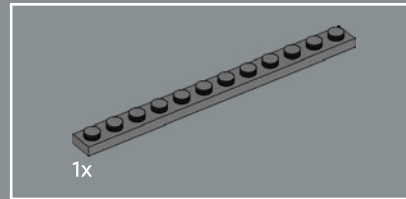
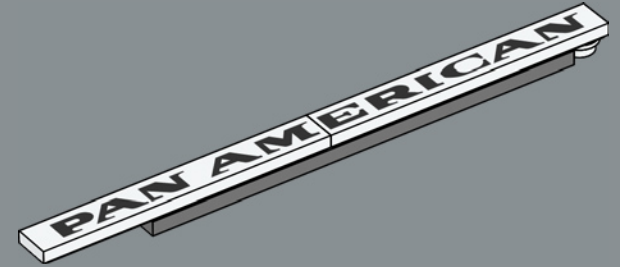

273

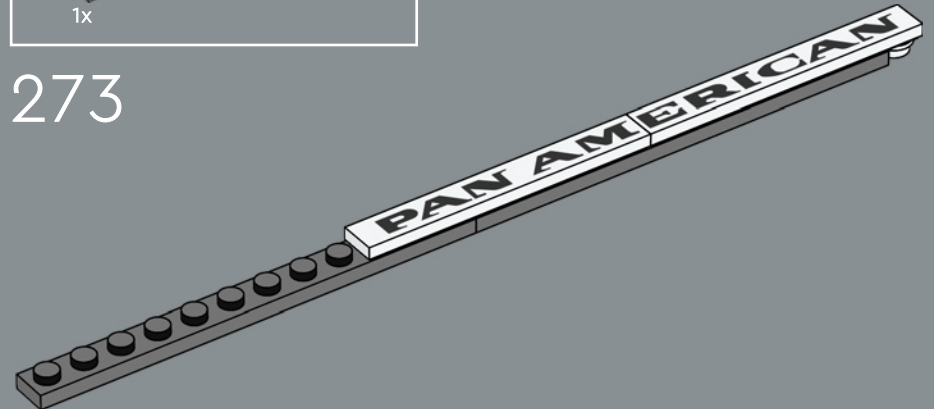



274

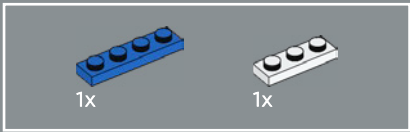
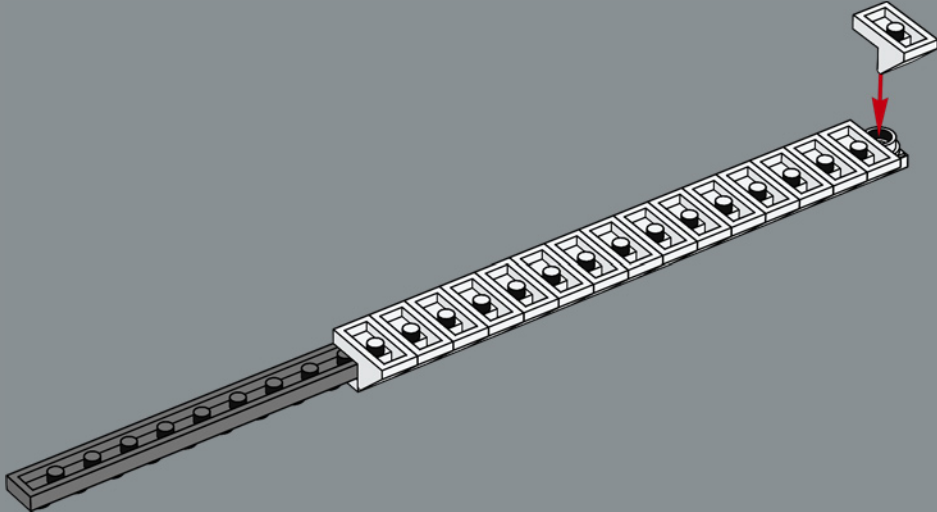

275

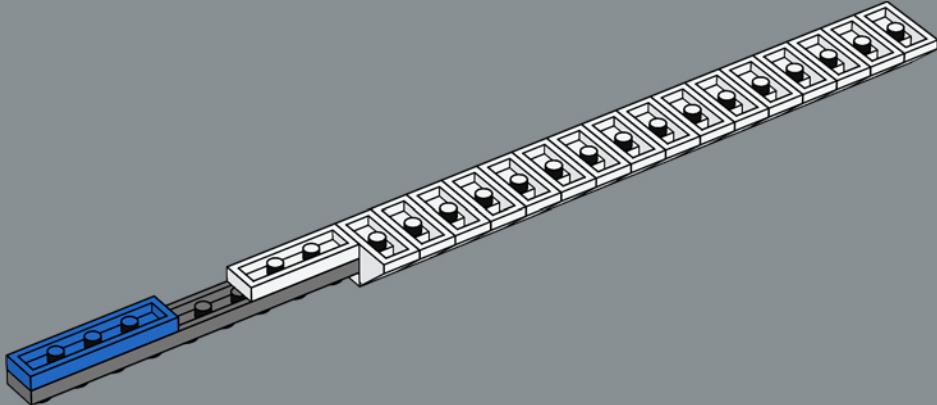

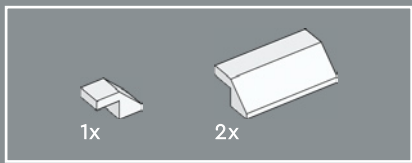

276

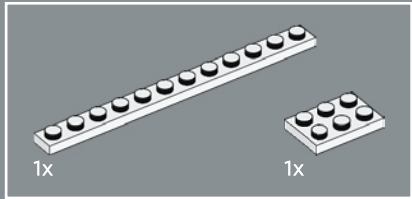
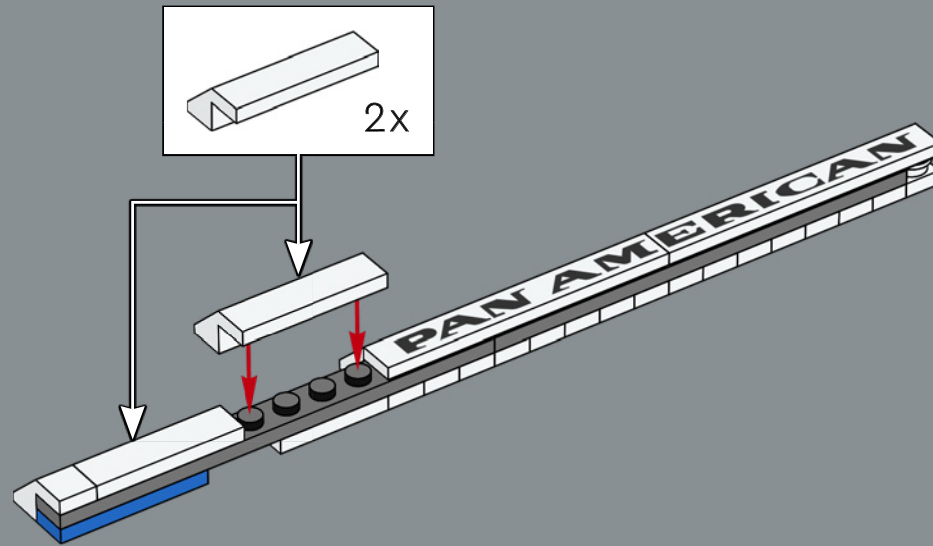

277

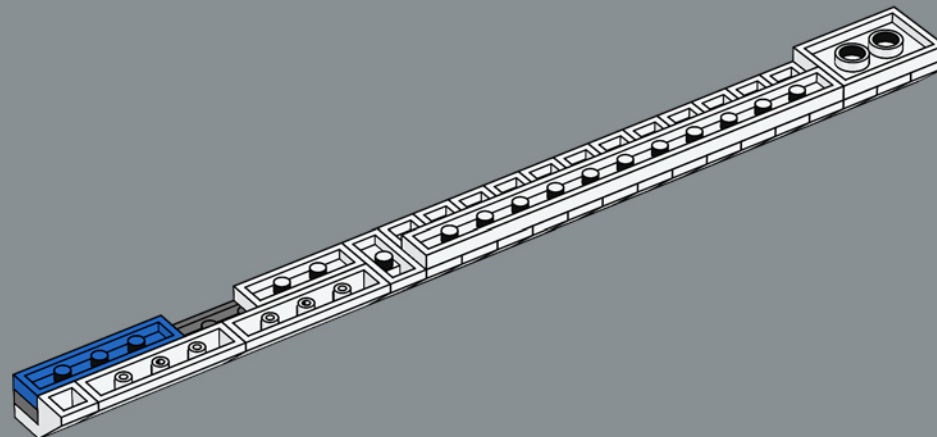

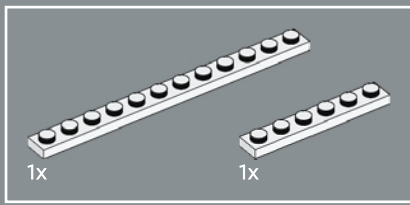

278

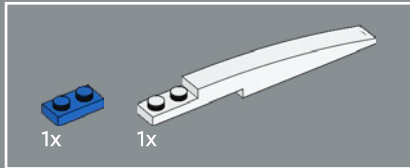
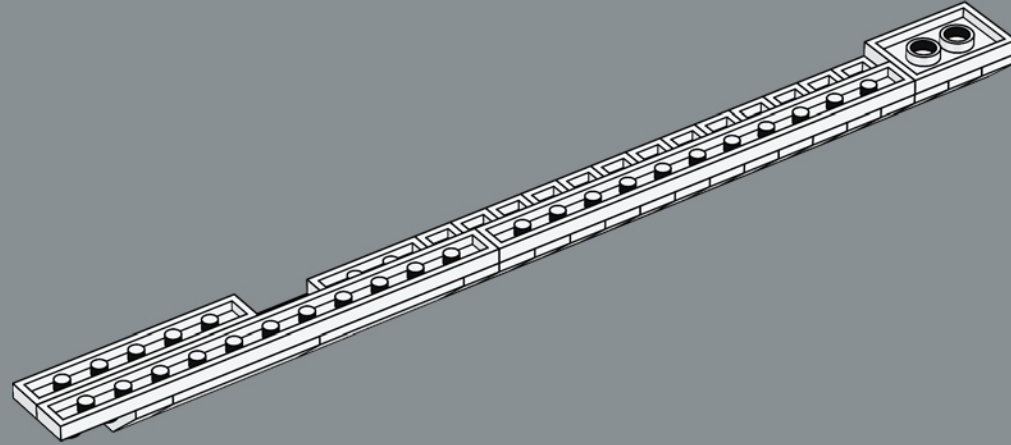

279

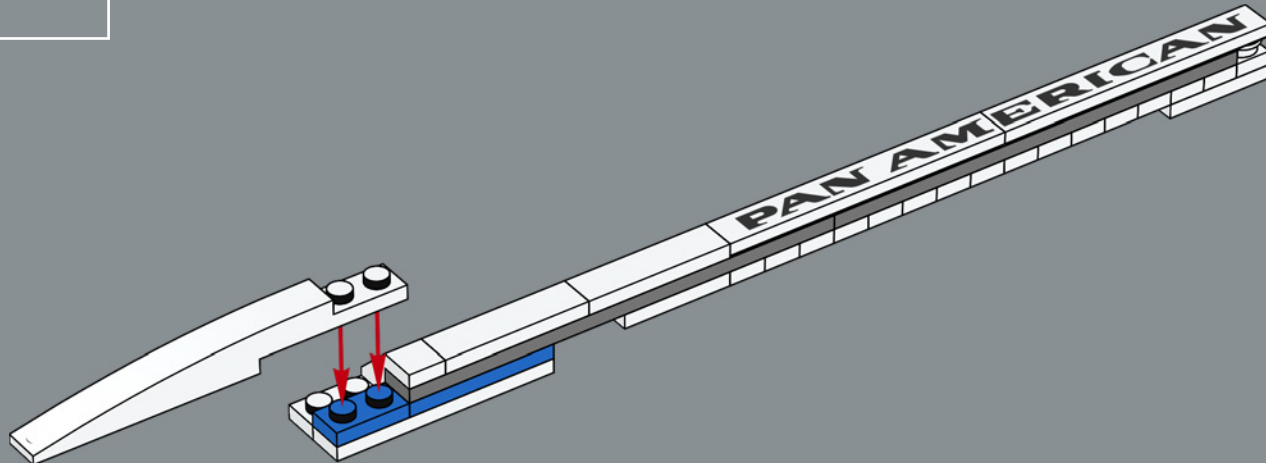



2x

280



2x

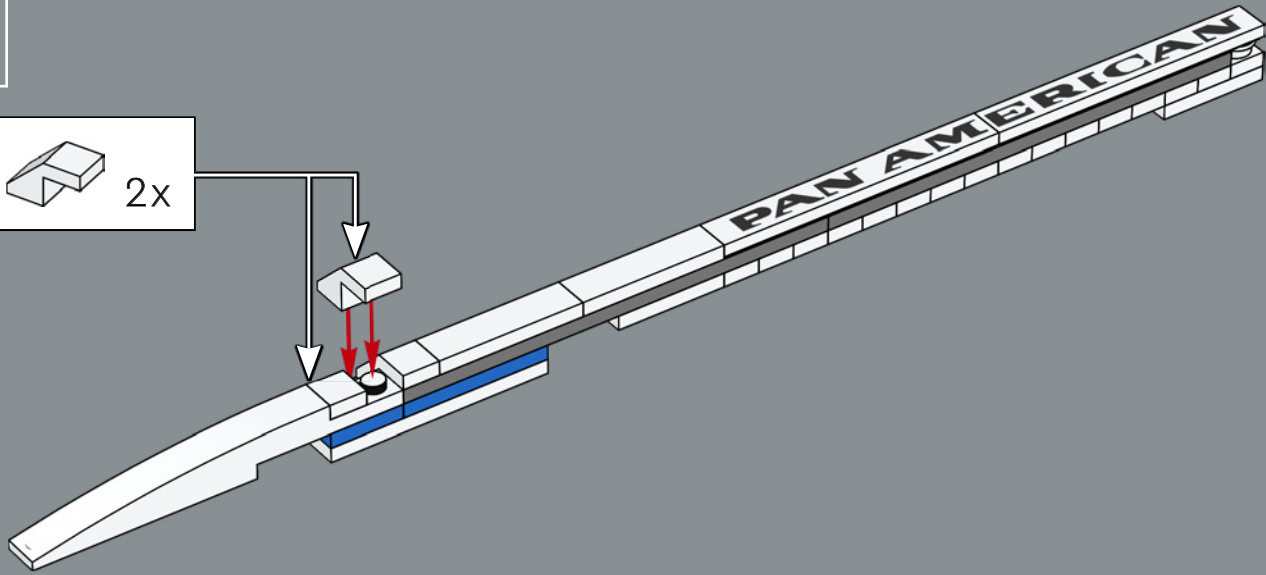

1x

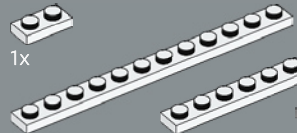

1x



1x



1x

281

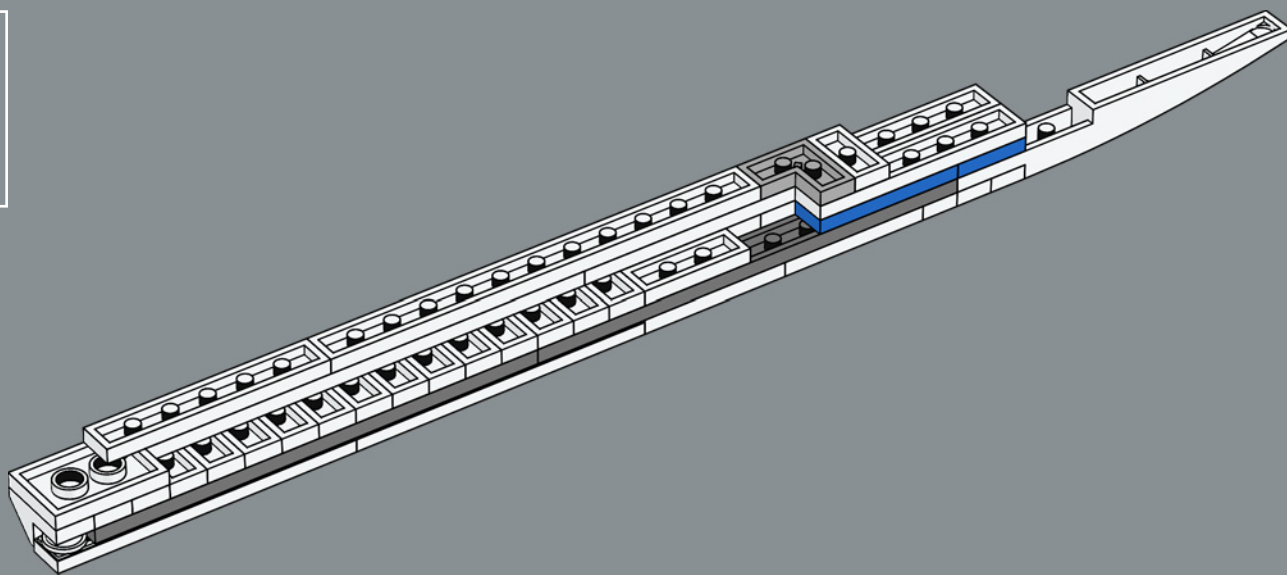

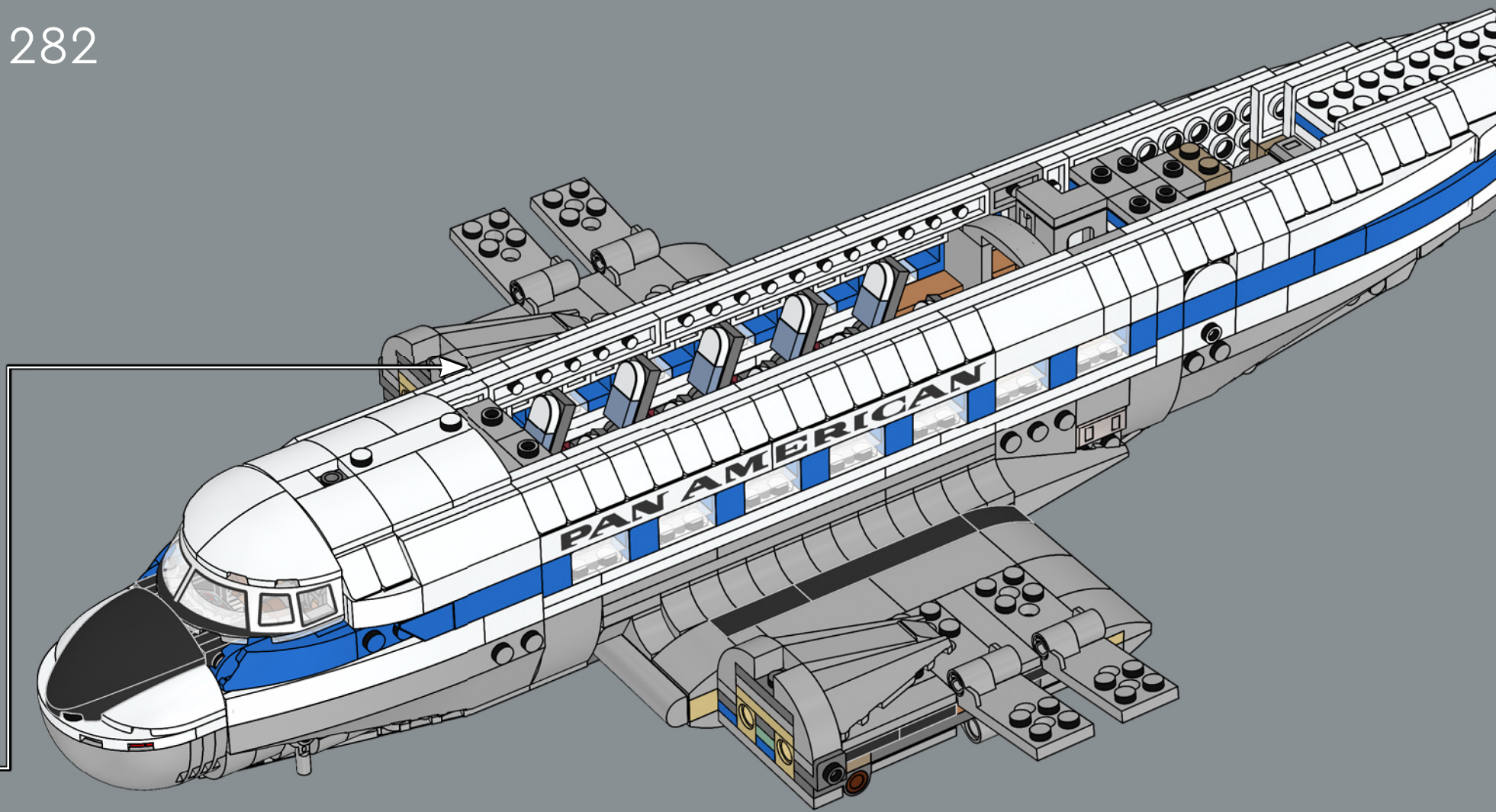

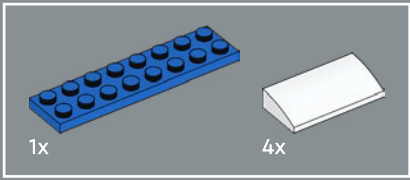

283

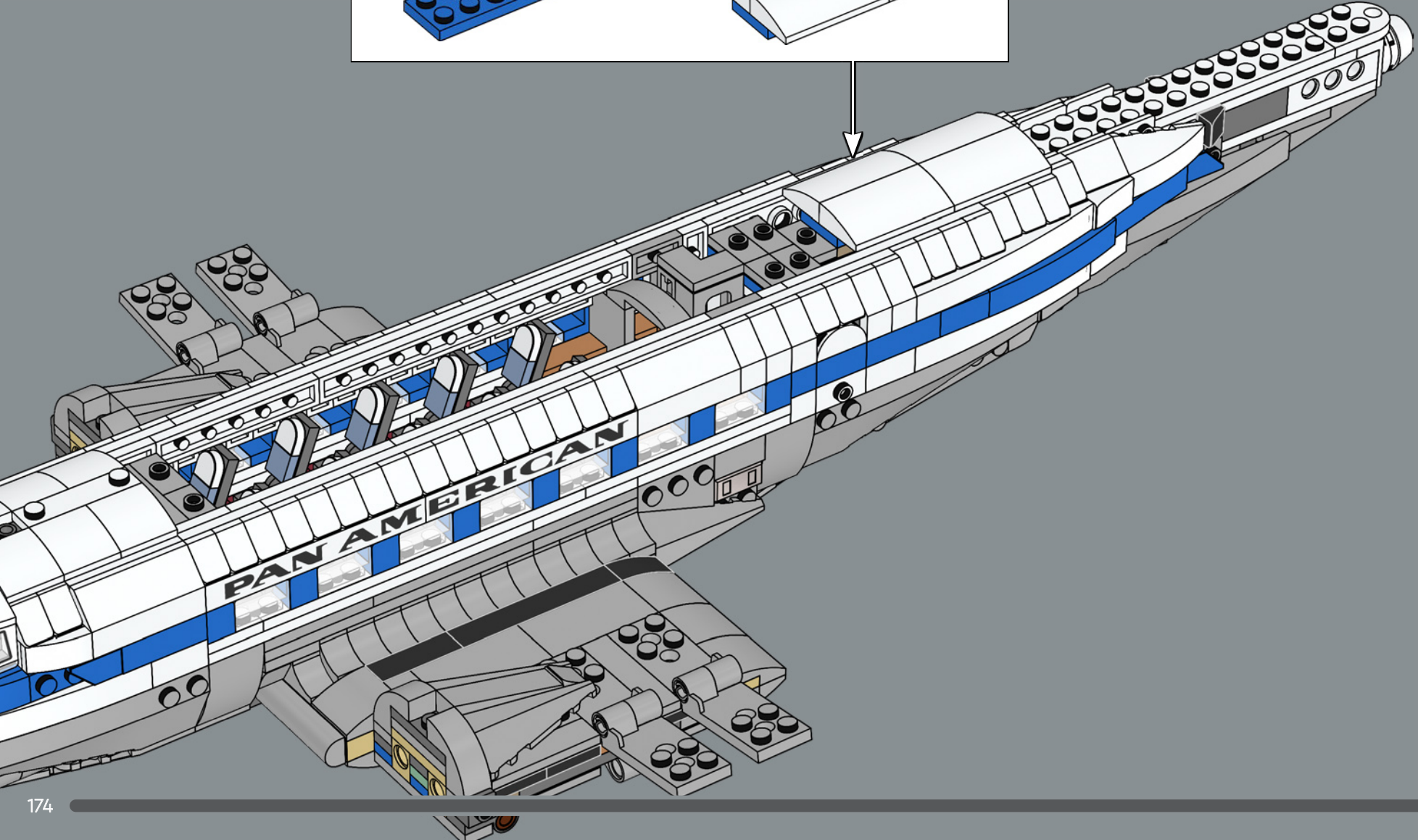
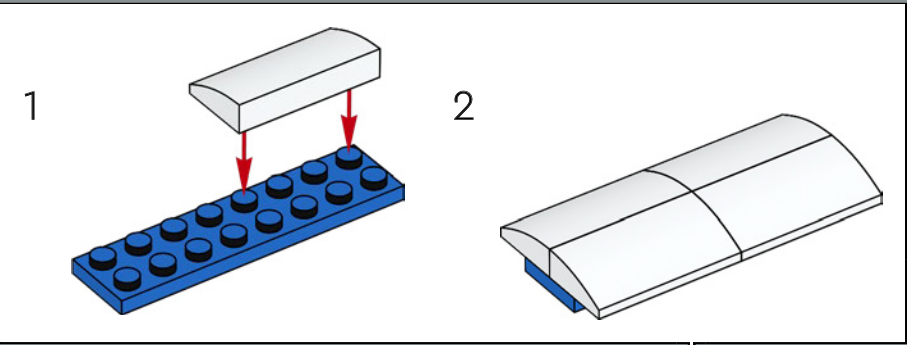

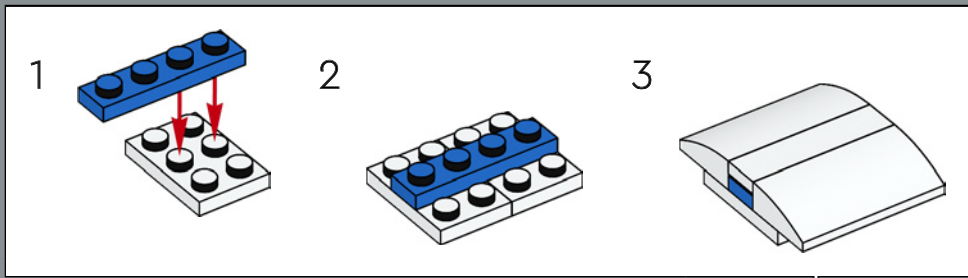
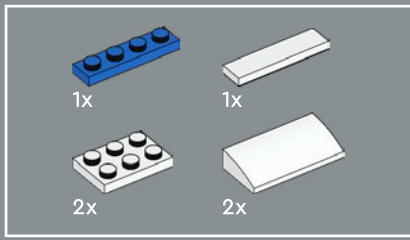

284

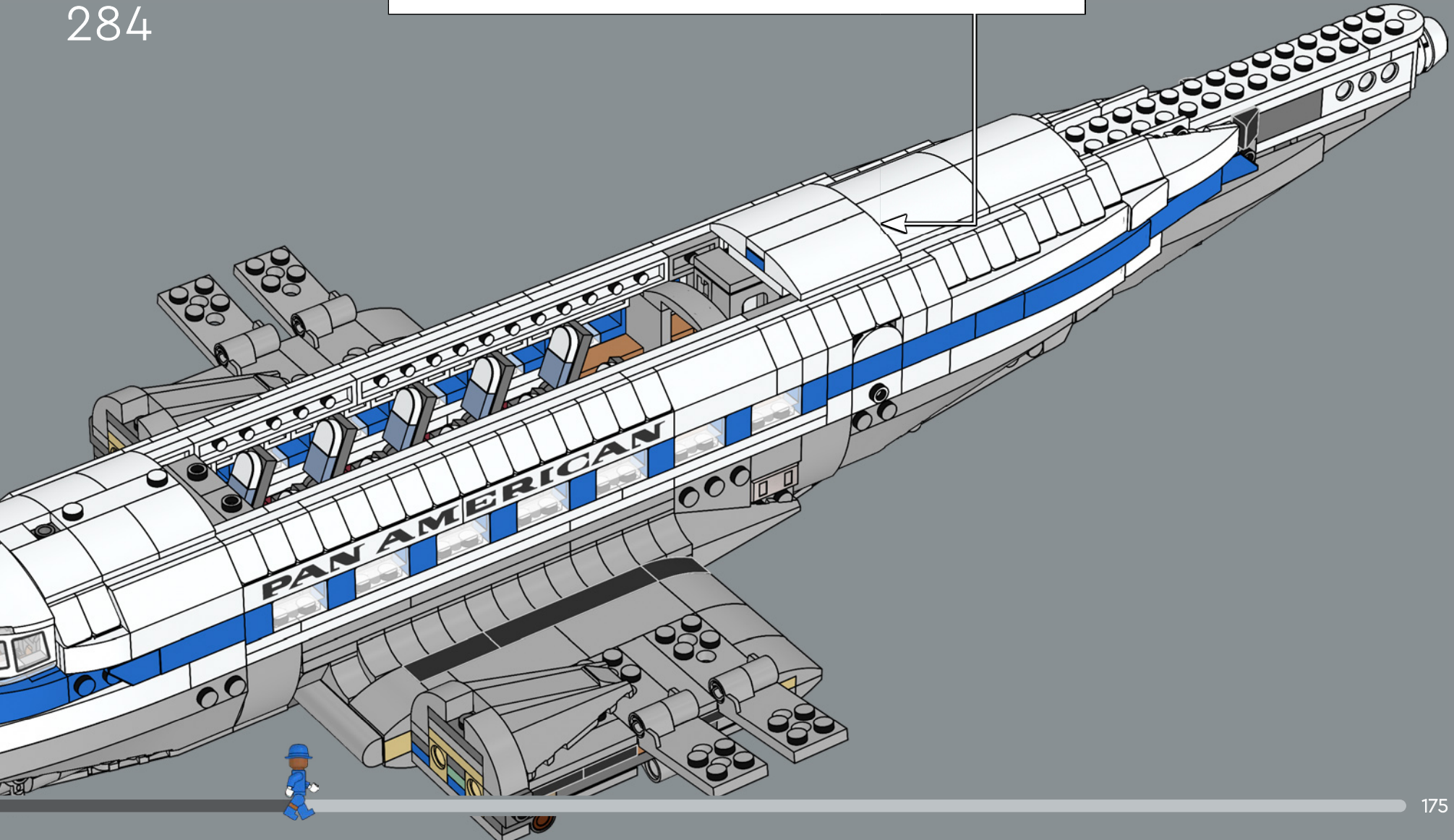

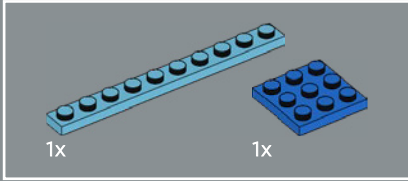
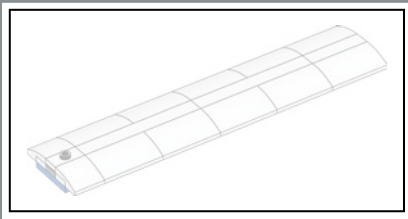

285

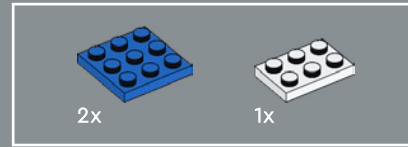
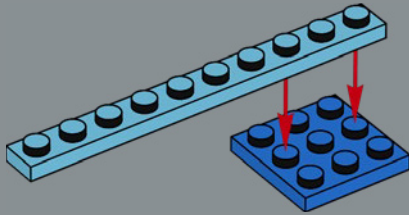

286

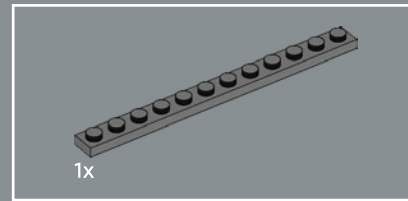
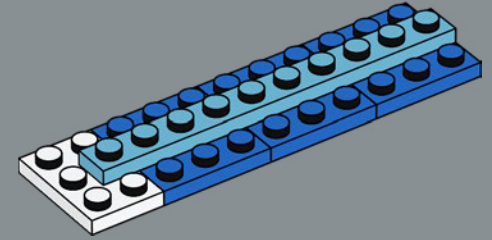

287

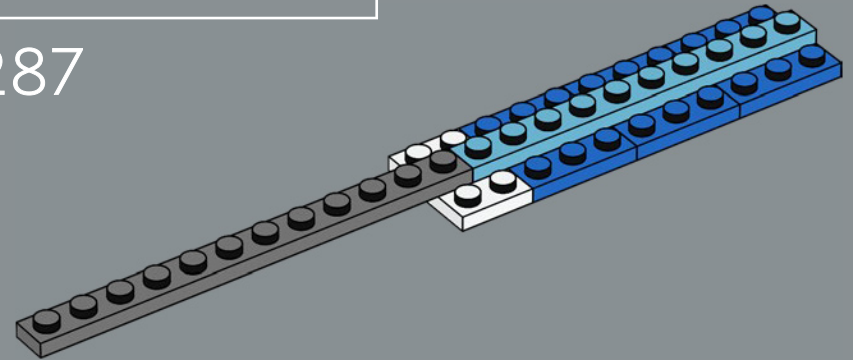

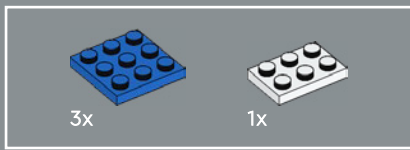

288

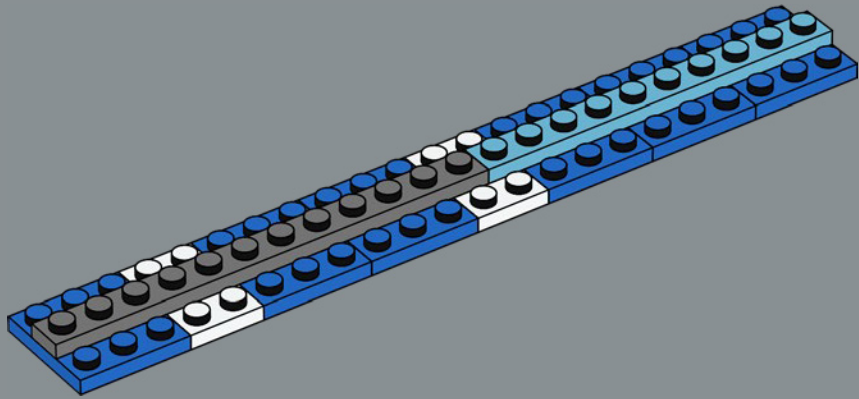

289

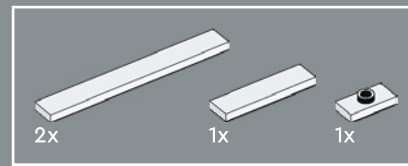
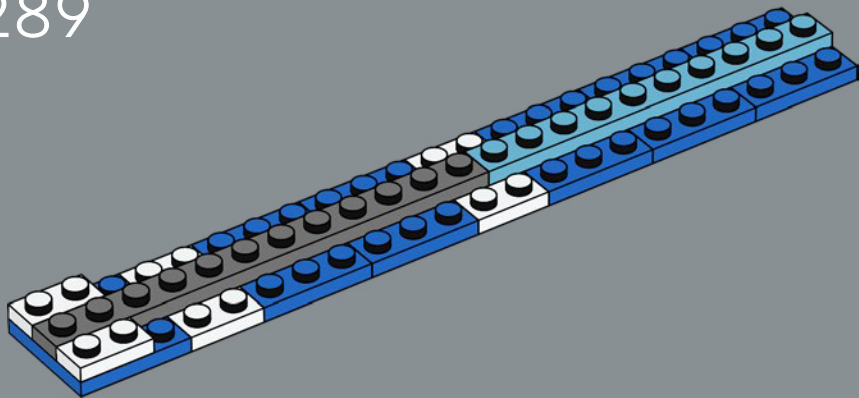

290

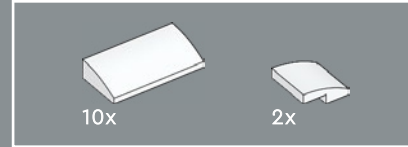
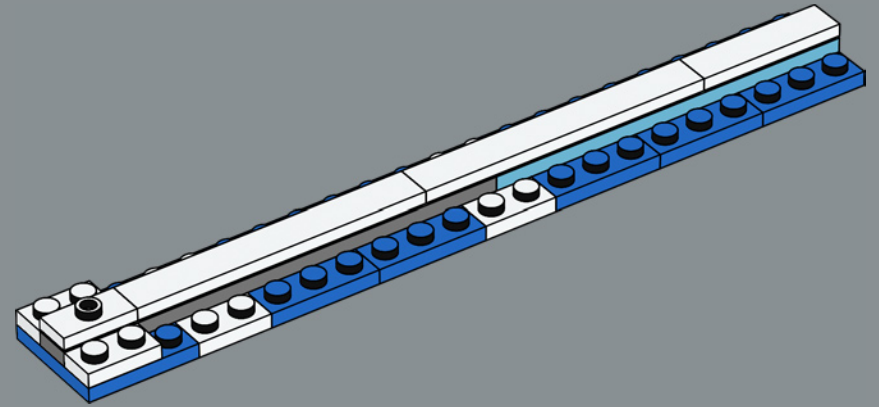

291

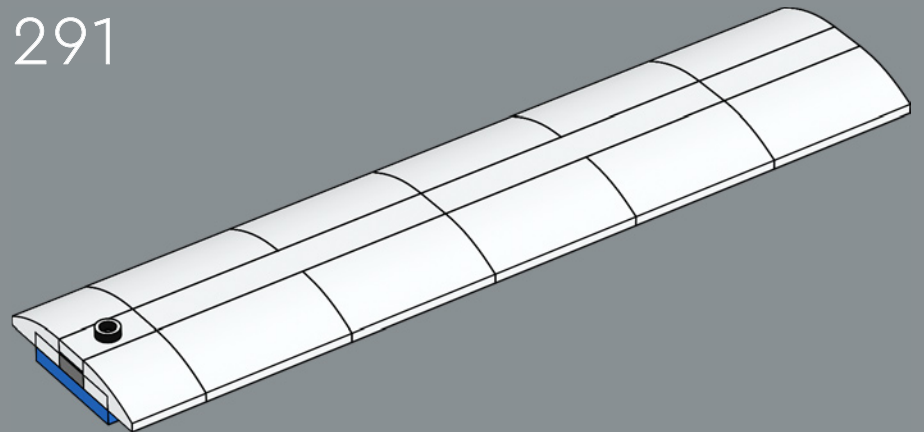

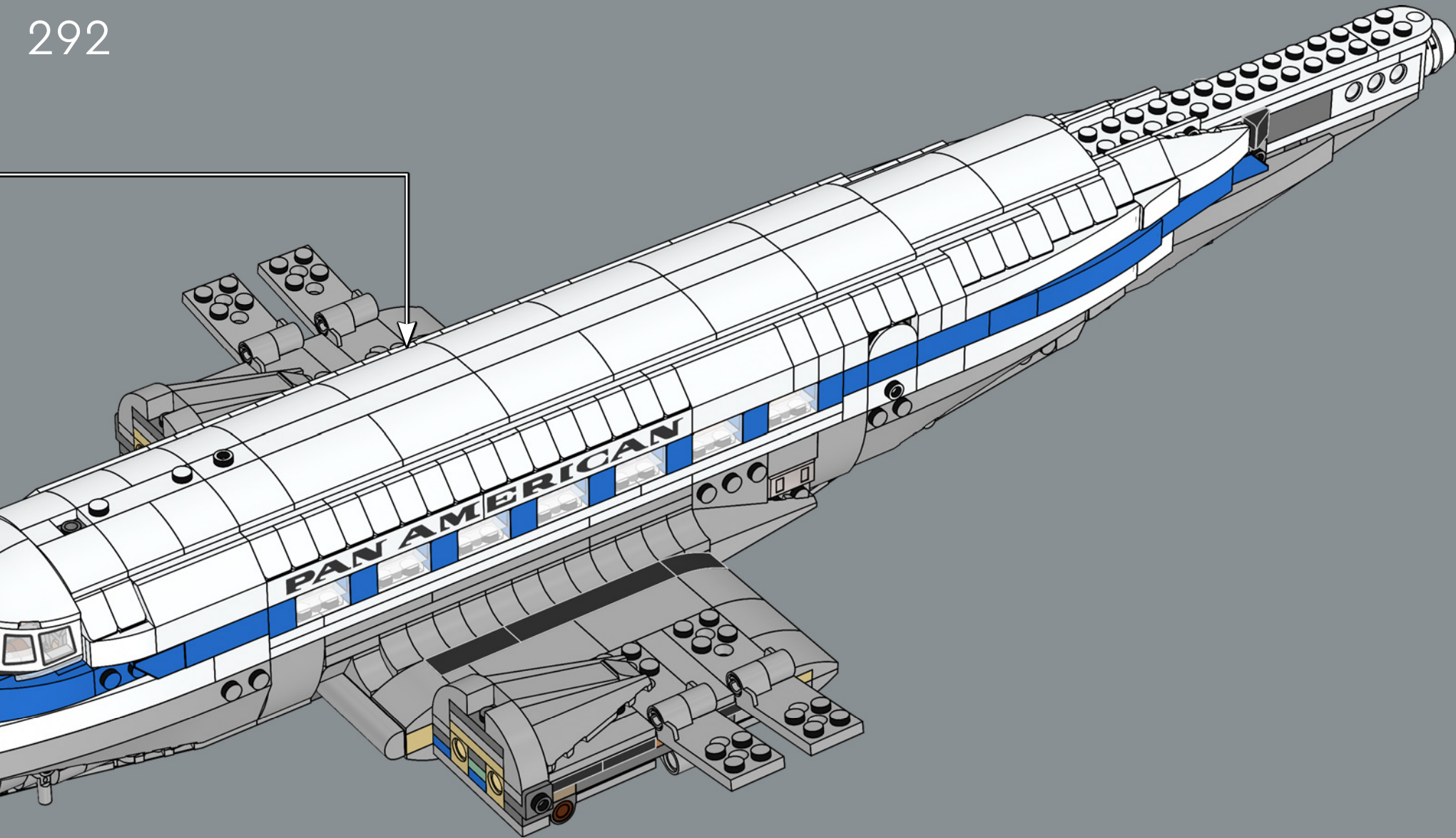

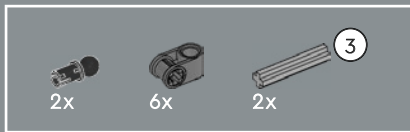

293

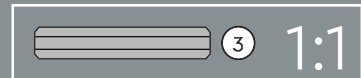
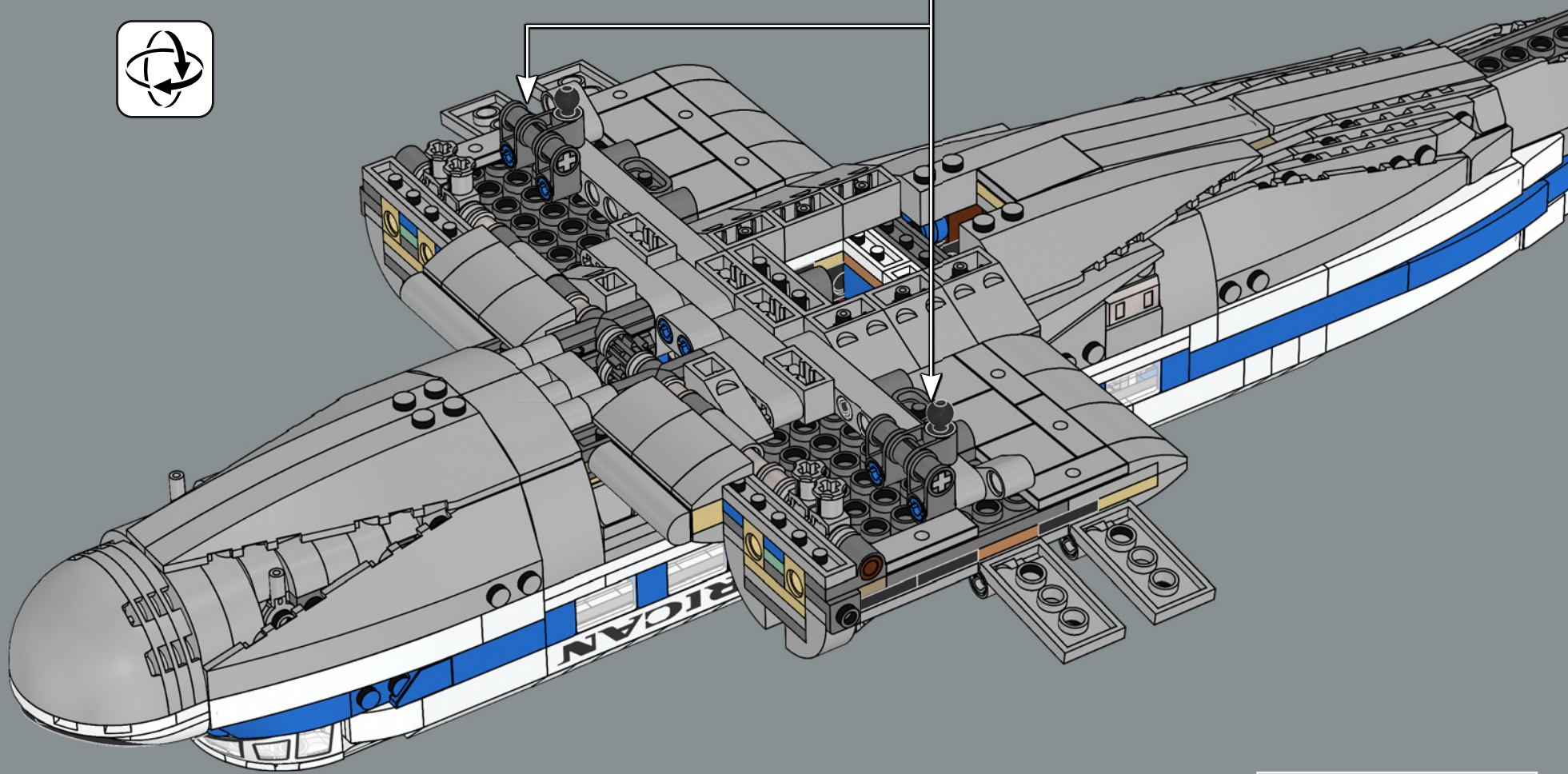
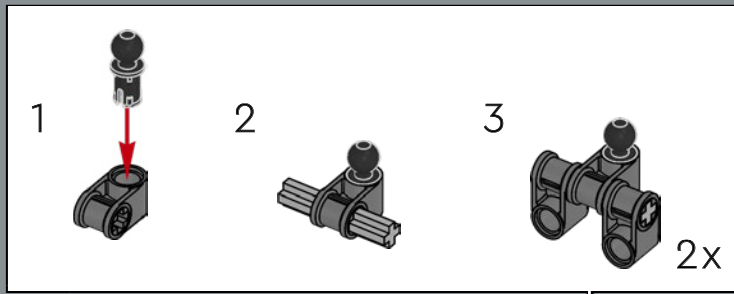

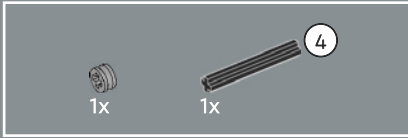
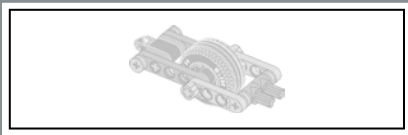

294

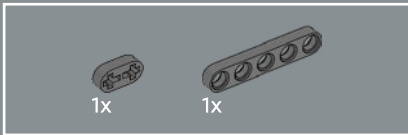

295

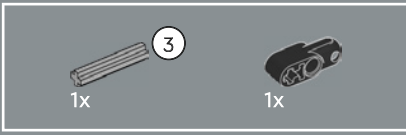
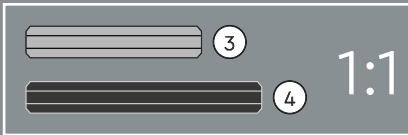
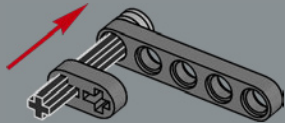

296

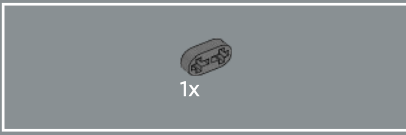
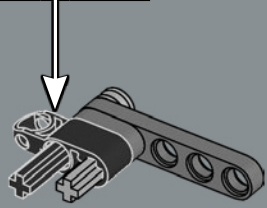
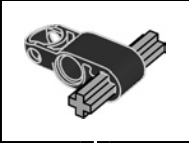

297

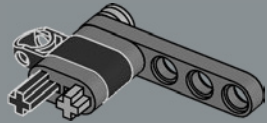

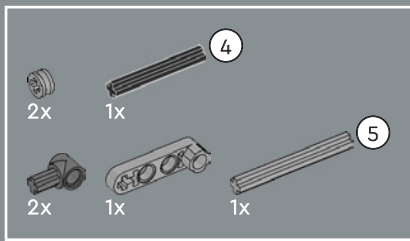

298

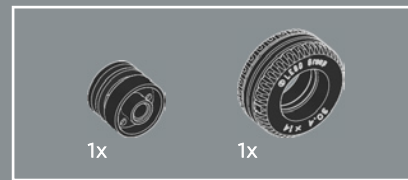
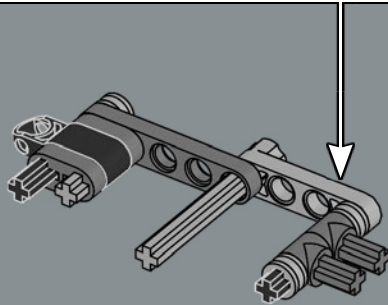
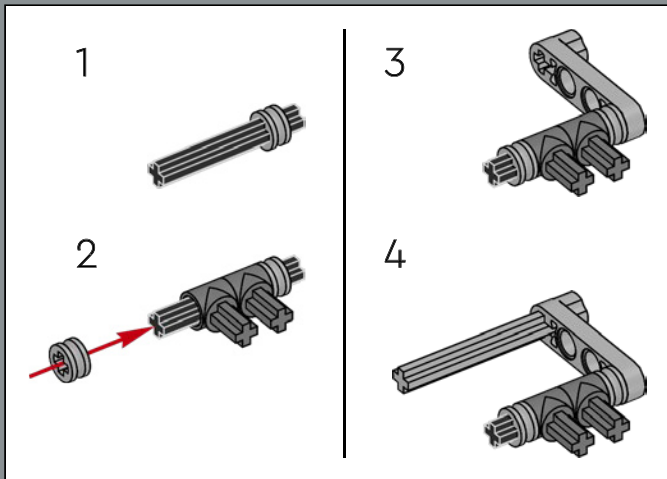

299

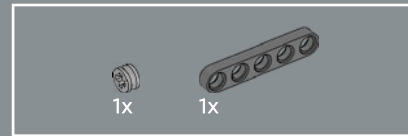
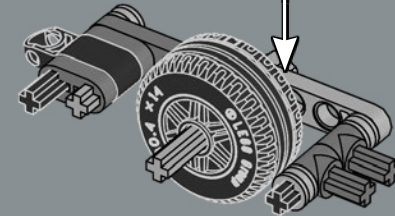
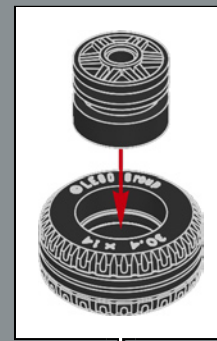

300

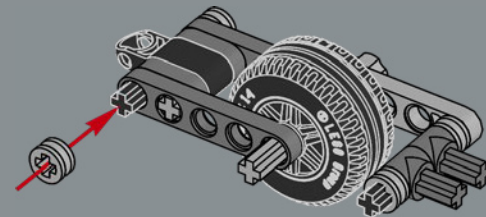



301

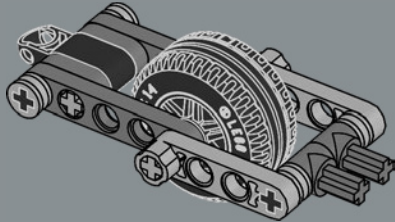

302

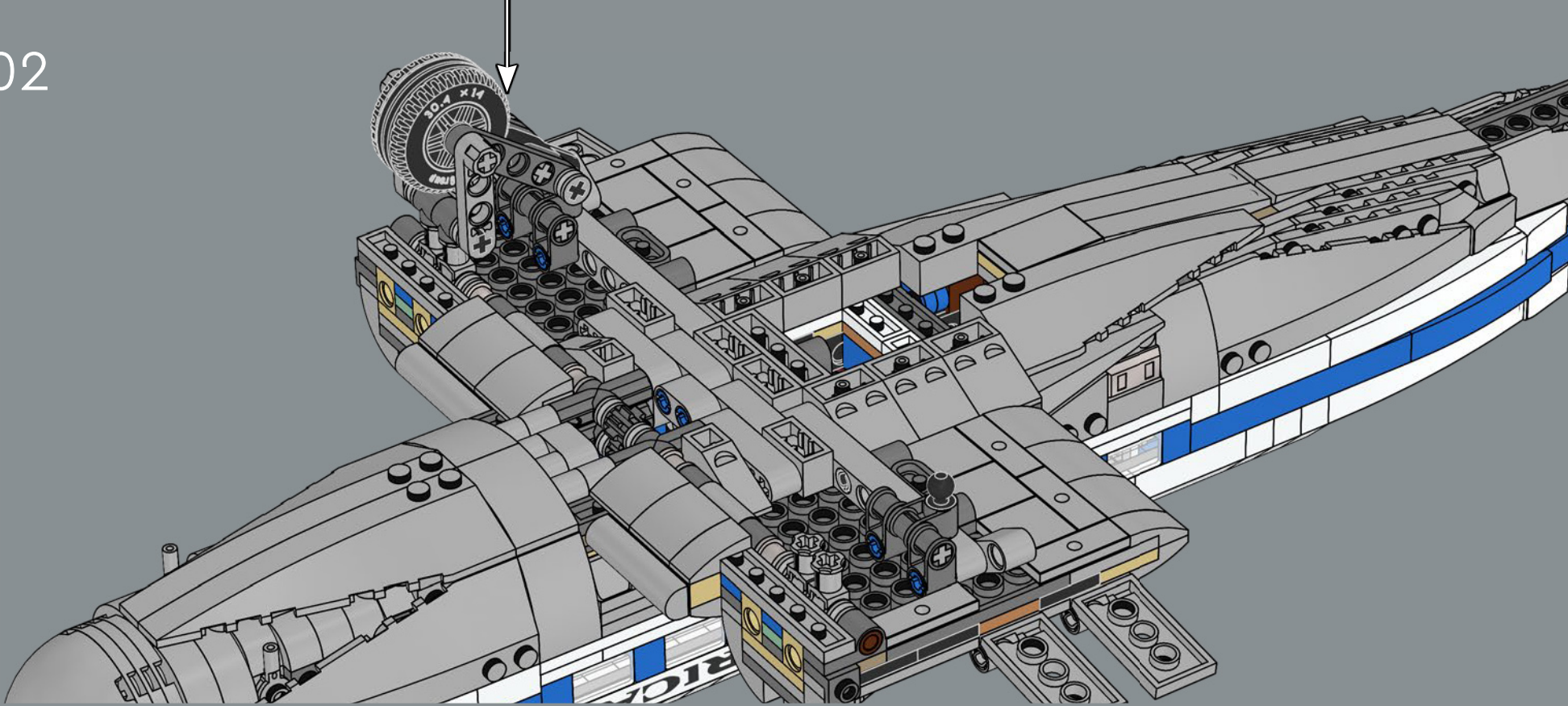

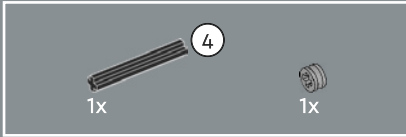
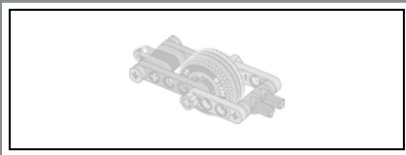

303

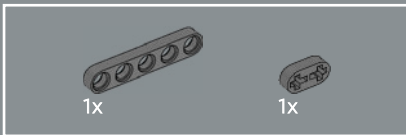

304

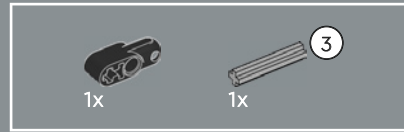
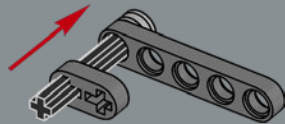

305

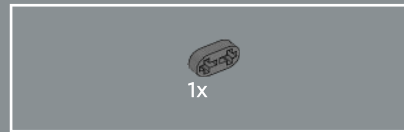
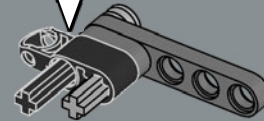
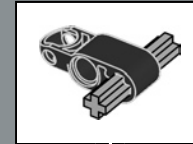

306

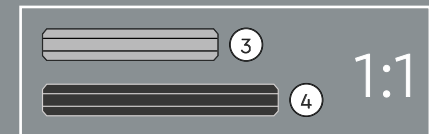
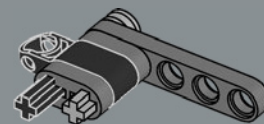

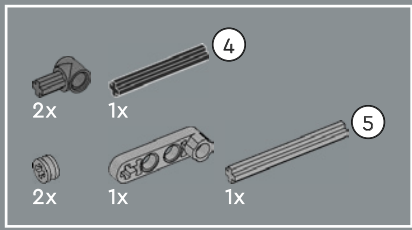

307

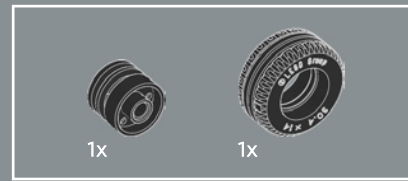
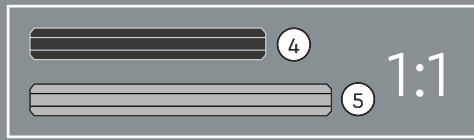
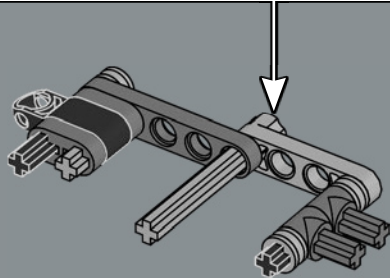
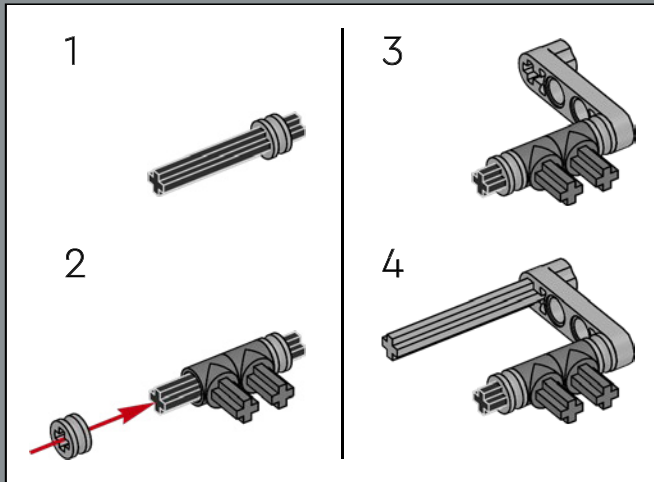

308

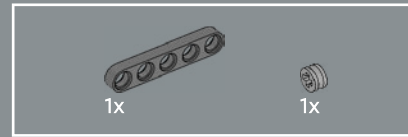
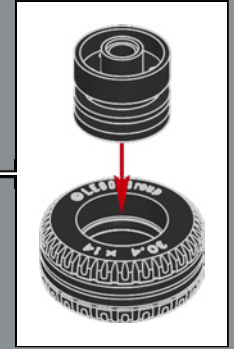
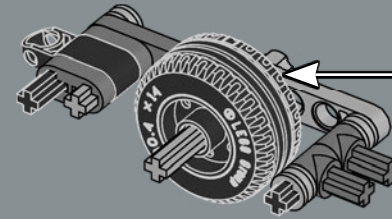

309

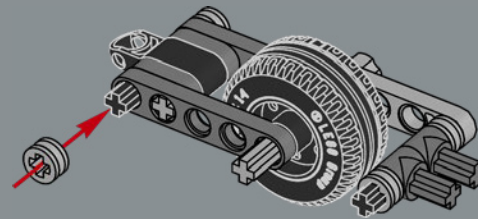



310

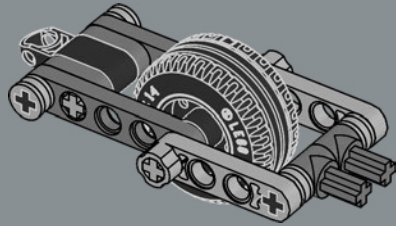

311

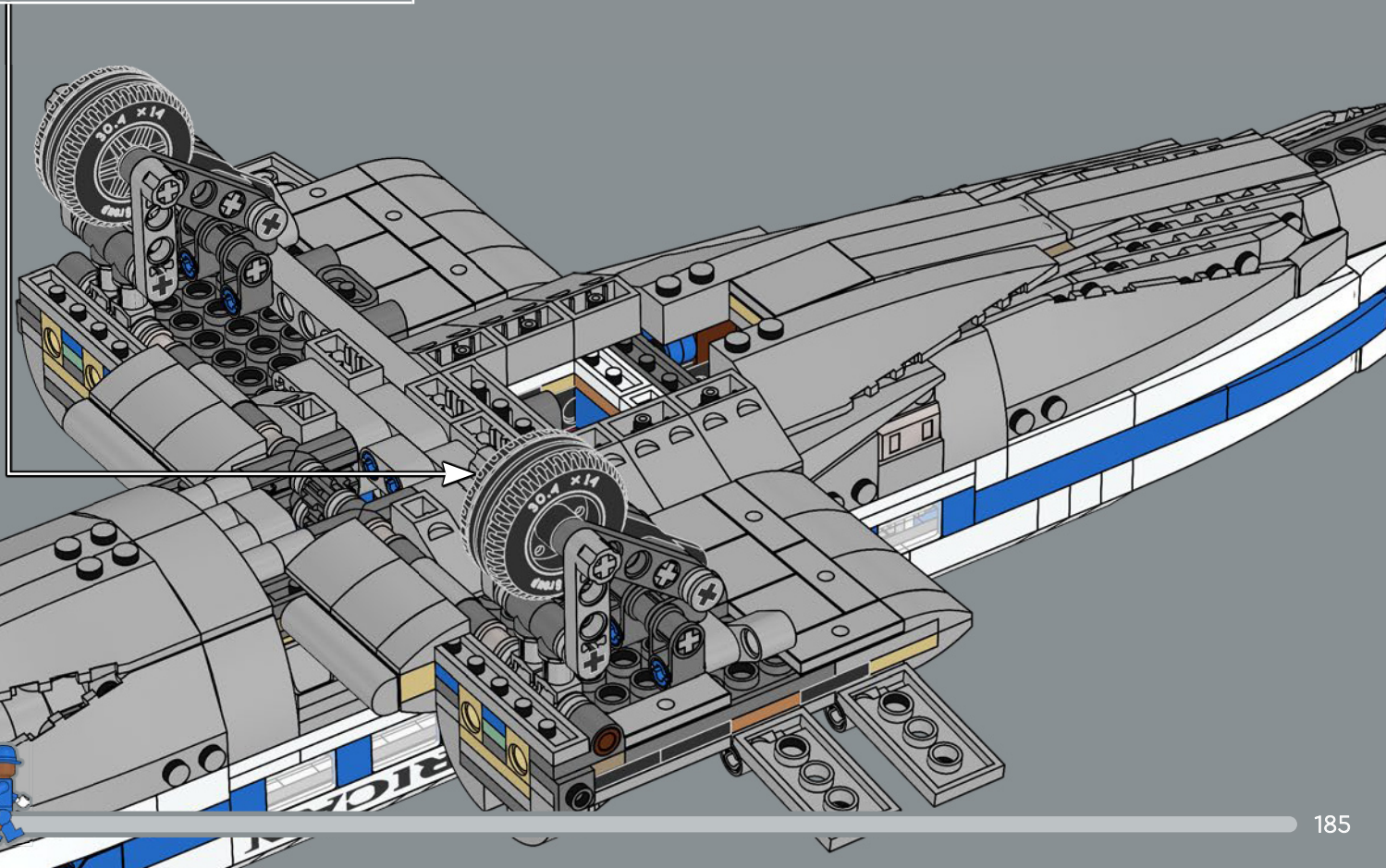

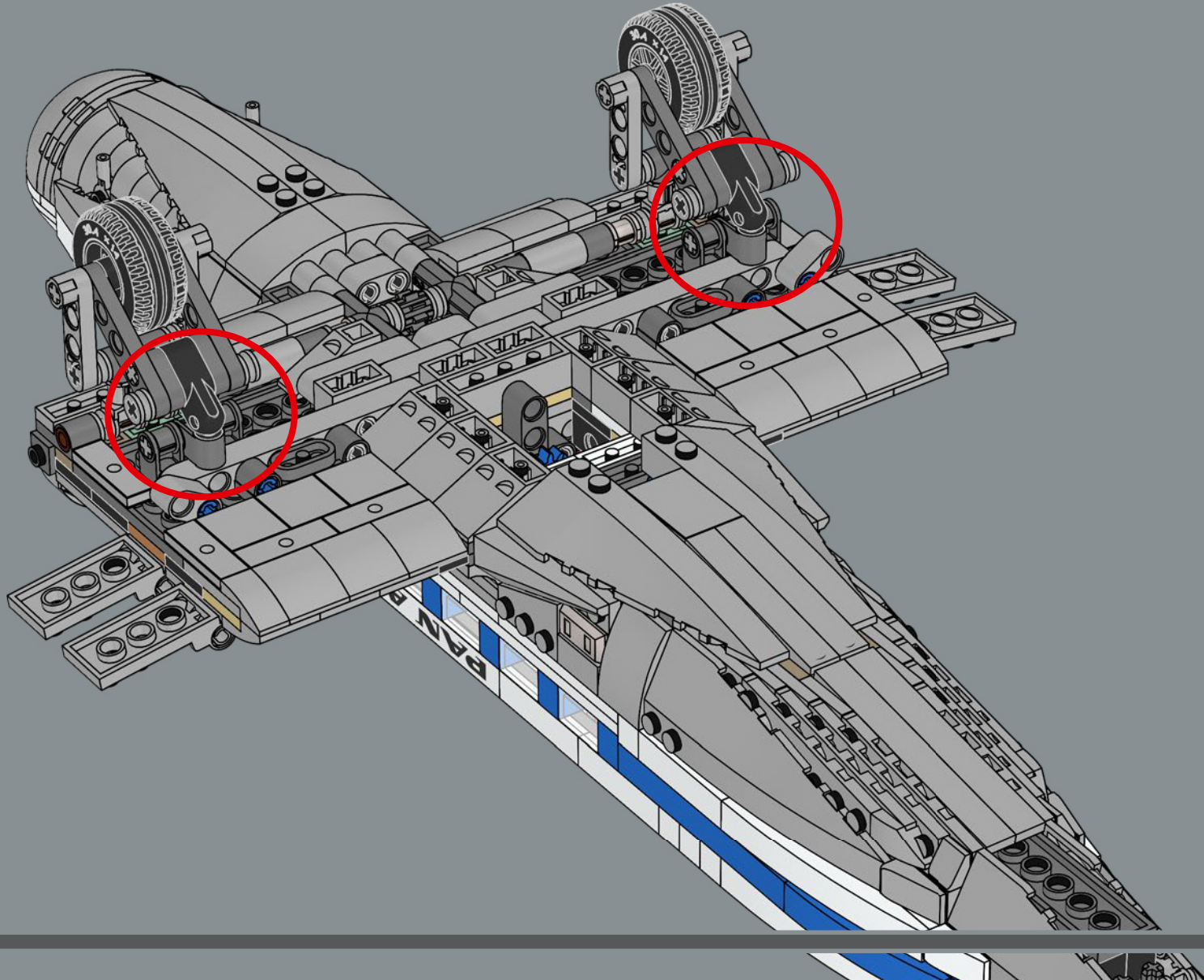



313

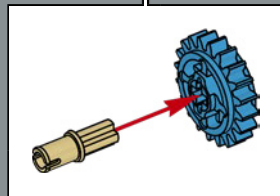
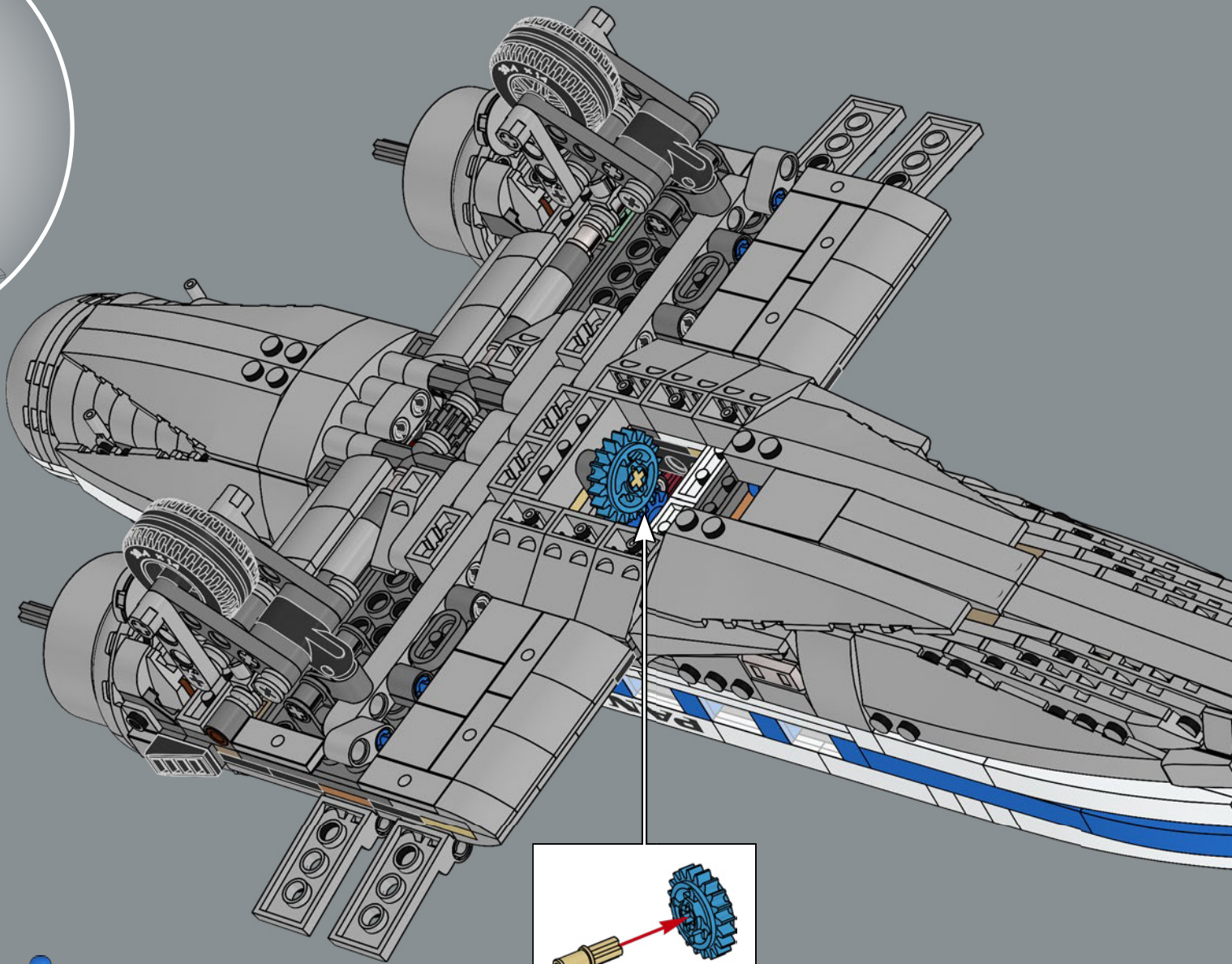

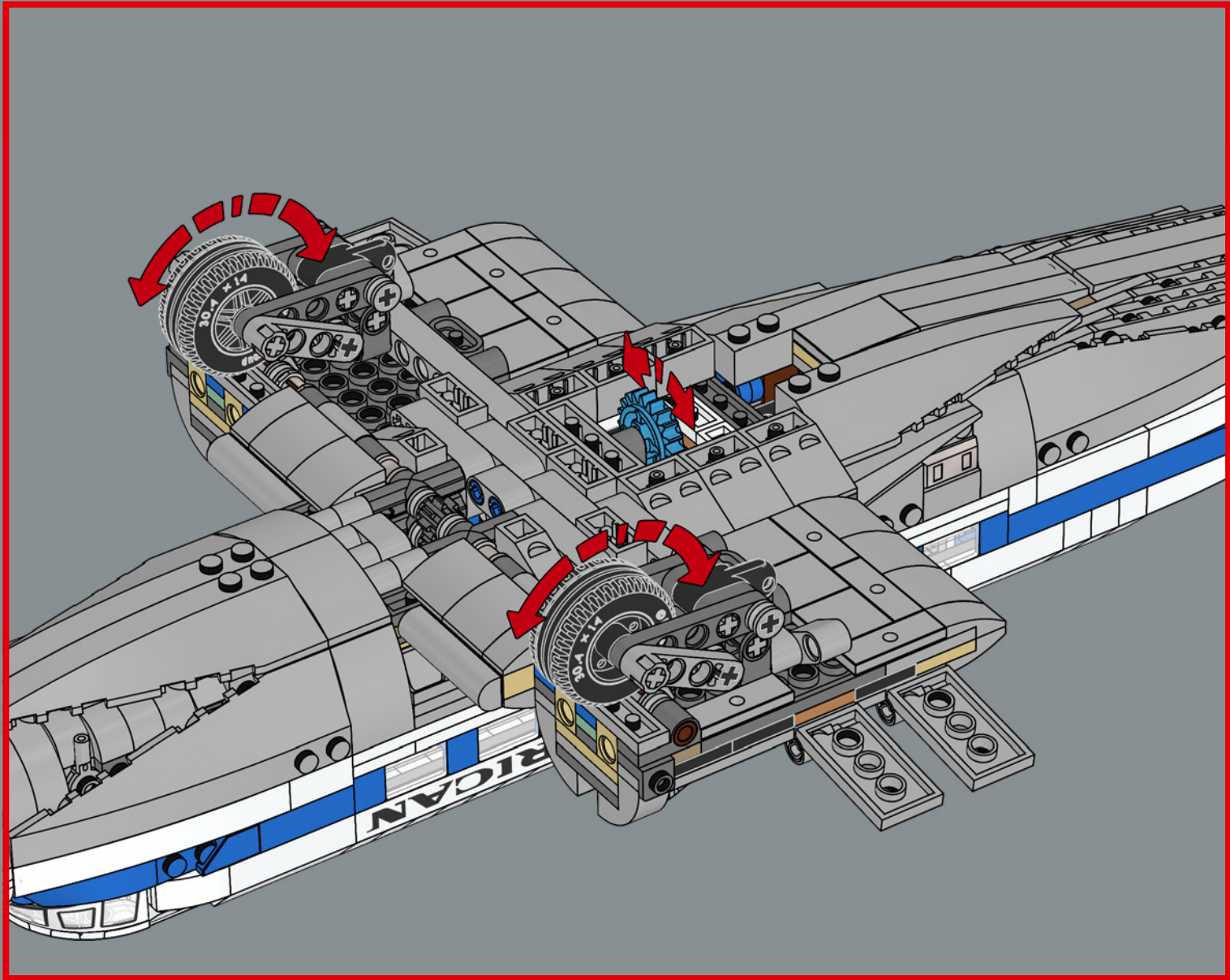

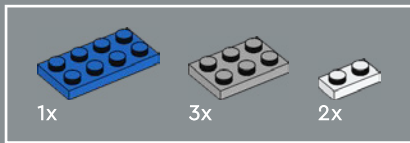

314

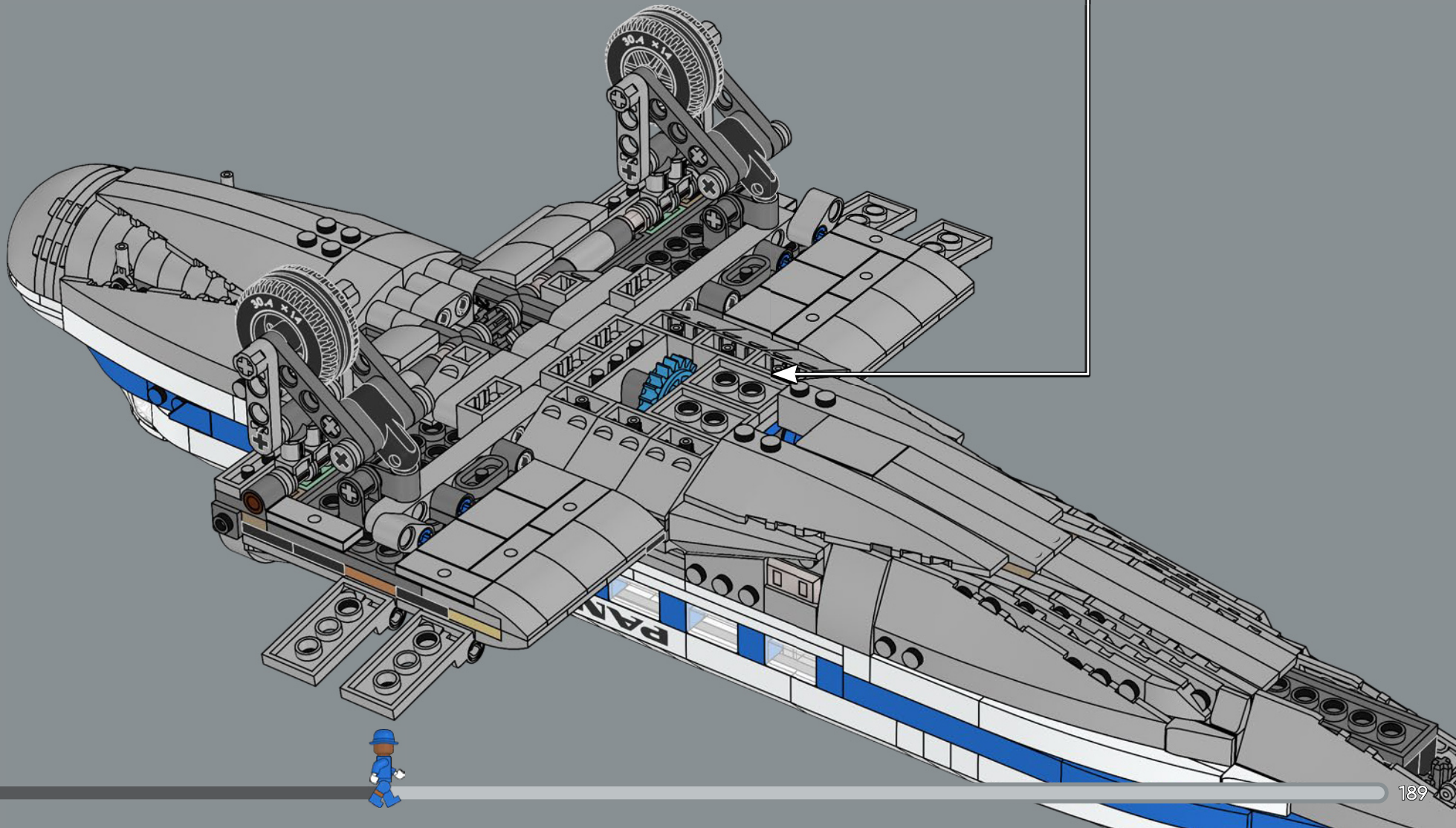
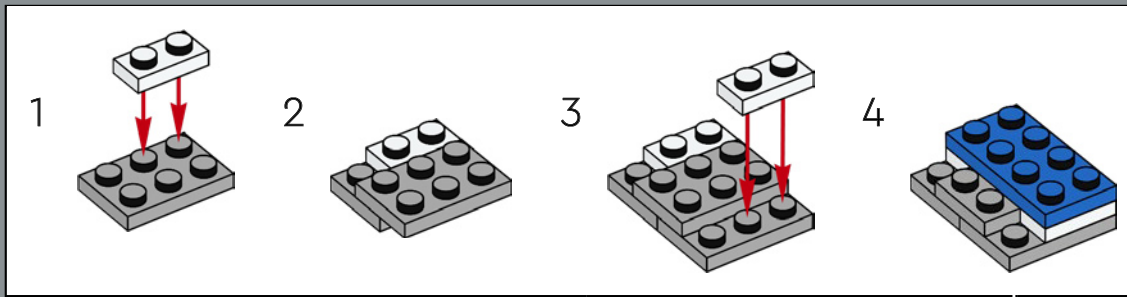



4x

315

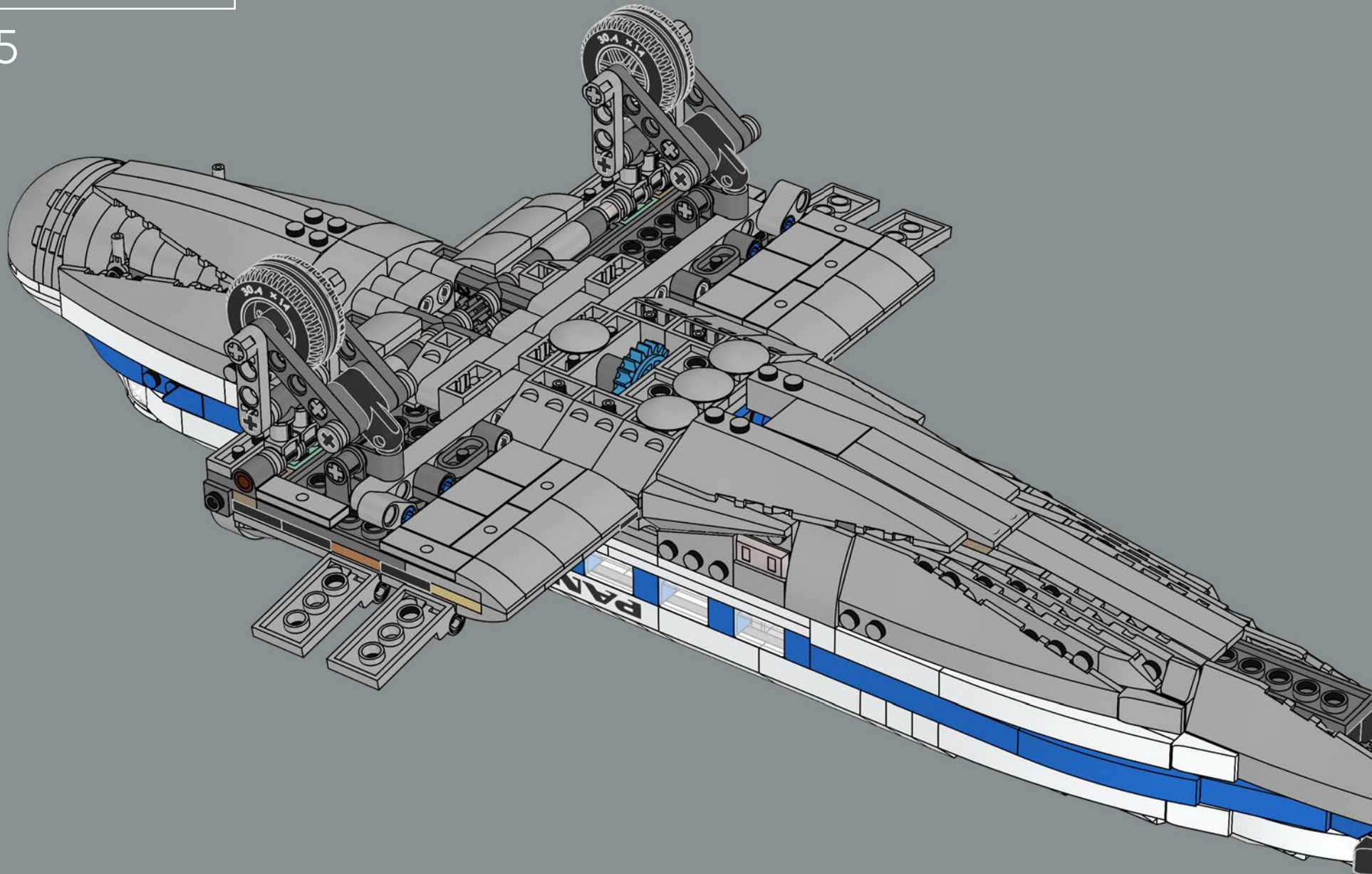

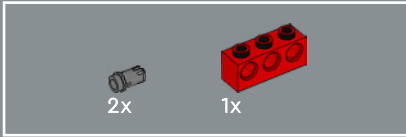
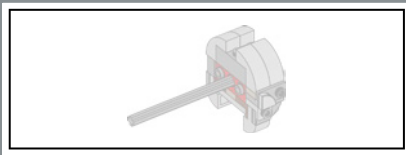

316

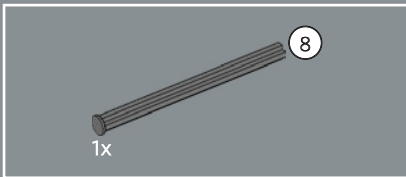
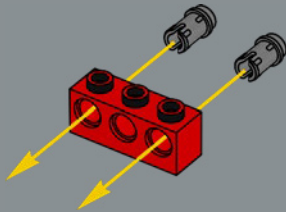

317

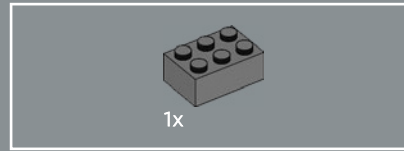
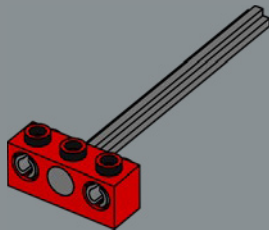

318

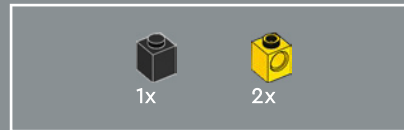
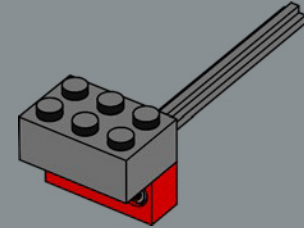

319

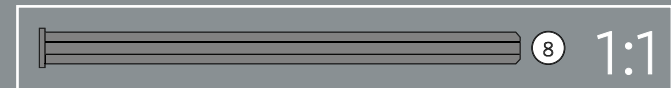
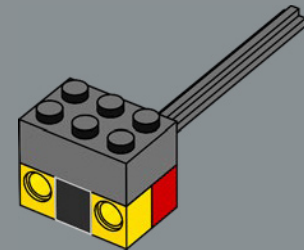

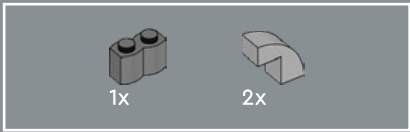

320

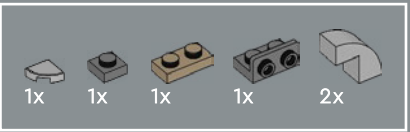
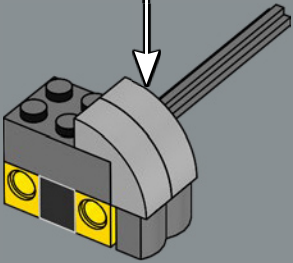
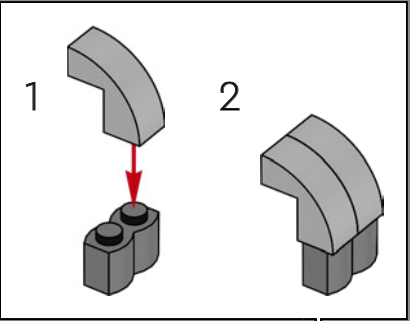

321

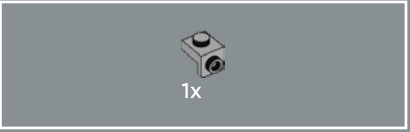
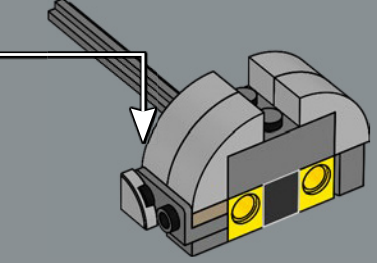
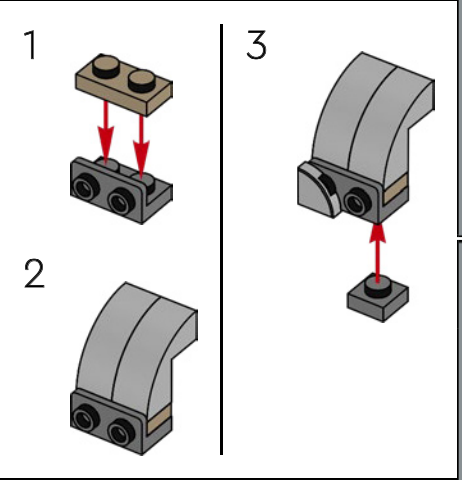

322

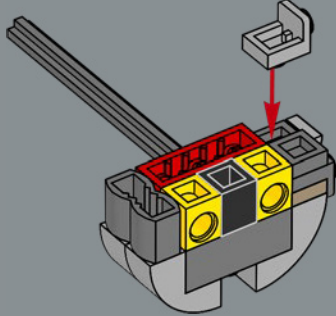

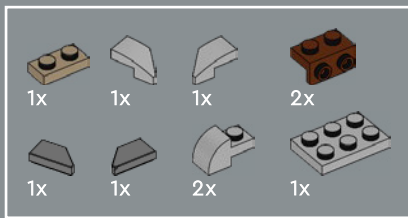

323

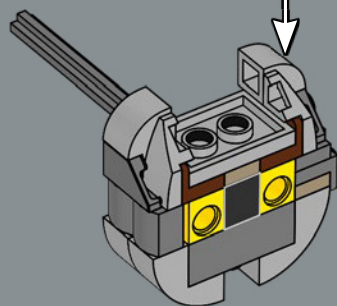
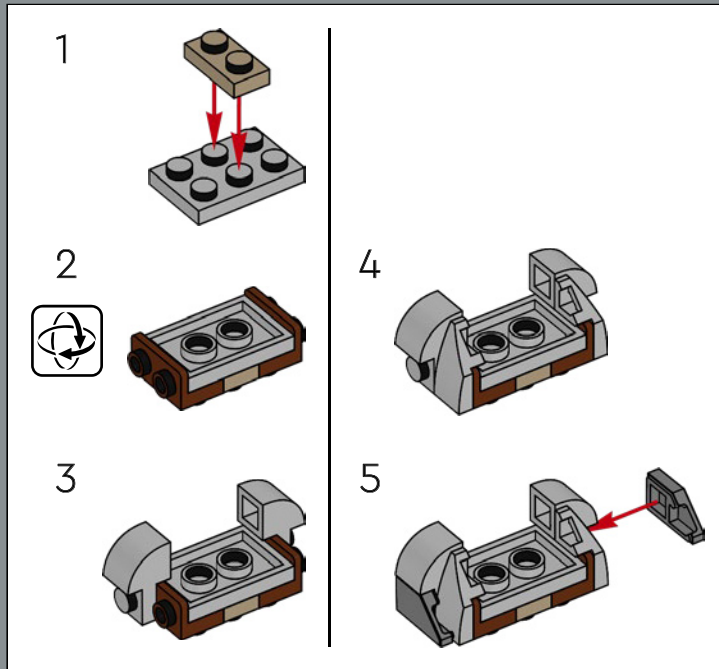

324

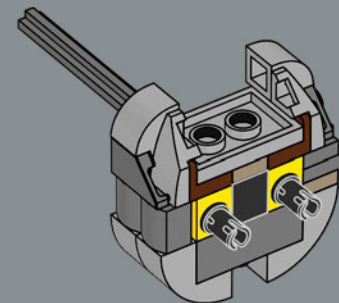



1x

325

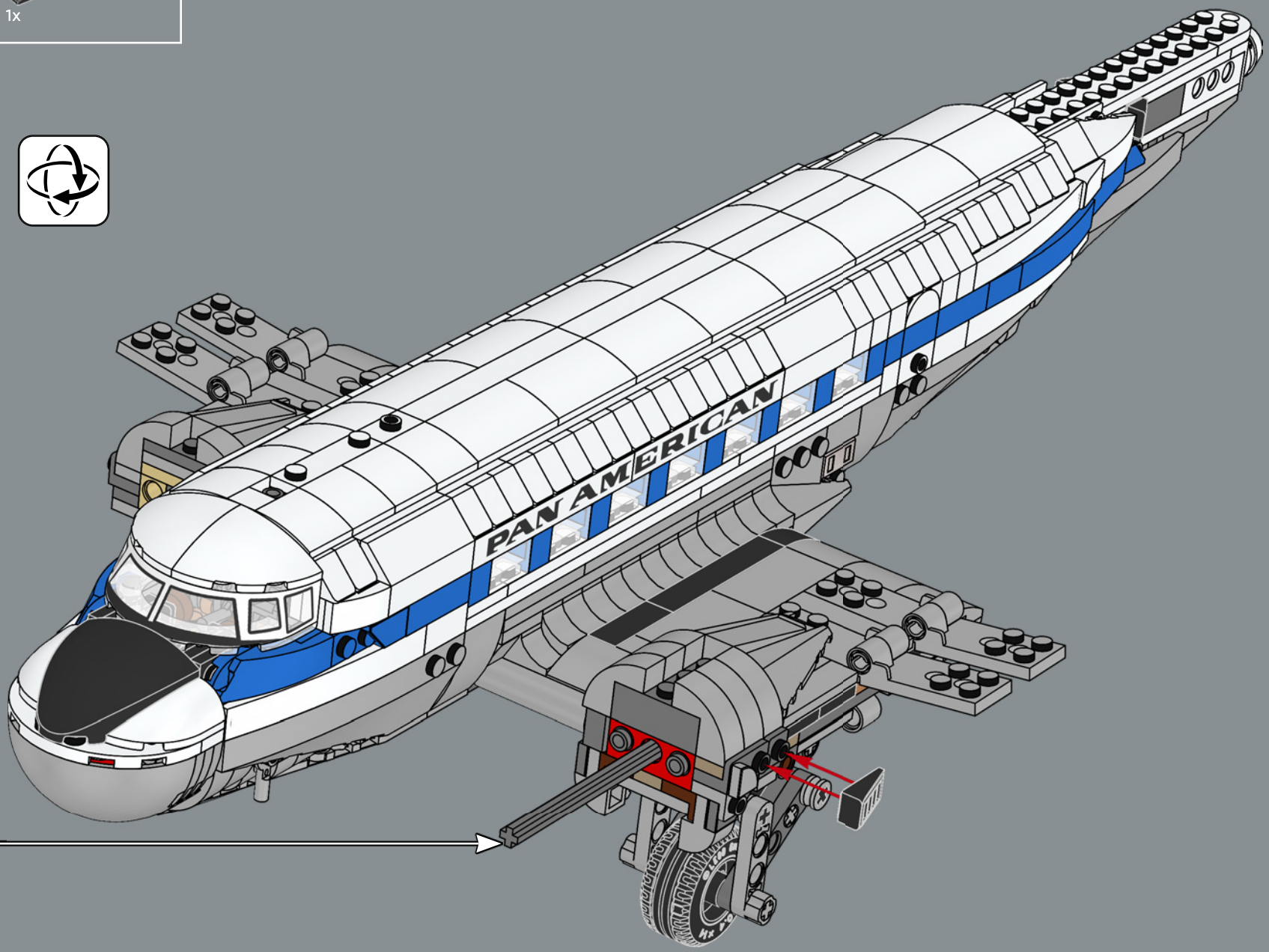

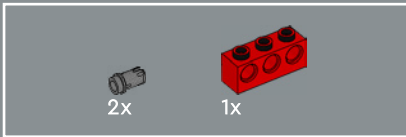
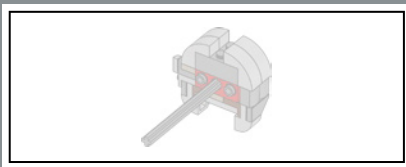

326

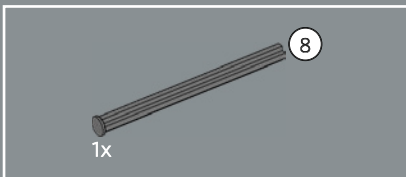
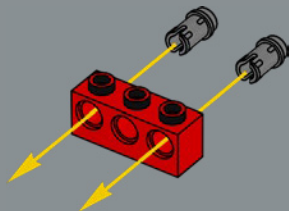

327

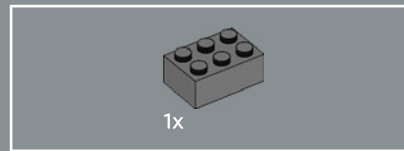
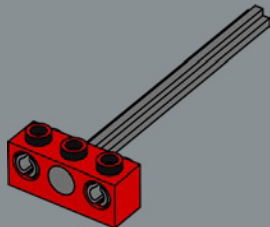

328

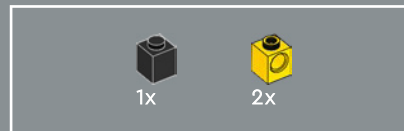
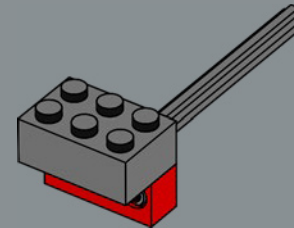

329

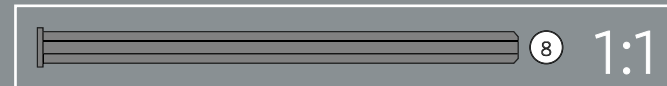
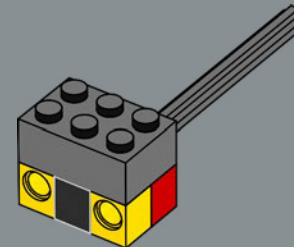

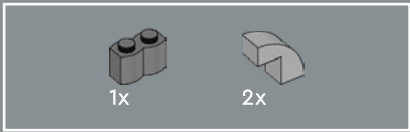

330

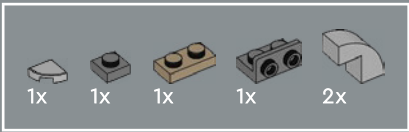
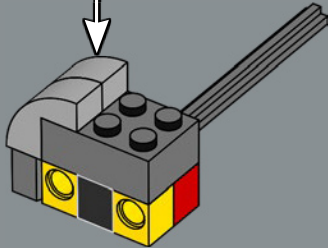
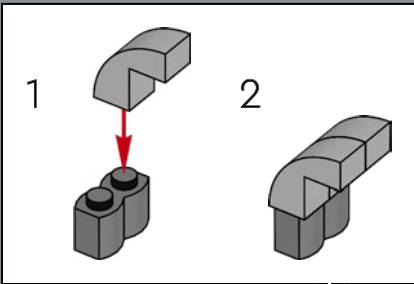

331

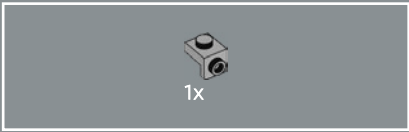
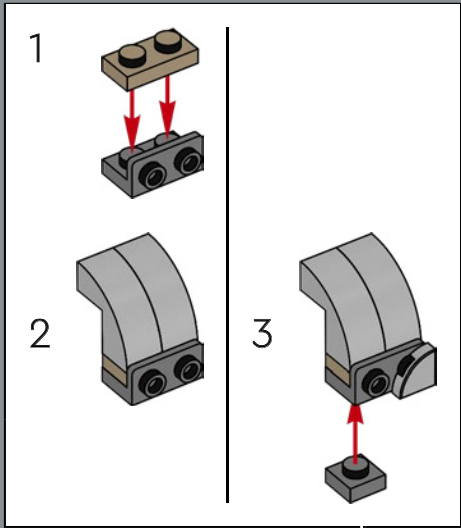
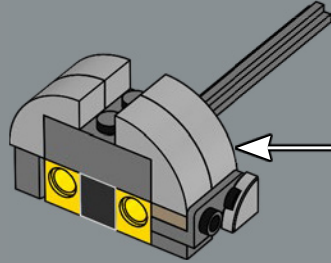

332

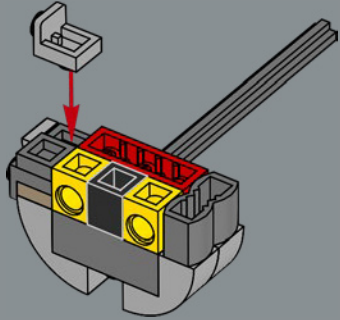



333

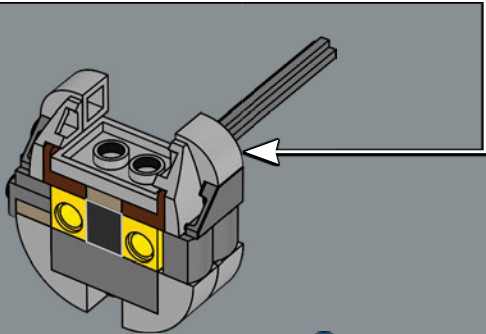
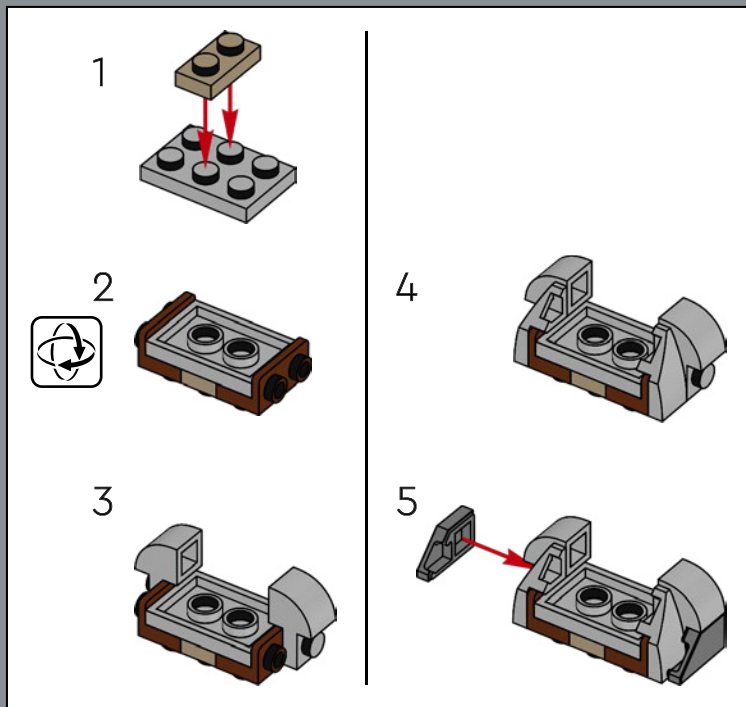

334

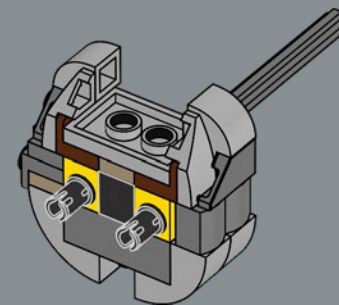



1x

335

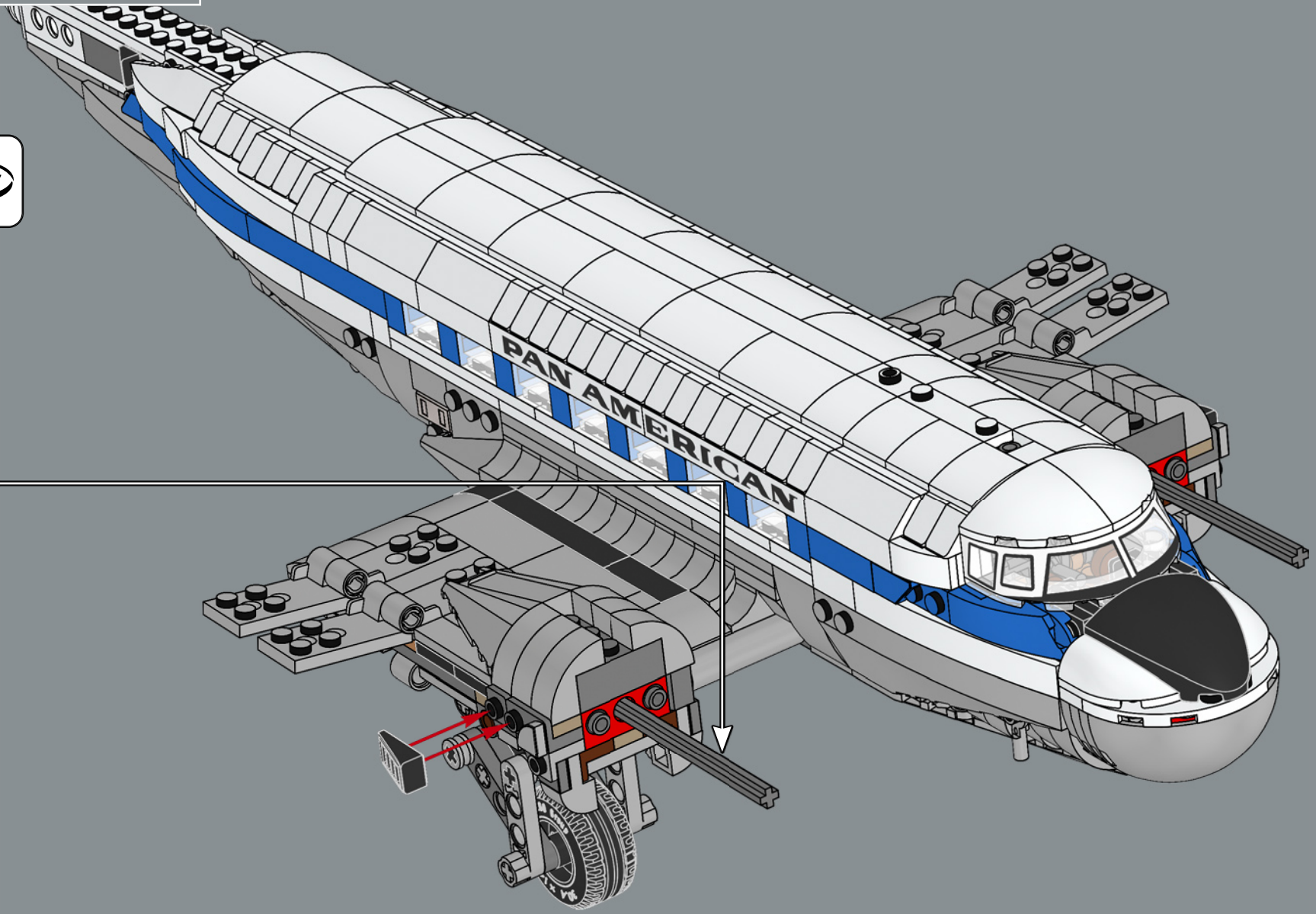

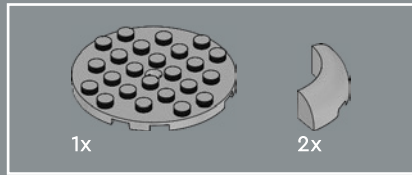

337

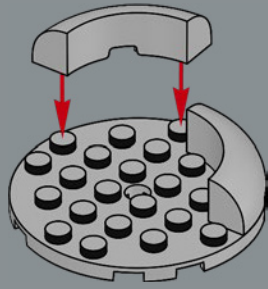

338

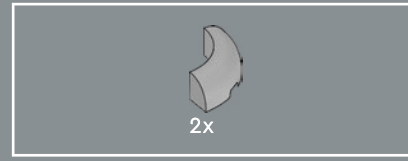
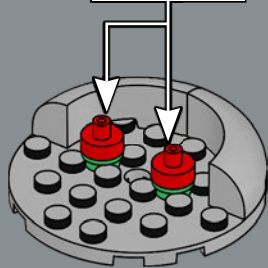
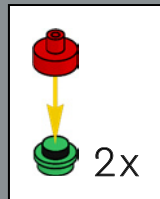

339

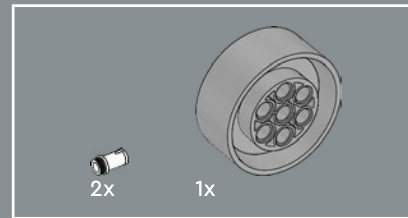
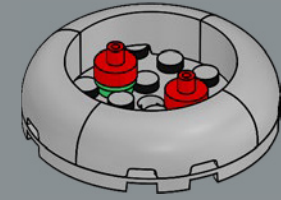

340

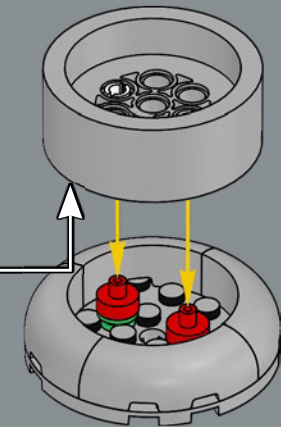
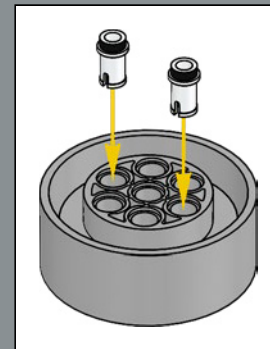

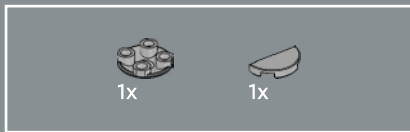

341

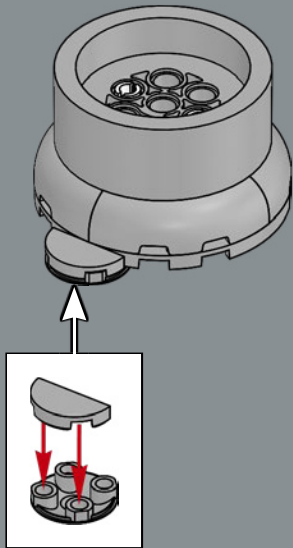

342

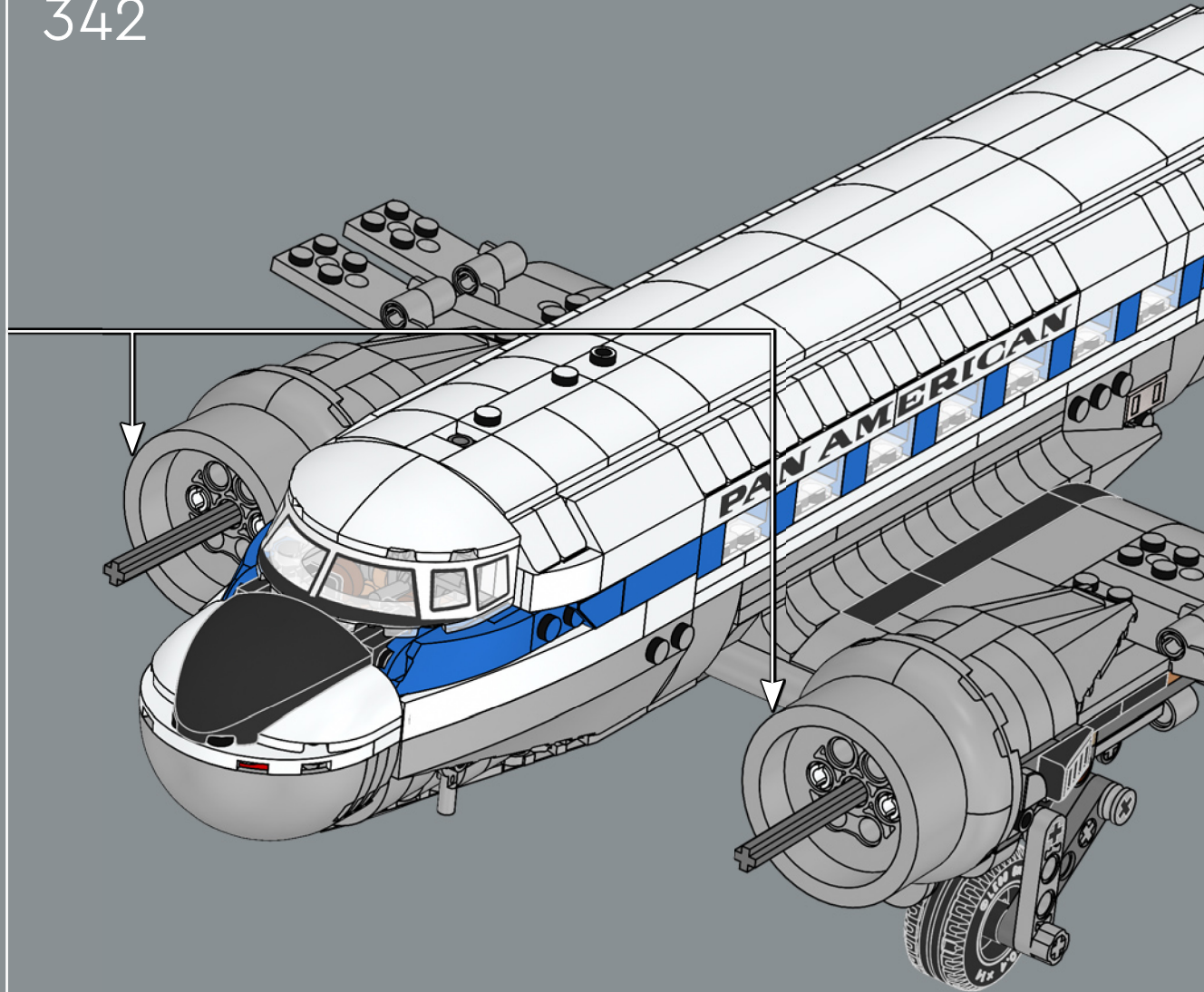

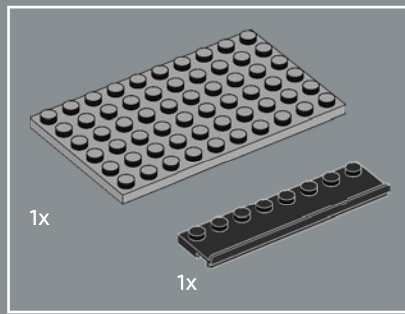
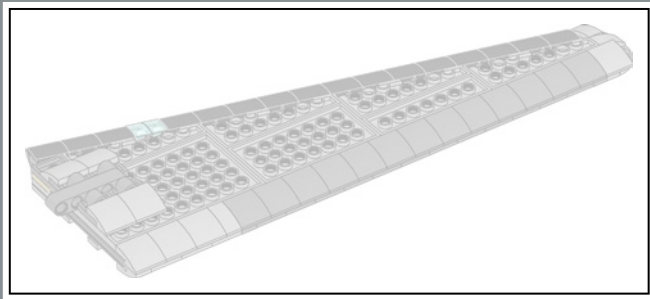

343

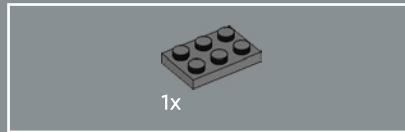
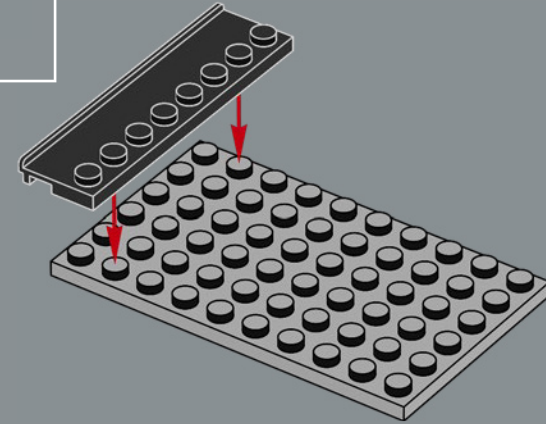

344

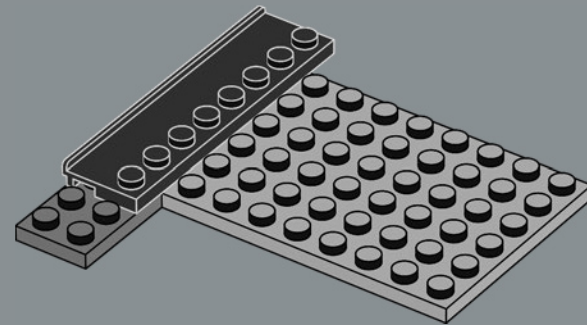

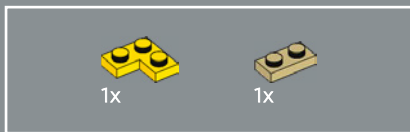

345

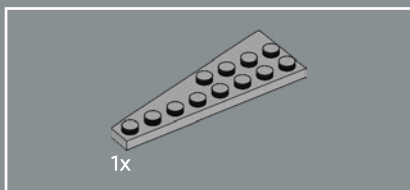
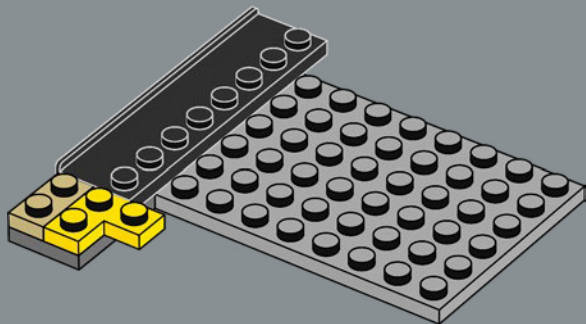

346

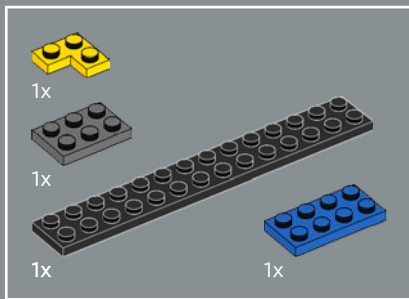
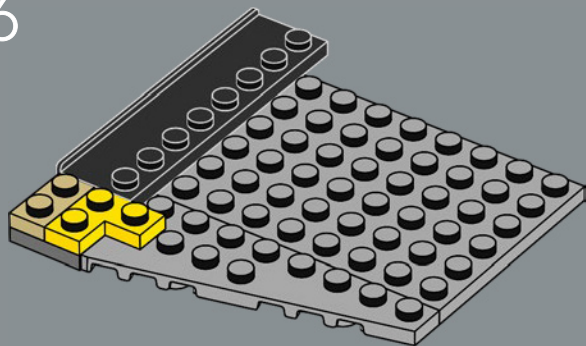

347

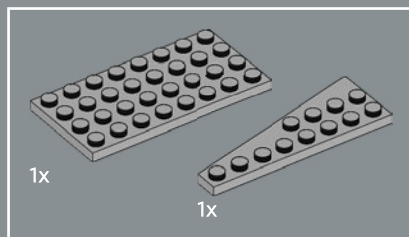
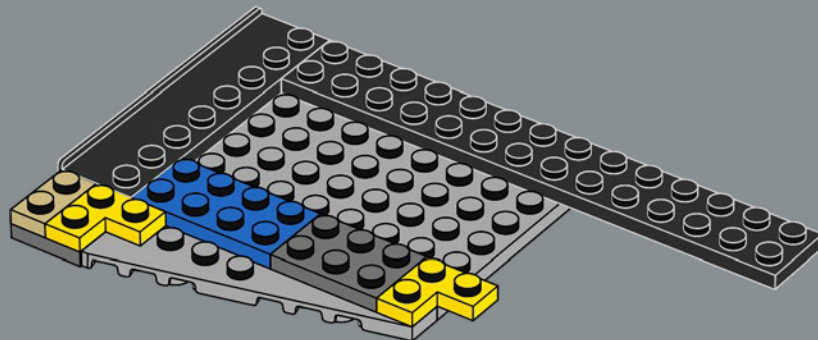

348

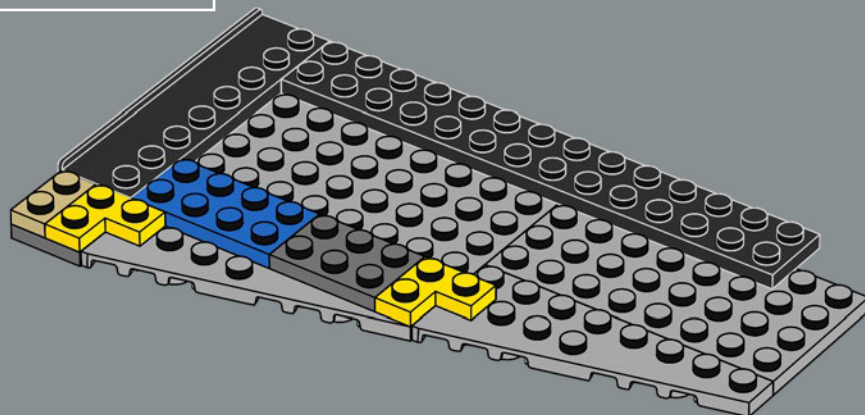

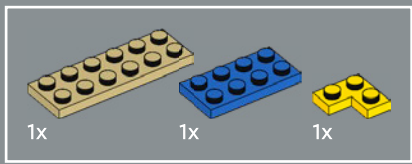

349

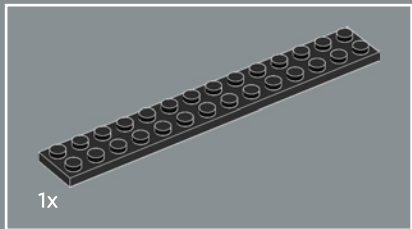
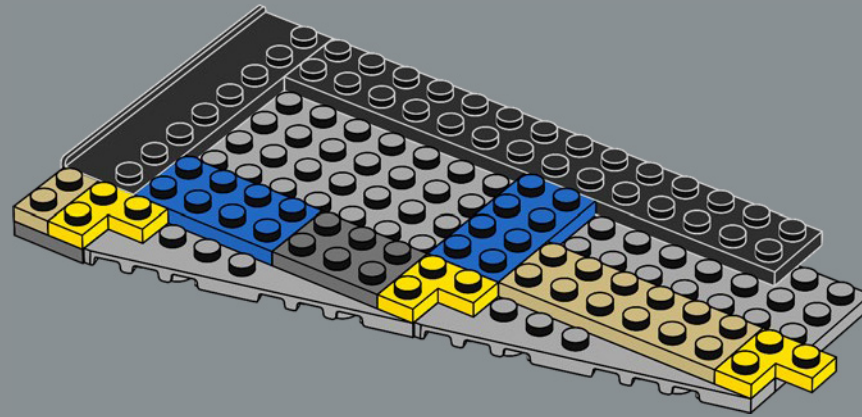

350

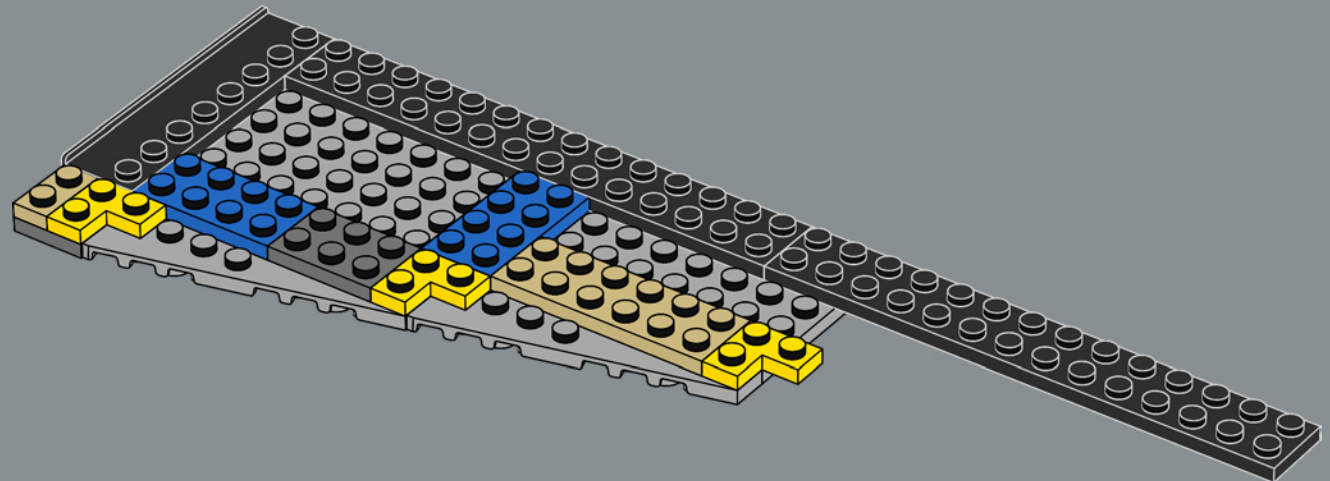

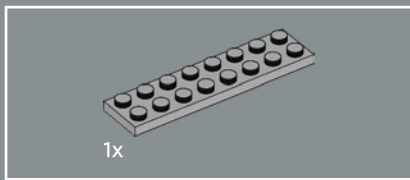

351

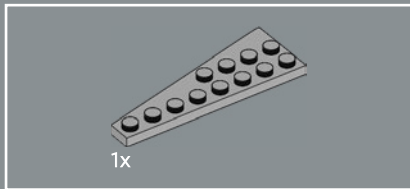
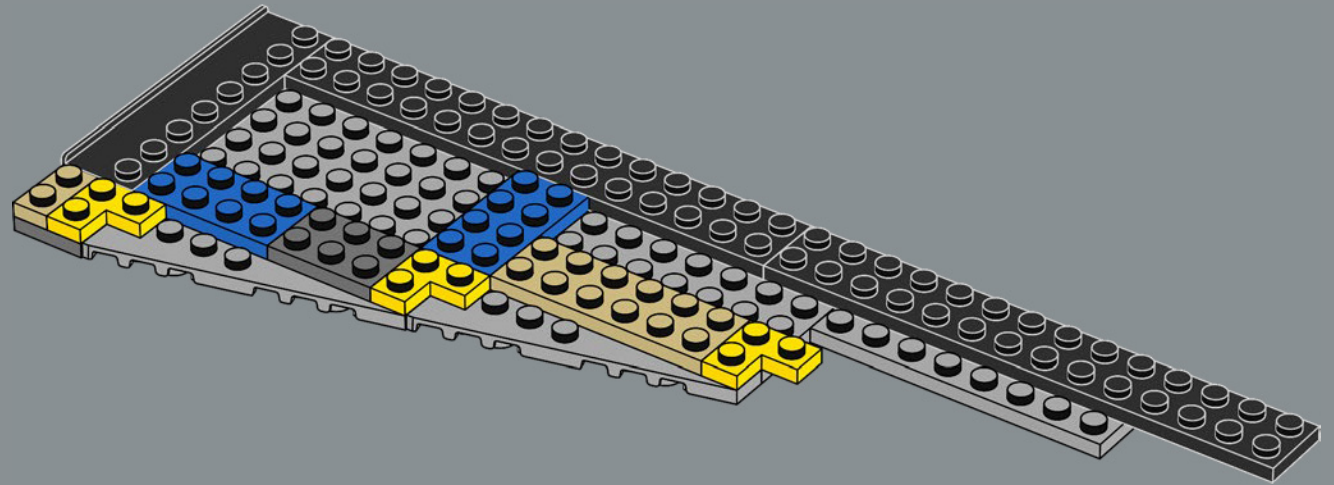

352

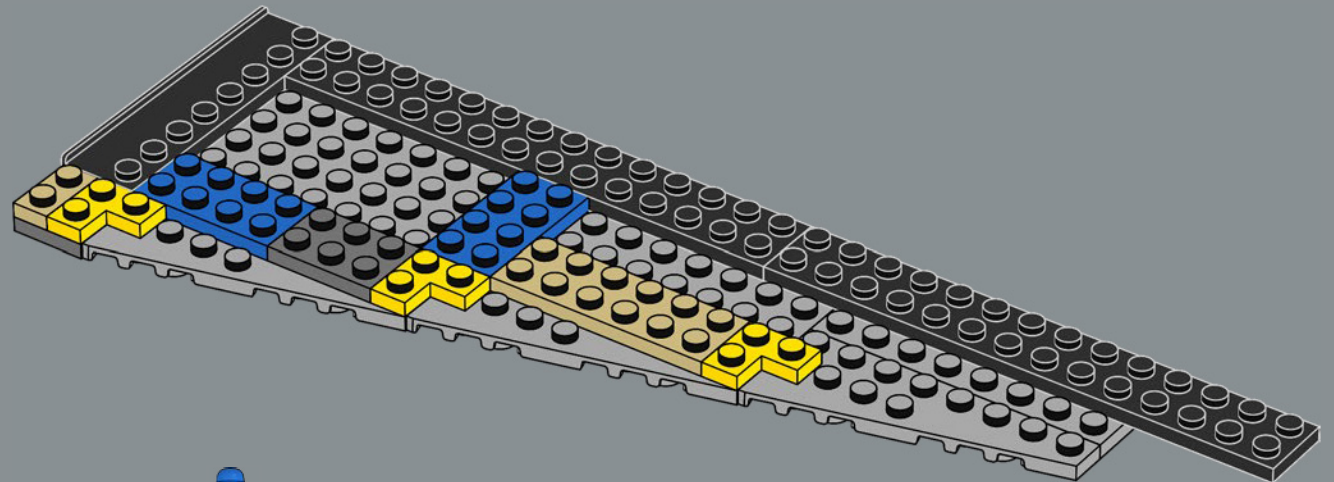

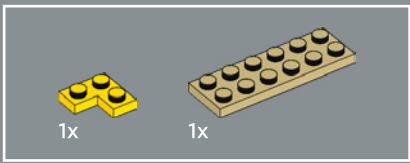

353

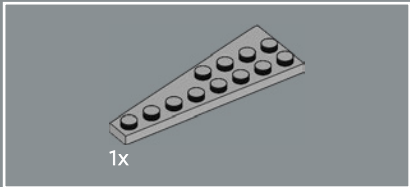
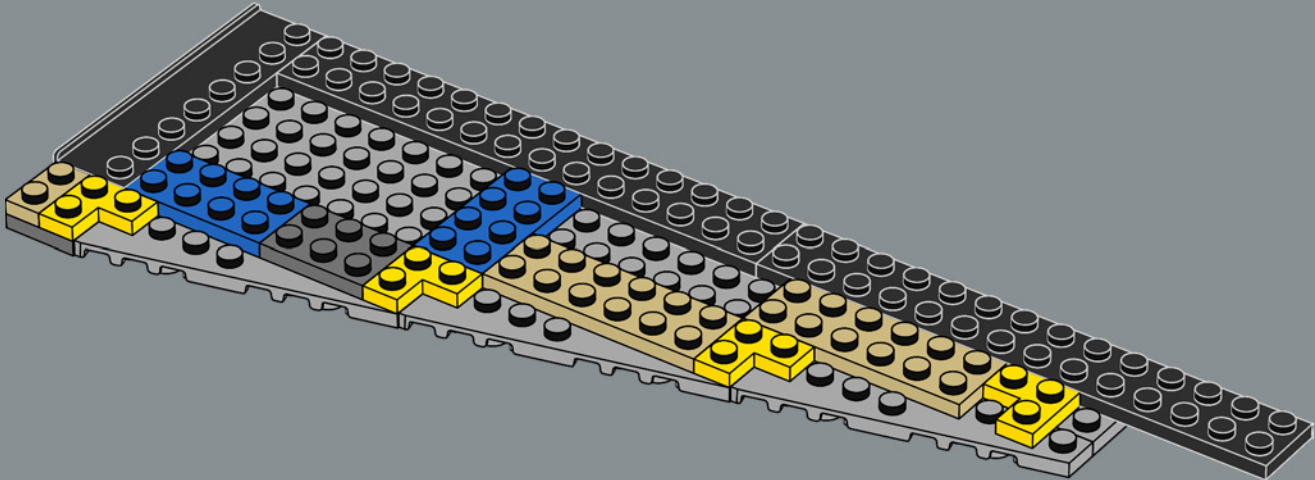

354

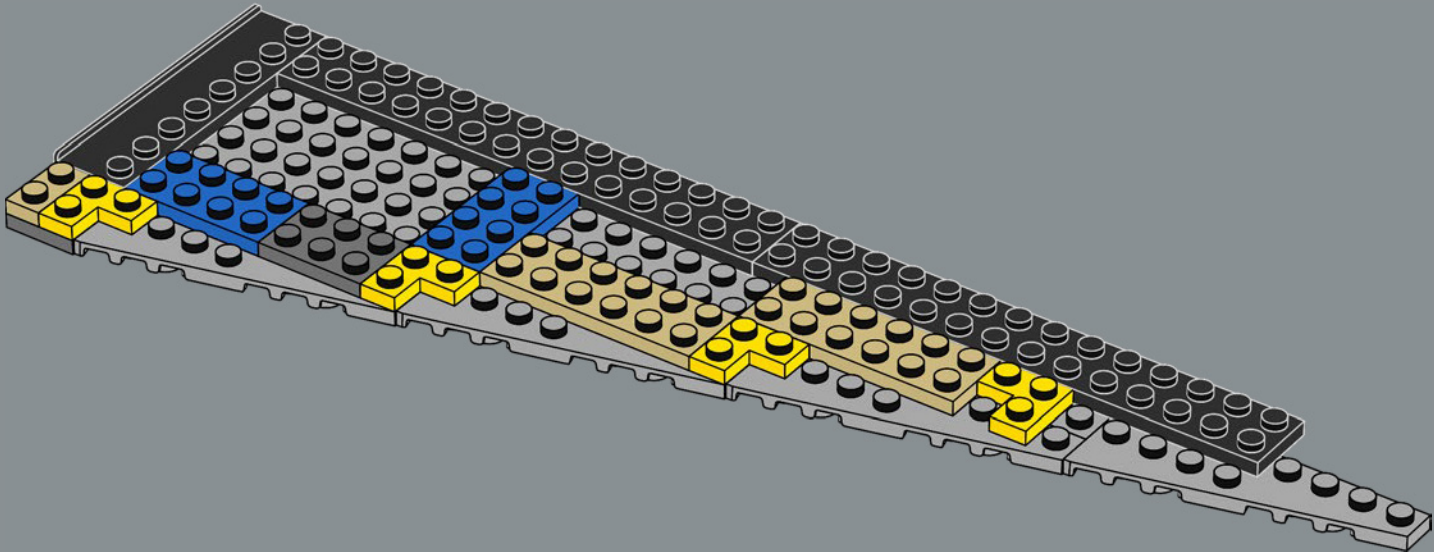

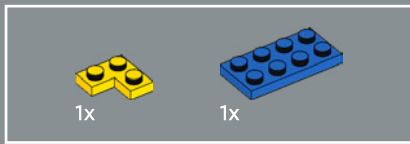

355

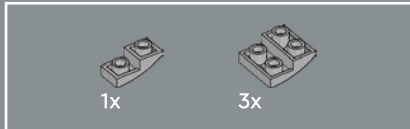
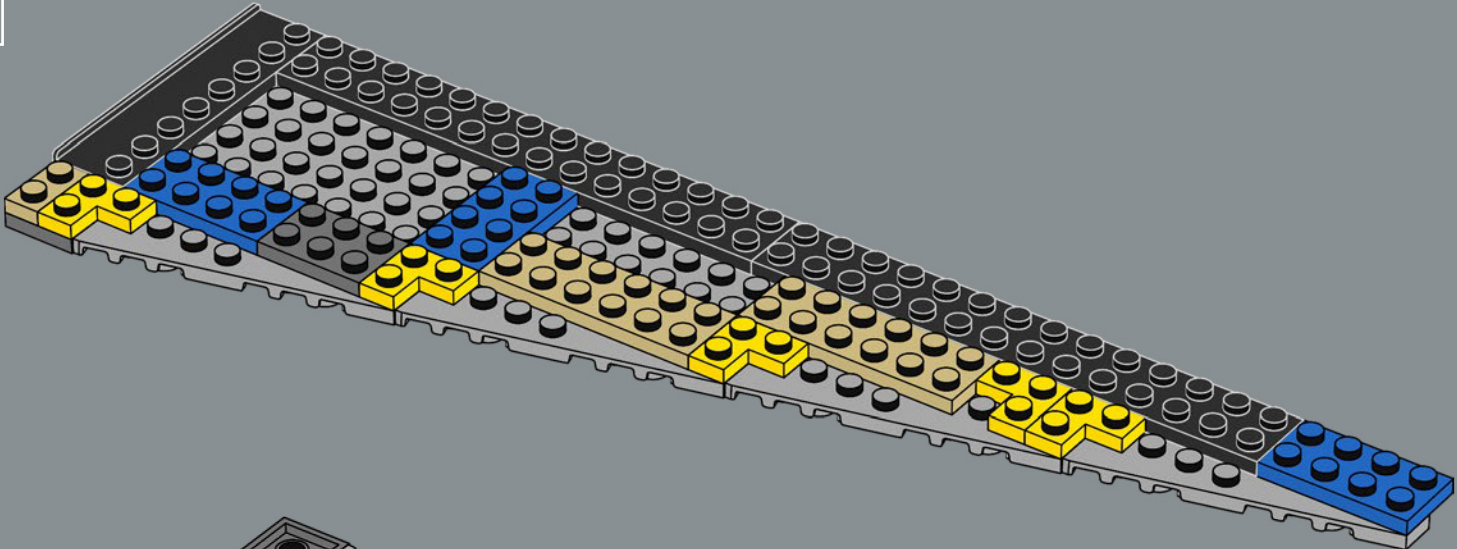

356

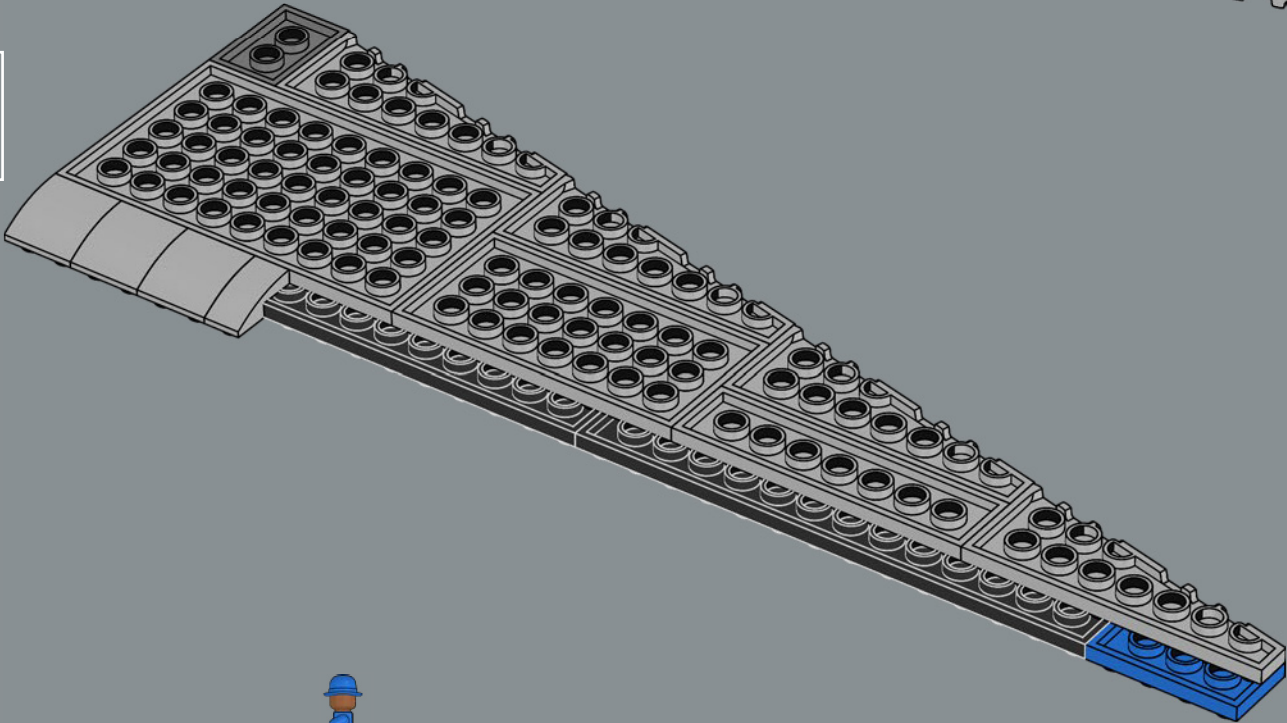

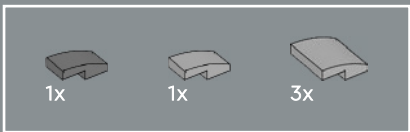

359

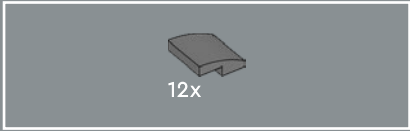
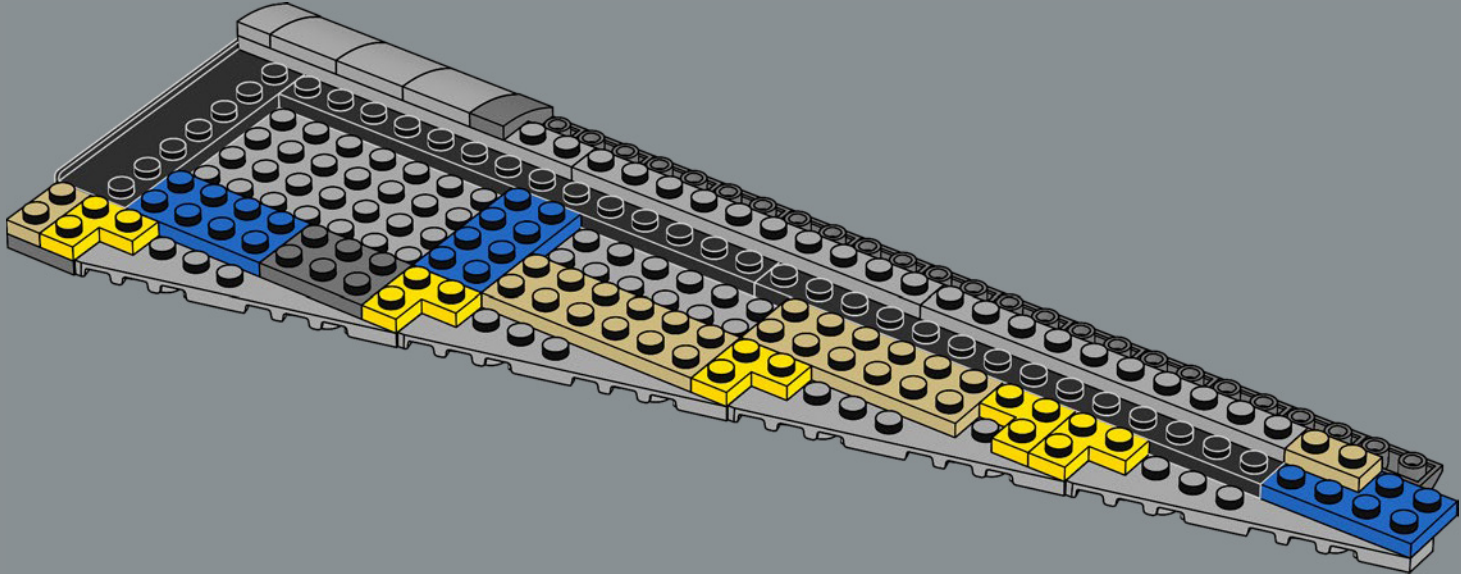

360

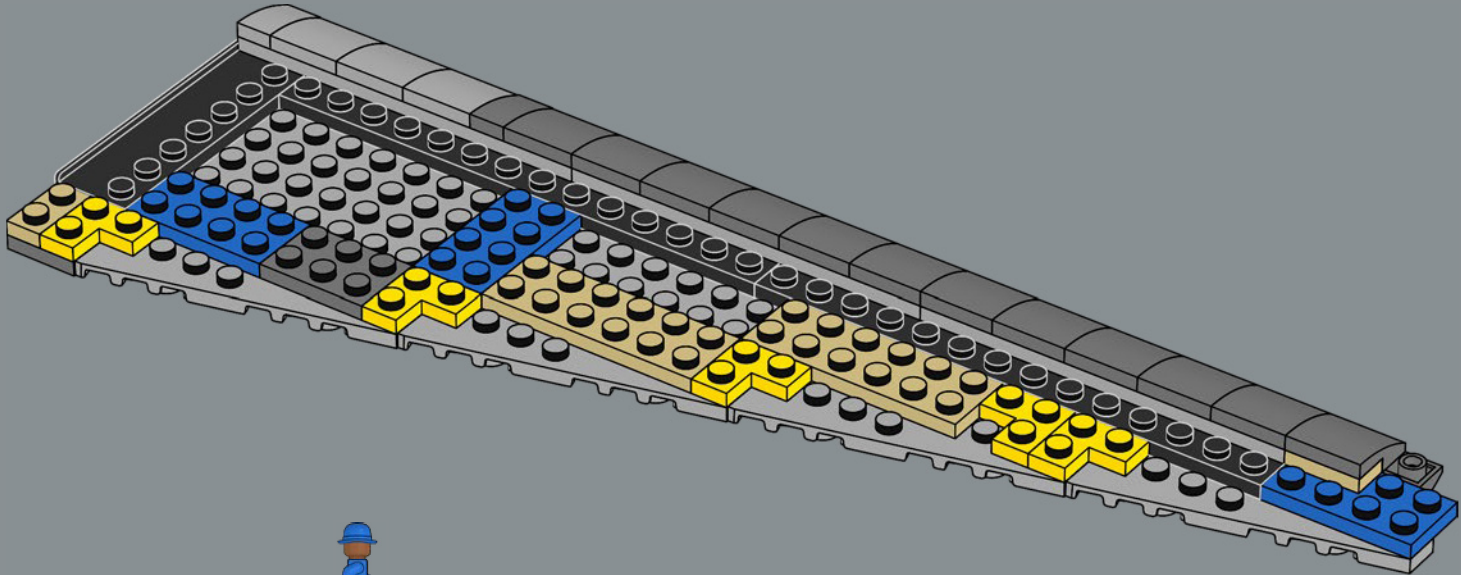

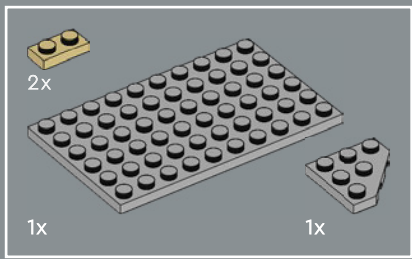

361

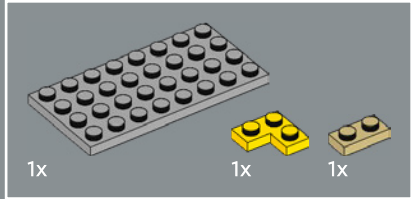
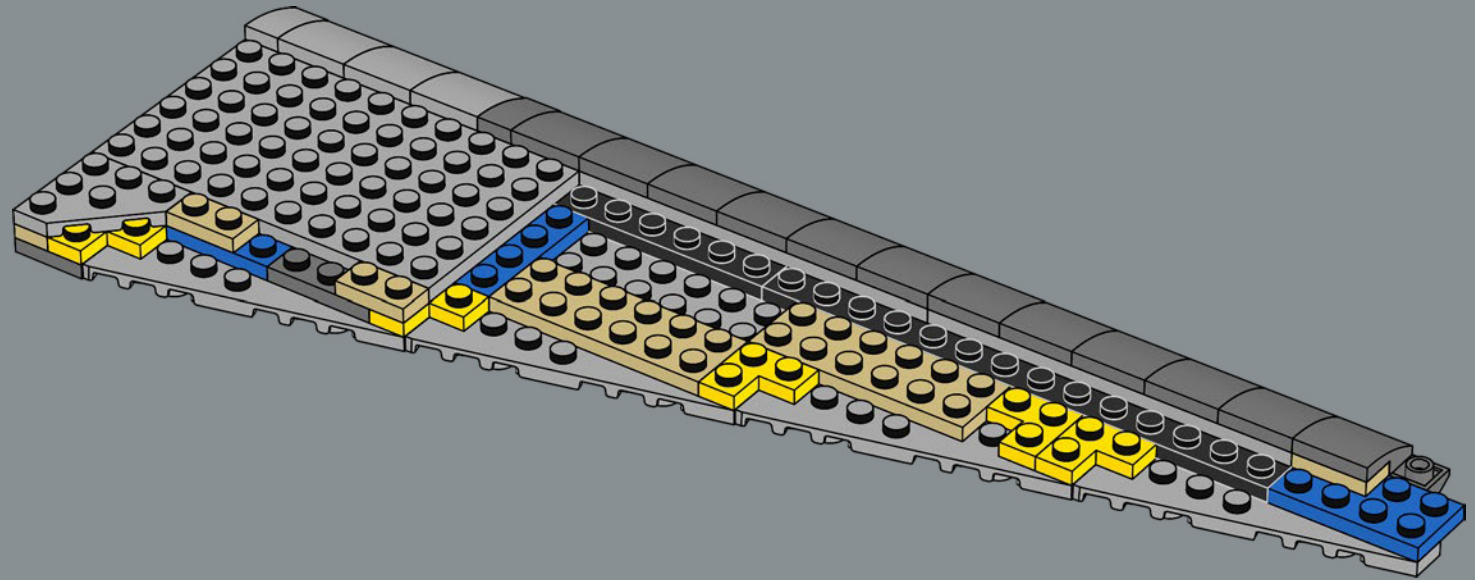

362

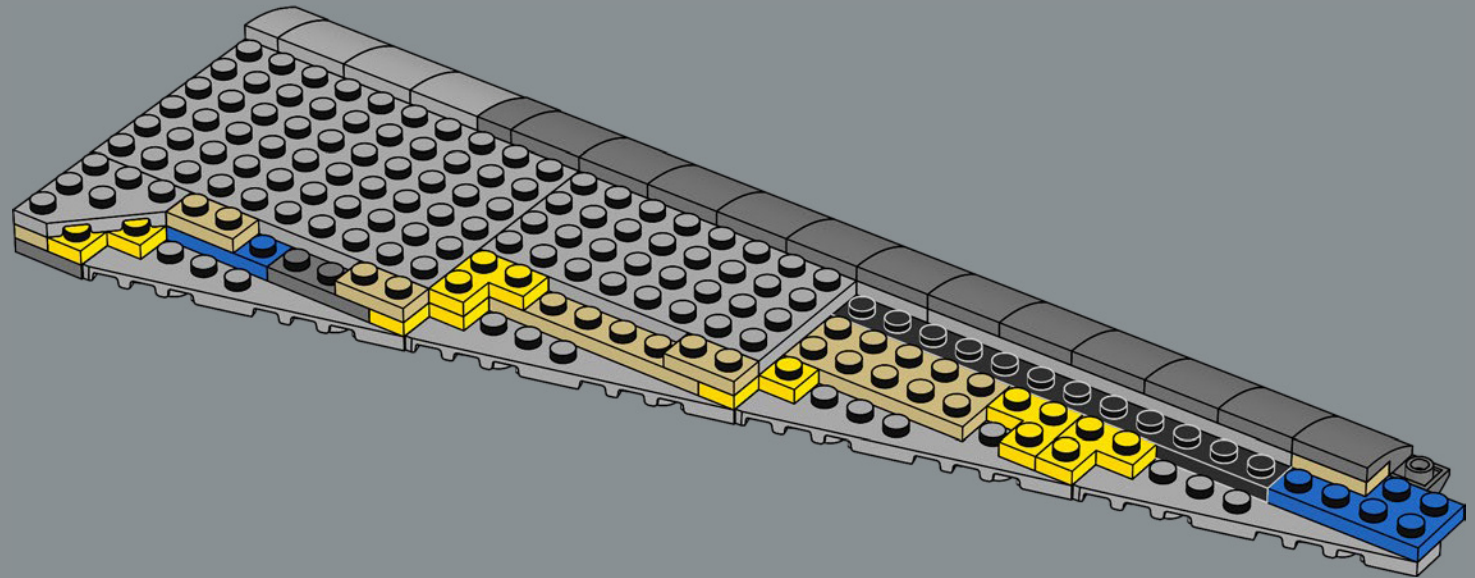

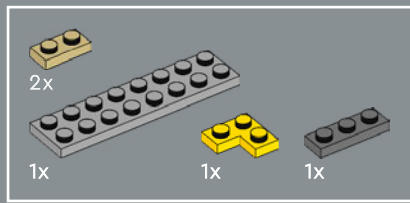

363

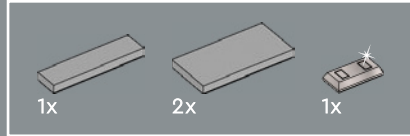
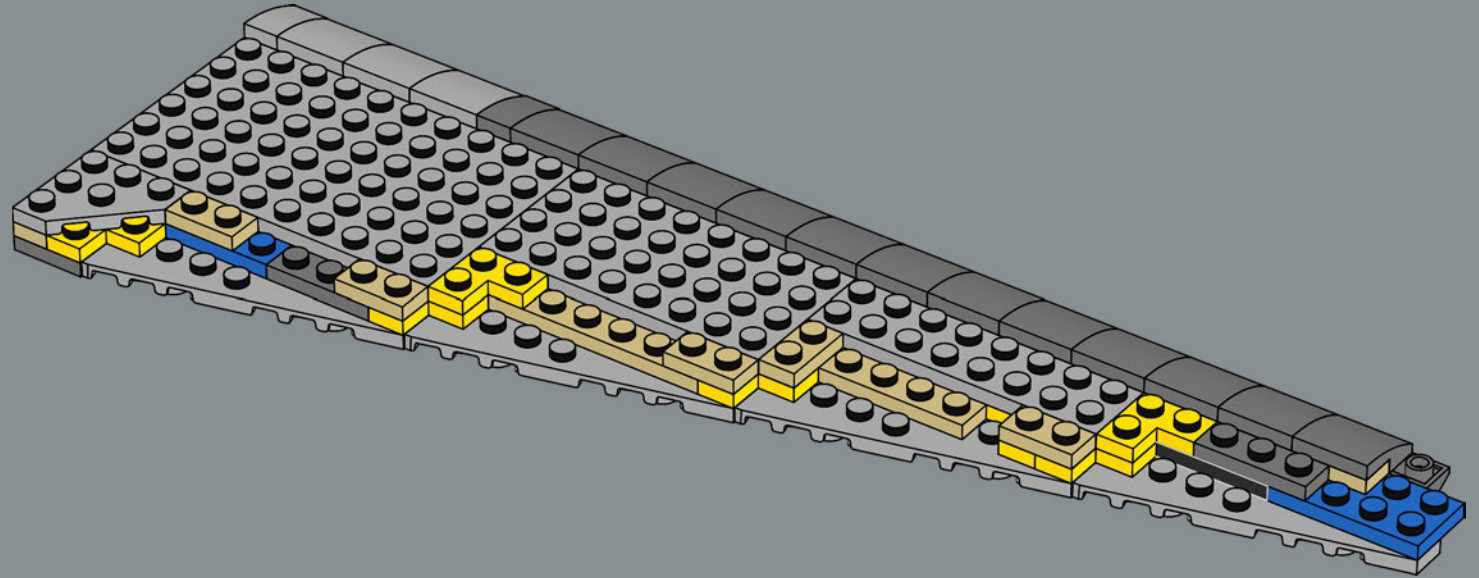

364

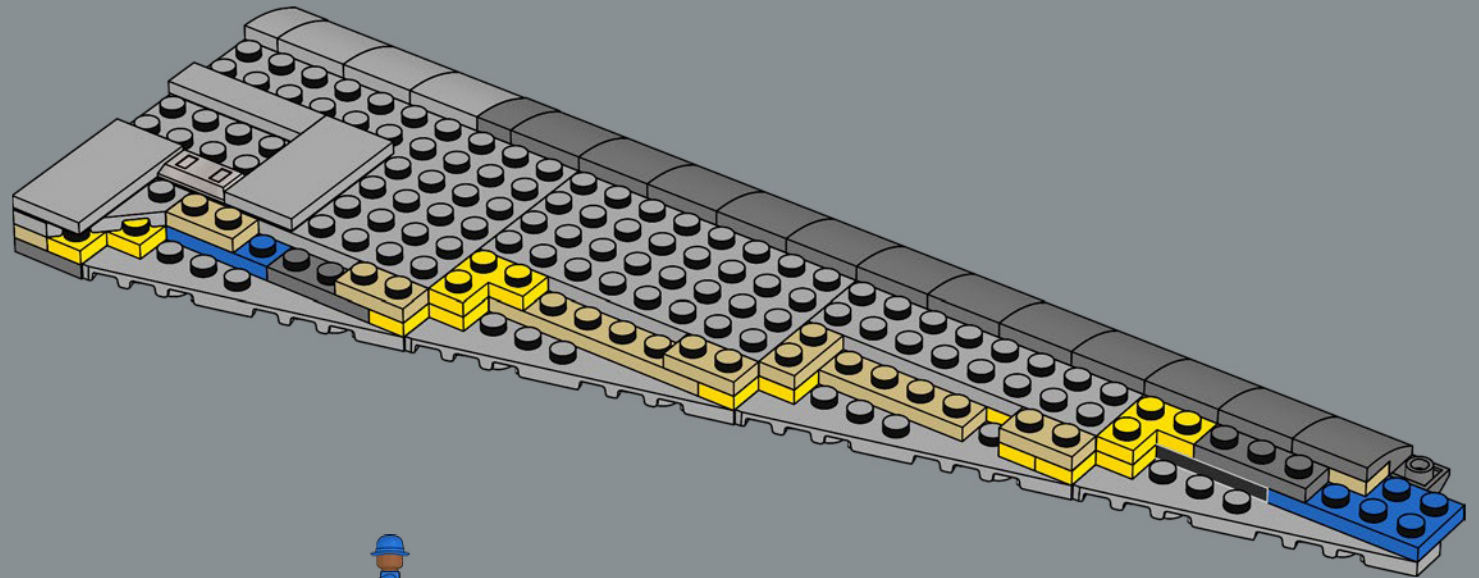

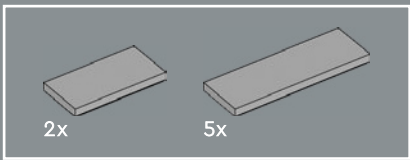

365

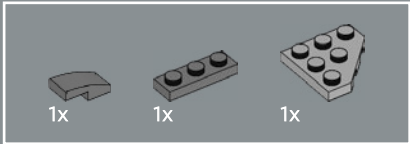
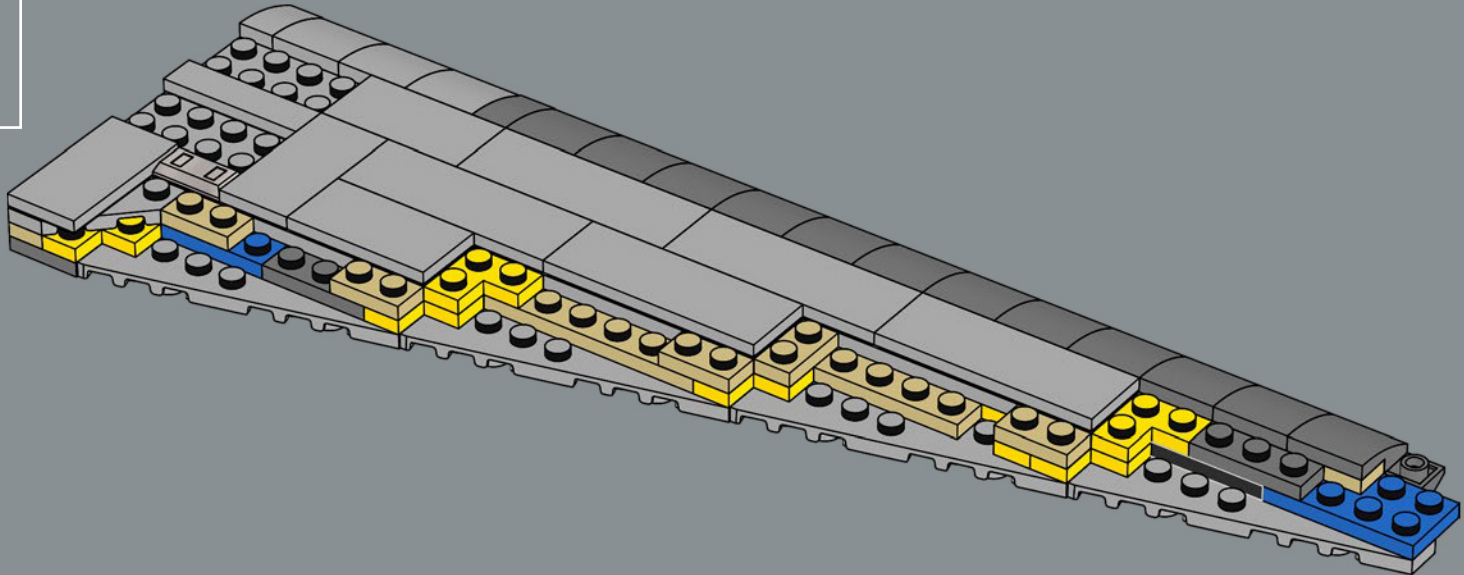

366

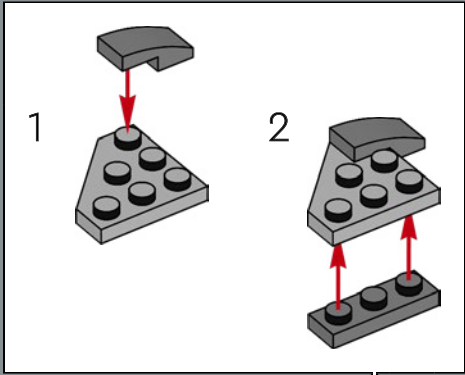
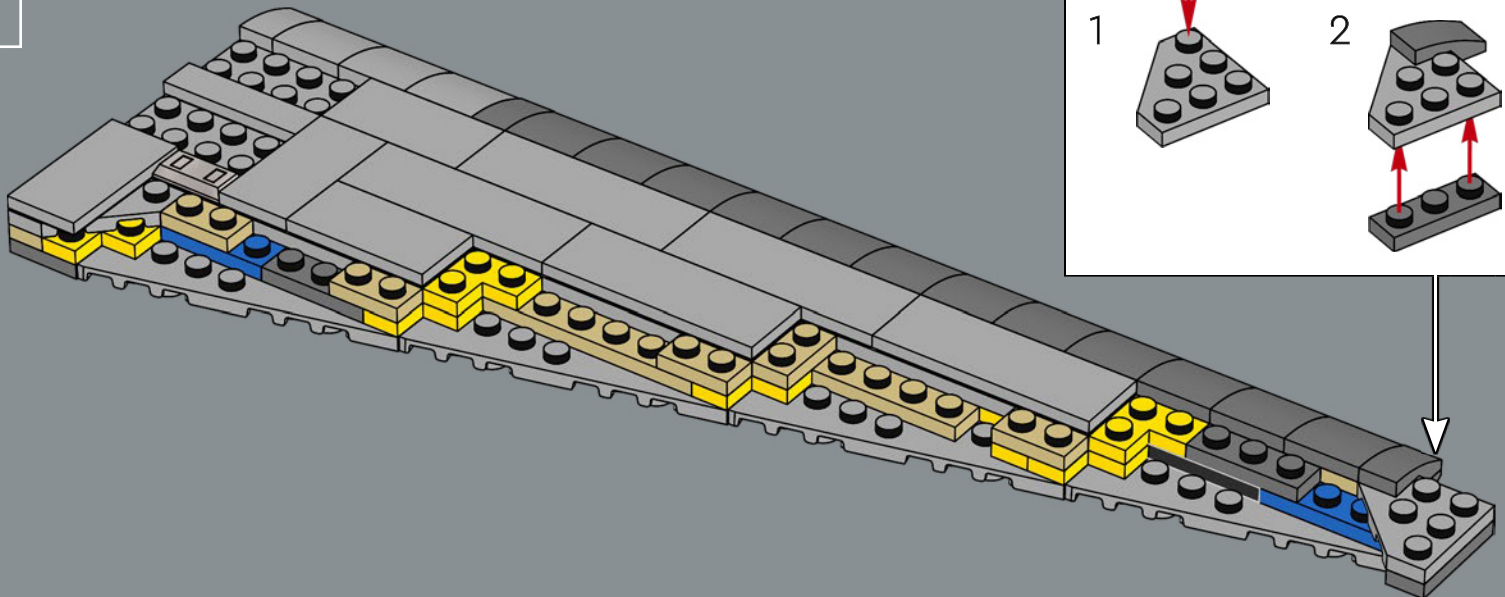

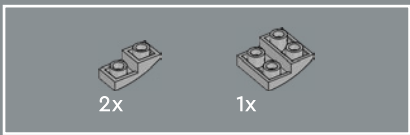

367

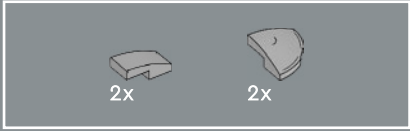
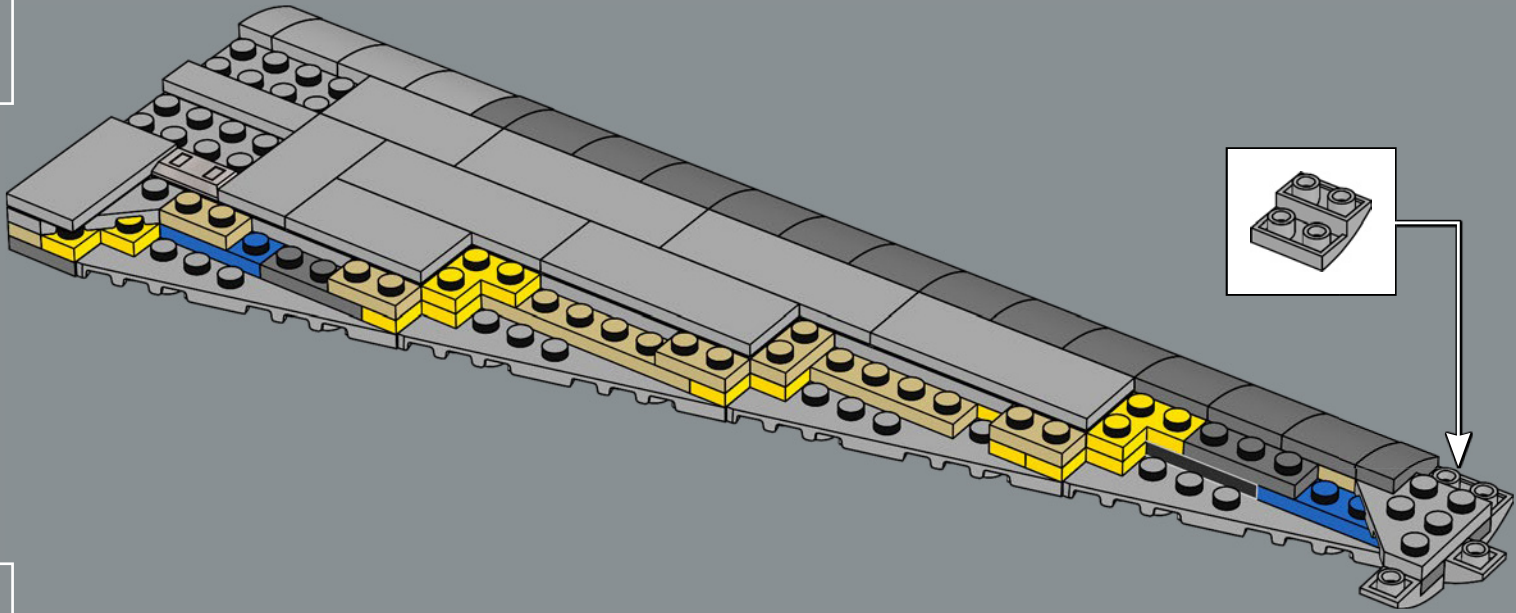

368

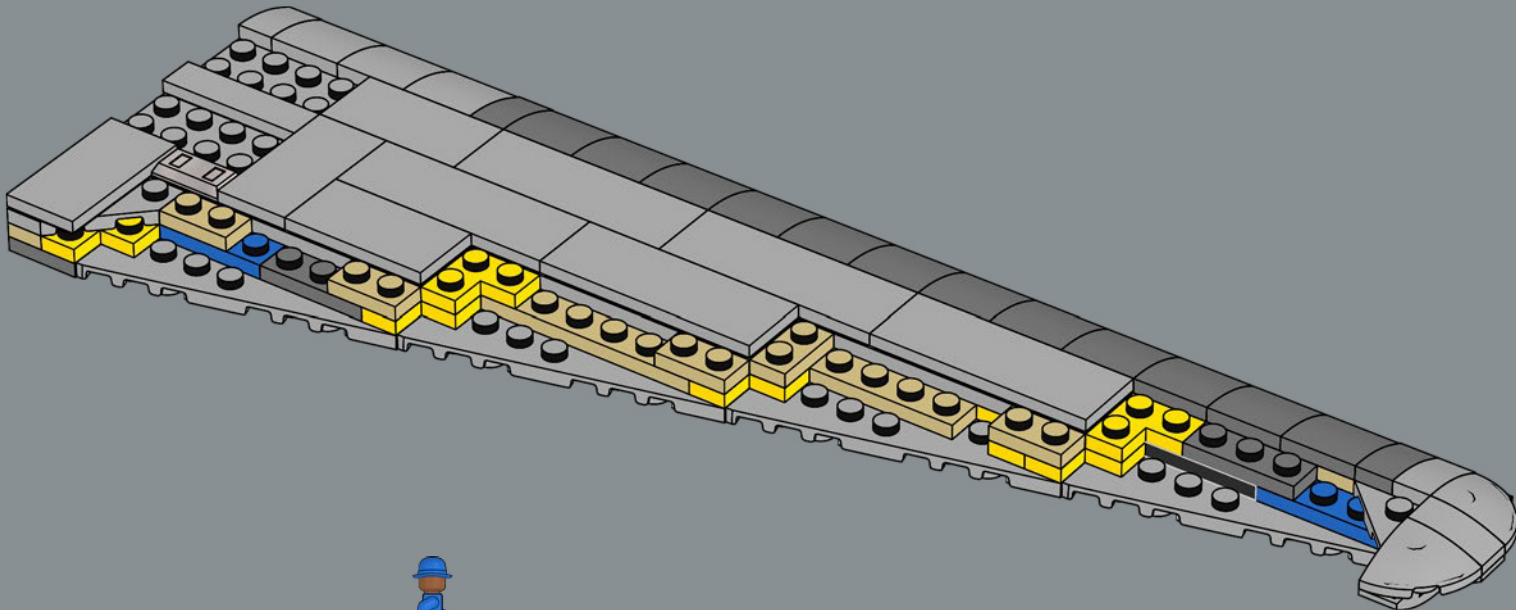

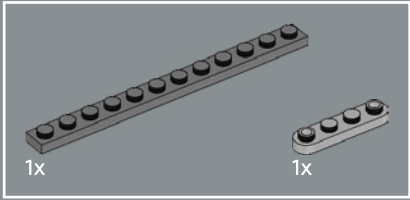
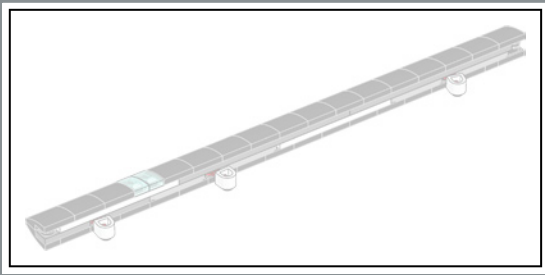

369

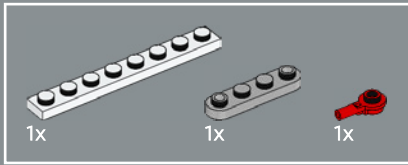
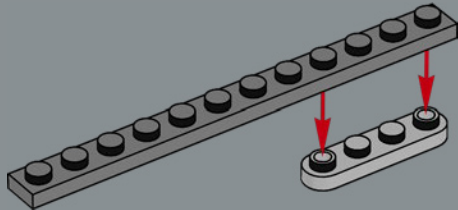

370

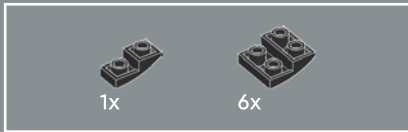
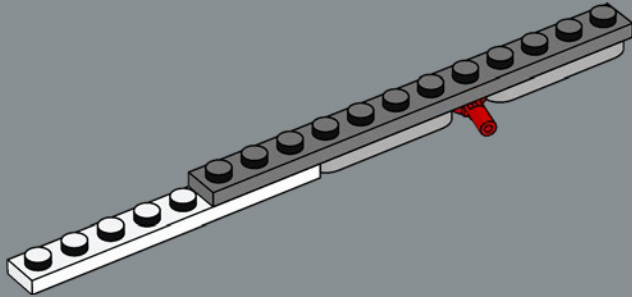

371

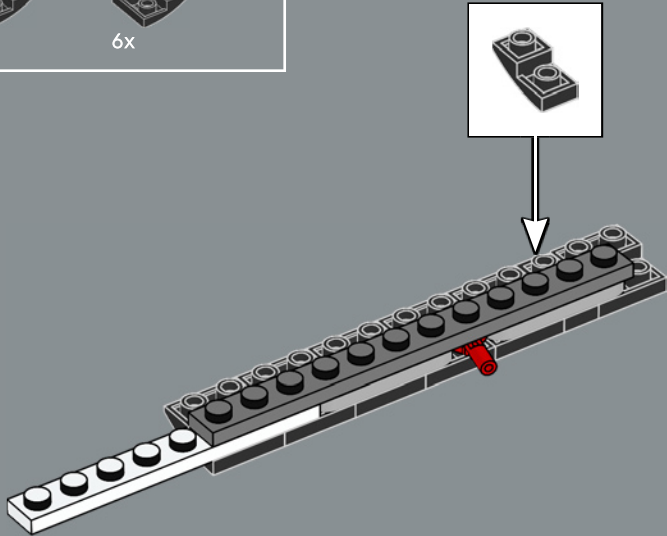



372

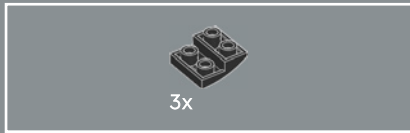
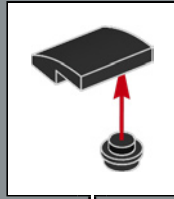
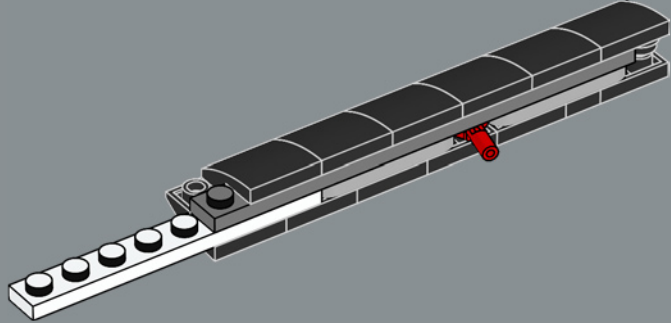

373

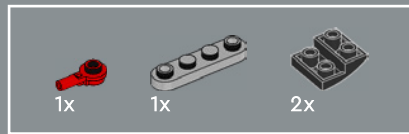
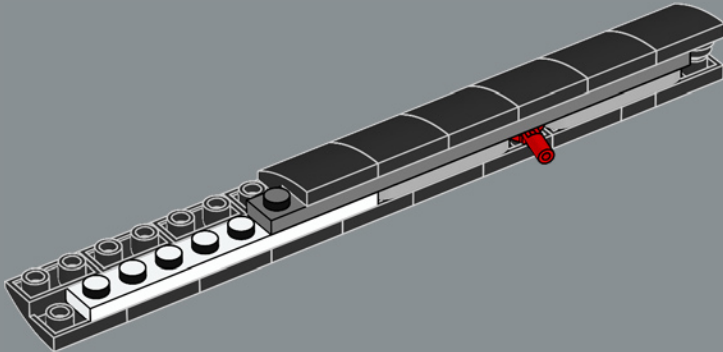

374

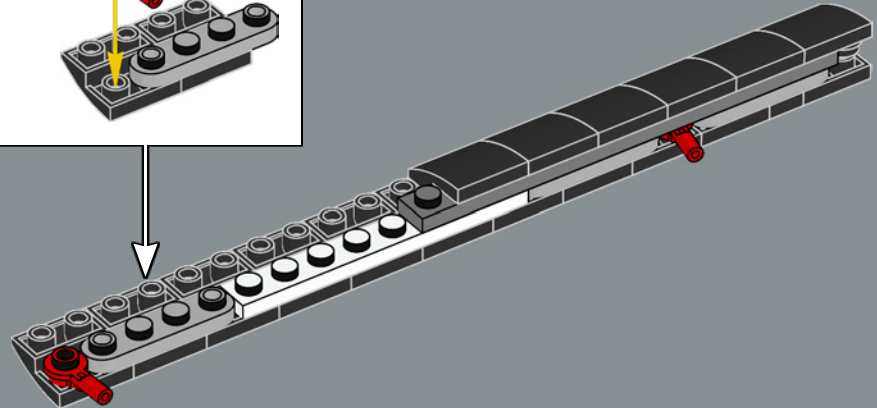
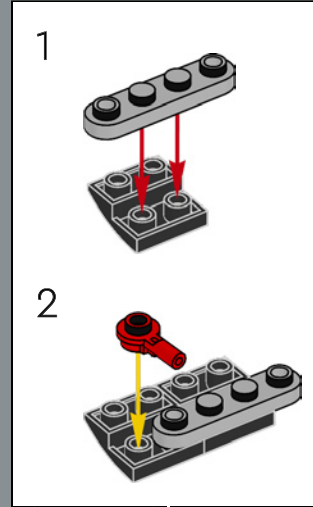

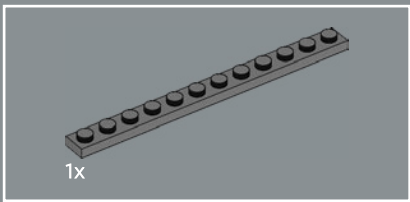

375

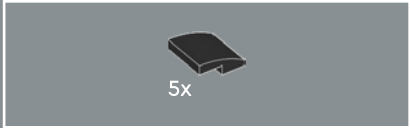
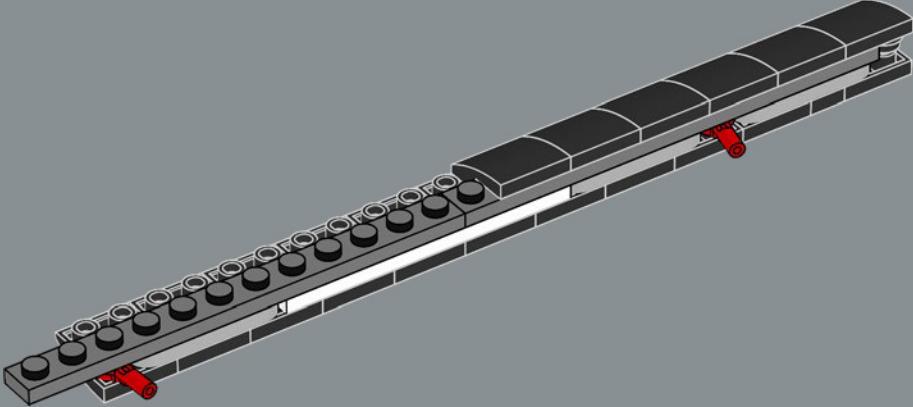

376

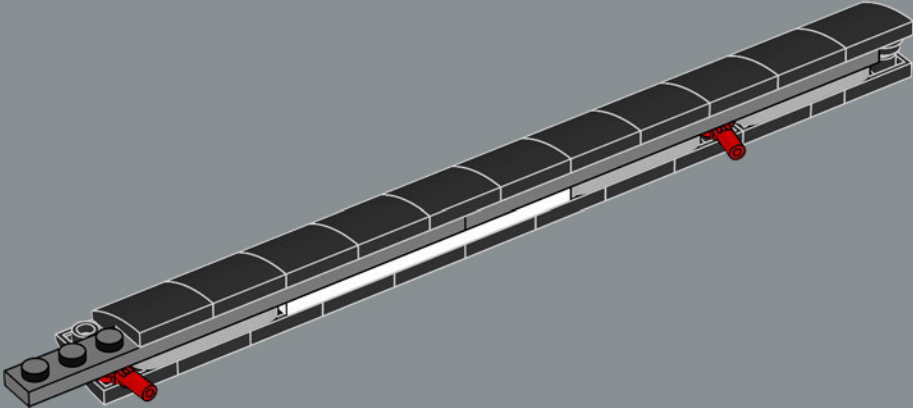

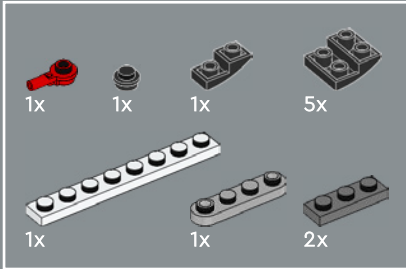
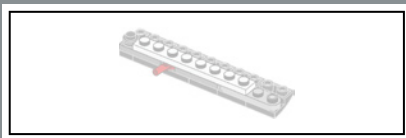

377

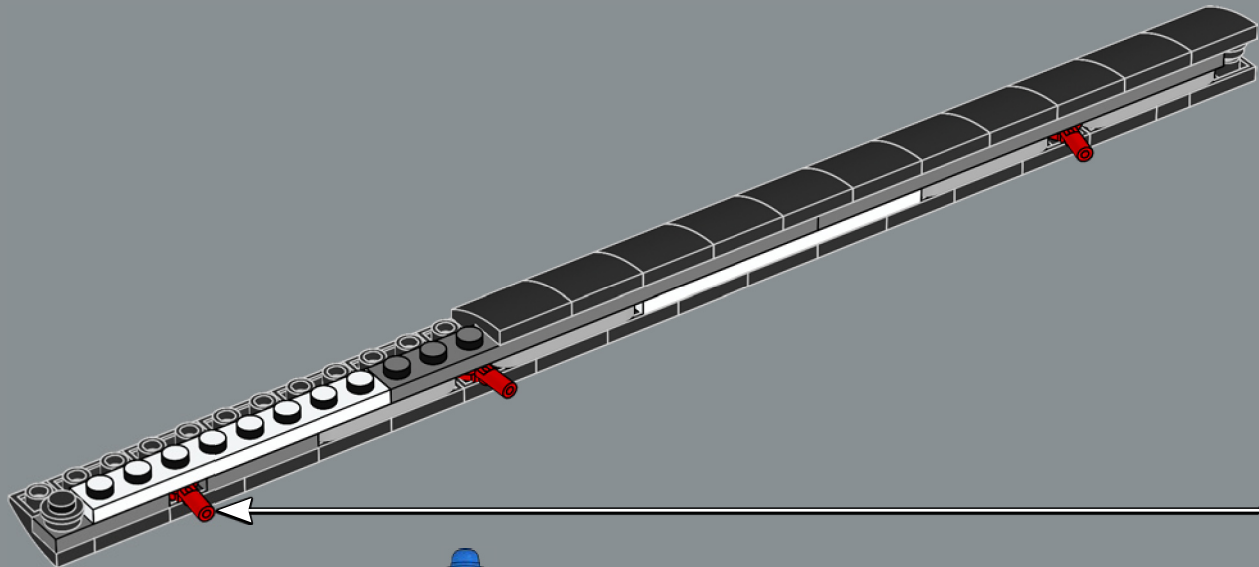
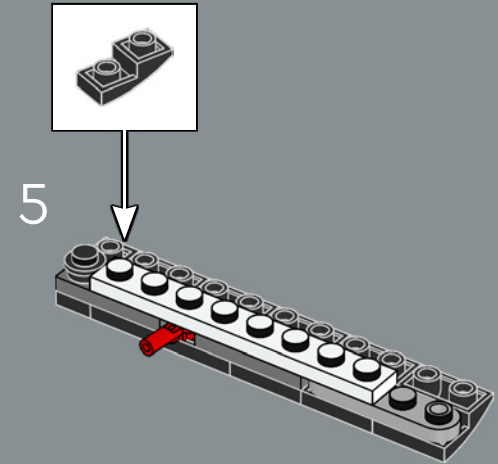
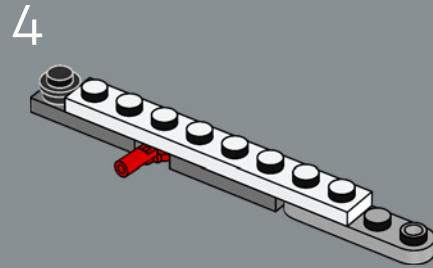
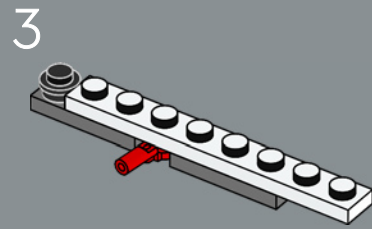
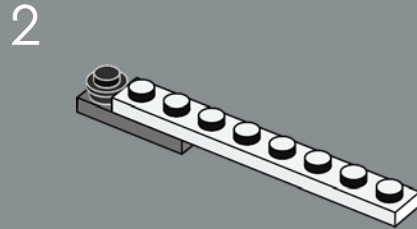
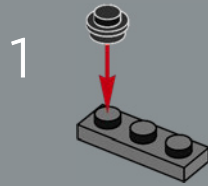



378

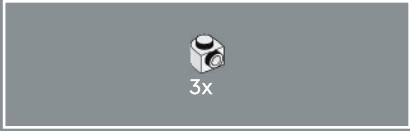
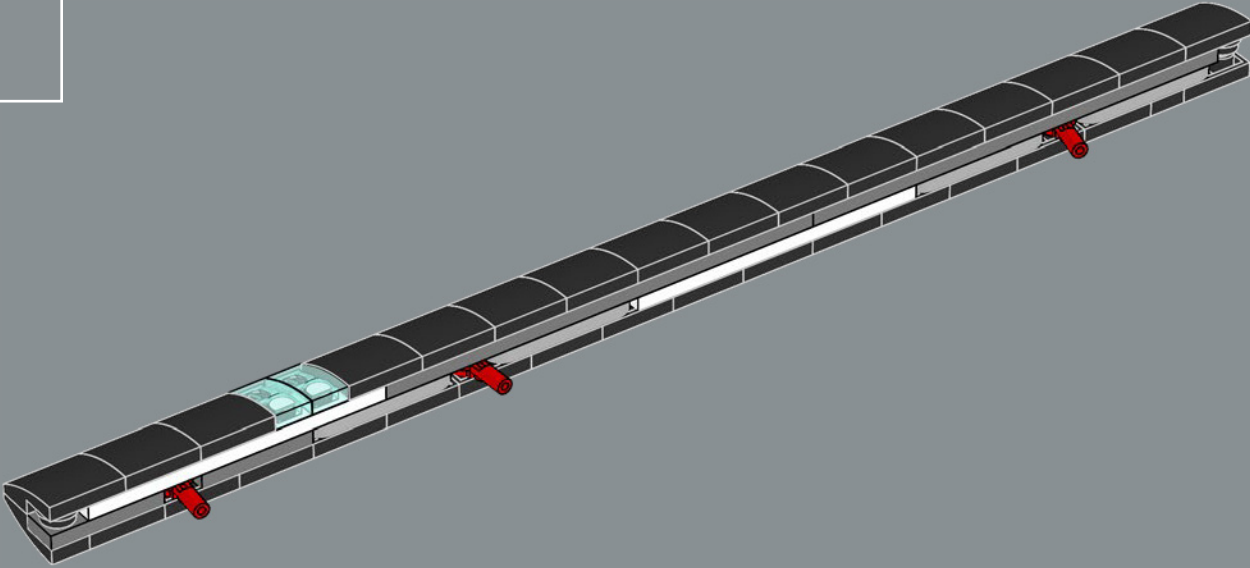

379

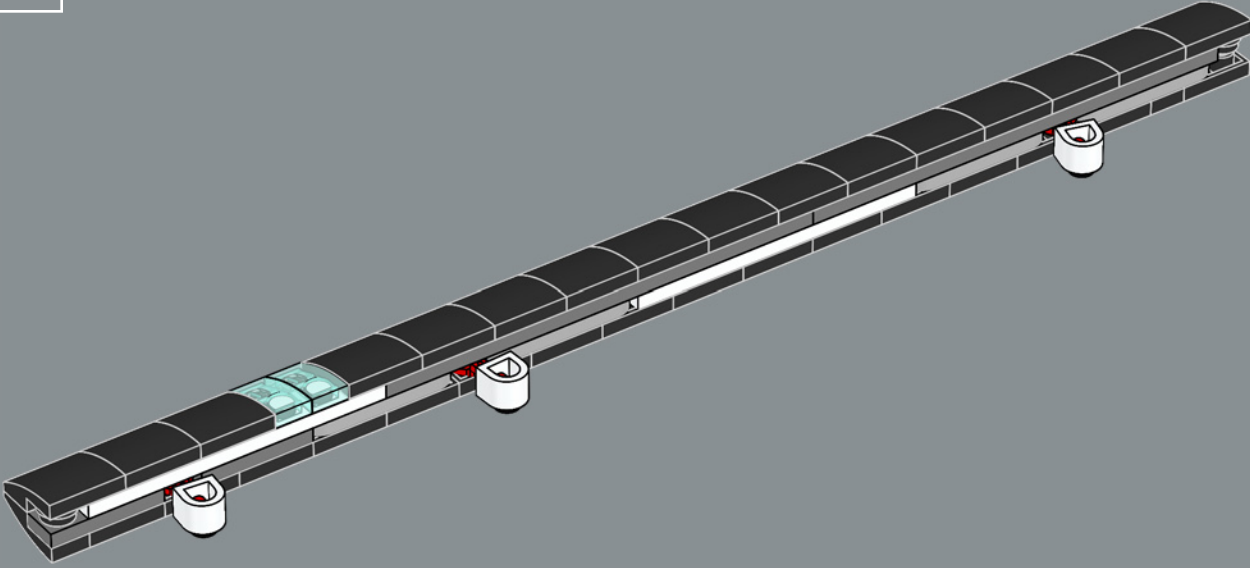

380

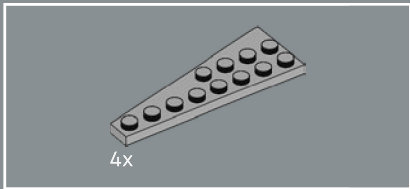
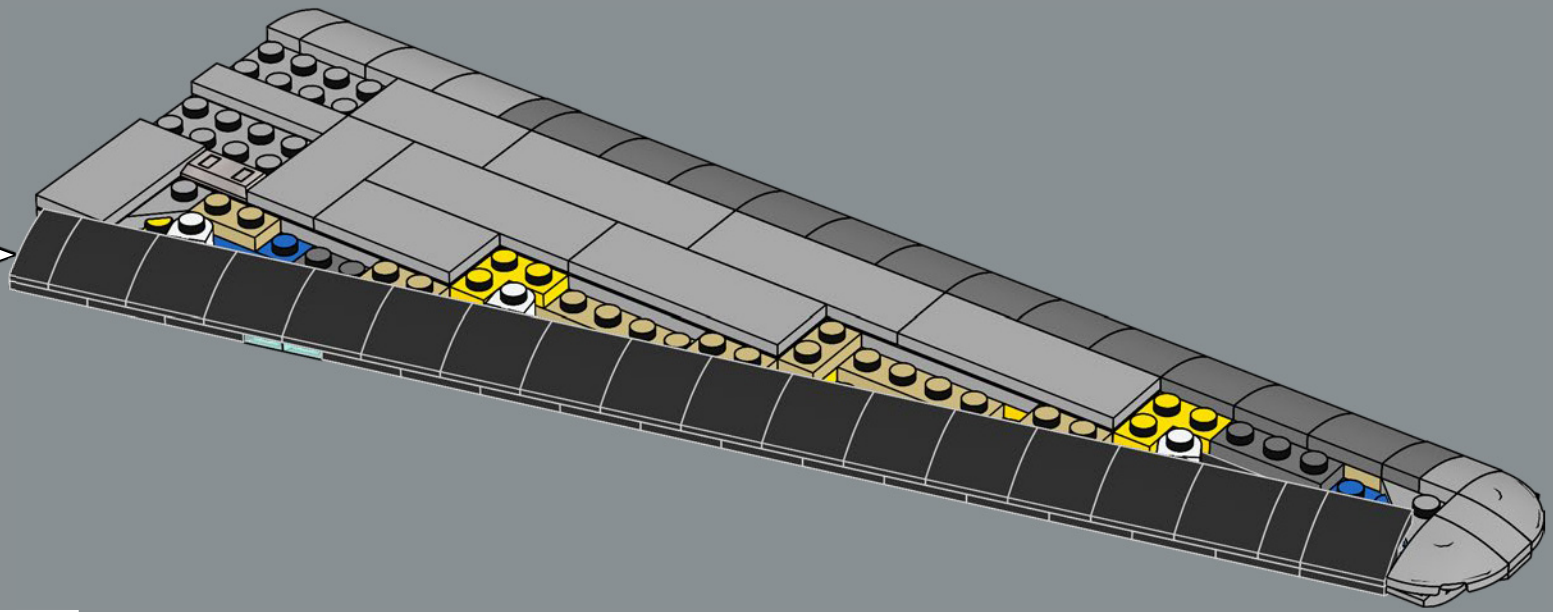

381

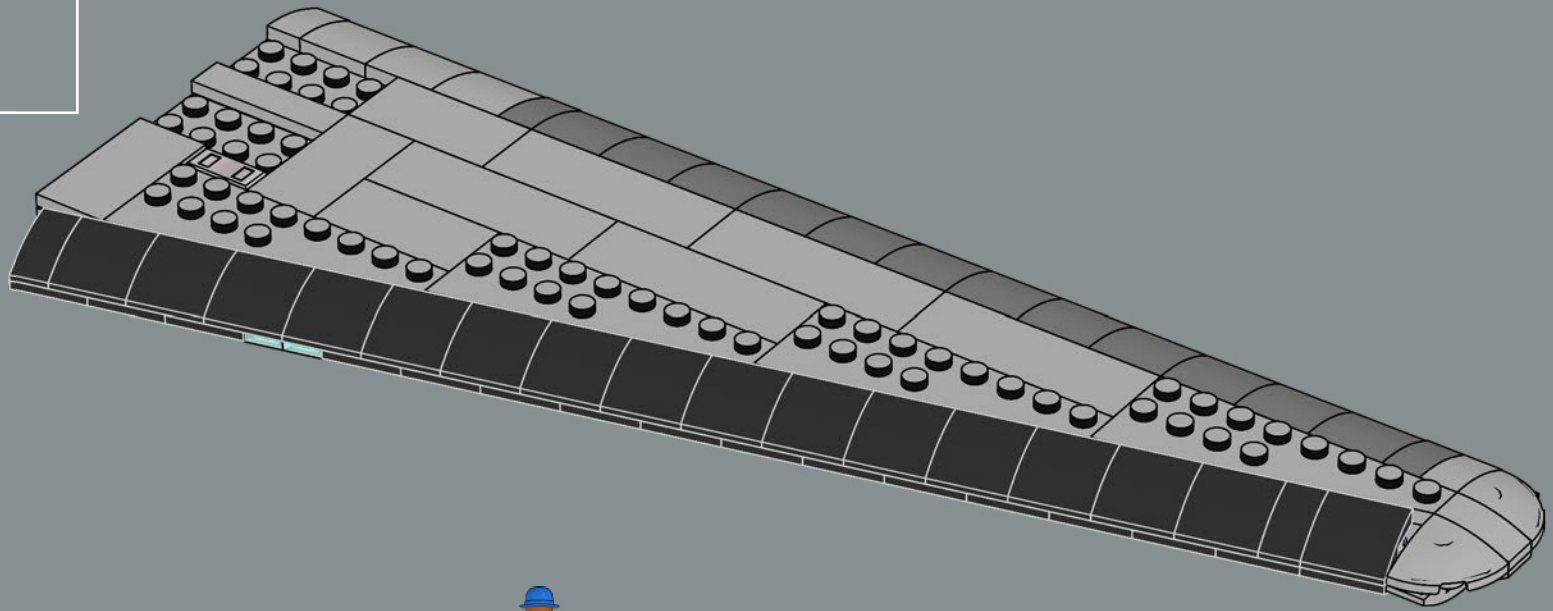

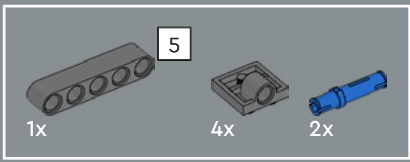

382

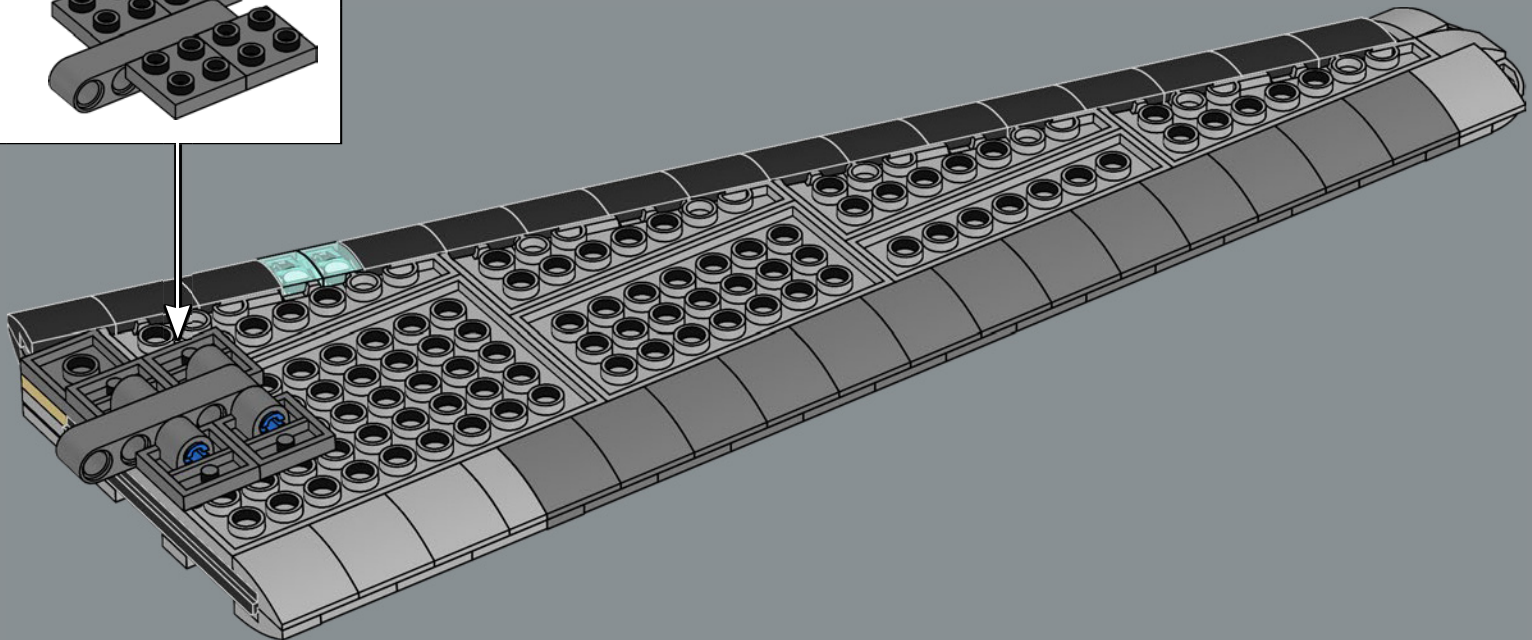
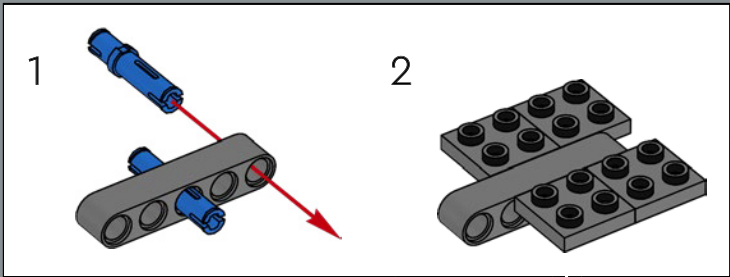



4x

383

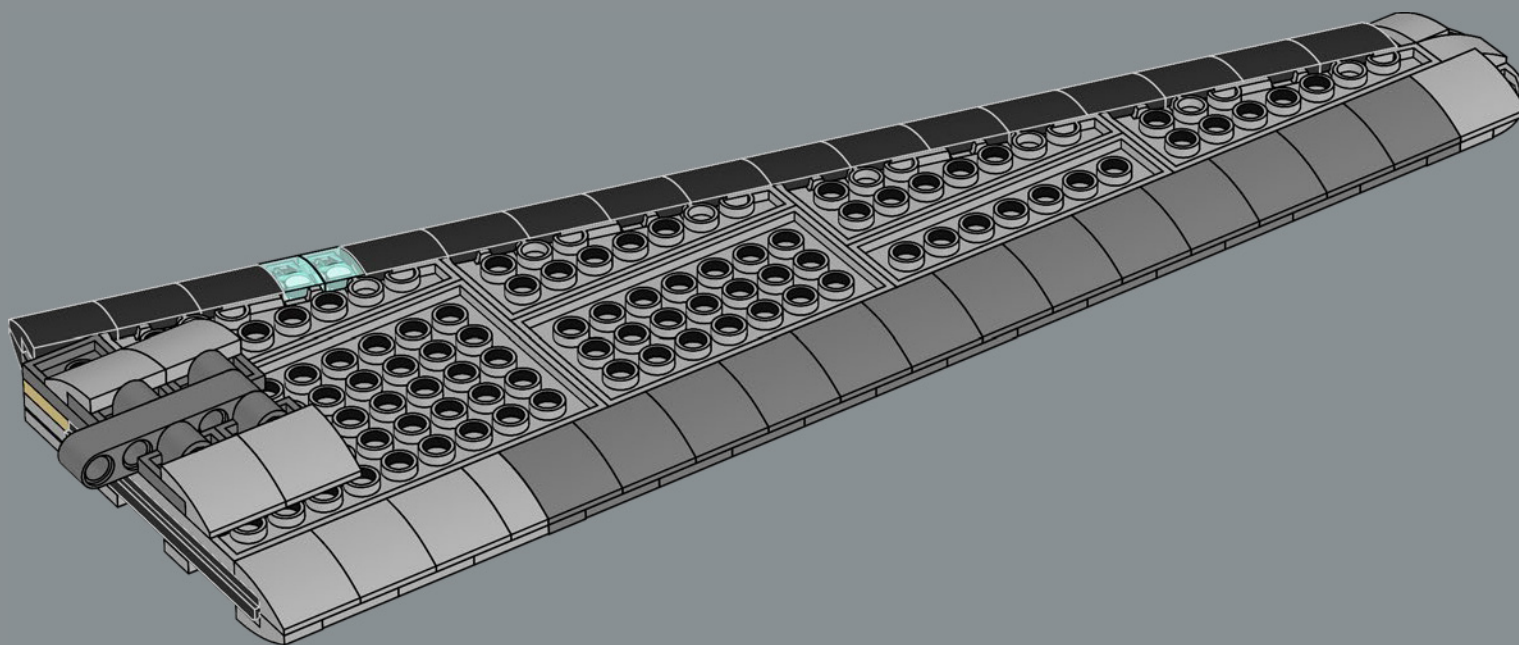

384

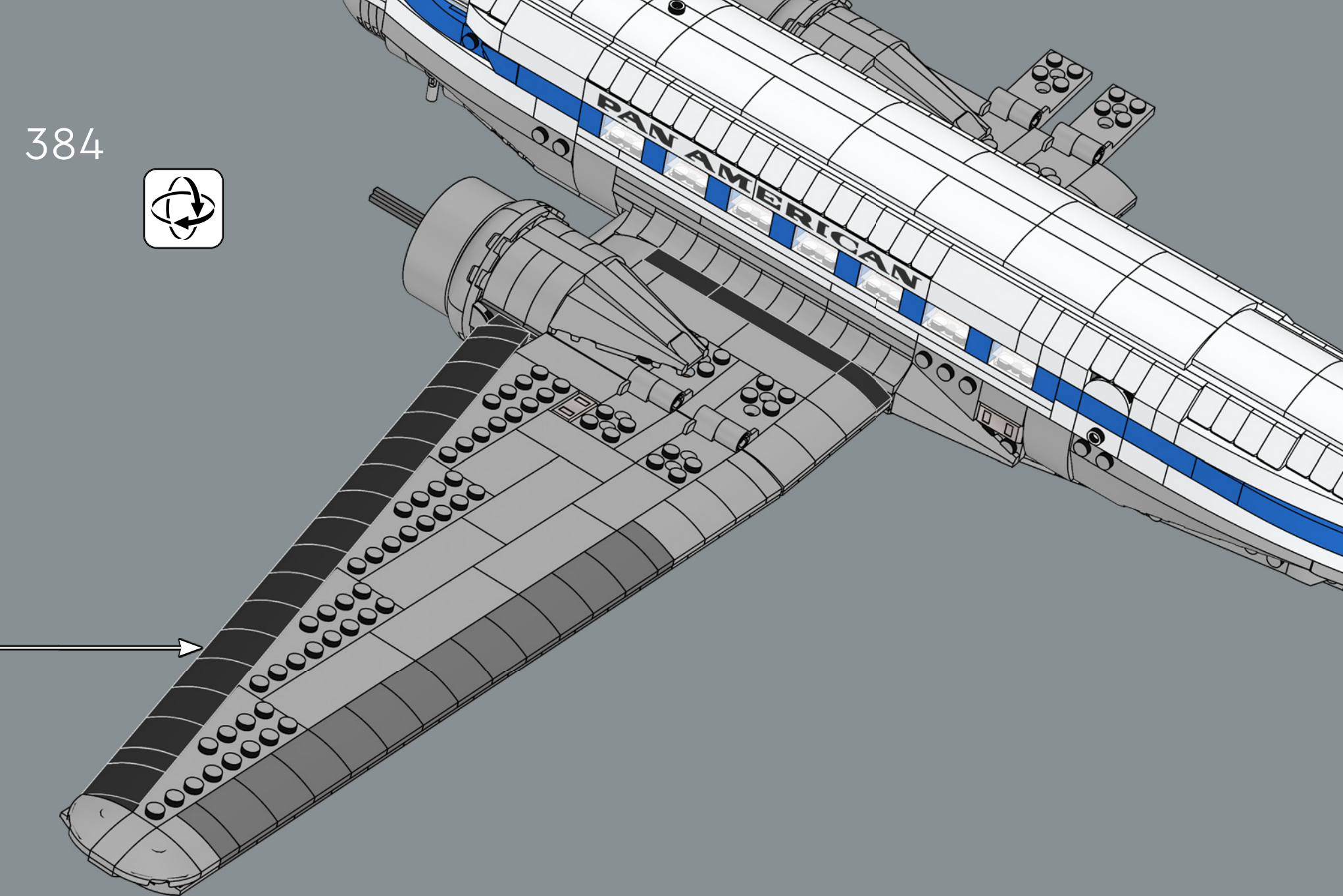

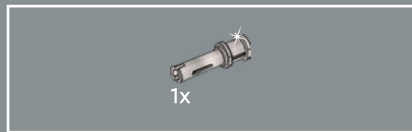

385



Un pasador LEGO® Technic fija el ala por la parte inferior. Los diseñadores de LEGO suelen llamar a esta pieza "válvula de bicicleta".

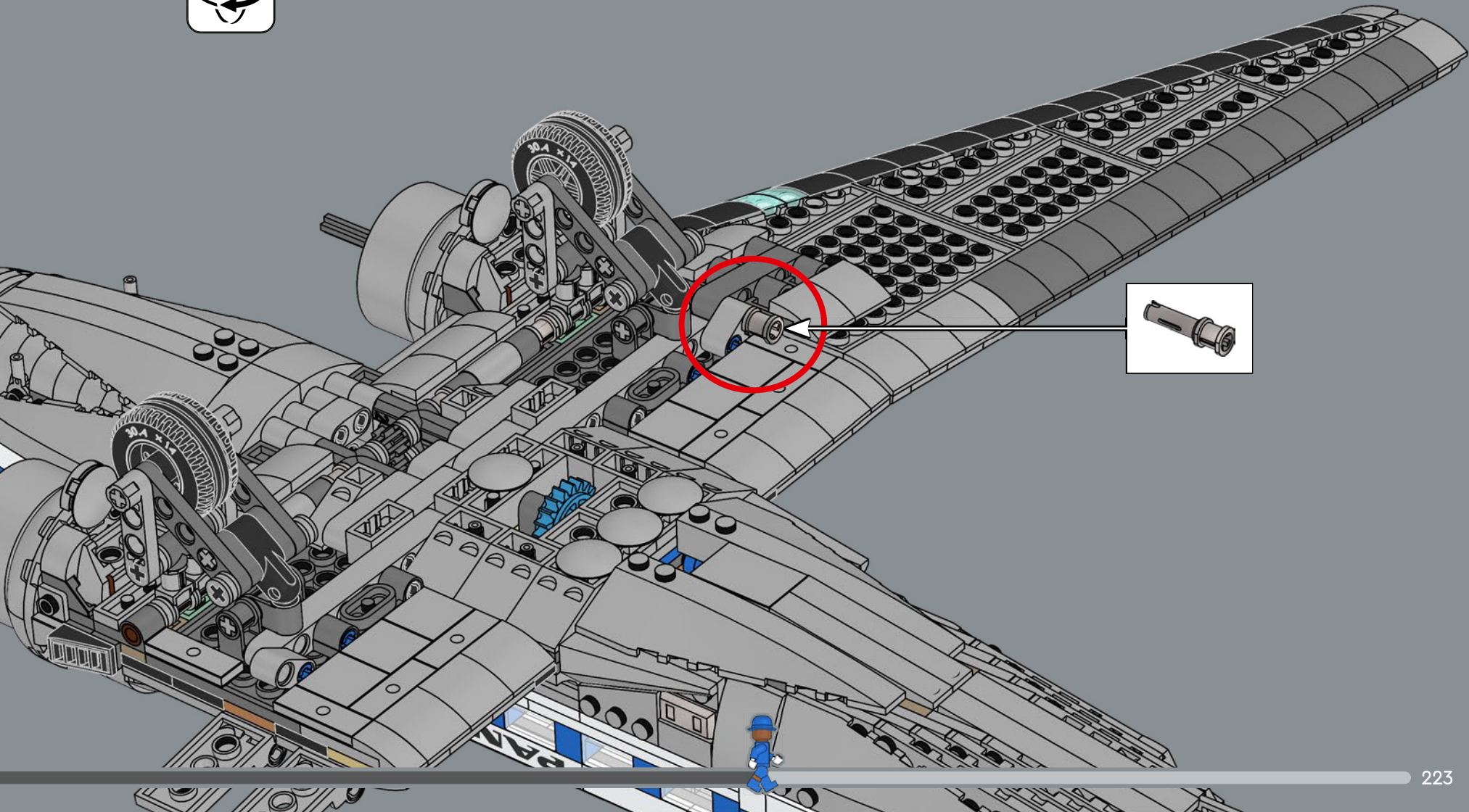

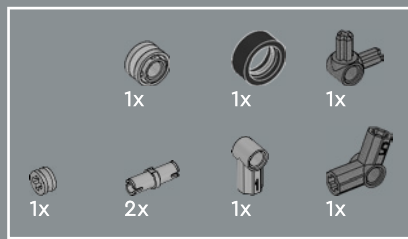

386



La época de los uniformes de diseñador empezó en 1958 con el lanzamiento del B-707. El diseñador de moda de Hollywood Don Loper creó los uniformes de las azafatas de Pan Am® para el inicio de la era del jet.

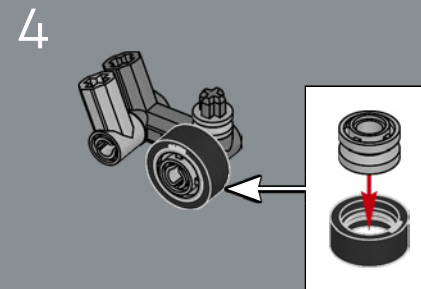
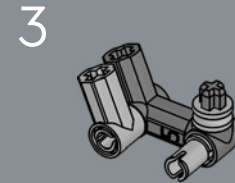
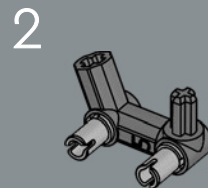
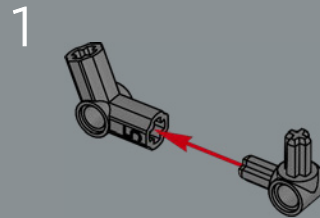
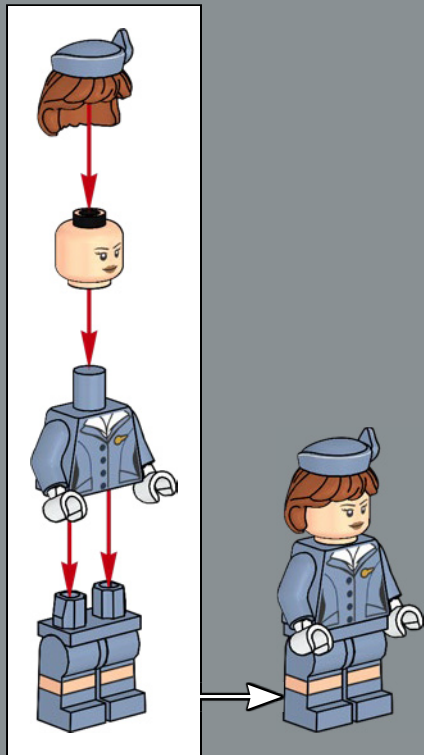



Los tripulantes de cabina, tanto masculinos como femeninos, podían ascender al puesto de auxiliar de vuelo (jefe) de la aeronave. A partir de la década de 1960, cada vez más mujeres desempeñaron esta función.

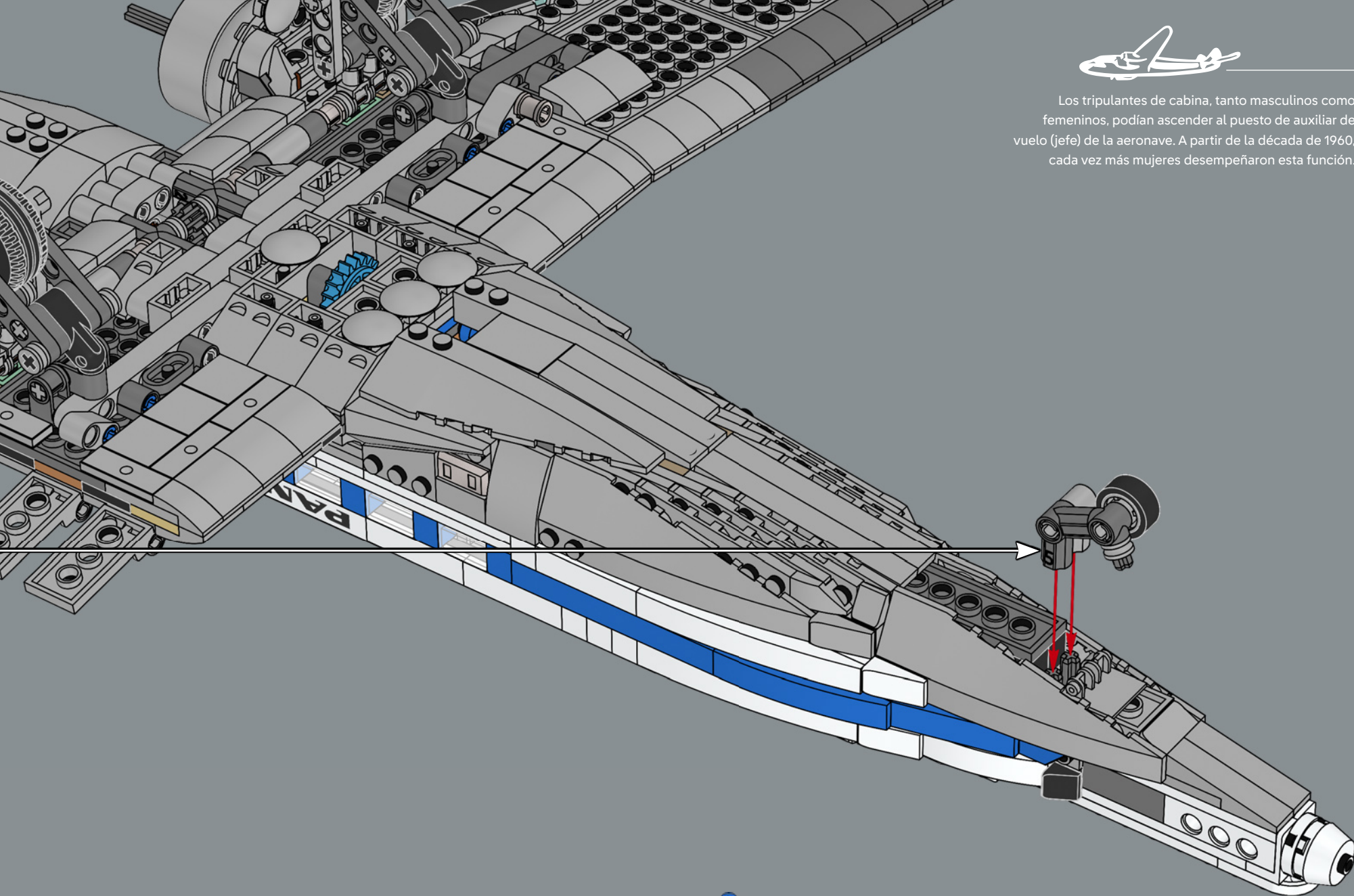

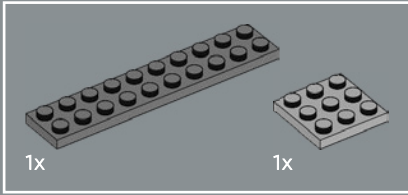
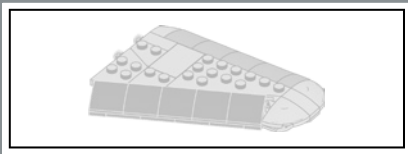

387

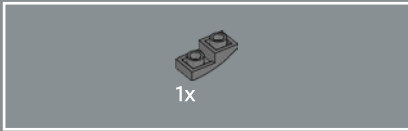
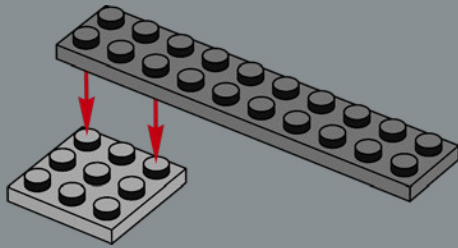

388

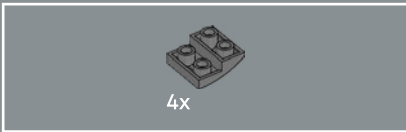
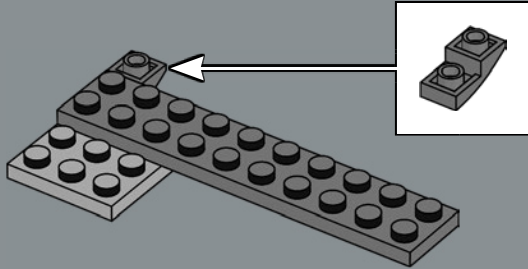

389

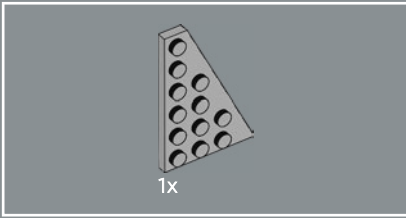
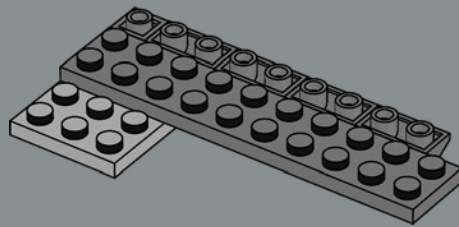

390

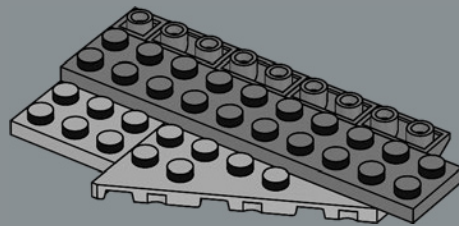

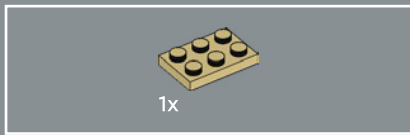

391

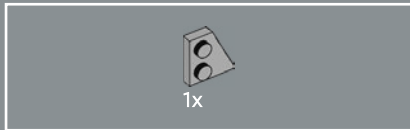
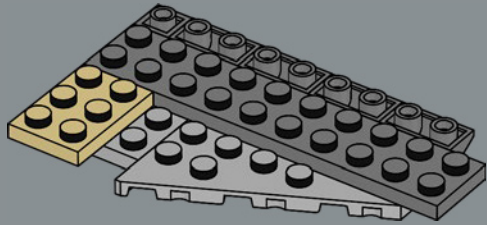

392

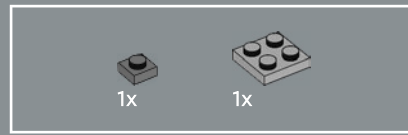
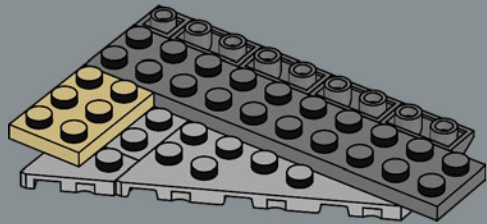

393

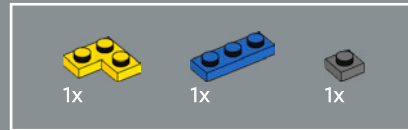
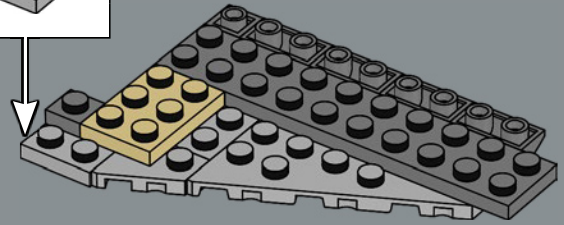
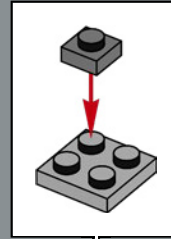

394

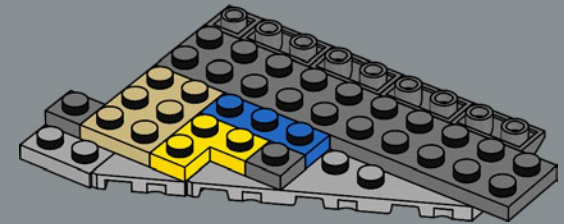



399

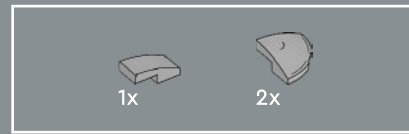
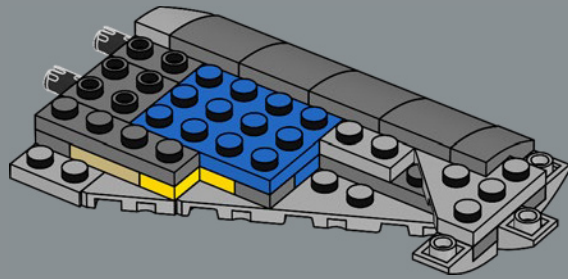

400

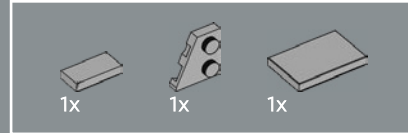
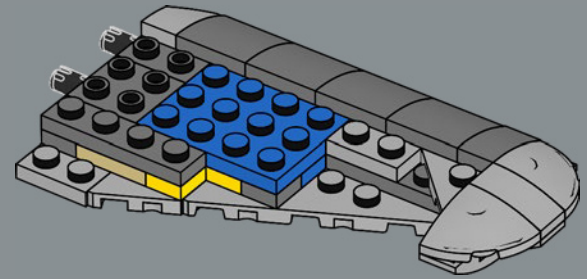

401

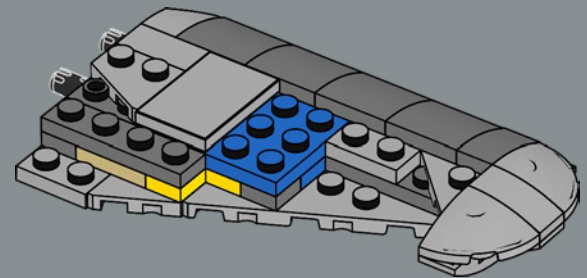

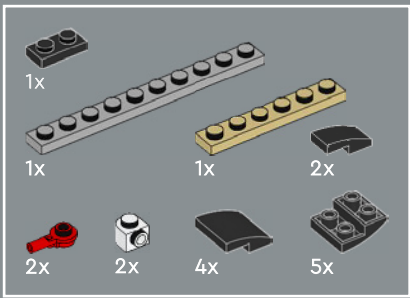

402

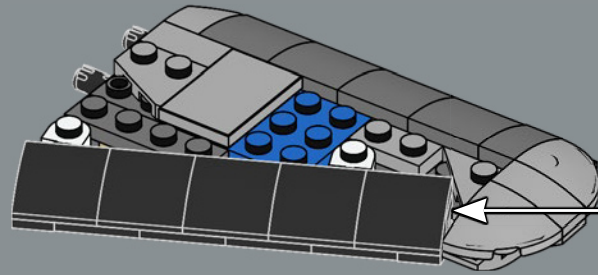
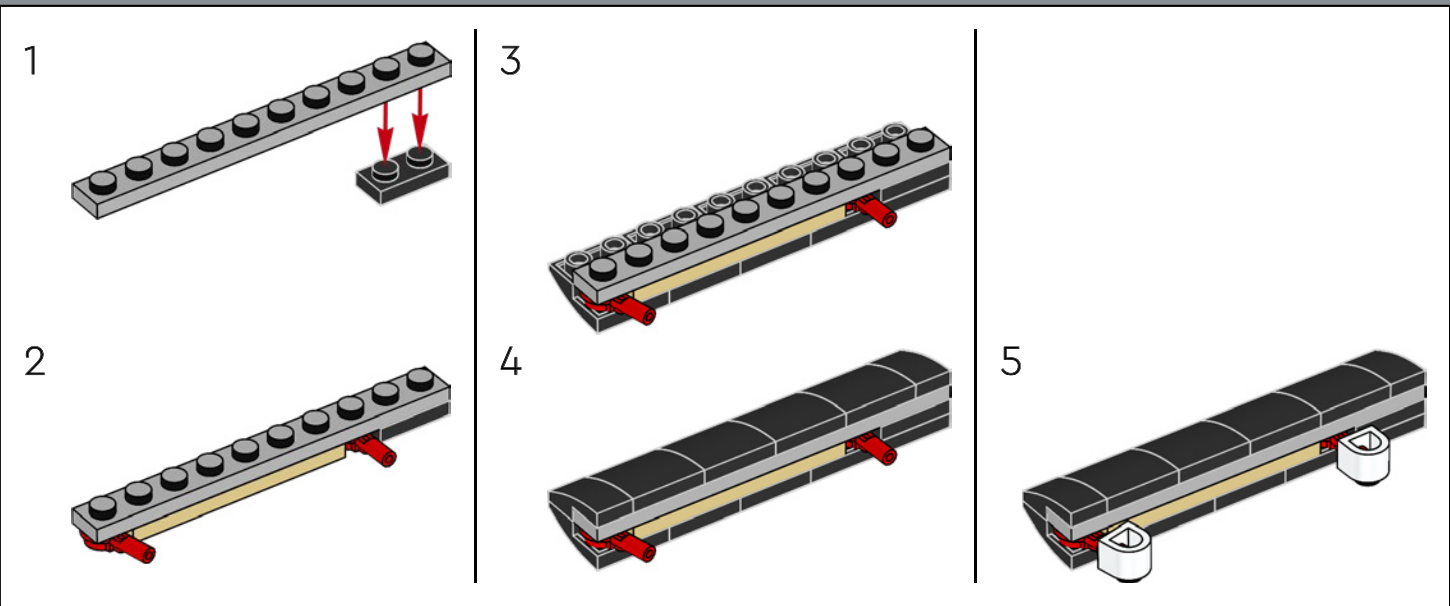

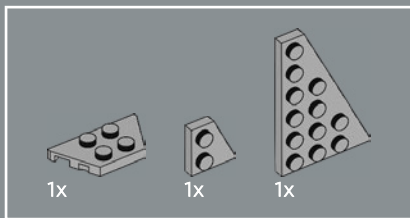

403

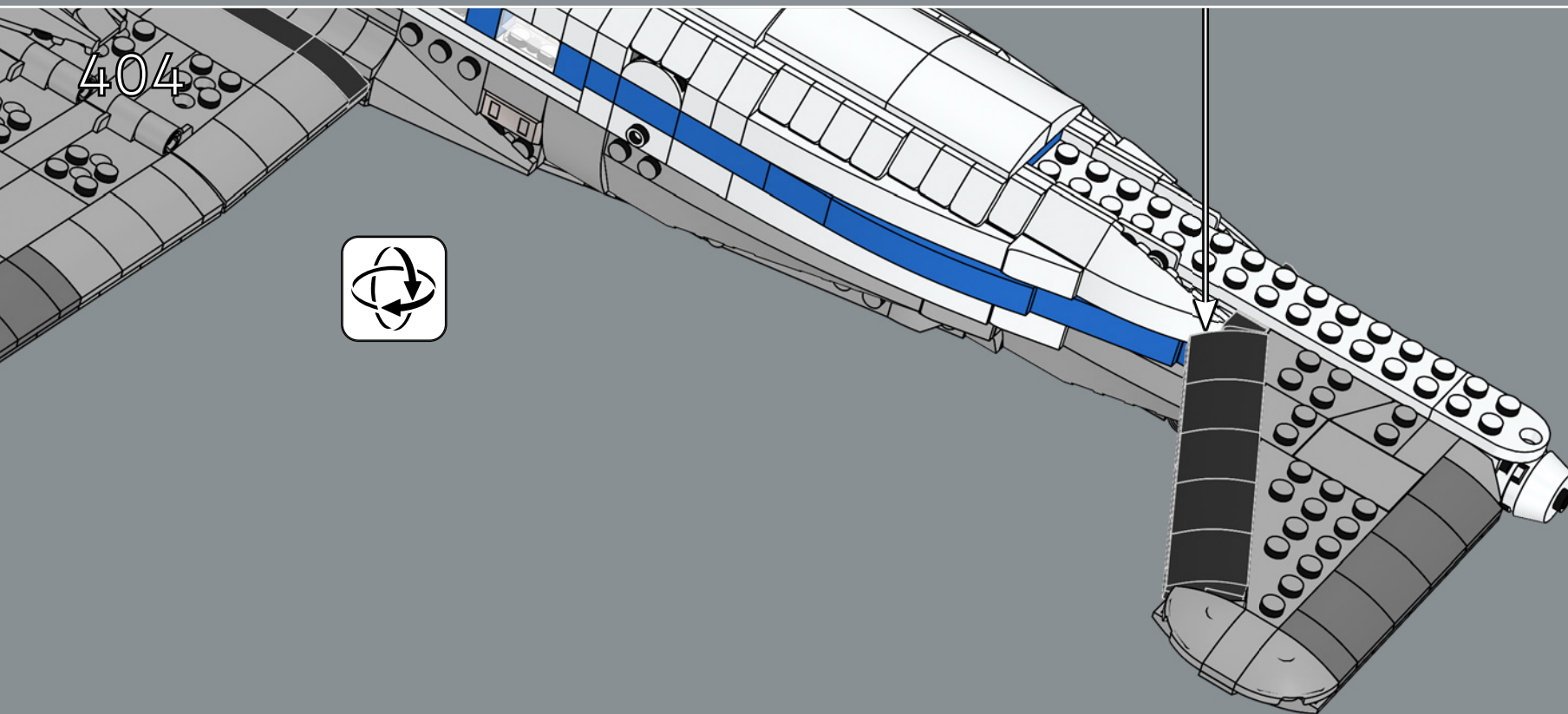
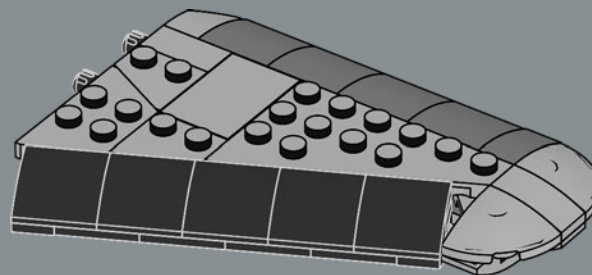

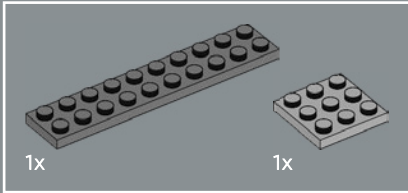
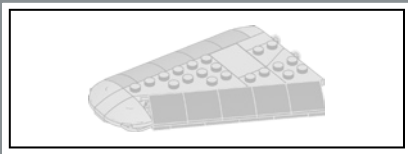

405

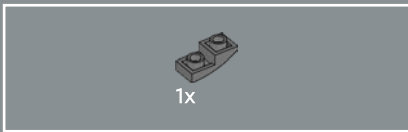
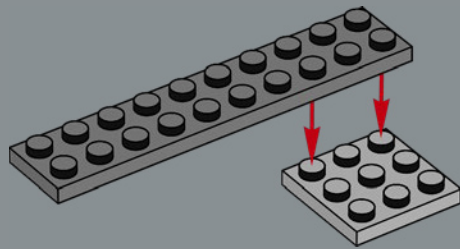

406

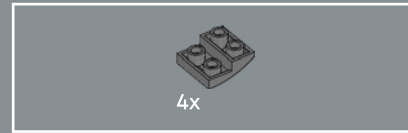
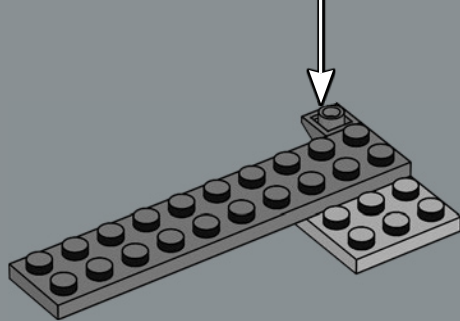
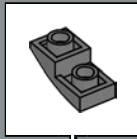

407

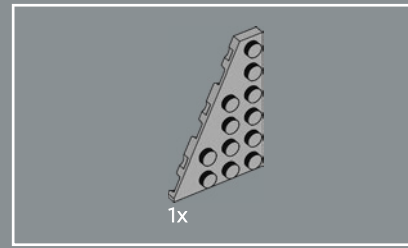
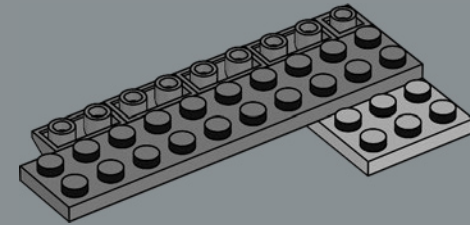

408

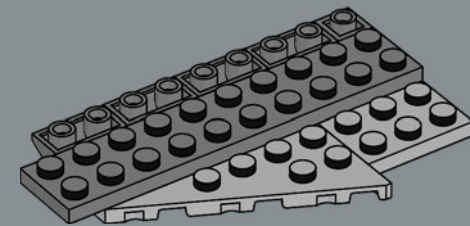

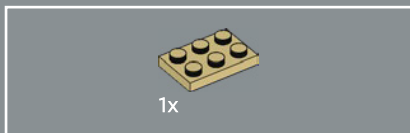

409

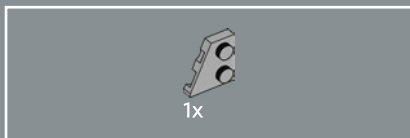
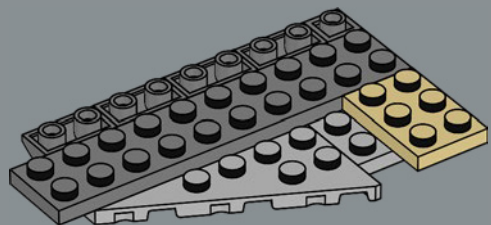

410

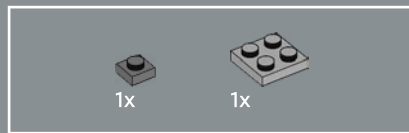
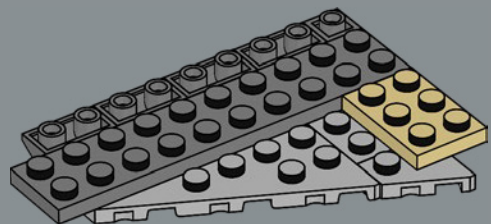

411

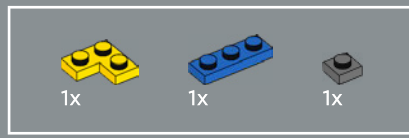
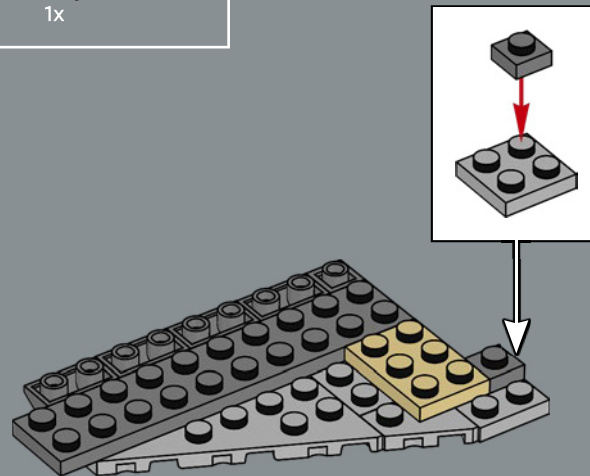

412

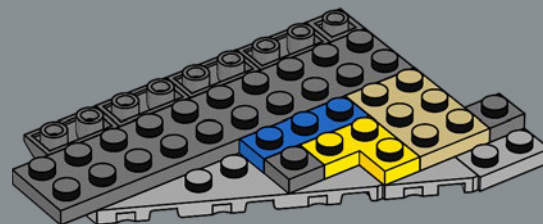



413

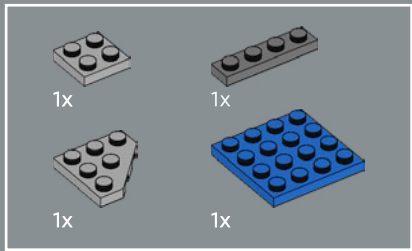
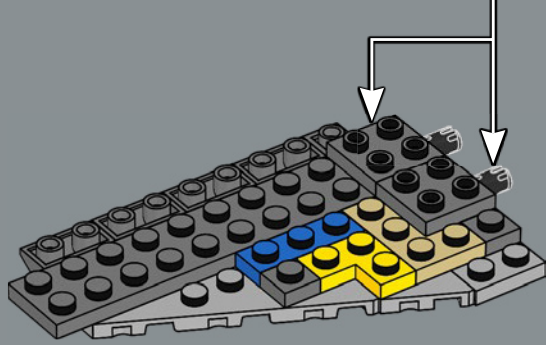
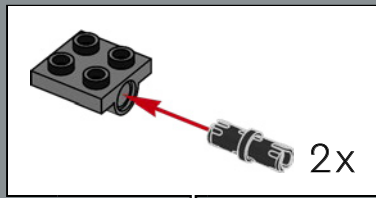

414

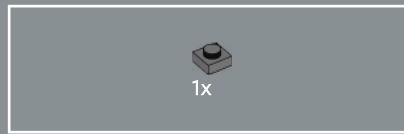
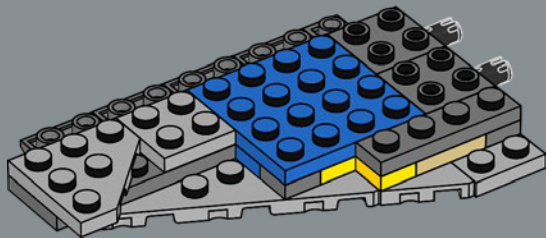

415

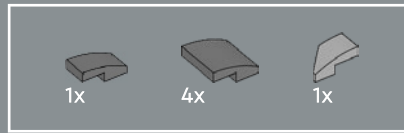
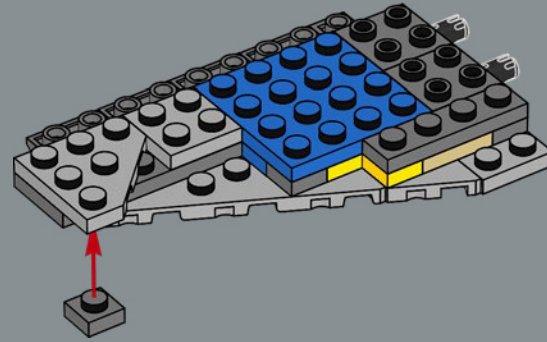

416

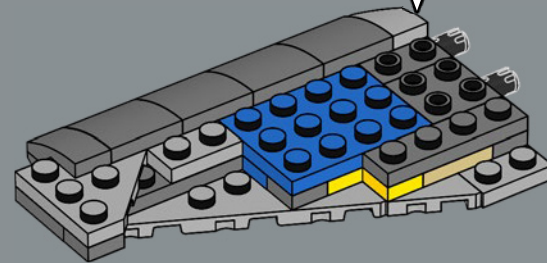
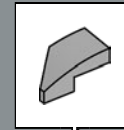

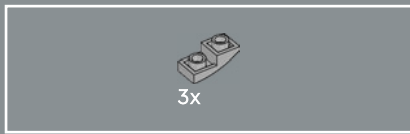

417

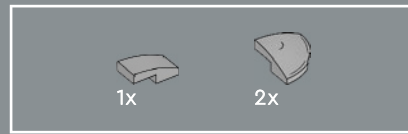
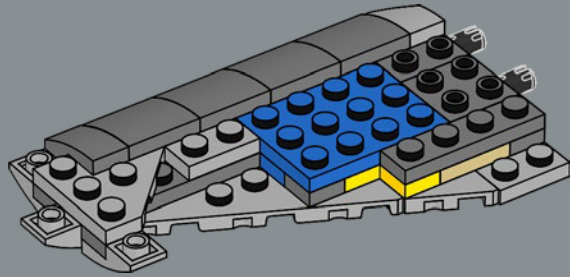

418

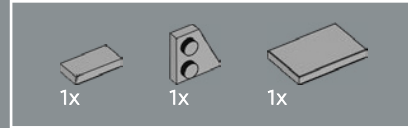
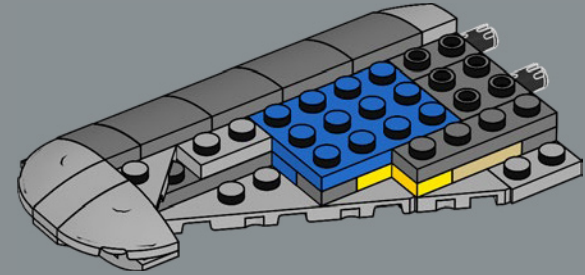

419

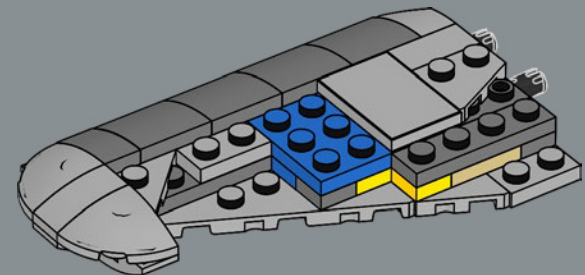

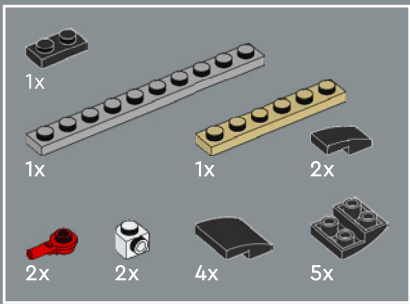

420

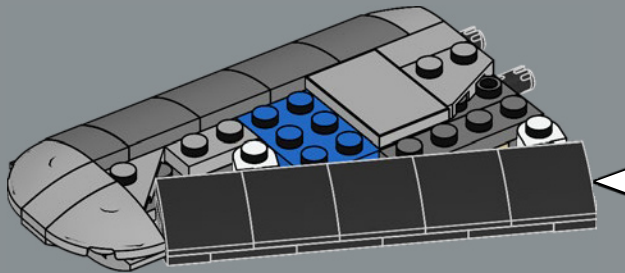
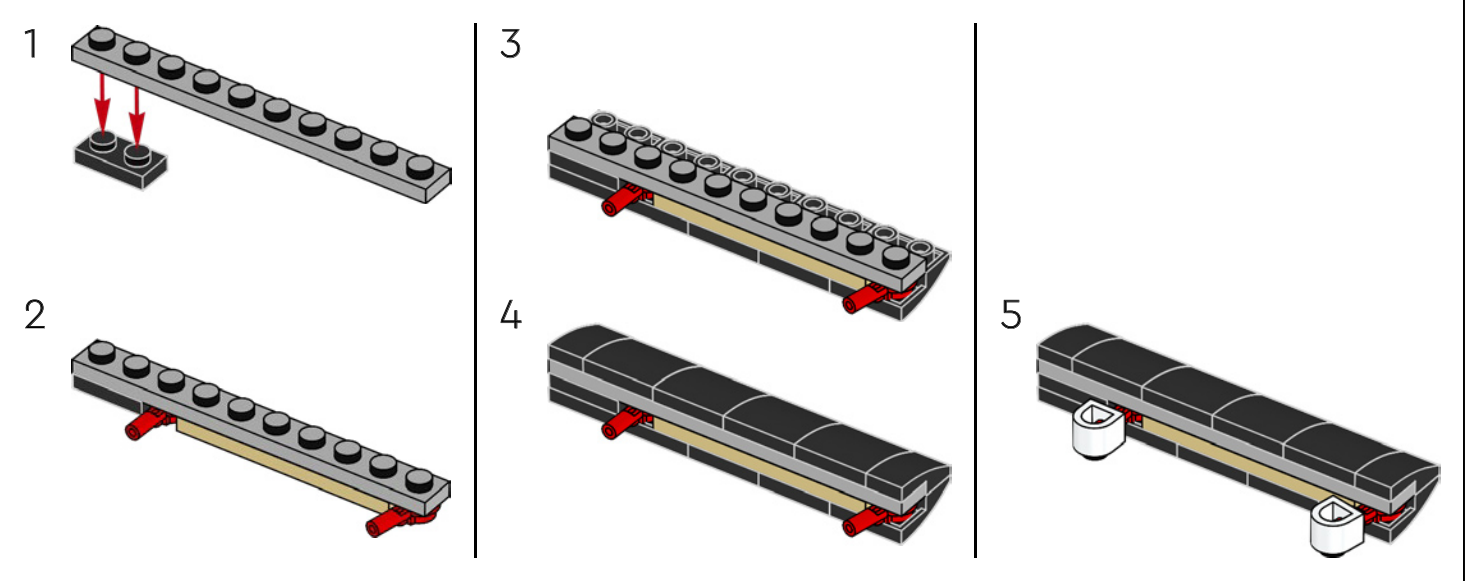

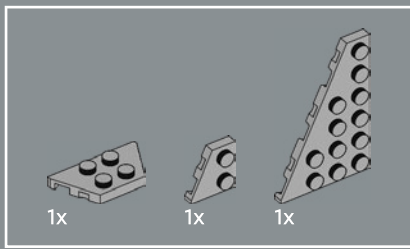

421

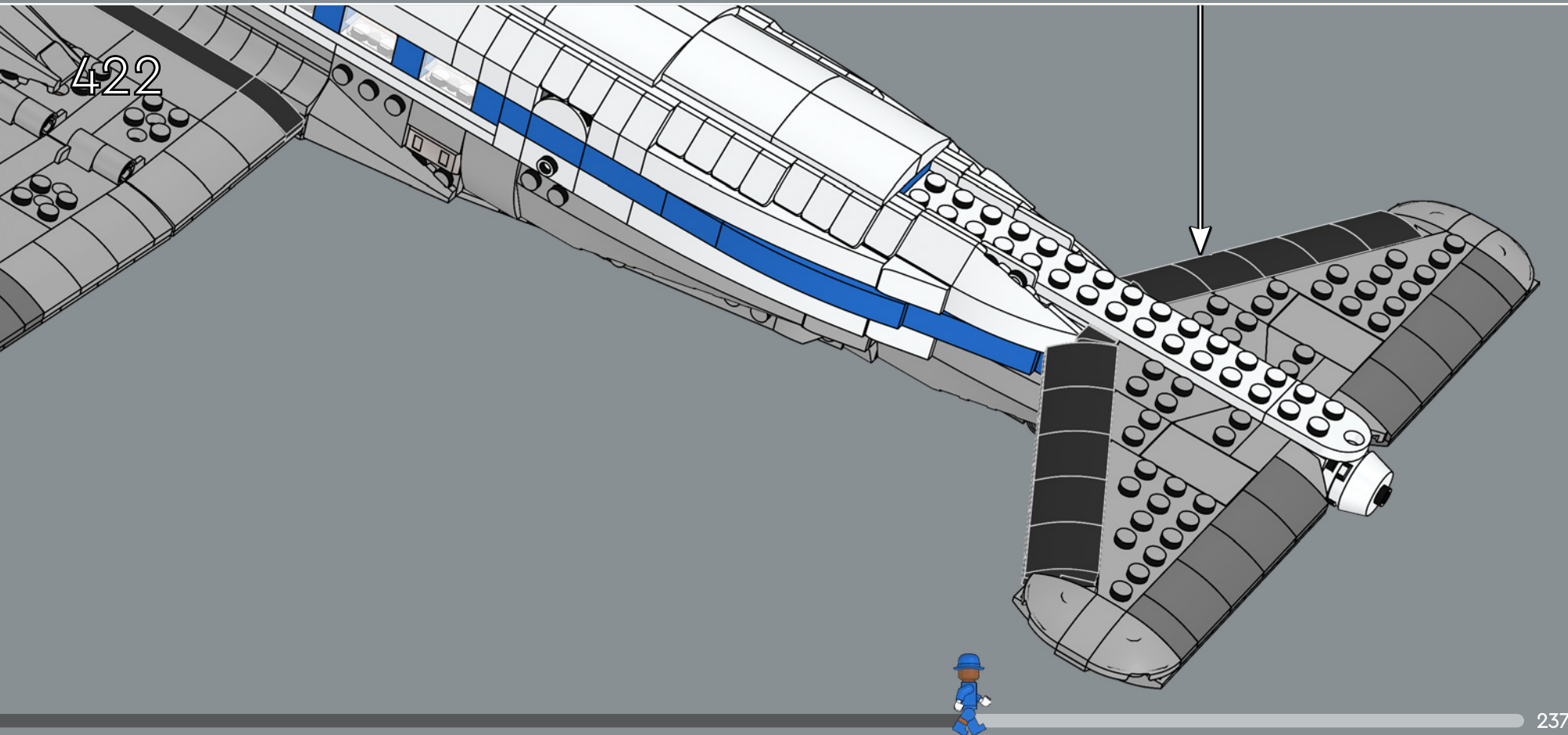
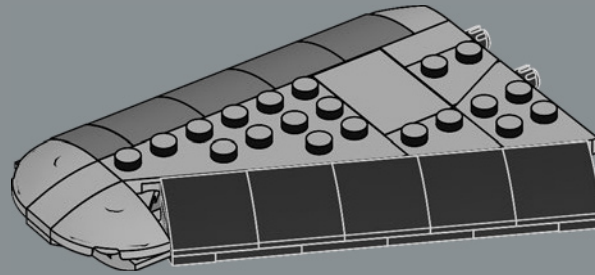

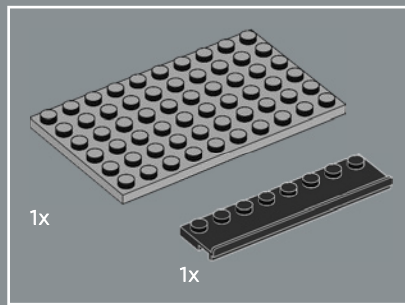
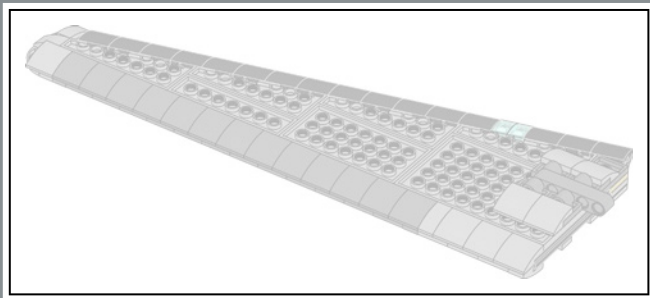

423

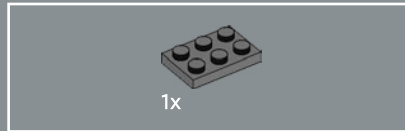
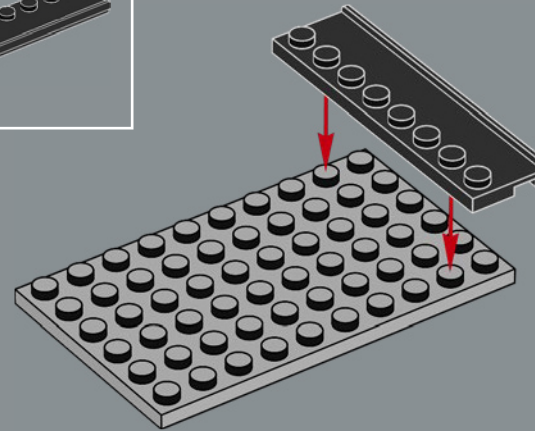

424

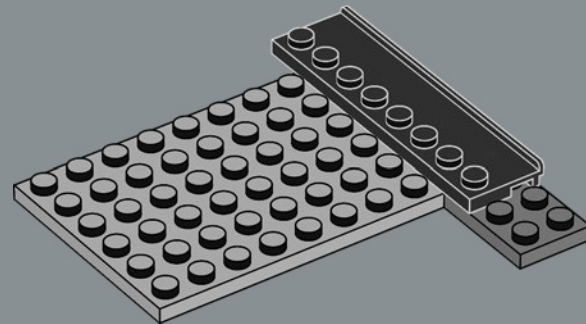



425

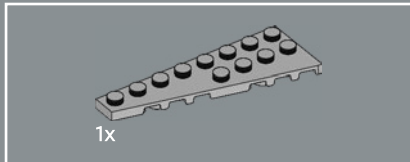
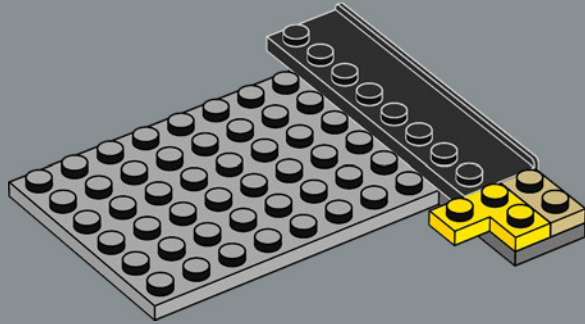

426

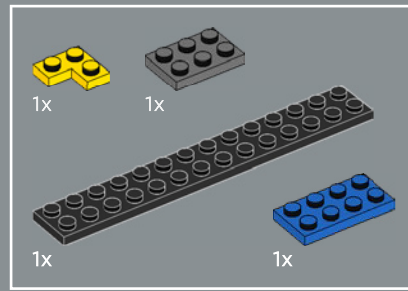
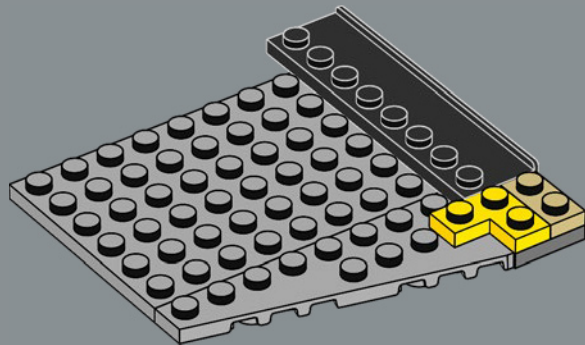

427

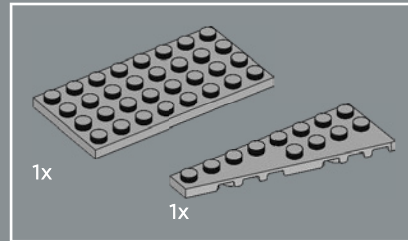
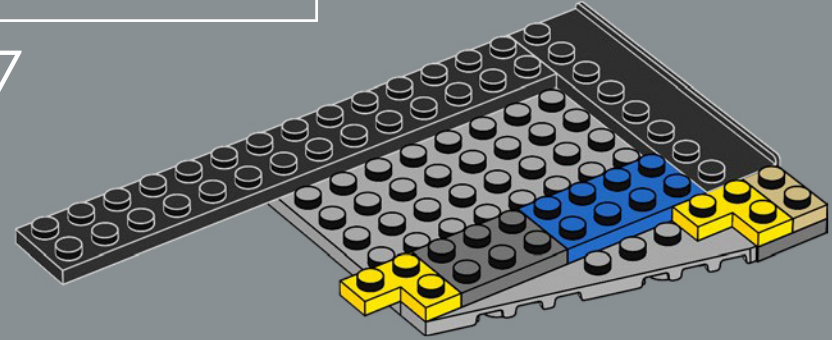

428

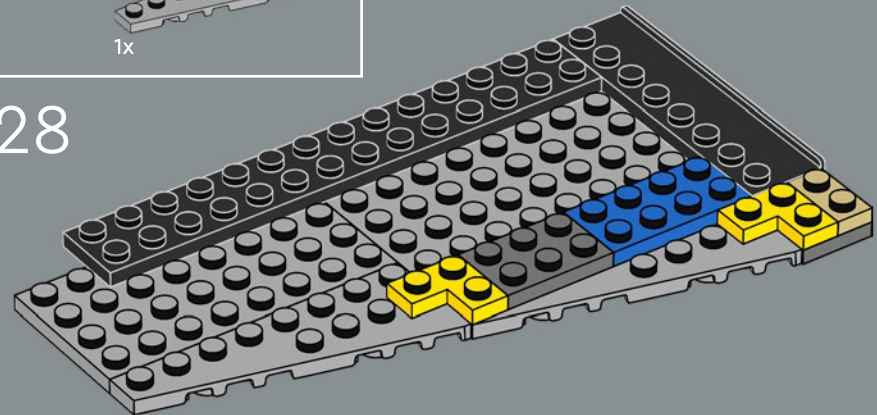

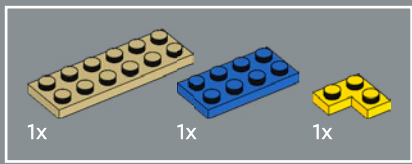

429

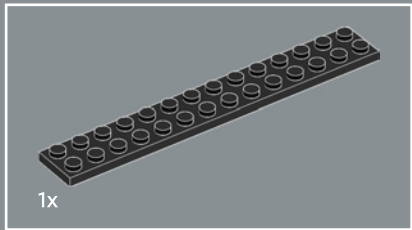
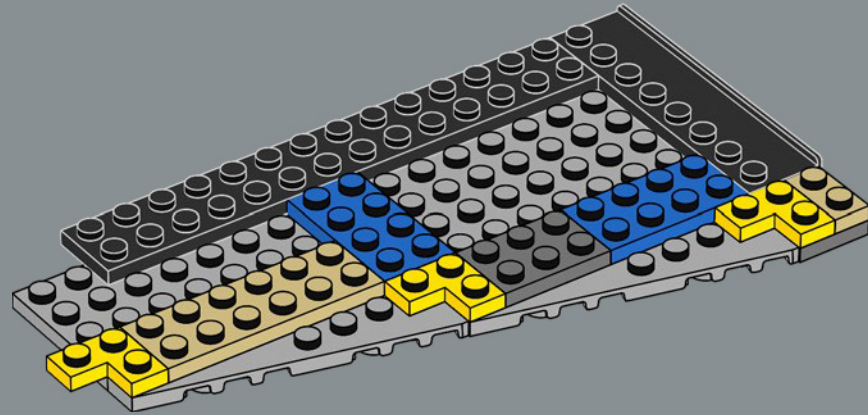

430

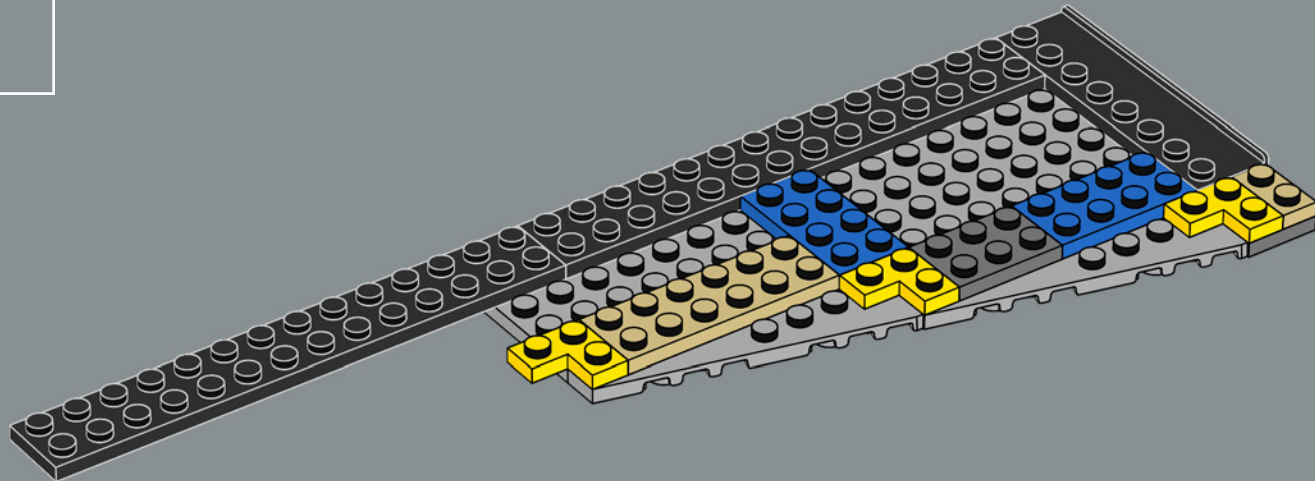

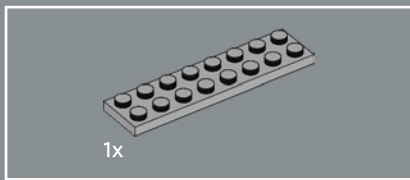

431

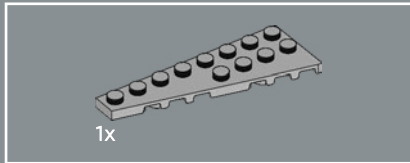
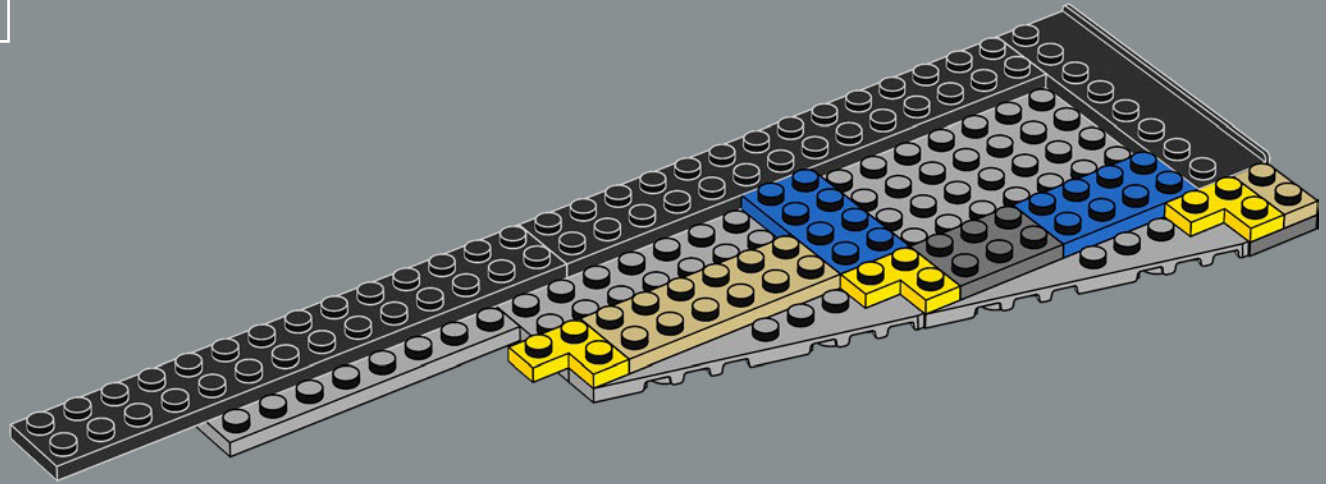

432

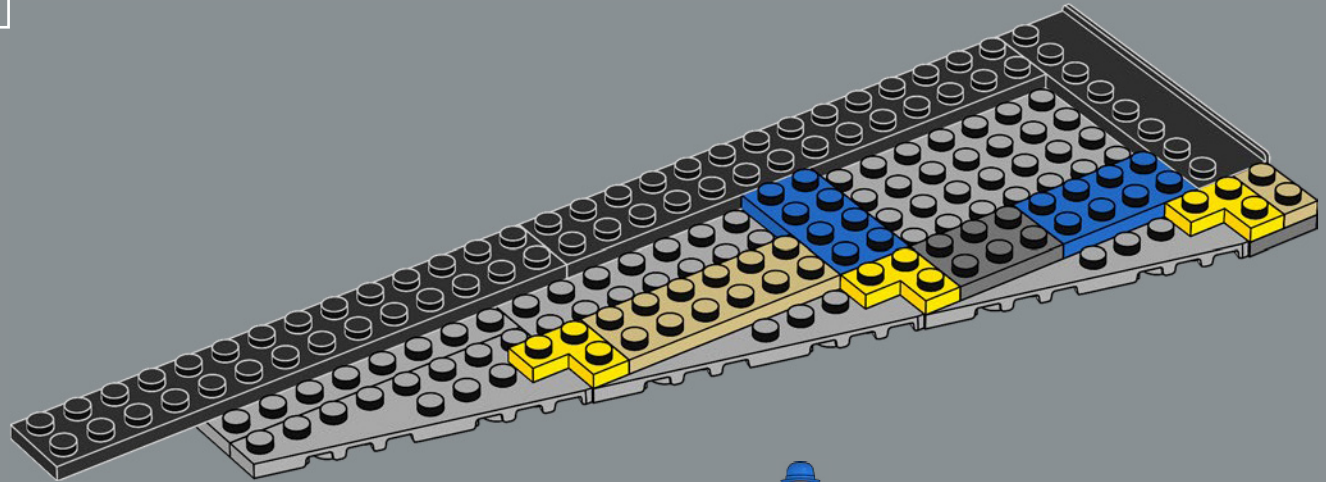

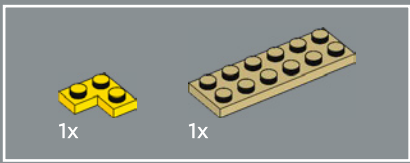

433

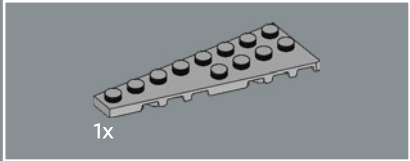
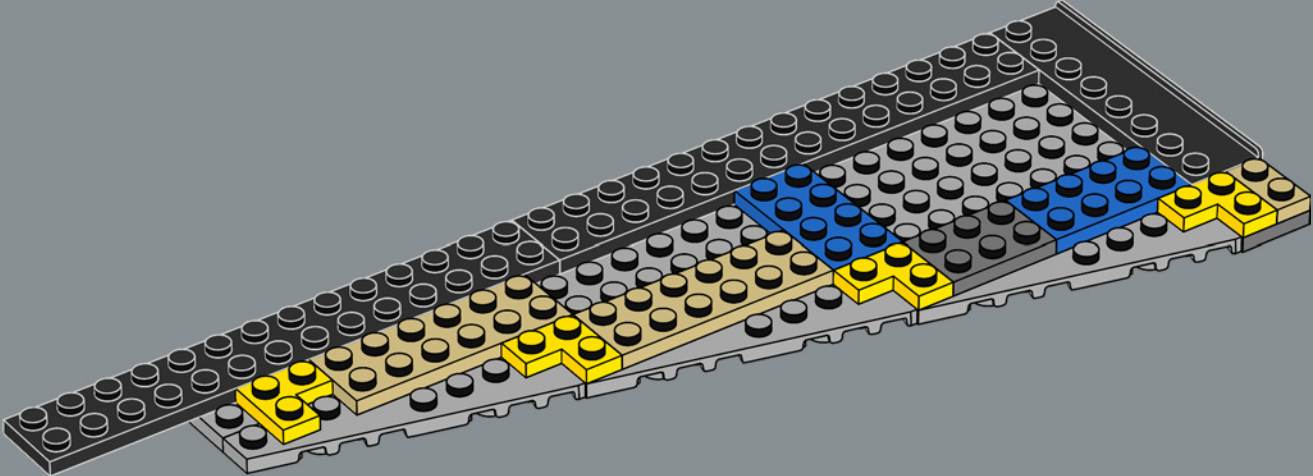

434

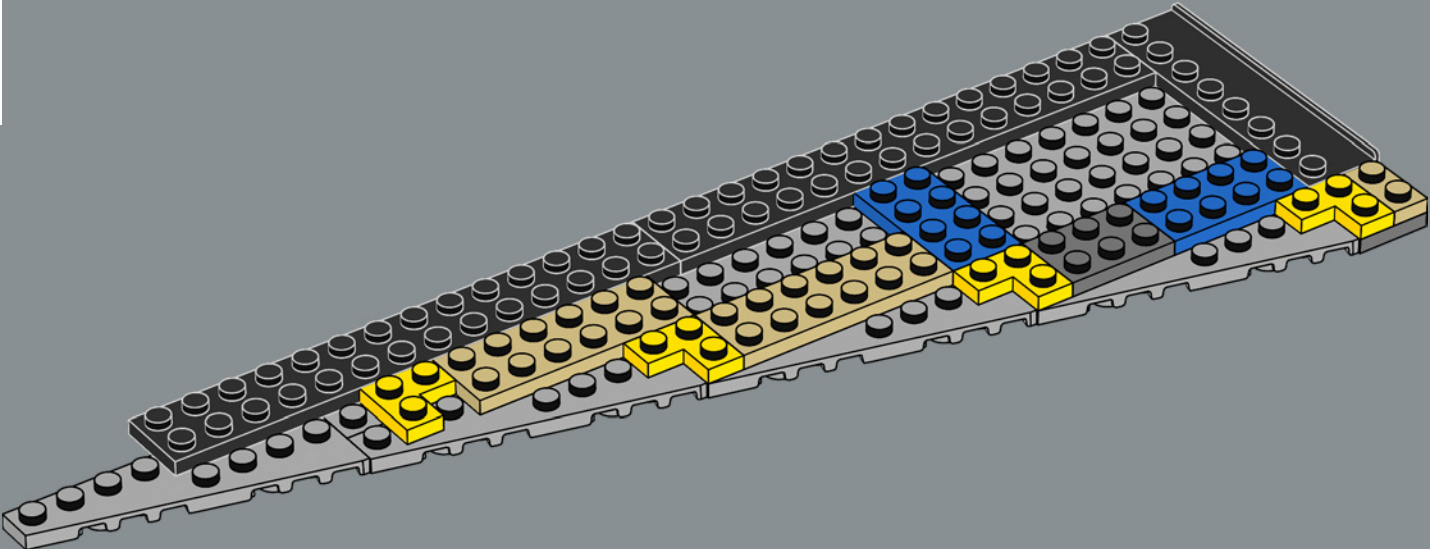

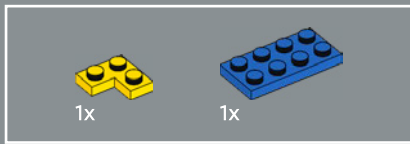

435

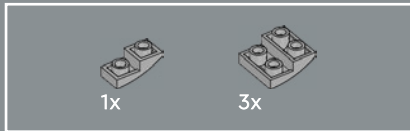
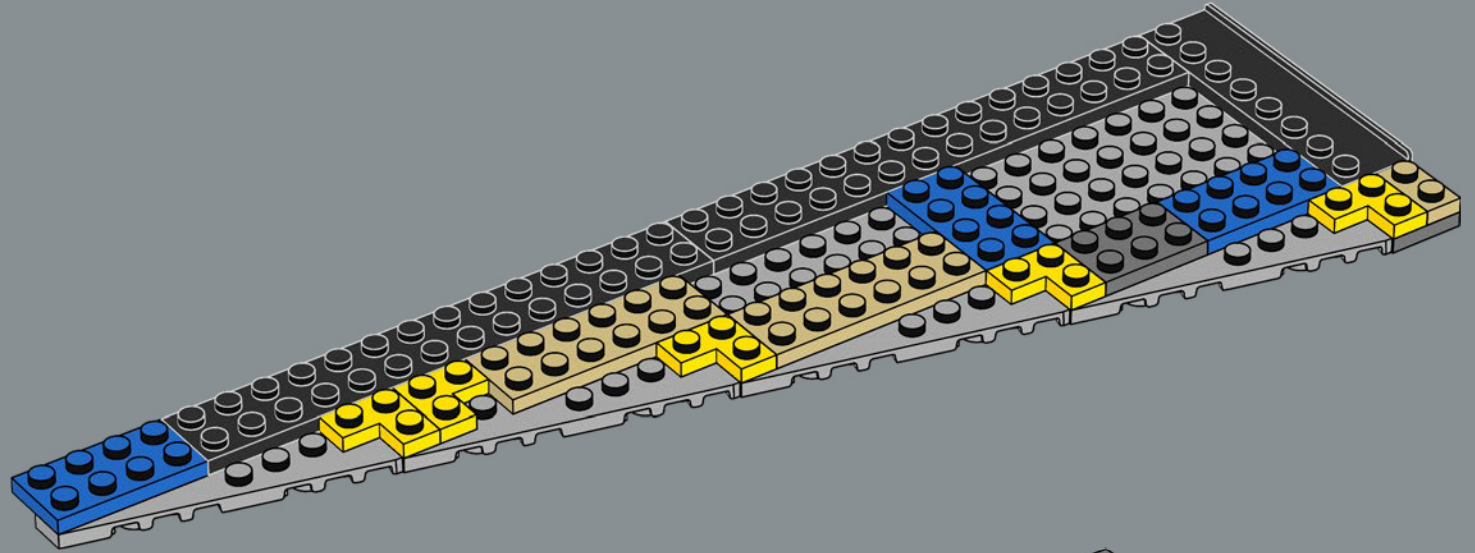

436

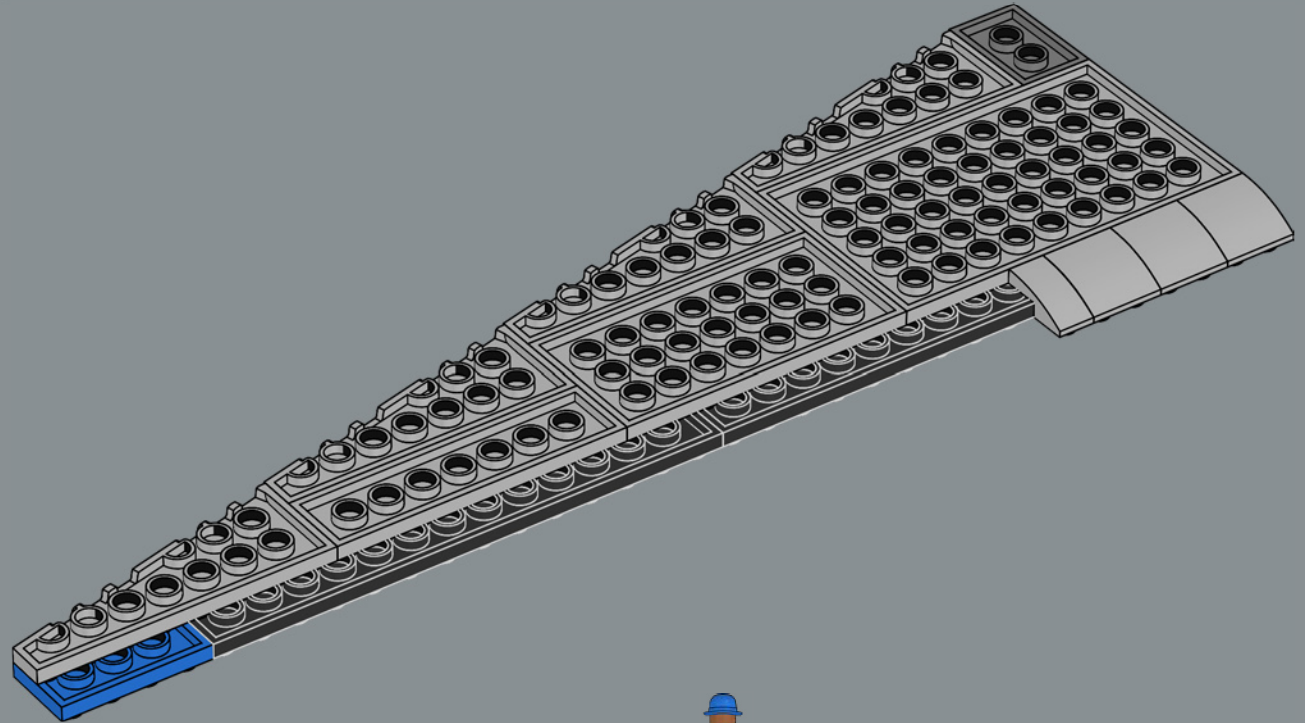

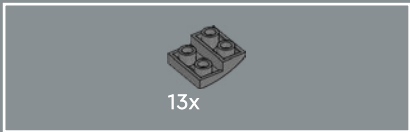

437

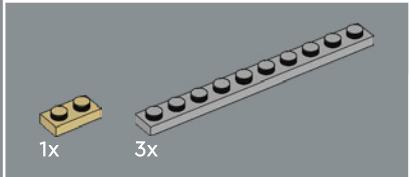
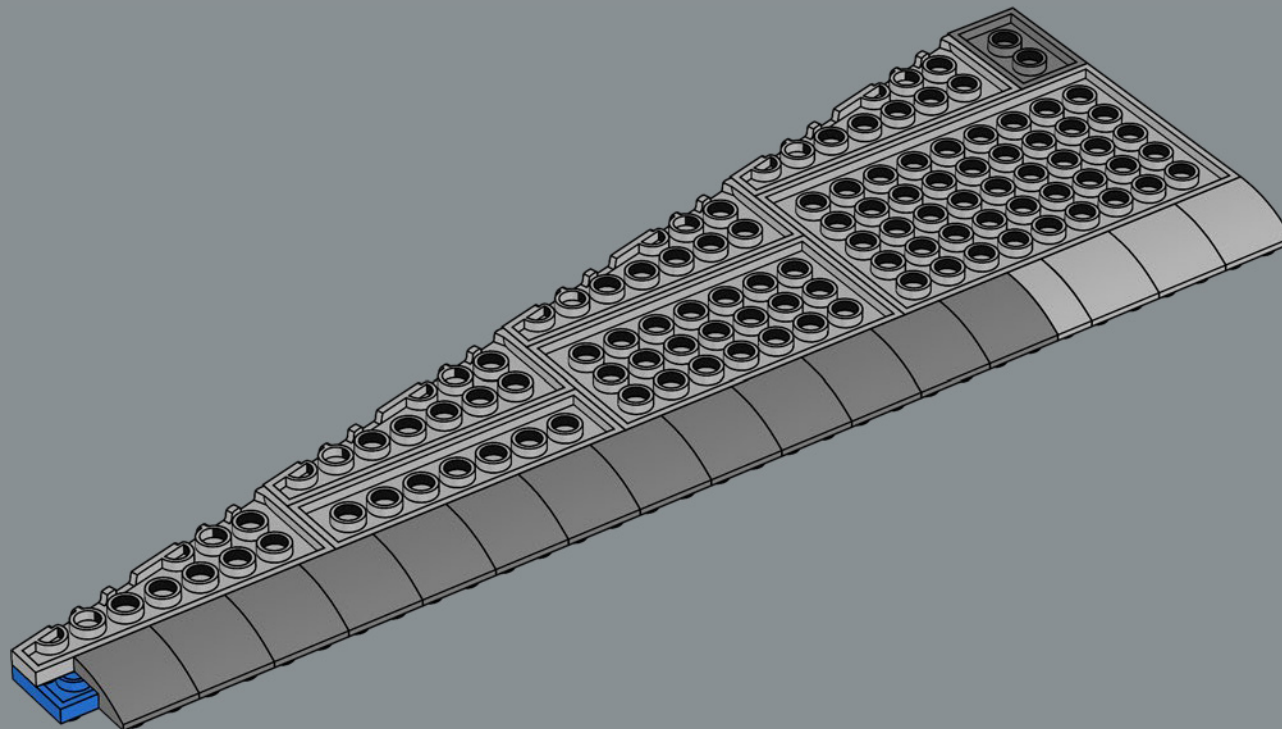

438

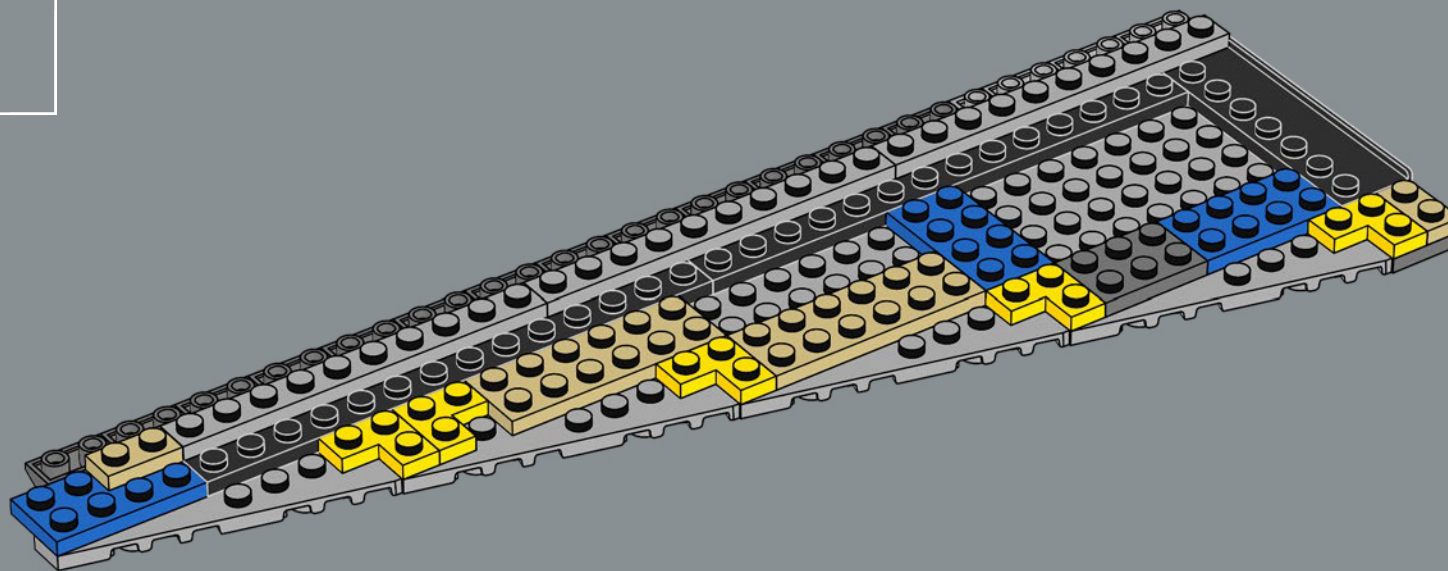

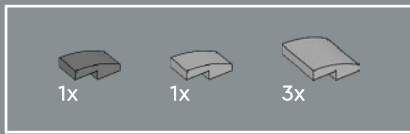

439

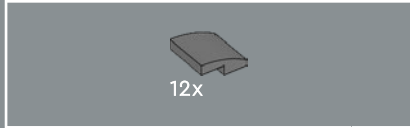
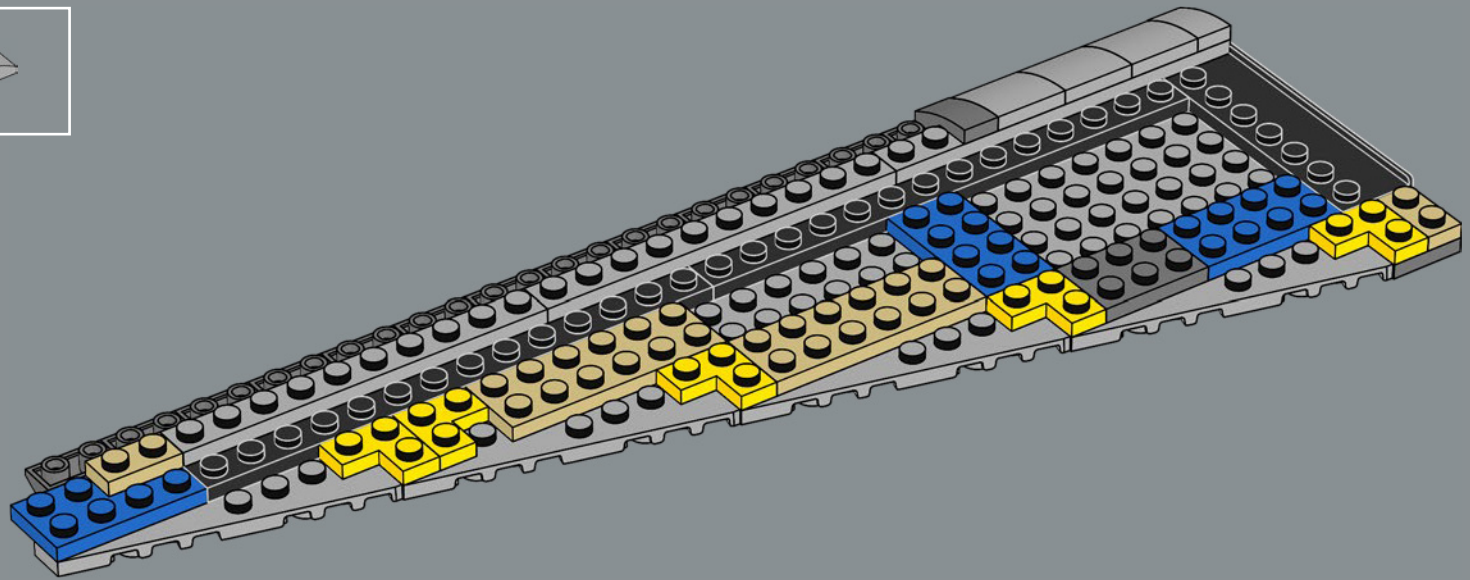

440

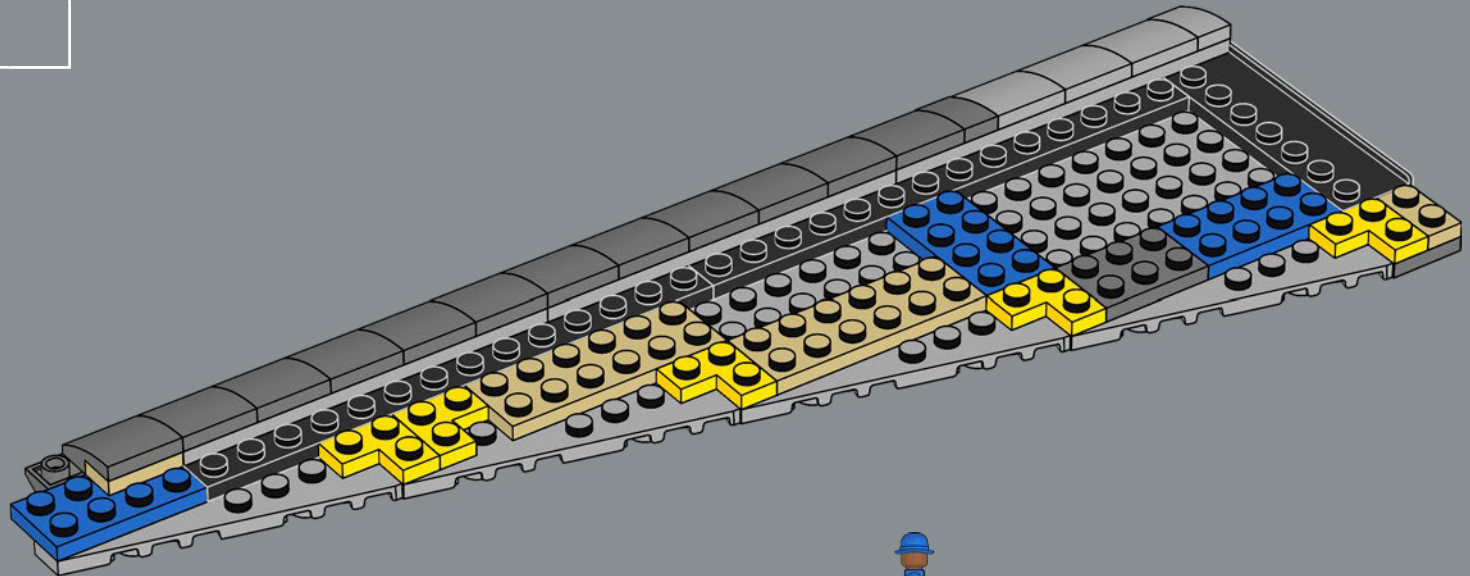

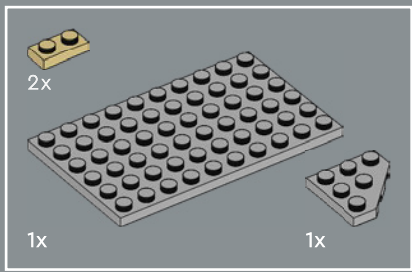

441

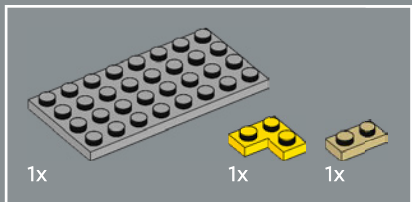
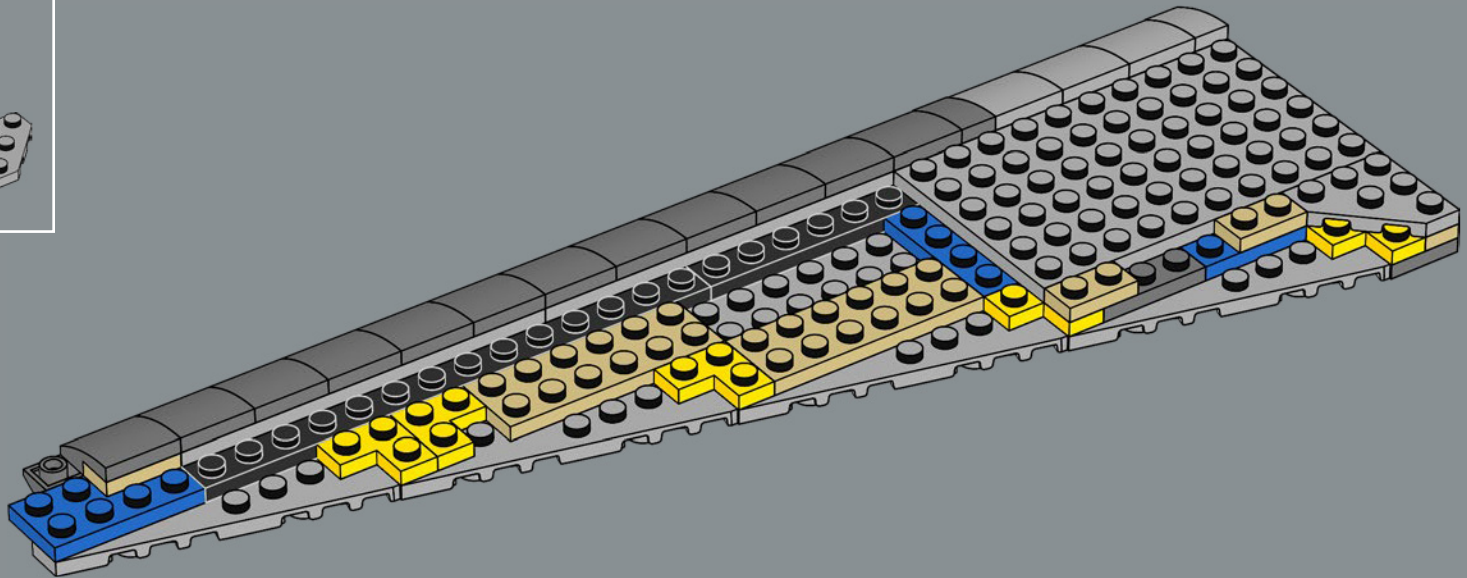

442

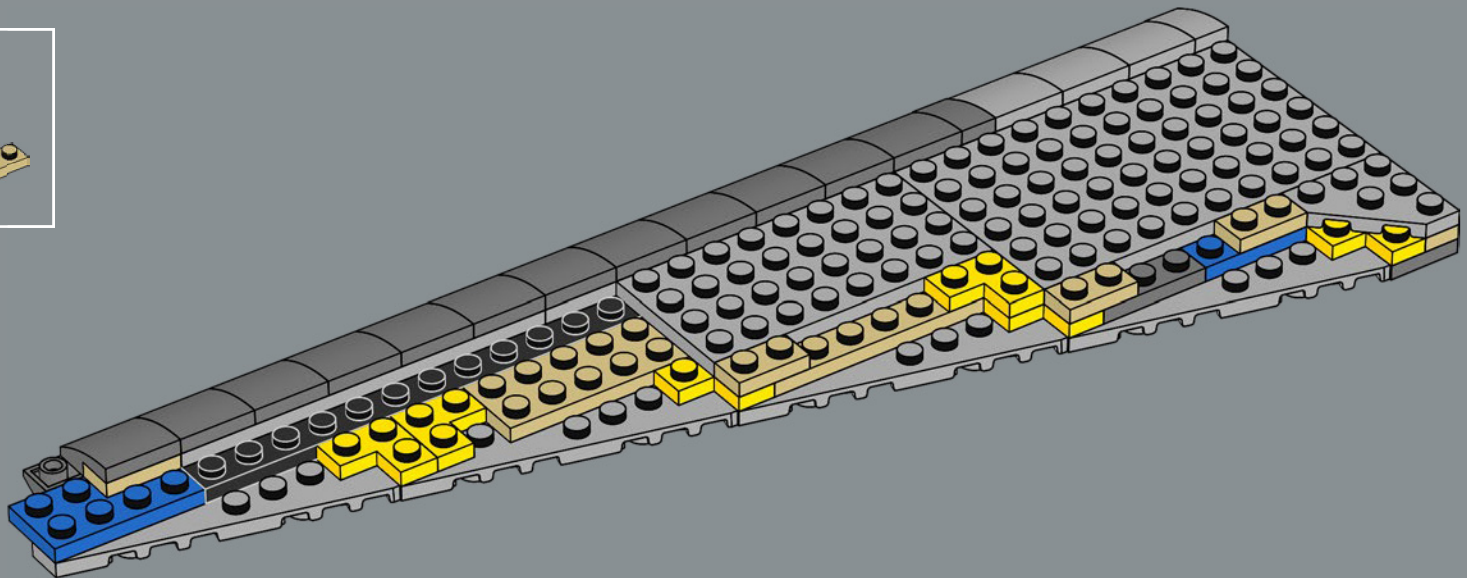

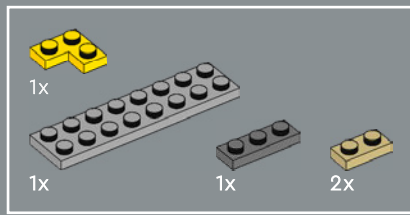

443

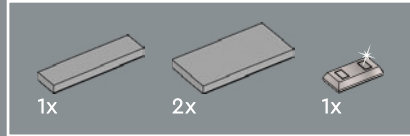
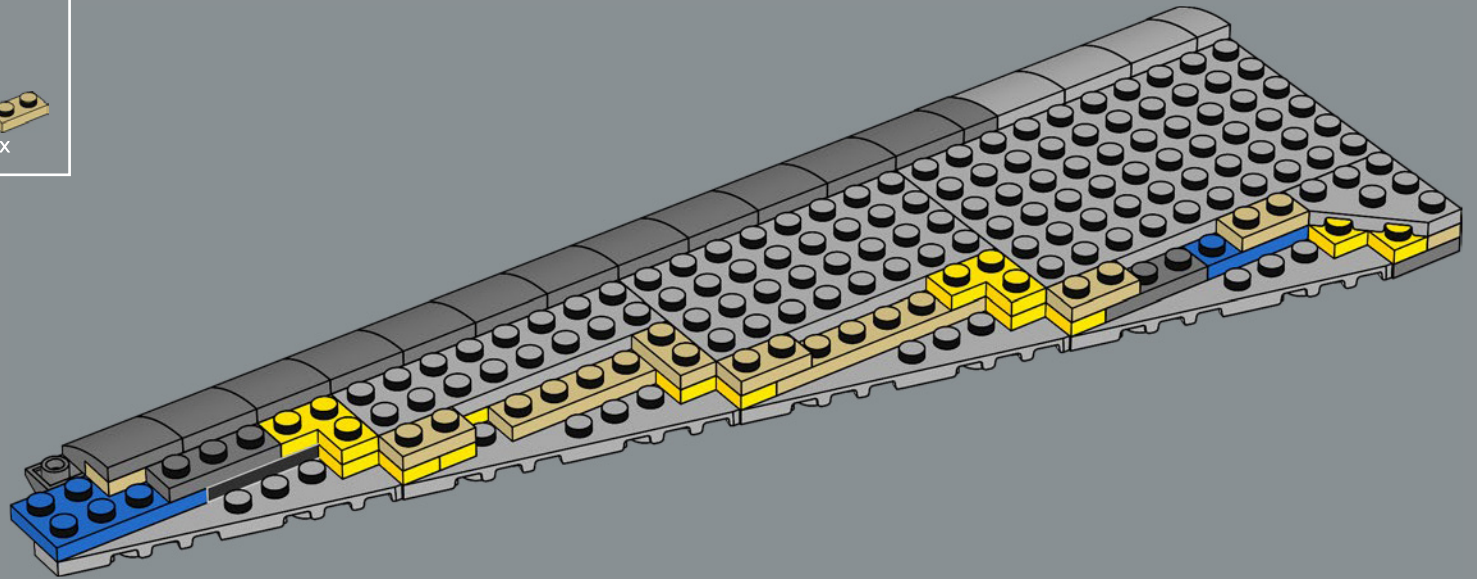

444

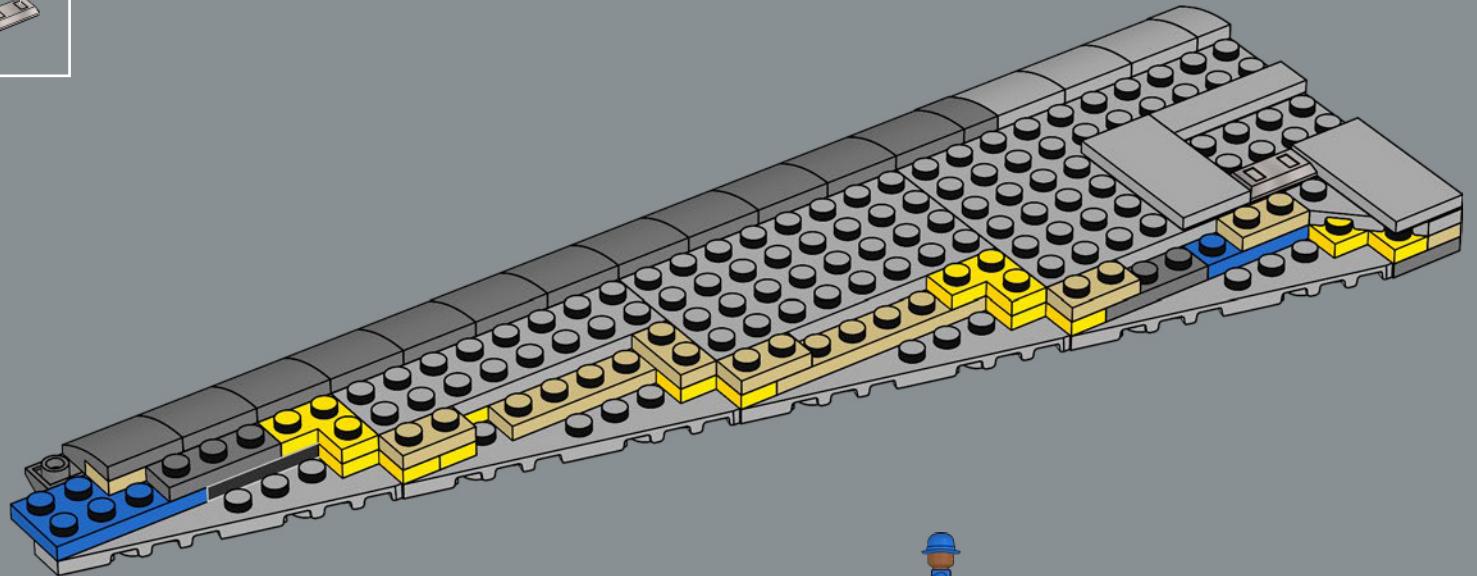

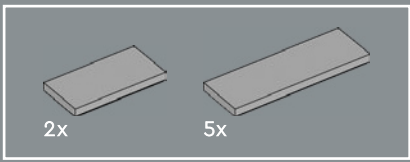

445

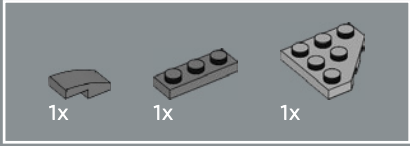
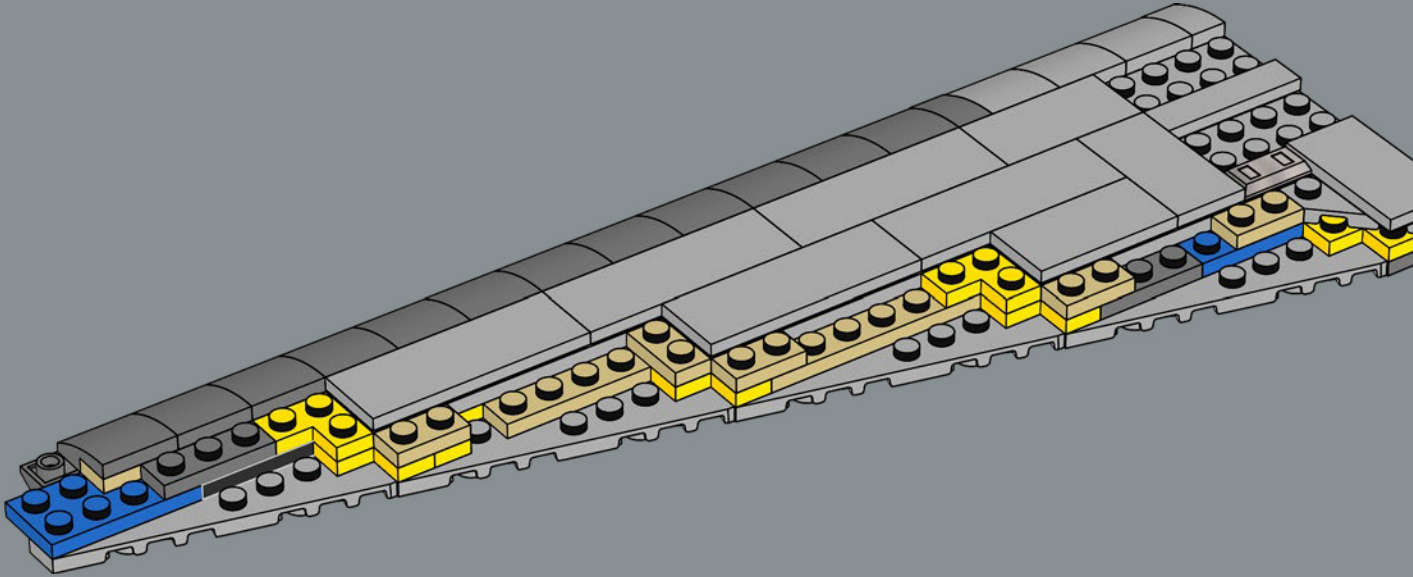

446

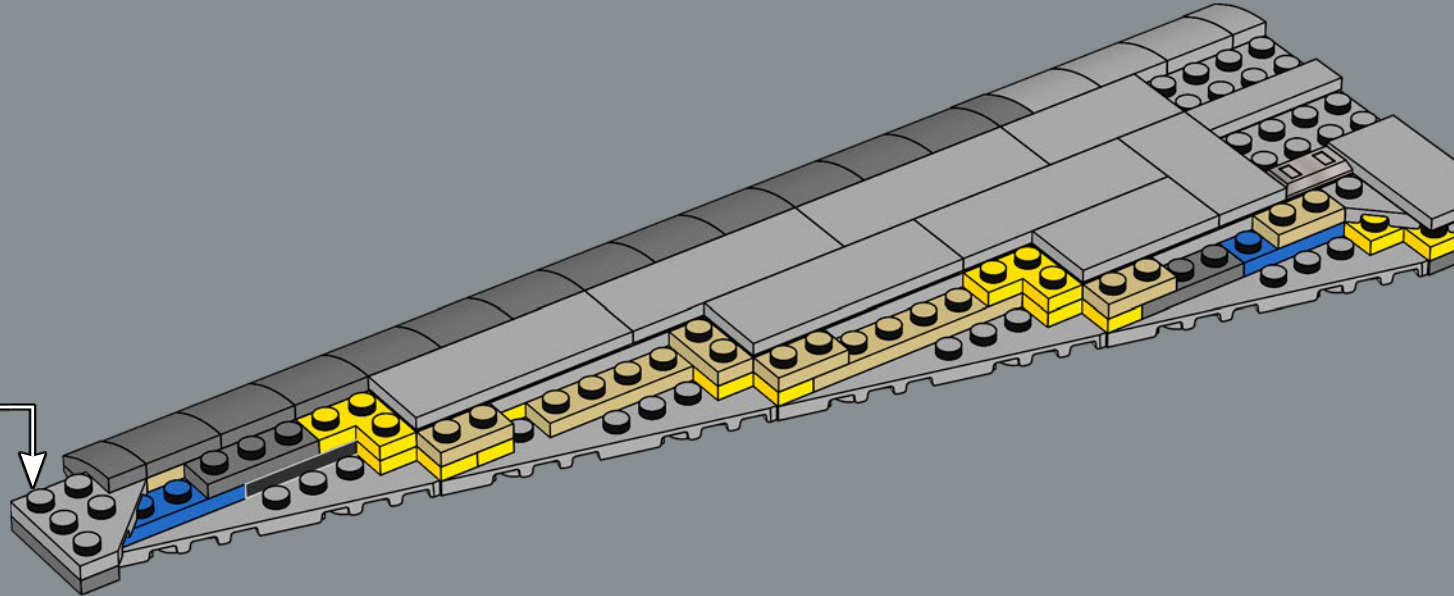
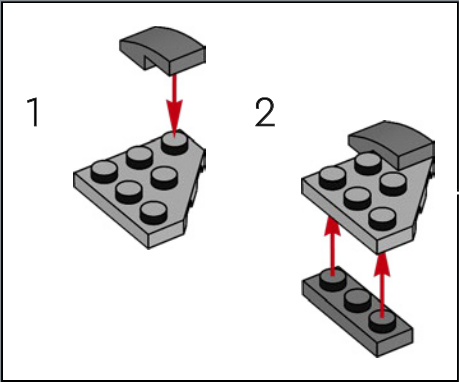

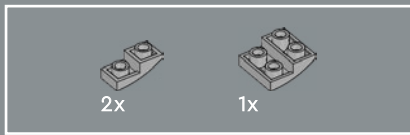

447

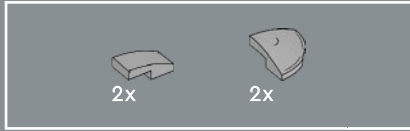
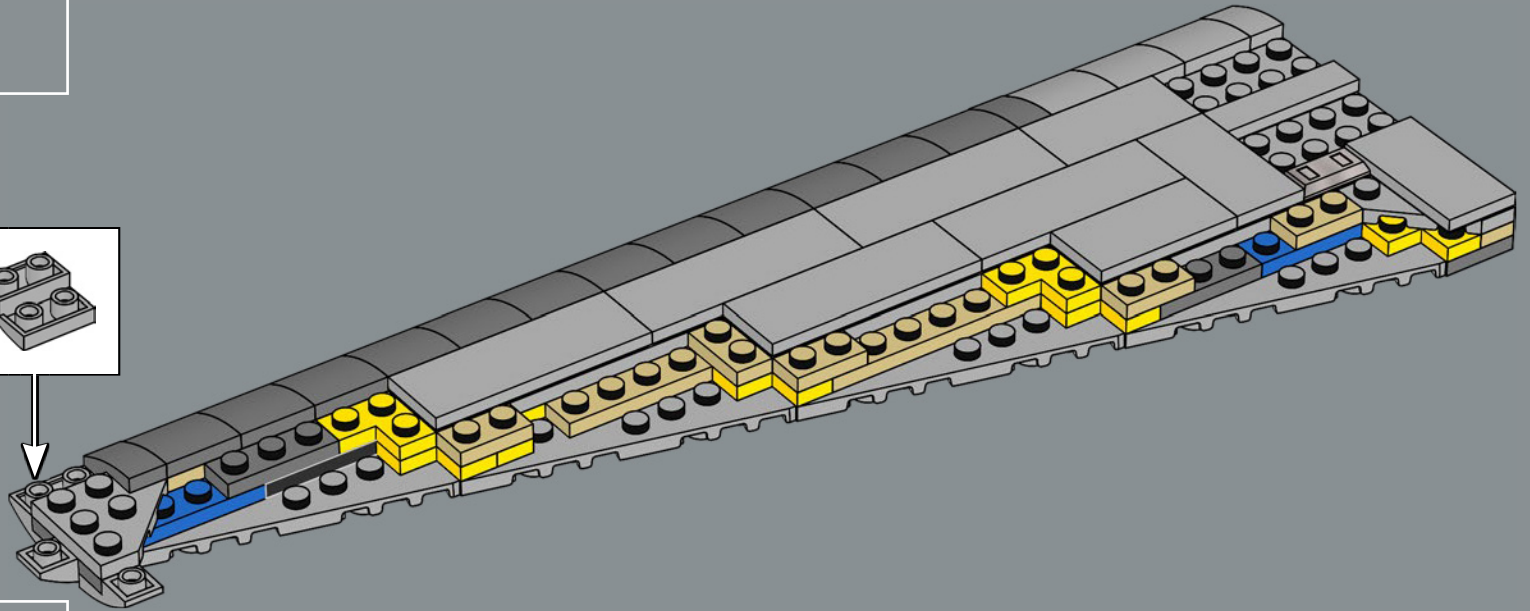
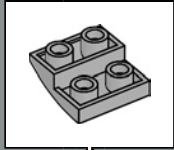

448

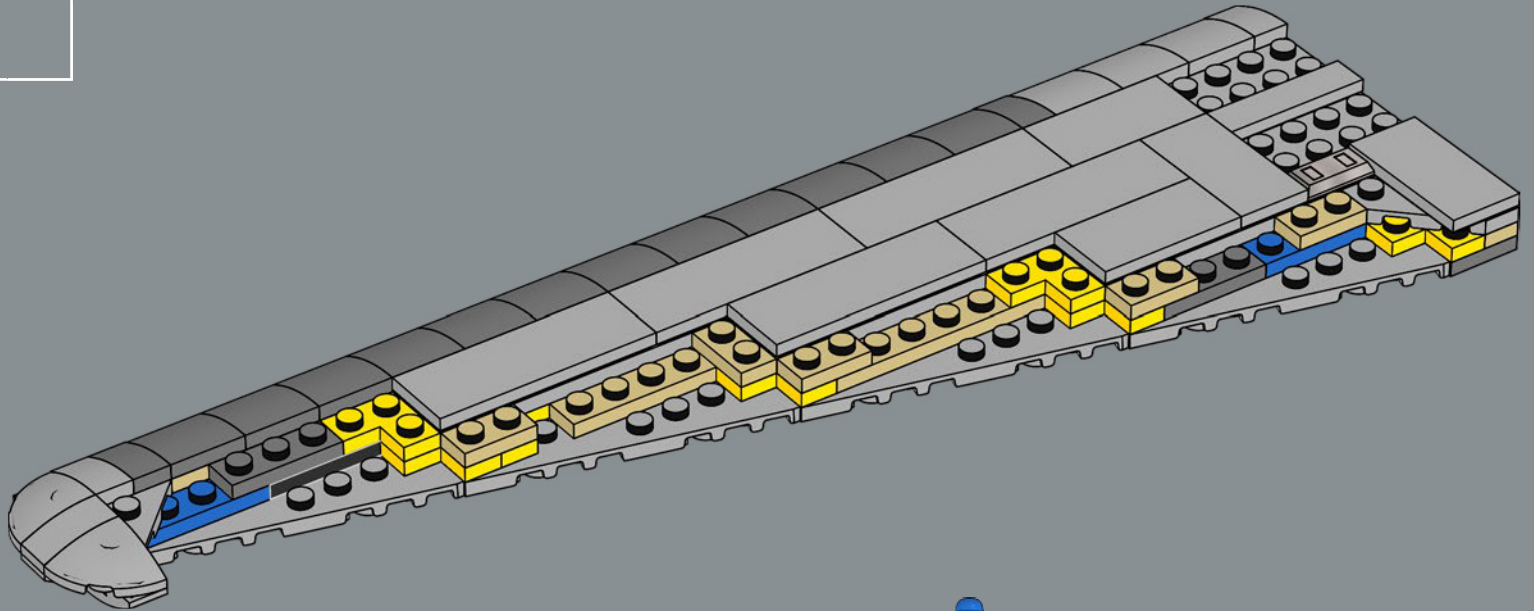

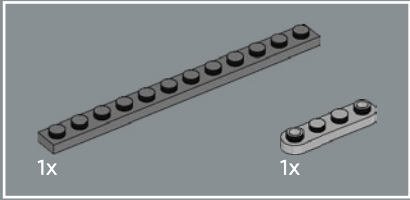
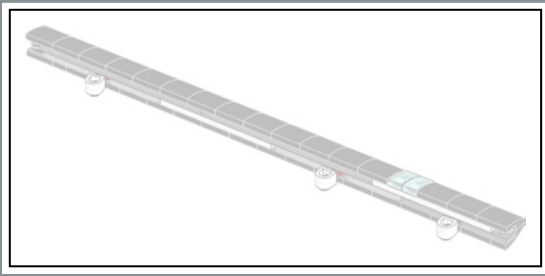

449

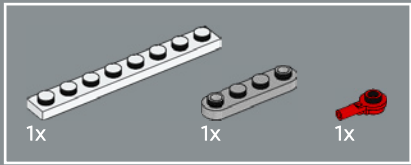
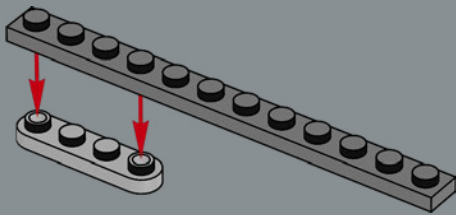

450

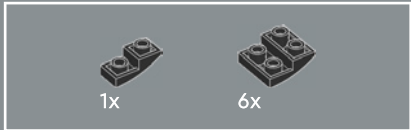
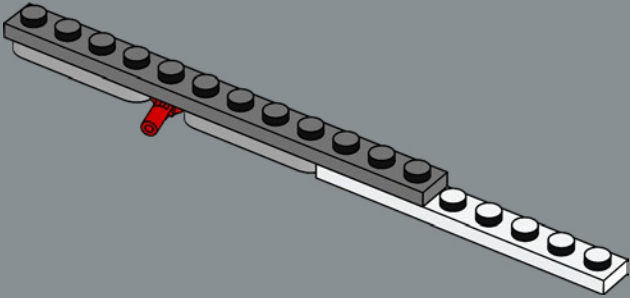

451

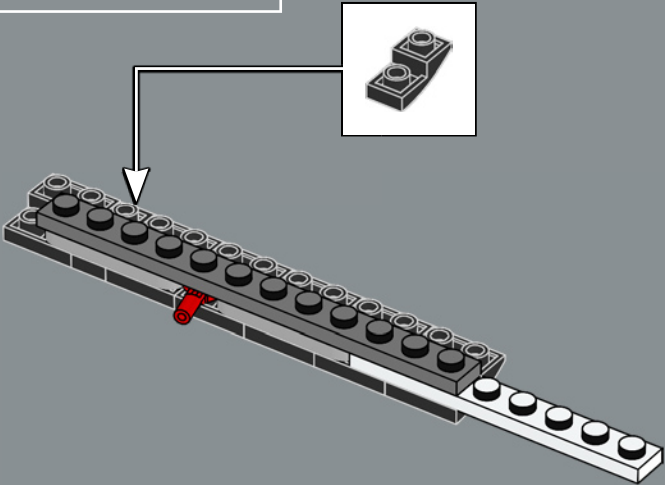



452

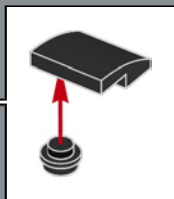
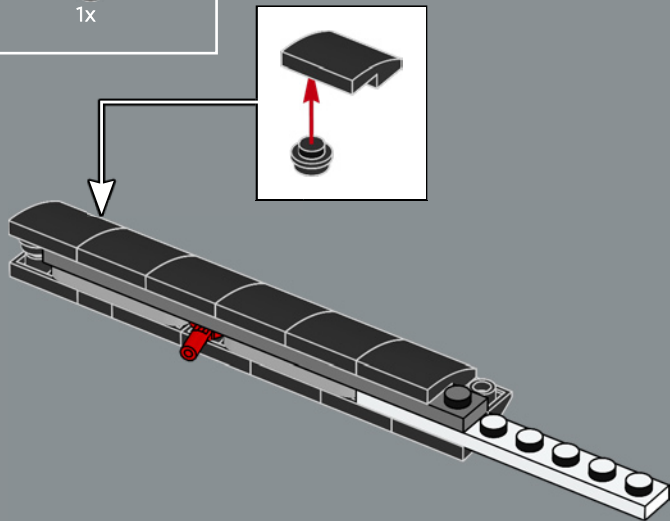

453

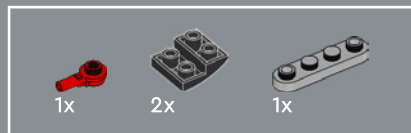
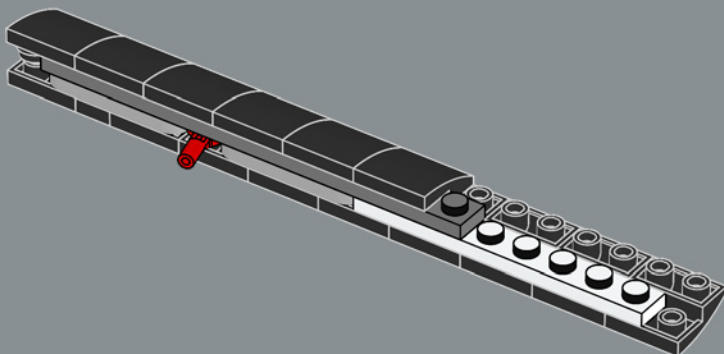

454

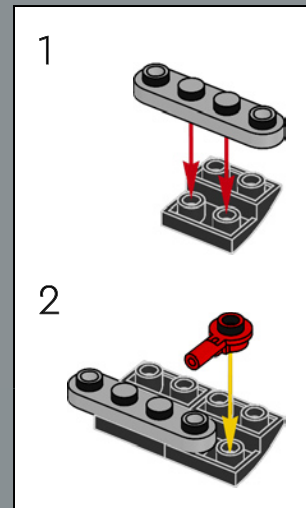
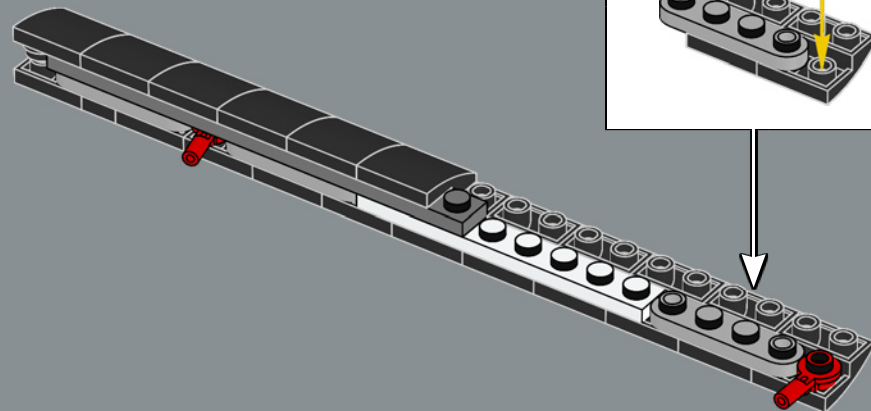

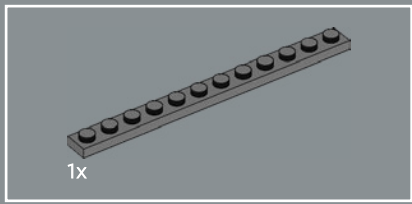

455

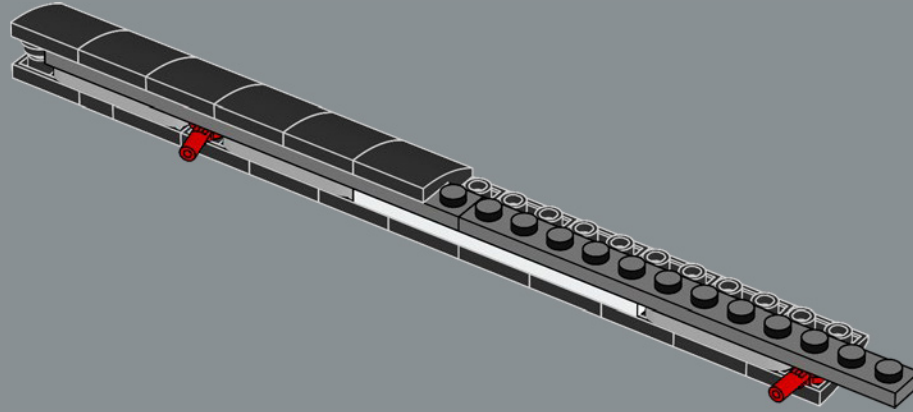

456

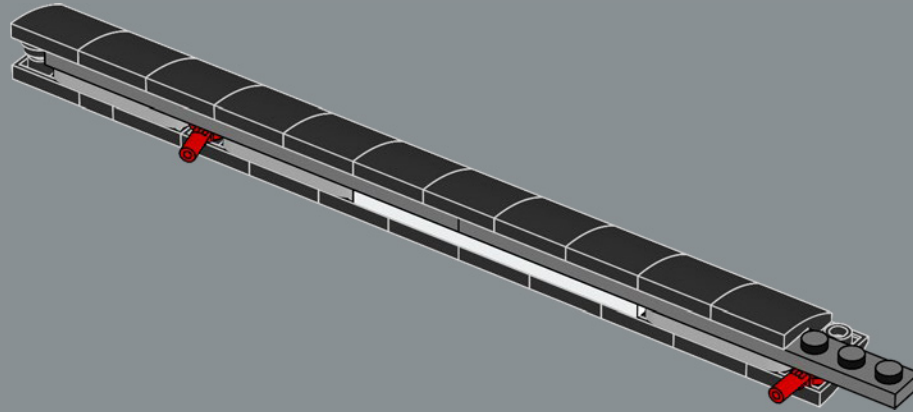

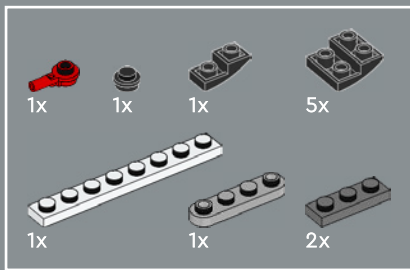

457

1

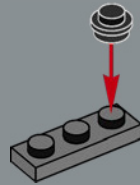

2

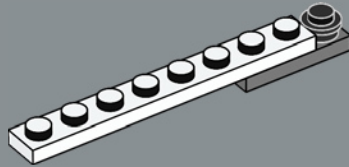

3

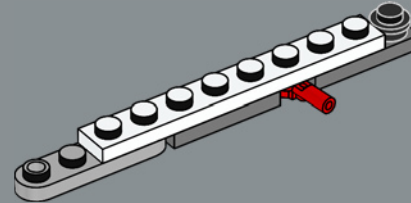

4

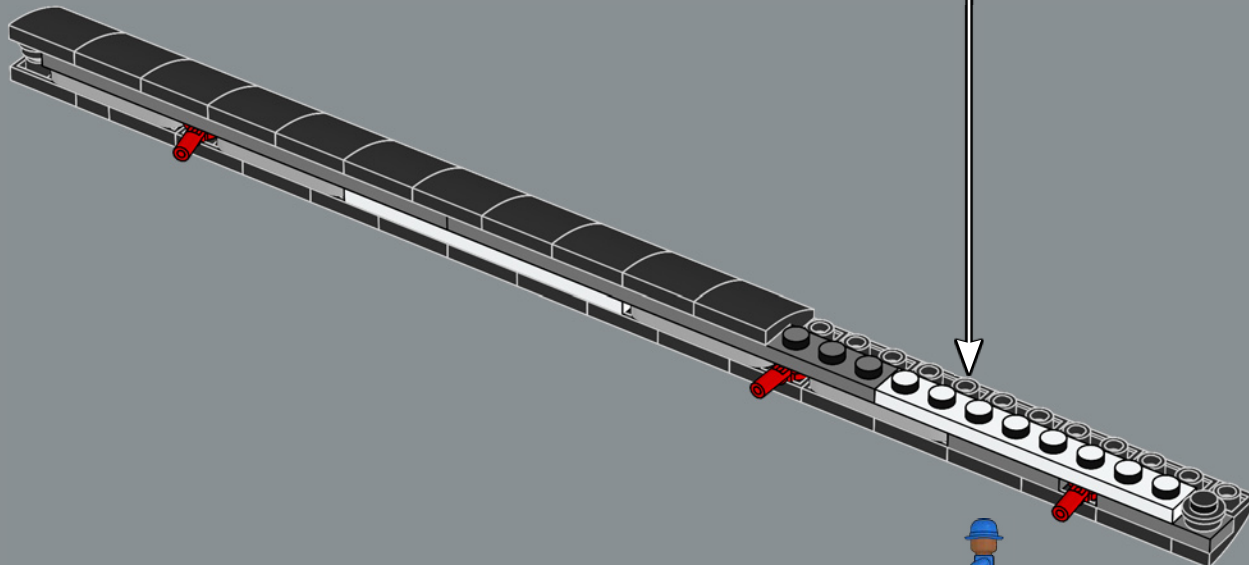
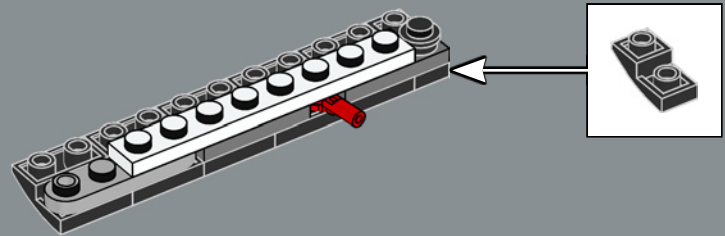



458

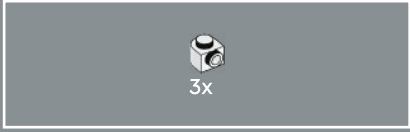
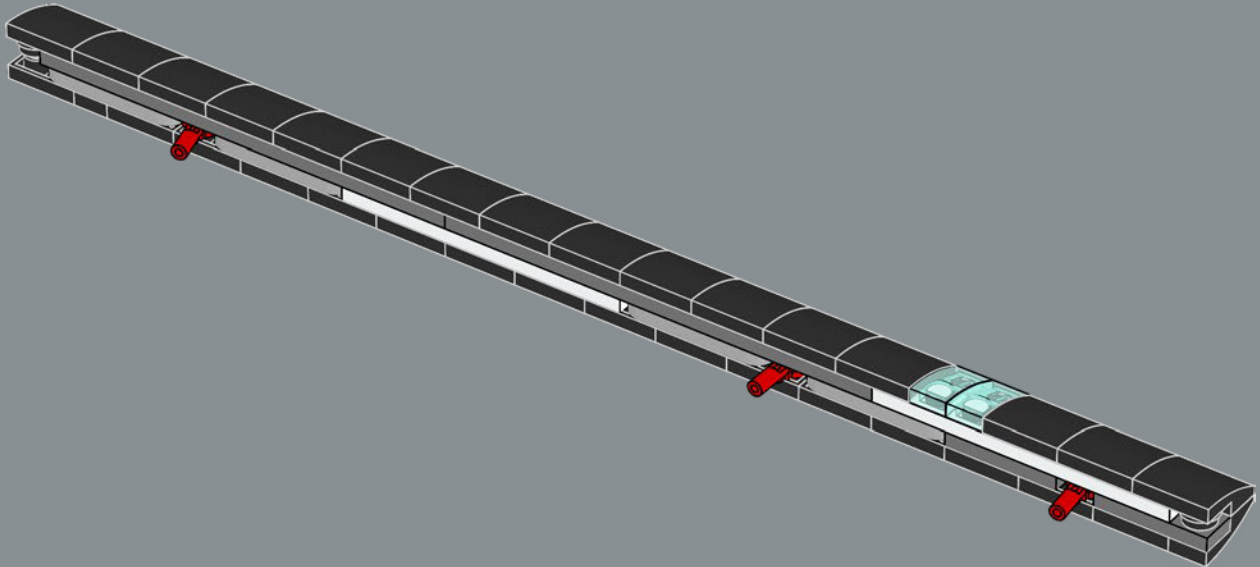

459

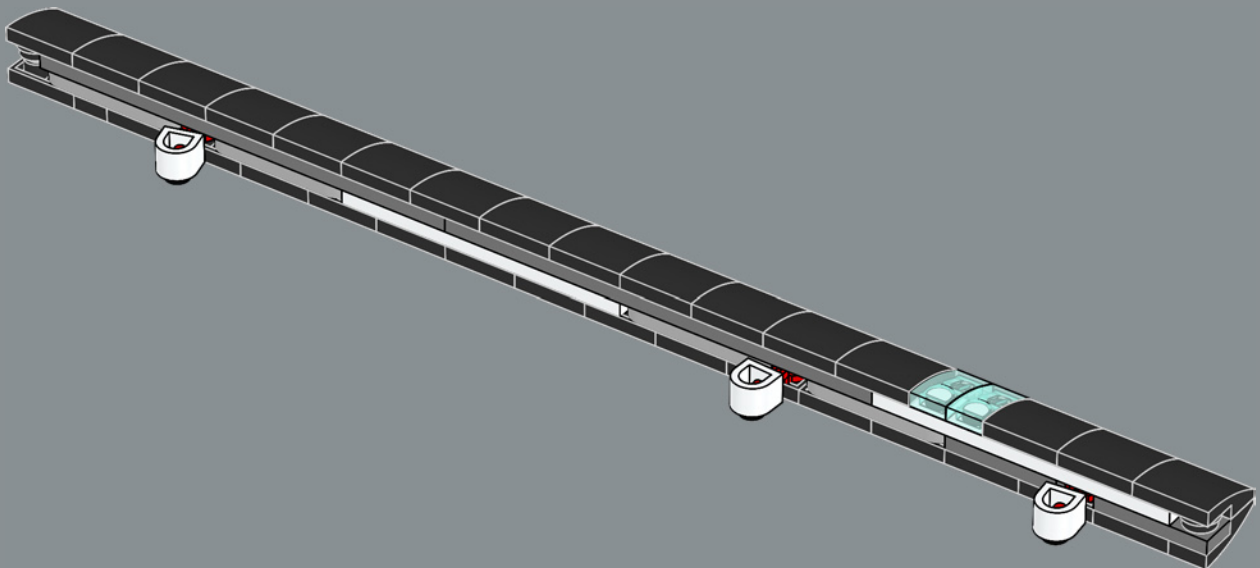

460

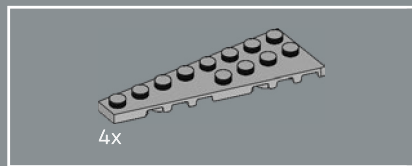
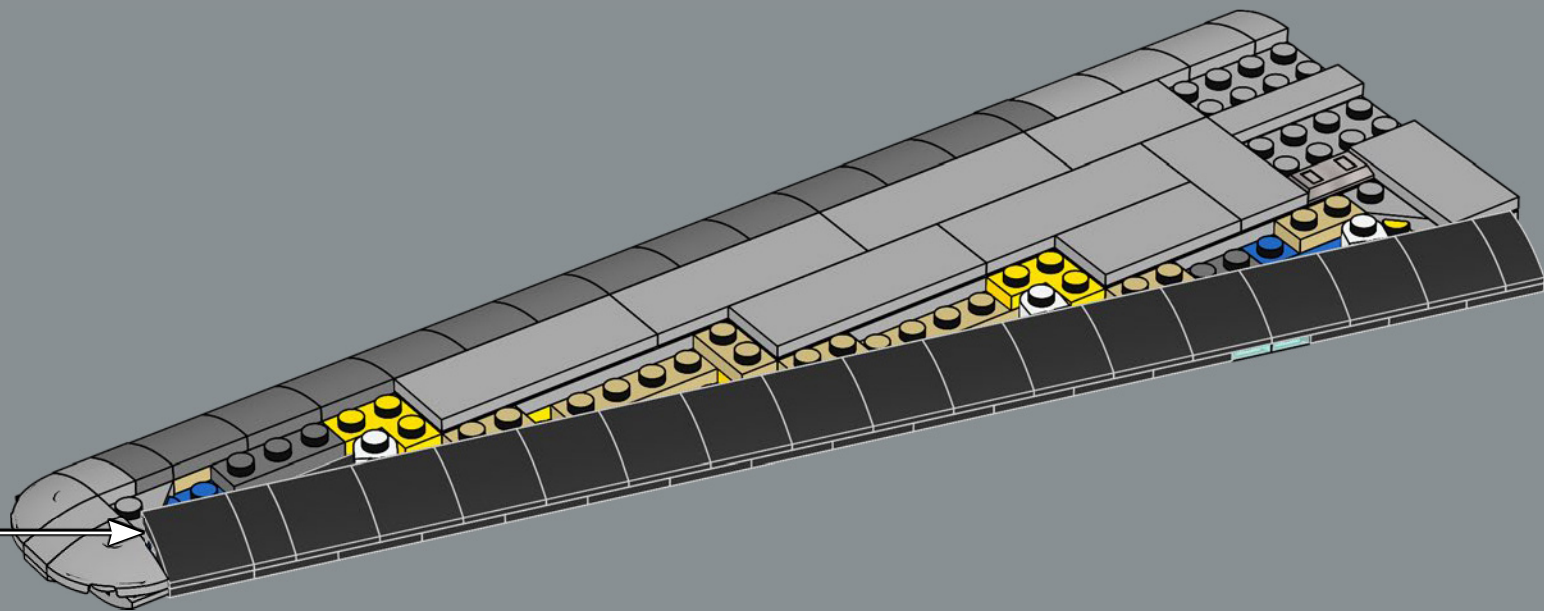

461

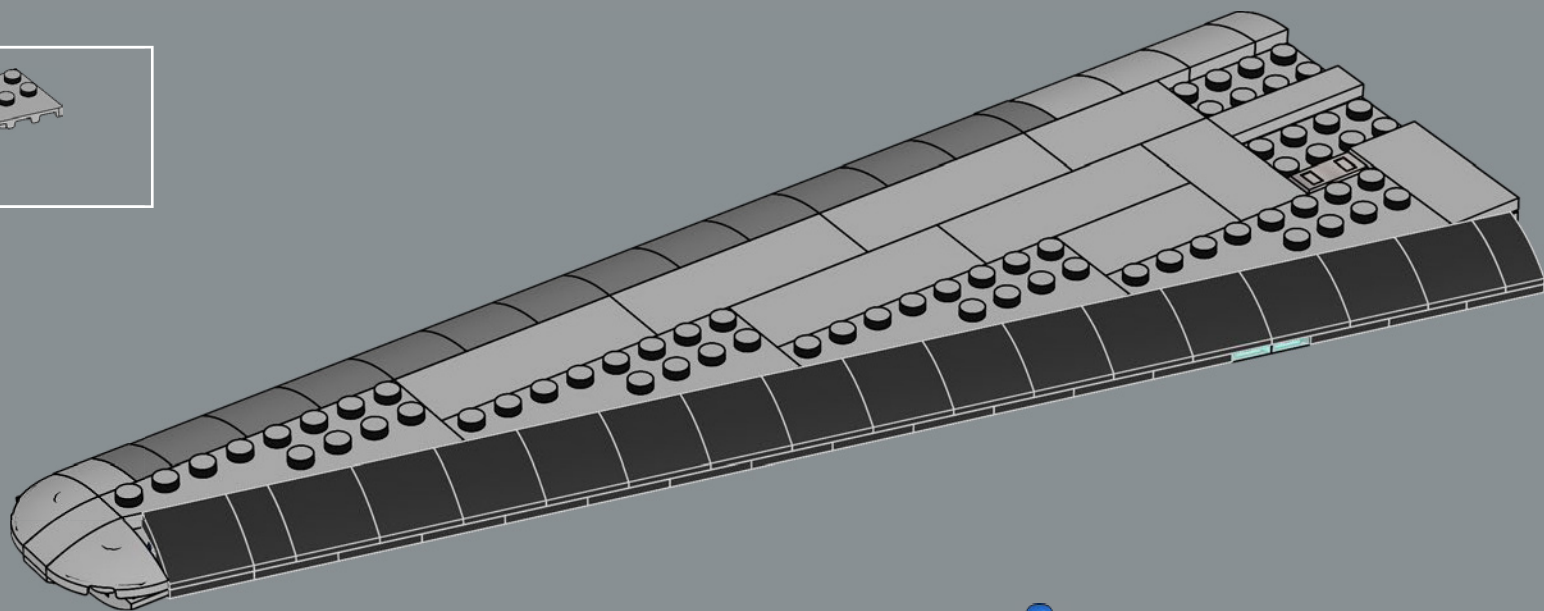

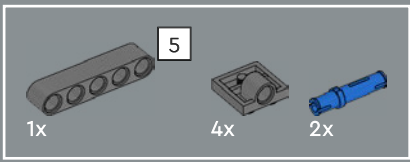

462

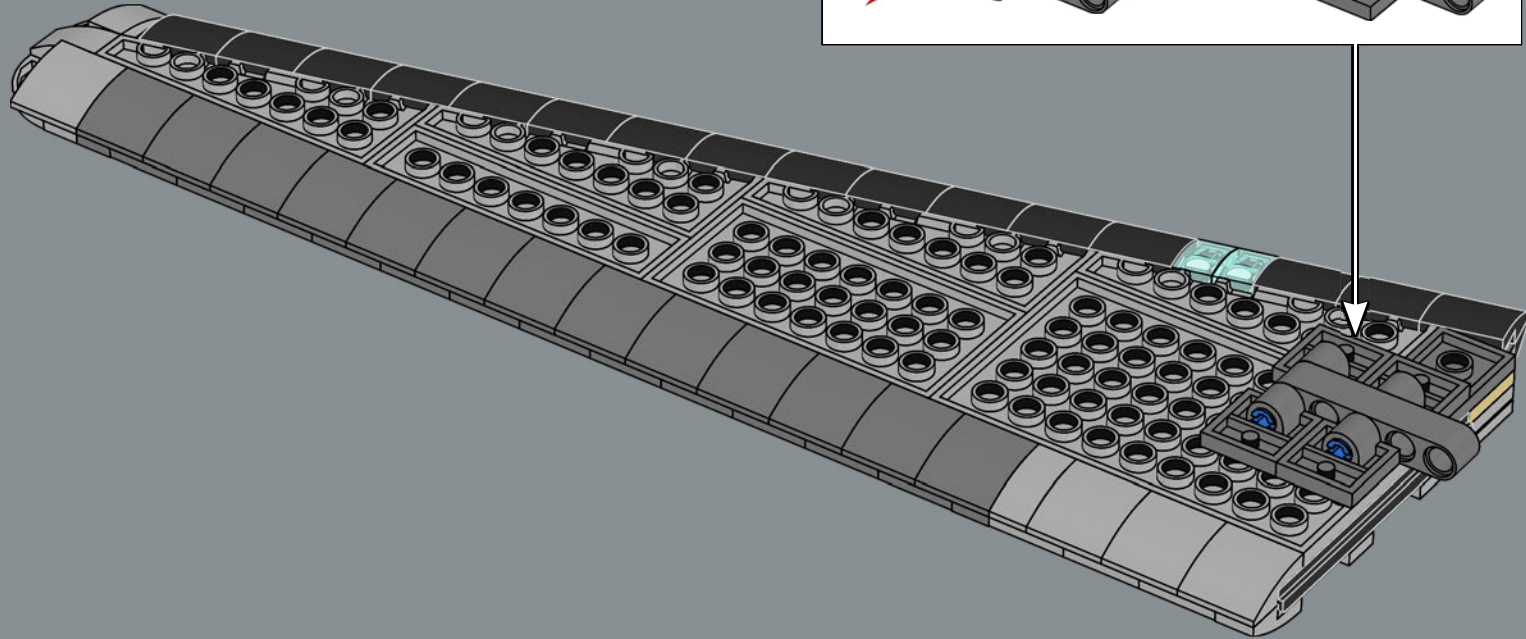
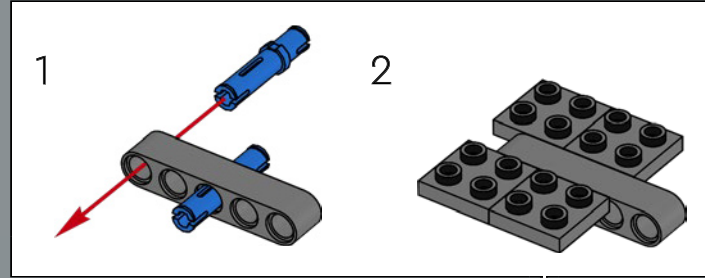



4x

463

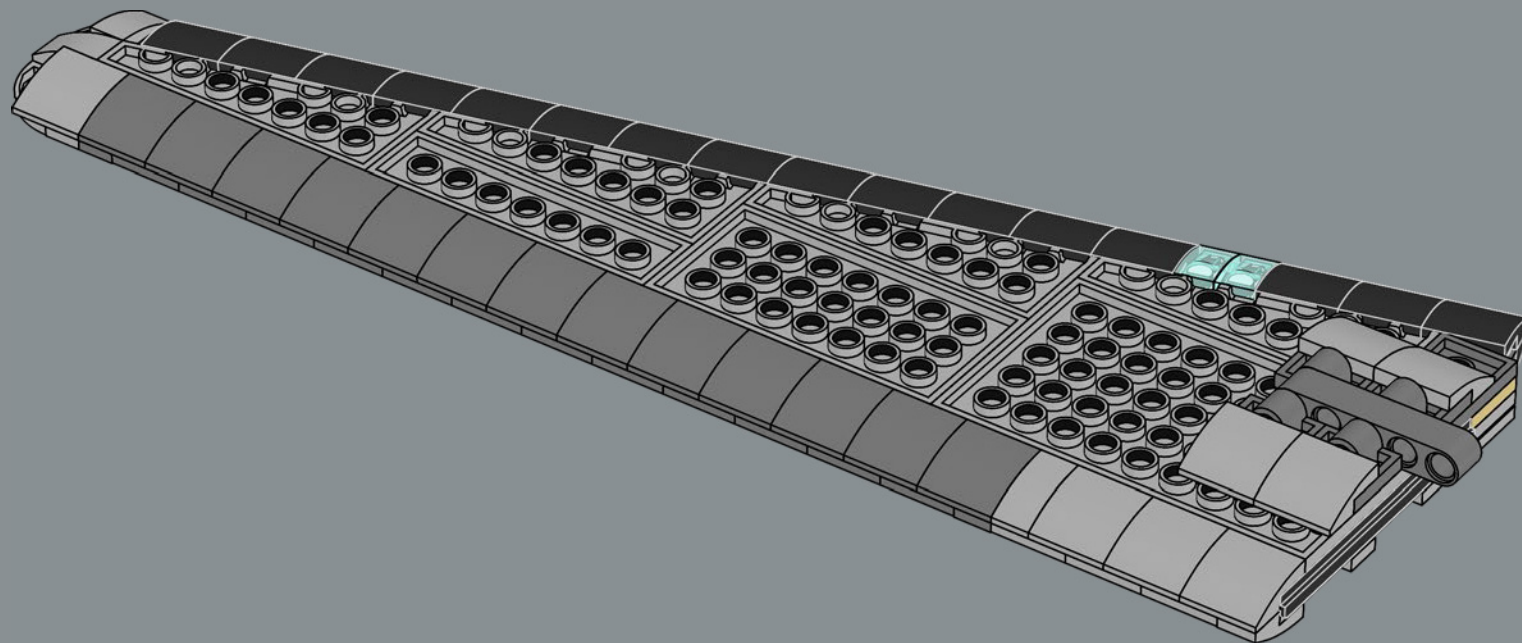

464

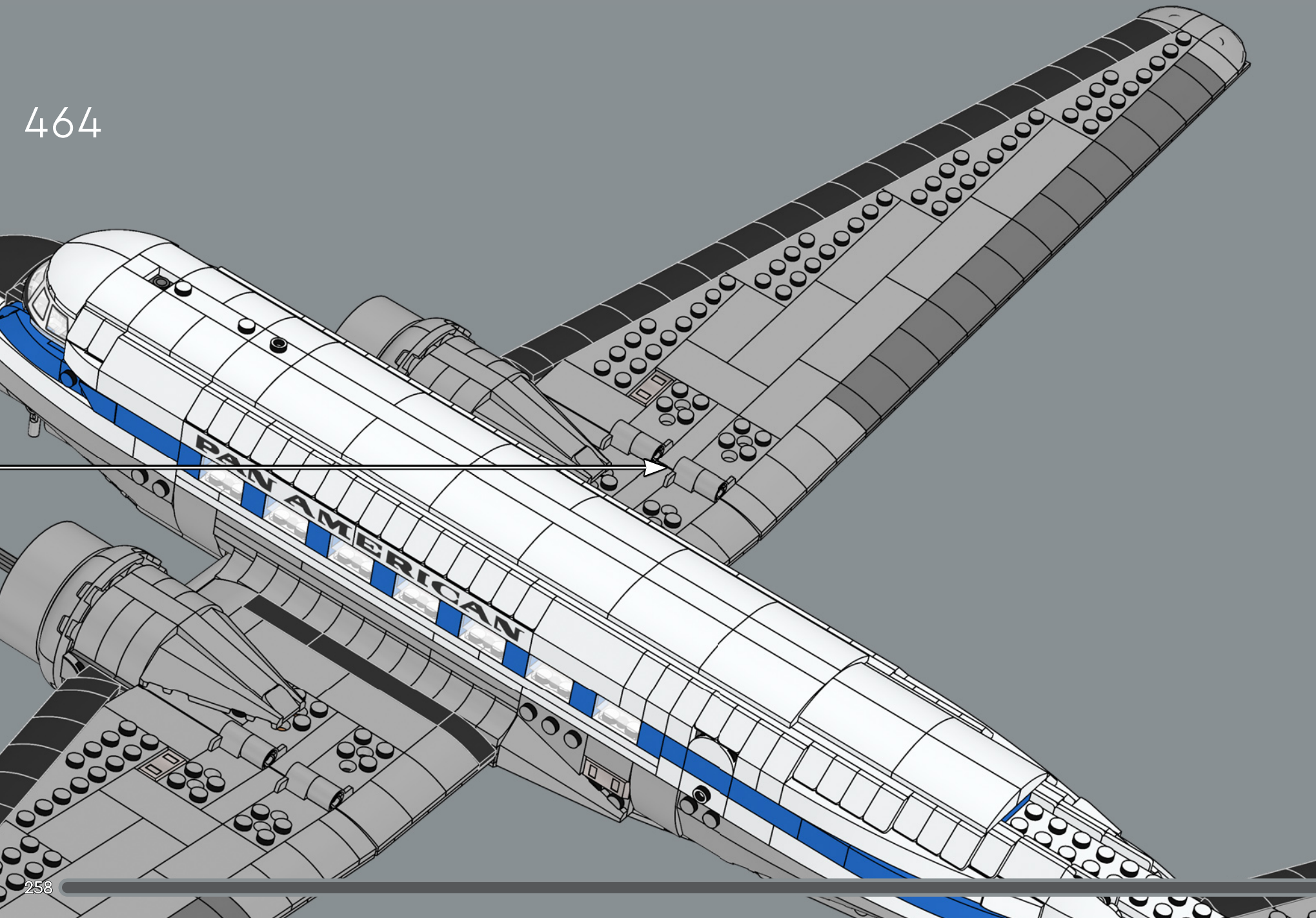



465

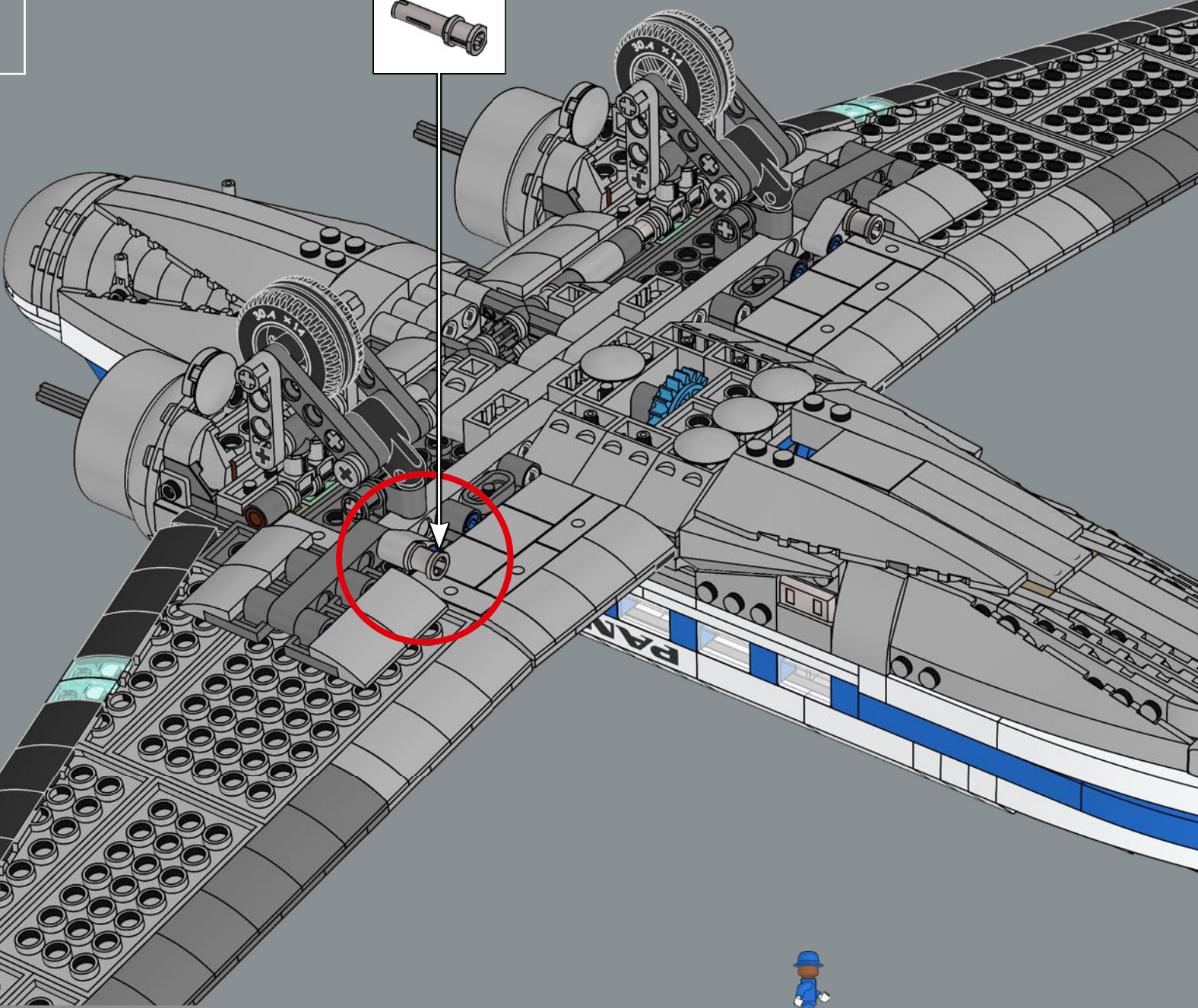



En 1980 se introdujeron nuevos uniformes diseñados por una firma de modas estadounidense. A los tripulantes de cabina masculinos se les llamaba auxiliares de vuelo.

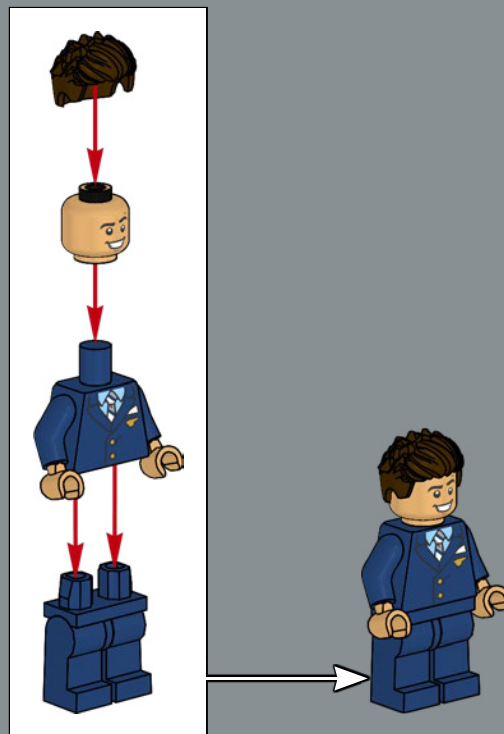

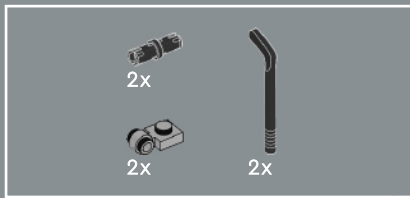

466

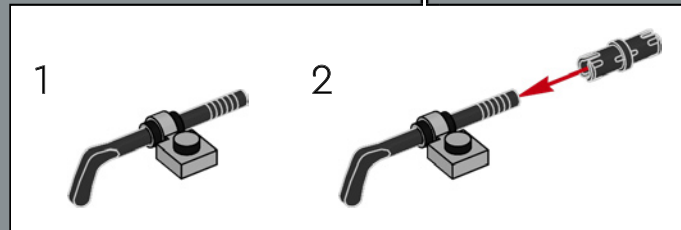
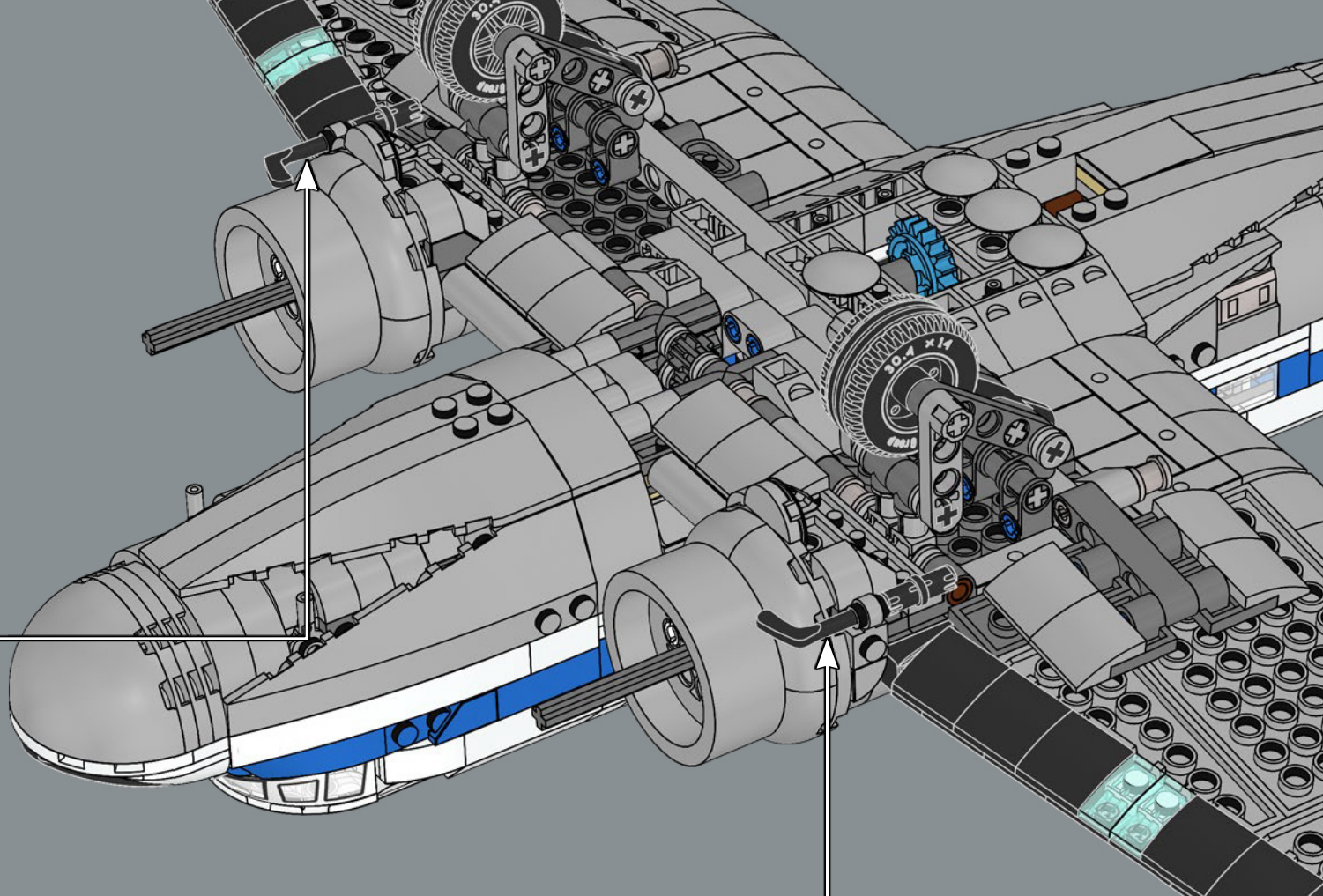
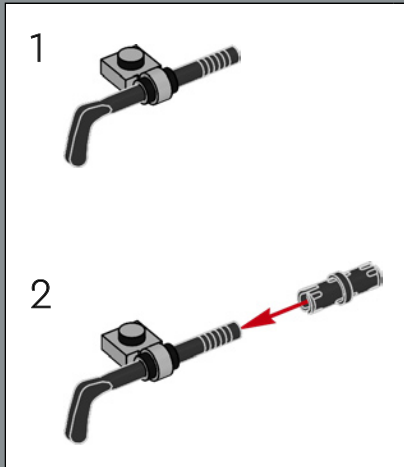



Las protuberancias bajo la cabina de vuelo representan sensores de velocidad aerodinámica.

467

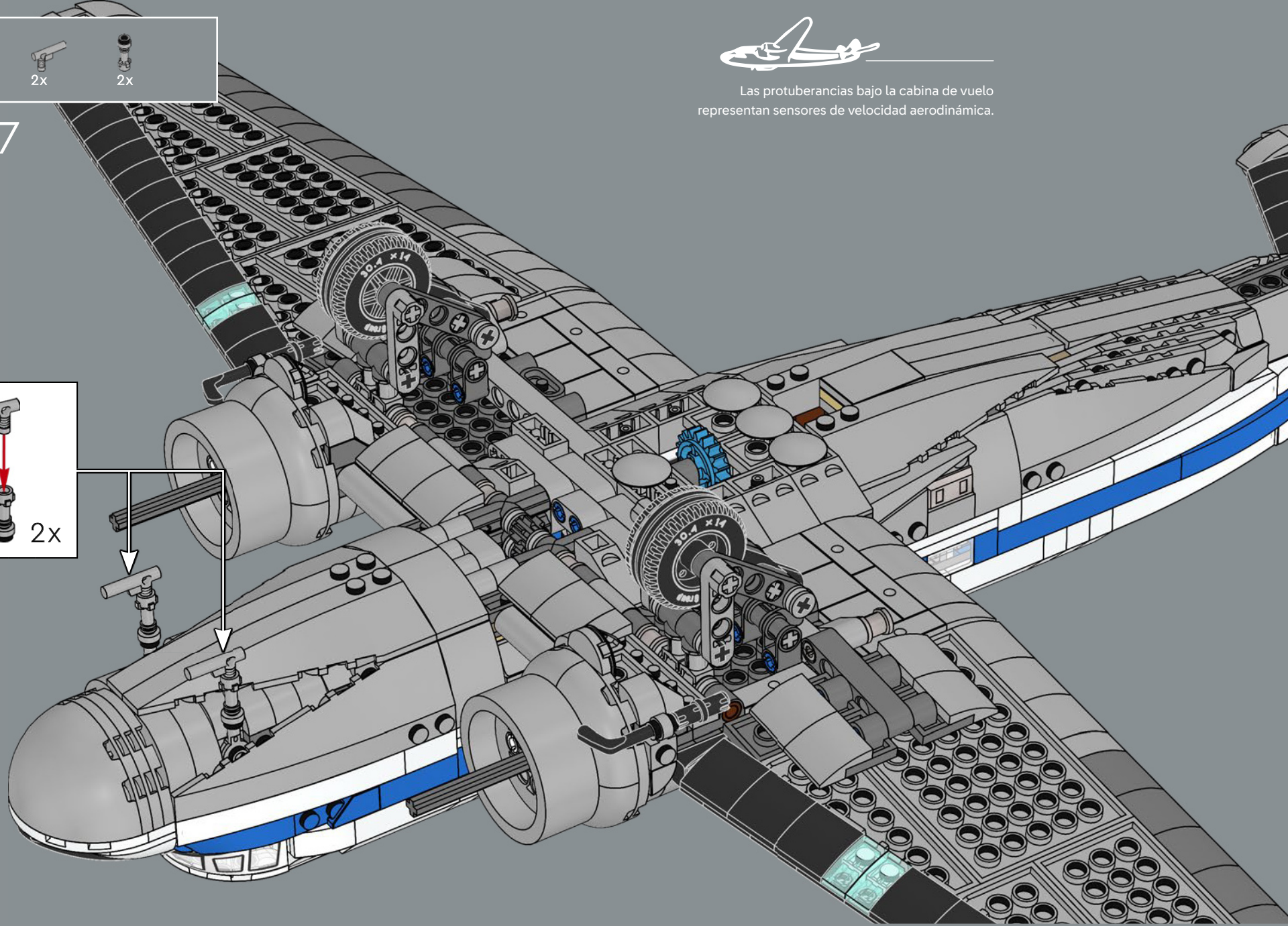
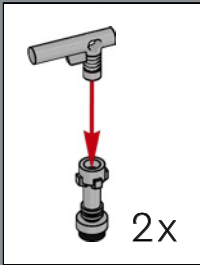

2x

468

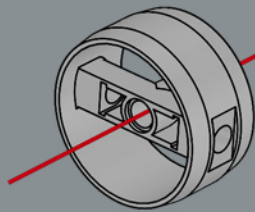

2x 2x



469

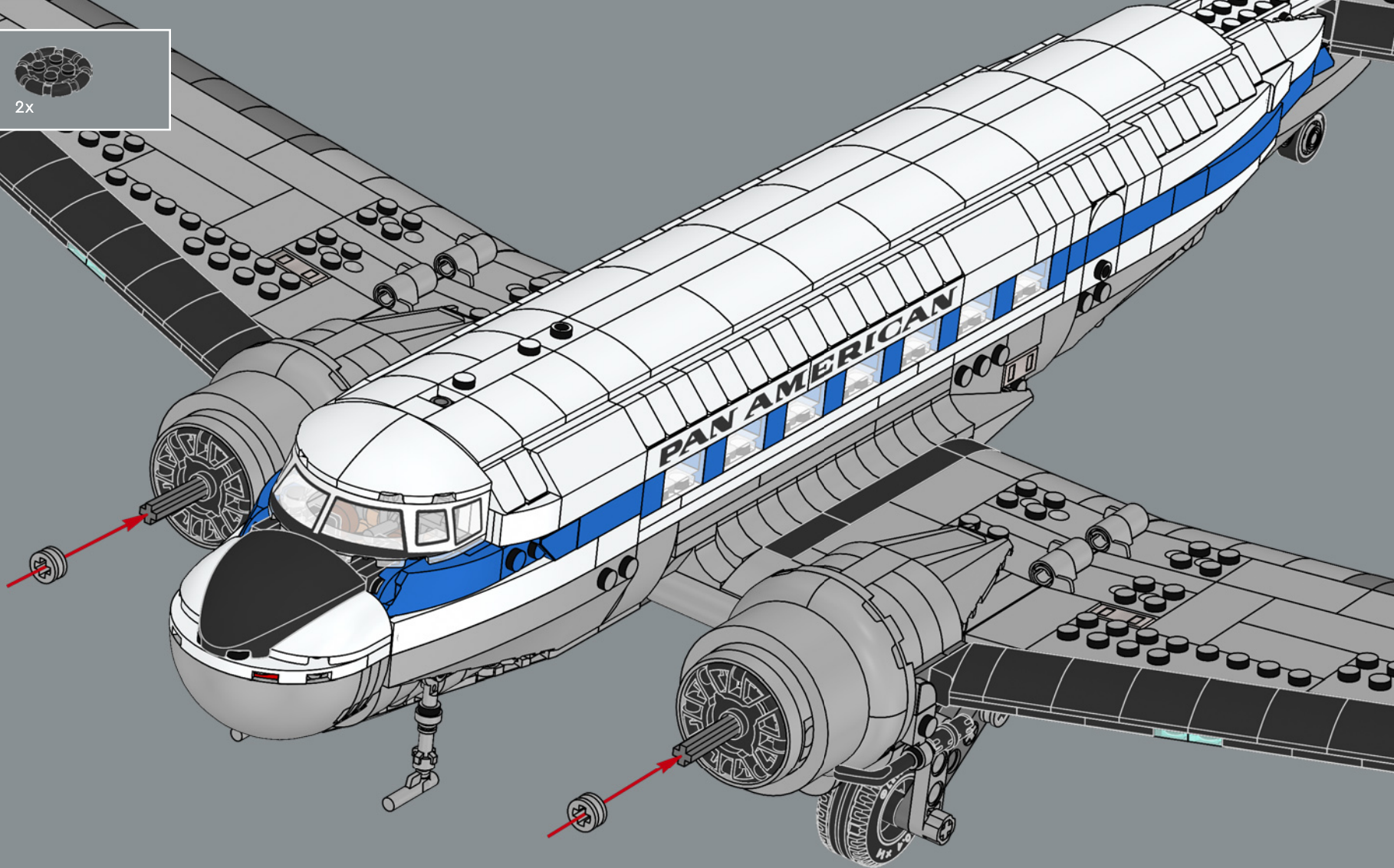

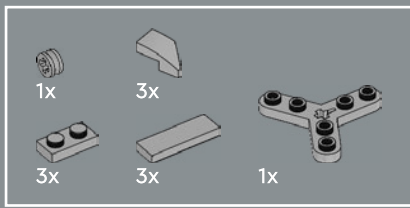

470

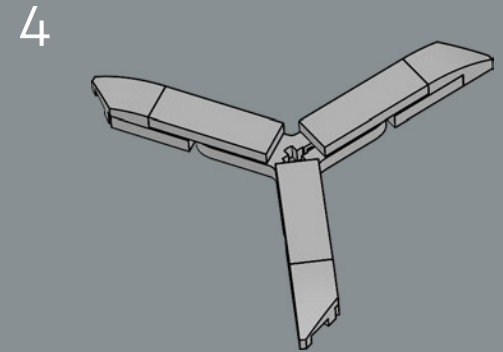
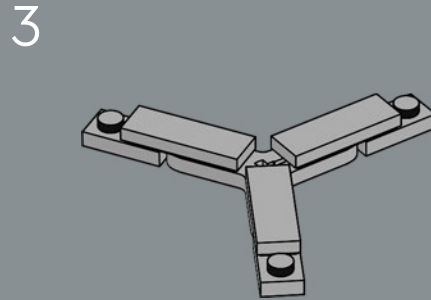
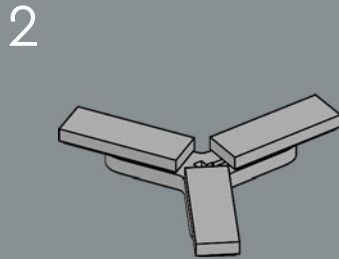
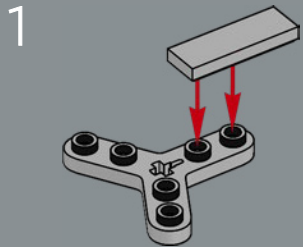

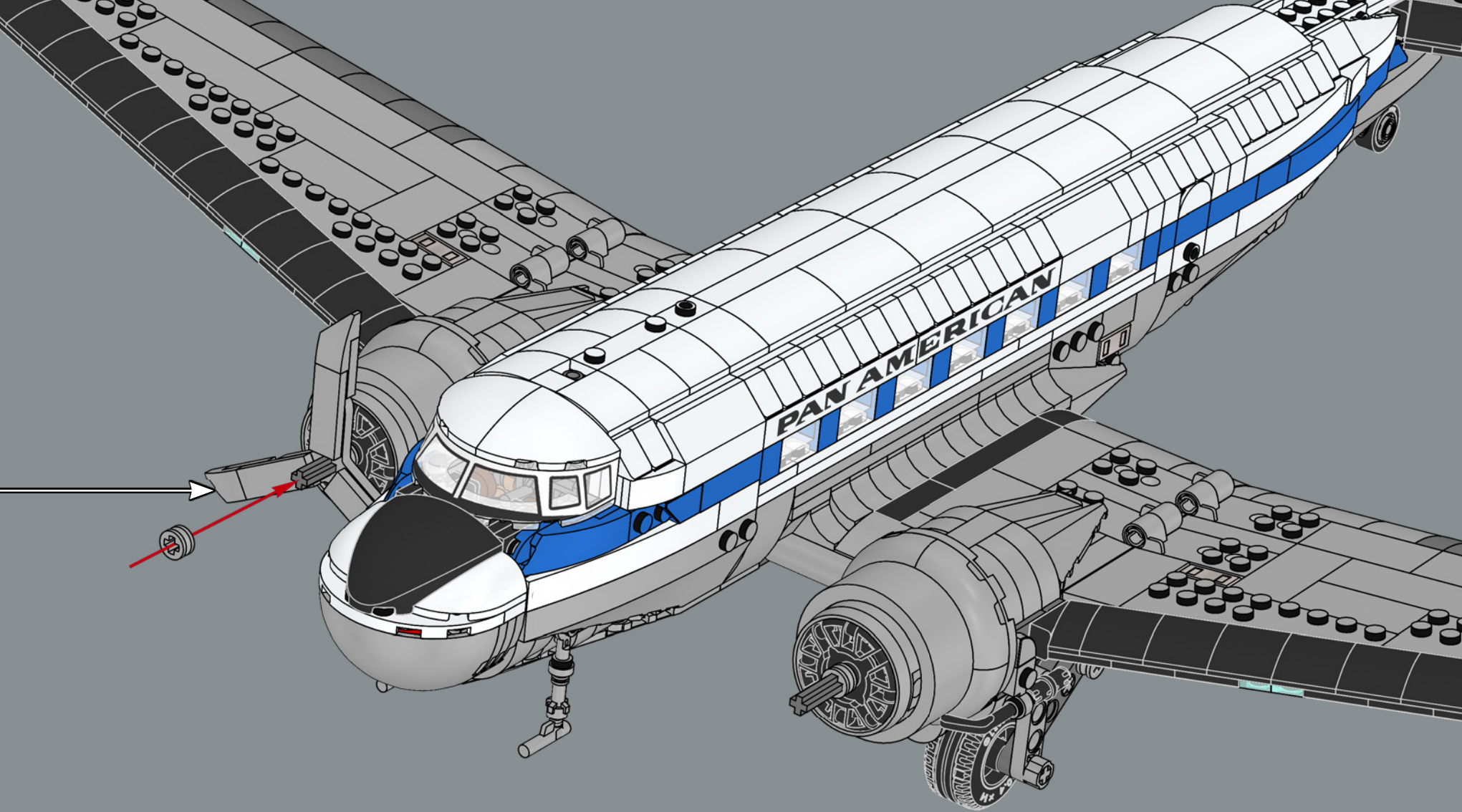

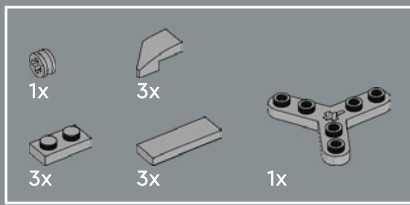

471

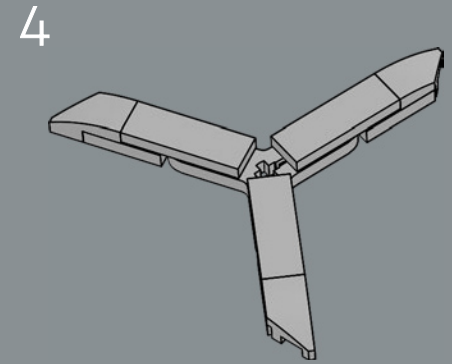
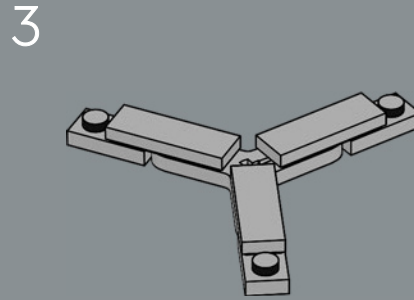
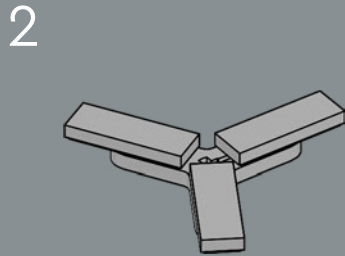
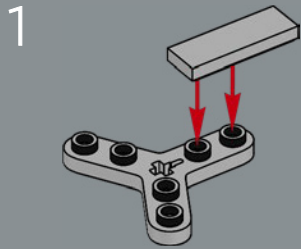

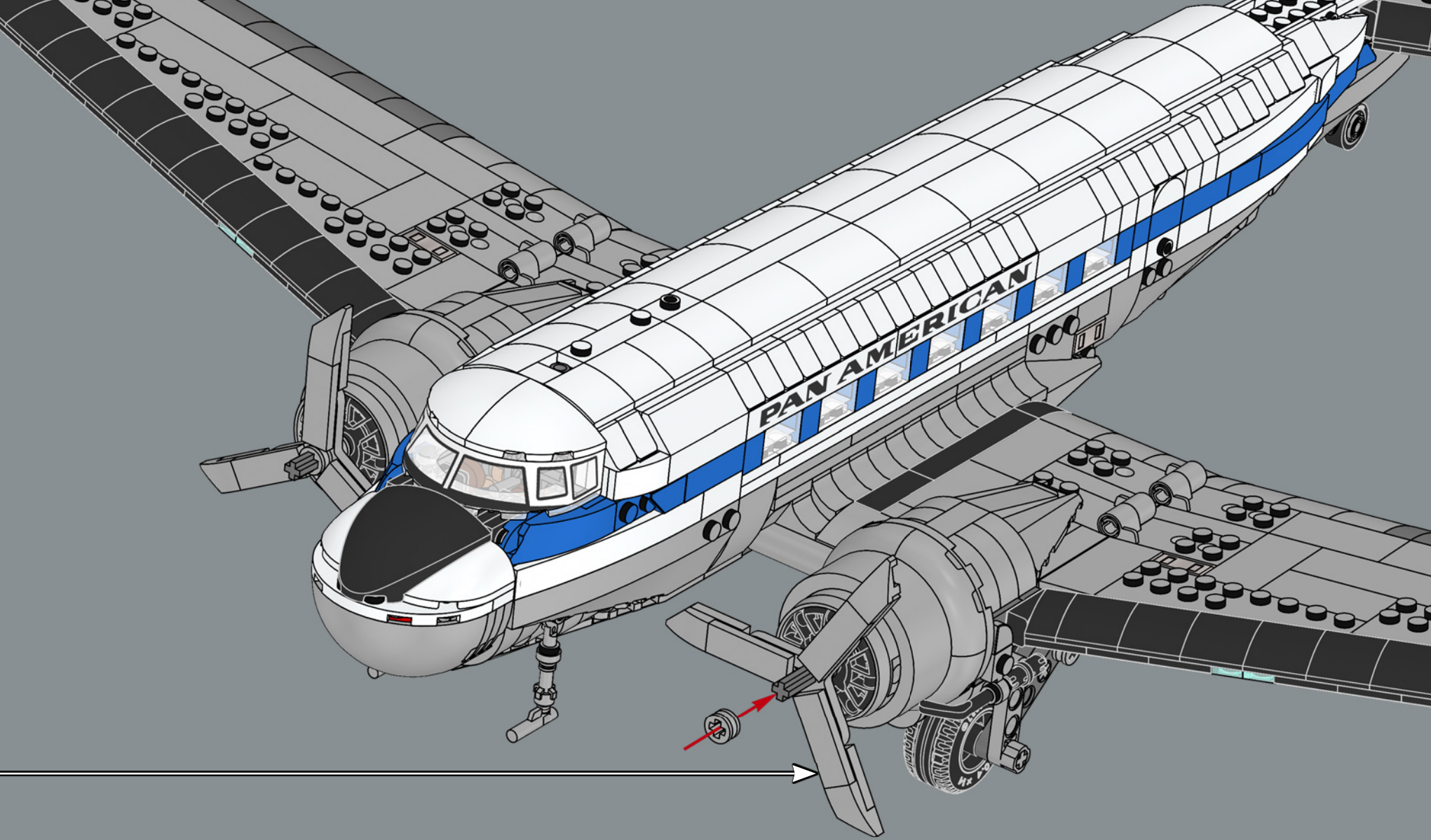



2x

472

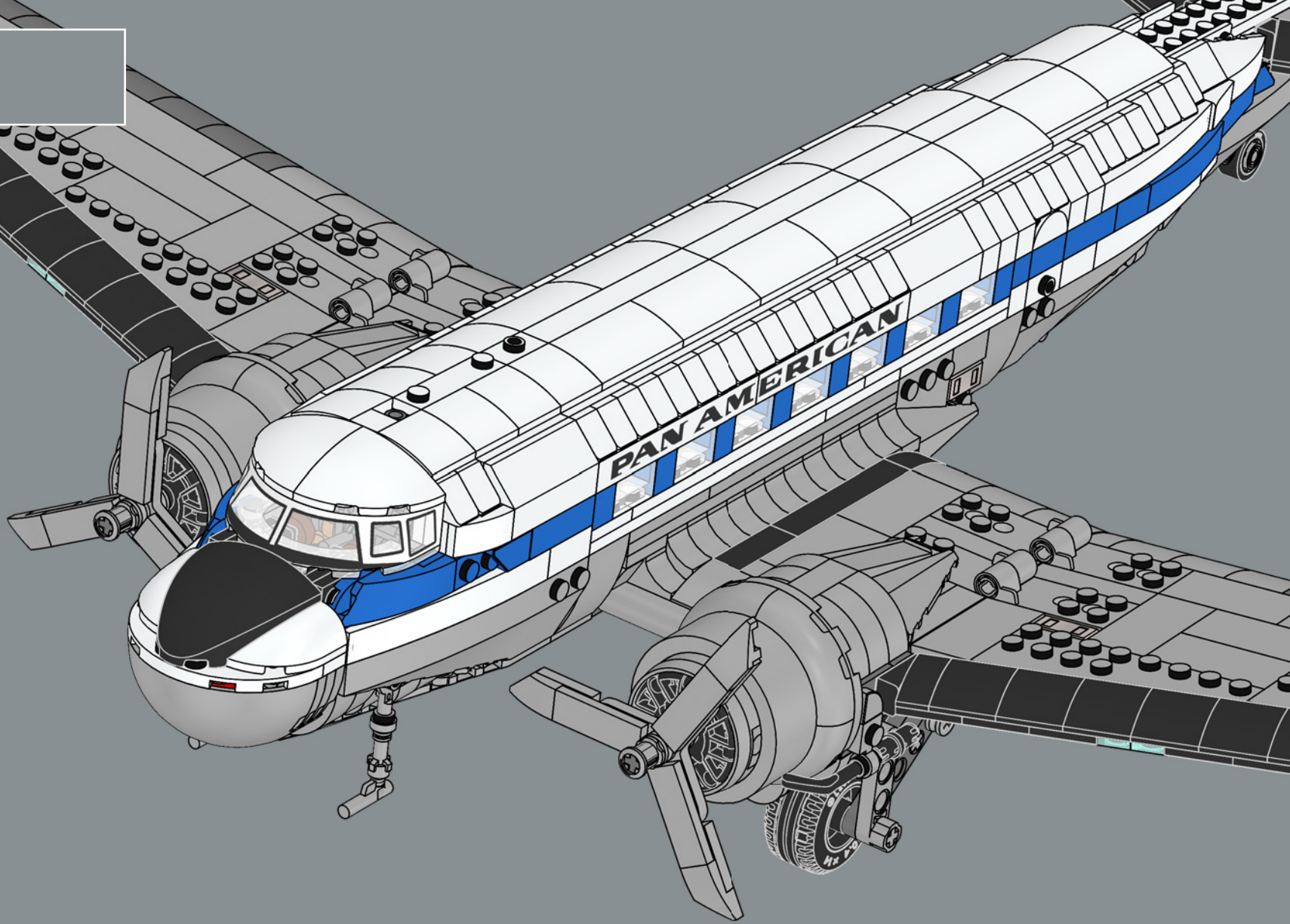

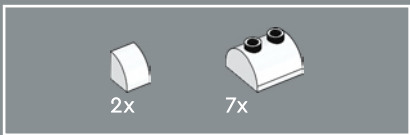

473

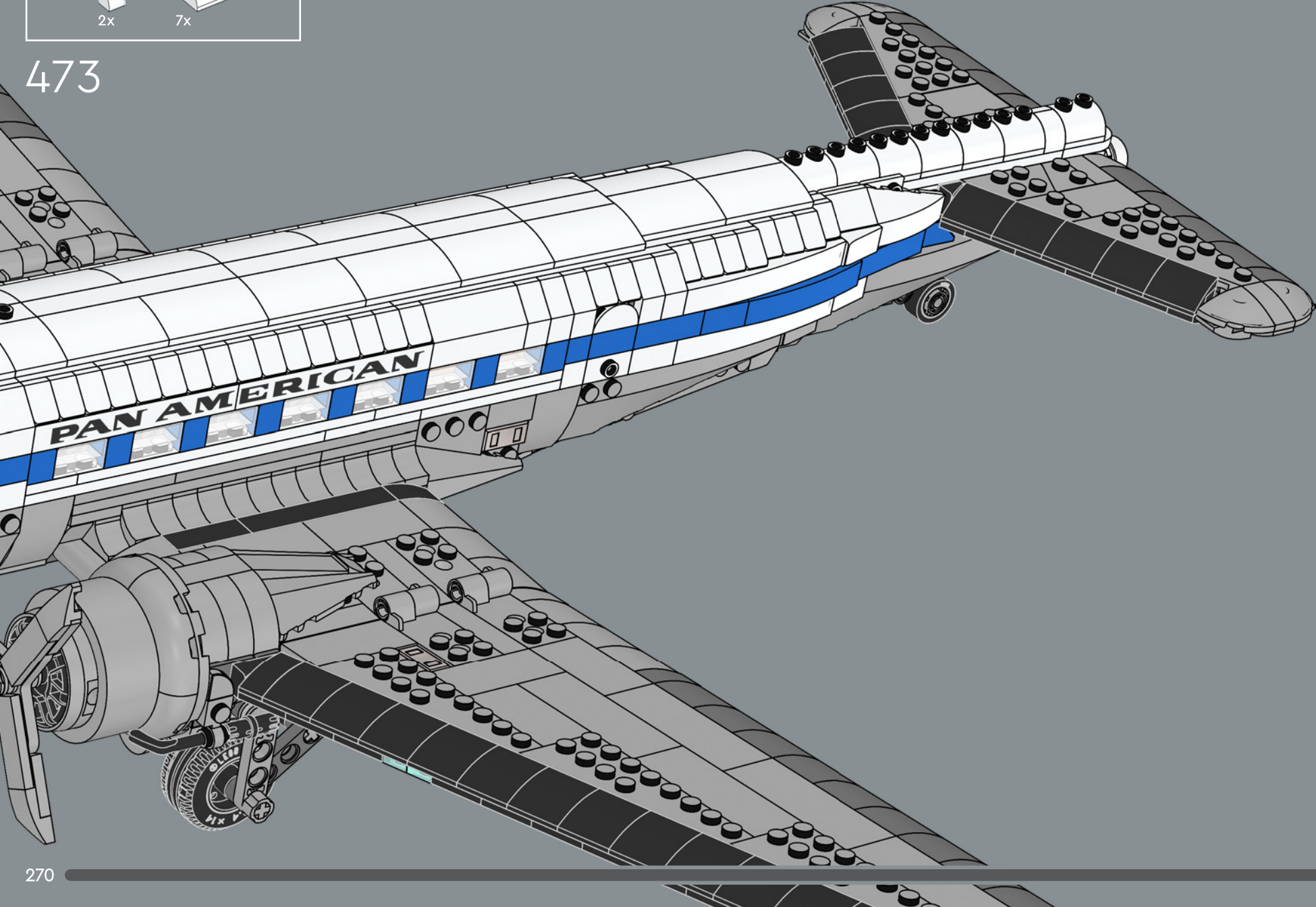

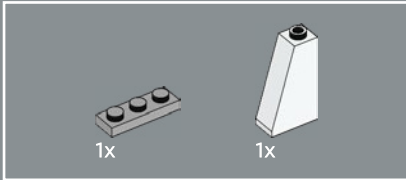
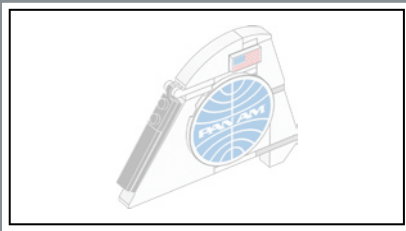

474

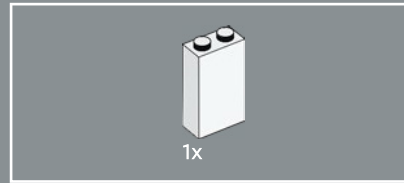
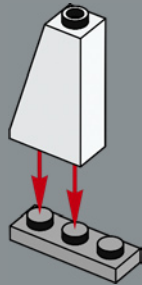

475

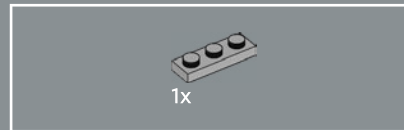
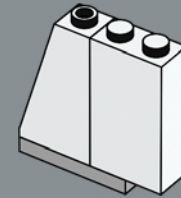

476

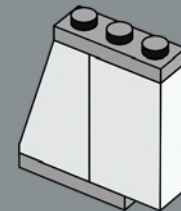

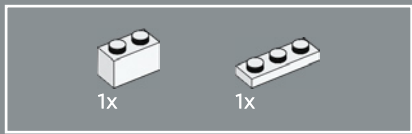

477

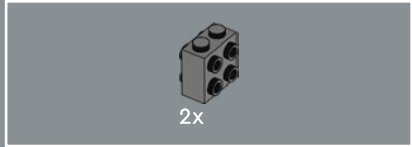
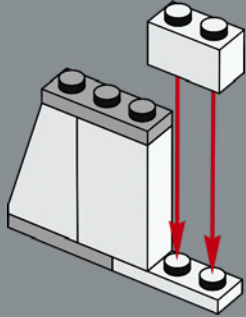

478

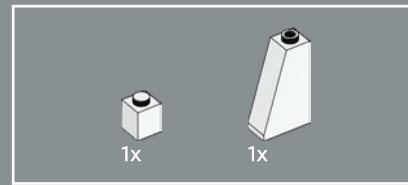
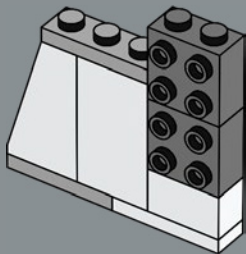

479

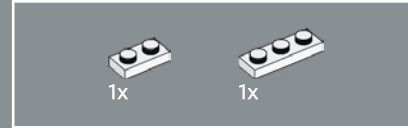
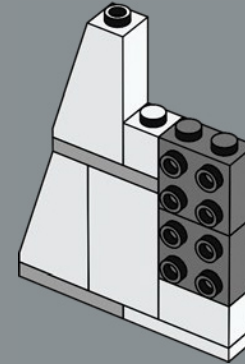

480

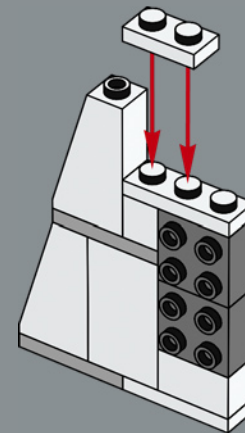

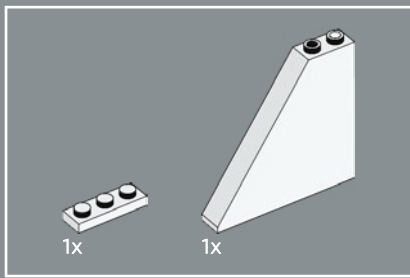

481

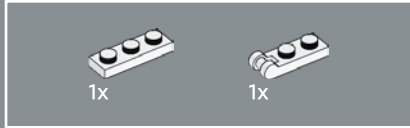
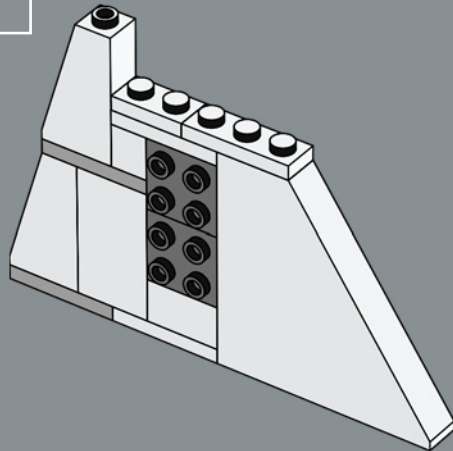

482

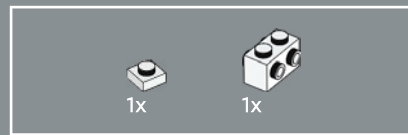
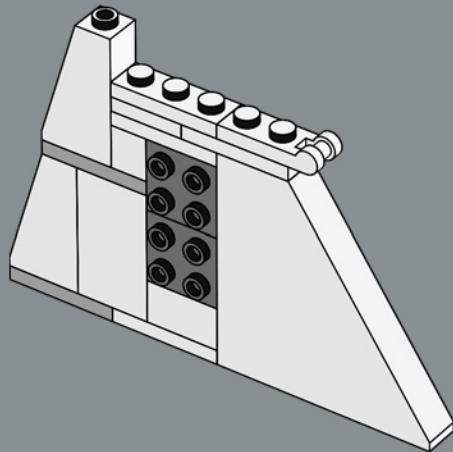

483

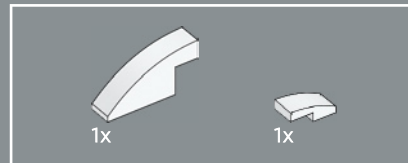
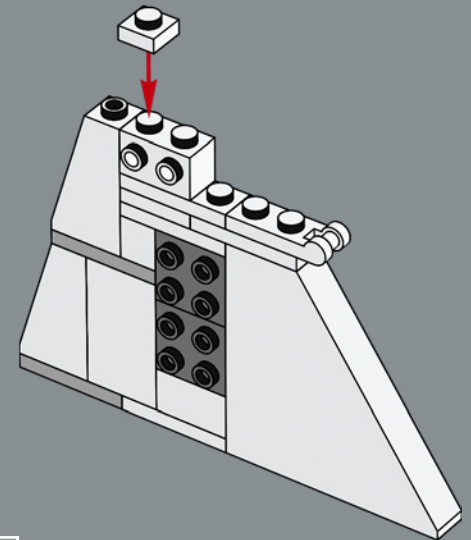

484

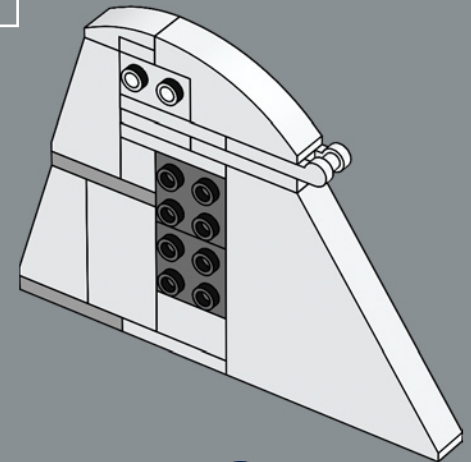

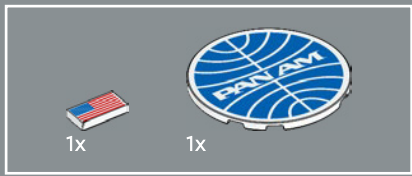

485

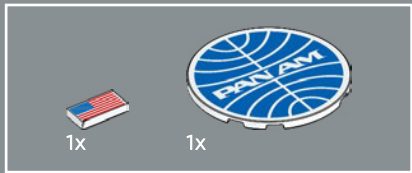
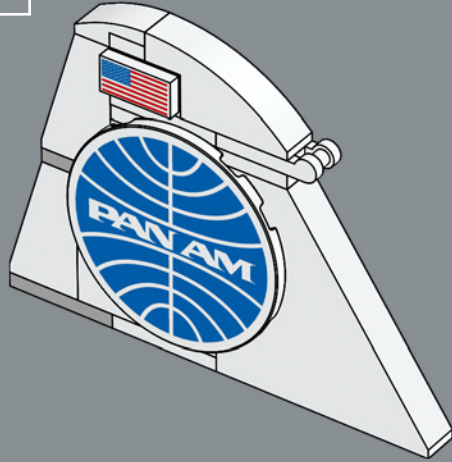

486

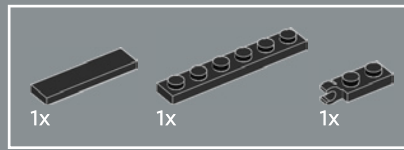
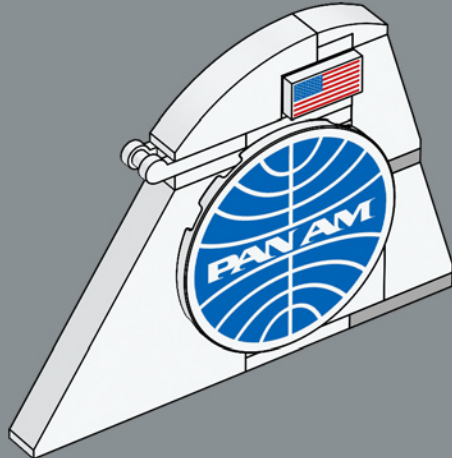

487

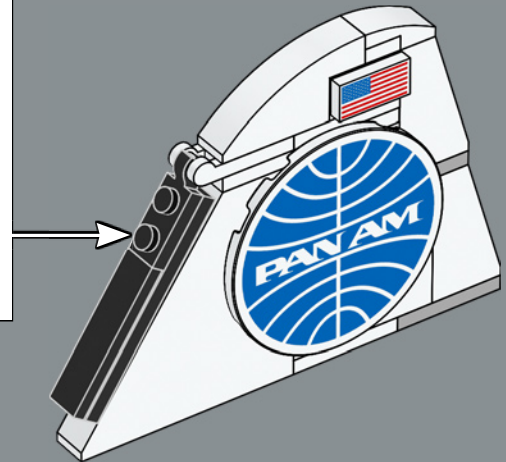
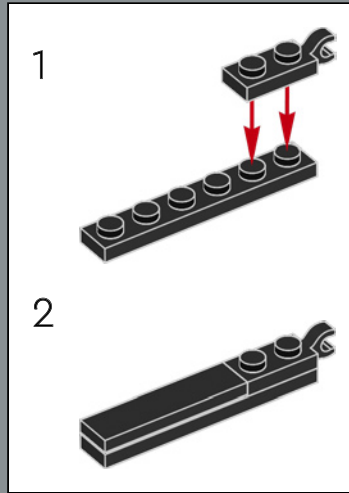



1x

488

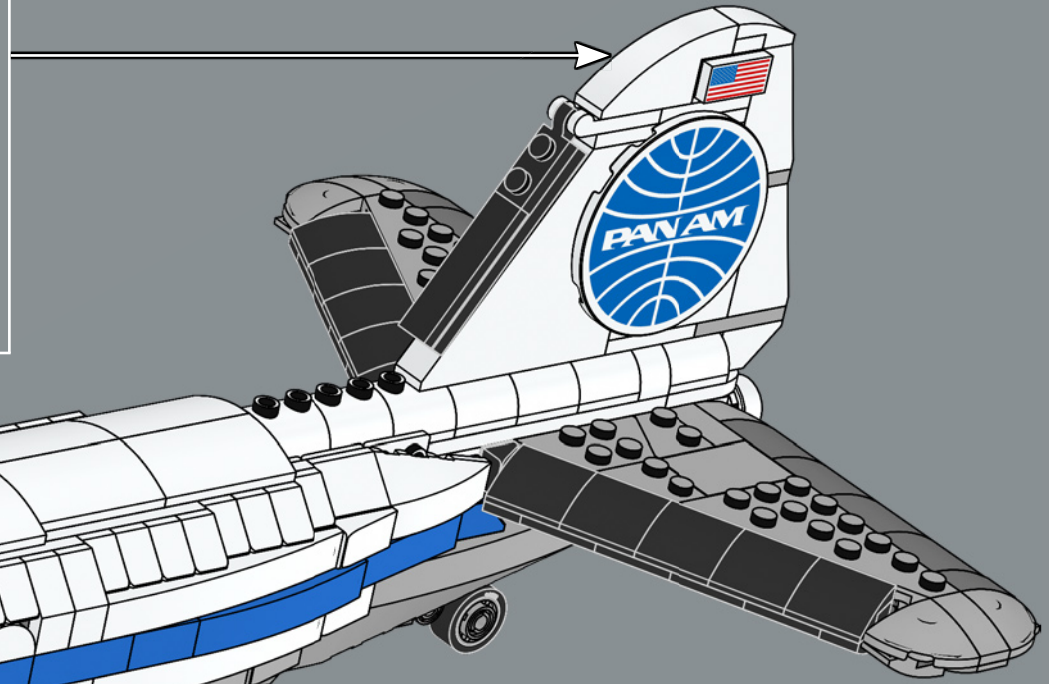
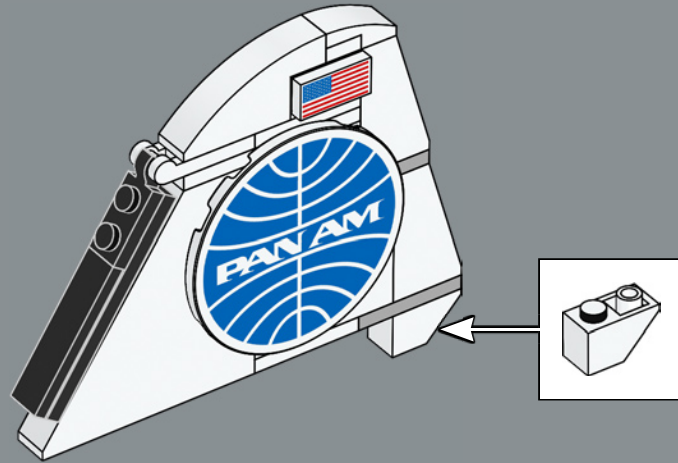

489

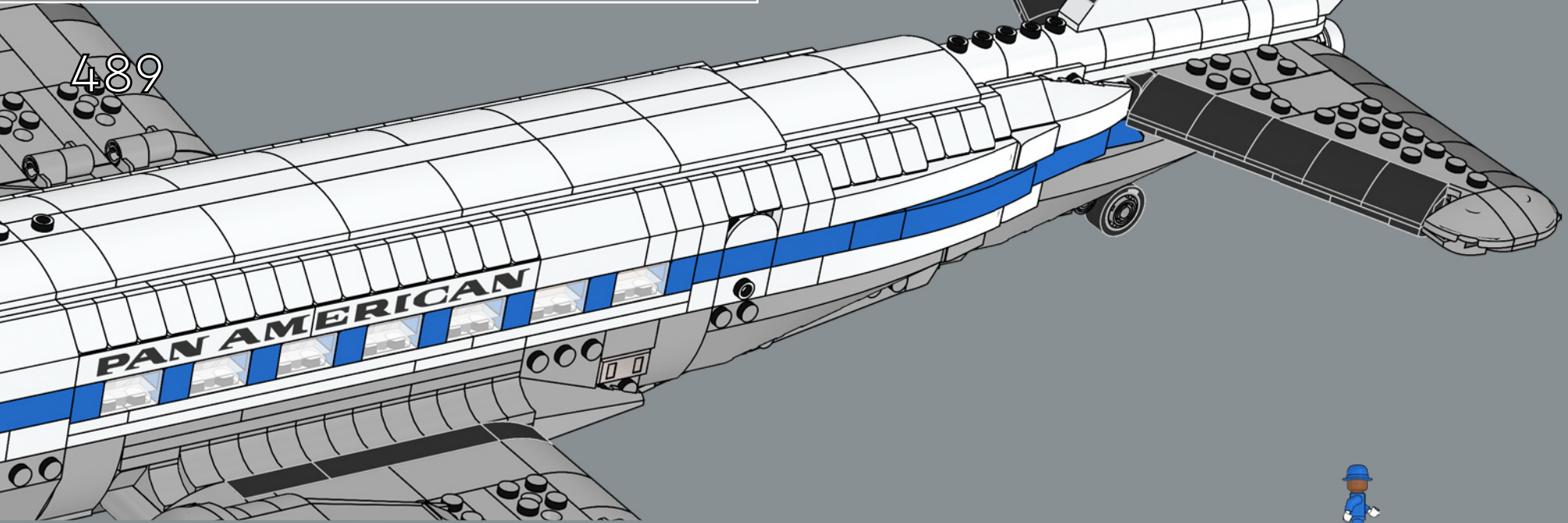

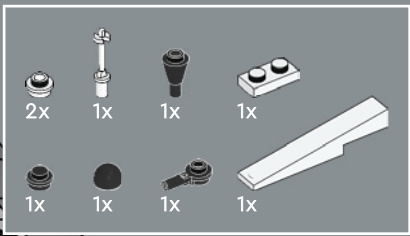

La cápsula negra forma parte del radiogoniómetro automático (ADF), un instrumento de radionavegación que muestra el rumbo relativo hacia una emisora de radio adecuada.

490

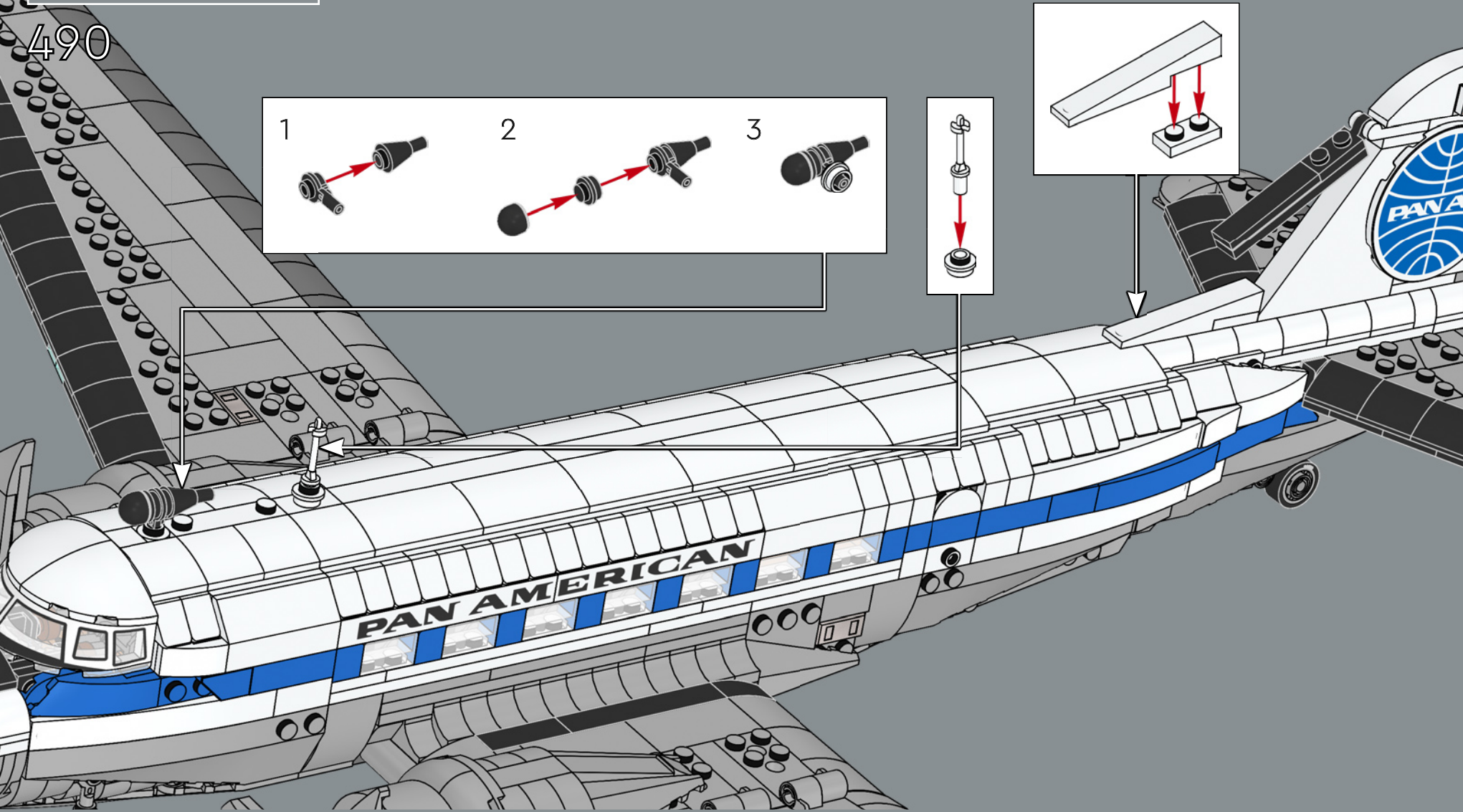
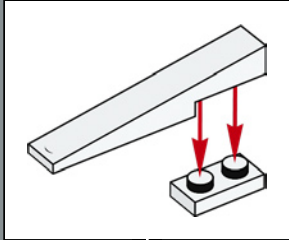
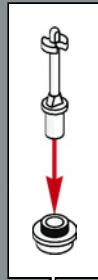
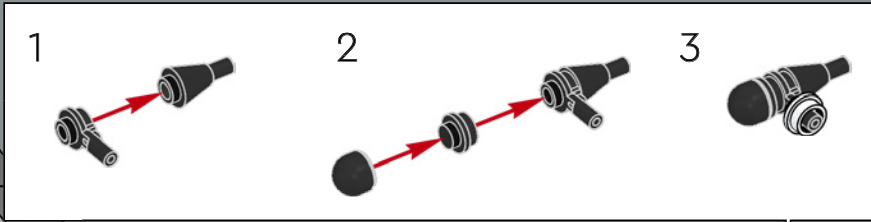

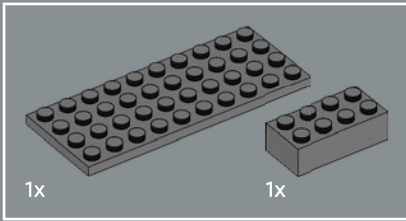
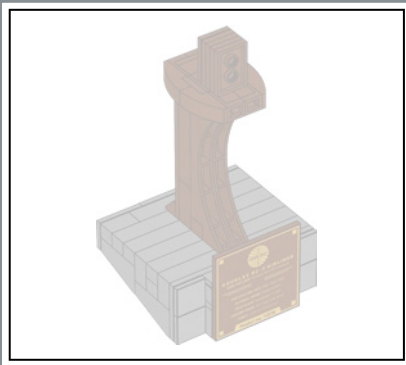

491

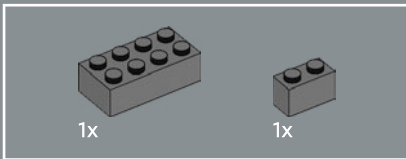
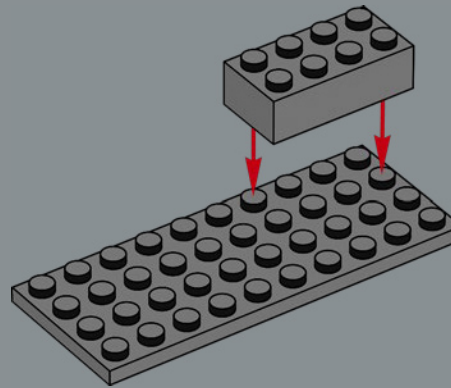

492

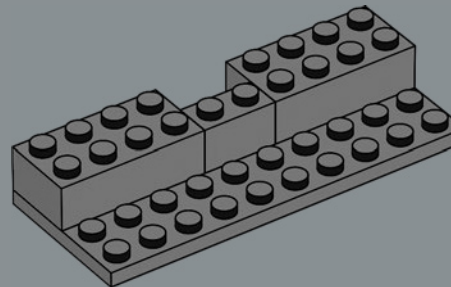

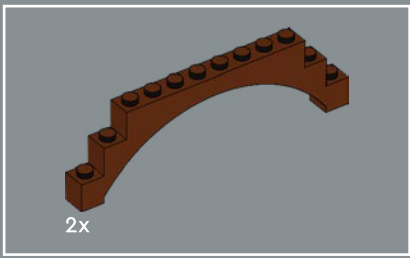

493

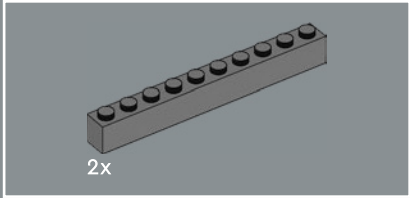
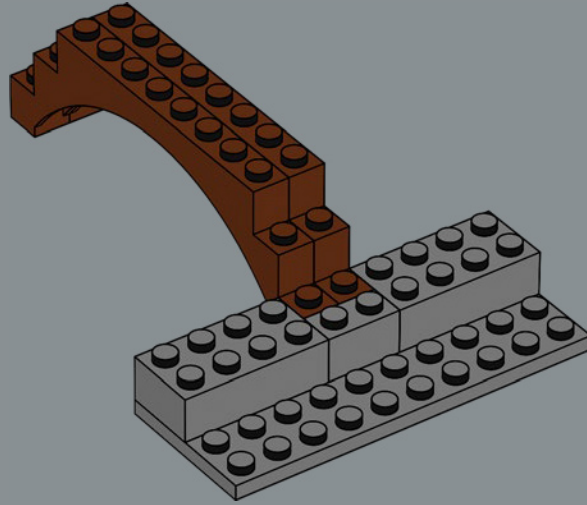

494

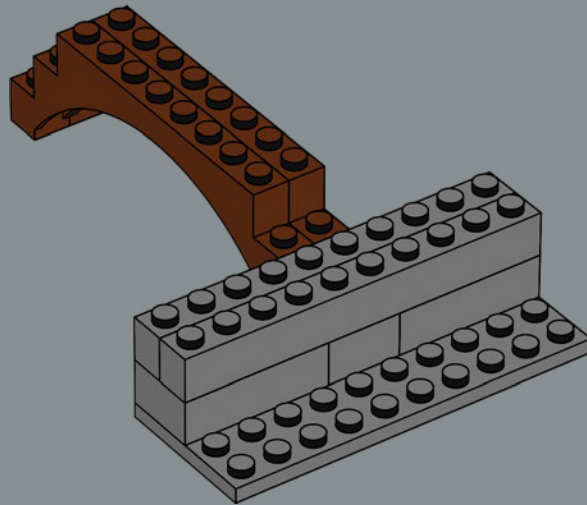

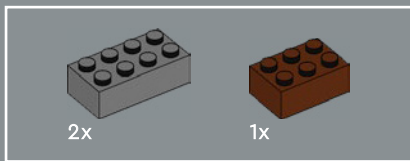

495

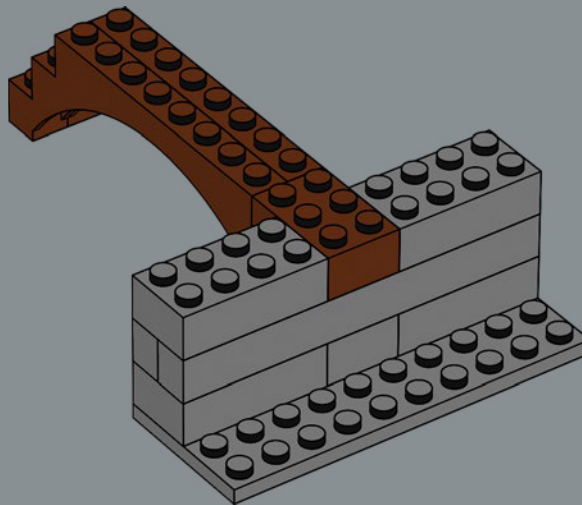

496

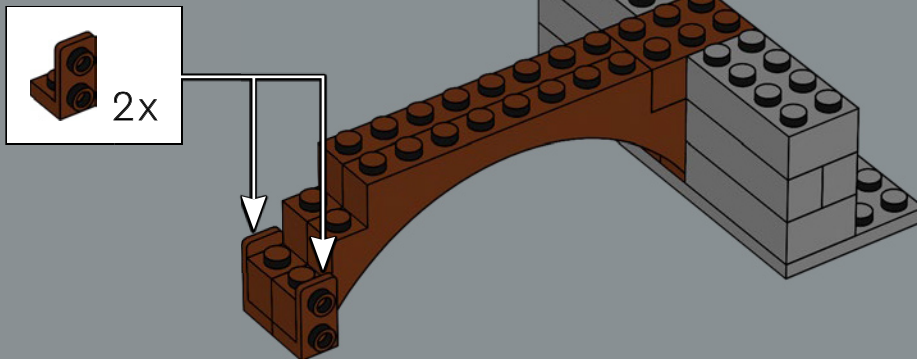

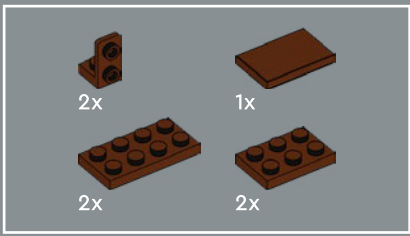

497

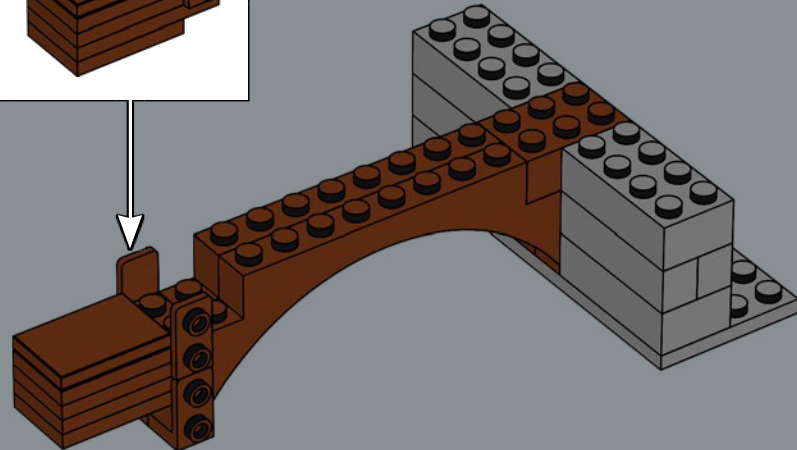
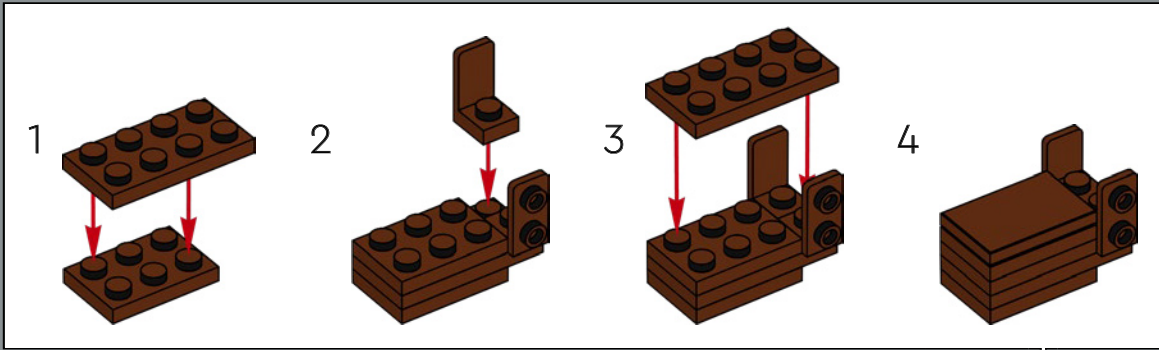

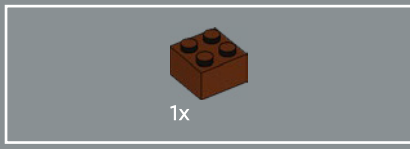

498

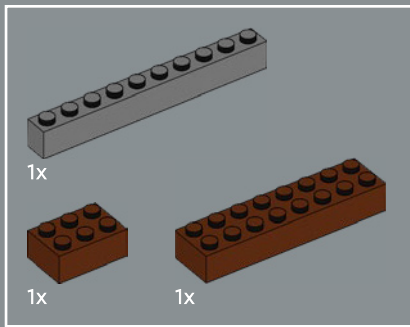
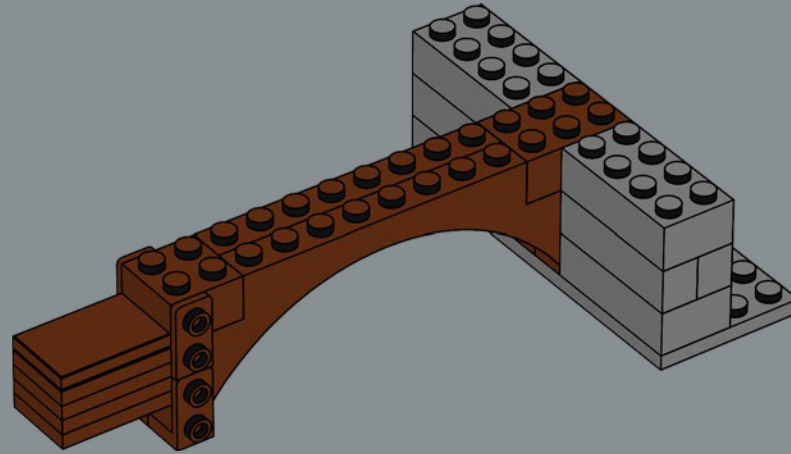

499

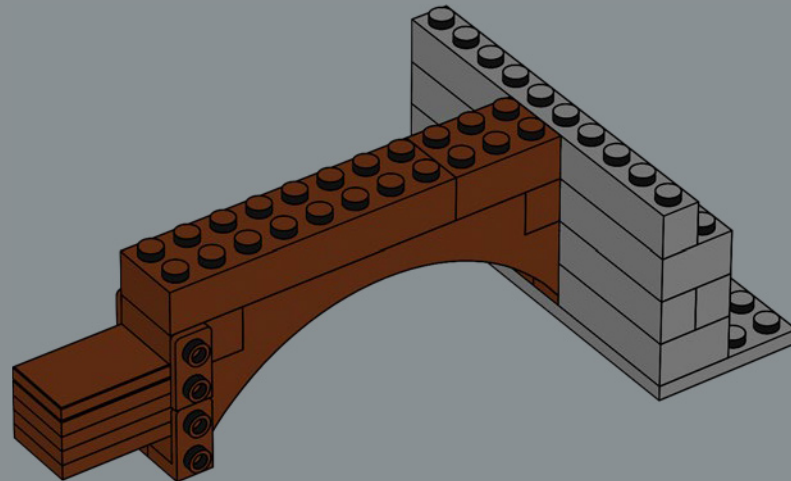

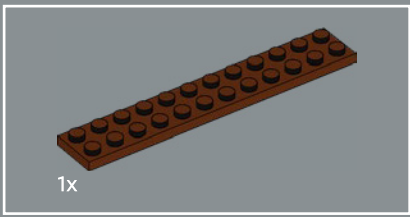

500

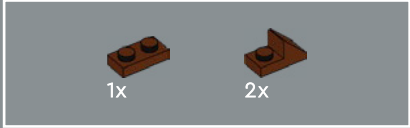
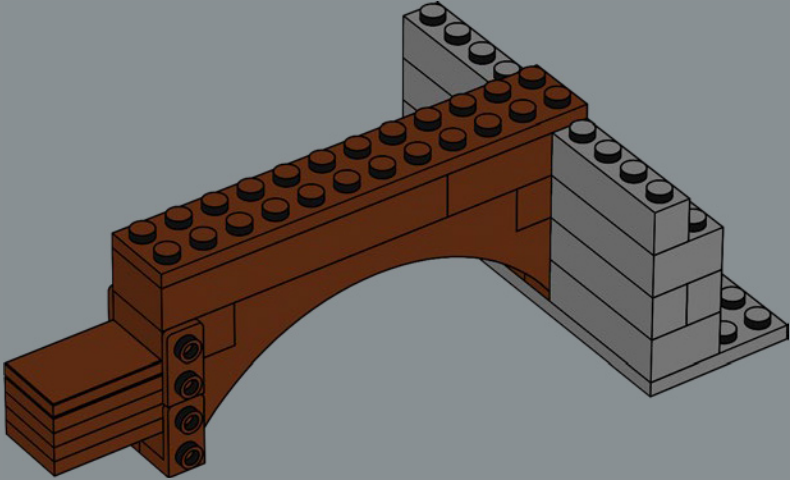

501

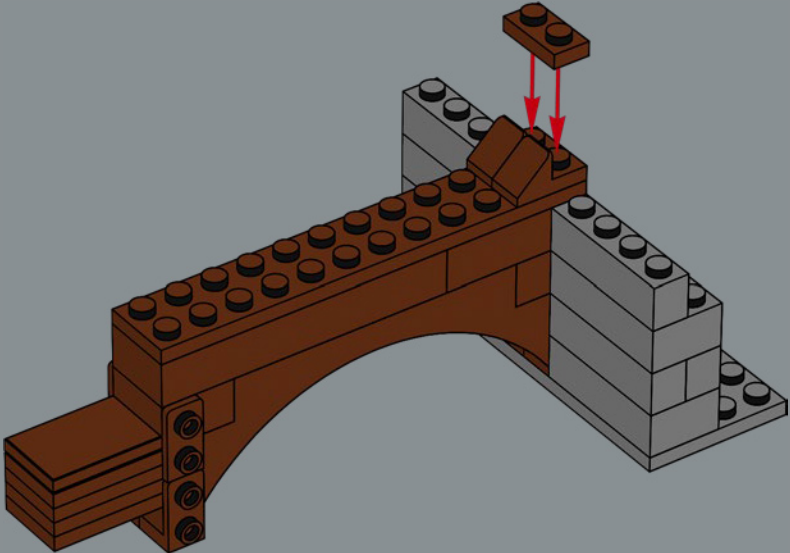



502

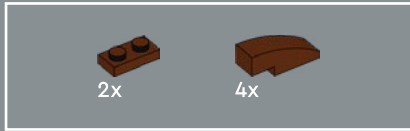
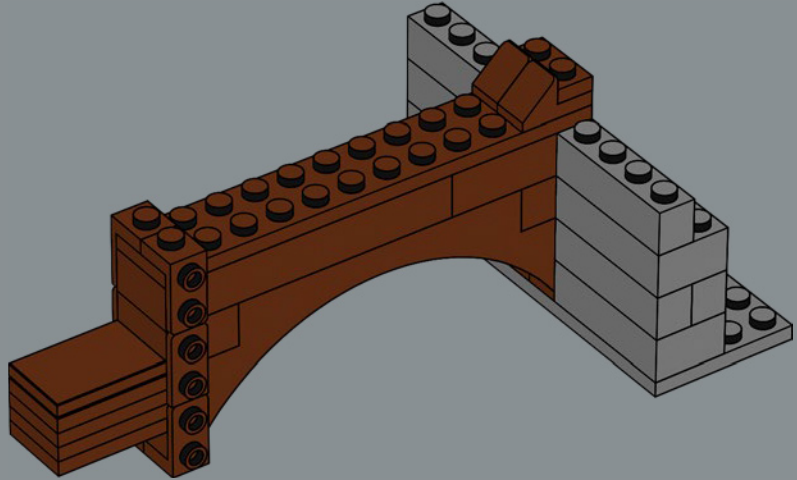

503

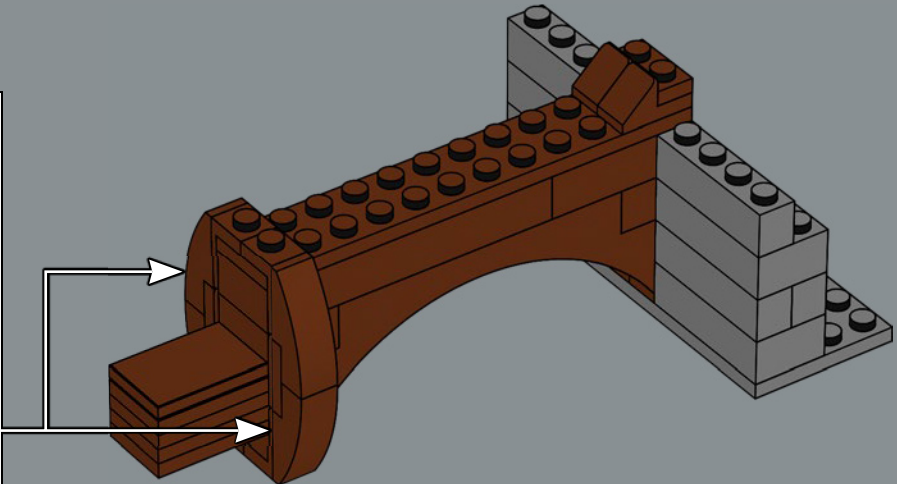
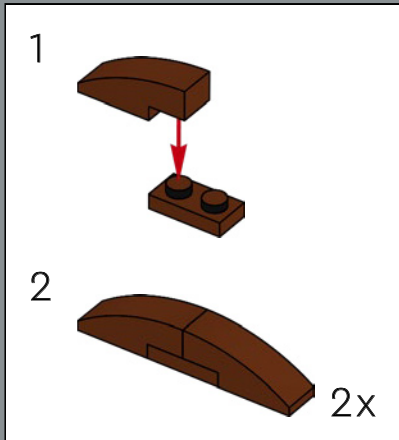



2x

504

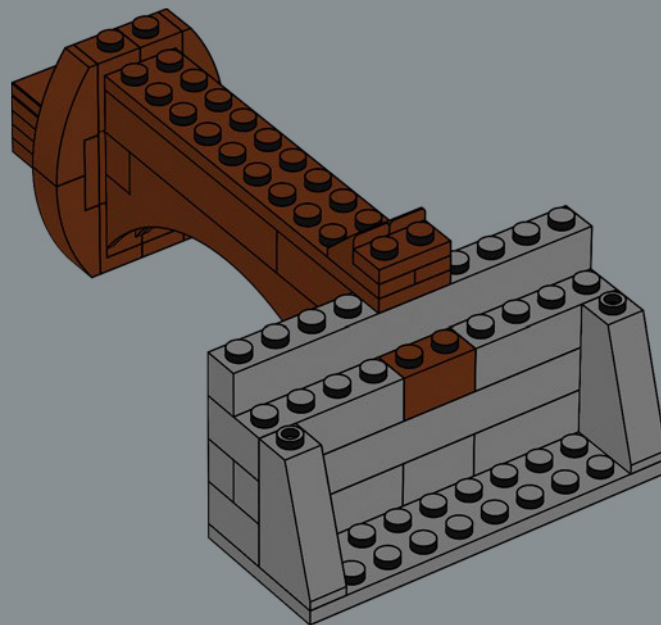

2x

505

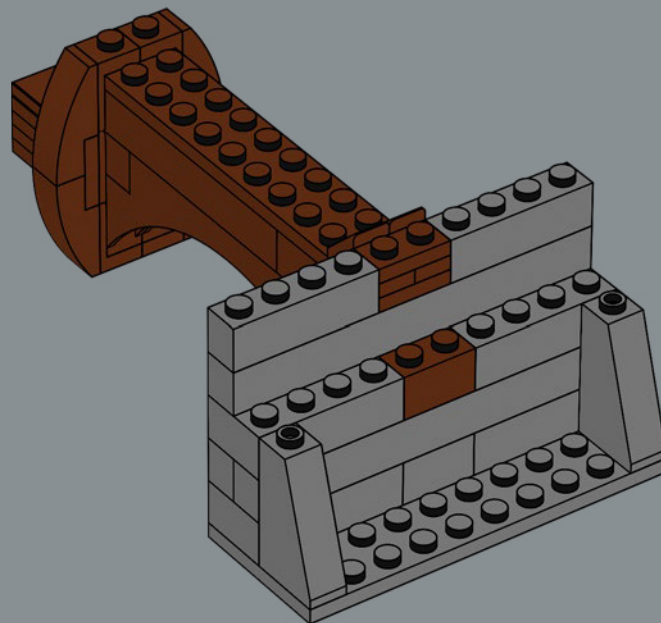

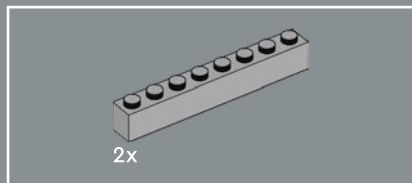

506

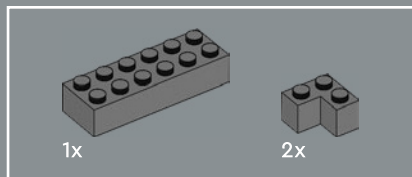
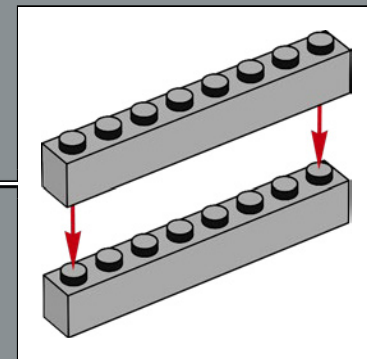
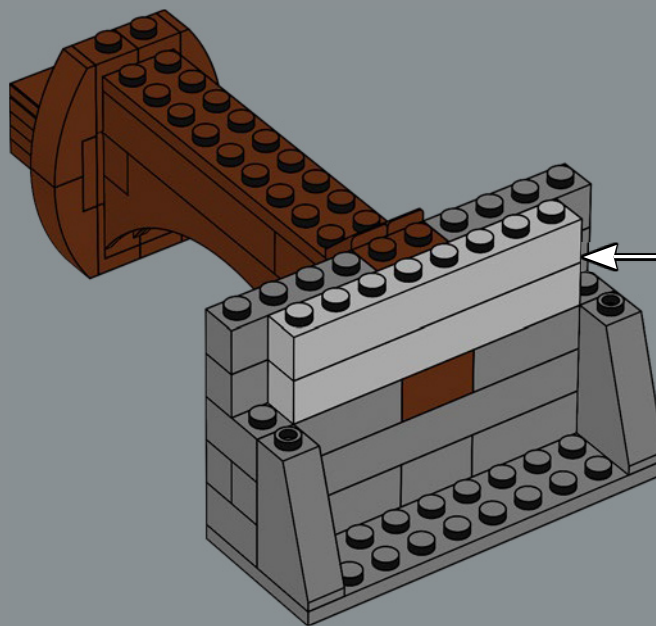

507

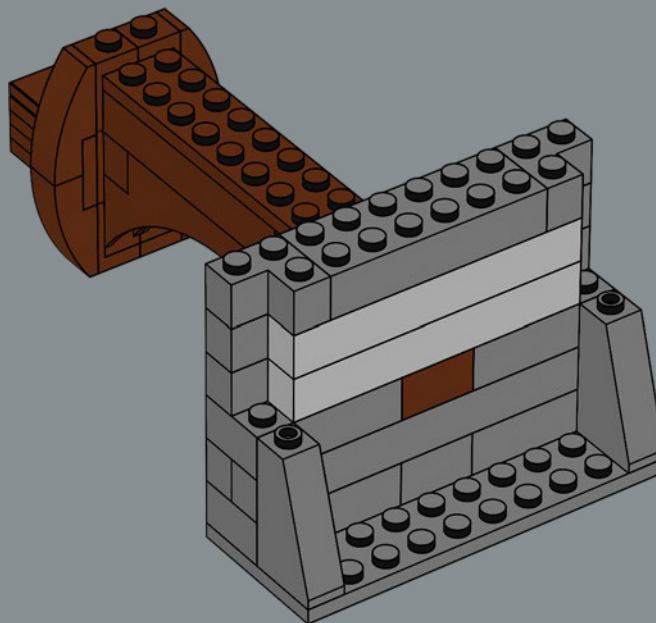

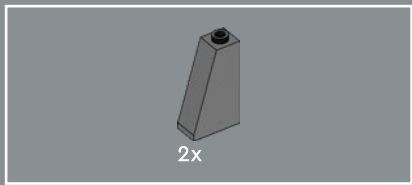

508

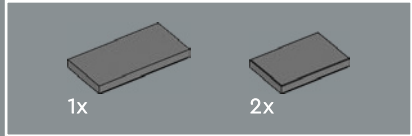
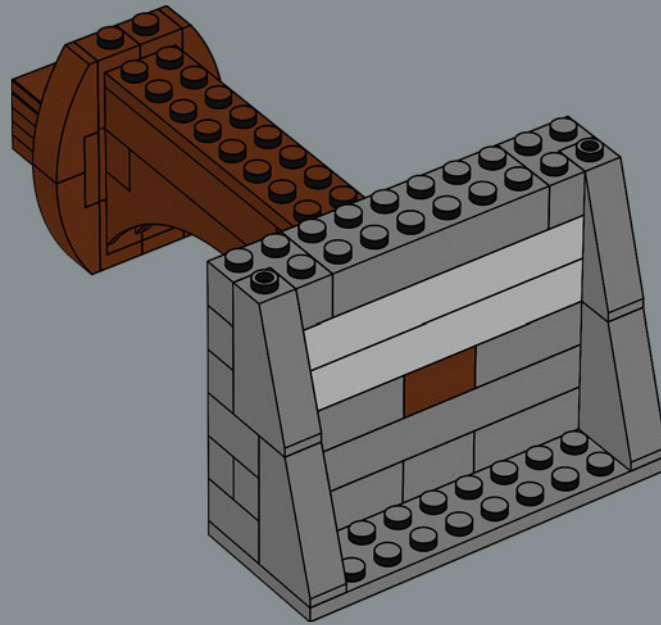

509

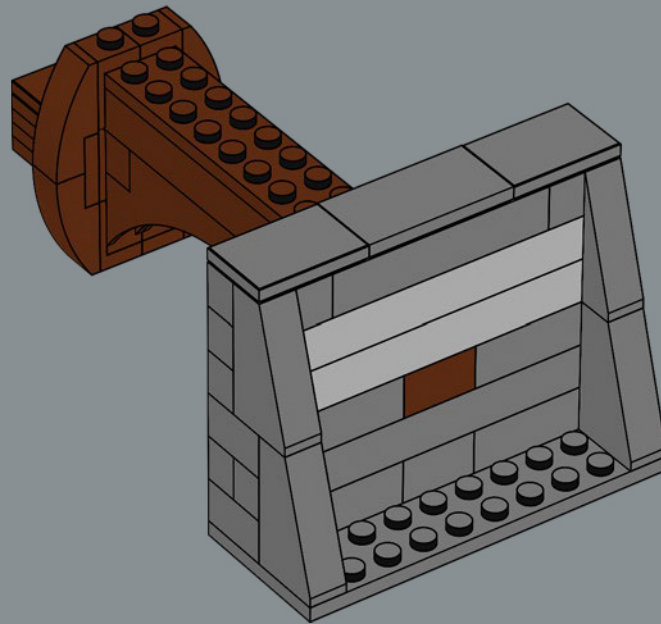



510

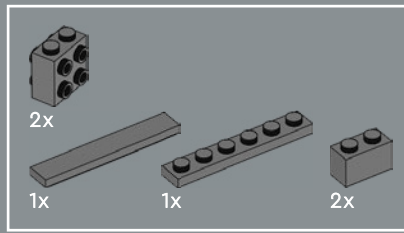
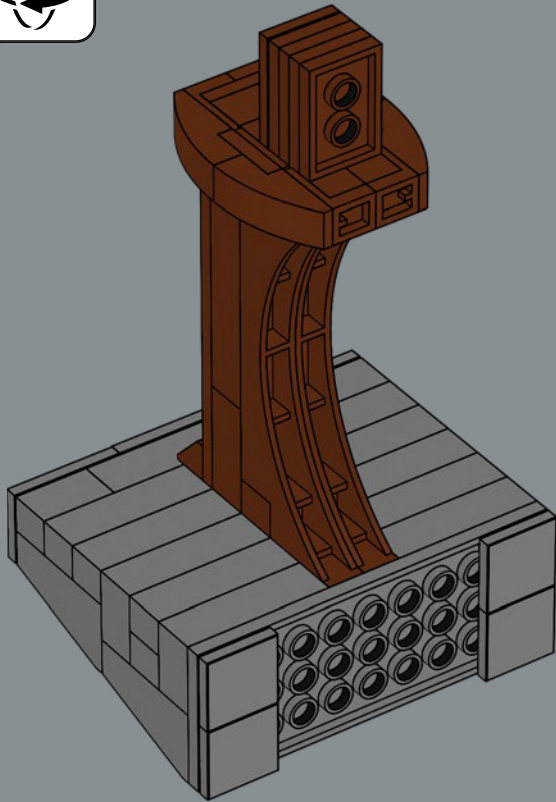

511

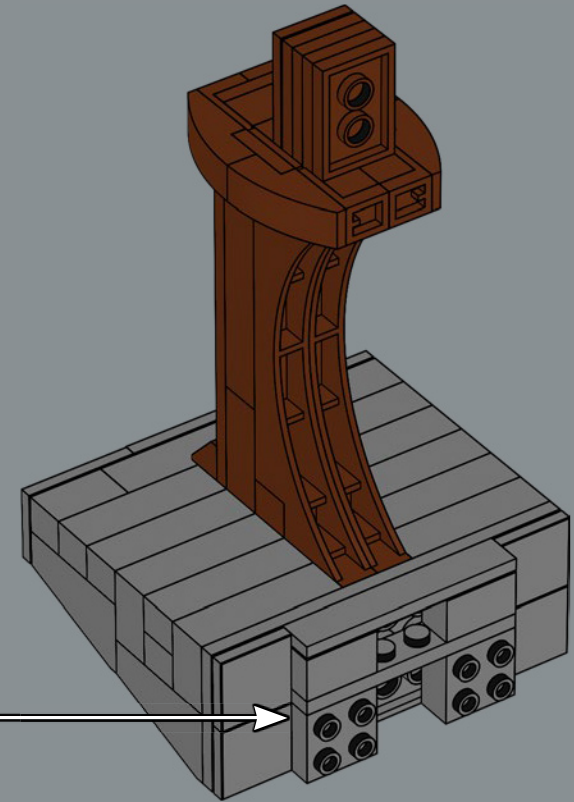
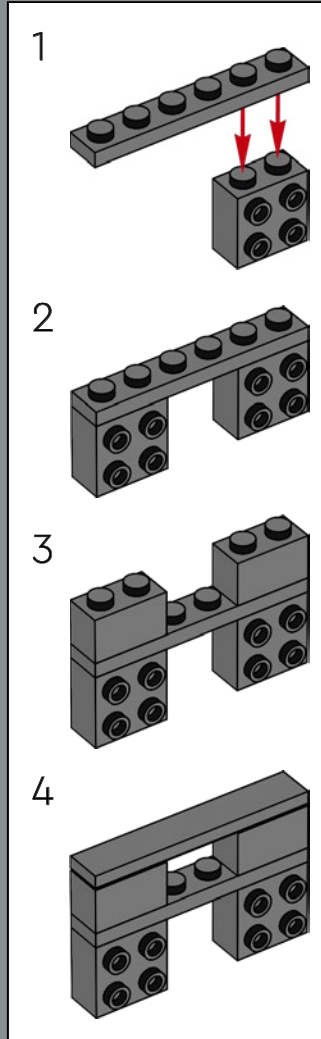



1x

512



513

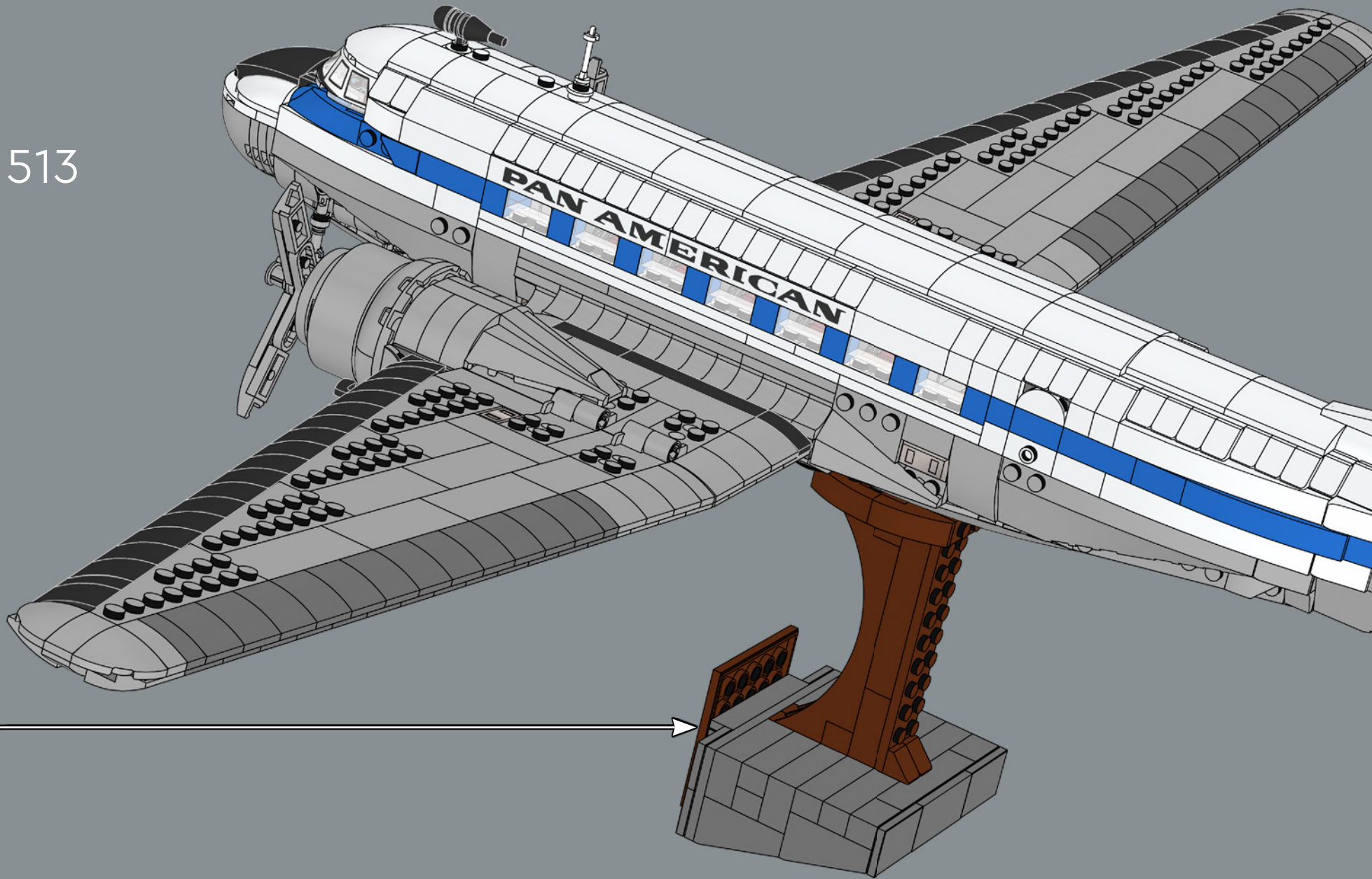



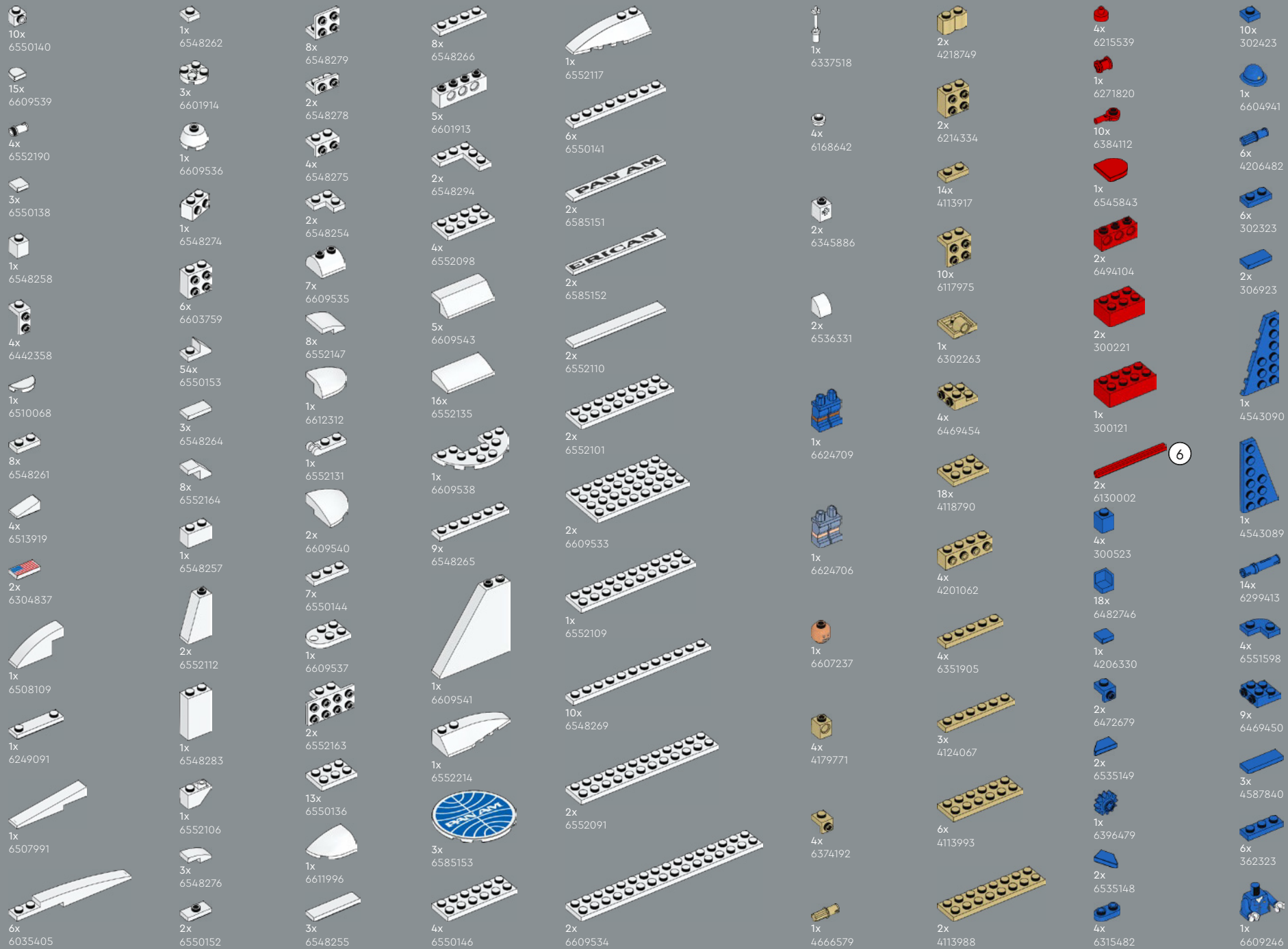

6

- 1x 6558857
- 1x 6558916
- 2x 371023
- 3x 301023
- 2x 6555137
- 6x 6307275
- 15x 302023
- 2x 300123
- 2x 6535145
- 2x 366623
- 2x 4243815
- 1x 416223
- 1x 303423
- 4x 654124
- 7x 6248971
- 2x 6206240
- 16x 242024
- 1x 6130007
- 5x 614126
- 1x 6538443
- 2x 6473449
- 2x 4558954
- 2x 4504382
- 2x 300526
- 2x 302426
- 2x 6299338
- 2x 6344752
- 1x 6585195
- 1x 6196548
- 1x 4246901
- 35x 6279875
- 1x 9339
- 4x 6147050
- 2x 6275806
- 2x 6138173
- 6x 6047276
- 2x 4541191
- 2x 302326
- 2x 6000650
- 2x 6325521
- 4x 6428168
- 1x 6336989
- 2x 6506201
- 40x 6053077
- 4x 302226
- 42x 6211476
- 2x 6109682
- 1x 6362991
- 2x 4558170
- 1x 6609279
- 2x 6537354
- 4x 370526
- 2x 6601610
- 1x 243126
- 1x 6597398
- 1x 366626
- 1x 6560654
- 2x 663626
- 2x 6161298
- 4x 273026
- 6x 383226
- 4x 6001494
- 4x 4569058
- 1x 6604940
- 14x 6514121
- 1x 6585145
- 4x 6508249
- 1x 6240515
- 1x 6486027
- 1x 6609230
- 39x 4528604
- 1x 4162916
- 1x 6609257
- 2x 6282619
- 10x 6092597
- 3x 4539097
- 2x 4585479
- 1x 4585751
- 1x 4583299
- 2x 6264030
- 5x 4539071
- 3x 4618986
- 1x 6604944
- 2x 6347304
- 2x 6365746
- 3x 6093494
- 4x 6208446
- 3x 4619636
- 6x 6287673
- 1x 6396480
- 1x 6423273
- 1x 6410056
- 1x 6404026
- 1x 6527824
- 1x 6508103
- 1x 6537328
- 3x 6177146
- 5x 6215606
- 2x 4539083
- 2x 6544174
- 15x 6138232
- 2x 6186673
- 4x 6341553
- 2x 6472546
- 2x 6223599
- 3x 4211150
- 2x 6075287
- 4x 6443654
- 1x 6551600
- 1x 4211210
- 4x 6135494
- 4x 6325975
- 4x 4211189

3

4

3



2x
4216668



1x
6311441



2x
4211186



2x
6159763

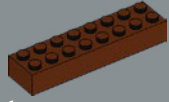

1x
6096701



1x
6609285

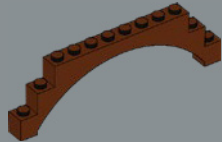

2x
6246843



1x
4225700



2x
4539481



21x
6271165



2x
6275844



1x
6296859



6x
4521921



2x
6253436



8x
4211399



2x
6176433



3x
6401023



1x
6335328



2x
6248078



7x
6225142



7x
6225139



1x
4211758



4x
6163478



4x
6163477



4x
6344702



2x
6510070



4x
6344703



2x
6510070



4x
6344703



4x
6344703



2x
6227897



1x
4211791



1x
4211794



8x
6294038



2x
6296894



2x
4514195



6x
6134378



2x
6134378



16x
6144138



16x
6548933



6x
4593679



12x
6539831



6x
4211398



1x
6146223



8x
6028813



4x
6028813



1x
6435915



2x
6280396



2x
6173127



9x
4211414



19x
6066097



2x
6493586



4x
4211541



26x
6396791



2x
6132886



14x
6102357



2x
4211387



26x
6185676



2x
4211881



4x
4211815



2x
4211655



8x
4211429



8x
6251044



2x
4211489



6x
4654582



1x
6265742



14x
4211353



1x
6065824



8x
4211397



6x
632886



14x
6102357



2x
4211387



26x
6185676



2x
4211881



4x
4211815



2x
4211655



8x
4211429



8x
6251044



2x
4211489



6x
4211361



8x
4558169



2x
6262083



2x
6262082



8x
6456718



2x
4507056



6x
6132207



7x
4211396



6x
6435930



4x
6171894



2x
6271831



4x
6331574



4x
6257593



4x
4211445



1x
4211394



7x
4211356



2x
6402876



4x
6558989



1x
4622803



21x
6015347



2x
4507052



3x
6493587



12x
4560183



8x
6258903



4x
4211395



2x
6307999



3x
4211639



2x
6372029



3x
6493589



2x
6303442



3x
6132983



1x
6597400



1x
6597400



1x
6597400



1x
6597400



1x
6597400



1x
6597400



1x
6597400



1x
6597400



1x
6597400



1x
6597400



1x
6597400

5

3

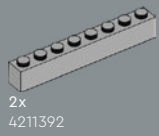

2x
4211392



3x
4211481



8x
6448327



4x
4211406

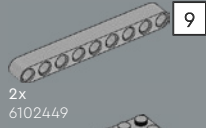

2x
6102449



8x
6448326

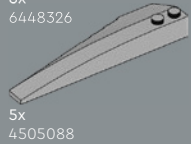

5x
4505088



14x
4251149



LEGO.com/service



4x
4211466



2x
6508016

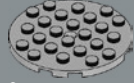

2x
6015349



10x
6318584

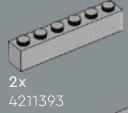

2x
4211393



5x
4505087

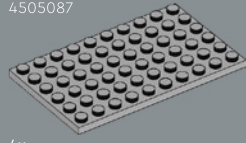

4x
4211405

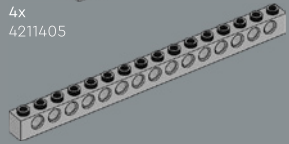

2x
4211095

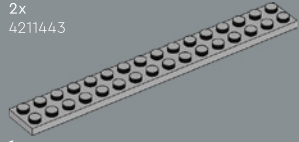

1x
4211486



2x
6510131



1x
6510213



15x
6360111



2x
6221607



4x
6338422



2x
4521512



6x
6261374



1x
4567887



3x
6005331



2x
4211095



4x
6135014



10x
6514456



1x
4516546



3x
4211088



4x
4221745



4x
4221745



1x
6342558



6x
6396058



1x
4211066



2x
6215212



6x
6029948



2x
6000606



1x
6271356



2x
6543014



1x
4529728



1x
4529727



4x
6013082



2x
4211109



33x
6071261



33x
6071261



7x
4211094



12x
6047417



34x
6344820



15x
4521187



1x
4552349



4x
6271876



14x
4211133



2x
6187008



3x
4211105



4x
4211043



1x
6083620



2x
4211103



10x
4211001



4x
6215176



4x
6215176



4x
6395635



2x
6631413



2x
6231765



4x
6439040



4x
6100030



4x
4211085



1x
4560184



2x
4210686



1x
4211056



1x
4210651



5x
4243831



1x
4210875



4x
4211002



2x
4499858



2x
4499858



12x
4210719



2x
6225494



2x
6510145



4x
4211044



2x
4210998



2x
4210997



1x
4257526



3x
4211107



2x
4210678



9x
6133611



1x
4211122



2x
4211114



2x
4211114



2x
4211114



2x
4211114

9

5

4

8



YOU COULD
WIN



**YOU COULD
WIN**

Your feedback will help shape the future development of this product series.

Visit:

**DU KÖNNTEST
GEWINNEN**

Dein Feedback trägt zur Weiterentwicklung dieser Produktreihe bei.

Geh auf:

**VOUS POURRIEZ
GAGNER**

Vos commentaires nous aideront à concevoir les futurs produits de cette gamme.

Visitez :

**POTRESTI
VINCERE TU**

La tua opinione ci aiuterà a migliorare la creazione futura di questa linea di prodotti.

Visita:

**PUEDES
GANAR**

Tu opinión contribuirá al futuro de esta serie de productos.

Visita:

轻松获奖

您的反馈将有助于我们在今后改进本产品系列。

请访问:

LEGO.com/productfeedback

You also have the chance to win a LEGO® set.

Terms and conditions apply.*

Außerdem hast du die Chance, ein LEGO® Set zu gewinnen.

Es gelten die Teilnahmebedingungen.*

Vous pourriez également gagner un ensemble LEGO®.

Des conditions s'appliquent.*

Hai anche la possibilità di vincere un set LEGO®.

Termini e condizioni sono applicabili.*

También tienes la oportunidad de ganar un set LEGO®.

Aplican términos y condiciones.*

您还有机会赢取乐高®套装。

条款和条件适用。*

*LEGO.com/productfeedback-terms



LEGO and the LEGO logo are trademarks of the LEGO Group. ©2026 The LEGO Group.

Produced under license from The Boeing Company. BOEING, DOUGLAS and DC-3 and the distinctive Boeing logos, product markings and trade dress are trademarks of The Boeing Company.
™ All related logos, characters, names, and distinctive likenesses thereof are the exclusive property of Pan American World Airways, LLC. Used under authorization.