

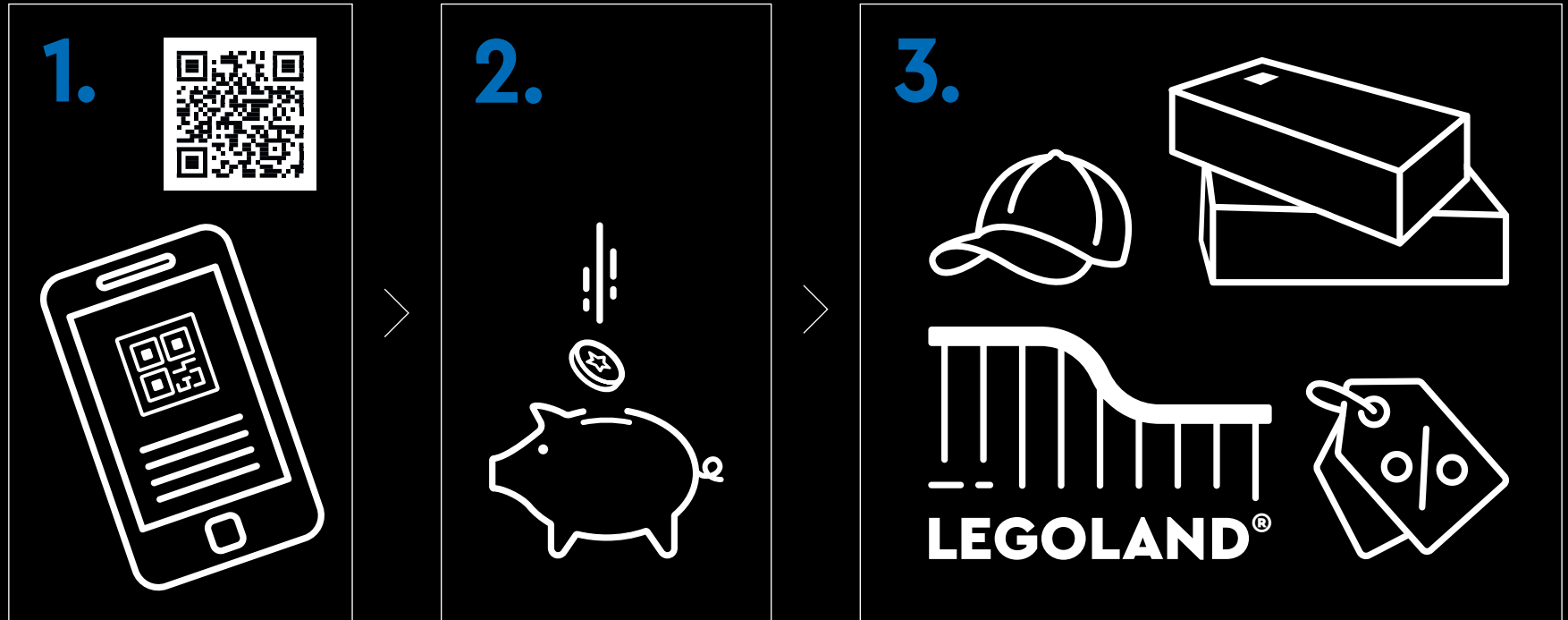

LEGO.com/sustainable-packaging

LEGO® VIP



1. Sign up **2.** Earn points for purchases **3.** Redeem points for rewards, experiences, discounts & more | **1.** Melde dich an **2.** Sammle Punkte bei jedem Kauf **3.** Löse die Punkte für Belohnungen, Erlebnisse, Rabatte und Ähnliches ein | **1.** Inscrivez-vous **2.** Gagnez des points lors de vos achats **3.** Échangez vos points contre des récompenses, des expériences, des remises et bien plus encore | **1.** Iscriviti **2.** Guadagna punti con i tuoi acquisti **3.** Riscatta punti per premi, esperienze, sconti e altro ancora | **1.** Regístrate **2.** Gana puntos por tus compras **3.** Canjea puntos por recompensas, experiencias, descuentos y mucho más | **1.** Registe-se **2.** Ganhe pontos em compras **3.** Troque os pontos para prémios, experiências, descontos e muito mais | **1.** 注册 **2.** 购物赚积分 **3.** 用积分兑换奖励、体验、折扣等 | **1.** Zarejestruj się **2.** Zdobywaj punkty za zakupy **3.** Wymieniaj punkty na rabaty, przygody i inne nagrody | **1.** Zaregistrujte se **2.** Sbírejte body za nákupy **3.** Vyměňujte body za odměny, zážitky, slevy a spoustu dalšího | **1.** Zaregistrujte se **2.** Získavajte body za nákupy **3.** Uplatnite si body a získajte odmeny, rôzne zážitky, zľavy a ešte viac | **1.** Regisztrálj **2.** Szerez pontokat minden vásárlással **3.** Váltsd be pontjaidat jutalmakra, élményekre, kedvezményekre és egyebekre | **1.** Înscric-te **2.** Câștigă puncte pentru achiziții **3.** Valorifică puncte pentru recompense, experiențe, reduceri și multe altele | **1.** Регистрируйте се **2.** Получайте точки за покупки **3.** Используйте точки за награды, услуги, отстъпки и т.н. | **1.** Reģistrējies **2.** Pelni punktus par pirkumiem **3.** Izmanto punktus, lai saņemtu balvas, izklaides iespējas, atlaides un daudz ko citu | **1.** Registreeru **2.** Teeni ostude eest punkte **3.** Lunasta punktide eest preemiad, elamused, allahindlused ja muu | **1.** Užsiregistruokite **2.** Pelnykite taškus už pirkinius **3.** Panaudokite taškus atlygiui, funkcijoms, nuolaidoms ir ne tik





一咬钟情

🍊 在 20 世纪 70 年代，第一批数字街机游戏在日本一经推出，就很快风靡全国。不久之后，这一浪潮席卷世界其它各地，玩家们争相涌向光线昏暗的游戏中心，被闪烁的图像、机械音乐和诱人的高分所吸引。射击游戏最受欢迎而且通常是唯一的选择，这主要是为了迎合男性玩家。日本游戏设计师岩谷彻 (Toru Iwatani) 提出，如果游戏环境和内容更友好、更吸引人一些，女性也可能会喜欢上玩游戏。在探索时尚、算命等另类游戏主题之后，岩谷先生选择了终极的社会包容性主题：食物。



灵感

🍕 有一天，在探寻游戏创意的过程中，他抓起一片披萨。他发现剩下的披萨构成了一个张着嘴的简单标志性人物的外形。“吃豆人”的想法随之诞生。

这款游戏原名为“Puck Man”，它的灵感来自日语短语“Paku paku taberu”，意为吞噬食物。当此游戏在美国推出时，发行商发现《吃豆人》将是一个更能迎合市场的名称。

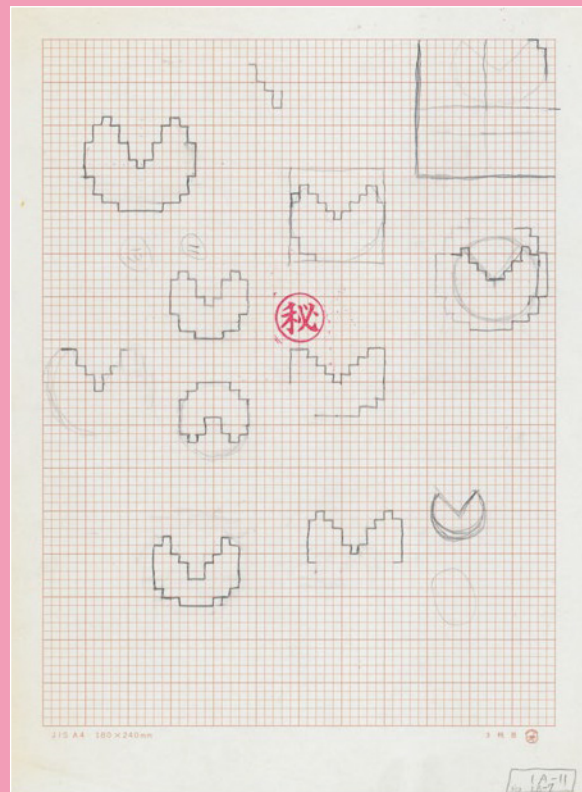

岩谷最初在方格纸上的“Puck Man”设计草图用于在16x16像素网格上绘制像素。



岩谷彻

岩谷先生还分享了一段插曲，当为“吃豆人”选择颜色时，他参考了乐高®积木的黄色。他之所以选择乐高黄色，是因为他认为这种暖色会令他的目标客户——女性和孩子——感觉更舒服。

全球游戏盛况

🍓 后来的事实证明，岩谷先生的理论远远超出他的想象。在 1980 年第一款《吃豆人》街机游戏发布后不久，它就演变成为前所未有的全球性现象。这款游戏立即吸引了那些从未考虑过来游戏厅的新受众。系列可爱的角色和直观的游戏玩法赢得了每一代玩家的心。成年男女、儿童、青少年和祖父母有史以来第一次可以一起体验家庭电子戏。该游戏在第一个十年中售出超过 30 万台游戏机。到本世纪之交，该游戏的总收入为 25 亿美元，并且仍然保持着迄今为止最受欢迎的街机游戏的记录。

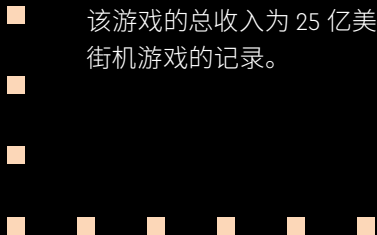

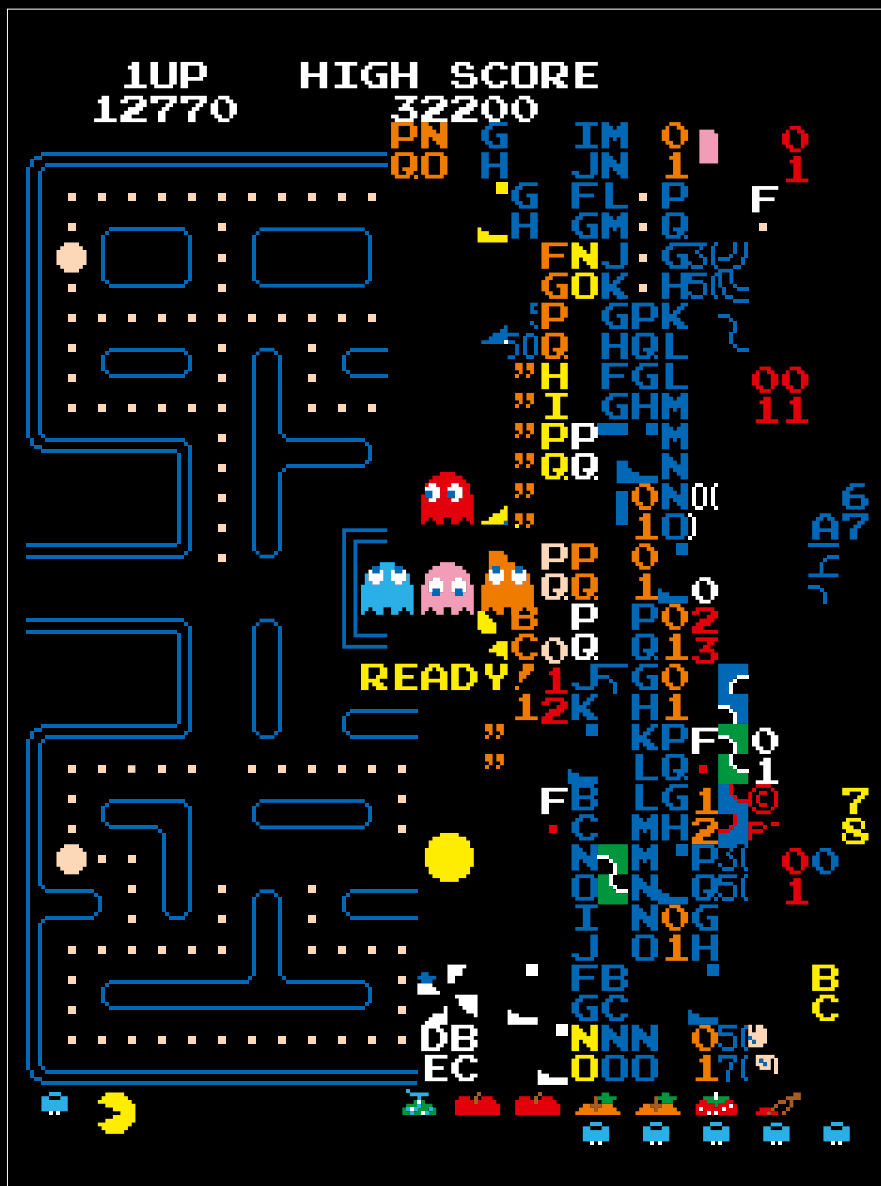

无法通过的第 256 关

🍄 岩谷和他的开发团队从未想过有玩家会闯到 256 关——事实上，这款游戏甚至没有设计最终目标或胜利场景。当你到达 256 关时，已没有足够的内存来生成完整的地图，你在《吃豆人》迷宫中的旅程也到此结束。（当然，除非你重新开始。）



讨厌的幽灵

🍌 《吃豆人》的粉丝们被这款游戏的配角（四个幽灵）深深吸引着。每个幽灵都拥有自己独特的个性，还可以不同的方式移动：



红色幽灵 Blinky

Blinky 是幽灵们的领导者，灵活且非常执着。



蓝色幽灵 Inky

Inky 的得力助手，比其他的幽灵同伴要害羞一些。



橙色幽灵 Clyde

Clyde 是一位探险家，经常在他能找到的每一个角落徘徊。



粉色幽灵 Pinky

不要被 Pinky 精致的外表所欺骗——她是一个致命的对手！

《吃豆人》 的坚持

🍓 几十年来，朴实无华的主角和顽皮的对手经历了无数次更迭。我们对原始街机游戏的怀旧之情仍然汹涌澎湃，《吃豆人》依然永恒，与我们有着千丝万缕的联系，还保持着无限的新技术适应性。





简约之美

“每一代游戏迷都对他们‘自己的’吃豆人版本有着美好的回忆。我清楚地记得那些经典的街机游戏厅！受 1980 年原始街机的启发，我们与 Bandai Namco Entertainment Inc. 合作创造了这款套装。街机的游戏机制、配色方案和像素化图形非常适合乐高® Icons 套装。我们希望通过模仿不同的功能来捕捉怀旧的游戏体验：可以按下投币槽旁的按钮打开灯，移动操纵杆并摇动侧面的控制杆以在迷宫中移动角色。黑色组件伪装成机械装置，链条上新开发的连杆组件允许角色急转弯。我们希望它也能为你带来所有美好的回忆。”

SVEN FRANIC
乐高® Icons 模型设计师

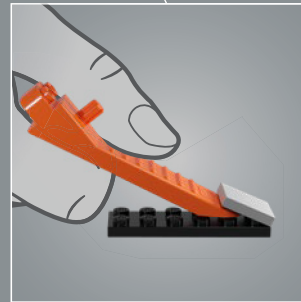
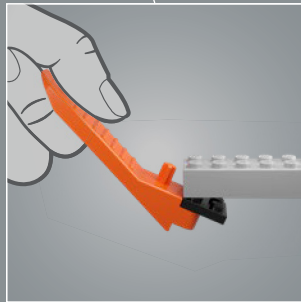
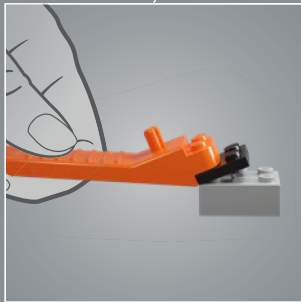
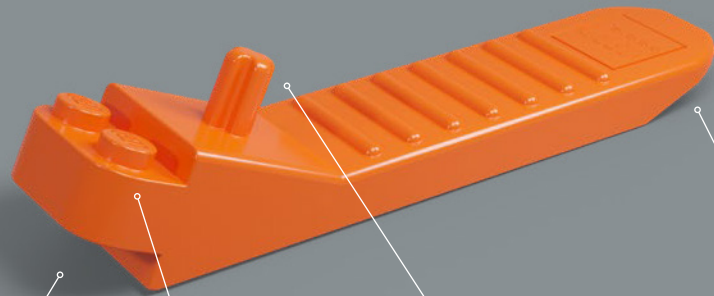

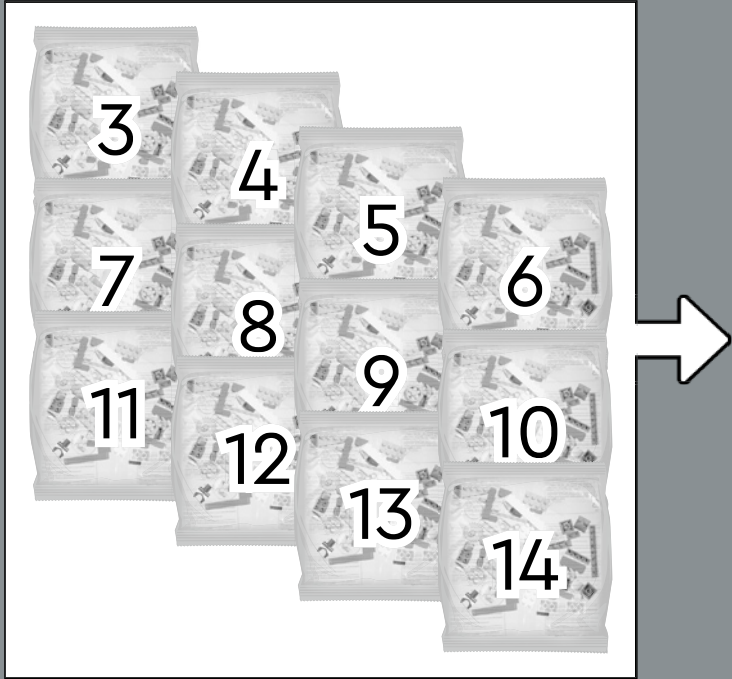
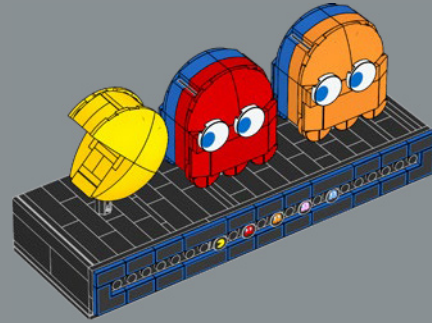

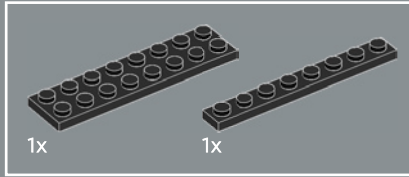
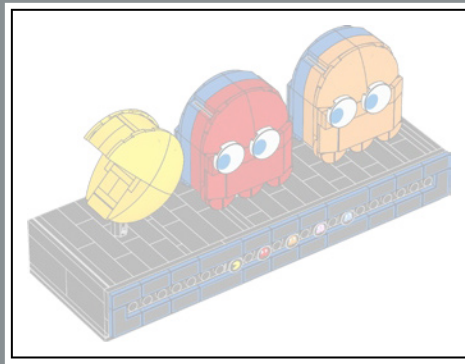

1

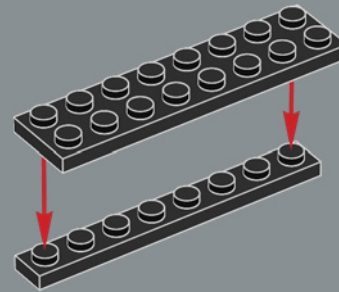



2

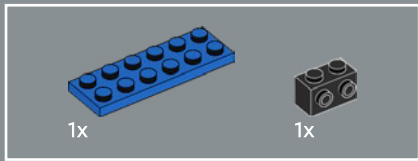
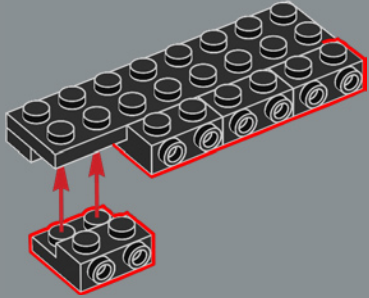

3

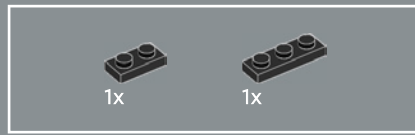
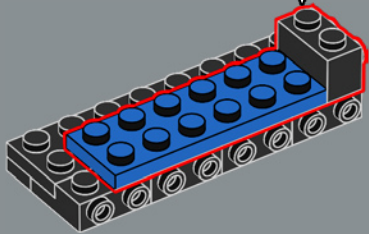
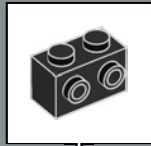

4

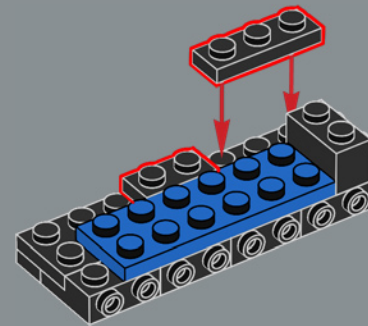

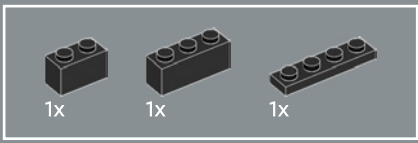

5

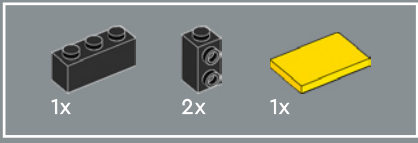
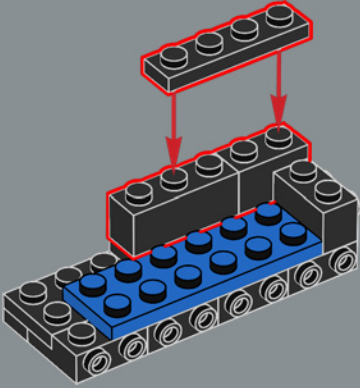

6

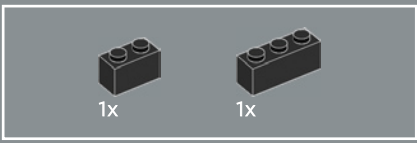
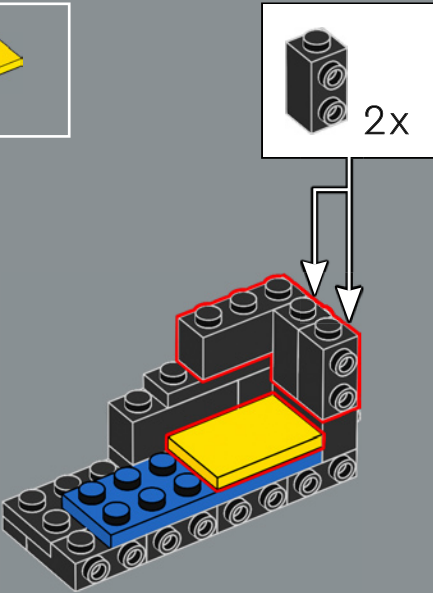

7

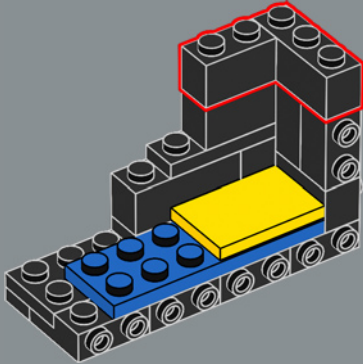

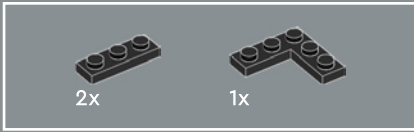
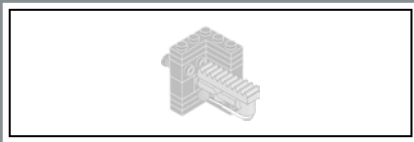

8

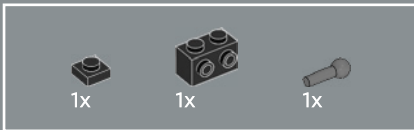
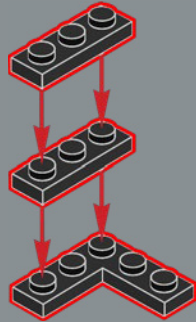

9

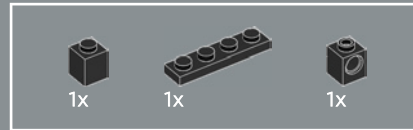
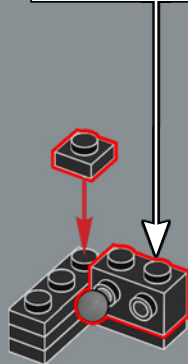
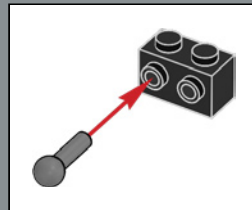

10

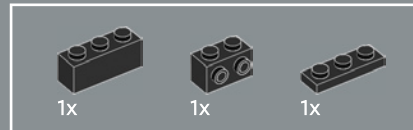
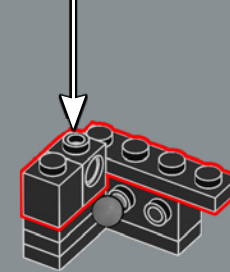
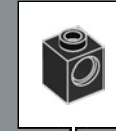

11

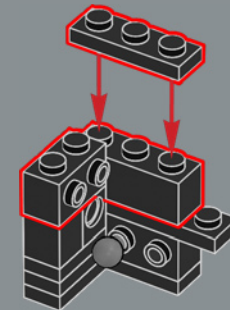

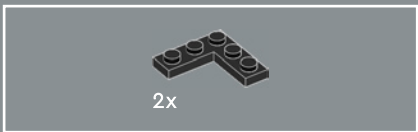

12

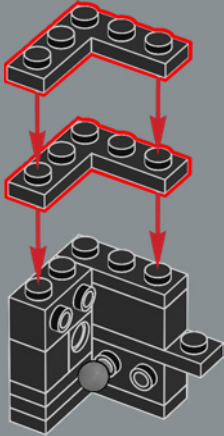

13

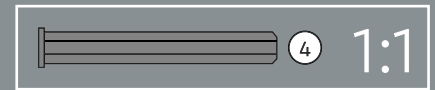
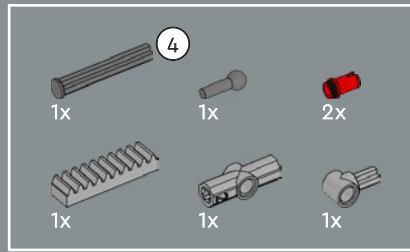
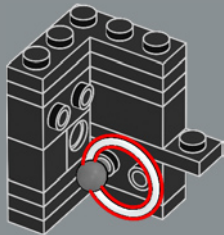

14

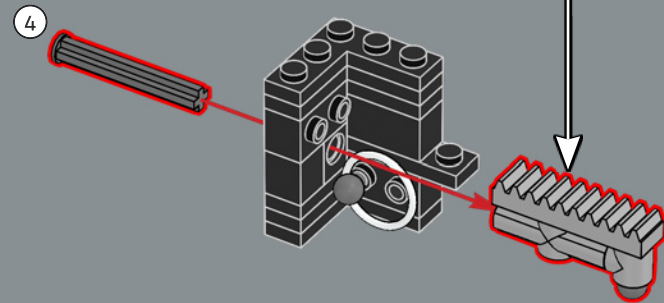
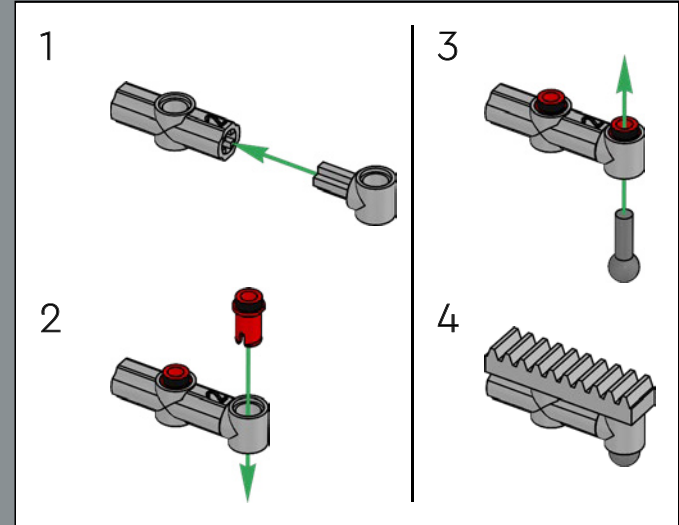

15

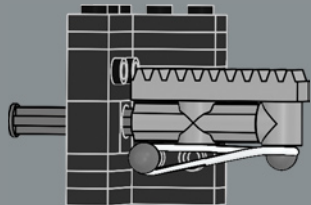

16

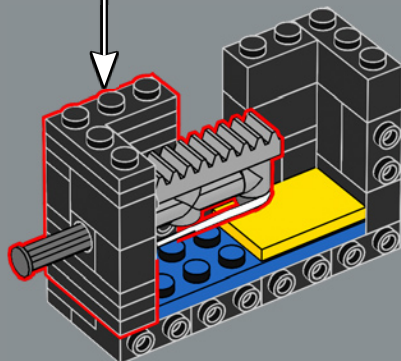

3x



1x

17

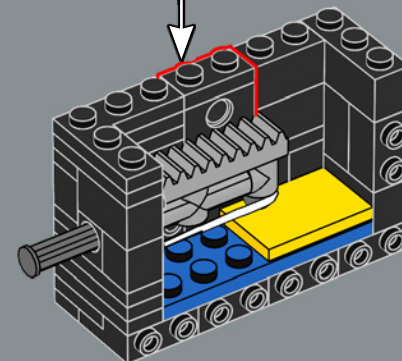
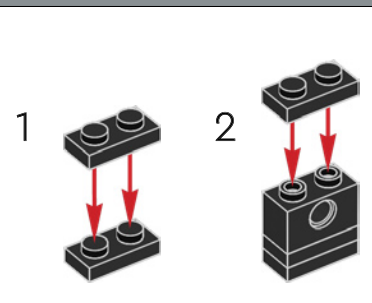

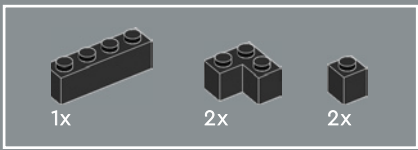

18

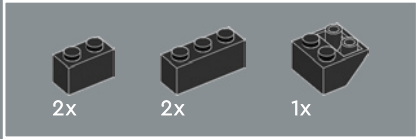
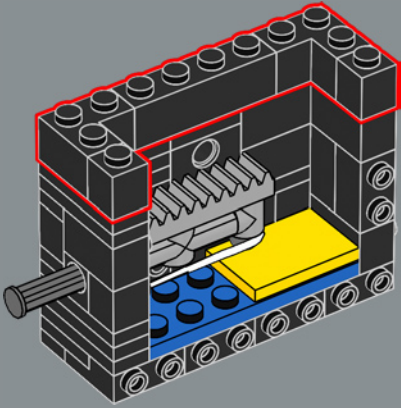

19

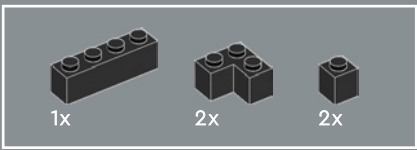
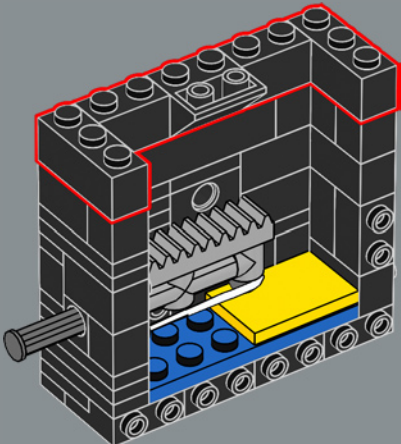

20

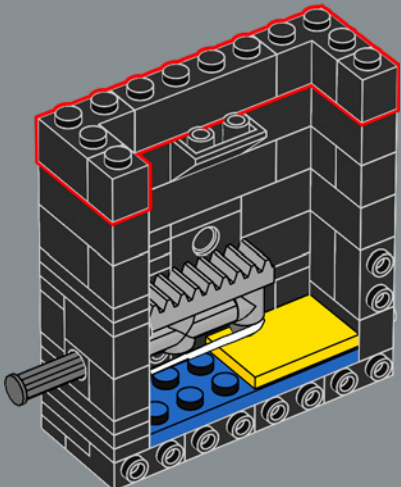

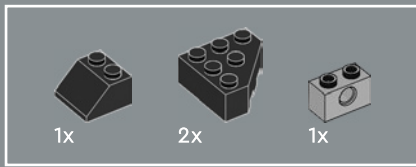

21

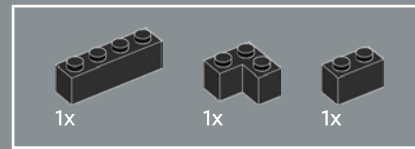
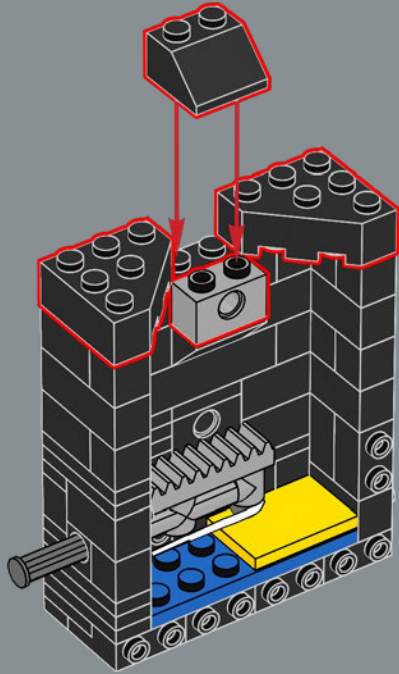

22

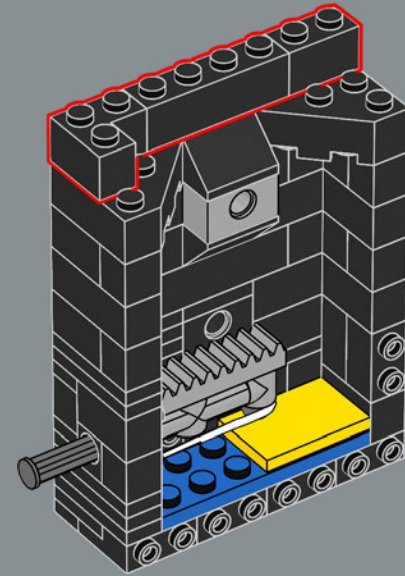

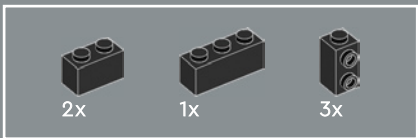

23

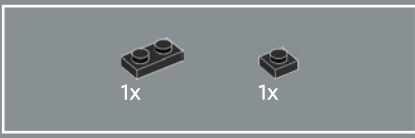
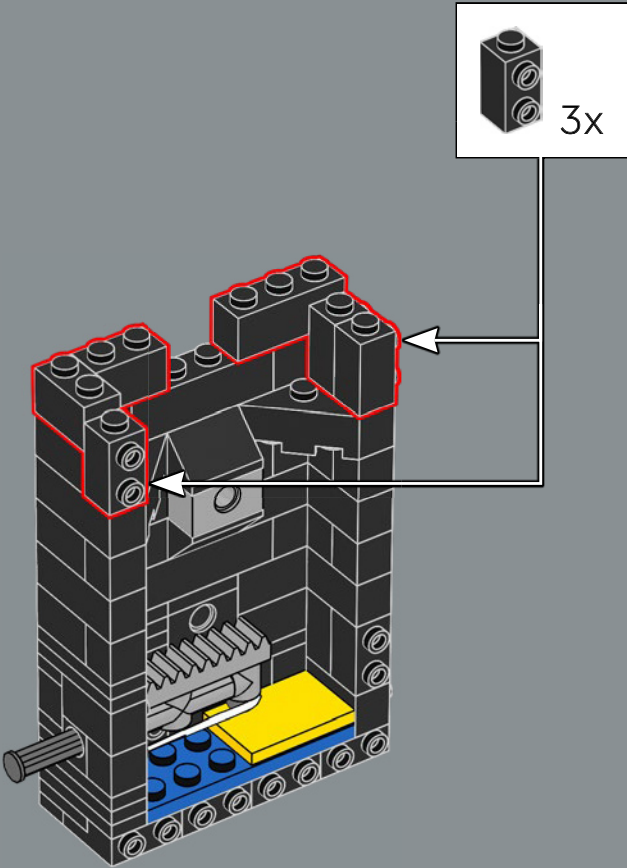

24

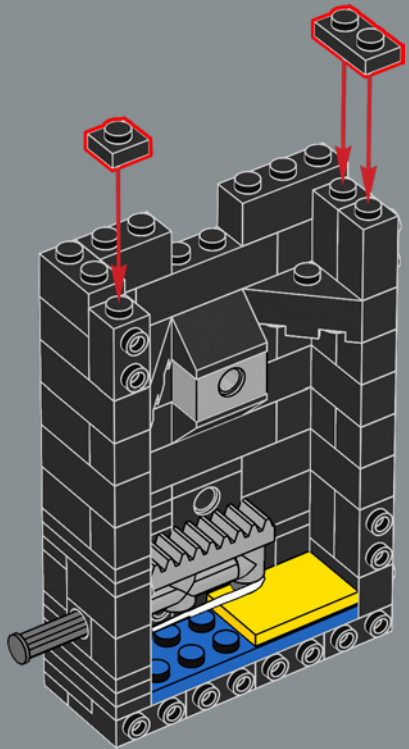

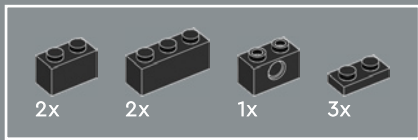

25

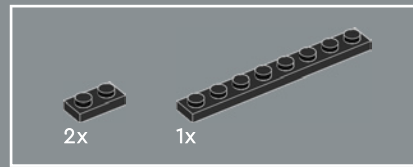
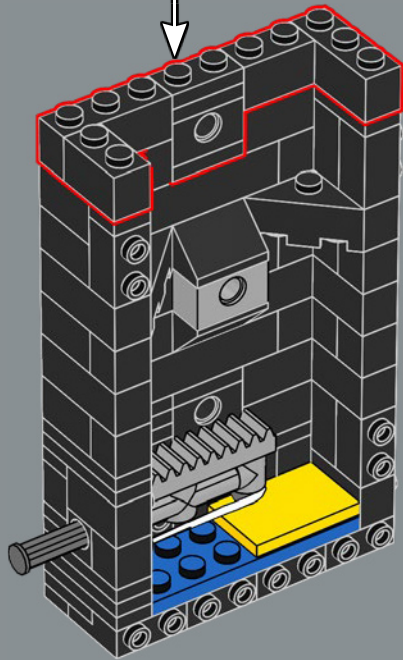
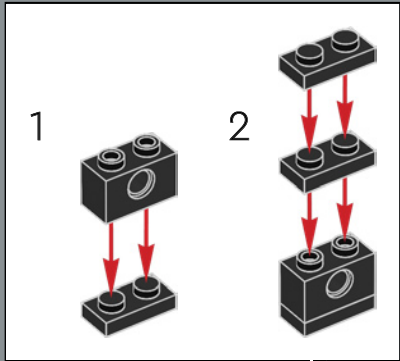

26

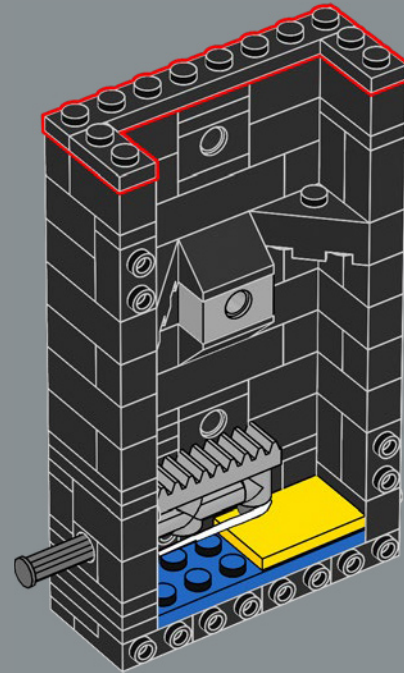

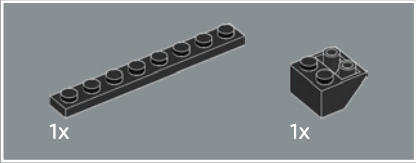
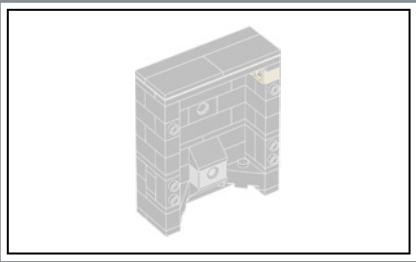

27

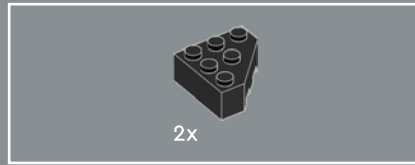
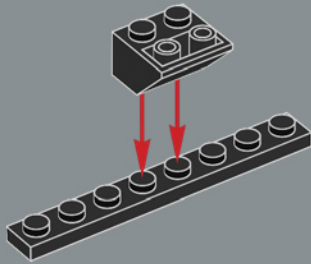

28

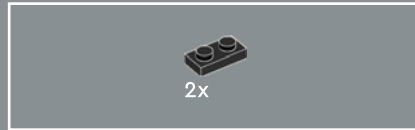
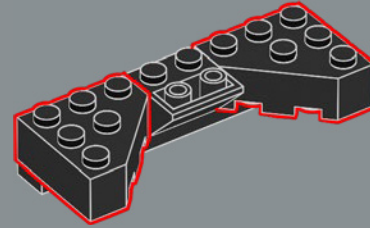

29

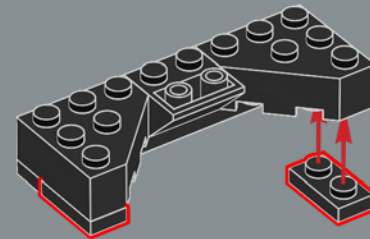

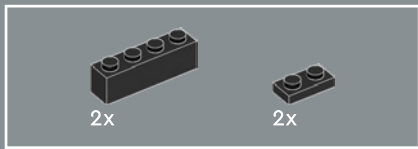

30

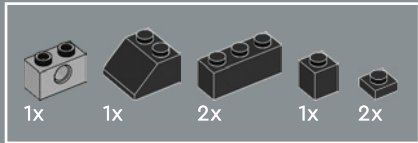
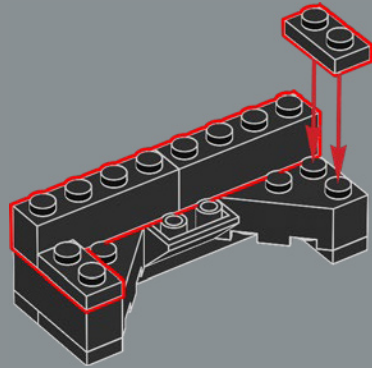

31

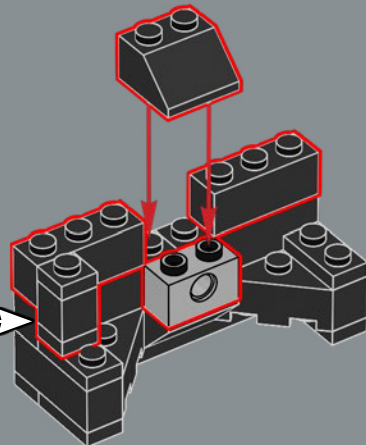
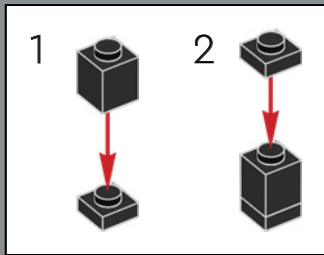

32

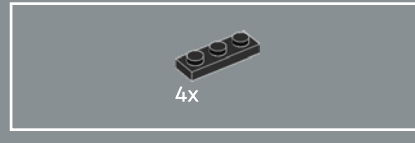
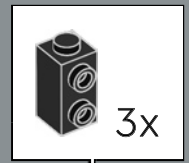
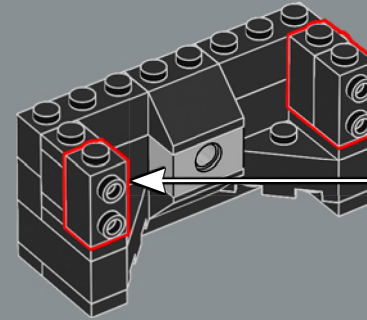

33

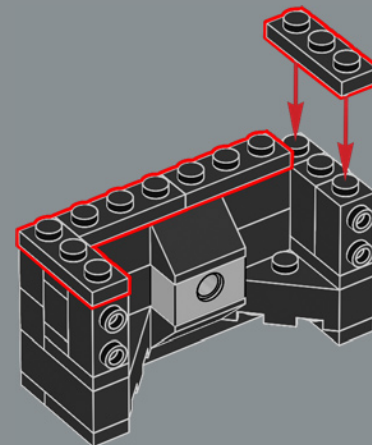

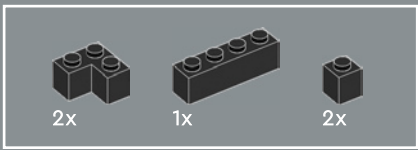

34

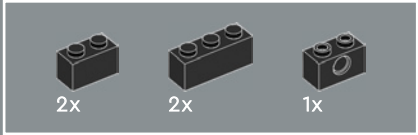
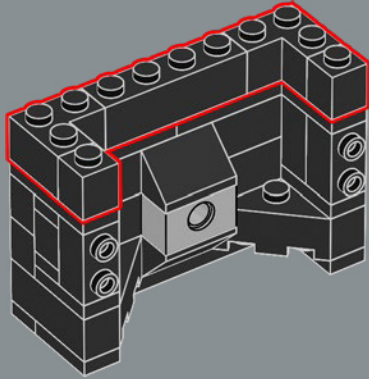

35

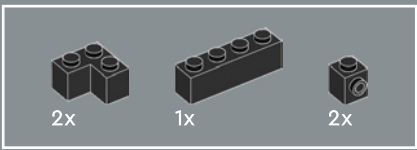
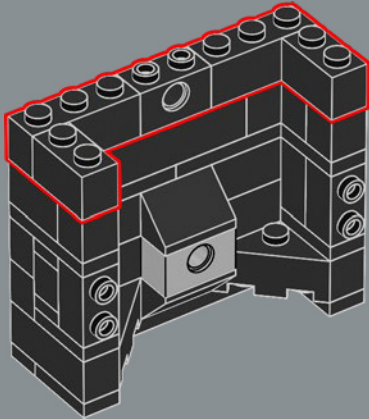

36

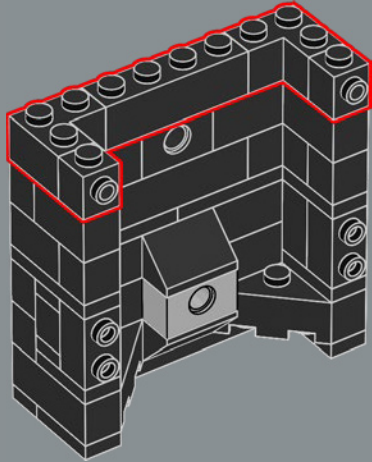

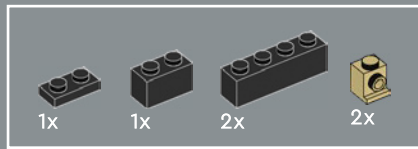

37

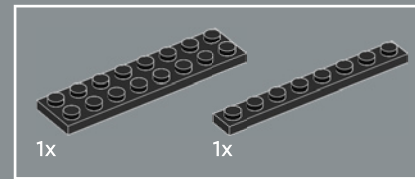
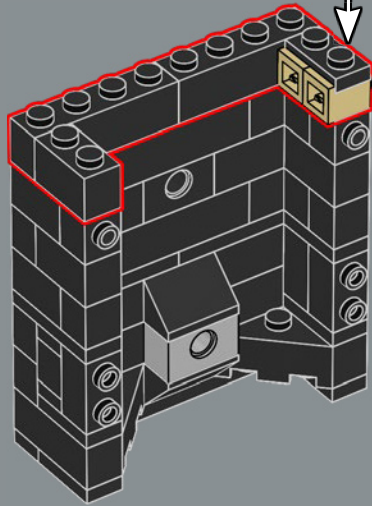
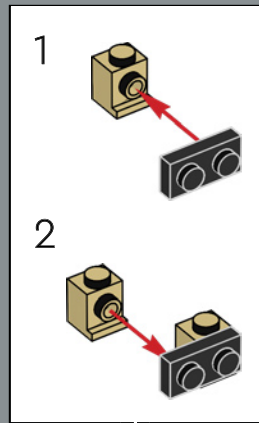

38

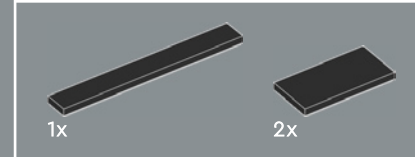
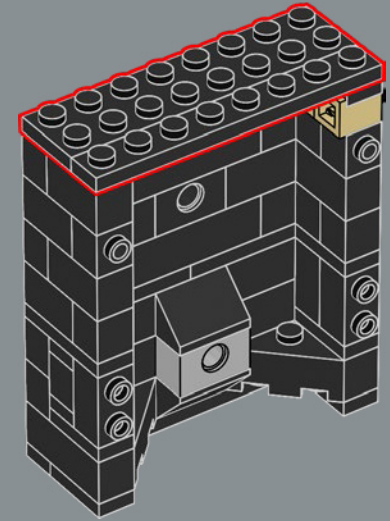

39

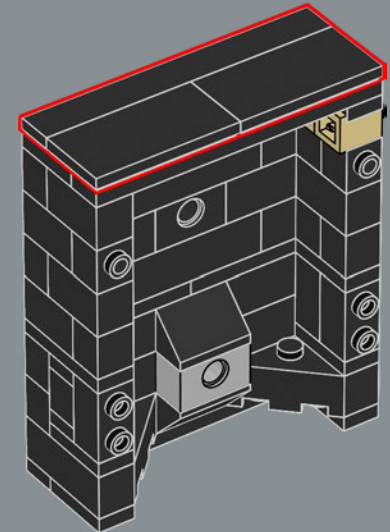

40

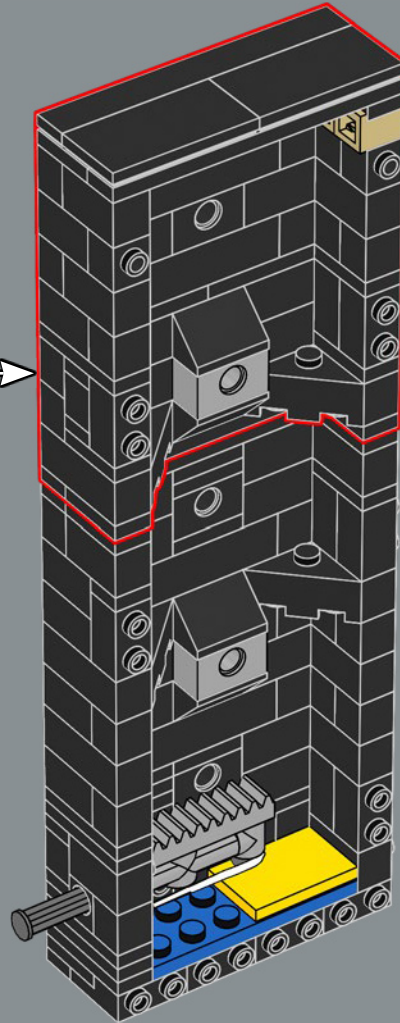

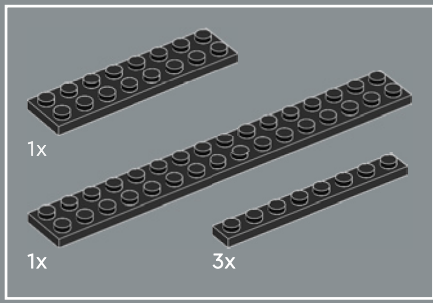

41

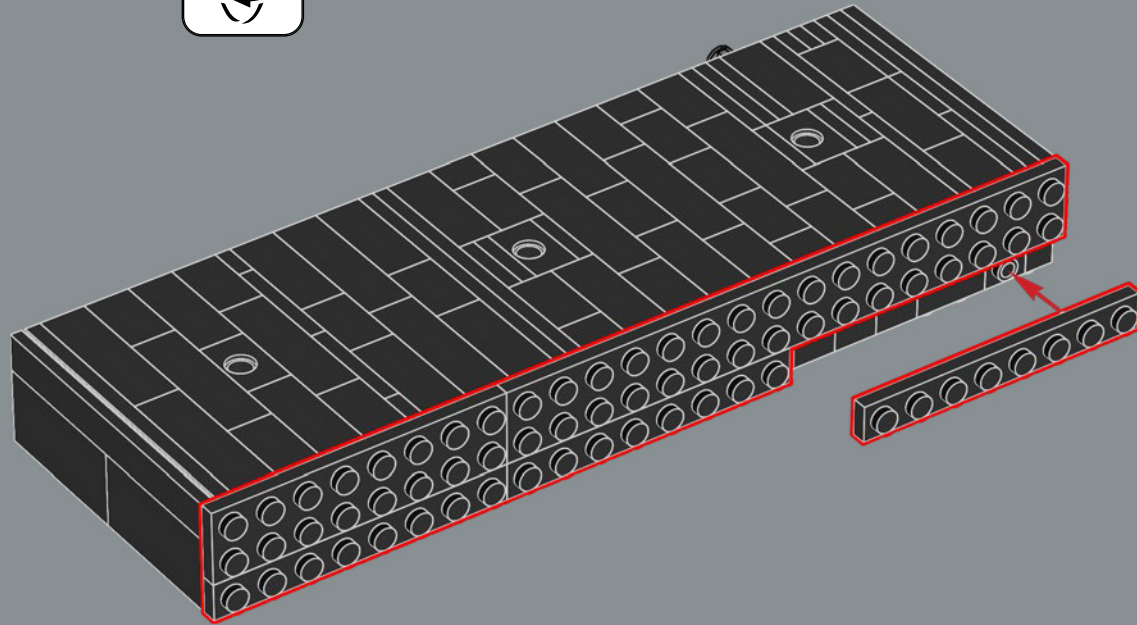

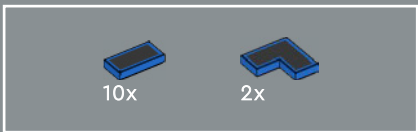

42

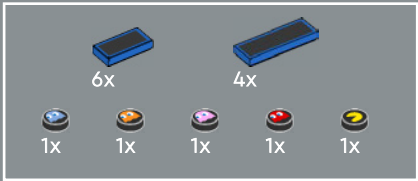
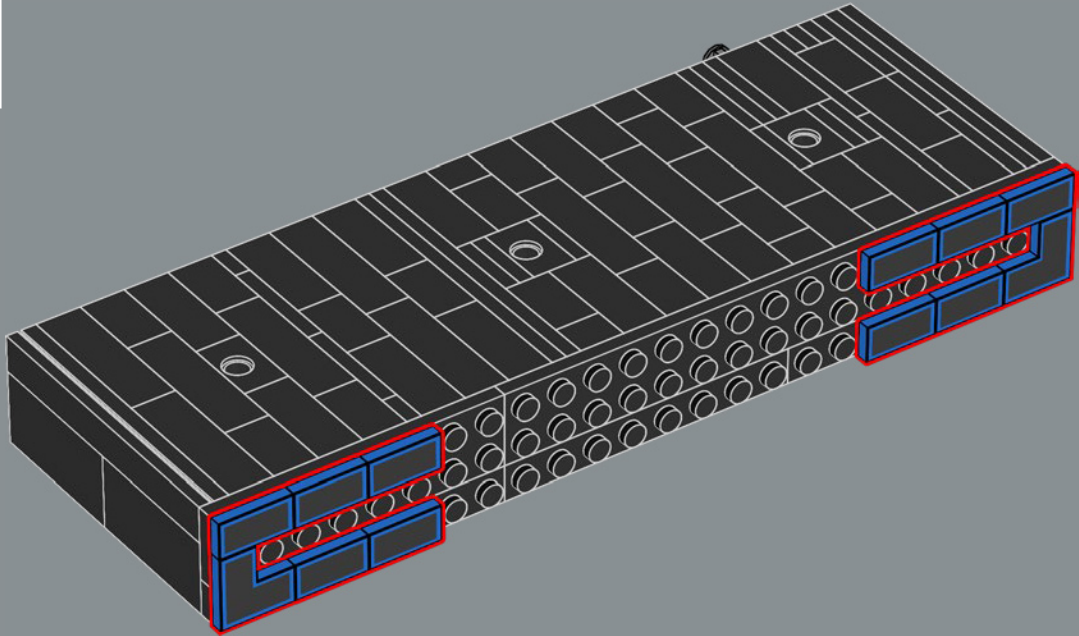

43

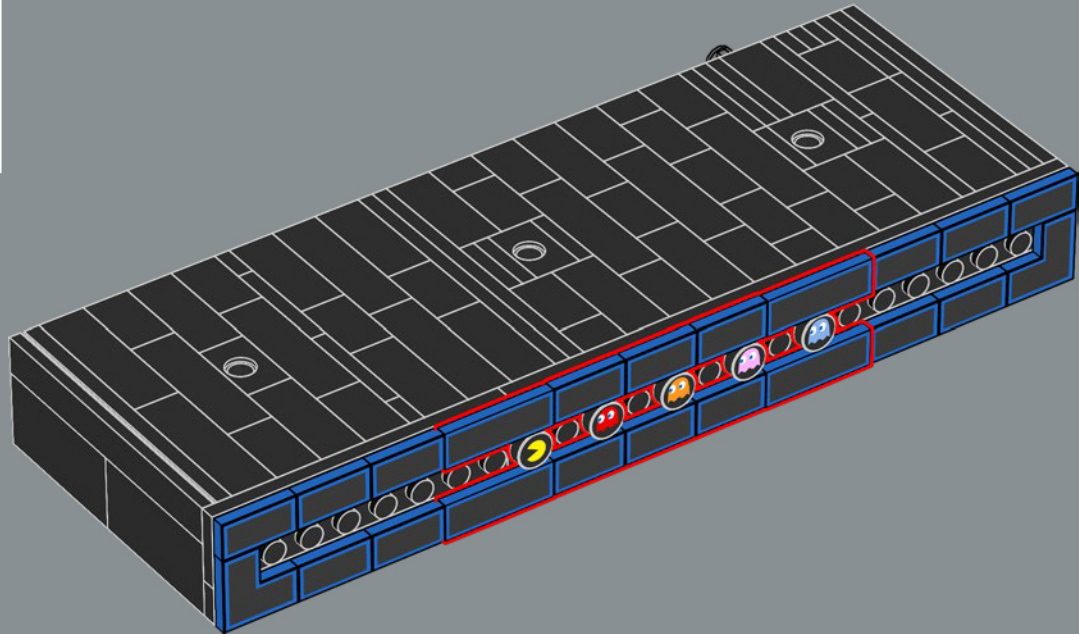



44

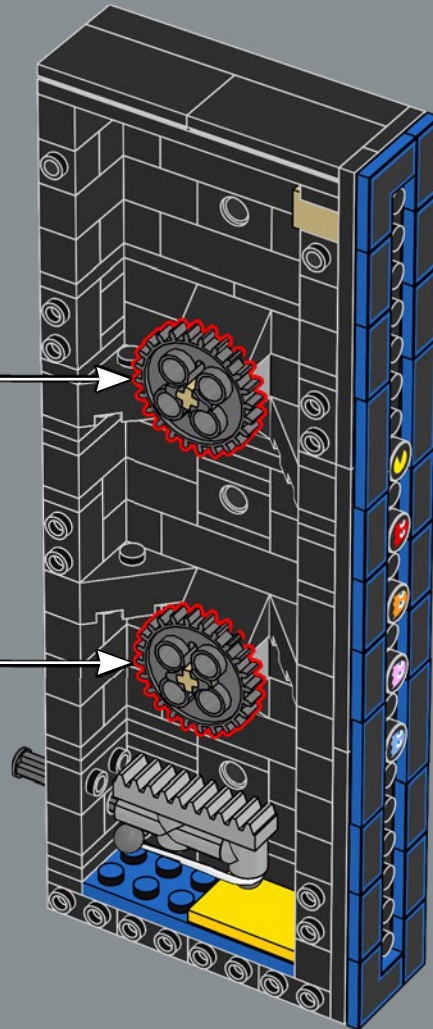
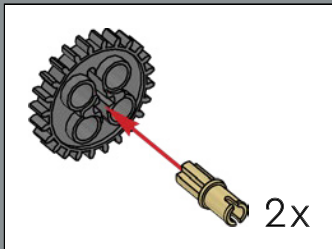

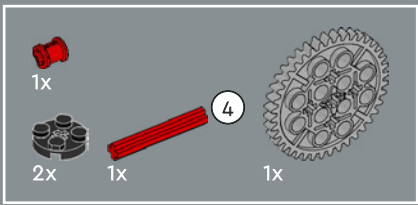

45

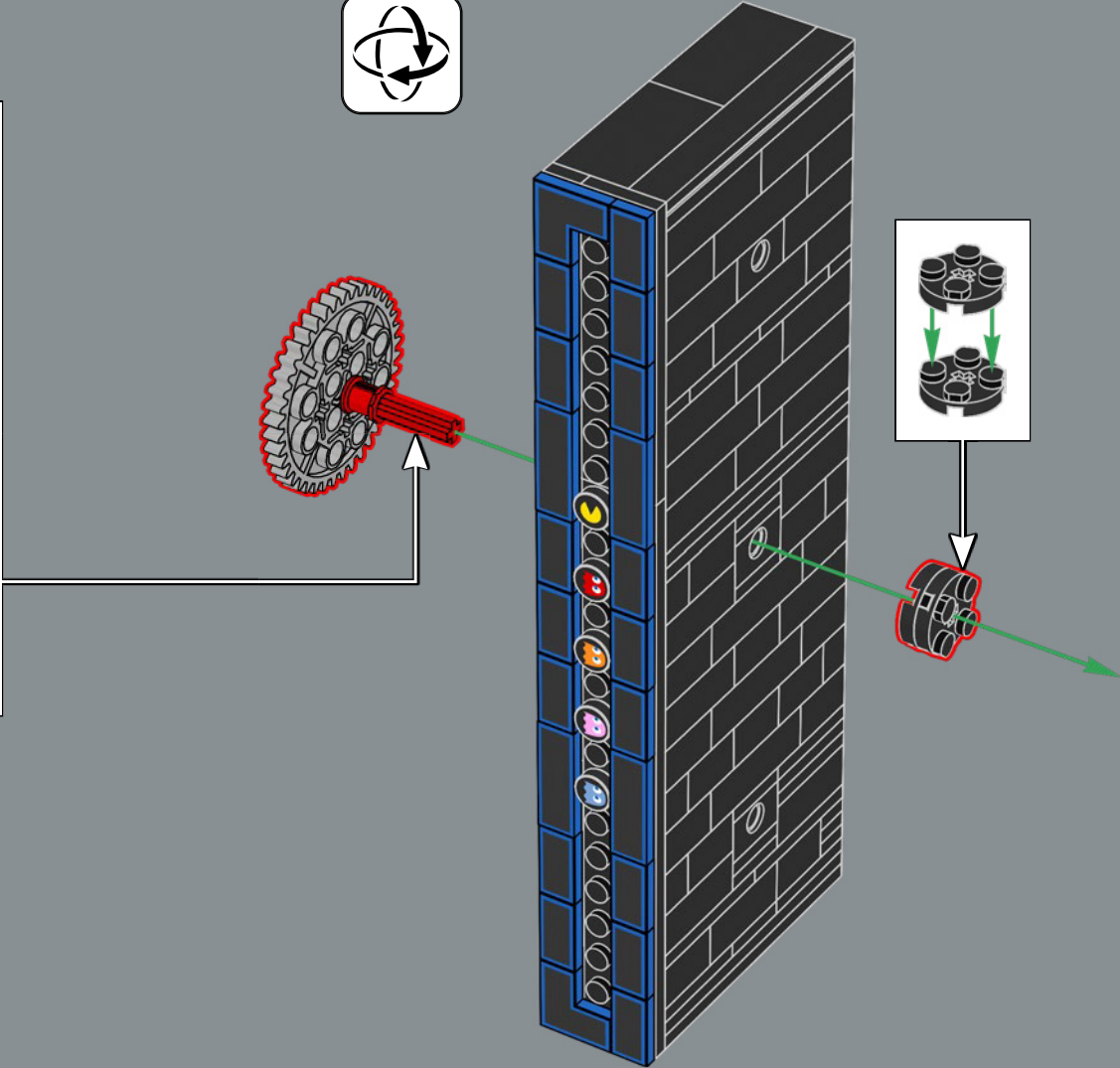
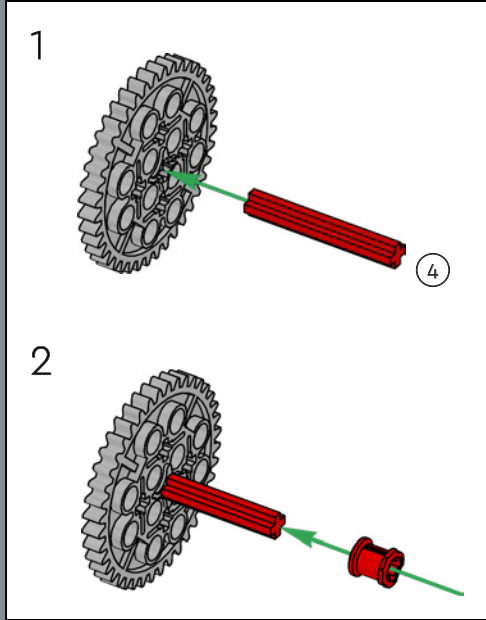

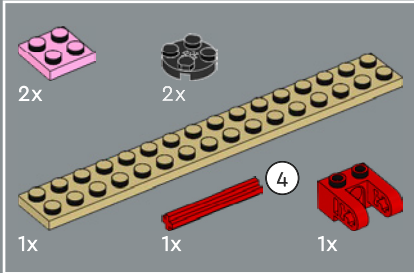
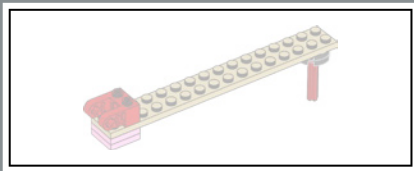

46

1

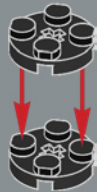

2

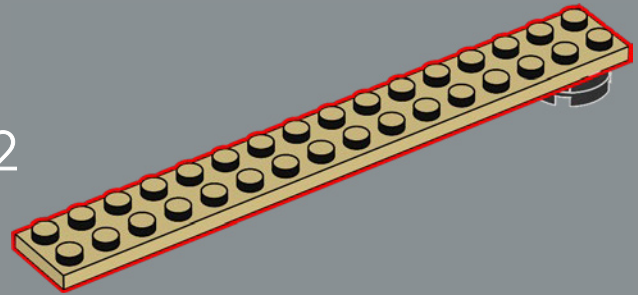

3

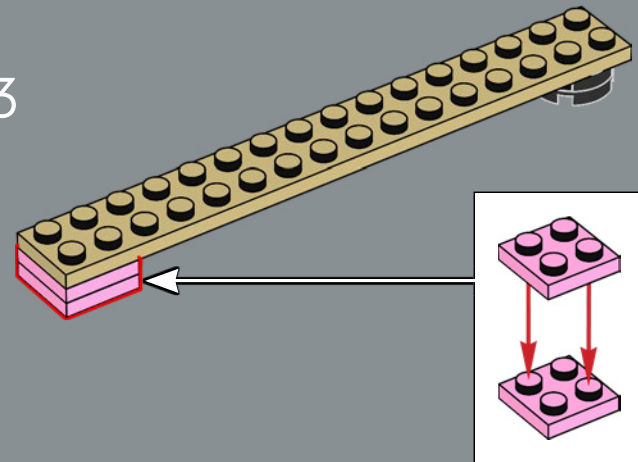

4

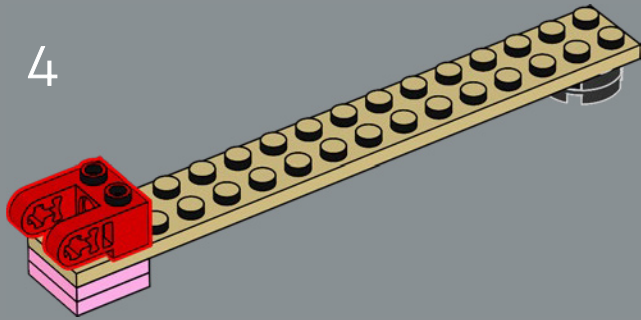

5

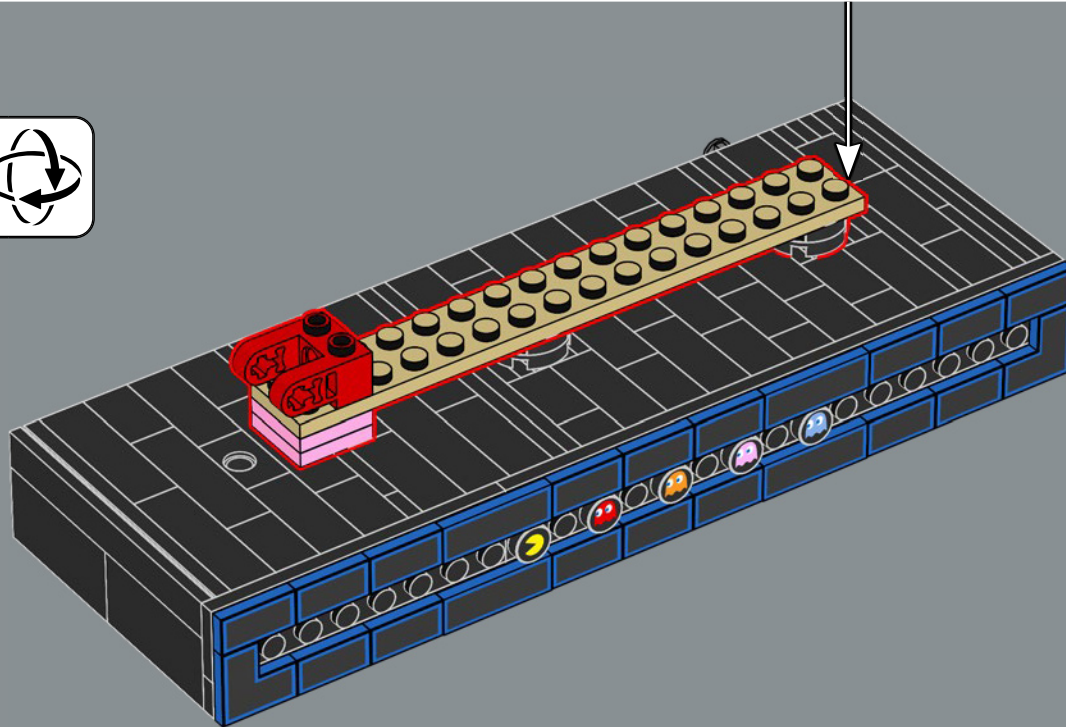
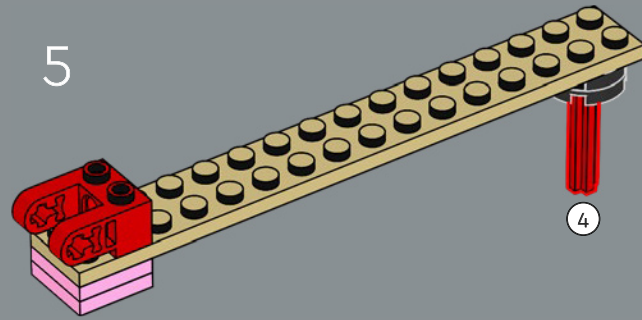

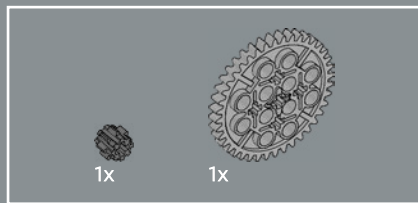

47

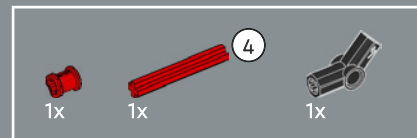
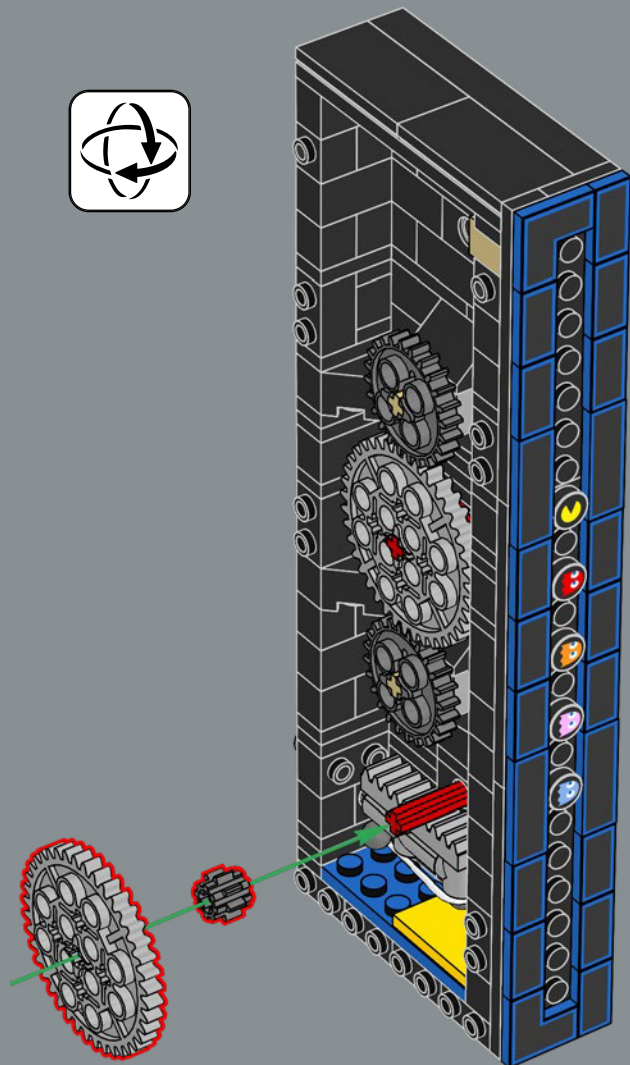

48

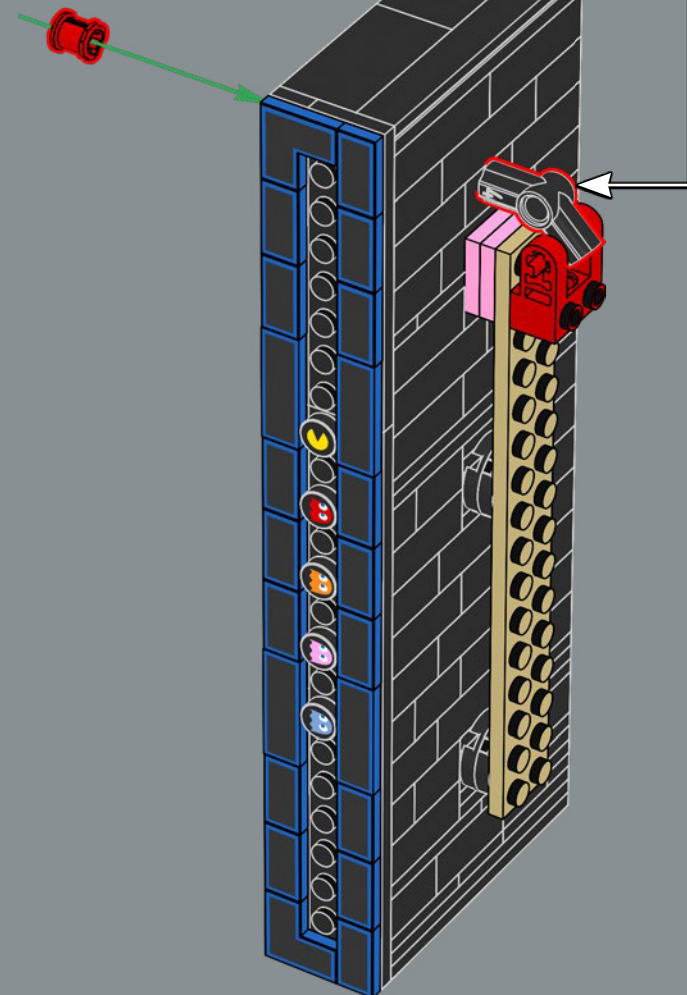
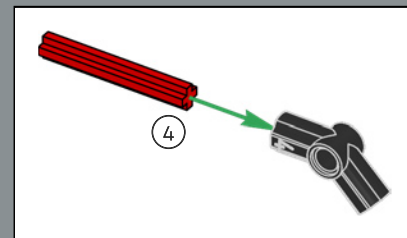

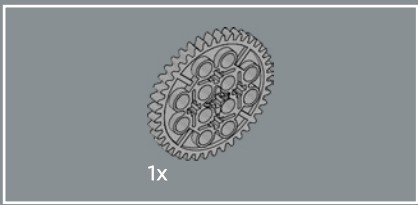

49

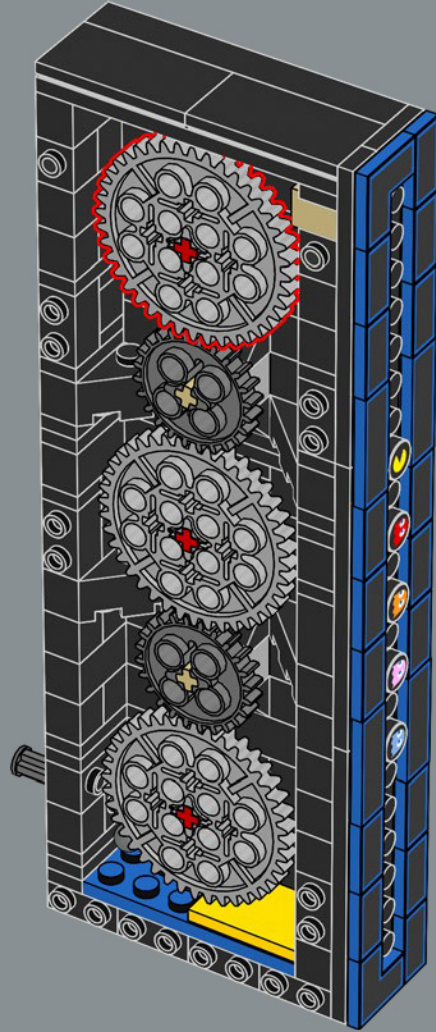

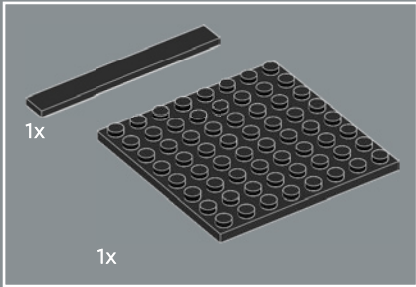
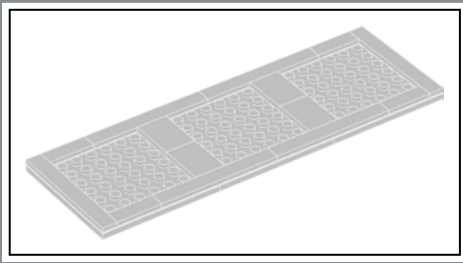

50

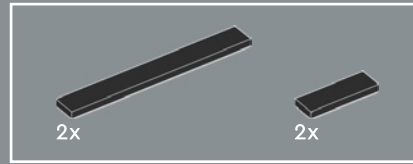
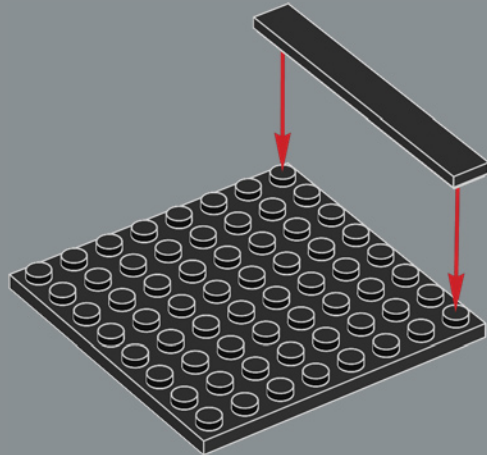

51

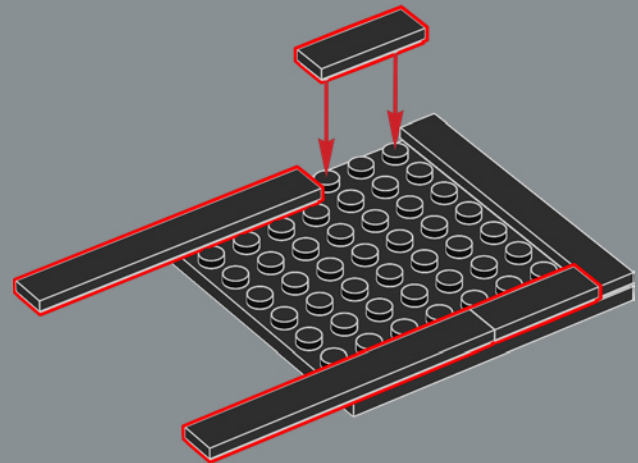

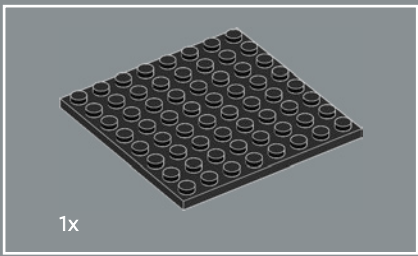

52

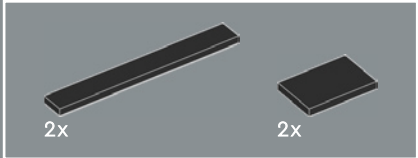
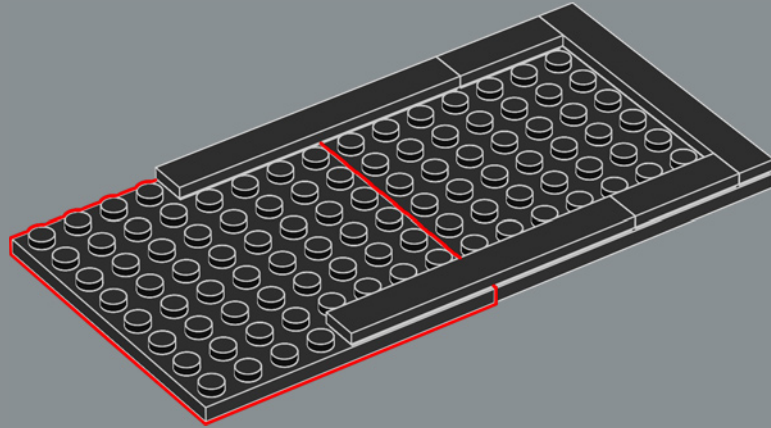

53

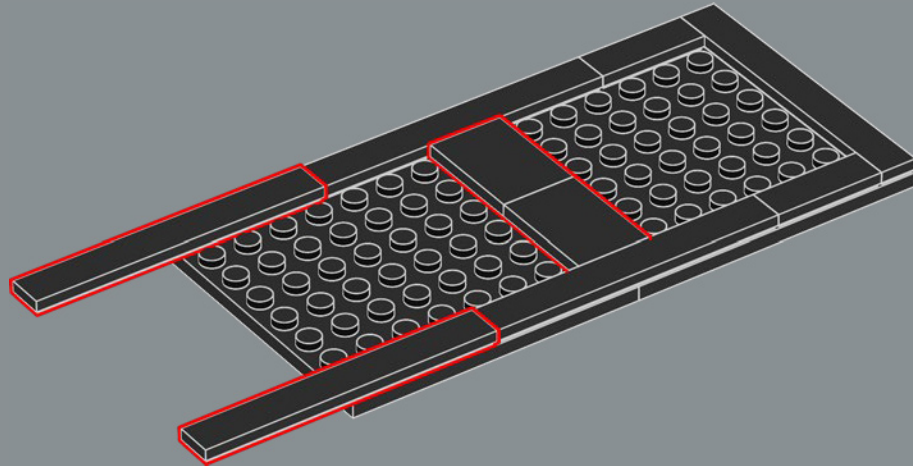

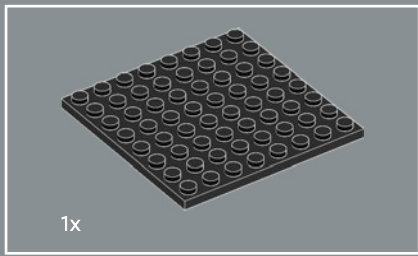

54

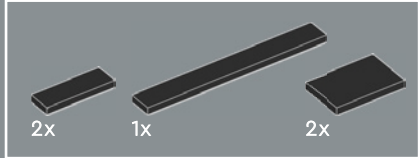
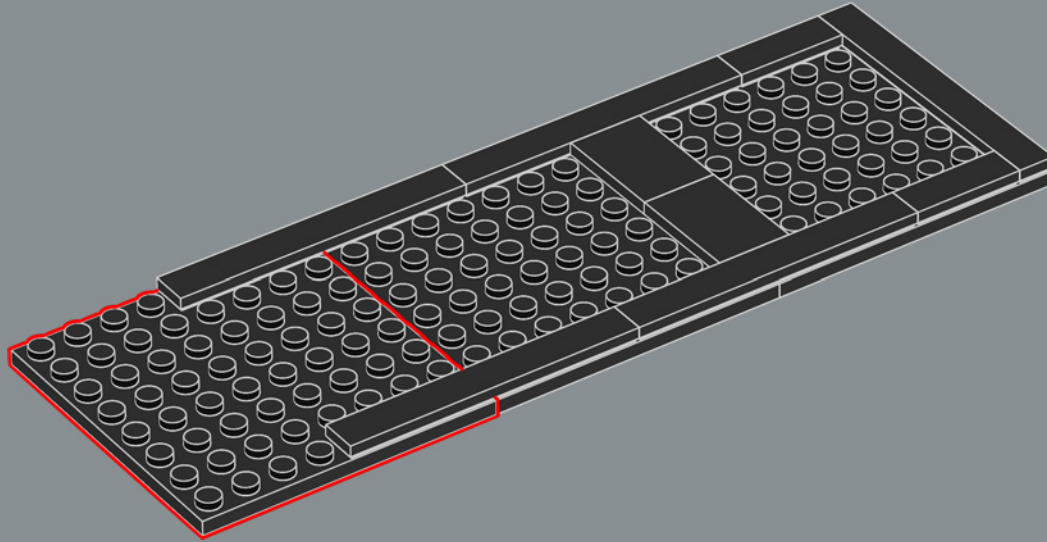

55

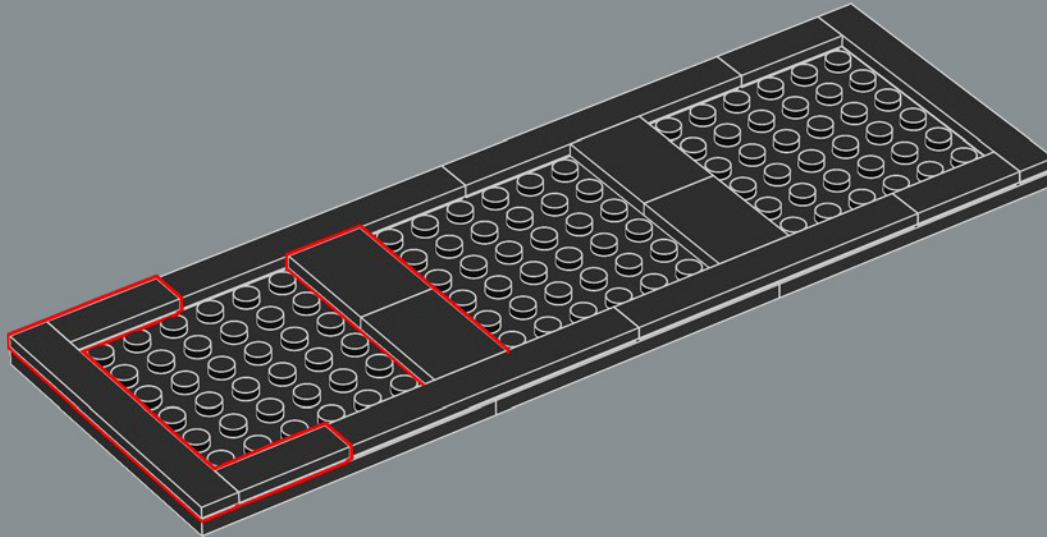

56

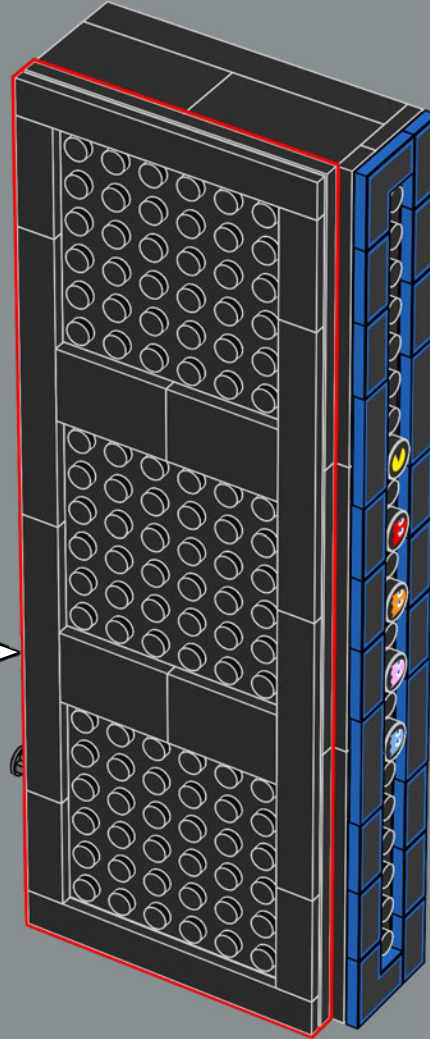

57



1

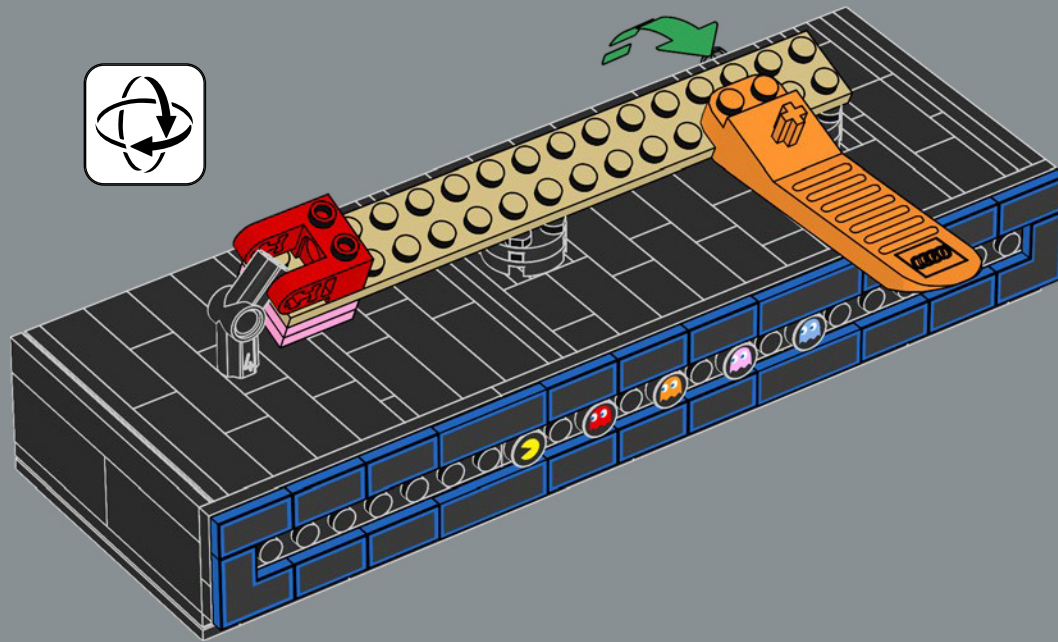

2

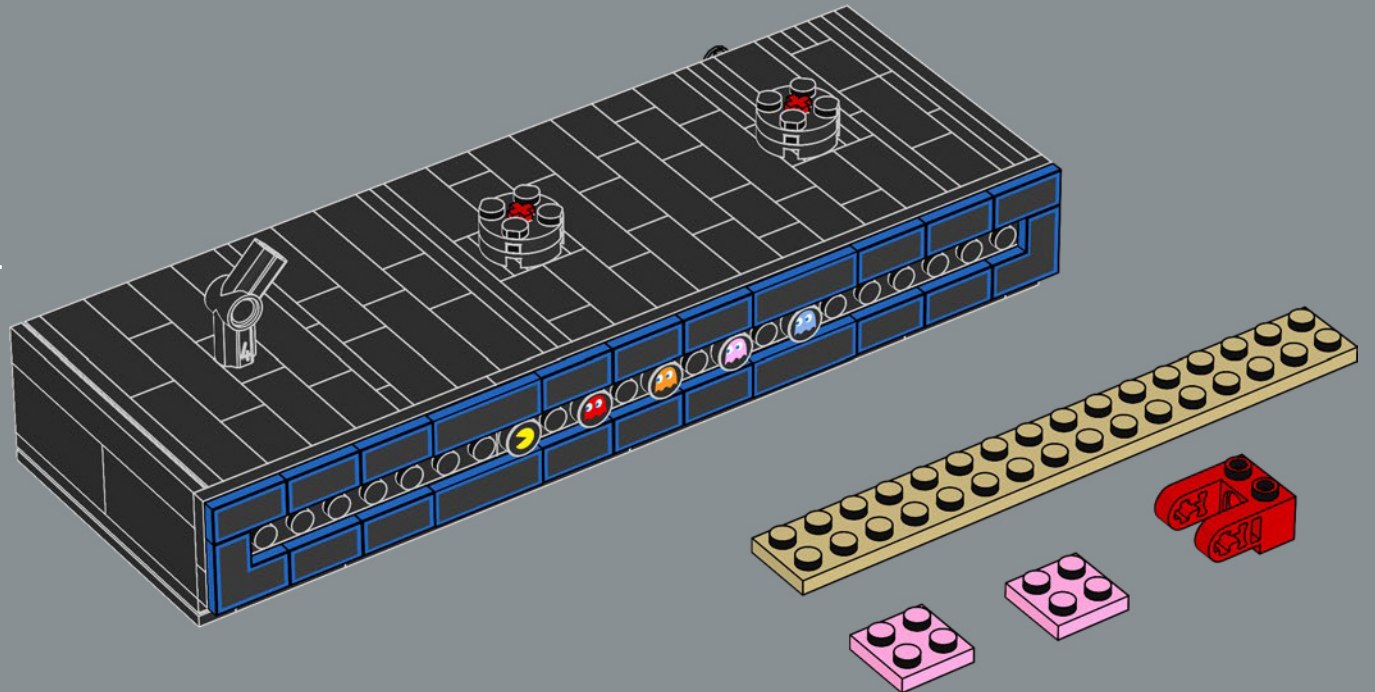

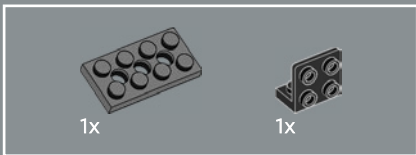
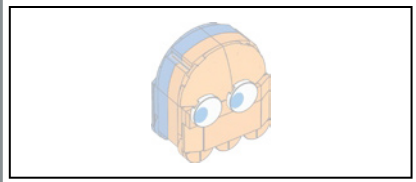

58

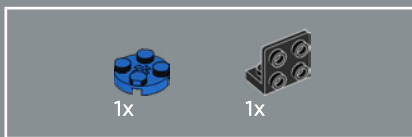
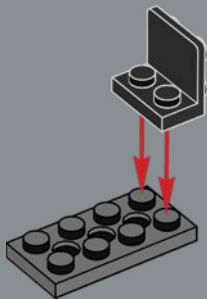

59

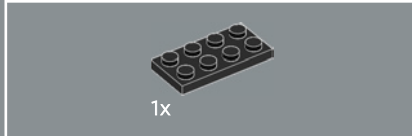
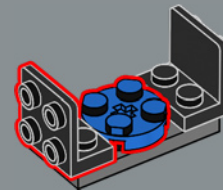

60

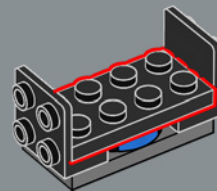

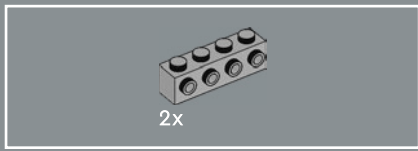

61

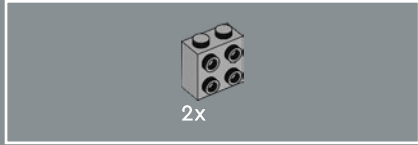
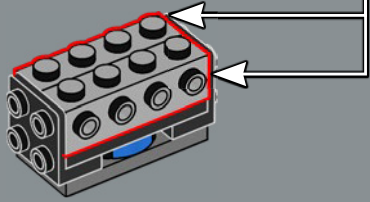
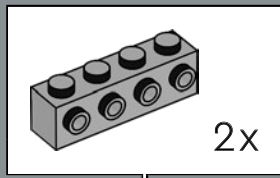

62

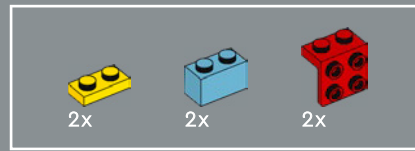
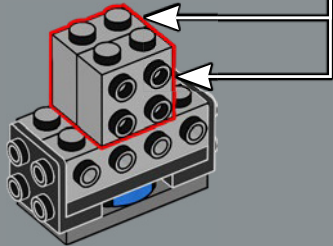
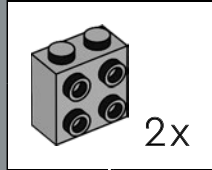

63

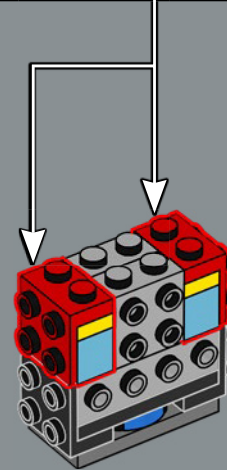
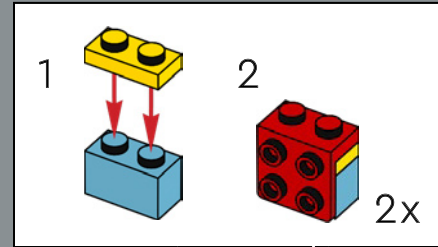



2x

64

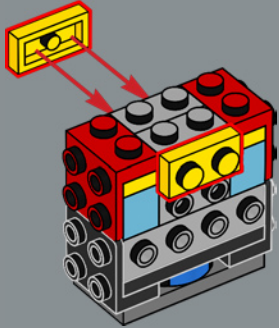

2x

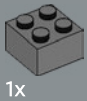

1x

65

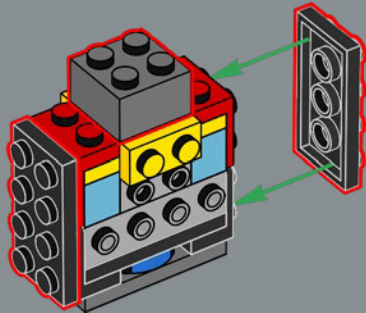

2x



1x



2x

66

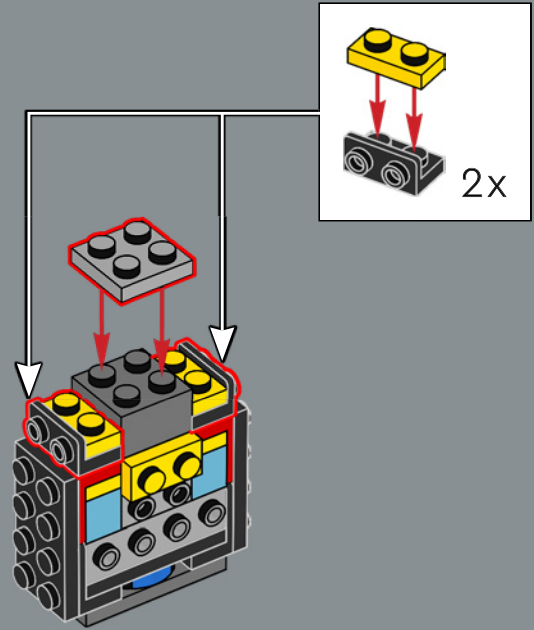



67

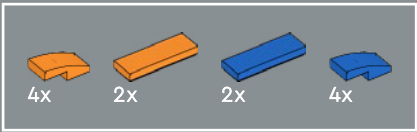
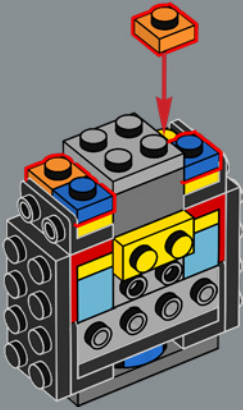

68

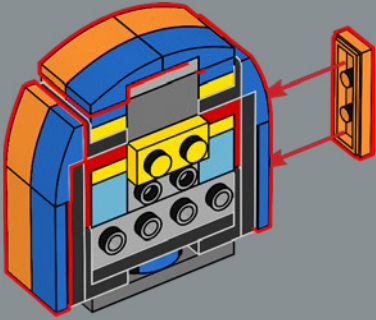

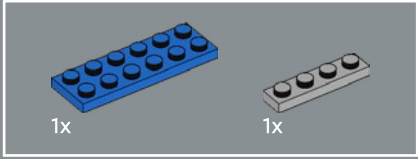
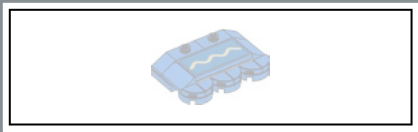

69

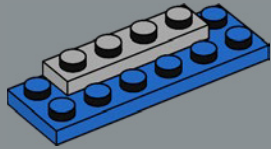

70

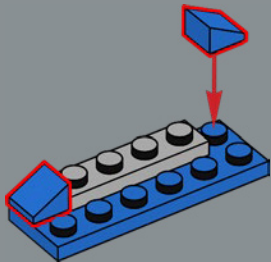

71

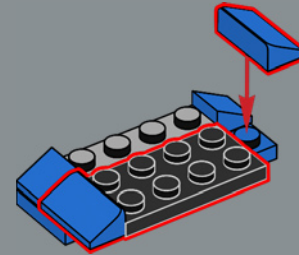

72

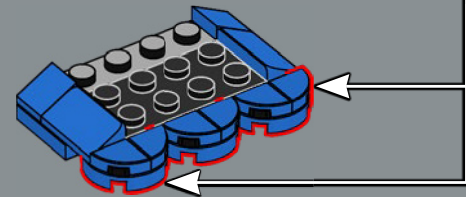
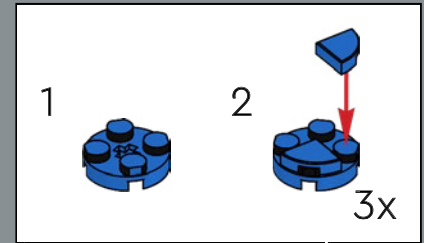

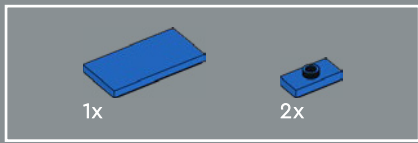

73

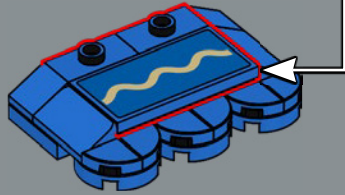
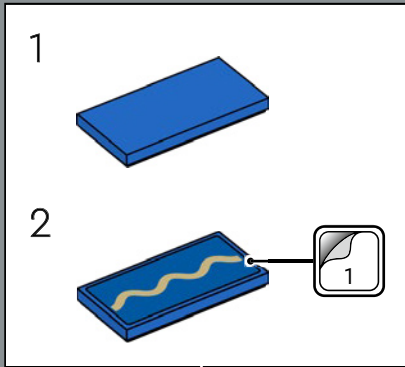

74

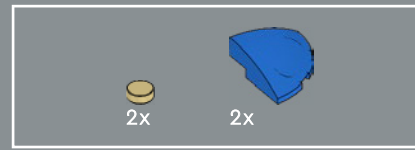
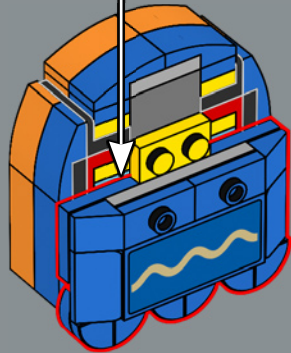

75

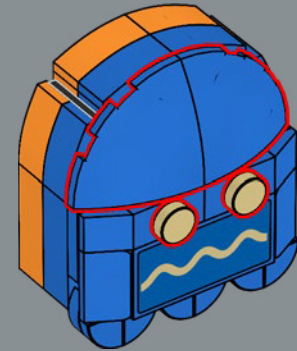

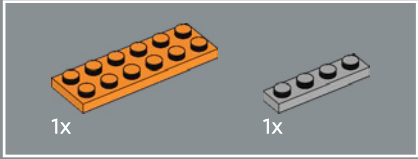
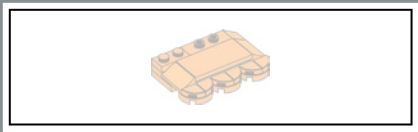

76

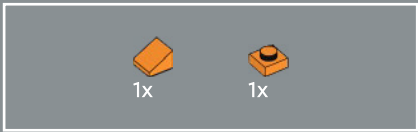
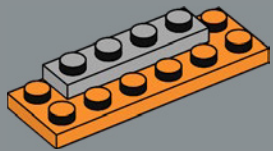

77

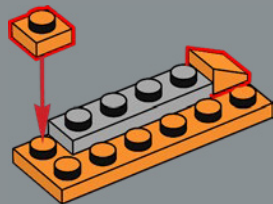

78

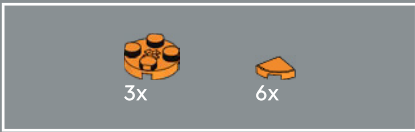
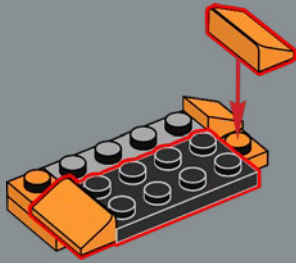

79

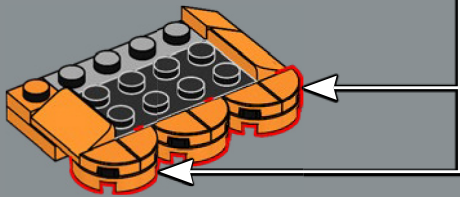
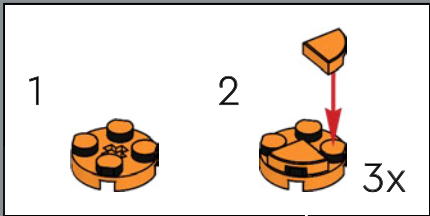



80

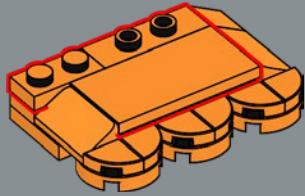

81



82

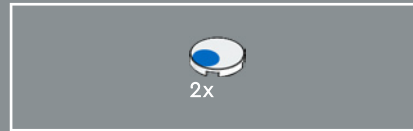
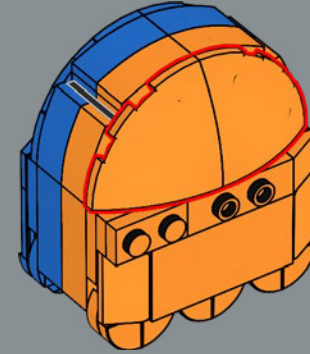

83

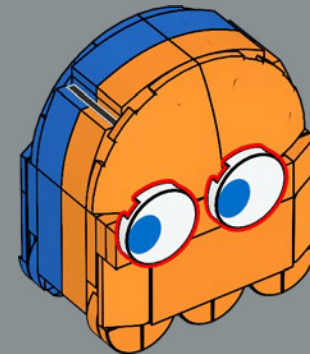



游戏迷也对幽灵们情有独钟，
我们希望在更大的积木版本中展现他们的个性。

84

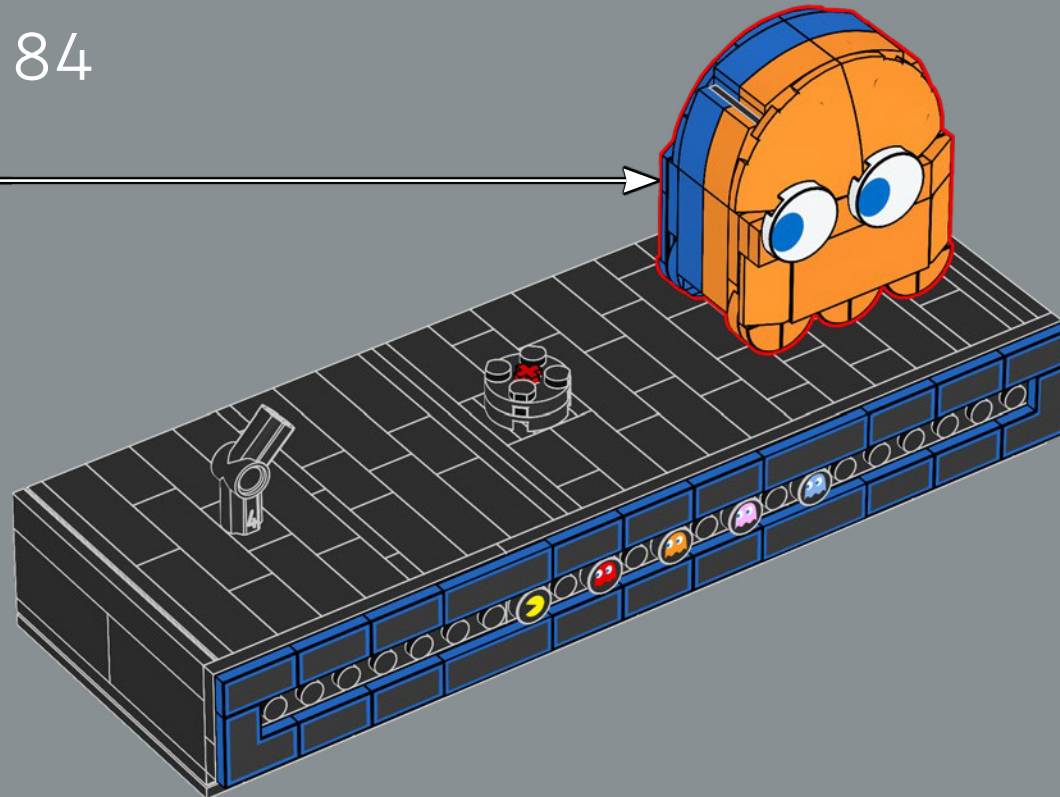

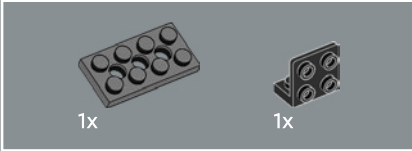
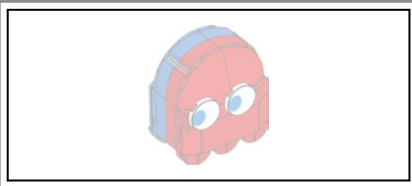

85

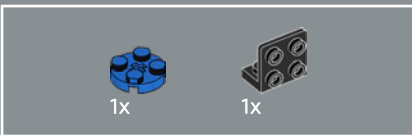
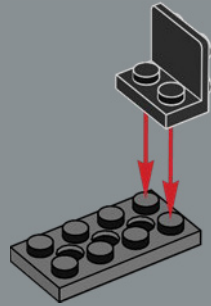

86

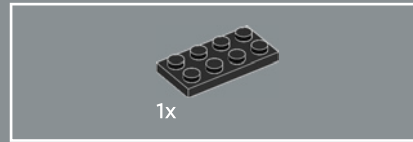
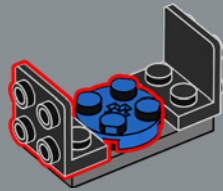

87

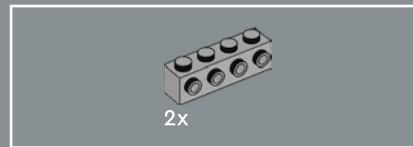
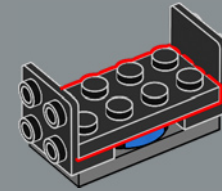

88

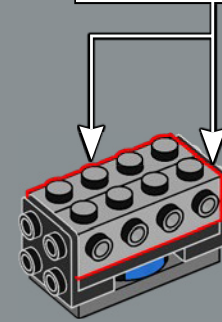
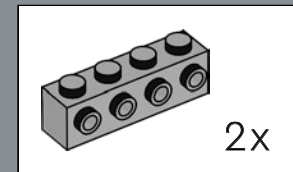

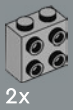

2x

89

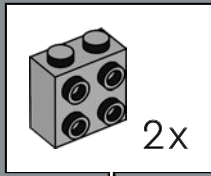

2x

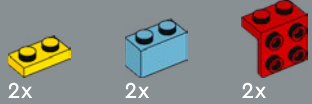
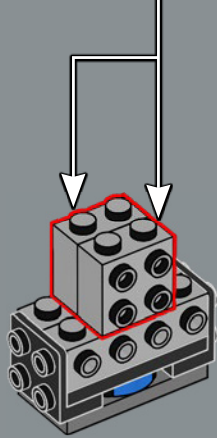

2x

2x

2x

90

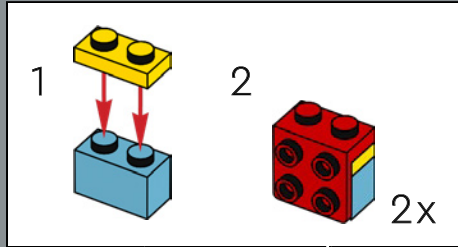

1

2

2x

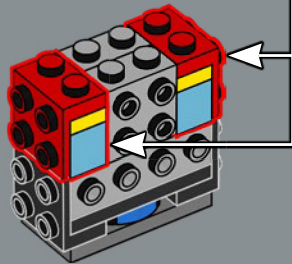

2x

91

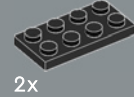
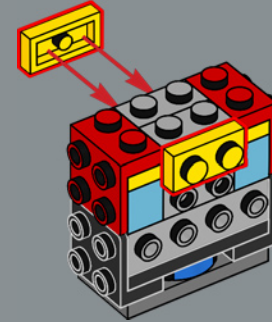

2x

1x

92

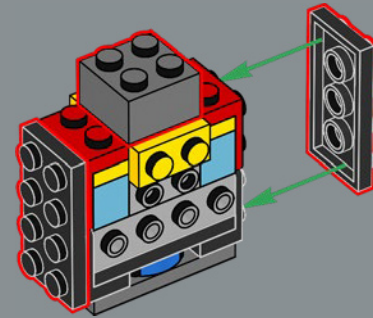

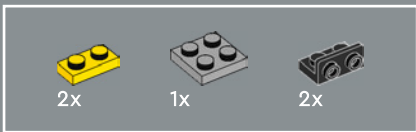

93

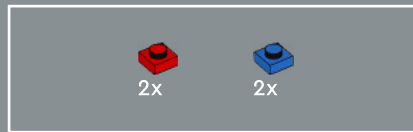
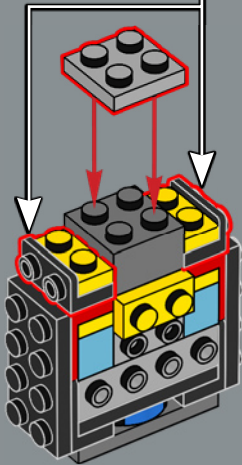
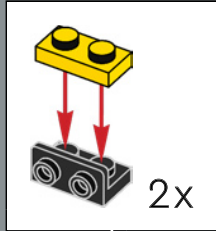

94

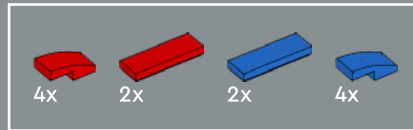
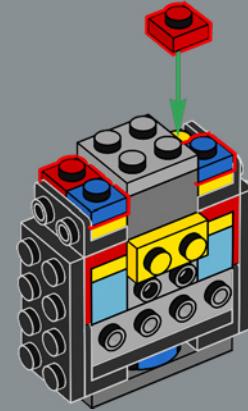

95

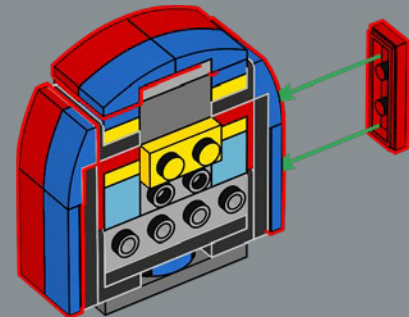

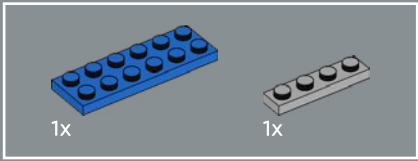
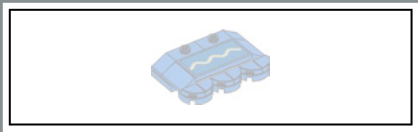

96

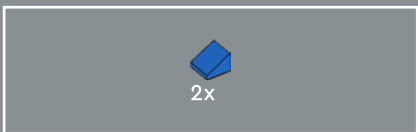
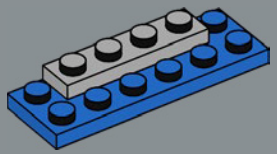

97

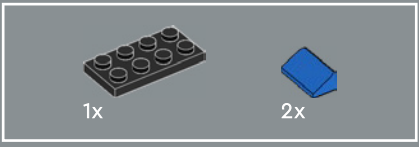
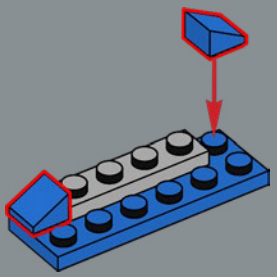

98

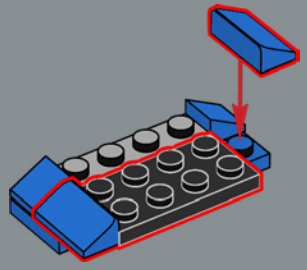

99

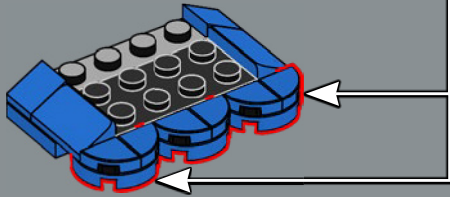
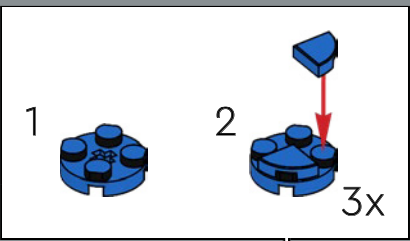

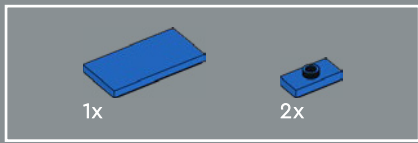

100

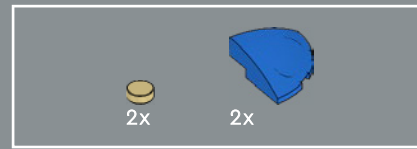
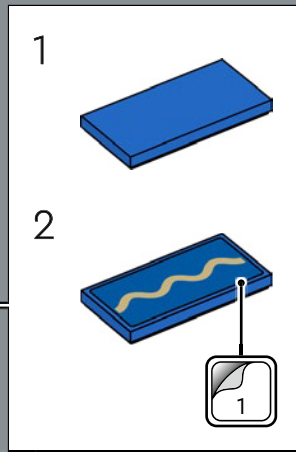
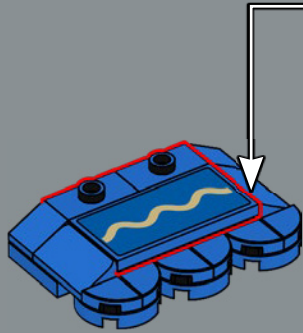

102

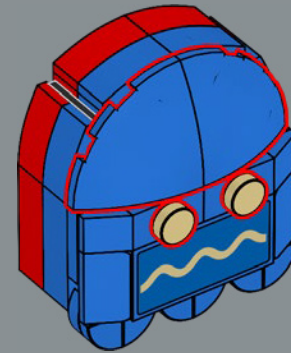

101

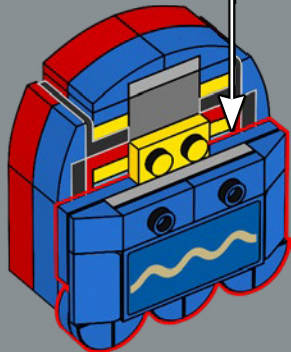

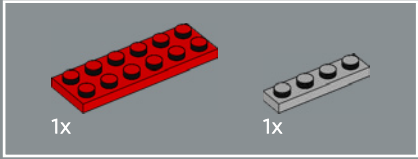
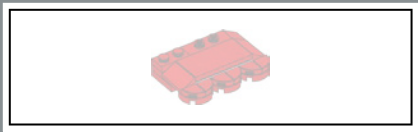

103

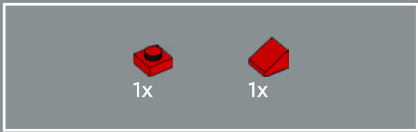
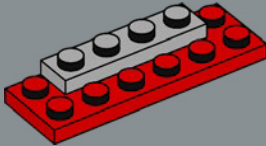

104

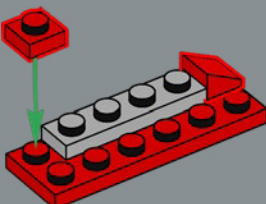

105

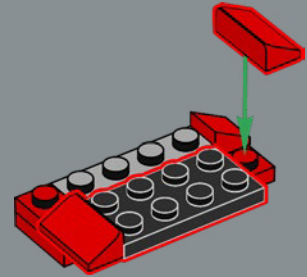

106

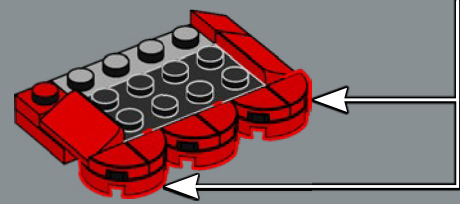
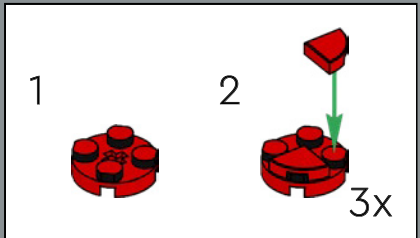

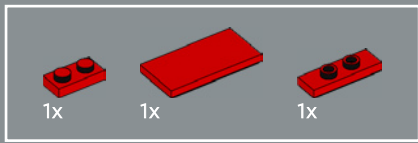

107

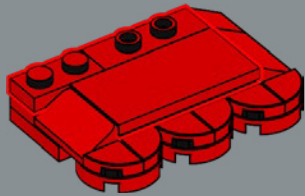

109

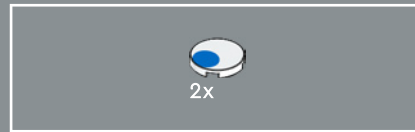
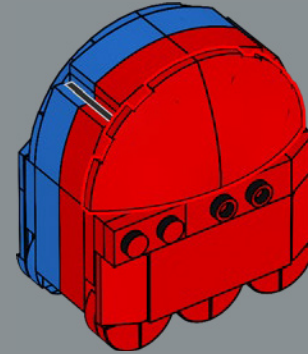

110

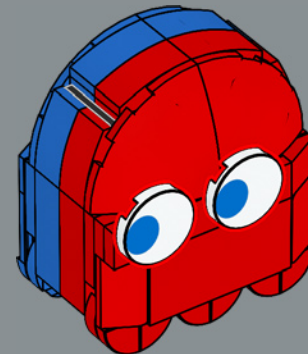

108

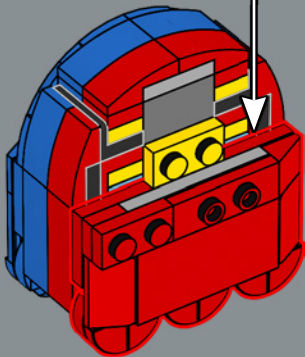

111

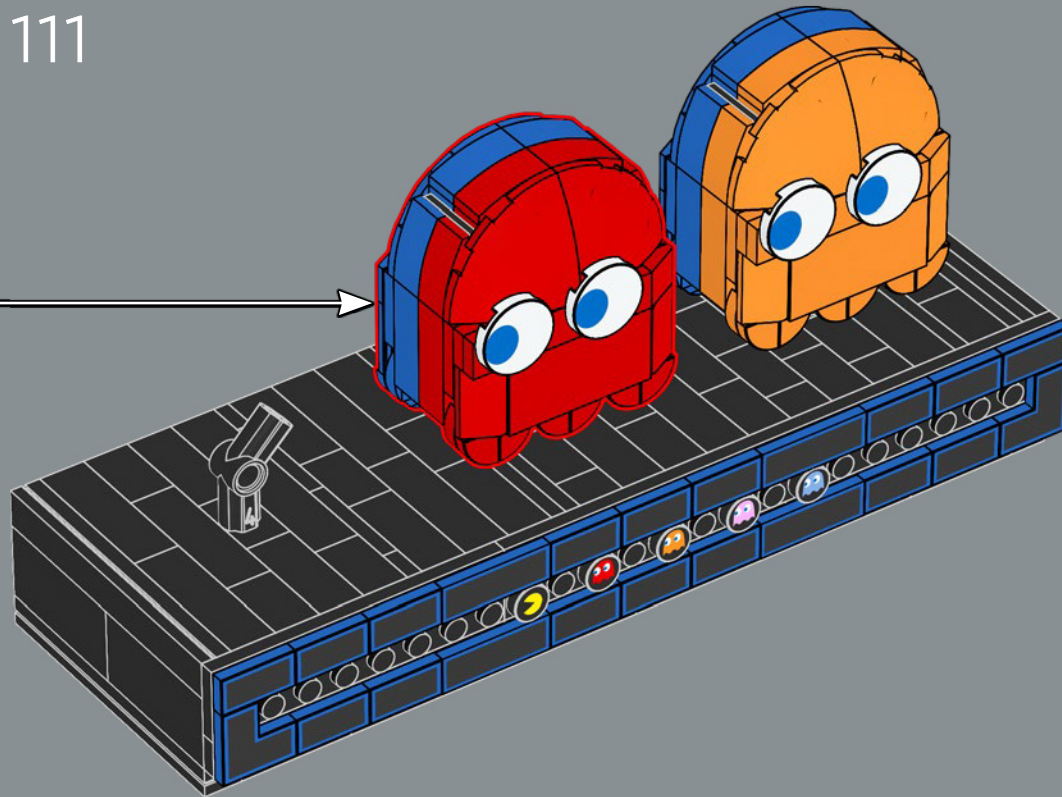

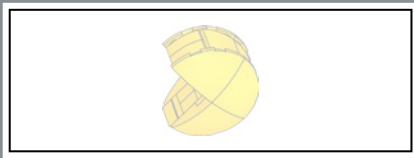

112

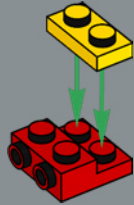

113

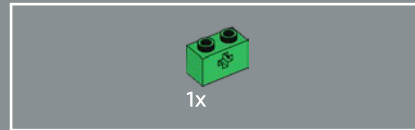
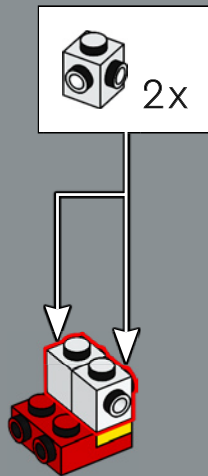

114

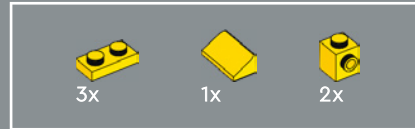
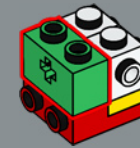

115

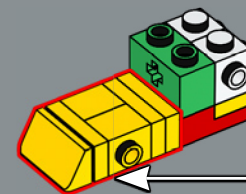
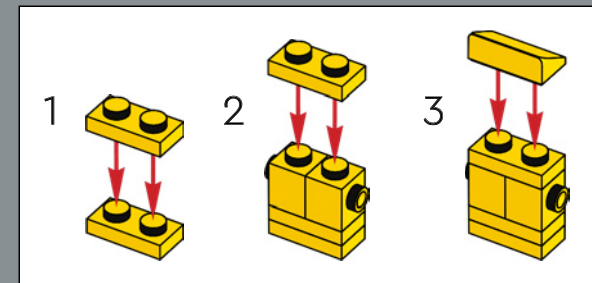

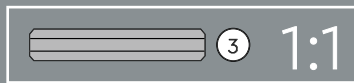
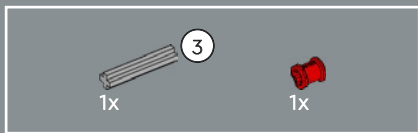

116

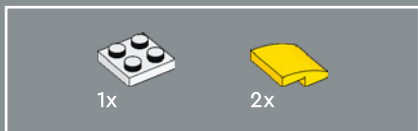
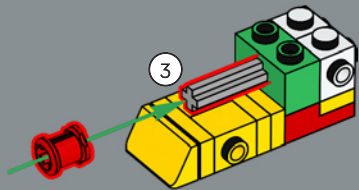

117

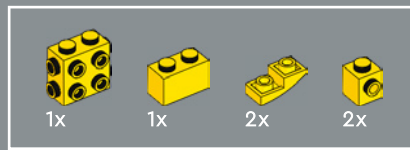
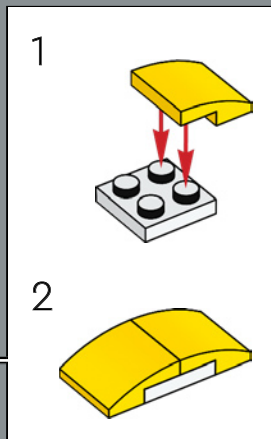
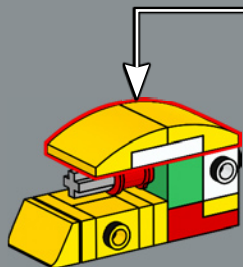

118

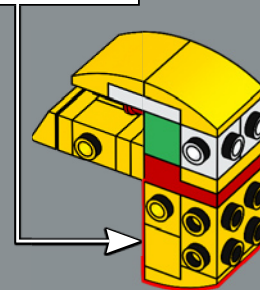
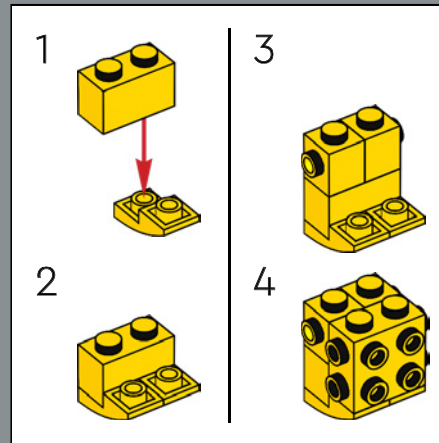

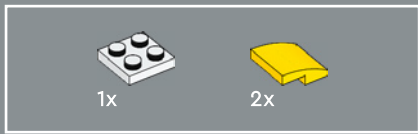

119

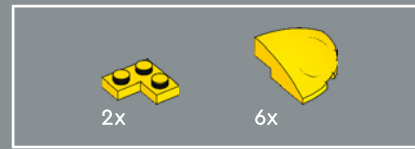
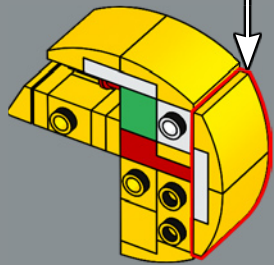
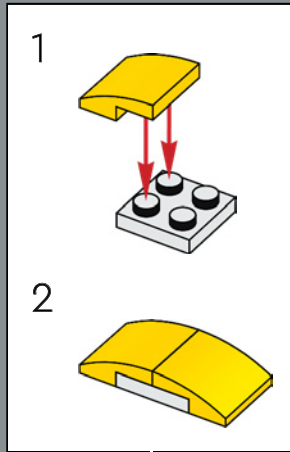

120

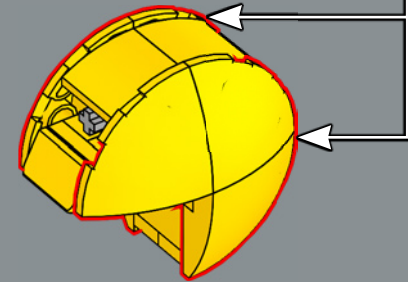
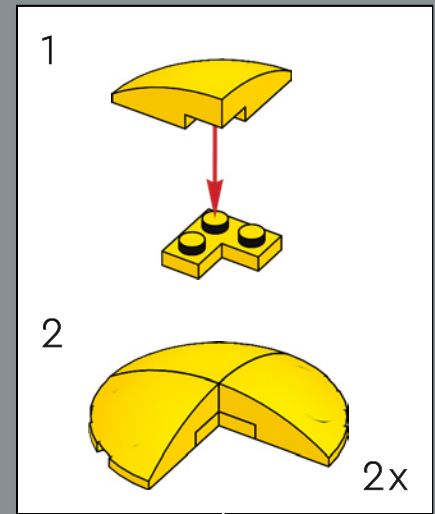

121

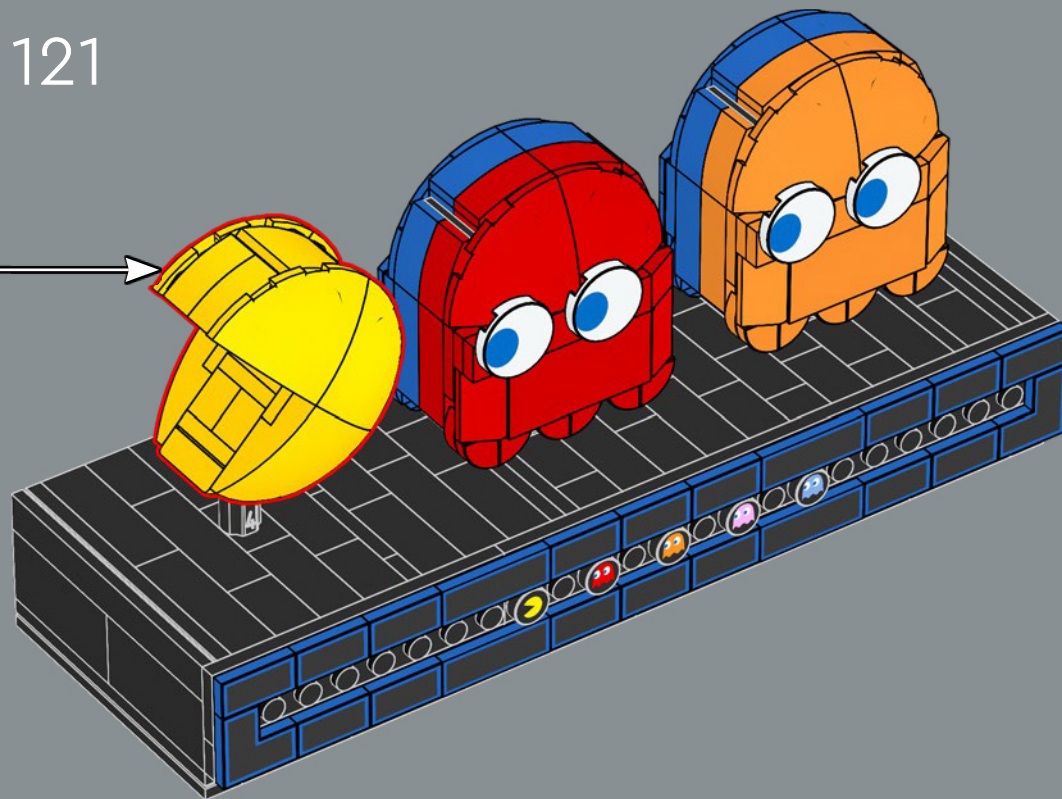

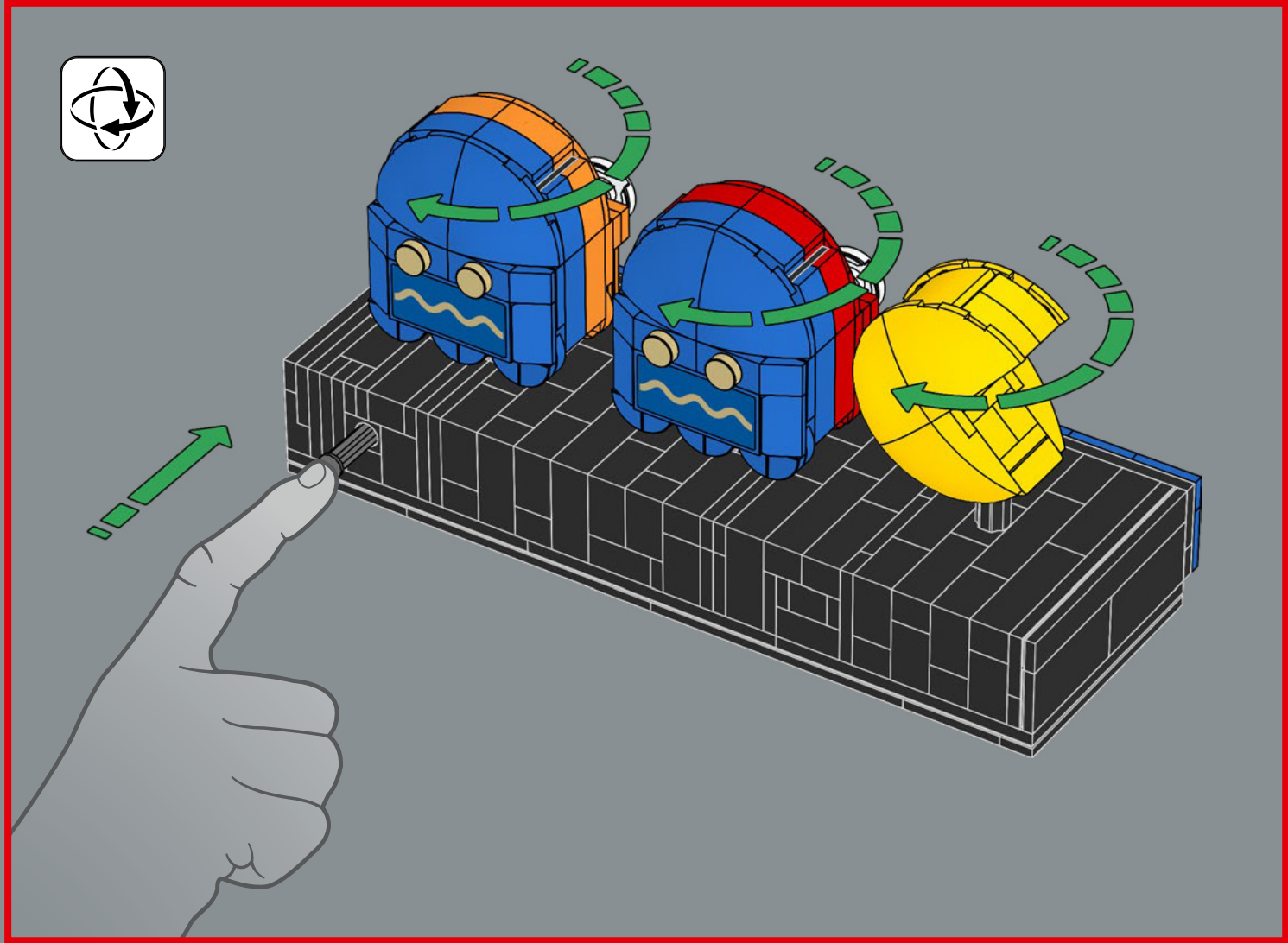

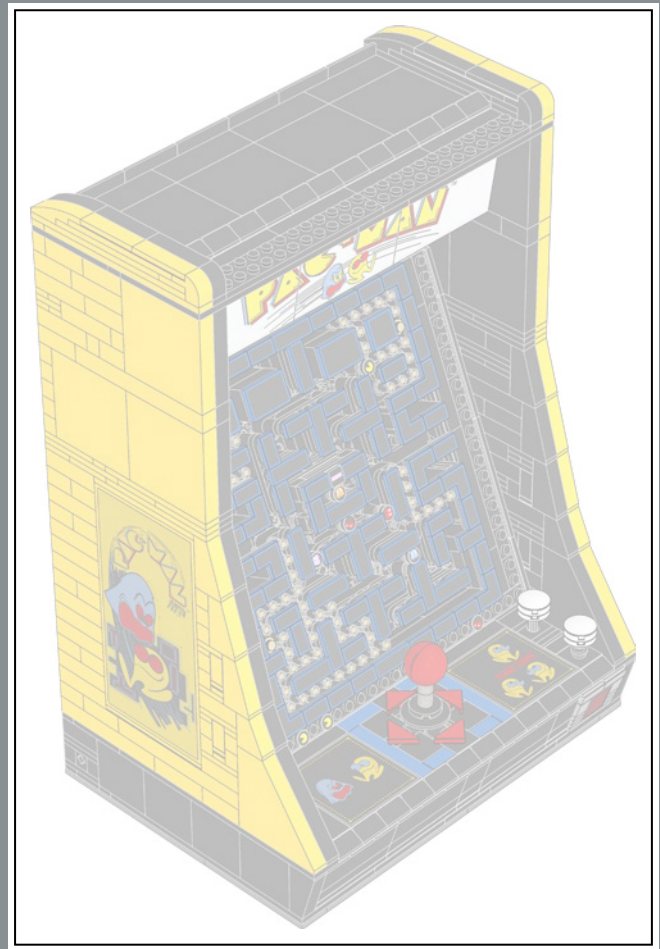
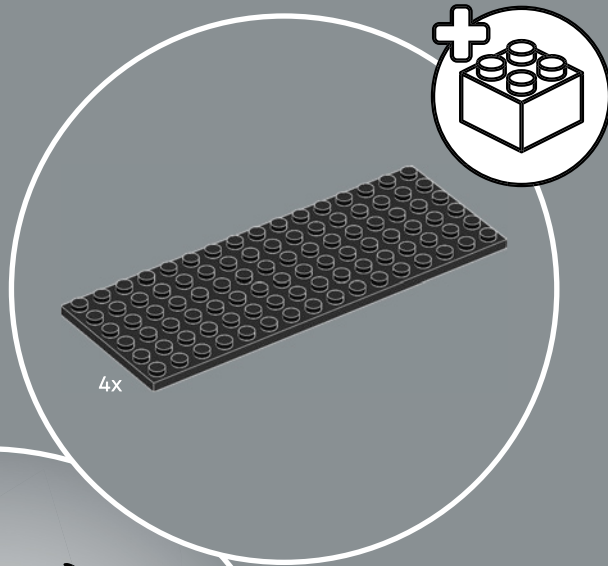
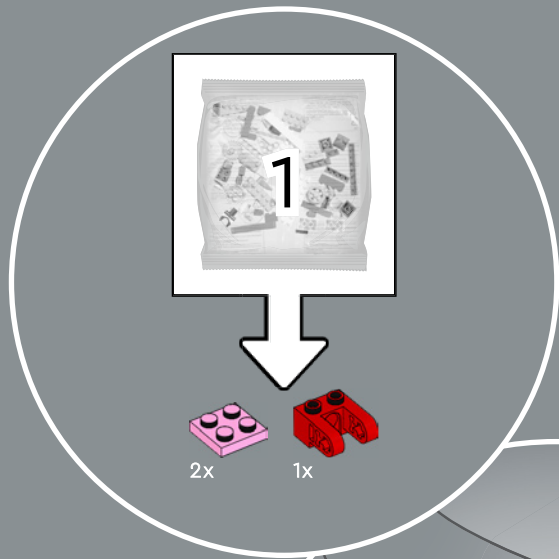

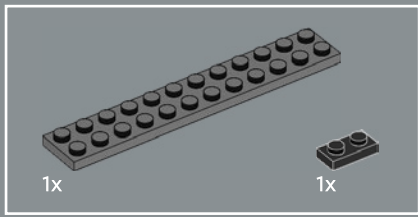

1

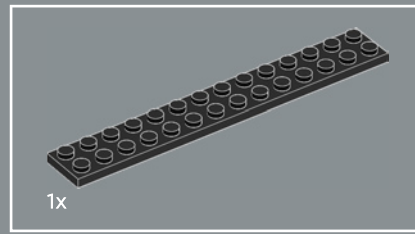
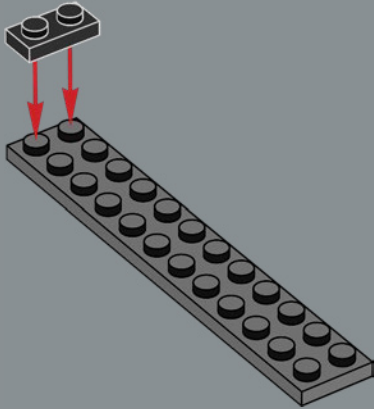

2

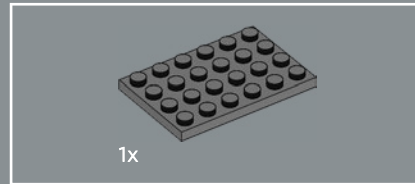
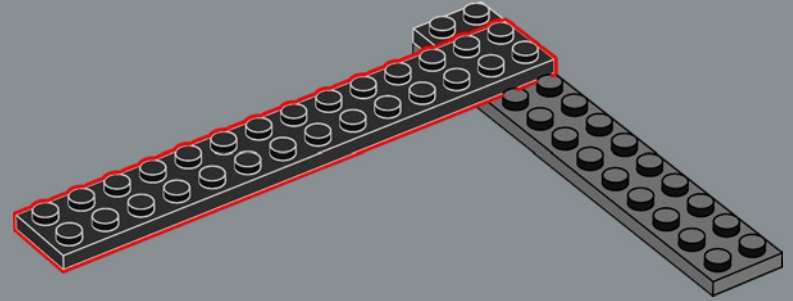

3

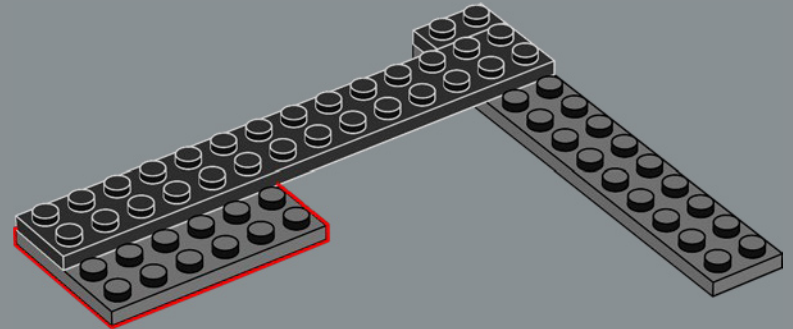

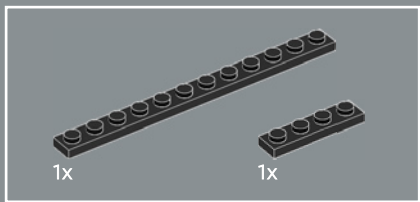

4

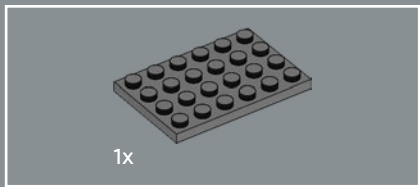
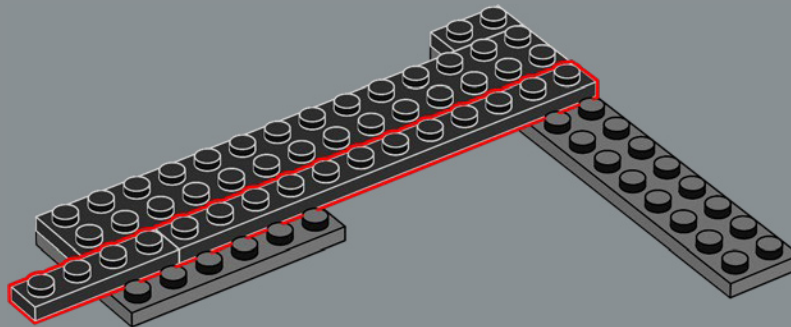

5

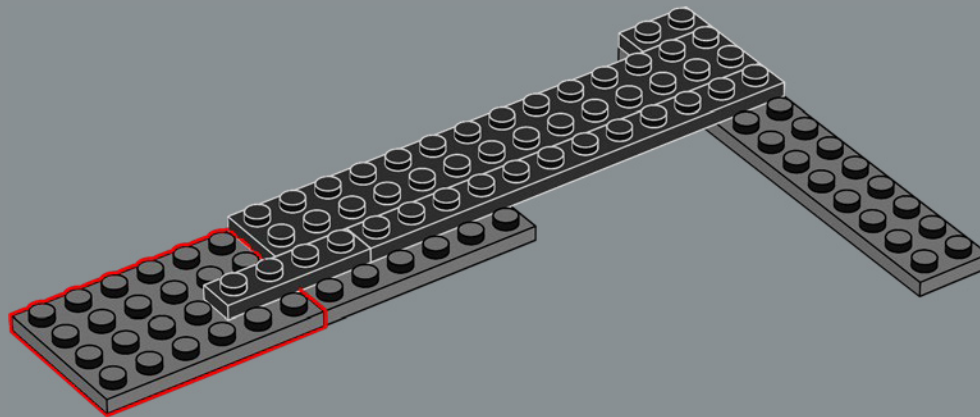

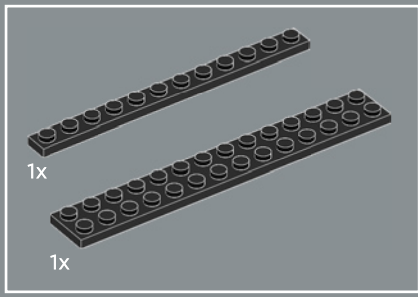

6

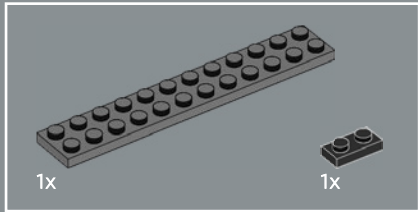
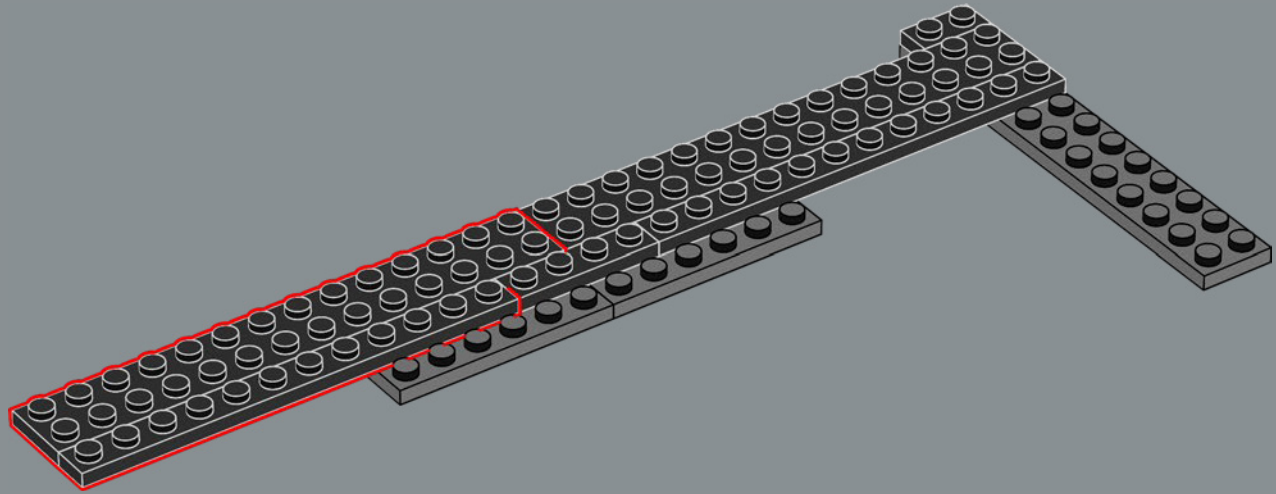

7

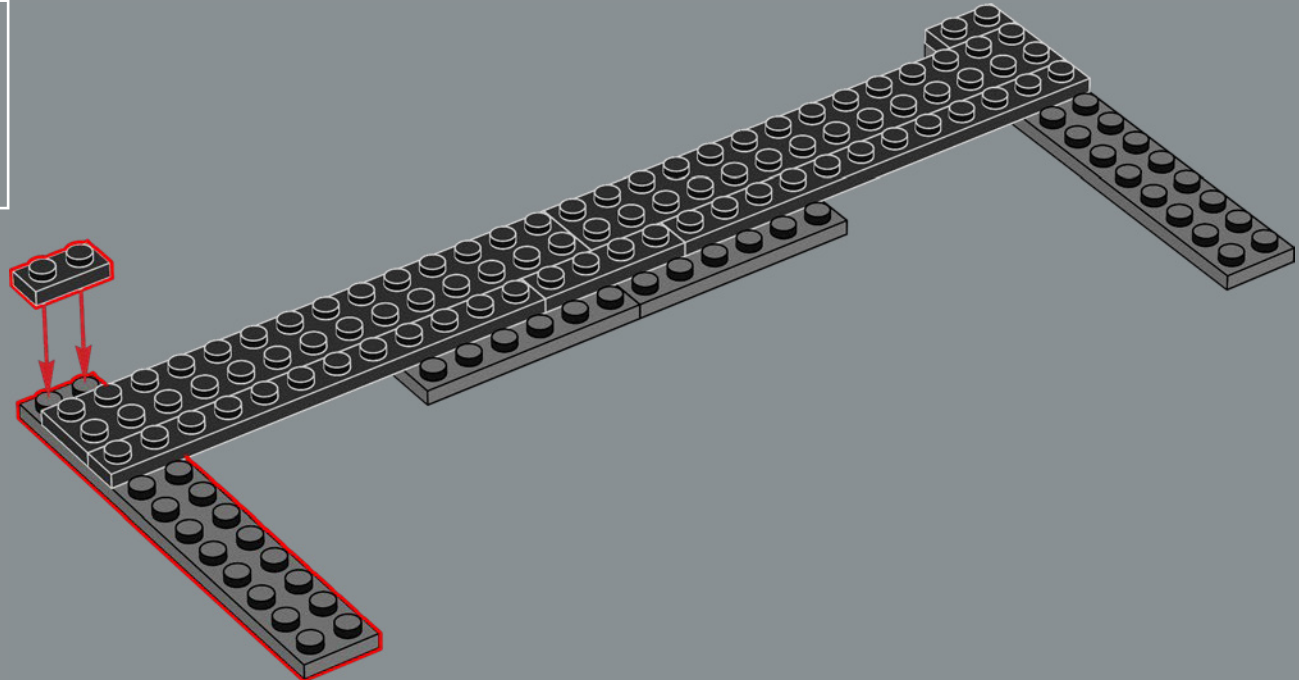

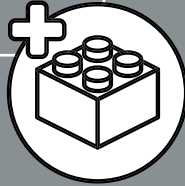
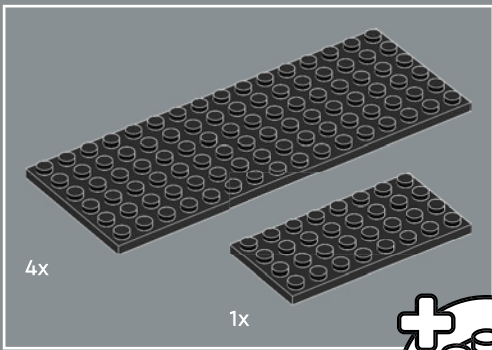

8

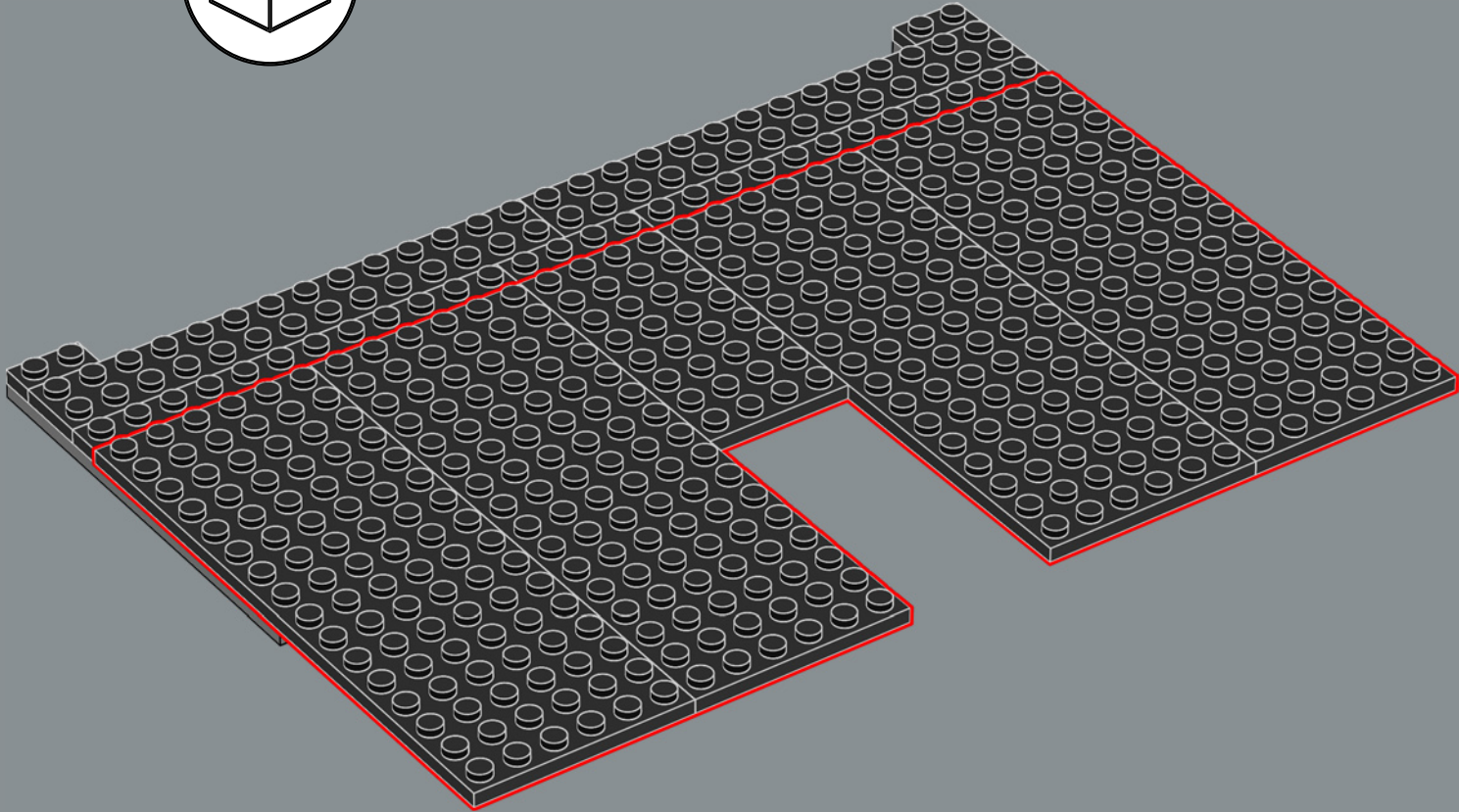

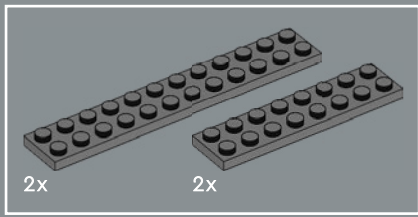

9

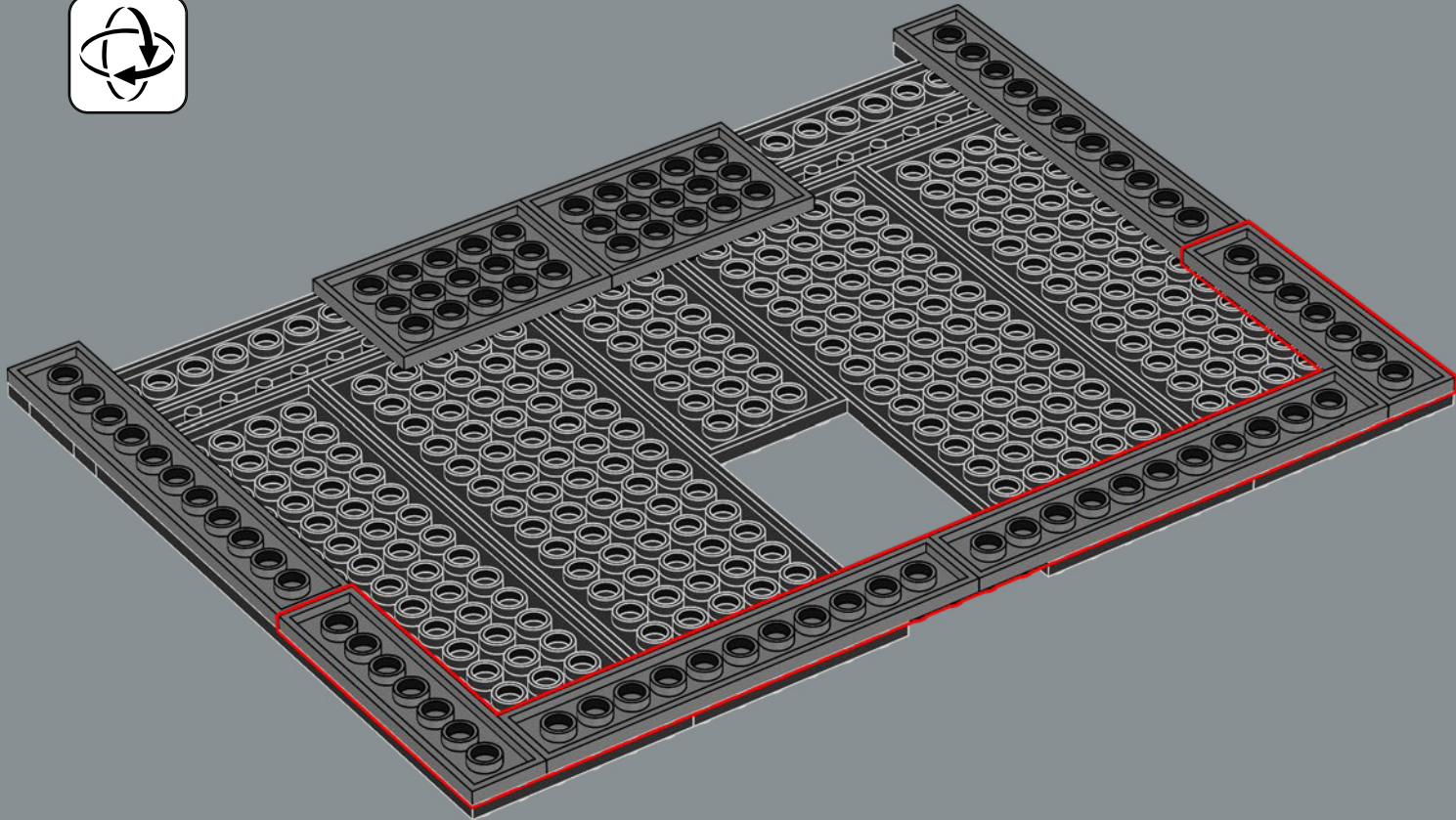

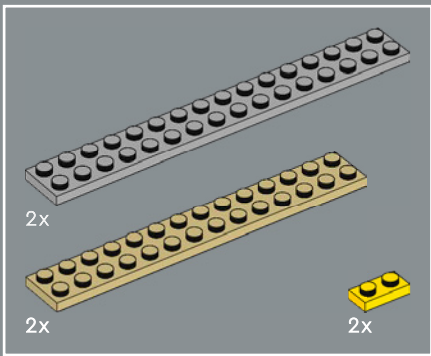

10

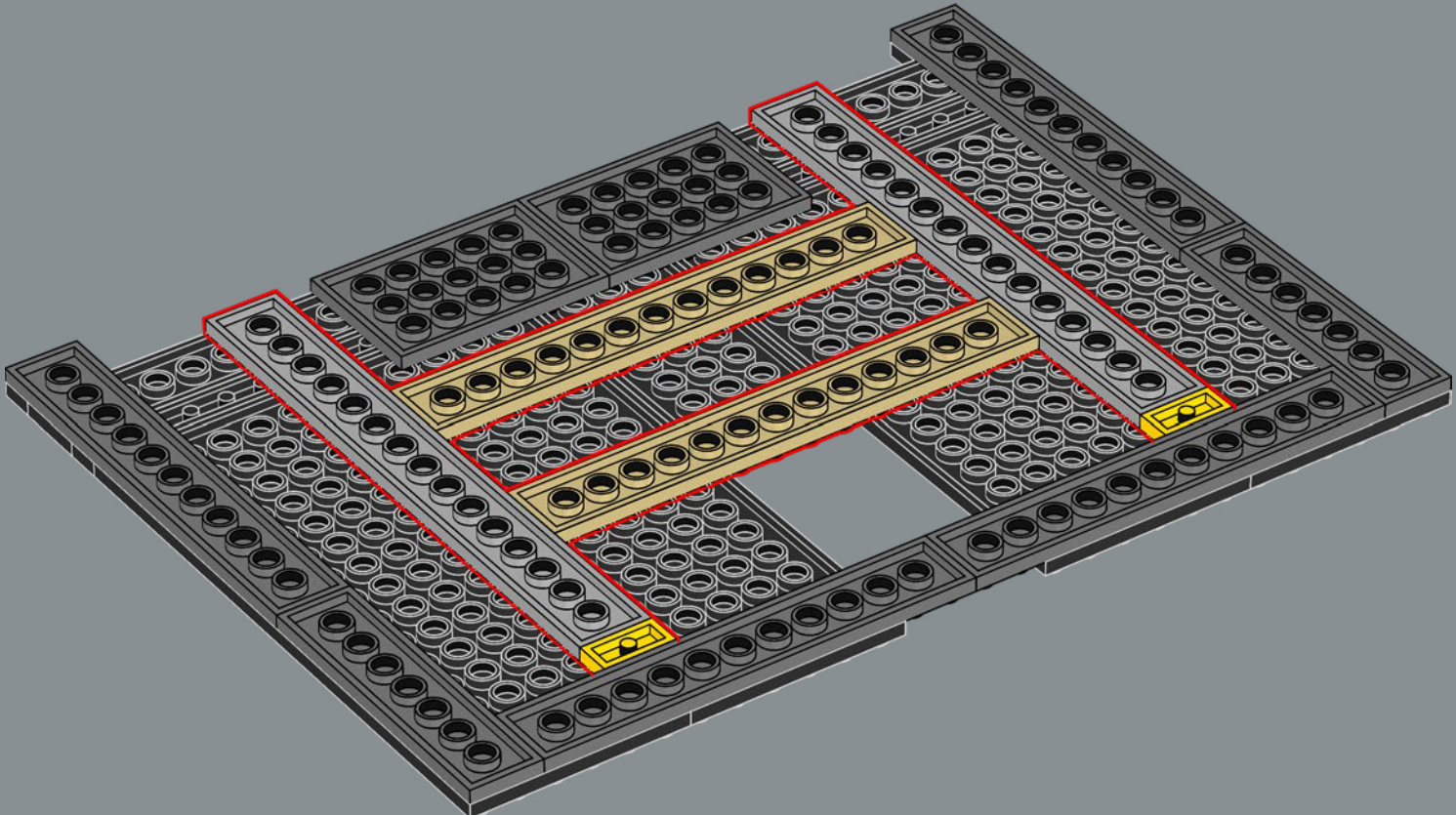

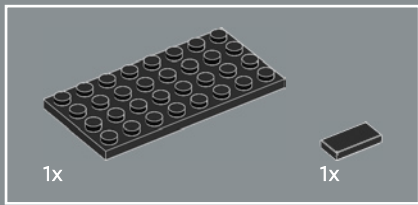

11

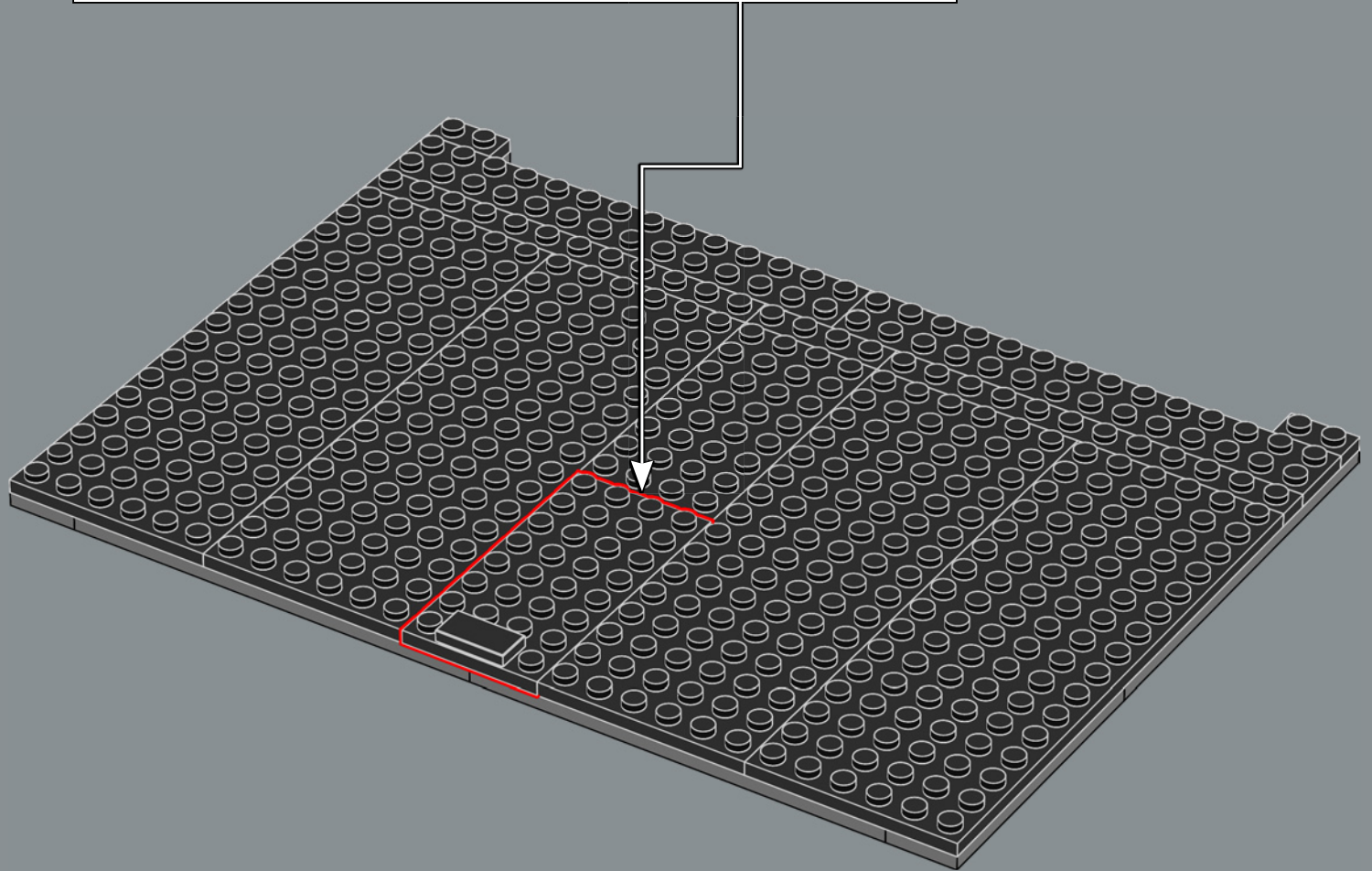
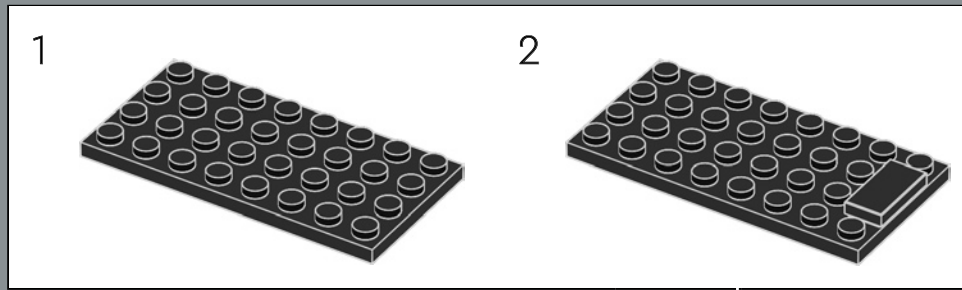



2x



4x



2x



2x

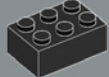

2x

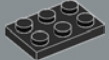

6x



4x

12

1

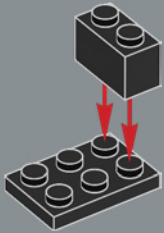

2

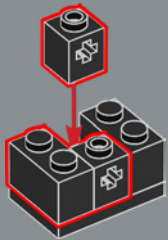

3

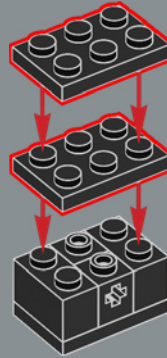

4

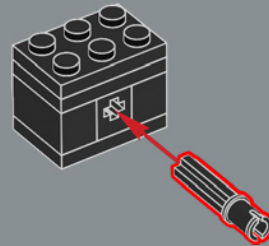

5

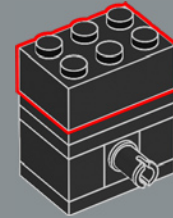

6

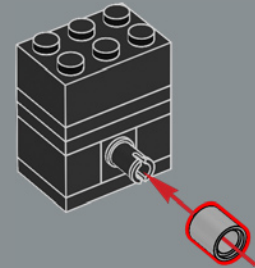

2x



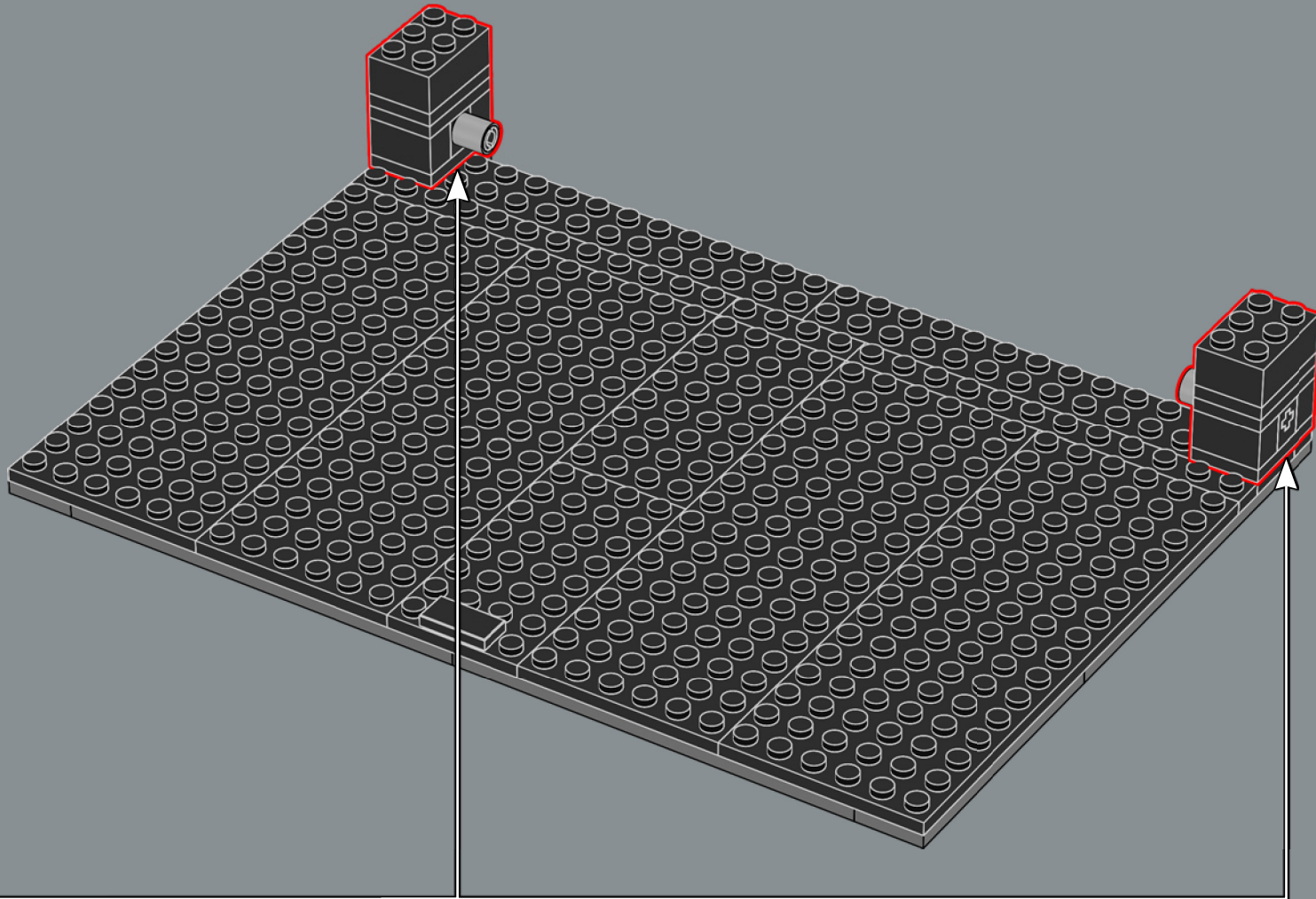

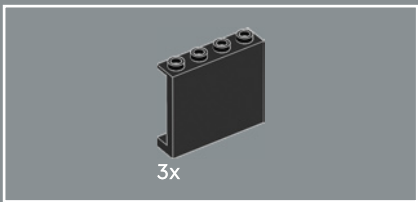

13

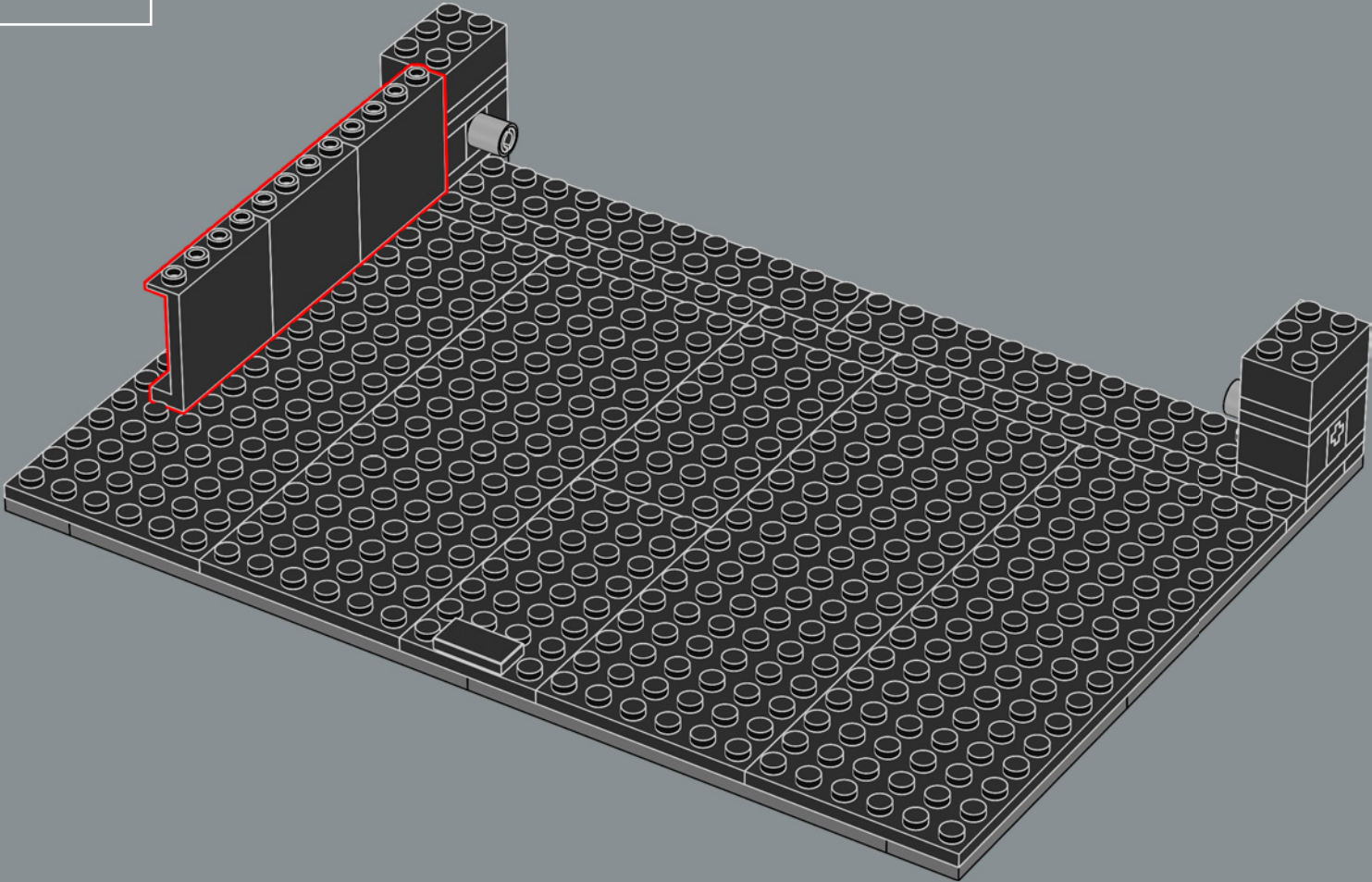

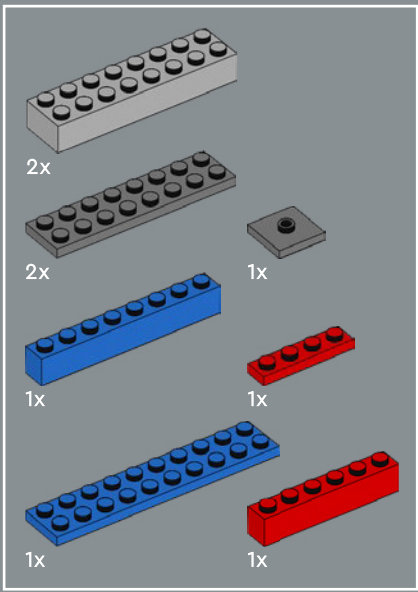

15

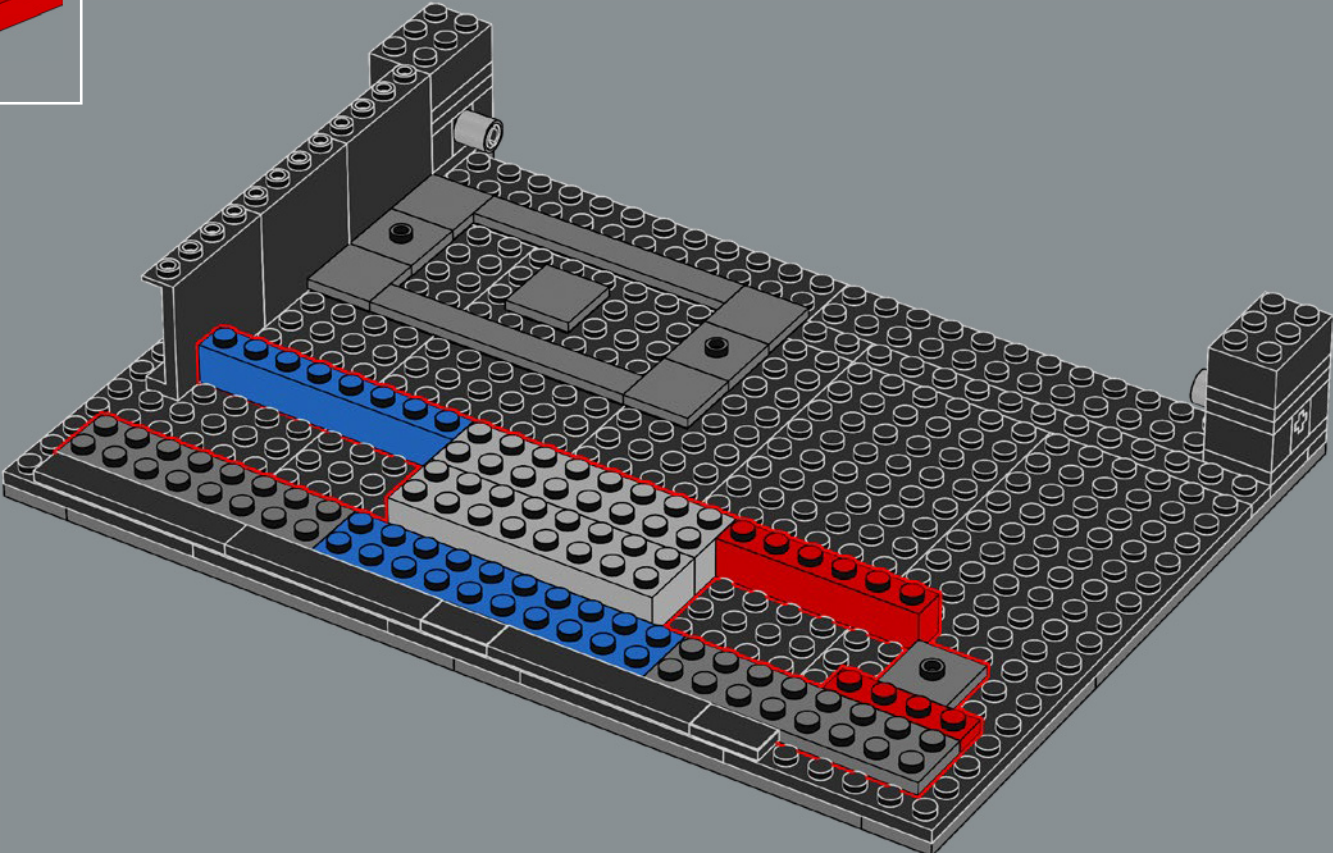



16

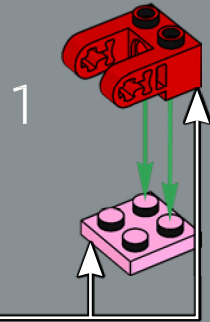
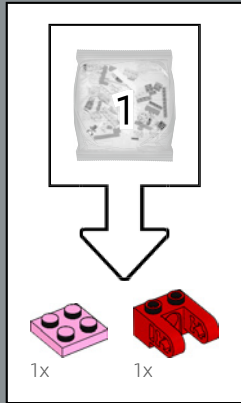

2

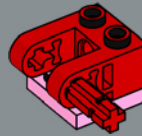

3

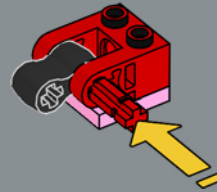

4

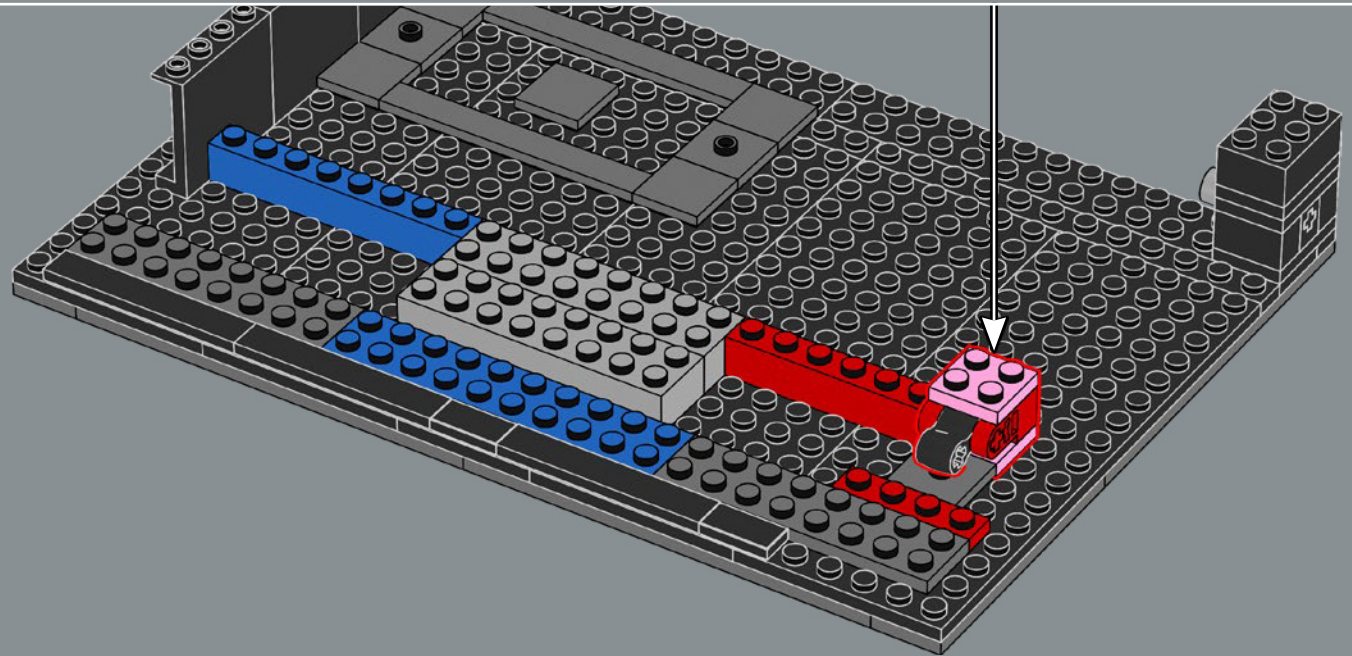
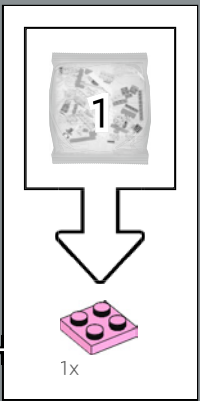
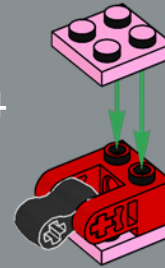

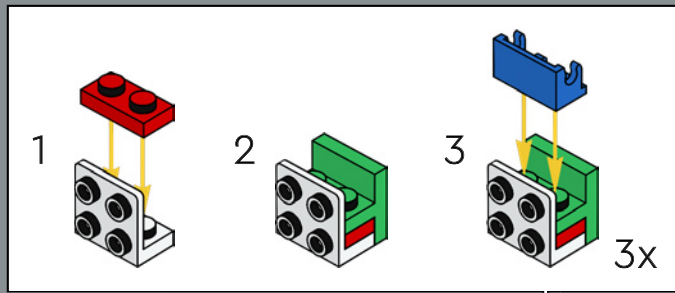
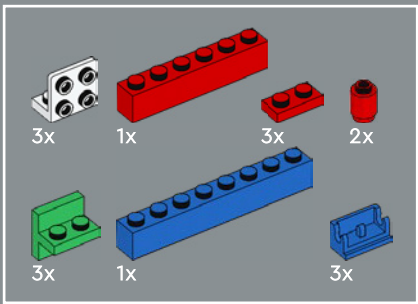

17

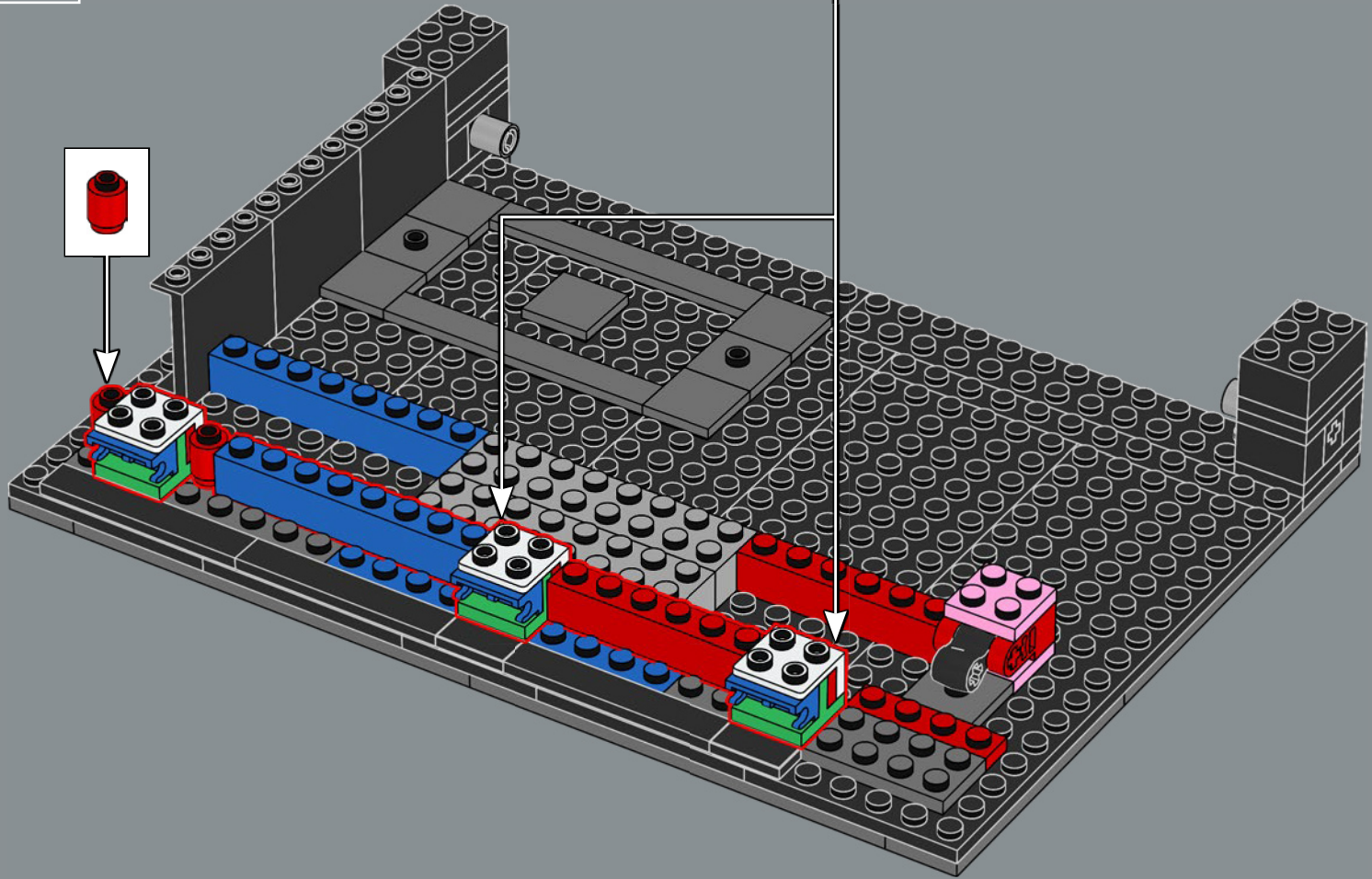

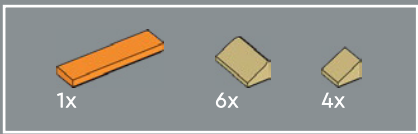

19

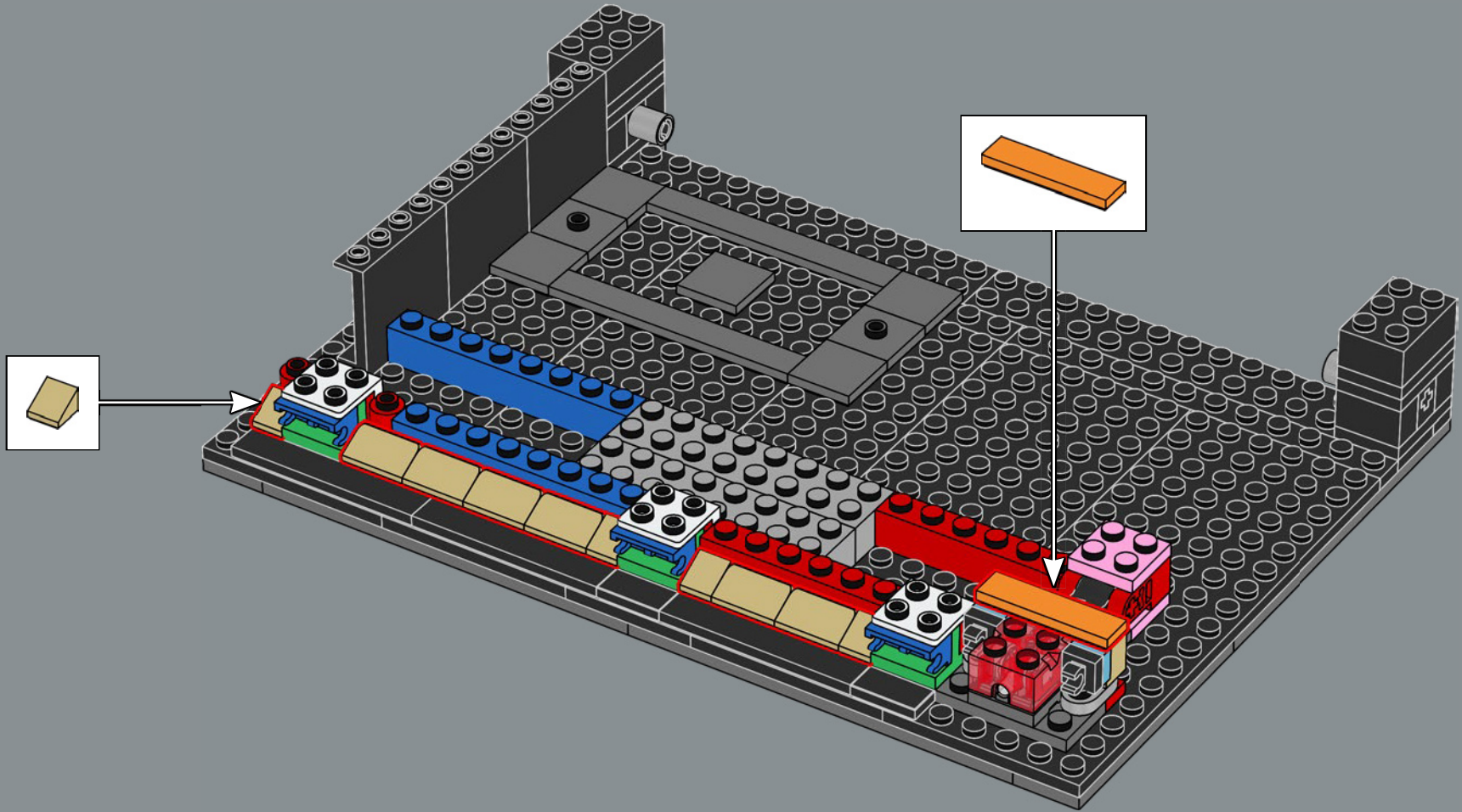

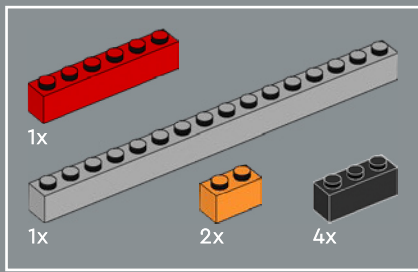

20

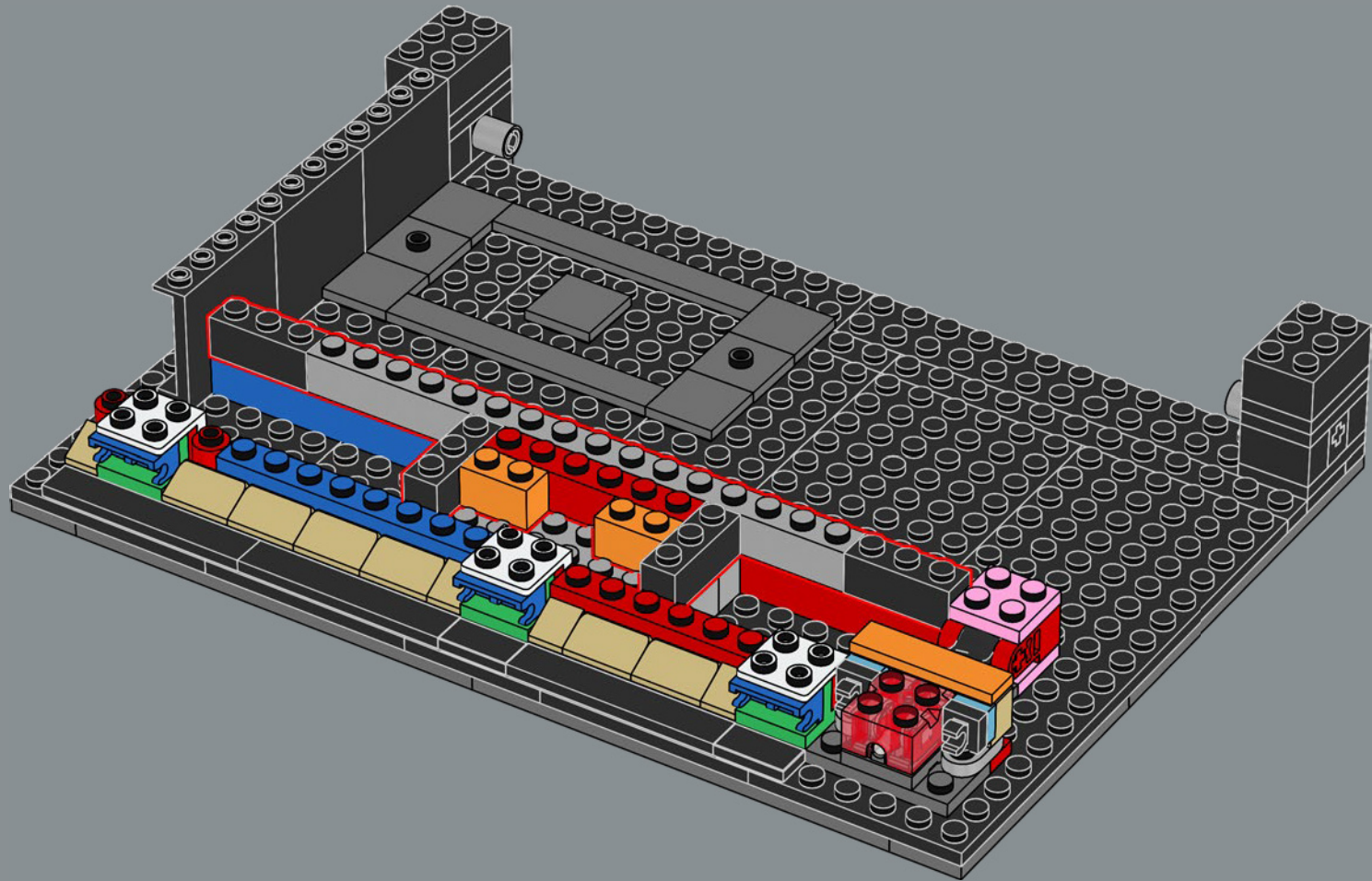

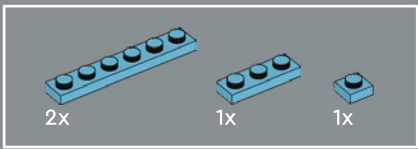

21

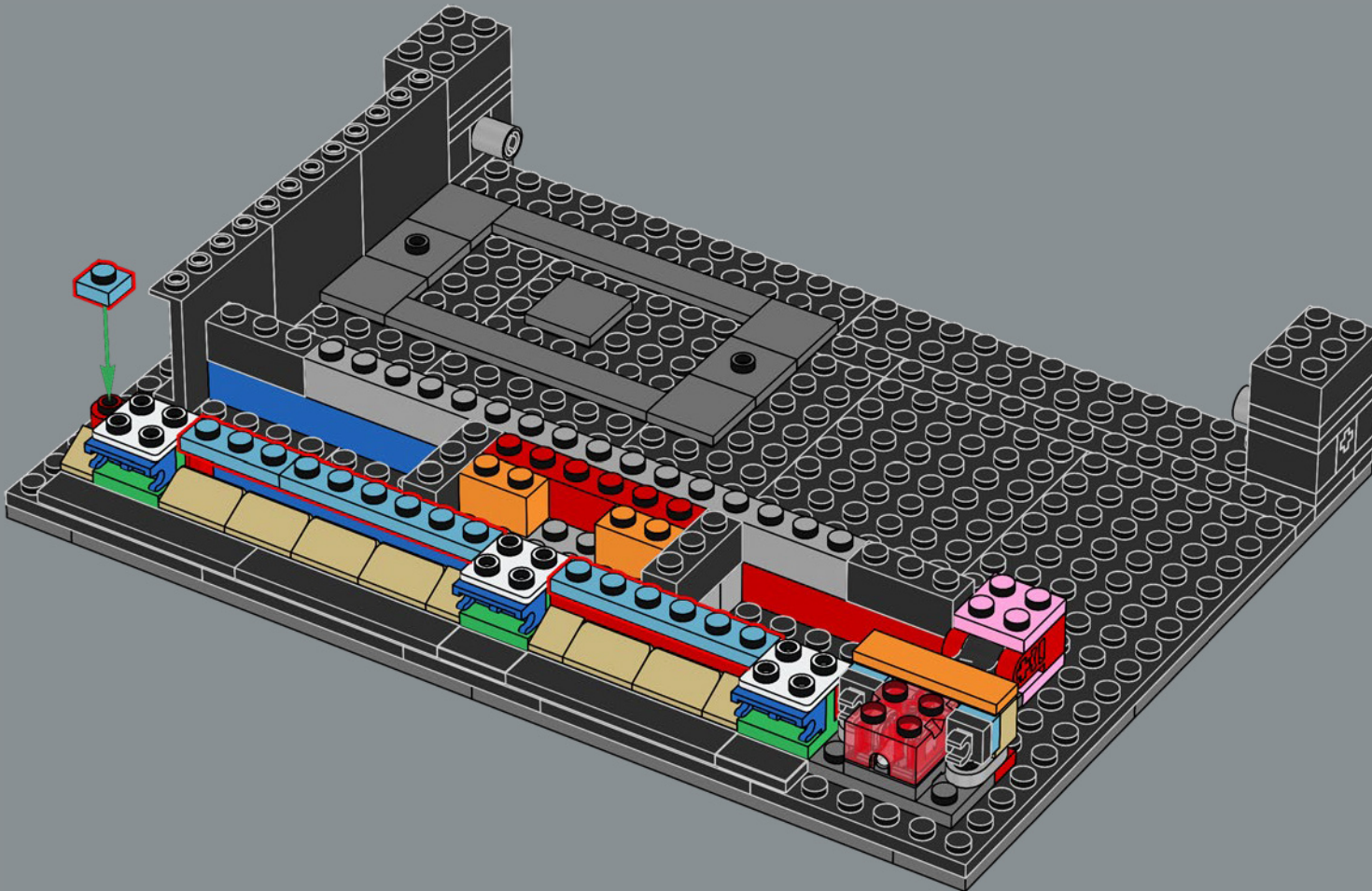

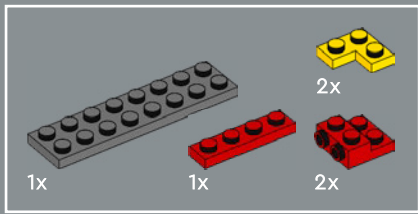

22

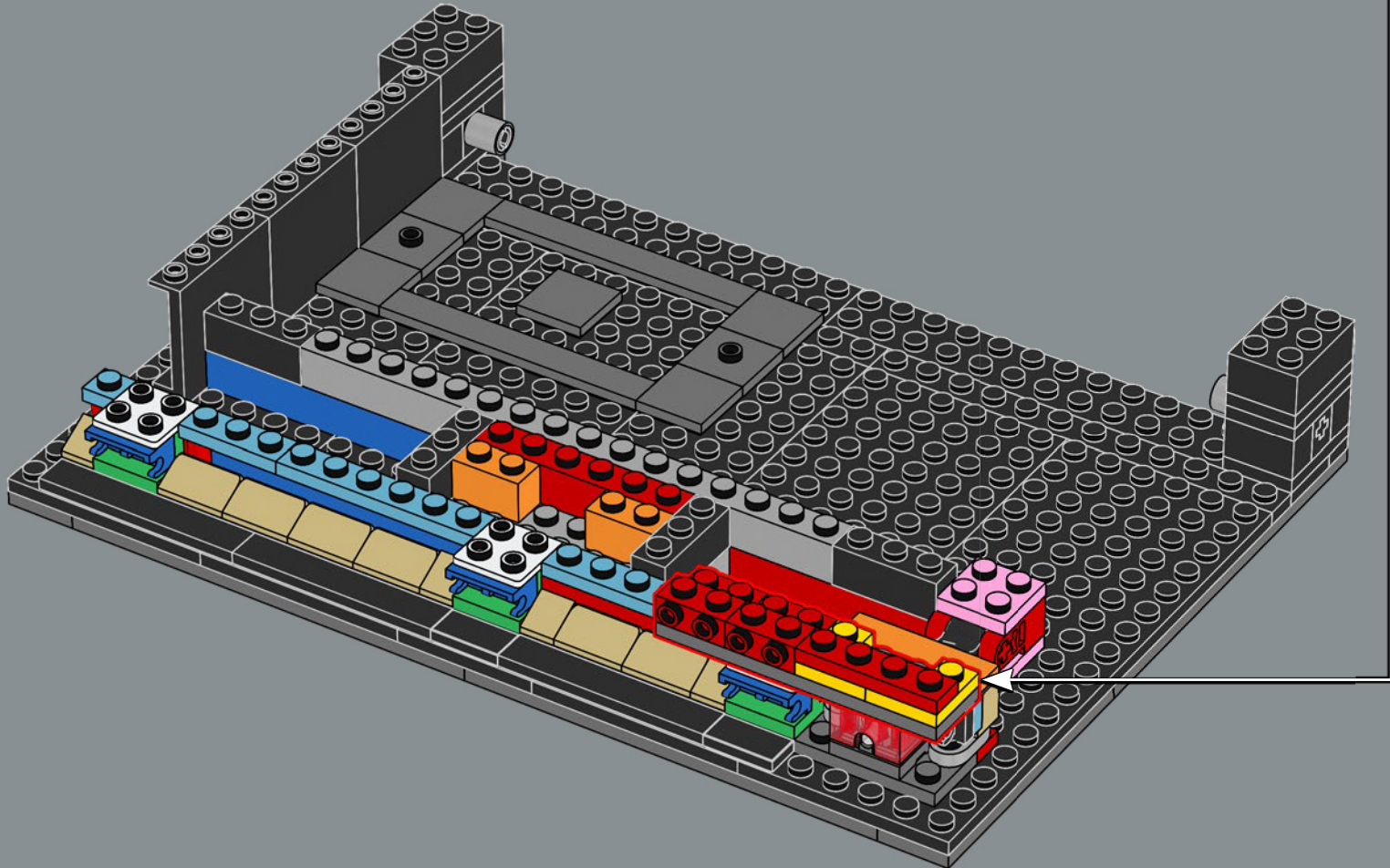
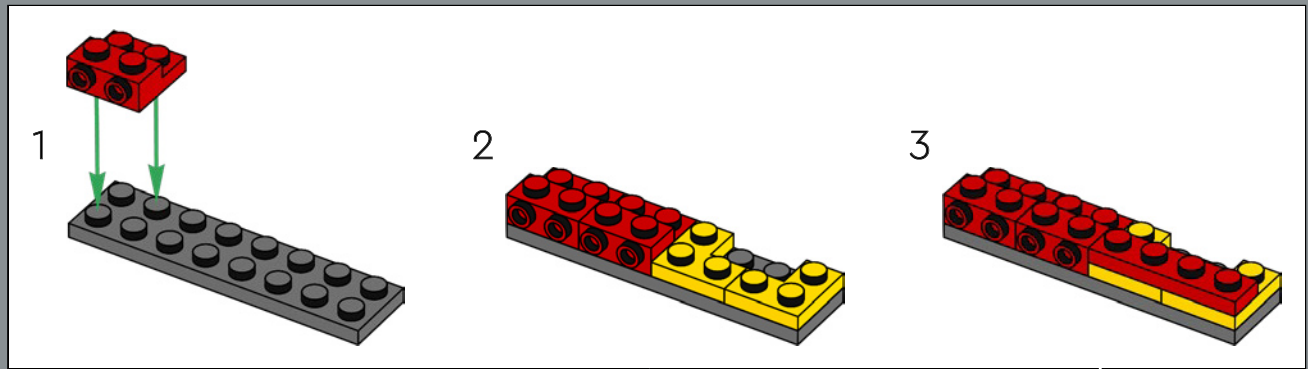

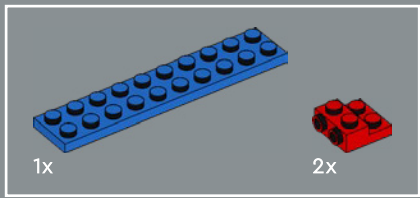

23

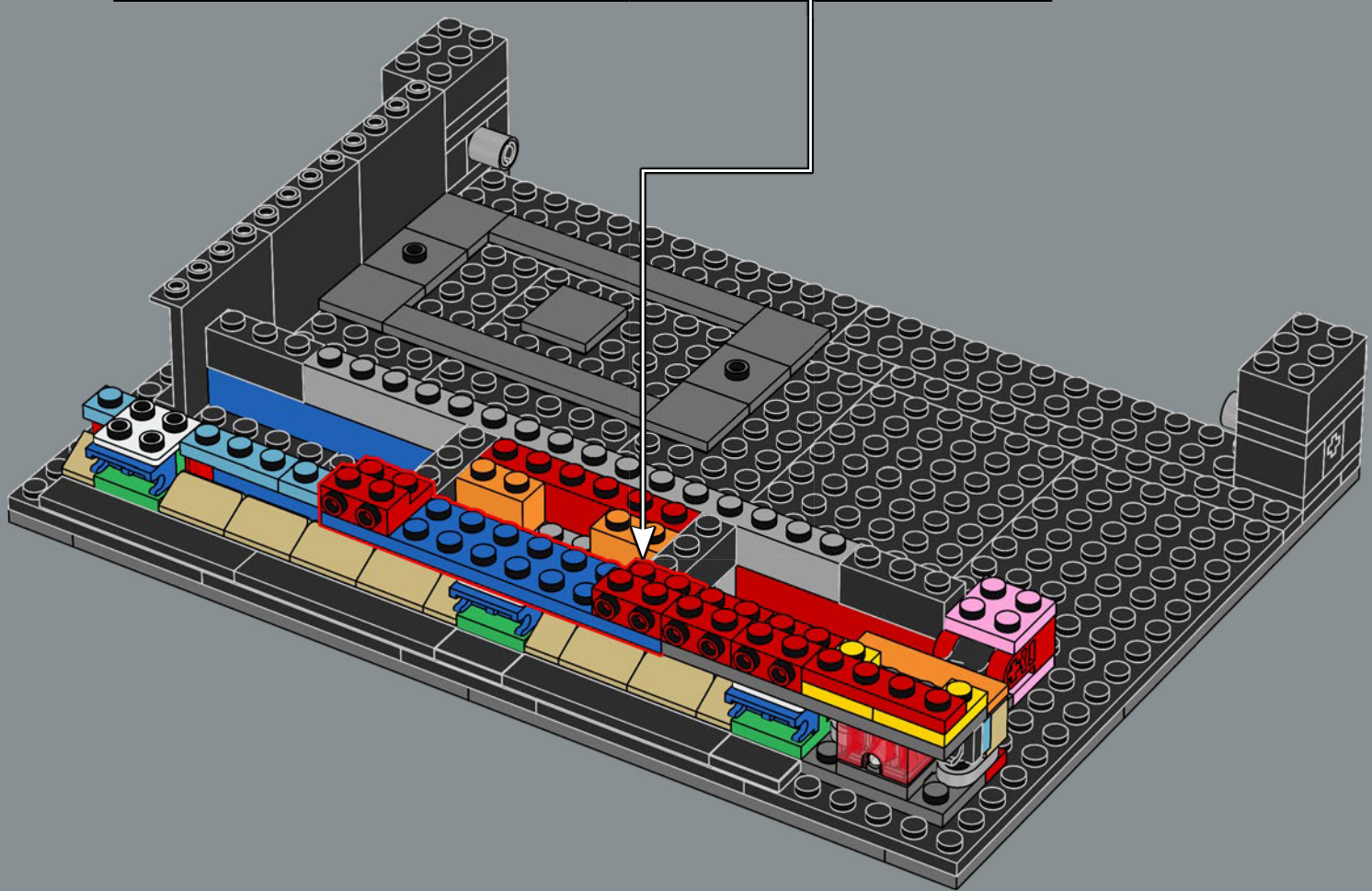
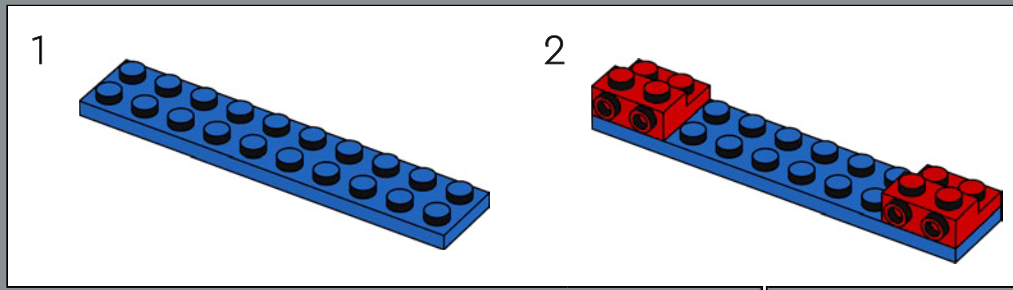

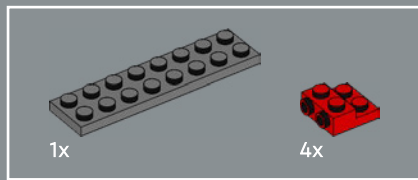

24

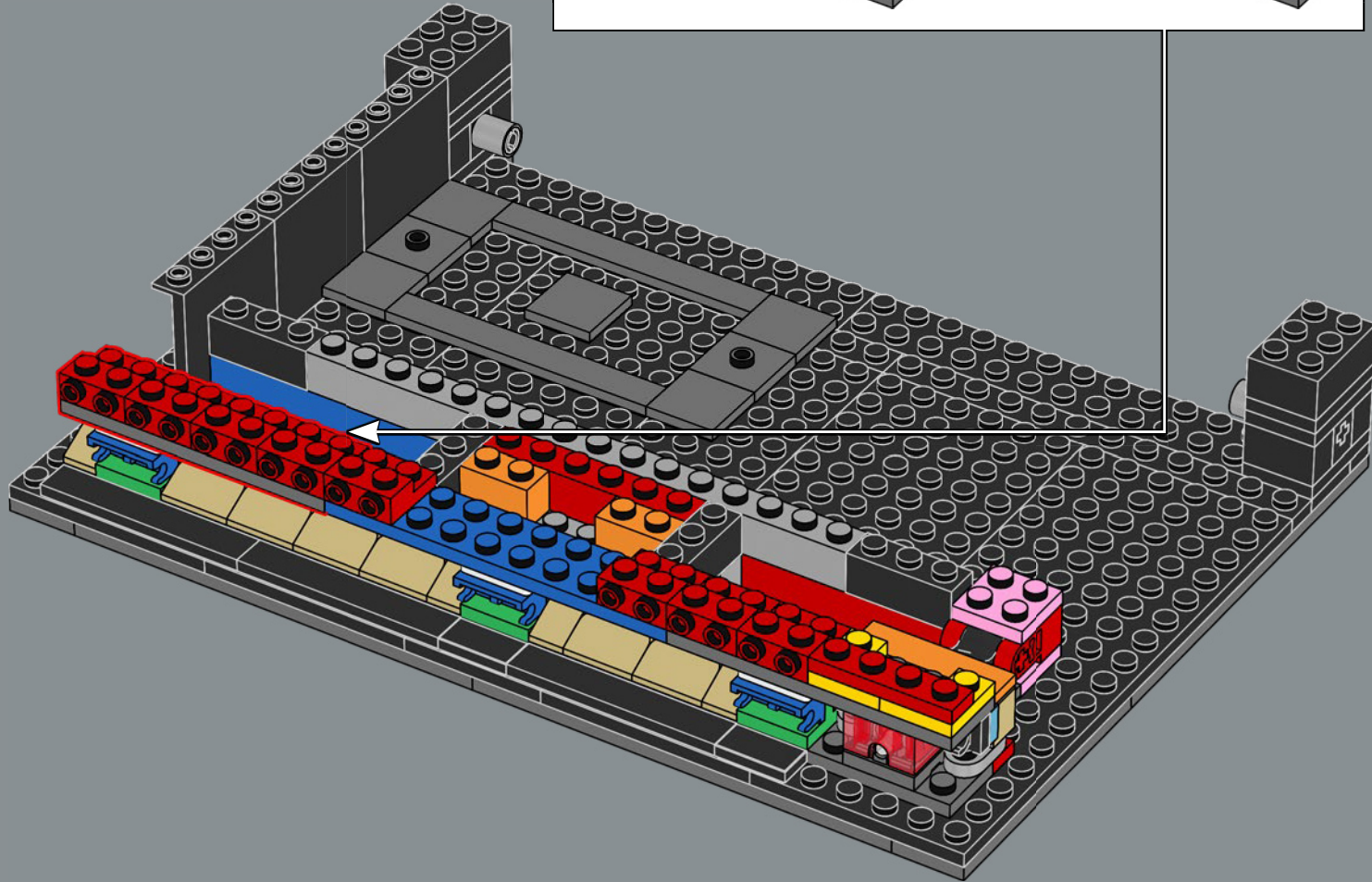
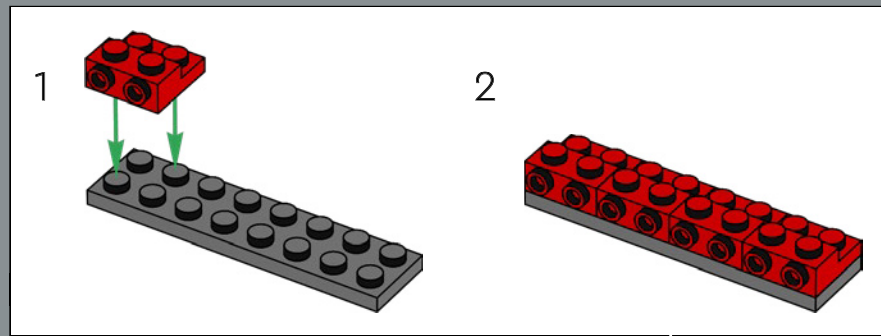

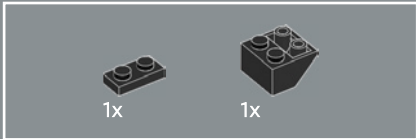
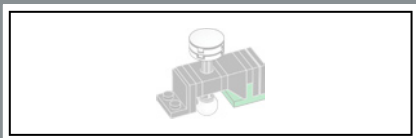

25

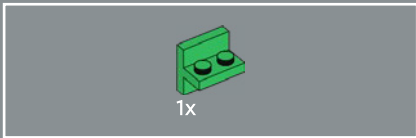
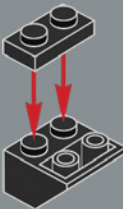

26

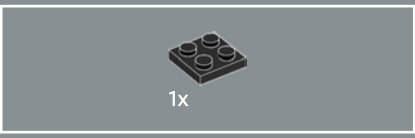

27

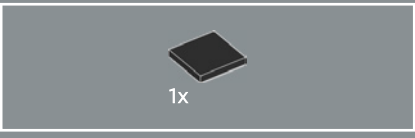
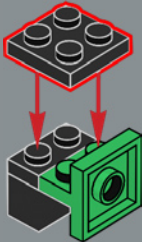

28

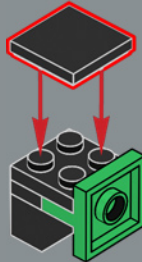

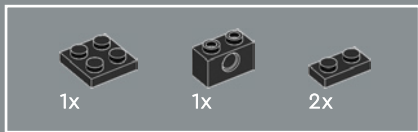

29

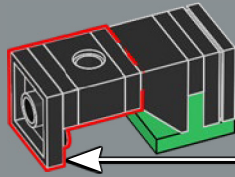
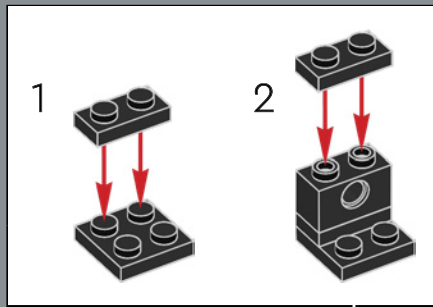

30

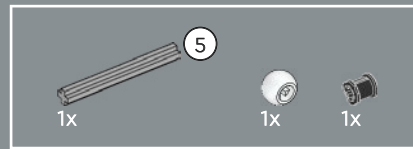
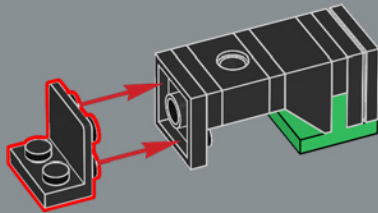

31

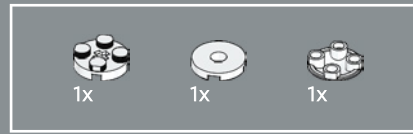
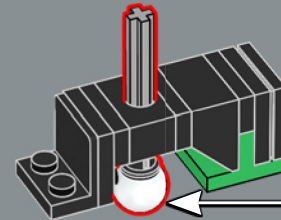
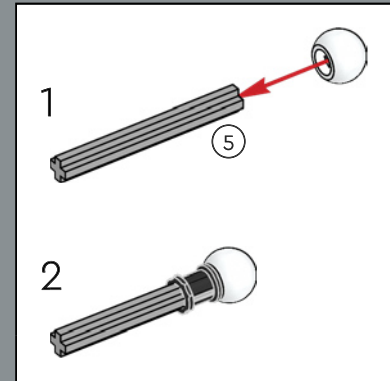

32

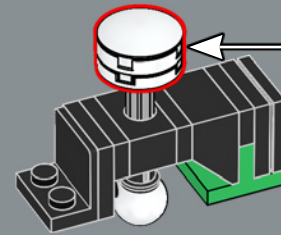
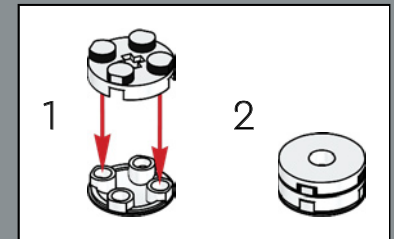

33

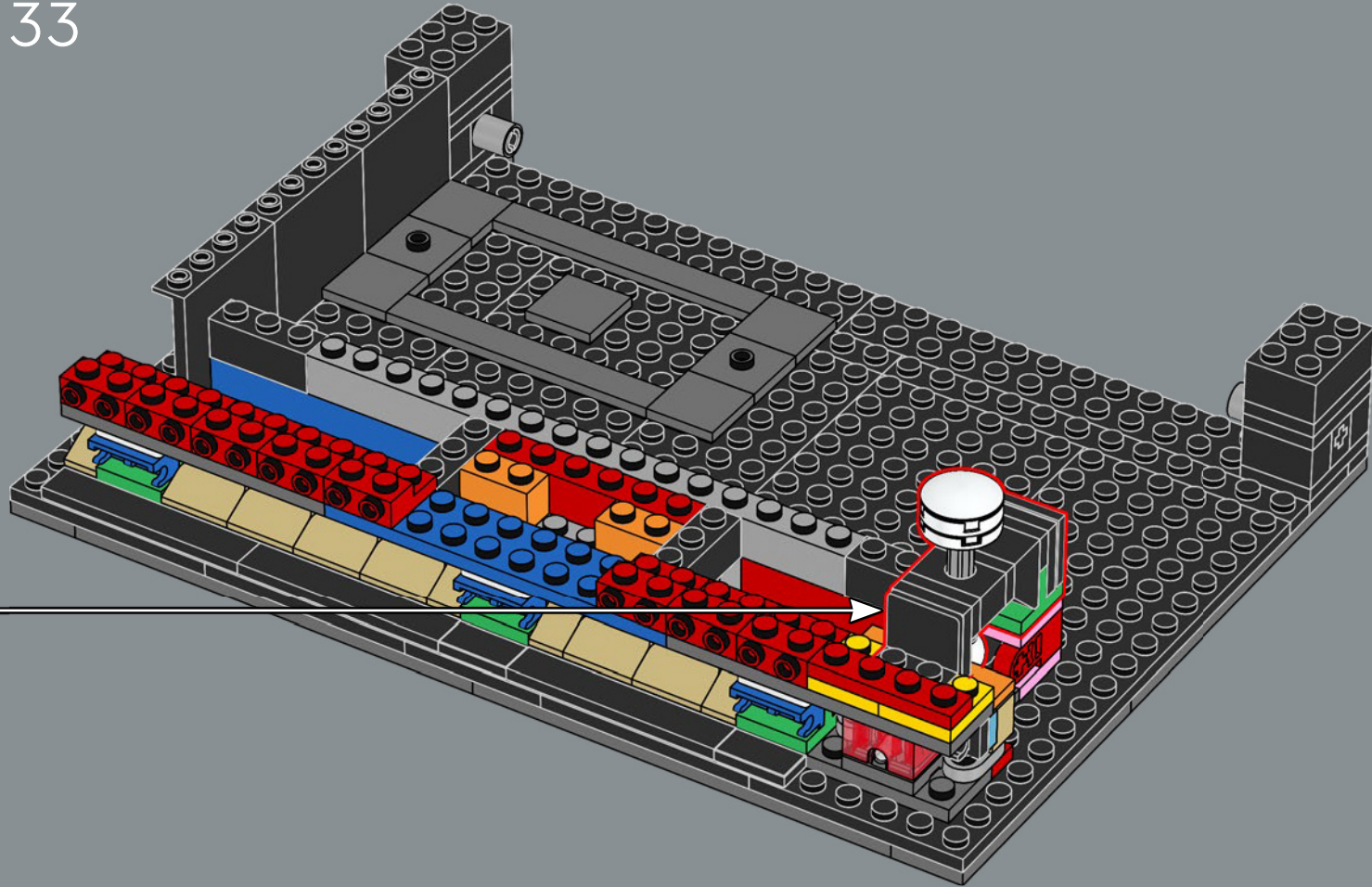

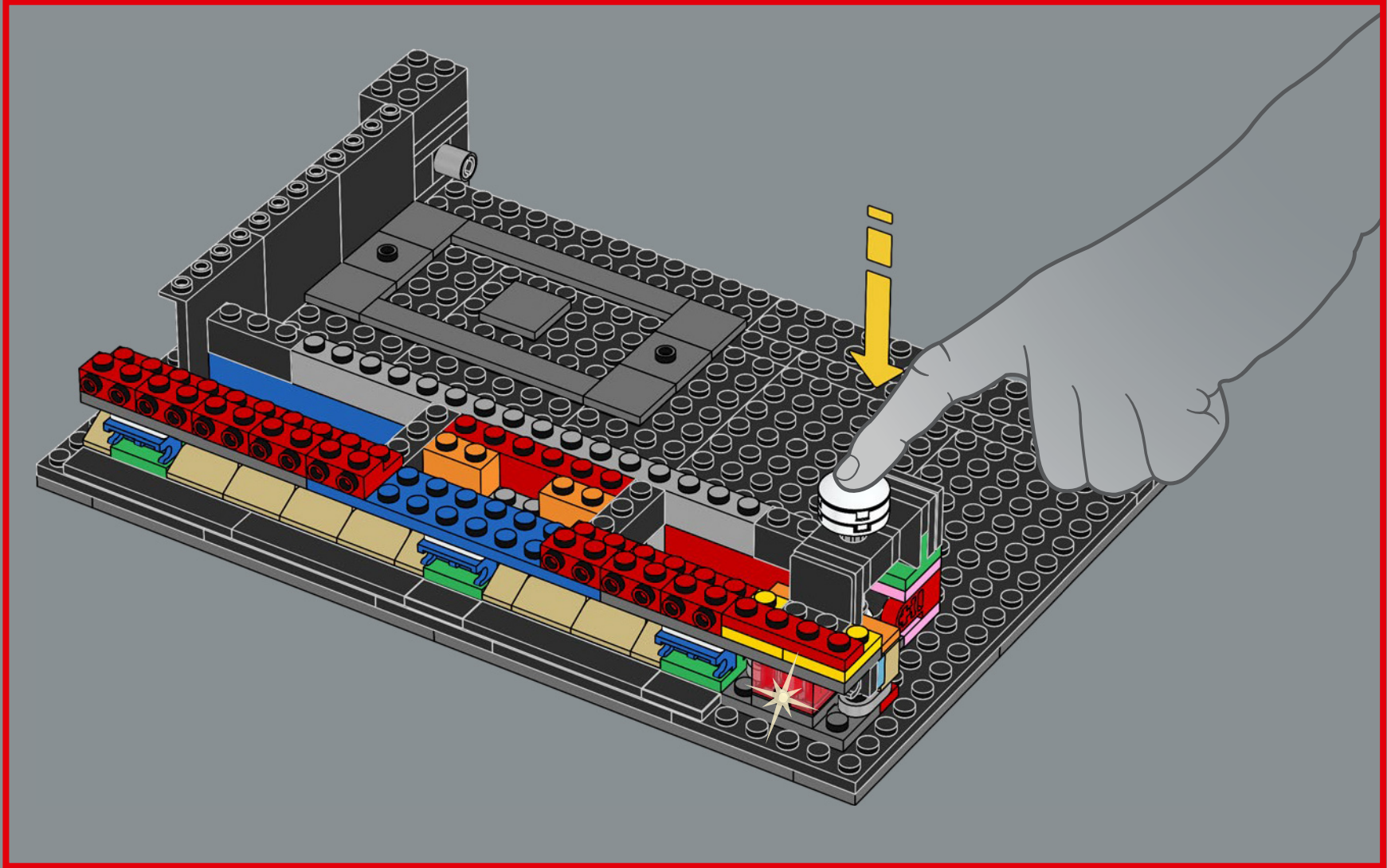

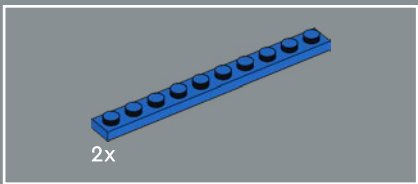

34

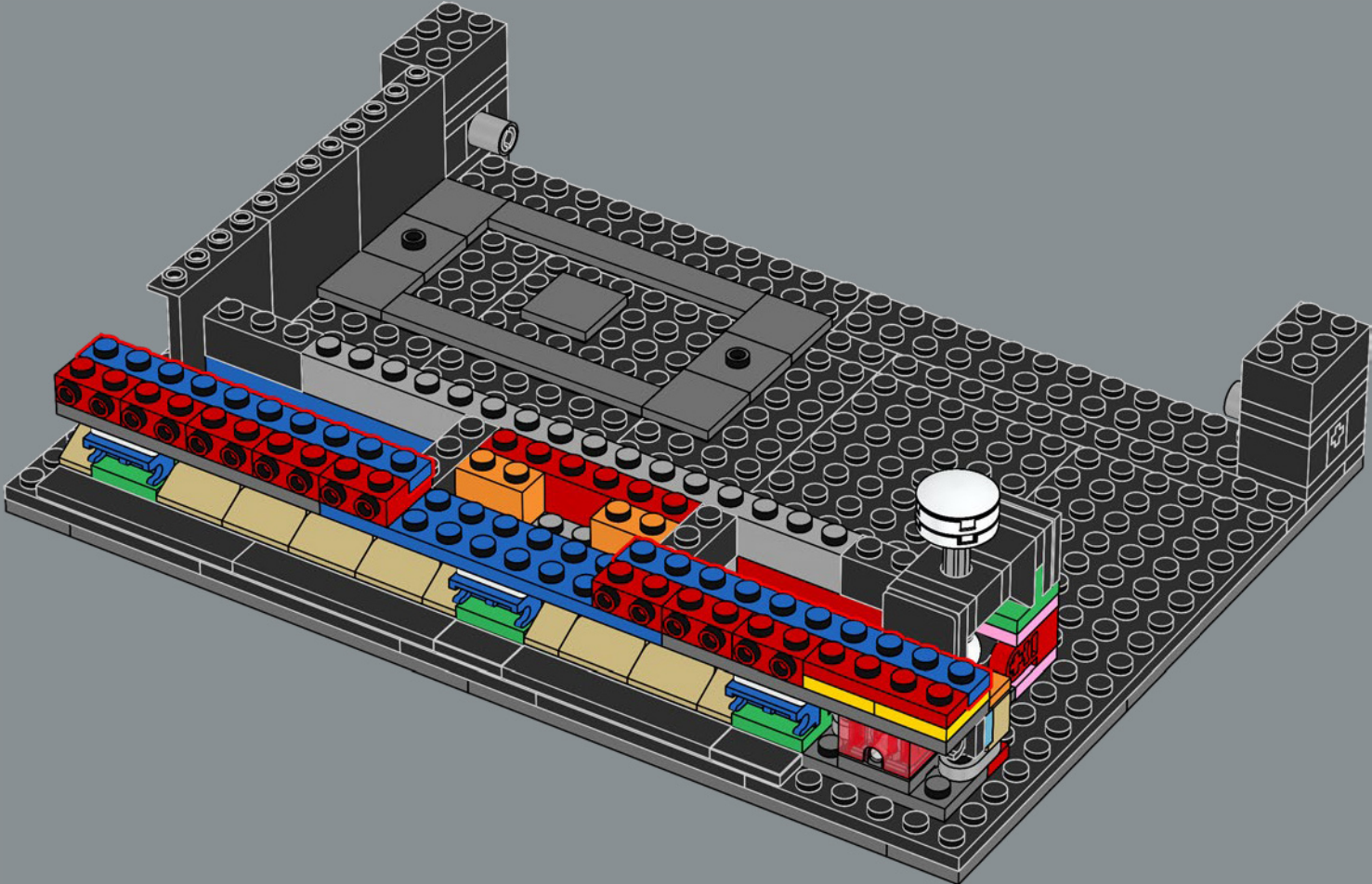

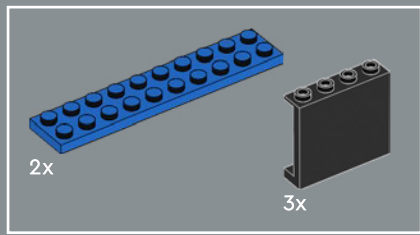

35

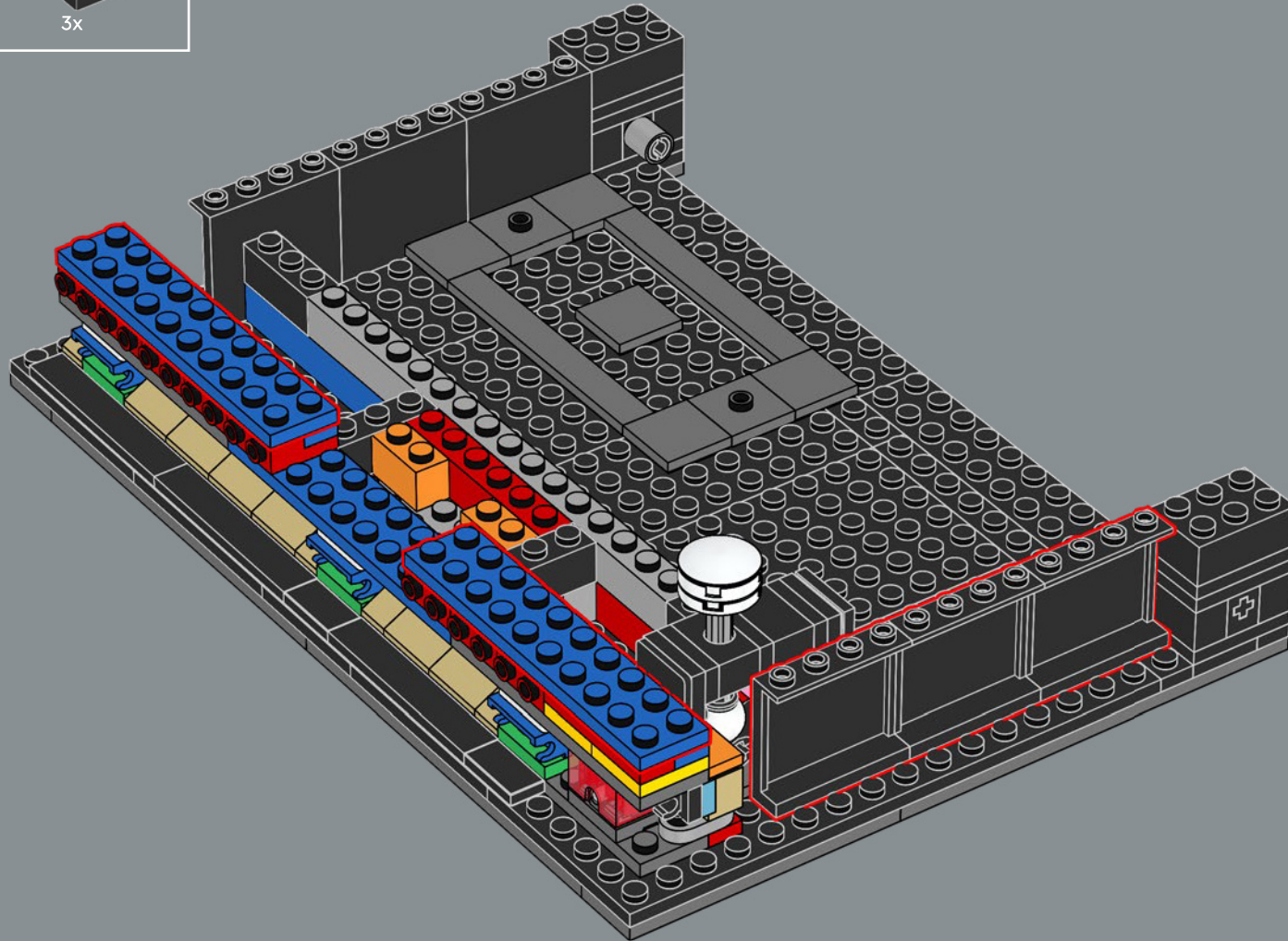

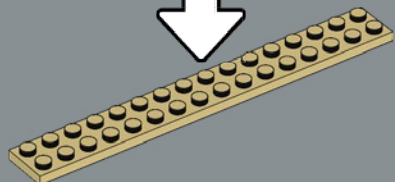

1x

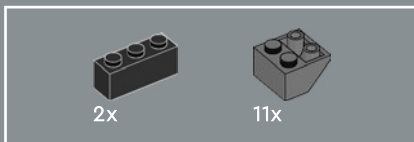

36

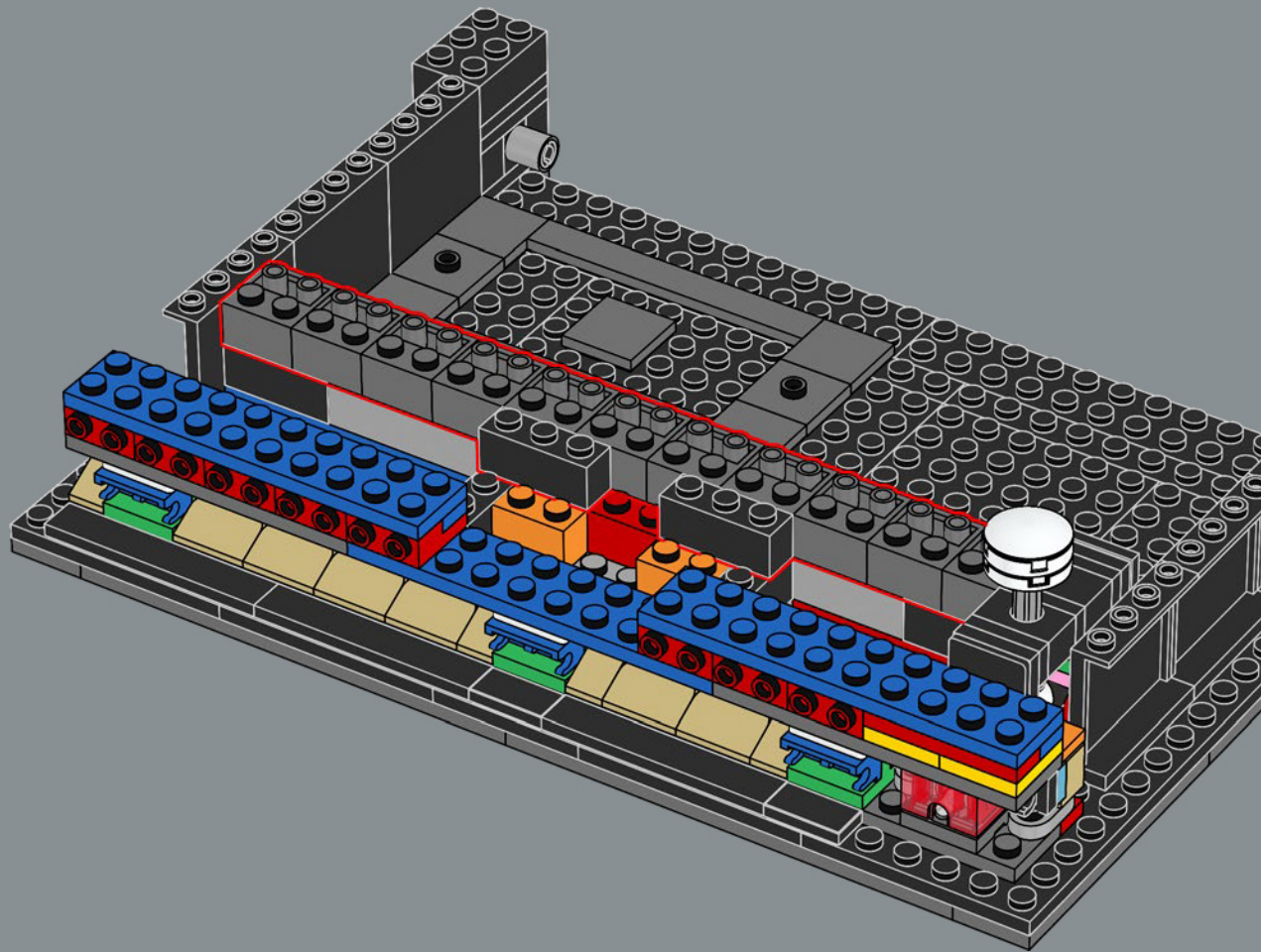

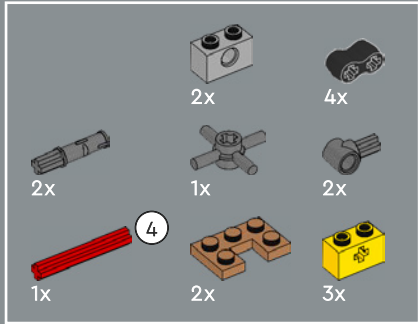
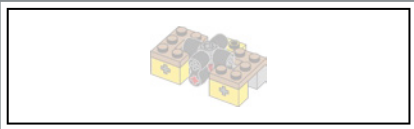

37

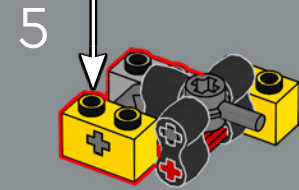
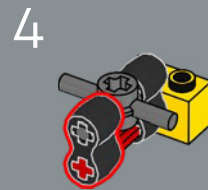
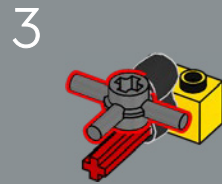
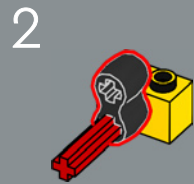
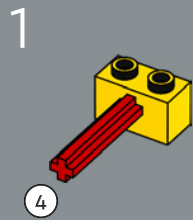
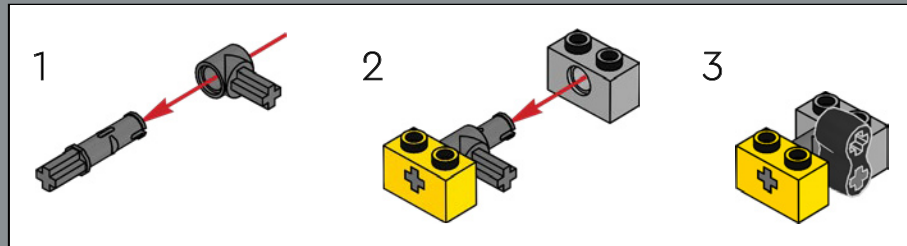

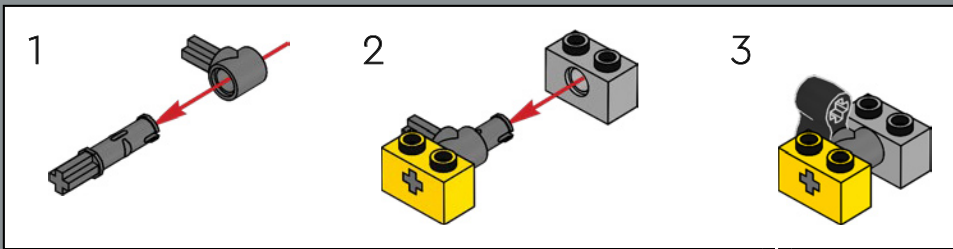

6

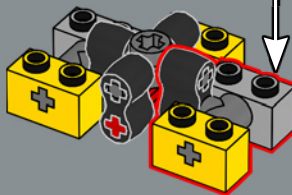

7

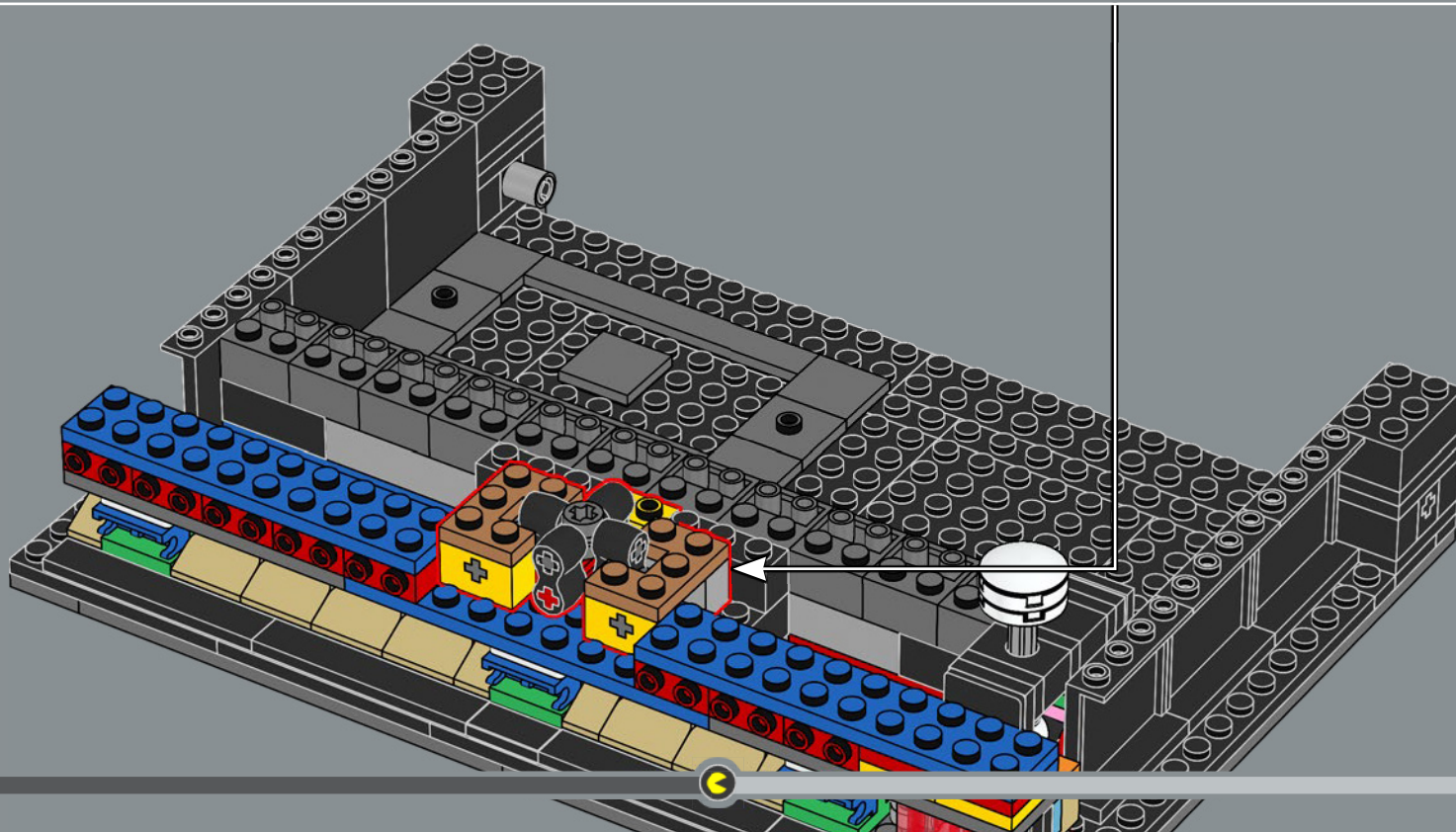
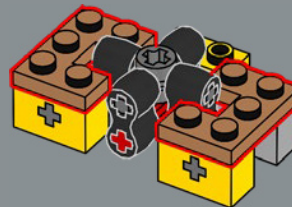

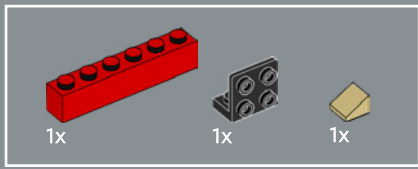

38

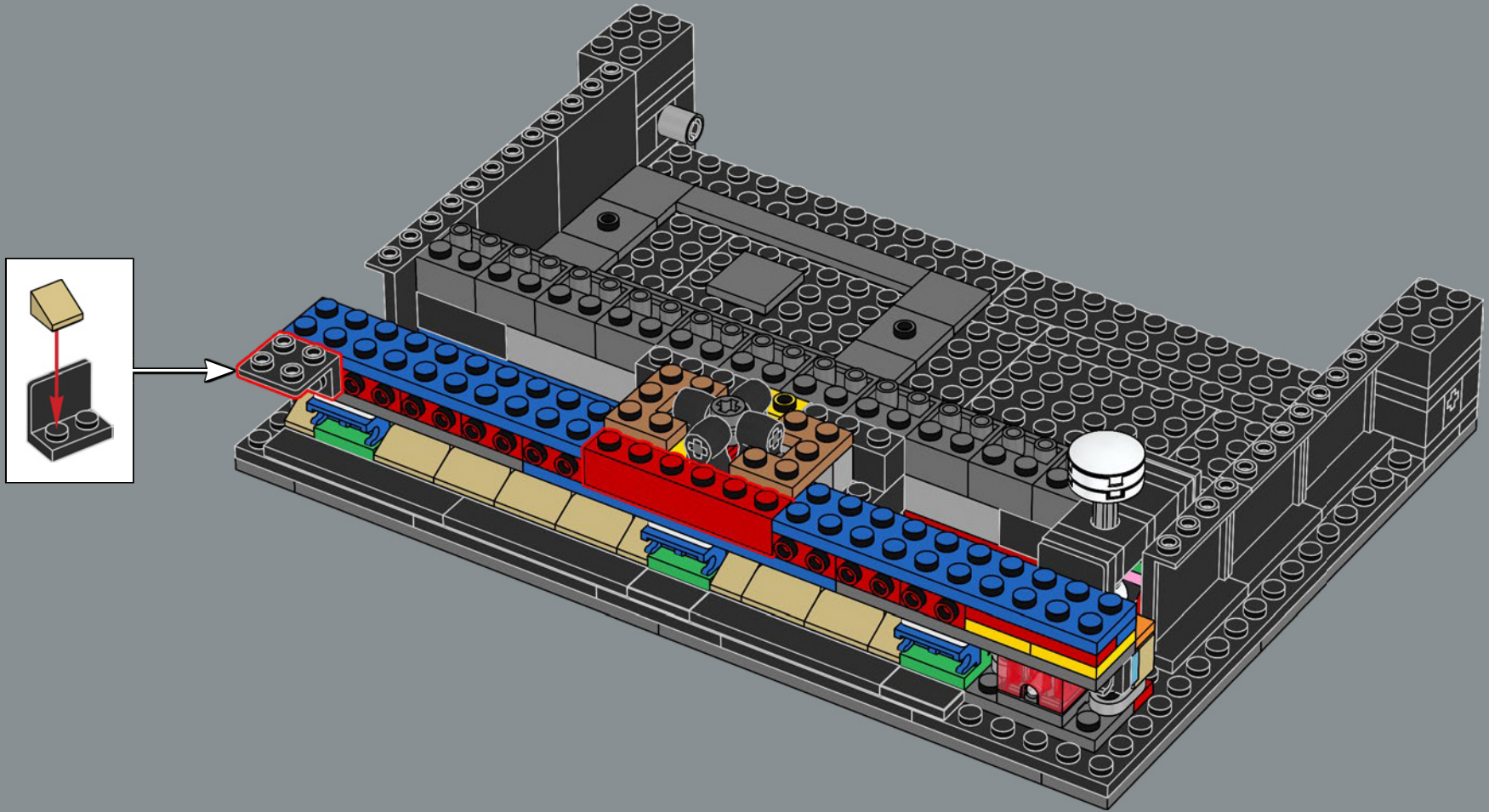



39

1

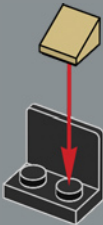

2

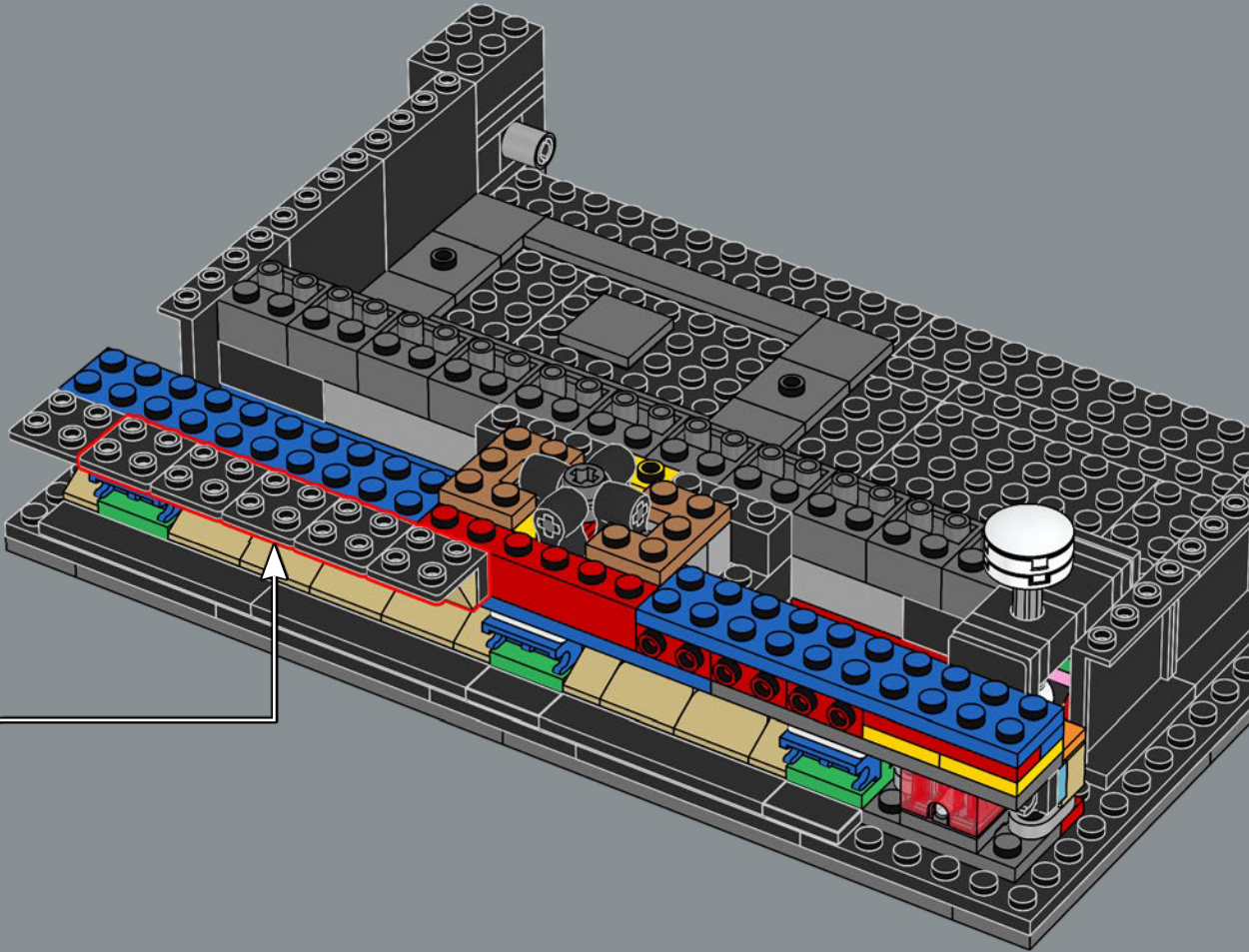
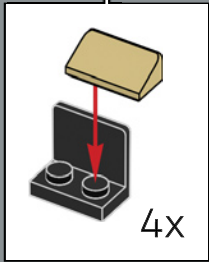
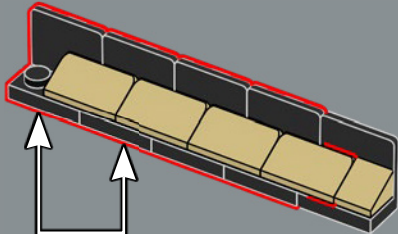



40

1

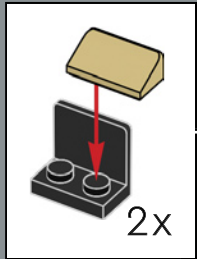
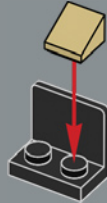

2

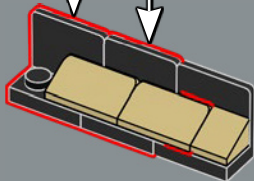

3

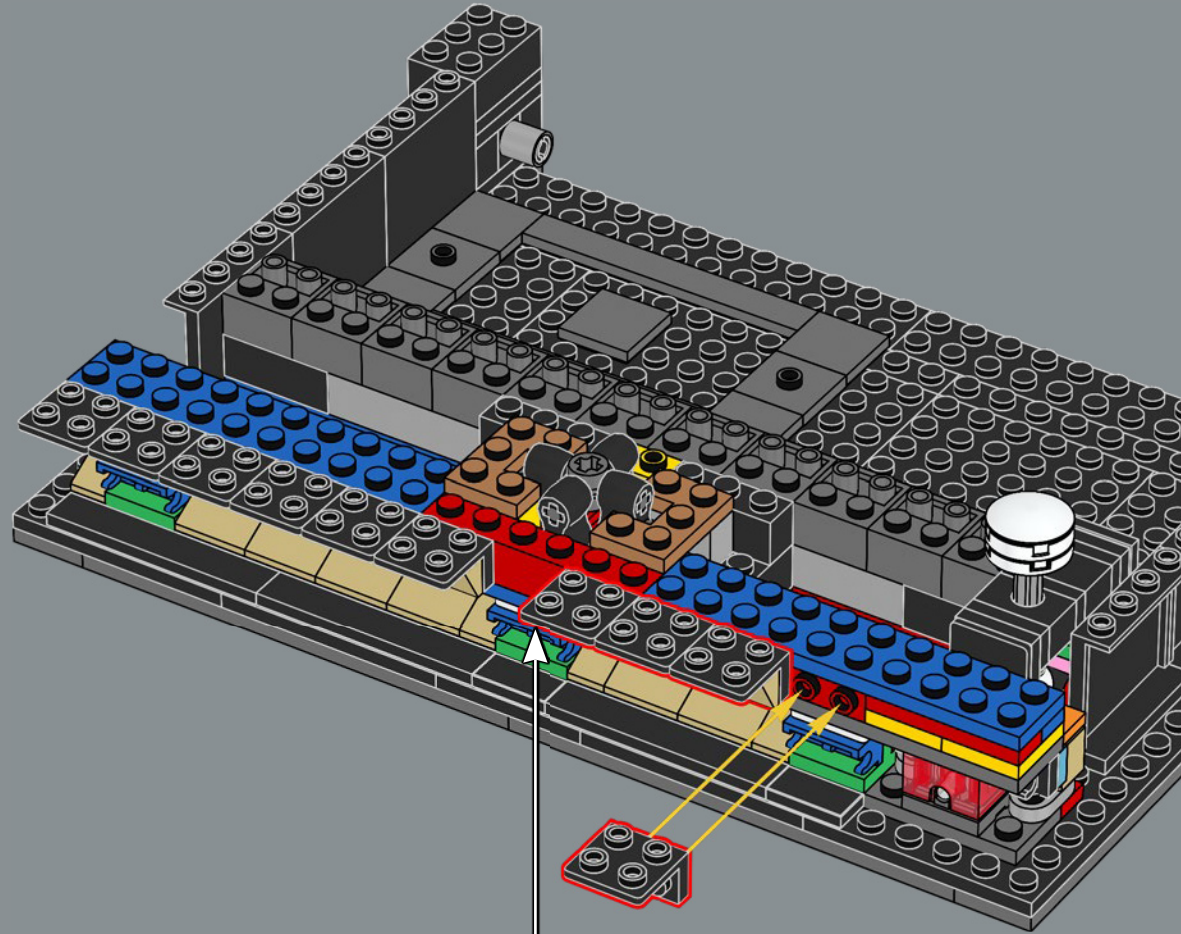
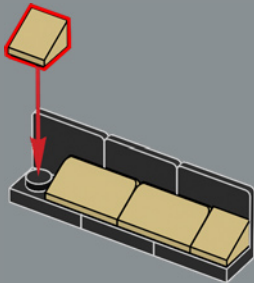

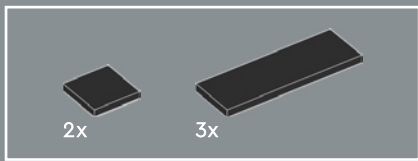

44

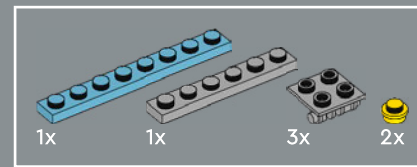
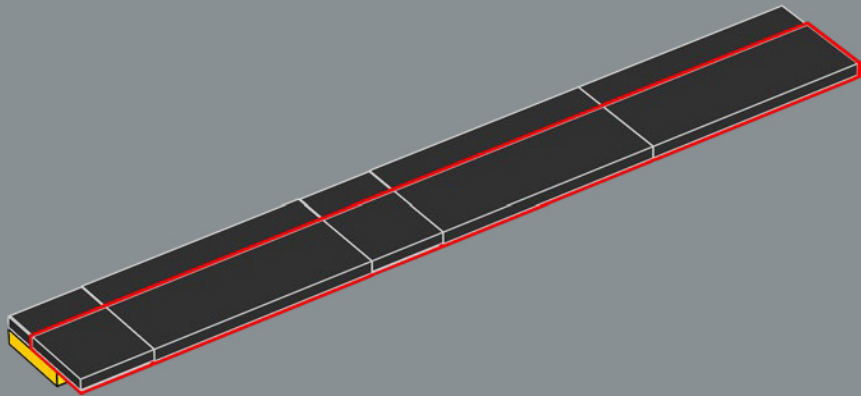

45

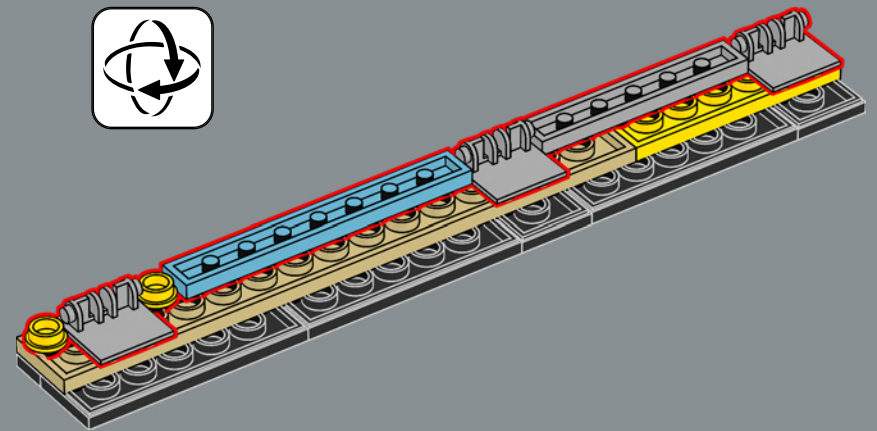

46

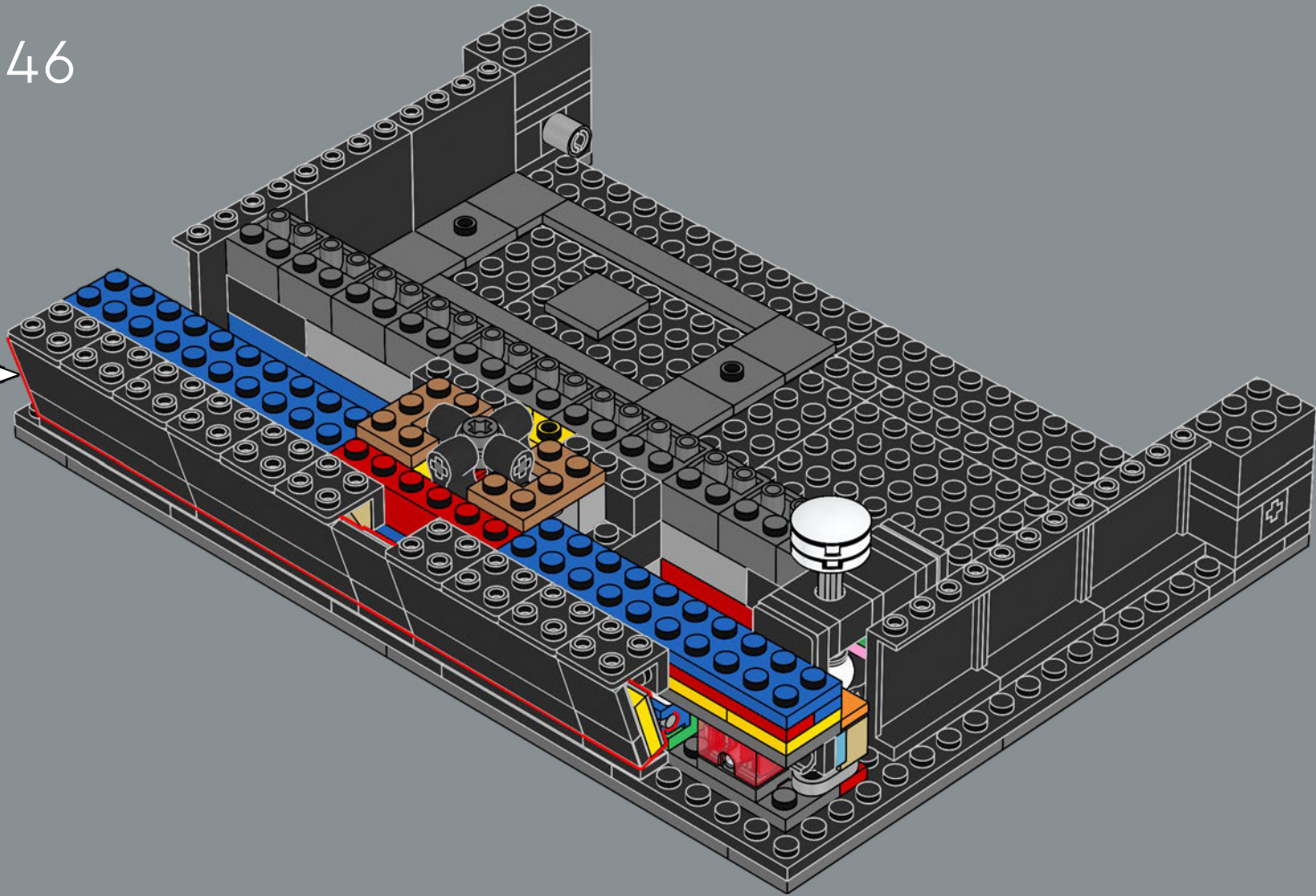

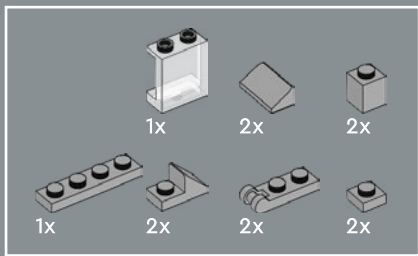

47

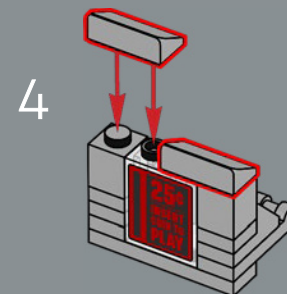
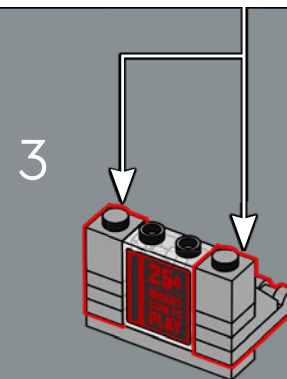
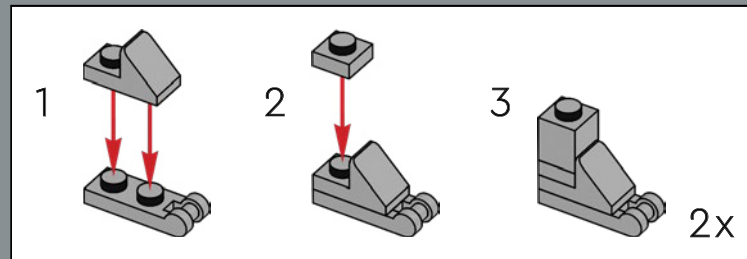
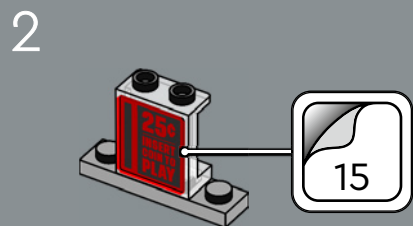
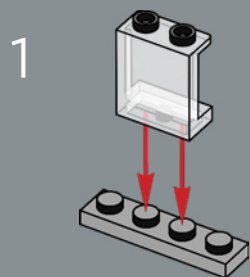

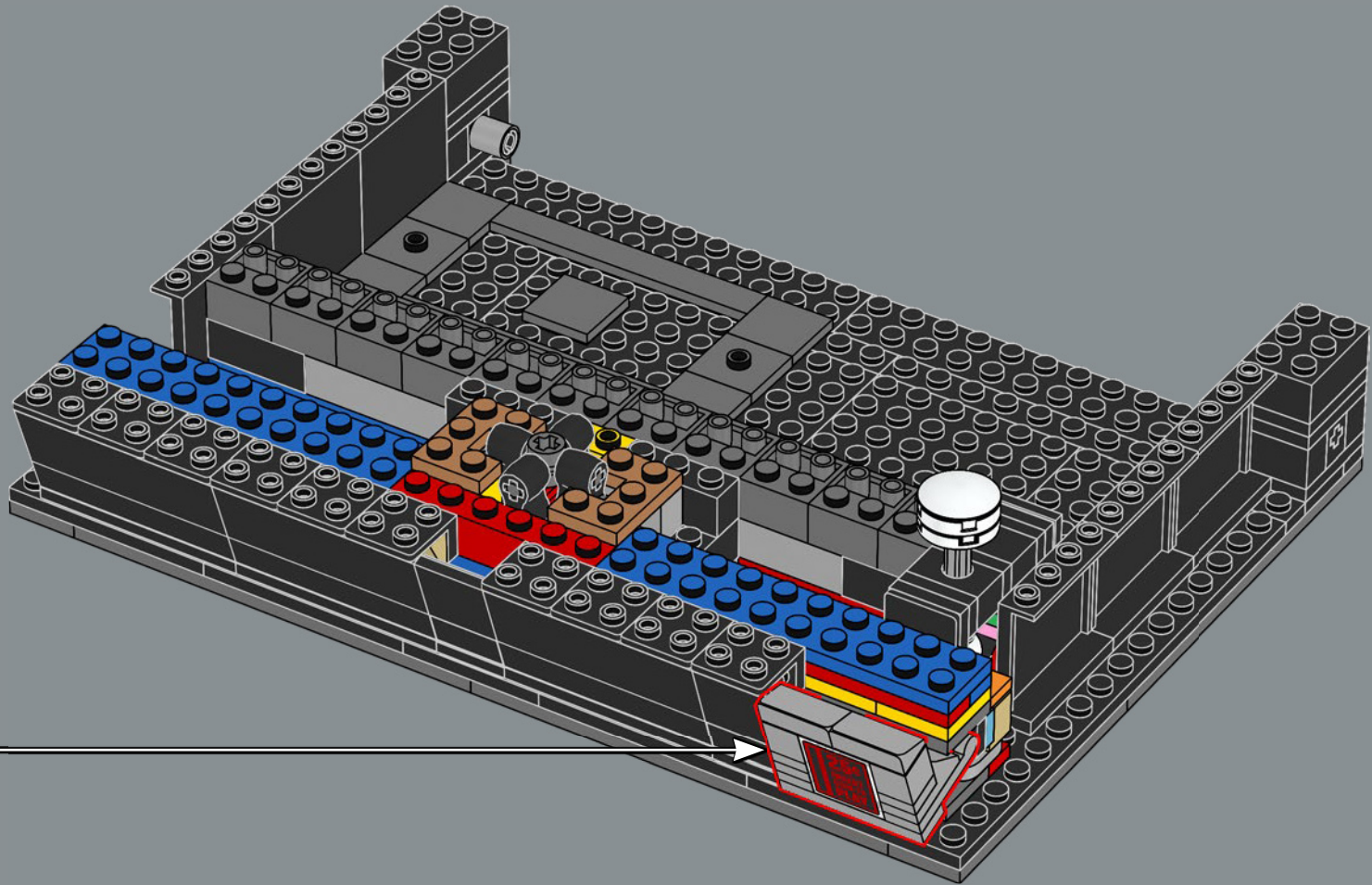

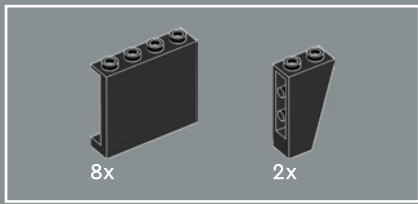

48

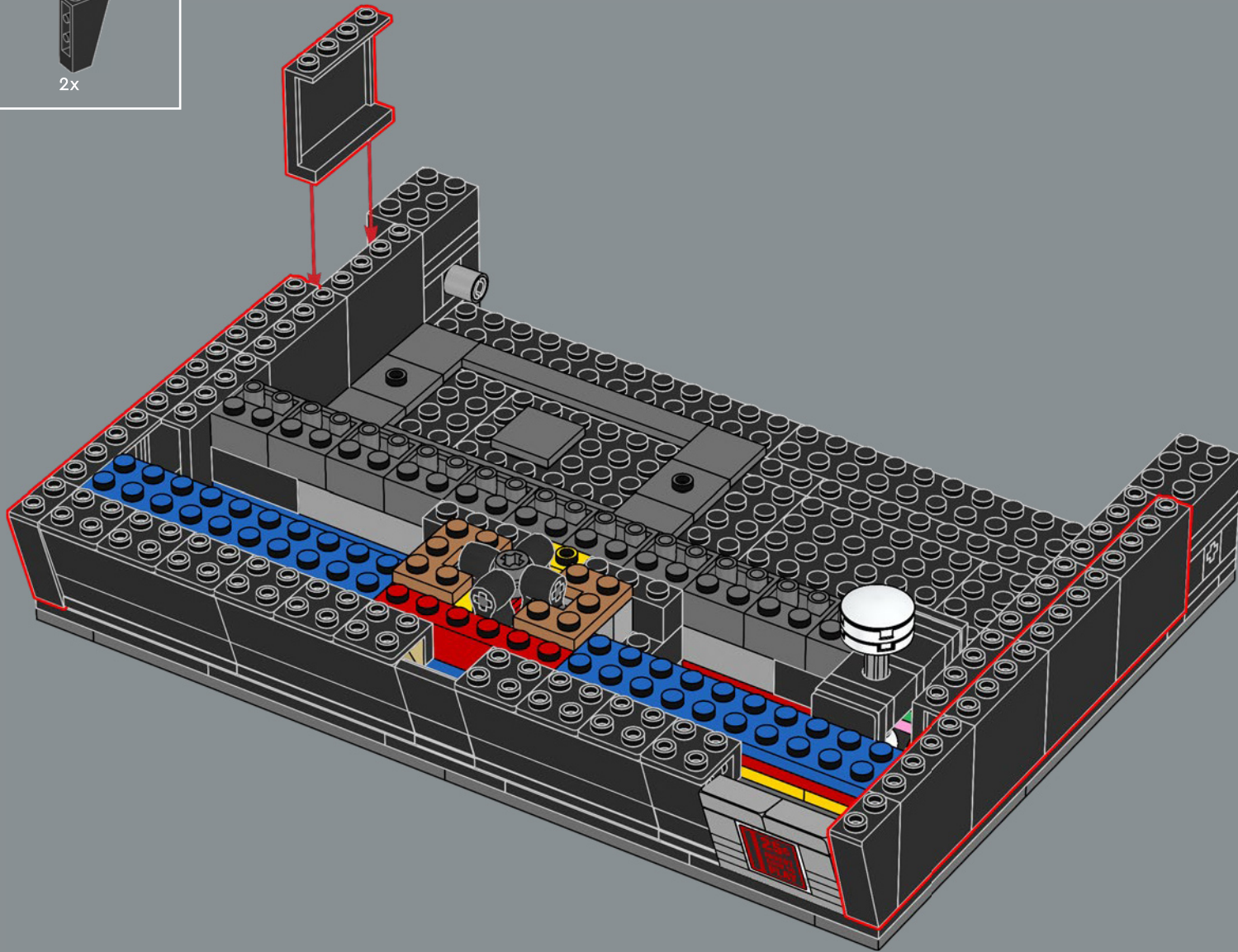

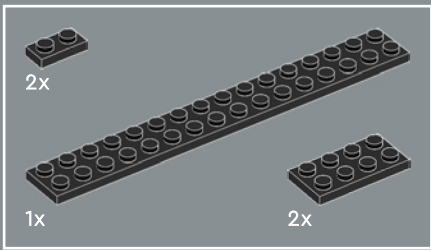

49

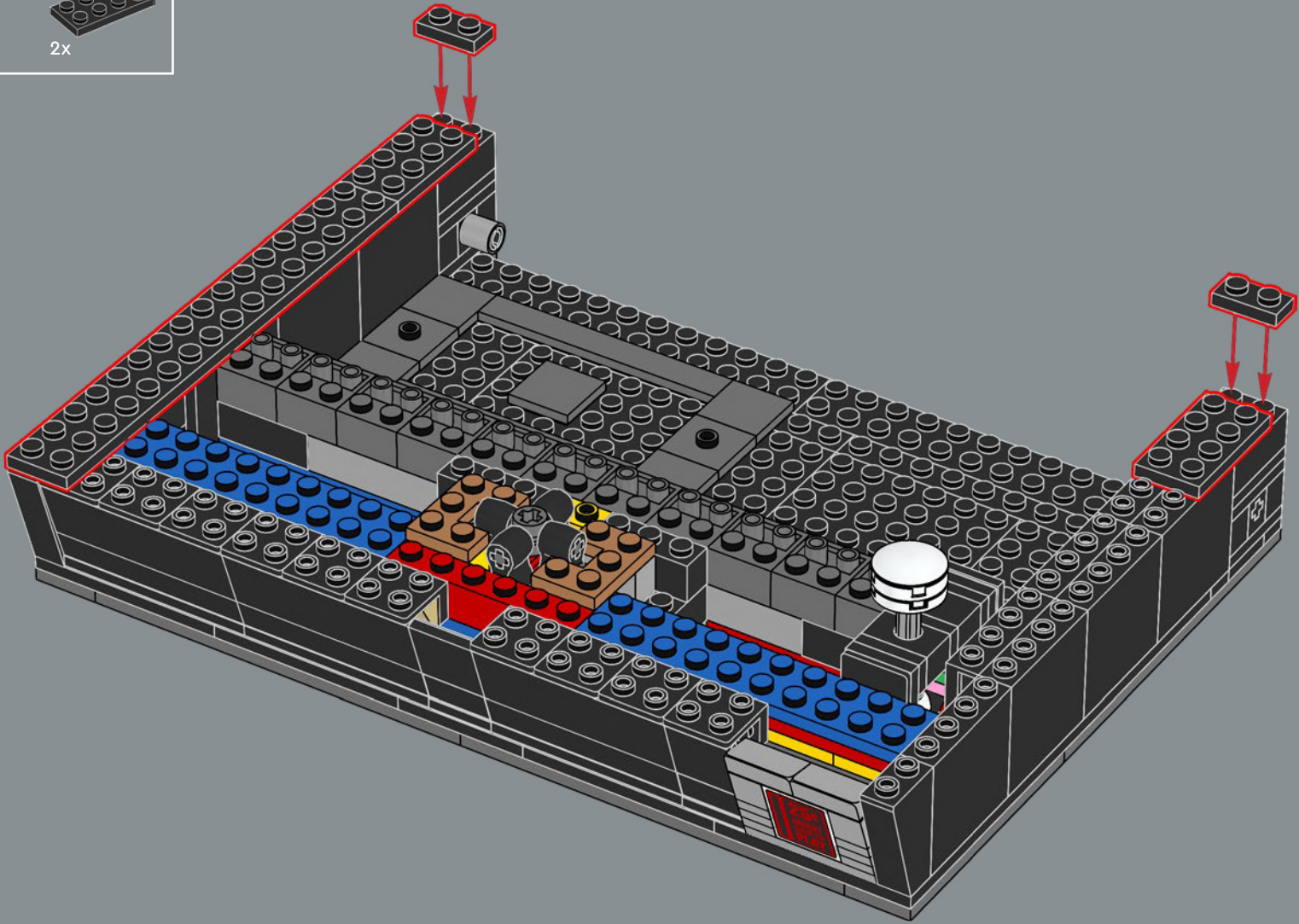

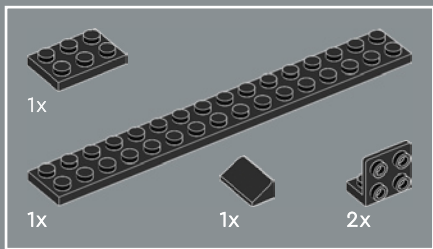

50

1

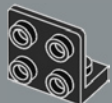

2

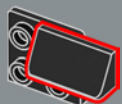

3

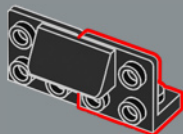

4

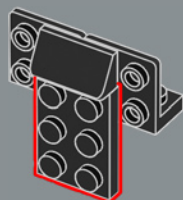

5

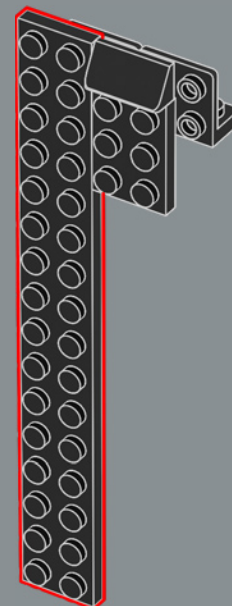

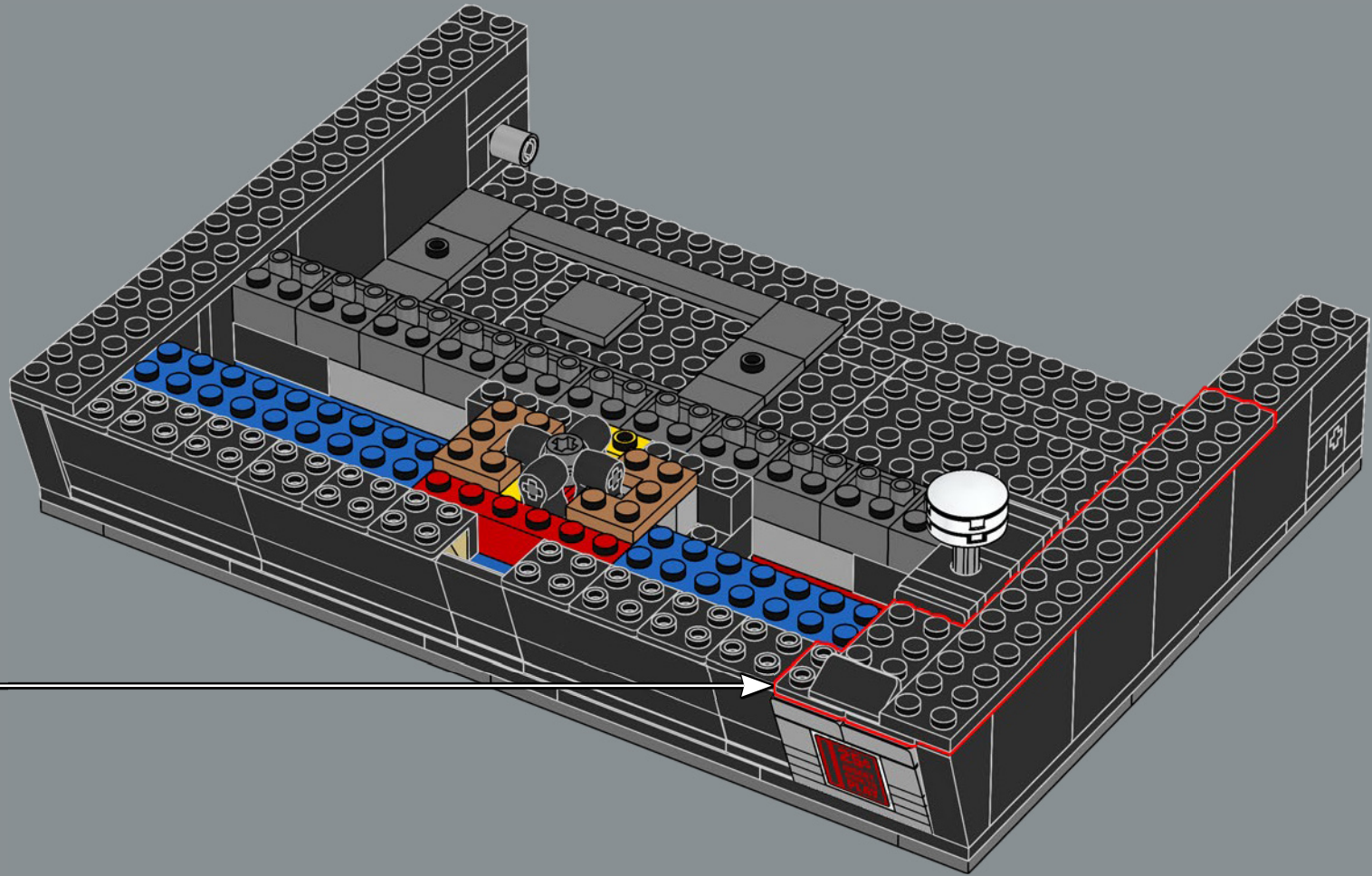

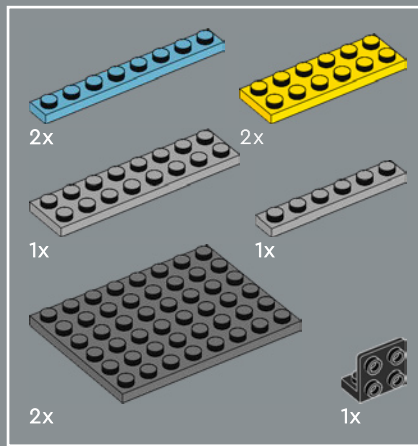

51

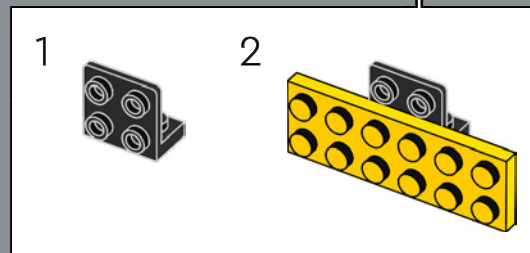
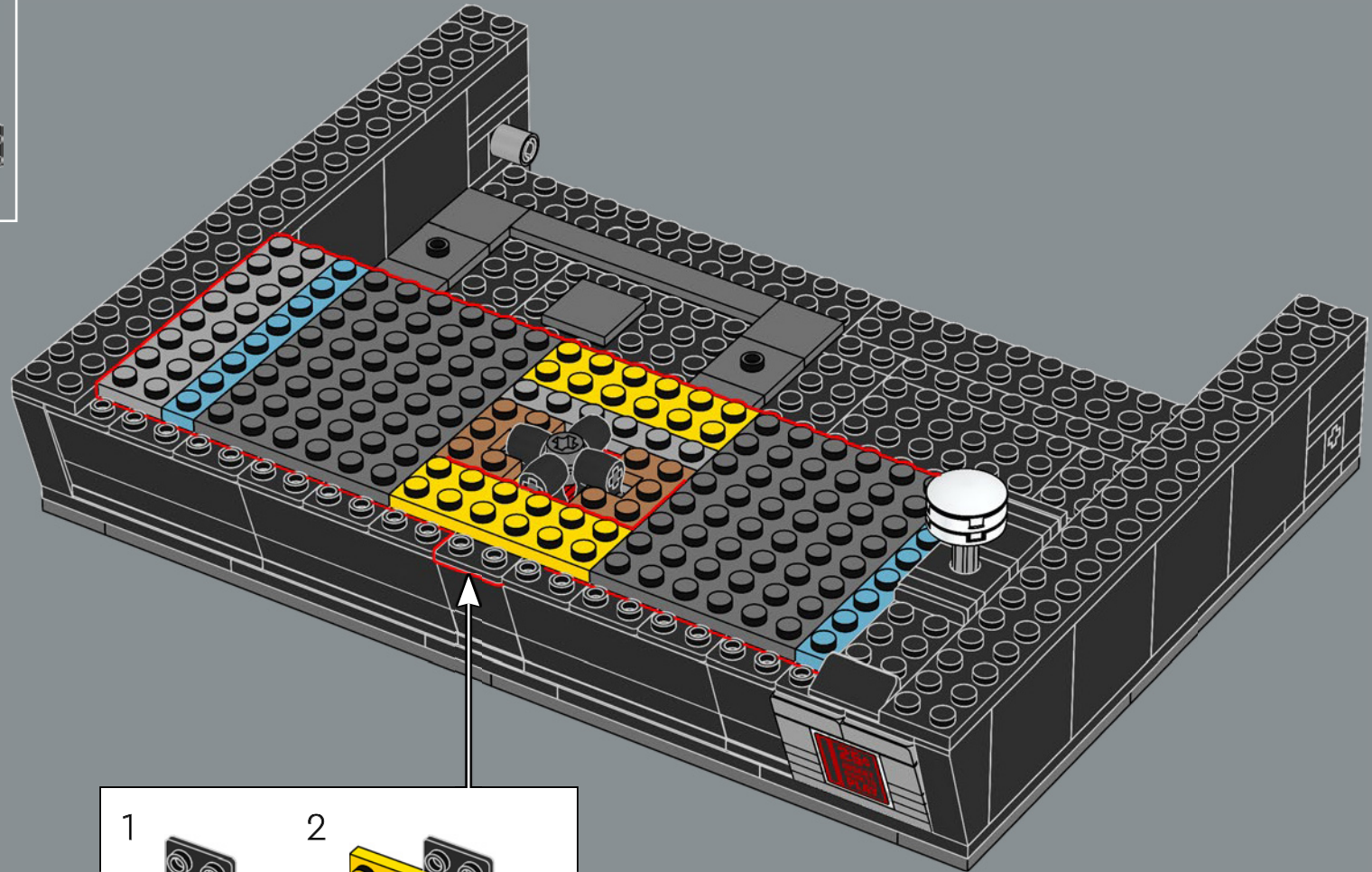

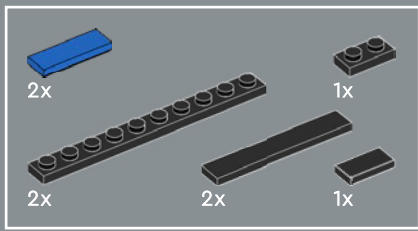

52

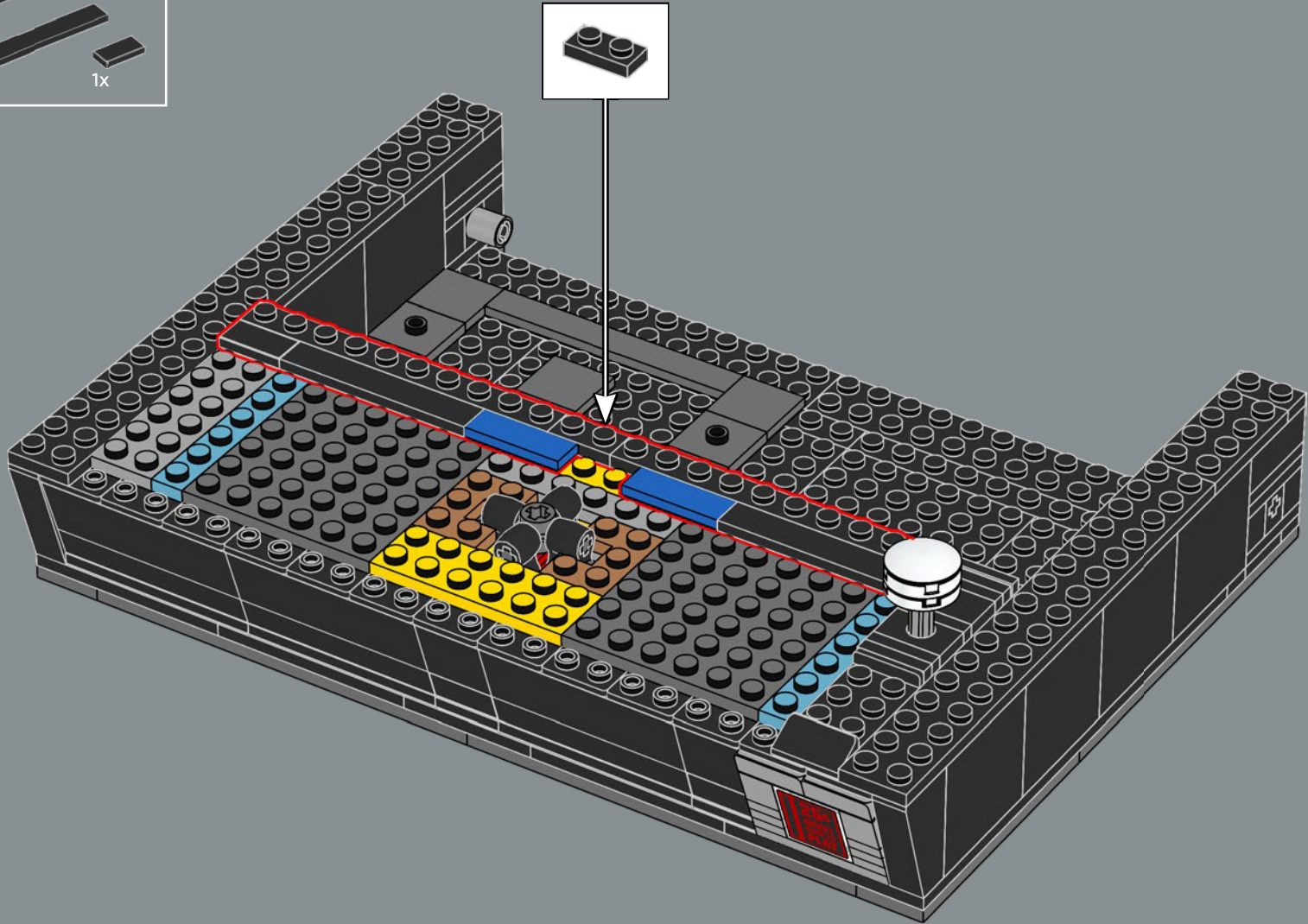

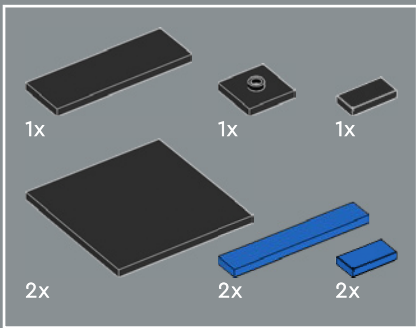

53

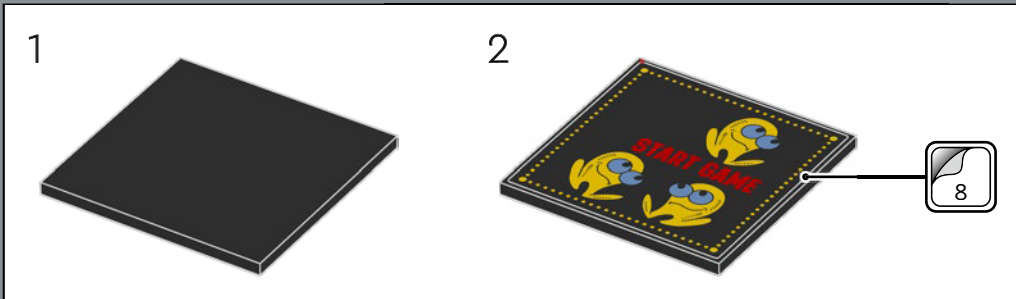
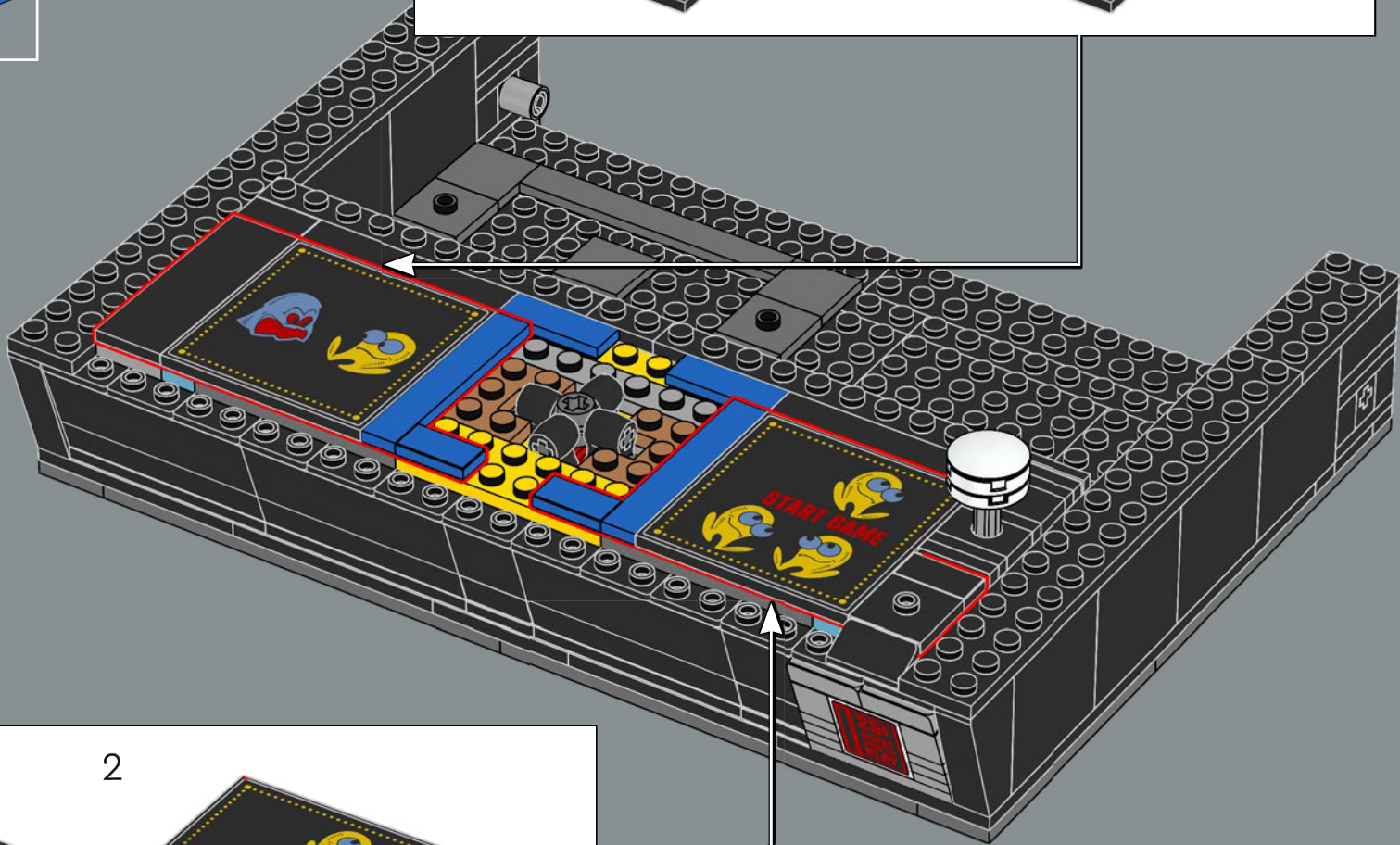
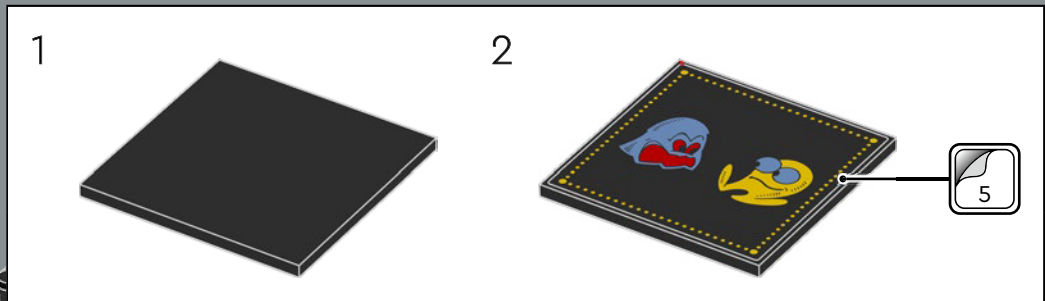

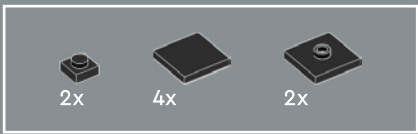

54

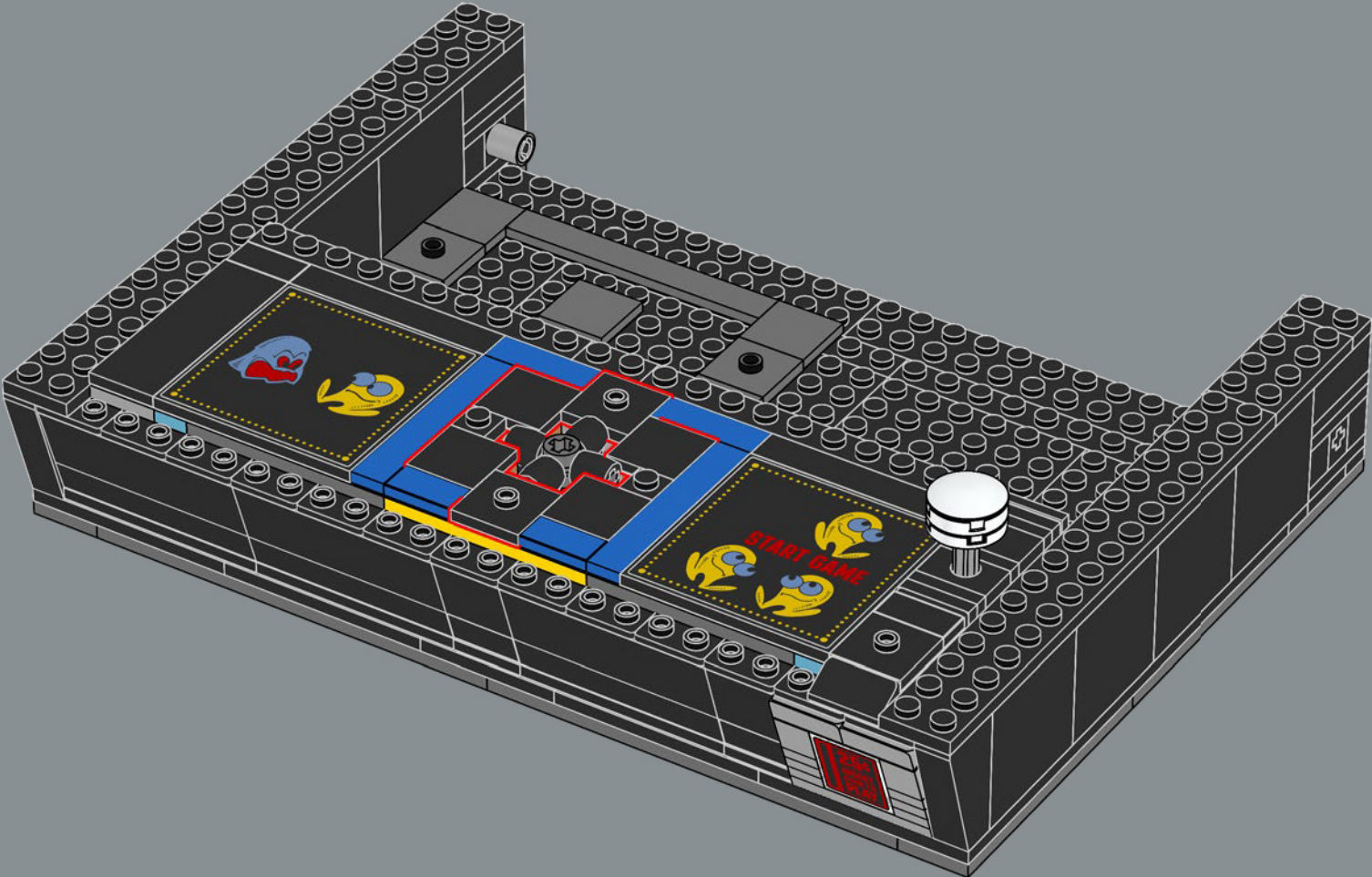



55

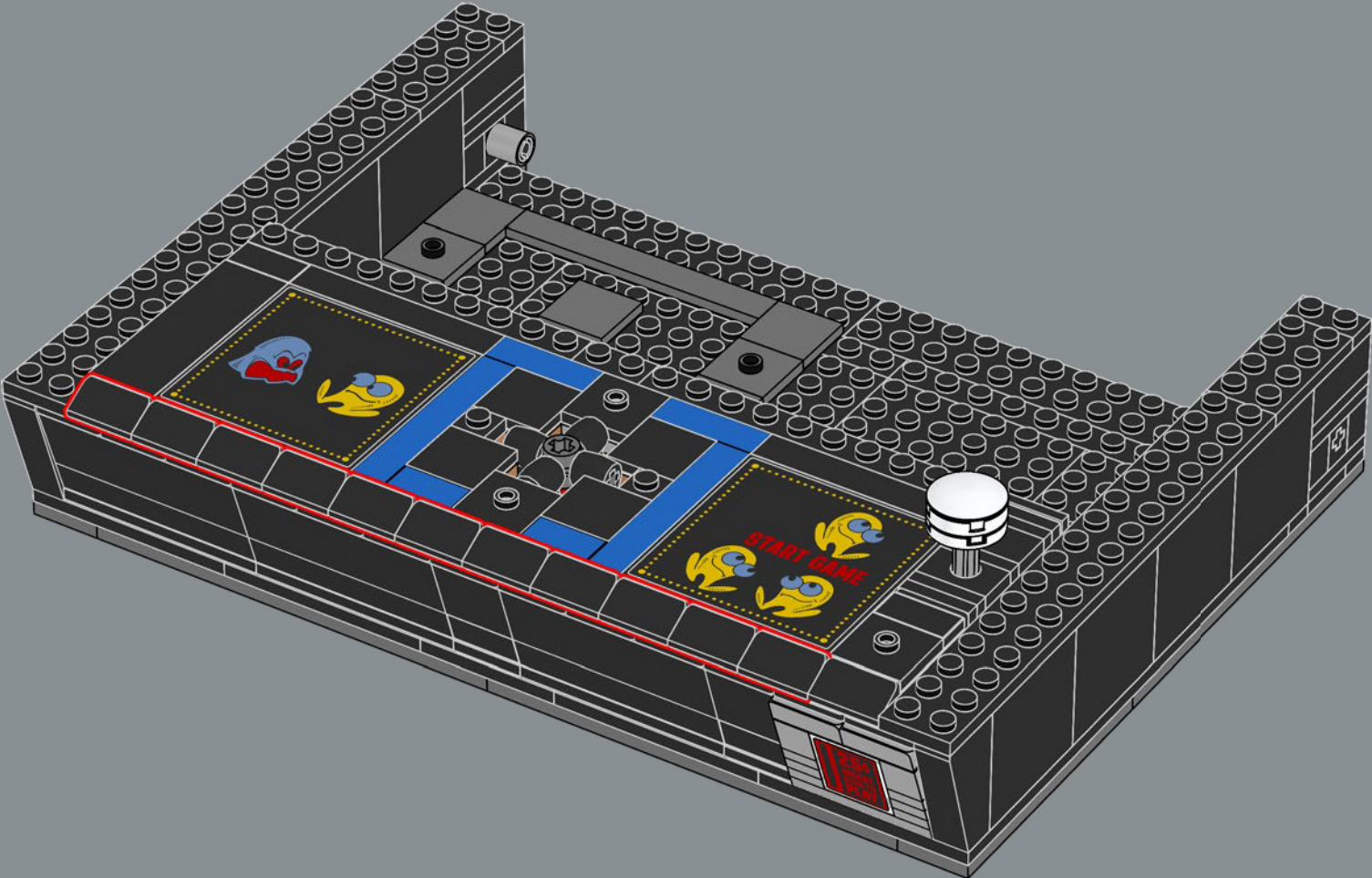



56

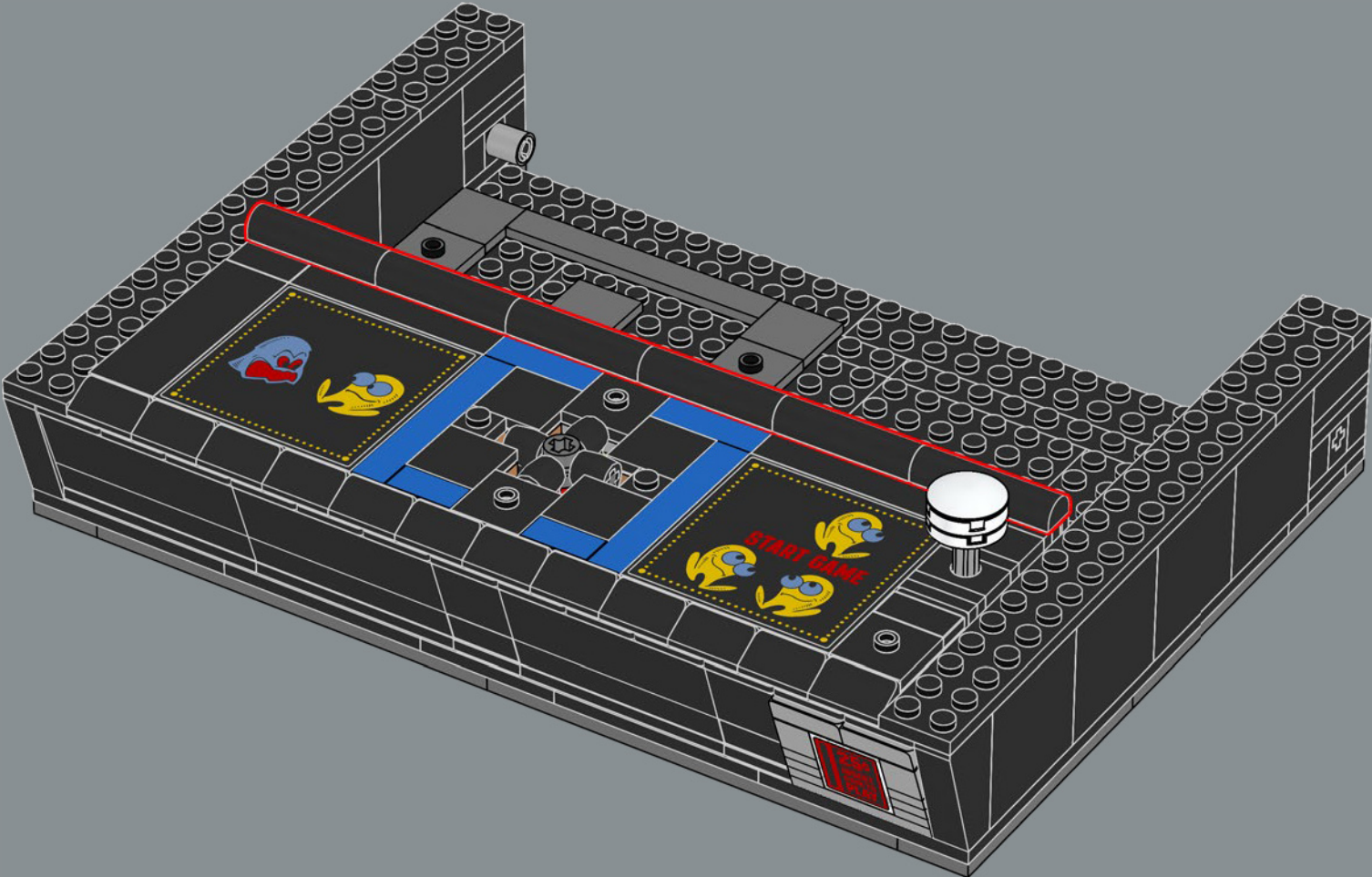



57

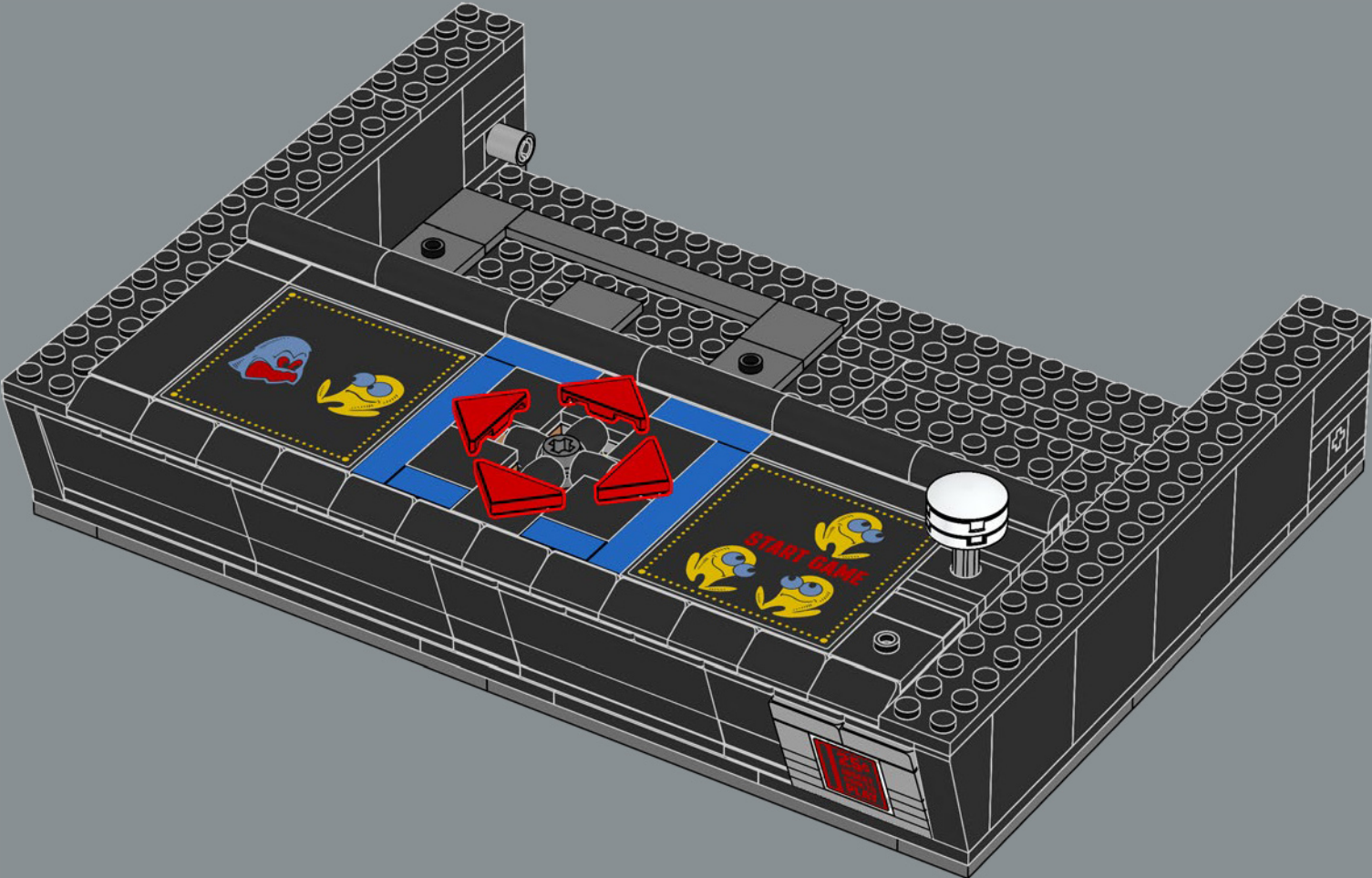

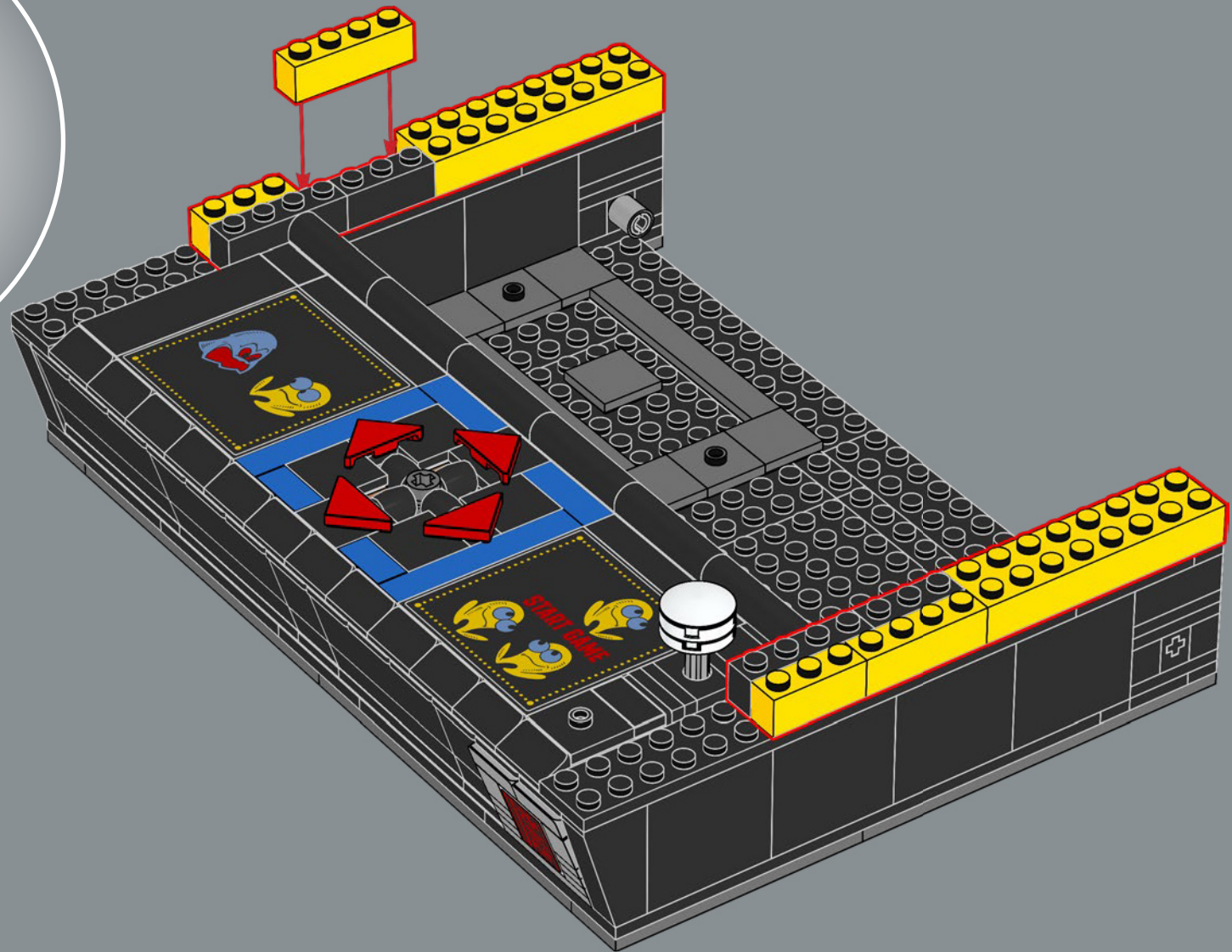
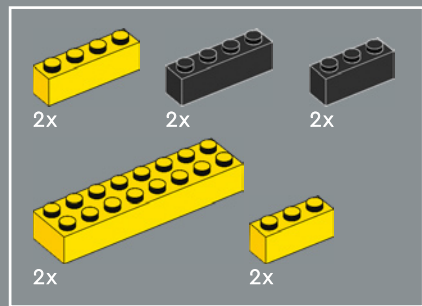

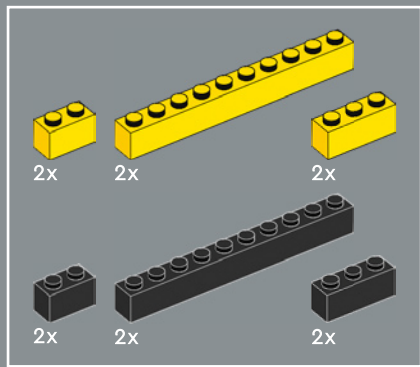

59

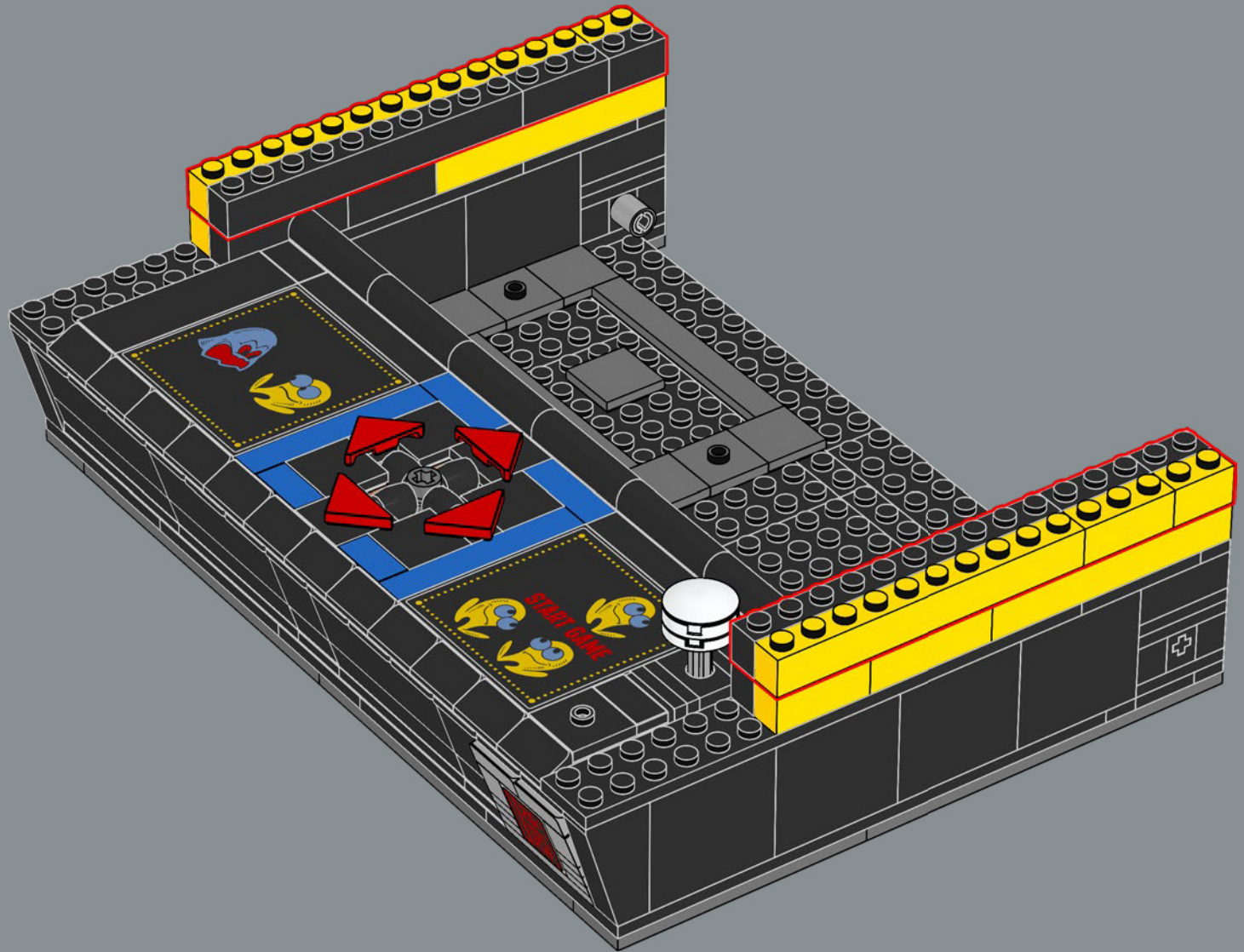

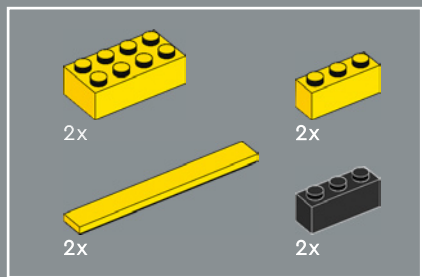

60

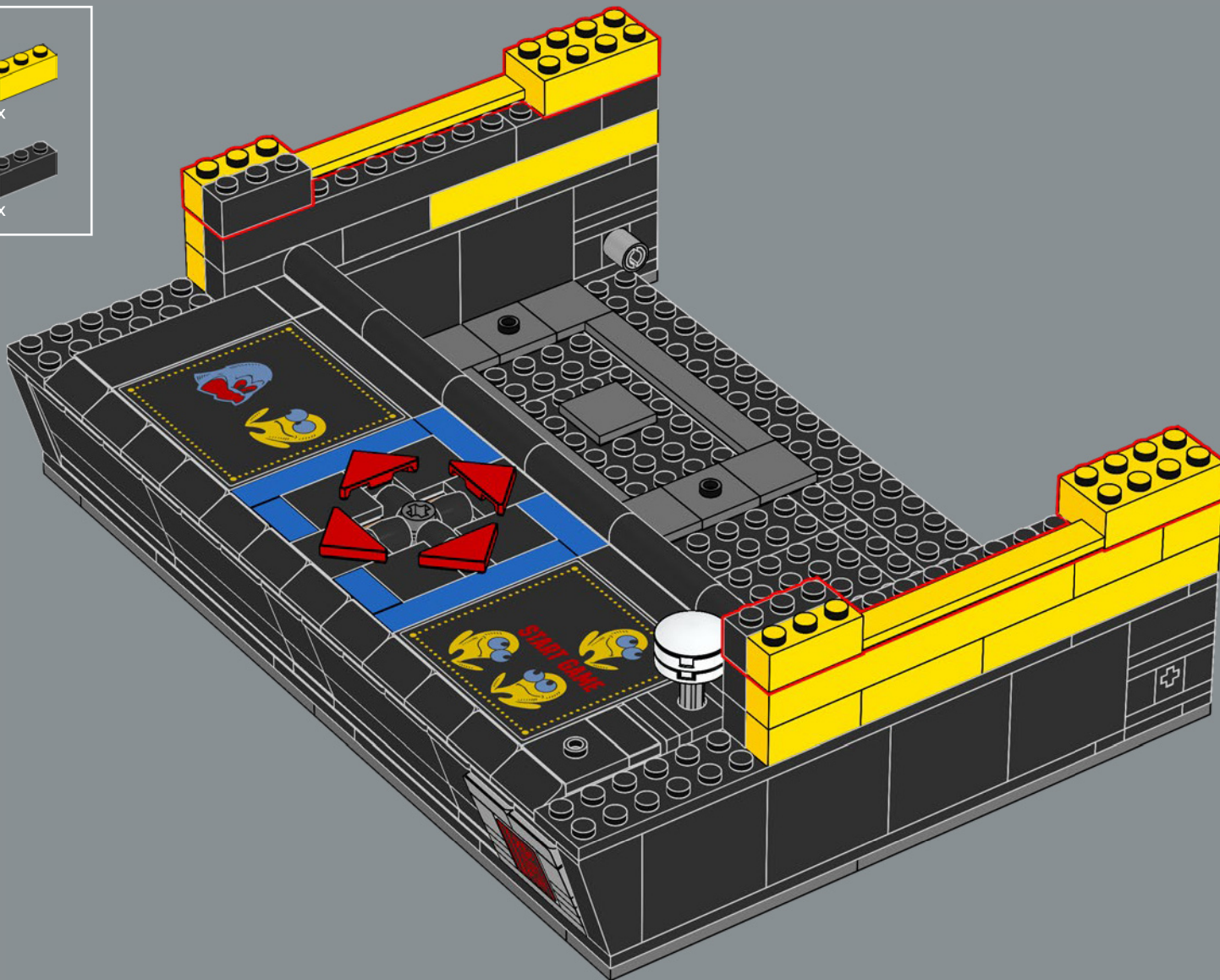

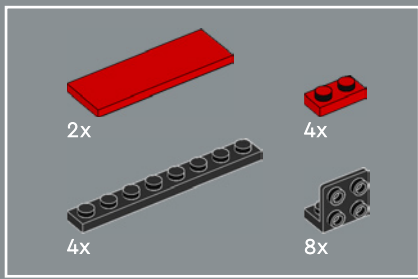

61

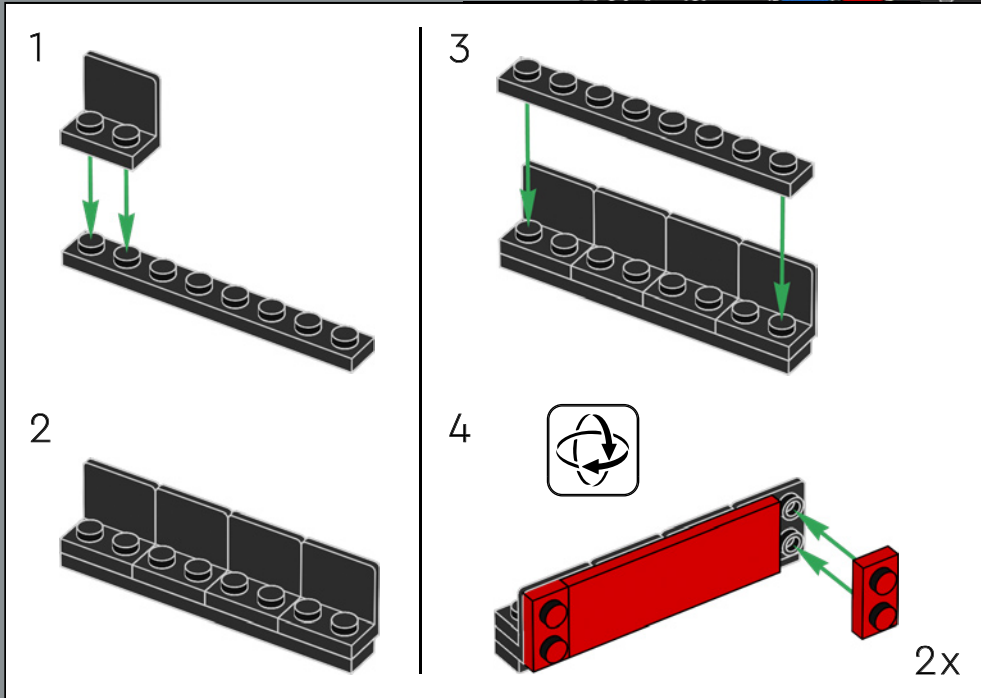
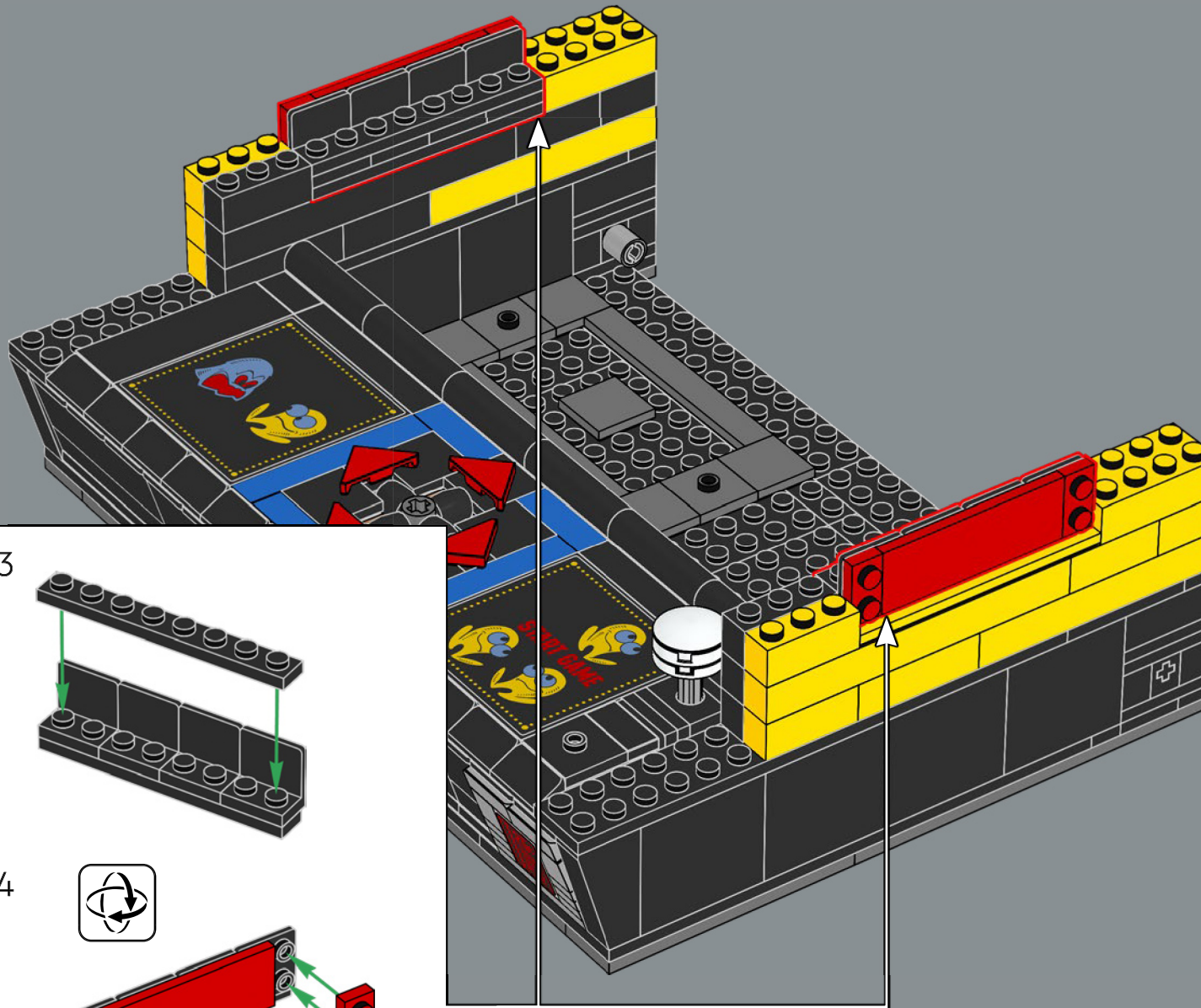

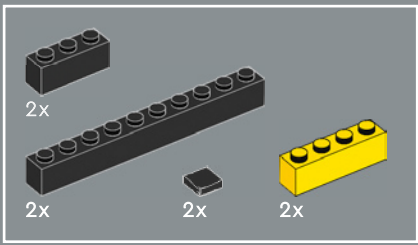

62

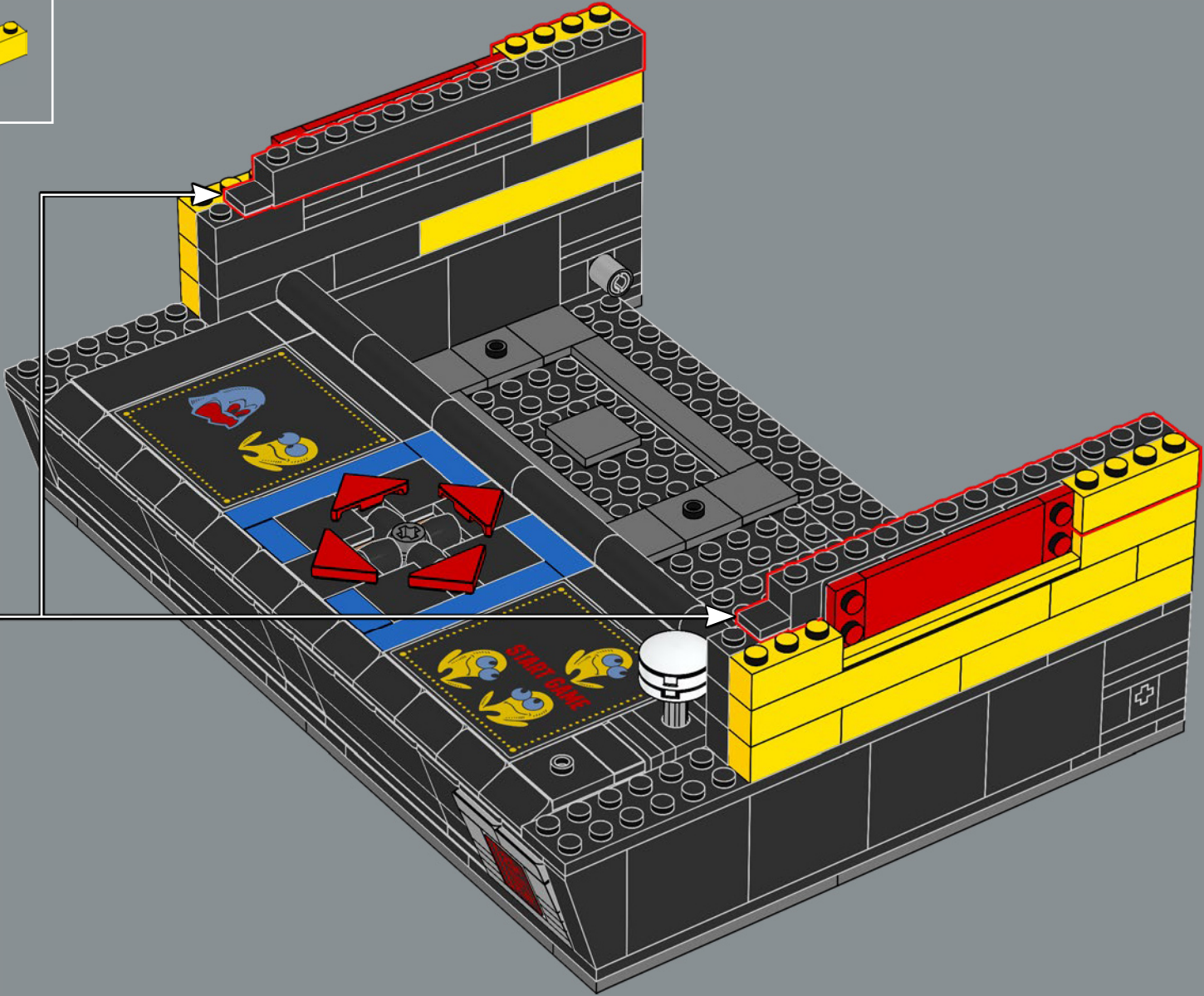

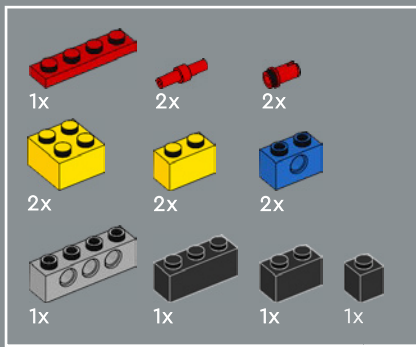

63

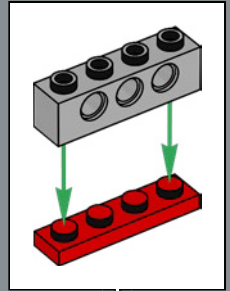
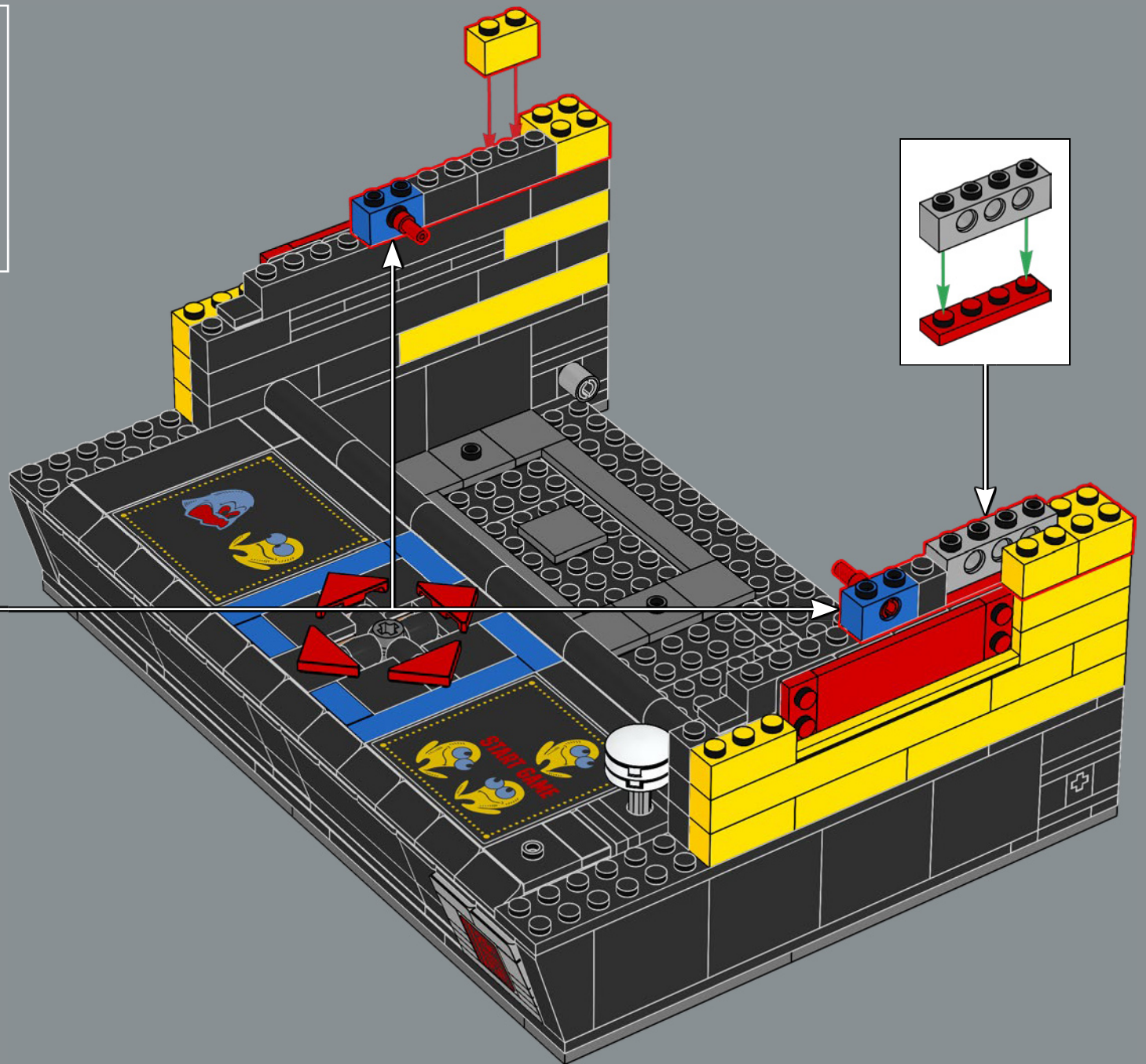
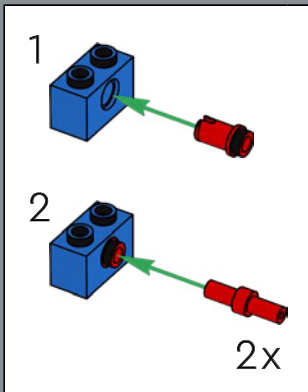

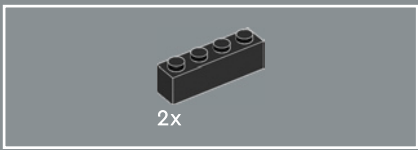

64

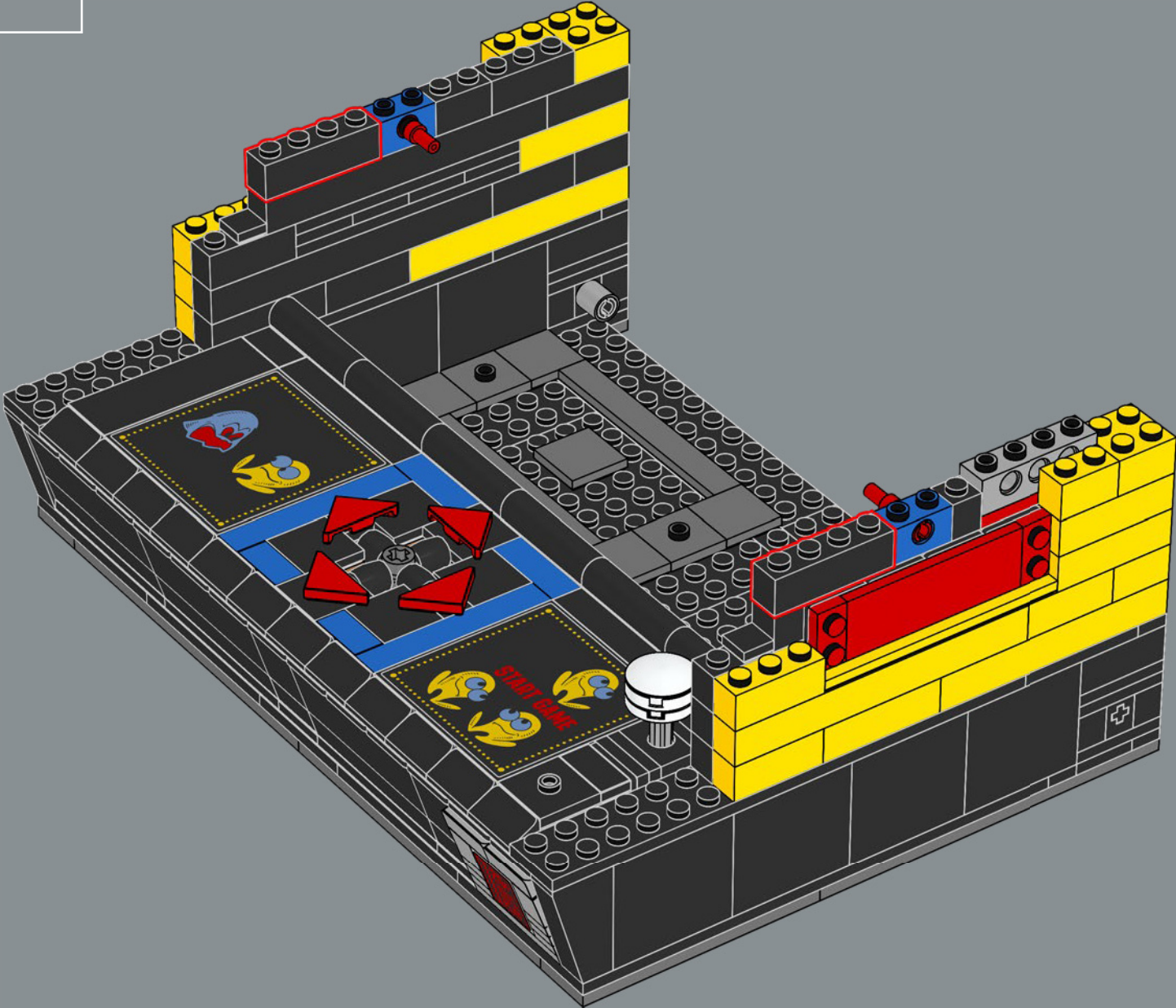

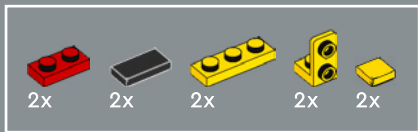

65

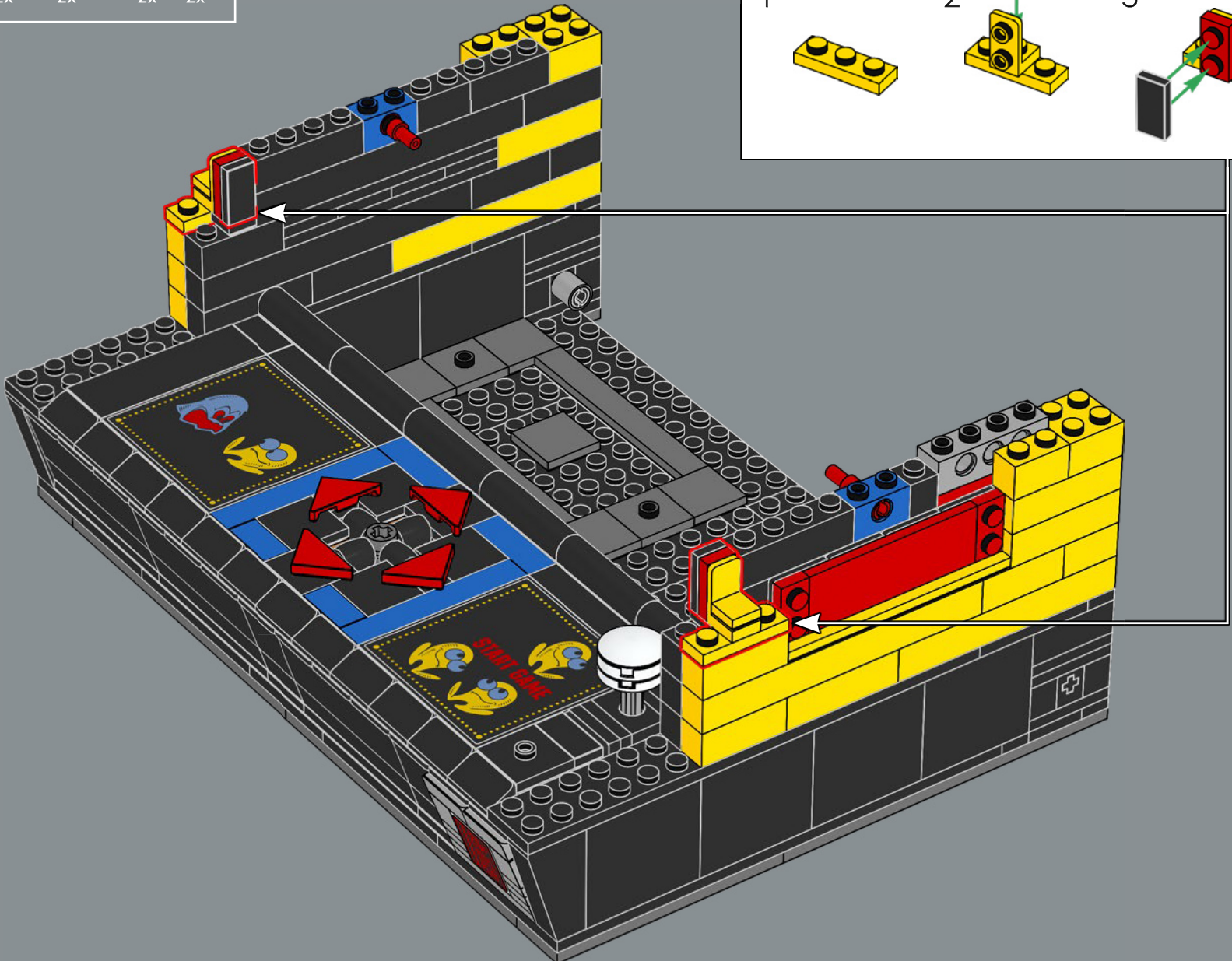
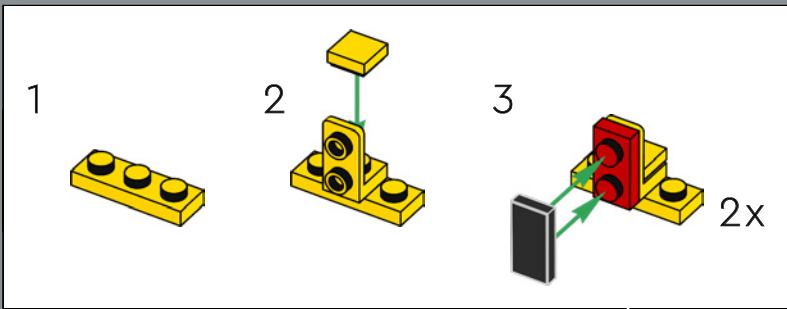



4x

66

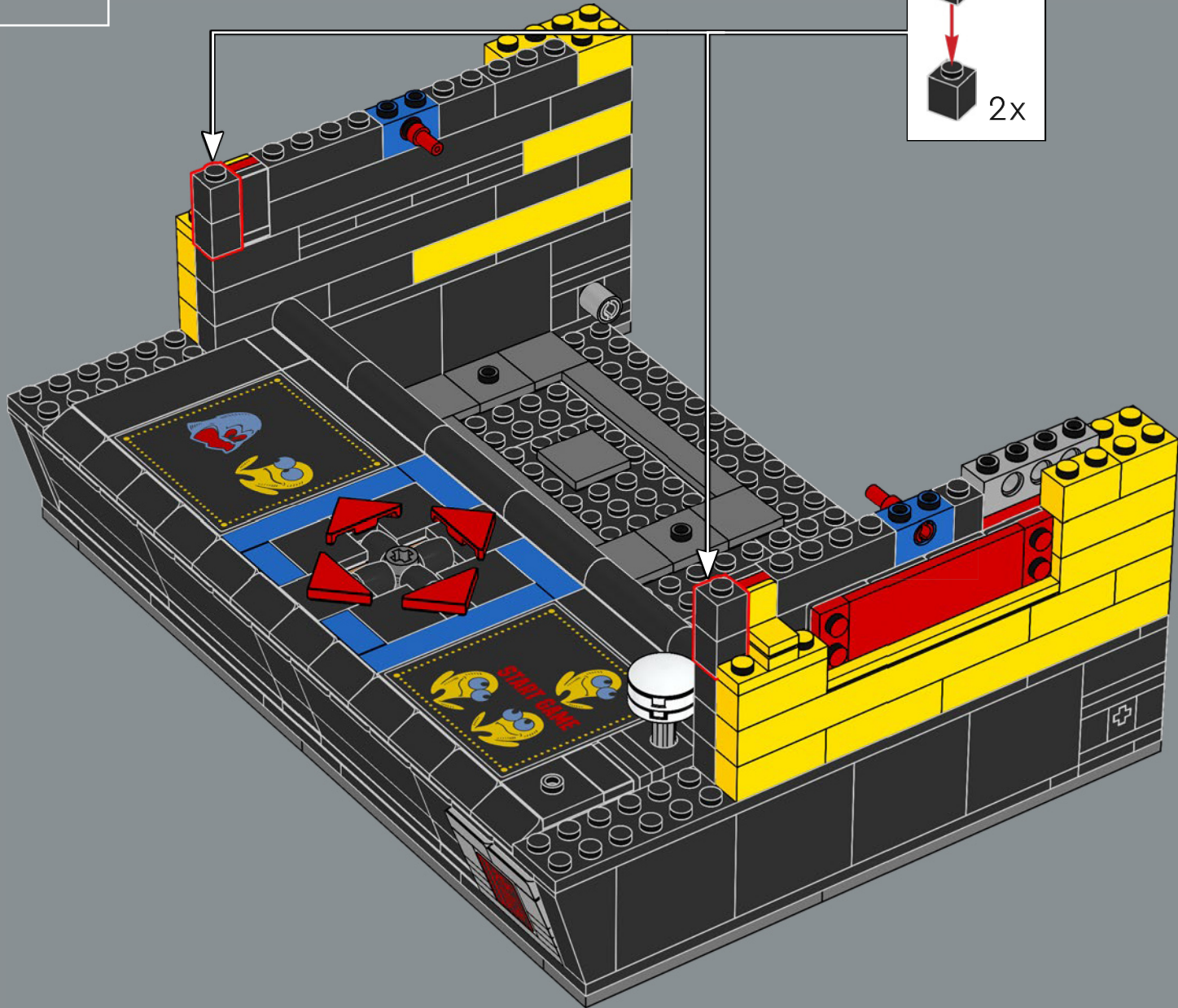

2x



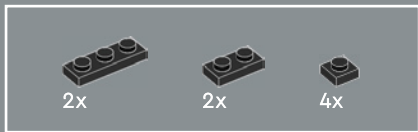

67

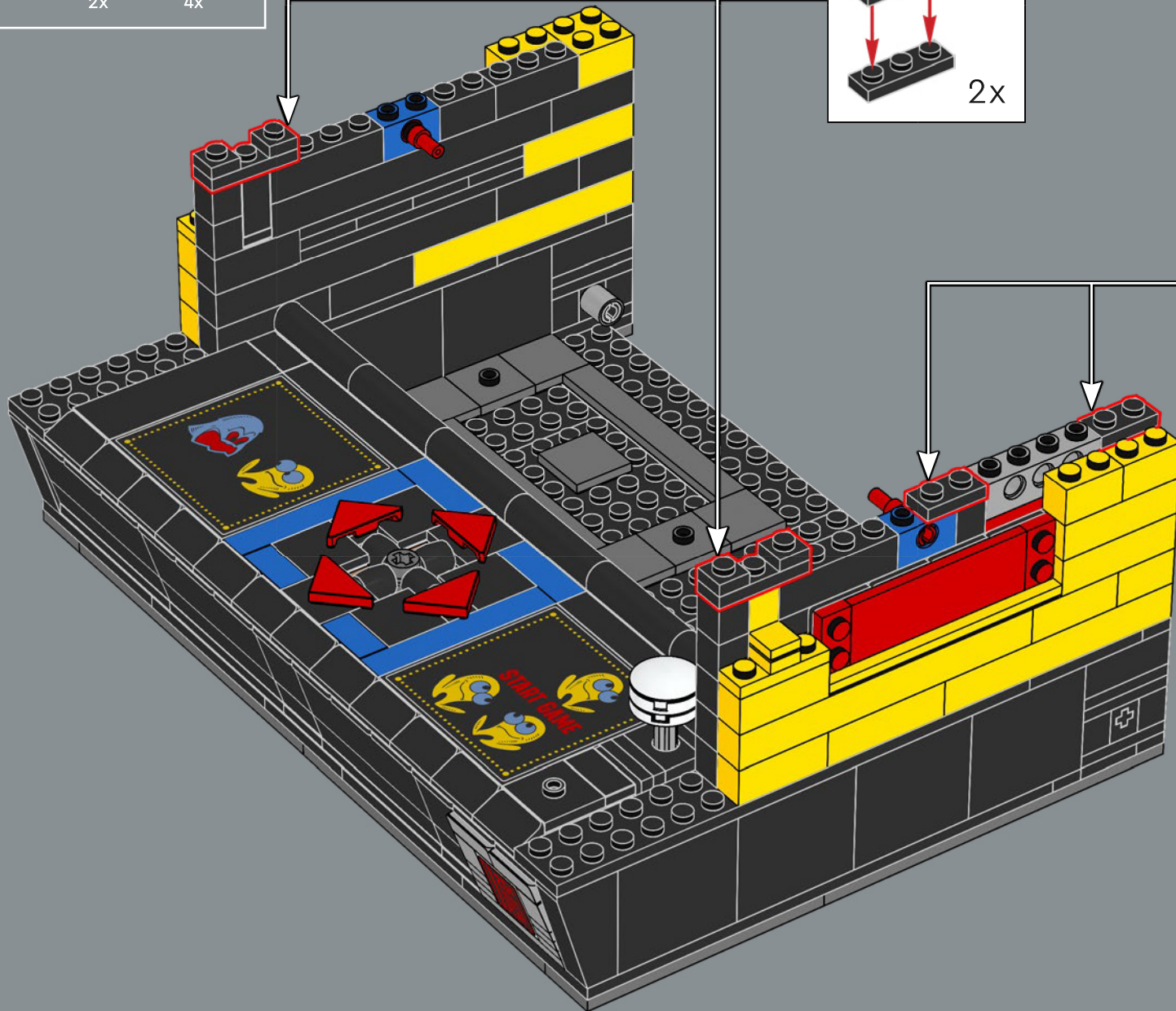
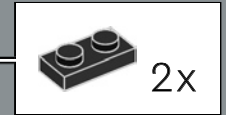
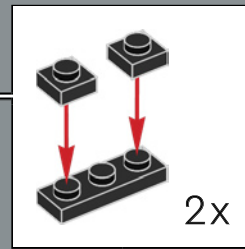

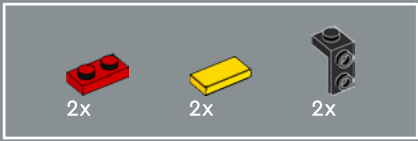

68

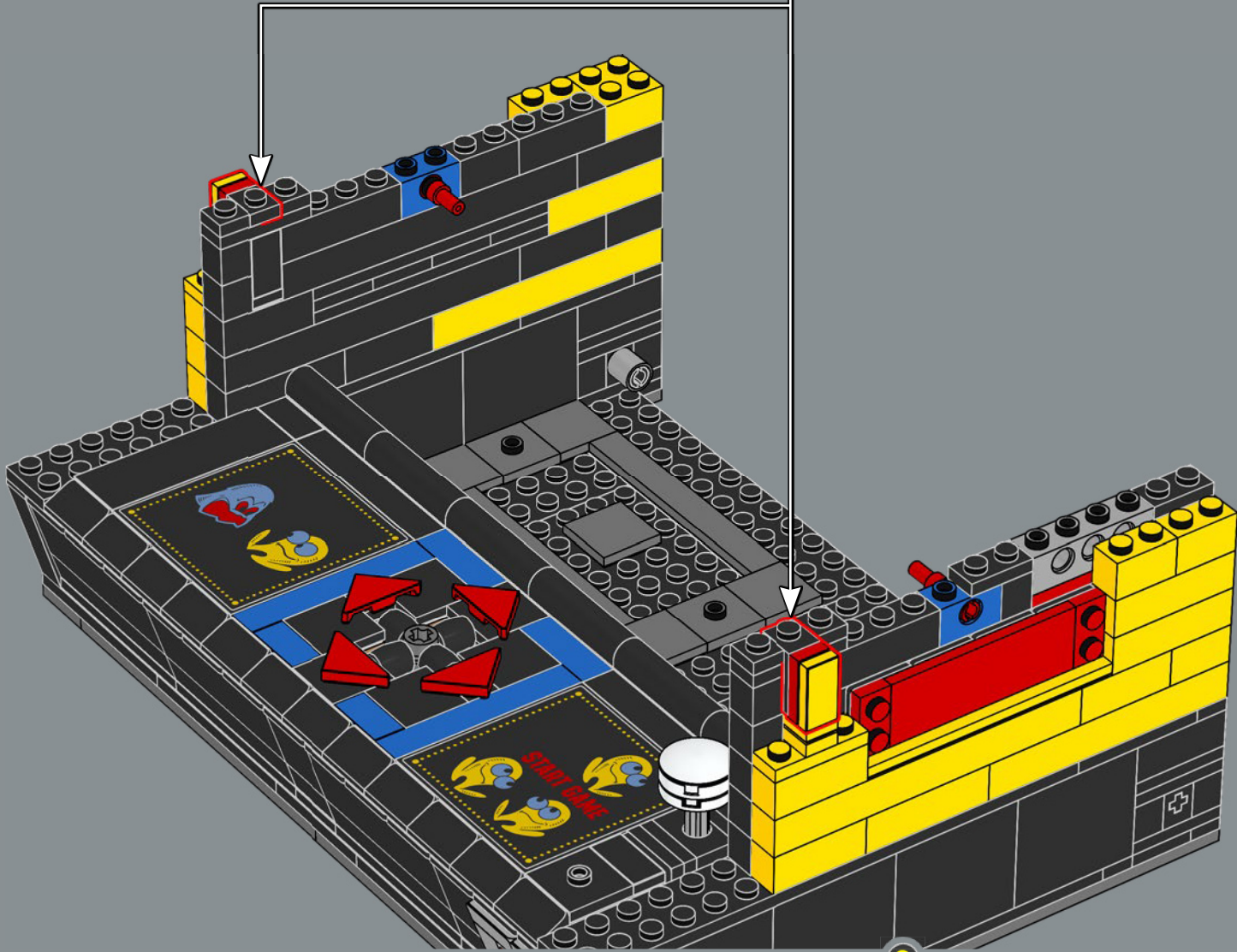
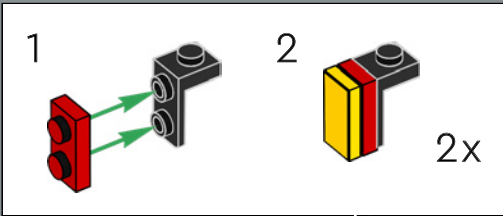

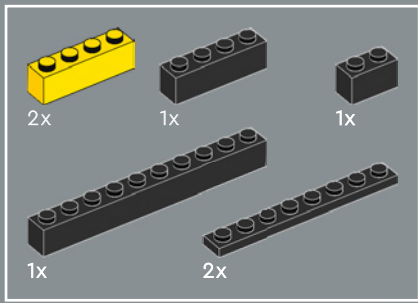

69

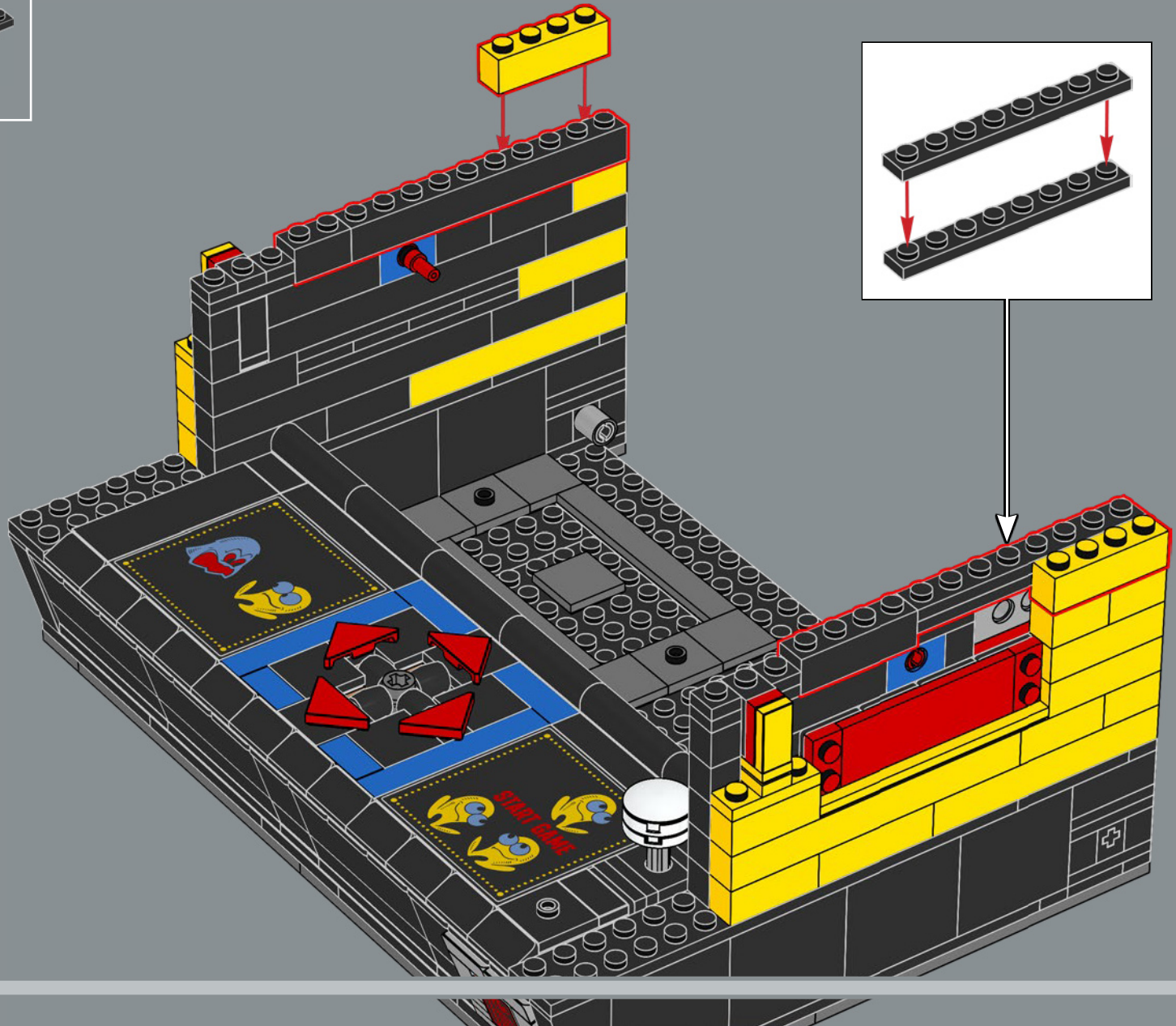

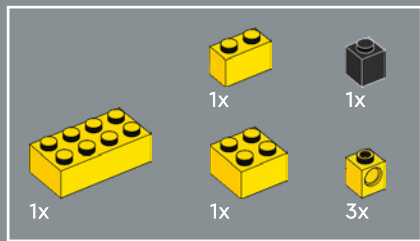

70

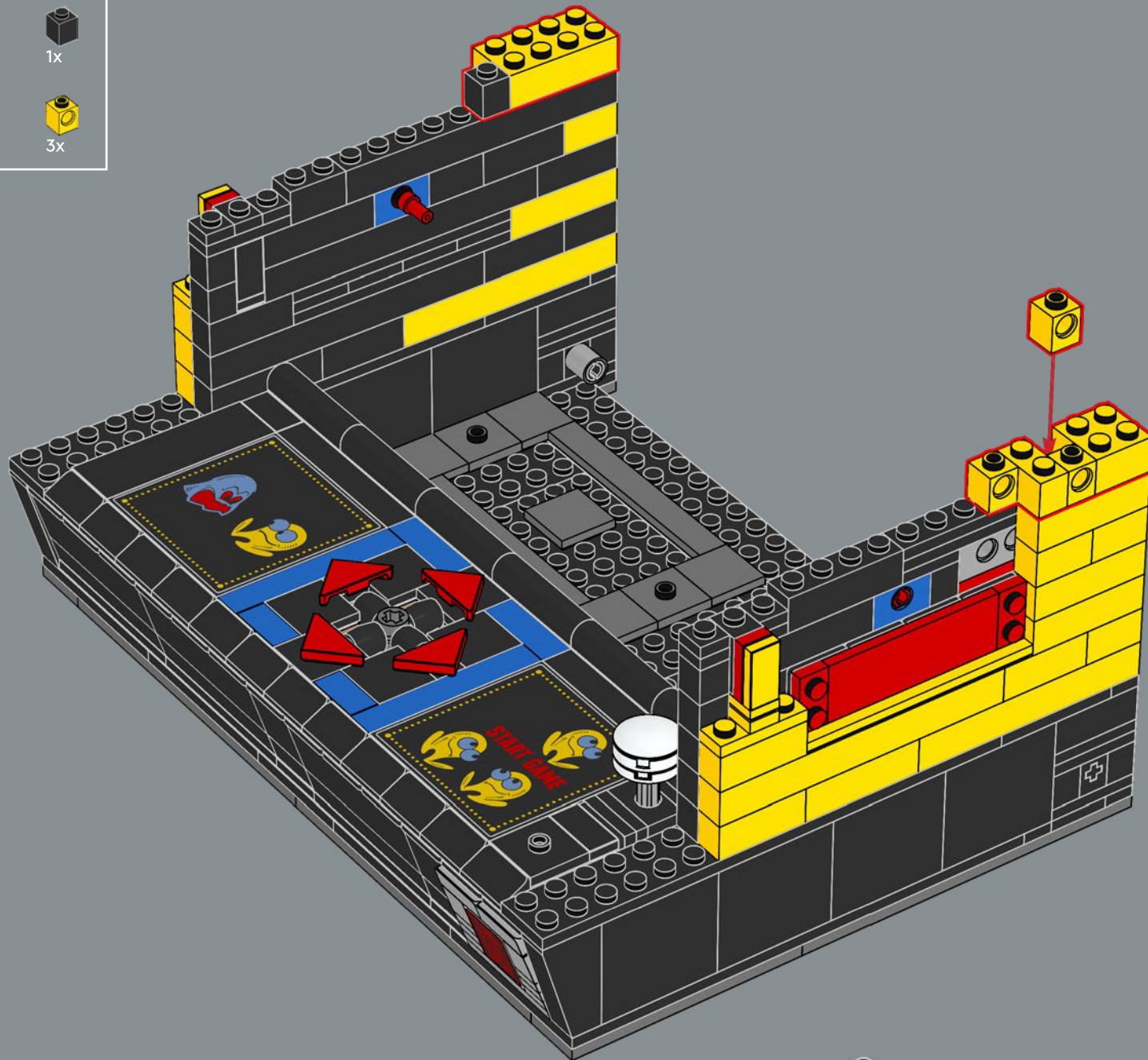

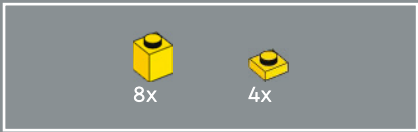

71

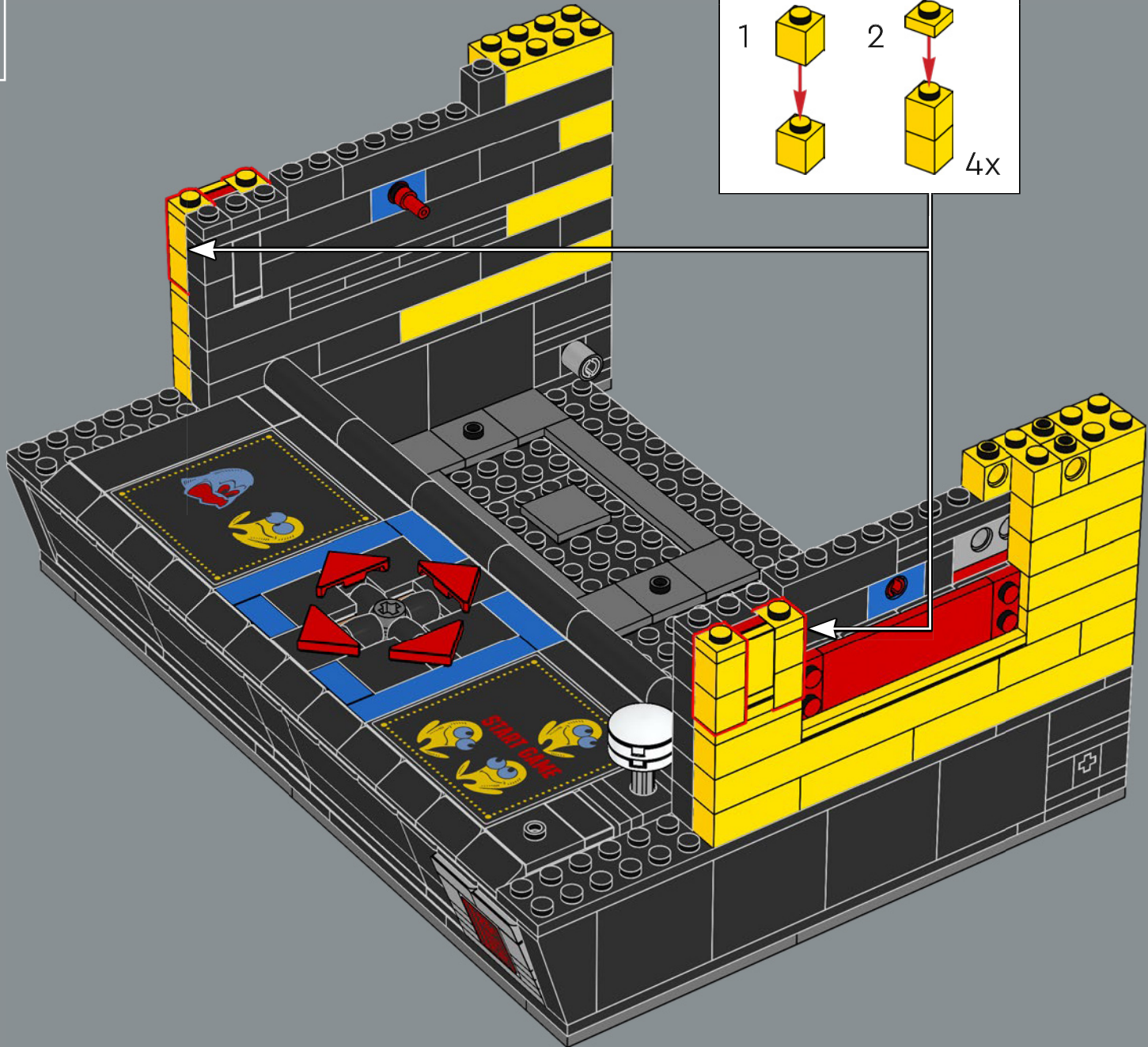
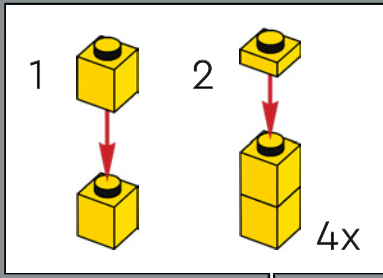



72

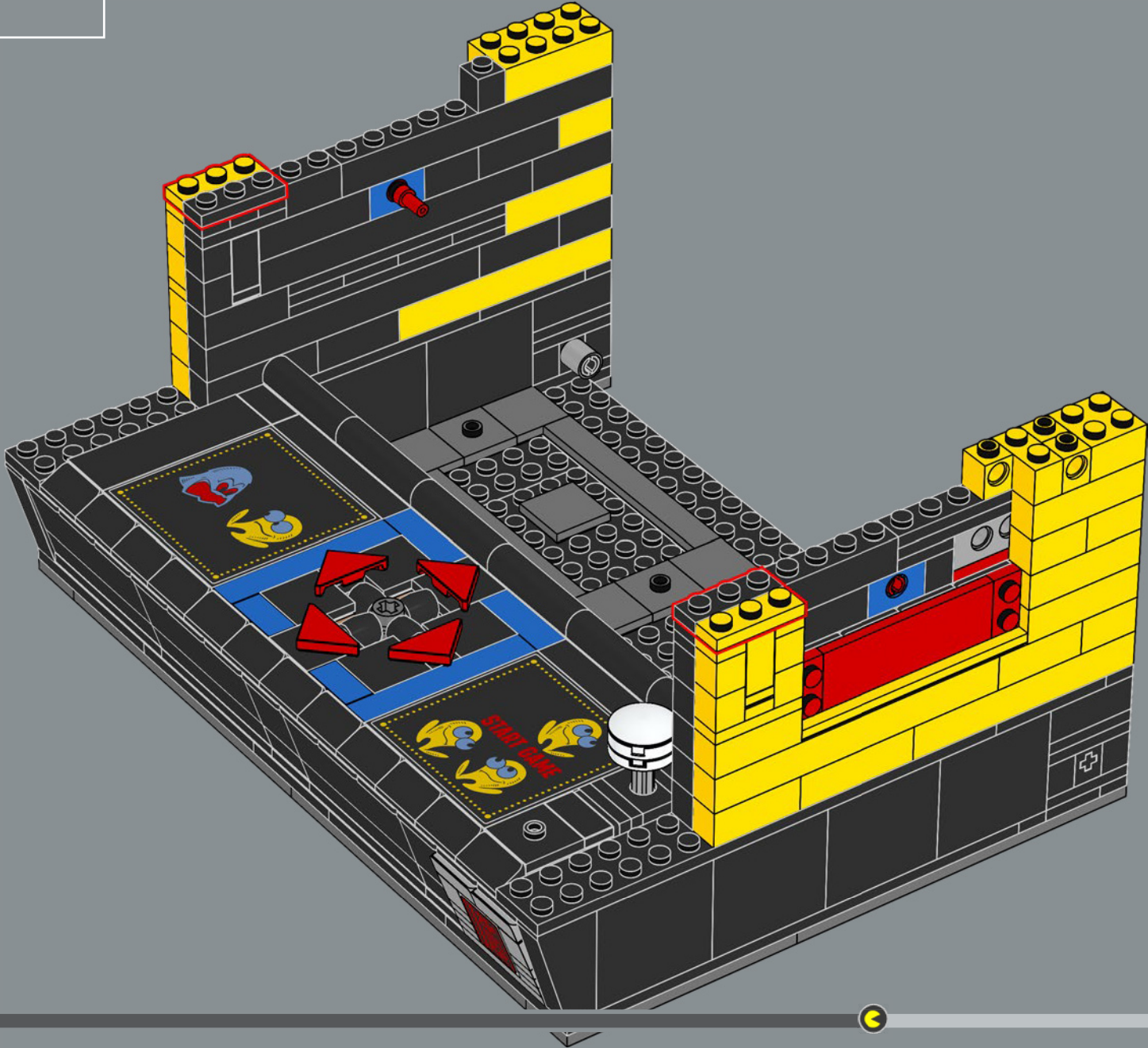

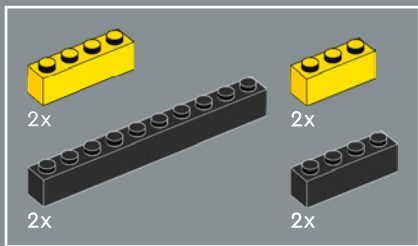

73

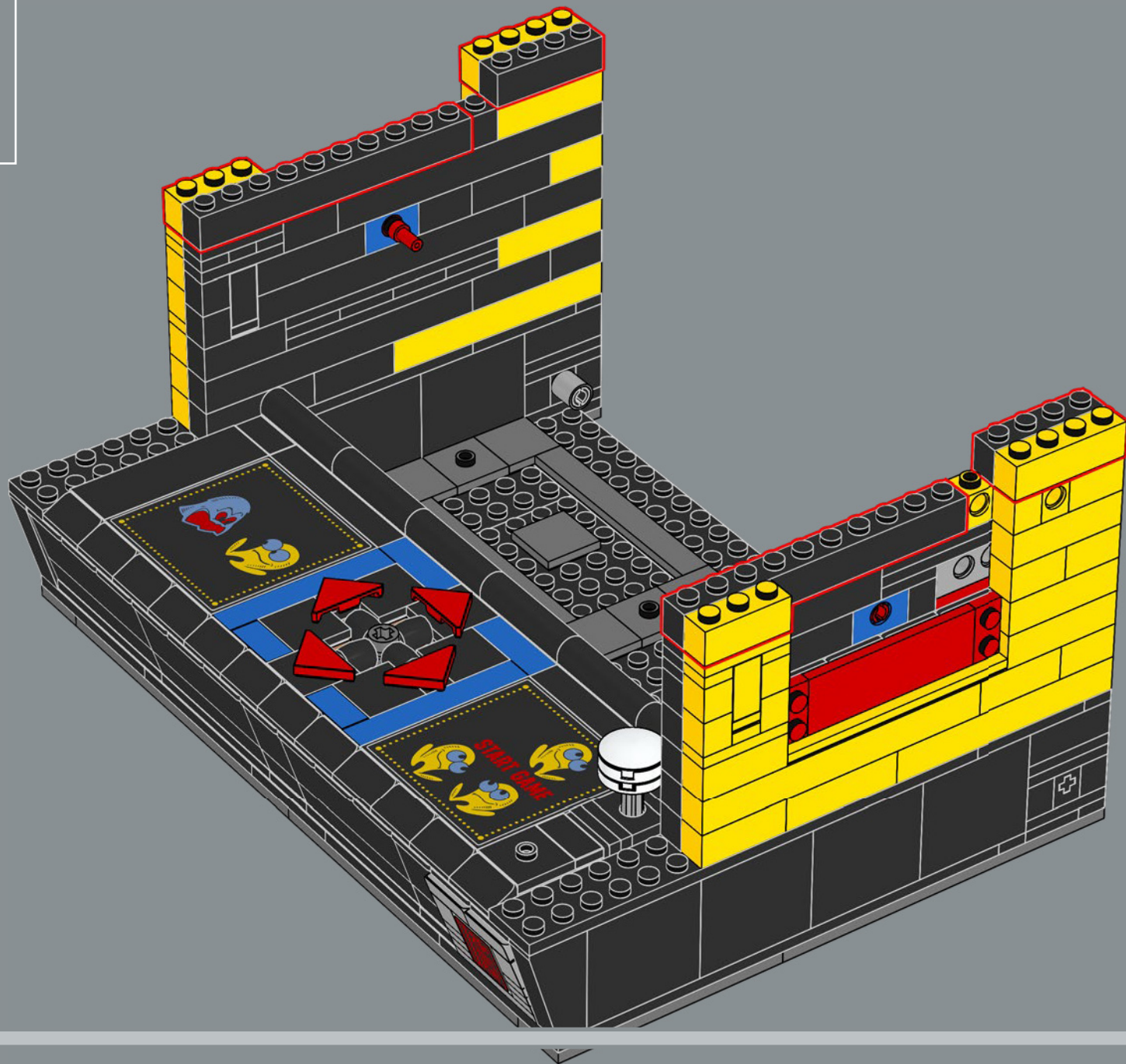

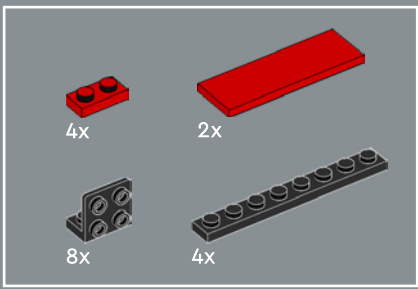

74

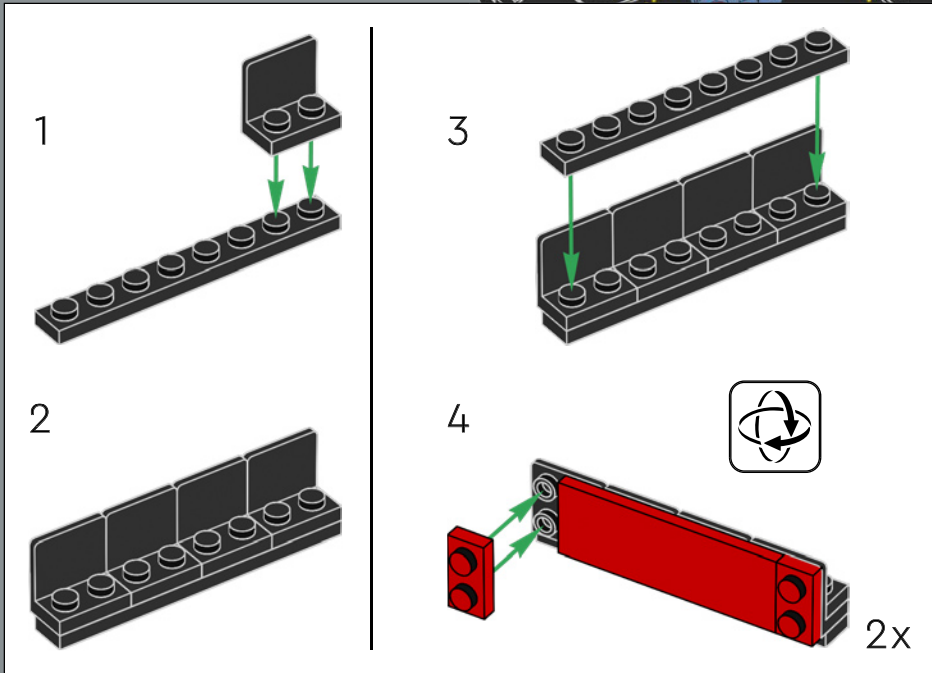
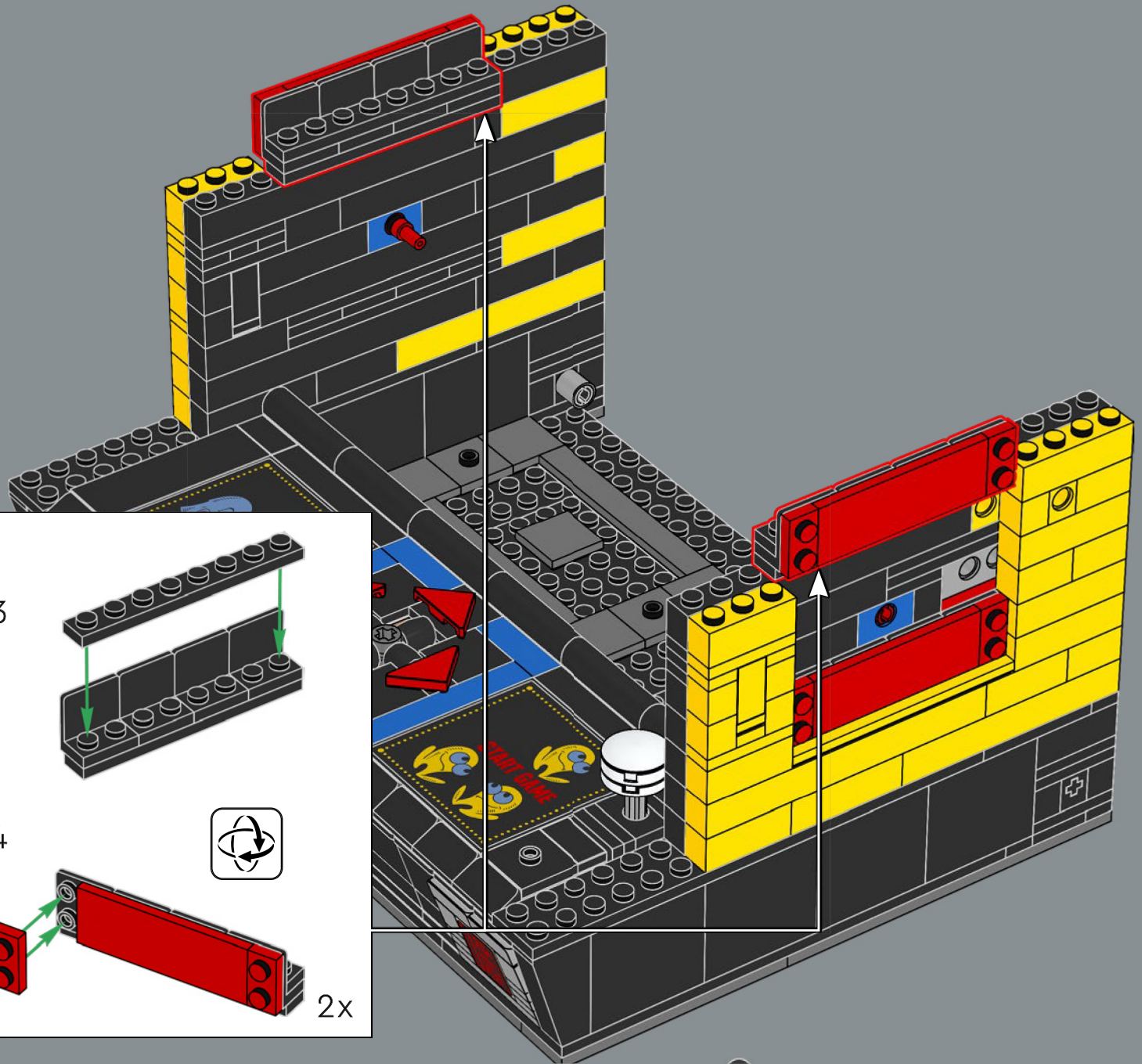



2x



2x

75

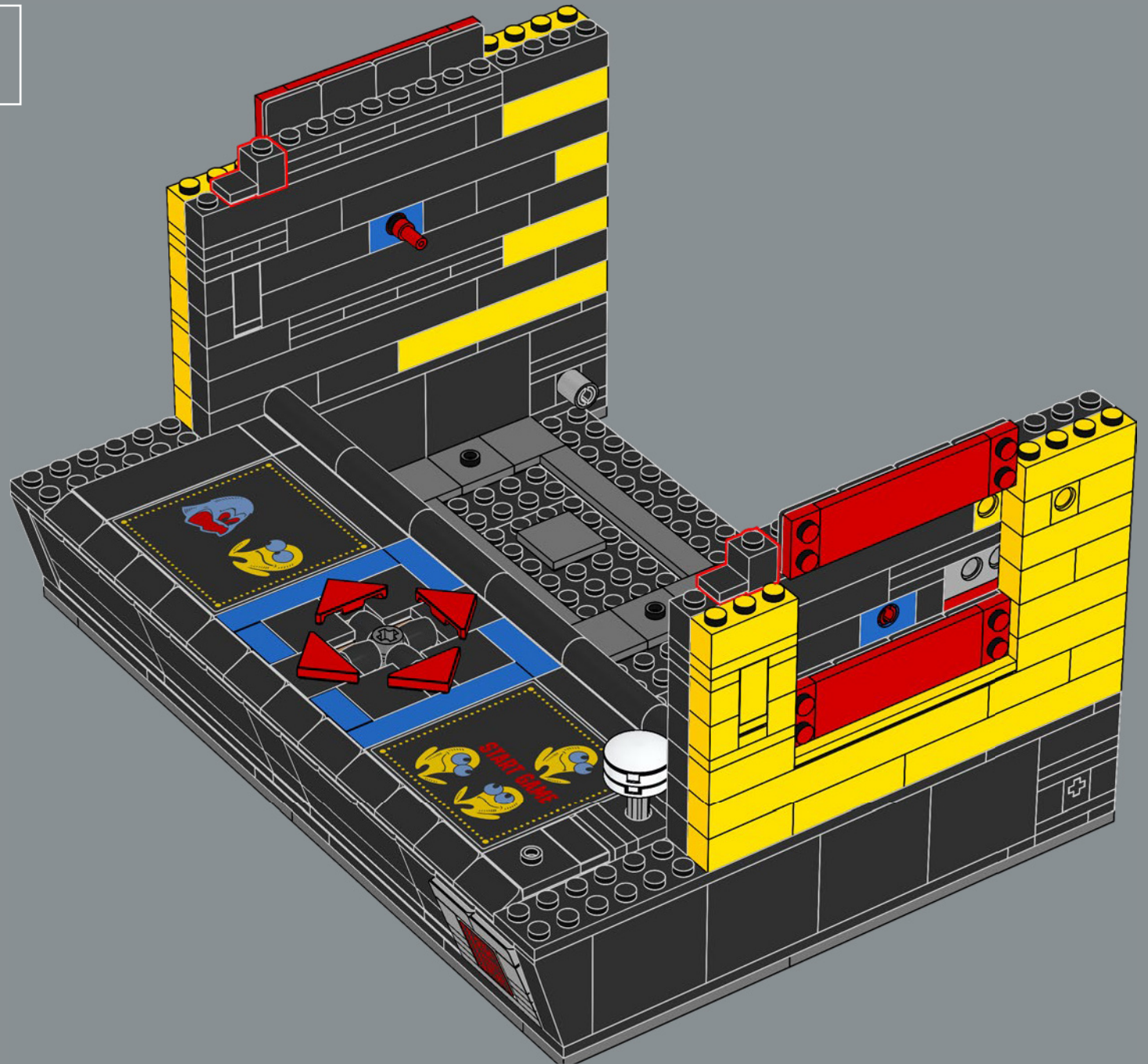

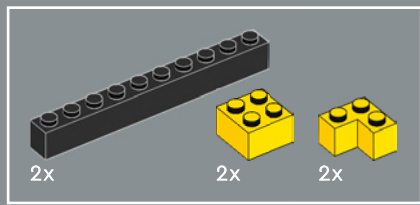

76

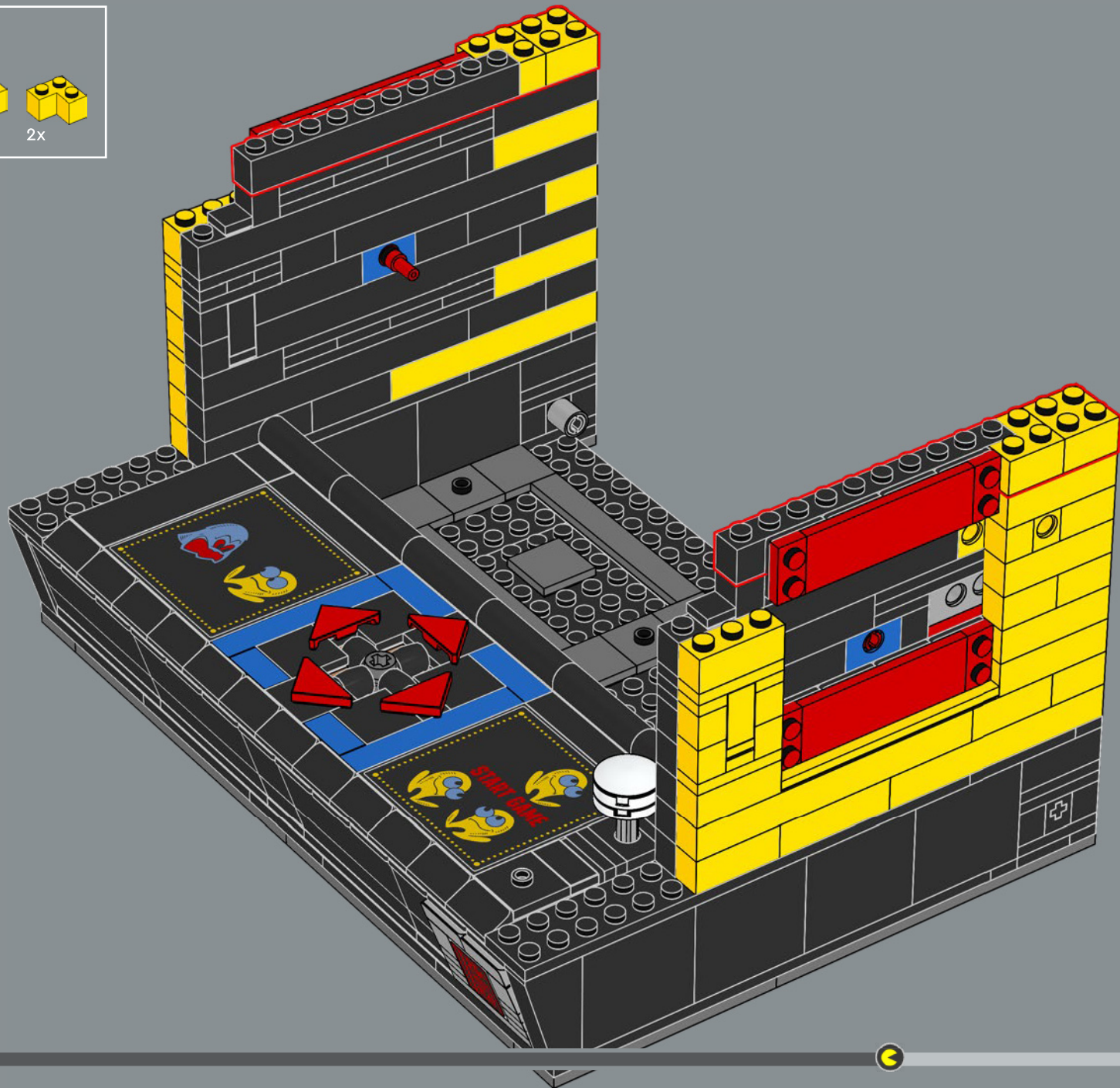

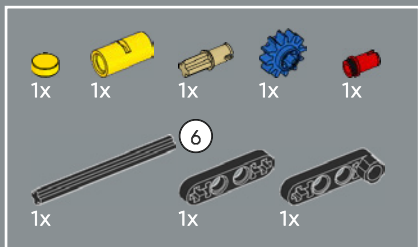

77

1



2

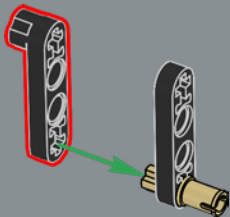

3

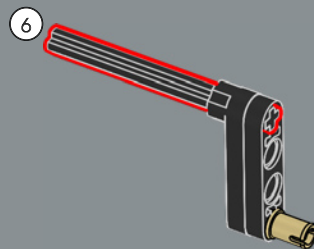

4

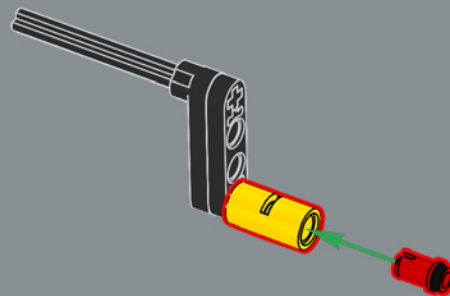

5

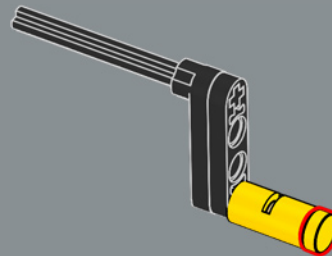

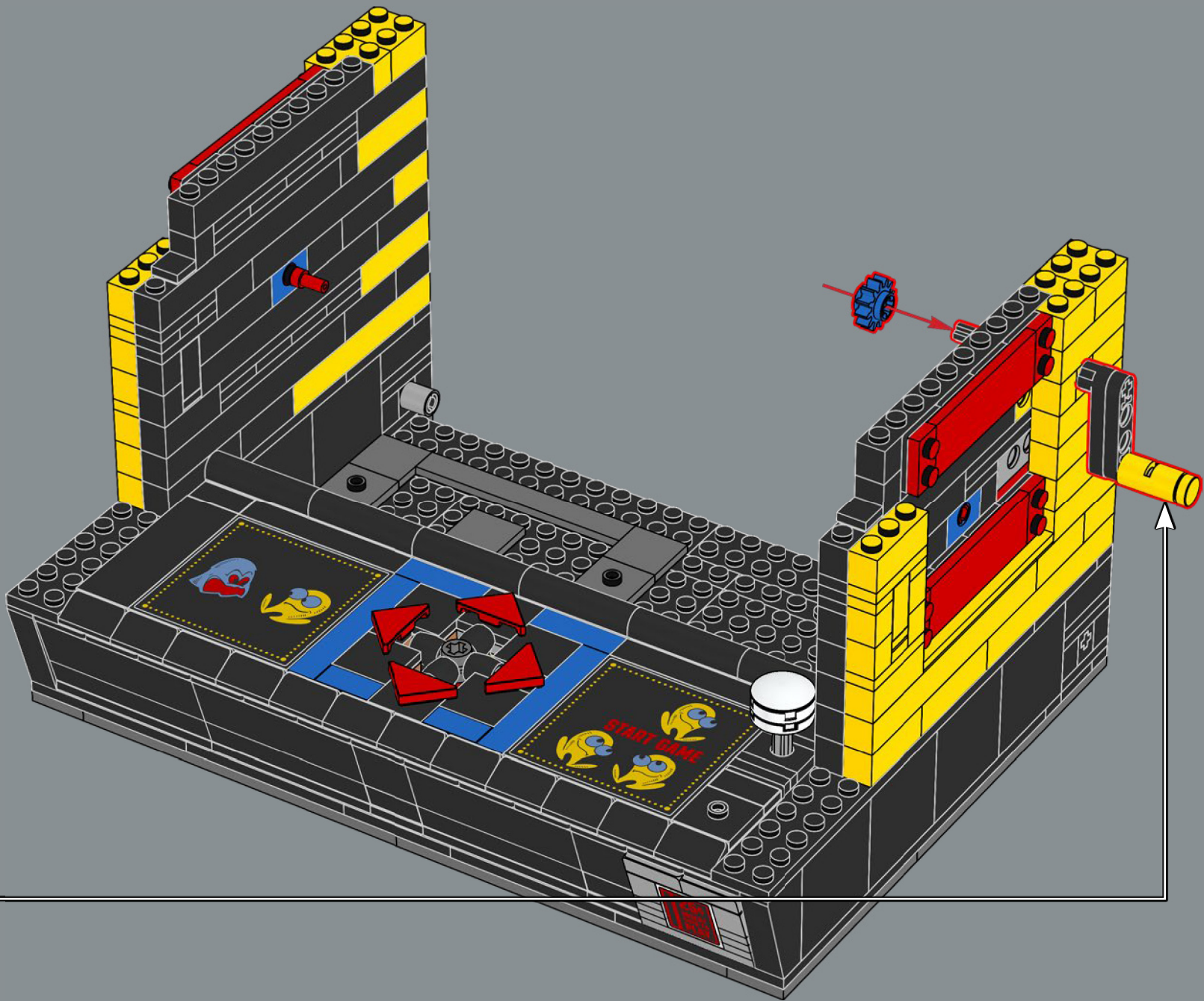

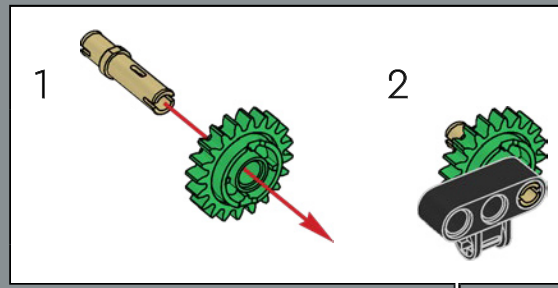
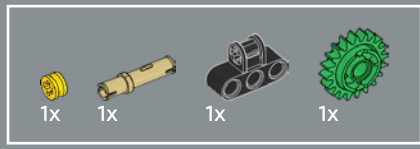

78

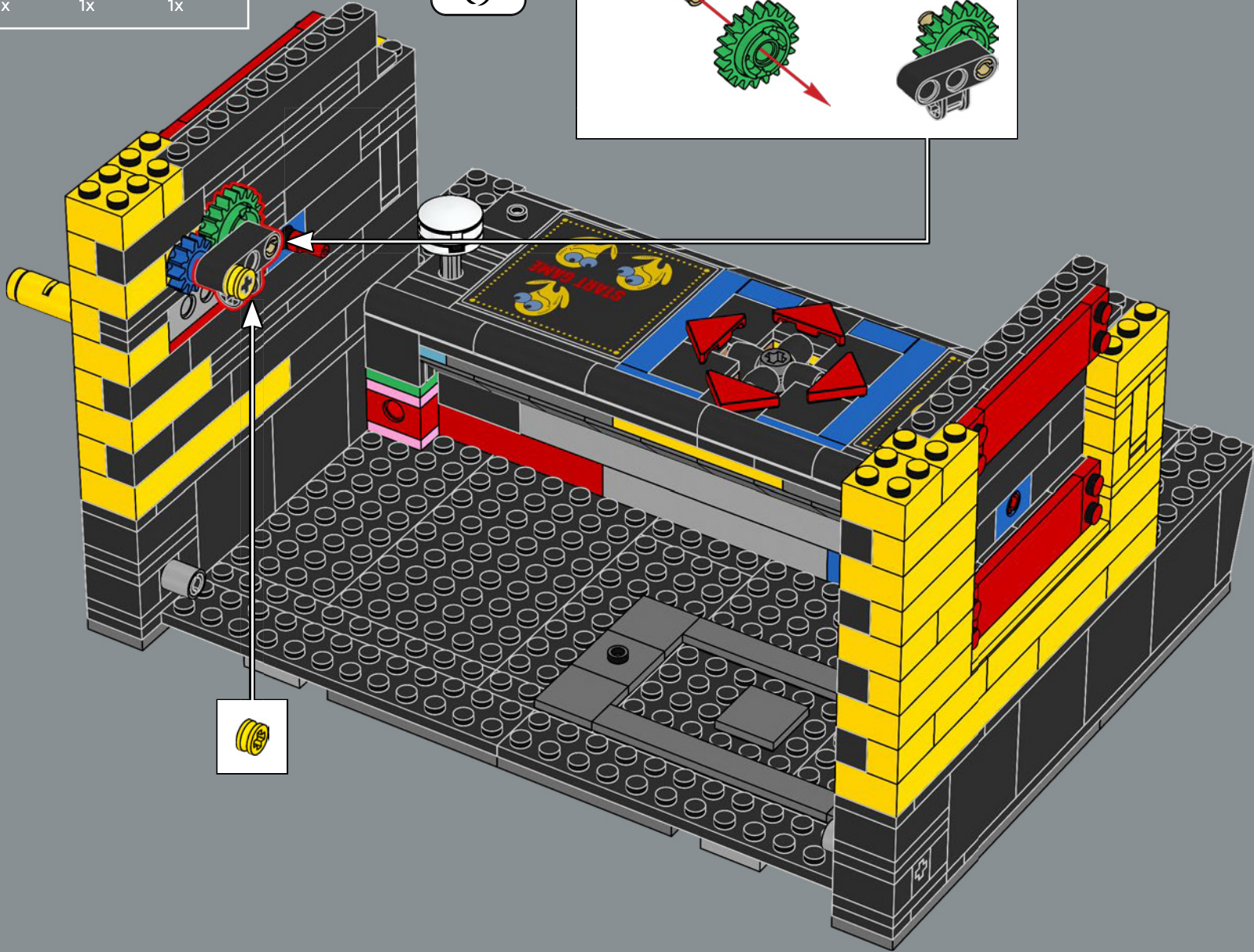

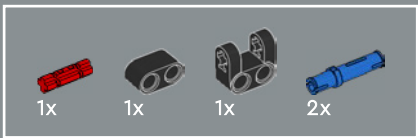

79

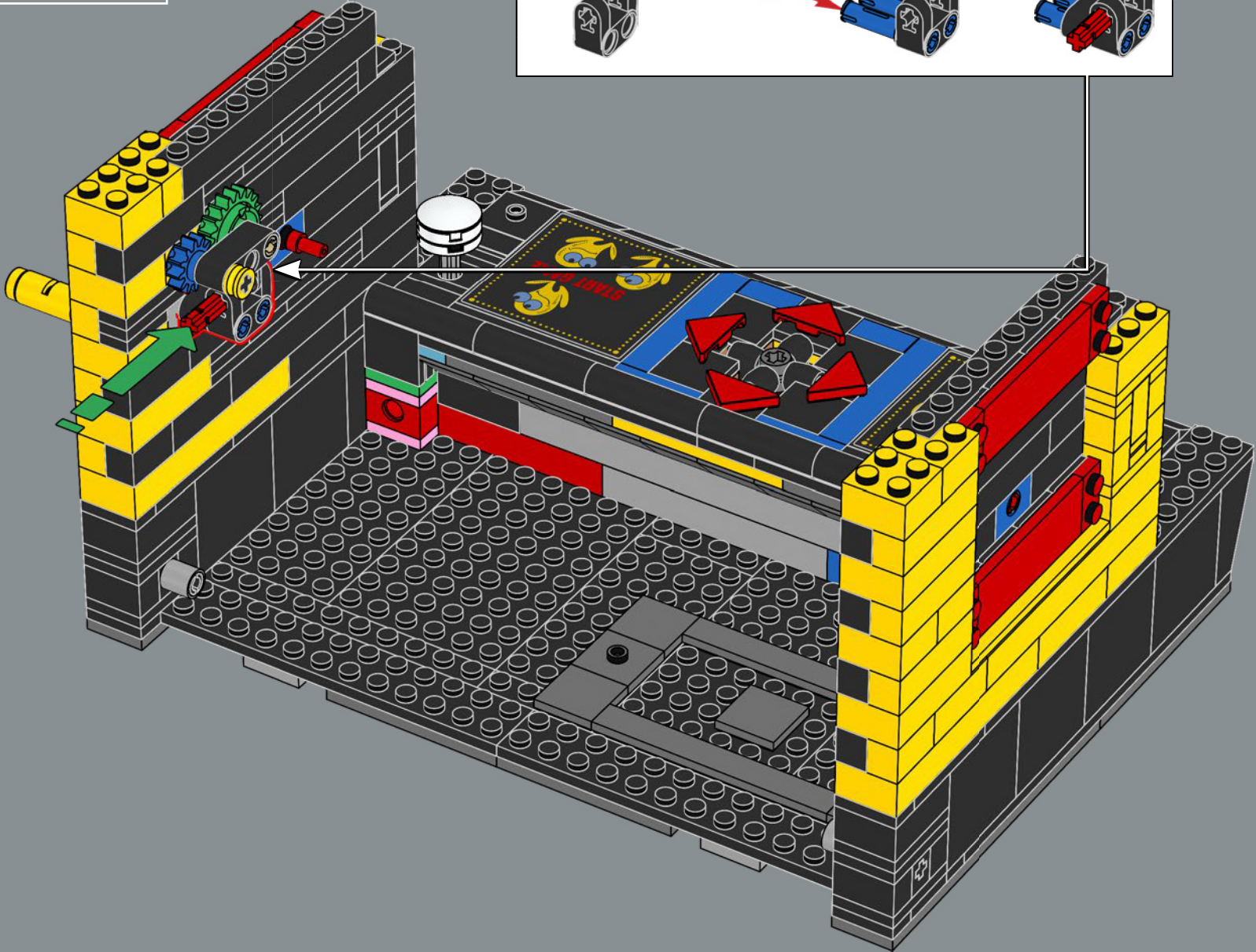
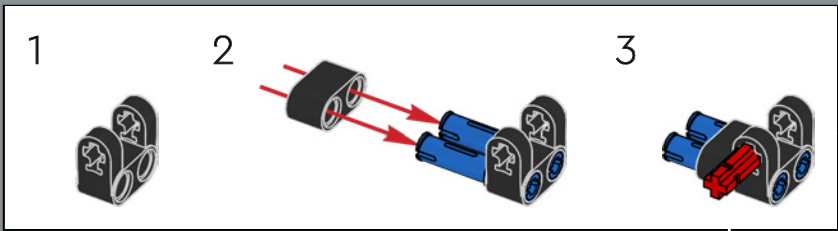

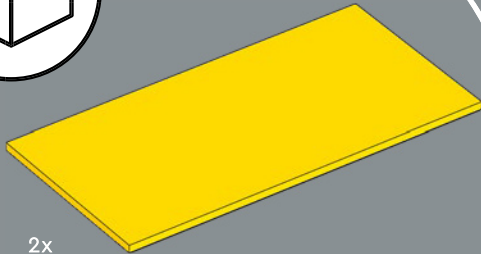
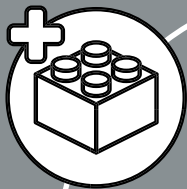

2x



6

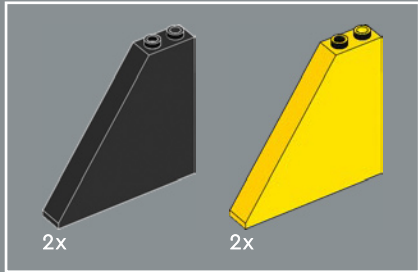
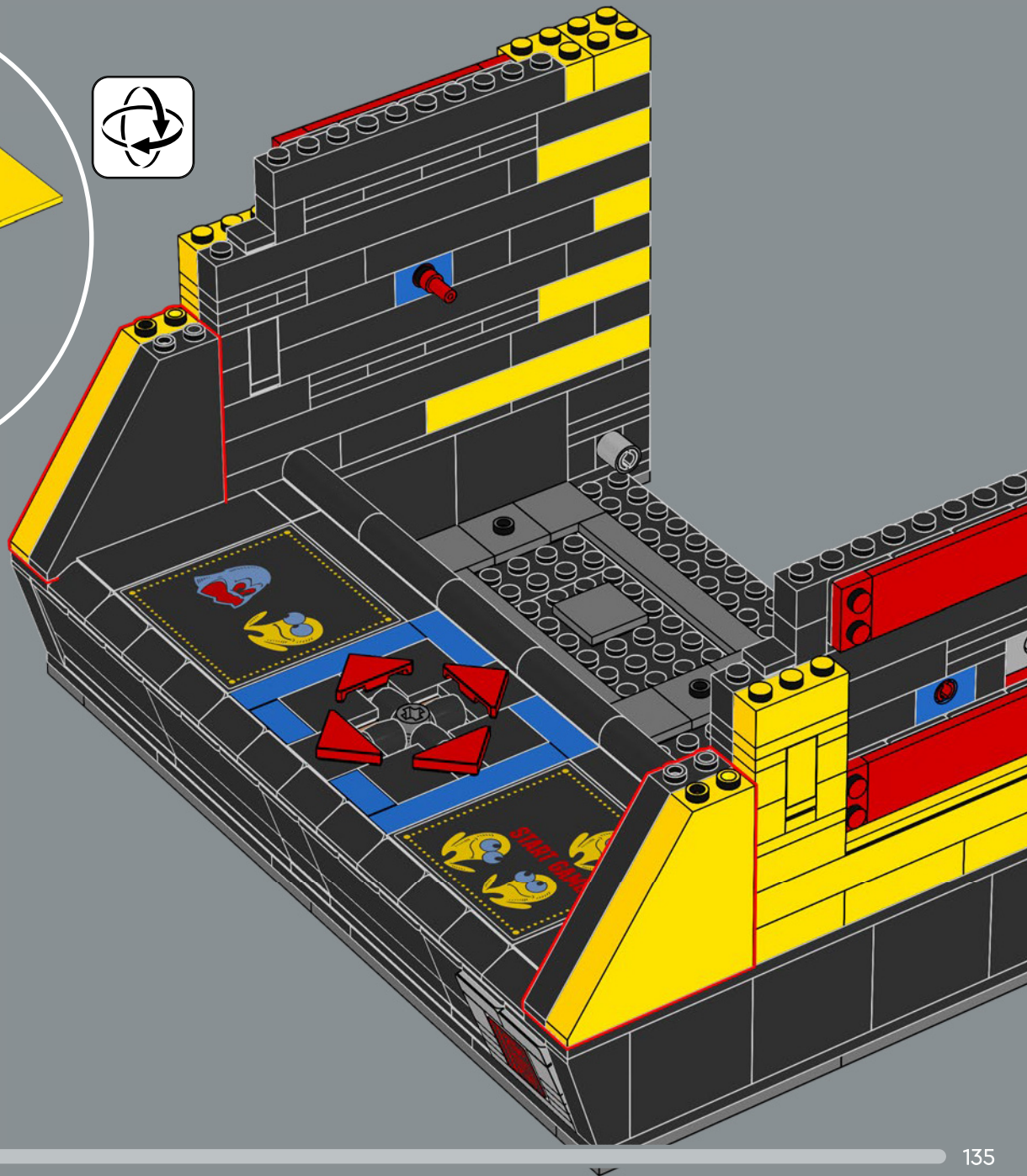

2x

2x

80

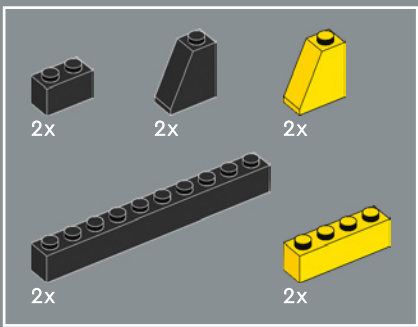

81

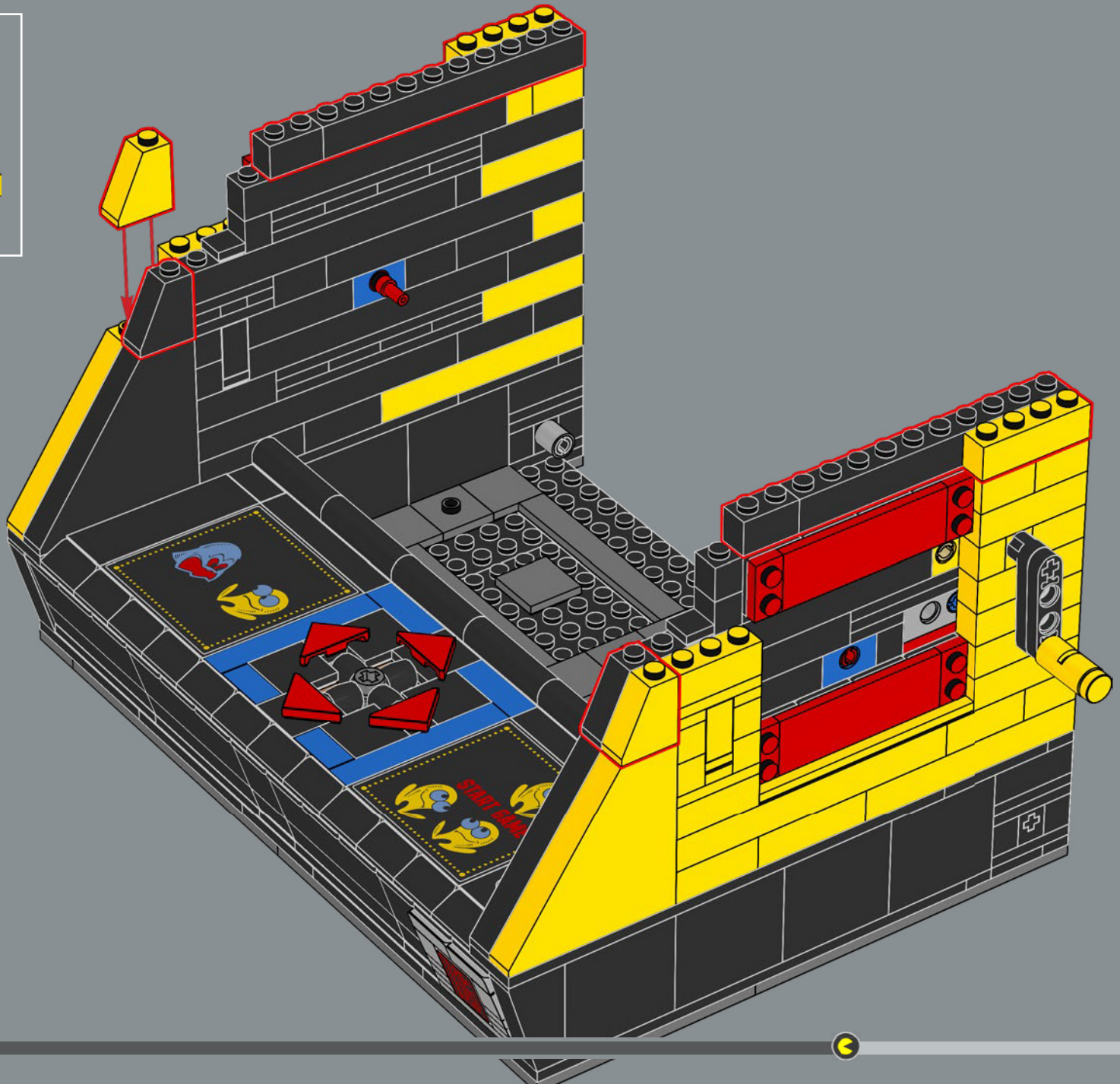



82

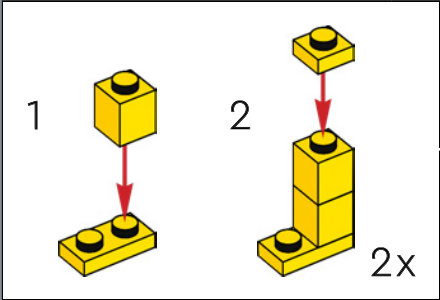
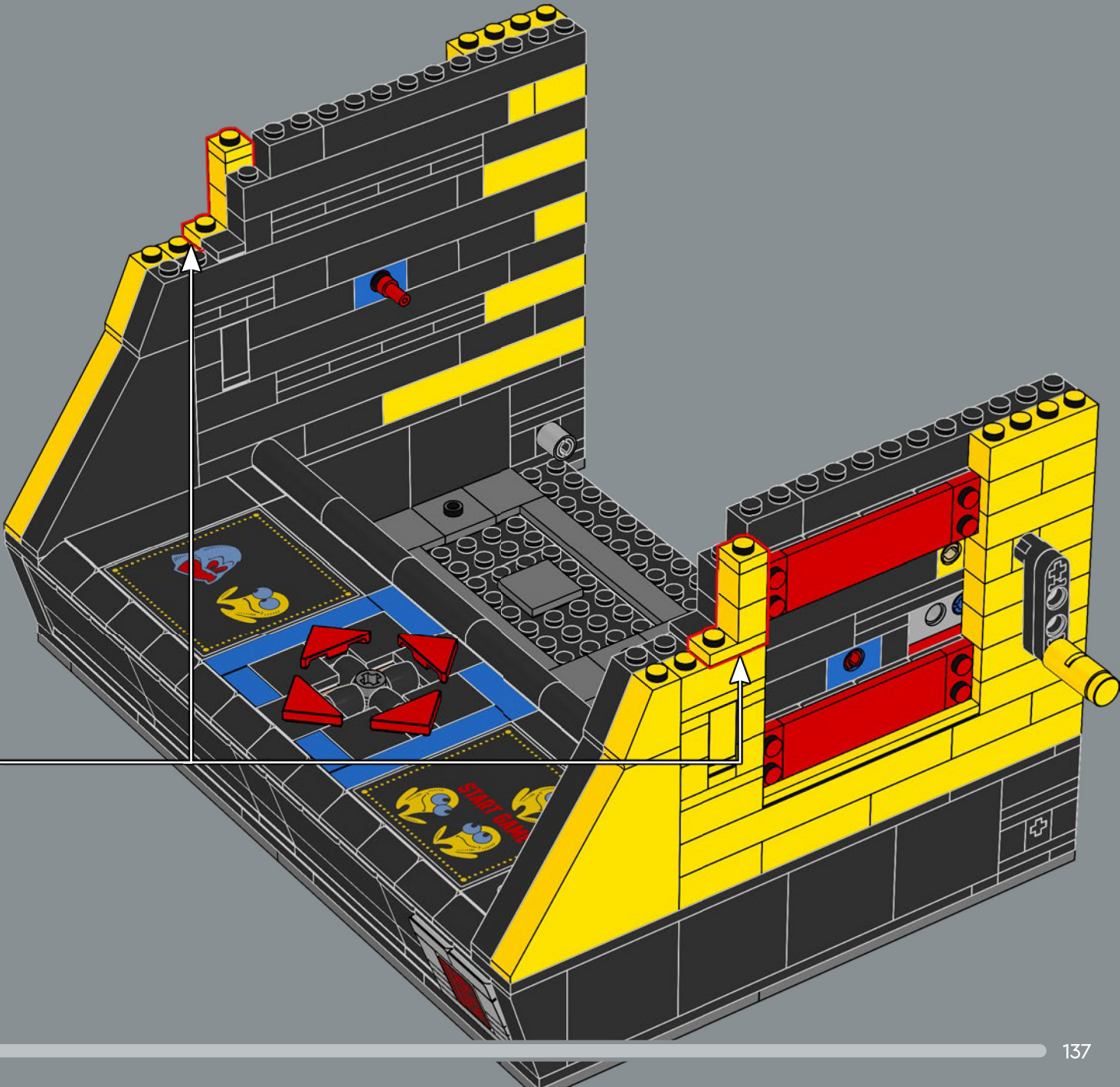

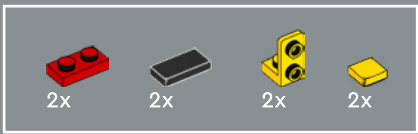

83

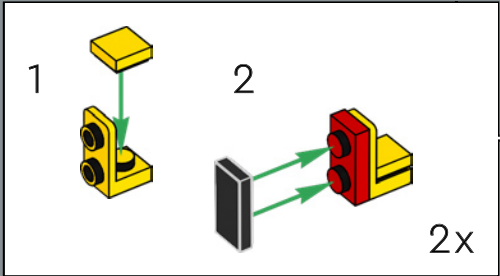
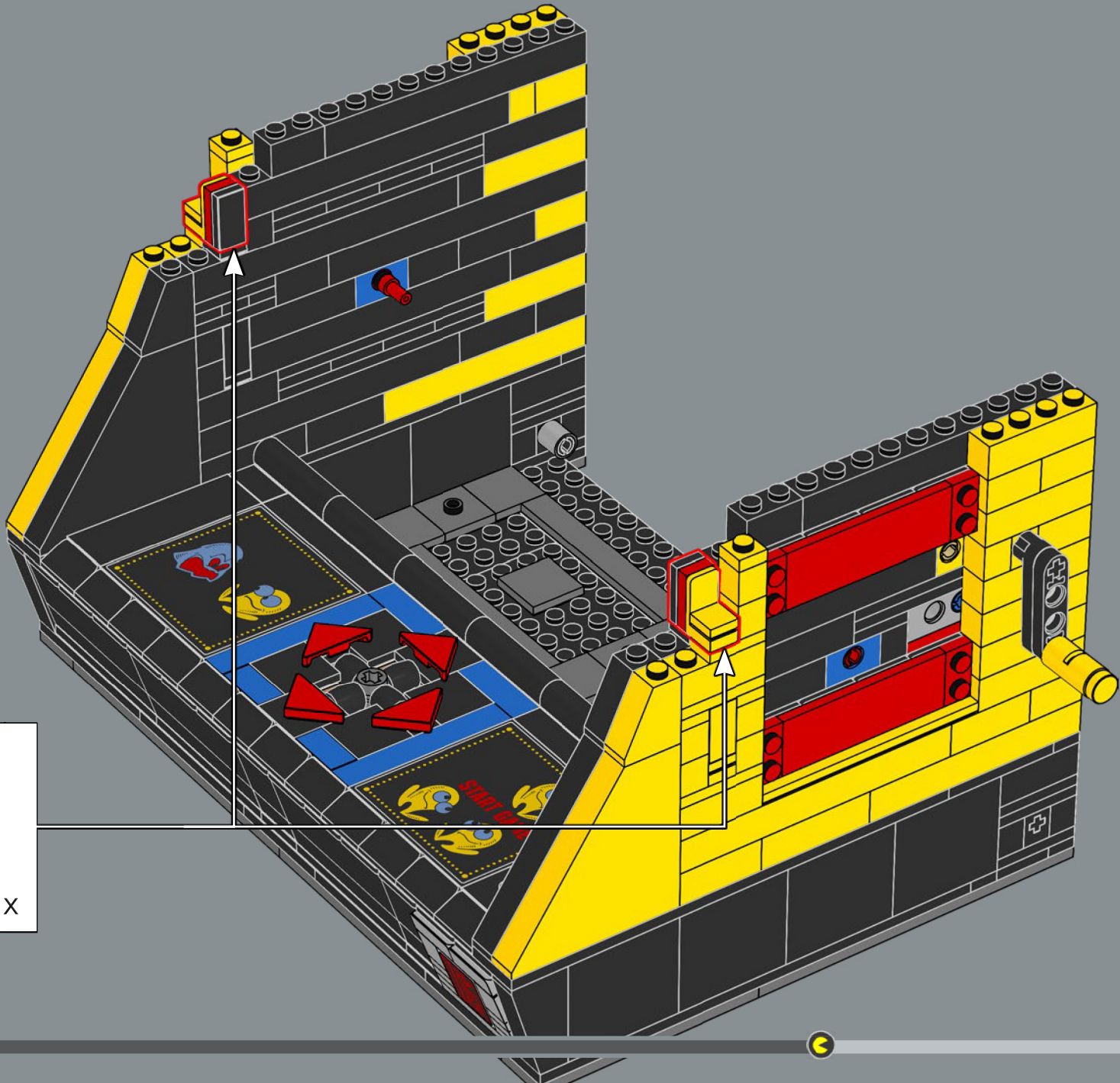

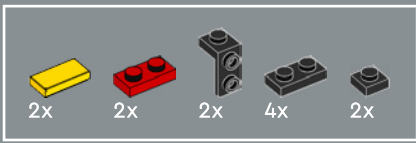

84

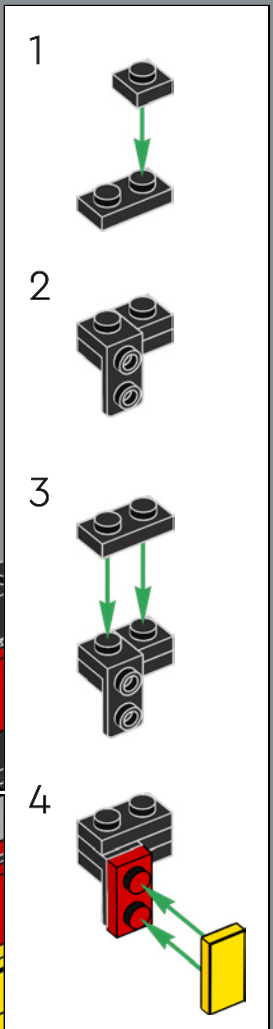
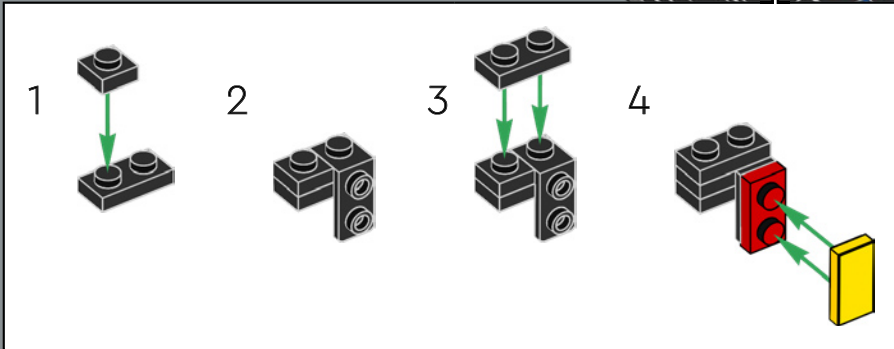
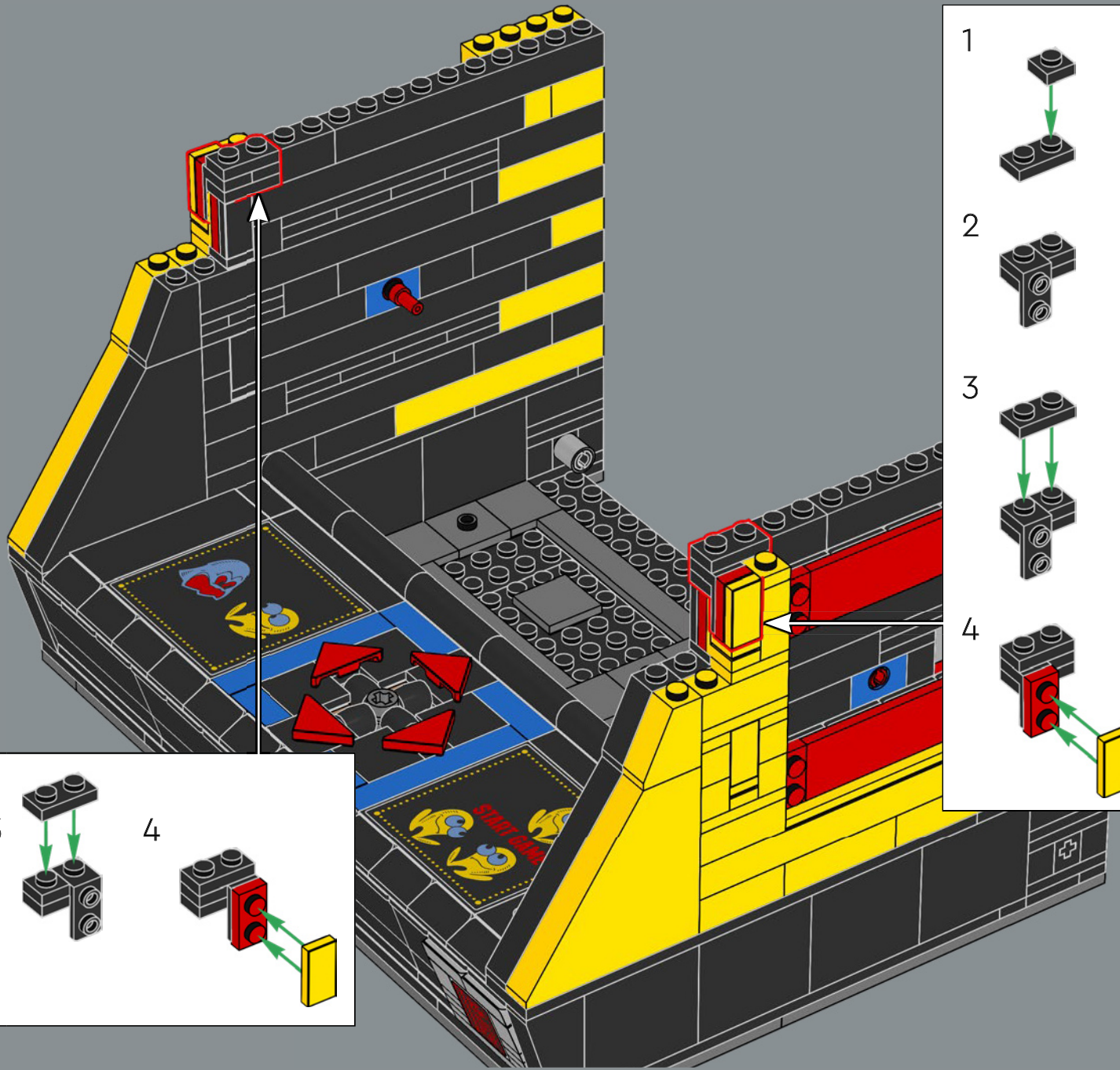

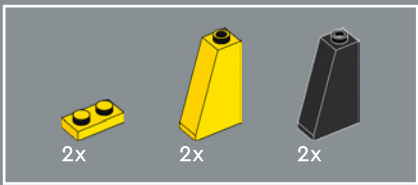

85

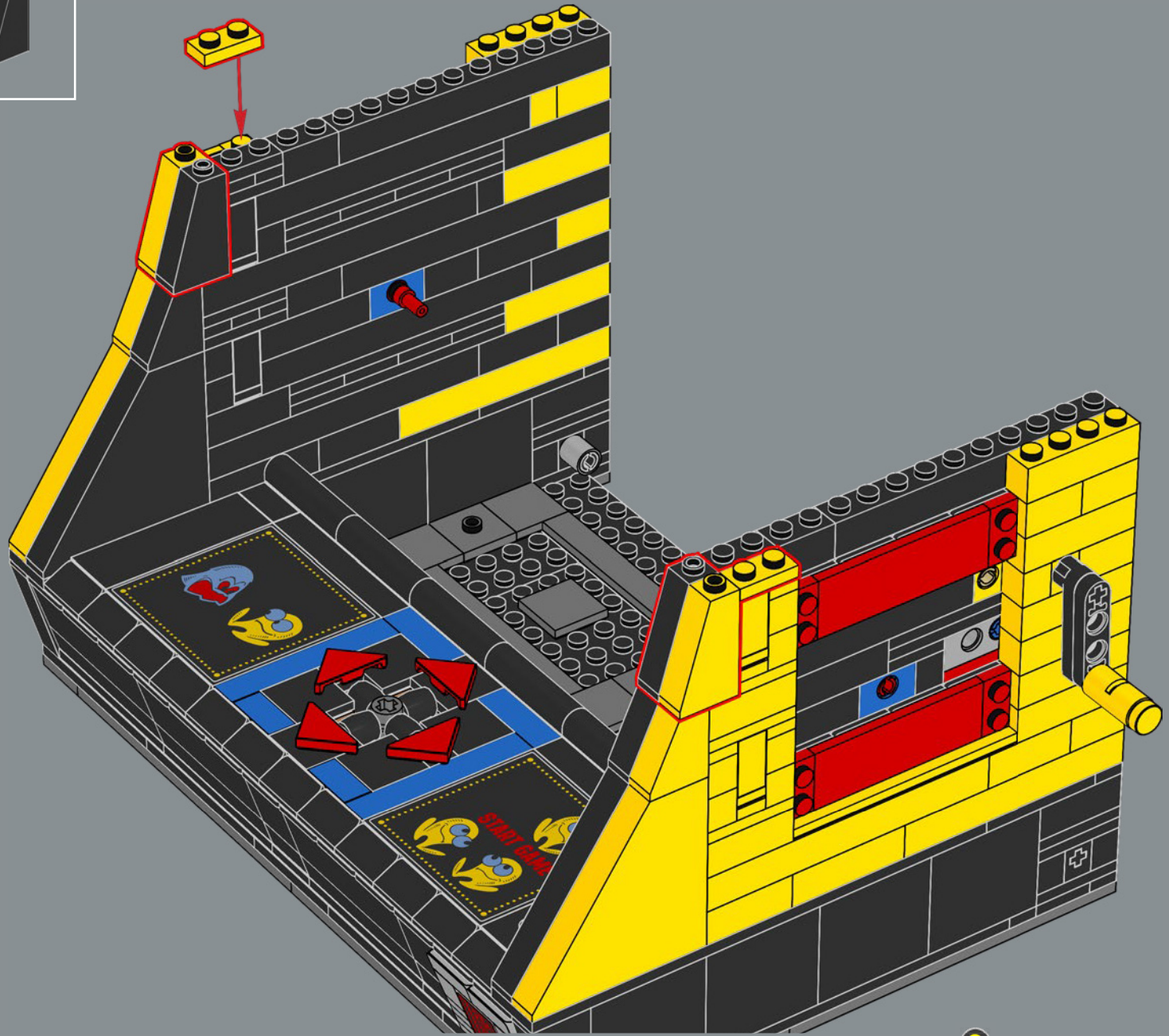

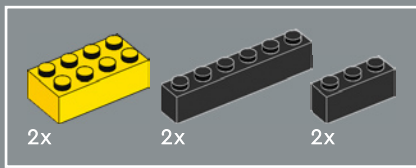

86

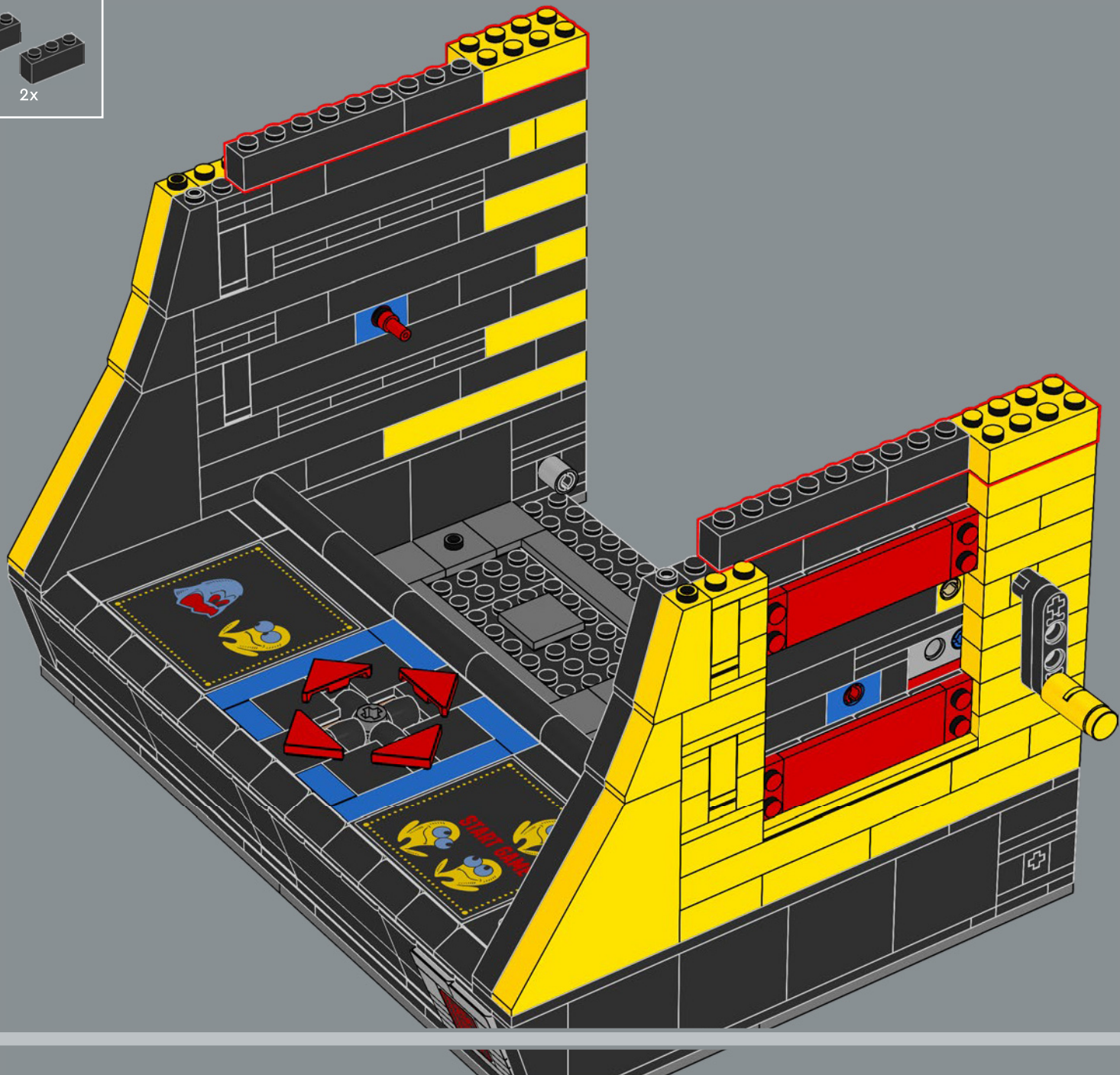

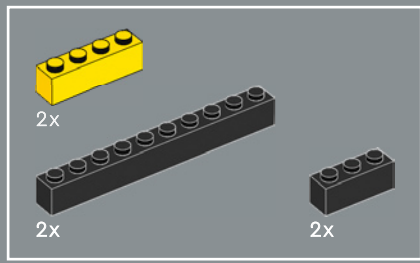

87

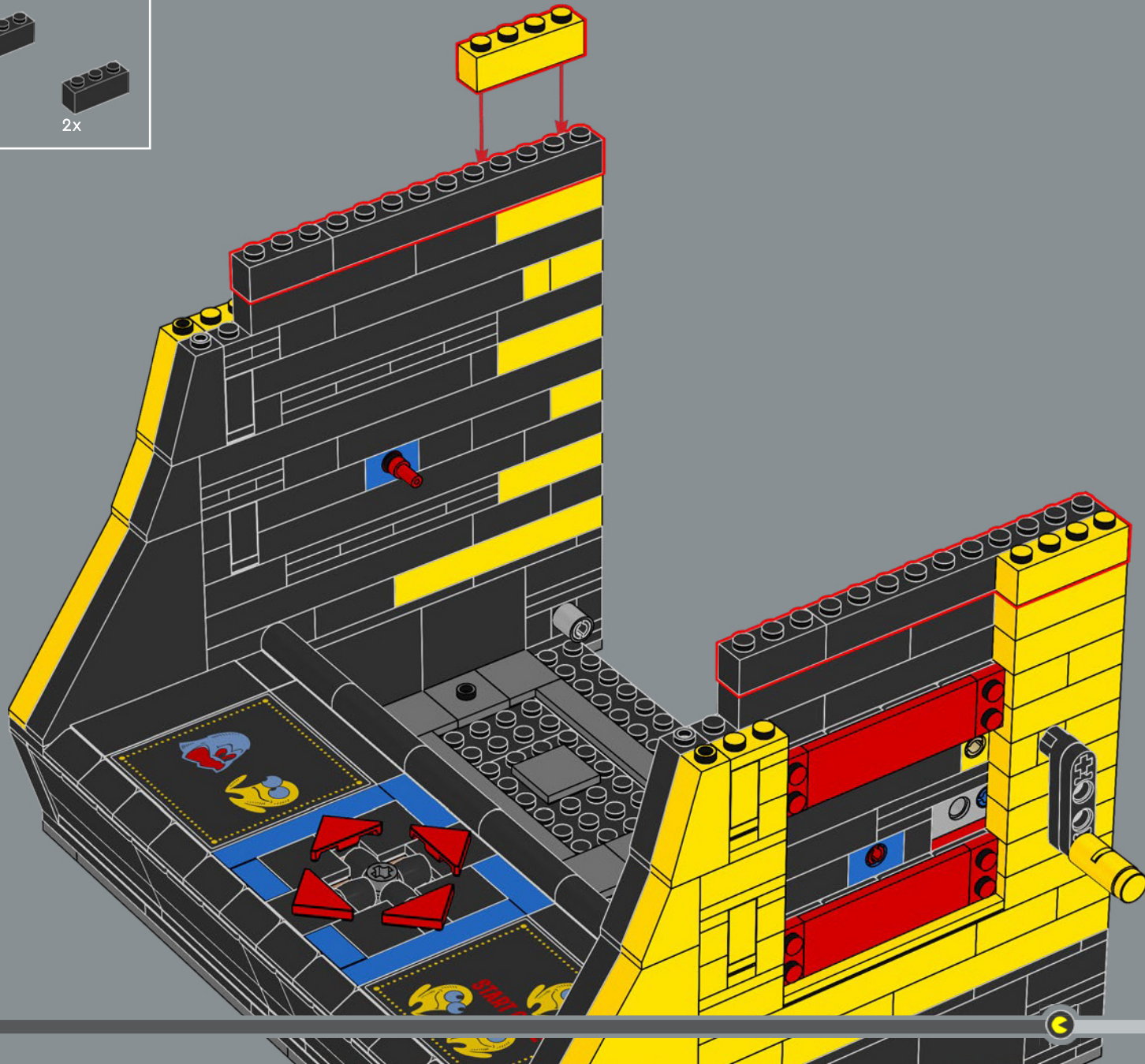

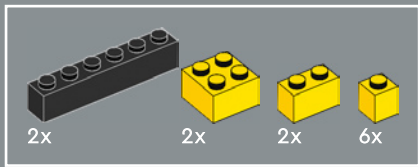

88

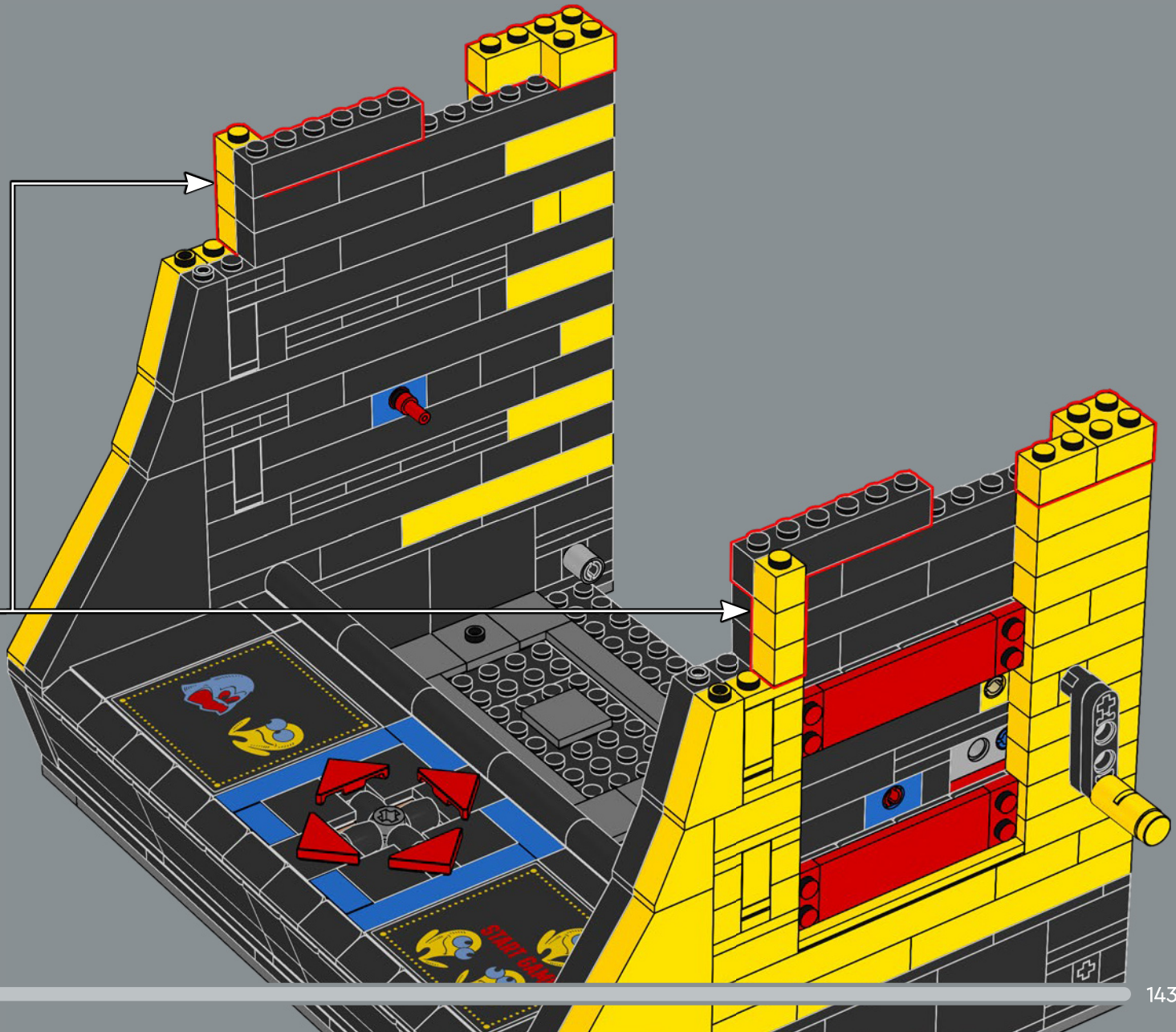
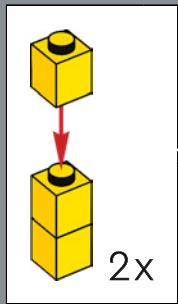

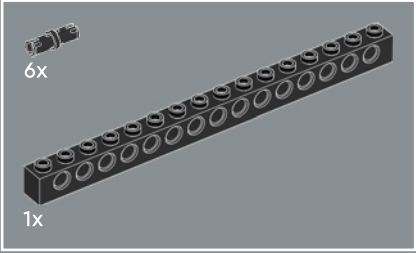
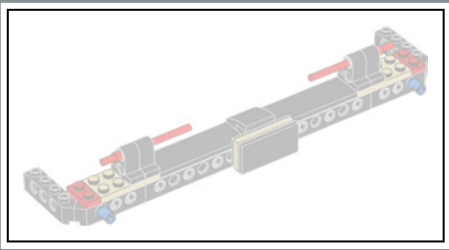

89

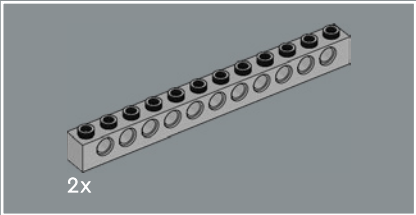
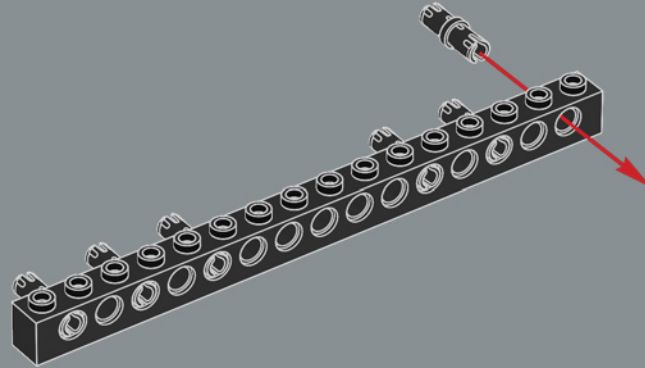

90

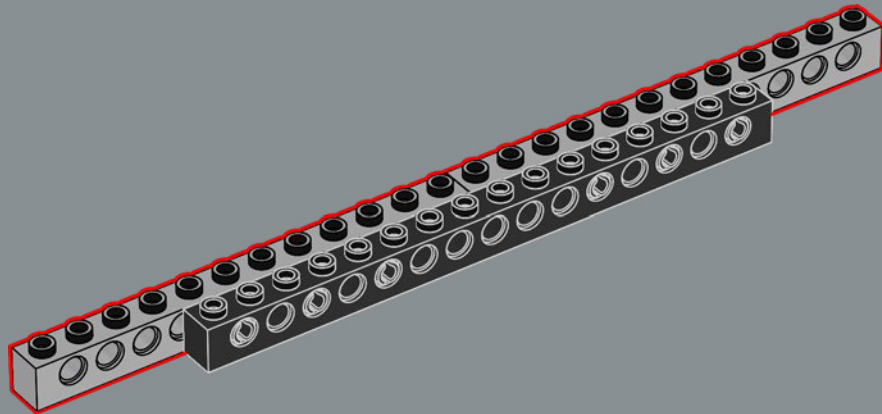



91

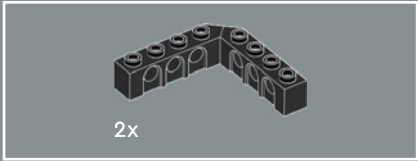
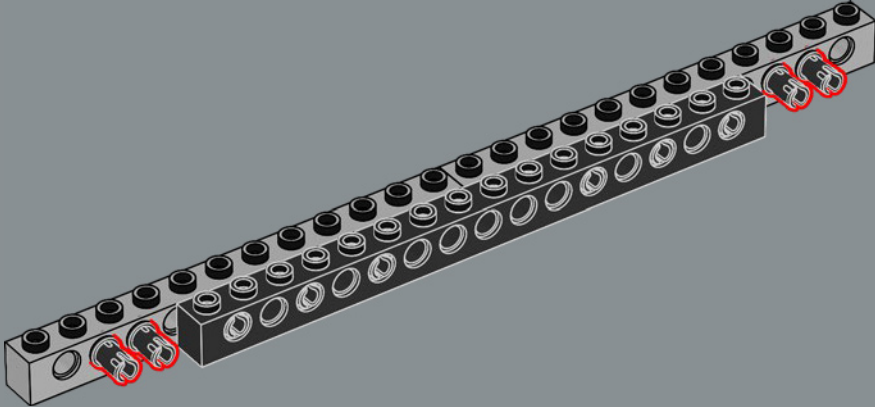

92

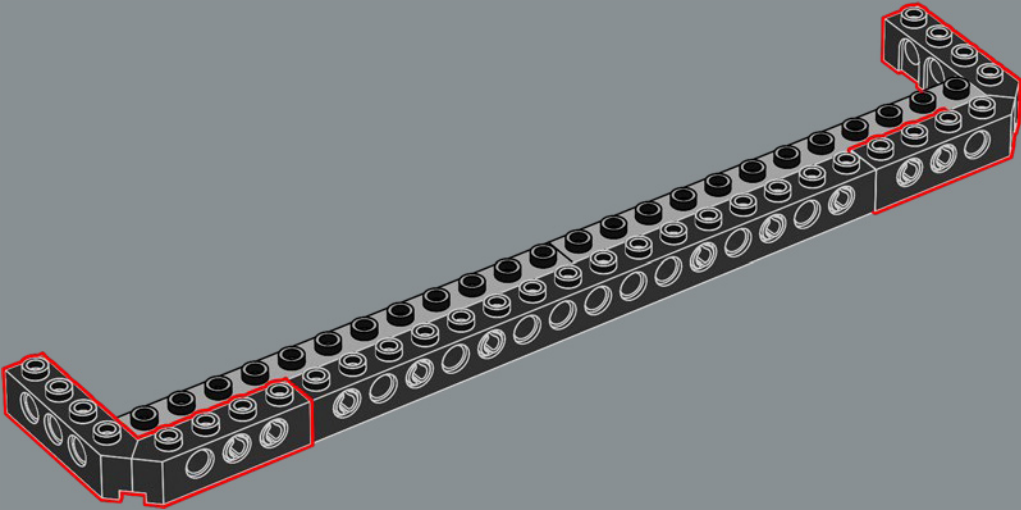



93

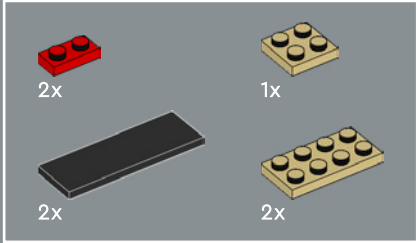
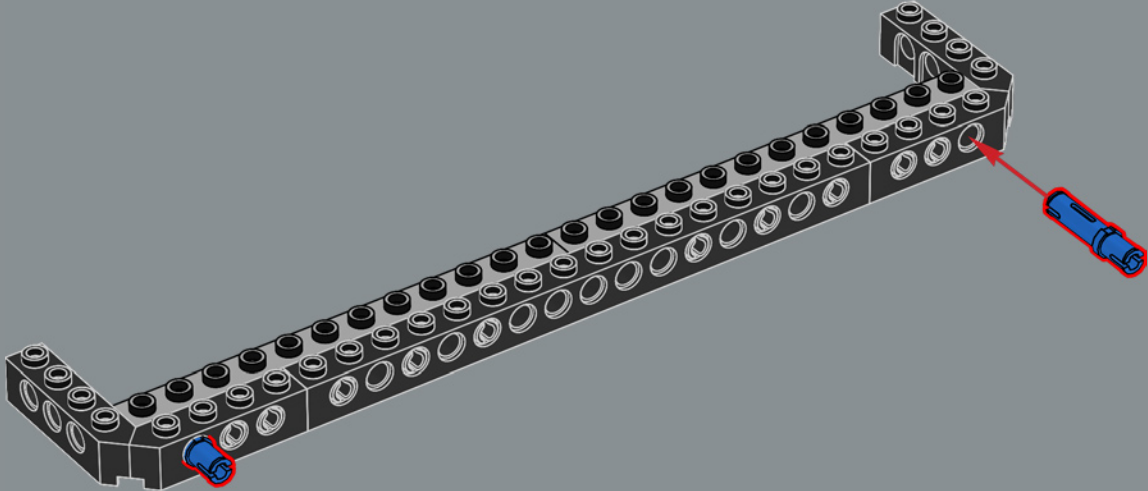

94

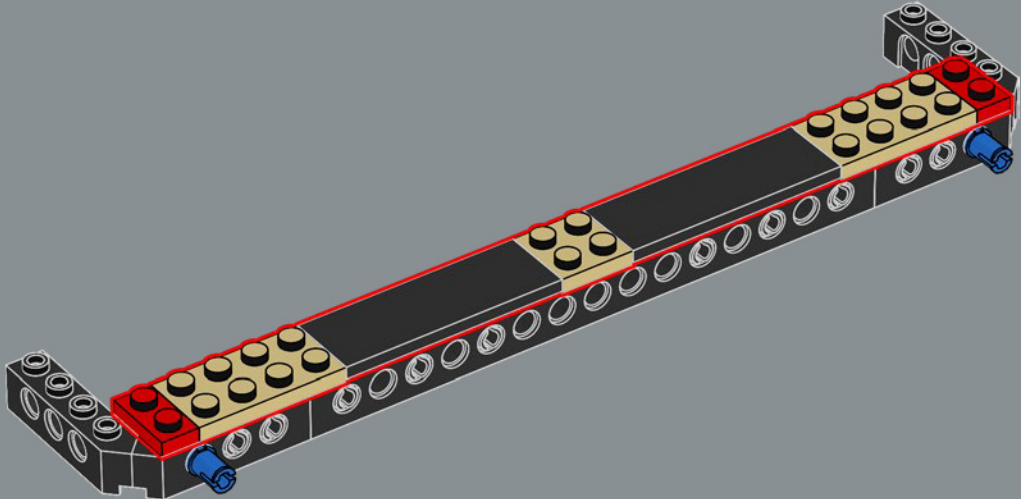

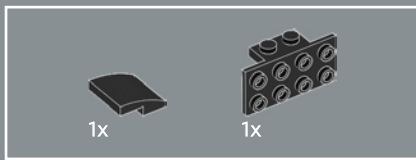

95

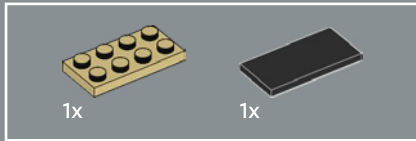
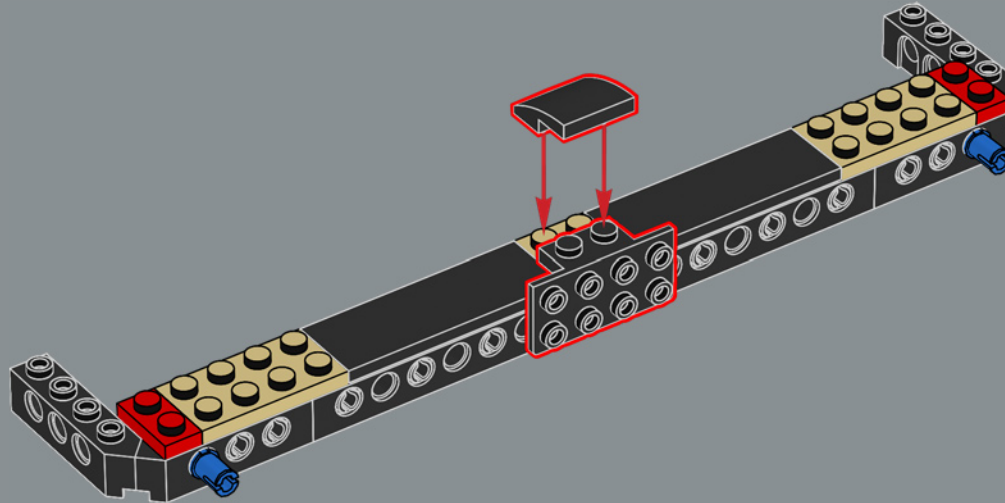

96

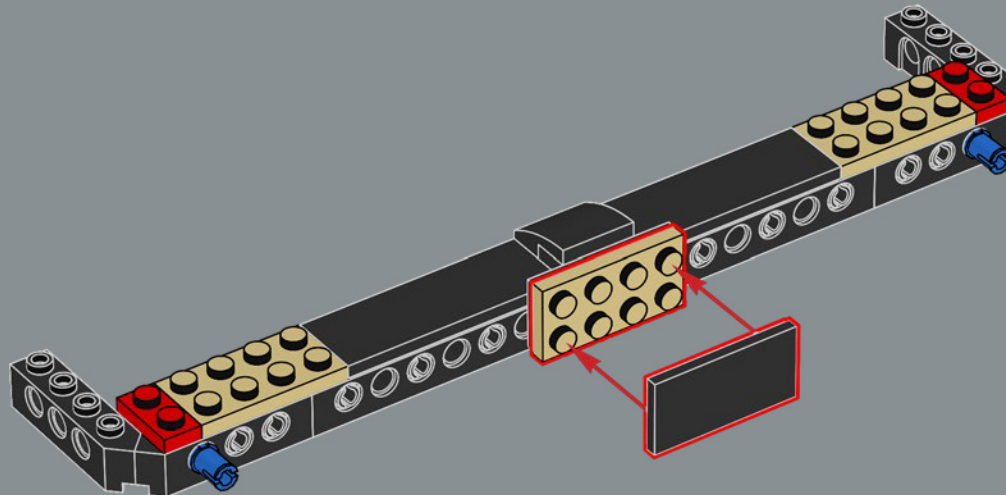

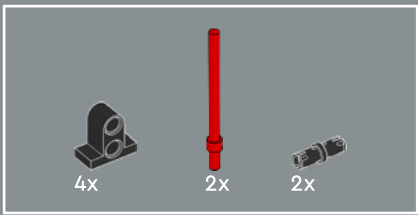

97

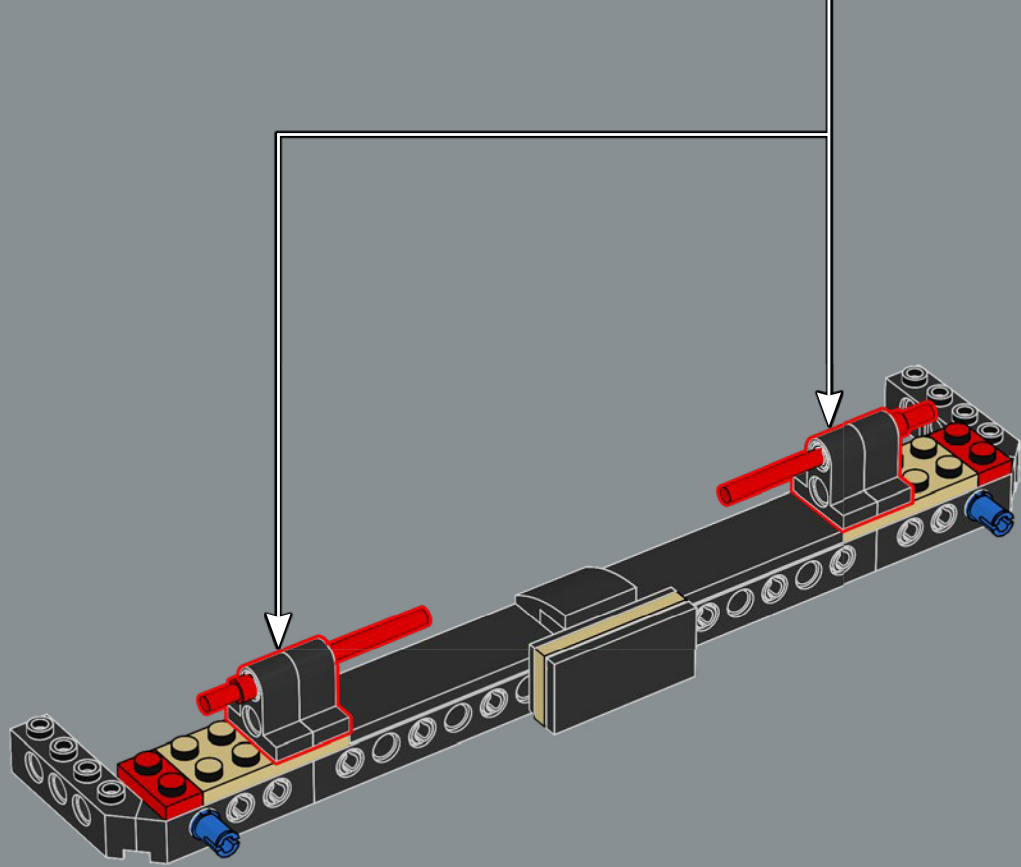
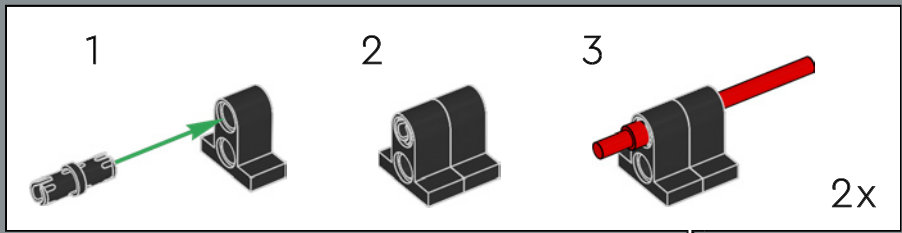

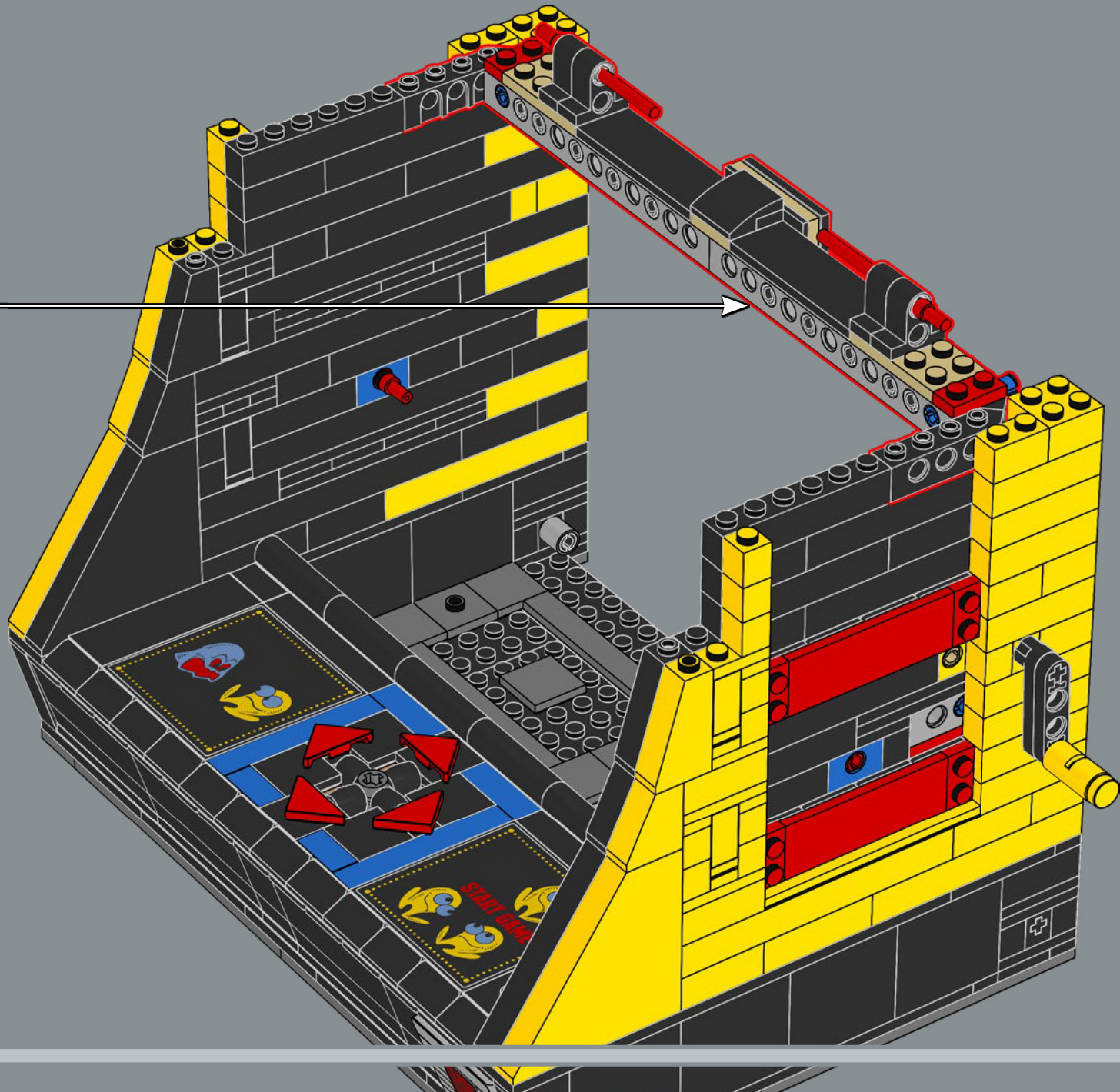

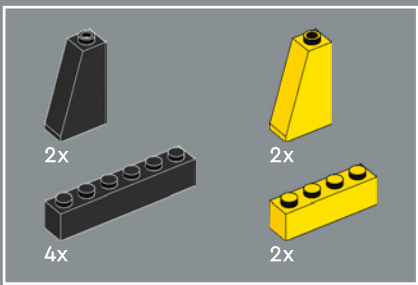

99

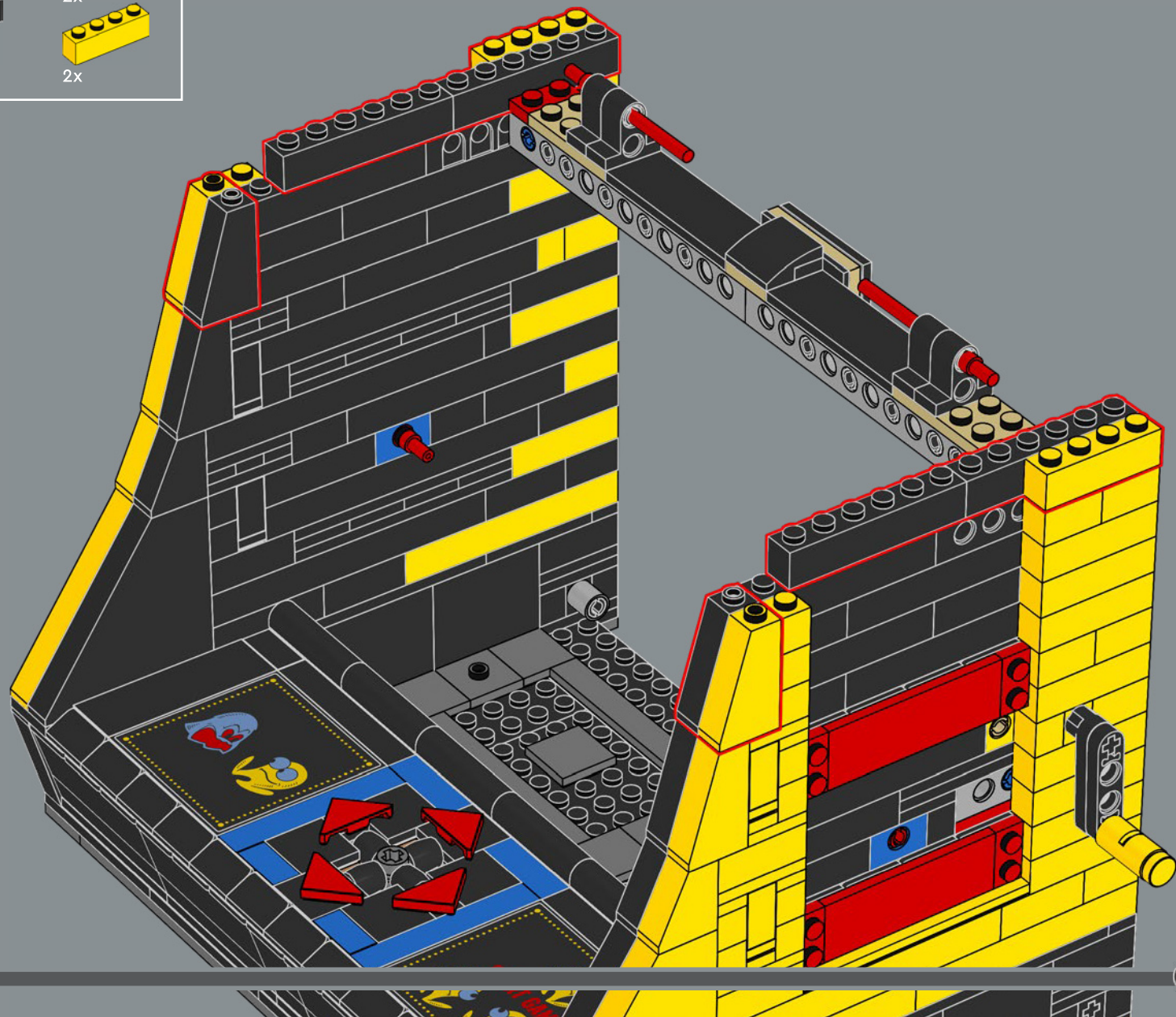

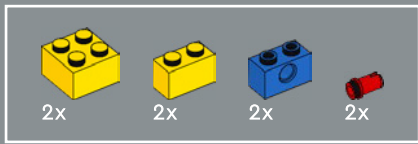

100

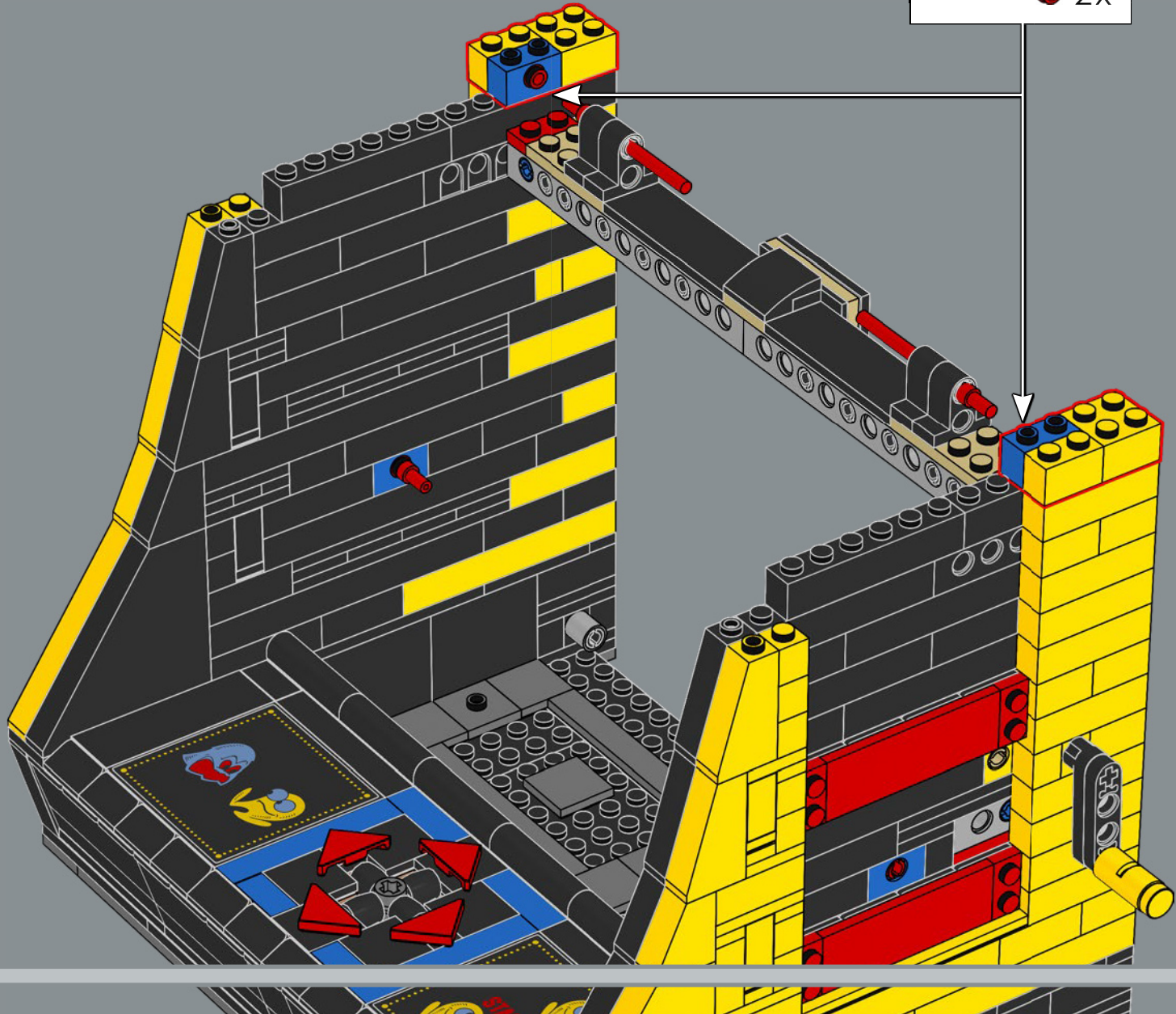
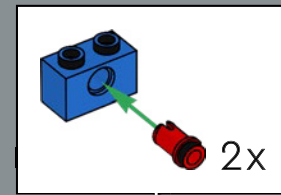

101

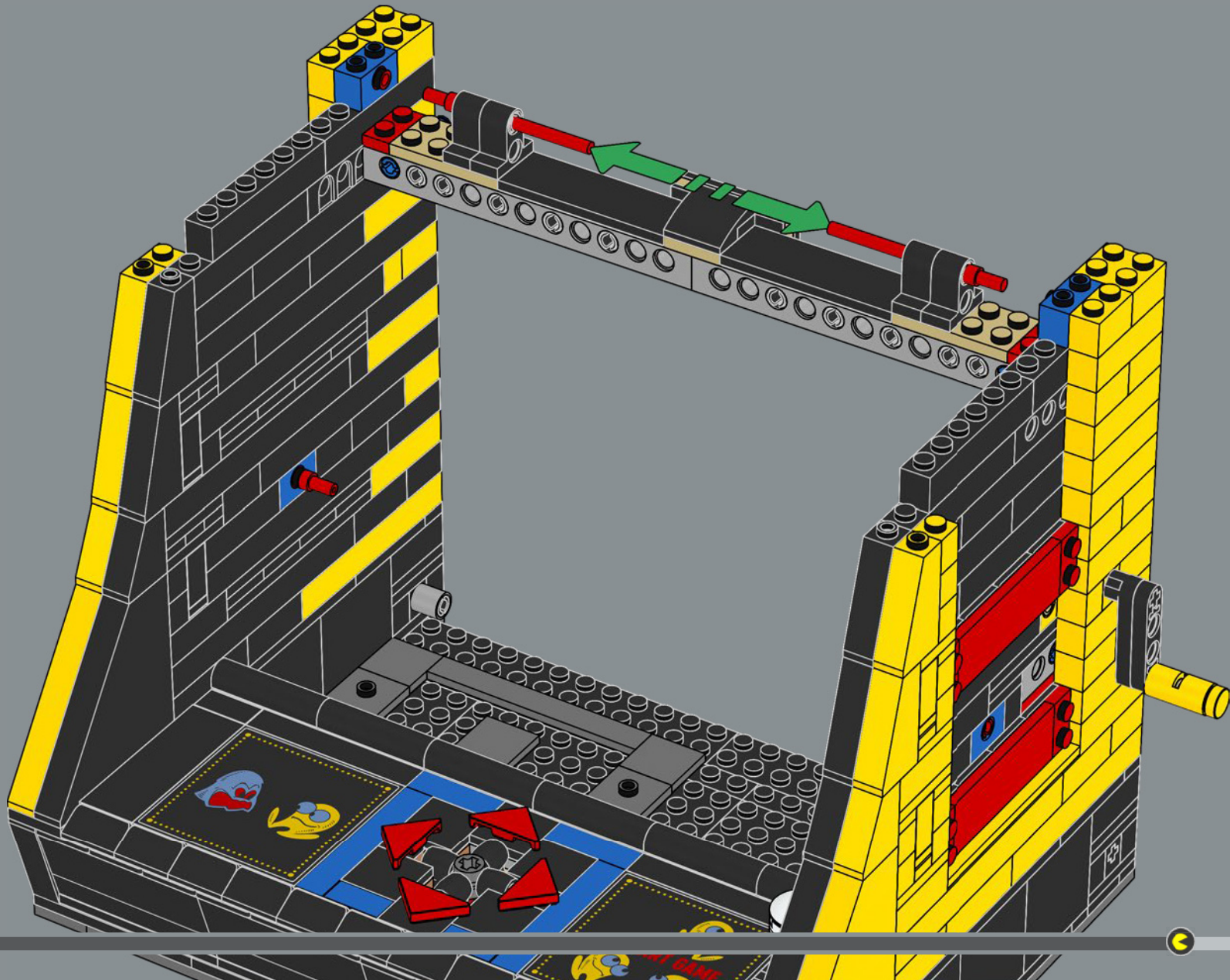

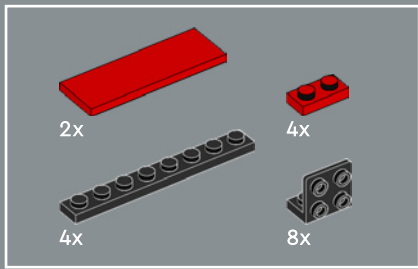

102

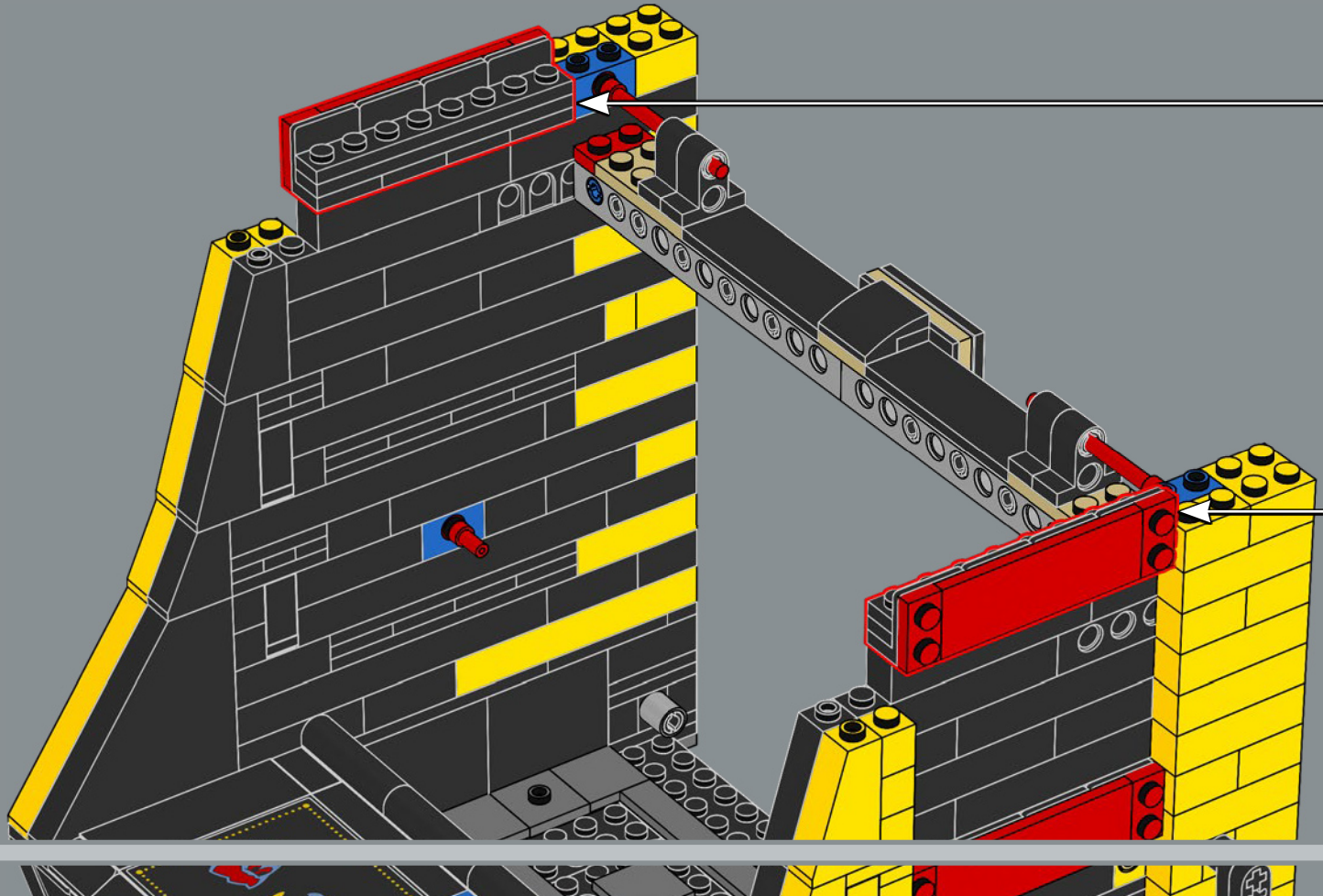
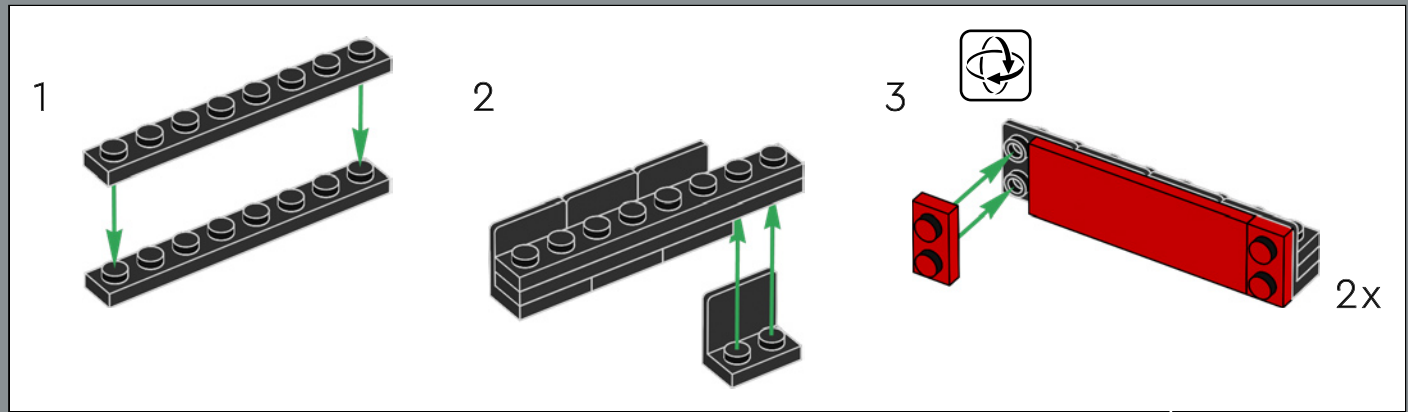

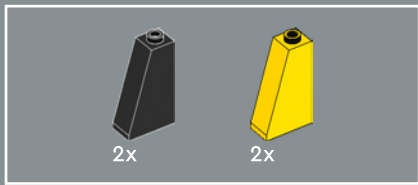

104

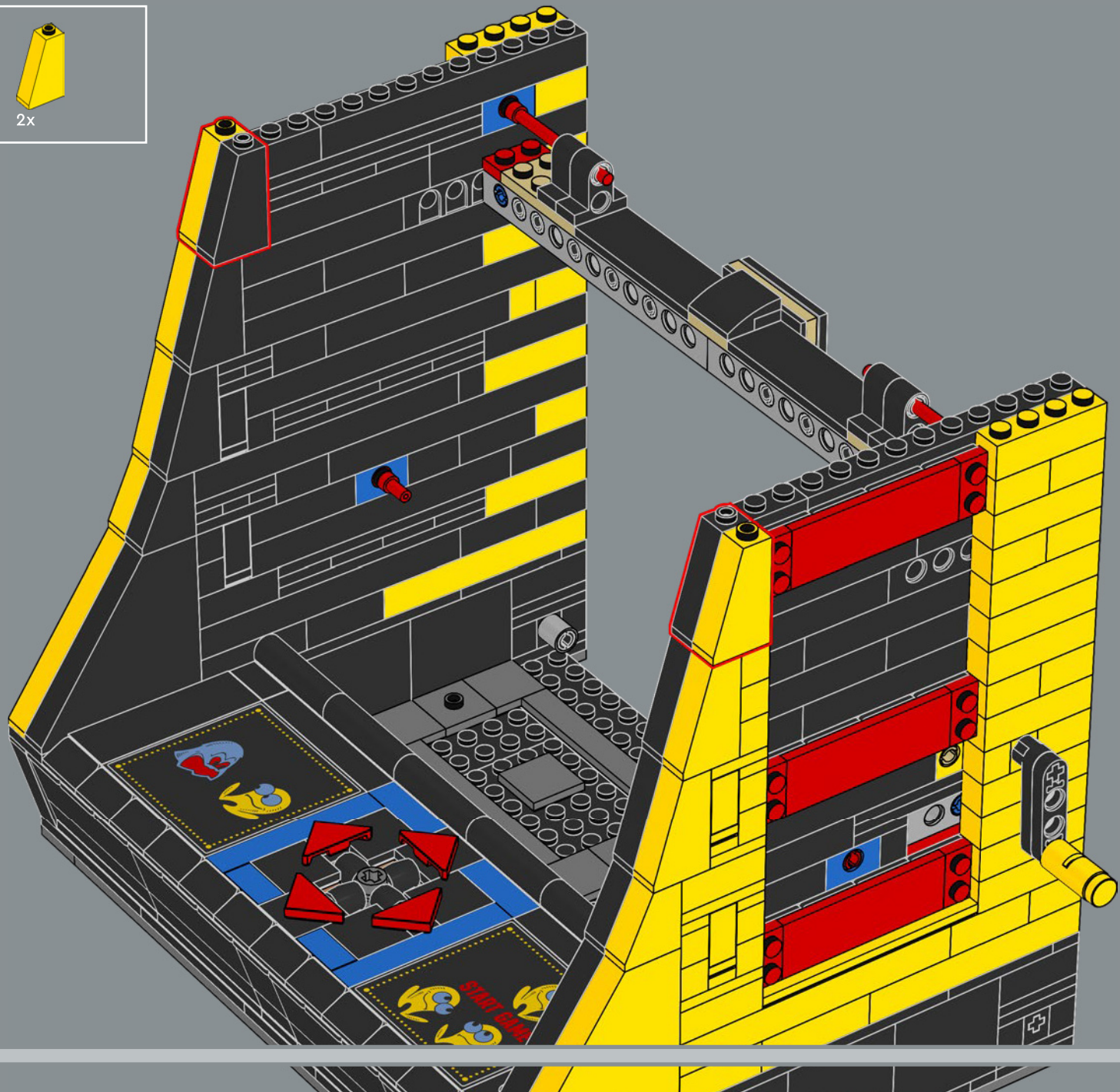

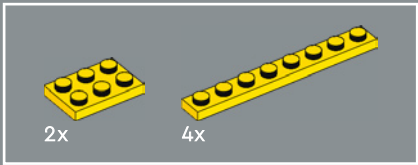

105

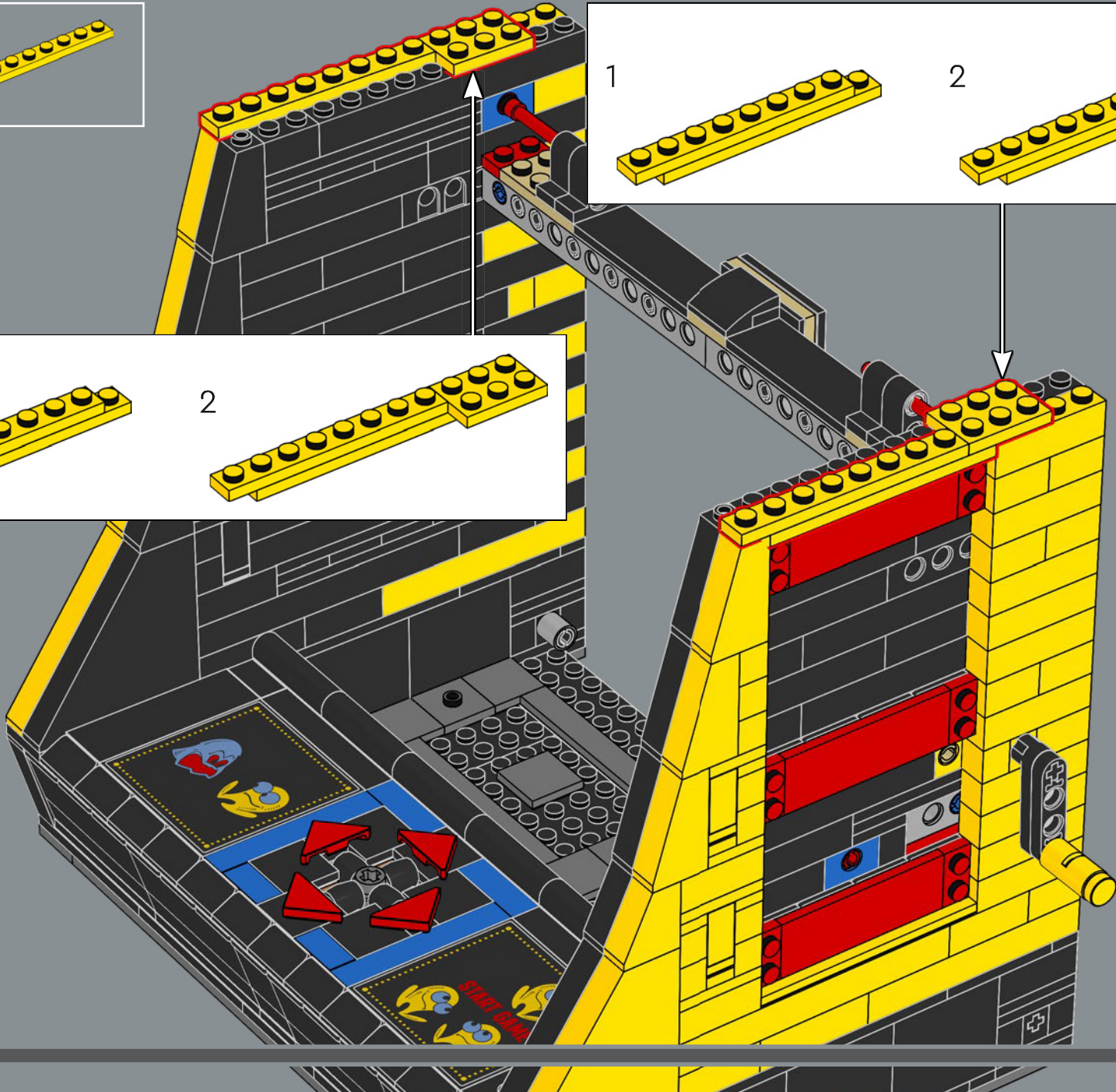
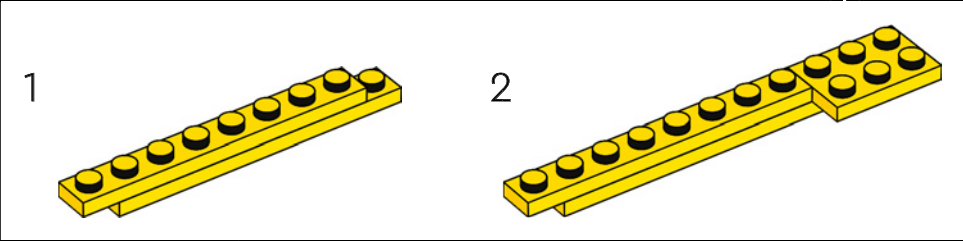
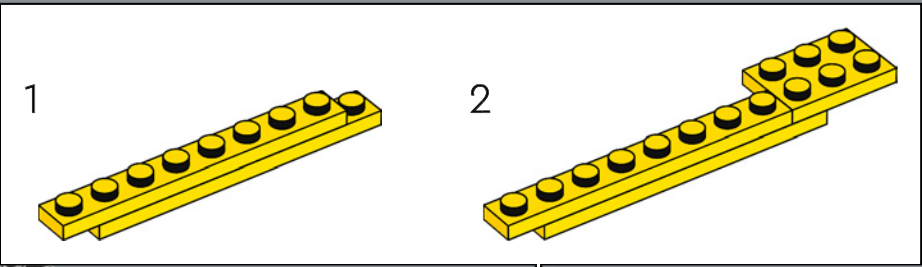

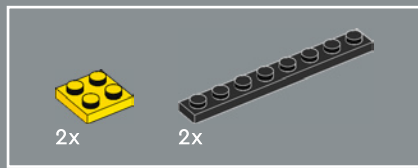

106

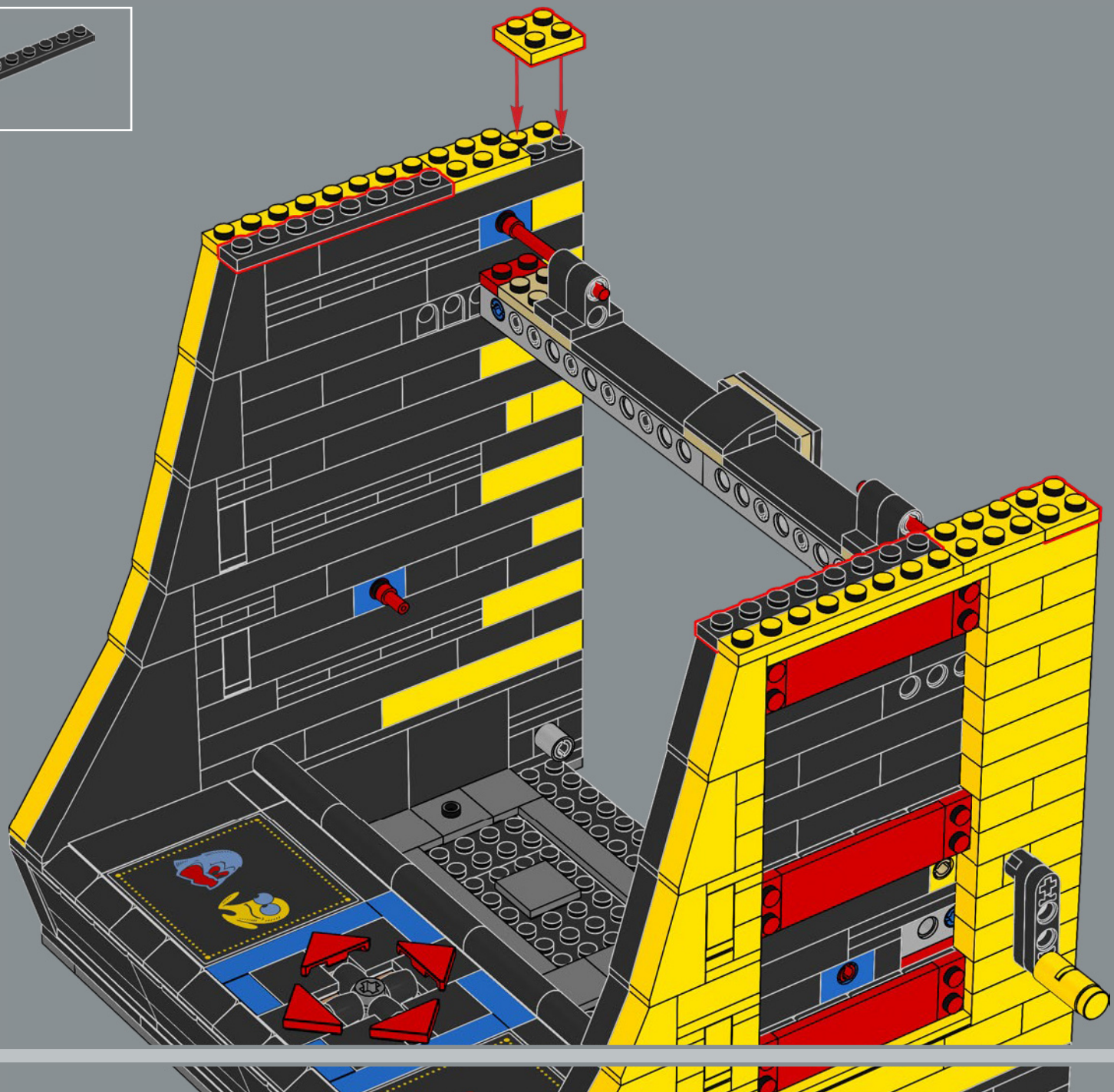



吃豆人这个角色的设计看起来非常快乐且无忧无虑，
能够向玩家传播快乐。

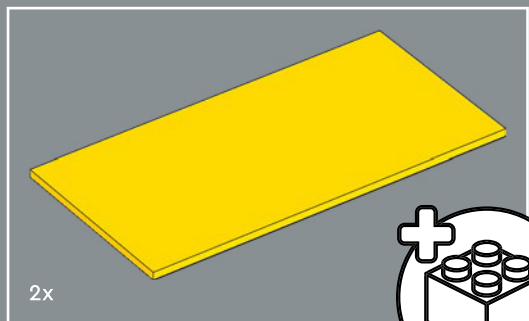

2x

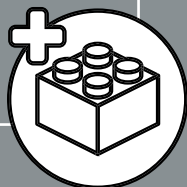

108

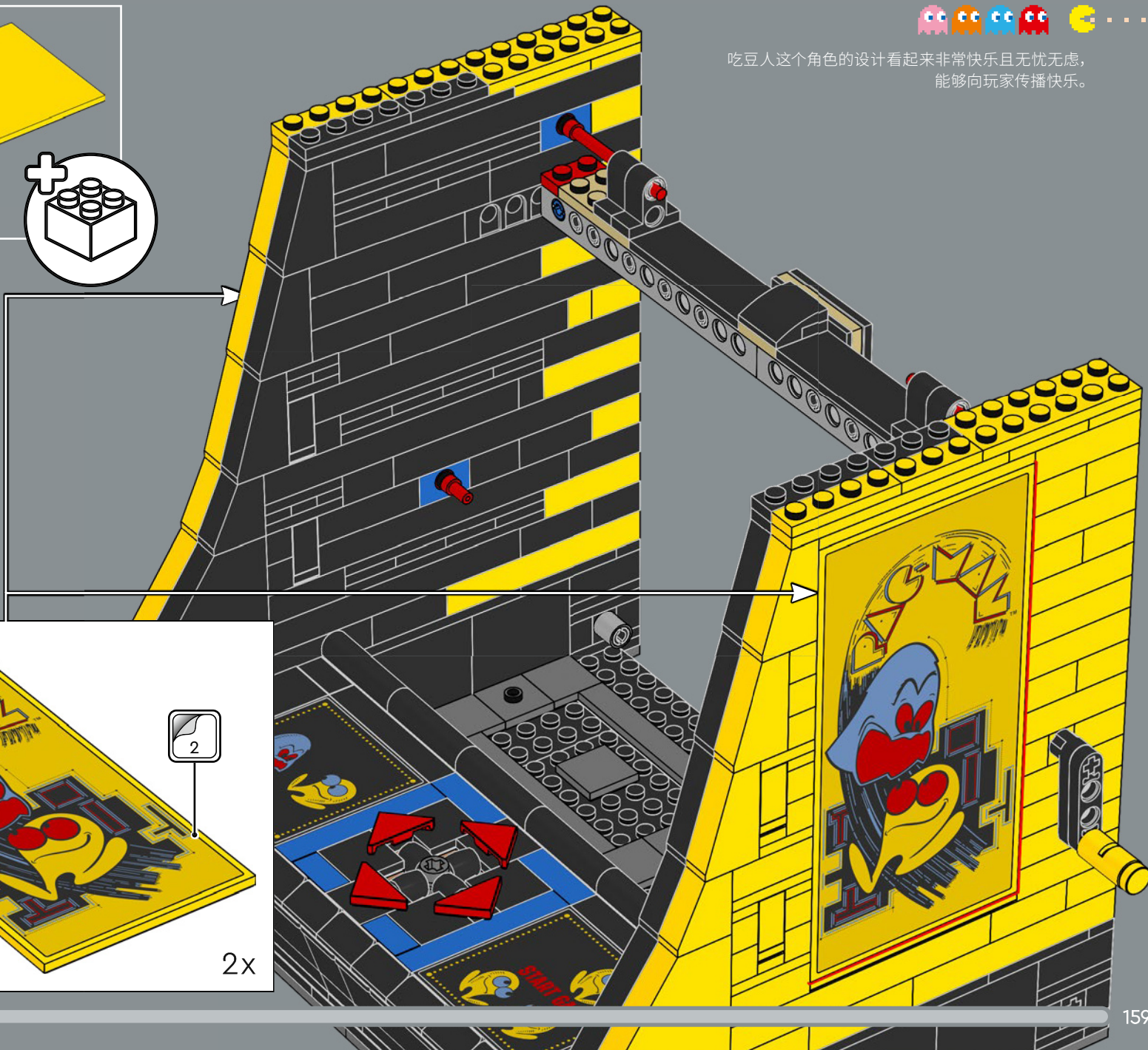

2x

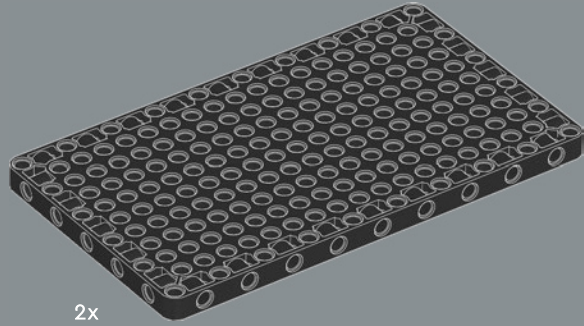
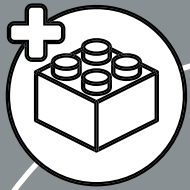

2x

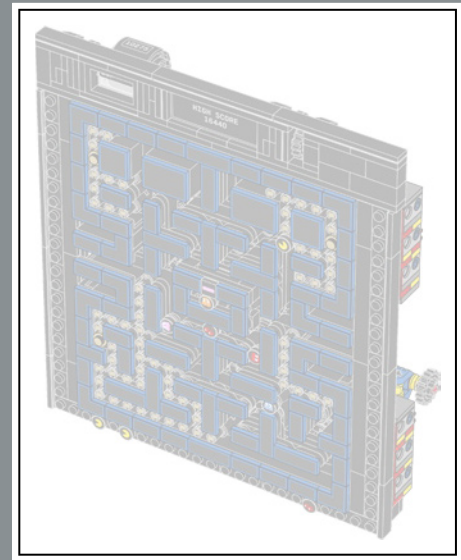

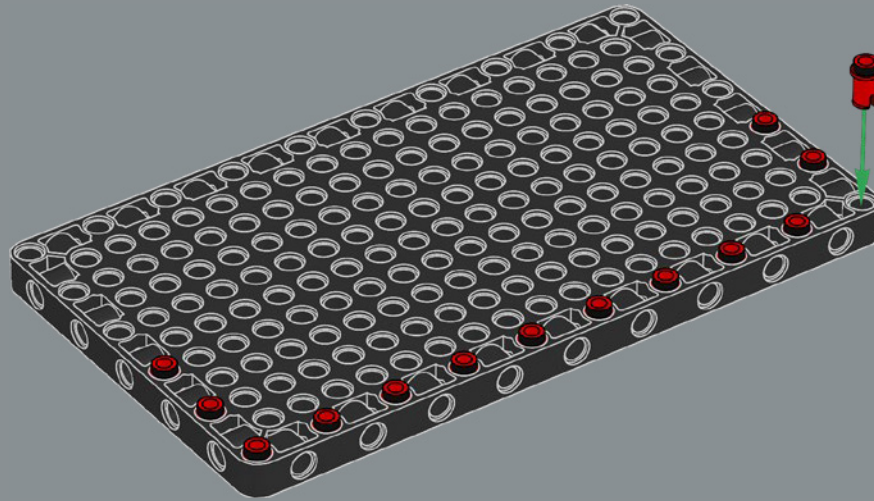
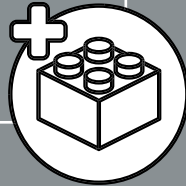
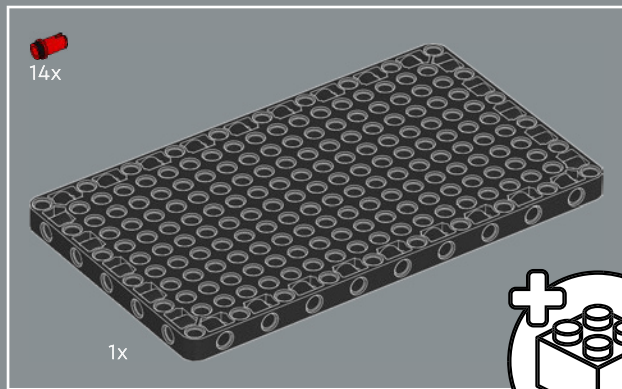

109

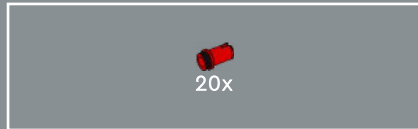

110

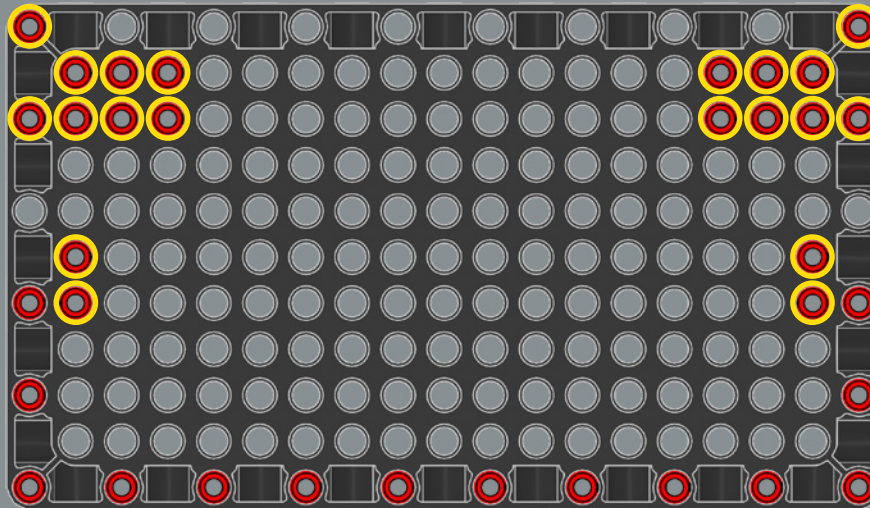

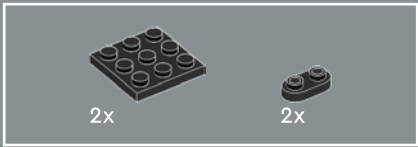

111

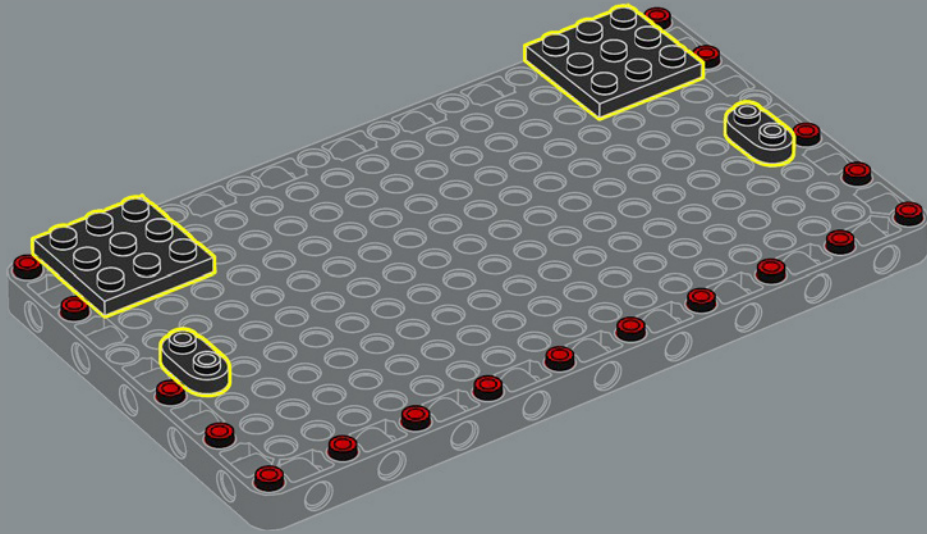

112

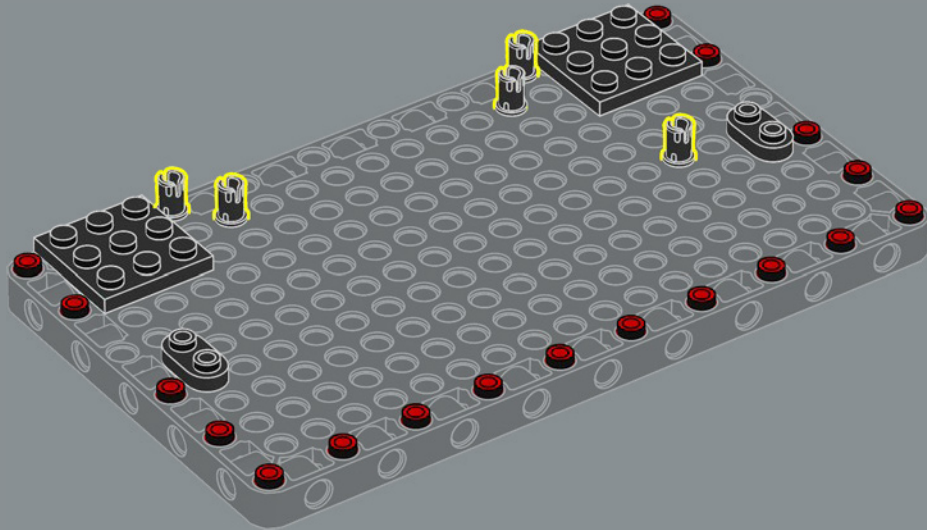



113

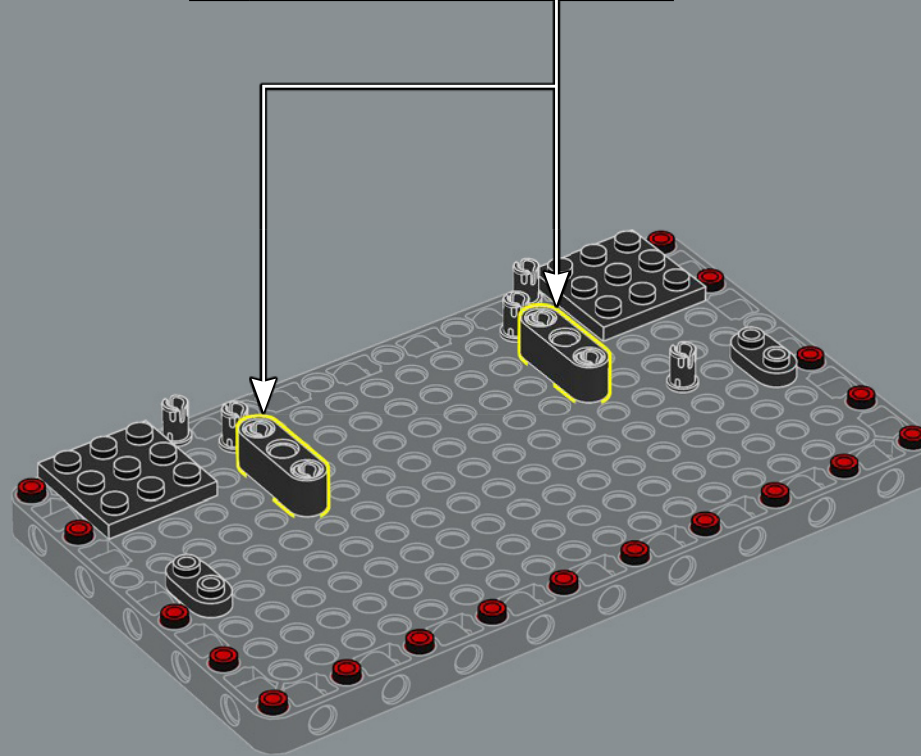
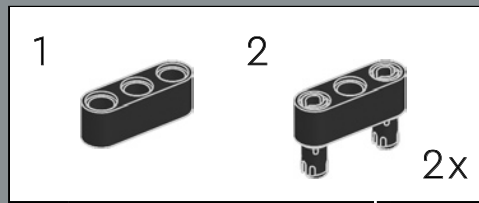

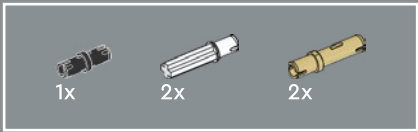

114

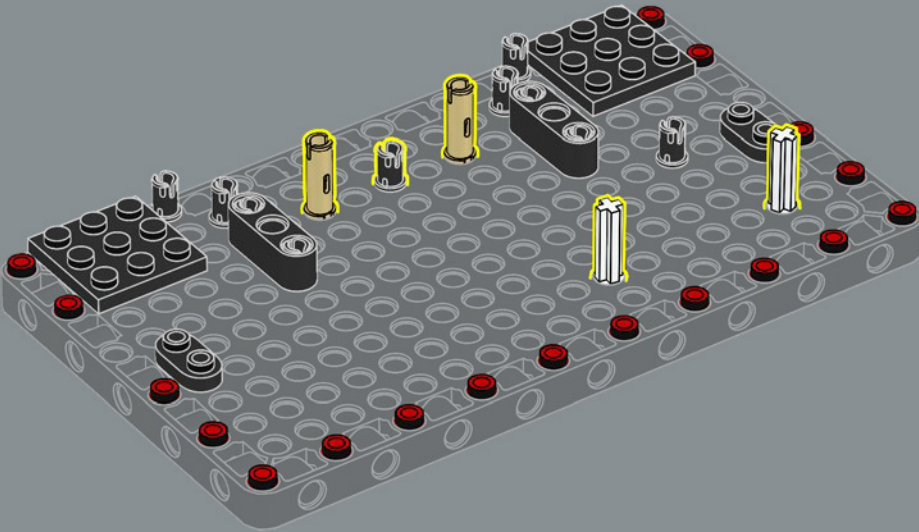
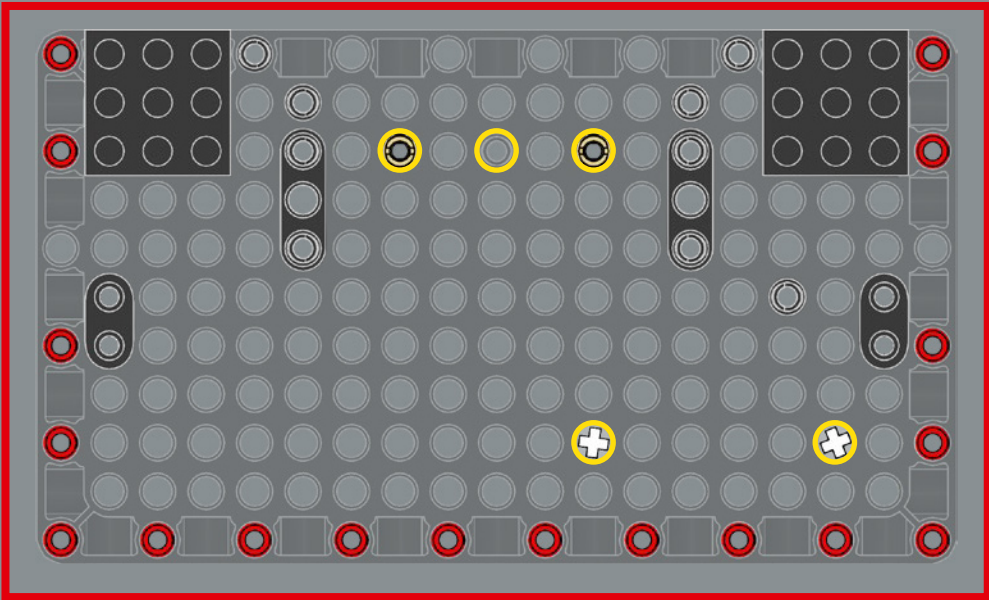



115

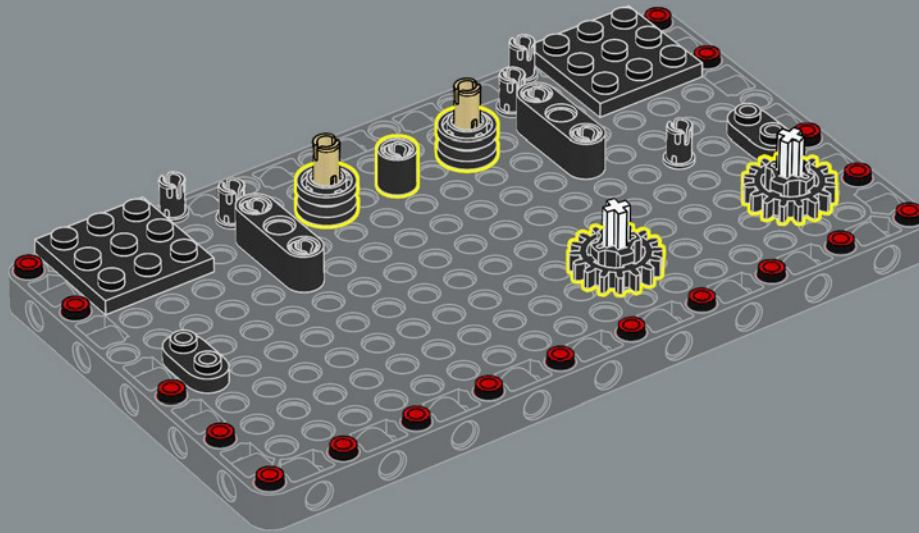

116

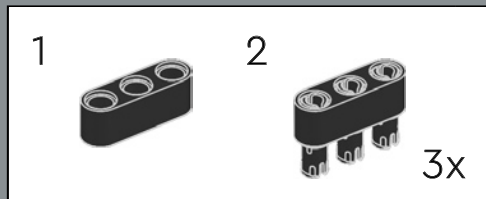
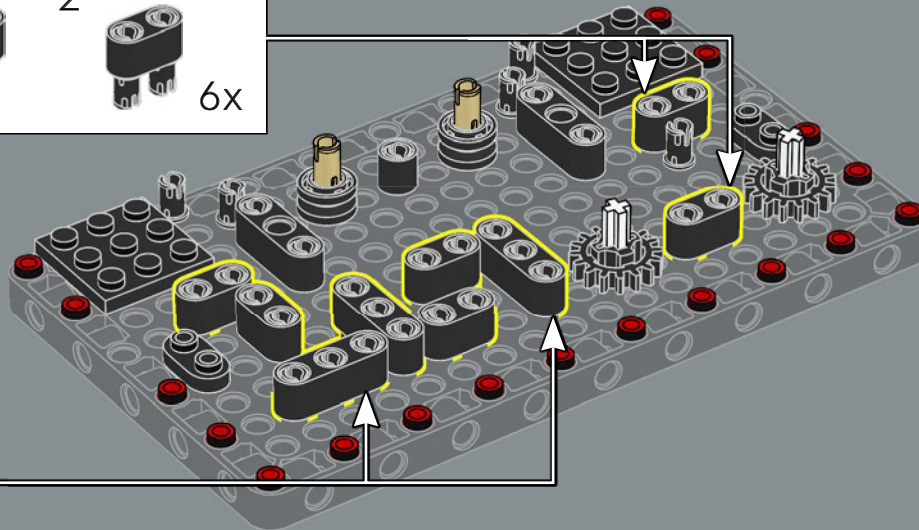
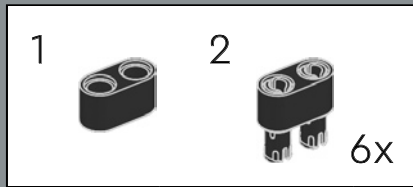



117

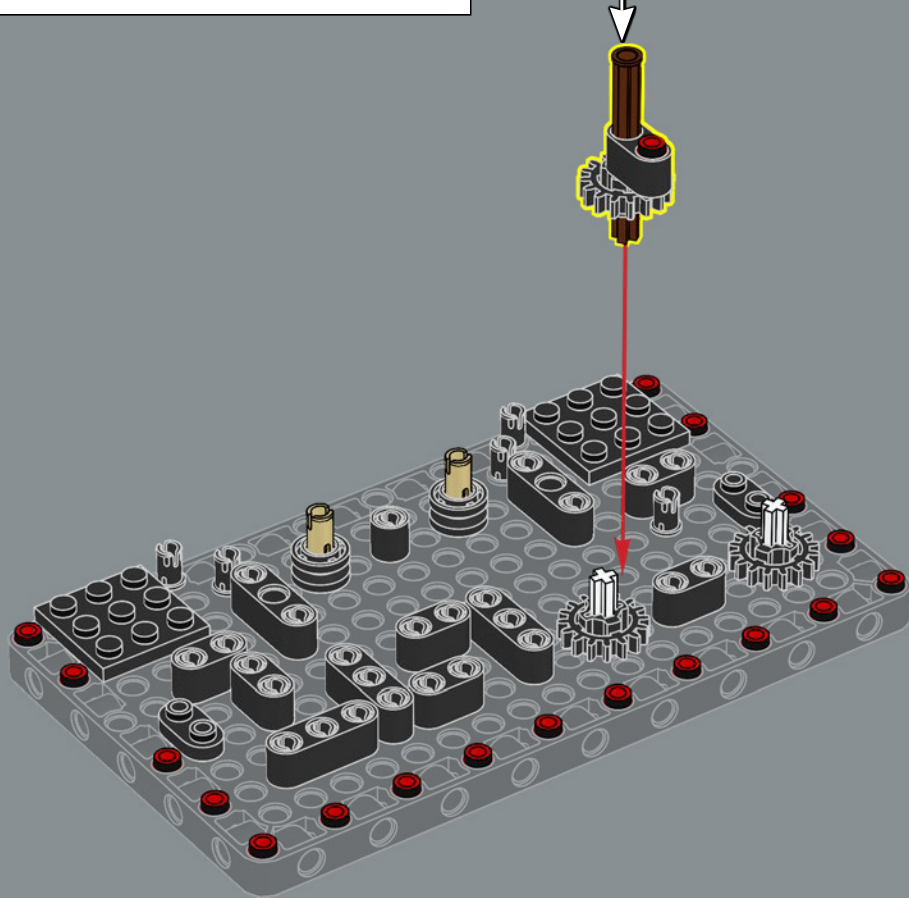
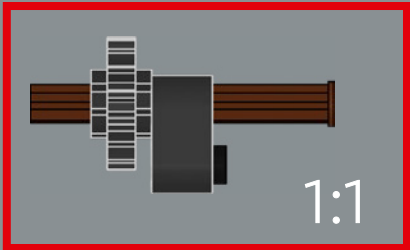
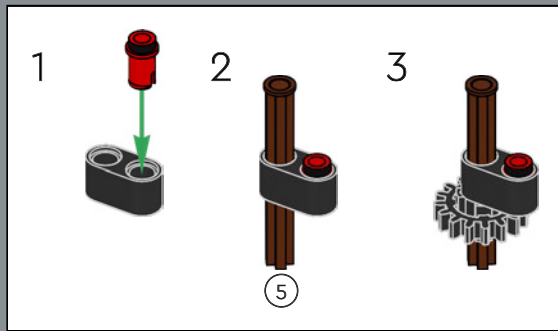

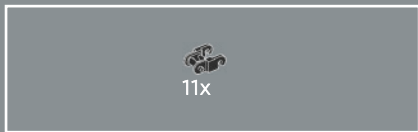

118

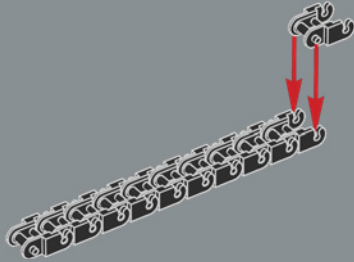

119

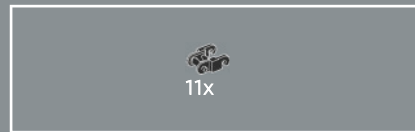
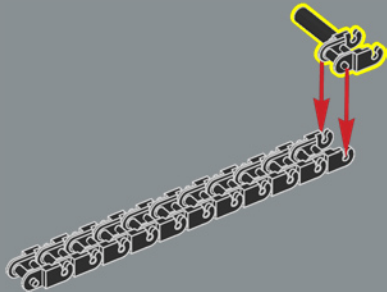

120

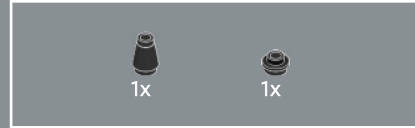
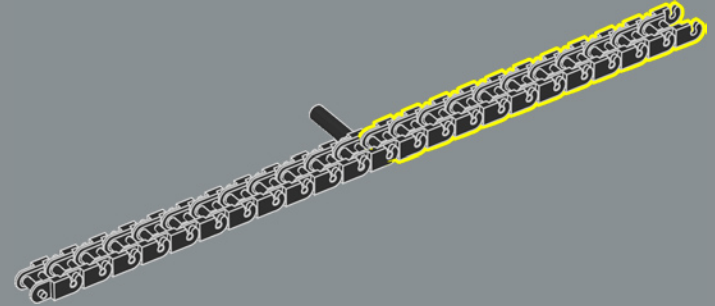

121

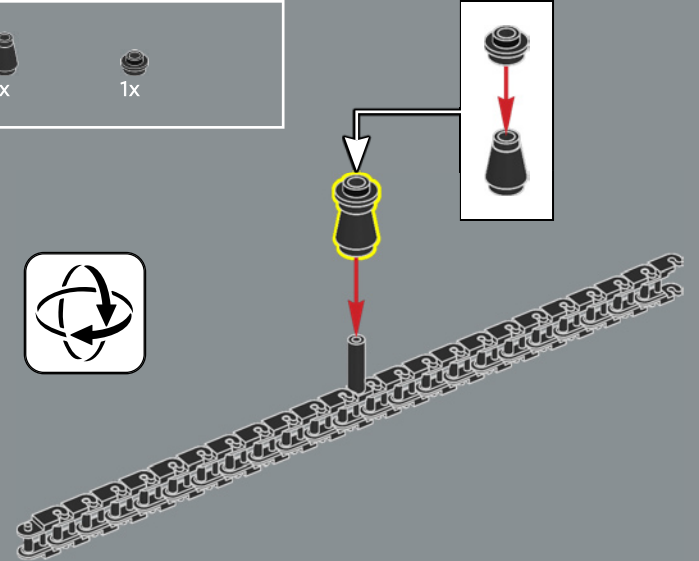

1x



122

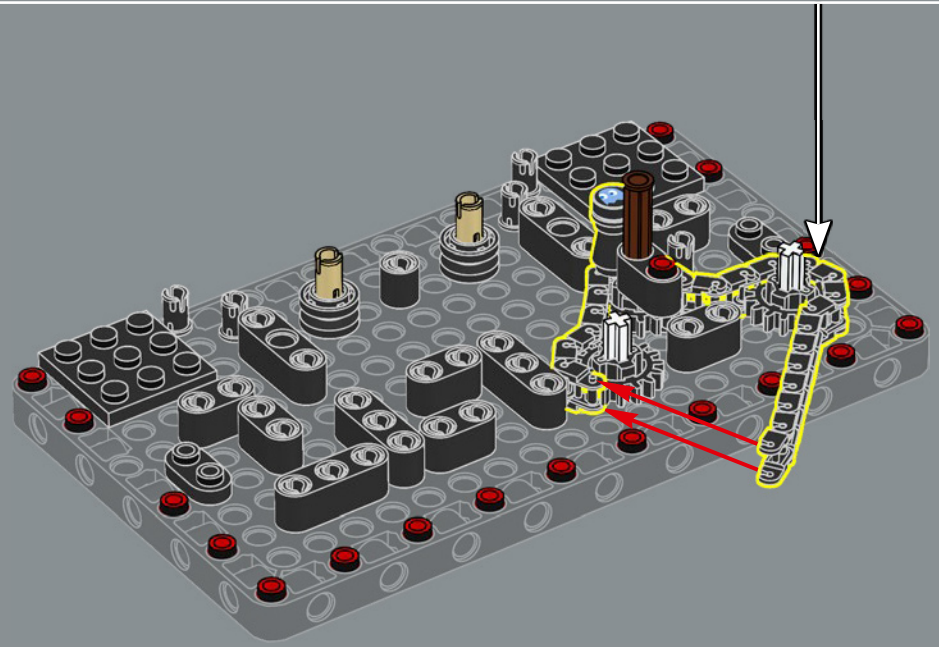
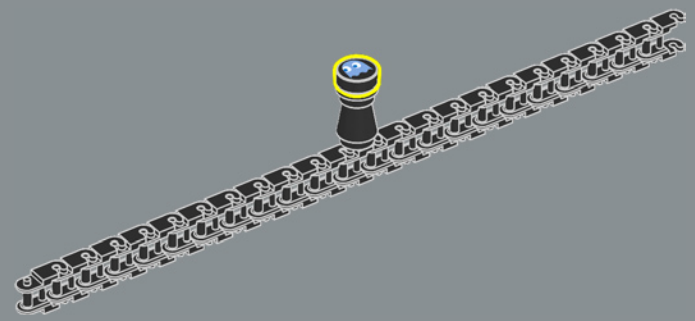

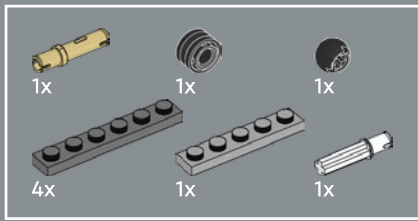

123

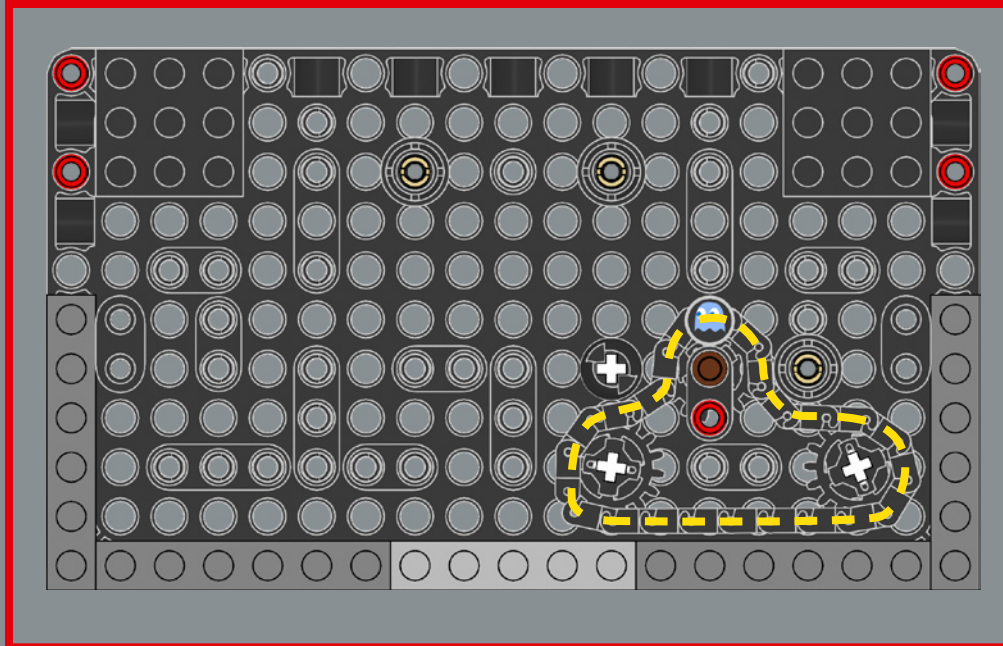
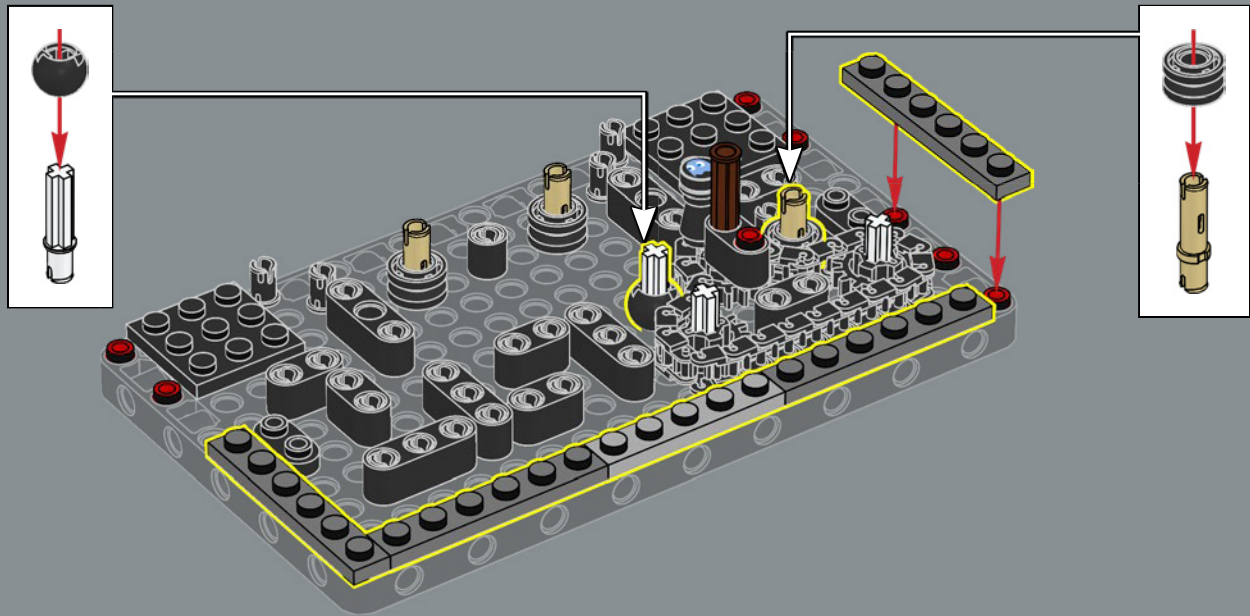

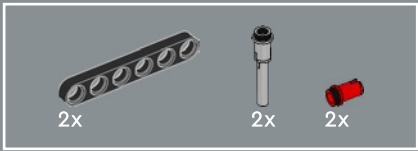

124

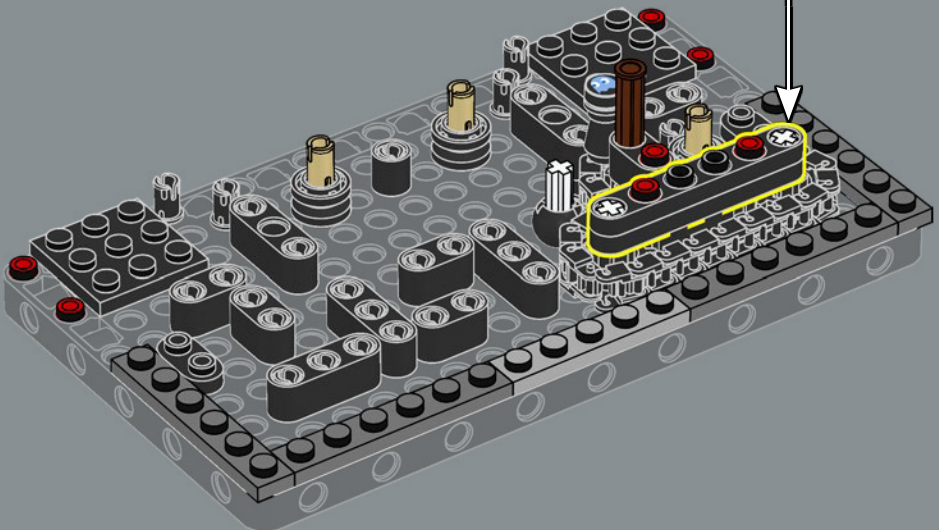
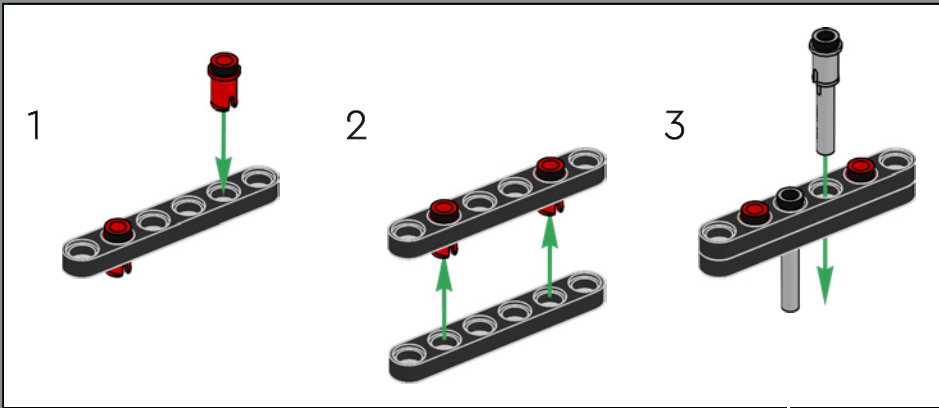

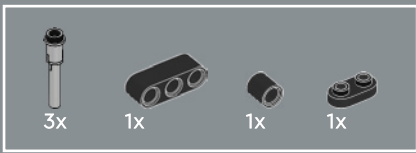

125

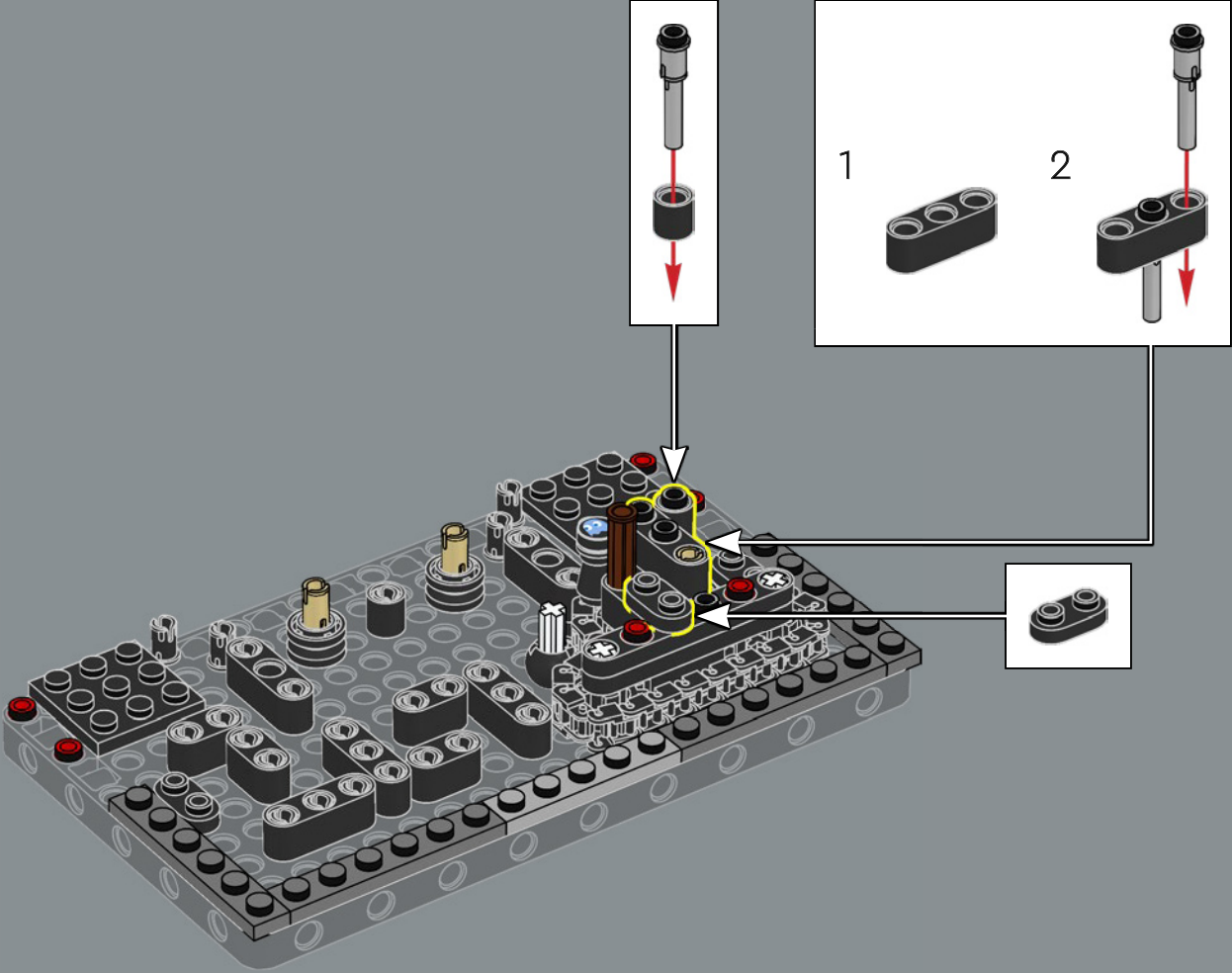

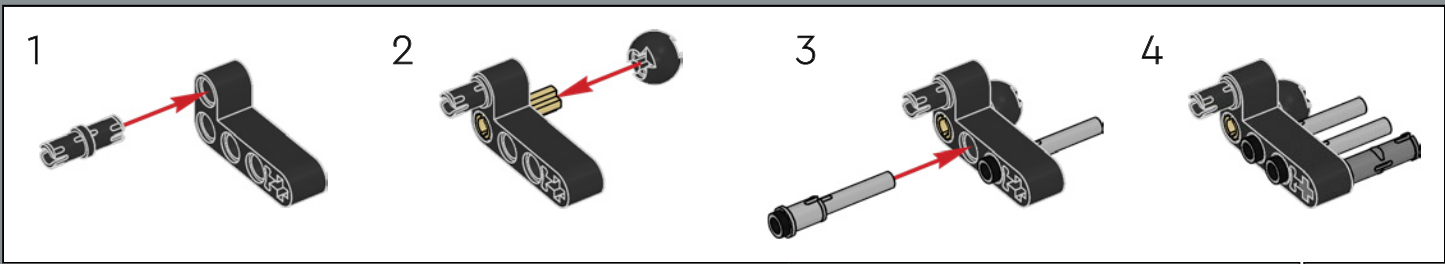
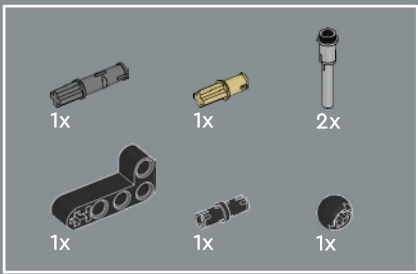

126

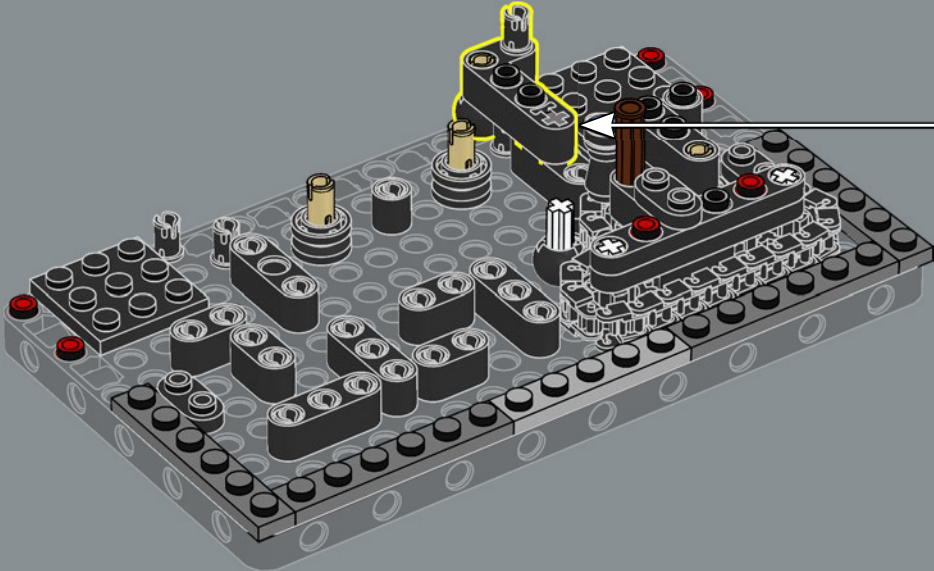

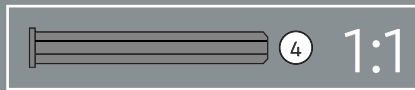
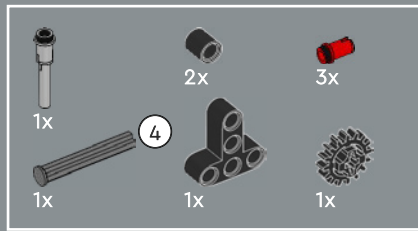

127

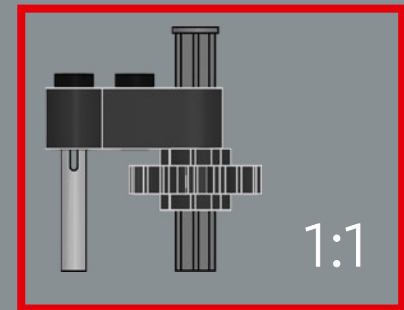
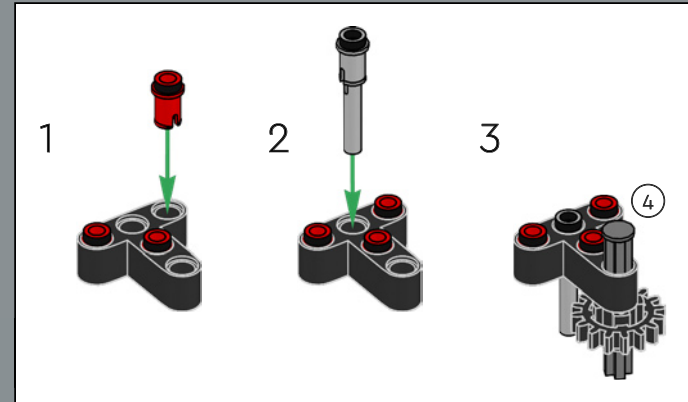
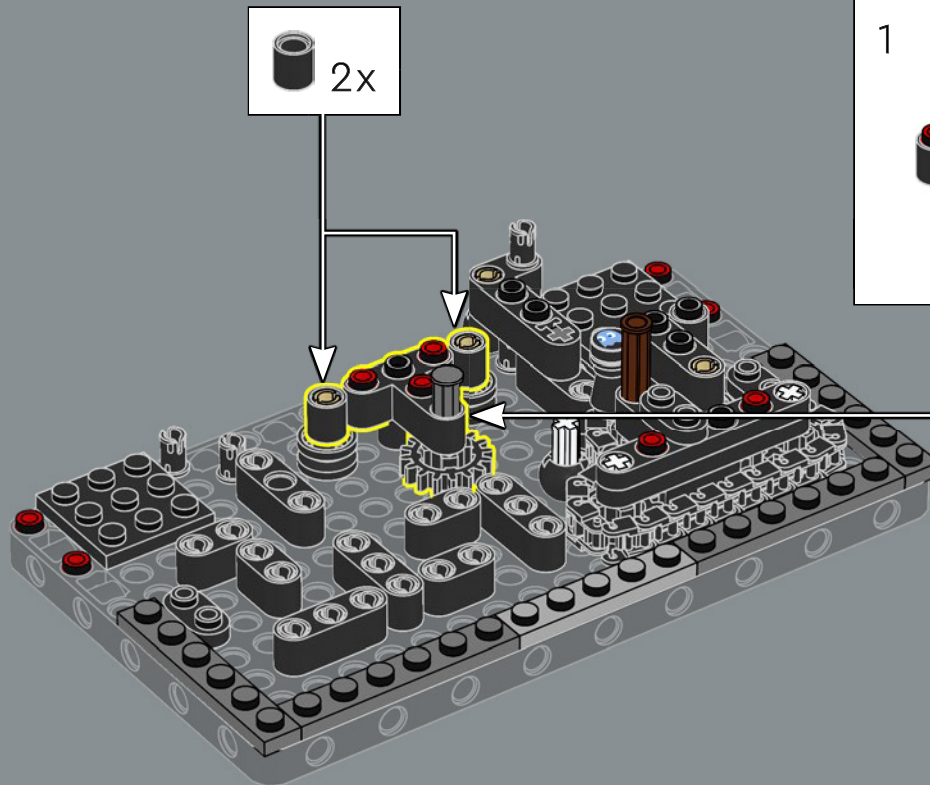

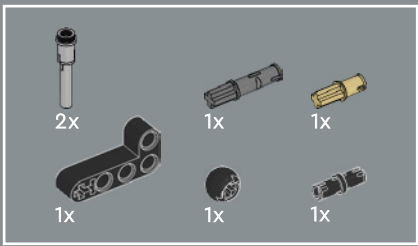

128

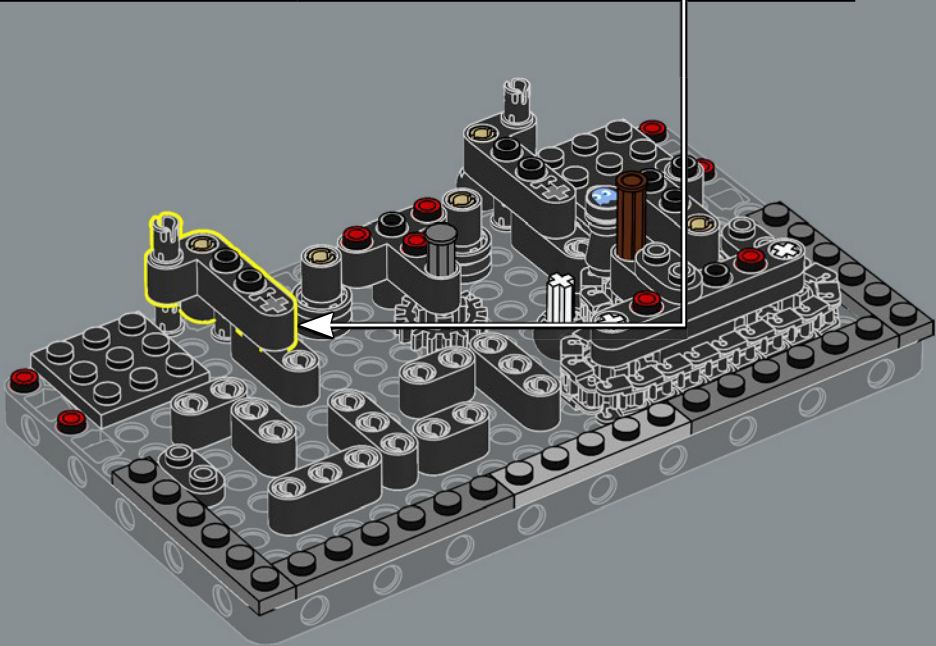
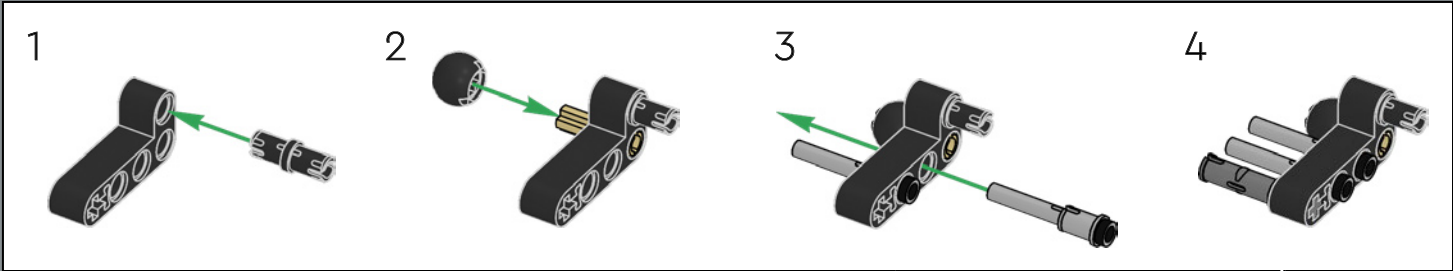

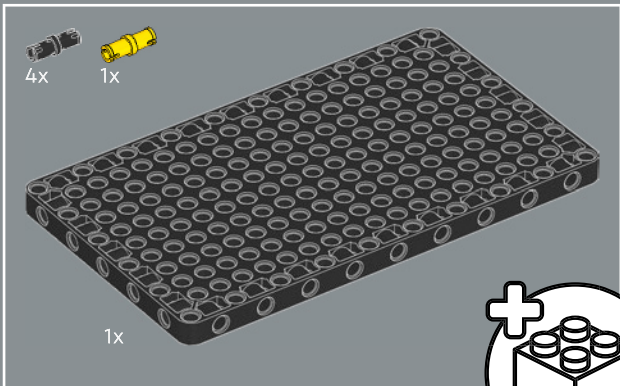
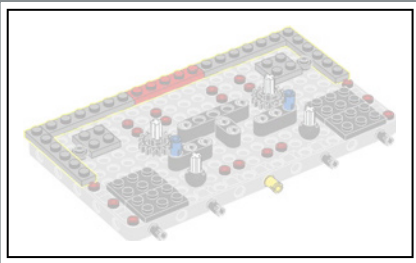

129

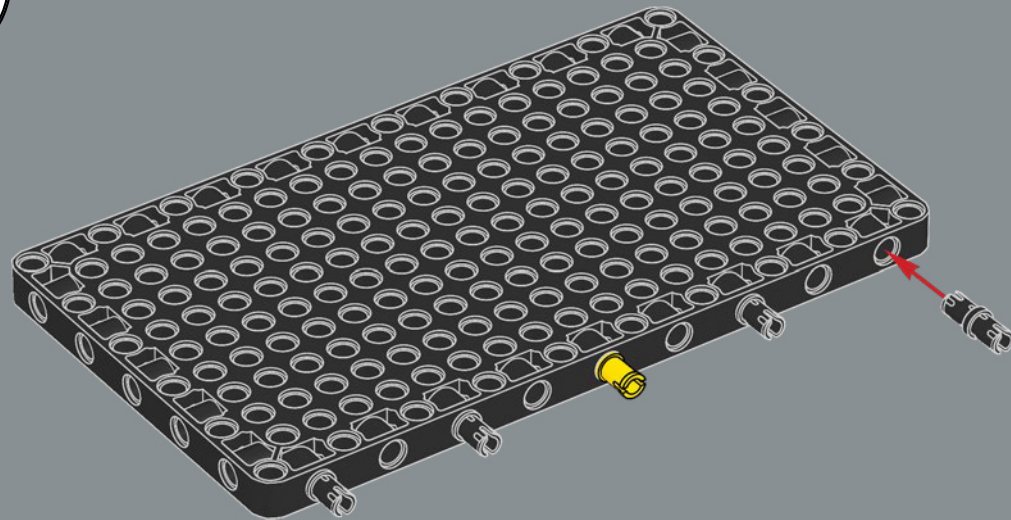



20x

130

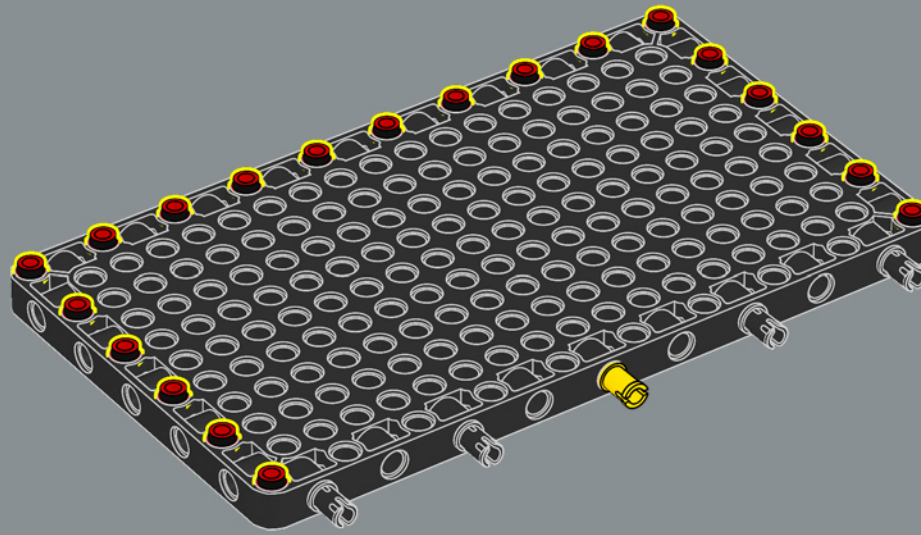

34x

131

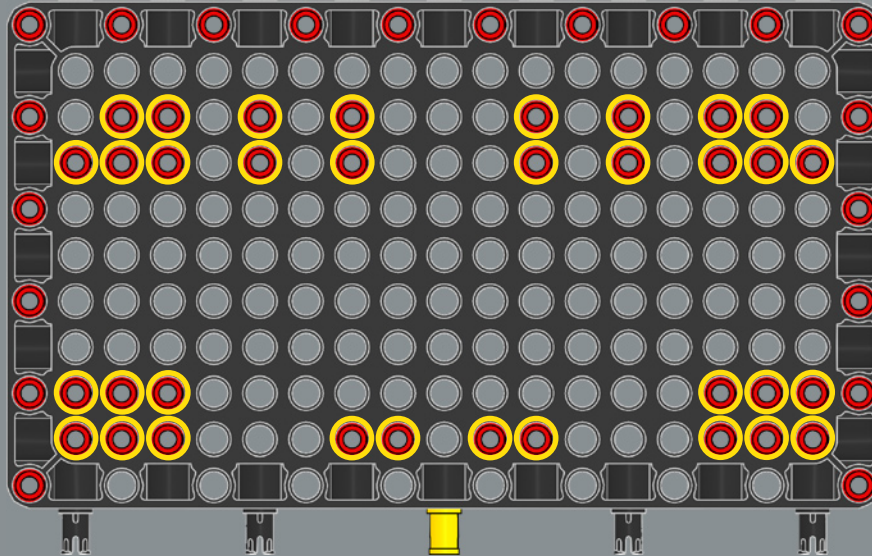

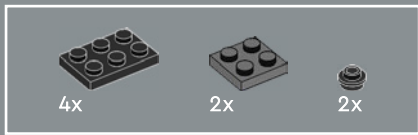

132

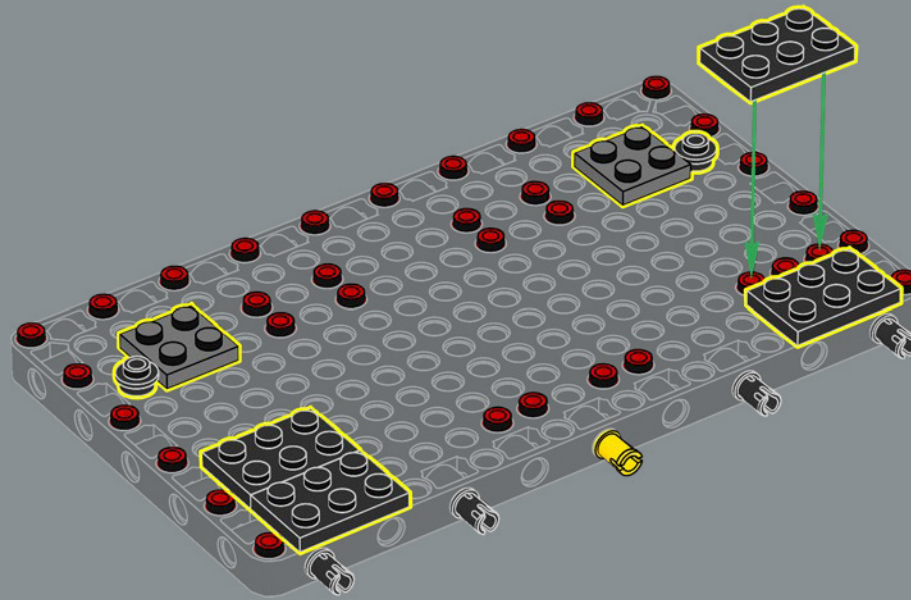

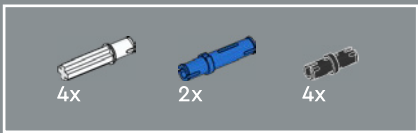

133

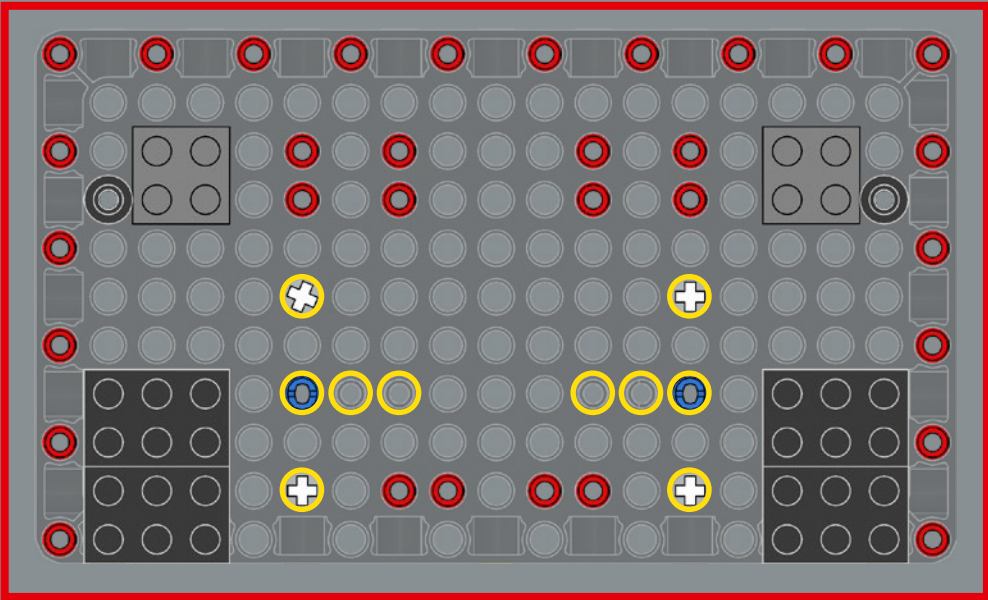
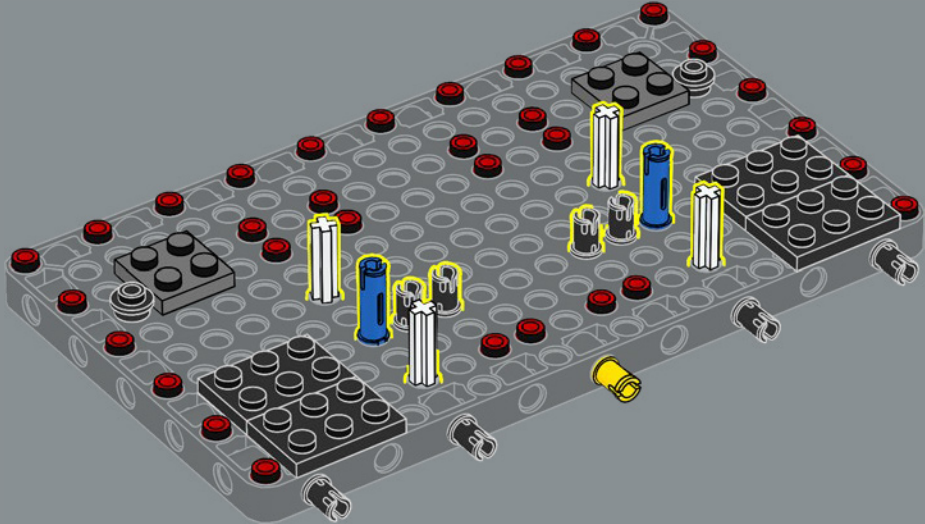

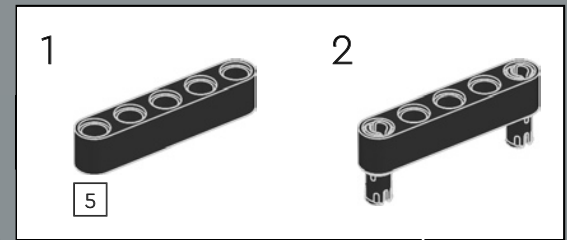
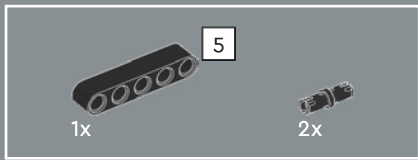

134

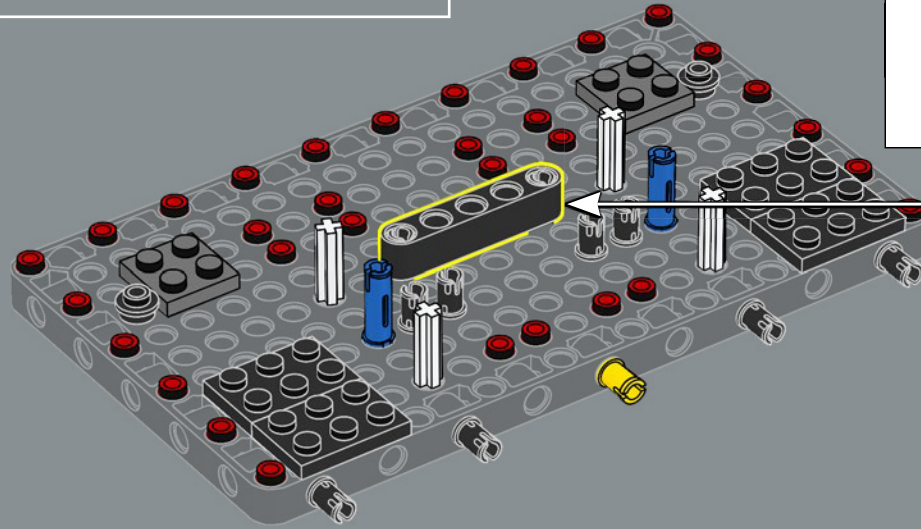

135

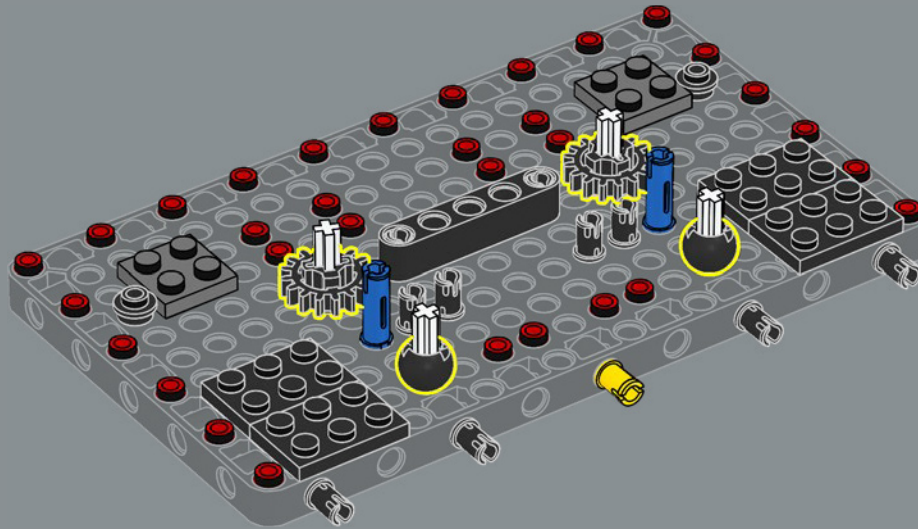



136

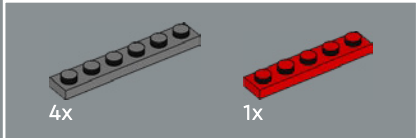
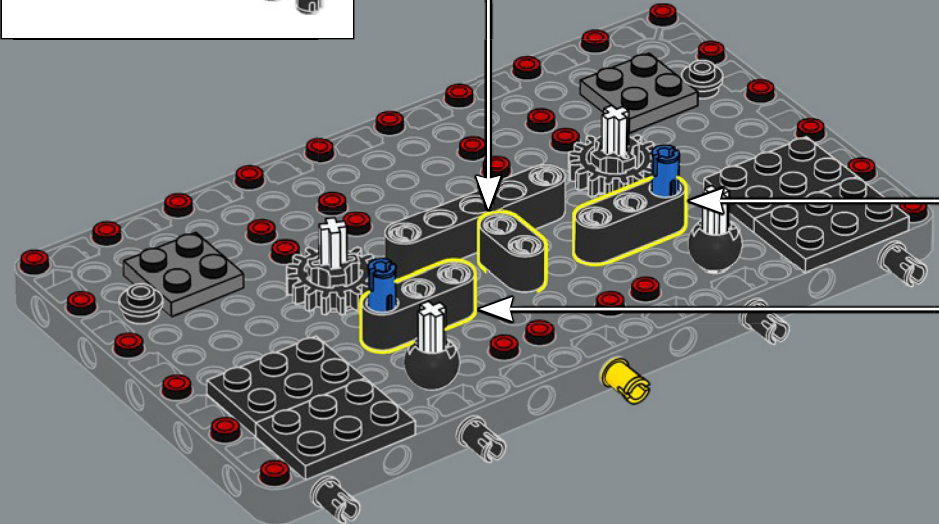
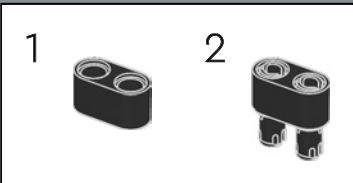

137

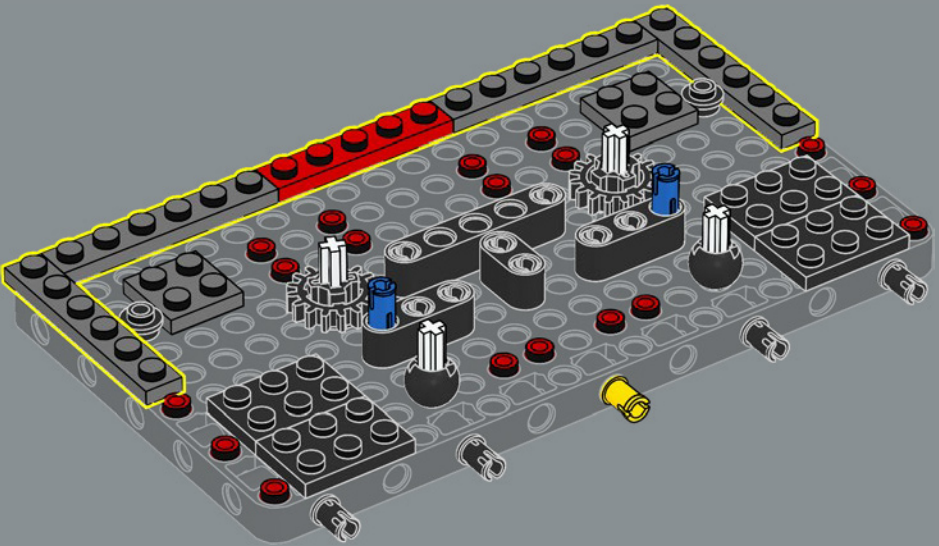

138

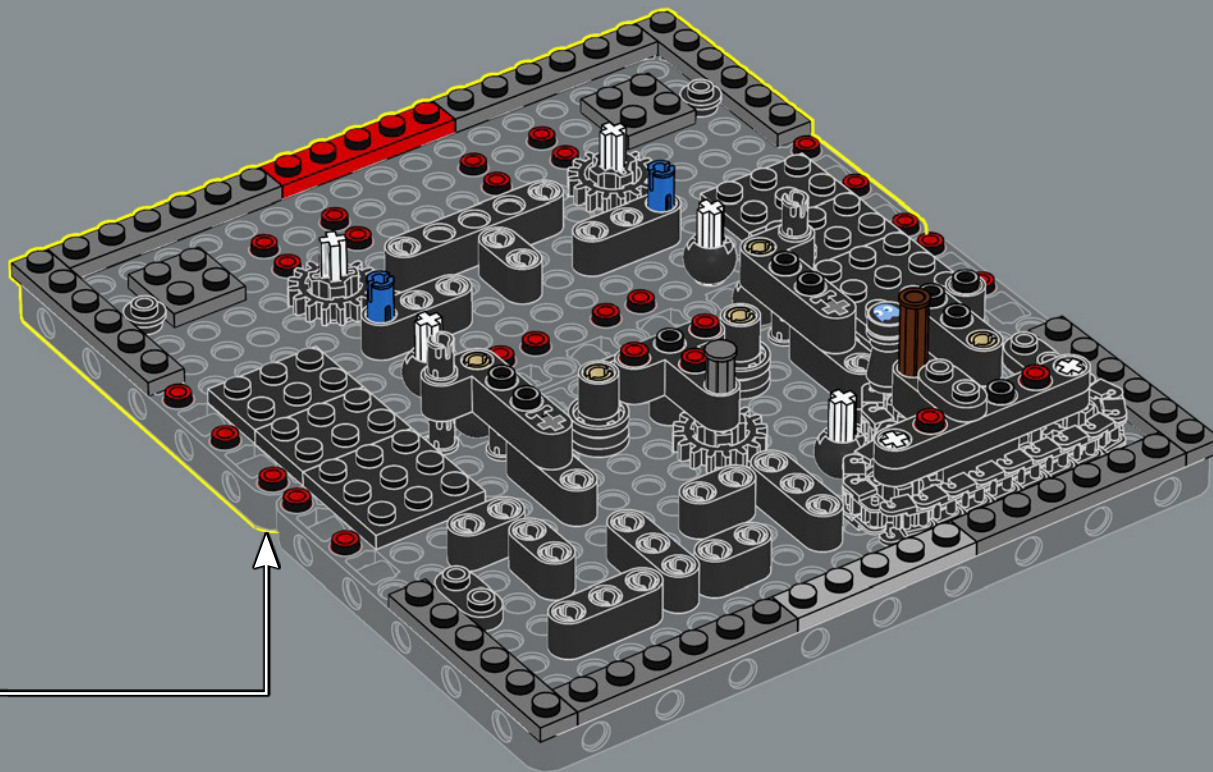

11x

139

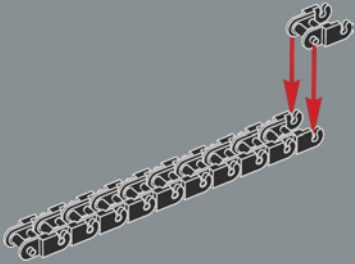

1x

140

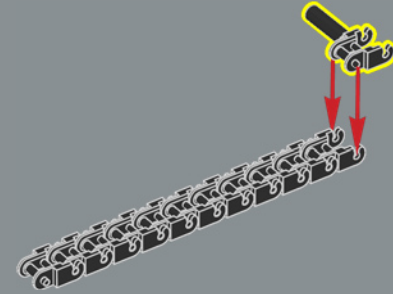

3x



141

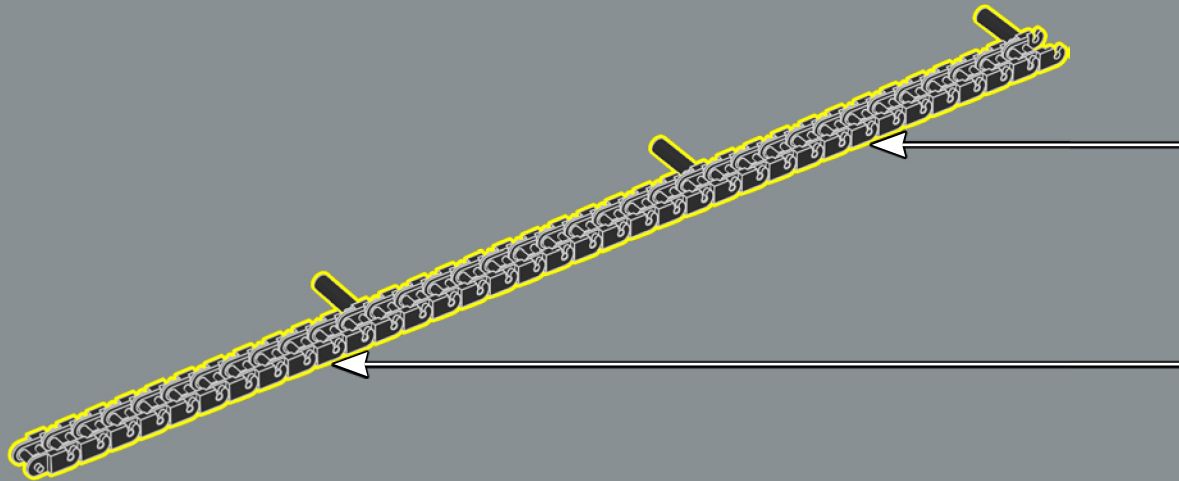



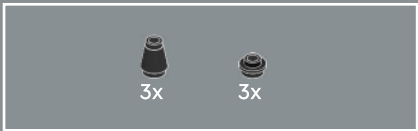
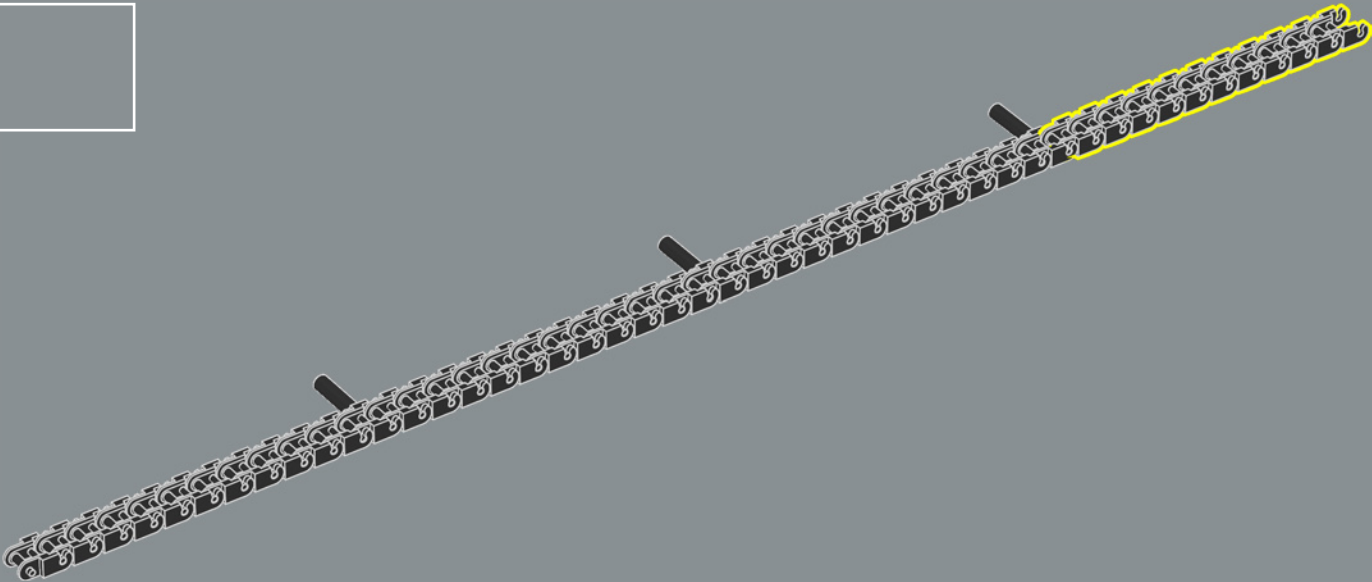

142

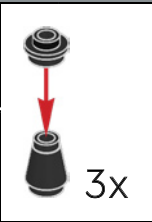
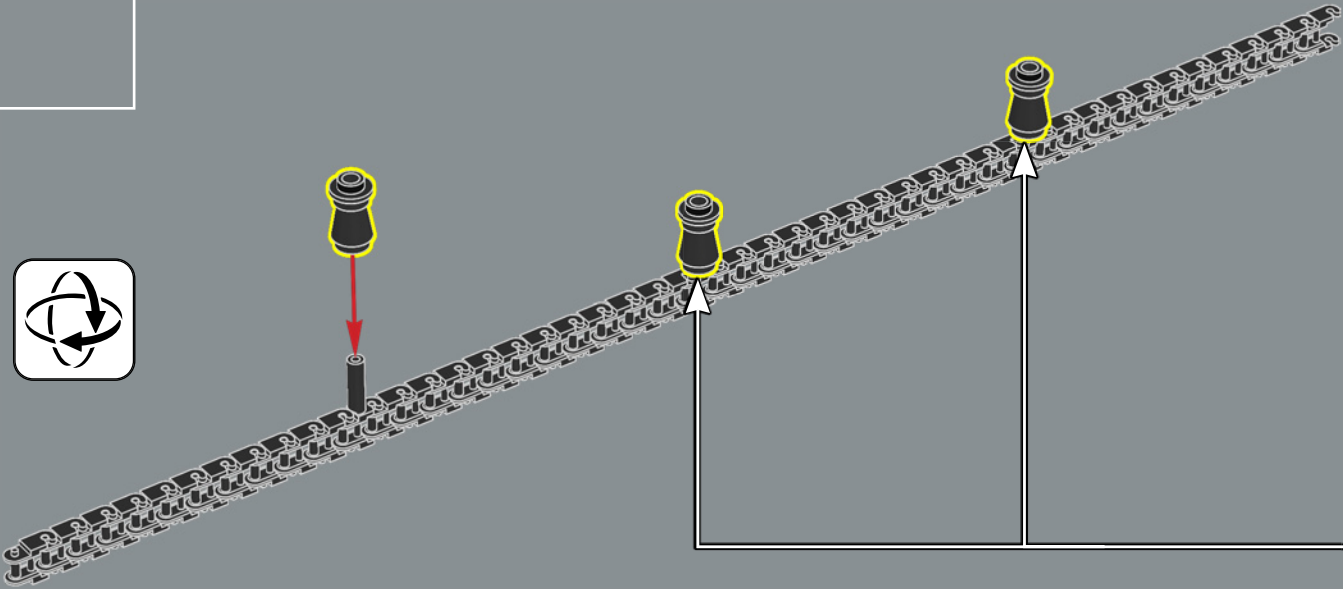

143



- 1x 
- 1x 
- 1x 

144

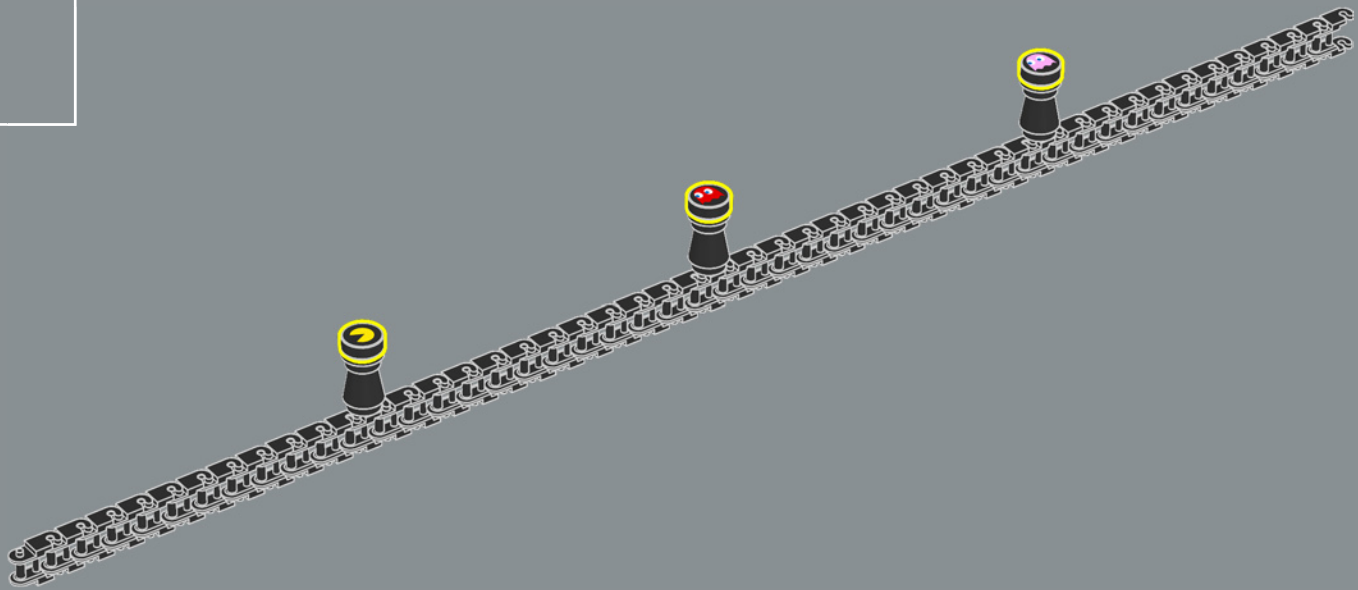

145

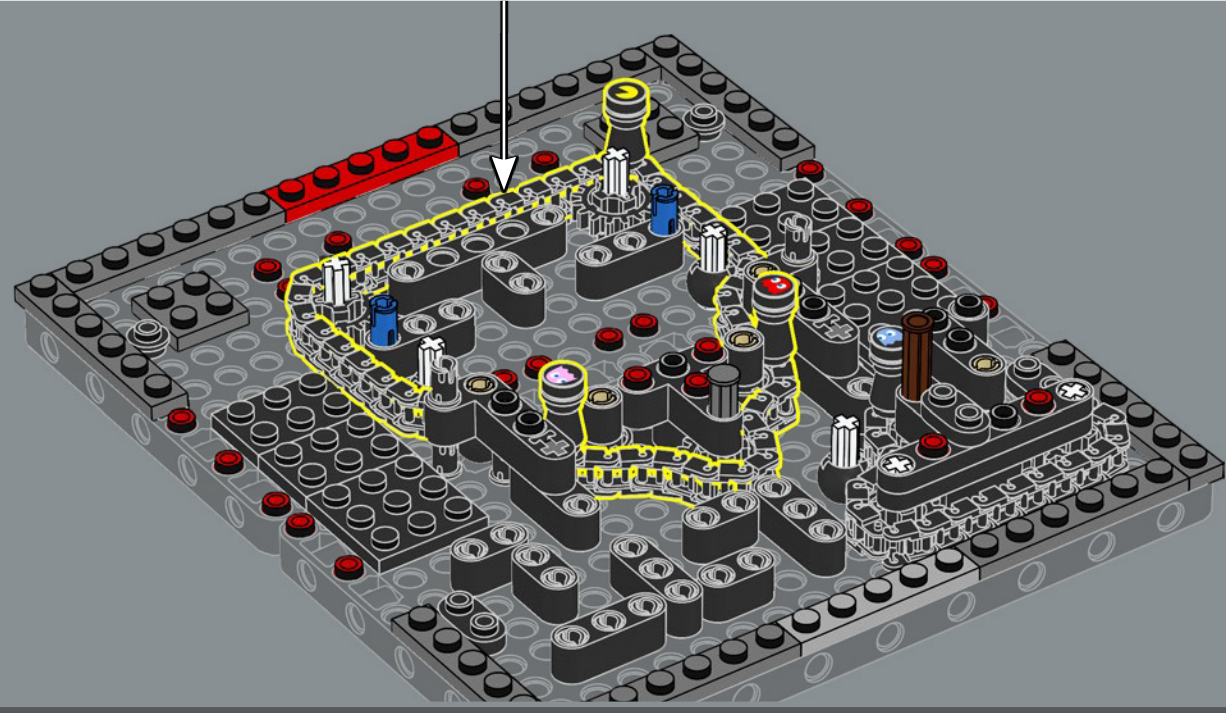

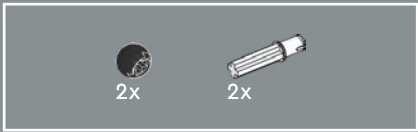

146

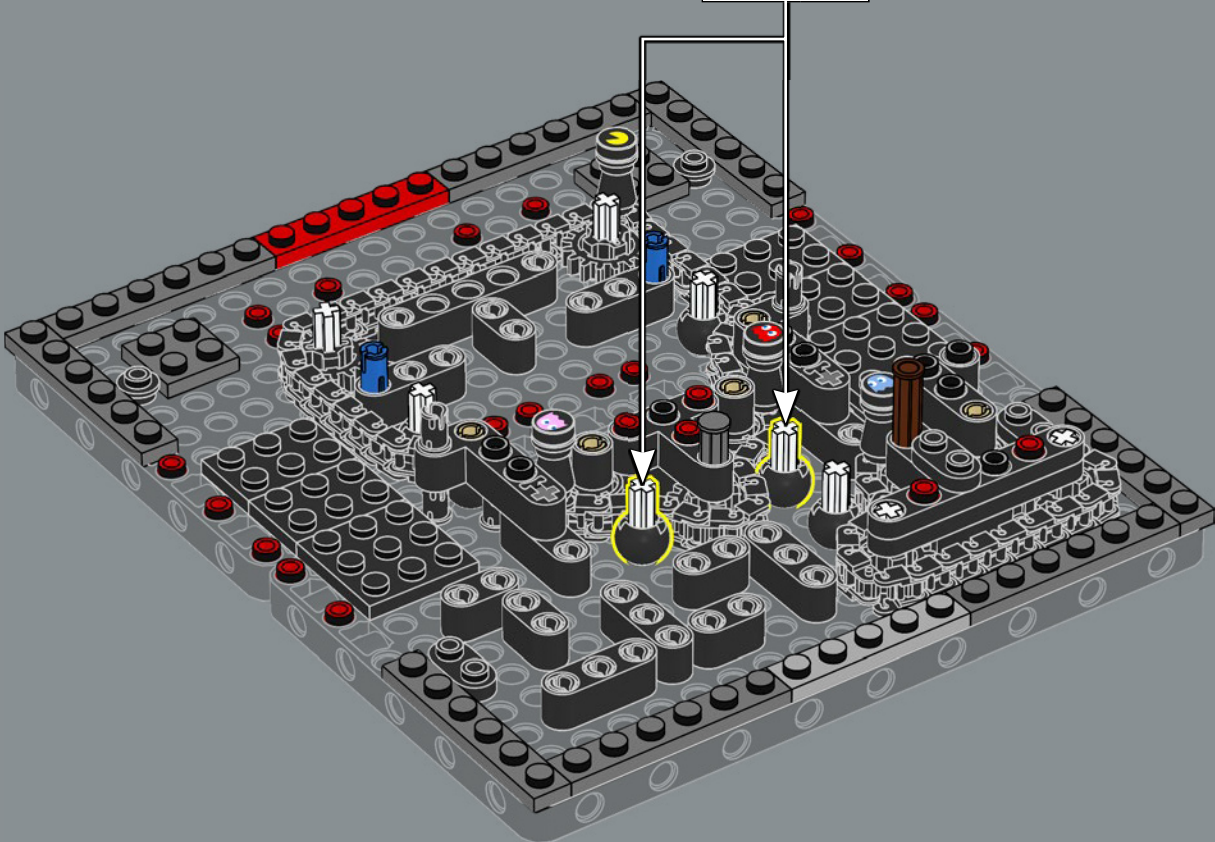
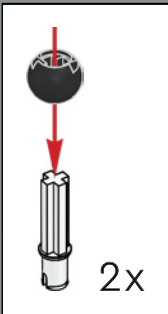

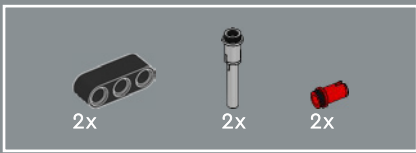

147

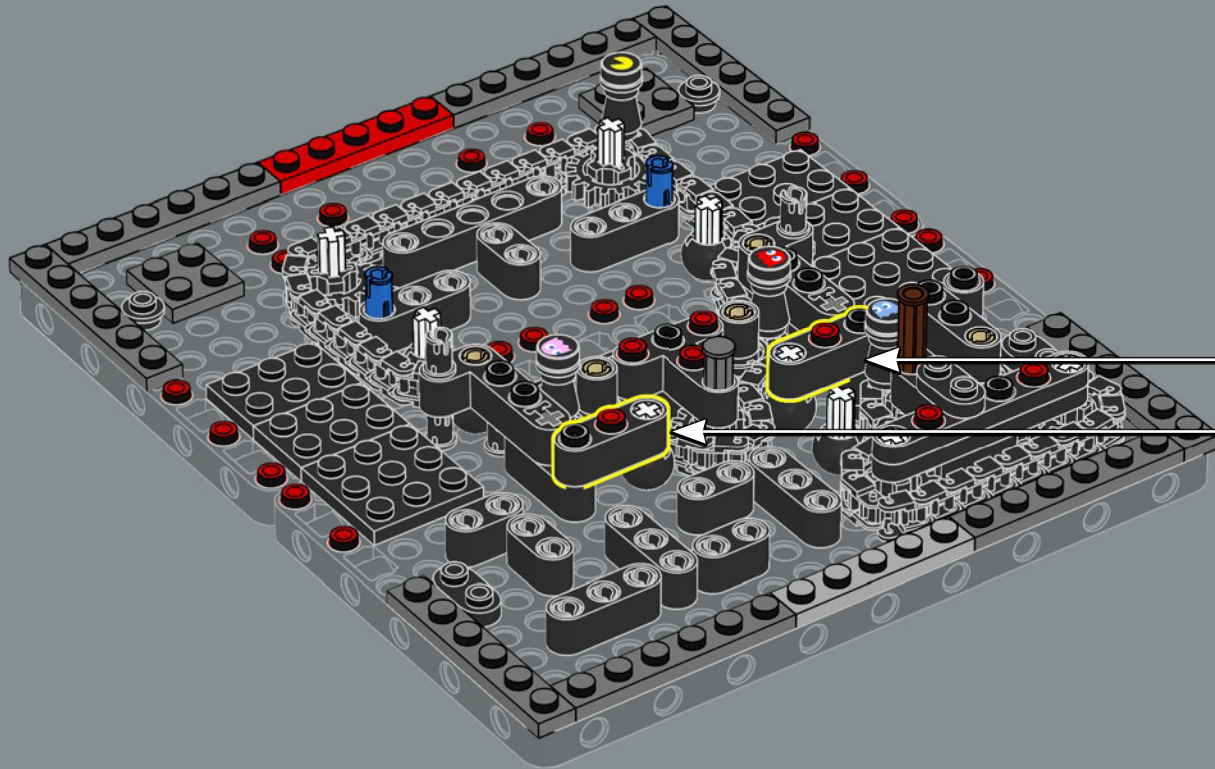
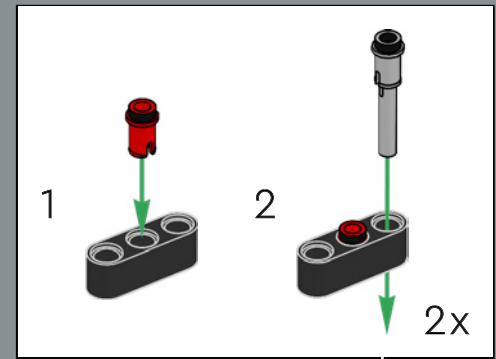

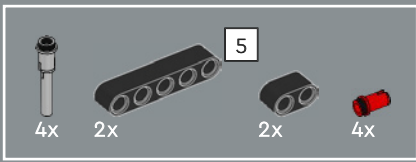

148

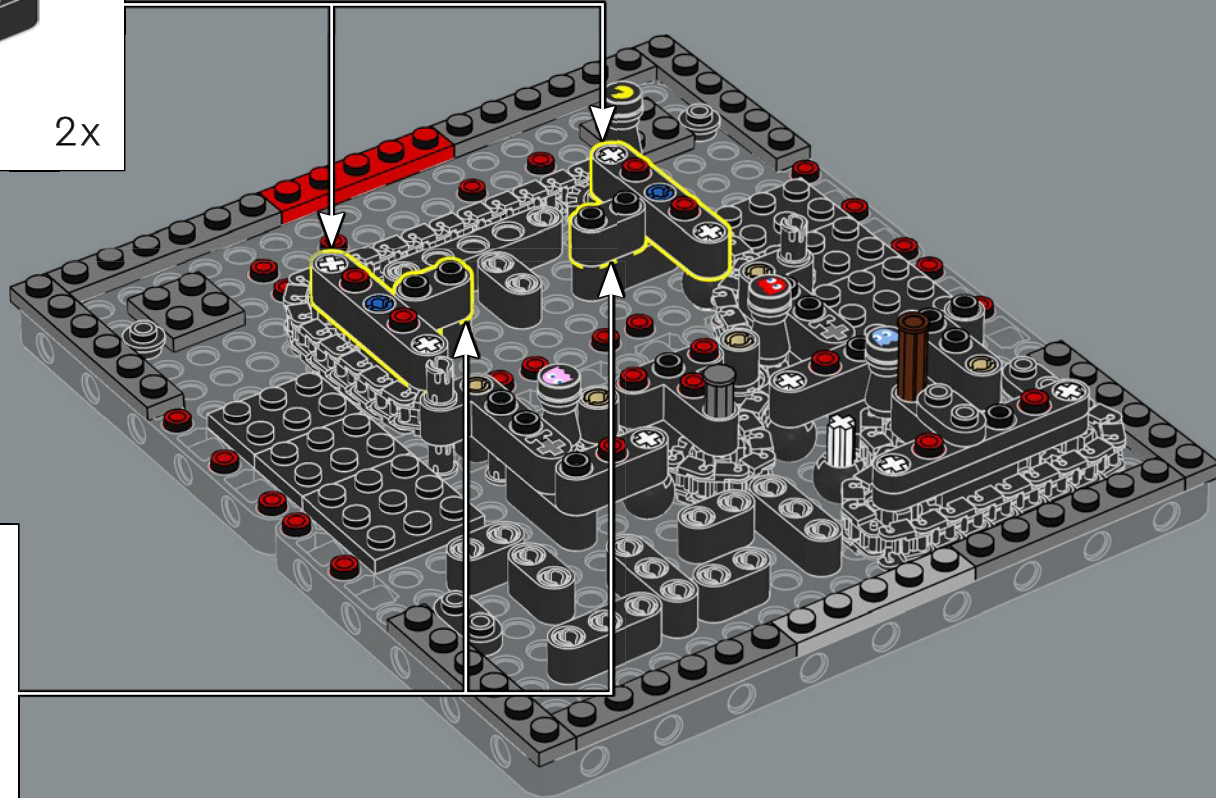
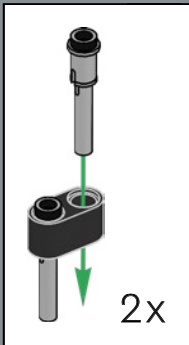
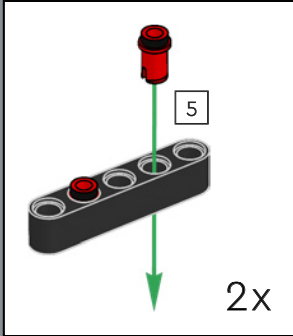

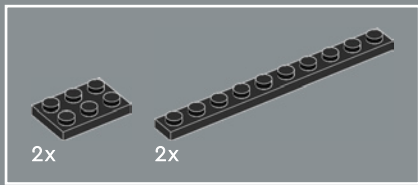

149

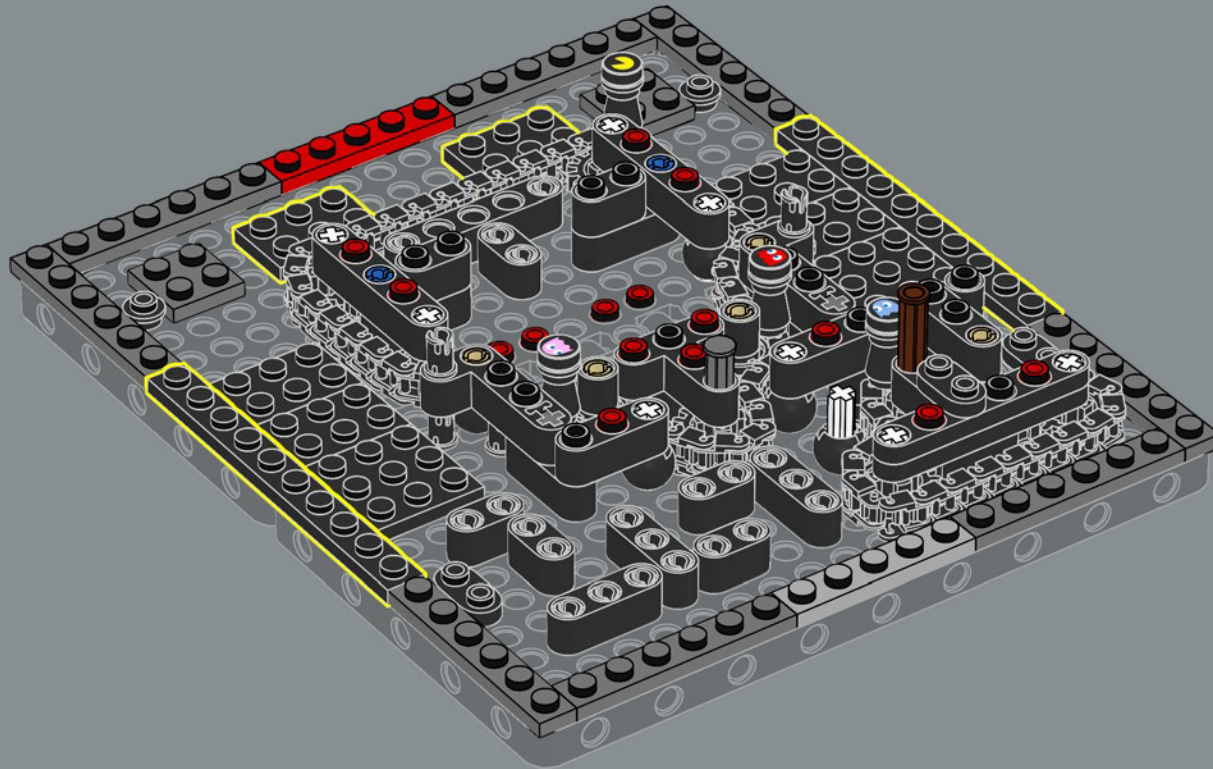

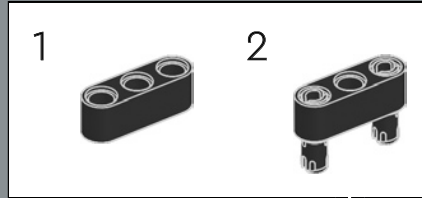

150

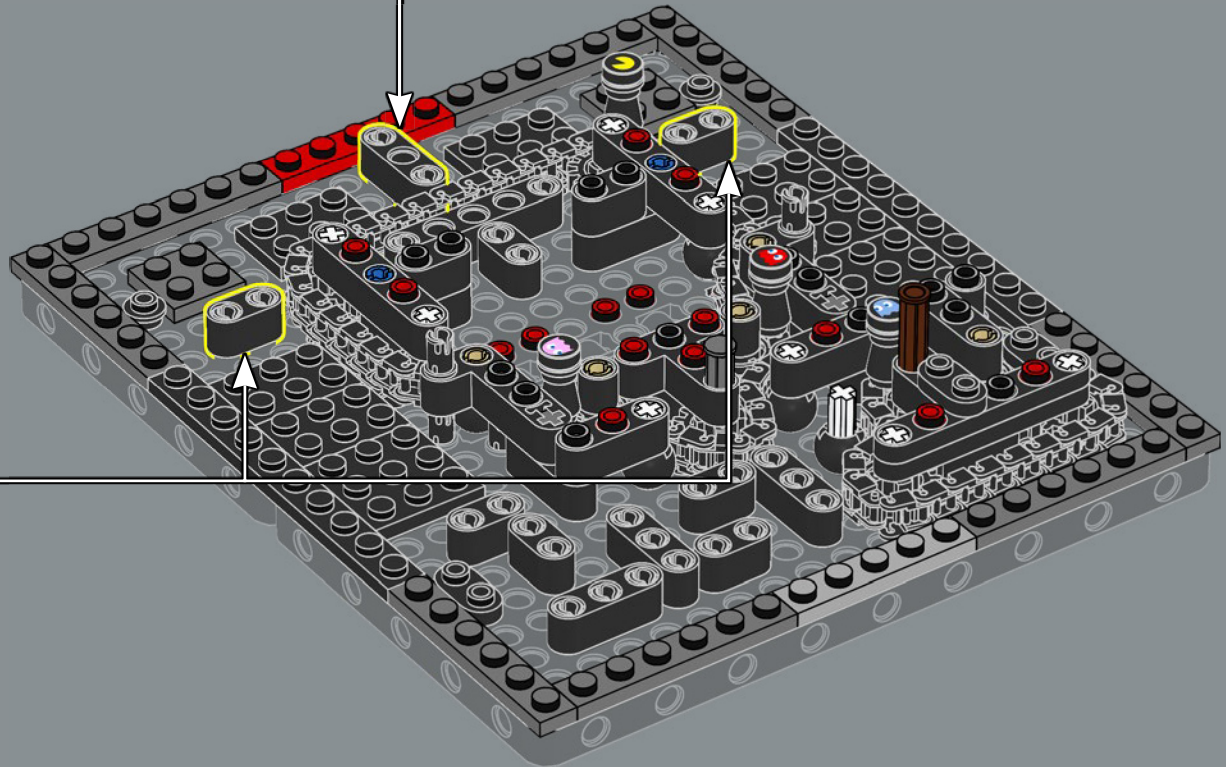
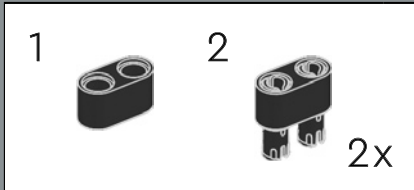

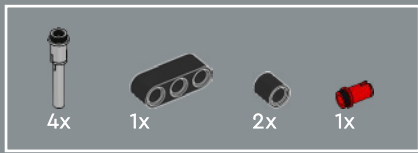

151

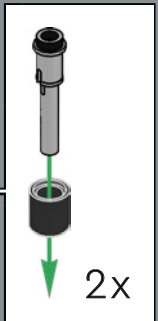
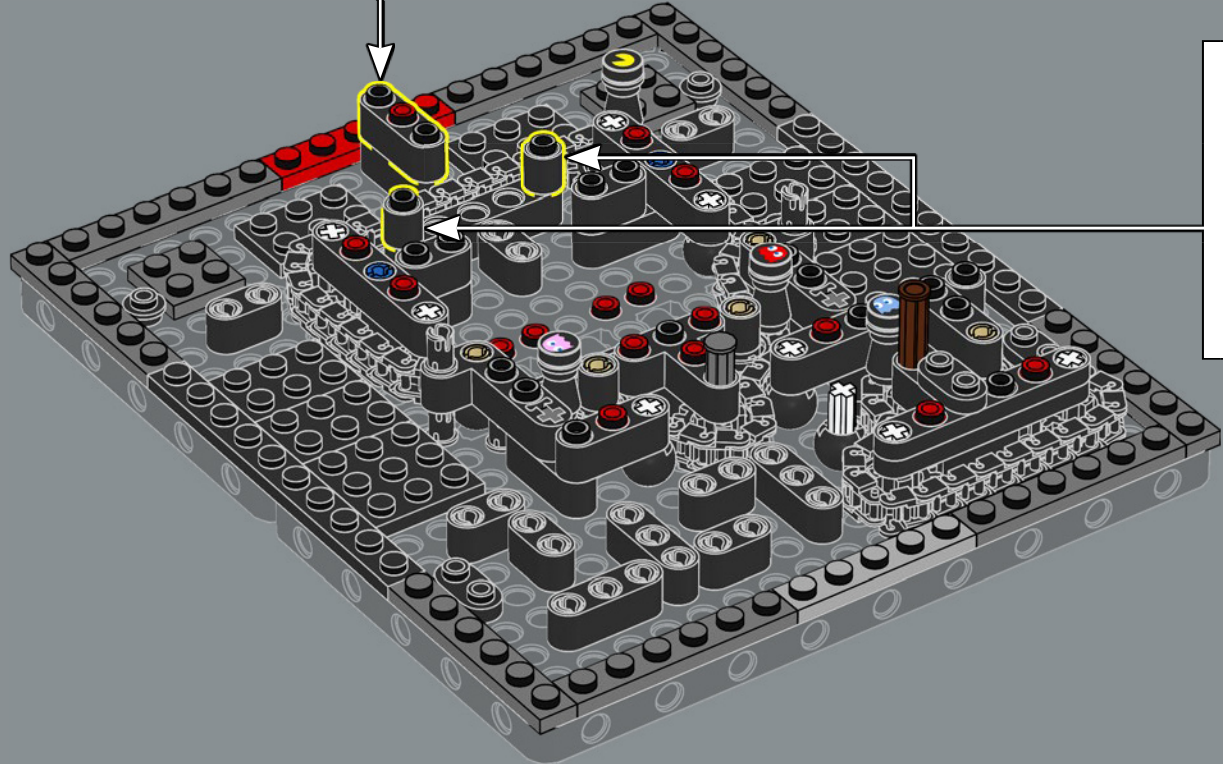
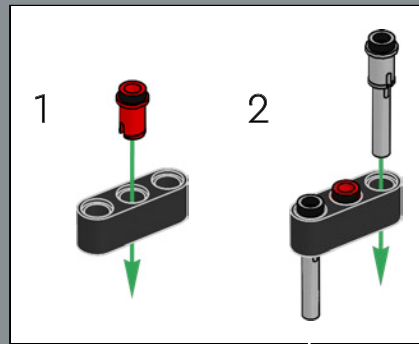

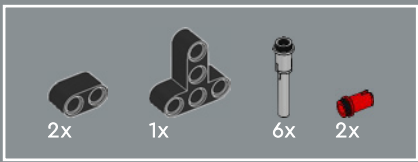

152

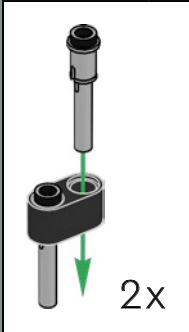
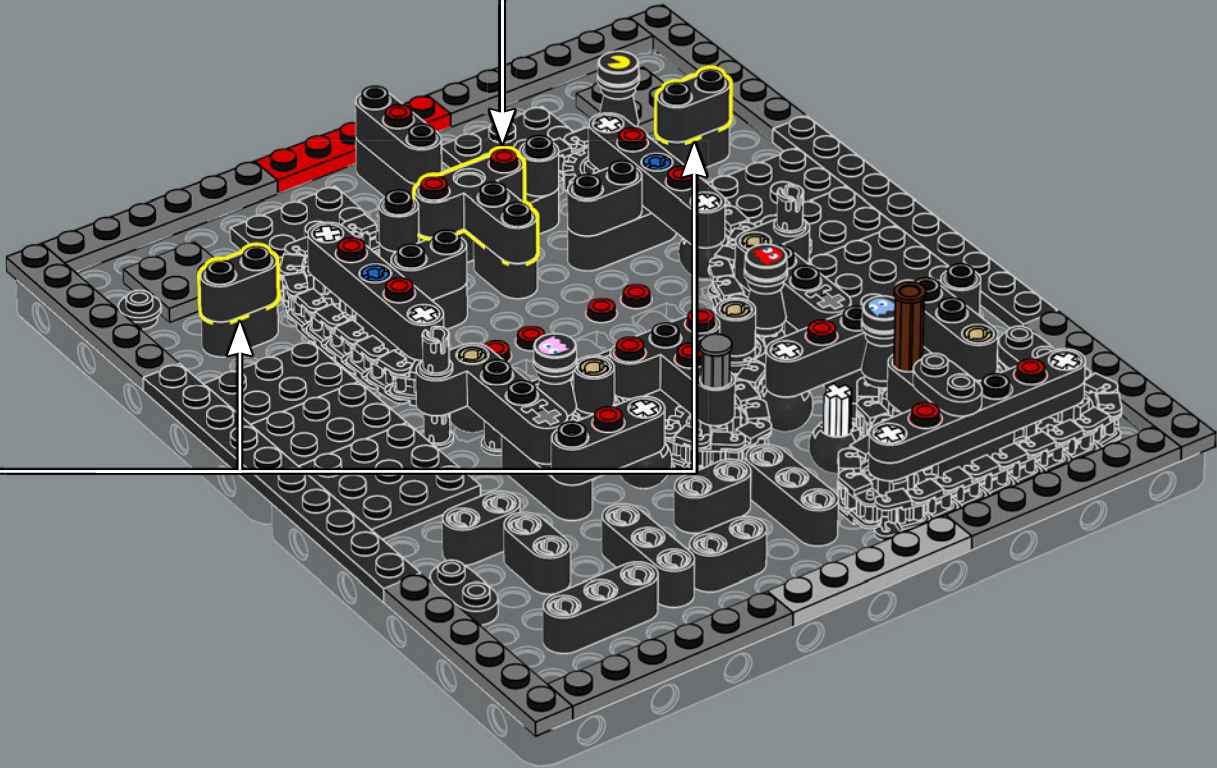
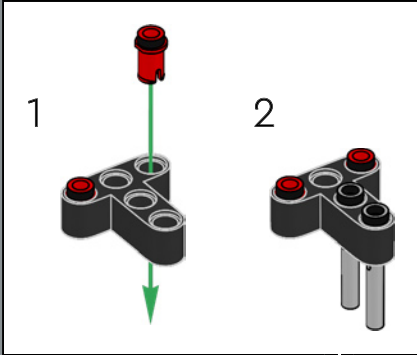

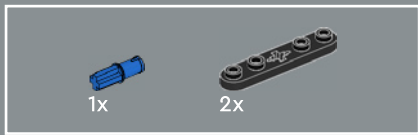

153

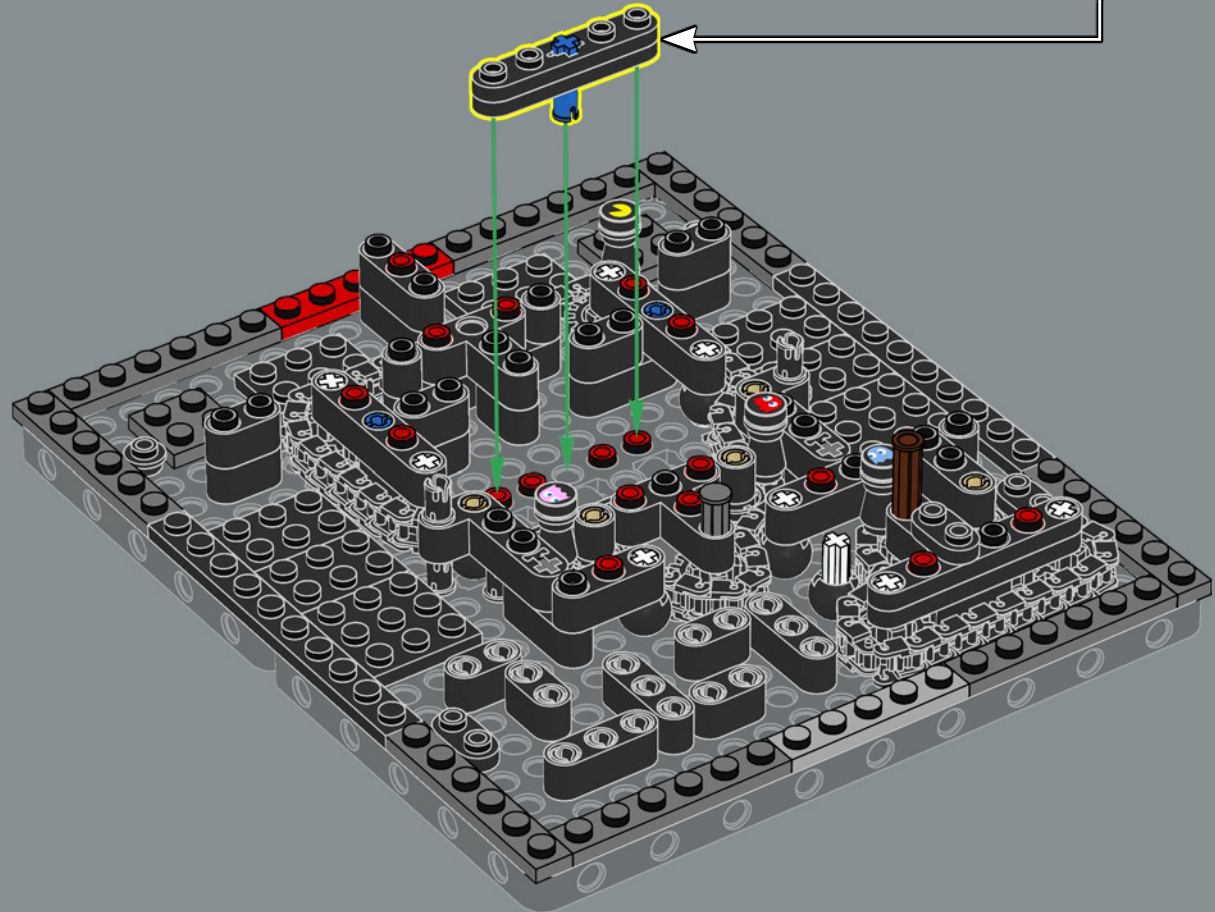
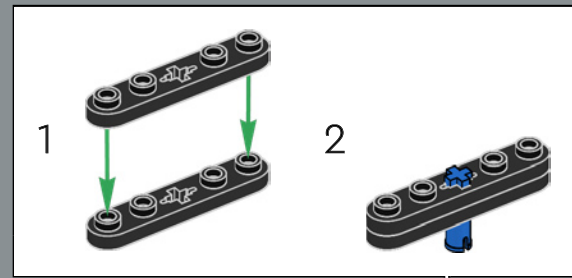



154

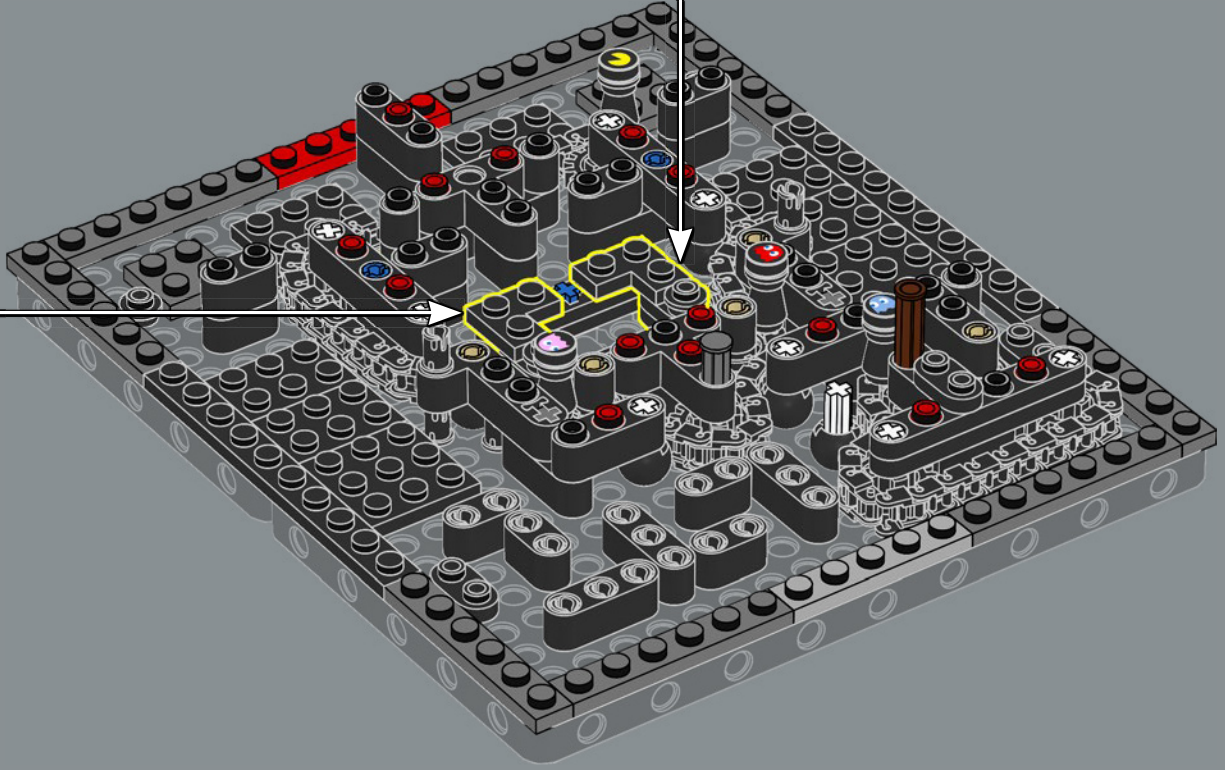
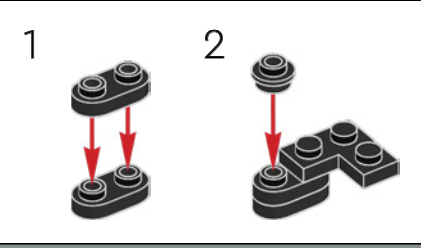
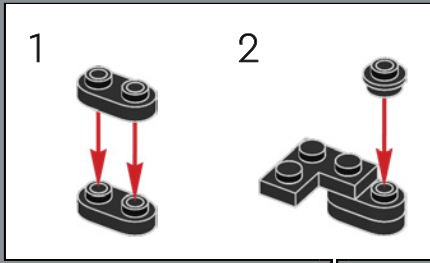

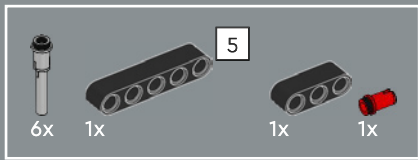

155

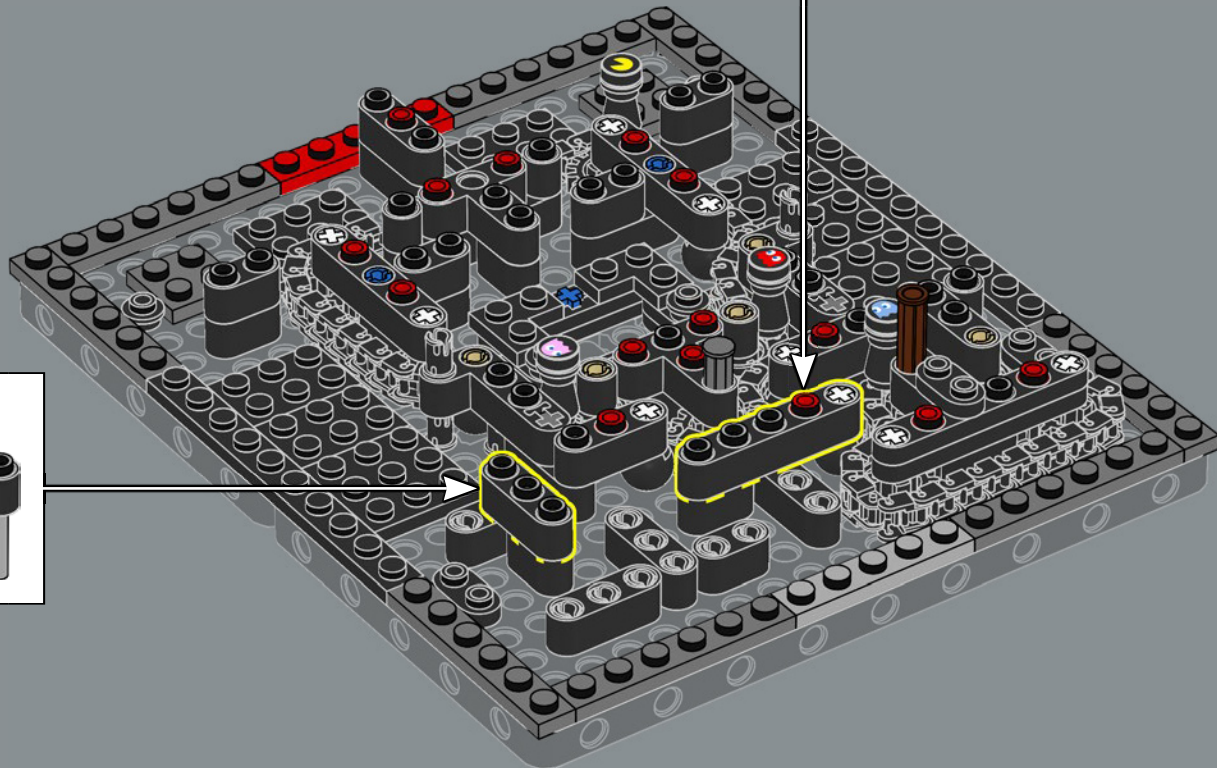
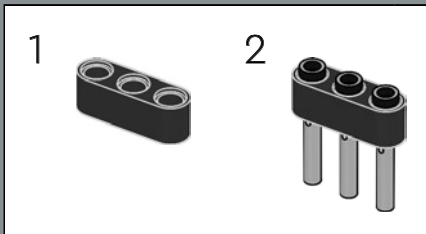
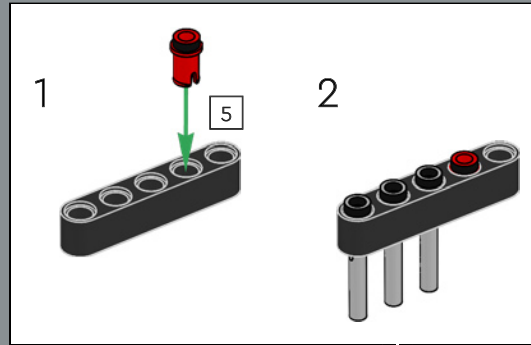

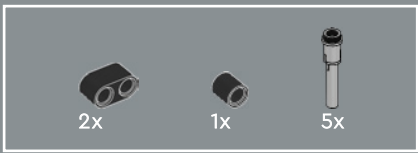

156

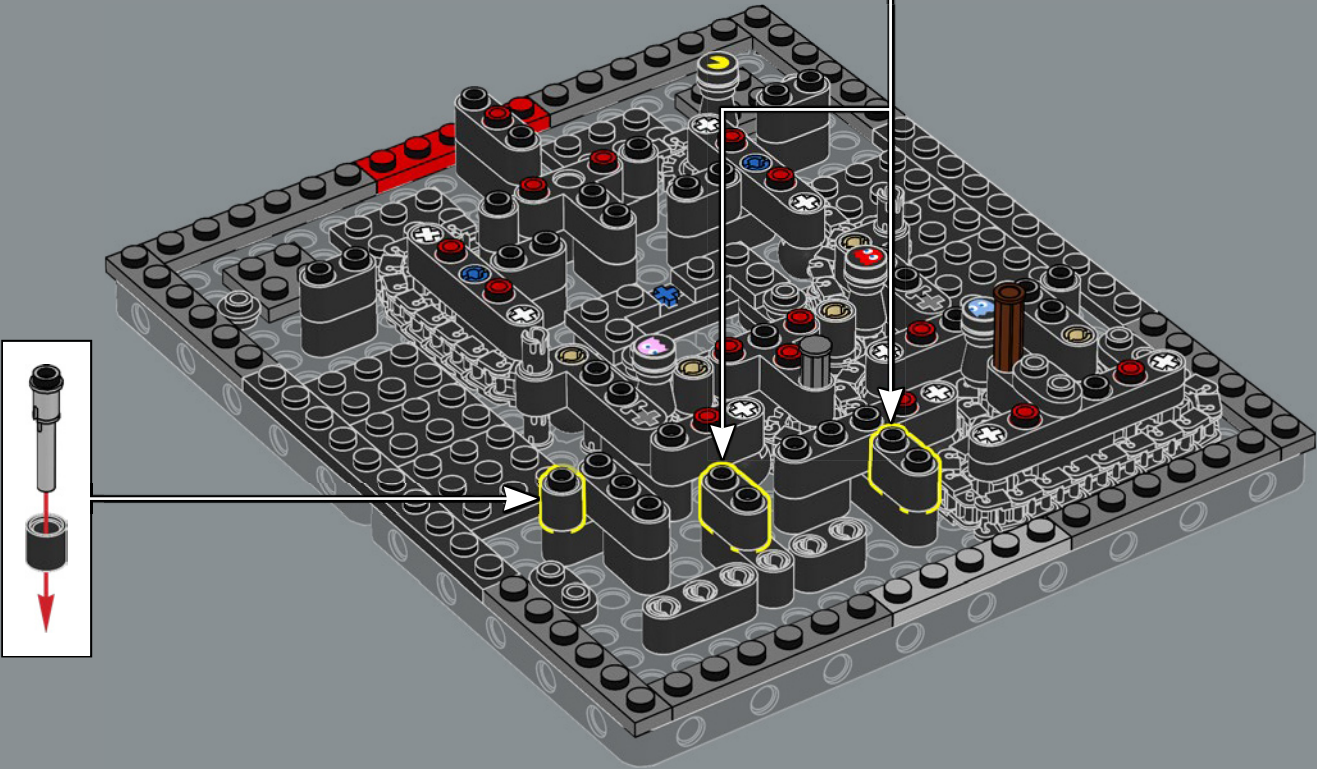
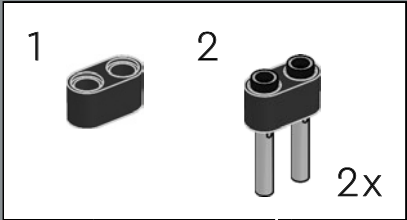

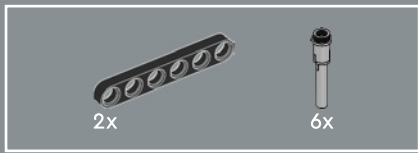

157

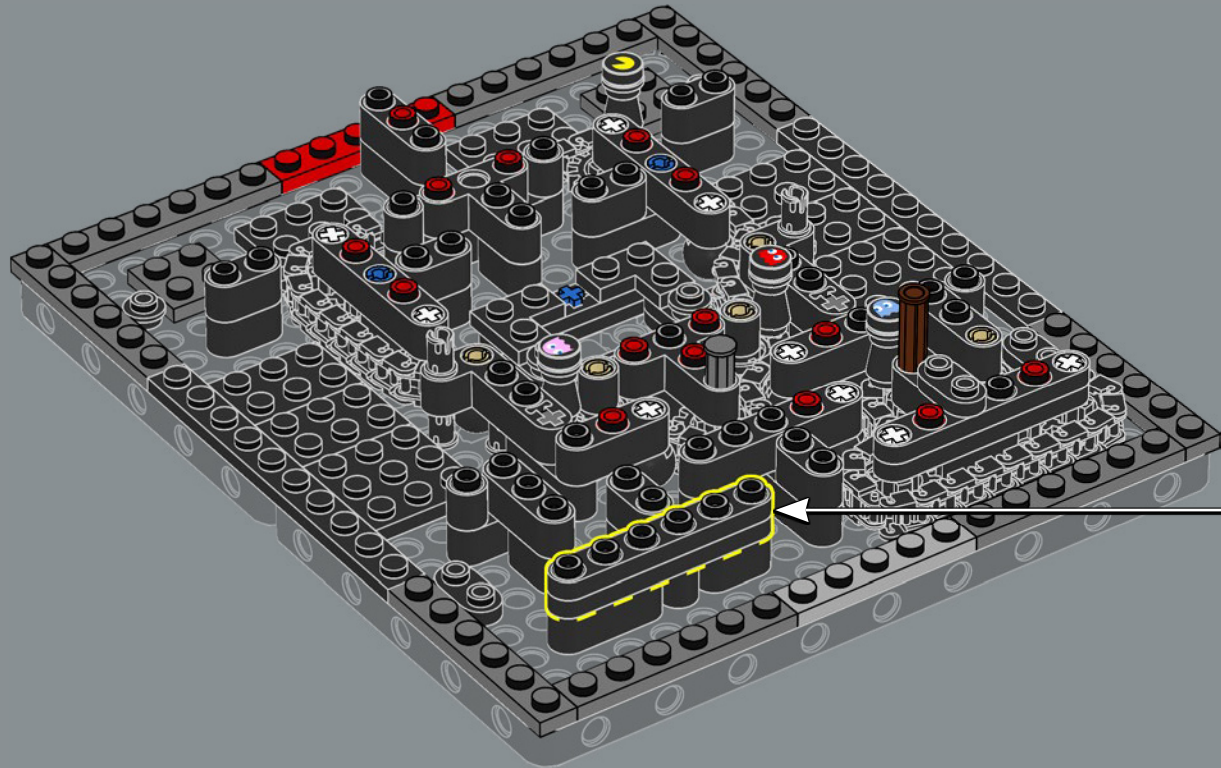
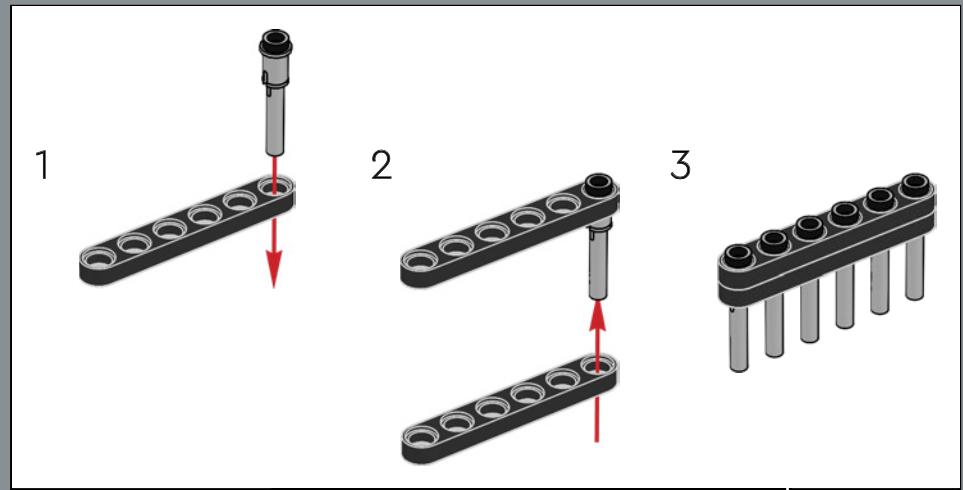



158

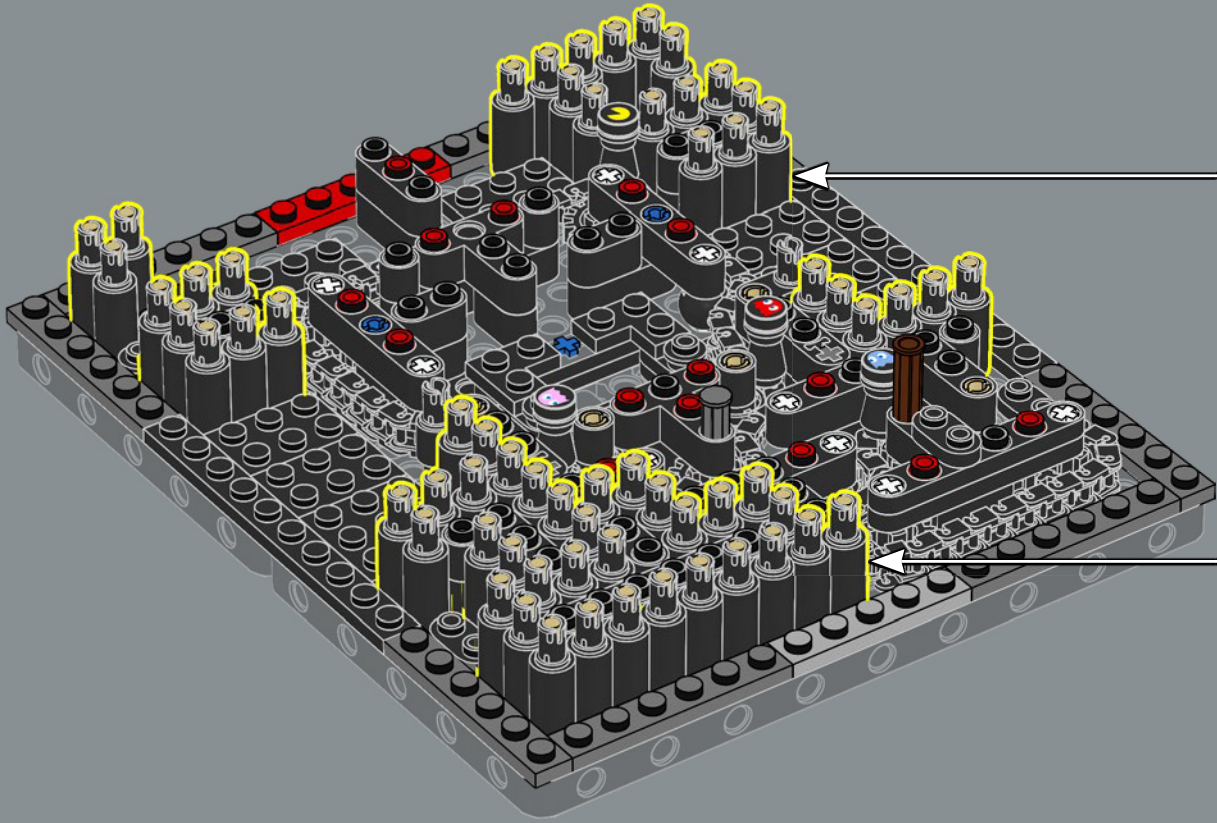
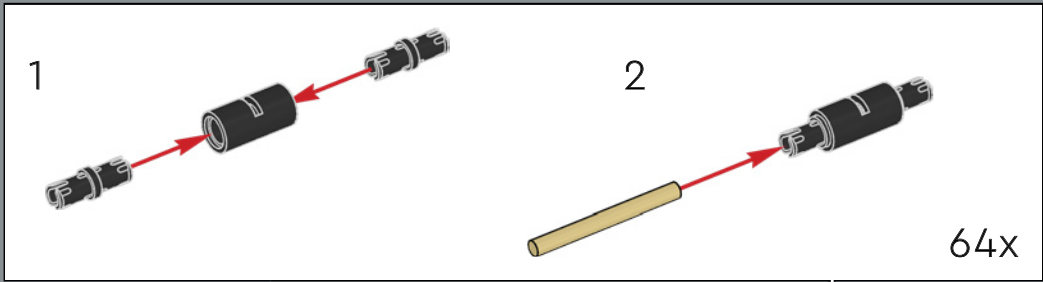

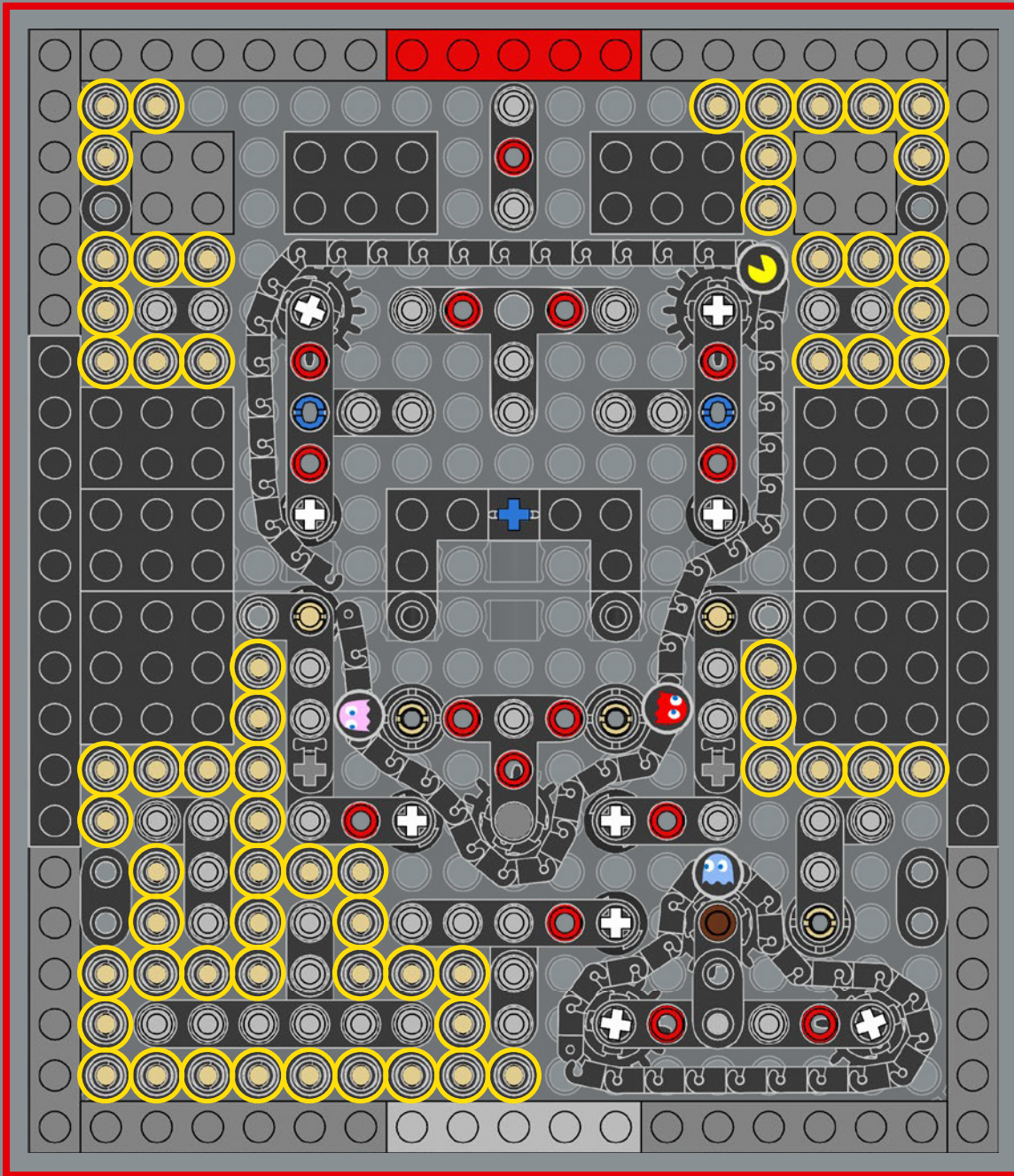



159

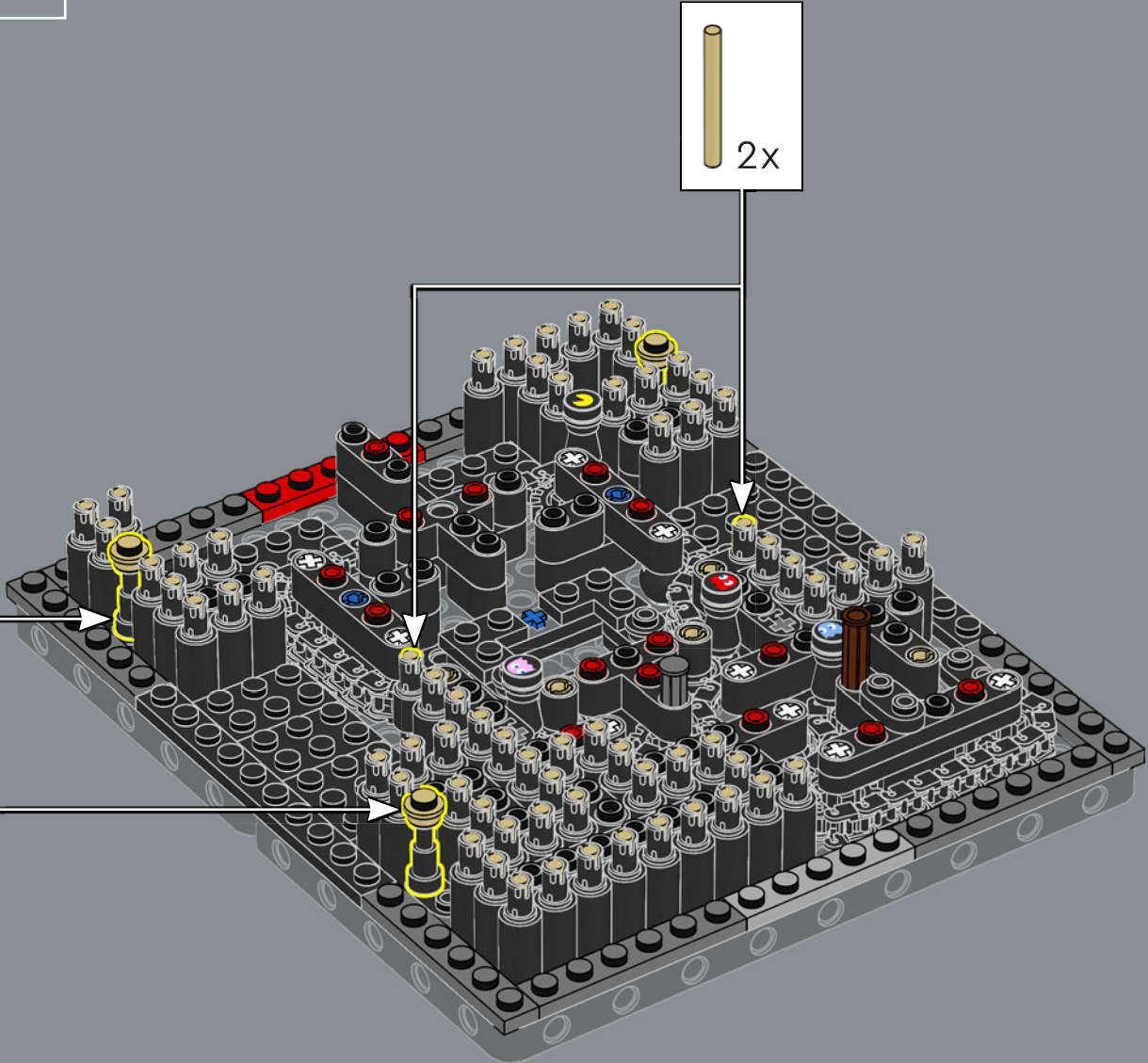
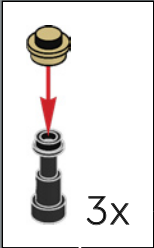
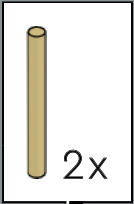

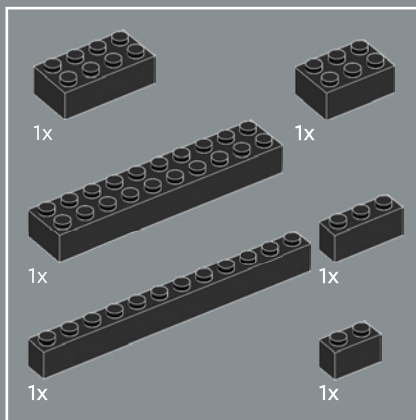

160

1

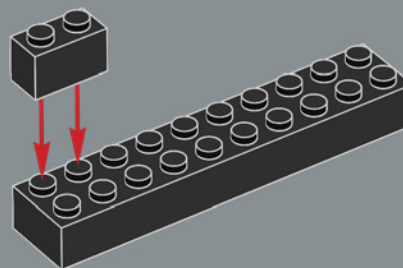

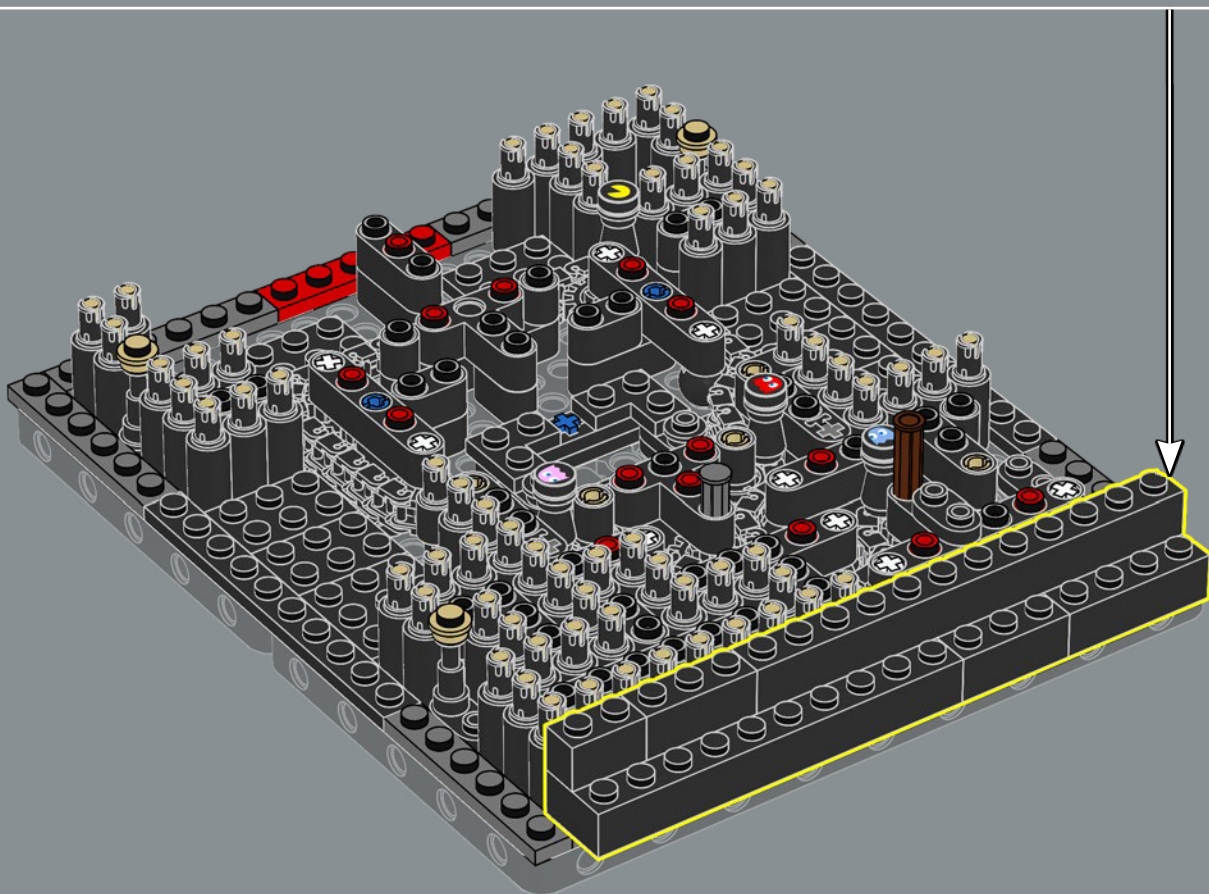
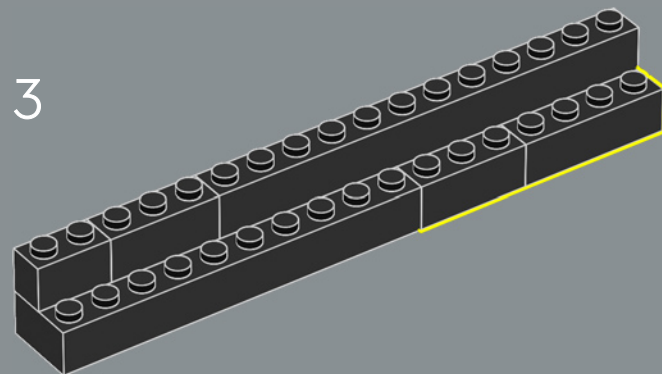
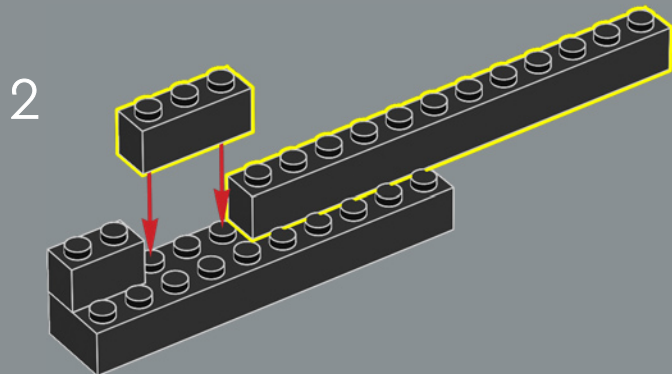

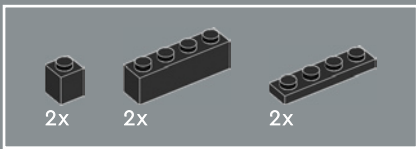

161

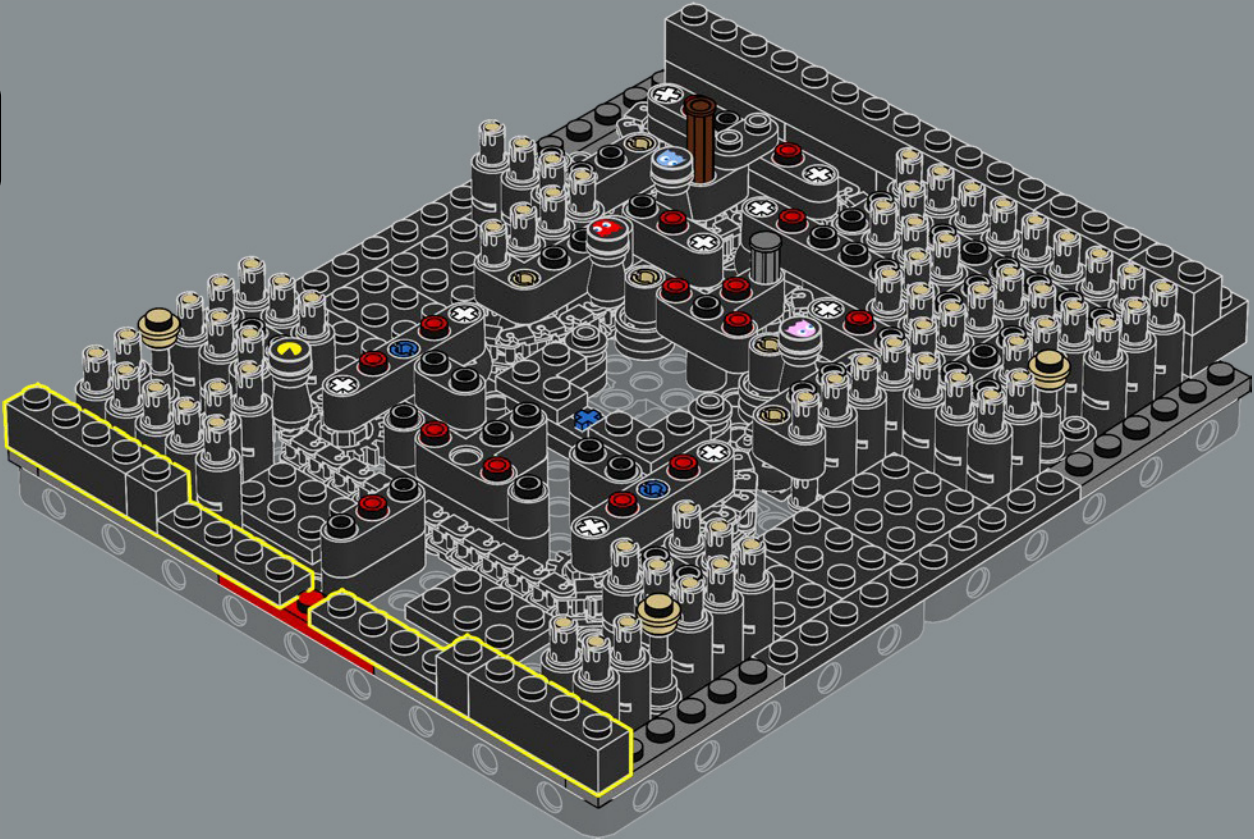

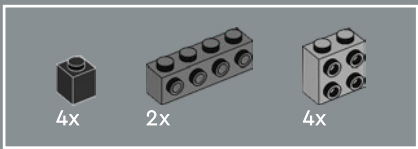

162

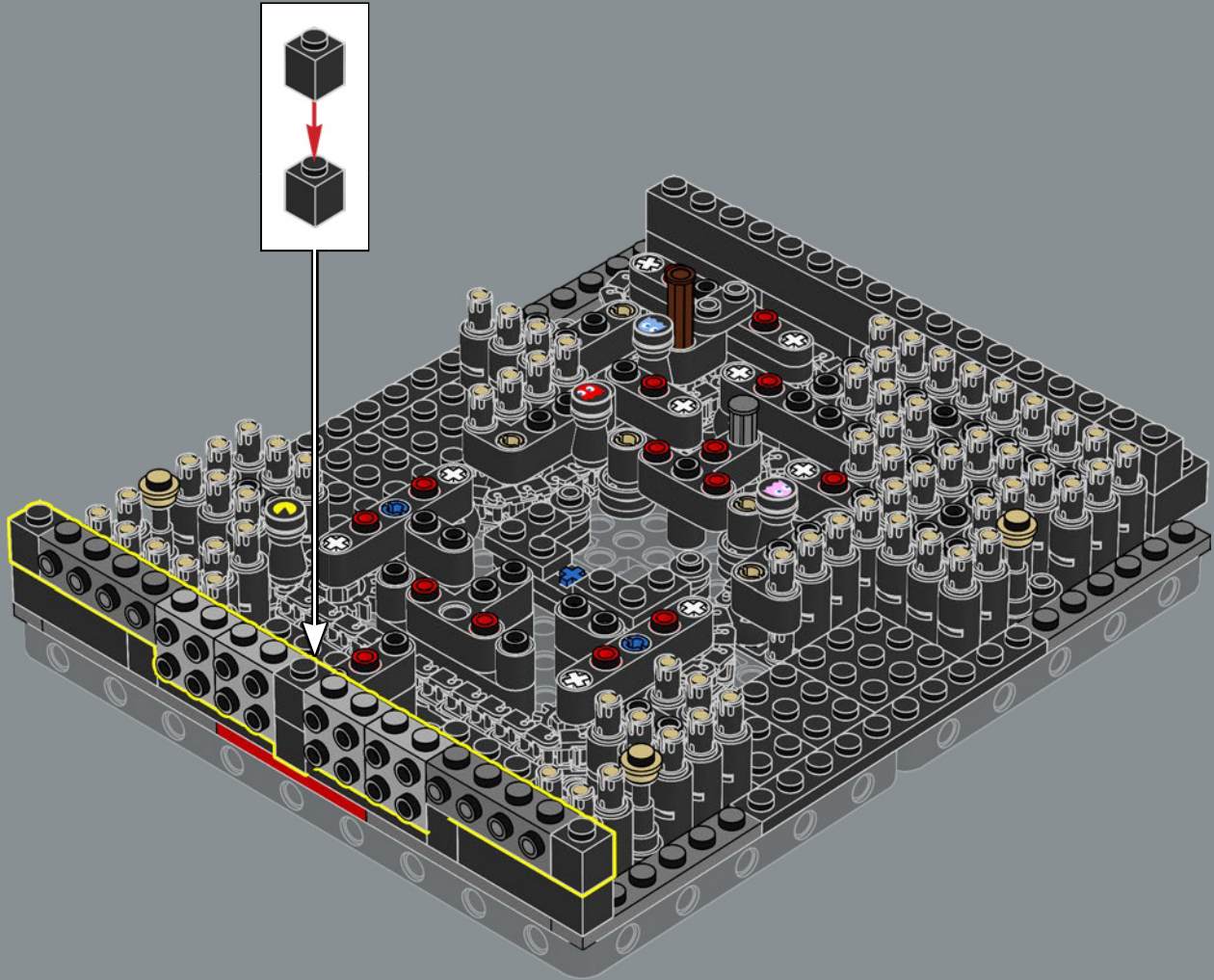

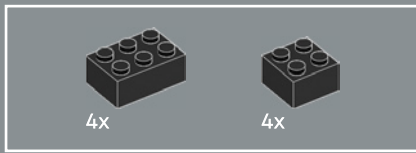

163

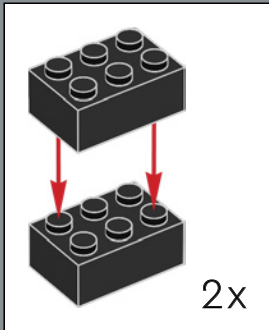
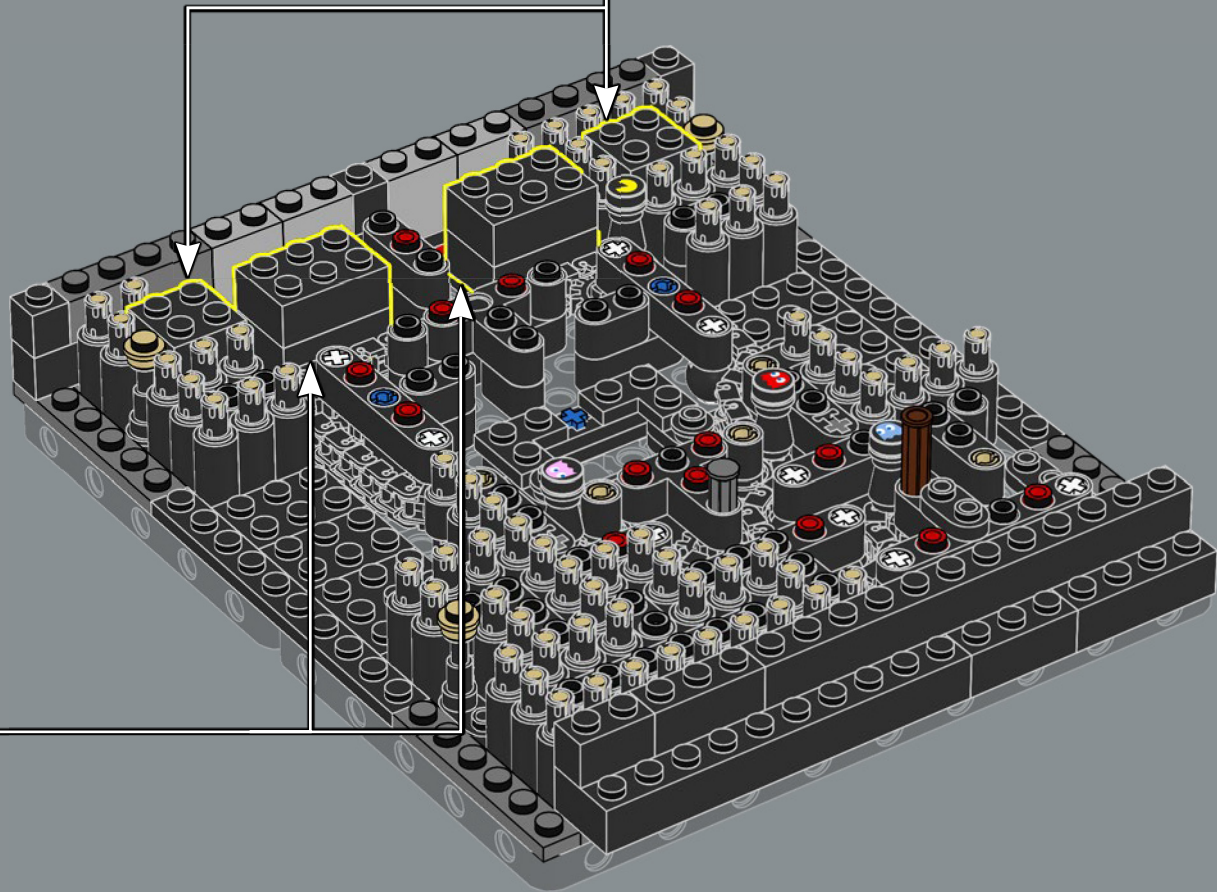
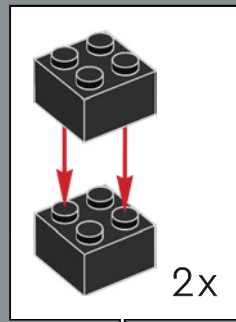

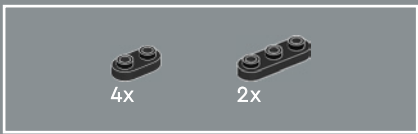

164

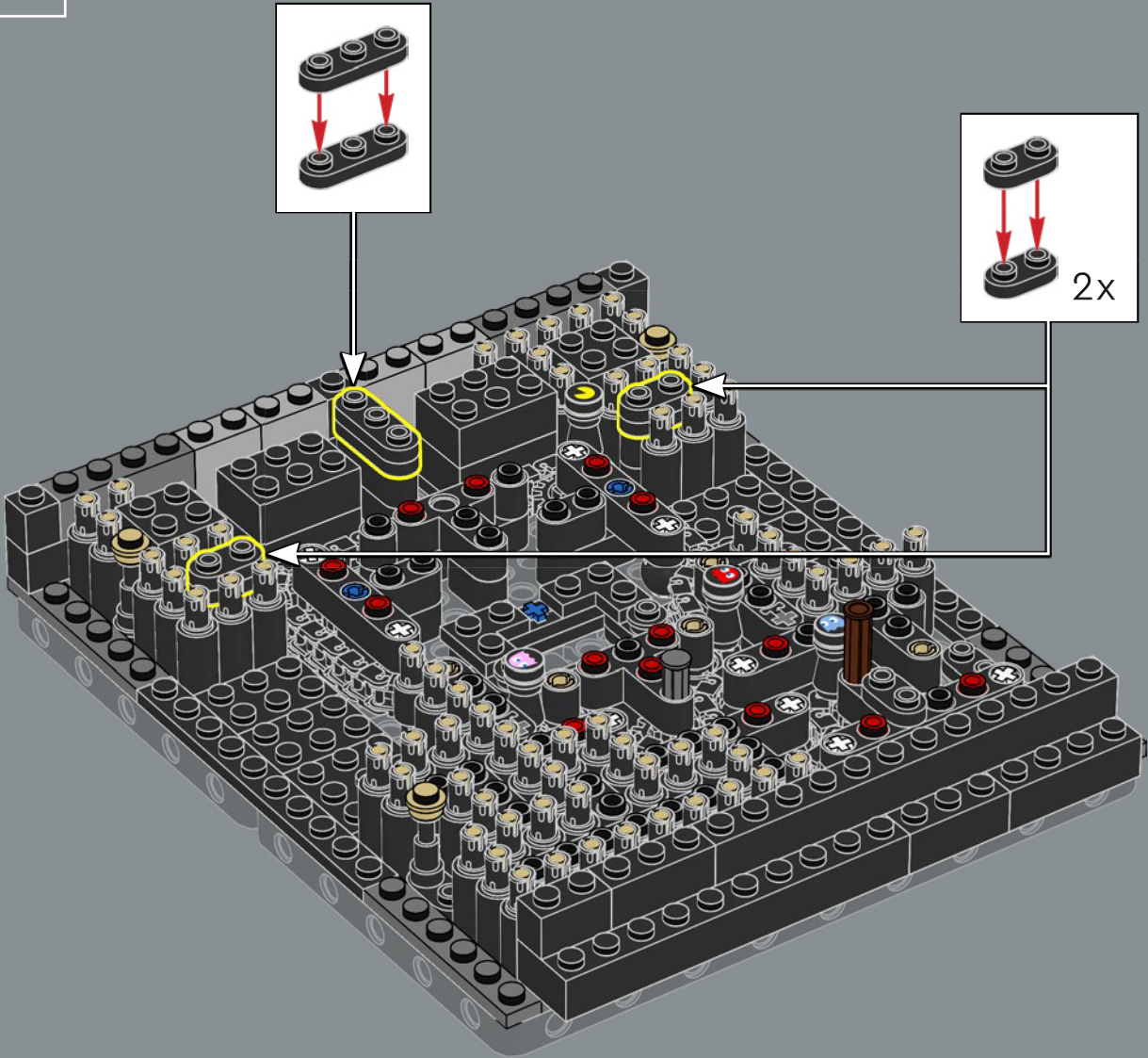

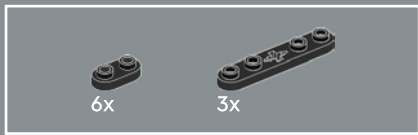

165

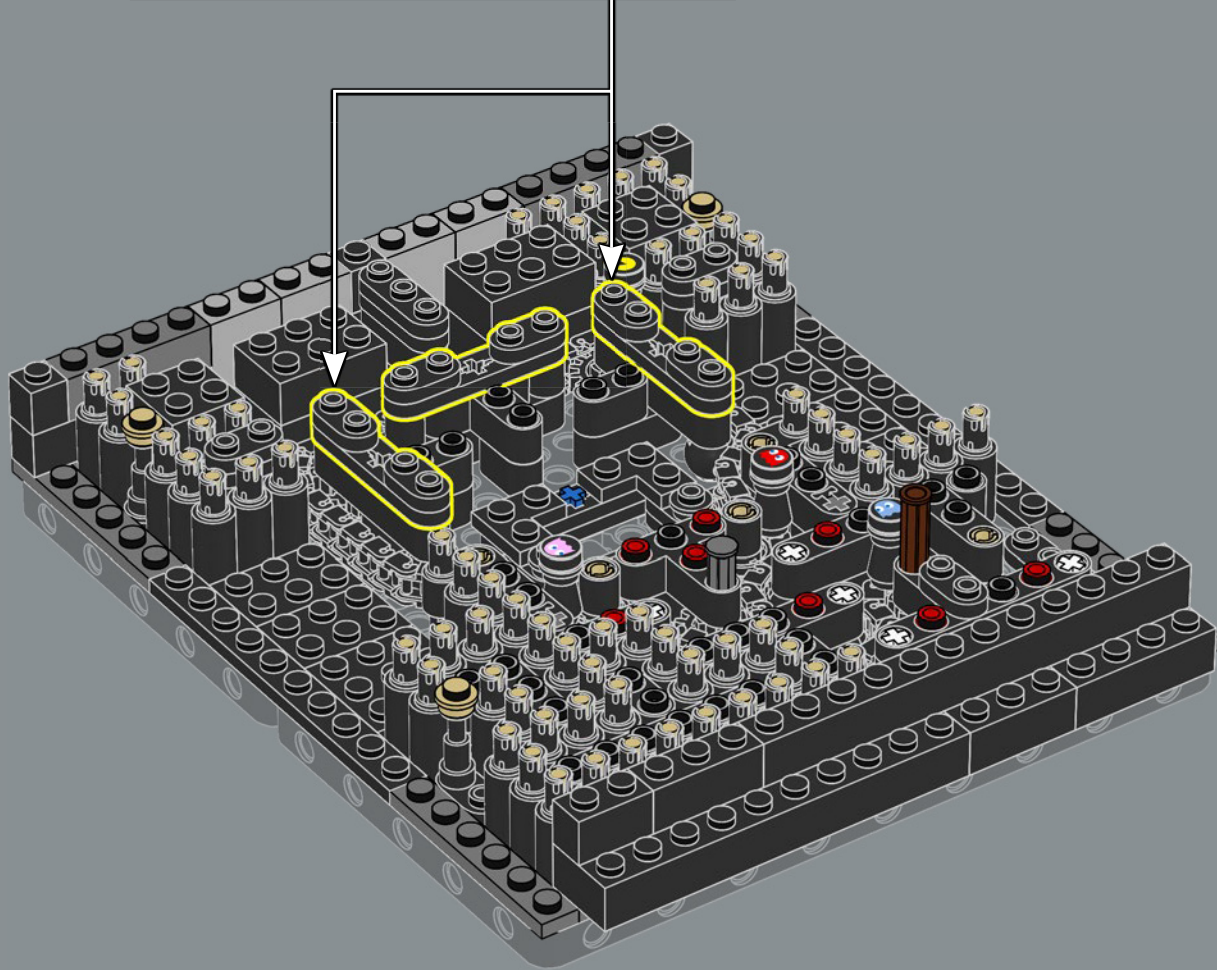
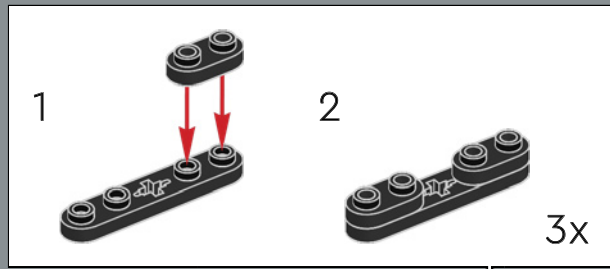

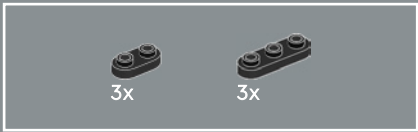

166

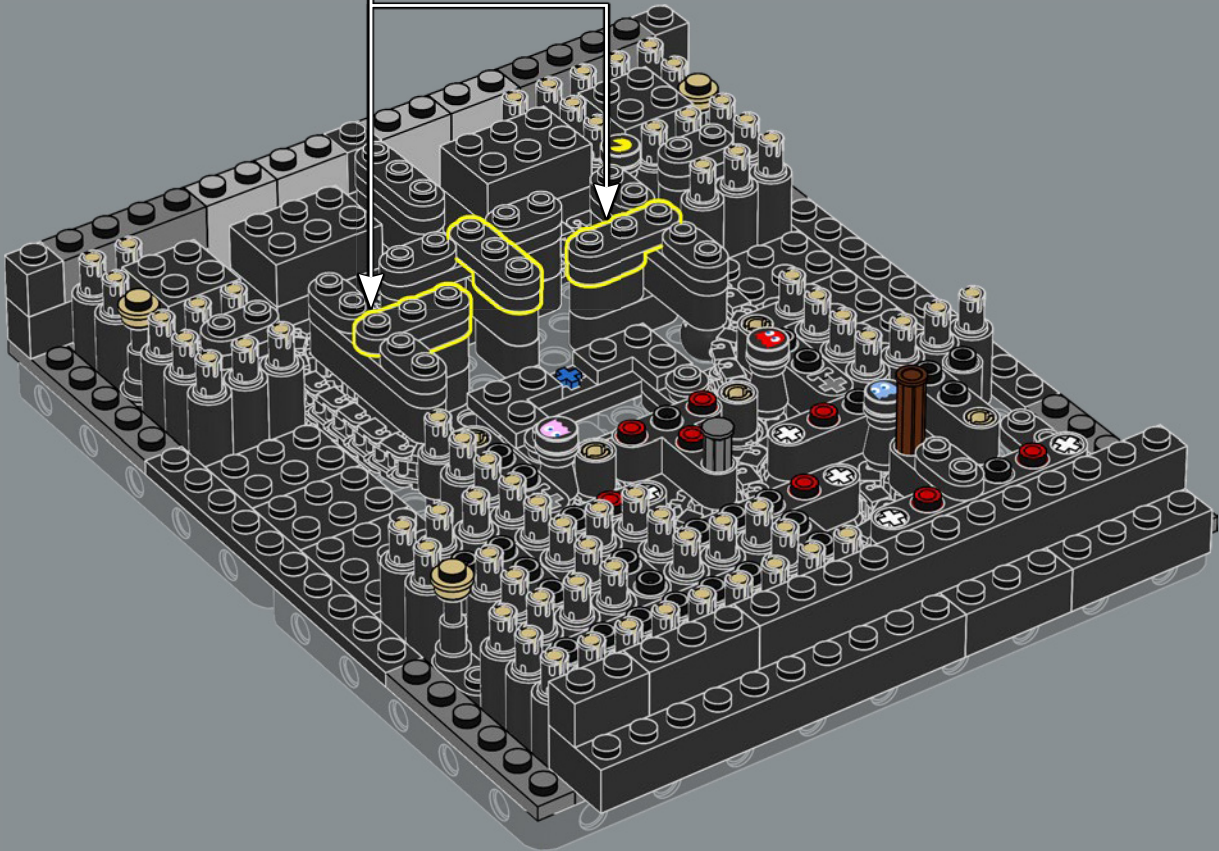
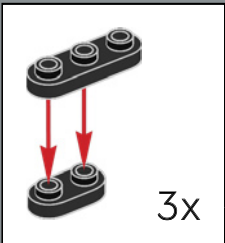



167

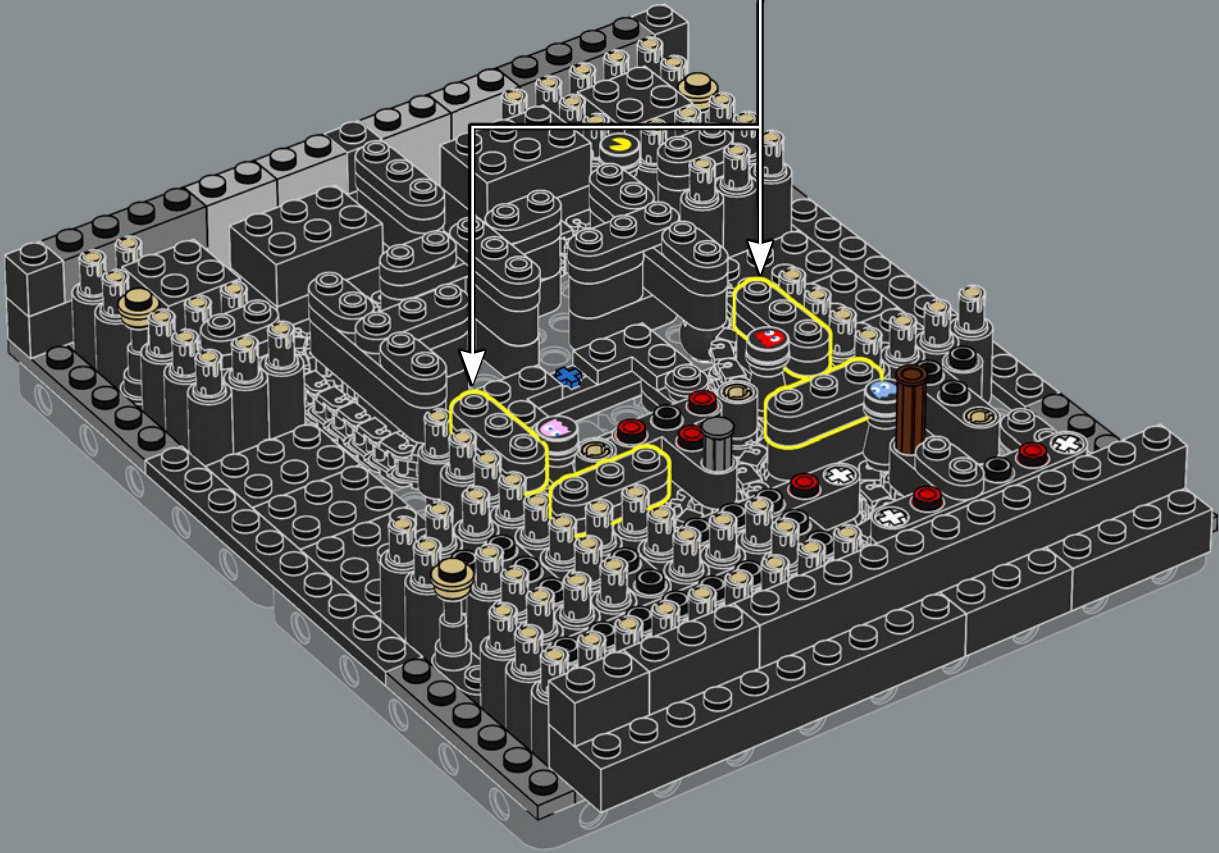
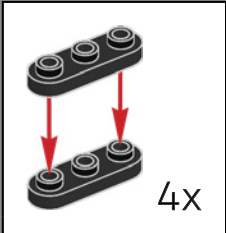



168

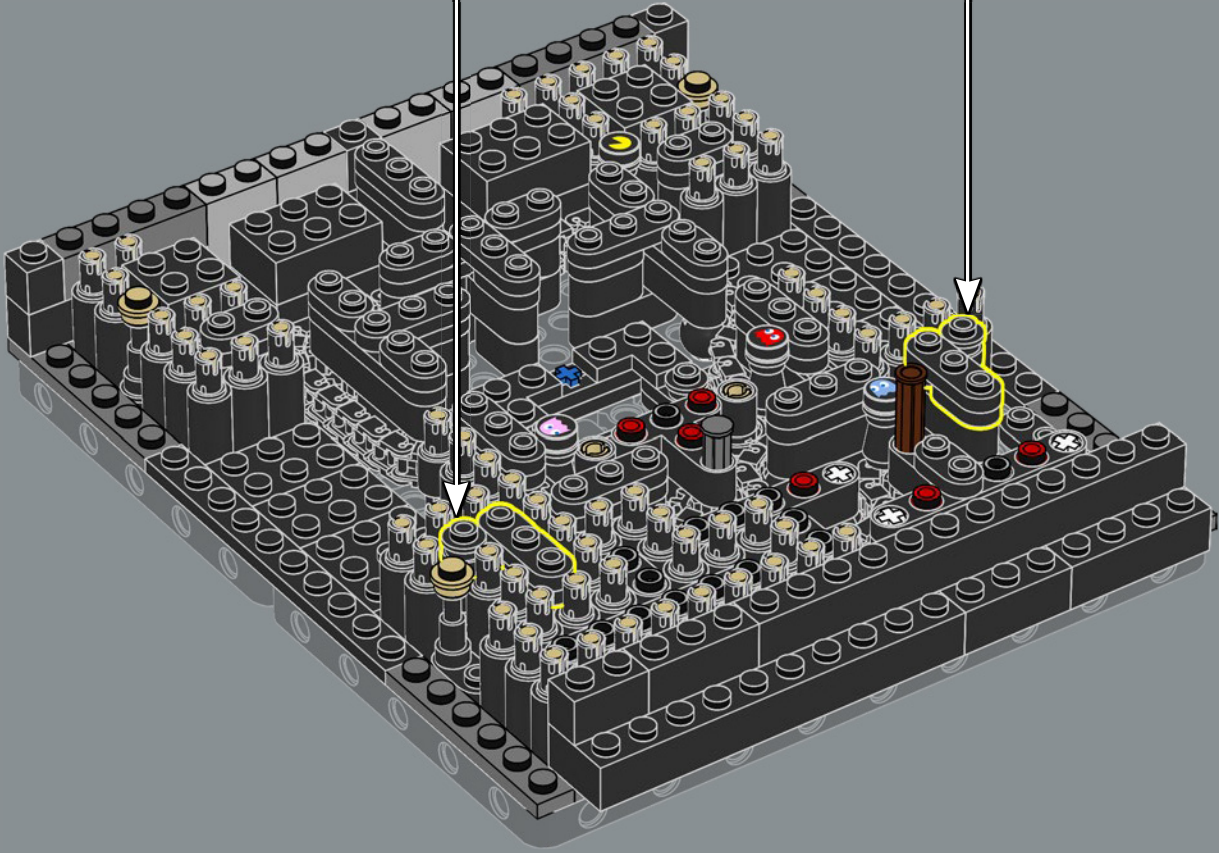
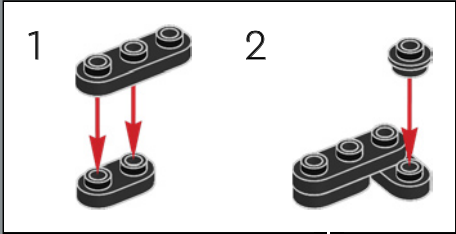
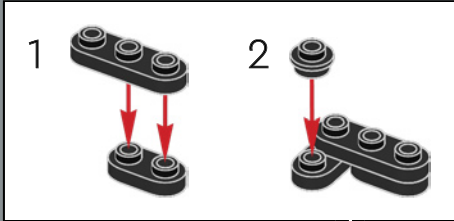



169

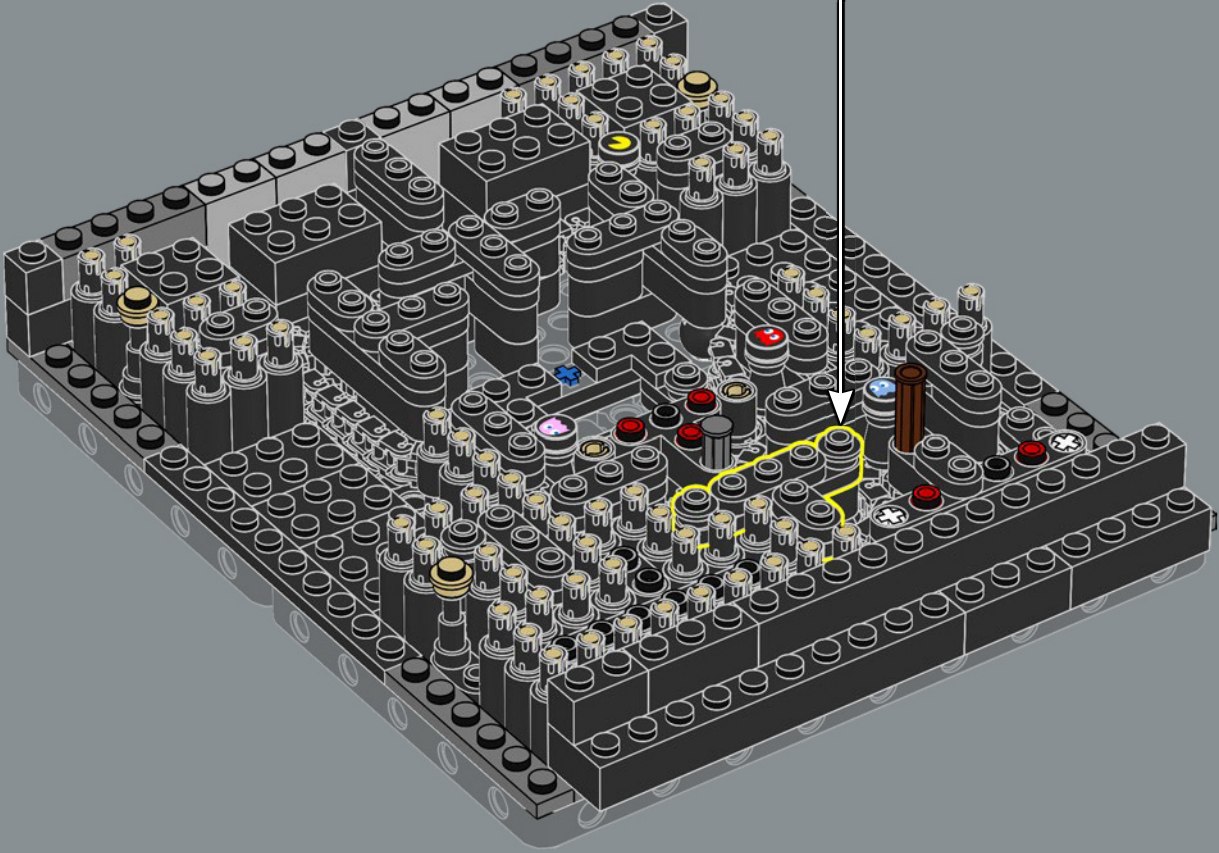
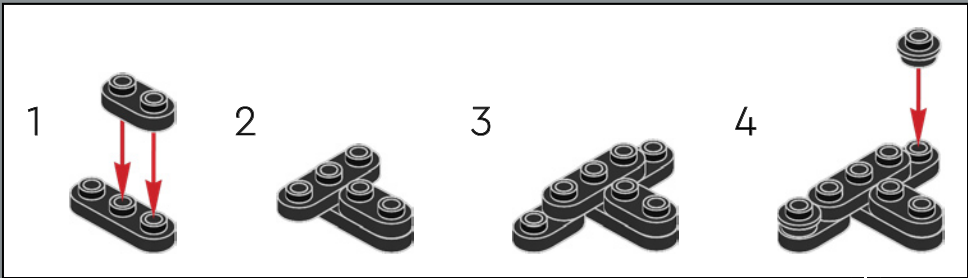

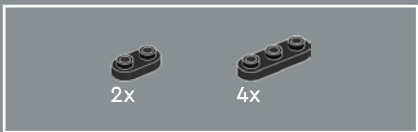

170

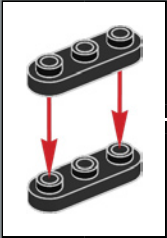
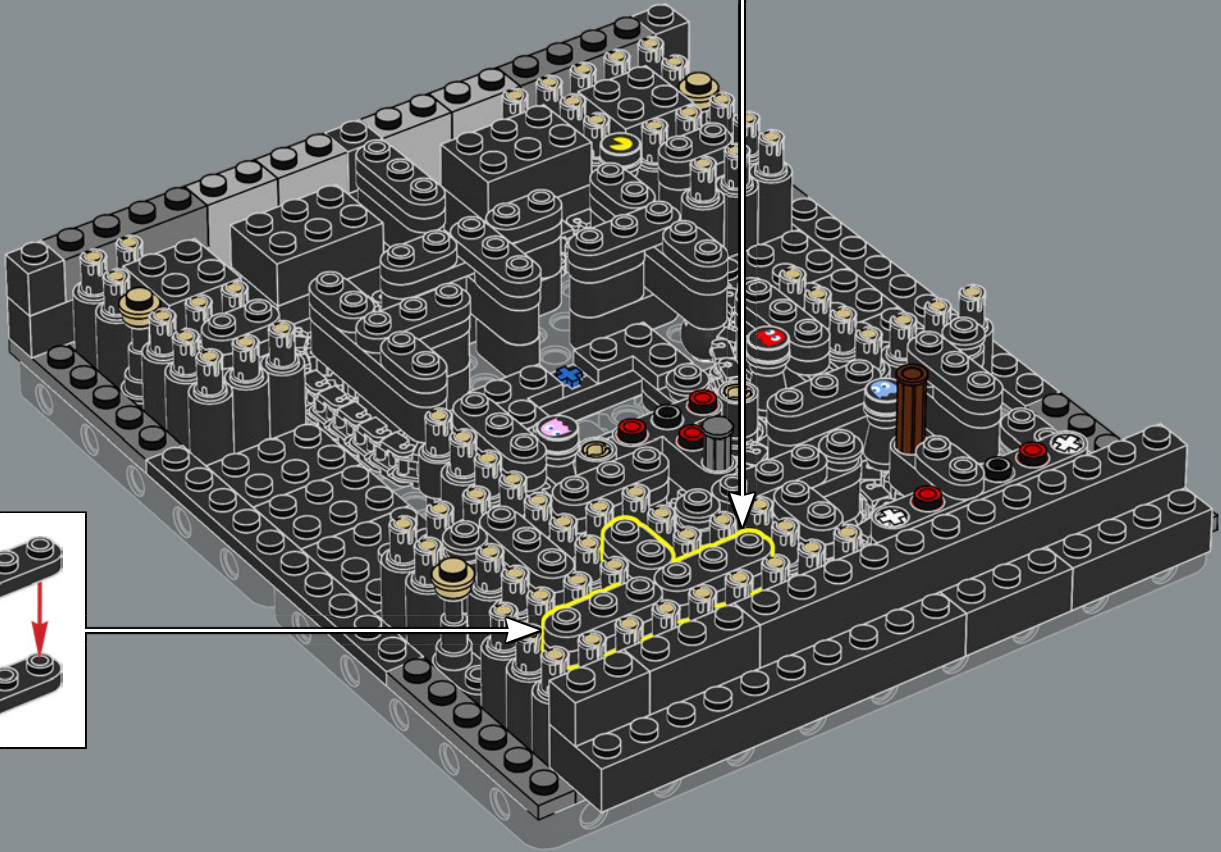

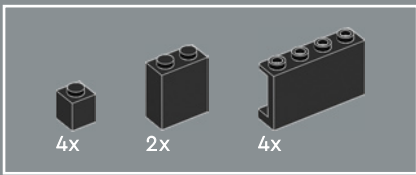

171

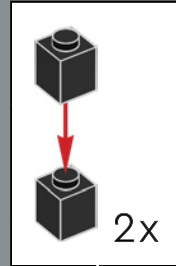
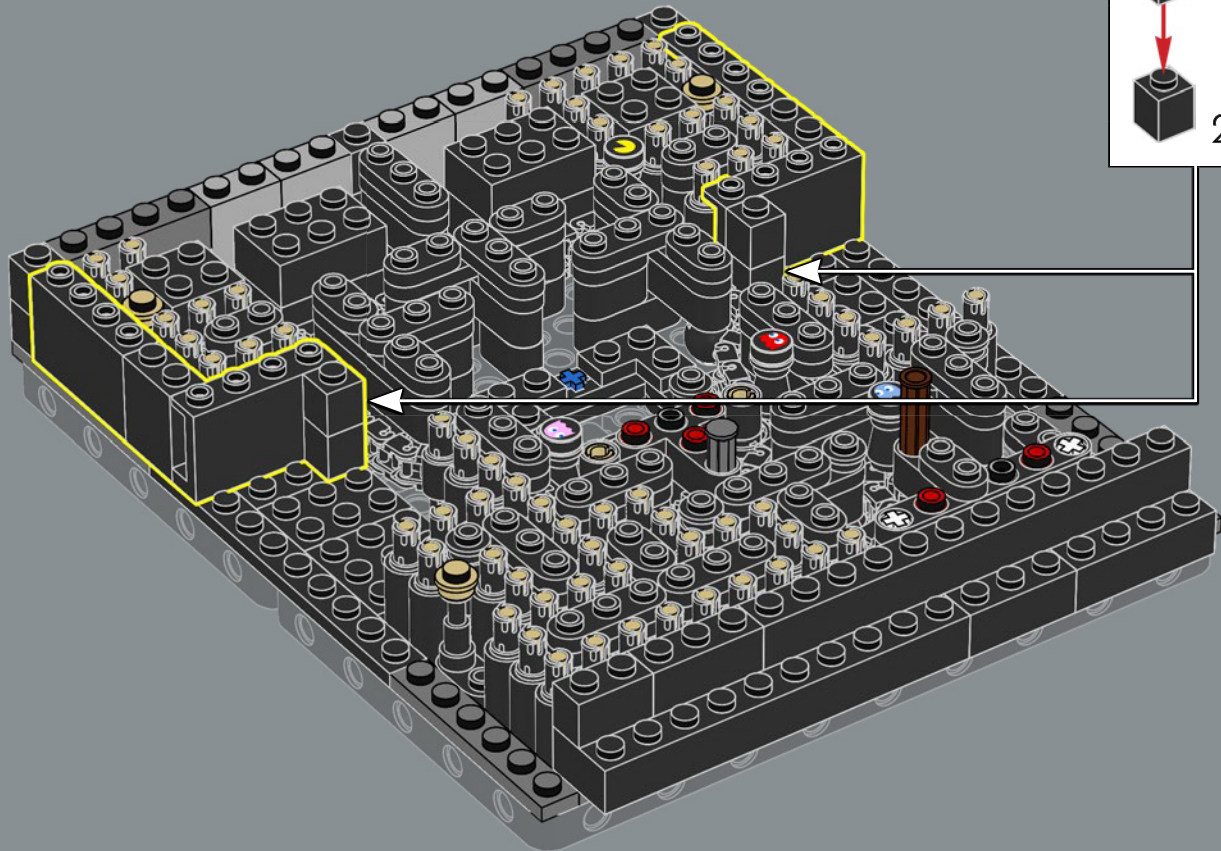

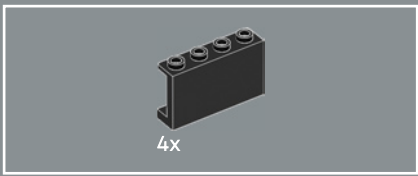

172

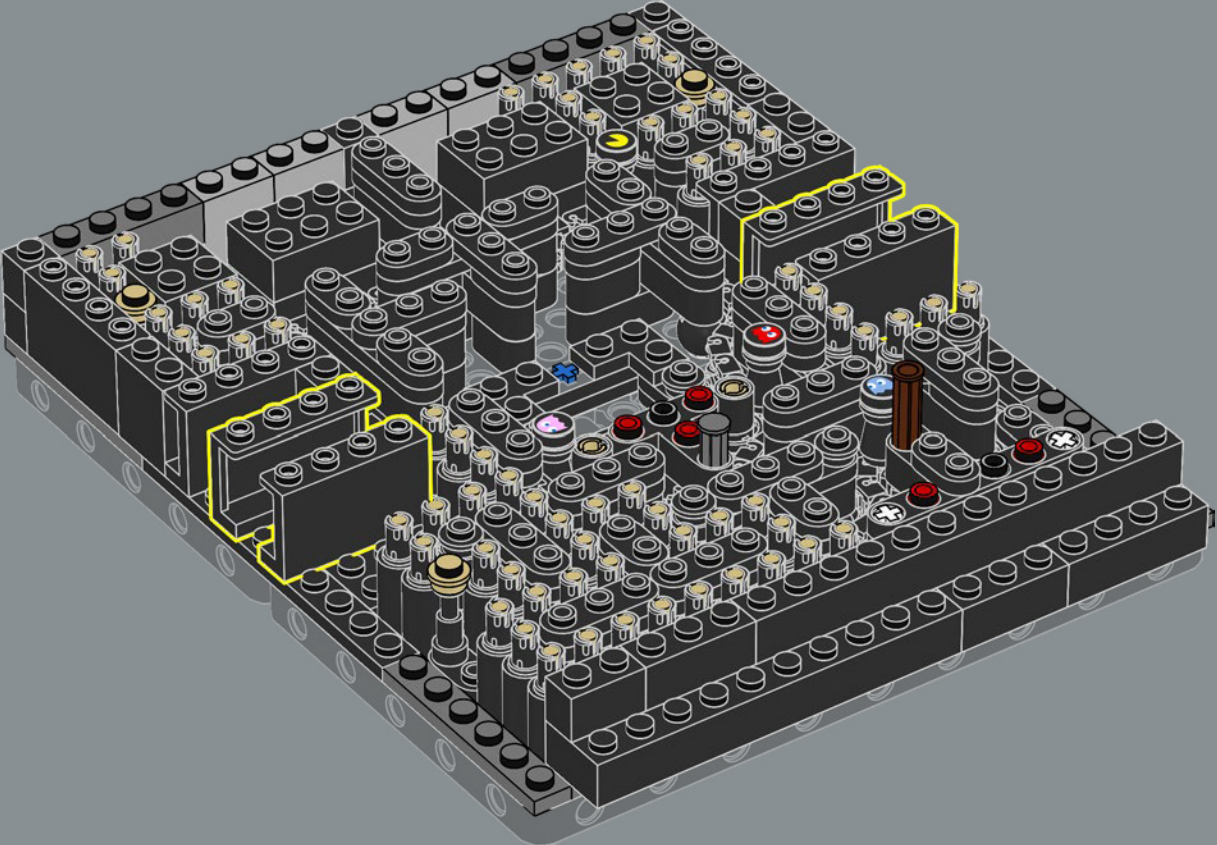

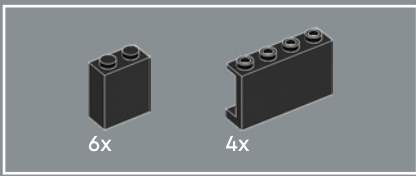

173

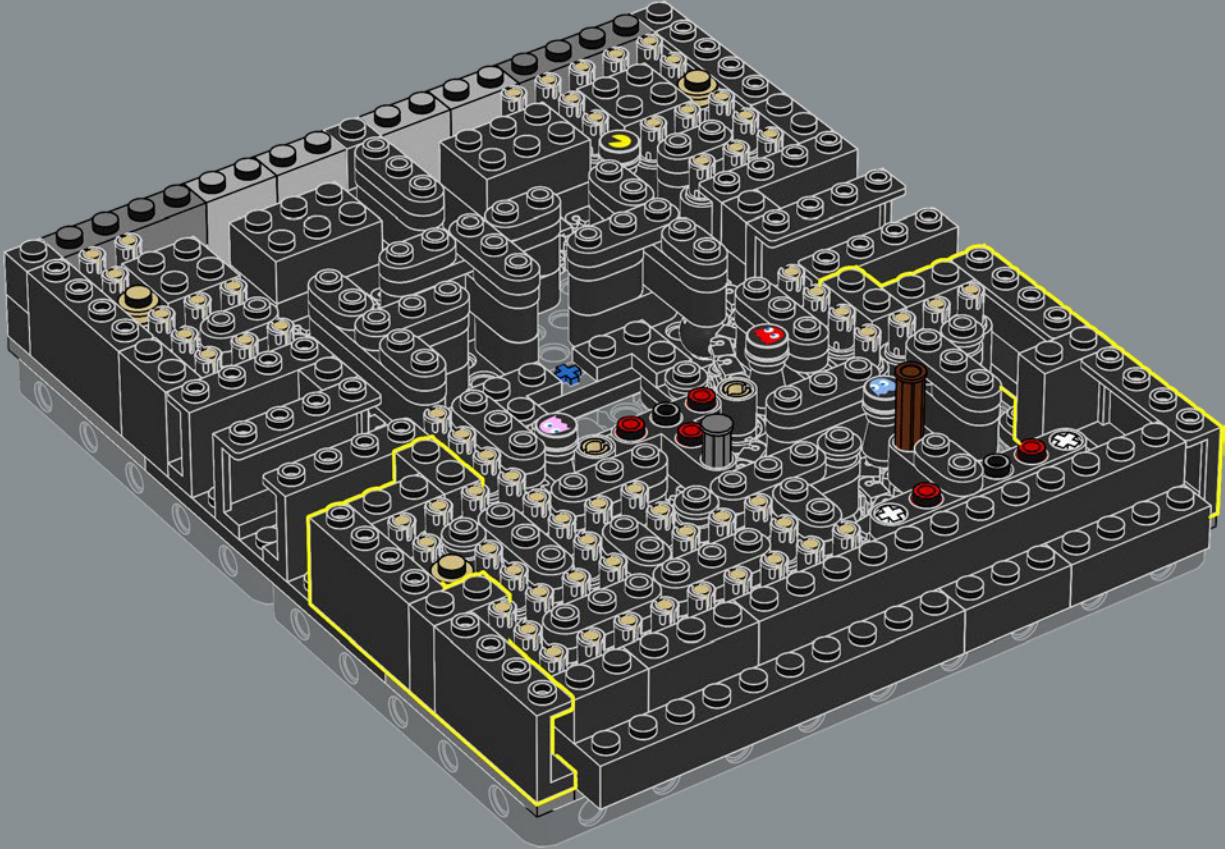

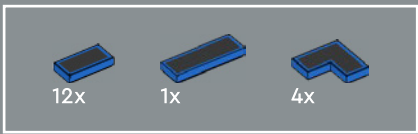

174

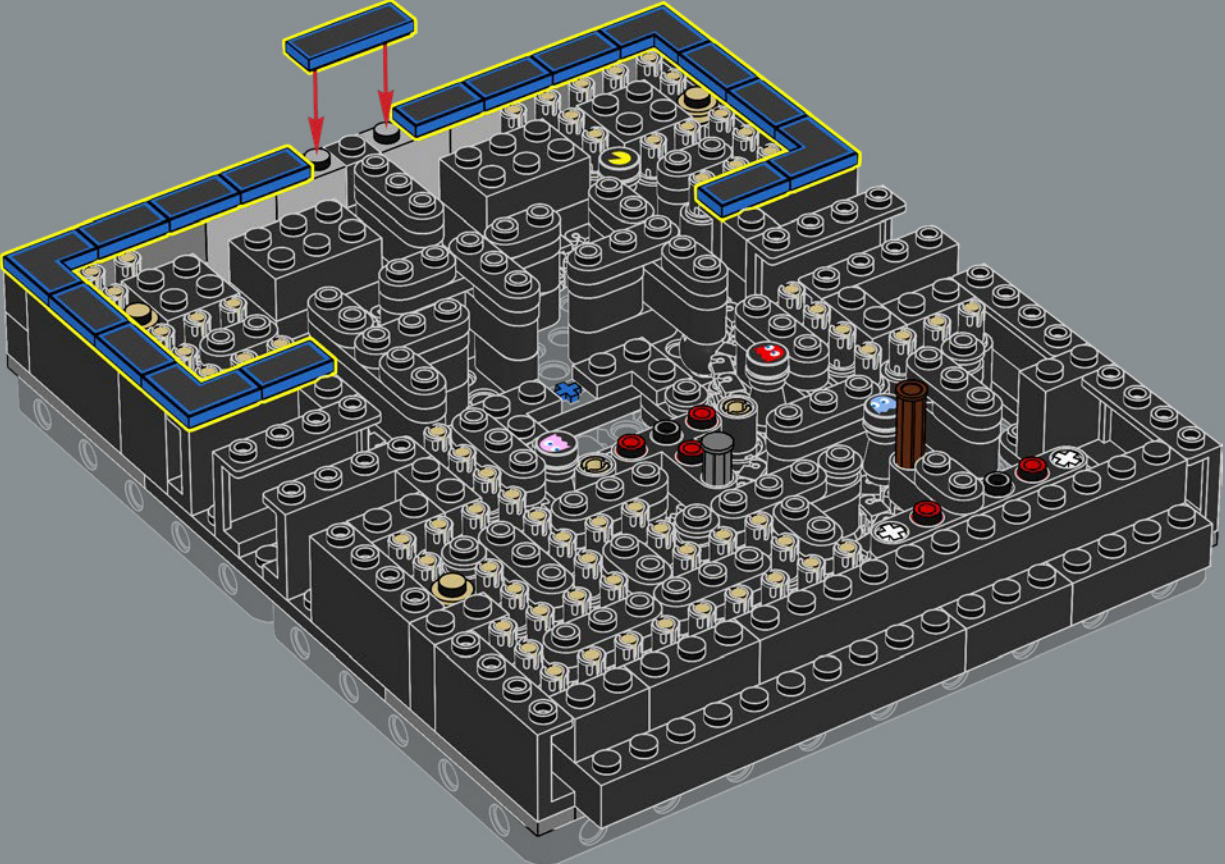

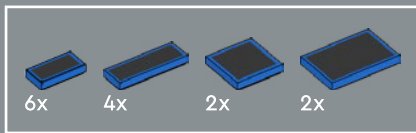

175

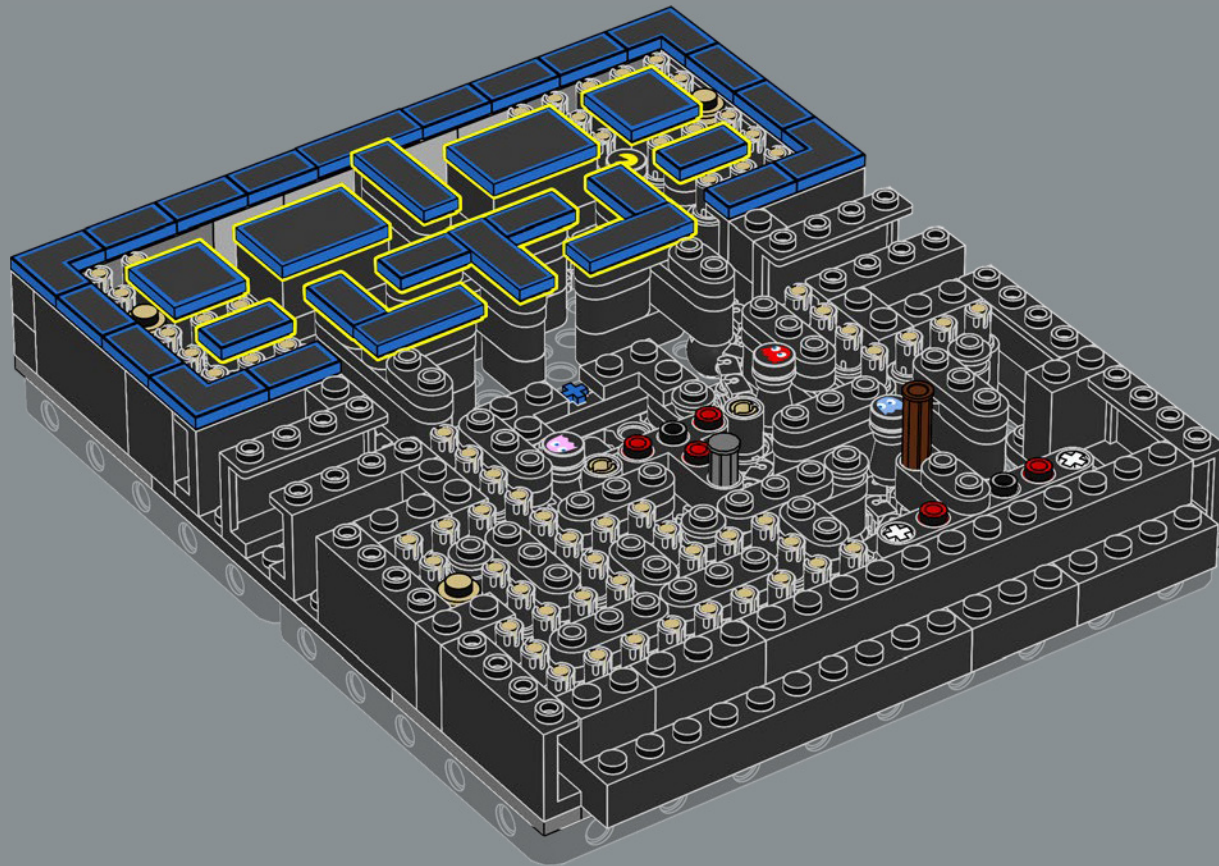

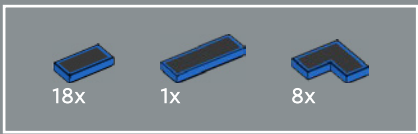

176

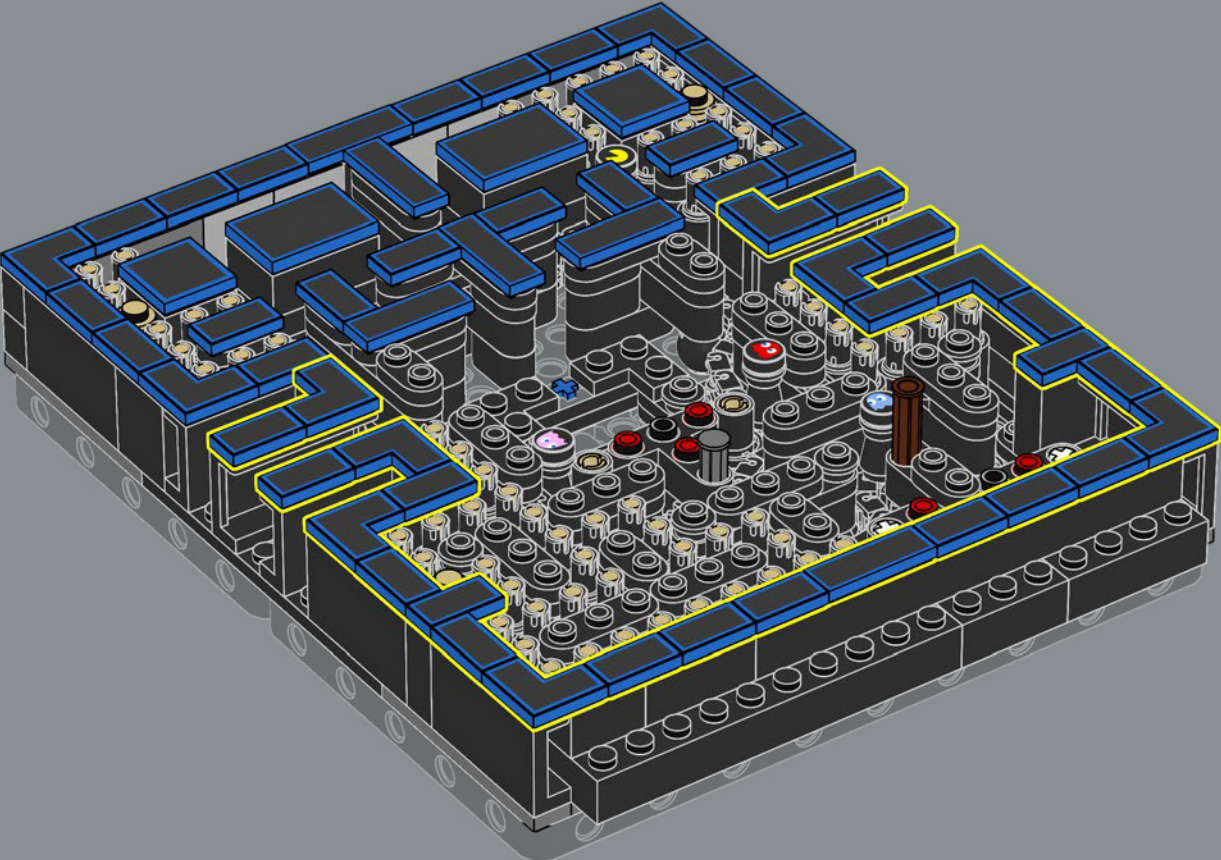

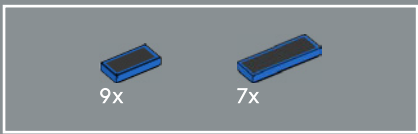

177

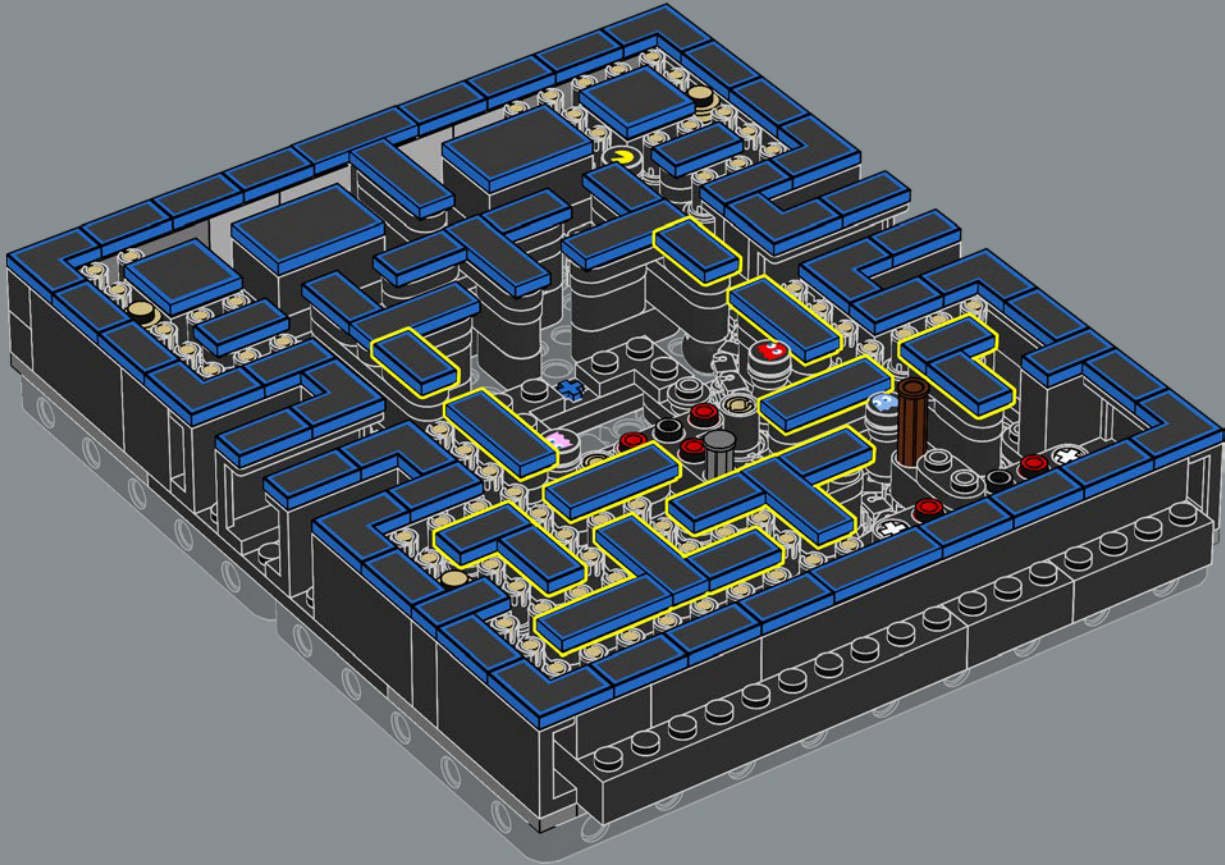



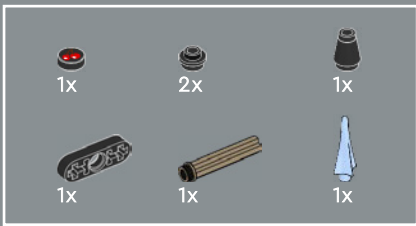

178

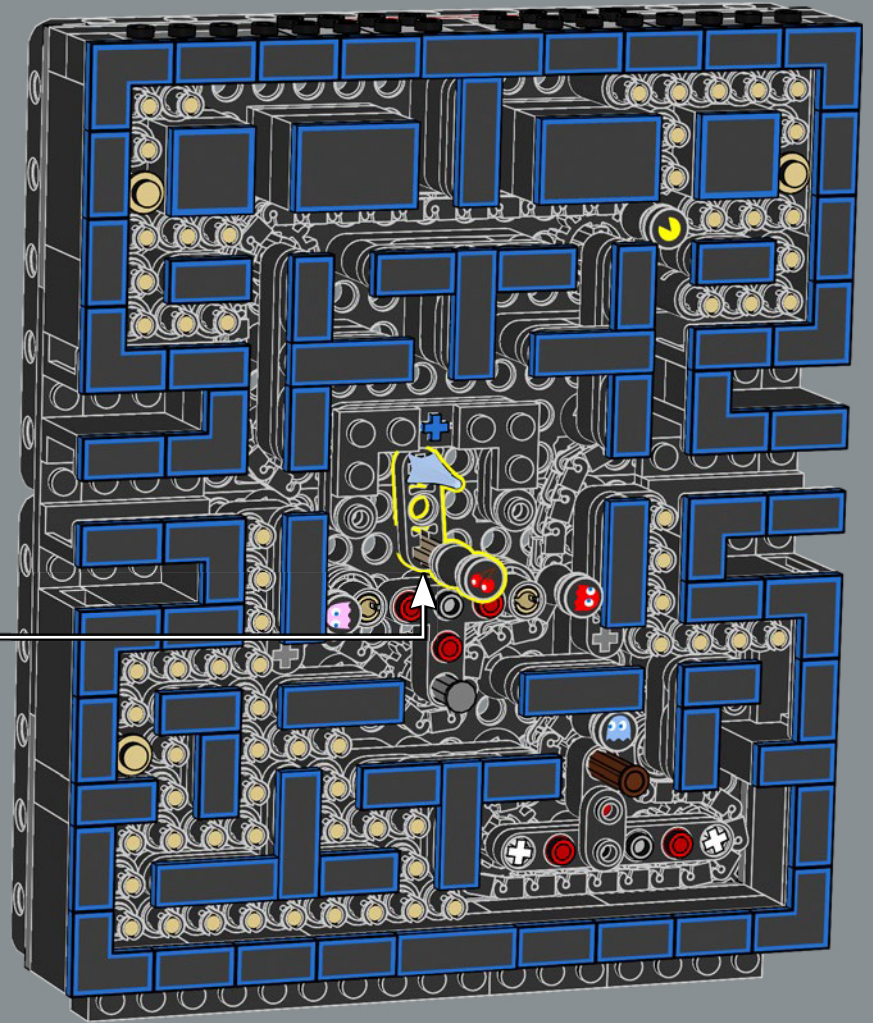
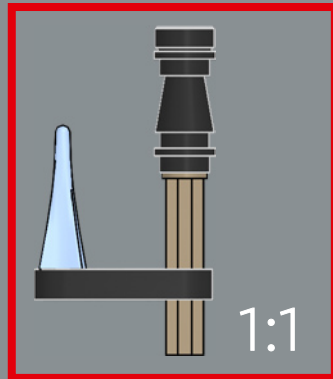
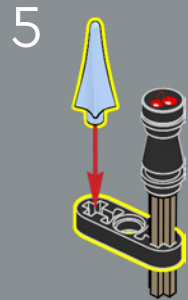
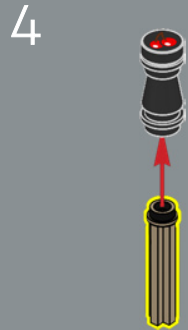
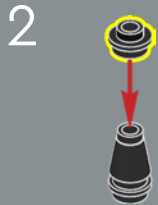
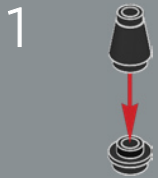

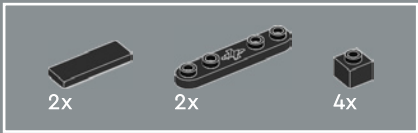

179

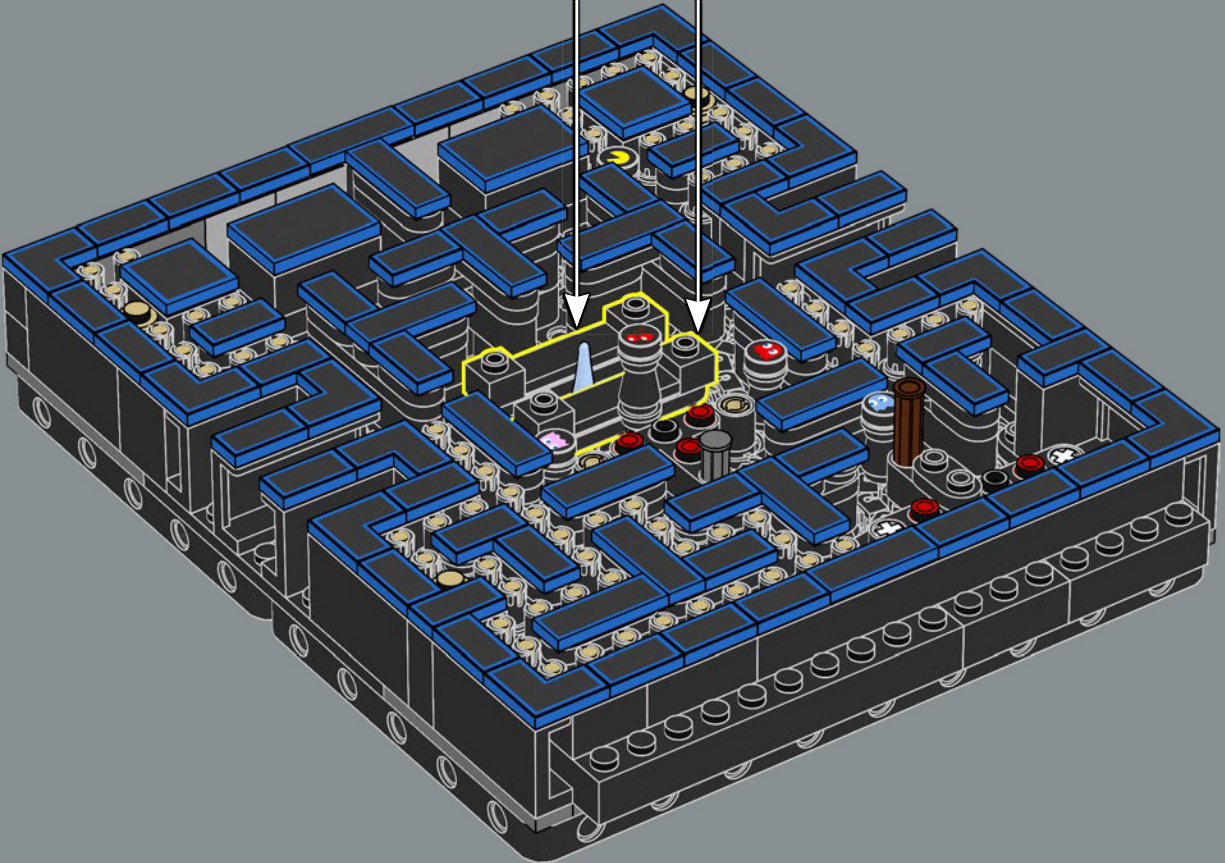
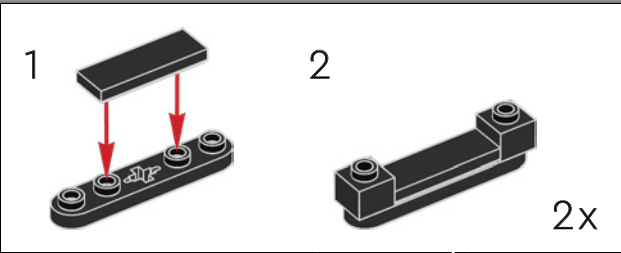

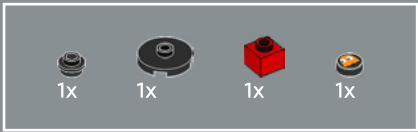

180

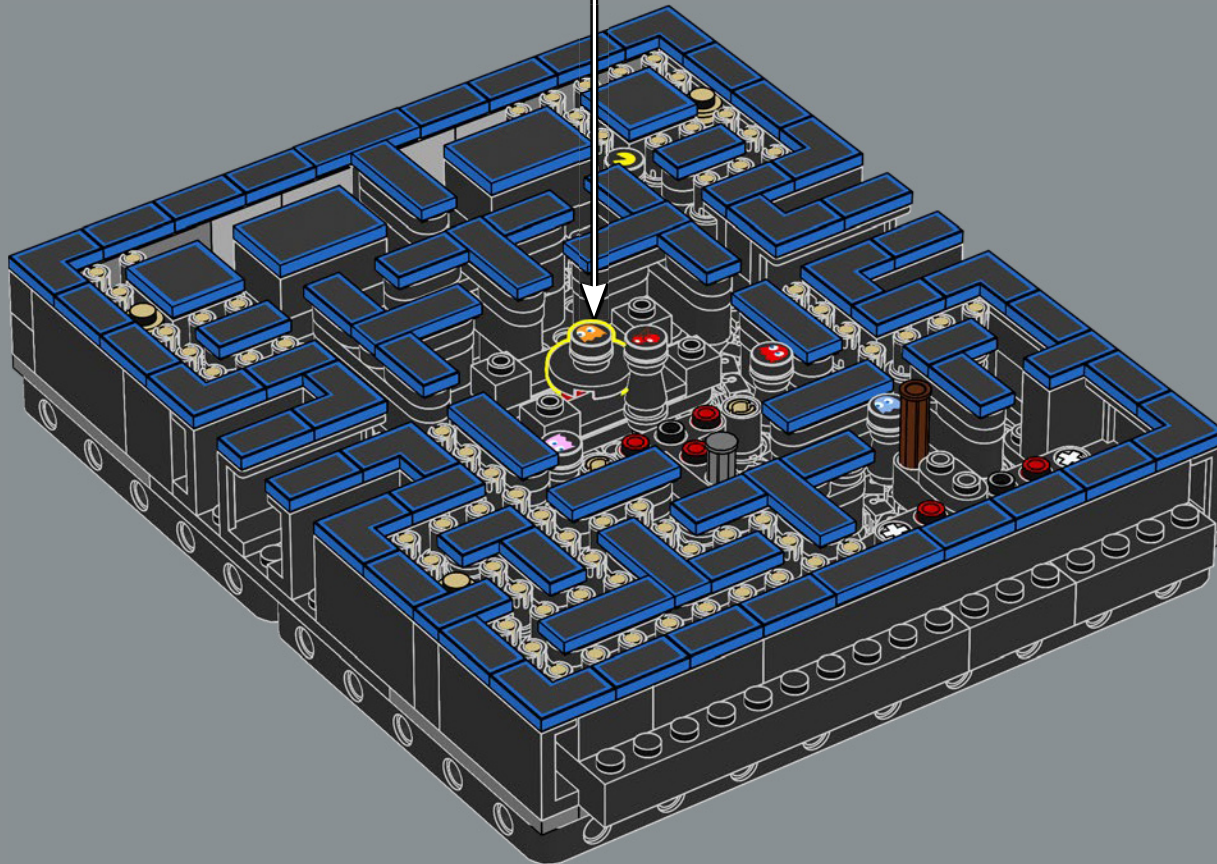
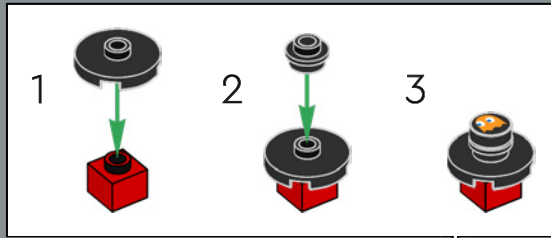

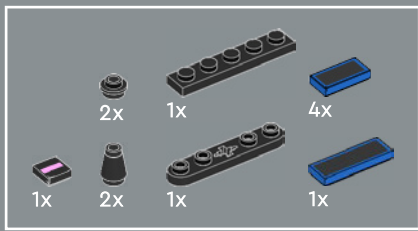

181

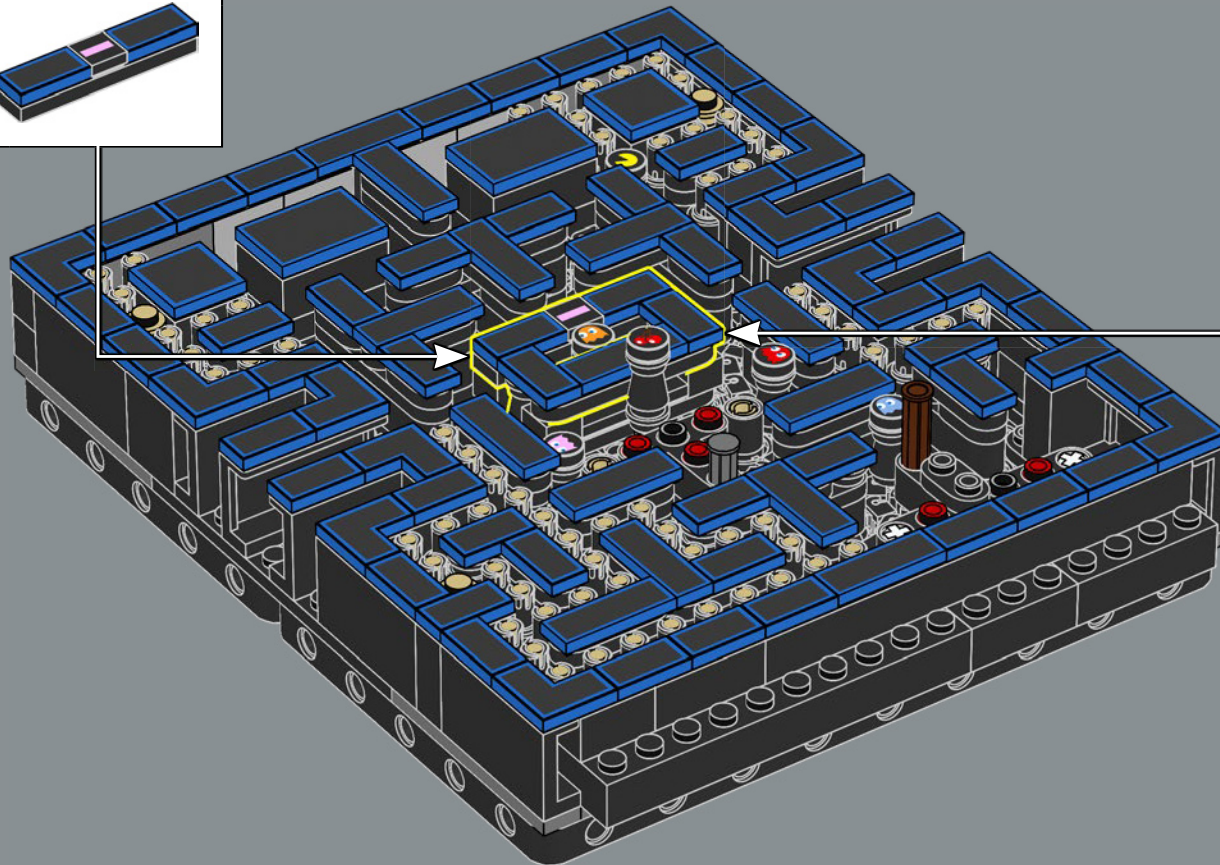
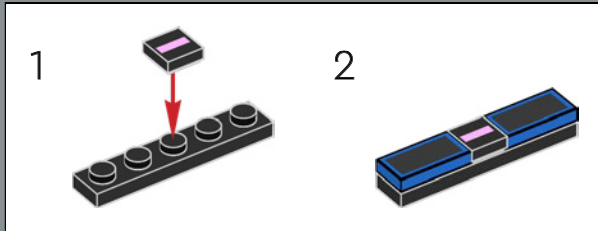
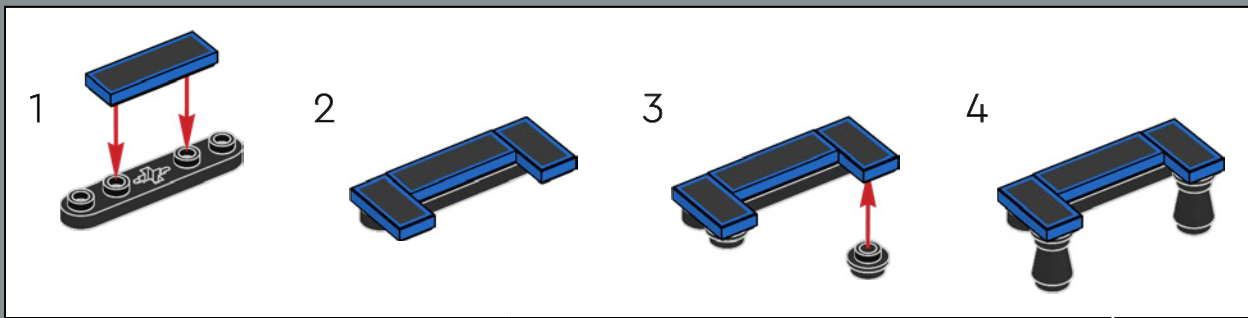

182

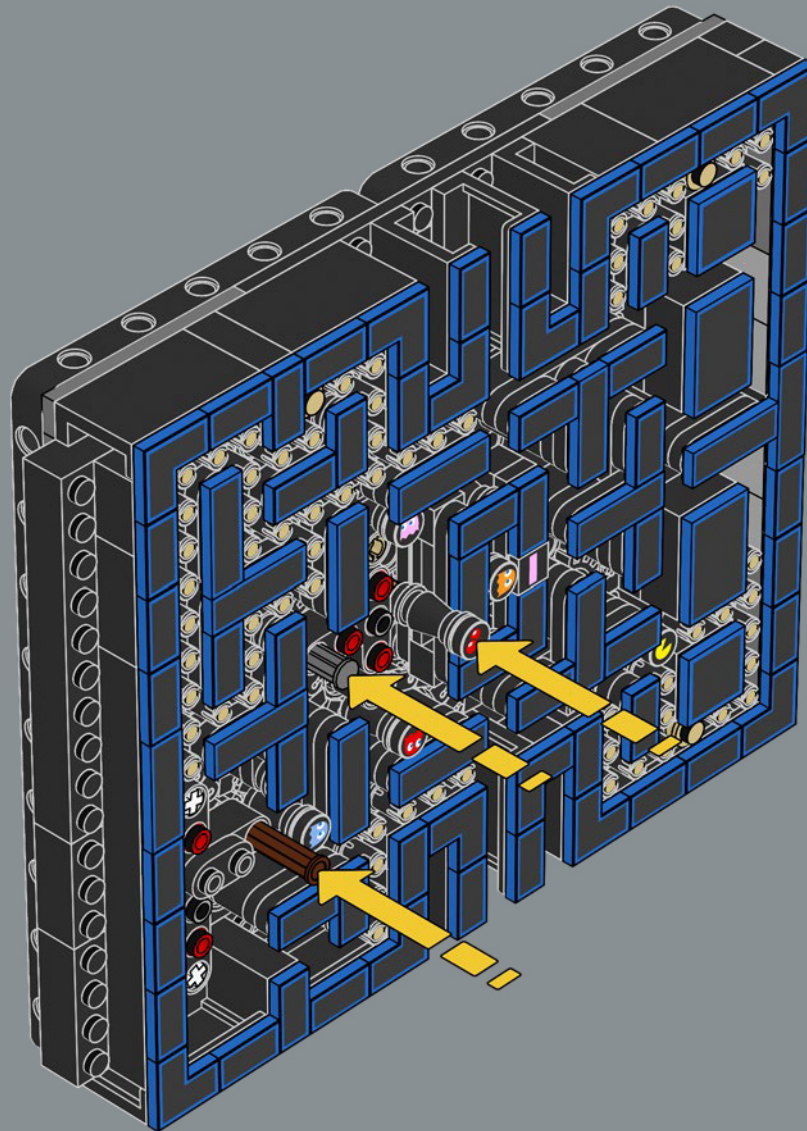

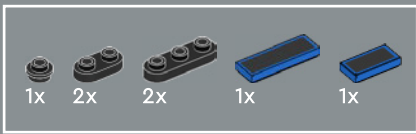

183

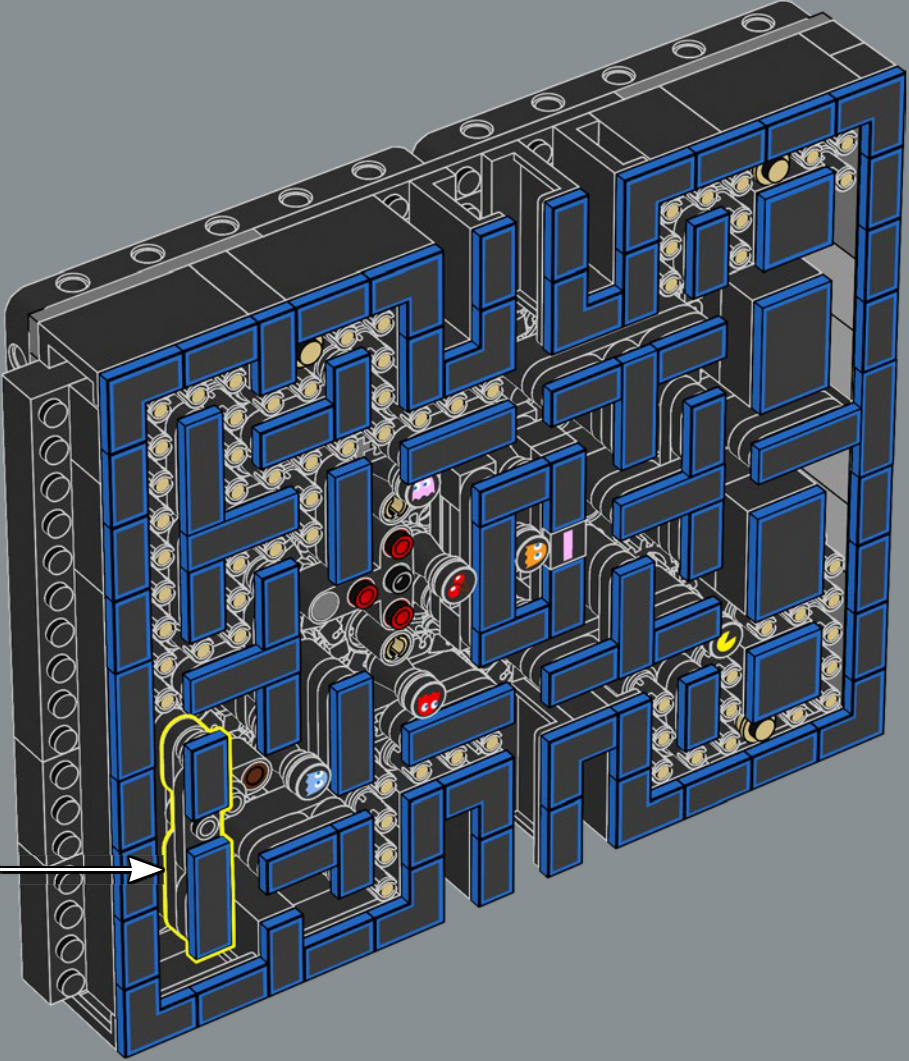
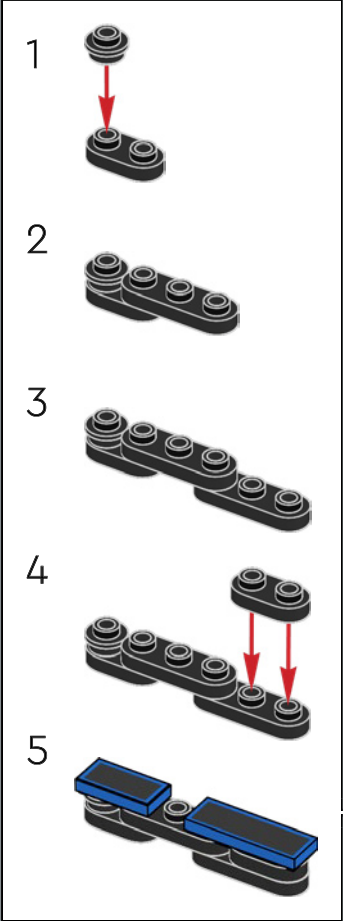

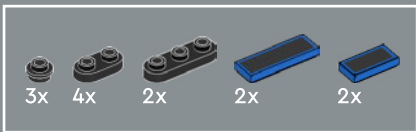

184

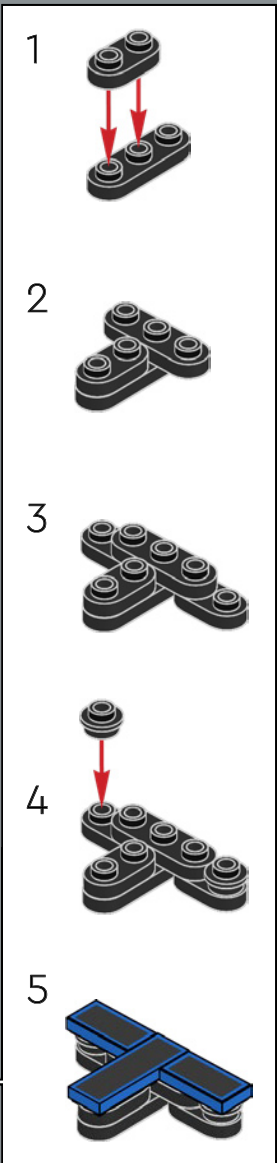
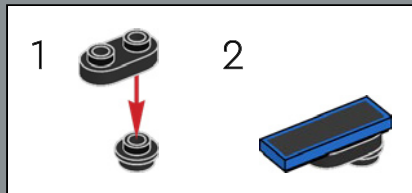
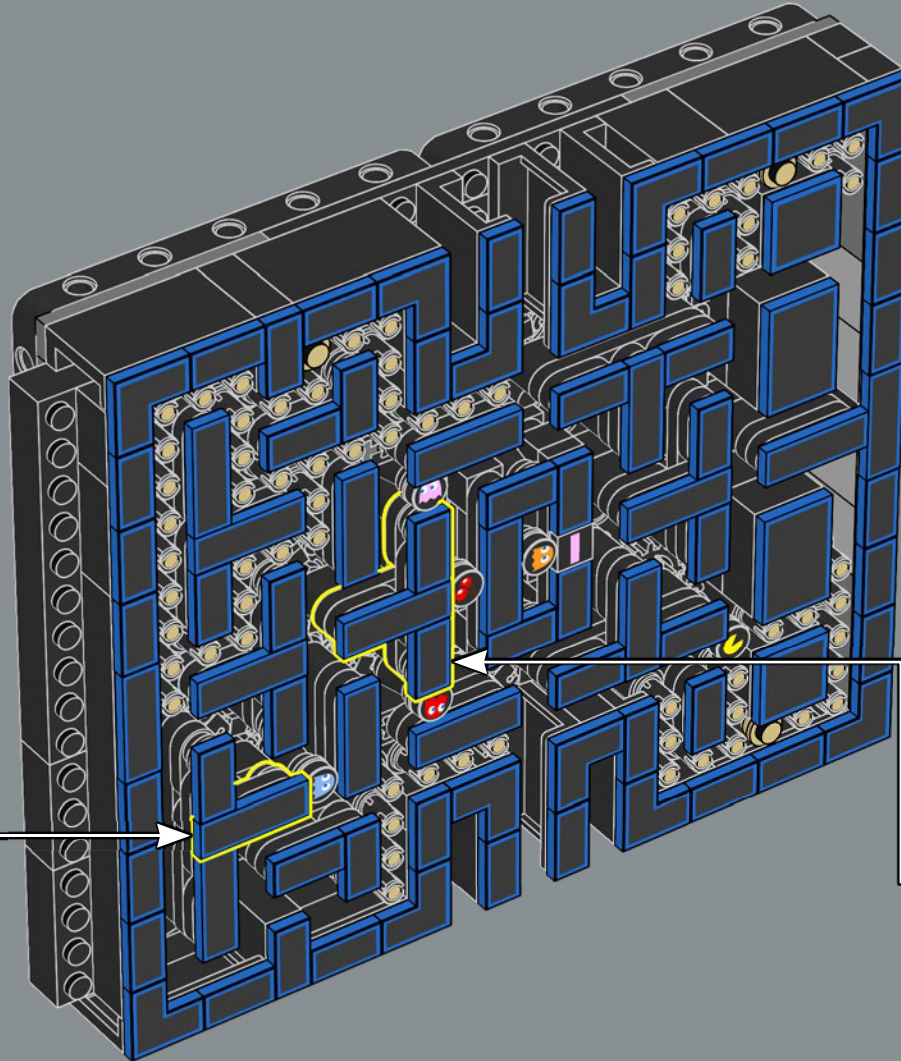

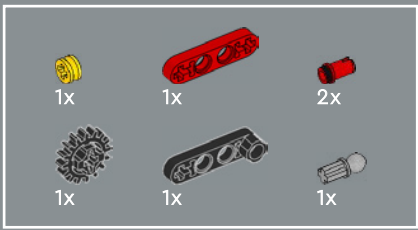

185

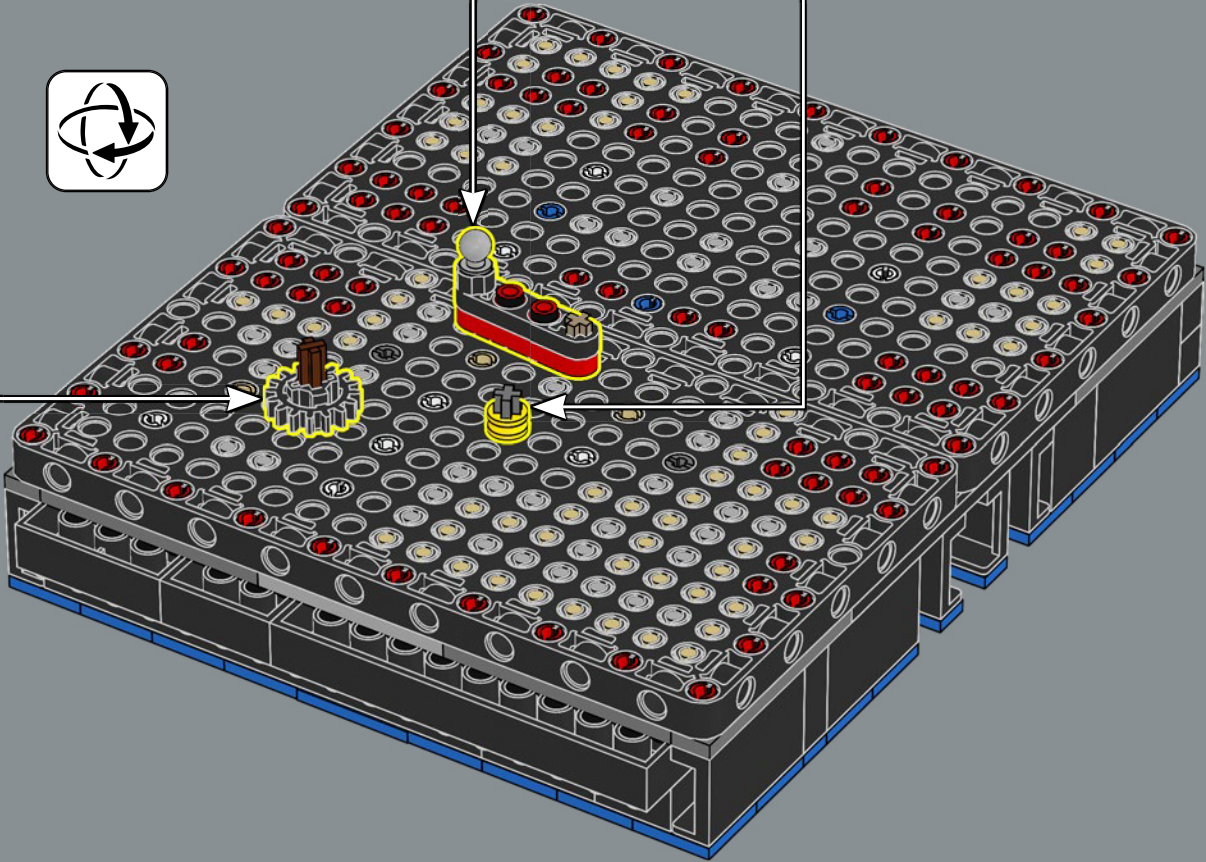
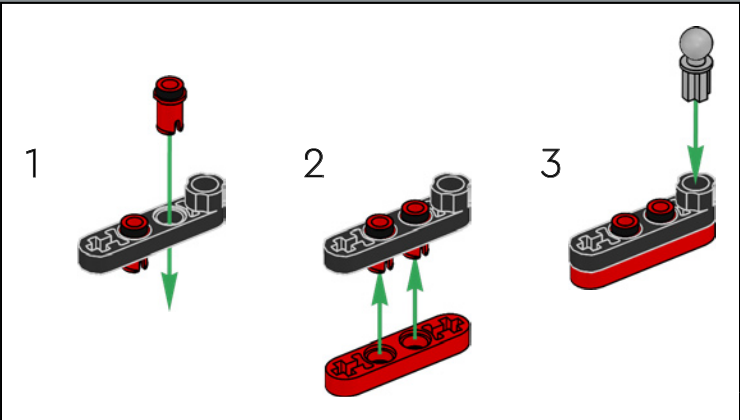

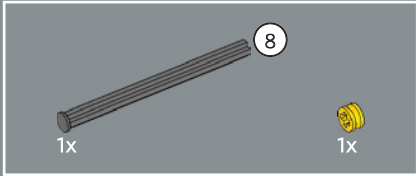
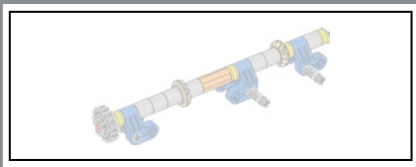

187

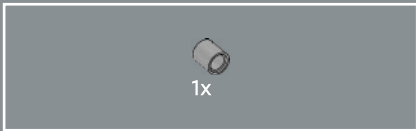
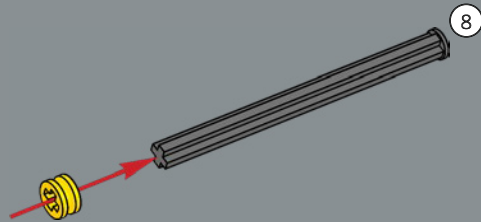

188

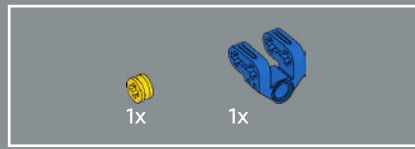
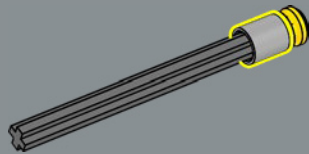

189

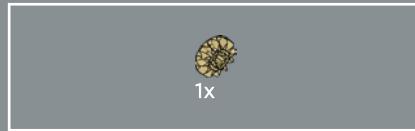
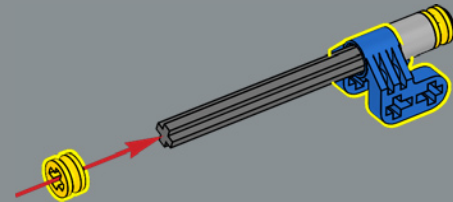

190

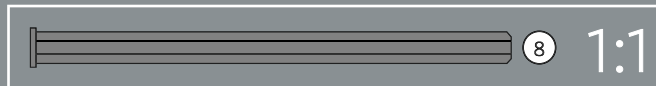
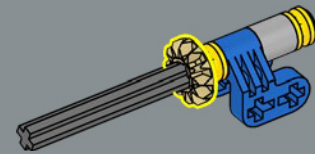



191

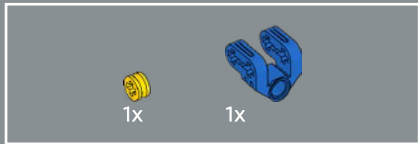
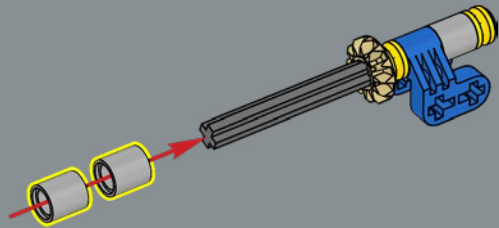

192

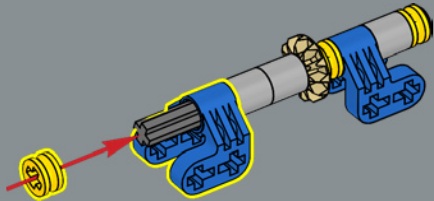

193

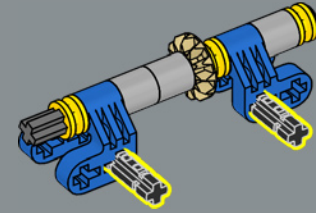

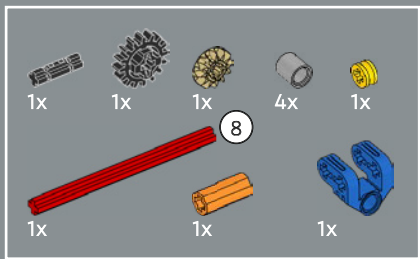

194

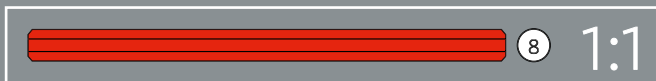
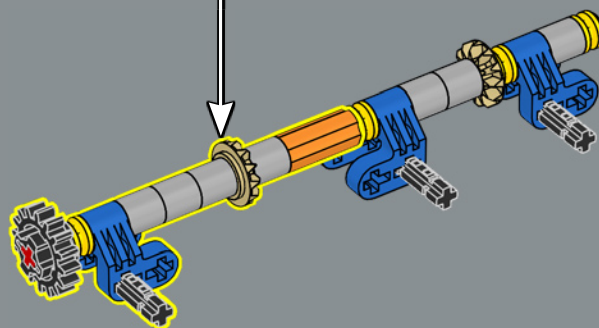
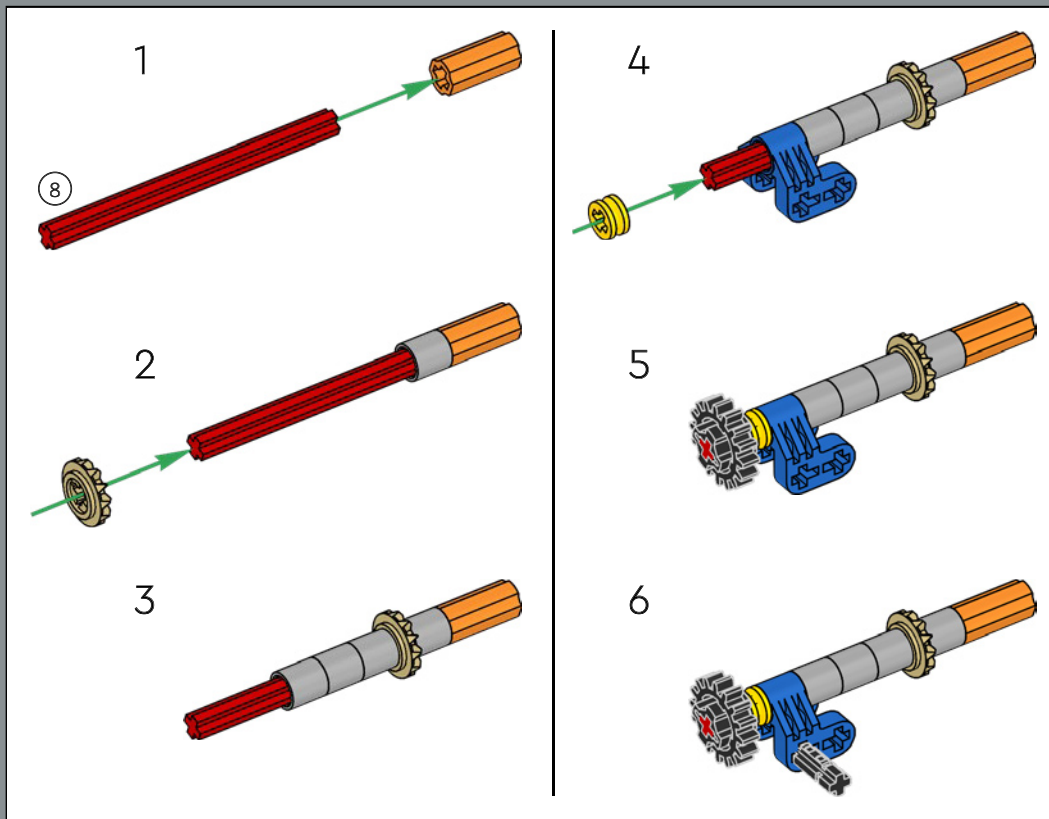

195

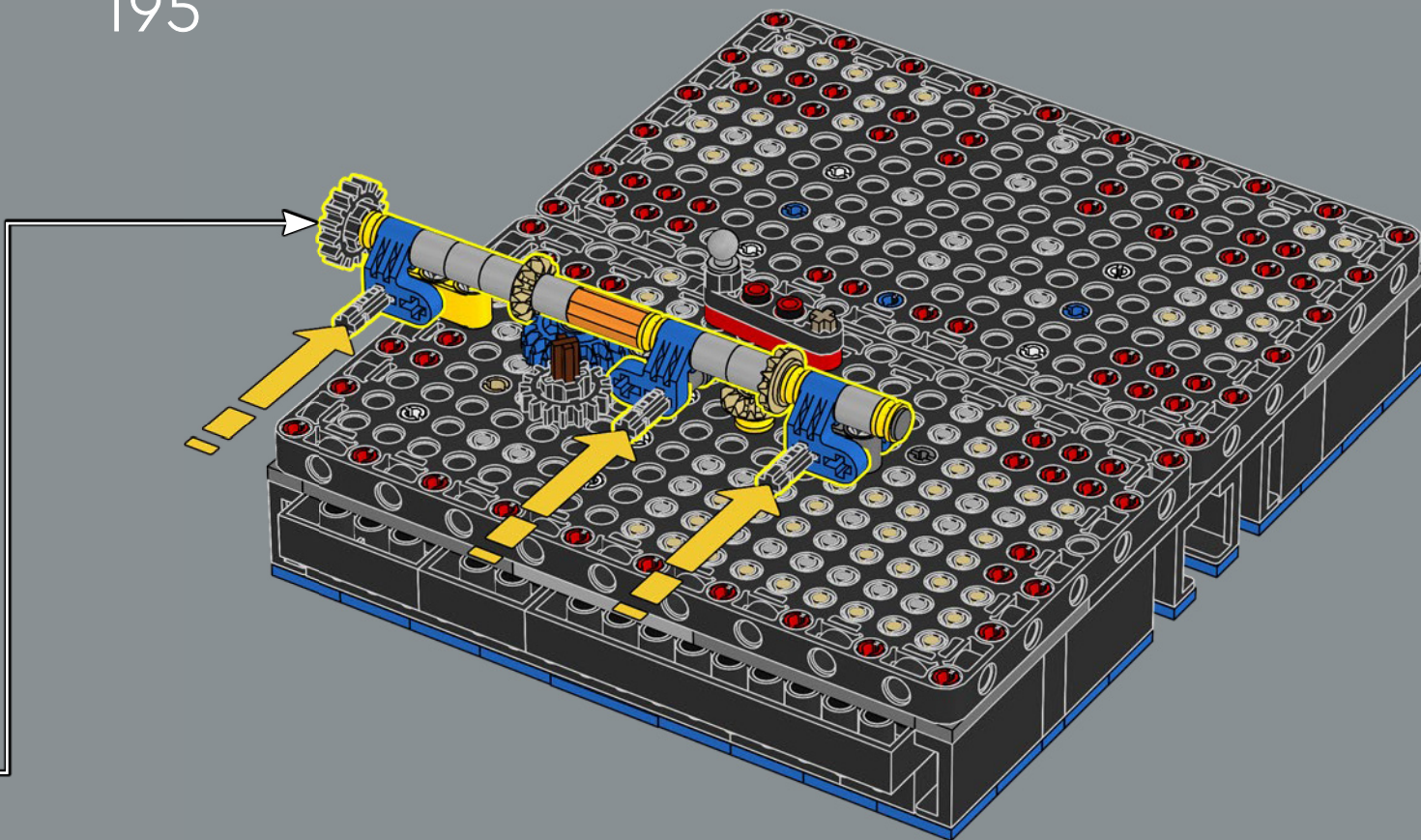



196

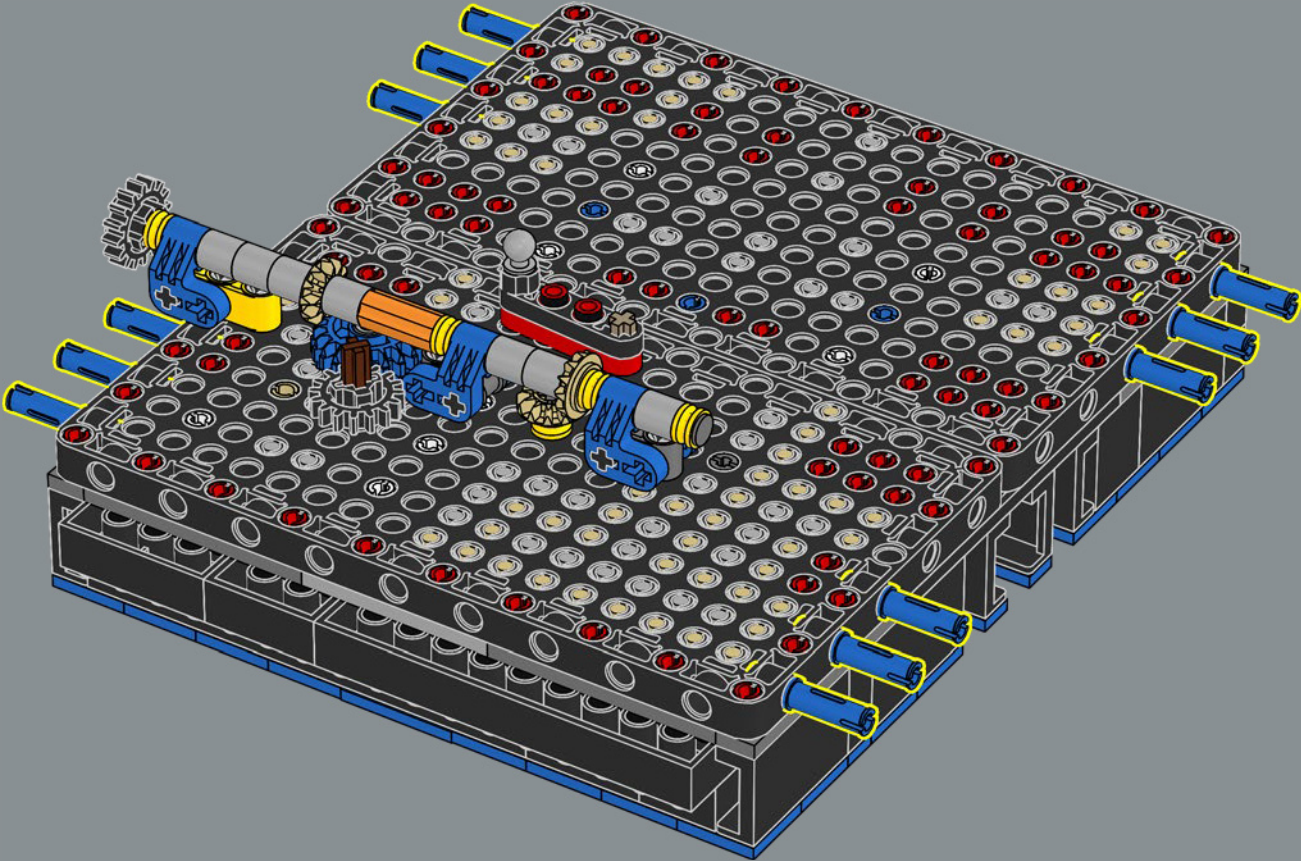

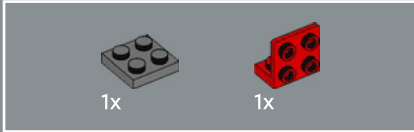
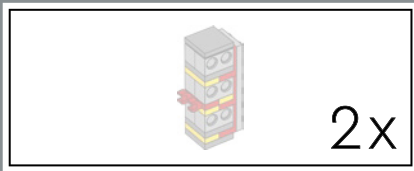

197

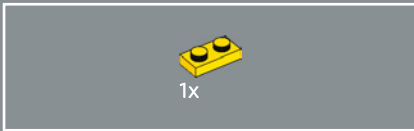
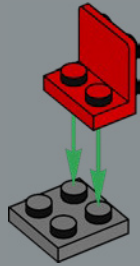

198

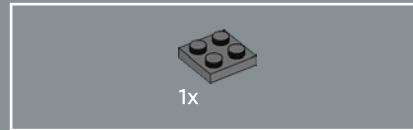

199

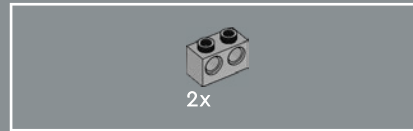

200

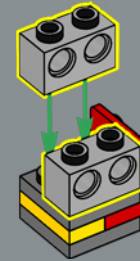

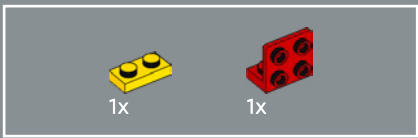

201

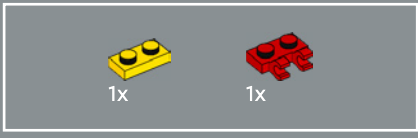
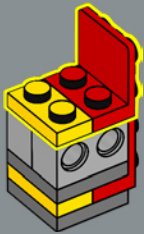

202

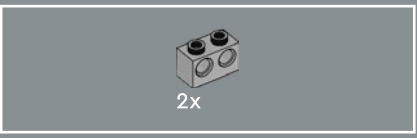
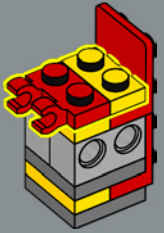

203

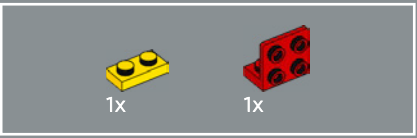
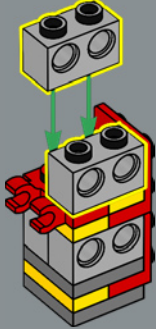

204

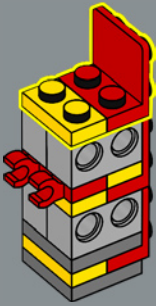

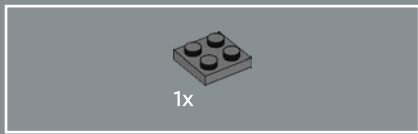

205

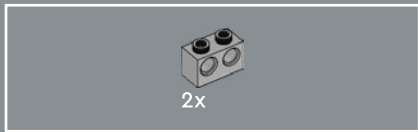
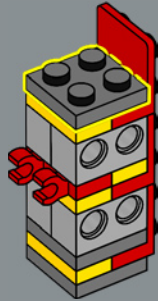

206

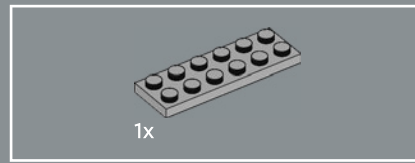
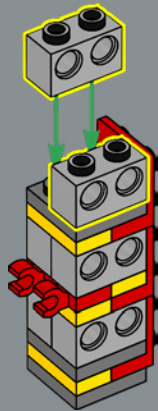

207

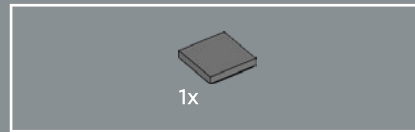
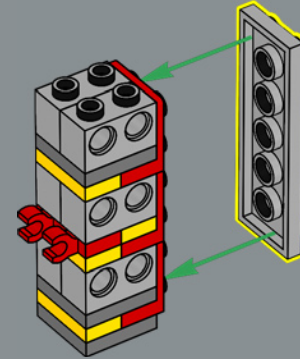

208

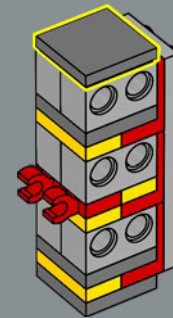

2x



209

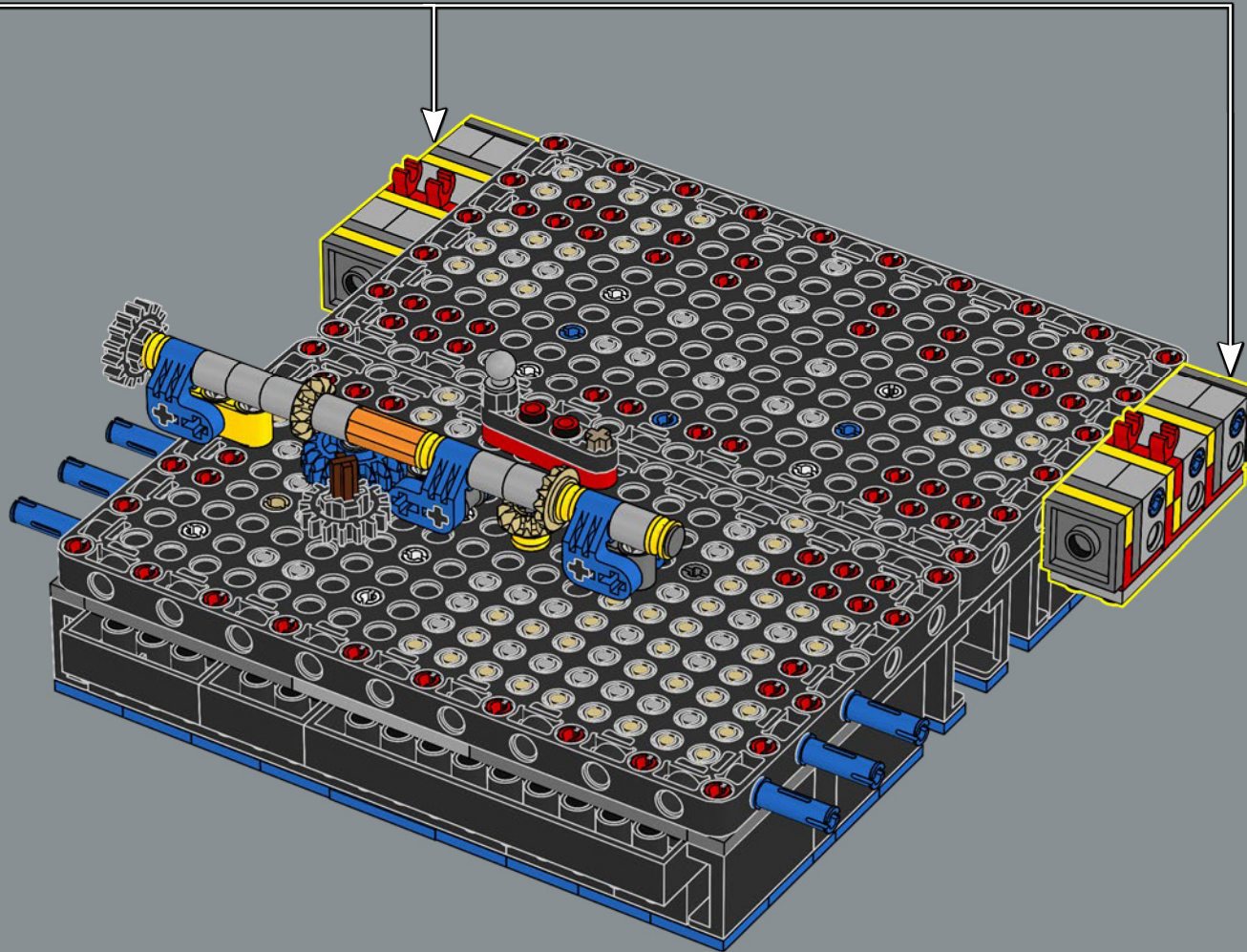

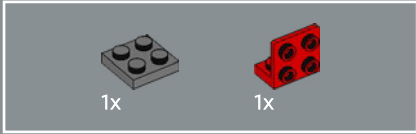
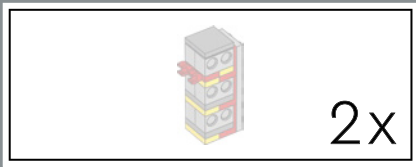

210

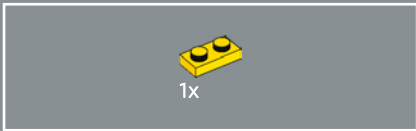
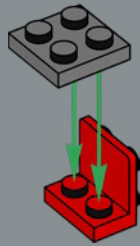

211

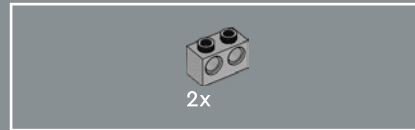
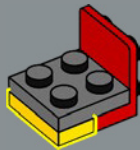

212

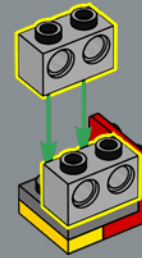

213

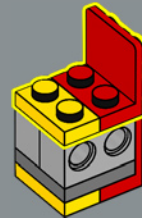

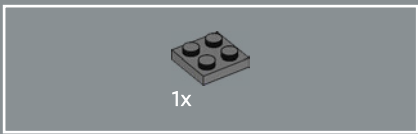

214

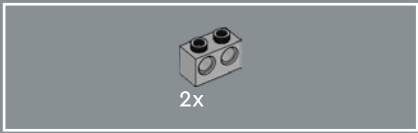

215

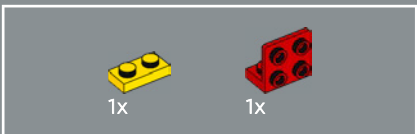
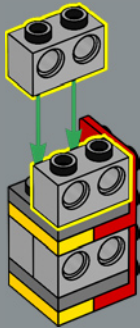

216

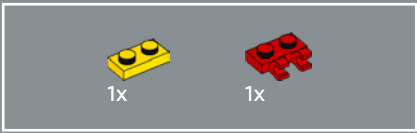
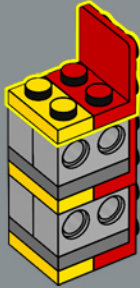

217

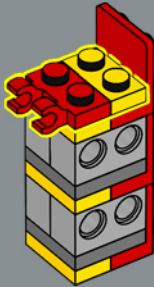

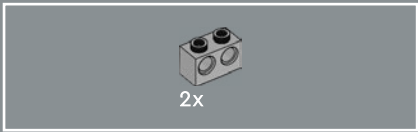

218

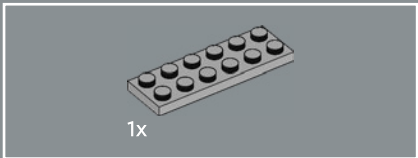
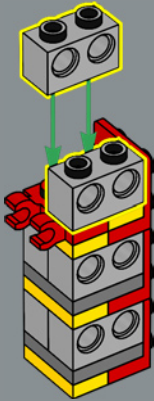

219

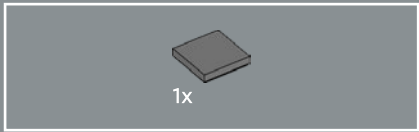
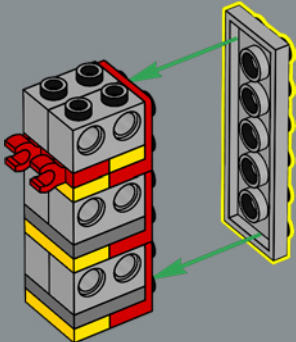

220

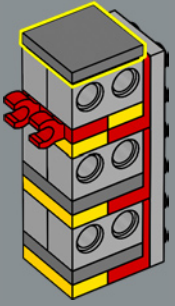

2x



221

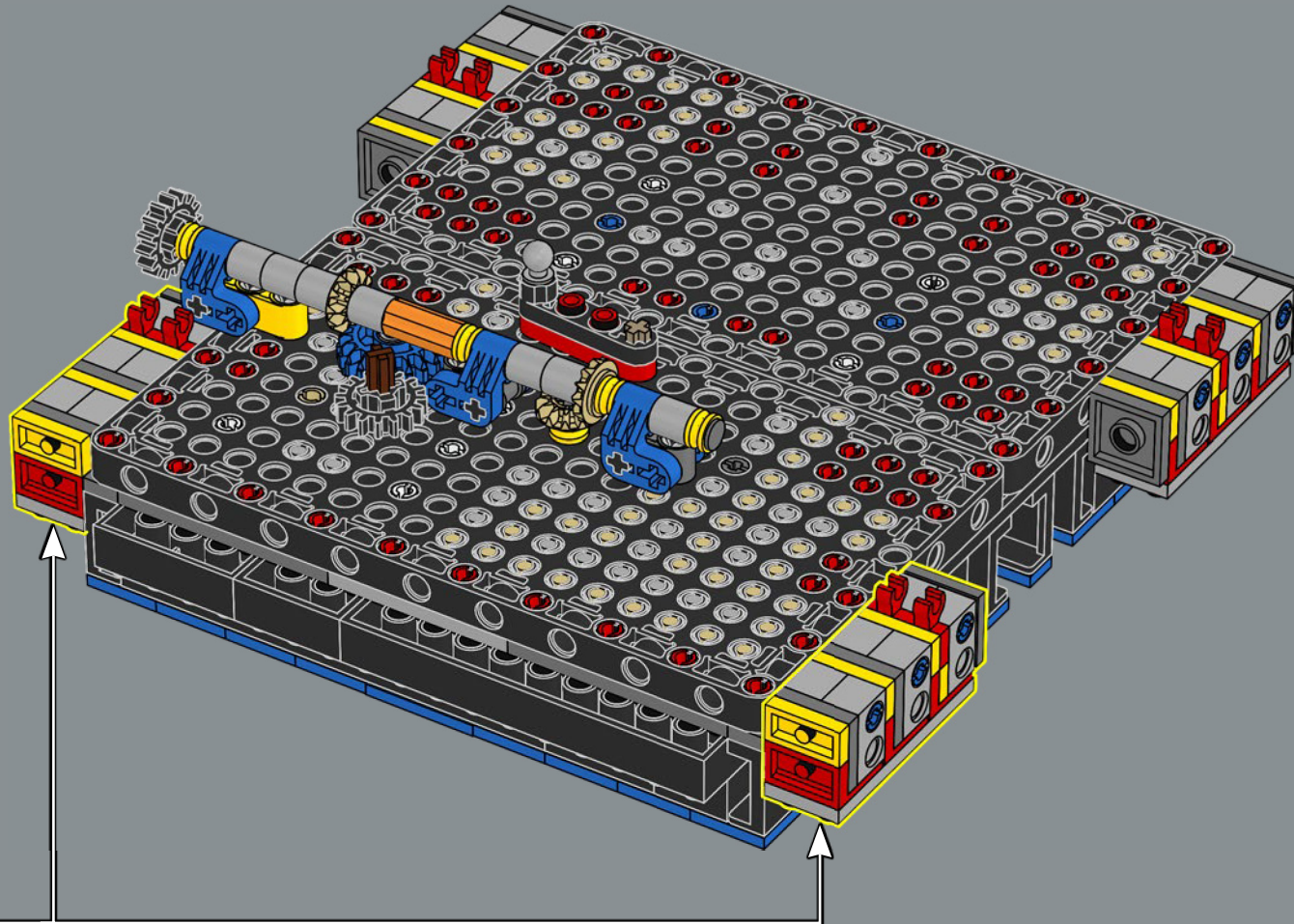

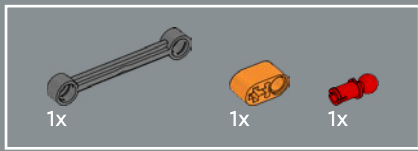

222

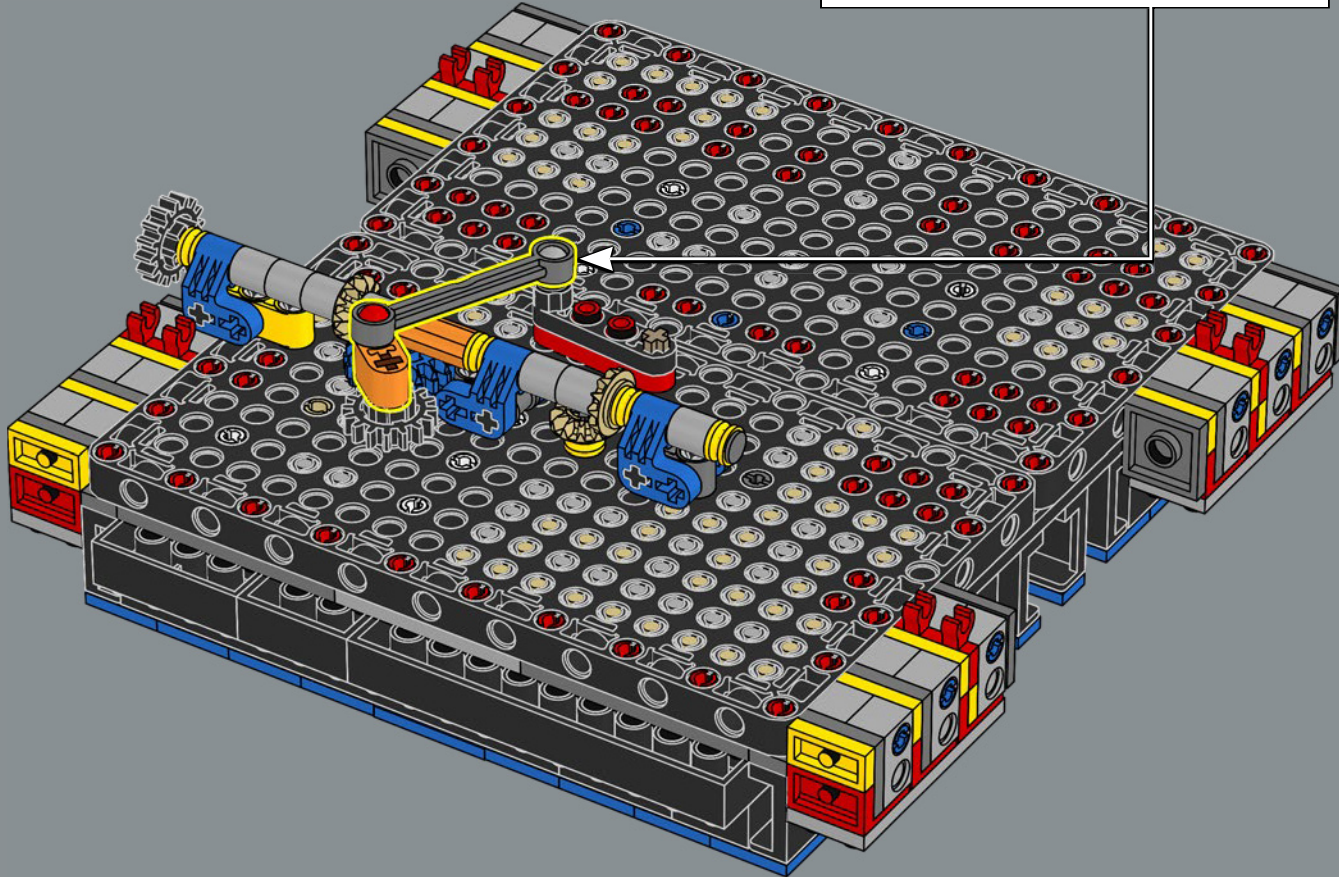
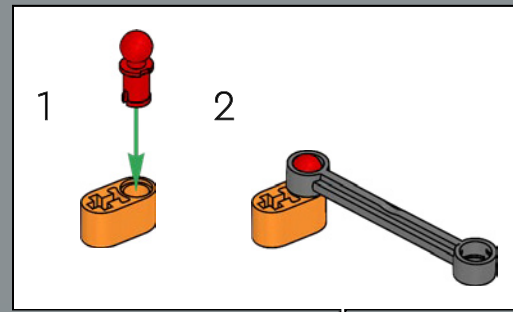

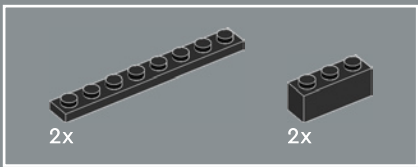

223

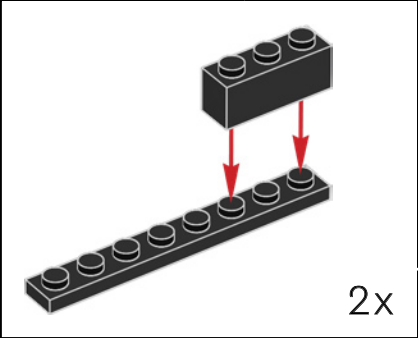
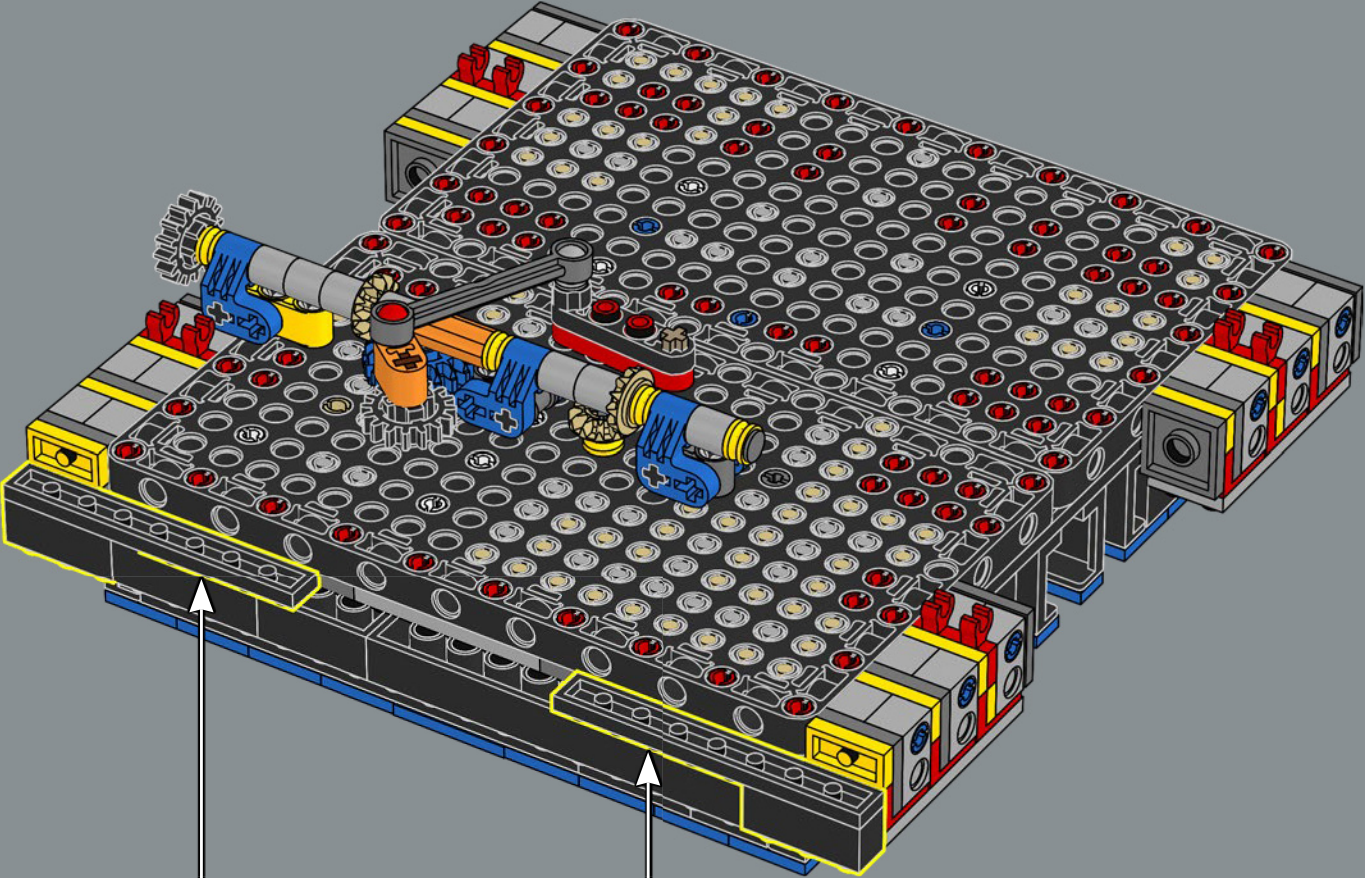

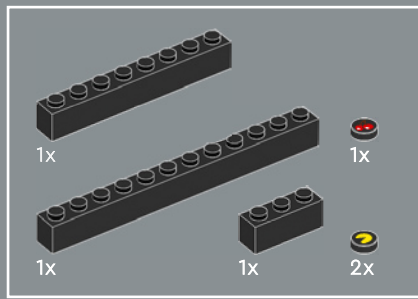

224

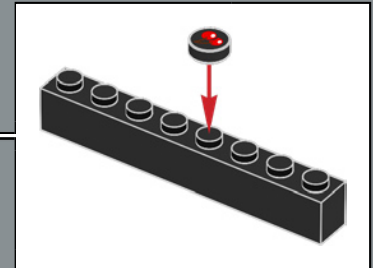
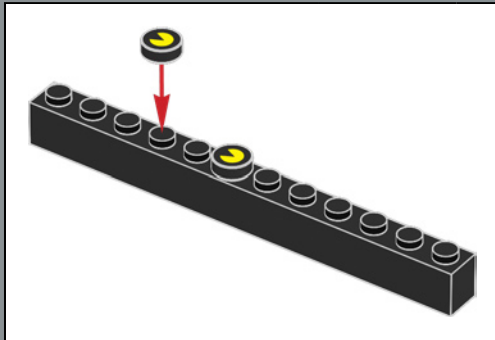
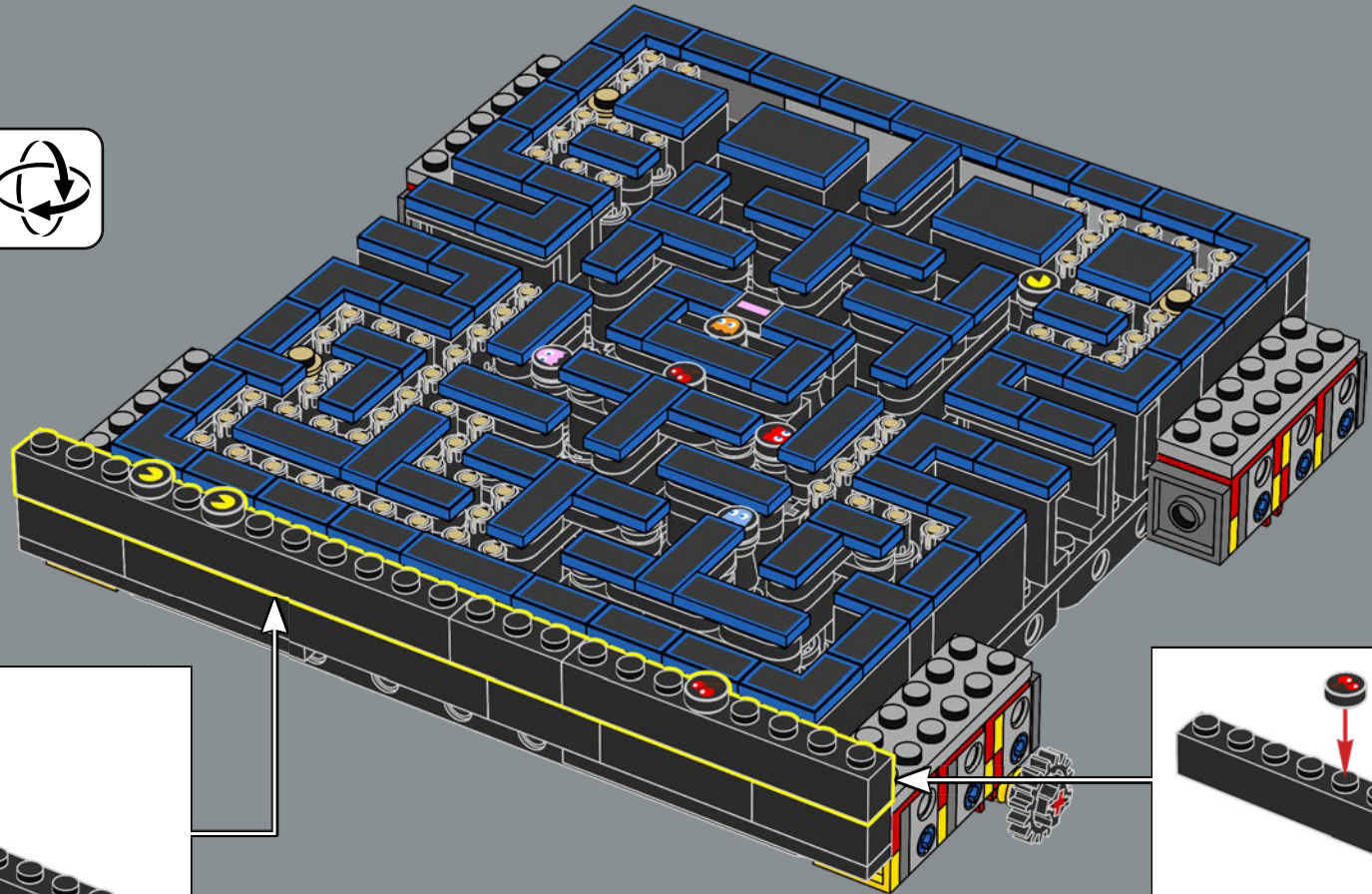

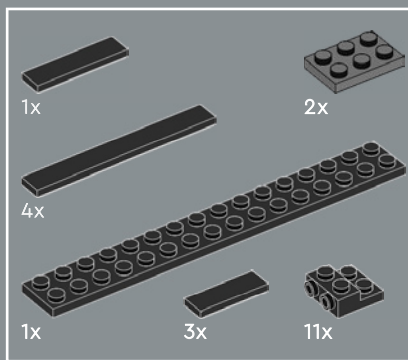
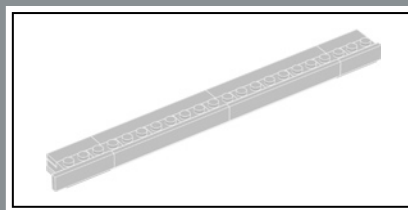

225

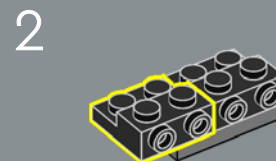
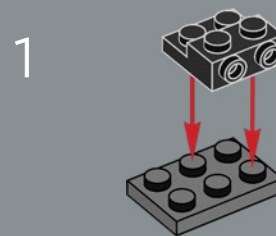

3

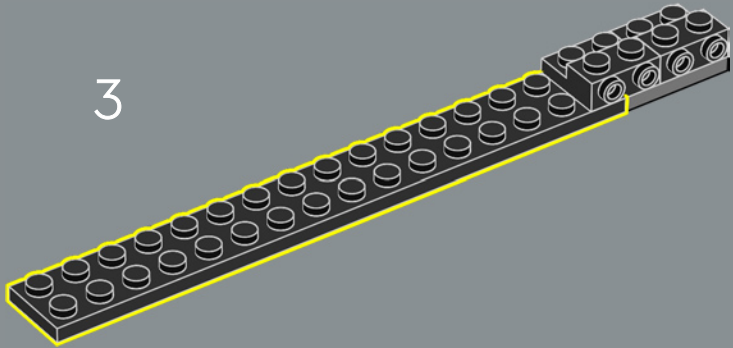

4

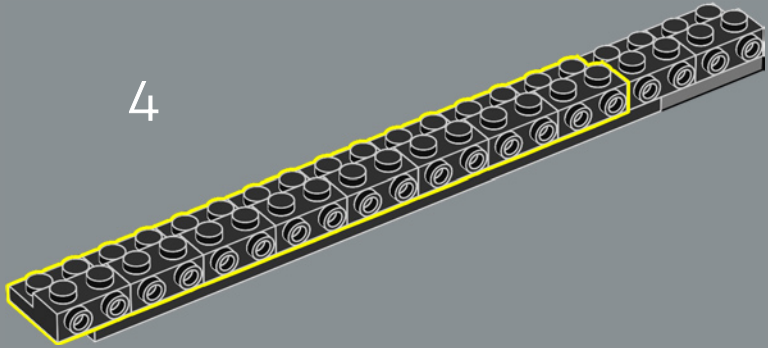

5

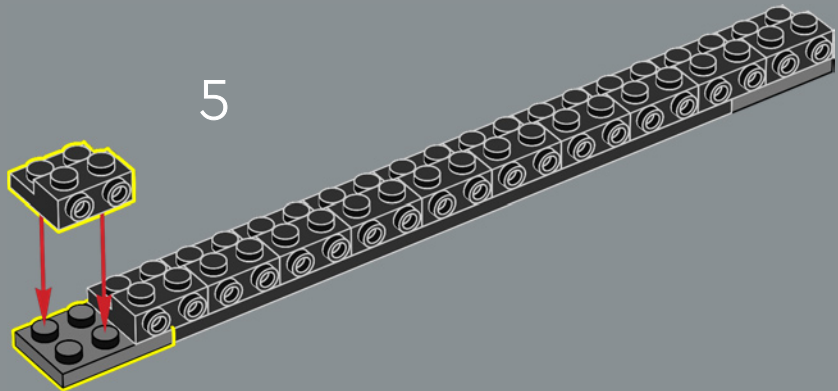

6

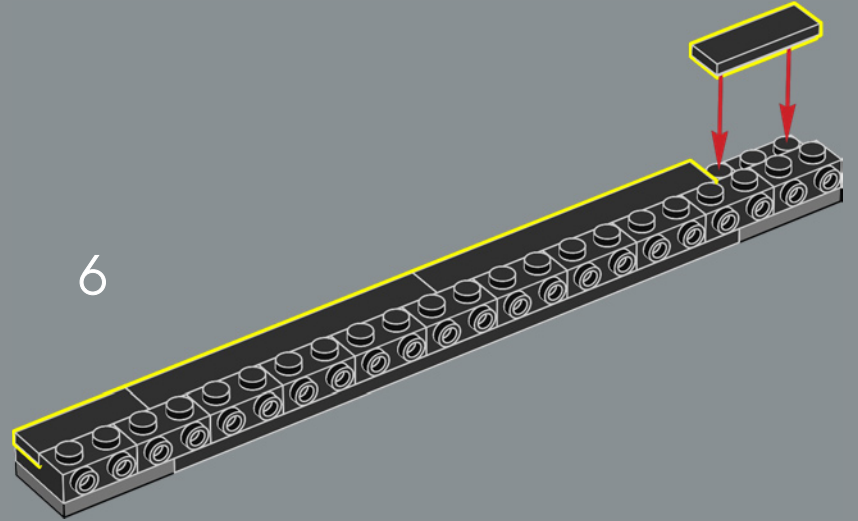

7

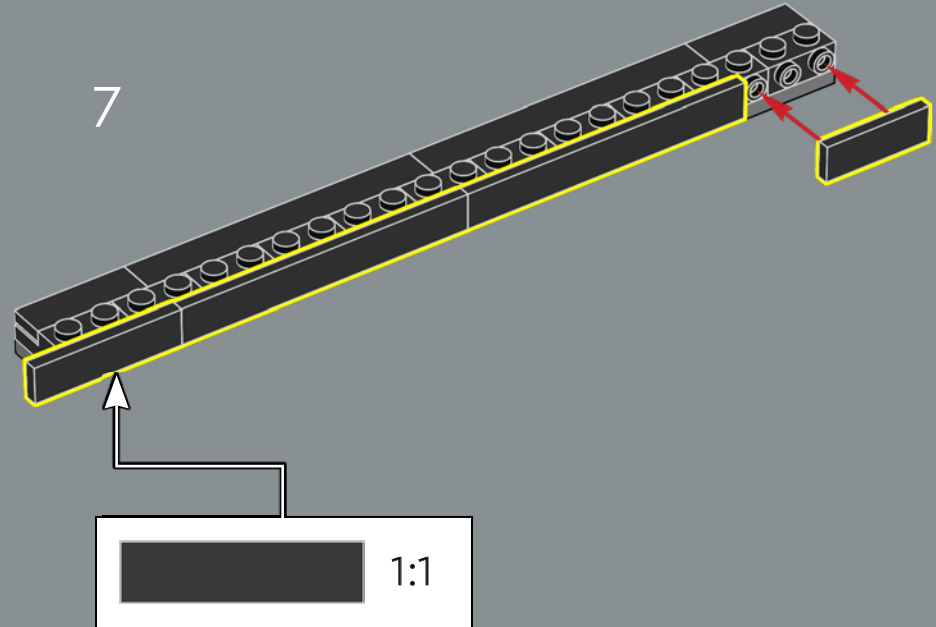

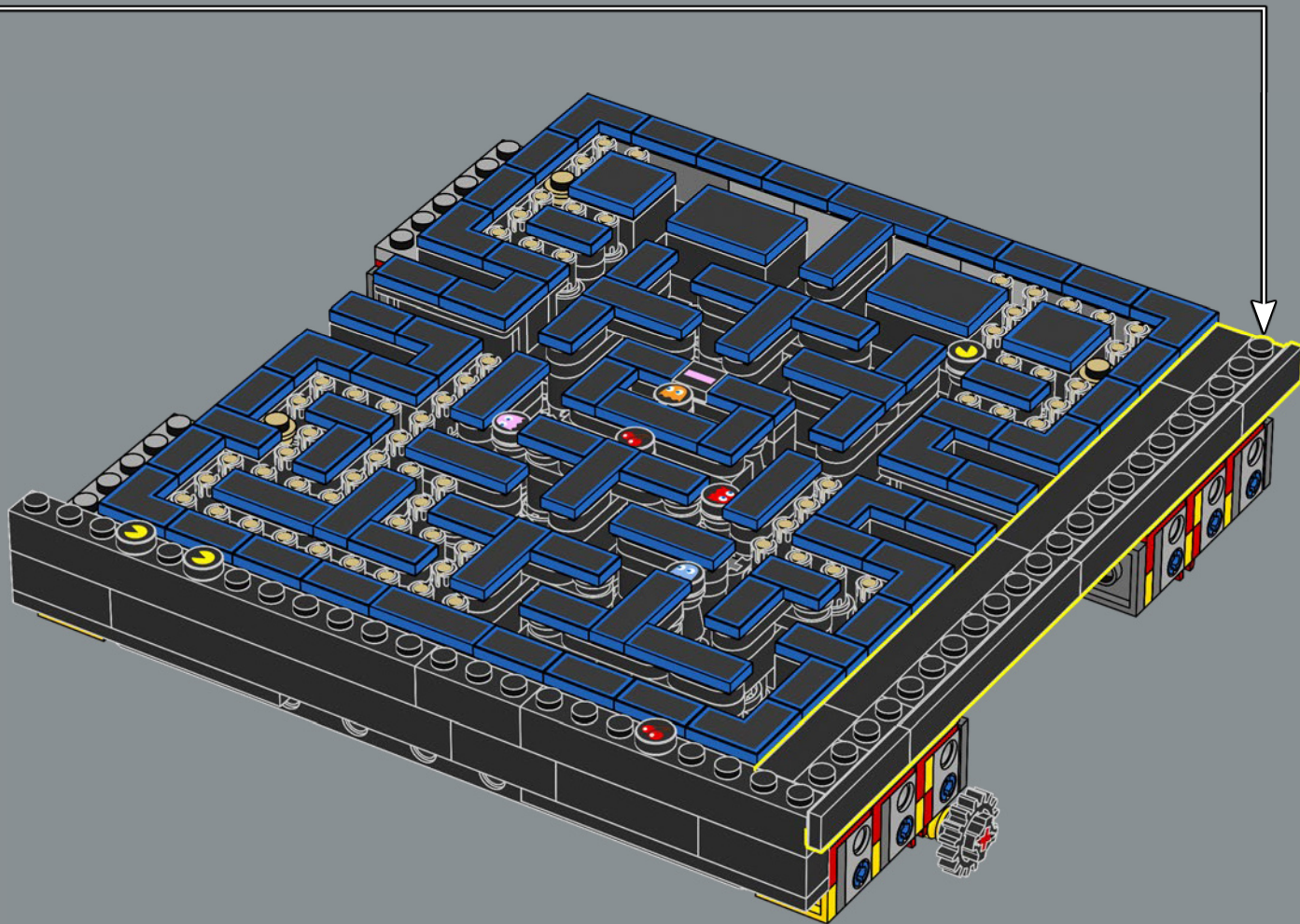

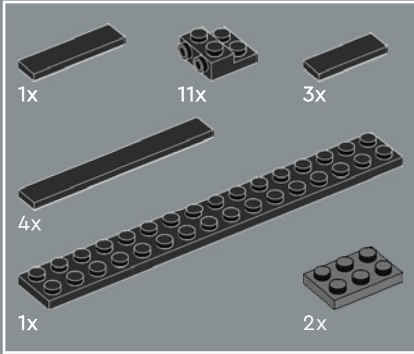
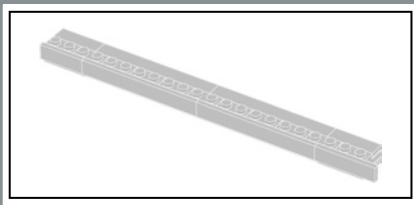

226

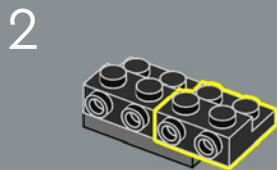
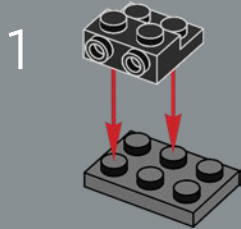

3

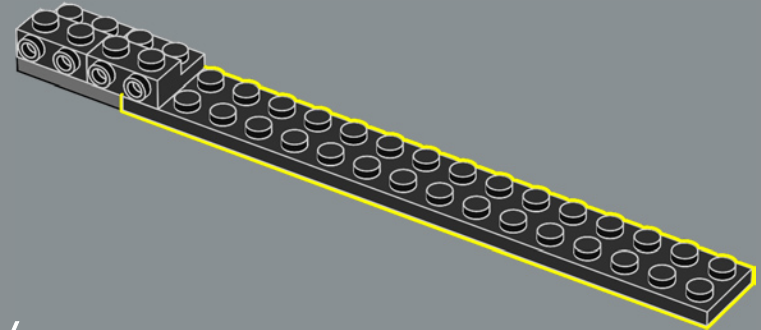

4

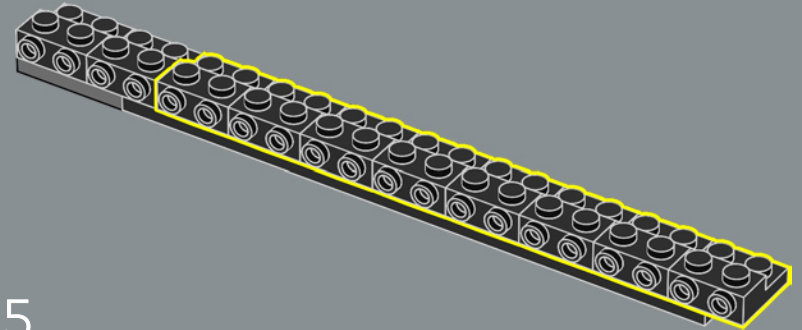

5

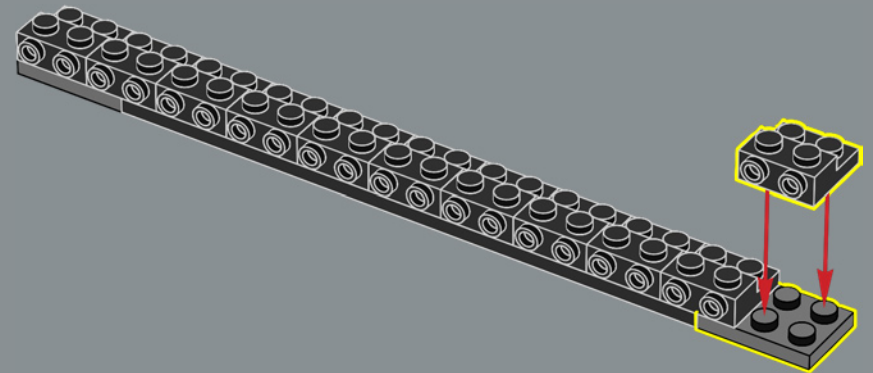

6

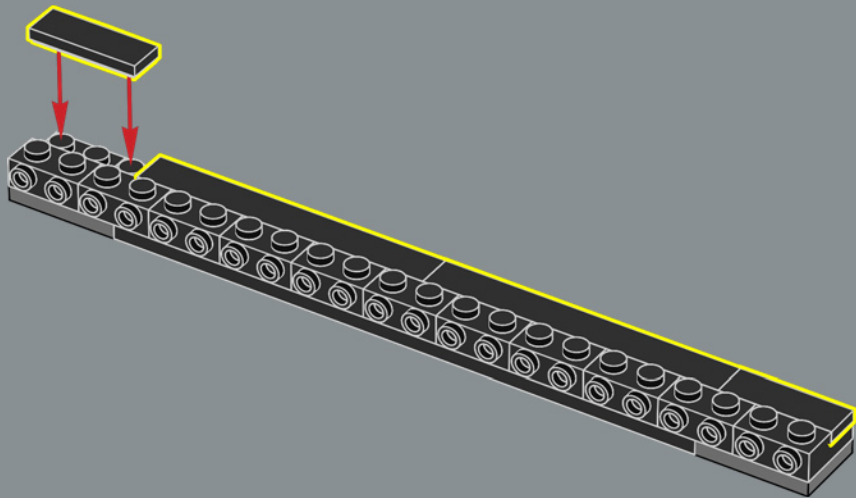

7

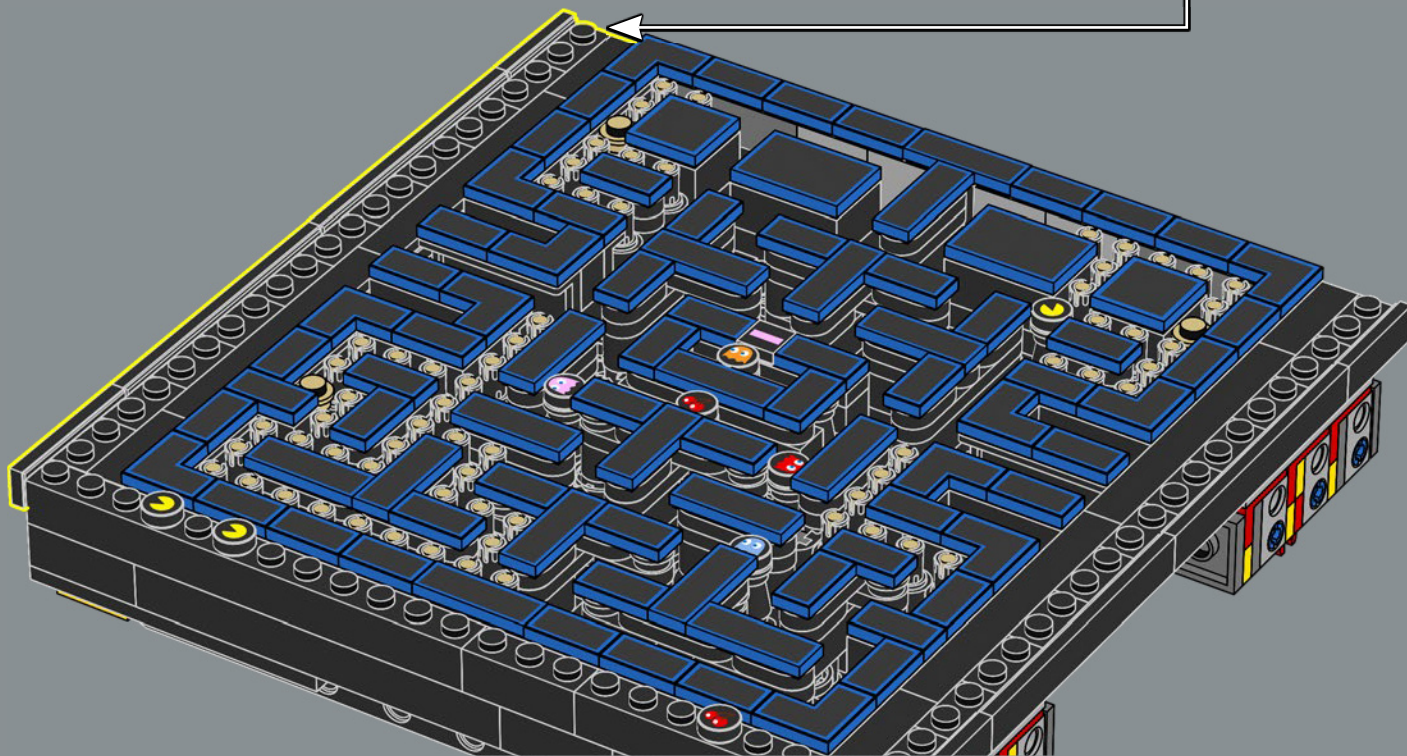
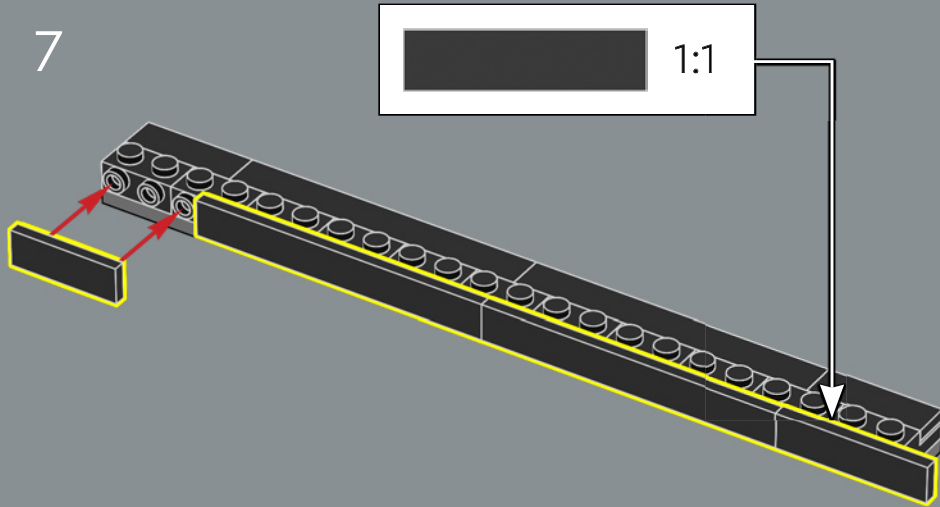

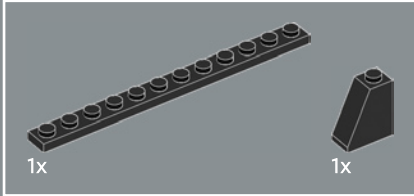
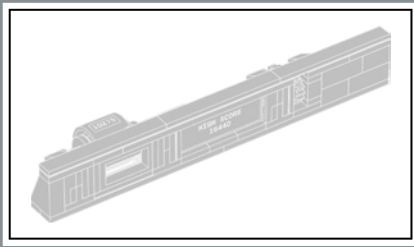

227

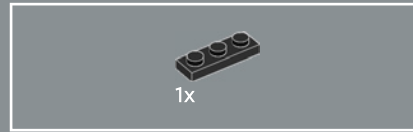
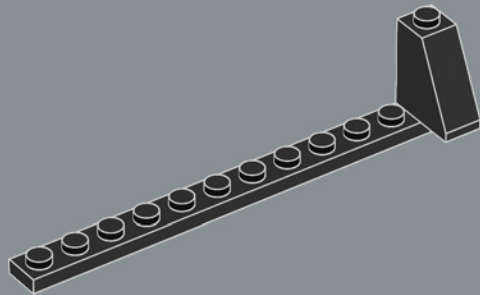

228

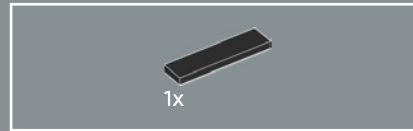
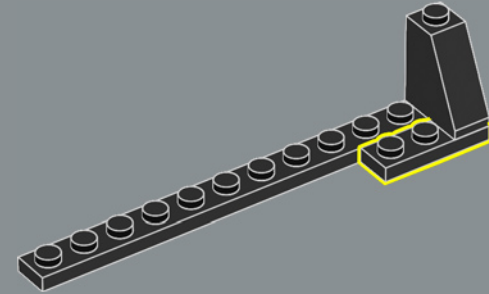

229

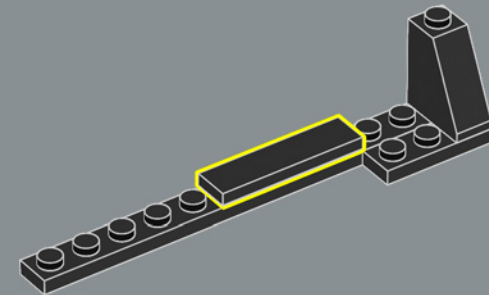

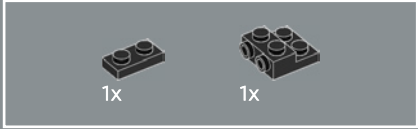
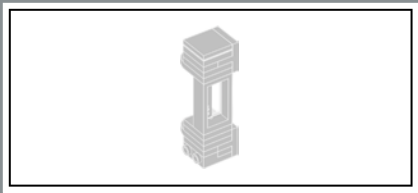

230

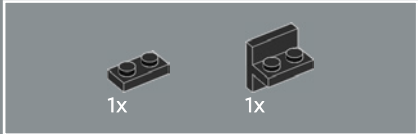
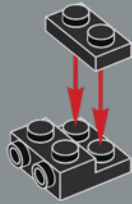

231

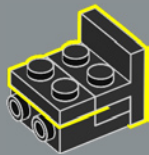

232

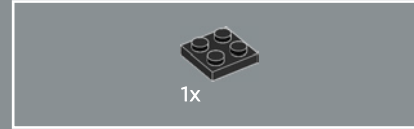
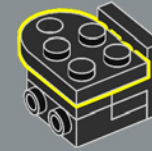

233

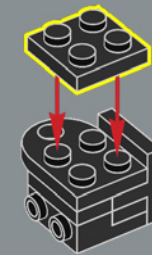

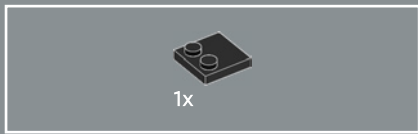

234

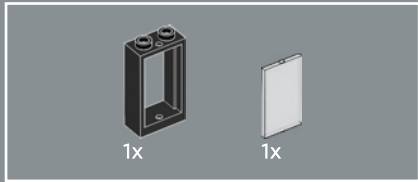
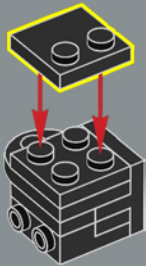

235

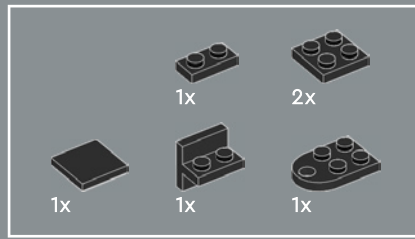
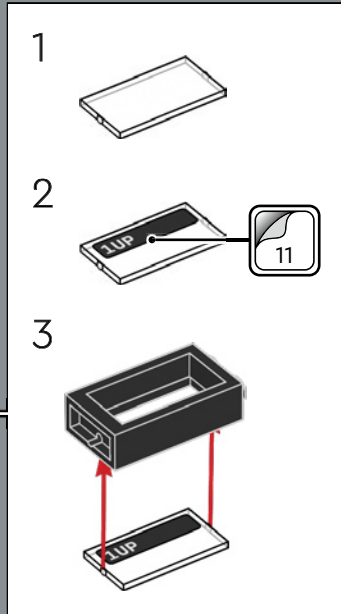
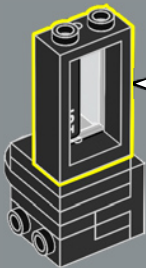

236

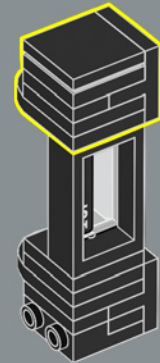
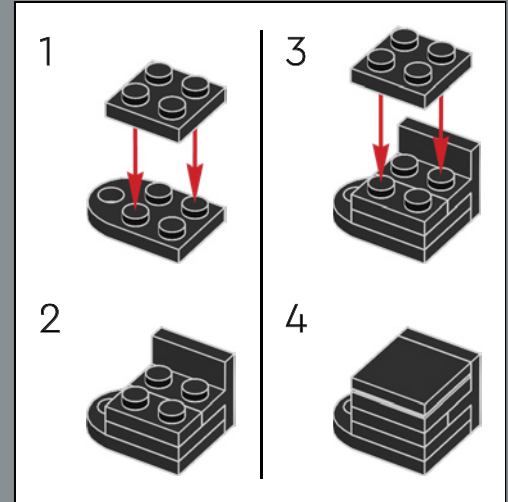

237

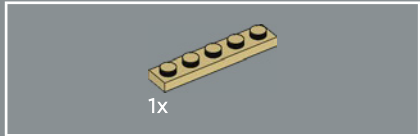
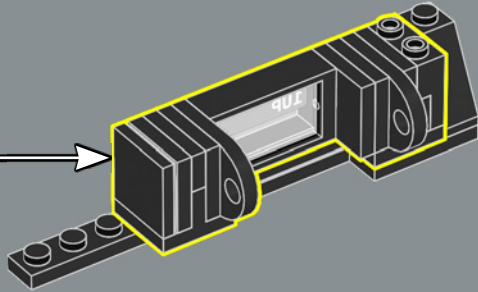

238

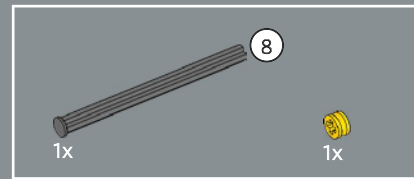
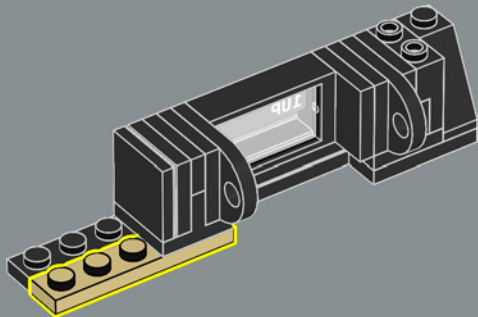

239

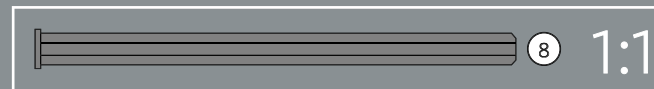
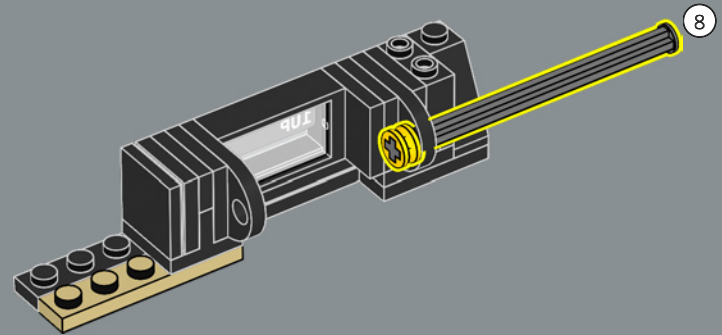

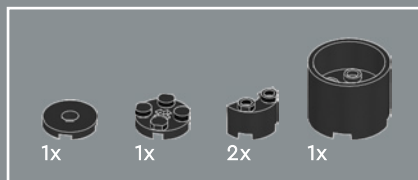

240

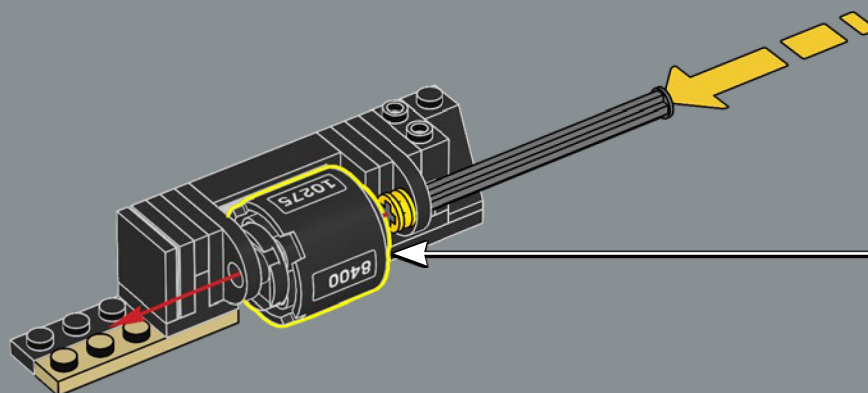
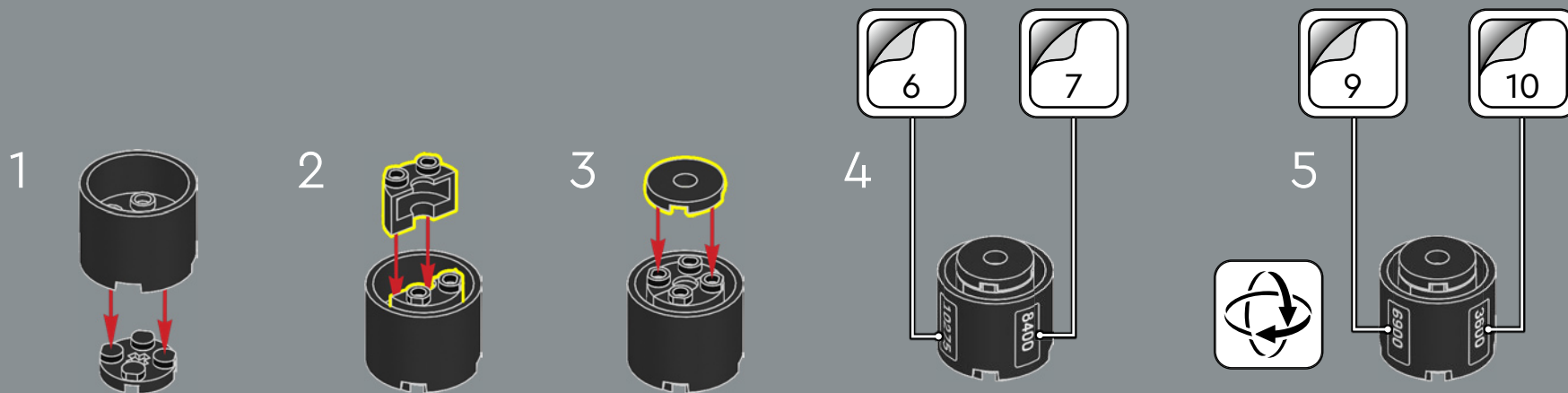



1x

241

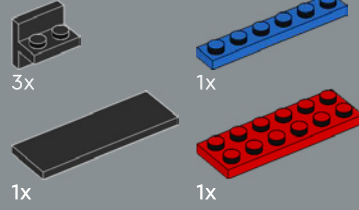
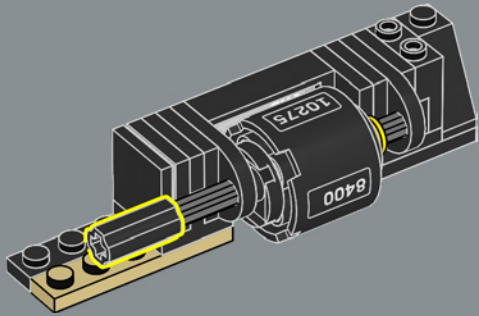

242

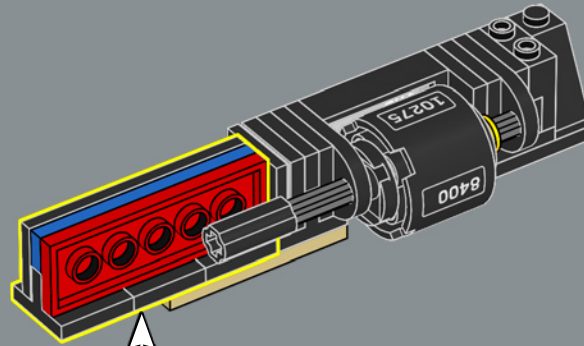

- 1
- 2
- 3
- 4
- 5

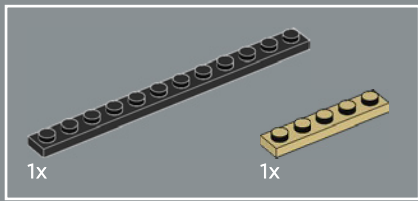

243

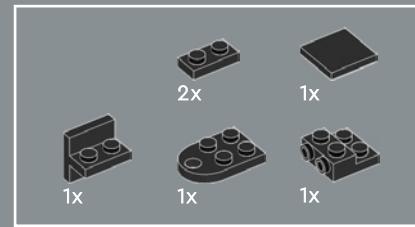
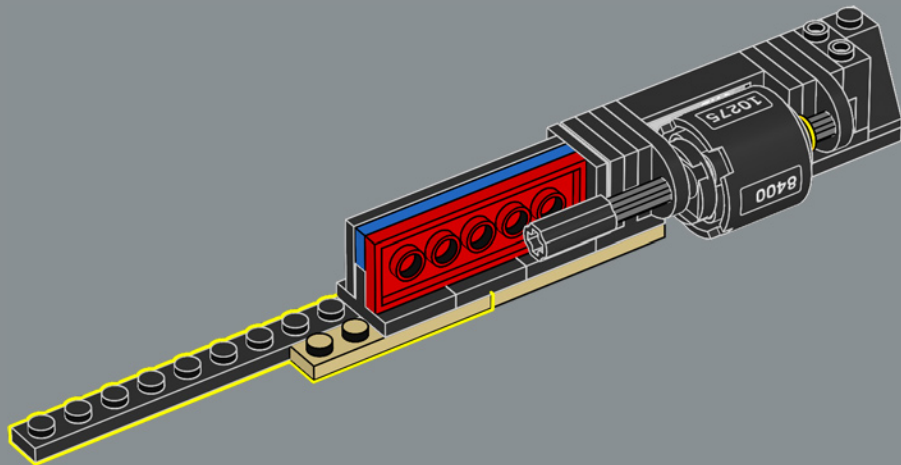

244

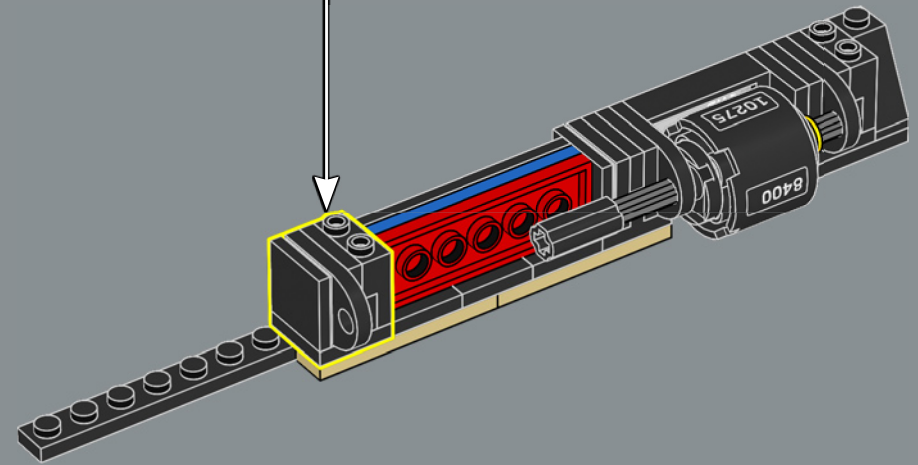
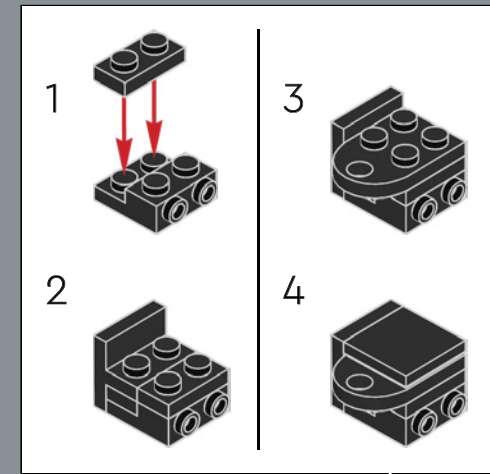

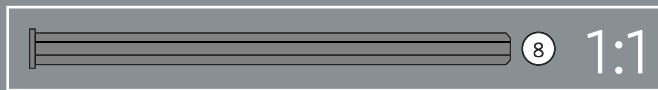
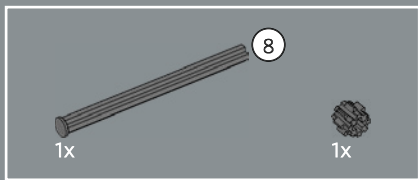

245

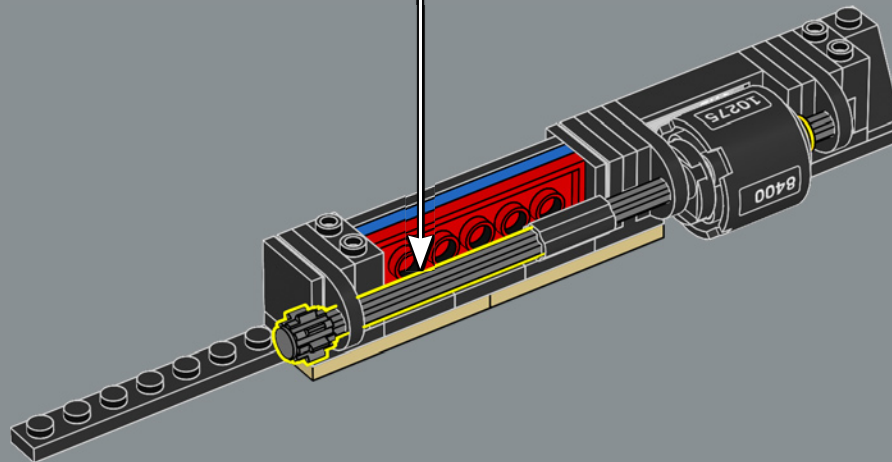
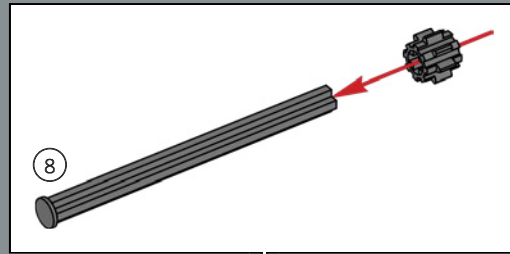

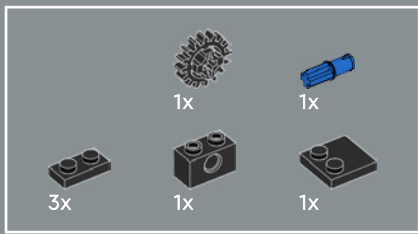

246

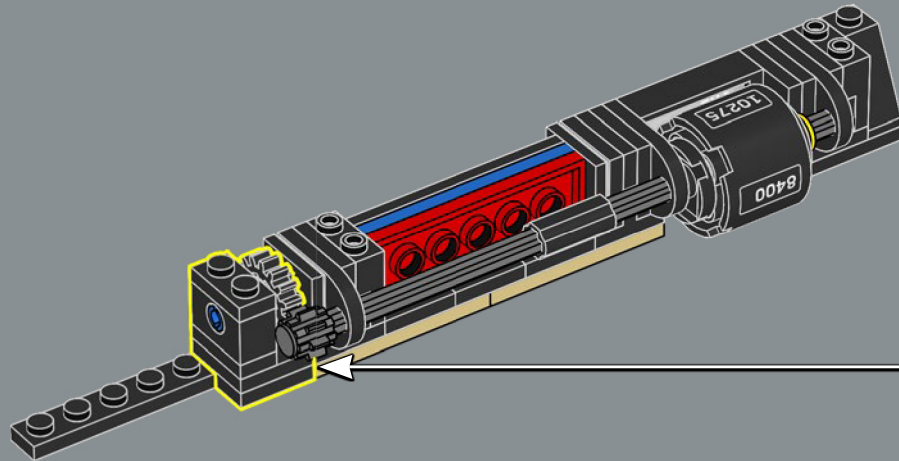
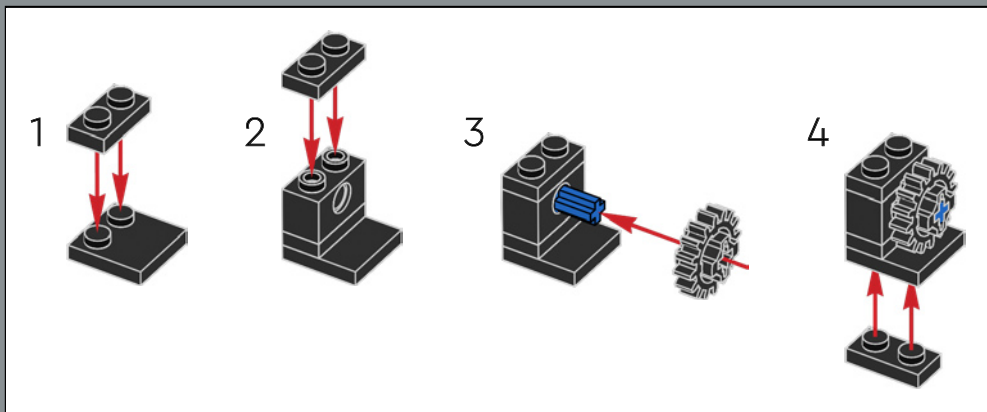

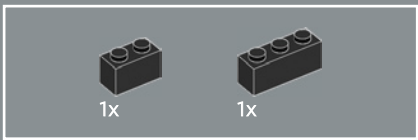

247

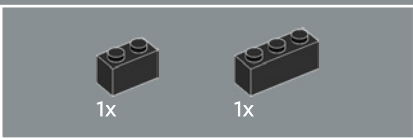
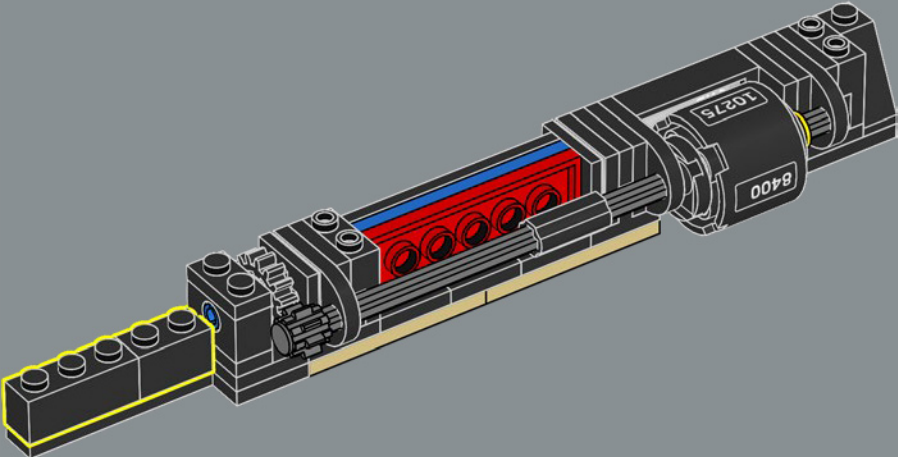

248

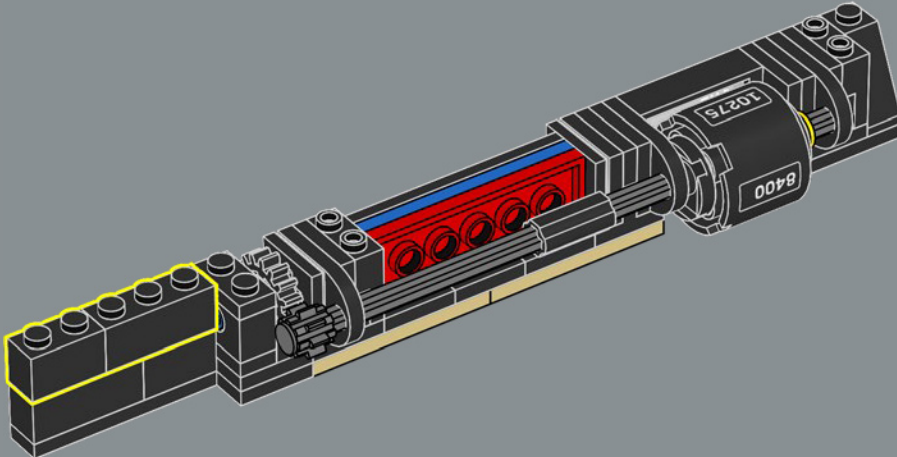

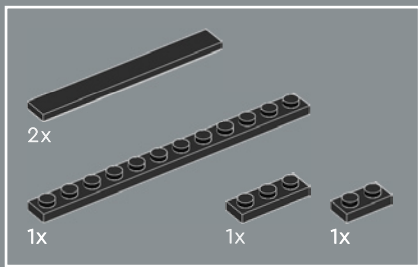

249

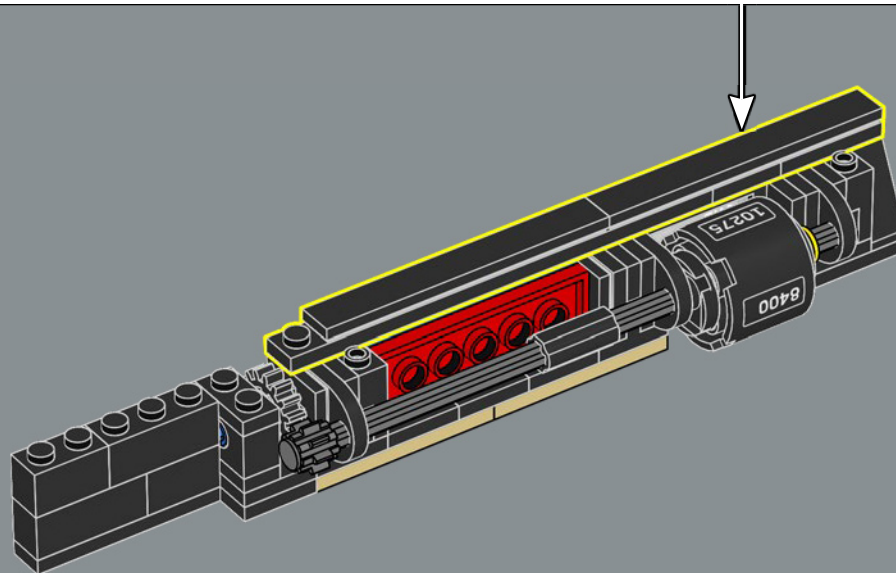
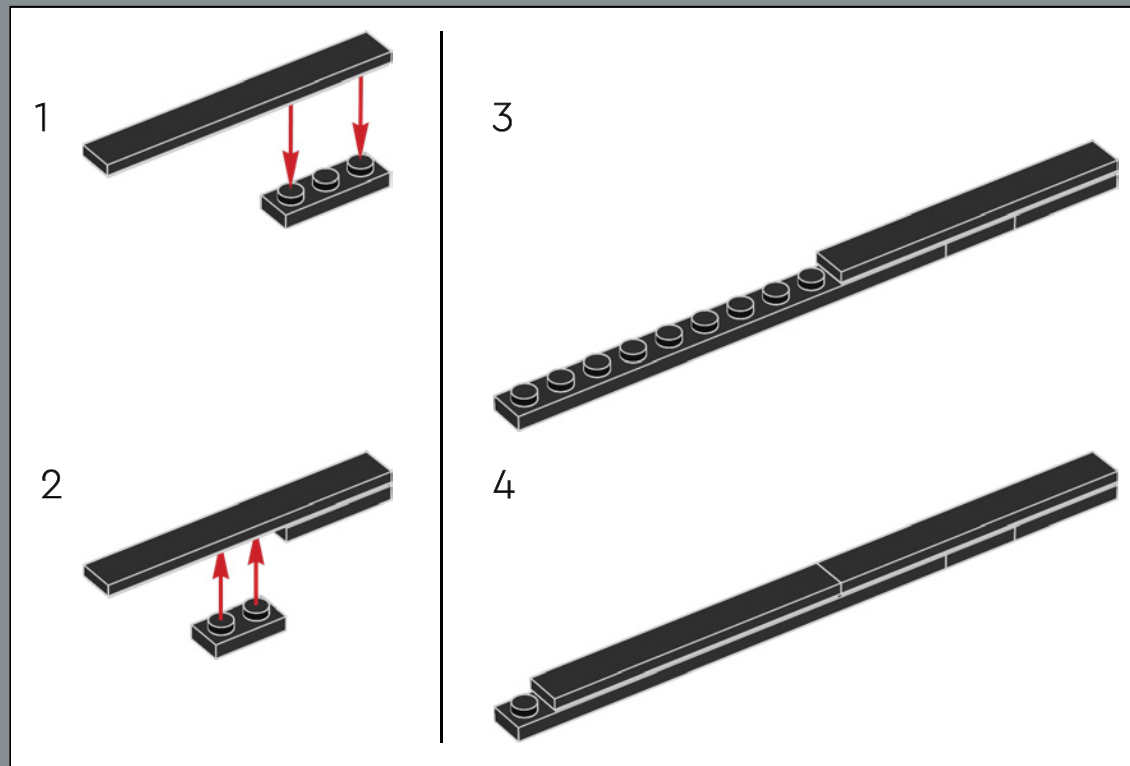

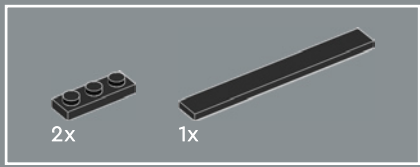

250

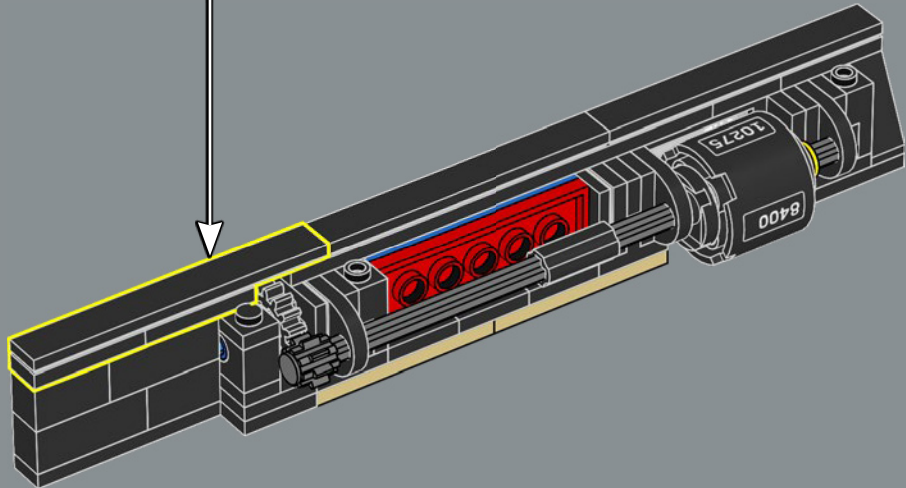
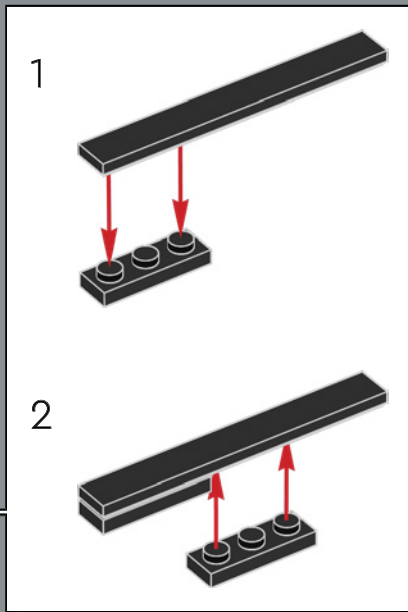

251

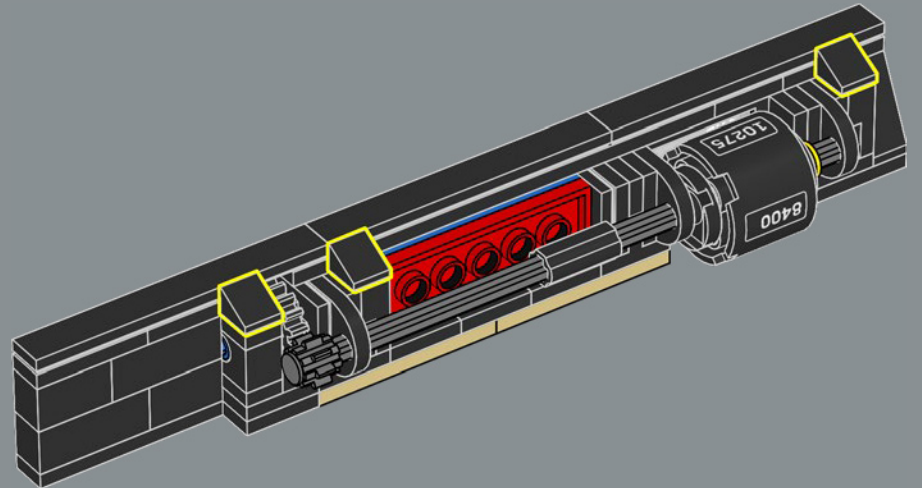

252

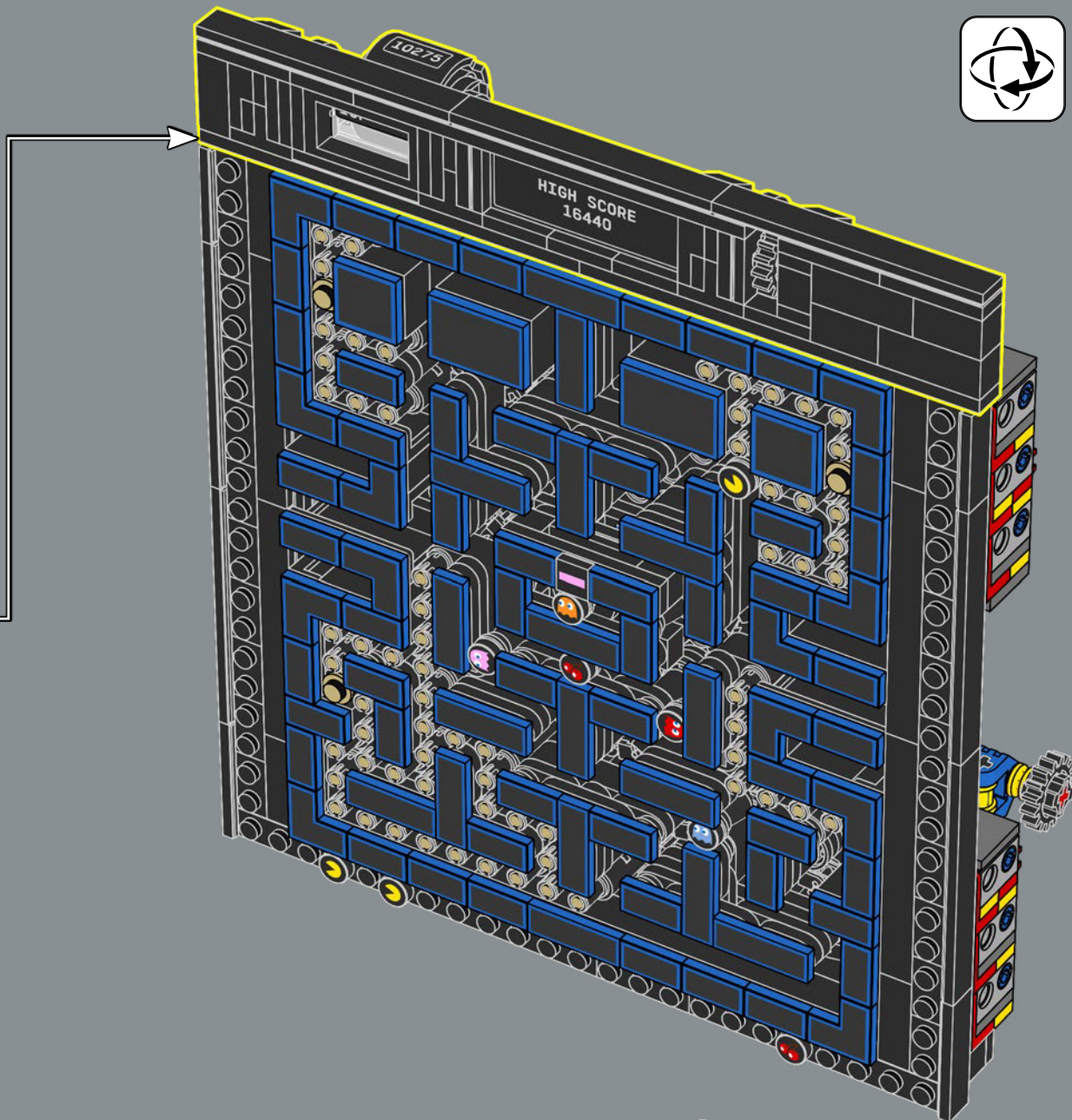

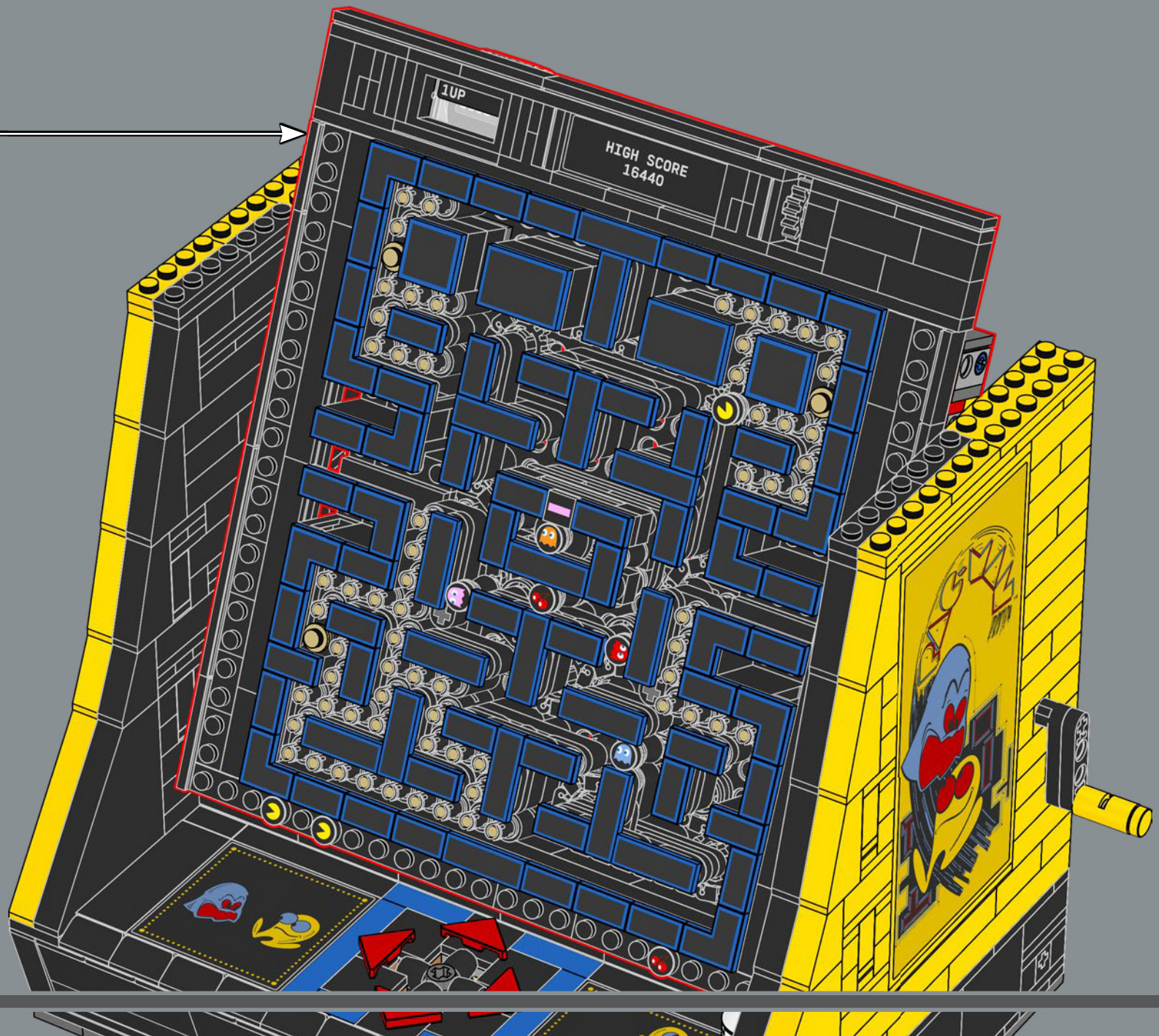

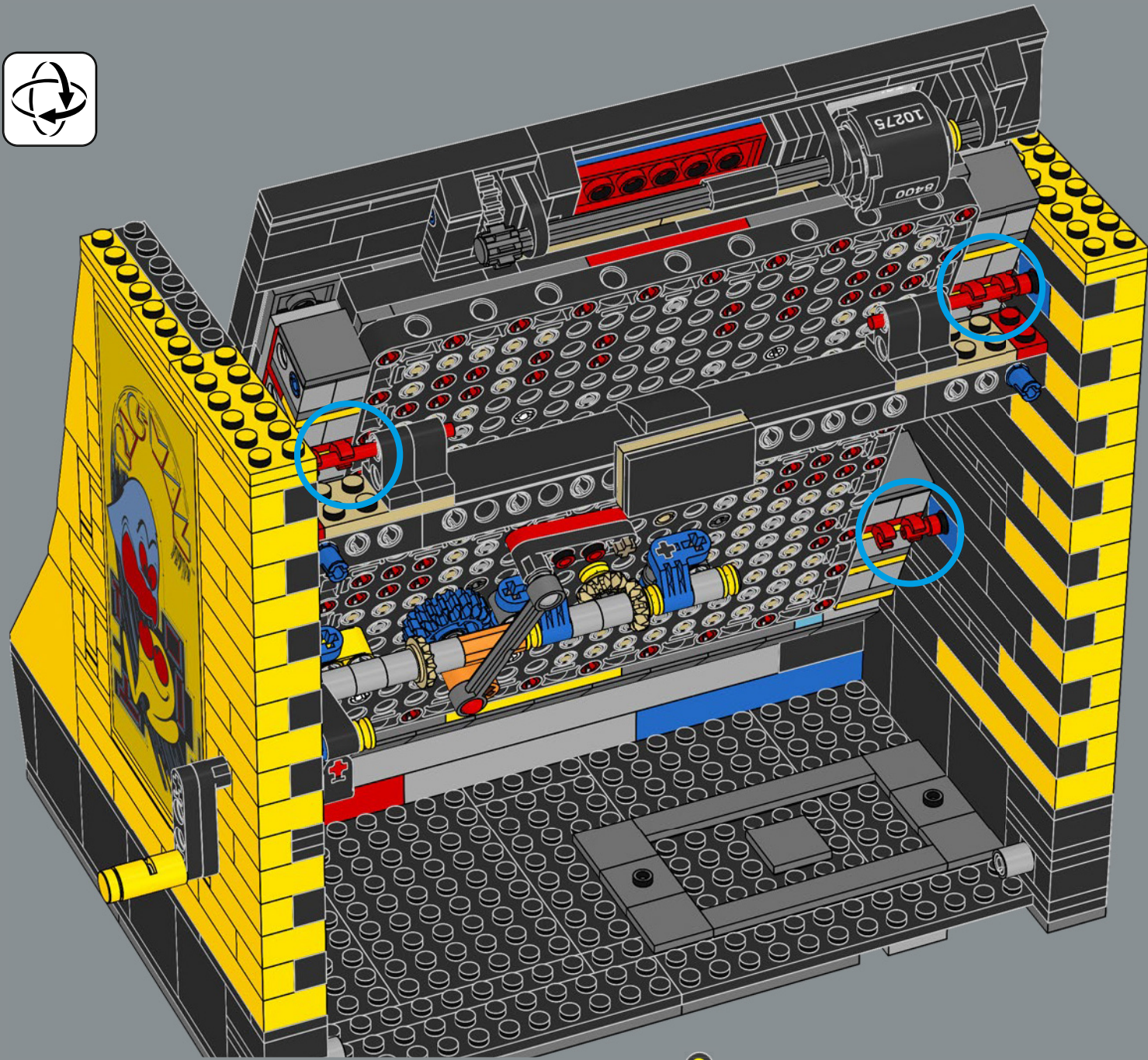



最大的挑战是让幽灵转弯而不被卡住。
我们用机器人对其进行了数千次测试，
以确保它的坚固性！

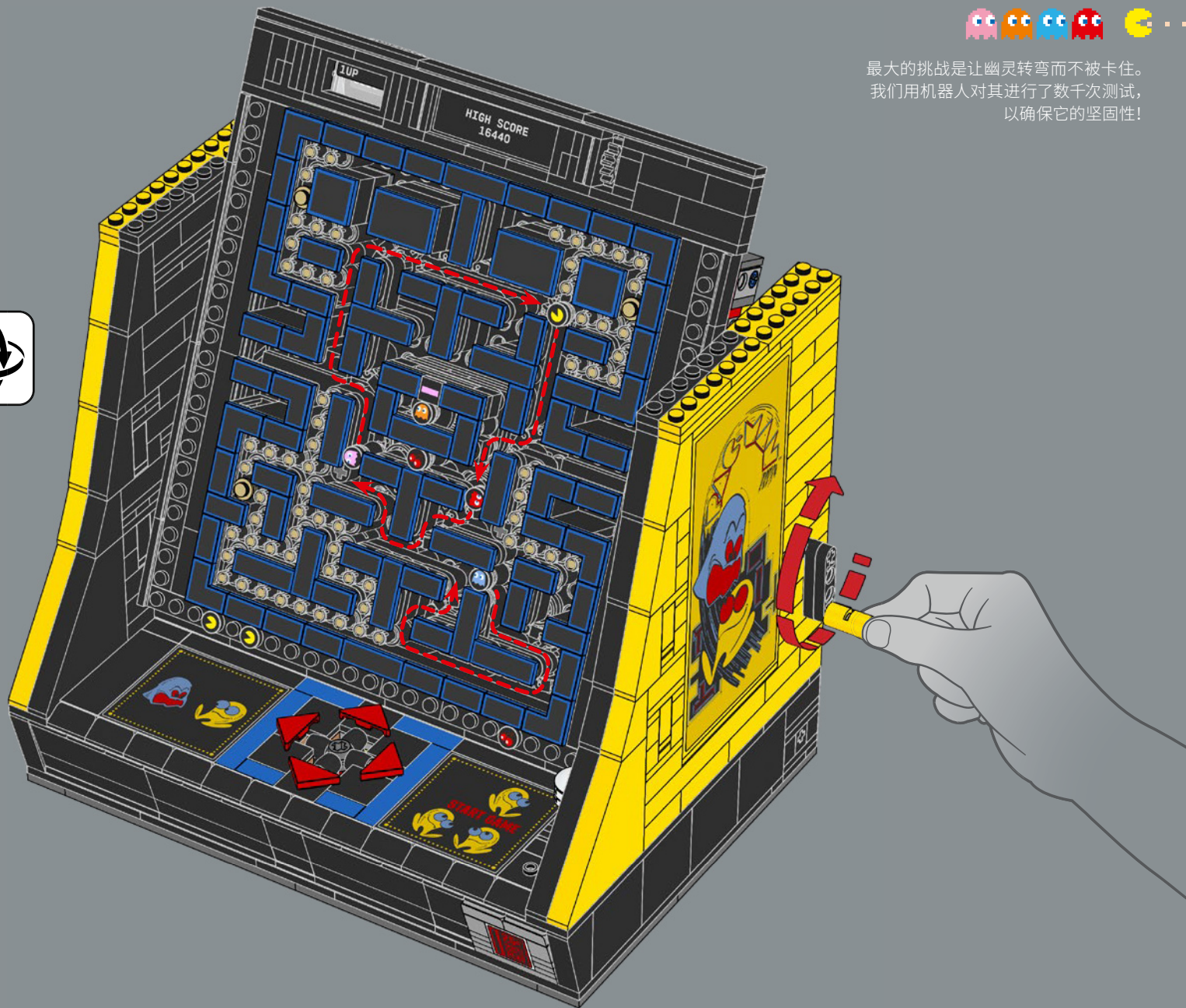

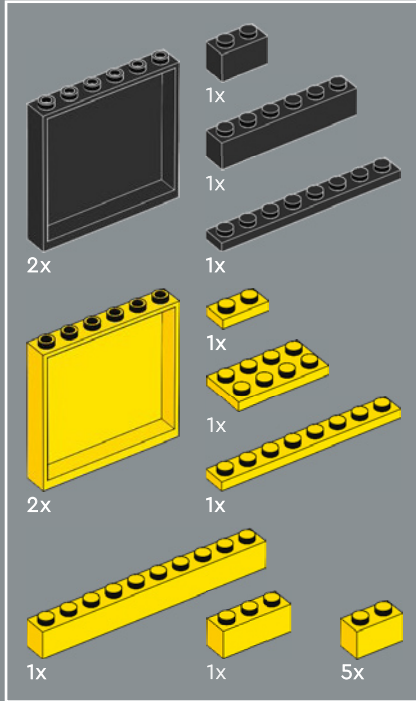
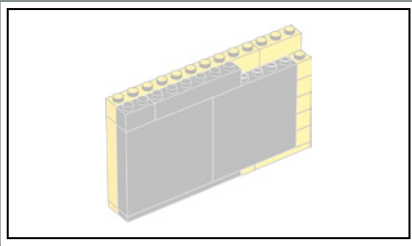

254

1

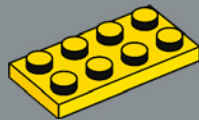

2

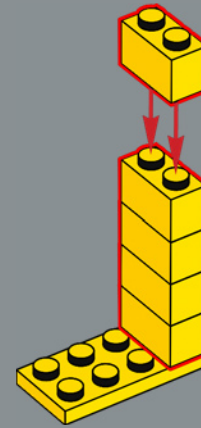

3

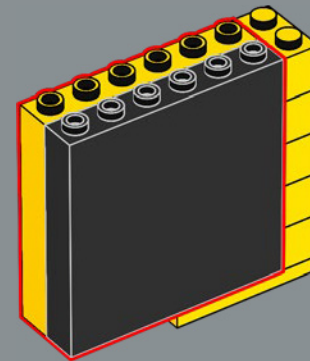

4

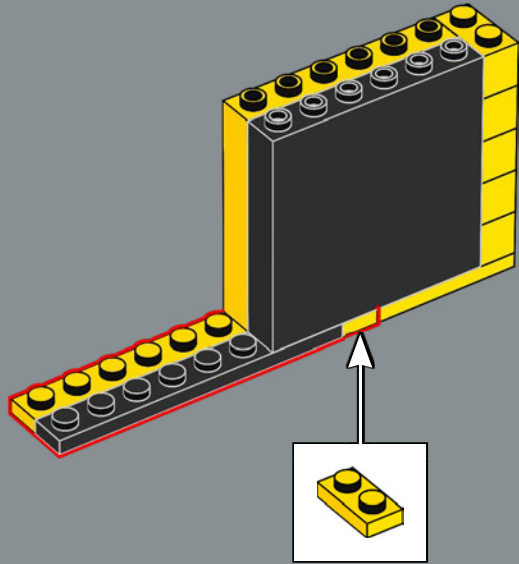

5

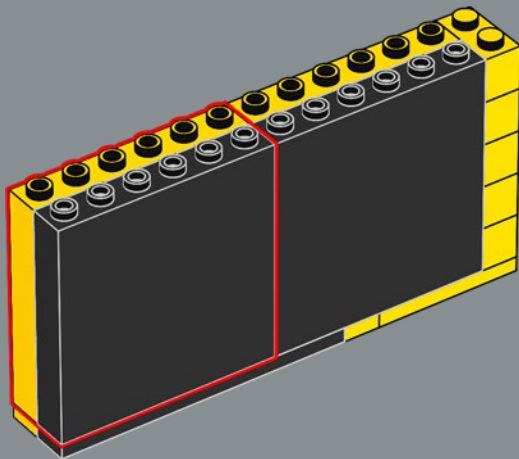

6

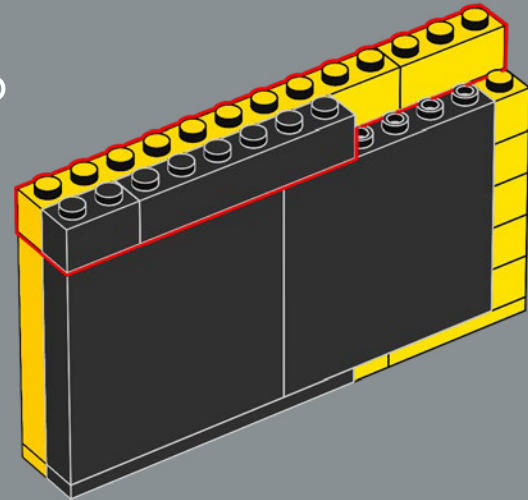

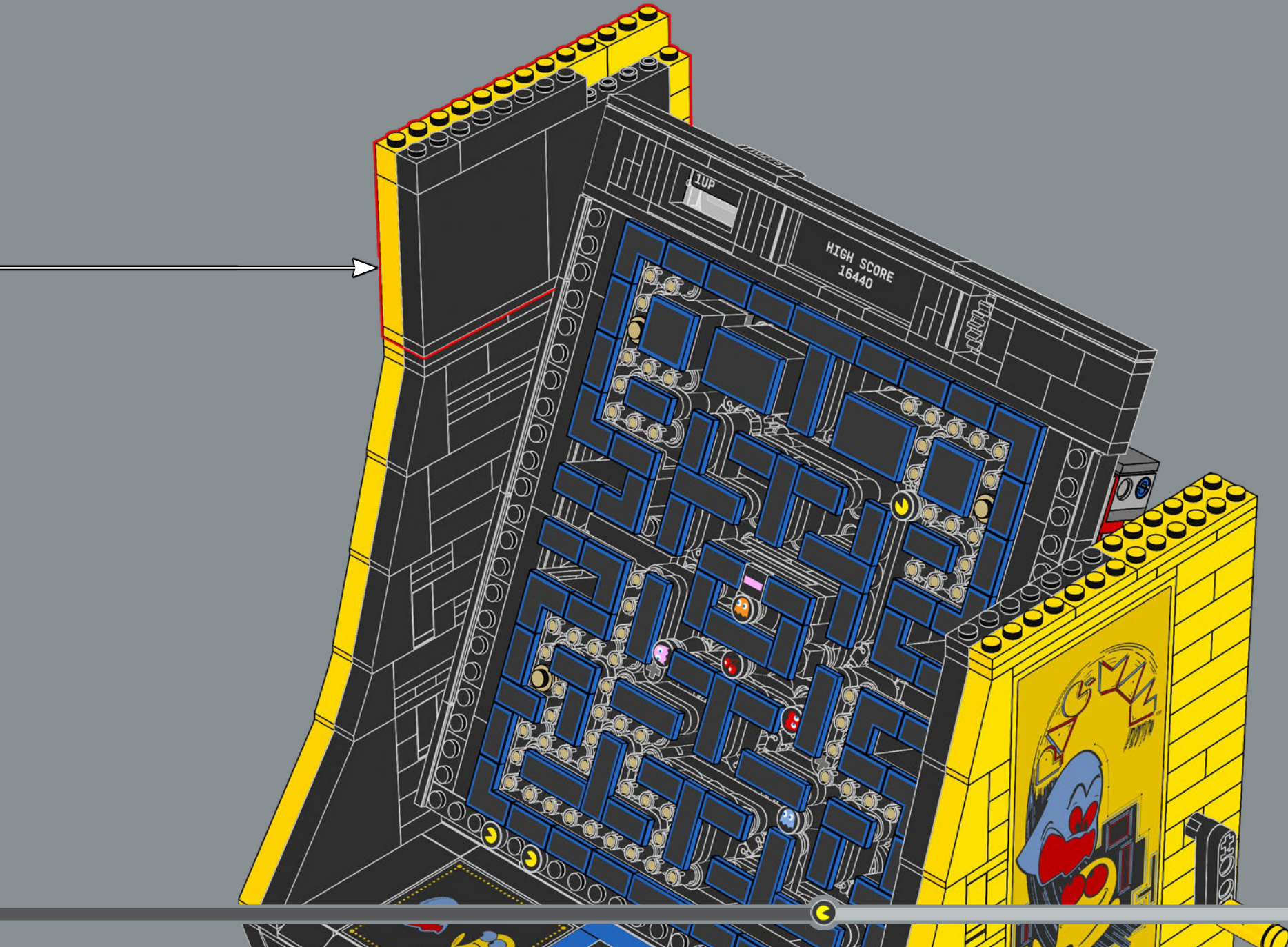

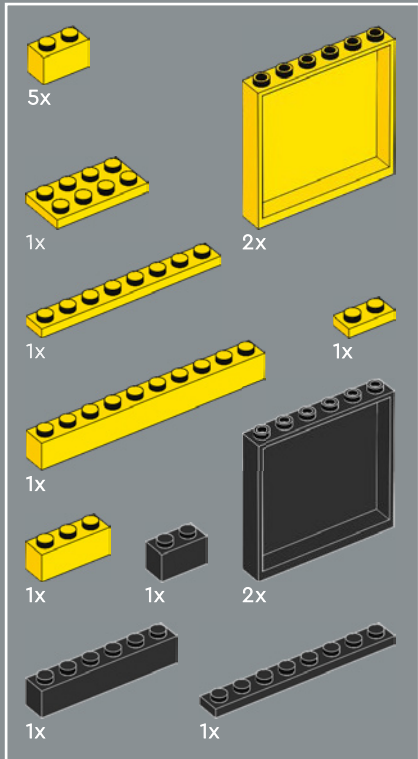
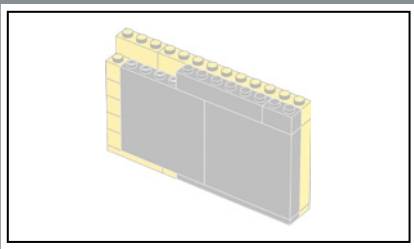

255

1

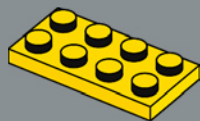

2

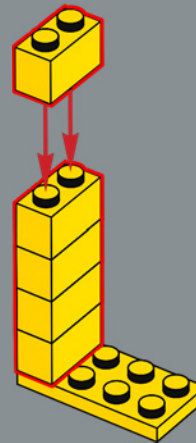

3

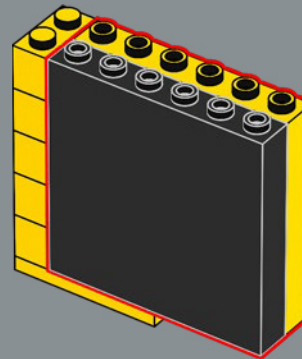

4

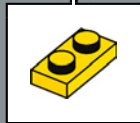
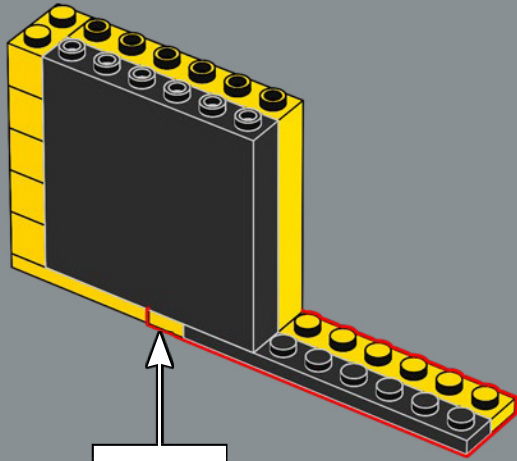

5

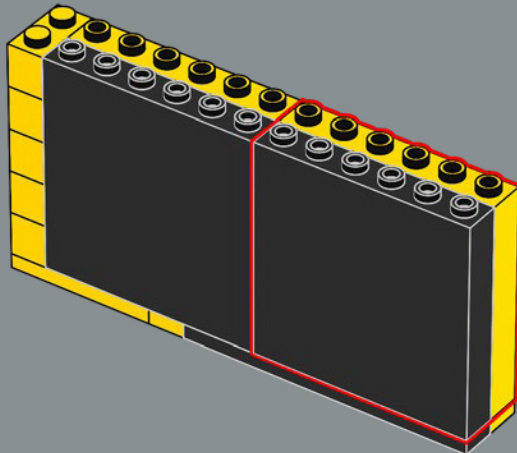

6

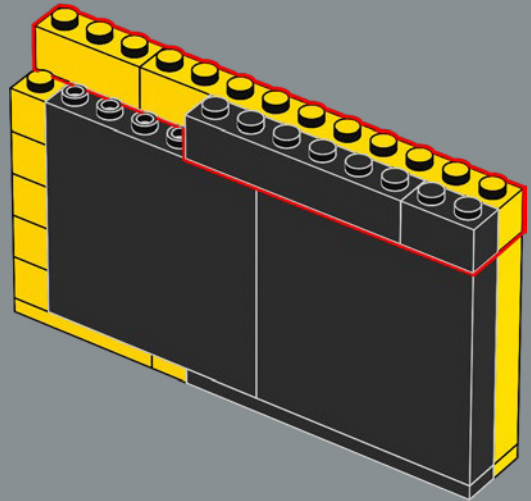

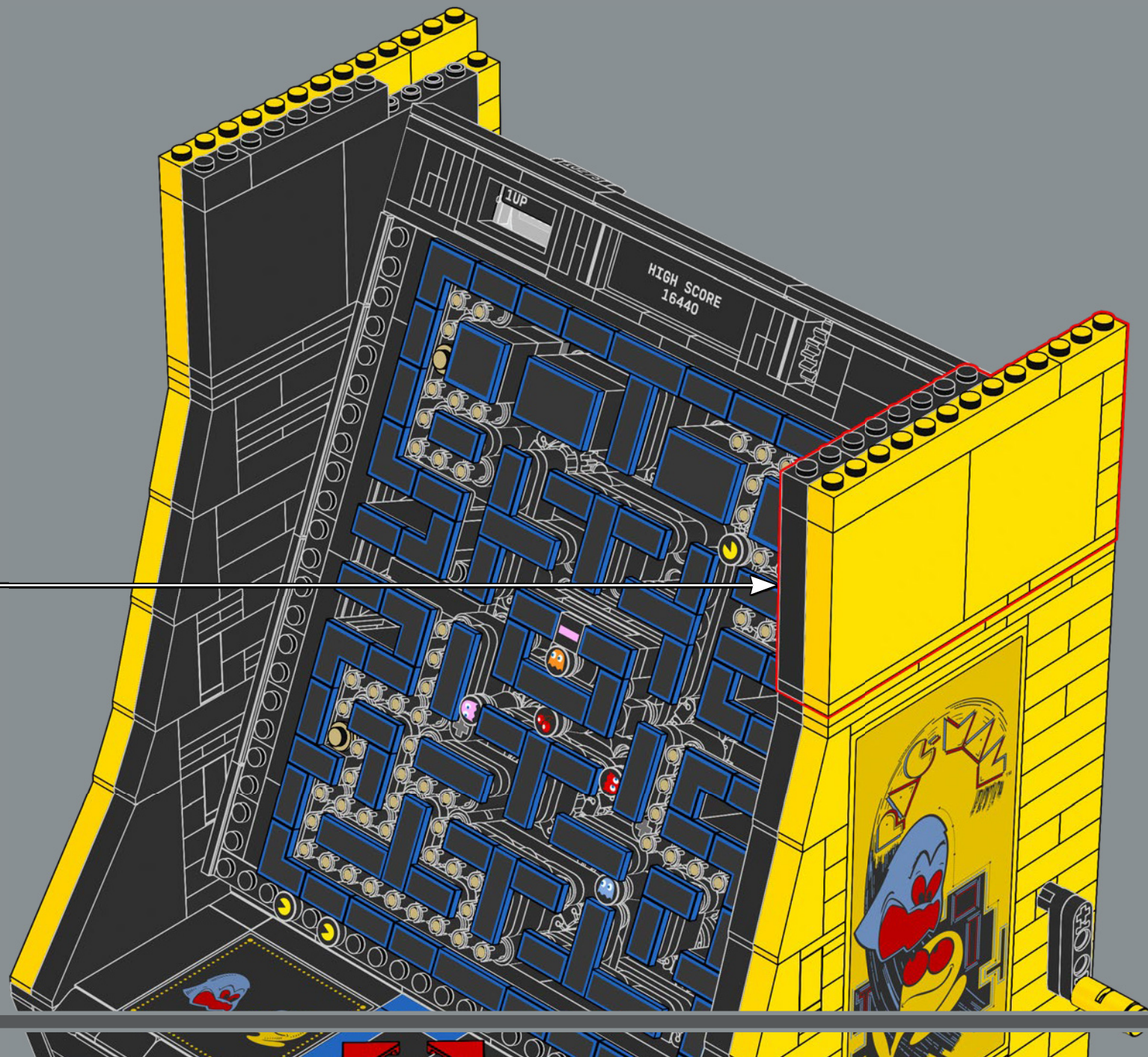

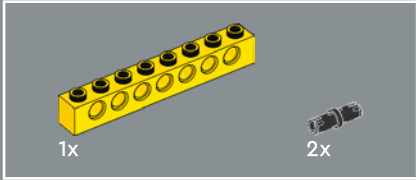
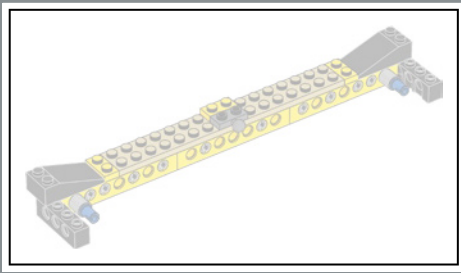

256

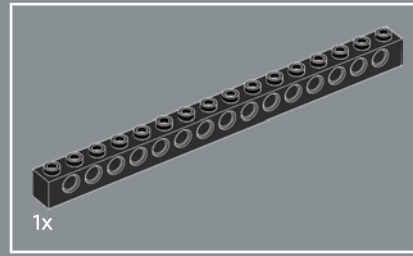
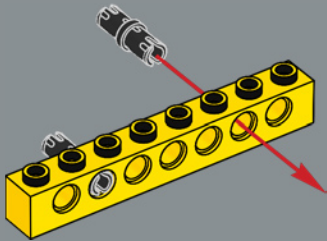

257

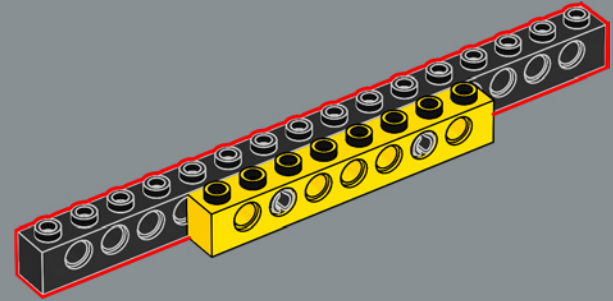

258

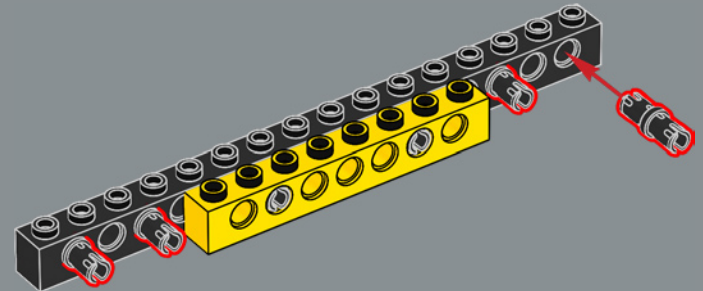

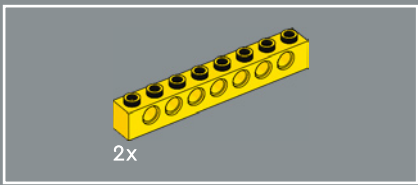

259

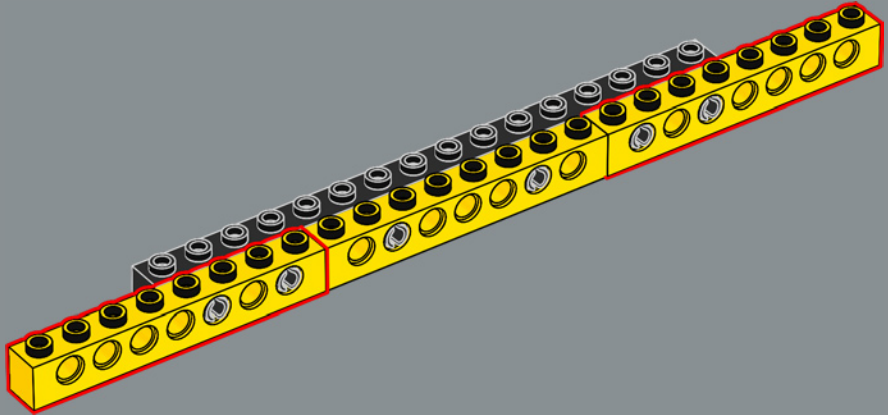

260

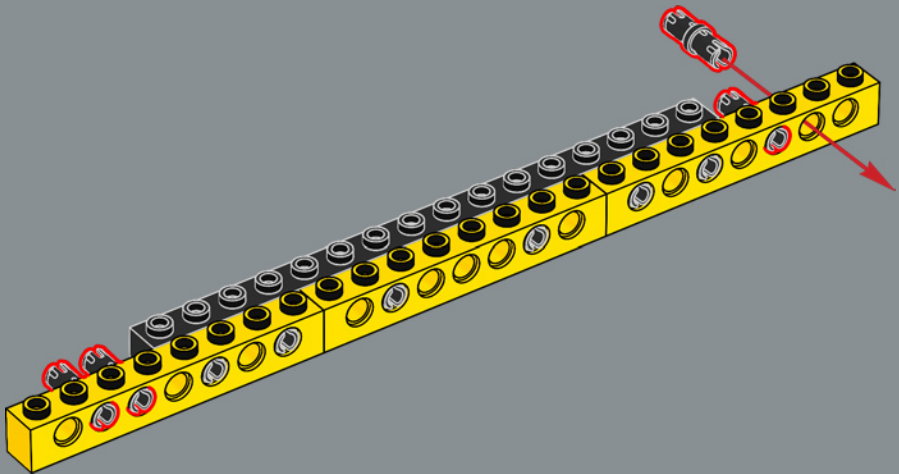

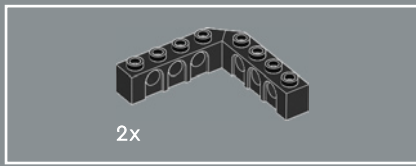

261

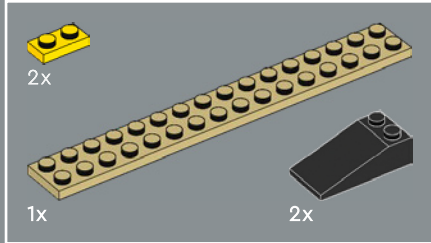
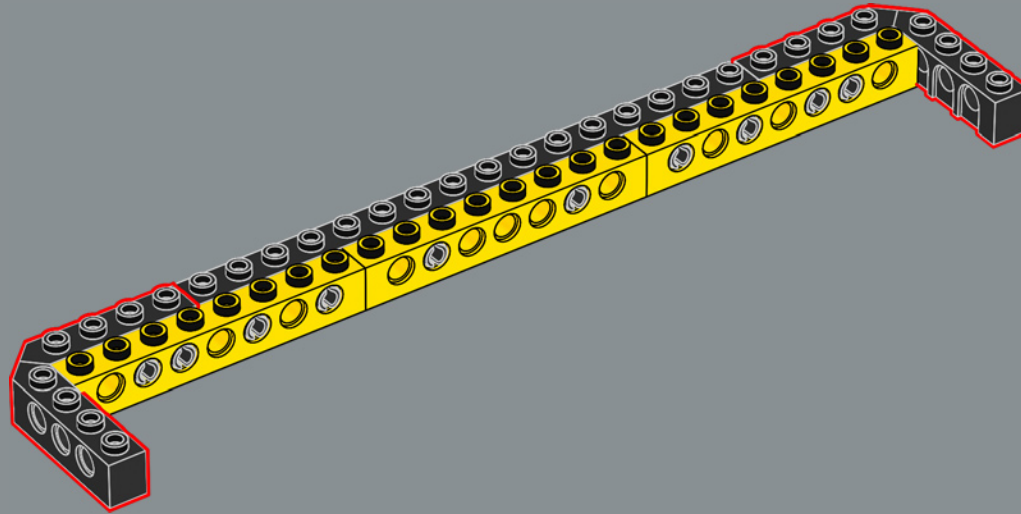

262

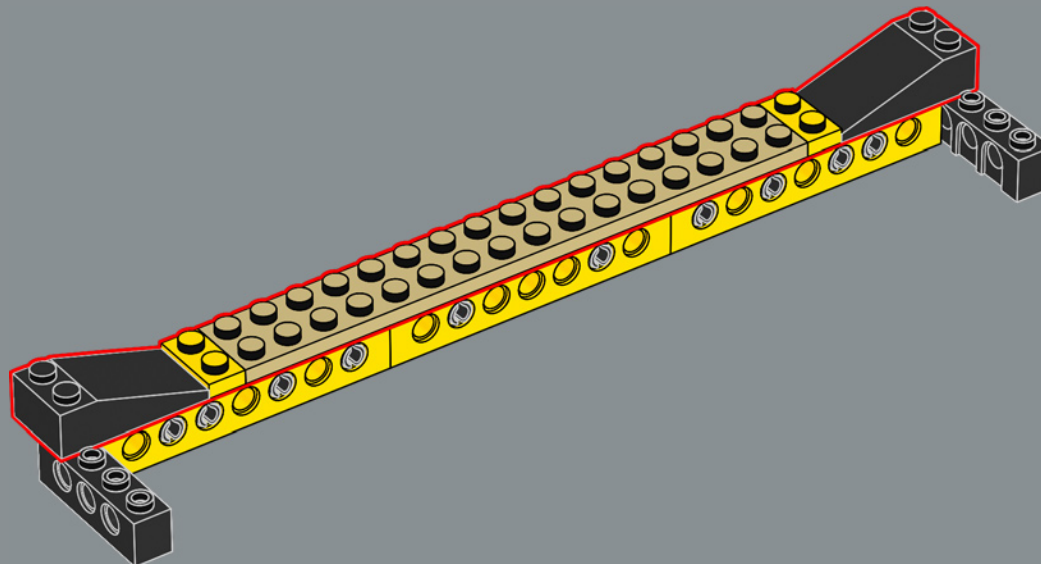

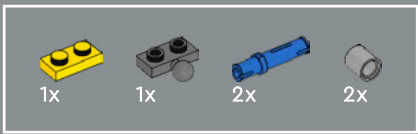

263

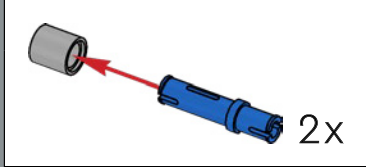
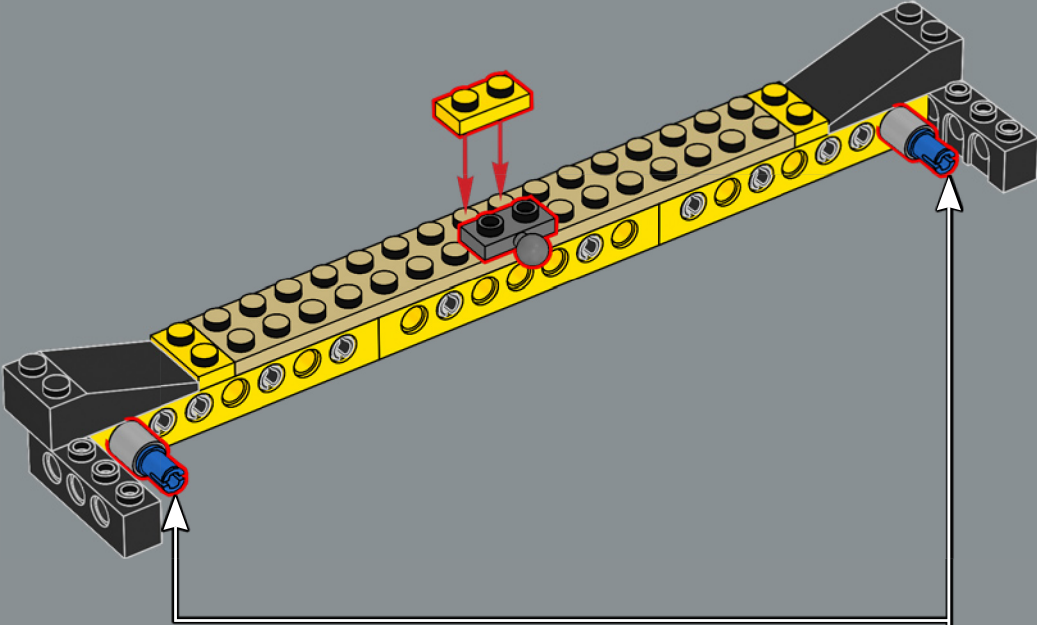

264

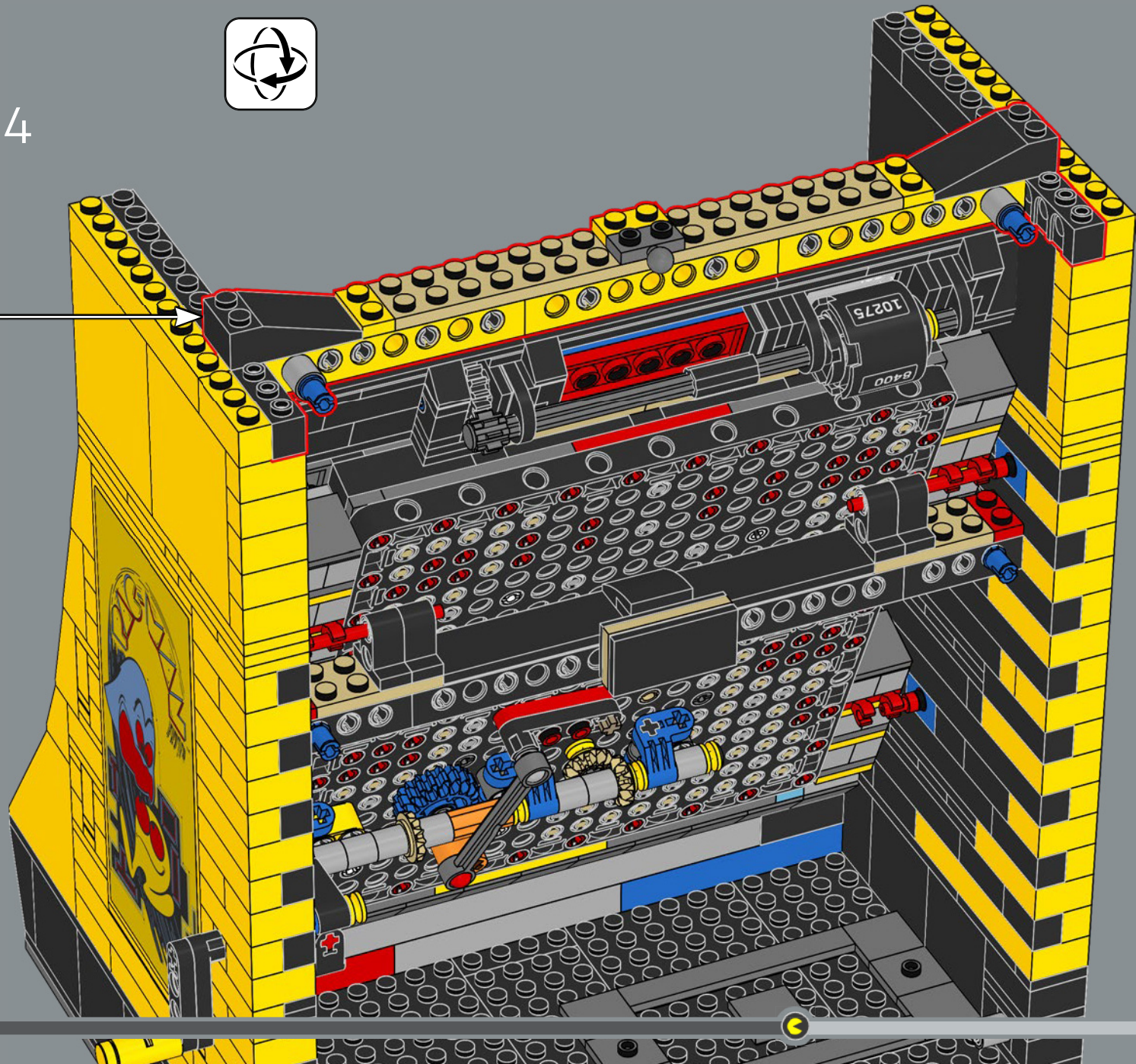

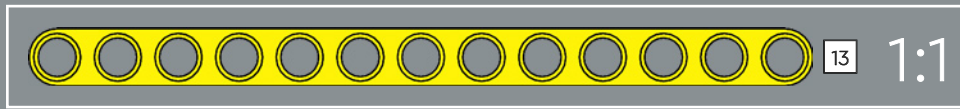
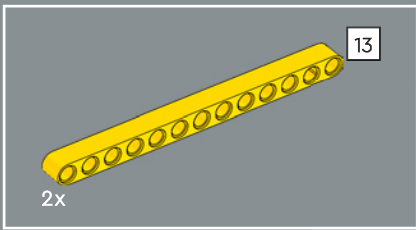

265

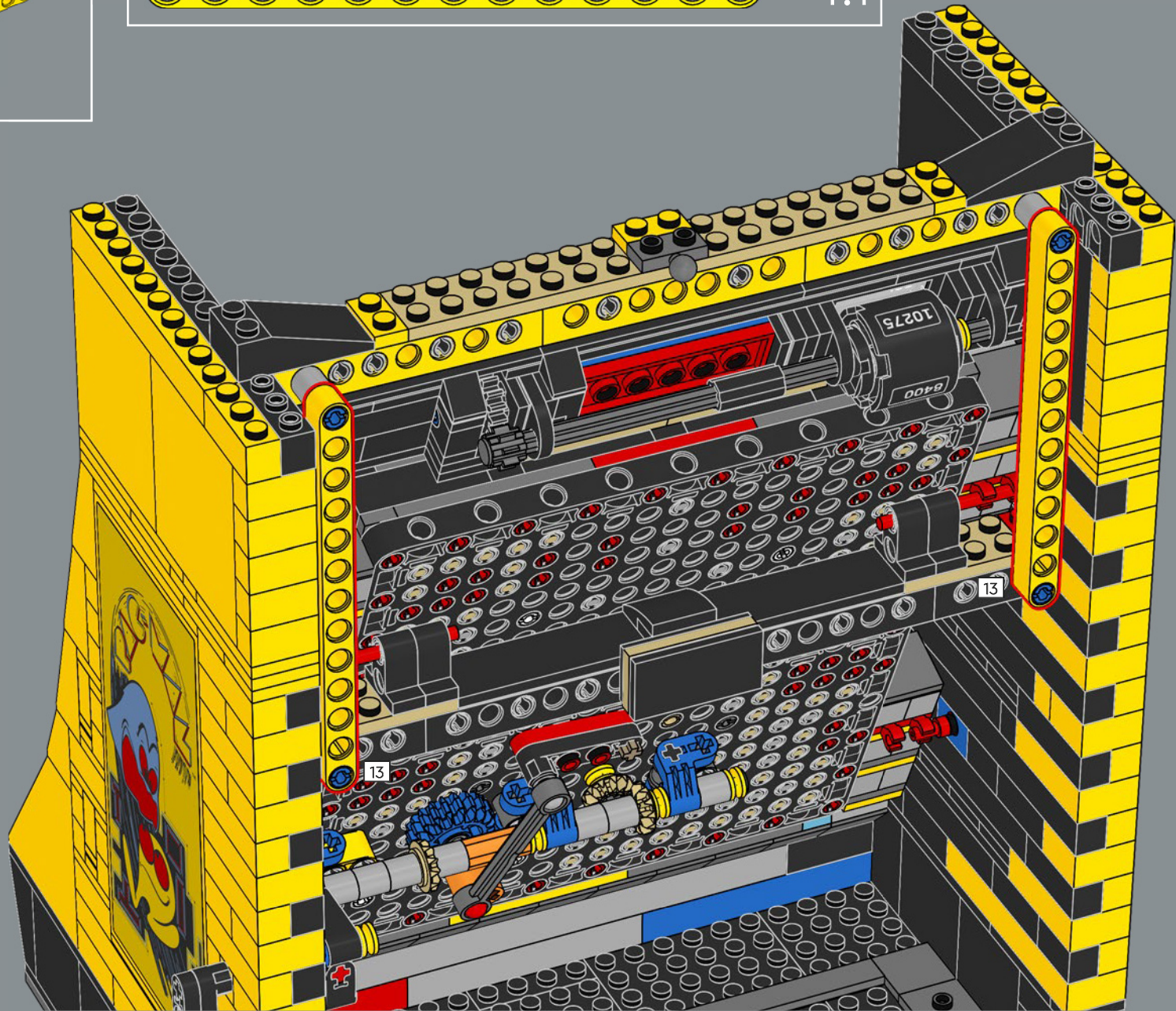



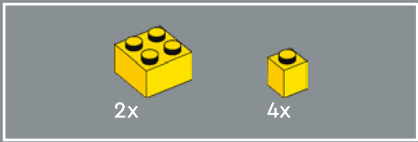

266

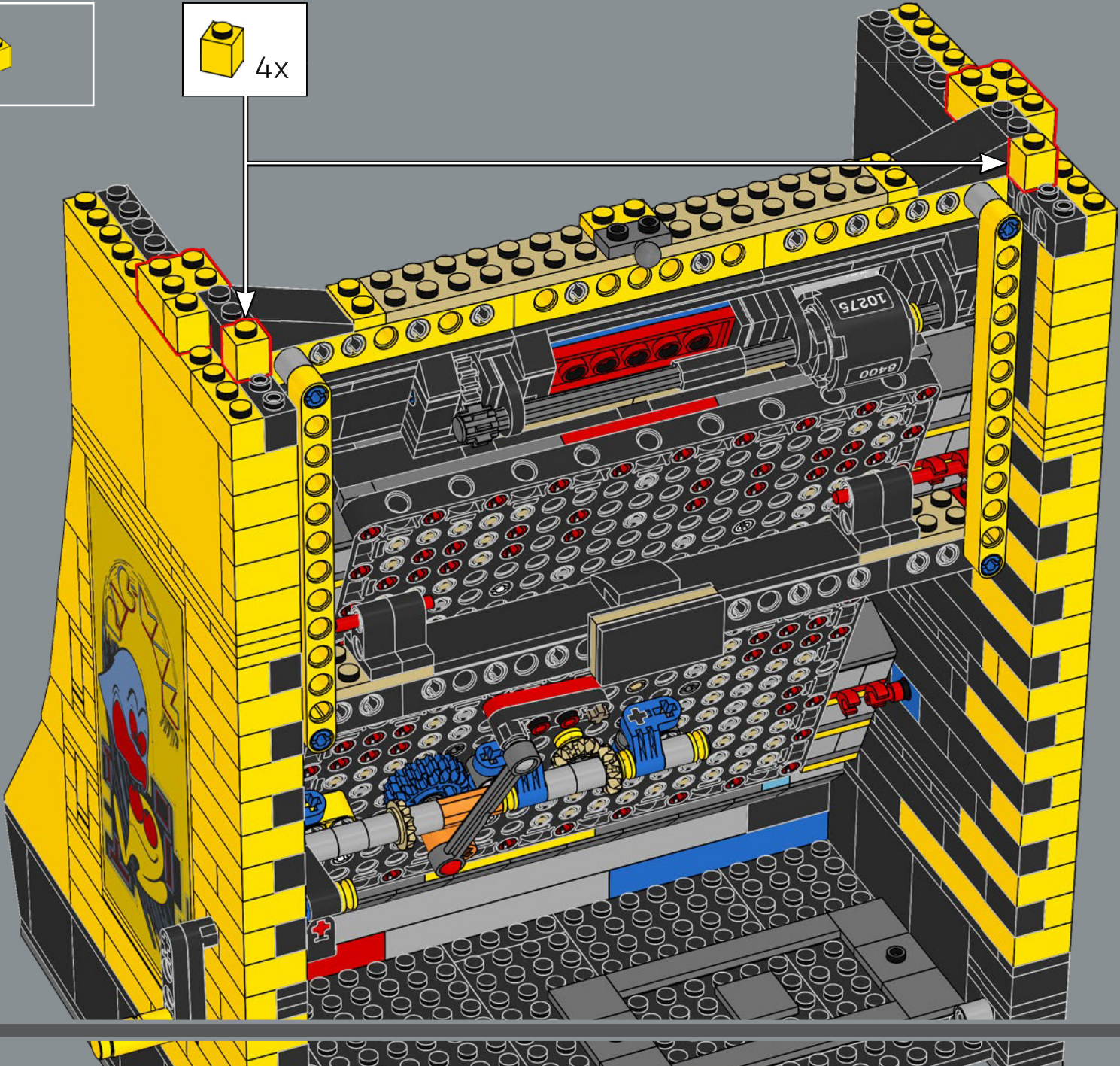

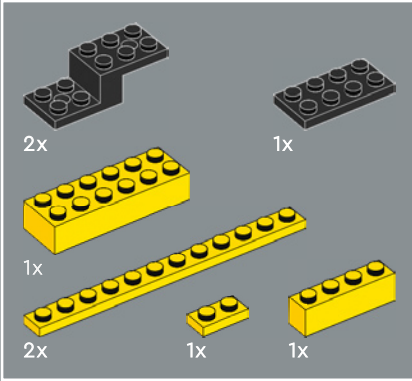
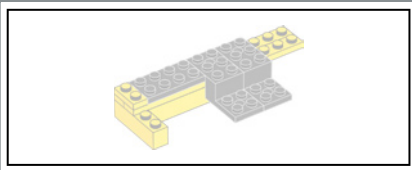

267

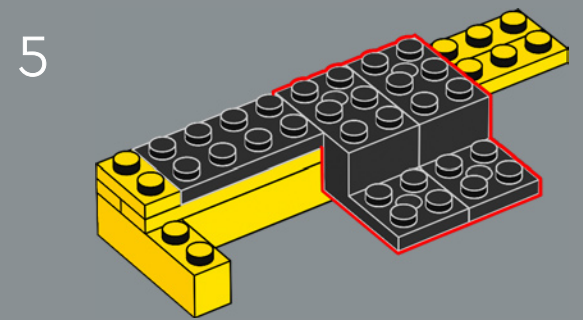
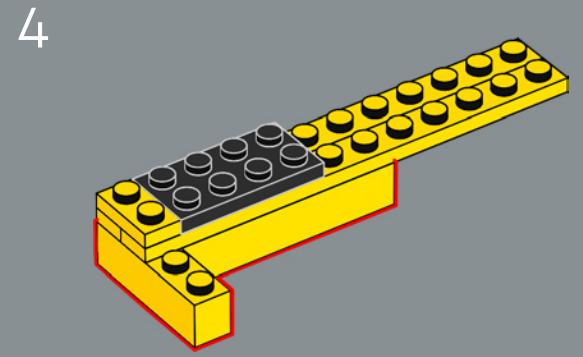
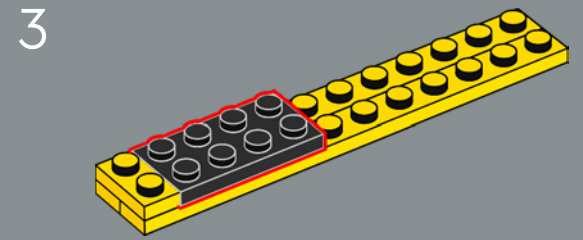
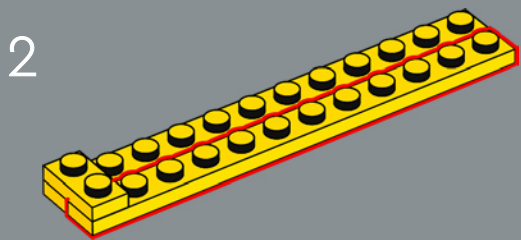
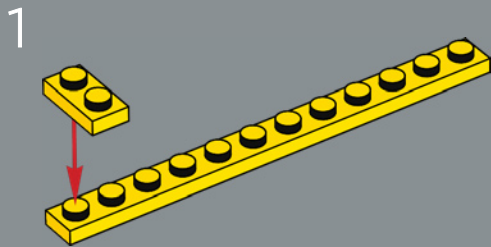

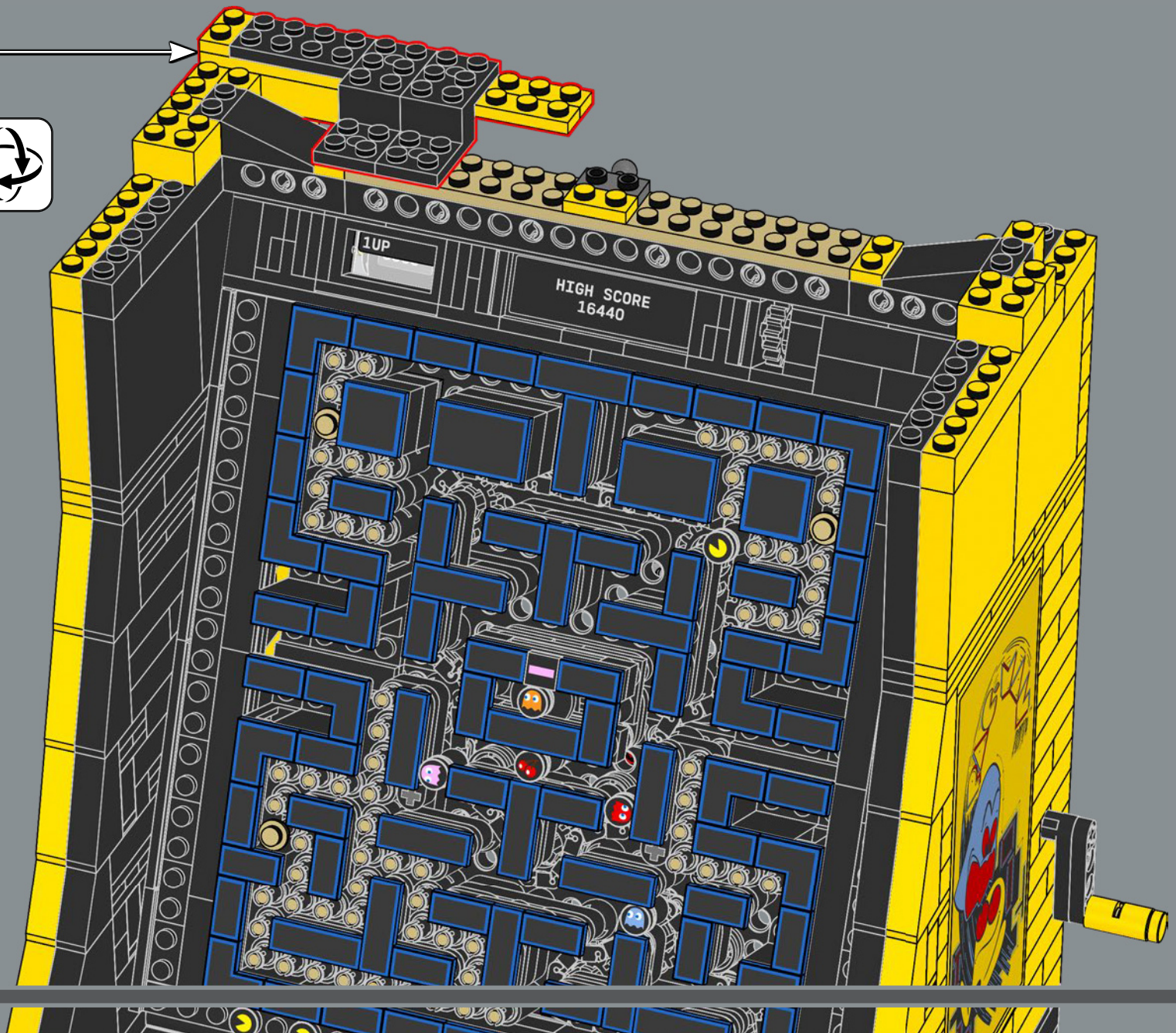

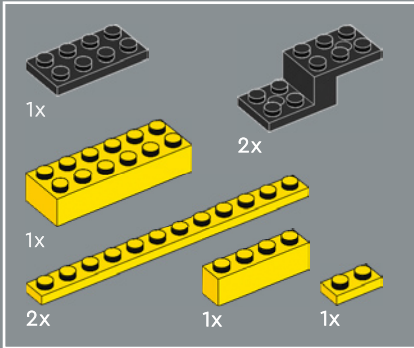
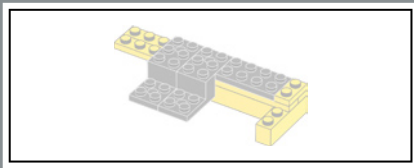

268

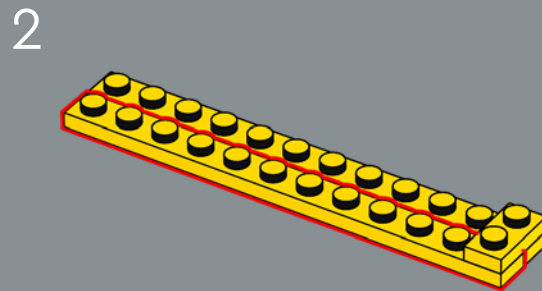
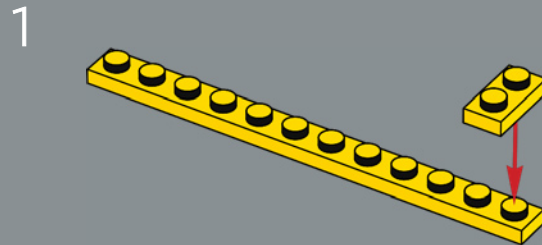

3

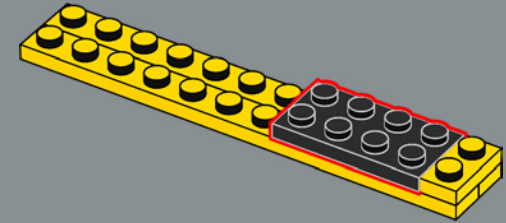

4

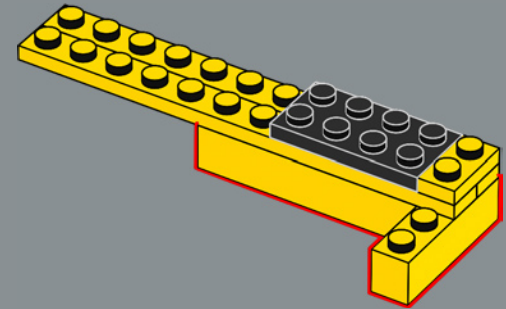

5

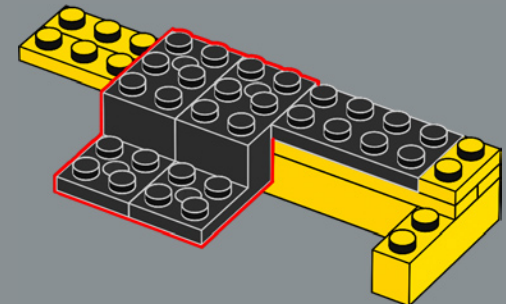

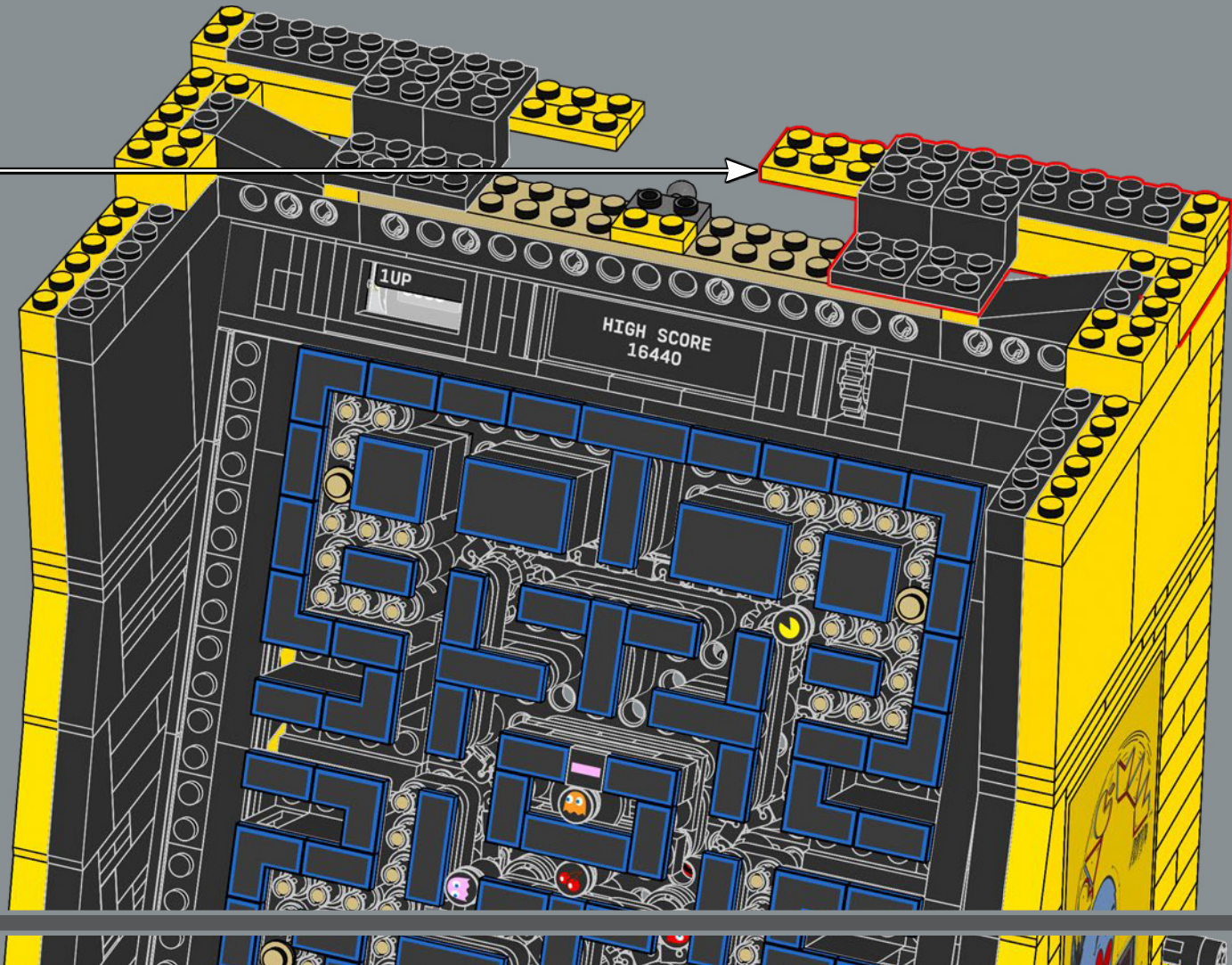

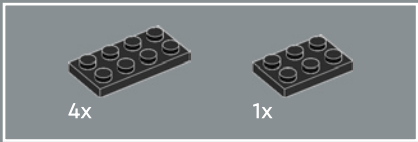

269

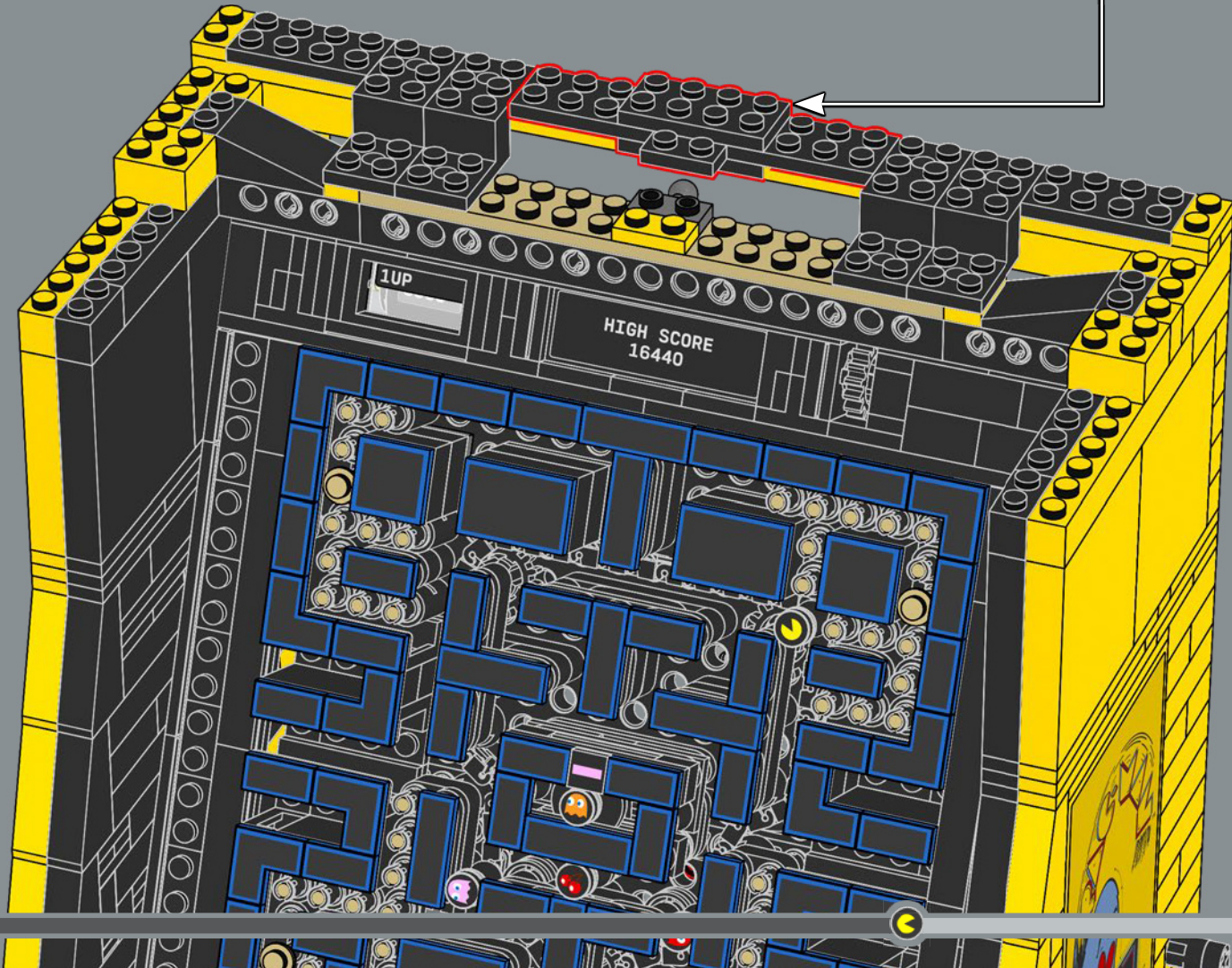
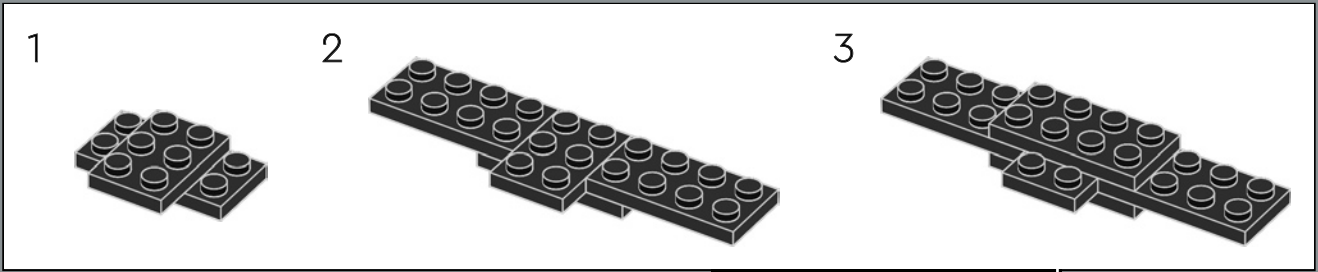

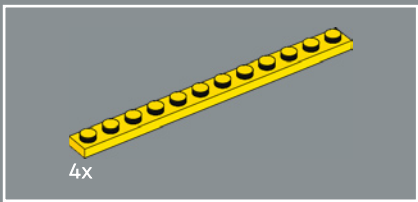

270

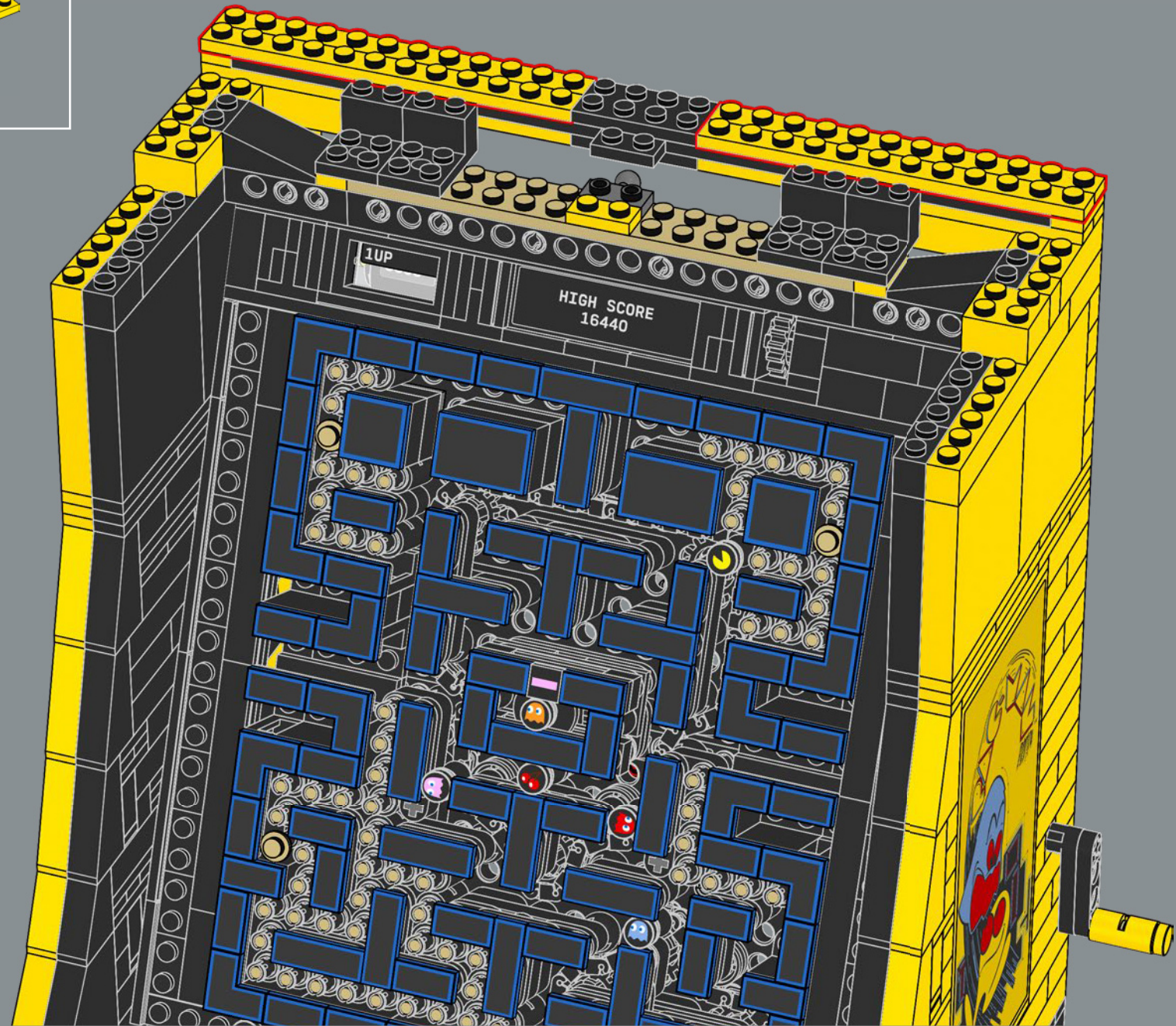

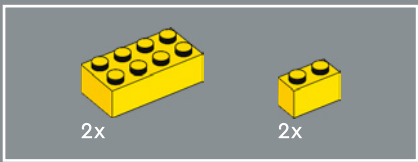

271

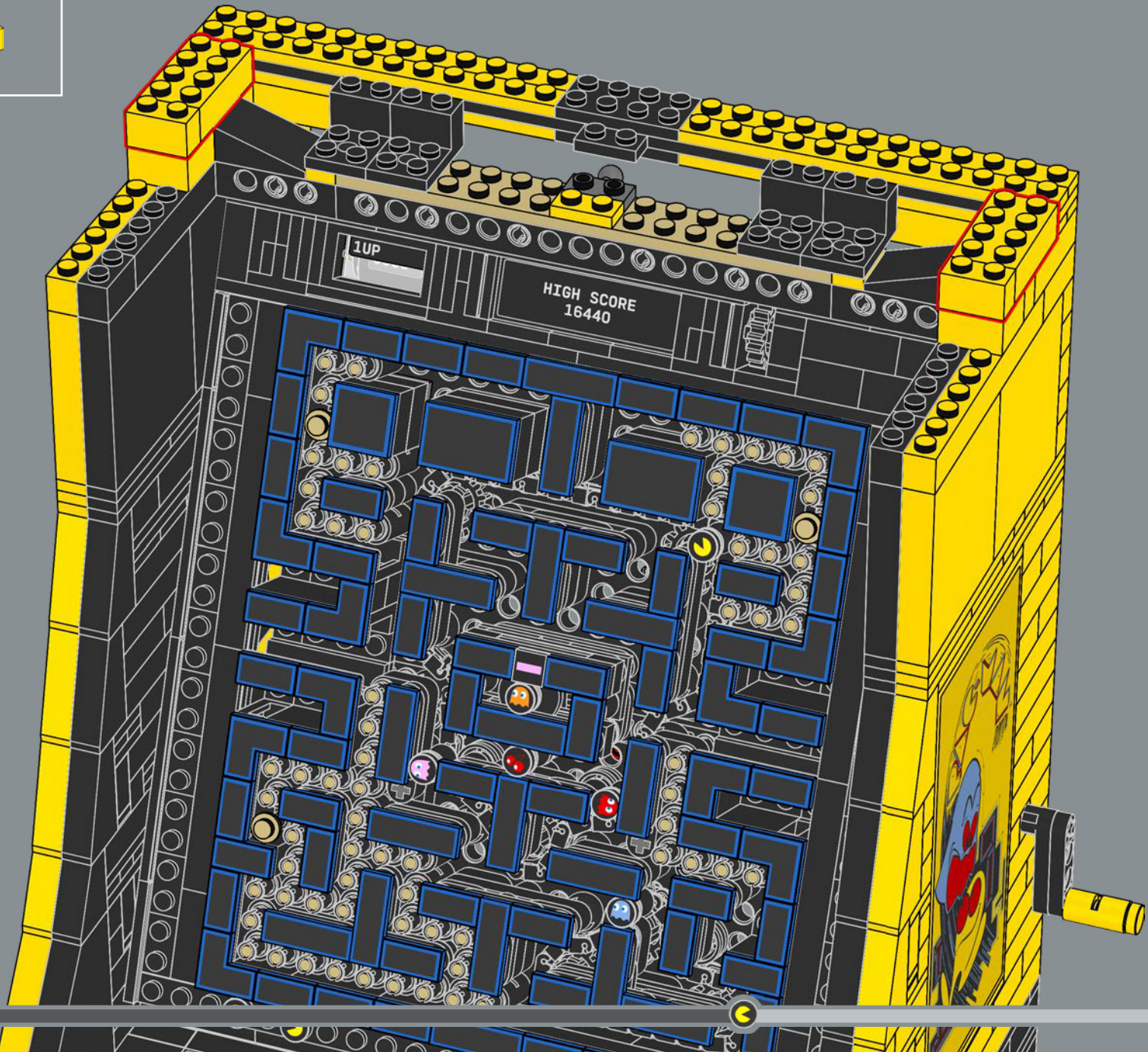

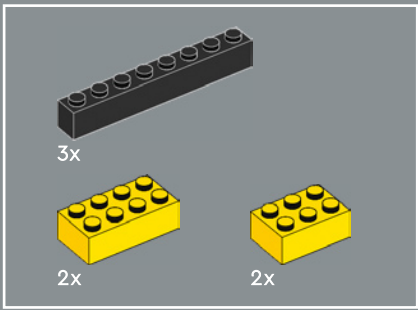

272

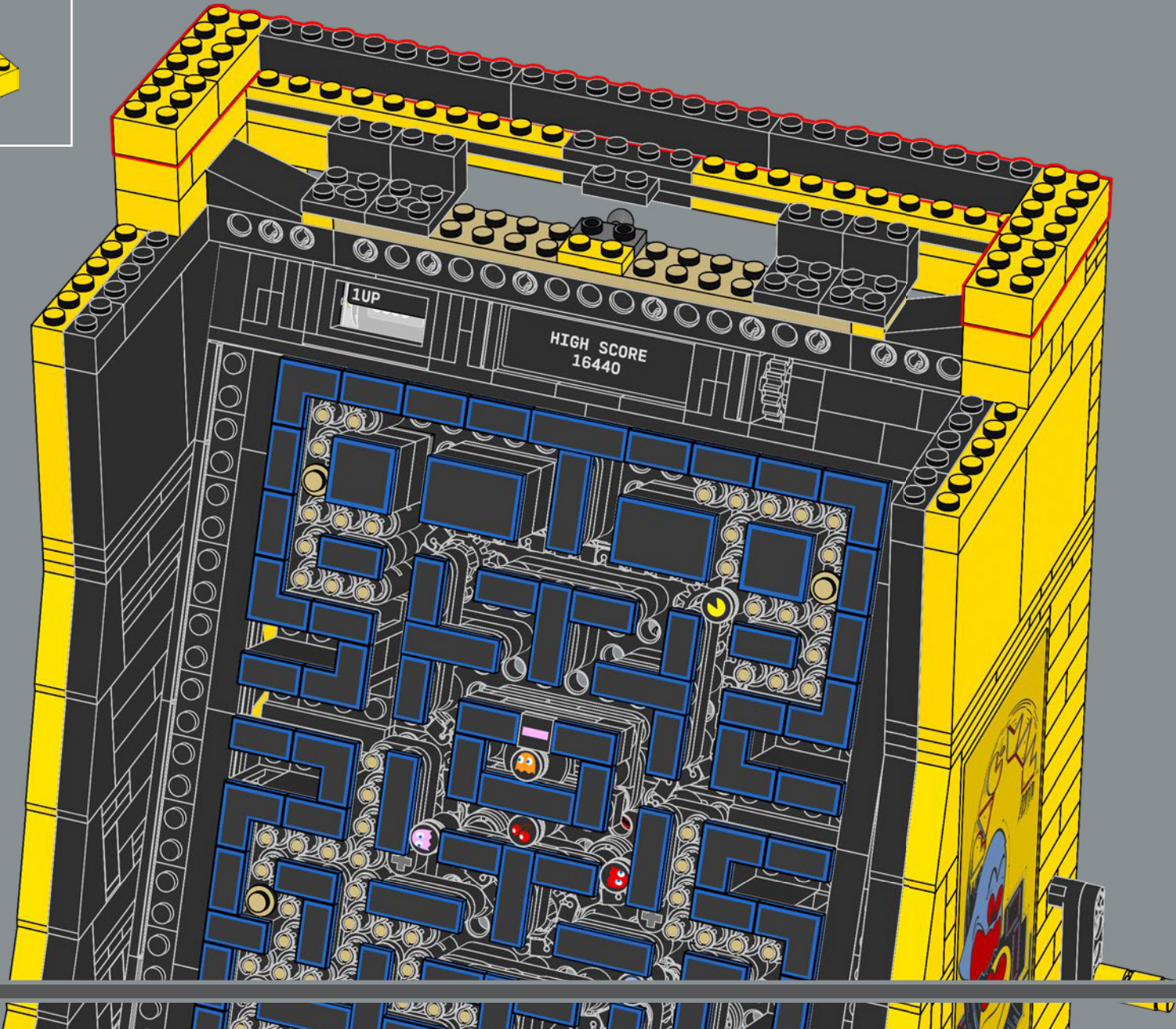

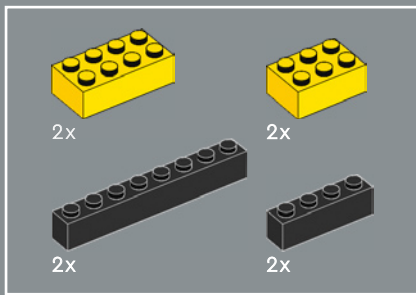

273

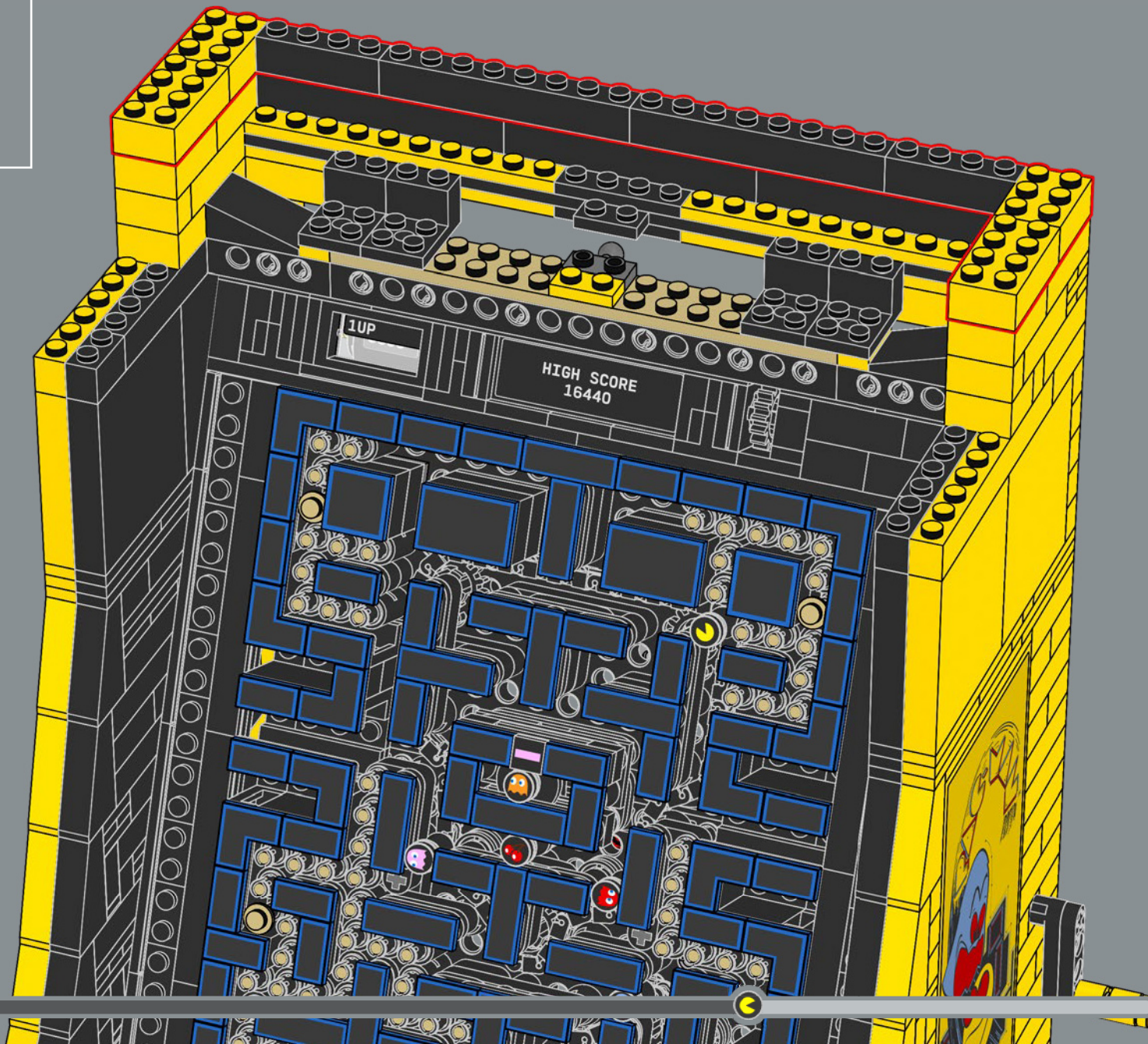

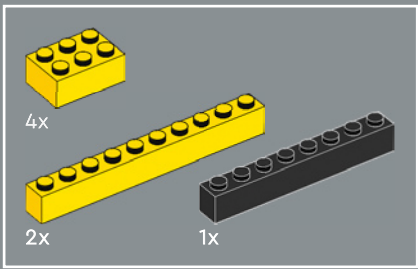

274

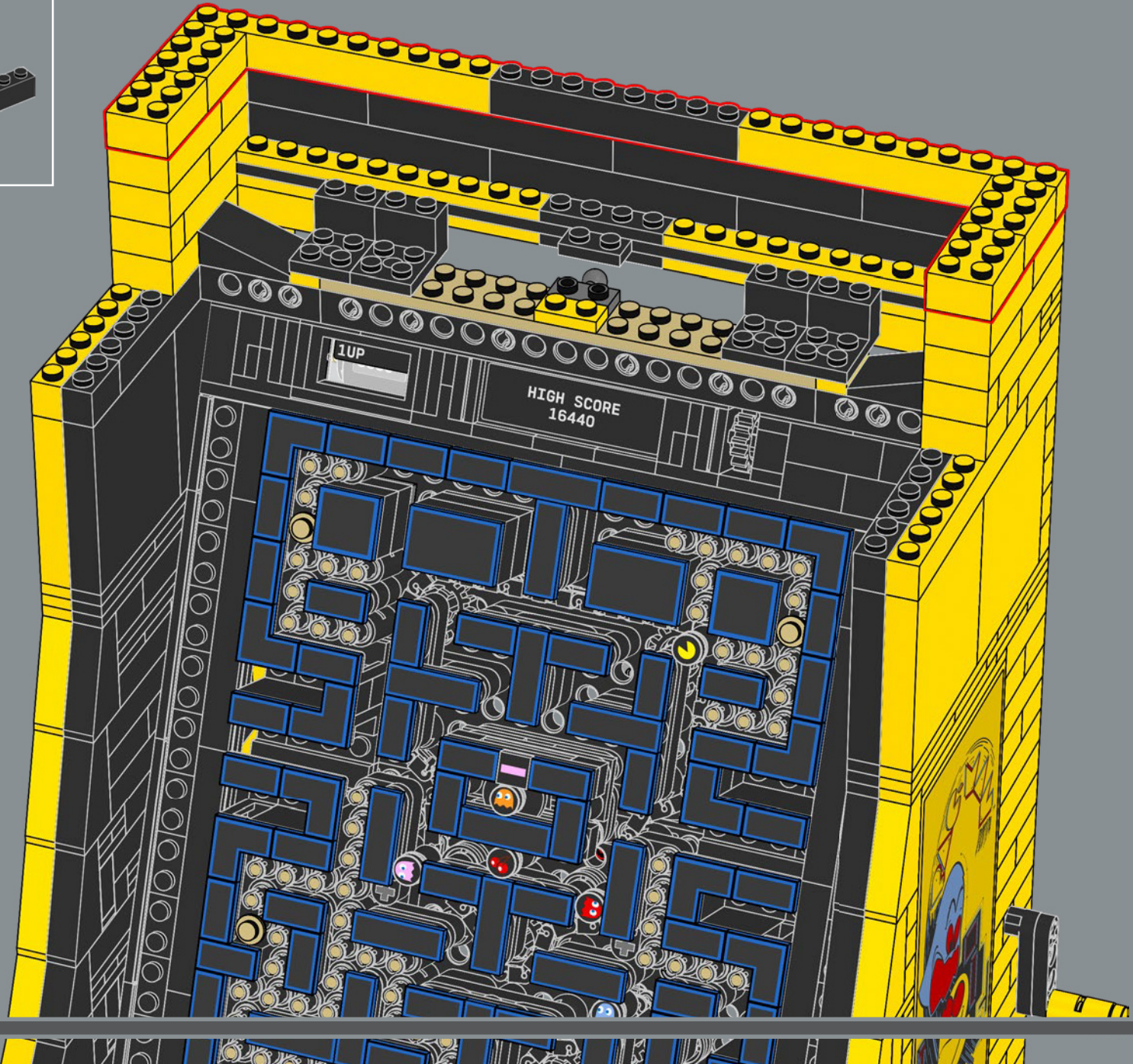

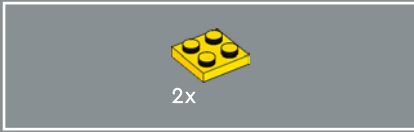
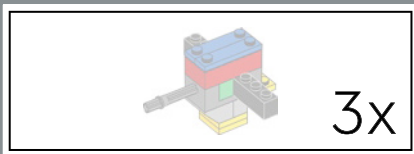

275

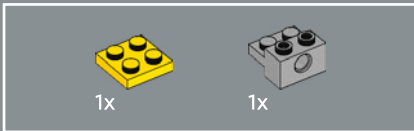
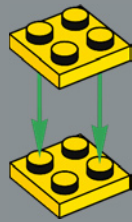

276

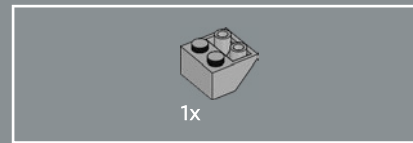
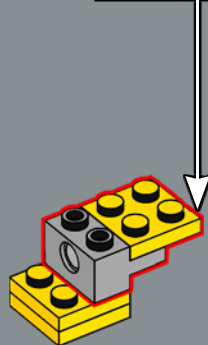
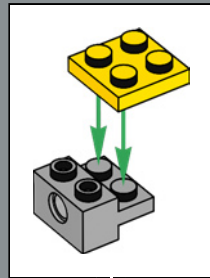

277

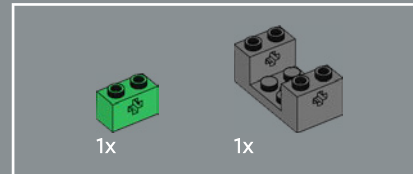
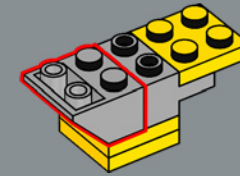

278

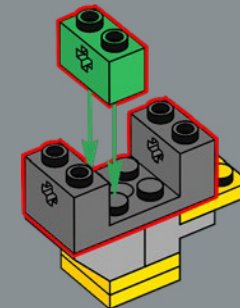

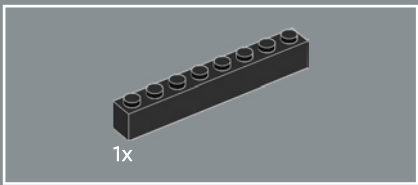

1x

279

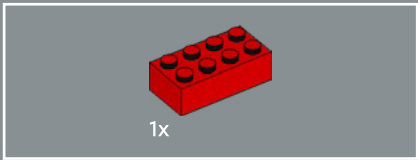
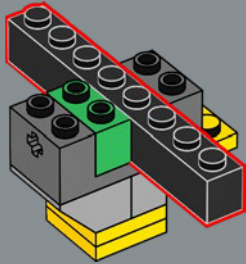

1x

280

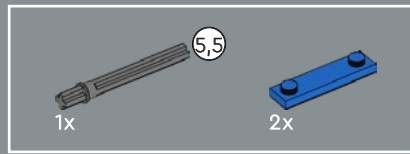
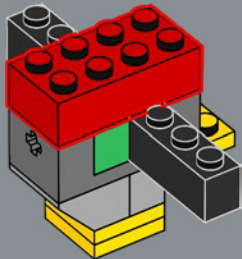

1x

2x

281

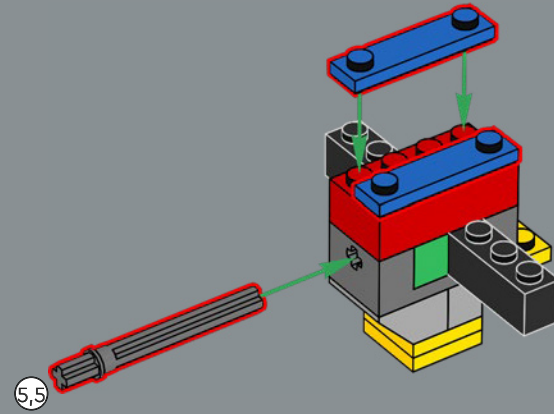

3x

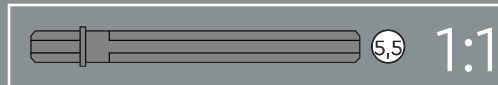

55

1:1

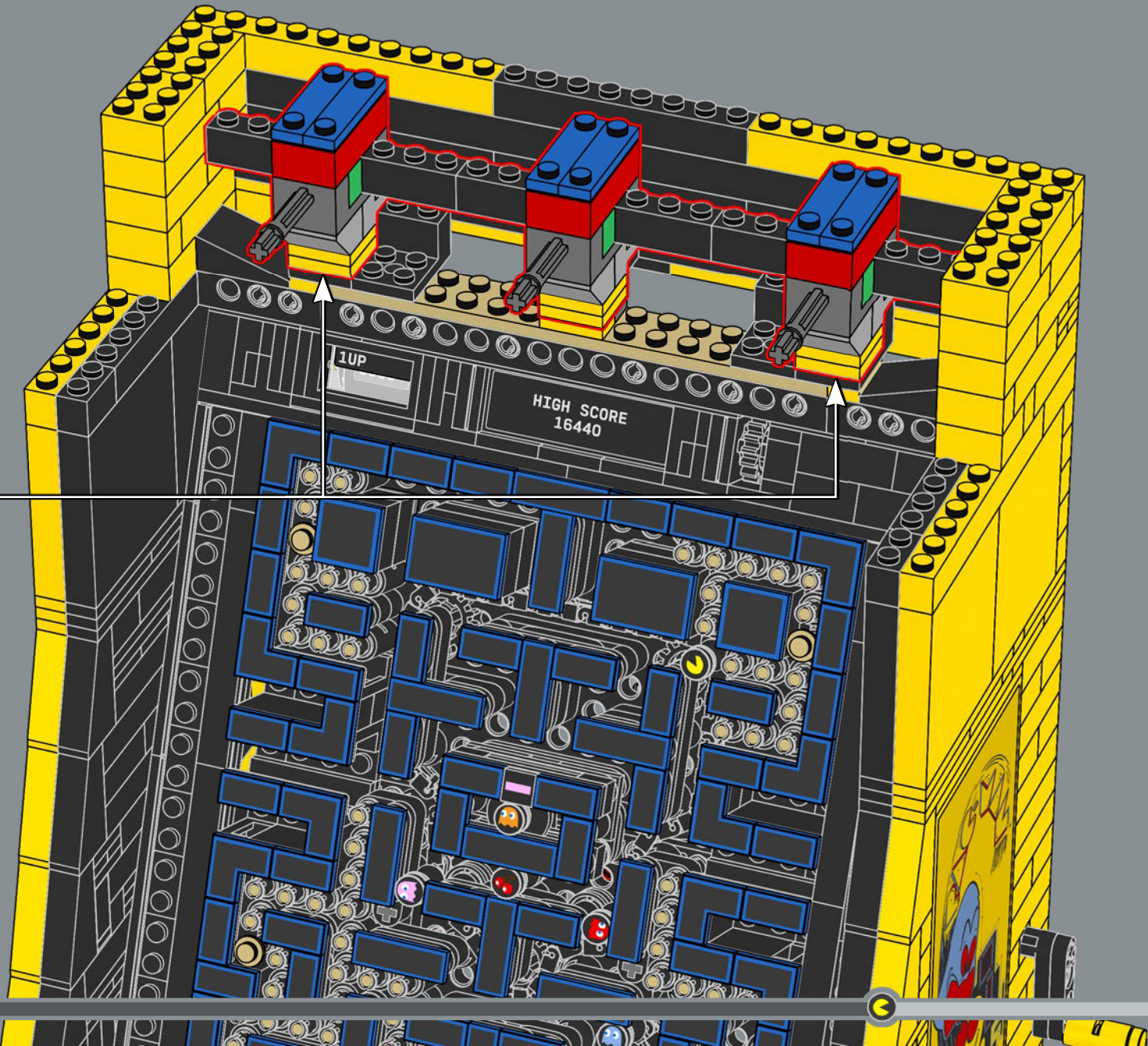

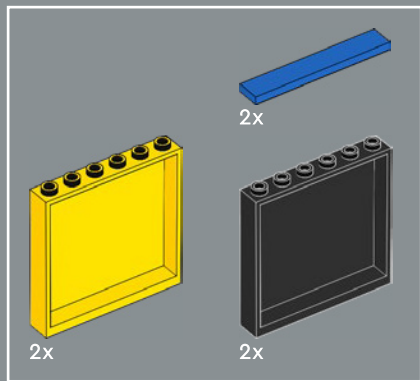

283

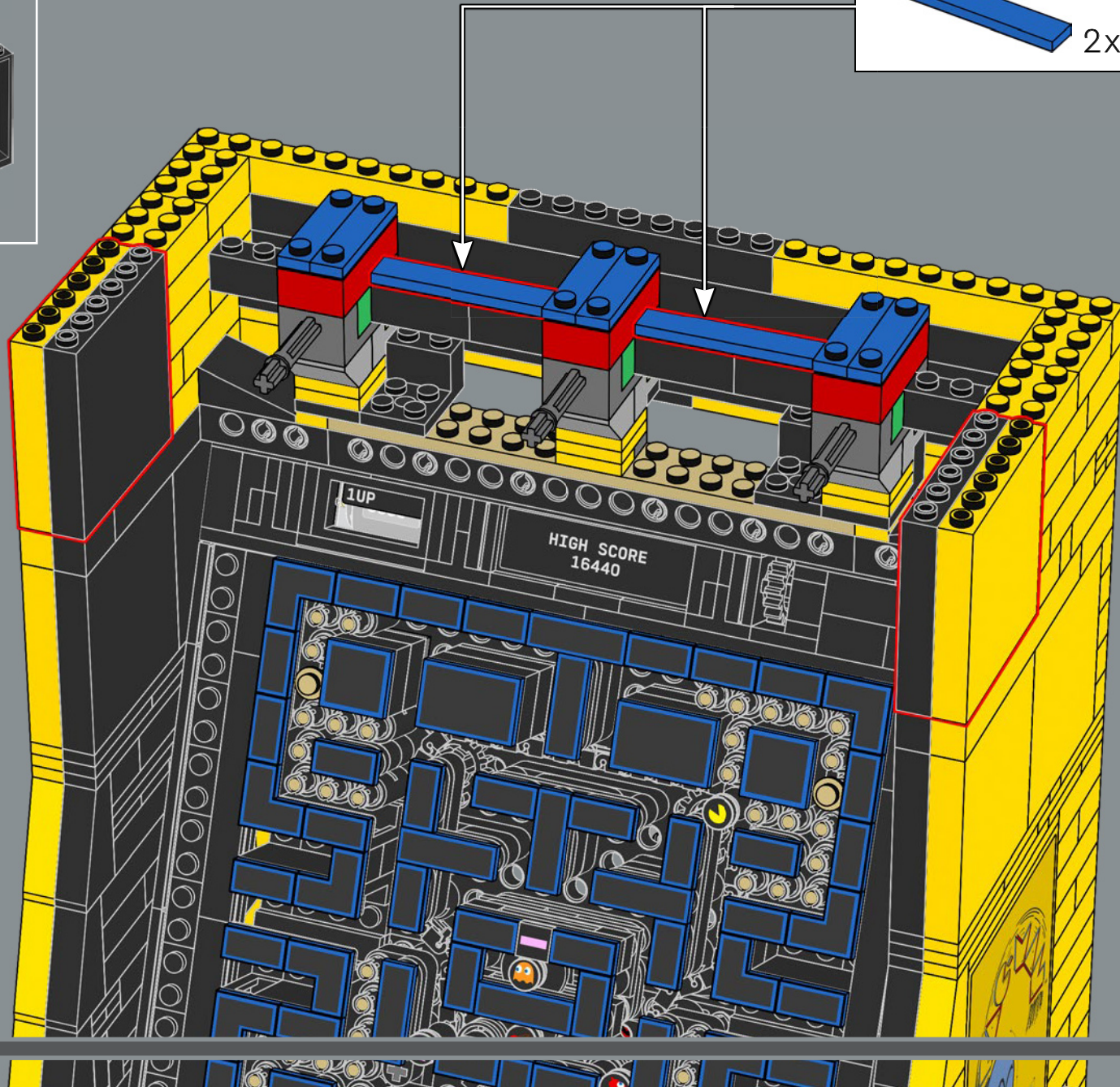
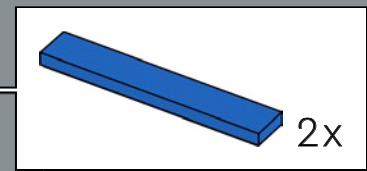

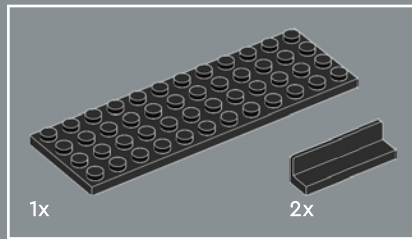
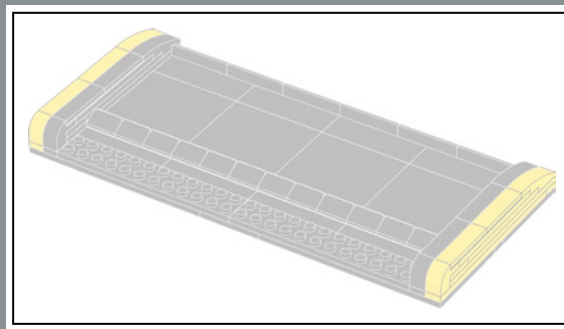

284

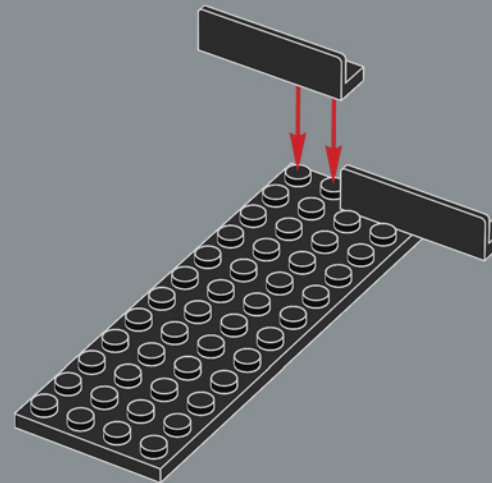

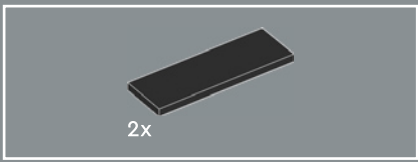

285

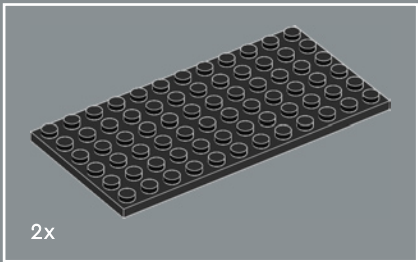
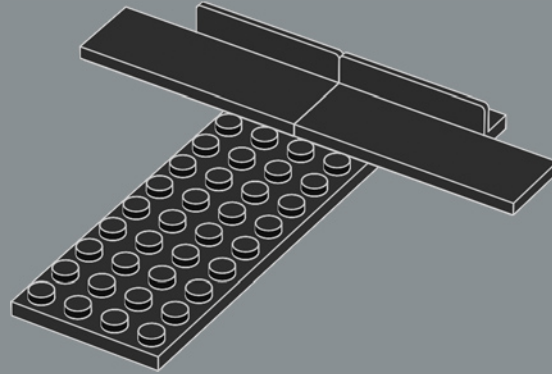

286

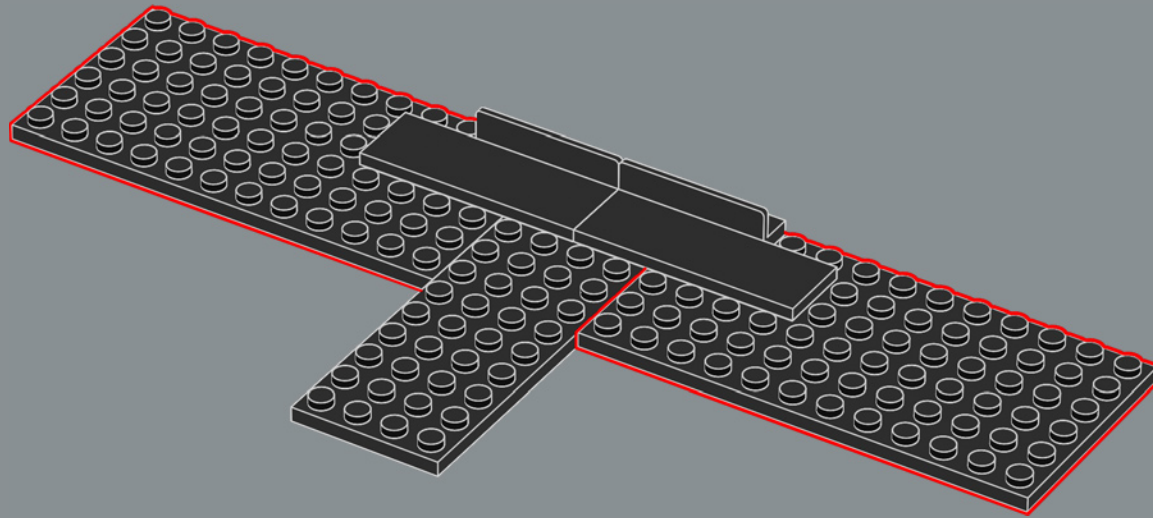

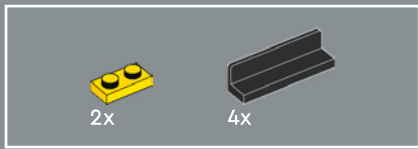

287

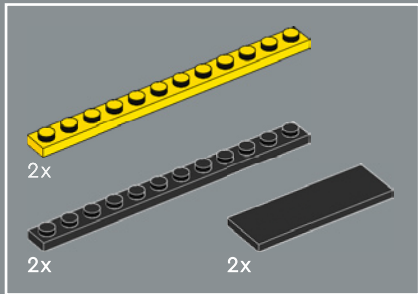
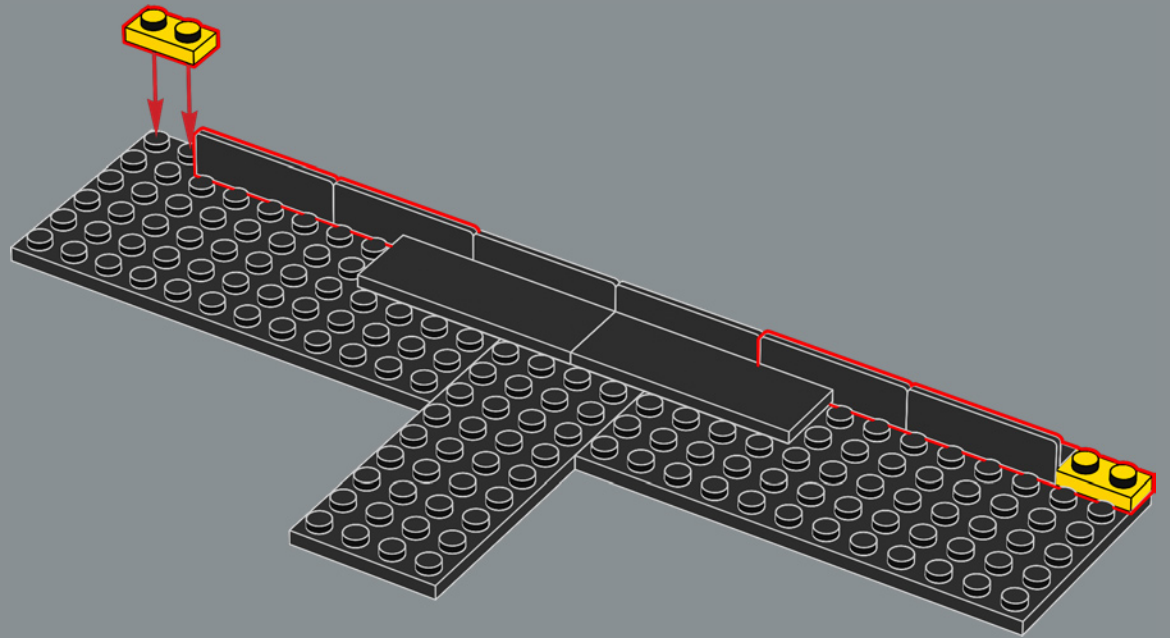

288

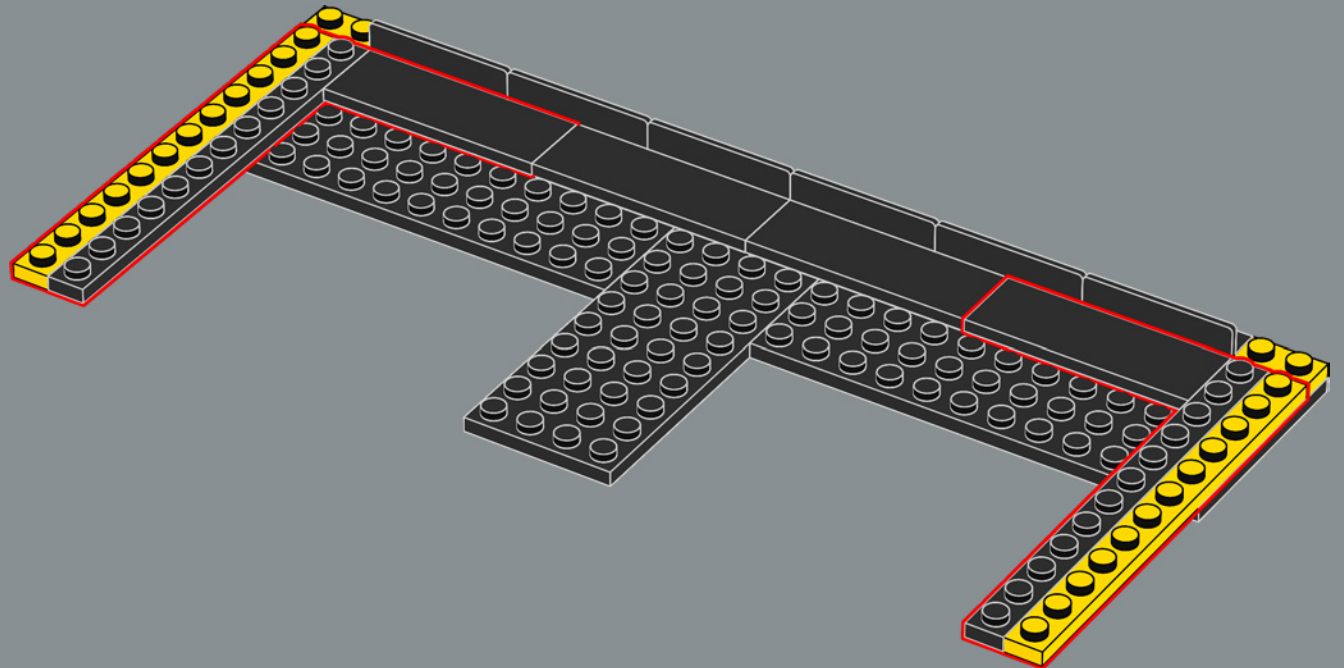

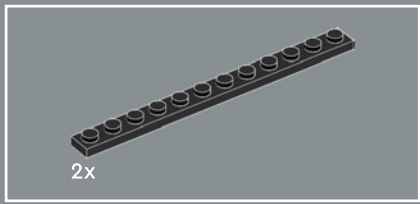

289

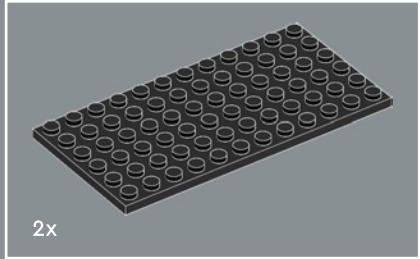
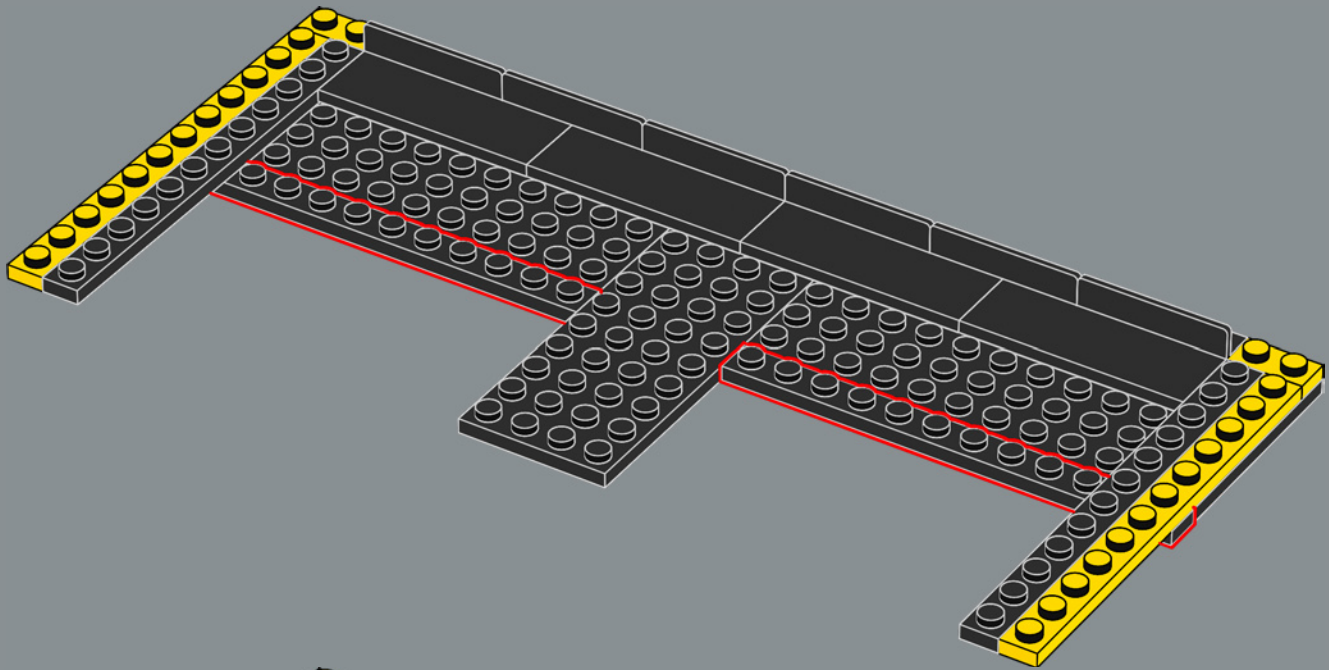

290

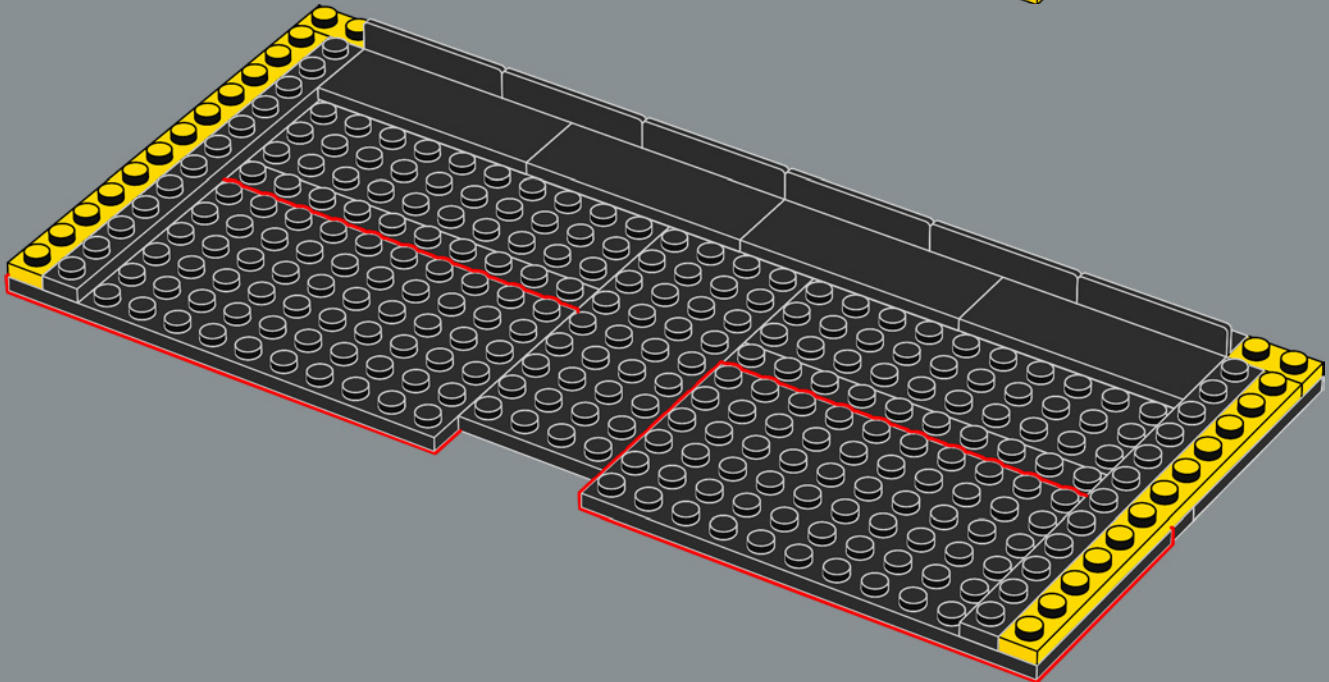

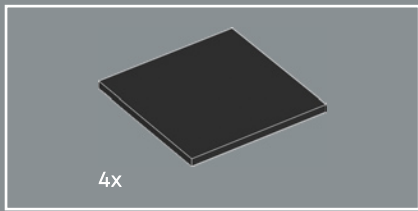

291

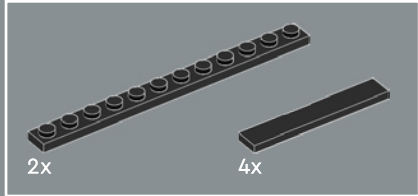
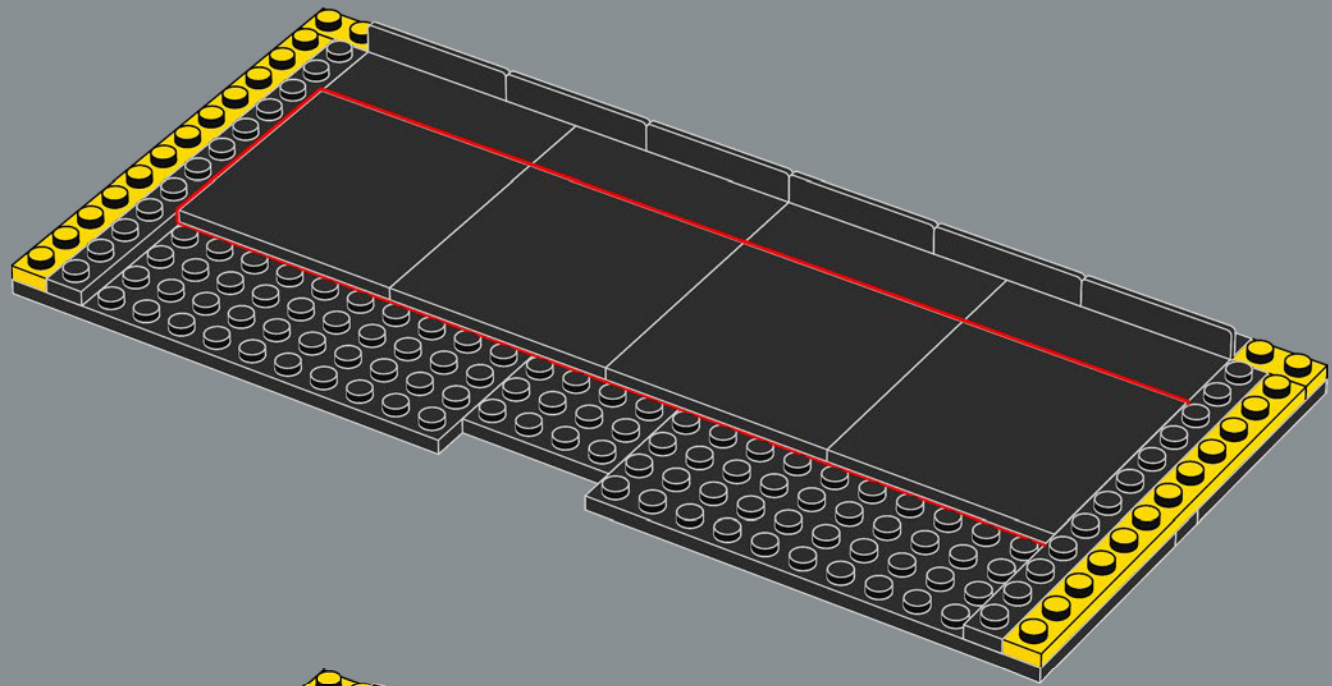

292

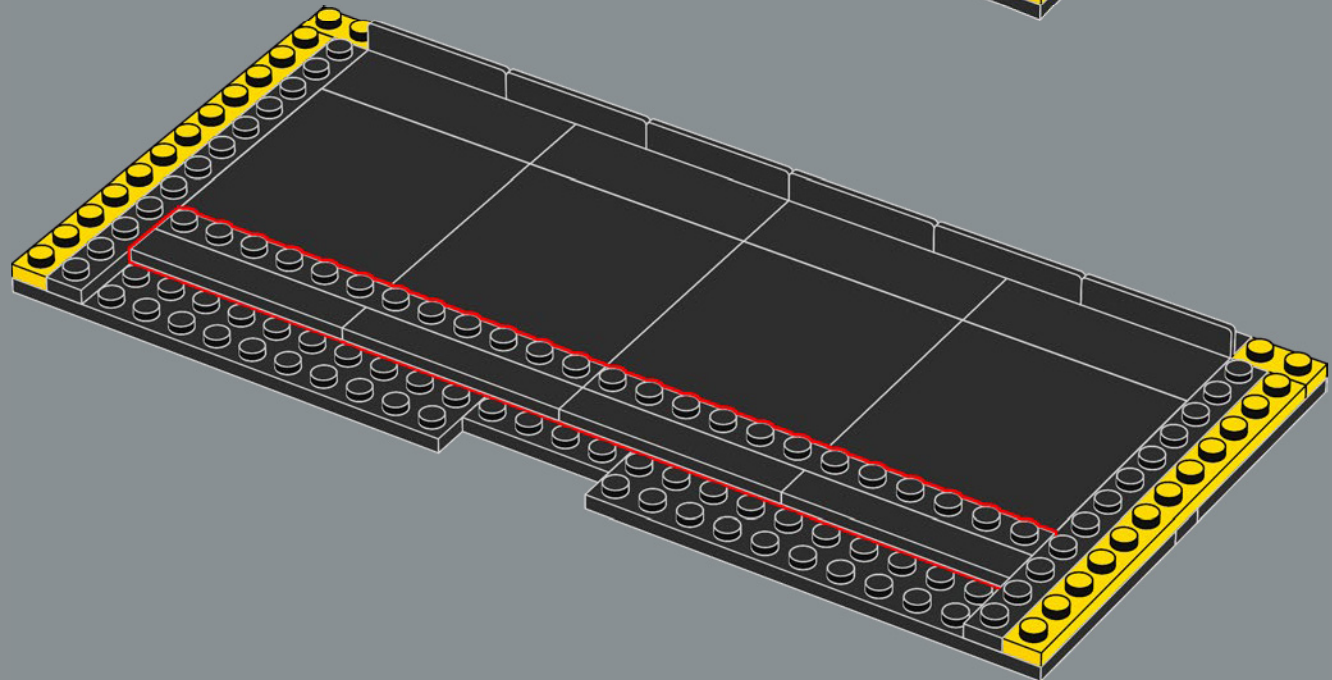

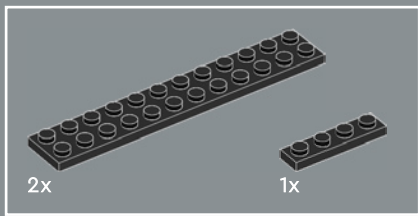

293

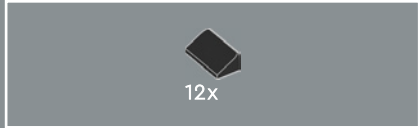
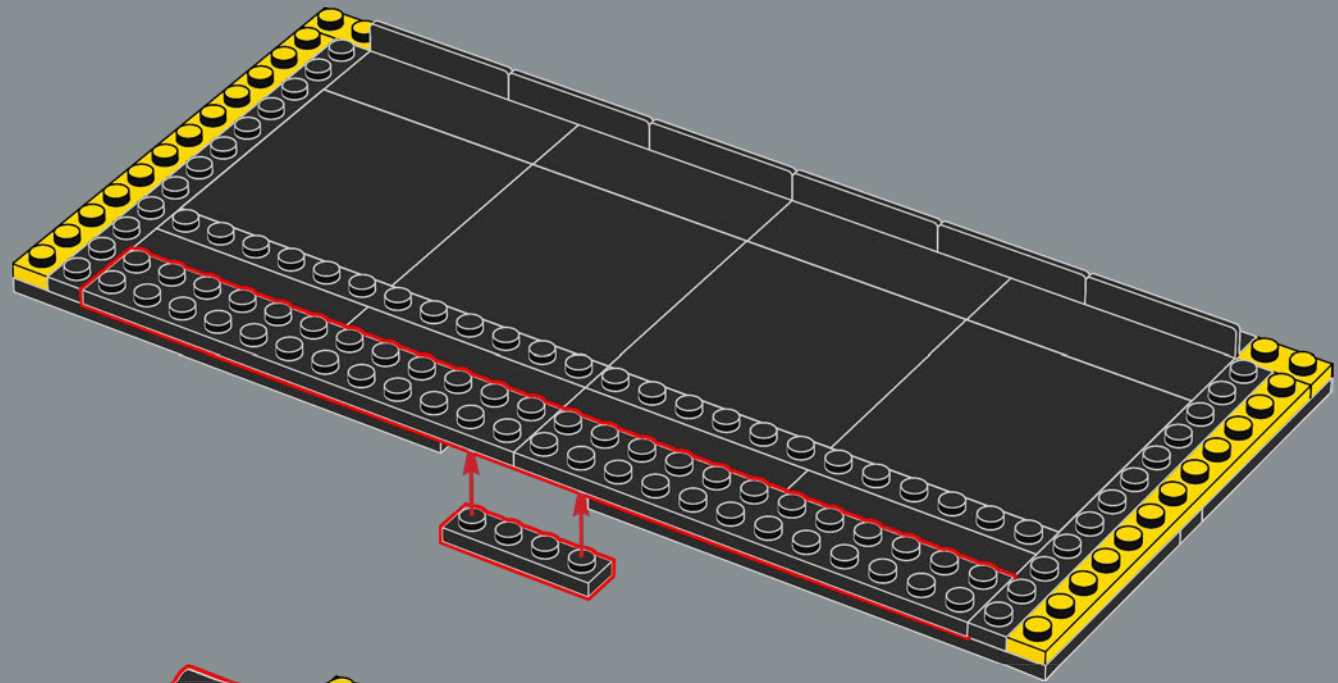

294

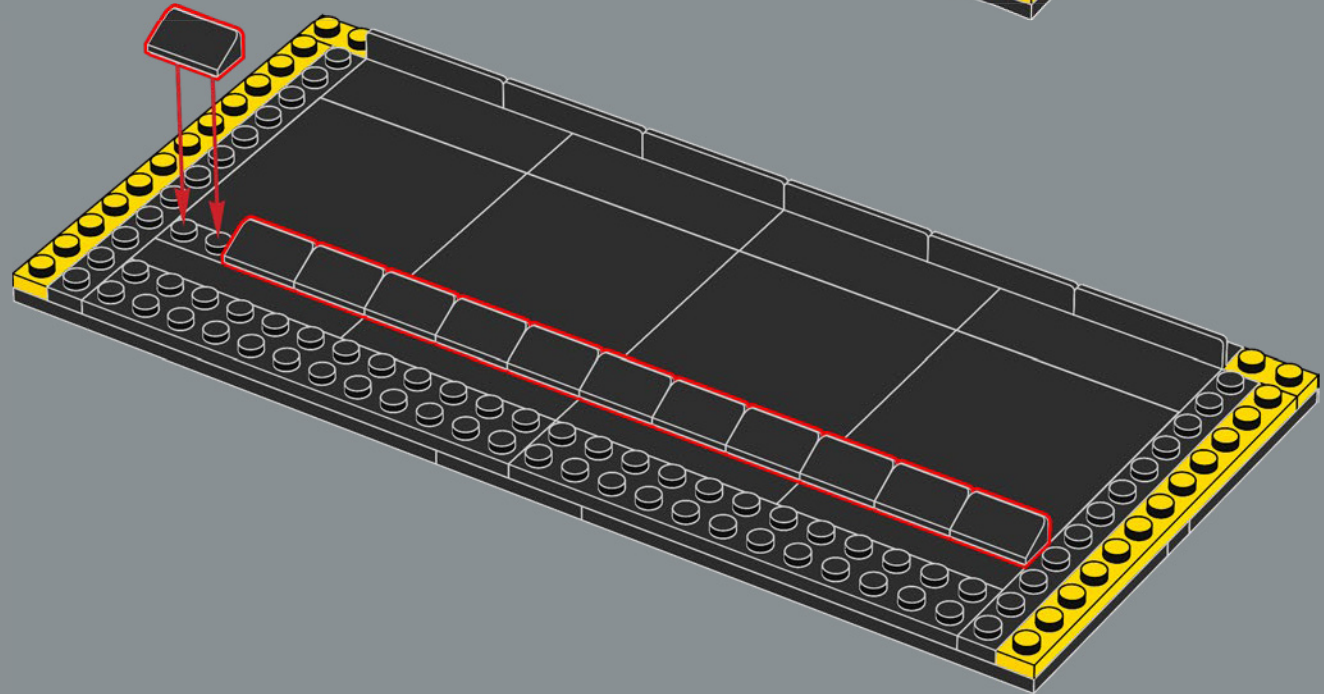

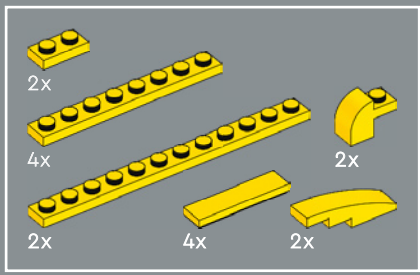

296

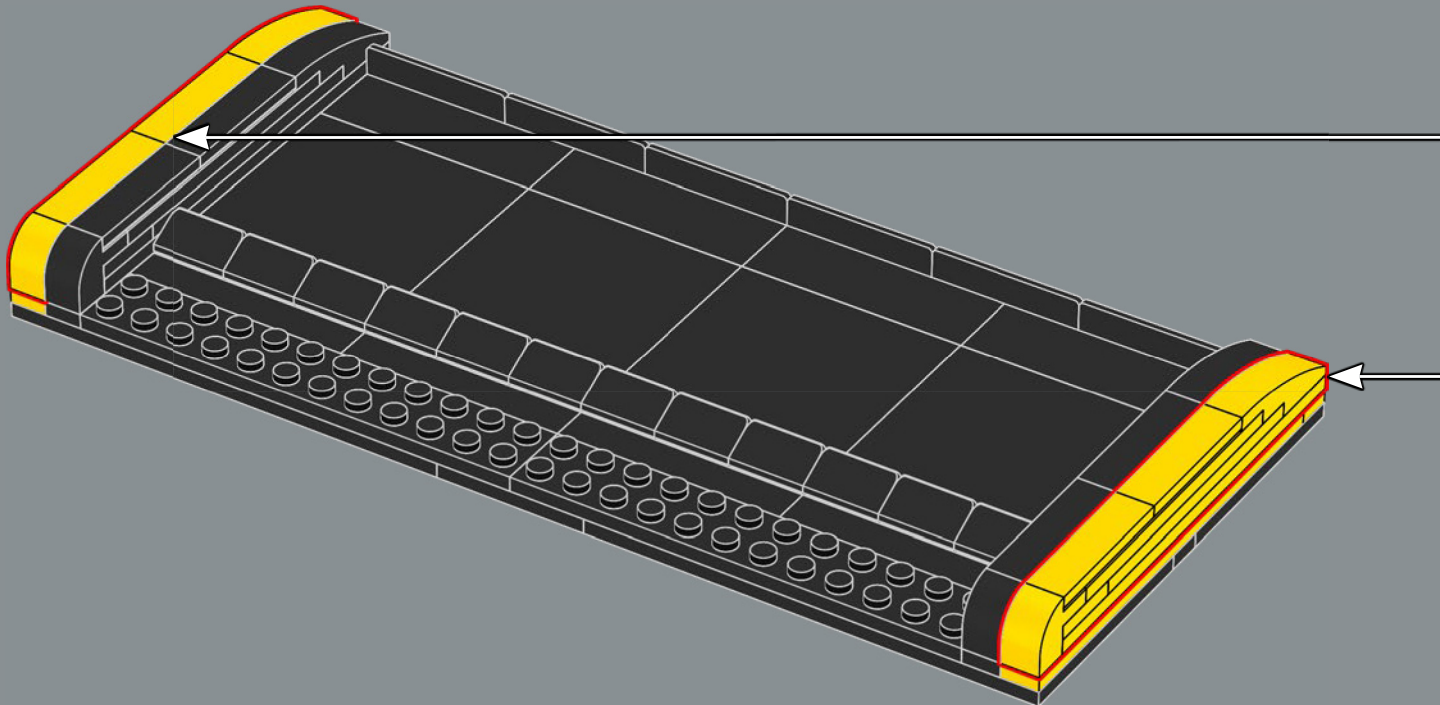
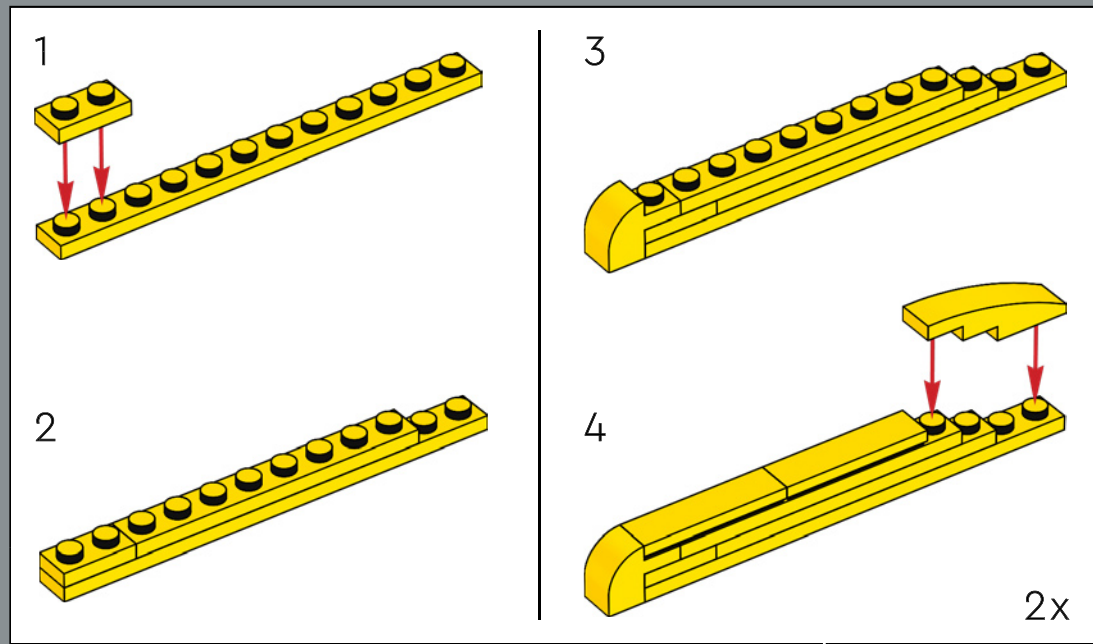

297

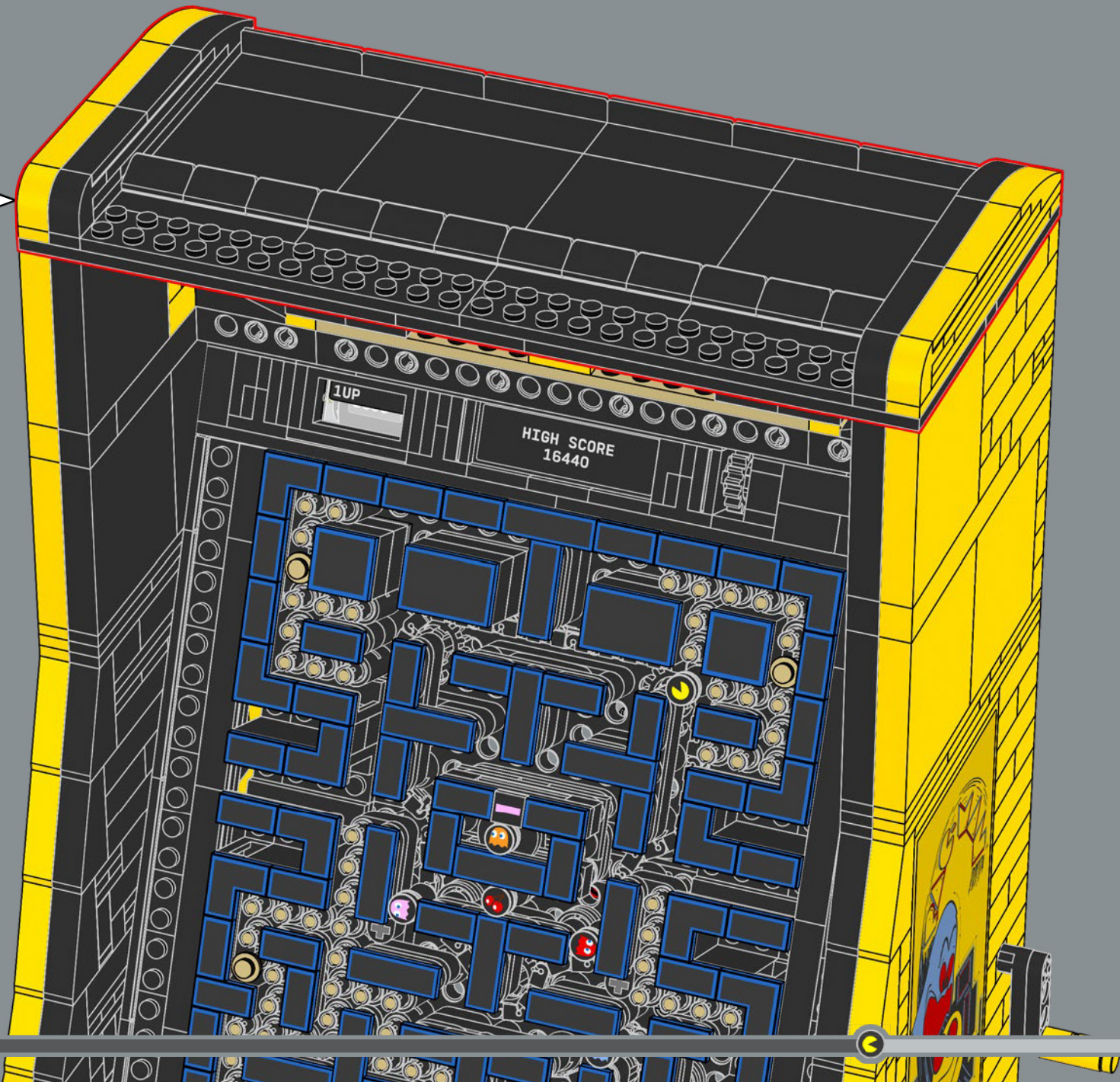

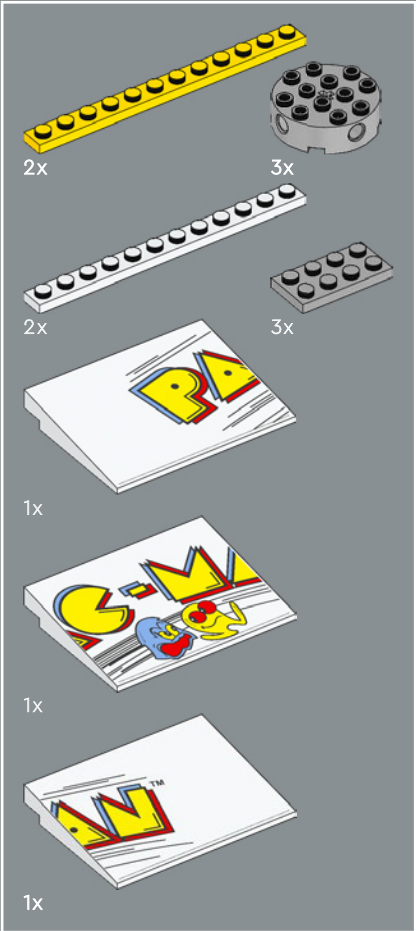
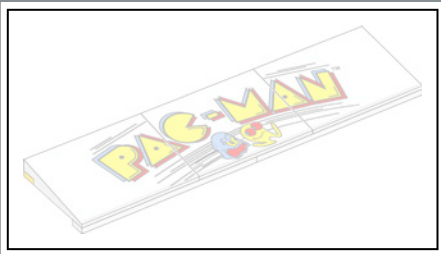

1

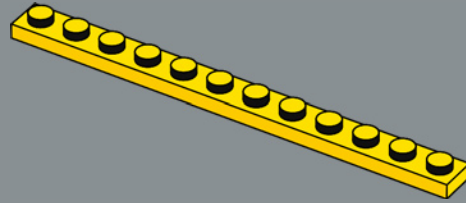

2



3

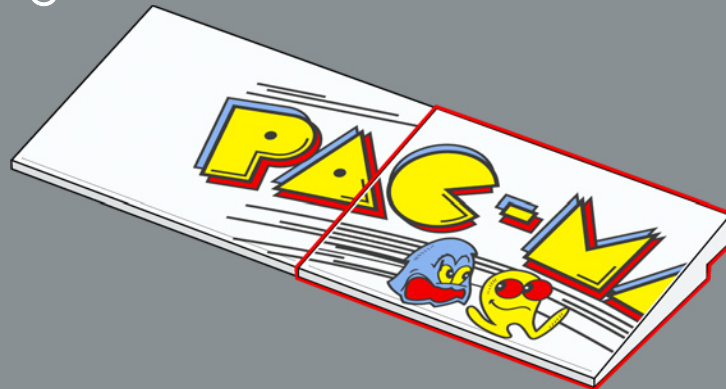

4

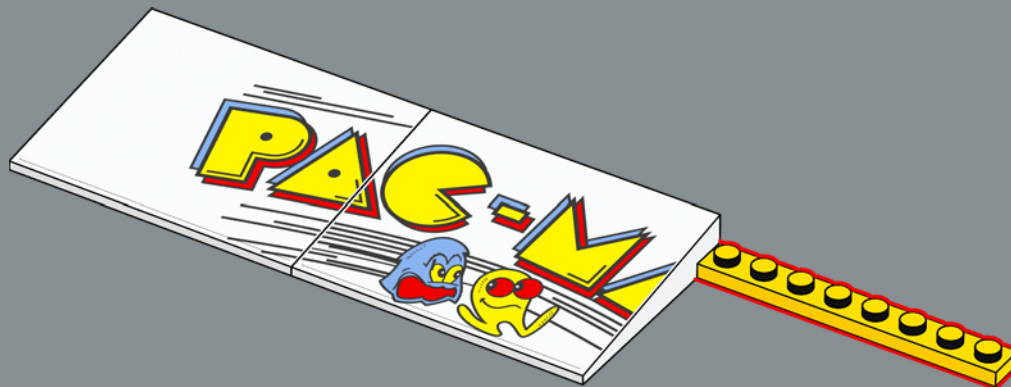

5

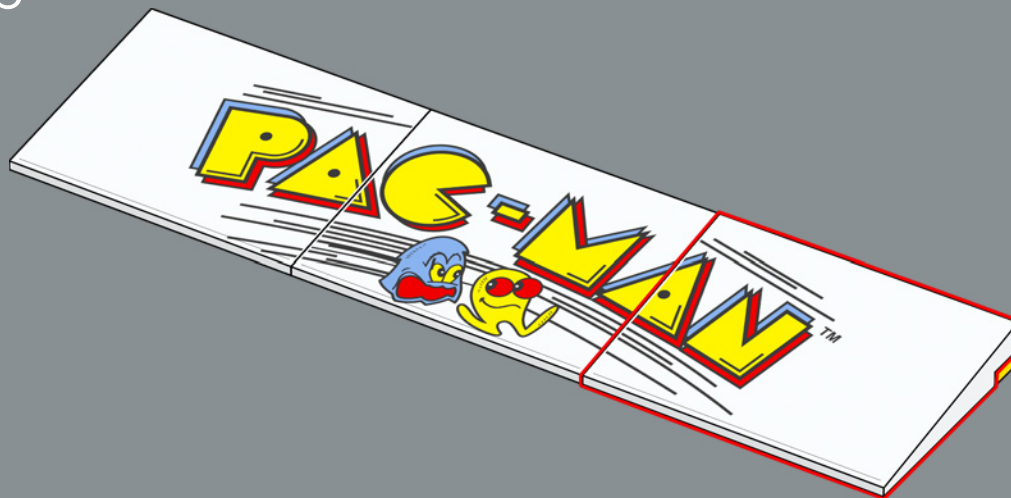



6

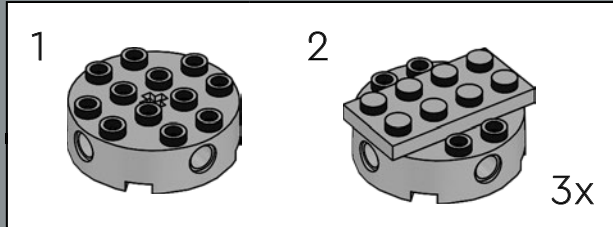
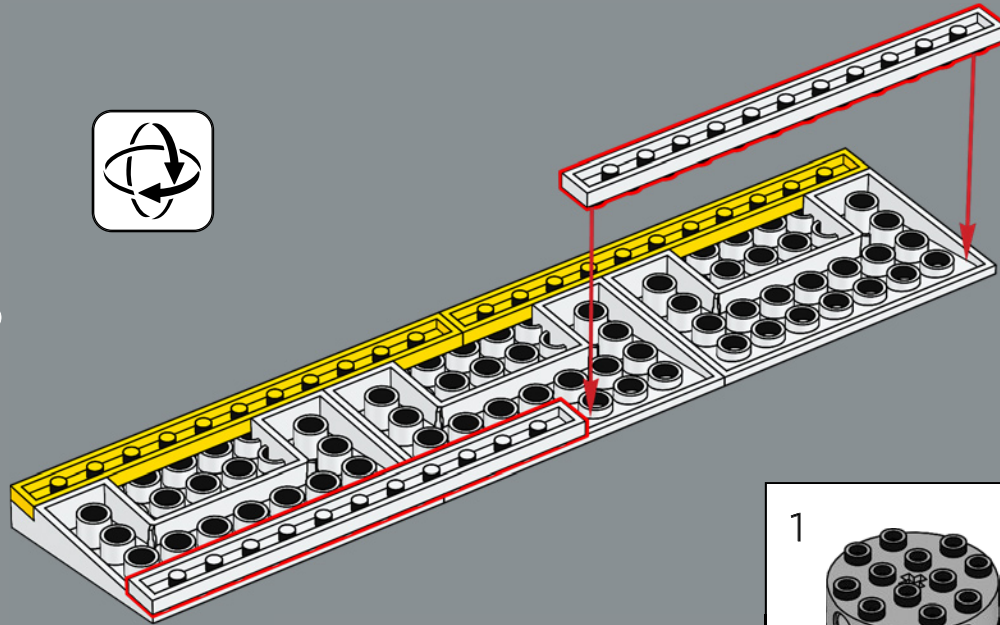

1



2

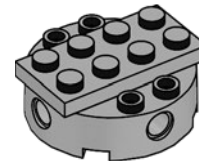

3x

7

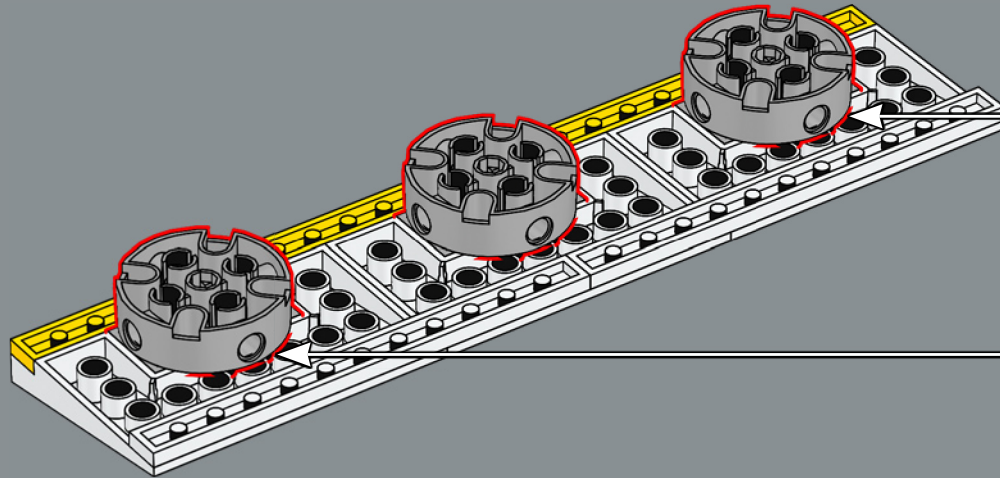

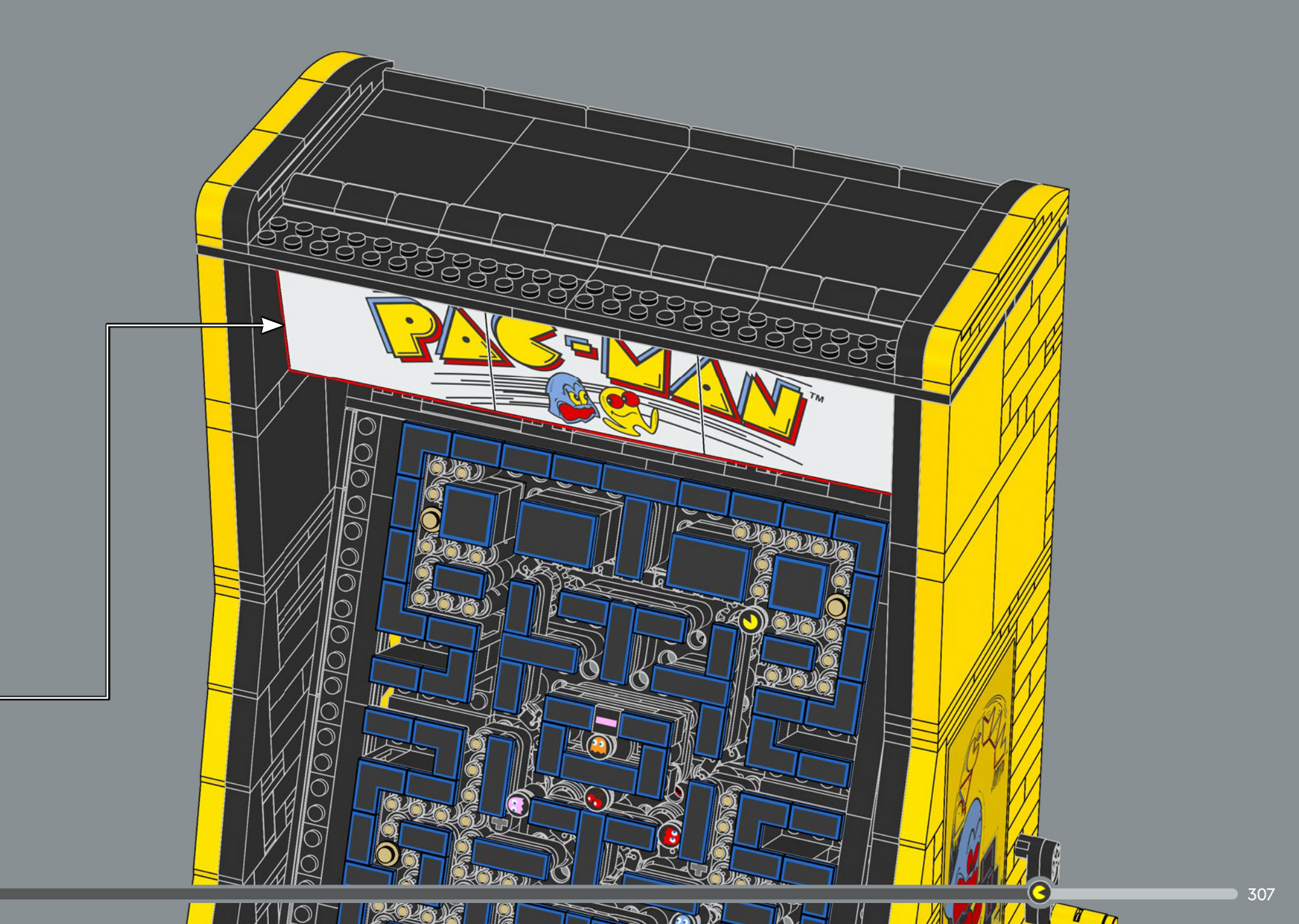

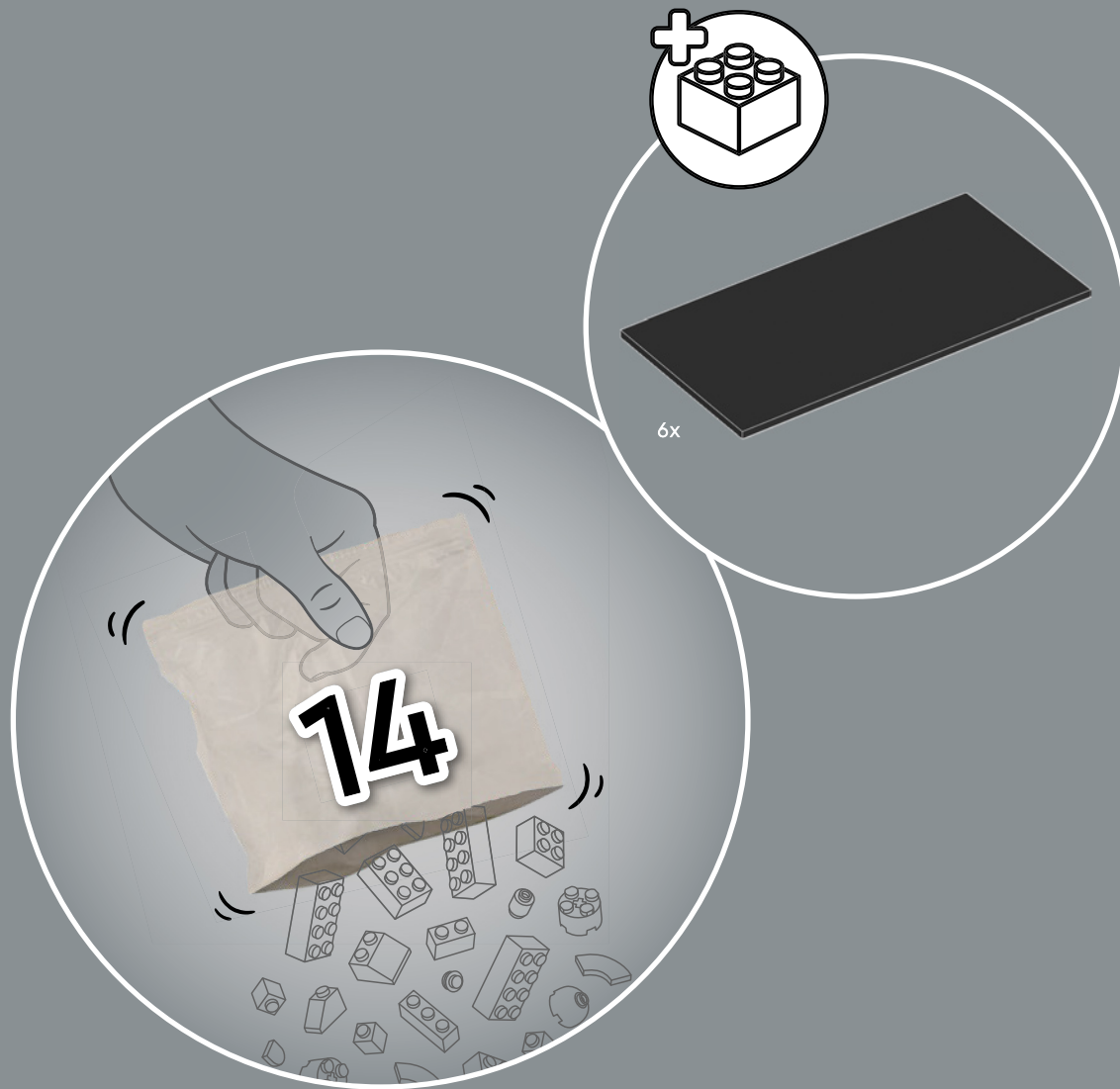

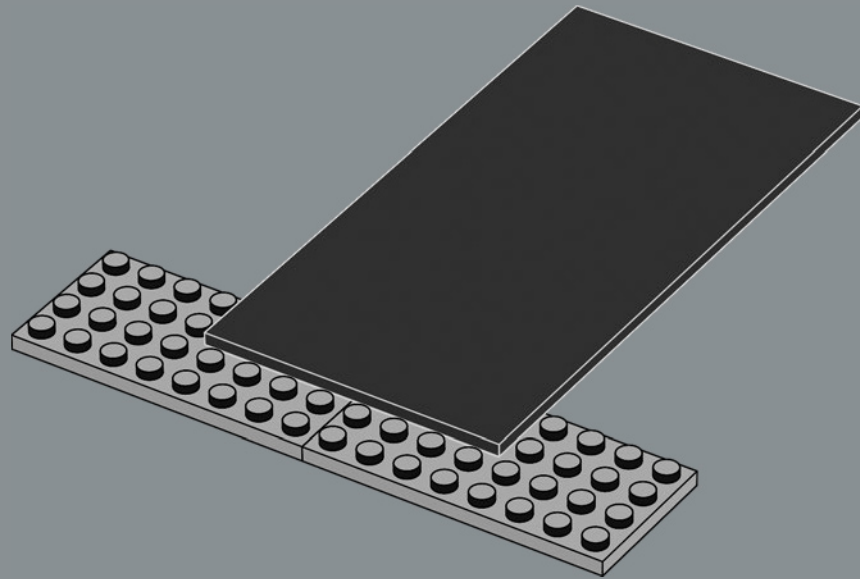
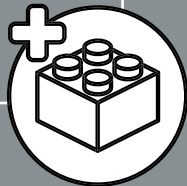
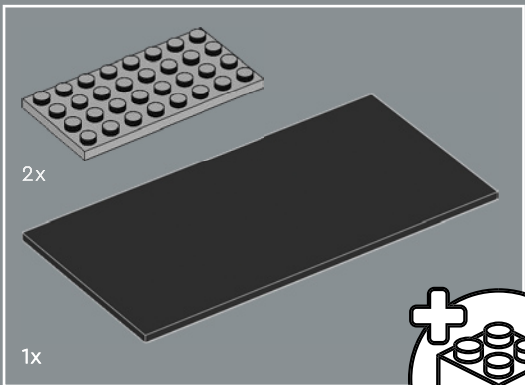
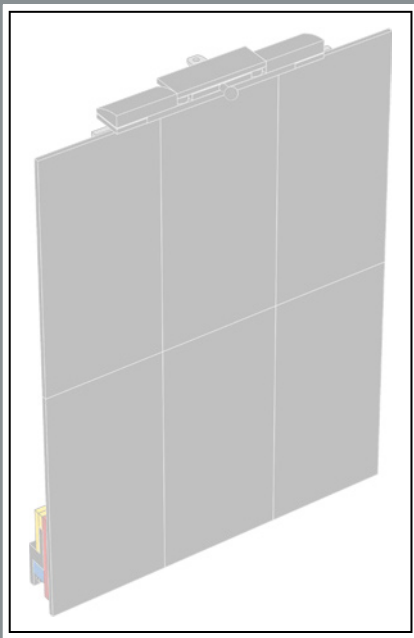

299

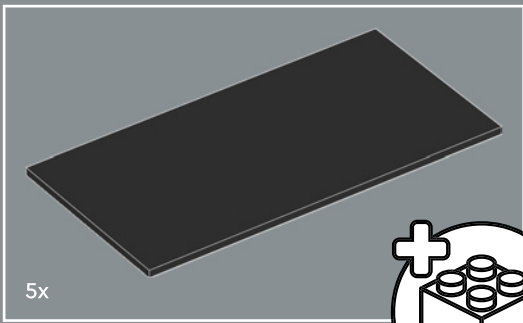

5x

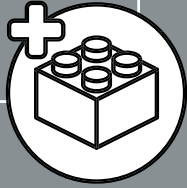

300

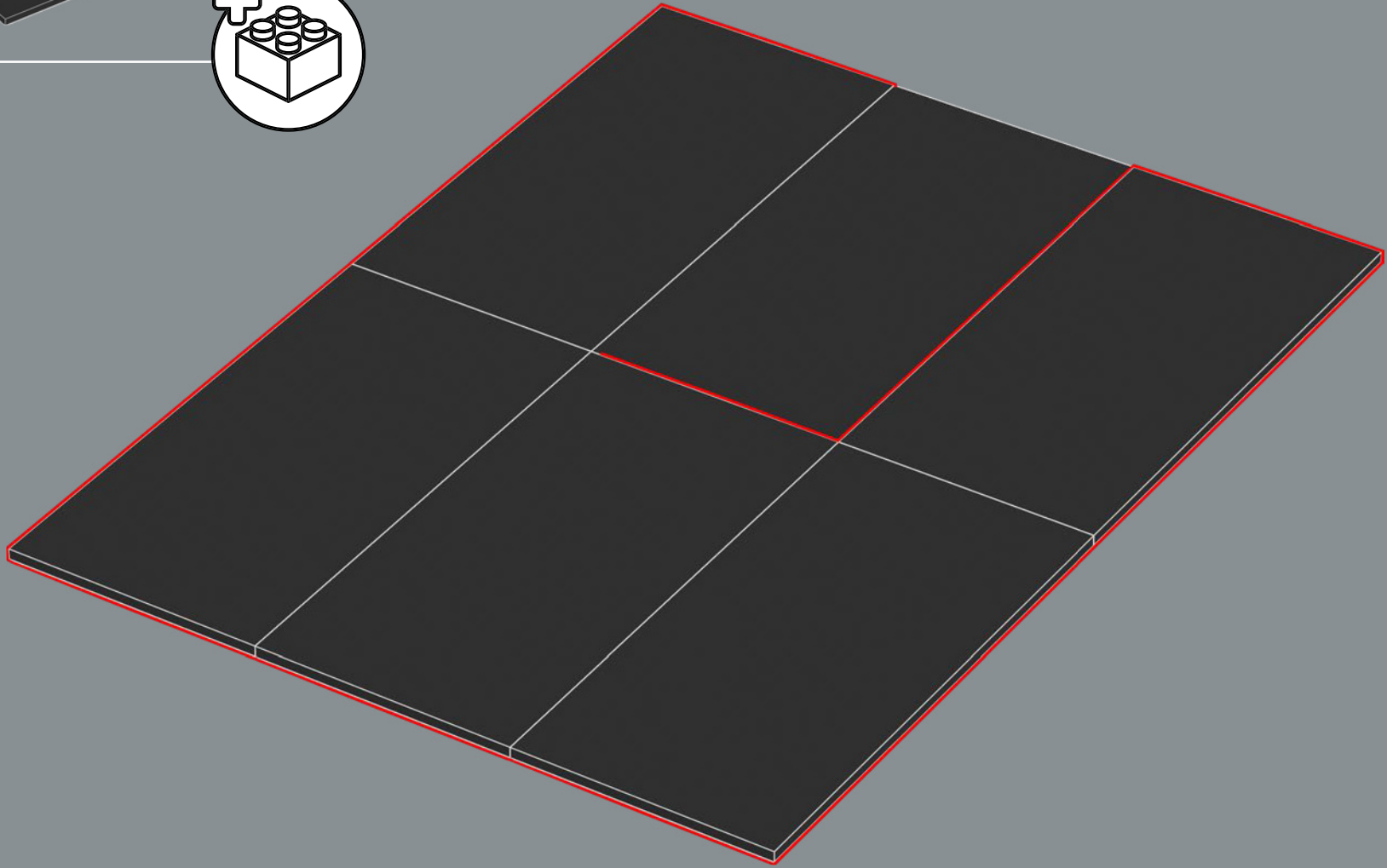

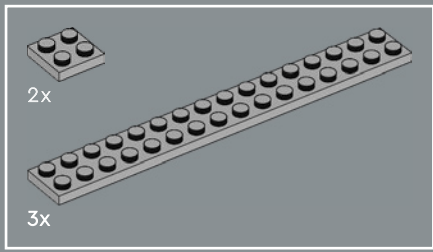

301

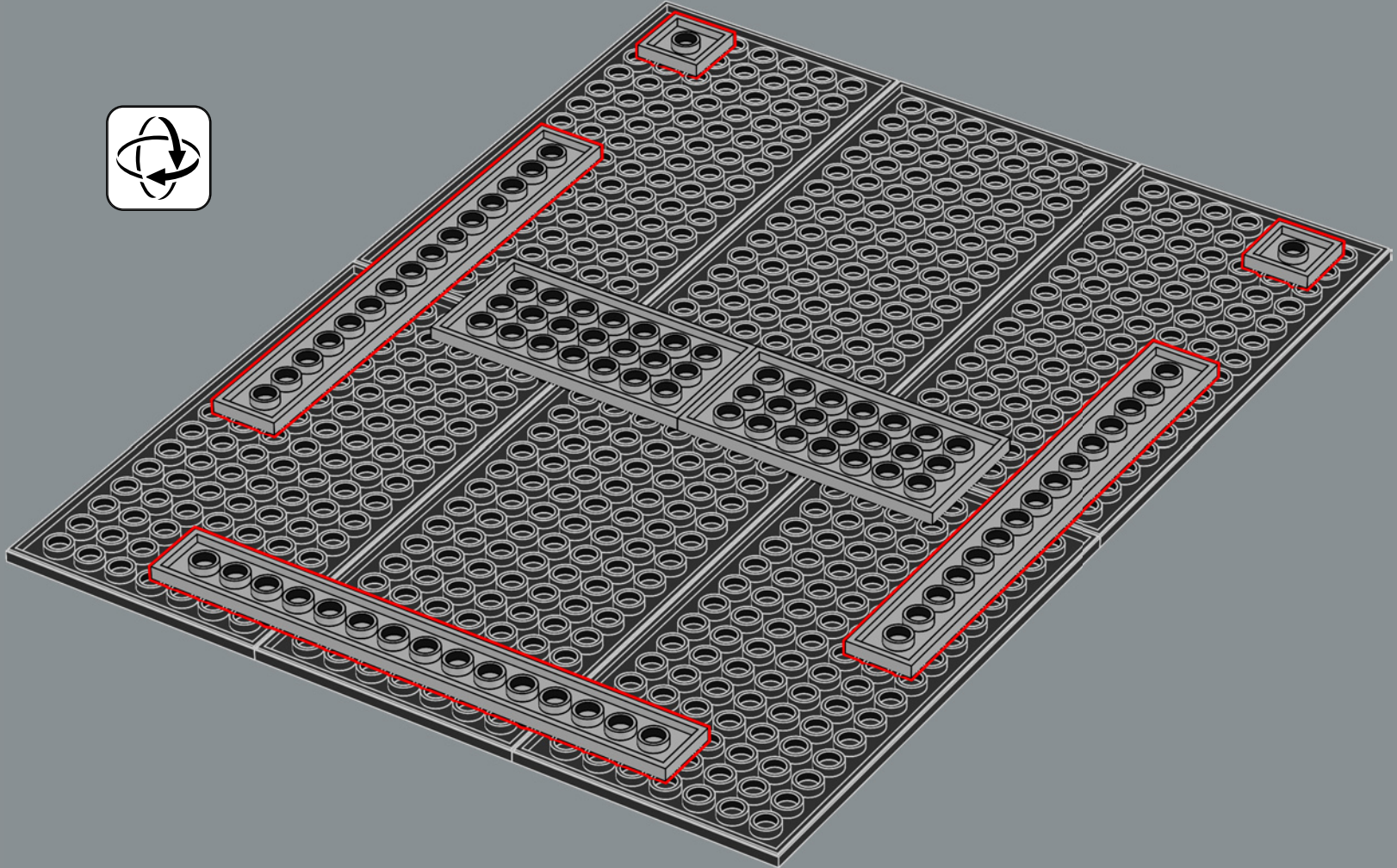

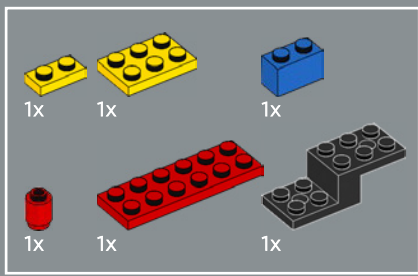

302

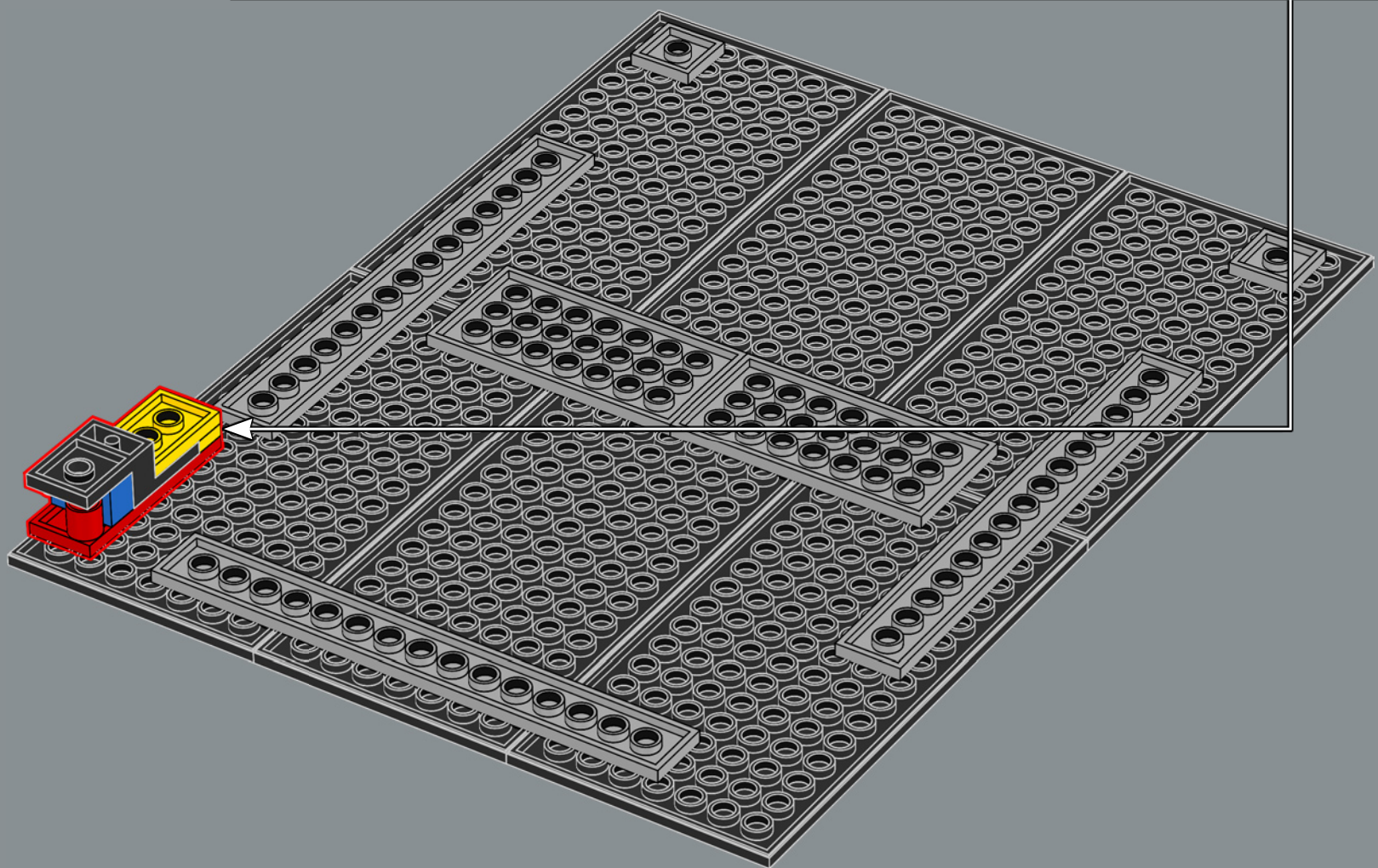
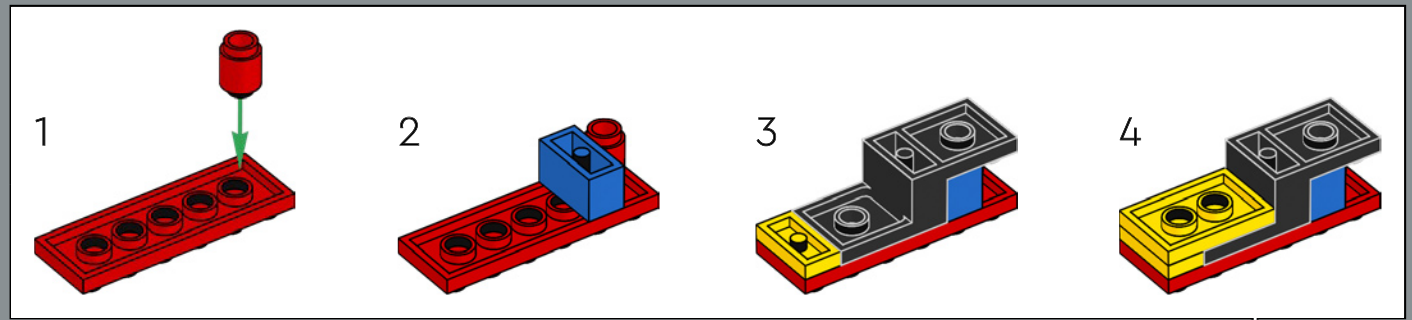

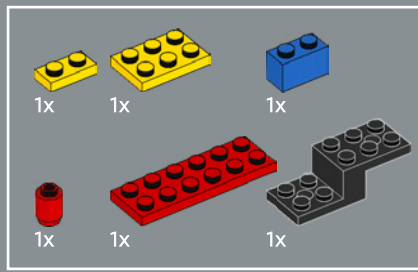

303

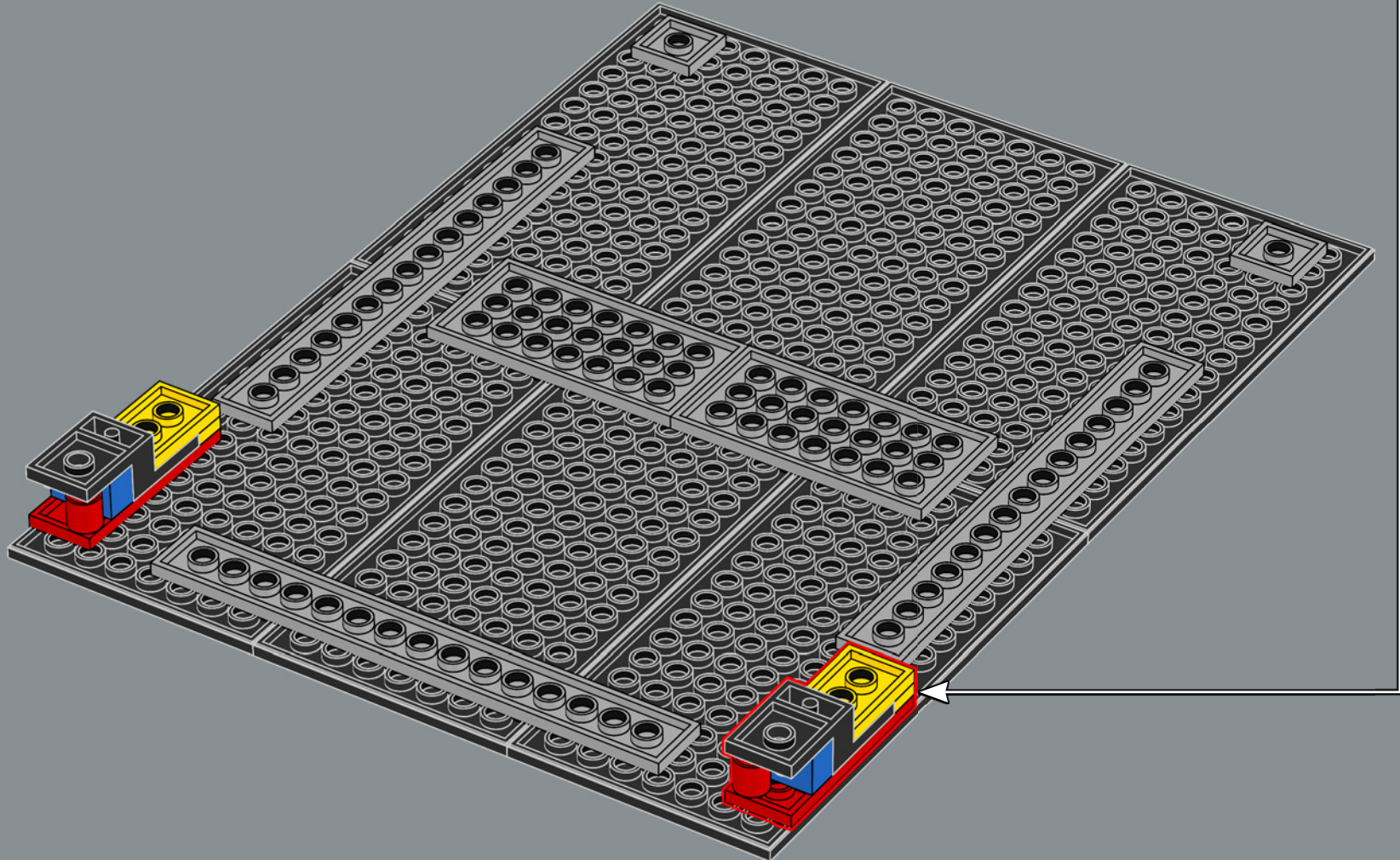
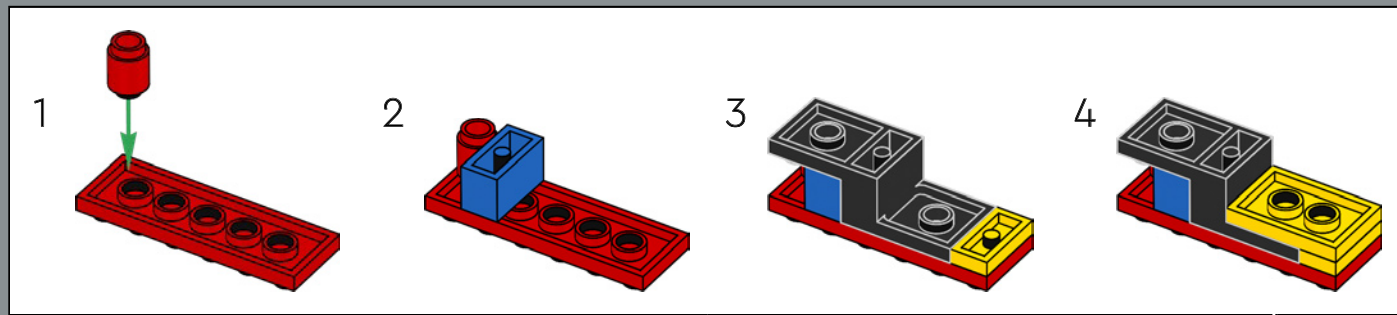

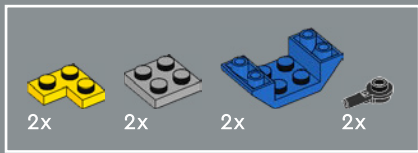

305

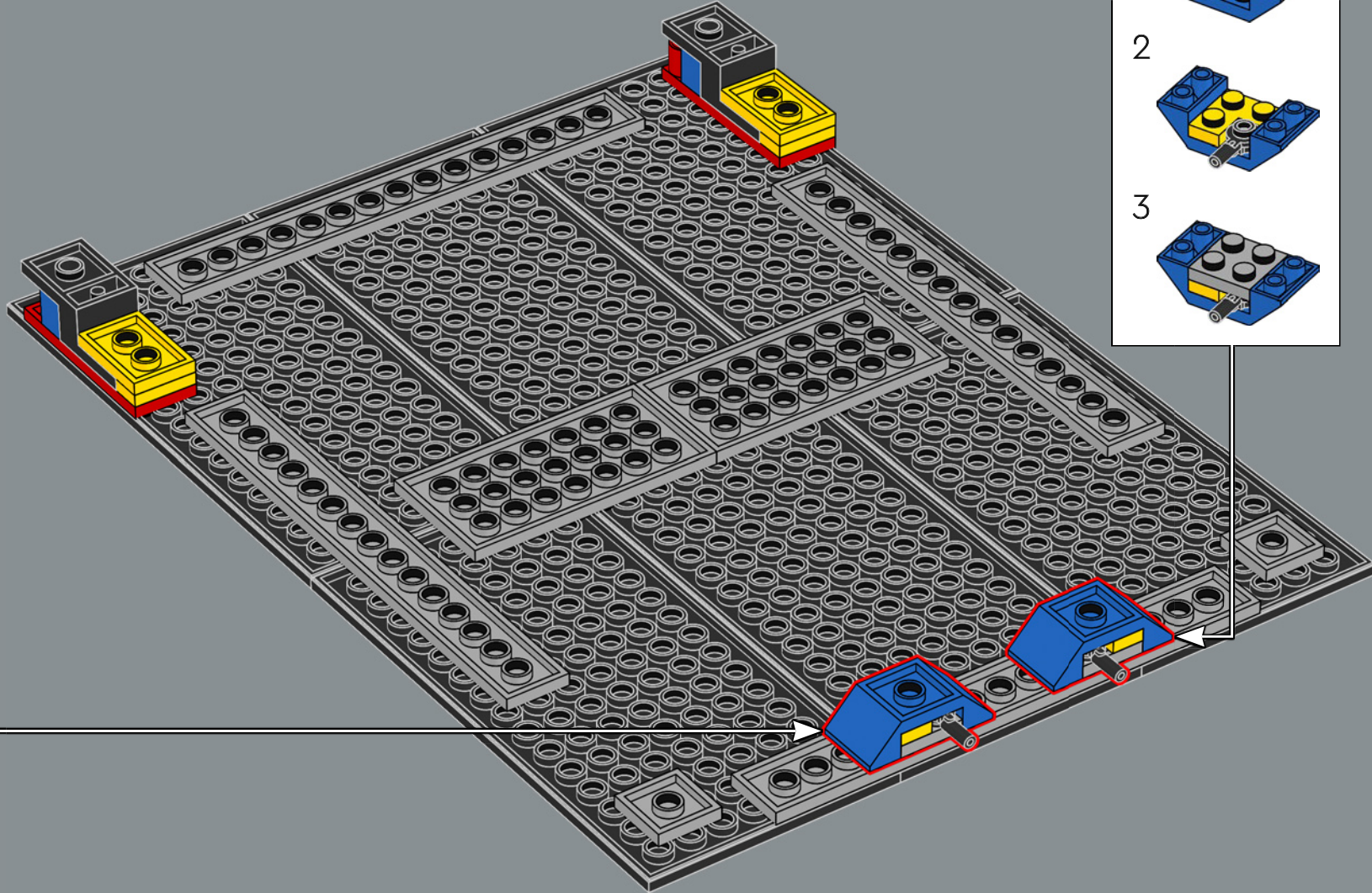
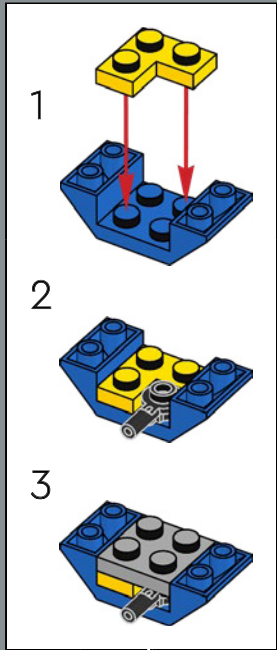
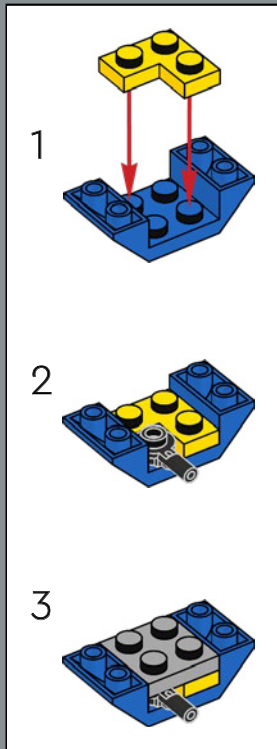

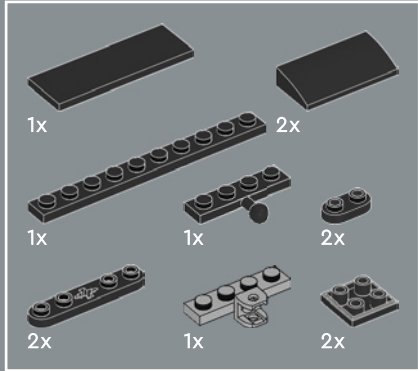
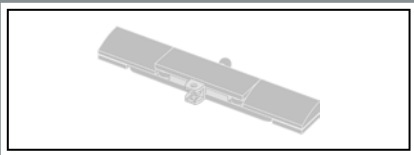

306

1

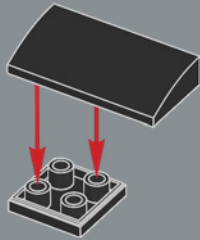

2

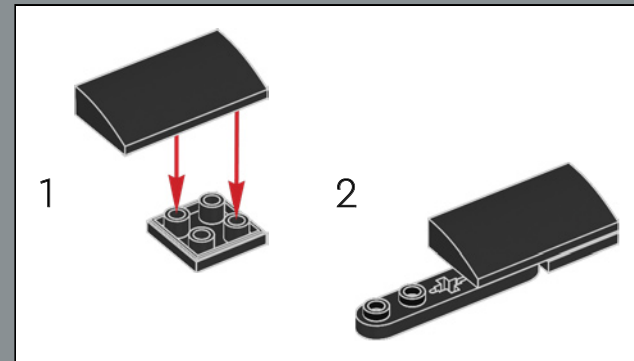
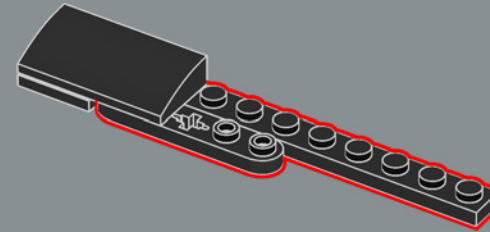

3

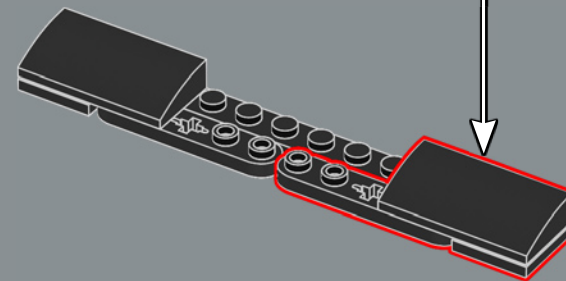

4

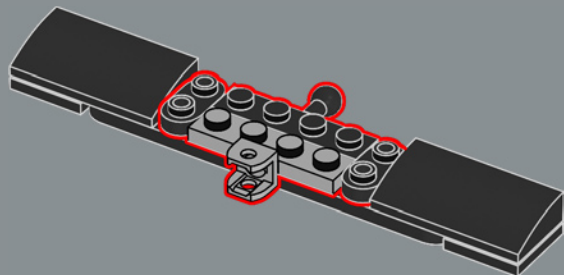

5

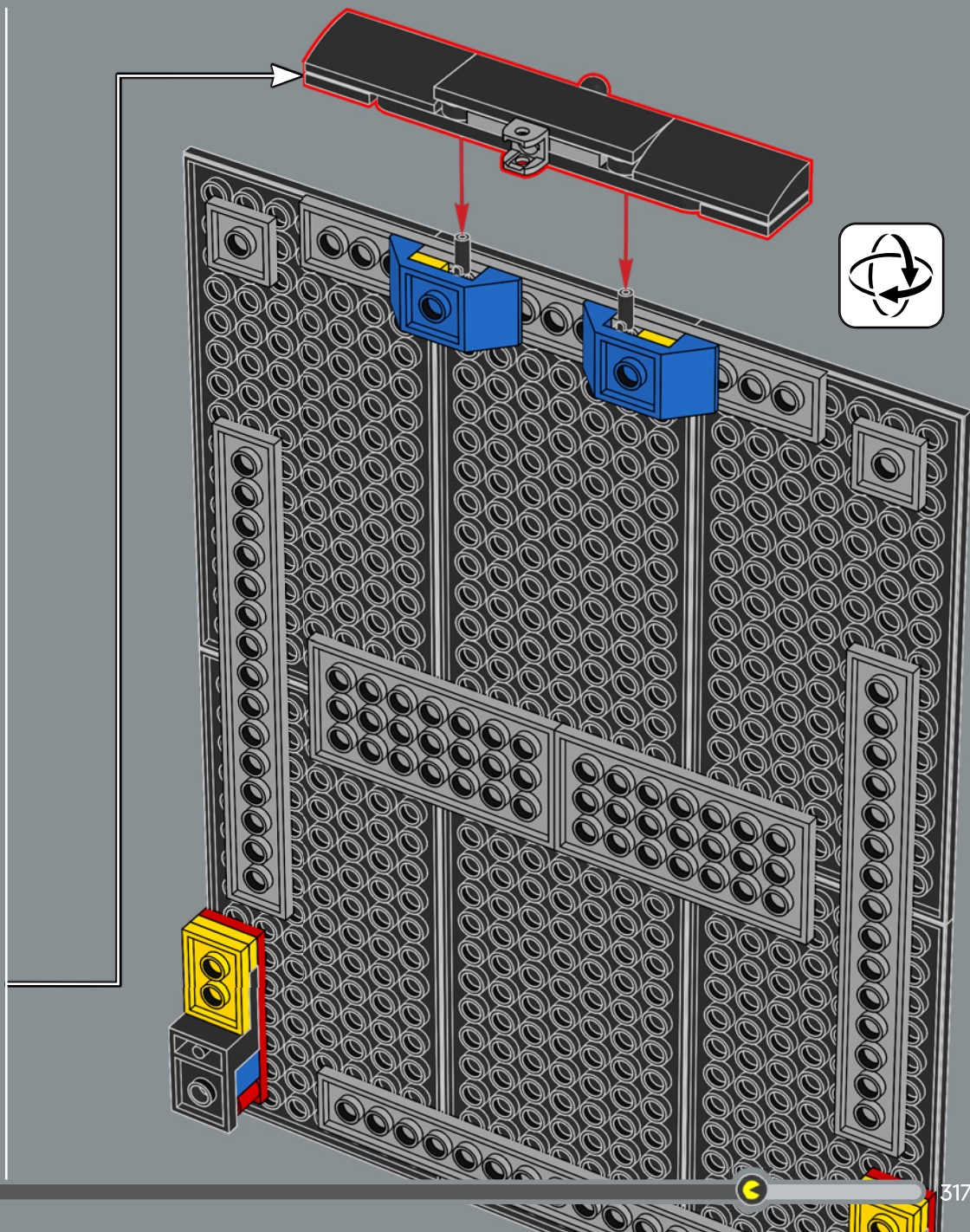
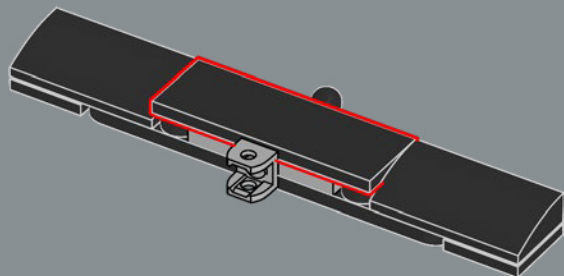

307

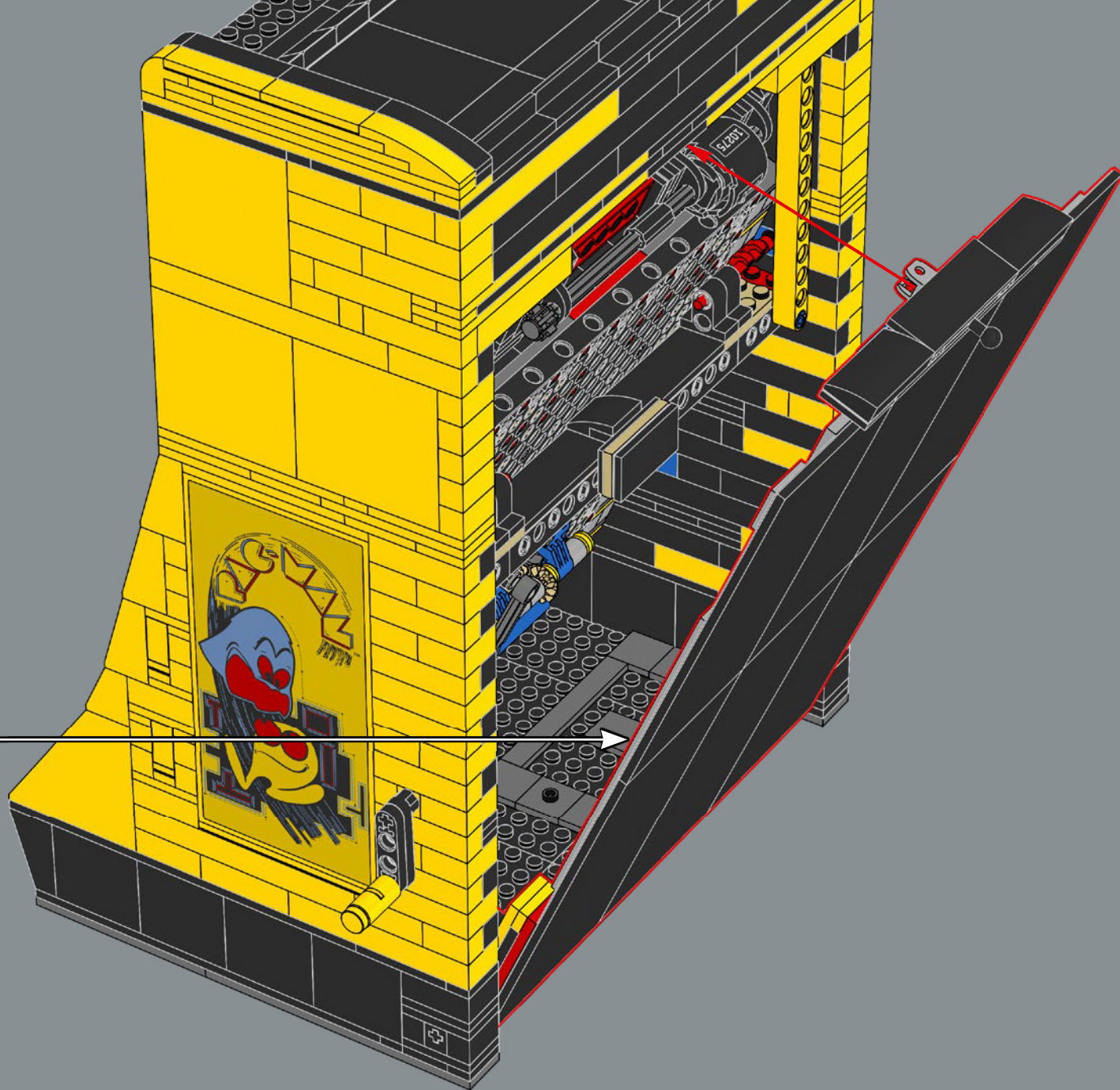

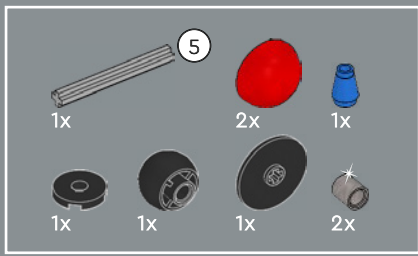

308

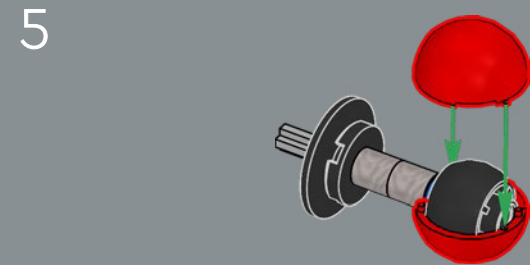
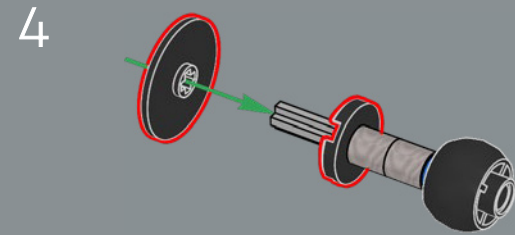
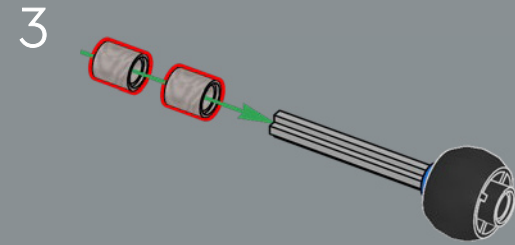
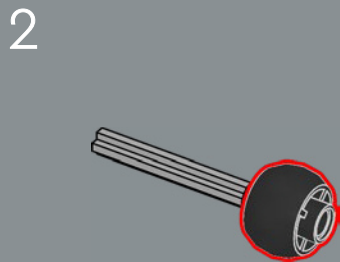
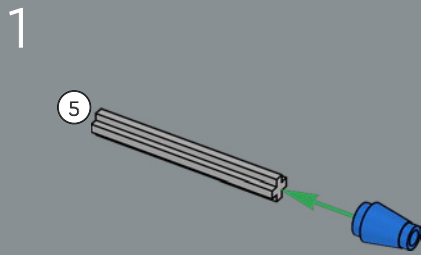

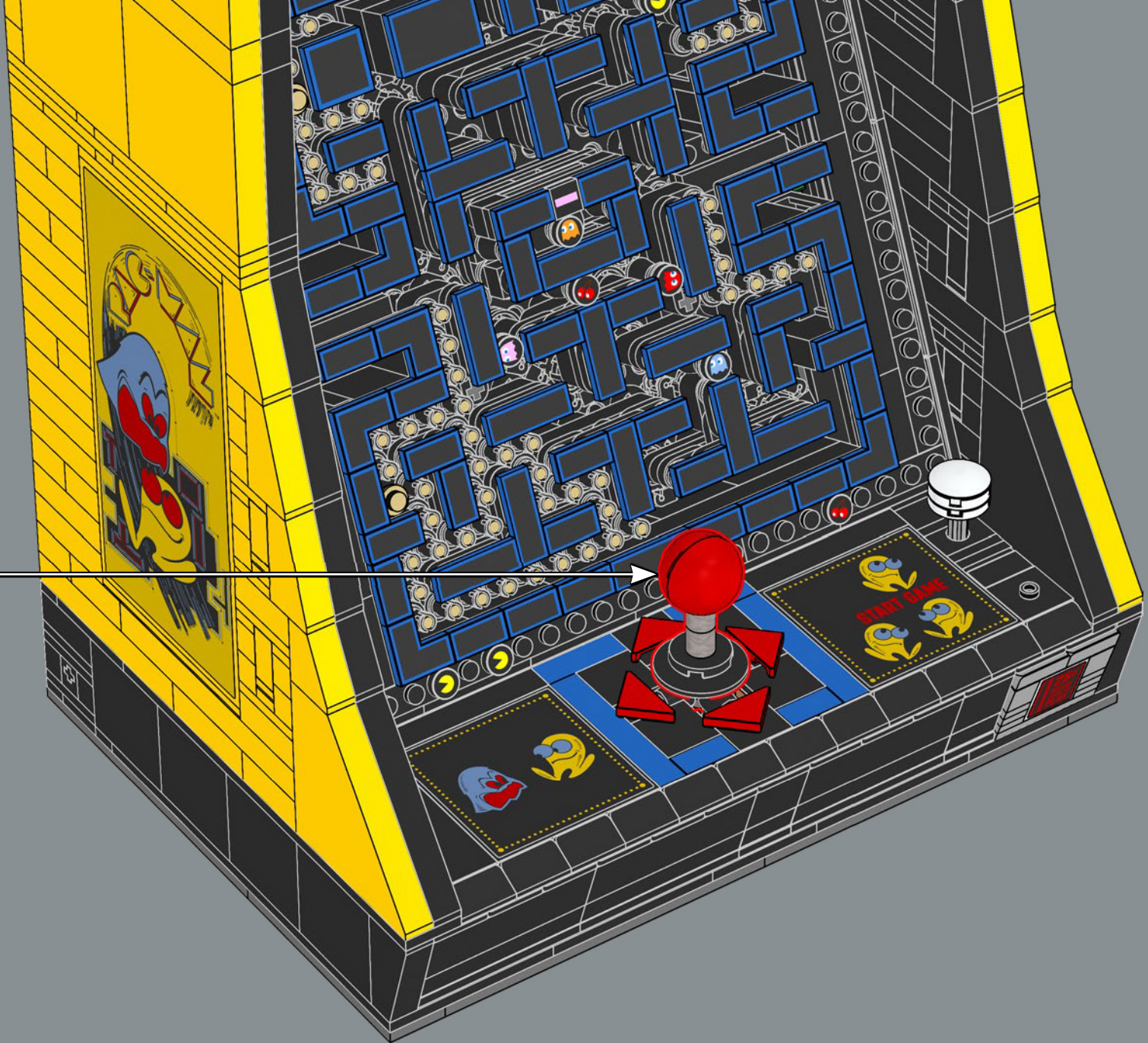

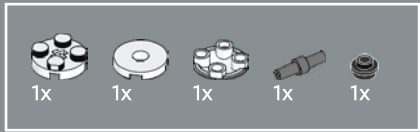

309

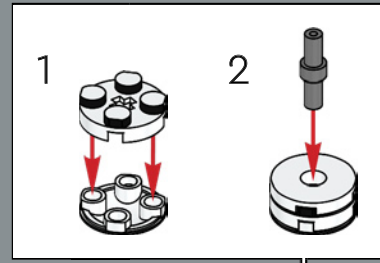
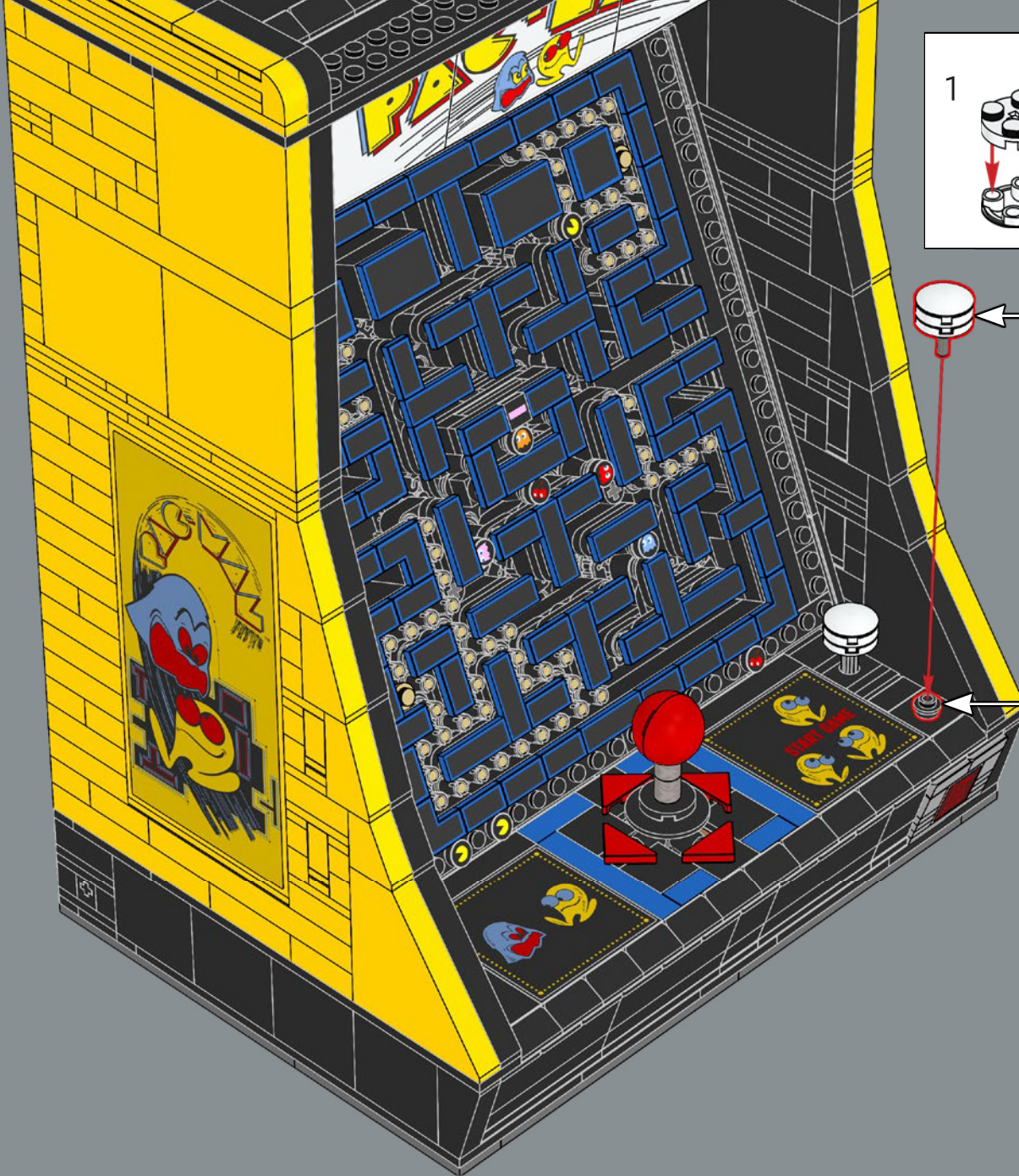



岩谷先生是弹球的忠实粉丝，《吃豆人》原始街机版本的图形设计灵感来自游戏板和老虎机。

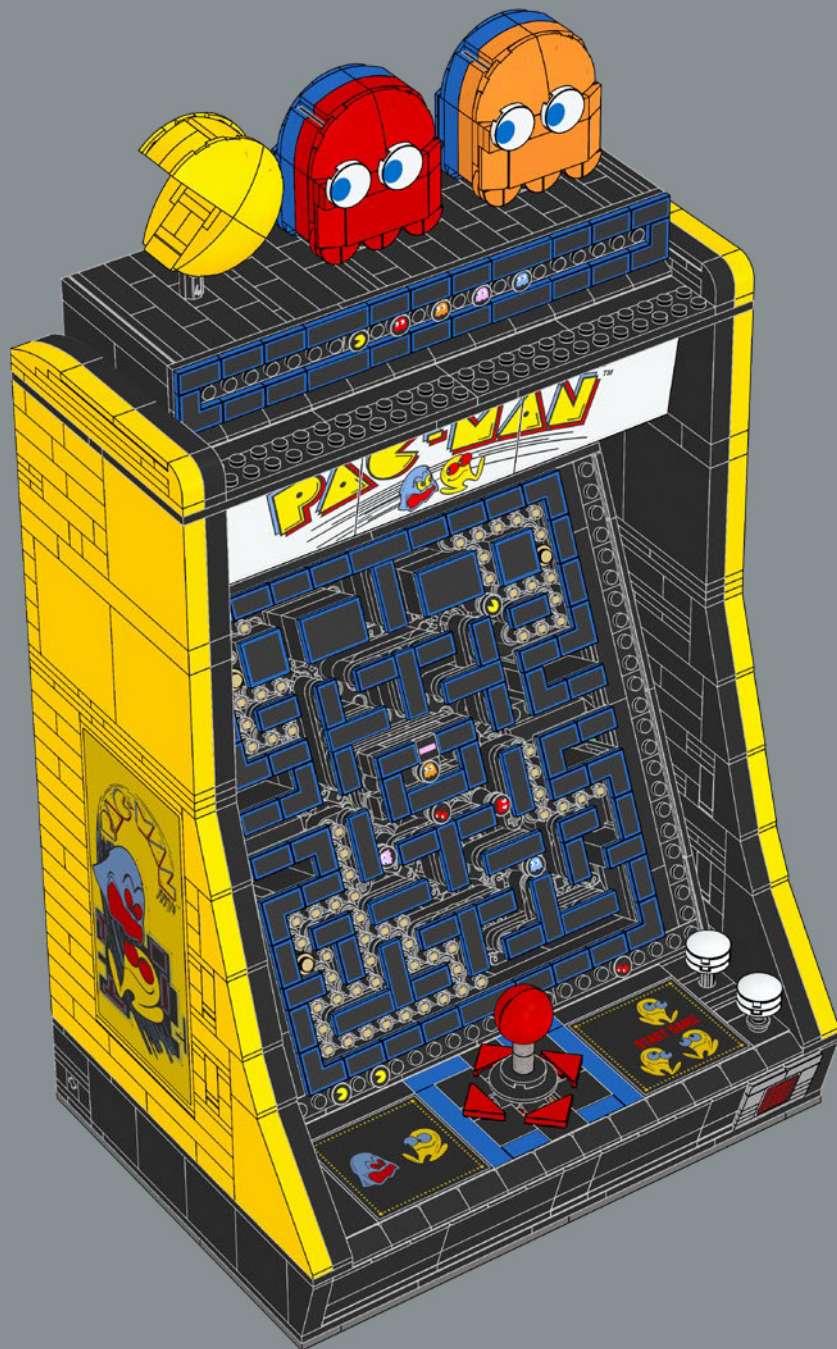

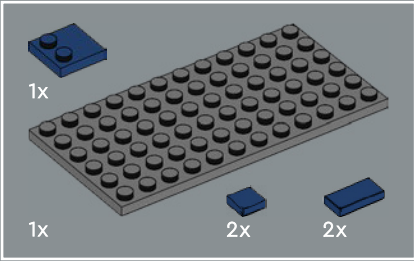
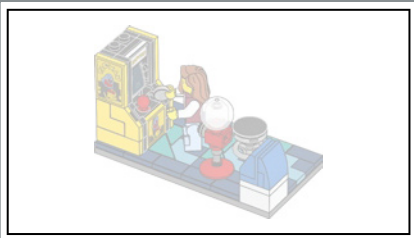

1

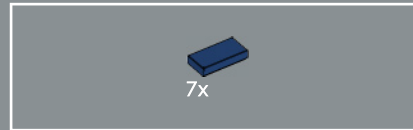
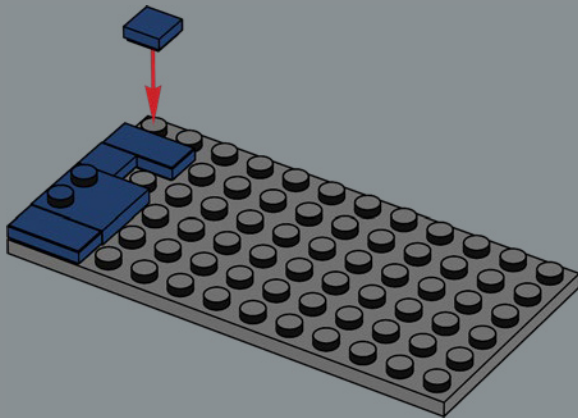

2

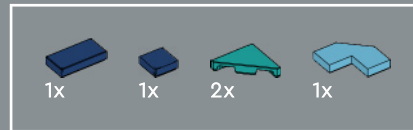
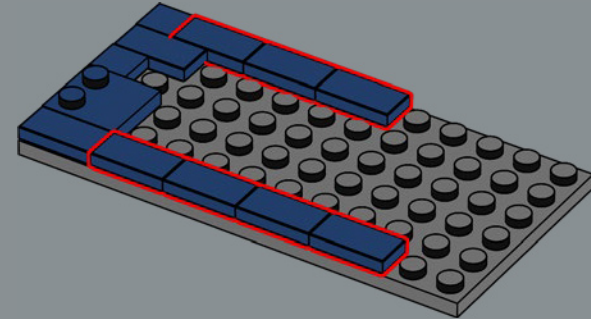

3

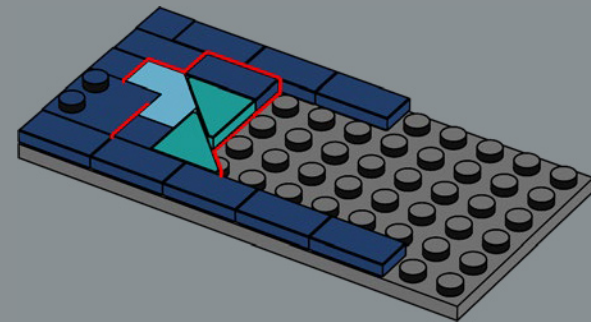



4

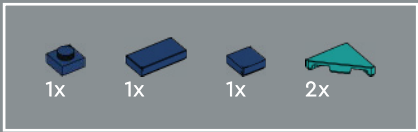
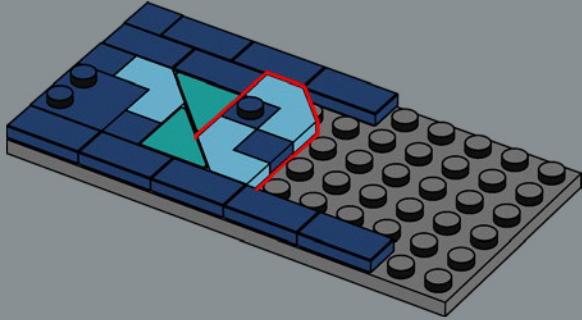

5

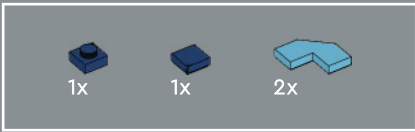
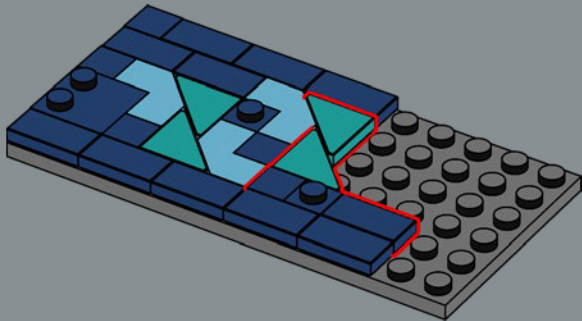

6

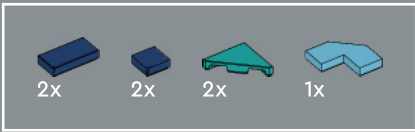
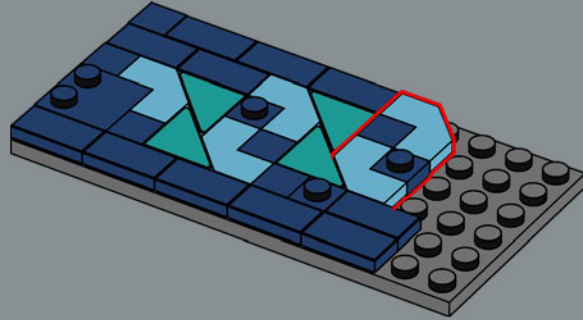

7

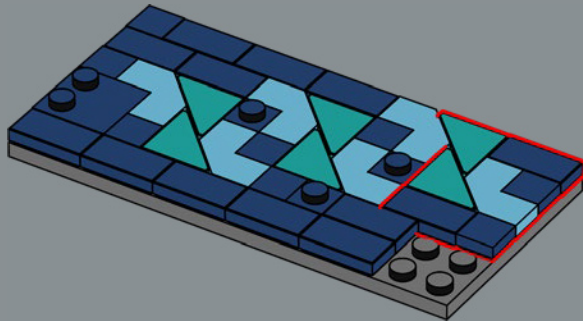

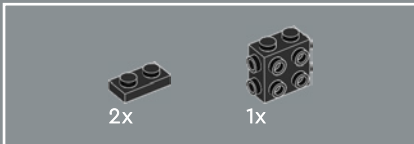
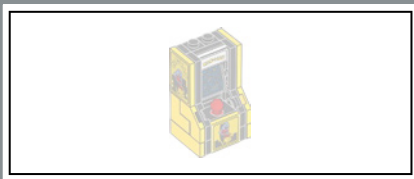

8

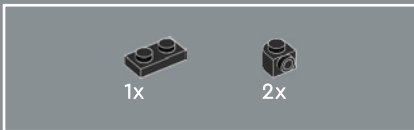
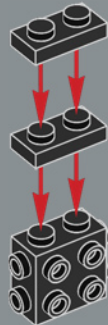

9

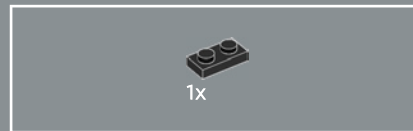
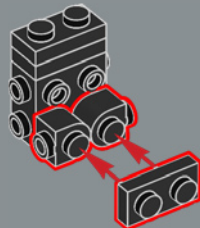

10

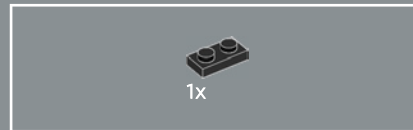
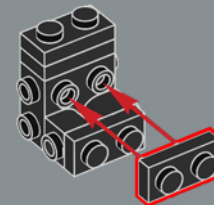

11

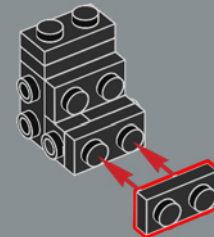

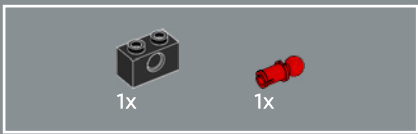

12

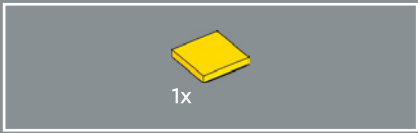
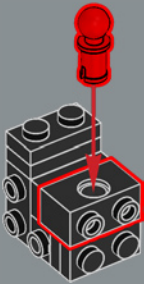

13

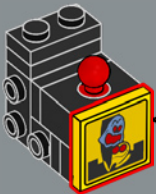
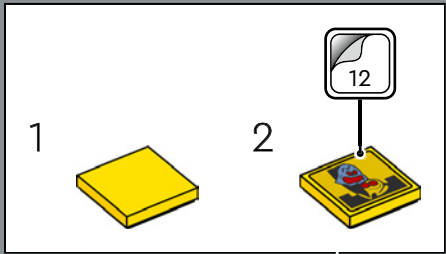

14

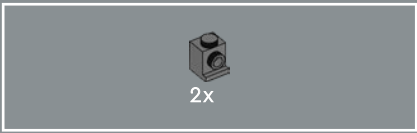
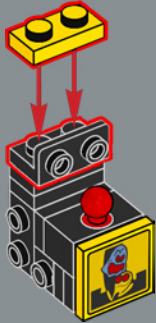

15

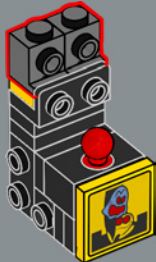



16

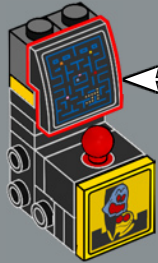
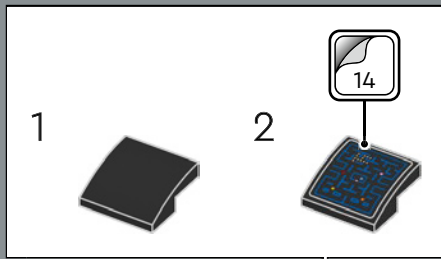

17

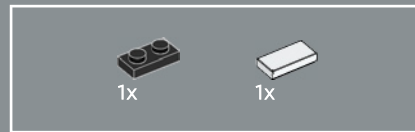
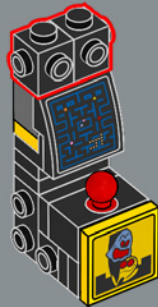

18

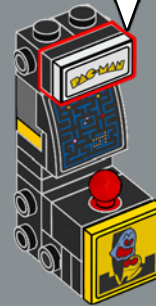
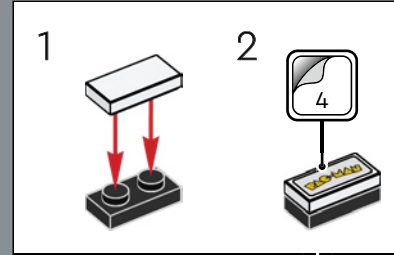

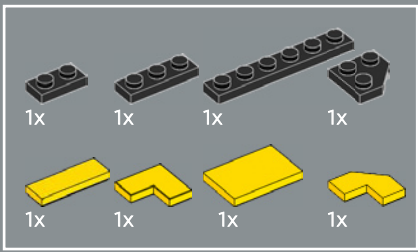

19

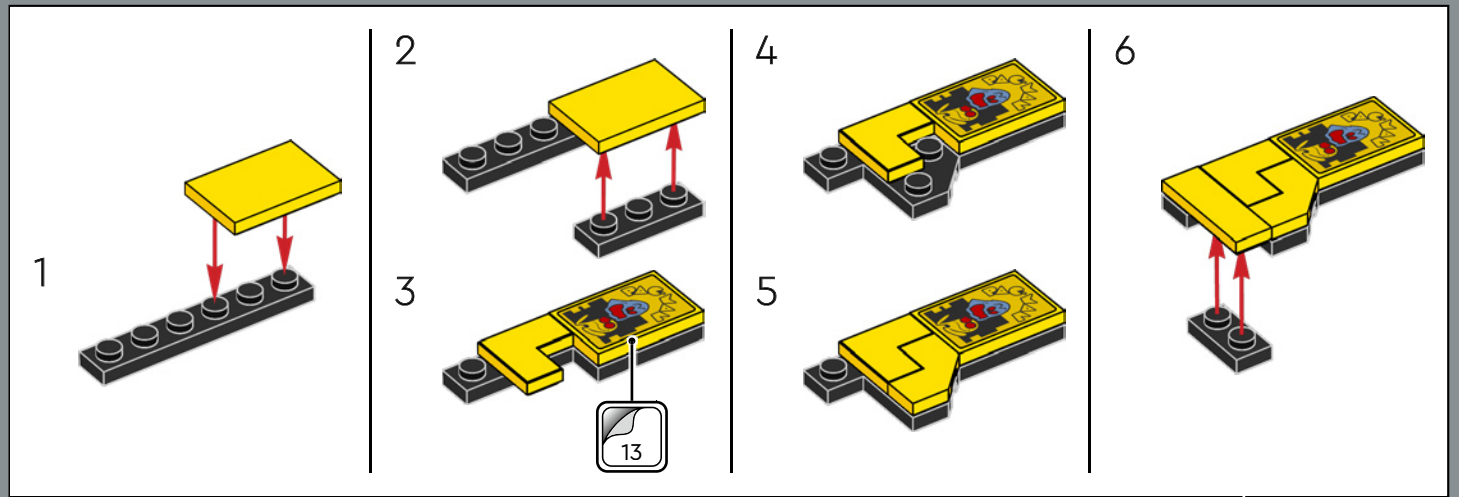

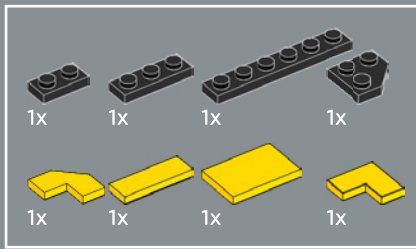

20

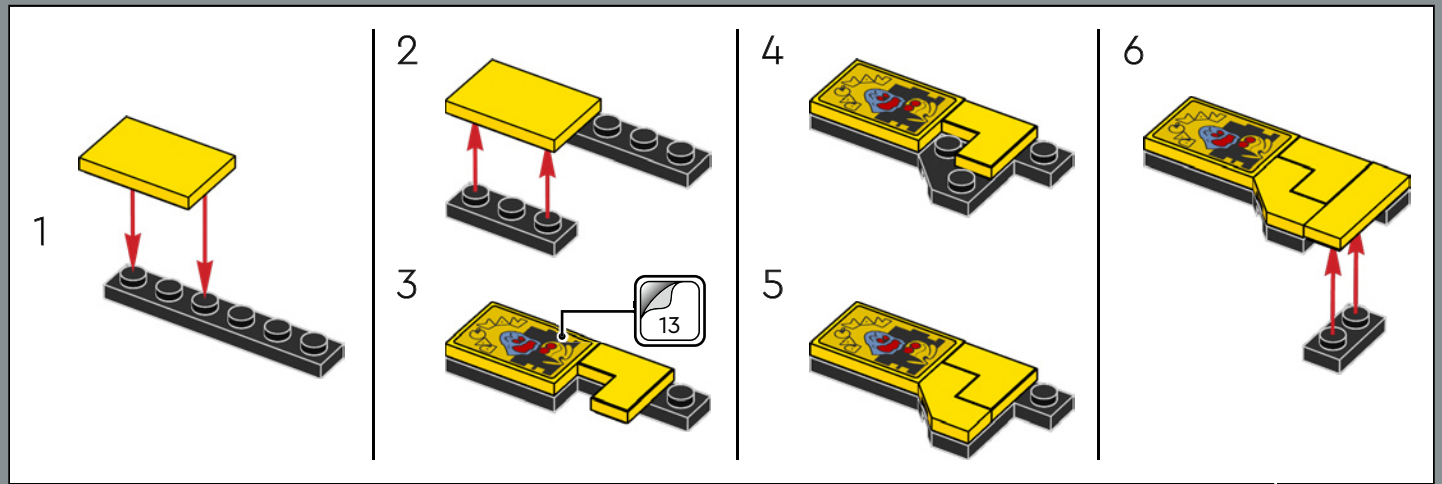

21

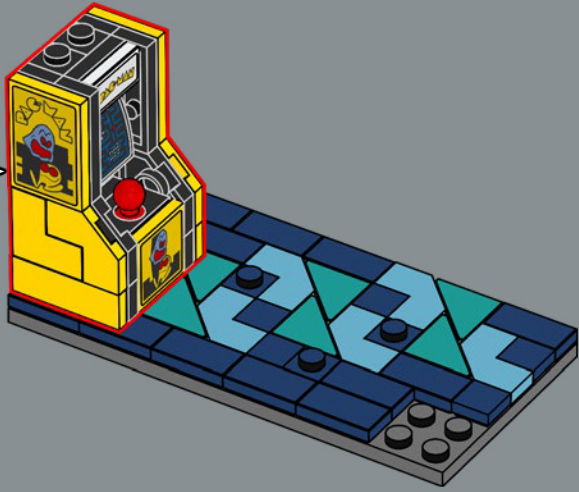

22

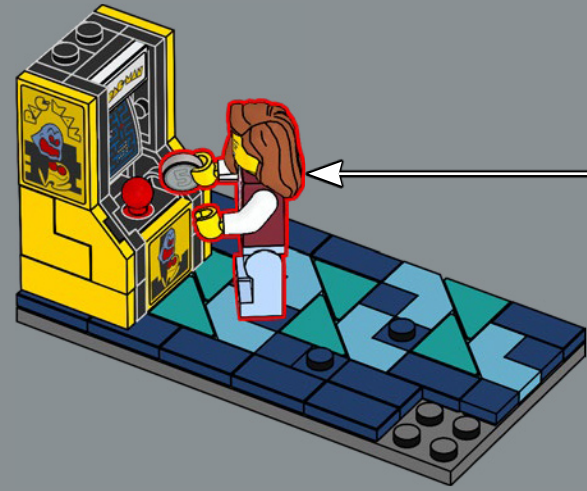
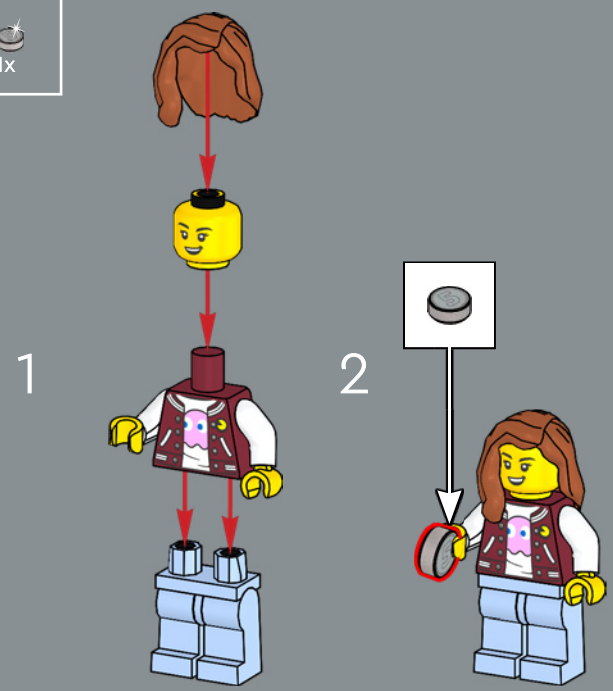

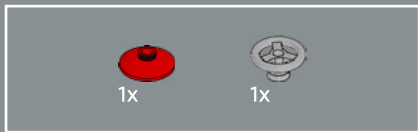

这个包含玩家小人仔和吃豆人游戏机的小场景是对经典街机游戏厅的致敬。

23

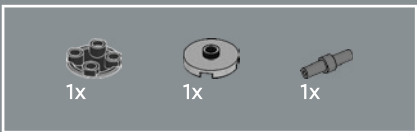
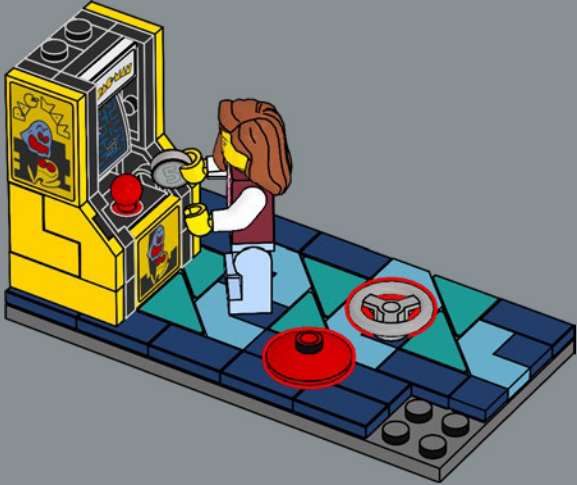

24

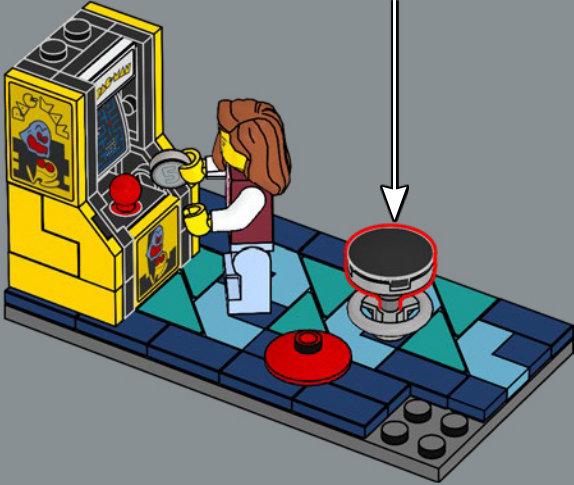
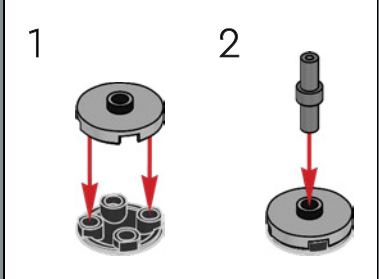

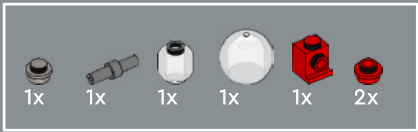

25

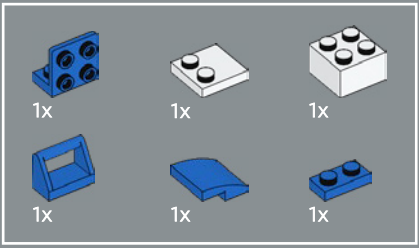
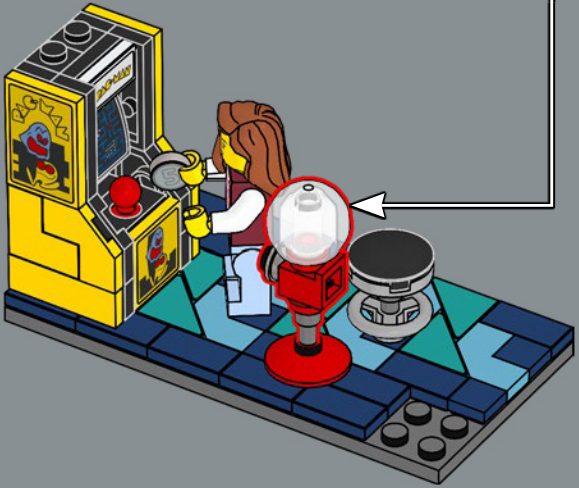
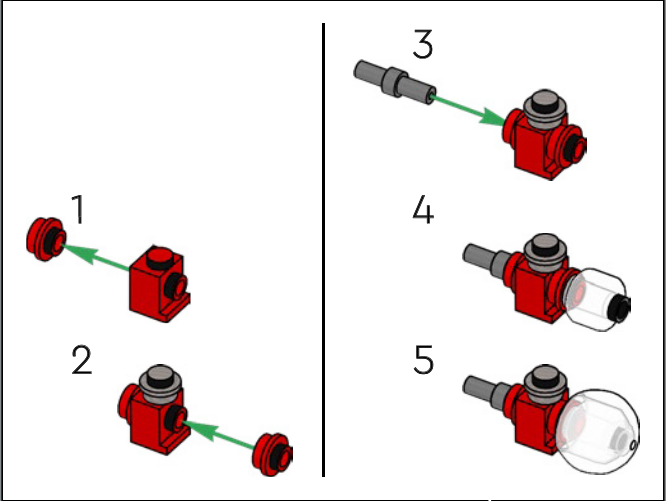

26

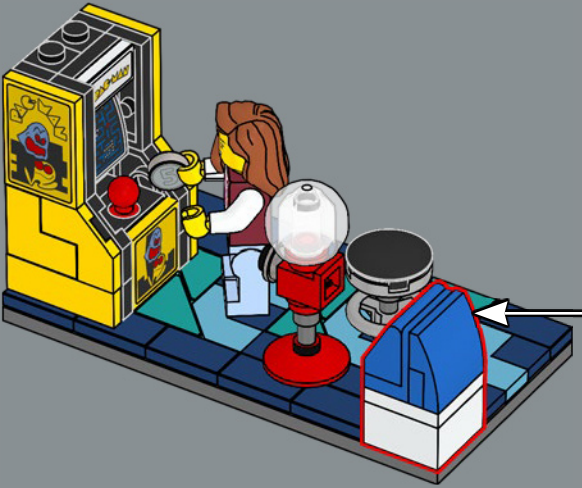
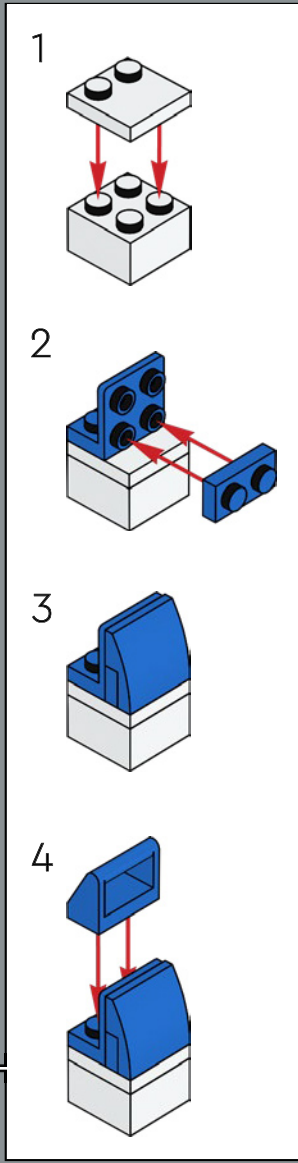

27

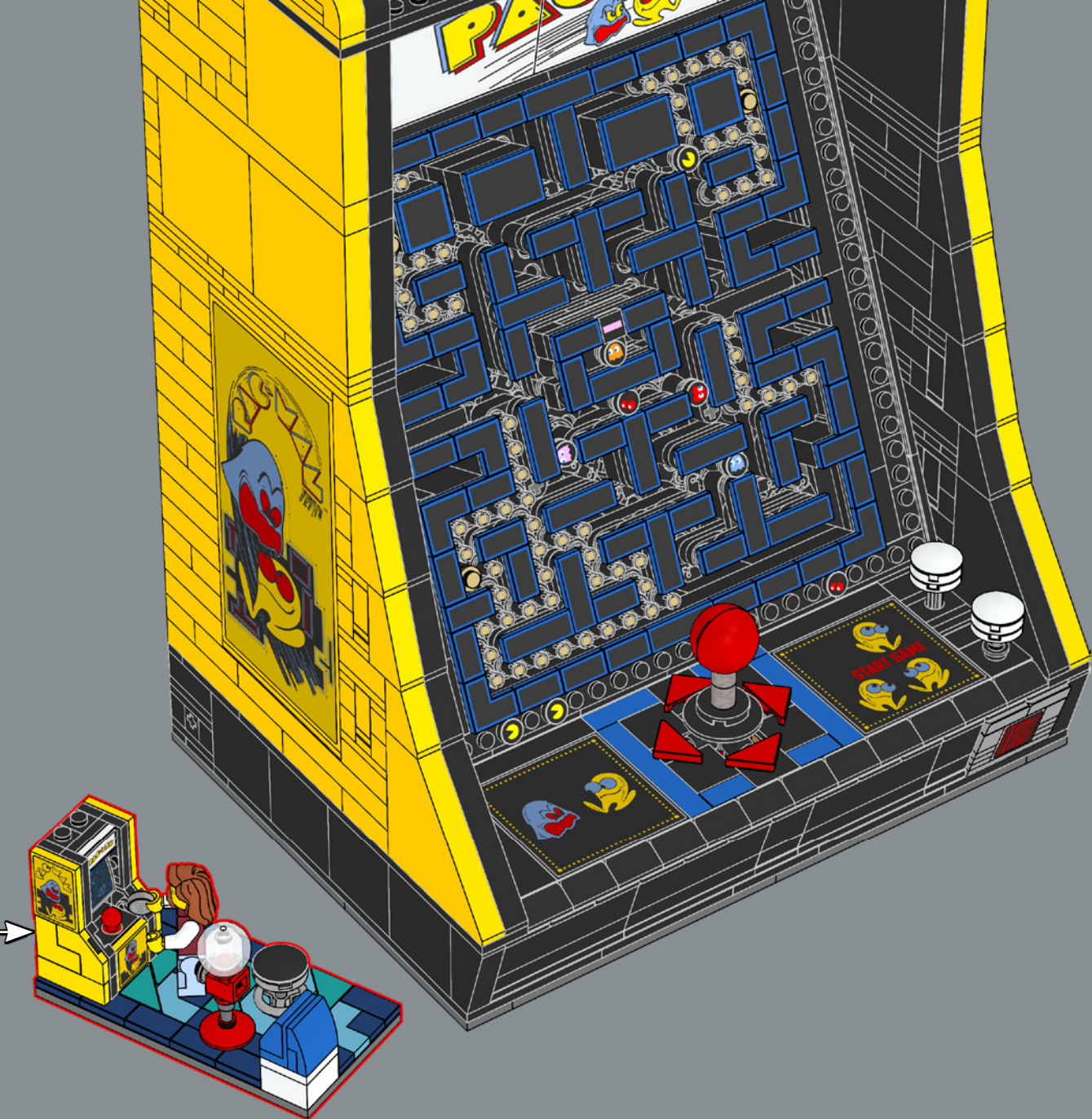

28

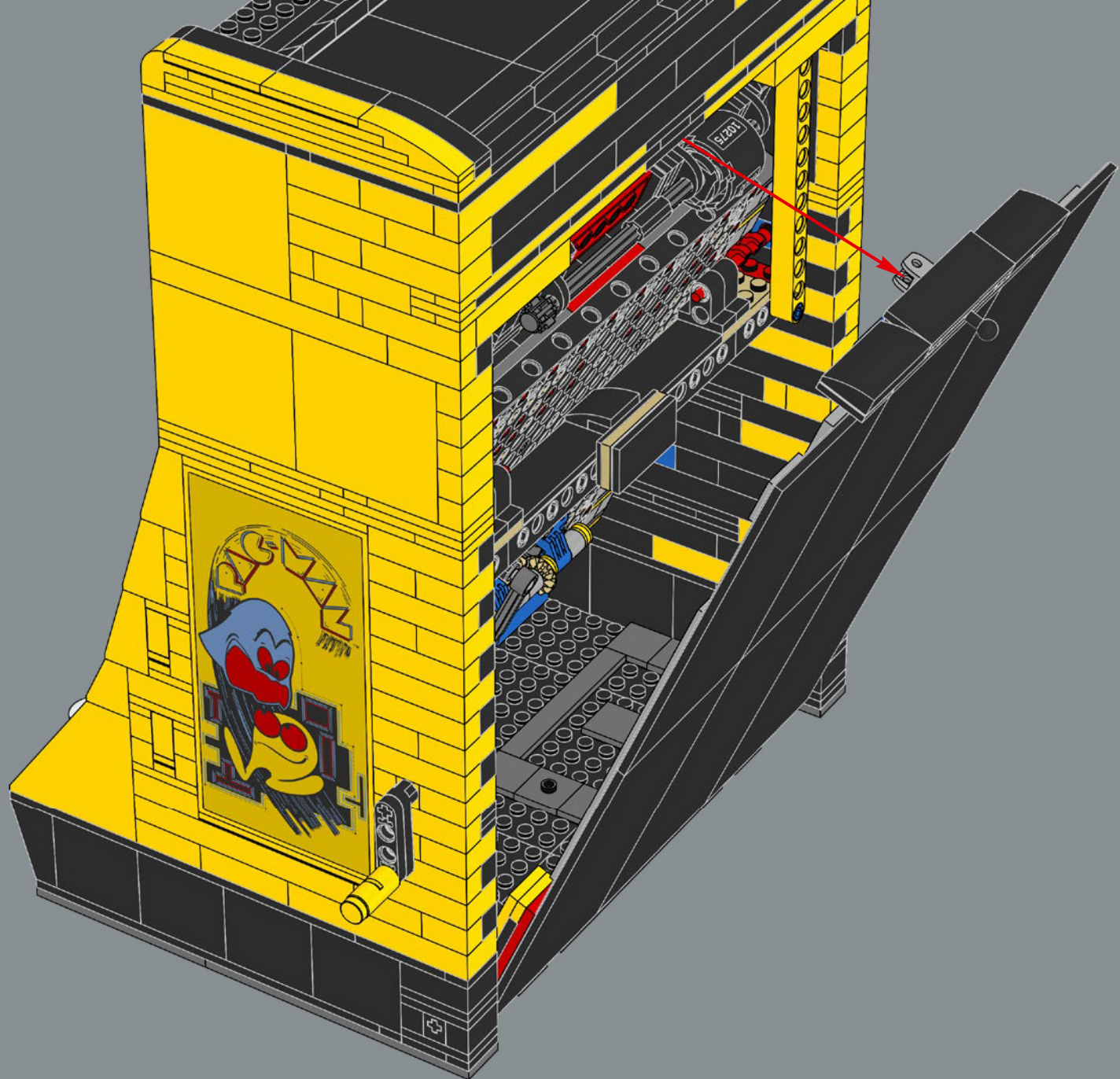

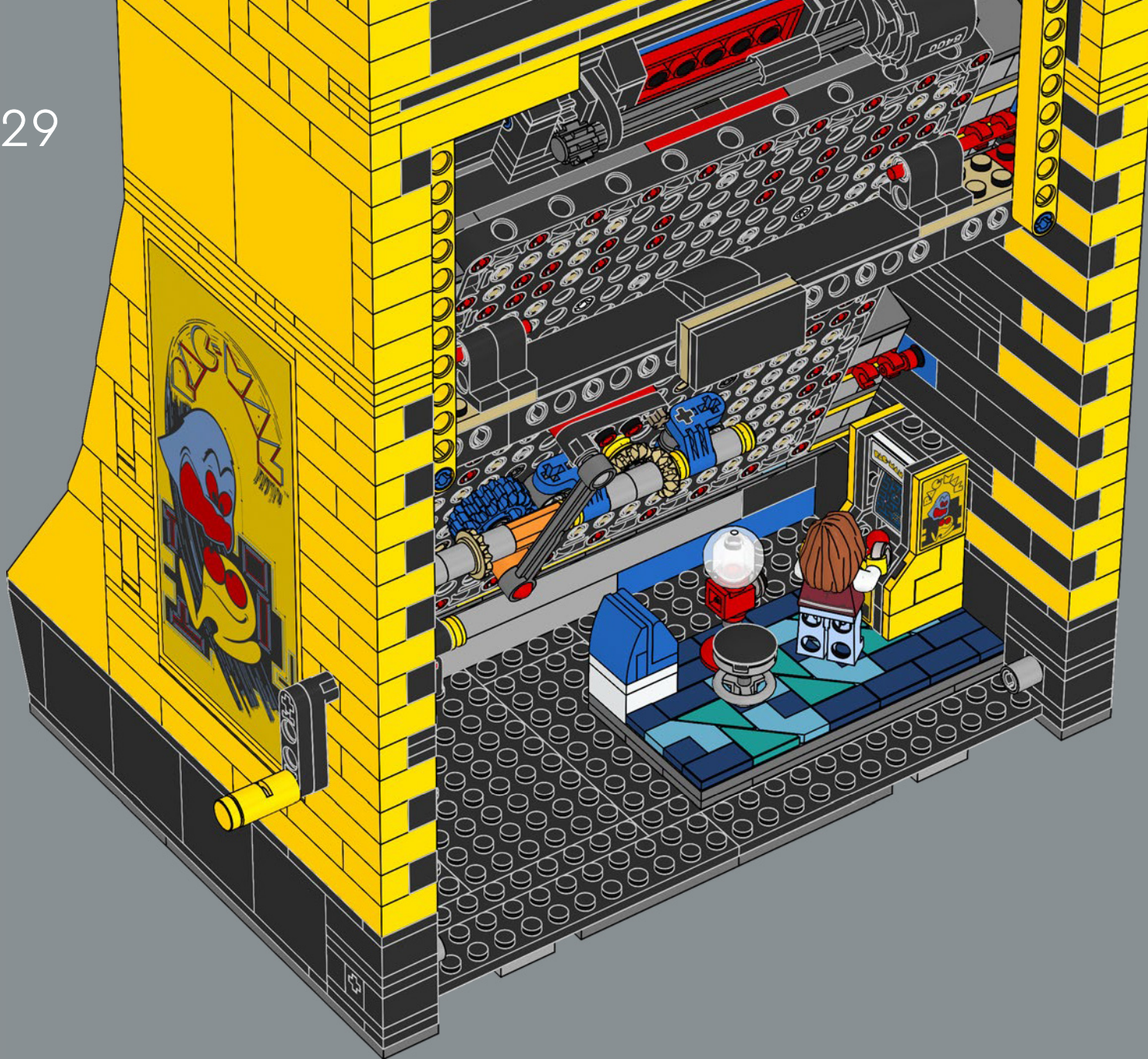

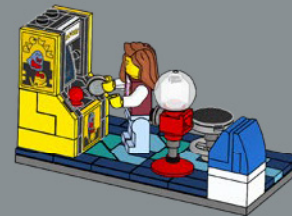
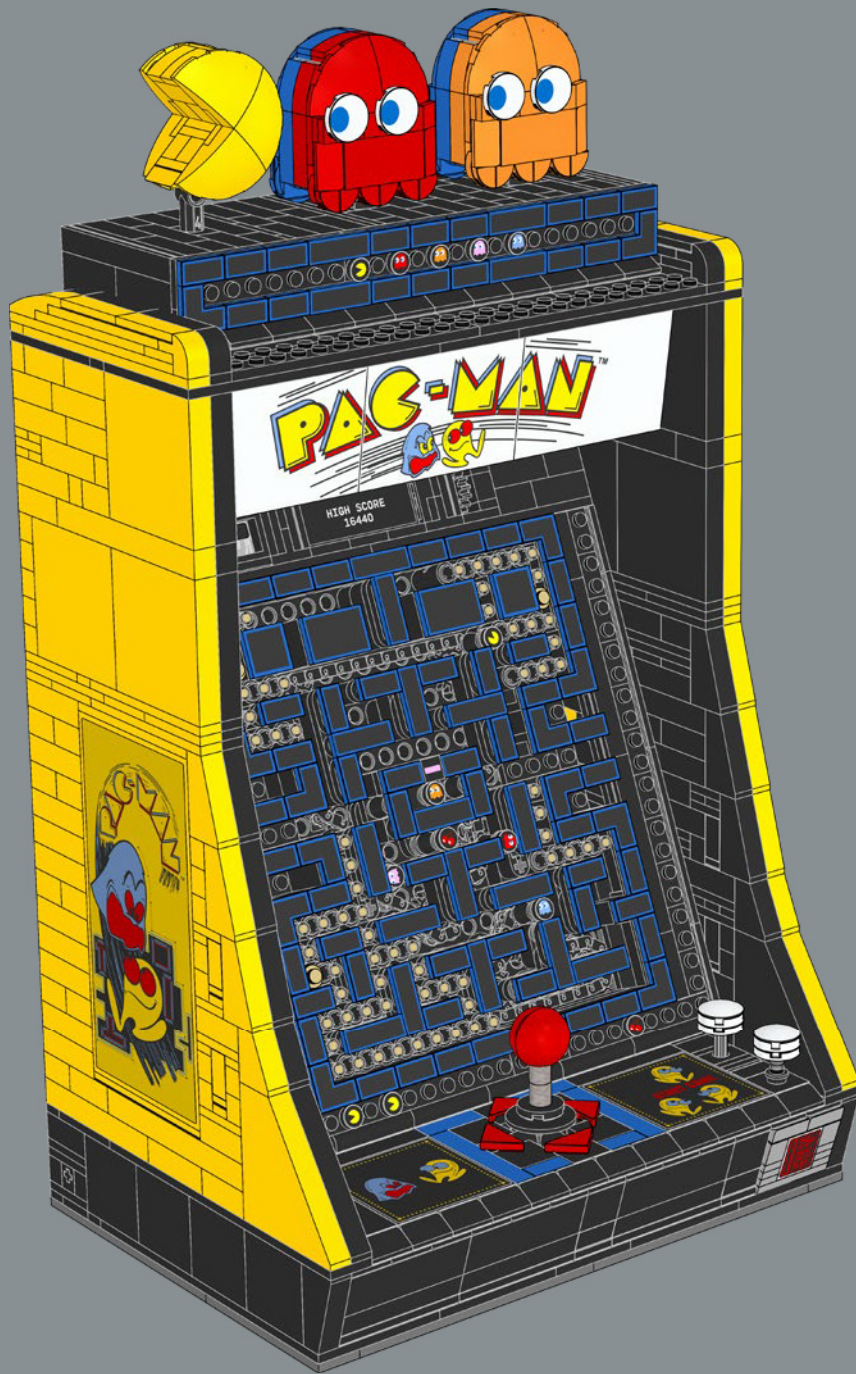



EN

Important information about batteries

Never use different types of batteries together, or a combination of old and new batteries. Always remove the batteries if the product is not to be used for a long time or if the batteries have run down. Never use damaged batteries. Only use alkaline type batteries. Insert the batteries so that the poles are correctly positioned. Never attempt to recharge non-rechargeable batteries. Never short-circuit the battery holder.

DE

Wichtige Informationen zu Batterien

Benutzen Sie niemals unterschiedliche Arten von Batterien oder alte und neue gleichzeitig. Nehmen Sie stets die Batterien heraus, wenn mit dem Modell längere Zeit nicht gespielt wird oder wenn die Batterien leer sind. Verwenden Sie niemals beschädigte Batterien. Verwenden Sie ausschließlich Alkali-Batterien. Achten Sie beim Einsetzen der Batterien auf die richtige Polung. Versuchen Sie unter keinen Umständen, „normale“ Batterien wieder aufzuladen. Schließen Sie das Batteriefach niemals kurz.

FR

Informations importantes concernant les piles

Ne jamais utiliser un mélange de différents types de piles, ou de piles neuves et de piles anciennes ou déjà utilisées. Toujours retirer les piles si le produit n'est pas utilisé durant une période prolongée ou si les piles sont vides. Ne jamais utiliser de piles endommagées. N'utiliser que des piles alcalines. En insérant les piles, respecter scrupuleusement le sens d'orientation des pôles (+/-). Ne jamais essayer de recharger des piles non rechargeables. Ne jamais court-circuiter le compartiment des piles.

IT

Importanti informazioni sulle batterie

Non usare mai contemporaneamente batterie di tipo diverso o batterie nuove e usate insieme. Rimuovere sempre le batterie qualora il prodotto non venga utilizzato per periodi prolungati, oppure se le batterie sono esauste. Non utilizzare mai batterie danneggiate. Utilizzare solo batterie di tipo alcalino. Inserire le batterie avendo cura che la loro polarità sia corretta. Non tentare mai di ricaricare batterie non ricaricabili. Non cortocircuitare mai il portabatterie.

NL

Belangrijke informatie over batterijen

Gebruik nooit verschillende soorten of een combinatie van oude en nieuwe batterijen tegelijkertijd. Verwijder de batterijen altijd als je het product lange tijd niet wilt gebruiken of als batterijen leeg zijn. Gebruik nooit beschadigde batterijen. Gebruik alleen alkalinebatterijen. Plaats de batterijen met de polen in de juiste richting. Probeer nooit niet-oplaadbare batterijen opnieuw op te laden. Laat de batterijhouder nooit kortsluiten.

ES

Información importante acerca de las pilas

No use pilas de diferentes tipos ni pilas nuevas y antiguas para alimentar el producto. Extraiga las pilas del producto si este va a permanecer sin uso durante un período prolongado de tiempo o aquellas se han agotado. No use pilas dañadas. Use solo pilas alcalinas. Inserte las pilas de modo que los polos queden situados en las posiciones correctas. No trate de cargar pilas no recargables. No cortocircuite el compartimento de las pilas.

DA

Vigtige oplysninger om batterier

Brug aldrig forskellige batterityper sammen eller en kombination af gamle og nye batterier. Fjern altid batterierne, hvis produktet ikke skal bruges i lang tid, eller hvis batterierne er flade. Brug aldrig beskadigede batterier. Brug kun alkaliske batterier. Sæt batterierne i, så polerne vender den rigtige vej. Forsøg aldrig at oplade ikke-genopladelige batterier. Kortslut aldrig batteriholderen.

IS

Mikilvægar upplýsingar um rafhlöður

Aldrei skal nota mismunandi gerðir rafhlaðna samtímis, né nýjar og eldri rafhlöður samtímis. Ef ekki á að nota tækið í lengri tíma eða ef rafhlöðurnar eru orðnar tómar skal fjarlægja rafhlöðurnar. Aldrei skal nota rafhlöður sem hafa skemmt. Eingöngu má nota alkaline-rafhlöður. Setja skal rafhlöðurnar í þannig að plús- og mínusskaut þeirra snúi rétt. Aldrei skal reyna að endurhlaða rafhlöður sem ekki eru endurhlaðanlegar. Aldrei ætti að valda skammhlaupi í rafhlöðuhólfinu.

FI

Tärkeää tietoa paristoista

Älä koskaan käytä erityyppisiä paristoja yhdessä. Älä myöskään käytä samassa laitteessa sekä vanhoja että uusia paristoja. Poista paristot tuotteesta aina, kun se on pitemmän aikaa käyttämättä, tai kun paristot ovat tyhjentyneet. Älä koskaan käytä viallisia paristoja. Käytä vain alkaliparistoja. Aseta paristot siten, että navat osoittavat oikeaan suuntaan. Älä koskaan aiheuta oikosulkuja pariston kosketinten välillä.

SV

Viktig information om batterier

Använd aldrig olika sorters batterier samtidigt, och inte heller en kombination av gamla och nya batterier. Ta alltid ur batterierna om produkten inte ska användas under en längre tid eller om batterierna är slut. Använd aldrig skadade batterier. Använd endast alkaliska batterier. Sätt i batterierna så att polerna hamnar i rätt läge. Försök aldrig ladda icke-laddningsbara batterier. Kortslut aldrig batteriutrymmets kontaktytor.

NO

Viktig informasjon om batterier

Bruk aldri ulike typer batterier sammen og heller aldri gamle og nye batterier sammen. Ta alltid ut batteriene hvis produktet ikke skal brukes på lang tid, eller hvis batteriene er brukt opp. Bruk aldri skadde batterier. Bruk bare alkaliske batterier. Sett inn batteriene med polene vendt riktig vei. Forsøk aldri å lade opp ikke-oppladbare batterier. Kortslett aldri batteriholderen.

PT

Informação importante sobre as pilhas

Nunca use diferentes tipos de pilhas em simultâneo, ou uma combinação de pilhas usadas e novas. Retire sempre as pilhas se o produto não for usado durante muito tempo ou se as pilhas já não tiverem carga. Nunca use pilhas danificadas. Use apenas pilhas alcalinas. Insira as pilhas de forma a que os polos fiquem corretamente posicionados. Nunca tente recarregar pilhas não recarregáveis. Nunca deixe o compartimento das pilhas entrar em curto-circuito.

EL

Σημαντικές πληροφορίες για τις μπαταρίες

Μην χρησιμοποιείτε ποτέ διαφορετικούς τύπους μπαταριών μαζί και μην συνδυάζετε παλιές και καινούργιες μπαταρίες. Αφαιρείτε πάντα τις μπαταρίες αν δεν σκοπεύετε να χρησιμοποιήσετε το προϊόν για αρκετό καιρό ή αν οι μπαταρίες έχουν αδειάσει. Ποτέ μην χρησιμοποιείτε μπαταρίες που έχουν φθορές. Χρησιμοποιείτε μόνο αλκαλικές μπαταρίες. Τοποθετήστε τις μπαταρίες με τους πόλους στη σωστή θέση. Μην επιχειρήσετε ποτέ να επαναφορτίσετε μη επαναφορτιζόμενες μπαταρίες. Ποτέ μην βραχυκυκλώνετε τη θήκη των μπαταριών.

JA

電池取扱いに関する重要事項

異なるタイプの電池や古い電池を混ぜて使用しないでください。商品を長時間使用しないときや電池が切れたときは、電池を必ず取り外してください。不具合のある電池は絶対に使用しないでください。アルカリタイプの電池のみを使用してください。電極を確認して電池を正しい向きに入れてください。充電式ではない電池は絶対に充電しないでください。電池ホルダーをショートさせないでください。

ZH

電池使用注意事項

请勿同时使用不同类型的电池，或把新旧程度不同的电池混合使用。如果产品将有很长时间不会使用，或者电池已经没电，请注意取出电池。切勿使用已破损的电池。仅可使用碱性电池。装入电池时请注意正负极。请勿尝试给非充电电池充电。切勿对电池仓进行短路连接。

KO

배터리 사용 시 주의사항

다른 종류의 배터리를 함께 사용하거나, 새 전지와 오래된 전지를 혼용하지 마세요. 배터리가 방전되었거나 장기간 제품을 작동하지 않을 때에는 반드시 배터리를 분리하세요. 파손된 배터리는 사용하지 마세요. 알칼라인 타입의 배터리만을 사용하세요. 양극과 음극의 위치를 잘 맞춰서 넣으세요. 일반 배터리는 충전해서 사용할 수 없습니다. 배터리 홀더의 접촉부에 배터리를 정확히 끼워서 사용하세요.

RU

Необходимая информация об элементах питания

Ни в коем случае не используйте одновременно элементы питания различных типов, а также элементы питания с разным сроком годности. В обязательном порядке вынимайте элементы питания из терминалов в случае, если вы не пользуетесь прибором в течение долгого времени, либо в случае, если в элементах питания закончился заряд. Ни в коем случае не используйте поврежденные элементы питания. Используйте только элементы питания щелочного типа. Установите элементы питания, соблюдая указанную полярность. Ни в коем случае не пытайтесь подзарядить перезаряжаемые элементы питания. Ни в коем случае не пытайтесь замкнуть полюса в устройстве для элементов питания.

PL

Ważne informacje dotyczące baterii

Nigdy nie należy stosować razem różnych rodzajów baterii ani stosować równocześnie starych i nowych baterii. Jeżeli produkt nie jest używany przez dłuższy czas lub jeżeli baterie się wyczerpały, należy wyjąć baterie. Nigdy nie należy stosować uszkodzonych baterii. Należy używać wyłącznie baterii alkalicznych. Przy wkładaniu baterii należy zwrócić uwagę na właściwe położenie biegunów. Nigdy nie należy próbować ładowania baterii jednorazowych. Nigdy nie należy doprowadzać do zwarcia w gnieździe baterii.

CZ

Důležitá informace o bateriích

Nikdy nepoužívejte najednou různé typy baterií nebo kombinaci starých a nových baterií. Nebude-li se výrobek delší dobu používat nebo jsou-li baterie vybité, vždy je vyjměte z výrobku. Nikdy nepoužívejte poškozené baterie. Používejte pouze alkalické baterie. Baterie instalujte se správnou orientací pólů. Nikdy se nesnažte nabíjet baterie, které nejsou nabíjecí. Nikdy nezkratujte kontakty v prostoru pro baterie.

SK

Dôležitá informácia o batériách

Nikdy nepoužívajte naraz odlišné typy batérií ani nekombinujte staré batérie s novými. Batérie vždy vyberte, ak sa výrobok nebude dlhšie používať, alebo ak sa batérie vybili. Nikdy nepoužívajte poškodené batérie. Používajte iba alkalické batérie. Batérie vkladajte so správnou orientáciou pólou. Nikdy sa nesnažte nabíjať batérie, ktoré nie sú nabíjateľné. Nikdy neskratujte kontakty v priestore pre batérie.

HU

Fontos tudnivalók az elemekről

Soha ne használjon különböző típusú elemeket, illetve ne használjon vegyesen új és használt elemeket. Mindig távolítsa el az elemeket, ha a készüléket előre láthatóan hosszabb ideig nem fogják használni, vagy ha az elemek lemerültek. Soha ne használjon megrongálódott elemeket. Csak alkáli elemeket használjon! Az elemeket helyesen helyezze be, a polaritásuknak megfelelően. Soha ne próbálja meg feltölteni a nem tölthető elemeket. Soha ne hozzon létre rövidzárlatot az elemtartó kivezetésén.

UA

Необхідна інформація про батарейки

Ніколи не використовуйте одночасно батарейки різних типів або батарейки з різним терміном придатності. Обов'язково вилучайте батарейки з приладу, якщо довго не користуєтесь ним, або якщо в батарейках уже скінчився заряд. Ніколи не використовуйте пошкоджені батарейки. Використовуйте лише лужні батарейки. Вставляйте батарейки, враховуючи задану полярність. У будь-якому випадку не намагайтеся підзарядити батарейки, що не підлягають підзарядці. У будь-якому випадку не намагайтеся зробити коротке замикання в приладі для батарей.

HR

Važne obavijesti o bateriji

Nikada nemoj koristiti različite vrste baterija zajedno, isto tako ni kombinaciju starih i novih baterija. Uvijek izvadite baterije ako dugo nećeš koristiti proizvod ili ako su one potrošene. Nikada nemoj koristiti oštećene baterije. Upotrebjavajte samo alkalne baterije. Umetni baterije pazeći da dobro okreneš polove. Nikada ne pokušavaj puniti baterije koje nisu predviđene za punjenje. Nikada ne izazivaj kratki spoj u držaču baterija.

SR

Важне информације о батеријама

Никада не користите различите типове батерија заједно нити комбинацију старих и нових батерија. Увек извадите батерије уколико производ нећете дуже време користити или уколико су батерије празне. Никада не користите оштећене батерије. Користите само алкалне батерије. Ставите батерије тако да су полови правилно позиционирани. Никада не покушавајте да пуните батерије које не могу да се пуне. Никада не изазивајте кратак спој у кућишту за батерије.

МК

Важни информации за батериите

Никогаш не користете различити типови батерији заједно или комбинација од стари и нови батерији. Секогаш отстранувајте ги батериите доколку не го користите производот подолго време или доколку се потрошиле. Никогаш не користете оштетени батерији. Користете само алкални батерији. Вметнете ги батериите така што точно ќе ги наместите половите. Никогаш не обидувајте се да ги полните батериите за еднократна употреба. Никогаш не предизвикувајте краток спој на држачот за батерији.

SL

Помембне информације о батеријах

Nikoli ne uporabljajte skupaj različnih baterij ali kombinacije starih in novih baterij. Vedno odstranite baterije, če izdelka dlje časa ne boste uporabljali ali če so iztrošene. Nikoli ne uporabljajte poškodovanih baterij. Uporabljajte le alkalne baterije. Baterije vstavite tako, da so njihovi polji pravilno obrnjeni. Nikoli ne poskušajte polniti baterij, ki niso akumulatorske. Pazite, da ležišč za baterije ne boste spravili v kratek stik.

RO

Informații importante despre baterii

Nu folosiți niciodată împreună tipuri diferite de baterii, sau o combinație de baterii vechi și noi. Îndepărtați întotdeauna bateriile dacă produsul nu este folosit timp îndelungat sau dacă bateriile s-au epuizat. Nu folosiți niciodată baterii deteriorate. Utilizați numai baterii de tip alcalin. Introduceți bateriile astfel ca polii să fie poziționați corect. Nu încercați niciodată să reîncărcați baterii nereîncărcabile.

Nu scurtcircuitați niciodată suportul bateriei.

BG

Важна информација за батериите

Никога не използвайте едновременно различни типове батерији или комбинация от стари и нови батерији. Винаги изваждайте батериите, ако издेलито няма да се използва продължително време или ако батериите са се изтозили. Никога не използвайте повредени батерији. Използвайте само алкални батерији. Поставете батериите така, че полюсите да са разположени правилно. Никога не опитвайте да зареждате батерији, които не са акумулаторни. Никога не свързвайте на късо контактите на отделението за батериите.

LV

Svarīga informācija par baterijām

Nekad vienlaikus nelietojiet dažādu tipu, kā arī vecas un jaunas baterijas. Vienmēr izņemiet baterijas, ja tās ir izlādējušās vai ja produkts ilgāku laiku netiek lietots. Nekad nelietojiet bojātas baterijas. Izmantojiet tikai sārma tipa baterijas. Ievietojiet baterijas, ievērojiet pareizu polaritāti. Nekad nemēģiniet uzlādēt baterijas, kas nav uzlādējamās. Nepieļaujiet issavienojumu bateriju nodalījumā.

ET

Oluline teave patareide kohta

Ära kunagi kasuta koos erinevat tüüpi patareisid, samuti vanu ja uusi patareisid. Kui märguasja ei kasutata pika aja jooksul, võta patarei sellest välja. Ära kunagi kasuta kahjustatud patareisid. Kasuta ainult leelispatareisid. Pane patareid märguasja sisse nii, et pluss- ja miinusklemmi asend oleks õige. Ära kunagi proovi akulaadijaga laadida tavalisi patareisid. Patareipesa klemmide vahel ei tohi tekkida lühis.

LT

Svarbi informacija apie elementus

Vienu metu nenaudokite skirtingų elementų, taip pat su naujais elementais nenaudokite senų. Jei nenaudosite gaminio ilgą laiką arba jei elementai išsekę, visuomet išimkite juos iš gaminio. Niekada nenaudokite pažeistų elementų. Naudokite tik šarminius elementus. Elementus dėkite atsižvelgdami į jų poliškumą. Niekada nebandykite įkrauti vienkartinį elementų. Saugokitės, kad elementų įdėkle nesukeltumėte trumpojo jungimo.

TR

Piller hakkında önemli bilgiler

Hiçbir zaman farklı tipte pilleri ya da eski pillerle yeni pilleri bir arada kullanmayın. Ürün uzun süre kullanılmayacaksa ya da piller bitmişse, pilleri ürünün içinden çıkarın. Hiçbir zaman zedelenmiş piller kullanmayın. Sadece alkalın piller kullanın. Pilleri kutupları doğru konumda olacak şekilde yerleştirin. Hiçbir zaman, sarj edilebilir olmayan pilleri sarj etmeye çalışmayın. Hiçbir zaman pil kutusuna kısa devre yaptırmayın.

AR

معلومات مهمة عن البطاريات

يحظر استخدام أنواع مختلفة من البطاريات معا أو مزيج من البطاريات القديمة و الجديدة. احرص دائما على نزع البطاريات في حال عدم استخدام المنتج لفترة طويلة أو إذا نفذت طاقة البطاريات. تجنب استخدام البطاريات التالفة. لا تستخدم إلا البطاريات القلوية فقط. قم بتكيب البطاريات بحيث تكون الأقطاب في موضعها الصحيح. يحظر إعادة شحن البطاريات غير القابلة لإعادة الشحن. تجنب إحداث دائرة قصر في حامل البطارية.

ID

Informasi penting tentang baterai

Jangan gunakan baterai yang jenisnya berlainan, atau mencampur baterai lama dan baterai baru. Lepas baterai jika produk tidak akan digunakan untuk waktu lama atau jika baterai sudah lemah. Jangan gunakan baterai yang rusak. Gunakan hanya baterai alkali. Masukkan baterai dengan posisi kutub yang tepat. Jangan pernah coba mengisi ulang baterai biasa. Jangan pernah membuat arus pendek pada dudukan baterai.

MS

Maklumat penting tentang bateri

Jangan guna jenis bateri yang berbeza bersama-sama, atau gabungan bateri baharu dan lama. Tanggalkan bateri jika produk tidak akan digunakan untuk tempoh masa yang lama atau jika bateri telah kehabisan kuasa. Jangan guna bateri yang rosak. Guna bateri jenis alkali sahaja. Selitkan bateri supaya paksi berada pada kedudukan yang betul. Jangan cuba untuk mengecap semula bateri yang tidak boleh dicalaskan semula. Jangan pintas litar pemegang bateri.

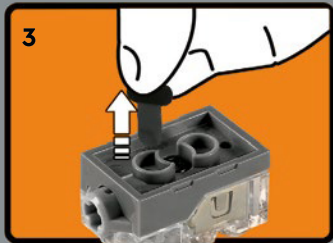

1:1
2x LR 41 1.5V



EN
WARNING: This product contains a Button or Coin Cell Battery.
A swallowed Button or Coin Cell battery can cause internal chemical burns in as little as two hours and lead to death. Dispose of used batteries immediately. Keep new and used batteries away from children. If you think batteries might have been swallowed or placed inside any part of the body, seek immediate medical attention.

DE
ACHTUNG: Dieses Produkt enthält eine Knopfzellenbatterie.
Eine verschluckte Knopfzellenbatterie kann innere chemische Verbrennungen verursachen und in weniger als zwei Stunden zum Tod führen. Entsorge umgehend gebrauchte Batterien. Halte neue und gebrauchte Batterien von Kindern fern. Wenn du glaubst, dass Batterien verschluckt wurden oder sich in einem Körperteil befinden, hole umgehend medizinische Hilfe.

FR
AVERTISSEMENT : Ce produit contient une pile bouton.
L'ingestion d'une pile bouton peut provoquer des brûlures chimiques internes en seulement deux heures et provoquer la mort. Jeter immédiatement les piles usagées. Conserver les piles neuves et usagées hors de portée des enfants. Si vous suspectez l'ingestion d'une pile ou sa présence où que ce soit à l'intérieur du corps, consultez immédiatement un médecin.

IT
ATTENZIONE: questo prodotto contiene una batteria a bottone.
Se inghiottita, una batteria a bottone può causare ustioni chimiche interne in sole due ore, con possibile morte. Smaltire immediatamente le batterie usate. Tenere le batterie nuove e usate lontano dai bambini. Se si pensa che una batteria sia stata inghiottita o inserita in una parte del corpo, rivolgersi immediatamente a un medico.

NL
WAARSCHUWING: dit product bevat een knoopcelbatterij.
Als een knoopcelbatterij wordt ingeslikt, kan deze binnen twee uur chemische brandwonden veroorzaken in het lichaam. Het inslikken van een dergelijke batterij kan zelfs leiden tot overlijden. Gooi gebruikte batterijen onmiddellijk weg. Bewaar nieuwe en gebruikte batterijen buiten bereik van kinderen. Als je denkt dat een kind batterijen heeft ingeslikt of ze in een lichaamsopening heeft gestopt, raadpleeg je direct een arts.

ES
ADVERTENCIA: Este producto contiene una pila de botón.
Ingerir una pila de botón puede dar lugar a quemaduras químicas internas en tan sólo dos horas y provocar la muerte. Las pilas usadas deben desecharse inmediatamente. Mantenga las pilas nuevas y usadas fuera del alcance de los niños. Si sospecha de la ingestión o la introducción de pilas en cualquier parte del cuerpo, busque atención médica inmediatamente.

DA
ADVARSEL: Dette produkt indeholder et knap- eller møntcellebatteri.
Hvis et knap- eller møntcellebatteri sluges, kan det forårsage indvendige ætninger på blot to timer og medføre døden. Bortskaf brugte batterier omgående. Hold både nye og brugte batterier uden for børns rækkevidde. Hvis du har mistanke om, at batterierne kan være blevet slugt eller kommet ind i nogen del af kroppen, skal du omgående søge lægehjælp.

IS
VIÐVÖRUN: Þessi vara inniheldur hnapparafhlöðu eða flata rafhlöðu.
Ef hnapparafhlaða eða flöt rafhlaða er gleypt getur hún valdið innvortis efnabruna á innan við tveimur klukkustundum og leitt til dauða. Fargaðu notuðum rafhlöðum tafarlaust. Geymdu nýjar og notaðar rafhlöður þar sem börn ná ekki til. Ef þú telur að rafhlöður hafi verið gleyptar eða á annan hátt komist inn í einhverjum hluta líkamans skaltu tafarlaust leita lækniástoðar.

FI
VAROITUS: Tämä tuote sisältää pienen tai isokokoisien nappipariston.
Nieltynä pieni tai isokokoinen nappiparisto voi aiheuttaa sisäisiä kemiallisia palovammoja jo kahden tunnin kuluessa ja johtaa kuolemaan. Käytetyt paristot on toimitettava heti keräyspisteeseen. Pidä uudet ja käytetyt paristot poissa lasten ulottuvilta. Jos epäilet jonkun nieleisseen pariston tai laittaneensa pariston kehoonsa, vie hänet välittömästi lääkäriin.

SV
VARNING: Denna produkt innehåller ett knapp- eller myntcells batteri.
Förtäring av ett knapp- eller myntcells batteri kan orsaka inre kemiska brännskador på så kort tid som två timmar och leda till döden. Kasserat förbrukade batterier omedelbart. Förvara nya och använda batterier utom räckhåll för barn. Om du tror att batterierna kan ha svalts eller placerats inuti någon del av kroppen, sök omedelbart läkarvård.

NO
ADVARSEL: Dette produktet inneholder et knapp- eller myntcellebatteri.
Ved svelging kan knapp- eller myntcellebatterier gi kjemisk brannskade innvendig på bare to timer og føre til død. Brukte batterier skal avhendes øyeblikkelig. Nye og brukte batterier skal oppbevares utilgjengelig for barn. Hvis du tror at batterier har blitt svelget eller puttet inn andre steder i kroppen, må du kontakte lege øyeblikkelig.

PT
AVISO: Este produto contém uma pilha tipo botão ou moeda.
Uma pilha tipo botão ou moeda que tenha sido engolidada pode provocar queimaduras químicas internas em menos de duas horas e levar à morte. Elimine as pilhas usadas imediatamente. Mantenha as pilhas novas e usadas fora do alcance das crianças. Se pensa que as pilhas podem ter sido engolidas ou colocadas no interior de alguma parte do corpo, procure de imediato assistência médica.

EL
ΠΡΟΕΙΔΟΠΟΙΗΣΗ: Αυτό το προϊόν περιέχει μία Στρογγυλή Μπαταρία Μεγέθους Κουμπιού ή Κέρματος.
Η κατάποση μιας Στρογγυλής Μπαταρίας Μεγέθους Κουμπιού ή Κέρματος μπορεί να προκαλέσει εσωτερικά χημικά εγκαύματα σε μόλις δύο ώρες και να οδηγήσει σε θάνατο. Πετάξτε αμέσως τις χρησιμοποιημένες μπαταρίες. Κρατήστε τις καινούργιες και τις χρησιμοποιημένες μπαταρίες μακριά από τα παιδιά. Εάν νομίζετε ότι κάποια μπαταρία έχει καταποθεί ή τοποθετηθεί εντός οποιουδήποτε μέρους του σώματος, ζητήστε αμέσως ιατρική βοήθεια.



JA

警告: 本製品には、ボタン型またはコイン型の電池が使用されています。ボタン型またはコイン型電池は誤飲すると2時間以内に体内で科学火傷を起こし、死に至る恐れがあります。使用済みの電池は直ちに廃棄してください。新しい電池および使用済み電池は、どちらもお子様の手の届かないところに保管してください。電池を誤飲した恐れがある、または電池が身体のどこかに入った恐れがある場合は、直ちに医師の診察を受けてください。

ZH

警告: 本品内含一颗纽扣电池。吞咽的纽扣电池仅在两小时内就会引起体内化学灼伤并导致死亡! 请立即处理使用过的电池。请将新、旧电池放置到儿童接触不到的地方。如果电池被不慎吞下, 或被置入身体的任何一个部位, 请立即就医!

KO

경고: 이 제품에는 버튼 또는 코인 셀 배터리가 포함되어 있습니다. 코인 셀 배터리를 삼킬 경우, 빠르면 2시간 이내에 체내에서 화학적 화상이 일어나고 심하면 사망에 이를 수 있습니다. 다 쓴 배터리는 즉시 폐기하십시오. 배터리를 어린이의 손에 닿지 않는 곳에 보관하십시오. 배터리를 삼켰거나 신체 어느 부위에든 들어간 것으로 판단될 경우, 즉각 의사의 도움을 구하십시오.

RU

ПРЕДОСТЕРЕЖЕНИЕ. Эта игрушка работает от батарейки таблеточного или кнопочного типа. Проглатывание батарейки таблеточного или кнопочного типа может (в течение двух часов) вызвать химические ожоги внутренних органов и привести к летальному исходу. Своевременно утилизируйте использованные батарейки. Храните новые и использованные батарейки в местах, недоступных для детей. Если у вас есть основания полагать, что ребенок проглотил батарейку или она попала внутрь какой-либо части его тела, немедленно обратитесь за медицинской помощью.

PL

OSTRZEŻENIE: w tym produkcie znajduje się płaska okrągła bateria. Połknięcie takiej baterii może spowodować chemiczne oparzenia wewnętrzne już po dwóch godzinach, a także doprowadzić do śmierci. Gdy bateria się zużyje, należy ją natychmiast zutylizować. Nowe i używane baterie należy przechowywać z dala od dzieci. W przypadku stwierdzenia, że baterie mogły zostać połknięte lub inaczej trafić do organizmu, należy natychmiast poszukać pomocy lekarskiej.

CZ

VAROVÁNÍ: Tento výrobek obsahuje knoflíkovou nebo mincovou baterii. Spolknutí knoflíkové nebo mincové baterie může během pouhých 2 hodin způsobit vnitřní poleptání sliznice a v některých případech mít za následek smrt. Použité baterie ihned vyjměte a zlikvidujte. Nové i použité baterie uchovávejte mimo dosah dětí. V případě spolknutí či uviznutí baterie v některé části těla okamžitě vyhledejte lékařskou pomoc.

SK

UPOZORNENIE: Tento produkt obsahuje gombíkovú alebo mincovú batériu. Prehltnutie gombíkovej alebo mincovej batérie môže spôsobiť vnútorné chemické popáleniny už do dvoch hodín a viesť k úmrtiu. Použité batérie ihneď vyhod'te. Nové aj použité batérie uchovávajte mimo dosahu detí. Ak si myslíte, že mohlo dôjsť k prehltnutiu batérie alebo sa batéria mohla dostať do vnútra ktorejkoľvek časti tela, okamžite vyhľadajte lekársku pomoc.

HU

FIGYELMEZTETÉS: Ez a termék gomebelemet illetve lapos gomebelemet tartalmaz! A lenyelt gomebelem vagy lapos gomebelem akár két óra alatt is belső vegyi sérüléseket okozhat, ami halálhoz vezethet. Az elhasznált elemeket azonnal dobja ki! Az új és a használt elemeket ne adja gyermekek kezébe! Ha úgy gondolja, hogy valaki lenyelt egy elemet, vagy bekerült valakinek valamely testrészébe, akkor azonnal kérjen orvosi segítséget!

UA

ОБЕРЕЖНО. Продукт містить мініатюрну батарейку типу «таблетка». Якщо проковтнути мініатюрну батарейку, вона може спричинити внутрішні хімічні опіки протягом двох годин і призвести до смерті. Негайно утилізуйте використані батарейки. Зберігайте нові та використані батарейки недосяжними для дітей. Якщо вам здається, що дитина проковтнула батарейку чи вона опинилася в будь-якій частині тіла дитини, негайно зверніться до лікаря.

HR

UPOZORENJE: Ovaj proizvod sadrži gumbastu bateriju ili bateriju oblika kovanice. Ako se gumbasta baterija ili baterija oblika kovanice proguta, za samo dva sata može uzrokovati unutarnje kemijske opekline i izazvati smrt. Iskorištene baterije odmah odložite u otpad. Čuvajte nove i stare baterije dalje od djece. Ako mislite da je baterija progutana ili je dospjela u bilo koji dijel tijela, odmah zatražite liječničku pomoć.

SR

UPOZORENJE: Ova proizvod sadrži dугmasta bateriju. Progutana dугmasta baterija može da dovede do internih hemijskih opekotina već za dva sata i dovede do smrti. Odmah odložite iskorištene baterije u otpad. Čuvajte nove i iskorištene baterije van domašaja dece. Ako mislite da je došlo do gutanja baterija ili stavljnja u bilo koji deo tela, odmah potražite pomoć lekara.

MK

ПРЕДУПРЕДУВАЊЕ: Овој производ содржи батерија тип копче или тип монета. Проголтувањето на батерија тип копче или тип монета може да предизвика внатрешно хемиско горење во рок од два часа и да доведе до смрт. Исфрлете ги веднаш искористените батерии. Држете ги новите и користените батерии подалеку од деца. Ако мислите дека е можно батерите да се проголтани или поставени во кој било дел на телото, веднаш побарајте медицинска помош.



SL

OPOZORILO: Ta izdelek vsebuje gumbasto baterijo.

Če oseba požre gumbasto baterijo, lahko to povzroči kemične opekline notranjih organov že v dveh urah po zaužitju. Tovrstne poškodbe lahko vodijo v smrt. Iztrošene baterije takoj zavrzite. Pazite, da nove ali iztrošene baterije ne bodo v dosegu otrok. Če menite, da je oseba zaužila baterijo ali si jo vstavila v kateri koli del telesa, takoj poiščite zdravniško pomoč.

RO

AVERTIZARE: Acest produs conține o baterie de tip pastilă.

Înghițirea unei baterii de tip pastilă poate cauza arsuri chimice interne în doar două ore, ducând la deces. Debarasați-vă imediat de bateriile uzate. Nu lăsați bateriile noi și uzate la îndemâna copiilor. Dacă credeți că bateriile ar fi putut fi înghițite sau ar fi putut ajunge în interiorul oricărei părți a corpului, solicitați imediat asistență medicală.

BG

ПРЕДУПРЕЖДЕНИЕ: Този продукт съдържа батерия тип „копче“ или „монета“.

При поглъщане батериите тип „копче“ или „монета“ могат да предизвикат вътрешни химически изгаряния в рамките на по-малко от два часа и да доведат до смърт. Незабавно изхвърляйте използваните батерии. Дръжте новите и стари батерии далеч от деца. Ако смятате, че е възможно батериите да са били погълнати или да са попаднали където и да е вътре в тялото, потърсете незабавно медицинска помощ.

LV

BRĪDINĀJUMS. Šim produktam ir pogas jeb monētas tipa akumulators.

Ja pogas jeb monētas tipa akumulators tiek norīts, tas jau divu stundu laikā var izraisīt iekšējus ķīmiskus apdegumus un izraisīt nāvi. Nekavējoties izlietotos akumulatorus. Jaunus un lietotus akumulatorus glabājiet bērniem nepieejamā vietā. Ja uzskatāt, ka akumulators varētu būt norīts vai ievietots kādā ķermeņa daļā, nekavējoties vērsieties pēc medicīniskās palīdzības.

ET

HOIATUS! See toode sisaldab nööp- või müntpatareid.

Alla neelatud nööp- või müntpatareid võib tekitada sisemisi keemilisi põletusi kõigest kahe tunniiga ning põhjustada surma. Kõrvaldage kasutatud patareid viivitamatult. Hoidke uusi ja kasutatud patareid lastele kättesaamatus kohas. Kui arvate, et keegi on patareid alla neelanud või need on sattunud mõnda kehaosasse, pöörduge kohe arsti poole.

LT

JSPĖJIMAS. Šiame gaminyje yra sagos arba monetos formos baterija.

Praryta sagos arba monetos formos baterija gali sukelti vidinius cheminius nudeginimus greičiau nei per dvi valandas ir galiausiai sukelti mirtį. Panaudotas baterijas nedelsiant utilizuokite. Naujas ir panaudotas baterijas laikykite atokiau nuo vaikų. Jei manote, kad vaikas galėjo praryti arba įsprauti bateriją sau į kūną, nedelsdami kreipkitės medicininės pagalbos.

TR

UYARI: Bu ürün bir düğme pil içerir.

Yutulmuş düğme pil, iki saat gibi kısa bir sürede iç kimyasal yanıklara neden olabilir ve ölüme yol açabilir. Kullanılmış pilleri derhal atın. Yeni ve kullanılmış pilleri çocuklardan uzak tutun. Pillerin yutulmuş ya da vücudun başka bir yerine sokulmuş olabileceğini düşünüyorsanız derhal doktora başvurun.

AR

تحذير: يحتوي هذا المنتج على بطارية خلايا قرصية أو بطارية خلايا على شكل عملة. قد يؤدي ابتلاع بطارية خلايا قرصية أو بطارية خلايا على شكل عملة إلى حدوث حروق كيميائية داخلية خلال فترة قصيرة لا تتجاوز ساعتين وقد يؤدي إلى الوفاة. يرجى التخلص من البطاريات المستعملة على الفور. مع الاحتفاظ بالبطاريات الجديدة والمستعملة بعيداً عن متناول الأطفال. إذا كنت تعتقد أن البطاريات تم ابتلاعها أو إدخالها إلى أي جزء من أجزاء الجسم، فاطلب المساعدة الطبية على الفور.

ID

PERINGATAN: Produk ini berisi Baterai Sel Kancing.

Baterai Sel Kancing yang tertelan dapat mengakibatkan Luka bakar kimiawi dalam tubuh minimal setelah dua jam dan dapat mengakibatkan kematian. Segera buang baterai yang sudah tidak digunakan. Jauhkan baterai baru maupun bekas dari jangkauan anak-anak. Jika Anda curiga baterai telah tertelan atau masuk ke dalam tubuh, segeralah minta bantuan dokter.

MS

AMARAN: Produk ini mengandungi Bateri Sel Butang atau Syiling.

Tertelan bateri Sel Butang atau Syiling boleh mengakibatkan lecuran kimia dalaman dalam tempoh sekurang-kurangnya dua jam dan menyebabkan kematian. Buang bateri terpakai dengan serta-merta. Jauhkan bateri baharu dan terpakai daripada kanak-kanak. Jika anda mendapati bateri mungkin telah ditelan atau termasuk ke dalam mana-mana bahagian badan, dapatkan rawatan perubatan dengan segera.

EN Please retain the leaflet and packaging as they contain important information

DE Broschüre und Verpackung bitte aufbewahren, sie enthalten wichtige Informationen

FR Veuillez conserver le dépliant et l'emballage, car ils contiennent des informations importantes

IT Conserva l'opuscolo e la confezione in quanto contengono informazioni importanti

NL Bewaar a.u.b. de folder en verpakking: die bevatten belangrijke informatie

ES Conserve el folleto y el embalaje; contienen información importante

DA Gem hæftet og emballagen, da de indeholder vigtige oplysninger

IS Geymið bæklinginn og umbúðirnar þar sem þau innihalda mikilvægar upplýsingar

FI Säilytä esite ja pakkaus, koska ne sisältävät tärkeää tietoa

SV Spara broschyren och förpackningen eftersom de innehåller viktig information

NO Heftet og emballasjen inneholder viktig informasjon og skal beholdes

PT Por favor guarde o folheto e a embalagem, pois contém informação importante

EL Κρατήστε το φυλλάδιο και τη συσκευασία γιατί περιέχουν σημαντικές πληροφορίες

JA 説明書とパッケージには重要な情報が含まれていますので保管しておいてください

ZH 说明书和包装均包含重要信息, 请妥善保管

KO 중요한 정보가 담겨 있으므로 리플릿과 포장을 보관해주세요

RU Пожалуйста, сохраните эту брошюру и упаковку, поскольку они содержат важную информацию

PL Prosimy zachować ulotkę i opakowanie, ponieważ zawierają one ważne informacje

CZ Ponechte si prosím leták i obal, neboť obsahují důležité informace

SK Ponechajte si prosím leták aj obal, pretože obsahujú dôležité informácie

HU Kérjük, őrizze meg a szórólapot és a csomagolást, mert fontos tudnivalókat tartalmaznak

UA Будь ласка, зберігайте вкладиш та упаковку, оскільки вони містять важливу інформацію

HR Spremite letak i ambalažu jer sadrže važne obavijesti

SR Молимо да сачувате упутство и паковање јер се на њима налазе важне информације

MK Чувајте ги брошурата и амбалажата бидејќи содржат важна информација

SL Prosimo, da brošurico in embalažo shranite, saj vključujeta pomembne informacije

RO Vă rugăm să păstrați prospectul și ambalajul întrucât conțin informații importante

BG Запазете листовката и опаковката, тъй като съдържат важна информация

LV Lūdzu, saglabājiet bukletu un iepakojumu, jo uz tā ir norādīta svarīga informācija

ET Hoidke infoleht ja pakend alles, sest nendele on märgitud oluline teave

LT Išsaugokite informaciją lapelį ir pakuotę, nes ant jų pateikiama svarbi informacija

TR Önemli bilgiler içerdiği için broşürü ve ambalajı saklayın

AR الرجاء الاحتفاظ بالبرشيرة والغلاف لاحتوائهما على معلومات هامة

ID Harap simpan brosur dan kemasan ini karena berisi informasi penting

MS Sila simpan risalah dan pembungkusan kerana ia mengandungi maklumat penting

LEGO System A/S
Aastvej 1
DK-7190 Billund



EN

Protect the environment by not disposing of this product with your household waste.
Check with your local authority for recycling advice and facilities. Penalties may apply for improper disposal.

DE

Schützen Sie die Umwelt und entsorgen Sie dieses Produkt nicht mit Ihrem Hausmüll.
Informationen zu Recycling-Möglichkeiten erhalten Sie bei den örtlichen Behörden. Bei unsachgemäßer Entsorgung können Strafen verhängt werden.

FR

Protégez l'environnement : ne jetez pas ce produit avec vos autres déchets ménagers.
Contactez les autorités locales pour obtenir des informations sur le recyclage et connaître les points de collecte. Des sanctions peuvent être appliquées en cas d'élimination inappropriée.



IT

Proteggi l'ambiente! Non smaltire questo prodotto con i rifiuti domestici.
Per consulenza sul riciclaggio dei rifiuti e le strutture di riciclaggio, rivolgersi alle proprie autorità locali. Uno smaltimento improprio può comportare sanzioni.

NL

Bescherm het milieu: gooi dit product niet samen met het andere huisvuil weg.
Raadpleeg de plaatselijke instanties voor locaties van milieustations en advies over hergebruik. In geval van onjuiste verwijdering kunnen boetes worden opgelegd.

ES

Proteja el medio ambiente no deshaciéndose de este producto junto con sus residuos domésticos.
Solicite asesoramiento e información sobre instalaciones de reciclaje a las autoridades locales. La eliminación inadecuada puede ser objeto de sanciones.

DA

Beskyt miljøet! Smid ikke dette produkt ud sammen med husholdningsaffaldet.
Få vejledning om genbrug og genbrugsstationer hos din kommune. Ukorrekt bortskaffelse kan medføre bøde eller straf.

IS

Stuðlið að umhverfisvernd með því að farga þessari vöru ekki með heimilissorpi.
Leitið upplýsinga um endurvinnslu- og förgunarstaði hjá yfirvöldum á hverjum stað. Viðurlögum kann að vera beitt ef förgun er ekki með réttum hætti.

FI

Tämä tuote on hävitettävä ympäristöystävällisesti ja erillään muusta talousjätteestä.
Tietoja kierrätyksestä ja keräyspisteiden sijainnista saat paikkakuntasi teknisestä virastosta. Epäasianmukaisesta hävittämisestä saattaa aiheutua seuraamuksia.

SV

Skydda miljön genom att inte kasta denna produkt bland ditt hushållsavfall.
Kontakta din kommun för frågor om återvinning och miljöstationer. Påföljder kan tillkomma för felaktigt avyttring.

NO

Beskytt miljøet. Ikke kast dette produktet i husholdningsavfall.
Kontakt kommunen for veiledning om gjenbruk og miljøstasjoner. Feil avfallshåndtering kan være straffbart.

PT

Proteja o ambiente não eliminando este produto com o seu lixo doméstico.
Consulte as autoridades locais para informação sobre reciclagem e sistemas de recolha. Podem ser aplicadas coimas por eliminação inadequada.

EL

Προστατέψτε το περιβάλλον. Μην πετάτε αυτό το προϊόν μαζί με τα συνηθισμένα οικιακά απορρίμματα.
Επικοινωνήστε με τις τοπικές αρχές σχετικά με συμβουλές και εγκαταστάσεις ανακύκλωσης. Ενδέχεται να επιβάλλονται κυρώσεις για ακατάλληλη διάθεση απορριμμάτων.

JA

環境保護のため、本製品は家庭ごみとは別に処分してください。
リサイクルに関する指示や施設については、お住まいの地方自治体にお問い合わせください。不適切な廃棄を行った場合、罰則が適用されることがあります。

ZH

注意保护环境，请勿将本产品与生活垃圾一起丢弃处理。
请咨询当地相关部门，了解与回收相关的设施与建议。
处理不当可能会导致处罚。

KO

환경 보호를 위해 이 제품을 생활폐기물과 함께 버리지 마십시오.
재활용 방법 및 시설에 관한 사항은 현지 관계 당국에 문의하십시오. 부적절하게 폐기할 경우 벌칙이 부과될 수 있습니다.

RU

Позаботьтесь об окружающей среде: не утилизируйте этот продукт вместе с бытовым мусором.
Узнайте в органах местного самоуправления правила вторичной переработки и утилизации таких отходов.
В случае ненадлежащей утилизации могут быть наложены штрафы.



PL

Aby chronić środowisko naturalne, nie należy wyrzucać tego produktu wraz z odpadkami z gospodarstwa domowego.
W celu uzyskania wskazówek dotyczących recyklingu oraz adresów zakładów należy skontaktować się z lokalnym urzędem.
Za nieprzestrzeganie zasad związanych z utylizacją odpadów grożą kary.

CZ

Nevyhazujte tento produkt do domácího odpadu, chráňte životní prostředí. Zjistěte si prosím u místních úřadů možnosti recyklace a dostupná zařízení. Nesprávná likvidace může být pokutována.

SK

Nevyhádzajte tento produkt do domáceho odpadu, chráňte životné prostredie. Zistite si na miestnych úradoch možnosti recyklácie a dostupné zariadenia. Za nesprávnu likvidáciu môžu byť uložené sankcie.

HU

Környezetét óvja, ha ettől a terméktől nem a háztartási hulladékkal együtt válik meg.
Érdeklődjék a lakóhelyéhez közel eső hatóságnál az újrahasznosítás módjáról és lehetőségeiről. A nem megfelelő hulladékelhelyezésért büntetés járhat.

UA

Допоможіть захистити довкілля: не утилізуйте цей виріб разом із побутовим сміттям.
Вказівки з утилізації та відомості про пункти прийому з'ясуйте в місцевих компетентних органів. У разі неналежної утилізації можуть застосовуватися штрафи.

HR

Zaštitite okoliš tako da ovaj proizvod ne odložite u otpad zajedno s kućanskim otpadom.
Od lokalnih vlasti zatražite savjet ili informacije o pogonima za recikliranje. Moгуća je kazna za nepropisno zbrinjavanje.

SR

Zaštitite životnu sredinu tako što nećete da odlažete ovaj proizvod sa kućnim otpadom.
Raspitajte se kod lokalnog nadležnog organa o načinu reciklaže i o sabirnom centru. U slučaju nepravilnog odlaganja u otpad, mogu biti izrečene kazne.

MK

Zaštitete ja okolinata tako što nema da se oslobodite od proizvodot so domashniot otpad.
Konsultirajte se so lokalnite vlasti za da doznaete za sovetite i objektite za recikliranje. Vozmožno e da bidat primeneti kazni za nepravilno isflanje.

SL

Zaščitite okolje! Okolje varujte tako, da tega izdelka ne zavržete skupaj z gospodinjanskimi odpadki.
Pri krajevni upravi preverite, kakšne možnosti in kateri obrati za recikliranje obstajajo v vaši okolici. Za nepravilno odlaganje odpadkov vas lahko doleti kazen.

RO

Protejați mediul înconjurător și nu vă debarașați de acest produs împreună cu deșeurile menajere.
Consultați autoritățile locale pentru îndrumări și facilități de reciclare.
Dezafectarea necorespunzătoare poate atrage sancțiuni.

BG

Защитете околната среда и не изхвърляйте този продукт заедно с битовите си отпадъци.
Свържете се с местните власти относно съвети и съоръжения за рециклиране. Възможно е да има глоби за неправилно изхвърляне.

LV

Lai saudzētu vidi, neizmetiet šo izstrādājumu kopā ar sadzīves atkritumiem. Vērsieties vietējās varas iestādēs, lai noskaidrotu, kur un kā tas nododams pārstrādei. Par neatbilstošu likvidēšanu var tikt piemērots sods.

ET

Keskkonda saate kaitsta nii, et ei kõrvalda seda toodet koos olmejäätmetega.
Nõuandeid toote taaskasutusse võtmise ja ümbertöötlemispunktide kohta saate asjaomaselt kohalikult asutuselt.
Nõuetele mittevastav kasutuselt kõrvaldamine võib kaasa tuua trahvid.

LT

Saugokite aplinką: nemeskite šio produkto kartu su buitinėmis atliekomis. Atsižvelkite į savo vietos valdžios rekomendacijas dėl pakartotinio panaudojimo ir sąlygas. Už netinkamą šalinimą gali būti taikomos baudos.

TR

Bu ürünü, evsel atıklarla birlikte atmayarak çevreyi koruyun.
Geri dönüşüm tavsiyeleri ve tesisler hakkında bilgi için yerel yönetimle iletişim kurun. Uygunsuz atılması durumunda cezalar uygulanabilir.

AR

احم البيئة بعدم التخلص من هذا المنتج مع المخلفات المنزلية.
استشر السلطة المحلية لديك للحصول على نصيح بخصوص إعادة تدوير المخلفات ومراقبته.
قد يتم تطبيق عقوبات على التخلص غير السليم.

ID

Jagalah lingkungan dengan tidak membuang produk ini bersama sampah rumah tangga Anda.
Periksa peraturan pemerintah setempat tentang saran dan fasilitas daur ulang. Pembuangan yang tidak sesuai ketentuan dapat dikenakan denda.

MS

Lindungi alam sekitar dengan tidak melupuskan produk ini bersama sisa isi rumah anda.
Rujuk pihak berkuasa tempatan anda tentang nasihat dan kemudahan kitar semula. Penalti boleh dikenakan untuk pelupusan yang tidak wajar.



YOU COULD WIN



YOU COULD WIN

Your feedback will help shape the future development of this product series.

Visit:

DU KÖNNTEST GEWINNEN

Dein Feedback trägt zur Weiterentwicklung dieser Produktreihe bei.

Geh auf:

VOUS POURRIEZ GAGNER

Vos commentaires nous aideront à concevoir les futurs produits de cette gamme.

Visitez :

POTRESTI VINCERE TU

La tua opinione ci aiuterà a migliorare la creazione futura di questa linea di prodotti.

Visita:

PUEDES GANAR

Tu opinión contribuirá al futuro de esta serie de productos.

Visita:

轻松获奖

您的反馈将有助于我们在今后改进本产品系列。

请访问:

[LEGO.com/productfeedback](https://www.lego.com/productfeedback)

You also have the chance to win a LEGO® set.

Terms and conditions apply.*

Außerdem hast du die Chance, ein LEGO® Set zu gewinnen.

Es gelten die Teilnahmebedingungen.*

Vous pourriez également gagner un ensemble LEGO®.

Des conditions s'appliquent.*

Hai anche la possibilità di vincere un set LEGO®.

Termini e condizioni sono applicabili.*

También tienes la oportunidad de ganar un set LEGO®.

Aplican términos y condiciones.*

您还有机会赢取乐高®套装。

条款和条件适用。*

*[LEGO.com/productfeedback-terms](https://www.lego.com/productfeedback-terms)

- 1x 6052864
- 2x 6224811
- 1x 4544140
- 4x 6436479
- 2x 403201
- 2x 4278271
- 2x 6310185
- 1x 306901
- 3x 6097637
- 1x 6446017
- 1x 6436480
- 1x 6446019
- 2x 4514842
- 2x 302201
- 1x 300301
- 1x 6218822
- 9x 6289797
- 4x 6284573
- 3x 4161734
- 4x 4118793
- 8x 4516055
- 3x 4565452
- 5x 4666579
- 12x 4624086
- 4x 6321305
- 1x 4114084
- 66x 6116614
- 3x 4114309
- 2x 6351905
- 2x 6036487
- 2x 6030980
- 2x 6170487
- 4x 306221
- 2x 6223427
- 3x 6271820
- 113x 6378120
- 1x 6397571
- 6x 6170390
- 1x 4504379
- 3x 302421
- 1x 407021
- 2x 6360104
- 2x 6399645
- 2x 4651524
- 3x 403221
- 2x 4142865
- 1x 4585146
- 4x 6029946
- 26x 302321
- 4x 6117974
- 12x 6001806
- 2x 6441098
- 4x 6360036
- 4x 6351892
- 9x 6061711
- 2x 6435045
- 1x 6251410
- 2x 4533742
- 1x 6371957
- 1x 6330205
- 4x 6129995
- 3x 371021
- 1x 4560179
- 3x 300121
- 1x 6371582
- 4x 300921
- 4x 379521
- 6x 6335578
- 1x 6130004
- 1x 4529235
- 4x 4504380
- 12x 6302961
- 4x 302423
- 1x 6396479
- 4x 4651236
- 8x 403223
- 2x 4206482
- 68x 6436474
- 4x 6092582
- 8x 6055065
- 3x 393723
- 2x 306923
- 4x 370023
- 2x 300423
- 1x 302323
- 1x 243223
- 1x 6133720
- 1x 6224999
- 3x 6279026
- 14x 6436477
- 20x 6299413
- 2x 6436476
- 1x 6116786
- 4x 6441096
- 21x 6436475
- 6x 4587840
- 2x 6436478
- 6x 6292291
- 2x 4560180
- 2x 4656767
- 4x 4118785
- 1x 366623
- 3x 379523
- 2x 300823
- 2x 447723
- 4x 383223
- 7x 6271167
- 2x 614124
- 1x 6284577
- 1x 6434831
- 4x 4624985
- 22x 300524
- 6x 302424
- 4x 307024
- 3x 654124
- 4x 6330893
- 1x 4550348
- 1x 6331822
- 22x 300424
- 52x 302324
- 2x 6167223
- 2x 6441088
- 2x 6361082
- 3x 6206240
- 4x 306924
- 6x 6375518
- 1x 6173122
- 1x 6310247
- 1x 6273711
- 4x 6079007
- 6x 242024
- 11x 300324

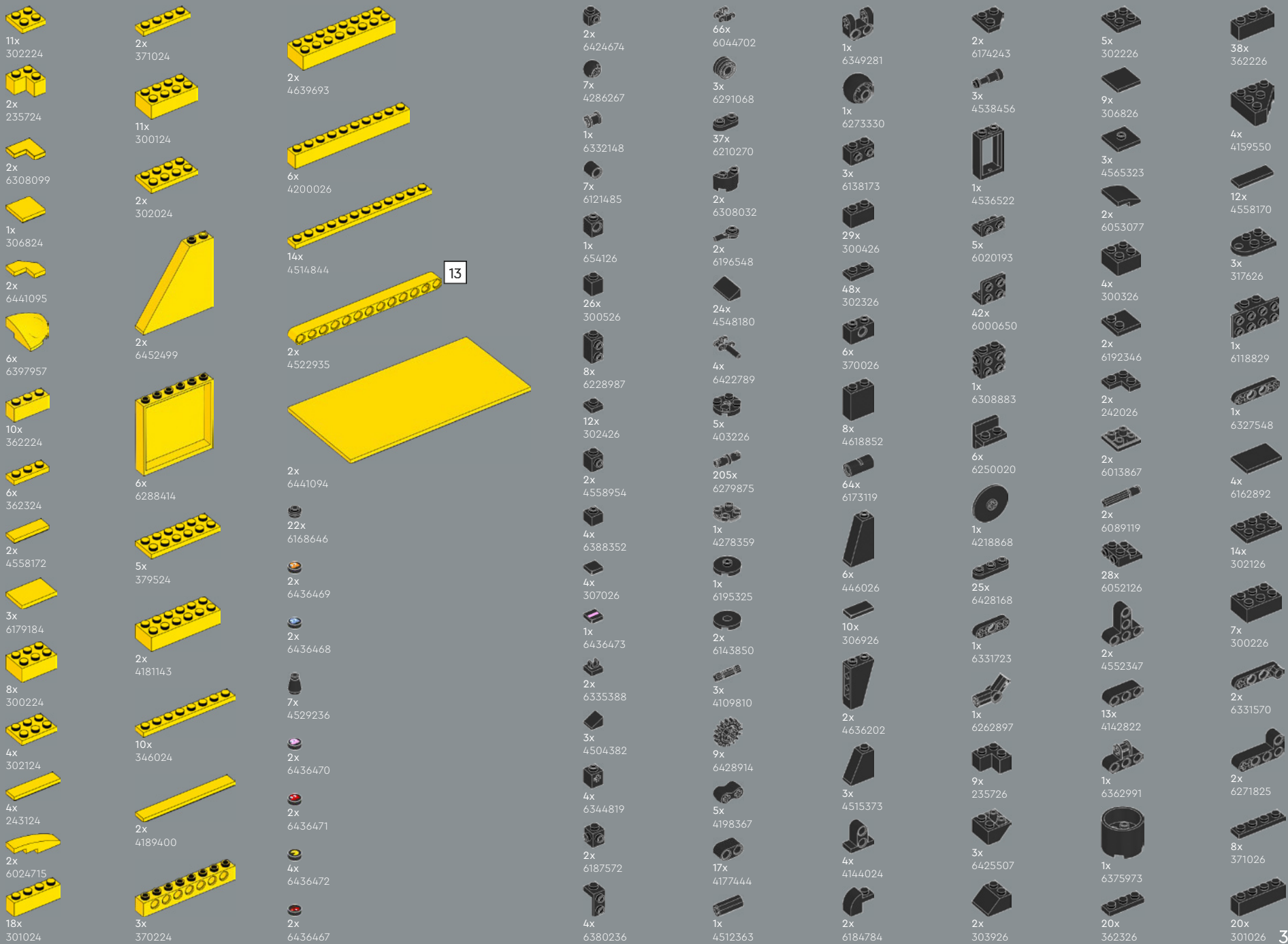

24x
4211541

2x
6093859

6x
4211397

3x
6326478

3x
6435857

1x
4211815

3x
4211881

2x
4515369

1x
6346487

1x
6457283

4x
4211452

2x
6037399

1x
4211406

4x
4211636

5x
4211445

1x
4211441

1x
6273218

3x
4211527

3x
4211395

2x
4211639

3x
6195314

1x
6372029

2x
4211438

2x
4211407

2x
4211860

1x
4211366

6x
4211486

2x
6096589

2x
4211115

6x
4210997

4x
4211067

2x
4210794

1x
4256149

2x
6012451

2x
4211044

2x
6364352

3x
6350724

2x
6261374

2x
6135014

1x
6039479

1x
6316692

2x
4211060

11x
4211000

12x
4211094

9x
4211055

3x
6126083

4x
6015356

2x
6133119

4x
4211043

1x
6396057

1x
6368313

2x
6336665

2x
6083620

2x
4210725

3x
6335115

2x
4227398

3x
4508553

1x
4629920

8x
4211056

3x
4499858

2x
4211008

1x
6429475

1x
6329604

3x
6097493

4x
6092674

6x
6348141

1x
6119107

2x
4625036

3x
6074793

1x
6051507

2x
6227958

3

5

4

5,5

8

LEGO.com/service



