

1

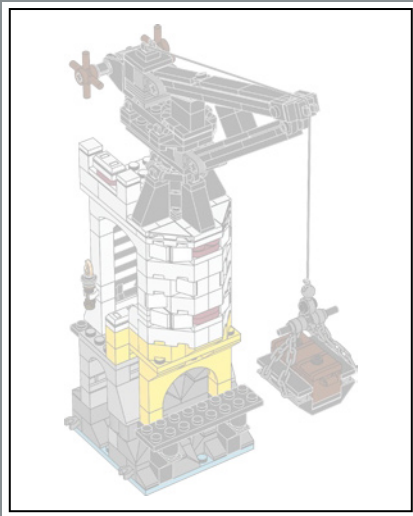

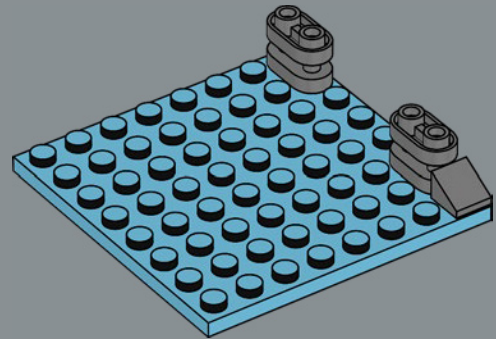

2

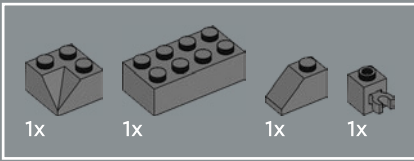
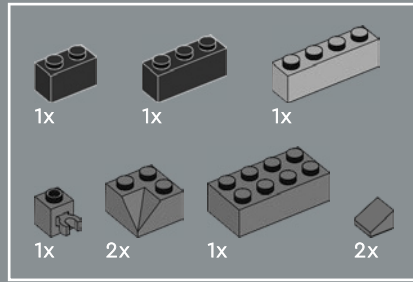
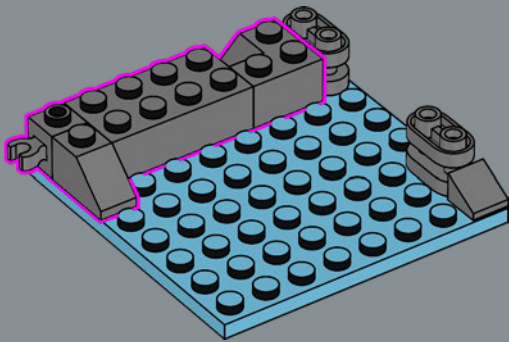

3

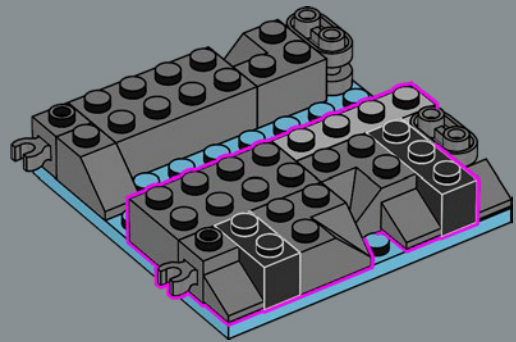



4

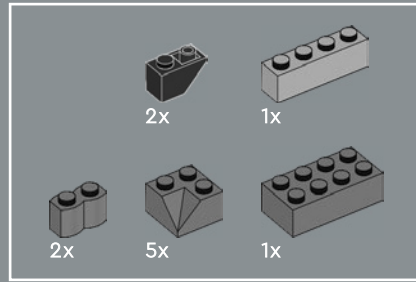
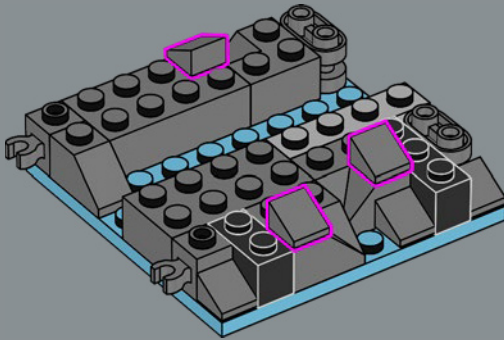

5

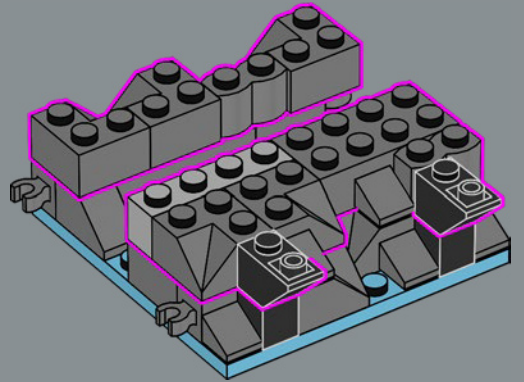



6

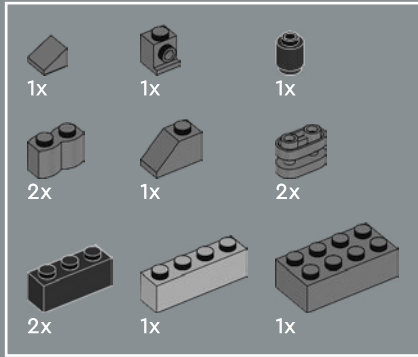
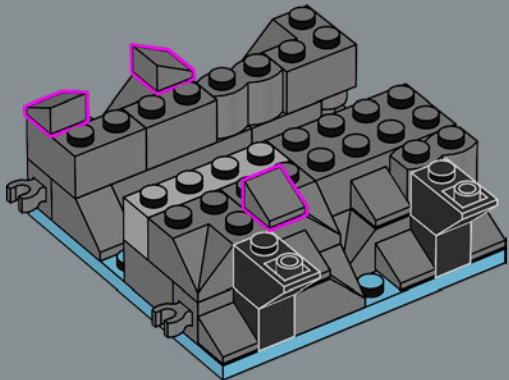

7

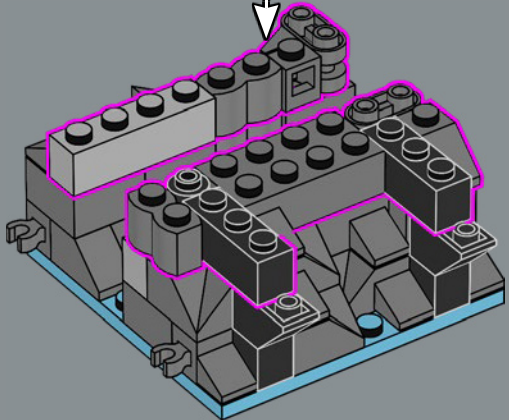
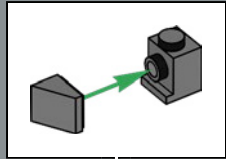

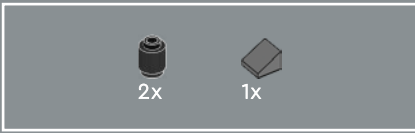

8

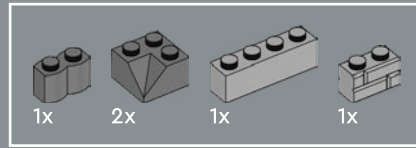
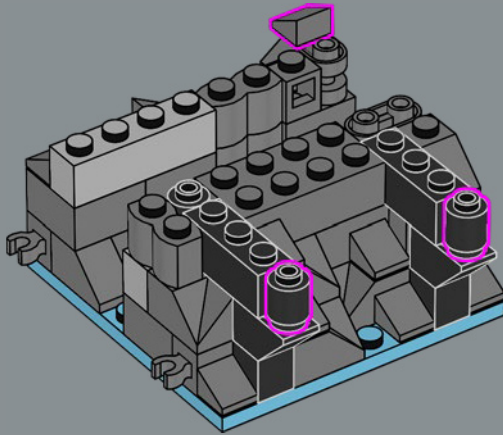

9

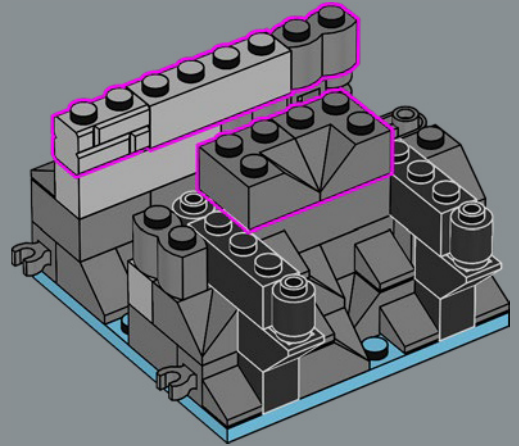

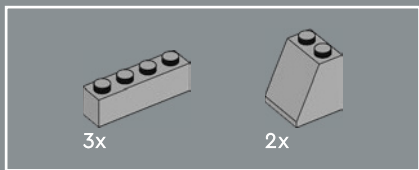

10

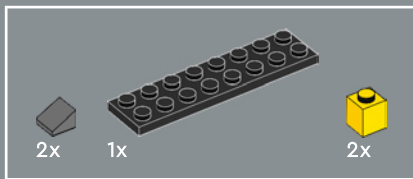
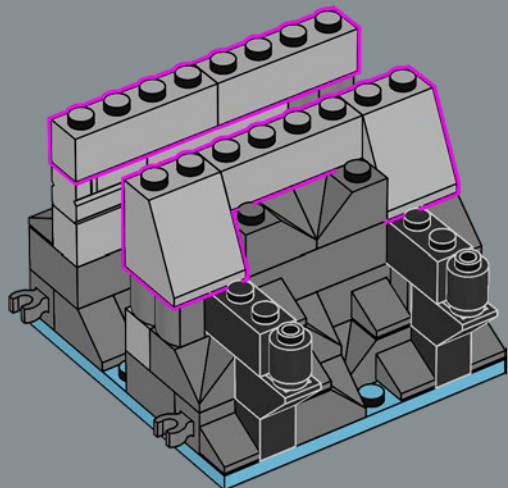

11

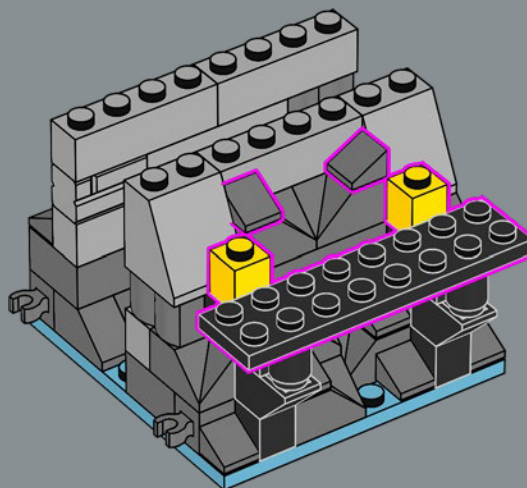

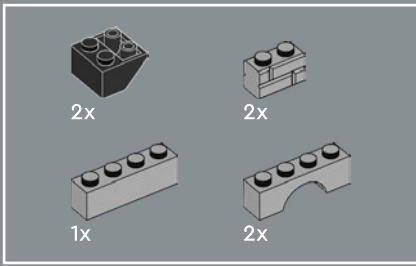

12

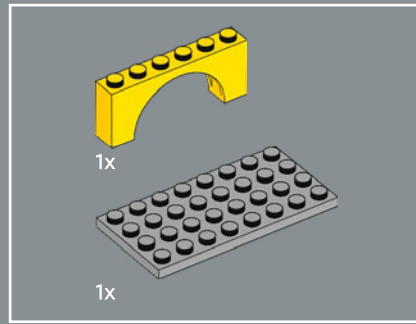
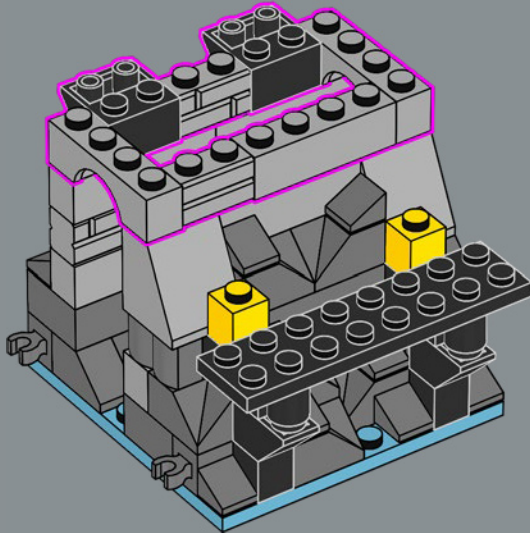

13

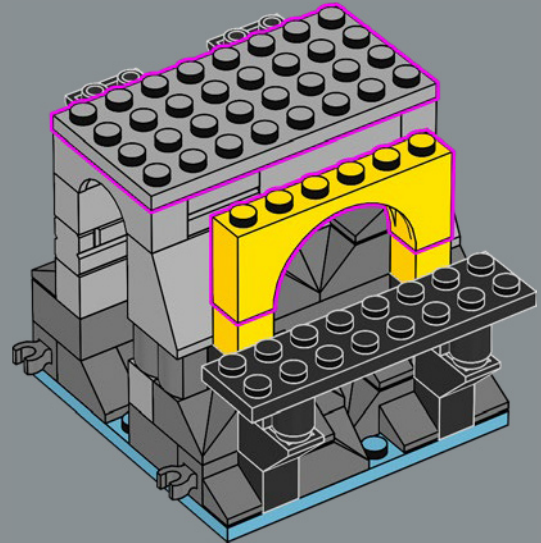

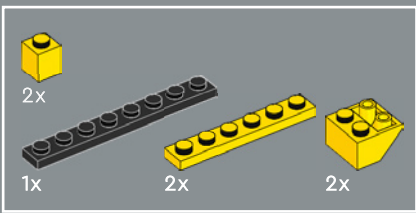

14

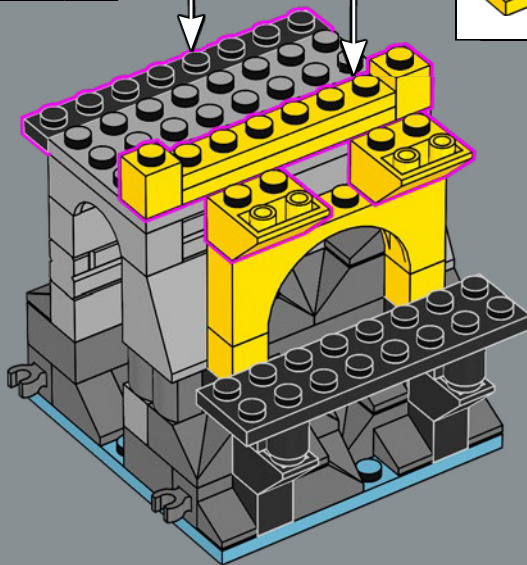
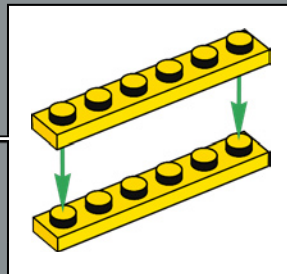
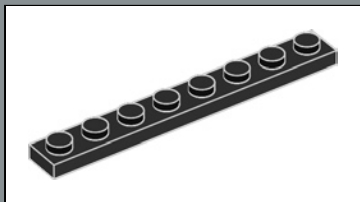

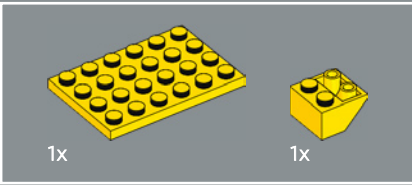
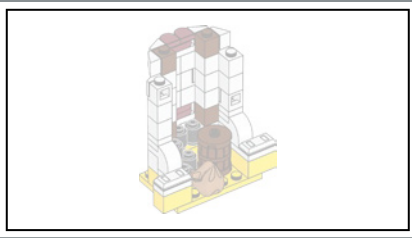

1x

1x

15

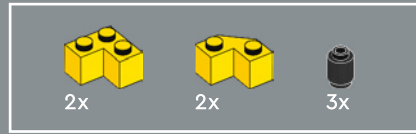
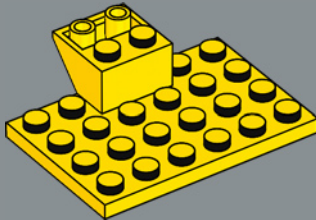

2x

2x

3x

16

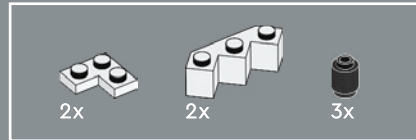
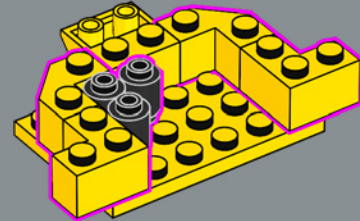

2x

2x

3x

17

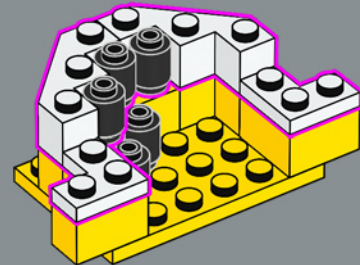

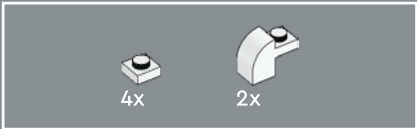

18

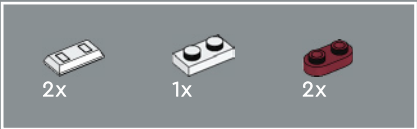
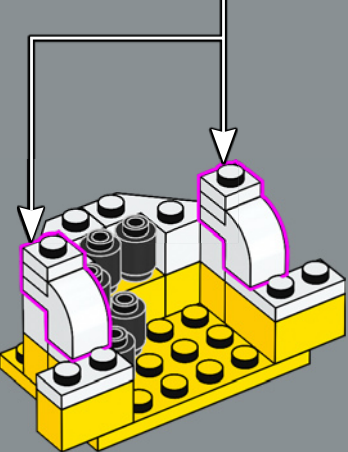
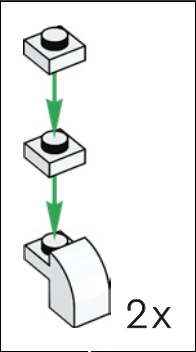

19

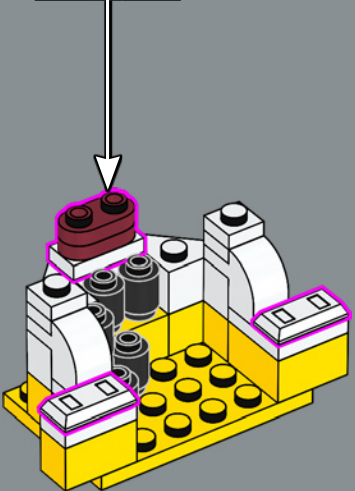
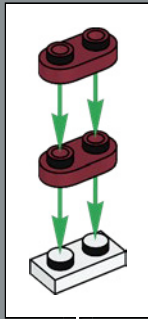

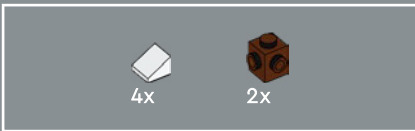

20

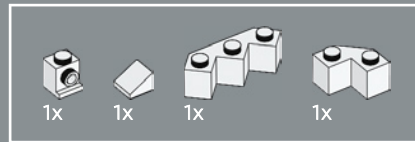
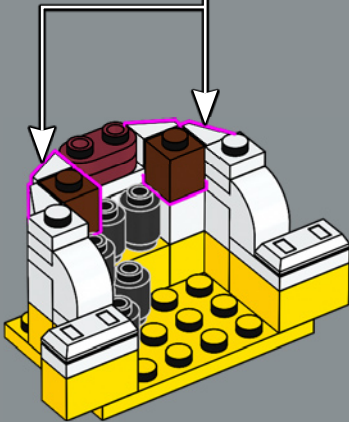
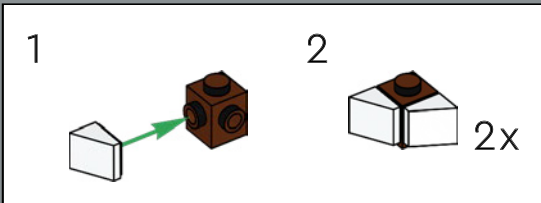

21

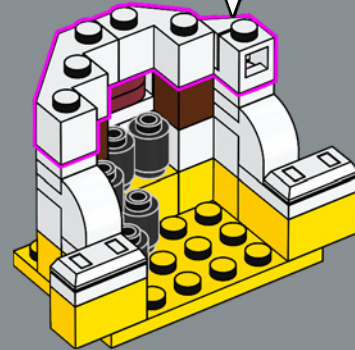
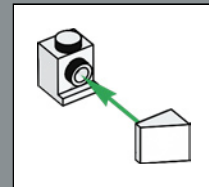

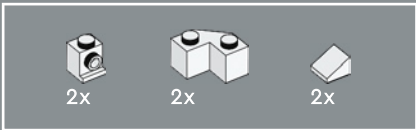

22

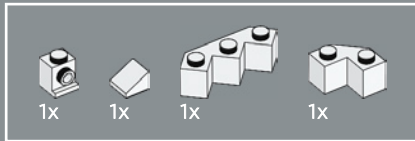
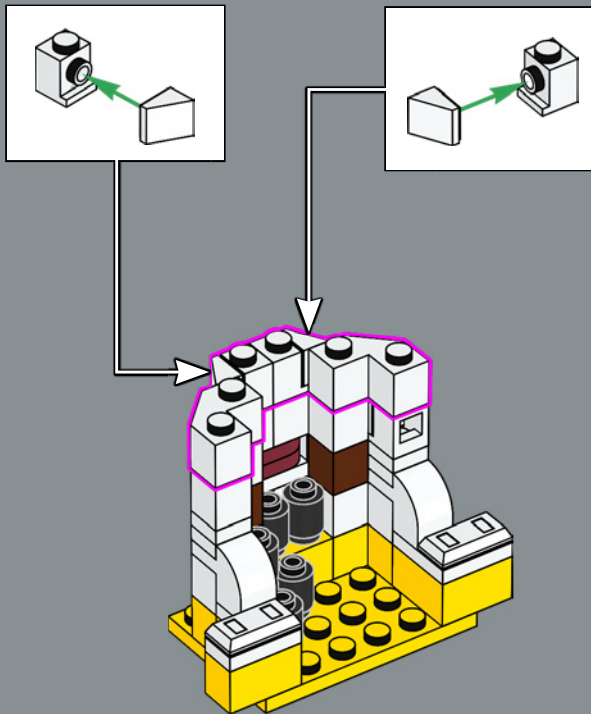

23

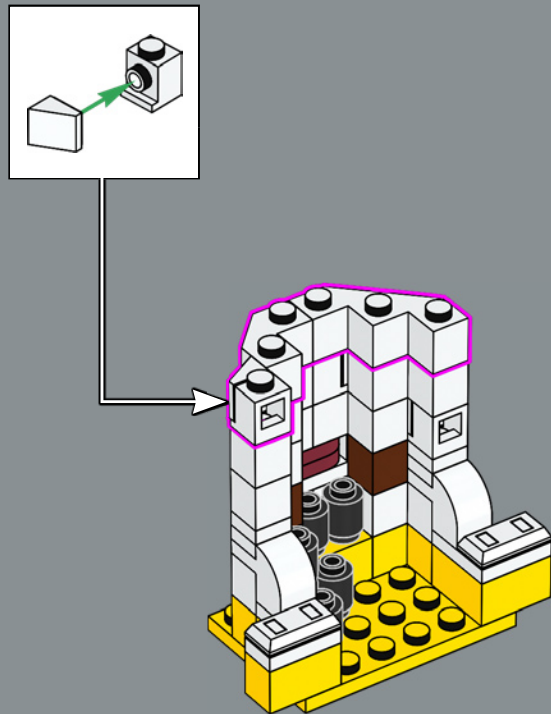



24

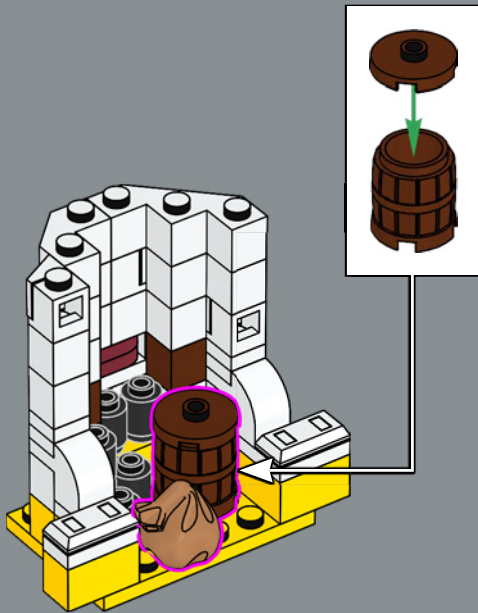

25

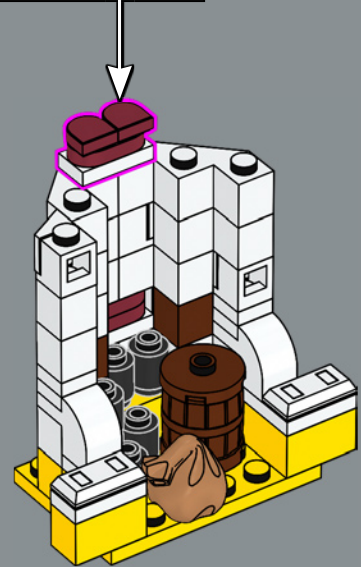
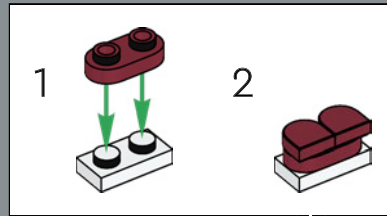



4x



2x

26

1



2



2x

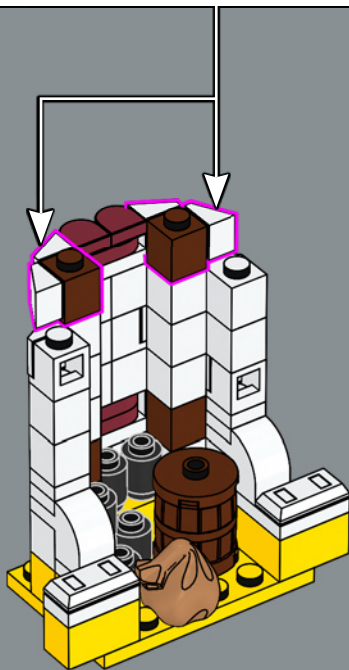

27

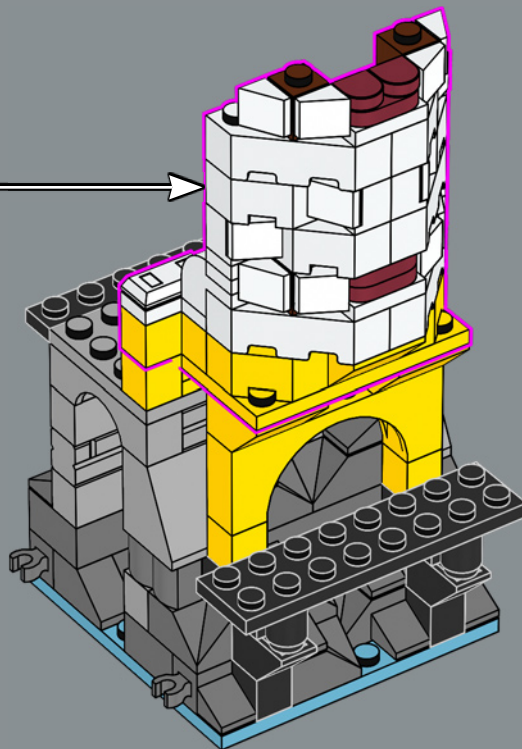

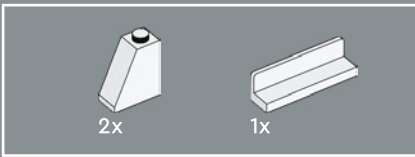

28

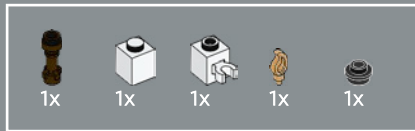
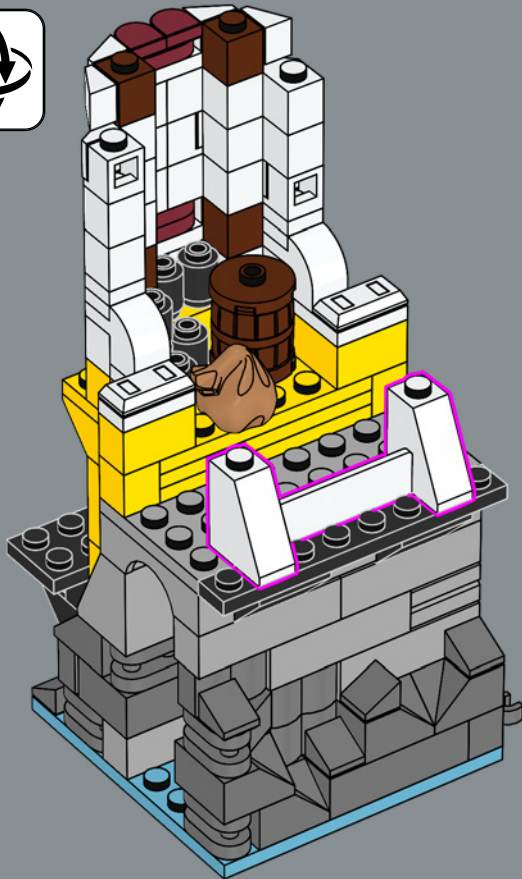

29

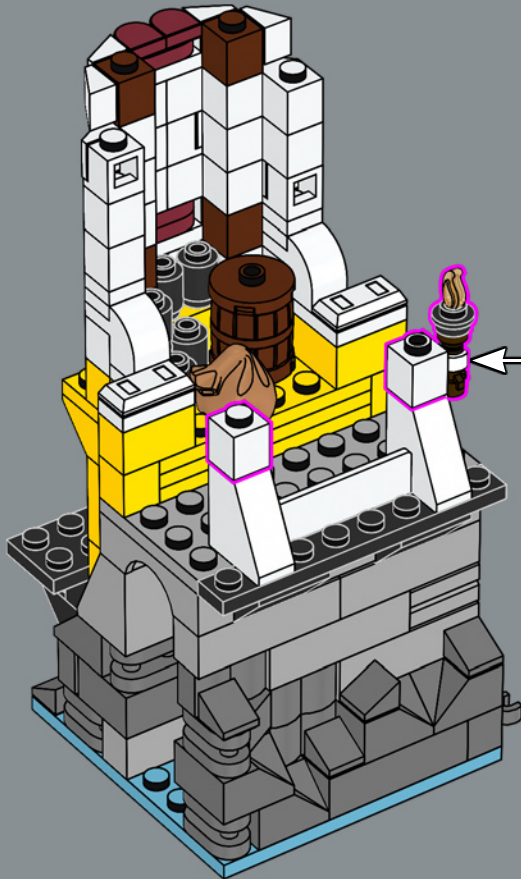



2x

30

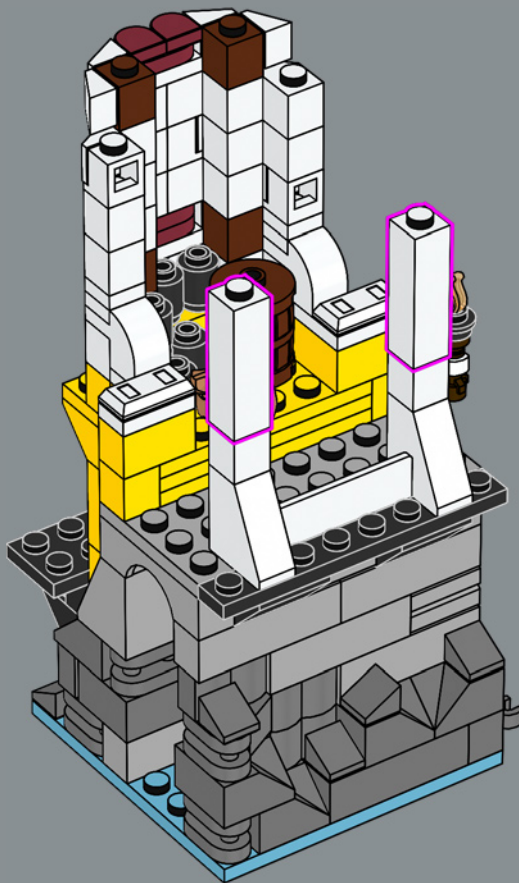

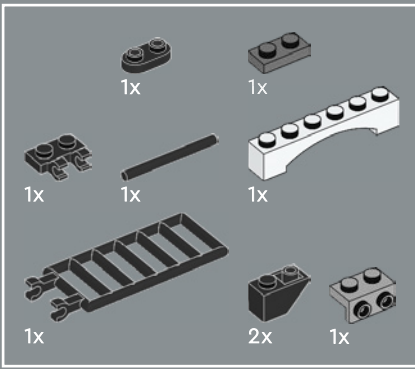

31

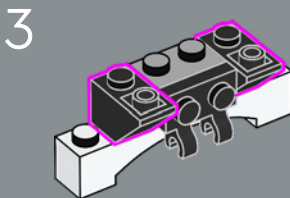
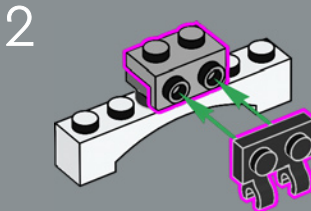
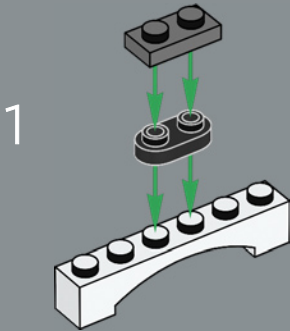

4

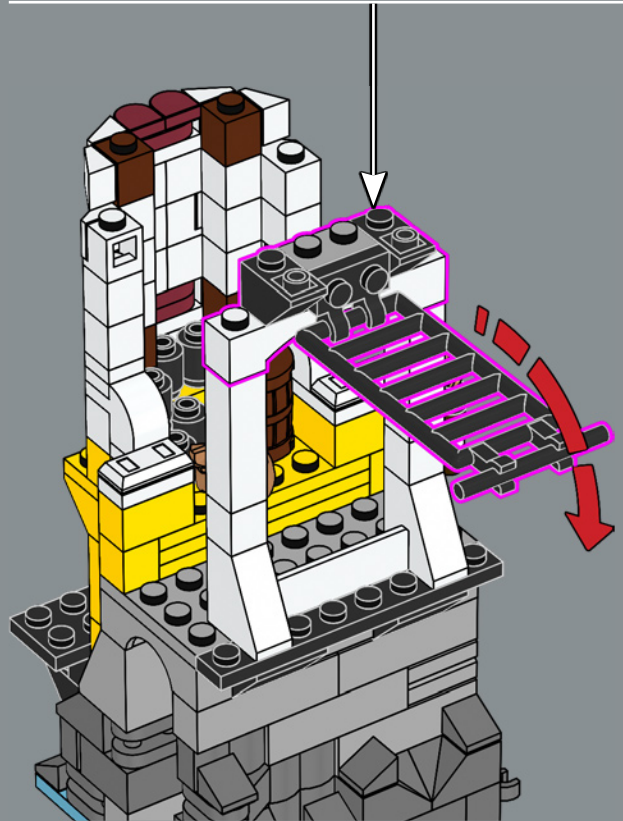
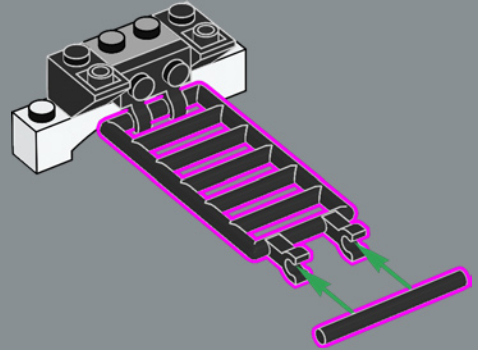

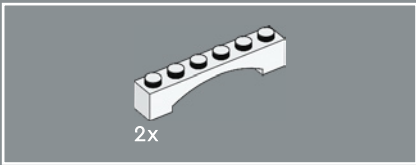

32

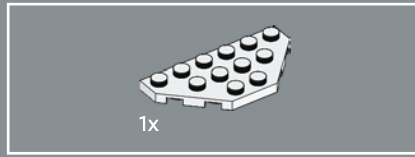
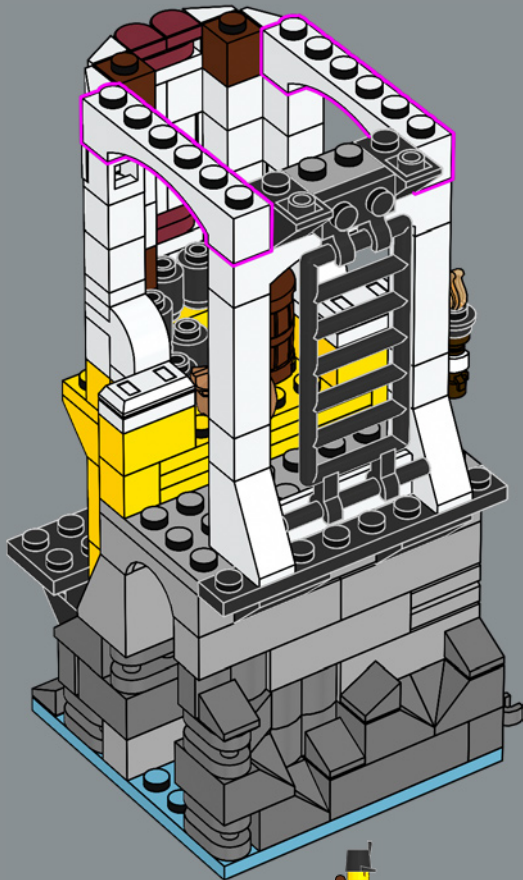

33

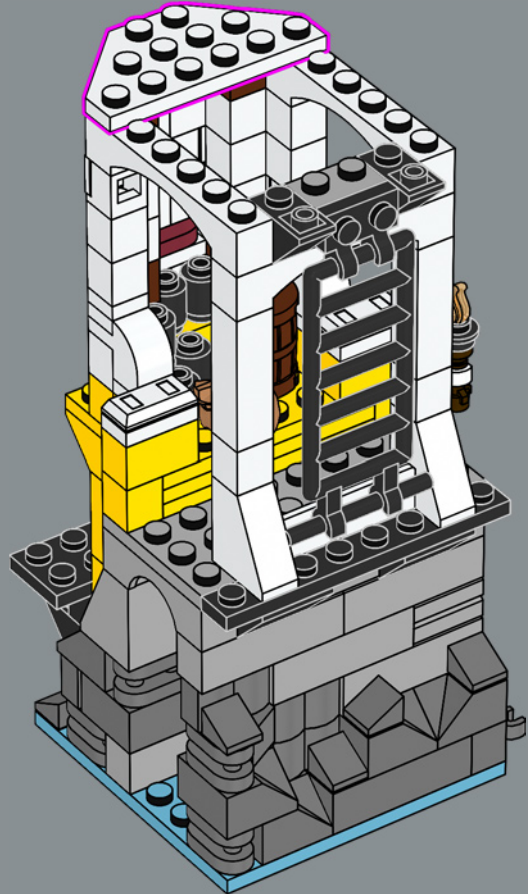

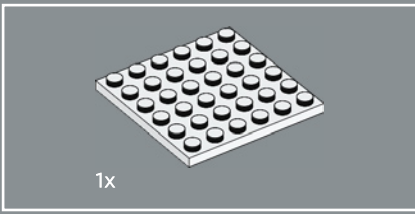

34

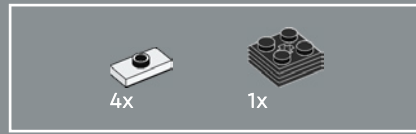
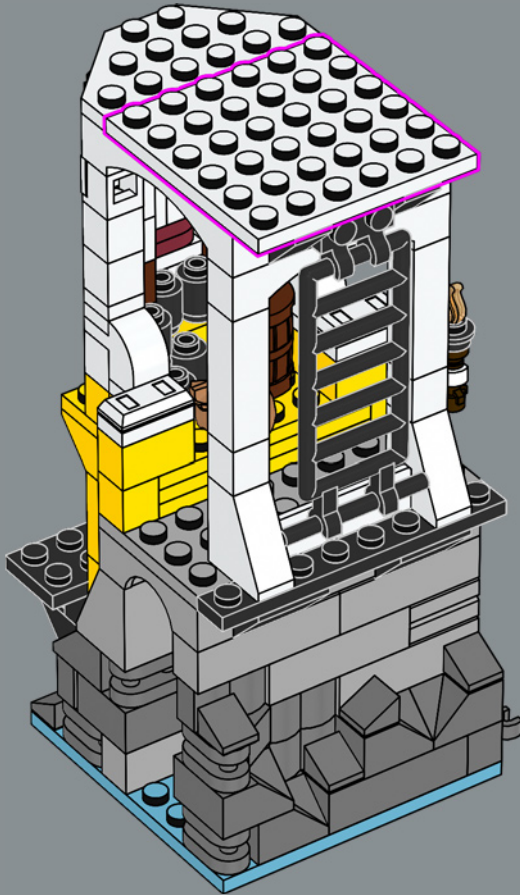

35

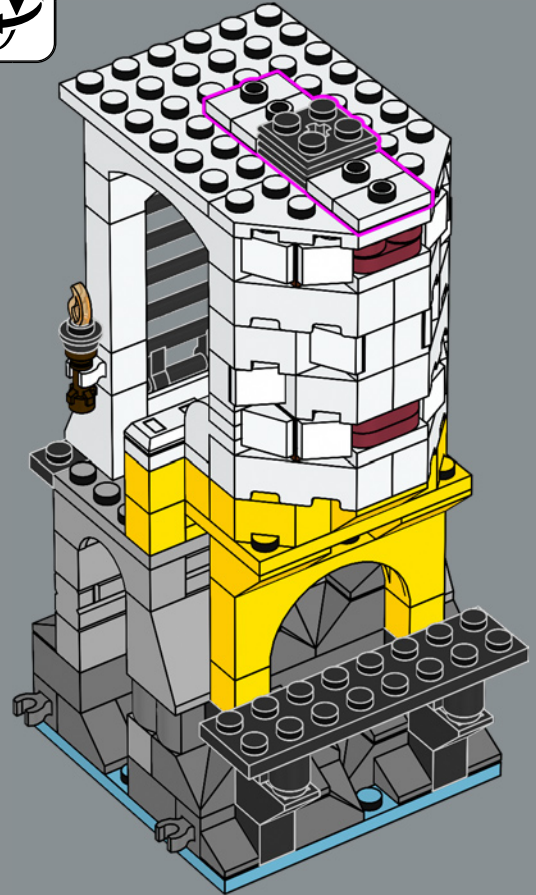

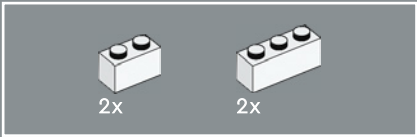

36

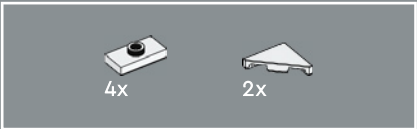
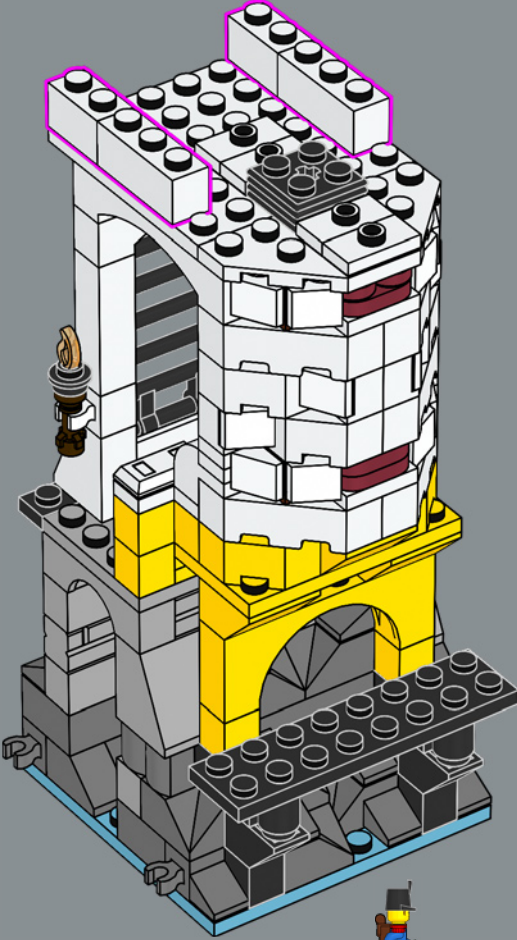

37

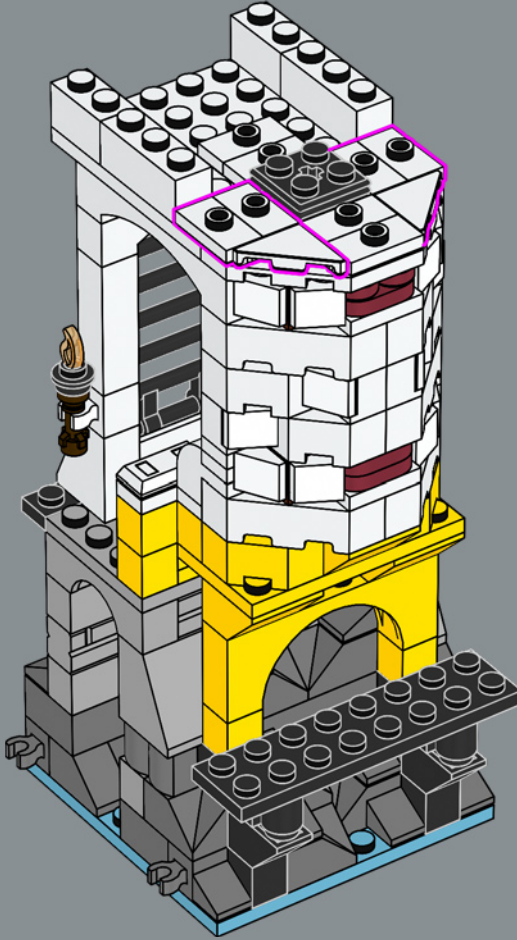

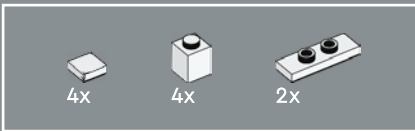

38

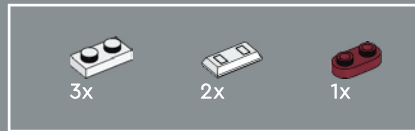
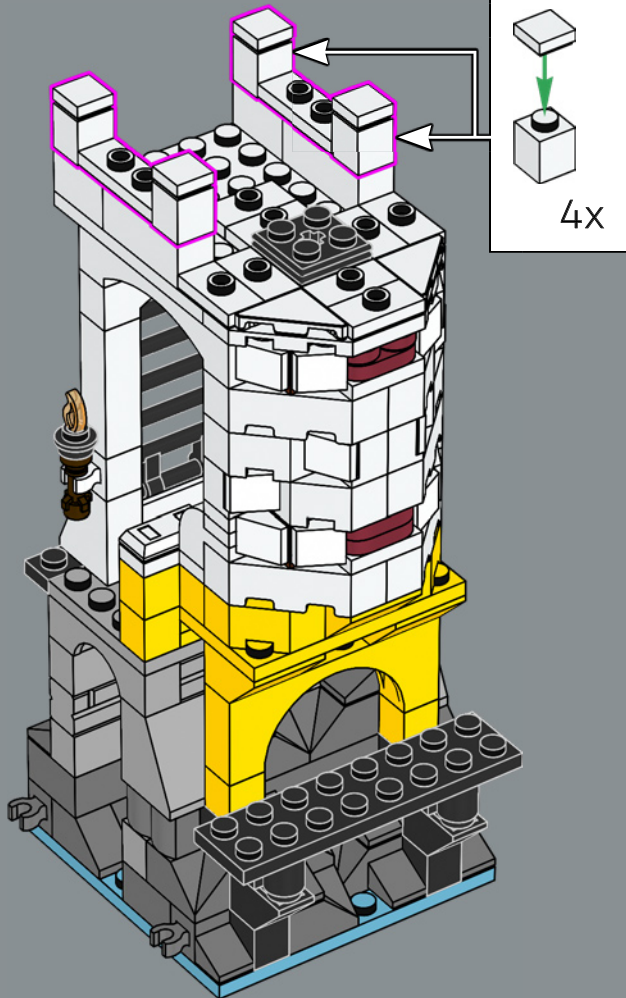

39

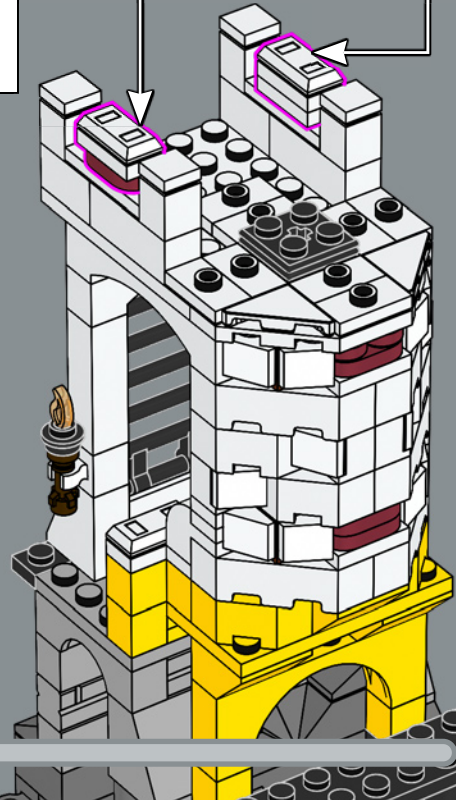
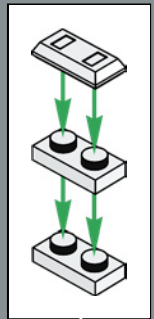
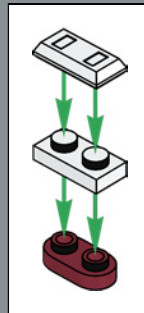

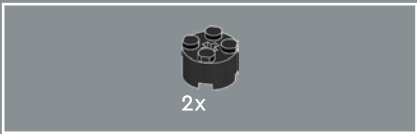

40

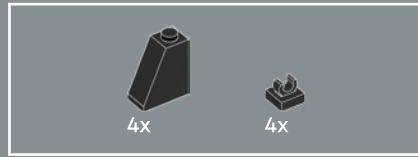
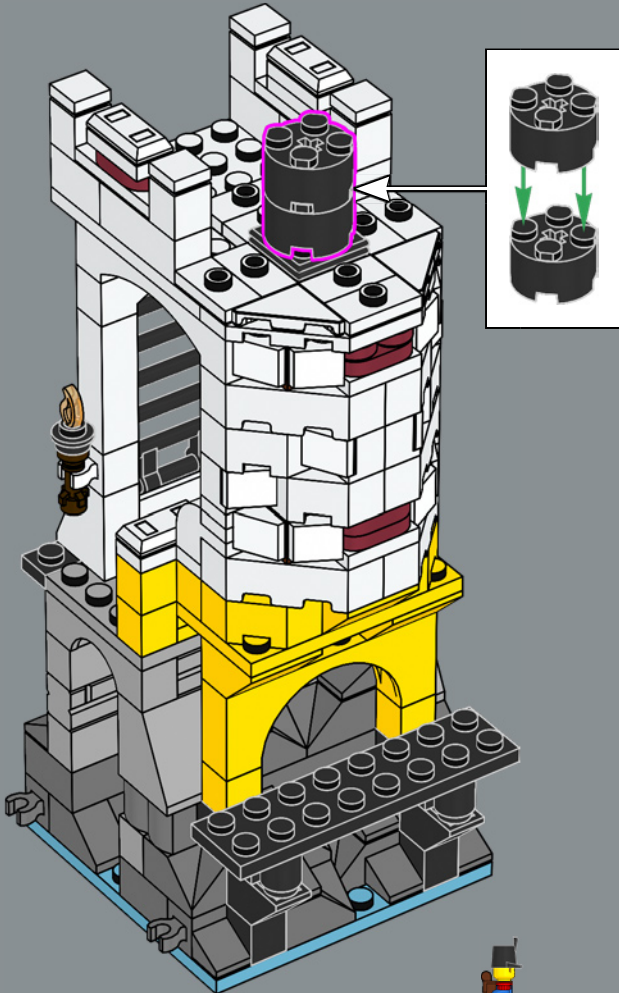

41

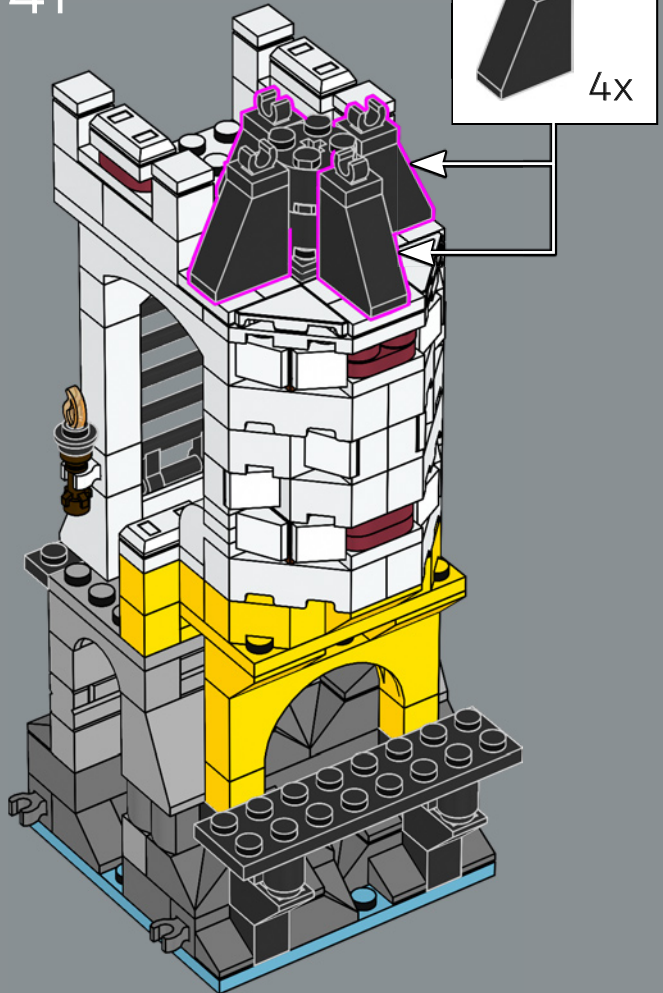



42

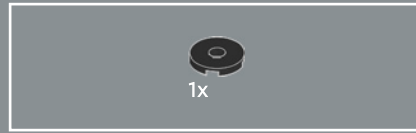
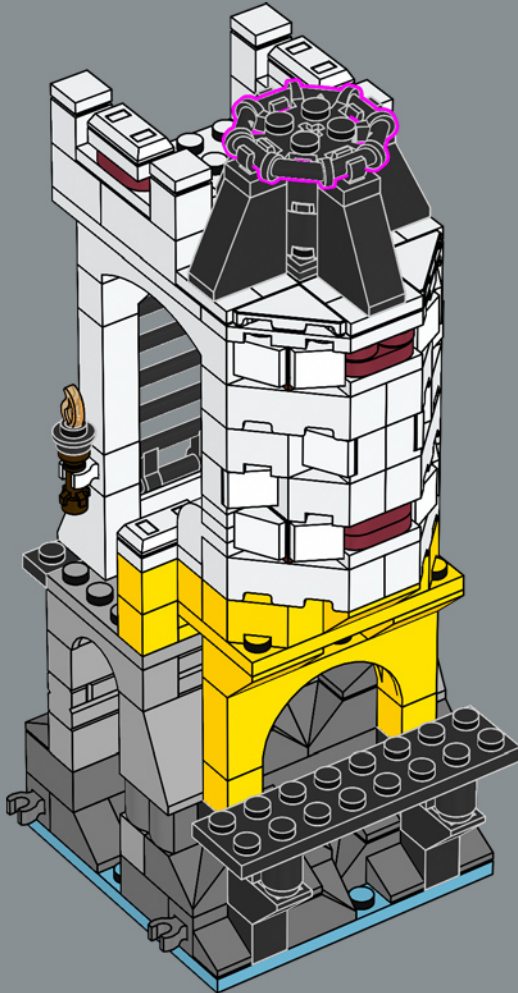

43

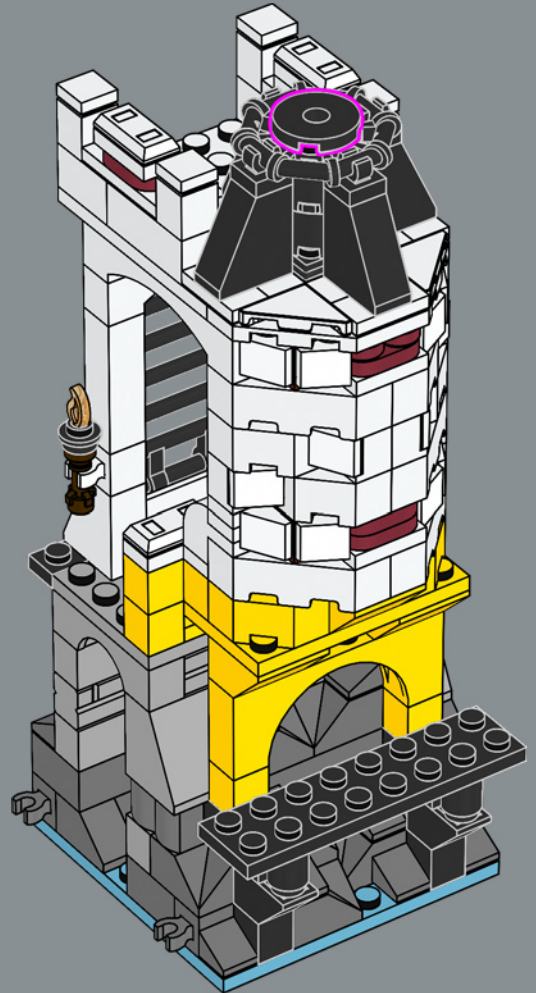

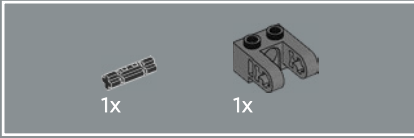
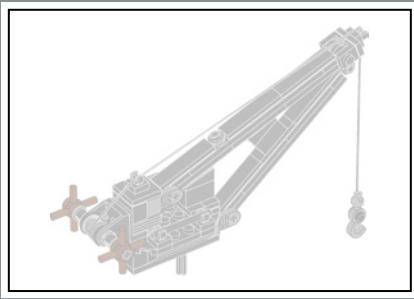

44

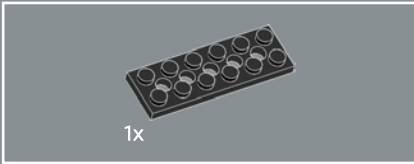
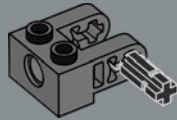

45

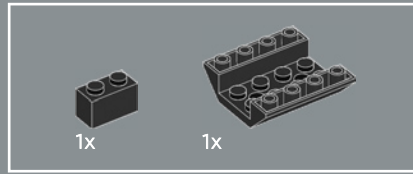
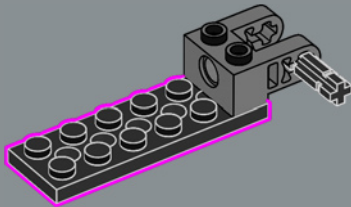

46

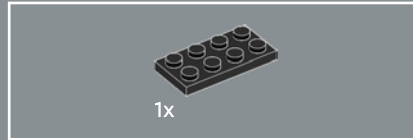
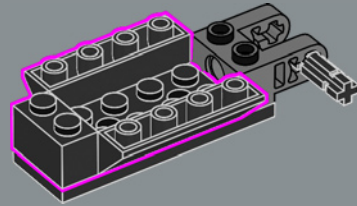

47

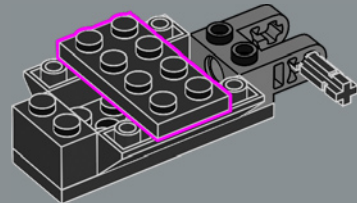

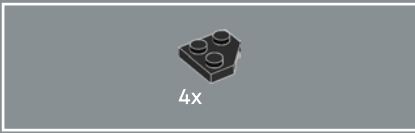

48

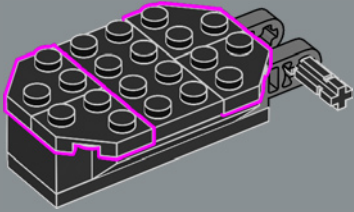

50

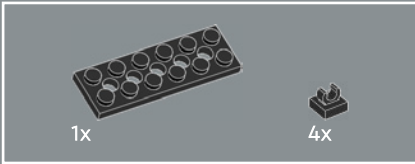
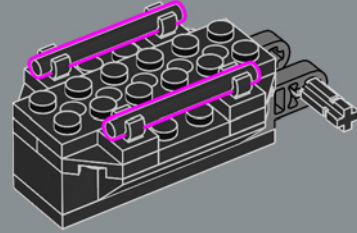

49

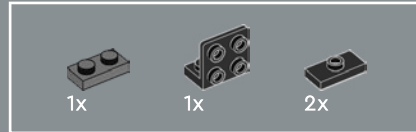
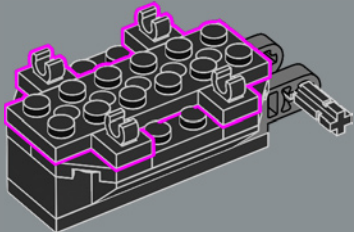

51

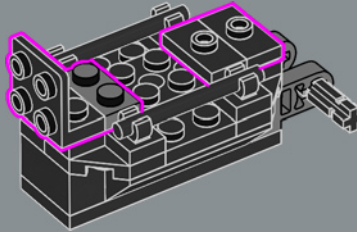

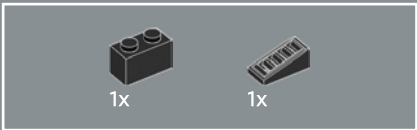

52

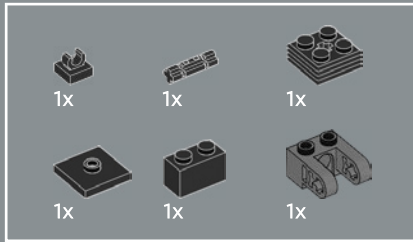
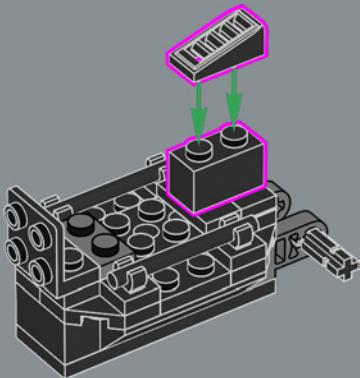

53

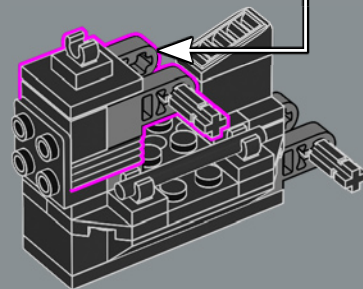
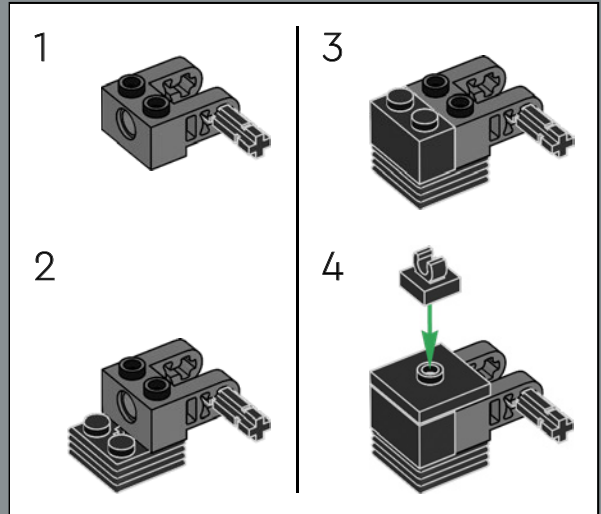

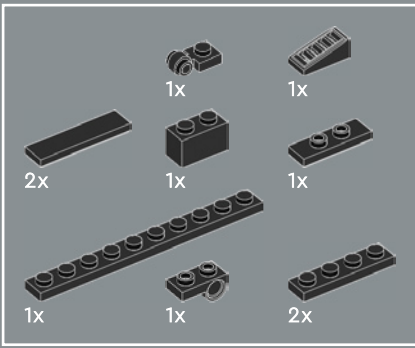

54

1

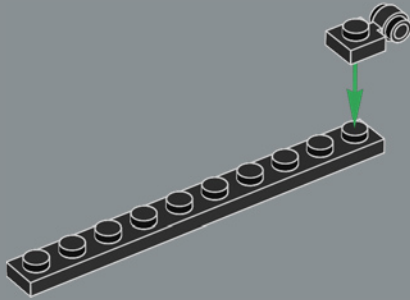

2

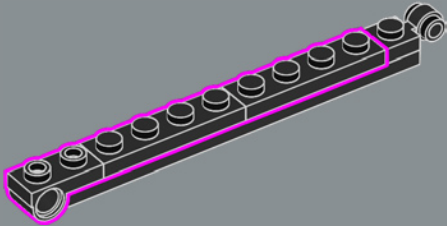

3

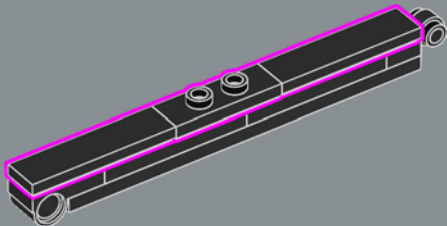

4

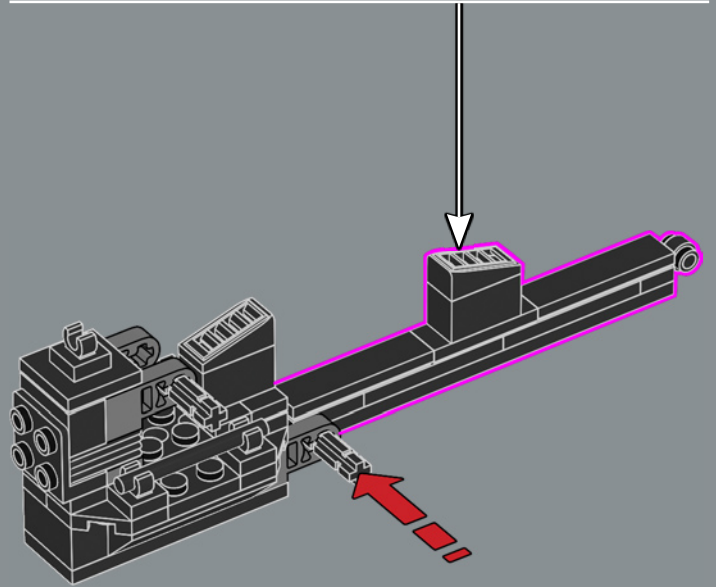
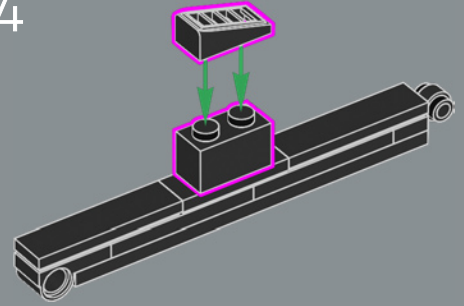

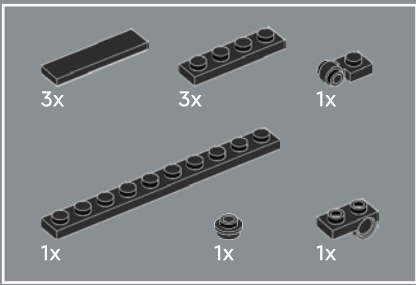

55

1

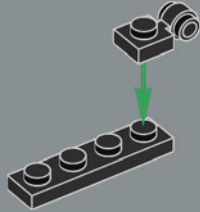

2

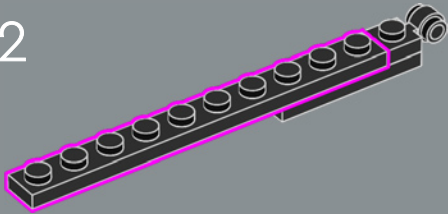

3

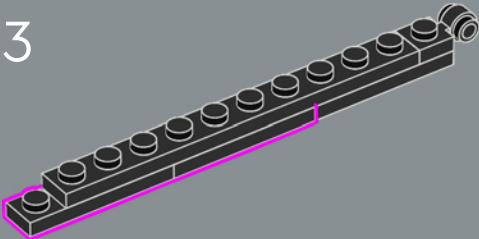

4

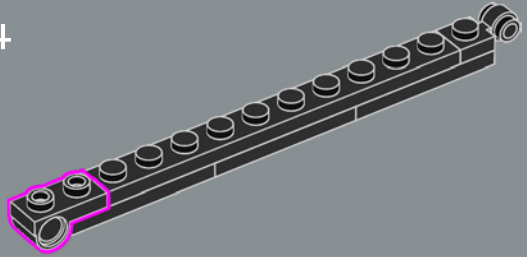

5

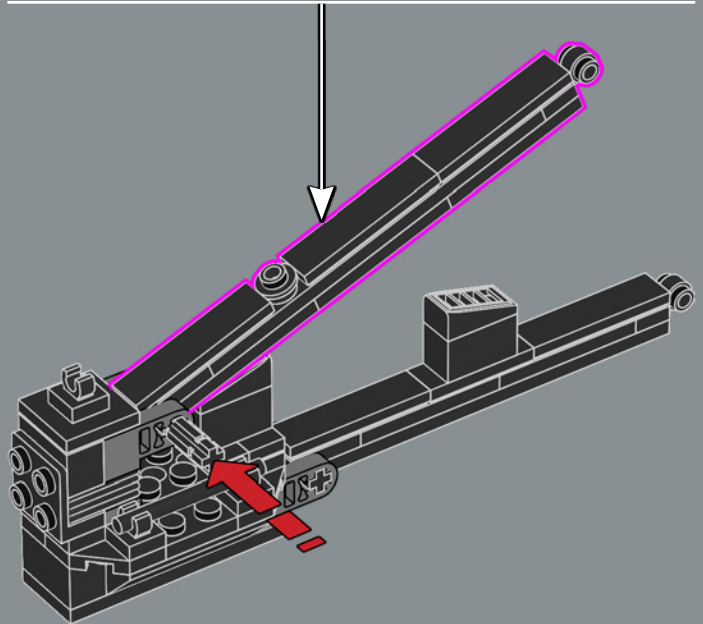
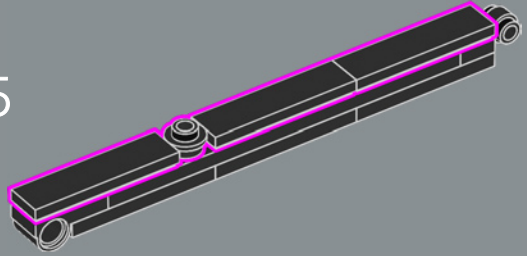



56

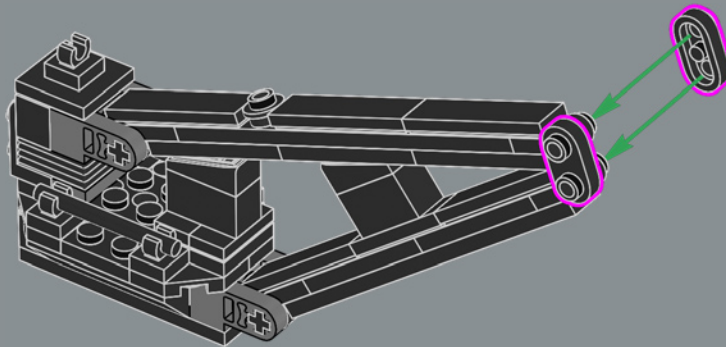

57

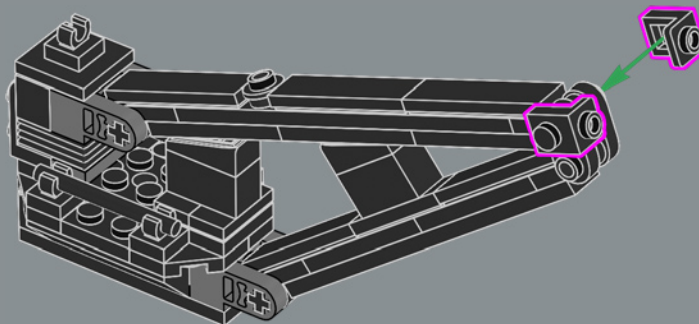

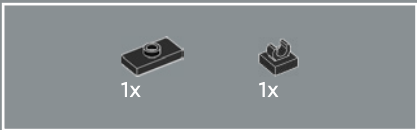

58

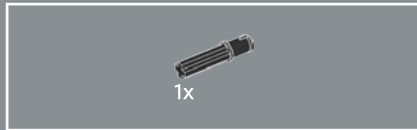
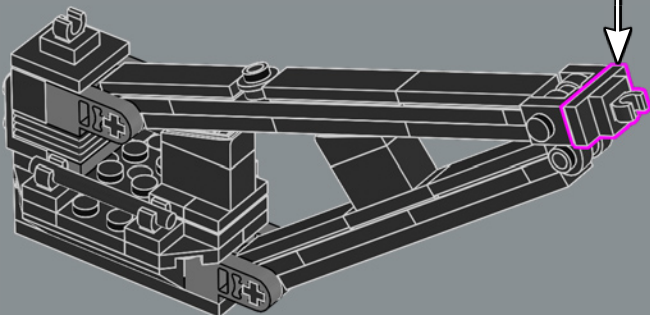
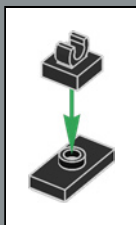

59

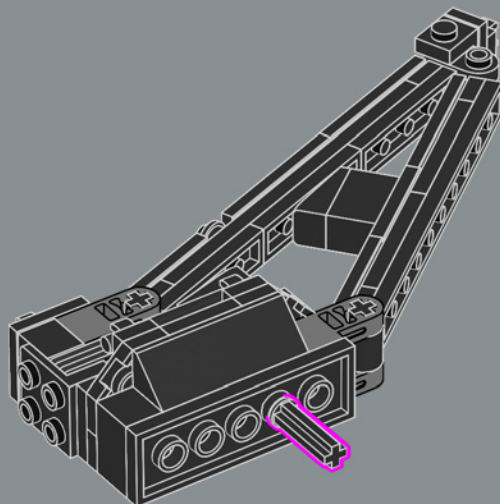

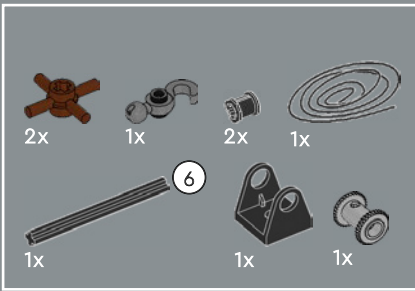

60

1

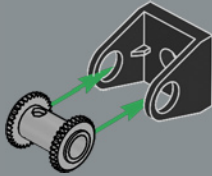

2

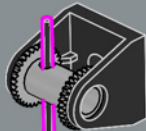

3

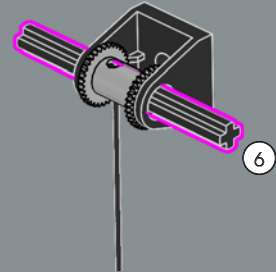

4

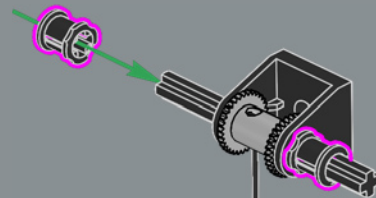

5

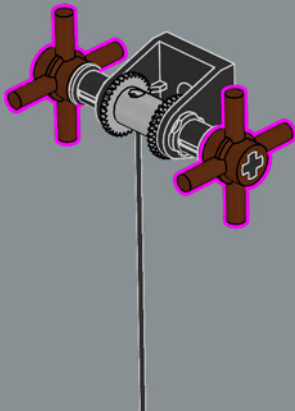

6

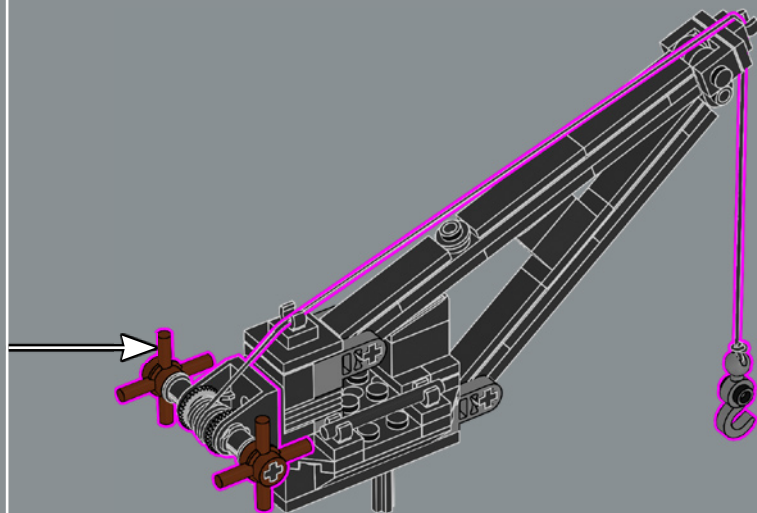
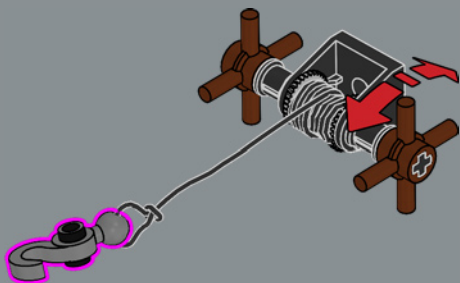



61

Con una grúa de mayor tamaño, el gobernador y su gente pueden levantar y mover cargas aún más pesadas.

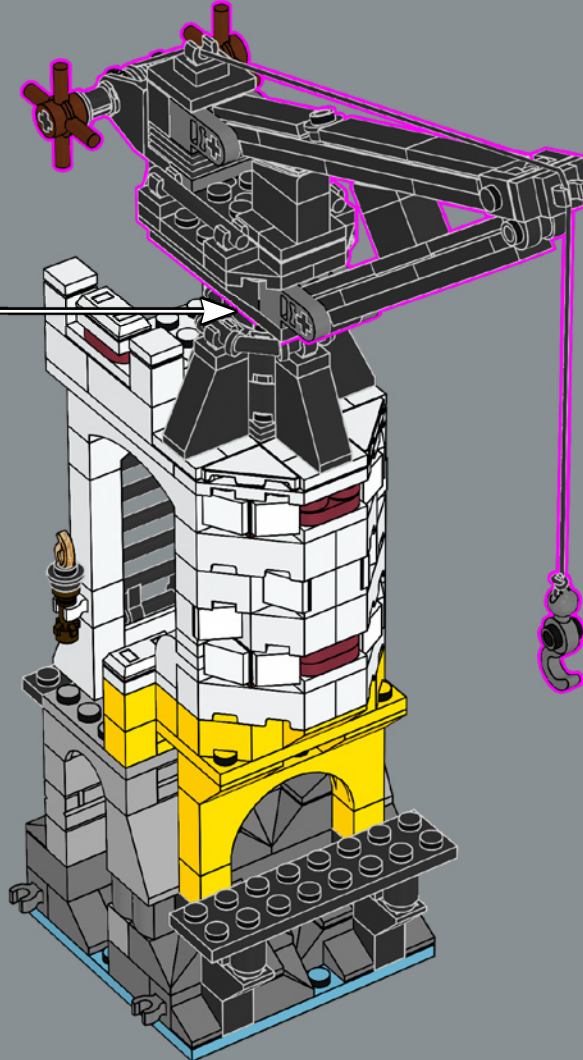

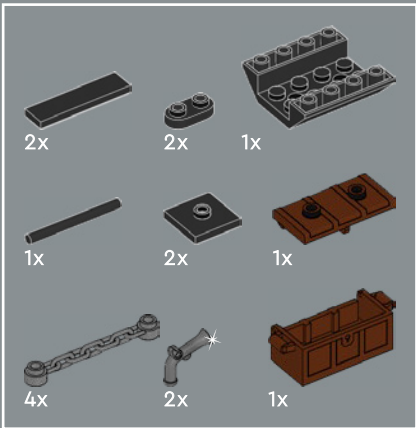

62

1

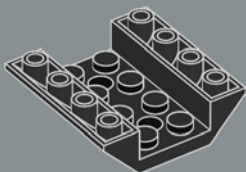

2

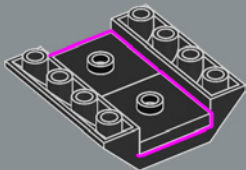

3

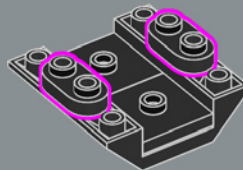

4

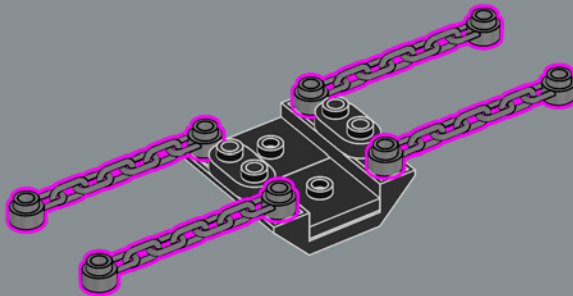

5

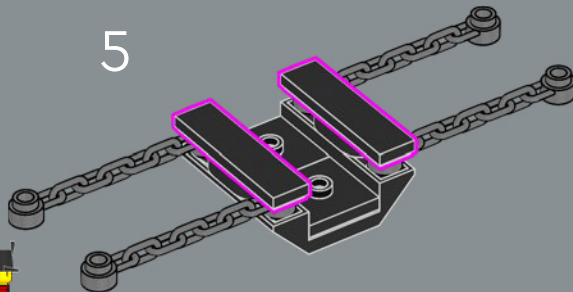

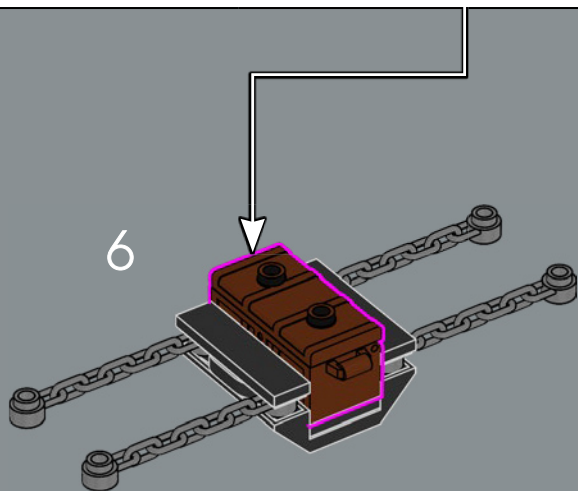
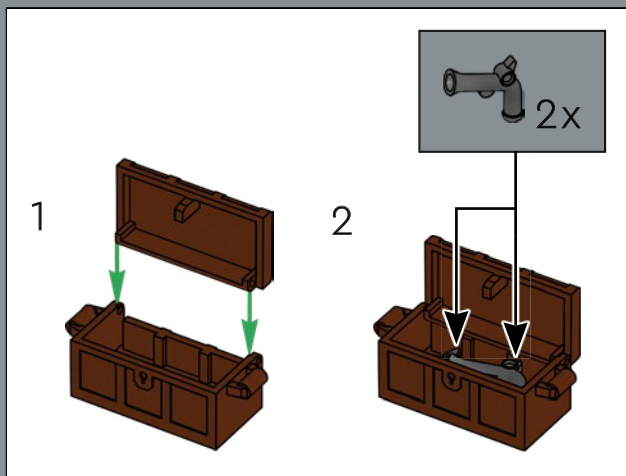

7

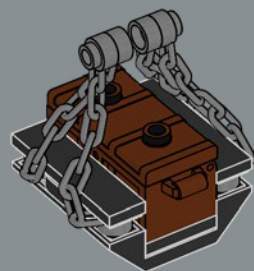

8

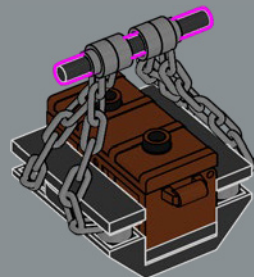

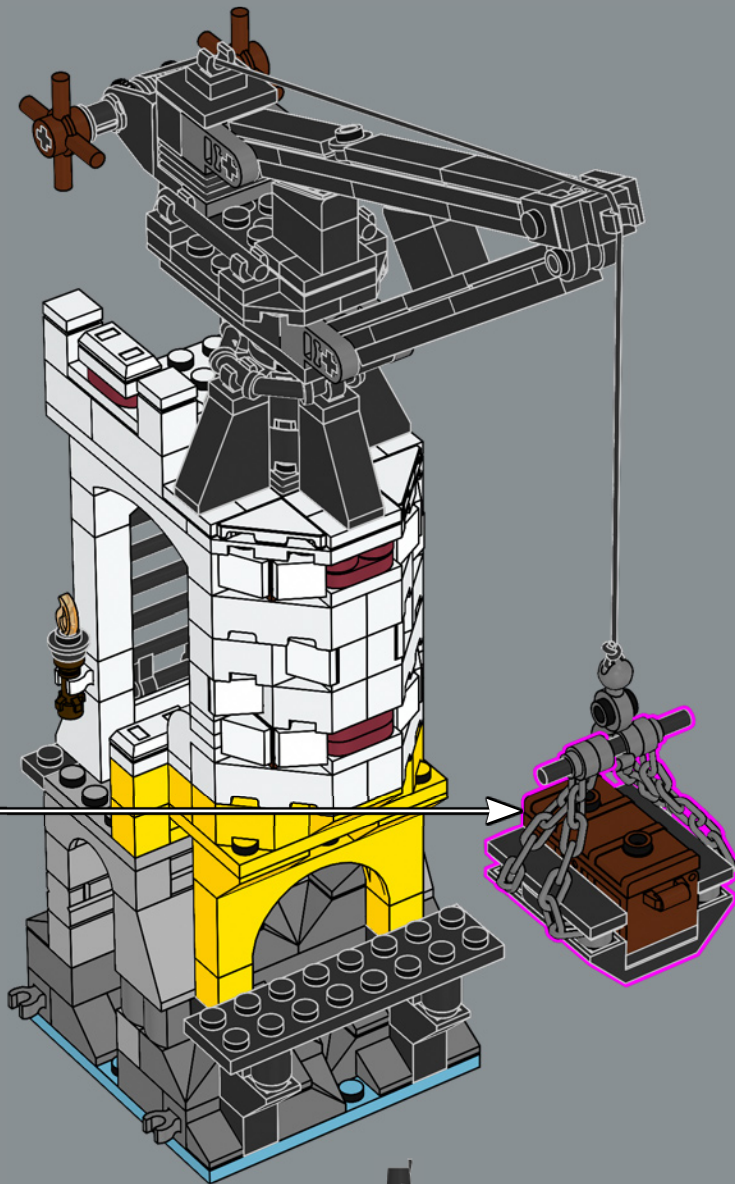

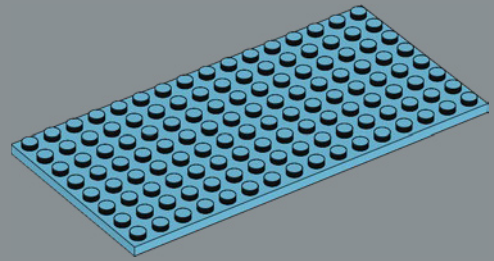
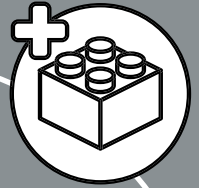

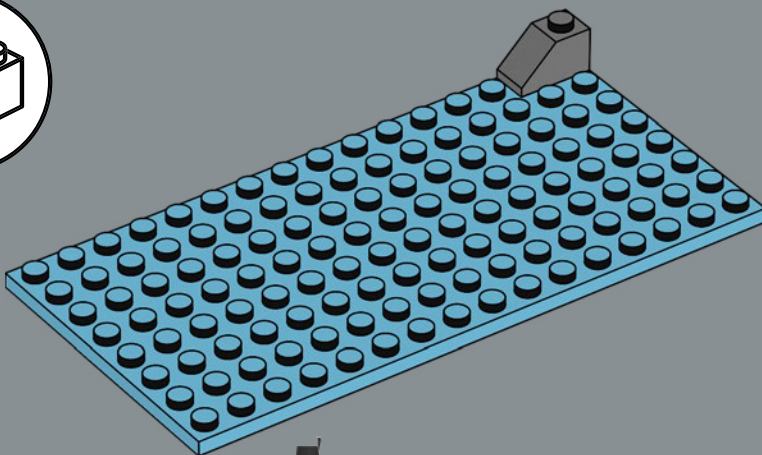
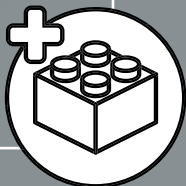
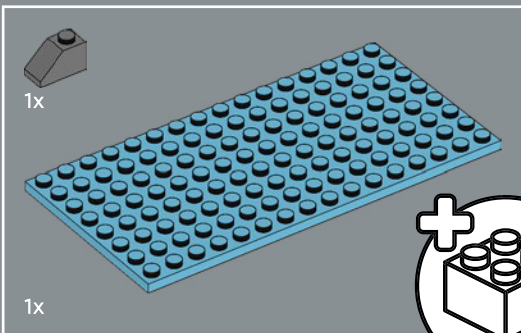
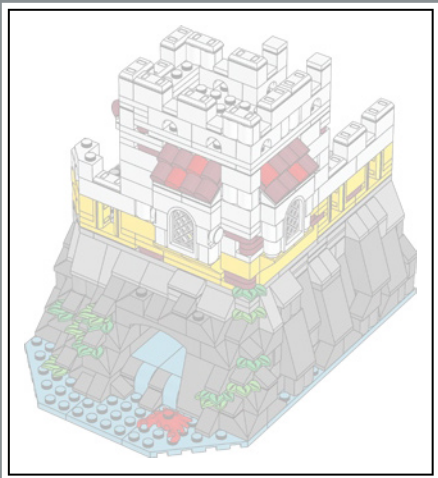

1



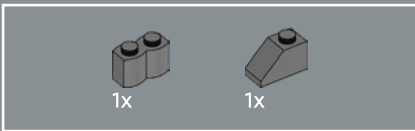

2

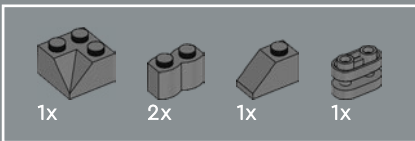
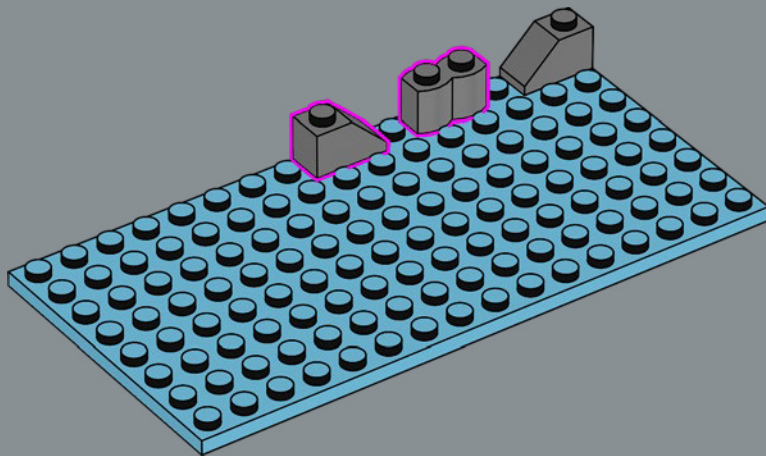

3

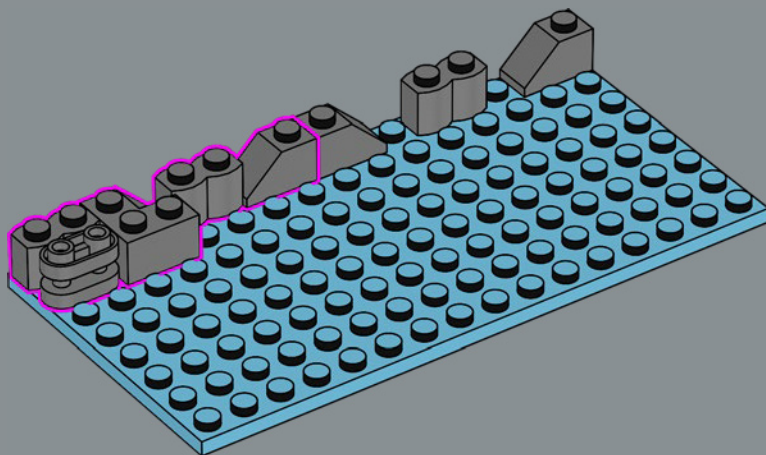

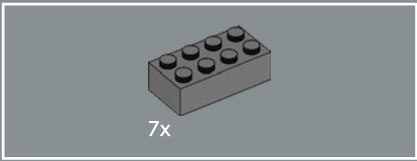

4

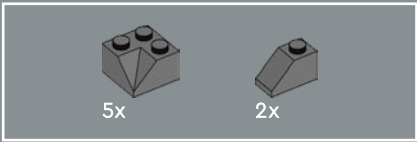
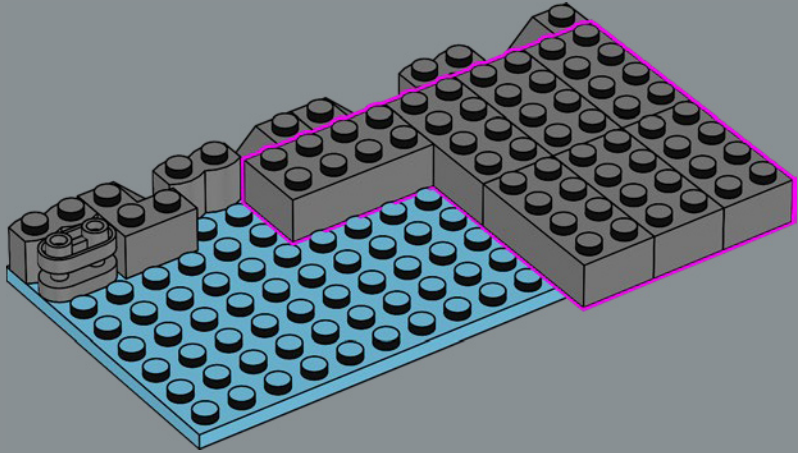

5

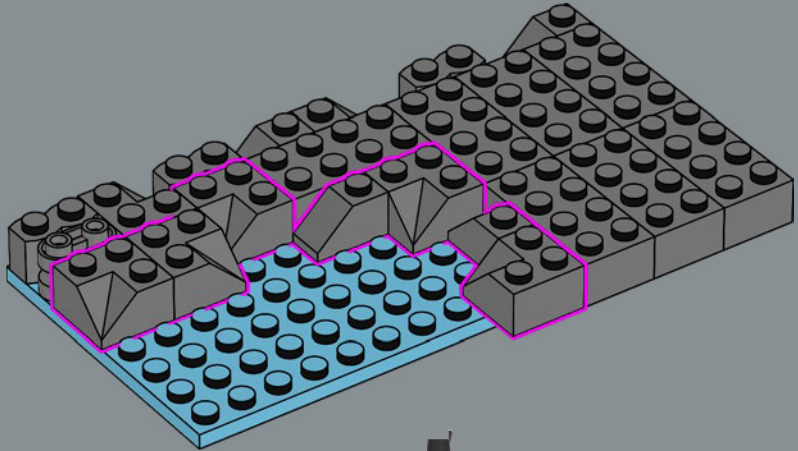

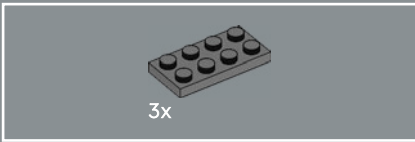

6

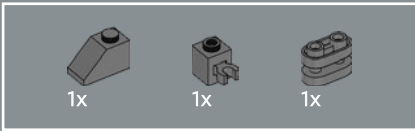
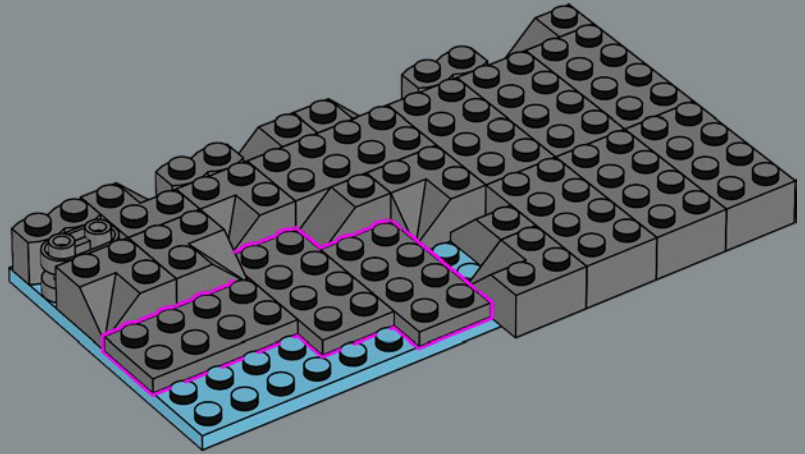

7

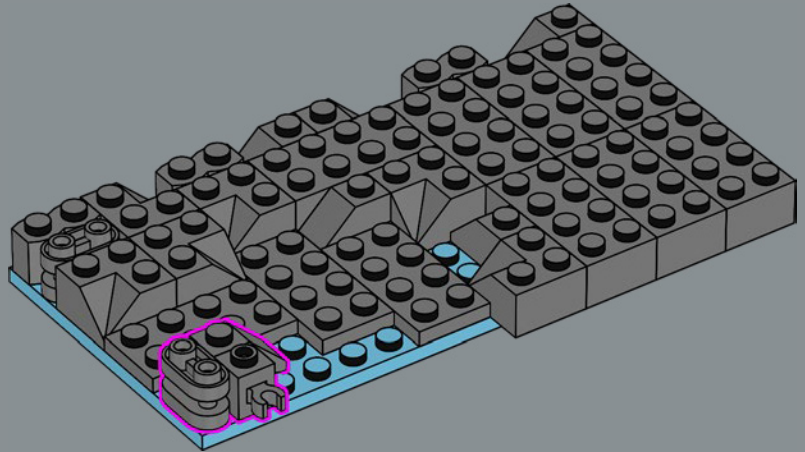

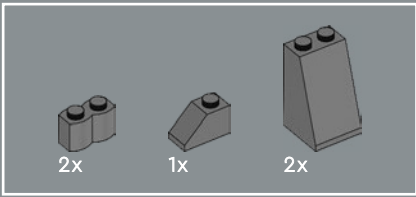

8

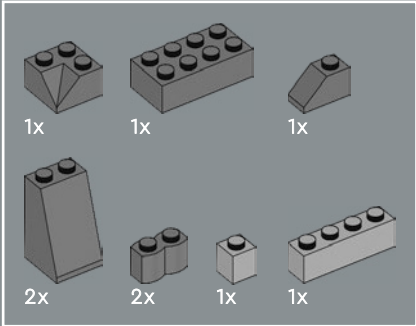
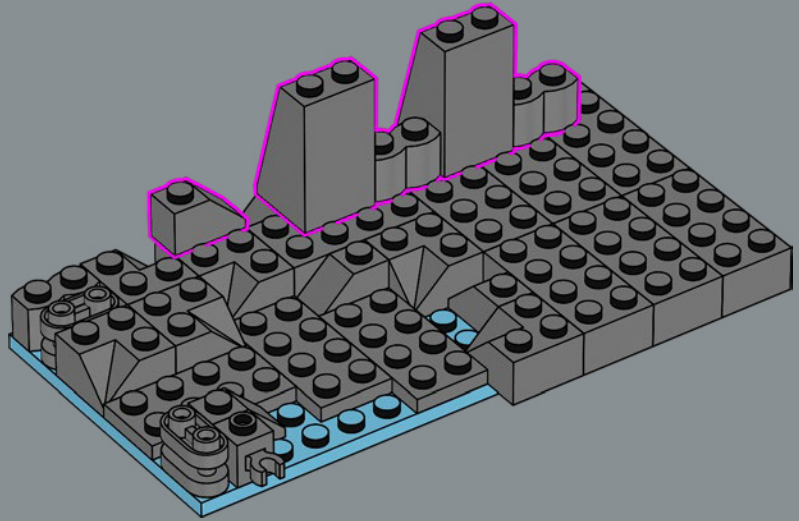

9

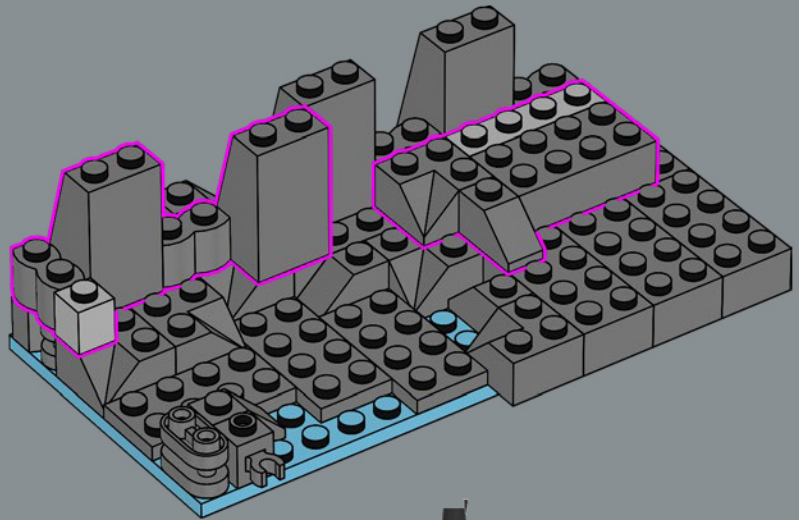

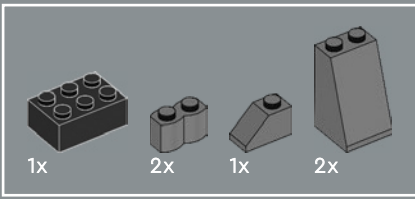

10

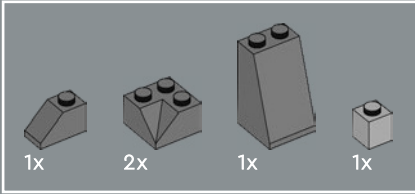
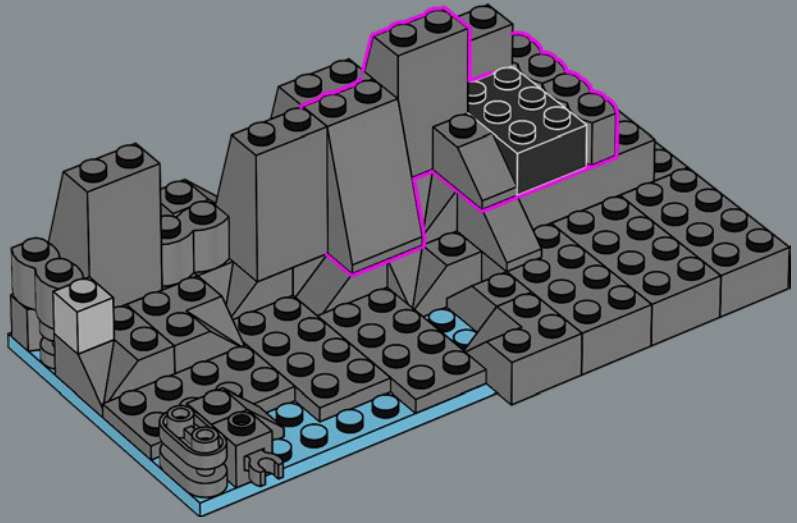

11

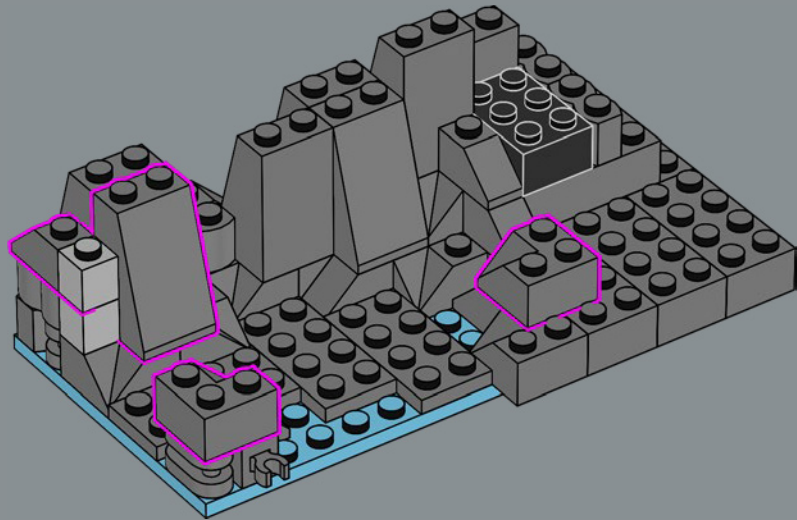

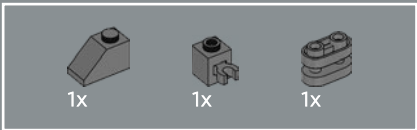

12

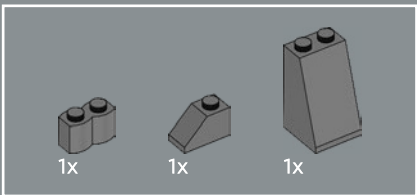
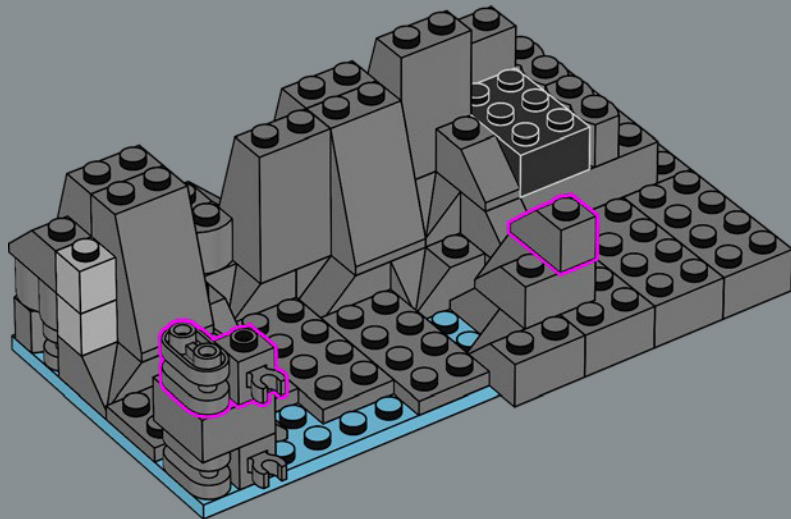

13

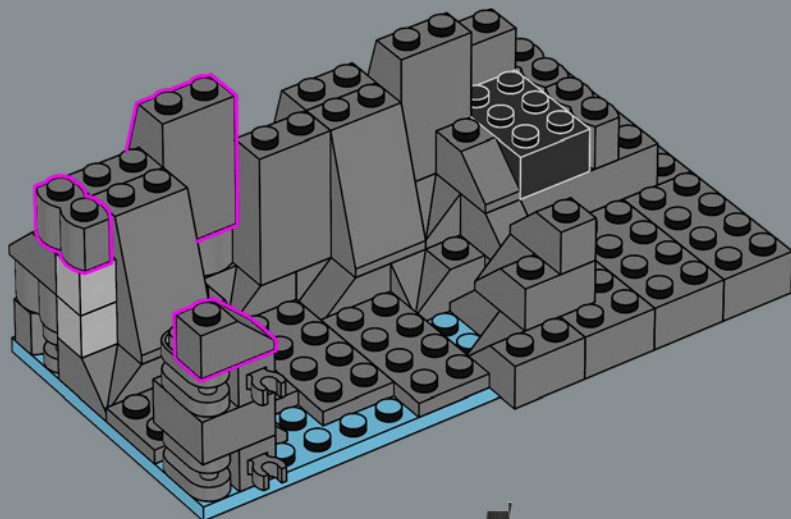

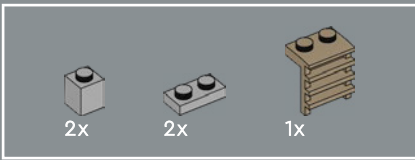

14

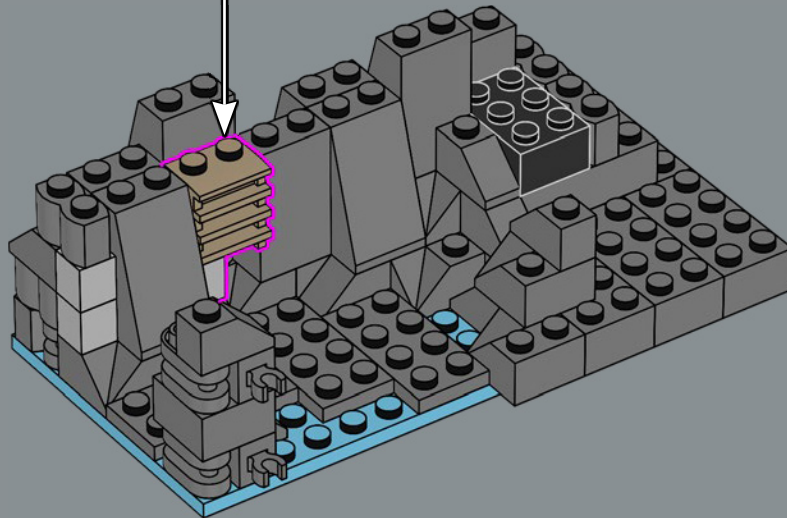
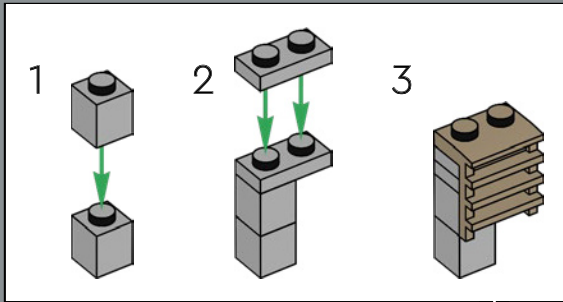

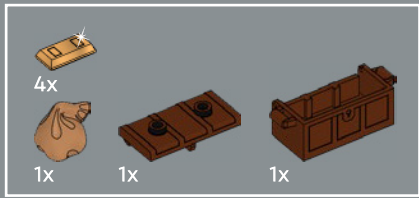

15

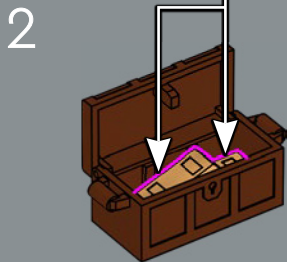
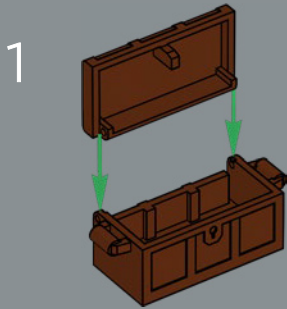

3

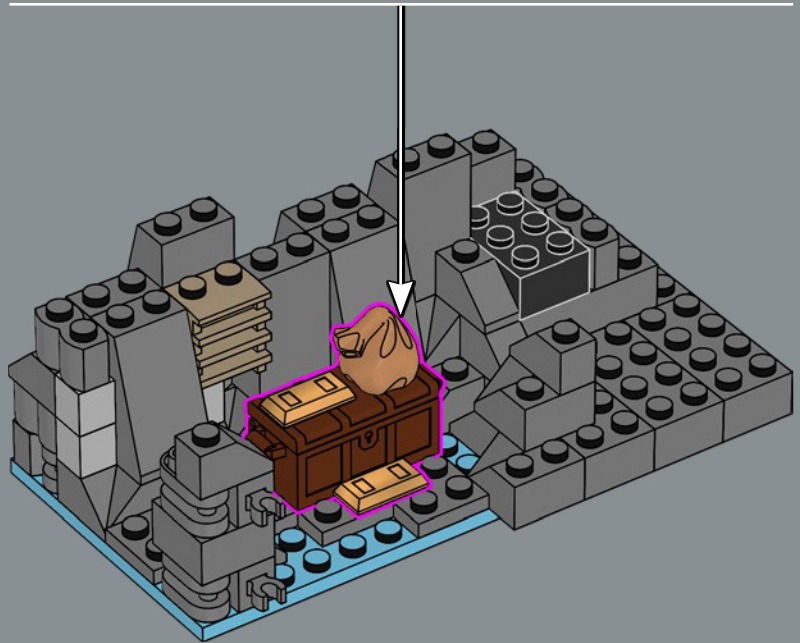

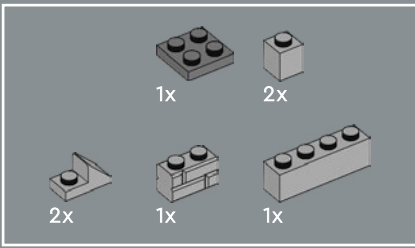

16

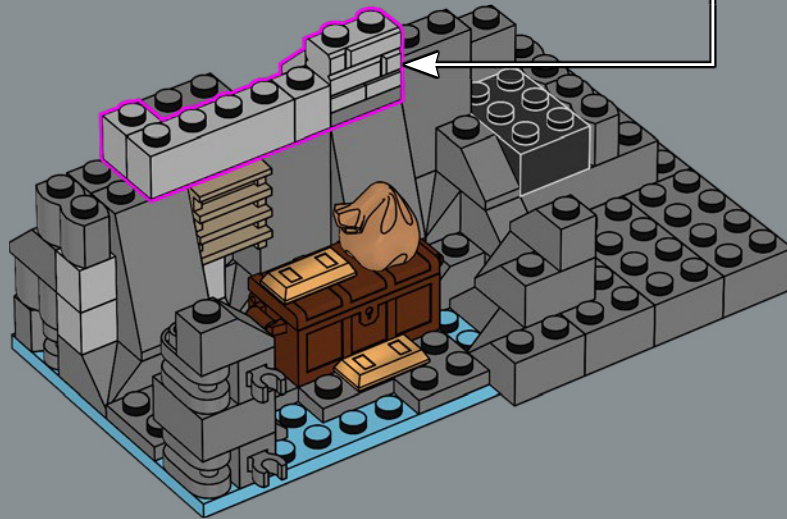
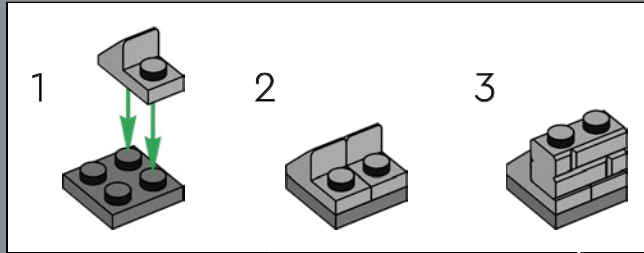

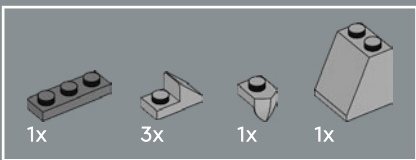

17

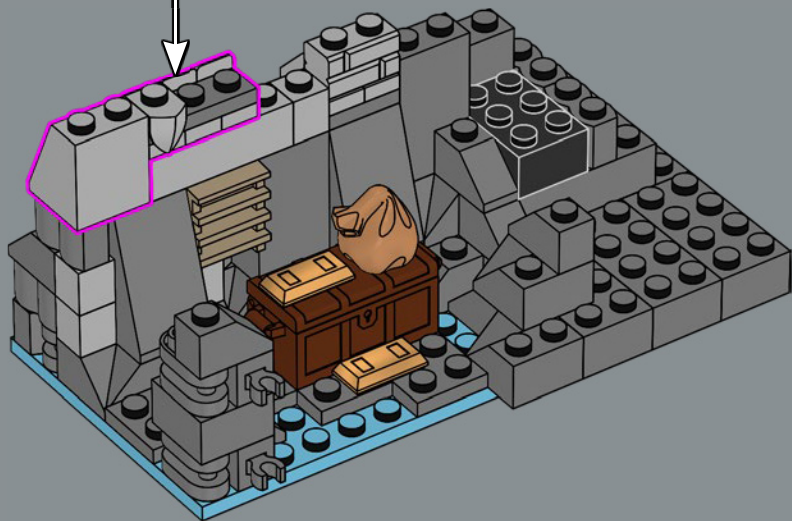
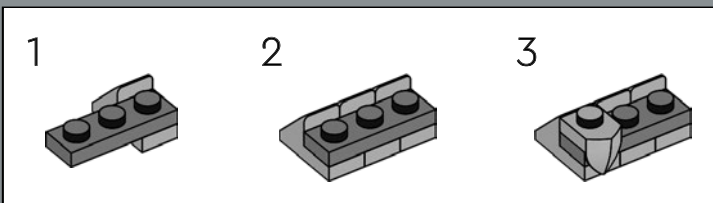

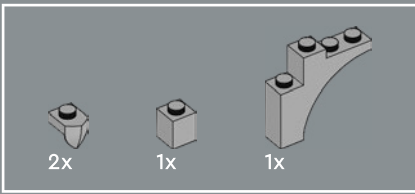

18

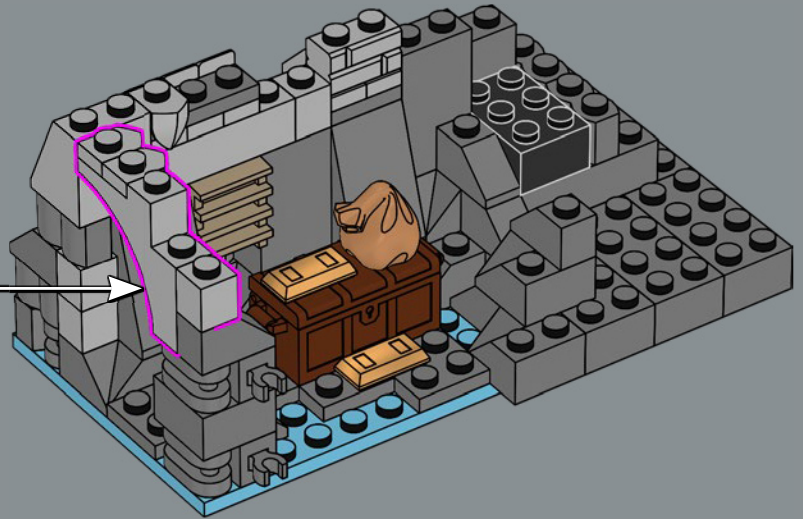
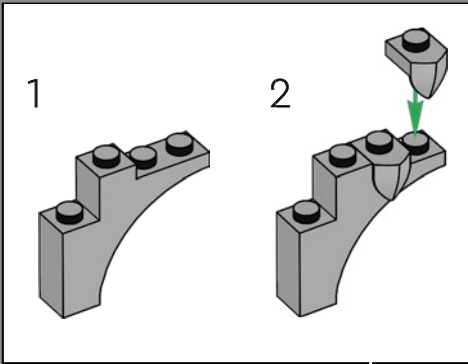

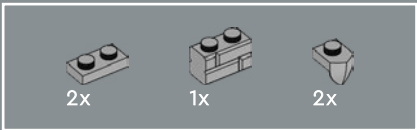

19

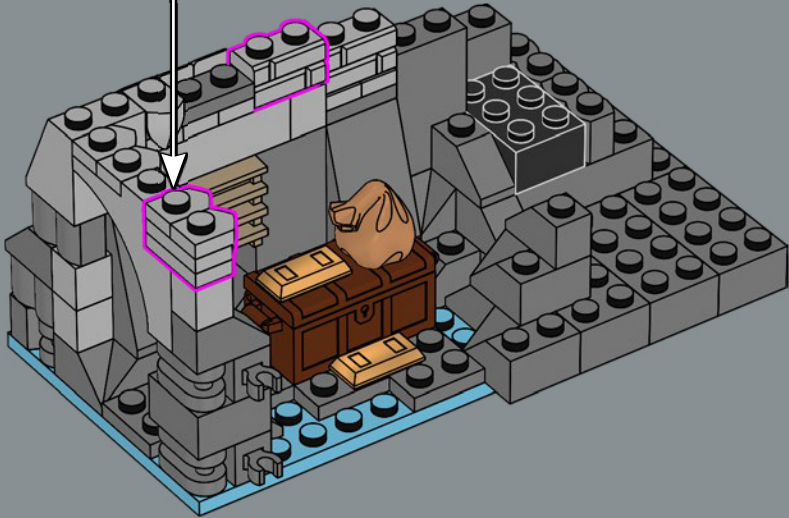
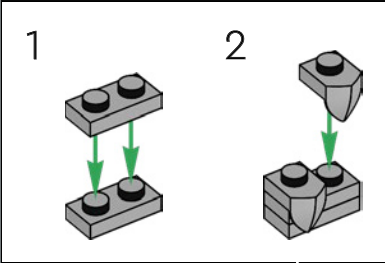

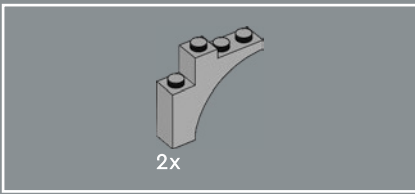

20

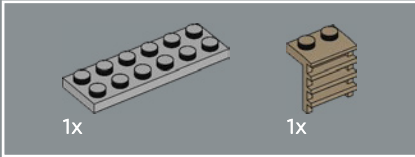
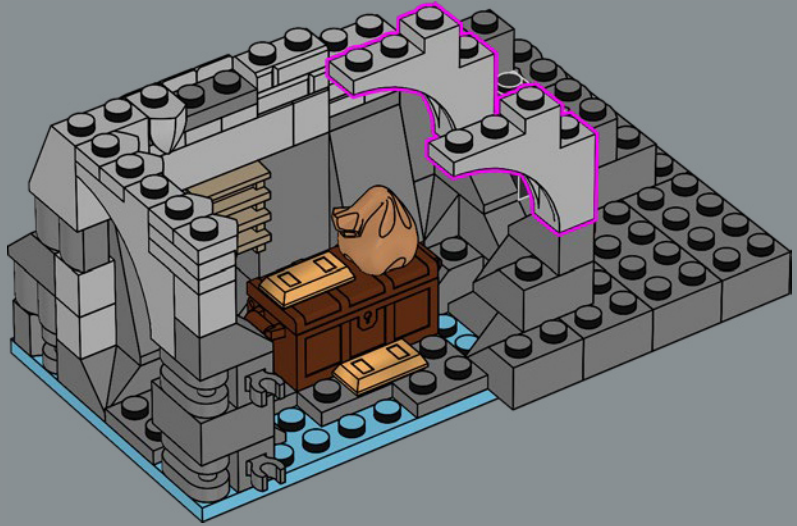

21

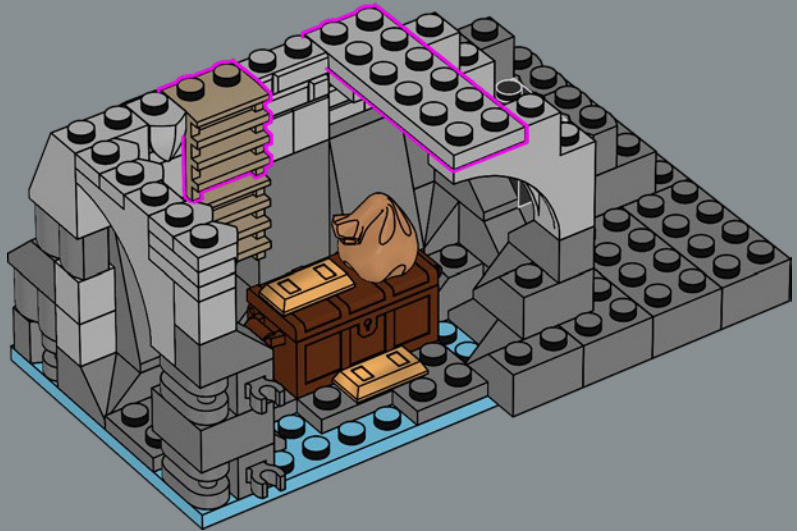

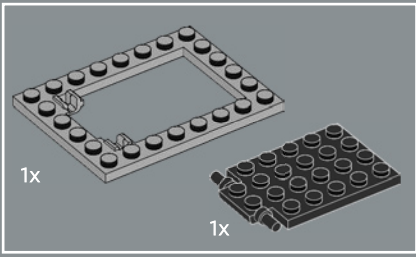

22

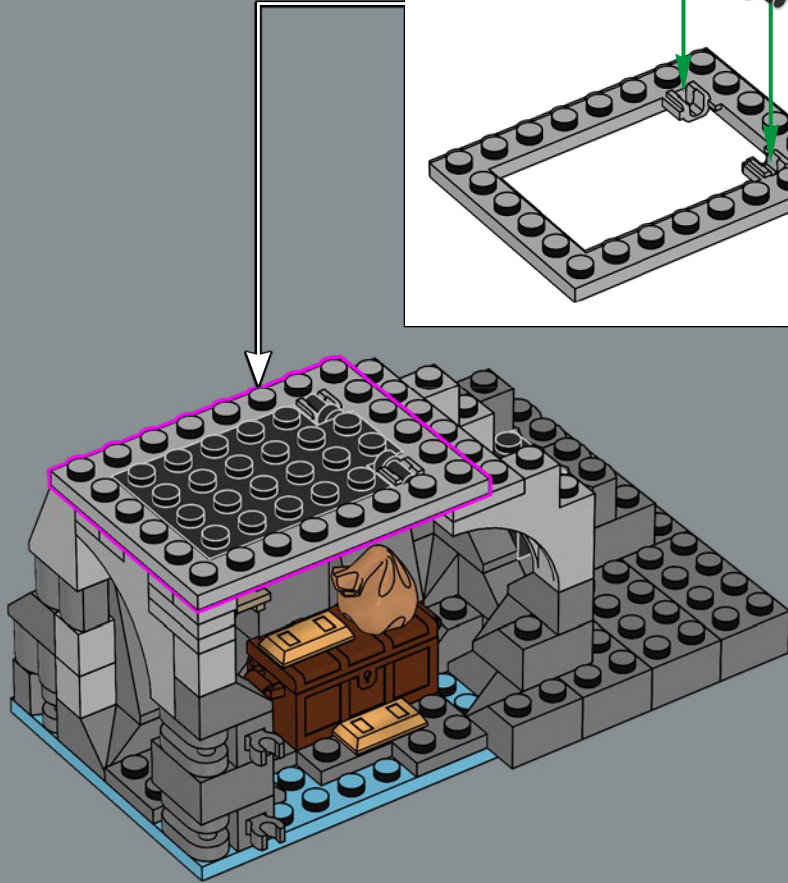
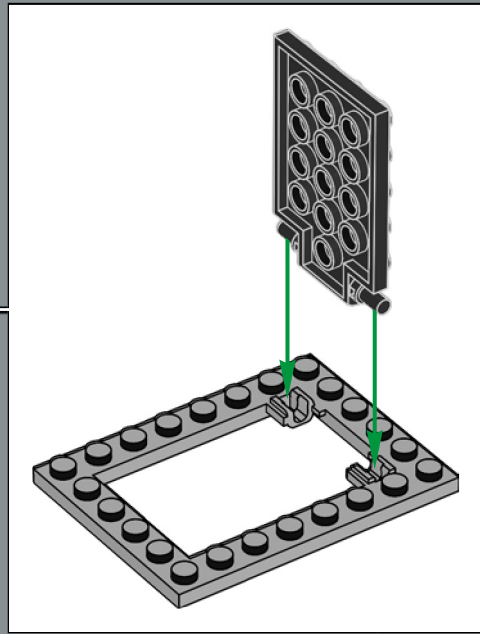

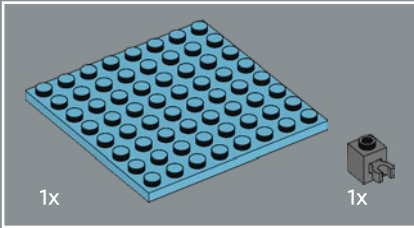
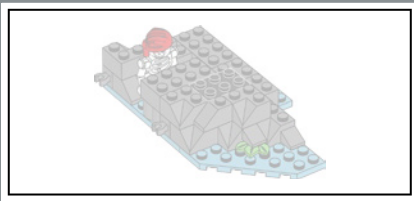

23

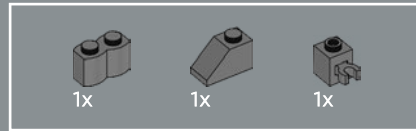
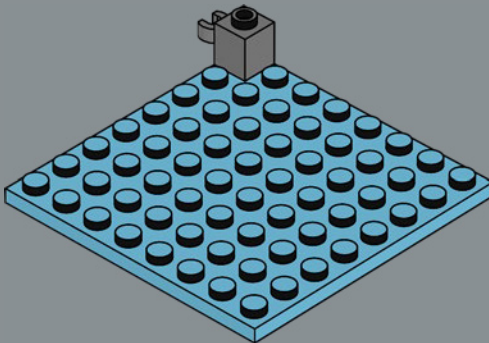

24

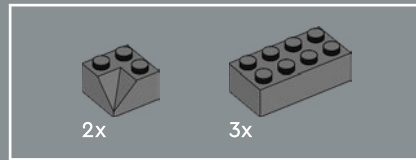
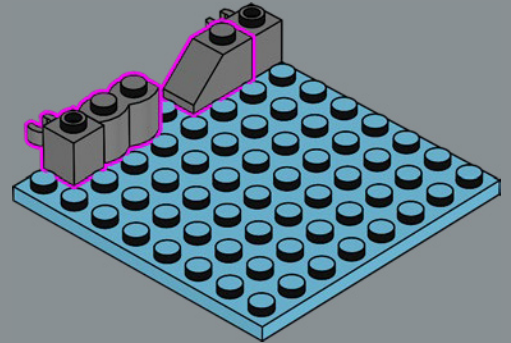

25

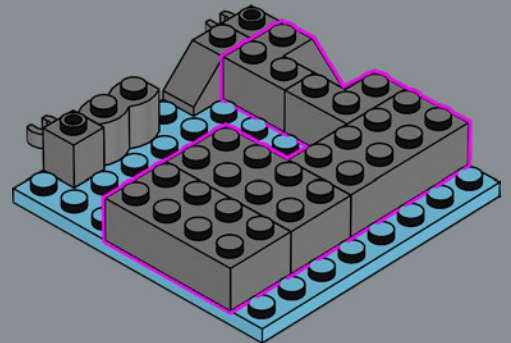

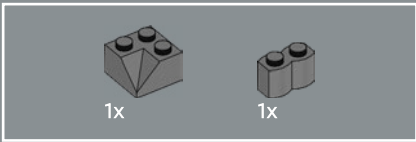

26



Se desconoce cómo encontró su destino este pobre esqueleto. ¿Quizá tratando de escapar? ¿O llegó hasta aquí buscando la carta oculta?

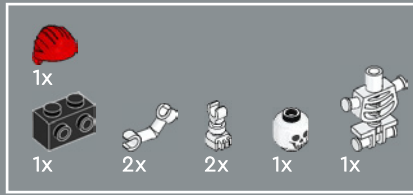

27

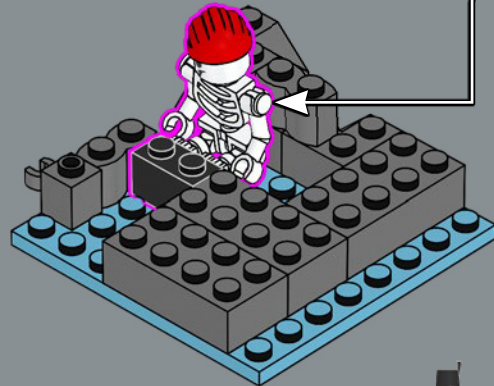
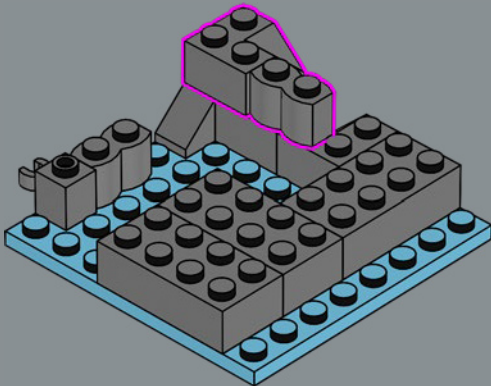
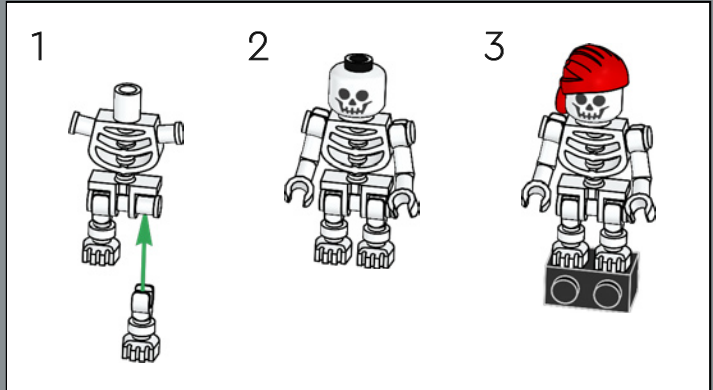

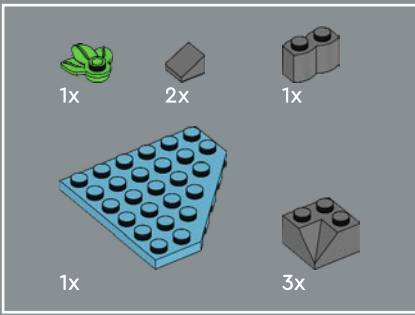

28

1

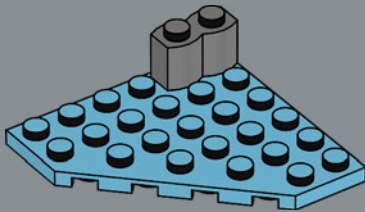

2

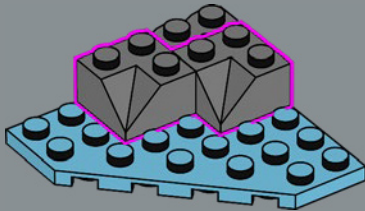

3

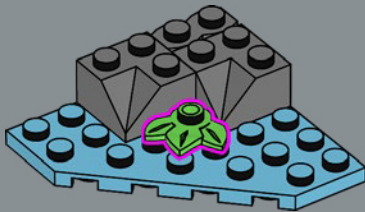

4

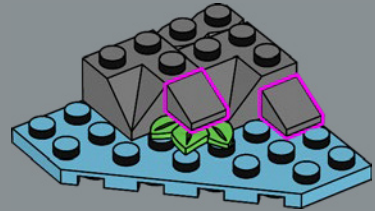

5

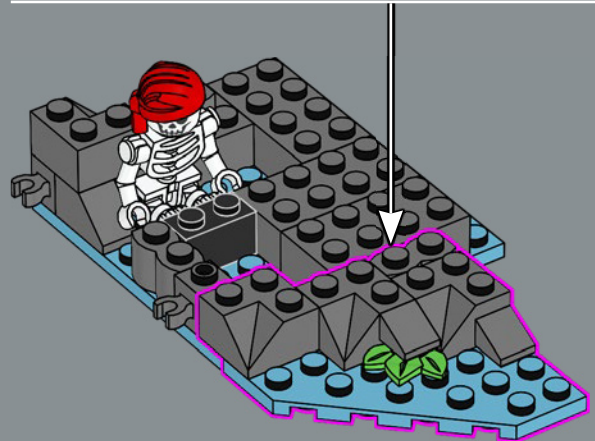
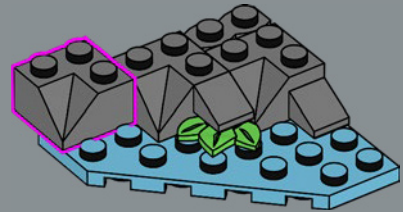

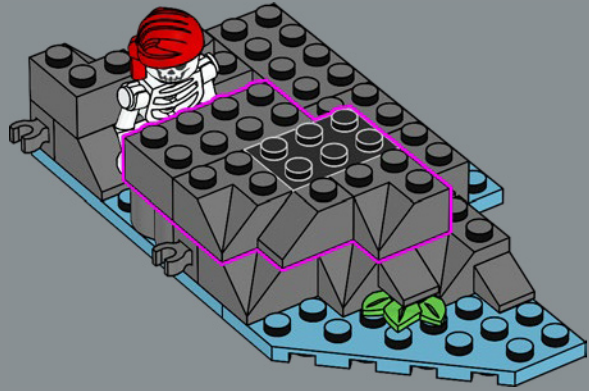
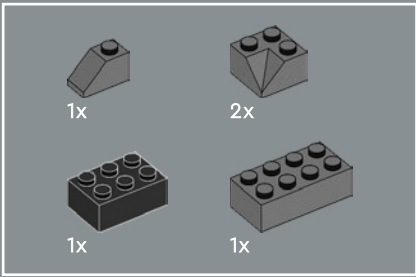

29

30

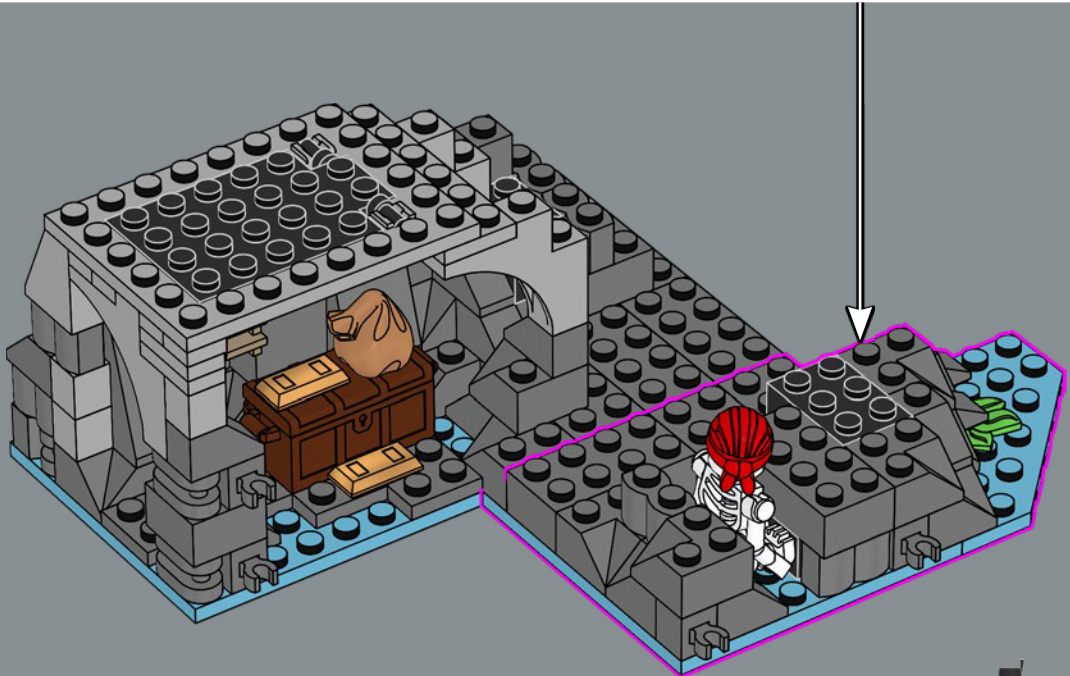

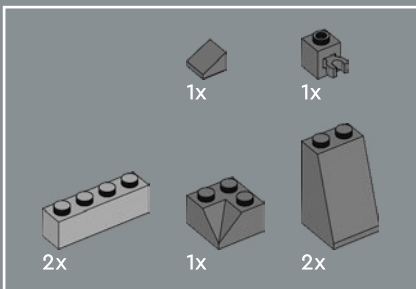

31

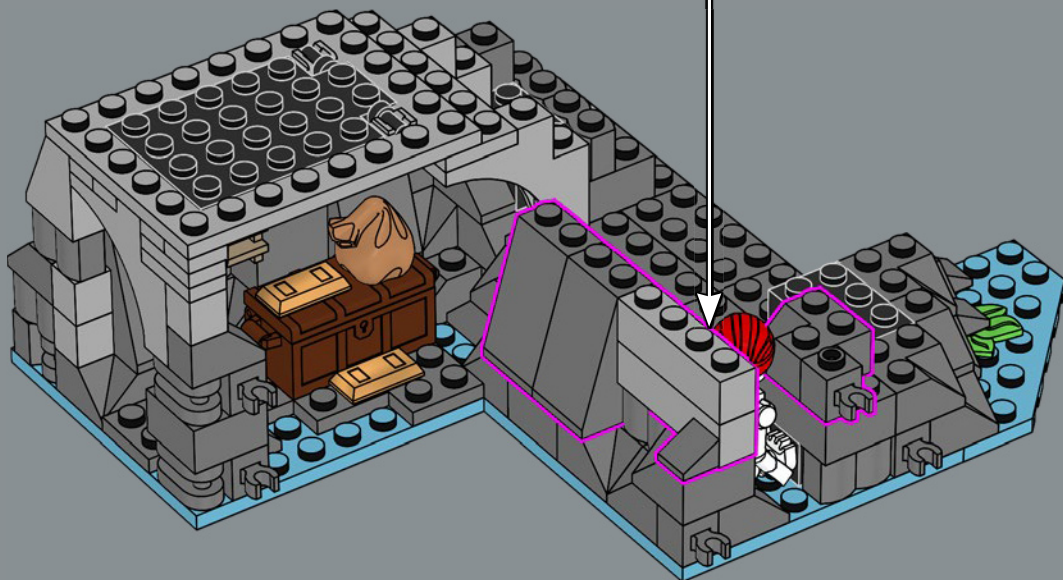
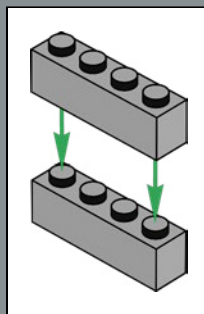

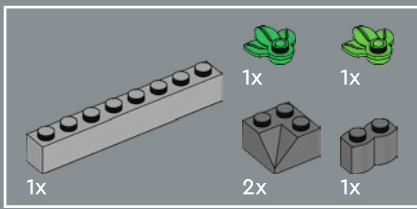

32

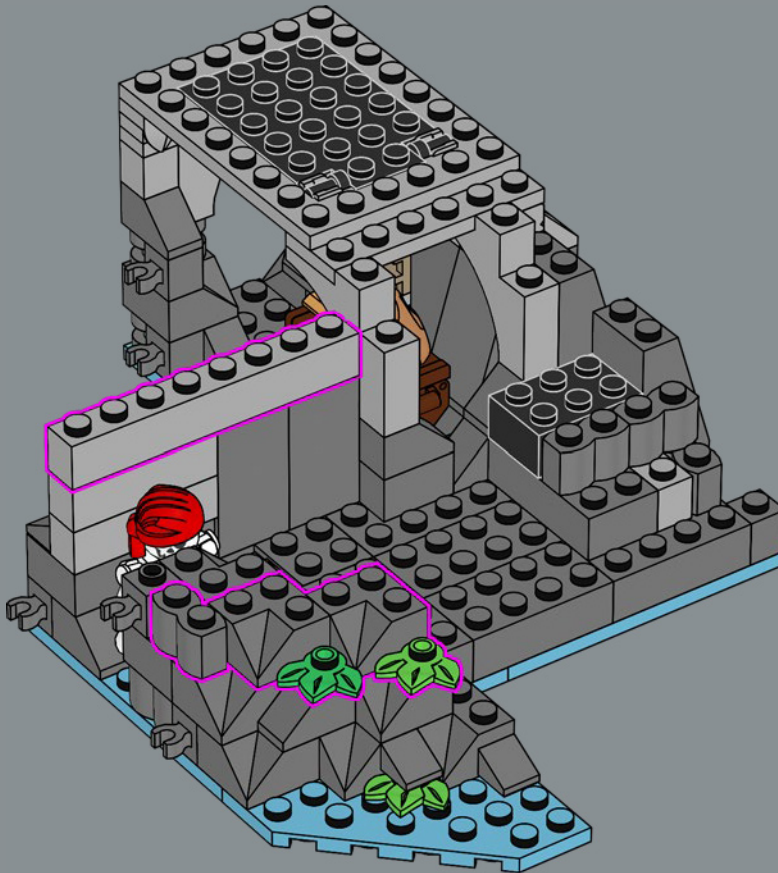

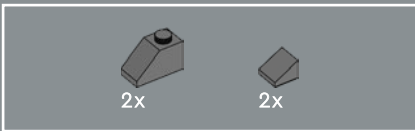

33

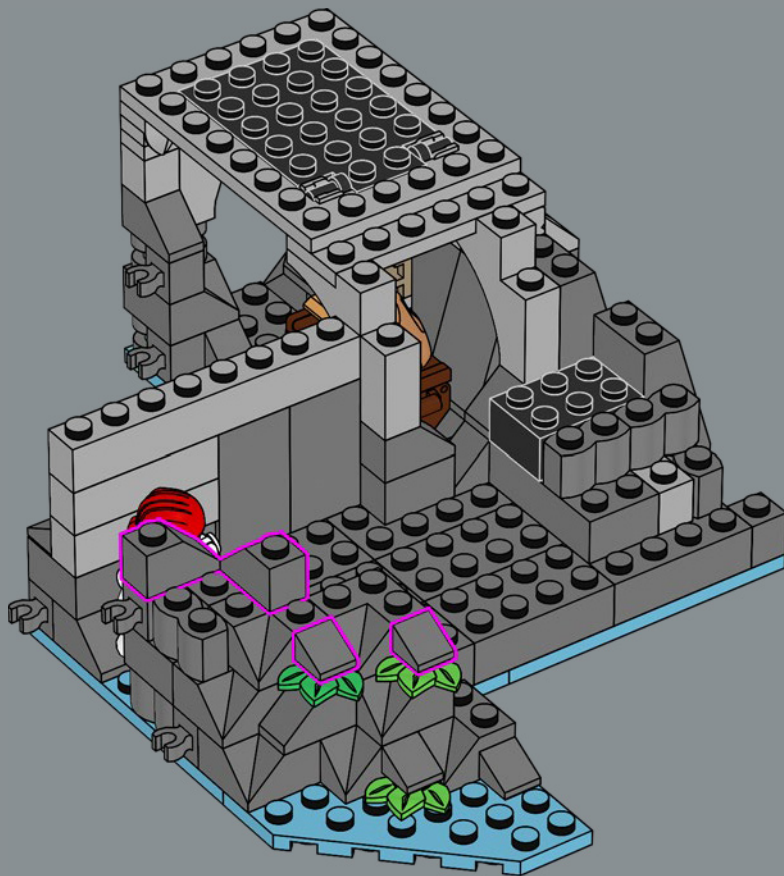

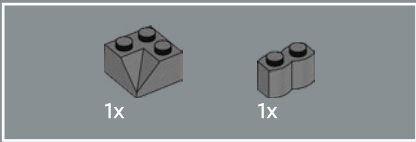

34

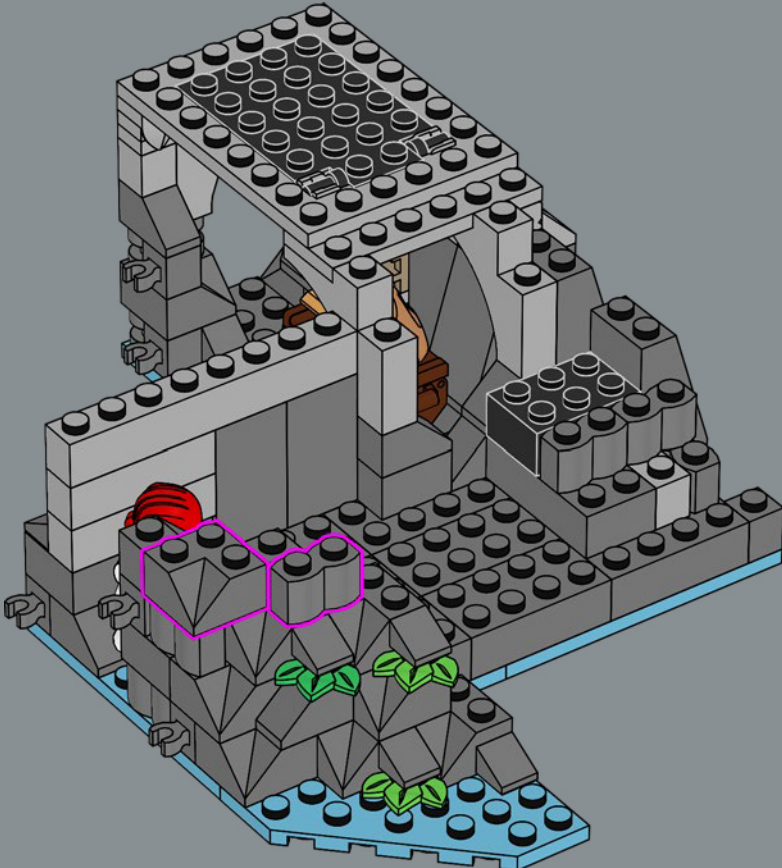

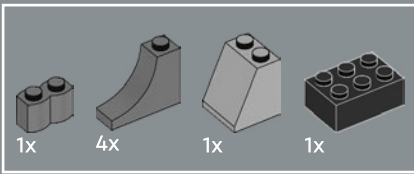

35

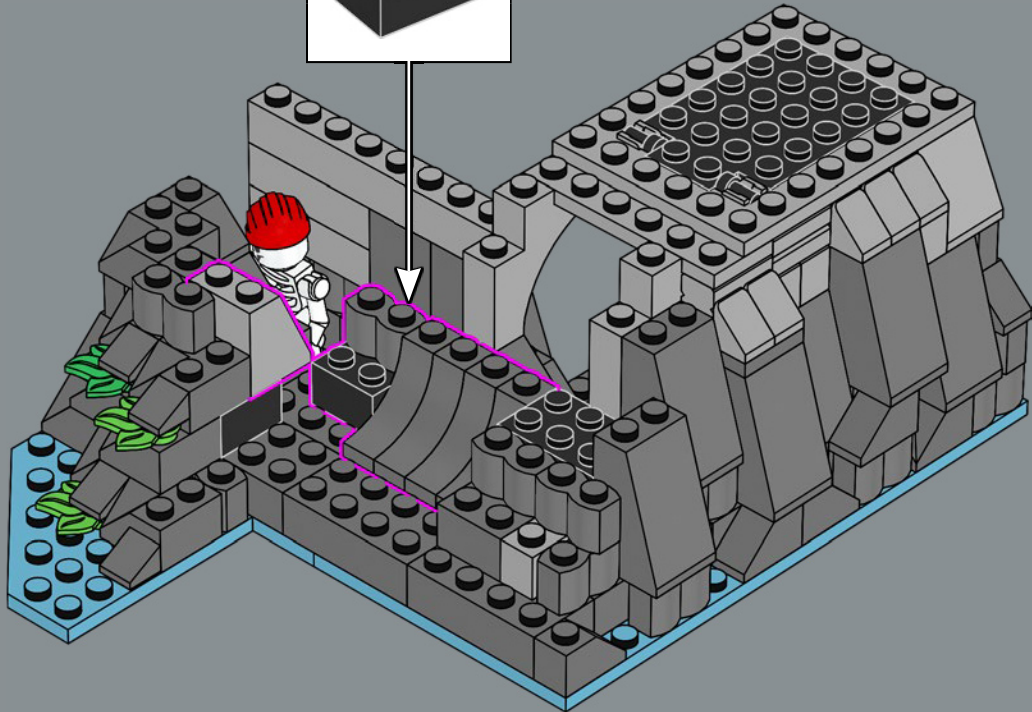
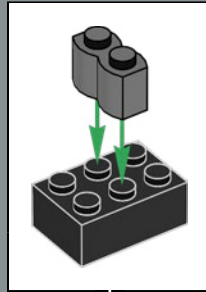

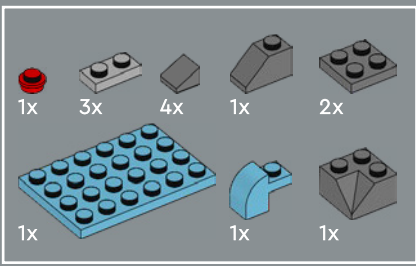

36

1

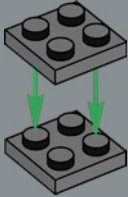

2

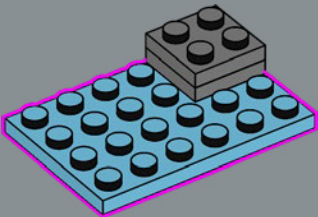

3

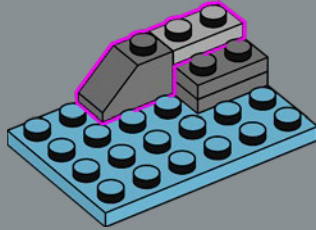

4

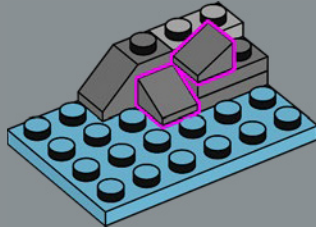

5

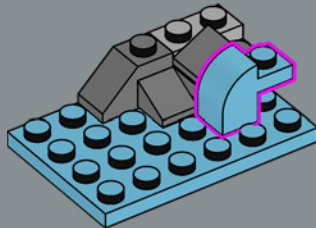

6

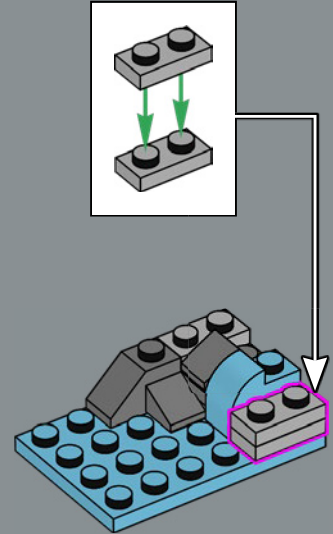

7

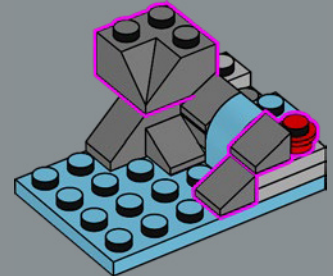

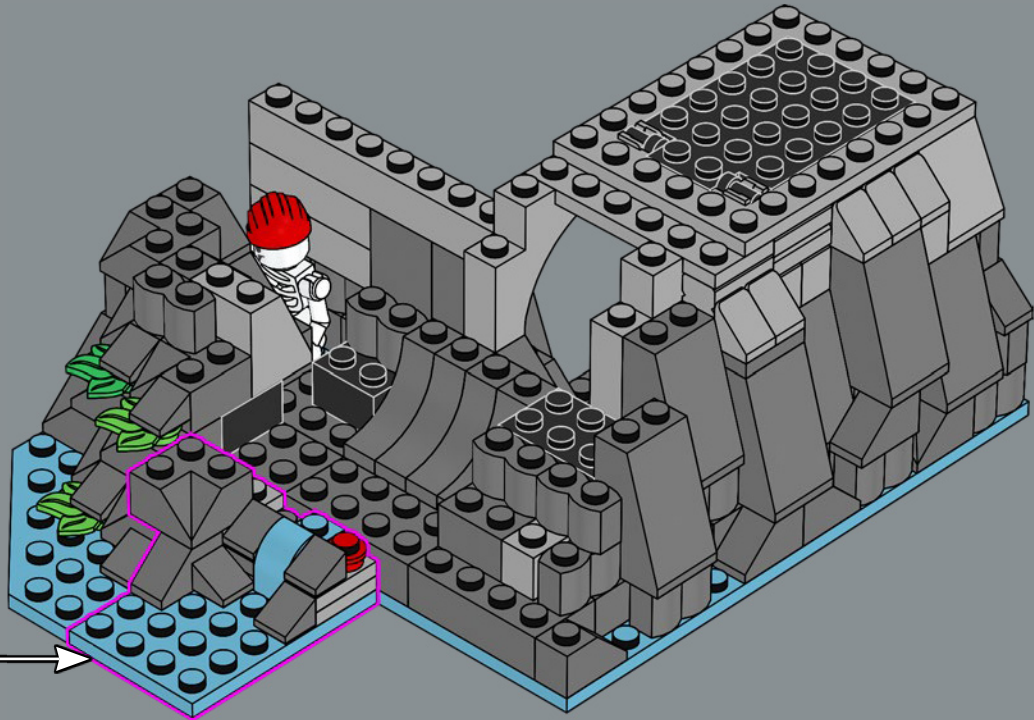

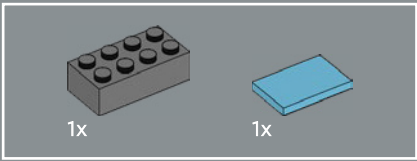

37

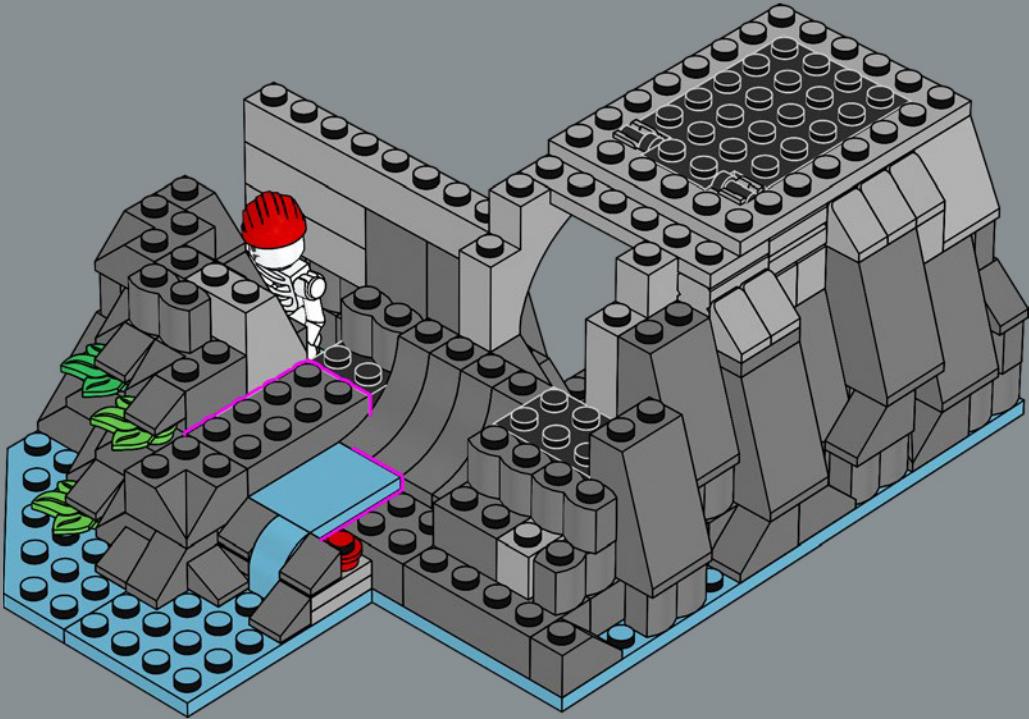

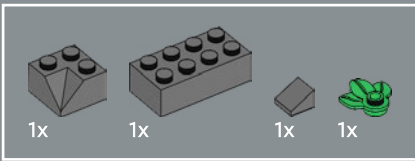

38

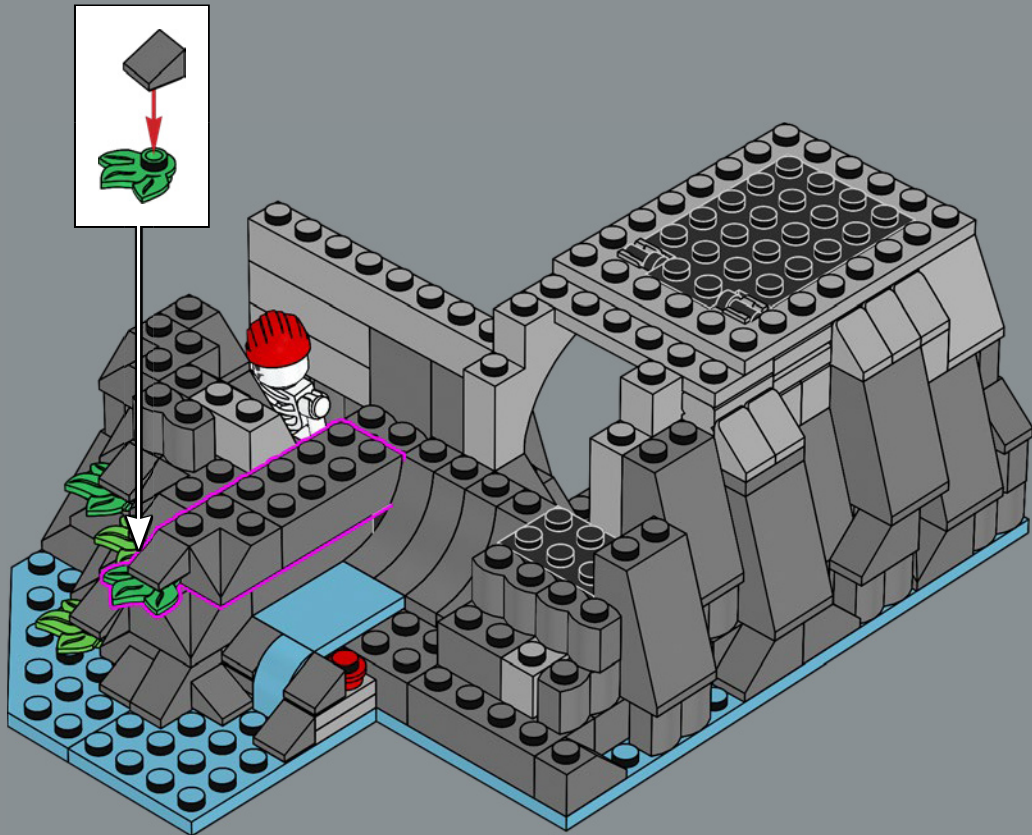

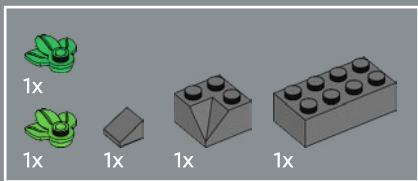

39

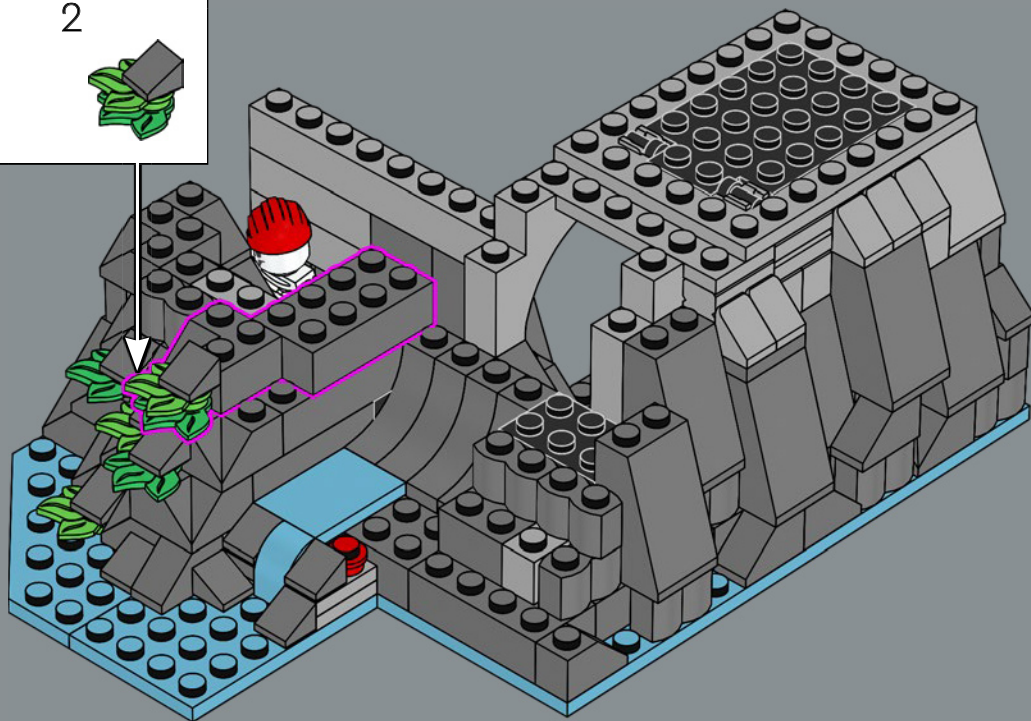
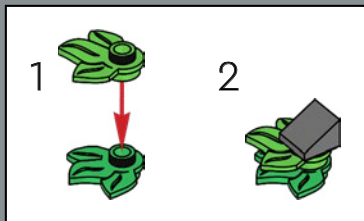

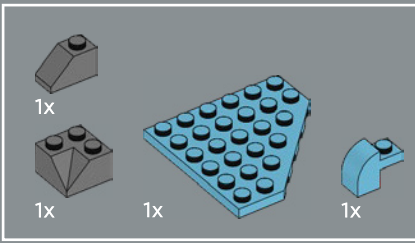

40

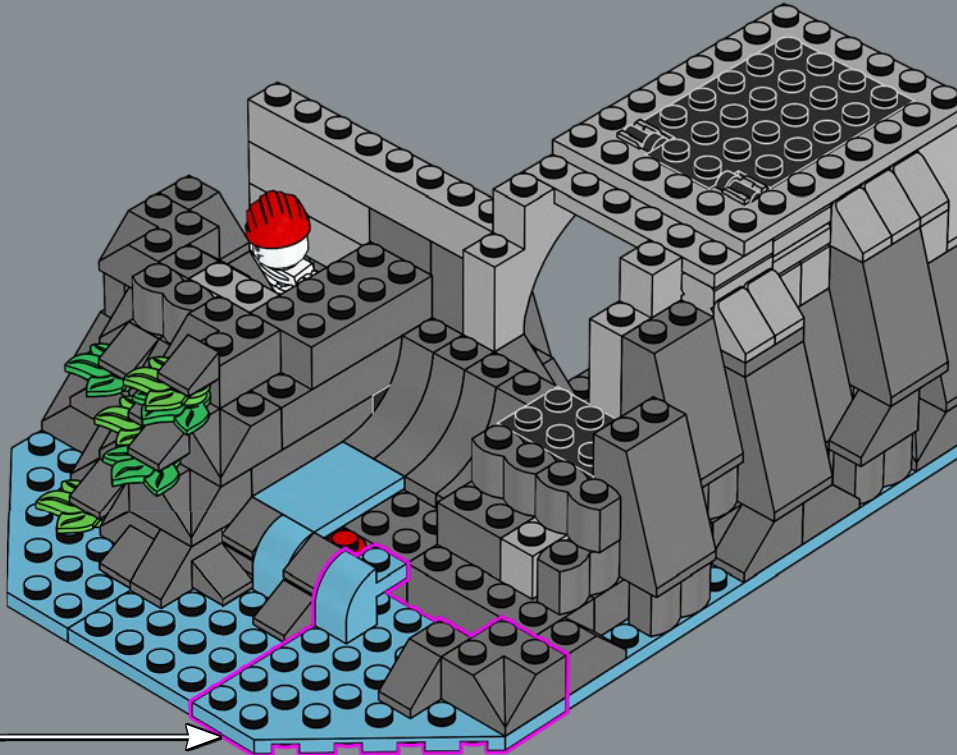
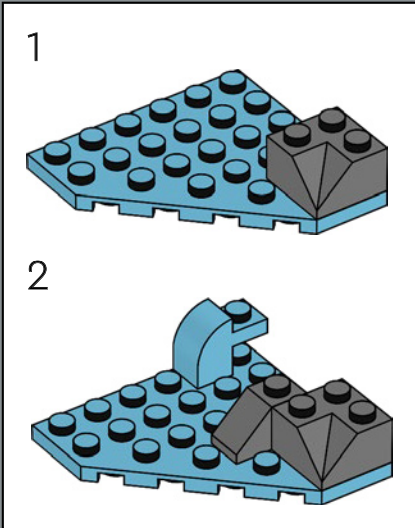

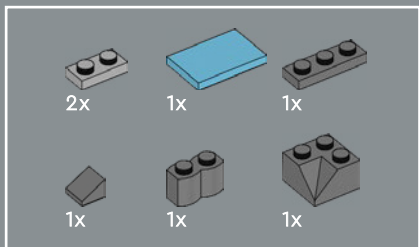

41

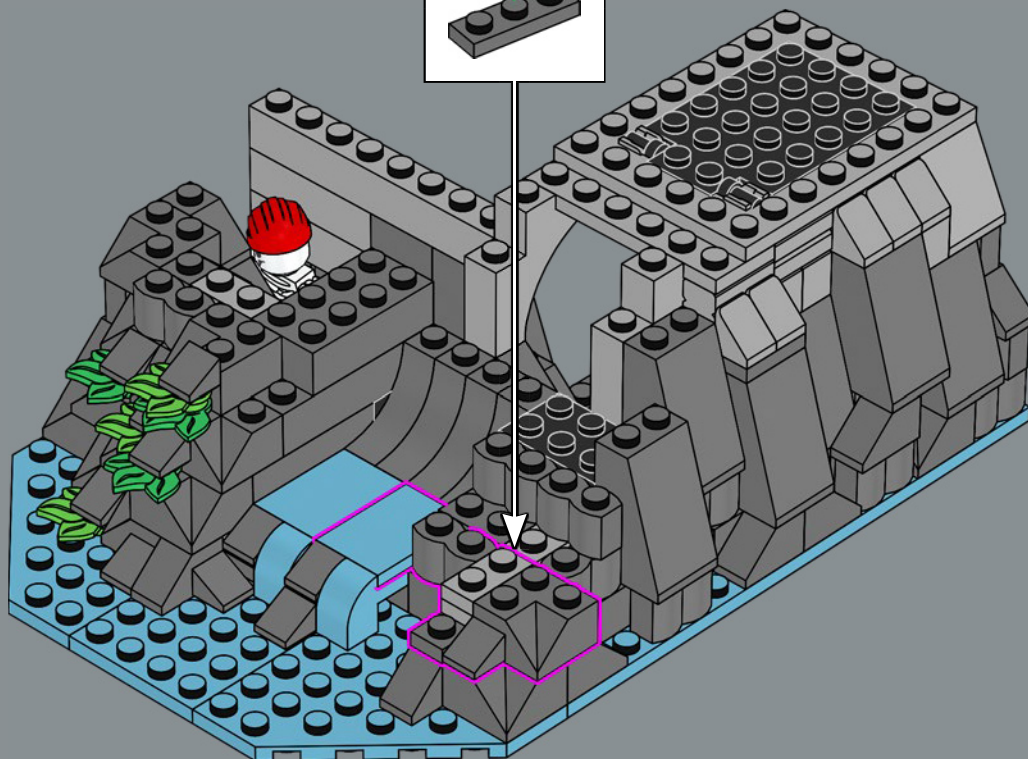
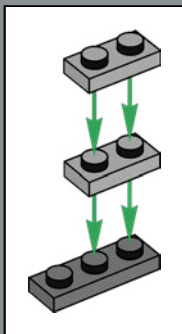

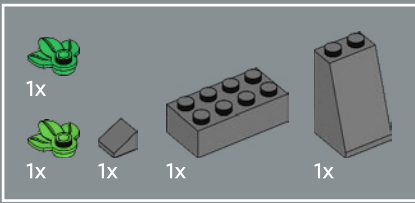

42

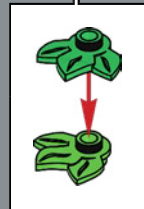
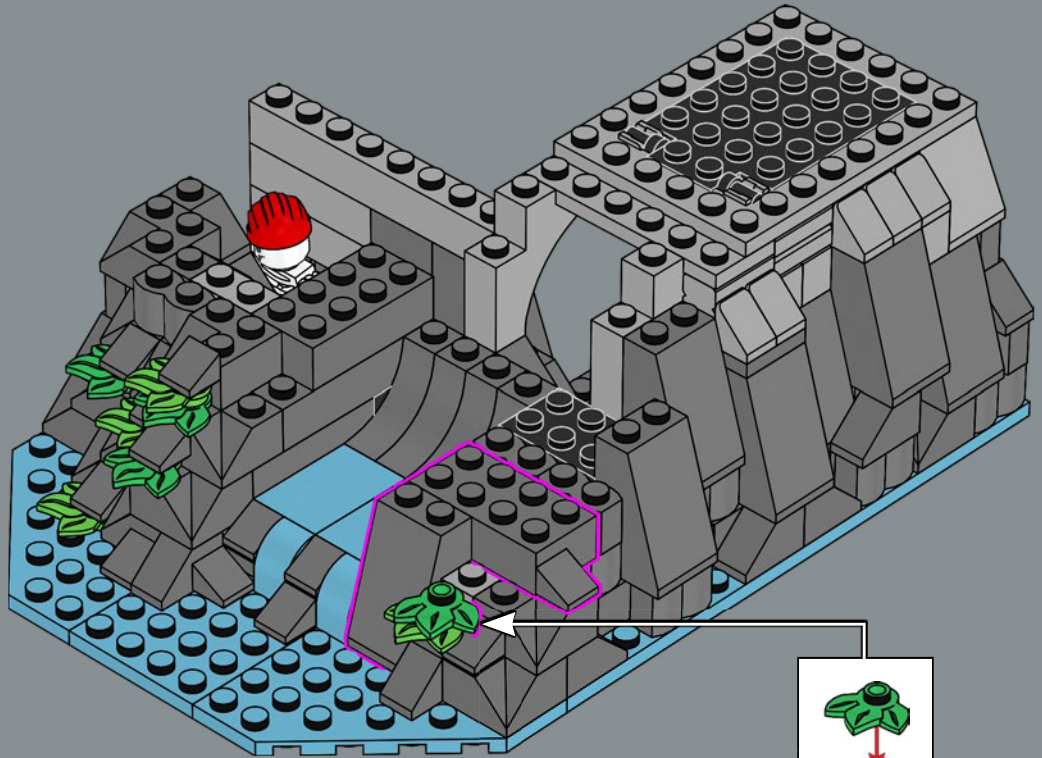

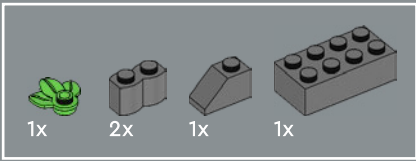

43

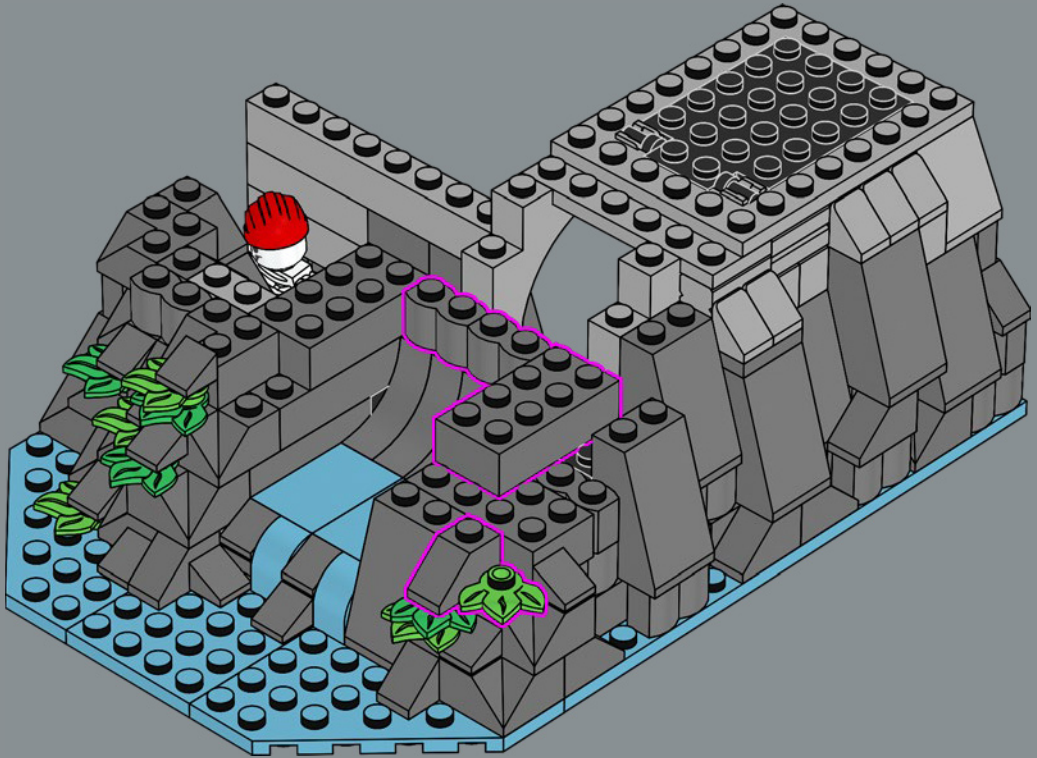

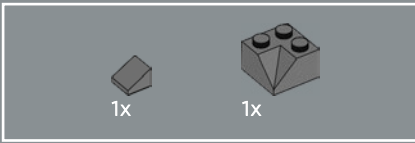

44

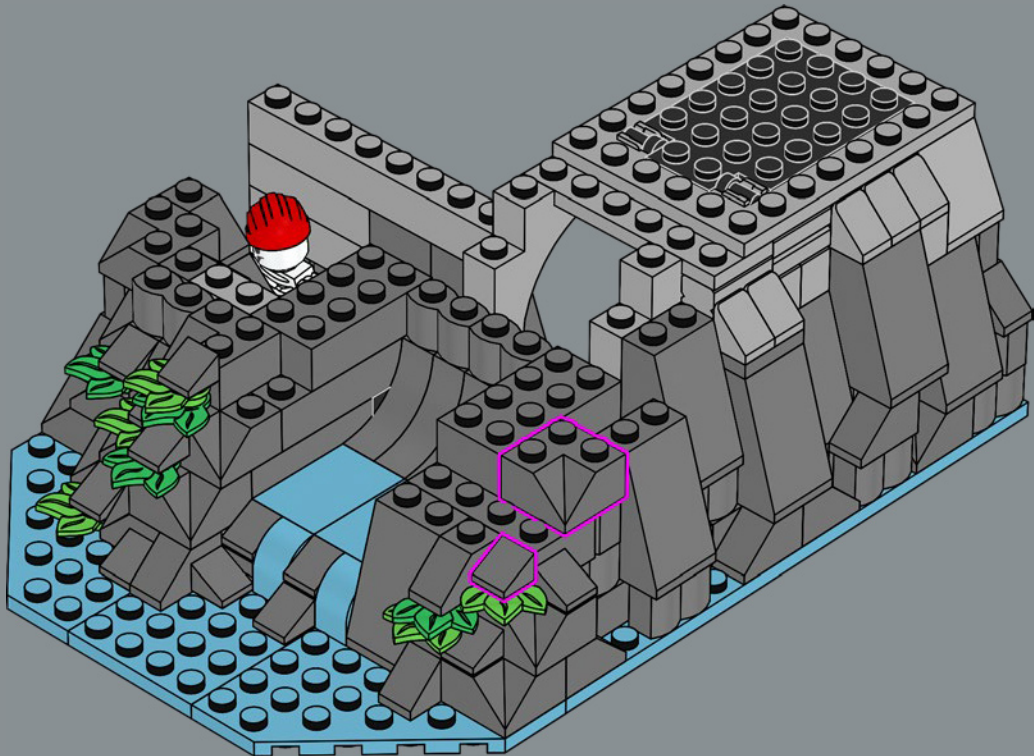

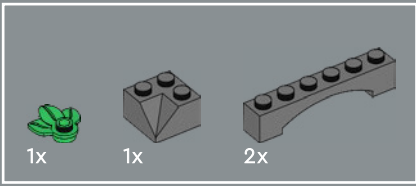

45

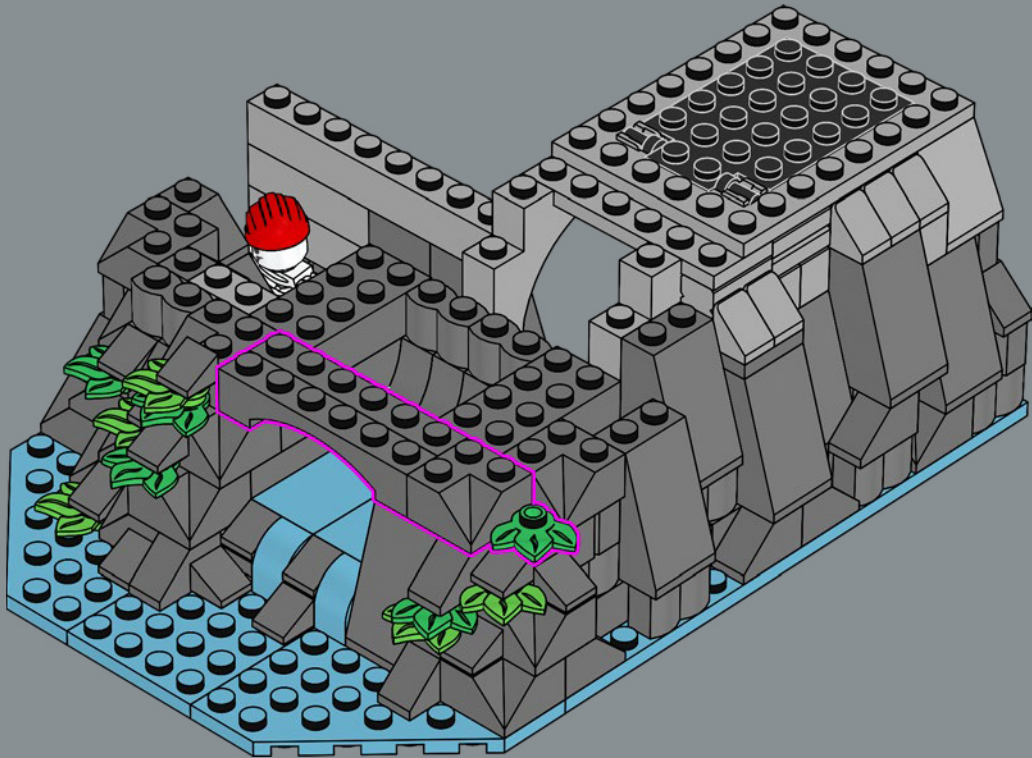

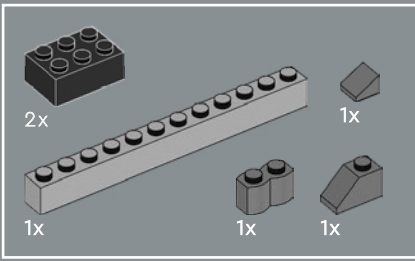

46

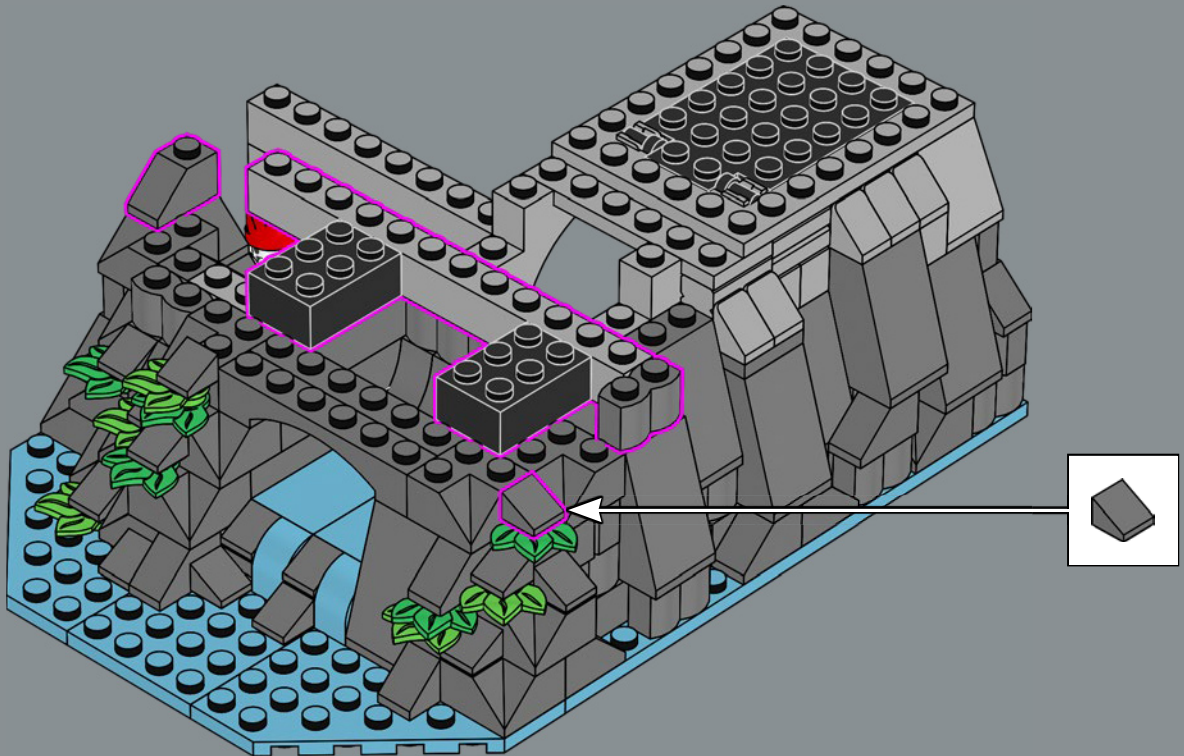

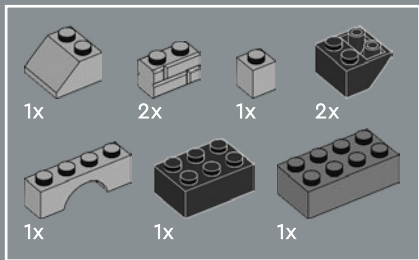

47

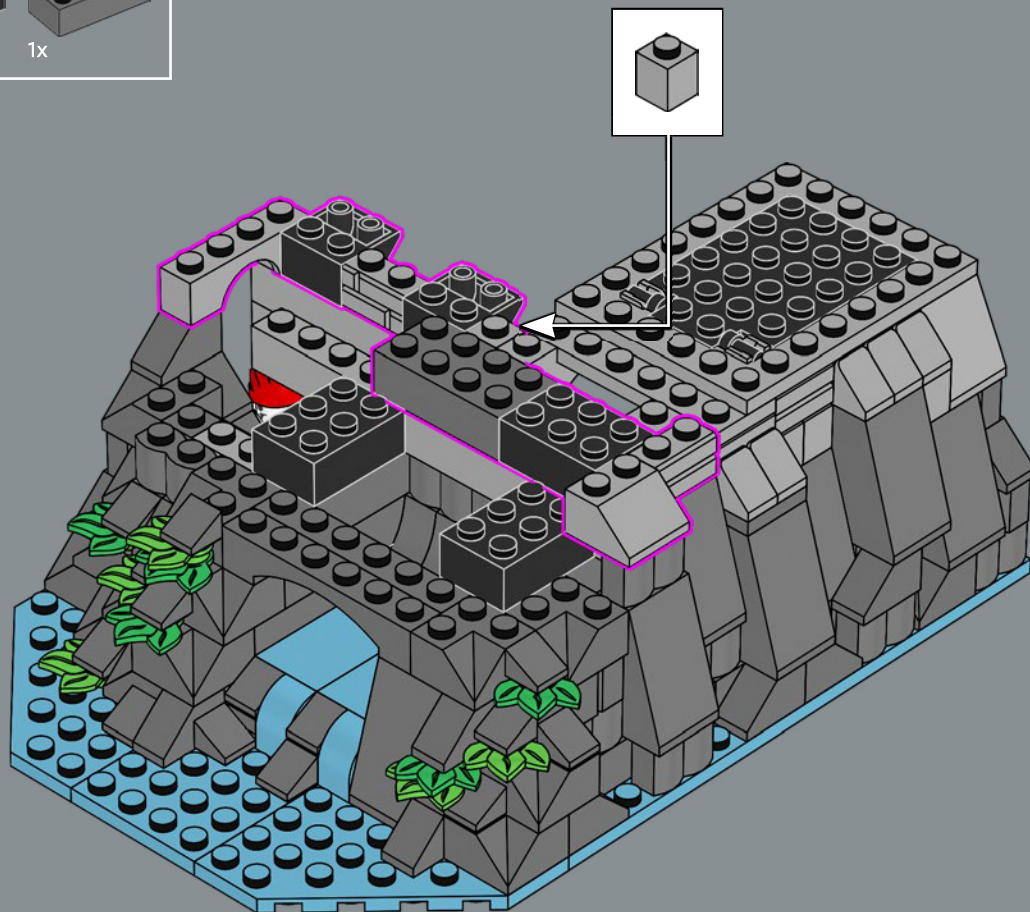

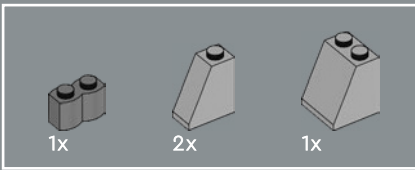

48

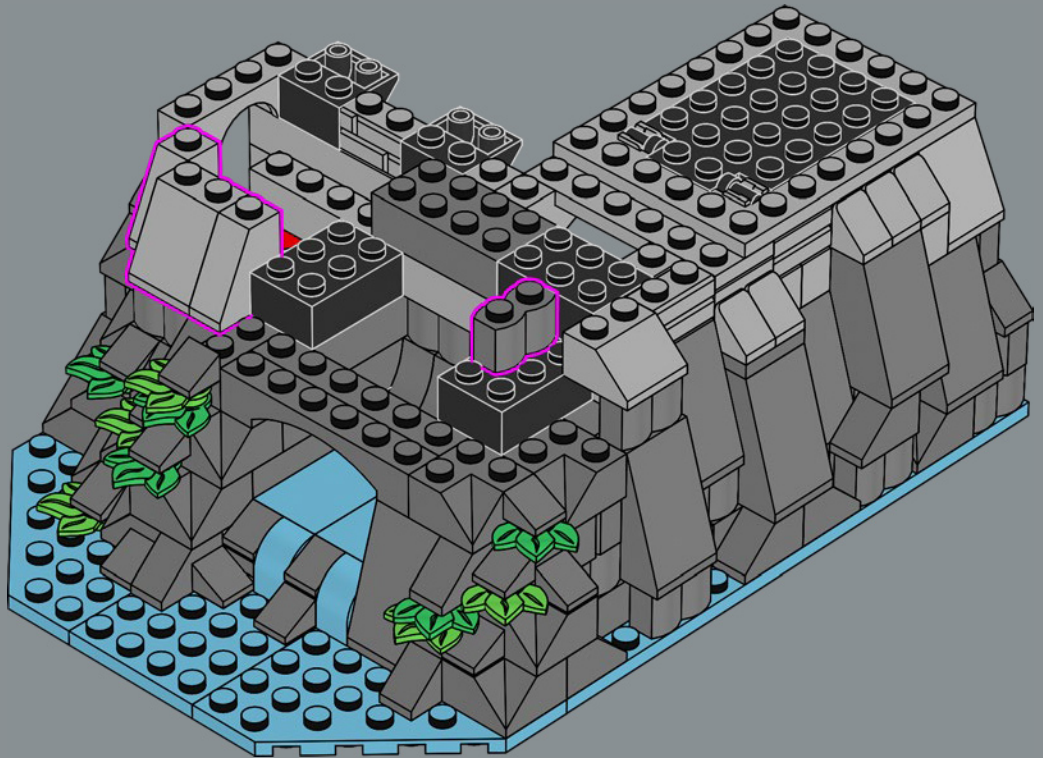

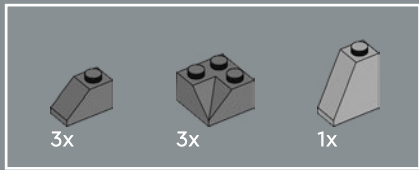

49

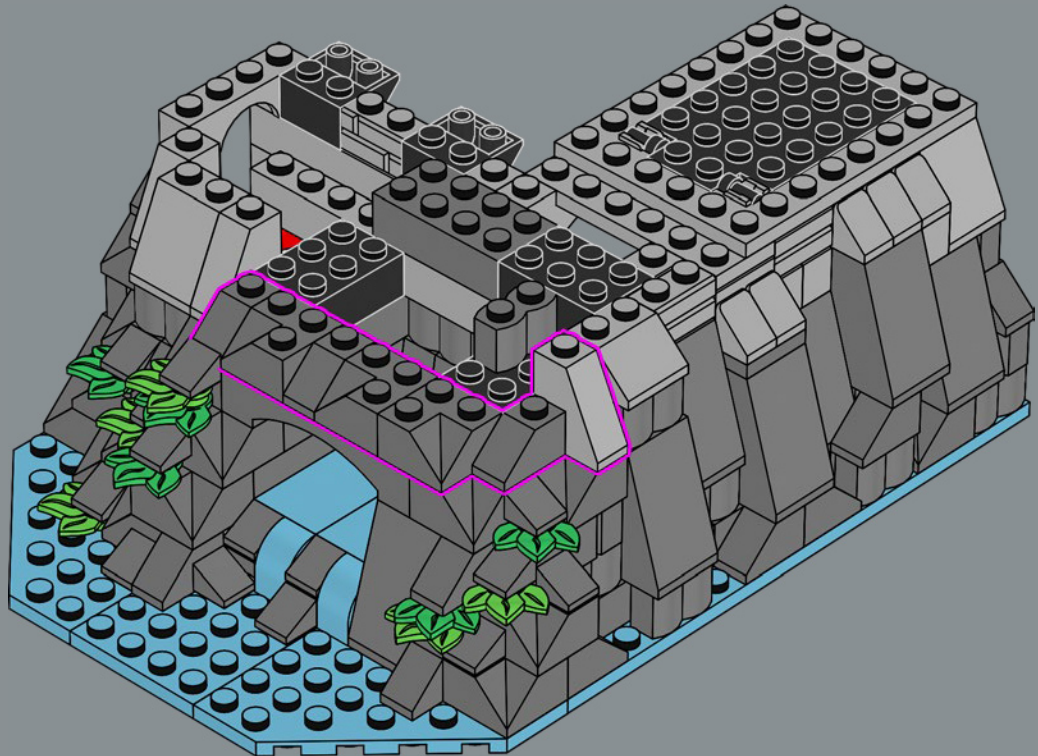

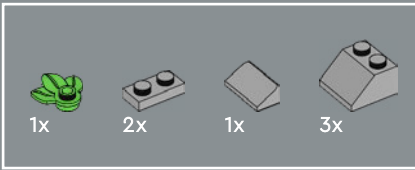

50

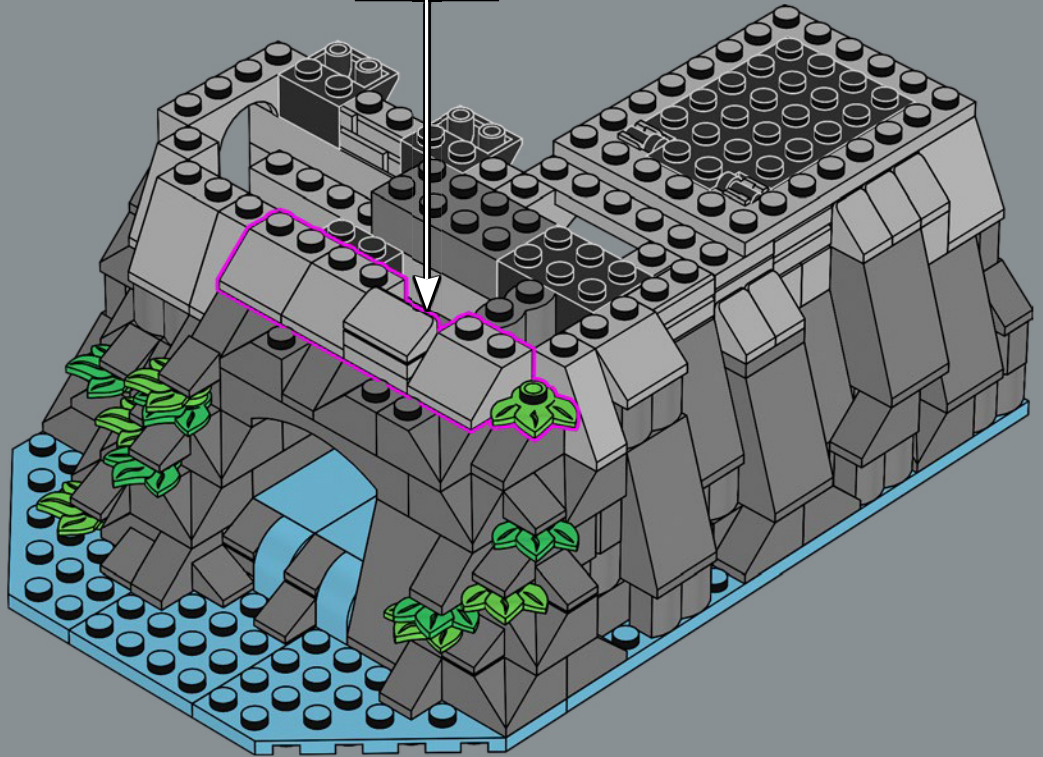
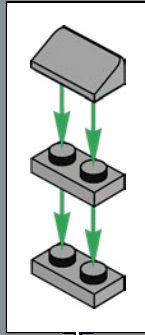

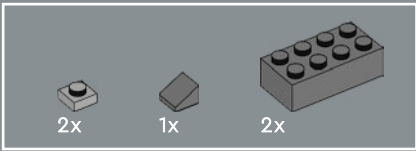

51

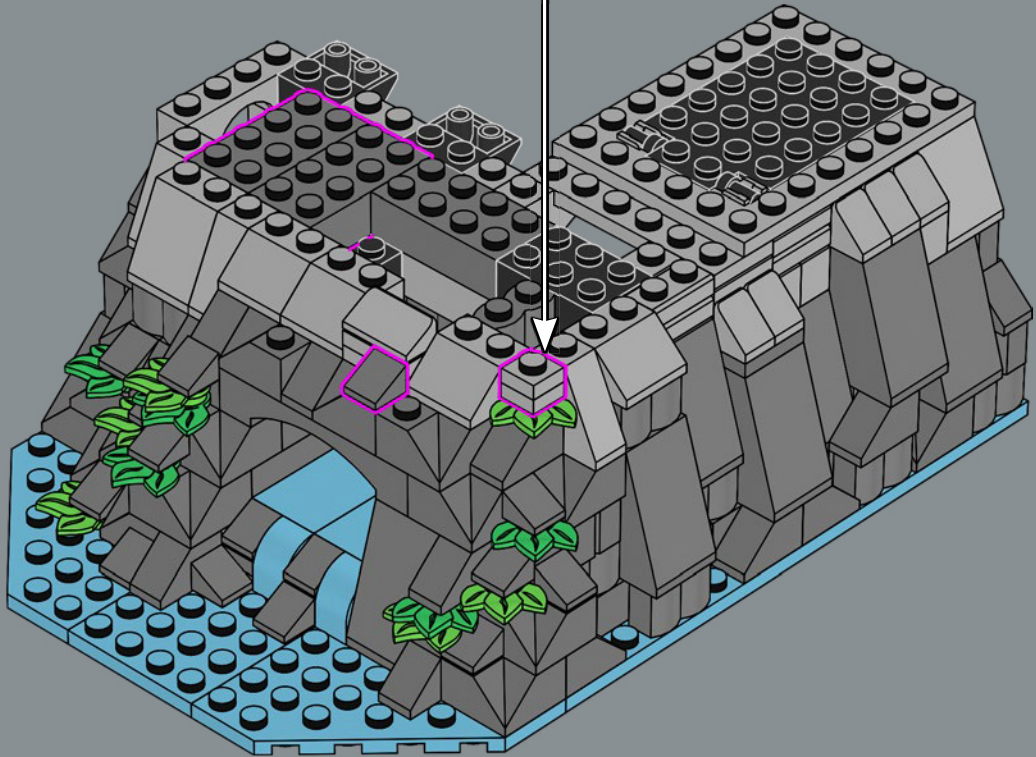
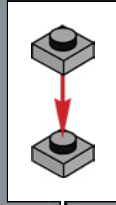

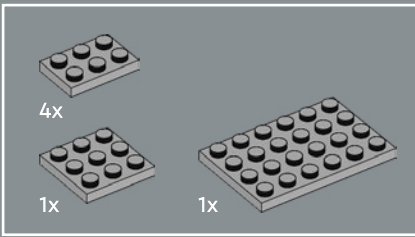

52

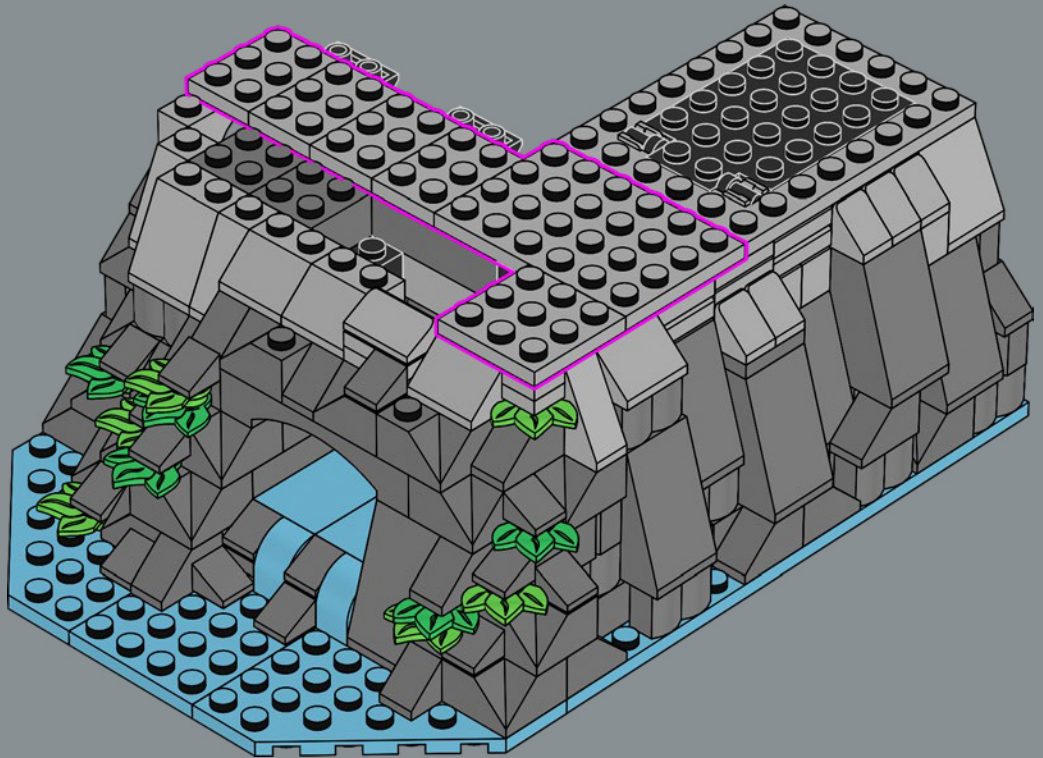

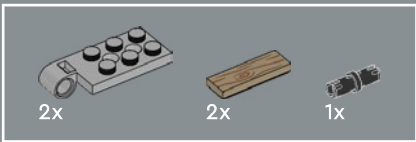

Una trampilla ingeniosamente oculta permite a los piratas escapar a la playa, donde los recogerán sus compañeros bucaneros.

53

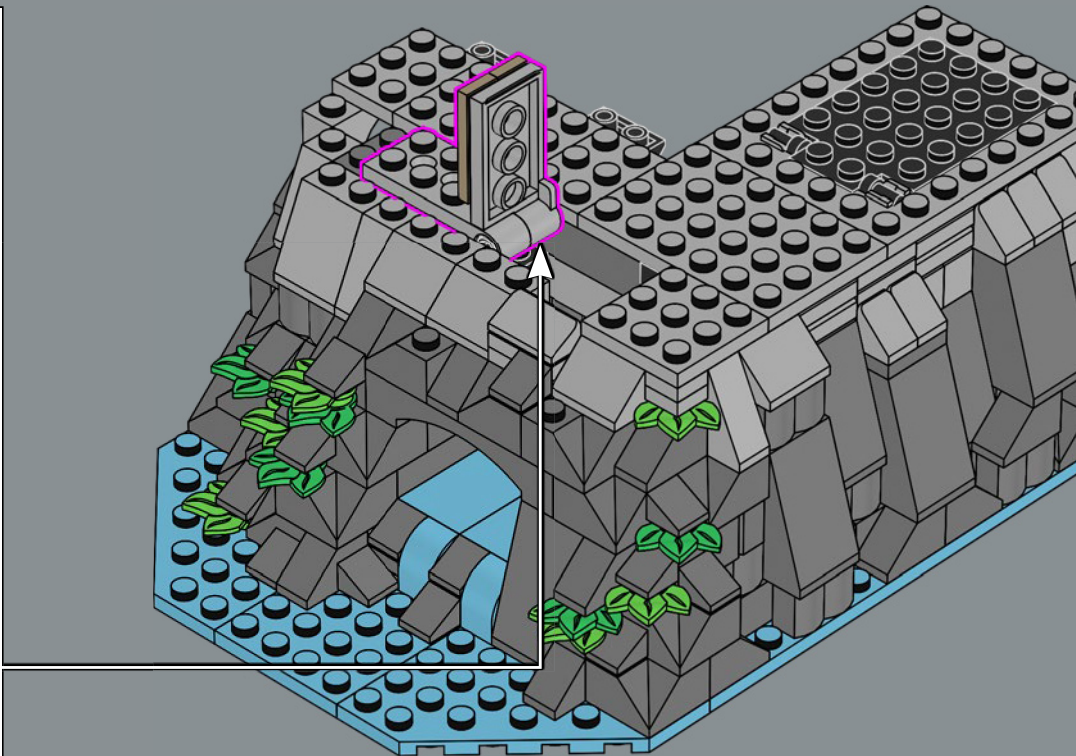
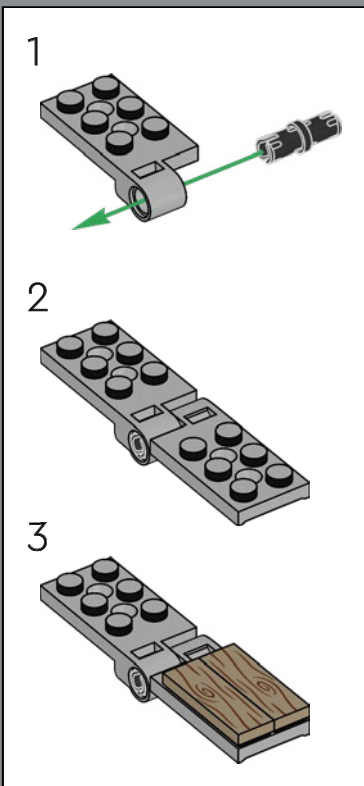

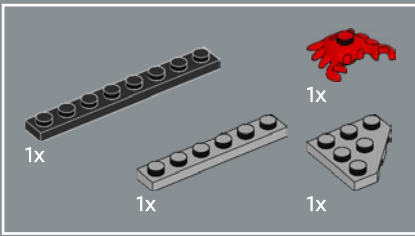

54

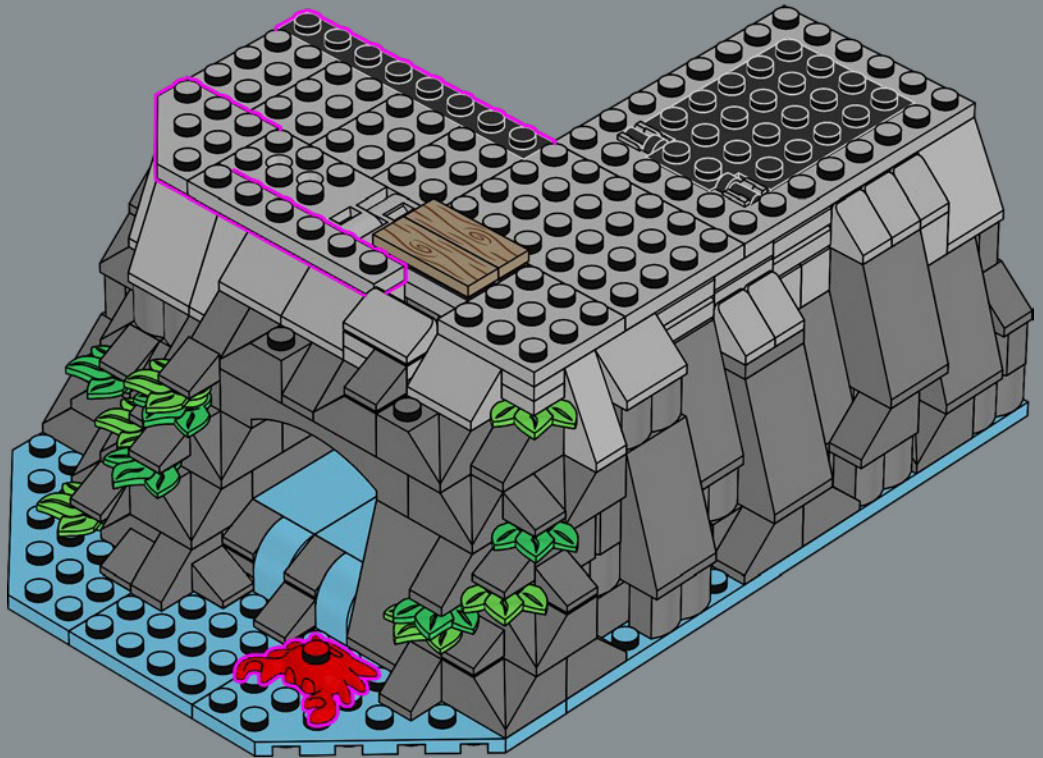



1

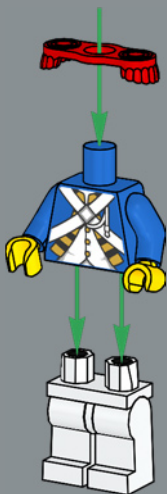

2



3



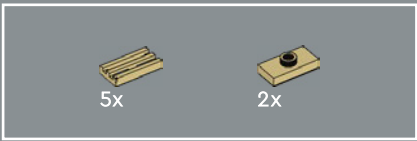

55

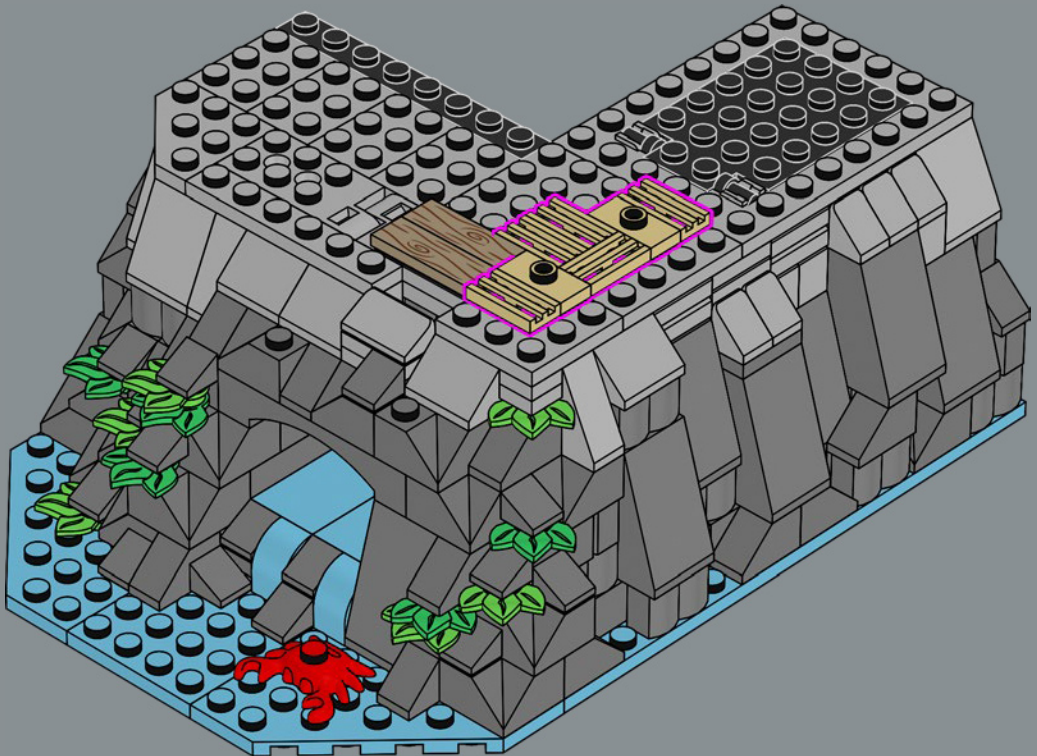

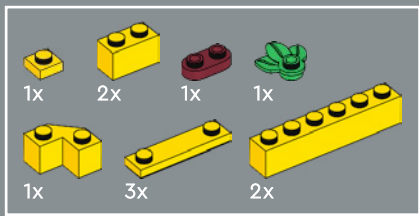

56

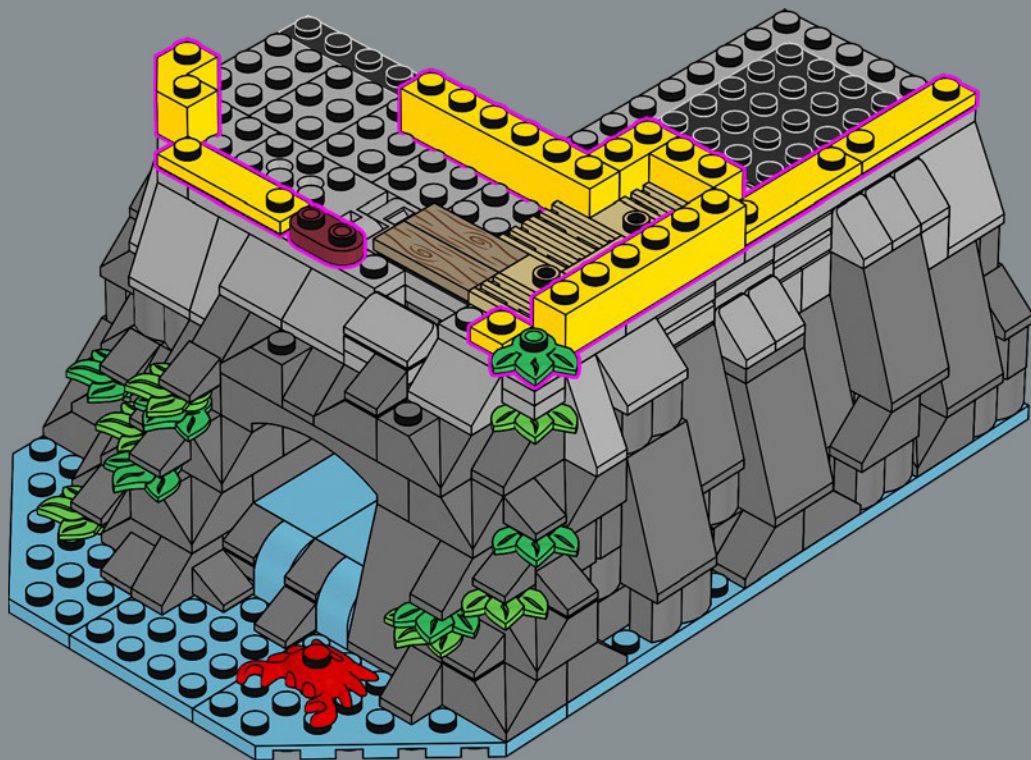



57

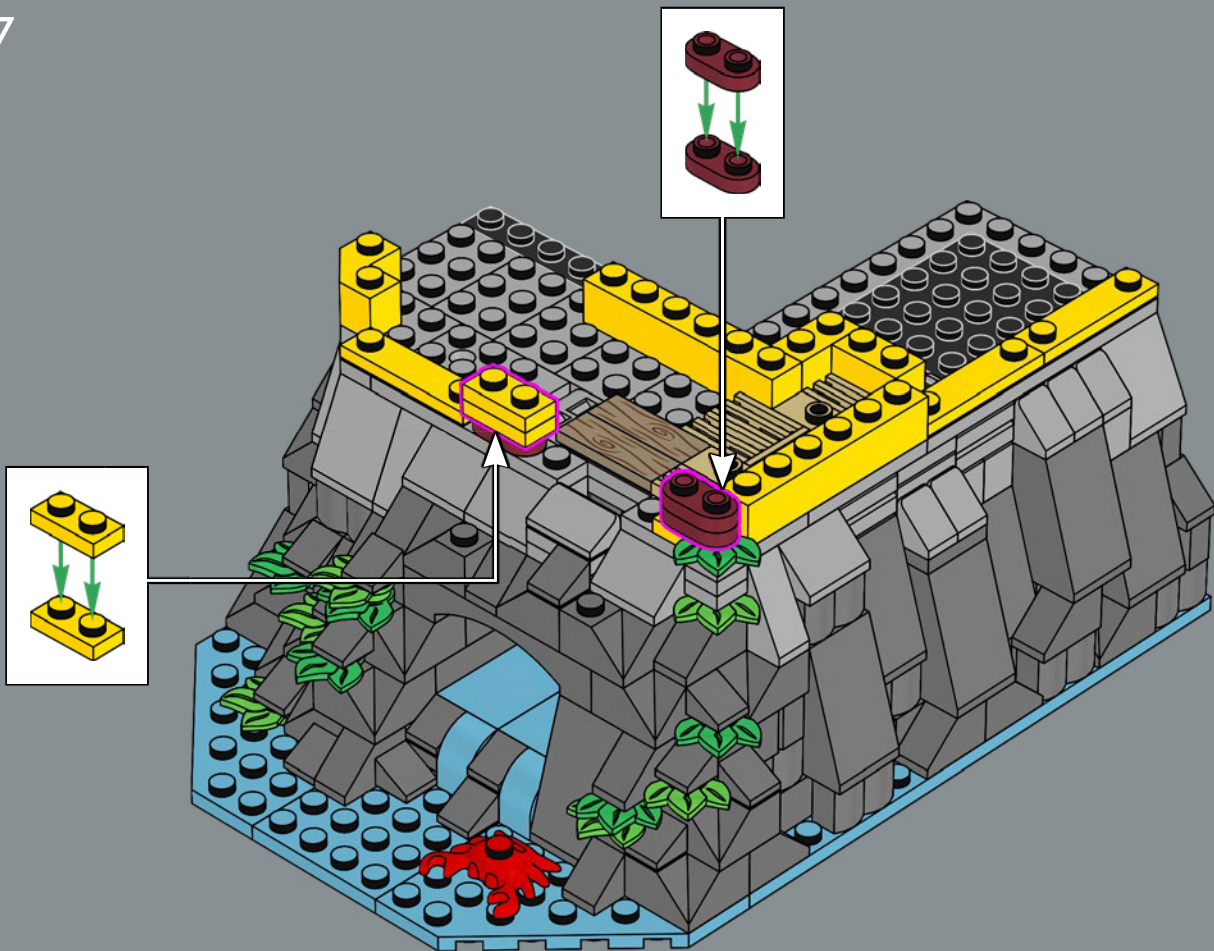

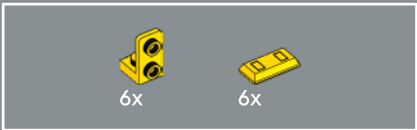

58

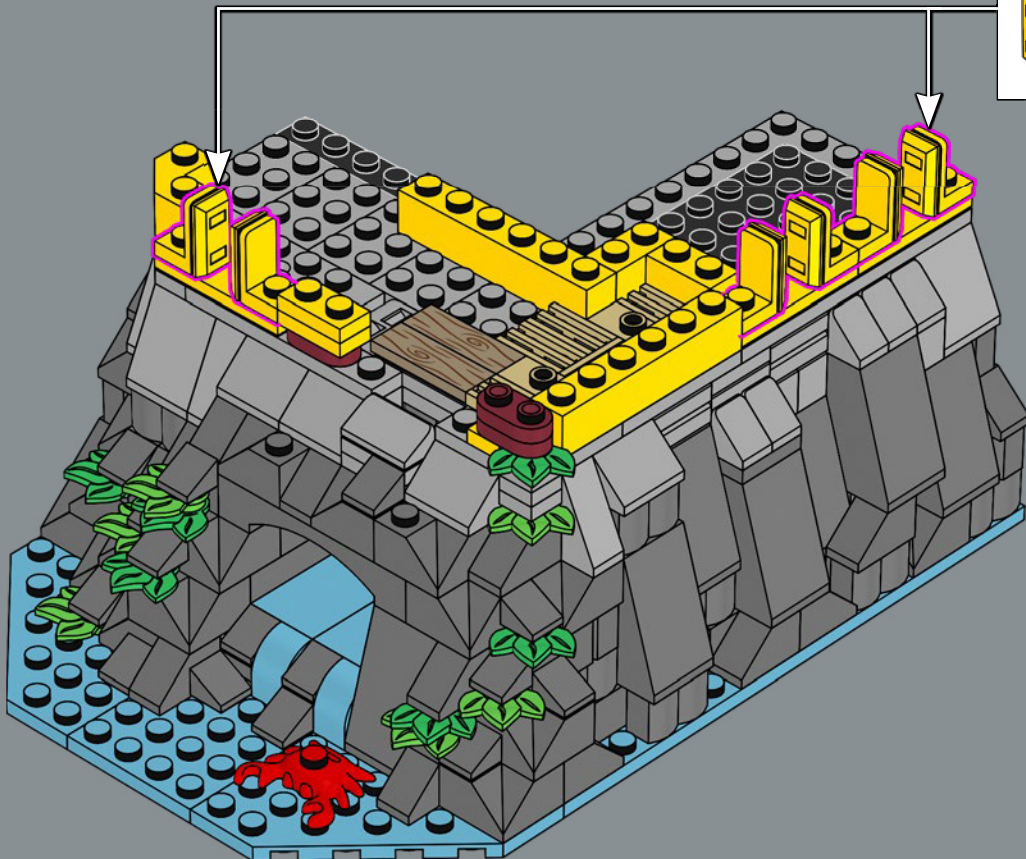
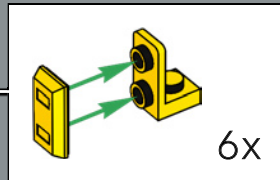



4x



1x

59

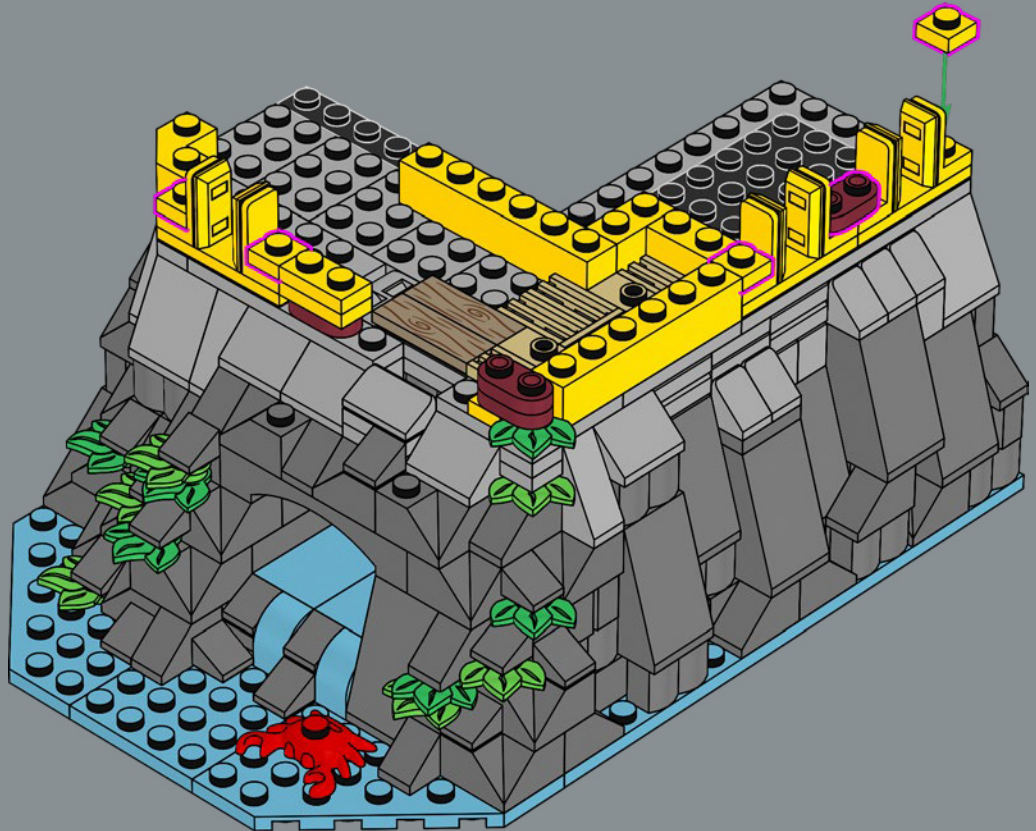



¡Las cosas también han mejorado para los prisioneros piratas! Ahora pueden descansar cómodamente en un colchón de heno.



60

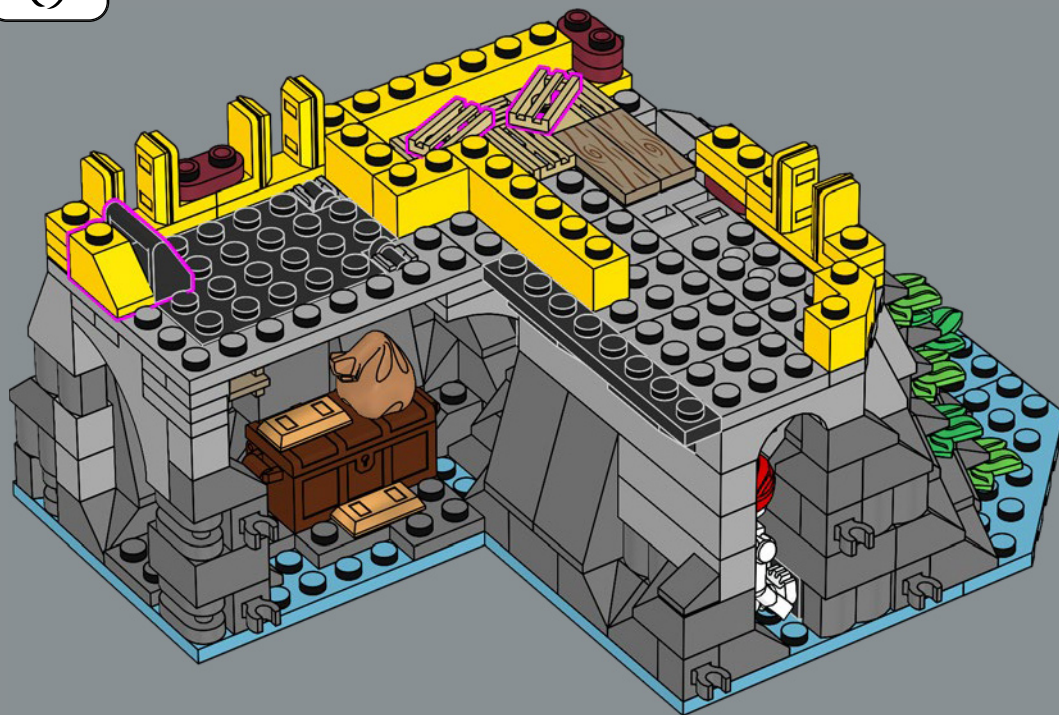



2x



2x



2x

61

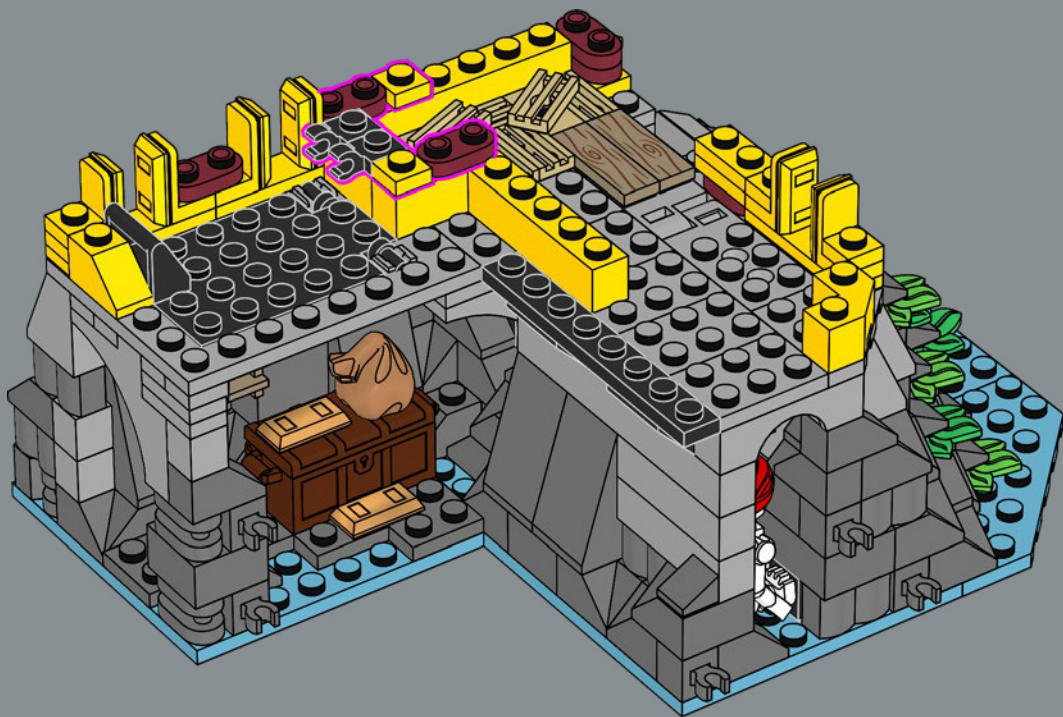



62

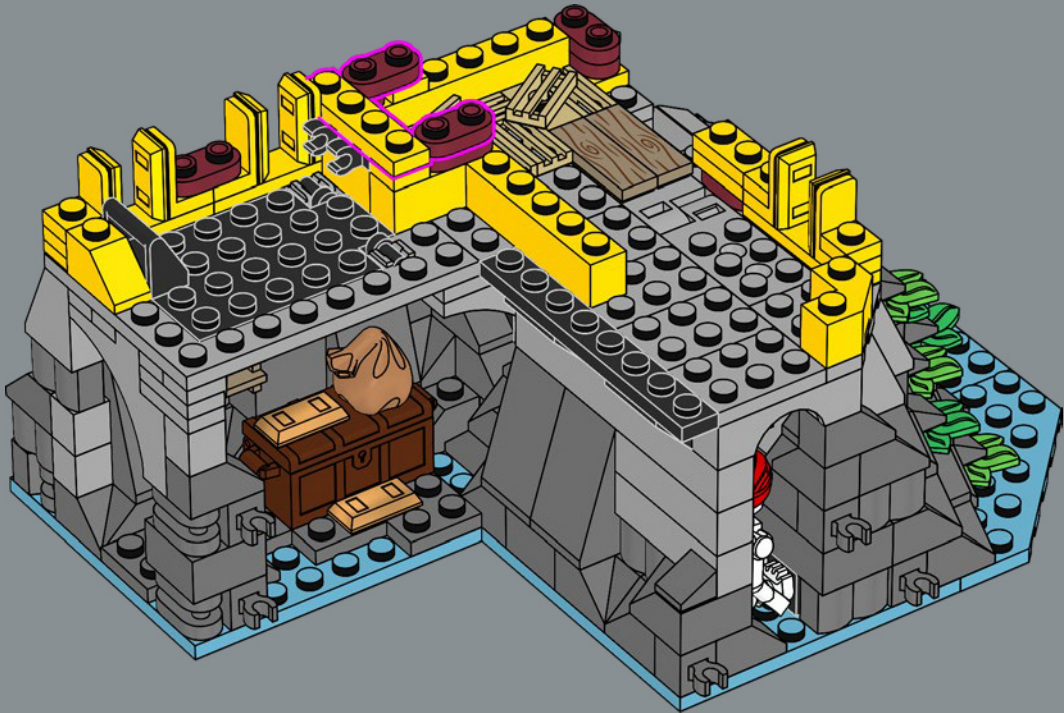

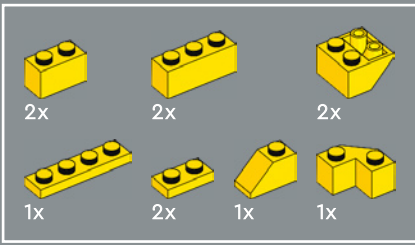

63

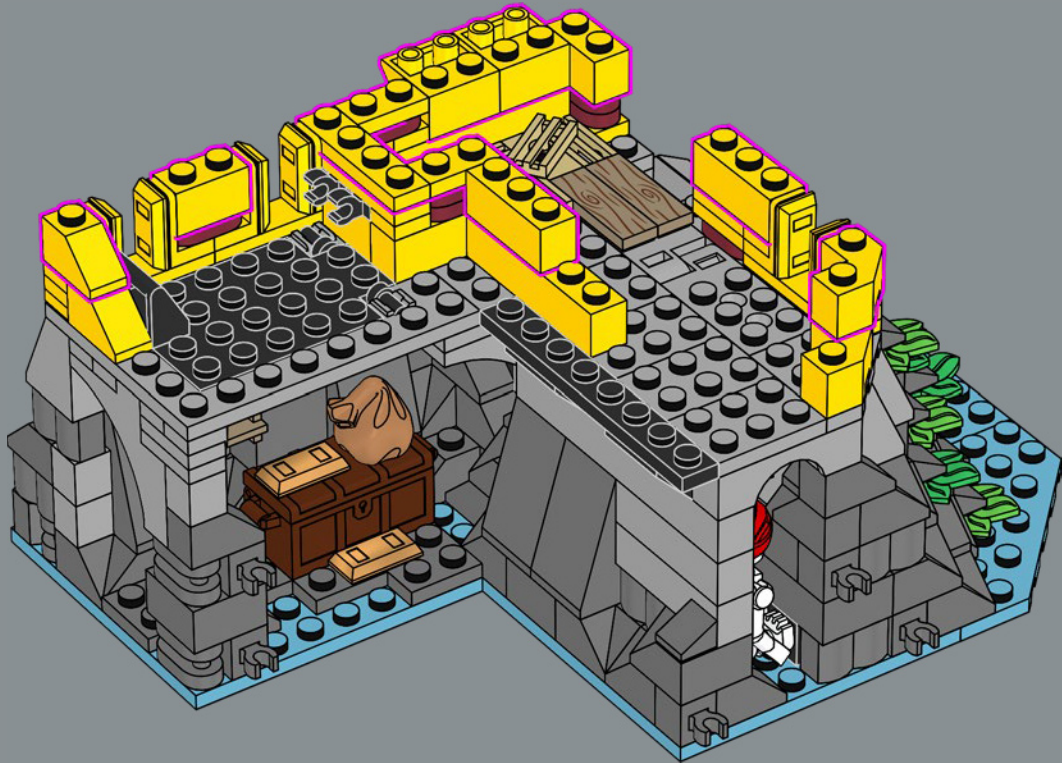



64

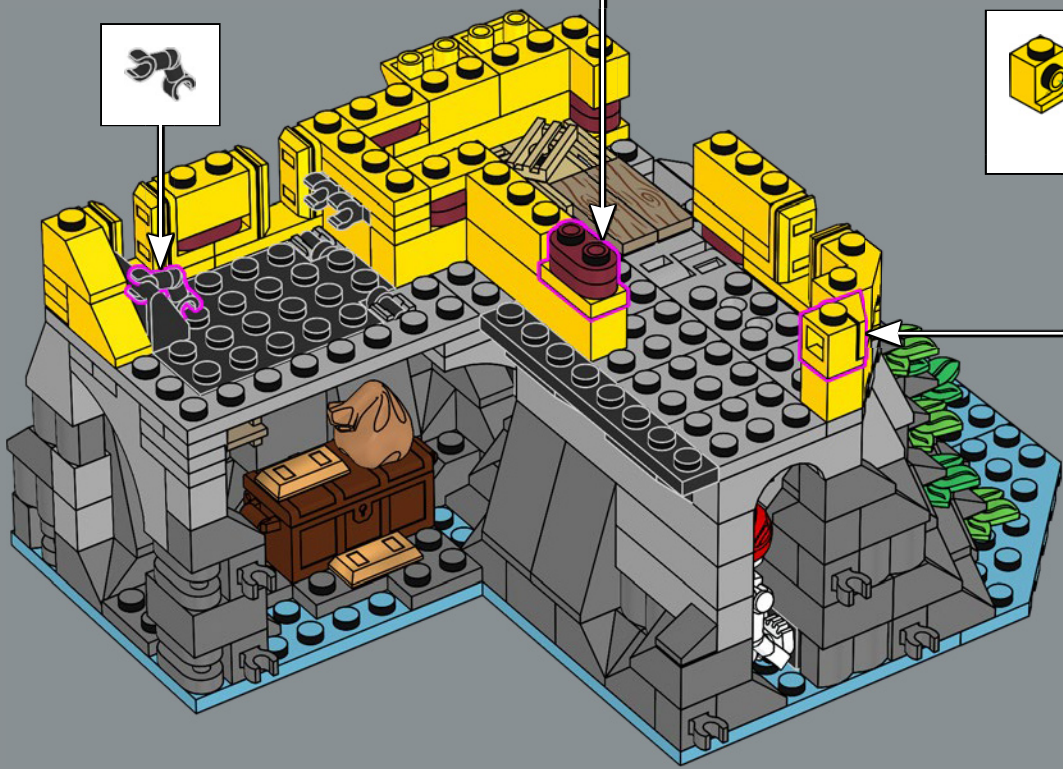
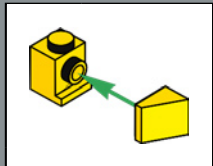
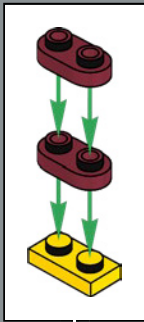

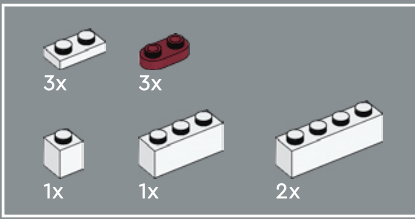

65

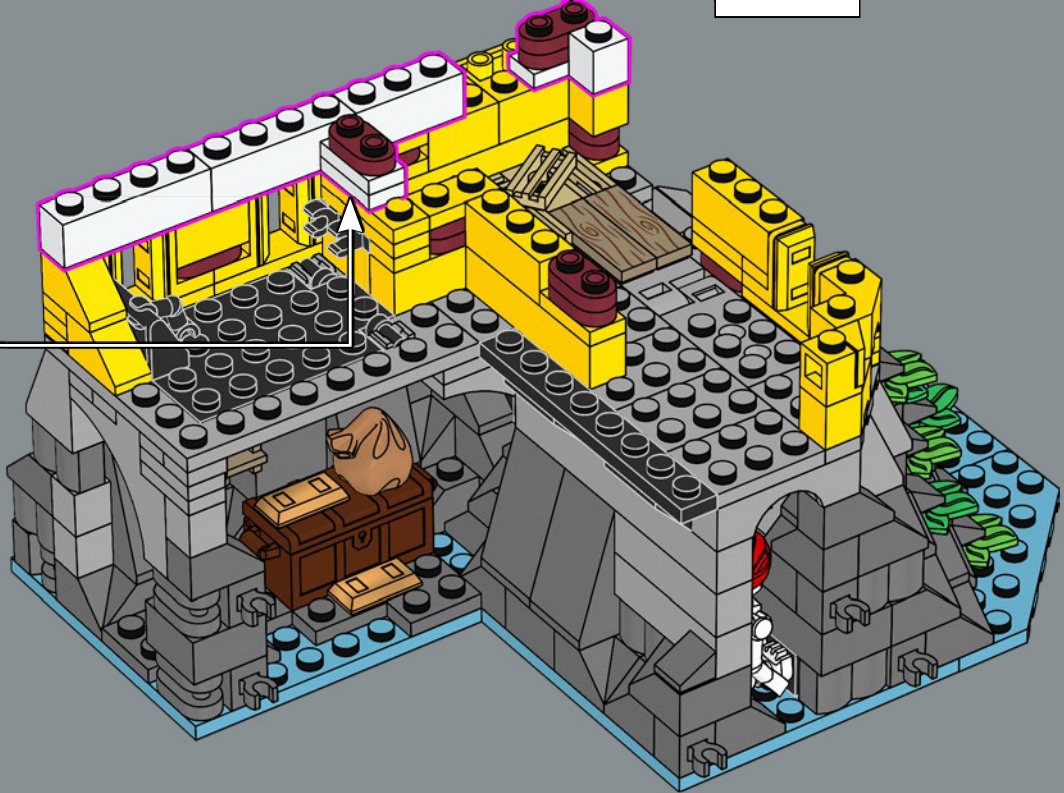
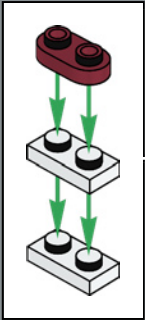
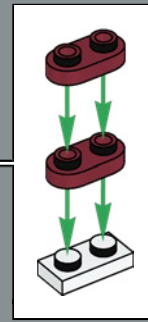

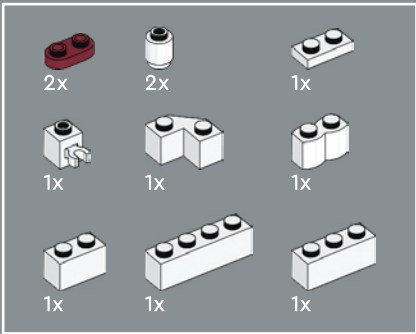

66

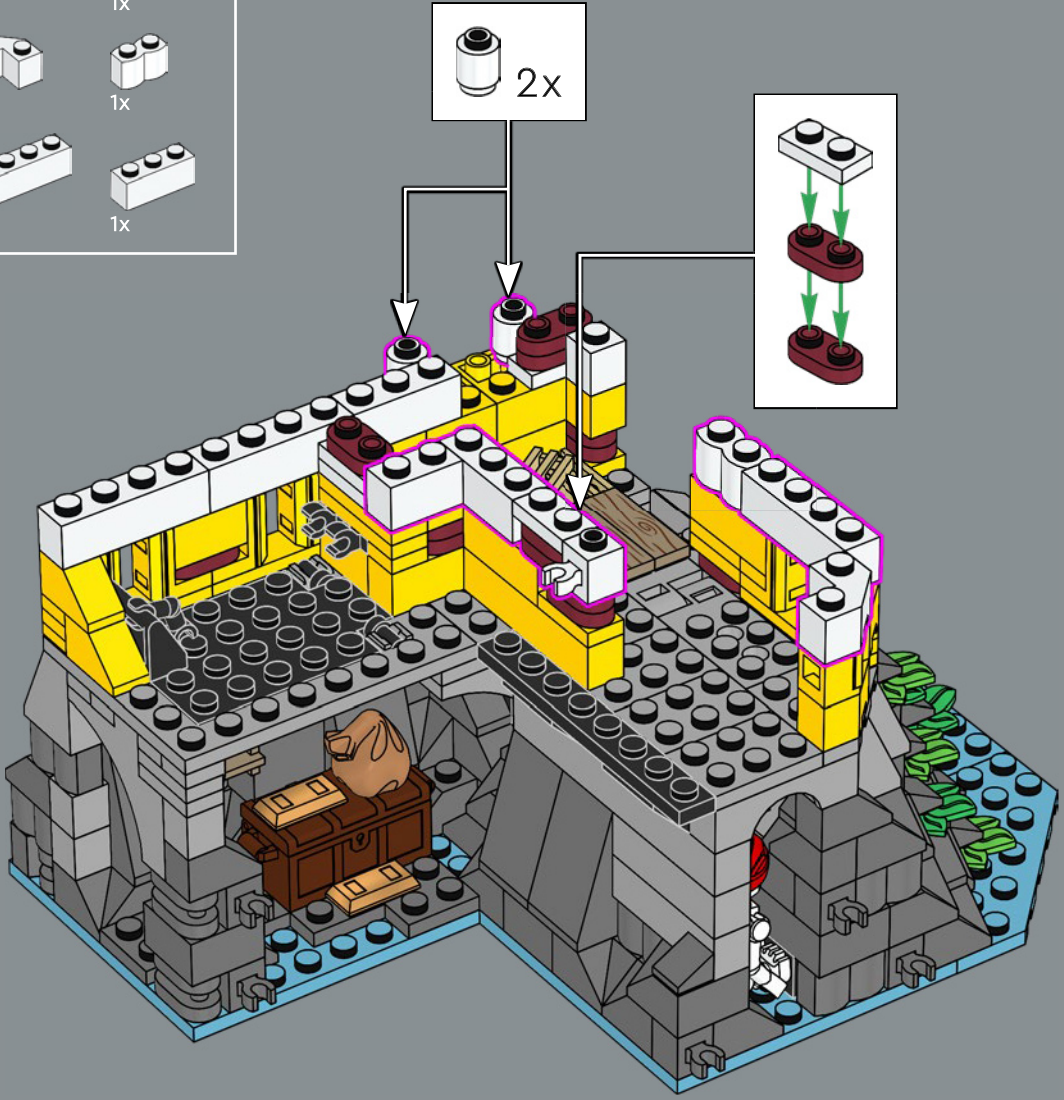
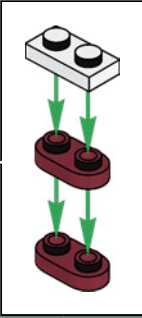
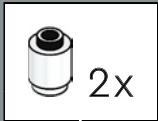

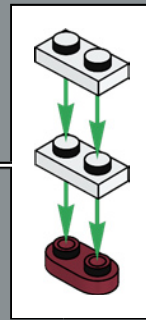
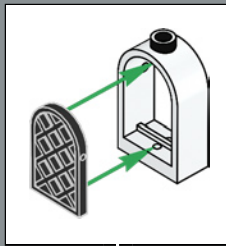
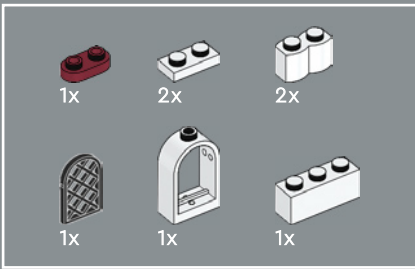

67

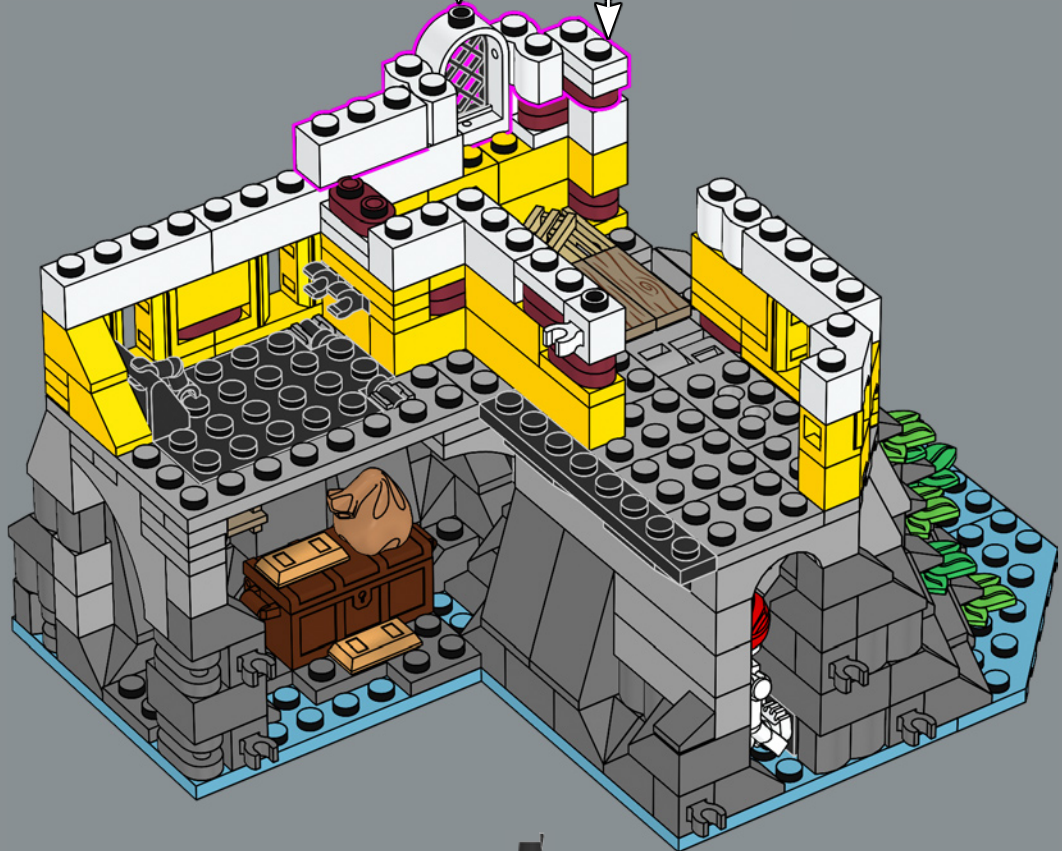

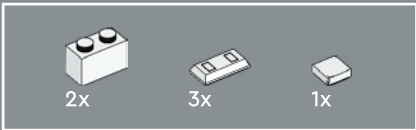

68

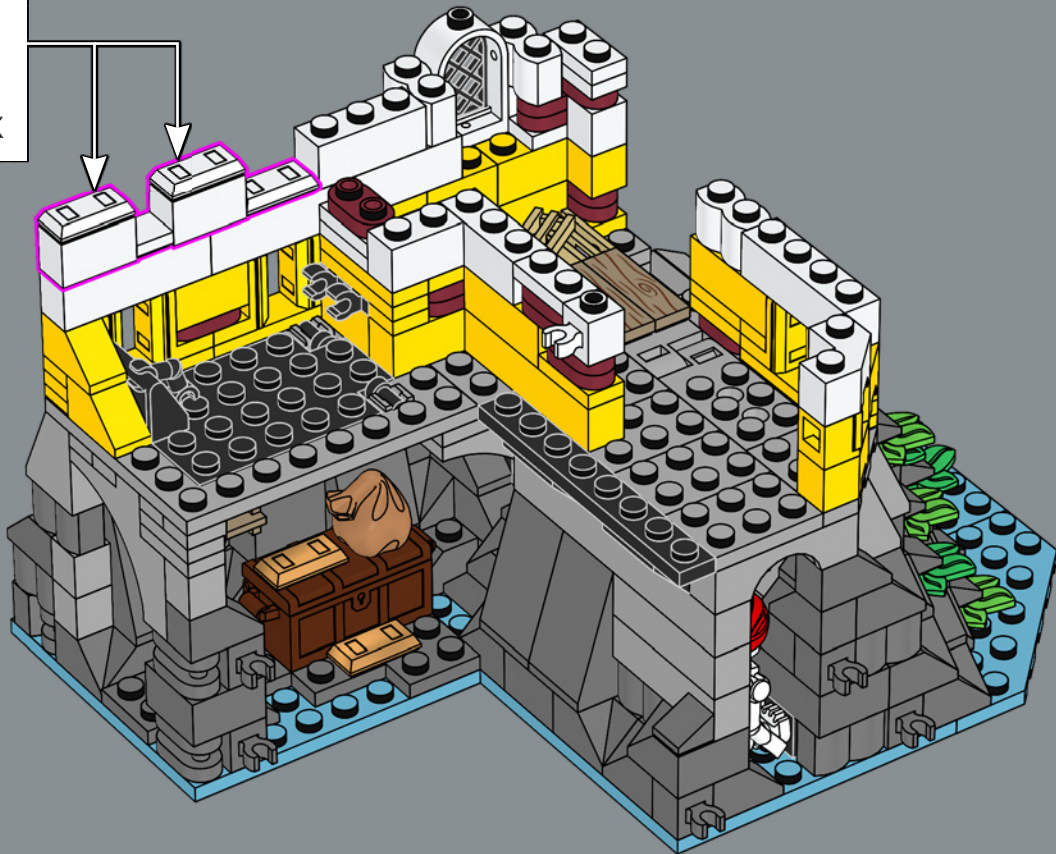
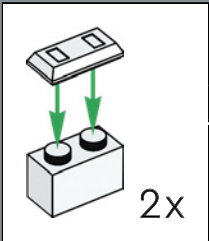

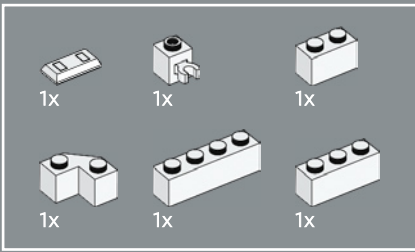

69

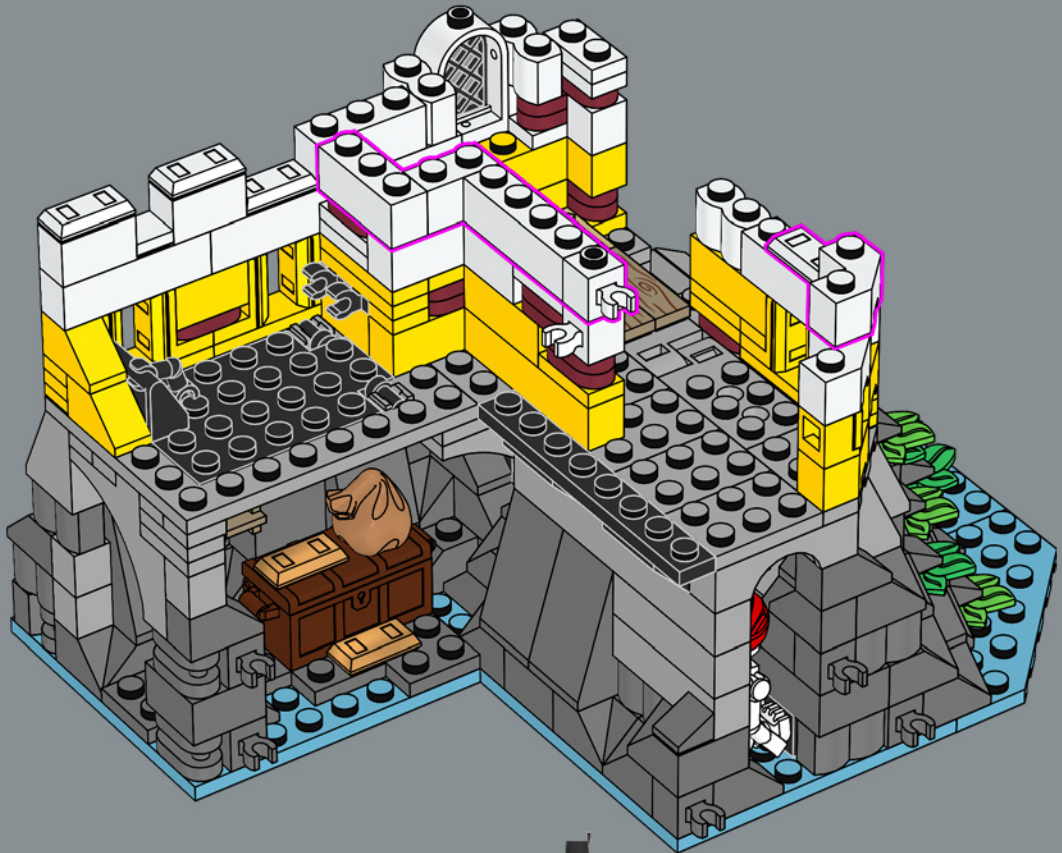

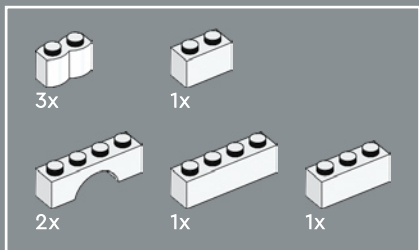

70



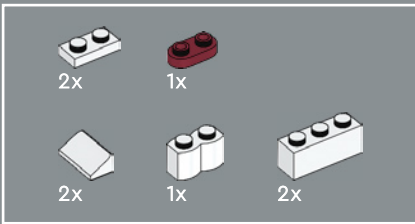

71

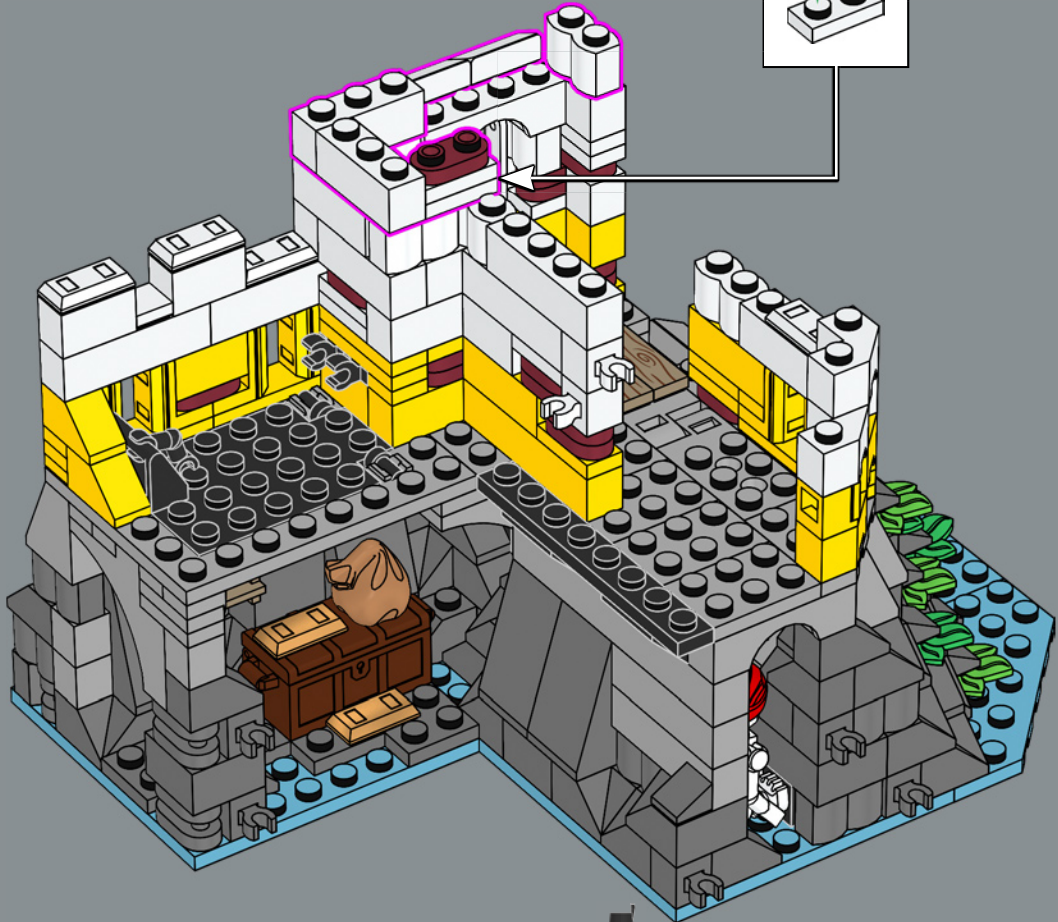
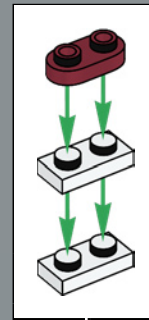

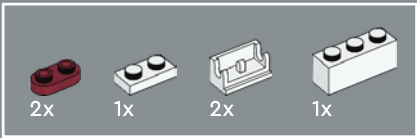

72

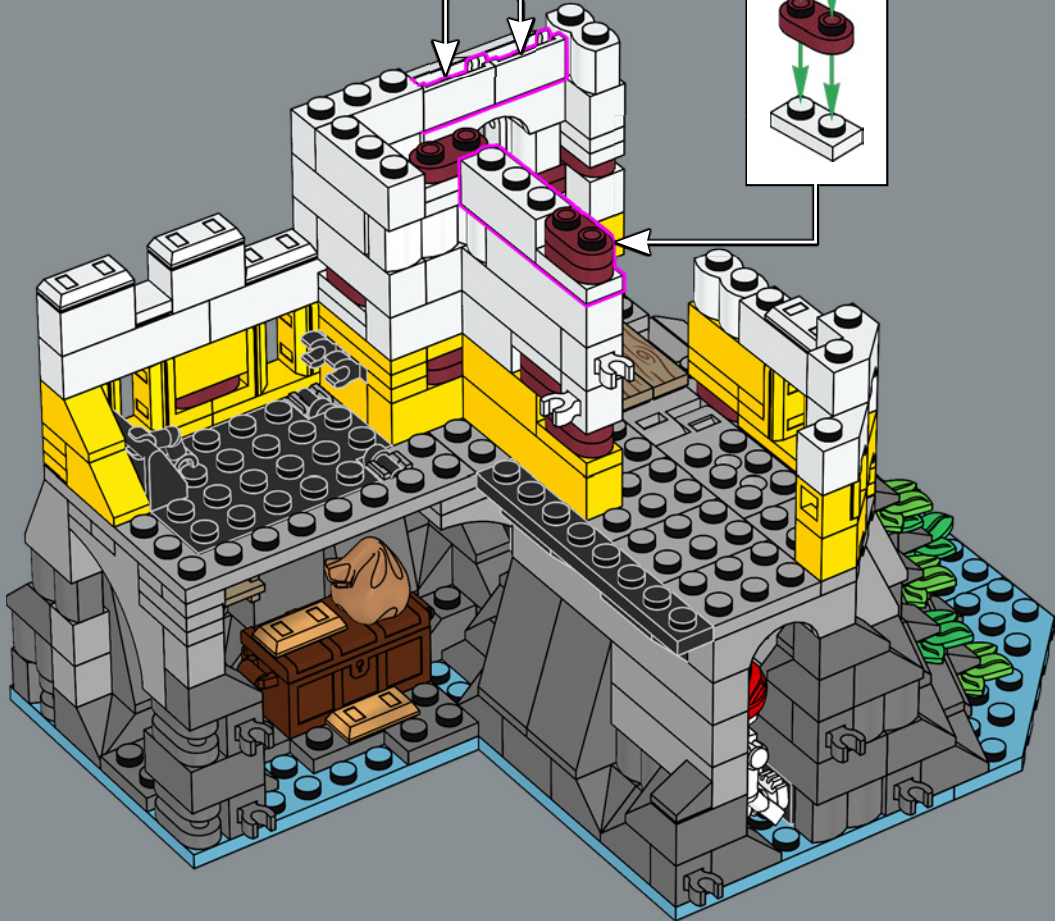
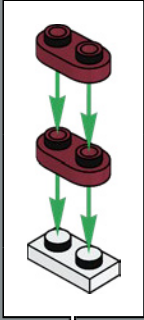
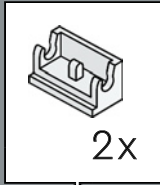

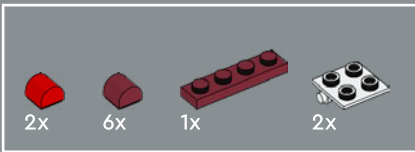

73

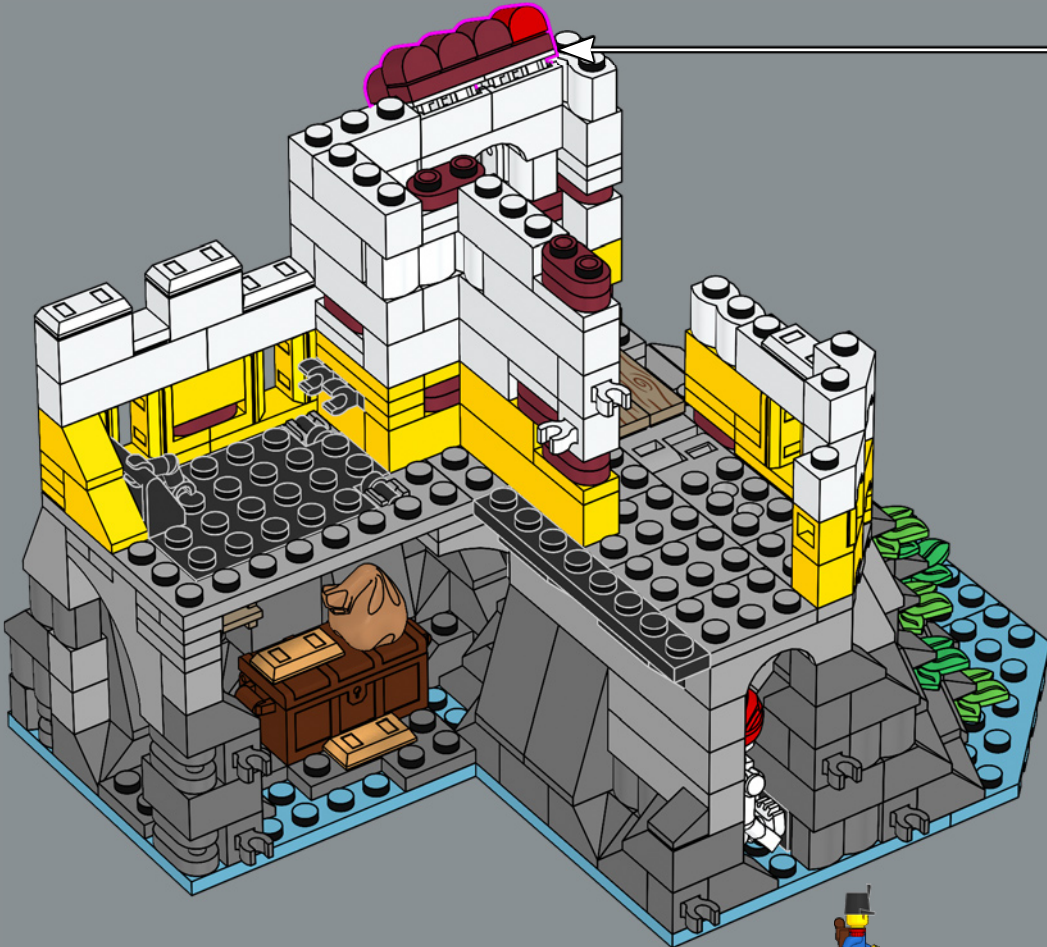
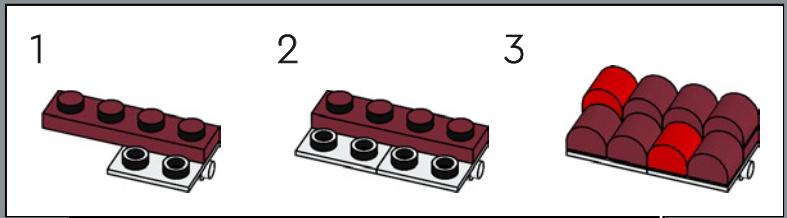

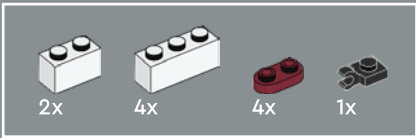

74

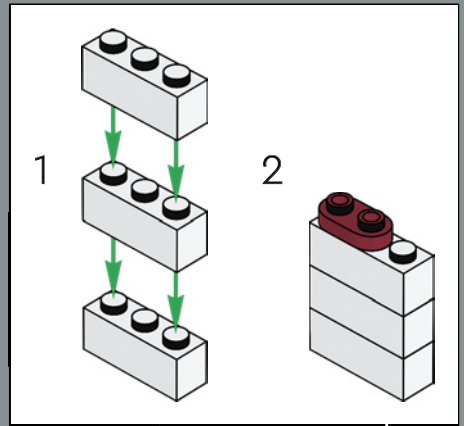
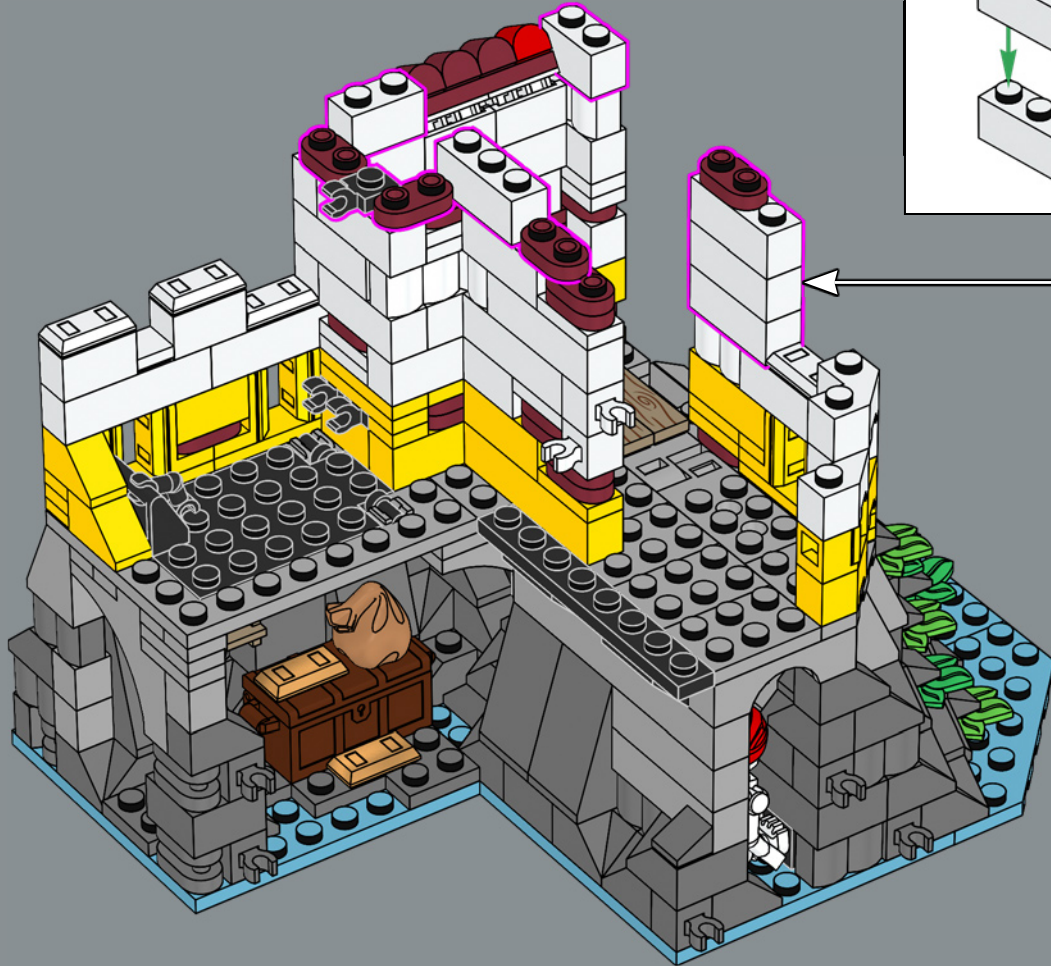

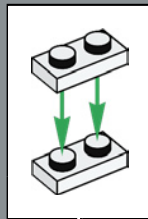
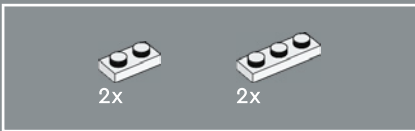

75

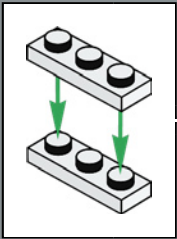

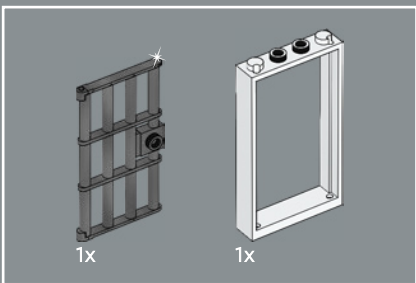

76

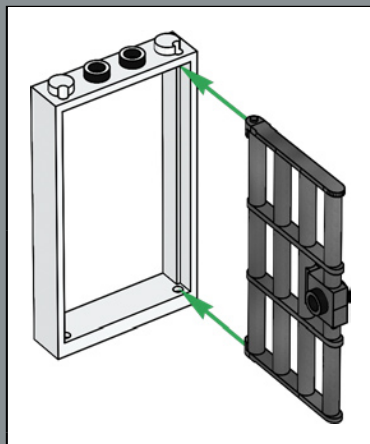

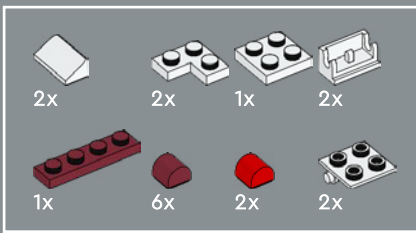

77

1



2

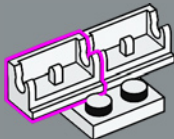

3

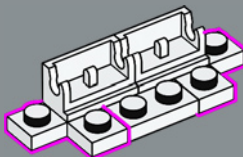

4

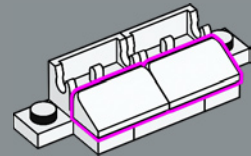

5

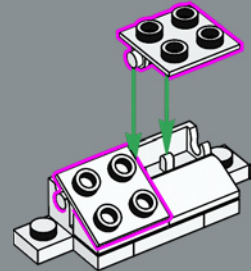

6

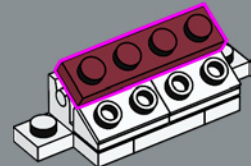

7

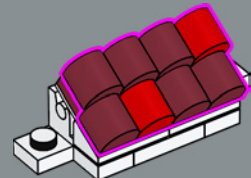

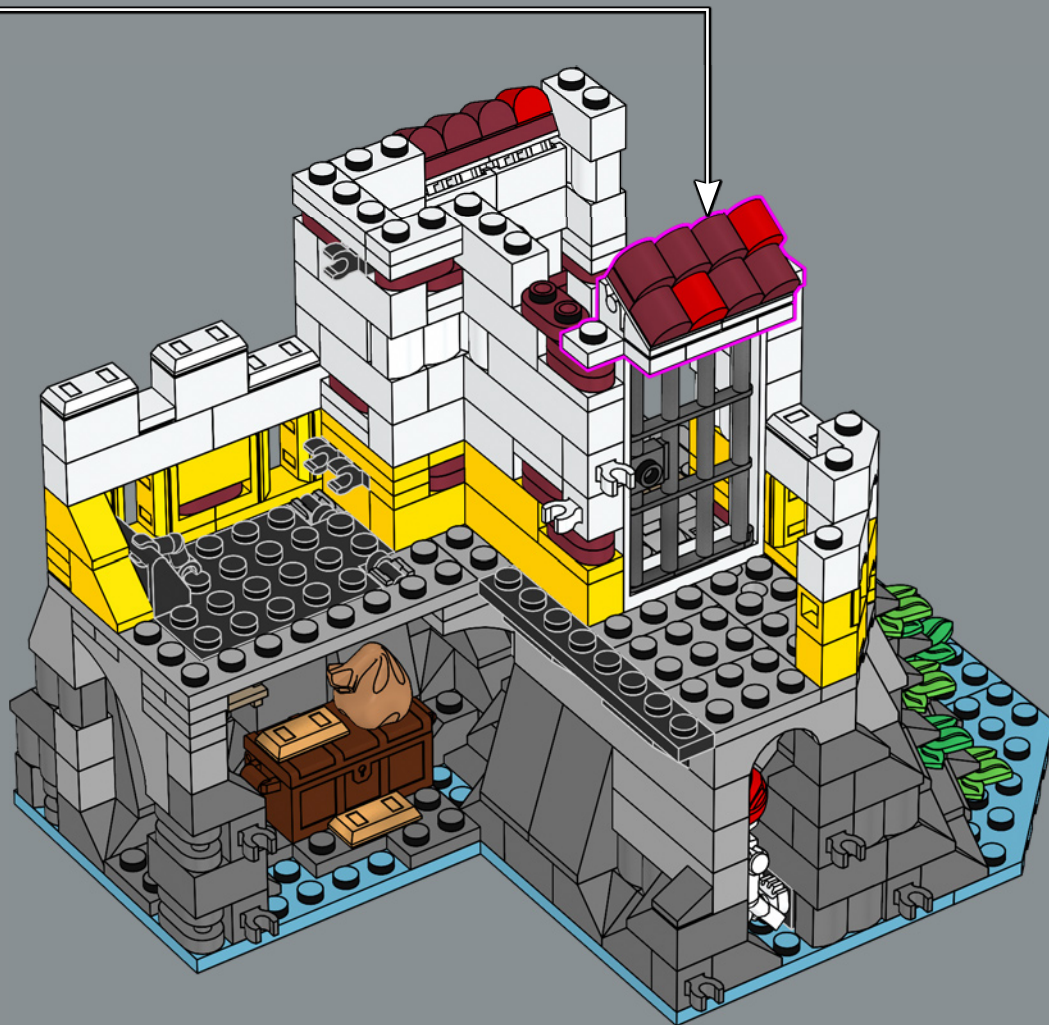

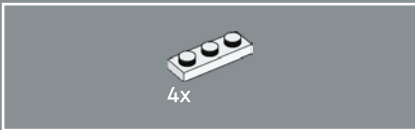

78

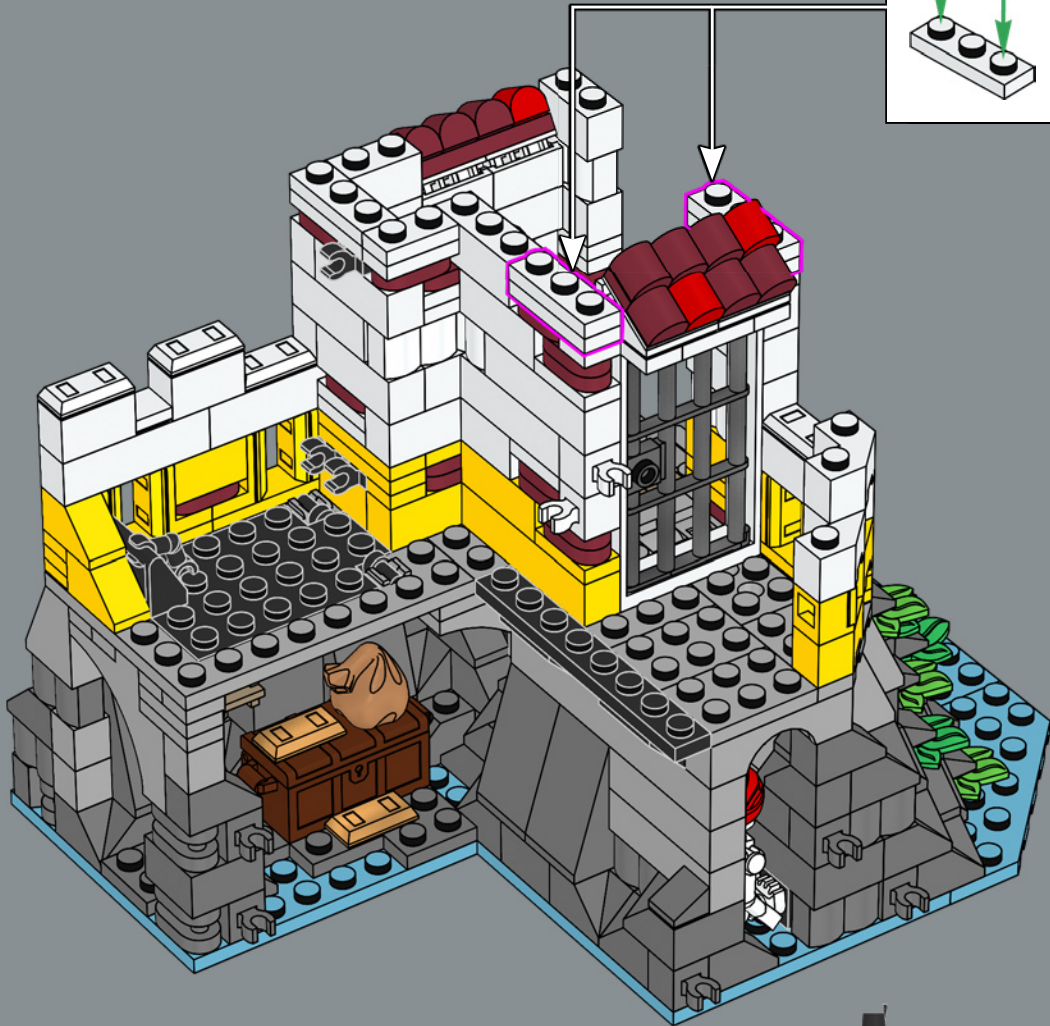
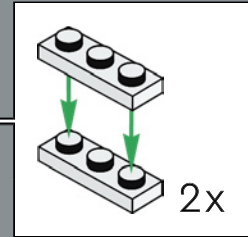

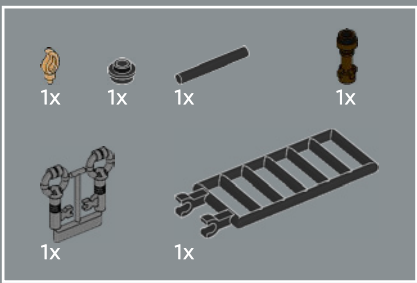

79

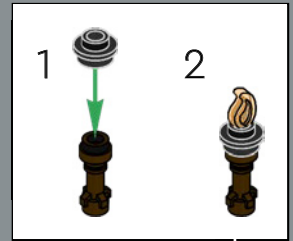
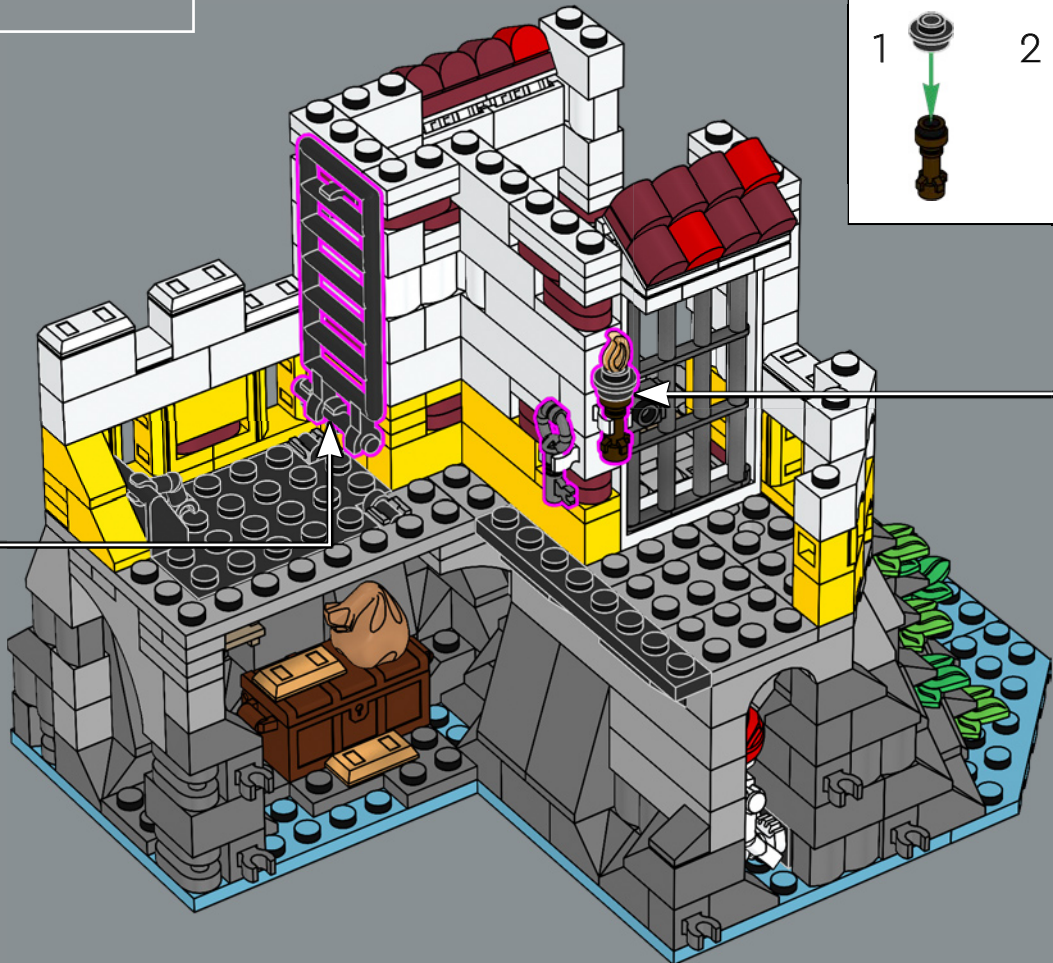
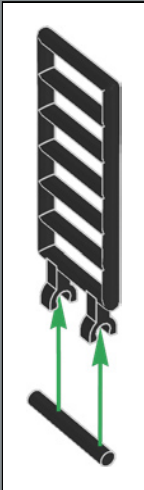

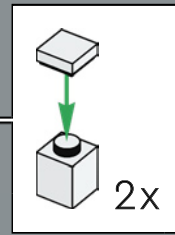
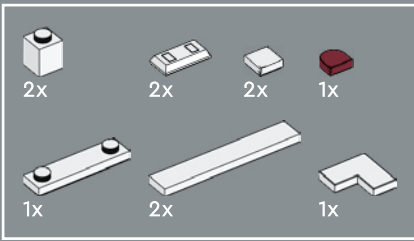

80

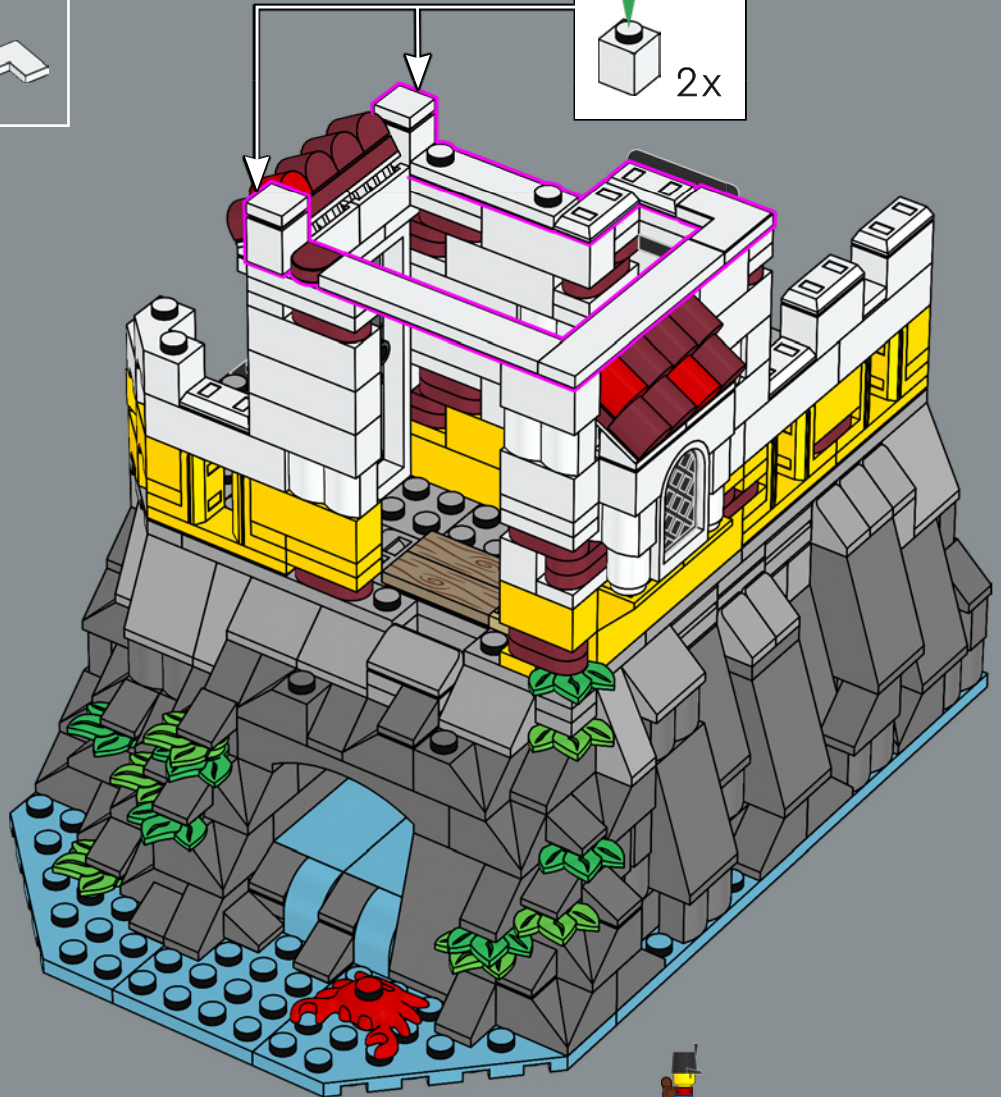

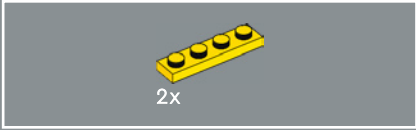
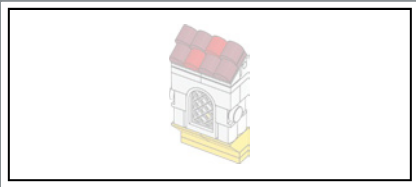

81

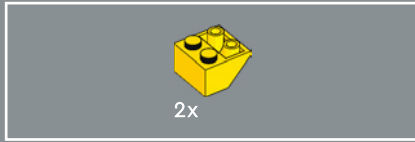
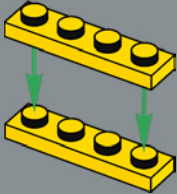

82

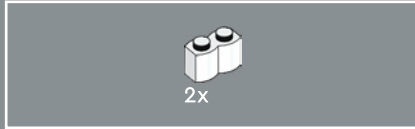
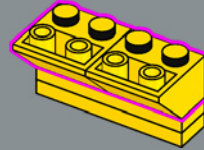

83

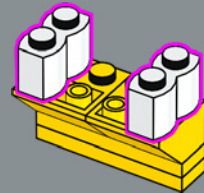

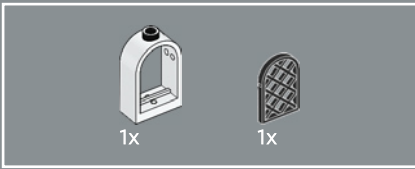

84

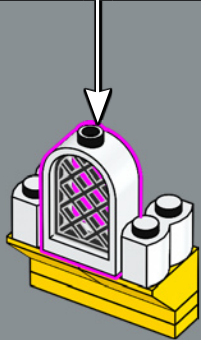
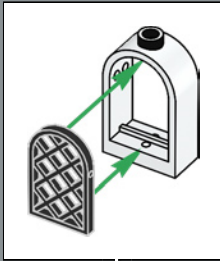

85

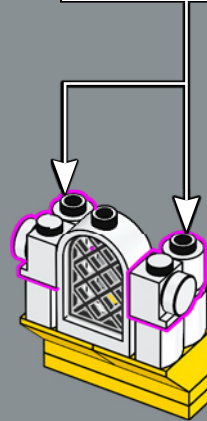
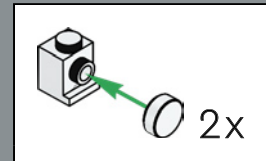

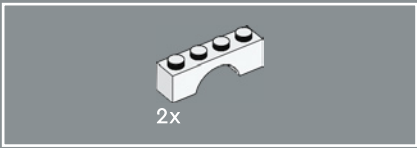

86

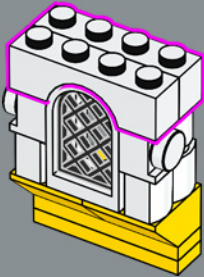

87

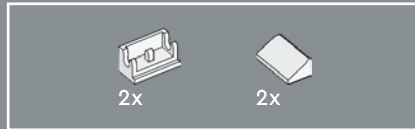
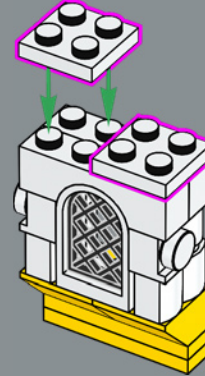

88

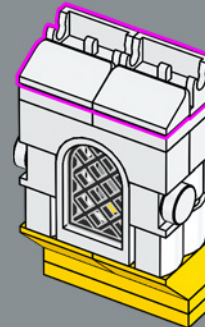



89

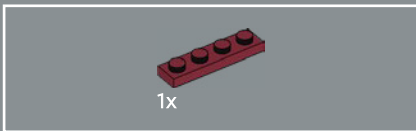
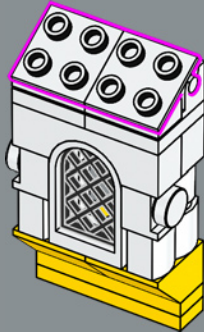

90



91





El techo y algunas de las ventanas se pueden quitar para acceder a las estancias del interior.

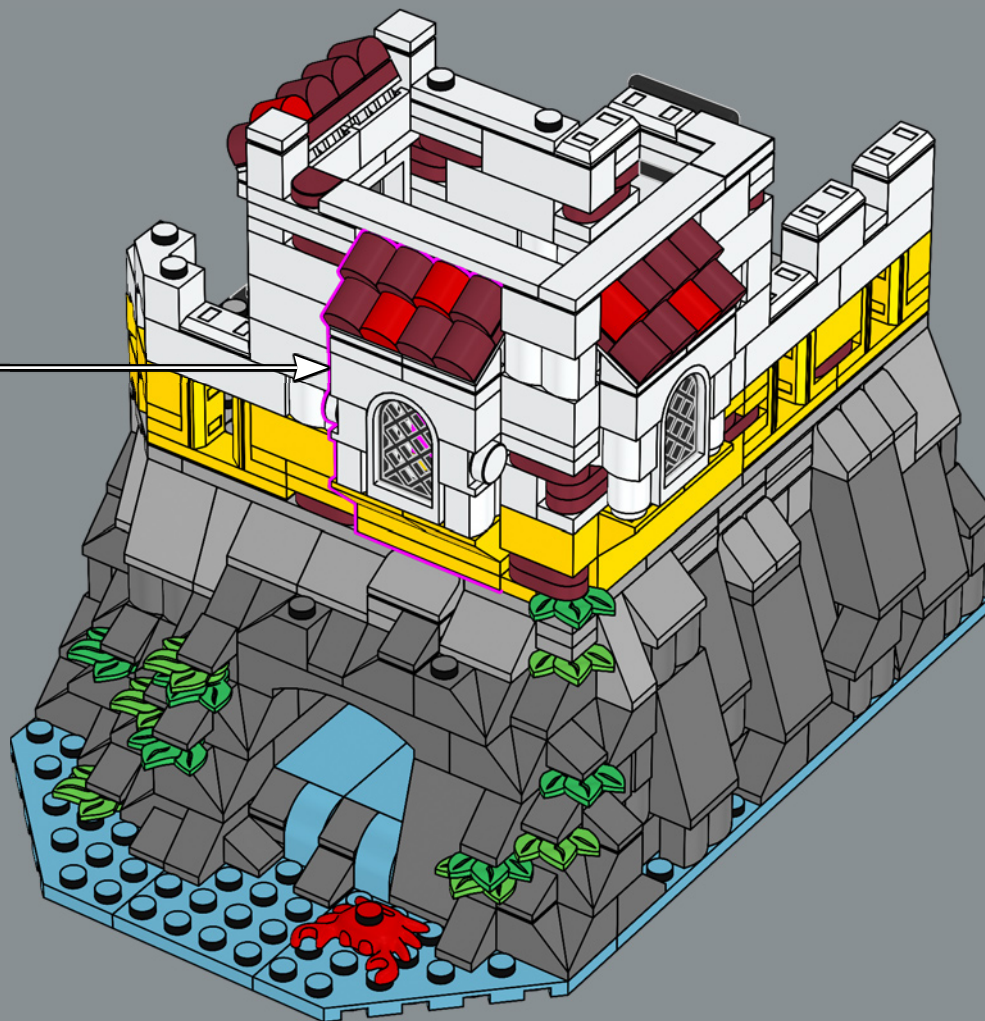

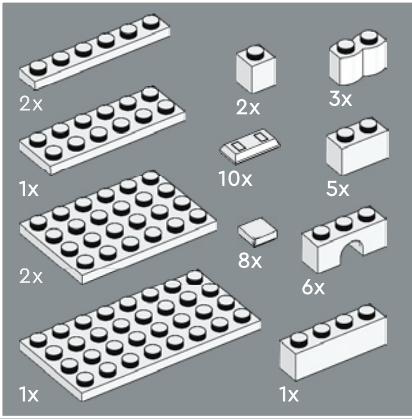
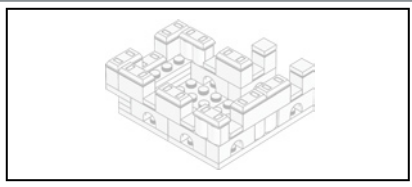

93

1

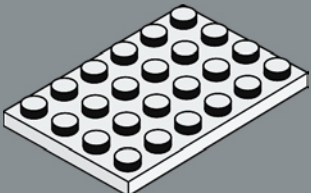

2

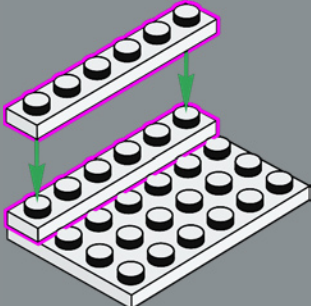

3

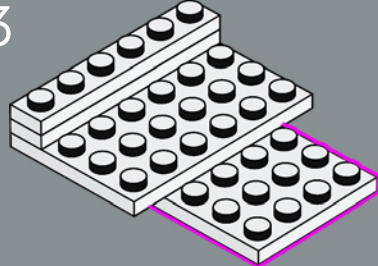

4

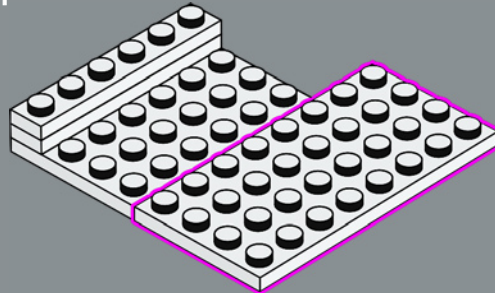

5

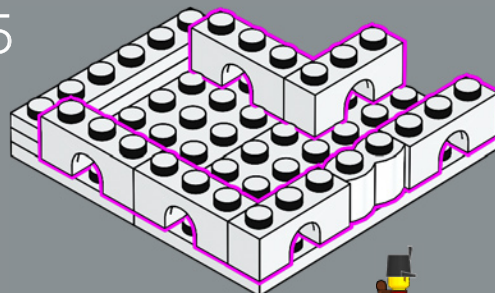

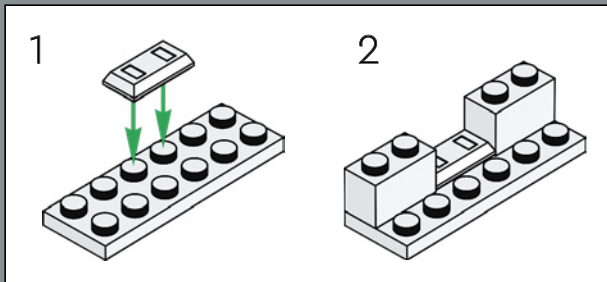

6

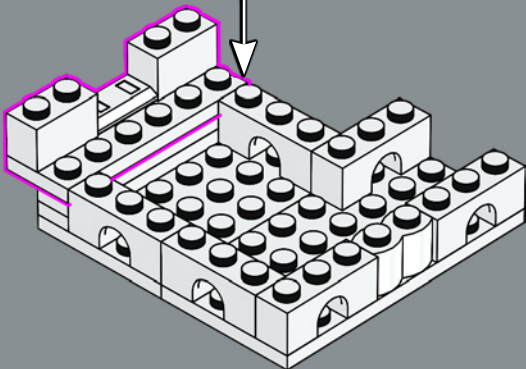

7

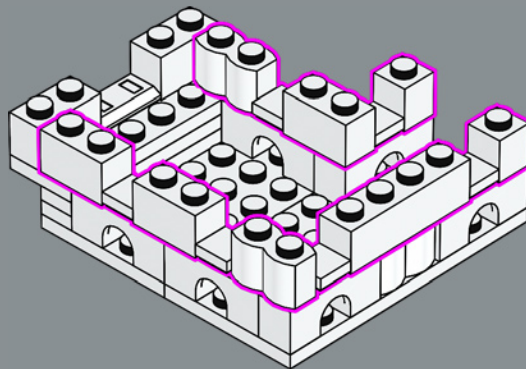

8

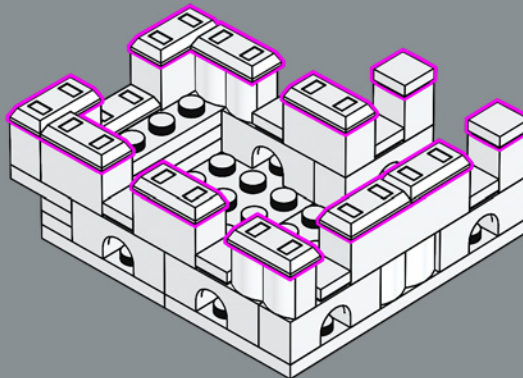

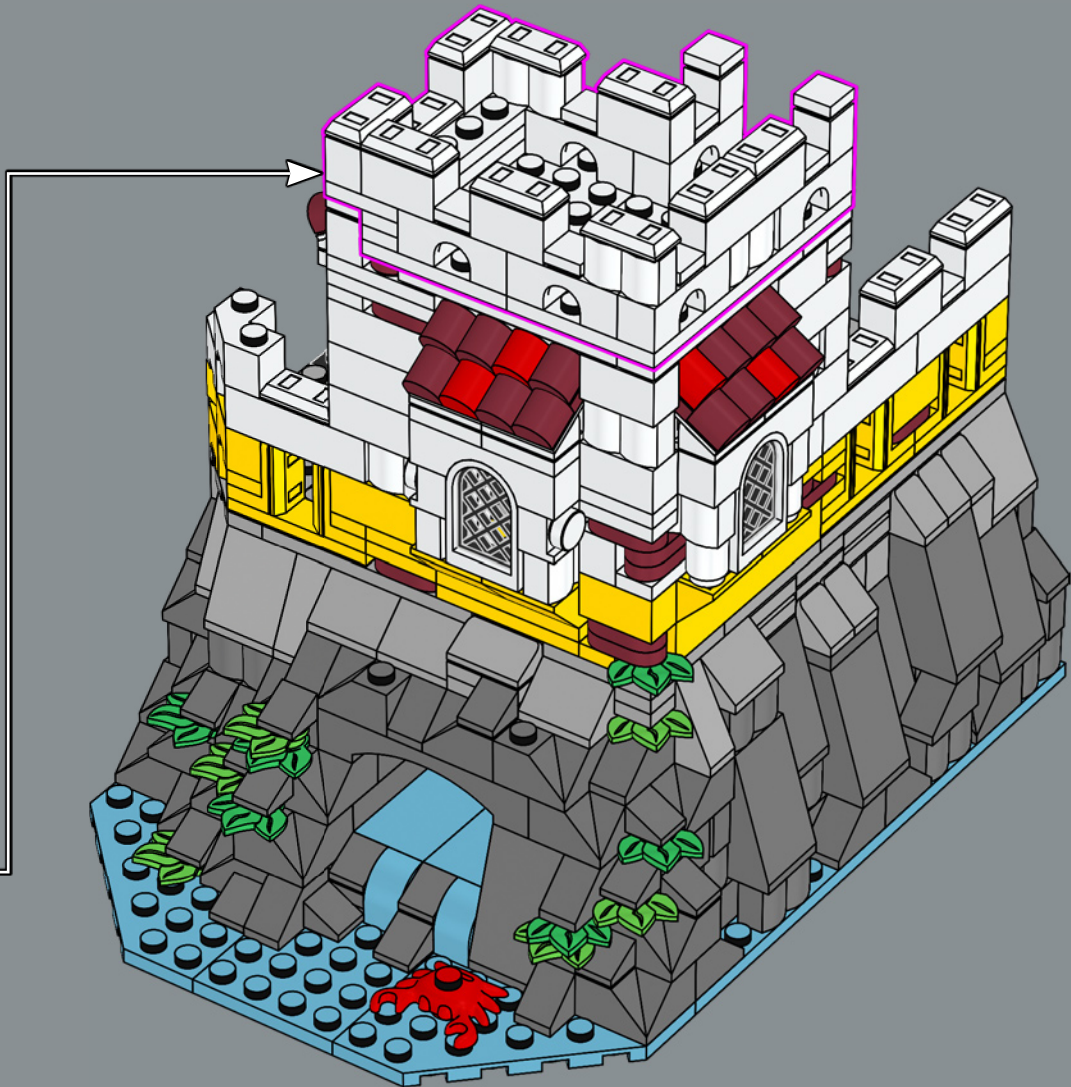



El modelo se despliega para exponer en mayor tamaño y detalle todas las penas y alegrías de los ocupantes (y sus prisioneros).

94



1

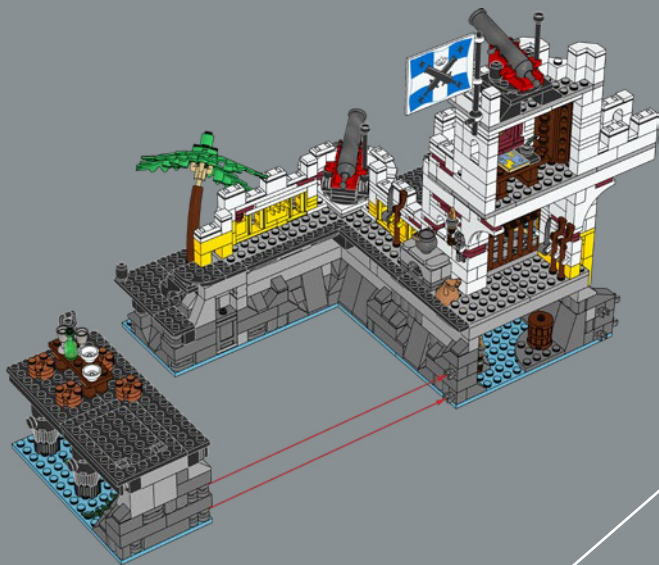

2

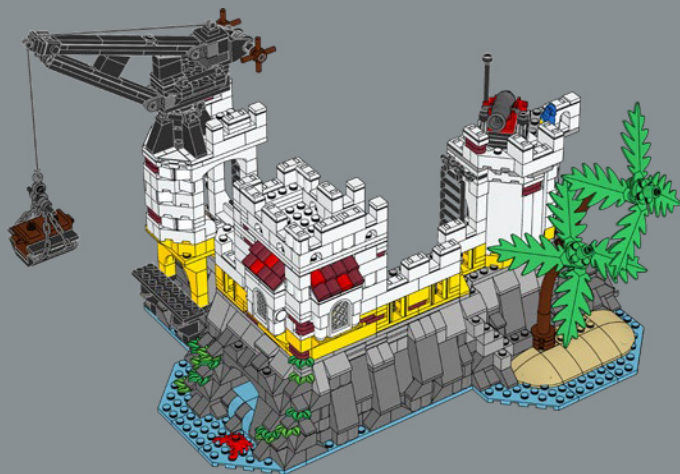
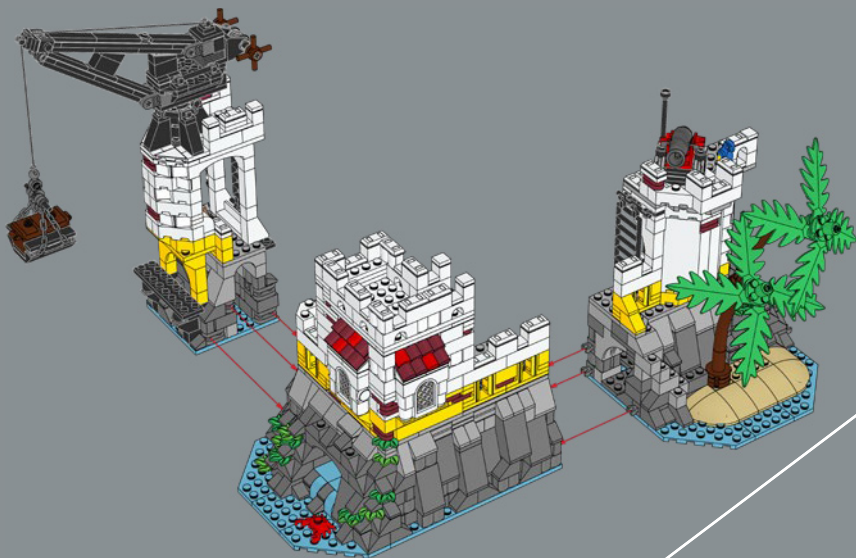

3

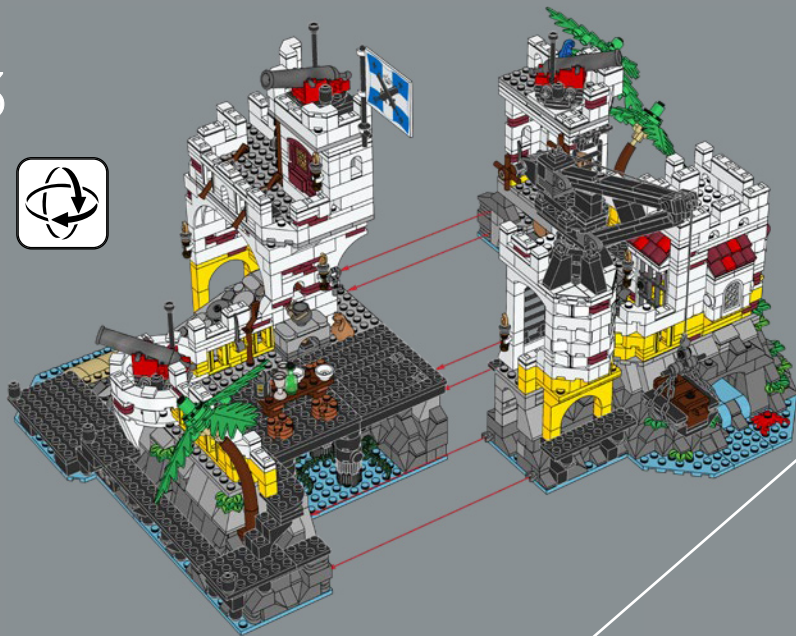



LEGO and the LEGO logo are trademarks of the LEGO Group.
©2023 The LEGO Group.