

1

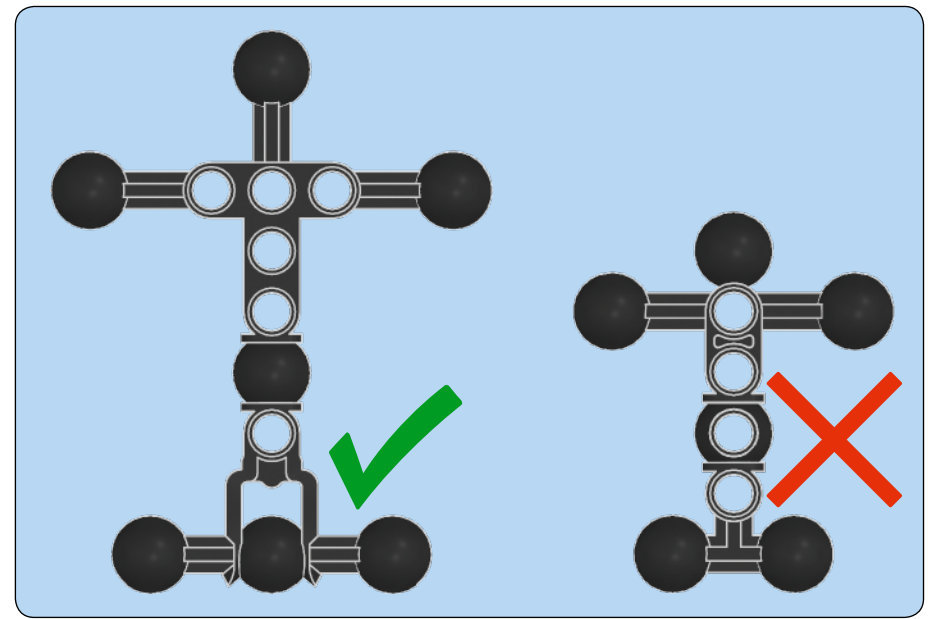

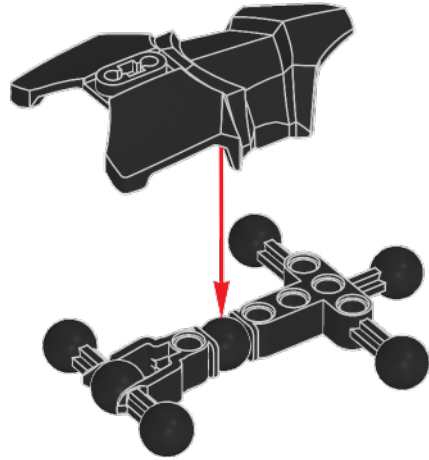

2

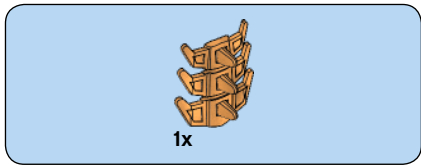
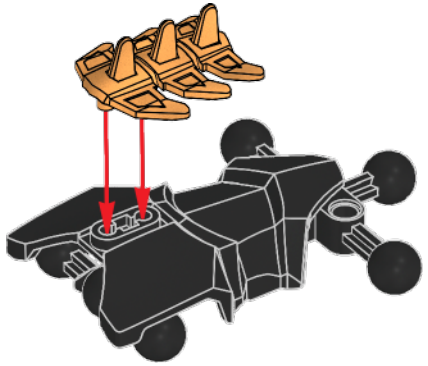

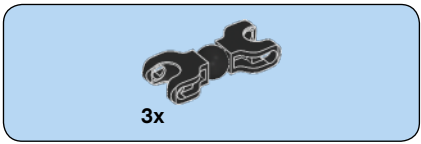

3

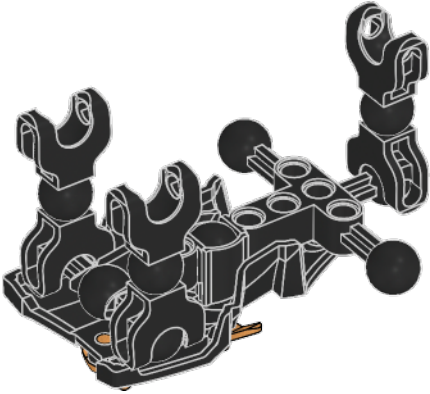
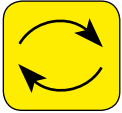

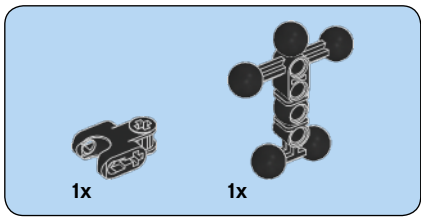

4

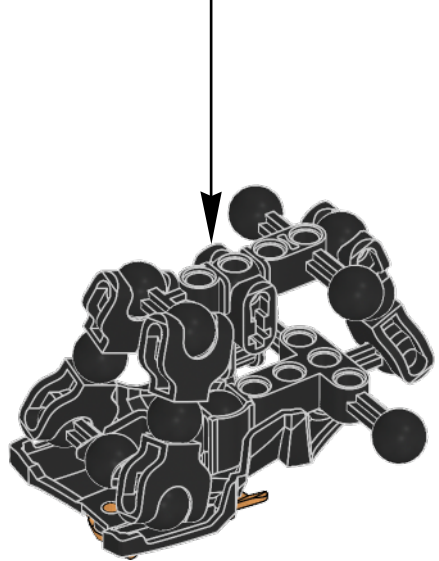
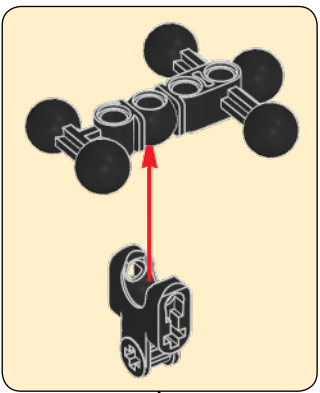

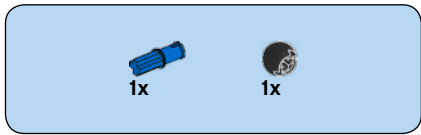

5

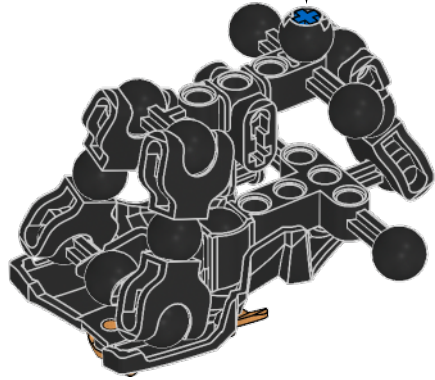
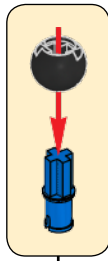

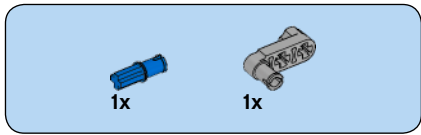

6

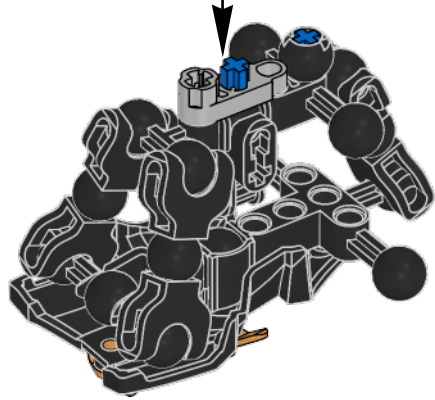
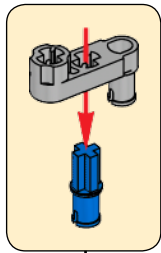

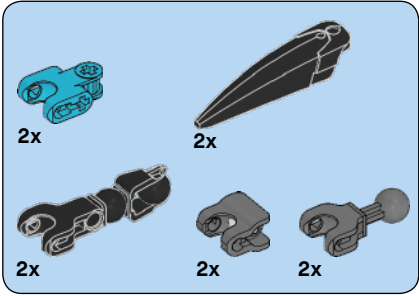
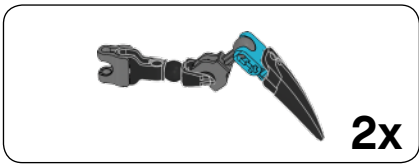

7

1



2

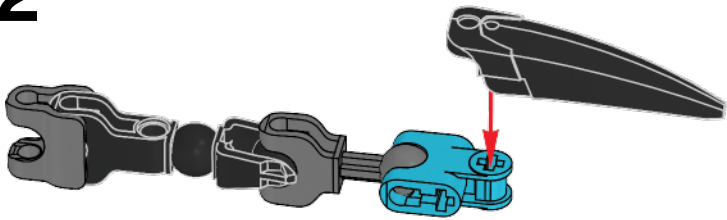

2x

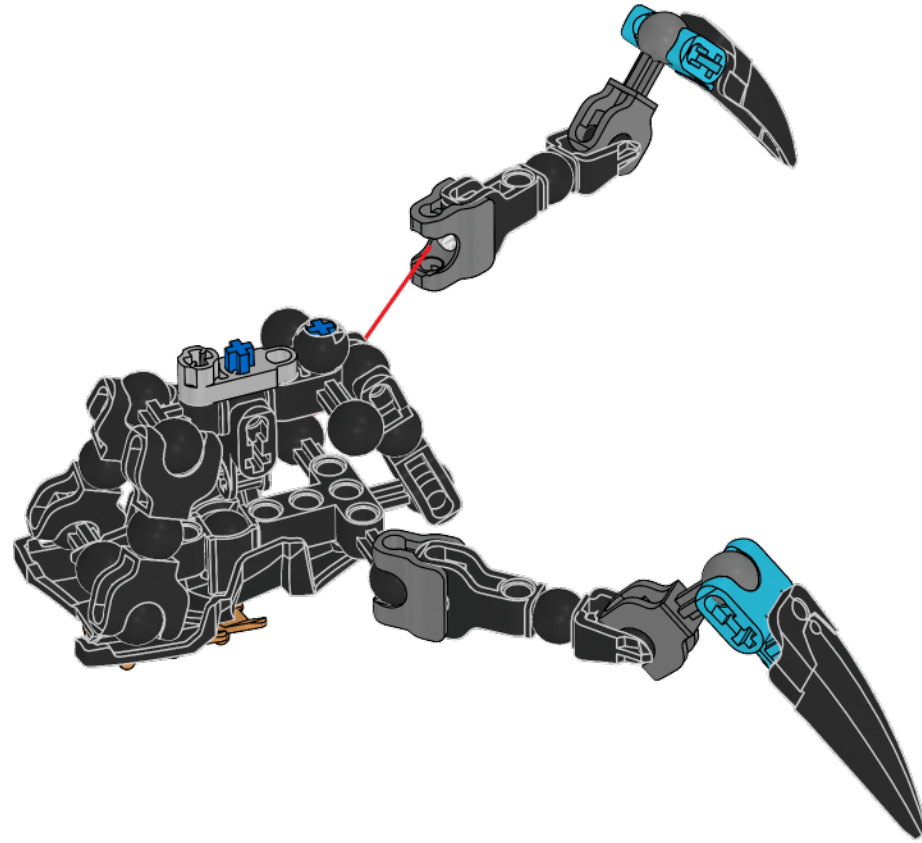

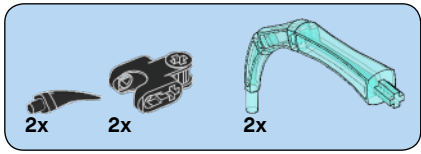

9

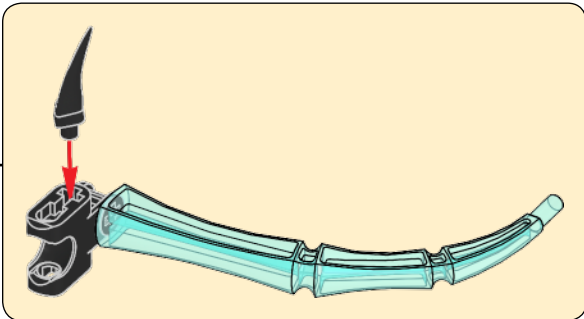
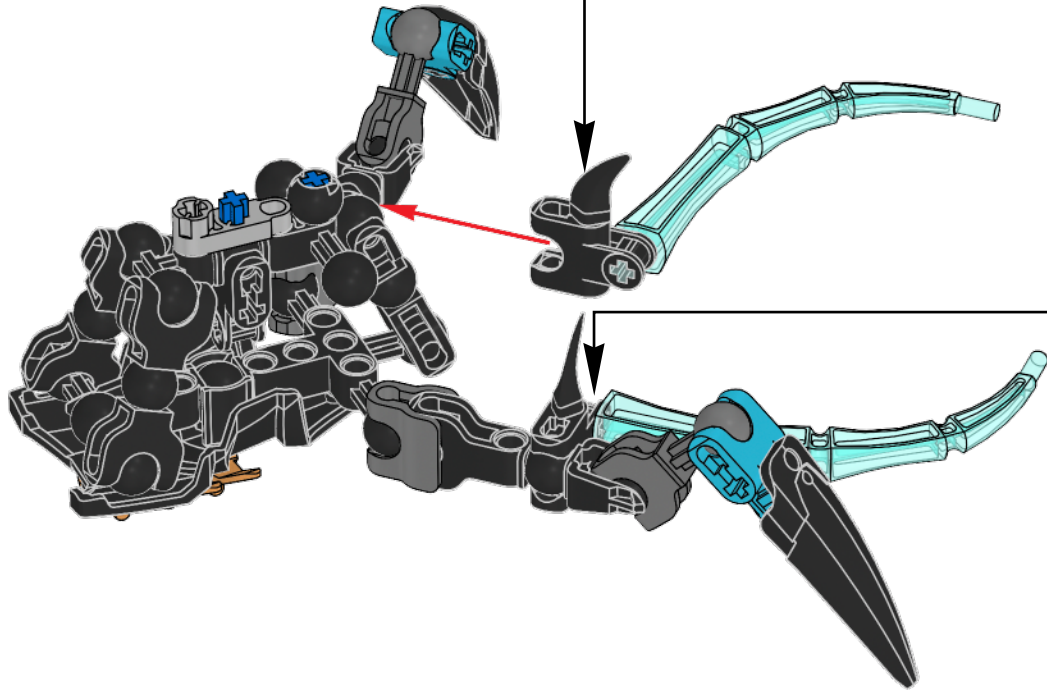
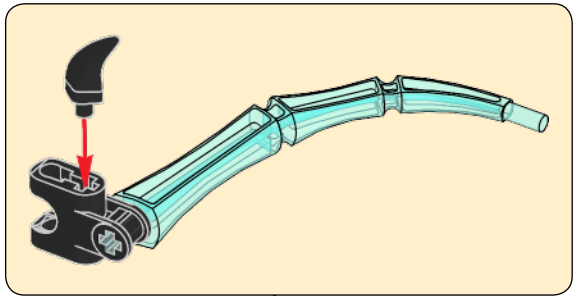

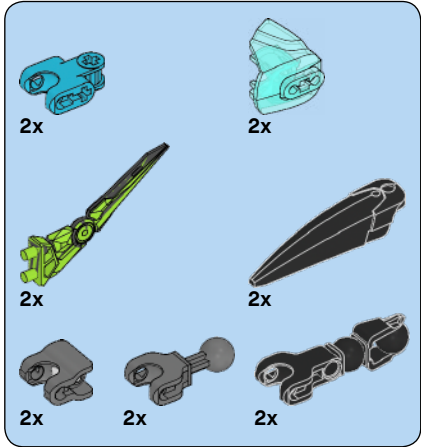
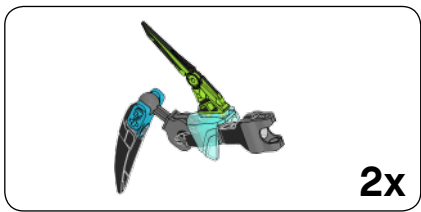

10

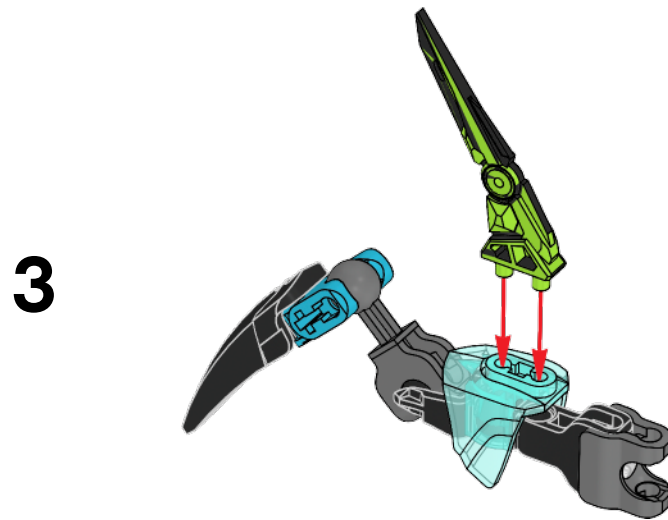
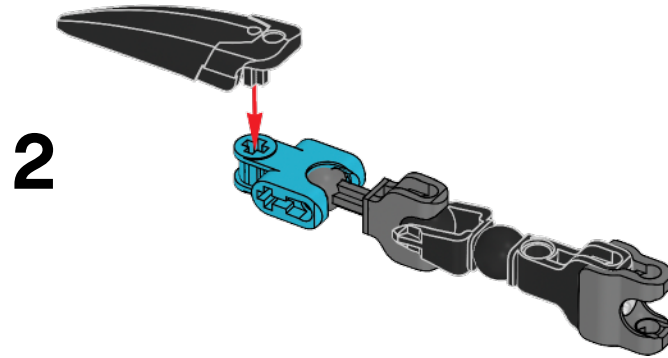
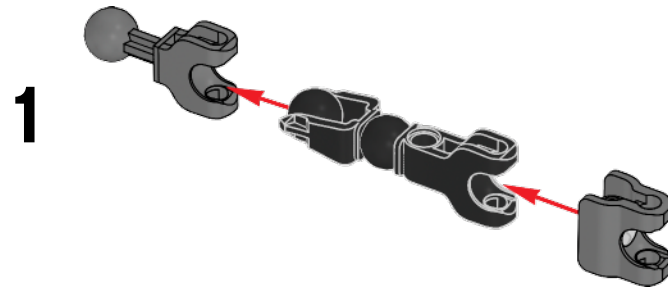

2x

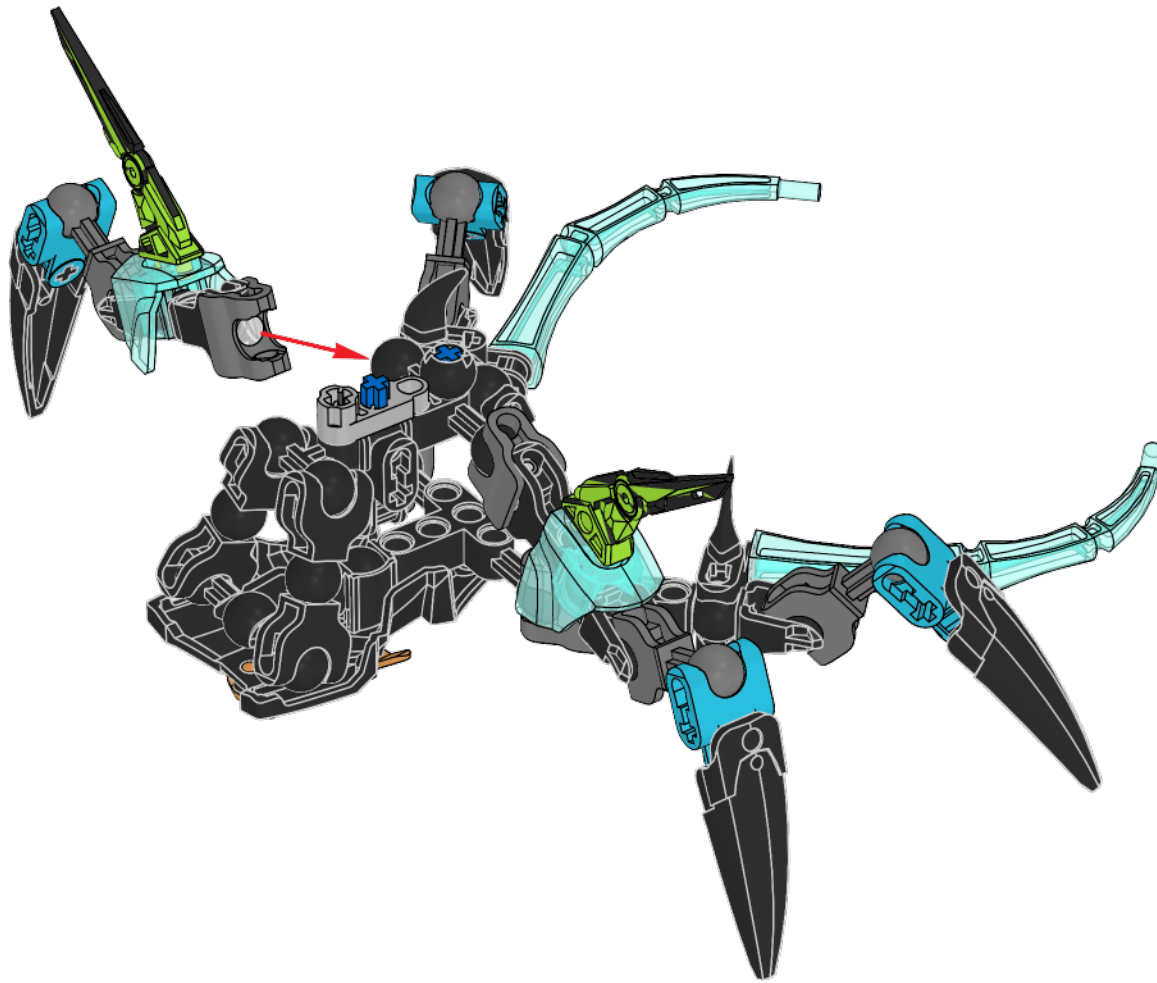

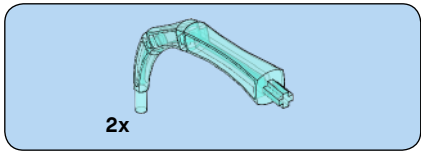

12

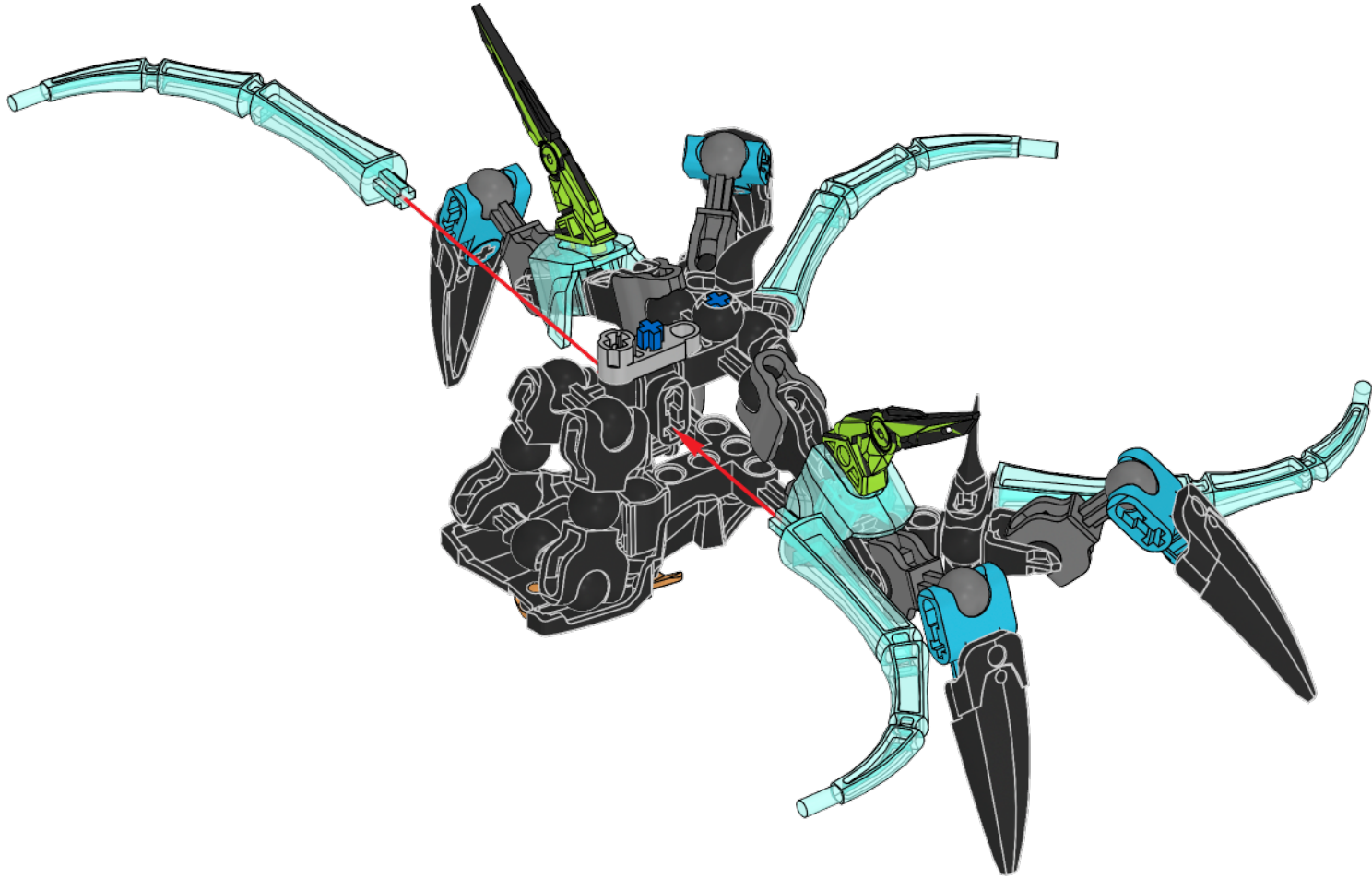

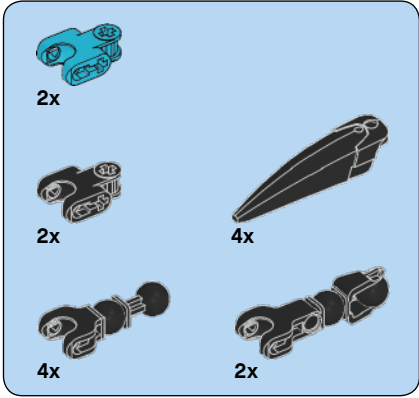
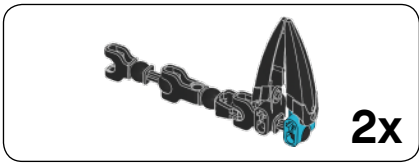

13

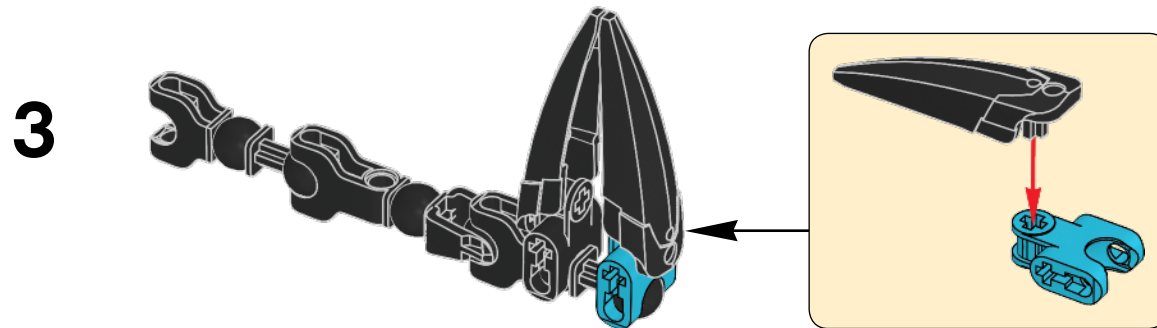
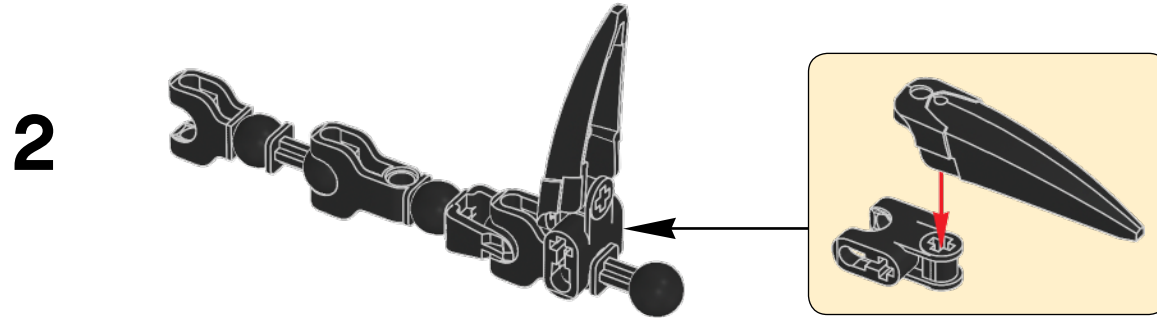
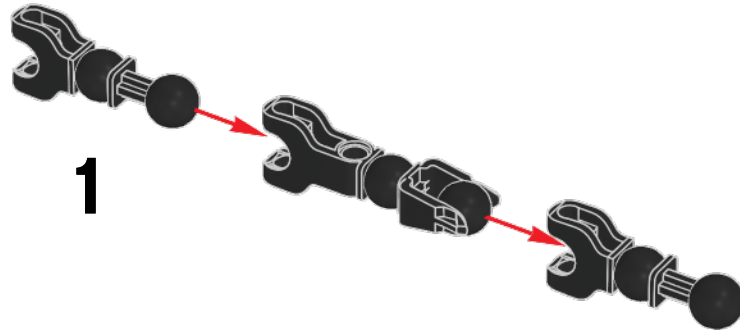

2x

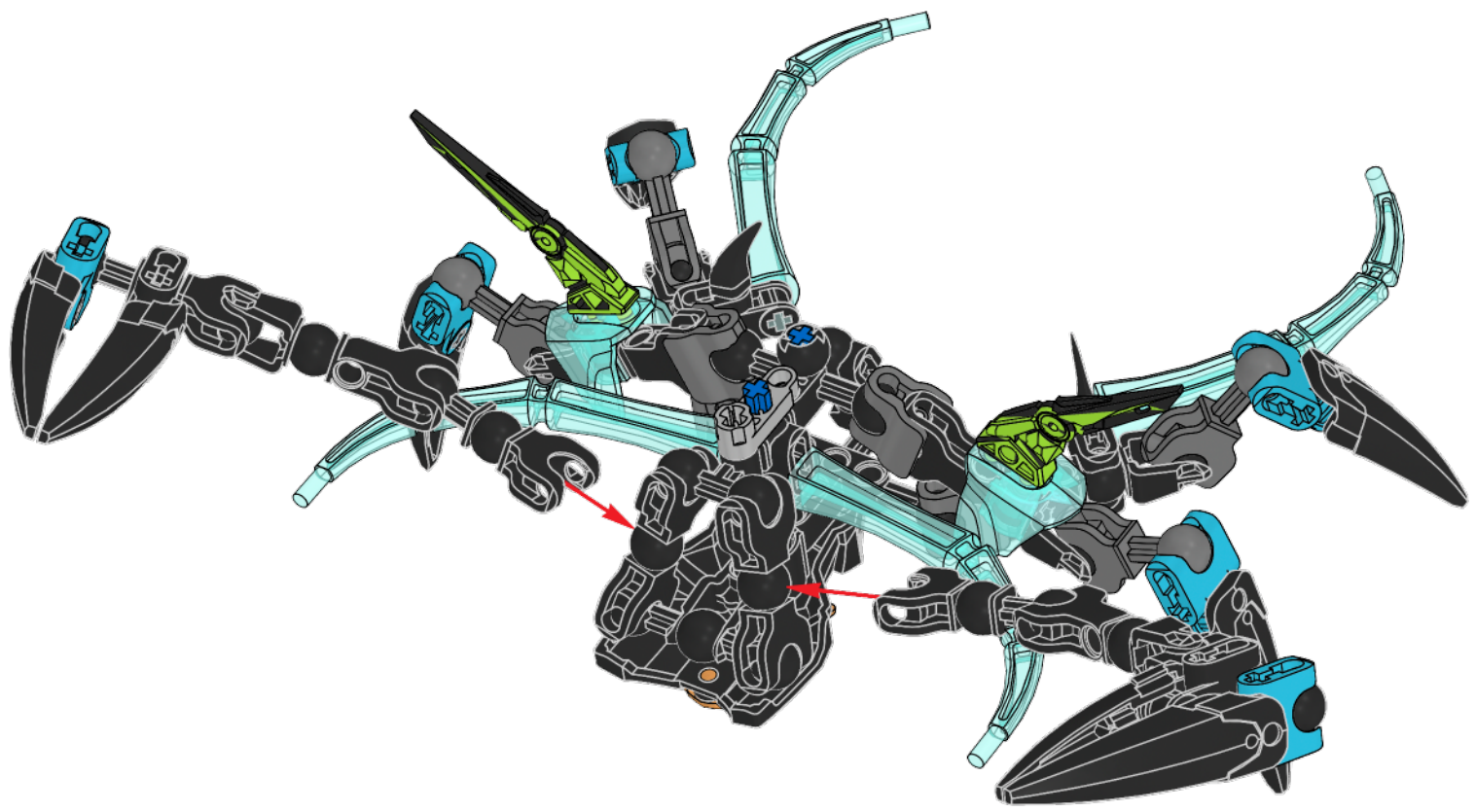

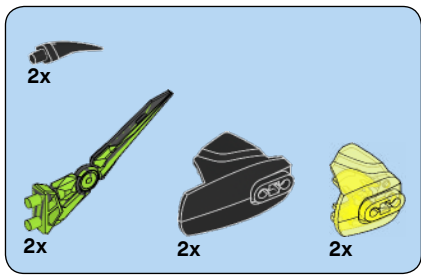

15

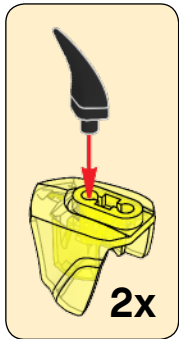
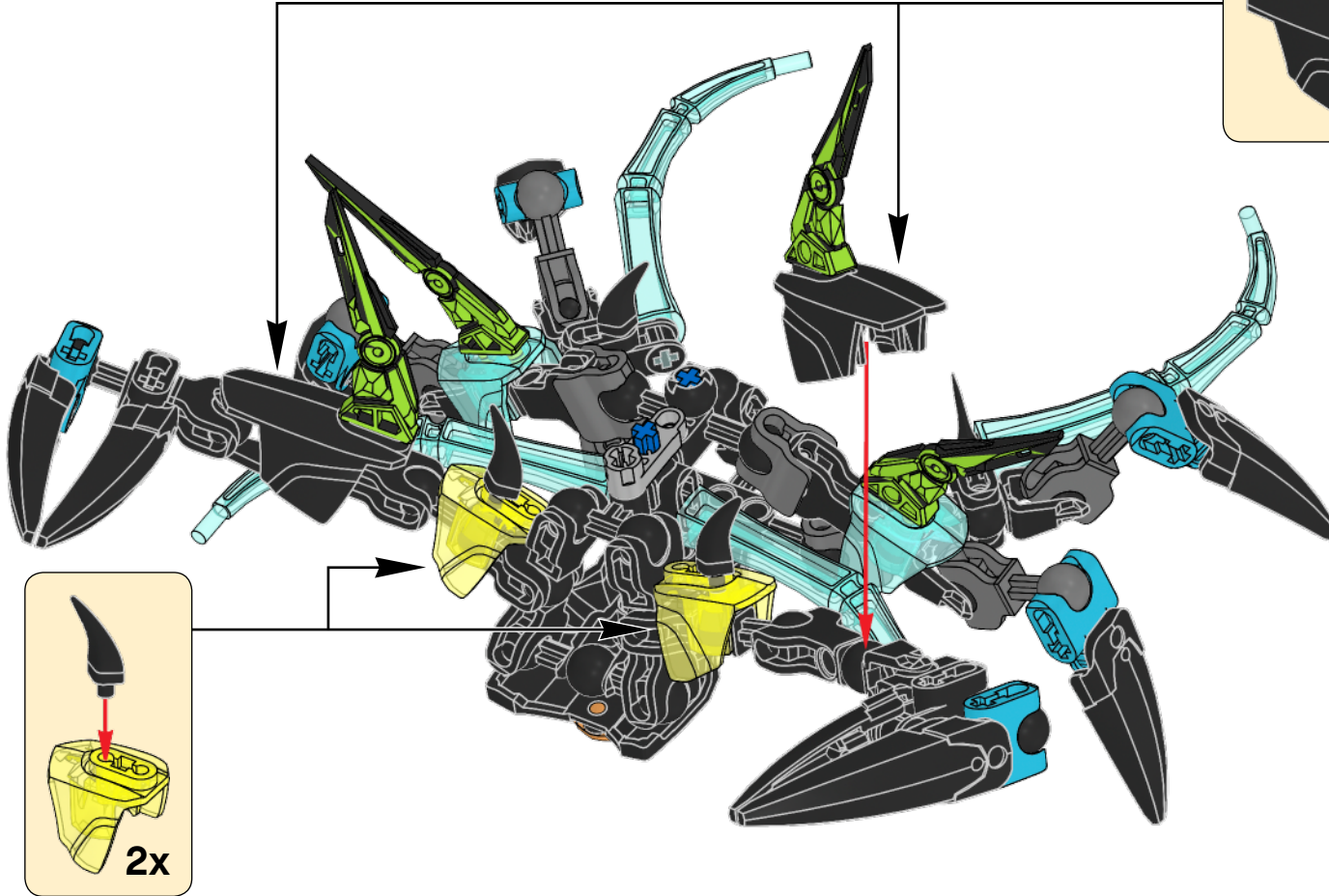
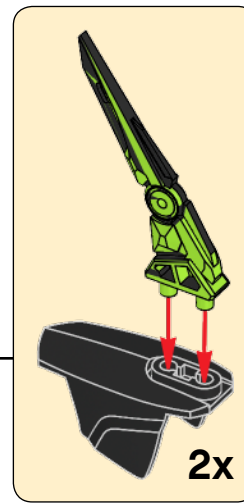

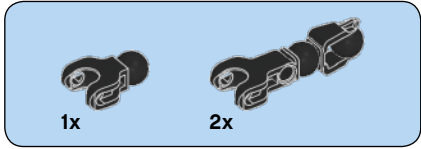
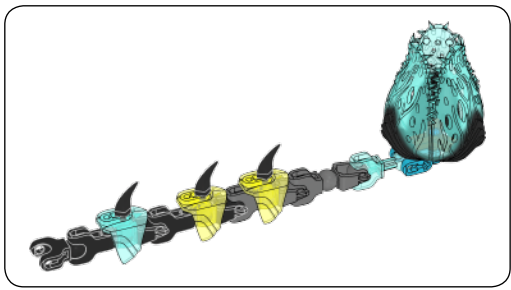

1

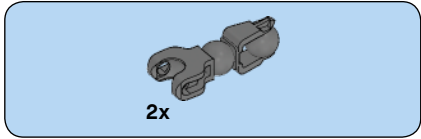
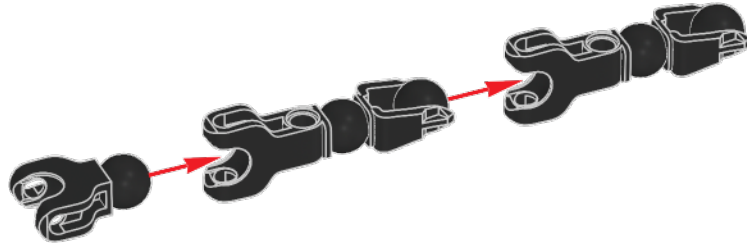

2

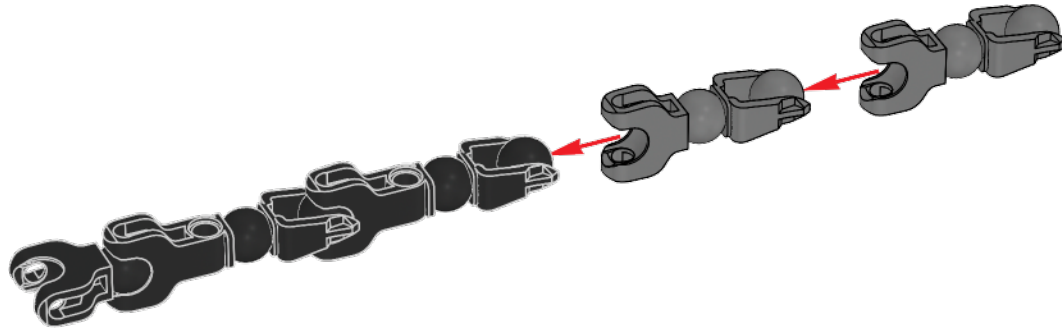

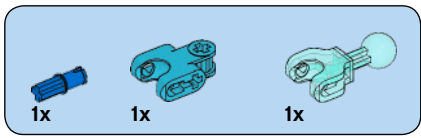

3

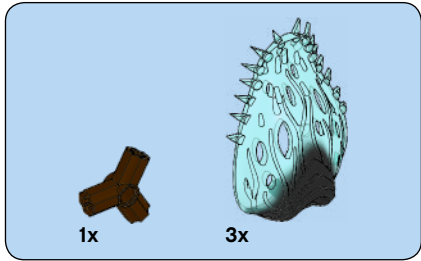
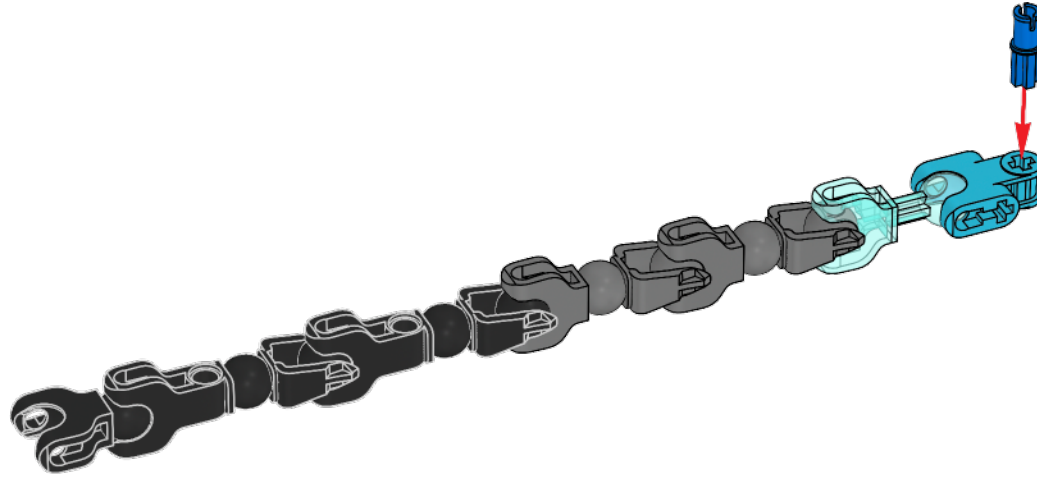

4

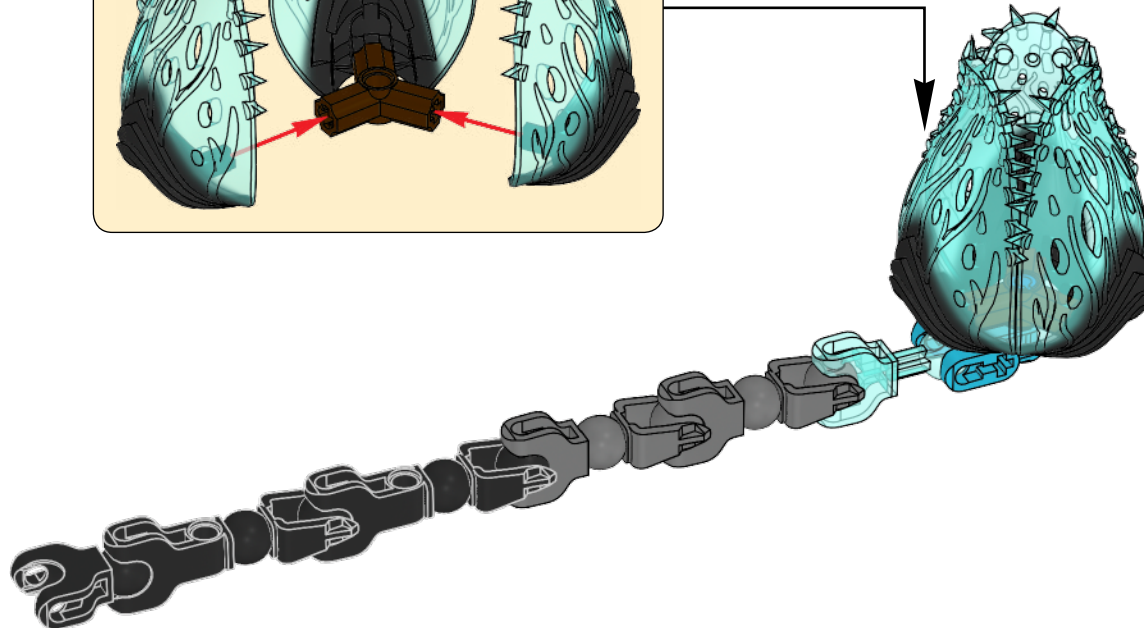
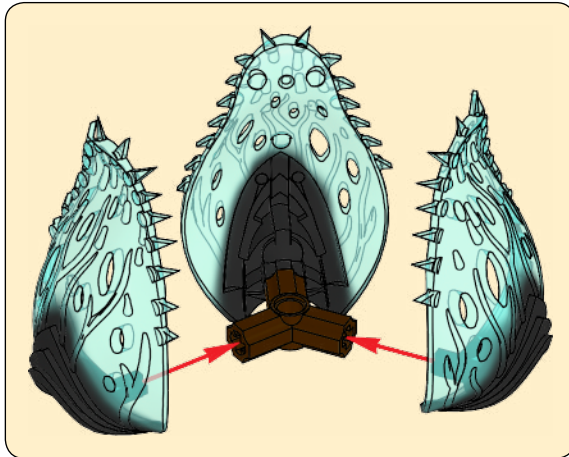

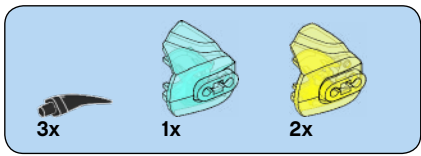

5

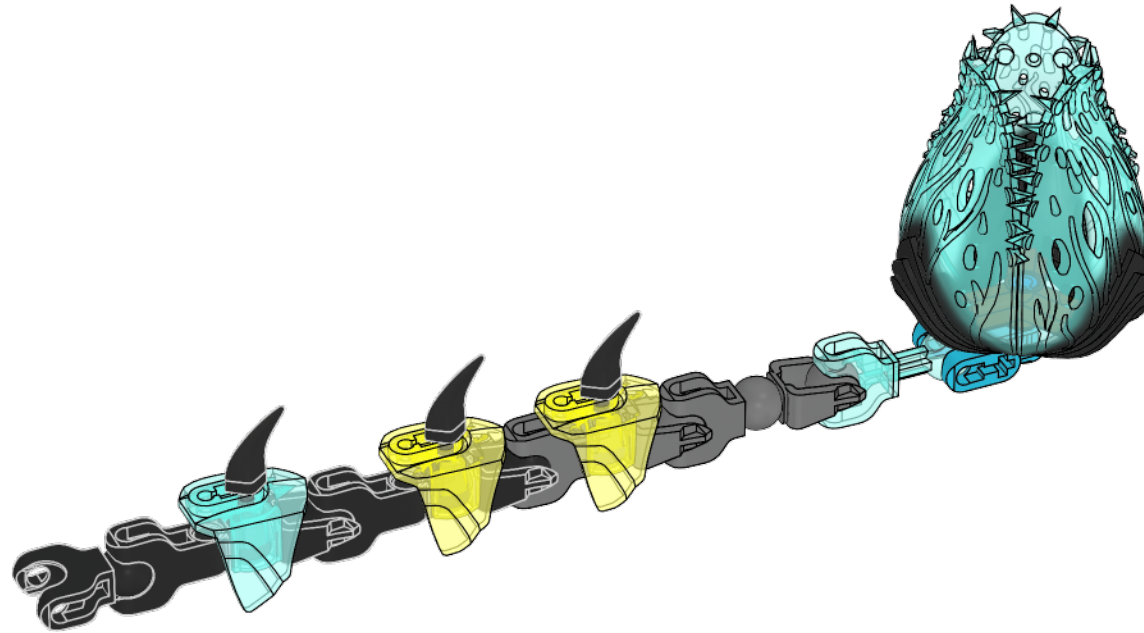

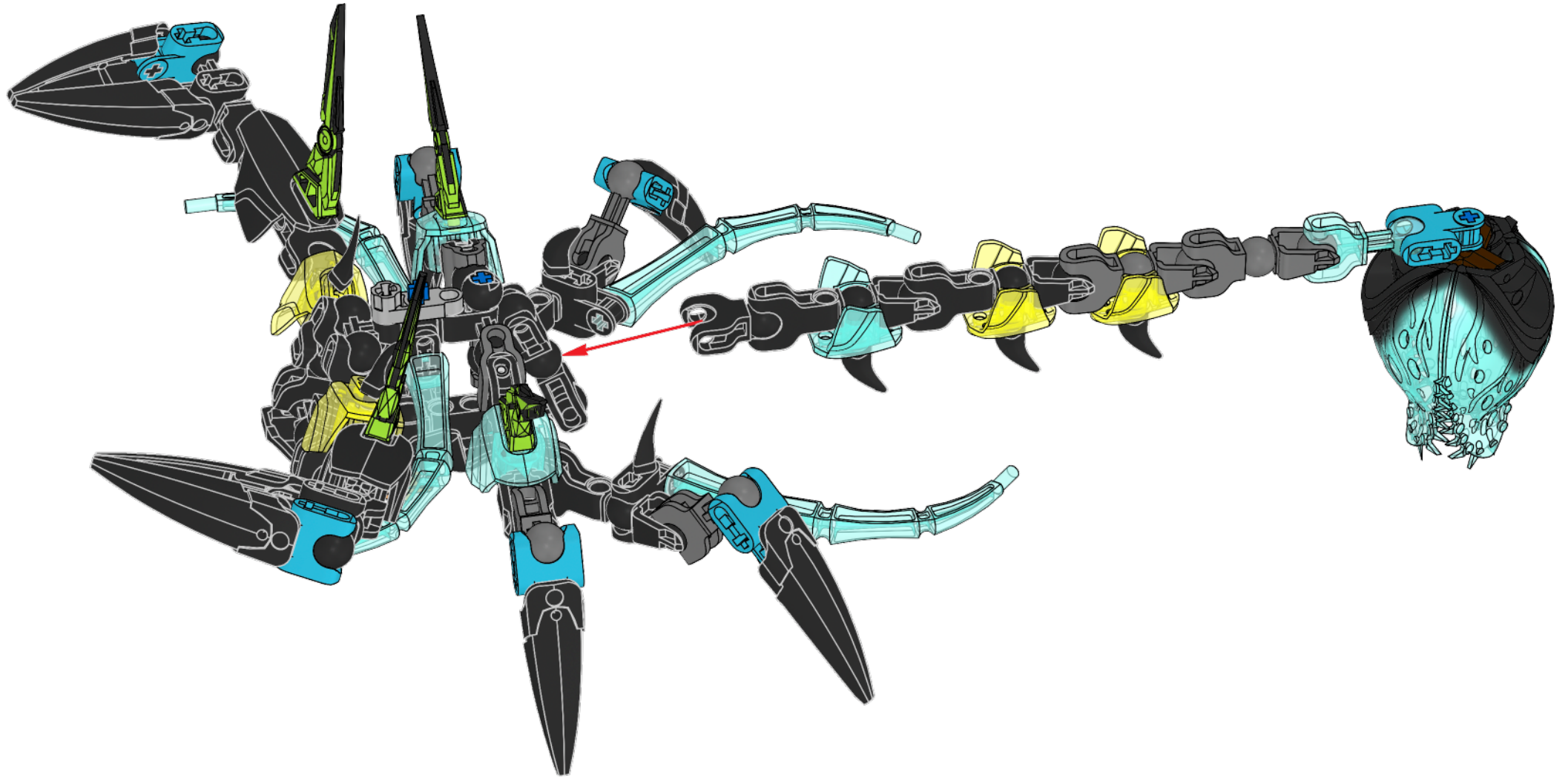

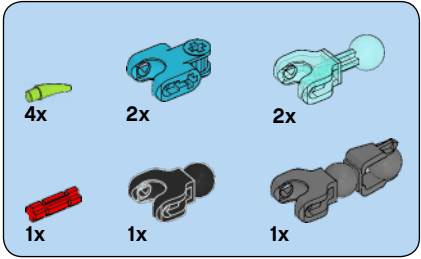
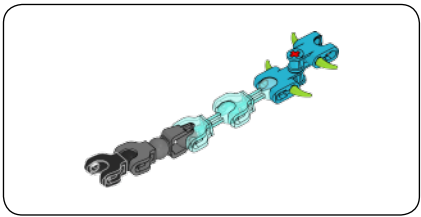

17

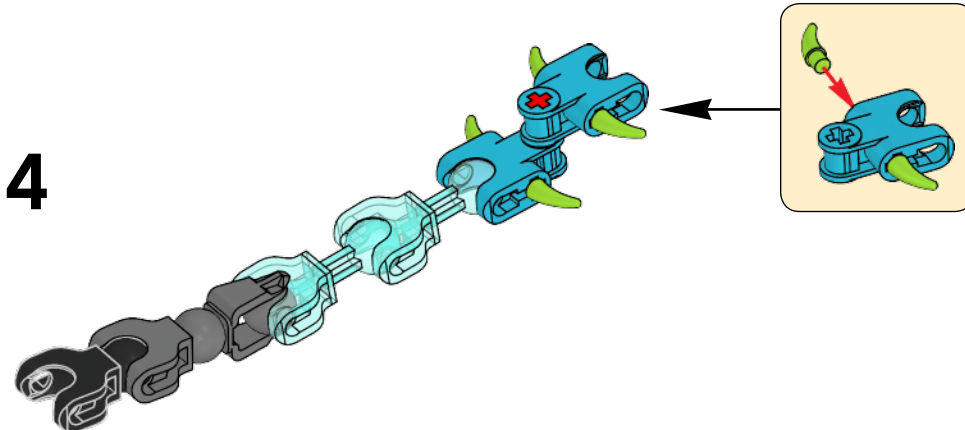
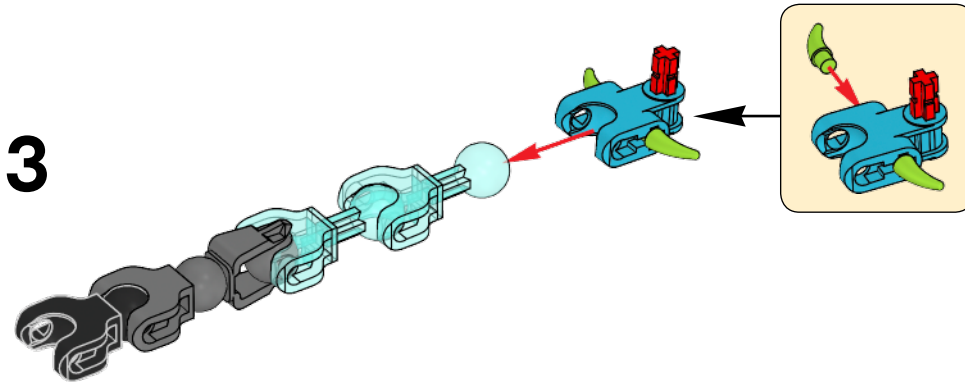
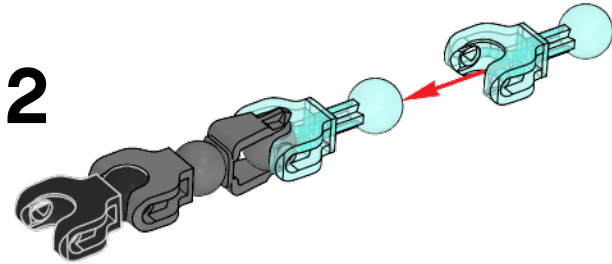
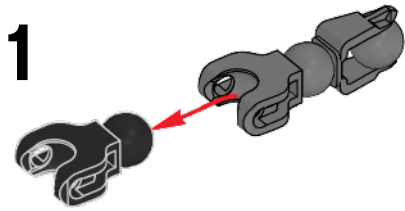

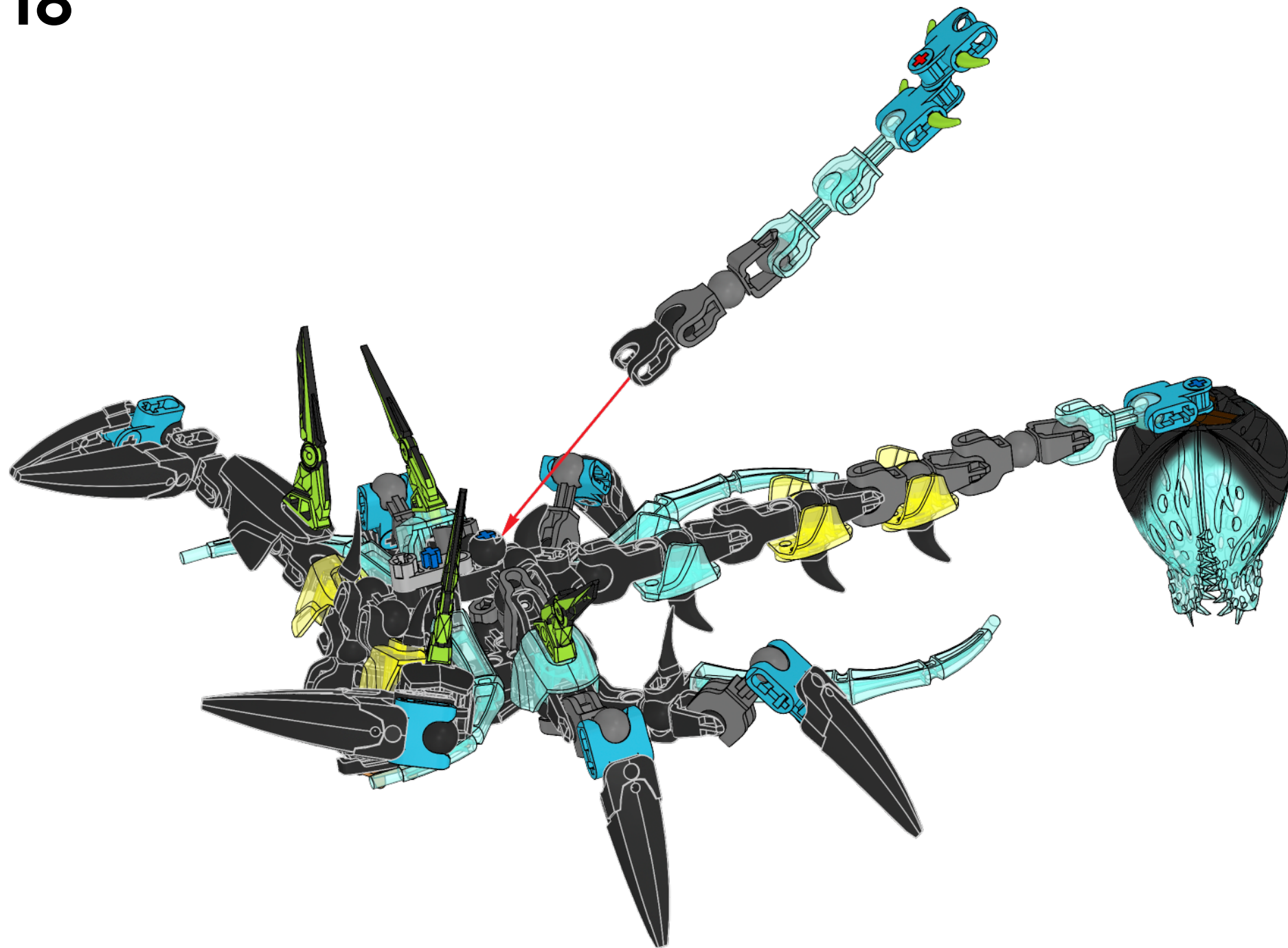

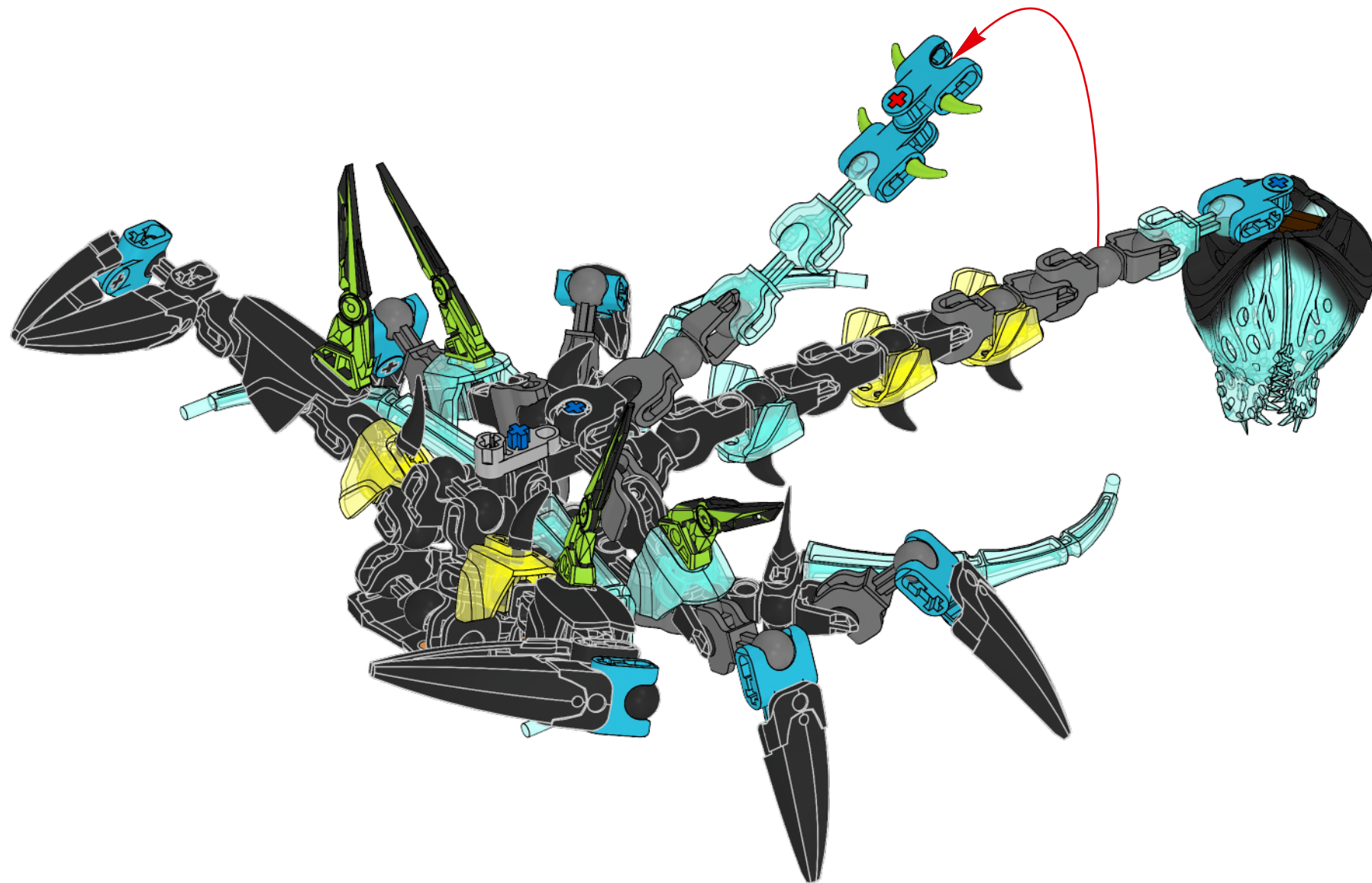

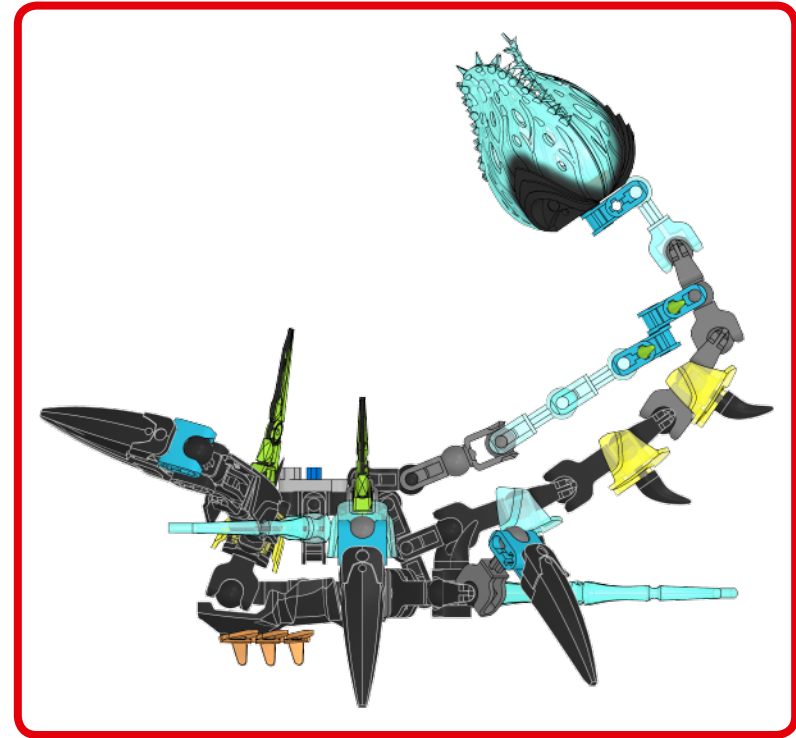
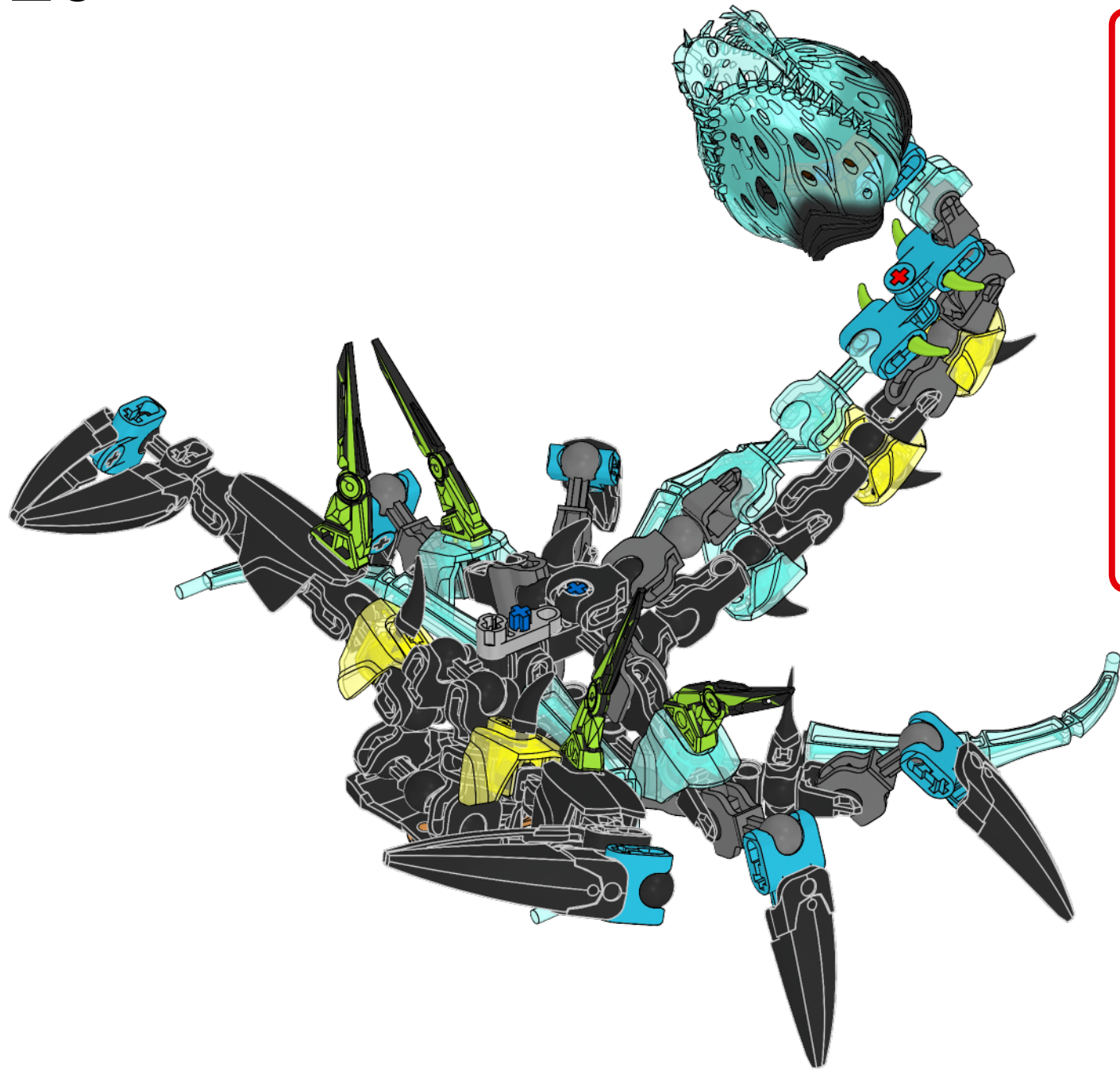

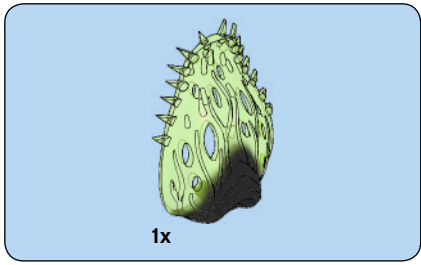

21



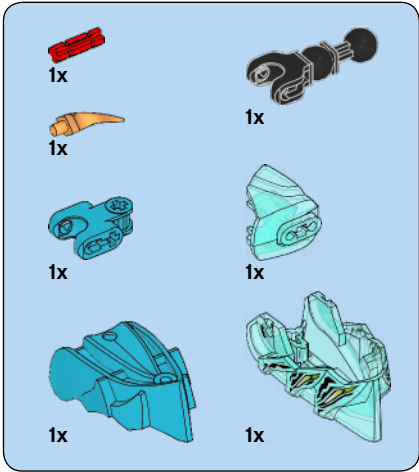
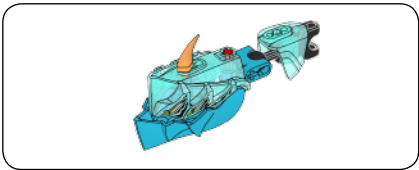

22

1

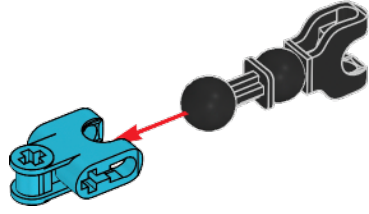

2

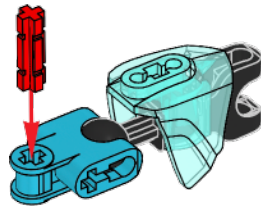

3

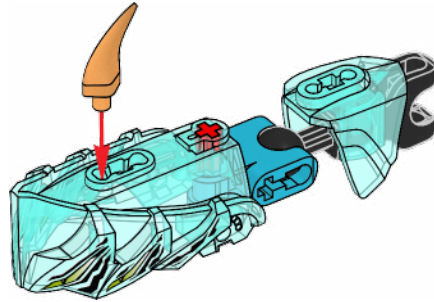

4

