



THE MAGAZINE



NEW LEGO SETS



COMICS

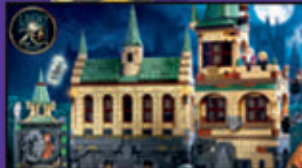

AWESOME POSTERS

HAPPY HALLOWEEN!
LOOK INSIDE FOR
SOME SPOOKY FUN
WITH ME AND ALL
MY FRIENDS!



SEPTEMBER 2021

WELCOME TO ISSUE 4!

WEB DESIGNER

HI, IT'S MAX!
WE'RE PUTTING TOGETHER PLENTY OF TREATS FOR YOU IN THIS ISSUE, AND THAT'S NO TRICK. AFTER I FINISH THIS HALLOWEEN ART, I'M GOING TO MAKE MY COSTUME... IF I CAN JUST FIND THE GLUE.

THERE'S A BIG TUB OF GLUE IN THE CLOSET. DON'T TAKE A BATH IN IT BY MISTAKE!

WHO USED UP ALL THE BLACK PAINT? OH, RIGHT, I DID.

MAX COMIC

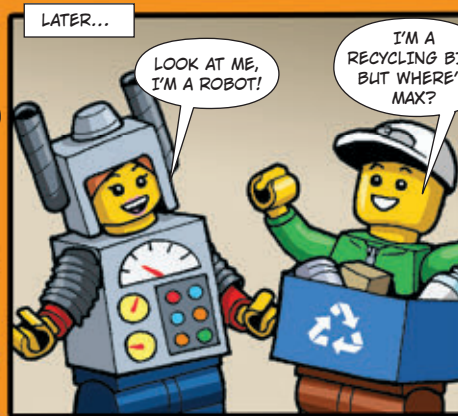

TELL US WHAT YOU THINK OF THIS MAGAZINE!

Ask a parent or guardian to **scan this code** or visit **LEGO.com/LIFESURVEY** to take the survey right away!



LEGO® Life Magazine

For information about LEGO® Life visit **LEGO.com/life**

For questions about your membership visit **LEGO.com/service** or call **1-877-518-5346**

 PO Box 1138
Enfield, CT
06082

 PO Box 600
Markham, ON
L3R 8G8



(US/CA)

LEGO, the LEGO logo, the Brick and Knob configurations, the Minifigure, the FRIENDS logo, NINJAGO and the NINJAGO logo are trademarks and/or copyrights of the LEGO Group. ©2021 The LEGO Group. All rights reserved.

Catch the awesome Max Halloween video in the LEGO® Life app!

HEY, I COULD USE EIGHT BRUSHES AT ONCE, IF I WANTED TO.

ZZZZZZ ... THANK YOU, MY COSTUME IS WONDERFUL ... ZZZZZZ

KNOW WHAT THEY CALL IT WHEN A GHOST MAKES A MISTAKE? A BOO-BOO.

LOOK!

Look for these icons on activity pages. They will tell you if the activity is easy, hard, or somewhere in between. Try them all and see how you do! **If you get stuck, the answers can be found on page 27.**



LEVEL 1

Easy



LEVEL 2

Somewhere in-between



LEVEL 3

Hard

DID YOU KNOW...



This wise old owl hides a surprise underneath: **a bat!**



FIND THE BATS!

6 bats are swooping and fluttering around the pages of this magazine. Can you spot them all?

Need Help? Answers can be found on page 27.

Don't have the LEGO® Life app yet?



You can download it today for **FREE** from one of the app stores and sign in with your LEGO Account.

available at **amazon appstore**

Download on the **App Store**

GET IT ON **Google Play**

Do you want to become an AWESOME BUILDER?



Get the free LEGO Building Instructions app and start building with digital instructions! Don't forget to ask a grown-up's permission before downloading apps.

Save your sets

Zoom in

Rotate your model while you build

Track your building completion!



LEGO® Building Instructions

Apple and the Apple logo are trademarks of Apple Inc., registered in the U.S. and other countries. App Store is a service mark of Apple Inc. Google Play is a trademark of Google Inc.

STUCK ON HALLOWEEN!

I CAN'T WAIT TO GET TO THE BIG HALLOWEEN PARTY!

ME EITHER. IT SURE IS WINDY, LEO. LEAVES ARE BLOWING EVERYWHERE.

YEAH, I NOTICED.

OH, I LOVE THESE LITTLE PUMPKINS.

I DO TOO.

WELL, I USED TO LIKE THEM.

I HOPE WE'RE ON TIME FOR THE COSTUME CONTEST.

WHOOPS!

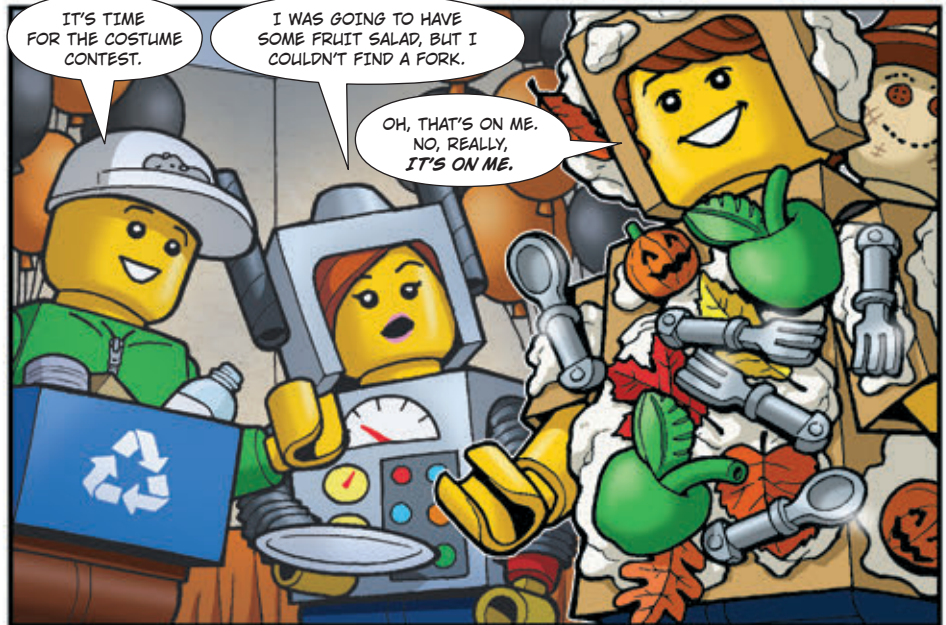

PHANTOMS OF THE FLOATING TOWER!



Phantoms are flying around the Floating Tower. There are 8 of them on this page including this one. Can you spot them all?

Need Help? Answers can be found on page 27.



Bonus!
Find the helmet and trident in this picture needed to battle the phantoms.

(They are in separate locations.)



















Sleep keeps phantoms away! Build a bed and share it in the #Minecraft group in the LEGO Life app!







THE WISDOM OF WU!

 Match the pictures to the words in the key below to complete the story.

"I can't get this to work!" said  . He was frustrated. He looked through a  for some tools, but only found  and an  . "What's the matter?" asked  . "My  is broken," said  . "None of the parts are working. I don't know what to do." "Hmmm," said  . "A machine has many parts. What else has many different parts?"

 thought about the question. "A puzzle. A model. A sentence. Even a training exercise can have different parts to it." "What else?"  smiled. "A team." "Correct," said  . "You,  ,  ,  ,  and  are a team. For the team to succeed, all of you must work together."

"Oh, I get it," said  . "All the parts of the machine have to work too. If one small part needs to be fixed, the whole  won't work."  went to work. He found a small wire that had become disconnected. Once he fixed it, the  roared to life. "Remember, a problem may seem as big as a mountain," said  . "But often the answer is as small as a pebble."

Get more ninja action at NINJAGO.com

Image Key



Lloyd



Master Wu



Oxygen Tank



Chest



Flippers



Hydro Mech



Cole



Kai



Nya



Jay



Zane

DANGER IN THE SODA JUNGLE!



The Soda Jungle is full of surprises for LEGO® Mario™. Solve these three puzzles to help stop his enemies. Here we go!

Put LEGO® Mario™ on the platform and move the Wiggler to unfold the secret bridge.

Avoid the poison swamp and defeat the Koopa Paratroopa!



There's more action and fun in the LEGO® Super Mario™ Adventure Zone in the LEGO Life app!



Find the Flower

Help this Wiggler find the flower by solving this maze. Let's-a-go!

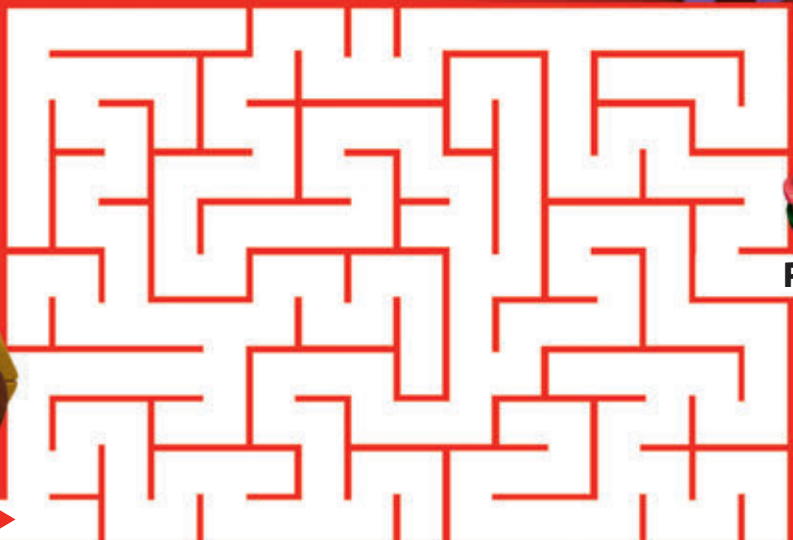

FINISH

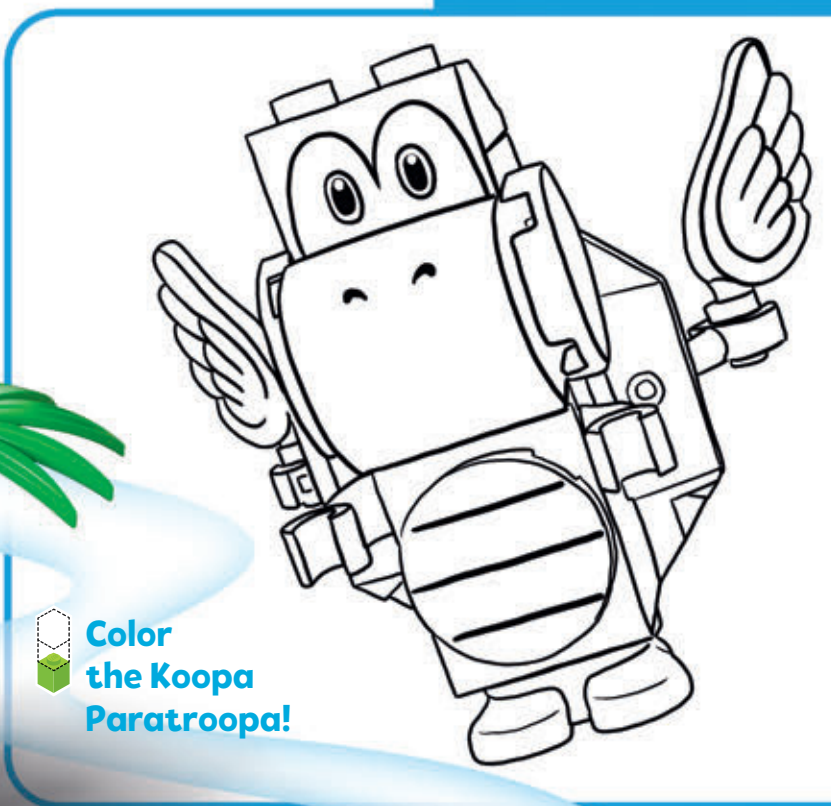

Color the Koopa Paratroopa!

Stomp on the Goomba to earn coins.

LEGO® Mario™ character featured in visual is sold separately.

Need help? All the answers to this page can be found on page 27.

DID YOU KNOW...?

Here are a few tips and tricks to have even more fun with LEGO® Super Mario™!

- Add your own bricks to create an even bigger level. Try red bricks for lava, blue bricks for water, green bricks for grass, or a cool combination.
- Use the Super Star Block to defeat enemies quickly, so you have a chance to go on a coin collecting spree!
- Challenges like the slider, the cloud and the rotator platforms offer more coins the longer you stay on.

V	D	K	E	P	C	X	I	B	D
S	Q	I	X	K	Y	U	Q	W	C
O	H	G	O	O	M	B	A	I	K
R	O	Y	B	Z	B	Y	U	G	L
L	X	B	G	O	P	B	P	G	T
H	P	W	W	U	B	D	F	L	R
E	R	S	K	W	Y	M	V	E	U
J	E	E	G	W	N	O	R	R	K
R	P	M	O	W	H	T	P	R	C
Y	X	S	S	B	V	P	F	A	H



LEGO® Super Mario™ Word Search

Find the names of LEGO Mario's enemies in this puzzle. Oh yeah!

- GOOMBA**
- SHY GUY**
- WIGGLER**
- BOWSER**
- THWOMP**
- BOO**



BATTLE OF THE BANDS!

THERE'S AN EXCITING CONCERT COMING TO TOWN!

Tonight at the Arena, Live in Concert
PUNK PIRATE SHIP



8 PM
ALL
TICKETS
FREE



HEY...

BE
COOL, FISH,
I'M ALMOST
DONE.

MAKE
THAT
TWO
EXCITING
CONCERTS.

TONIGHT
at the Stadium



Live in Concert
K-PAWP
8 PM - All Tickets FREE



OUR SHOW
RULES, UNICORN! WE DO
ALL PIRATE MUSIC,
ALL THE TIME!



HA! WE DRESS LIKE
CHICKENS AND OUR HIT SONG
IS "BAWK BAWK BAWK!"

WE PLAY INSIDE A
BLOCK OF JELLY WHILE
RIDING MOTORCYCLES!

THAT'S
NOTHING! WE
GROW TENTACLES
AND BURP TO THE
MUSIC!

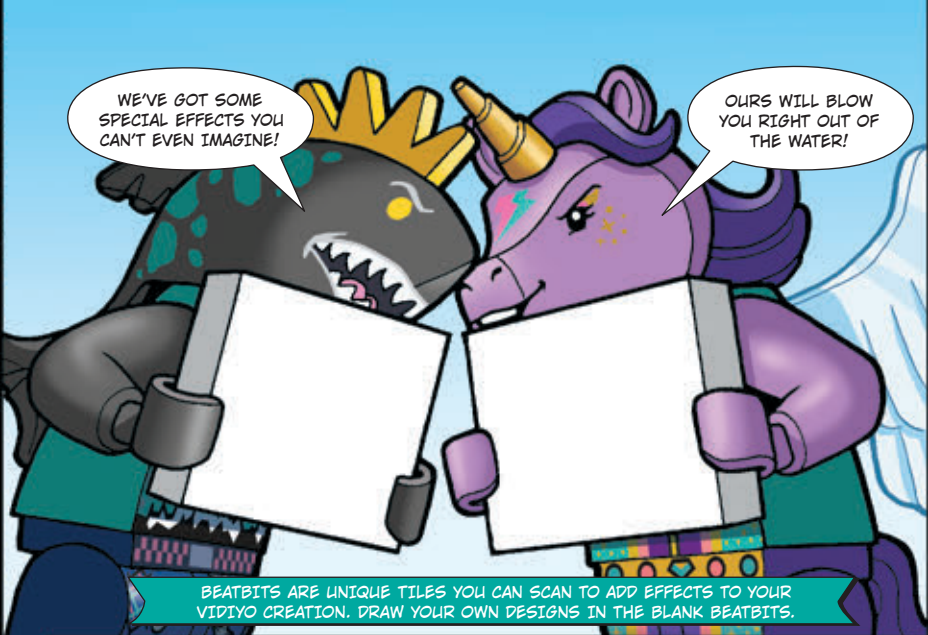

BEATBITS ARE UNIQUE TILES YOU CAN SCAN TO ADD EFFECTS TO YOUR VIDIYO CREATION. DRAW YOUR OWN DESIGNS IN THE BLANK BEATBITS.

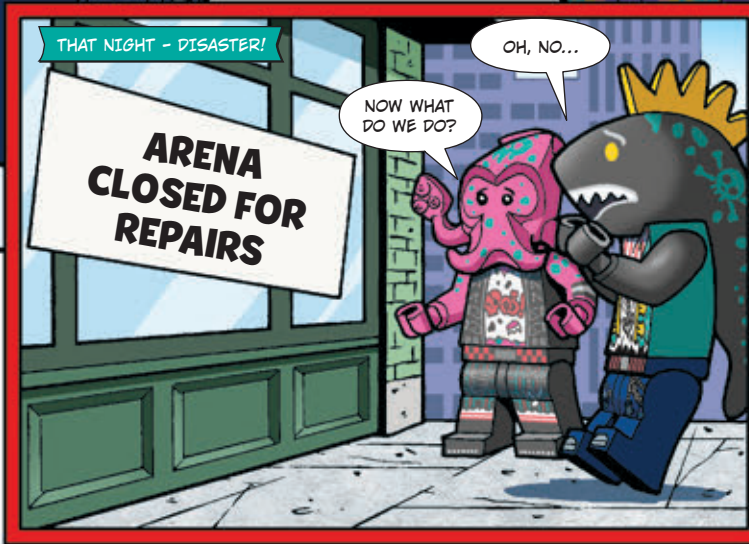

COMPLETE THE COMIC BY DRAWING YOUR IDEA OF WHAT THE FINAL CONCERT LOOKS LIKE. ADD YOUR OWN BEATBIT EFFECTS FROM ABOVE TO MAKE IT SUPER SPECIAL!

LEGO Harry Potter

HAPPY ANNIVERSARY LEGO® HARRY POTTER™!



HARRY POTTER characters, names and related indicia are © & ™ Warner Bros. Entertainment Inc. WB SHIELD, © & ™ WBEI. WIZARDING WORLD trademark and logo © & ™ Warner Bros. Entertainment Inc. Publishing Rights © JKR. (s21)

WIZARDING
WORLD



A HOGWARTS™ HALLOWEEN!

Check out some of the magical things that have happened on Halloween at Hogwarts!

Harry Potter and the Sorcerer's Stone™

Harry, Ron and Hermione become good friends while they defend Hogwarts against a troll.



Harry Potter and the Chamber of Secrets™

The Chamber of Secrets is reopened.

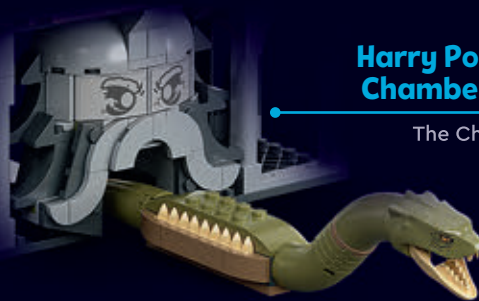

Harry Potter and the Prisoner of Azkaban™

Sirius Black™ sneaks into Hogwarts on Halloween and causes panic.



Harry Potter and the Goblet of Fire™

Harry is named one of the Triwizard Champions.



NINJAGO

LEGO





LEGO, the LEGO logo, NINJAGO, the NINJAGO logo and the Minifigure are trademarks and/or copyrights of the LEGO Group. © 2021 The LEGO Group. All rights reserved.

SPACED OUT!

The Space Shuttle is on the way to bring supplies to the astronauts on the Moon. Come on along!



HOW DO YOU KNOW WHEN THE MOON HAS HAD ENOUGH TO EAT? WHEN IT'S FULL.

WHY DID THE ASTRONAUTS BLAST OFF FOR MARS? THEY NEEDED SOME SPACE.



HOW CAN YOU TELL SATURN IS MARRIED? IT WEARS A RING.

DID YOU KNOW... THAT WE HAVE A LOT OF CHOICES FOR FOOD, INCLUDING FRUIT, NUTS, PEANUT BUTTER, CHICKEN, BEEF AND SEAFOOD.

ALL THE FOOD COMES IN DISPOSABLE PACKAGES. SALT AND PEPPER COMES AS A LIQUID, SINCE GRAINS OF SALT AND PEPPER WOULD FLOAT AROUND AND CLOG MACHINERY.

How Do Astronauts Use the Bathroom?

Space toilets are very different from the normal stuff you use. Astronauts pee into a funnel and hose and it's recycled into drinking water. Amazing! Poop is vacuumed into sealed bags which are loaded onto a cargo ship and launched back to Earth. The ship burns up in the atmosphere.

So when you see a shooting star, it might be a meteor or it might be flaming poop!



Build a Space Toilet!



Scan this QR Code or go to LEGO.com/legomagazine for step-by-step instructions to build this fun model.

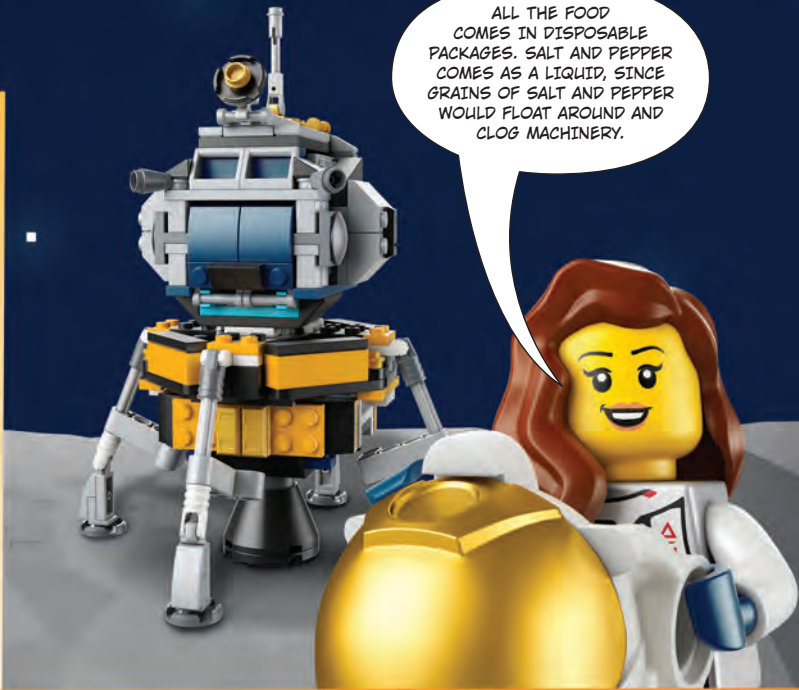

Space Vehicle Match-Up!

Outer space is full of amazing vehicles. Find the matching sets in this out-of-this-world scene.

Bonus Puzzle: Look for the vehicle that doesn't match any other!



Need some help? Check out page 27 for the answers

BACK TO SCHOOL!



WELL, TREE HOUSE, IT'S BEEN A GREAT SUMMER. BUT TOMORROW IS THE FIRST DAY OF SCHOOL AND I CAN'T WAIT TO SEE ALL MY FRIENDS!



ANOTHER SCHOOL YEAR BEGINS.

HI!
HOW ARE YOU?

HOW WAS YOUR SUMMER?

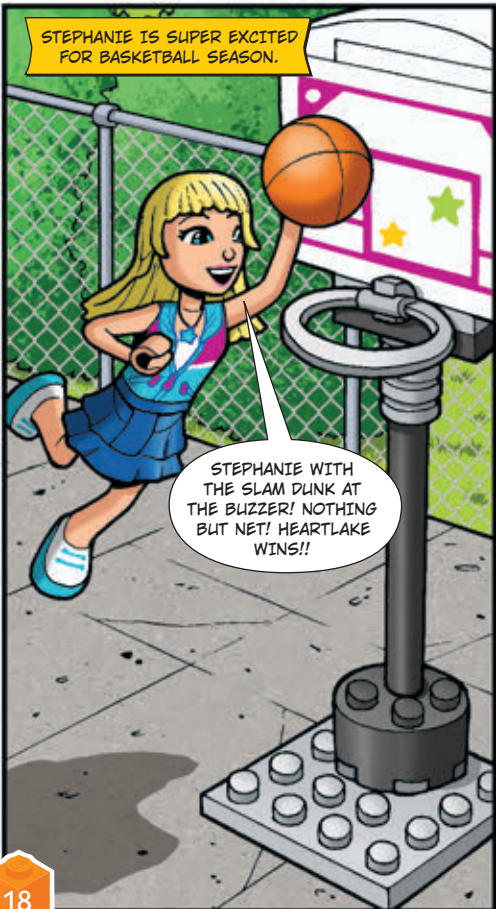

STEPHANIE IS SUPER EXCITED FOR BASKETBALL SEASON.

STEPHANIE WITH THE SLAM DUNK AT THE BUZZER! NOTHING BUT NET! HEARTLAKE WINS!!



WHAT ARE WE TALKING ABOUT TODAY?

FROGS, MIA. I ASKED EMMA TO GET ONE OF OUR CLASS PETS OUT OF THE TERRARIUM.

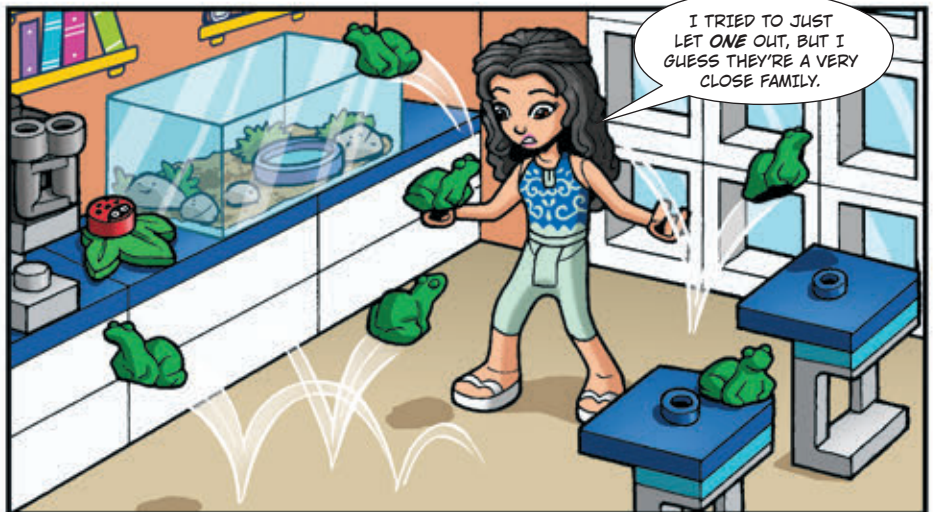

I TRIED TO JUST LET ONE OUT, BUT I GUESS THEY'RE A VERY CLOSE FAMILY.

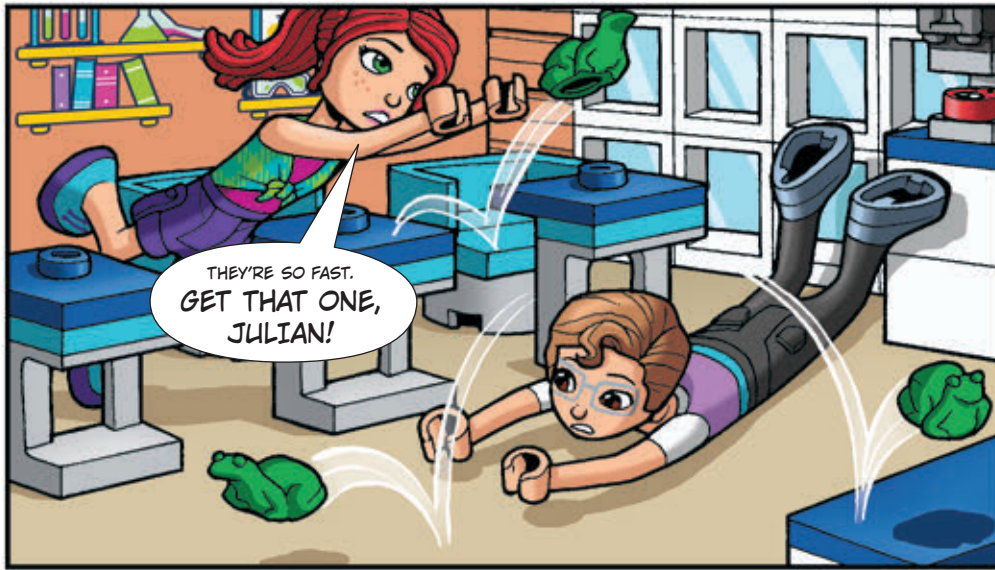

THEY'RE SO FAST.
GET THAT ONE,
JULIAN!

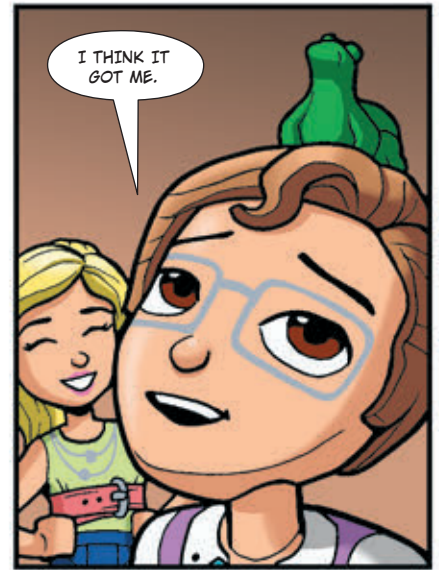

I THINK IT
GOT ME.



- AND THEN ONE HOPPED INTO
MY BACKPACK. MOM WOULD HAVE BEEN
PRETTY SURPRISED IF I BROUGHT
ANOTHER PET FROG HOME!



IT'S JUST THE FIRST DAY
AND IT'S ALREADY BEEN
SO MUCH FUN.



IT'S GOING TO BE A GREAT YEAR.

JUST THE BEGINNING...

COOL CREATIONS



Cuphead
Tyler, age 9,
USA

**Museum
of History**
Zoe, age 8,
Canada



**Planetary
Space
Station X**
Gram,
age 6,
USA

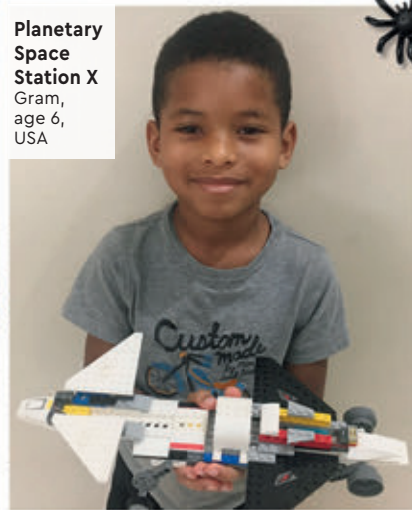

Do you have an **AWESOME BUILD** you would like to share with other builders?

SEND US YOUR PHOTO!

- 1 Have a photo taken of you with your build. You might see it on this page in a future issue.
- 2 Ask a parent or guardian to go to LEGO.com/magazine.
- 3 There they can download and complete the Submission Form, then email it along with your photo. See the Submission Form for the email address.
- 4 Remember that you can send us a story about your model too. Tell us how you built it, what's going on in the scene, or whatever you like. We'd love to hear all about it!



**Undercover Jail
and Treehouse**
Sierra, age 9, and
Mikayla, age 7,
Canada



LEGO® Museum
Chase, age 7, USA



**Jeffrow and
Grandma**
Hoddy's Home
Elias, age 9, USA

CHECK OUT THE
ONLINE GALLERY AT
LEGO.COM/LEGOMAGAZINE
FOR MORE
COOL CREATIONS.

THANKS TO EVERYONE
WHO SENT IN THEIR
CREATIONS, INCLUDING
RACHEL, ELLIE, BEN, MADISON,
ORLIN, SOLENNNA, DIEGO,
AYDEN AND ANTONIO!
YOU ROCK!



Mega Trooper
Asher, age 7, USA



Rainbow Village
Ellora, age 5, Canada



Vet and Babysitting Facility
Flynn, age 9, Canada



Mario and Luigi Point Board
Clive, age 6, Canada

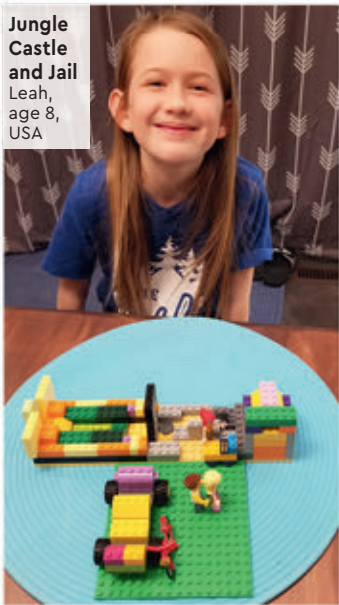

Jungle Castle and Jail
Leah, age 8, USA



Family Resort
Rosie, age 7, and Michael, age 9, USA



Super Deluxe Train Collection
Terrell, age 6, USA



LEGO City
Aishwarya, age 6, USA



Team Strikeforce
Michael, age 7, Canada

LEGO® CITY JAMBOREE!



Wow! Looks like everyone is catching some sun and fun in the LEGO® City park. Join in!

Spot the City Superstars!

Sam Grizzled and Mayor Fleck need seven more players for the LEGO City softball team! Can you find the other players by their descriptions? Check off the boxes as you spot them! (We've given you picture clues to help.)

1. I'm **Cluster Clampots!** You can recognize me by my hat with earflaps.



2. I'm **Duke DeTain!** I've got curly hair and I wear a badge.



3. I'm **Ice**, a cool bandit with blue hair and a black mask.



4. **Snake Rattler's** my name! You'll know me by my cowboy hat.



Need Help? Answers can be found on page 27.

DOT MYTHICAL CREATURES TO LIFE!

DOTS™



Hang your unicorn and dragon on your backpack (but watch out that they don't eat your snacks!). Can you spot the names of some famous mythical creatures in this puzzle?

NEW!

Find them all and you are a Mighty Myth Master!

GRIFFIN UNICORN DRAGON
CENTAUR MERMAID YETI

WHAT'S MY NAME?
THE WORD DRAGON COMES FROM THE LATIN WORD DRACONEM, WHICH MEANS "HUGE SERPENT."



Puzzled? You'll find the answers on page 27.



THE UNICORN IS THE NATIONAL ANIMAL OF SCOTLAND. BUT CAN IT PLAY THE BAGPIPES?



Build your own mythical creature and share it in the #DOTS group in the LEGO® Life app!

CRETACEOUS CONFUSION!



Oh, no! The Triceratops knocked over the T. rex skeleton and it fell apart. Help Darius and Owen get it back together by matching the bones to the places they belong. Write the correct letter in the circle. We've done the first one for you!

NEW!



HEY, OWEN, IS THIS A DINOSAUR EGG?

NO, THAT'S MY LUNCH!

Need Help? Answers can be found on page 27.



A



B



C



D

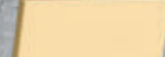

E



F



G

H

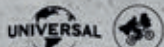

© Universal City Studios LLC and Amblin Entertainment, Inc. All Rights Reserved.

TOW TRUCK RESCUE!



OH, NO! OUR CAR IS STUCK AND WE'LL MISS THE HALLOWEEN PARTY!

WE'D BETTER GO FIND A TOW TRUCK... BUT WILL WE BE ABLE TO FIND ONE IN THIS MAZE OF ROADS?

Minifigures and car not included in the set.



Help the minifigures locate the Tow Truck. Ready, set, GO!

NEW!

PNEUMATIC FUN FACTS

- Pneumatic systems use compressed air to generate and transmit power.
- The LEGO® Technic™ Tow Truck uses pneumatics to operate its booms.
- Pneumatics are used in bus, train and truck brakes, jackhammers, dental drills and more.



Get more action in the #Technic group in the LEGO® Life app.

START

FINISH



QUIZ

Can you guess if these statements are true or false?

(Hint: The answers are all on this page.)

Need Help? Answers can be found on page 27.

- 1 Pneumatic systems use water to generate power.
True False
- 2 The pneumatic system in the Technic Tow Truck can be used to lift the booms.
True False
- 3 Pneumatics are used in bus and truck brakes.
True False
- 4 Pneumatics are also found in jackhammers and dental drills.
True False

BUILD A MOUSE ON WHEELS!

What's faster than a mouse on wheels? (Not much, except maybe a squirrel in a sports car.) You can use this cute little "road-ent" for a Halloween decoration or just add it to your creative creature collection!

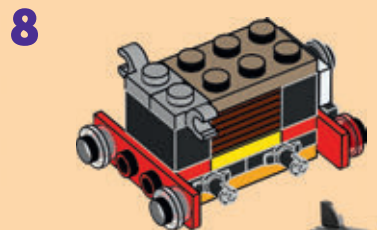
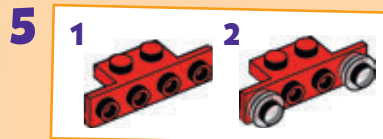
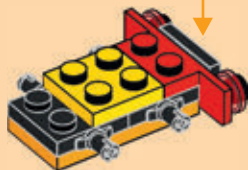

LEGO CLASSIC

Creepy Creature Mash-Up!

Combine different creatures, add some wheels, and you have a whole new Halloween creation. Check out these two, then try building your own!



Mix a bat, a horse and a set of wheels and you have one strange sight rolling down the road on Halloween night.

Rebuild
the
world

It's a duck ... it's a vampire ... it's a wheeled wonder heading your way both night and day!

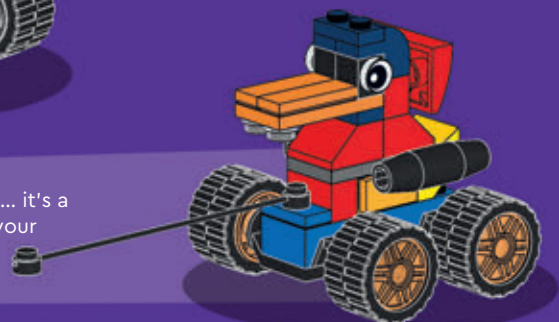

9

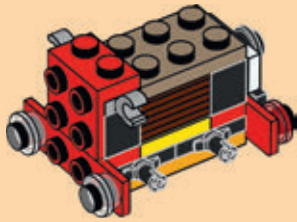

10



11

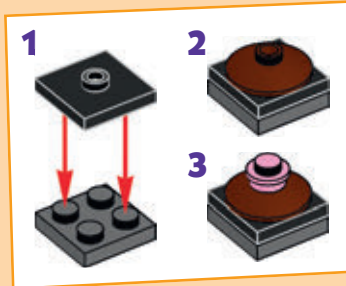

12

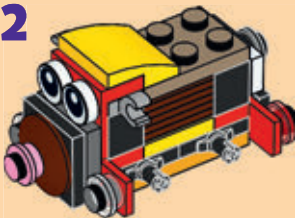

13

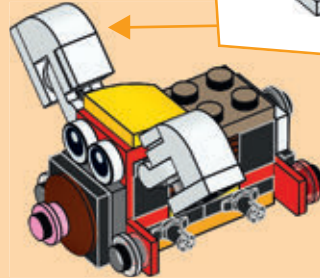
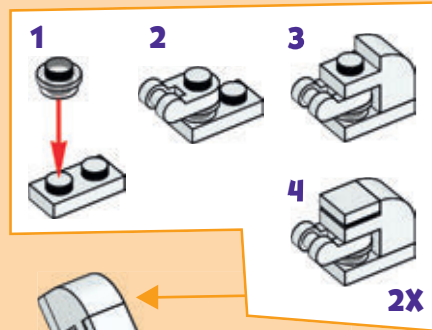

14

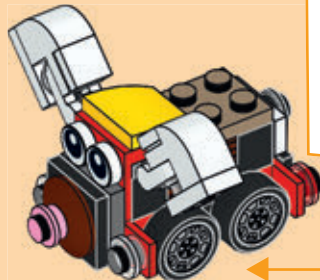

15

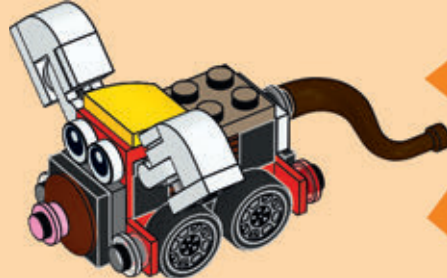

ANSWERS:

Bat Find-It, p. 3: LEGO® Minecraft®, p. 6:



p. 4



p. 19



p. 20



p. 22



p. 25



p. 26



LEGO® Super Mario™, p. 8-9:

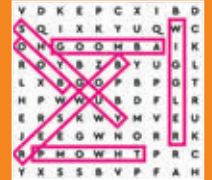
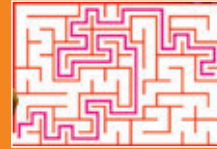

LEGO Creator, p. 17:



LEGO City, p. 22-23: LEGO DOTS, p. 24:

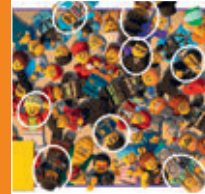

LEGO Jurassic World, p. 24:



LEGO Technic™, p. 25:

- 1. False
- 2. True
- 3. True
- 4. True



Sea Serpent Ahoy!

This sea serpent makes an awesome pen and pencil holder. Hope he doesn't swim away with all the school supplies! Try building one of your own to add to your Halloween decorations. You'll find this model and many more in the book LEGO® 100 Ways to Rebuild the World, from DK Publishing!

ADVERTISEMENT

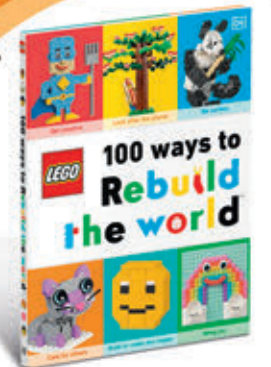
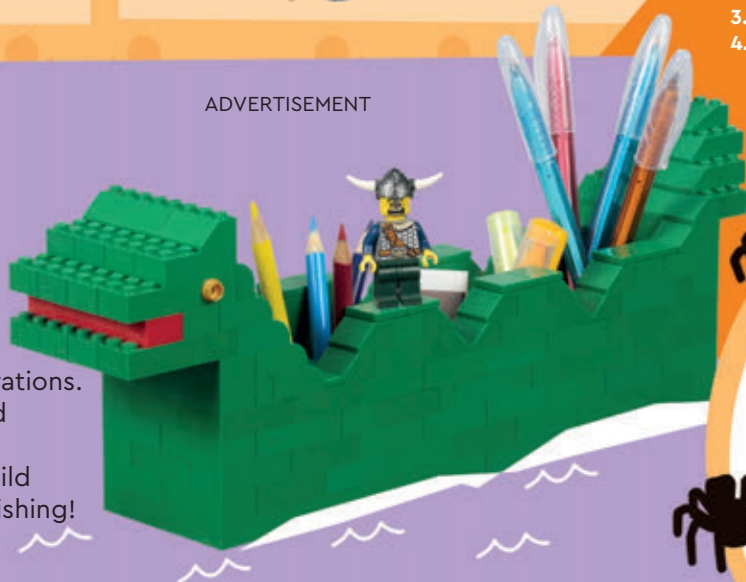

Next issue of LEGO® Life Magazine out in November!



THE CONTEST

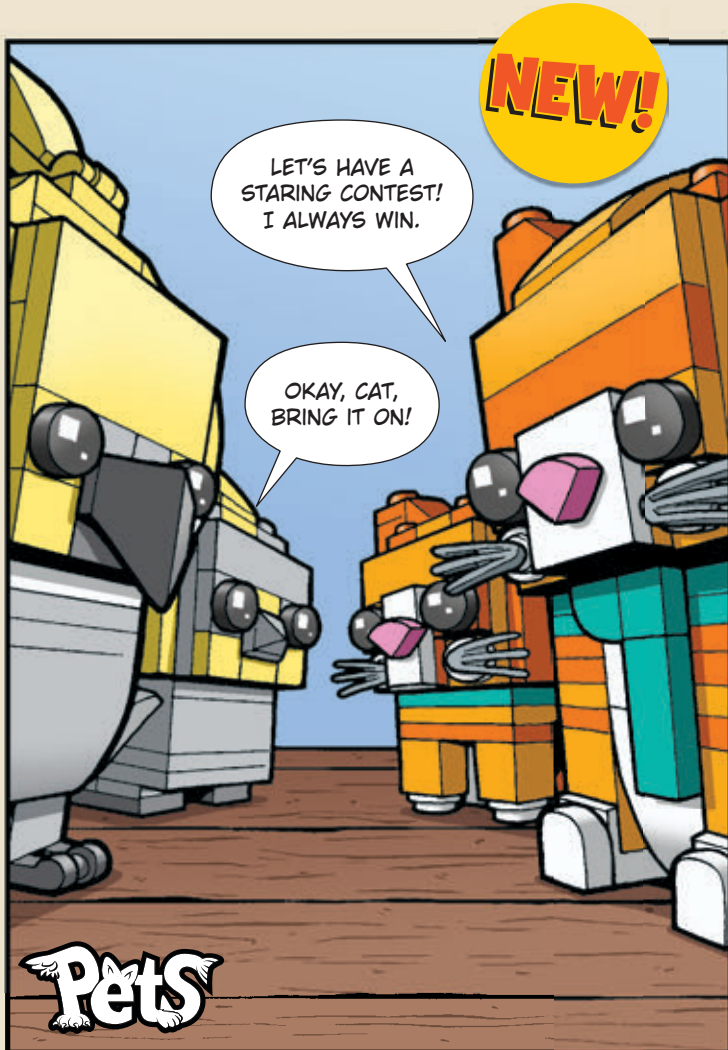

THIRTY YEARS LATER...

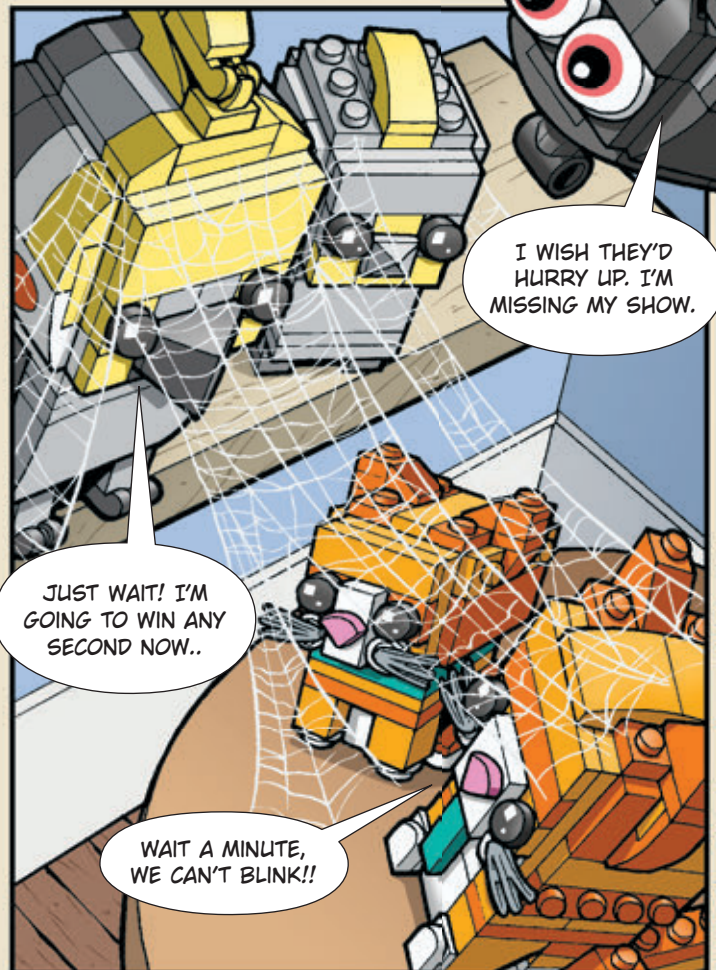

Spider is not part of LEGO® BrickHeadz®.