

Rebuild  
the *FESTIVE*  
SEASON!

This issue  
features  
activities  
**ESPECIALLY  
FOR YOU!**

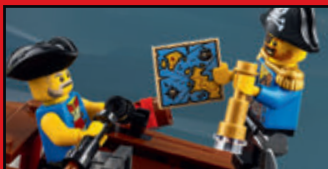

# THE **MAGAZINE**



New LEGO® Models!



Comic Action!



Activities!

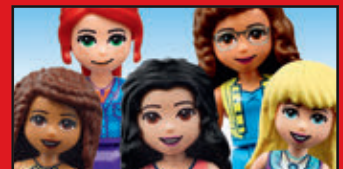

Awesome Posters!

# DISCOVER THE WORLD OF LEGO® SUPER MARIO™!

ADVERTISEMENT



Nothing can stop Mario. He's always prepared for trouble, ready to defeat his enemies and overcome obstacles all along the way. You'll be ready for anything too, after you read these awesome tips for the LEGO® Super Mario™ Adventures with Mario Starter Course. Take control of a LEGO® Mario™ figure who reacts to what goes on while playing, and collect digital coins as you challenge each new level.

## Build Your First Level

Use the Starter Set to create a level packed with challenges, obstacles and enemies. When you finish playing through it, you can take the level apart and rebuild it.

## Take LEGO Mario For a Spin

Put him on the platform and spin him around to collect coins.

## What Will It Be?

Put LEGO Mario on the ? block to find out his reward.

## Beware of Bowser Jr.

Knock Bowser Jr. off his platform and defeat him by jumping on his back to add to your coin collection. Then head for the flag to finish your level.

## Let's-a Go!

Begin in the Start Pipe. You have 60 seconds to finish the level, while collecting as many coins as you can. GO!

## Defeat the Goomba

Jump on the Goomba to get coins, but don't take too long – time is running out.

COLOR YOUR OWN LEGO MARIO!



## LEGO SUPER MARIO TRIVIA

Test your LEGO Super Mario knowledge with this short quiz.

1. What do you collect in the Starter Course?
2. How much time do you have to defeat the level?
3. How do you defeat the Goomba?
4. Where do you begin the Starter Course?
5. Where do you end in the Starter Course?

Need help? Answers can be found on page 27.

1. \_\_\_\_\_
2. \_\_\_\_\_
3. \_\_\_\_\_
4. \_\_\_\_\_
5. \_\_\_\_\_



# WELCOME TO ISSUE 4!

It's time for another LEGO® Life Magazine, featuring special puzzle pages, posters and activities handpicked just for you!

We're celebrating the season with plenty of fun in LEGO Life Magazine. Dive into the deep with LEGO City, team up with the Avengers, and meet LEGO® Super Mario™.

 What's your favorite part of the season? Unscramble the words below to find out Max's.

LIYAFM NDA

SIENRDF

Need help? Answers can be found on page 27.



HI, IT'S MAX... SEASON'S GREETINGS! I LOVE THIS TIME OF YEAR, THERE IS SO MUCH TO CELEBRATE.

I CAN'T WAIT FOR WORLD KINDNESS DAY ON NOVEMBER 13<sup>TH</sup>! IT'S A DAY TO CELEBRATE MAKING THE WORLD A BETTER PLACE BY DOING GOOD DEEDS.

EVERY DAY IS 'BE KIND TO DOGS DAY'!

## MAX COMIC

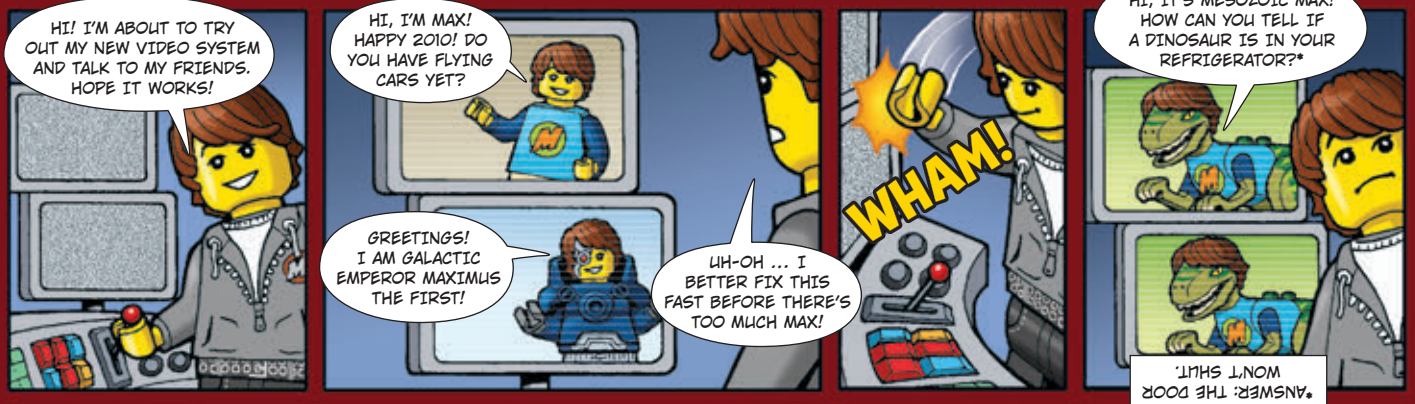

## LOOK!

Look for these icons on activity pages. They will tell you if the activity is easy, hard, or somewhere in between. Try them all and see how you do! If you get stuck, the answers can be found on page 27.



(US/CA)

LEGO, the LEGO logo, the Minifigure, the FRIENDS logo, the MINIFIGURES logo and NINJAGO are trademarks and/or copyrights of the LEGO Group. ©2020 The LEGO Group. All rights reserved.



## LEGO® Life Magazine

For information about LEGO® Life visit [LEGO.com/life](https://LEGO.com/life)

For questions about your membership visit [LEGO.com/service](https://LEGO.com/service) or call 1-877-518-5346

 PO Box 1138  
Enfield, CT  
06082

 PO Box 600  
Markham, ON  
L3R 8G8





I DECIDED TO MAKE SOME SURPRISE VISITS TO MY FRIENDS DURING THIS HAPPY SEASON OF THE YEAR. WHY DON'T YOU COME ALONG?

# HAPPY HELLOS!

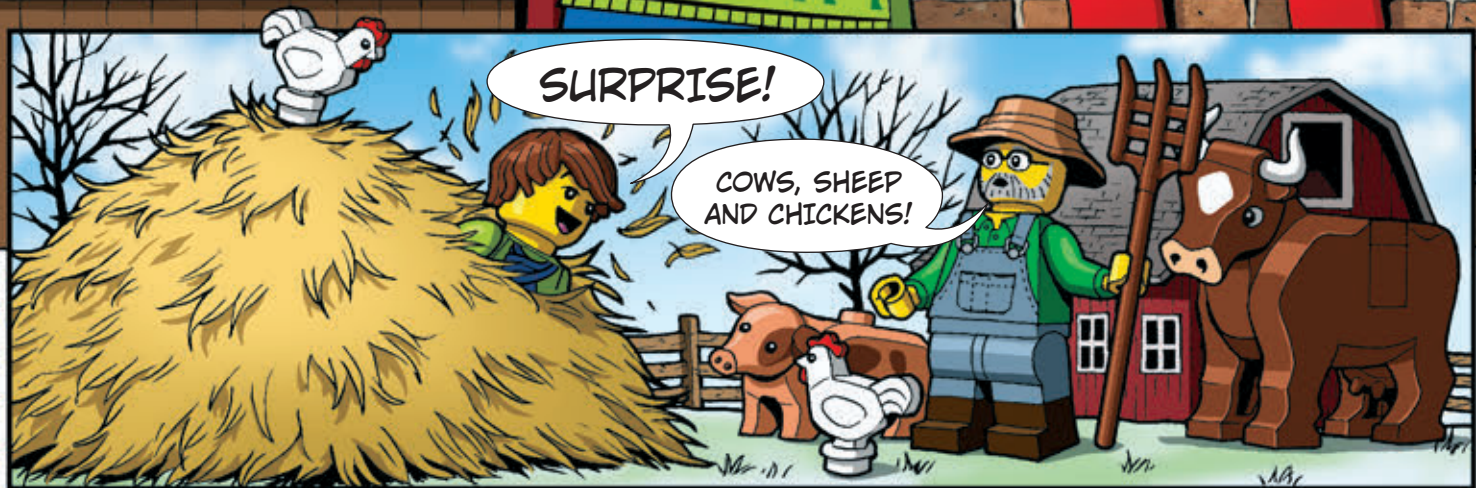

SURPRISE!

COWS, SHEEP AND CHICKENS!



GREETINGS!

WELL, STAMP MY LETTER, IT'S MAX!



HEY THERE!

YIKES!

WELL, THAT'S ... DIFFERENT.

I THINK I'LL HAVE COOKIES INSTEAD.



SEASON'S GREETINGS!

JUST WHAT I ALWAYS WANTED!





WHO'S A GOOD BOY?



YIP!

I THINK I NEED A WALK NOW ...



BRRRRR!  
COLD IN THERE!

SUFFERING SNOWFLAKES!



!

GOOD MORNING!



WELL, THAT WAS FUN ...  
FOR ME, ANYWAY!  
I HOPE THIS FESTIVE SEASON IS FULL OF JOY, LAUGHTER AND -



SURPRISES!!



# SAVE THE VILLAGERS FROM THE PILLAGERS!

There's double trouble at this LEGO® Minecraft™ village! Pillagers are raiding and a Ravager is trampling the crops. Worse, the Pillagers have captured an Iron Golem! It's going to take quick action, your building skills and a little help from a visiting ninja to save the day. Challenge a friend to see who can do the best job of protecting the village.

## HOW TO PLAY

1. You will need one dice and LEGO bricks you can use as playing pieces. You will also need some LEGO bricks to build models during the game.
2. Roll to see who goes first.
3. Follow the instructions on each space.
4. First one to the Finish space is the winner!



And don't forget to upload and share your builds to the #Minecraft™ group on the LEGO Life app.



Build a shield to block Pillager arrows.

**Advance 1 space.**

Shield build not included in sets.



You find TNT you can use to free the Iron Golem!

**Advance 1 space.**

Build a wall to protect your village.



Pillagers loot your village.

**Go back 1 space.**

Draw your own banner.

**Advance 1 space.**



Creepers!

**Go back 1 space.**

**A Ravager is trampling the garden!**





# MINECRAFT



Village alarm bell is ringing!

**Lose 1 turn.**

Kai, Fire Ninja, shows up to help fight off Pillagers.  
**Roll again.**

Your cat scares away a Creeper™!

**Advance 1 space.**

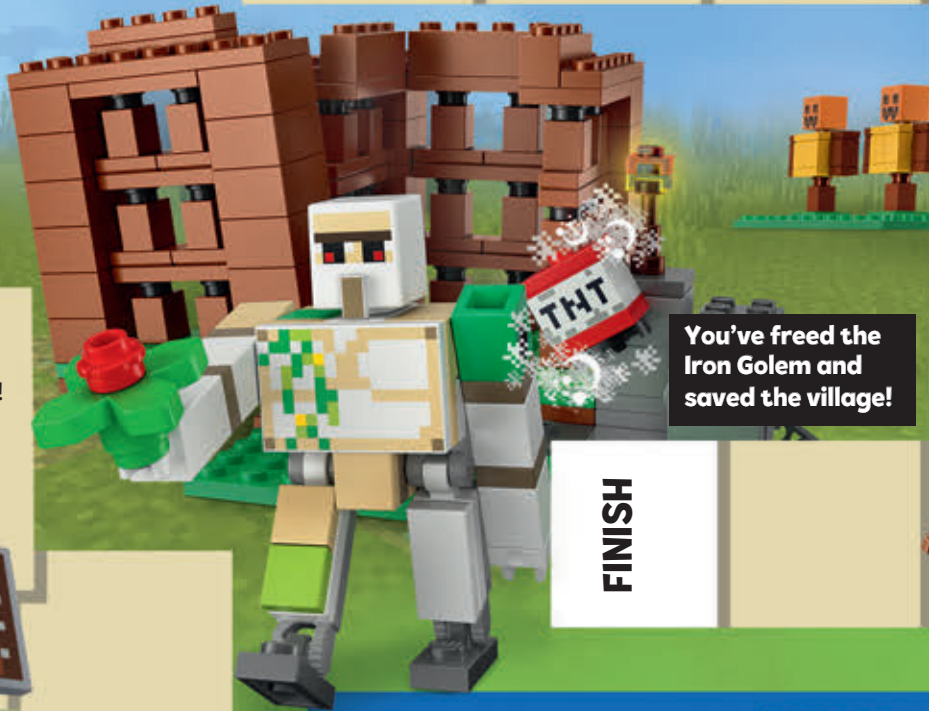

**You've freed the Iron Golem and saved the village!**

**FINISH**

Get ready for the raid!

**Advance 1 space.**

Pillager raid!

**Go back 1 space.**

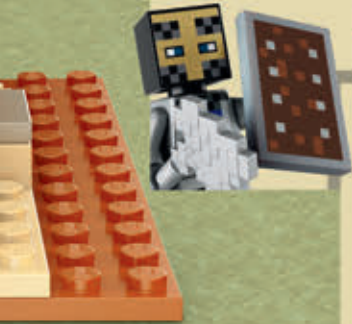

You got diamond armor at the trading post.

**Advance 1 space.**

## ARE YOU A VILLAGER OR A PILLAGER?

Take this quiz and find out!

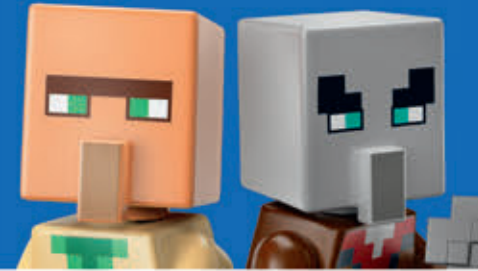

- When you see a field of wheat, you:
  - Harvest it for your village
  - Steal it for yourself

- What do you like to do with Iron Golems?
  - Summon them
  - Fire crossbows at them

- Your favorite thing to do is:
  - Work on the farm
  - Raid a farm

- Your least favorite piece of equipment is:
  - A crossbow
  - A shield

- When the village alarm bell rings, you:
  - Get scared
  - Charge!

**Add up your scores. If you have more A's, you're a Villager. If you have more B's, you're a Pillager.**

**Trading post has diamond armor**





# SHOWDOWN WITH THE SKULL SORCERER!

When the ninja travel to the peaceful kingdom of Shintaro, they discover its terrible secret. Beneath the beautiful city, slaves toil in dark dungeons under the command of the dreaded Skull Sorcerer and his skeletal dragon! Can the ninja find new allies and defeat these powerful new enemies?

## ZANE TITANIUM NINJA

In the kingdom of the Geckles, Zane frees a fearsome creature called a Mino from captivity and makes friends with the powerful beast. Together, they will confront the Skull Sorcerer!

## COLE EARTH NINJA

Cole must master the power of the Spinjitzu Burst and guide a ragtag group of adventurers up from the depths of Shintaro Mountain. His abilities as a leader will be tested like never before!

## NYA WATER NINJA

Nya is forced to fight to save Jay from having to marry the Munce Queen, Murtessa. But Nya learns that the Munce Queen is a powerful fighter who does not give up easily.





## LLOYD GREEN NINJA

Lloyd must deal with his problems trusting others when Princess Vania offers to aid the ninja against the Skull Sorcerer. Is she telling the truth, or is this a trap for the heroes?



# BE A NINJA FAMILY!

Here are some fun ninja activities you can do with your family and a little imagination. You can even use a stopwatch to time these and see who can do them the fastest.

## KAI FIRE NINJA

Kai must somehow be a peacemaker to unite two warring tribes, the Geckles and the Munce, against their common enemy – the Skull Sorcerer!

## JAY LIGHTNING NINJA

Jay finds himself in a strange situation when Murtessa, the fierce Queen of the Munce, decides he should be their king and stay in their underground kingdom forever!

### 1 NINJA TRAINING COURSE

Use paper, tape, pillows and couch cushions to design a ninja training course in your house. Who can make it from one side of the room to the other the fastest, avoiding all obstacles? Who can walk a straight line balancing a tower of LEGO® bricks in one hand?

### 2 CROSSING THE CAVE

You must use your ninja skills to make it across a volcanic cavern, but watch out! At any moment, lava could erupt from the cave floor! Better be prepared to leap to safety when someone yells, "Lava!"

### 3 NINJA CAMOUFLAGE

One member of the family is Master Wu and the rest are ninja. Use your stealth skills to show Master Wu how well you can hide as he tries his best to find you. Can you disappear into the shadows and avoid being spotted?

## DECODE THE ANCIENT WRITINGS!

The ninja have discovered carvings on the cave wall that tell about the legendary weapons that can be used to defeat the Skull Sorcerer. Use the NINJAGO® alphabet to decode the message and discover the secret!

X	カ	介	𐄂	𐄃	𐄄	𐄅
A	B	C	D	E	F	G
𐄆	𐄇	𐄈	𐄉	𐄊	𐄋	𐄌
H	I	J	K	L	M	N
𐄍	𐄎	𐄏	𐄐	𐄑	𐄒	𐄓
O	P	Q	R	S	T	
𐄔	𐄕	𐄖	𐄗	𐄘	𐄙	𐄚
U	V	W	X	Y	Z	

カ 𐄊 X 𐄂 𐄃 𐄄 𐄅 𐄆 𐄇

𐄂 𐄃 𐄄 𐄅 𐄆 𐄇 𐄈 𐄉 X 𐄊 𐄋 𐄌



Need help?  
Answers can be  
found on page 27.





WHAT LIVES IN THE OCEAN, HAS LOTS OF TEETH, AND IS VERY NERVOUS? A SHARK WITH A DENTIST APPOINTMENT.

WHAT'S A PIRATE'S FAVORITE COLOR? GOLD

WHAT'S THE BEST THING TO GIVE A SEASICK WHALE? PLENTY OF ROOM!

WHAT TIME IS IT WHEN PIRATES CAPTURE YOUR SHIP? TIME TO GET A NEW SHIP.

# FIND THE PIRATE TREASURE!

Me and my pirate crew hid our treasure on Skull Island. That was so long ago that we've forgotten where the beautiful treasure chest is buried! We have a map, but part of it is in code and we can't remember the code either! Hint... Beauty is in the EYE of the beholder!

The map says "On the way to the island, ask the shark if it knows anything."

20 1 11 5 6 9 22 5 16 1 3 5 19 6 18 15 13  
 20 8 5 23 1 20 5 18 19 5 4 7 5 15 14  
 19 11 21 12 12 9 19 12 1 14 4

## CODE KEY

A	B	C	D	E	F
1	2	3	4	5	6
G	H	I	J	K	
7	8	9	10	11	
L	M	N	O	P	
12	13	14	15	16	
Q	R	S	T	U	
17	18	19	20	21	
V	W	X	Y	Z	
22	23	24	25	26	



Need help? Answers can be found on page 27.



# DANGER IN THE AIR!

KZZZAKKKK!

ON THE WAY HOME FROM A SUCCESSFUL MISSION IN THE HELICARRIER, THE AVENGERS ARE AMBUSHED!

WHO WOULD DARE ATTACK EARTH'S MIGHTIEST HEROES? M.O.D.O.K. THE MERCLESS!

HA! NOT EVEN THE AVENGERS CAN SURVIVE MY BRAIN BLAST!

THE HELICARRIER IS IN TROUBLE!

TELL ME YOU CAN FLY THIS THING, BLACK WIDOW.

IT'S LIKE PILOTING A BIG ROCK, FURY. AVENGERS ASSEMBLE!

"YOU KNOW WHAT TO DO - SAVE THIS SHIP!" SAYS BLACK WIDOW.

I'VE GOT THIS!

BUT YOU WON'T MIND A LITTLE HELP.

HEY, I CAN HANDLE IT!

OOOF -

NO PROBLEM

JUST HAVE TO GET IN THE RIGHT POSITION -

LNNGH - REMIND ME TO DESIGN A LIGHTER HELICARRIER ...

LET ME GIVE YOU A HAND, SHELLHEAD. OR TWO.

TURN THE PAGE TO FIND OUT WHAT HAPPENS NEXT!



CONTINUED  
FROM PAGE 11

THOR SHALL  
SUMMON MIGHTY WINDS  
TO KEEP YON VESSEL IN  
THE AIR!

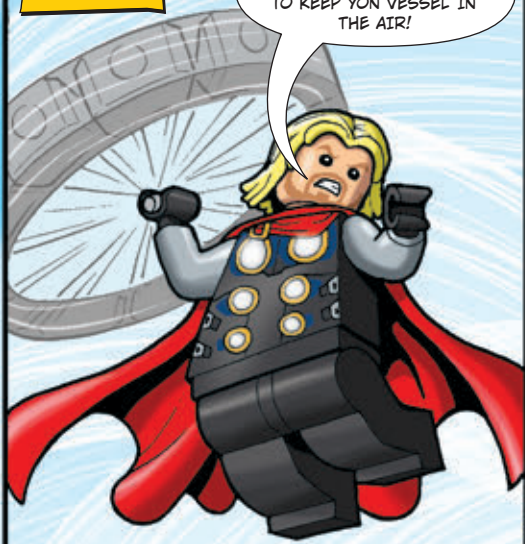

THOR'S WINDSTORM  
SENDS M.O.D.O.K. FLYING!

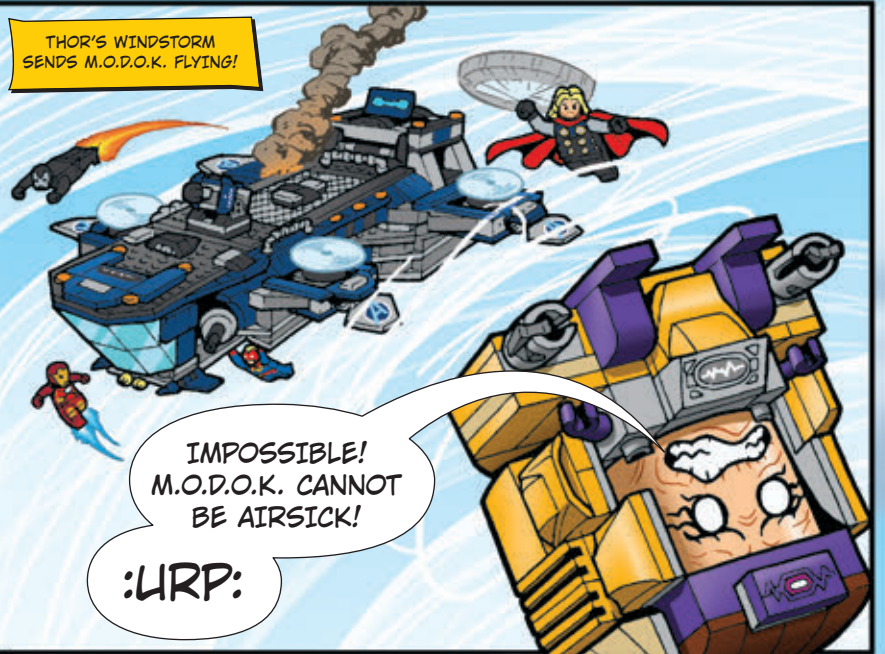

IMPOSSIBLE!  
M.O.D.O.K. CANNOT  
BE AIRSICK!

:LRP:



THE HELICARRIER'S DEFENSE  
SYSTEMS HAVE GONE WILD! SO I  
GUESS I GET TO PLAY GOALIE.

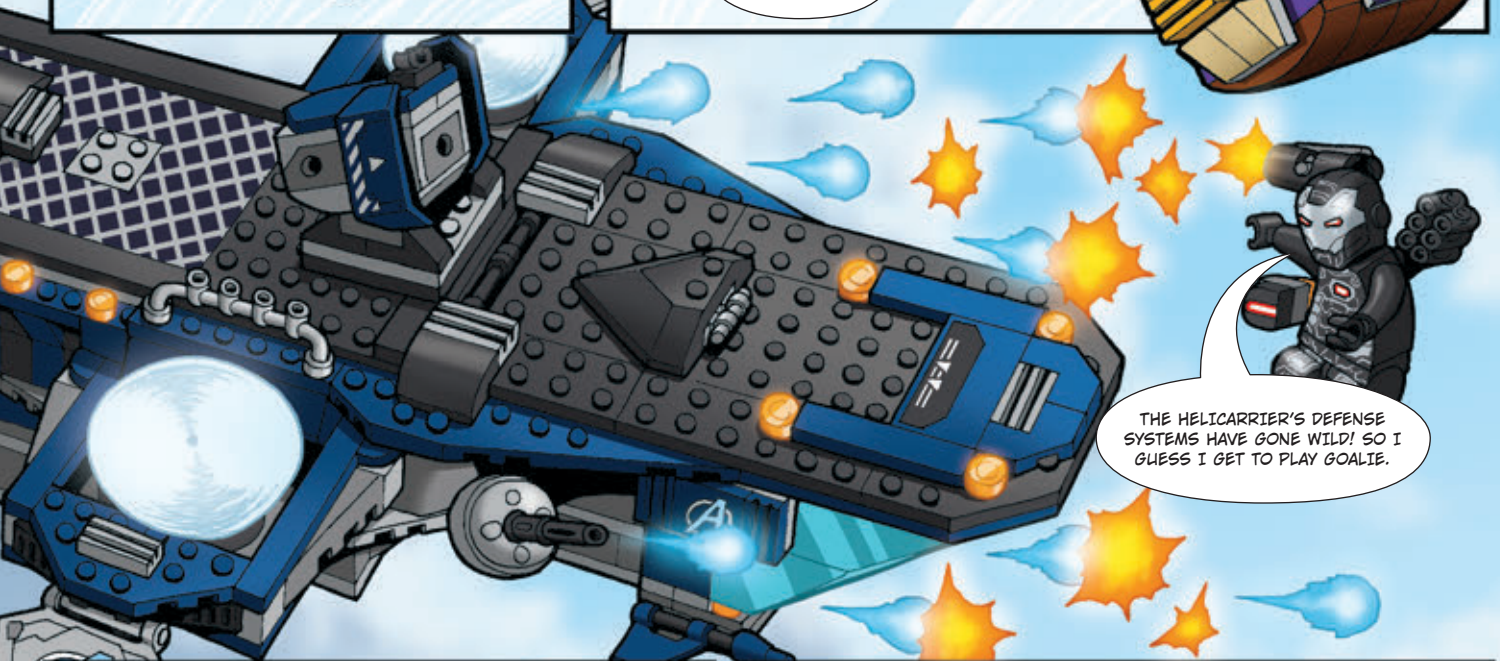

EVERYTHING'S SECURE  
OUT HERE, FURY. HOW'S  
BLACK WIDOW?



SHE STEPPED OUT  
FOR A MINUTE,  
AVENGER ...

I'LL GO GET SOME  
HELP TO FIX THE HELICARRIER.  
IT'S HARD TO FIND A TOW  
TRUCK UP HERE!



THE END





# STAR WARS





## THE SKYWALKER SAGA



LEGO® STAR WARS™: THE SKYWALKER SAGA. SOFTWARE © 2020 TT Games Ltd. Produced by Minifigure are trademarks and/or copyrights of the LEGO Group. ©2020 The LEGO Group. STAR WARS. Lucasfilm Ltd. Bros. Entertainment Inc. (s20)





TT games   XBOX ONE  PS4  PC  NINTENDO SWITCH

© 2017 TT Games under license from the LEGO Group. LEGO, the LEGO logo, the Brick and the Knob configurations and the Star Wars characters, names, likenesses, indicia, costumes, accessories, and other indicia are trademarks of Lucasfilm Ltd. All rights reserved. Used under authorization of Warner Bros. Entertainment Inc. WB GAMES LOGO, WB SHIELD: ™ & © Warner





**HOLIDAY  
MEMORIES!**







# TOP GEAR™ + LEGO® BRICKS = **AWESOME!**

The LEGO® Technic™ Top Gear Rally Car roars out of the Top Gear television program and into the race. Tires grip the road as it battles for first place with other high-performance rally cars. Tearing through the closed-off streets of a major city, the Top Gear Rally Car edges ahead at the last second and takes the victory!



For more Top Gear Rally Car fun, check out the #Technic Group in the LEGO Life app!



## RIDDLE ME THIS!

Think you know cars?  
Choose the right answer!

1. If the Top Gear Rally Car has four tires, and you take away three, how many do you have?

- A) seven tires
- B) no tires!
- C) three tires

2. Which one is heavier:

- A) 1200 kg Rally Car
- B) 1200 kg of feathers
- C) they are the same

3. To find out what time the race starts, you add 5 to 9 and get 2. That's correct, but why?

- A) who cares, we are always racing!
- B) because 14:00H is 2 AM
- C) because 14:00H is 2 PM



Create your own Technic story with the CONTROL+ app:



Drive forwards and backwards



Take on challenges and earn achievements



BBC, TOP GEAR and THE STIG (word marks and logos) are trademarks of the British Broadcasting Corporation and are used under licence. BBC logo © BBC 1996. Top Gear logo © BBC 2005. Licensed by BBC Studios.



**Need help?** Answers can be found on page 27.



# READY... SET... **RACE!**

**LEGO** **TECHNIC**

Imagine a Dragster and a Race Truck driving around a race track. Engines roar and tires squeal as they battle for first place. Which one would win if they were racing around your town?



## **Race Your Family in a Game of I-Spy!**

The next time you are out with your family, whether in a car, on a walk, or on your bikes, **see who can spot each of the items on the list fastest!** The one who is first to spot the most items, wins! Feel free to add other things to the list.

 **Want a Bigger Challenge?**

Make this game even more fun by looking for vehicles of different colors

or

Find items that start with each letter of the alphabet

- |  |  |
|--|--|
| <input type="checkbox"/> A tree                                  | <input type="checkbox"/> A gas station             |
| <input type="checkbox"/> A road sign                             | <input type="checkbox"/> A bus                     |
| <input type="checkbox"/> A friend's house                        | <input type="checkbox"/> A restaurant              |
| <input type="checkbox"/> A blue car                              | <input type="checkbox"/> A coffee shop             |
| <input type="checkbox"/> Something that starts with the letter R | <input type="checkbox"/> Someone walking their dog |



# LEGO® LIFE STUFF!

HI MEMBERS!

NOTHING MAKES THIS FESTIVE SEASON BRIGHTER THAN BUILDING TOGETHER. WHETHER YOU'RE CREATING A GIFT FOR SOMEONE IN YOUR LIFE OR JUST HAVING FUN, YOU ARE MAKING MEMORIES ALL ALONG THE WAY. I'D LOVE TO SEE WHAT YOU BUILD, WHAT YOU DRAW, AND EVEN YOUR LETTERS. SEND THEM ALONG TO ME AND LET'S ALL HAVE A FESTIVE TIME AND A WONDERFUL NEW YEAR!

NINJA GIFTS ARE THE COOLEST - ONLY PROBLEM IS YOU CAN'T SEE THEM!

I LOVE TO MAKE GIFTS, THEN BURY THEM IN THE SAND AND GIVE MY FRIENDS MAPS TO FIND THEM.



## LEGO Life Member Submissions

DEAR MAX,

I HAVE A PILE OF LEGO PIECES BUT I DON'T KNOW WHAT TO BUILD. CAN YOU HELP?

-Andrew, age 8

HI ANDREW,

SURE! YOU CAN CHECK OUT WHAT OTHER FANS HAVE BUILT ON THE LEGO LIFE APP FOR IDEAS TO HELP YOU GET INSPIRED. OR JUST LOOK AT THE WORLD AROUND YOU AND SEE WHAT YOU THINK MIGHT MAKE A GOOD MODEL.

TRY BUILDING SOMETHING YOU KNOW WELL, LIKE YOUR HOUSE, SCHOOL OR YOUR PET.

**MAX**



DuchessCreativeCauliflower

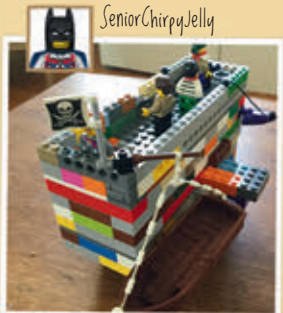

SeniorChirpyJelly



**SHARE WHAT YOU THINK OF THIS MAGAZINE!**

Ask a parent or guardian for their help to visit [LEGO.com/LIFESURVEY](http://LEGO.com/LIFESURVEY) today!



YoungestSublimeLemon

## To-Do List!

- BUILD and/or DRAW** something **AWESOME!**
- TAKE A PIC!** Send in letters, drawings and photos of your awesome LEGO build or favorite jokes. You might see them on this page in a future issue!
- SEND IT TO US!** Ask a parent/guardian to download and complete the Submission Form from [LEGO.com/magazine](http://LEGO.com/magazine). Then email it along with your letter, drawing or photo to me, Max.

See the Submission Form for your country's email address.

Don't have the LEGO Life app yet?



You can download it today for **FREE** from one of the app stores and sign in with your LEGO Account.



Apple and the Apple logo are trademarks of Apple Inc., registered in the U.S. and other countries. App Store is a service mark of Apple Inc. Google Play is a trademark of Google Inc.

**LOOK for this symbol in the Magazine!**



When you see it, you'll know that page includes a LEGO set that features Instructions PLUS interactive digital building instructions!

**1 Download** the **Free** LEGO Life app.



**2 Scan the QR code on the instructions booklet** of your LEGO set, or enter the set number into the app.



**3 Once that's done, tap on the image of the set** you just entered and start building!



**Hi, I'm Captain Safety!**

Want to know more about how you can stay safe online? Look for me in the LEGO Life app for tips on what you and your parents can do to make sure time online is fun and safe for everyone.

CAPTAIN SAFETY IS HERE TO HELP, TODAY AND EVERY DAY. NOVEMBER 30<sup>th</sup> IS COMPUTER SECURITY DAY IN THE USA.

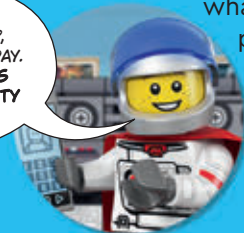



# Cool Creations

Does your child have an awesome build that they would like to share with other builders?

## SEND US YOUR PHOTO!

1. Take a photo of your child's awesome build. You might see it on this page in a future issue.
2. Go to [LEGO.com/magazine](http://LEGO.com/magazine).
3. Download and complete the Submission Form from [LEGO.com/magazine](http://LEGO.com/magazine). Then email it along with your photo.

See the Submission Form for the email address.



**Superhero Motor Bike**  
Chloe, age 10, and Mael, age 8, Canada



**LEGO® Monster City Attack!**  
Randy, age 8, USA



**London Museum and Crown Jewels**  
Ela, age 8, and Rohan, age 6, United Kingdom

INTERNATIONAL CIVIL AVIATION DAY IS DECEMBER 7<sup>TH</sup>. I'M GOING TO CELEBRATE BY BUILDING AN AEROPLANE TO HONOR THE PLANES THAT DELIVER YOUR LETTERS TO US!

NOVEMBER 8<sup>TH</sup> IS WORLD TOWN PLANNING DAY... I'M GOING TO BUILD MY HOME IN LEGO® CITY!

NOVEMBER 20<sup>TH</sup> IS UNIVERSAL CHILDREN'S DAY! I'M GOING TO CELEBRATE BY LOOKING AT ALL OF THE AMAZING COOL CREATIONS THAT HAVE BEEN SUBMITTED BY AWESOME BUILDERS JUST LIKE YOU! KEEP UP THE GREAT WORK!

## VOTE NOW!

Choose your favorite in the LEGO® Life app. #Polls Group

What would you like to see MORE OF in the LEGO Life Magazine next year?



Comics



Cool Creations



Activities & Building Instructions

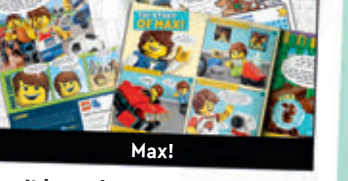

Max!

Don't have the LEGO Life app yet? You can download it today for FREE from one of the app stores and sign in with your LEGO Account.



Apple and the Apple logo are trademarks of Apple Inc., registered in the U.S. and other countries. App Store is a service mark of Apple Inc. Google Play is a trademark of Google Inc.





**Ghost Ship**  
Walkor, age 9, Canada



**The Prison**  
Mazet, age 7, France



**War Ship**  
Gabriel, age 9, USA



**Tree-mendous Friends Treehouse**  
Kylie, age 10, and Aimee, age 8, New Zealand



**My LEGO Universe**  
Romeo, age 6, France



**Power Station Dragon**  
Lucas, age 9, Netherlands



**The Ninja Counter**  
Clara, age 9, and David, age 6, Germany



**Super Mushroom and Flower**  
Mingkun, age 8, Australia



**The Crazy Cruise Mobile**  
Shailee, age 11, United Kingdom



**Scout Campsite**  
Oliver, age 9, Sweden



**My LEGO World**  
Sebastian, age 6, Australia



**Plane of the Night**  
Willum, age 7, Denmark

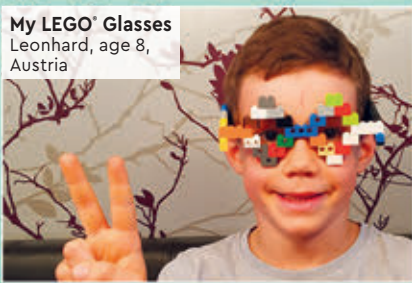

**My LEGO Glasses**  
Leonhard, age 8, Austria

**Rebuild the world**



# SURPRISE BENEATH THE SEA!

THE LEGO CITY OCEAN EXPLORER IS INVESTIGATING REPORTS OF FISH ACTING STRANGELY.

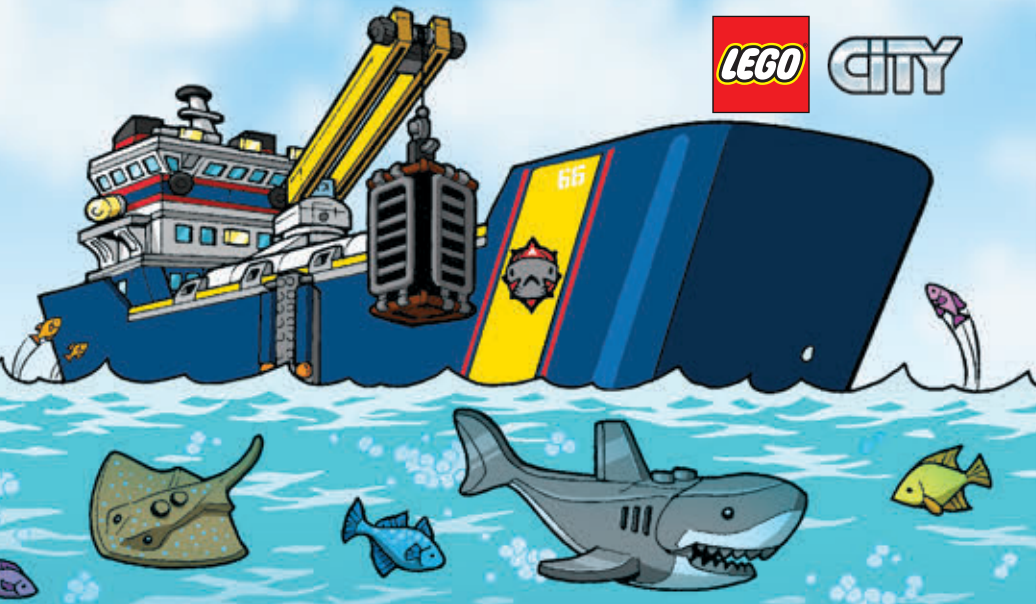

LUCKILY, EXPLORER JESSICA SHARPE AND HER FRIEND HARL HUBBS ARE ON BOARD FOR THIS VOYAGE!

BOY, THOSE FISH ARE SURE BEING WEIRD! I THINK I JUST SAW A DOLPHIN PACKING A SUITCASE. WHAT ARE YOU HEARING ON THE UNDERSEA MICROPHONE?

IT SOUNDS LIKE ... THE OCEAN HAS GAS.

AFTER A LONG JOURNEY BENEATH THE WAVES, JESSICA APPROACHES THE SOURCE OF THE STRANGE SOUNDS.

I GO WHERE THE DANGER IS! SOMETIMES IT DOESN'T EVEN SHOW UP UNTIL I'M THERE.

A VOLCANO IS ERUPTING UNDER THE SEA! AND THAT MEANS -

SHOCK WAVE!!



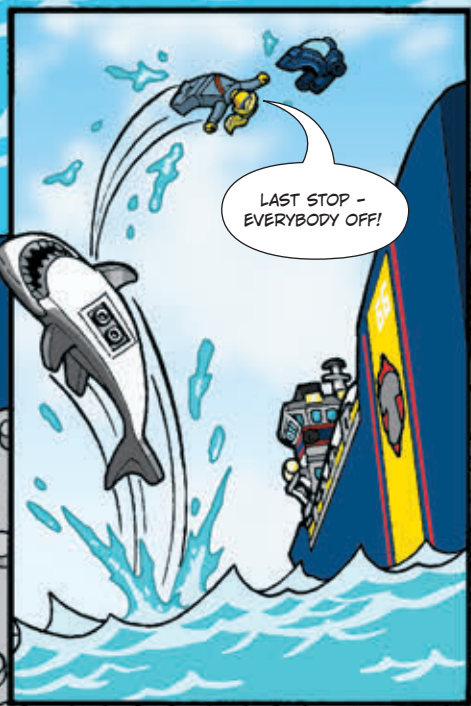
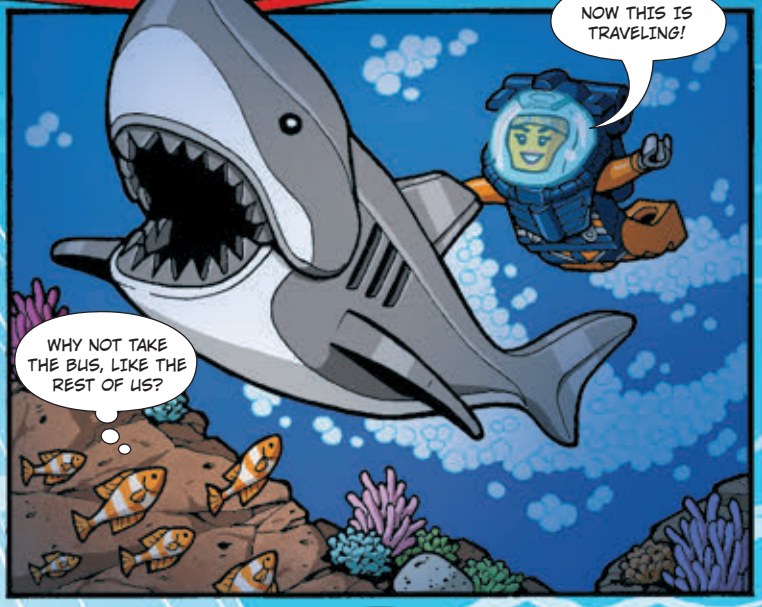



# EXPLORE THE HOGWARTS™ ASTRONOMY TOWER!

The young witches and wizards of Hogwarts™ study the stars while visiting the Astronomy Tower. Then it's time for Potions class where they try to mix things just right. But now, they are searching for items that have gone missing from the school – a telescope, a potion and more. **Can you help find them?**

## SEEING THE STARS

Draco Malfoy™ is using the telescope to look at the night sky. What could he be plotting?

## TIME FOR A PARTY

The students in the Slug Club are excited to go to Professor Slughorn's party.



WIZARDING WORLD characters, names and related indicia are © & ™ Warner Bros. Entertainment Inc. WB SHIELD: © & ™ WBEI. Publishing Rights © JKR. (s20)



Harry Potter



Help Harry and the other students **find these missing items** in the Astronomy Tower!





# MEET THE NEW



## LEGO® MINIFIGURES HARRY POTTER™ SERIES



**Albus Dumbledore™**

Brilliant and powerful Headmaster of Hogwarts™ School of Witchcraft and Wizardry.



**Ron Weasley™**

Harry Potter's best friend, known for his humor and loyalty.



**Ginny Weasley™**

Youngest of the Weasley children, she came up with the name "Dumbledore's Army."



**Luna Lovegood™**

Young witch with a lion hat that roars, she believes in creatures that even wizards think are myths.



**Fred Weasley**

Ron's older brother, known for playing pranks and creating inventions.



**George Weasley**

Twin brother of Fred, whose good business sense made the Weasleys' Wizard Wheezes™ shop a success.



**Neville Longbottom™**

Gryffindor™ who was an important member of Dumbledore's Army.



**Moaning Myrtle**

Ghost who haunts the second floor girls' bathroom at Hogwarts.



**Hermione Granger™**

Brilliant and loyal witch, an expert on spells, potions and magical creatures.



**Griphook**

Goblin who worked at Gringotts™ Wizard Bank and wants the Sword of Gryffindor.



**Kingsley Shacklebolt**

Wizard secretly working for the Order of the Phoenix.



**Professor Sprout**

Head of the Herbology department at Hogwarts, she goes all-out to look after the plants in her care.



**Lily Potter**

Mother of Harry Potter who perished protecting her son from Voldemort.



**Bellatrix Lestrange**

Dangerous Death Eater™ and enemy of Harry Potter who wields the Cruciatius Curse.



**James Potter**

Father of Harry Potter who fought to save his son from Voldemort.



### HARRY POTTER QUIZ

Do you remember all the facts about Harry Potter's friends and foes? Try answering all these questions – you can write your answers in the spaces provided. (If you need a little help, read the descriptions above.)

1. Who wears a hat that roars? \_\_\_\_\_
2. Who is Fred Weasley's twin brother? \_\_\_\_\_
3. Who haunts the second floor girls' bathroom? \_\_\_\_\_
4. Who wields the Cruciatius Curse? \_\_\_\_\_
5. What was the name of the Weasleys' shop? \_\_\_\_\_

Need help? Answers can be found on page 27.



# CREATE A GINGERBREAD HOUSE!

Talk about a sweet place to live. This gingerbread house with icing on its roof is for builders with 'great taste'!

Use these instructions to build your own sweet creation, or create a completely different gingerbread house with colorful bricks from your own LEGO® collection!



1

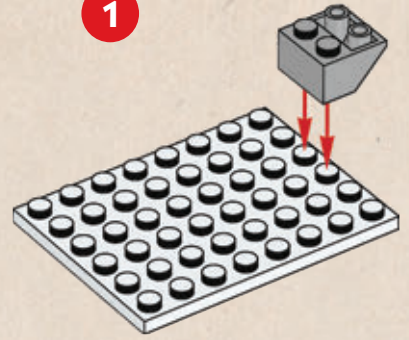

4

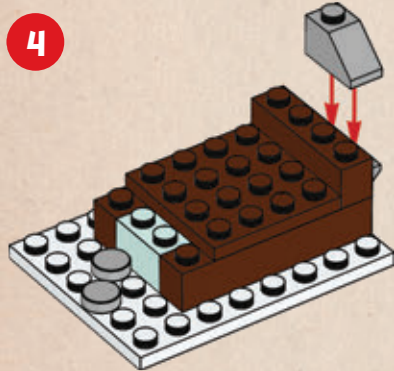

5

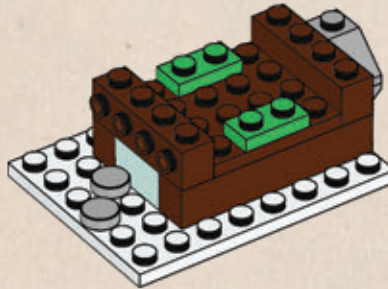

6

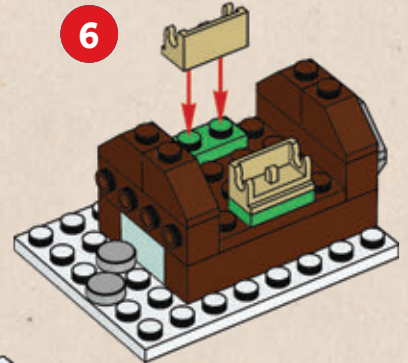

9

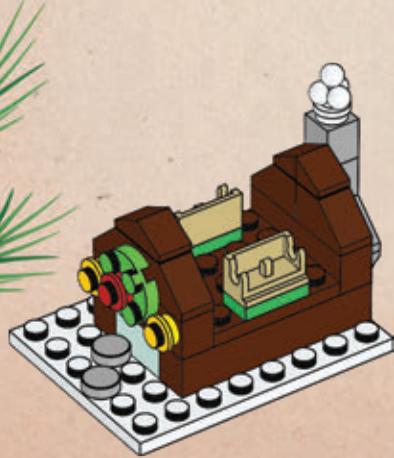

10

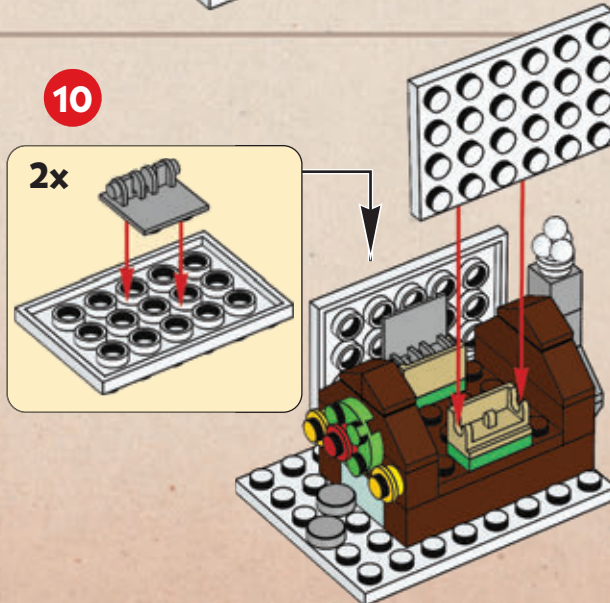

11

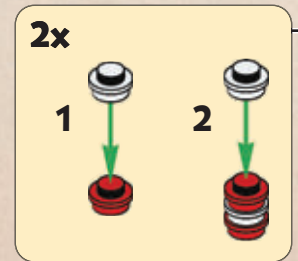

**LEGO CLASSIC**

**BUILD FUN AND FESTIVE HOUSES!**

You can create these houses with LEGO® Classic Bricks and Houses pieces! You can also rebuild your own models and add your decorations. Look at our builds!





2

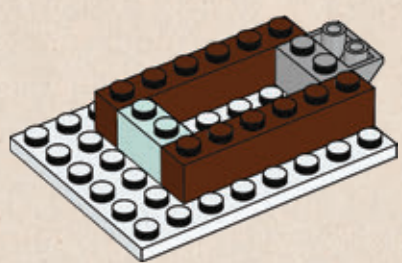

3

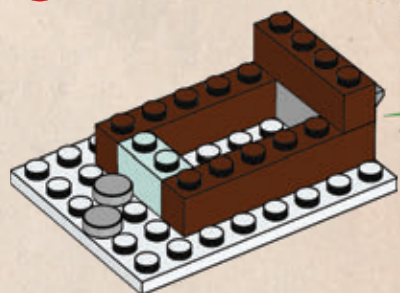

7

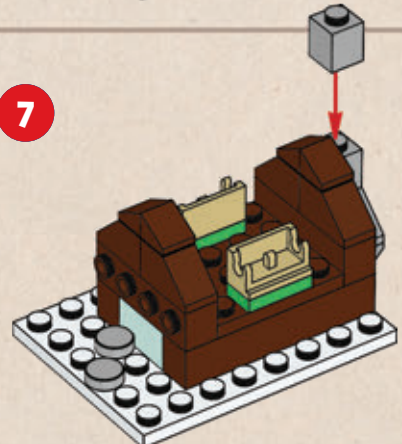

8

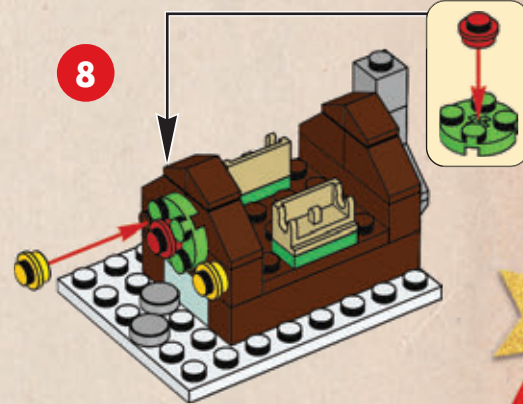

12

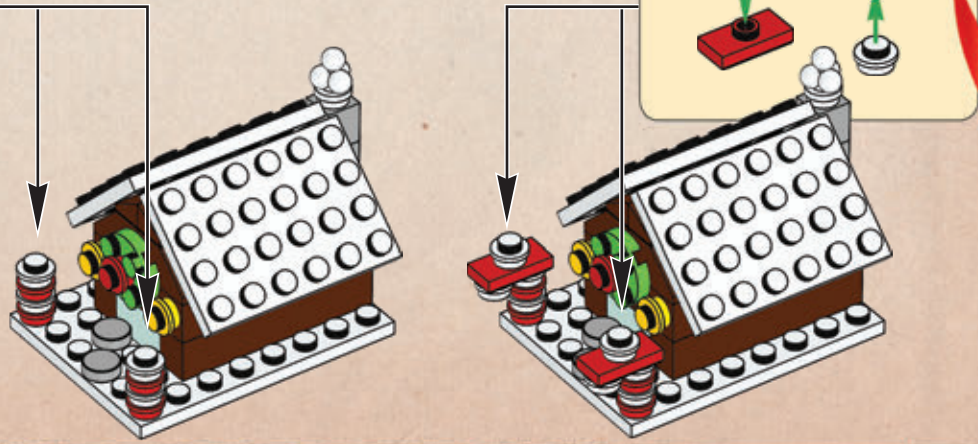

# SOLUTIONS

## LEGO® Super Mario™: Page 2

1. Coins
2. 60 seconds
3. Jump on him
4. In the Start Pipe
5. At the flag

Welcome: Page 3  
Family and Friends

## LEGO NINJAGO™: Pages 8-9

Blades of Deliverance

## LEGO Creator: Page 10

Take five paces from the water's edge on Skull Island

## LEGO Technic™: Page 17

1. C, 2. C, 3. C

## LEGO Harry Potter™: Pages 24-25

1. Luna Lovegood
2. George Weasley
3. Moaning Myrtle
4. Bellatrix Lestrange
5. Weasleys' Wizard Wheezes

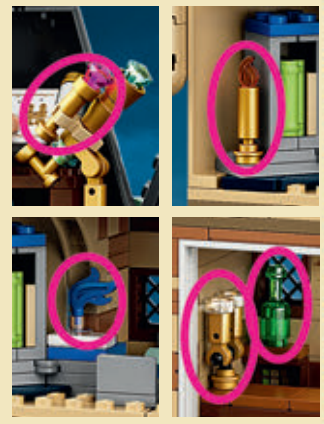

## A WILD WINDMILL AND MORE!

When imagination meets LEGO bricks, crazy things can happen. Here we rebuilt some fun seasonal houses. Not sure you would see anything quite like these in your town, but it would be cool if you did!



Go to the LEGO Life app and share your festive houses in the #Rebuild the World group.

Rebuild the world

VOLUNTEERS AROUND THE GLOBE DONATE THEIR TIME AND THEIR HARD WORK TO REBUILD THE WORLD AROUND THEM. WE CELEBRATE ALL THEY DO ON INTERNATIONAL VOLUNTEER DAY ON DECEMBER 5<sup>th</sup>.





**LEGO® Life**

PO Box 1138  
Enfield, CT 06082

Presorted Standard  
U.S. Postage  
PAID  
LEGO Direct

# GIVE A GIFT!

 Go DOT the world of a friend or a relative with a special gift you've made all by yourself. **Snap a photo or draw a picture and put it in the frame below after you've decorated it with DOTS elements.**

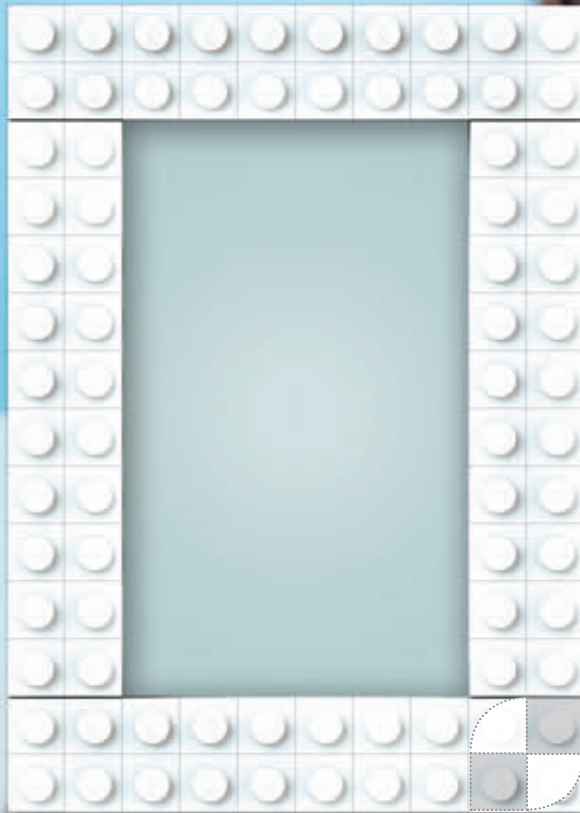

Next issue of LEGO® Life Magazine  
out in January!